

Plot file version 1 created 16-OCT-2012 11:56:27

DA193 RO006.UVDATA.1

Freq = 4.9270 GHz, Bw = 16.000 MH No calibration applied and no bandpass applied

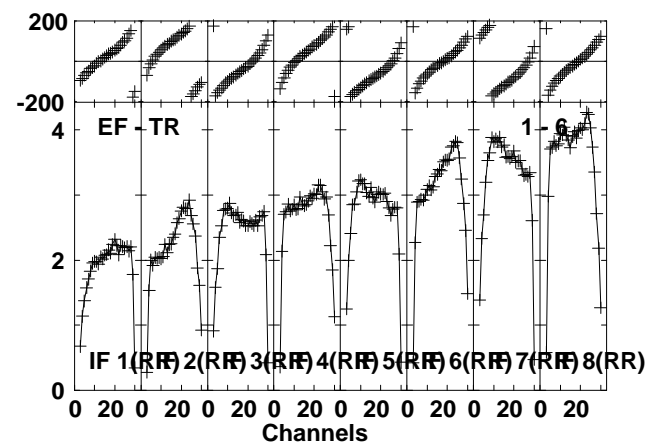
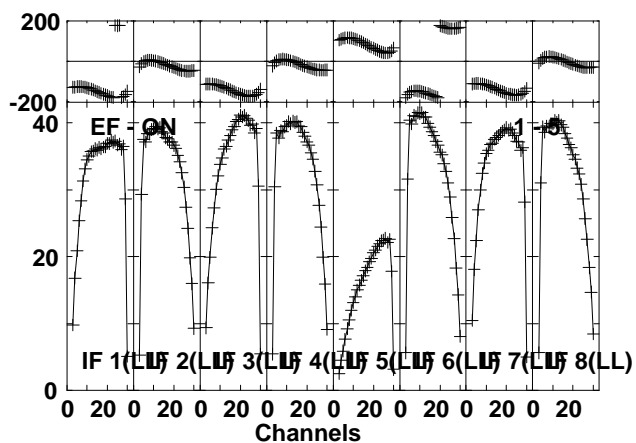
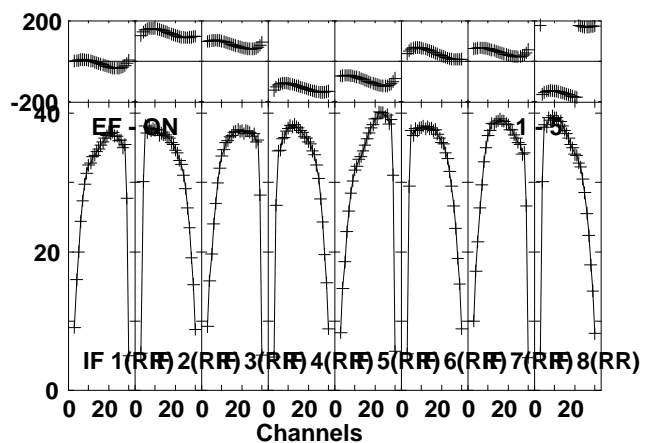
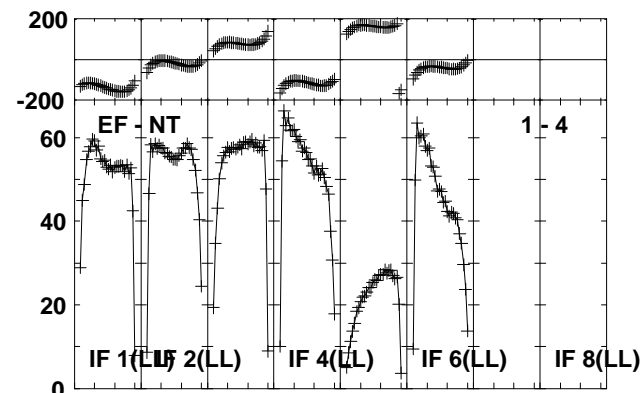
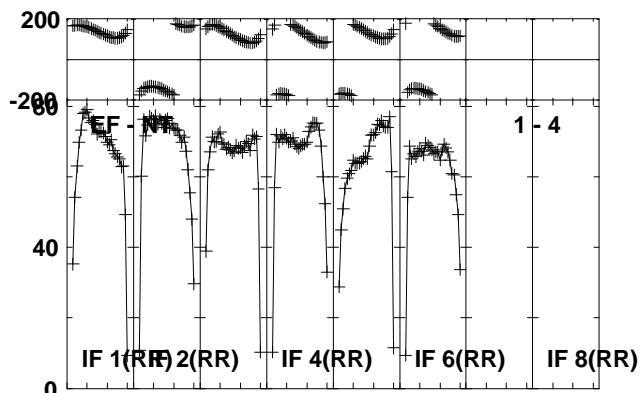
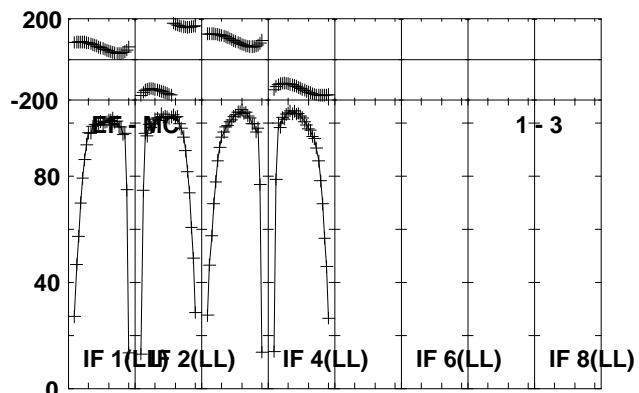
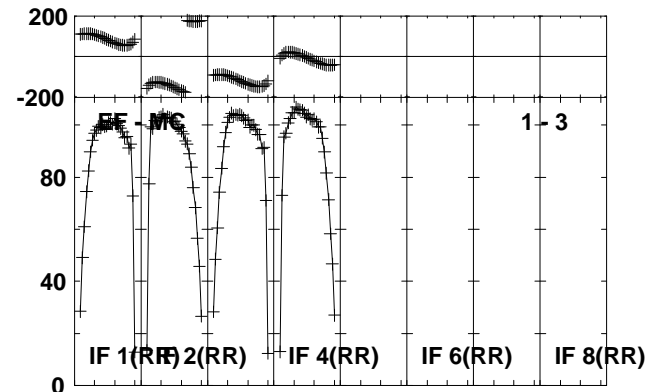
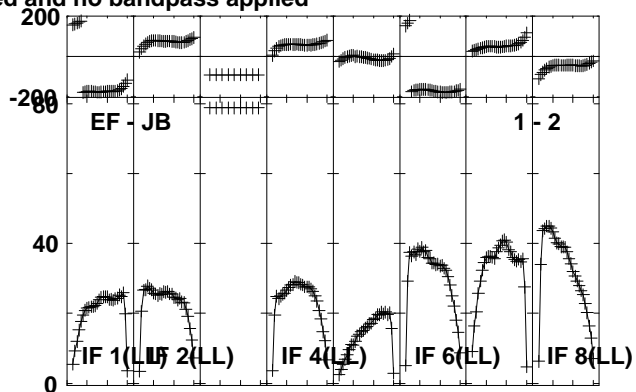
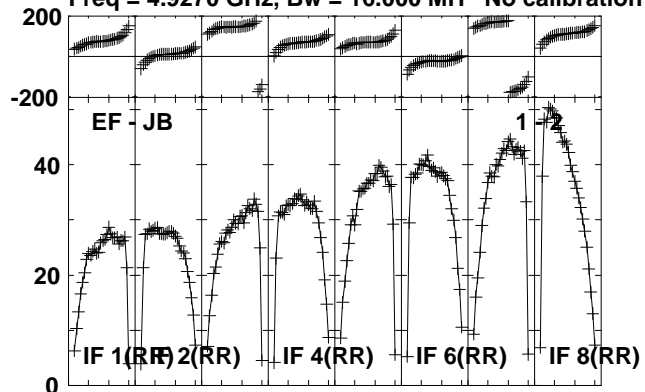

Lower frame: Milli Ampl Jy Top frame: Phas deg
Vector averaged cross-power spectrum Several baselines displayed
Timerange: 00/00:48:17 to 00/01:01:19

Plot file version 2 created 16-OCT-2012 11:56:29

DA193 RO006.UVDATA.1

Freq = 4.9270 GHz, Bw = 16.000 MH No calibration applied and no bandpass applied

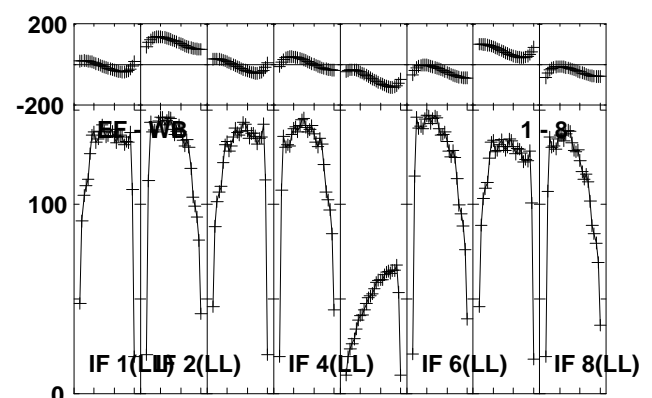
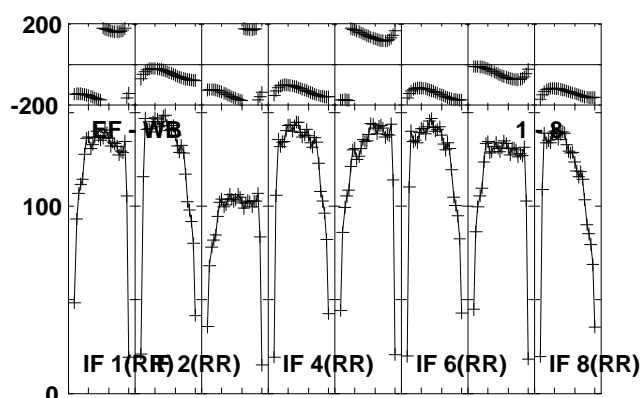
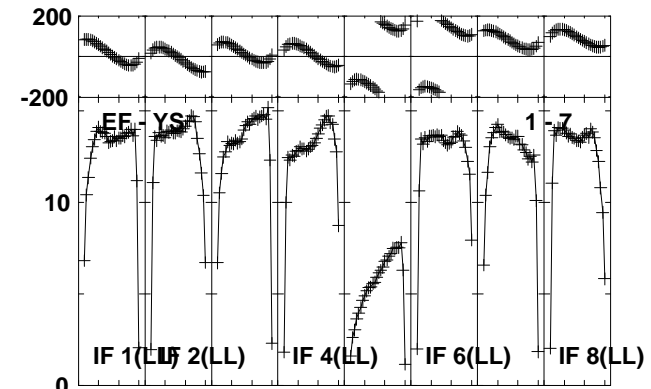
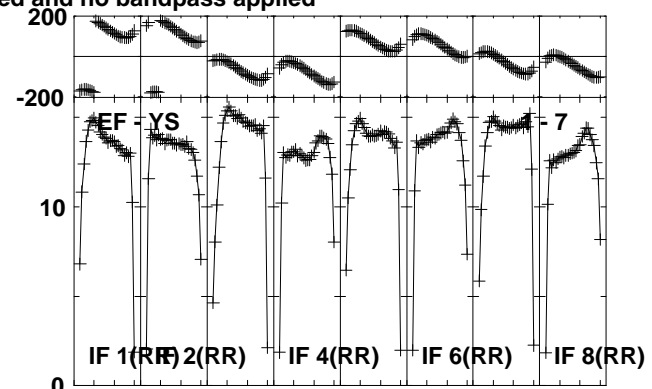
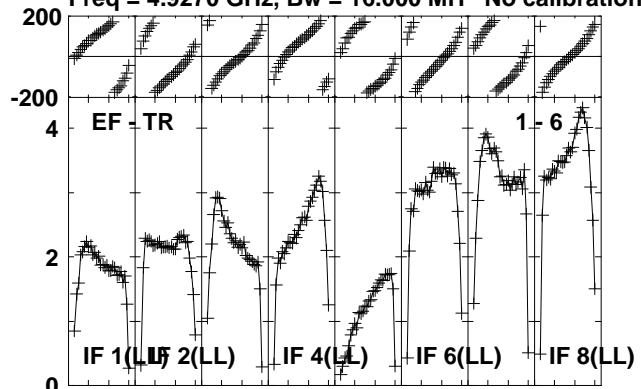

Lower frame: Milli Ampl Jy Top frame: Phas deg
Vector averaged cross-power spectrum Several baselines displayed
Timerange: 00/00:48:17 to 00/01:01:19

Plot file version 3 created 16-OCT-2012 11:56:31

J0645+0541 RO006.UVDATA.1

Freq = 4.9270 GHz, Bw = 16.000 MH No calibration applied and no bandpass applied

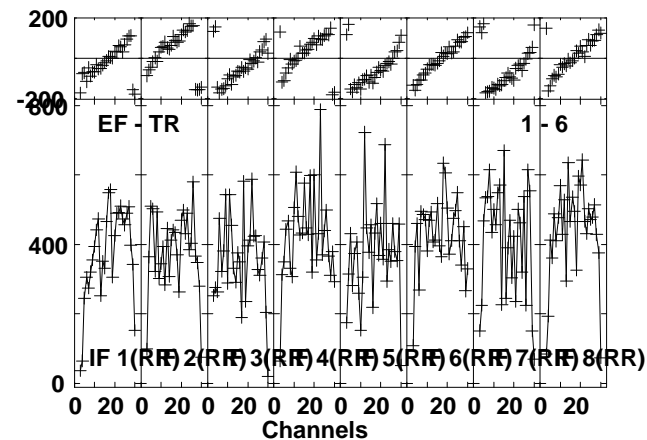
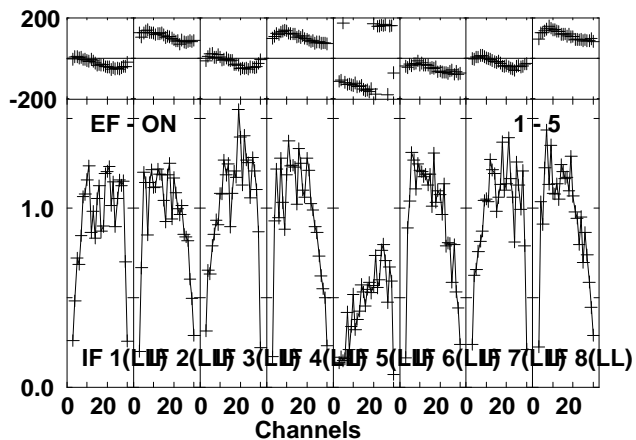
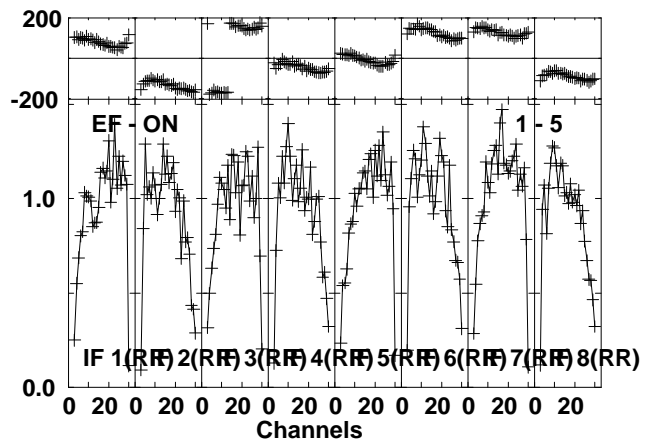
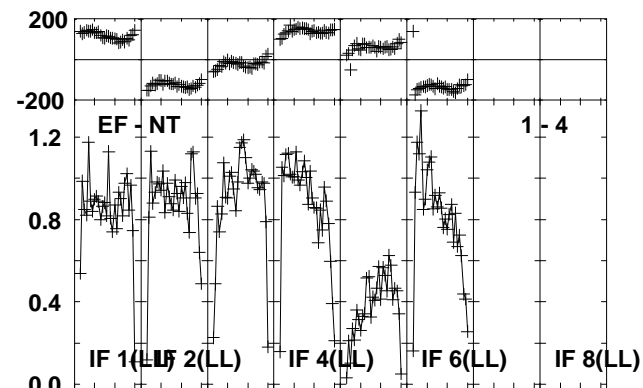
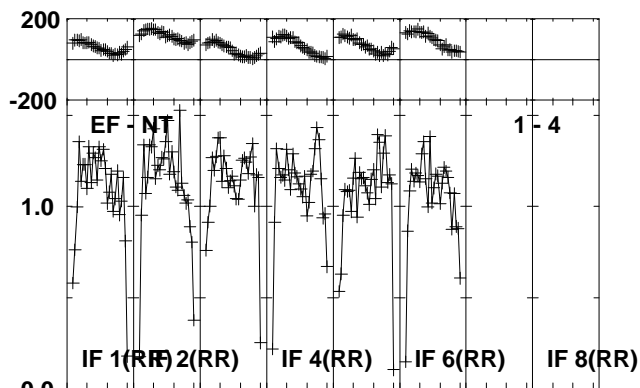
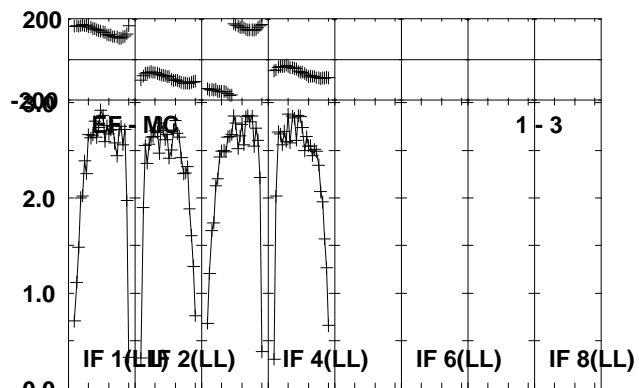
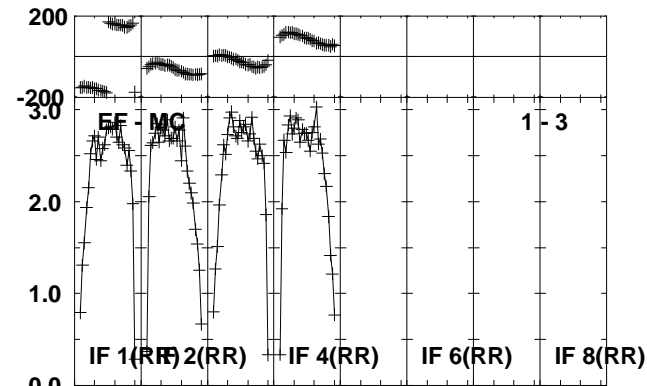
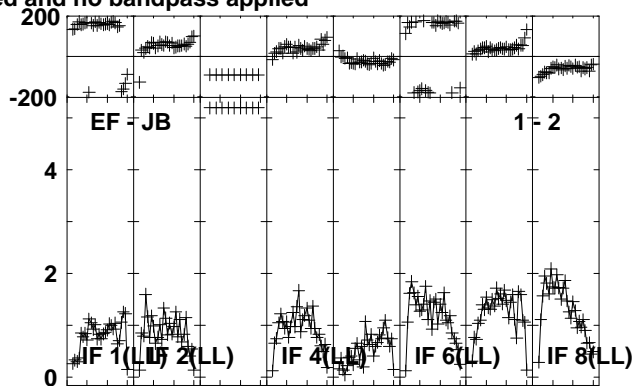
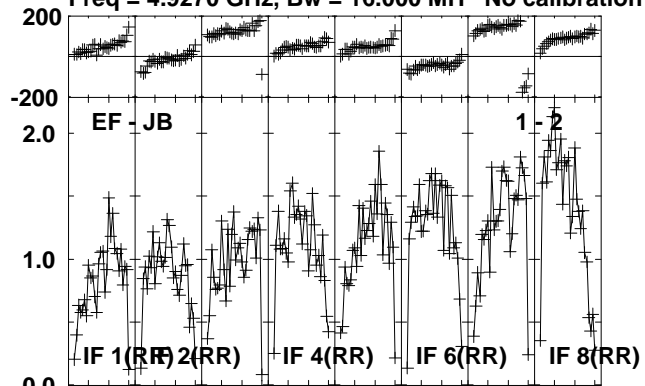

Lower frame: Milli Ampl Jy Top frame: Phas deg
Vector averaged cross-power spectrum Several baselines displayed
Timerange: 00/01:04:17 to 00/01:14:19

Plot file version 4 created 16-OCT-2012 11:56:33

J0645+0541 RO006.UVDATA.1

Freq = 4.9270 GHz, Bw = 16.000 MH No calibration applied and no bandpass applied

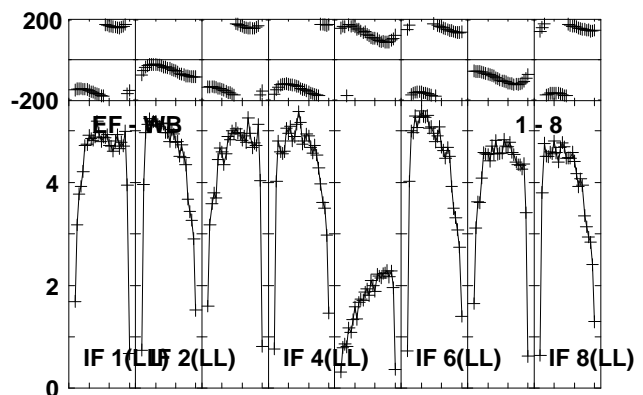
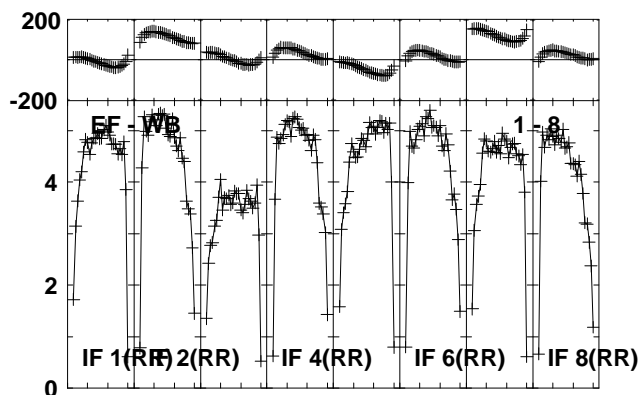
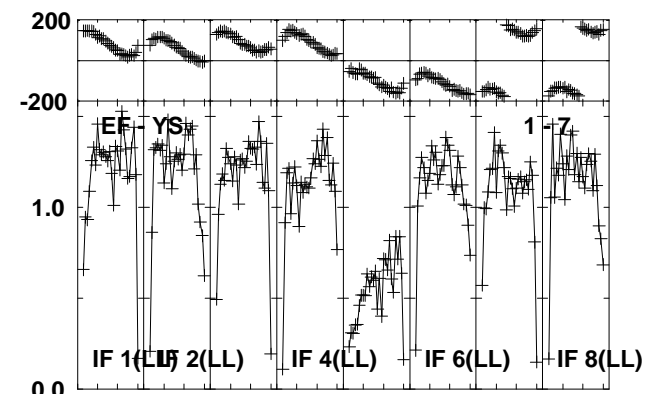
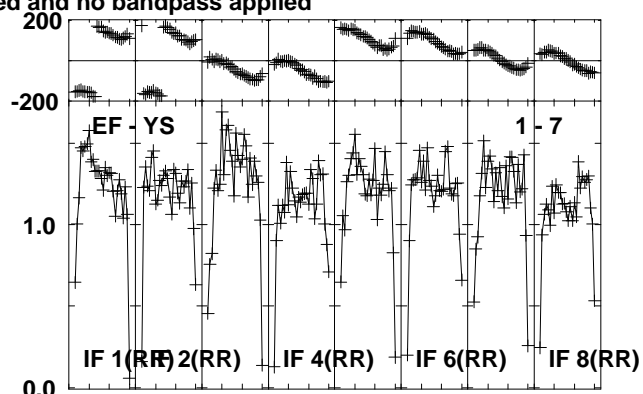
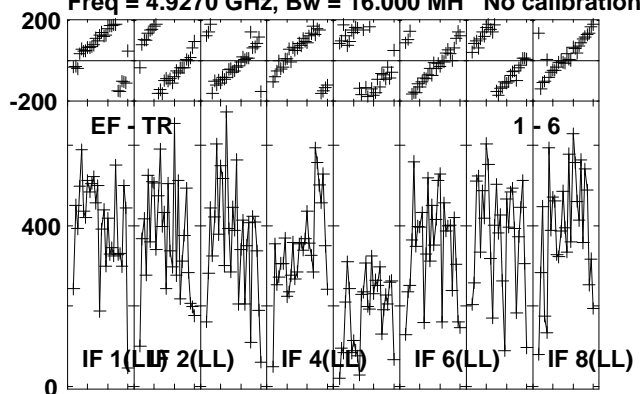

Lower frame: Micro Ampl Jy Top frame: Phas deg
Vector averaged cross-power spectrum Several baselines displayed
Timerange: 00/01:04:17 to 00/01:14:19

Plot file version 5 created 16-OCT-2012 11:56:34

J0645+0541 RO006.UVDATA.1

Freq = 4.9270 GHz, Bw = 16.000 MH No calibration applied and no bandpass applied

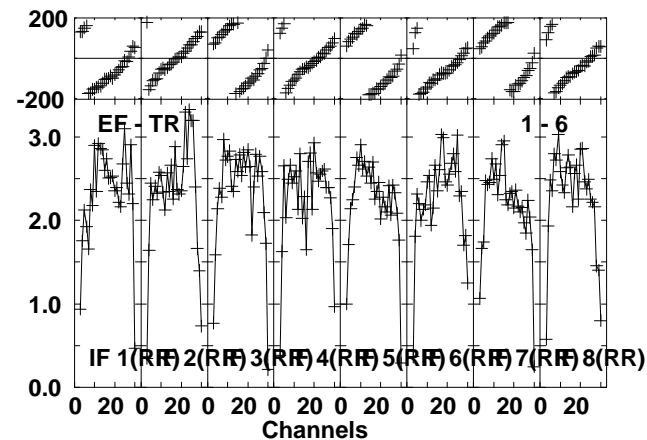
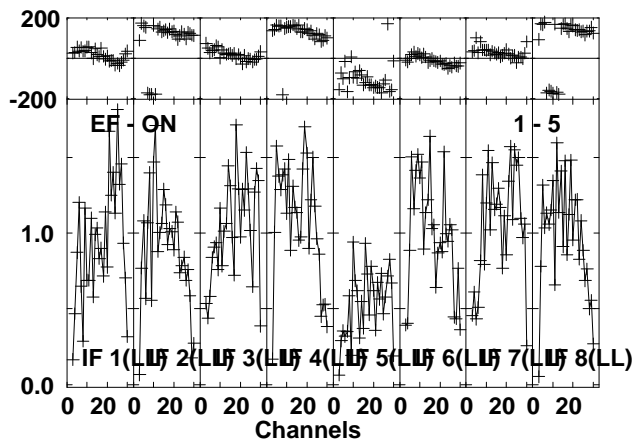
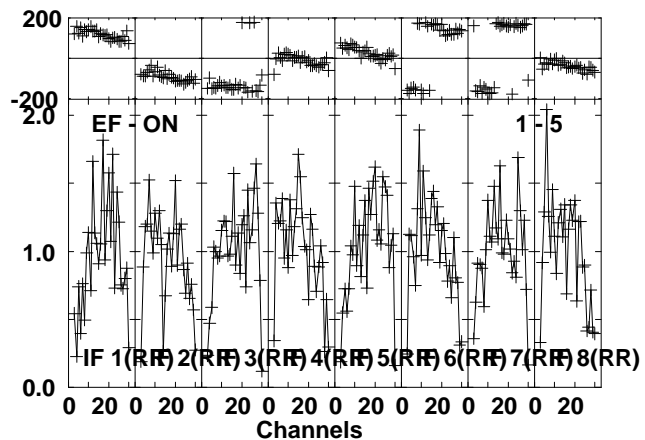
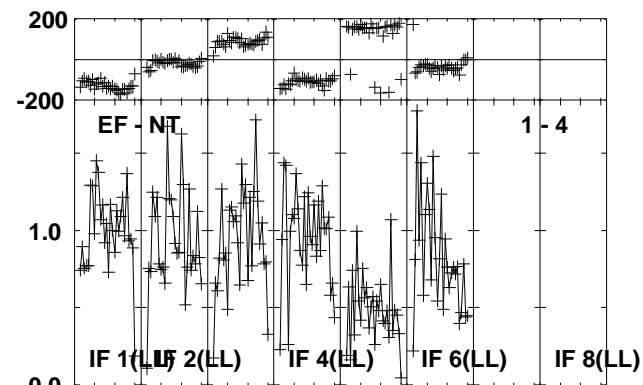
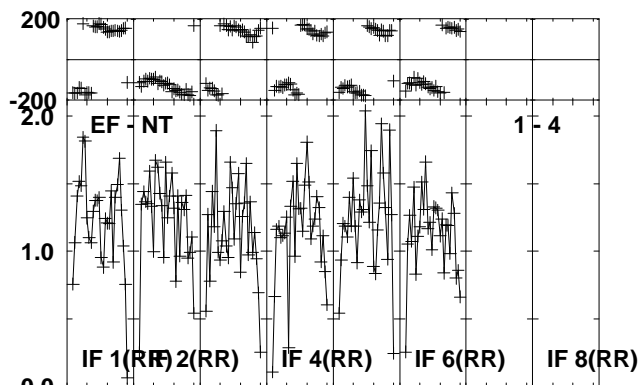
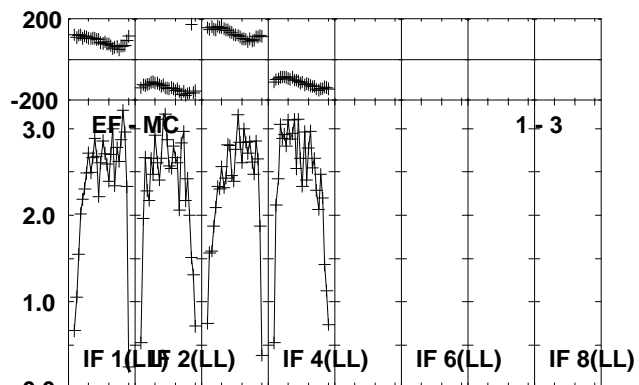
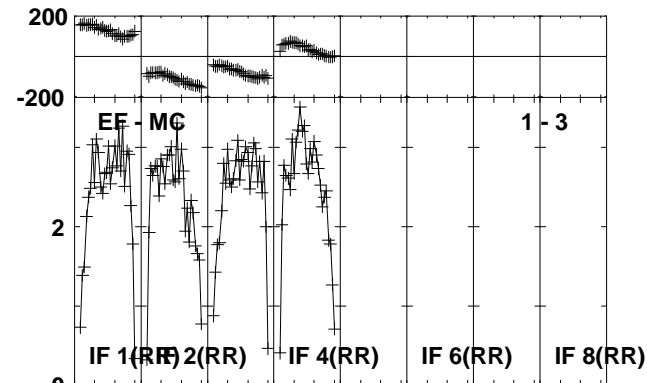
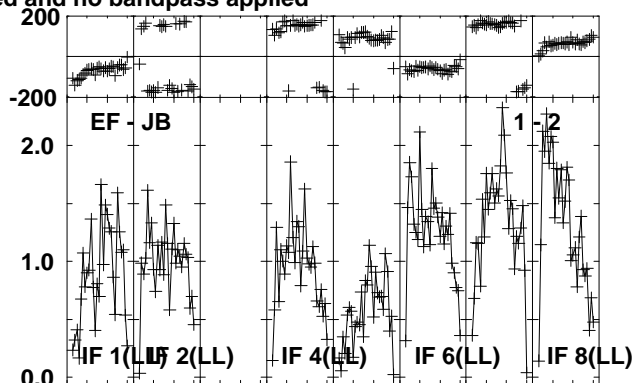
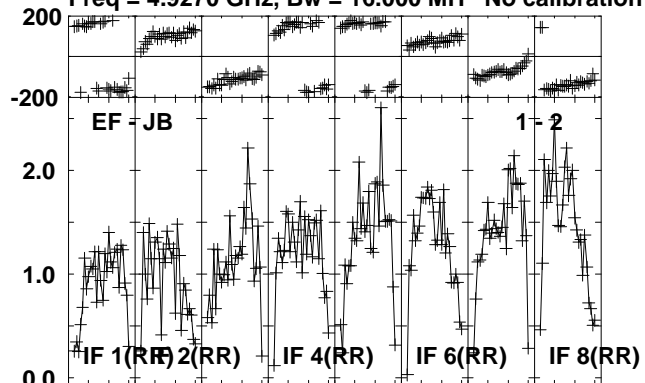

Lower frame: Milli Ampl Jy Top frame: Phas deg
Vector averaged cross-power spectrum Several baselines displayed
Timerange: 00/01:16:17 to 00/01:17:19

Plot file version 6 created 16-OCT-2012 11:56:34
J0645+0541 RO006.UVDATA.1

Freq = 4.9270 GHz, Bw = 16.000 MH No calibration applied and no bandpass applied

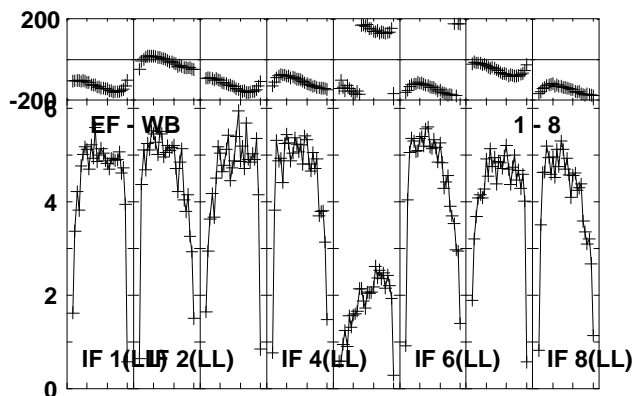
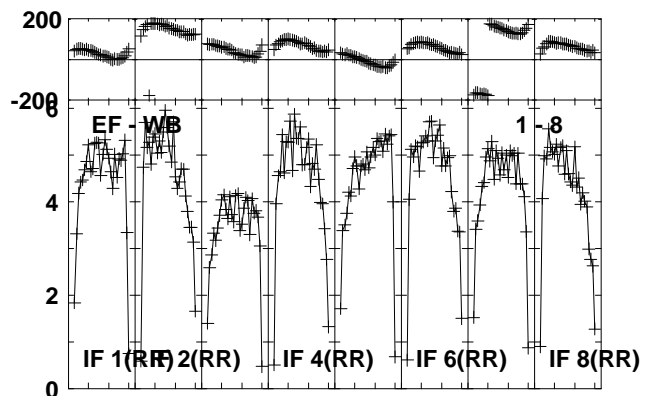
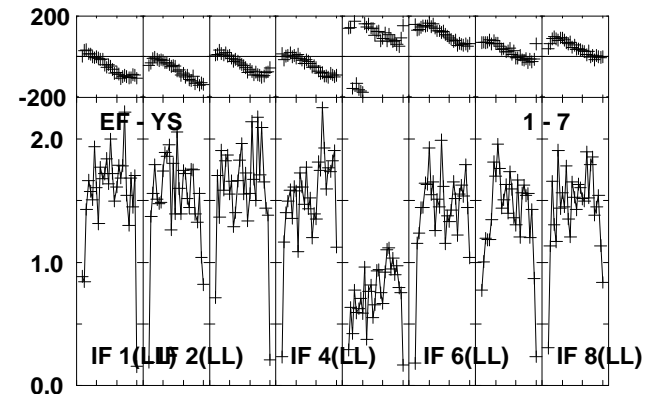
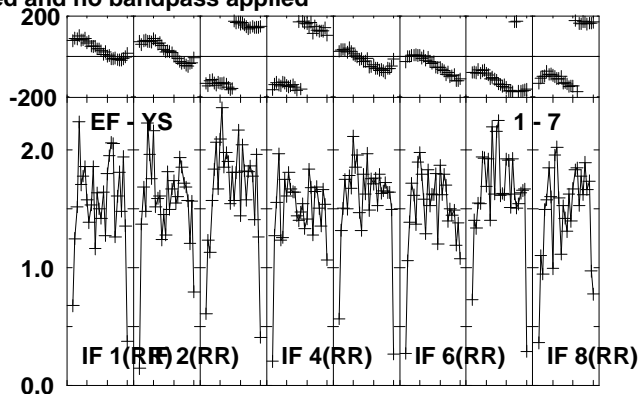
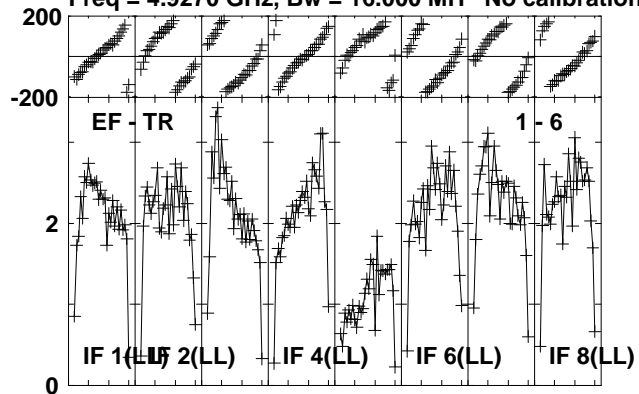

Lower frame: Milli Ampl Jy Top frame: Phas deg
Vector averaged cross-power spectrum Several baselines displayed
Timerange: 00/01:16:17 to 00/01:17:19

Plot file version 7 created 16-OCT-2012 11:56:34

NOVA-MON RO006.UVDATA.1

Freq = 4.9270 GHz, Bw = 16.000 MH No calibration applied and no bandpass applied

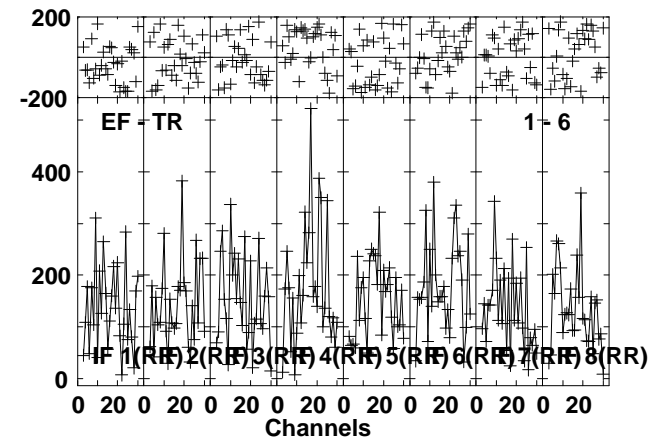
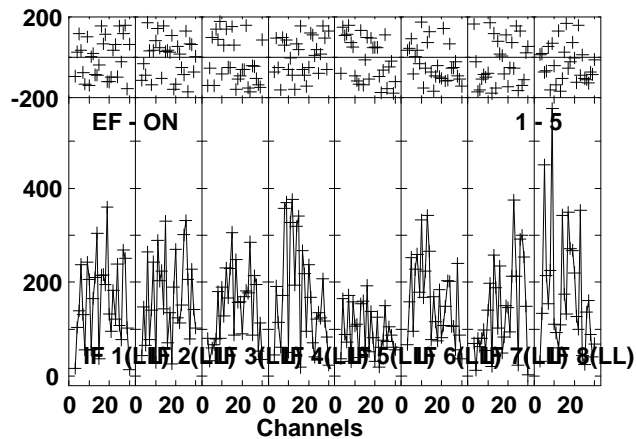
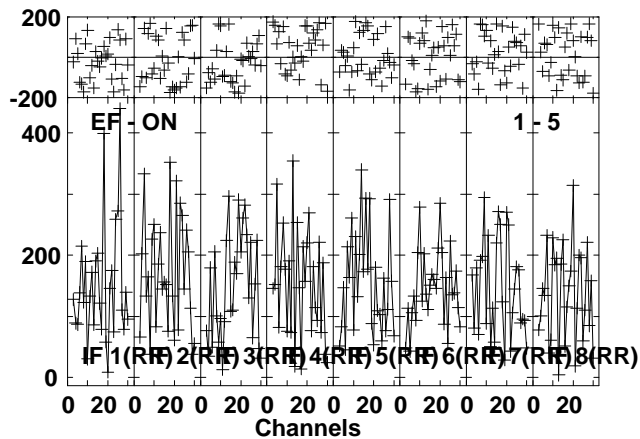
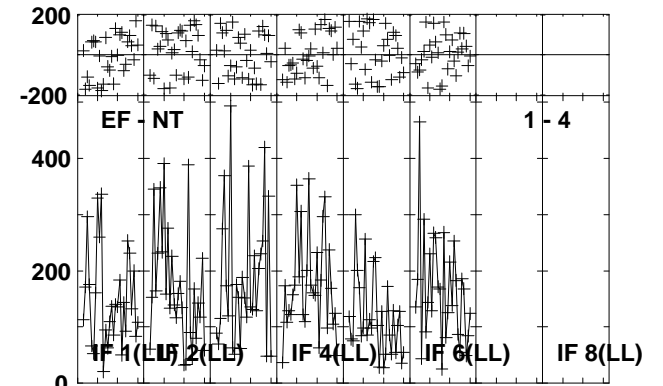
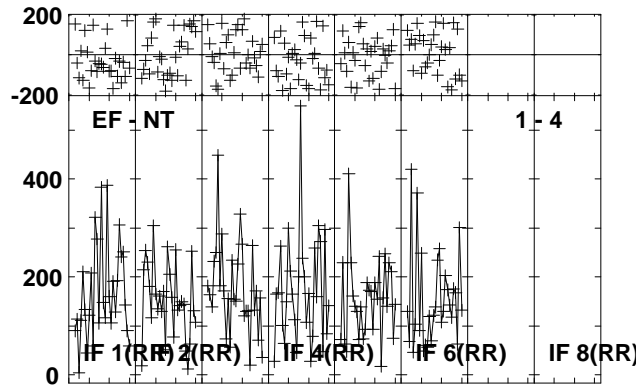
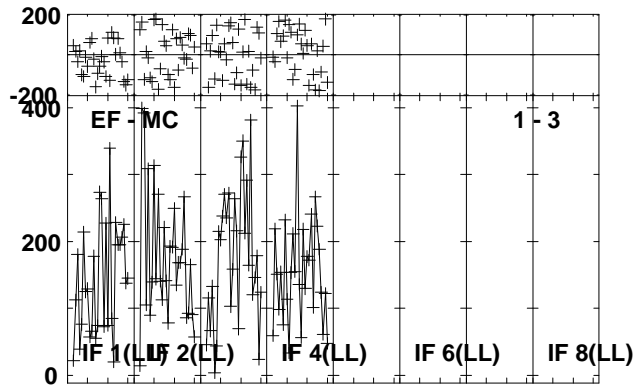
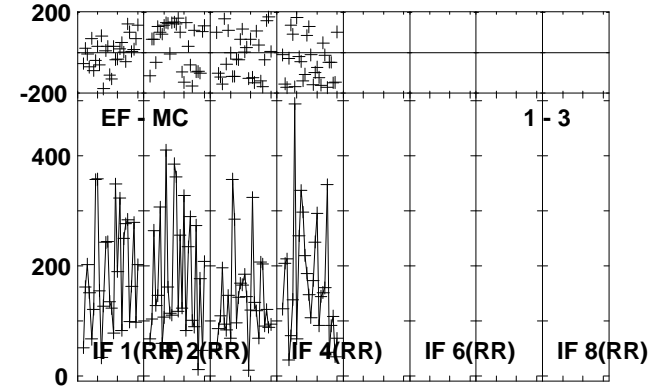
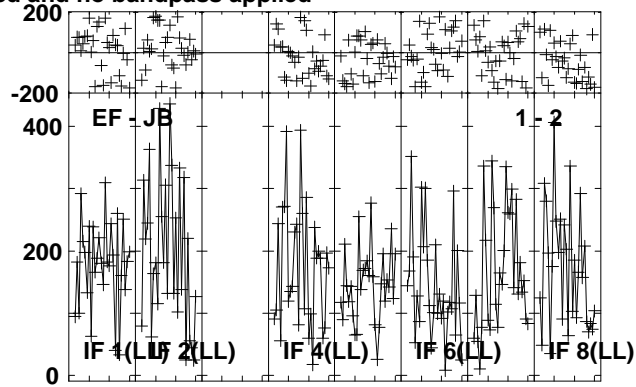
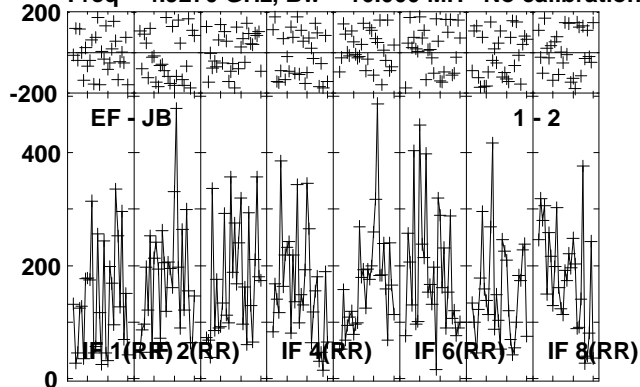

Lower frame: Micro Ampl Jy Top frame: Phas deg
Vector averaged cross-power spectrum Several baselines displayed
Timerange: 00/01:17:23 to 00/01:20:19

Plot file version 8 created 16-OCT-2012 11:56:34

NOVA-MON RO006.UVDATA.1

Freq = 4.9270 GHz, Bw = 16.000 MH No calibration applied and no bandpass applied

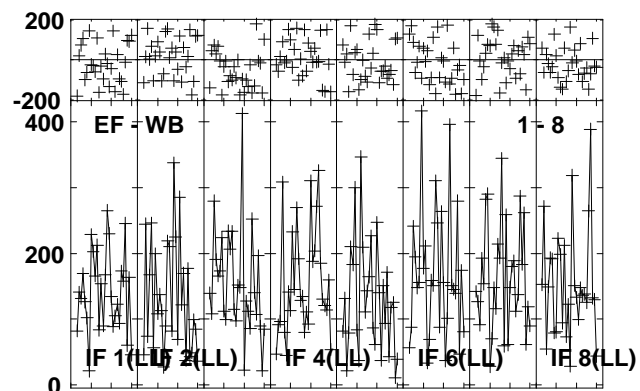
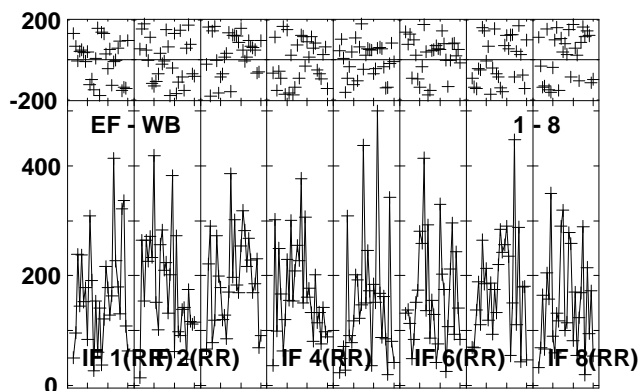
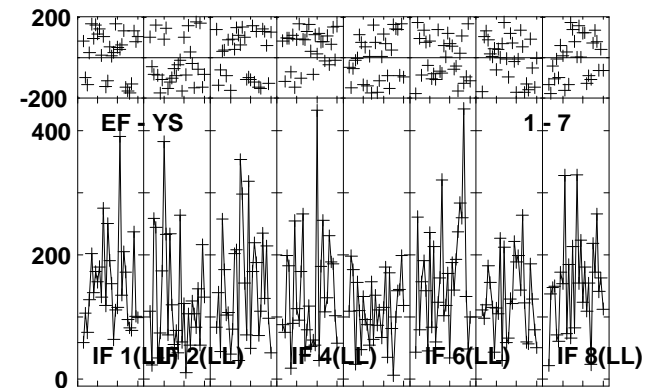
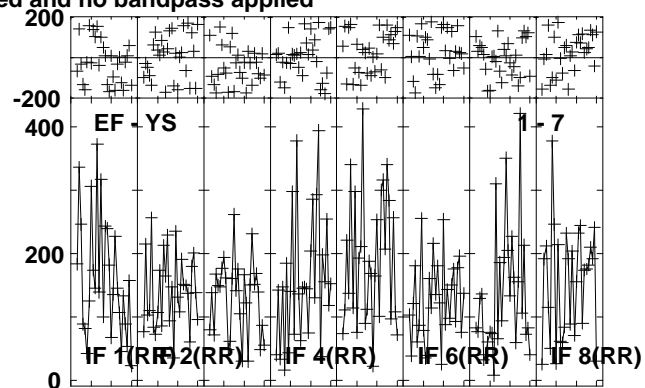
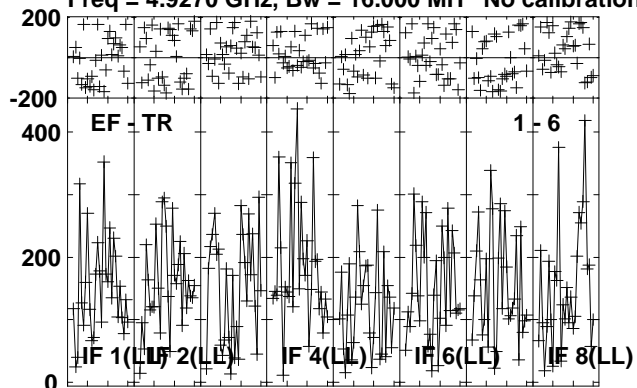

Lower frame: Micro Ampl Jy Top frame: Phas deg
Vector averaged cross-power spectrum Several baselines displayed
Timerange: 00/01:17:23 to 00/01:20:19

Plot file version 9 created 16-OCT-2012 11:56:35

J0639+0601 RO006.UVDATA.1

Freq = 4.9270 GHz, Bw = 16.000 MH No calibration applied and no bandpass applied

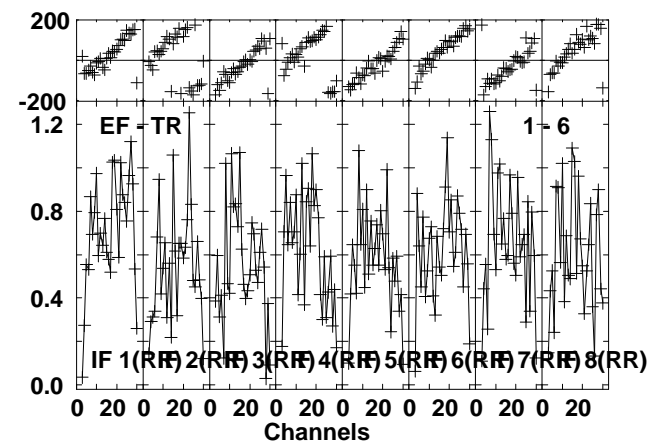
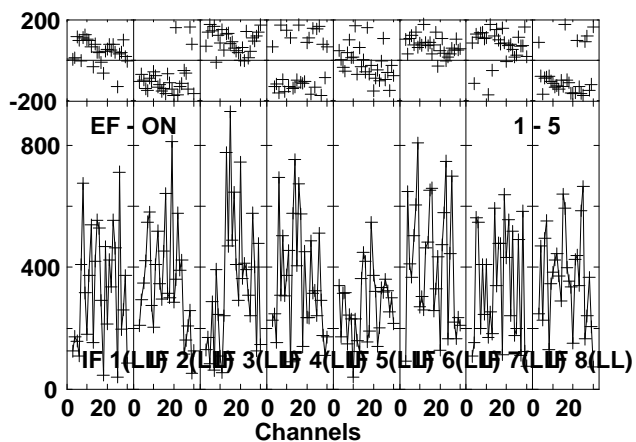
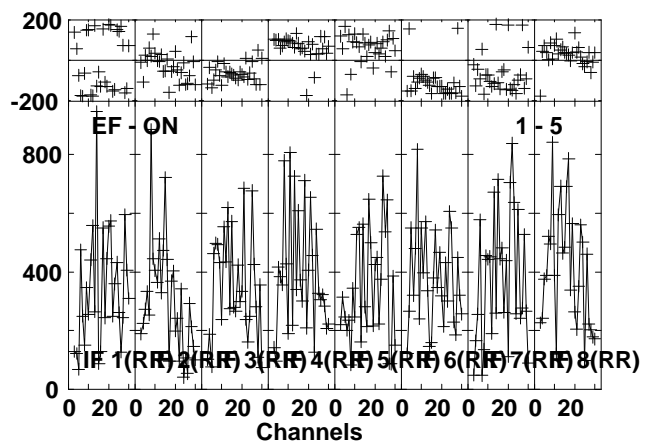
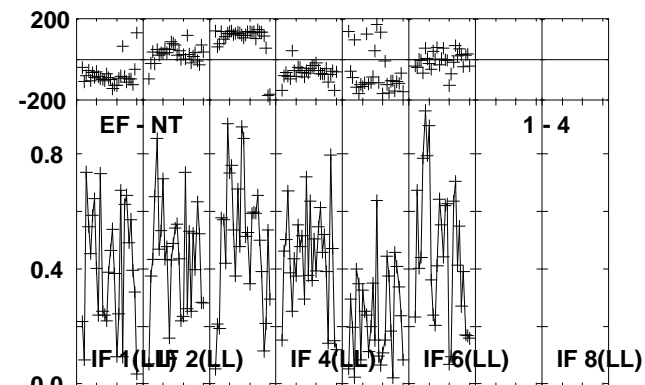
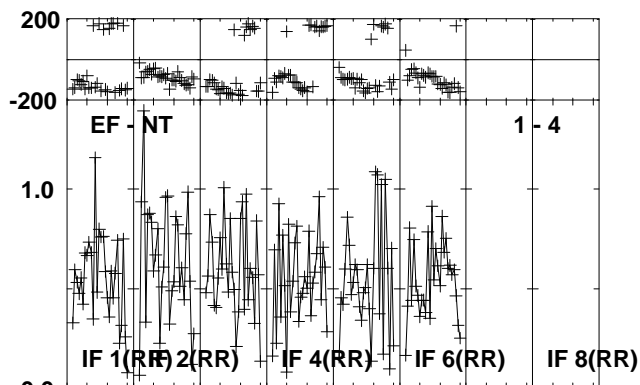
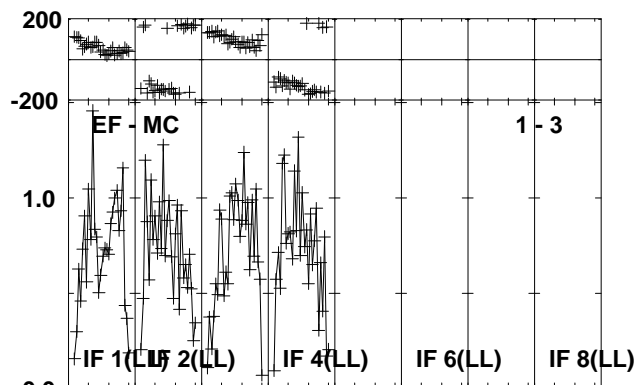
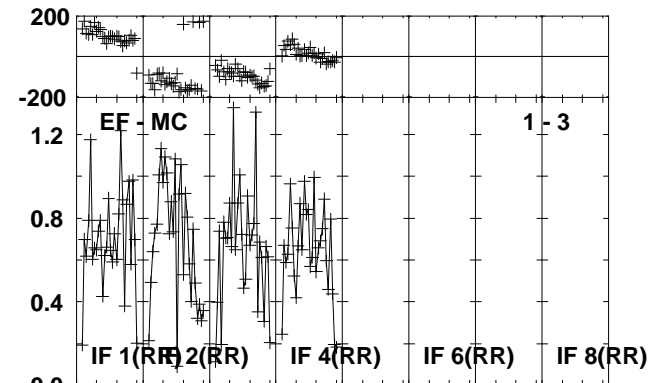
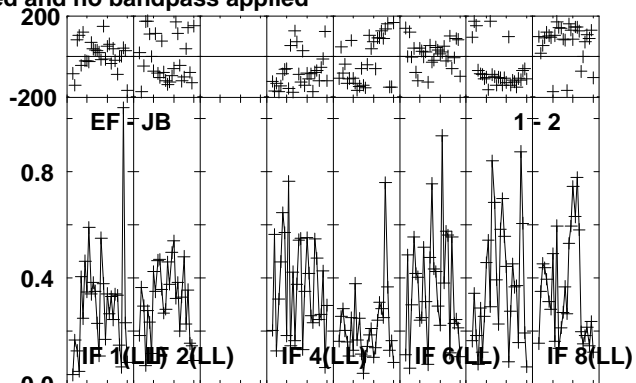
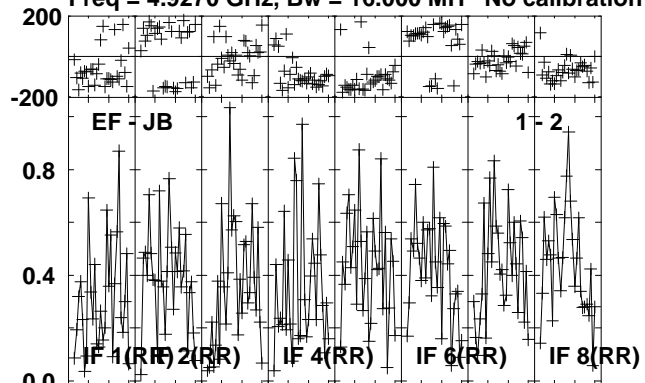

Lower frame: Milli Ampl Jy Top frame: Phas deg
Vector averaged cross-power spectrum Several baselines displayed
Timerange: 00/01:20:23 to 00/01:21:33

Plot file version 10 created 16-OCT-2012 11:56:35

J0639+0601 RO006.UVDATA.1

Freq = 4.9270 GHz, Bw = 16.000 MH No calibration applied and no bandpass applied

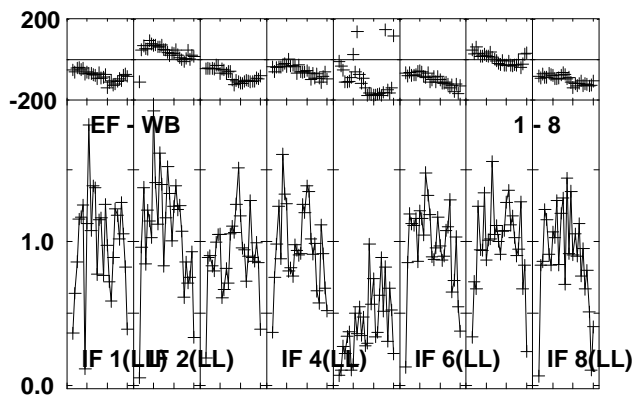
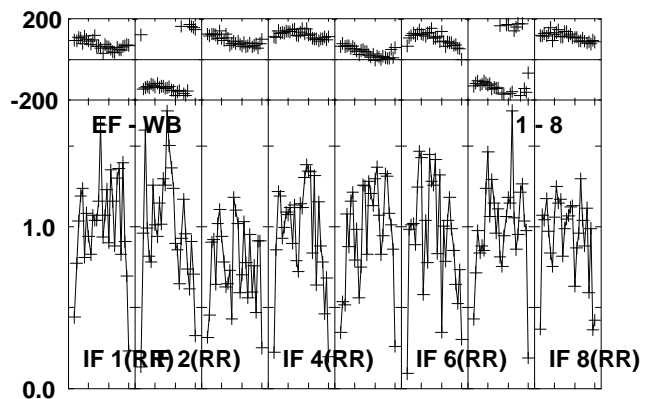
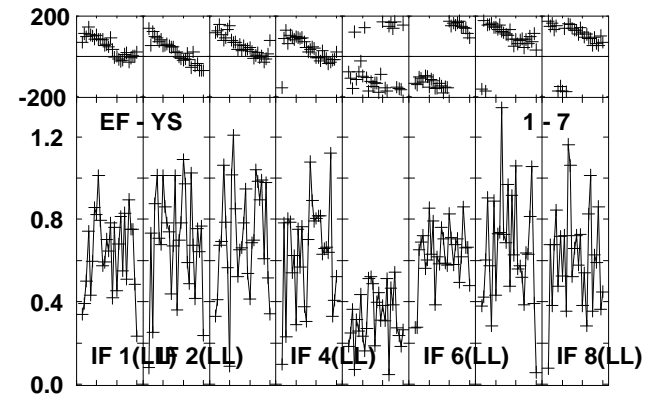
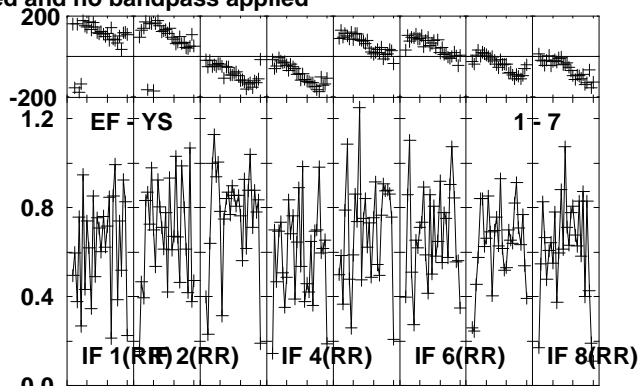
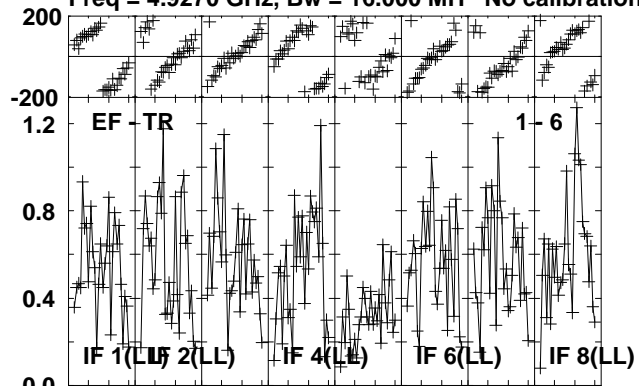

Lower frame: Milli Ampl Jy Top frame: Phas deg
Vector averaged cross-power spectrum Several baselines displayed
Timerange: 00/01:20:23 to 00/01:21:33

Plot file version 11 created 16-OCT-2012 11:56:35

J0645+0541 RO006.UVDATA.1

Freq = 4.9270 GHz, Bw = 16.000 MH No calibration applied and no bandpass applied

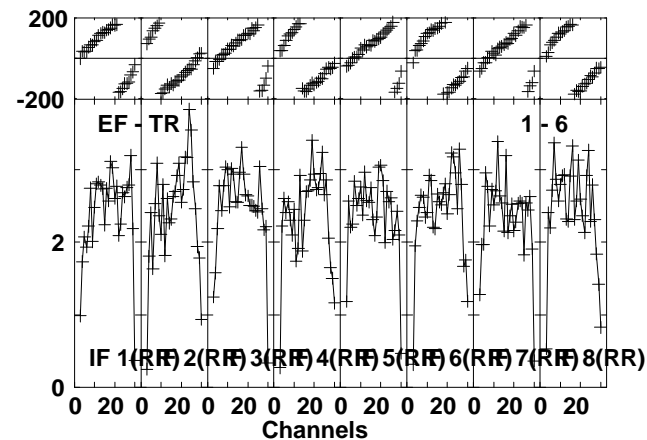
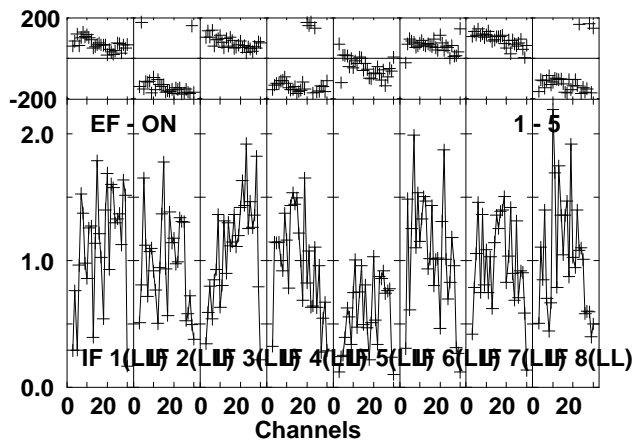
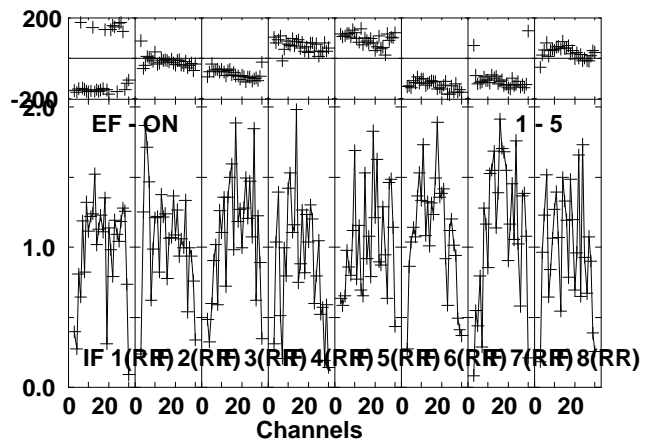
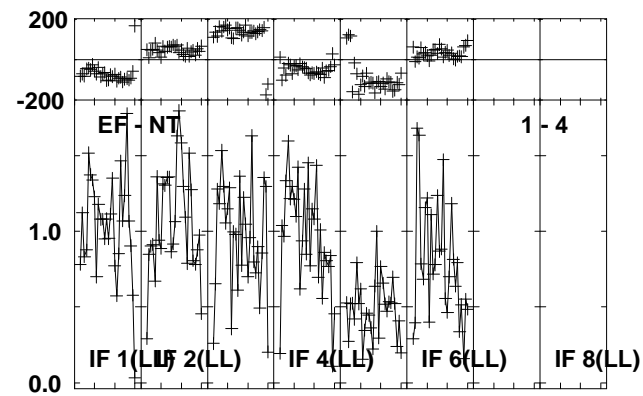
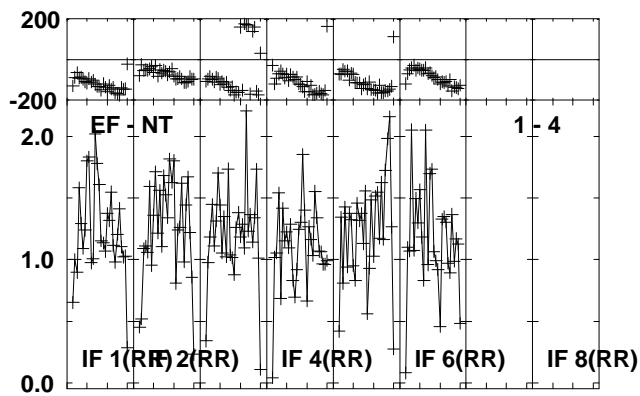
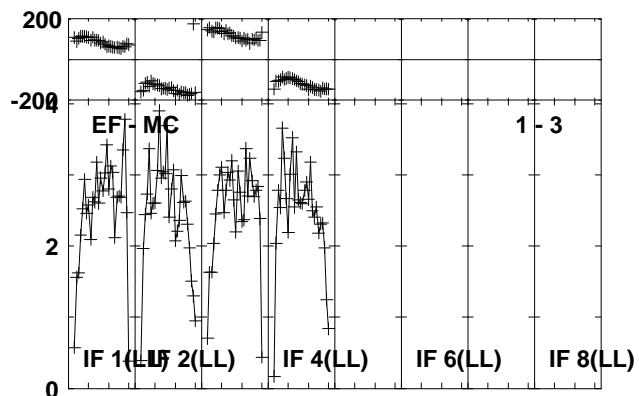
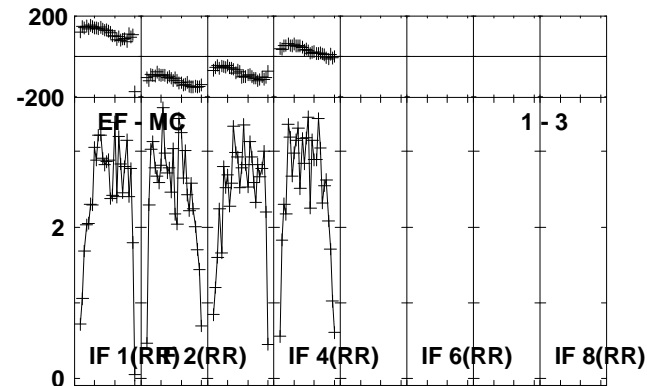
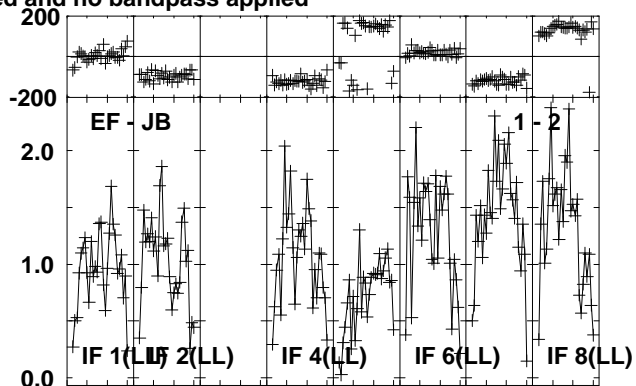
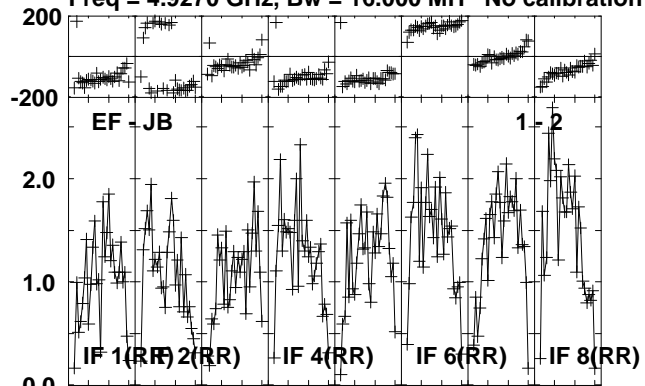

Lower frame: Milli Ampl Jy Top frame: Phas deg
Vector averaged cross-power spectrum Several baselines displayed
Timerange: 00/01:21:37 to 00/01:22:33

Plot file version 12 created 16-OCT-2012 11:56:36

J0645+0541 RO006.UVDATA.1

Freq = 4.9270 GHz, Bw = 16.000 MH No calibration applied and no bandpass applied

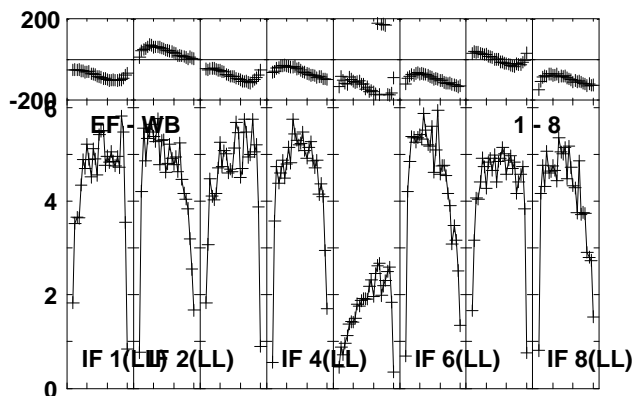
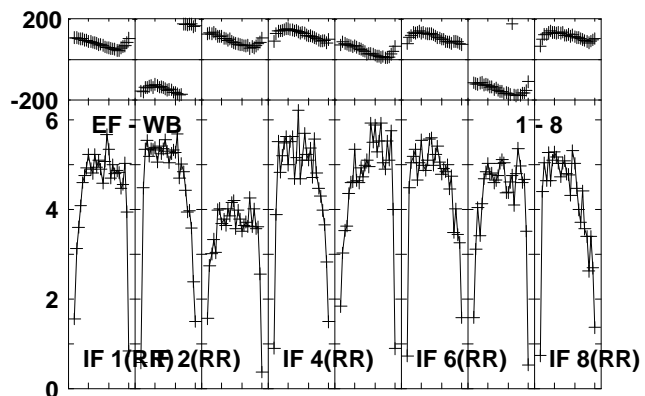
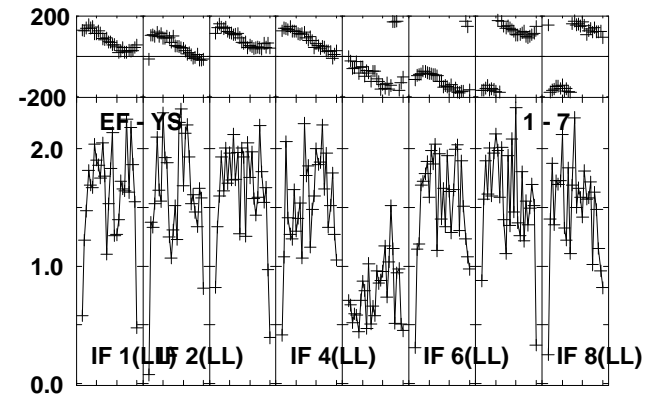
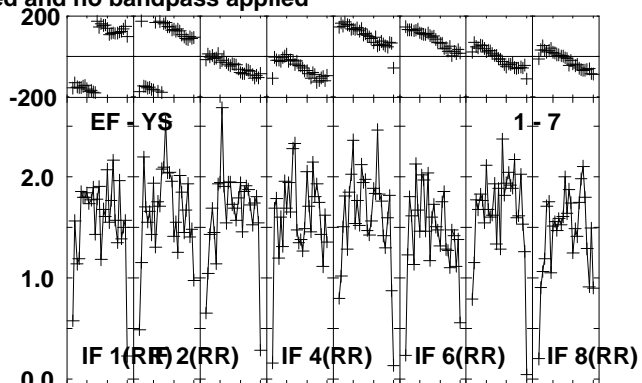
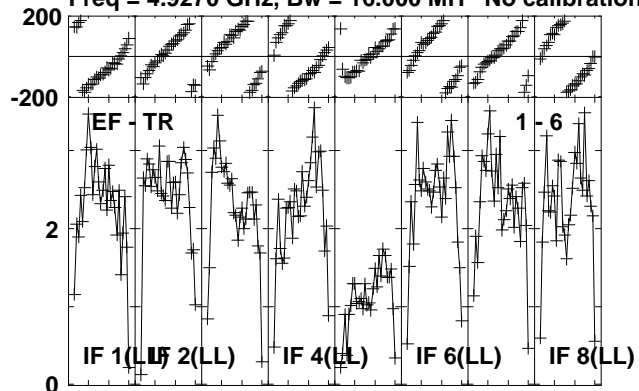

Lower frame: Milli Ampl Jy Top frame: Phas deg
Vector averaged cross-power spectrum Several baselines displayed
Timerange: 00/01:21:37 to 00/01:22:33

Plot file version 13 created 16-OCT-2012 11:56:36

NOVA-MON RO006.UVDATA.1

Freq = 4.9270 GHz, Bw = 16.000 MH No calibration applied and no bandpass applied

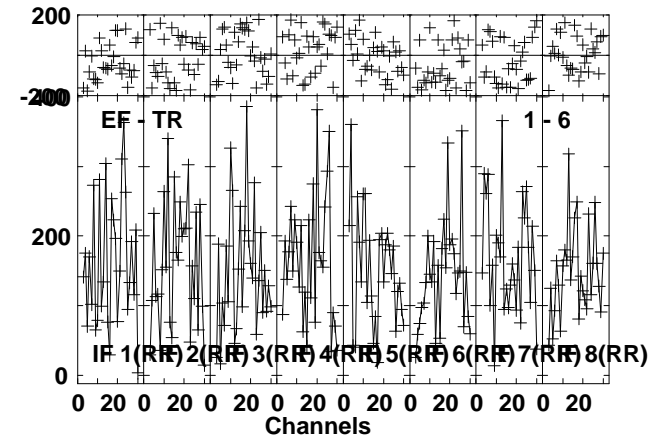
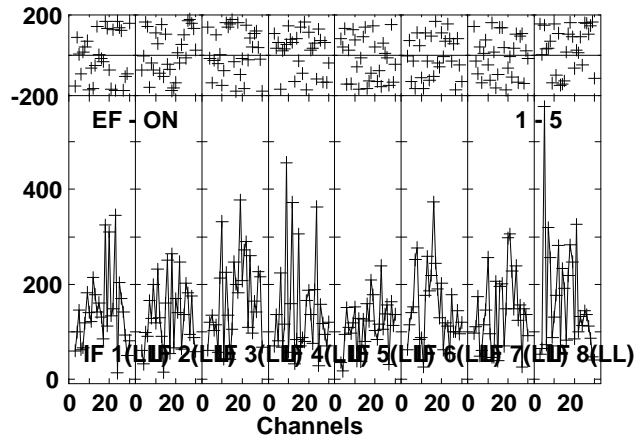
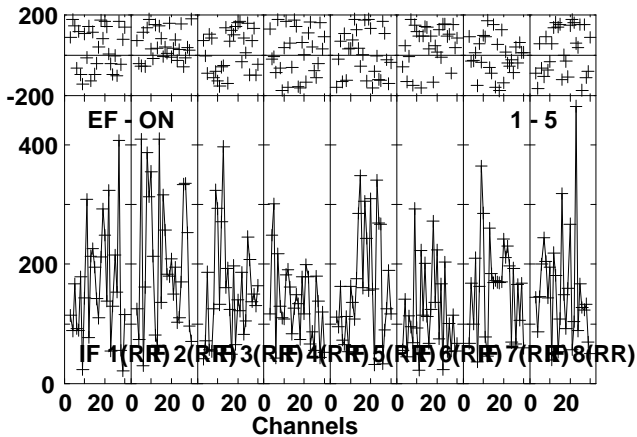
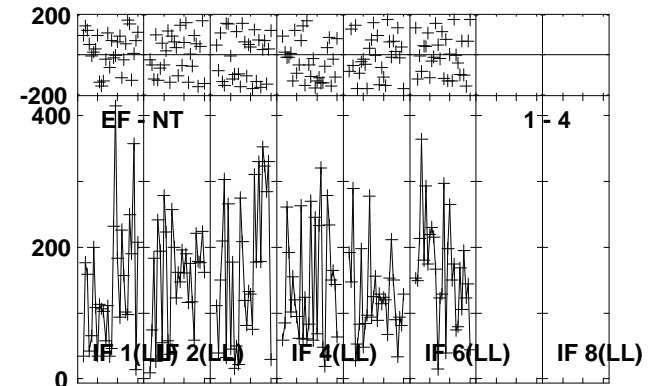
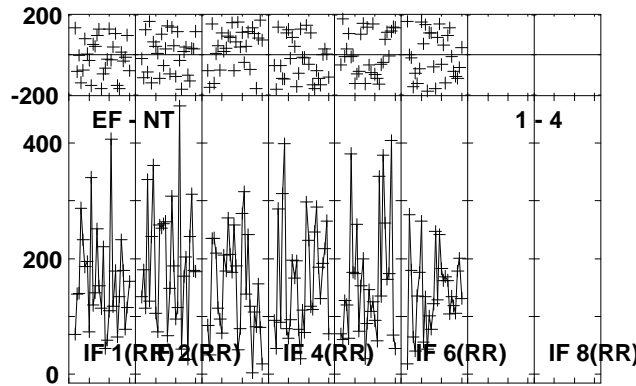
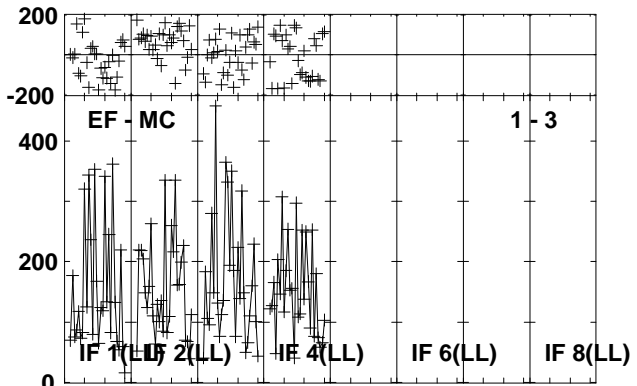
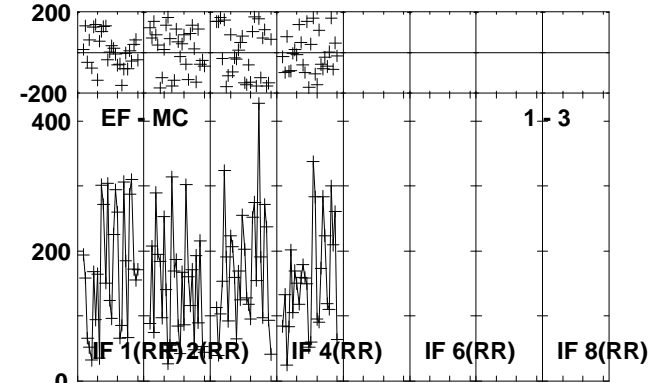
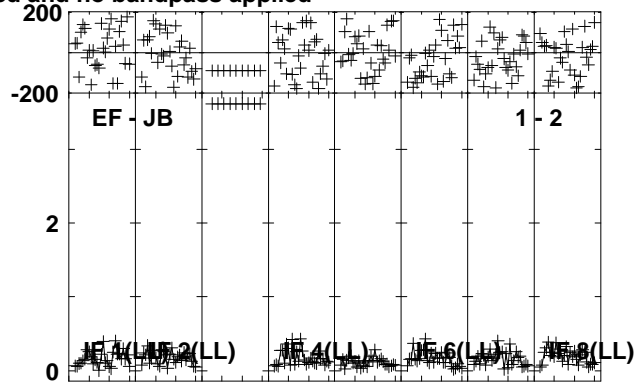
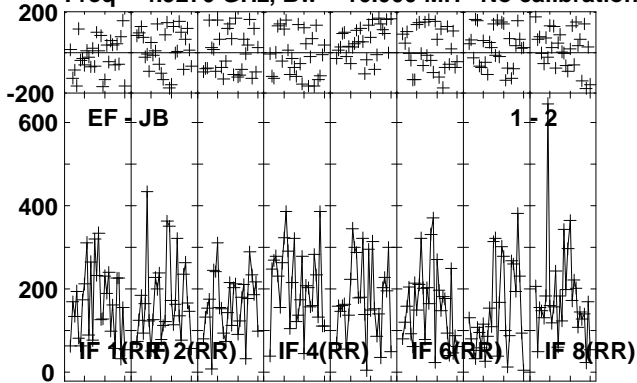

Lower frame: Micro Ampl Jy Top frame: Phas deg
Vector averaged cross-power spectrum Several baselines displayed
Timerange: 00/01:22:37 to 00/01:25:33

Plot file version 14 created 16-OCT-2012 11:56:36

NOVA-MON RO006.UVDATA.1

Freq = 4.9270 GHz, Bw = 16.000 MH No calibration applied and no bandpass applied

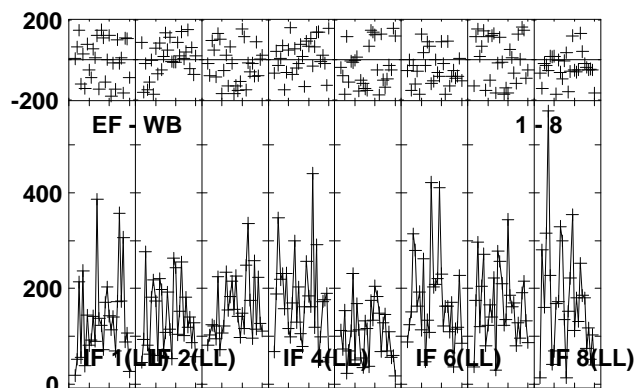
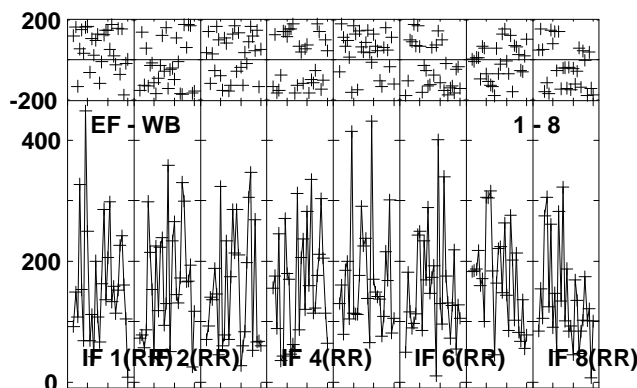
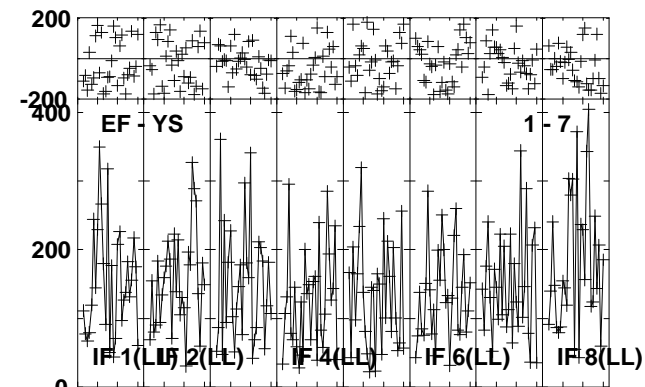
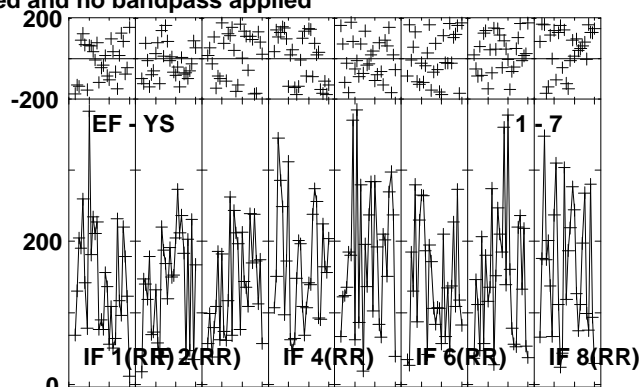
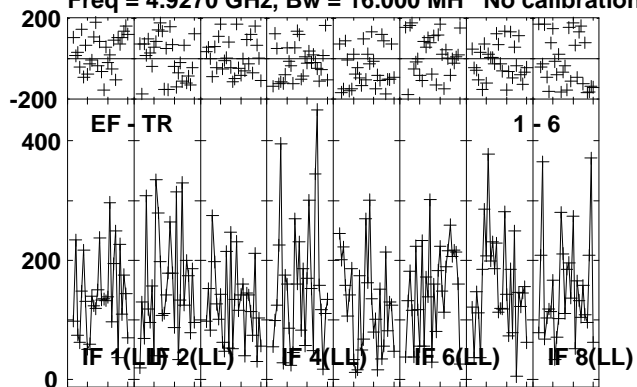

Lower frame: Micro Ampl Jy Top frame: Phas deg
Vector averaged cross-power spectrum Several baselines displayed
Timerange: 00/01:22:37 to 00/01:25:33

Plot file version 15 created 16-OCT-2012 11:56:37

J0639+0601 RO006.UVDATA.1

Freq = 4.9270 GHz, Bw = 16.000 MH No calibration applied and no bandpass applied

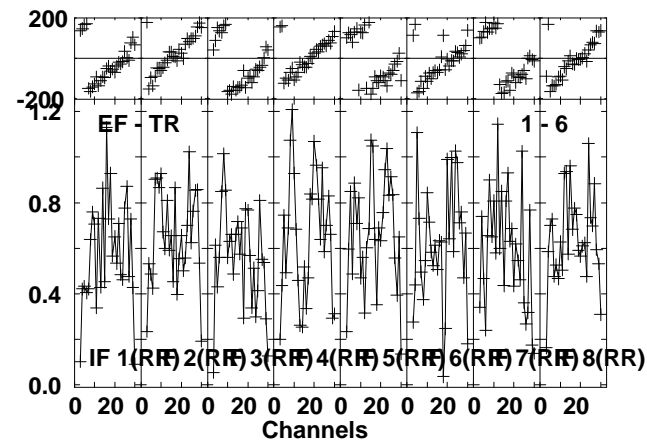
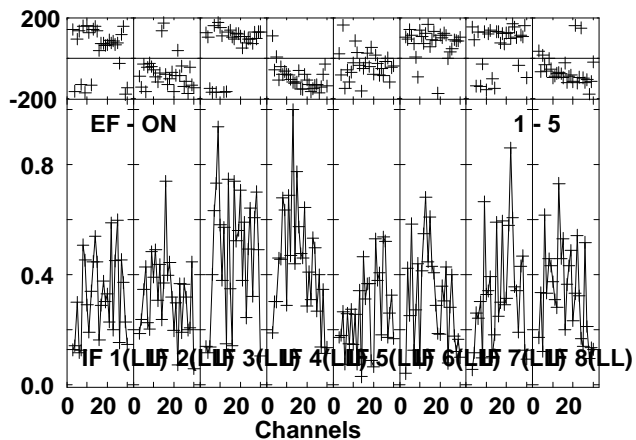
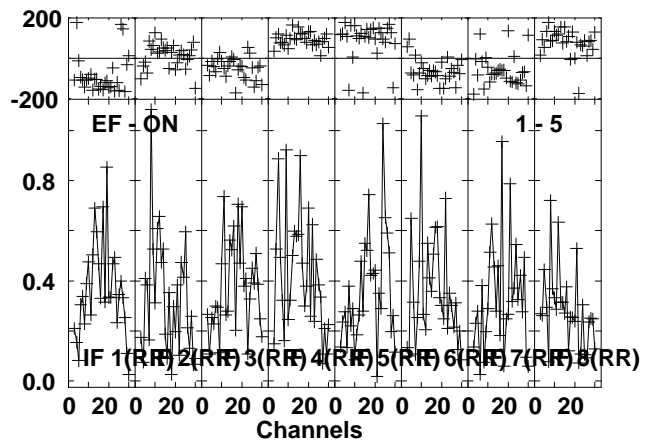
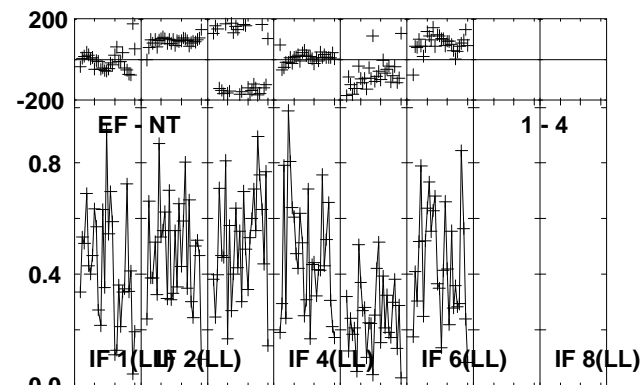
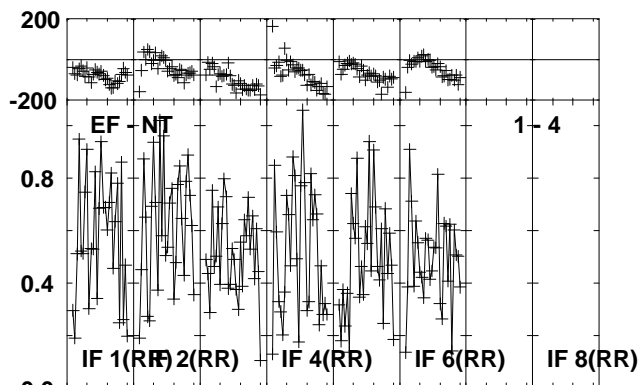
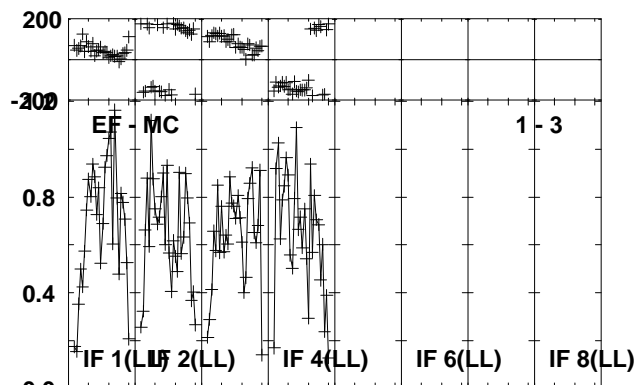
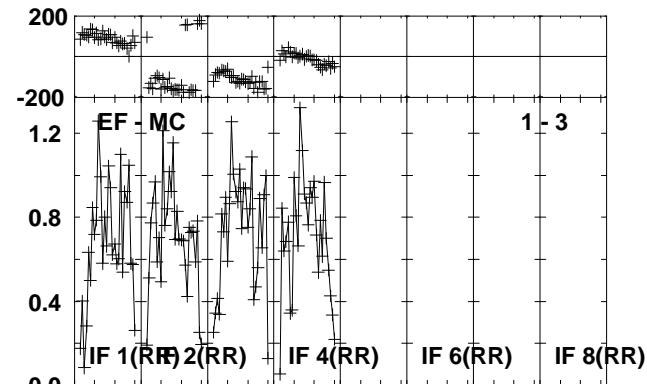
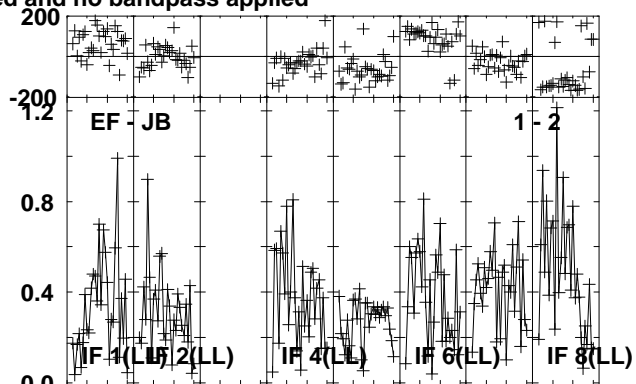
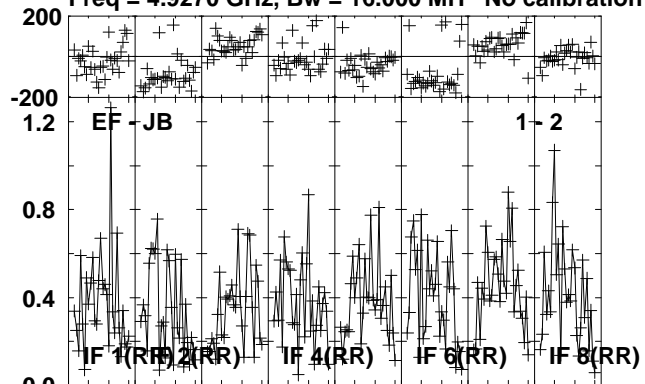

Lower frame: Milli Ampl Jy Top frame: Phas deg
Vector averaged cross-power spectrum Several baselines displayed
Timerange: 00/01:26:03 to 00/01:27:03

Plot file version 16 created 16-OCT-2012 11:56:37

J0639+0601 RO006.UVDATA.1

Freq = 4.9270 GHz, Bw = 16.000 MH No calibration applied and no bandpass applied

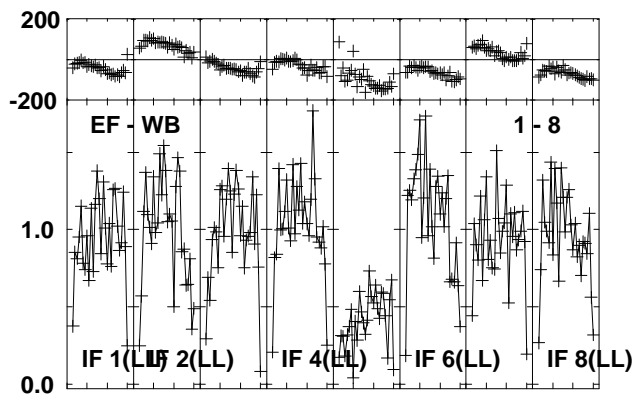
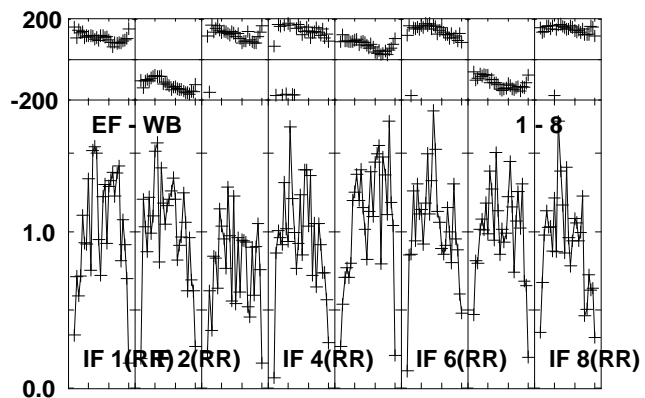
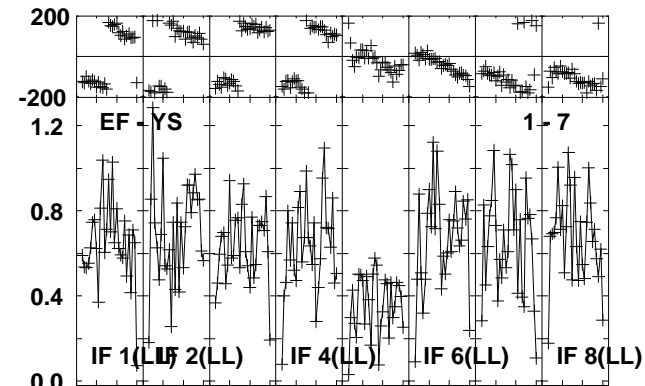
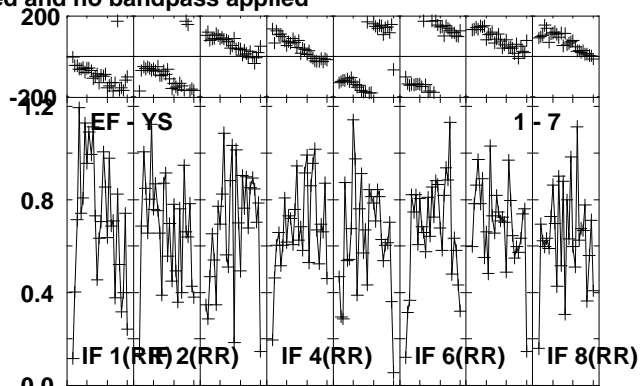
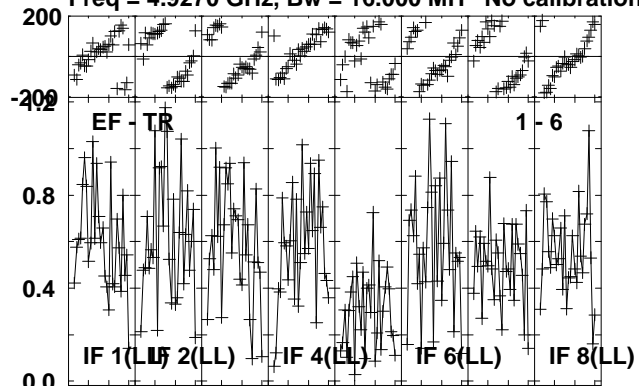

Lower frame: Milli Ampl Jy Top frame: Phas deg
Vector averaged cross-power spectrum Several baselines displayed
Timerange: 00/01:26:03 to 00/01:27:03

Plot file version 17 created 16-OCT-2012 11:56:37

J0645+0541 RO006.UVDATA.1

Freq = 4.9270 GHz, Bw = 16.000 MH No calibration applied and no bandpass applied

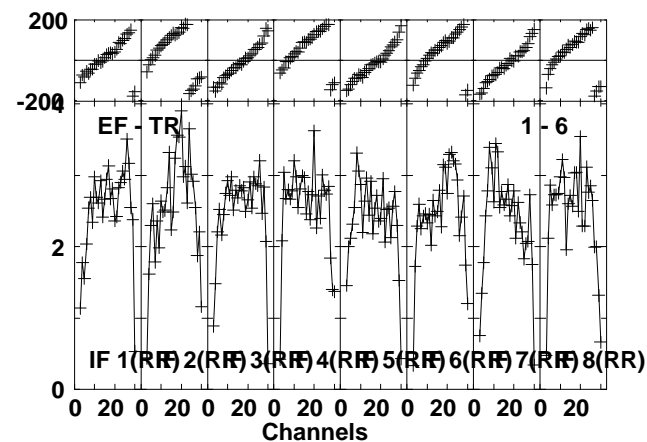
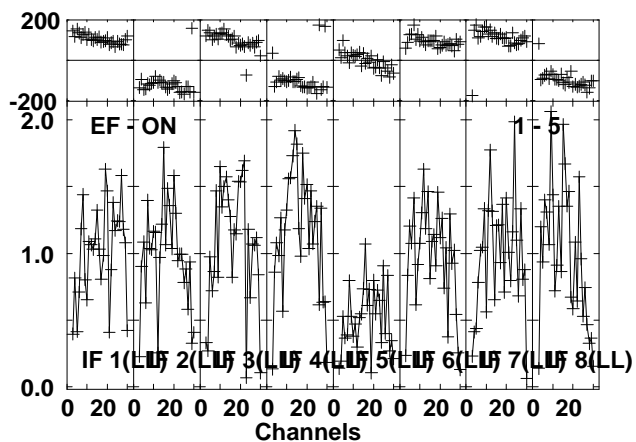
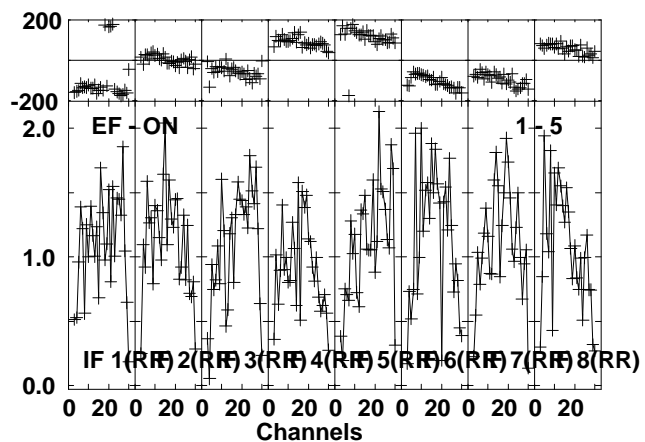
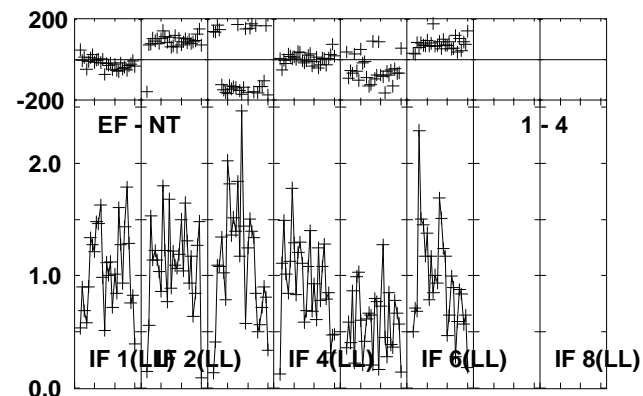
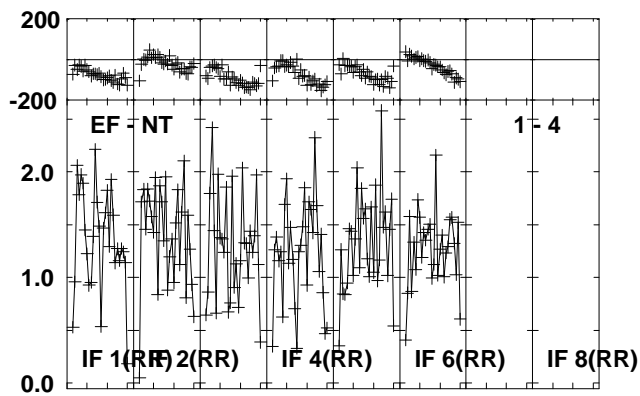
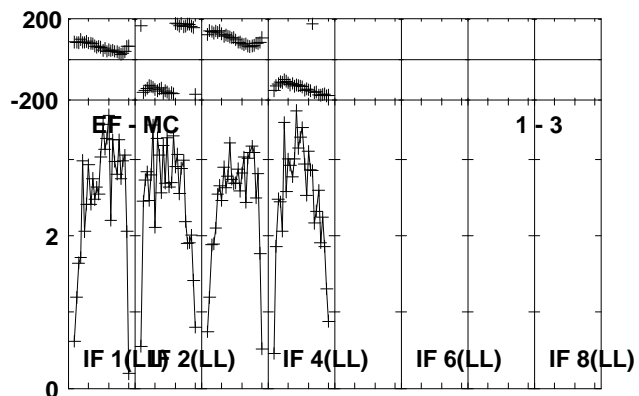
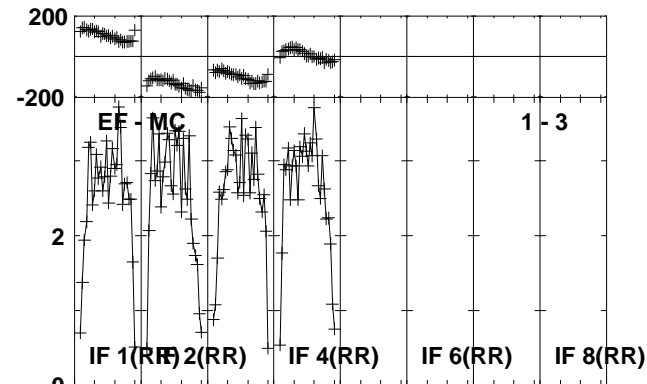
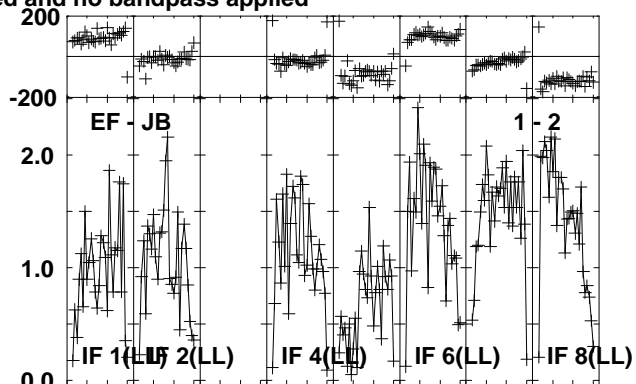
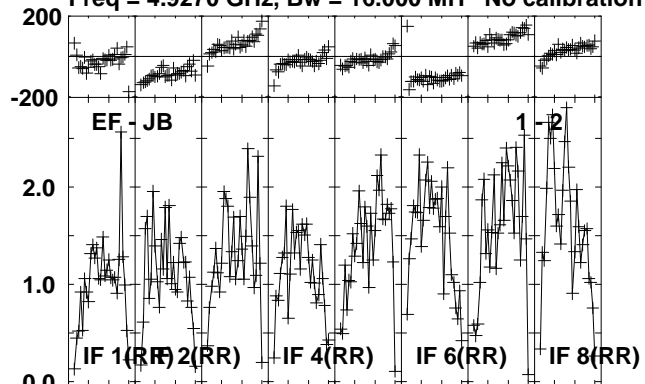

Lower frame: Milli Ampl Jy Top frame: Phas deg
Vector averaged cross-power spectrum Several baselines displayed
Timerange: 00/01:27:07 to 00/01:28:03

Plot file version 18 created 16-OCT-2012 11:56:37

J0645+0541 RO006.UVDATA.1

Freq = 4.9270 GHz, Bw = 16.000 MH No calibration applied and no bandpass applied

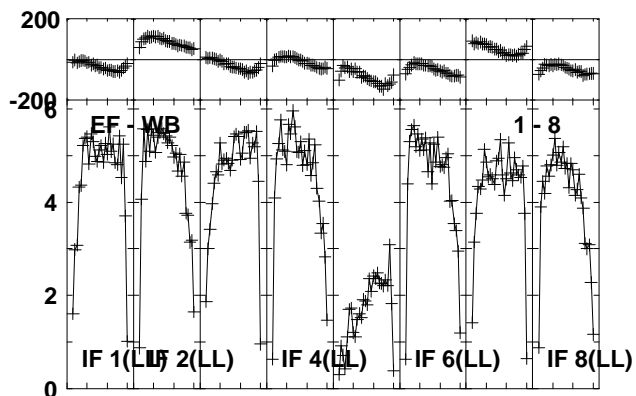
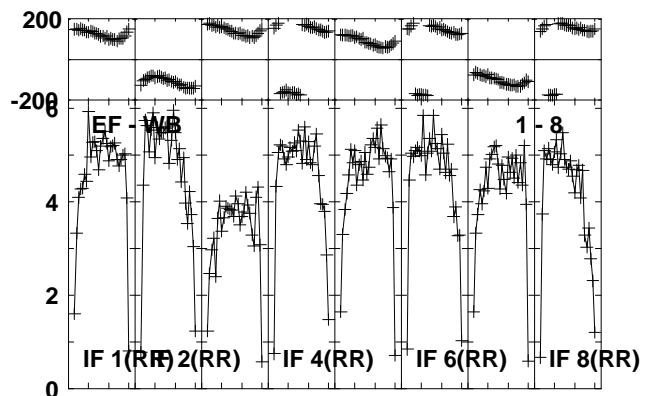
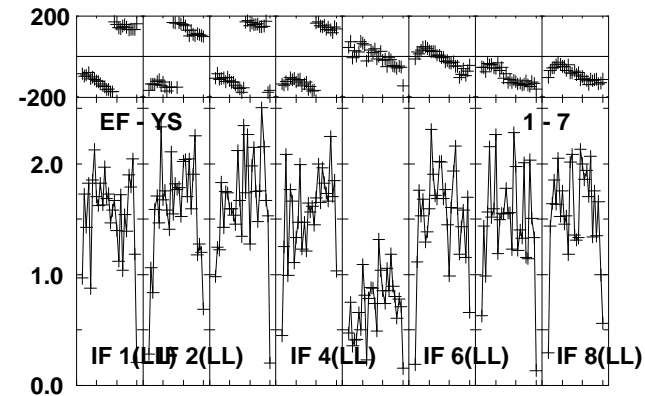
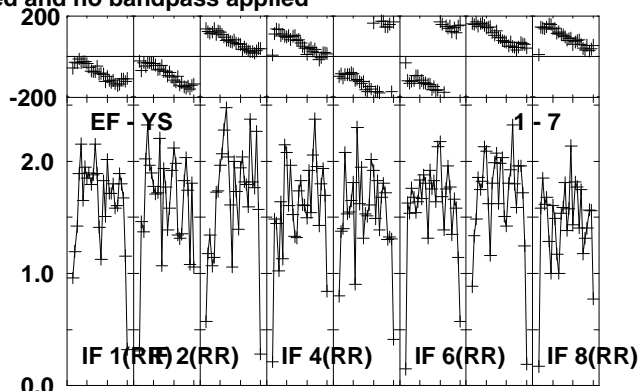
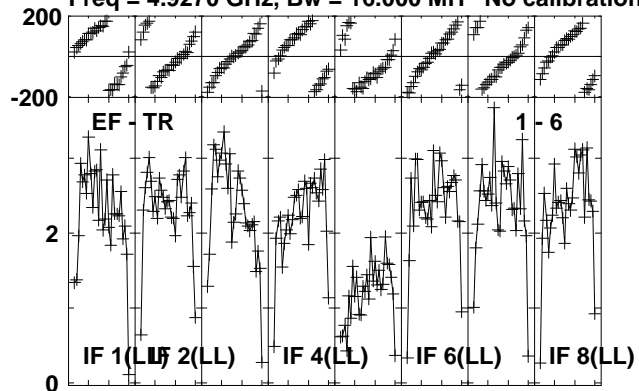

Lower frame: Milli Ampl Jy Top frame: Phas deg
Vector averaged cross-power spectrum Several baselines displayed
Timerange: 00/01:27:07 to 00/01:28:03

Plot file version 19 created 16-OCT-2012 11:56:38

NOVA-MON RO006.UVDATA.1

Freq = 4.9270 GHz, Bw = 16.000 MH No calibration applied and no bandpass applied

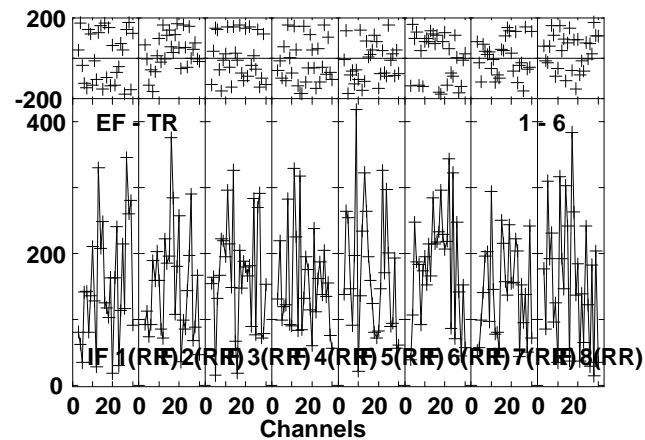
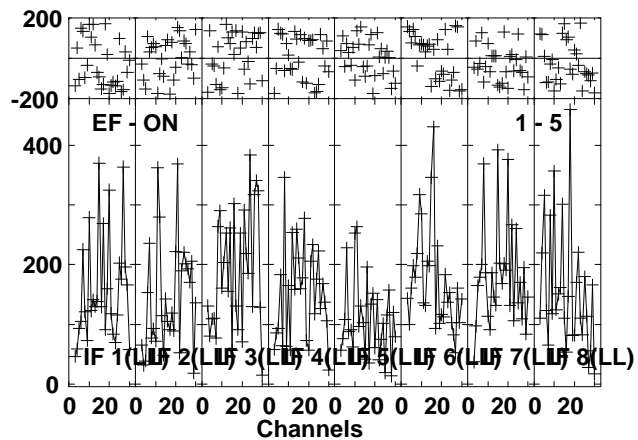
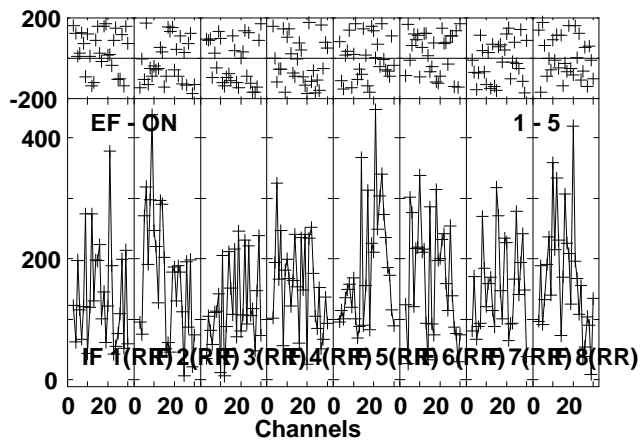
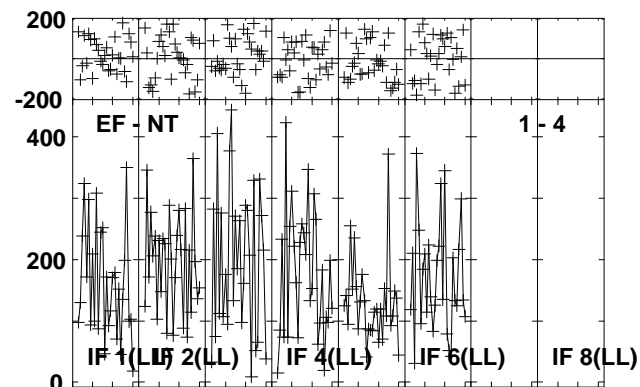
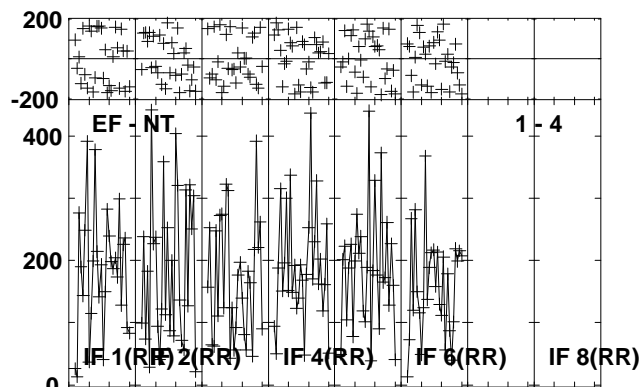
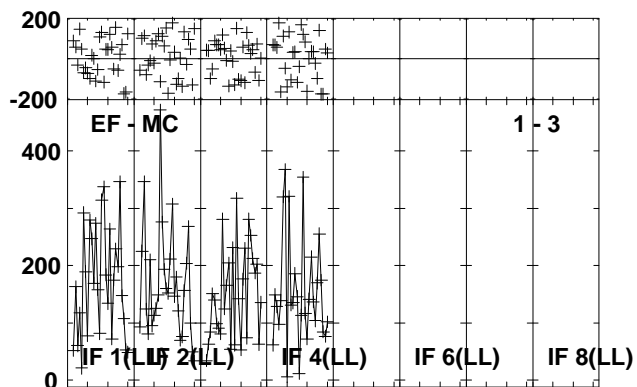
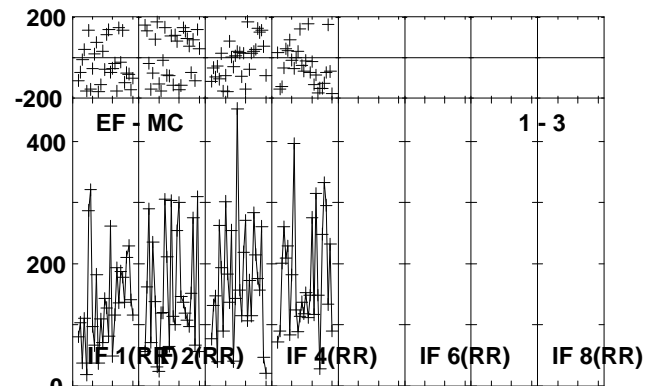
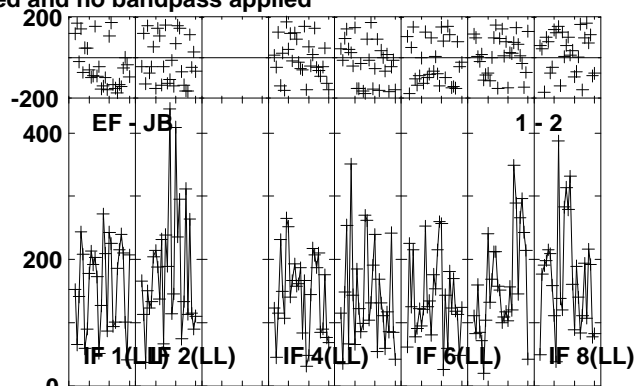
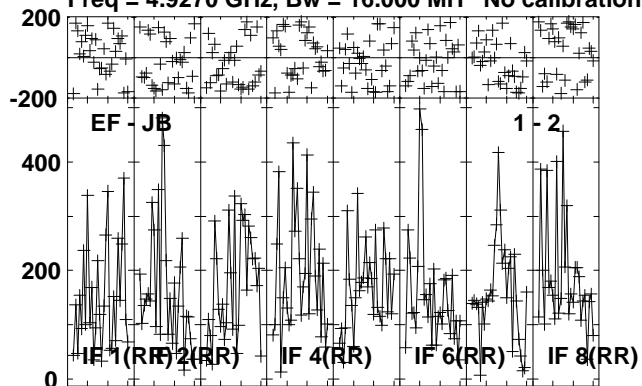

Lower frame: Micro Ampl Jy Top frame: Phas deg
Vector averaged cross-power spectrum Several baselines displayed
Timerange: 00/01:28:07 to 00/01:31:03

Plot file version 20 created 16-OCT-2012 11:56:38

NOVA-MON RO006.UVDATA.1

Freq = 4.9270 GHz, Bw = 16.000 MH No calibration applied and no bandpass applied

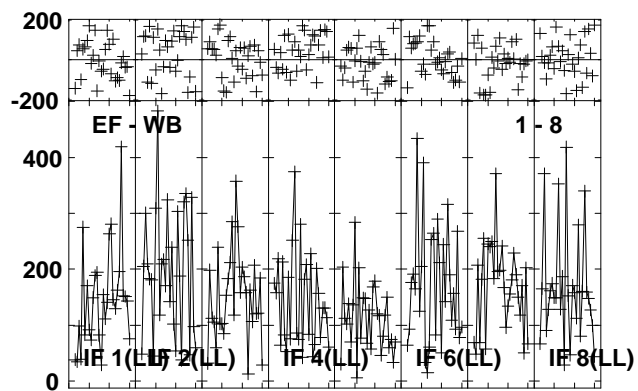
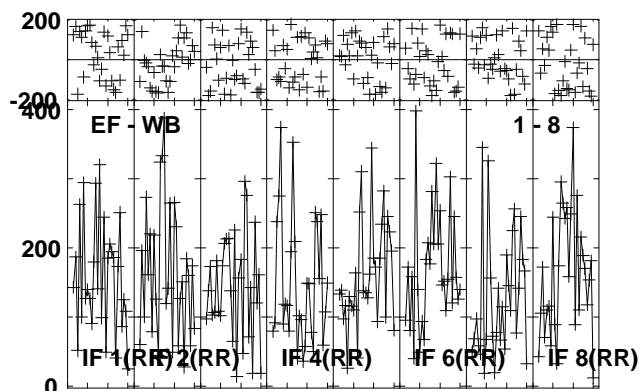
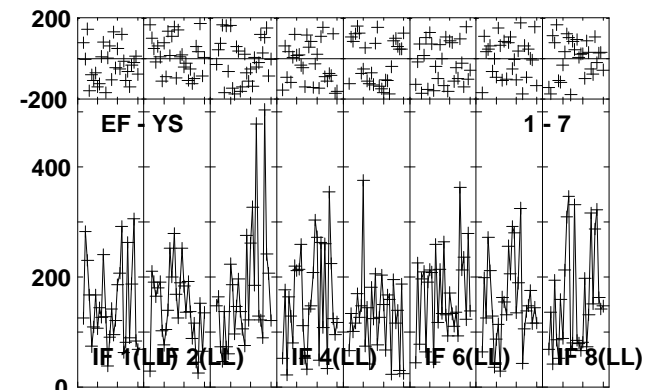
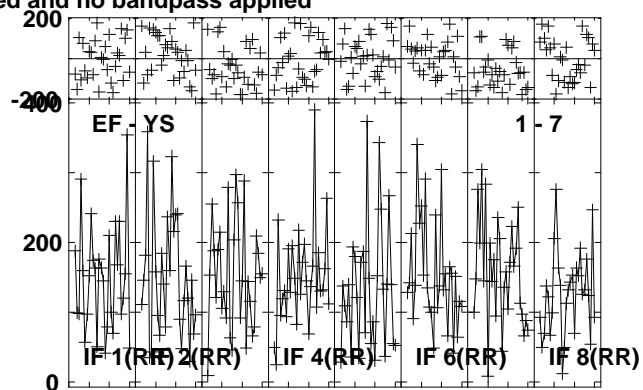
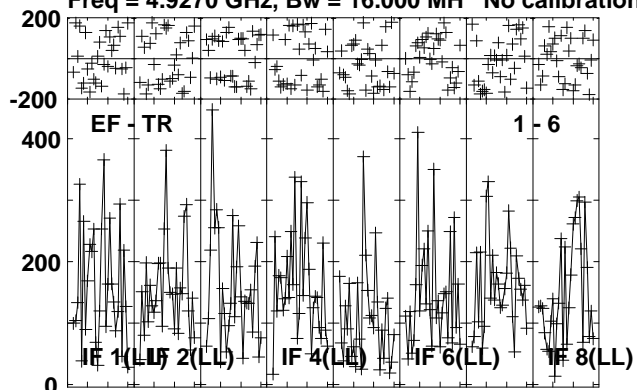

Lower frame: Micro Ampl Jy Top frame: Phas deg
Vector averaged cross-power spectrum Several baselines displayed
Timerange: 00/01:28:07 to 00/01:31:03

Plot file version 21 created 16-OCT-2012 11:56:39

J0639+0601 RO006.UVDATA.1

Freq = 4.9270 GHz, Bw = 16.000 MH No calibration applied and no bandpass applied

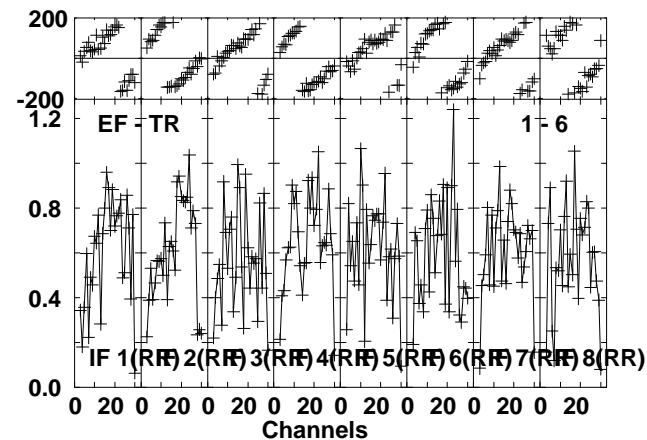
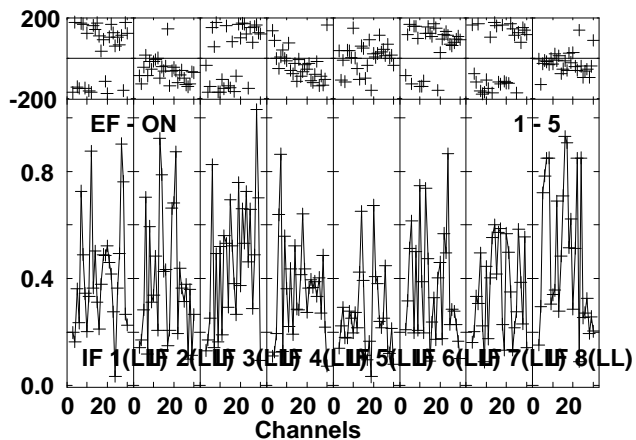
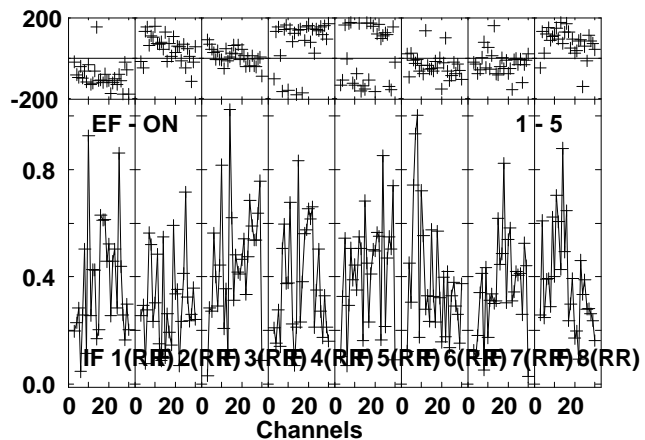
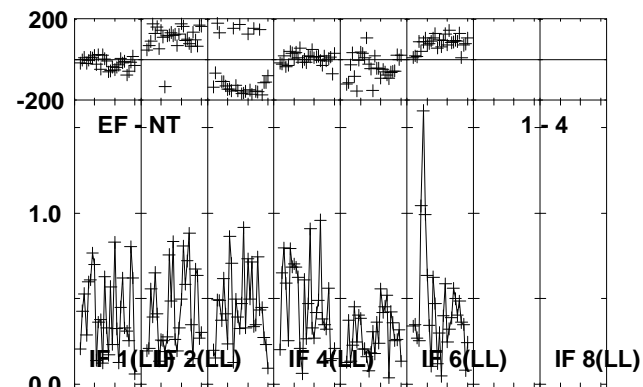
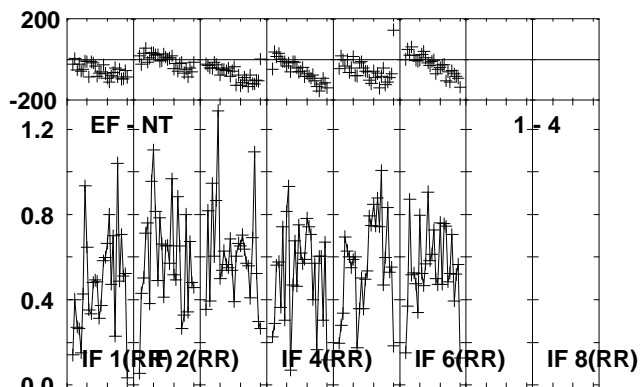
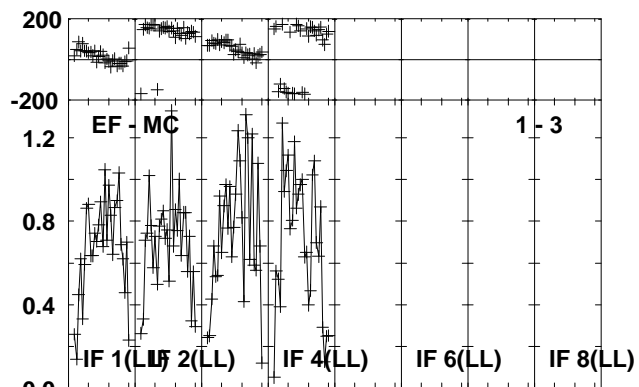
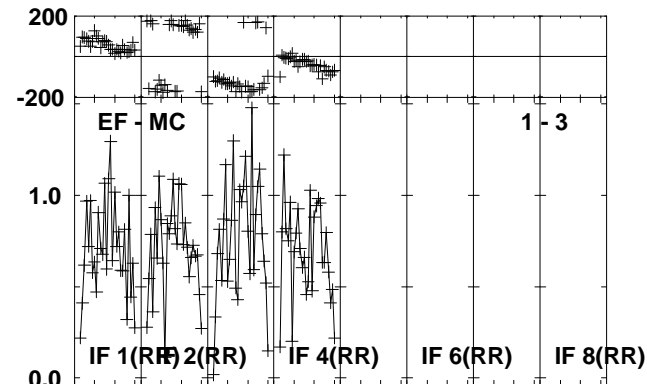
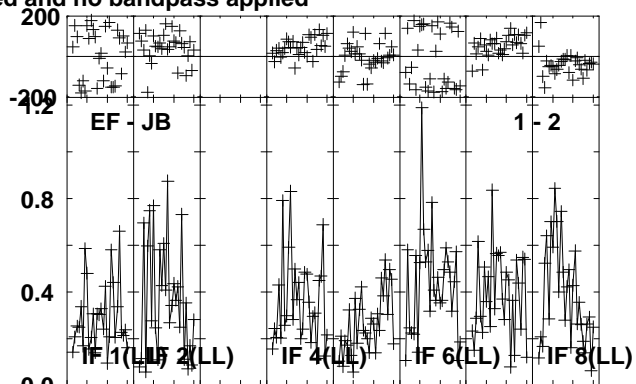
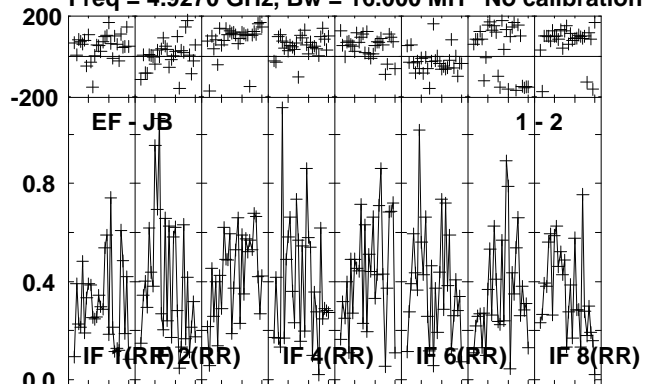

Lower frame: Milli Ampl Jy Top frame: Phas deg
Vector averaged cross-power spectrum Several baselines displayed
Timerange: 00/01:31:07 to 00/01:32:19

Plot file version 22 created 16-OCT-2012 11:56:39

J0639+0601 RO006.UVDATA.1

Freq = 4.9270 GHz, Bw = 16.000 MH No calibration applied and no bandpass applied

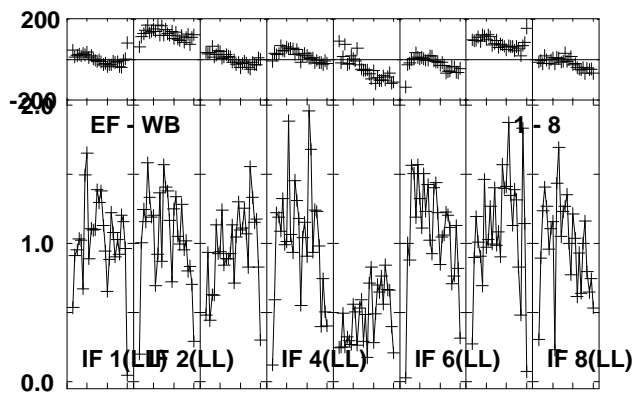
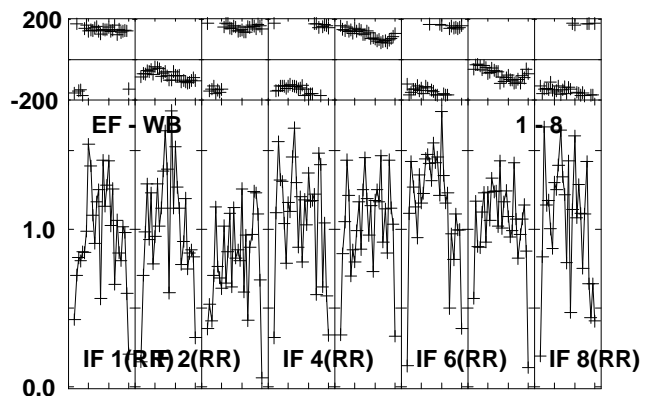
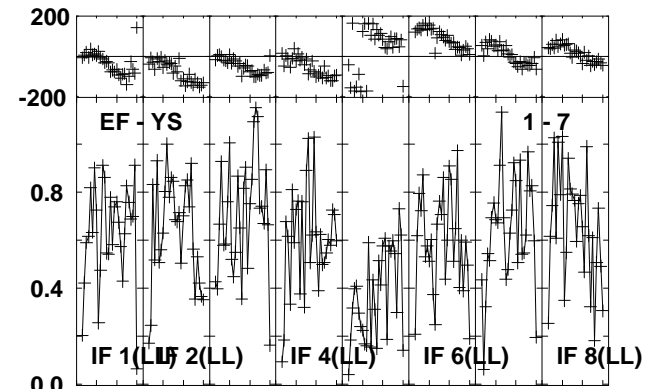
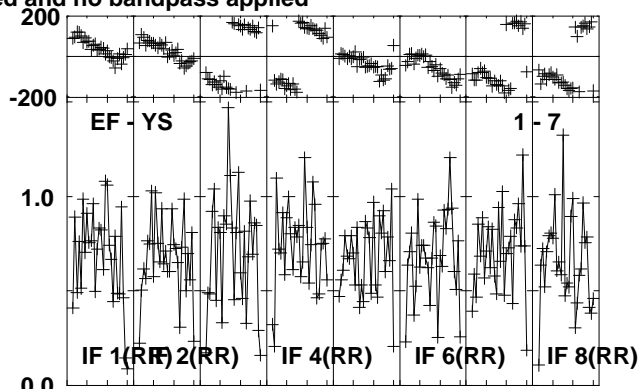
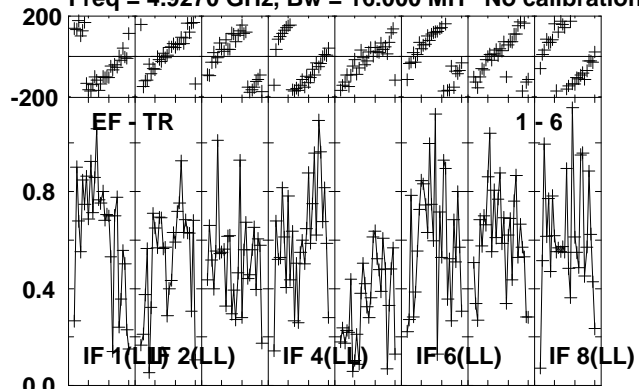

Lower frame: Milli Ampl Jy Top frame: Phas deg
Vector averaged cross-power spectrum Several baselines displayed
Timerange: 00/01:31:07 to 00/01:32:19

Plot file version 23 created 16-OCT-2012 11:56:39

J0645+0541 RO006.UVDATA.1

Freq = 4.9270 GHz, Bw = 16.000 MH No calibration applied and no bandpass applied

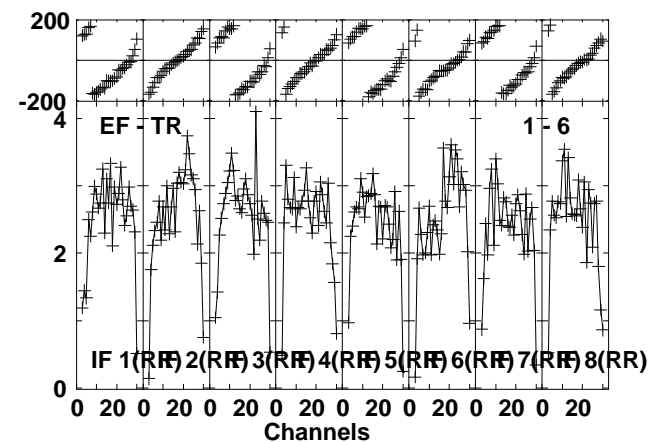
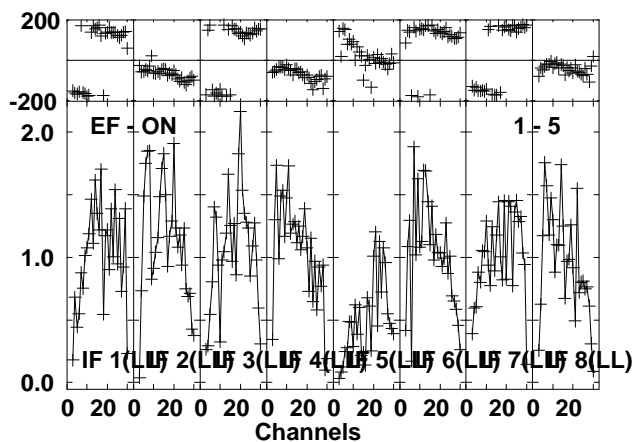
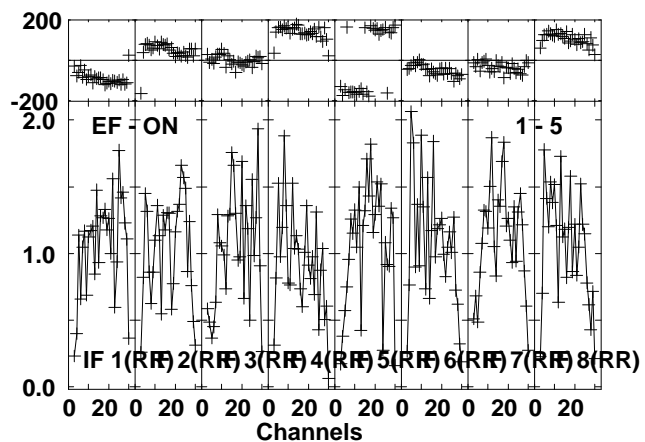
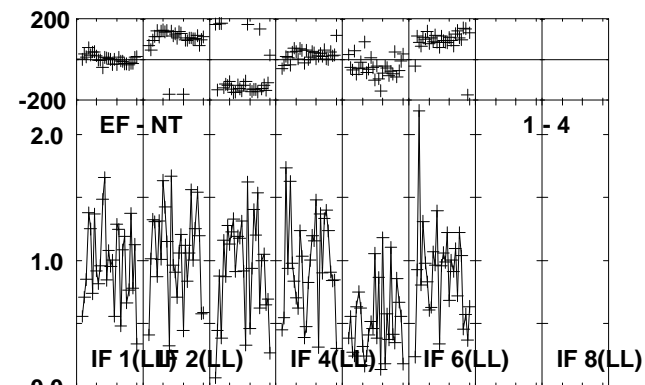
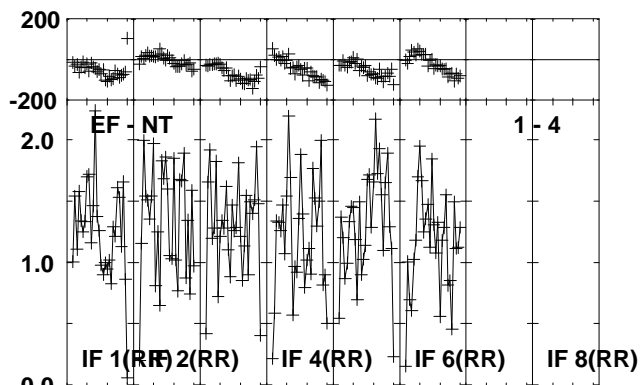
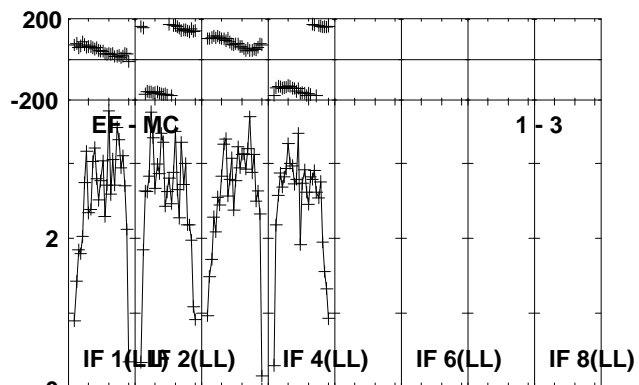
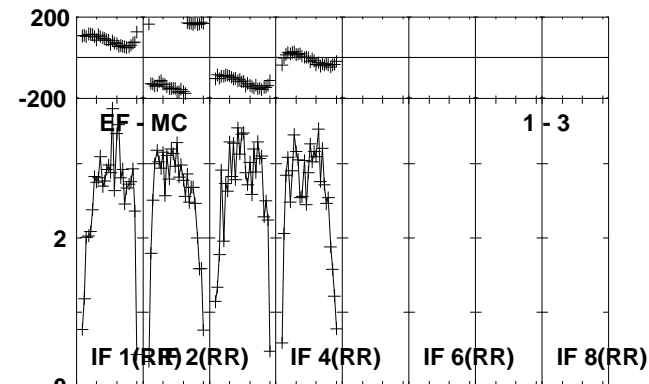
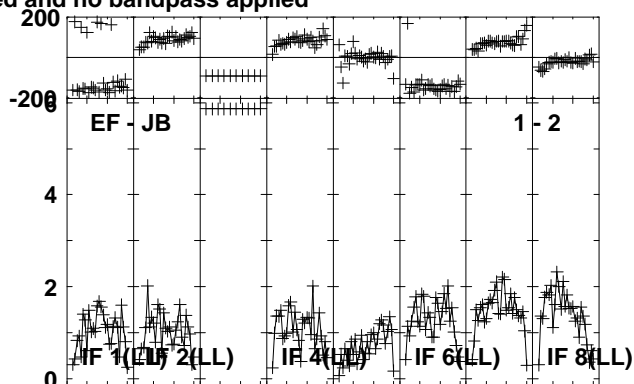
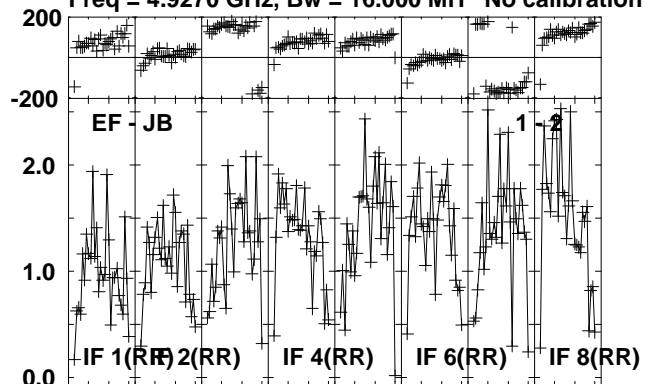

Lower frame: Milli Ampl Jy Top frame: Phas deg
Vector averaged cross-power spectrum Several baselines displayed
Timerange: 00/01:32:23 to 00/01:33:19

Plot file version 24 created 16-OCT-2012 11:56:39

J0645+0541 RO006.UVDATA.1

Freq = 4.9270 GHz, Bw = 16.000 MH No calibration applied and no bandpass applied

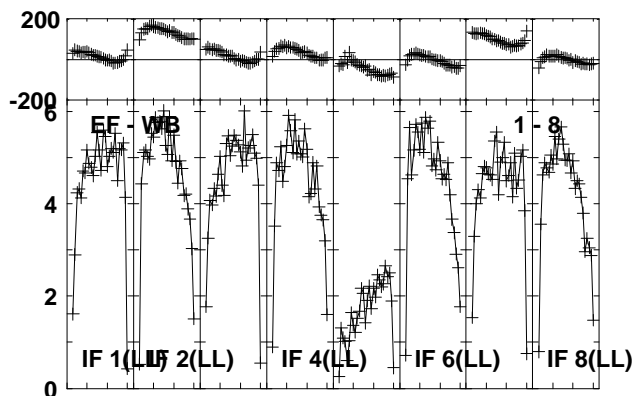
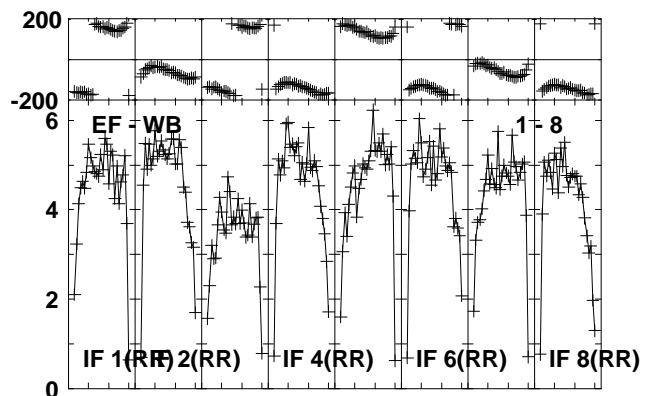
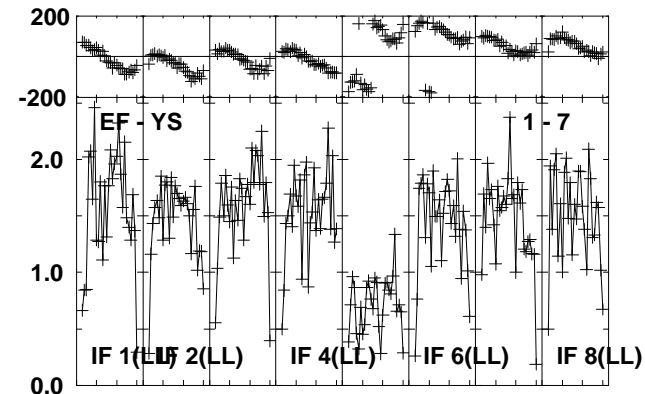
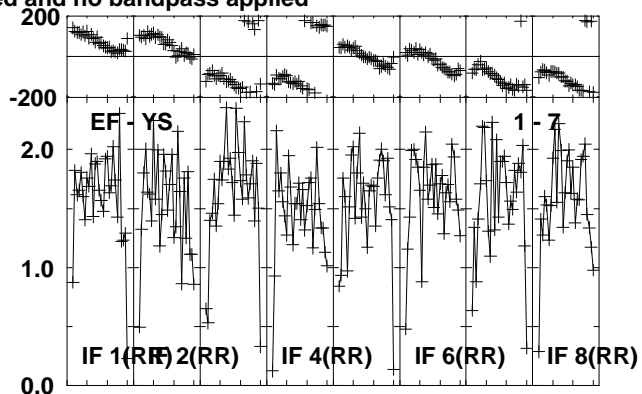
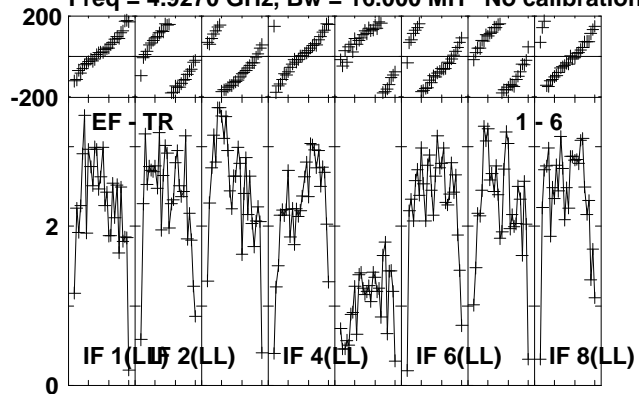

Lower frame: Milli Ampl Jy Top frame: Phas deg
Vector averaged cross-power spectrum Several baselines displayed
Timerange: 00/01:32:23 to 00/01:33:19

Plot file version 25 created 16-OCT-2012 11:56:39

NOVA-MON RO006.UVDATA.1

Freq = 4.9270 GHz, Bw = 16.000 MH No calibration applied and no bandpass applied

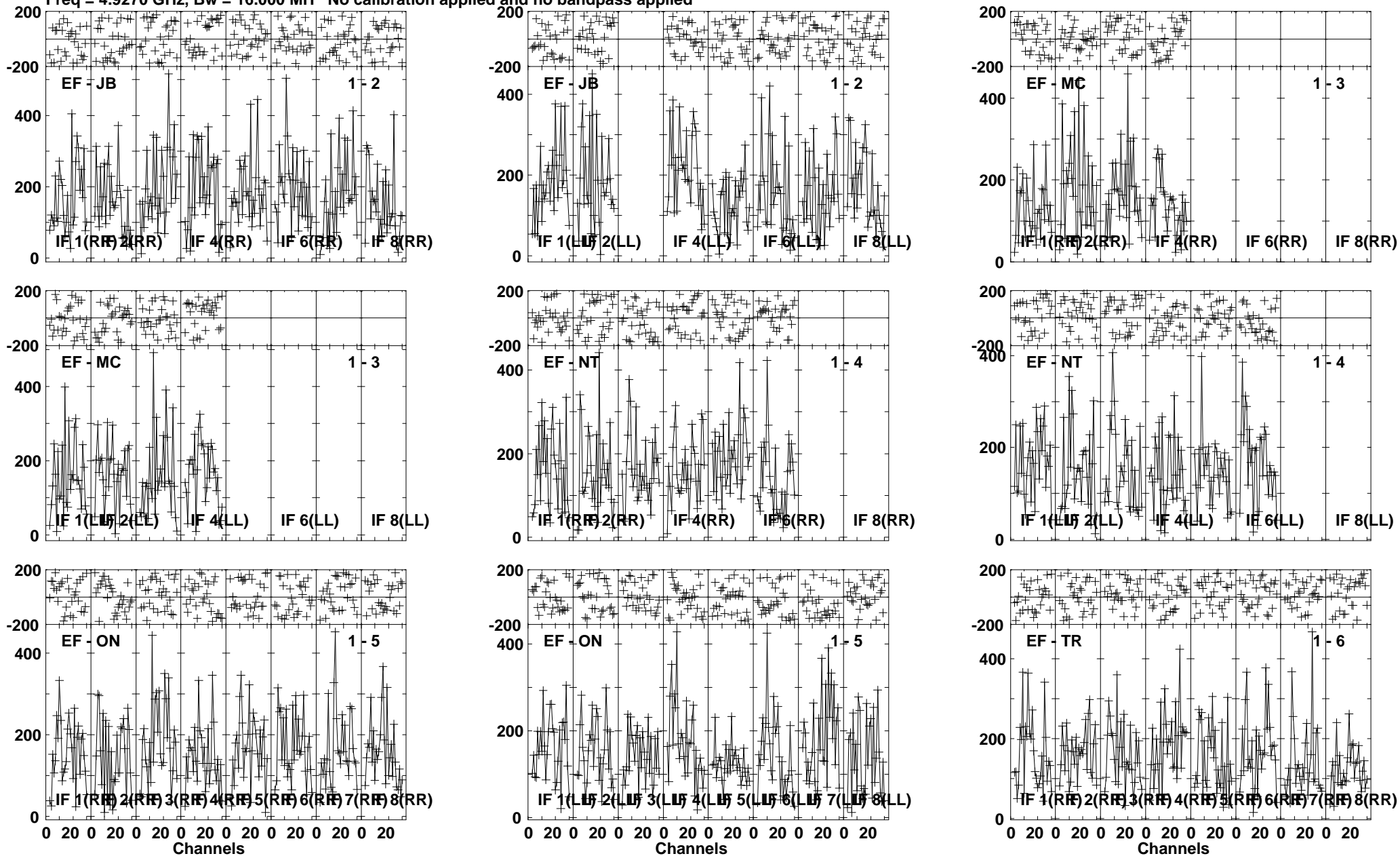

Lower frame: Micro Ampl Jy Top frame: Phas deg
Vector averaged cross-power spectrum Several baselines displayed
Timerange: 00/01:33:23 to 00/01:36:19

Plot file version 26 created 16-OCT-2012 11:56:40

NOVA-MON RO006.UVDATA.1

Freq = 4.9270 GHz, Bw = 16.000 MH No calibration applied and no bandpass applied

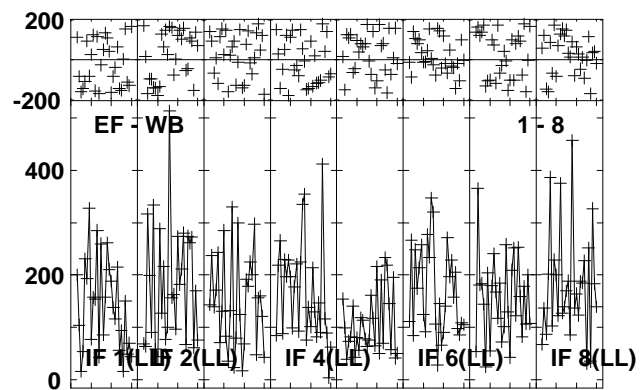
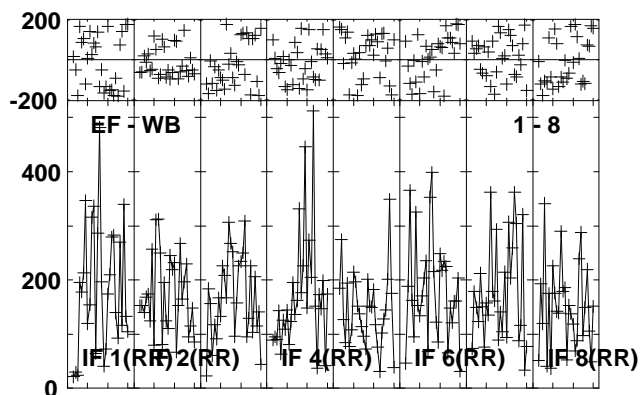
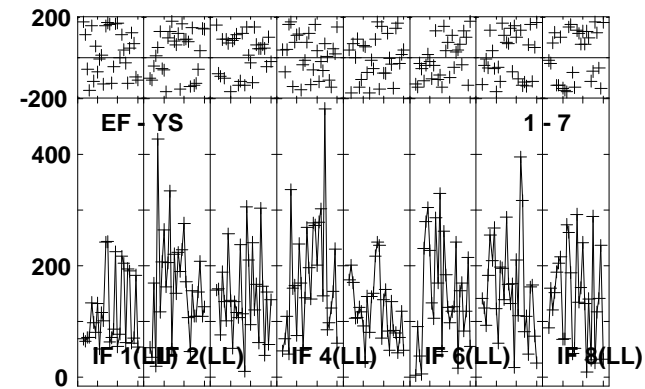
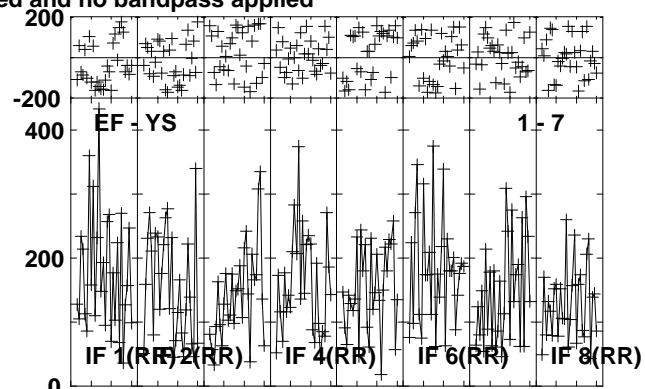
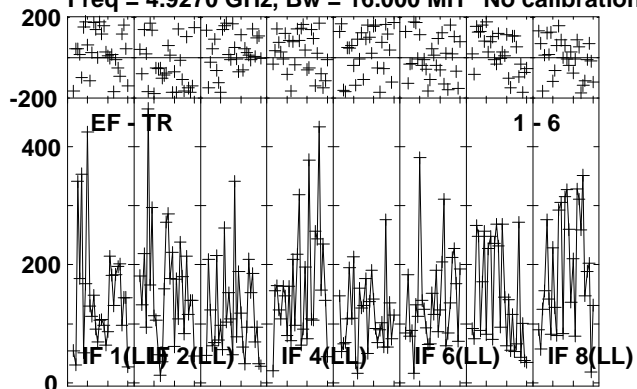

Lower frame: Micro Ampl Jy Top frame: Phas deg
Vector averaged cross-power spectrum Several baselines displayed
Timerange: 00/01:33:23 to 00/01:36:19

Plot file version 27 created 16-OCT-2012 11:56:40

J0639+0601 RO006.UVDATA.1

Freq = 4.9270 GHz, Bw = 16.000 MH No calibration applied and no bandpass applied

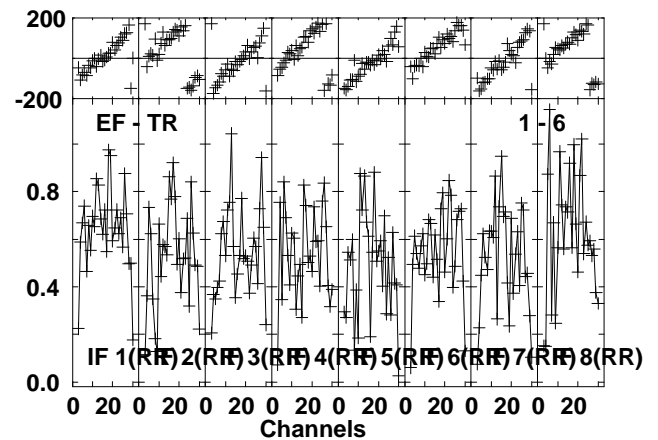
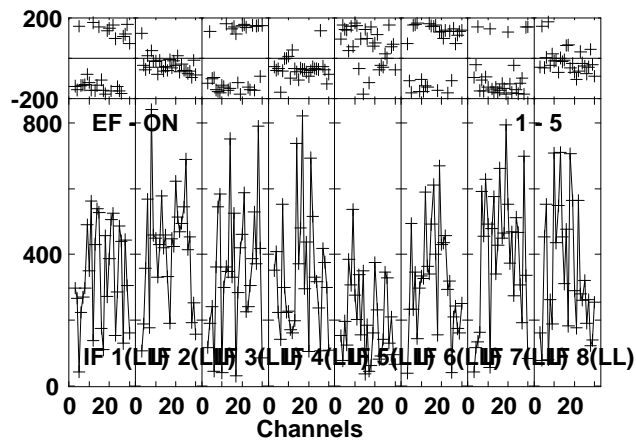
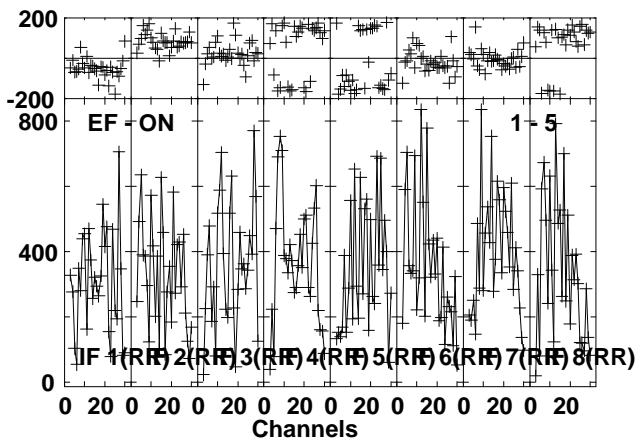
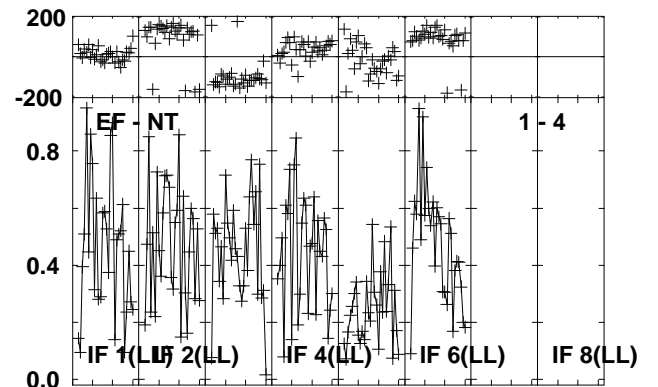
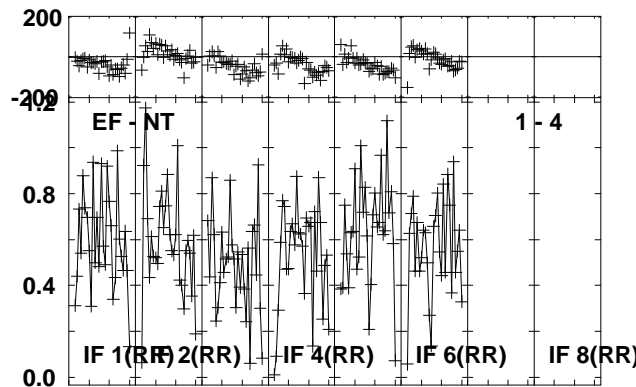
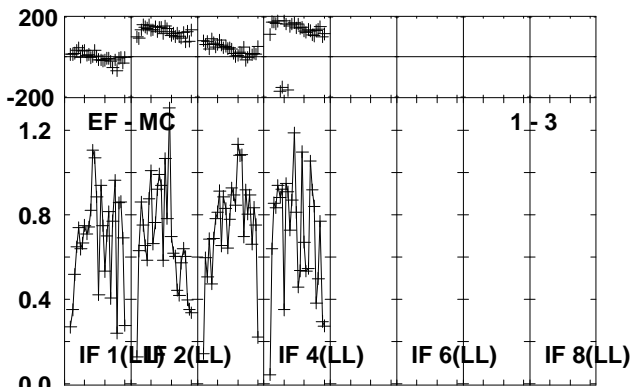
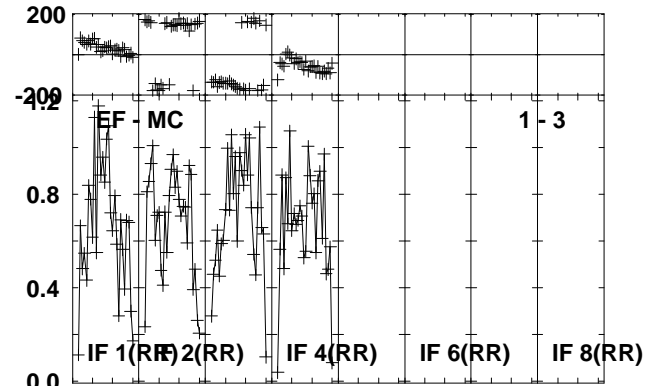
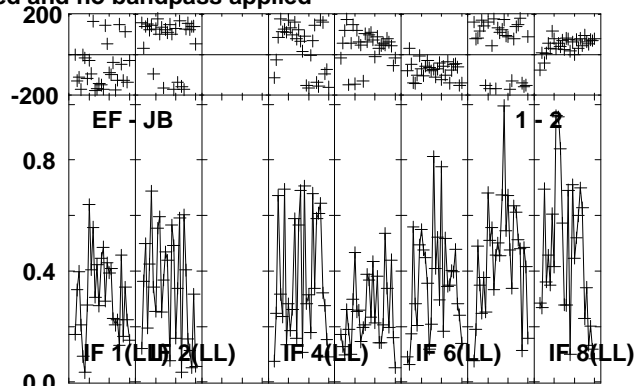
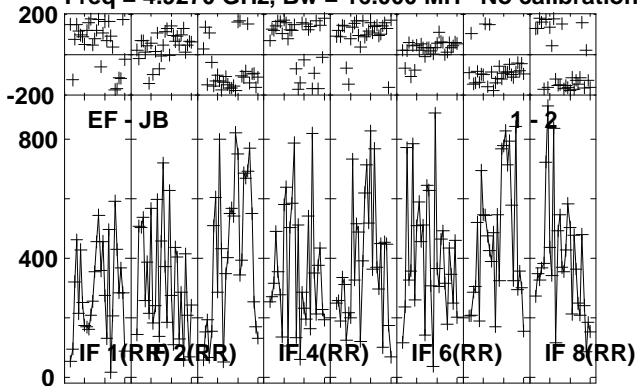

Lower frame: Micro Ampl Jy Top frame: Phas deg
Vector averaged cross-power spectrum Several baselines displayed
Timerange: 00/01:36:47 to 00/01:37:49

Plot file version 28 created 16-OCT-2012 11:56:40

J0639+0601 RO006.UVDATA.1

Freq = 4.9270 GHz, Bw = 16.000 MH No calibration applied and no bandpass applied

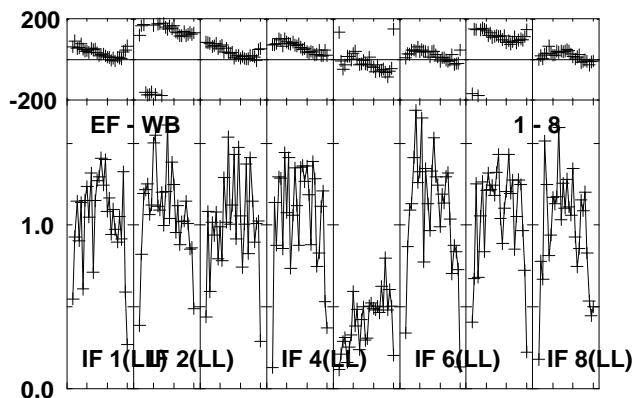
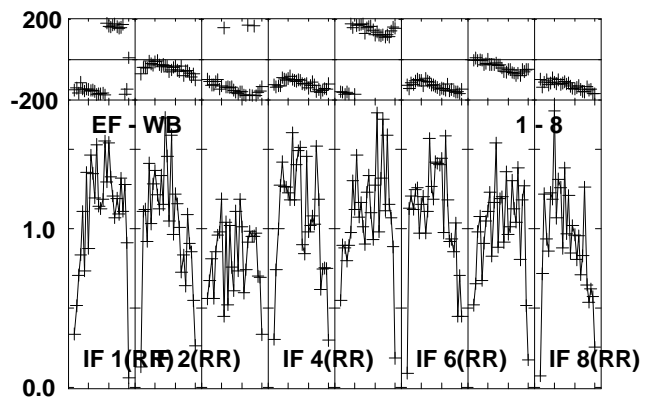
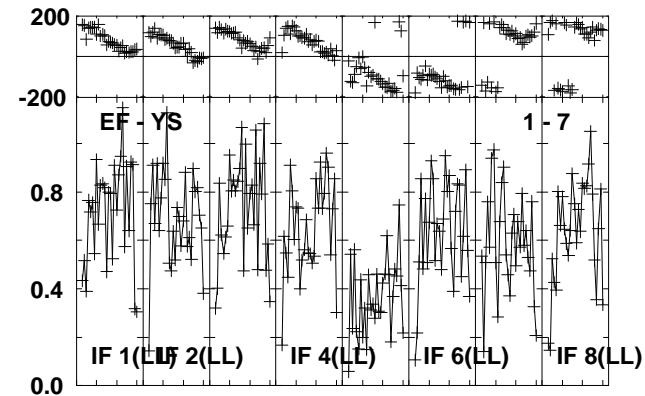
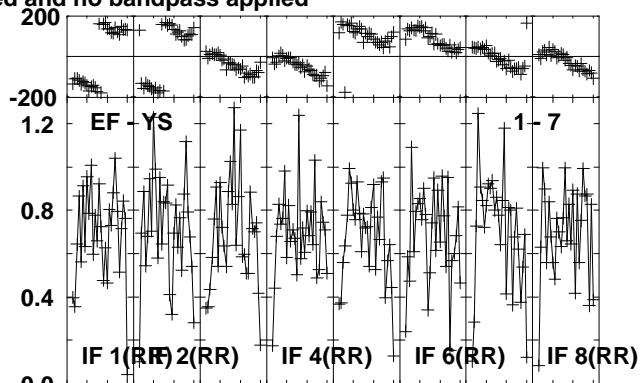
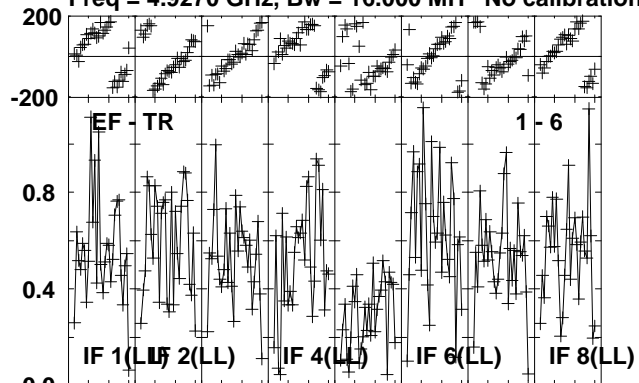

Lower frame: Milli Ampl Jy Top frame: Phas deg
Vector averaged cross-power spectrum Several baselines displayed
Timerange: 00/01:36:47 to 00/01:37:49

Plot file version 29 created 16-OCT-2012 11:56:40

J0645+0541 RO006.UVDATA.1

Freq = 4.9270 GHz, Bw = 16.000 MH No calibration applied and no bandpass applied

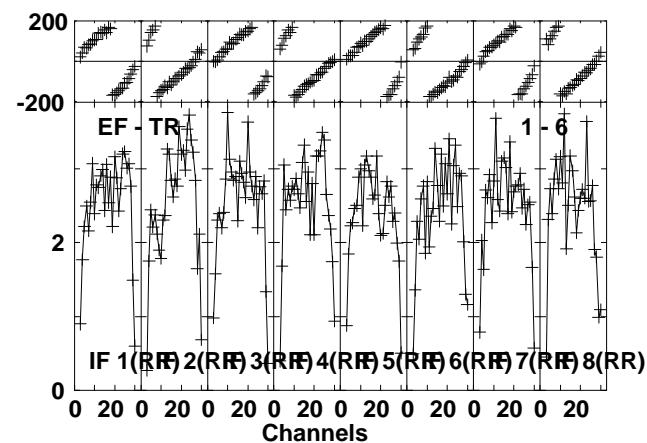
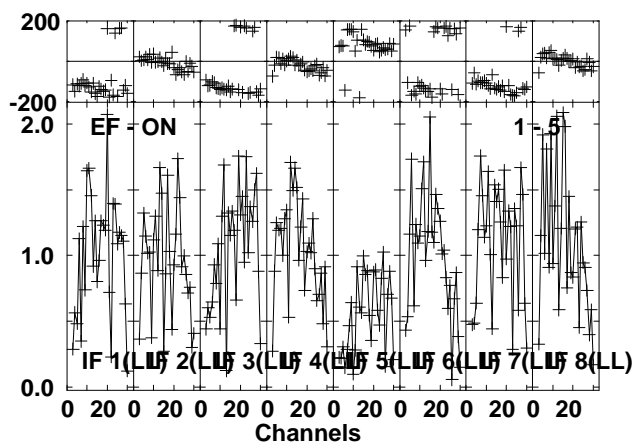
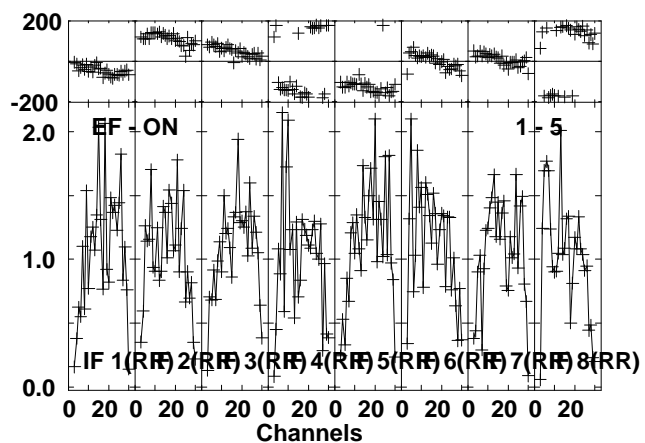
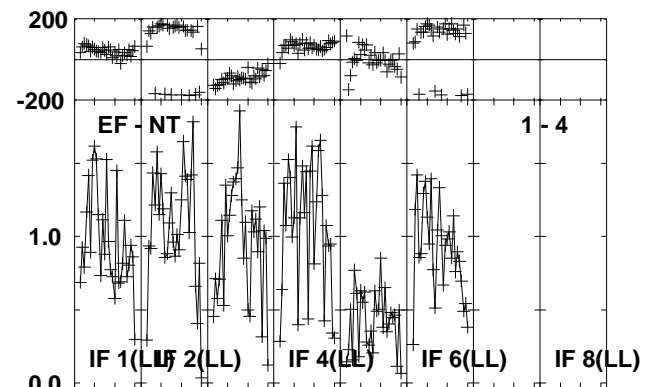
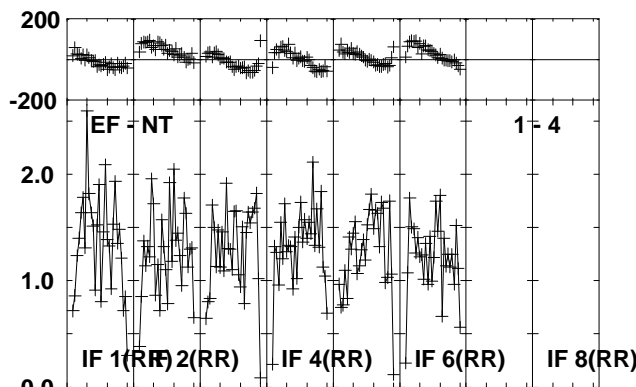
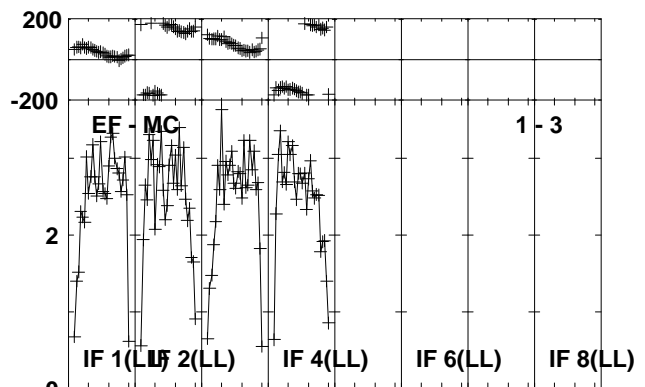
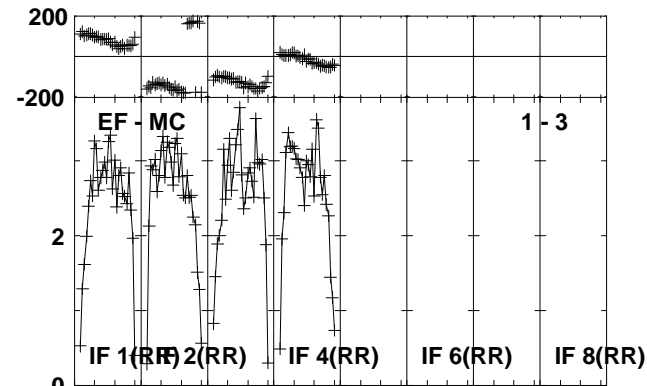
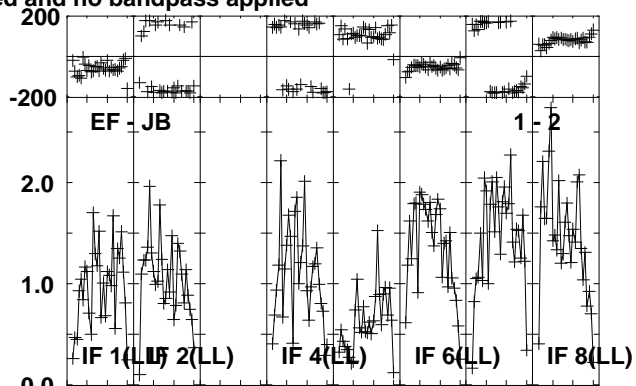
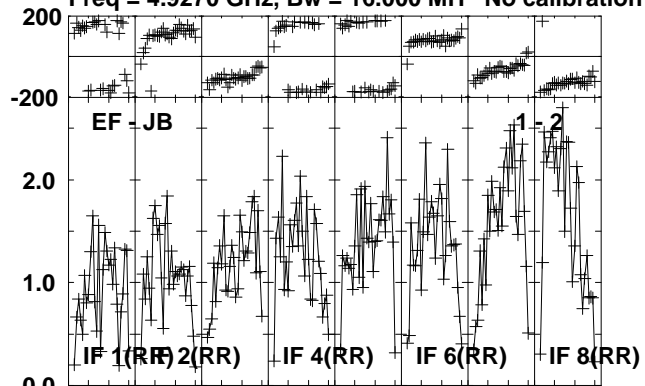

Lower frame: Milli Ampl Jy Top frame: Phas deg
Vector averaged cross-power spectrum Several baselines displayed
Timerange: 00/01:37:53 to 00/01:38:49

Plot file version 30 created 16-OCT-2012 11:56:41

J0645+0541 RO006.UVDATA.1

Freq = 4.9270 GHz, Bw = 16.000 MH No calibration applied and no bandpass applied

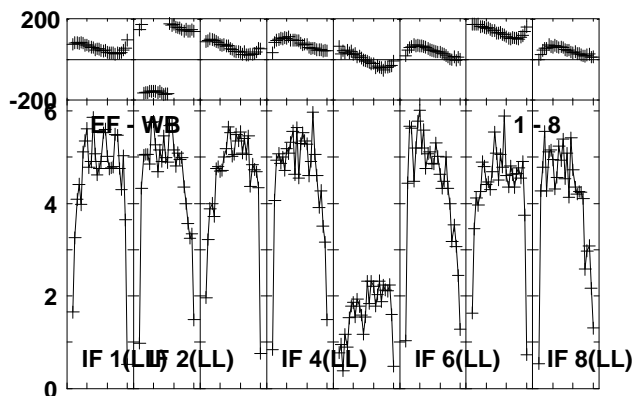
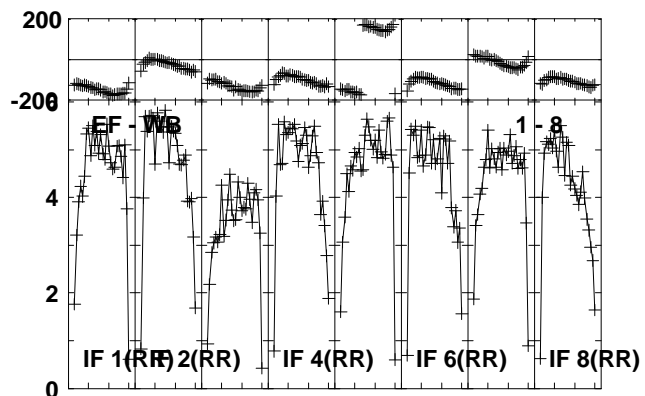
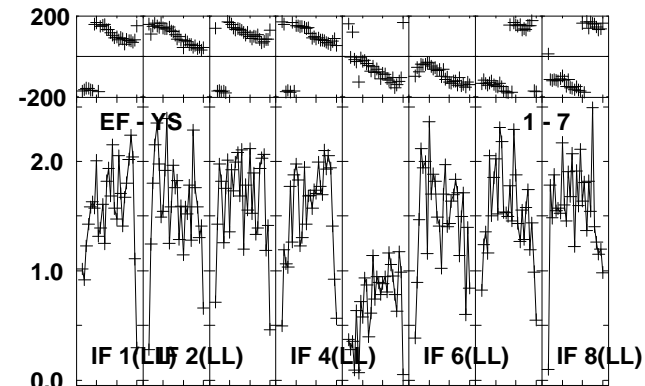
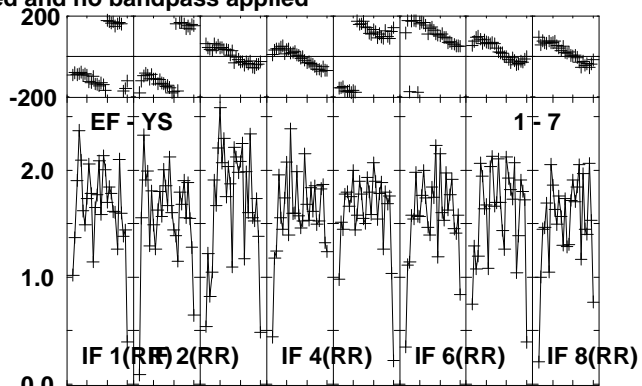
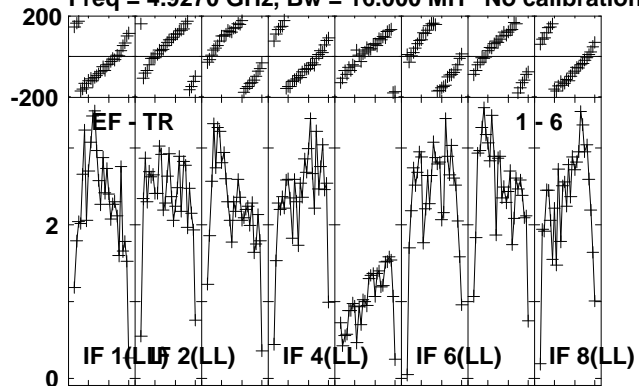

Lower frame: Milli Ampl Jy Top frame: Phas deg
Vector averaged cross-power spectrum Several baselines displayed
Timerange: 00/01:37:53 to 00/01:38:49

Plot file version 31 created 16-OCT-2012 11:56:41

NOVA-MON RO006.UVDATA.1

Freq = 4.9270 GHz, Bw = 16.000 MH No calibration applied and no bandpass applied

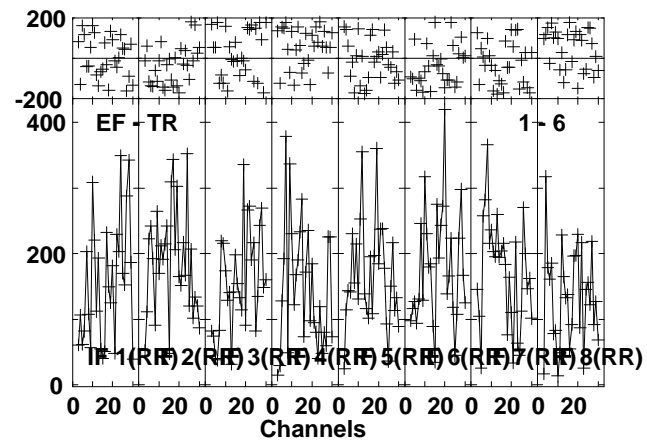
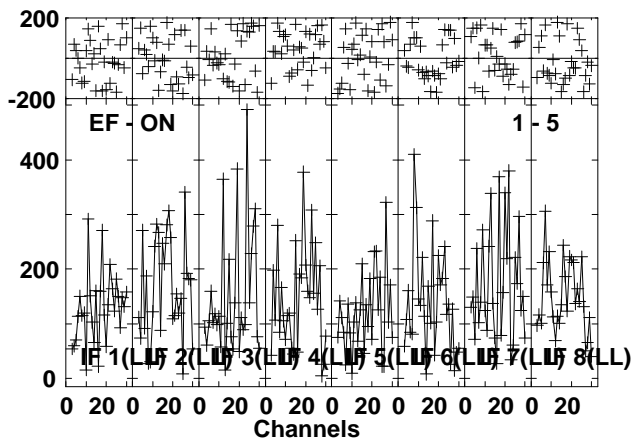
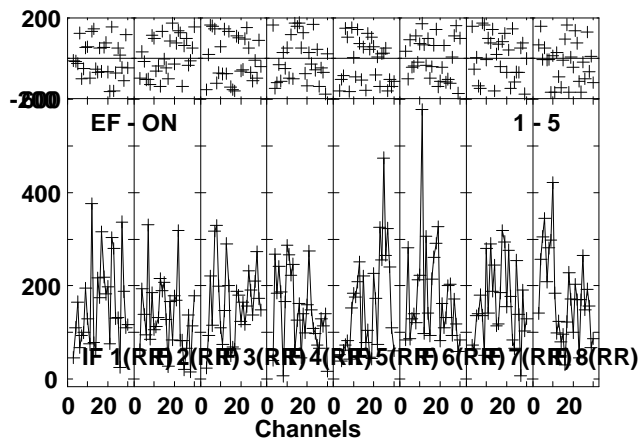
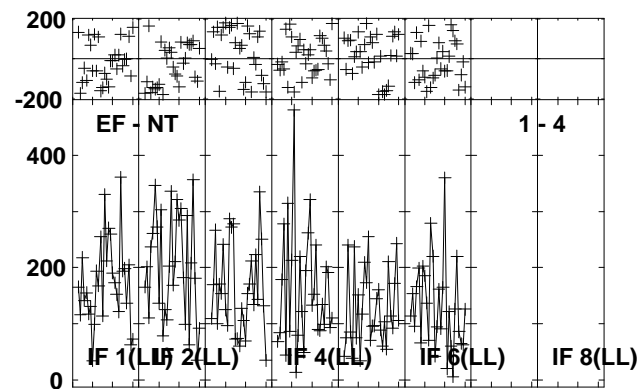
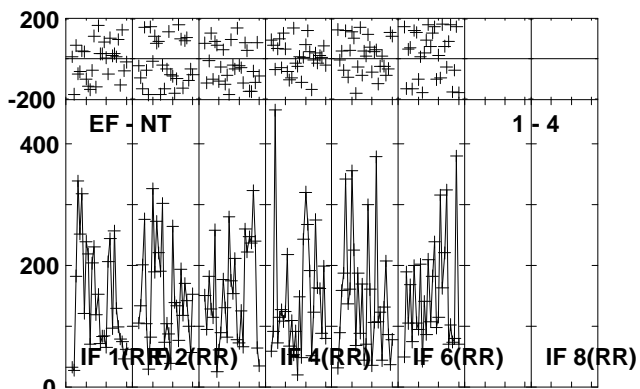
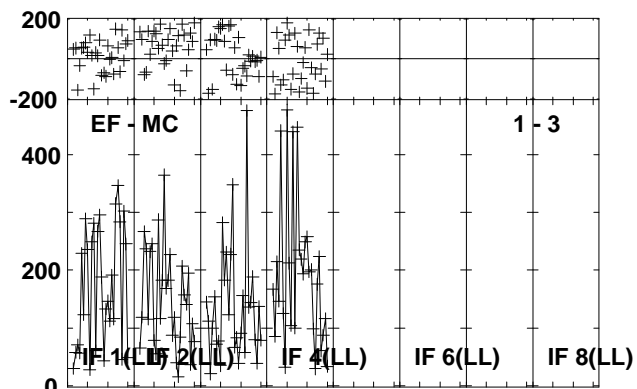
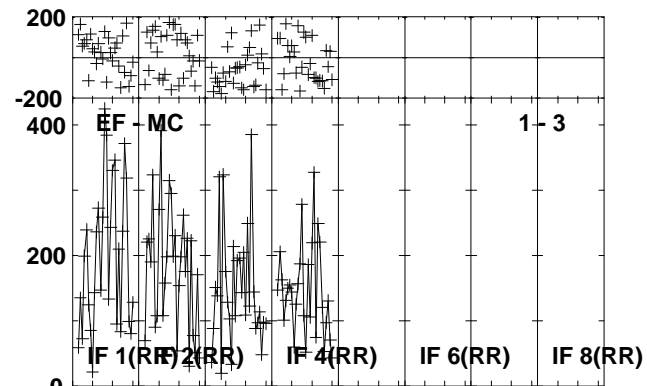
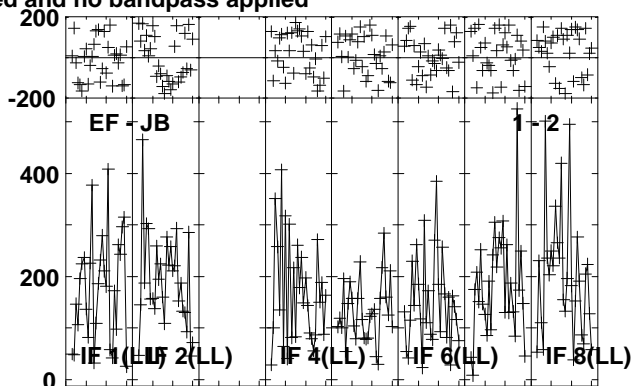
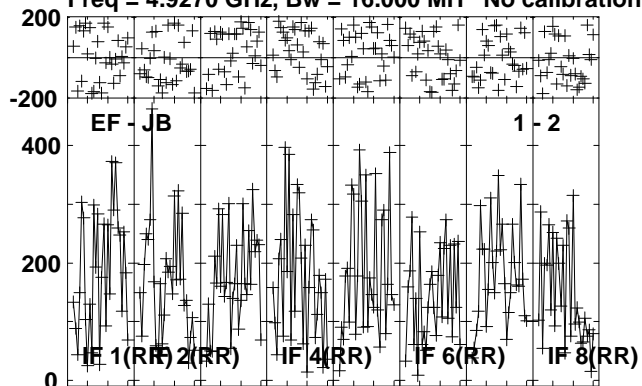

Lower frame: Micro Ampl Jy Top frame: Phas deg
Vector averaged cross-power spectrum Several baselines displayed
Timerange: 00/01:38:53 to 00/01:41:49

Plot file version 32 created 16-OCT-2012 11:56:41

NOVA-MON RO006.UVDATA.1

Freq = 4.9270 GHz, Bw = 16.000 MH No calibration applied and no bandpass applied

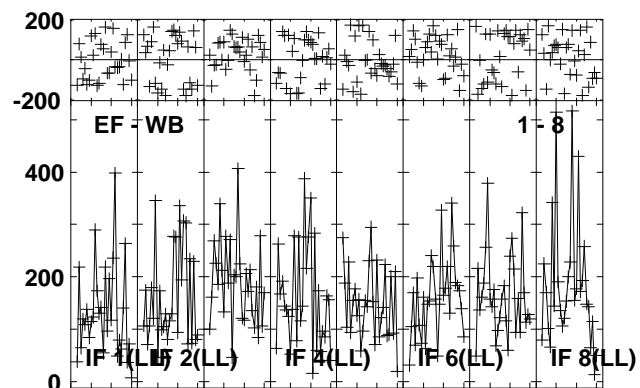
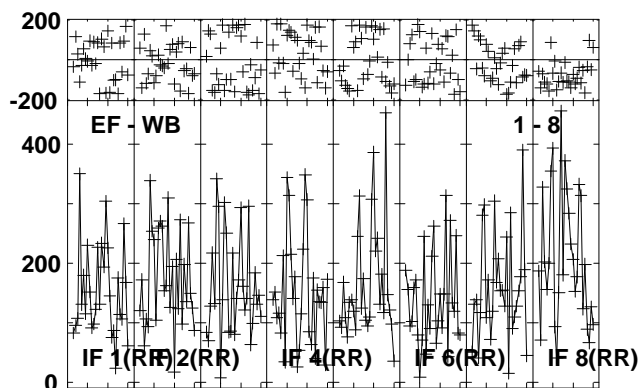
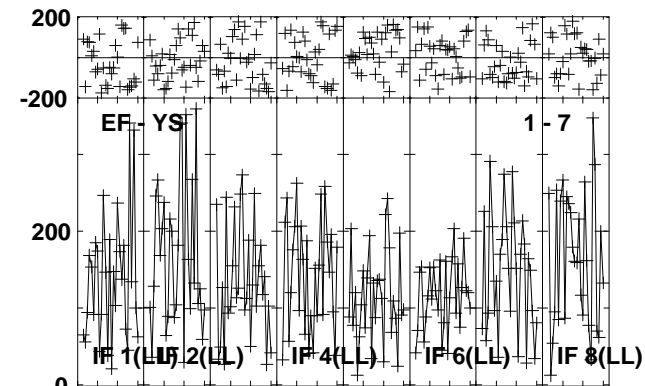
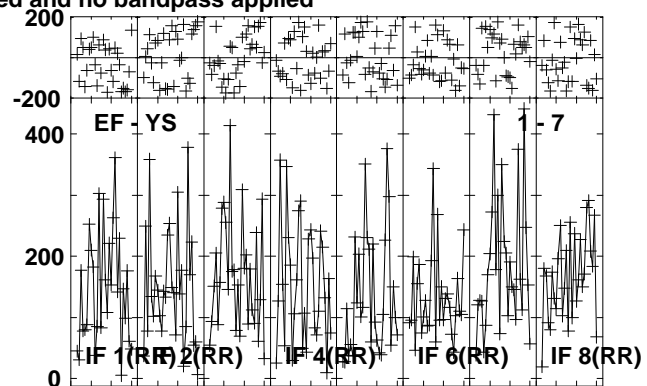
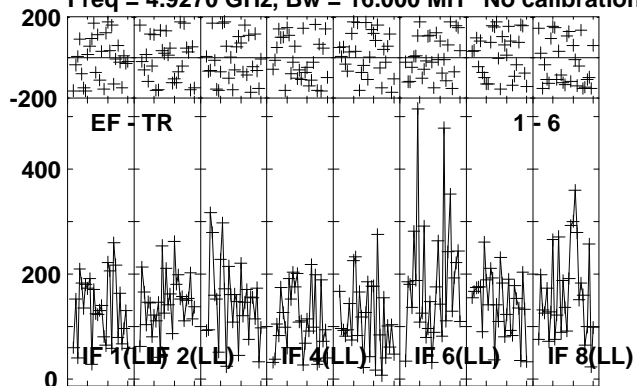

Lower frame: Micro Ampl Jy Top frame: Phas deg
Vector averaged cross-power spectrum Several baselines displayed
Timerange: 00/01:38:53 to 00/01:41:49

Plot file version 33 created 16-OCT-2012 11:56:42

J0639+0601 RO006.UVDATA.1

Freq = 4.9270 GHz, Bw = 16.000 MH No calibration applied and no bandpass applied

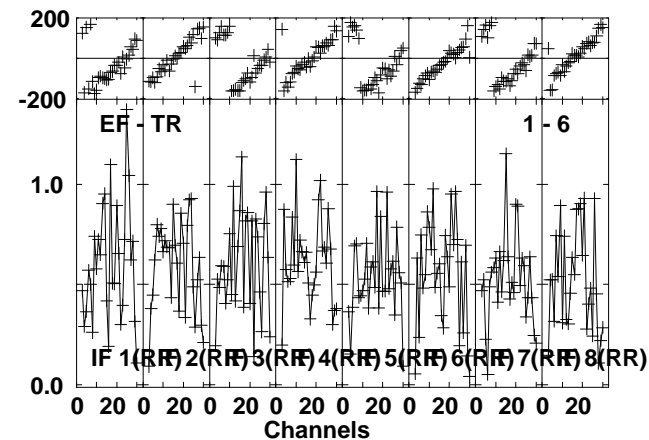
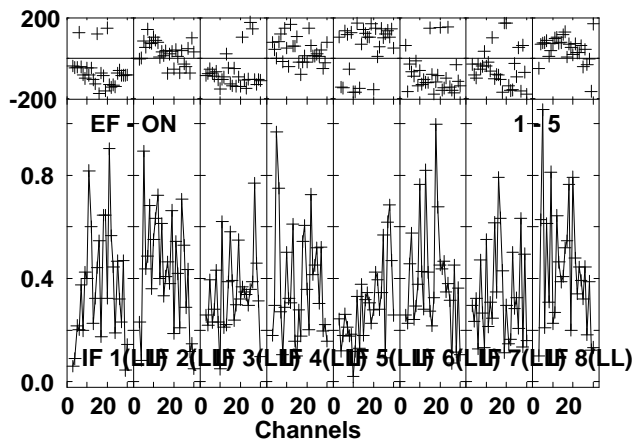
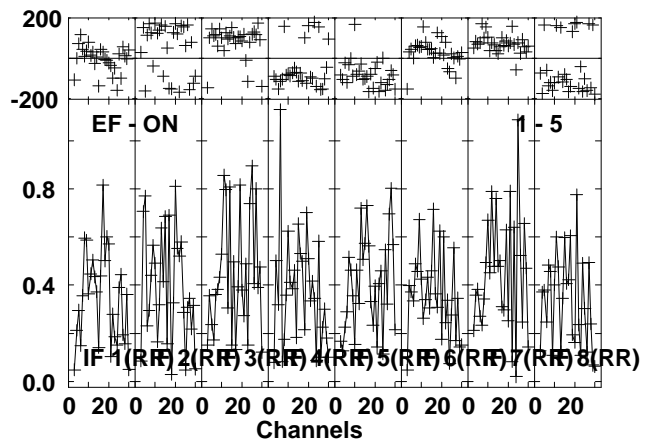
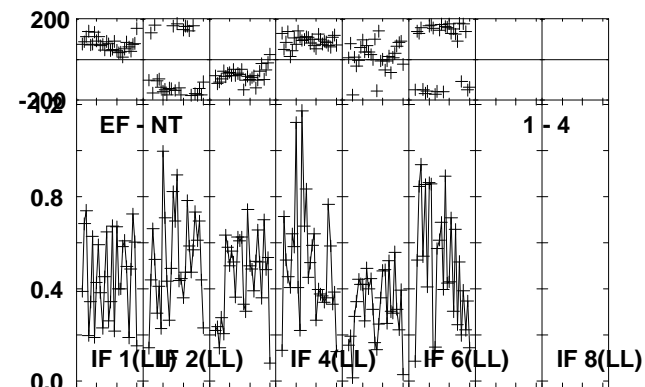
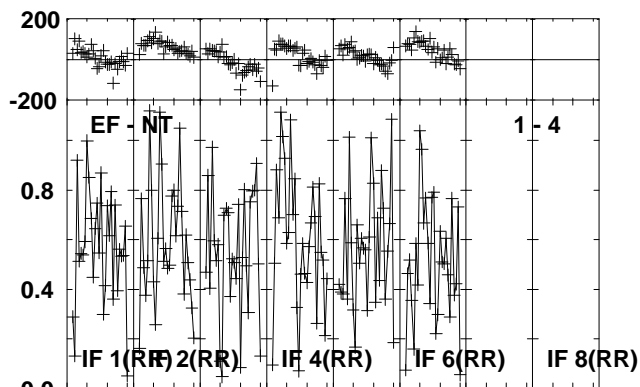
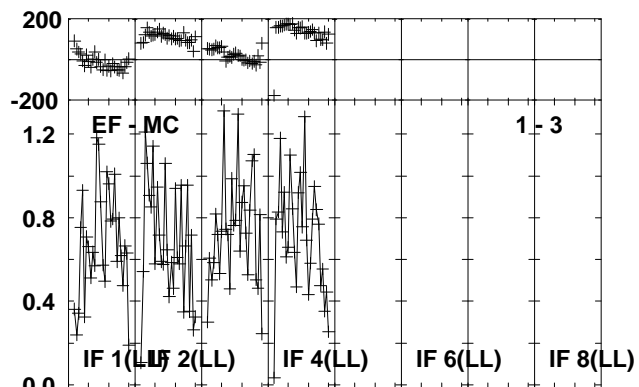
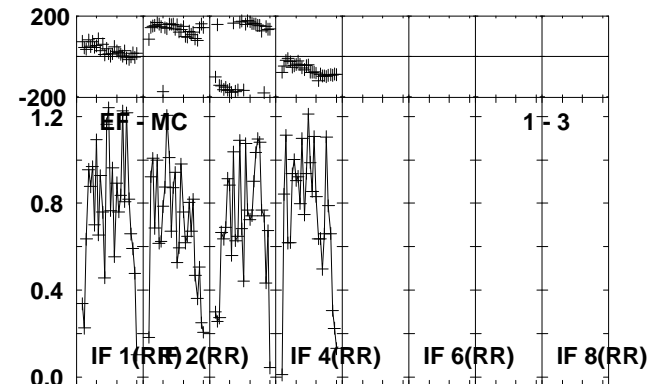
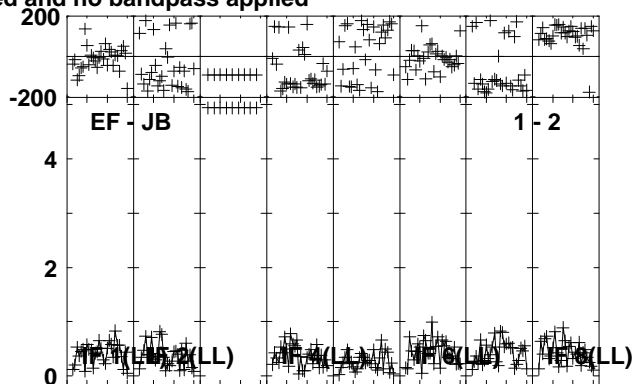
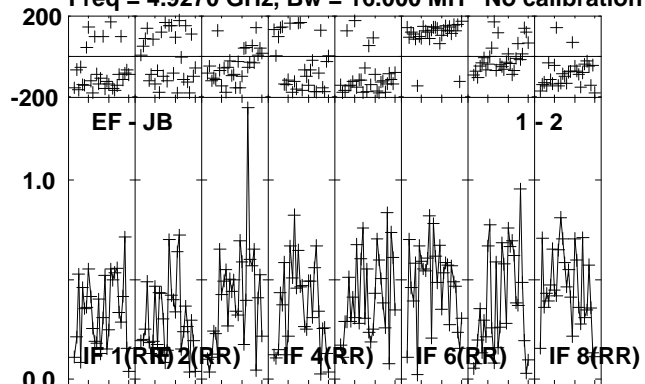

Lower frame: Milli Ampl Jy Top frame: Phas deg
Vector averaged cross-power spectrum Several baselines displayed
Timerange: 00/01:41:53 to 00/01:43:03

Plot file version 34 created 16-OCT-2012 11:56:42

J0639+0601 RO006.UVDATA.1

Freq = 4.9270 GHz, Bw = 16.000 MH No calibration applied and no bandpass applied

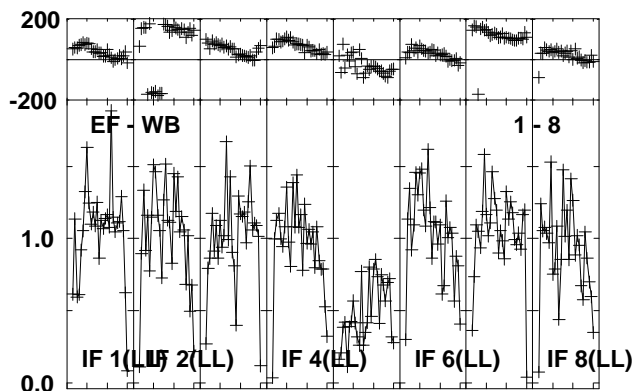
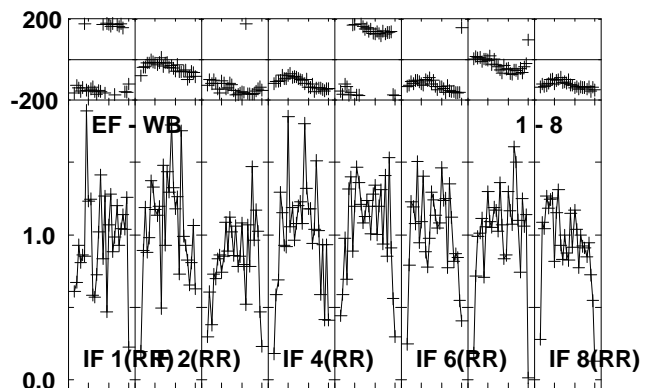
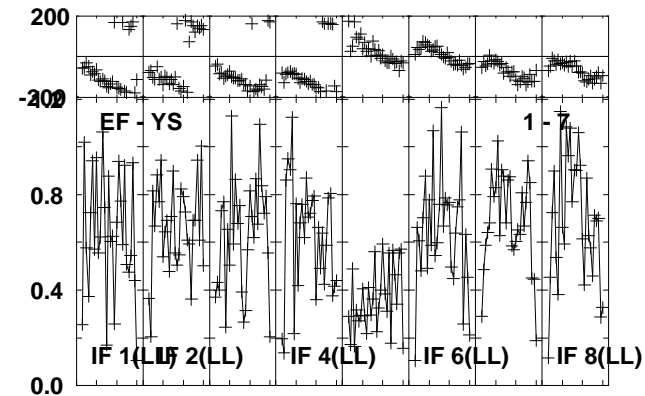
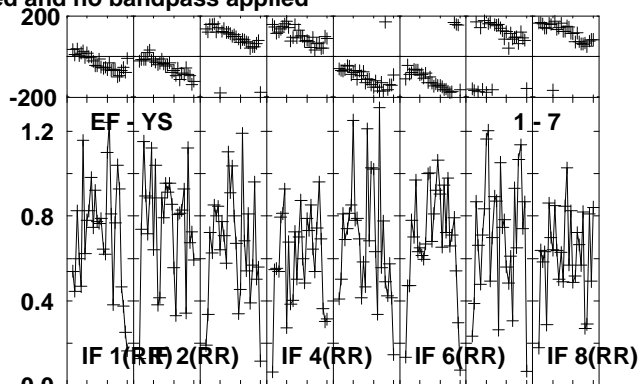
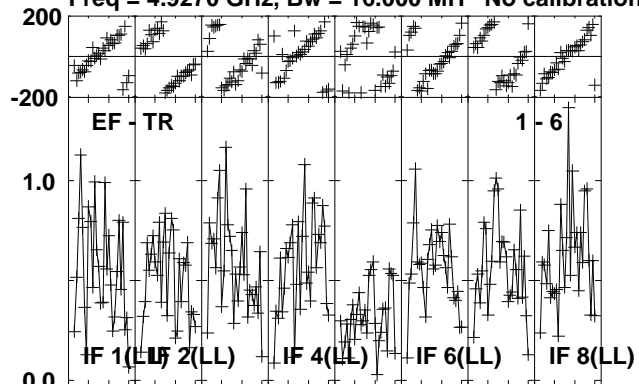

Lower frame: Milli Ampl Jy Top frame: Phas deg
Vector averaged cross-power spectrum Several baselines displayed
Timerange: 00/01:41:53 to 00/01:43:03

Plot file version 35 created 16-OCT-2012 11:56:42

J0645+0541 RO006.UVDATA.1

Freq = 4.9270 GHz, Bw = 16.000 MH No calibration applied and no bandpass applied

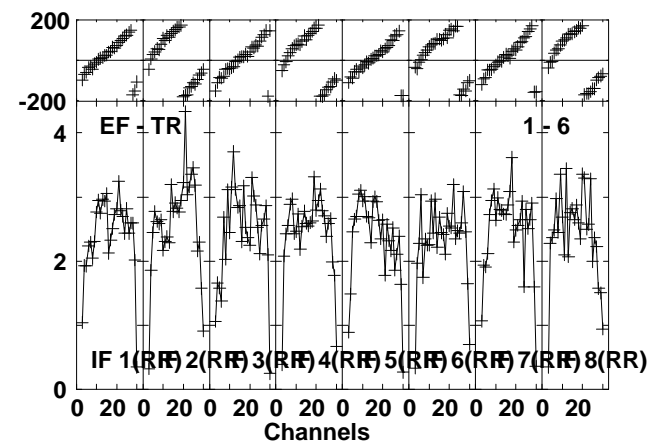
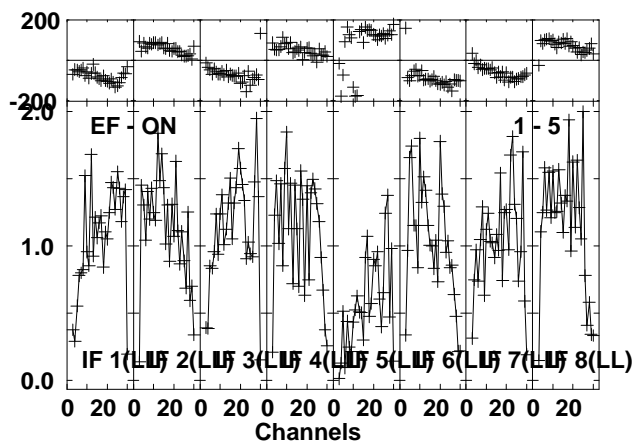
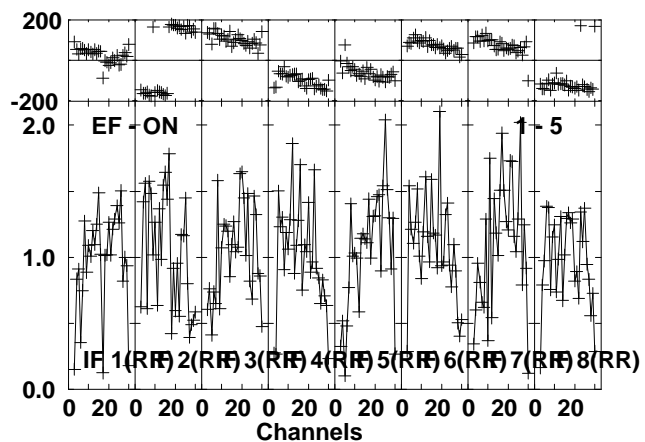
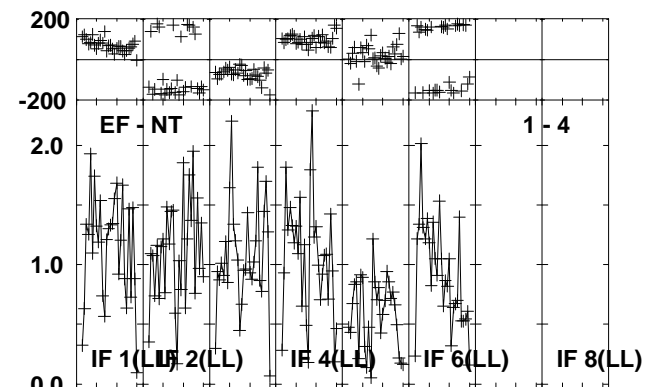
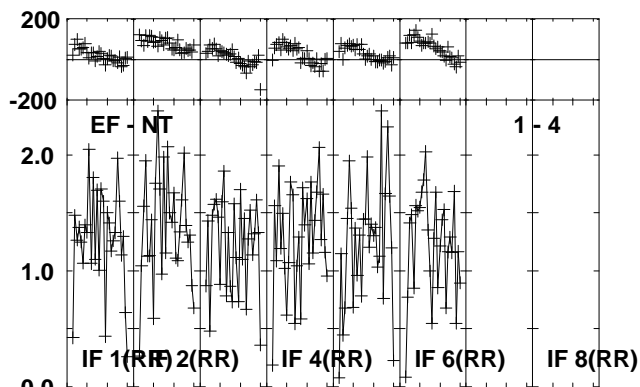
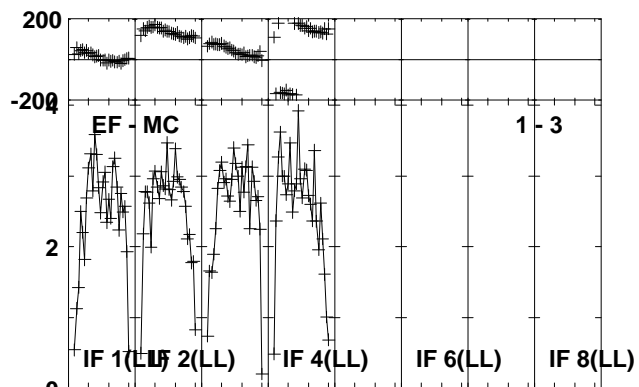
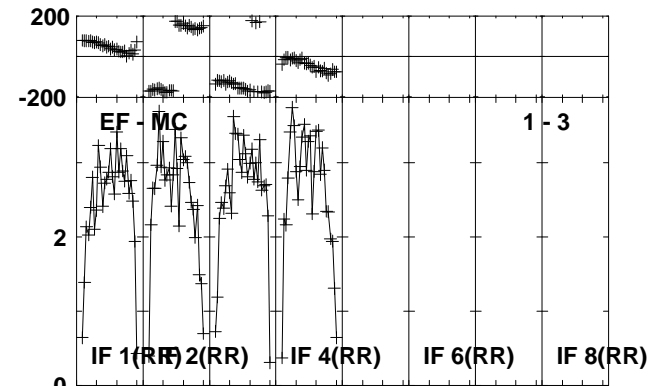
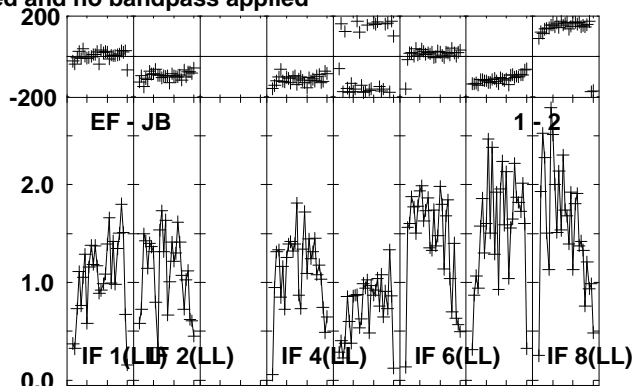
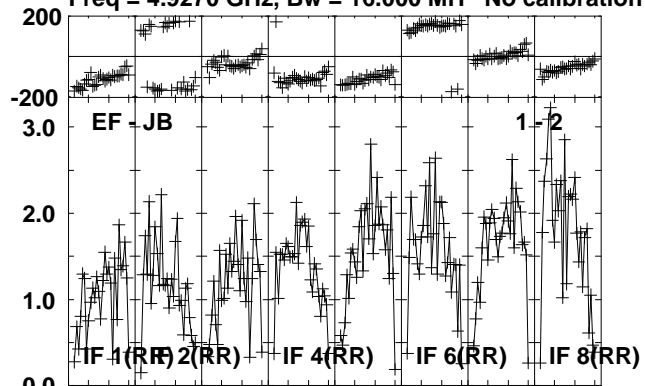

Lower frame: Milli Ampl Jy Top frame: Phas deg
Vector averaged cross-power spectrum Several baselines displayed
Timerange: 00/01:43:07 to 00/01:44:03

Plot file version 36 created 16-OCT-2012 11:56:43

J0645+0541 RO006.UVDATA.1

Freq = 4.9270 GHz, Bw = 16.000 MH No calibration applied and no bandpass applied

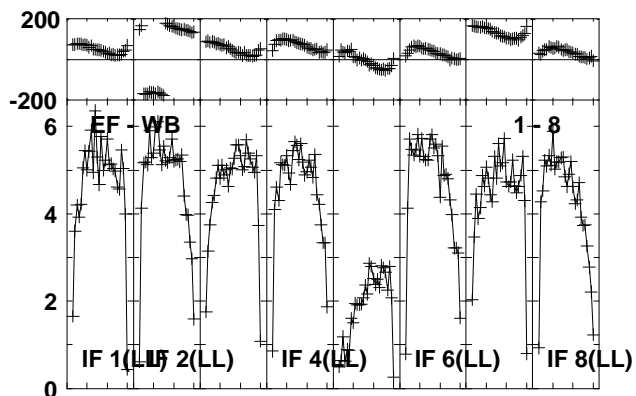
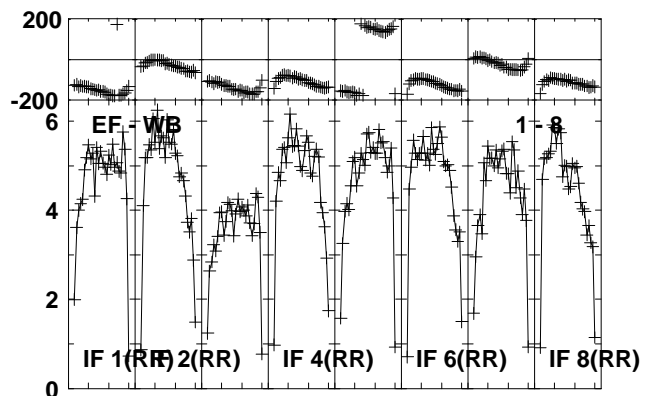
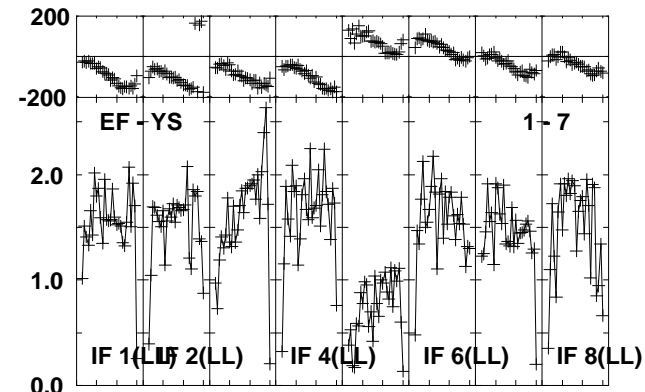
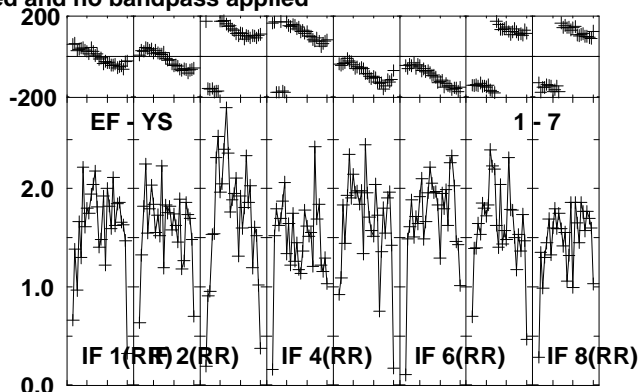
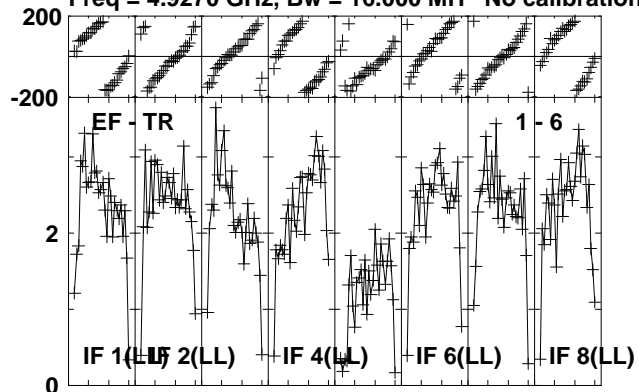

Lower frame: Milli Ampl Jy Top frame: Phas deg
Vector averaged cross-power spectrum Several baselines displayed
Timerange: 00/01:43:07 to 00/01:44:03

Plot file version 37 created 16-OCT-2012 11:56:43

NOVA-MON RO006.UVDATA.1

Freq = 4.9270 GHz, Bw = 16.000 MH No calibration applied and no bandpass applied

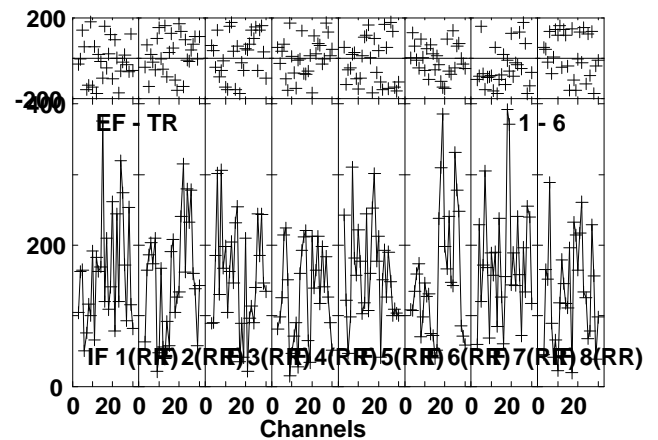
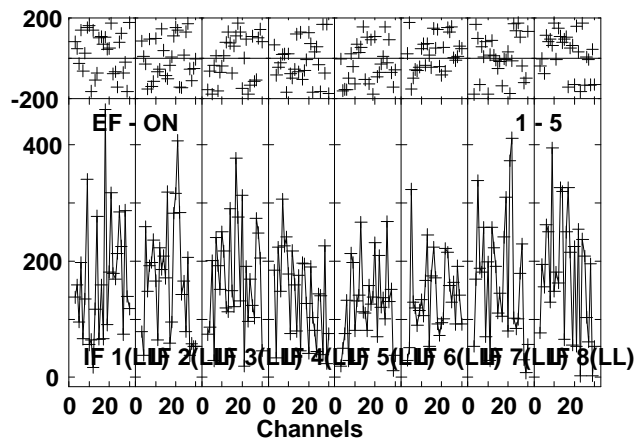
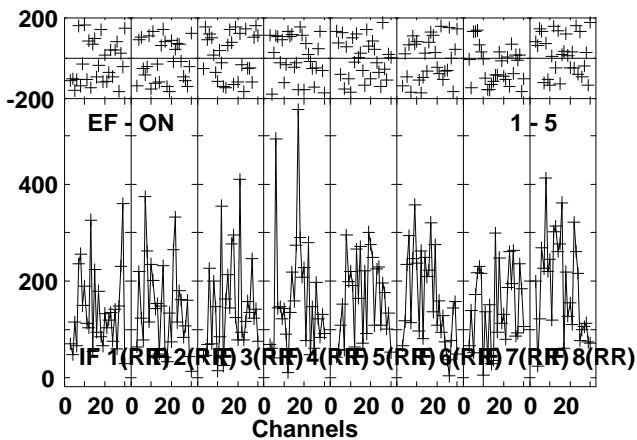
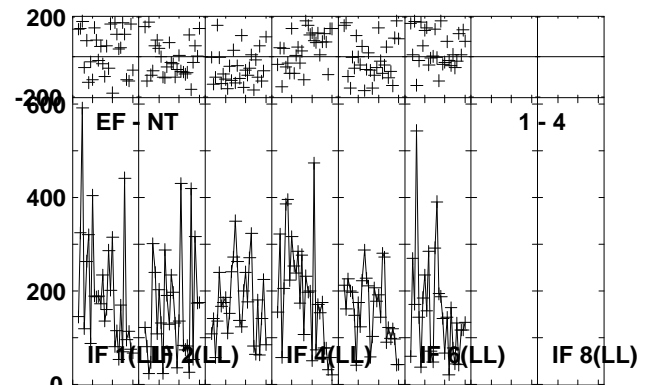
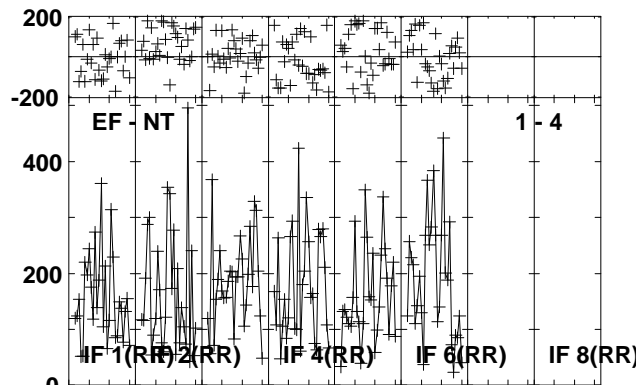
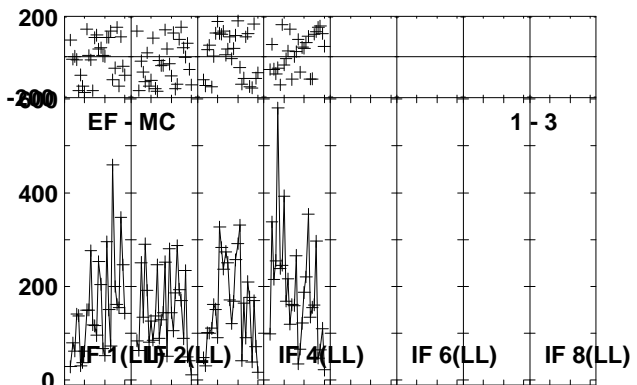
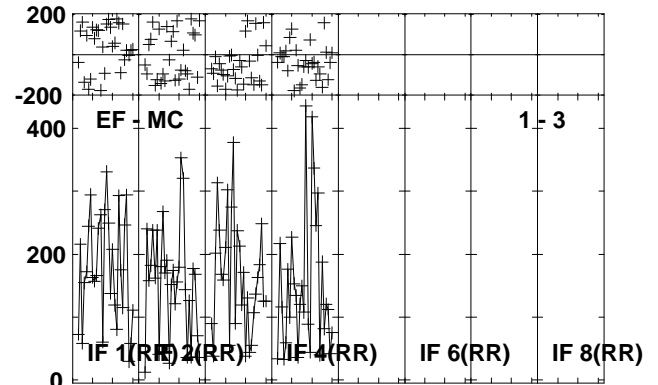
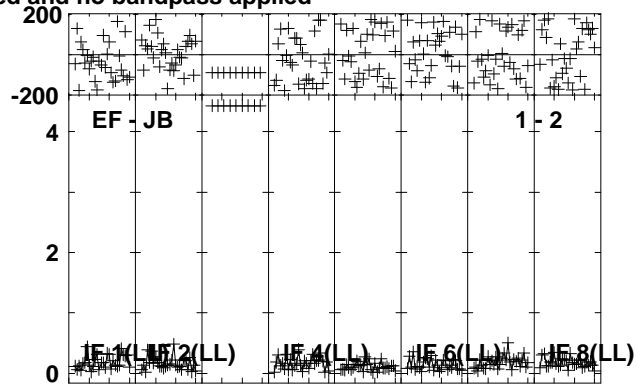
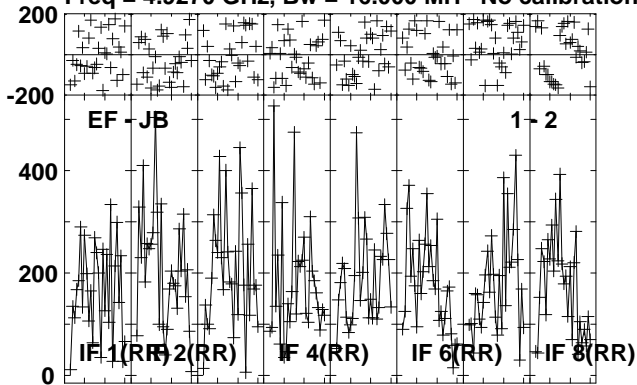

Lower frame: Micro Ampl Jy Top frame: Phas deg
Vector averaged cross-power spectrum Several baselines displayed
Timerange: 00/01:44:07 to 00/01:47:03

Plot file version 38 created 16-OCT-2012 11:56:43

NOVA-MON RO006.UVDATA.1

Freq = 4.9270 GHz, Bw = 16.000 MH No calibration applied and no bandpass applied

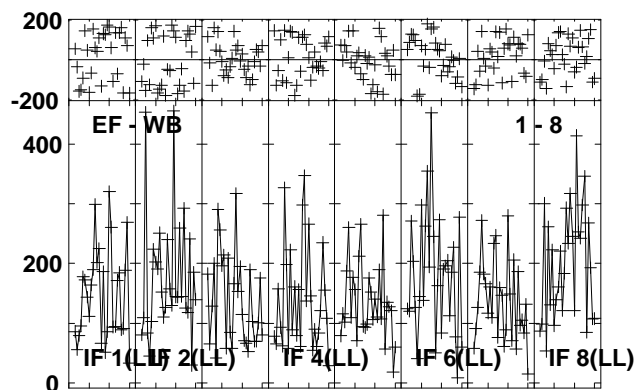
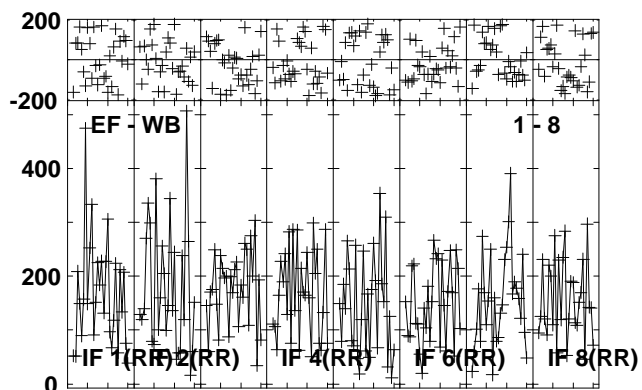
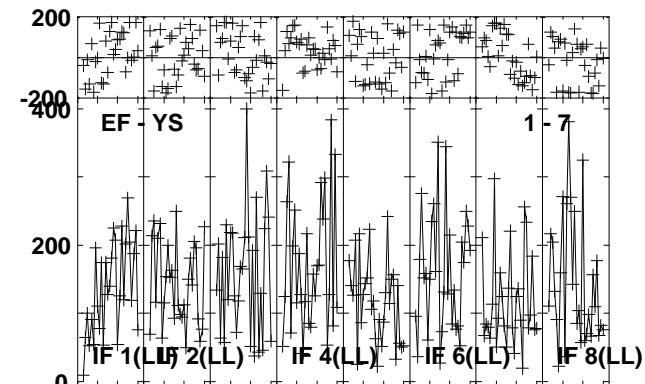
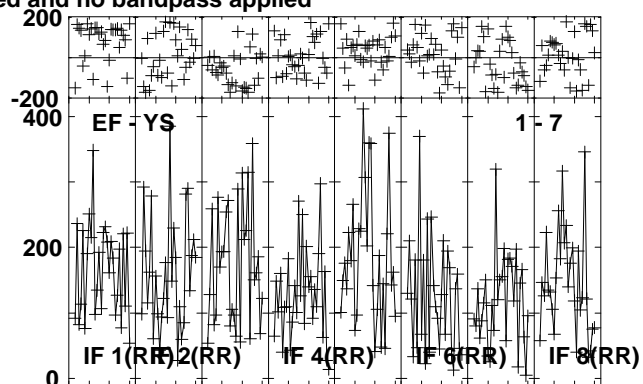
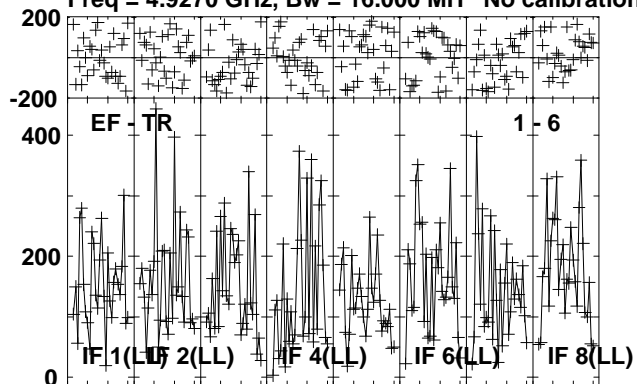

Lower frame: Micro Ampl Jy Top frame: Phas deg
Vector averaged cross-power spectrum Several baselines displayed
Timerange: 00/01:44:07 to 00/01:47:03

Plot file version 39 created 16-OCT-2012 11:56:44

J0639+0601 RO006.UVDATA.1

Freq = 4.9270 GHz, Bw = 16.000 MH No calibration applied and no bandpass applied

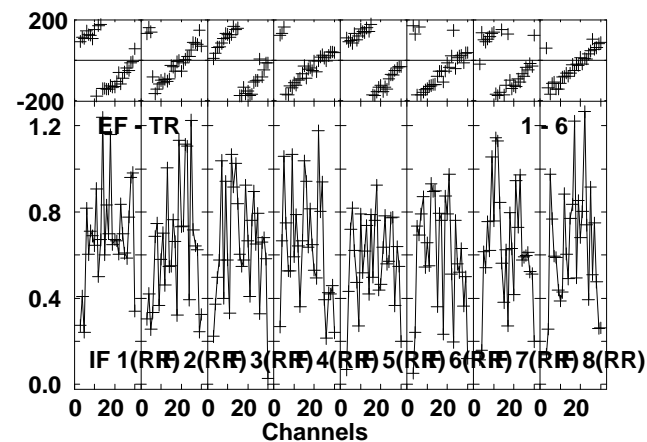
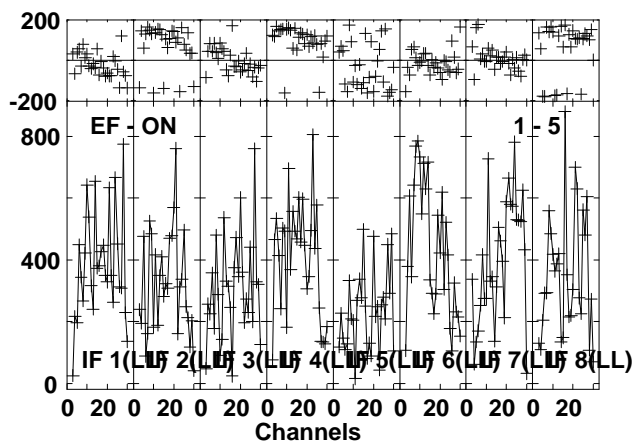
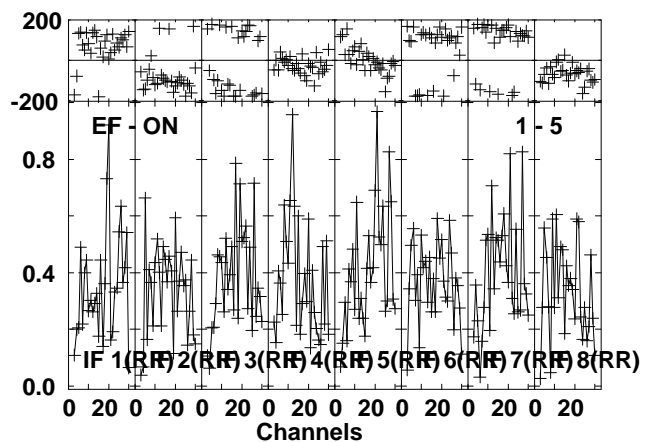
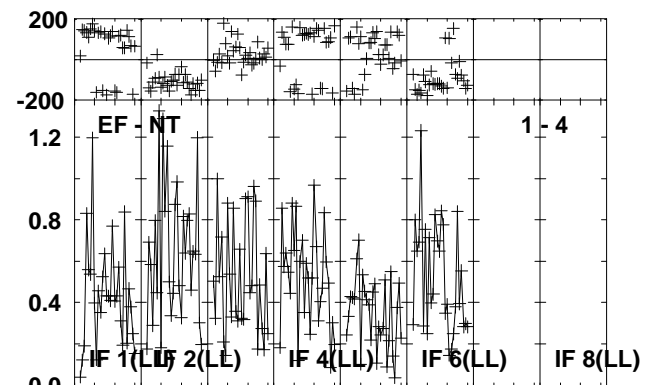
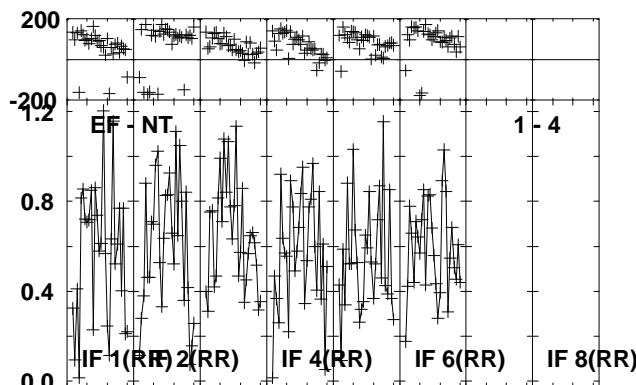
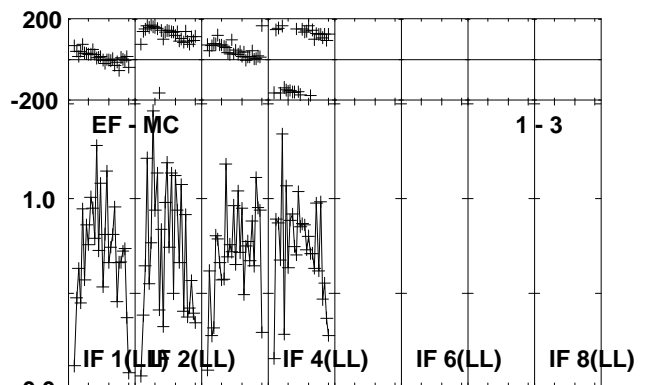
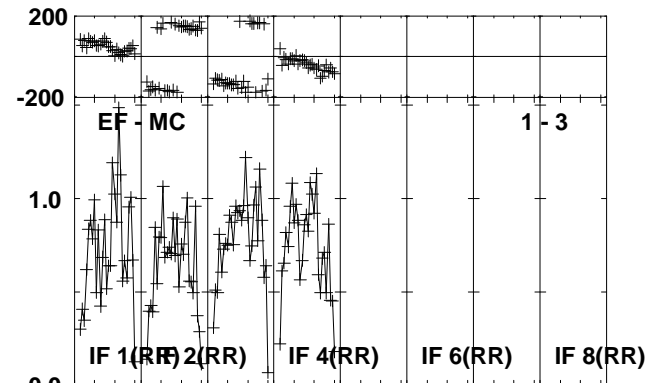
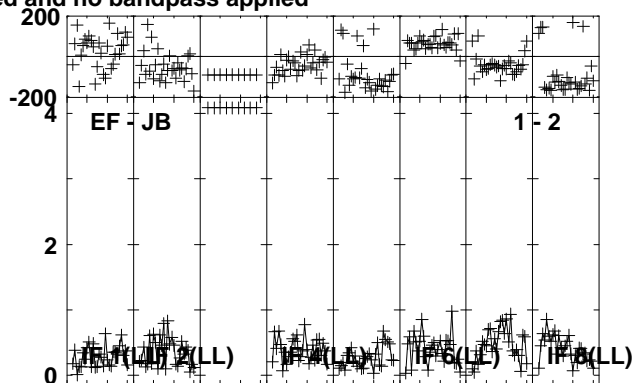
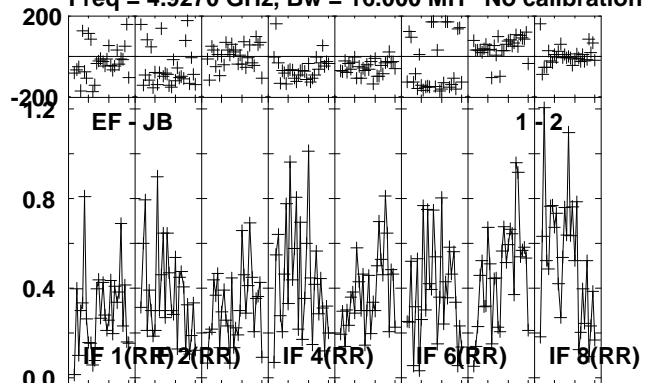

Lower frame: Milli Ampl Jy Top frame: Phas deg
Vector averaged cross-power spectrum Several baselines displayed
Timerange: 00/01:47:33 to 00/01:48:33

Plot file version 40 created 16-OCT-2012 11:56:44

J0639+0601 RO006.UVDATA.1

Freq = 4.9270 GHz, Bw = 16.000 MH No calibration applied and no bandpass applied

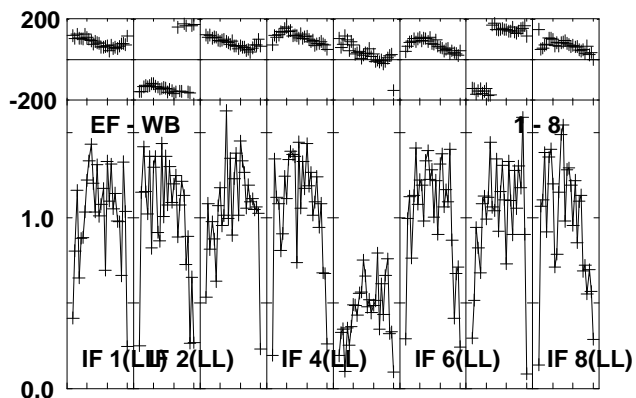
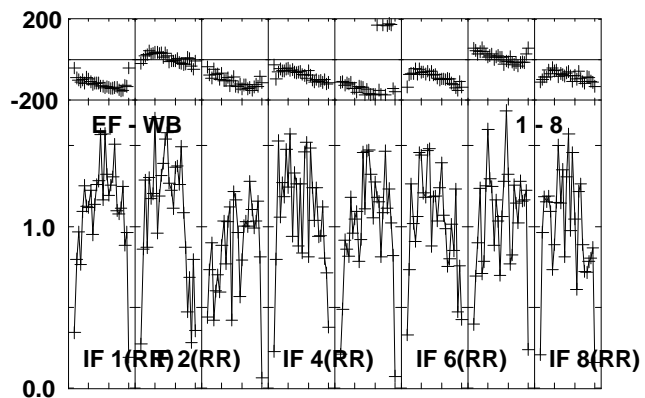
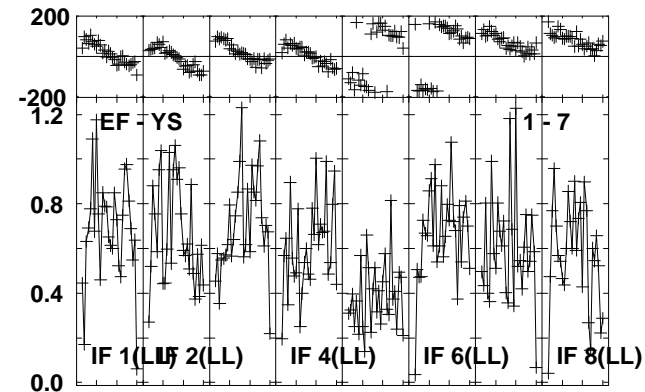
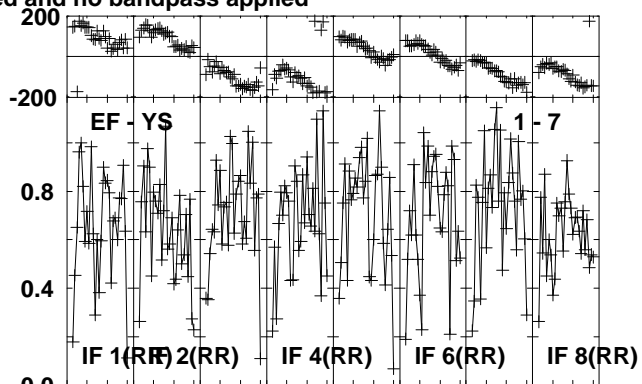
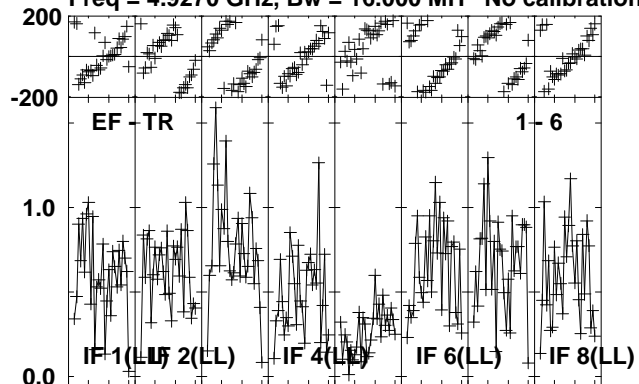

Lower frame: Milli Ampl Jy Top frame: Phas deg
Vector averaged cross-power spectrum Several baselines displayed
Timerange: 00/01:47:33 to 00/01:48:33

Plot file version 41 created 16-OCT-2012 11:56:44

J0645+0541 RO006.UVDATA.1

Freq = 4.9270 GHz, Bw = 16.000 MH No calibration applied and no bandpass applied

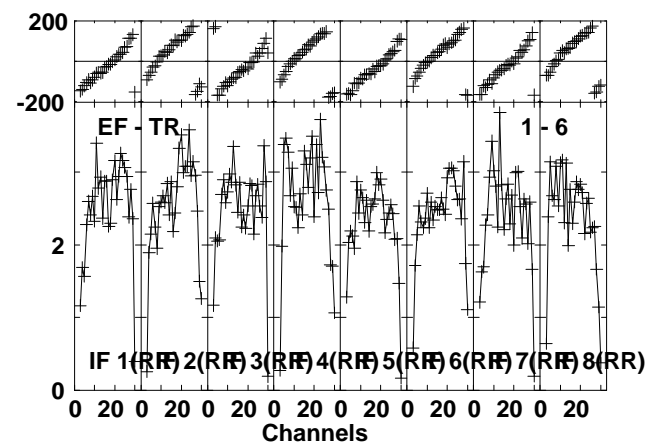
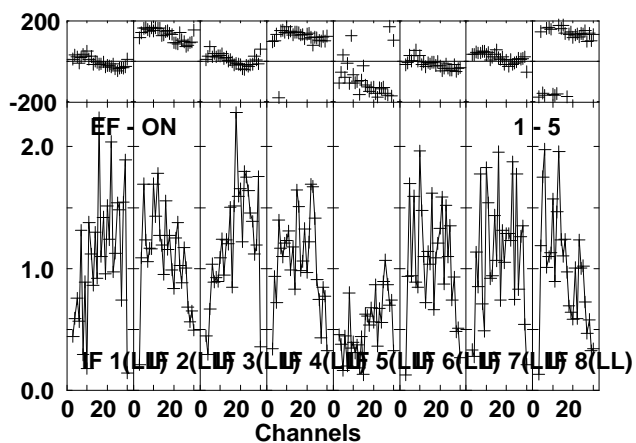
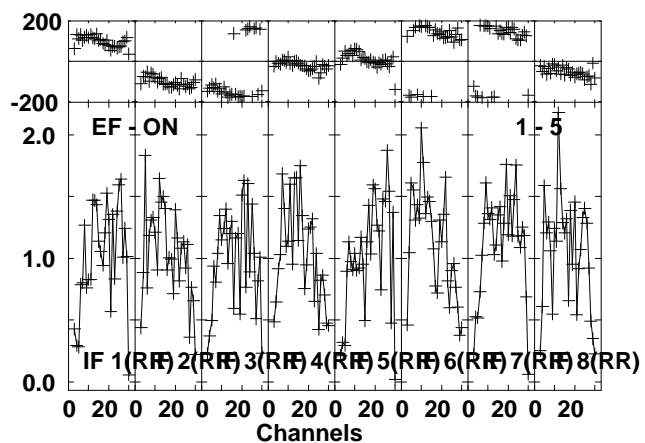
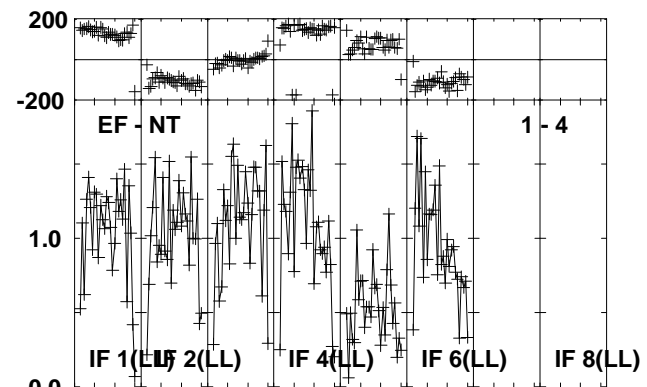
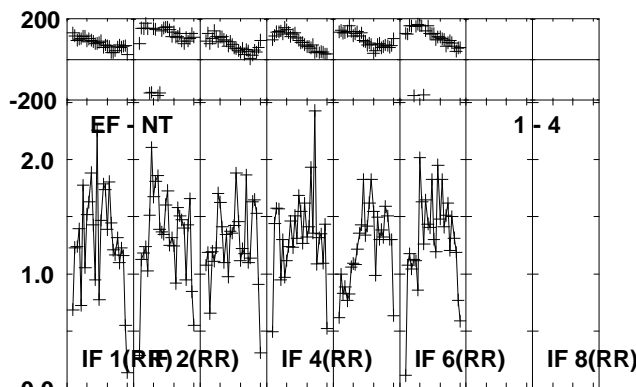
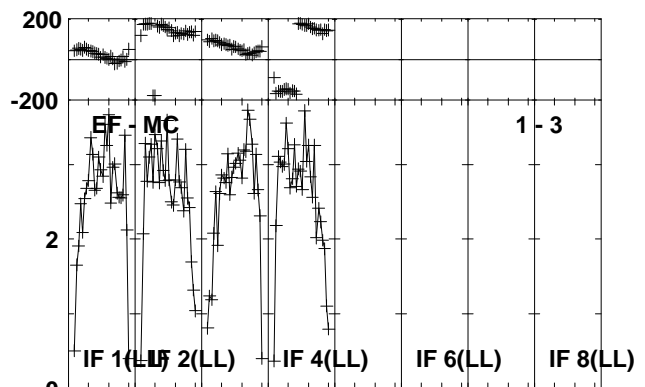
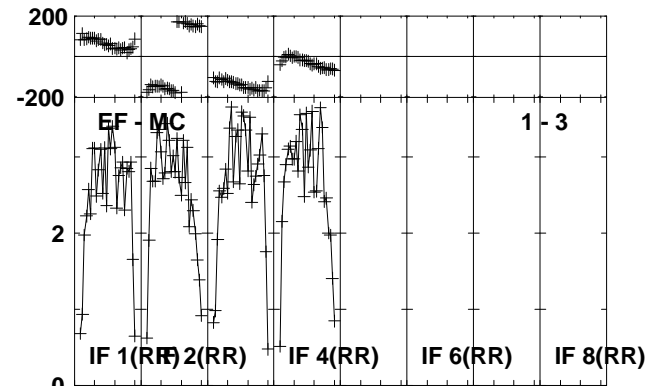
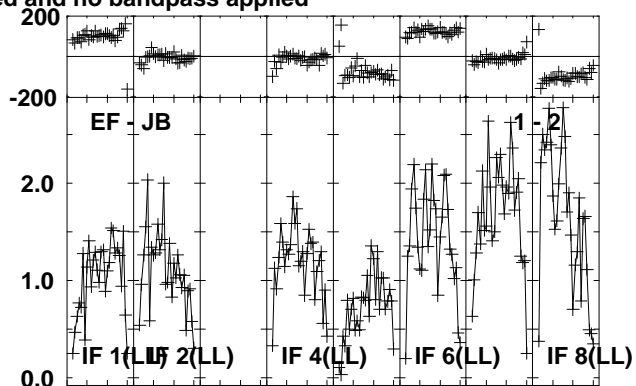
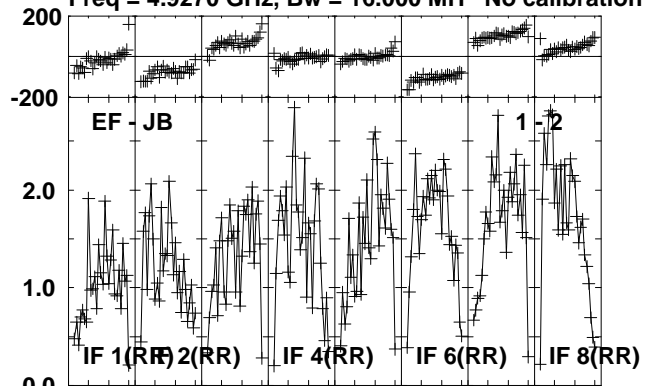

Lower frame: Milli Ampl Jy Top frame: Phas deg
Vector averaged cross-power spectrum Several baselines displayed
Timerange: 00/01:48:37 to 00/01:49:33

Plot file version 42 created 16-OCT-2012 11:56:44

J0645+0541 RO006.UVDATA.1

Freq = 4.9270 GHz, Bw = 16.000 MH No calibration applied and no bandpass applied

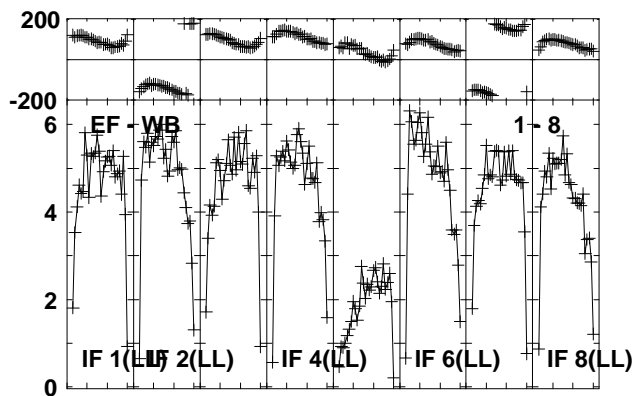
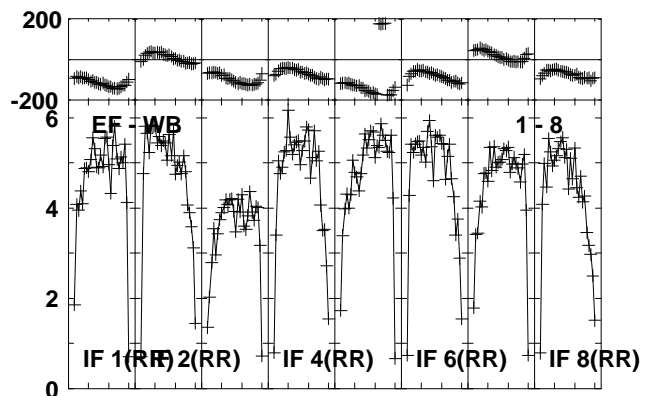
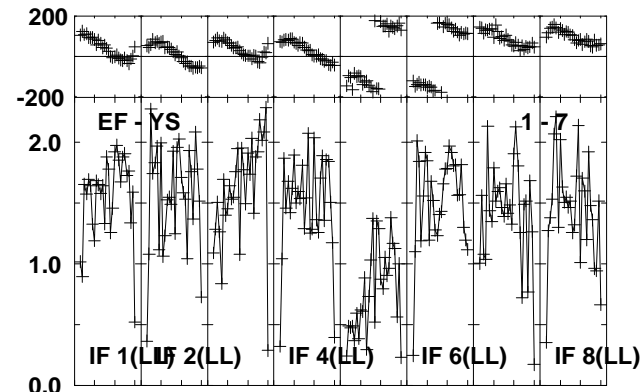
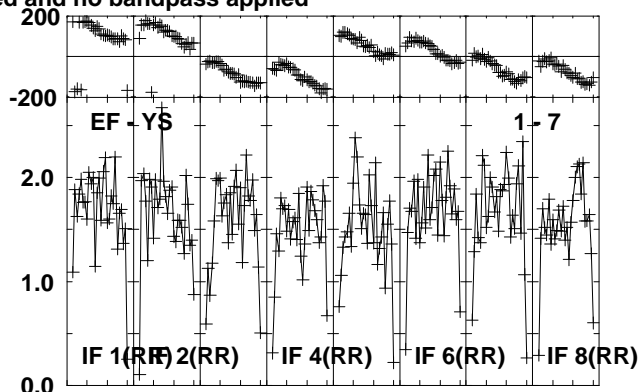
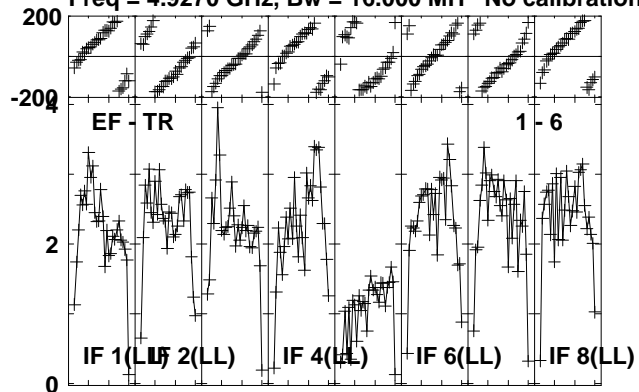

Lower frame: Milli Ampl Jy Top frame: Phas deg
Vector averaged cross-power spectrum Several baselines displayed
Timerange: 00/01:48:37 to 00/01:49:33

Plot file version 43 created 16-OCT-2012 11:56:45

NOVA-MON RO006.UVDATA.1

Freq = 4.9270 GHz, Bw = 16.000 MH No calibration applied and no bandpass applied

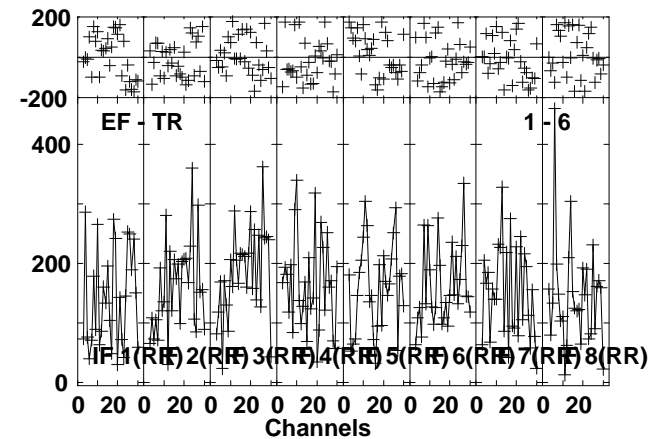
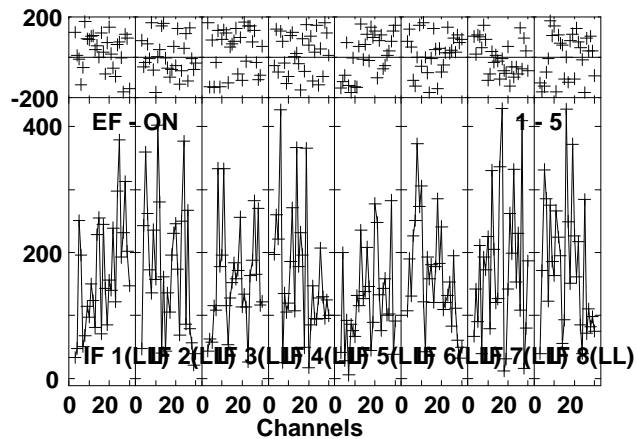
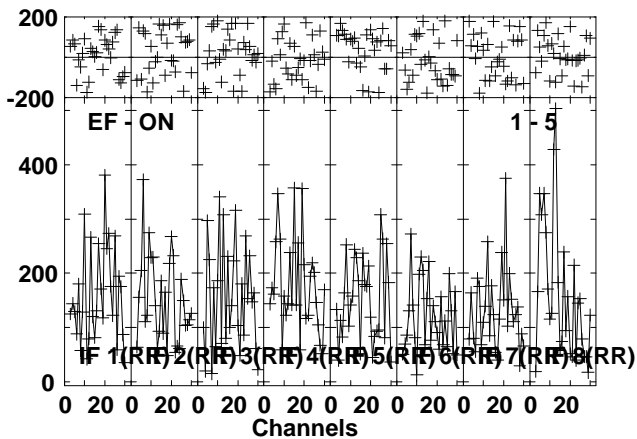
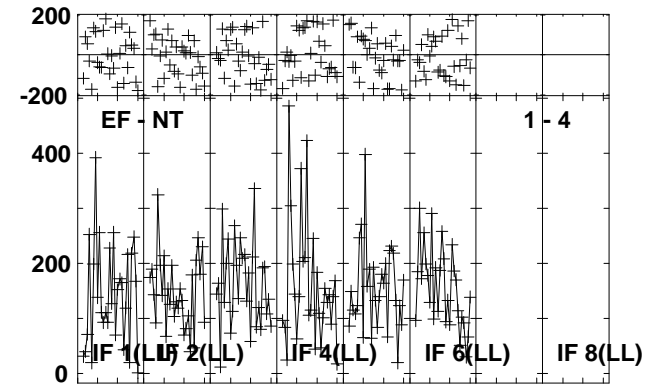
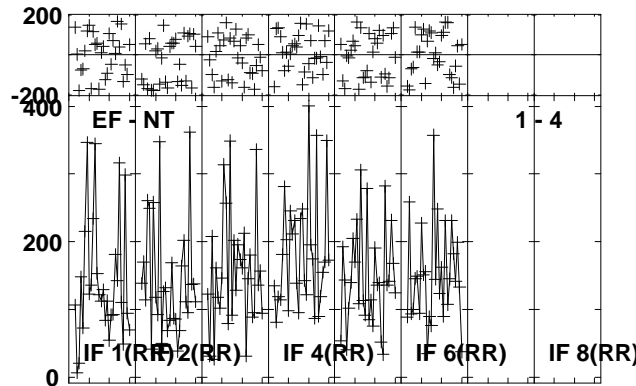
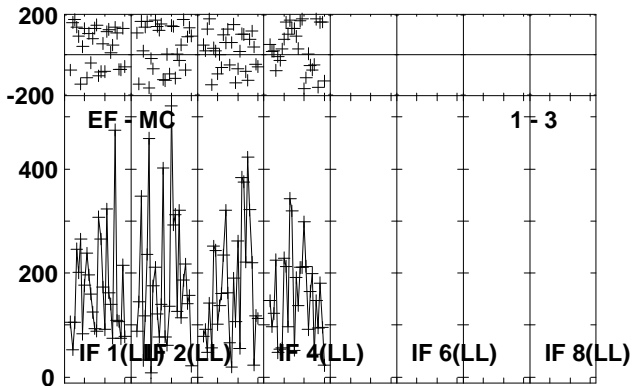
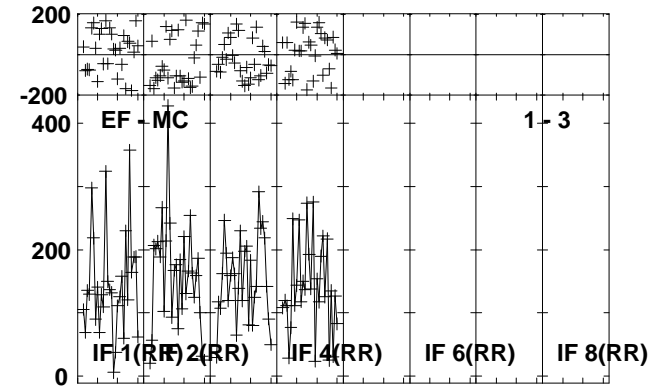
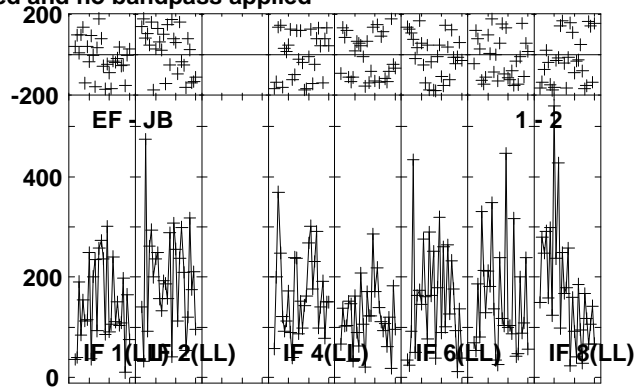
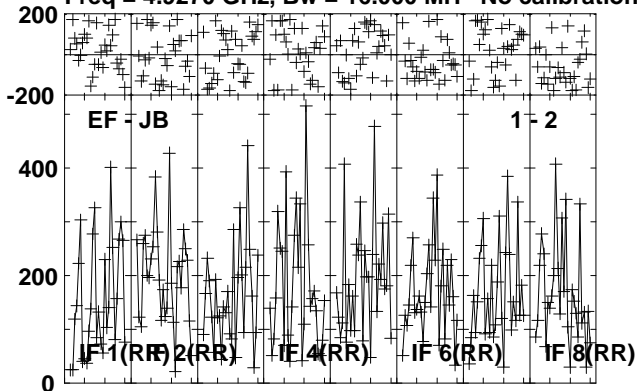

Lower frame: Micro Ampl Jy Top frame: Phas deg
Vector averaged cross-power spectrum Several baselines displayed
Timerange: 00/01:49:37 to 00/01:52:33

Plot file version 44 created 16-OCT-2012 11:56:45

NOVA-MON RO006.UVDATA.1

Freq = 4.9270 GHz, Bw = 16.000 MH No calibration applied and no bandpass applied

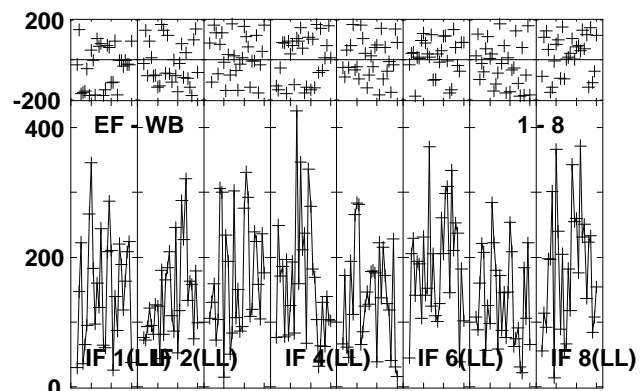
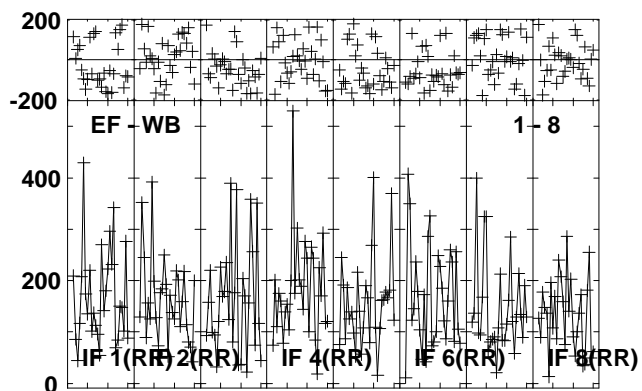
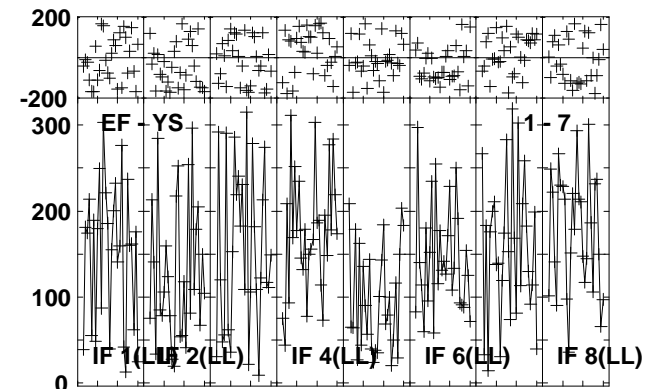
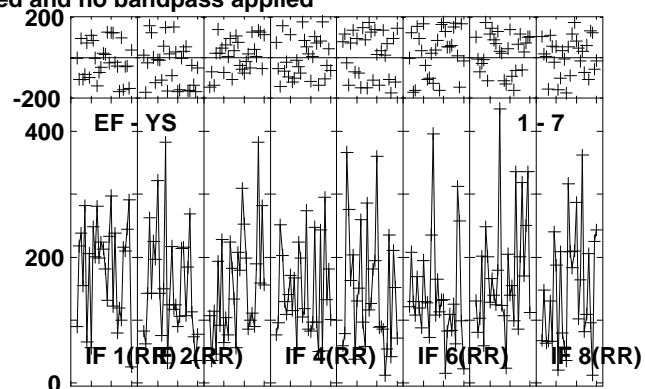
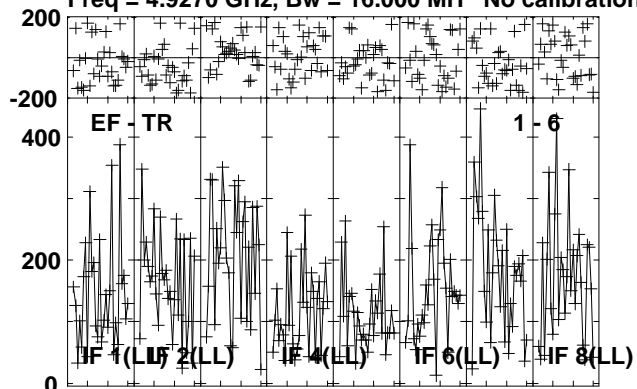

Lower frame: Micro Ampl Jy Top frame: Phas deg
Vector averaged cross-power spectrum Several baselines displayed
Timerange: 00/01:49:37 to 00/01:52:33

Plot file version 45 created 16-OCT-2012 11:56:46

J0639+0601 RO006.UVDATA.1

Freq = 4.9270 GHz, Bw = 16.000 MH No calibration applied and no bandpass applied

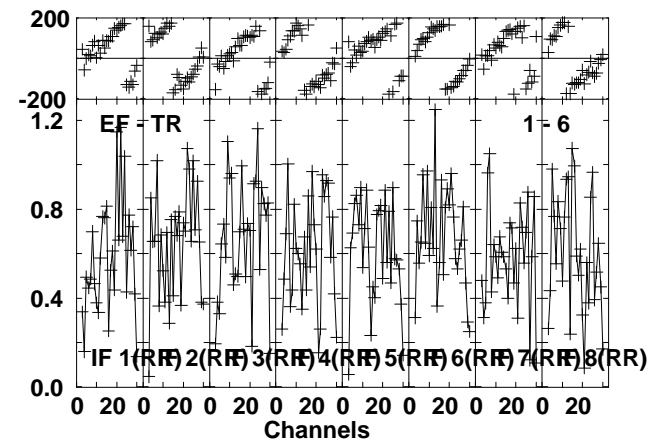
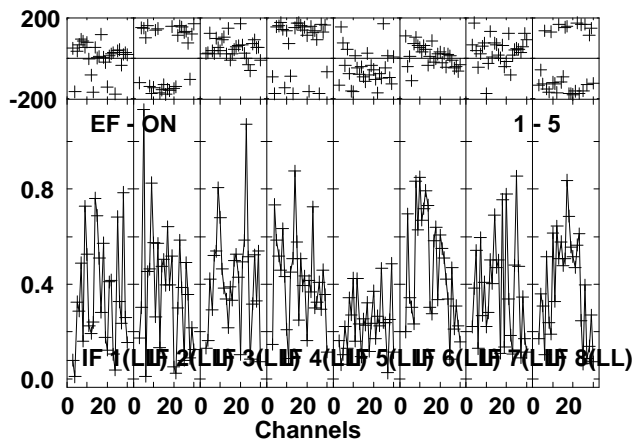
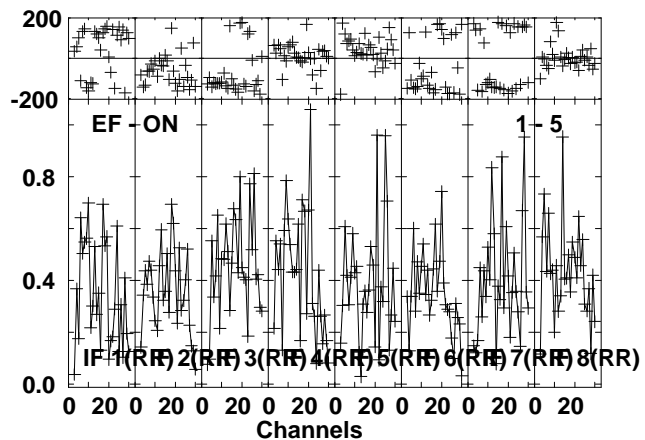
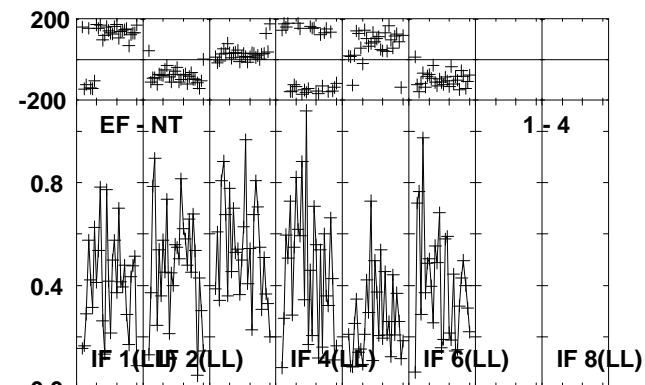
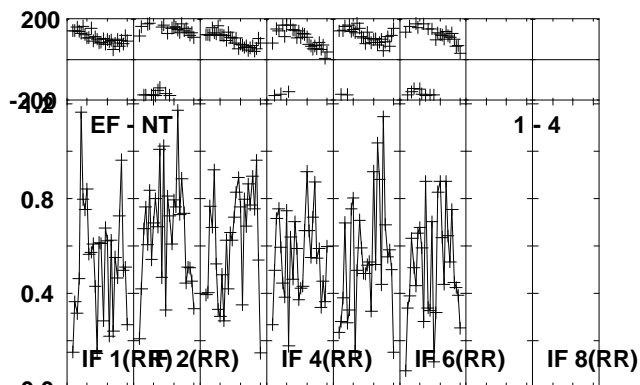
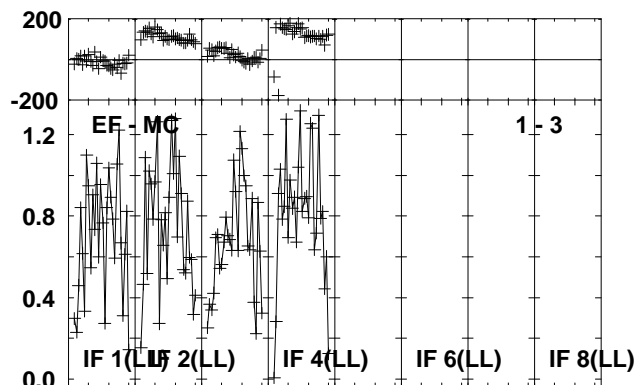
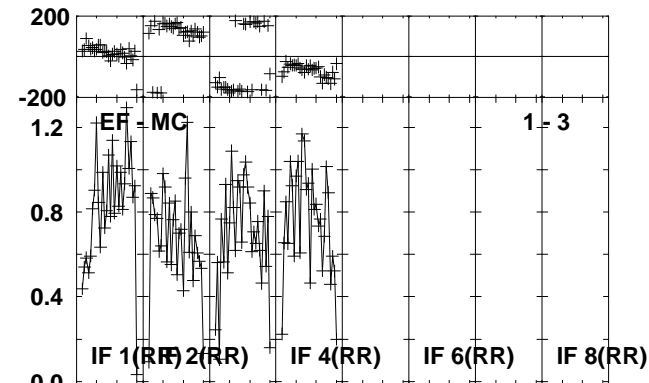
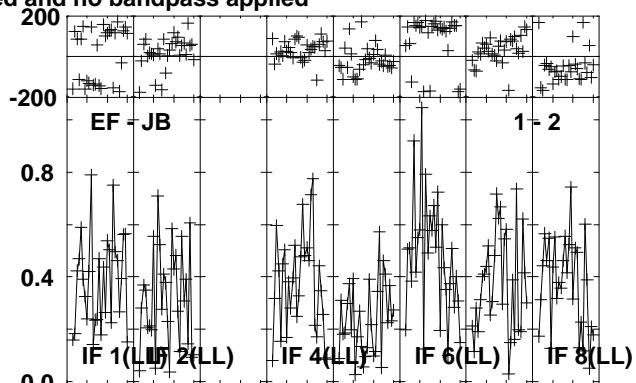
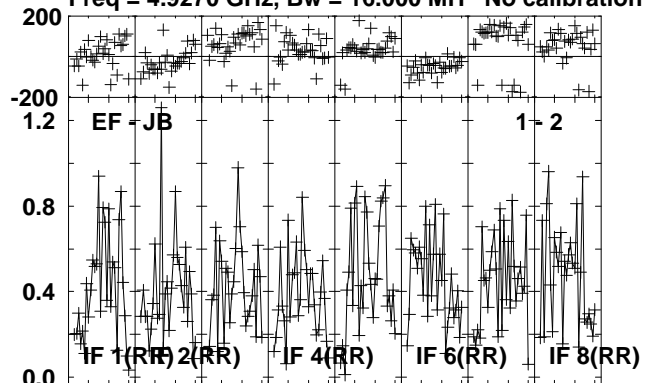

Lower frame: Milli Ampl Jy Top frame: Phas deg
Vector averaged cross-power spectrum Several baselines displayed
Timerange: 00/01:52:37 to 00/01:53:49

Plot file version 46 created 16-OCT-2012 11:56:46

J0639+0601 RO006.UVDATA.1

Freq = 4.9270 GHz, Bw = 16.000 MH No calibration applied and no bandpass applied

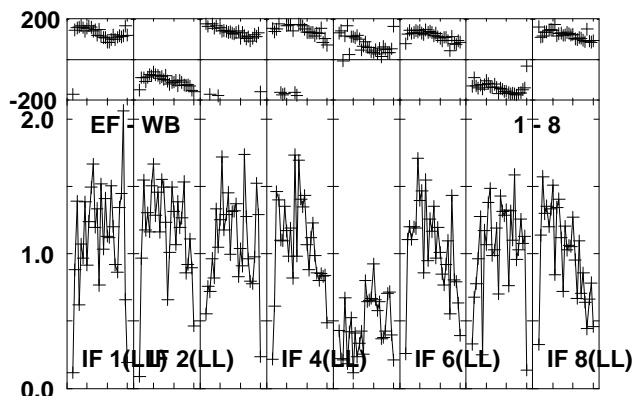
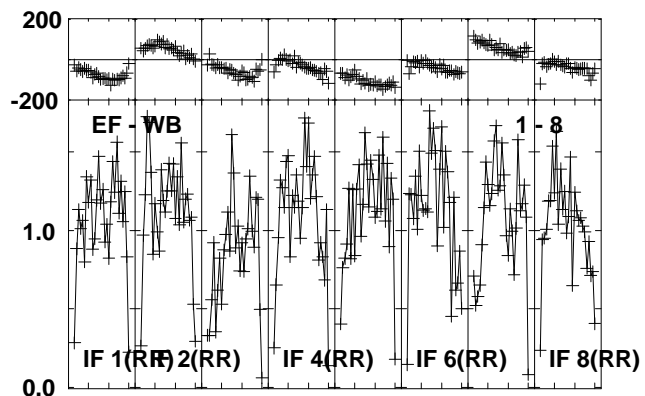
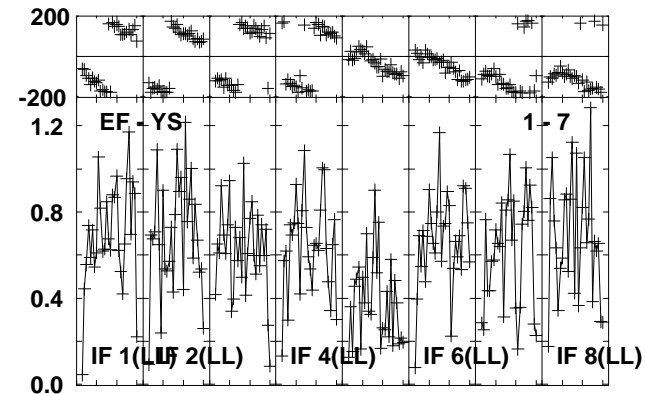
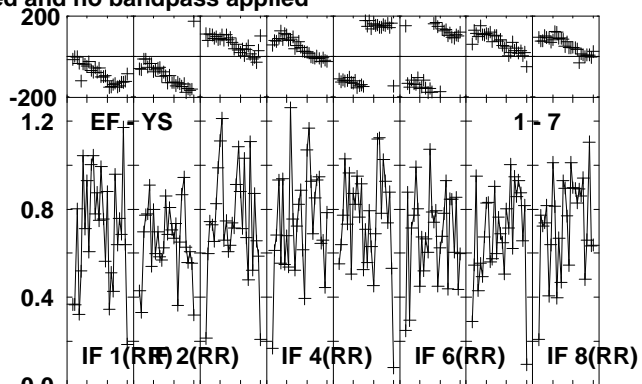
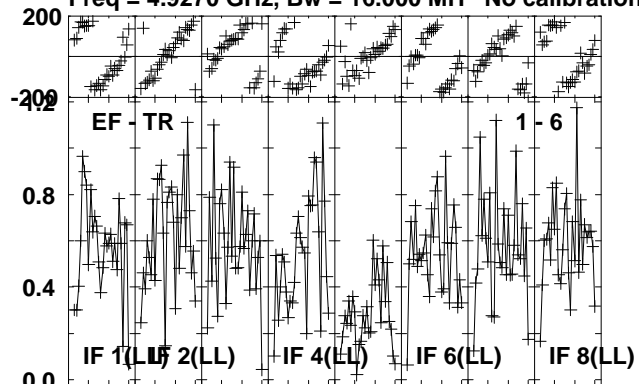

Lower frame: Milli Ampl Jy Top frame: Phas deg
Vector averaged cross-power spectrum Several baselines displayed
Timerange: 00/01:52:37 to 00/01:53:49

Plot file version 48 created 16-OCT-2012 11:56:46

J0645+0541 RO006.UVDATA.1

Freq = 4.9270 GHz, Bw = 16.000 MH No calibration applied and no bandpass applied

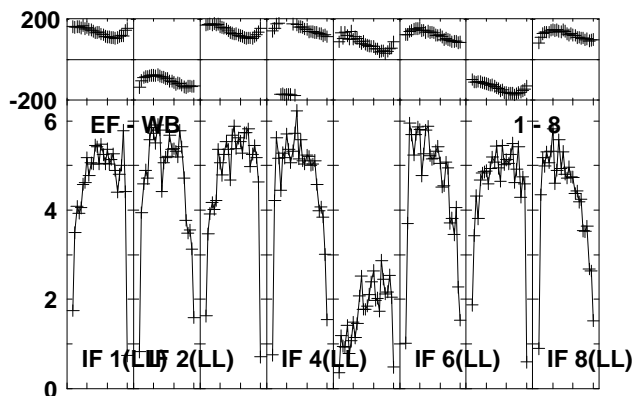
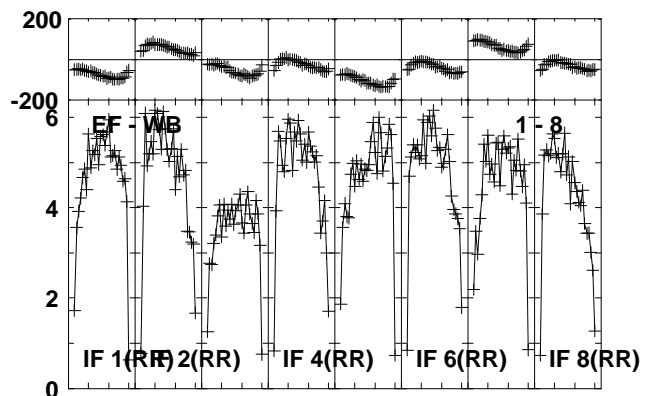
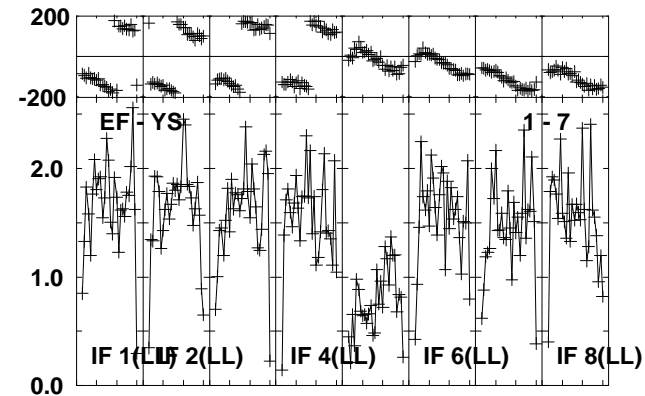
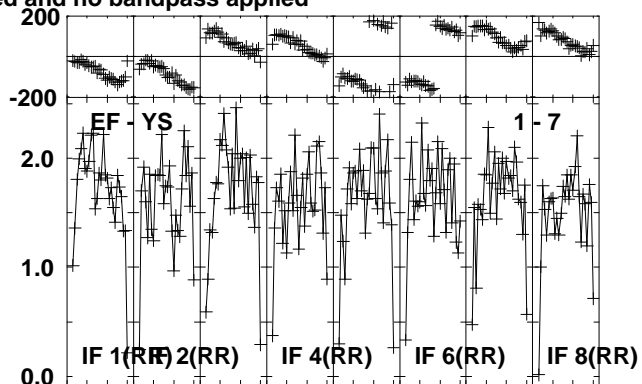
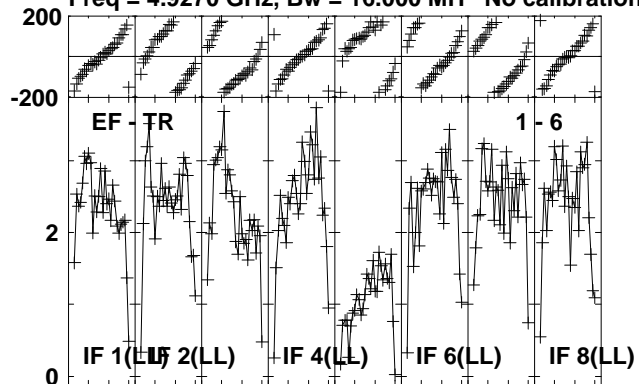

Lower frame: Milli Ampl Jy Top frame: Phas deg
Vector averaged cross-power spectrum Several baselines displayed
Timerange: 00/01:53:53 to 00/01:54:49

Plot file version 49 created 16-OCT-2012 11:56:46

NOVA-MON RO006.UVDATA.1

Freq = 4.9270 GHz, Bw = 16.000 MH No calibration applied and no bandpass applied

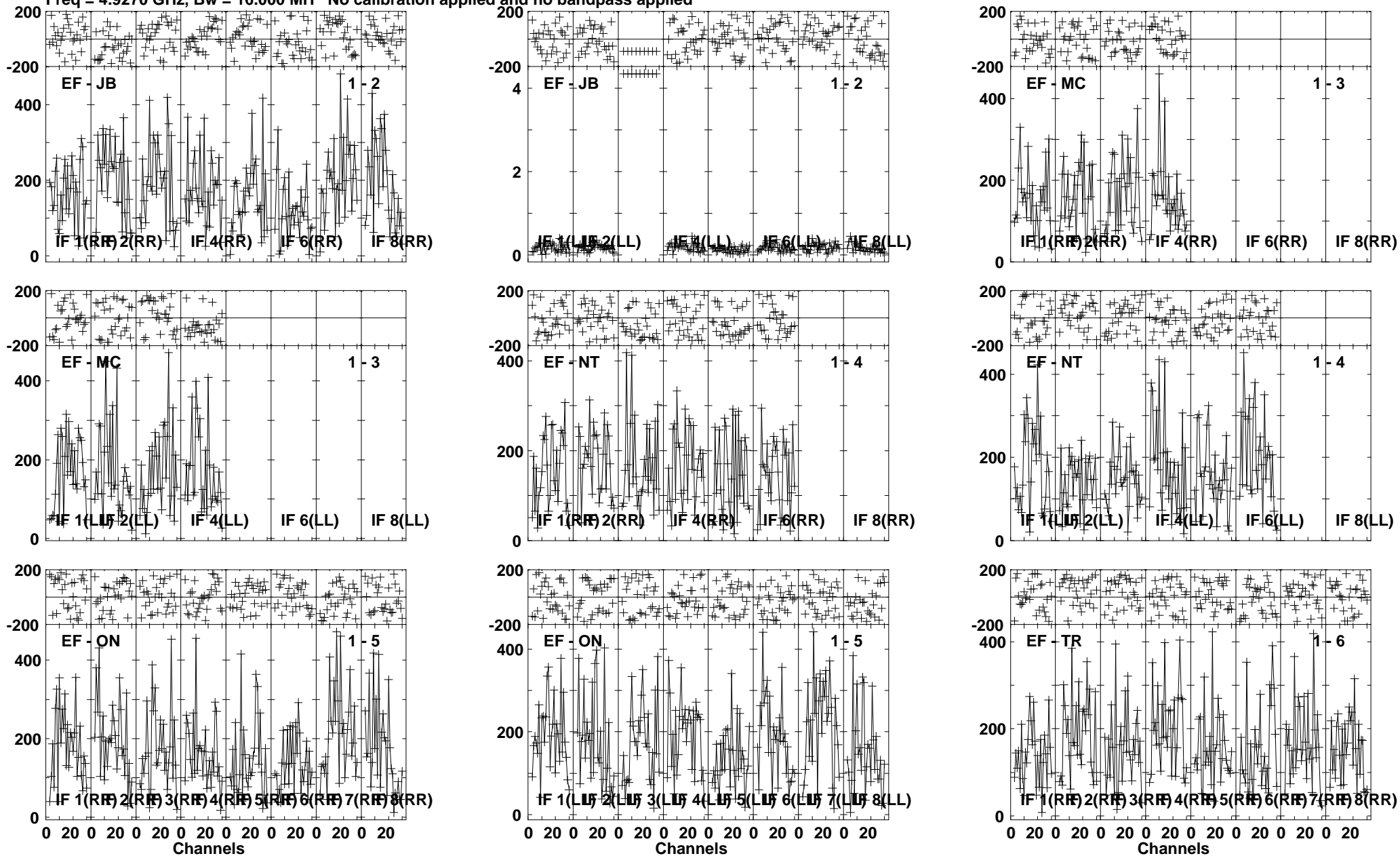

Lower frame: Micro Ampl Jy Top frame: Phas deg
Vector averaged cross-power spectrum Several baselines displayed
Timerange: 00/01:54:53 to 00/01:57:49

Plot file version 50 created 16-OCT-2012 11:56:47

NOVA-MON RO006.UVDATA.1

Freq = 4.9270 GHz, Bw = 16.000 MH No calibration applied and no bandpass applied

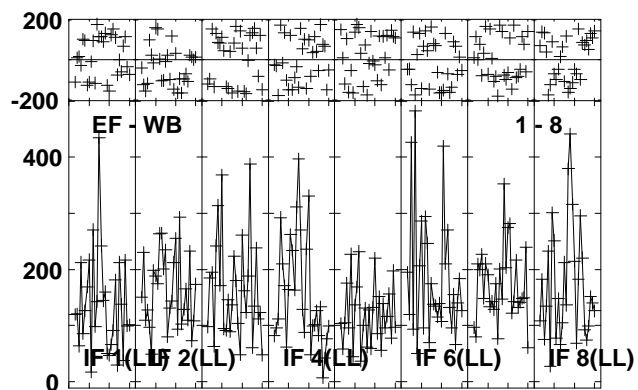
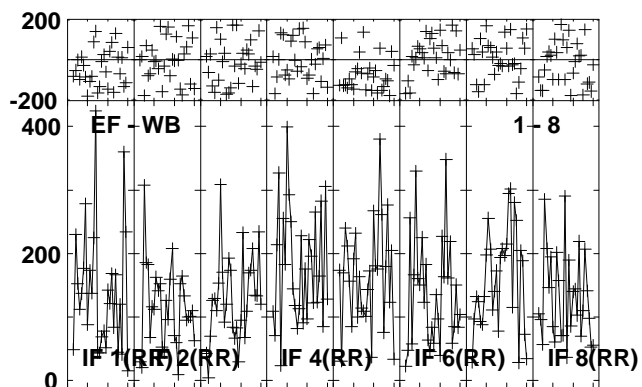
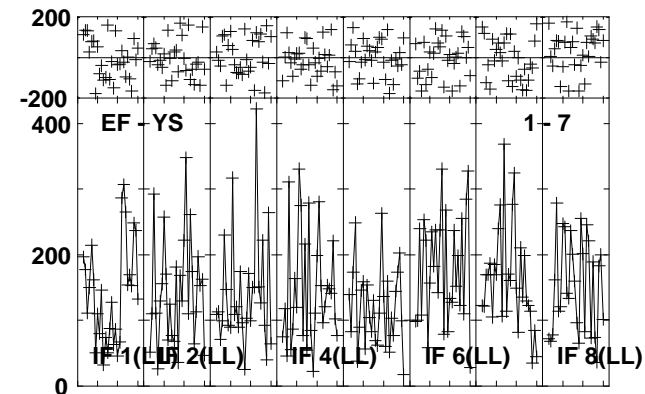
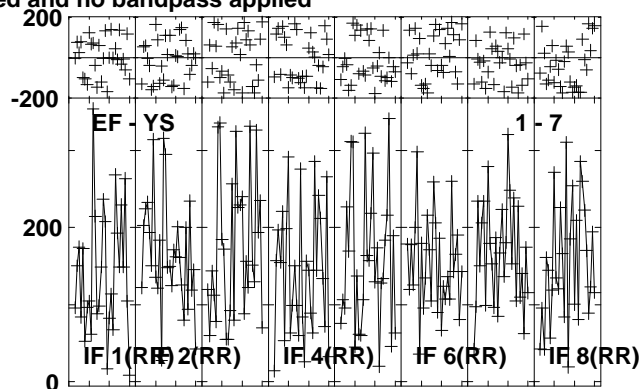
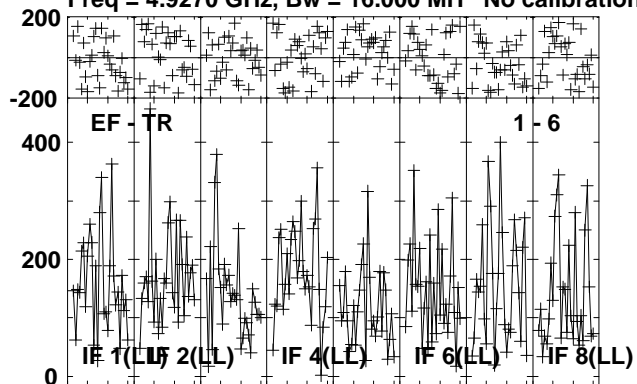

Lower frame: Micro Ampl Jy Top frame: Phas deg
Vector averaged cross-power spectrum Several baselines displayed
Timerange: 00/01:54:53 to 00/01:57:49

Plot file version 51 created 16-OCT-2012 11:56:47

J0639+0601 RO006.UVDATA.1

Freq = 4.9270 GHz, Bw = 16.000 MH No calibration applied and no bandpass applied

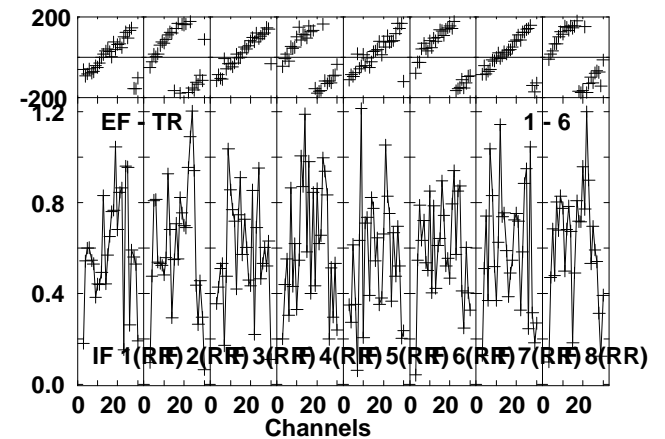
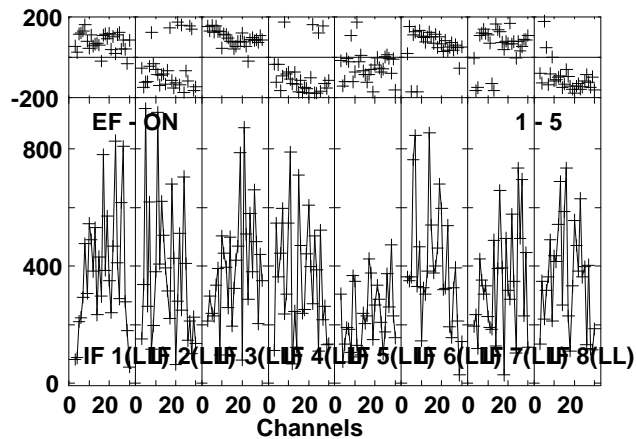
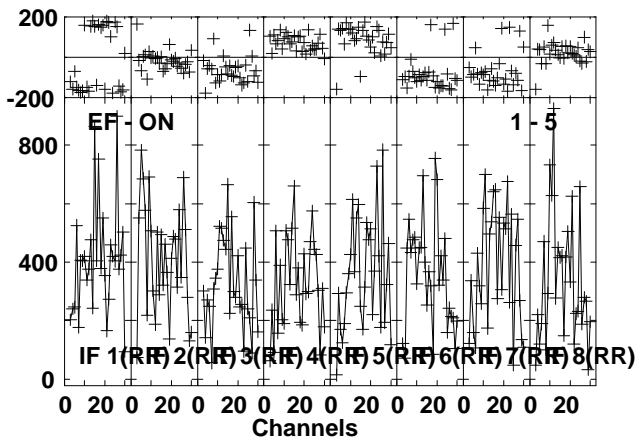
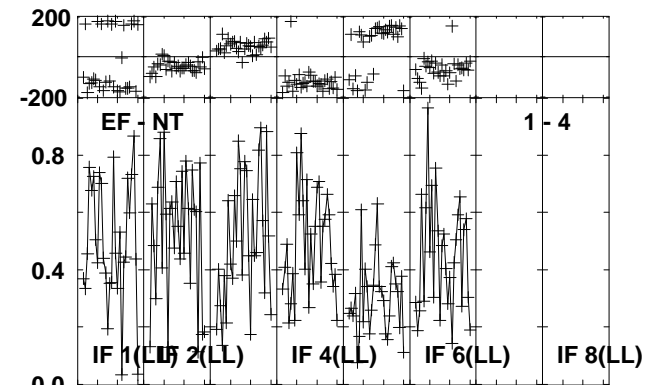
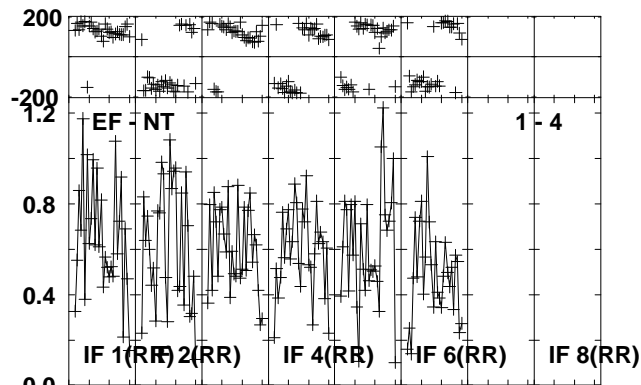
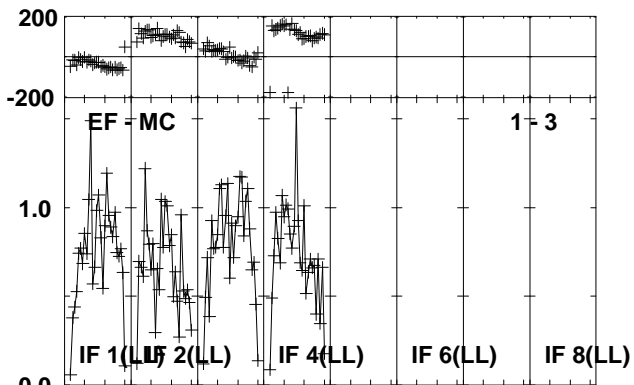
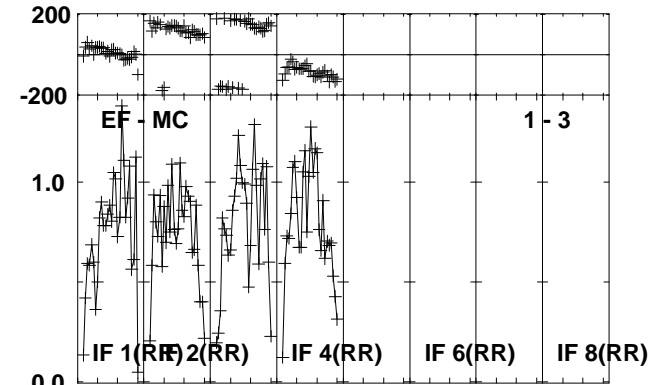
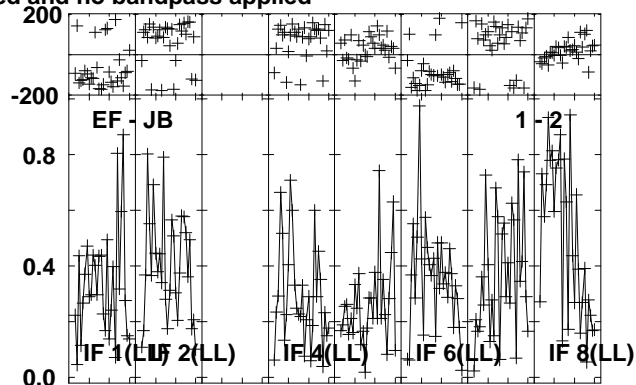
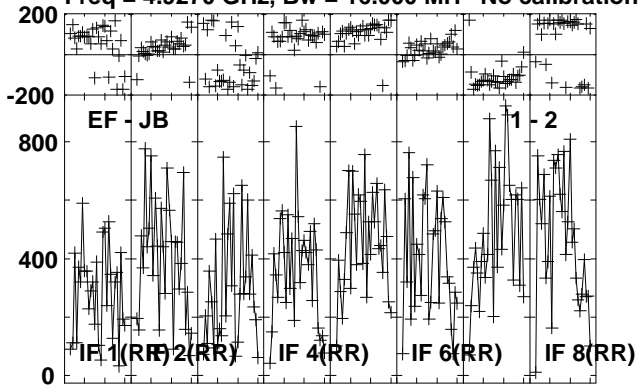

Lower frame: Micro Ampl Jy Top frame: Phas deg
Vector averaged cross-power spectrum Several baselines displayed
Timerange: 00/01:58:17 to 00/01:59:19

Plot file version 52 created 16-OCT-2012 11:56:48

J0639+0601 RO006.UVDATA.1

Freq = 4.9270 GHz, Bw = 16.000 MH No calibration applied and no bandpass applied

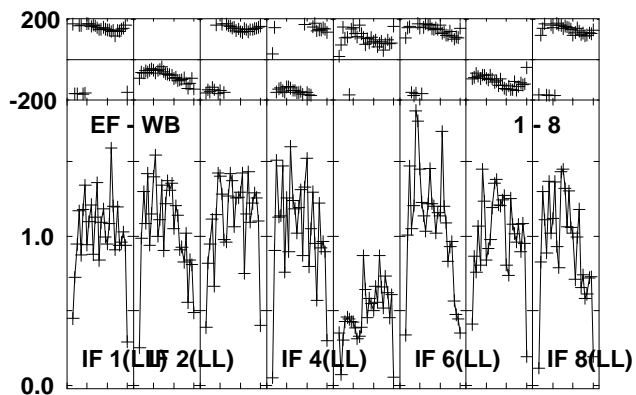
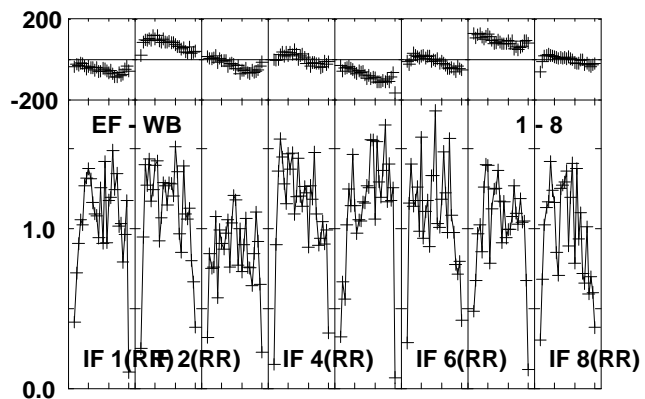
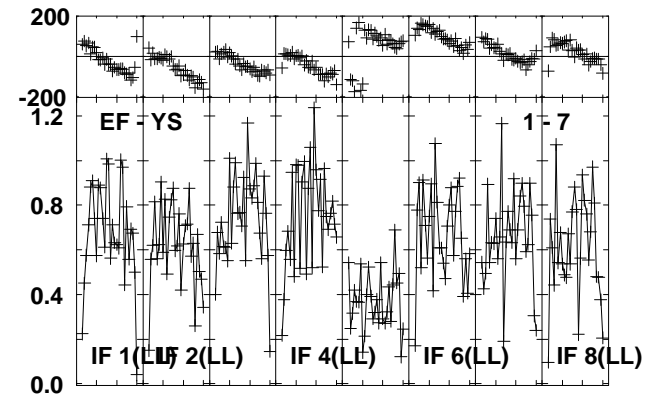
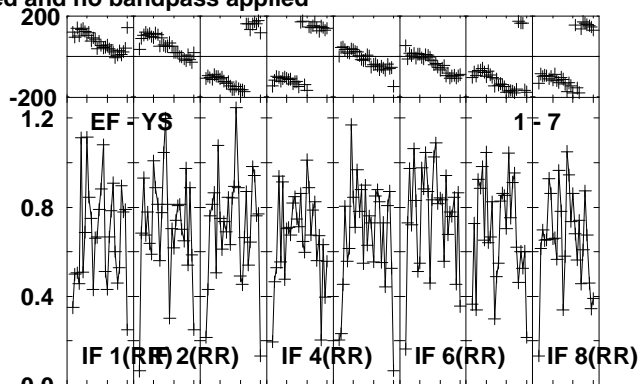
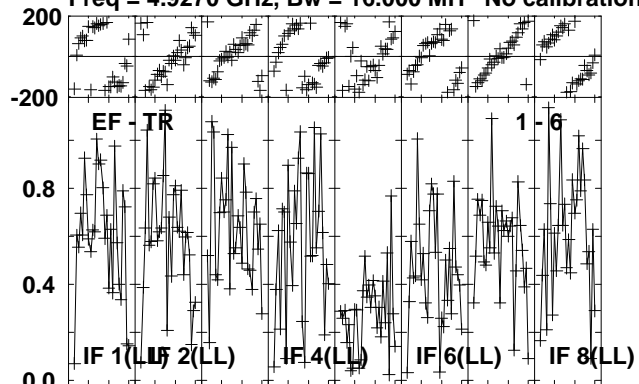

Lower frame: Milli Ampl Jy Top frame: Phas deg
Vector averaged cross-power spectrum Several baselines displayed
Timerange: 00/01:58:17 to 00/01:59:19

Plot file version 53 created 16-OCT-2012 11:56:48

0528+134 RO006.UVDATA.1

Freq = 4.9270 GHz, Bw = 16.000 MH No calibration applied and no bandpass applied

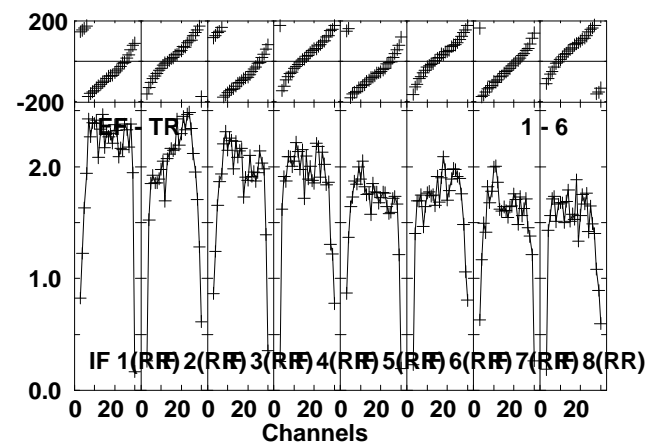
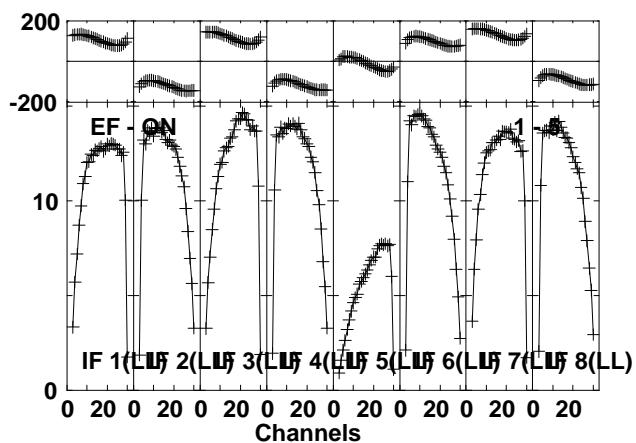
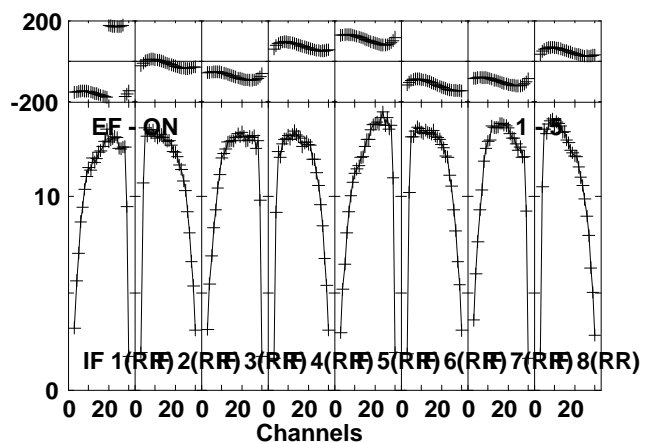
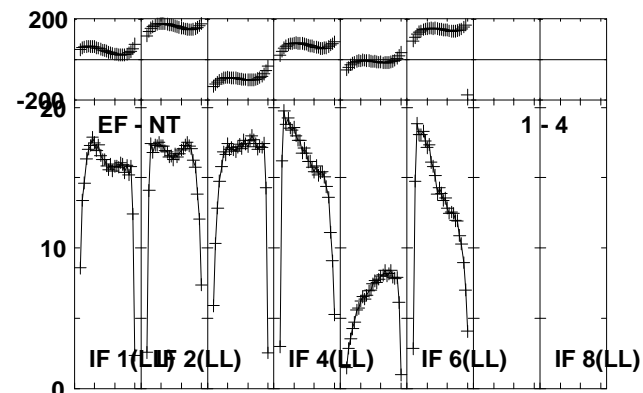
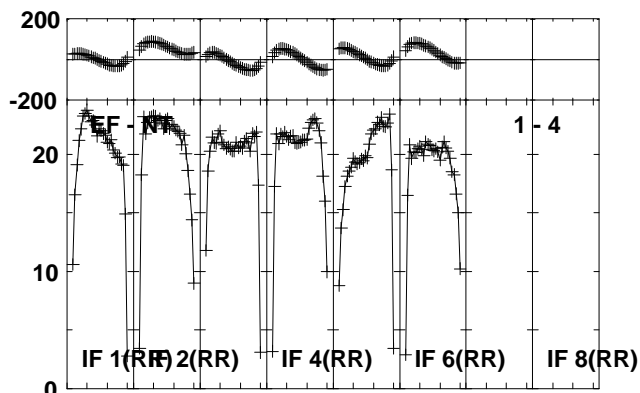
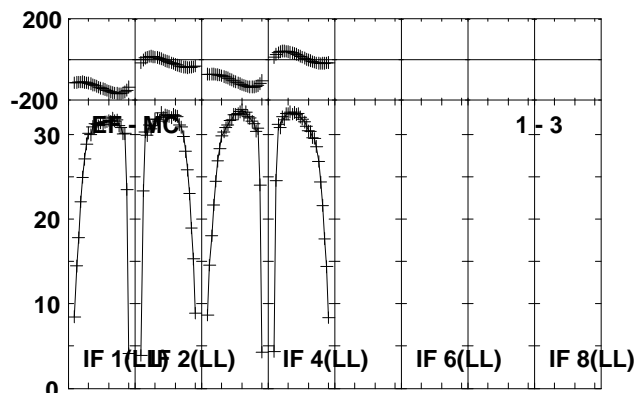
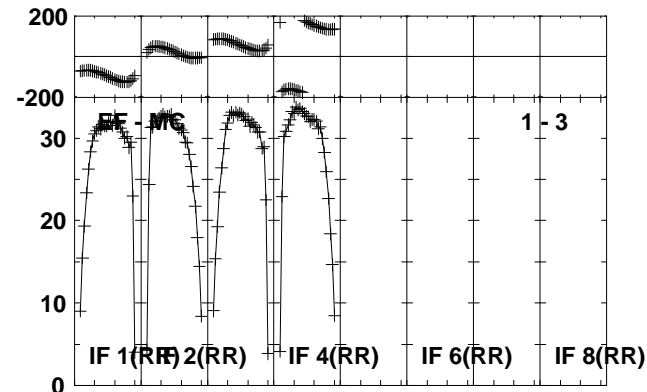
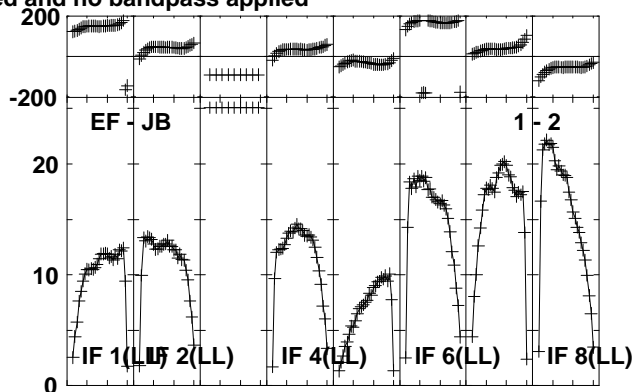
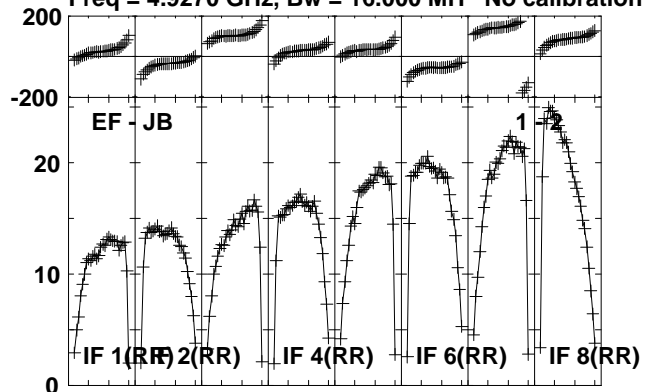

Lower frame: Milli Ampl Jy Top frame: Phas deg
Vector averaged cross-power spectrum Several baselines displayed
Timerange: 00/02:01:17 to 00/02:04:19

Plot file version 54 created 16-OCT-2012 11:56:48

0528+134 RO006.UVDATA.1

Freq = 4.9270 GHz, Bw = 16.000 MH No calibration applied and no bandpass applied

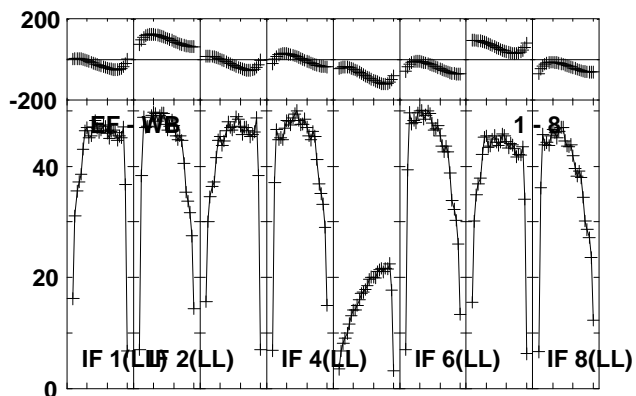
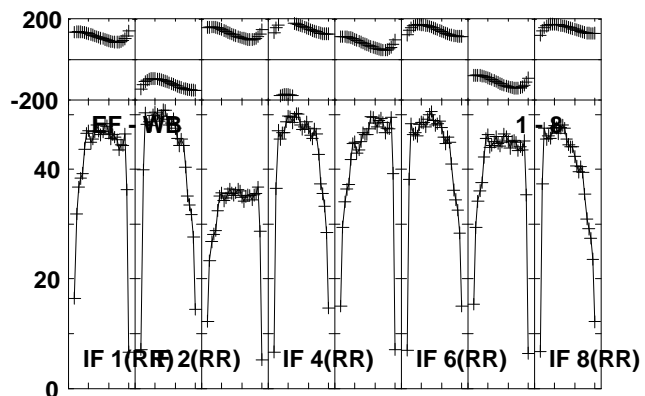
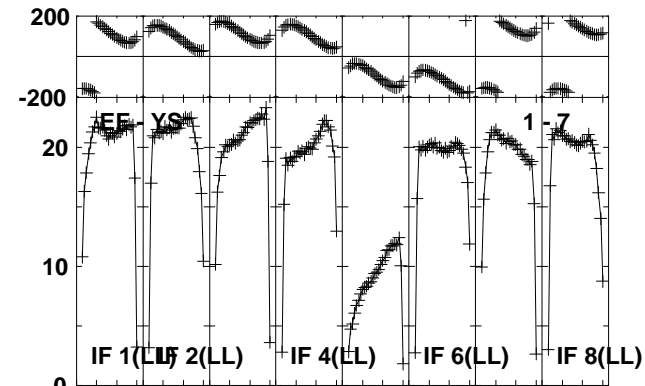
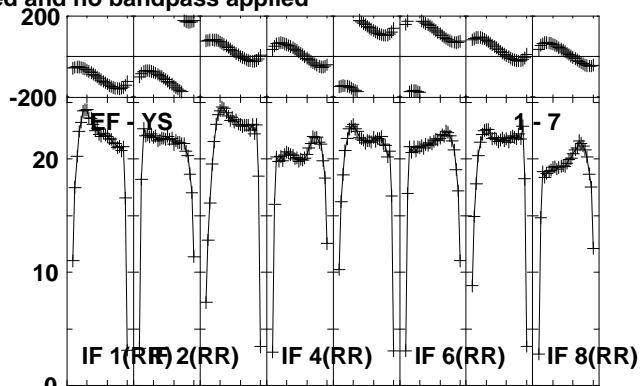
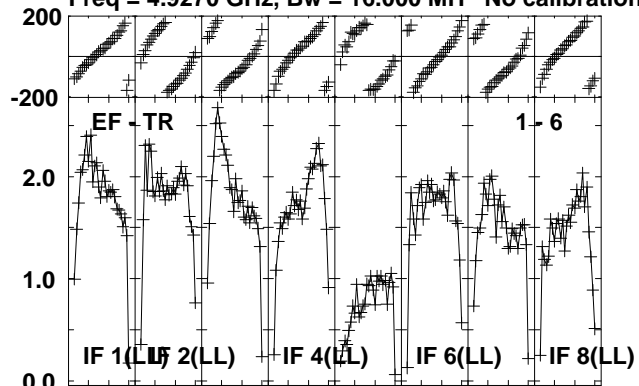

Lower frame: Milli Ampl Jy Top frame: Phas deg
Vector averaged cross-power spectrum Several baselines displayed
Timerange: 00/02:01:17 to 00/02:04:19

Plot file version 55 created 16-OCT-2012 11:56:49

J0645+0541 RO006.UVDATA.1

Freq = 4.9270 GHz, Bw = 16.000 MH No calibration applied and no bandpass applied

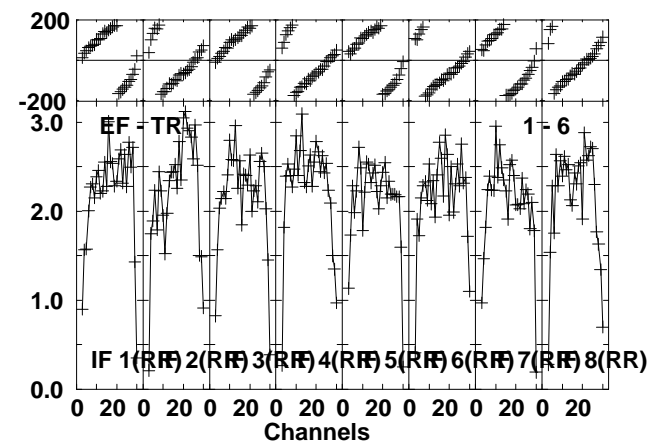
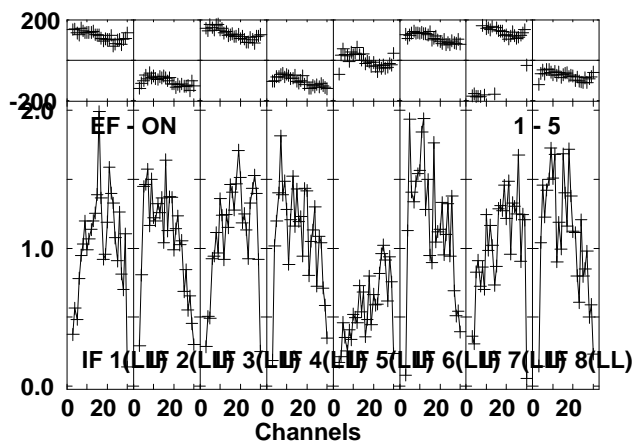
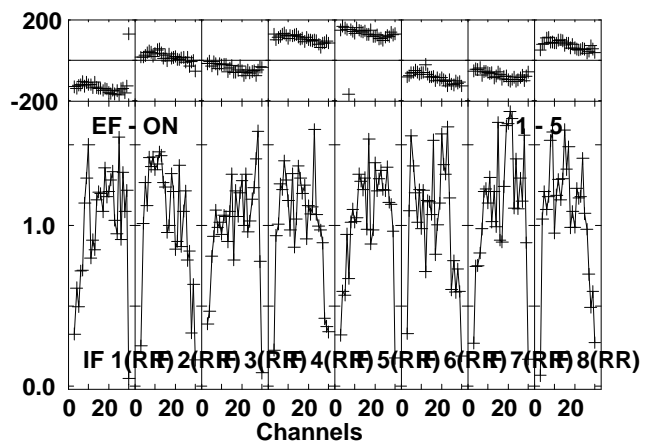
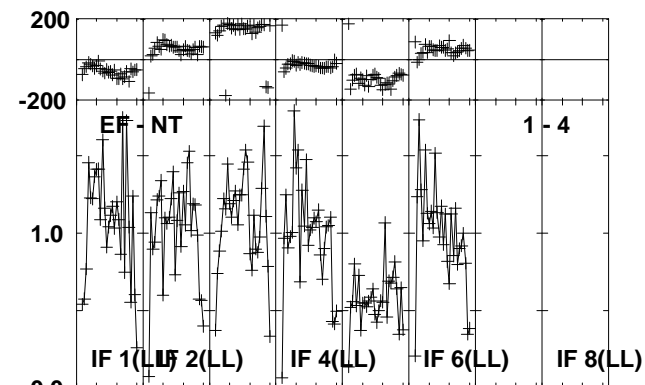
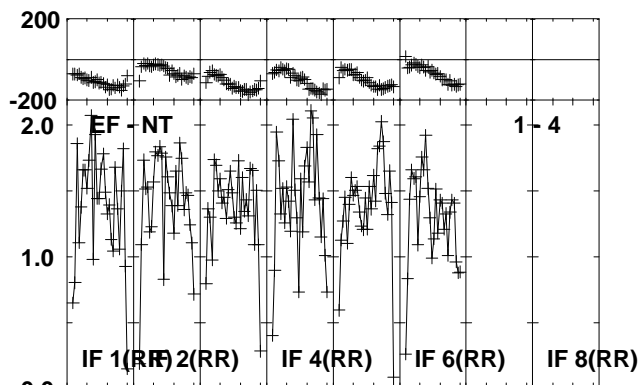
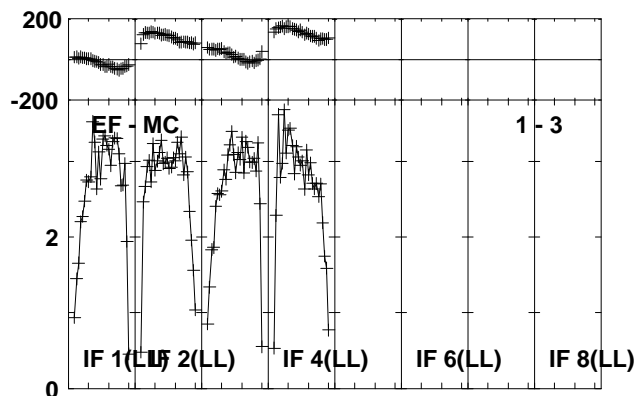
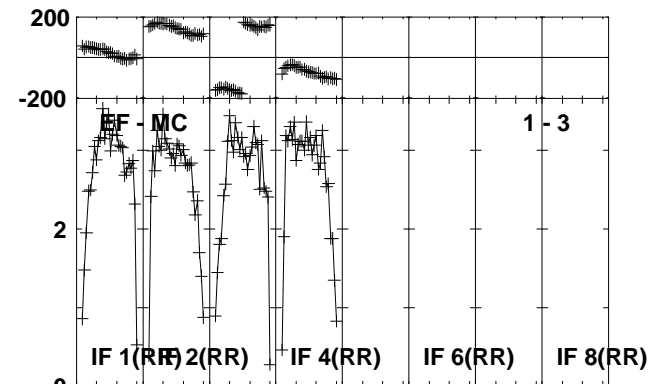
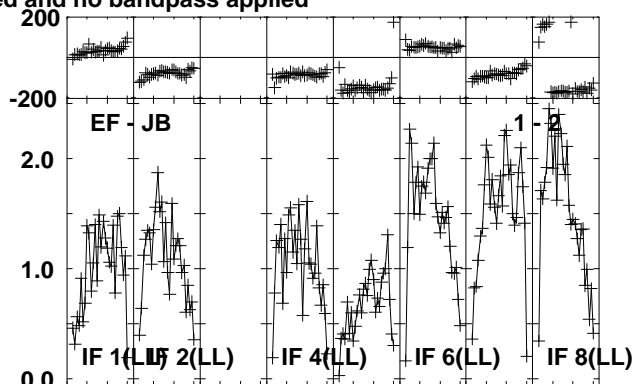
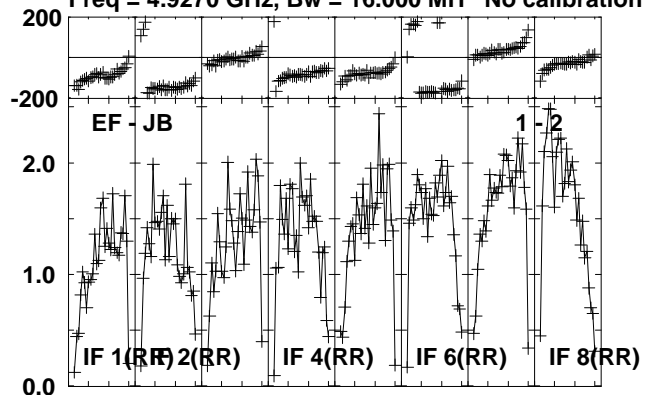

Lower frame: Milli Ampl Jy Top frame: Phas deg
Vector averaged cross-power spectrum Several baselines displayed
Timerange: 00/02:06:17 to 00/02:07:19

Plot file version 56 created 16-OCT-2012 11:56:49

J0645+0541 RO006.UVDATA.1

Freq = 4.9270 GHz, Bw = 16.000 MH No calibration applied and no bandpass applied

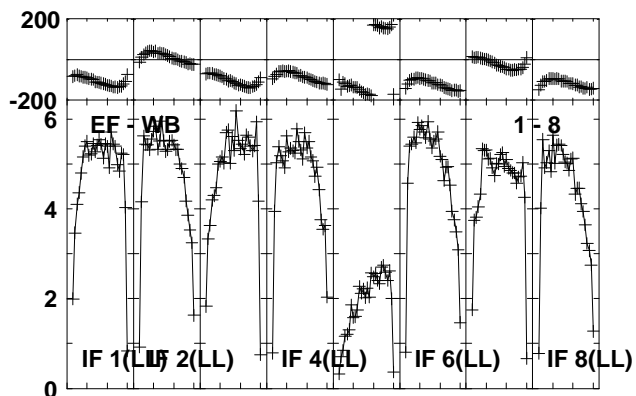
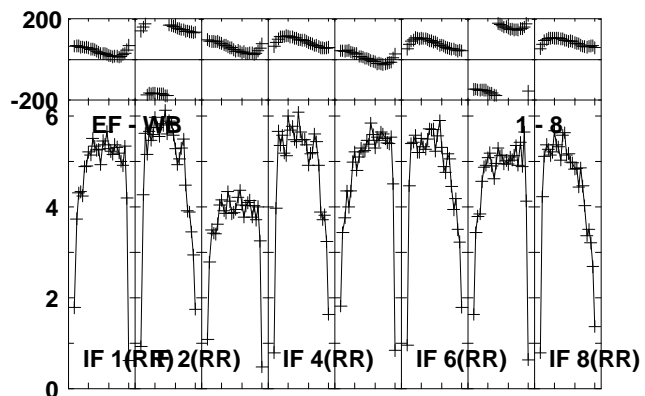
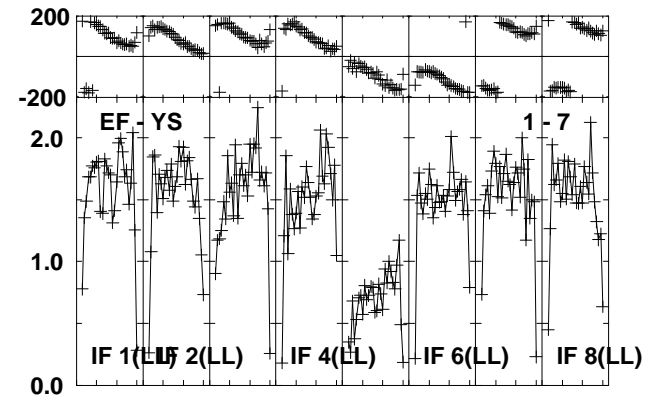
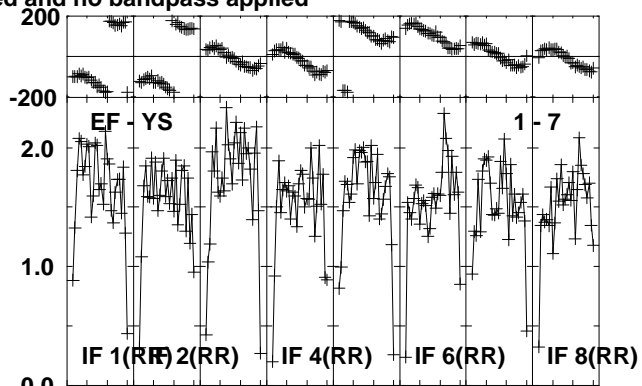
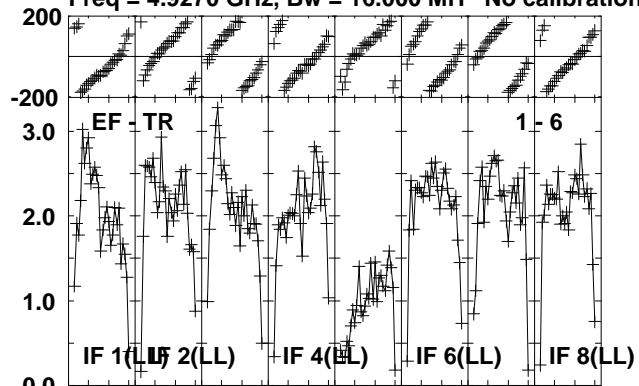

Lower frame: Milli Ampl Jy Top frame: Phas deg
Vector averaged cross-power spectrum Several baselines displayed
Timerange: 00/02:06:17 to 00/02:07:19

Plot file version 57 created 16-OCT-2012 11:56:49

NOVA-MON RO006.UVDATA.1

Freq = 4.9270 GHz, Bw = 16.000 MH No calibration applied and no bandpass applied

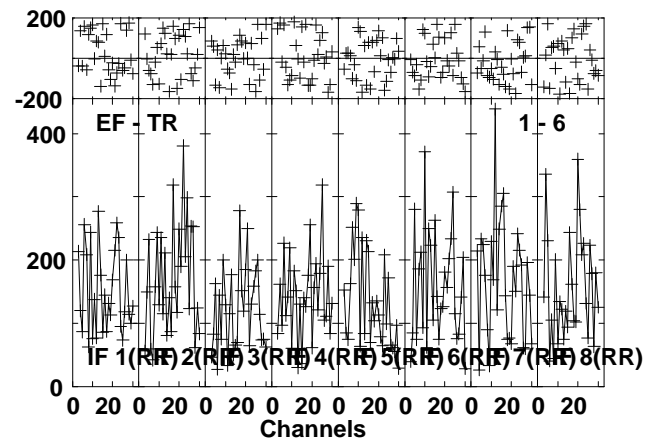
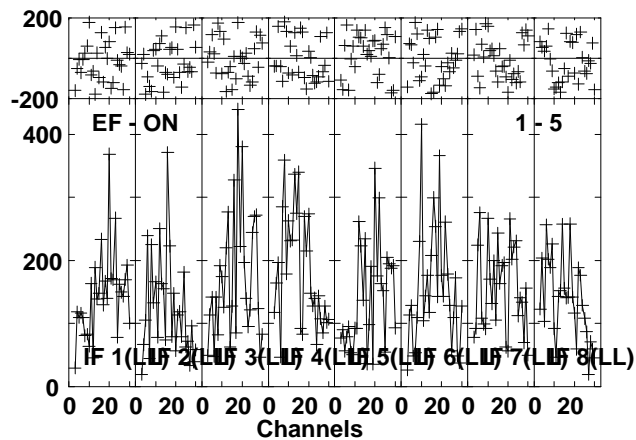
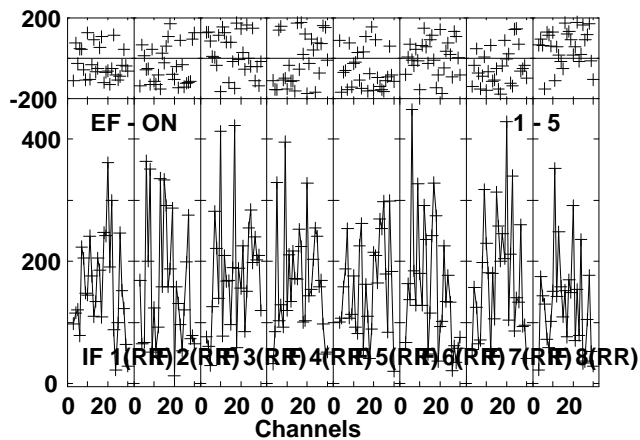
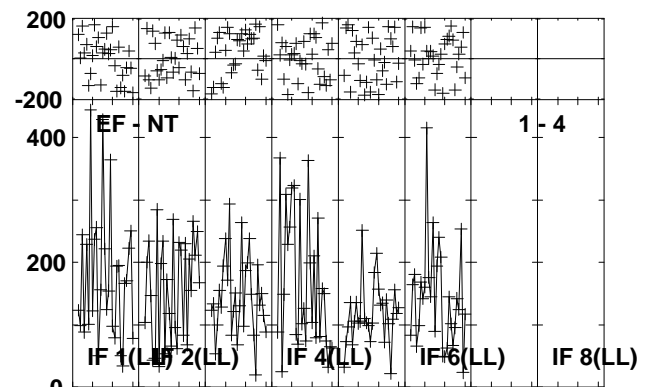
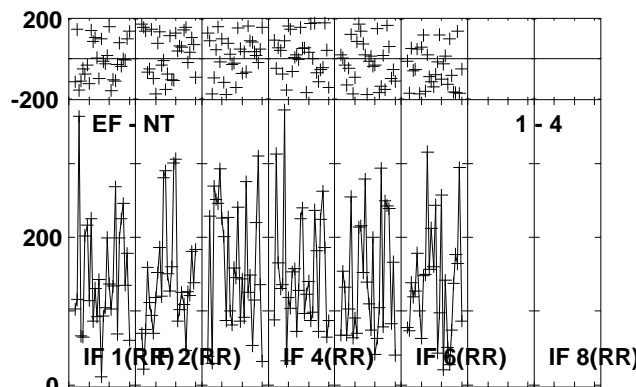
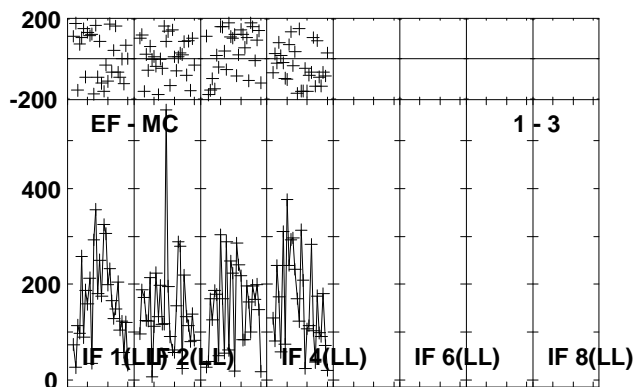
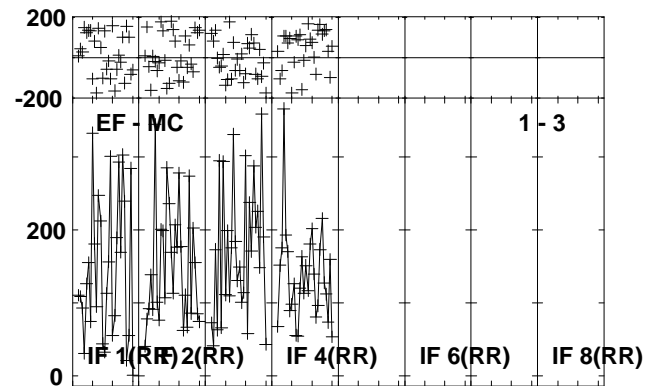
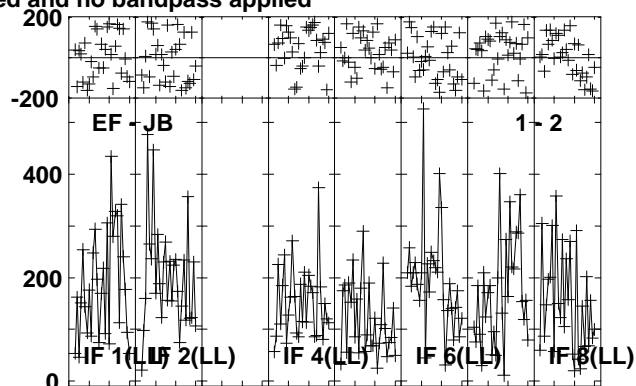
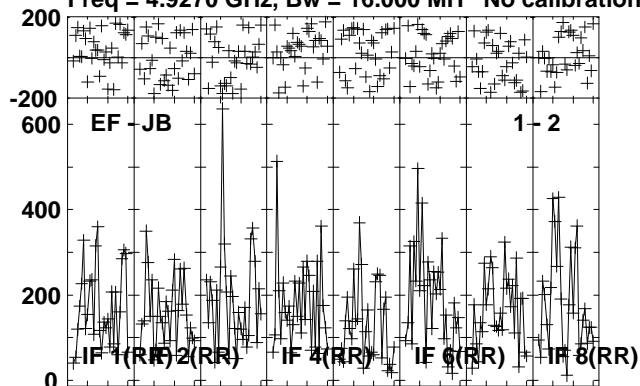

Lower frame: Micro Ampl Jy Top frame: Phas deg
Vector averaged cross-power spectrum Several baselines displayed
Timerange: 00/02:07:23 to 00/02:10:19

Plot file version 58 created 16-OCT-2012 11:56:50

NOVA-MON RO006.UVDATA.1

Freq = 4.9270 GHz, Bw = 16.000 MH No calibration applied and no bandpass applied

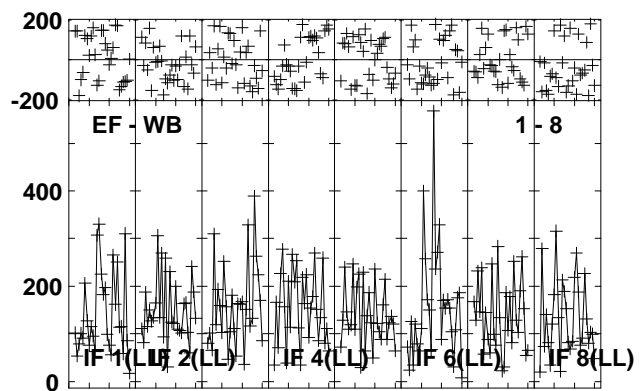
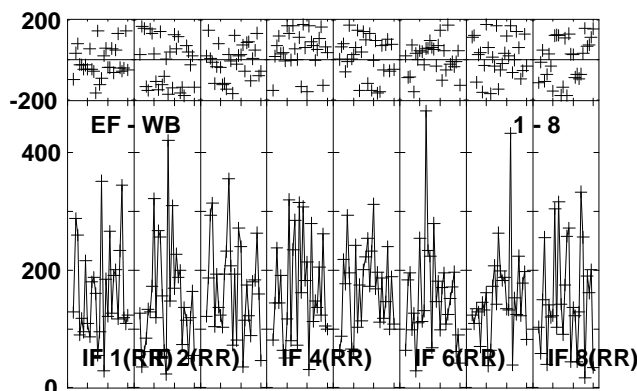
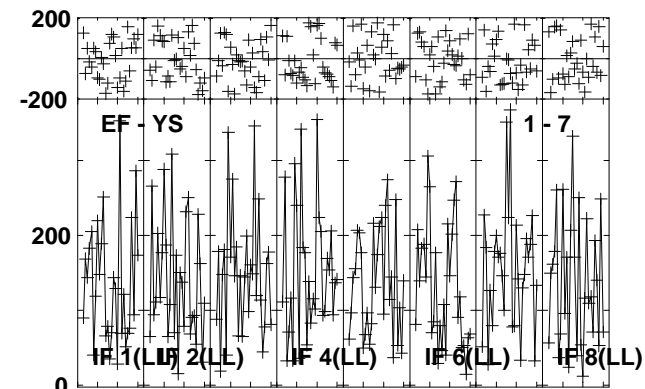
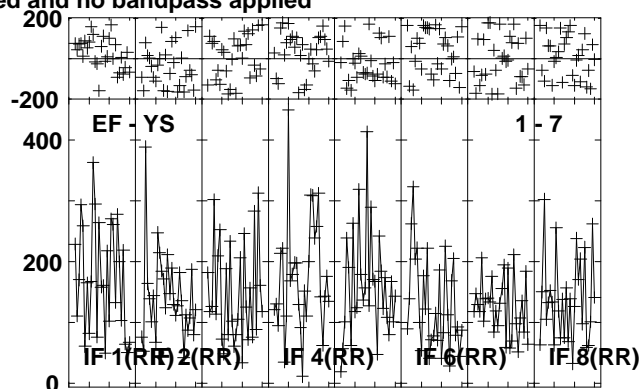
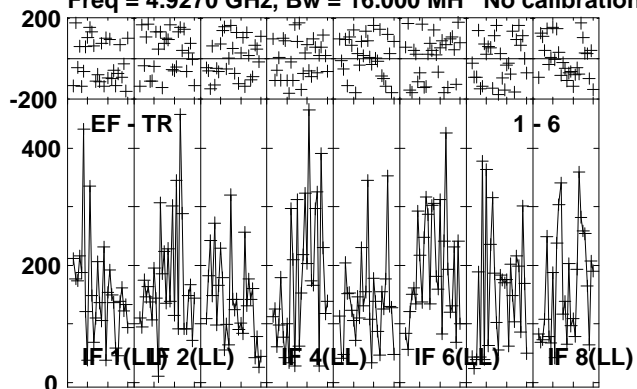

Lower frame: Micro Ampl Jy Top frame: Phas deg
Vector averaged cross-power spectrum Several baselines displayed
Timerange: 00/02:07:23 to 00/02:10:19

Plot file version 59 created 16-OCT-2012 11:56:50

J0639+0601 RO006.UVDATA.1

Freq = 4.9270 GHz, Bw = 16.000 MH No calibration applied and no bandpass applied

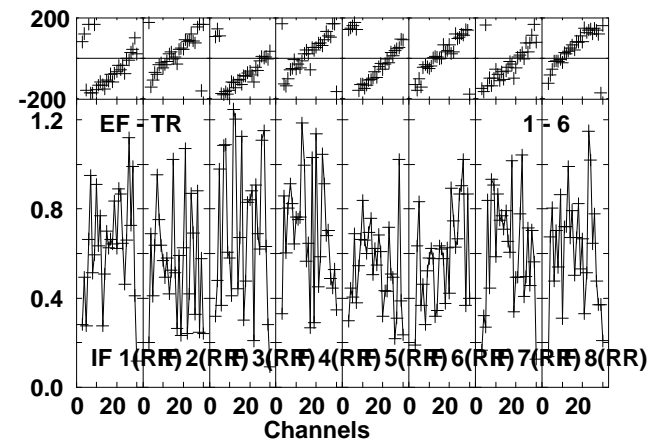
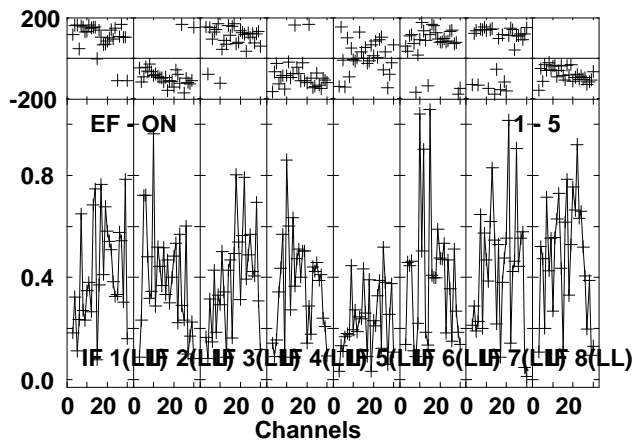
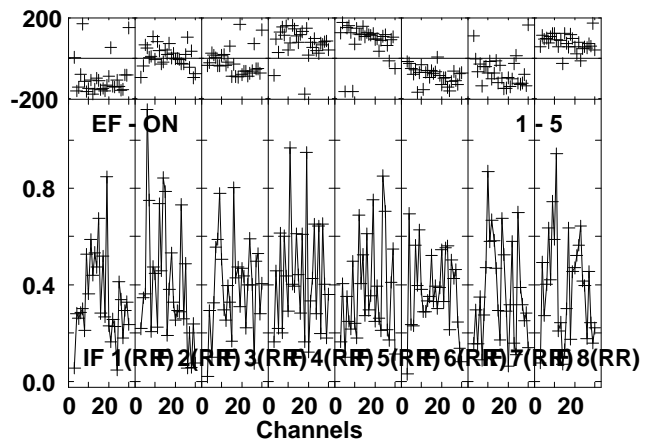
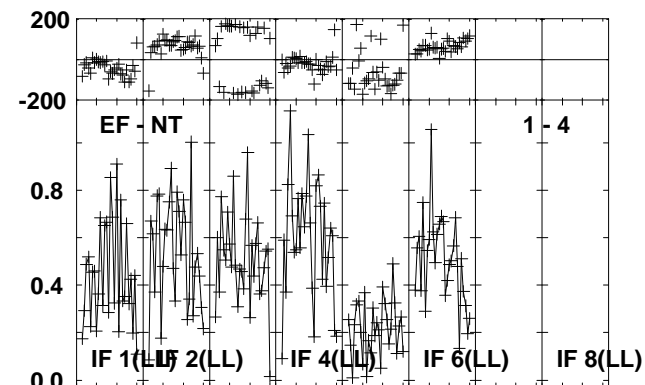
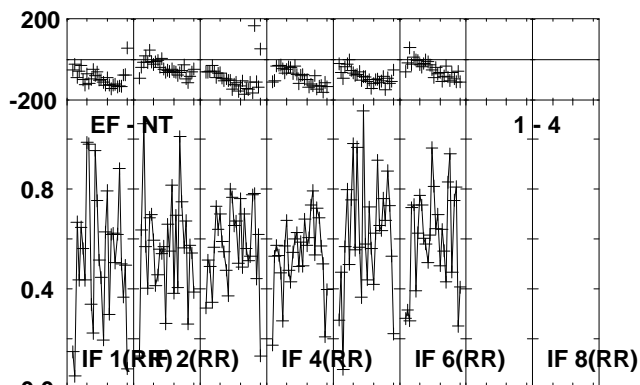
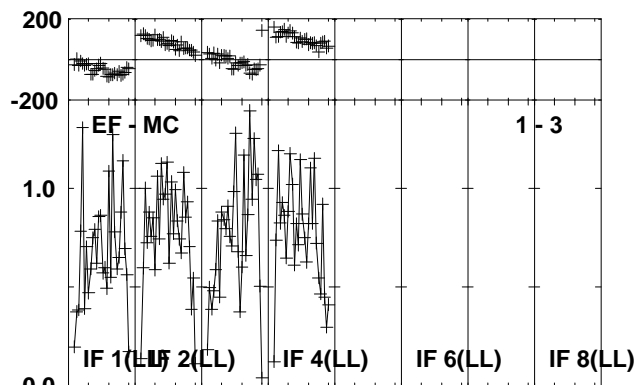
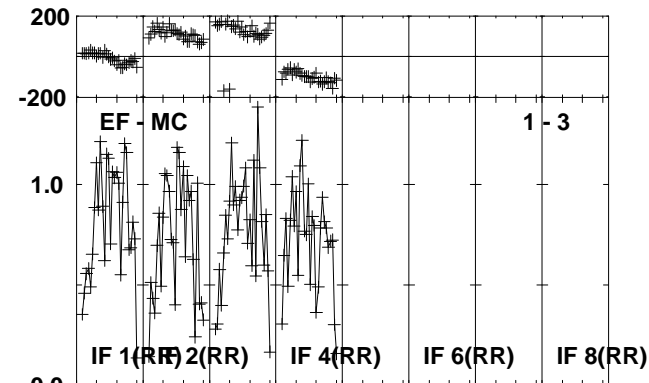
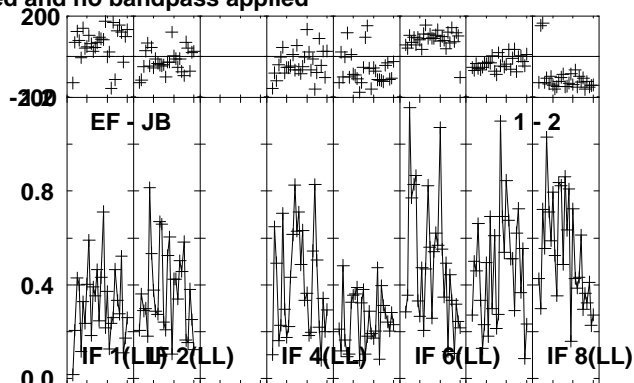
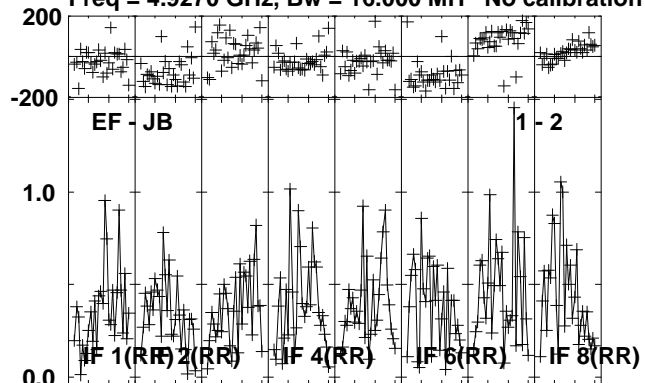

Lower frame: Milli Ampl Jy Top frame: Phas deg
Vector averaged cross-power spectrum Several baselines displayed
Timerange: 00/02:10:23 to 00/02:11:33

Plot file version 60 created 16-OCT-2012 11:56:50

J0639+0601 RO006.UVDATA.1

Freq = 4.9270 GHz, Bw = 16.000 MH No calibration applied and no bandpass applied

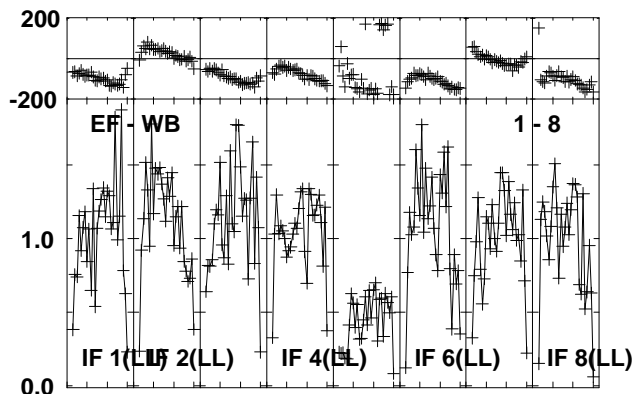
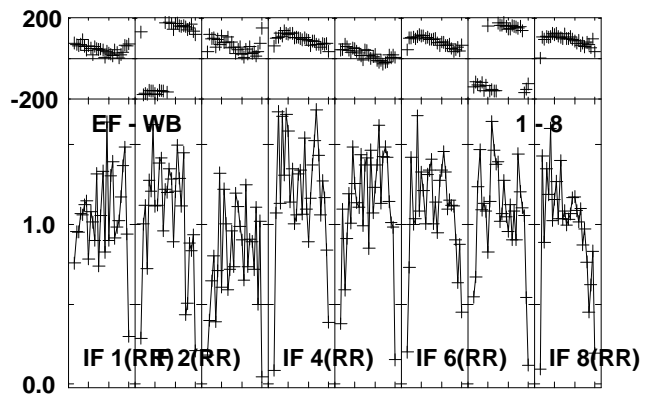
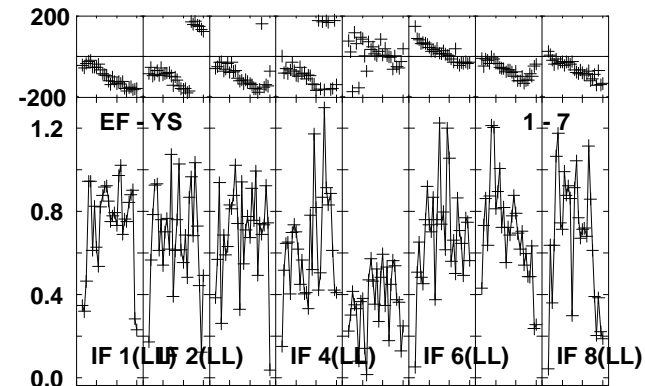
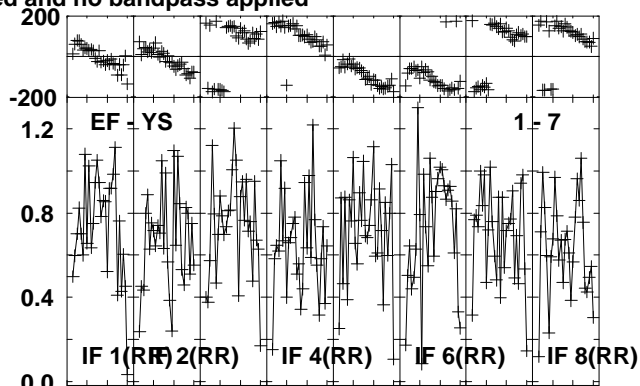
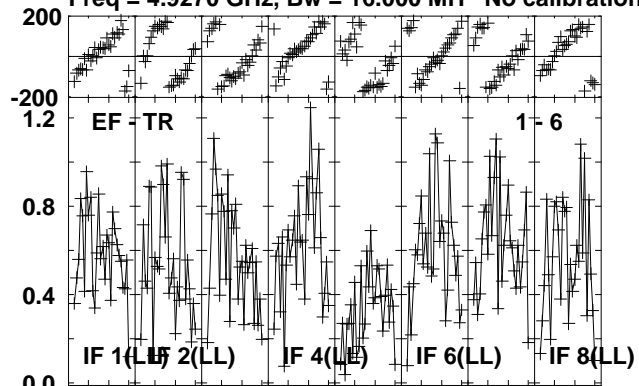

Lower frame: Milli Ampl Jy Top frame: Phas deg
Vector averaged cross-power spectrum Several baselines displayed
Timerange: 00/02:10:23 to 00/02:11:33

Plot file version 61 created 16-OCT-2012 11:56:51

J0645+0541 RO006.UVDATA.1

Freq = 4.9270 GHz, Bw = 16.000 MH No calibration applied and no bandpass applied

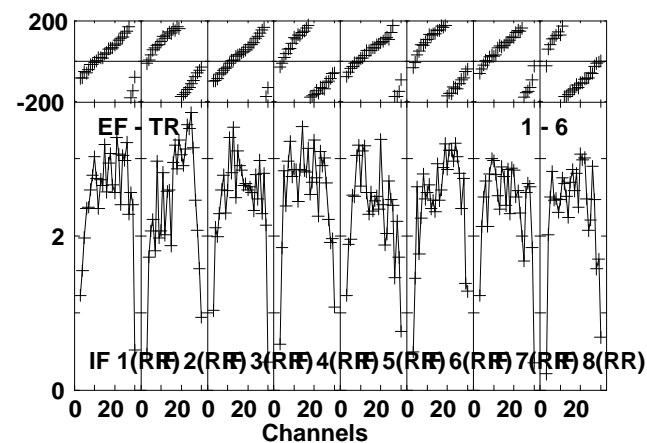
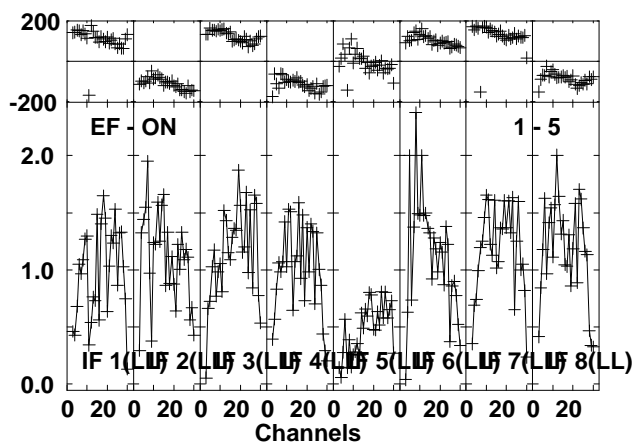
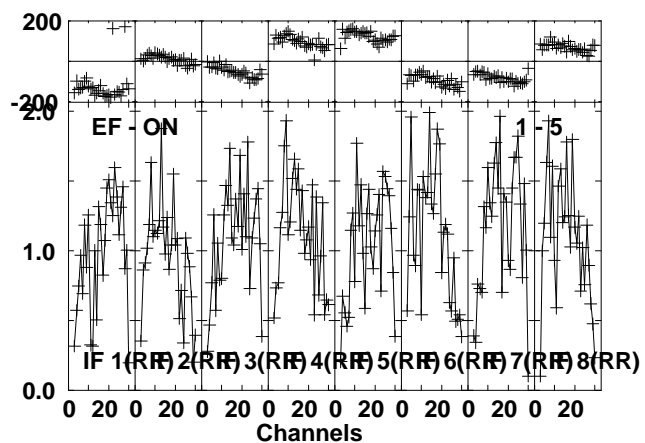
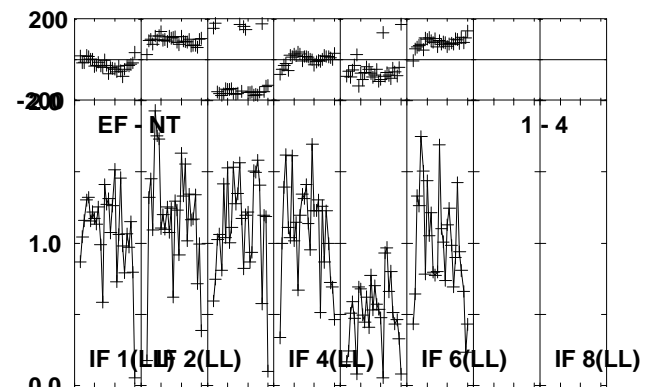
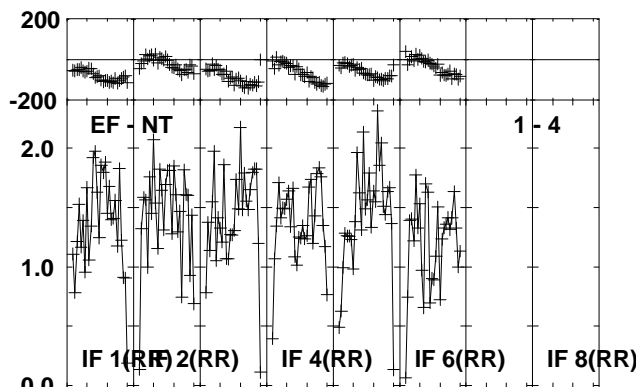
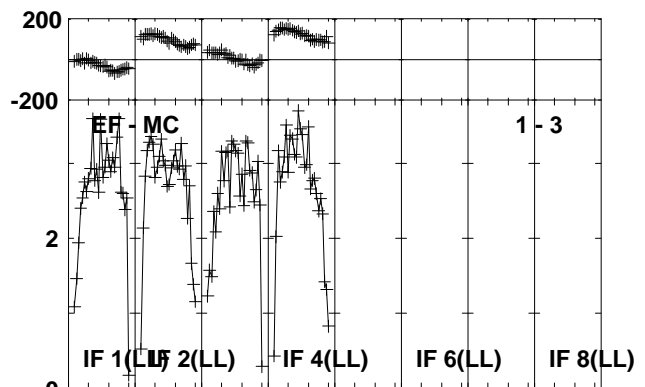
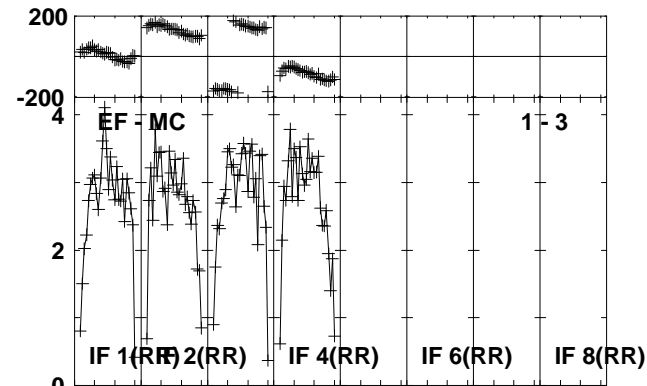
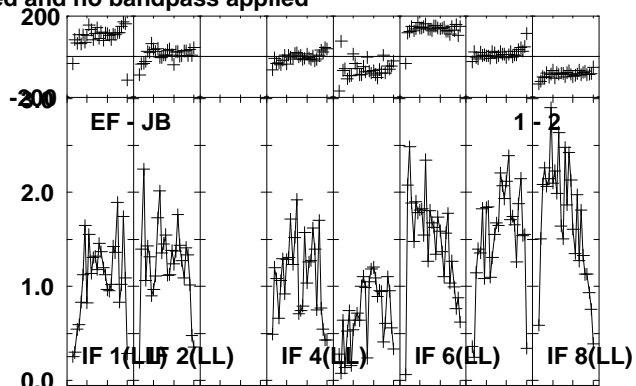
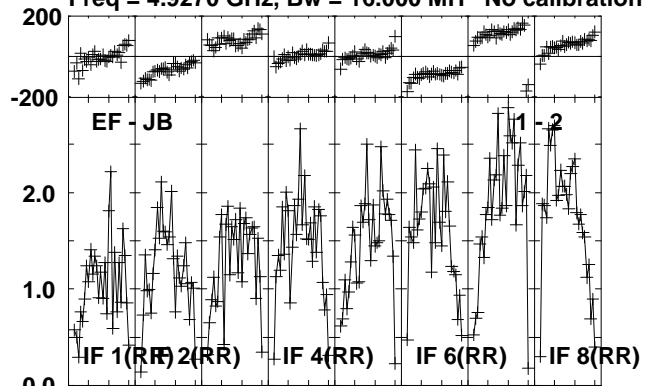

Lower frame: Milli Ampl Jy Top frame: Phas deg
Vector averaged cross-power spectrum Several baselines displayed
Timerange: 00/02:11:37 to 00/02:12:33

Plot file version 62 created 16-OCT-2012 11:56:51

J0645+0541 RO006.UVDATA.1

Freq = 4.9270 GHz, Bw = 16.000 MH No calibration applied and no bandpass applied

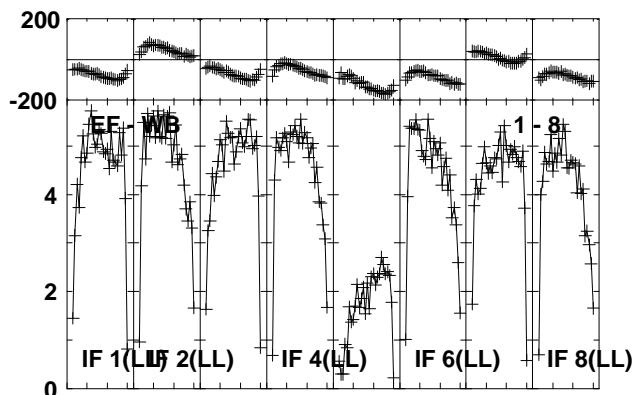
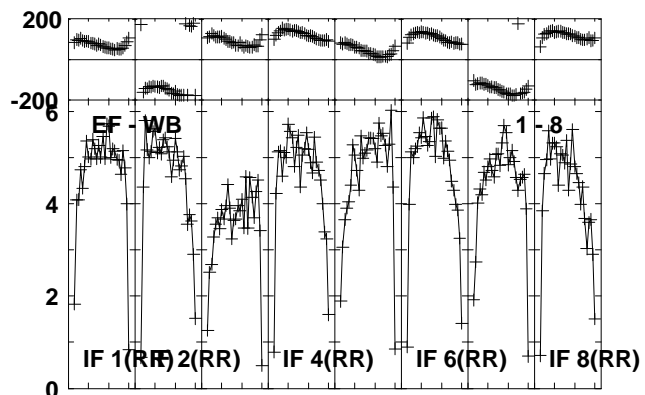
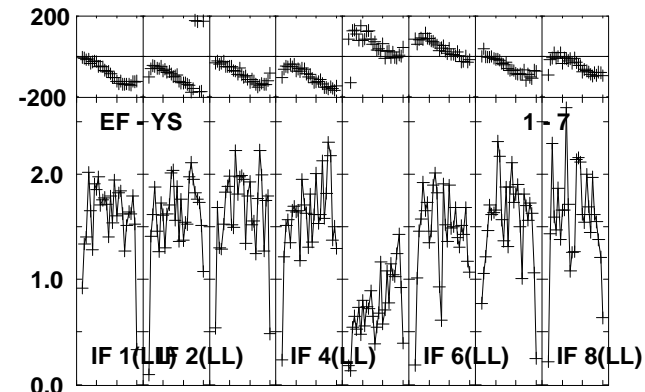
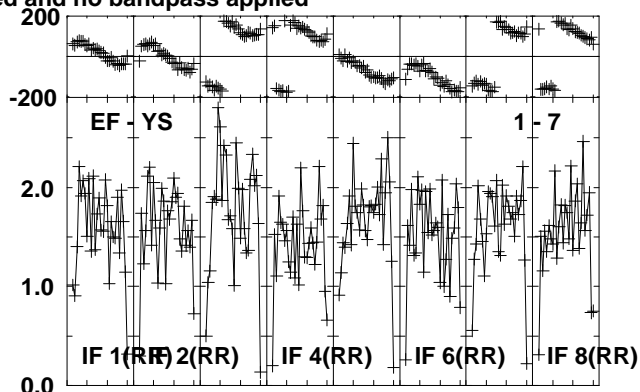
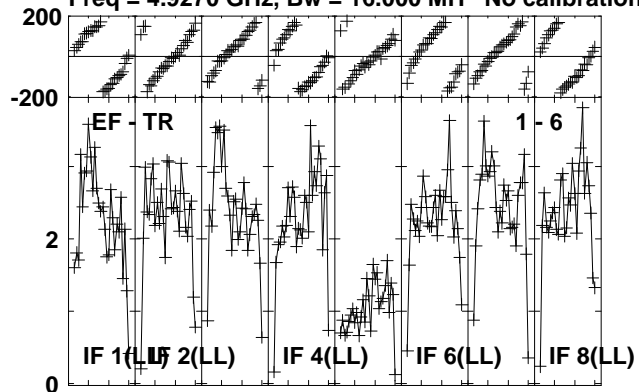

Lower frame: Milli Ampl Jy Top frame: Phas deg
Vector averaged cross-power spectrum Several baselines displayed
Timerange: 00/02:11:37 to 00/02:12:33

Plot file version 63 created 16-OCT-2012 11:56:51

NOVA-MON RO006.UVDATA.1

Freq = 4.9270 GHz, Bw = 16.000 MH No calibration applied and no bandpass applied

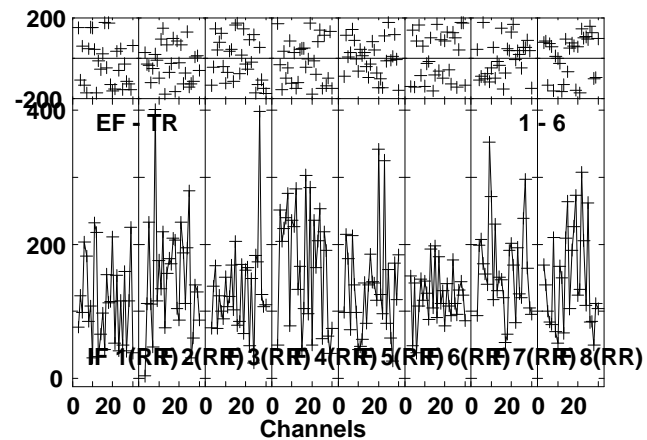
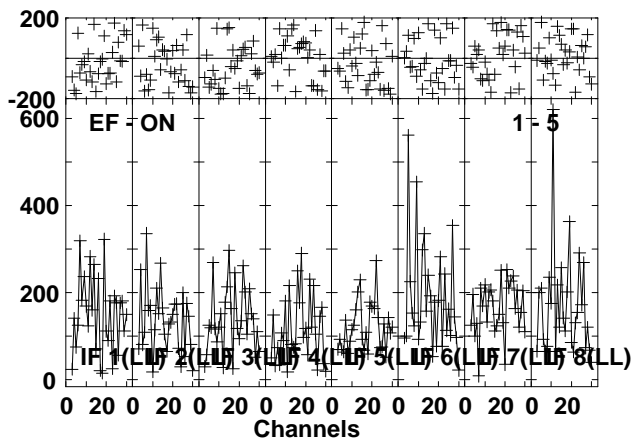
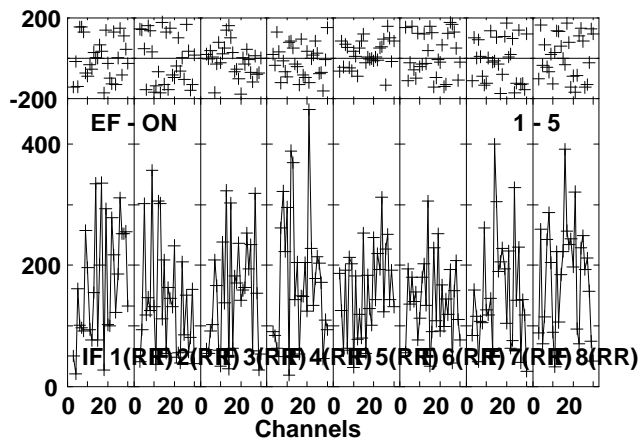
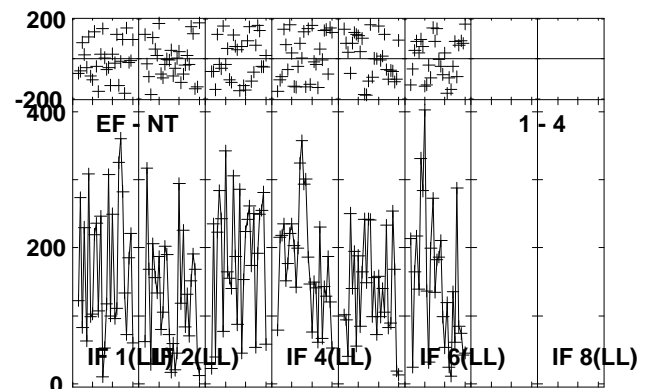
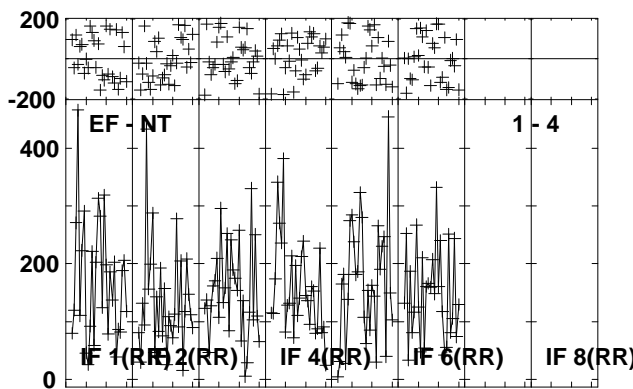
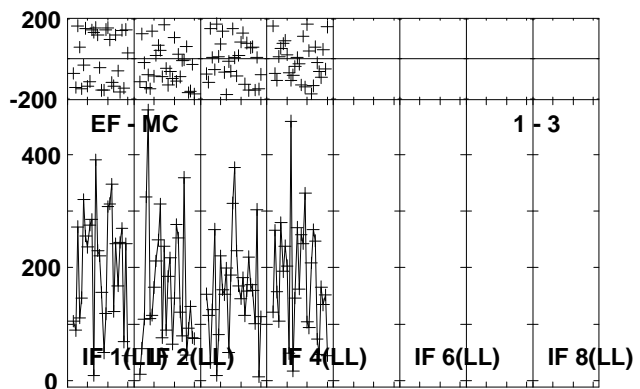
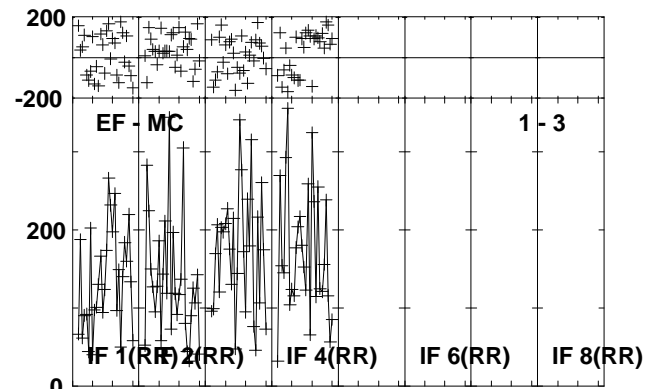
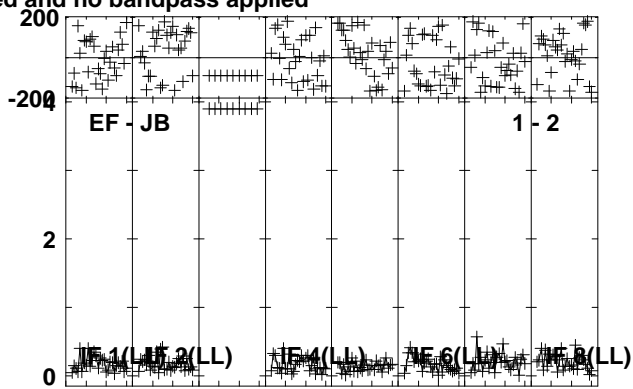
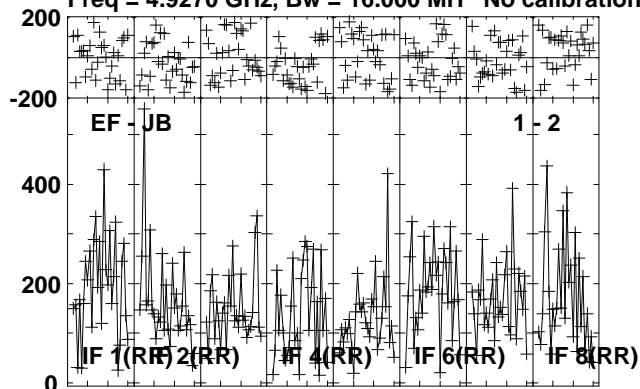

Lower frame: Micro Ampl Jy Top frame: Phas deg
Vector averaged cross-power spectrum Several baselines displayed
Timerange: 00/02:12:37 to 00/02:15:33

Plot file version 64 created 16-OCT-2012 11:56:51

NOVA-MON RO006.UVDATA.1

Freq = 4.9270 GHz, Bw = 16.000 MH No calibration applied and no bandpass applied

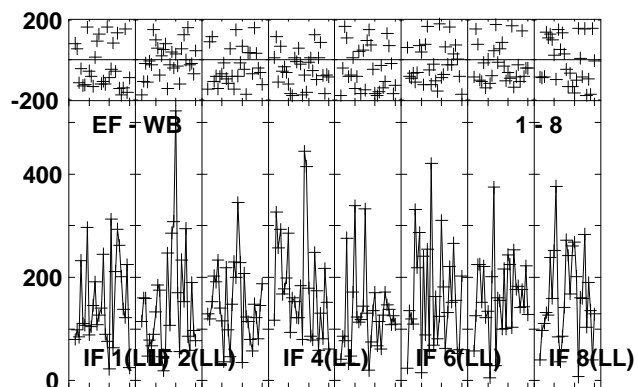
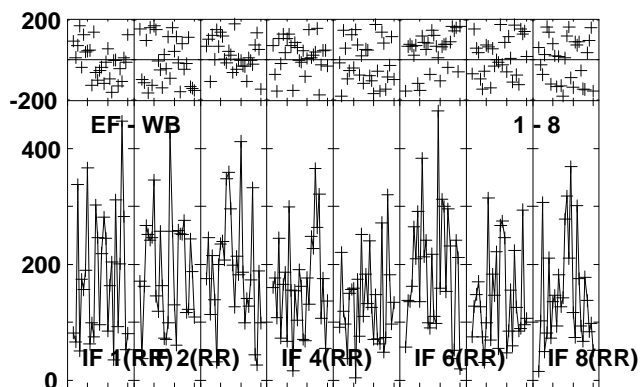
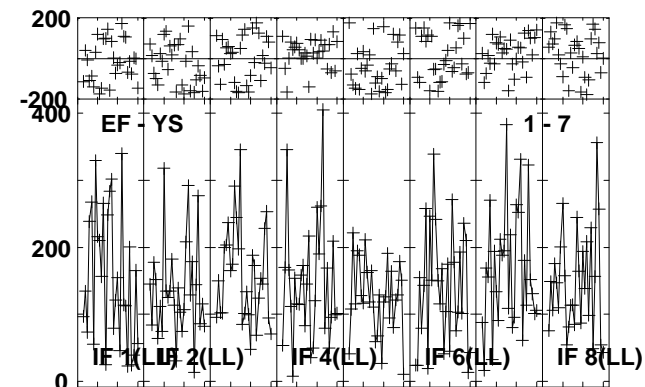
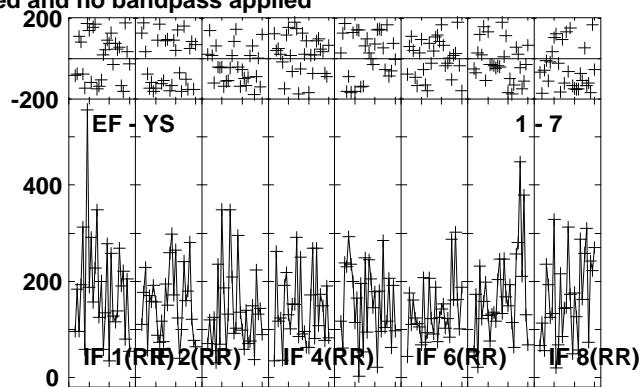
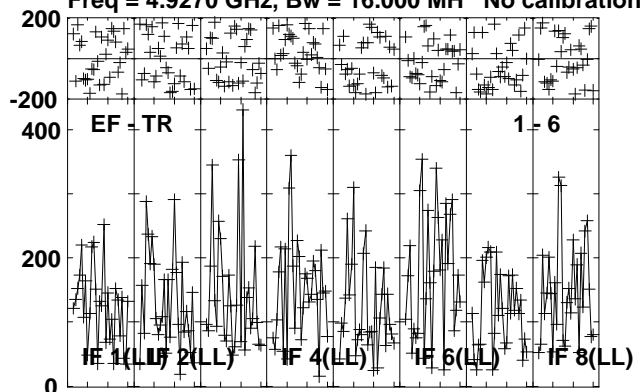

Lower frame: Micro Ampl Jy Top frame: Phas deg
Vector averaged cross-power spectrum Several baselines displayed
Timerange: 00/02:12:37 to 00/02:15:33

Plot file version 65 created 16-OCT-2012 11:56:52

J0639+0601 RO006.UVDATA.1

Freq = 4.9270 GHz, Bw = 16.000 MH No calibration applied and no bandpass applied

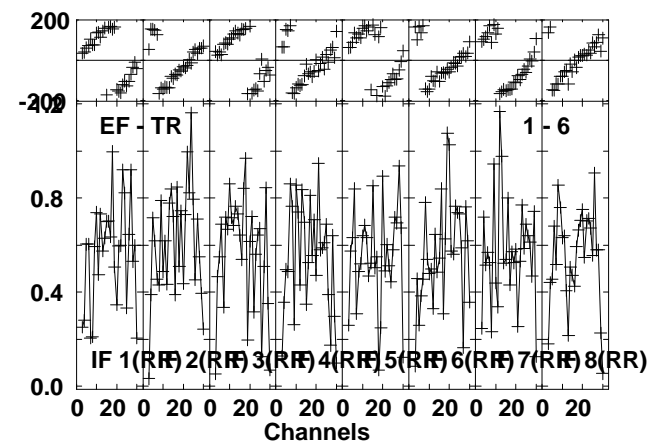
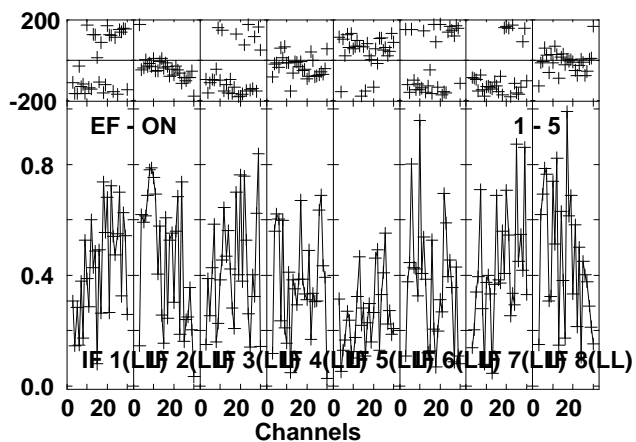
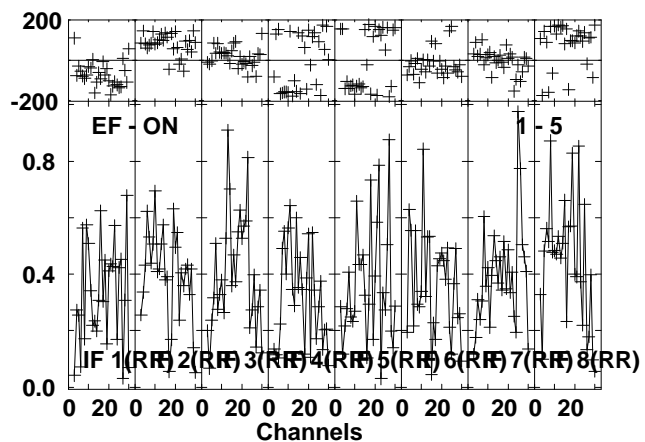
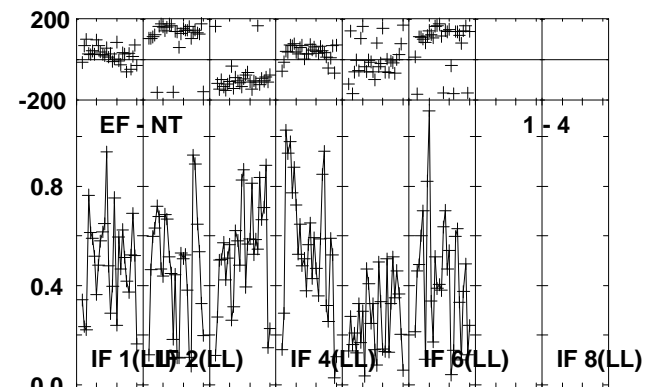
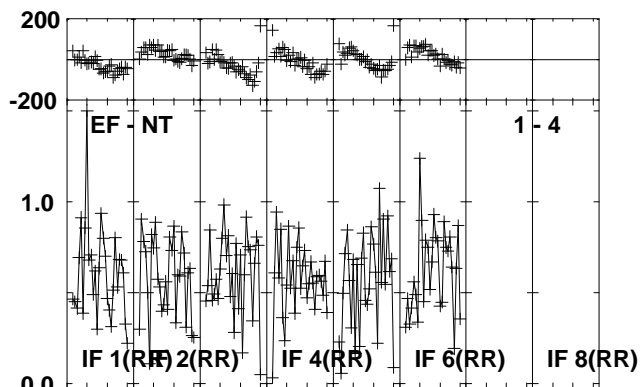
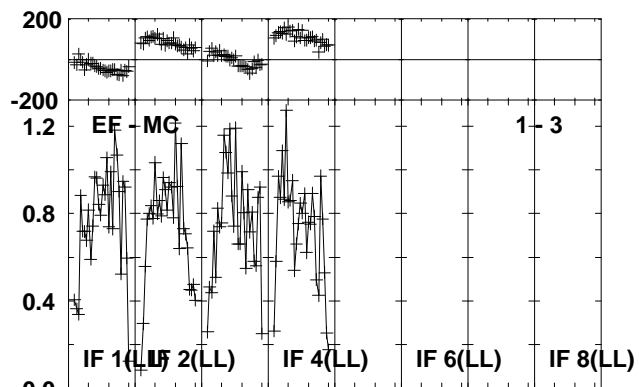
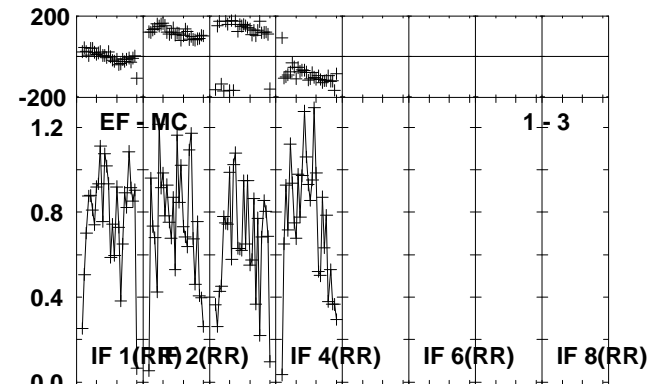
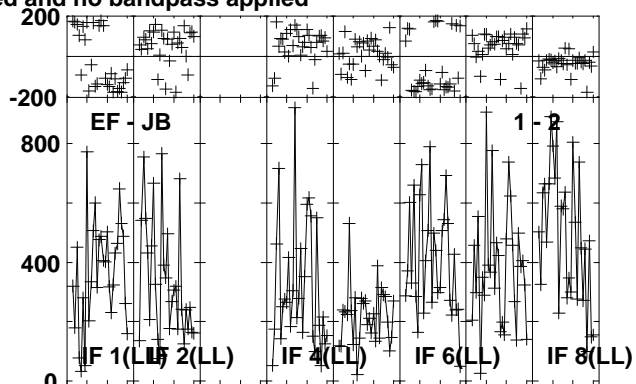
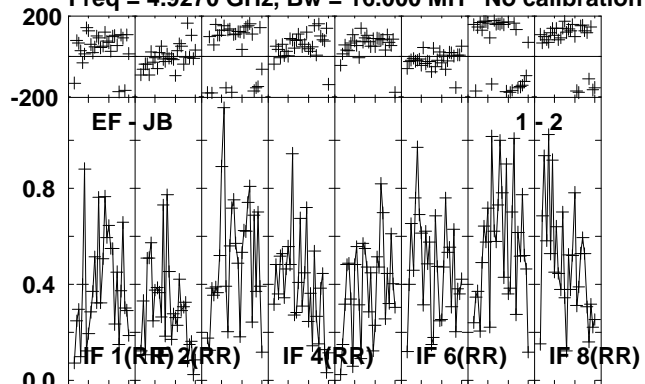

Lower frame: Milli Ampl Jy Top frame: Phas deg
Vector averaged cross-power spectrum Several baselines displayed
Timerange: 00/02:16:03 to 00/02:17:03

Plot file version 66 created 16-OCT-2012 11:56:52

J0639+0601 RO006.UVDATA.1

Freq = 4.9270 GHz, Bw = 16.000 MH No calibration applied and no bandpass applied

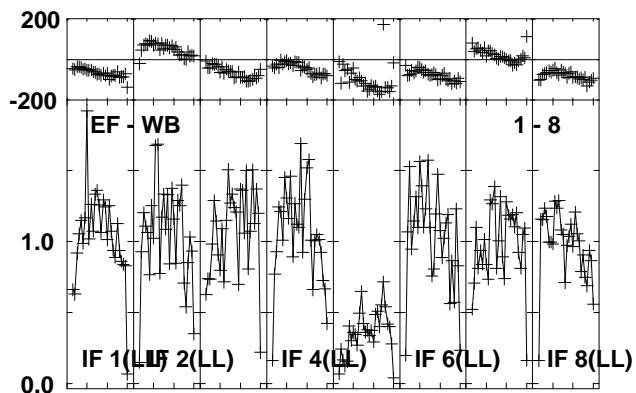
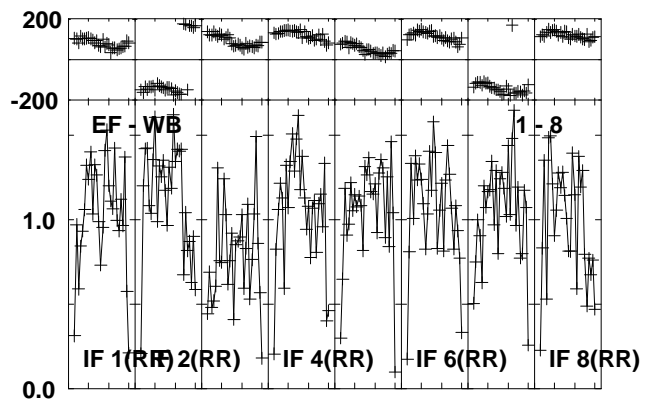
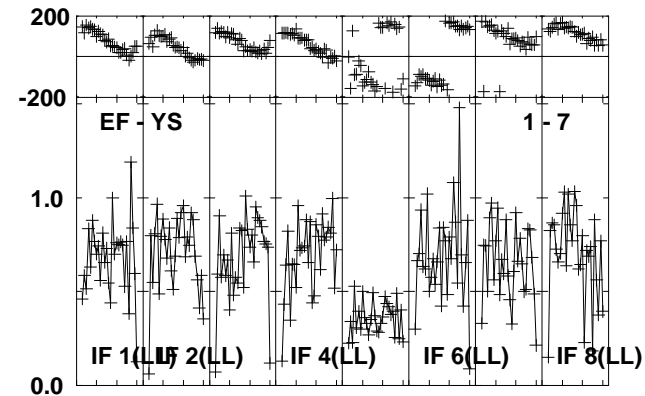
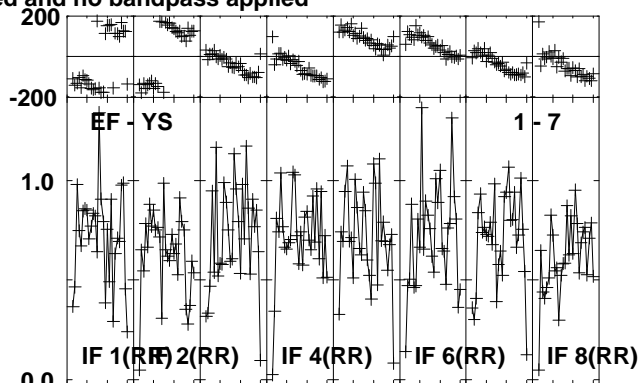
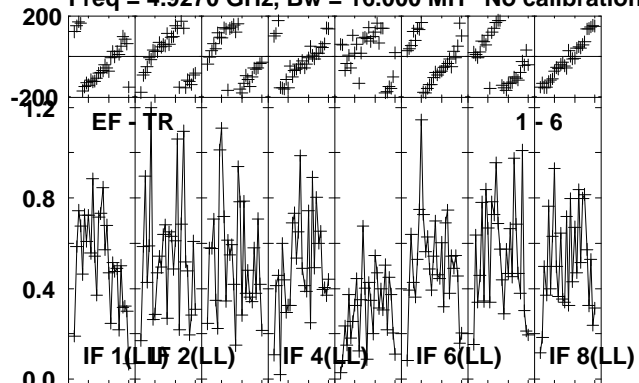

Lower frame: Milli Ampl Jy Top frame: Phas deg
Vector averaged cross-power spectrum Several baselines displayed
Timerange: 00/02:16:03 to 00/02:17:03

Plot file version 67 created 16-OCT-2012 11:56:52

J0645+0541 RO006.UVDATA.1

Freq = 4.9270 GHz, Bw = 16.000 MH No calibration applied and no bandpass applied

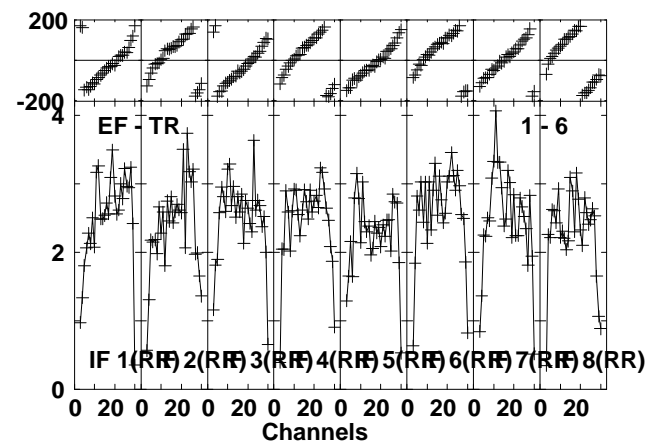
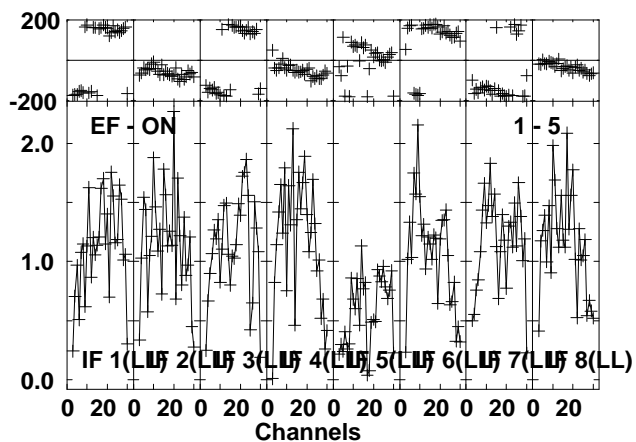
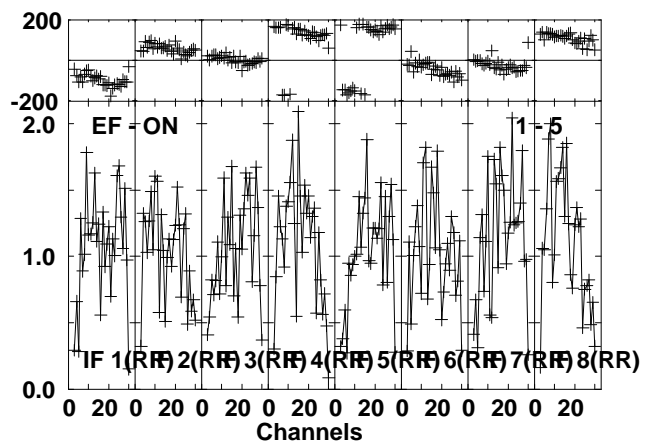
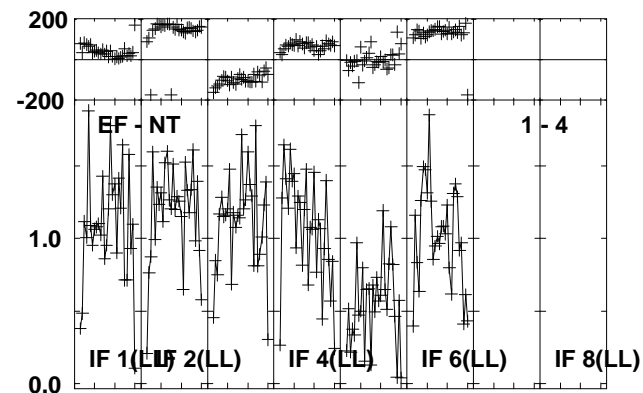
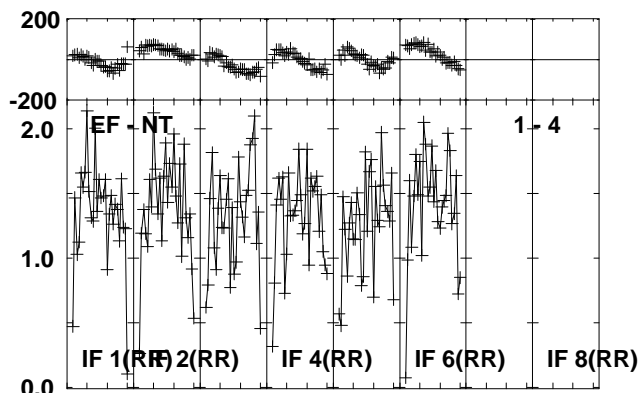
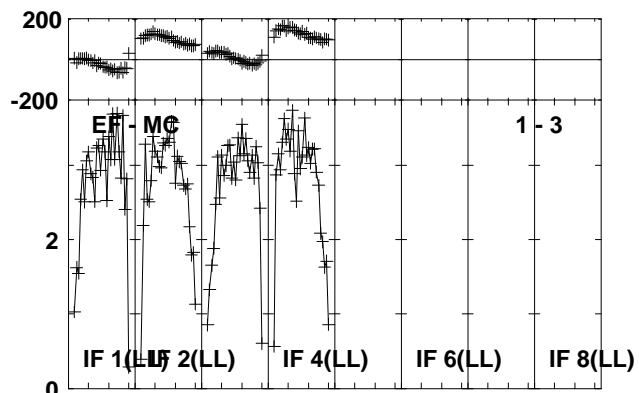
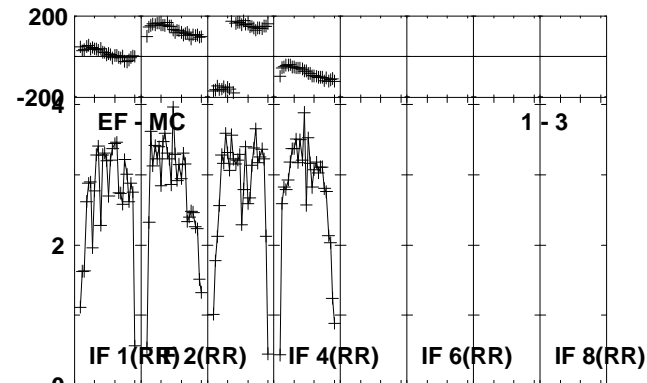
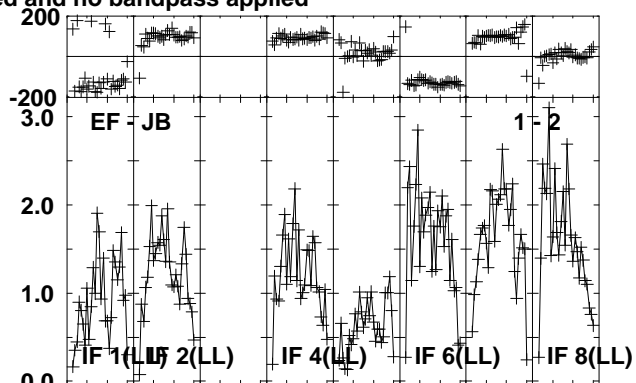
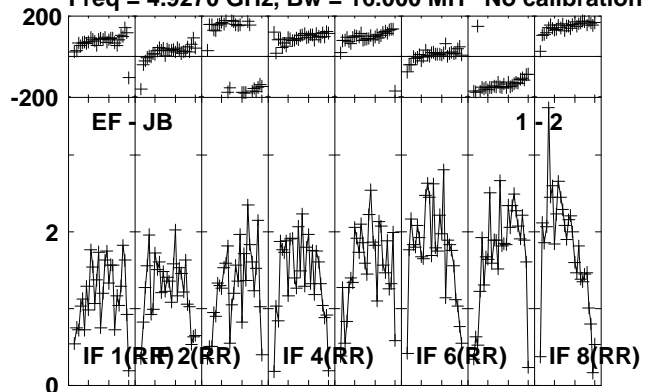

Lower frame: Milli Ampl Jy Top frame: Phas deg
Vector averaged cross-power spectrum Several baselines displayed
Timerange: 00/02:17:07 to 00/02:18:03

Plot file version 68 created 16-OCT-2012 11:56:53

J0645+0541 RO006.UVDATA.1

Freq = 4.9270 GHz, Bw = 16.000 MH No calibration applied and no bandpass applied

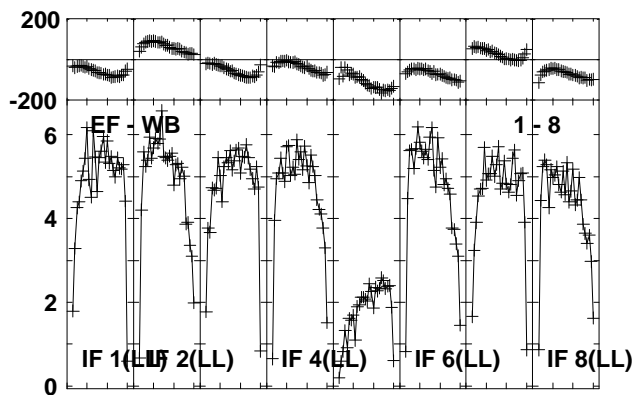
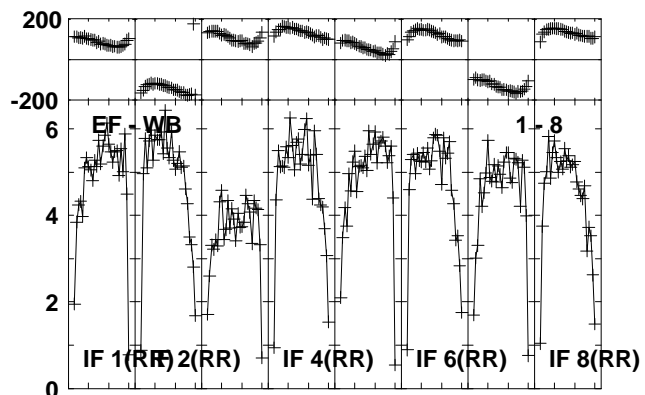
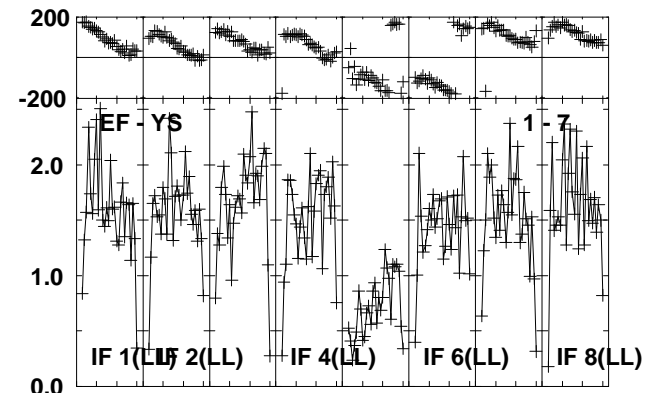
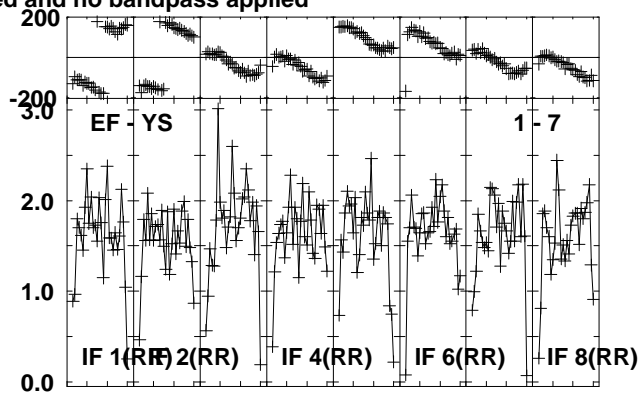
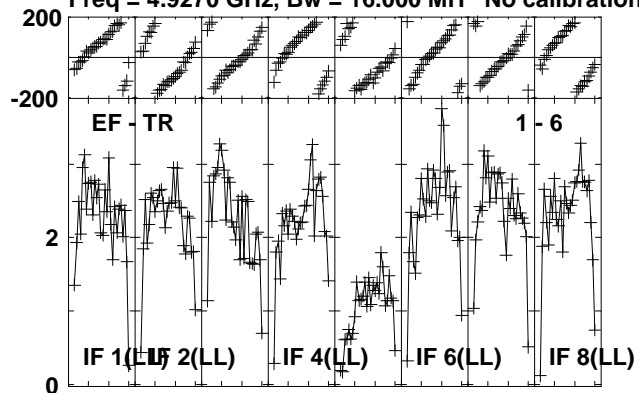

Lower frame: Milli Ampl Jy Top frame: Phas deg
Vector averaged cross-power spectrum Several baselines displayed
Timerange: 00/02:17:07 to 00/02:18:03

Plot file version 69 created 16-OCT-2012 11:56:53

NOVA-MON RO006.UVDATA.1

Freq = 4.9270 GHz, Bw = 16.000 MH No calibration applied and no bandpass applied

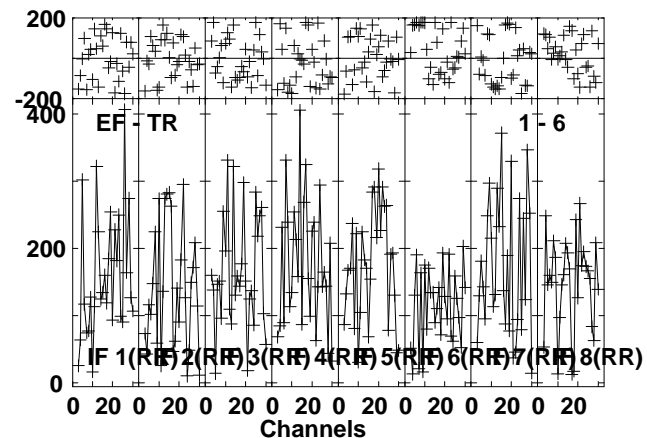
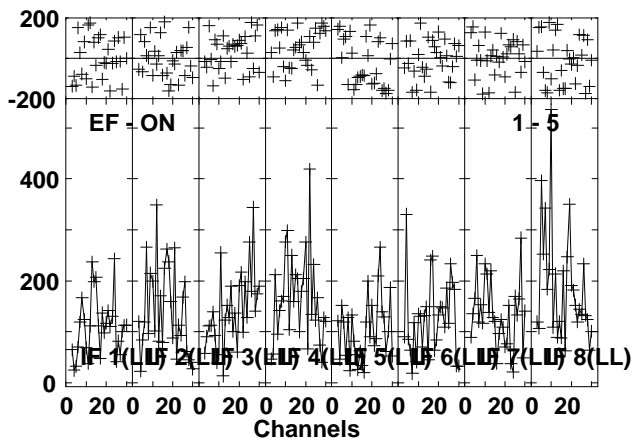
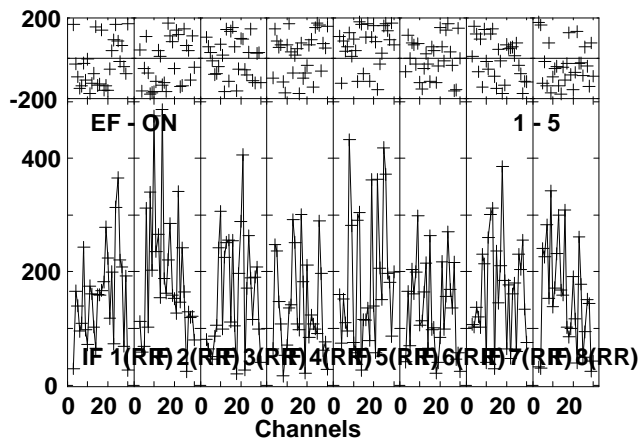
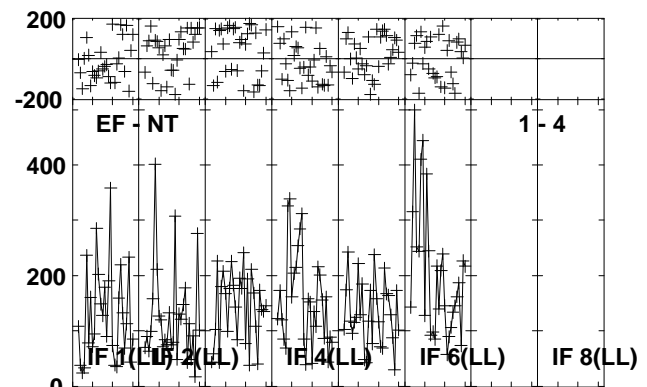
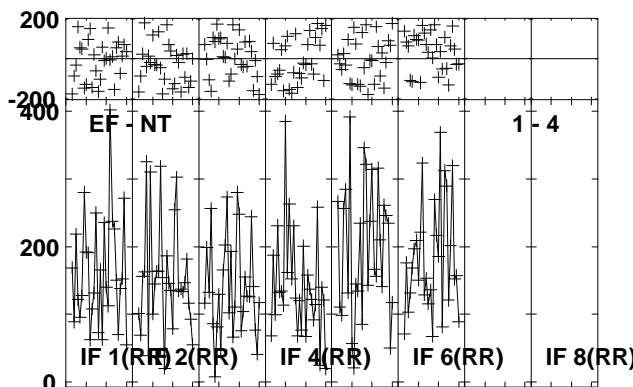
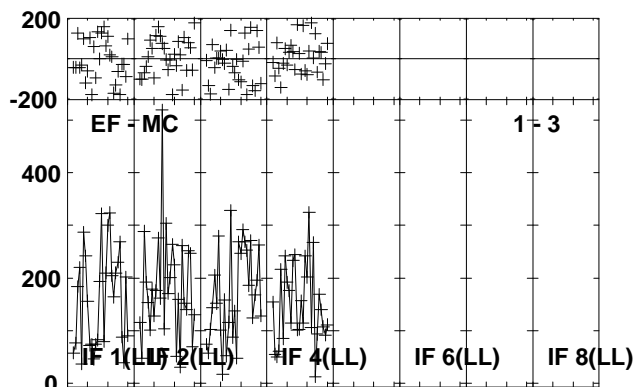
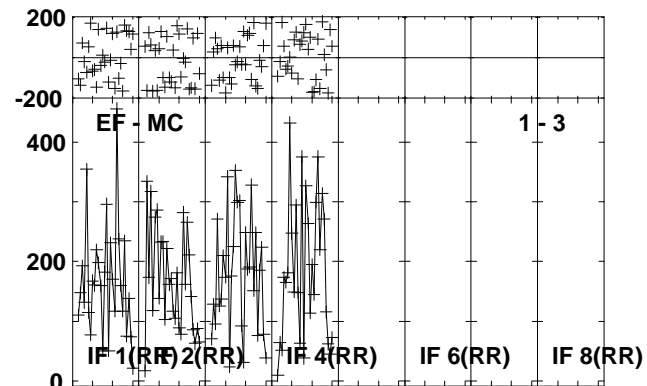
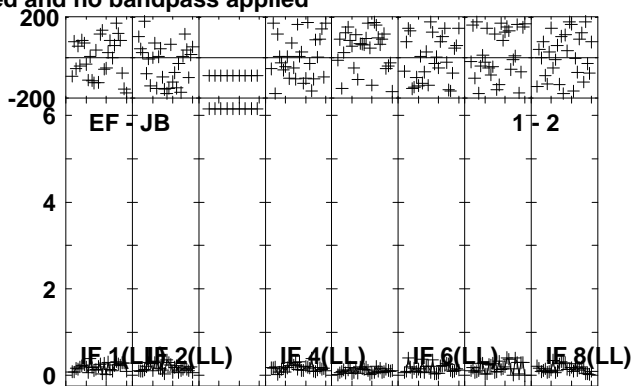
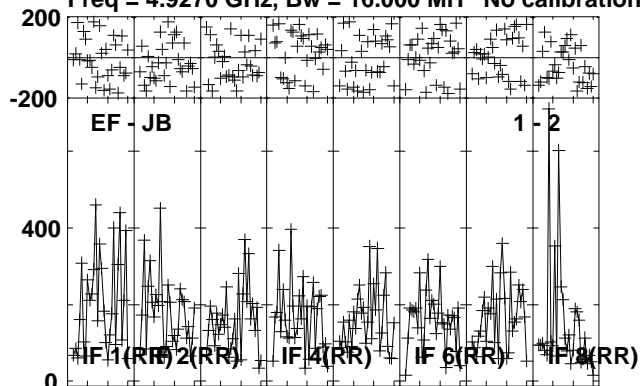

Lower frame: Micro Ampl Jy Top frame: Phas deg
Vector averaged cross-power spectrum Several baselines displayed
Timerange: 00/02:18:07 to 00/02:21:03

Plot file version 70 created 16-OCT-2012 11:56:53

NOVA-MON RO006.UVDATA.1

Freq = 4.9270 GHz, Bw = 16.000 MH No calibration applied and no bandpass applied

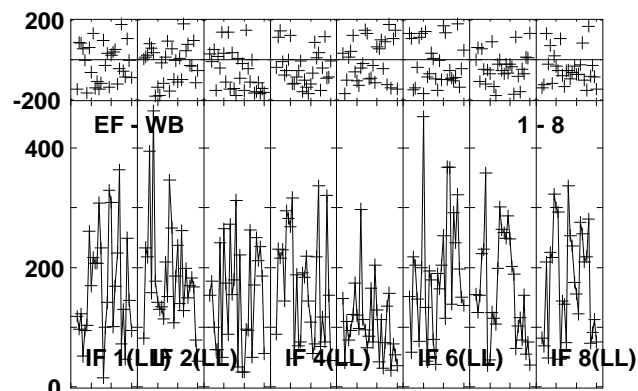
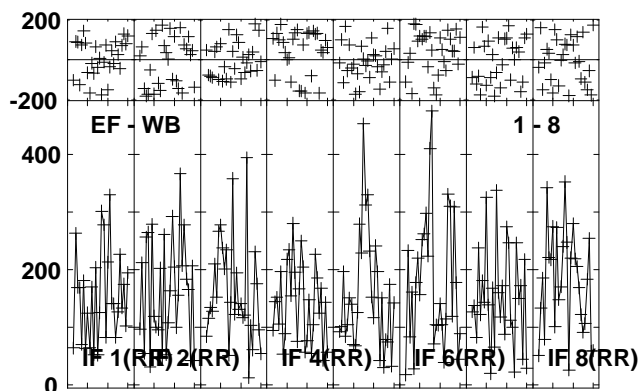
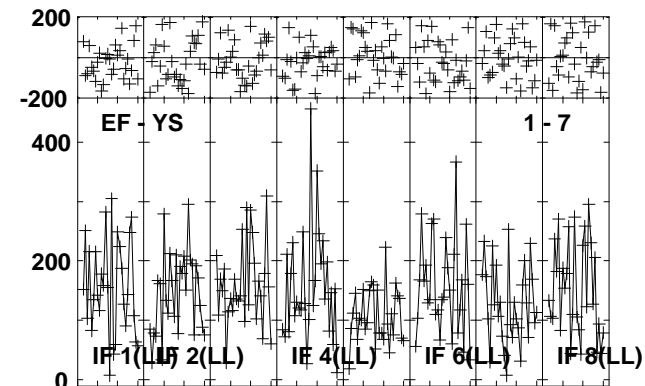
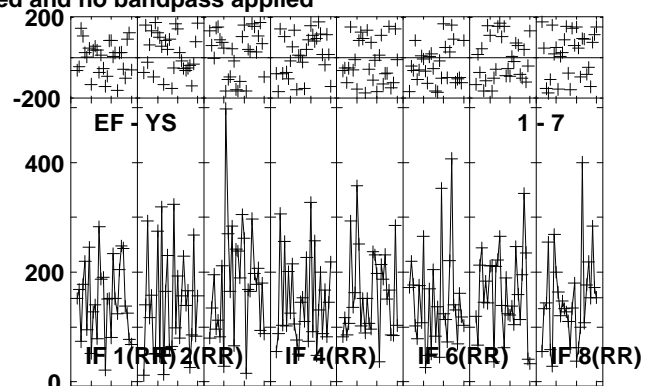
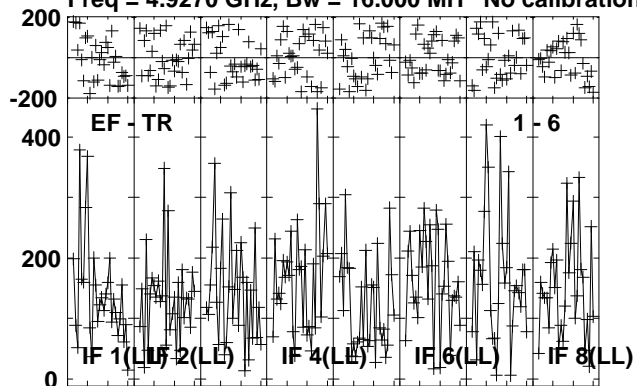

Lower frame: Micro Ampl Jy Top frame: Phas deg
Vector averaged cross-power spectrum Several baselines displayed
Timerange: 00/02:18:07 to 00/02:21:03

Plot file version 71 created 16-OCT-2012 11:56:54

J0639+0601 RO006.UVDATA.1

Freq = 4.9270 GHz, Bw = 16.000 MH No calibration applied and no bandpass applied

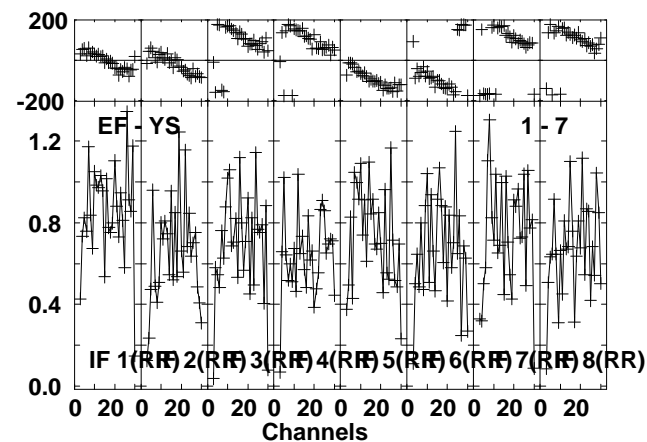
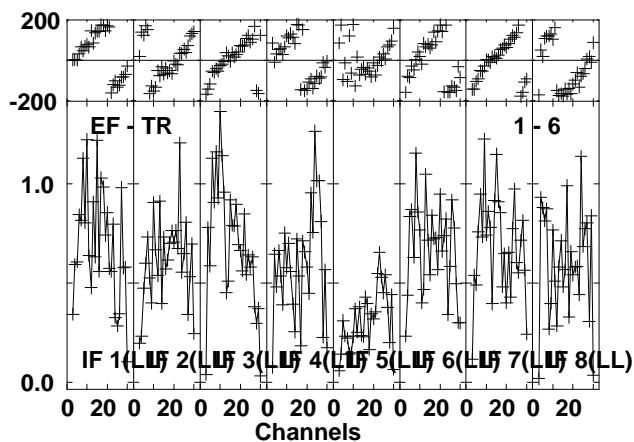
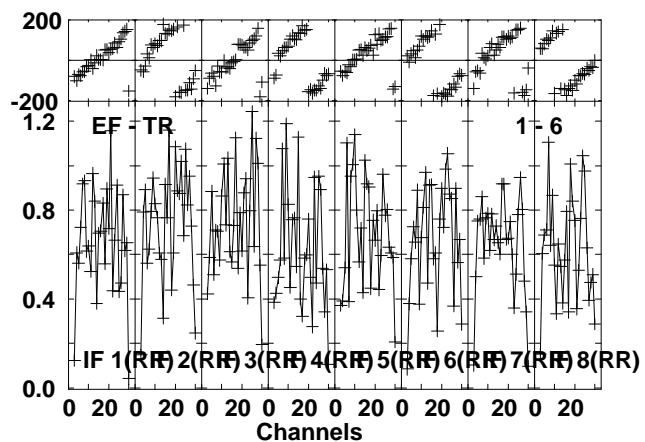
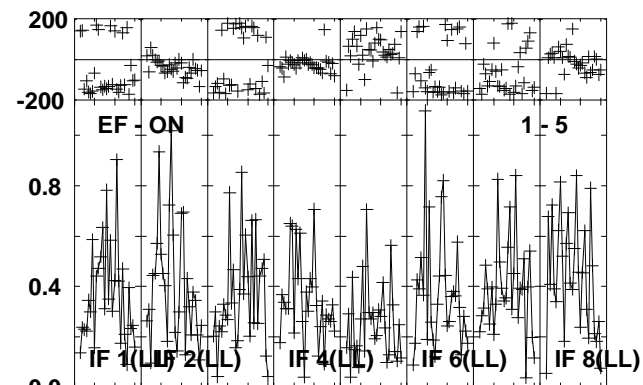
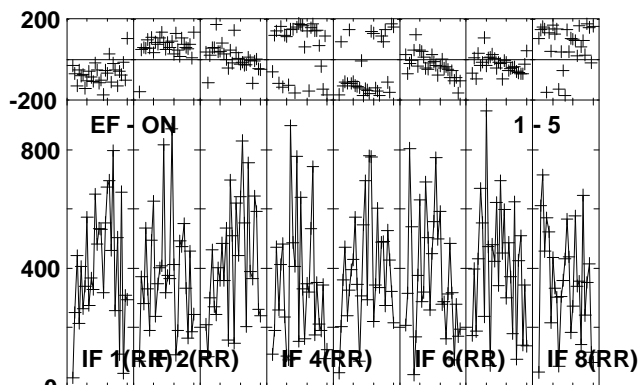
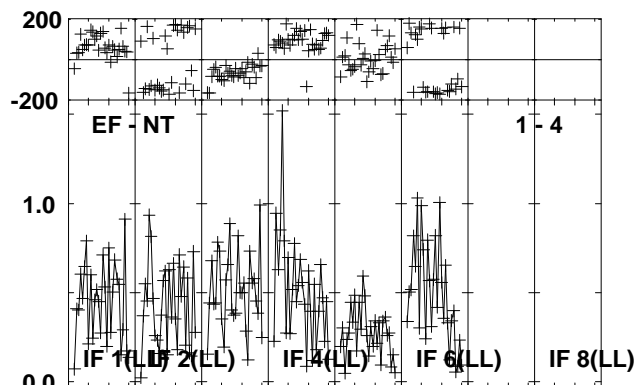
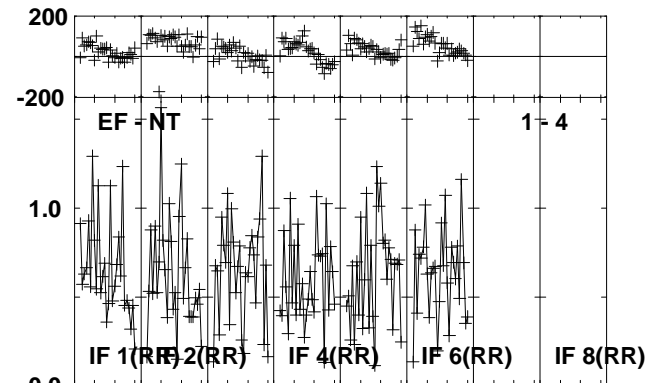
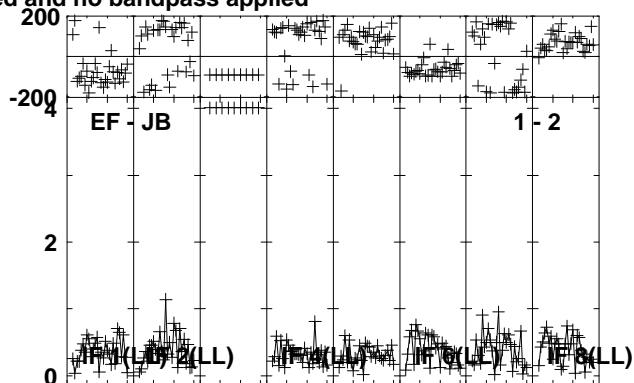
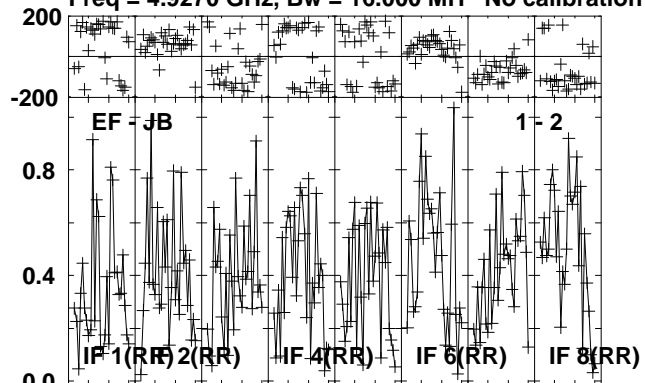

Lower frame: Milli Ampl Jy Top frame: Phas deg
Vector averaged cross-power spectrum Several baselines displayed
Timerange: 00/02:21:07 to 00/02:22:19

Plot file version 72 created 16-OCT-2012 11:56:54

J0639+0601 RO006.UVDATA.1

Freq = 4.9270 GHz, Bw = 16.000 MH No calibration applied and no bandpass applied

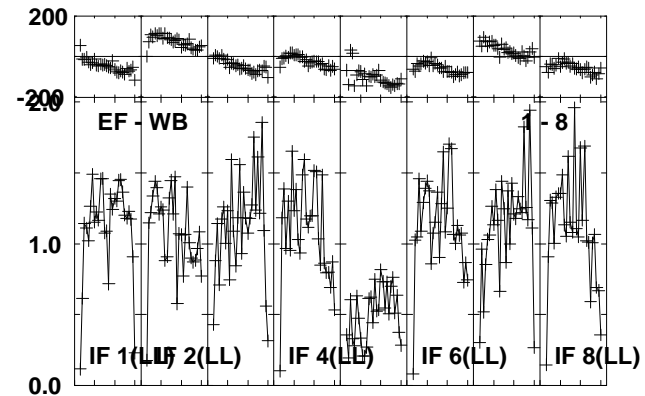
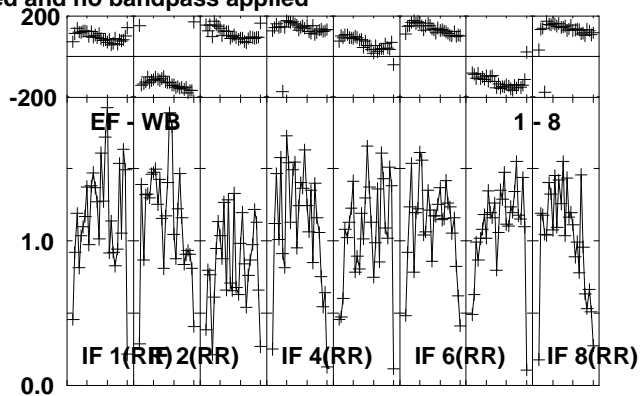
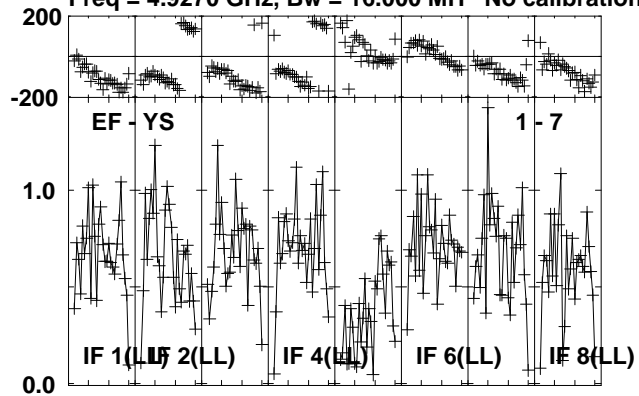

Lower frame: Milli Ampl Jy Top frame: Phas deg
Vector averaged cross-power spectrum Several baselines displayed
Timerange: 00/02:21:07 to 00/02:22:19

Plot file version 73 created 16-OCT-2012 11:56:54

J0645+0541 RO006.UVDATA.1

Freq = 4.9270 GHz, Bw = 16.000 MH No calibration applied and no bandpass applied

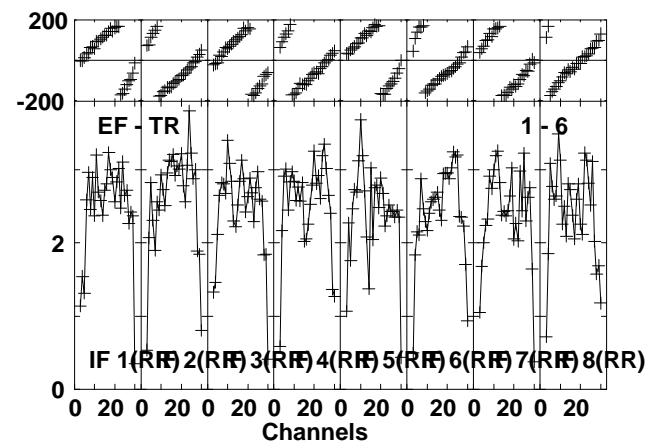
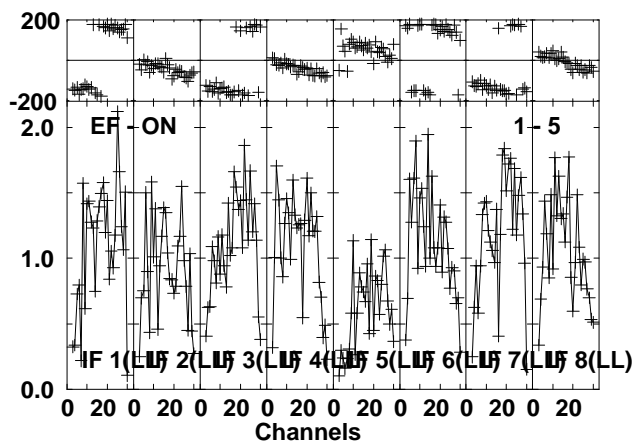
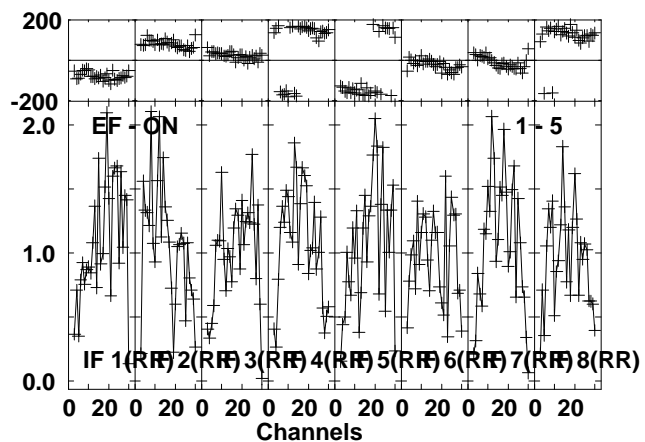
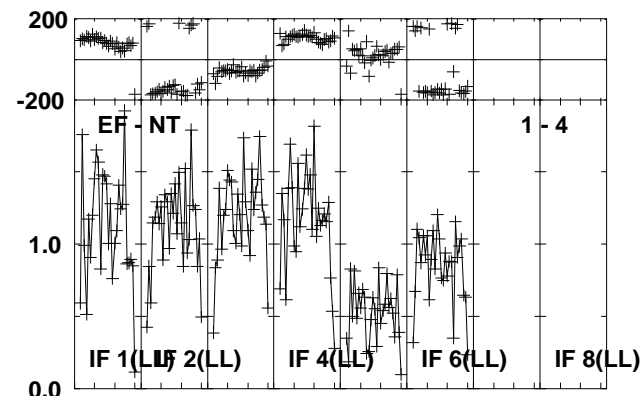
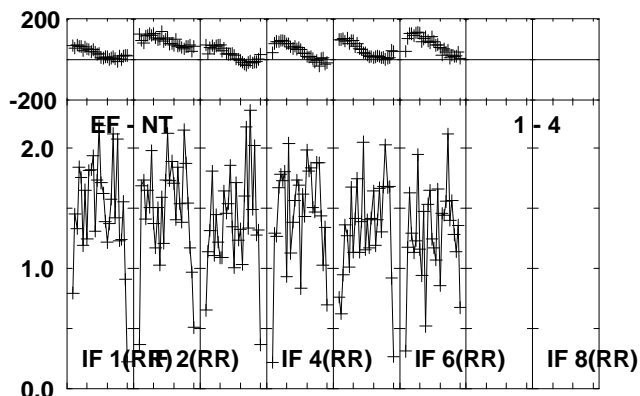
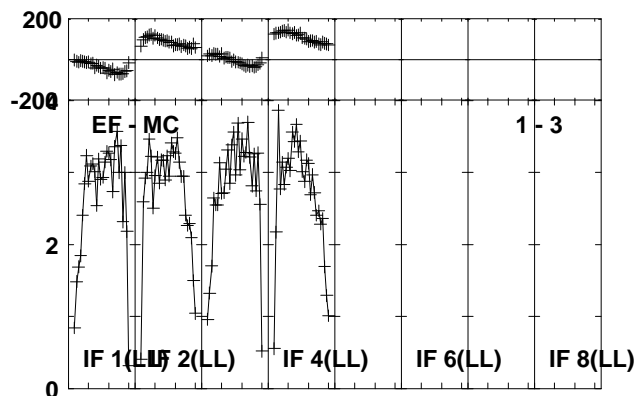
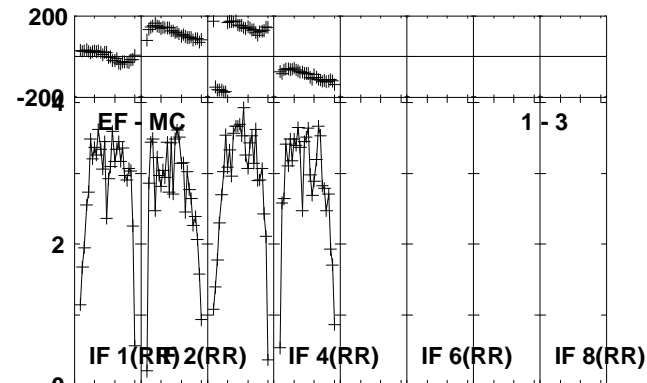
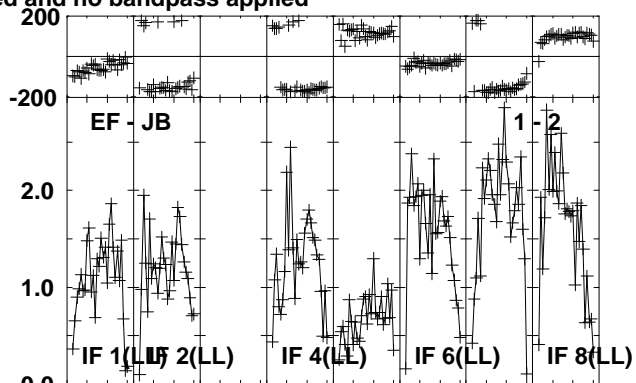
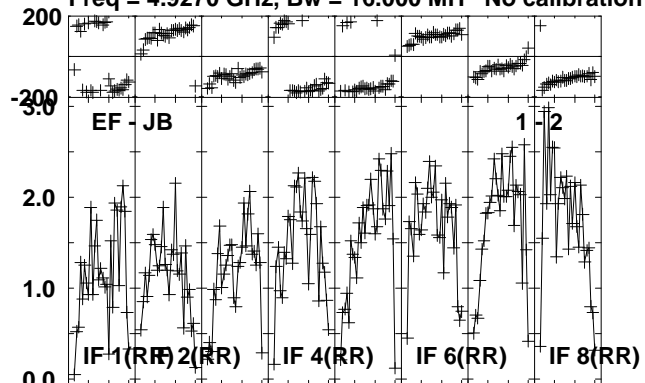

Lower frame: Milli Ampl Jy Top frame: Phas deg
Vector averaged cross-power spectrum Several baselines displayed
Timerange: 00/02:22:23 to 00/02:23:19

Plot file version 74 created 16-OCT-2012 11:56:54

J0645+0541 RO006.UVDATA.1

Freq = 4.9270 GHz, Bw = 16.000 MH No calibration applied and no bandpass applied

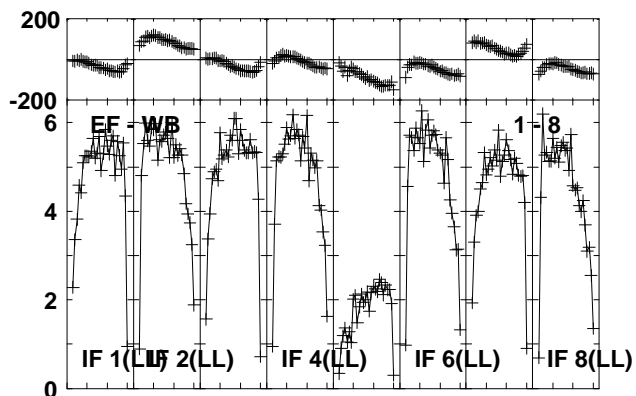
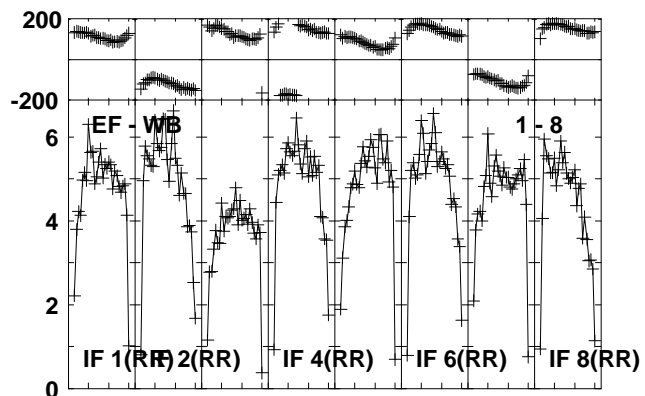
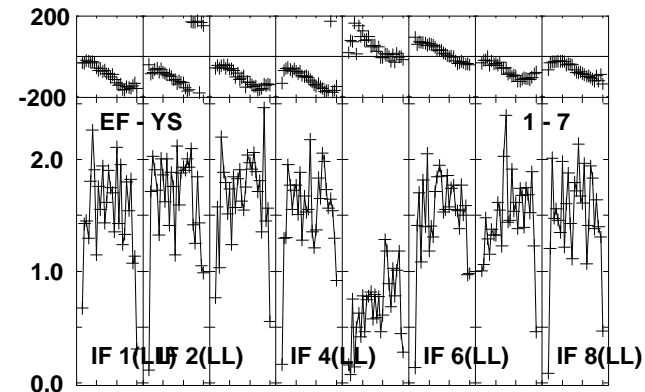
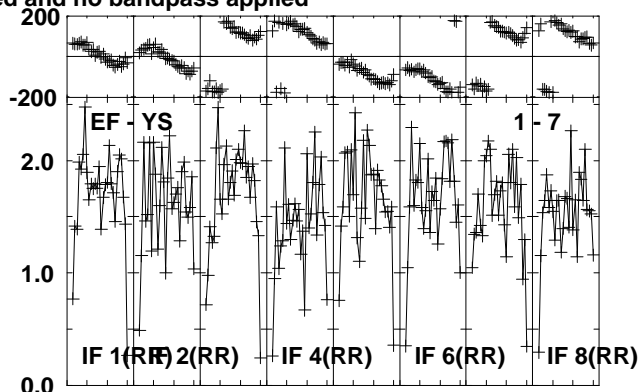
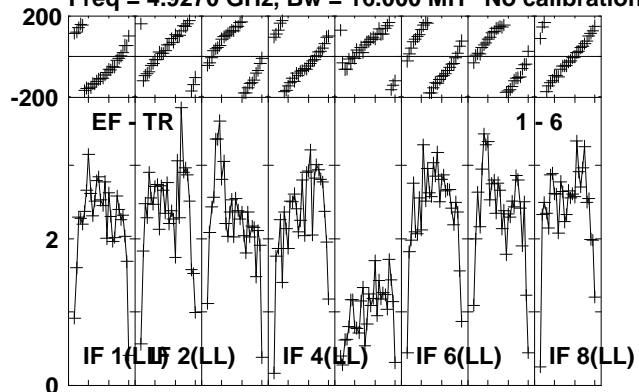

Lower frame: Milli Ampl Jy Top frame: Phas deg
Vector averaged cross-power spectrum Several baselines displayed
Timerange: 00/02:22:23 to 00/02:23:19

Plot file version 75 created 16-OCT-2012 11:56:54

NOVA-MON RO006.UVDATA.1

Freq = 4.9270 GHz, Bw = 16.000 MH No calibration applied and no bandpass applied

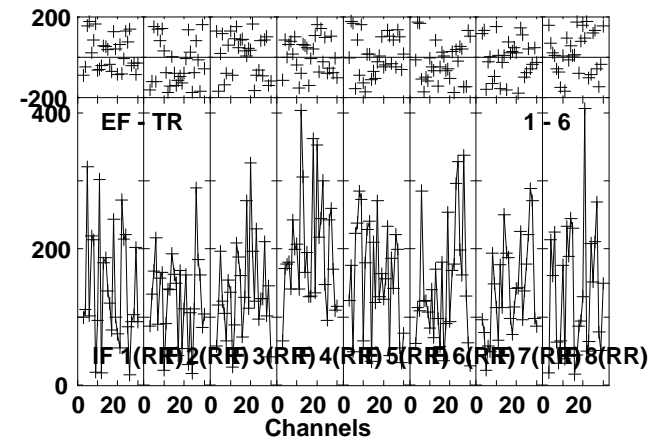
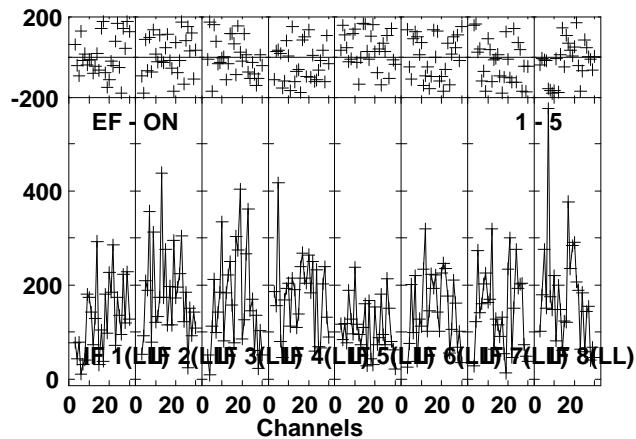
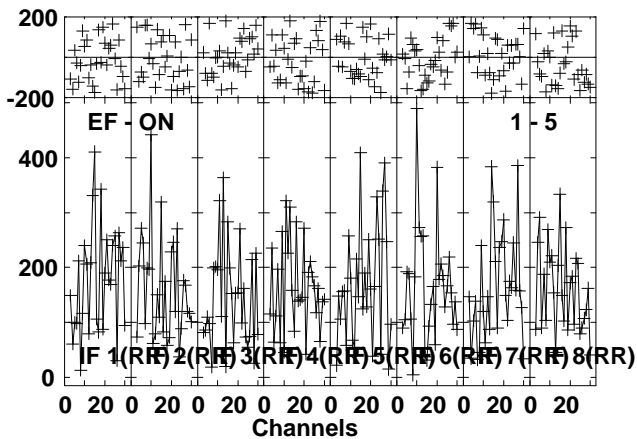
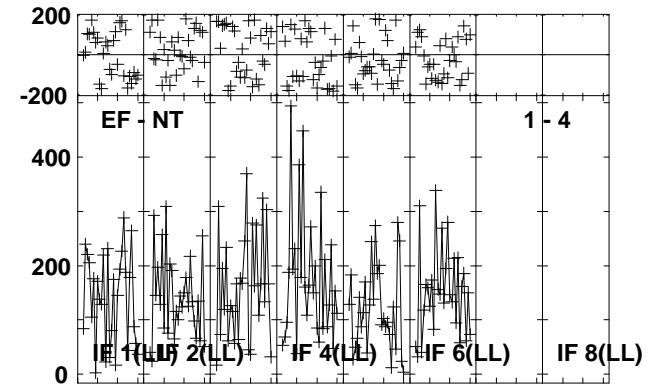
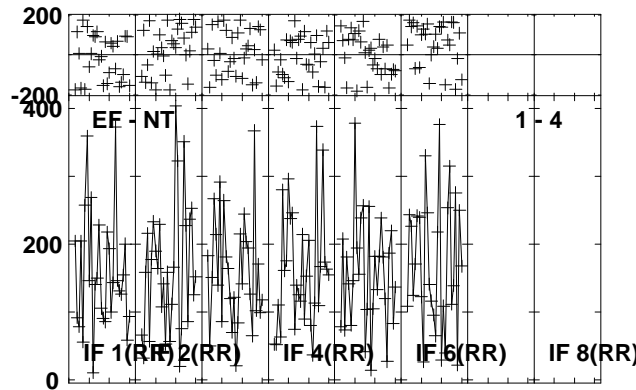
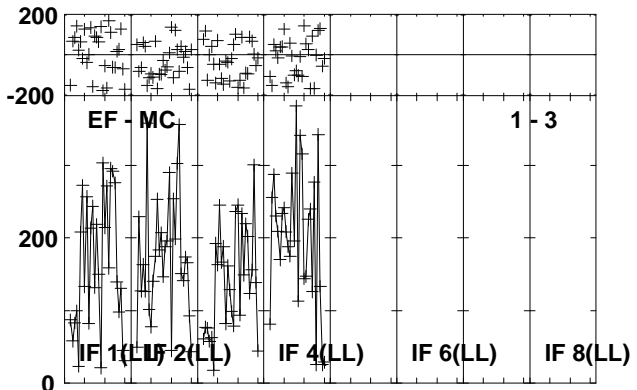
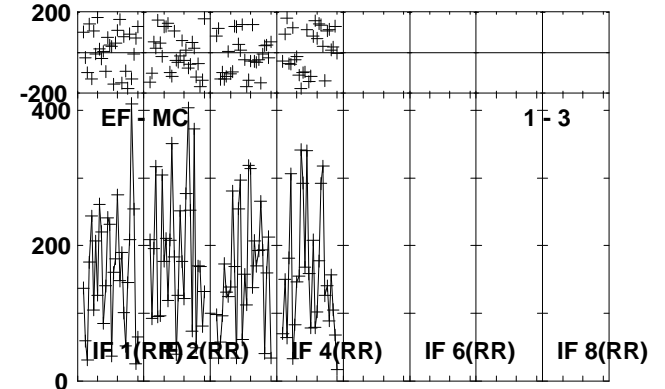
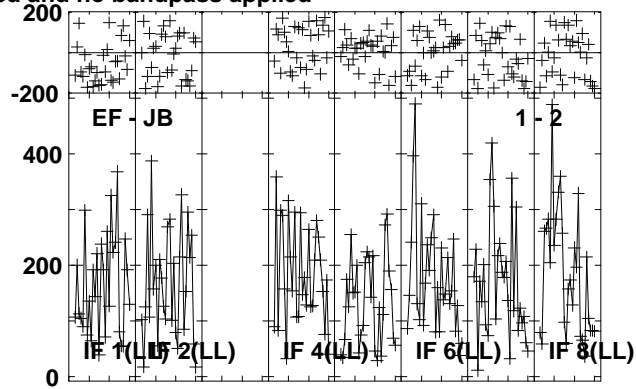
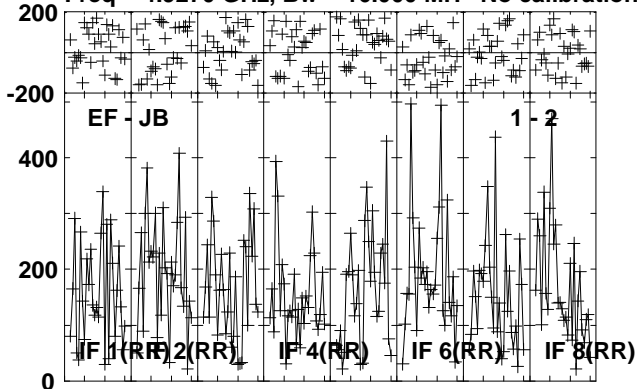

Lower frame: Micro Ampl Jy Top frame: Phas deg
Vector averaged cross-power spectrum Several baselines displayed
Timerange: 00/02:23:23 to 00/02:26:19

Plot file version 76 created 16-OCT-2012 11:56:55

NOVA-MON RO006.UVDATA.1

Freq = 4.9270 GHz, Bw = 16.000 MH No calibration applied and no bandpass applied

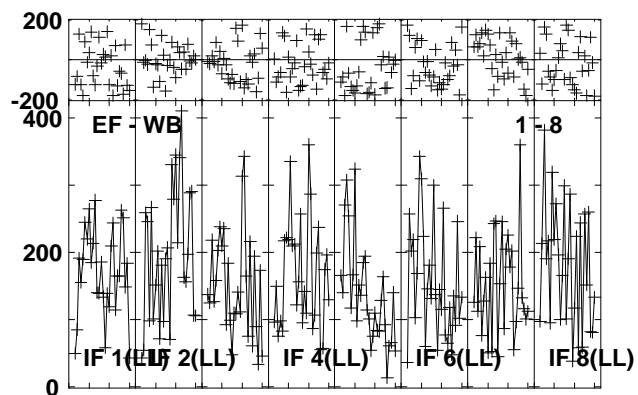
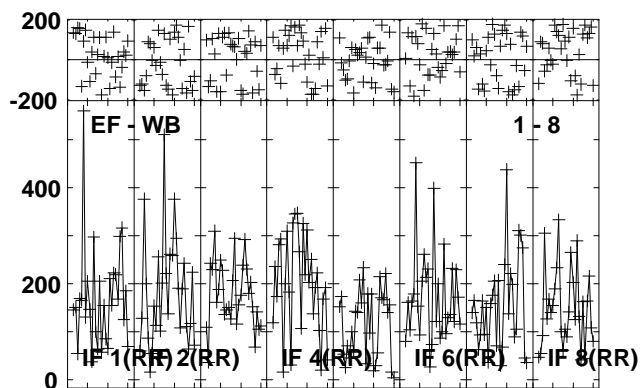
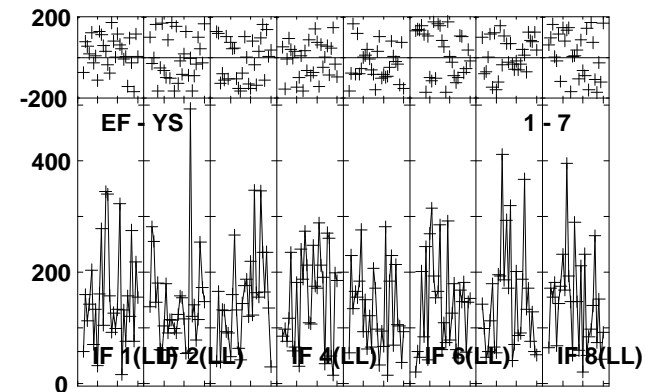
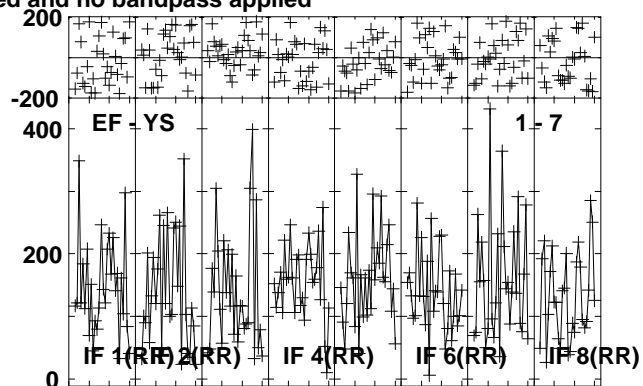
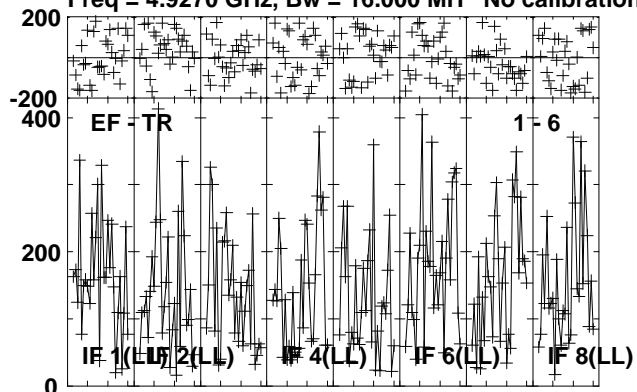

Lower frame: Micro Ampl Jy Top frame: Phas deg
Vector averaged cross-power spectrum Several baselines displayed
Timerange: 00/02:23:23 to 00/02:26:19

Plot file version 77 created 16-OCT-2012 11:56:55

J0639+0601 RO006.UVDATA.1

Freq = 4.9270 GHz, Bw = 16.000 MH No calibration applied and no bandpass applied

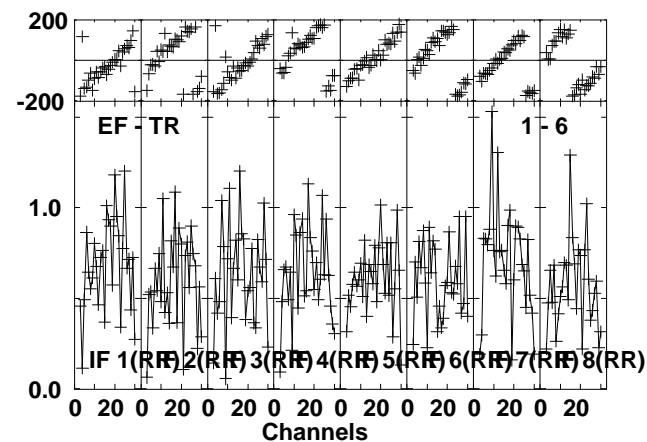
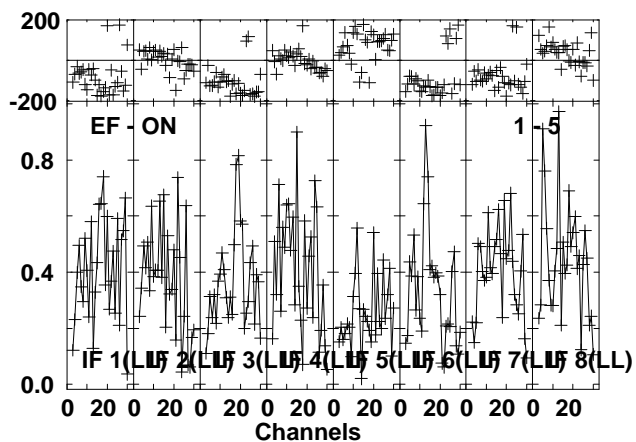
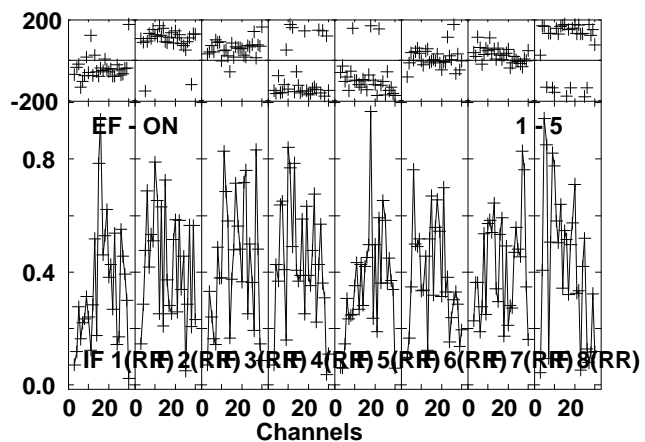
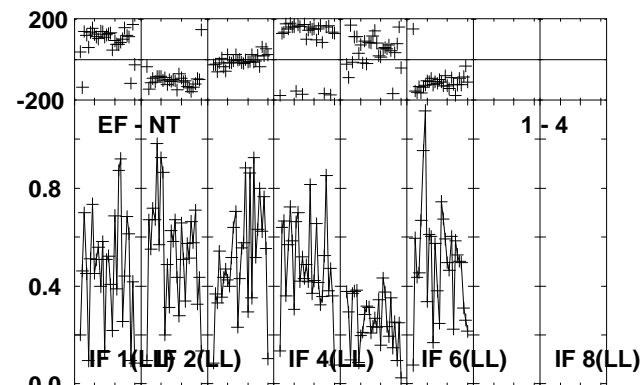
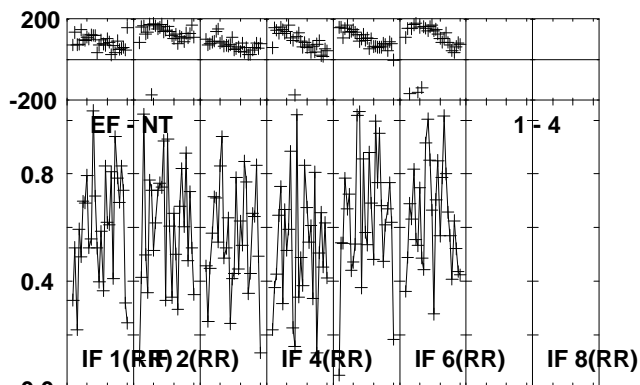
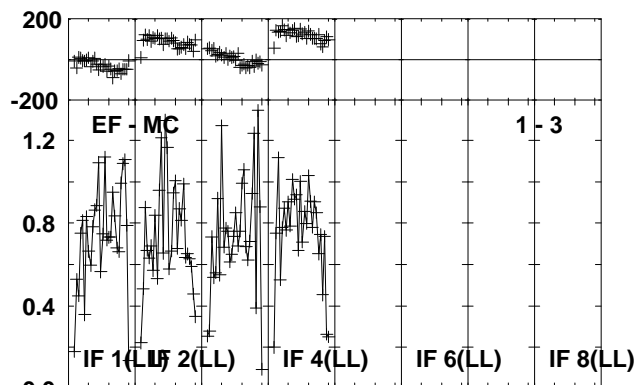
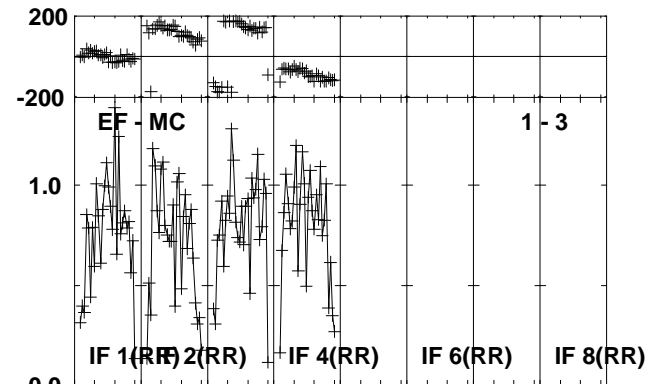
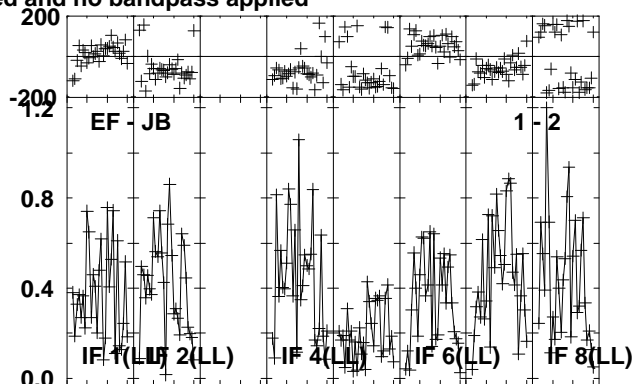
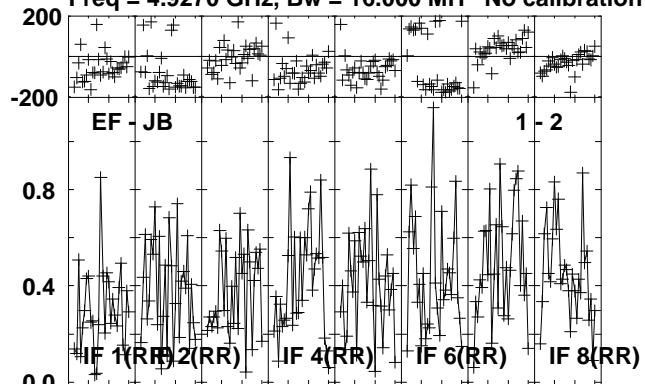

Lower frame: Milli Ampl Jy Top frame: Phas deg
Vector averaged cross-power spectrum Several baselines displayed
Timerange: 00/02:26:47 to 00/02:27:49

Plot file version 78 created 16-OCT-2012 11:56:56

J0639+0601 RO006.UVDATA.1

Freq = 4.9270 GHz, Bw = 16.000 MH No calibration applied and no bandpass applied

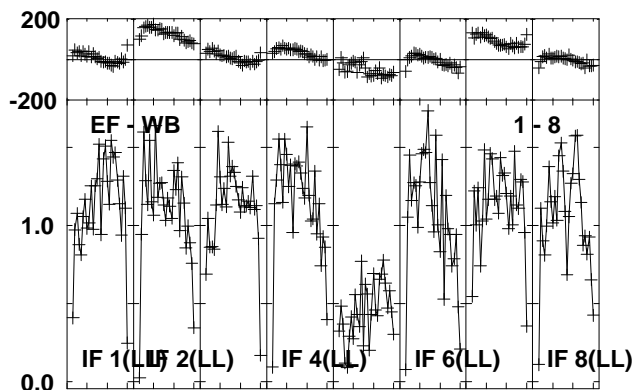
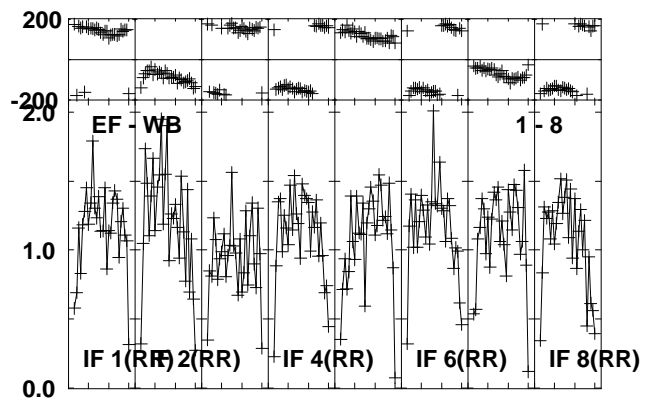
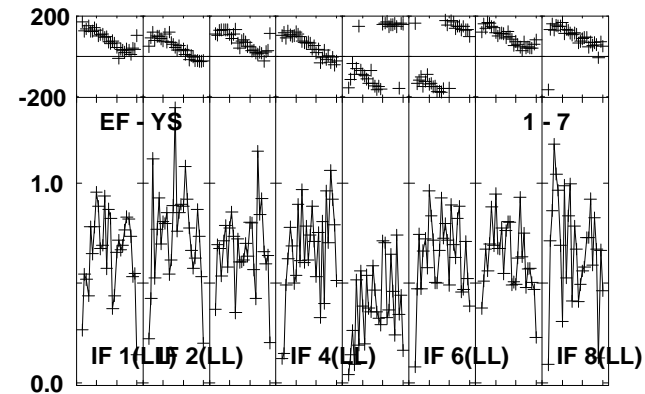
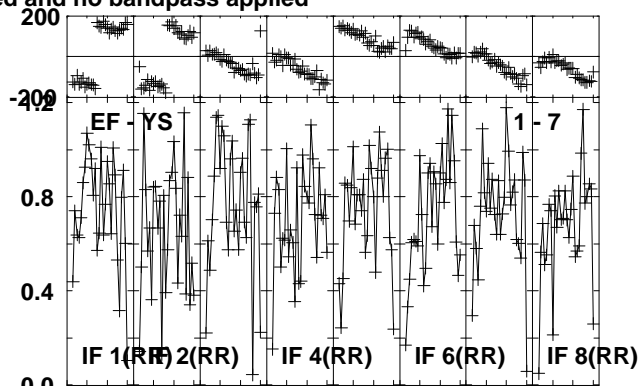
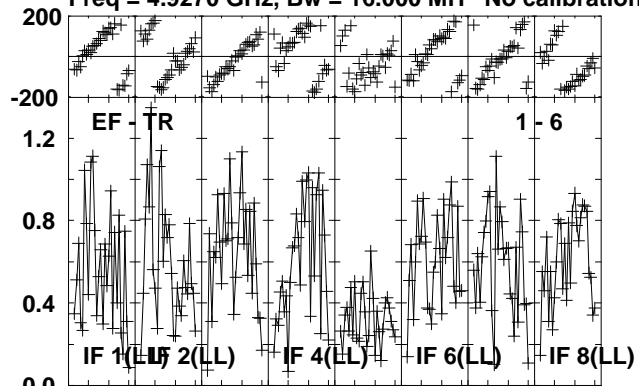

Lower frame: Milli Ampl Jy Top frame: Phas deg
Vector averaged cross-power spectrum Several baselines displayed
Timerange: 00/02:26:47 to 00/02:27:49

Plot file version 79 created 16-OCT-2012 11:56:56

J0645+0541 RO006.UVDATA.1

Freq = 4.9270 GHz, Bw = 16.000 MH No calibration applied and no bandpass applied

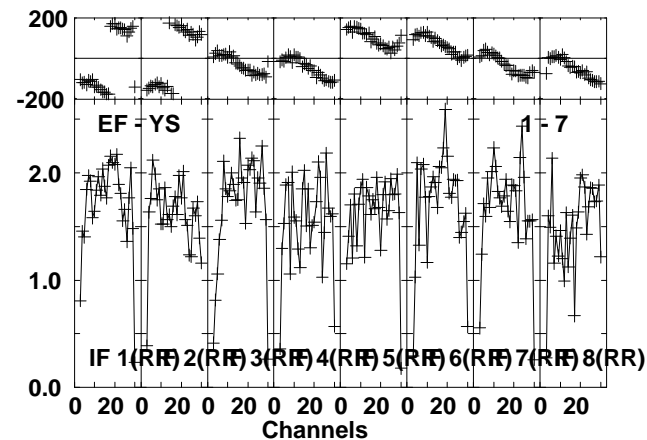
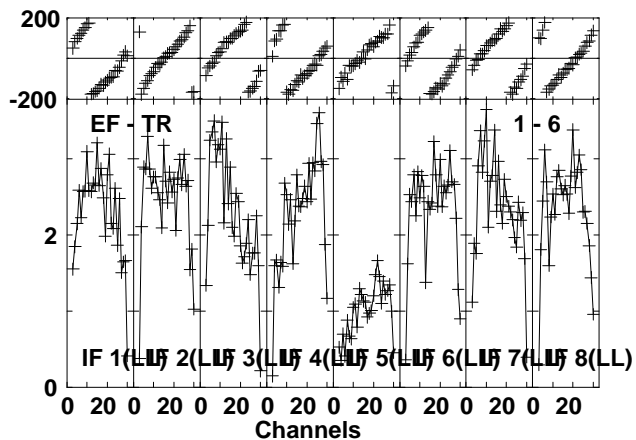
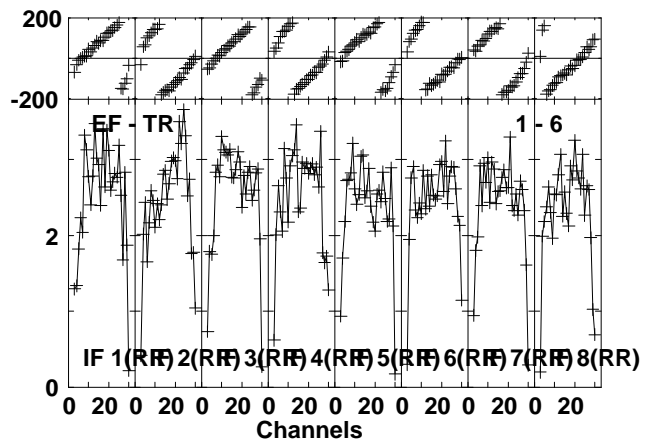
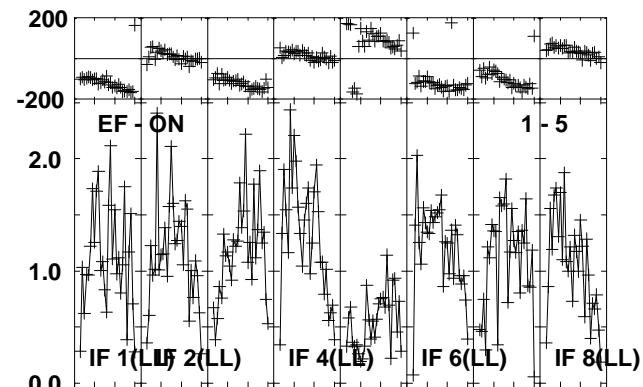
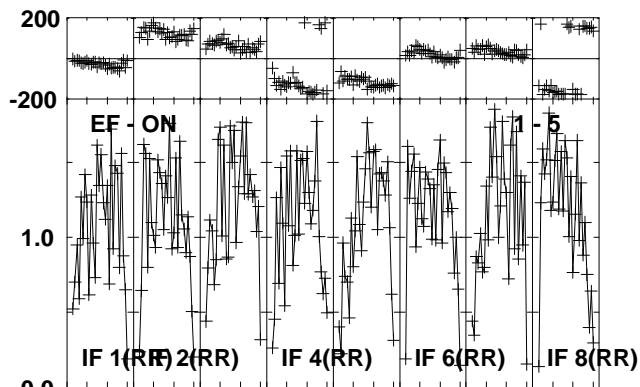
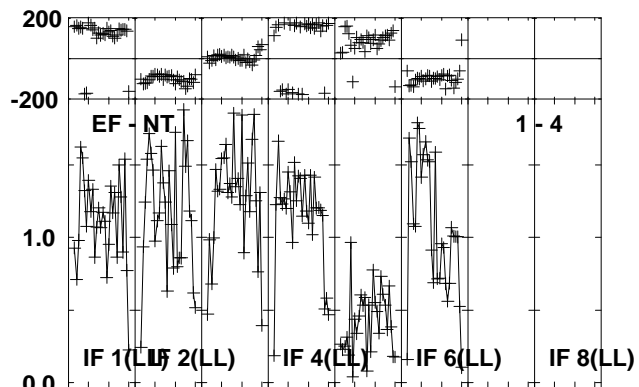
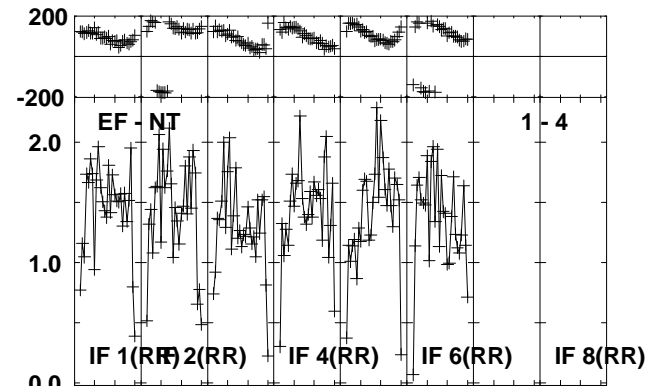
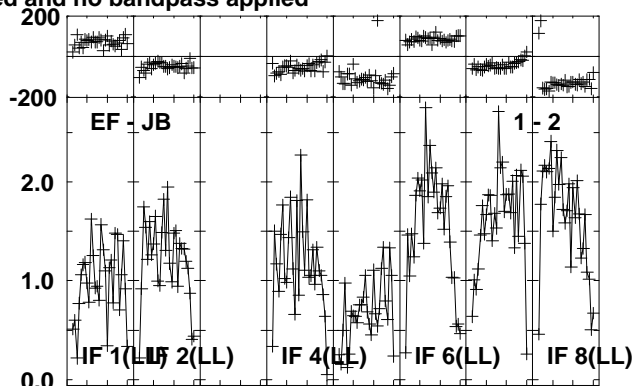
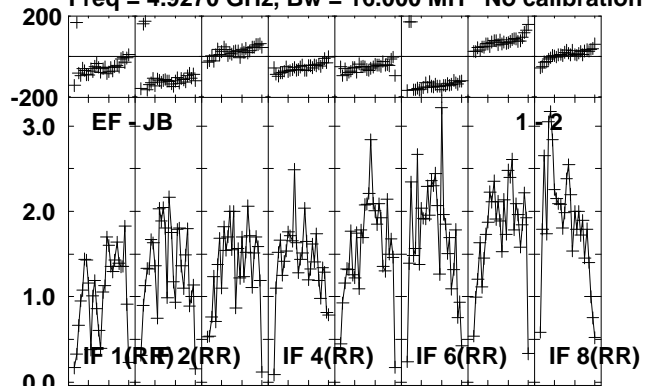

Lower frame: Milli Ampl Jy Top frame: Phas deg
Vector averaged cross-power spectrum Several baselines displayed
Timerange: 00/02:27:53 to 00/02:28:49

Plot file version 80 created 16-OCT-2012 11:56:56

J0645+0541 RO006.UVDATA.1

Freq = 4.9270 GHz, Bw = 16.000 MH No calibration applied and no bandpass applied

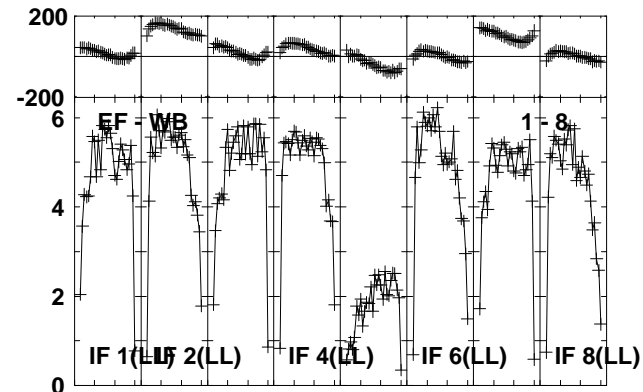
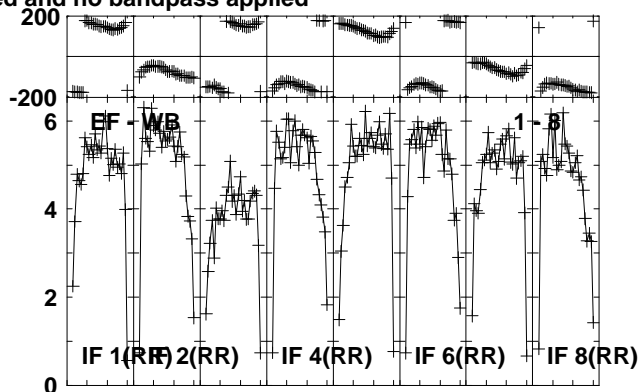
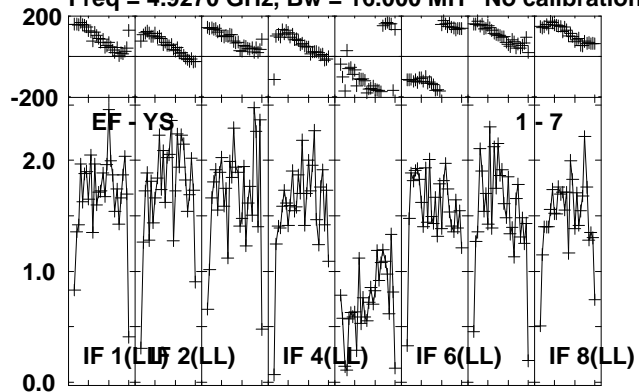

Lower frame: Milli Ampl Jy Top frame: Phas deg
Vector averaged cross-power spectrum Several baselines displayed
Timerange: 00/02:27:53 to 00/02:28:49

Plot file version 81 created 16-OCT-2012 11:56:56

NOVA-MON RO006.UVDATA.1

Freq = 4.9270 GHz, Bw = 16.000 MH No calibration applied and no bandpass applied

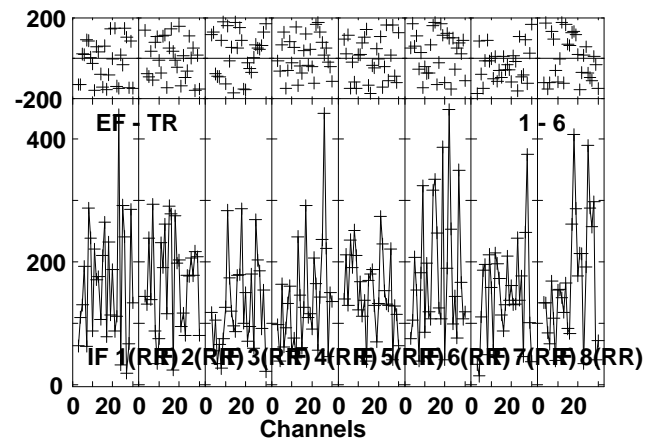
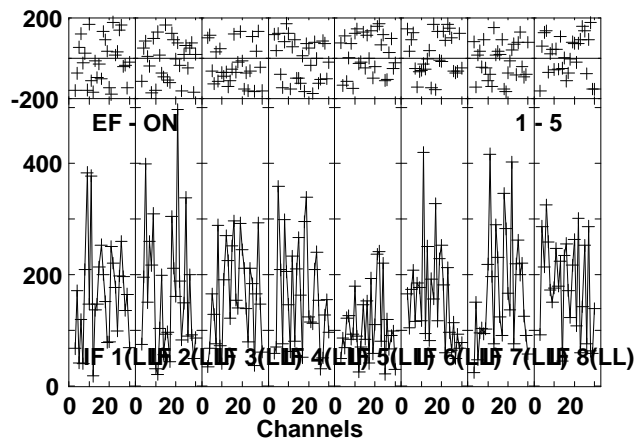
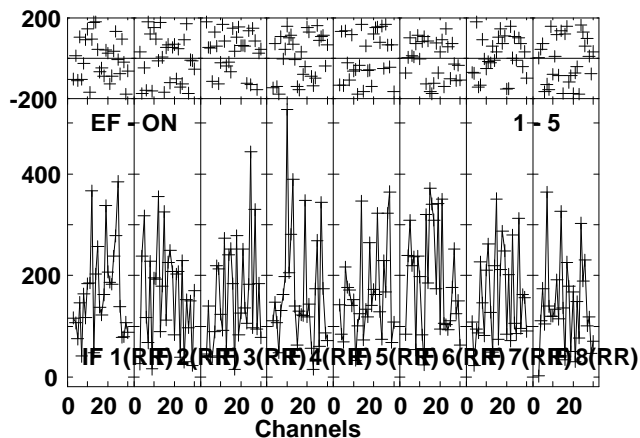
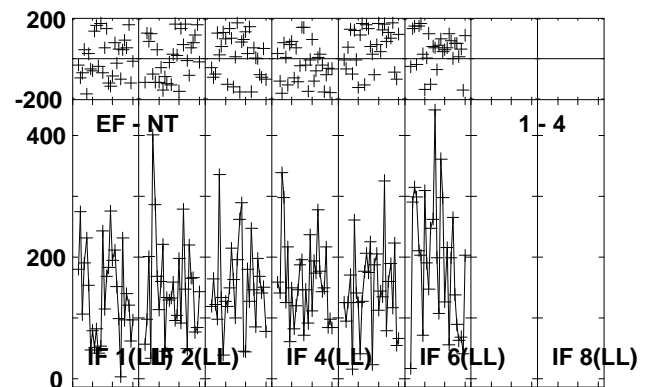
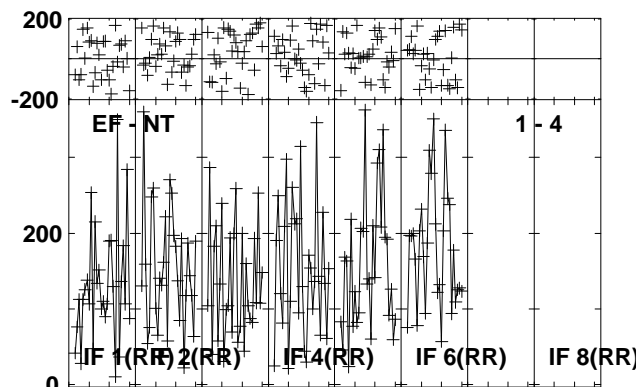
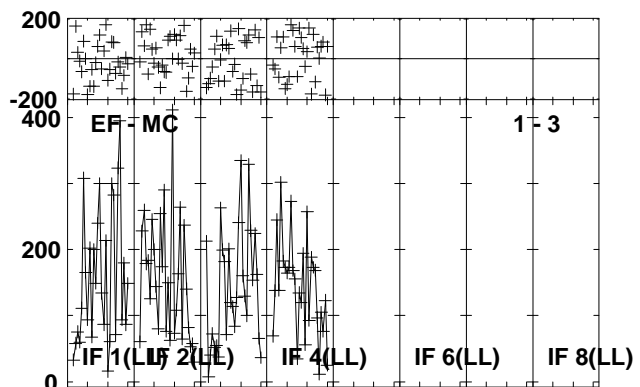
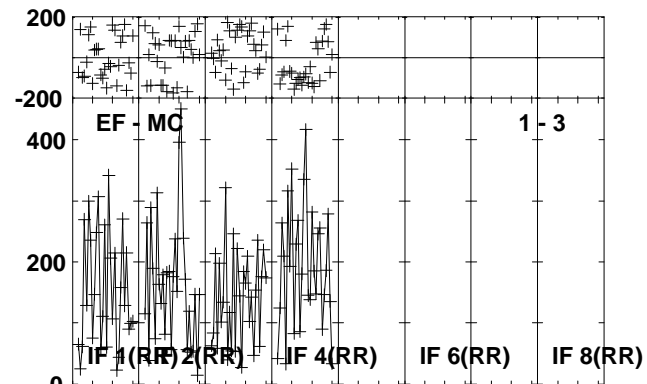
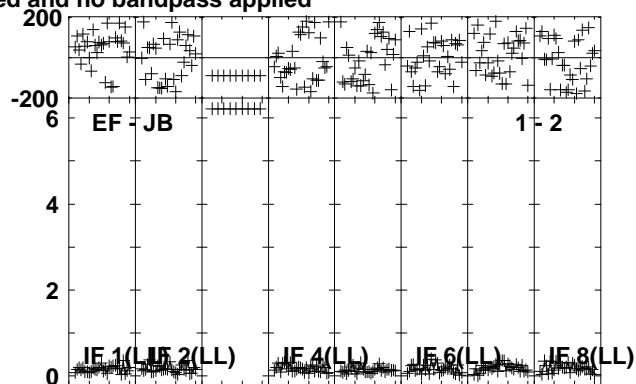
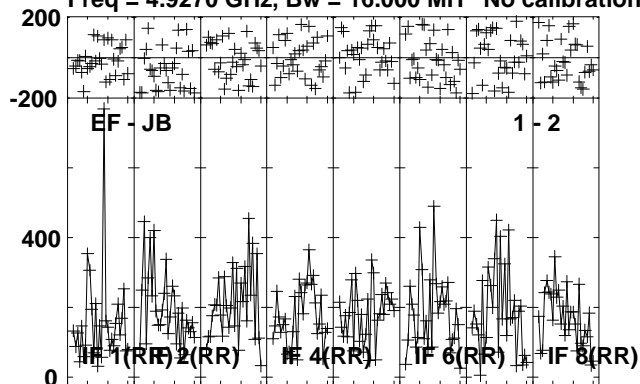

Lower frame: Micro Ampl Jy Top frame: Phas deg
Vector averaged cross-power spectrum Several baselines displayed
Timerange: 00/02:28:53 to 00/02:31:49

Plot file version 82 created 16-OCT-2012 11:56:57

NOVA-MON RO006.UVDATA.1

Freq = 4.9270 GHz, Bw = 16.000 MH No calibration applied and no bandpass applied

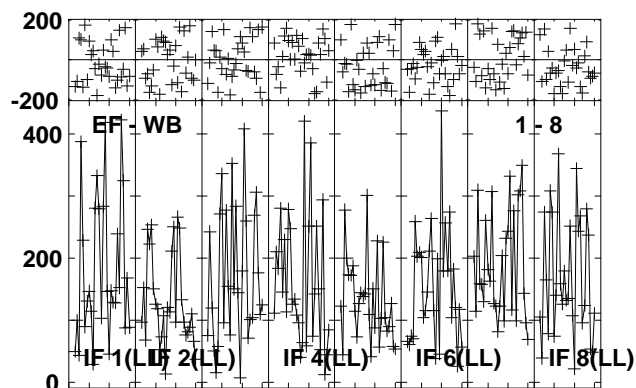
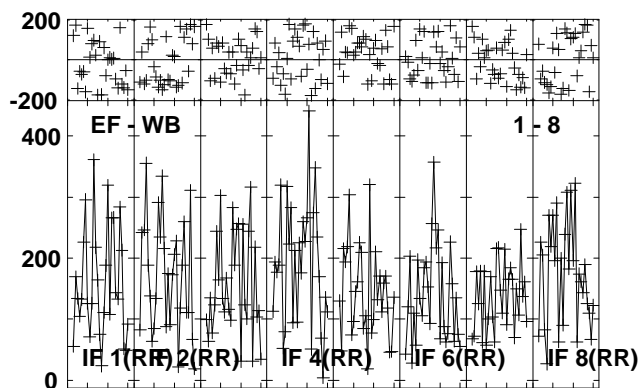
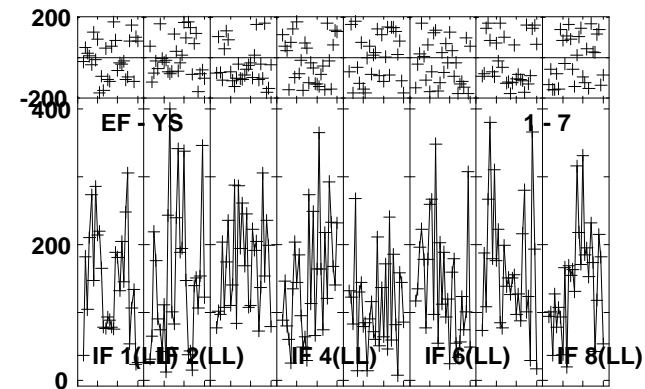
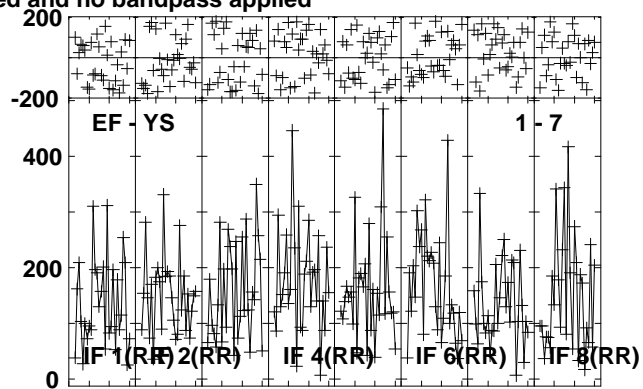
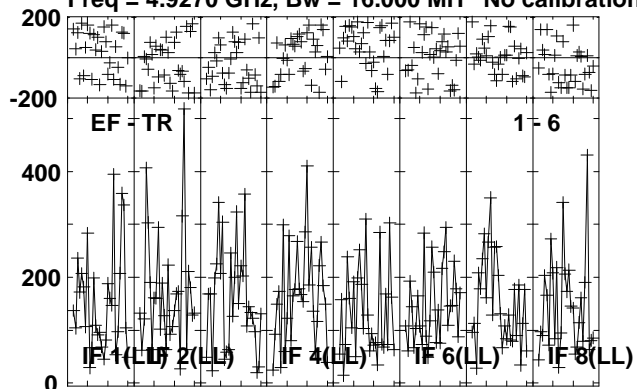

Lower frame: Micro Ampl Jy Top frame: Phas deg
Vector averaged cross-power spectrum Several baselines displayed
Timerange: 00/02:28:53 to 00/02:31:49

Plot file version 83 created 16-OCT-2012 11:56:57

J0639+0601 RO006.UVDATA.1

Freq = 4.9270 GHz, Bw = 16.000 MH No calibration applied and no bandpass applied

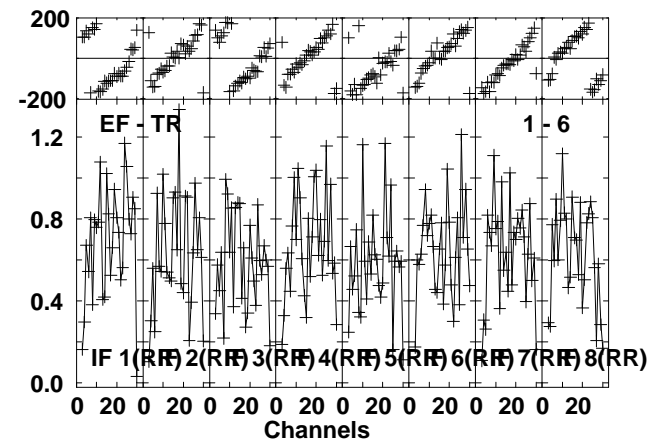
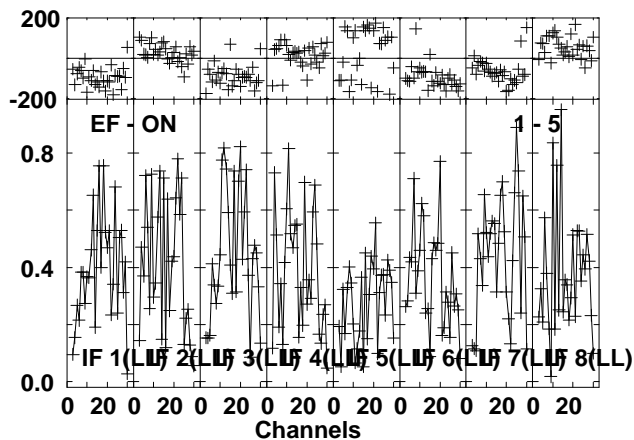
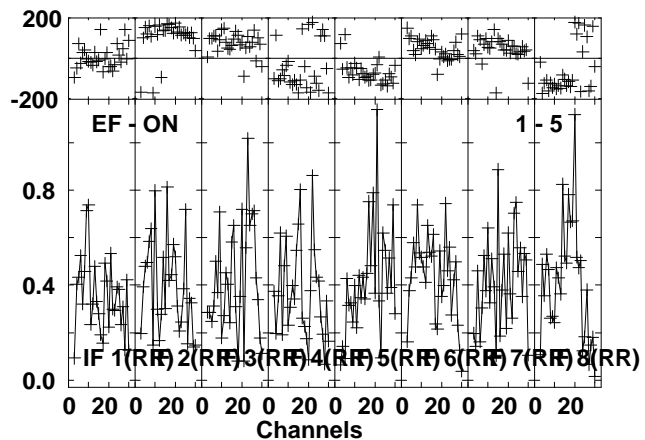
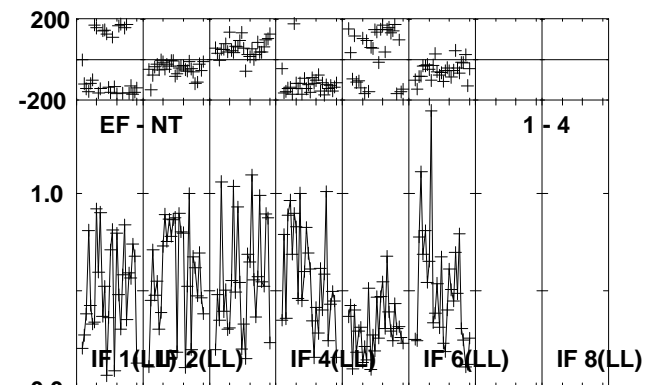
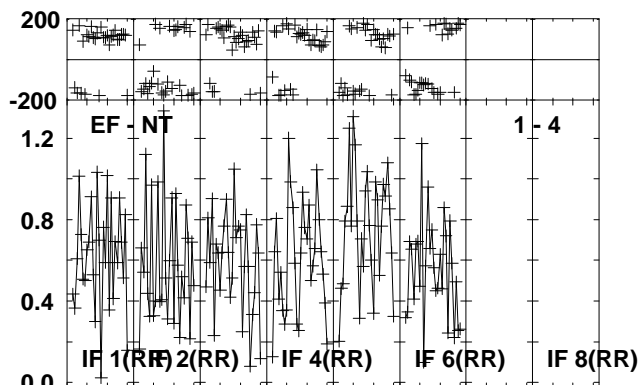
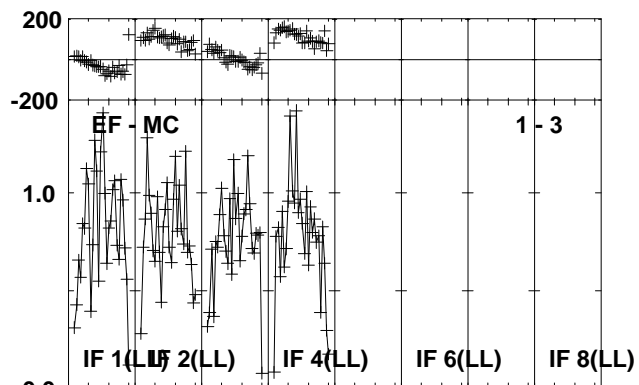
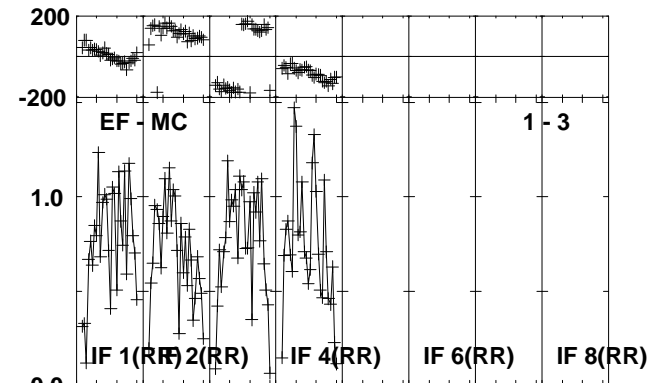
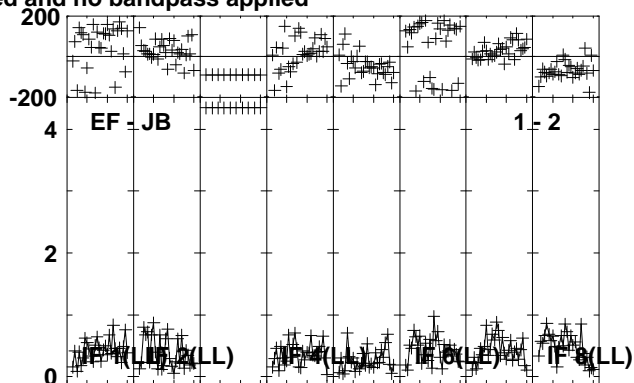
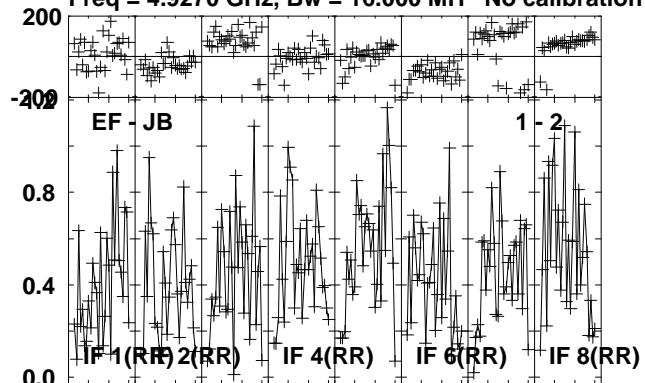

Lower frame: Milli Ampl Jy Top frame: Phas deg
Vector averaged cross-power spectrum Several baselines displayed
Timerange: 00/02:31:53 to 00/02:33:03

Plot file version 84 created 16-OCT-2012 11:56:57

J0639+0601 RO006.UVDATA.1

Freq = 4.9270 GHz, Bw = 16.000 MH No calibration applied and no bandpass applied

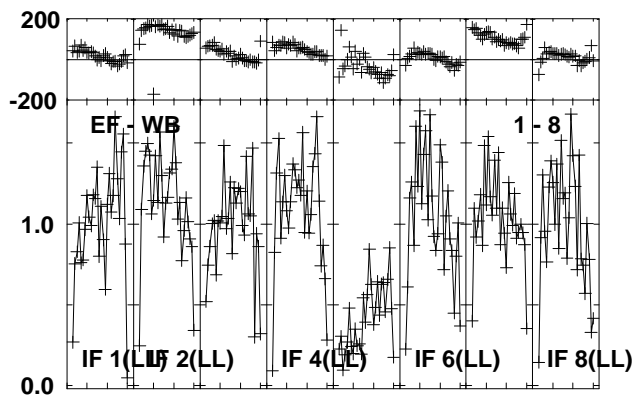
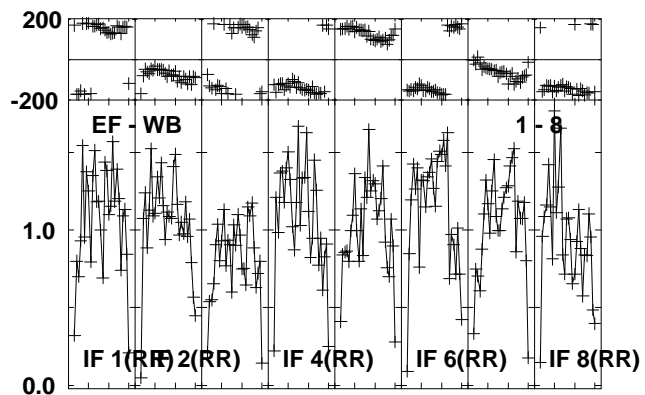
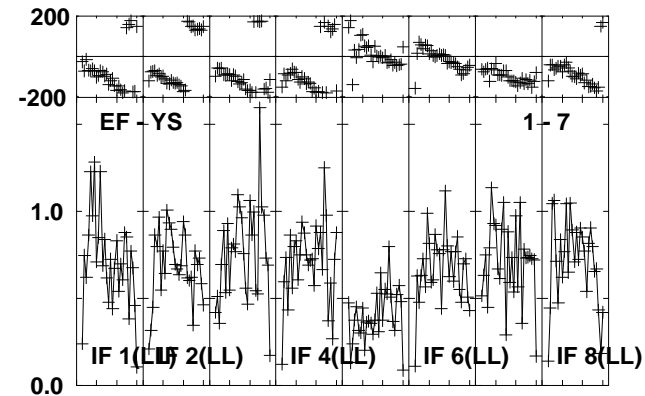
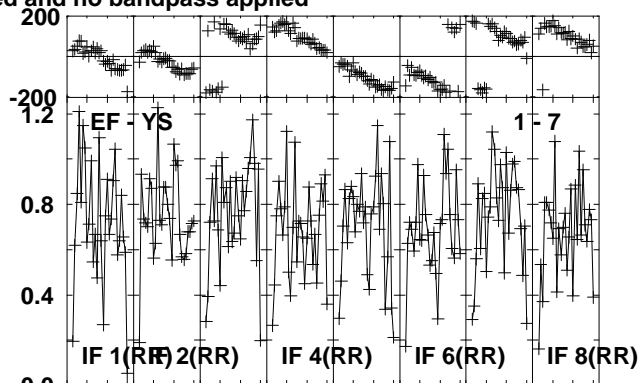
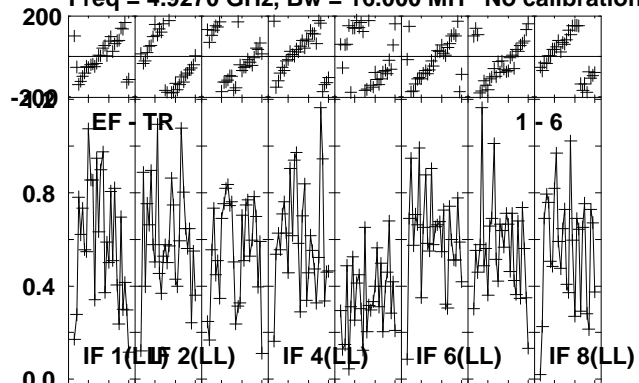

Lower frame: Milli Ampl Jy Top frame: Phas deg
Vector averaged cross-power spectrum Several baselines displayed
Timerange: 00/02:31:53 to 00/02:33:03

Plot file version 85 created 16-OCT-2012 11:56:57

J0645+0541 RO006.UVDATA.1

Freq = 4.9270 GHz, Bw = 16.000 MH No calibration applied and no bandpass applied

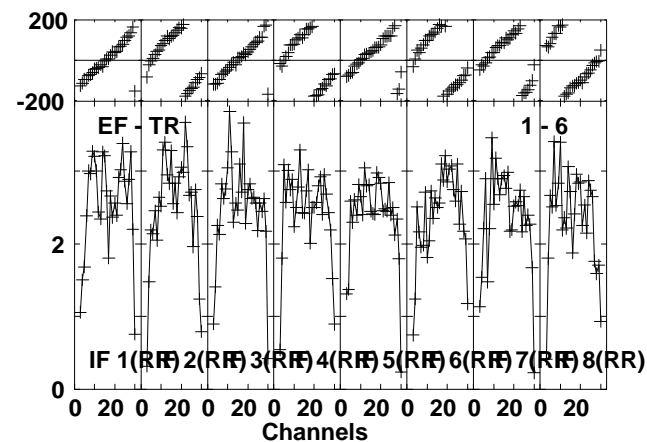
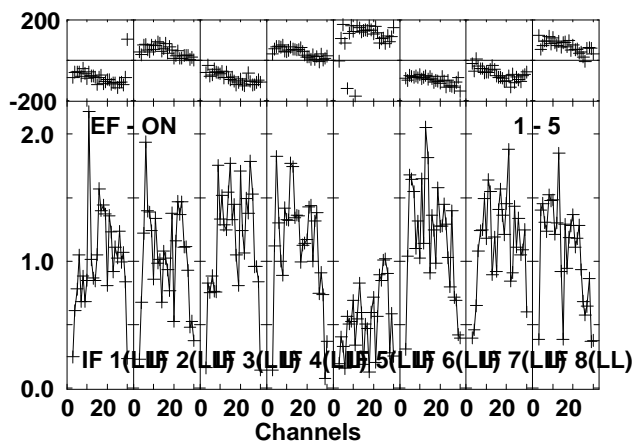
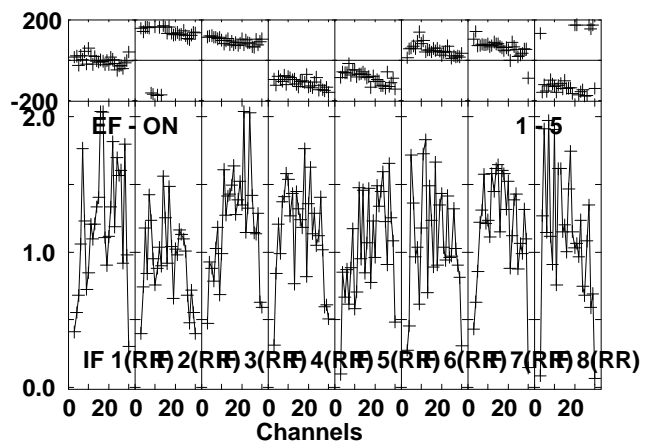
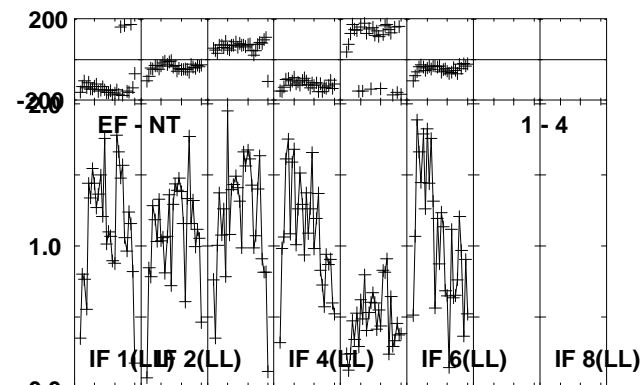
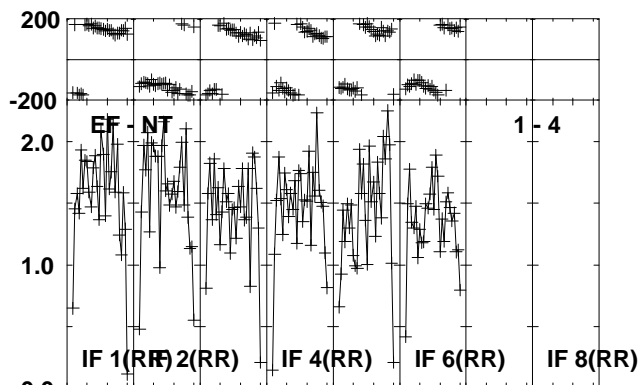
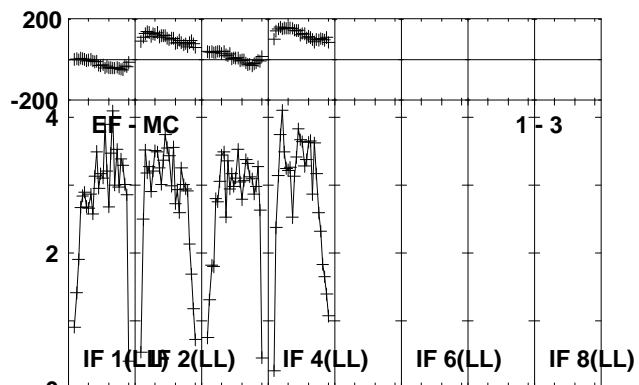
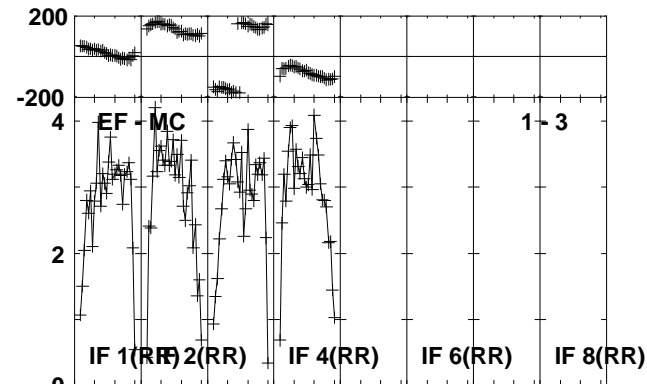
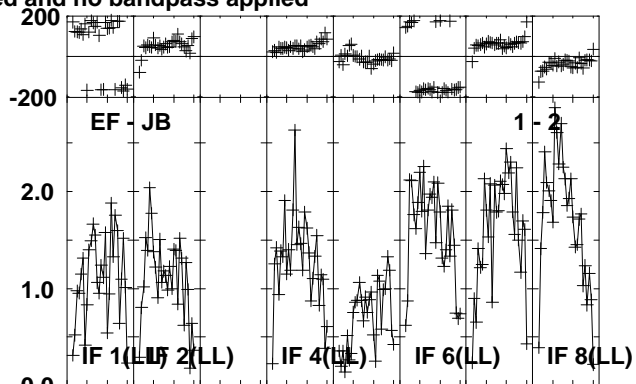
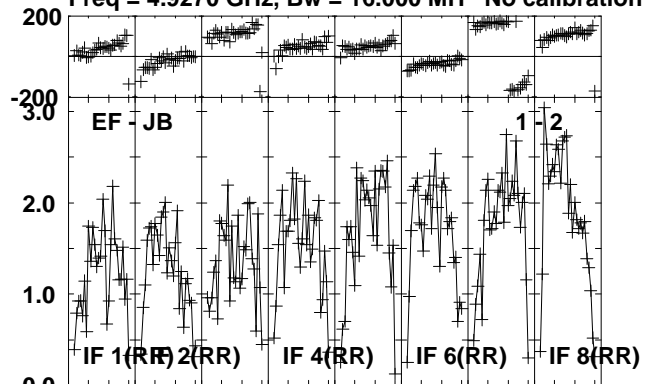

Lower frame: Milli Ampl Jy Top frame: Phas deg
Vector averaged cross-power spectrum Several baselines displayed
Timerange: 00/02:33:07 to 00/02:34:03

Plot file version 86 created 16-OCT-2012 11:56:58

J0645+0541 RO006.UVDATA.1

Freq = 4.9270 GHz, Bw = 16.000 MH No calibration applied and no bandpass applied

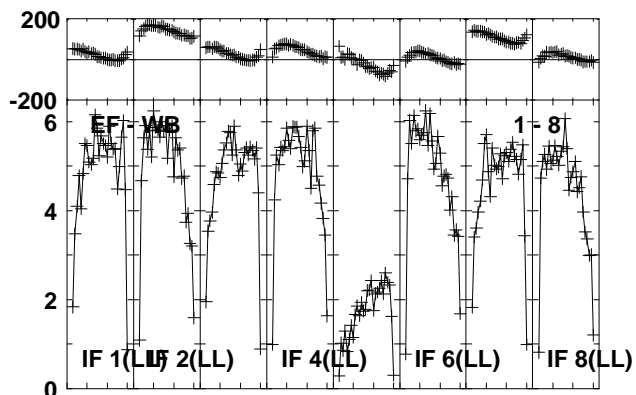
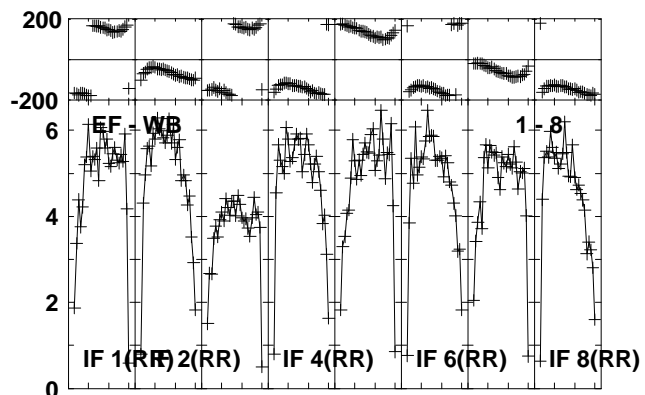
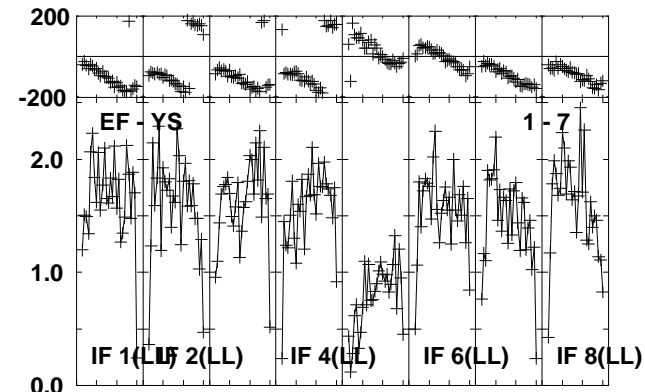
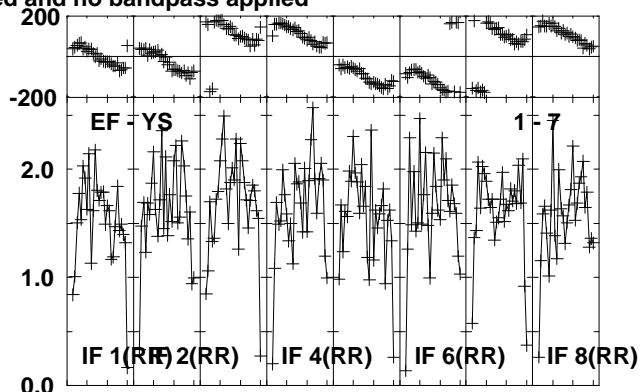
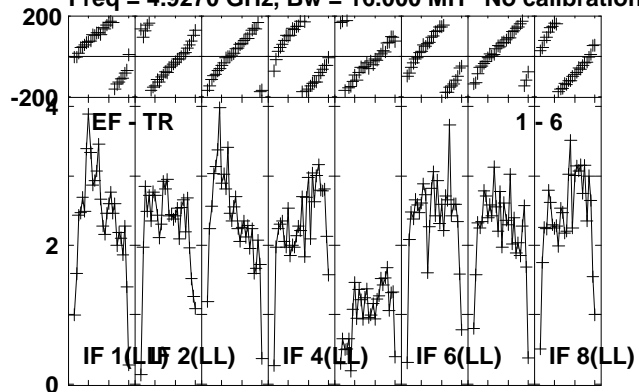

Lower frame: Milli Ampl Jy Top frame: Phas deg
Vector averaged cross-power spectrum Several baselines displayed
Timerange: 00/02:33:07 to 00/02:34:03

Plot file version 87 created 16-OCT-2012 11:56:58

NOVA-MON RO006.UVDATA.1

Freq = 4.9270 GHz, Bw = 16.000 MH No calibration applied and no bandpass applied

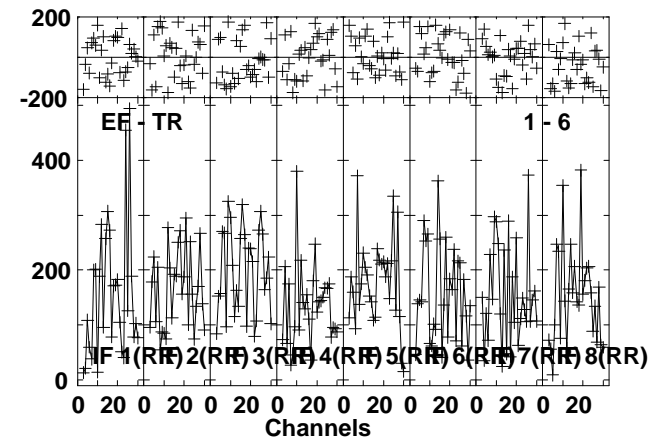
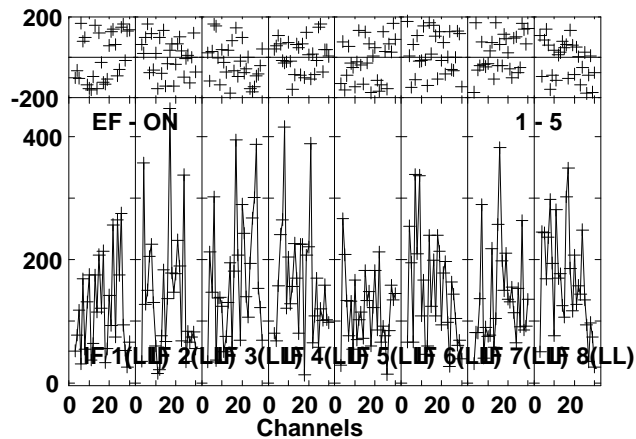
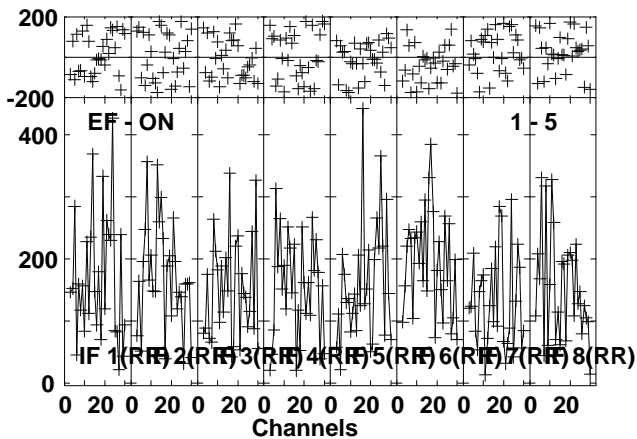
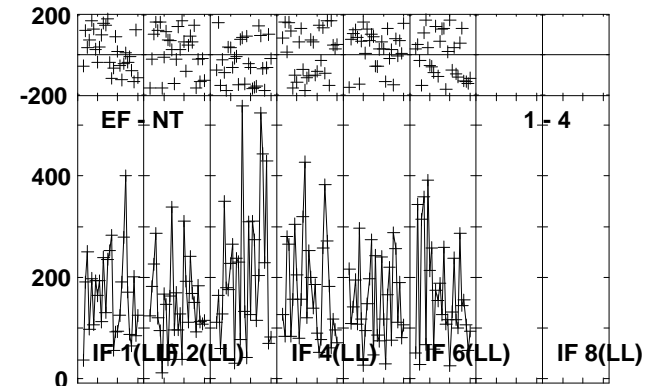
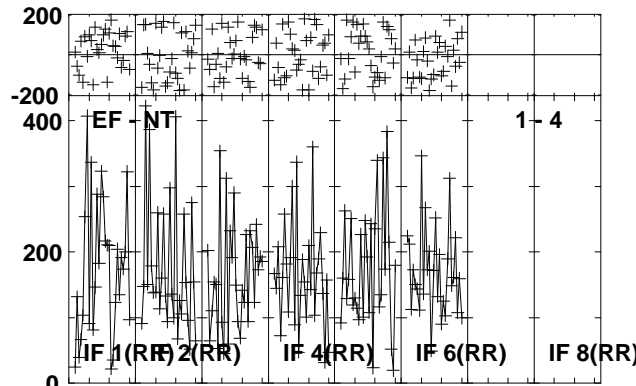
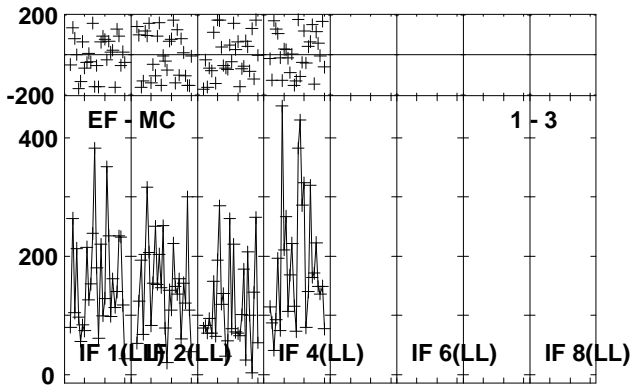
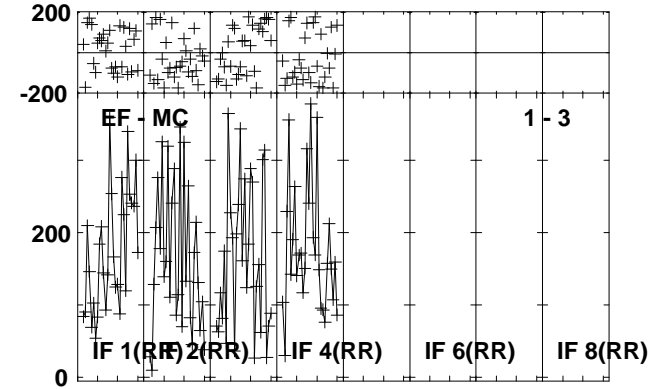
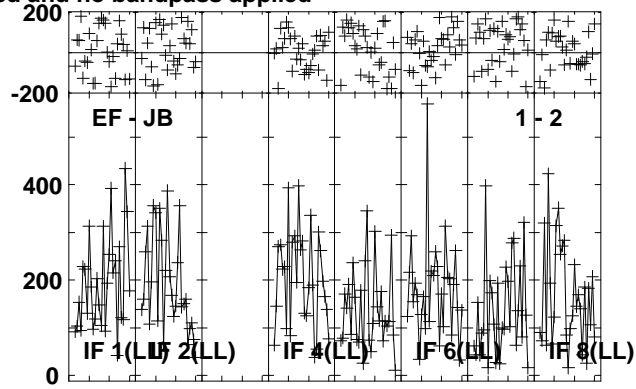
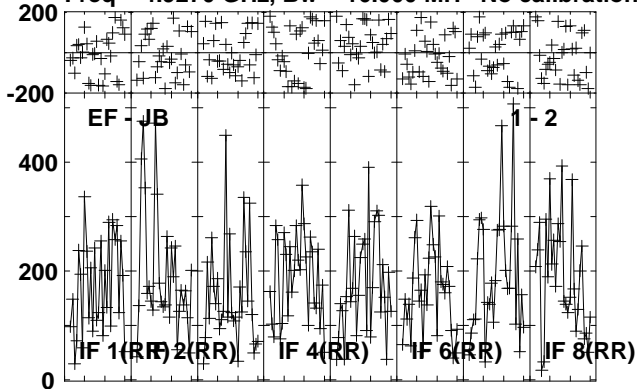

Lower frame: Micro Ampl Jy Top frame: Phas deg
Vector averaged cross-power spectrum Several baselines displayed
Timerange: 00/02:34:07 to 00/02:37:03

Plot file version 88 created 16-OCT-2012 11:56:58

NOVA-MON RO006.UVDATA.1

Freq = 4.9270 GHz, Bw = 16.000 MH No calibration applied and no bandpass applied

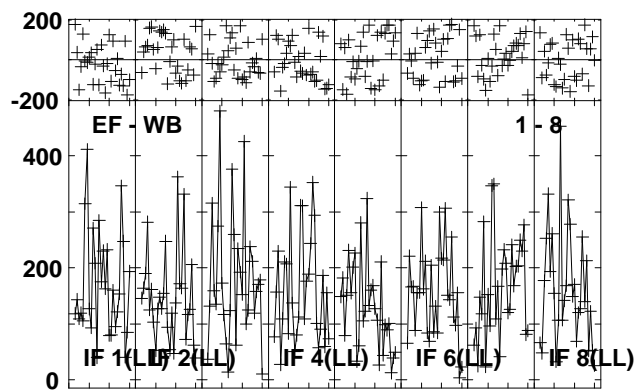
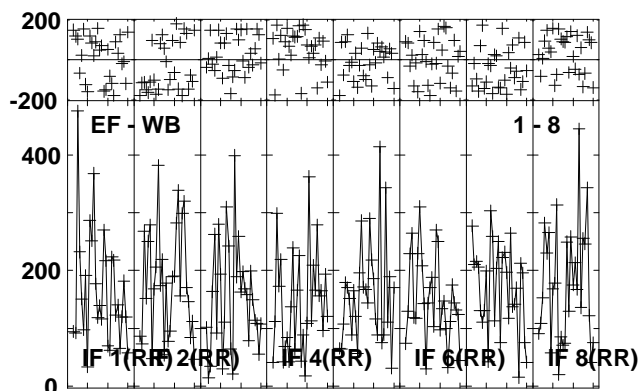
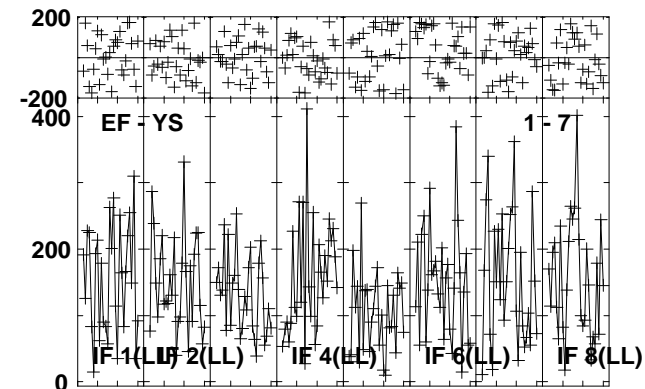
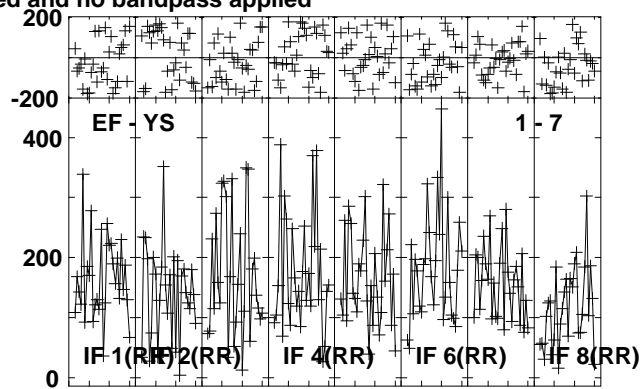
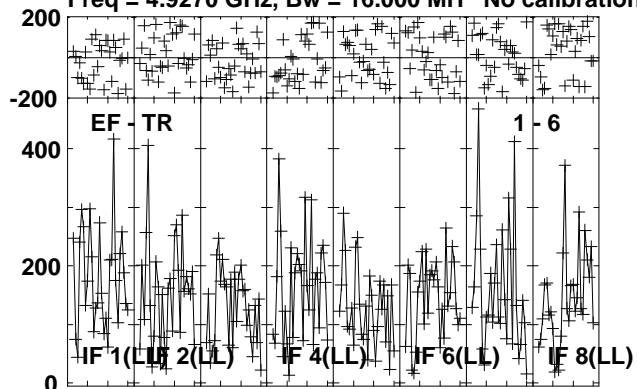

Lower frame: Micro Ampl Jy Top frame: Phas deg
Vector averaged cross-power spectrum Several baselines displayed
Timerange: 00/02:34:07 to 00/02:37:03

Plot file version 89 created 16-OCT-2012 11:56:59

J0639+0601 RO006.UVDATA.1

Freq = 4.9270 GHz, Bw = 16.000 MH No calibration applied and no bandpass applied

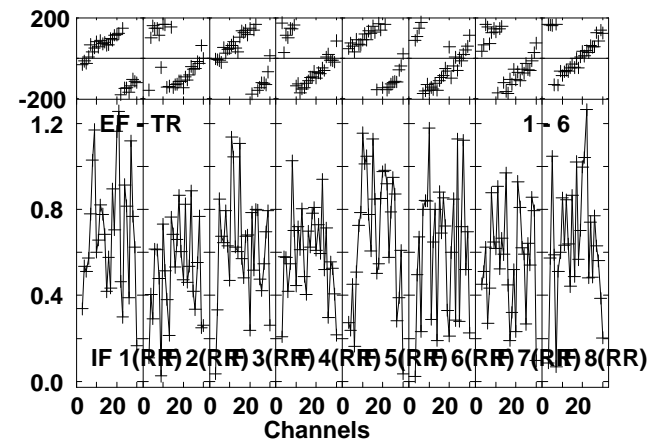
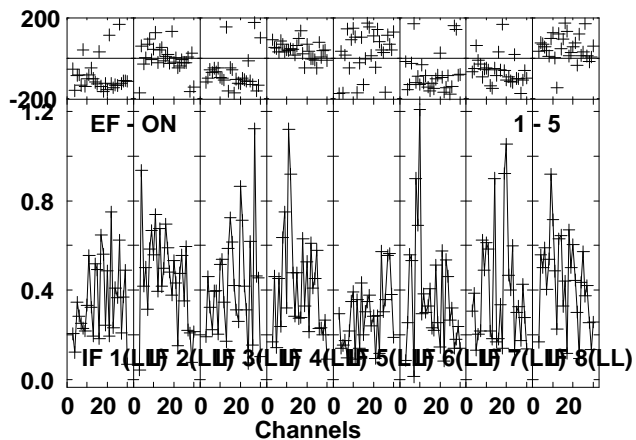
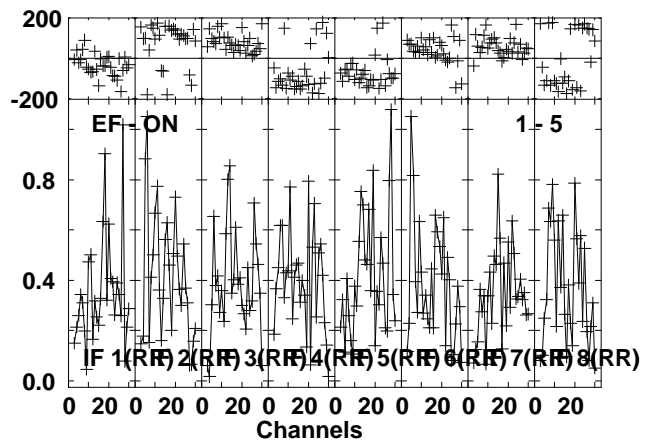
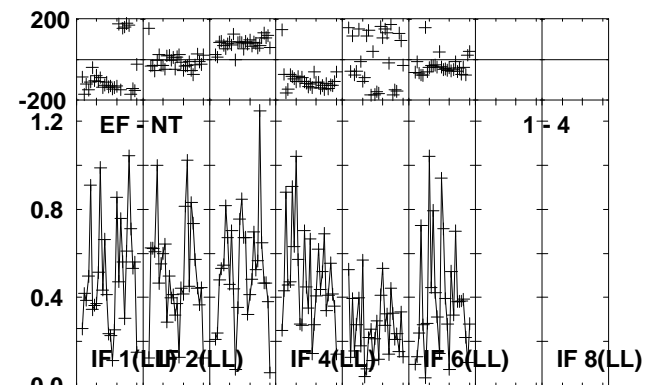
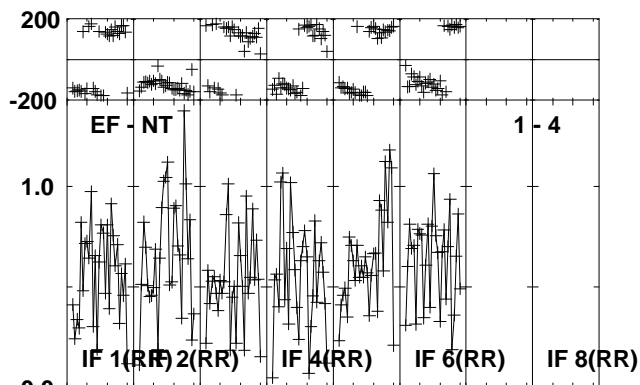
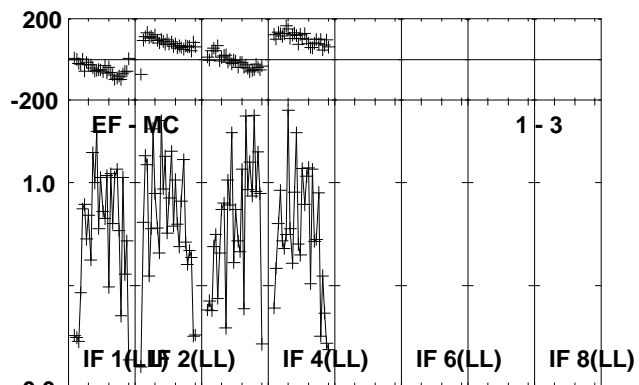
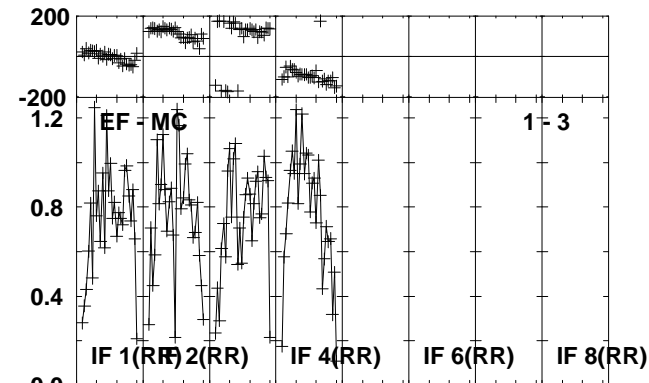
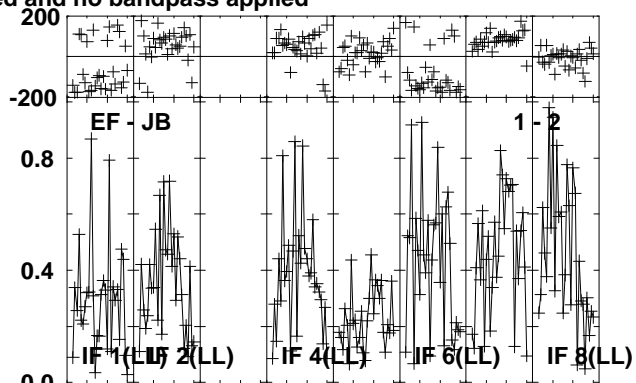
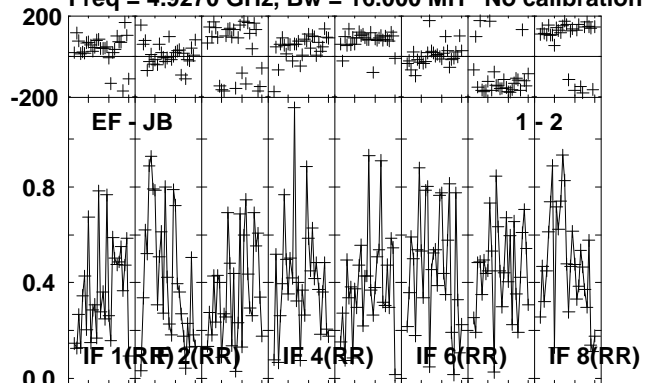

Lower frame: Milli Ampl Jy Top frame: Phas deg
Vector averaged cross-power spectrum Several baselines displayed
Timerange: 00/02:37:33 to 00/02:38:33

Plot file version 90 created 16-OCT-2012 11:56:59

J0639+0601 RO006.UVDATA.1

Freq = 4.9270 GHz, Bw = 16.000 MH No calibration applied and no bandpass applied

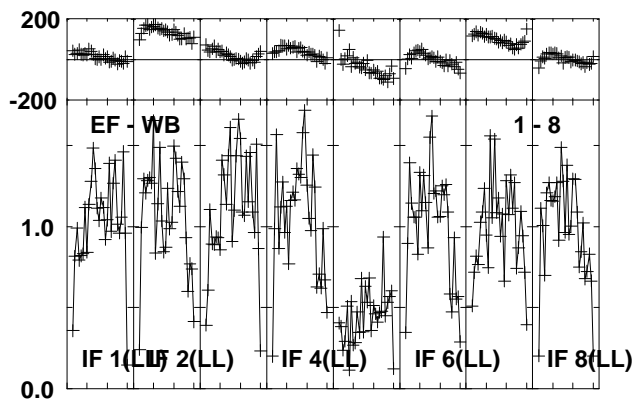
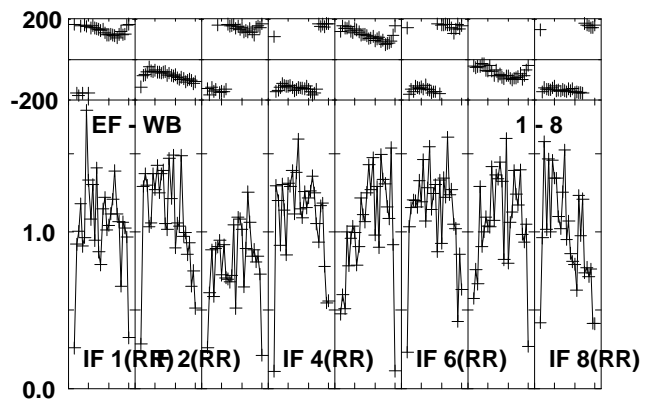
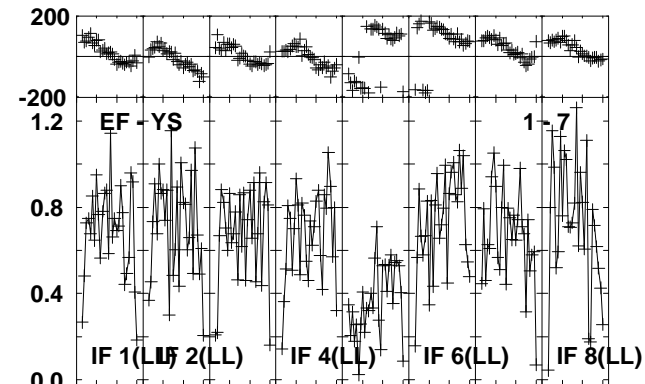
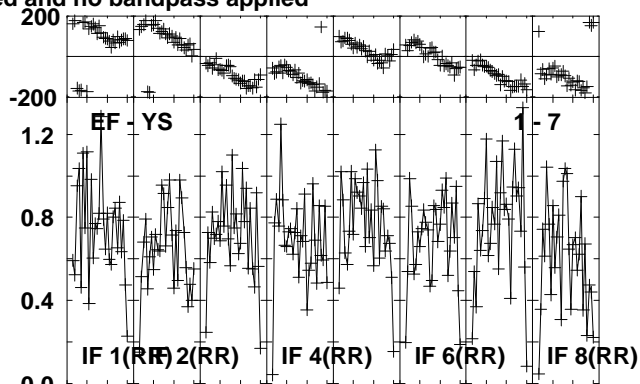
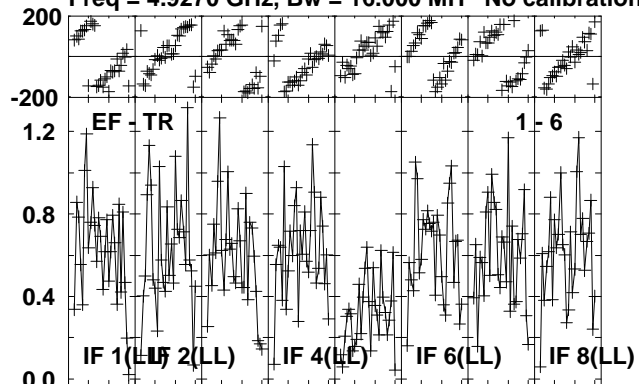

Lower frame: Milli Ampl Jy Top frame: Phas deg
Vector averaged cross-power spectrum Several baselines displayed
Timerange: 00/02:37:33 to 00/02:38:33

Plot file version 91 created 16-OCT-2012 11:56:59

J0645+0541 RO006.UVDATA.1

Freq = 4.9270 GHz, Bw = 16.000 MH No calibration applied and no bandpass applied

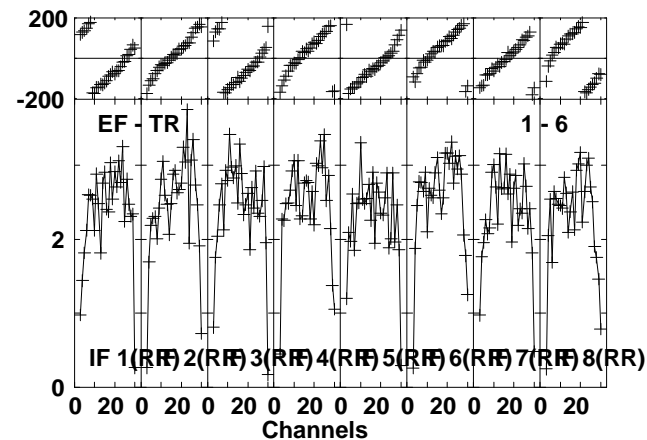
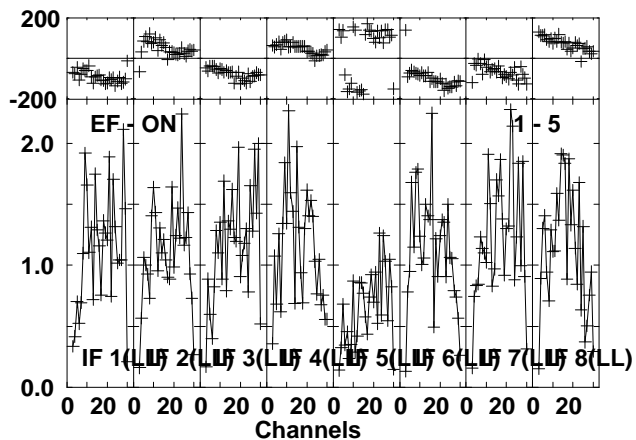
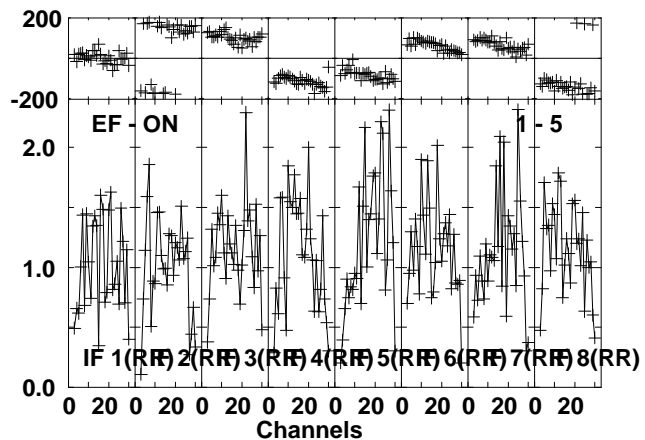
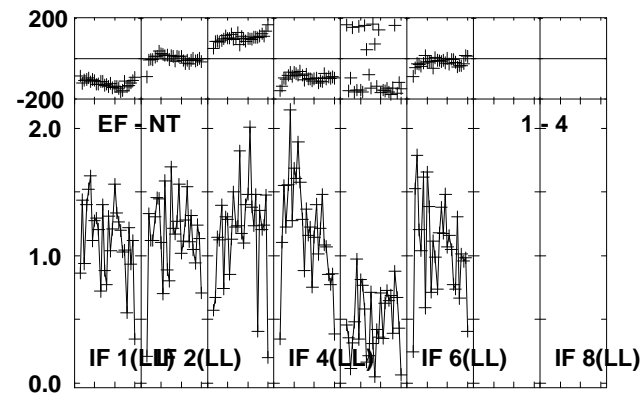
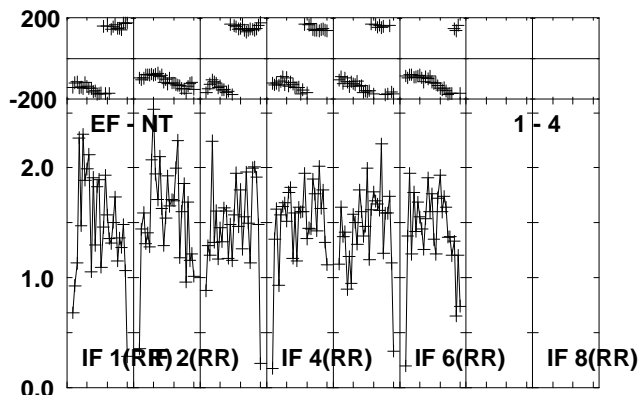
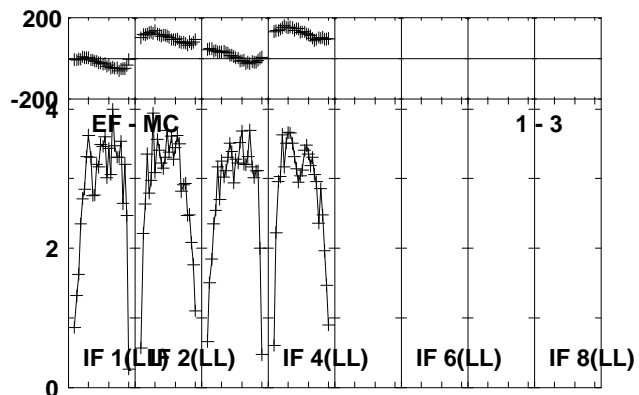
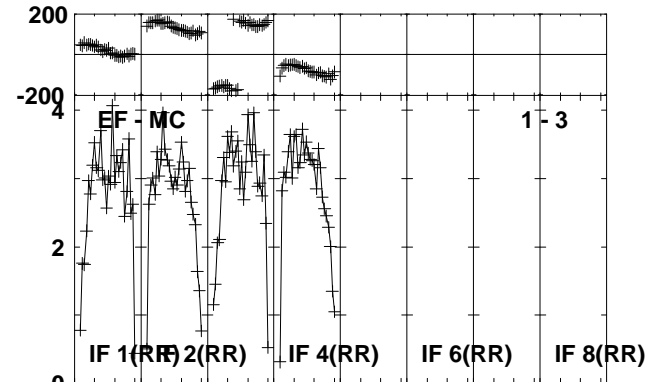
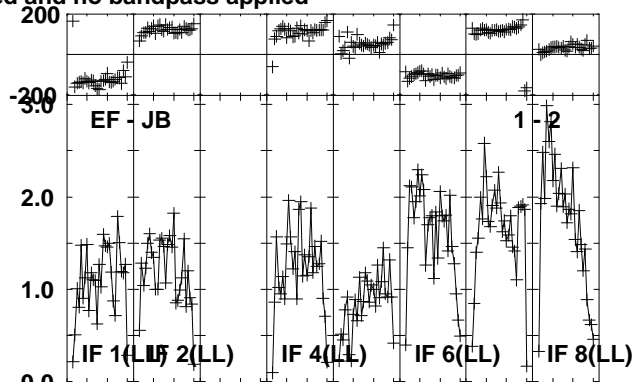
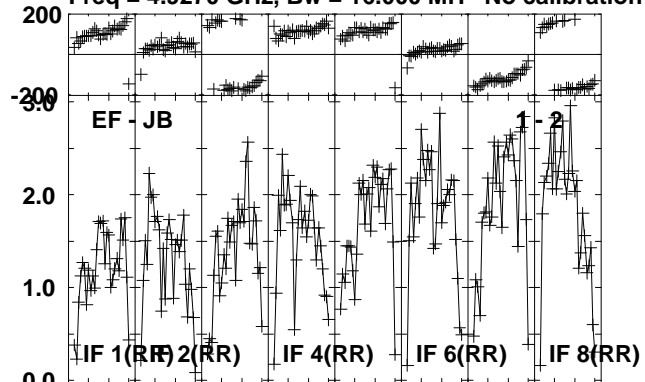

Lower frame: Milli Ampl Jy Top frame: Phas deg
Vector averaged cross-power spectrum Several baselines displayed
Timerange: 00/02:38:37 to 00/02:39:33

Plot file version 92 created 16-OCT-2012 11:56:59

J0645+0541 RO006.UVDATA.1

Freq = 4.9270 GHz, Bw = 16.000 MH No calibration applied and no bandpass applied

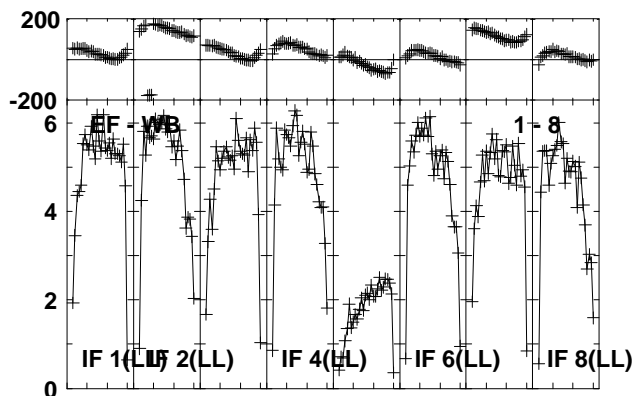
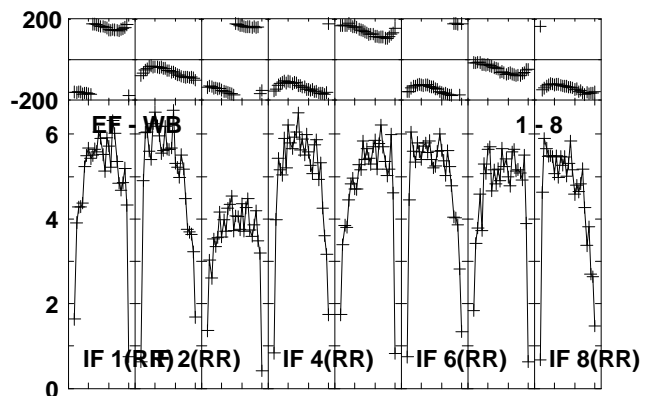
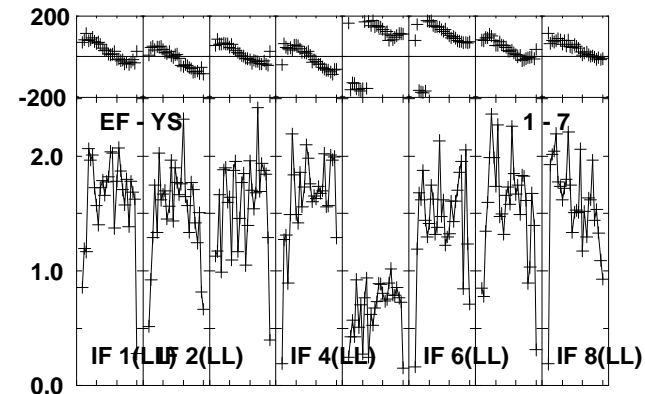
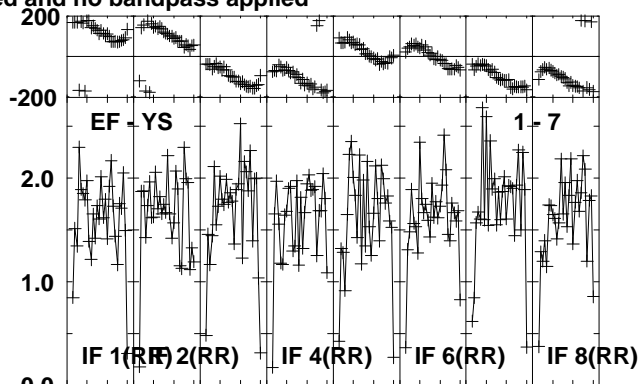
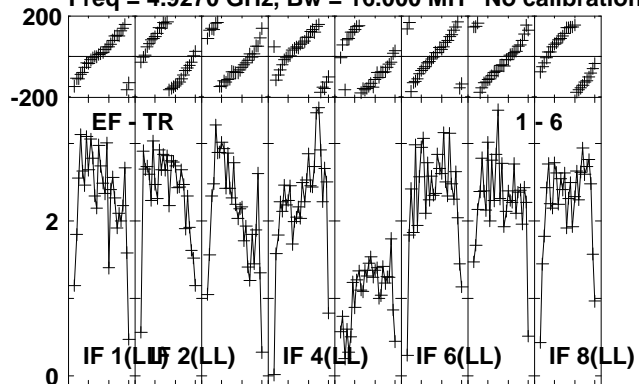

Lower frame: Milli Ampl Jy Top frame: Phas deg
Vector averaged cross-power spectrum Several baselines displayed
Timerange: 00/02:38:37 to 00/02:39:33

Plot file version 93 created 16-OCT-2012 11:56:59

NOVA-MON RO006.UVDATA.1

Freq = 4.9270 GHz, Bw = 16.000 MH No calibration applied and no bandpass applied

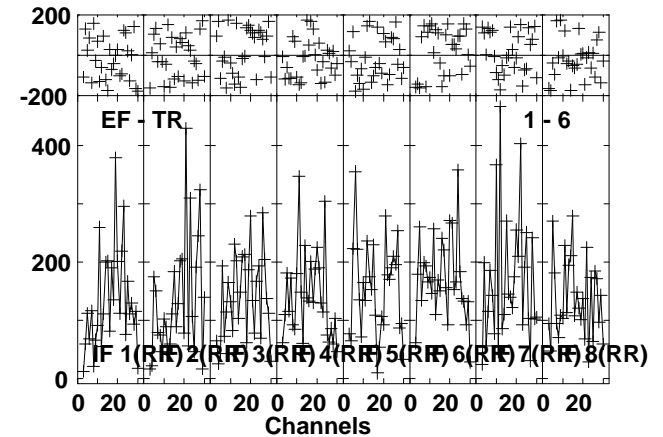
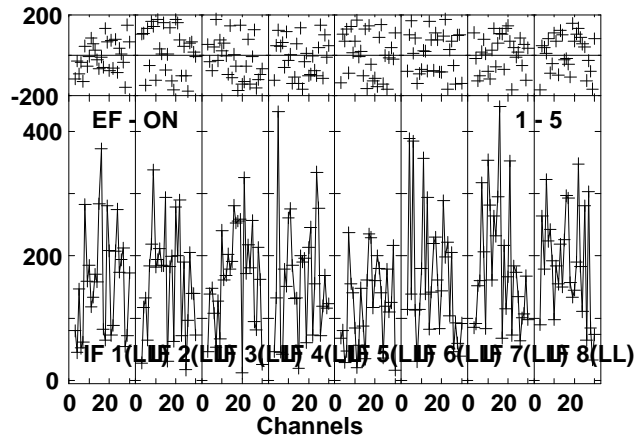
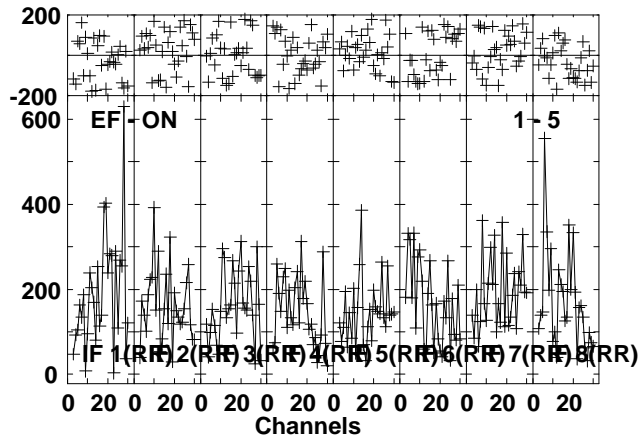
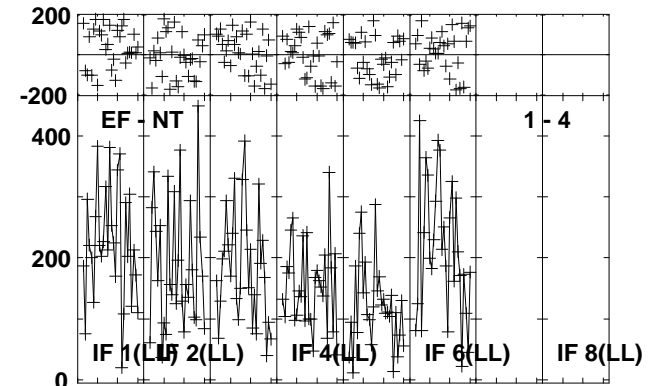
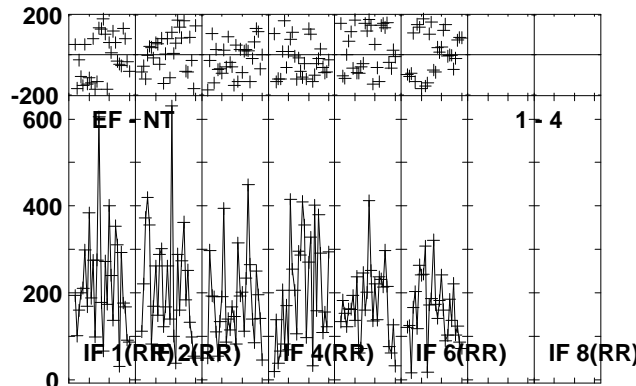
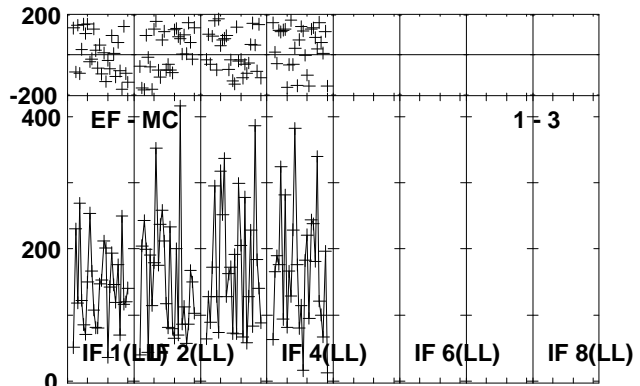
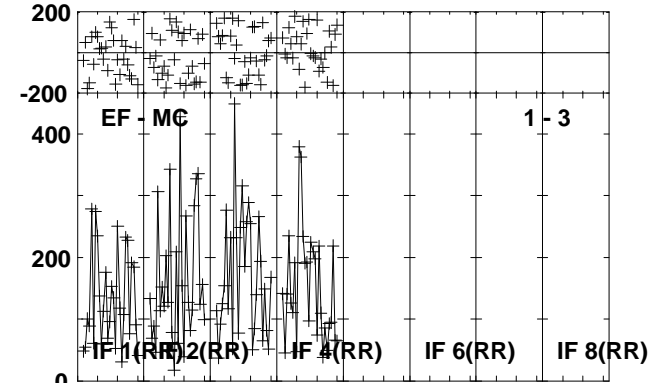
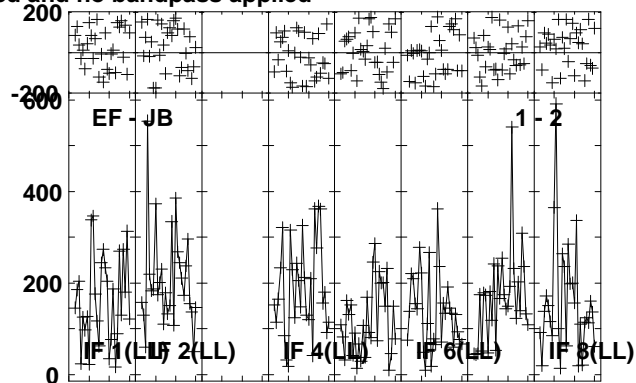
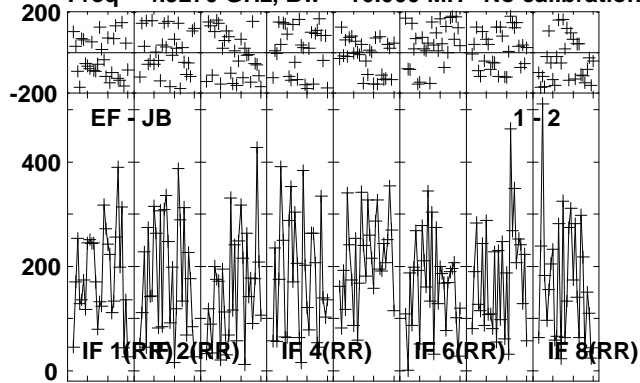

Lower frame: Micro Ampl Jy Top frame: Phas deg
Vector averaged cross-power spectrum Several baselines displayed
Timerange: 00/02:39:37 to 00/02:42:33

Plot file version 94 created 16-OCT-2012 11:57:00

NOVA-MON RO006.UVDATA.1

Freq = 4.9270 GHz, Bw = 16.000 MH No calibration applied and no bandpass applied

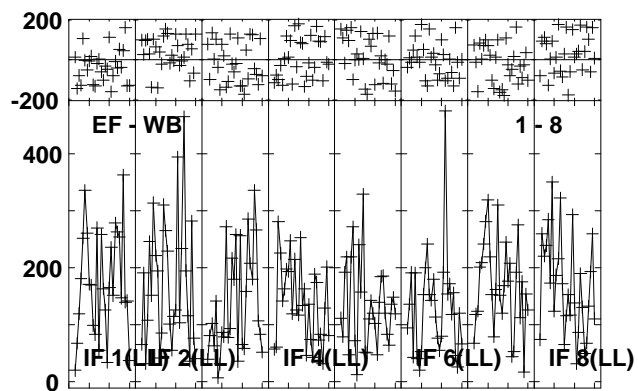
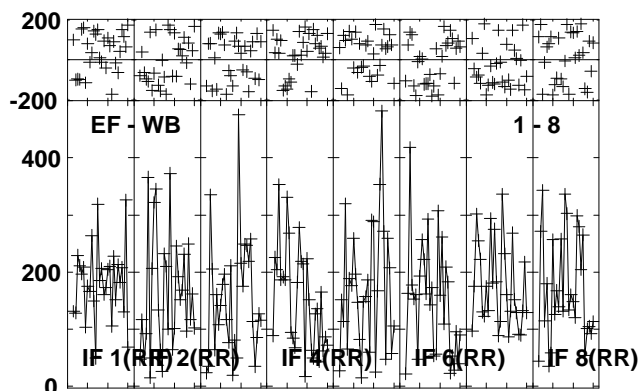
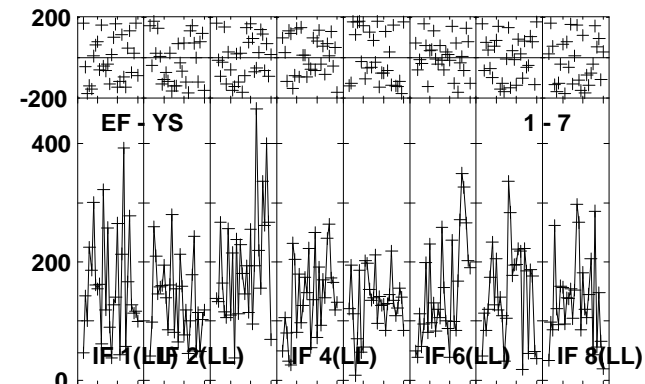
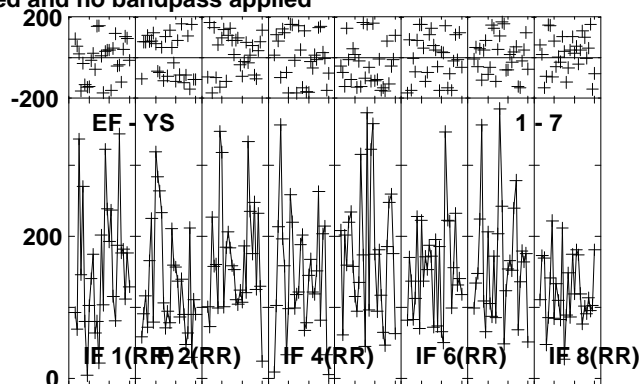
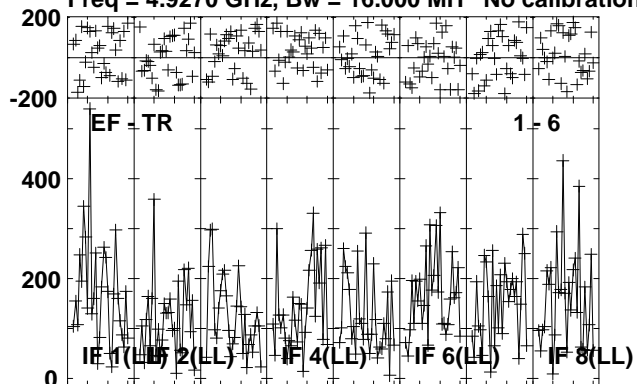

Lower frame: Micro Ampl Jy Top frame: Phas deg
Vector averaged cross-power spectrum Several baselines displayed
Timerange: 00/02:39:37 to 00/02:42:33

Plot file version 95 created 16-OCT-2012 11:57:00

J0639+0601 RO006.UVDATA.1

Freq = 4.9270 GHz, Bw = 16.000 MH No calibration applied and no bandpass applied

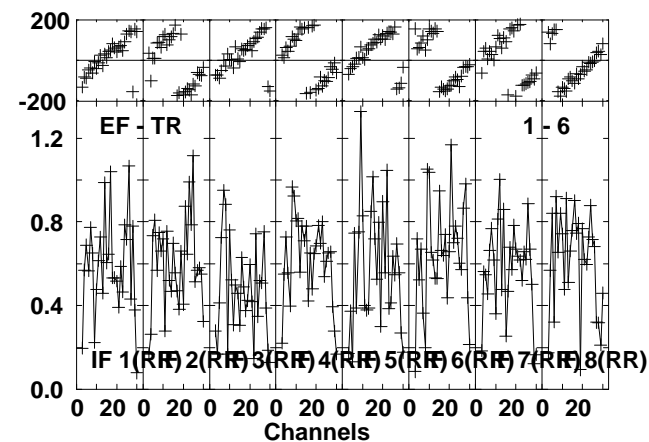
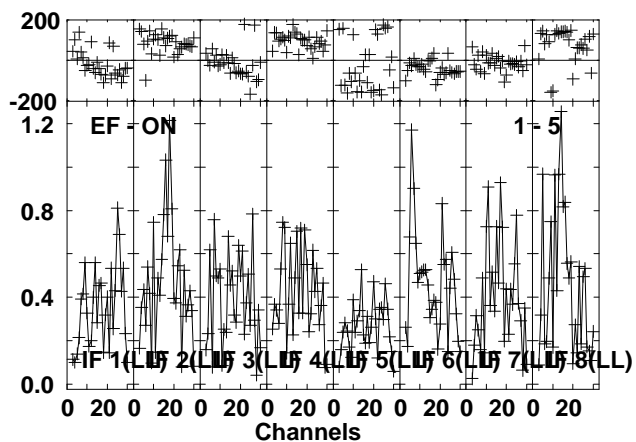
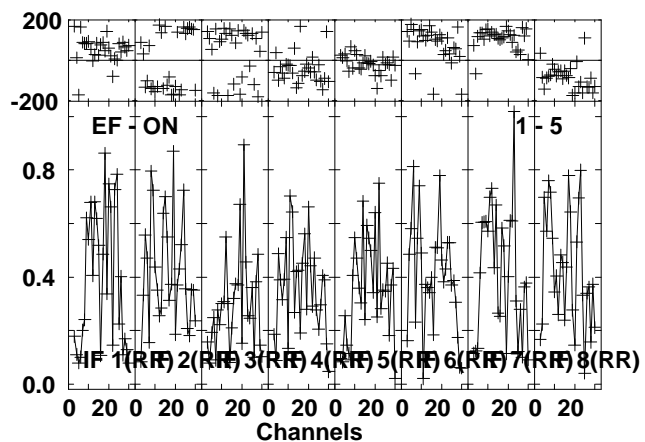
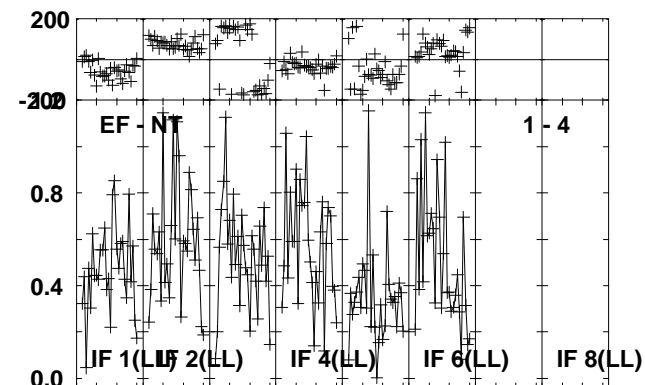
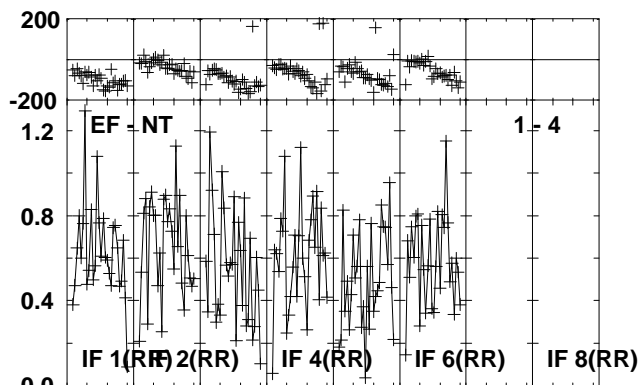
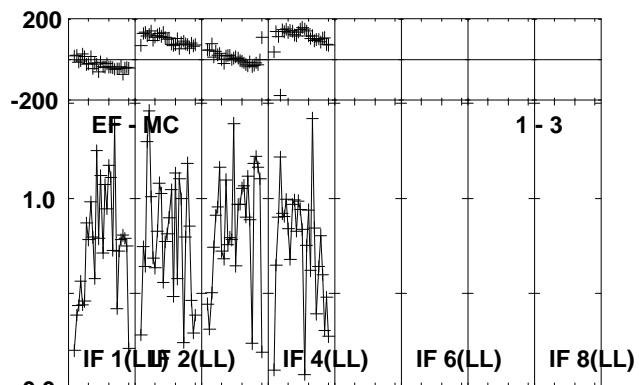
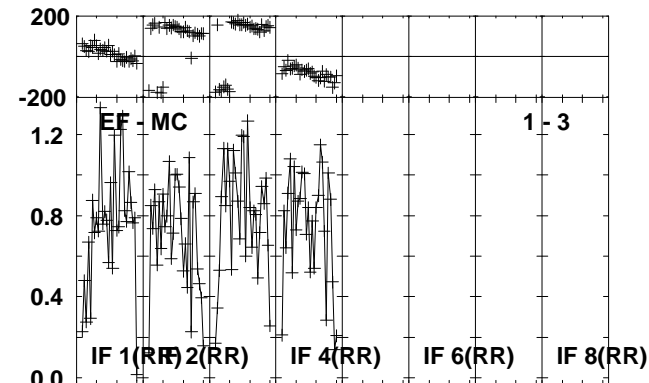
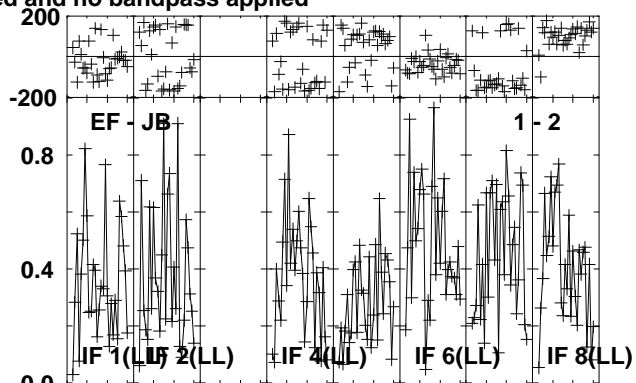
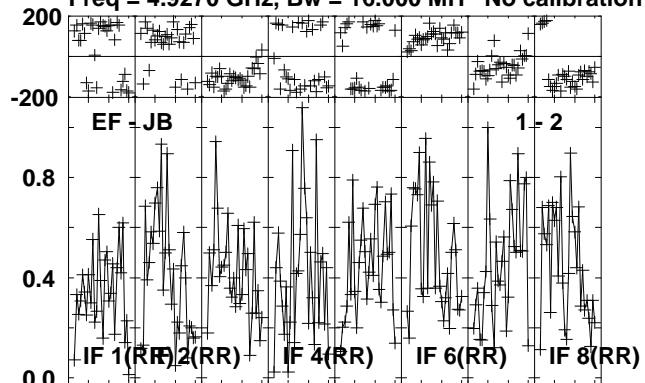

Lower frame: Milli Ampl Jy Top frame: Phas deg
Vector averaged cross-power spectrum Several baselines displayed
Timerange: 00/02:42:37 to 00/02:43:49

Plot file version 96 created 16-OCT-2012 11:57:00

J0639+0601 RO006.UVDATA.1

Freq = 4.9270 GHz, Bw = 16.000 MH No calibration applied and no bandpass applied

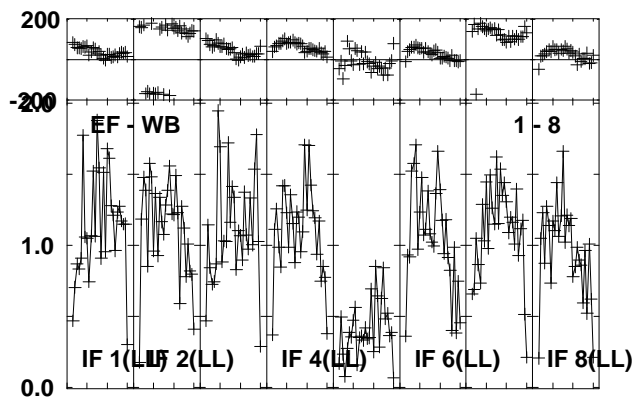
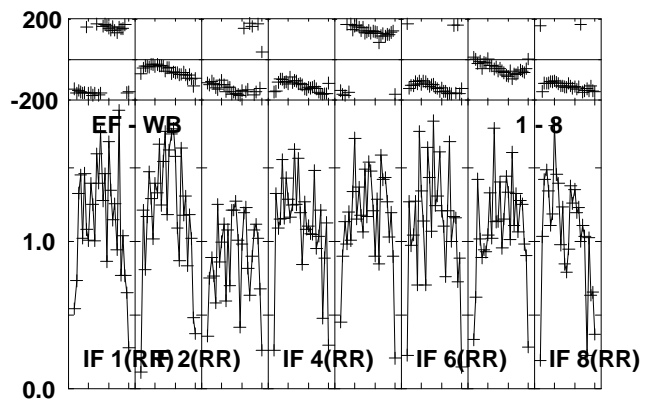
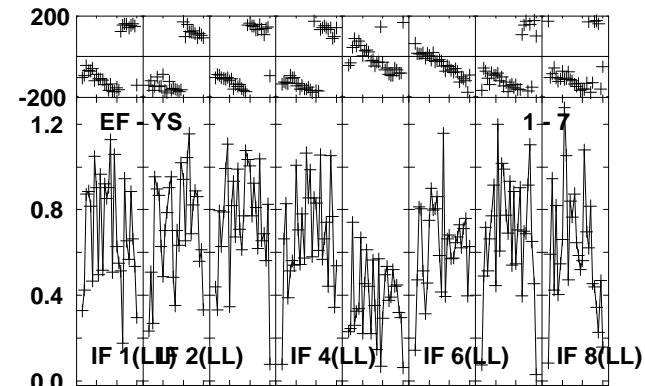
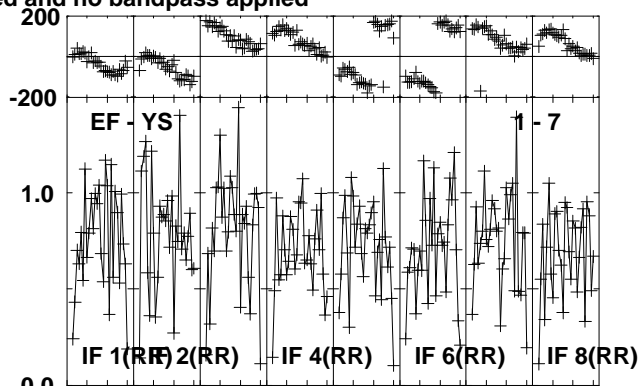
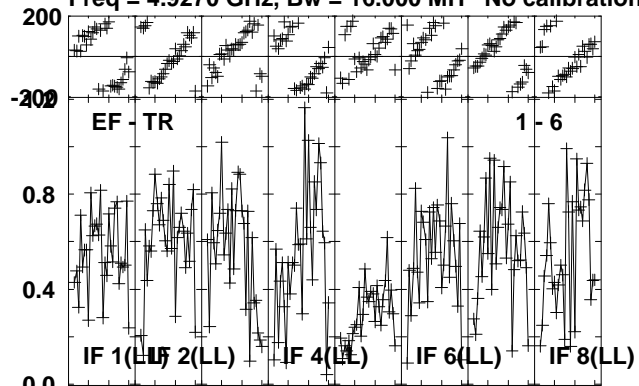

Lower frame: Milli Ampl Jy Top frame: Phas deg
Vector averaged cross-power spectrum Several baselines displayed
Timerange: 00/02:42:37 to 00/02:43:49

Plot file version 97 created 16-OCT-2012 11:57:01

J0645+0541 RO006.UVDATA.1

Freq = 4.9270 GHz, Bw = 16.000 MH No calibration applied and no bandpass applied

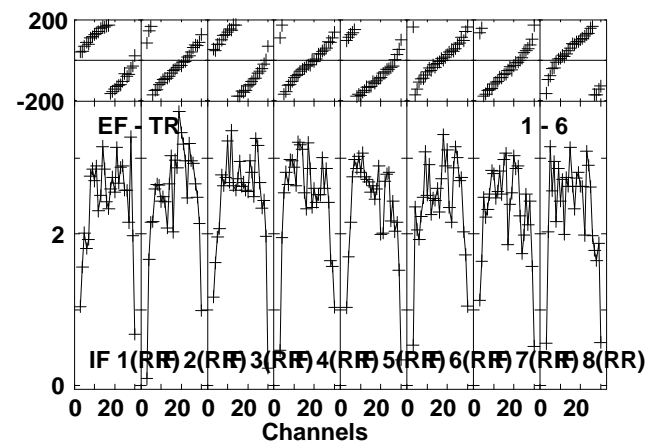
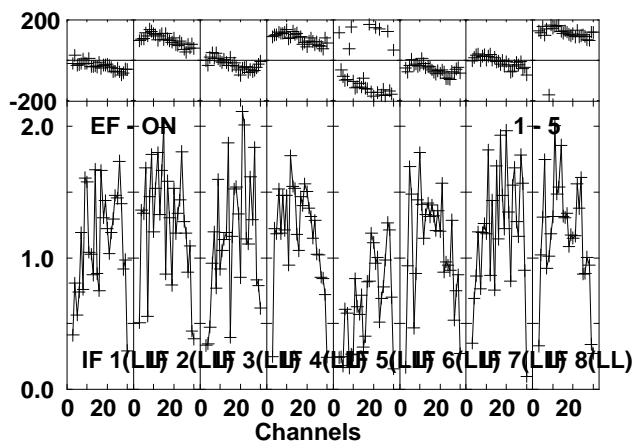
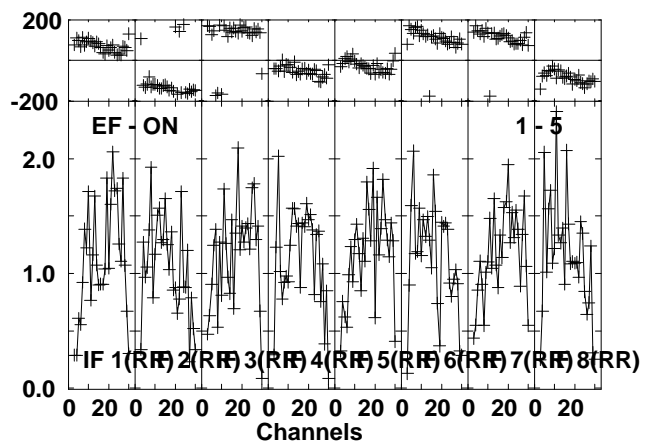
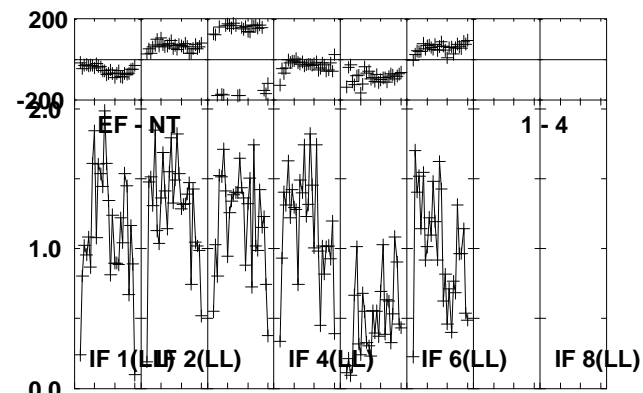
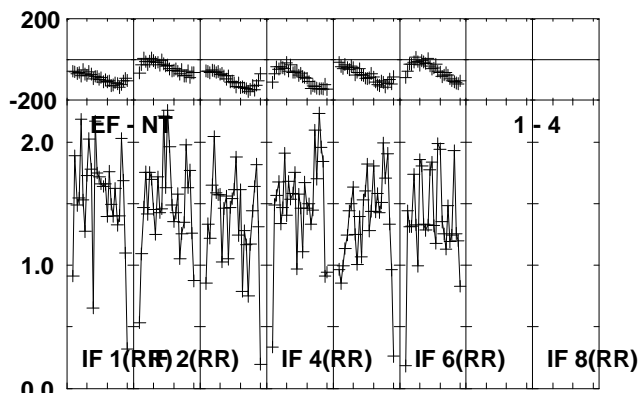
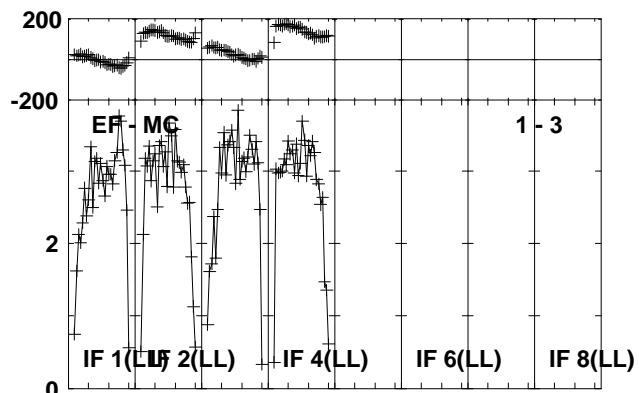
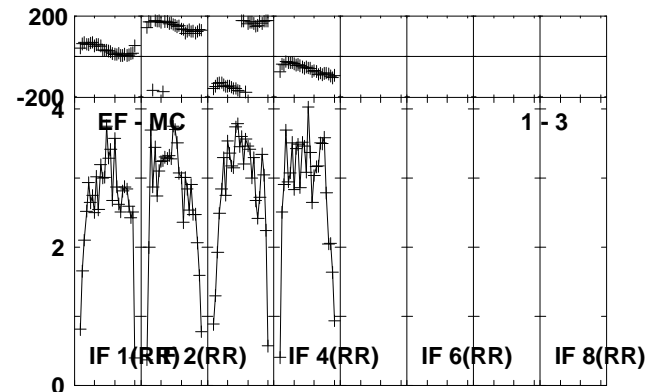
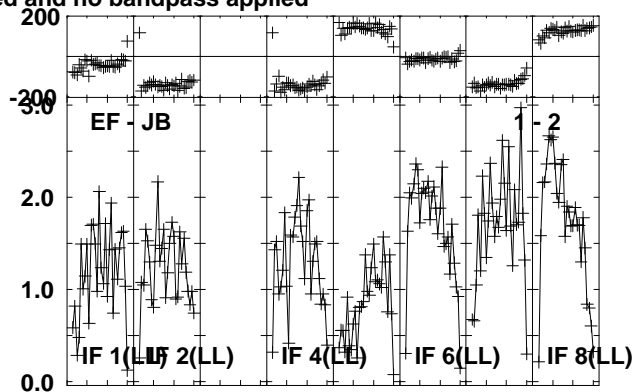
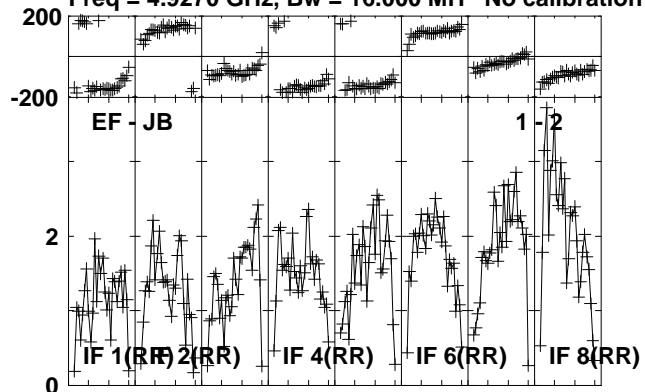

Lower frame: Milli Ampl Jy Top frame: Phas deg
Vector averaged cross-power spectrum Several baselines displayed
Timerange: 00/02:43:53 to 00/02:44:49

Plot file version 98 created 16-OCT-2012 11:57:01

J0645+0541 RO006.UVDATA.1

Freq = 4.9270 GHz, Bw = 16.000 MH No calibration applied and no bandpass applied

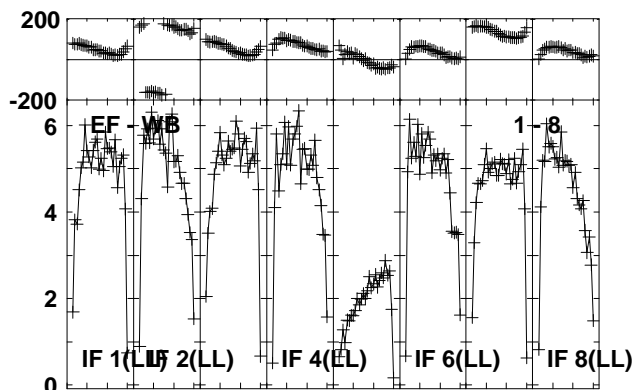
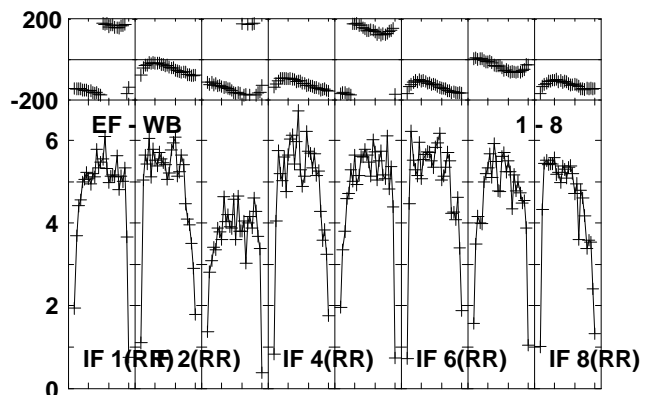
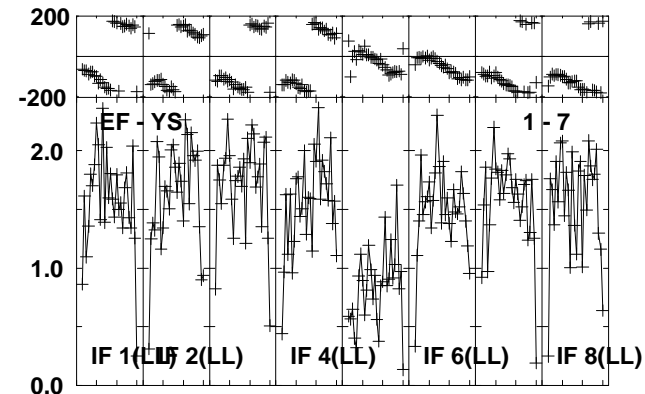
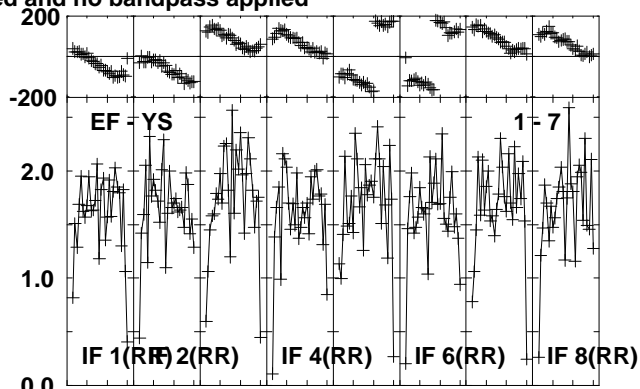
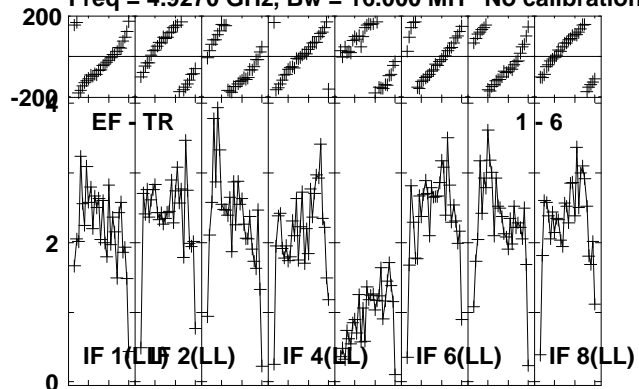

Lower frame: Milli Ampl Jy Top frame: Phas deg
Vector averaged cross-power spectrum Several baselines displayed
Timerange: 00/02:43:53 to 00/02:44:49

Plot file version 99 created 16-OCT-2012 11:57:01

NOVA-MON RO006.UVDATA.1

Freq = 4.9270 GHz, Bw = 16.000 MH No calibration applied and no bandpass applied

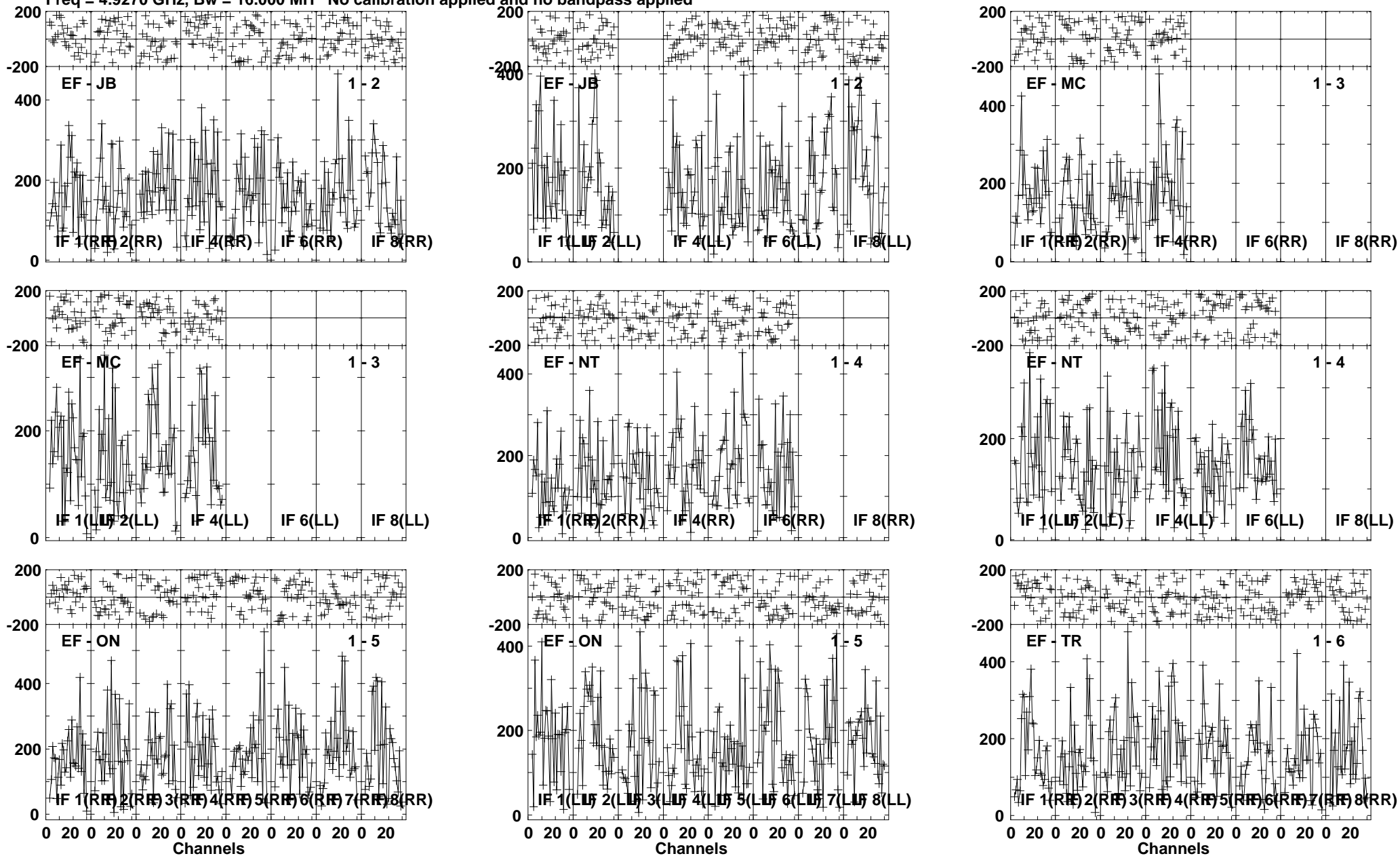

Lower frame: Micro Ampl Jy Top frame: Phas deg
Vector averaged cross-power spectrum Several baselines displayed
Timerange: 00/02:44:53 to 00/02:47:49

Plot file version 100 created 16-OCT-2012 11:57:02

NOVA-MON RO006.UVDATA.1

Freq = 4.9270 GHz, Bw = 16.000 MH No calibration applied and no bandpass applied

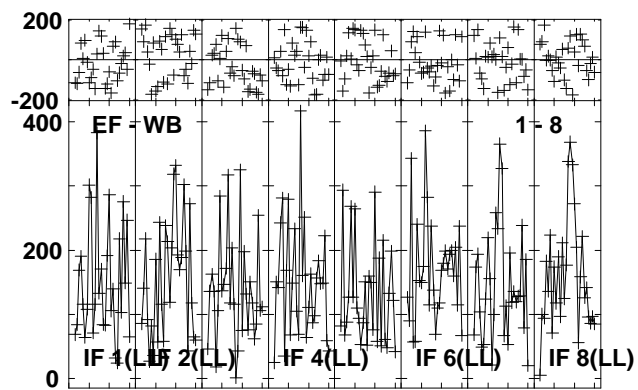
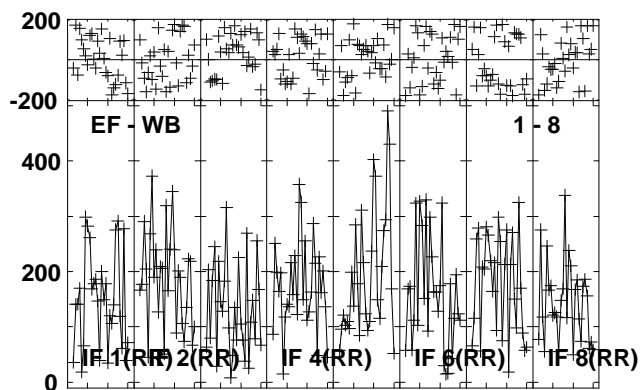
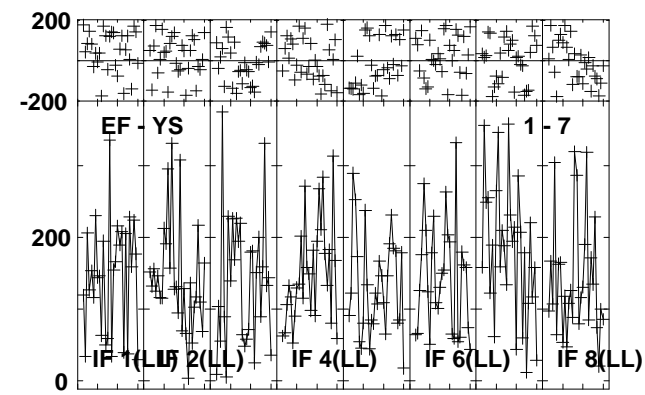
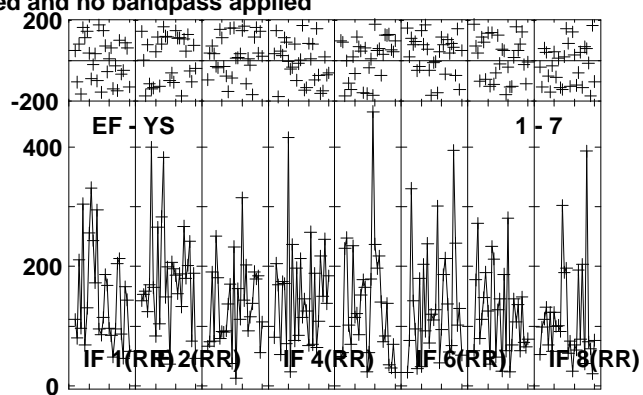
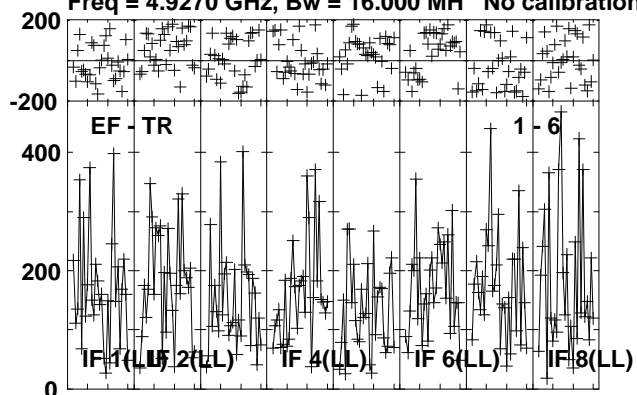

Lower frame: Micro Ampl Jy Top frame: Phas deg
Vector averaged cross-power spectrum Several baselines displayed
Timerange: 00/02:44:53 to 00/02:47:49

Plot file version 101 created 16-OCT-2012 11:57:02

J0639+0601 RO006.UVDATA.1

Freq = 4.9270 GHz, Bw = 16.000 MH No calibration applied and no bandpass applied

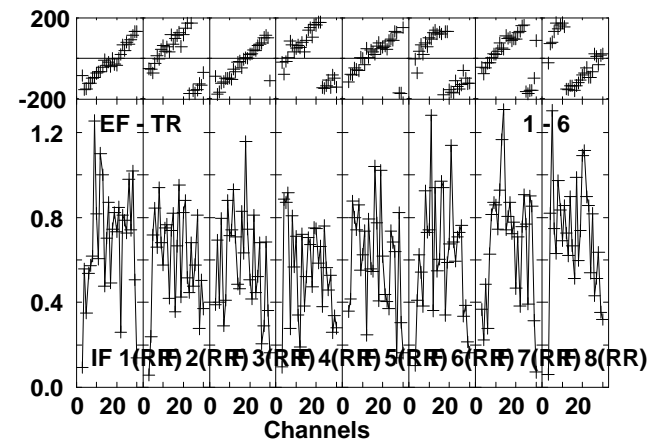
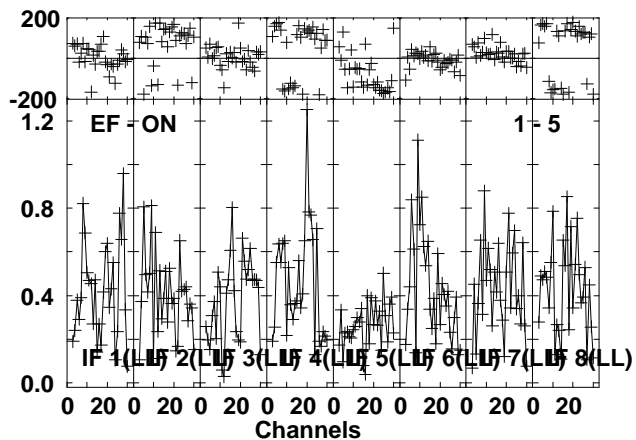
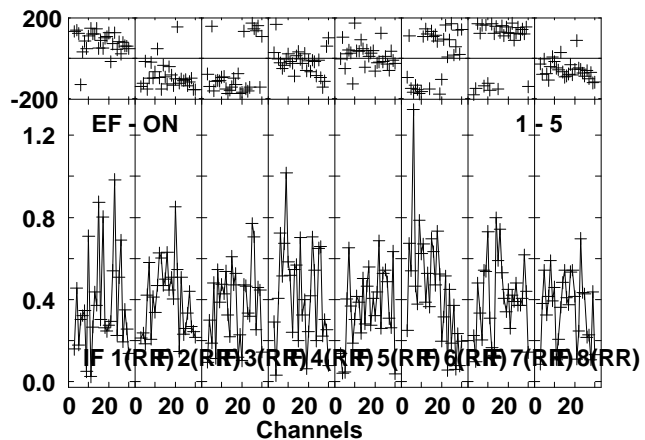
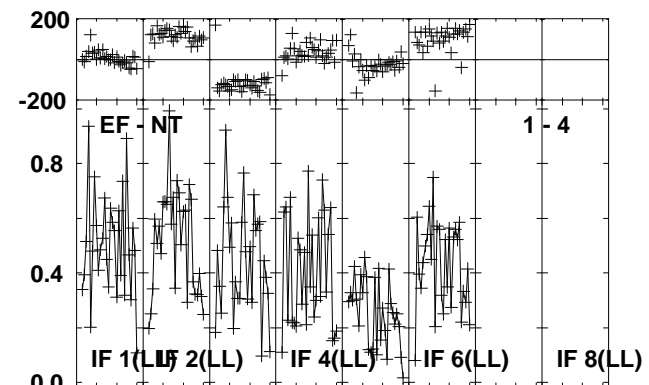
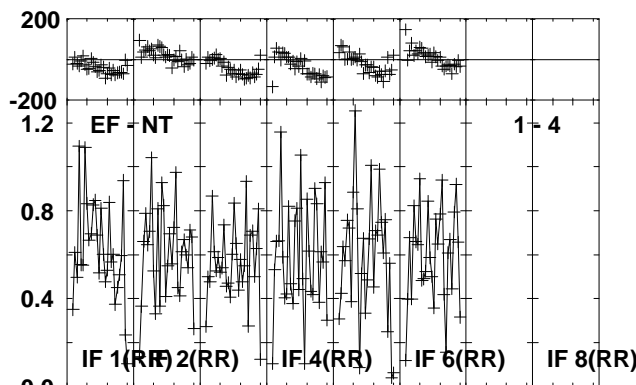
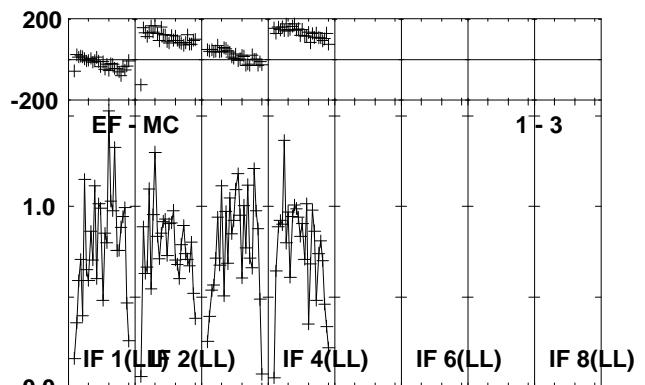
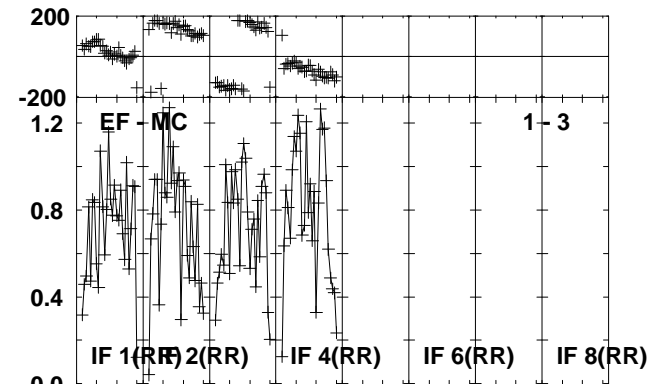
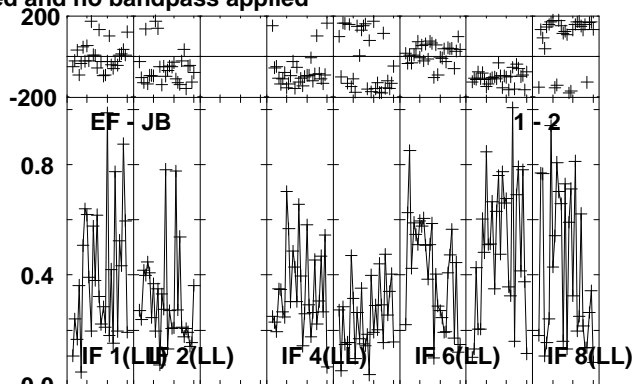
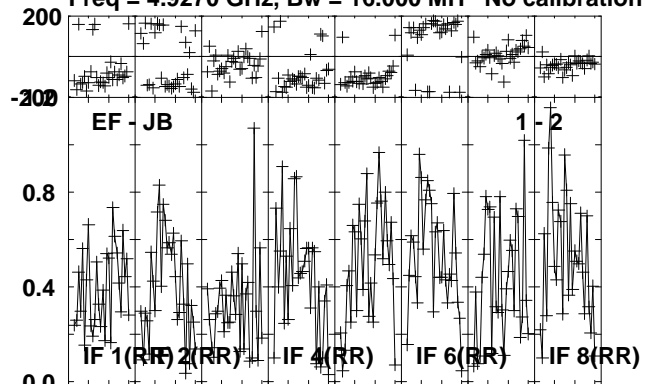

Lower frame: Milli Ampl Jy Top frame: Phas deg
Vector averaged cross-power spectrum Several baselines displayed
Timerange: 00/02:48:17 to 00/02:49:19

Plot file version 102 created 16-OCT-2012 11:57:02

J0639+0601 RO006.UVDATA.1

Freq = 4.9270 GHz, Bw = 16.000 MH No calibration applied and no bandpass applied

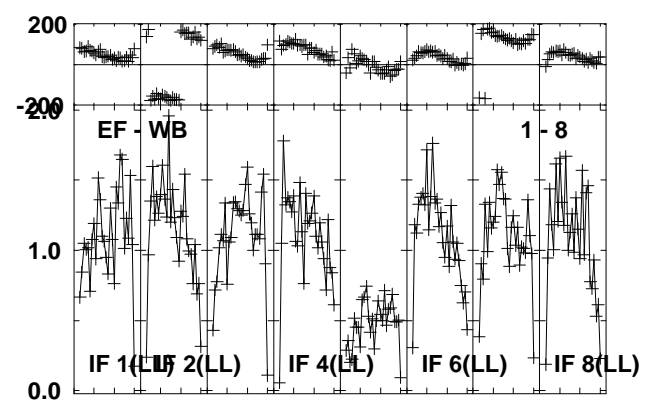
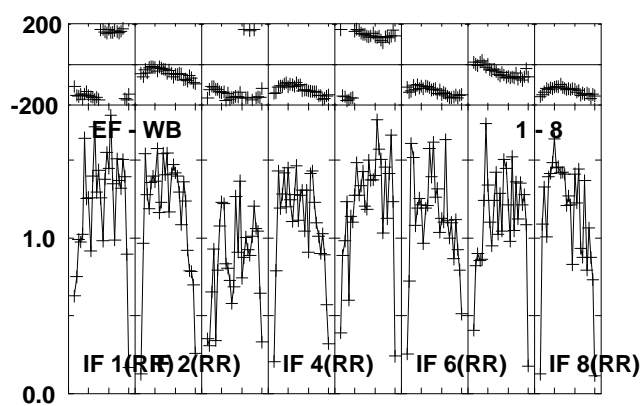
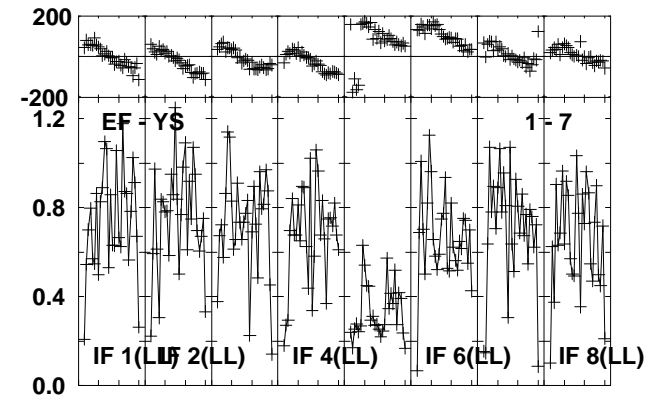
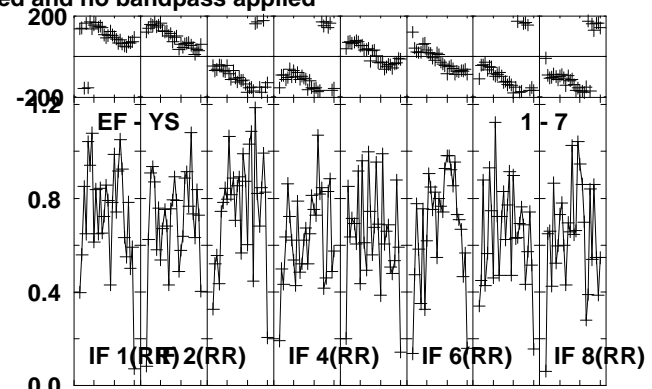
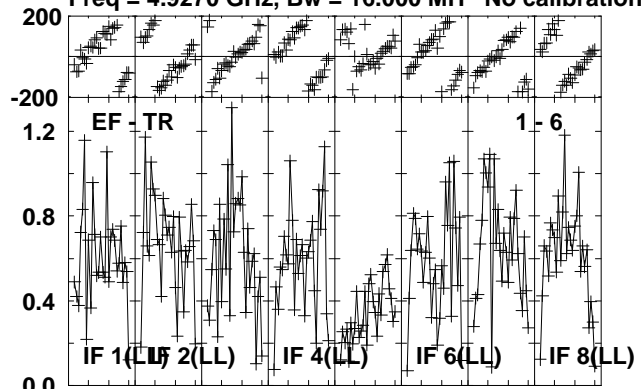

Lower frame: Milli Ampl Jy Top frame: Phas deg
Vector averaged cross-power spectrum Several baselines displayed
Timerange: 00/02:48:17 to 00/02:49:19

Plot file version 103 created 16-OCT-2012 11:57:03

0528+134 RO006.UVDATA.1

Freq = 4.9270 GHz, Bw = 16.000 MH No calibration applied and no bandpass applied

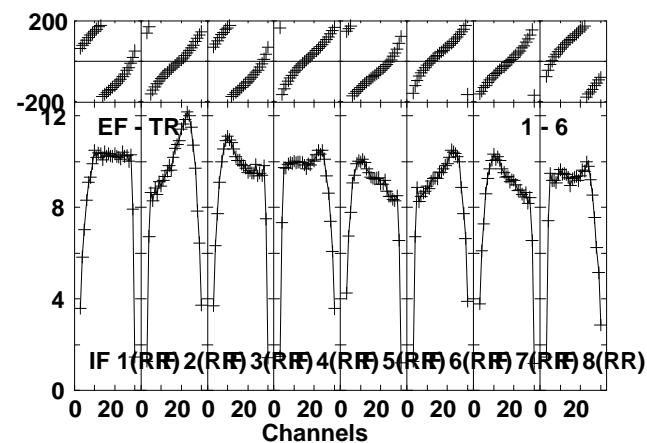
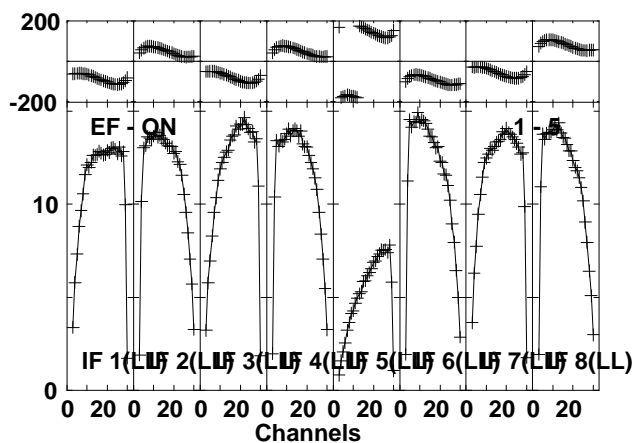
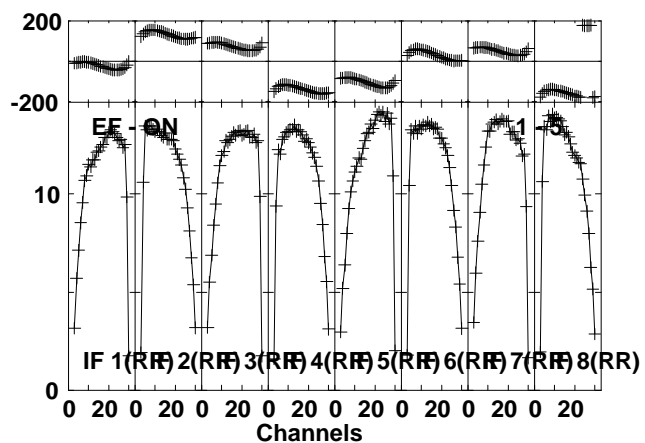
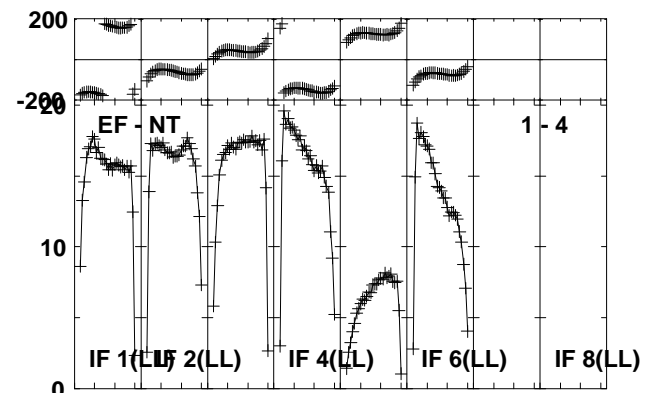
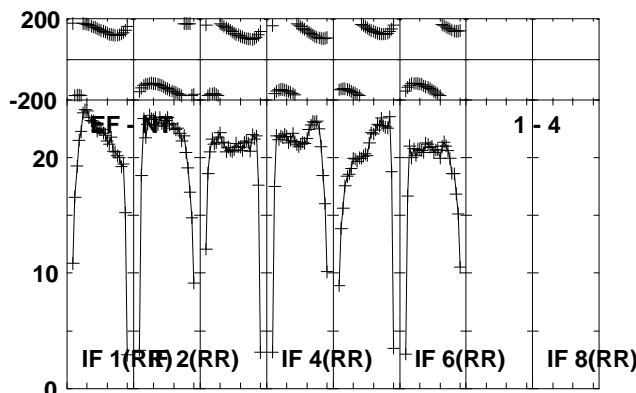
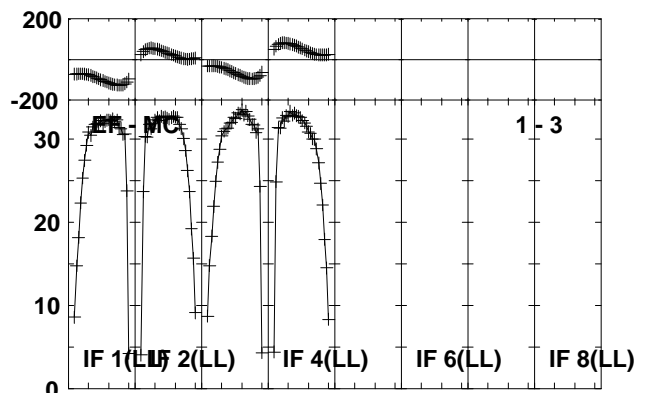
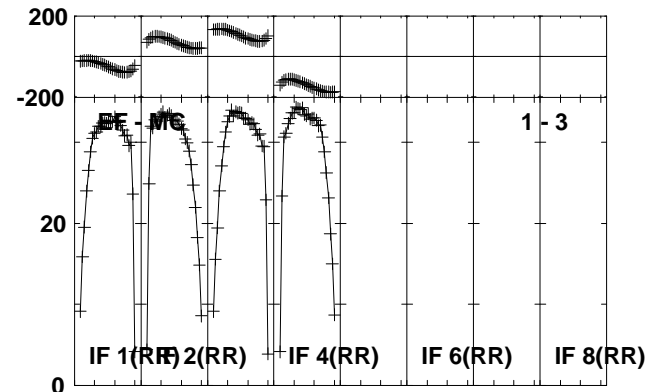
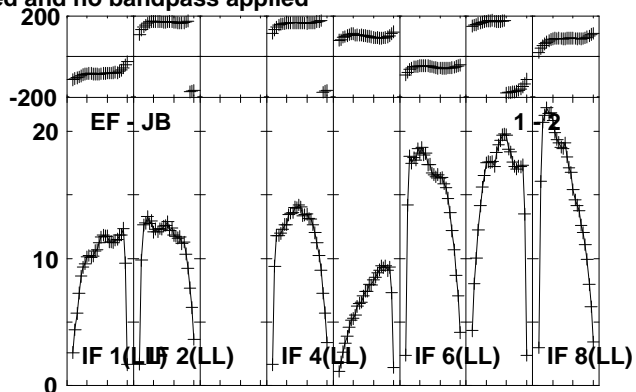
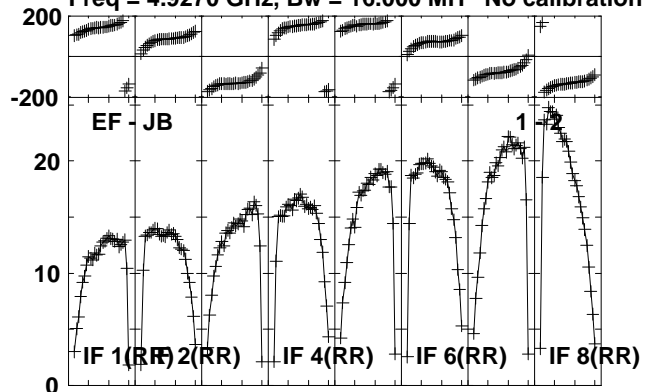

Lower frame: Milli Ampl Jy Top frame: Phas deg
Vector averaged cross-power spectrum Several baselines displayed
Timerange: 00/02:51:17 to 00/02:54:19

Plot file version 104 created 16-OCT-2012 11:57:03

0528+134 RO006.UVDATA.1

Freq = 4.9270 GHz, Bw = 16.000 MH No calibration applied and no bandpass applied

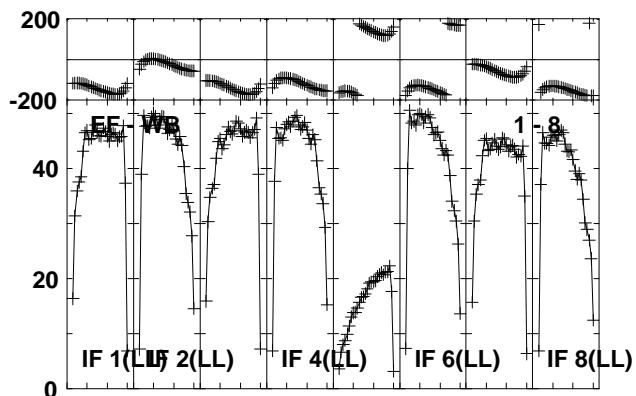
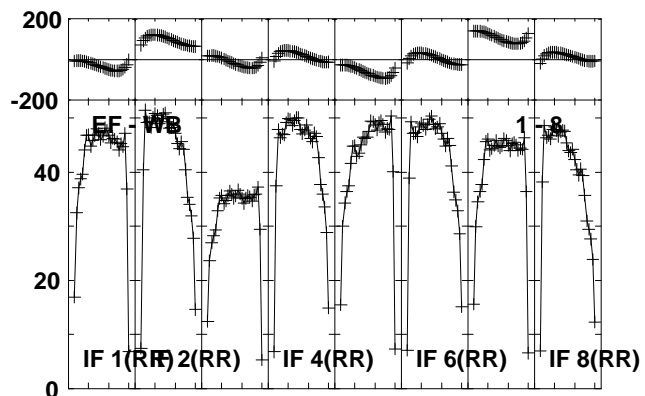
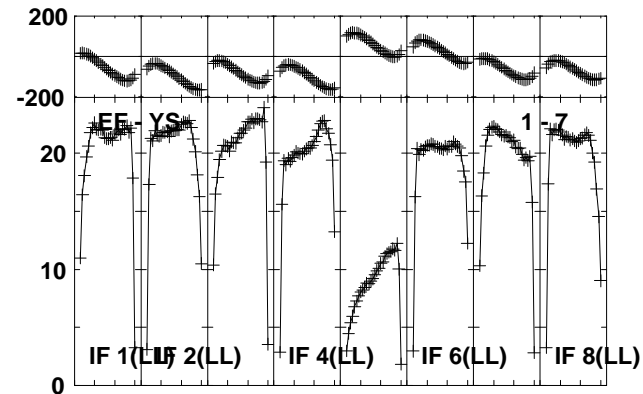
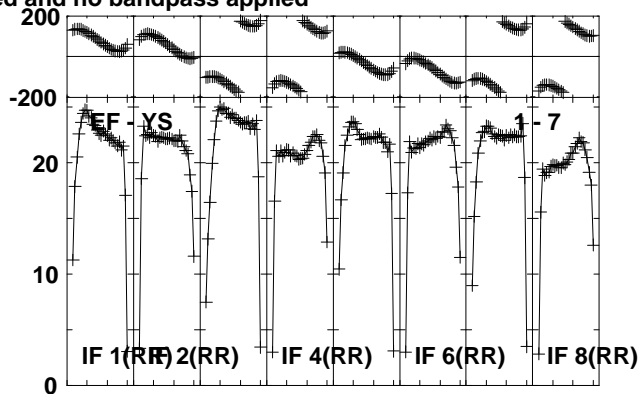
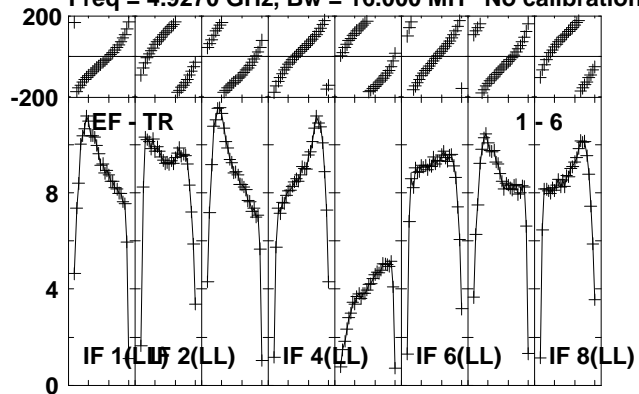

Lower frame: Milli Ampl Jy Top frame: Phas deg
Vector averaged cross-power spectrum Several baselines displayed
Timerange: 00/02:51:17 to 00/02:54:19

Plot file version 105 created 16-OCT-2012 11:57:04

J0645+0541 RO006.UVDATA.1

Freq = 4.9270 GHz, Bw = 16.000 MH No calibration applied and no bandpass applied

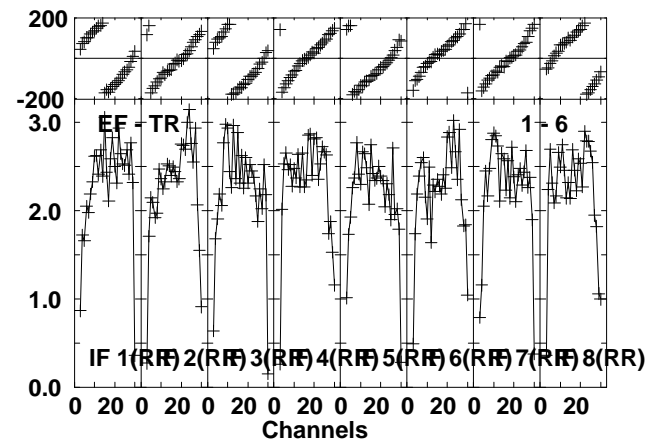
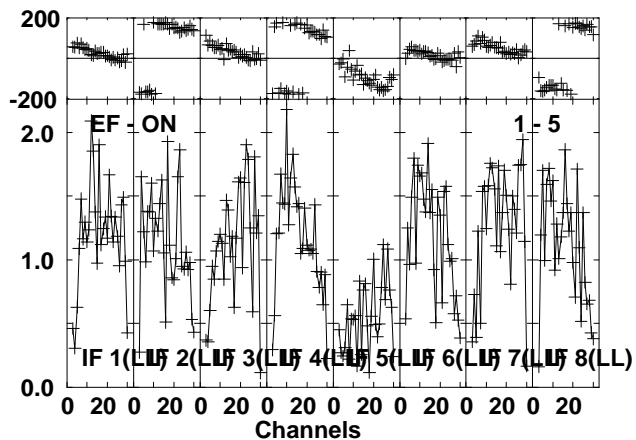
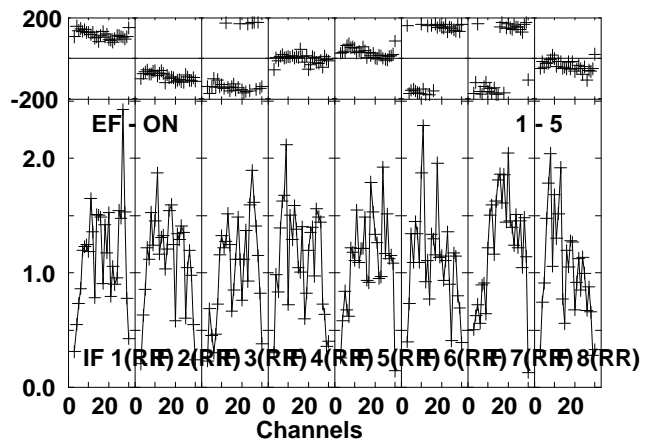
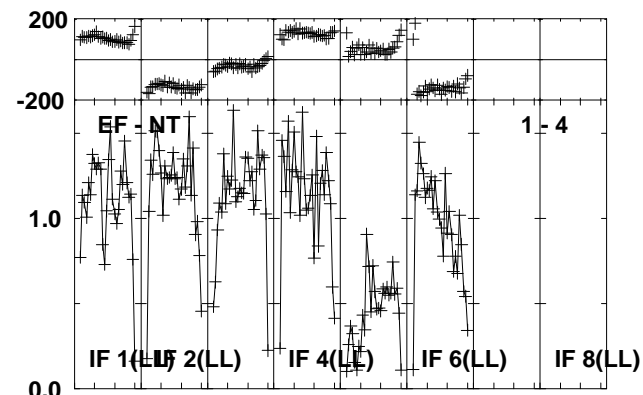
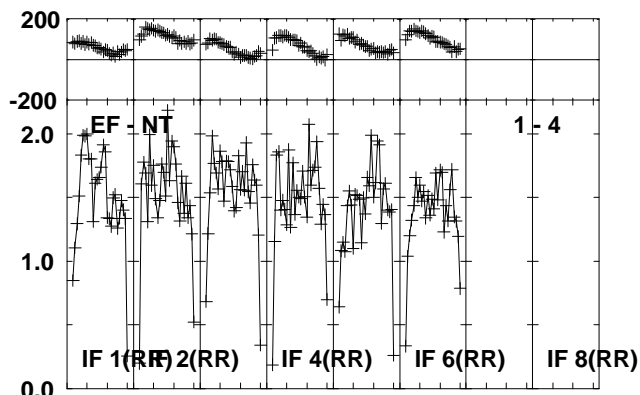
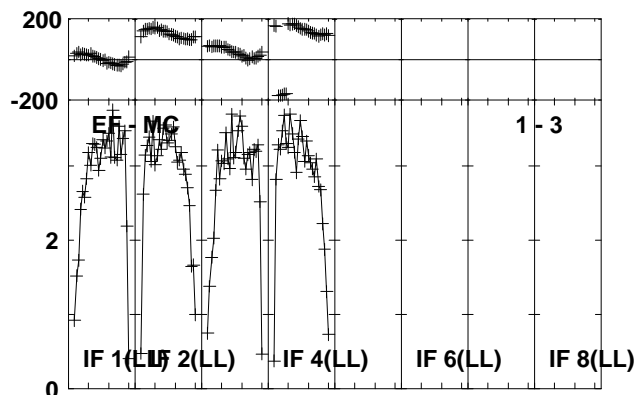
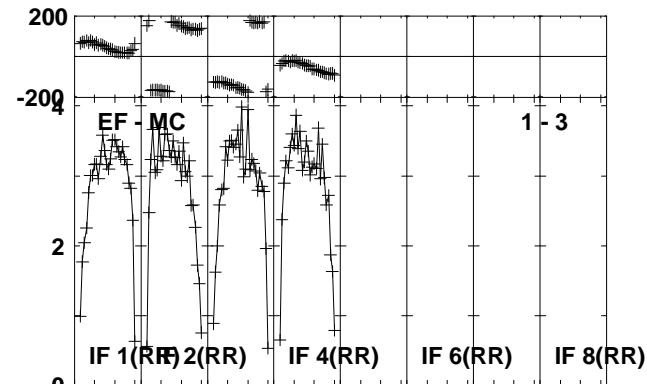
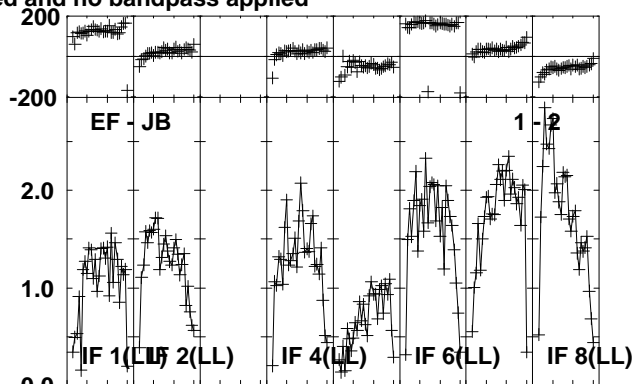
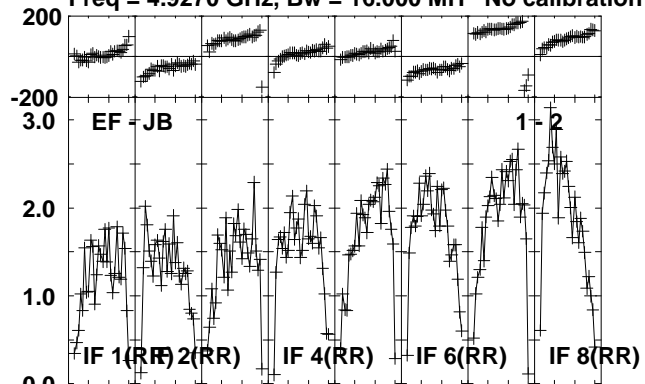

Lower frame: Milli Ampl Jy Top frame: Phas deg
Vector averaged cross-power spectrum Several baselines displayed
Timerange: 00/02:56:17 to 00/02:57:19

Plot file version 106 created 16-OCT-2012 11:57:04

J0645+0541 RO006.UVDATA.1

Freq = 4.9270 GHz, Bw = 16.000 MH No calibration applied and no bandpass applied

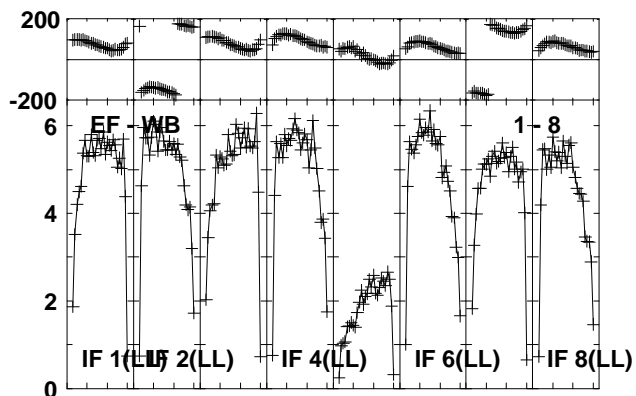
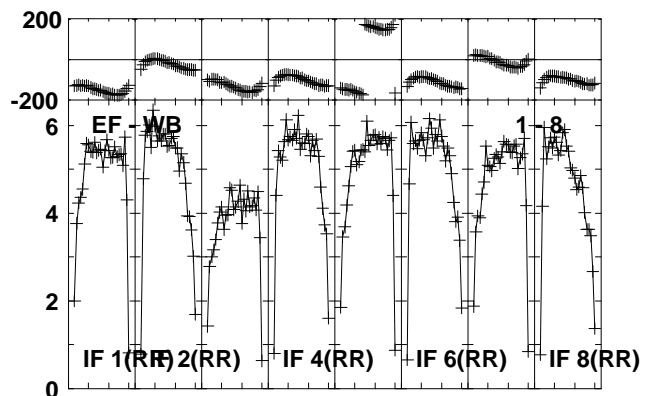
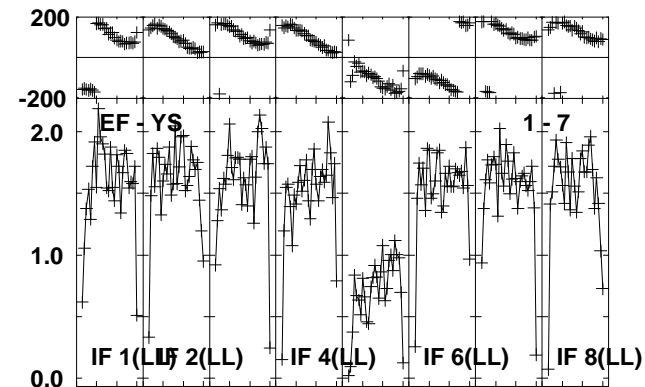
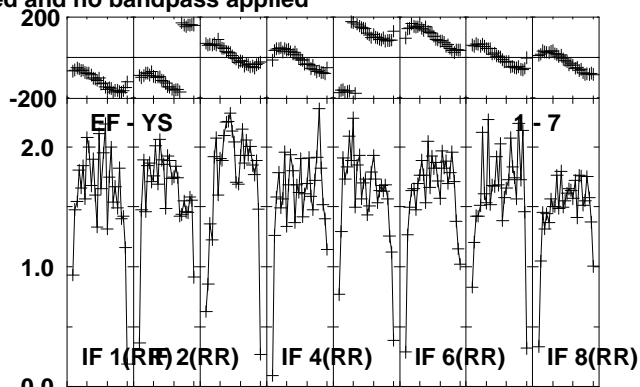
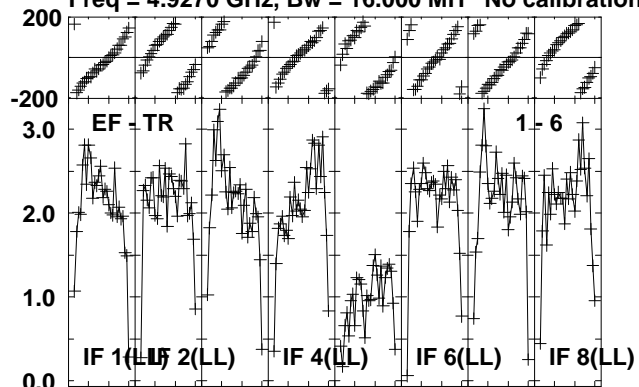

Lower frame: Milli Ampl Jy Top frame: Phas deg
Vector averaged cross-power spectrum Several baselines displayed
Timerange: 00/02:56:17 to 00/02:57:19

Plot file version 107 created 16-OCT-2012 11:57:04

NOVA-MON RO006.UVDATA.1

Freq = 4.9270 GHz, Bw = 16.000 MH No calibration applied and no bandpass applied

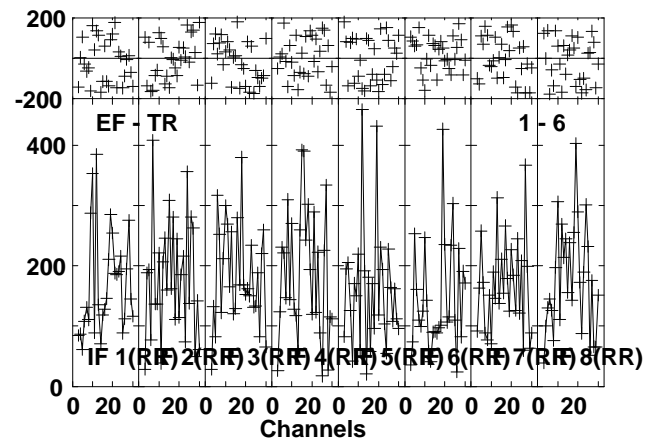
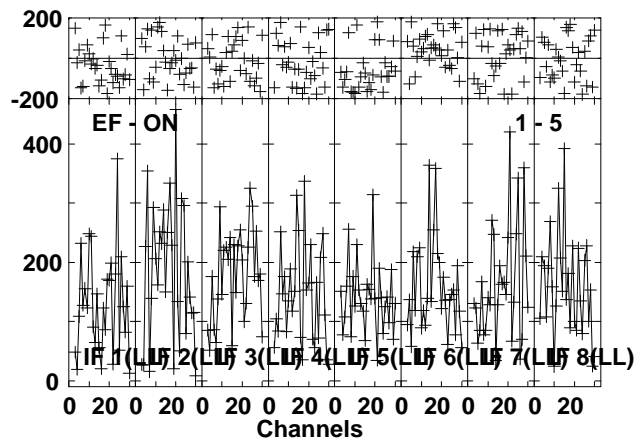
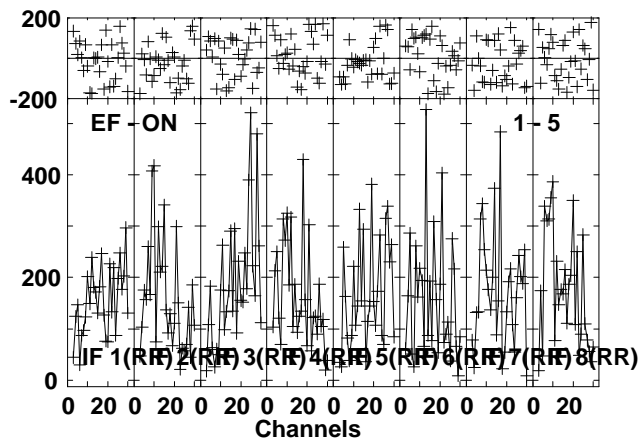
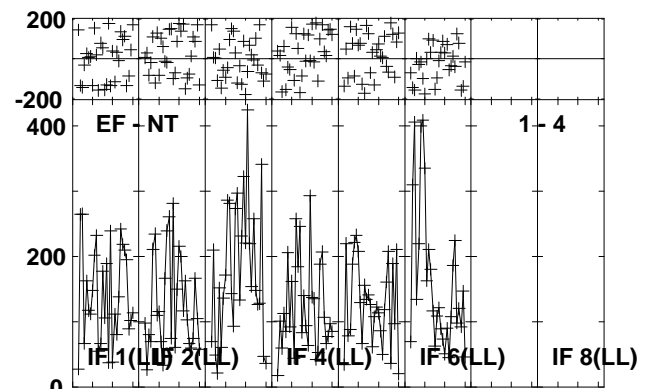
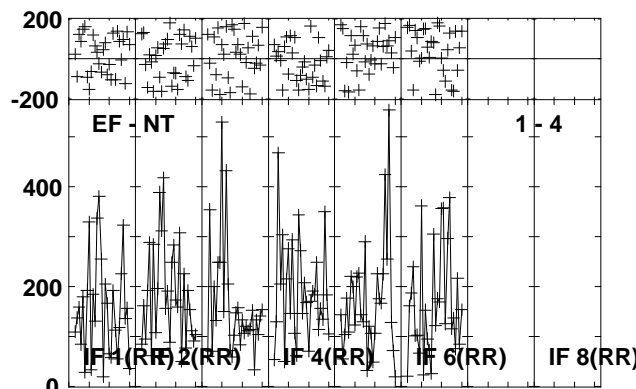
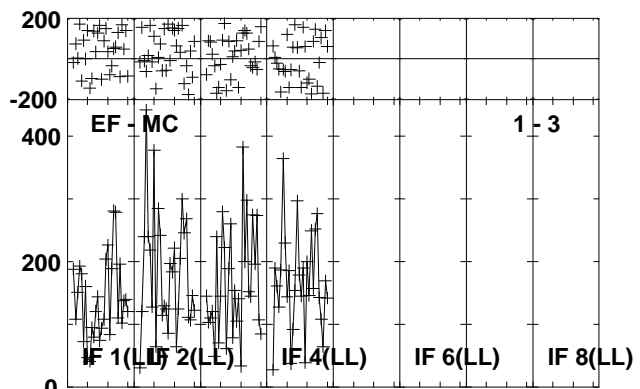
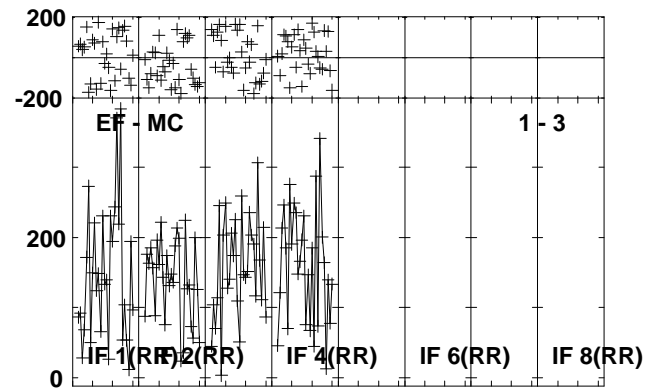
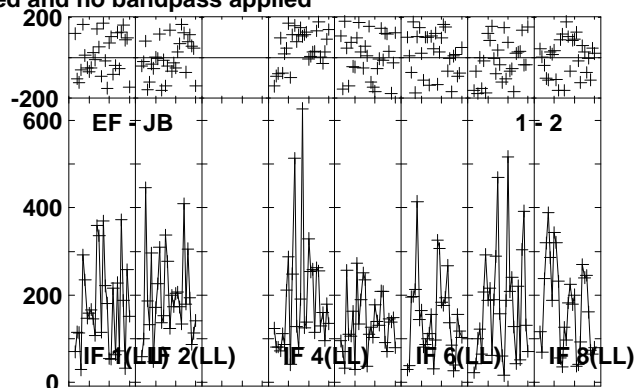
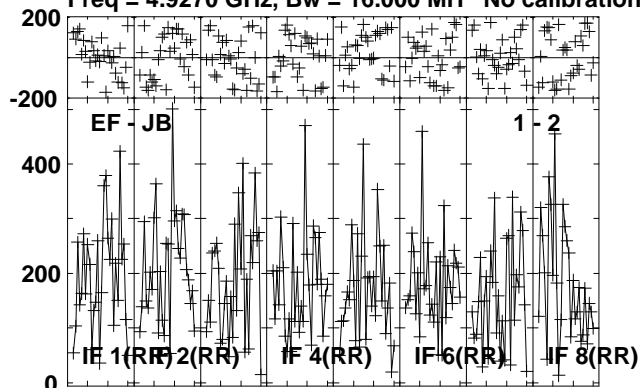

Lower frame: Micro Ampl Jy Top frame: Phas deg
Vector averaged cross-power spectrum Several baselines displayed
Timerange: 00/02:57:23 to 00/03:00:19

Plot file version 108 created 16-OCT-2012 11:57:04

NOVA-MON RO006.UVDATA.1

Freq = 4.9270 GHz, Bw = 16.000 MH No calibration applied and no bandpass applied

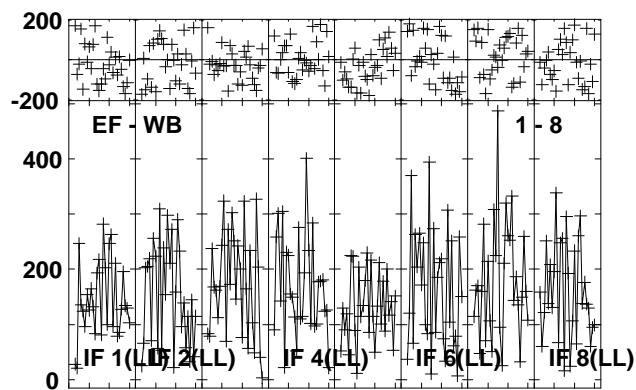
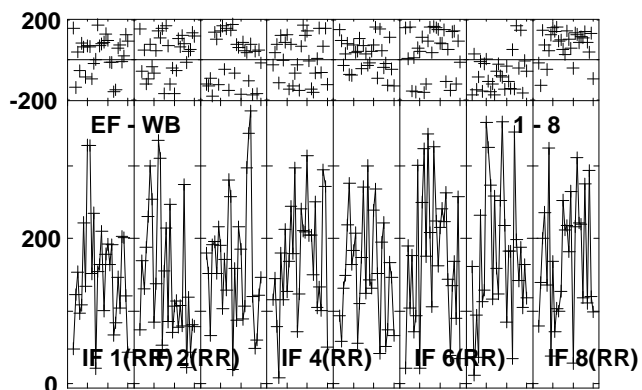
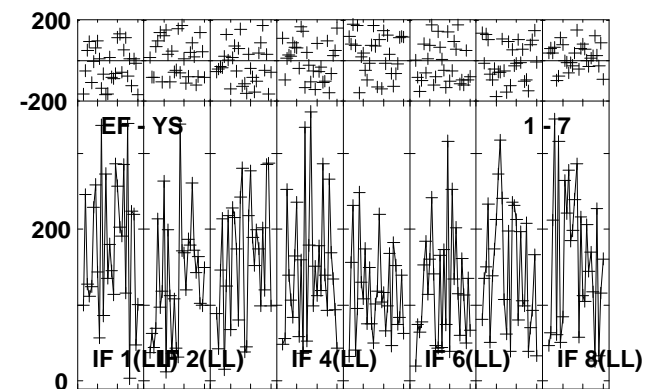
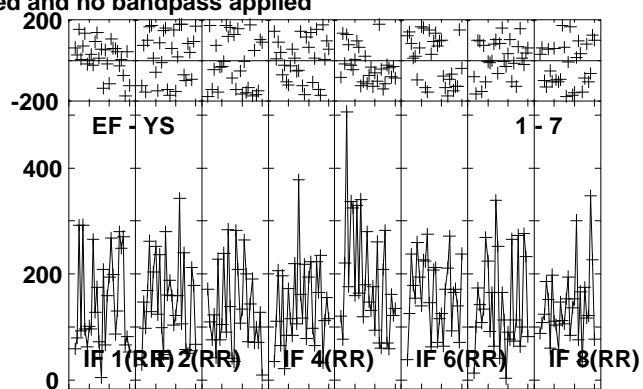
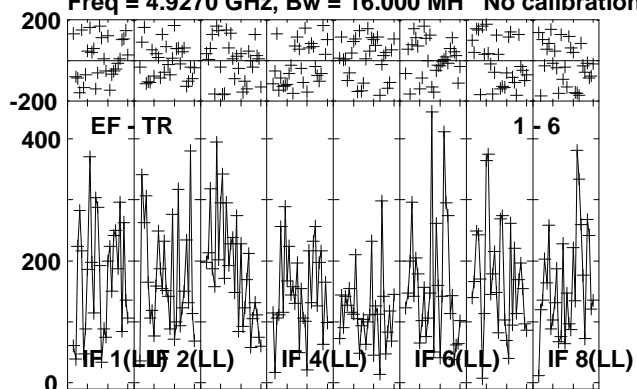

Lower frame: Micro Ampl Jy Top frame: Phas deg
Vector averaged cross-power spectrum Several baselines displayed
Timerange: 00/02:57:23 to 00/03:00:19

Plot file version 109 created 16-OCT-2012 11:57:05

J0639+0601 RO006.UVDATA.1

Freq = 4.9270 GHz, Bw = 16.000 MH No calibration applied and no bandpass applied

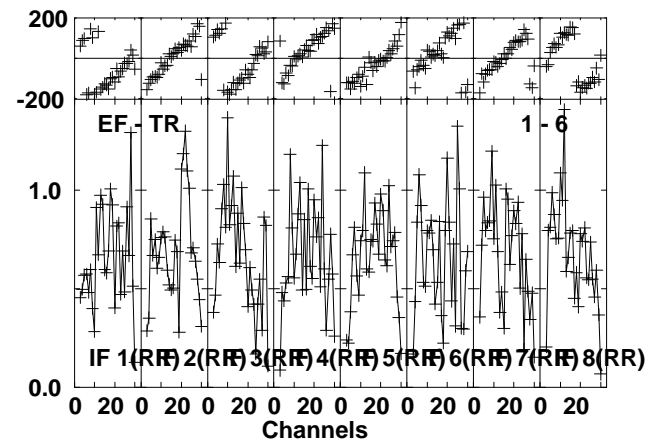
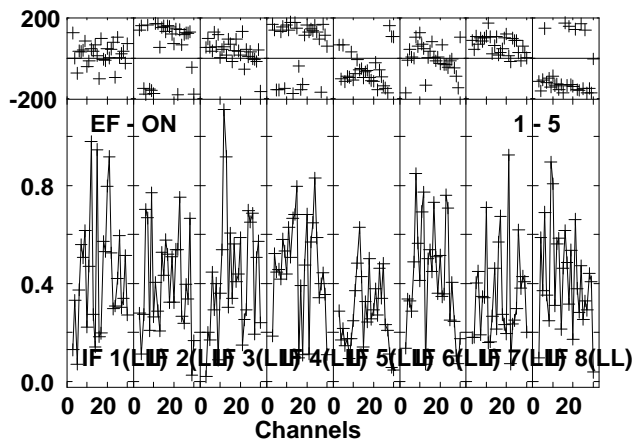
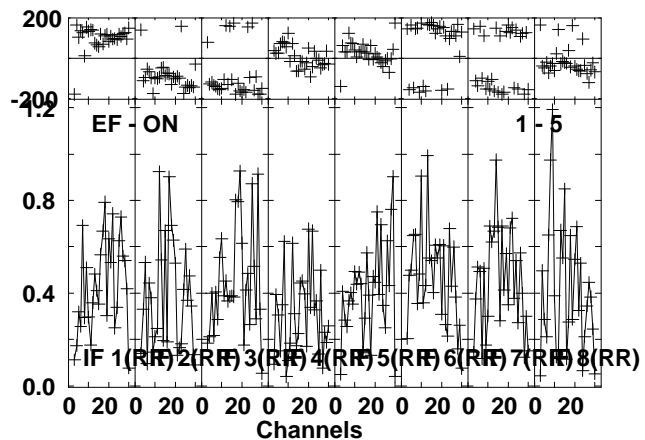
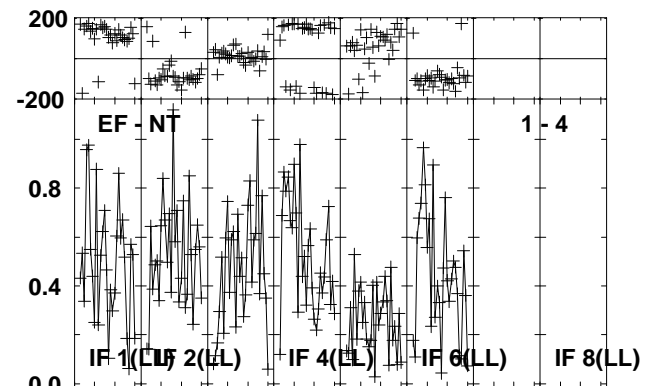
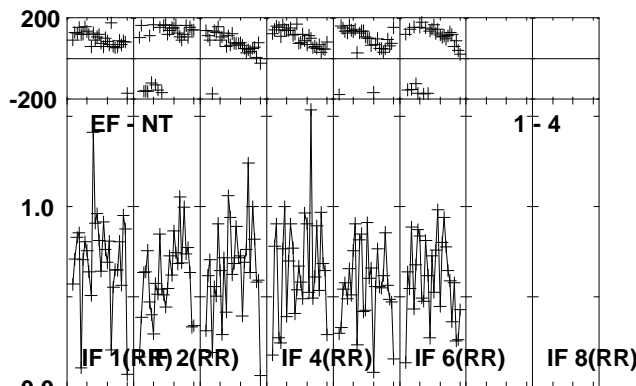
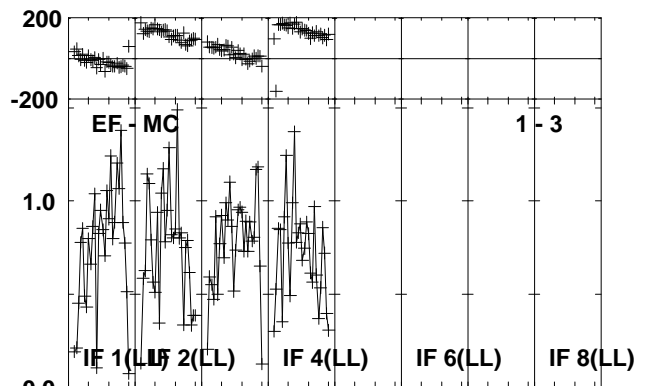
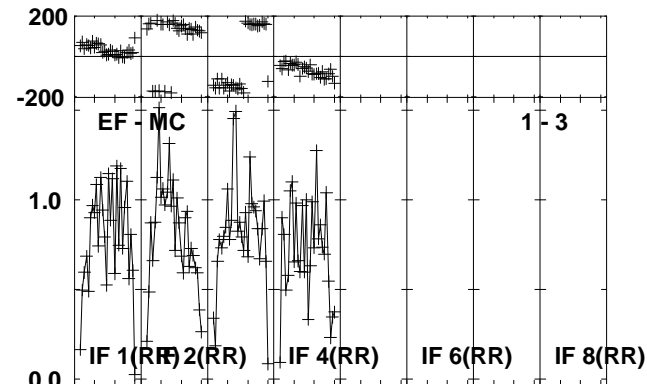
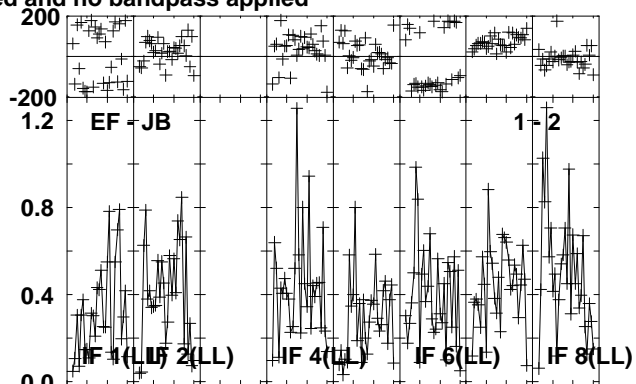
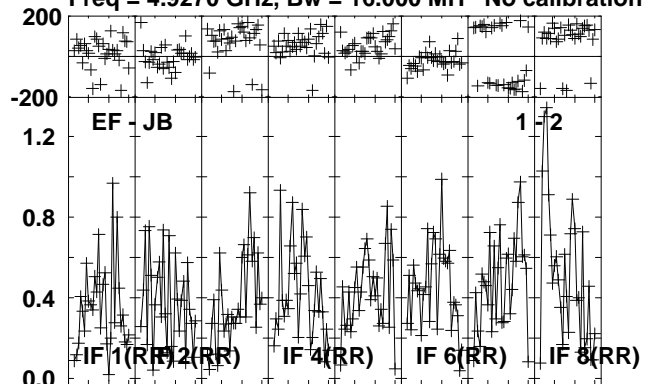

Lower frame: Milli Ampl Jy Top frame: Phas deg
Vector averaged cross-power spectrum Several baselines displayed
Timerange: 00/03:00:23 to 00/03:01:33

Plot file version 110 created 16-OCT-2012 11:57:05

J0639+0601 RO006.UVDATA.1

Freq = 4.9270 GHz, Bw = 16.000 MH No calibration applied and no bandpass applied

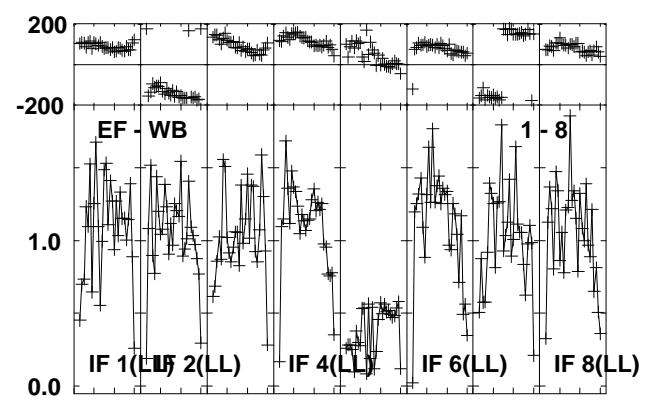
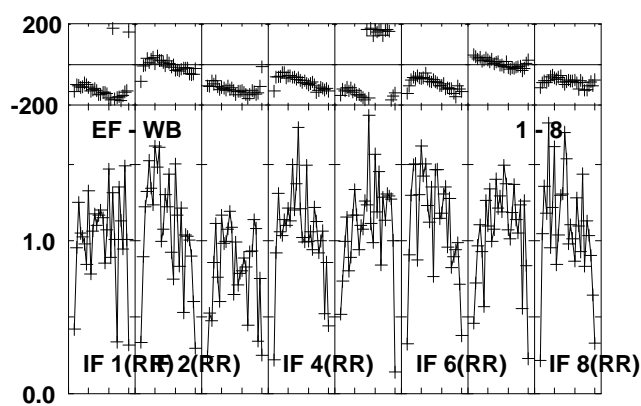
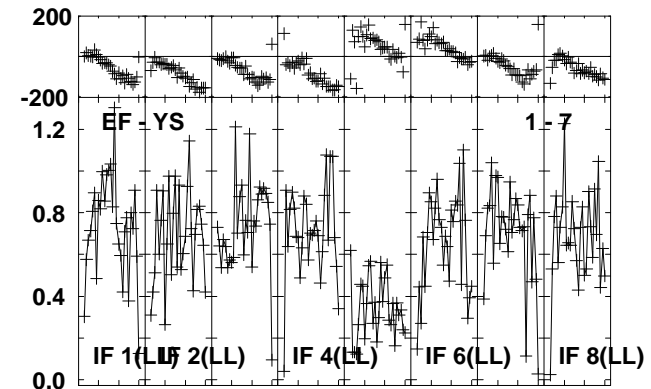
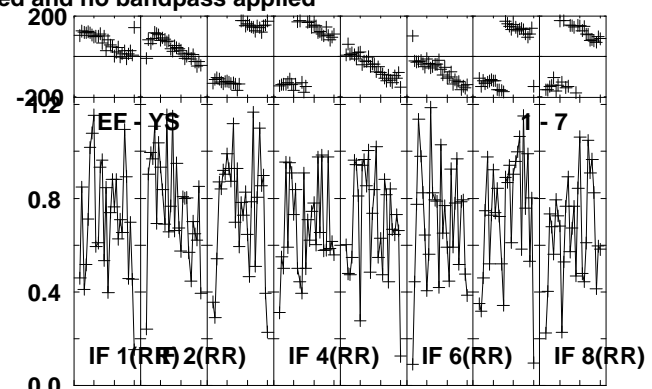
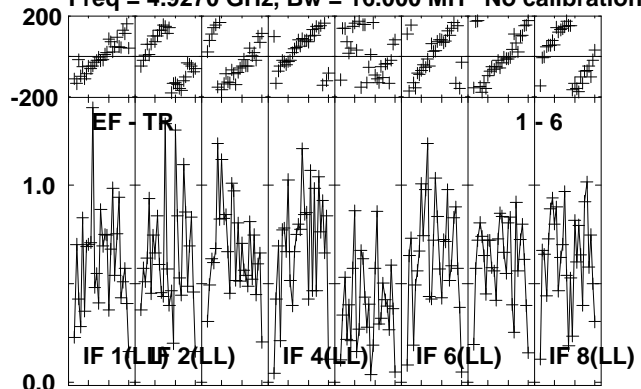

Lower frame: Milli Ampl Jy Top frame: Phas deg
Vector averaged cross-power spectrum Several baselines displayed
Timerange: 00/03:00:23 to 00/03:01:33

Plot file version 111 created 16-OCT-2012 11:57:05

J0645+0541 RO006.UVDATA.1

Freq = 4.9270 GHz, Bw = 16.000 MH No calibration applied and no bandpass applied

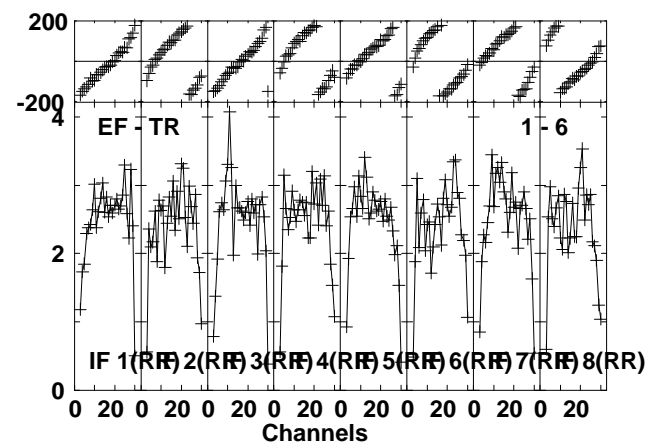
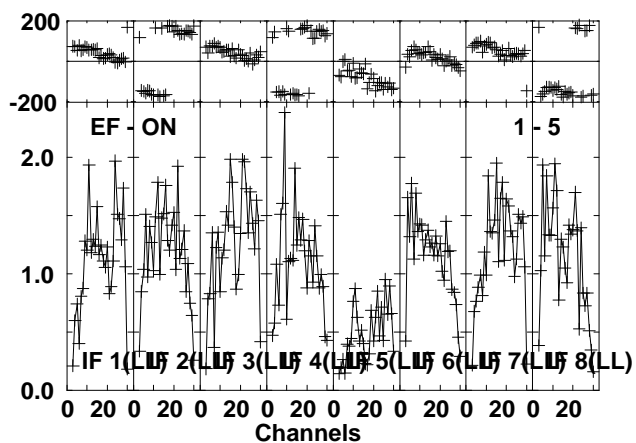
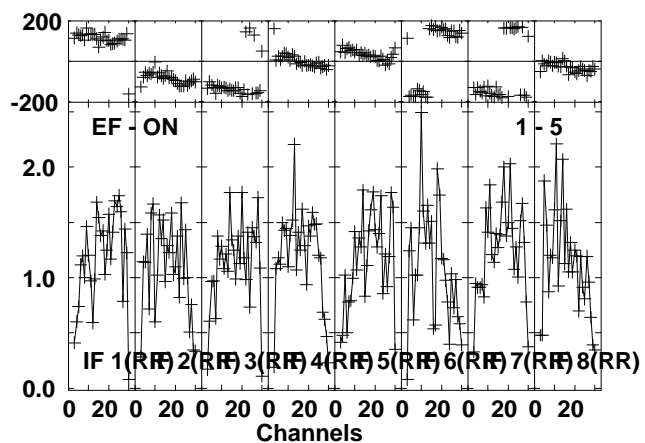
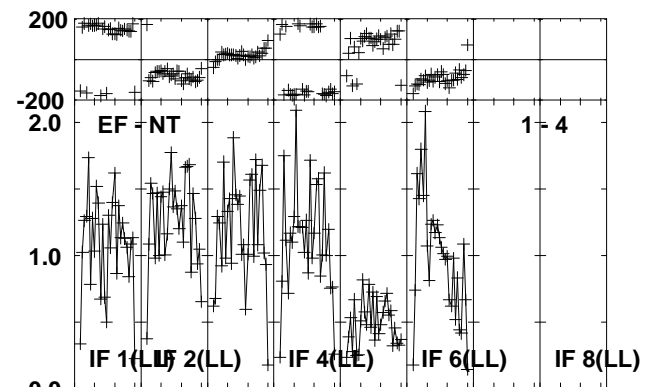
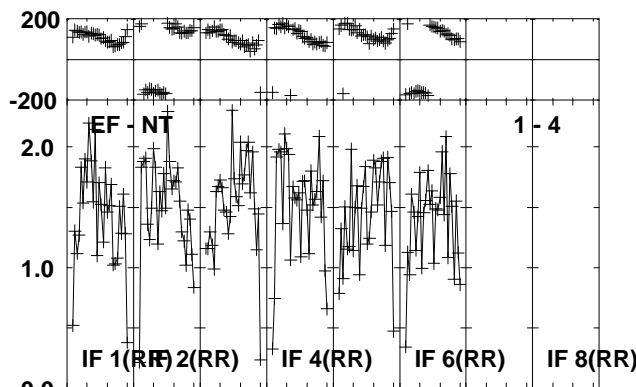
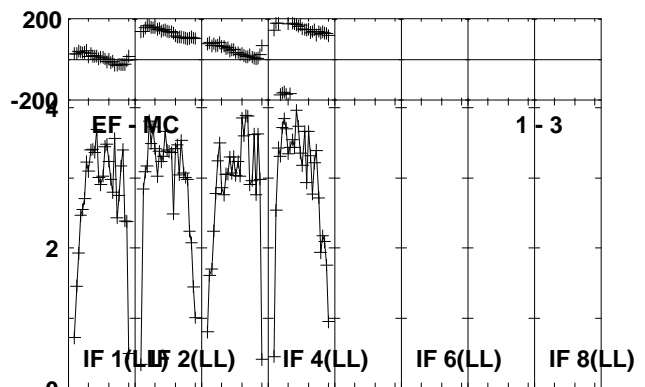
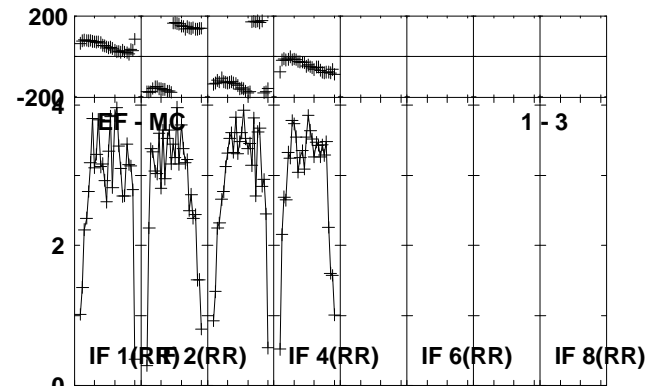
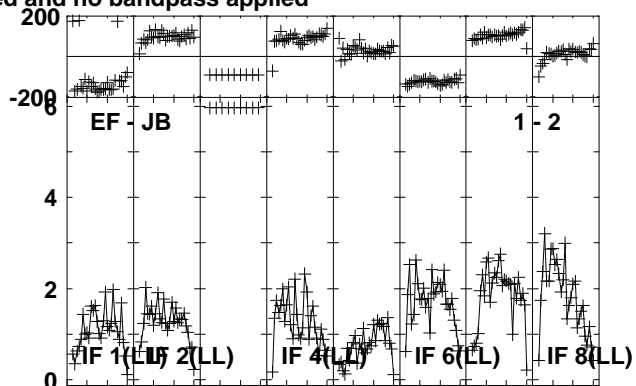
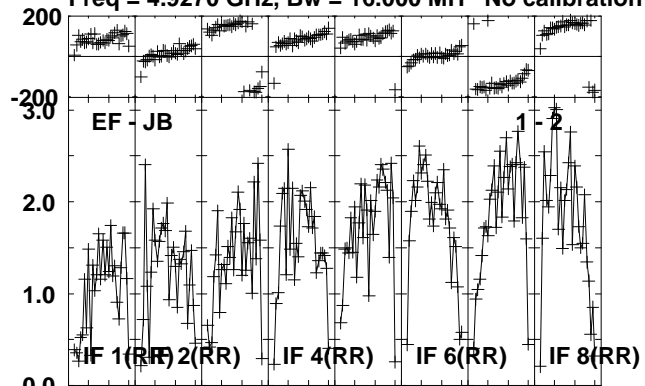

Lower frame: Milli Ampl Jy Top frame: Phas deg
Vector averaged cross-power spectrum Several baselines displayed
Timerange: 00/03:01:37 to 00/03:02:33

Plot file version 112 created 16-OCT-2012 11:57:05

J0645+0541 RO006.UVDATA.1

Freq = 4.9270 GHz, Bw = 16.000 MH No calibration applied and no bandpass applied

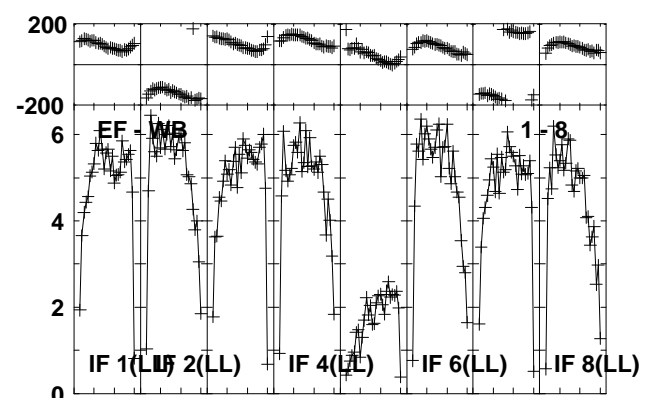
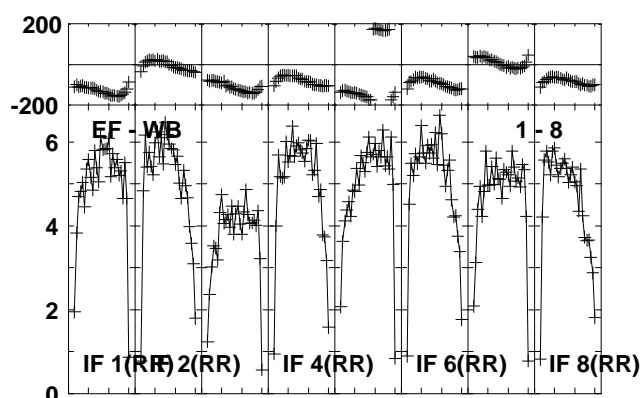
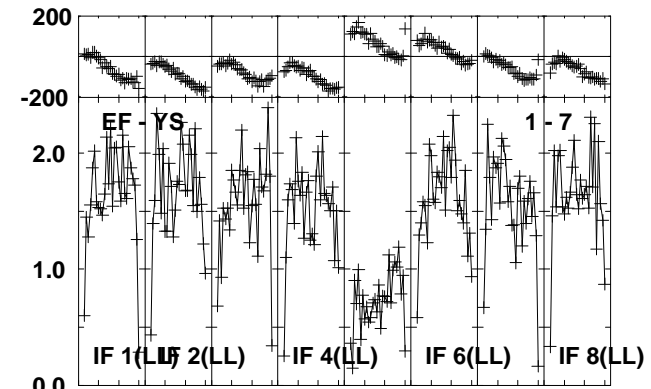
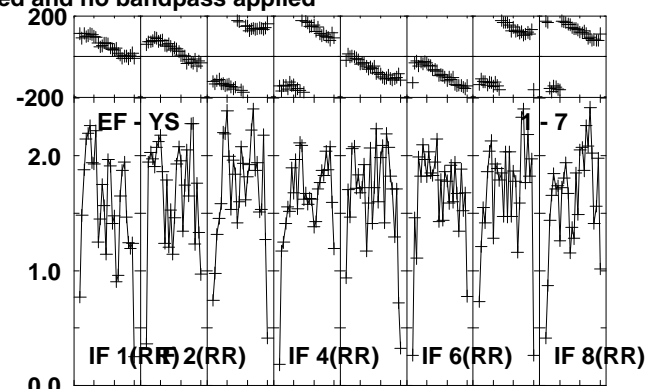
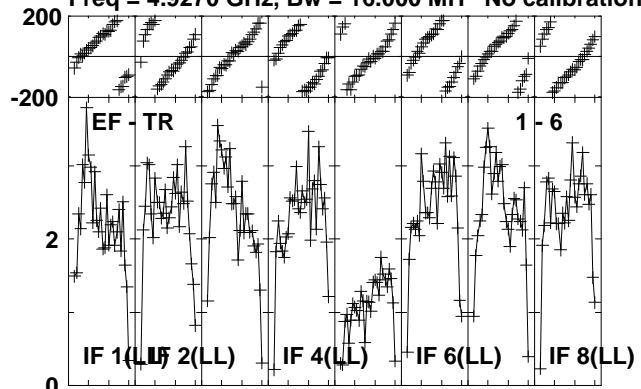

Lower frame: Milli Ampl Jy Top frame: Phas deg
Vector averaged cross-power spectrum Several baselines displayed
Timerange: 00/03:01:37 to 00/03:02:33

Plot file version 114 created 16-OCT-2012 11:57:06

NOVA-MON RO006.UVDATA.1

Freq = 4.9270 GHz, Bw = 16.000 MH No calibration applied and no bandpass applied

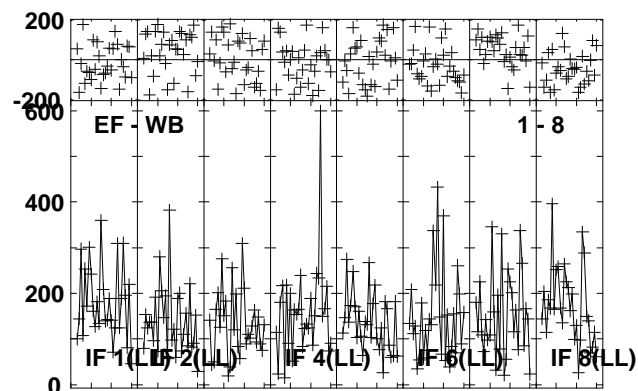
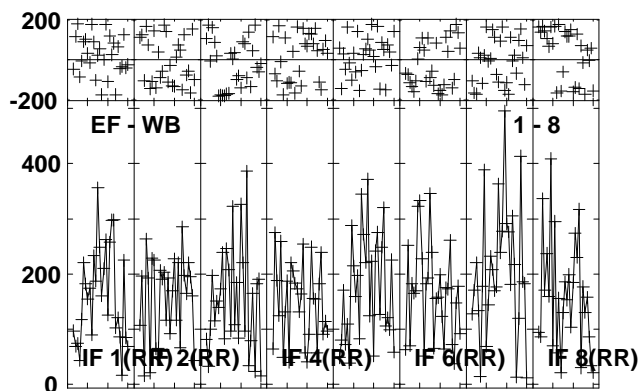
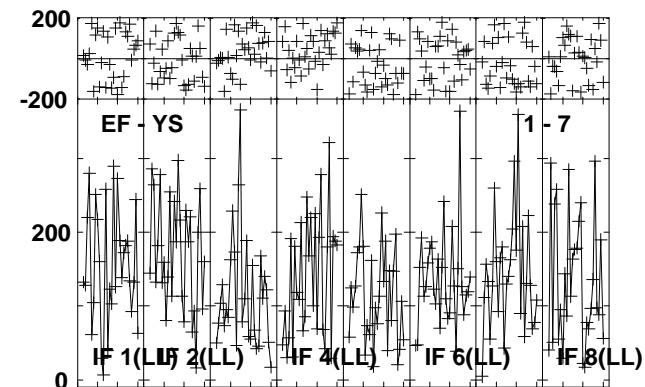
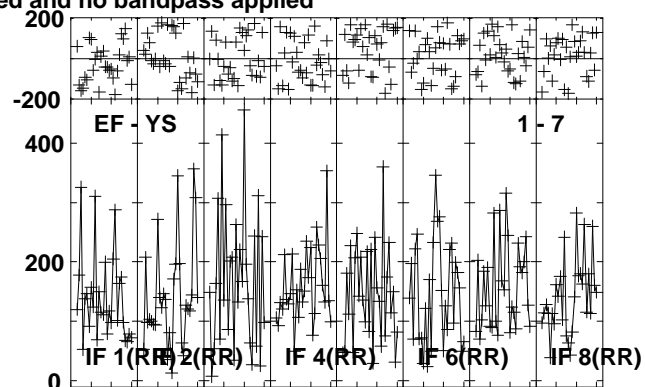
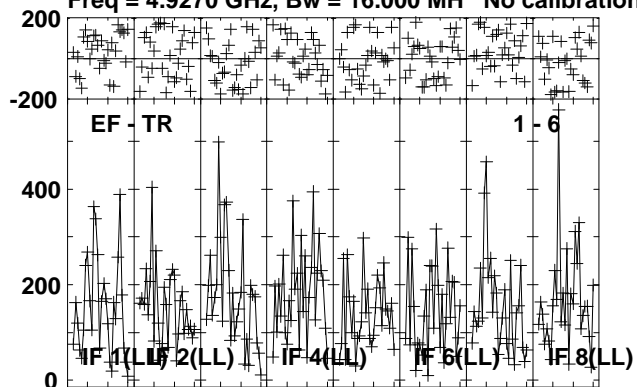

Lower frame: Micro Ampl Jy Top frame: Phas deg
Vector averaged cross-power spectrum Several baselines displayed
Timerange: 00/03:02:37 to 00/03:05:33

Plot file version 115 created 16-OCT-2012 11:57:06

J0639+0601 RO006.UVDATA.1

Freq = 4.9270 GHz, Bw = 16.000 MH No calibration applied and no bandpass applied

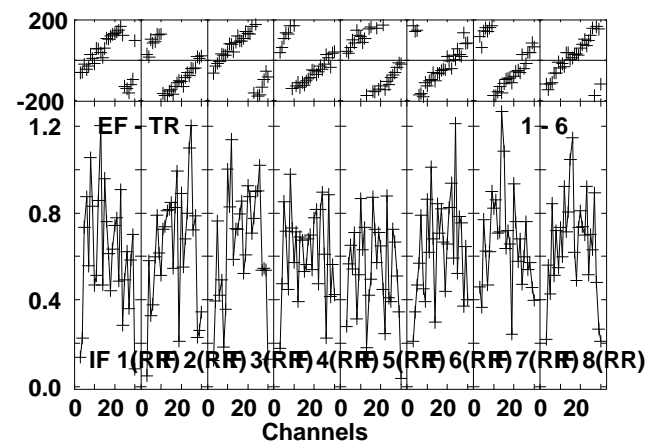
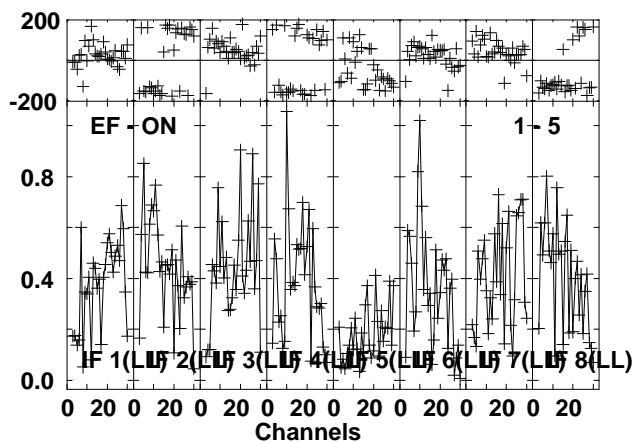
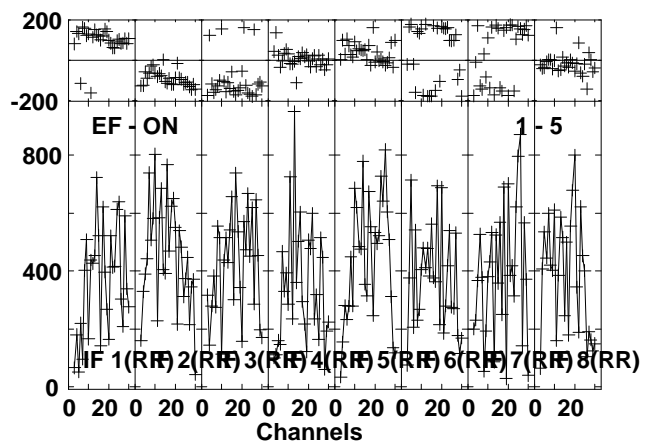
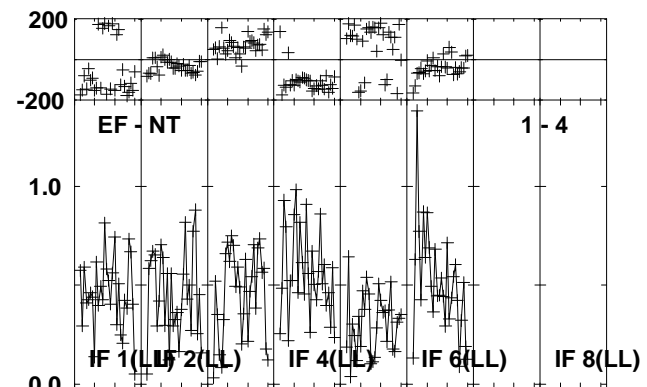
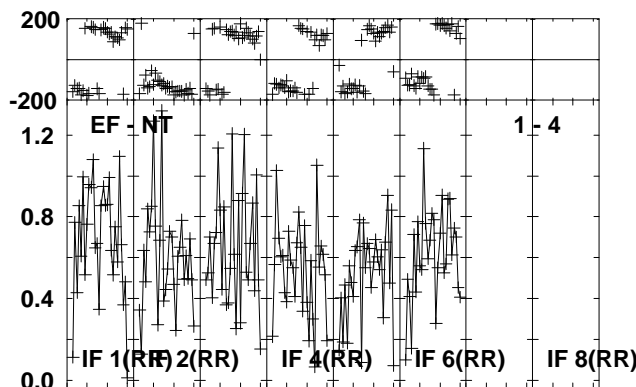
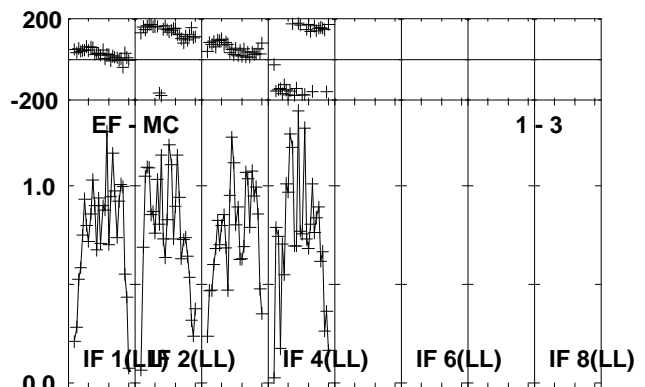
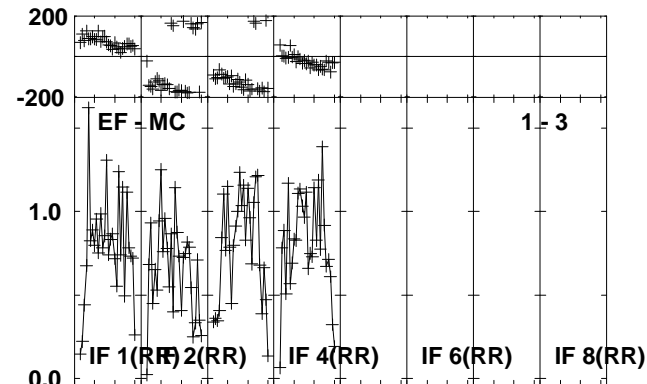
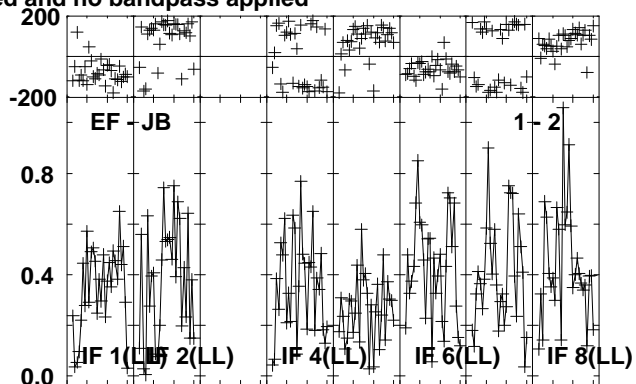
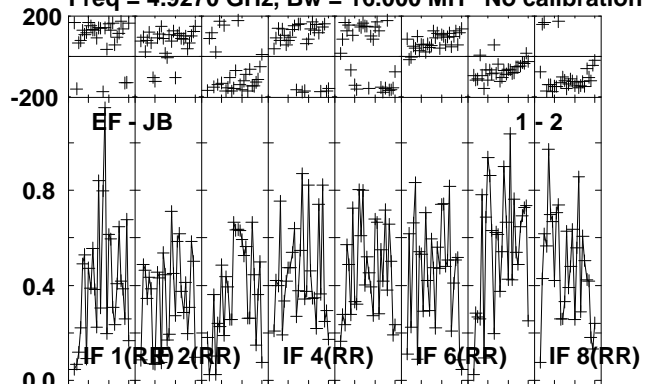

Lower frame: Milli Ampl Jy Top frame: Phas deg
Vector averaged cross-power spectrum Several baselines displayed
Timerange: 00/03:06:03 to 00/03:07:03

Plot file version 116 created 16-OCT-2012 11:57:07

J0639+0601 RO006.UVDATA.1

Freq = 4.9270 GHz, Bw = 16.000 MH No calibration applied and no bandpass applied

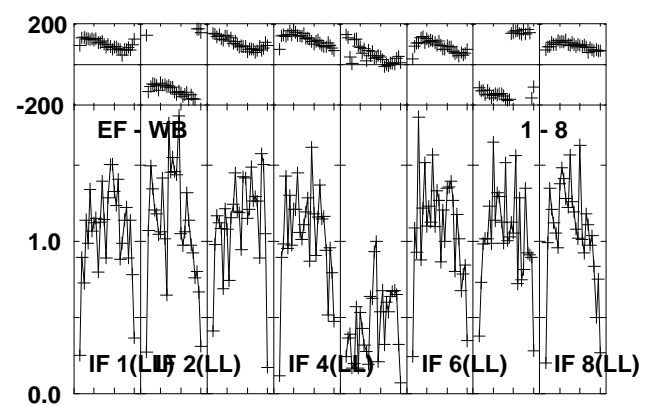
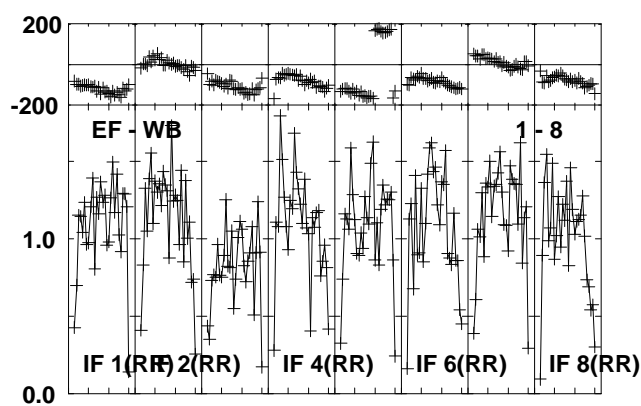
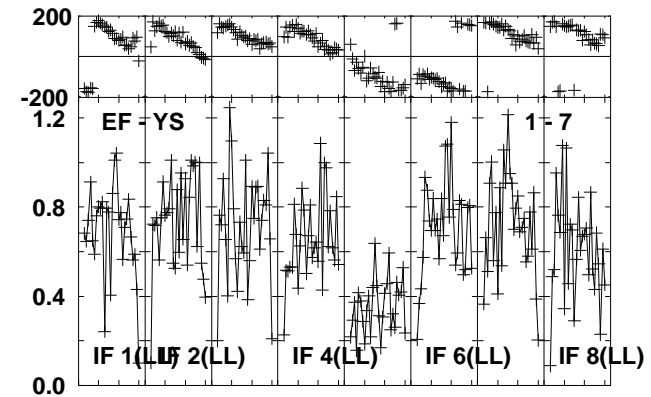
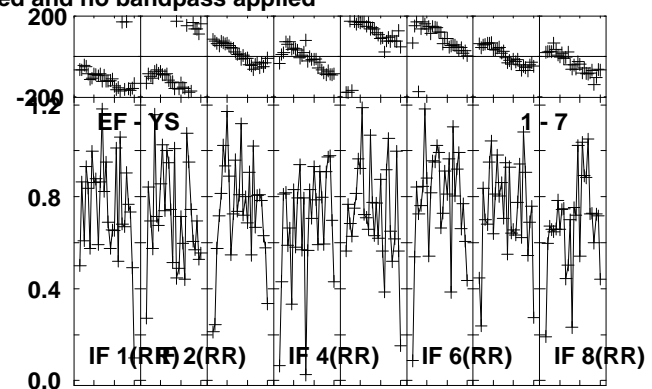
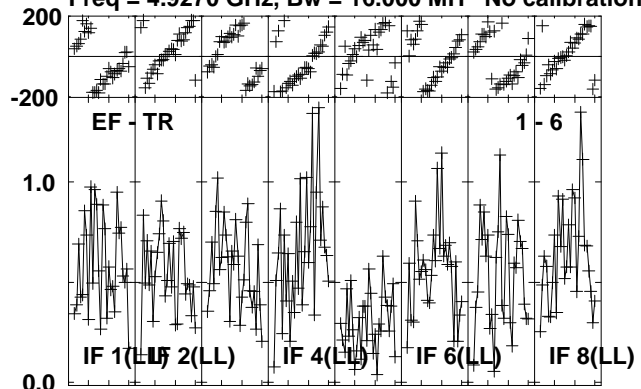

Lower frame: Milli Ampl Jy Top frame: Phas deg
Vector averaged cross-power spectrum Several baselines displayed
Timerange: 00/03:06:03 to 00/03:07:03

Plot file version 117 created 16-OCT-2012 11:57:07

J0645+0541 RO006.UVDATA.1

Freq = 4.9270 GHz, Bw = 16.000 MH No calibration applied and no bandpass applied

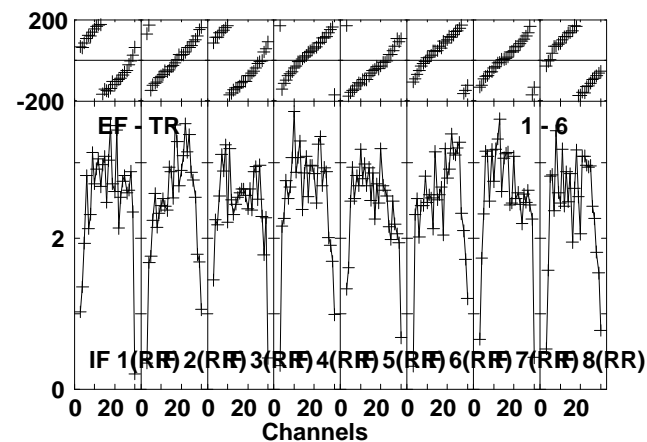
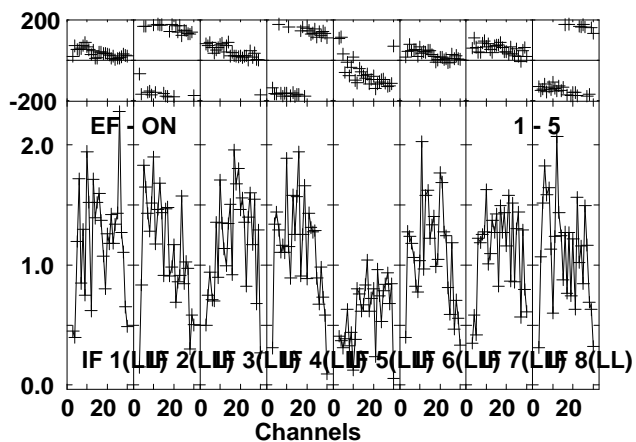
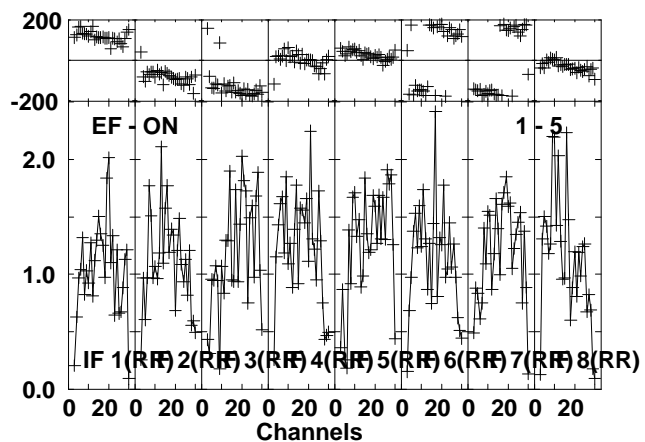
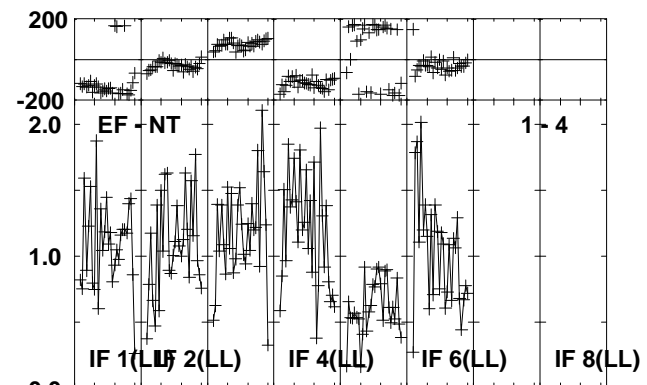
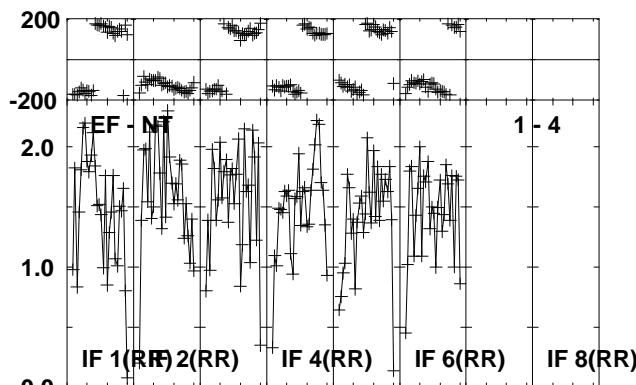
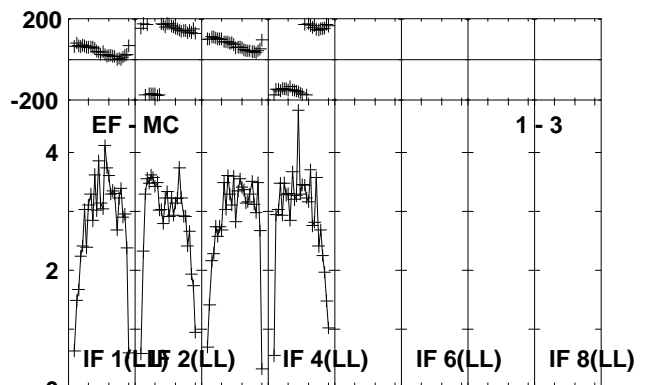
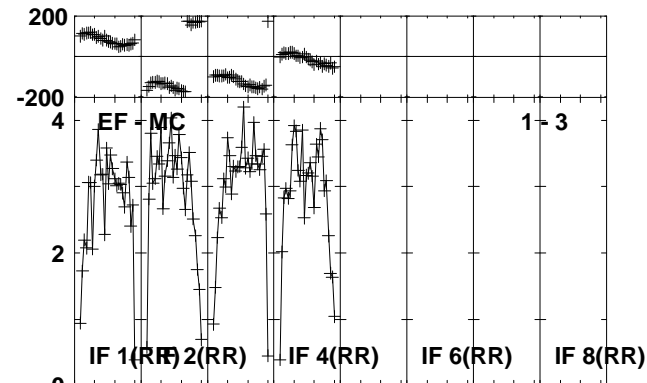
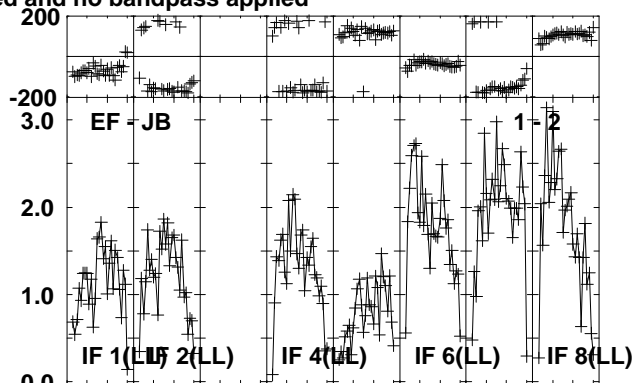
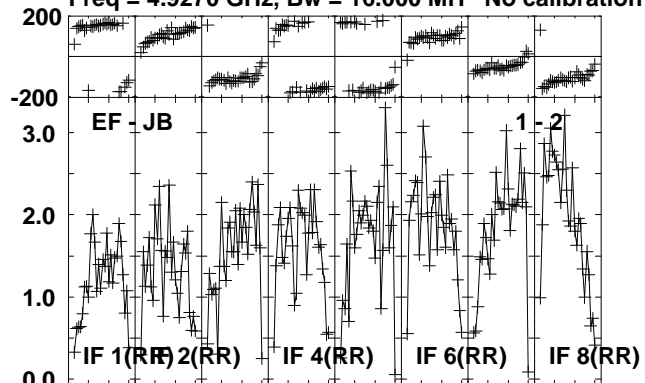

Lower frame: Milli Ampl Jy Top frame: Phas deg
Vector averaged cross-power spectrum Several baselines displayed
Timerange: 00/03:07:07 to 00/03:08:03

Plot file version 118 created 16-OCT-2012 11:57:07

J0645+0541 RO006.UVDATA.1

Freq = 4.9270 GHz, Bw = 16.000 MH No calibration applied and no bandpass applied

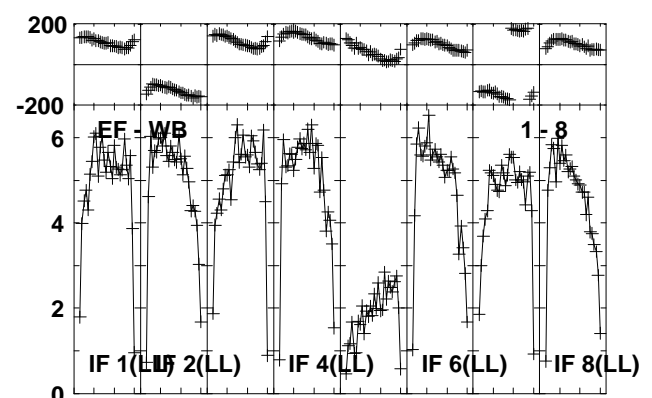
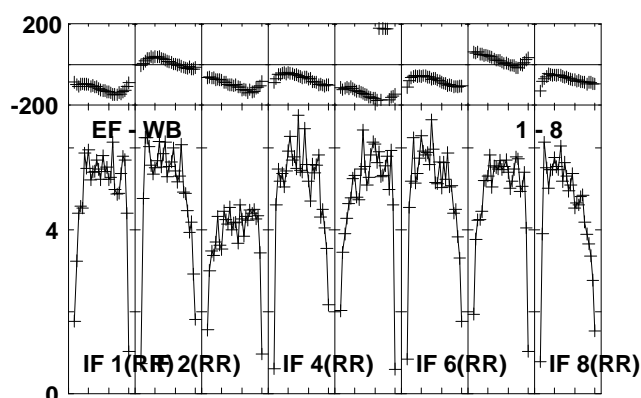
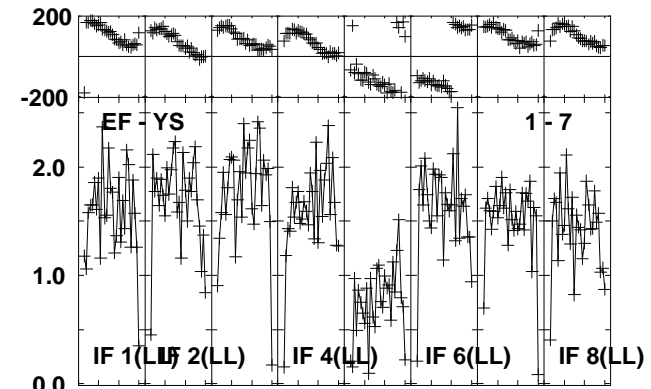
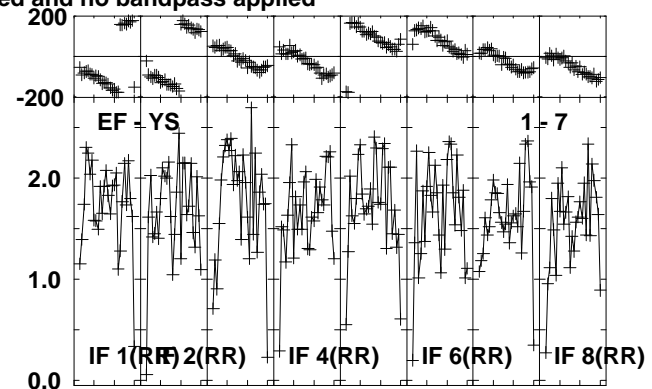
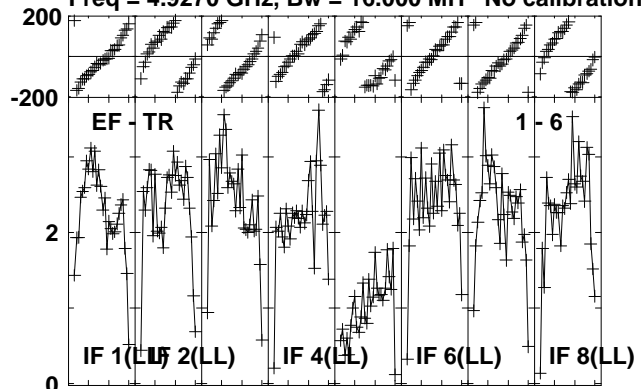

Lower frame: Milli Ampl Jy Top frame: Phas deg
Vector averaged cross-power spectrum Several baselines displayed
Timerange: 00/03:07:07 to 00/03:08:03

Plot file version 119 created 16-OCT-2012 11:57:07

NOVA-MON RO006.UVDATA.1

Freq = 4.9270 GHz, Bw = 16.000 MH No calibration applied and no bandpass applied

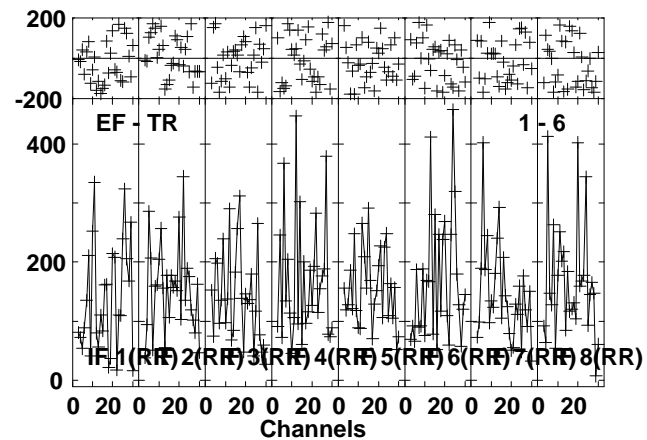
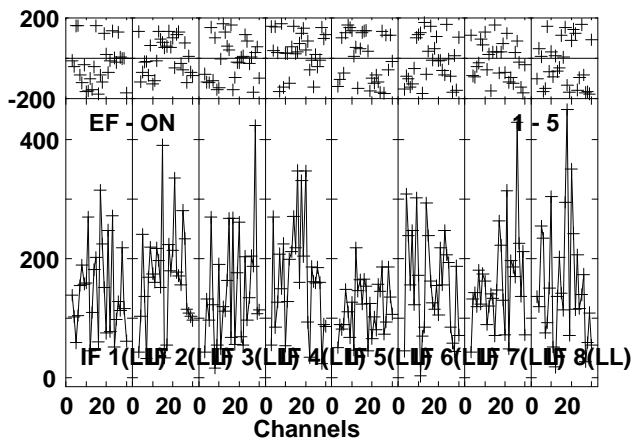
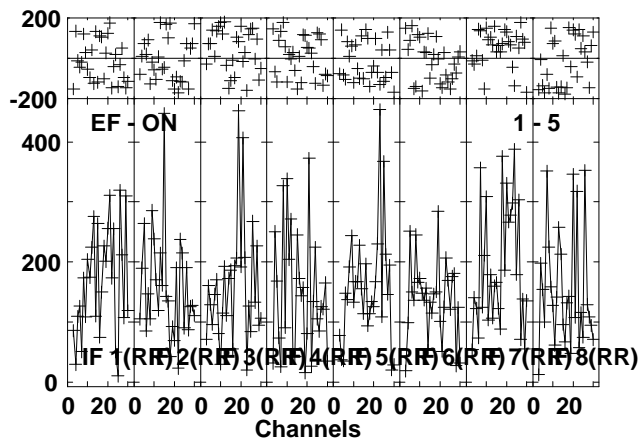
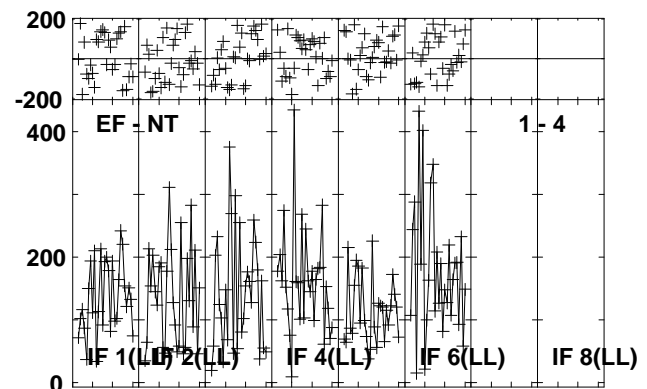
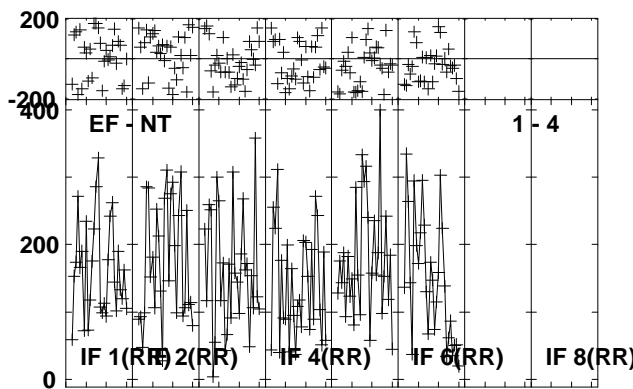
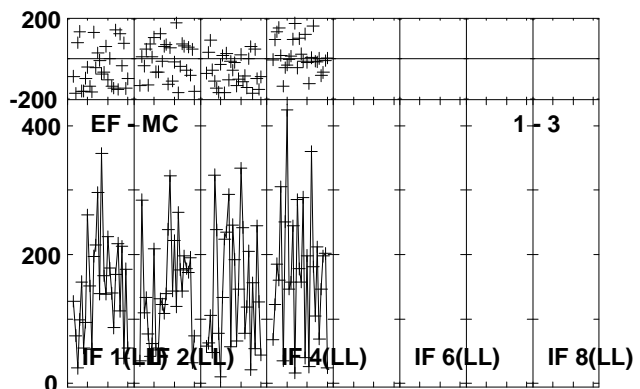
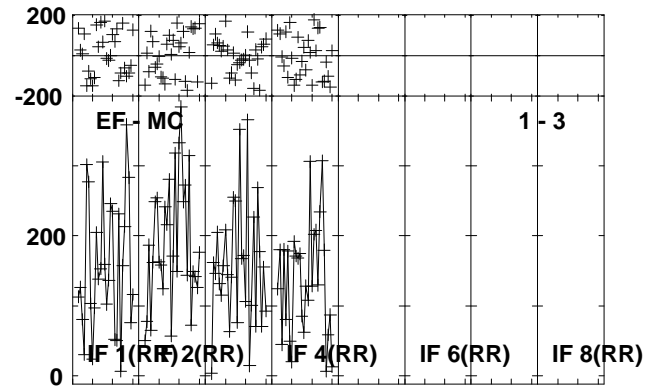
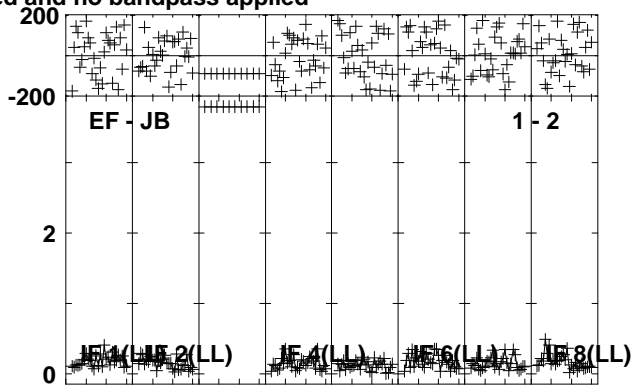
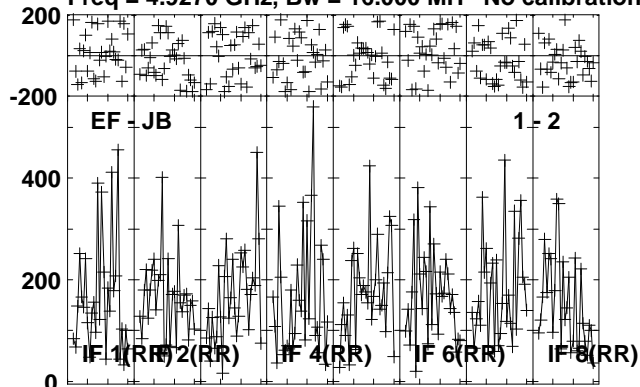

Lower frame: Micro Ampl Jy Top frame: Phas deg
Vector averaged cross-power spectrum Several baselines displayed
Timerange: 00/03:08:07 to 00/03:11:03

Plot file version 120 created 16-OCT-2012 11:57:08

NOVA-MON RO006.UVDATA.1

Freq = 4.9270 GHz, Bw = 16.000 MH No calibration applied and no bandpass applied

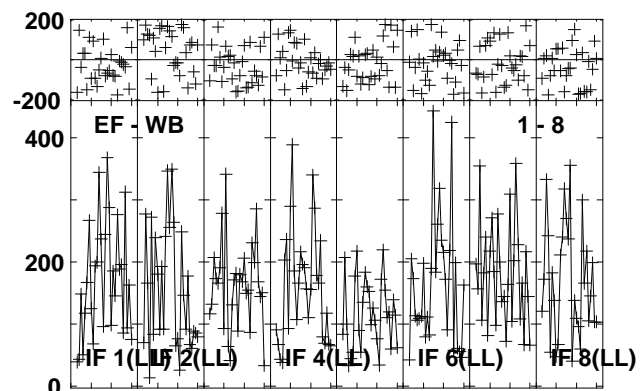
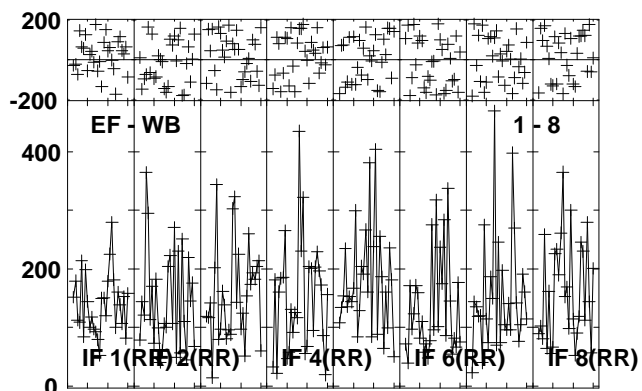
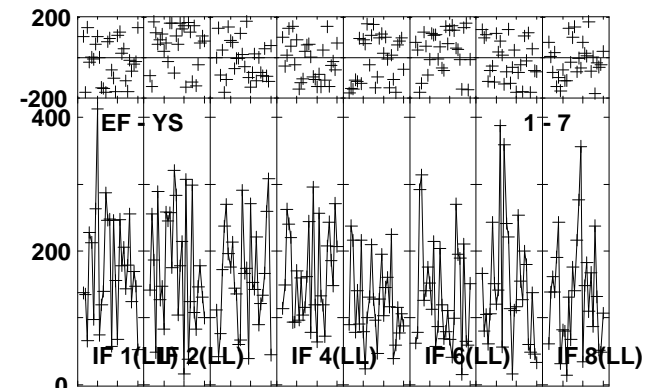
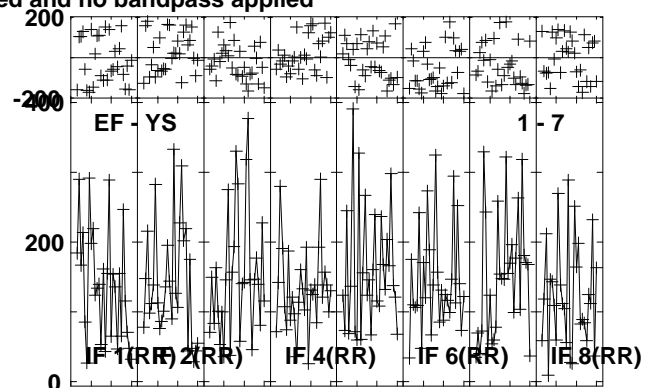
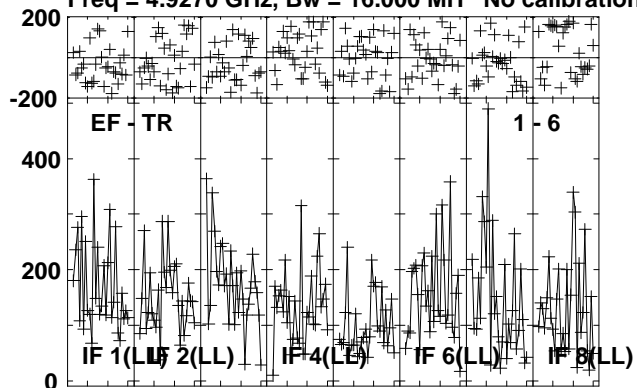

Lower frame: Micro Ampl Jy Top frame: Phas deg
Vector averaged cross-power spectrum Several baselines displayed
Timerange: 00/03:08:07 to 00/03:11:03

Plot file version 121 created 16-OCT-2012 11:57:08

J0639+0601 RO006.UVDATA.1

Freq = 4.9270 GHz, Bw = 16.000 MH No calibration applied and no bandpass applied

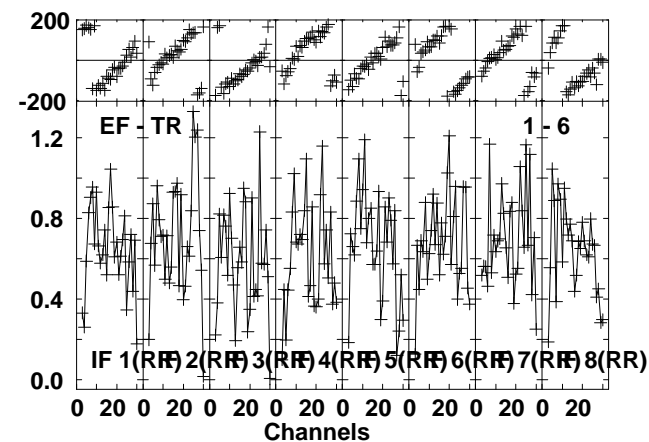
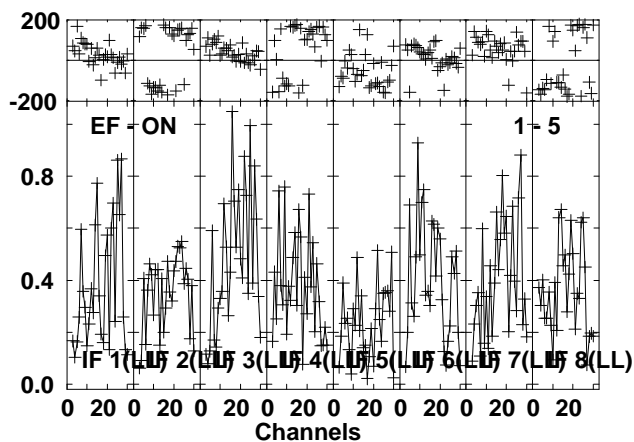
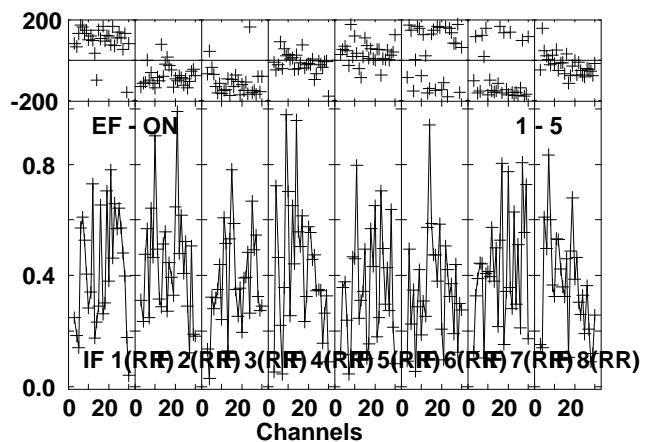
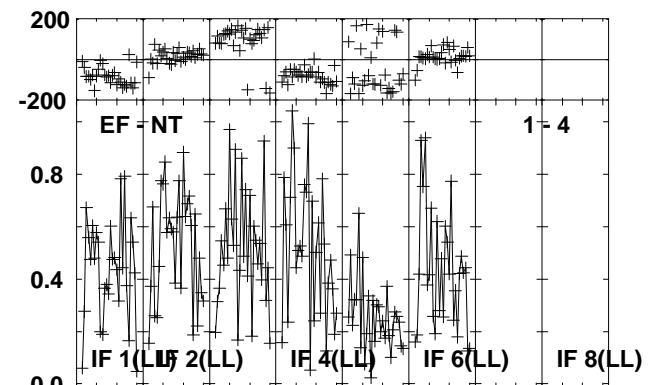
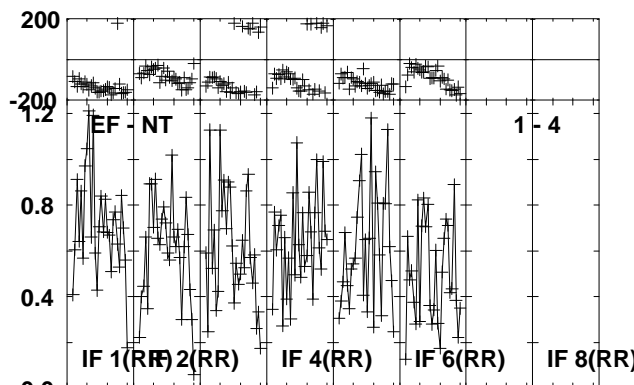
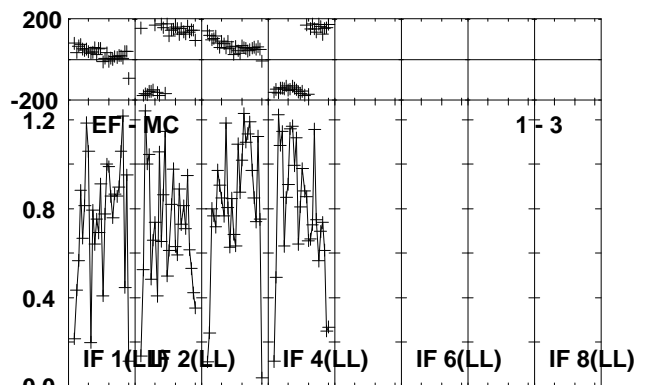
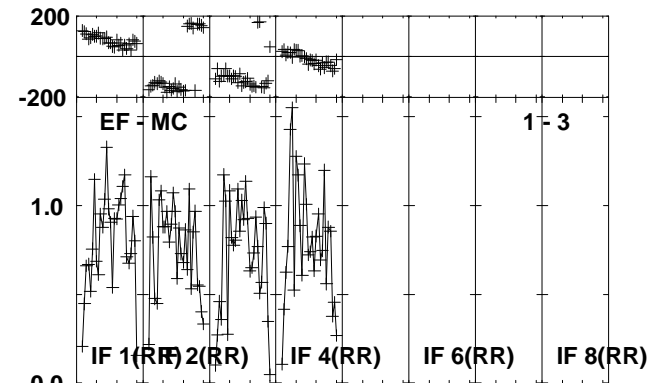
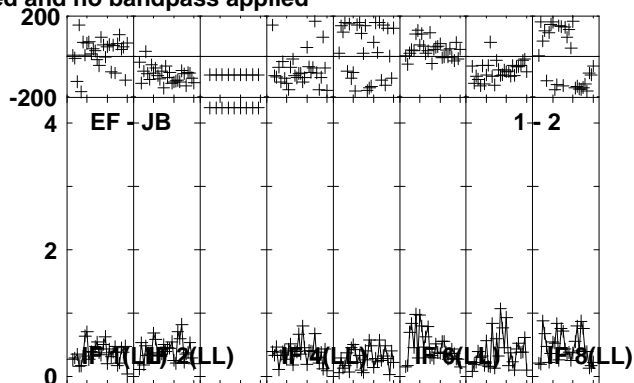
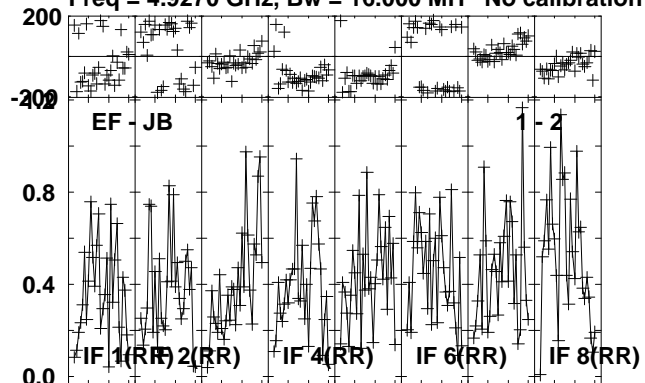

Lower frame: Milli Ampl Jy Top frame: Phas deg
Vector averaged cross-power spectrum Several baselines displayed
Timerange: 00/03:11:07 to 00/03:12:19

Plot file version 122 created 16-OCT-2012 11:57:08

J0639+0601 RO006.UVDATA.1

Freq = 4.9270 GHz, Bw = 16.000 MH No calibration applied and no bandpass applied

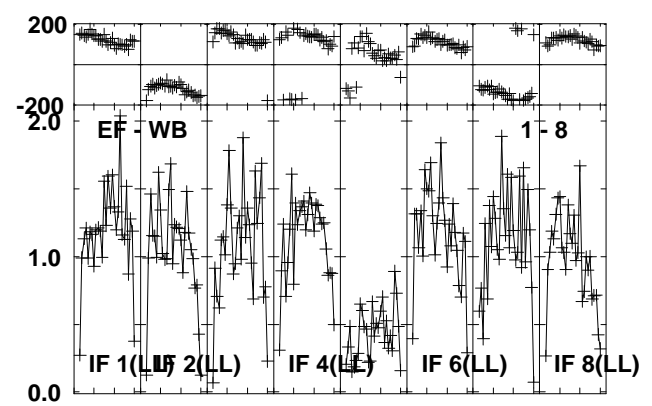
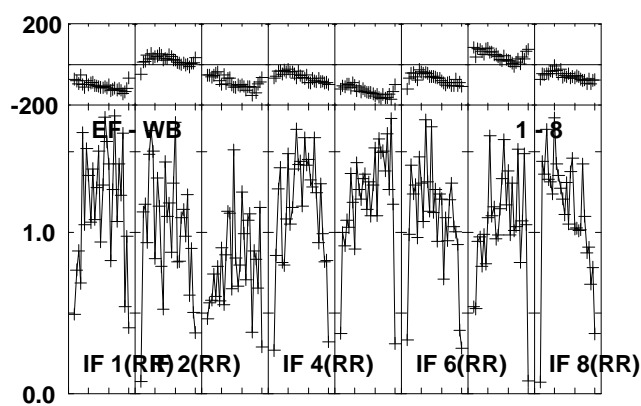
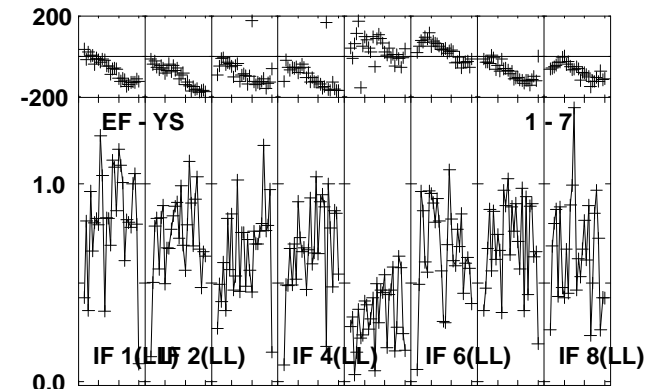
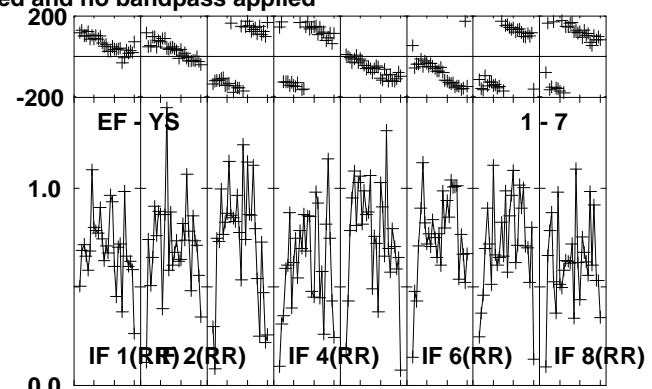
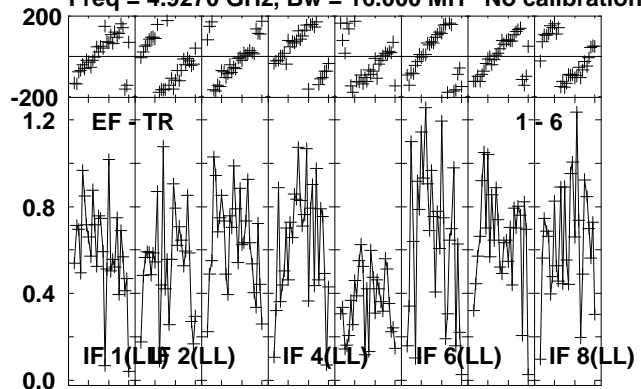

Lower frame: Milli Ampl Jy Top frame: Phas deg
Vector averaged cross-power spectrum Several baselines displayed
Timerange: 00/03:11:07 to 00/03:12:19

Plot file version 123 created 16-OCT-2012 11:57:08

J0645+0541 RO006.UVDATA.1

Freq = 4.9270 GHz, Bw = 16.000 MH No calibration applied and no bandpass applied

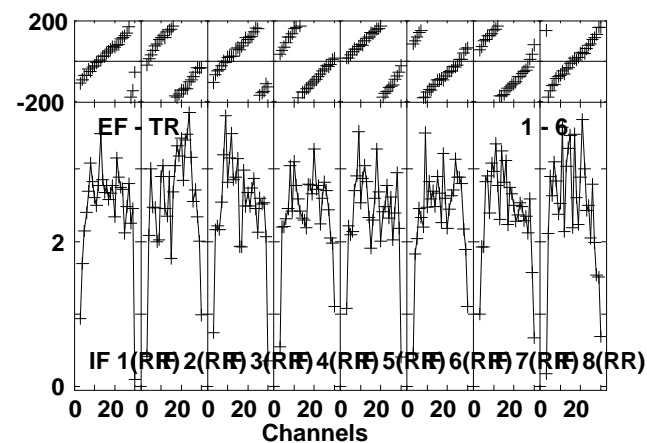
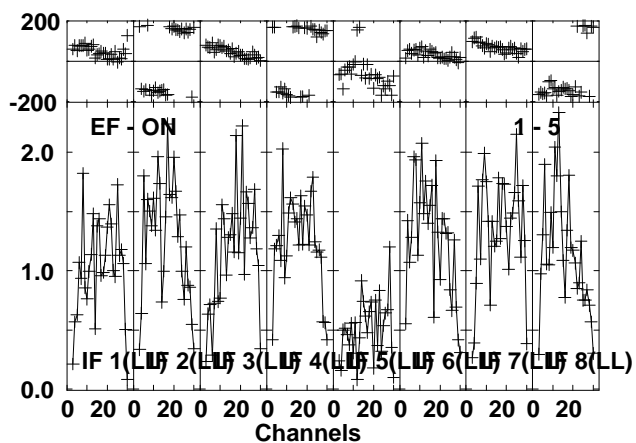
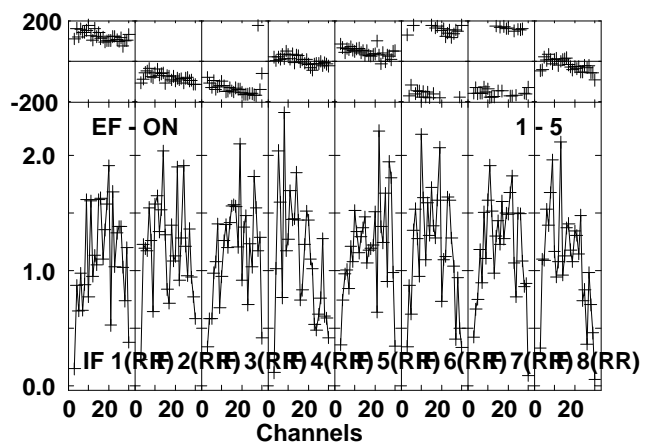
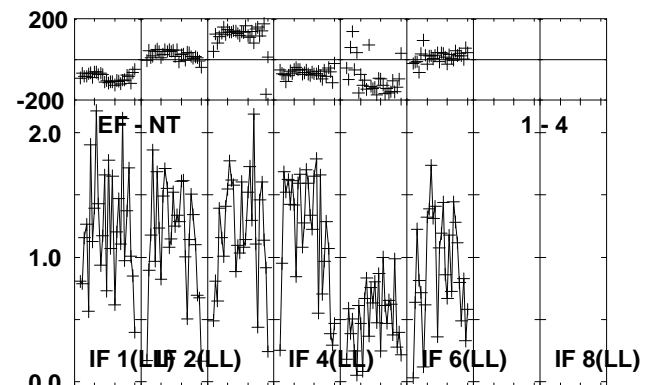
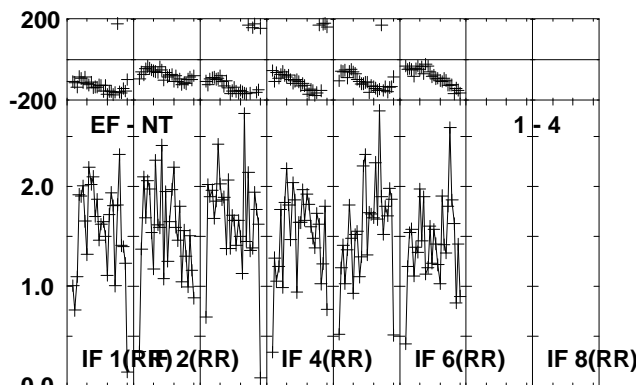
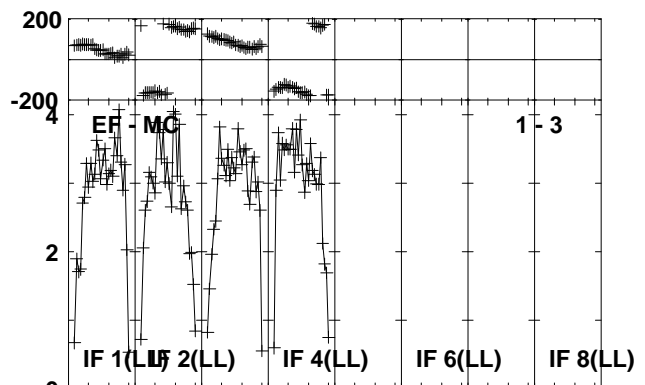
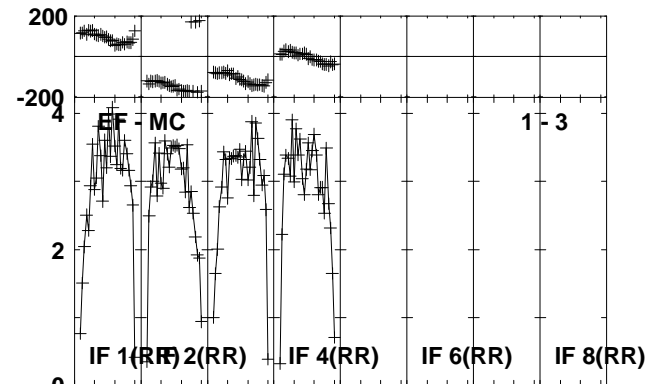
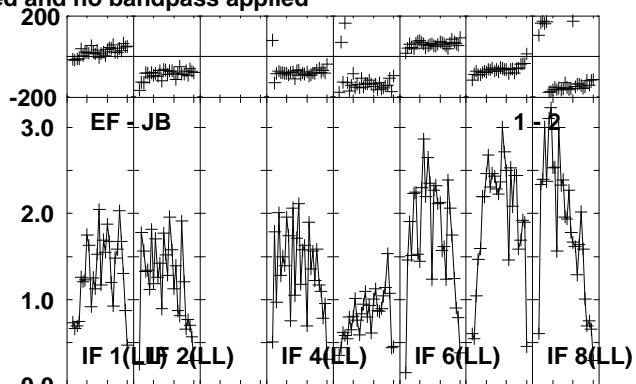
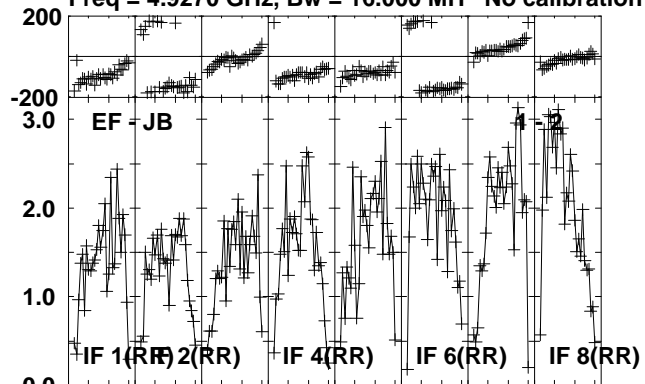

Lower frame: Milli Ampl Jy Top frame: Phas deg
Vector averaged cross-power spectrum Several baselines displayed
Timerange: 00/03:12:23 to 00/03:13:19

Plot file version 124 created 16-OCT-2012 11:57:09

J0645+0541 RO006.UVDATA.1

Freq = 4.9270 GHz, Bw = 16.000 MH No calibration applied and no bandpass applied

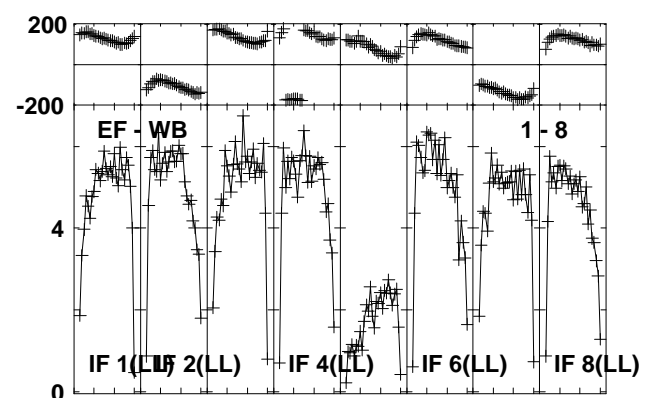
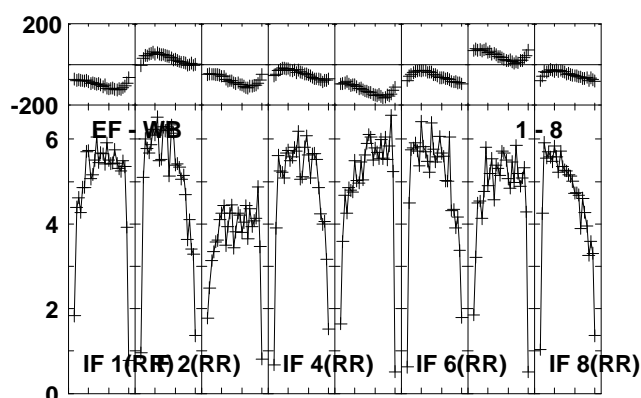
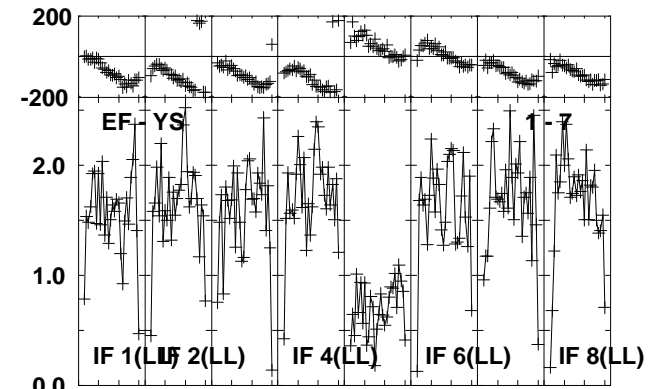
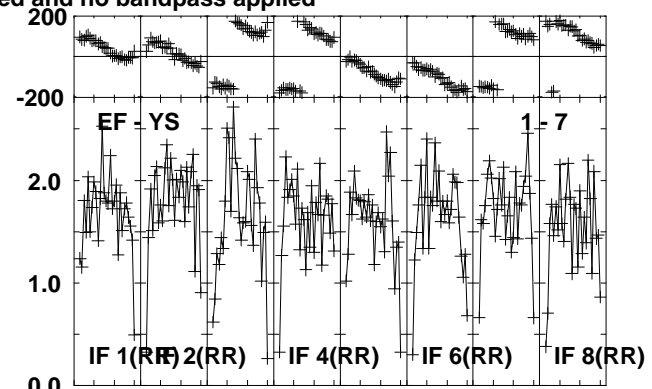
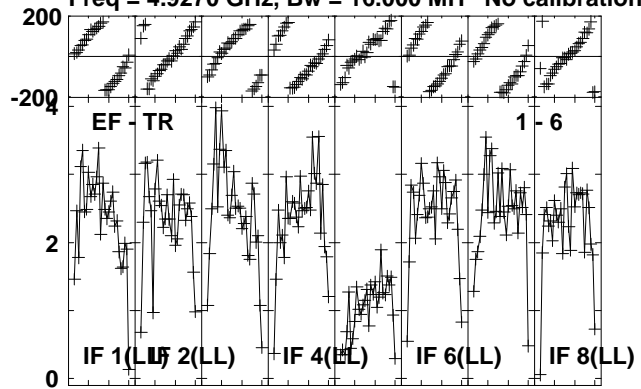

Lower frame: Milli Ampl Jy Top frame: Phas deg
Vector averaged cross-power spectrum Several baselines displayed
Timerange: 00/03:12:23 to 00/03:13:19

Plot file version 125 created 16-OCT-2012 11:57:09

NOVA-MON RO006.UVDATA.1

Freq = 4.9270 GHz, Bw = 16.000 MH No calibration applied and no bandpass applied

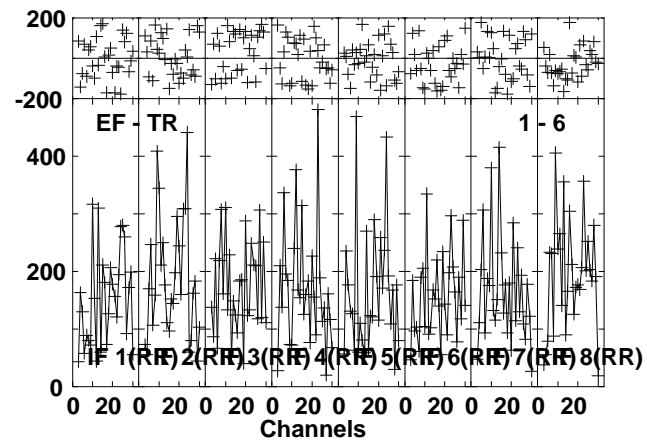
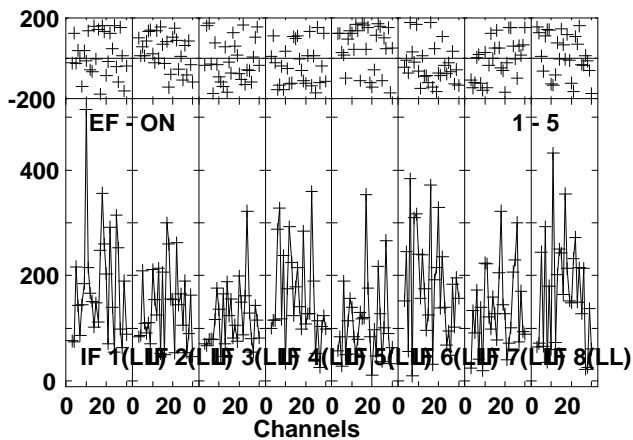
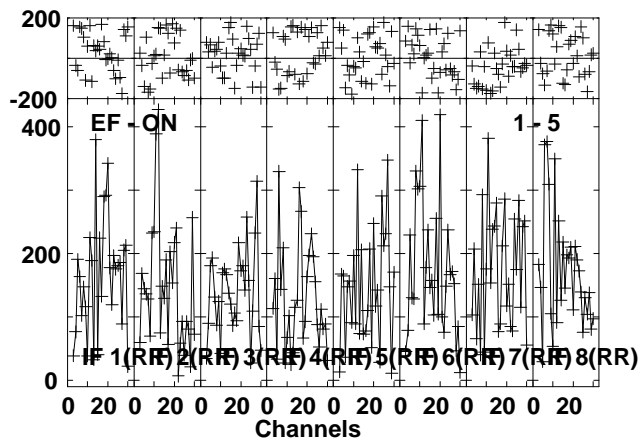
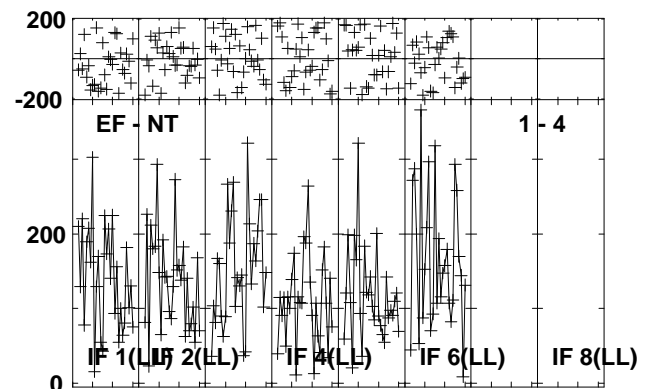
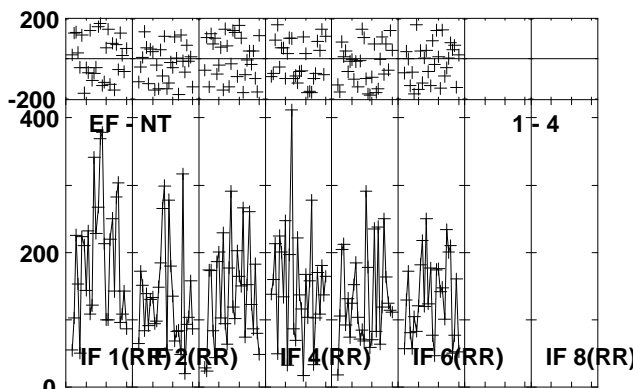
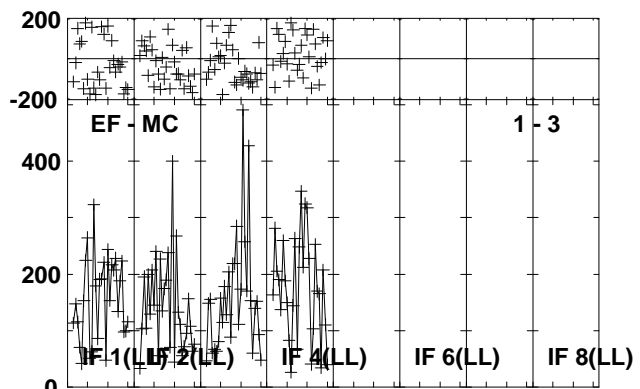
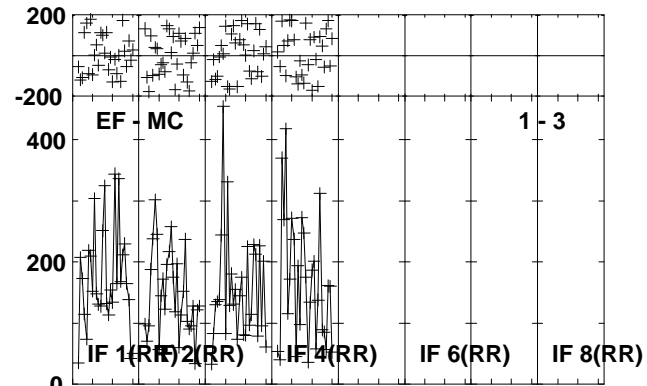
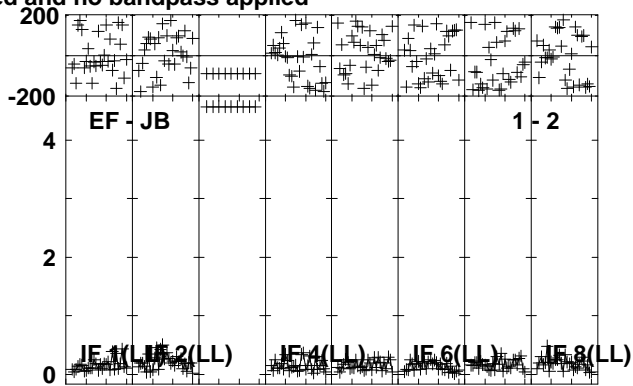
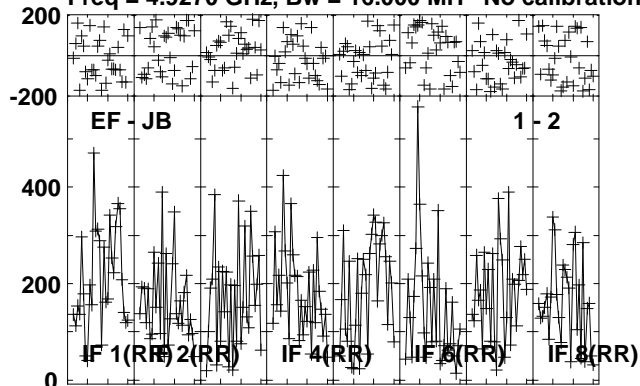

Lower frame: Micro Ampl Jy Top frame: Phas deg
Vector averaged cross-power spectrum Several baselines displayed
Timerange: 00/03:13:23 to 00/03:16:19

Plot file version 126 created 16-OCT-2012 11:57:09

NOVA-MON RO006.UVDATA.1

Freq = 4.9270 GHz, Bw = 16.000 MH No calibration applied and no bandpass applied

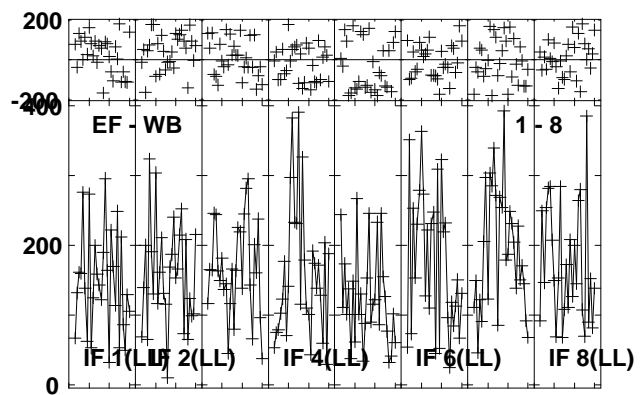
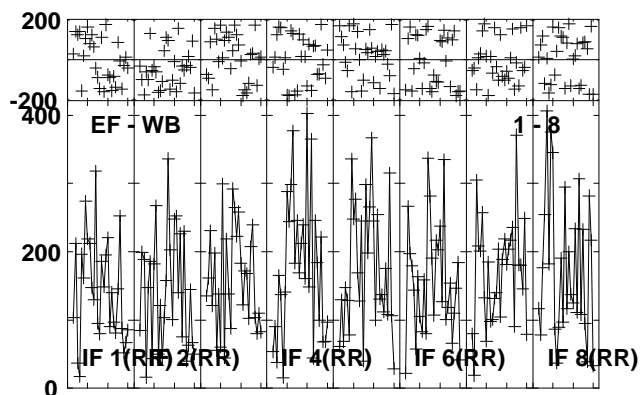
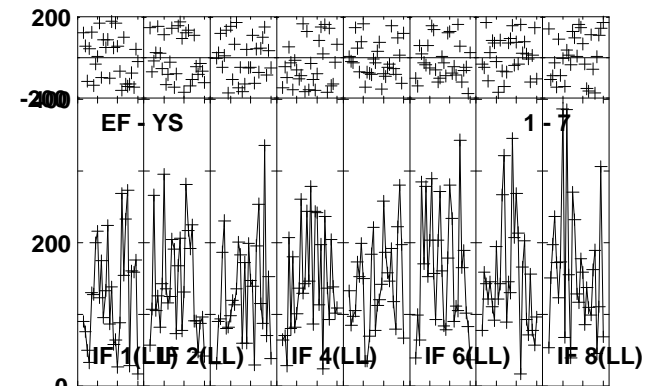
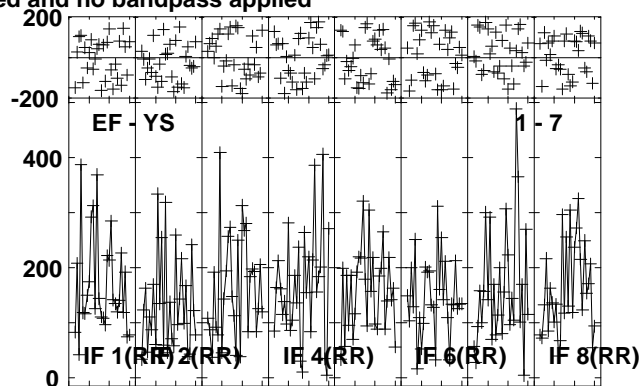
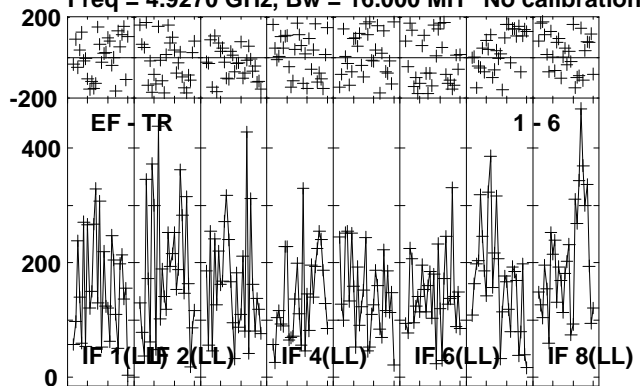

Lower frame: Micro Ampl Jy Top frame: Phas deg
Vector averaged cross-power spectrum Several baselines displayed
Timerange: 00/03:13:23 to 00/03:16:19

Plot file version 127 created 16-OCT-2012 11:57:10

J0639+0601 RO006.UVDATA.1

Freq = 4.9270 GHz, Bw = 16.000 MH No calibration applied and no bandpass applied

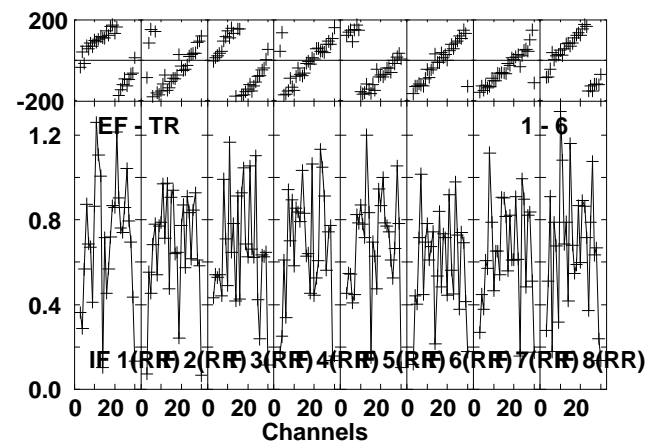
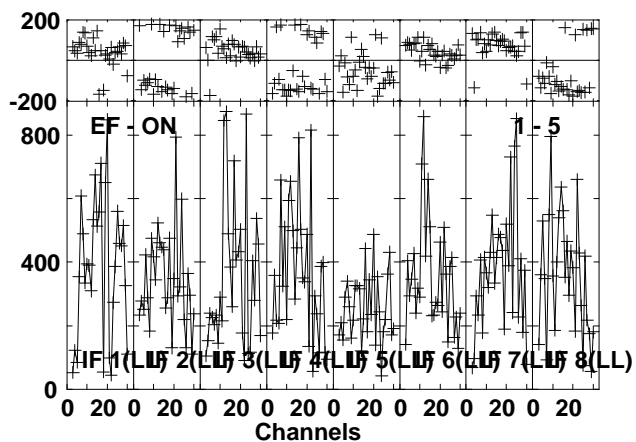
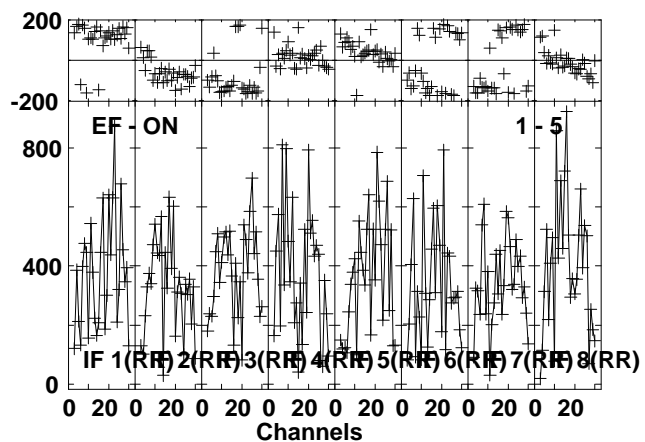
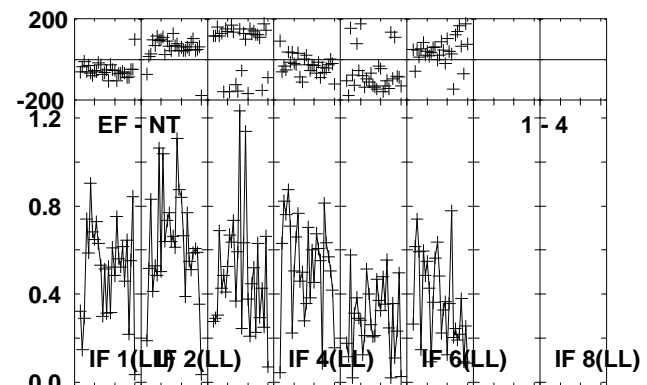
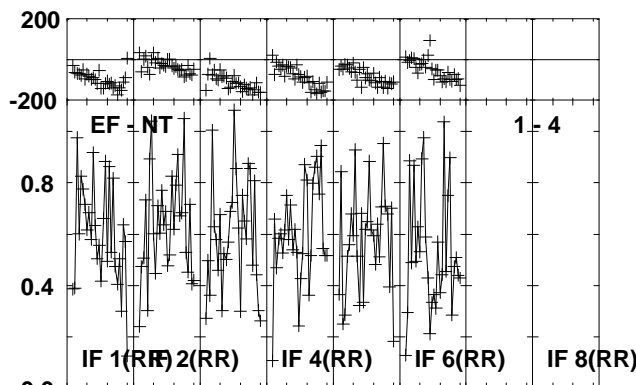
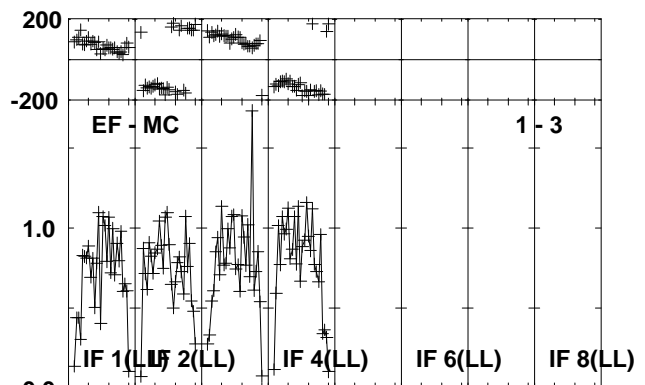
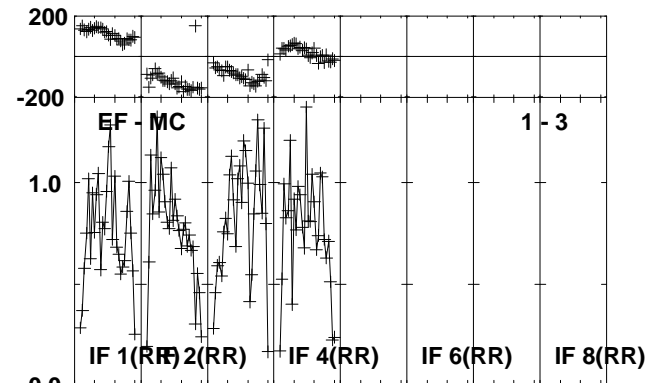
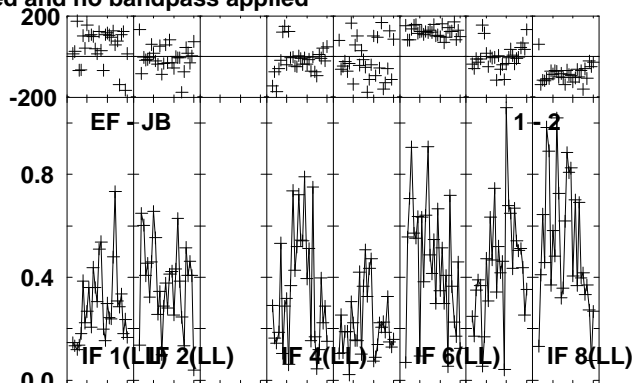
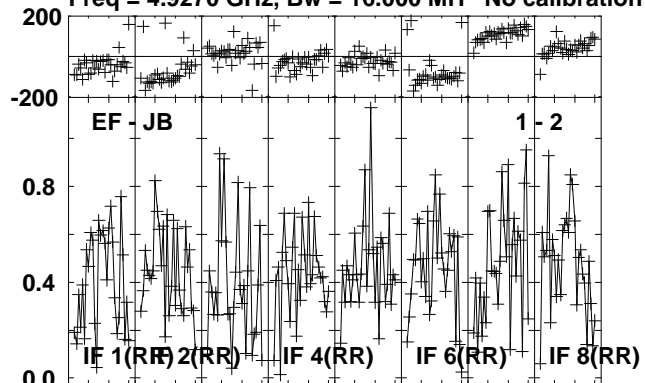

Lower frame: Milli Ampl Jy Top frame: Phas deg
Vector averaged cross-power spectrum Several baselines displayed
Timerange: 00/03:16:47 to 00/03:17:49

Plot file version 128 created 16-OCT-2012 11:57:10

J0639+0601 RO006.UVDATA.1

Freq = 4.9270 GHz, Bw = 16.000 MH No calibration applied and no bandpass applied

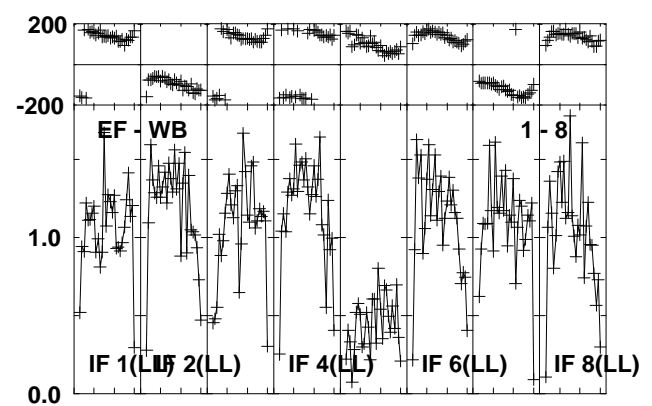
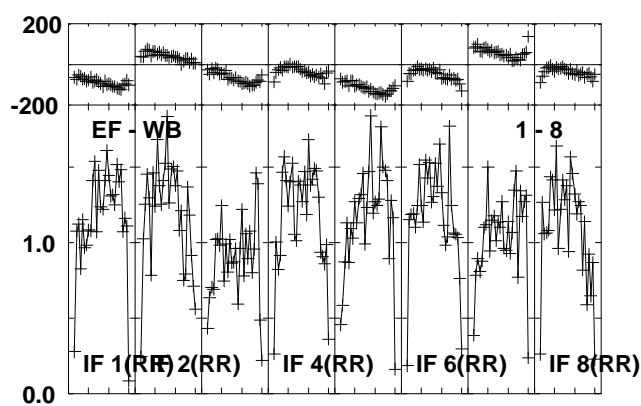
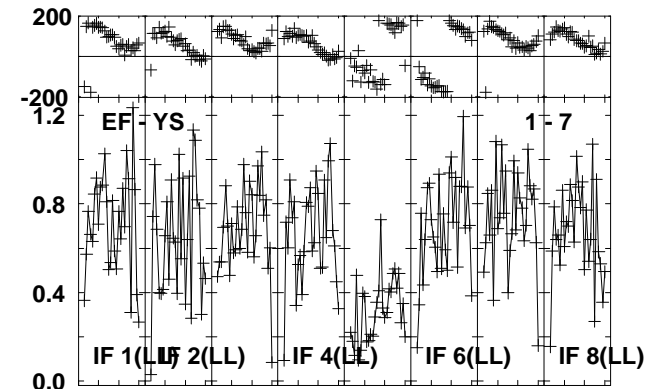
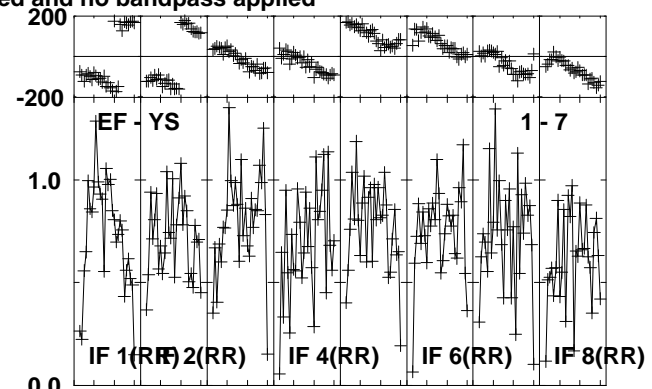
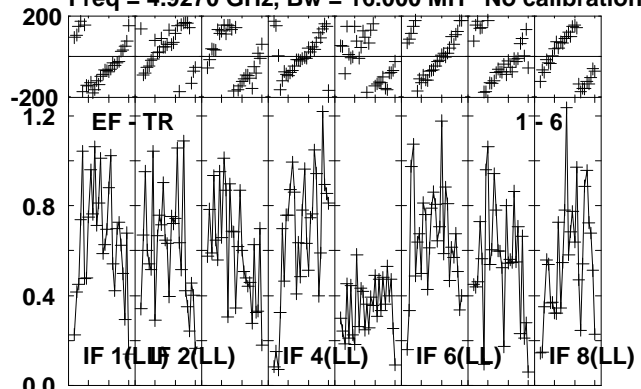

Lower frame: Milli Ampl Jy Top frame: Phas deg
Vector averaged cross-power spectrum Several baselines displayed
Timerange: 00/03:16:47 to 00/03:17:49

Plot file version 129 created 16-OCT-2012 11:57:10

J0645+0541 RO006.UVDATA.1

Freq = 4.9270 GHz, Bw = 16.000 MH No calibration applied and no bandpass applied

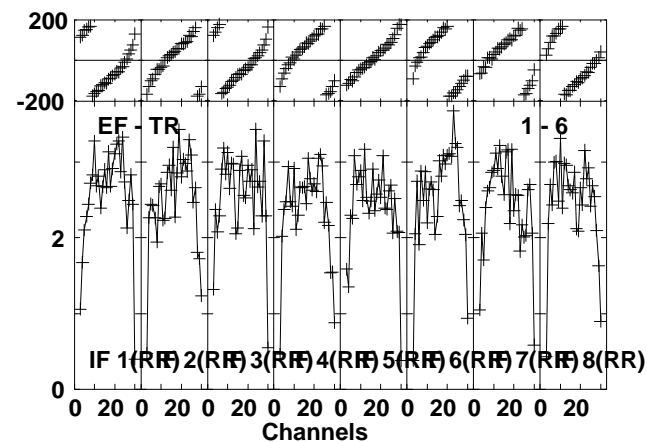
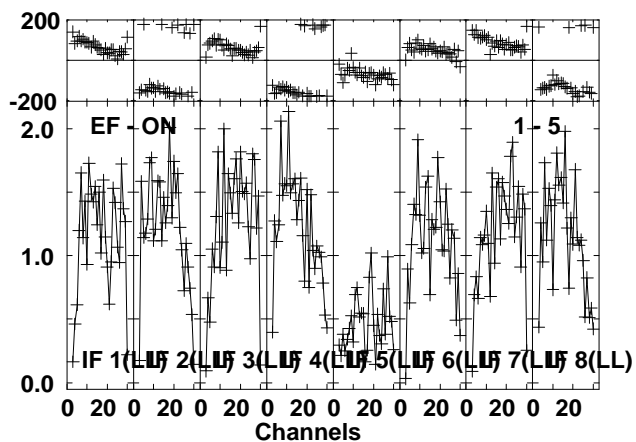
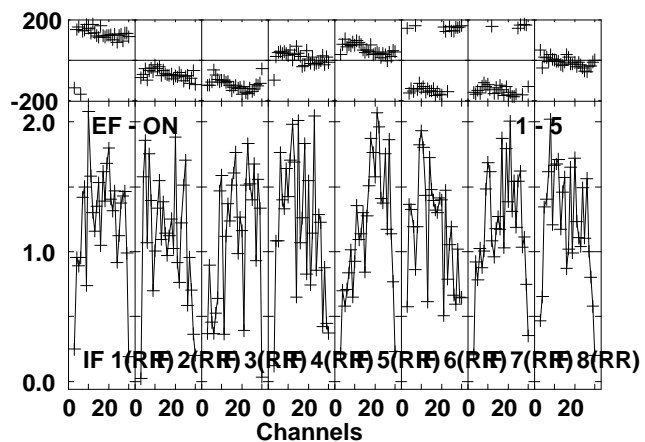
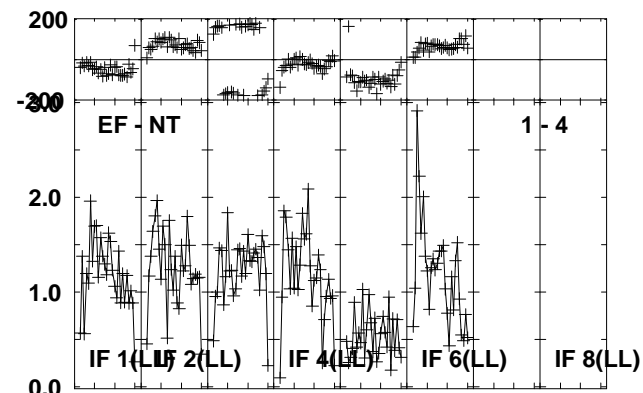
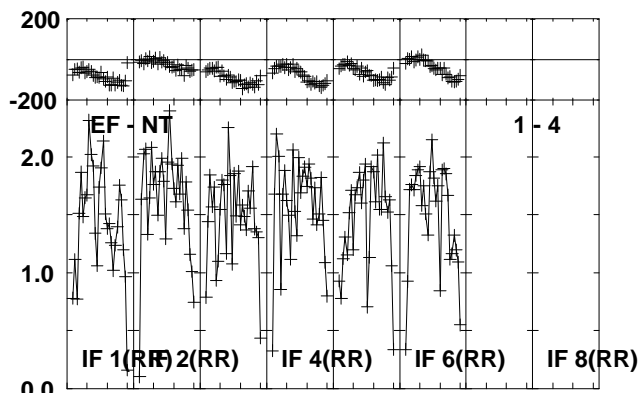
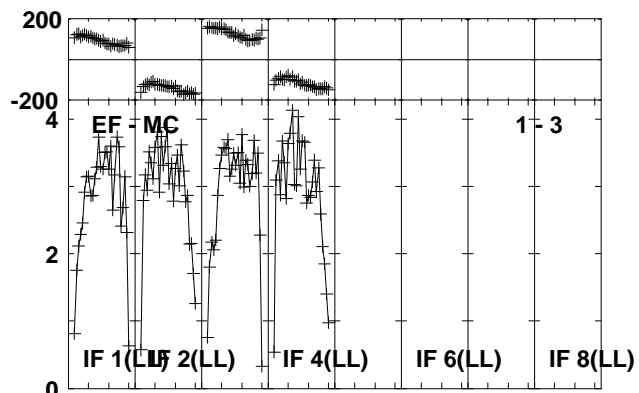
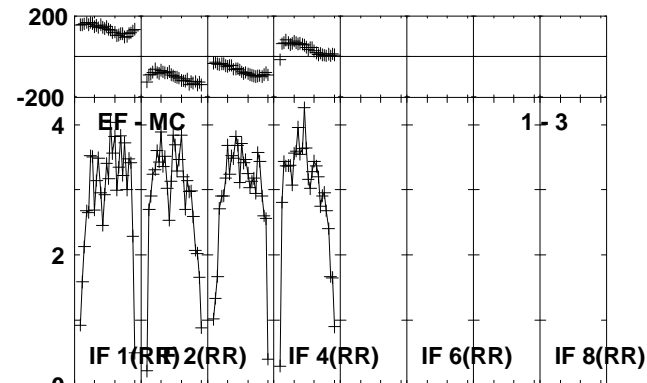
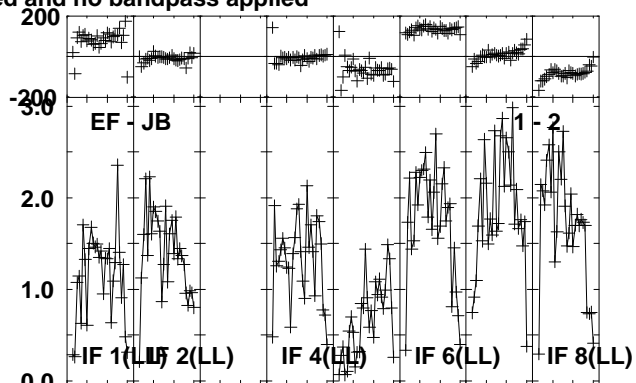
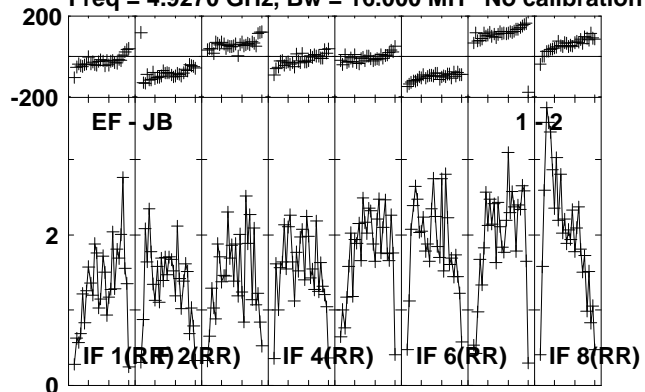

Lower frame: Milli Ampl Jy Top frame: Phas deg
Vector averaged cross-power spectrum Several baselines displayed
Timerange: 00/03:17:53 to 00/03:18:49

Plot file version 130 created 16-OCT-2012 11:57:10

J0645+0541 RO006.UVDATA.1

Freq = 4.9270 GHz, Bw = 16.000 MH No calibration applied and no bandpass applied

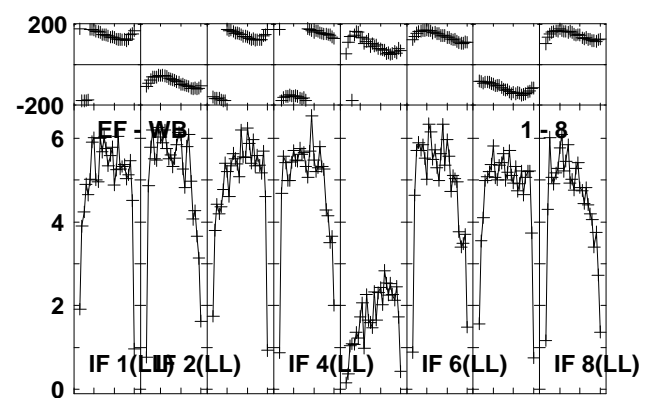
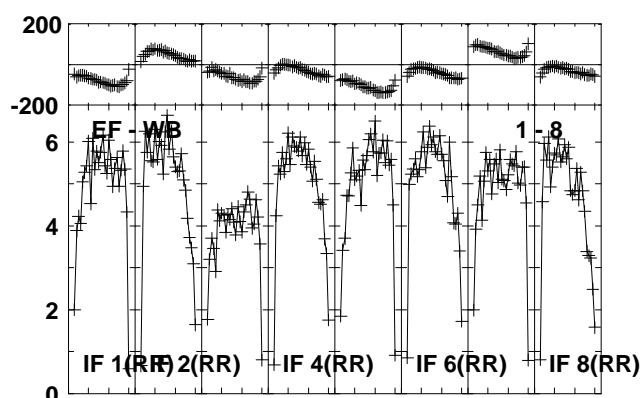
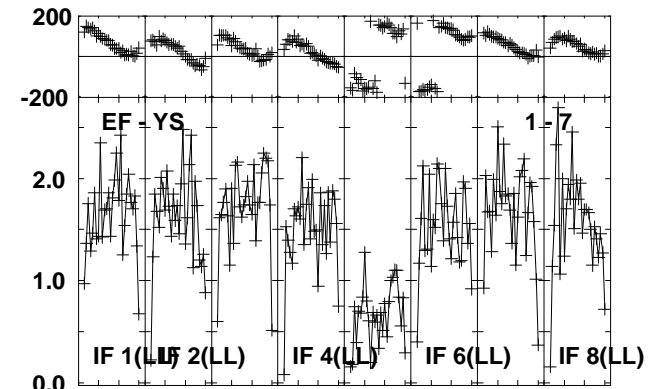
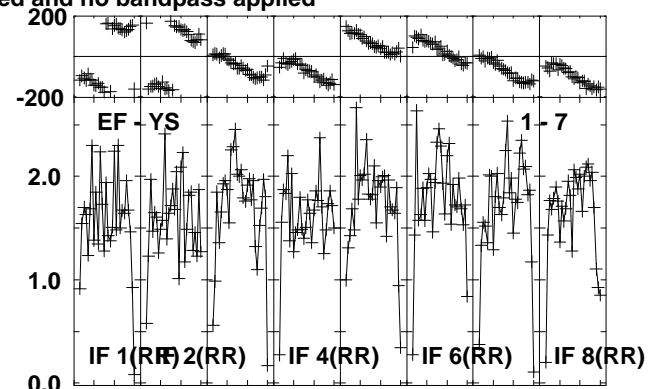
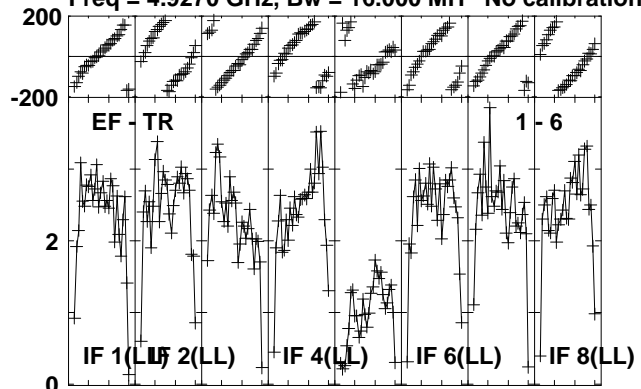

Lower frame: Milli Ampl Jy Top frame: Phas deg
Vector averaged cross-power spectrum Several baselines displayed
Timerange: 00/03:17:53 to 00/03:18:49

Plot file version 131 created 16-OCT-2012 11:57:10

NOVA-MON RO006.UVDATA.1

Freq = 4.9270 GHz, Bw = 16.000 MH No calibration applied and no bandpass applied

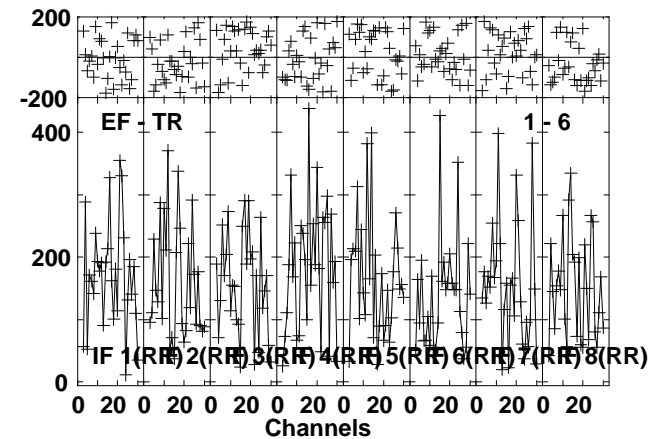
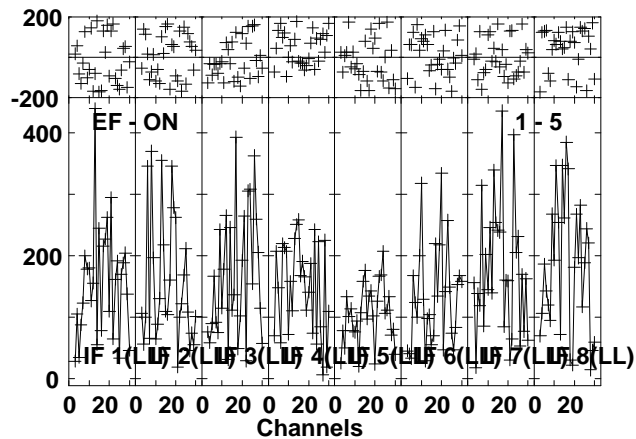
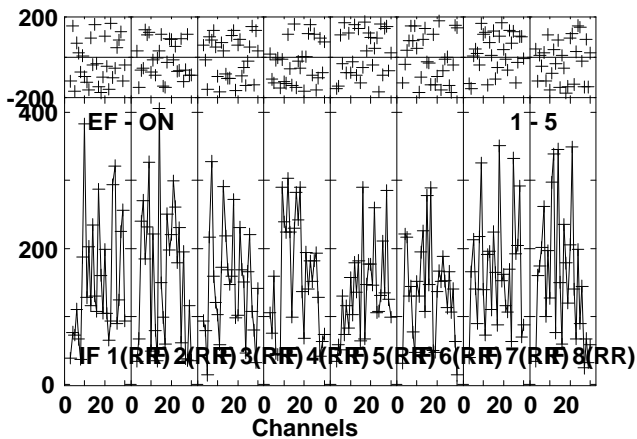
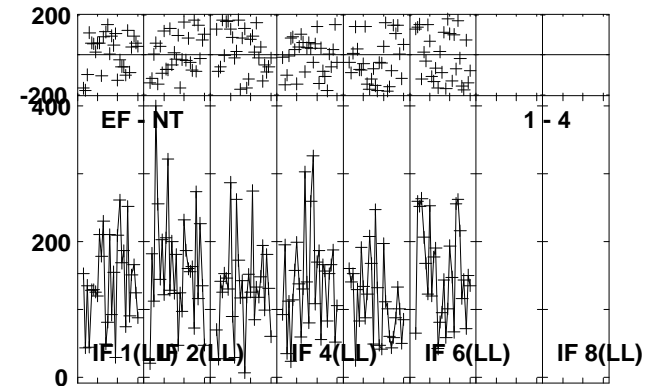
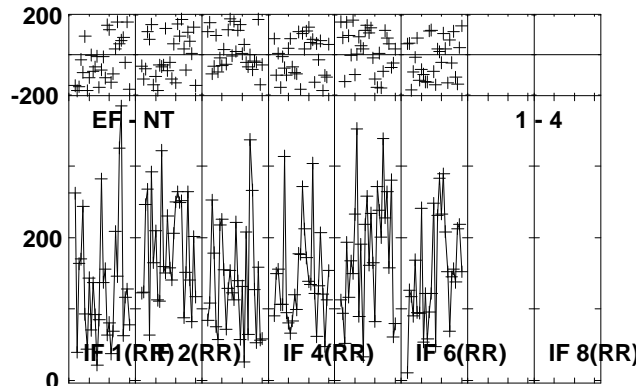
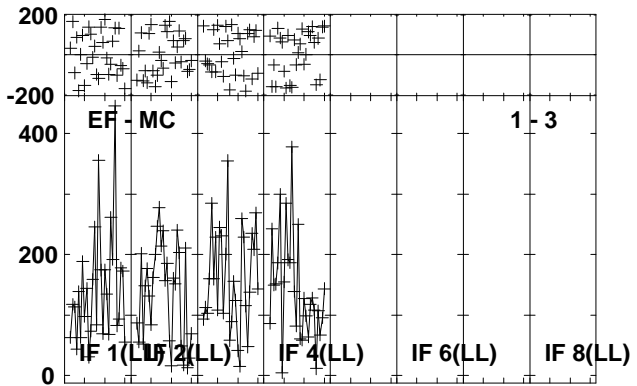
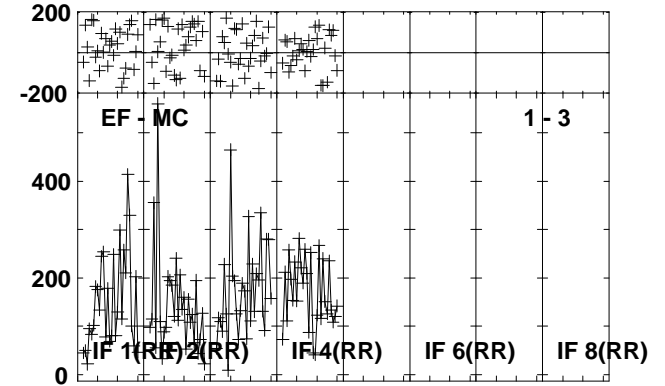
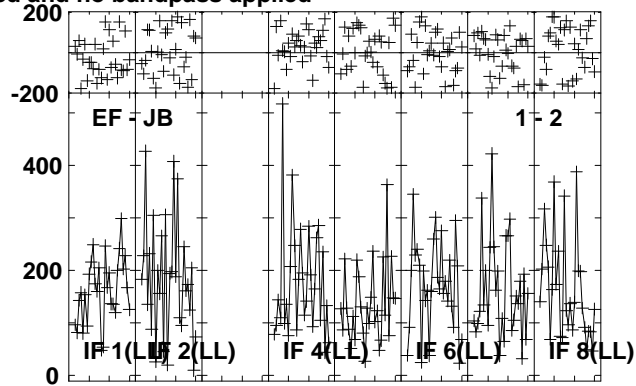
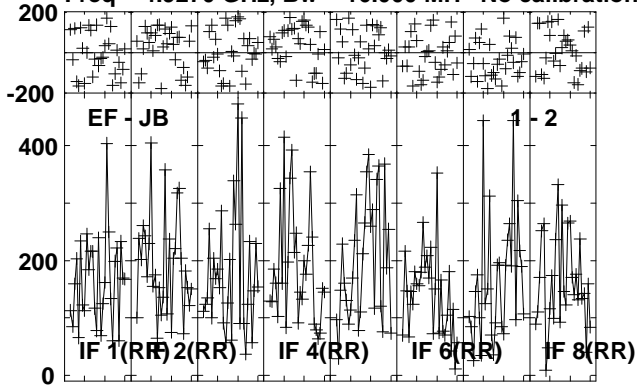

Lower frame: Micro Ampl Jy Top frame: Phas deg
Vector averaged cross-power spectrum Several baselines displayed
Timerange: 00/03:18:53 to 00/03:21:49

Plot file version 132 created 16-OCT-2012 11:57:11

NOVA-MON RO006.UVDATA.1

Freq = 4.9270 GHz, Bw = 16.000 MH No calibration applied and no bandpass applied

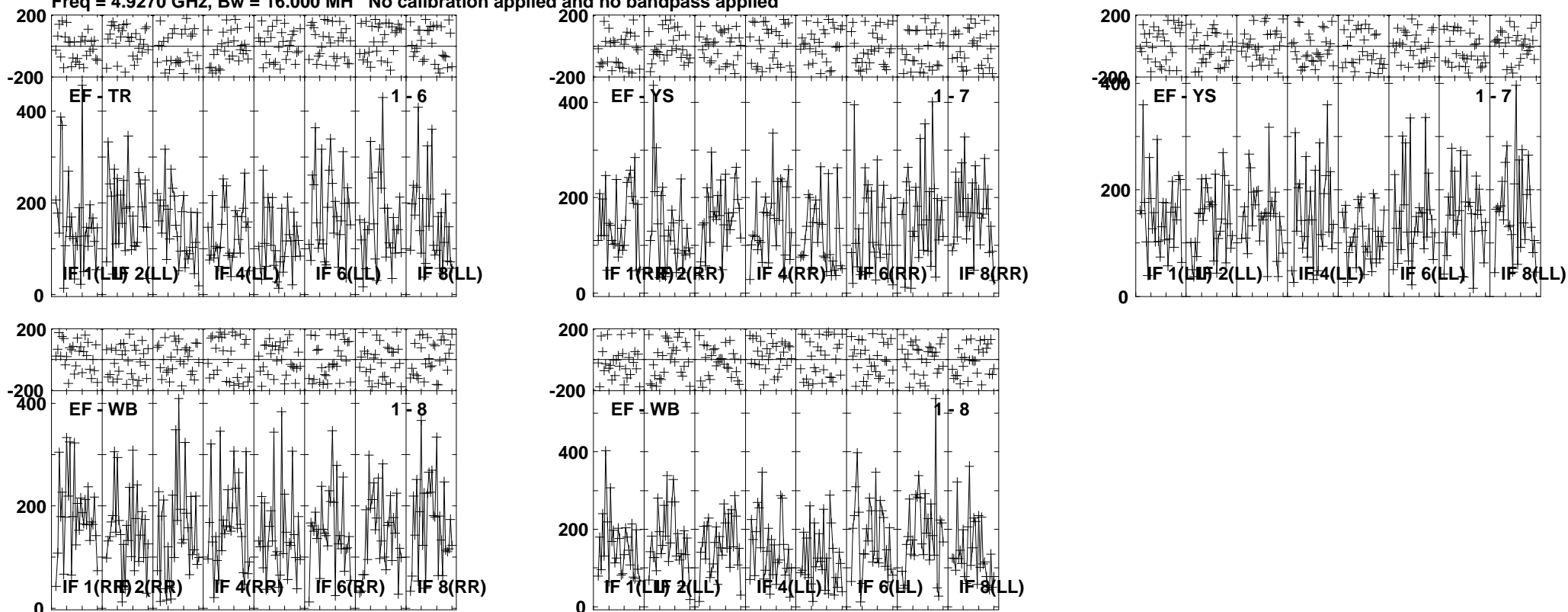

Lower frame: Micro Ampl Jy Top frame: Phas deg
Vector averaged cross-power spectrum Several baselines displayed
Timerange: 00/03:18:53 to 00/03:21:49

Plot file version 133 created 16-OCT-2012 11:57:11

J0639+0601 RO006.UVDATA.1

Freq = 4.9270 GHz, Bw = 16.000 MH No calibration applied and no bandpass applied

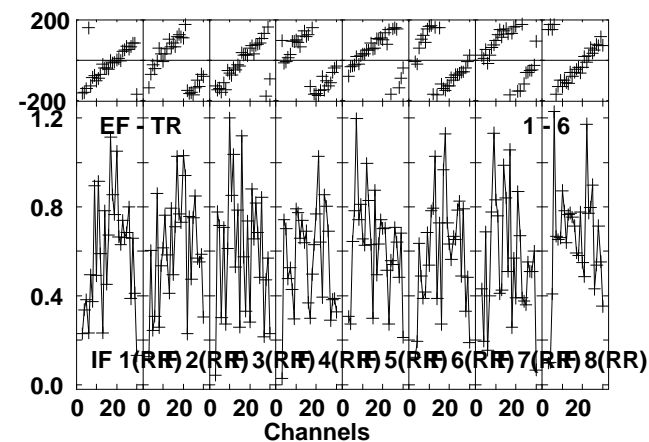
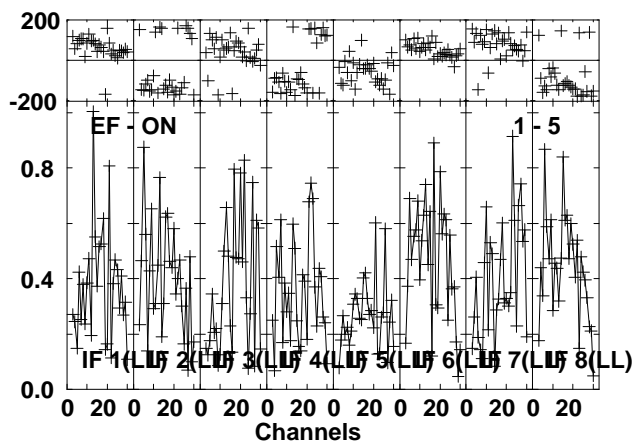
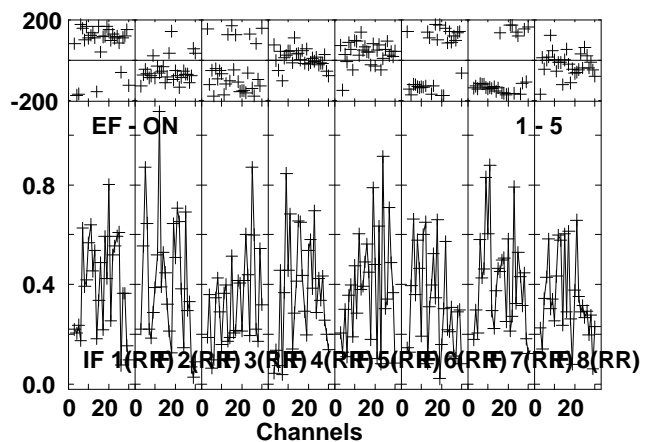
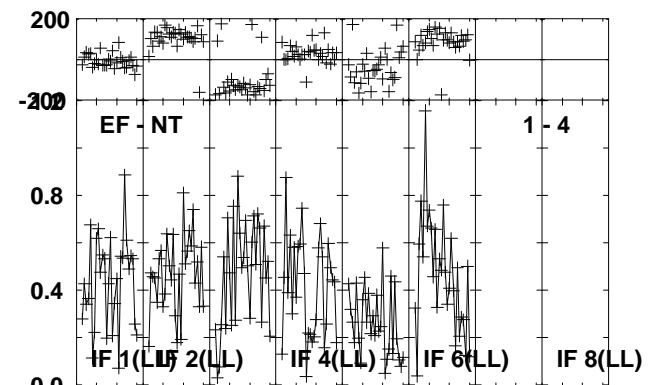
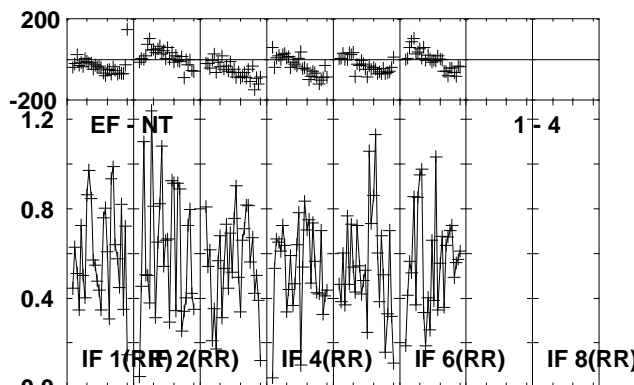
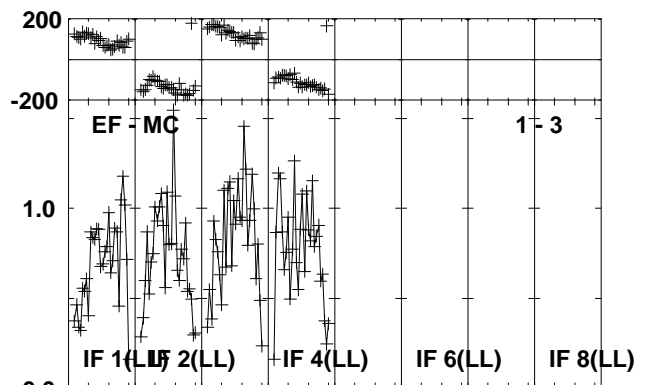
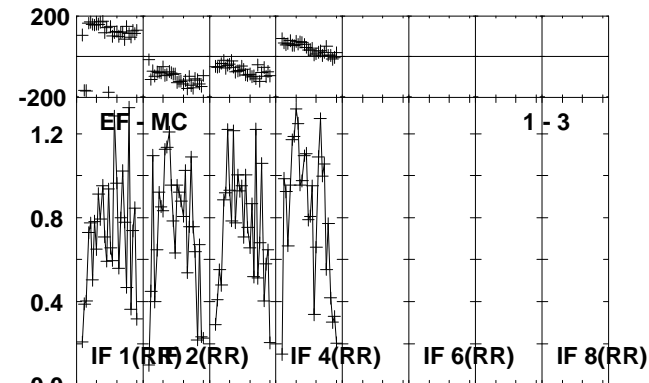
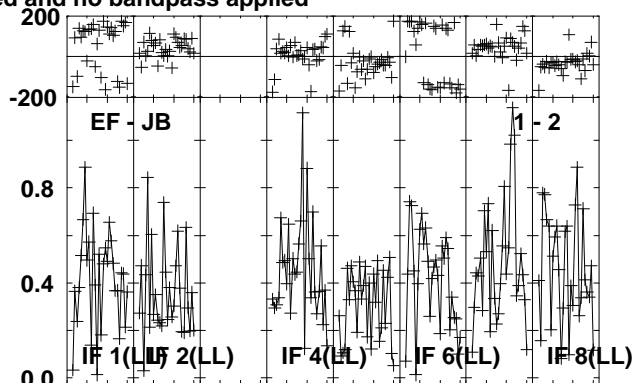
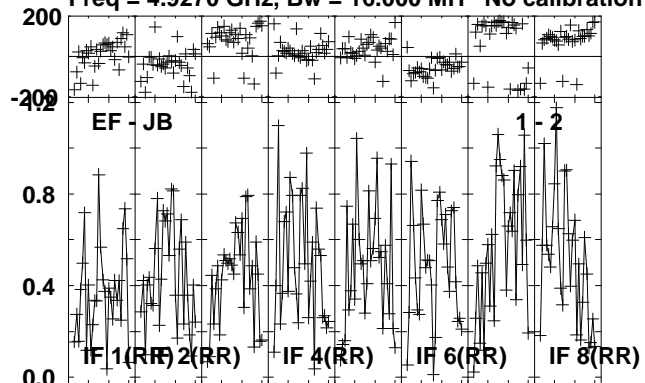

Lower frame: Milli Ampl Jy Top frame: Phas deg
Vector averaged cross-power spectrum Several baselines displayed
Timerange: 00/03:21:53 to 00/03:23:03

Plot file version 134 created 16-OCT-2012 11:57:12

J0639+0601 RO006.UVDATA.1

Freq = 4.9270 GHz, Bw = 16.000 MH No calibration applied and no bandpass applied

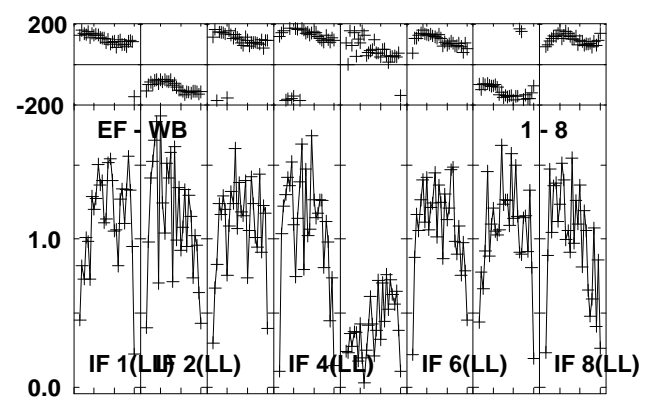
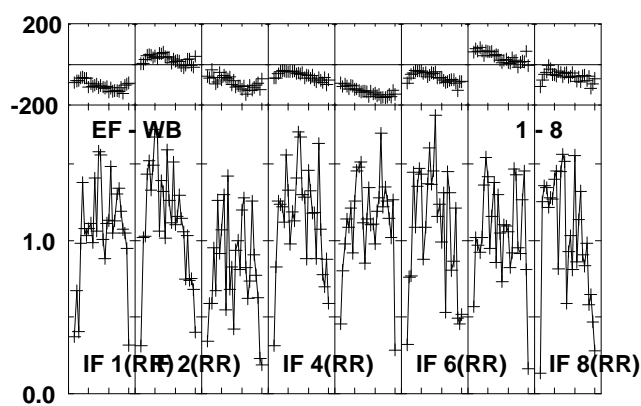
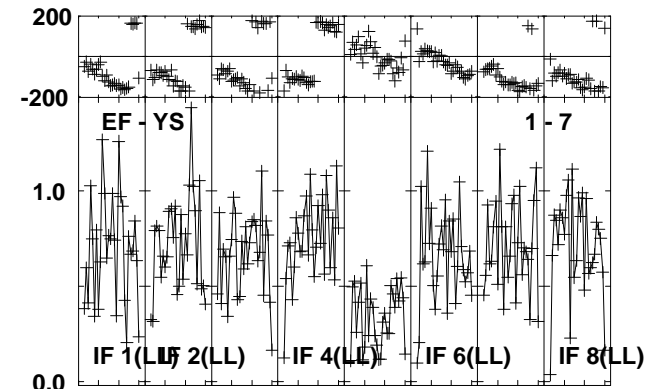
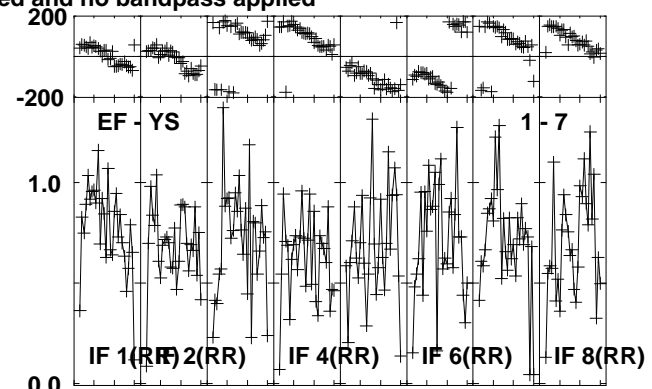
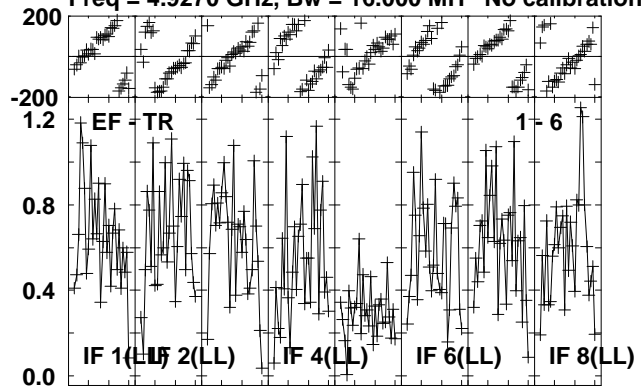

Lower frame: Milli Ampl Jy Top frame: Phas deg
Vector averaged cross-power spectrum Several baselines displayed
Timerange: 00/03:21:53 to 00/03:23:03

Plot file version 135 created 16-OCT-2012 11:57:12

J0645+0541 RO006.UVDATA.1

Freq = 4.9270 GHz, Bw = 16.000 MH No calibration applied and no bandpass applied

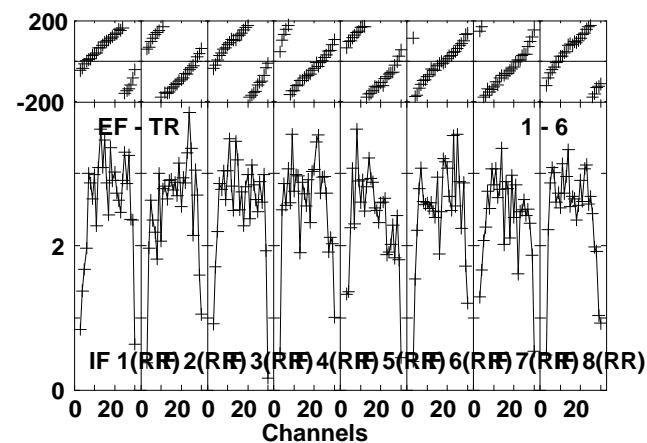
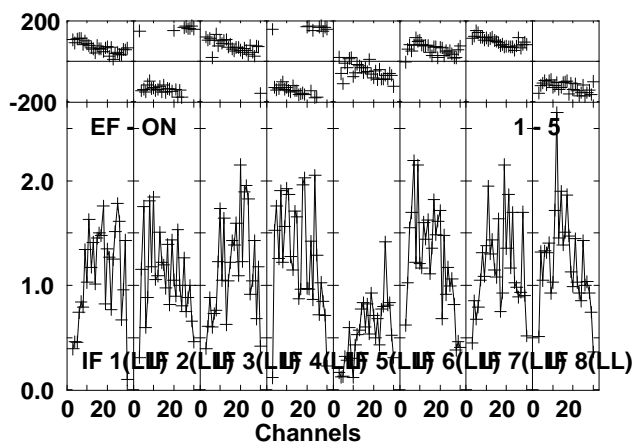
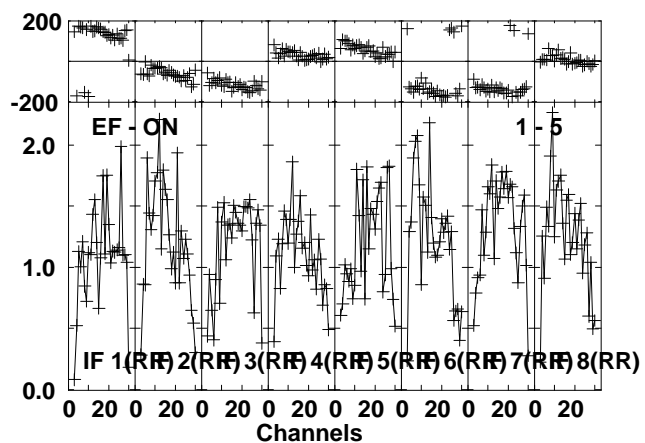
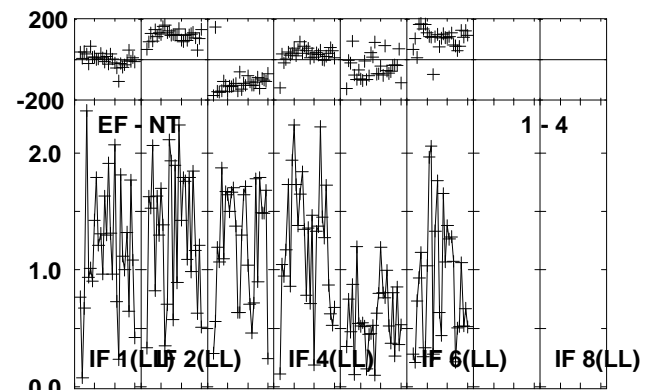
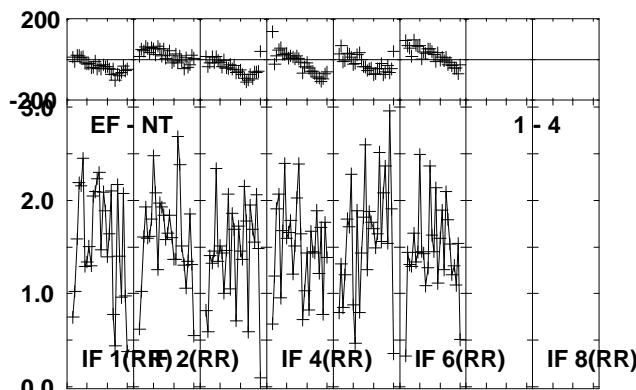
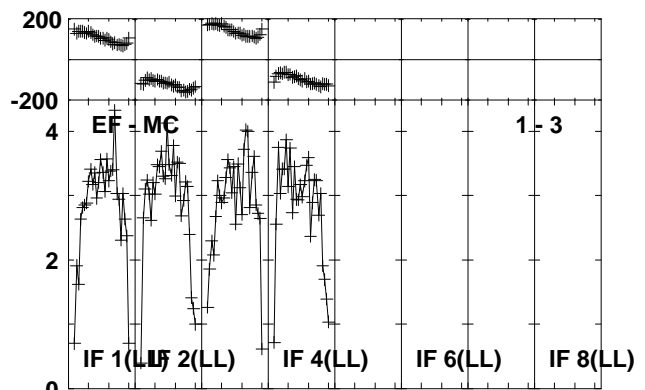
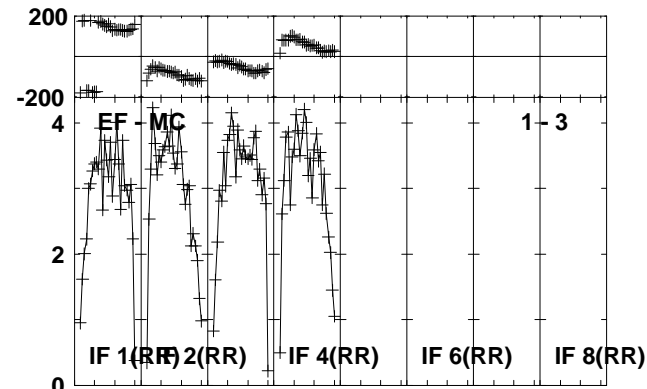
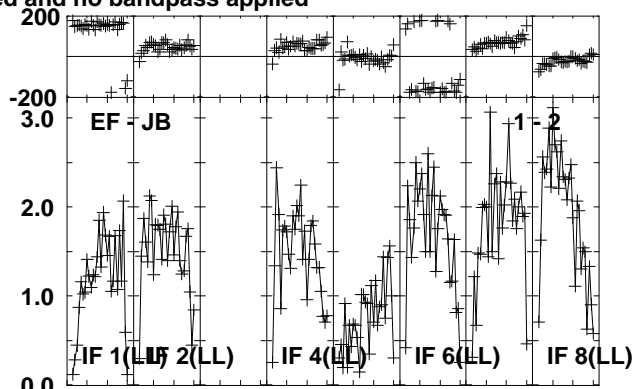
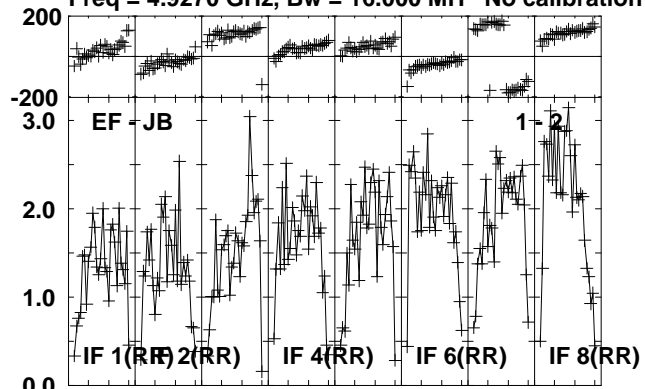

Lower frame: Milli Ampl Jy Top frame: Phas deg
Vector averaged cross-power spectrum Several baselines displayed
Timerange: 00/03:23:07 to 00/03:24:03

Plot file version 136 created 16-OCT-2012 11:57:12

J0645+0541 RO006.UVDATA.1

Freq = 4.9270 GHz, Bw = 16.000 MH No calibration applied and no bandpass applied

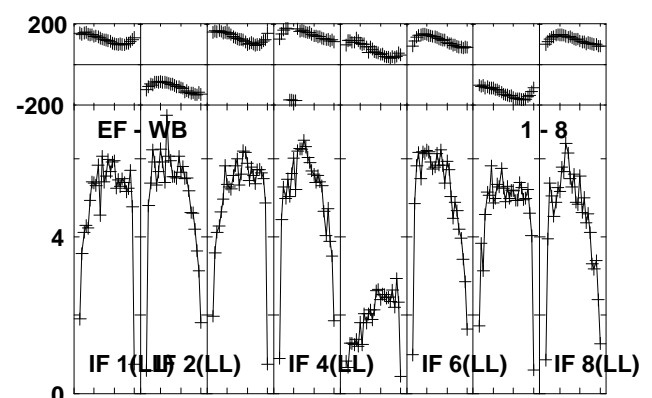
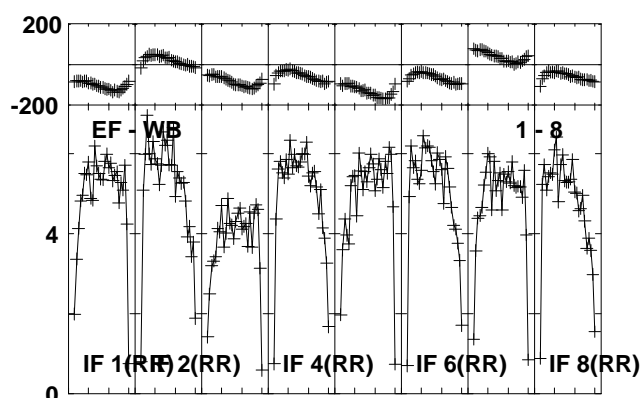
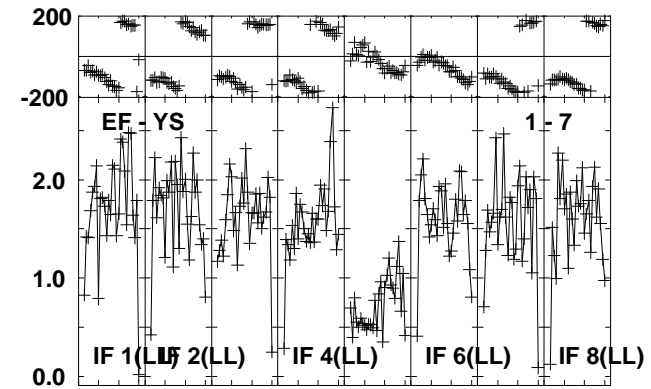
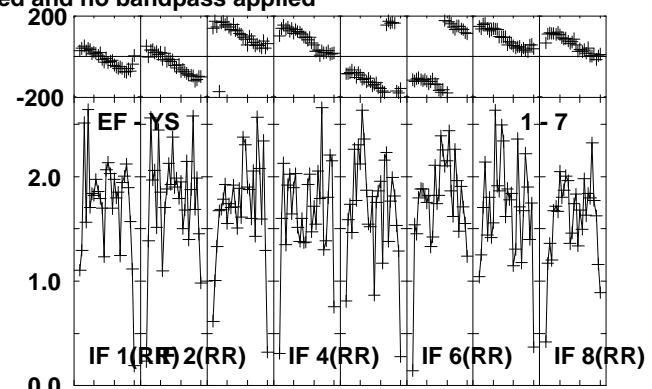
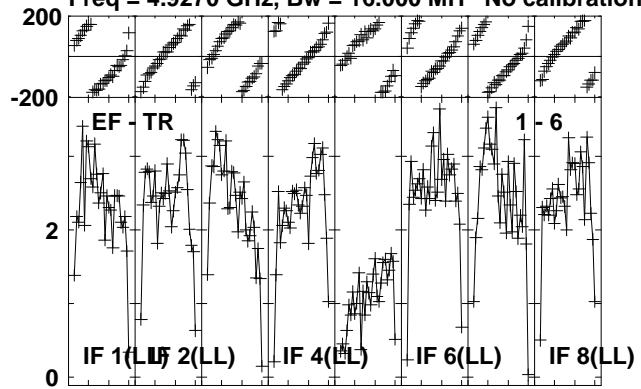

Lower frame: Milli Ampl Jy Top frame: Phas deg
Vector averaged cross-power spectrum Several baselines displayed
Timerange: 00/03:23:07 to 00/03:24:03

Plot file version 137 created 16-OCT-2012 11:57:12

NOVA-MON RO006.UVDATA.1

Freq = 4.9270 GHz, Bw = 16.000 MH No calibration applied and no bandpass applied

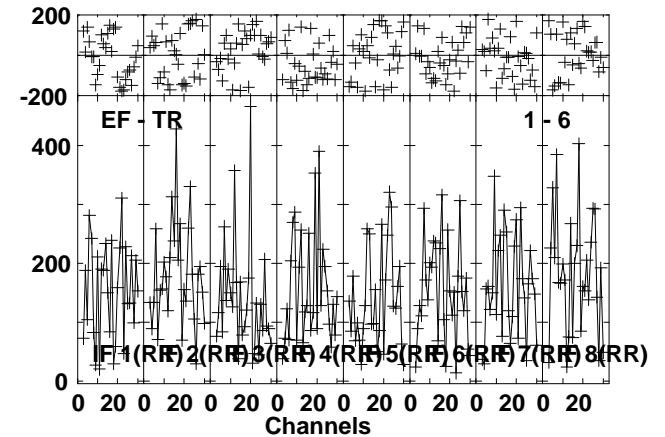
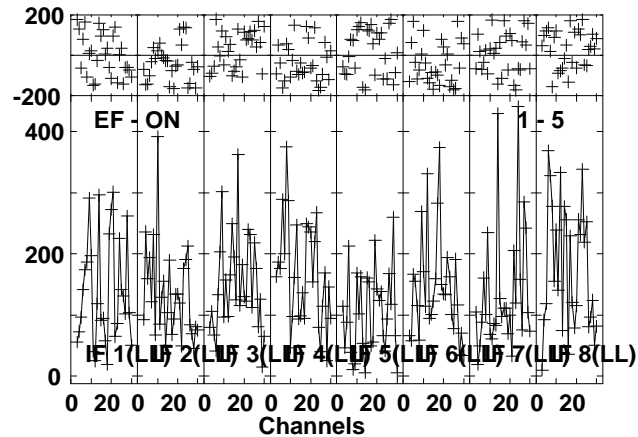
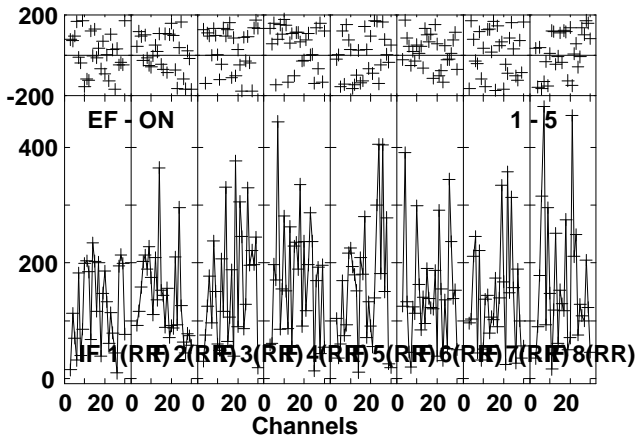
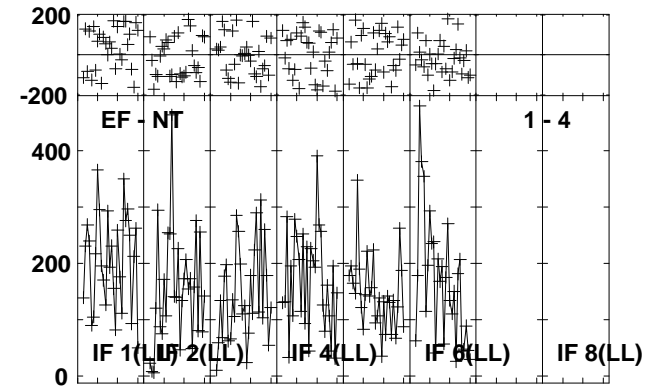
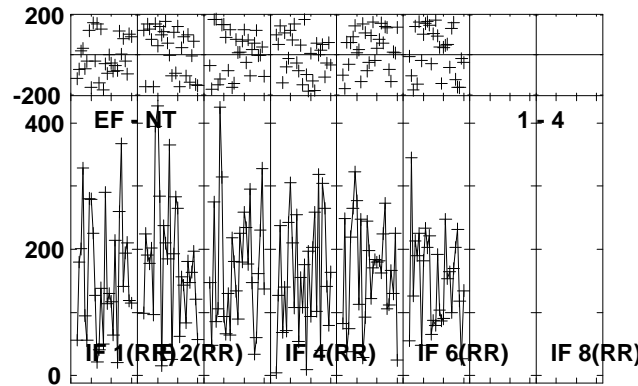
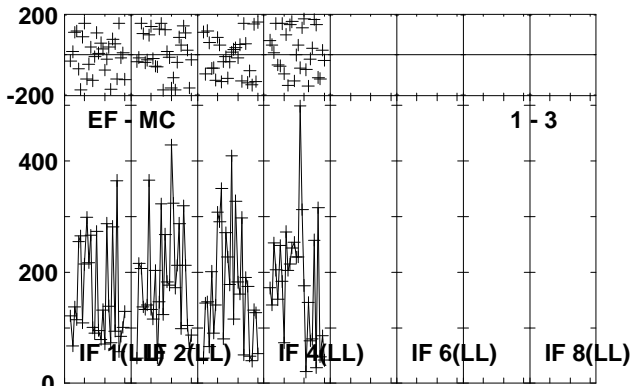
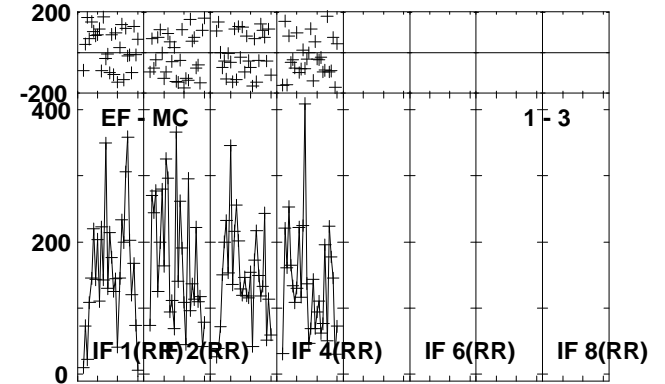
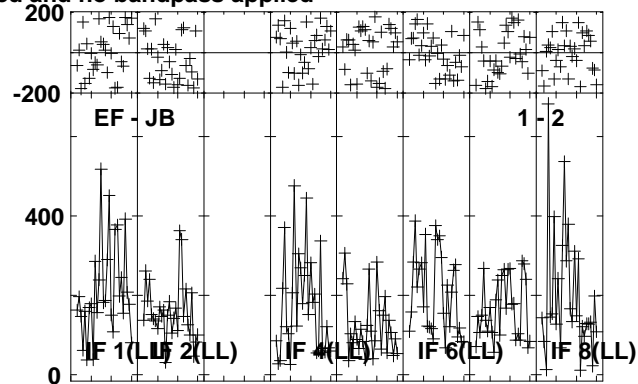
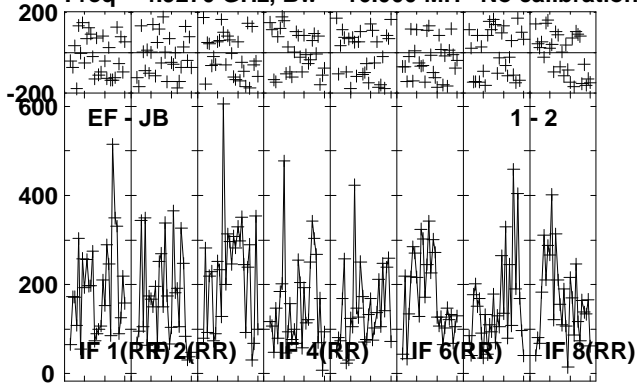

Lower frame: Micro Ampl Jy Top frame: Phas deg
Vector averaged cross-power spectrum Several baselines displayed
Timerange: 00/03:24:07 to 00/03:27:03

Plot file version 138 created 16-OCT-2012 11:57:13

NOVA-MON RO006.UVDATA.1

Freq = 4.9270 GHz, Bw = 16.000 MH No calibration applied and no bandpass applied

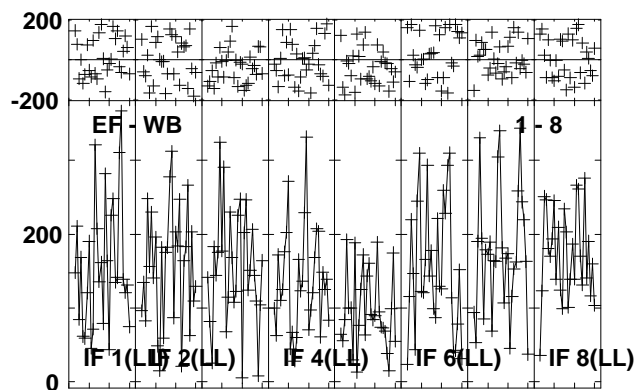
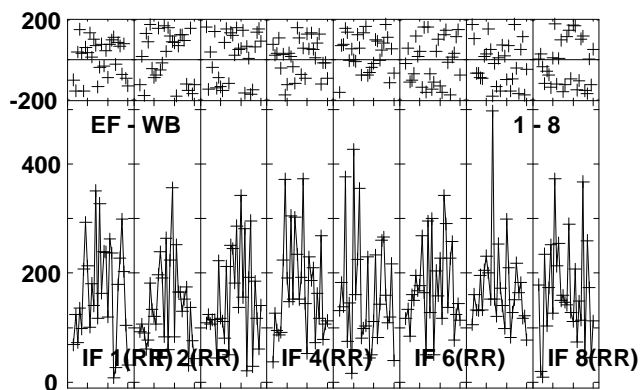
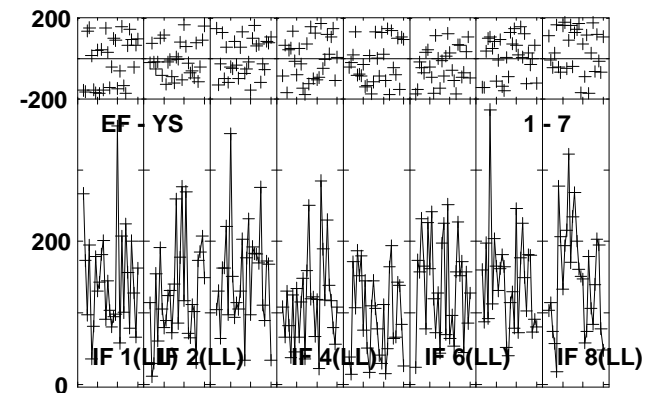
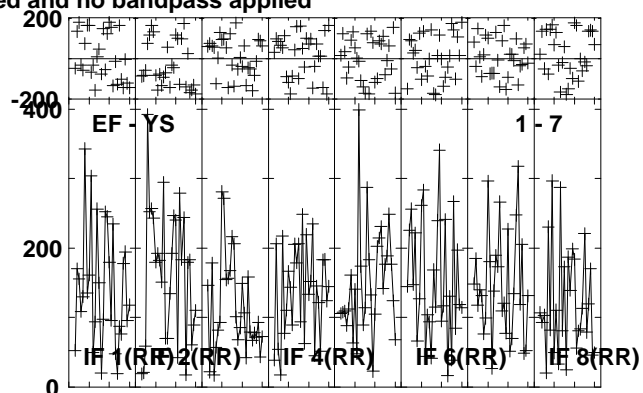
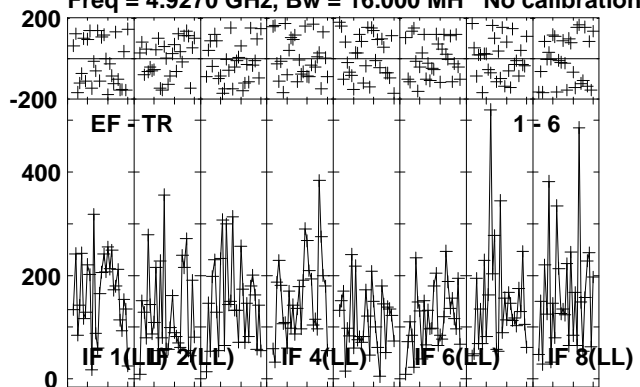

Lower frame: Micro Ampl Jy Top frame: Phas deg
Vector averaged cross-power spectrum Several baselines displayed
Timerange: 00/03:24:07 to 00/03:27:03

Plot file version 139 created 16-OCT-2012 11:57:13

J0639+0601 RO006.UVDATA.1

Freq = 4.9270 GHz, Bw = 16.000 MH No calibration applied and no bandpass applied

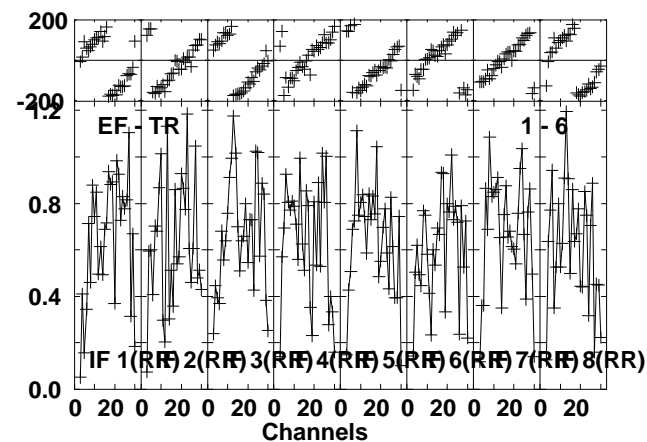
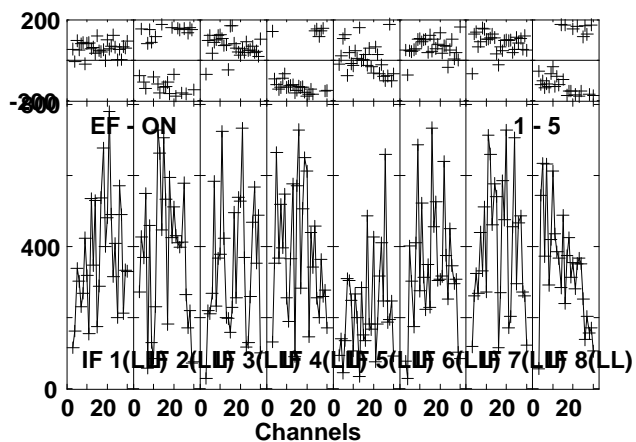
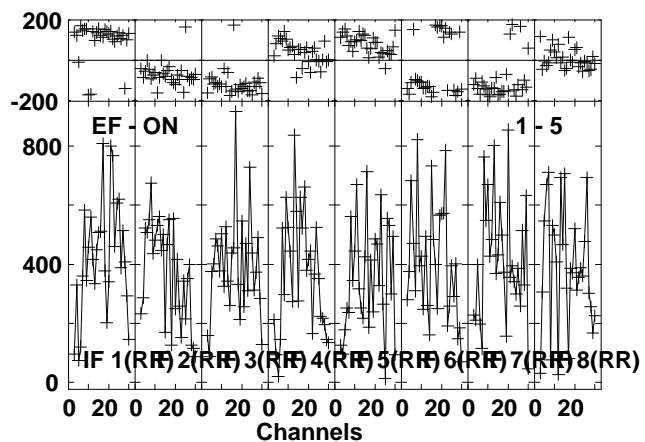
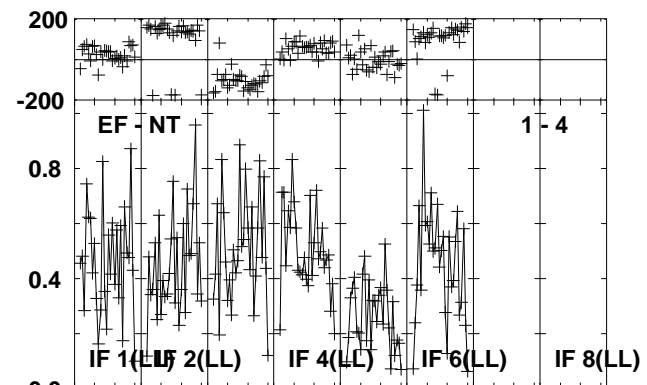
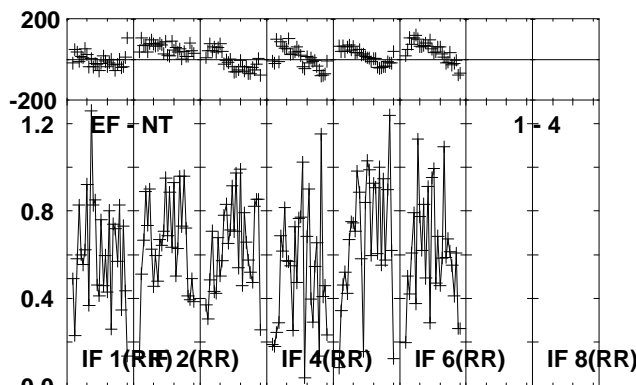
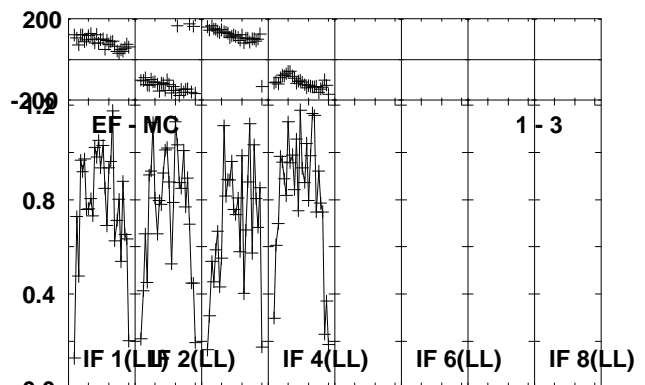
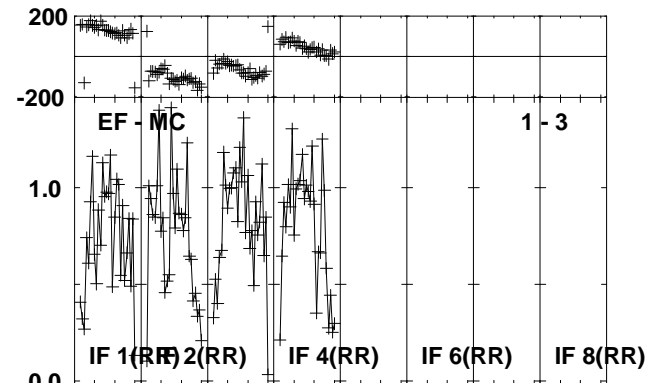
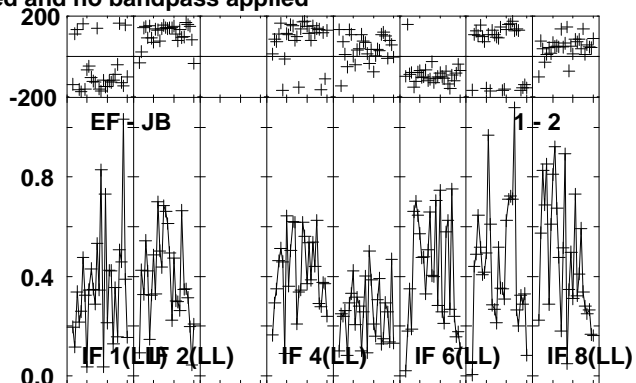
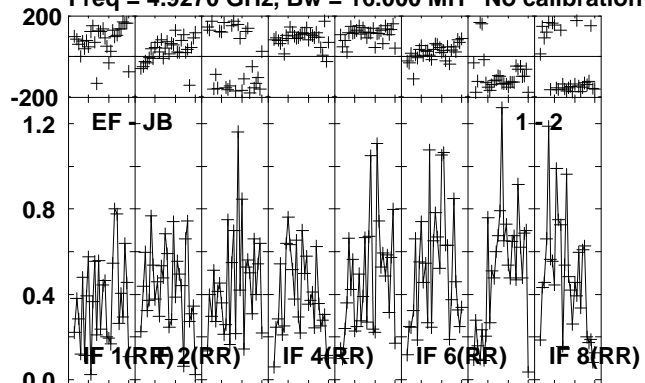

Lower frame: Milli Ampl Jy Top frame: Phas deg
Vector averaged cross-power spectrum Several baselines displayed
Timerange: 00/03:27:33 to 00/03:28:33

Plot file version 140 created 16-OCT-2012 11:57:13

J0639+0601 RO006.UVDATA.1

Freq = 4.9270 GHz, Bw = 16.000 MH No calibration applied and no bandpass applied

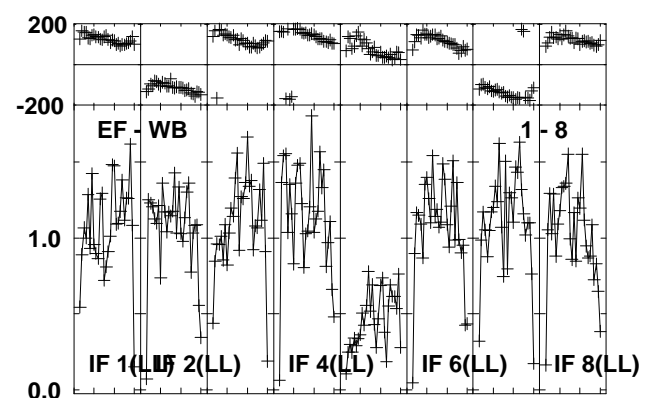
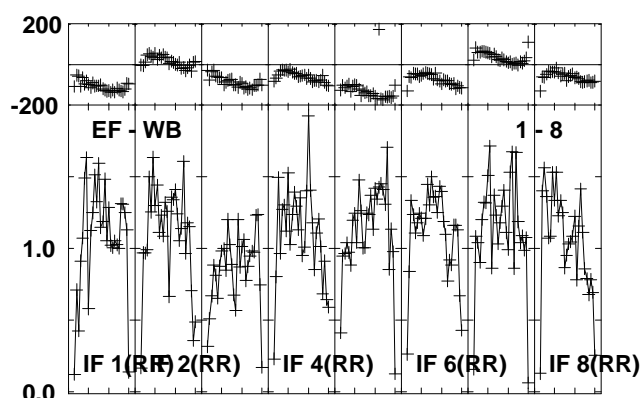
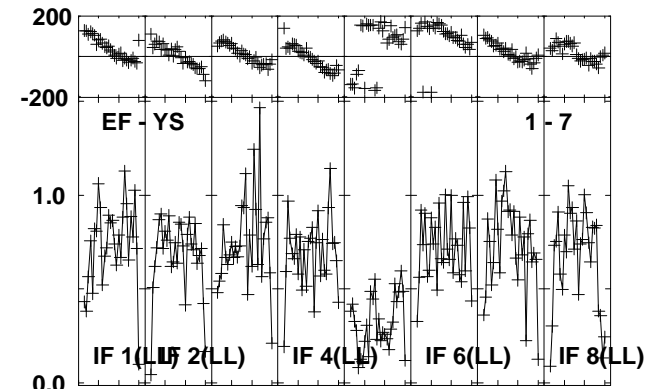
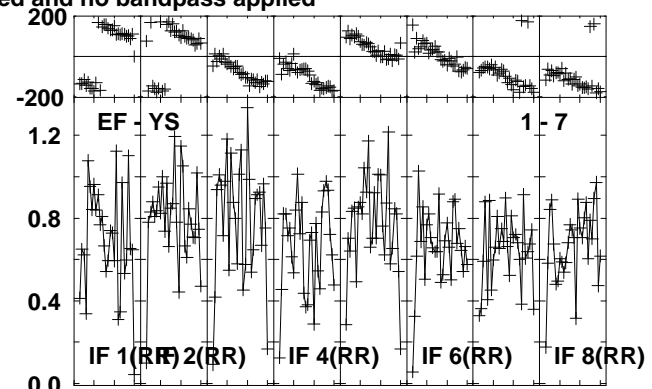
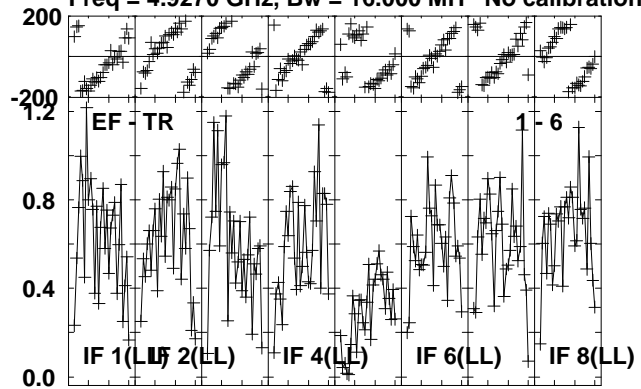

Lower frame: Milli Ampl Jy Top frame: Phas deg
Vector averaged cross-power spectrum Several baselines displayed
Timerange: 00/03:27:33 to 00/03:28:33

Plot file version 141 created 16-OCT-2012 11:57:13

J0645+0541 RO006.UVDATA.1

Freq = 4.9270 GHz, Bw = 16.000 MH No calibration applied and no bandpass applied

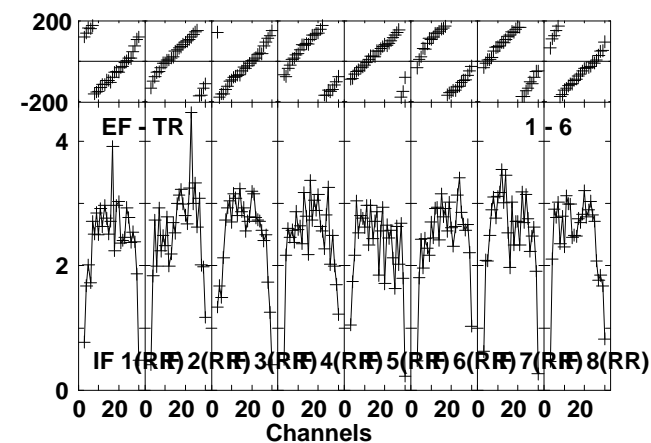
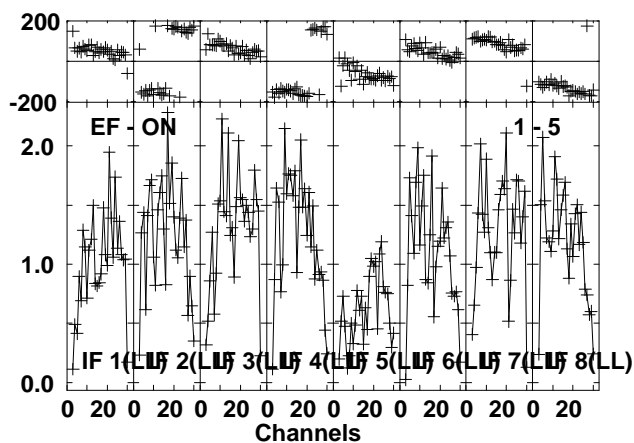
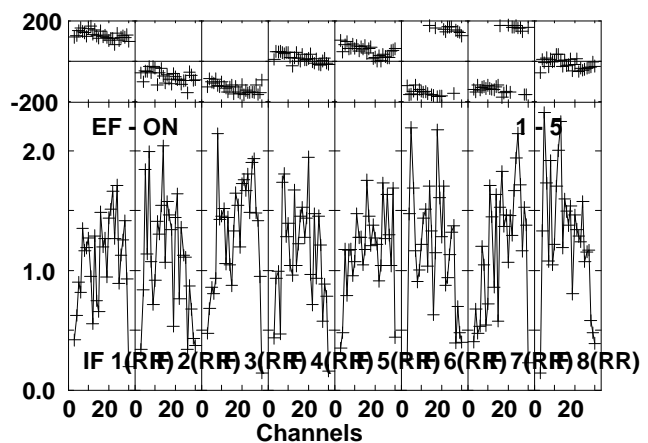
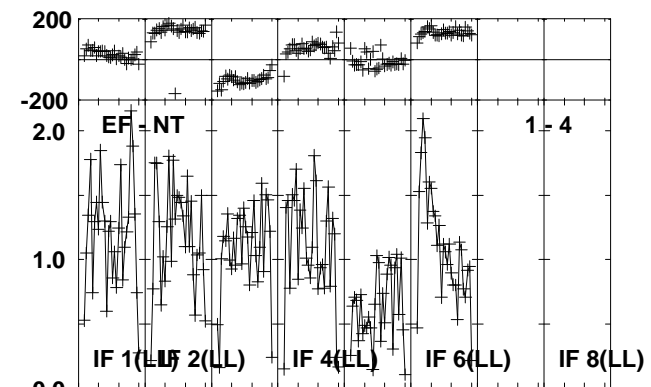
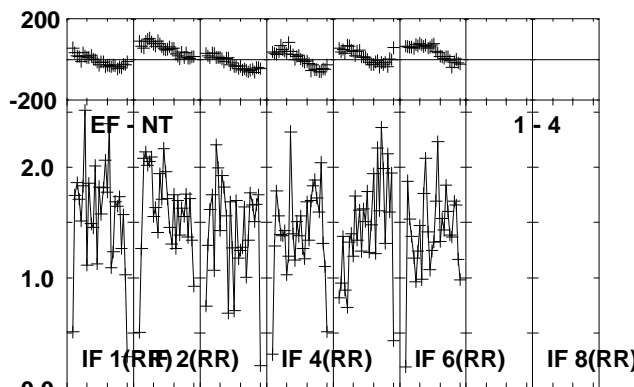
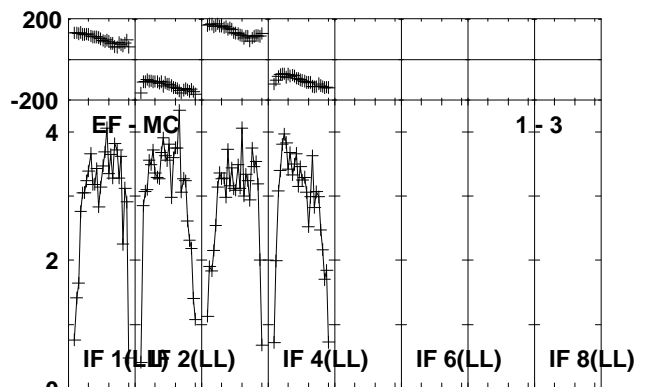
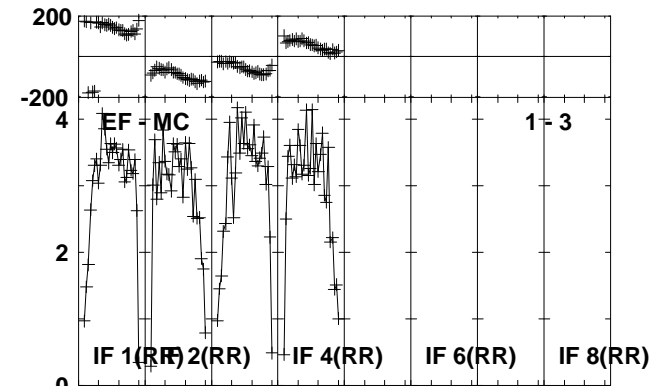
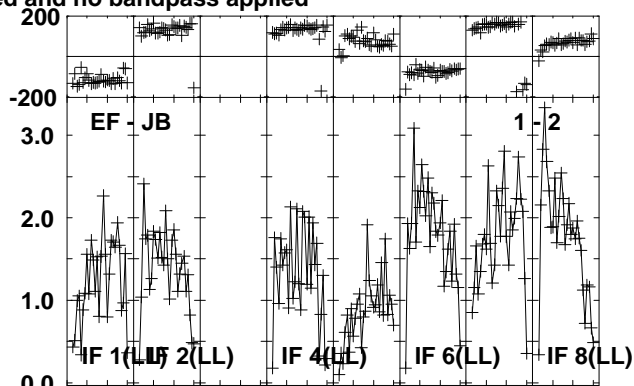
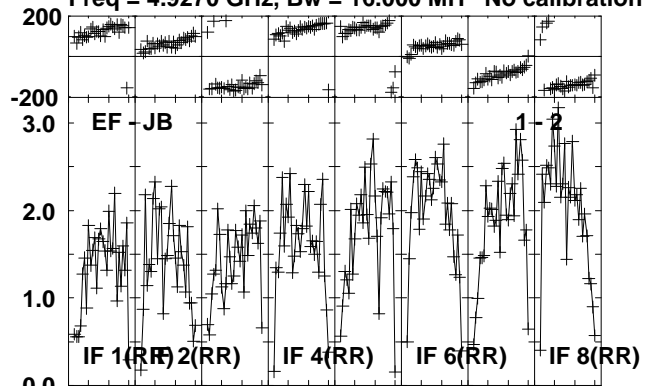

Lower frame: Milli Ampl Jy Top frame: Phas deg
Vector averaged cross-power spectrum Several baselines displayed
Timerange: 00/03:28:37 to 00/03:29:33

Plot file version 142 created 16-OCT-2012 11:57:13

J0645+0541 RO006.UVDATA.1

Freq = 4.9270 GHz, Bw = 16.000 MH No calibration applied and no bandpass applied

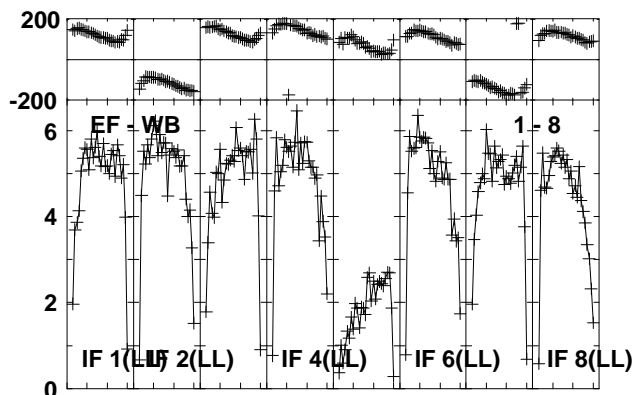
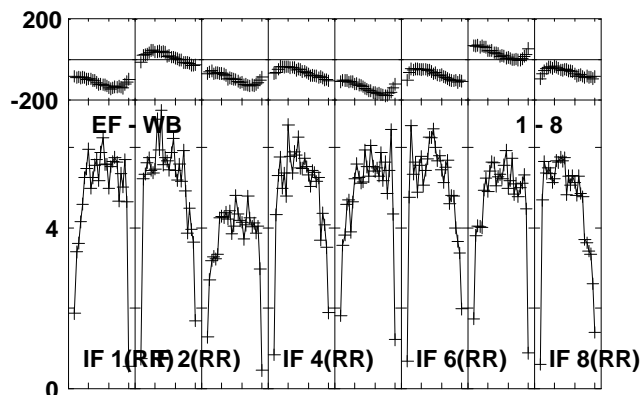
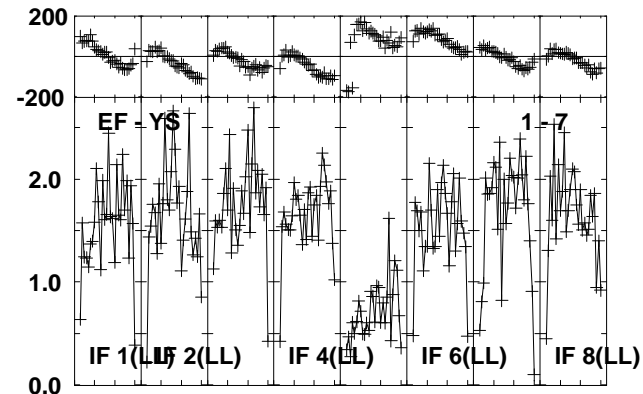
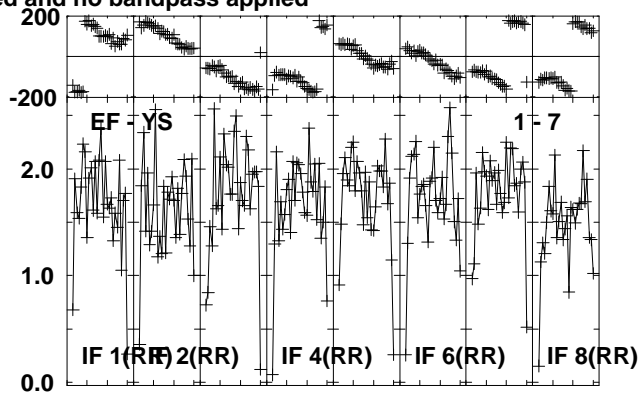
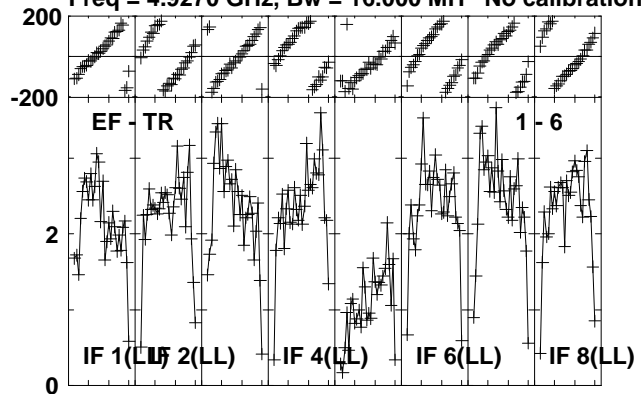

Lower frame: Milli Ampl Jy Top frame: Phas deg
Vector averaged cross-power spectrum Several baselines displayed
Timerange: 00/03:28:37 to 00/03:29:33

Plot file version 144 created 16-OCT-2012 11:57:14

NOVA-MON RO006.UVDATA.1

Freq = 4.9270 GHz, Bw = 16.000 MH No calibration applied and no bandpass applied

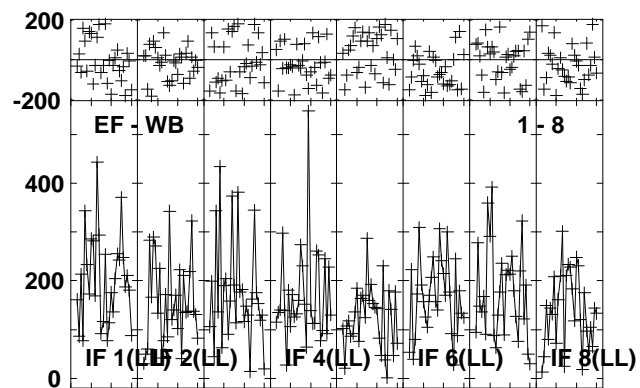
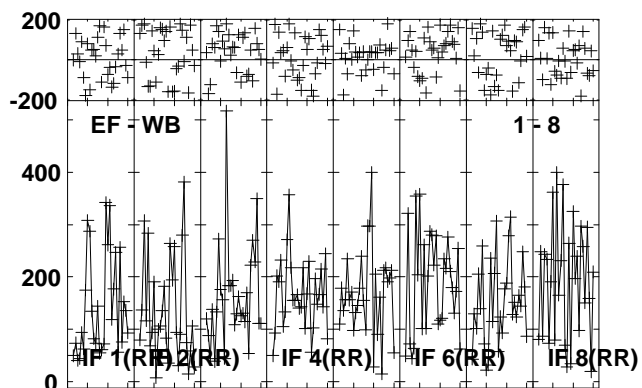
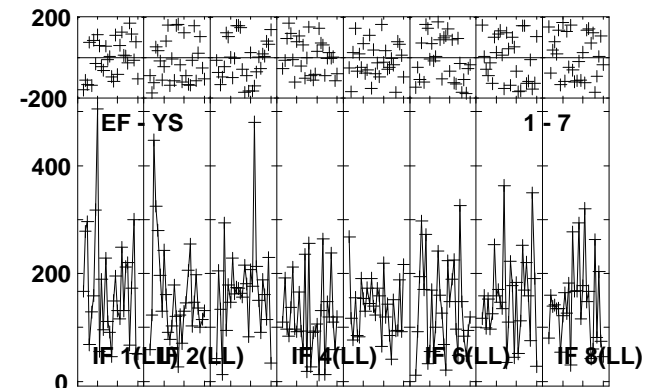
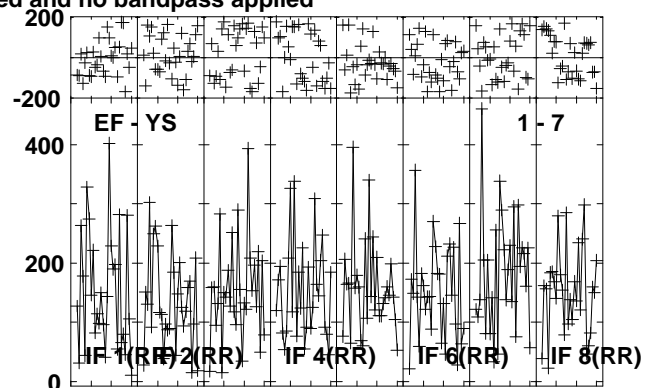
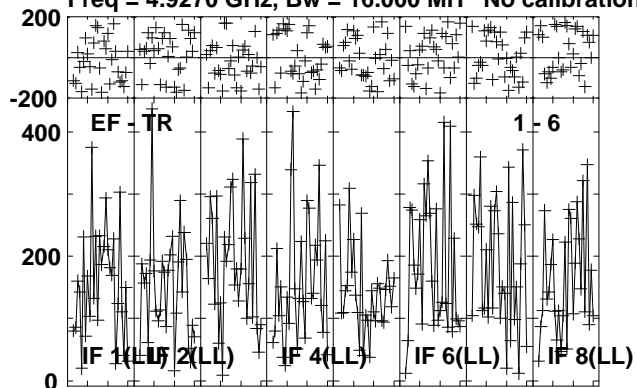

Lower frame: Micro Ampl Jy Top frame: Phas deg
Vector averaged cross-power spectrum Several baselines displayed
Timerange: 00/03:29:37 to 00/03:32:33

Plot file version 145 created 16-OCT-2012 11:57:15

J0639+0601 RO006.UVDATA.1

Freq = 4.9270 GHz, Bw = 16.000 MH No calibration applied and no bandpass applied

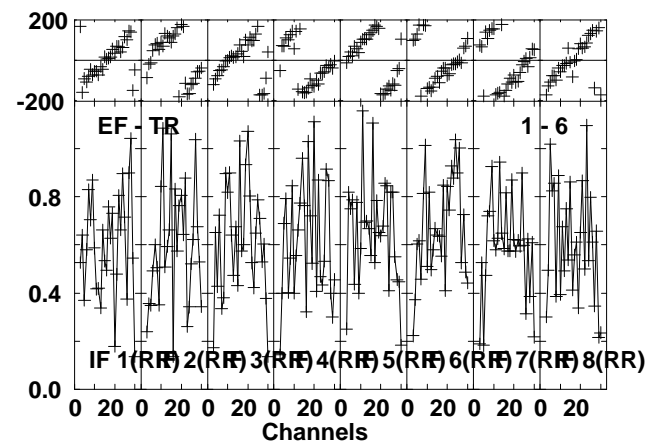
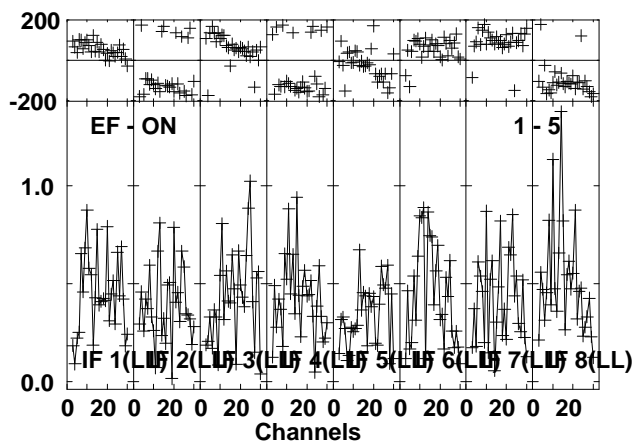
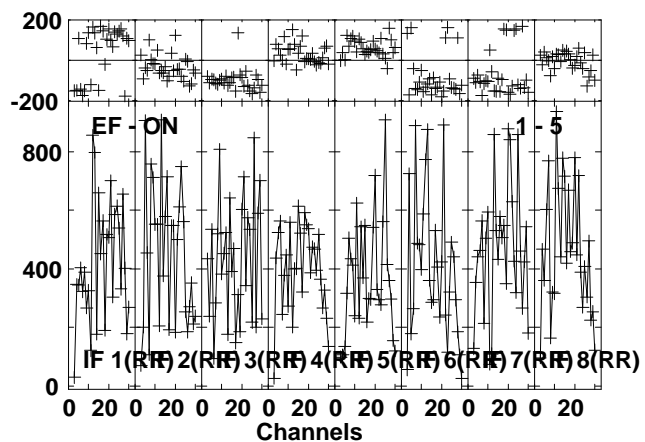
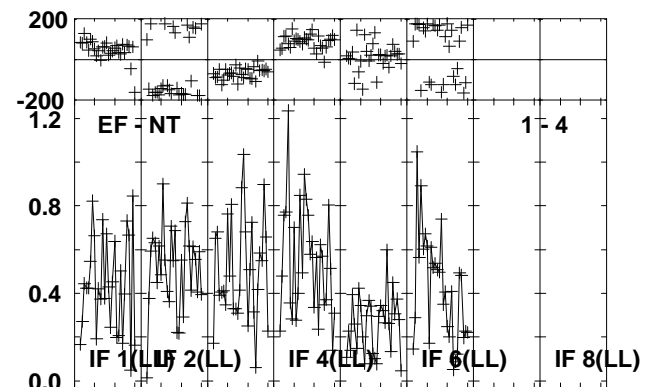
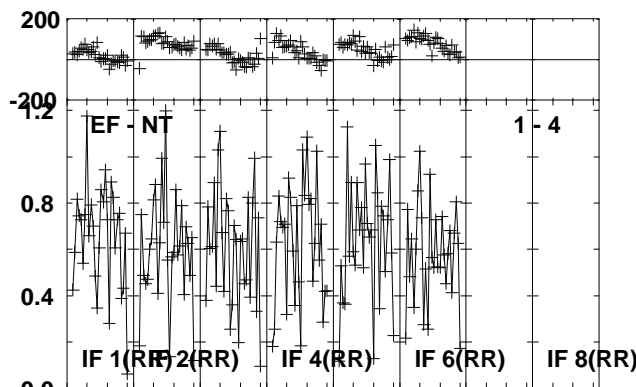
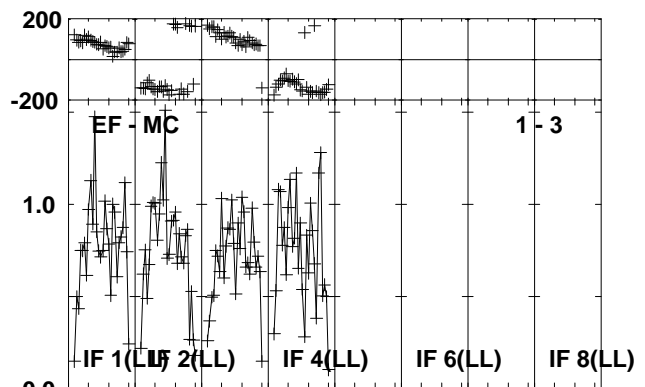
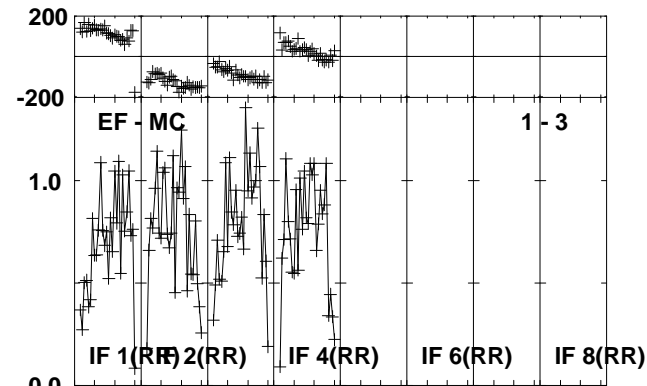
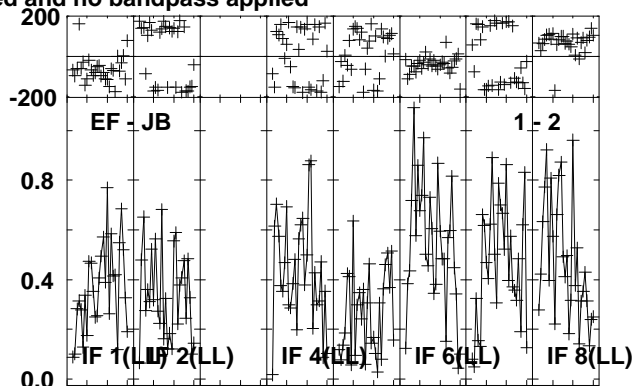
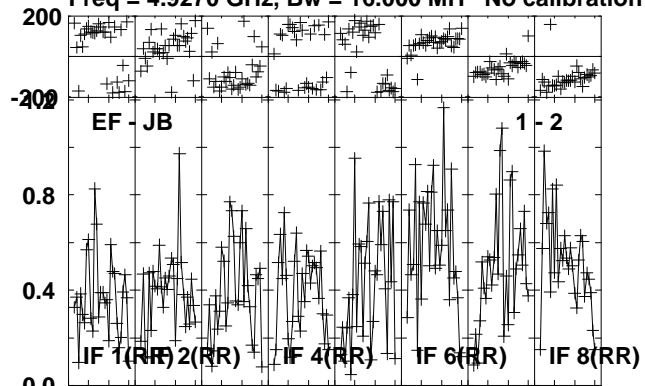

Lower frame: Milli Ampl Jy Top frame: Phas deg
Vector averaged cross-power spectrum Several baselines displayed
Timerange: 00/03:32:37 to 00/03:33:49

Plot file version 146 created 16-OCT-2012 11:57:15

J0639+0601 RO006.UVDATA.1

Freq = 4.9270 GHz, Bw = 16.000 MH No calibration applied and no bandpass applied

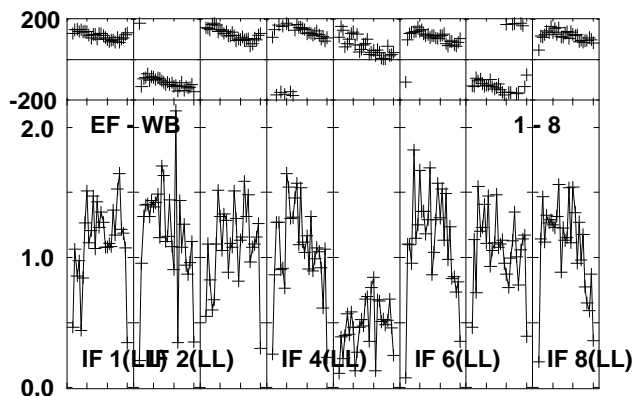
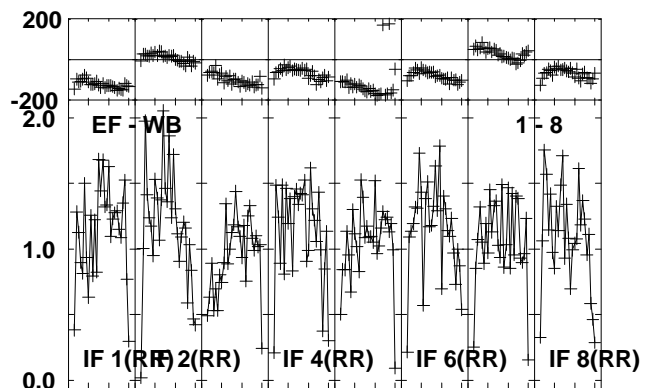
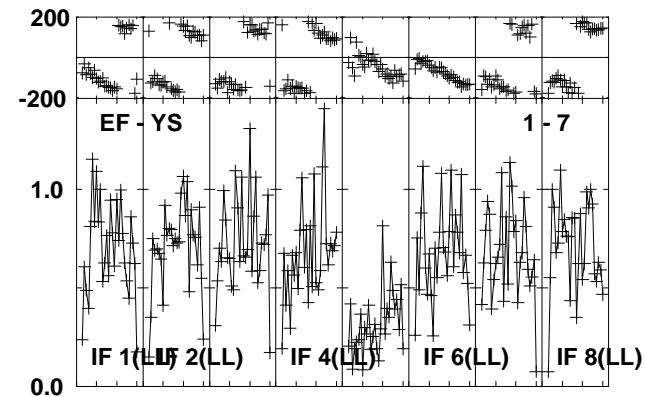
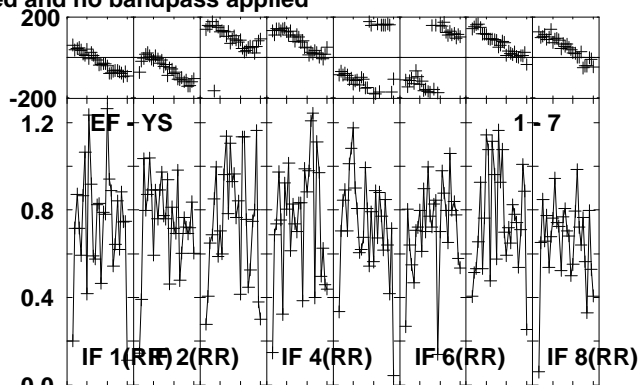
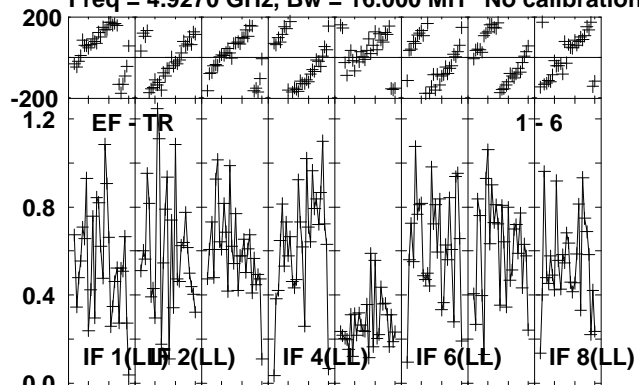

Lower frame: Milli Ampl Jy Top frame: Phas deg
Vector averaged cross-power spectrum Several baselines displayed
Timerange: 00/03:32:37 to 00/03:33:49

Plot file version 147 created 16-OCT-2012 11:57:15

J0645+0541 RO006.UVDATA.1

Freq = 4.9270 GHz, Bw = 16.000 MH No calibration applied and no bandpass applied

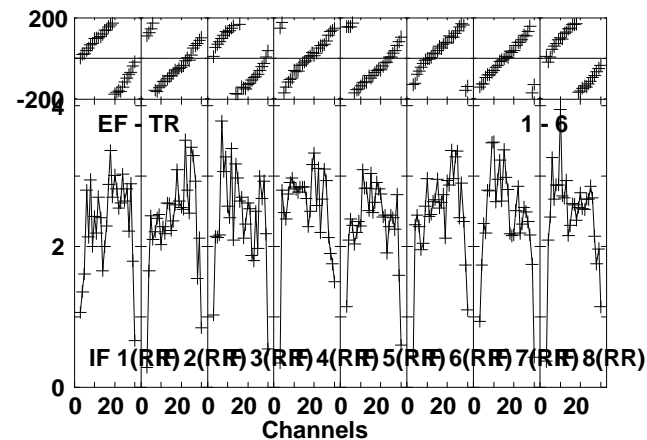
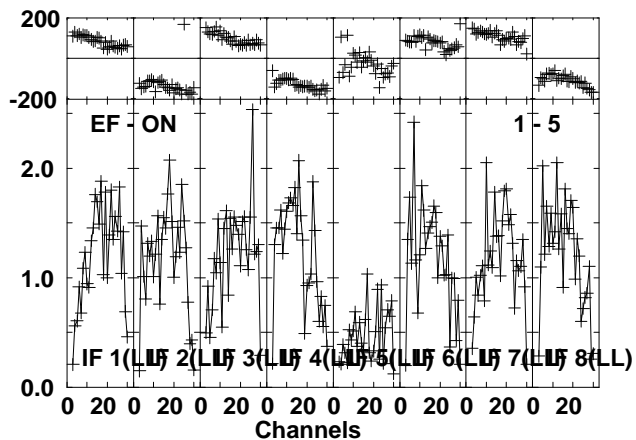
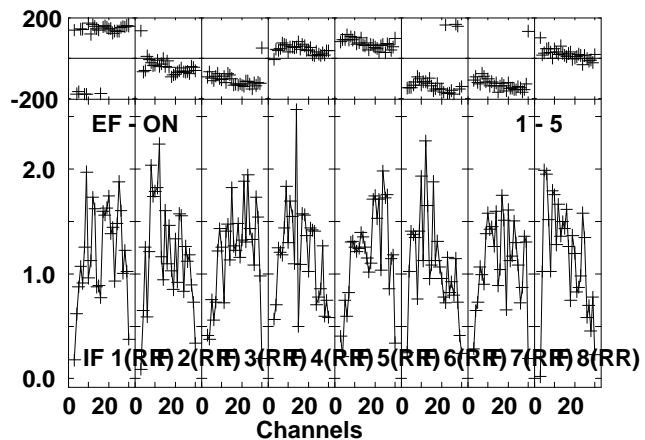
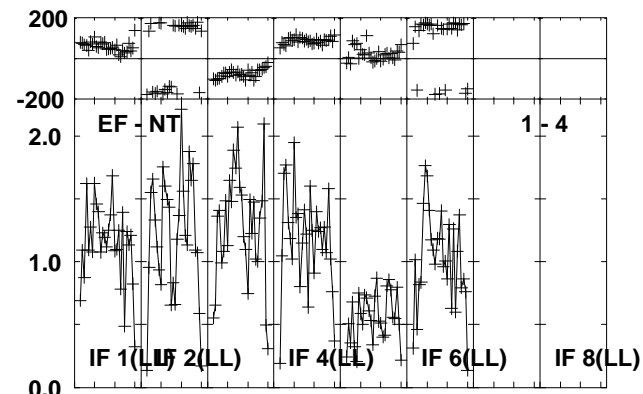
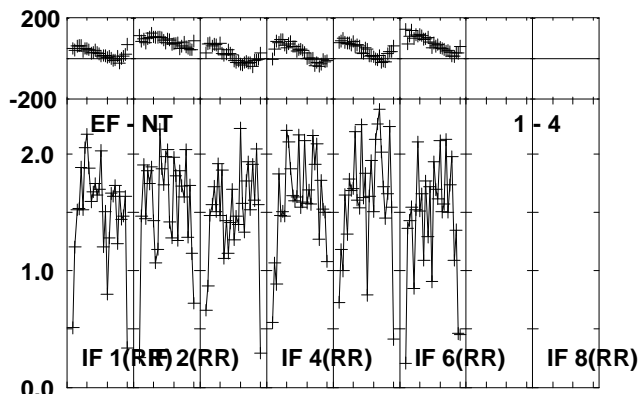
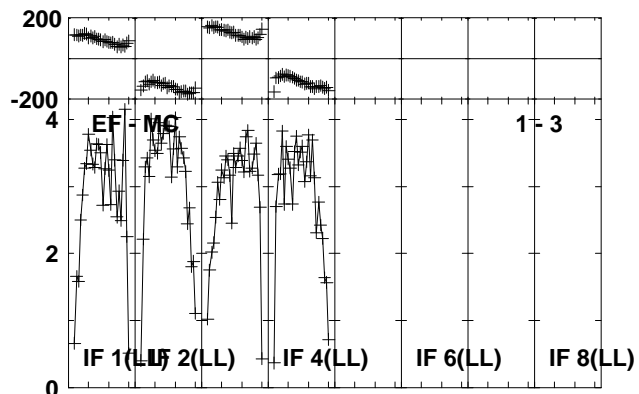
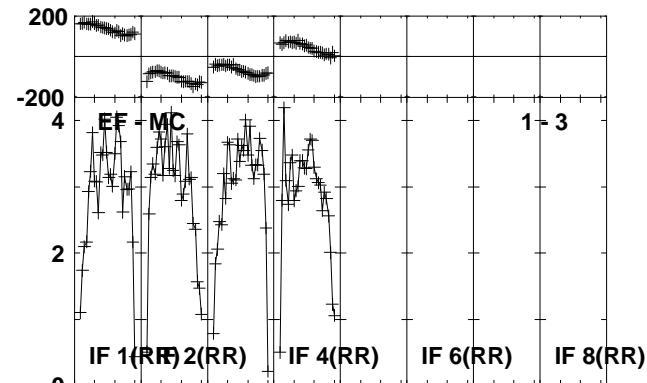
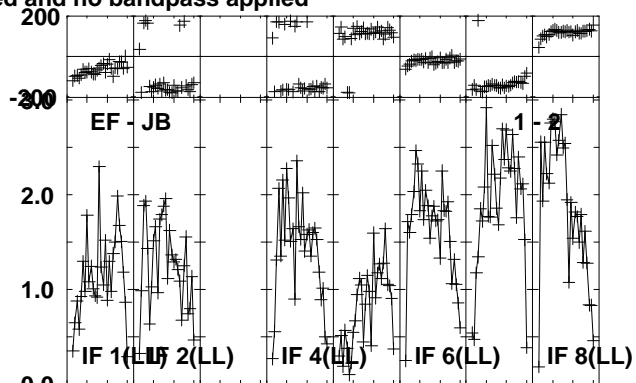
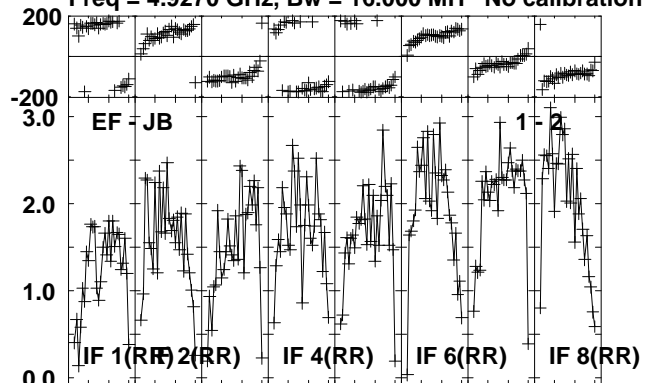

Lower frame: Milli Ampl Jy Top frame: Phas deg
Vector averaged cross-power spectrum Several baselines displayed
Timerange: 00/03:33:53 to 00/03:34:49

Plot file version 148 created 16-OCT-2012 11:57:15

J0645+0541 RO006.UVDATA.1

Freq = 4.9270 GHz, Bw = 16.000 MH No calibration applied and no bandpass applied

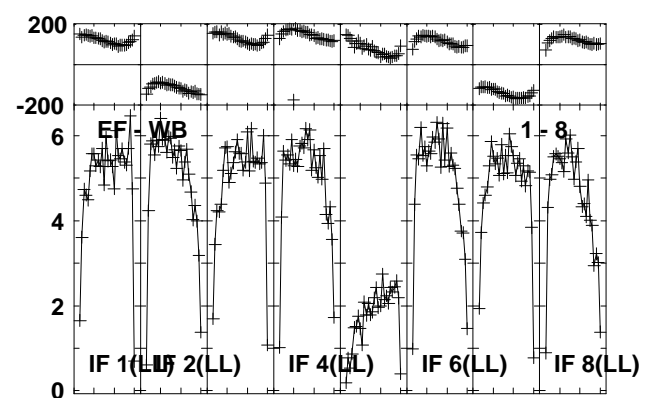
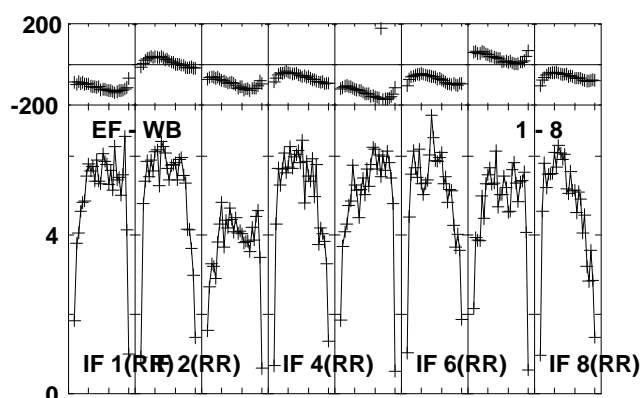
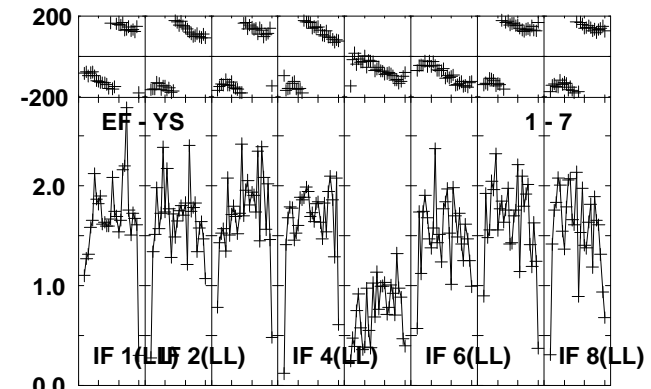
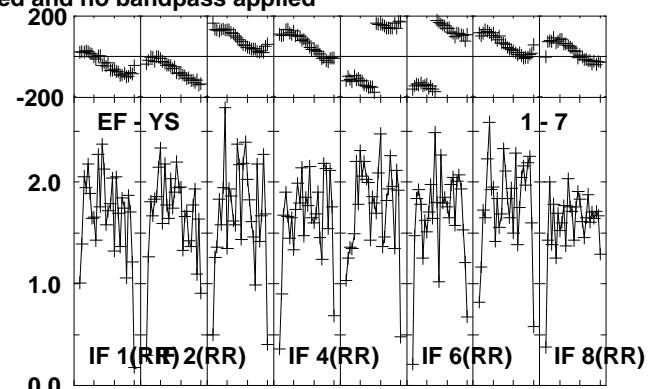
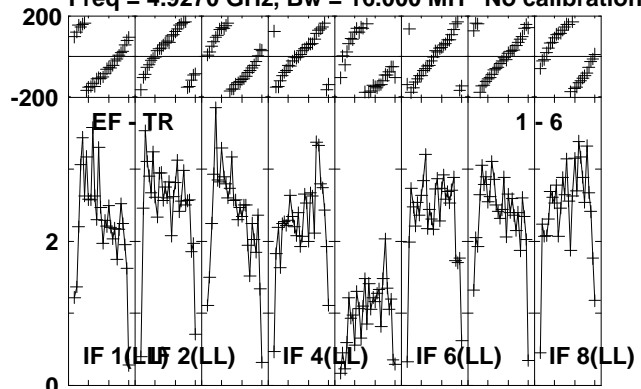

Lower frame: Milli Ampl Jy Top frame: Phas deg
Vector averaged cross-power spectrum Several baselines displayed
Timerange: 00/03:33:53 to 00/03:34:49

Plot file version 149 created 16-OCT-2012 11:57:15

NOVA-MON RO006.UVDATA.1

Freq = 4.9270 GHz, Bw = 16.000 MH No calibration applied and no bandpass applied

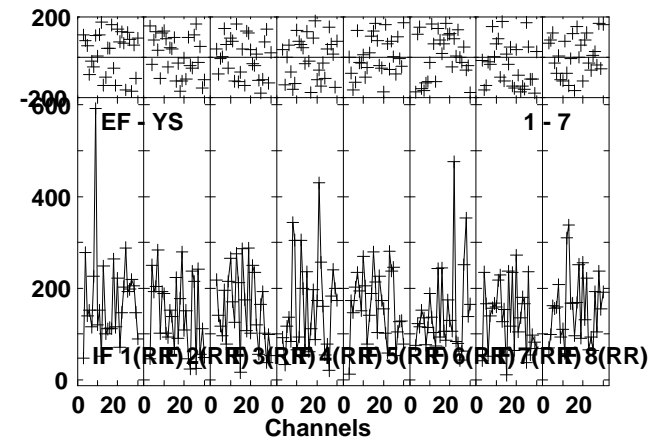
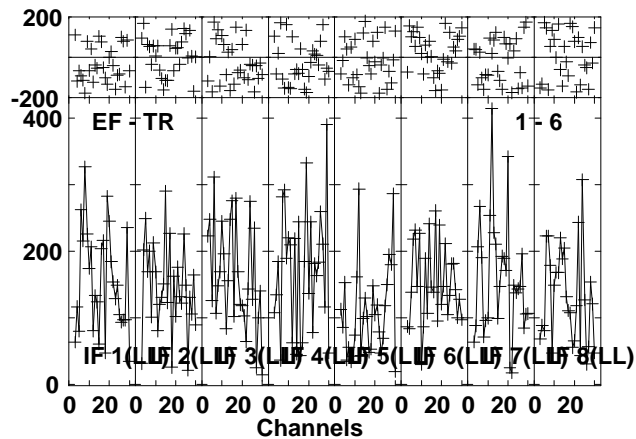
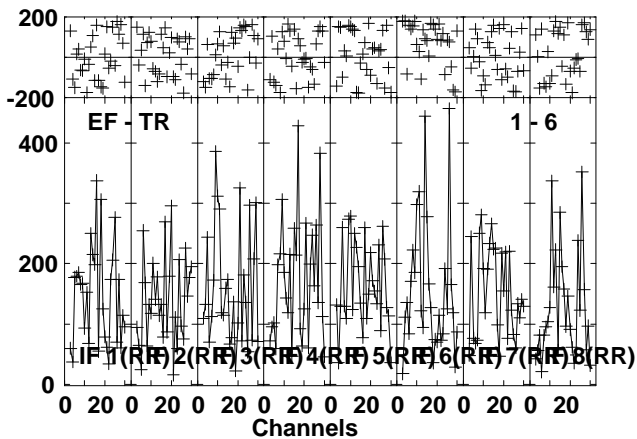
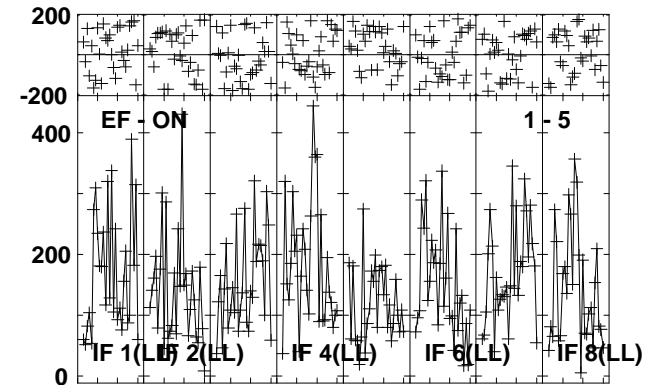
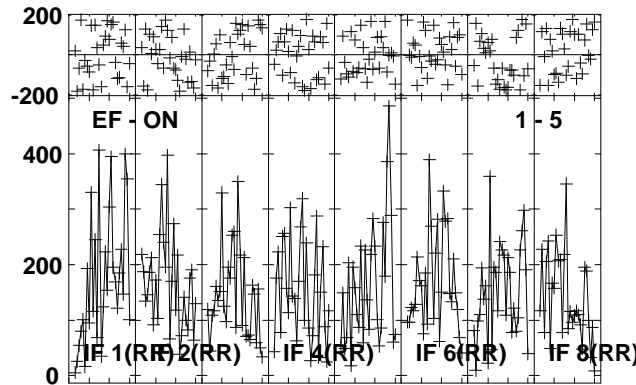
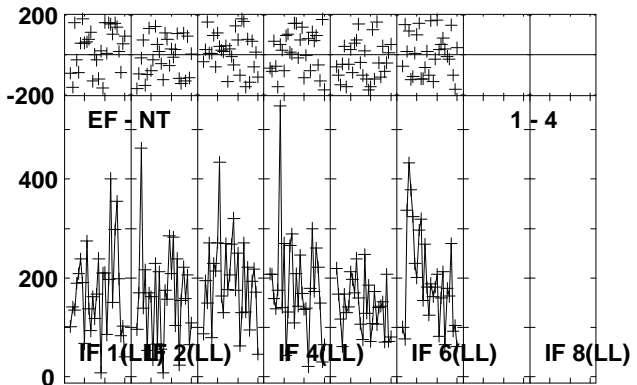
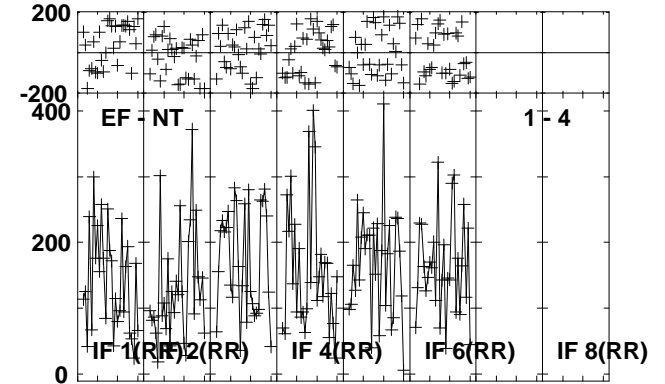
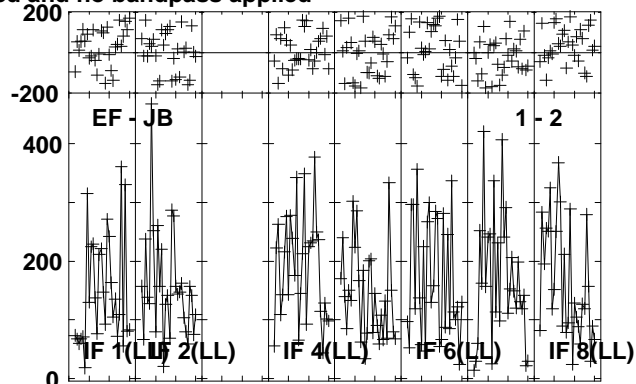
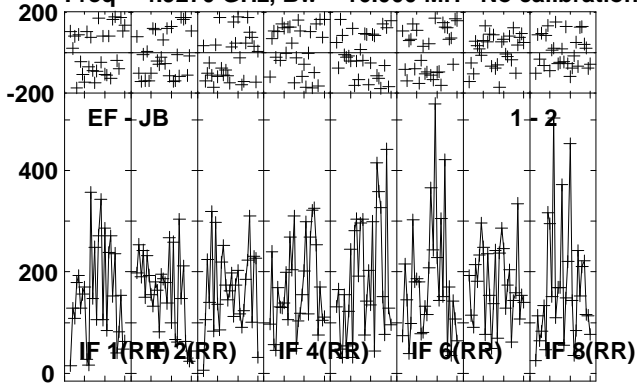

Lower frame: Micro Ampl Jy Top frame: Phas deg
Vector averaged cross-power spectrum Several baselines displayed
Timerange: 00/03:34:53 to 00/03:37:49

Plot file version 150 created 16-OCT-2012 11:57:16

NOVA-MON RO006.UVDATA.1

Freq = 4.9270 GHz, Bw = 16.000 MH No calibration applied and no bandpass applied

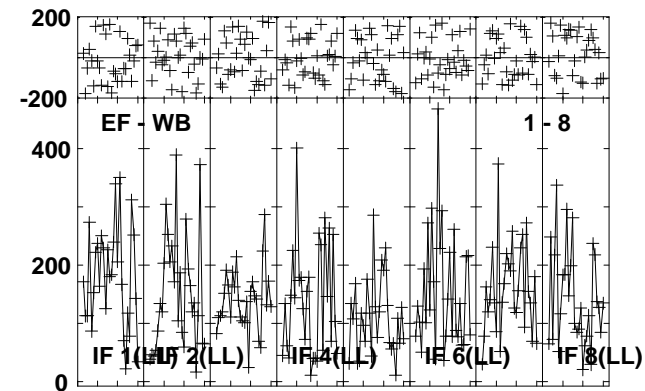
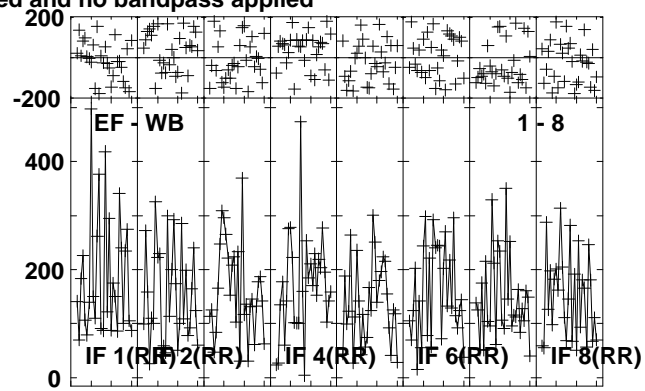
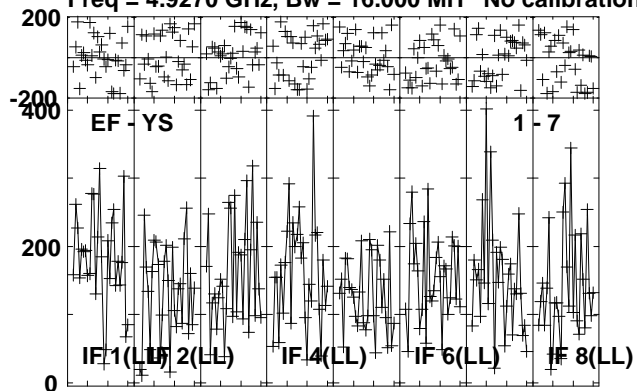

Lower frame: Micro Ampl Jy Top frame: Phas deg
Vector averaged cross-power spectrum Several baselines displayed
Timerange: 00/03:34:53 to 00/03:37:49

Plot file version 151 created 16-OCT-2012 11:57:16

J0639+0601 RO006.UVDATA.1

Freq = 4.9270 GHz, Bw = 16.000 MH No calibration applied and no bandpass applied

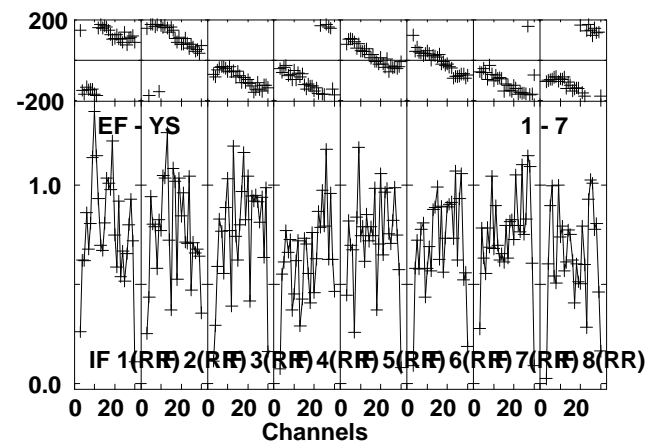
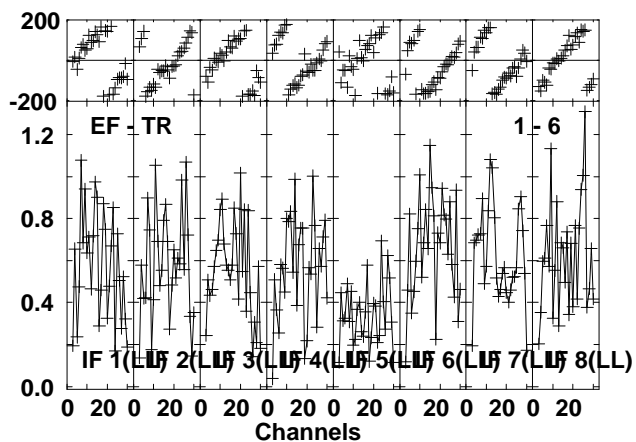
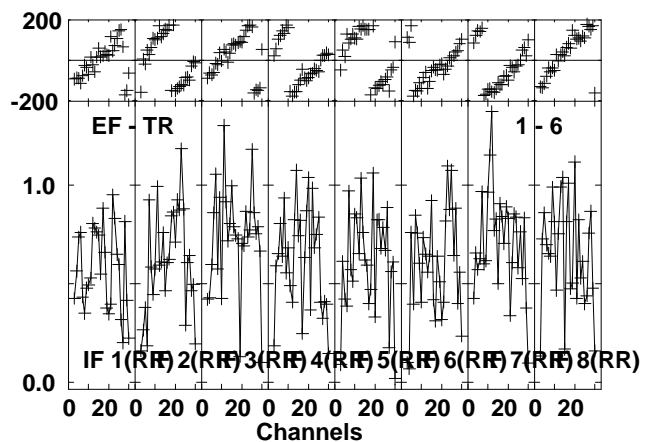
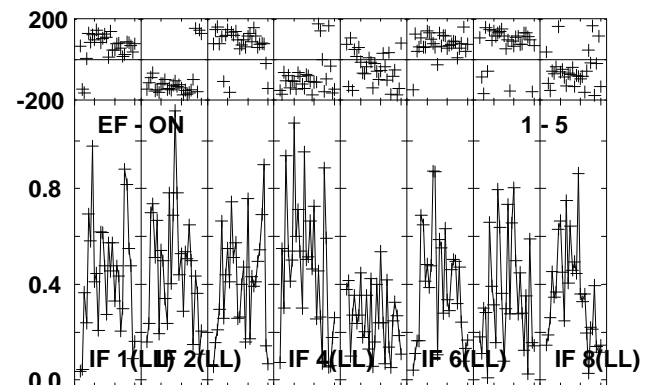
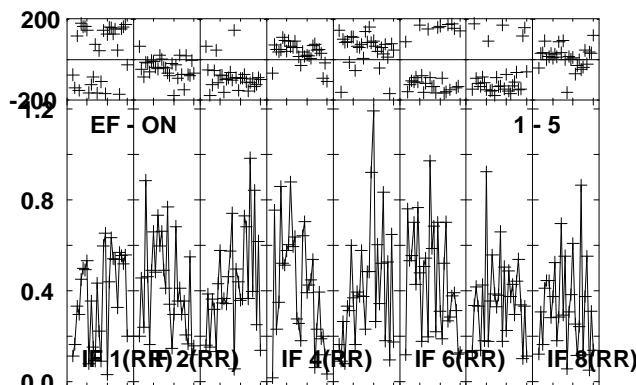
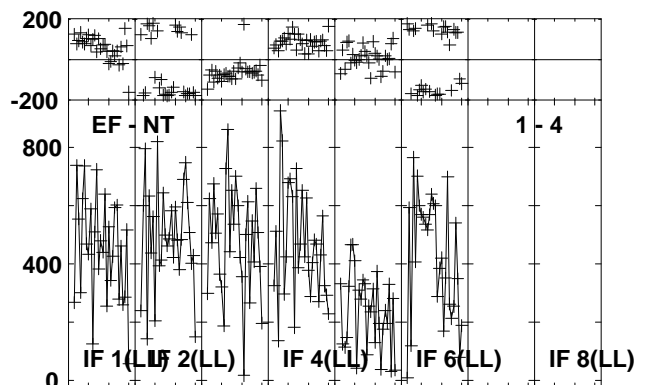
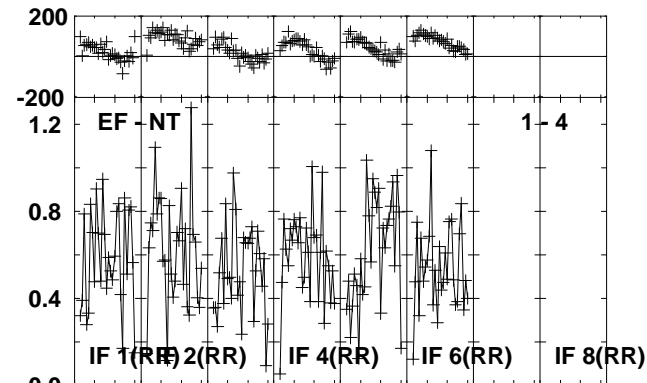
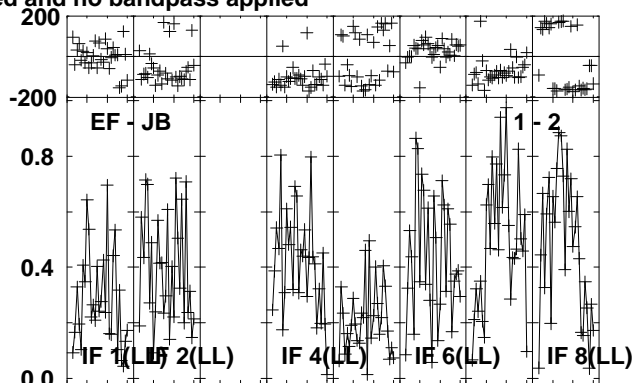
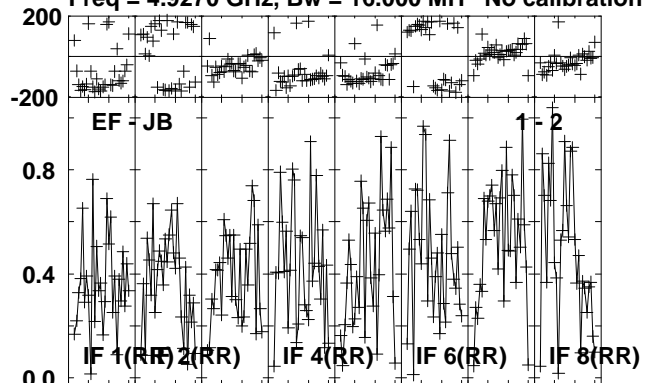

Lower frame: Milli Ampl Jy Top frame: Phas deg
Vector averaged cross-power spectrum Several baselines displayed
Timerange: 00/03:38:17 to 00/03:39:19

Plot file version 152 created 16-OCT-2012 11:57:17

J0639+0601 RO006.UVDATA.1

Freq = 4.9270 GHz, Bw = 16.000 MH No calibration applied and no bandpass applied

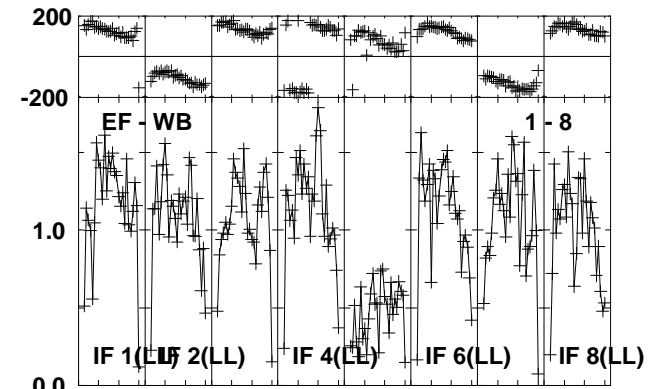
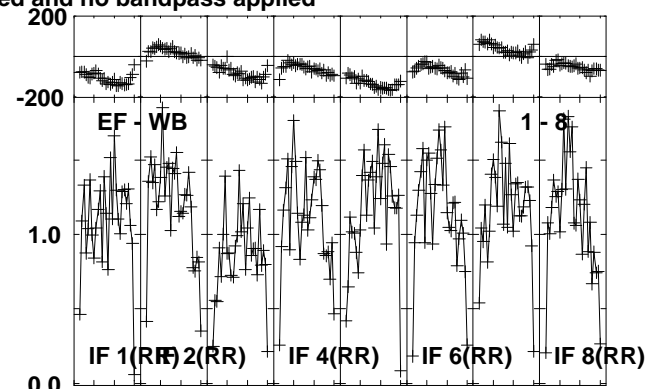
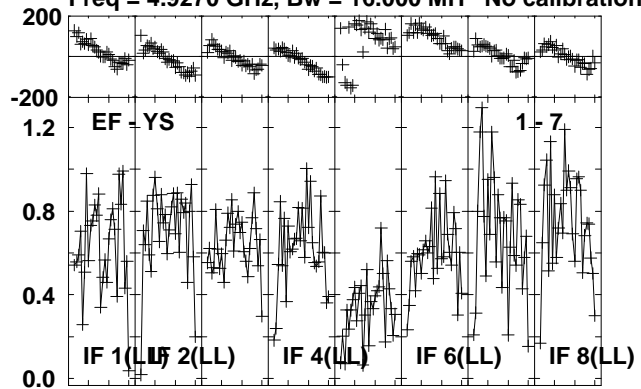

Lower frame: Milli Ampl Jy Top frame: Phas deg
Vector averaged cross-power spectrum Several baselines displayed
Timerange: 00/03:38:17 to 00/03:39:19

Plot file version 153 created 16-OCT-2012 11:57:17

0528+134 RO006.UVDATA.1

Freq = 4.9270 GHz, Bw = 16.000 MH No calibration applied and no bandpass applied

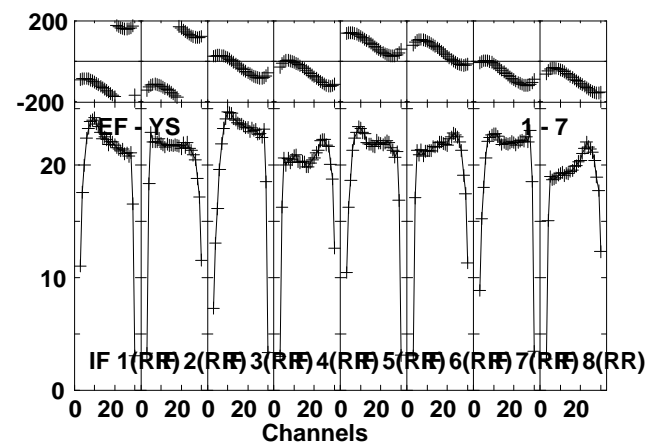
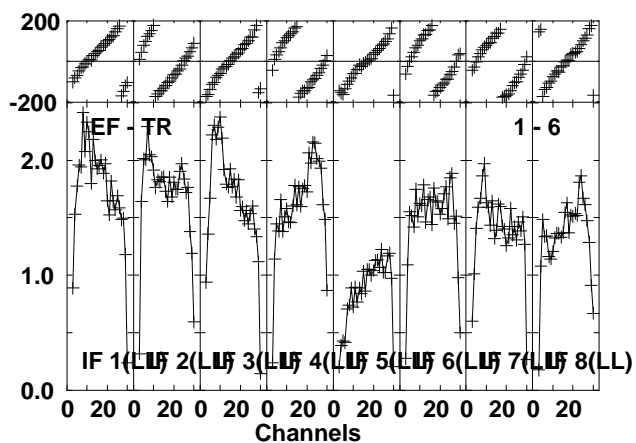
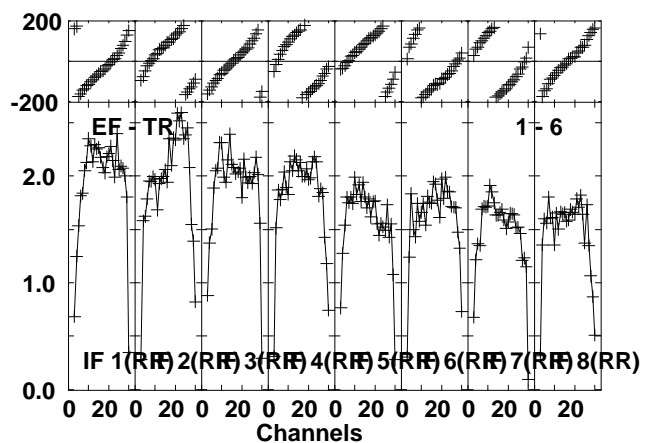
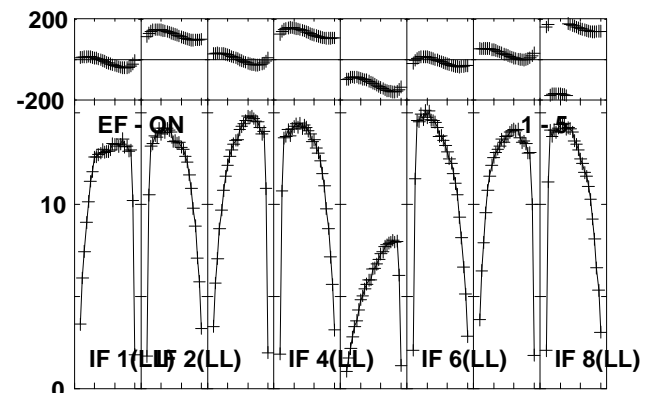
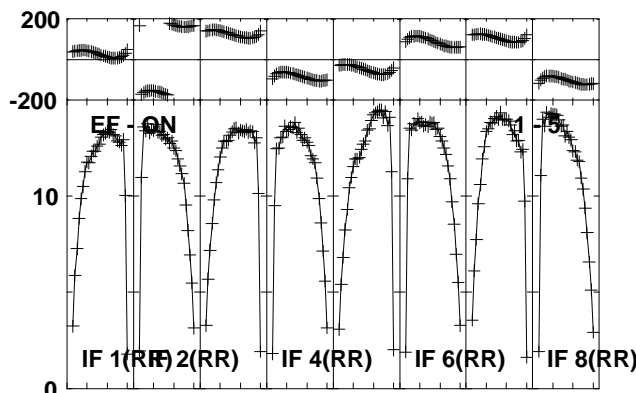
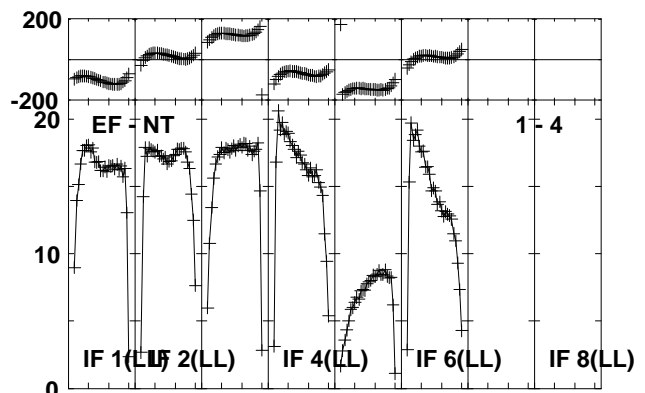
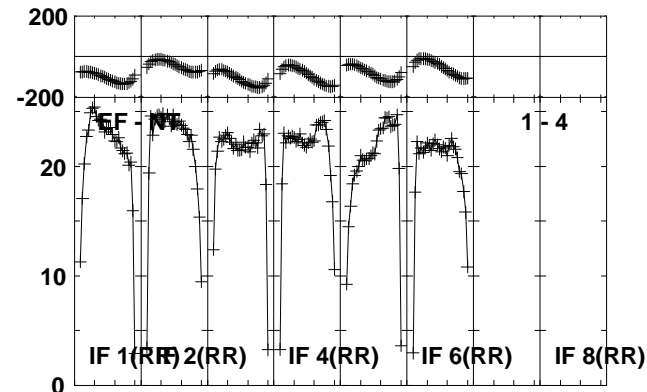
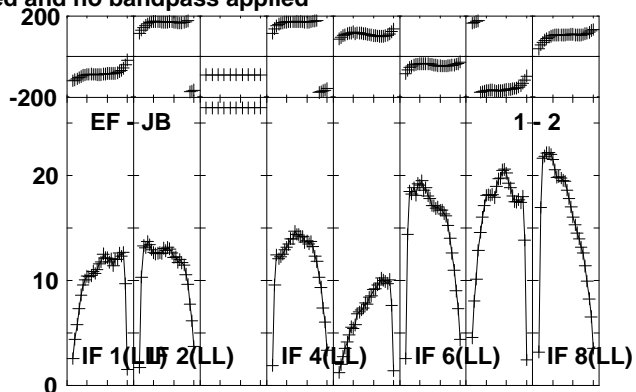
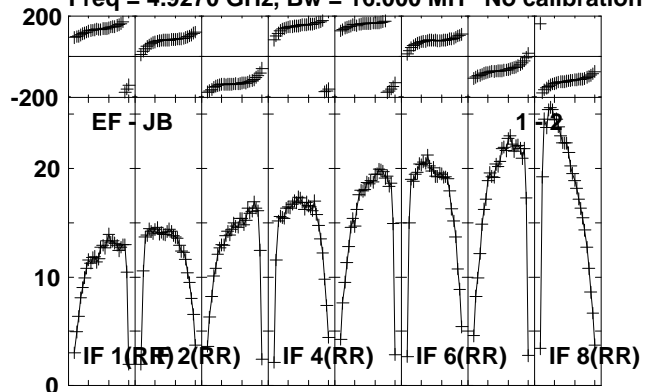

Lower frame: Milli Ampl Jy Top frame: Phas deg
Vector averaged cross-power spectrum Several baselines displayed
Timerange: 00/03:41:17 to 00/03:44:19

Plot file version 154 created 16-OCT-2012 11:57:17

0528+134 RO006.UVDATA.1

Freq = 4.9270 GHz, Bw = 16.000 MH No calibration applied and no bandpass applied

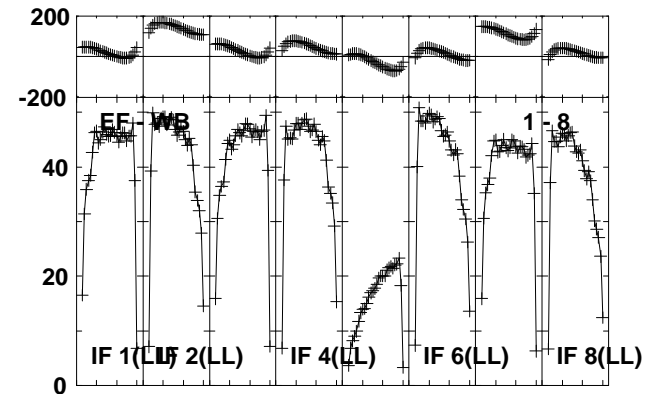
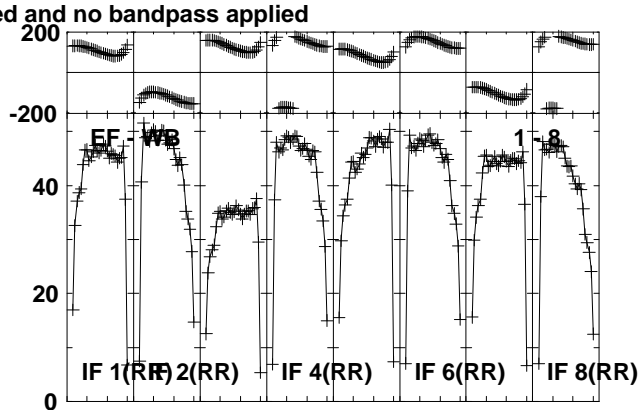
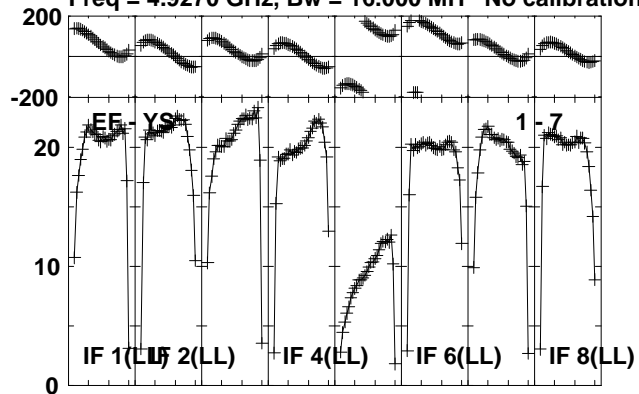

Lower frame: Milli Ampl Jy Top frame: Phas deg
Vector averaged cross-power spectrum Several baselines displayed
Timerange: 00/03:41:17 to 00/03:44:19

Plot file version 155 created 16-OCT-2012 11:57:18

J0645+0541 RO006.UVDATA.1

Freq = 4.9270 GHz, Bw = 16.000 MH No calibration applied and no bandpass applied

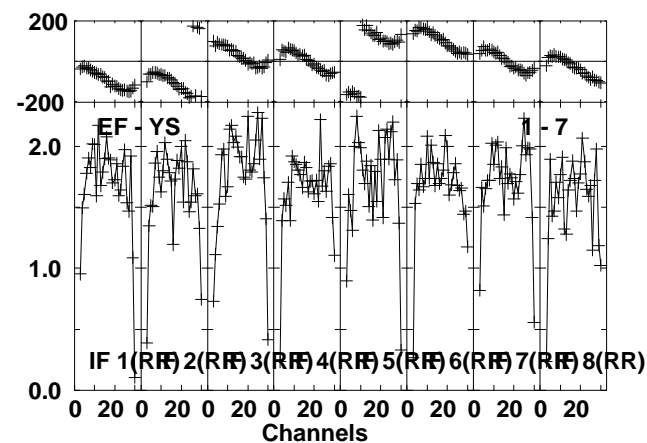
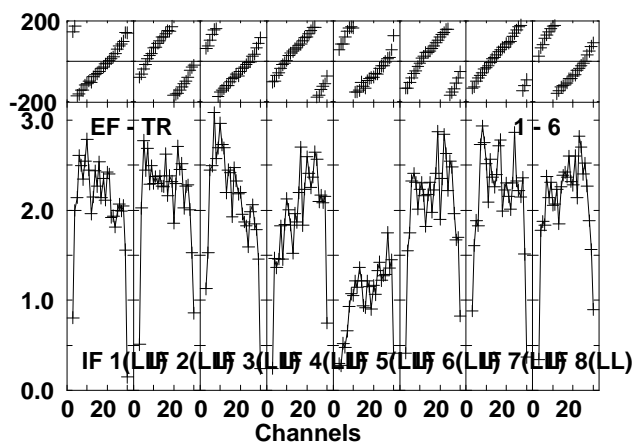
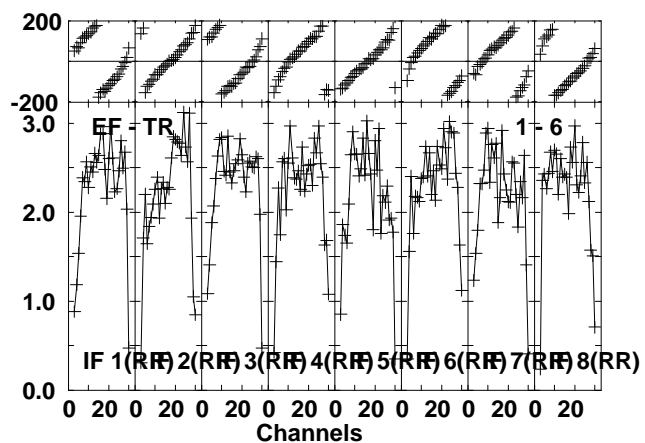
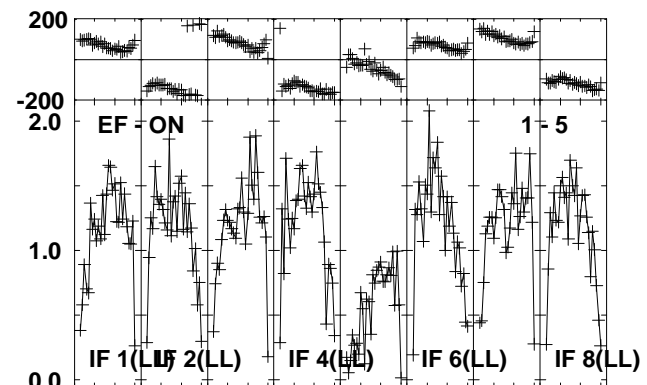
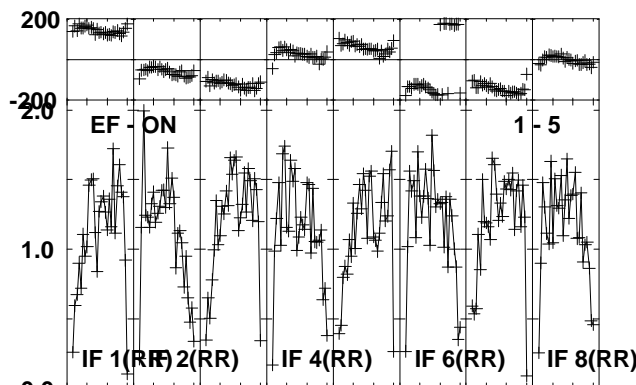
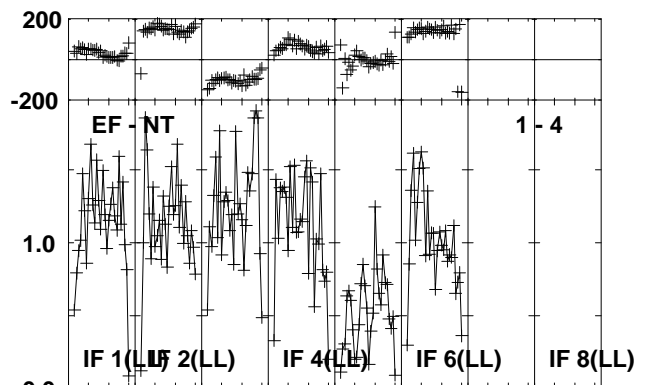
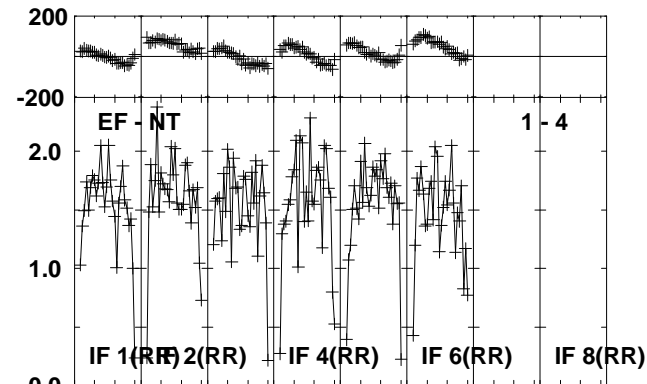
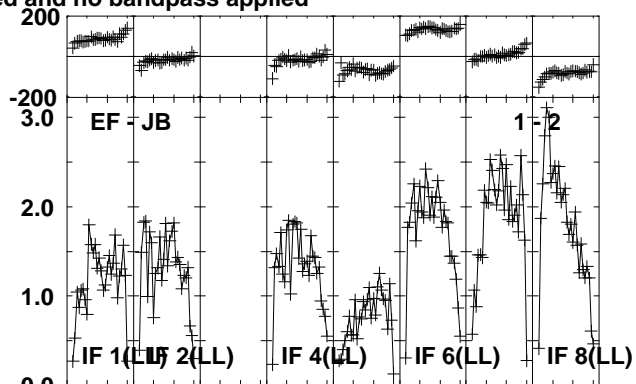
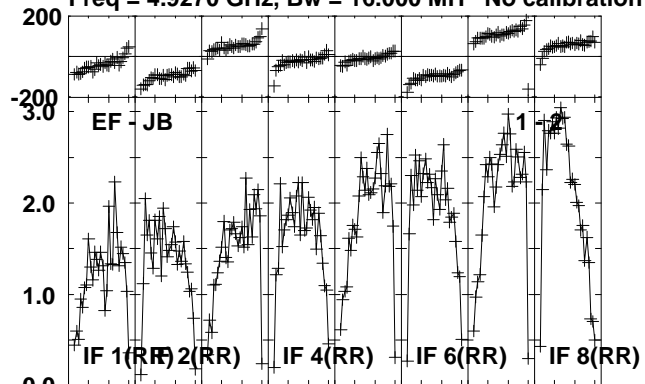

Lower frame: Milli Ampl Jy Top frame: Phas deg
Vector averaged cross-power spectrum Several baselines displayed
Timerange: 00/03:46:17 to 00/03:47:19

Plot file version 156 created 16-OCT-2012 11:57:18

J0645+0541 RO006.UVDATA.1

Freq = 4.9270 GHz, Bw = 16.000 MH No calibration applied and no bandpass applied

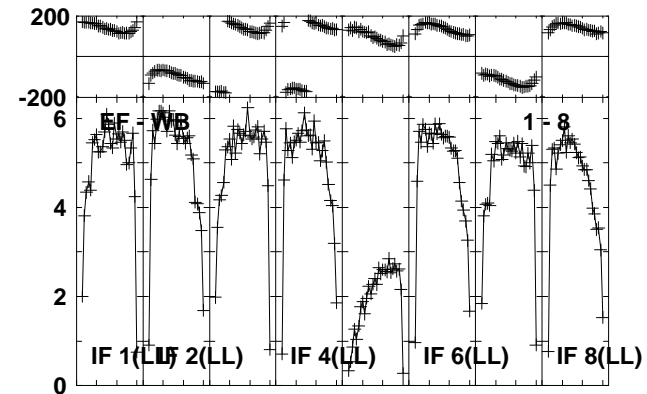
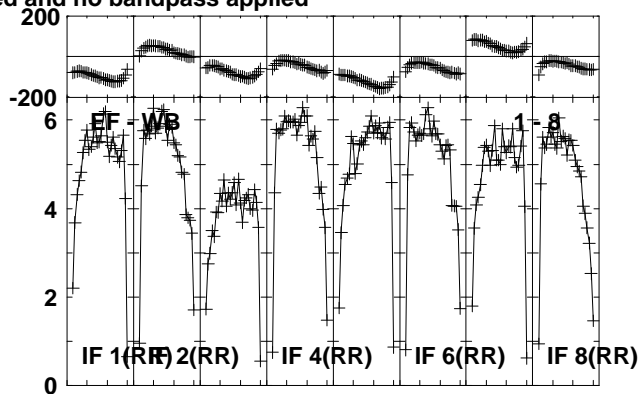
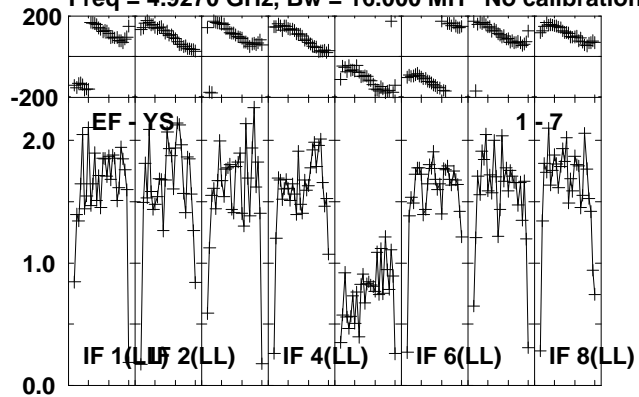

Lower frame: Milli Ampl Jy Top frame: Phas deg
Vector averaged cross-power spectrum Several baselines displayed
Timerange: 00/03:46:17 to 00/03:47:19

Plot file version 157 created 16-OCT-2012 11:57:18

NOVA-MON RO006.UVDATA.1

Freq = 4.9270 GHz, Bw = 16.000 MH No calibration applied and no bandpass applied

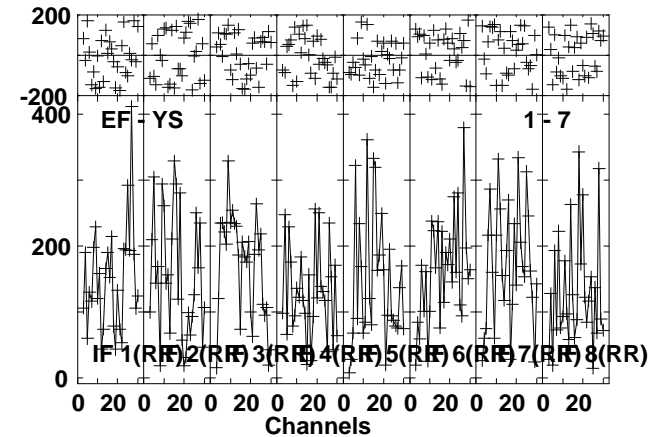
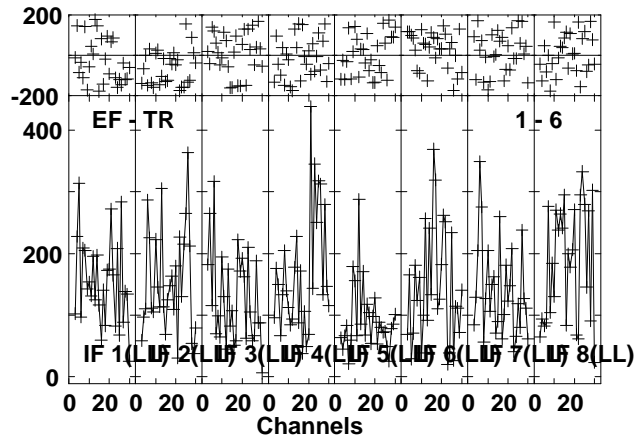
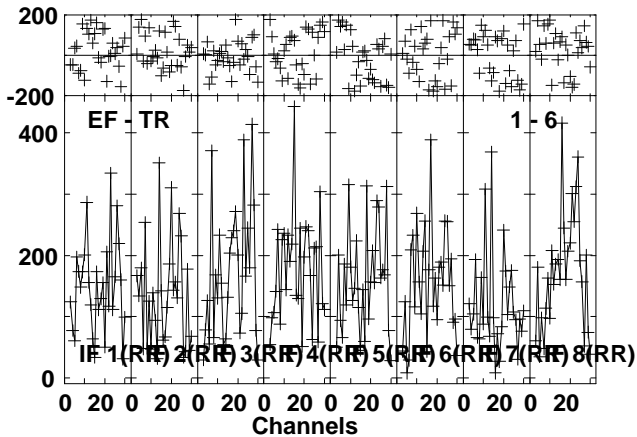
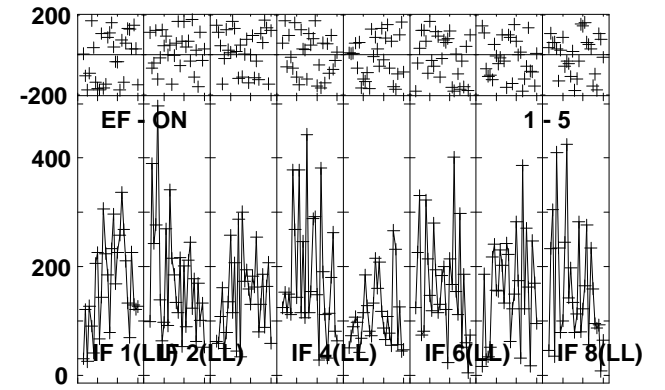
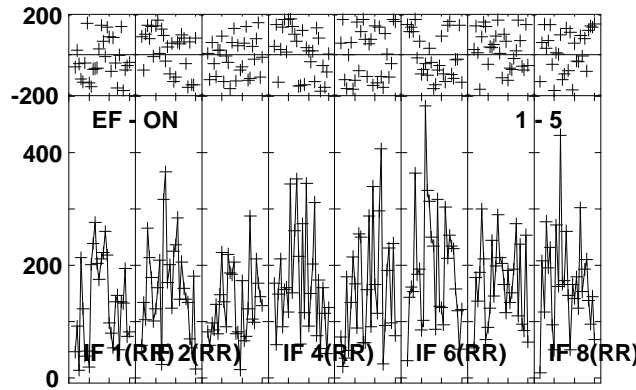
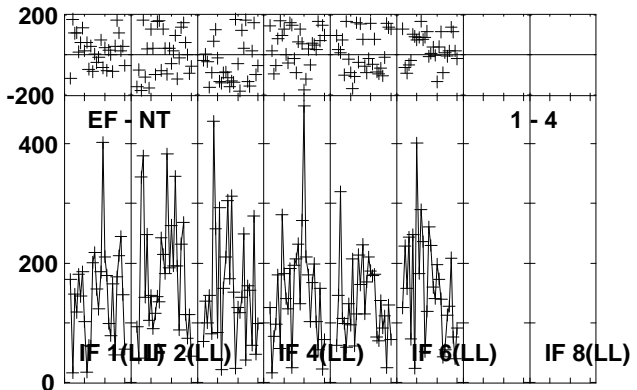
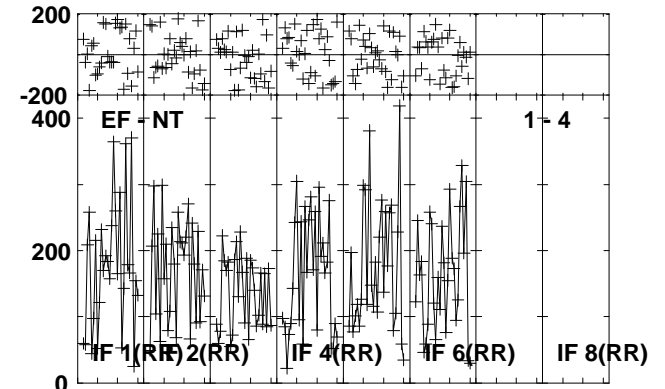
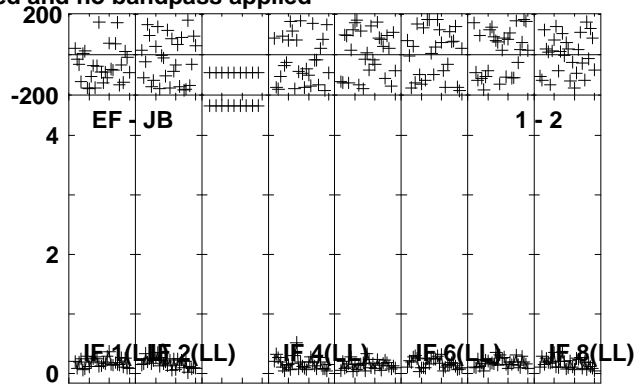
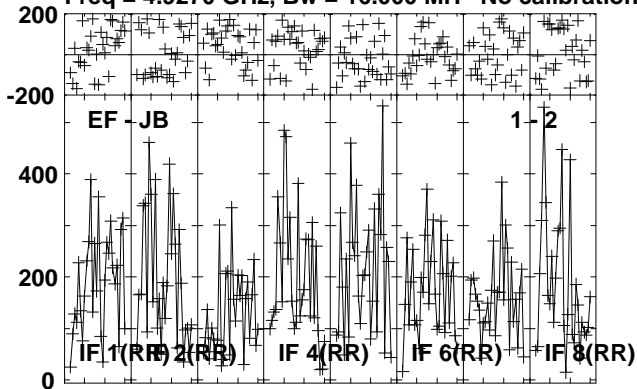

Lower frame: Micro Ampl Jy Top frame: Phas deg
Vector averaged cross-power spectrum Several baselines displayed
Timerange: 00/03:47:23 to 00/03:50:19

Plot file version 158 created 16-OCT-2012 11:57:19

NOVA-MON RO006.UVDATA.1

Freq = 4.9270 GHz, Bw = 16.000 MH No calibration applied and no bandpass applied

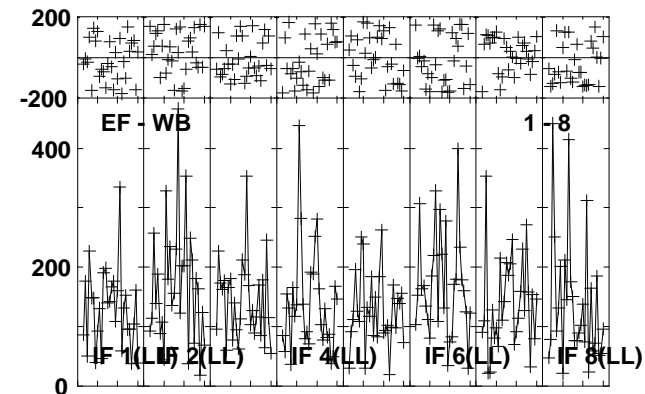
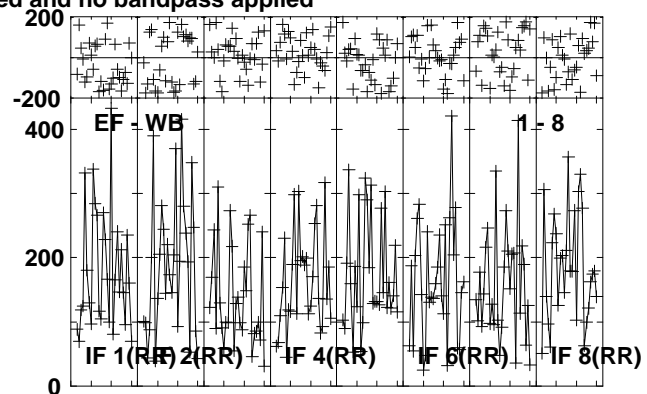
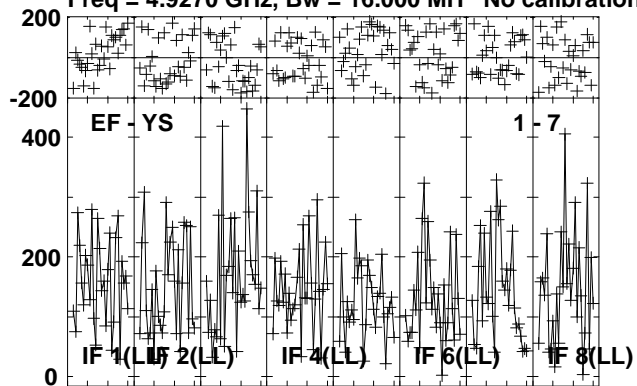

Lower frame: Micro Ampl Jy Top frame: Phas deg
Vector averaged cross-power spectrum Several baselines displayed
Timerange: 00/03:47:23 to 00/03:50:19

Plot file version 159 created 16-OCT-2012 11:57:19

J0639+0601 RO006.UVDATA.1

Freq = 4.9270 GHz, Bw = 16.000 MH No calibration applied and no bandpass applied

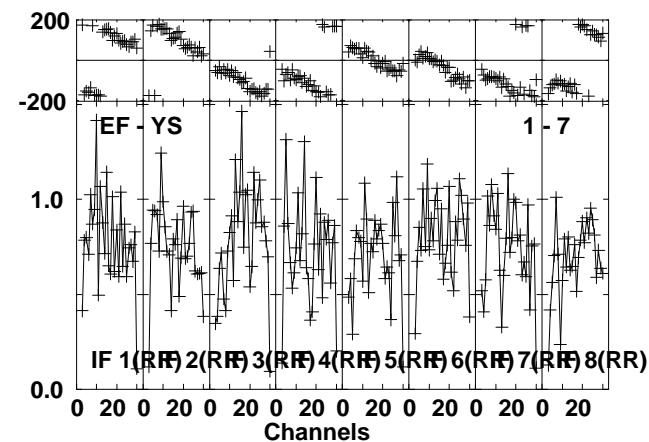
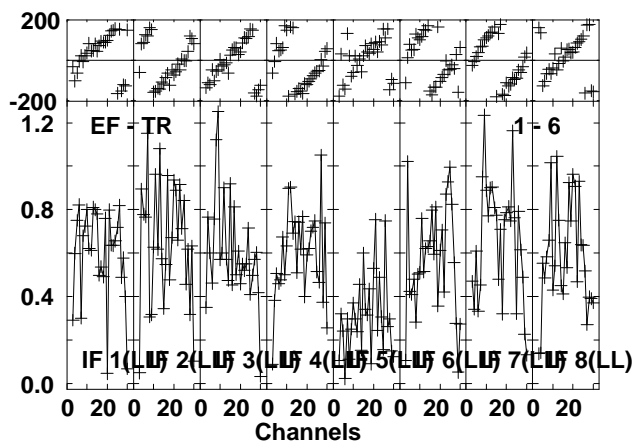
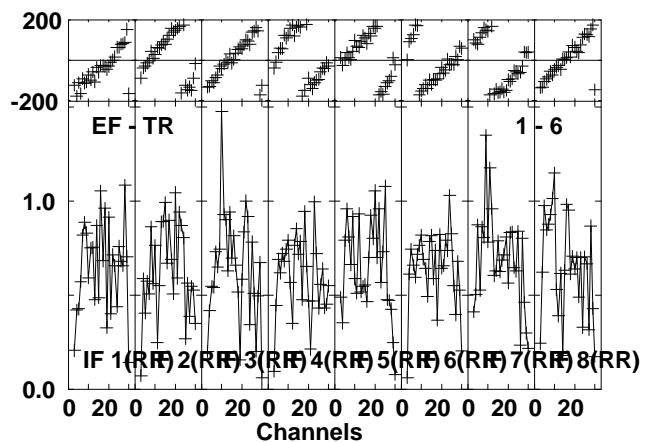
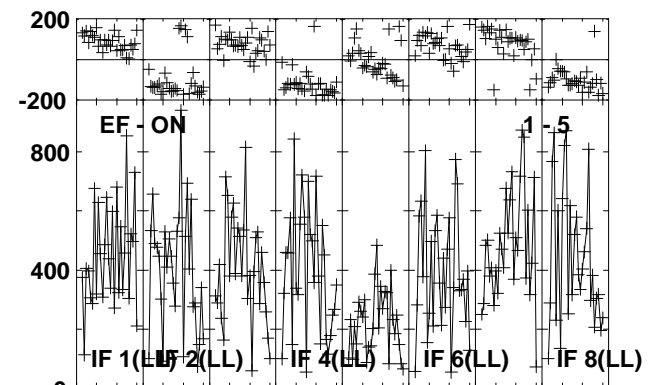
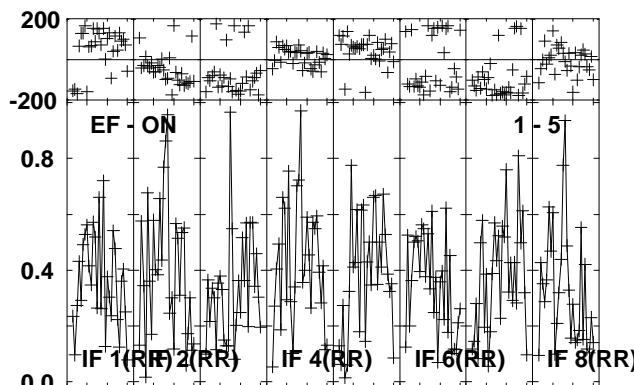
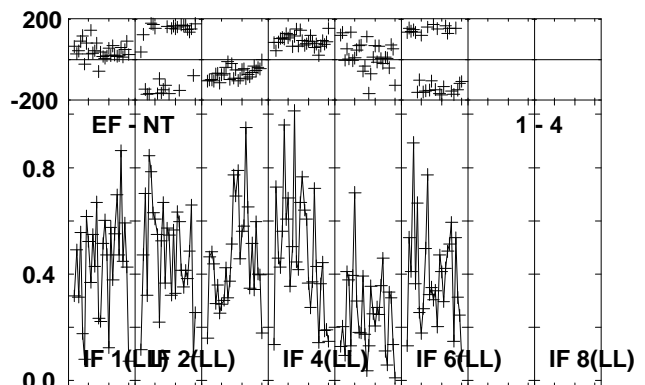
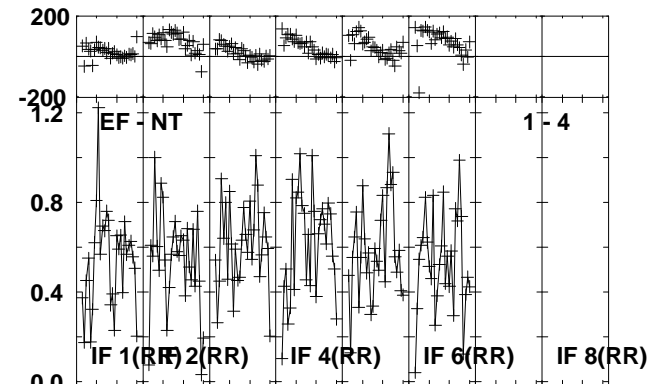
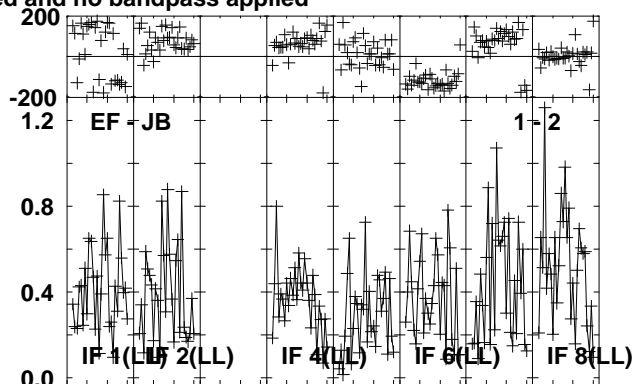
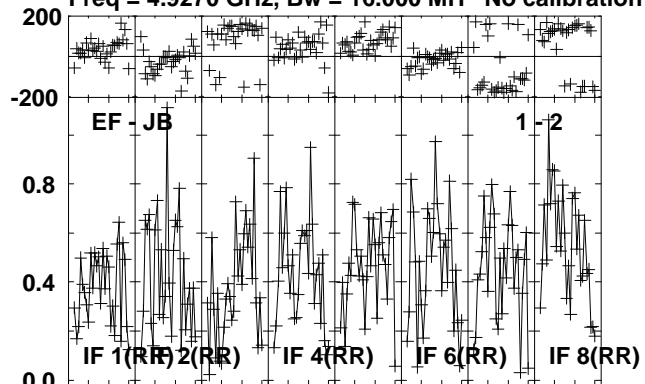

Lower frame: Milli Ampl Jy Top frame: Phas deg
Vector averaged cross-power spectrum Several baselines displayed
Timerange: 00/03:50:23 to 00/03:51:33

Plot file version 160 created 16-OCT-2012 11:57:19

J0639+0601 RO006.UVDATA.1

Freq = 4.9270 GHz, Bw = 16.000 MH No calibration applied and no bandpass applied

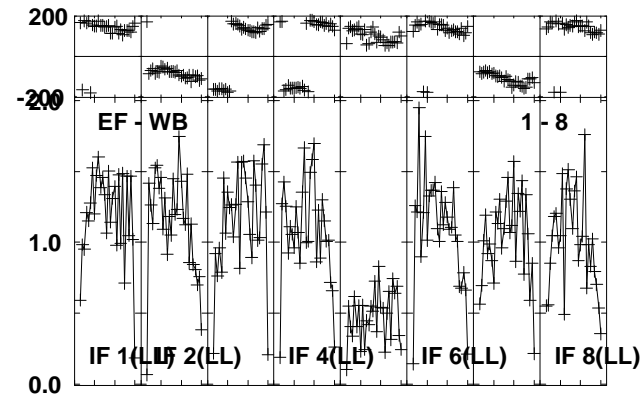
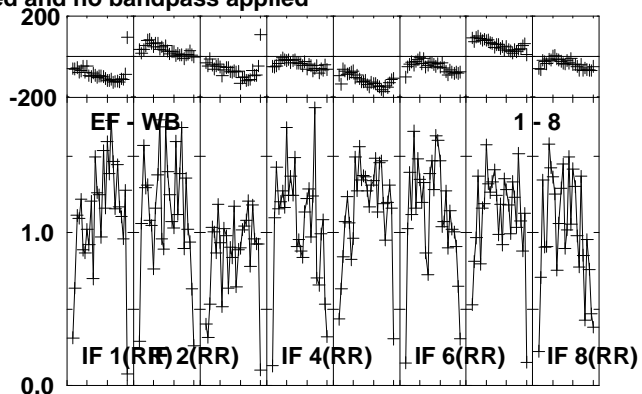
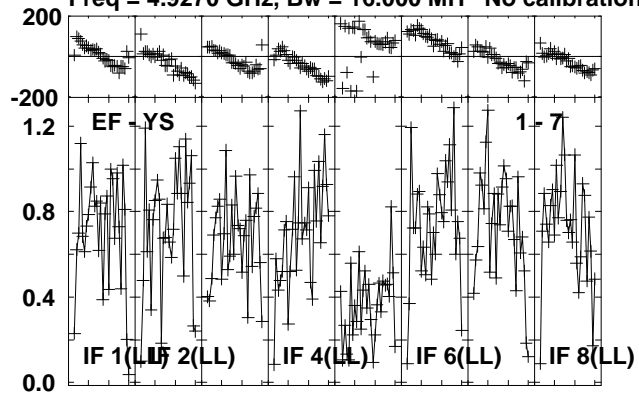

Lower frame: Milli Ampl Jy Top frame: Phas deg
Vector averaged cross-power spectrum Several baselines displayed
Timerange: 00/03:50:23 to 00/03:51:33

Plot file version 161 created 16-OCT-2012 11:57:19

J0645+0541 RO006.UVDATA.1

Freq = 4.9270 GHz, Bw = 16.000 MH No calibration applied and no bandpass applied

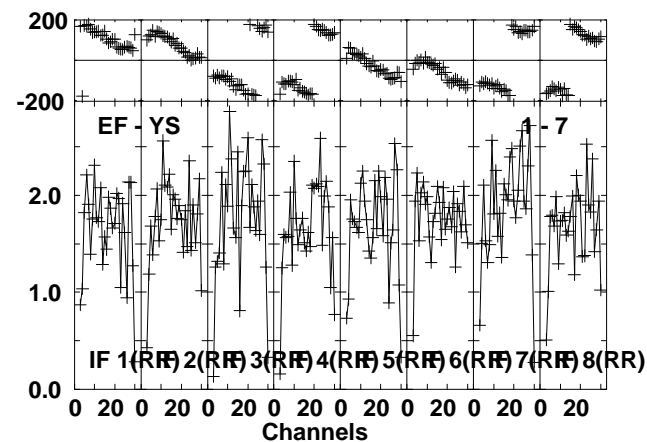
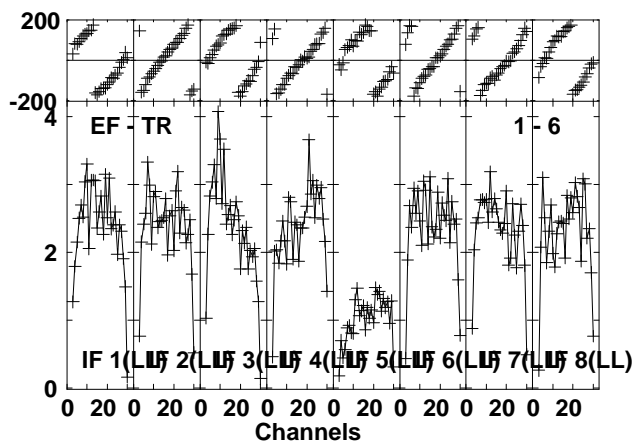
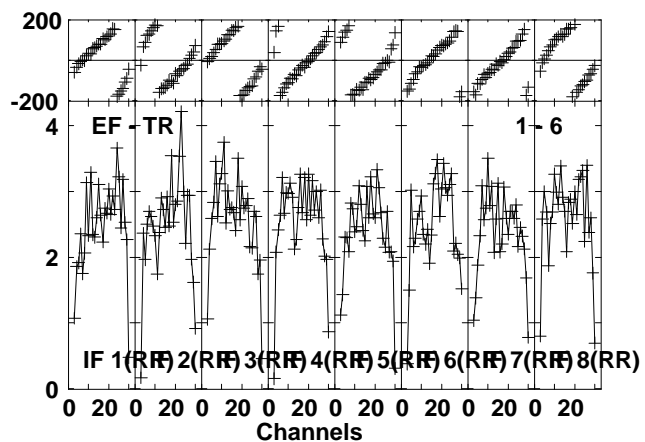
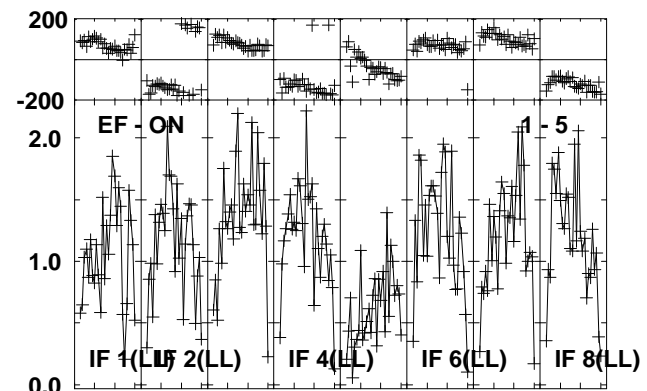
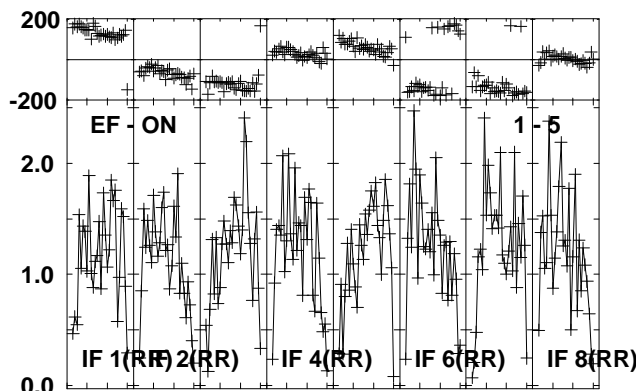
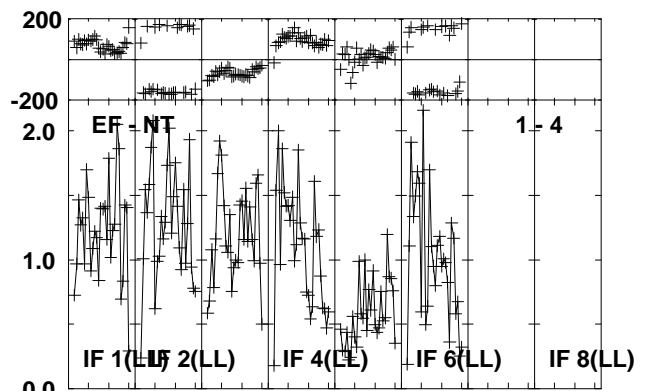
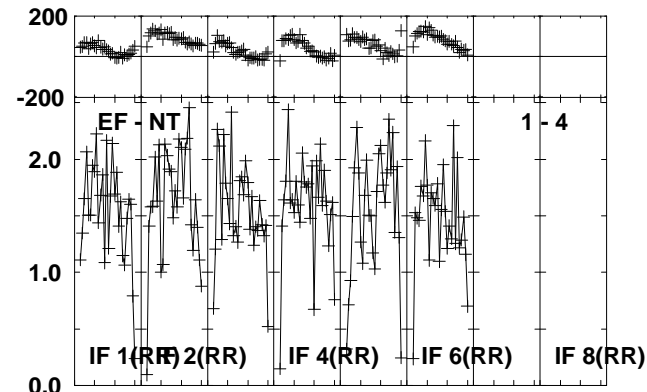
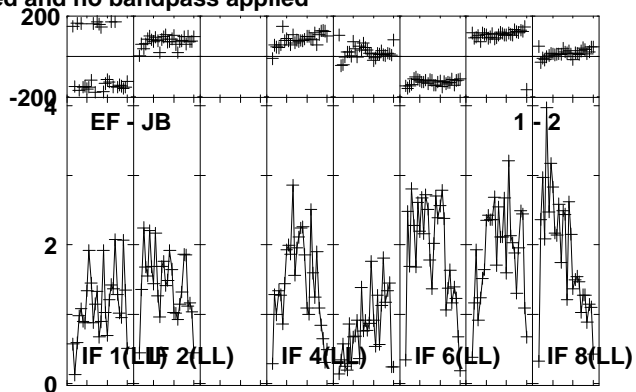
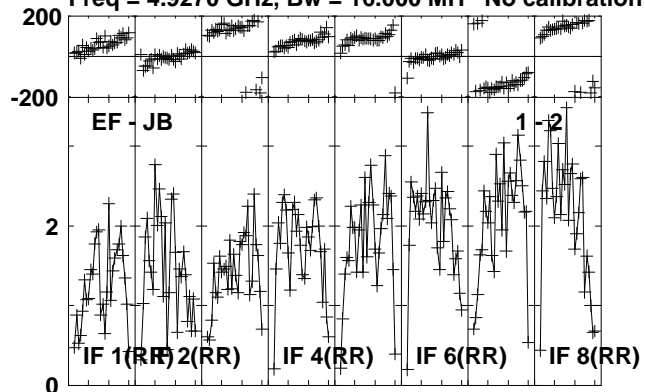

Lower frame: Milli Ampl Jy Top frame: Phas deg
Vector averaged cross-power spectrum Several baselines displayed
Timerange: 00/03:51:37 to 00/03:52:33

Plot file version 162 created 16-OCT-2012 11:57:19

J0645+0541 RO006.UVDATA.1

Freq = 4.9270 GHz, Bw = 16.000 MH No calibration applied and no bandpass applied

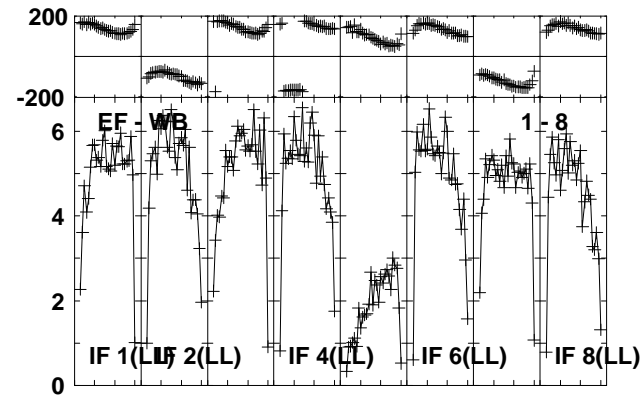
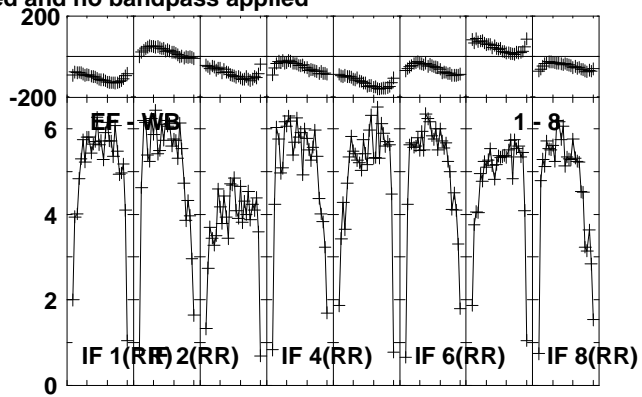
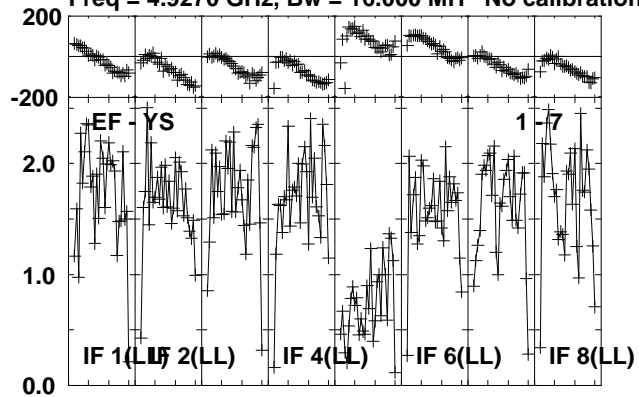

Lower frame: Milli Ampl Jy Top frame: Phas deg
Vector averaged cross-power spectrum Several baselines displayed
Timerange: 00/03:51:37 to 00/03:52:33

Plot file version 163 created 16-OCT-2012 11:57:20

NOVA-MON RO006.UVDATA.1

Freq = 4.9270 GHz, Bw = 16.000 MH No calibration applied and no bandpass applied

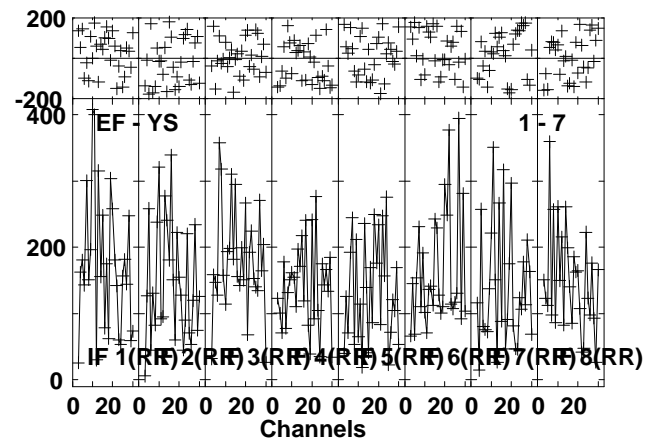
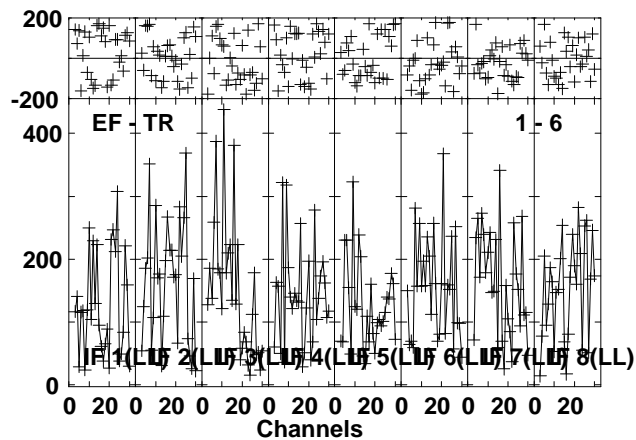
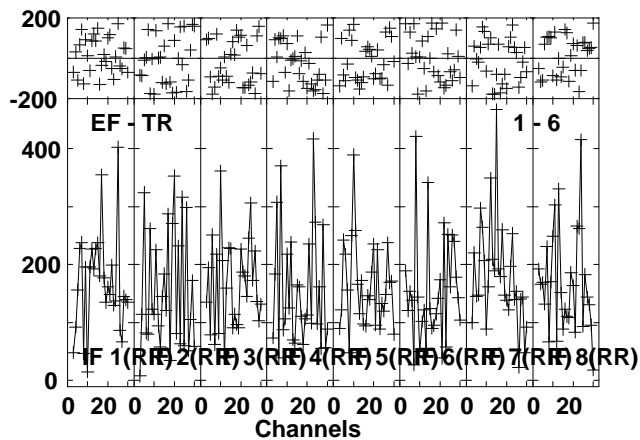
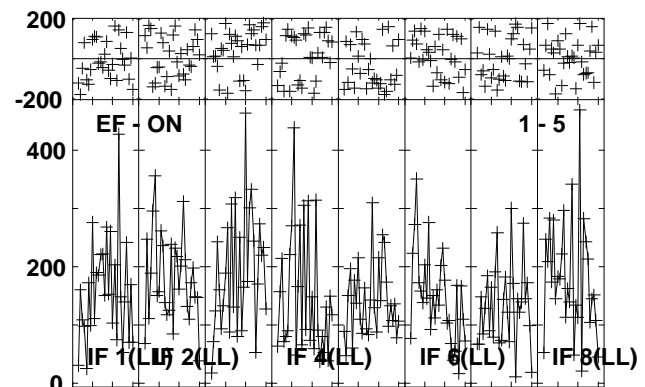
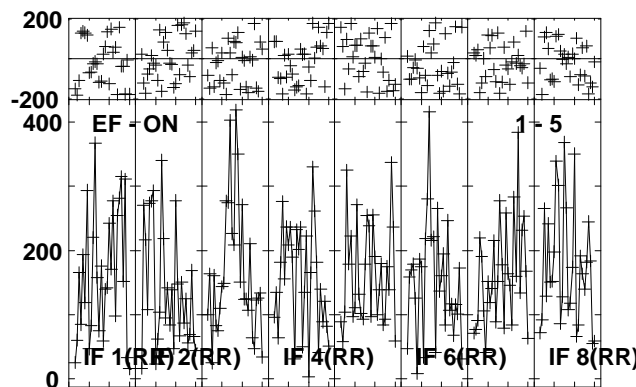
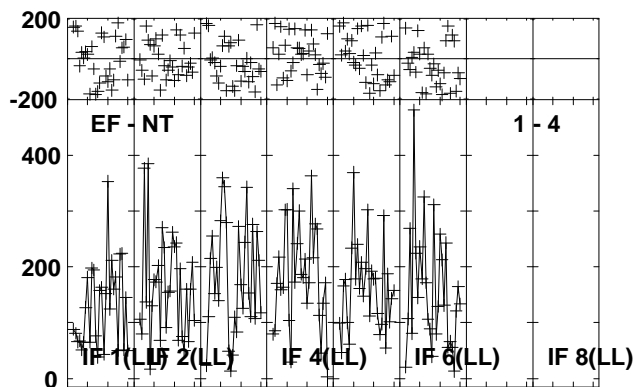
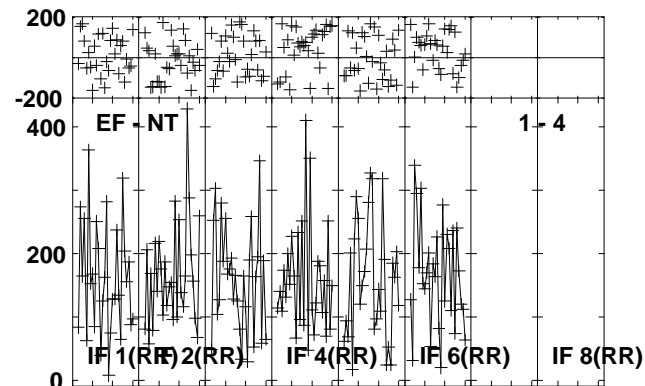
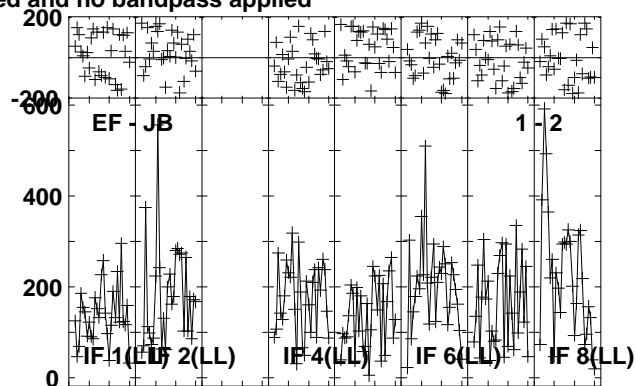
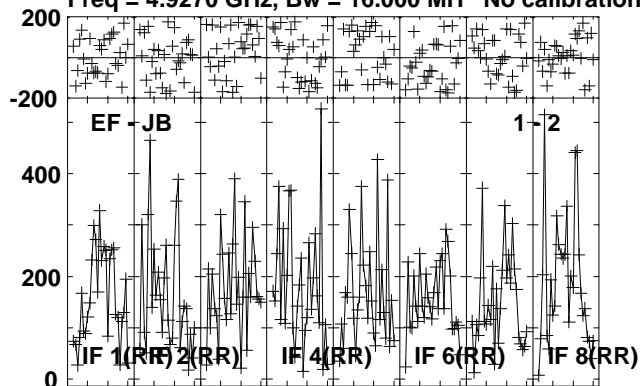

Lower frame: Micro Ampl Jy Top frame: Phas deg
Vector averaged cross-power spectrum Several baselines displayed
Timerange: 00/03:52:37 to 00/03:55:33

Plot file version 164 created 16-OCT-2012 11:57:20

NOVA-MON RO006.UVDATA.1

Freq = 4.9270 GHz, Bw = 16.000 MH No calibration applied and no bandpass applied

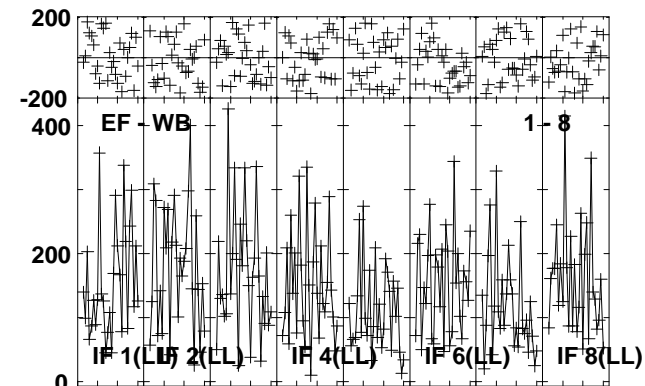
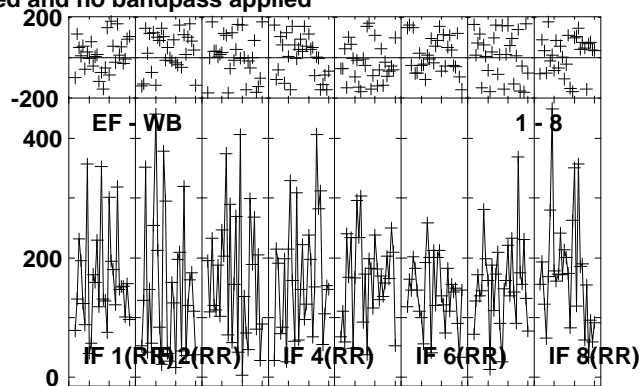
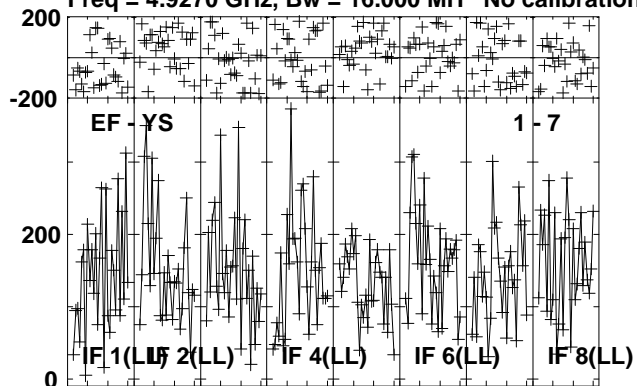

Lower frame: Micro Ampl Jy Top frame: Phas deg
Vector averaged cross-power spectrum Several baselines displayed
Timerange: 00/03:52:37 to 00/03:55:33

Plot file version 165 created 16-OCT-2012 11:57:20

J0639+0601 RO006.UVDATA.1

Freq = 4.9270 GHz, Bw = 16.000 MH No calibration applied and no bandpass applied

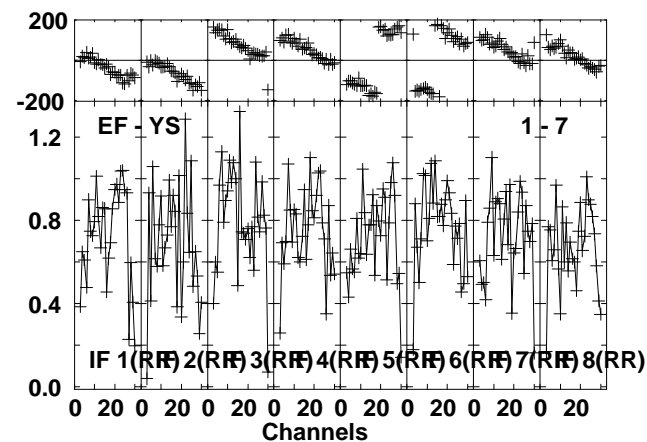
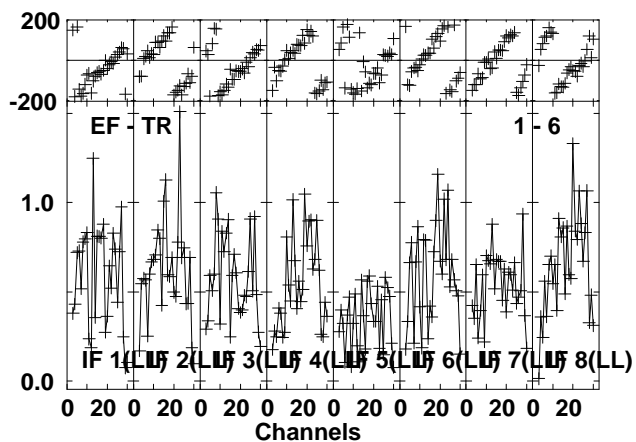
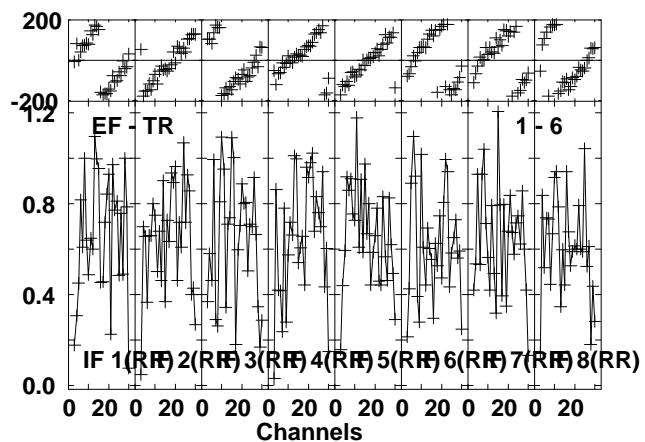
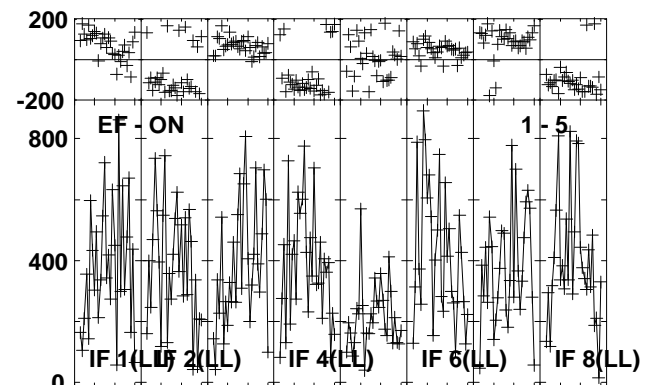
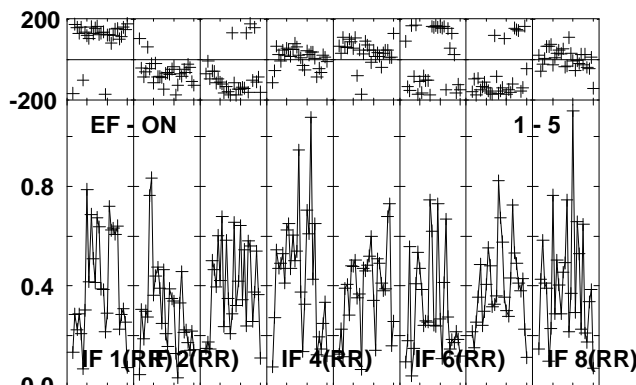
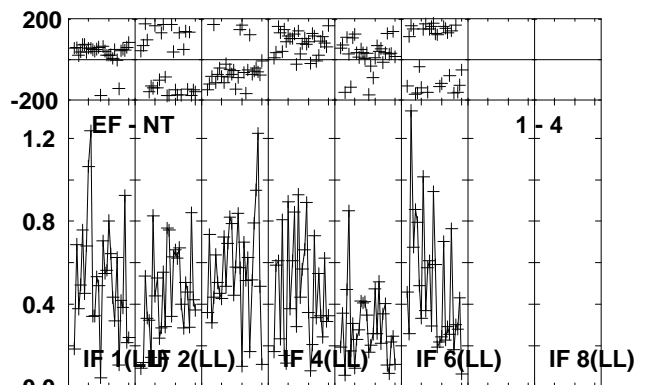
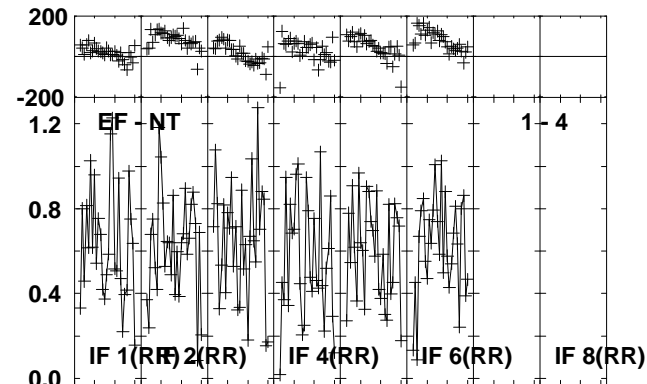
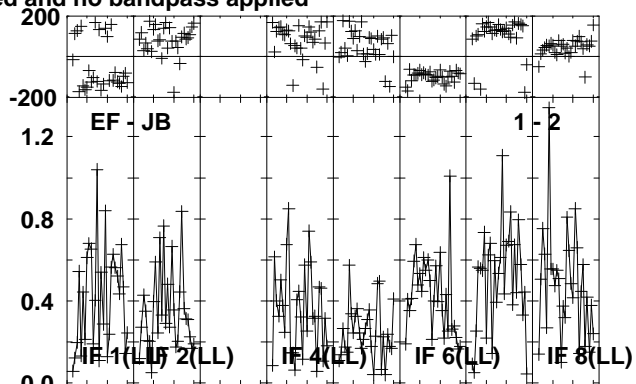
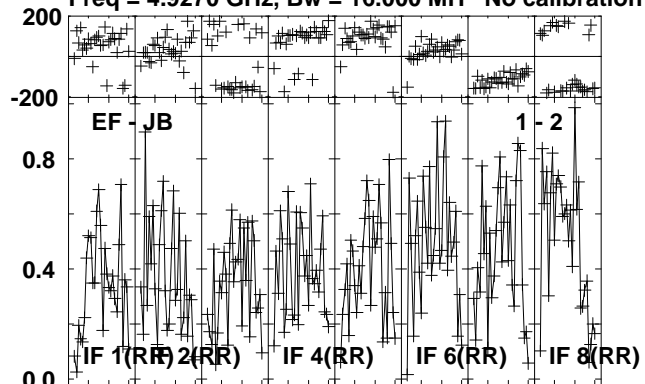

Lower frame: Milli Ampl Jy Top frame: Phas deg
Vector averaged cross-power spectrum Several baselines displayed
Timerange: 00/03:56:03 to 00/03:57:03

Plot file version 166 created 16-OCT-2012 11:57:21

J0639+0601 RO006.UVDATA.1

Freq = 4.9270 GHz, Bw = 16.000 MH No calibration applied and no bandpass applied

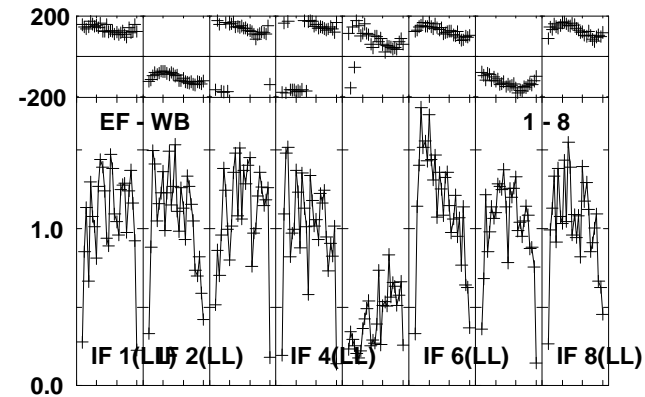
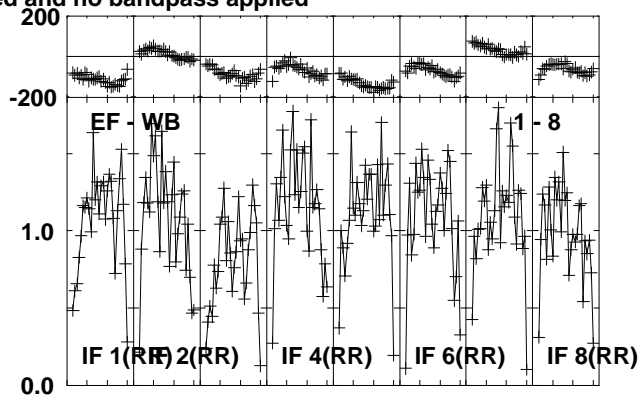
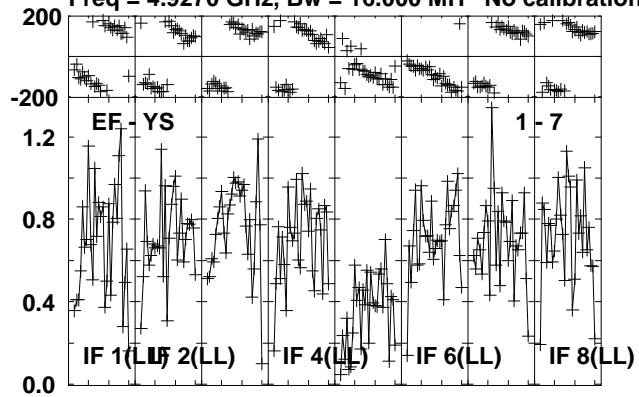

Lower frame: Milli Ampl Jy Top frame: Phas deg
Vector averaged cross-power spectrum Several baselines displayed
Timerange: 00/03:56:03 to 00/03:57:03

Plot file version 167 created 16-OCT-2012 11:57:21

J0645+0541 RO006.UVDATA.1

Freq = 4.9270 GHz, Bw = 16.000 MH No calibration applied and no bandpass applied

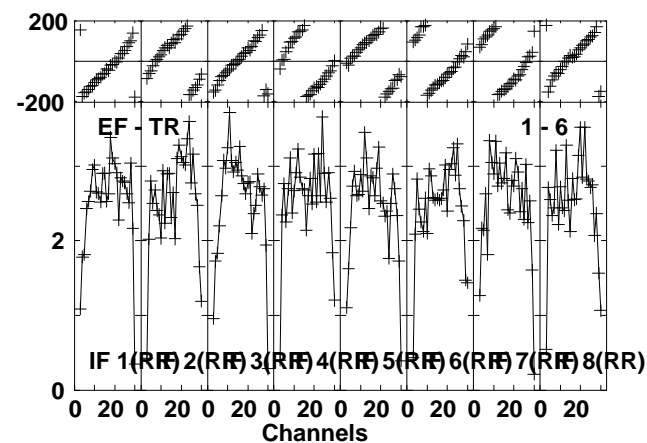
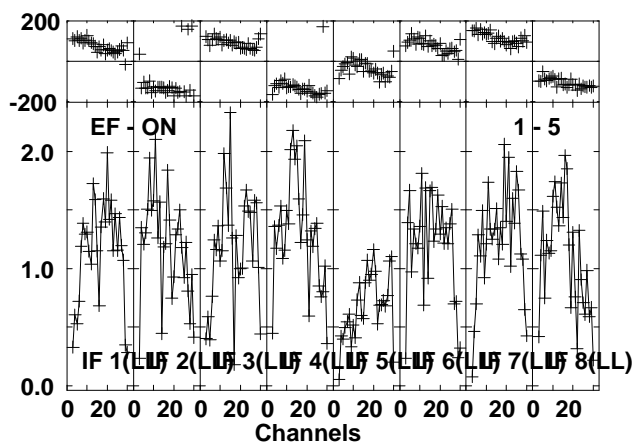
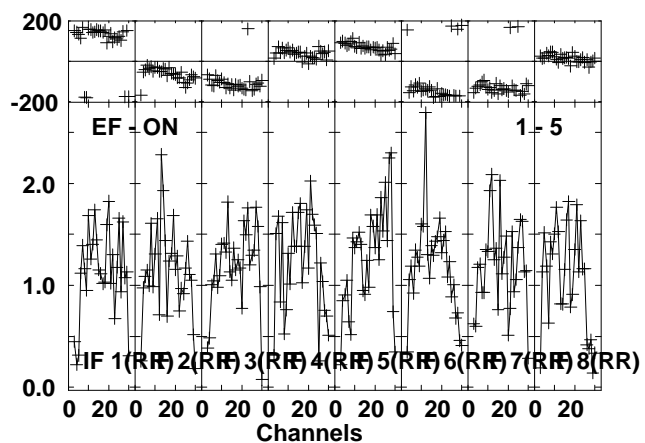
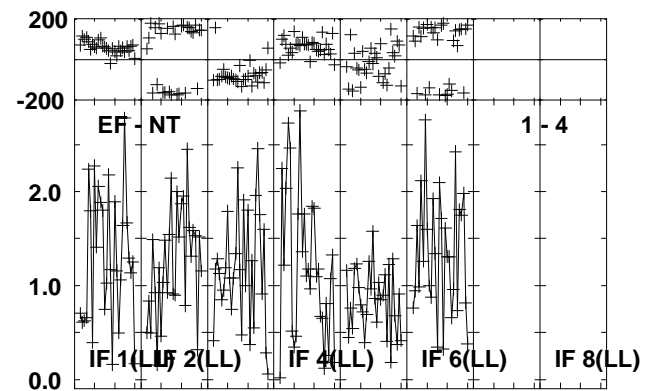
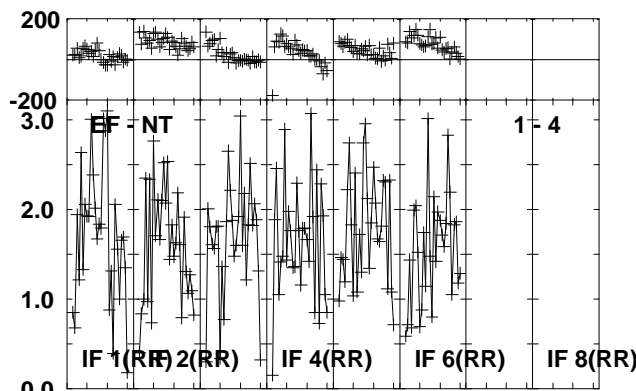
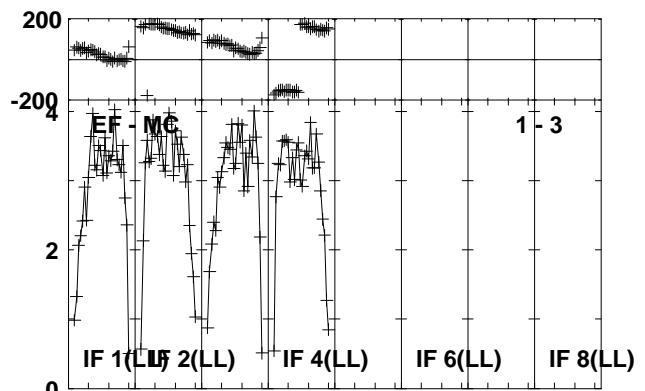
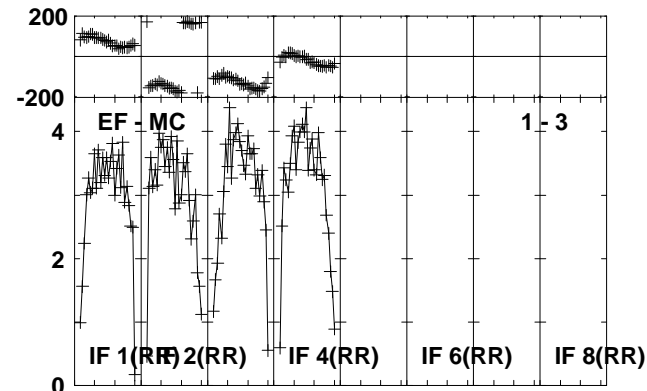
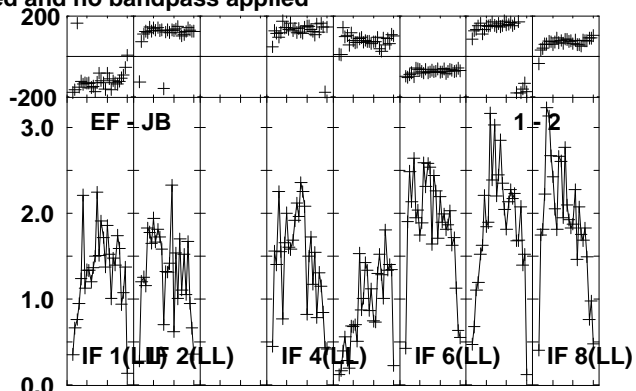
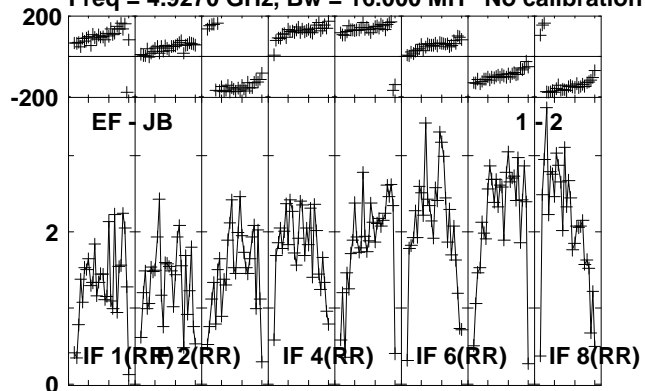

Lower frame: Milli Ampl Jy Top frame: Phas deg
Vector averaged cross-power spectrum Several baselines displayed
Timerange: 00/03:57:07 to 00/03:58:03

Plot file version 168 created 16-OCT-2012 11:57:21
J0645+0541 RO006.UVDATA.1

Freq = 4.9270 GHz, Bw = 16.000 MH No calibration applied and no bandpass applied

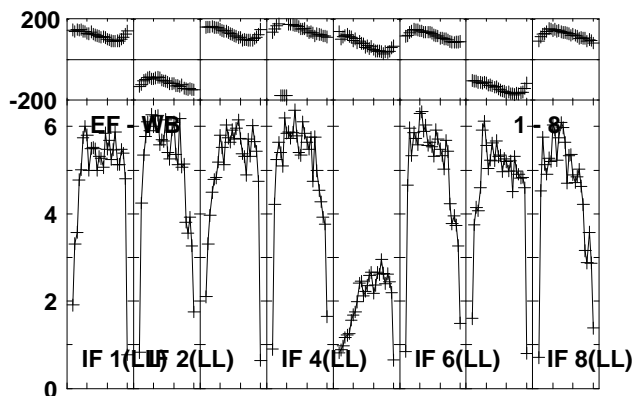
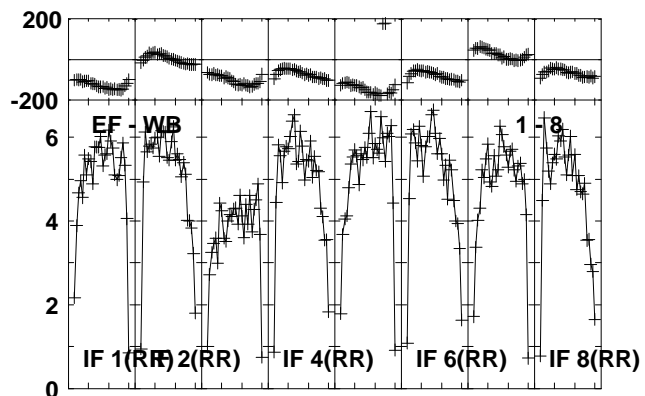
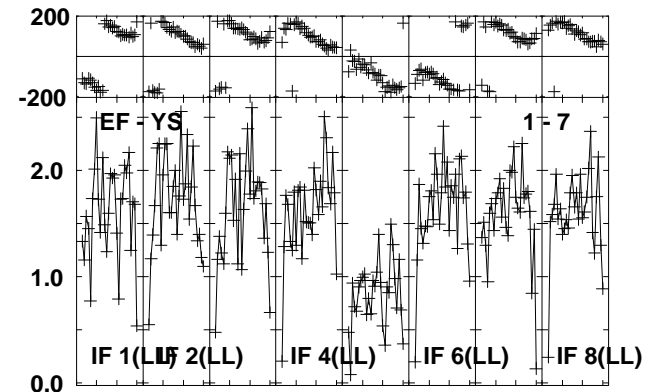
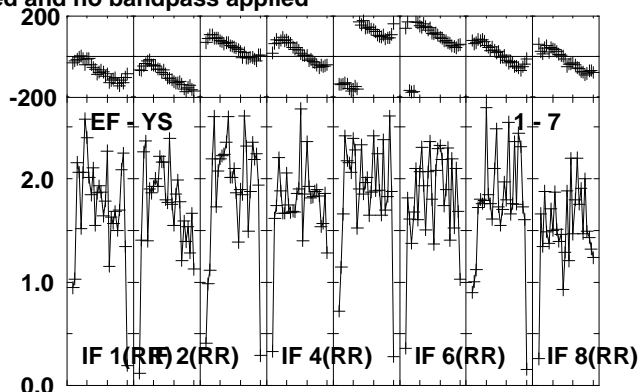
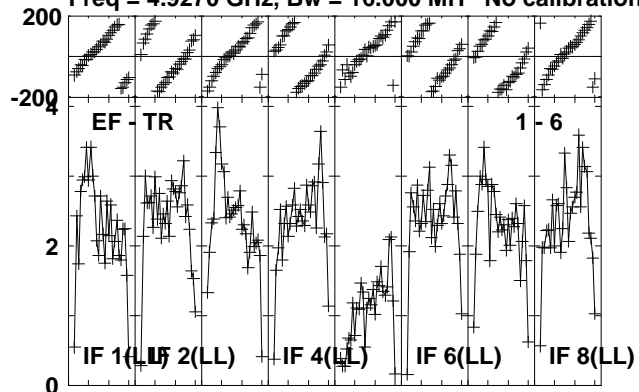

Lower frame: Milli Ampl Jy Top frame: Phas deg
Vector averaged cross-power spectrum Several baselines displayed
Timerange: 00/03:57:07 to 00/03:58:03

Plot file version 170 created 16-OCT-2012 11:57:22

NOVA-MON RO006.UVDATA.1

Freq = 4.9270 GHz, Bw = 16.000 MH No calibration applied and no bandpass applied

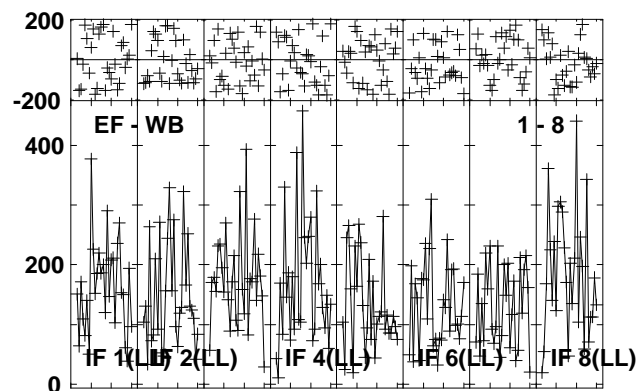
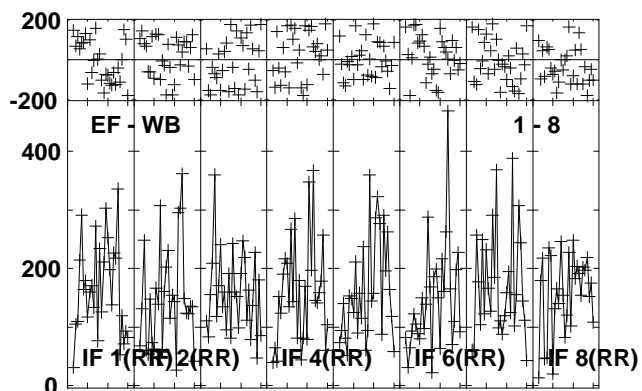
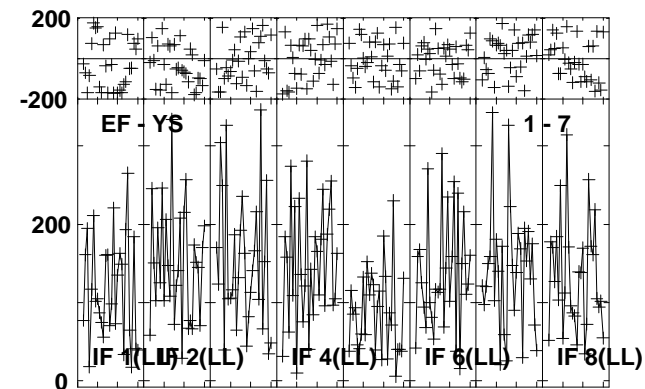
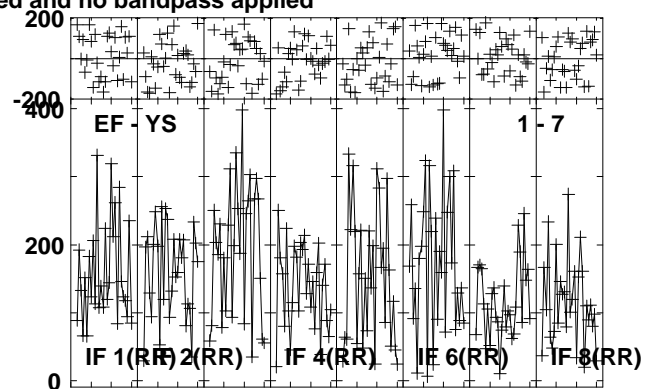
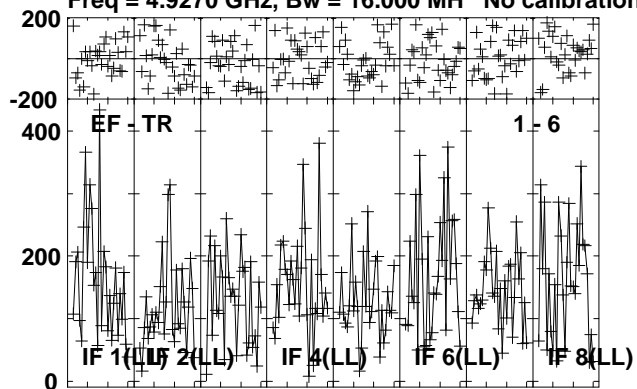

Lower frame: Micro Ampl Jy Top frame: Phas deg
Vector averaged cross-power spectrum Several baselines displayed
Timerange: 00/03:58:07 to 00/04:01:03

Plot file version 171 created 16-OCT-2012 11:57:22

J0639+0601 RO006.UVDATA.1

Freq = 4.9270 GHz, Bw = 16.000 MH No calibration applied and no bandpass applied

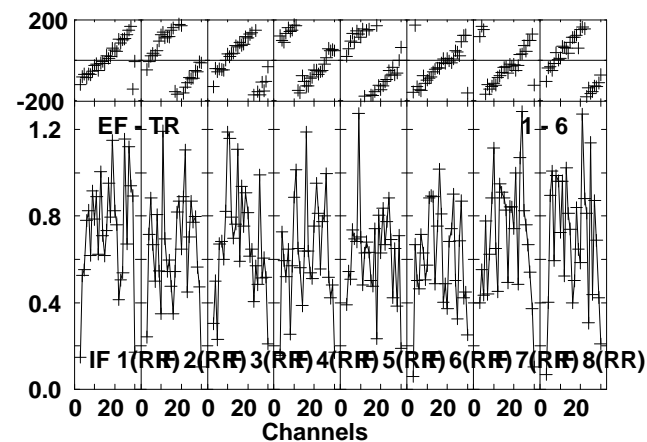
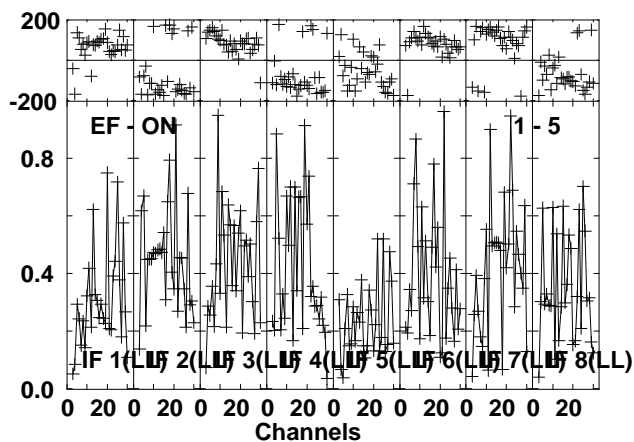
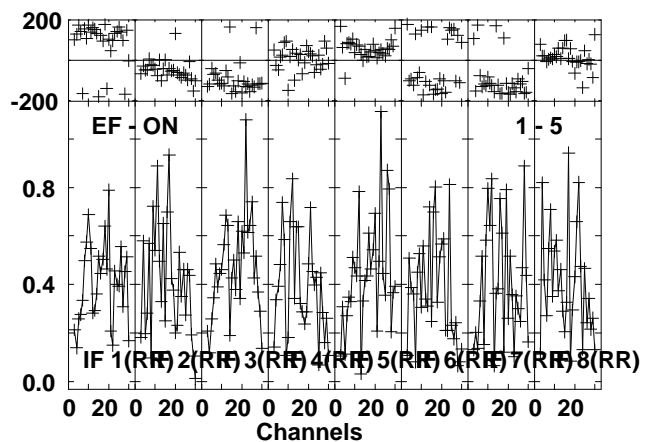
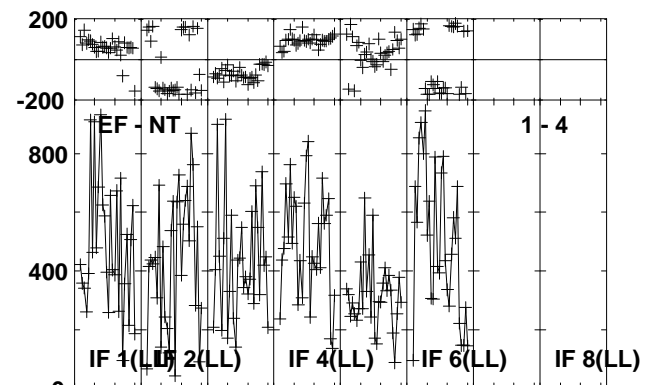
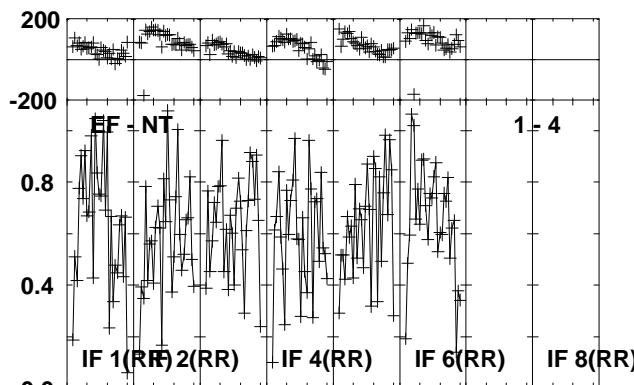
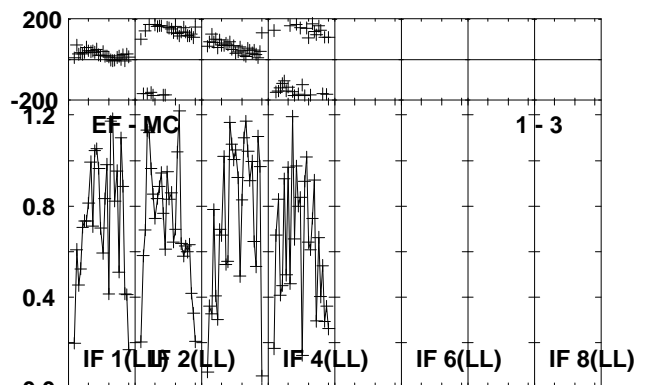
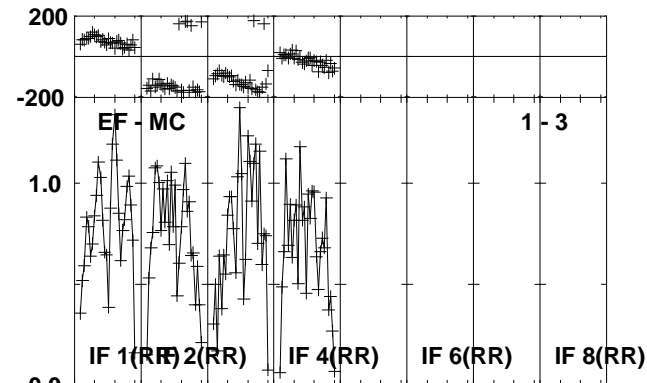
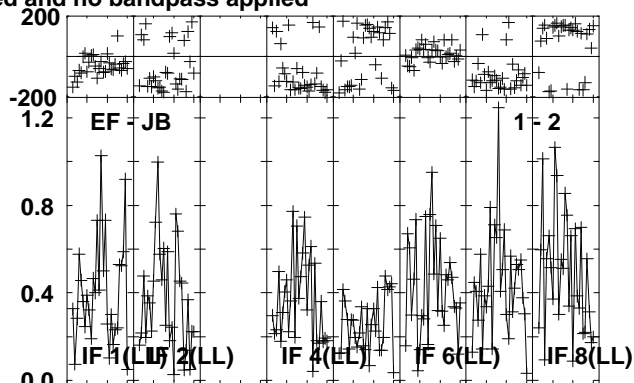
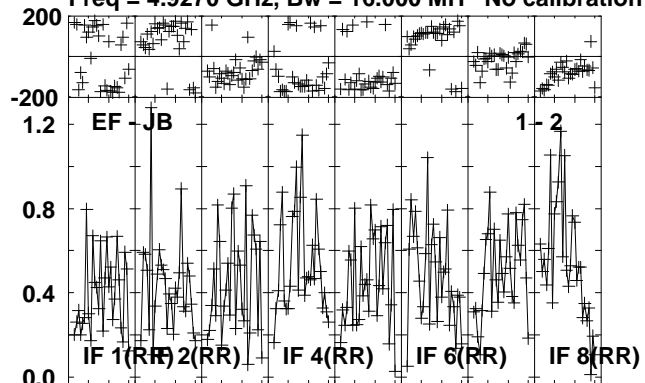

Lower frame: Milli Ampl Jy Top frame: Phas deg
Vector averaged cross-power spectrum Several baselines displayed
Timerange: 00/04:01:07 to 00/04:02:19

Plot file version 172 created 16-OCT-2012 11:57:22

J0639+0601 RO006.UVDATA.1

Freq = 4.9270 GHz, Bw = 16.000 MH No calibration applied and no bandpass applied

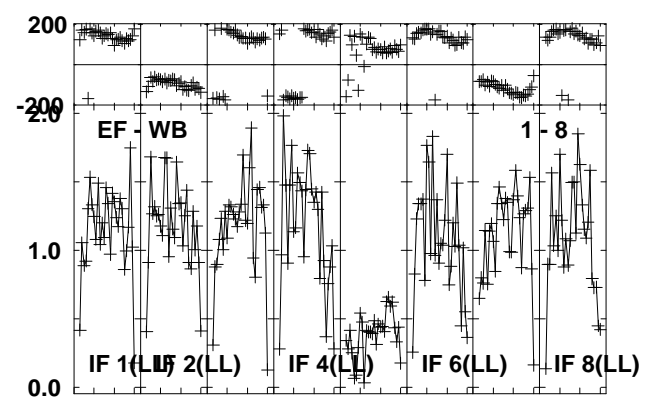
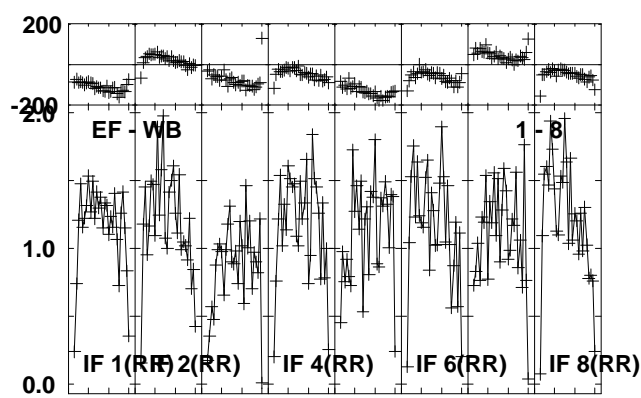
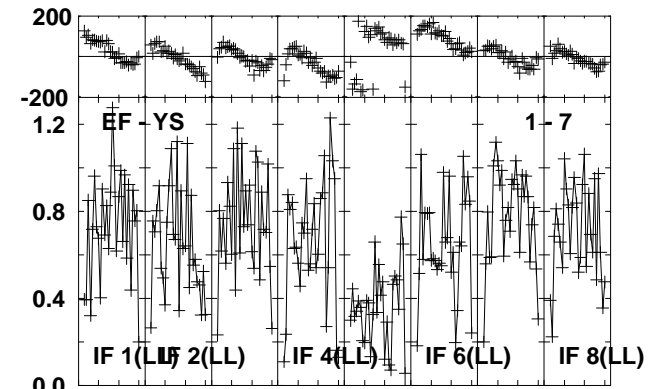
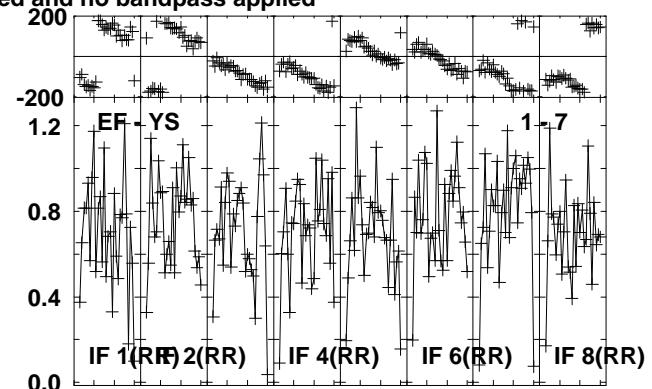
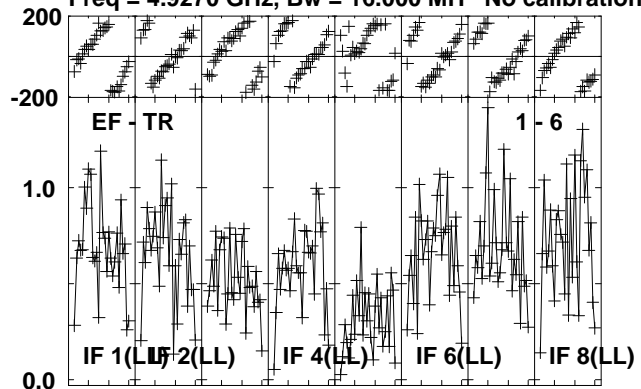

Lower frame: Milli Ampl Jy Top frame: Phas deg
Vector averaged cross-power spectrum Several baselines displayed
Timerange: 00/04:01:07 to 00/04:02:19

Plot file version 173 created 16-OCT-2012 11:57:23

J0645+0541 RO006.UVDATA.1

Freq = 4.9270 GHz, Bw = 16.000 MH No calibration applied and no bandpass applied

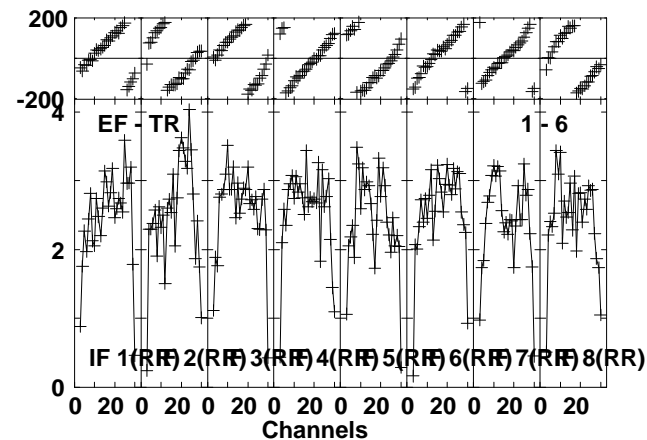
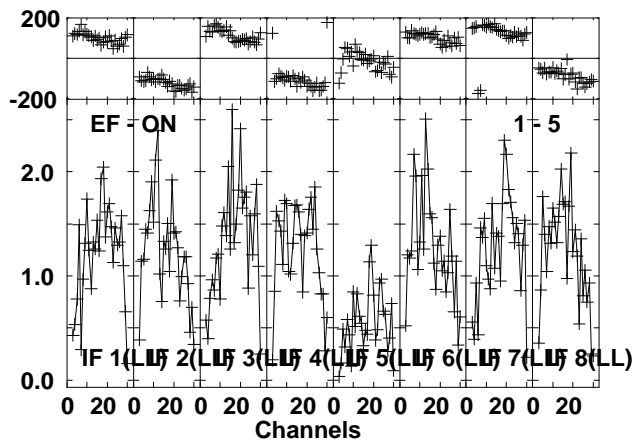
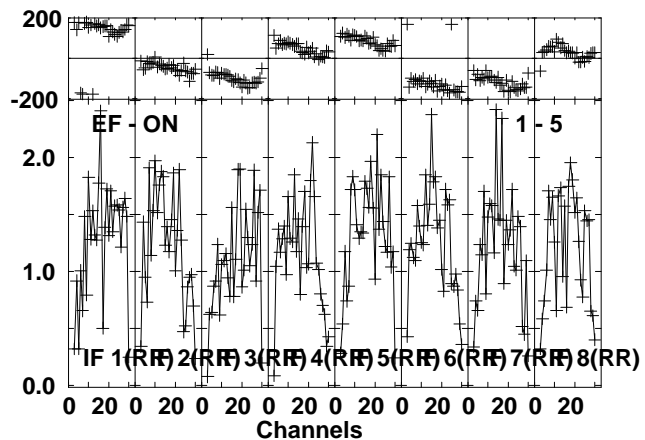
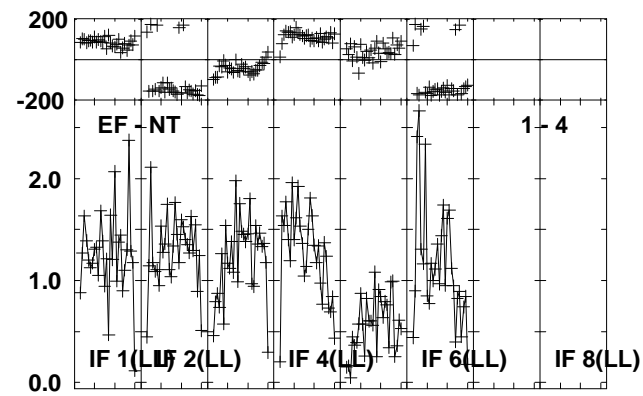
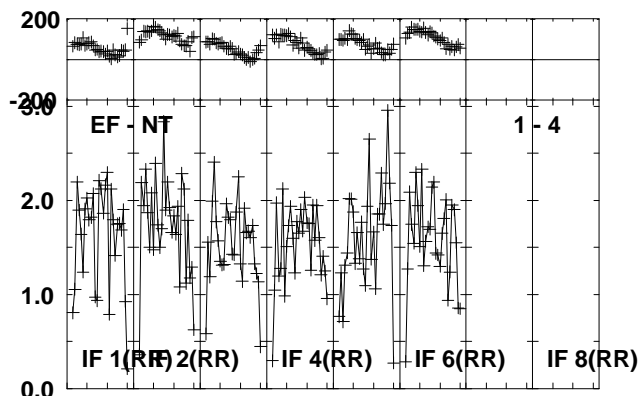
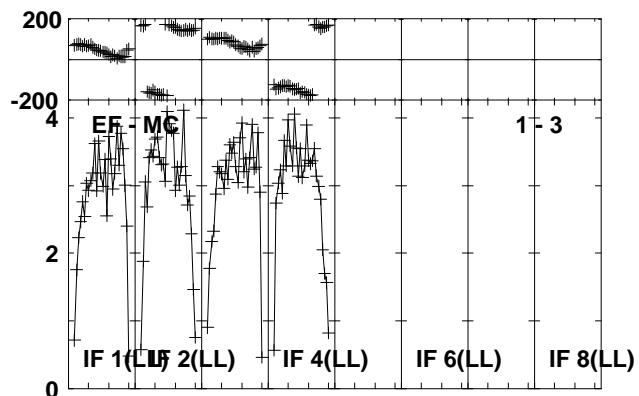
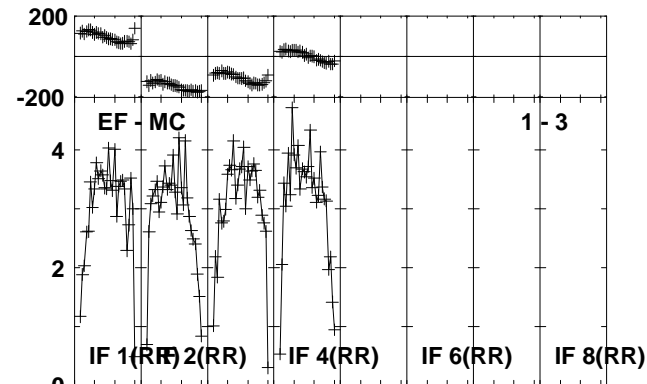
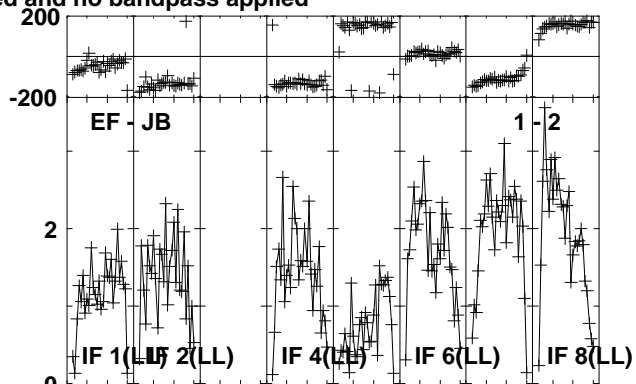
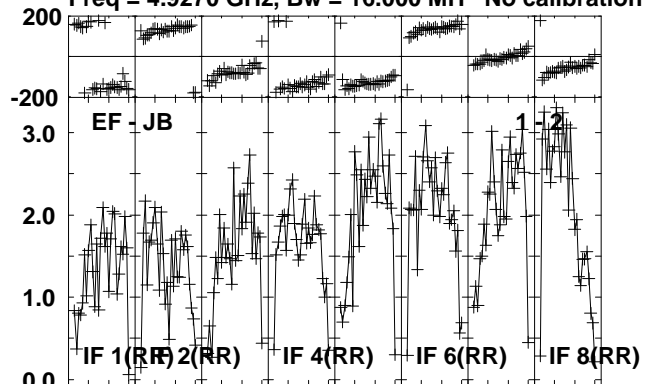

Lower frame: Milli Ampl Jy Top frame: Phas deg
Vector averaged cross-power spectrum Several baselines displayed
Timerange: 00/04:02:23 to 00/04:03:19

Plot file version 174 created 16-OCT-2012 11:57:23

J0645+0541 RO006.UVDATA.1

Freq = 4.9270 GHz, Bw = 16.000 MH No calibration applied and no bandpass applied

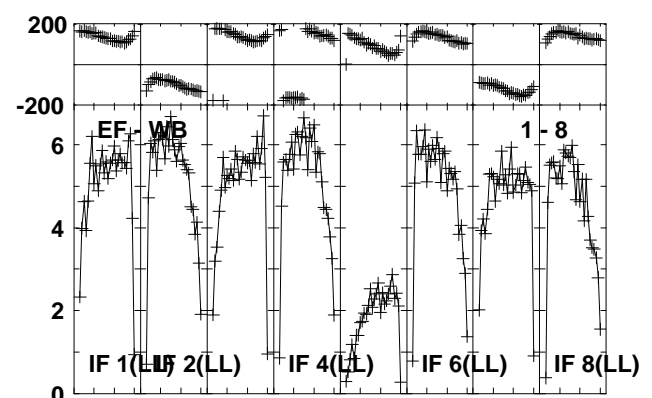
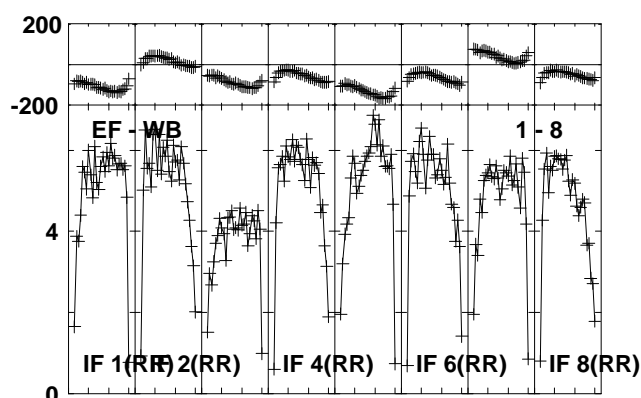
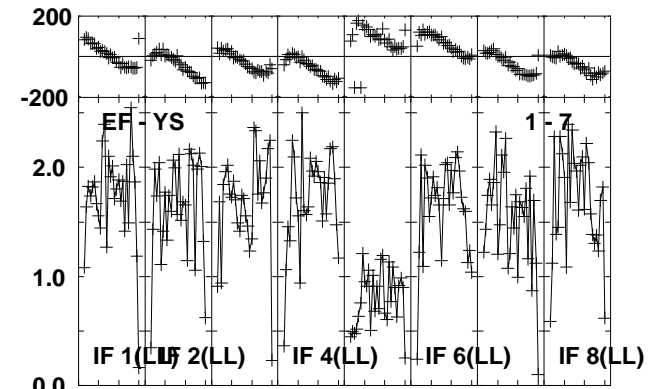
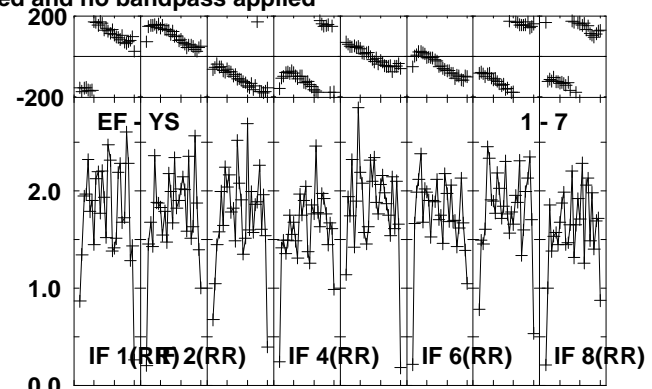
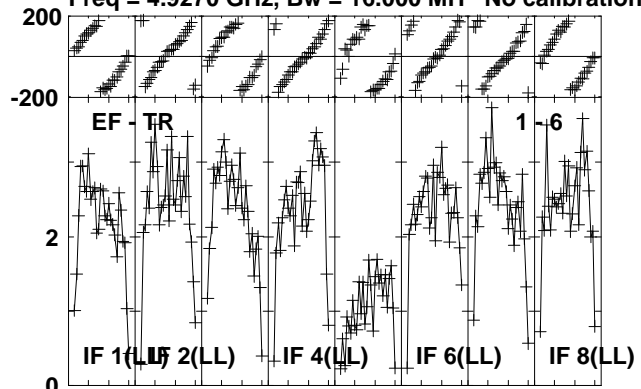

Lower frame: Milli Ampl Jy Top frame: Phas deg
Vector averaged cross-power spectrum Several baselines displayed
Timerange: 00/04:02:23 to 00/04:03:19

Plot file version 175 created 16-OCT-2012 11:57:23

NOVA-MON RO006.UVDATA.1

Freq = 4.9270 GHz, Bw = 16.000 MH No calibration applied and no bandpass applied

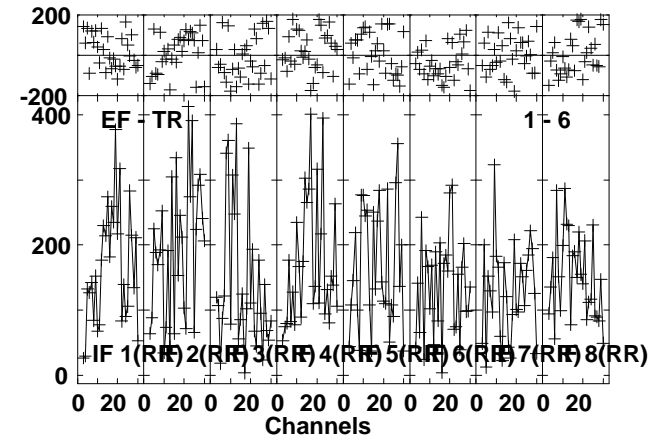
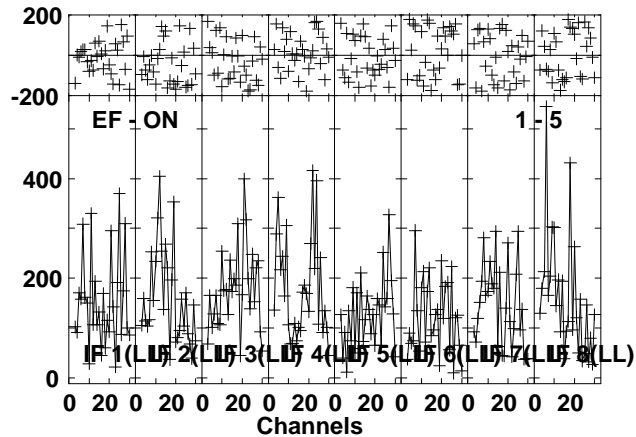
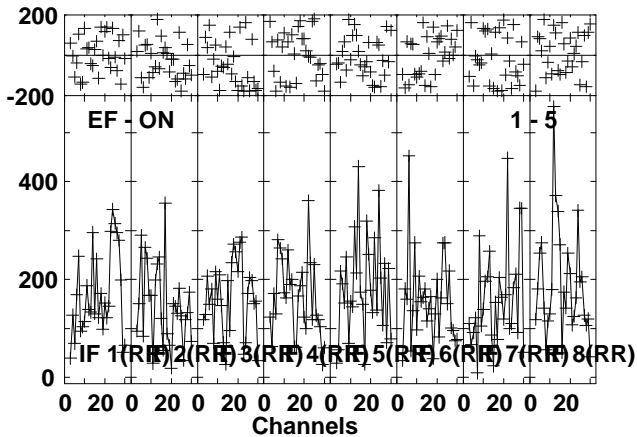
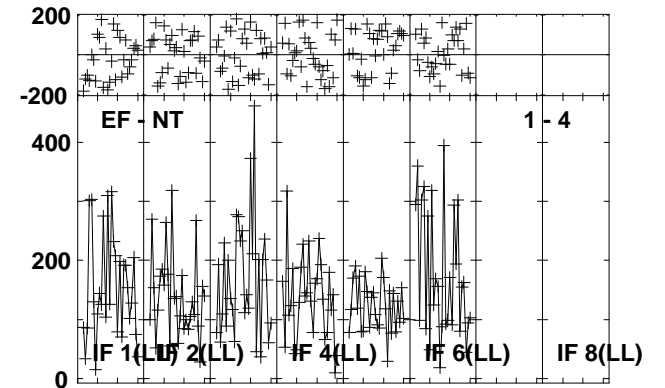
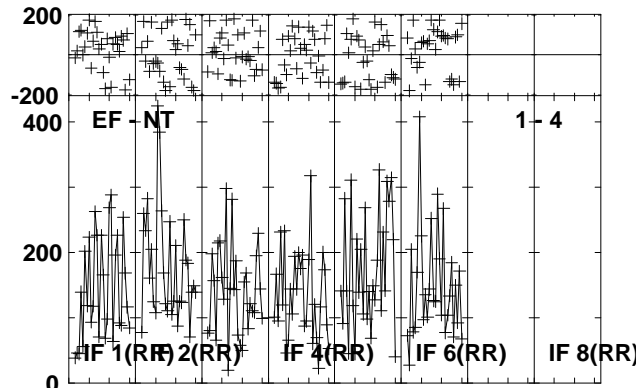
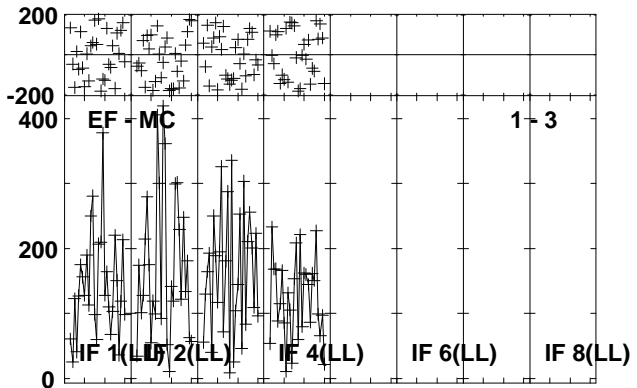
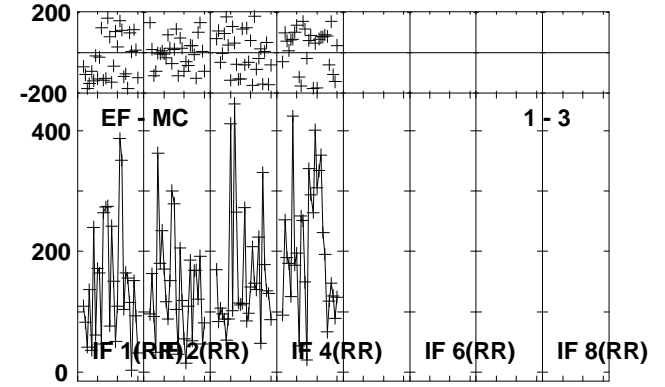
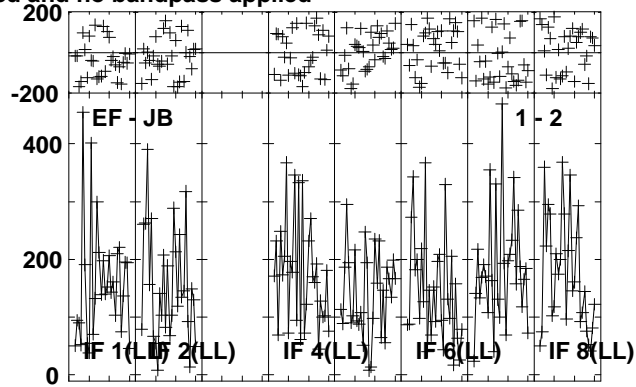
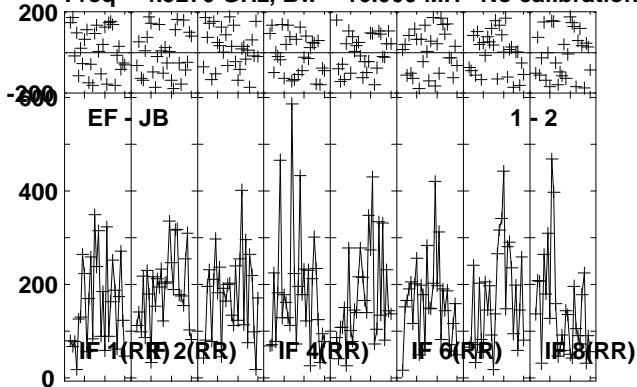

Lower frame: Micro Ampl Jy Top frame: Phas deg
Vector averaged cross-power spectrum Several baselines displayed
Timerange: 00/04:03:23 to 00/04:06:19

Plot file version 176 created 16-OCT-2012 11:57:23

NOVA-MON RO006.UVDATA.1

Freq = 4.9270 GHz, Bw = 16.000 MH No calibration applied and no bandpass applied

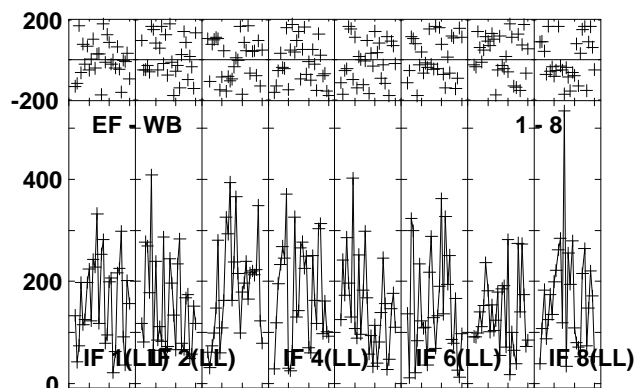
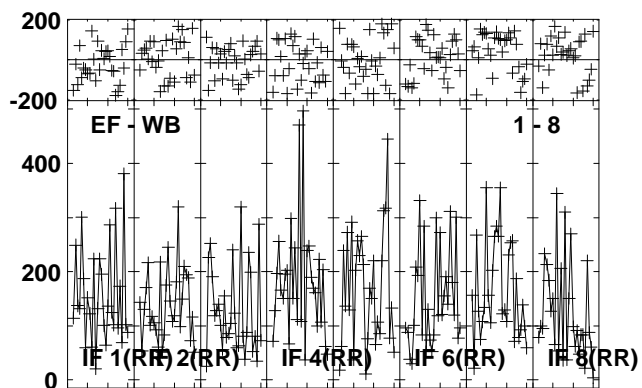
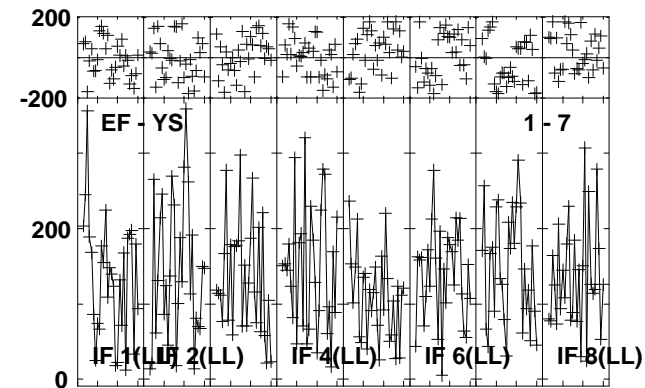
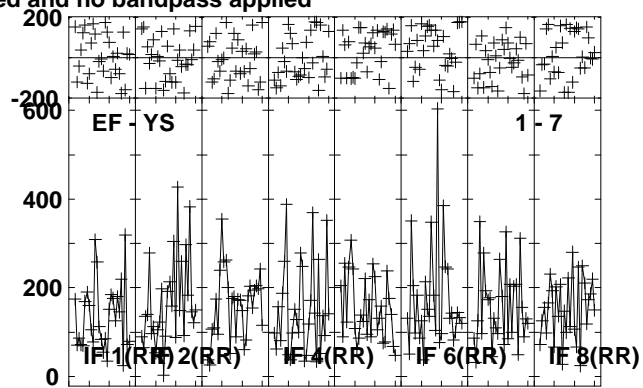
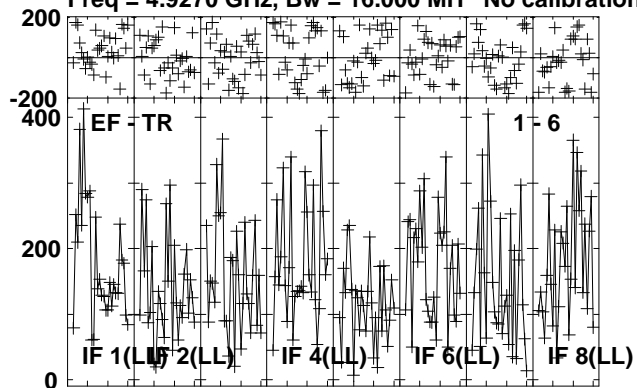

Lower frame: Micro Ampl Jy Top frame: Phas deg
Vector averaged cross-power spectrum Several baselines displayed
Timerange: 00/04:03:23 to 00/04:06:19

Plot file version 177 created 16-OCT-2012 11:57:24

J0639+0601 RO006.UVDATA.1

Freq = 4.9270 GHz, Bw = 16.000 MH No calibration applied and no bandpass applied

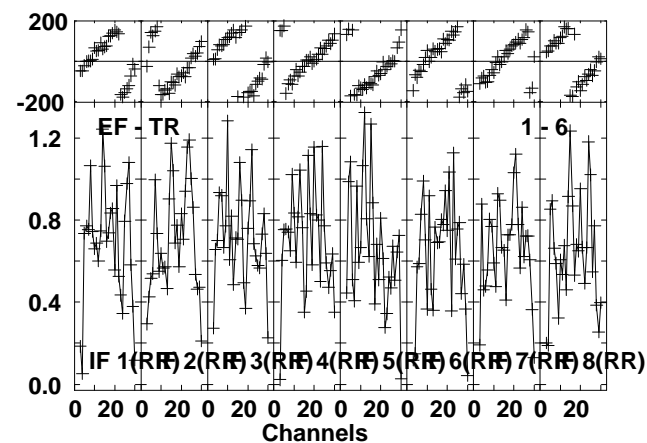
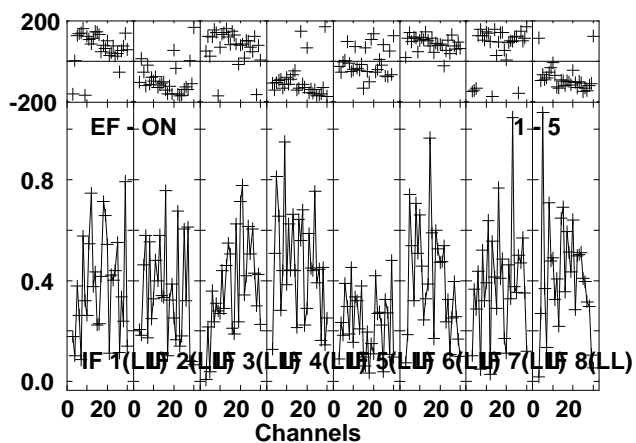
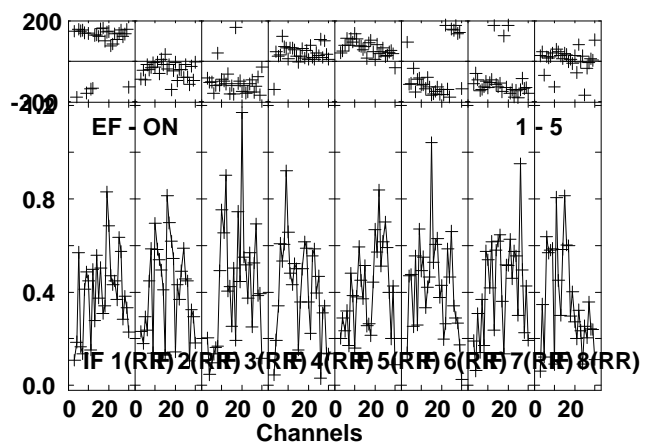
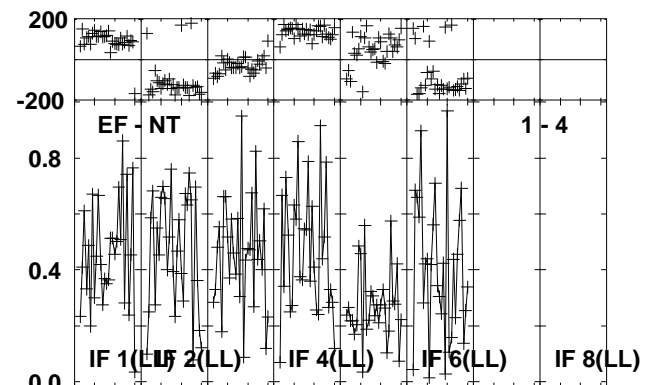
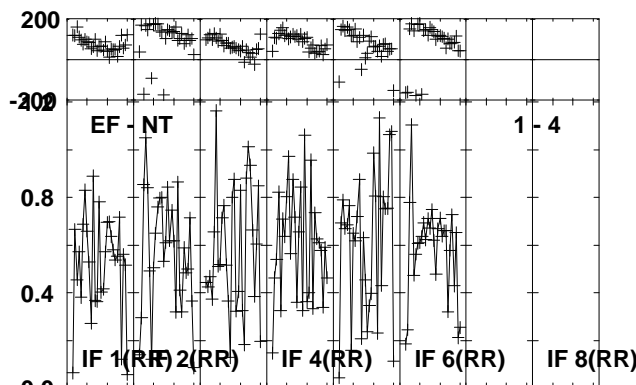
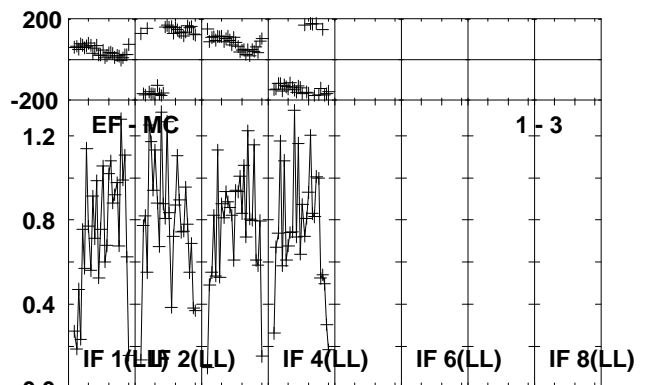
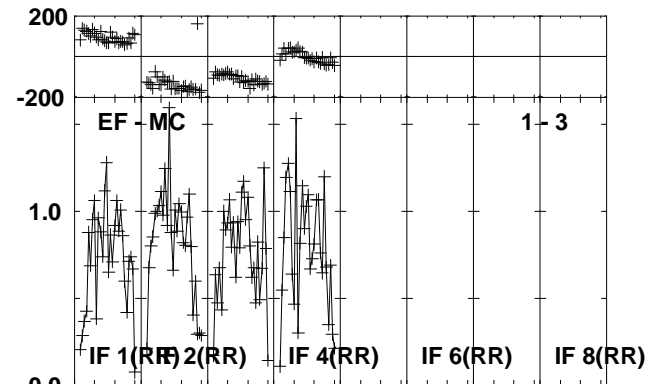
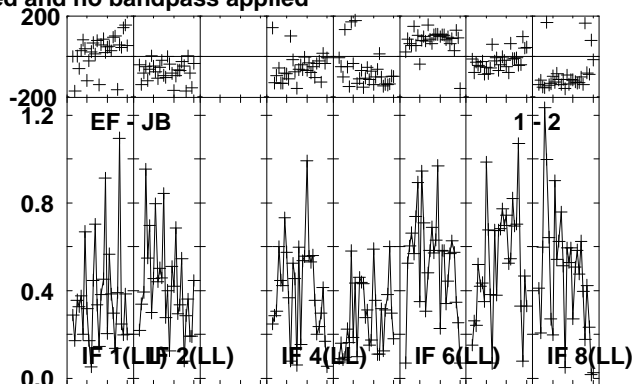
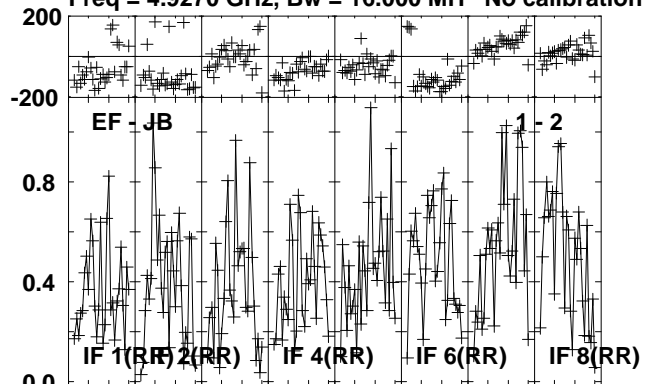

Lower frame: Milli Ampl Jy Top frame: Phas deg
Vector averaged cross-power spectrum Several baselines displayed
Timerange: 00/04:06:47 to 00/04:07:49

Plot file version 178 created 16-OCT-2012 11:57:24

J0639+0601 RO006.UVDATA.1

Freq = 4.9270 GHz, Bw = 16.000 MH No calibration applied and no bandpass applied

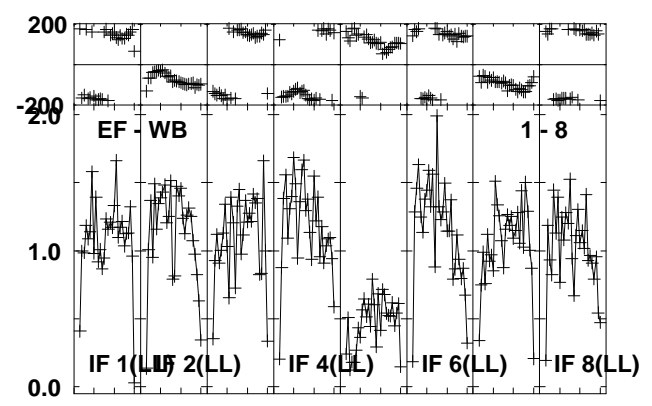
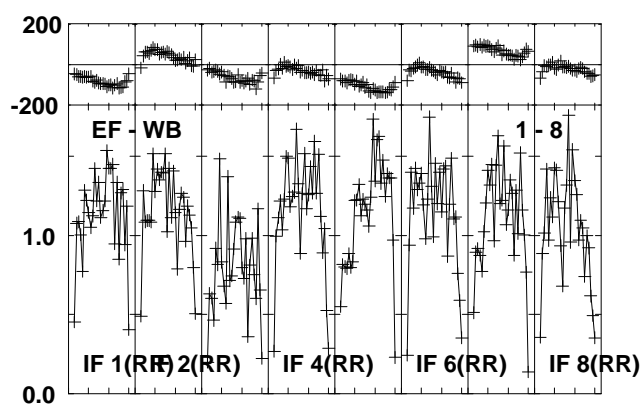
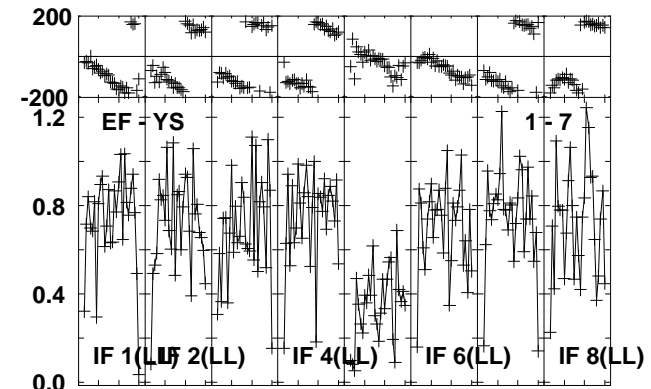
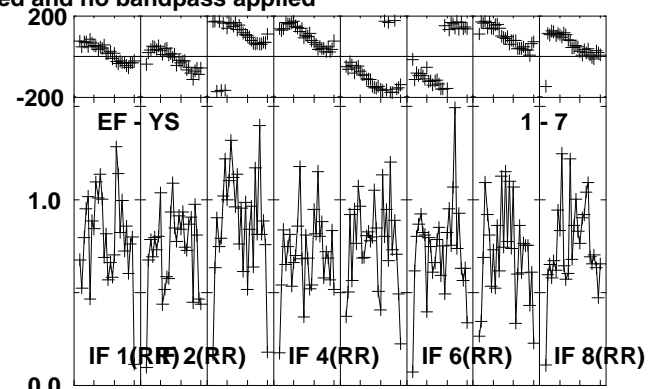
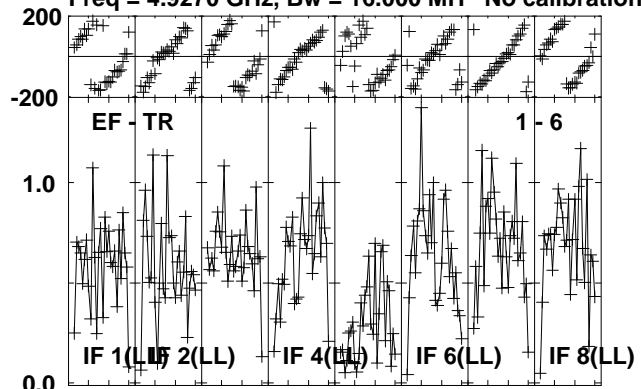

Lower frame: Milli Ampl Jy Top frame: Phas deg
Vector averaged cross-power spectrum Several baselines displayed
Timerange: 00/04:06:47 to 00/04:07:49

Plot file version 179 created 16-OCT-2012 11:57:24

J0645+0541 RO006.UVDATA.1

Freq = 4.9270 GHz, Bw = 16.000 MH No calibration applied and no bandpass applied

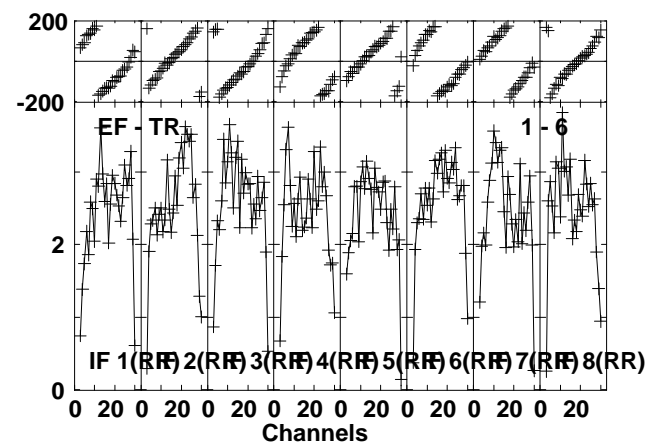
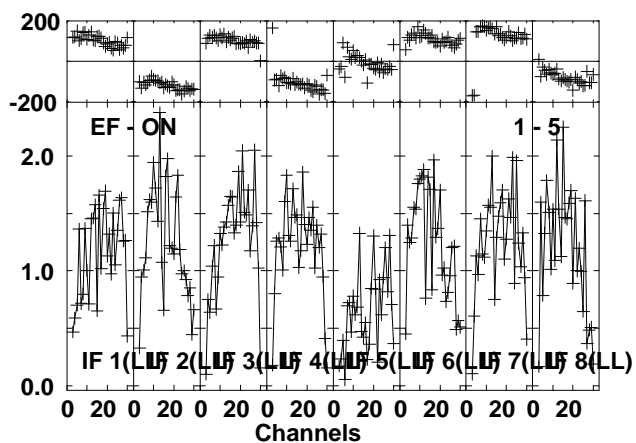
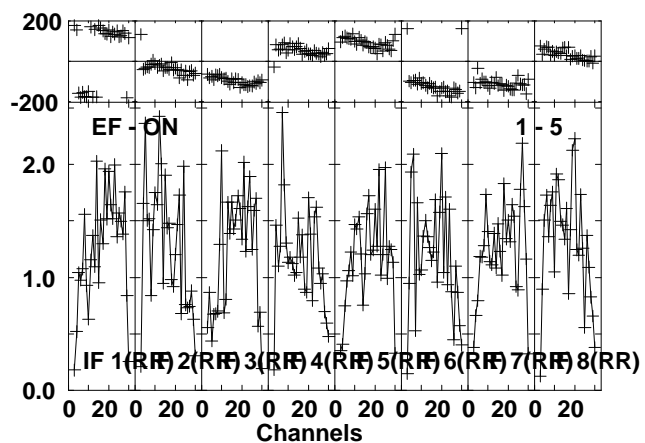
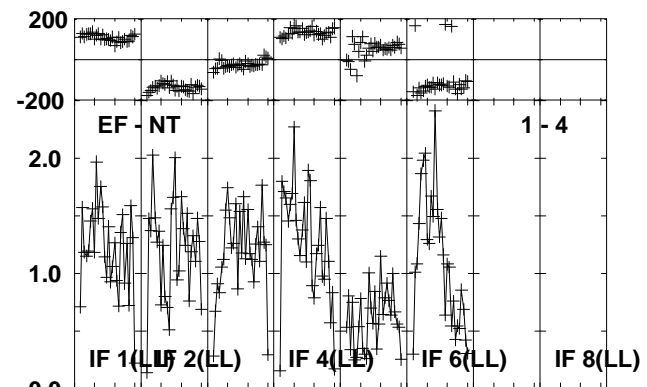
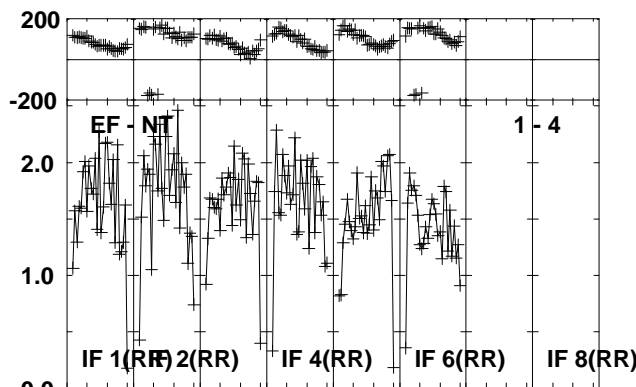
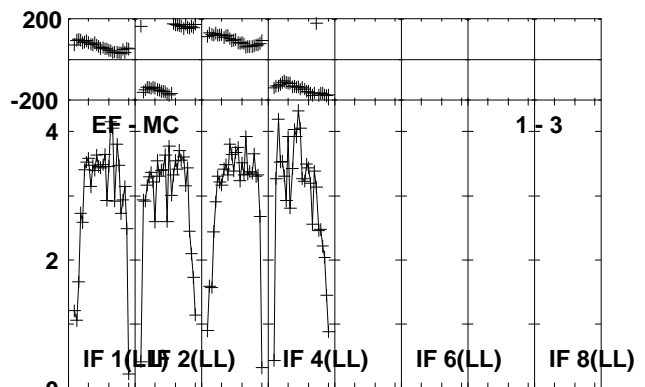
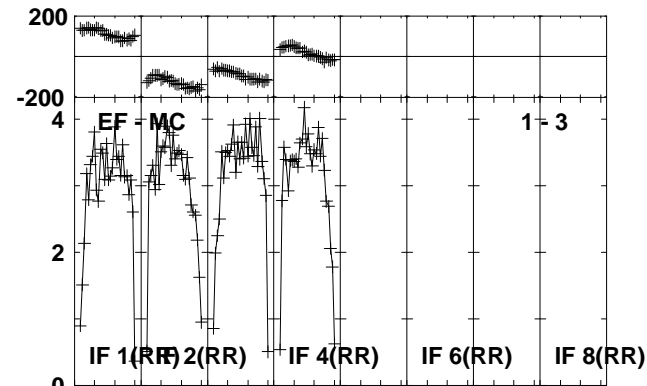
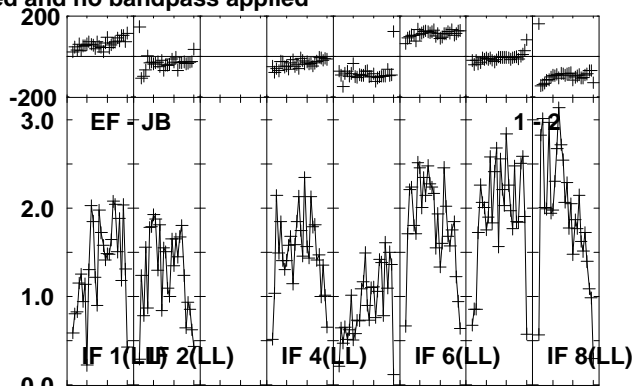
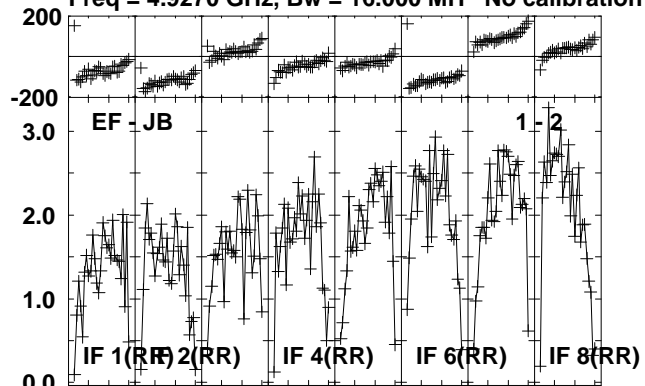

Lower frame: Milli Ampl Jy Top frame: Phas deg
Vector averaged cross-power spectrum Several baselines displayed
Timerange: 00/04:07:53 to 00/04:08:49

Plot file version 180 created 16-OCT-2012 11:57:24

J0645+0541 RO006.UVDATA.1

Freq = 4.9270 GHz, Bw = 16.000 MH No calibration applied and no bandpass applied

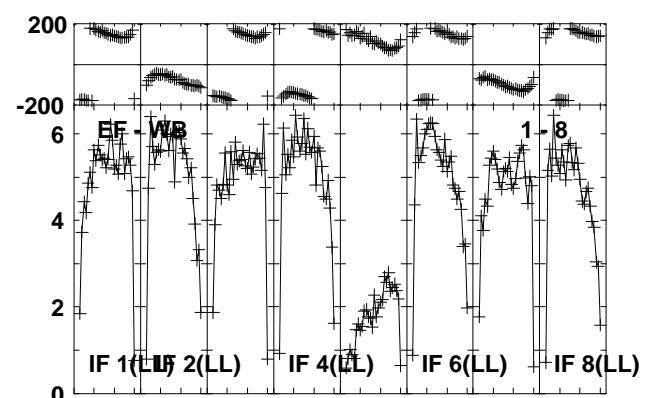
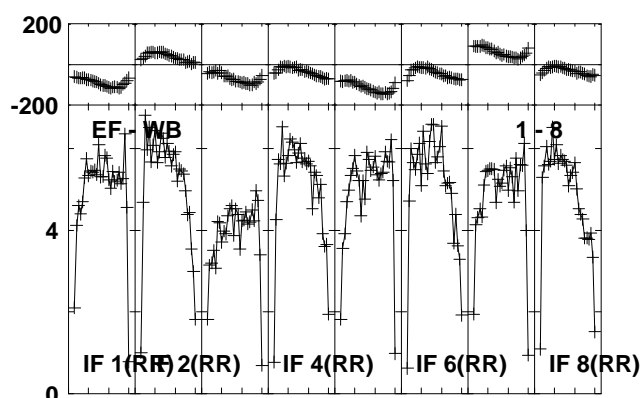
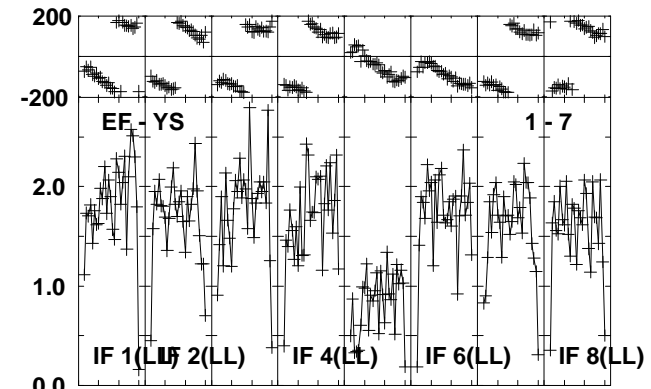
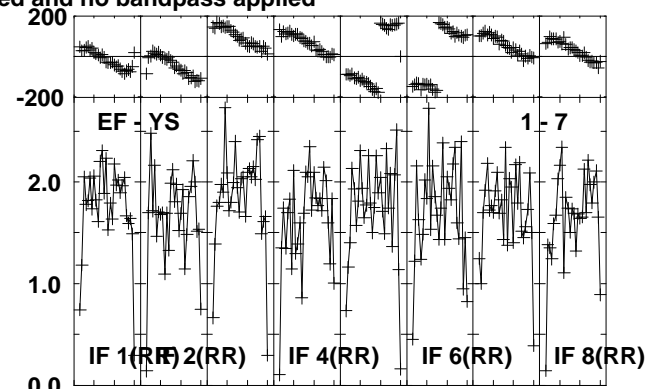
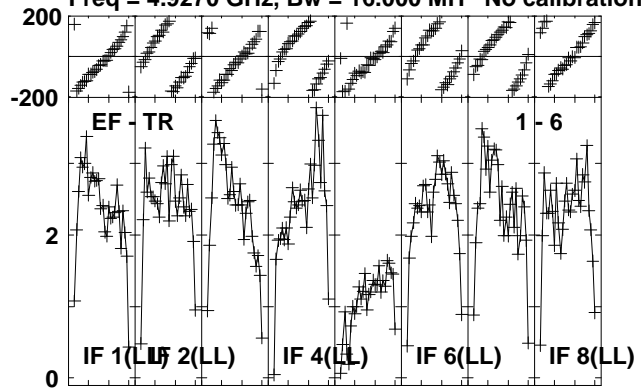

Lower frame: Milli Ampl Jy Top frame: Phas deg
Vector averaged cross-power spectrum Several baselines displayed
Timerange: 00/04:07:53 to 00/04:08:49

Plot file version 181 created 16-OCT-2012 11:57:25

NOVA-MON RO006.UVDATA.1

Freq = 4.9270 GHz, Bw = 16.000 MH No calibration applied and no bandpass applied

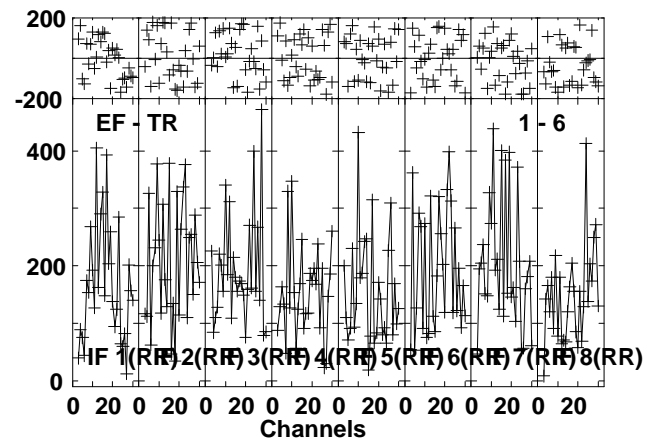
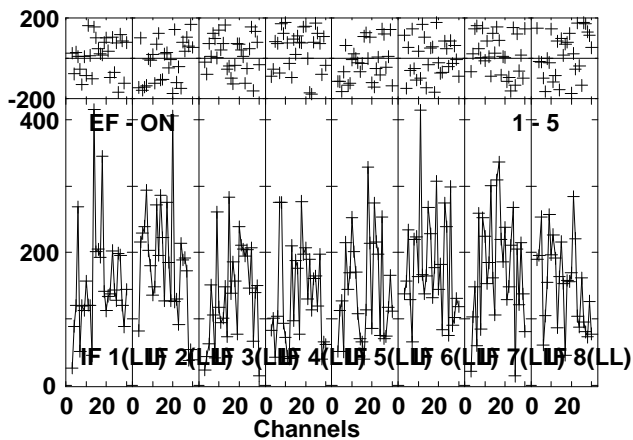
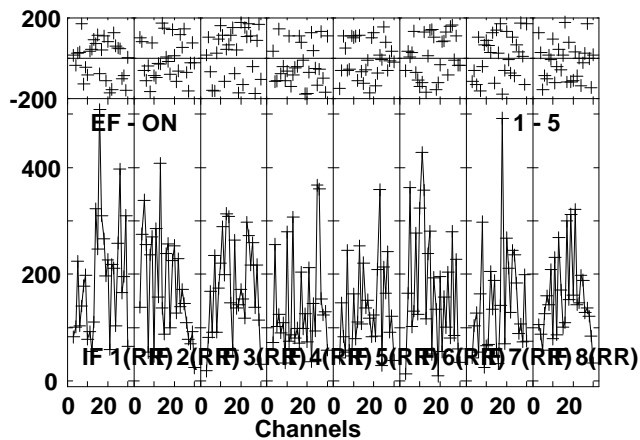
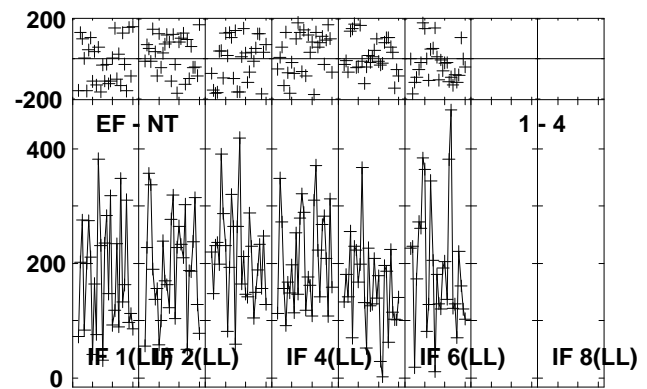
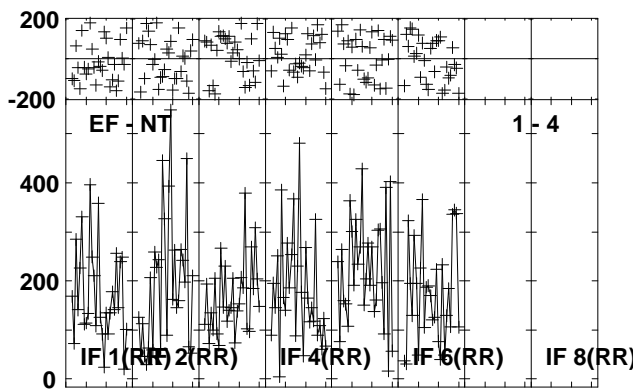
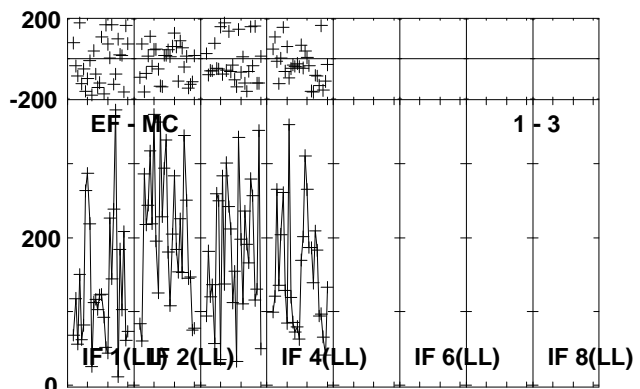
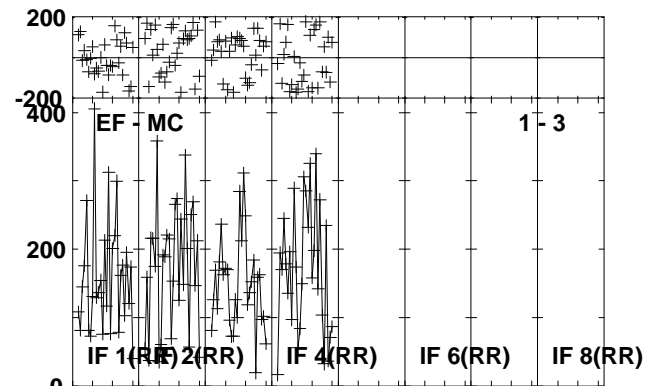
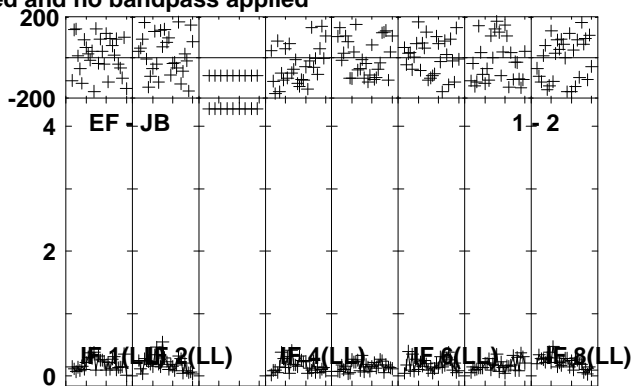
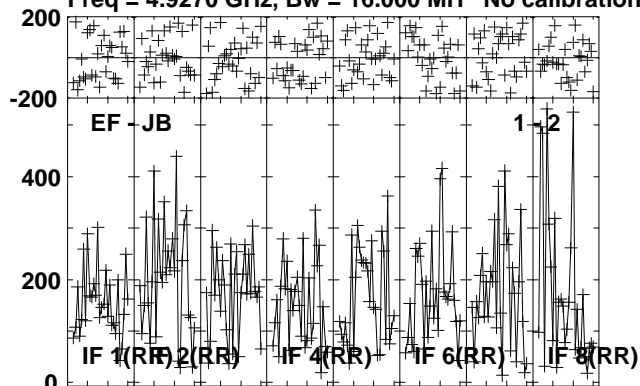

Lower frame: Micro Ampl Jy Top frame: Phas deg
Vector averaged cross-power spectrum Several baselines displayed
Timerange: 00/04:08:53 to 00/04:11:49

Plot file version 182 created 16-OCT-2012 11:57:25

NOVA-MON RO006.UVDATA.1

Freq = 4.9270 GHz, Bw = 16.000 MH No calibration applied and no bandpass applied

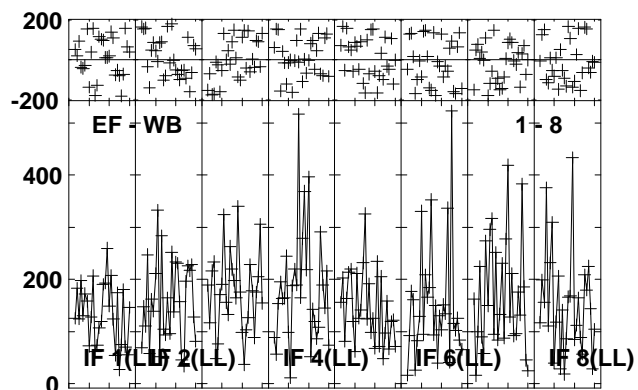
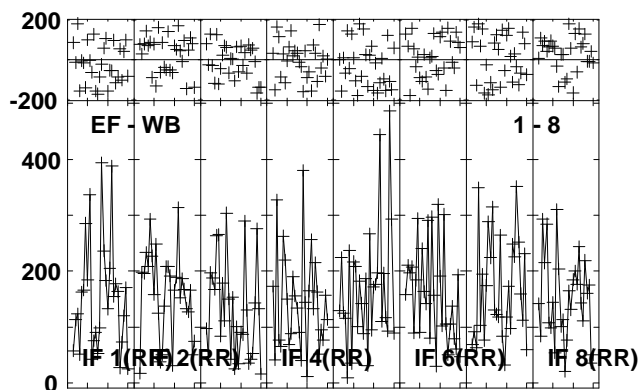
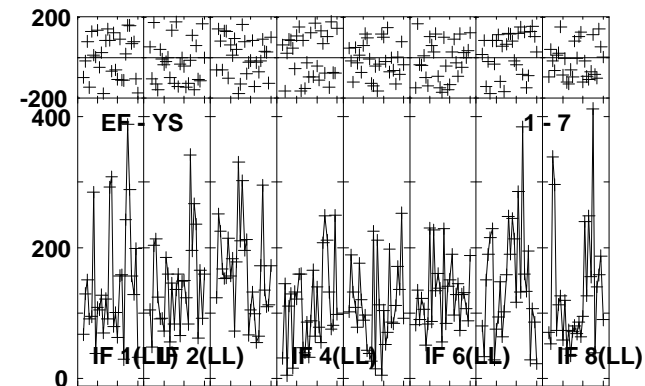
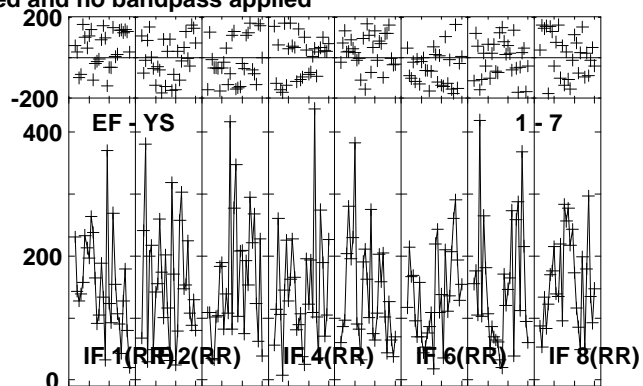
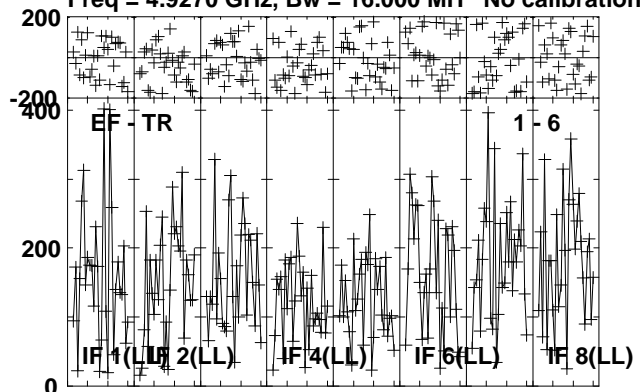

Lower frame: Micro Ampl Jy Top frame: Phas deg
Vector averaged cross-power spectrum Several baselines displayed
Timerange: 00/04:08:53 to 00/04:11:49

Plot file version 183 created 16-OCT-2012 11:57:25

J0639+0601 RO006.UVDATA.1

Freq = 4.9270 GHz, Bw = 16.000 MH No calibration applied and no bandpass applied

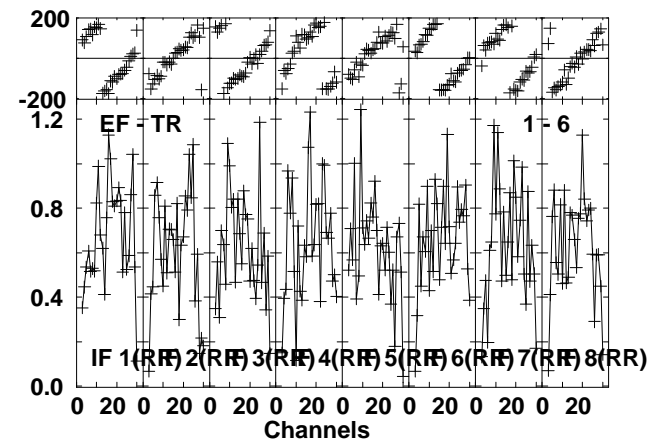
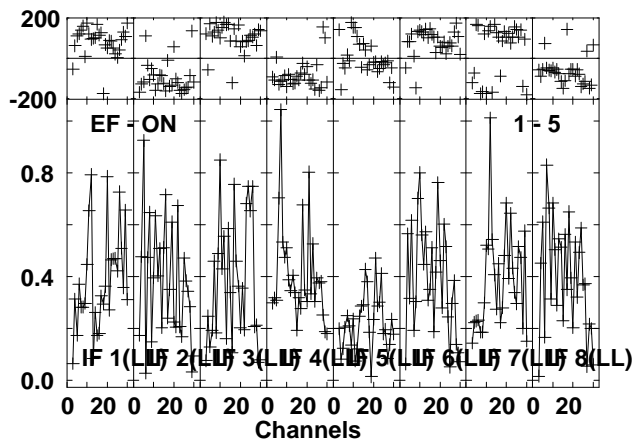
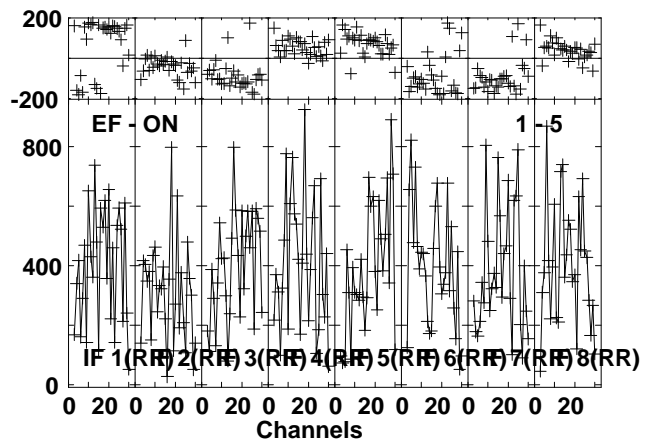
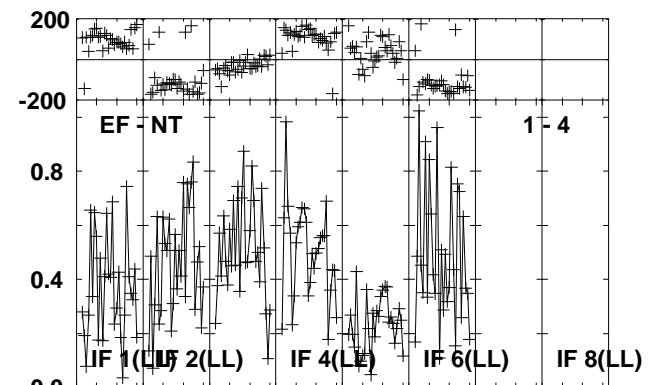
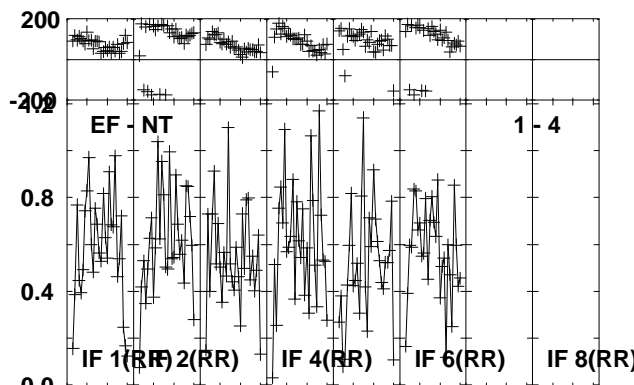
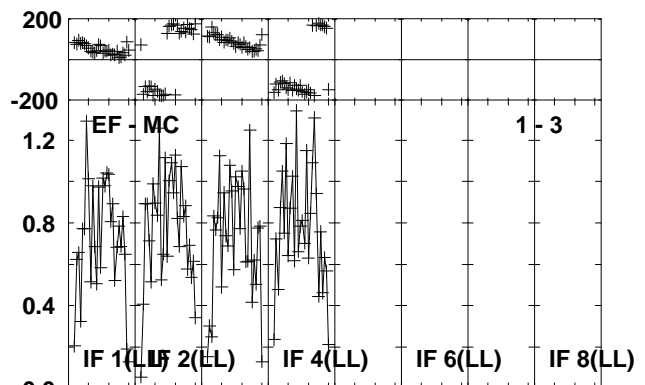
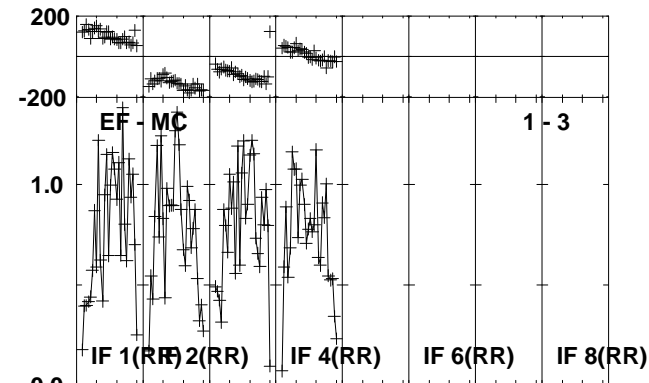
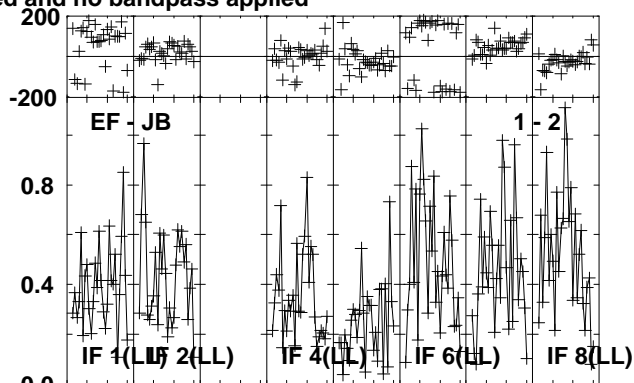
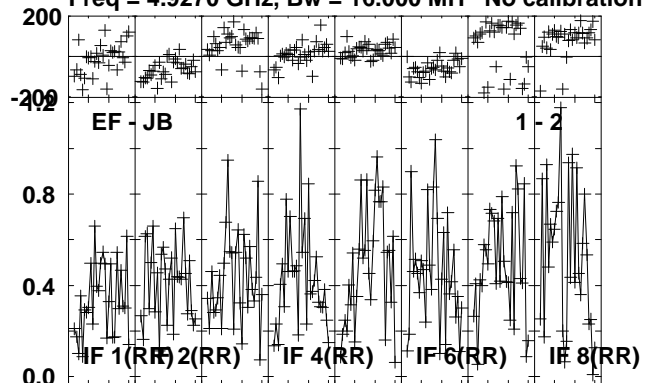

Lower frame: Milli Ampl Jy Top frame: Phas deg
Vector averaged cross-power spectrum Several baselines displayed
Timerange: 00/04:11:53 to 00/04:13:03

Plot file version 184 created 16-OCT-2012 11:57:26

J0639+0601 RO006.UVDATA.1

Freq = 4.9270 GHz, Bw = 16.000 MH No calibration applied and no bandpass applied

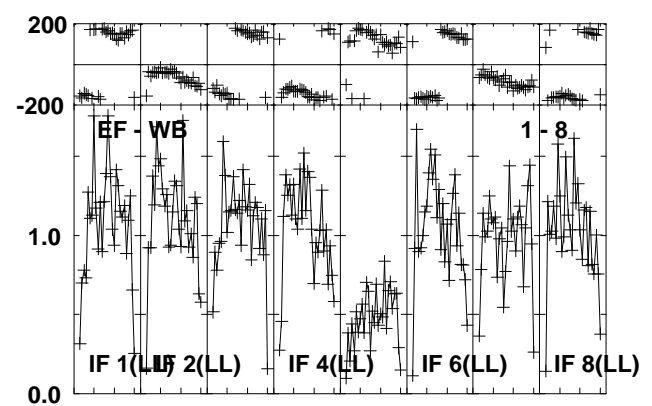
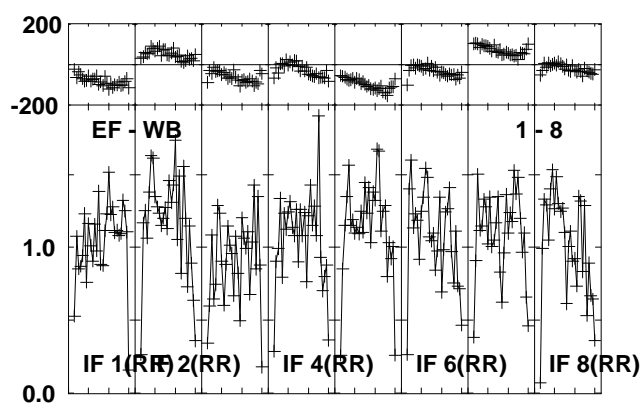
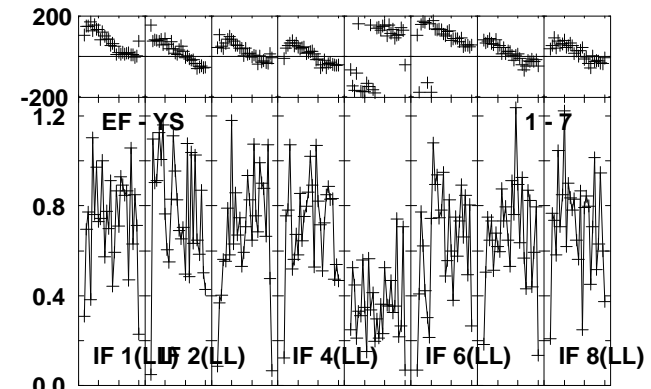
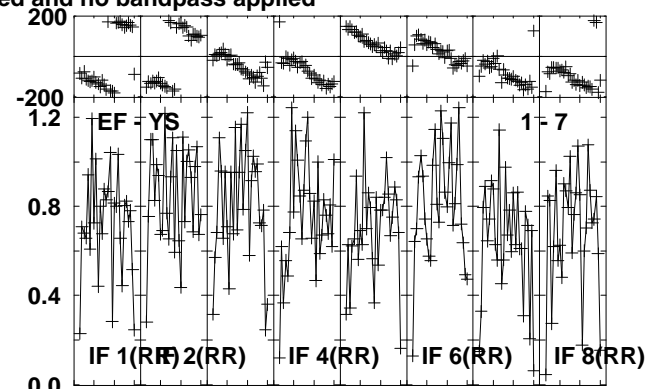
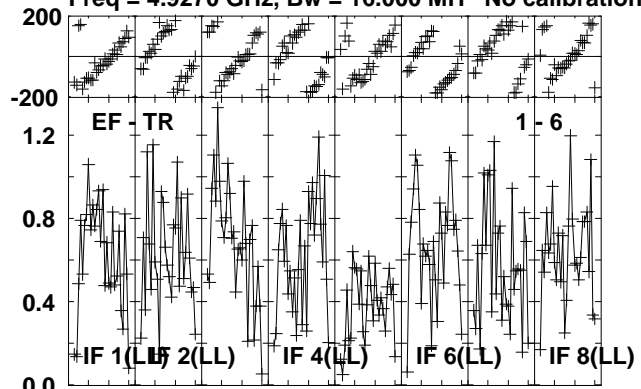

Lower frame: Milli Ampl Jy Top frame: Phas deg
Vector averaged cross-power spectrum Several baselines displayed
Timerange: 00/04:11:53 to 00/04:13:03

Plot file version 185 created 16-OCT-2012 11:57:26

J0645+0541 RO006.UVDATA.1

Freq = 4.9270 GHz, Bw = 16.000 MH No calibration applied and no bandpass applied

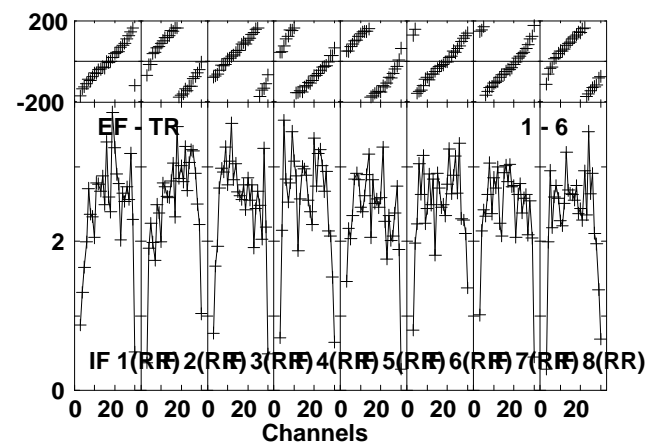
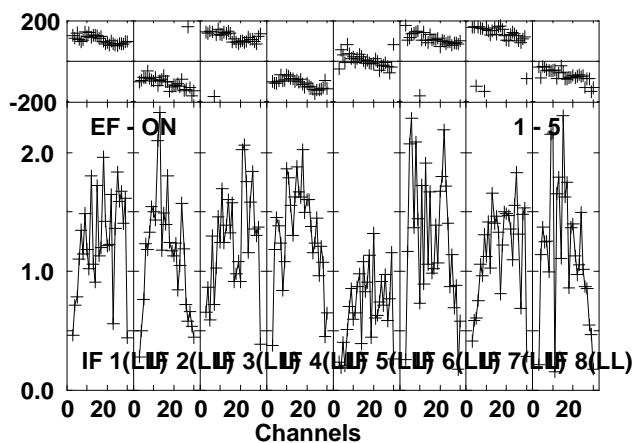
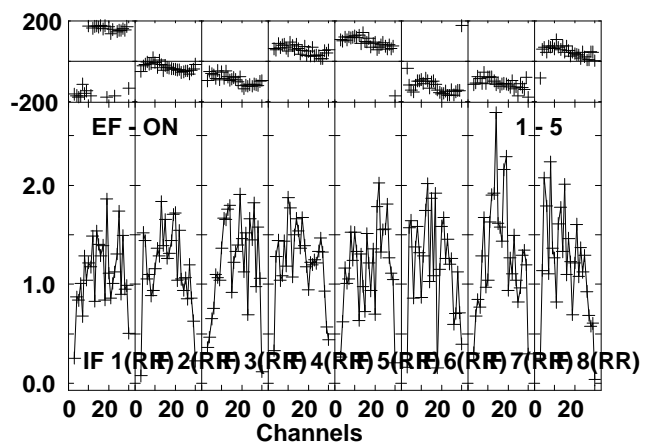
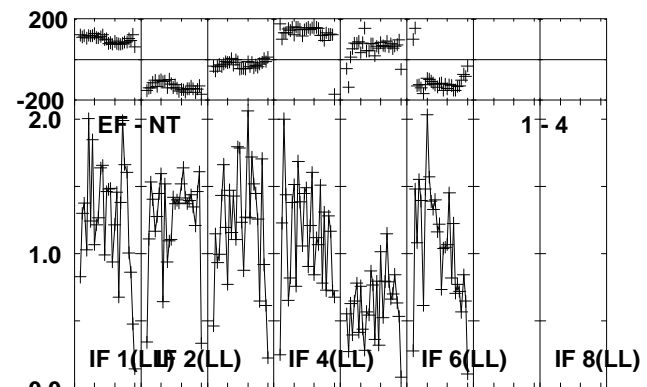
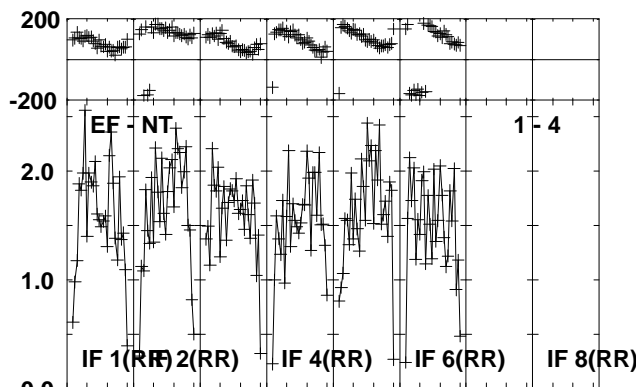
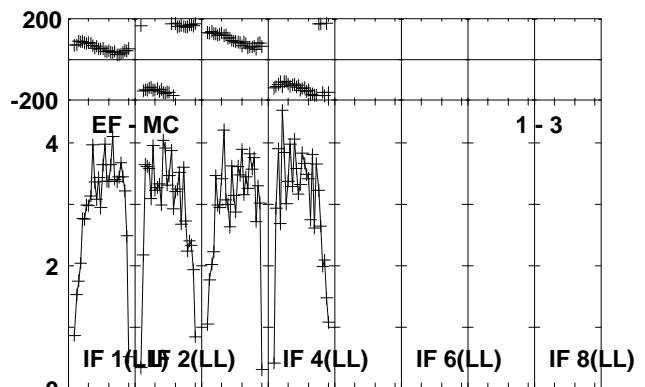
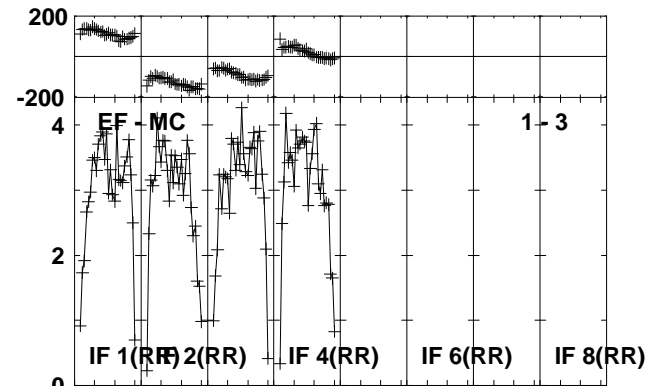
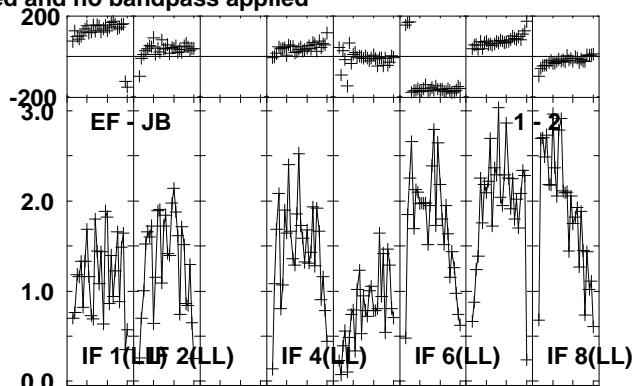
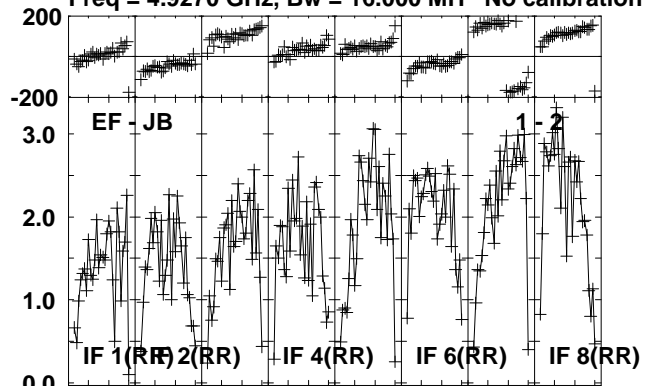

Lower frame: Milli Ampl Jy Top frame: Phas deg
Vector averaged cross-power spectrum Several baselines displayed
Timerange: 00/04:13:07 to 00/04:14:03

Plot file version 186 created 16-OCT-2012 11:57:26
J0645+0541 RO006.UVDATA.1

Freq = 4.9270 GHz, Bw = 16.000 MH No calibration applied and no bandpass applied

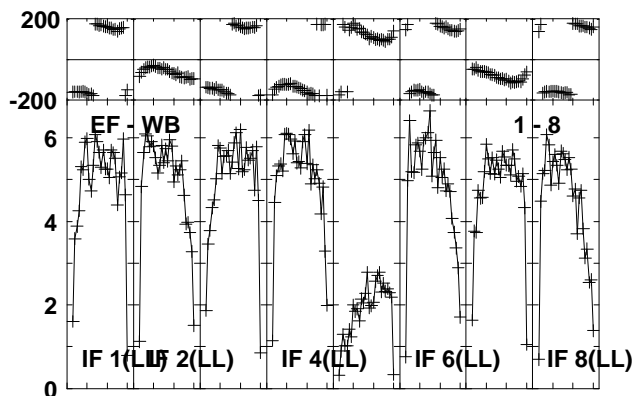
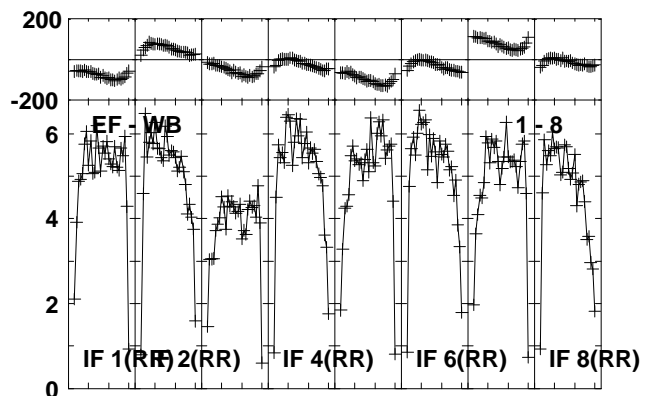
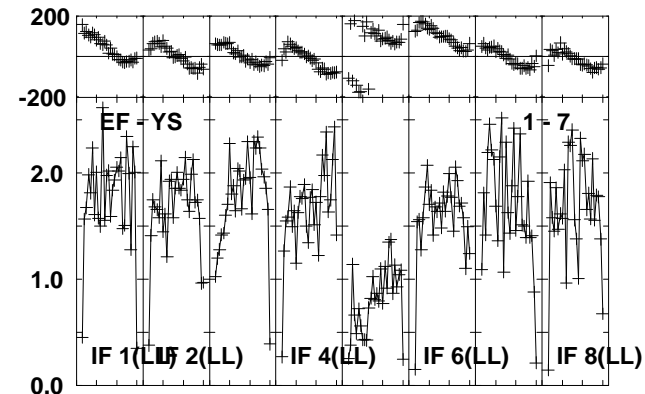
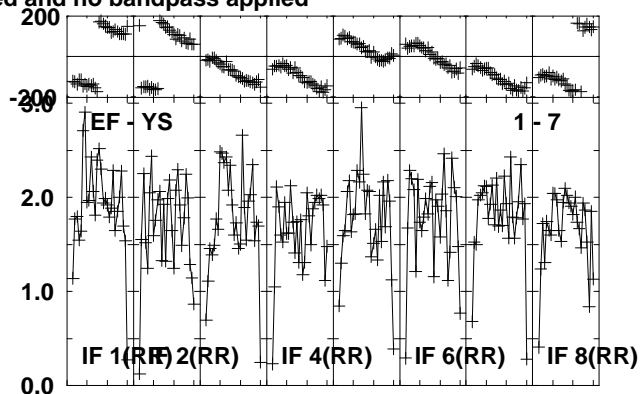
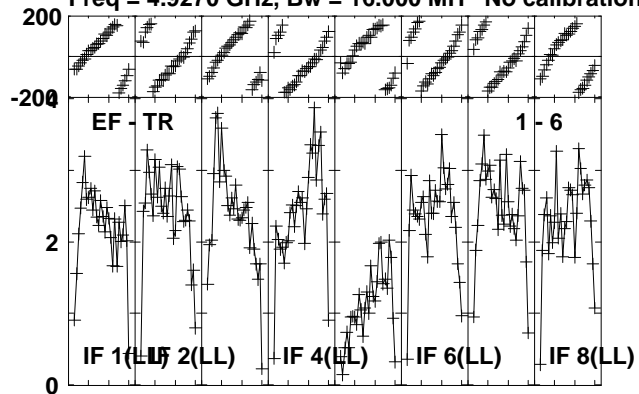

Lower frame: Milli Ampl Jy Top frame: Phas deg
Vector averaged cross-power spectrum Several baselines displayed
Timerange: 00/04:13:07 to 00/04:14:03

Plot file version 187 created 16-OCT-2012 11:57:26

NOVA-MON RO006.UVDATA.1

Freq = 4.9270 GHz, Bw = 16.000 MH No calibration applied and no bandpass applied

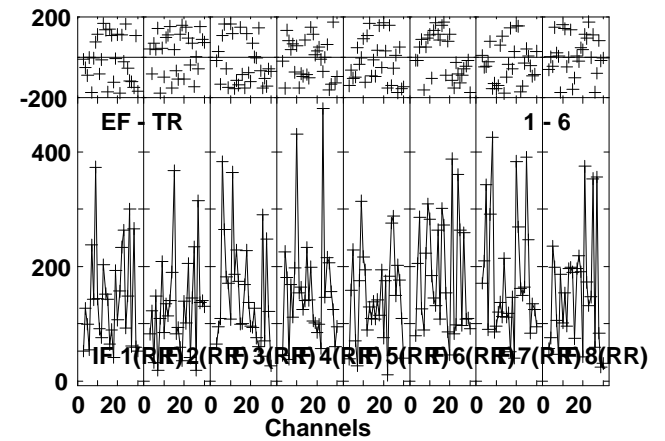
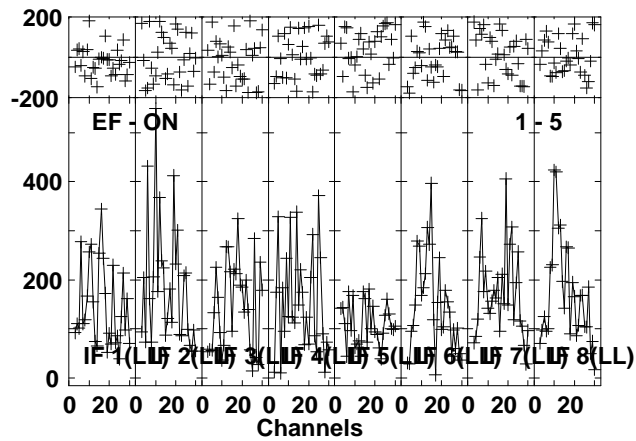
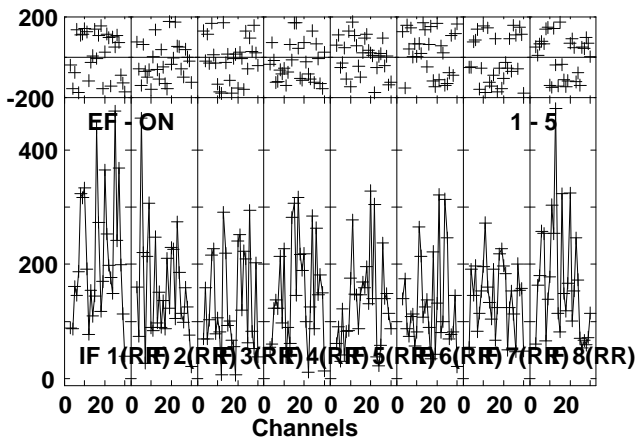
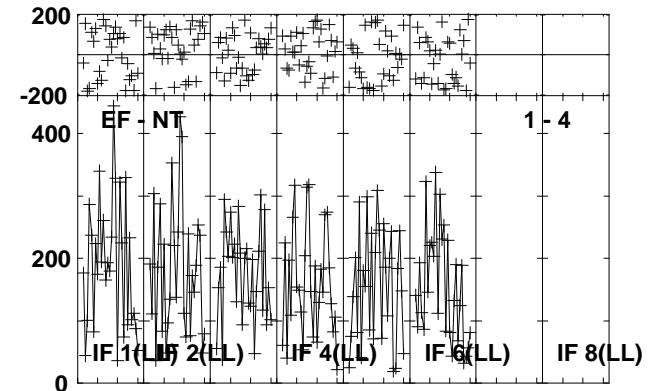
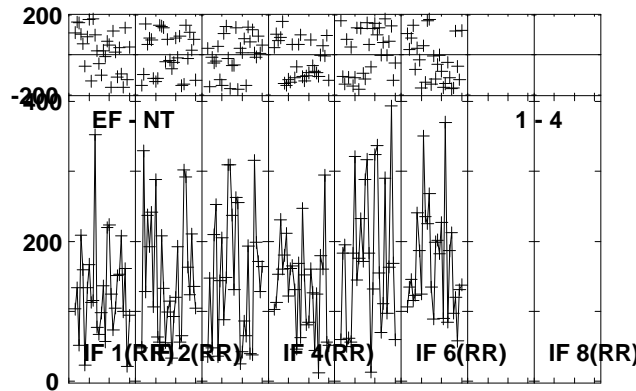
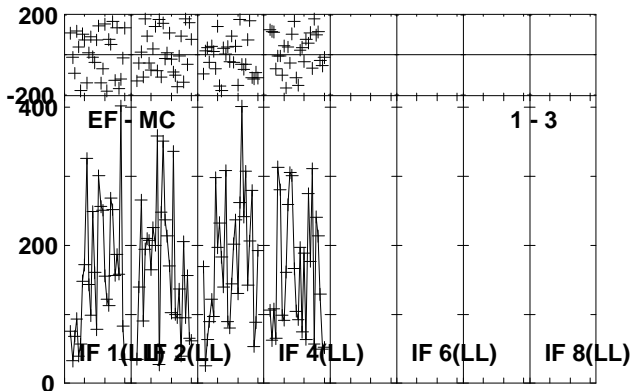
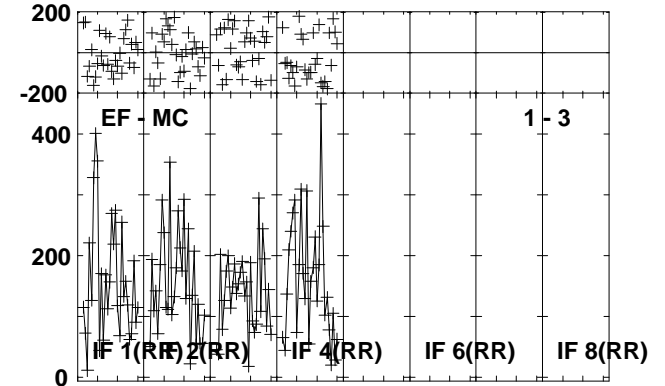
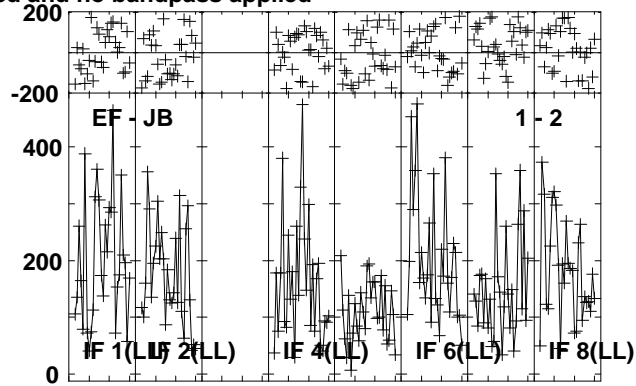
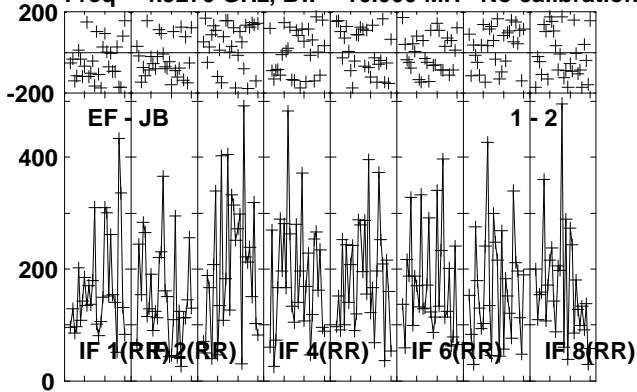

Lower frame: Micro Ampl Jy Top frame: Phas deg
Vector averaged cross-power spectrum Several baselines displayed
Timerange: 00/04:14:07 to 00/04:17:03

Plot file version 188 created 16-OCT-2012 11:57:27

NOVA-MON RO006.UVDATA.1

Freq = 4.9270 GHz, Bw = 16.000 MH No calibration applied and no bandpass applied

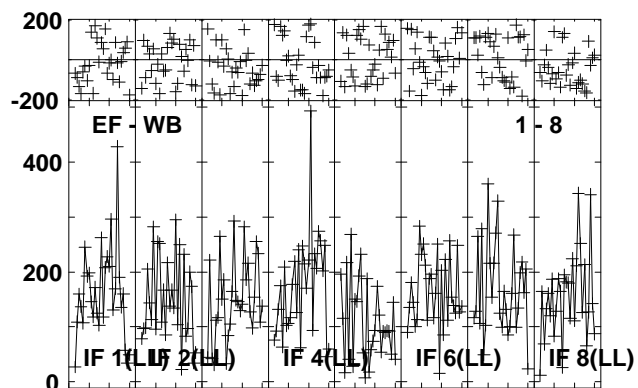
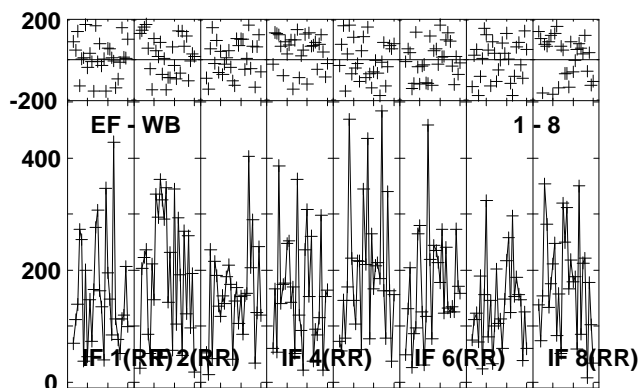
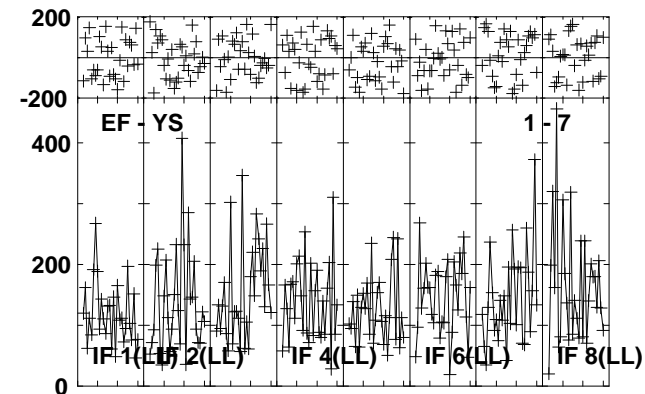
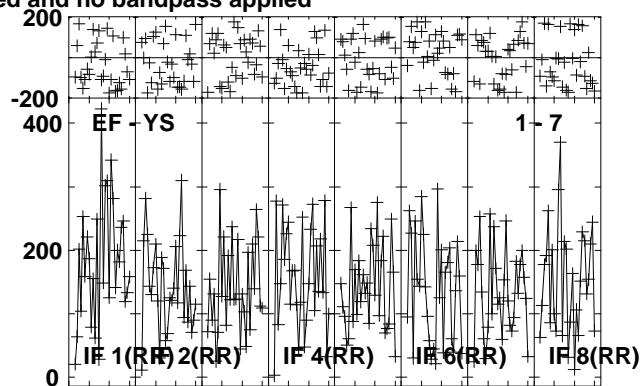
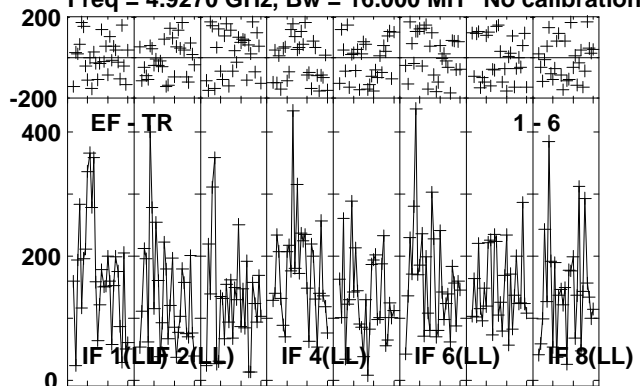

Lower frame: Micro Ampl Jy Top frame: Phas deg
Vector averaged cross-power spectrum Several baselines displayed
Timerange: 00/04:14:07 to 00/04:17:03

Plot file version 189 created 16-OCT-2012 11:57:27

J0639+0601 RO006.UVDATA.1

Freq = 4.9270 GHz, Bw = 16.000 MH No calibration applied and no bandpass applied

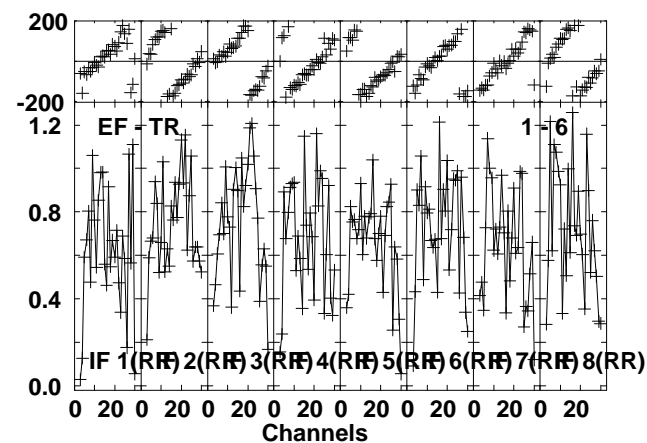
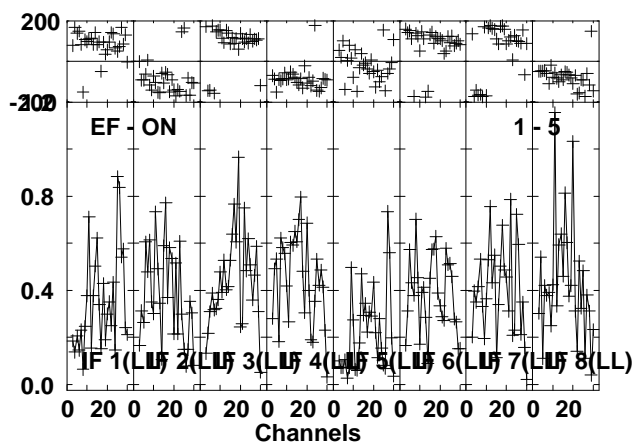
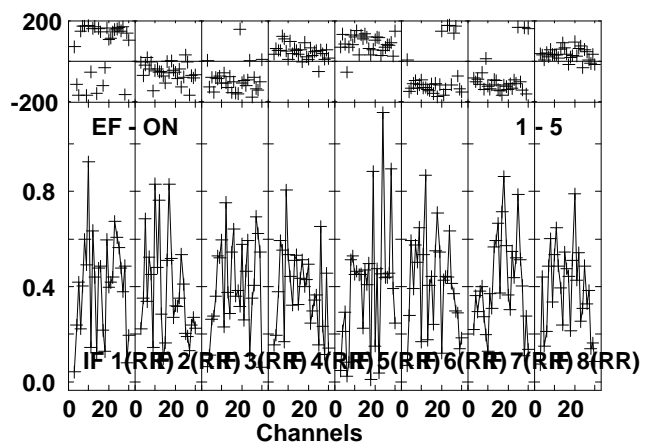
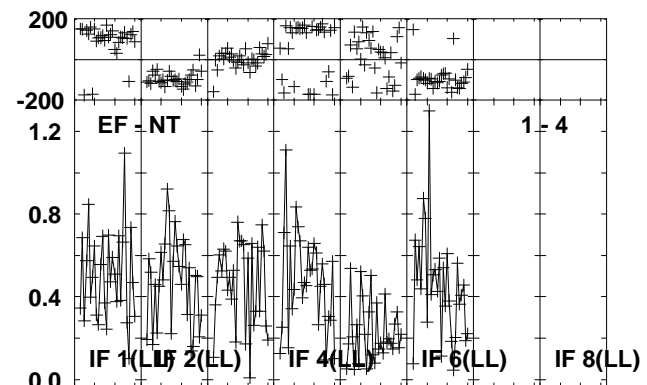
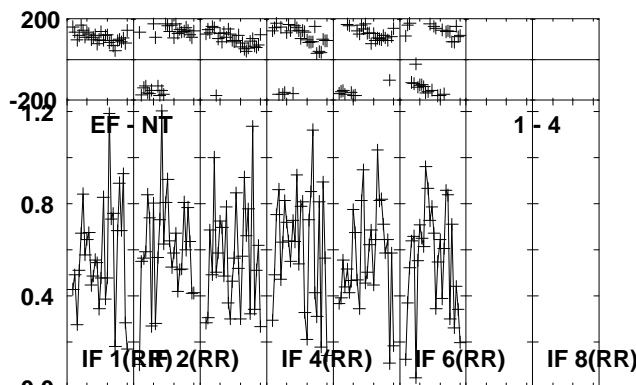
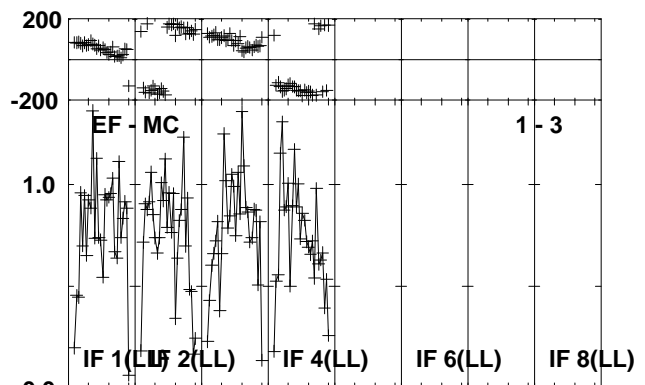
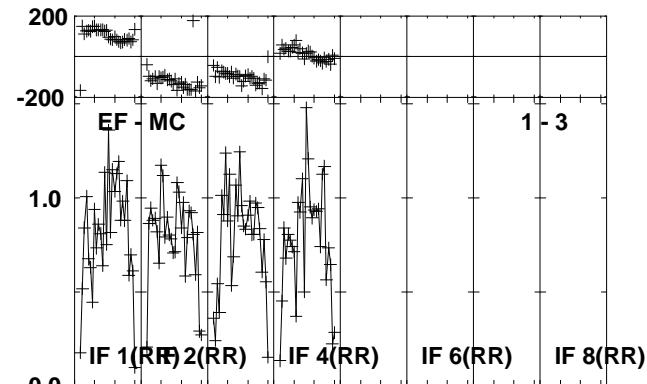
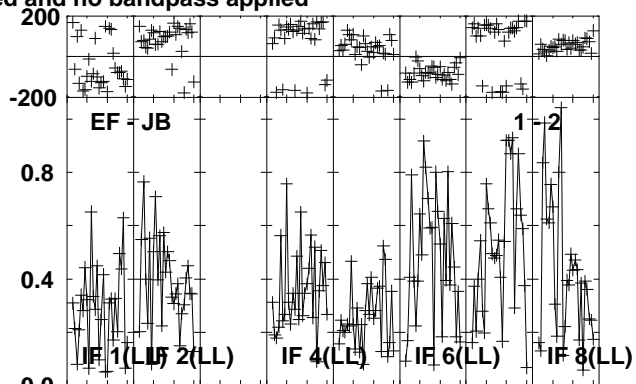
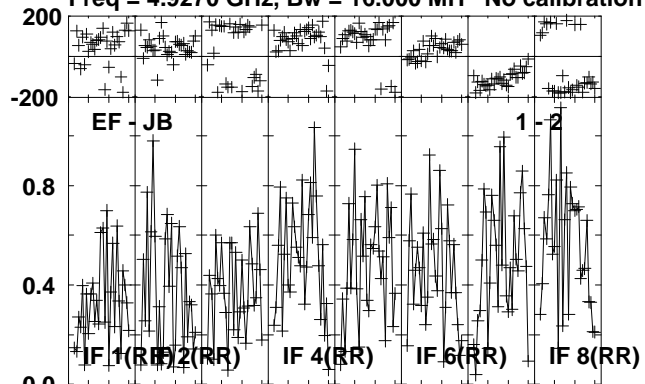

Lower frame: Milli Ampl Jy Top frame: Phas deg
Vector averaged cross-power spectrum Several baselines displayed
Timerange: 00/04:17:33 to 00/04:18:33

Plot file version 190 created 16-OCT-2012 11:57:27

J0639+0601 RO006.UVDATA.1

Freq = 4.9270 GHz, Bw = 16.000 MH No calibration applied and no bandpass applied

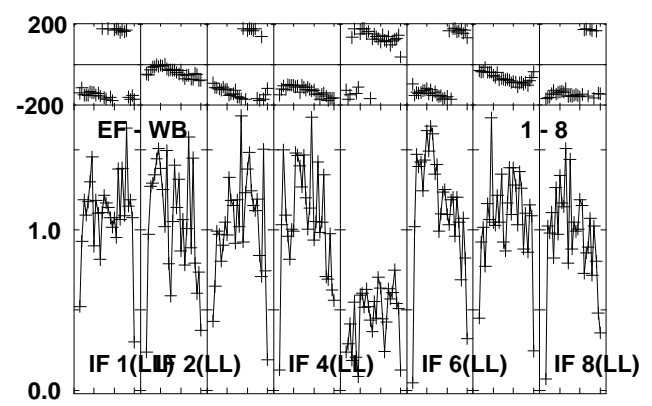
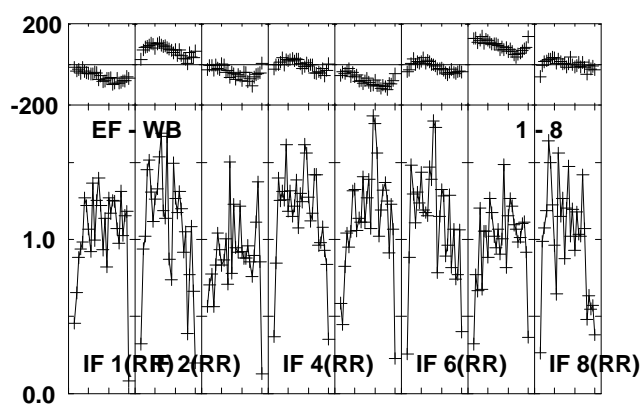
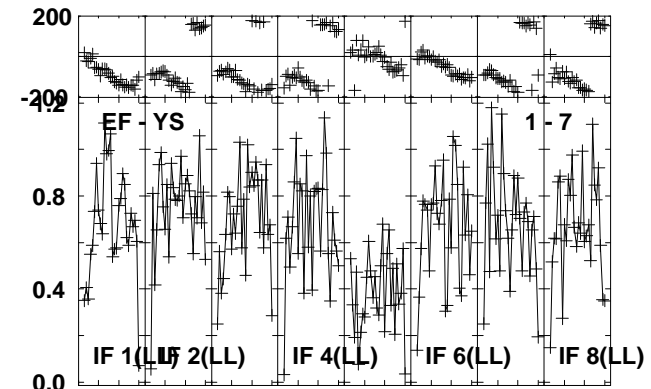
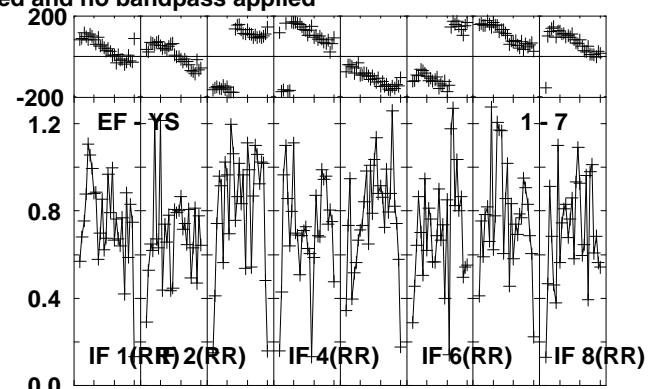
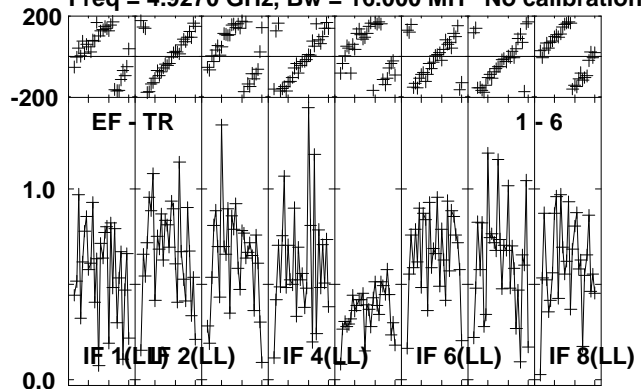

Lower frame: Milli Ampl Jy Top frame: Phas deg
Vector averaged cross-power spectrum Several baselines displayed
Timerange: 00/04:17:33 to 00/04:18:33

Plot file version 191 created 16-OCT-2012 11:57:28

J0645+0541 RO006.UVDATA.1

Freq = 4.9270 GHz, Bw = 16.000 MH No calibration applied and no bandpass applied

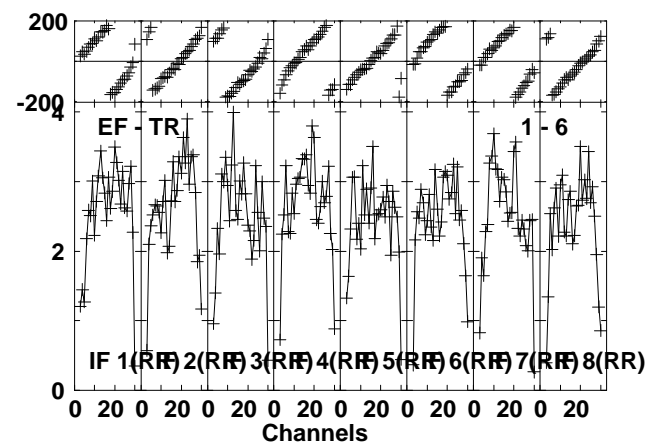
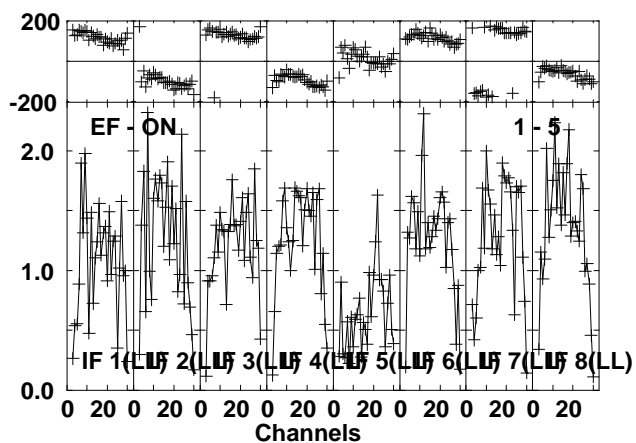
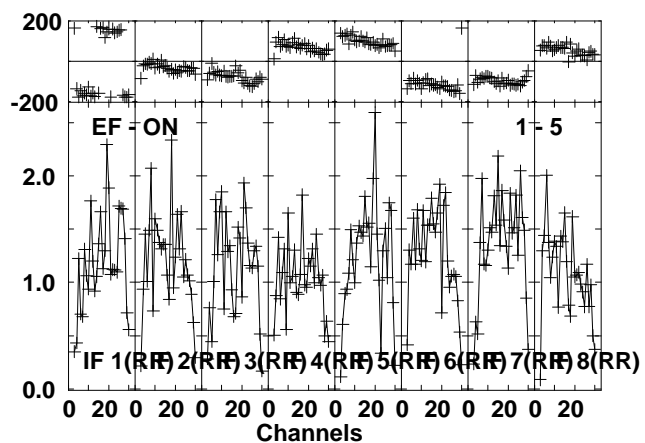
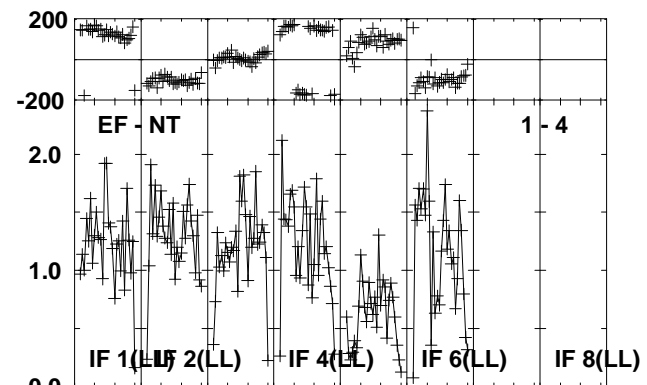
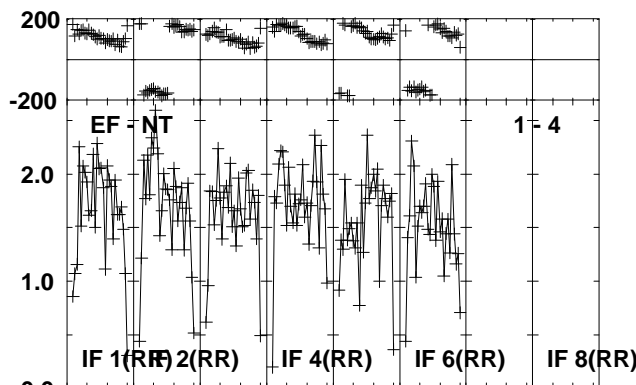
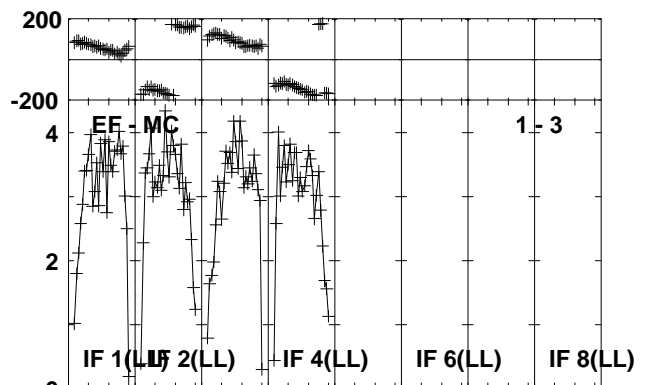
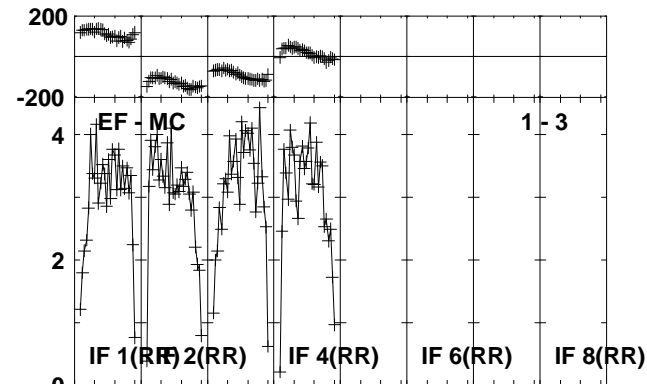
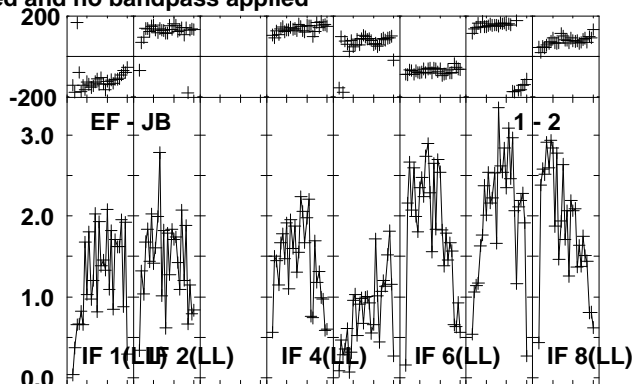
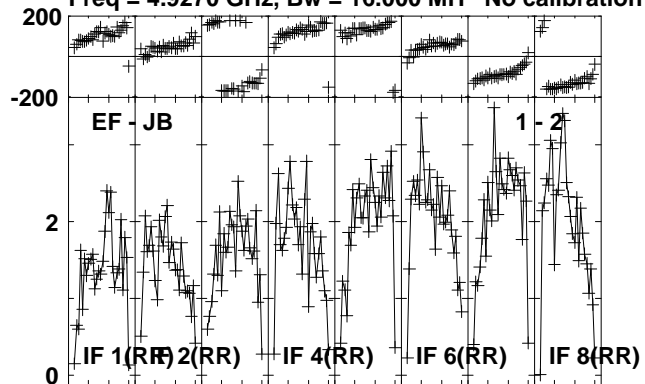

Lower frame: Milli Ampl Jy Top frame: Phas deg
Vector averaged cross-power spectrum Several baselines displayed
Timerange: 00/04:18:37 to 00/04:19:33

Plot file version 192 created 16-OCT-2012 11:57:28

J0645+0541 RO006.UVDATA.1

Freq = 4.9270 GHz, Bw = 16.000 MH No calibration applied and no bandpass applied

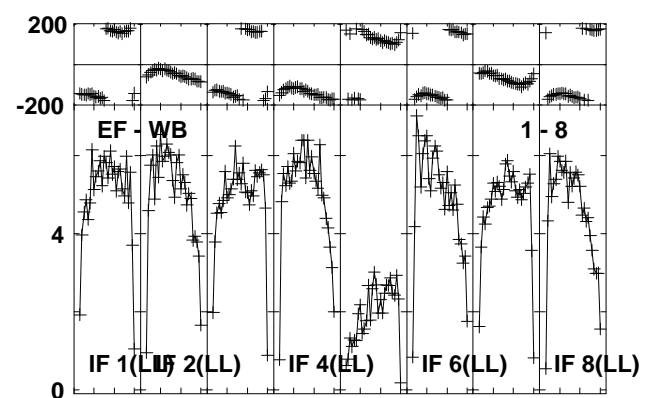
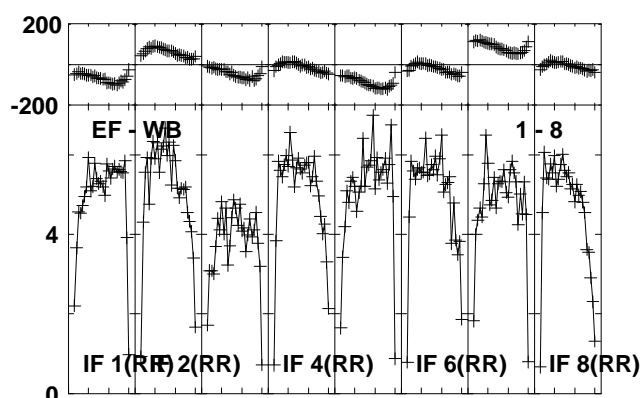
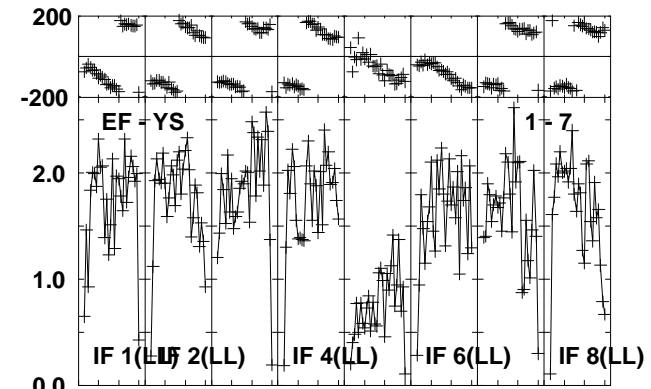
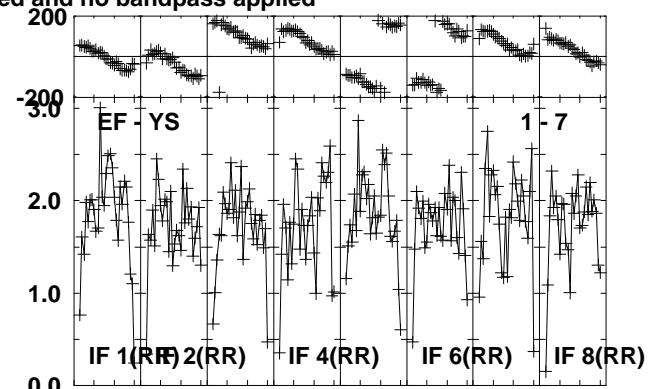
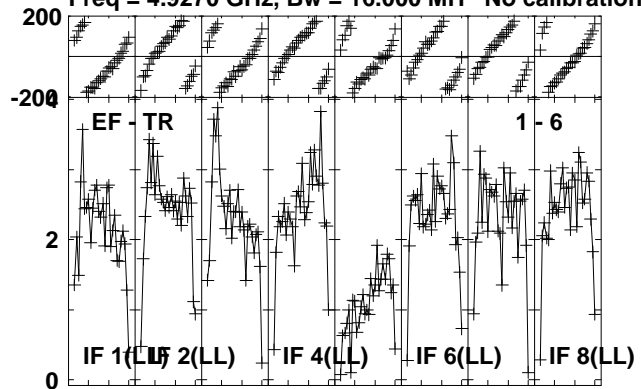

Lower frame: Milli Ampl Jy Top frame: Phas deg
Vector averaged cross-power spectrum Several baselines displayed
Timerange: 00/04:18:37 to 00/04:19:33

Plot file version 193 created 16-OCT-2012 11:57:28

NOVA-MON RO006.UVDATA.1

Freq = 4.9270 GHz, Bw = 16.000 MH No calibration applied and no bandpass applied

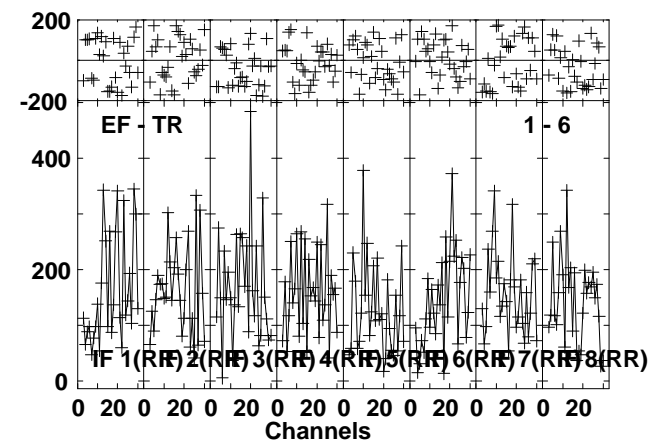
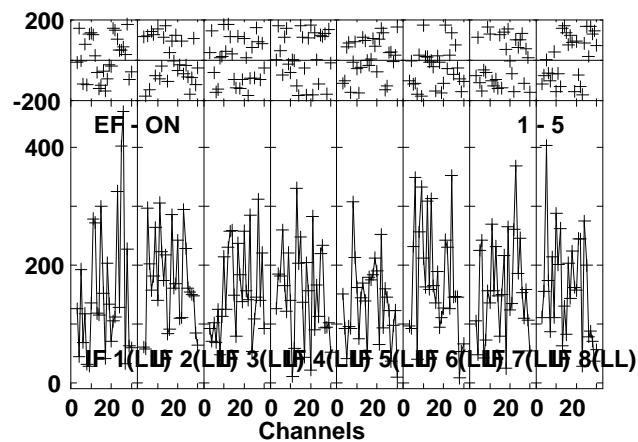
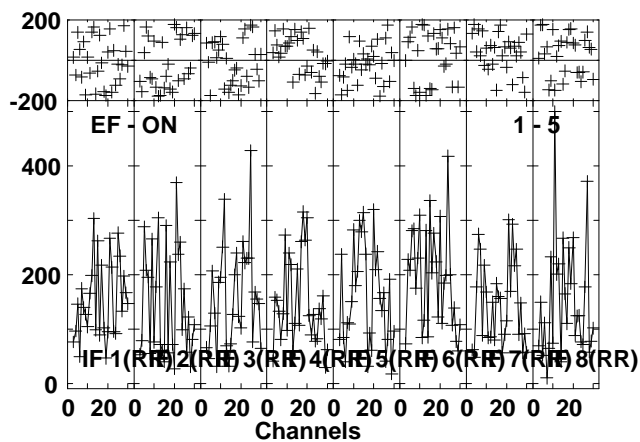
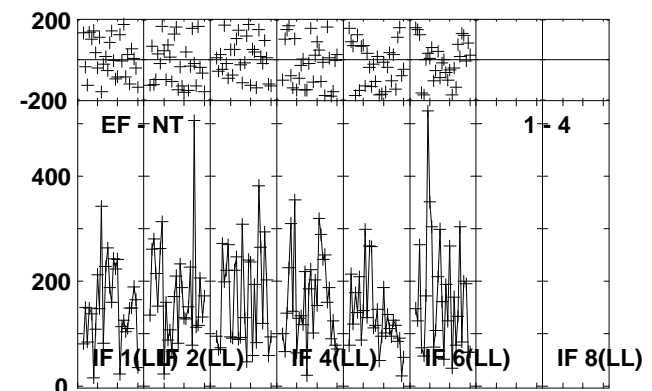
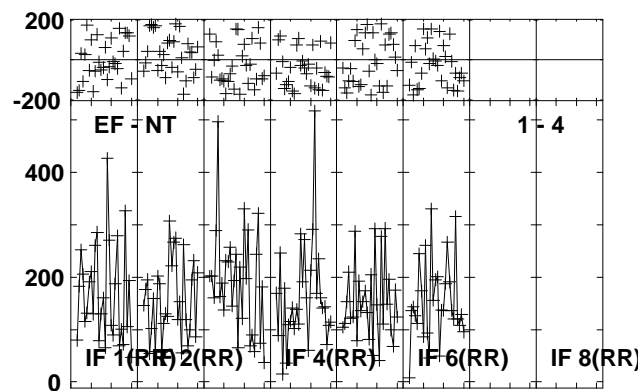
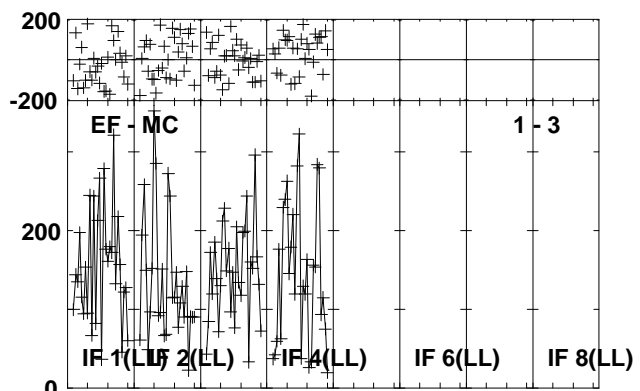
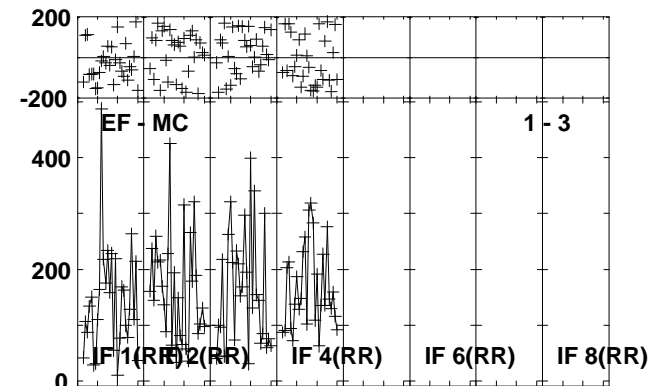
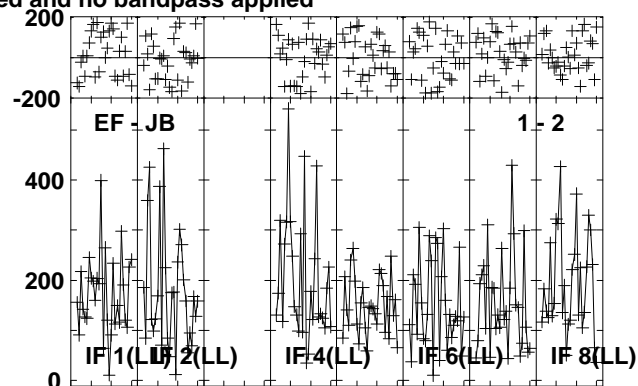
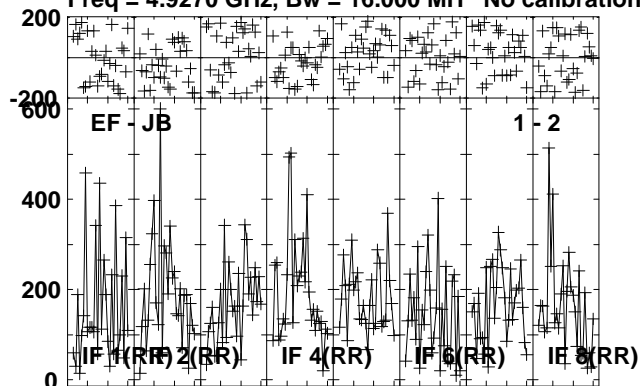

Lower frame: Micro Ampl Jy Top frame: Phas deg
Vector averaged cross-power spectrum Several baselines displayed
Timerange: 00/04:19:37 to 00/04:22:33

Plot file version 194 created 16-OCT-2012 11:57:29

NOVA-MON RO006.UVDATA.1

Freq = 4.9270 GHz, Bw = 16.000 MH No calibration applied and no bandpass applied

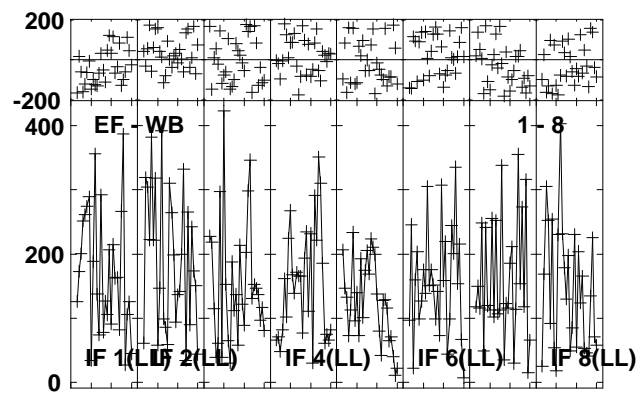
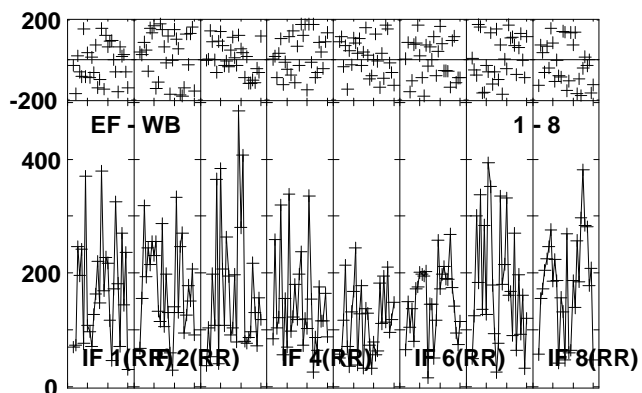
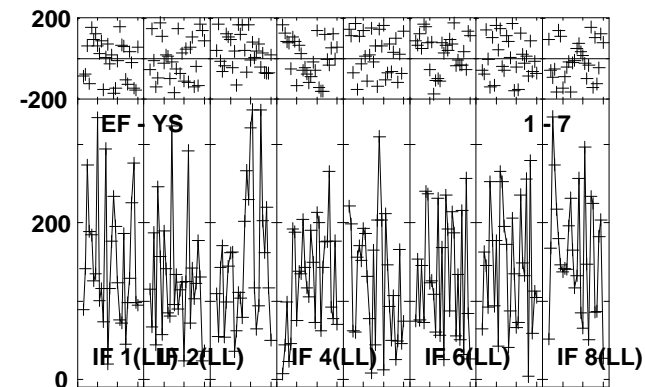
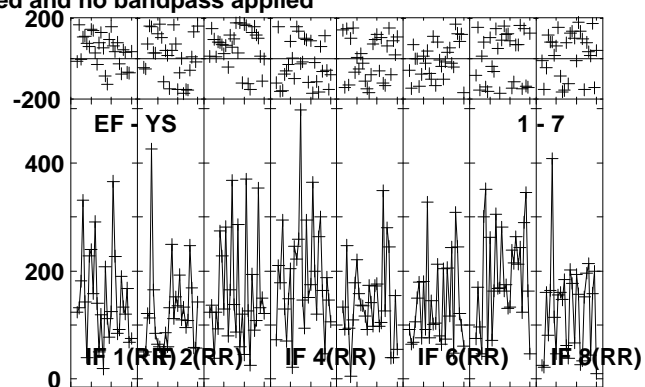
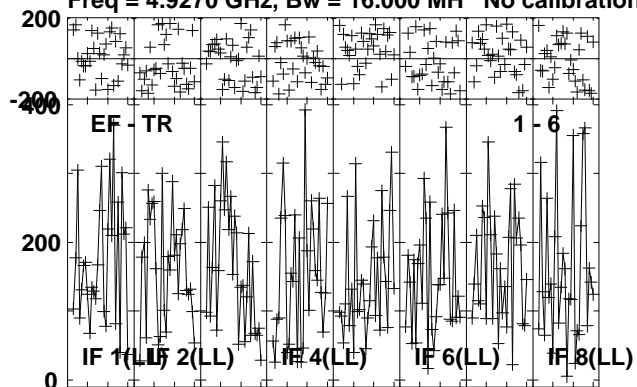

Lower frame: Micro Ampl Jy Top frame: Phas deg
Vector averaged cross-power spectrum Several baselines displayed
Timerange: 00/04:19:37 to 00/04:22:33

Plot file version 195 created 16-OCT-2012 11:57:29

J0639+0601 RO006.UVDATA.1

Freq = 4.9270 GHz, Bw = 16.000 MH No calibration applied and no bandpass applied

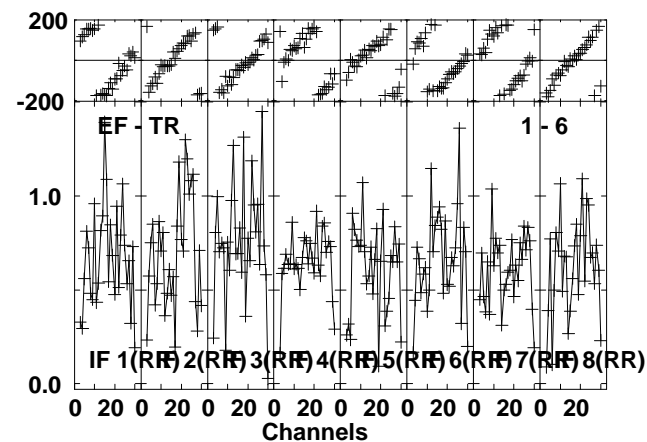
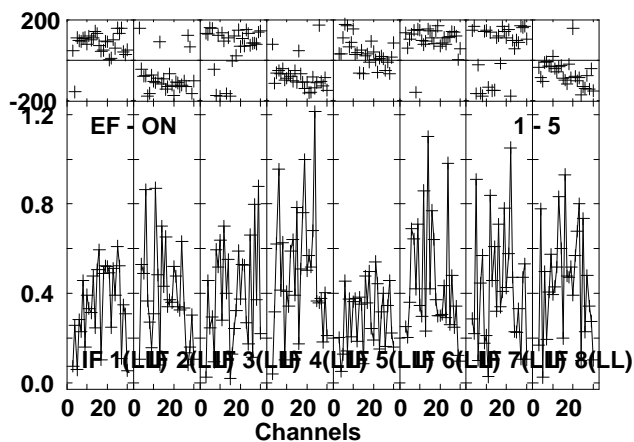
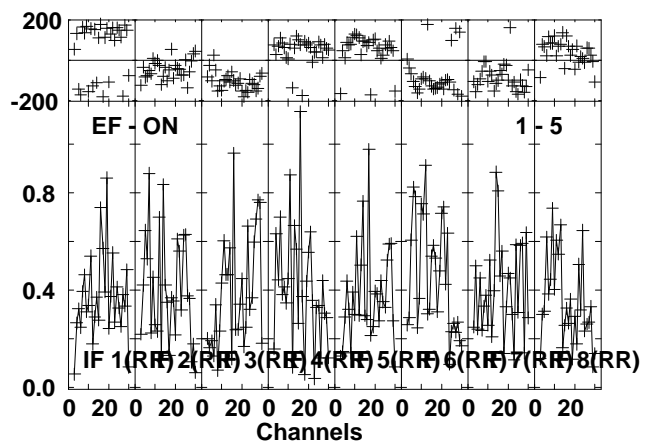
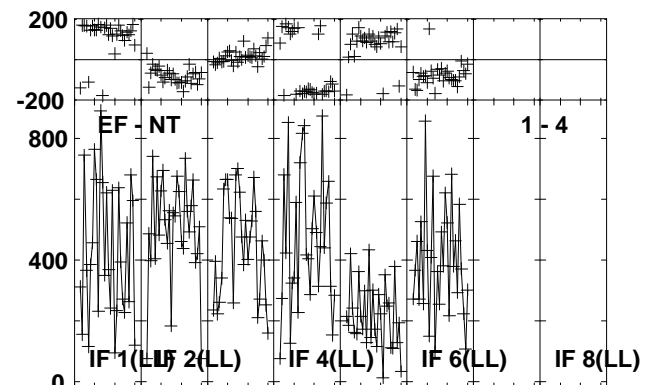
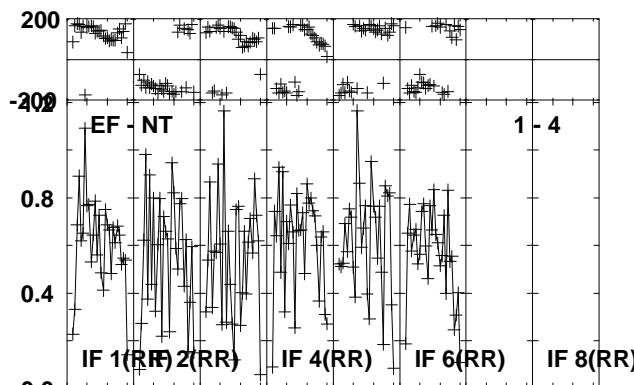
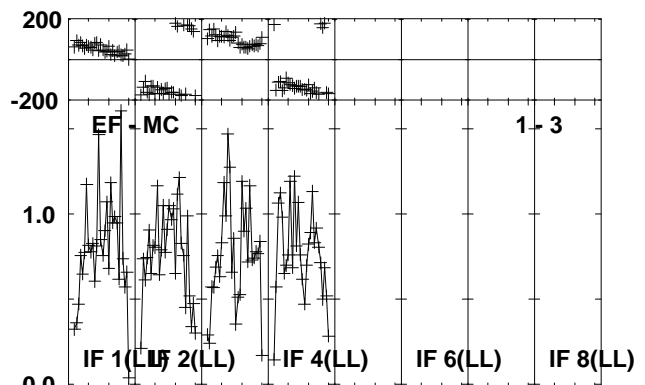
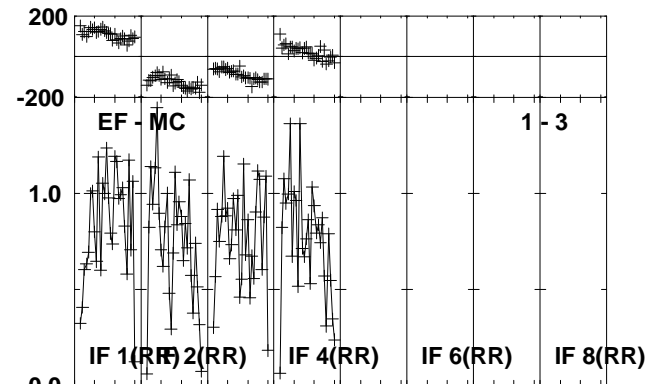
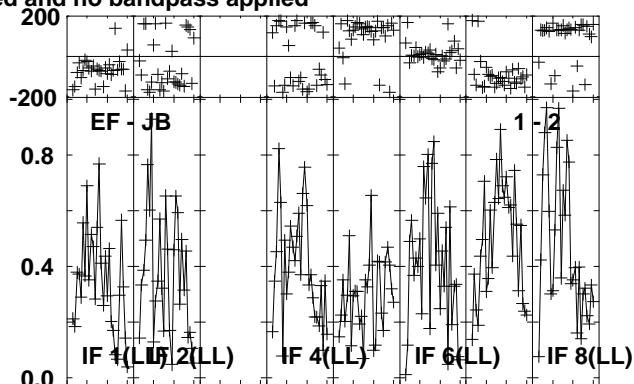
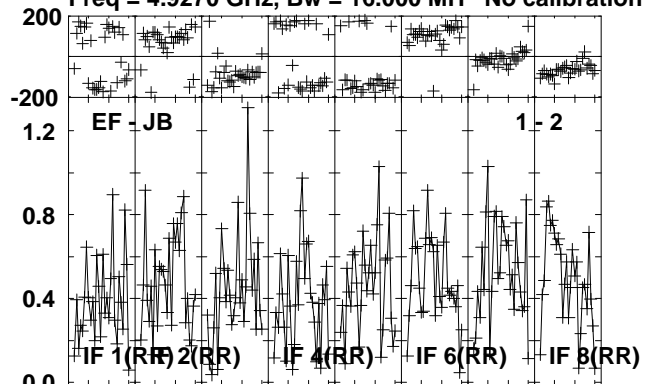

Lower frame: Milli Ampl Jy Top frame: Phas deg
Vector averaged cross-power spectrum Several baselines displayed
Timerange: 00/04:22:37 to 00/04:23:49

Plot file version 196 created 16-OCT-2012 11:57:29

J0639+0601 RO006.UVDATA.1

Freq = 4.9270 GHz, Bw = 16.000 MH No calibration applied and no bandpass applied

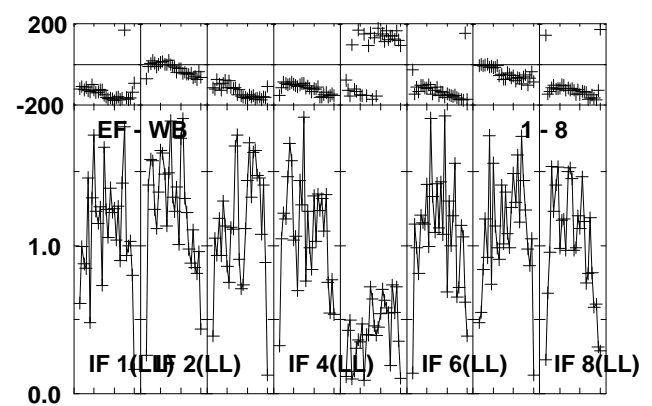
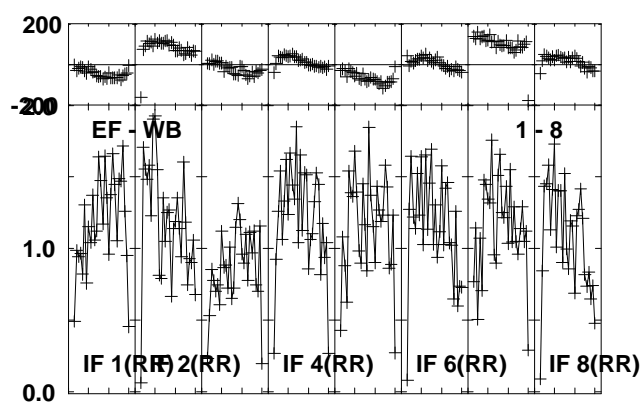
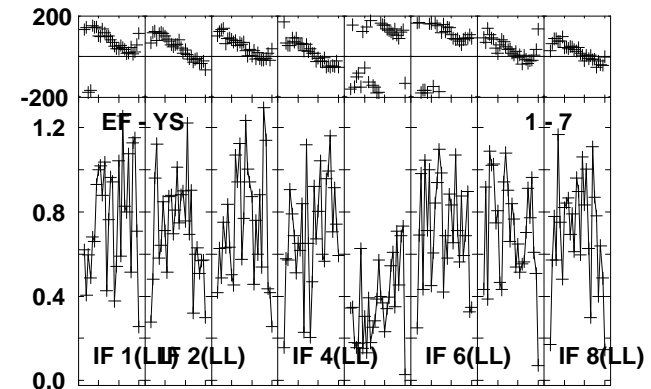
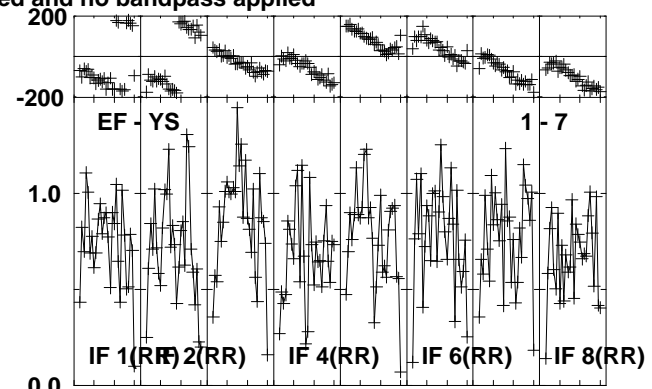
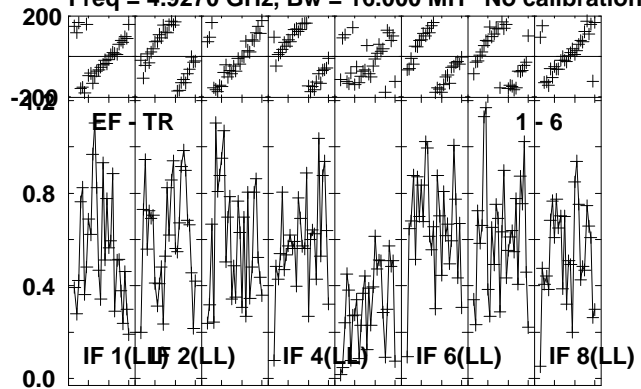

Lower frame: Milli Ampl Jy Top frame: Phas deg
Vector averaged cross-power spectrum Several baselines displayed
Timerange: 00/04:22:37 to 00/04:23:49

Plot file version 197 created 16-OCT-2012 11:57:29

J0645+0541 RO006.UVDATA.1

Freq = 4.9270 GHz, Bw = 16.000 MH No calibration applied and no bandpass applied

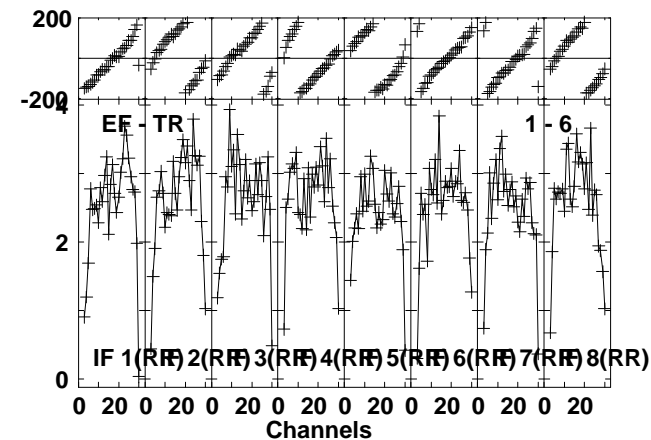
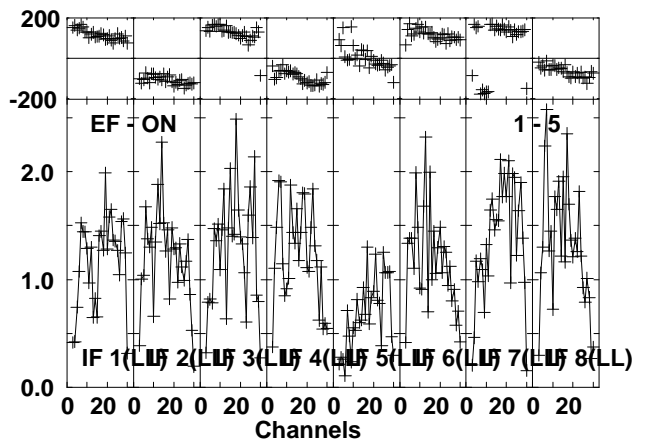
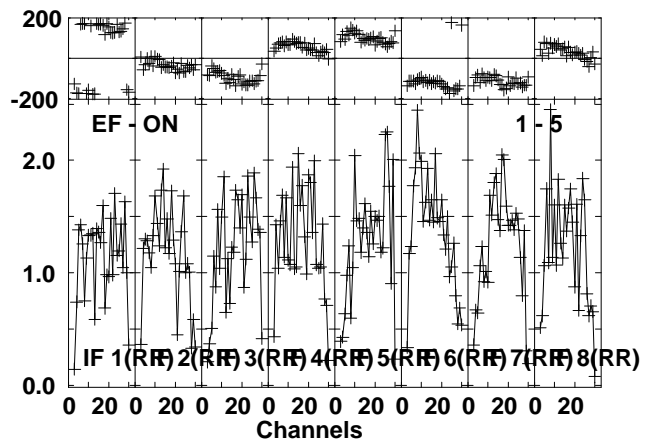
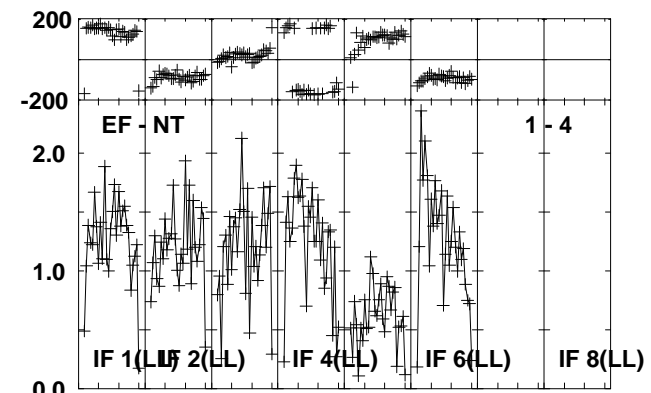
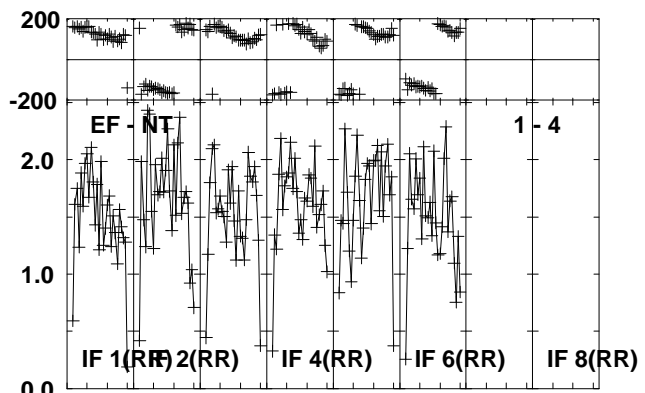
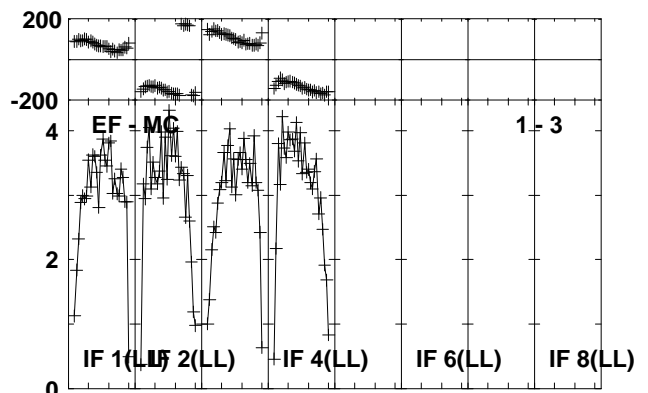
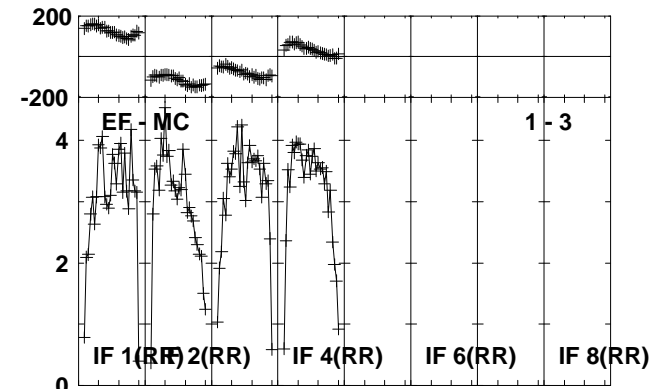
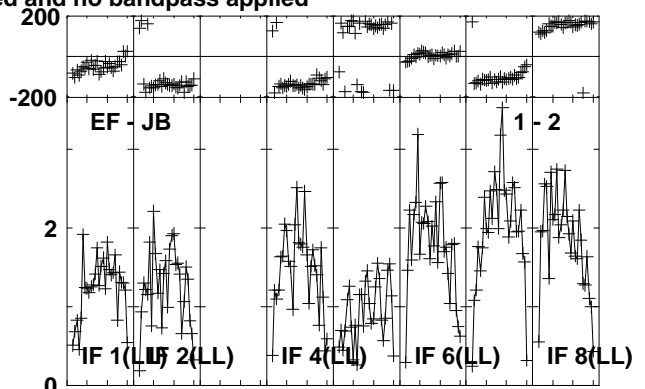
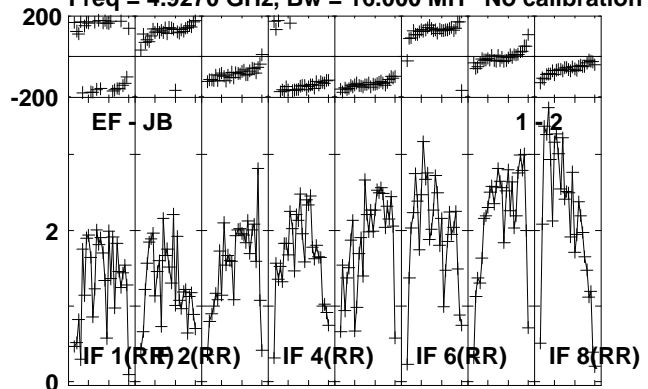

Lower frame: Milli Ampl Jy Top frame: Phas deg
Vector averaged cross-power spectrum Several baselines displayed
Timerange: 00/04:23:53 to 00/04:24:49

Plot file version 198 created 16-OCT-2012 11:57:30

J0645+0541 RO006.UVDATA.1

Freq = 4.9270 GHz, Bw = 16.000 MH No calibration applied and no bandpass applied

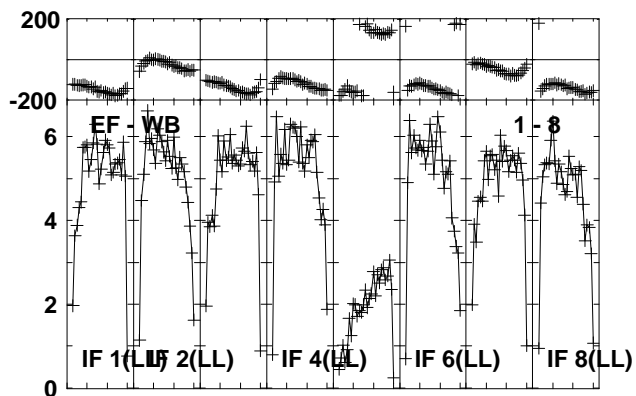
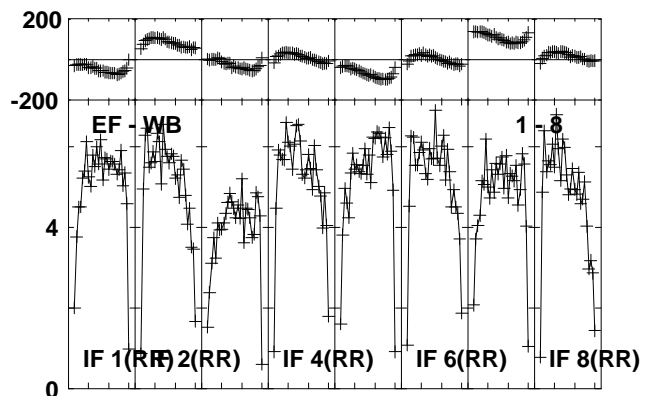
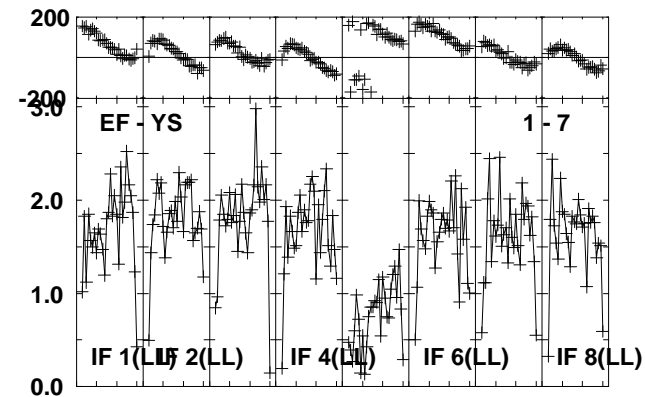
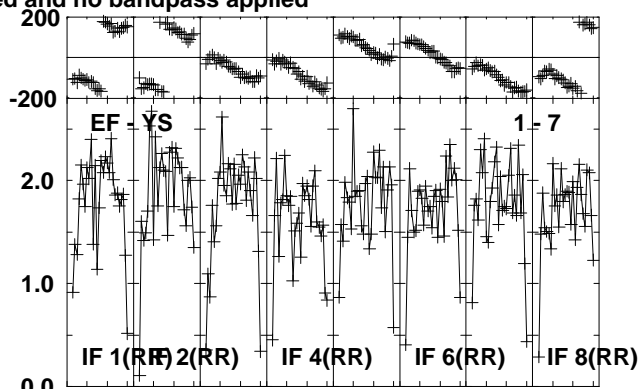
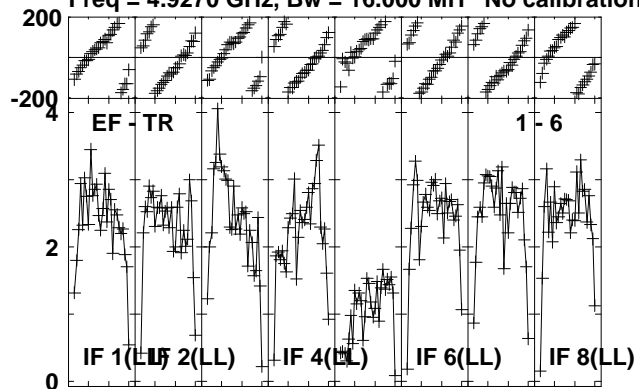

Lower frame: Milli Ampl Jy Top frame: Phas deg
Vector averaged cross-power spectrum Several baselines displayed
Timerange: 00/04:23:53 to 00/04:24:49

Plot file version 199 created 16-OCT-2012 11:57:30

NOVA-MON RO006.UVDATA.1

Freq = 4.9270 GHz, Bw = 16.000 MH No calibration applied and no bandpass applied

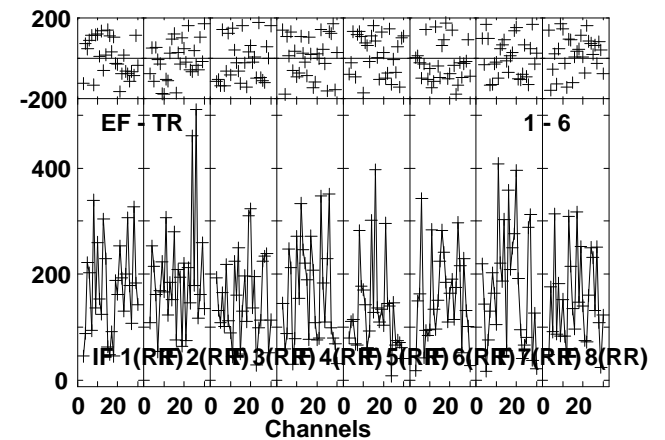
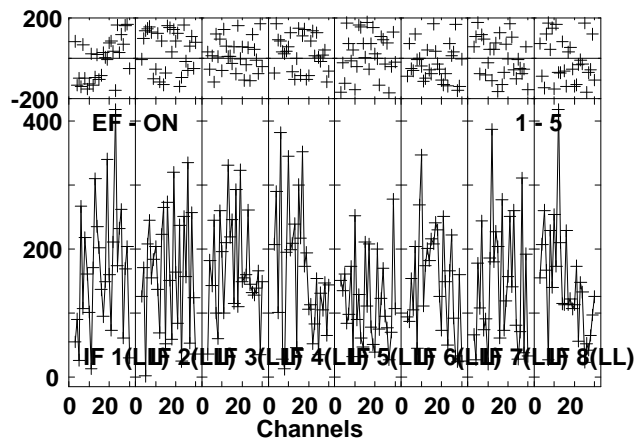
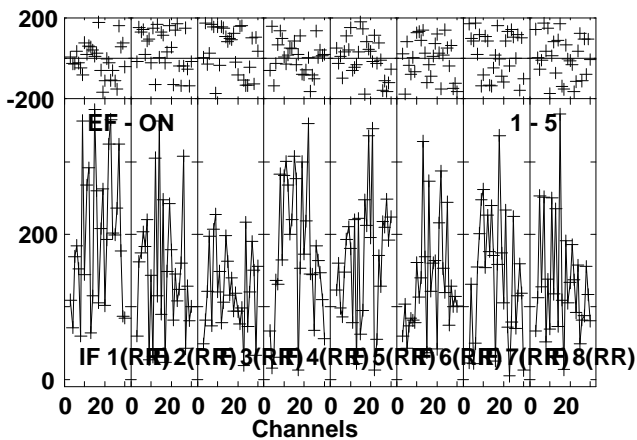
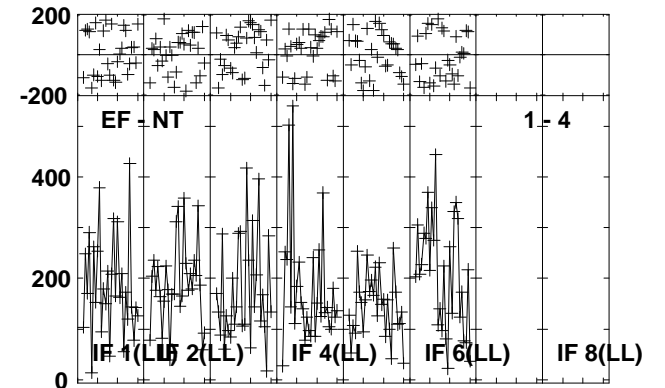
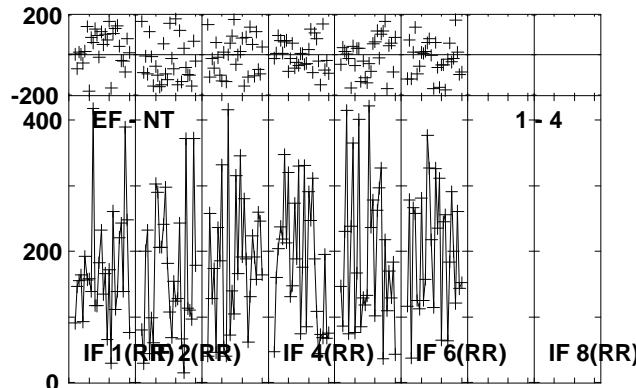
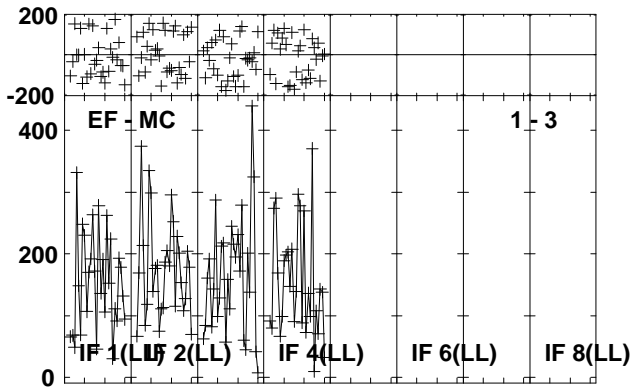
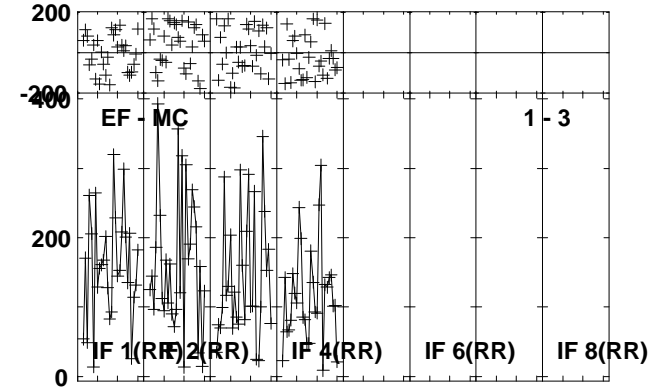
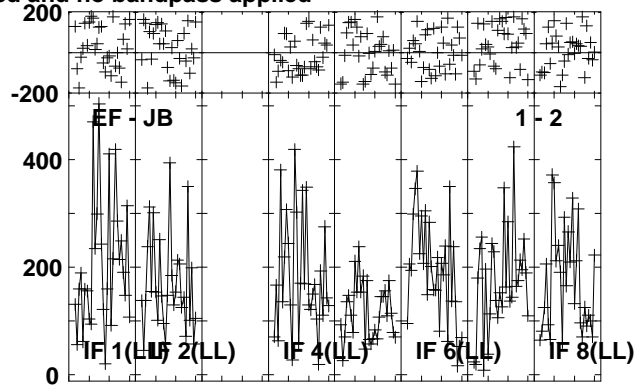
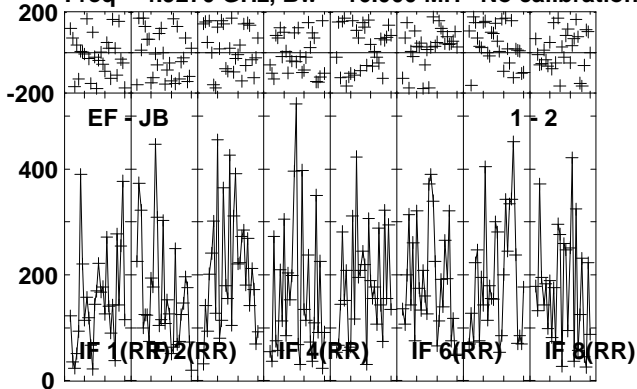

Lower frame: Micro Ampl Jy Top frame: Phas deg
Vector averaged cross-power spectrum Several baselines displayed
Timerange: 00/04:24:53 to 00/04:27:49

Plot file version 200 created 16-OCT-2012 11:57:30

NOVA-MON RO006.UVDATA.1

Freq = 4.9270 GHz, Bw = 16.000 MH No calibration applied and no bandpass applied

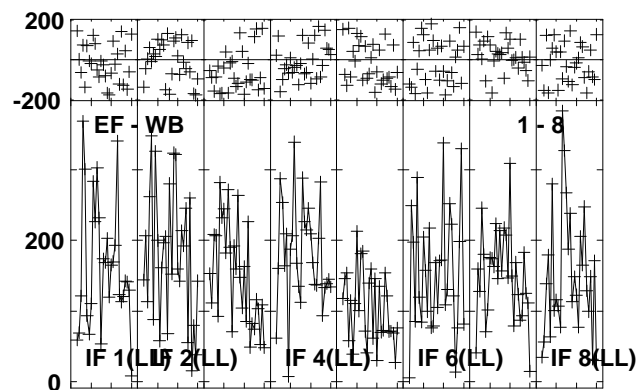
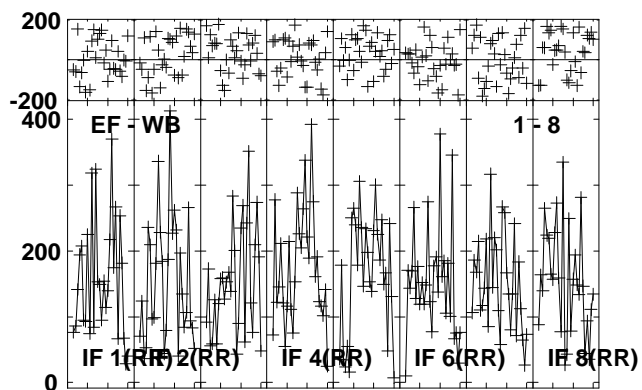
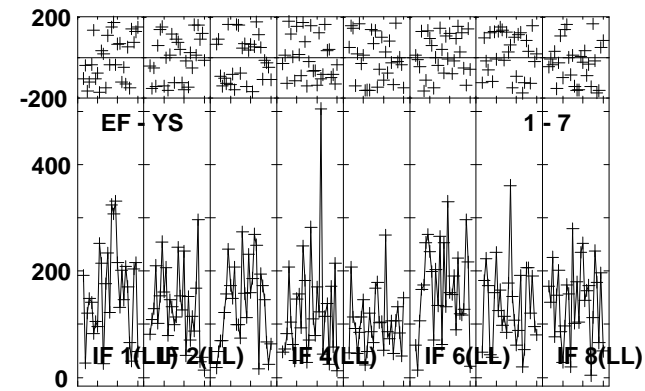
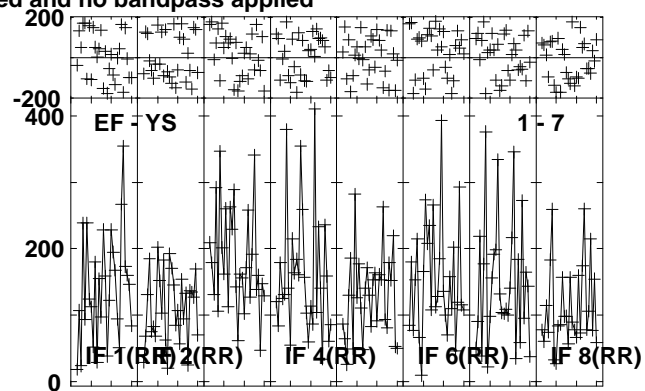
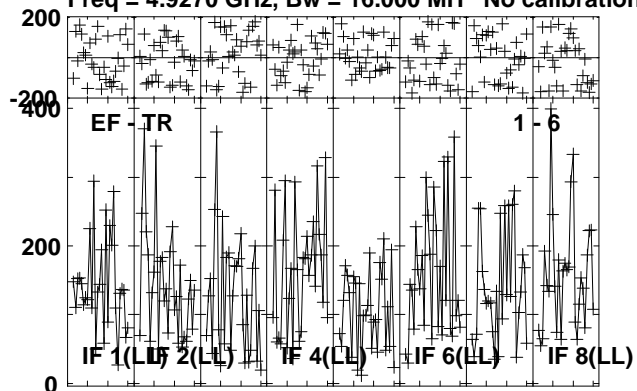

Lower frame: Micro Ampl Jy Top frame: Phas deg
Vector averaged cross-power spectrum Several baselines displayed
Timerange: 00/04:24:53 to 00/04:27:49

Plot file version 201 created 16-OCT-2012 11:57:31

J0639+0601 RO006.UVDATA.1

Freq = 4.9270 GHz, Bw = 16.000 MH No calibration applied and no bandpass applied

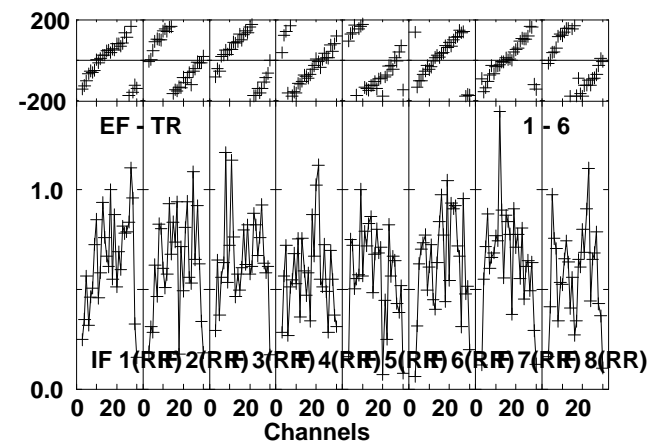
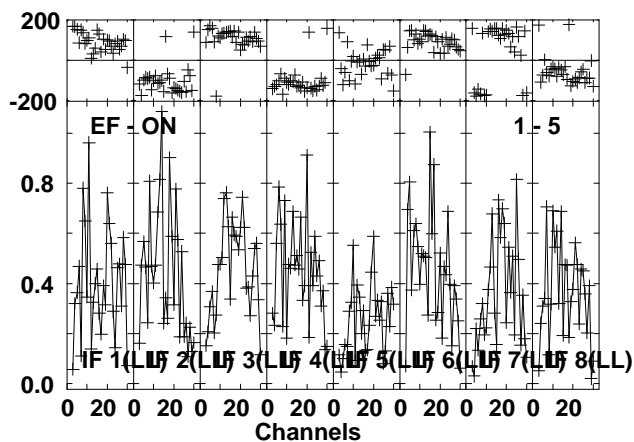
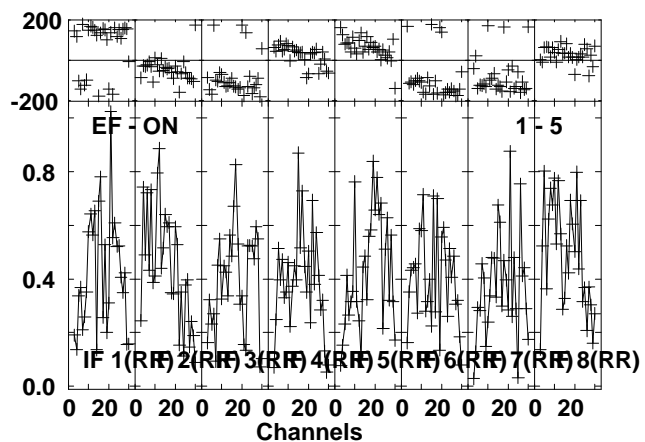
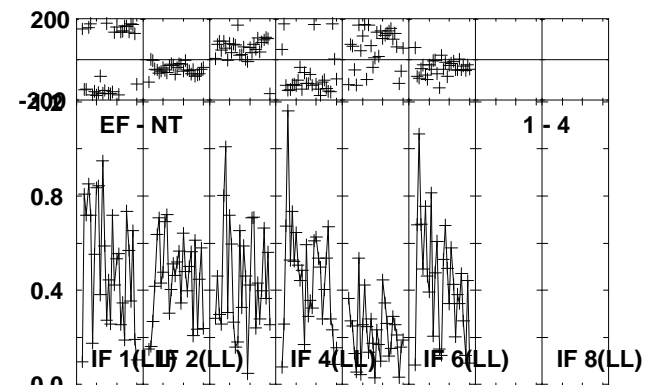
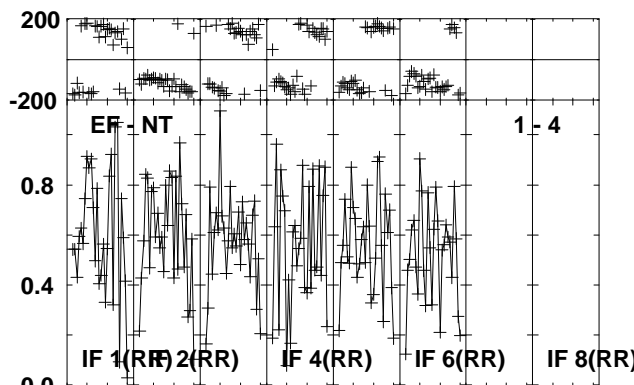
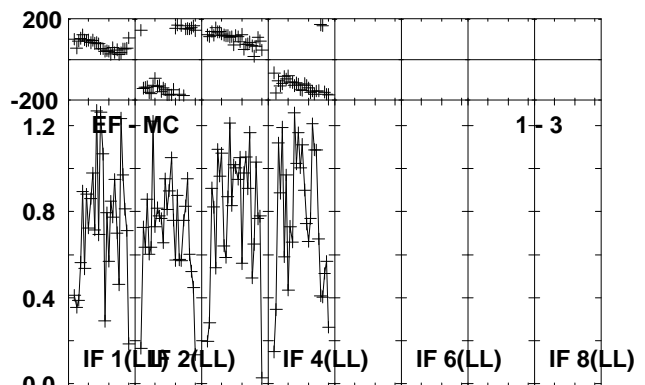
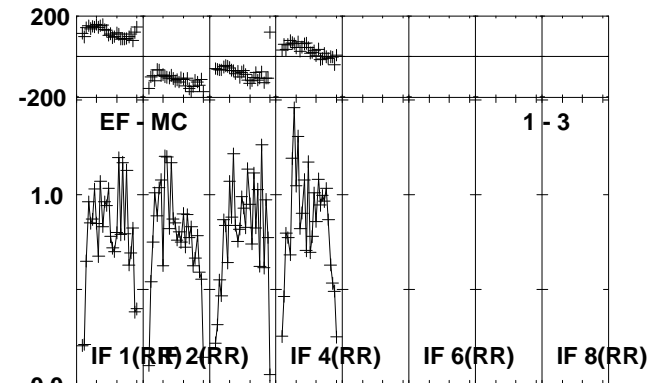
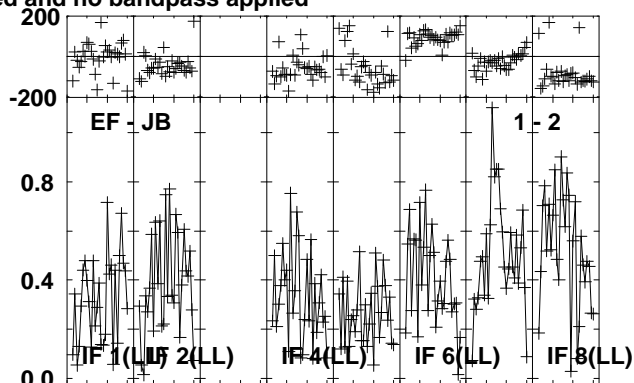
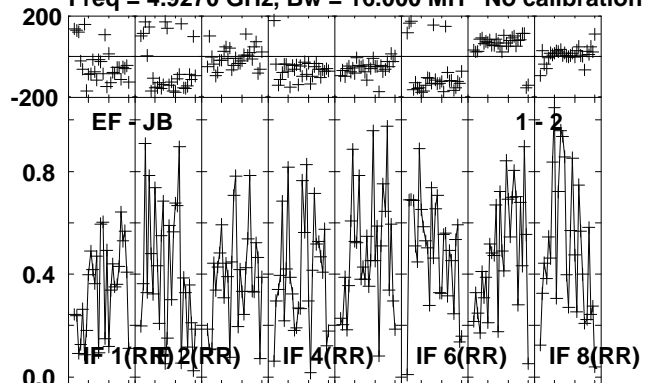

Lower frame: Milli Ampl Jy Top frame: Phas deg
Vector averaged cross-power spectrum Several baselines displayed
Timerange: 00/04:28:17 to 00/04:29:19

Plot file version 202 created 16-OCT-2012 11:57:31

J0639+0601 RO006.UVDATA.1

Freq = 4.9270 GHz, Bw = 16.000 MH No calibration applied and no bandpass applied

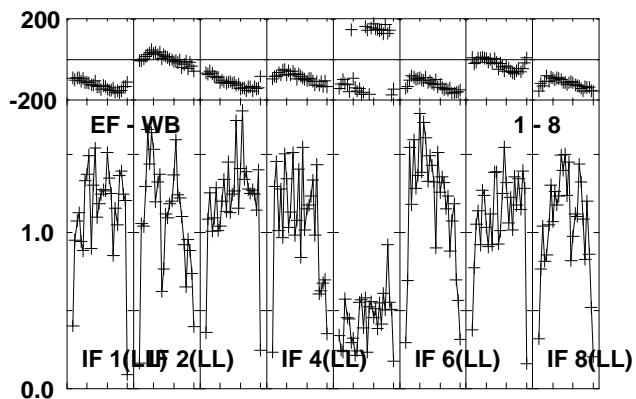
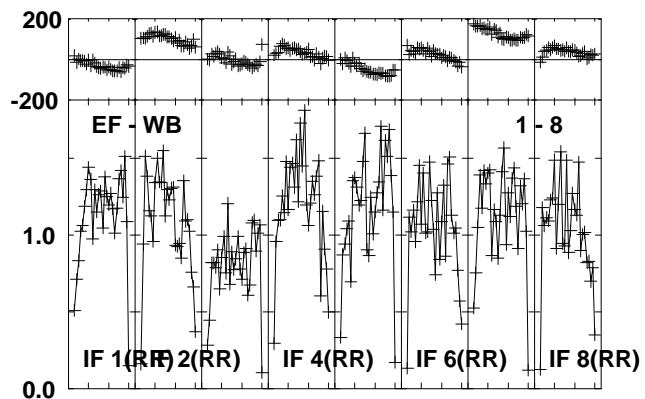
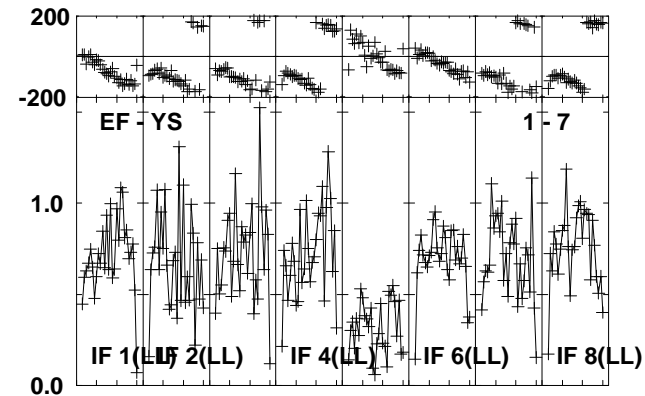
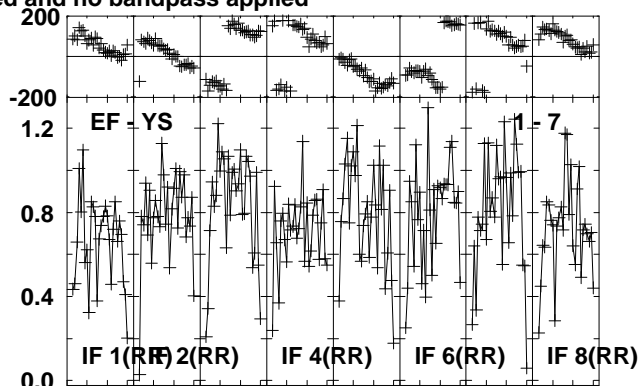
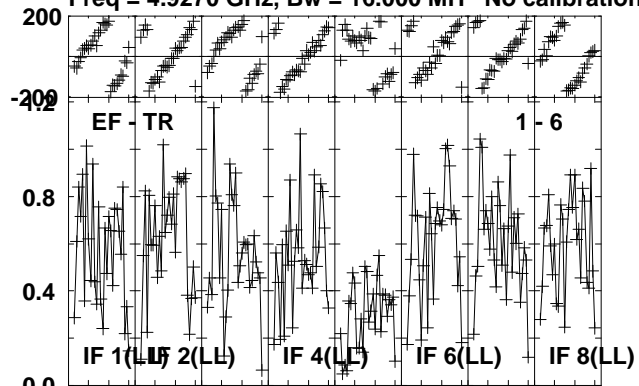

Lower frame: Milli Ampl Jy Top frame: Phas deg
Vector averaged cross-power spectrum Several baselines displayed
Timerange: 00/04:28:17 to 00/04:29:19

Plot file version 203 created 16-OCT-2012 11:57:31

0528+134 RO006.UVDATA.1

Freq = 4.9270 GHz, Bw = 16.000 MH No calibration applied and no bandpass applied

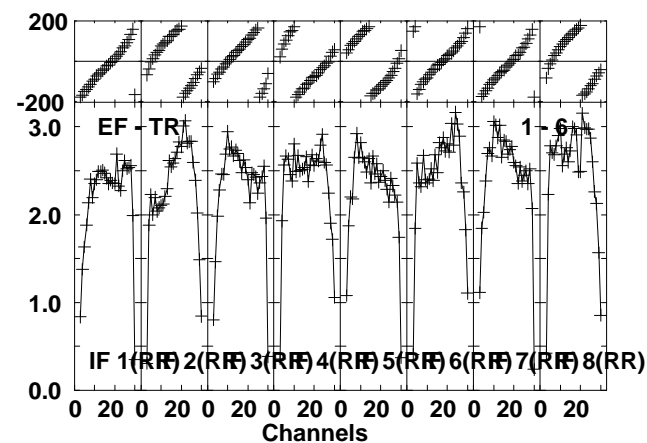
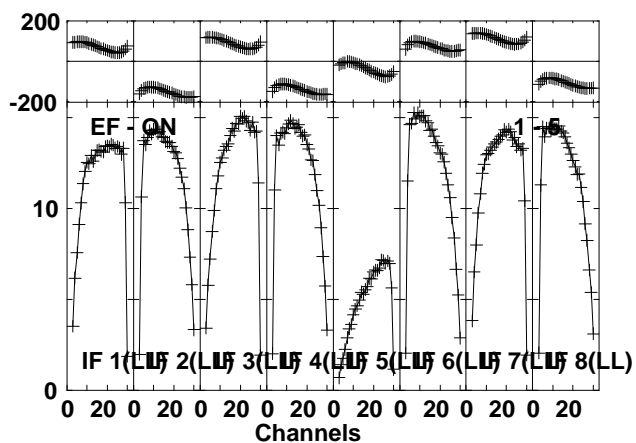
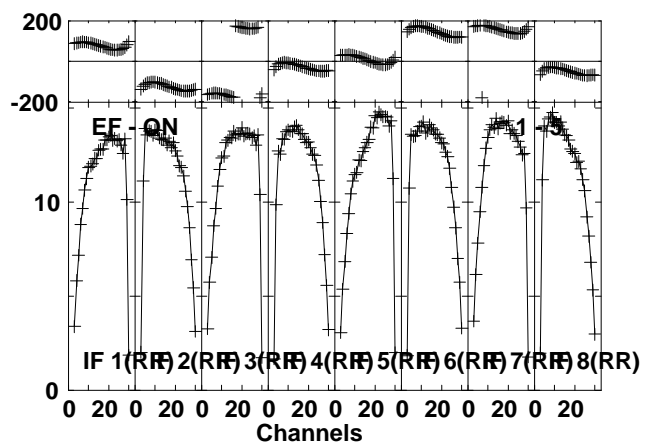
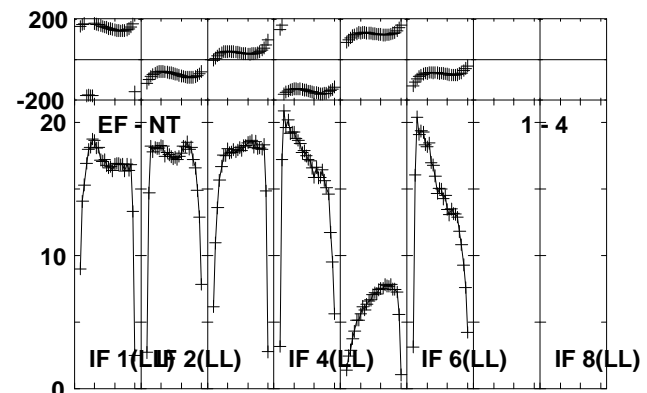
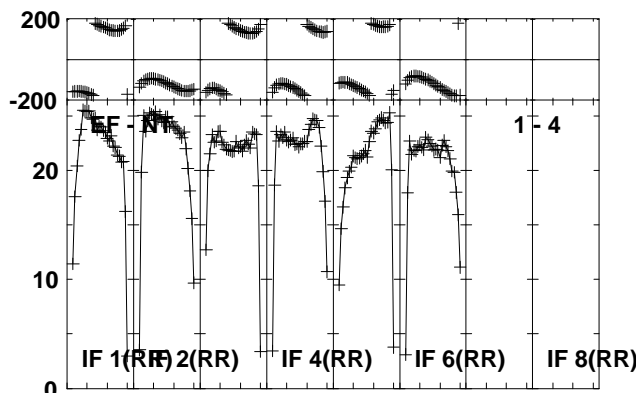
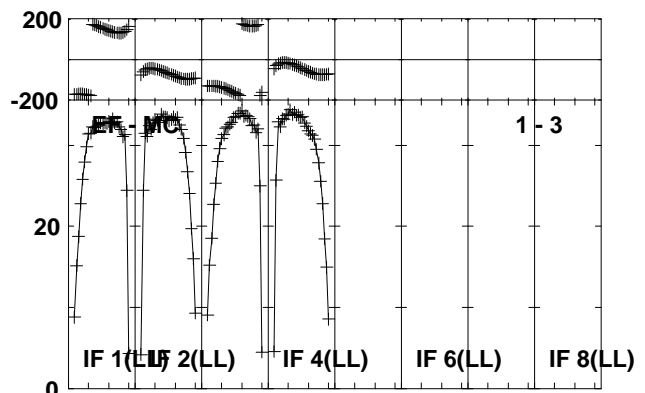
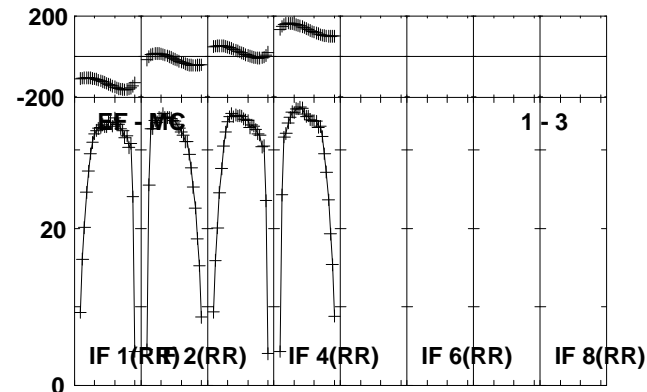
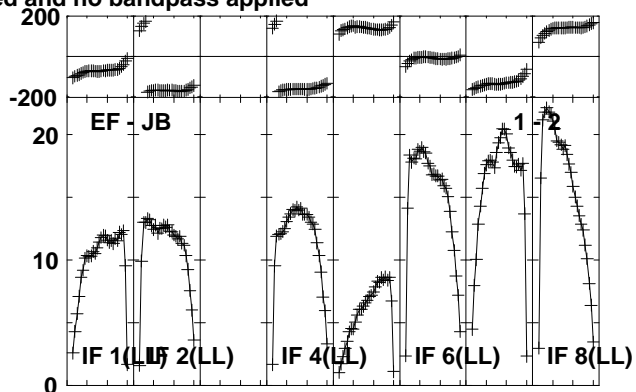
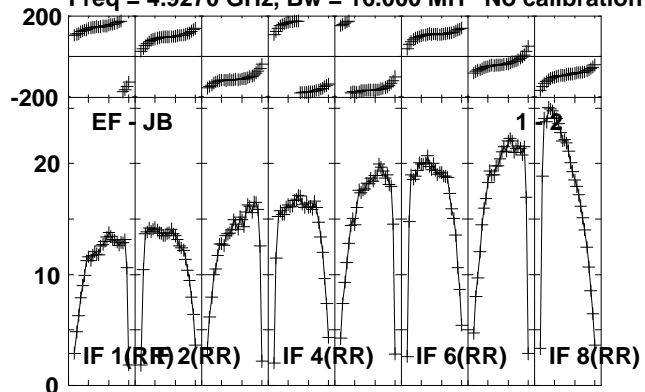

Lower frame: Milli Ampl Jy Top frame: Phas deg
Vector averaged cross-power spectrum Several baselines displayed
Timerange: 00/04:31:17 to 00/04:34:19

Plot file version 204 created 16-OCT-2012 11:57:32

0528+134 RO006.UVDATA.1

Freq = 4.9270 GHz, Bw = 16.000 MH No calibration applied and no bandpass applied

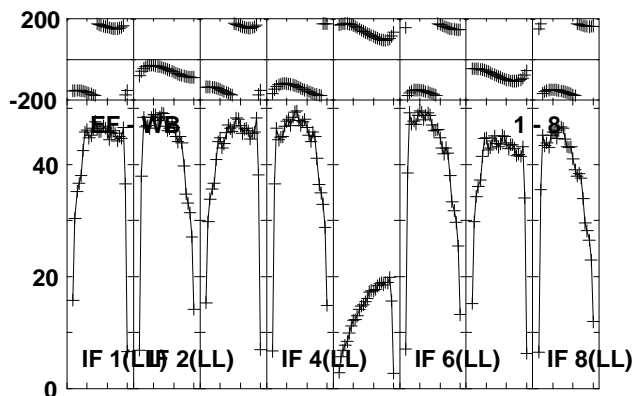
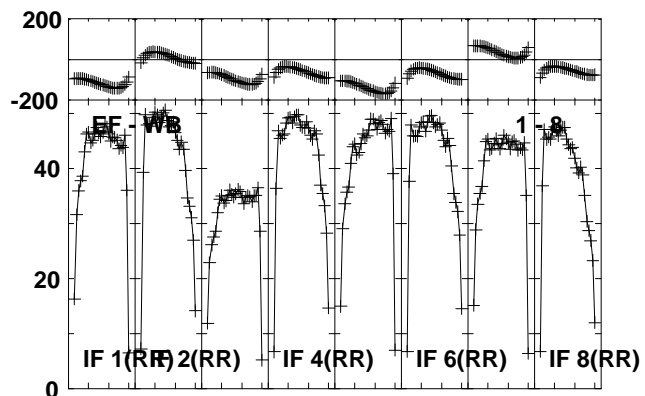
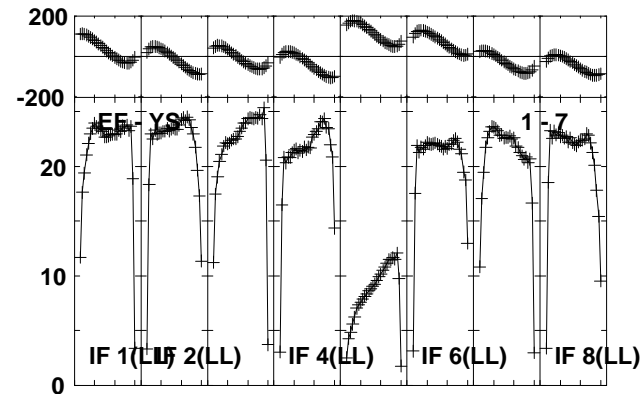
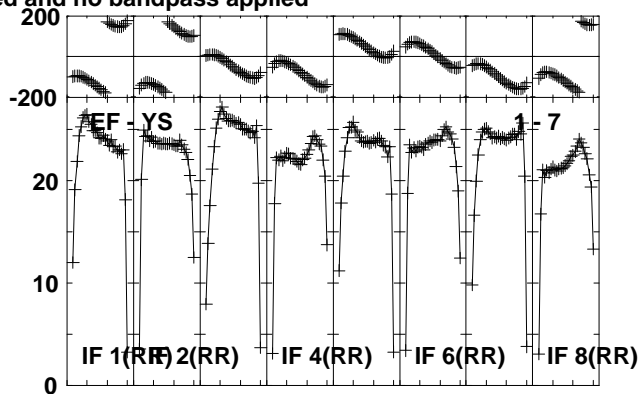
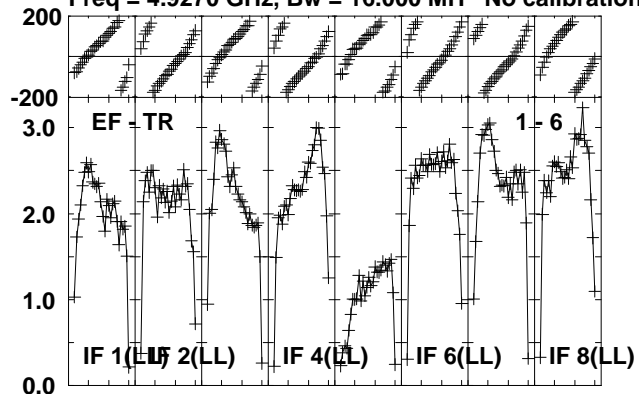

Lower frame: Milli Ampl Jy Top frame: Phas deg
Vector averaged cross-power spectrum Several baselines displayed
Timerange: 00/04:31:17 to 00/04:34:19

Plot file version 205 created 16-OCT-2012 11:57:32

J0645+0541 RO006.UVDATA.1

Freq = 4.9270 GHz, Bw = 16.000 MH No calibration applied and no bandpass applied

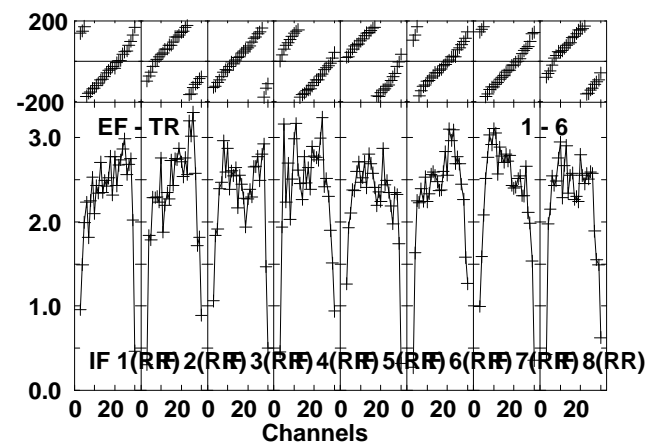
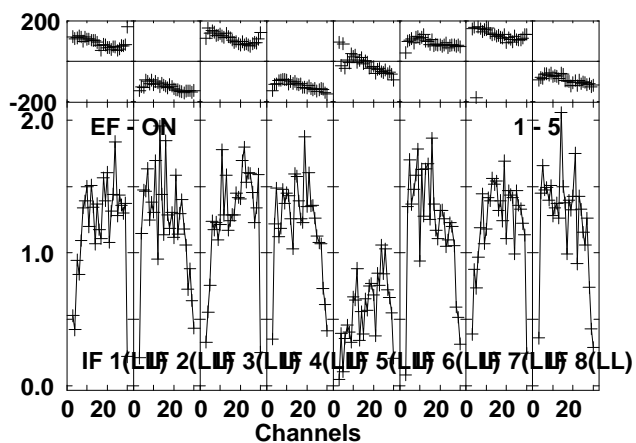
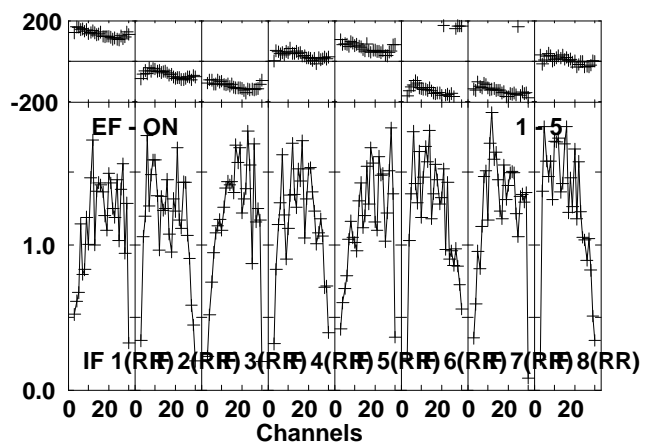
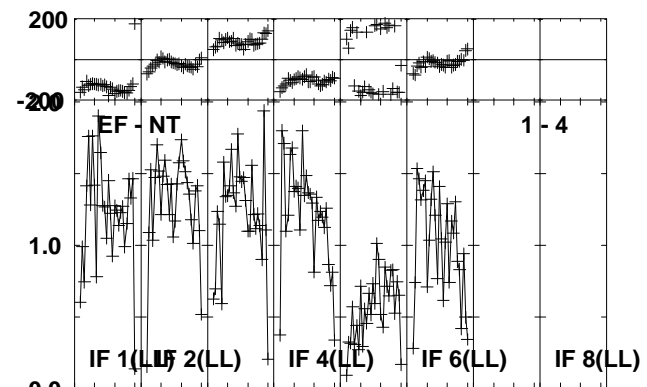
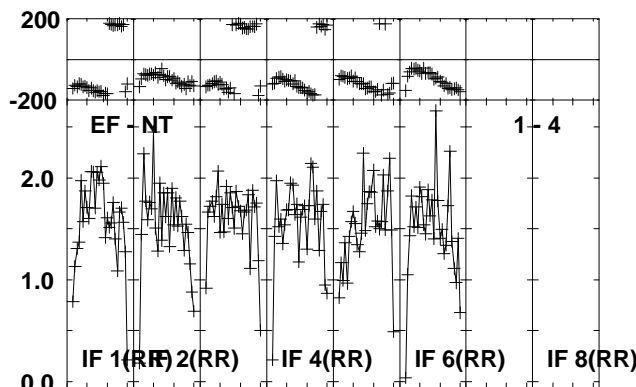
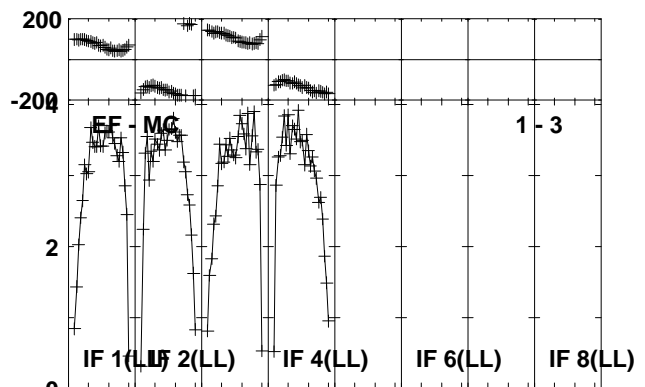
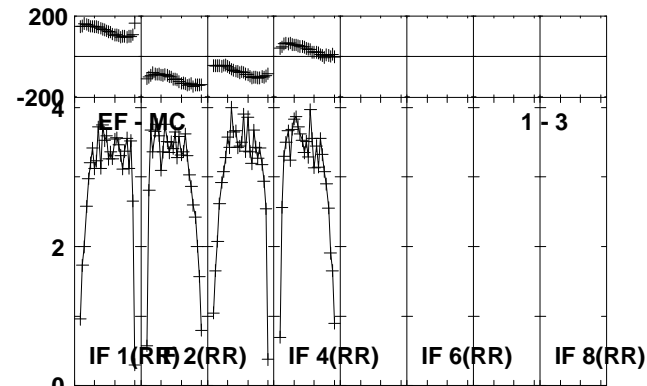
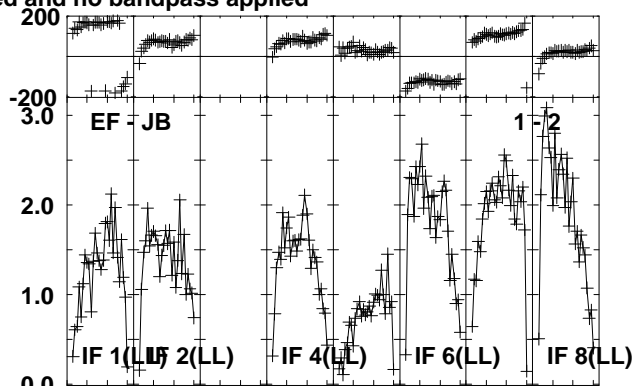
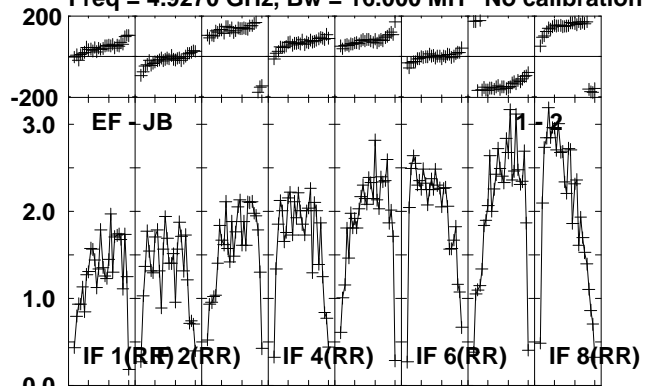

Lower frame: Milli Ampl Jy Top frame: Phas deg
Vector averaged cross-power spectrum Several baselines displayed
Timerange: 00/04:36:17 to 00/04:37:19

Plot file version 206 created 16-OCT-2012 11:57:32

J0645+0541 RO006.UVDATA.1

Freq = 4.9270 GHz, Bw = 16.000 MH No calibration applied and no bandpass applied

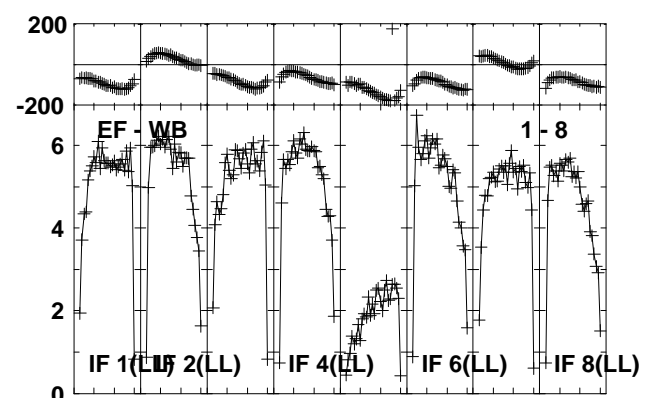
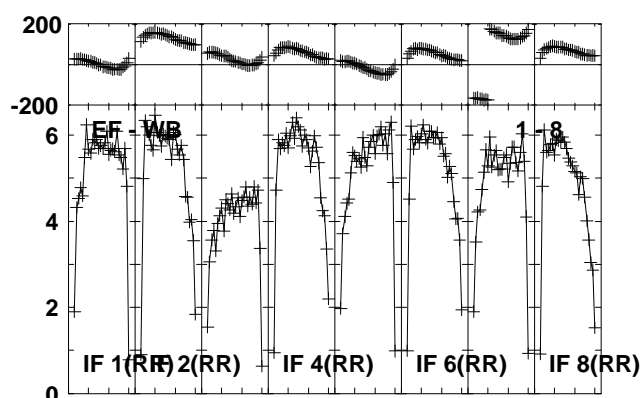
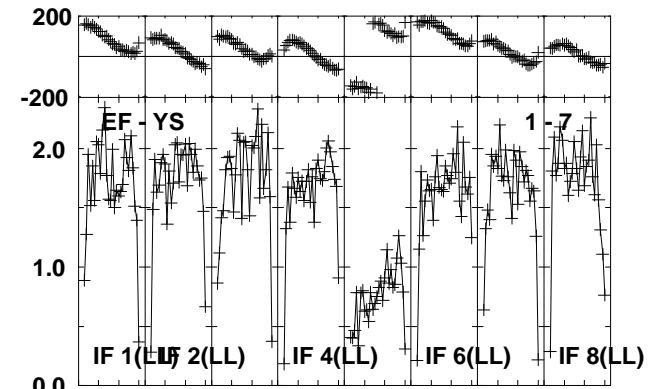
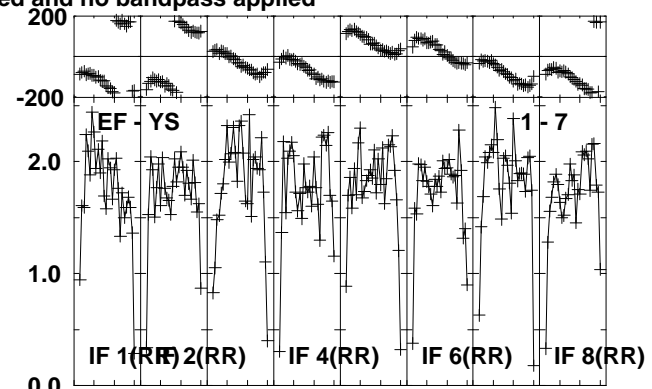
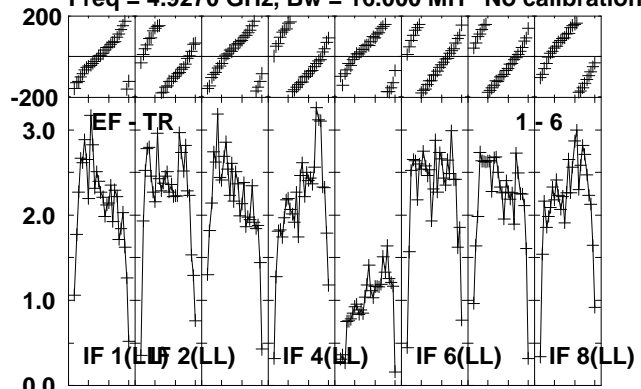

Lower frame: Milli Ampl Jy Top frame: Phas deg
Vector averaged cross-power spectrum Several baselines displayed
Timerange: 00/04:36:17 to 00/04:37:19

Plot file version 207 created 16-OCT-2012 11:57:33

NOVA-MON RO006.UVDATA.1

Freq = 4.9270 GHz, Bw = 16.000 MH No calibration applied and no bandpass applied

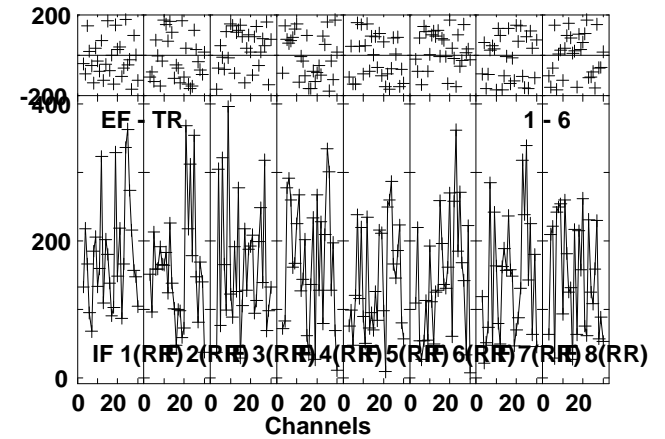
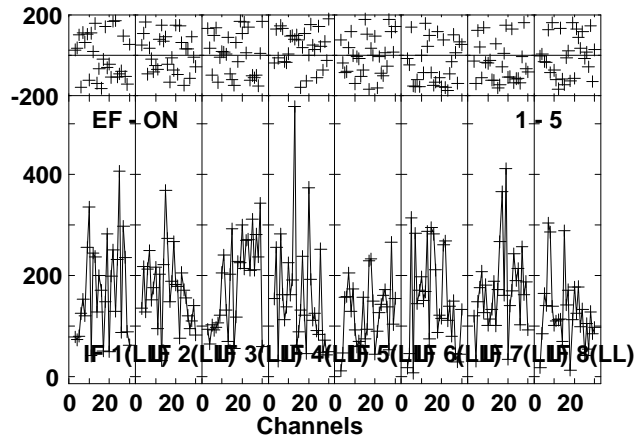
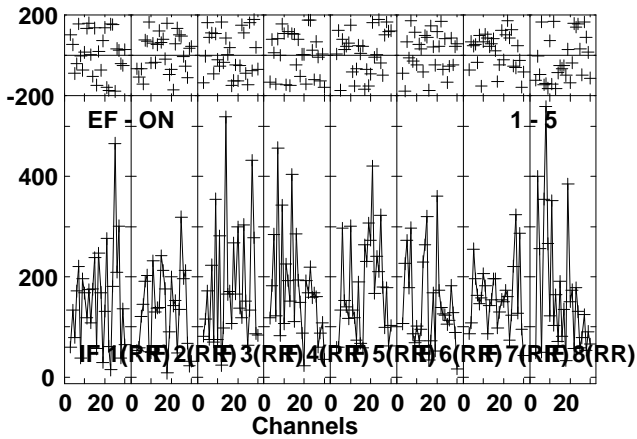
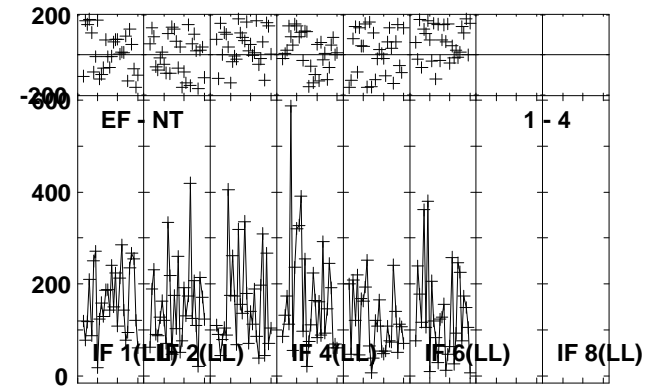
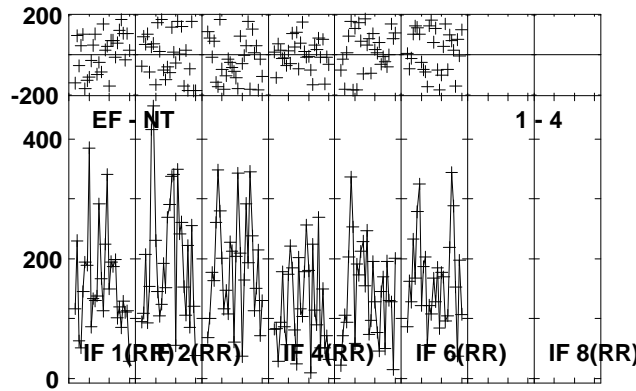
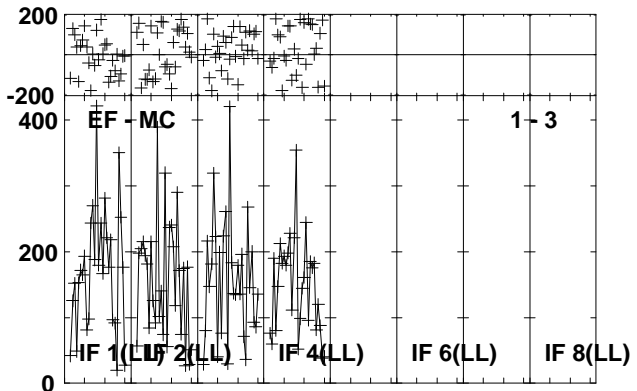
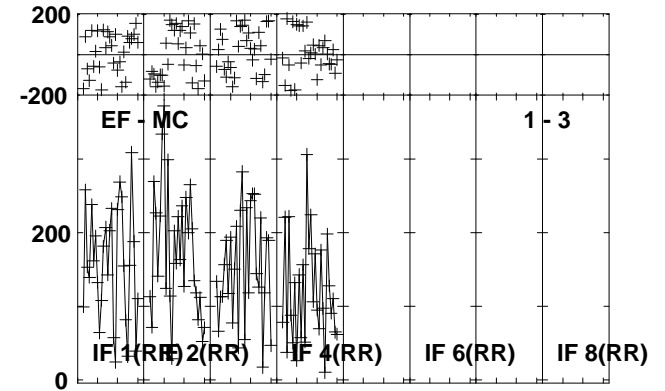
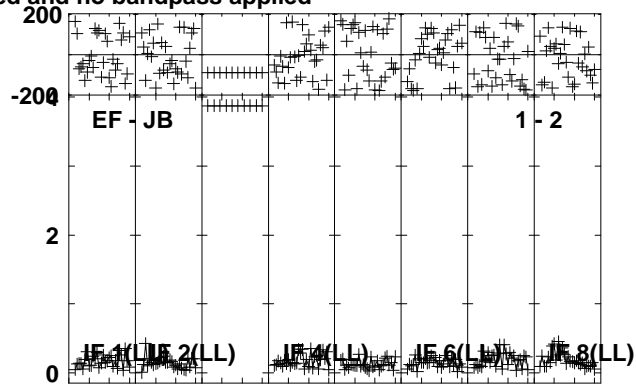
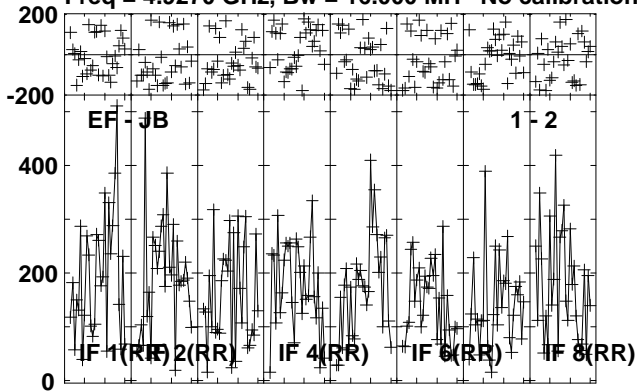

Lower frame: Micro Ampl Jy Top frame: Phas deg
Vector averaged cross-power spectrum Several baselines displayed
Timerange: 00/04:37:23 to 00/04:40:19

Plot file version 208 created 16-OCT-2012 11:57:33

NOVA-MON RO006.UVDATA.1

Freq = 4.9270 GHz, Bw = 16.000 MH No calibration applied and no bandpass applied

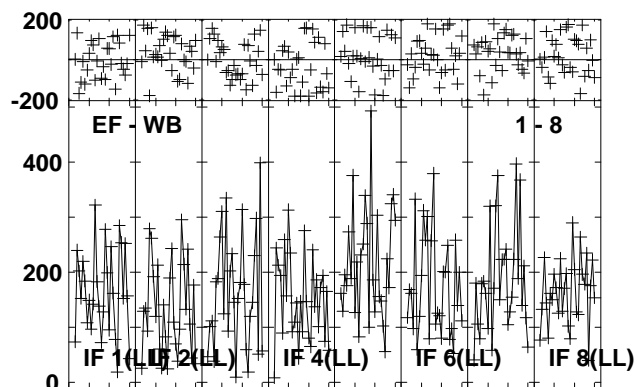
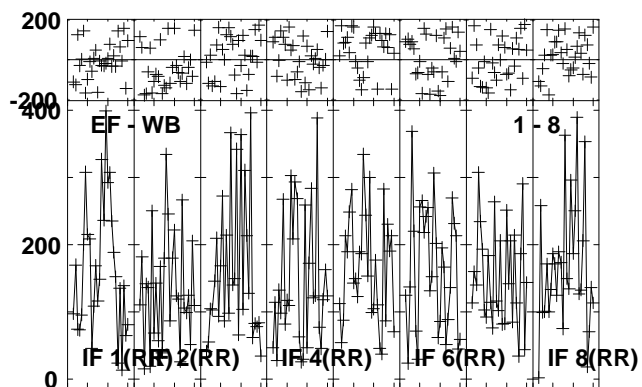
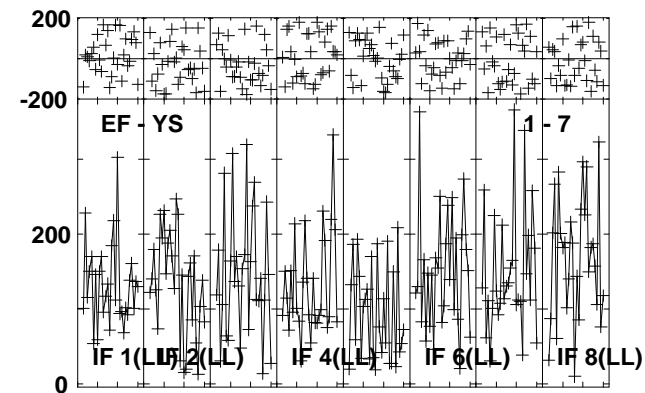
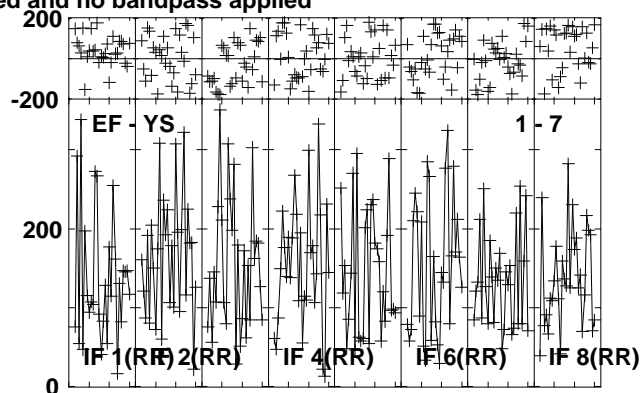
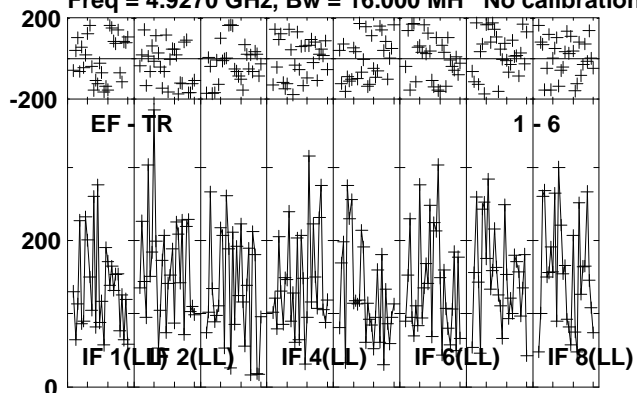

Lower frame: Micro Ampl Jy Top frame: Phas deg
Vector averaged cross-power spectrum Several baselines displayed
Timerange: 00/04:37:23 to 00/04:40:19

Plot file version 209 created 16-OCT-2012 11:57:34

J0639+0601 RO006.UVDATA.1

Freq = 4.9270 GHz, Bw = 16.000 MH No calibration applied and no bandpass applied

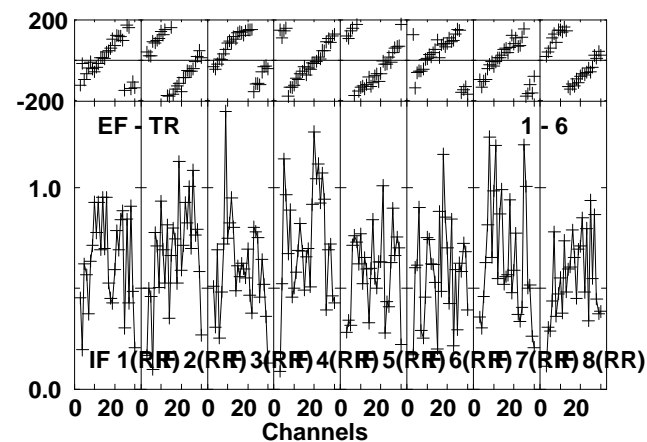
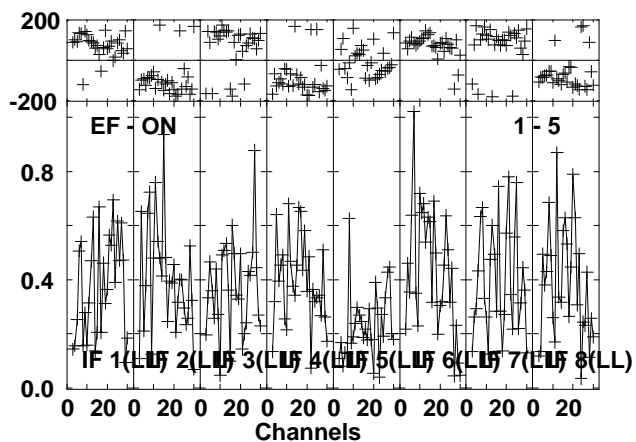
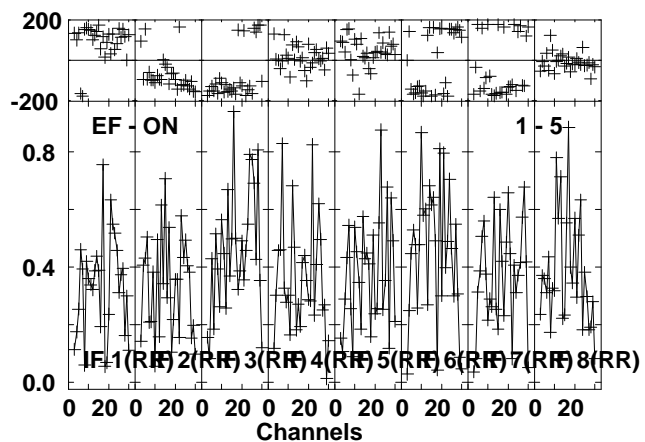
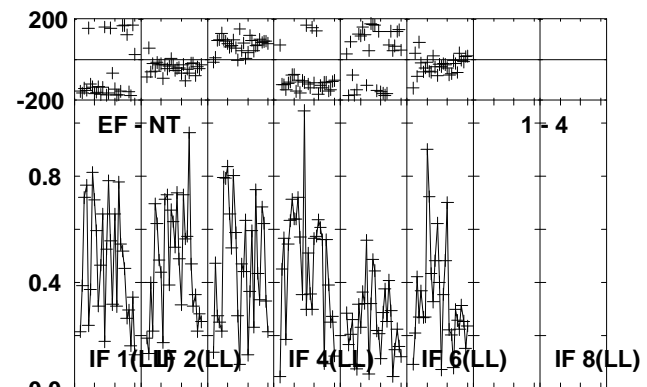
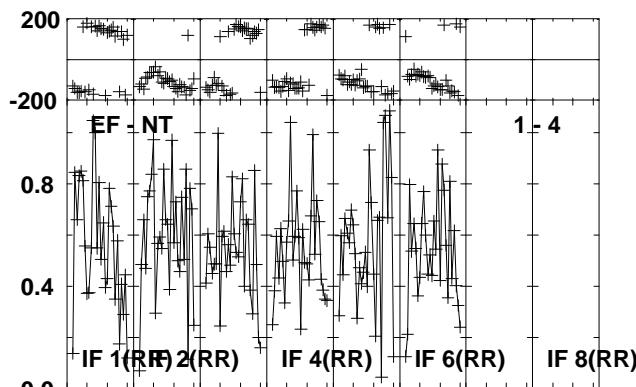
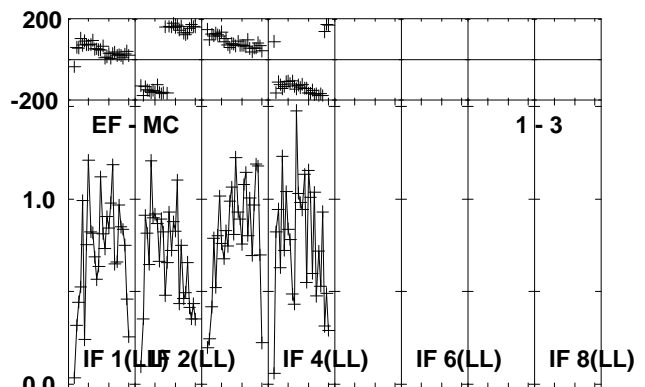
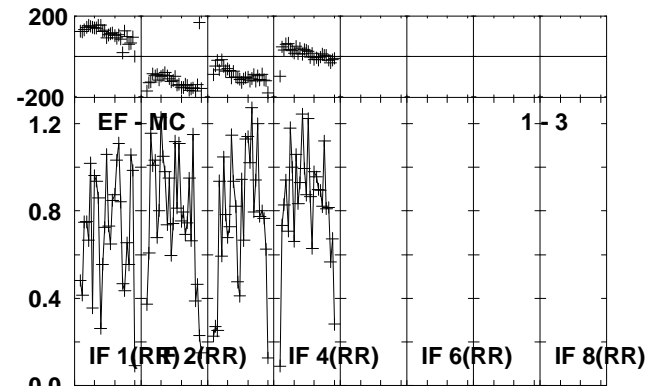
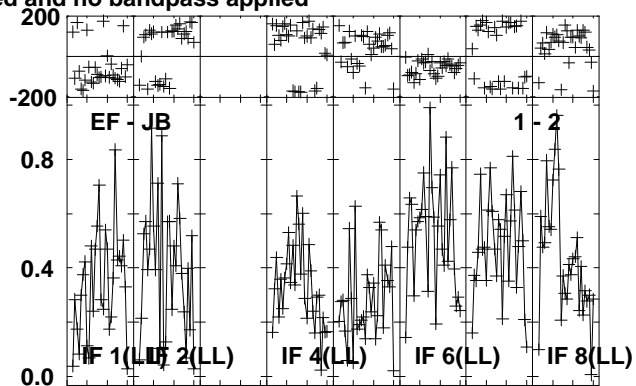
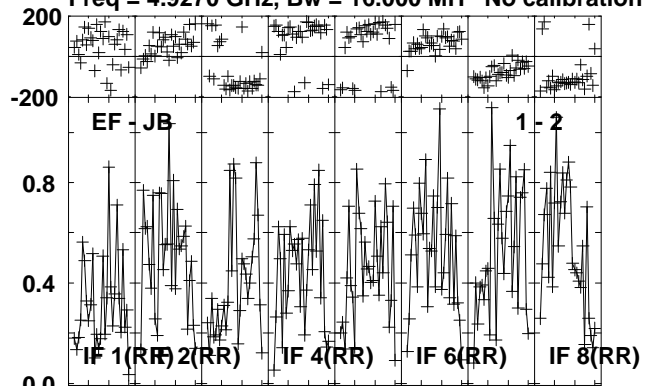

Lower frame: Milli Ampl Jy Top frame: Phas deg
Vector averaged cross-power spectrum Several baselines displayed
Timerange: 00/04:40:23 to 00/04:41:33

Plot file version 210 created 16-OCT-2012 11:57:34

J0639+0601 RO006.UVDATA.1

Freq = 4.9270 GHz, Bw = 16.000 MH No calibration applied and no bandpass applied

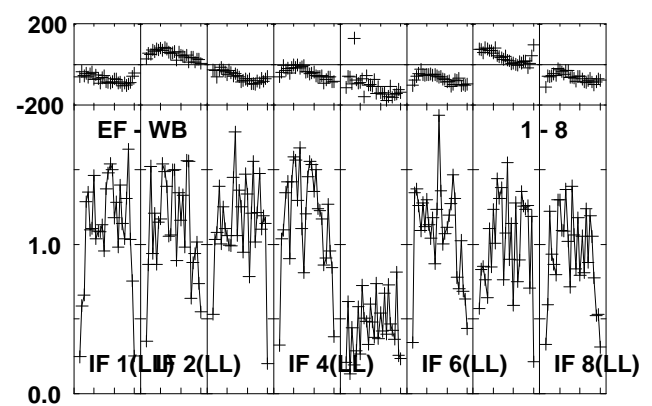
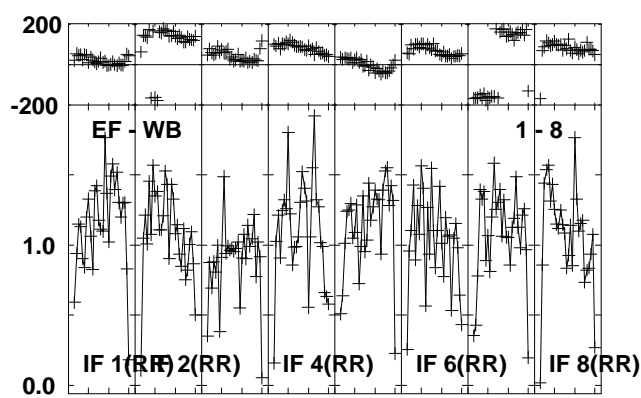
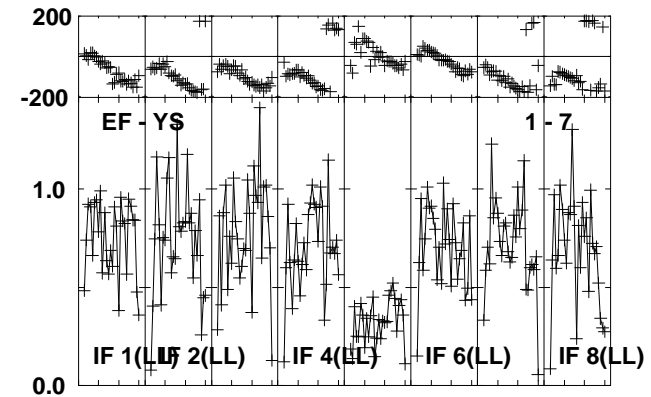
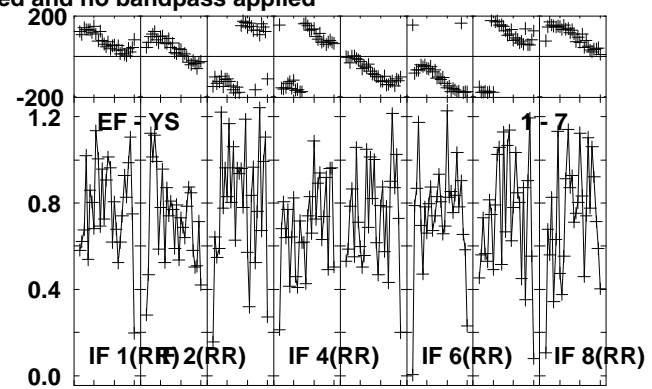
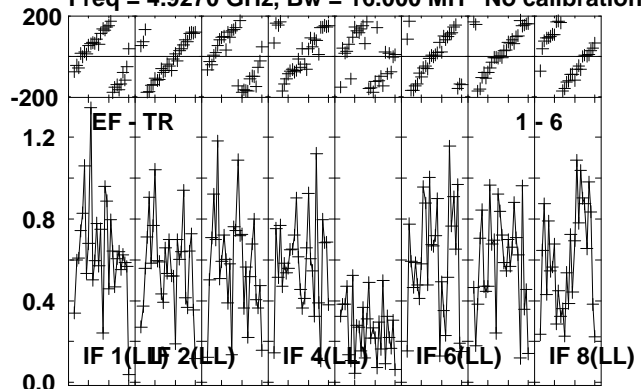

Lower frame: Milli Ampl Jy Top frame: Phas deg
Vector averaged cross-power spectrum Several baselines displayed
Timerange: 00/04:40:23 to 00/04:41:33

Plot file version 211 created 16-OCT-2012 11:57:34

J0645+0541 RO006.UVDATA.1

Freq = 4.9270 GHz, Bw = 16.000 MH No calibration applied and no bandpass applied

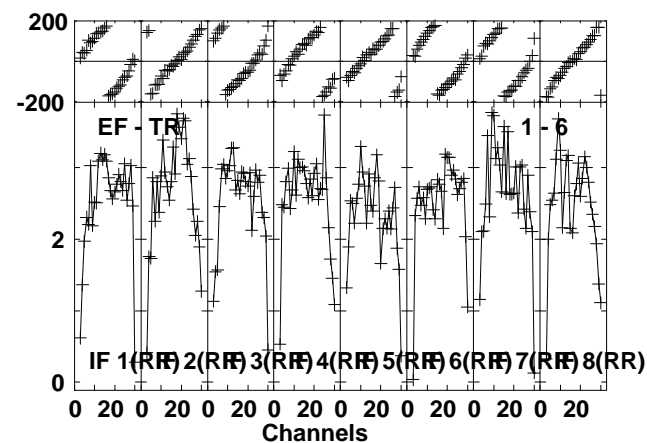
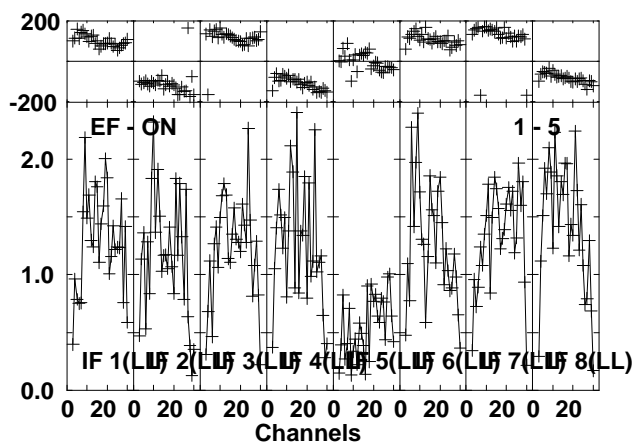
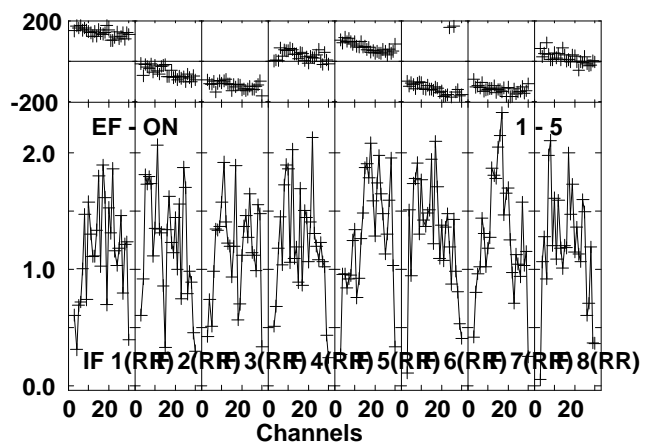
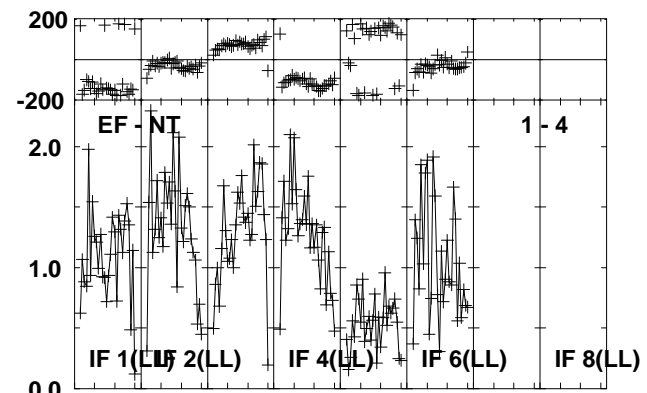
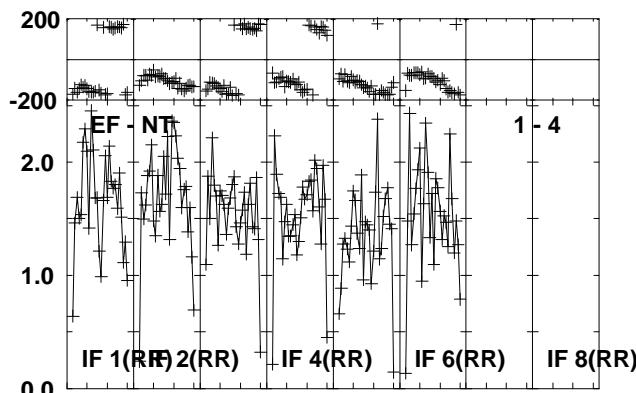
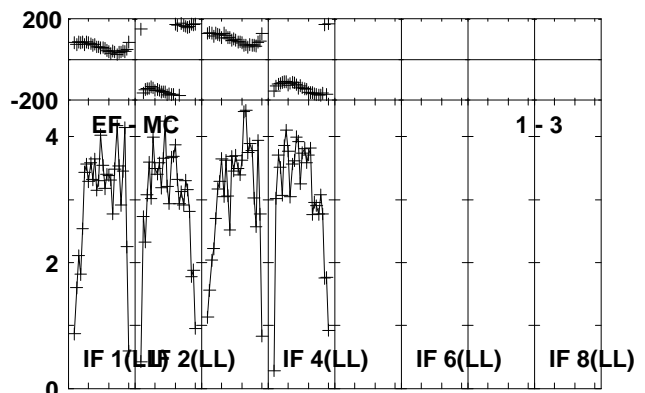
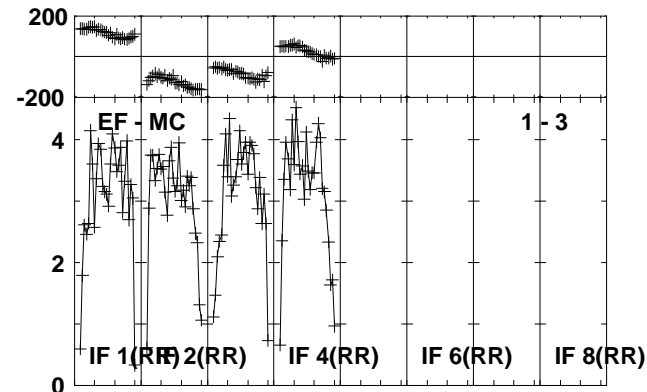
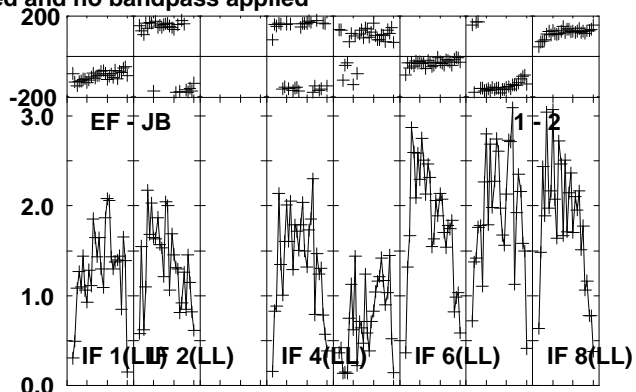
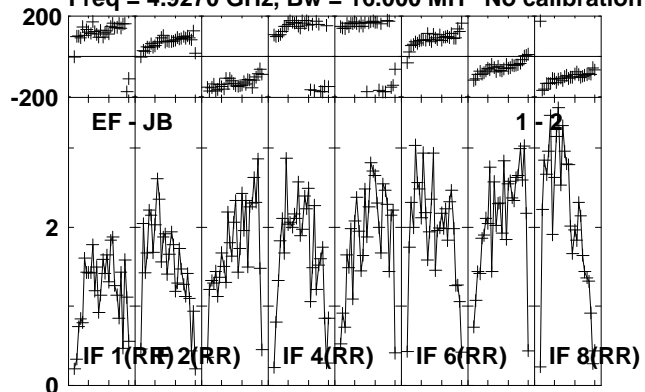

Lower frame: Milli Ampl Jy Top frame: Phas deg
Vector averaged cross-power spectrum Several baselines displayed
Timerange: 00/04:41:37 to 00/04:42:33

Plot file version 212 created 16-OCT-2012 11:57:34

J0645+0541 RO006.UVDATA.1

Freq = 4.9270 GHz, Bw = 16.000 MH No calibration applied and no bandpass applied

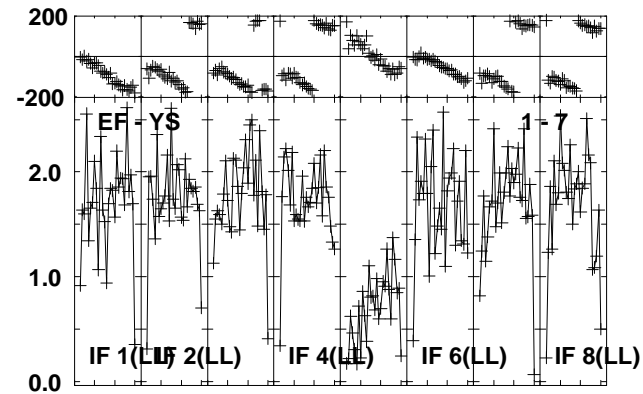
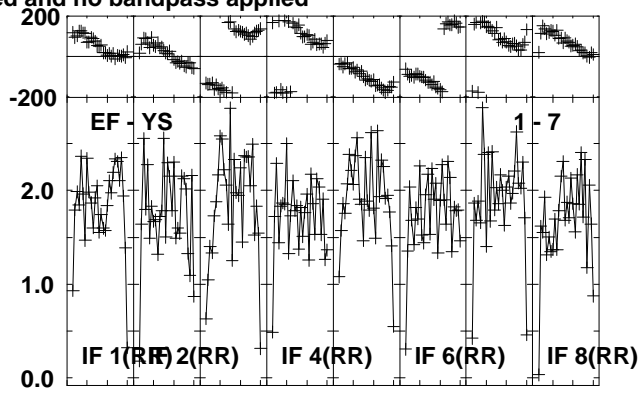
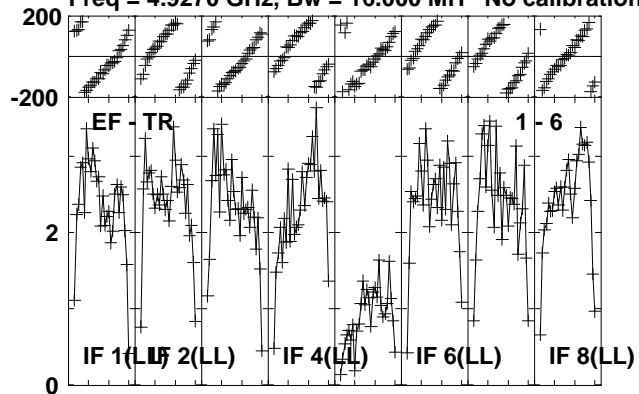

Lower frame: Milli Ampl Jy Top frame: Phas deg
Vector averaged cross-power spectrum Several baselines displayed
Timerange: 00/04:41:37 to 00/04:42:33

Plot file version 213 created 16-OCT-2012 11:57:34

NOVA-MON RO006.UVDATA.1

Freq = 4.9270 GHz, Bw = 16.000 MH No calibration applied and no bandpass applied

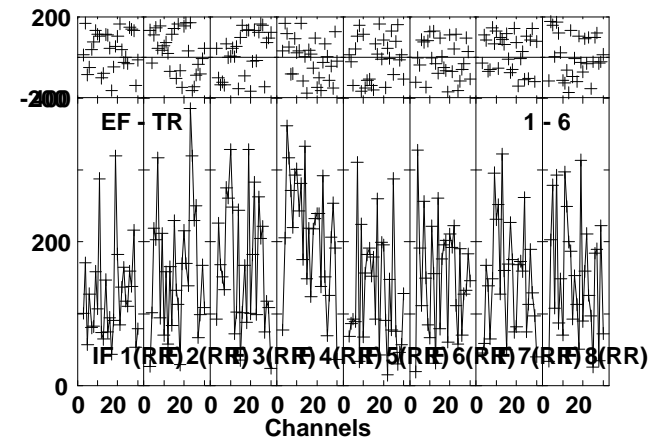
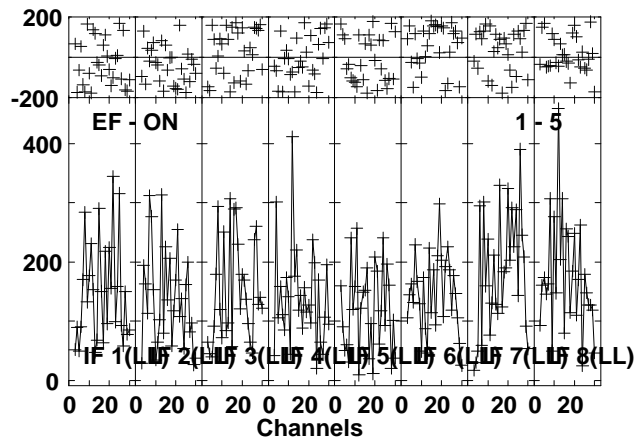
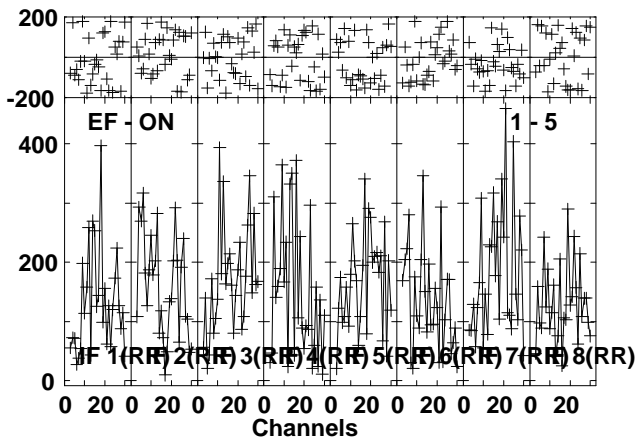
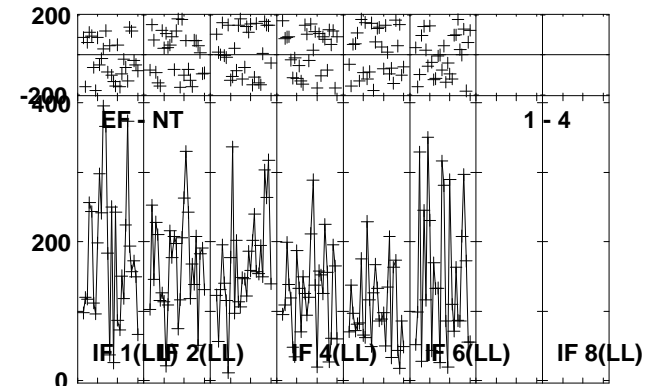
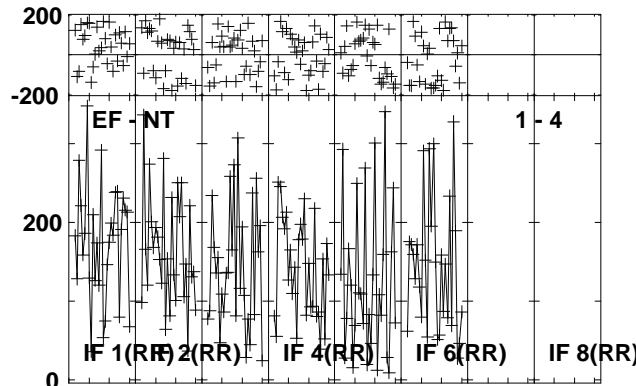
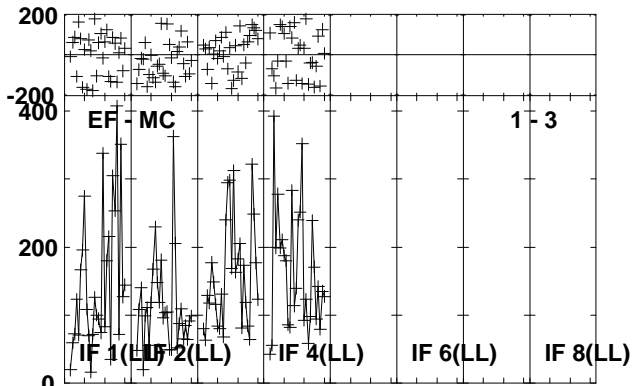
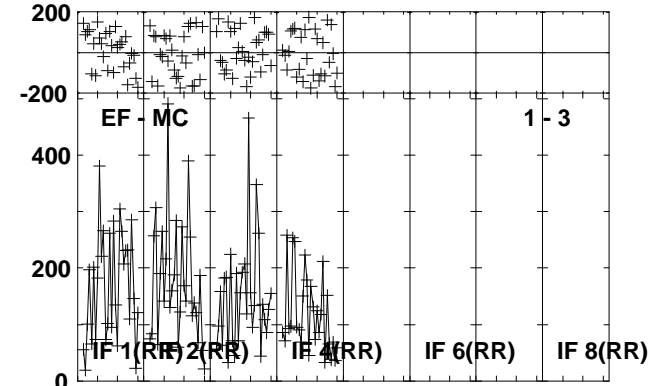
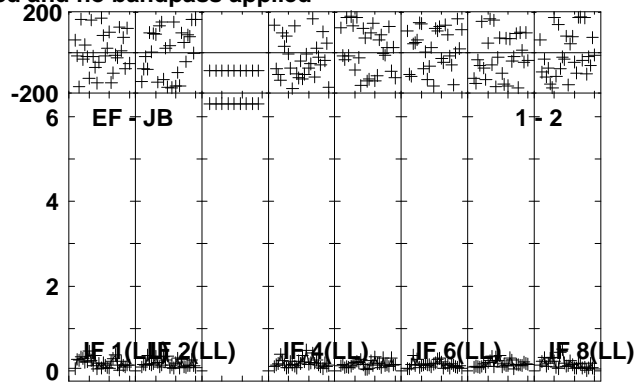
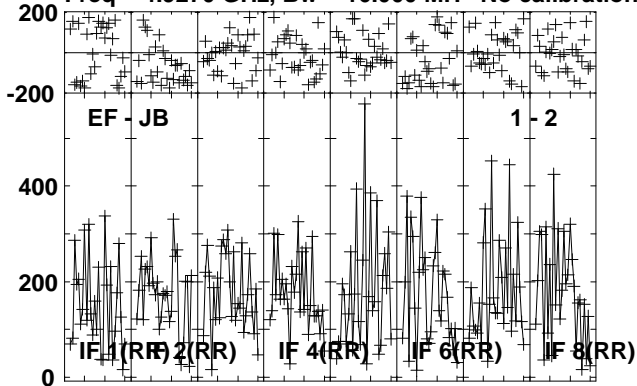

Lower frame: Micro Ampl Jy Top frame: Phas deg
Vector averaged cross-power spectrum Several baselines displayed
Timerange: 00/04:42:37 to 00/04:45:33

Plot file version 214 created 16-OCT-2012 11:57:35

NOVA-MON RO006.UVDATA.1

Freq = 4.9270 GHz, Bw = 16.000 MH No calibration applied and no bandpass applied

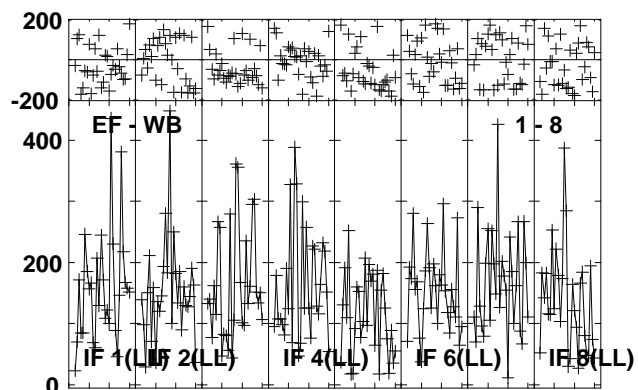
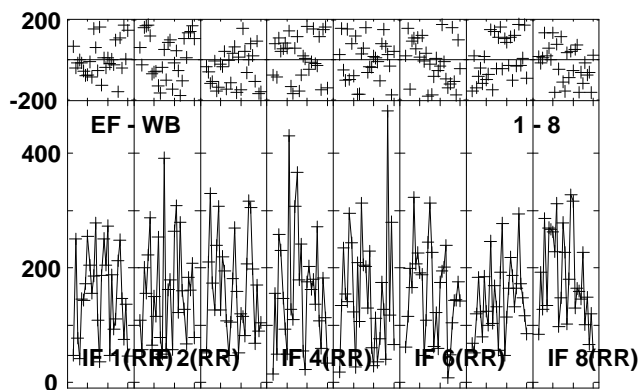
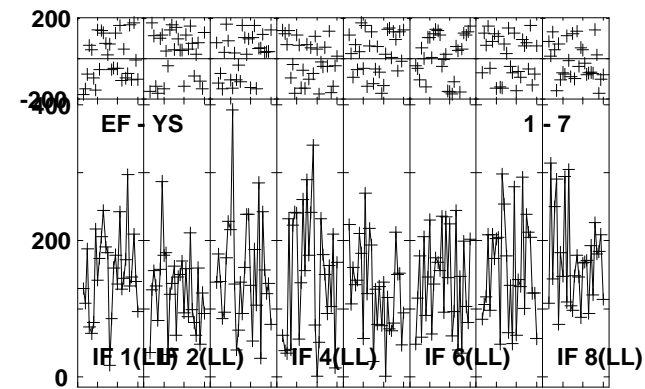
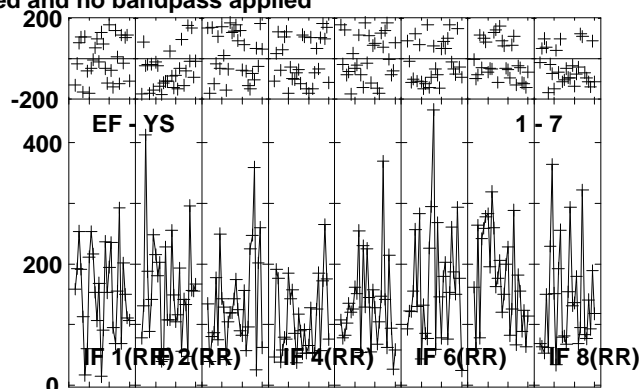
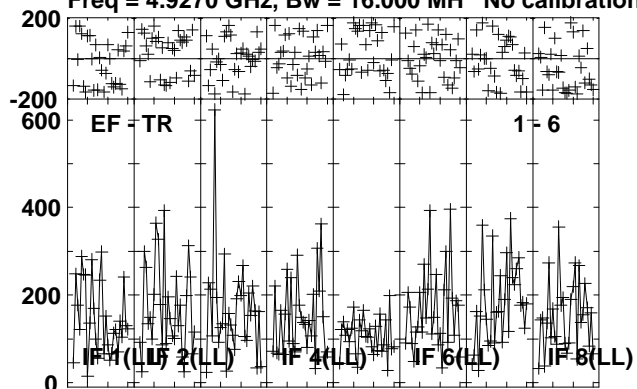

Lower frame: Micro Ampl Jy Top frame: Phas deg
Vector averaged cross-power spectrum Several baselines displayed
Timerange: 00/04:42:37 to 00/04:45:33

Plot file version 215 created 16-OCT-2012 11:57:35

J0639+0601 RO006.UVDATA.1

Freq = 4.9270 GHz, Bw = 16.000 MH No calibration applied and no bandpass applied

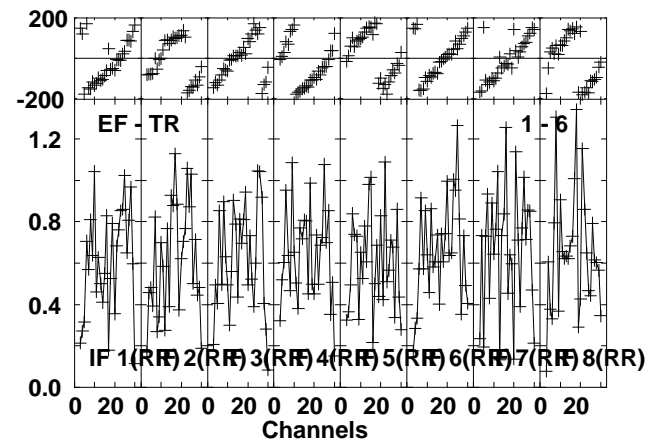
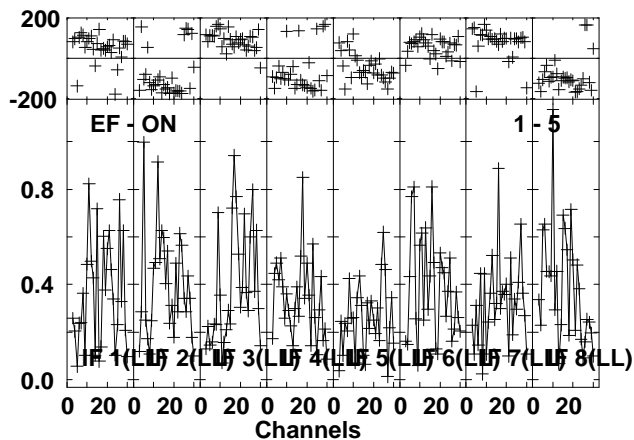
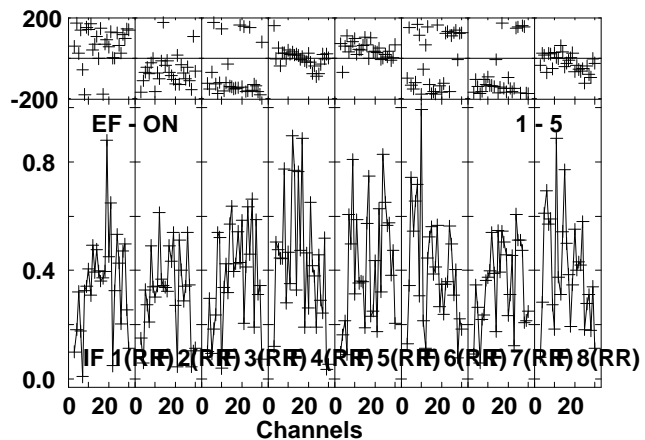
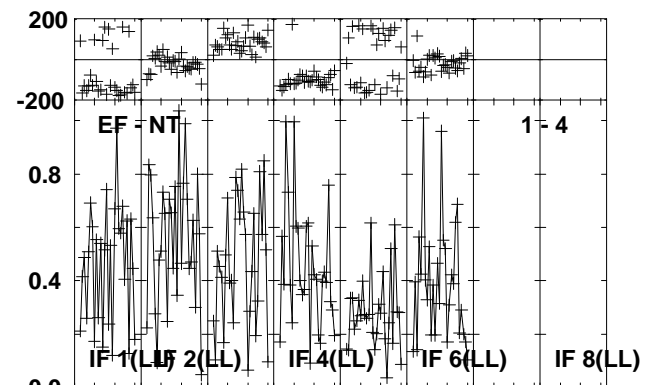
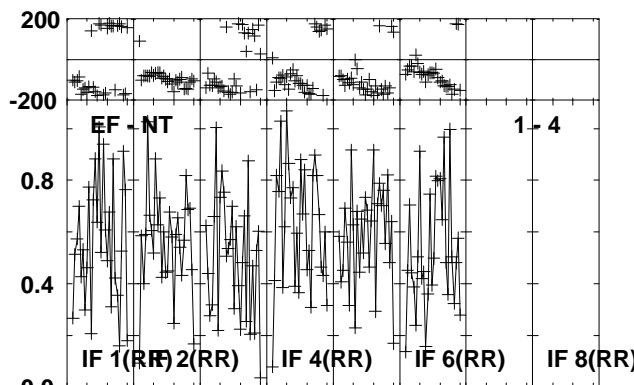
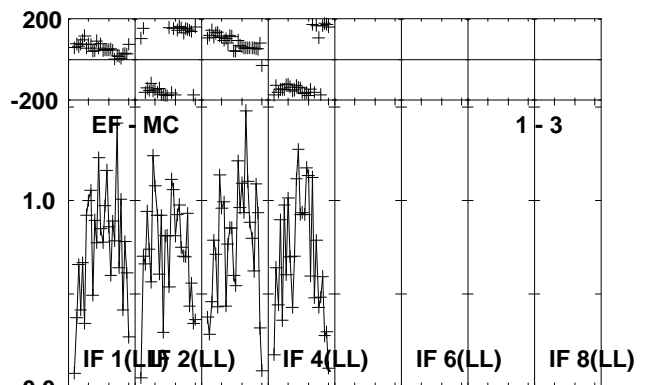
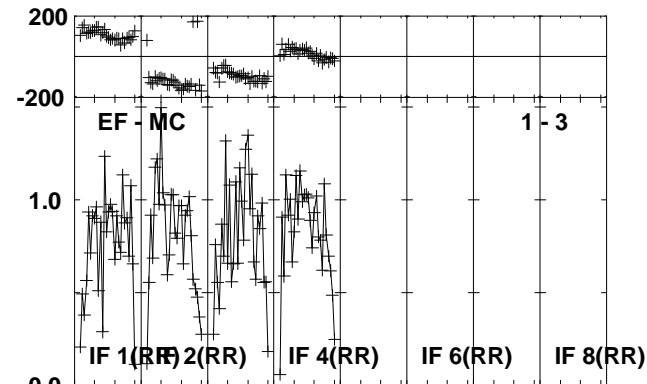
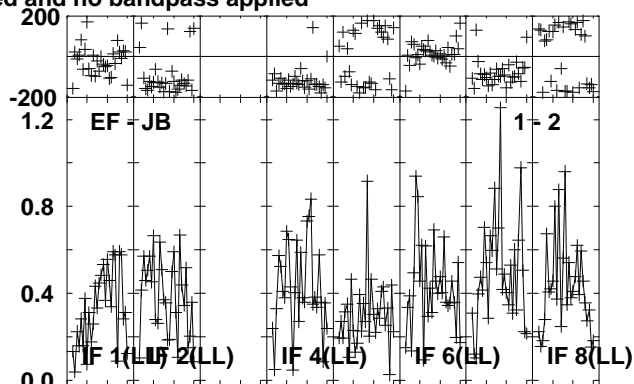
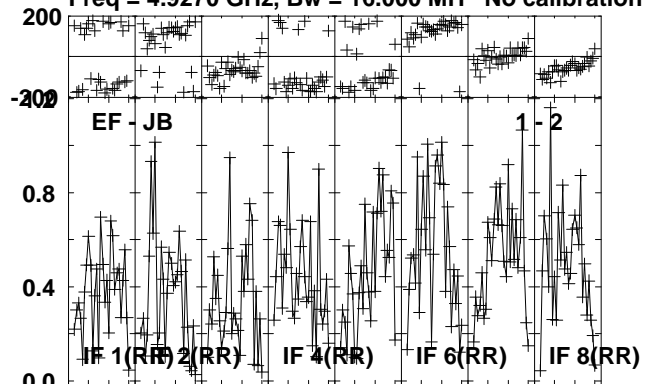

Lower frame: Milli Ampl Jy Top frame: Phas deg
Vector averaged cross-power spectrum Several baselines displayed
Timerange: 00/04:46:03 to 00/04:47:03

Plot file version 216 created 16-OCT-2012 11:57:35

J0639+0601 RO006.UVDATA.1

Freq = 4.9270 GHz, Bw = 16.000 MH No calibration applied and no bandpass applied

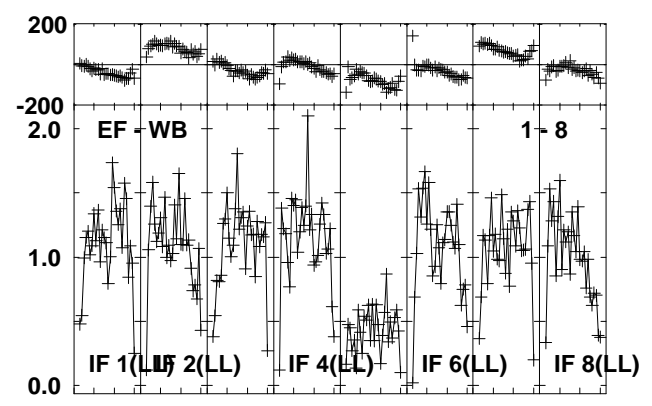
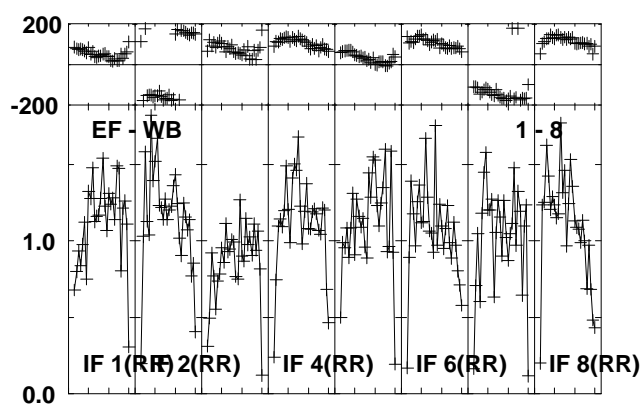
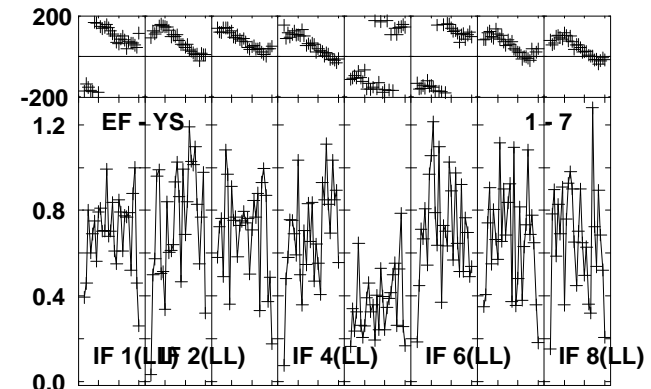
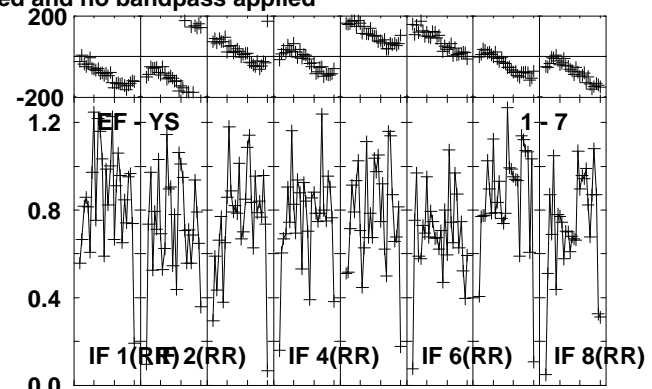
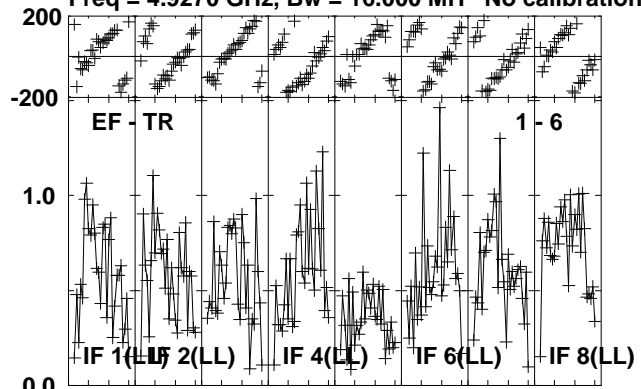

Lower frame: Milli Ampl Jy Top frame: Phas deg
Vector averaged cross-power spectrum Several baselines displayed
Timerange: 00/04:46:03 to 00/04:47:03

Plot file version 217 created 16-OCT-2012 11:57:36

J0645+0541 RO006.UVDATA.1

Freq = 4.9270 GHz, Bw = 16.000 MH No calibration applied and no bandpass applied

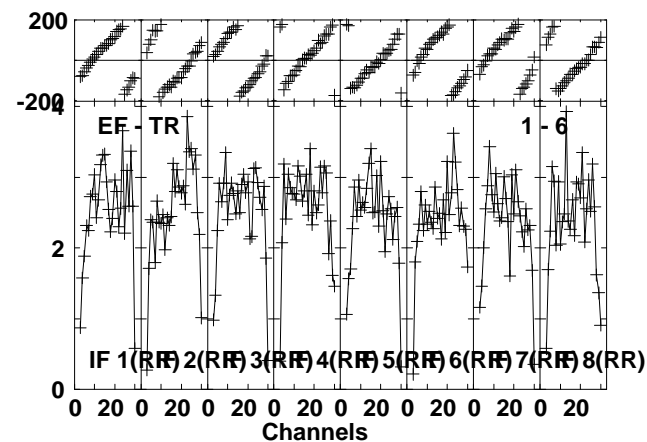
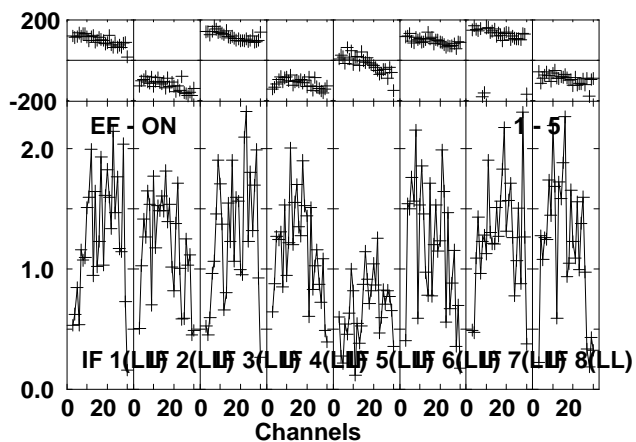
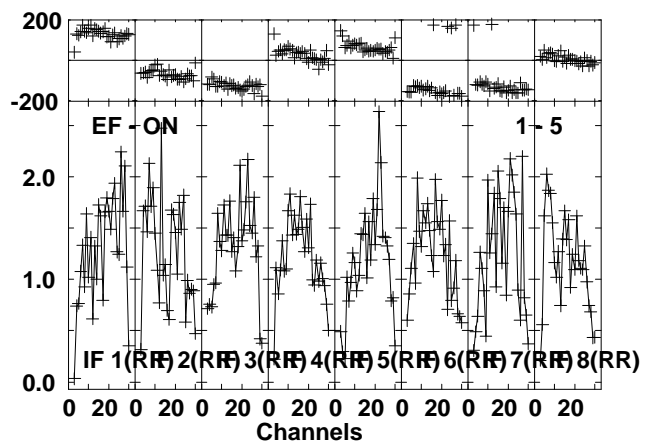
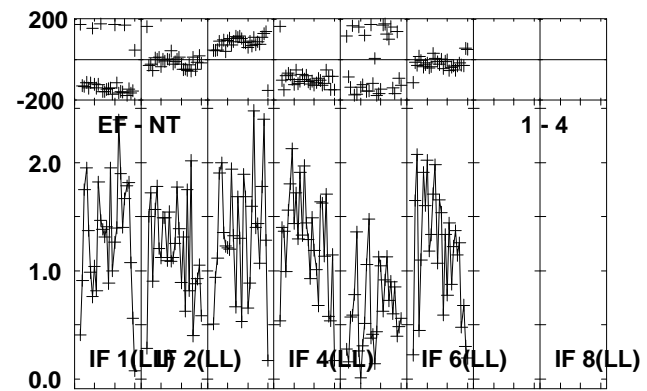
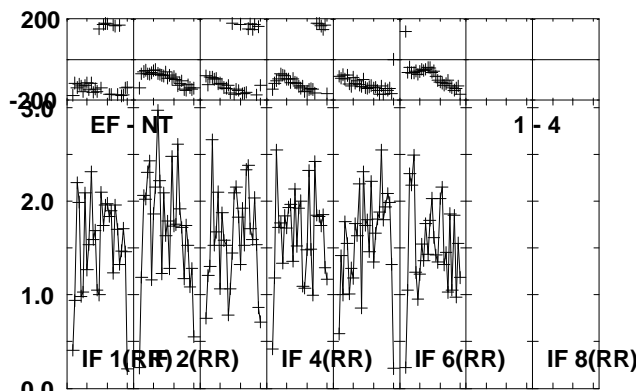
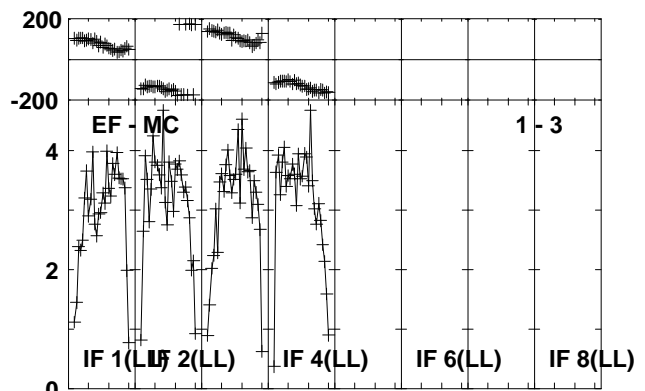
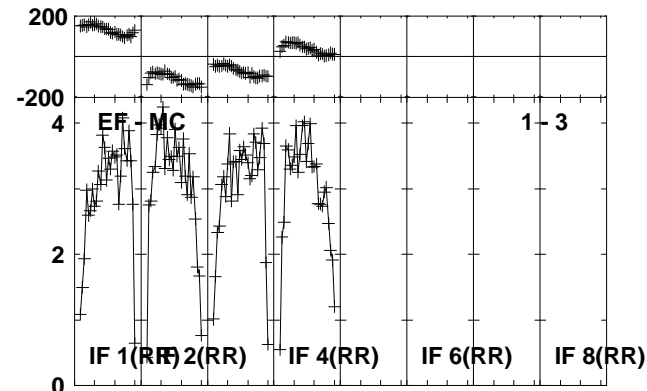
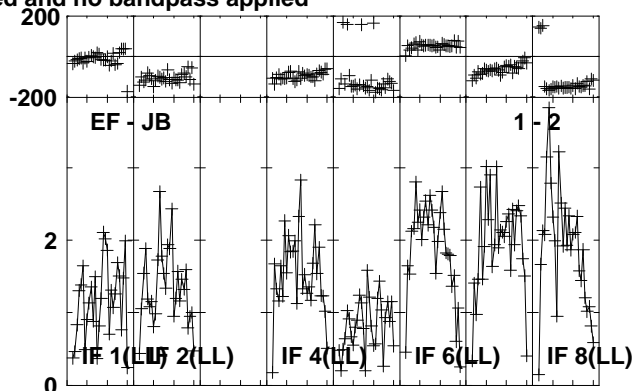
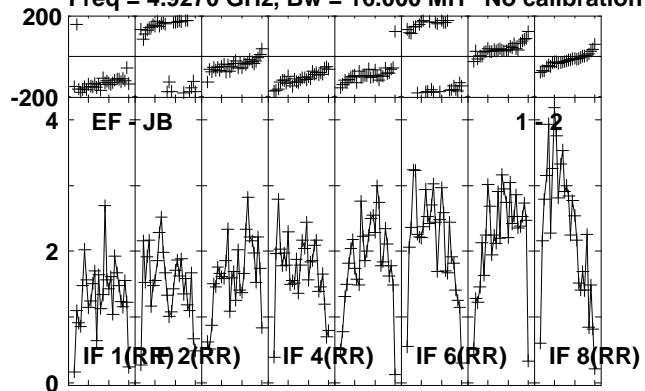

Lower frame: Milli Ampl Jy Top frame: Phas deg
Vector averaged cross-power spectrum Several baselines displayed
Timerange: 00/04:47:07 to 00/04:48:03

Plot file version 218 created 16-OCT-2012 11:57:36

J0645+0541 RO006.UVDATA.1

Freq = 4.9270 GHz, Bw = 16.000 MH No calibration applied and no bandpass applied

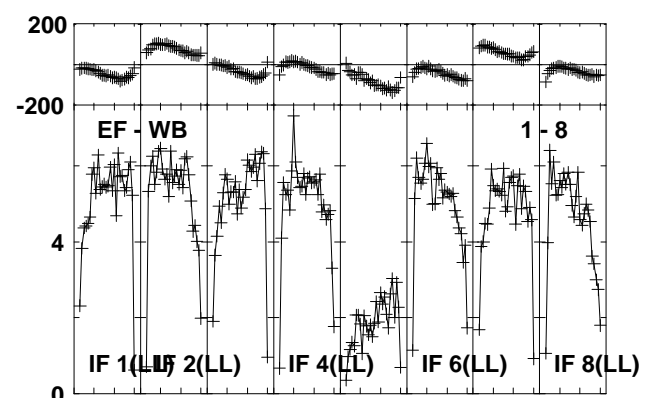
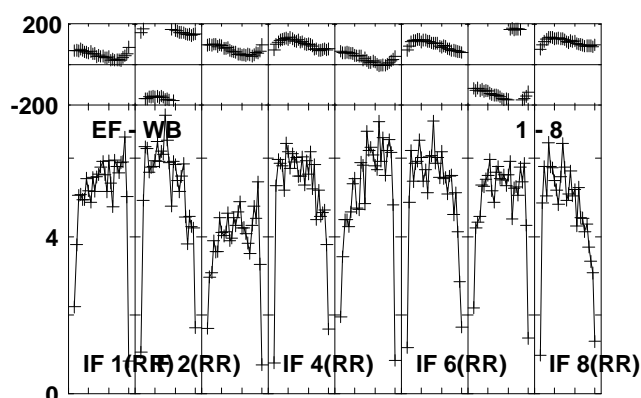
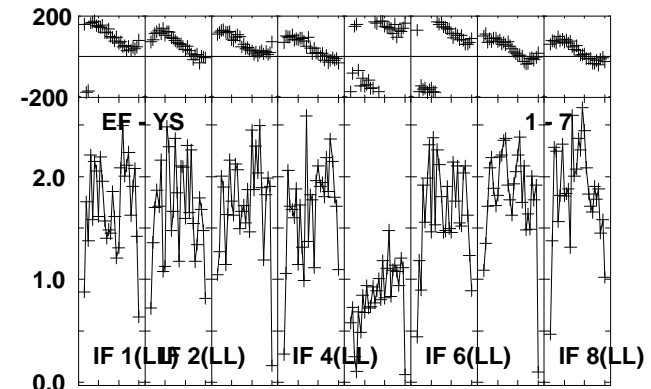
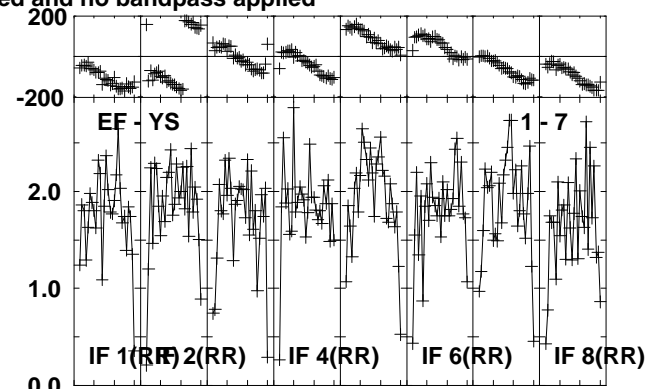
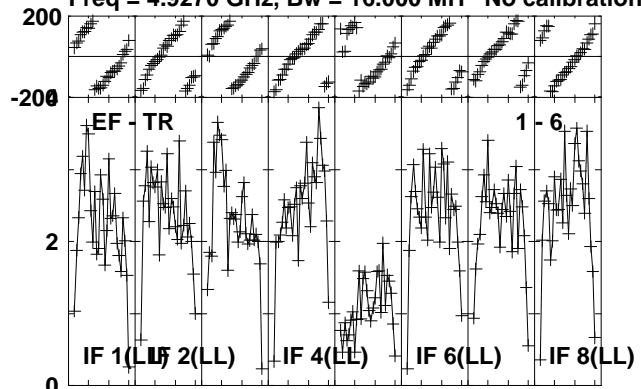

Lower frame: Milli Ampl Jy Top frame: Phas deg
Vector averaged cross-power spectrum Several baselines displayed
Timerange: 00/04:47:07 to 00/04:48:03

Plot file version 219 created 16-OCT-2012 11:57:36

NOVA-MON RO006.UVDATA.1

Freq = 4.9270 GHz, Bw = 16.000 MH No calibration applied and no bandpass applied

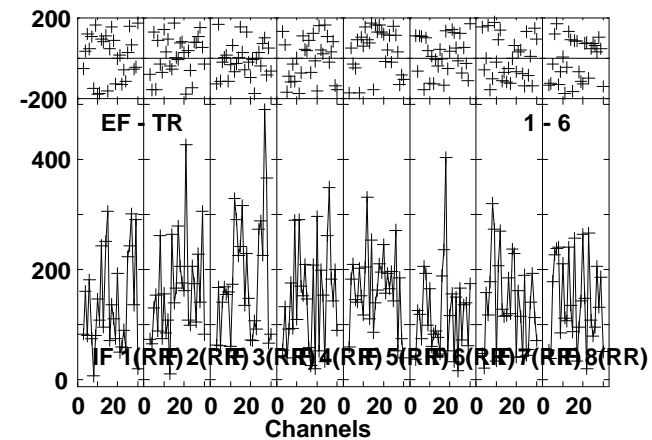
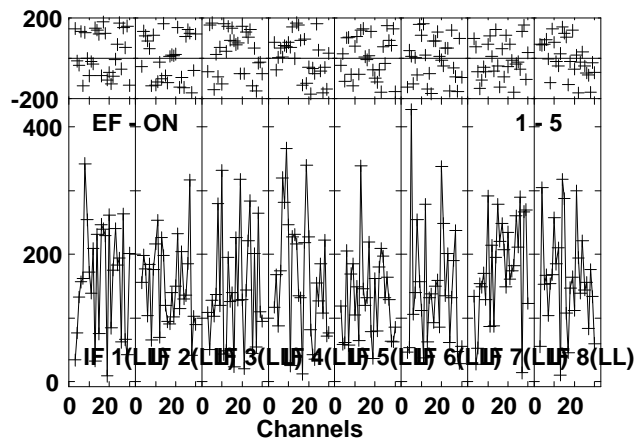
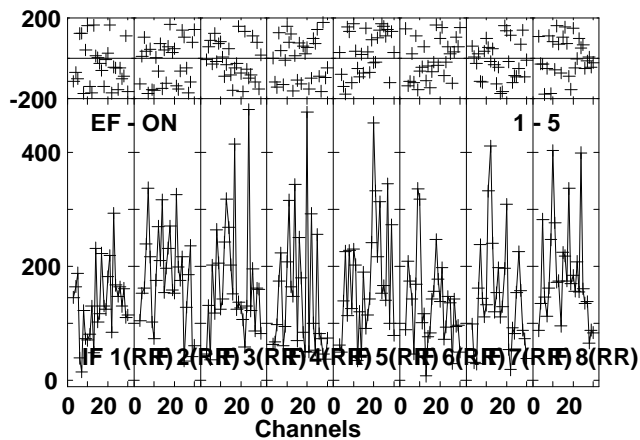
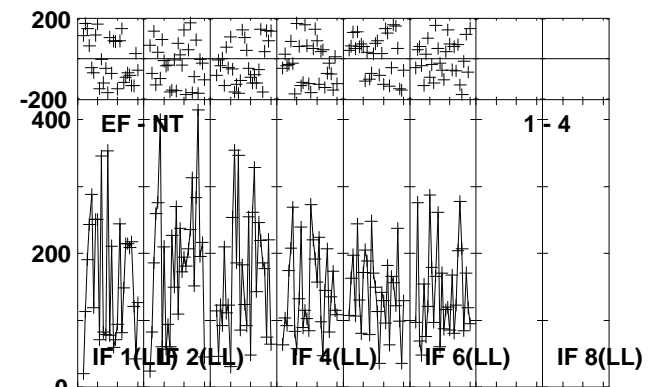
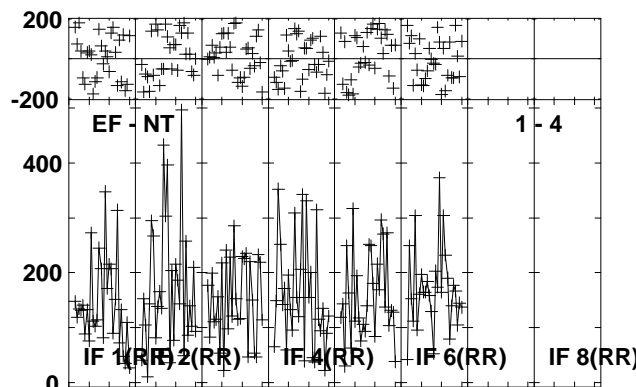
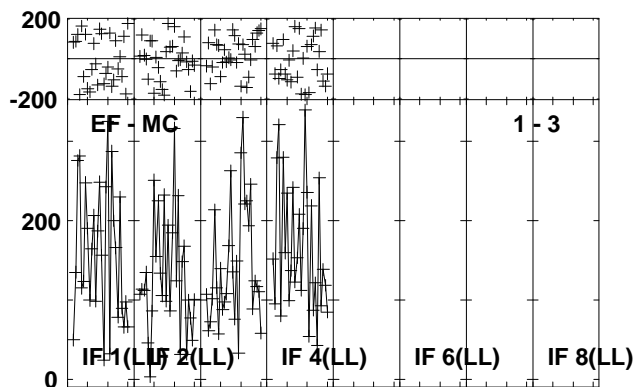
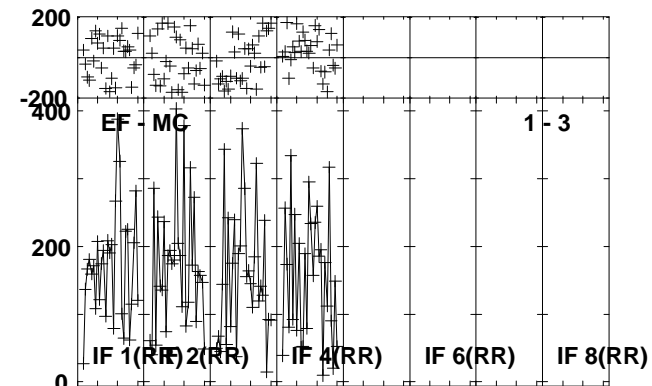
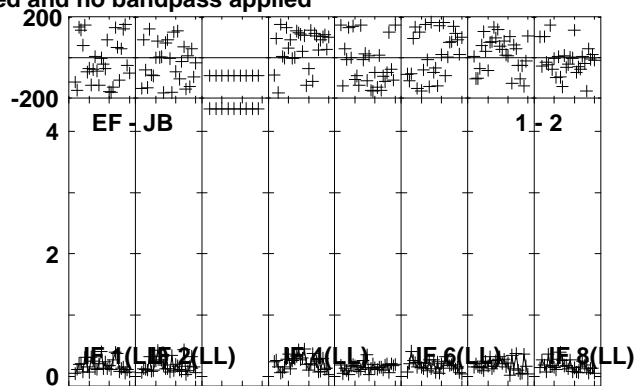
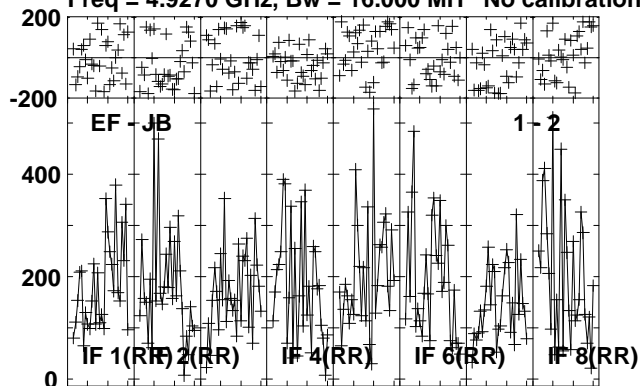

Lower frame: Micro Ampl Jy Top frame: Phas deg
Vector averaged cross-power spectrum Several baselines displayed
Timerange: 00/04:48:07 to 00/04:51:03

Plot file version 220 created 16-OCT-2012 11:57:37

NOVA-MON RO006.UVDATA.1

Freq = 4.9270 GHz, Bw = 16.000 MH No calibration applied and no bandpass applied

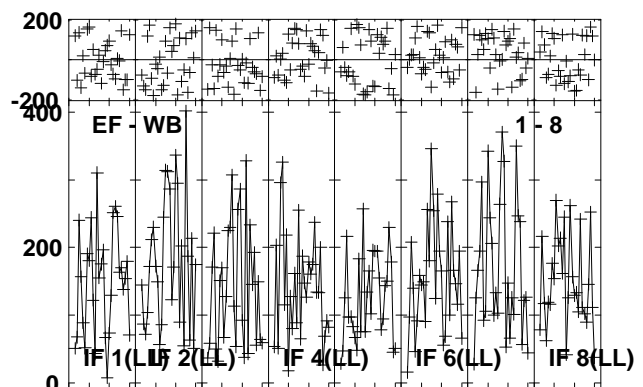
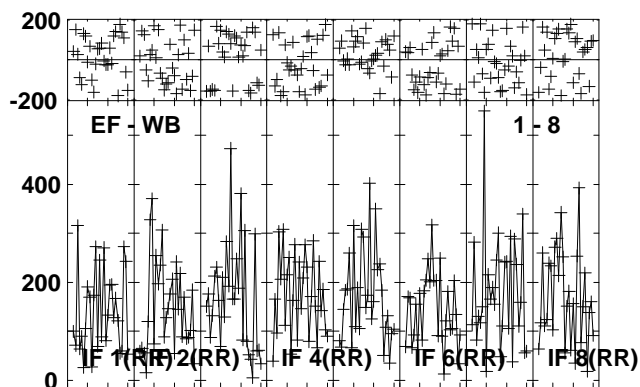
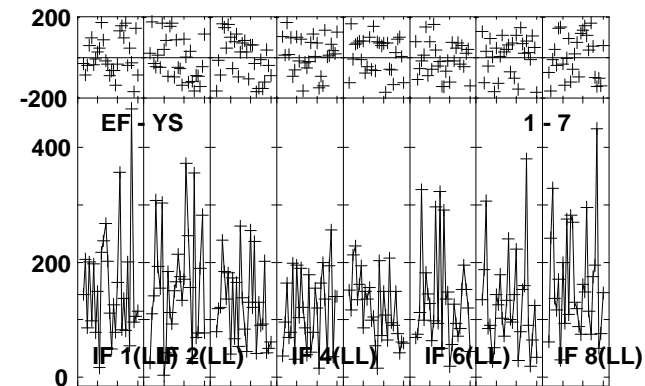
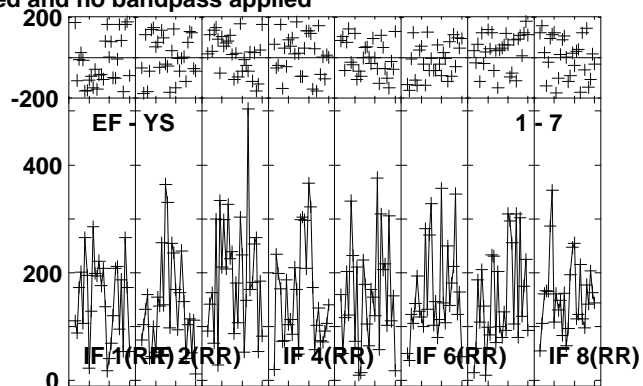
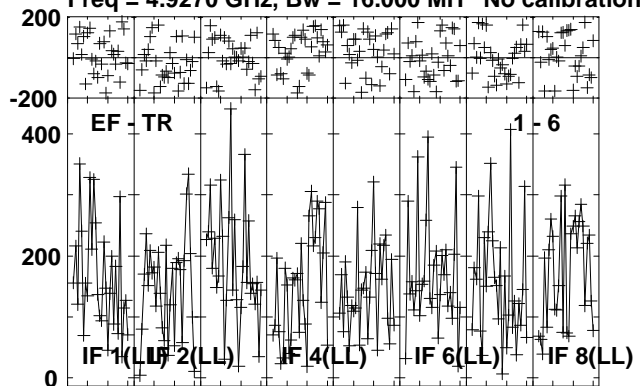

Lower frame: Micro Ampl Jy Top frame: Phas deg
Vector averaged cross-power spectrum Several baselines displayed
Timerange: 00/04:48:07 to 00/04:51:03

Plot file version 221 created 16-OCT-2012 11:57:37

J0639+0601 RO006.UVDATA.1

Freq = 4.9270 GHz, Bw = 16.000 MH No calibration applied and no bandpass applied

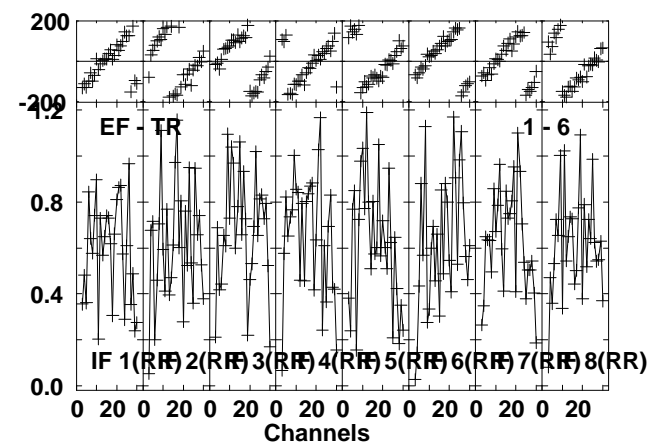
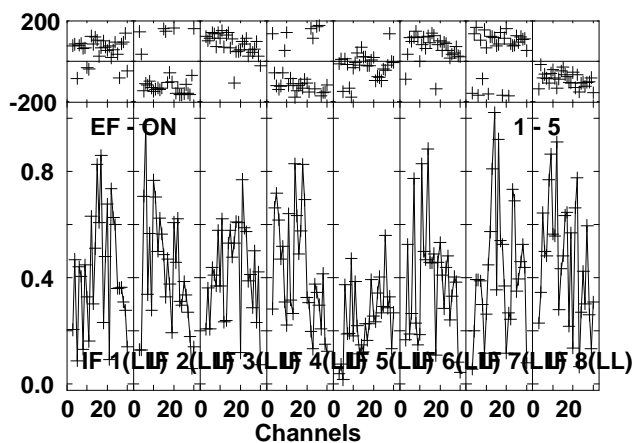
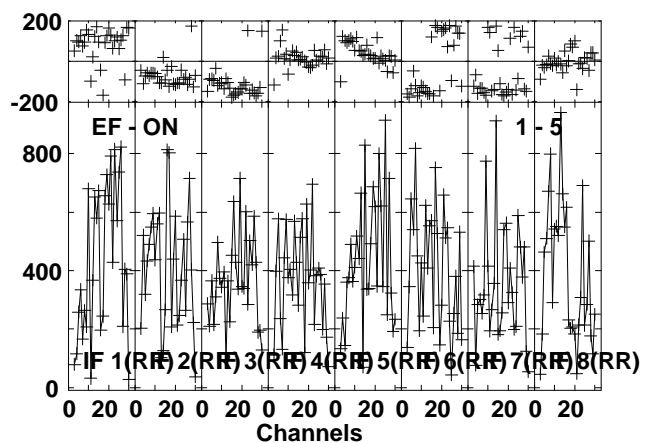
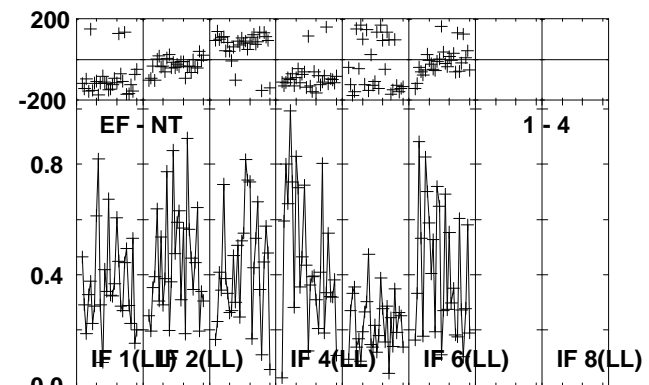
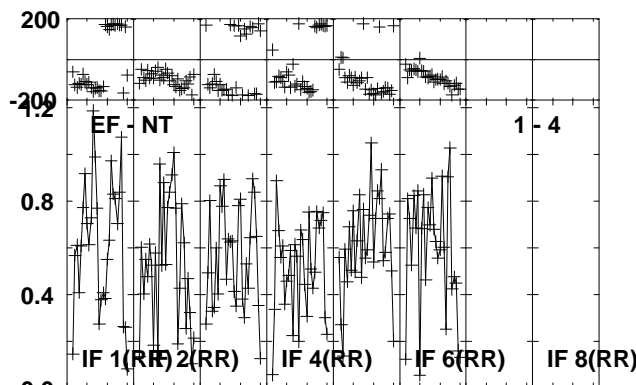
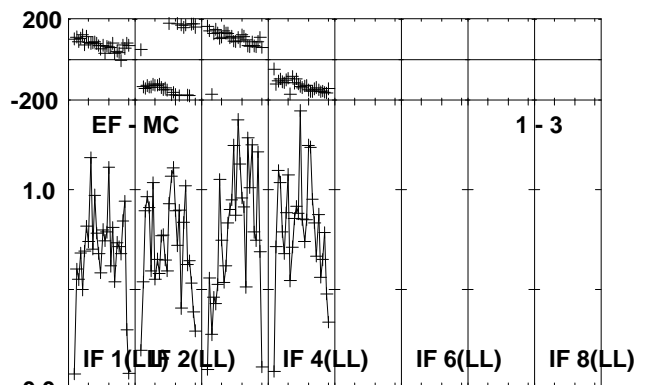
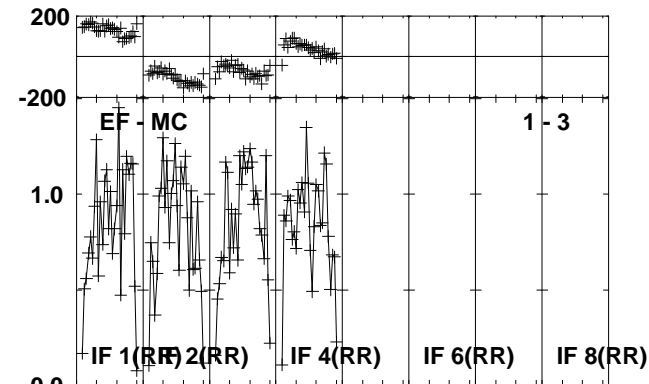
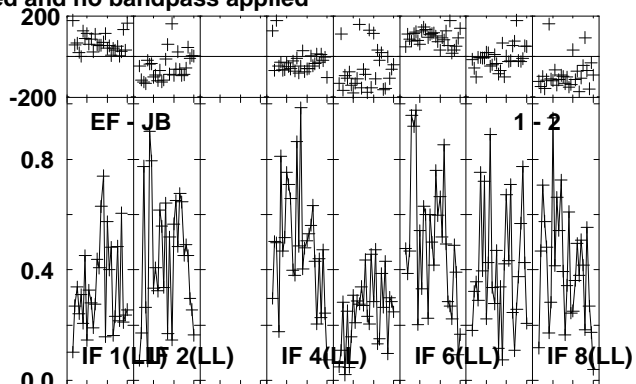
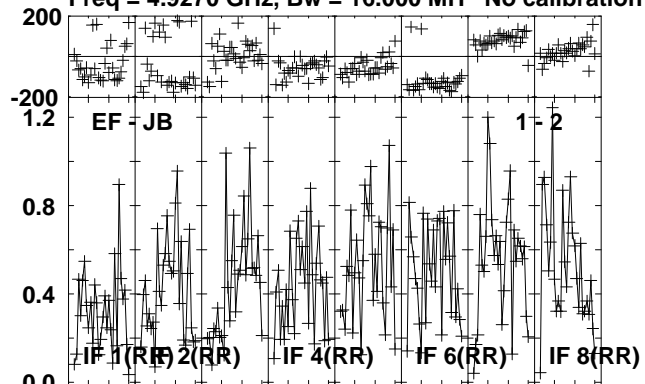

Lower frame: Milli Ampl Jy Top frame: Phas deg
Vector averaged cross-power spectrum Several baselines displayed
Timerange: 00/04:51:07 to 00/04:52:19

Plot file version 222 created 16-OCT-2012 11:57:37

J0639+0601 RO006.UVDATA.1

Freq = 4.9270 GHz, Bw = 16.000 MH No calibration applied and no bandpass applied

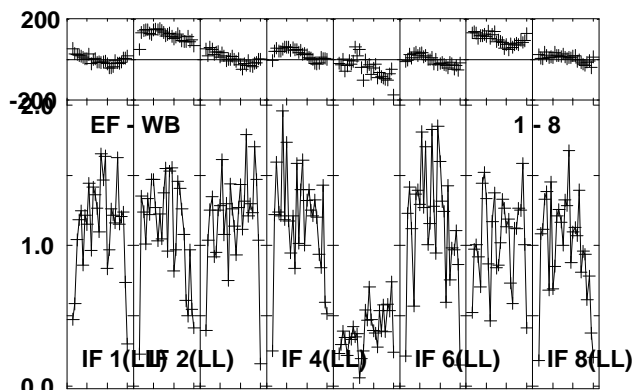
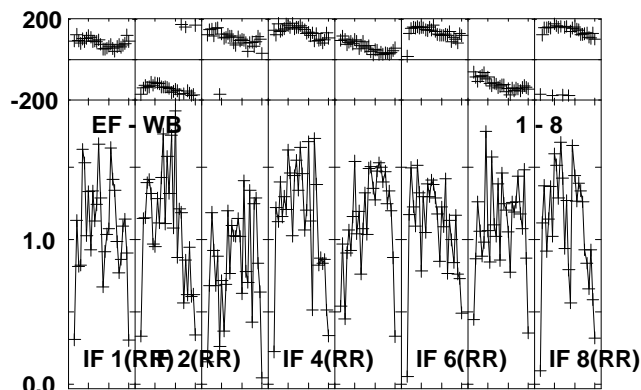
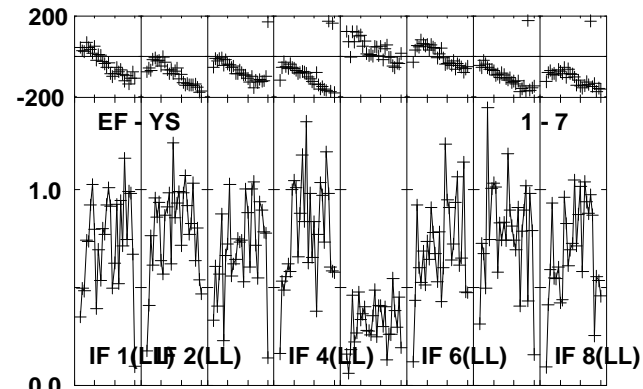
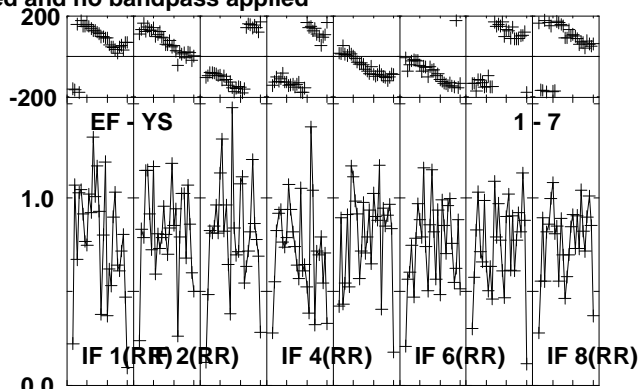
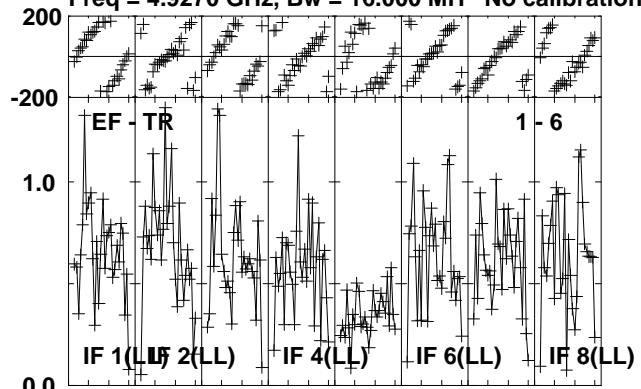

Lower frame: Milli Ampl Jy Top frame: Phas deg
Vector averaged cross-power spectrum Several baselines displayed
Timerange: 00/04:51:07 to 00/04:52:19

Plot file version 223 created 16-OCT-2012 11:57:37

J0645+0541 RO006.UVDATA.1

Freq = 4.9270 GHz, Bw = 16.000 MH No calibration applied and no bandpass applied

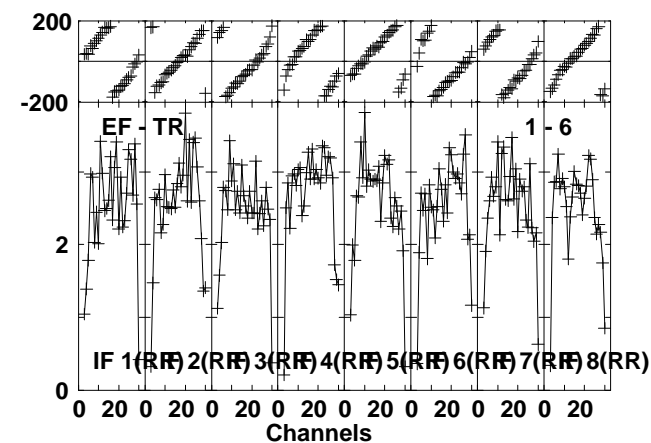
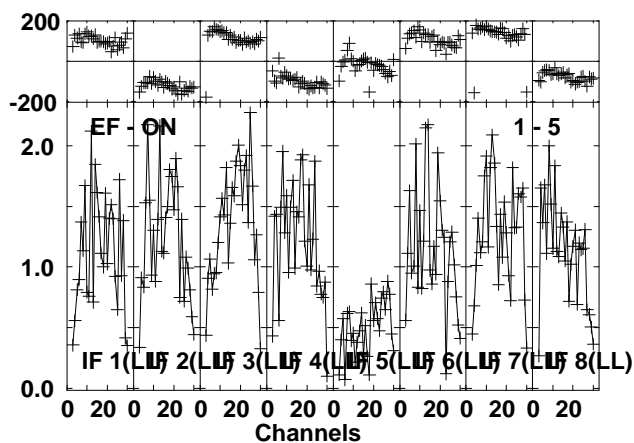
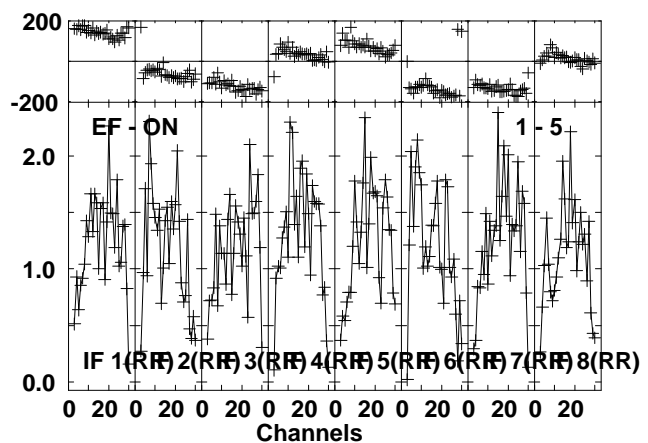
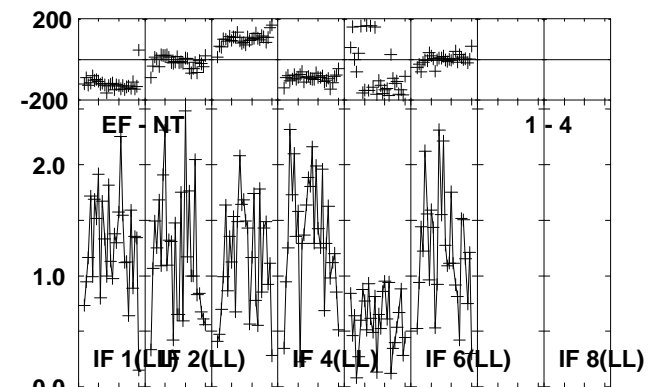
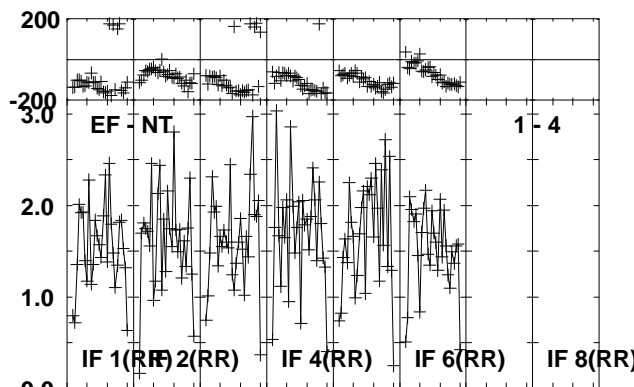
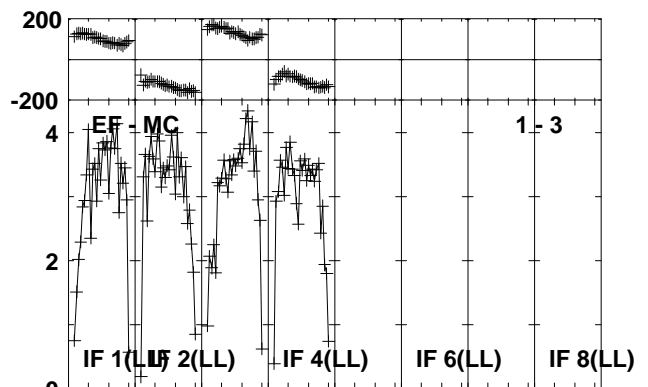
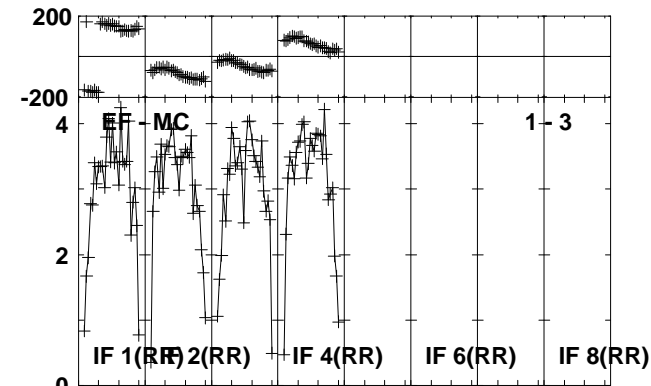
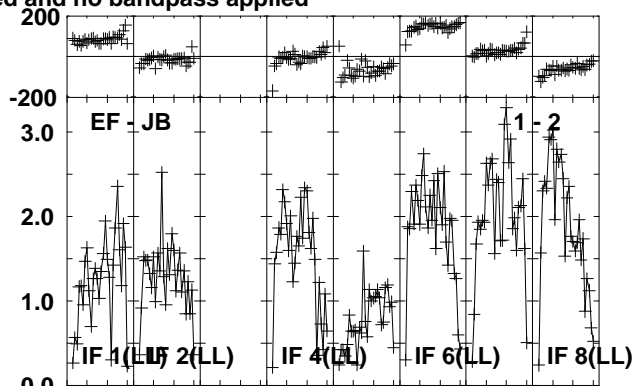
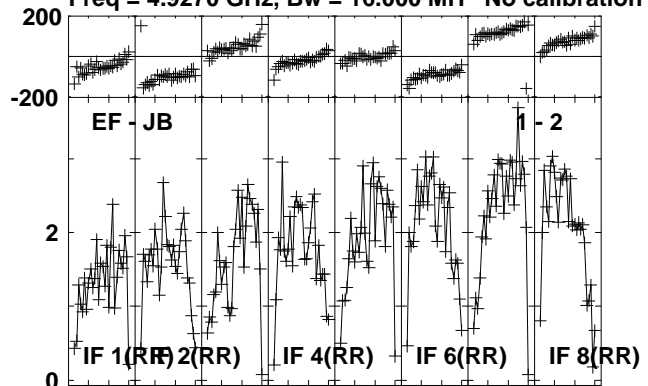

Lower frame: Milli Ampl Jy Top frame: Phas deg
Vector averaged cross-power spectrum Several baselines displayed
Timerange: 00/04:52:23 to 00/04:53:19

Plot file version 224 created 16-OCT-2012 11:57:38

J0645+0541 RO006.UVDATA.1

Freq = 4.9270 GHz, Bw = 16.000 MH No calibration applied and no bandpass applied

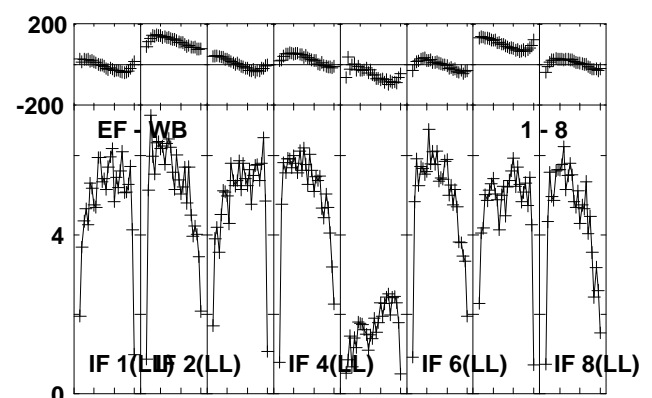
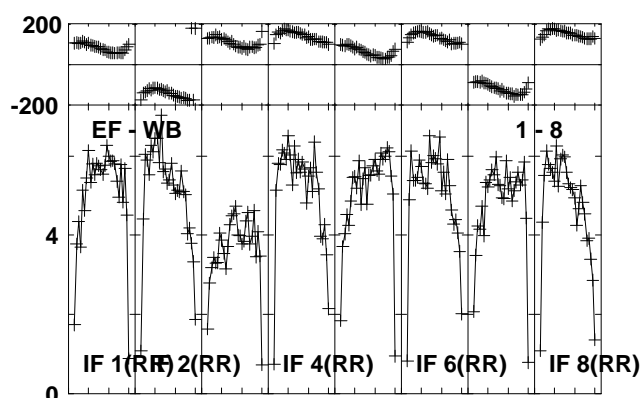
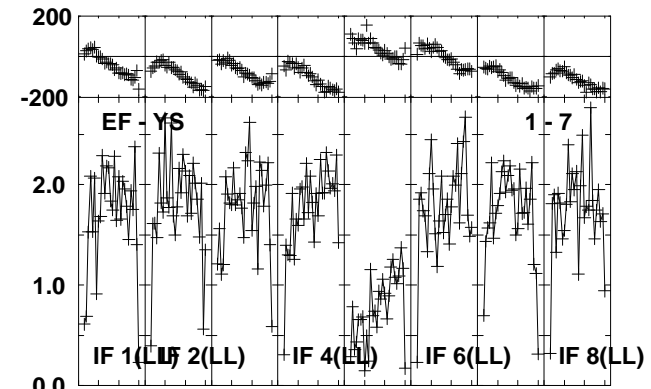
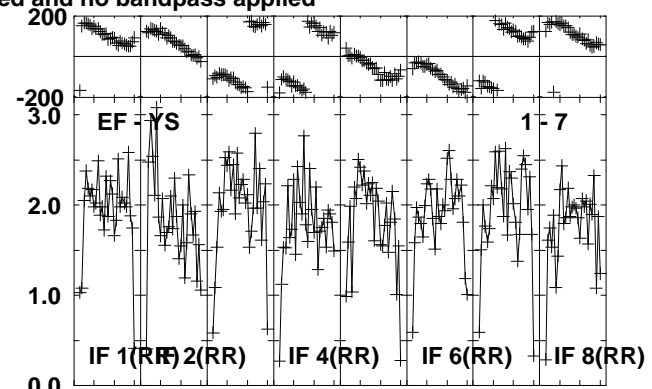
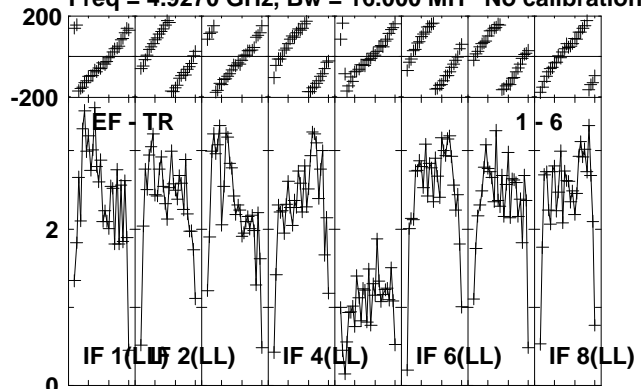

Lower frame: Milli Ampl Jy Top frame: Phas deg
Vector averaged cross-power spectrum Several baselines displayed
Timerange: 00/04:52:23 to 00/04:53:19

Plot file version 225 created 16-OCT-2012 11:57:38

NOVA-MON RO006.UVDATA.1

Freq = 4.9270 GHz, Bw = 16.000 MH No calibration applied and no bandpass applied

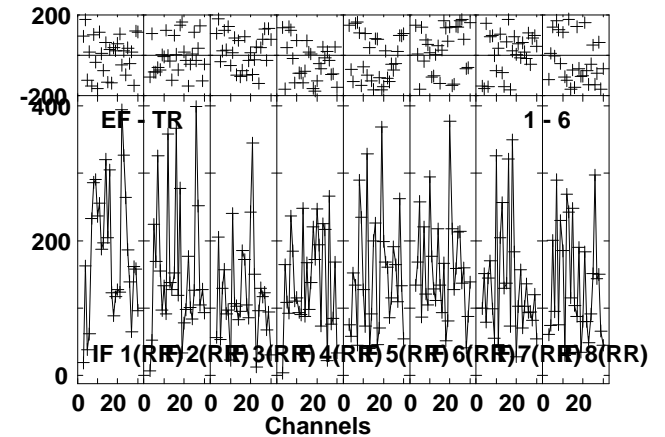
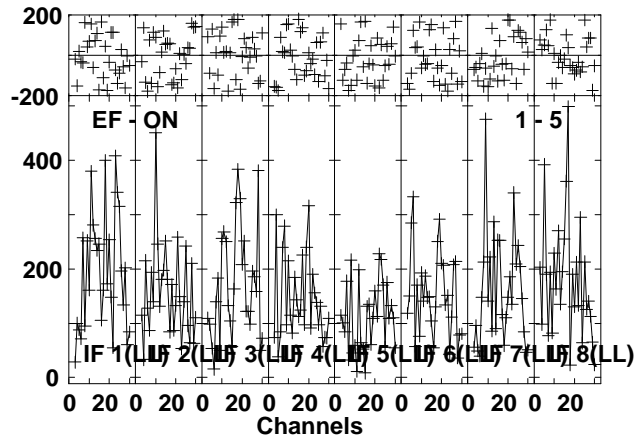
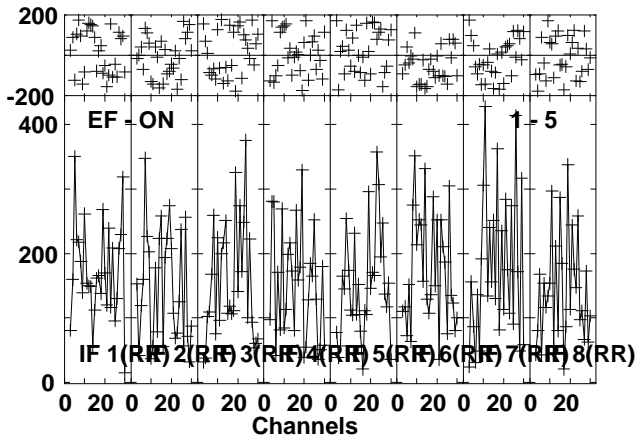
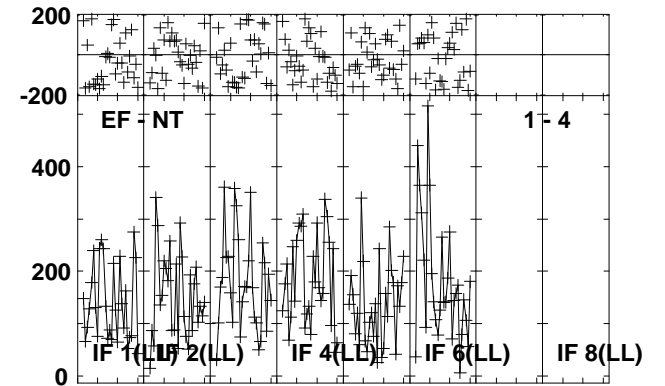
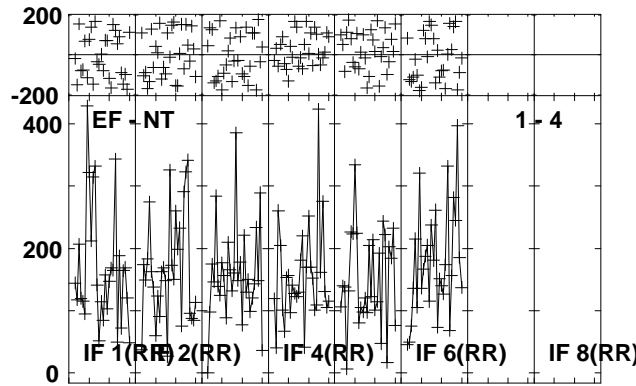
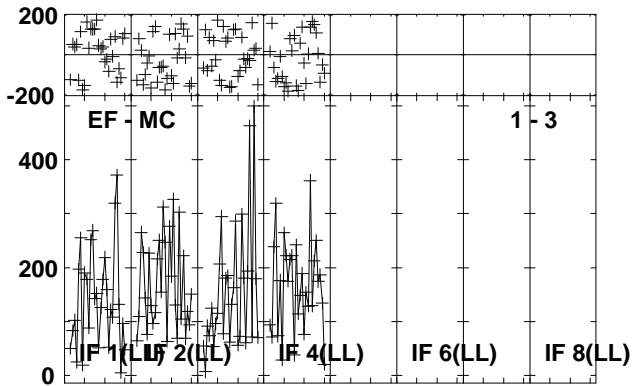
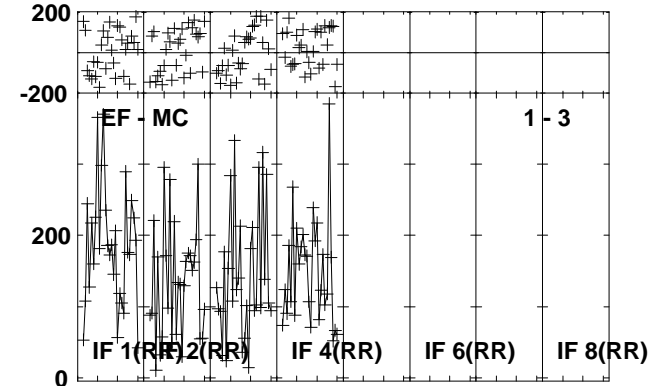
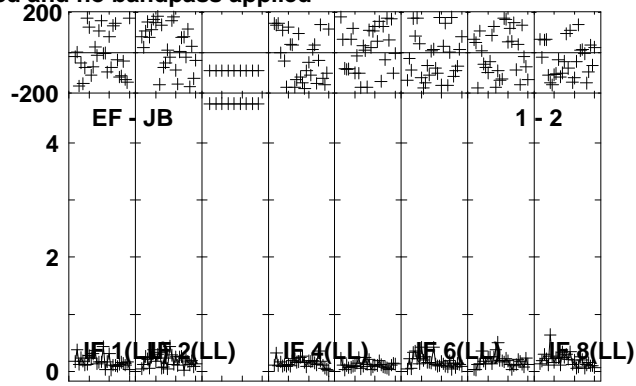
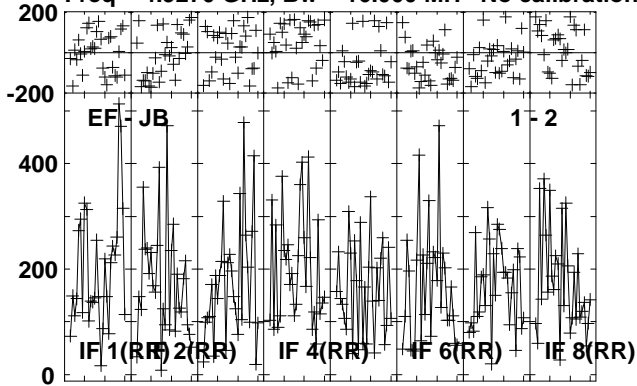

Lower frame: Micro Ampl Jy Top frame: Phas deg
Vector averaged cross-power spectrum Several baselines displayed
Timerange: 00/04:53:23 to 00/04:56:19

Plot file version 226 created 16-OCT-2012 11:57:38

NOVA-MON RO006.UVDATA.1

Freq = 4.9270 GHz, Bw = 16.000 MH No calibration applied and no bandpass applied

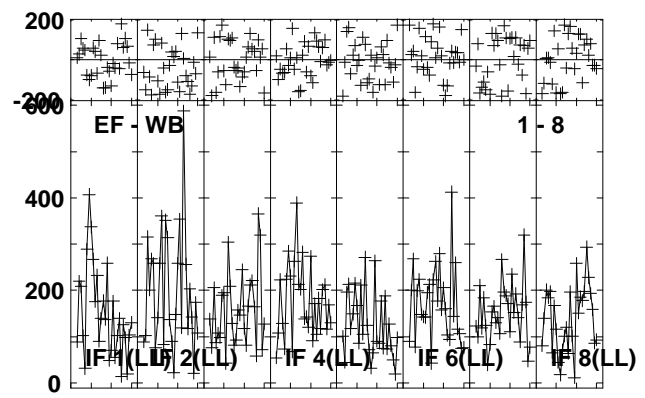
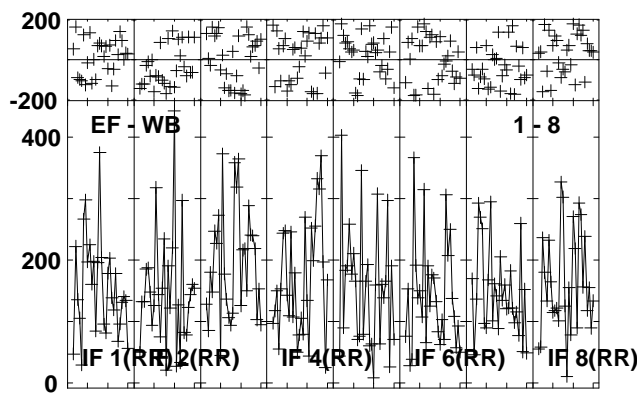
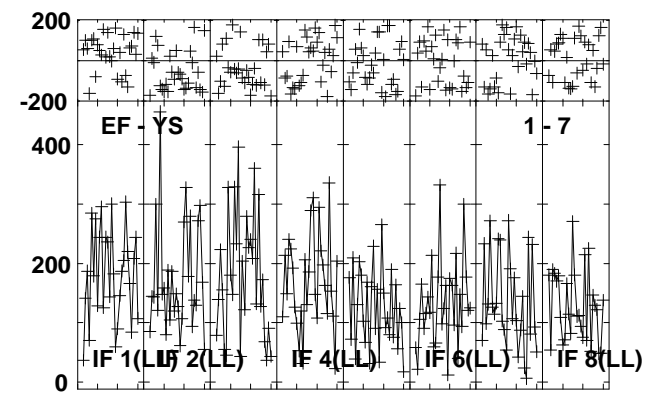
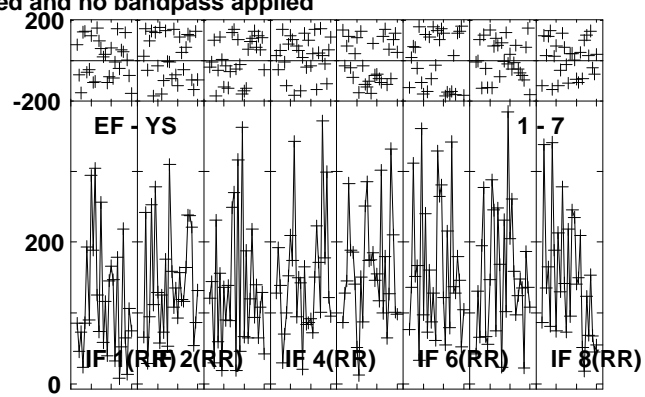
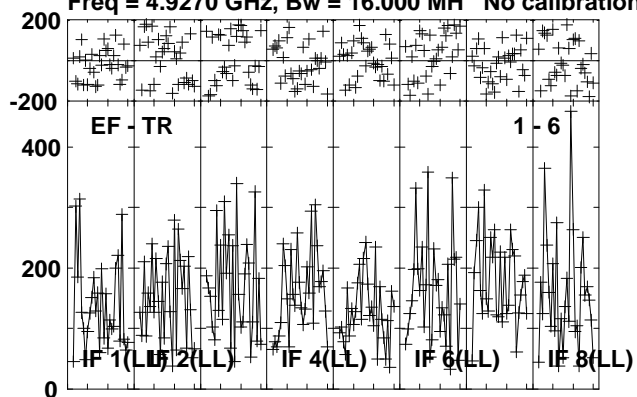

Lower frame: Micro Ampl Jy Top frame: Phas deg
Vector averaged cross-power spectrum Several baselines displayed
Timerange: 00/04:53:23 to 00/04:56:19

Plot file version 227 created 16-OCT-2012 11:57:39

J0639+0601 RO006.UVDATA.1

Freq = 4.9270 GHz, Bw = 16.000 MH No calibration applied and no bandpass applied

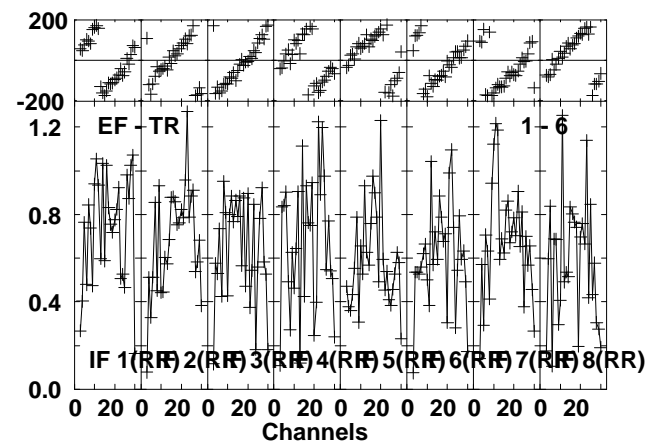
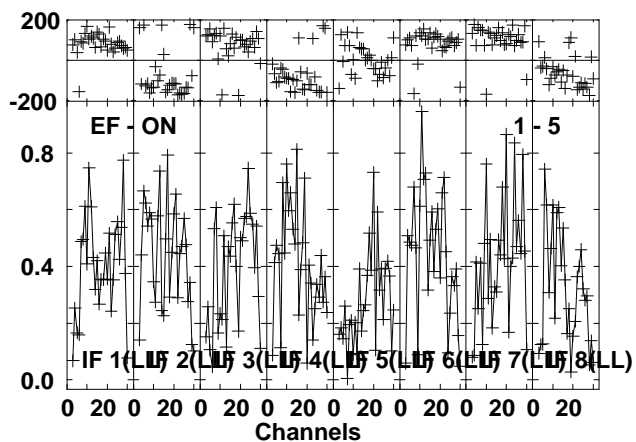
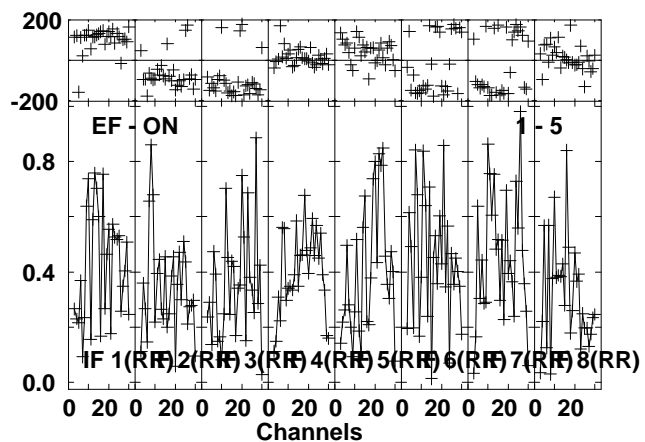
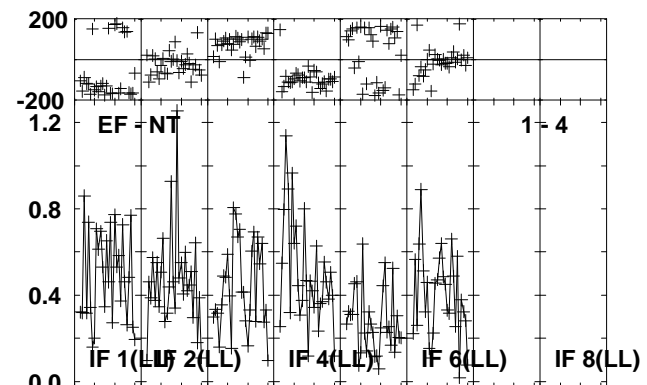
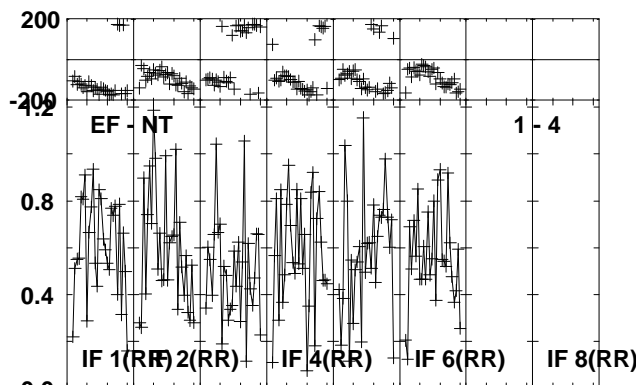
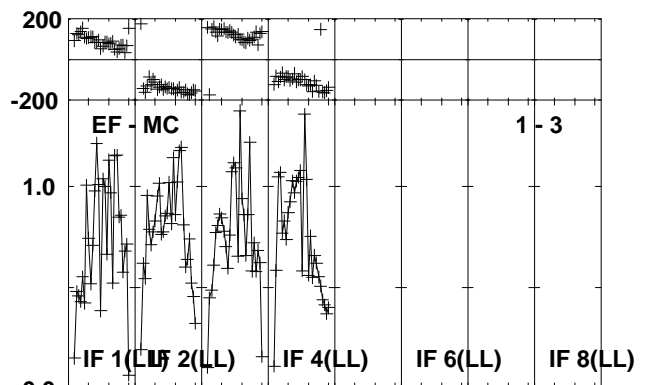
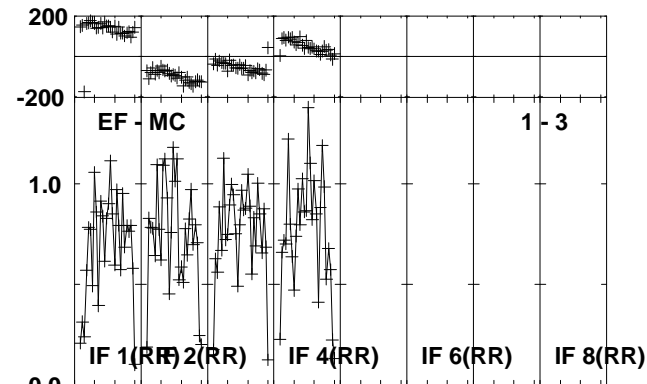
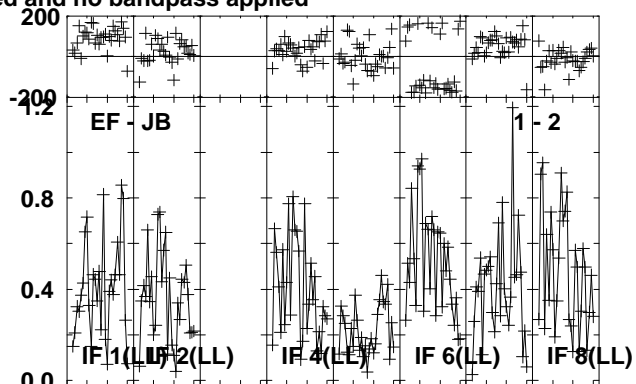
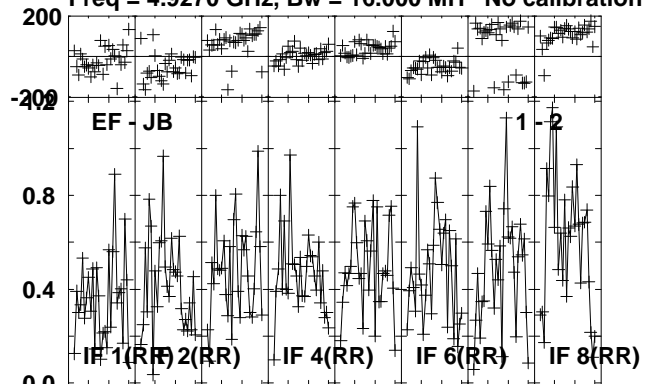

Lower frame: Milli Ampl Jy Top frame: Phas deg
Vector averaged cross-power spectrum Several baselines displayed
Timerange: 00/04:56:47 to 00/04:57:49

Plot file version 228 created 16-OCT-2012 11:57:39

J0639+0601 RO006.UVDATA.1

Freq = 4.9270 GHz, Bw = 16.000 MH No calibration applied and no bandpass applied

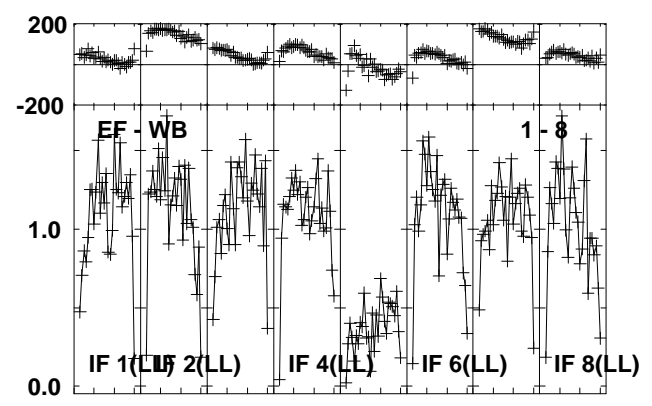
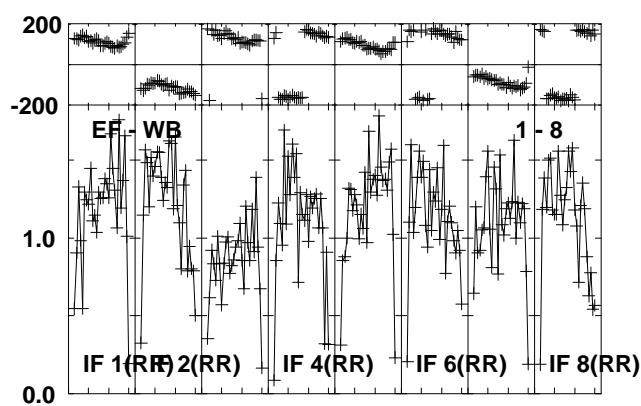
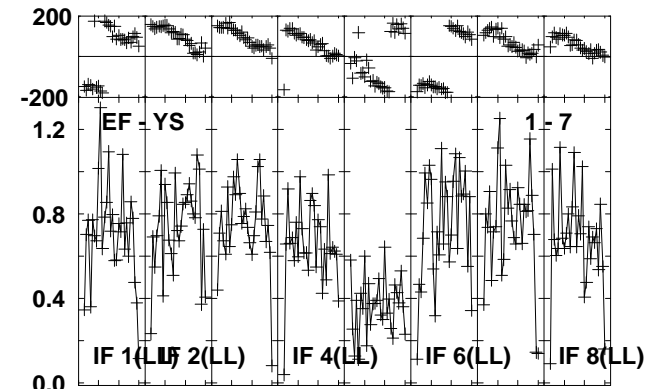
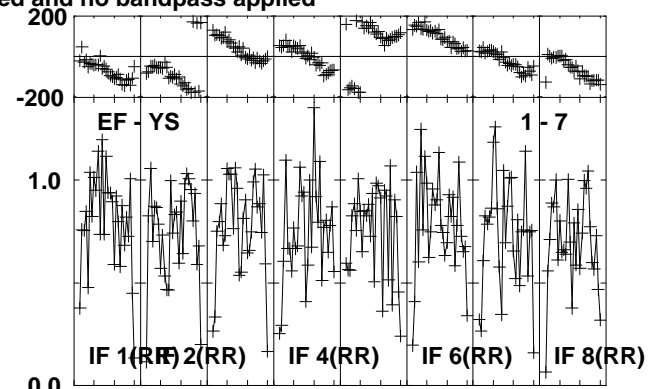
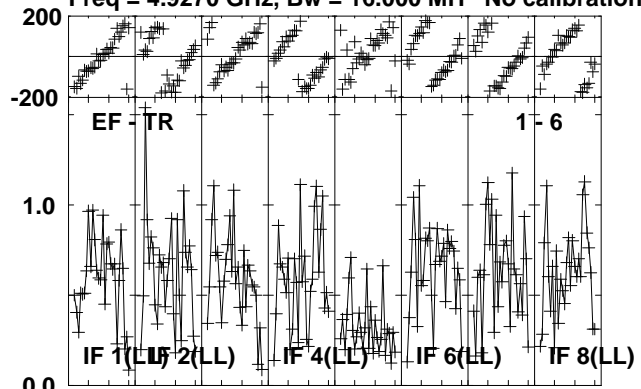

Lower frame: Milli Ampl Jy Top frame: Phas deg
Vector averaged cross-power spectrum Several baselines displayed
Timerange: 00/04:56:47 to 00/04:57:49

Plot file version 229 created 16-OCT-2012 11:57:39

J0645+0541 RO006.UVDATA.1

Freq = 4.9270 GHz, Bw = 16.000 MH No calibration applied and no bandpass applied

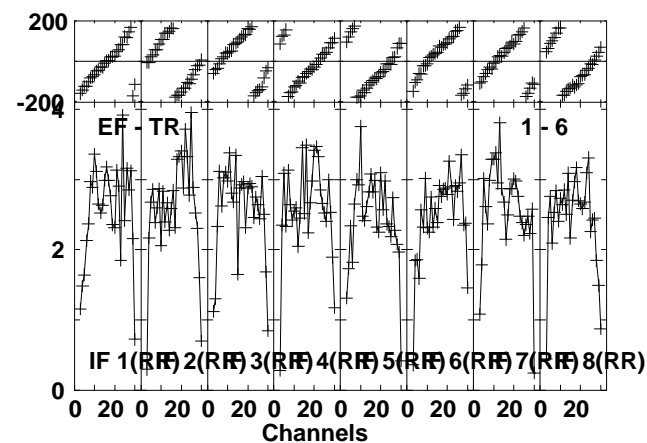
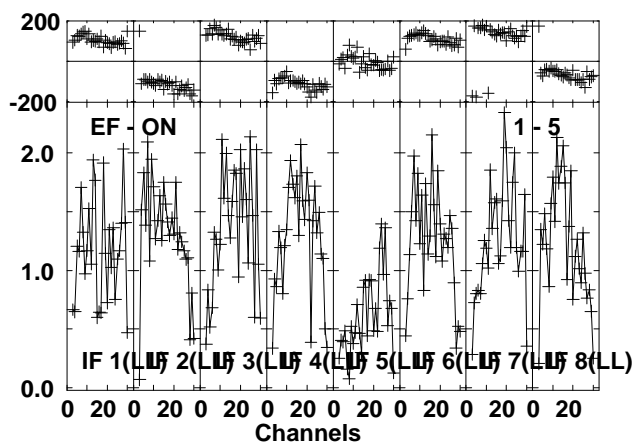
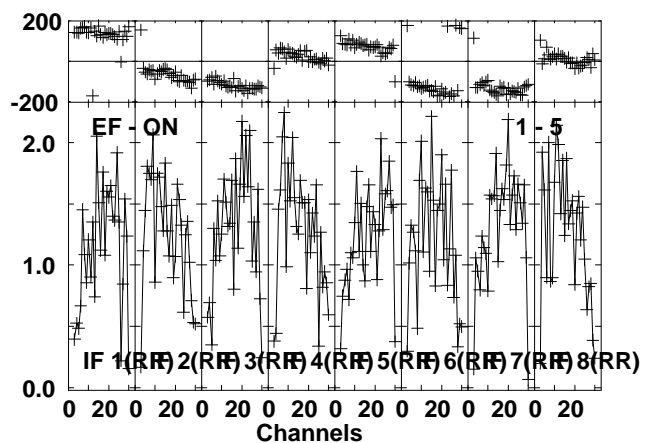
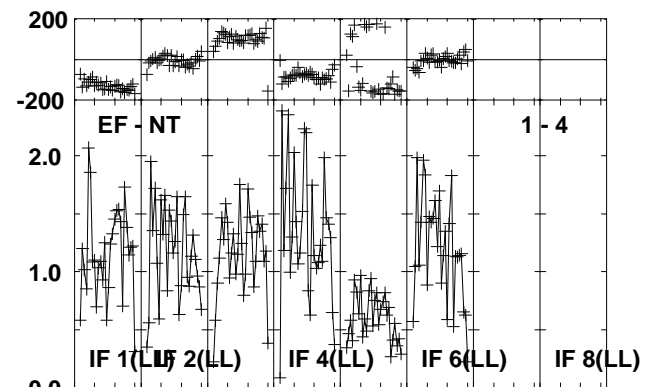
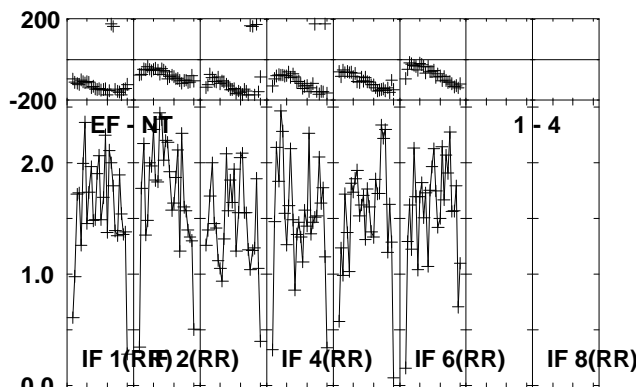
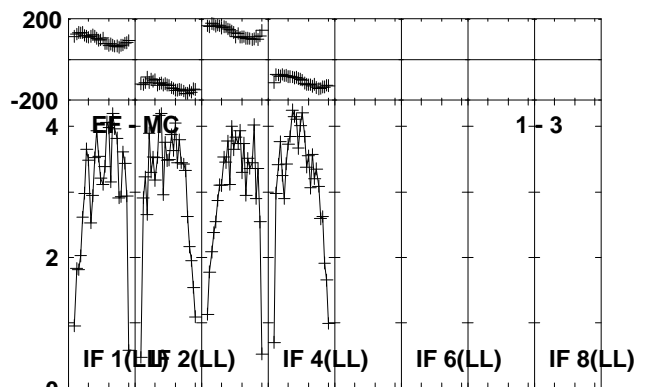
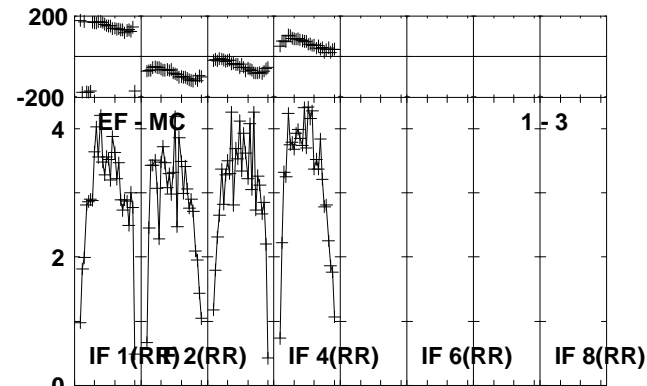
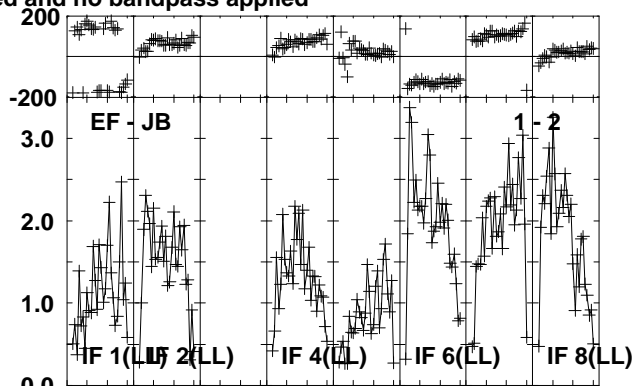
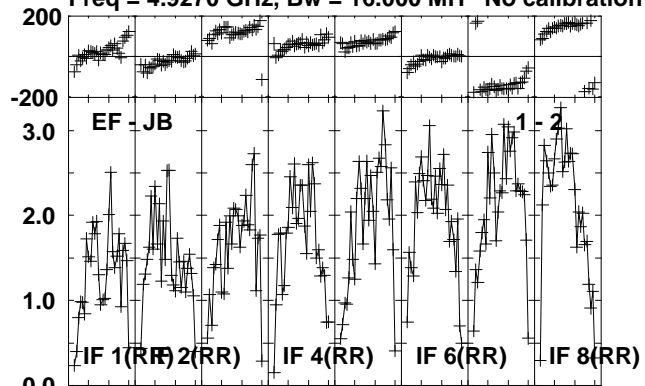

Lower frame: Milli Ampl Jy Top frame: Phas deg
Vector averaged cross-power spectrum Several baselines displayed
Timerange: 00/04:57:53 to 00/04:58:49

Plot file version 230 created 16-OCT-2012 11:57:39

J0645+0541 RO006.UVDATA.1

Freq = 4.9270 GHz, Bw = 16.000 MH No calibration applied and no bandpass applied

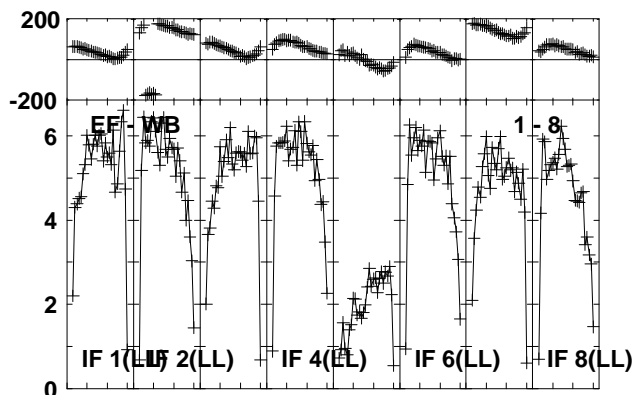
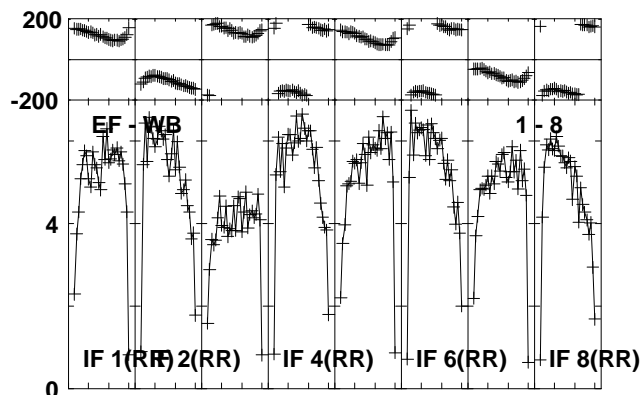
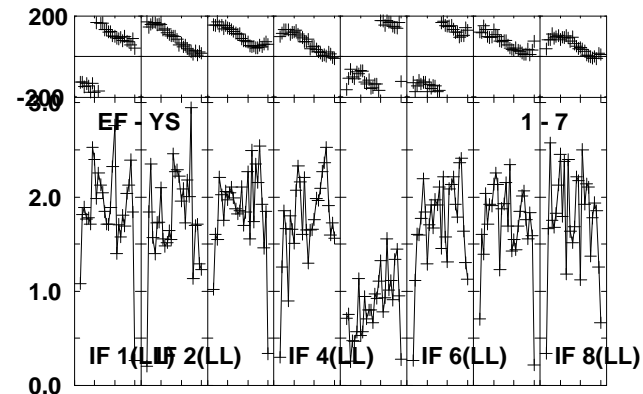
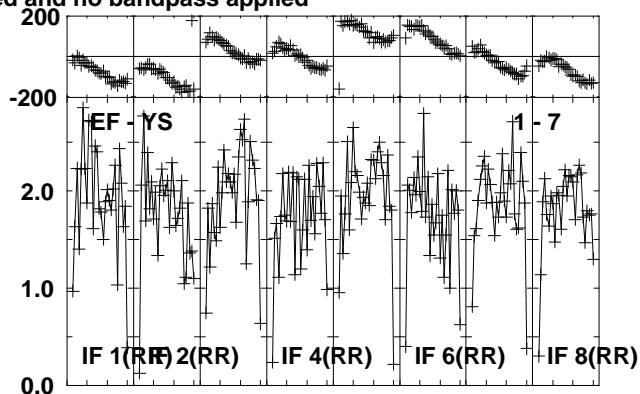
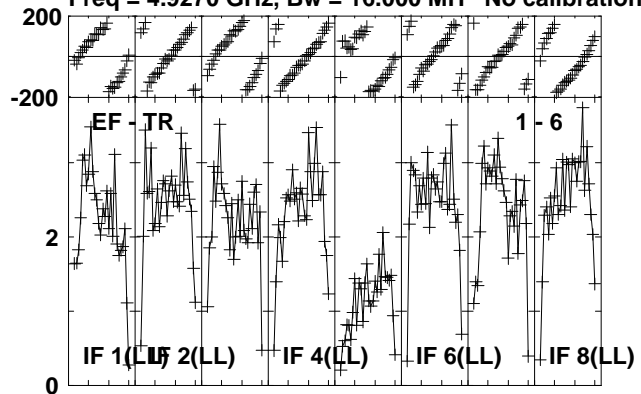

Lower frame: Milli Ampl Jy Top frame: Phas deg
Vector averaged cross-power spectrum Several baselines displayed
Timerange: 00/04:57:53 to 00/04:58:49

Plot file version 231 created 16-OCT-2012 11:57:40

NOVA-MON RO006.UVDATA.1

Freq = 4.9270 GHz, Bw = 16.000 MH No calibration applied and no bandpass applied

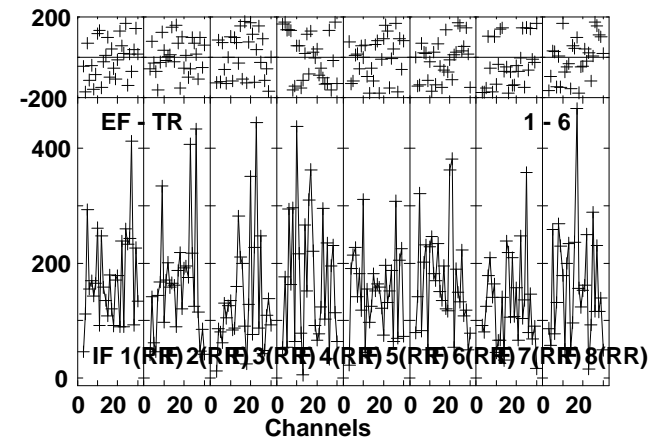
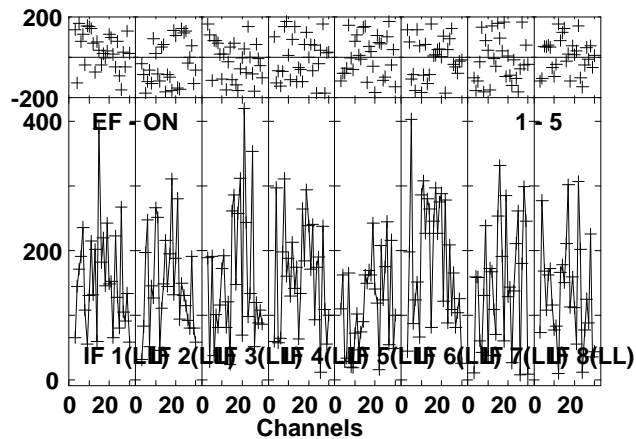
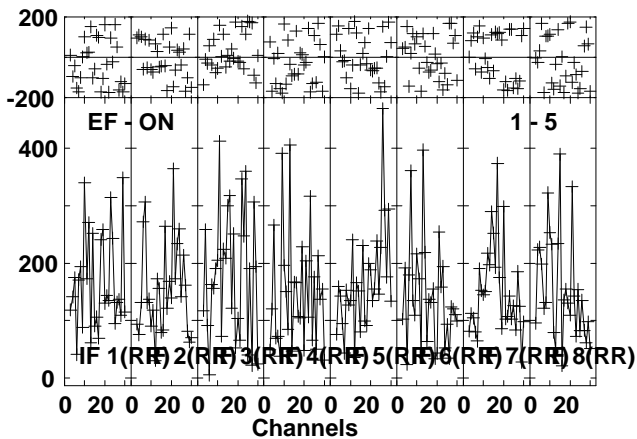
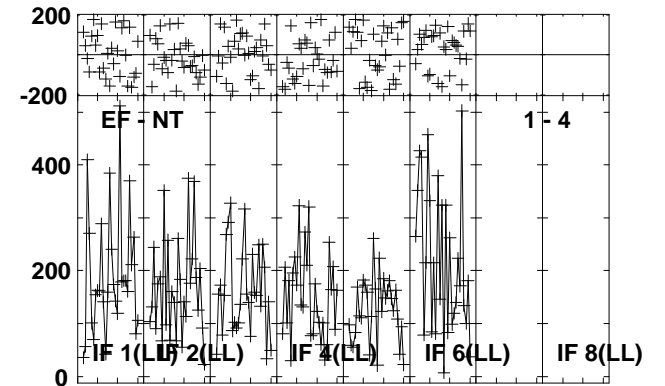
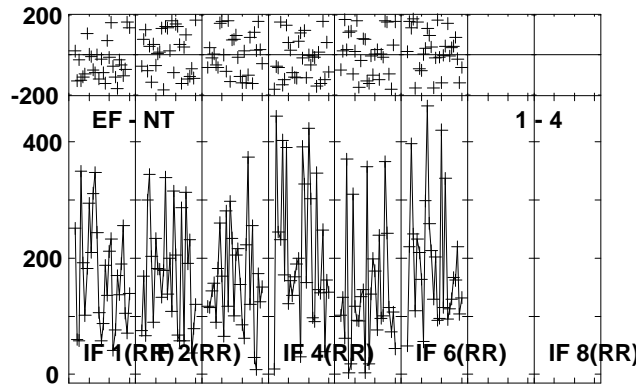
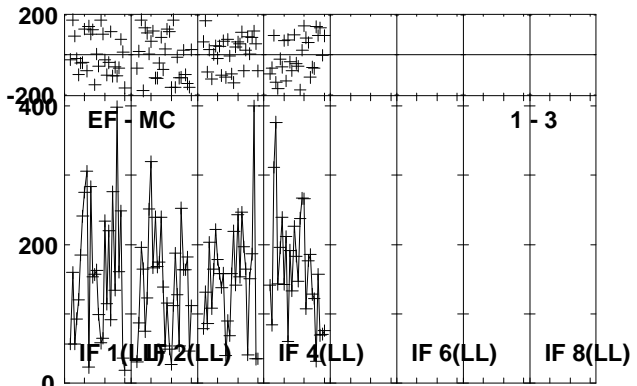
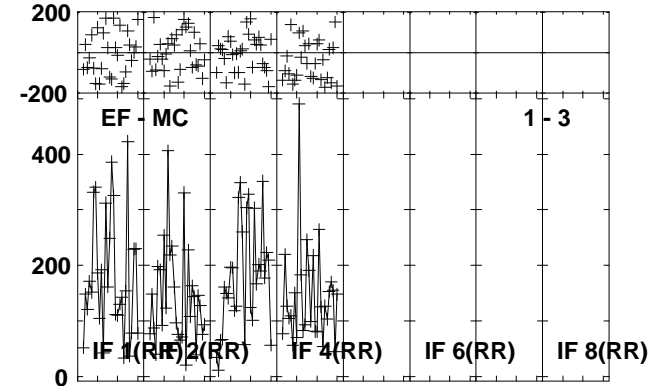
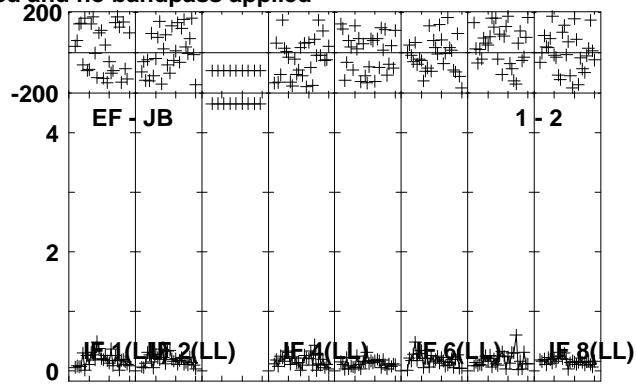
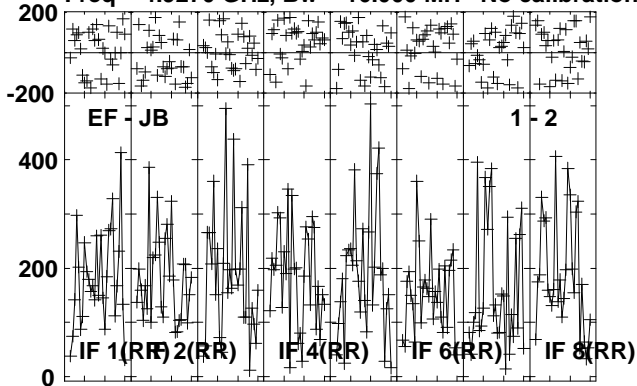

Lower frame: Micro Ampl Jy Top frame: Phas deg
Vector averaged cross-power spectrum Several baselines displayed
Timerange: 00/04:58:53 to 00/05:01:49

Plot file version 232 created 16-OCT-2012 11:57:40

NOVA-MON RO006.UVDATA.1

Freq = 4.9270 GHz, Bw = 16.000 MH No calibration applied and no bandpass applied

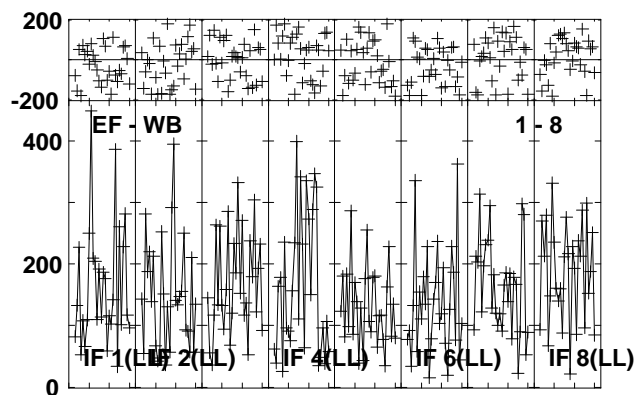
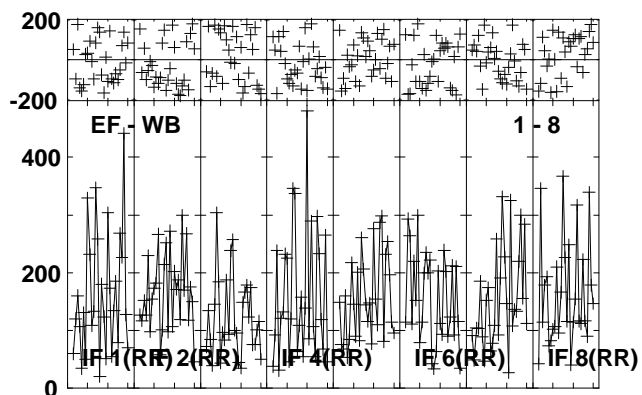
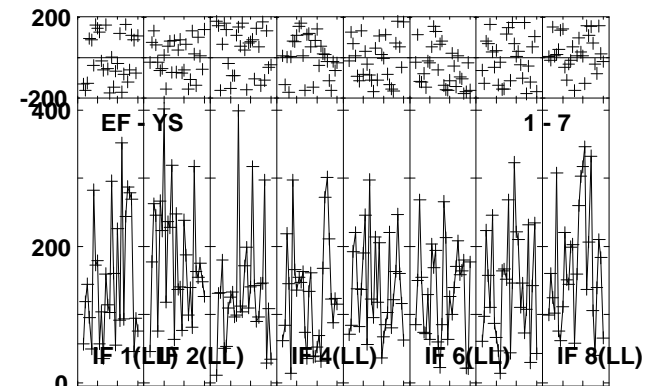
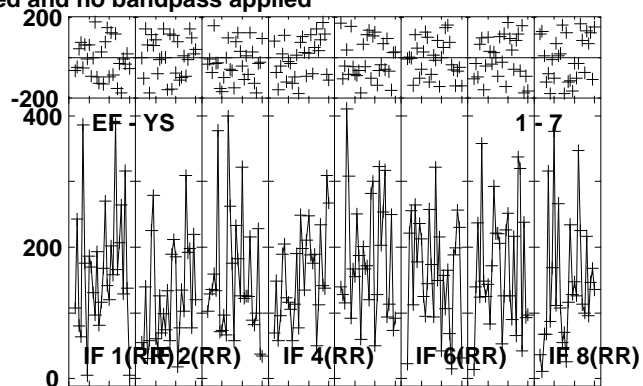
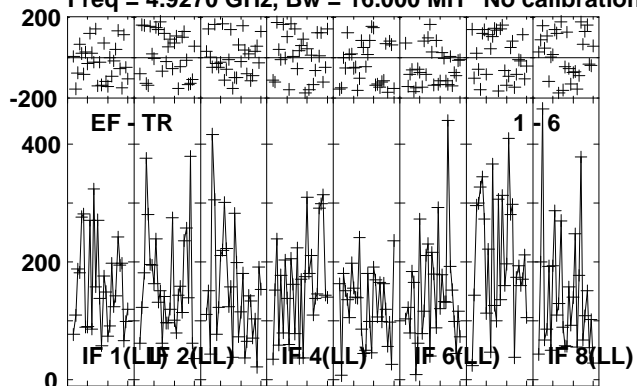

Lower frame: Micro Ampl Jy Top frame: Phas deg
Vector averaged cross-power spectrum Several baselines displayed
Timerange: 00/04:58:53 to 00/05:01:49

Plot file version 233 created 16-OCT-2012 11:57:40

J0639+0601 RO006.UVDATA.1

Freq = 4.9270 GHz, Bw = 16.000 MH No calibration applied and no bandpass applied

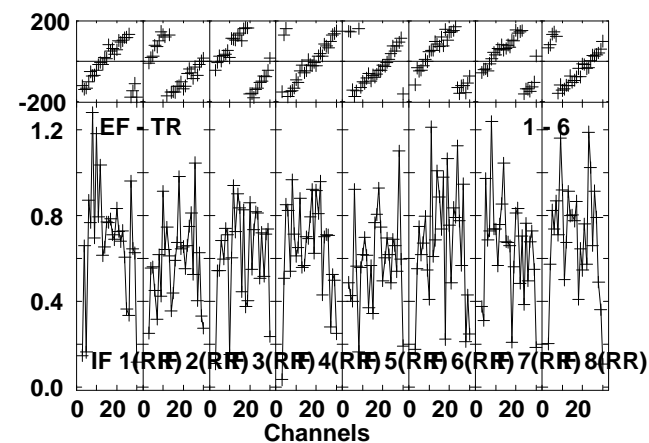
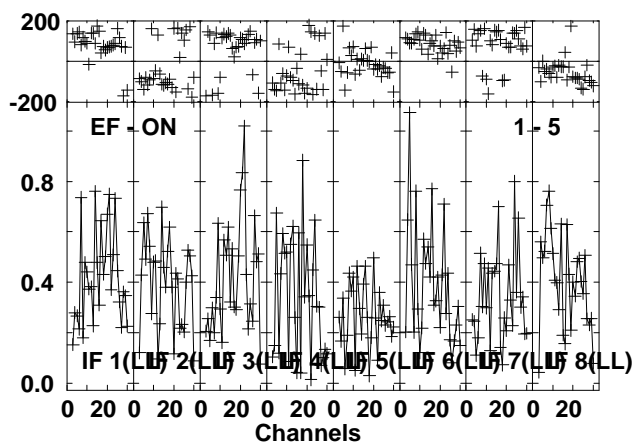
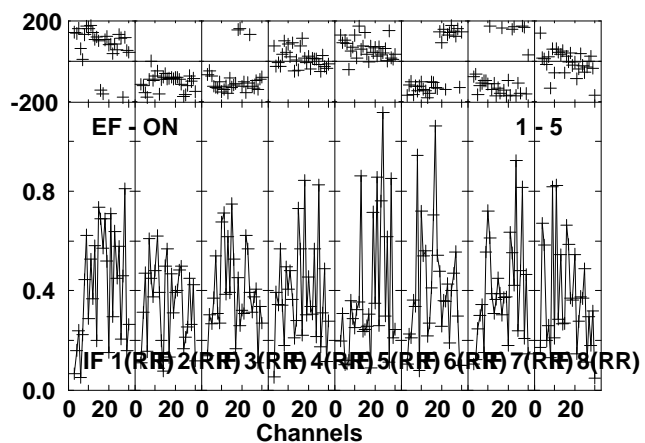
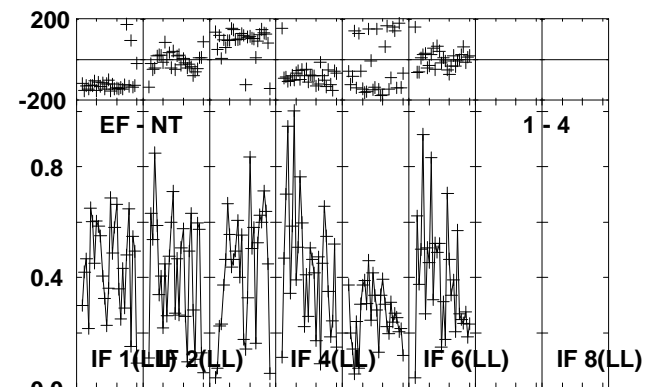
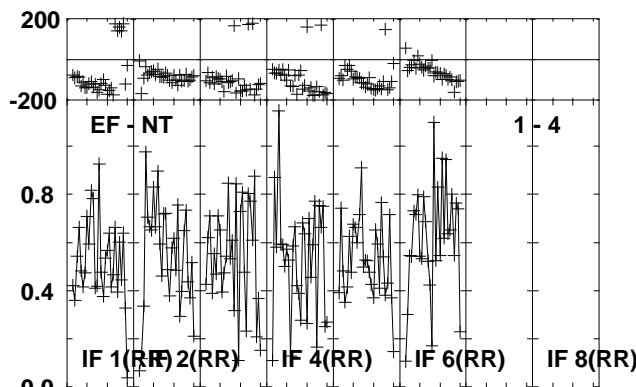
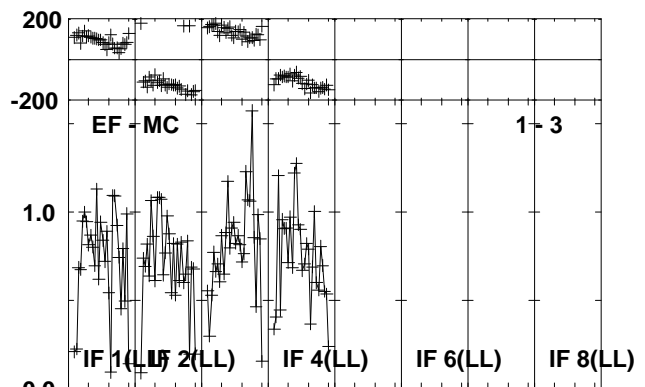
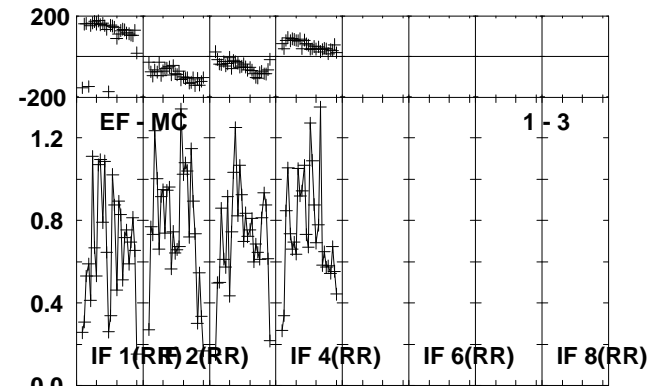
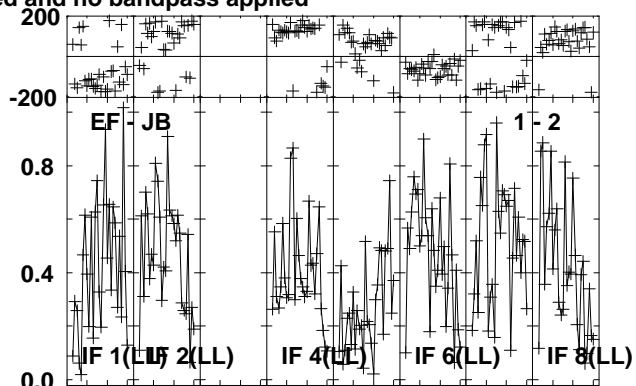
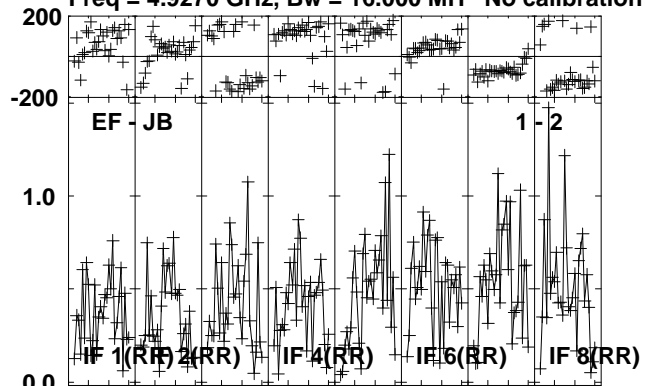

Lower frame: Milli Ampl Jy Top frame: Phas deg
Vector averaged cross-power spectrum Several baselines displayed
Timerange: 00/05:01:53 to 00/05:03:03

Plot file version 234 created 16-OCT-2012 11:57:41

J0639+0601 RO006.UVDATA.1

Freq = 4.9270 GHz, Bw = 16.000 MH No calibration applied and no bandpass applied

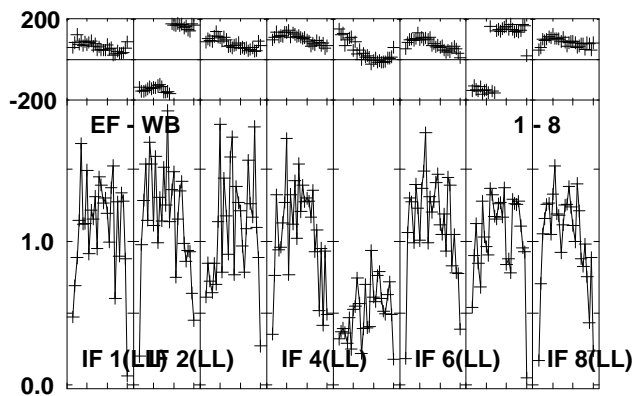
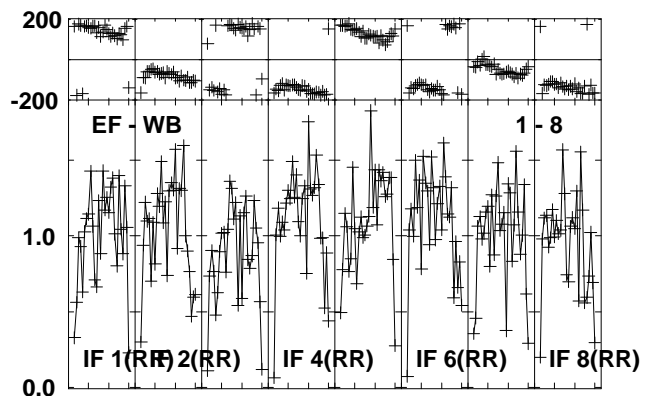
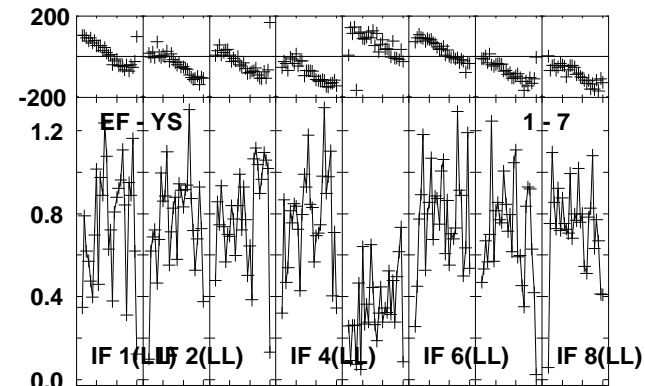
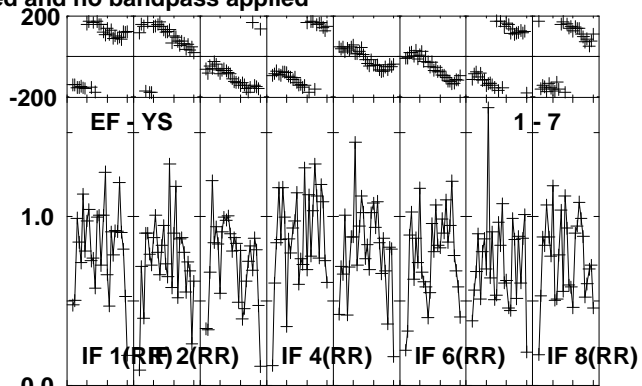
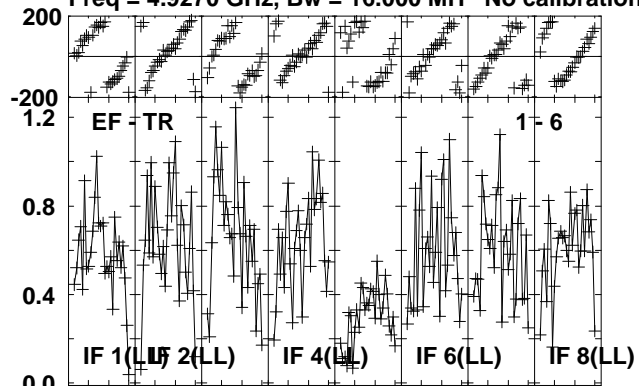

Lower frame: Milli Ampl Jy Top frame: Phas deg
Vector averaged cross-power spectrum Several baselines displayed
Timerange: 00/05:01:53 to 00/05:03:03

Plot file version 235 created 16-OCT-2012 11:57:41

J0645+0541 RO006.UVDATA.1

Freq = 4.9270 GHz, Bw = 16.000 MH No calibration applied and no bandpass applied

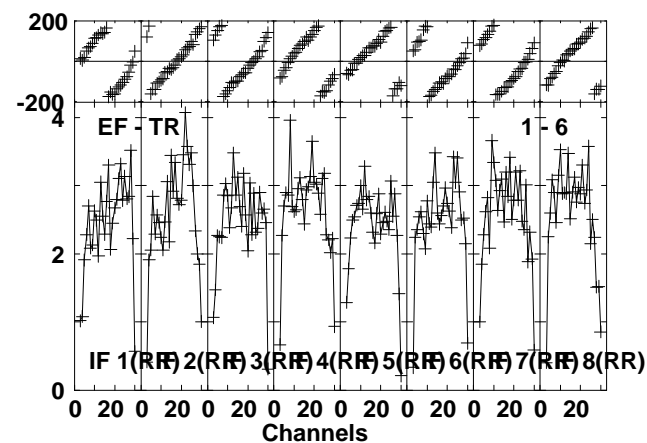
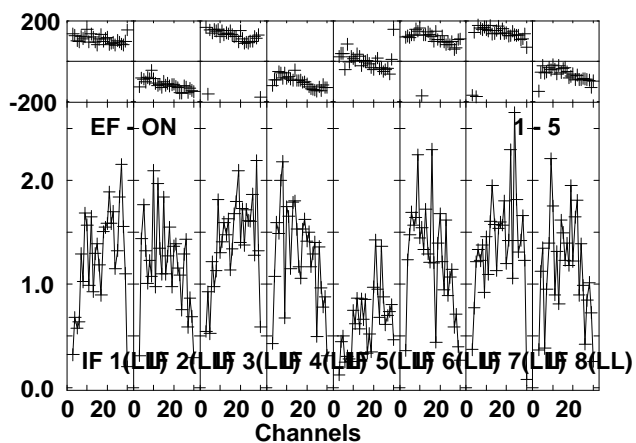
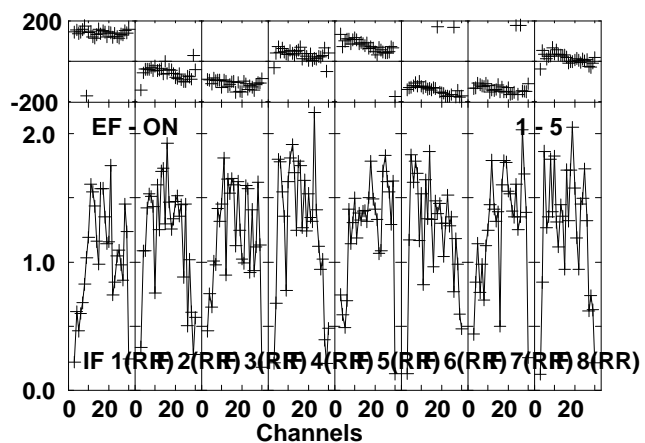
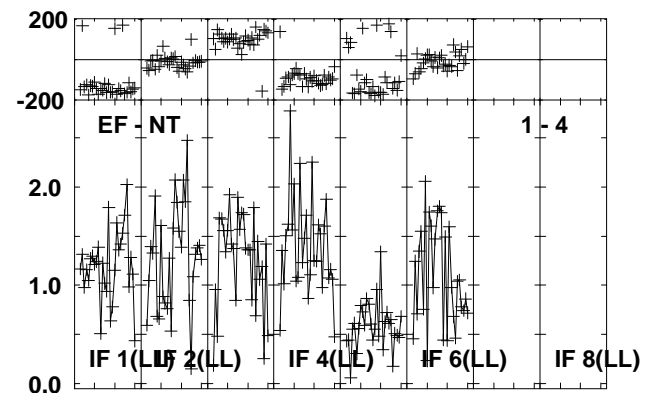
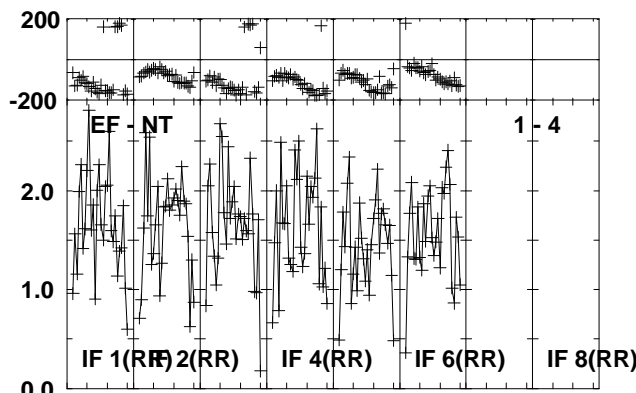
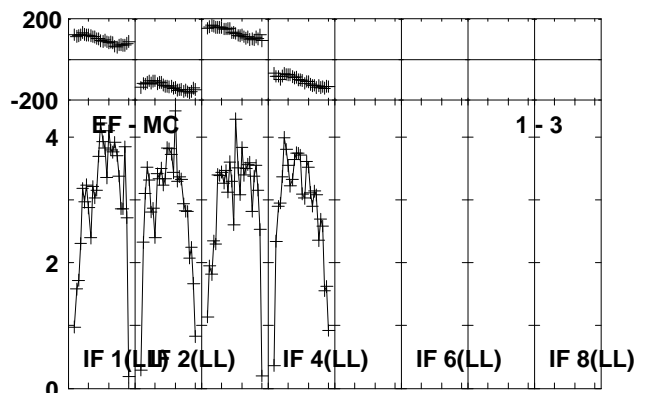
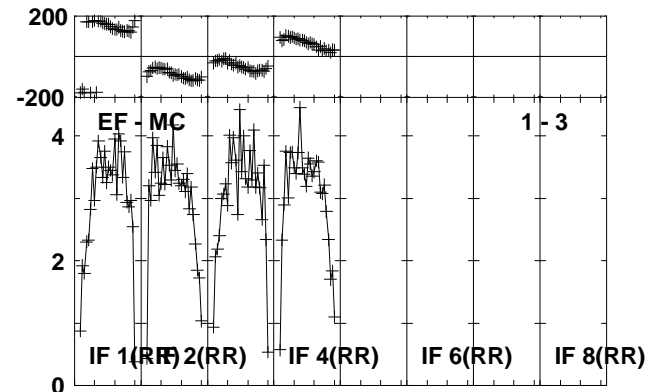
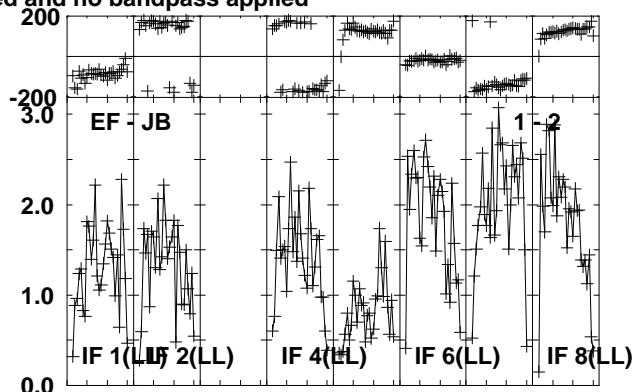
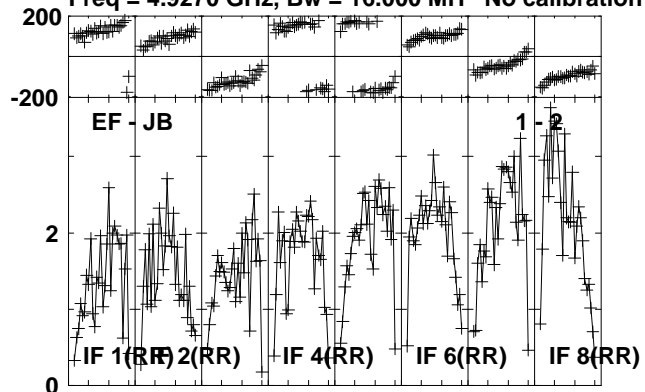

Lower frame: Milli Ampl Jy Top frame: Phas deg
Vector averaged cross-power spectrum Several baselines displayed
Timerange: 00/05:03:07 to 00/05:04:03

Plot file version 236 created 16-OCT-2012 11:57:41

J0645+0541 RO006.UVDATA.1

Freq = 4.9270 GHz, Bw = 16.000 MH No calibration applied and no bandpass applied

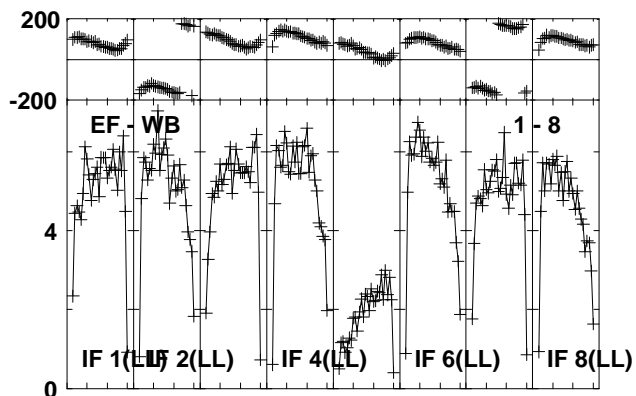
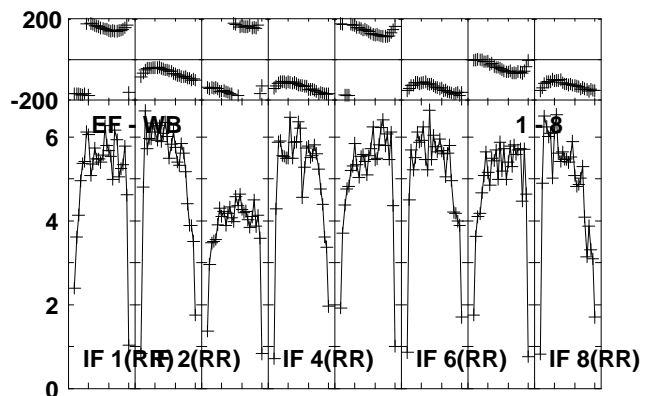
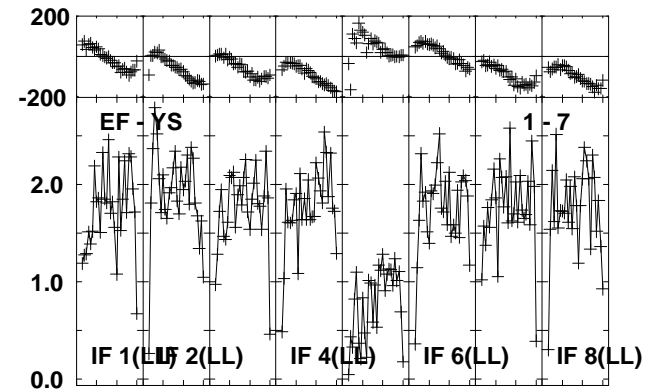
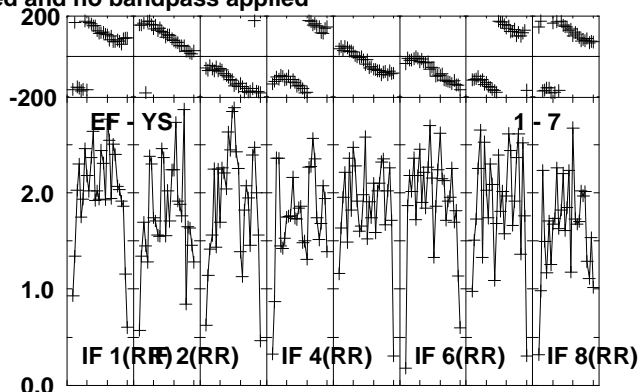
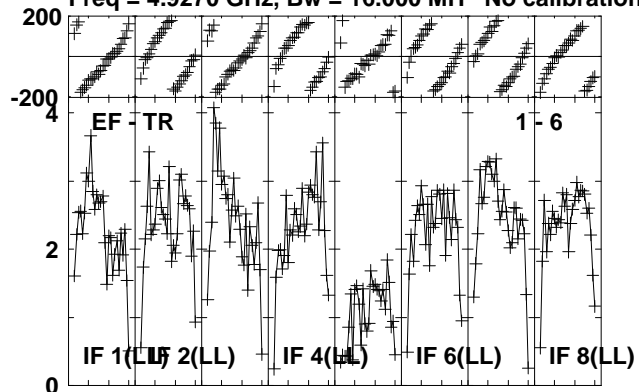

Lower frame: Milli Ampl Jy Top frame: Phas deg
Vector averaged cross-power spectrum Several baselines displayed
Timerange: 00/05:03:07 to 00/05:04:03

Plot file version 237 created 16-OCT-2012 11:57:41

NOVA-MON RO006.UVDATA.1

Freq = 4.9270 GHz, Bw = 16.000 MH No calibration applied and no bandpass applied

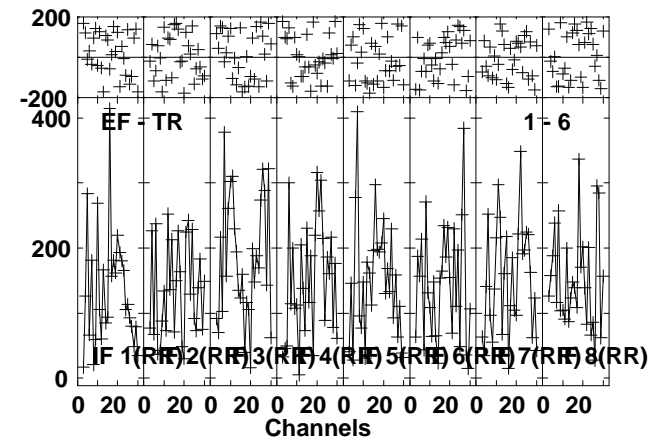
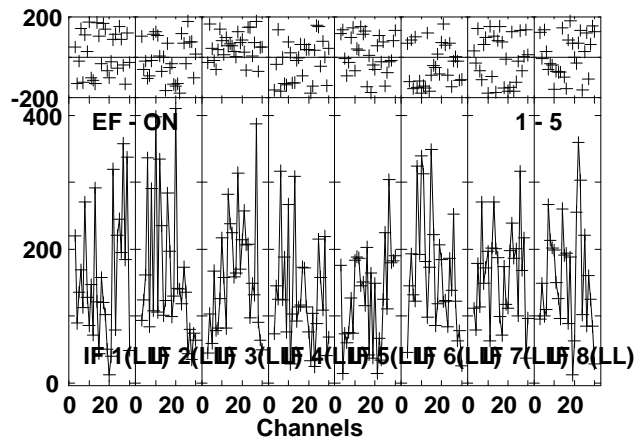
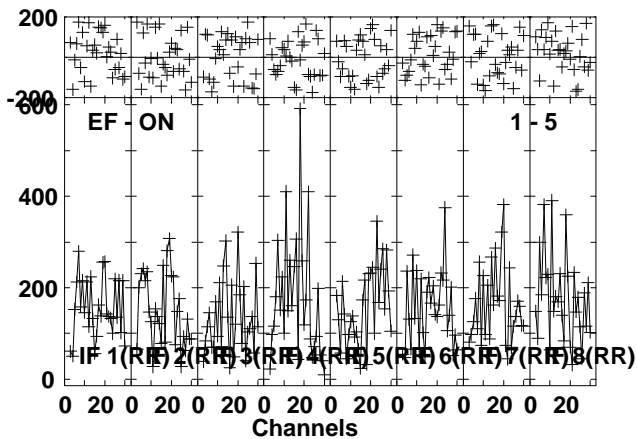
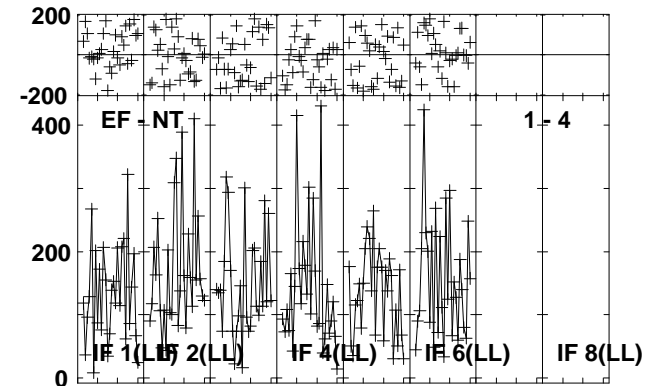
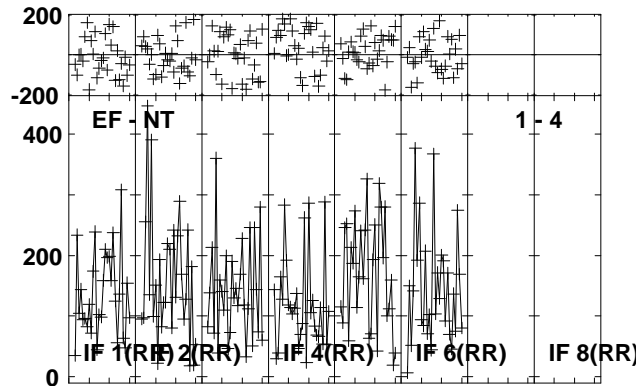
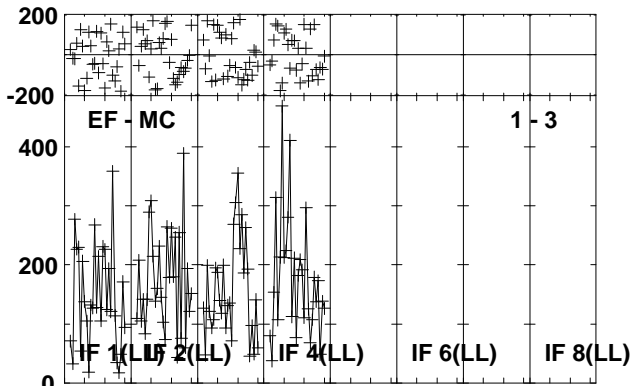
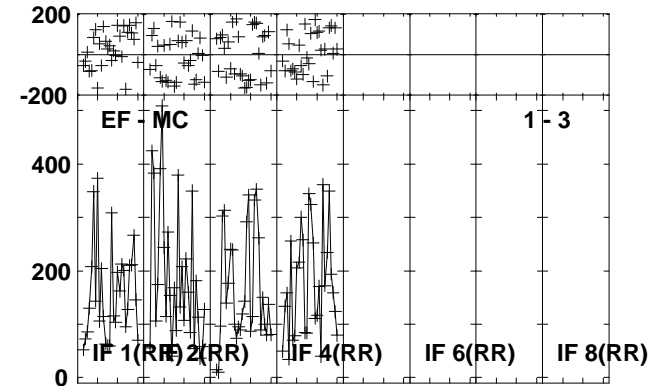
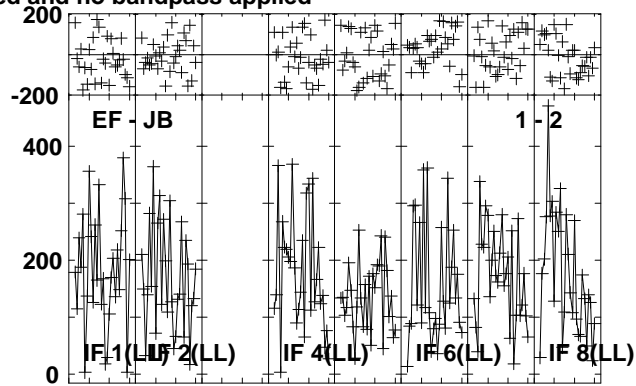
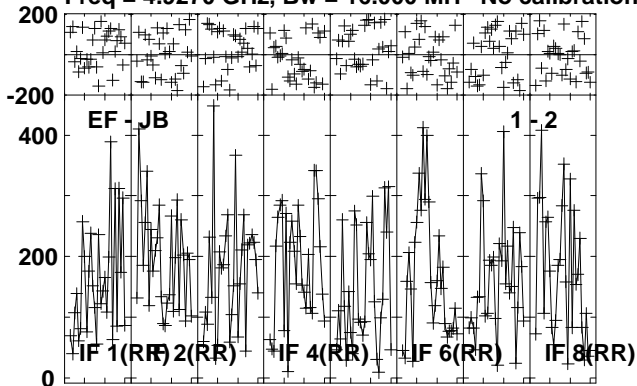

Lower frame: Micro Ampl Jy Top frame: Phas deg
Vector averaged cross-power spectrum Several baselines displayed
Timerange: 00/05:04:07 to 00/05:07:03

Plot file version 238 created 16-OCT-2012 11:57:42

NOVA-MON RO006.UVDATA.1

Freq = 4.9270 GHz, Bw = 16.000 MH No calibration applied and no bandpass applied

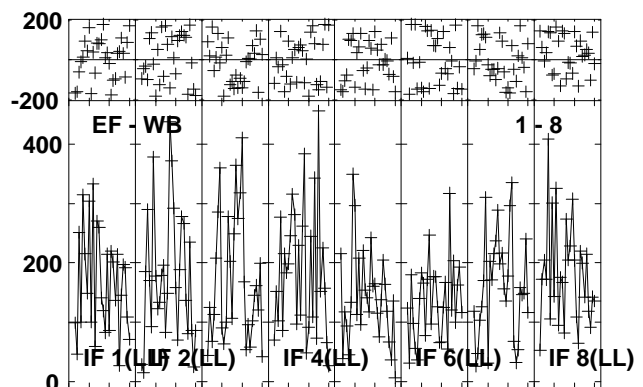
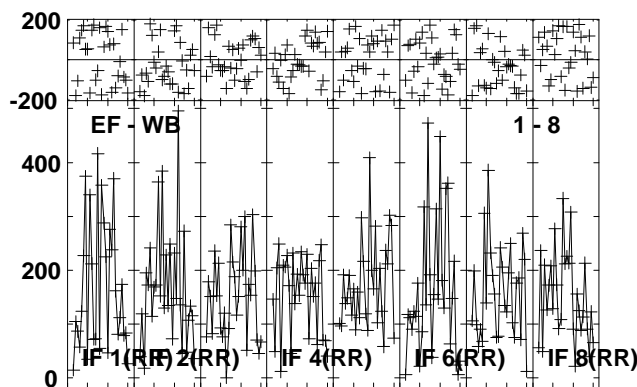
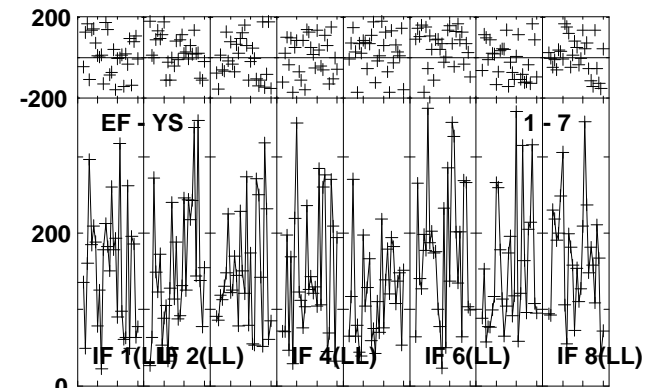
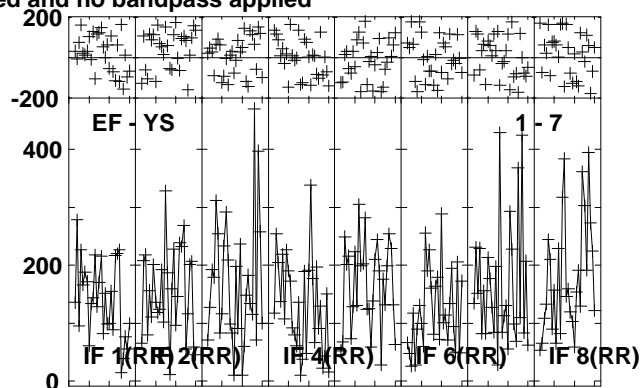
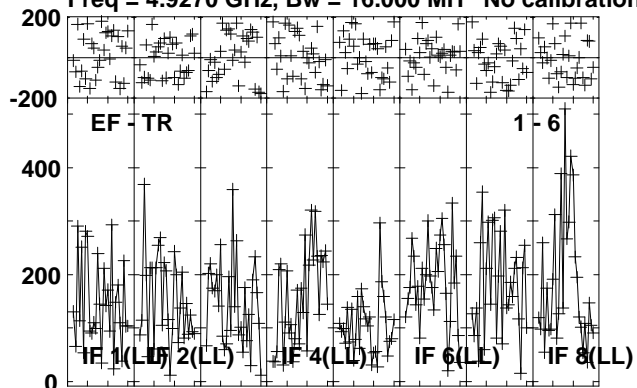

Lower frame: Micro Ampl Jy Top frame: Phas deg
Vector averaged cross-power spectrum Several baselines displayed
Timerange: 00/05:04:07 to 00/05:07:03

Plot file version 239 created 16-OCT-2012 11:57:42

J0639+0601 RO006.UVDATA.1

Freq = 4.9270 GHz, Bw = 16.000 MH No calibration applied and no bandpass applied

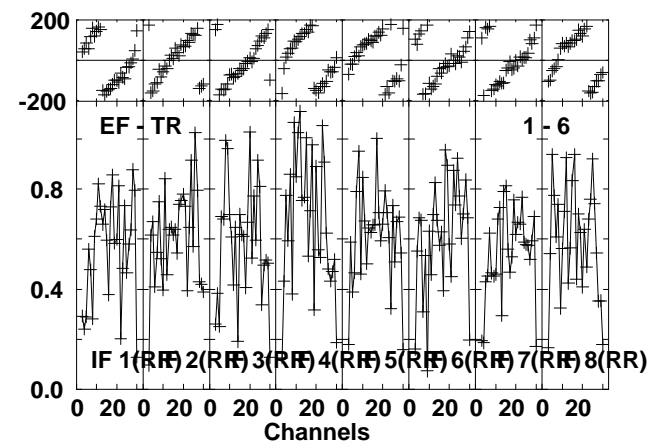
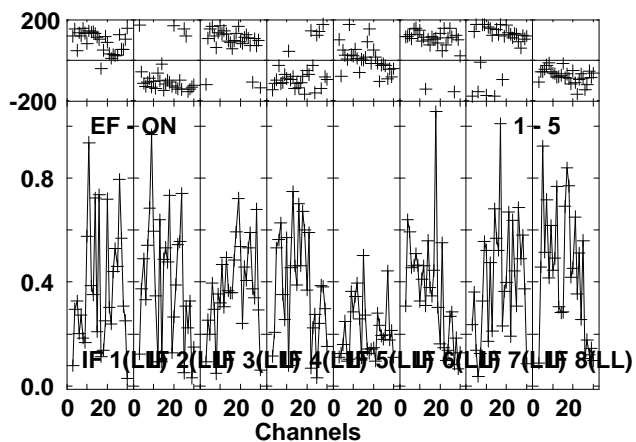
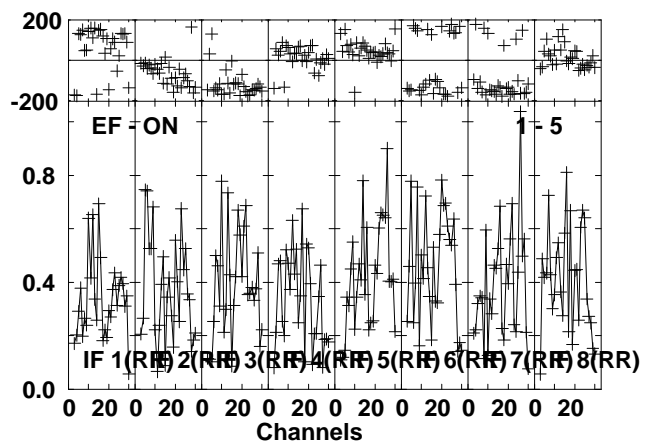
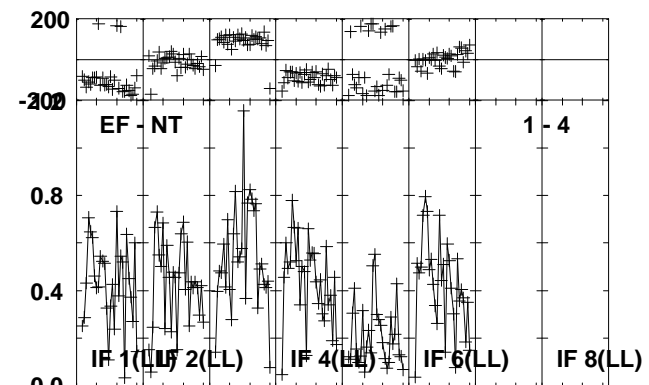
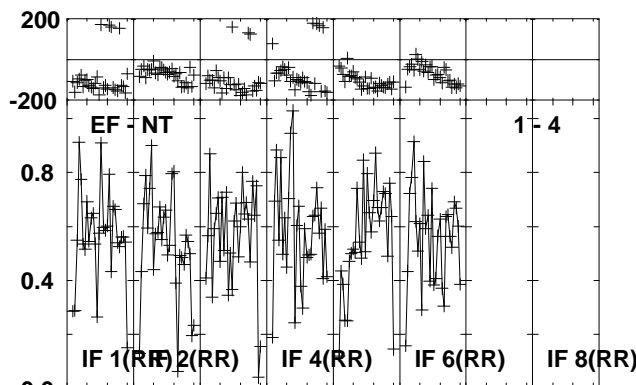
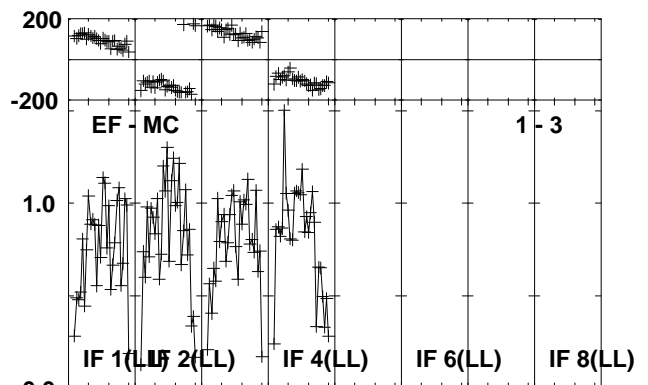
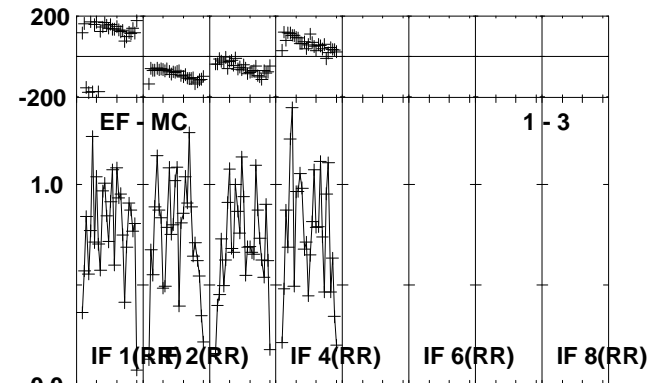
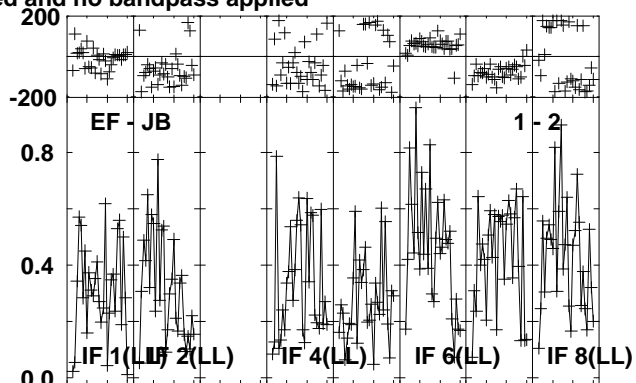
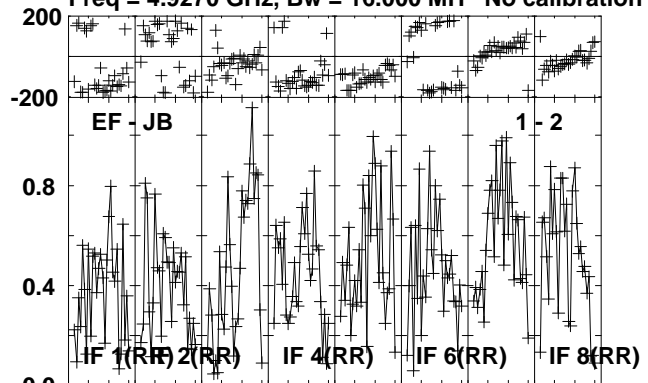

Lower frame: Milli Ampl Jy Top frame: Phas deg
Vector averaged cross-power spectrum Several baselines displayed
Timerange: 00/05:07:33 to 00/05:08:33

Plot file version 240 created 16-OCT-2012 11:57:42

J0639+0601 RO006.UVDATA.1

Freq = 4.9270 GHz, Bw = 16.000 MH No calibration applied and no bandpass applied

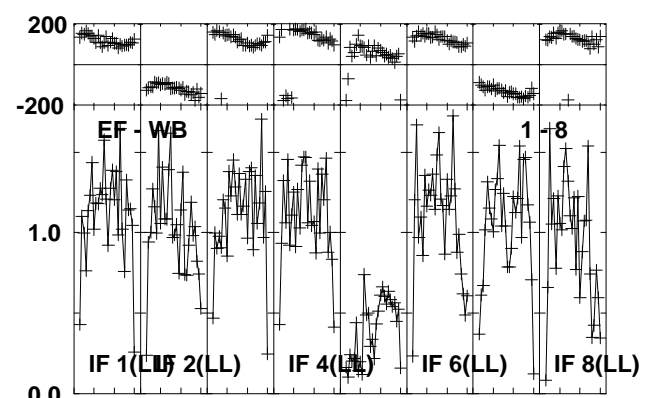
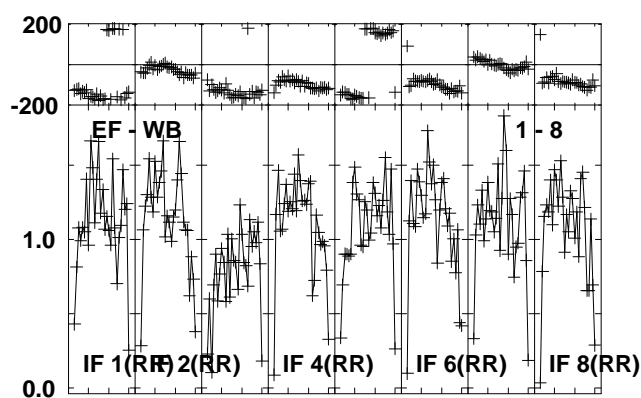
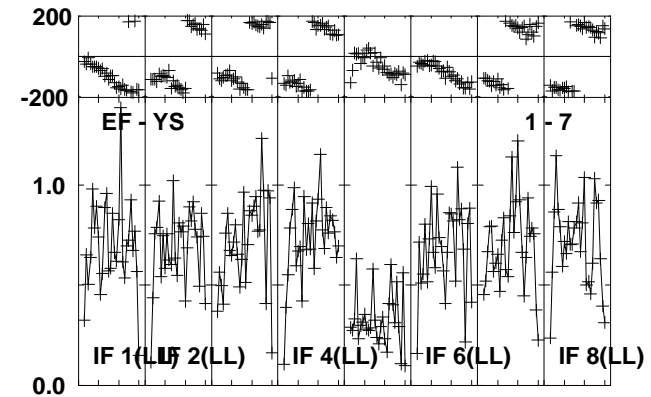
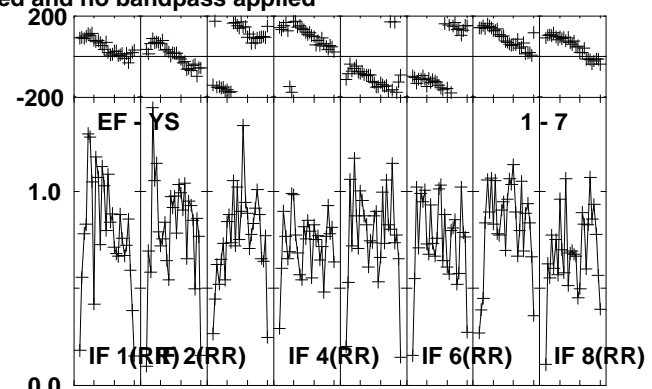
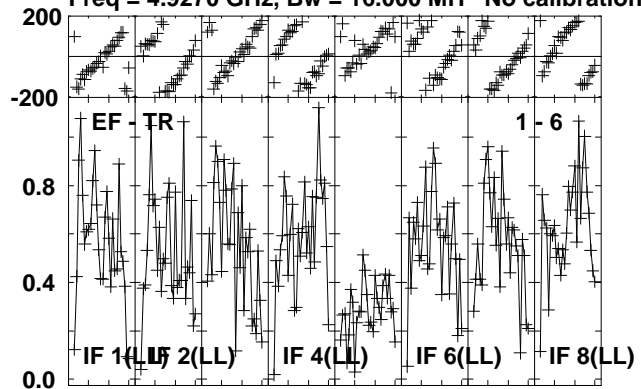

Lower frame: Milli Ampl Jy Top frame: Phas deg
Vector averaged cross-power spectrum Several baselines displayed
Timerange: 00/05:07:33 to 00/05:08:33

Plot file version 241 created 16-OCT-2012 11:57:43

J0645+0541 RO006.UVDATA.1

Freq = 4.9270 GHz, Bw = 16.000 MH No calibration applied and no bandpass applied

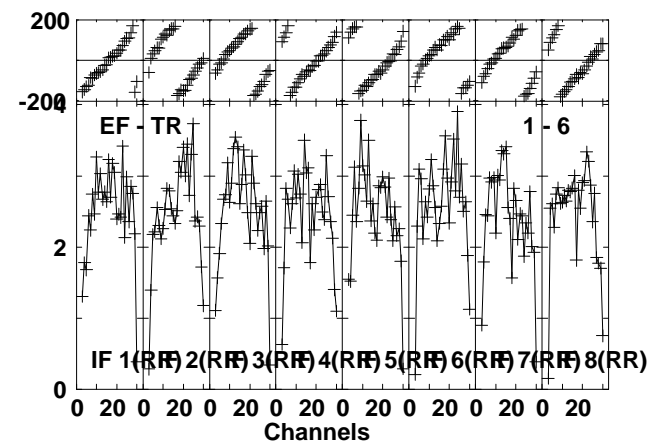
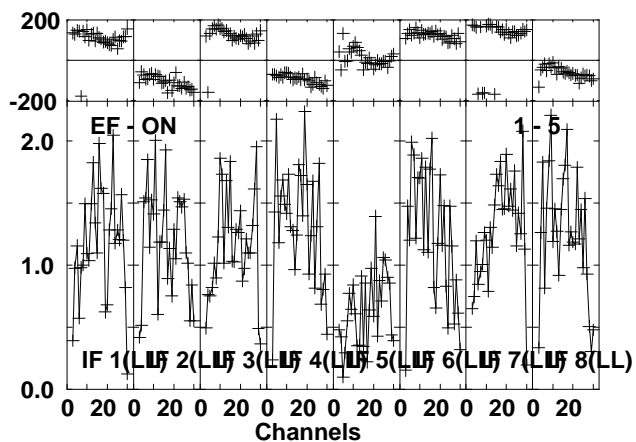
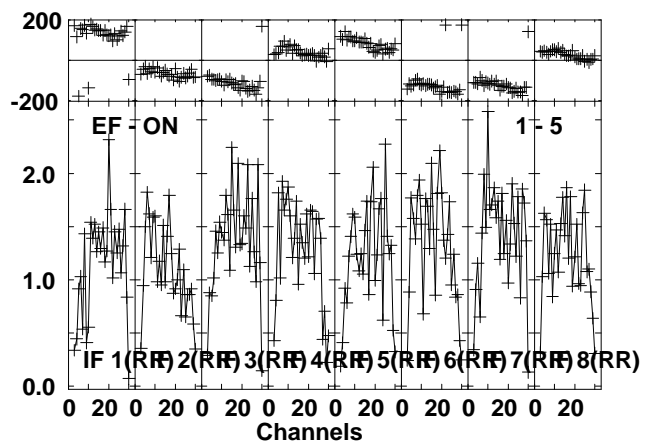
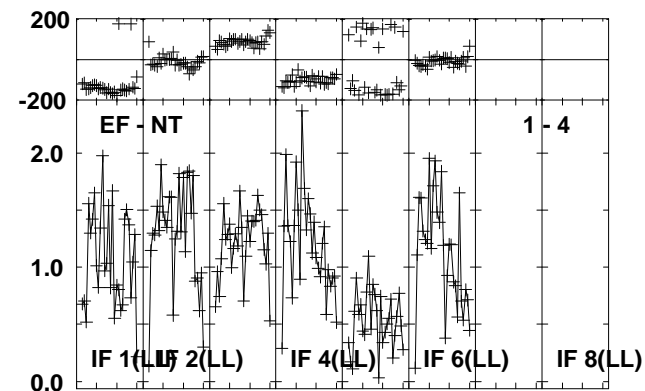
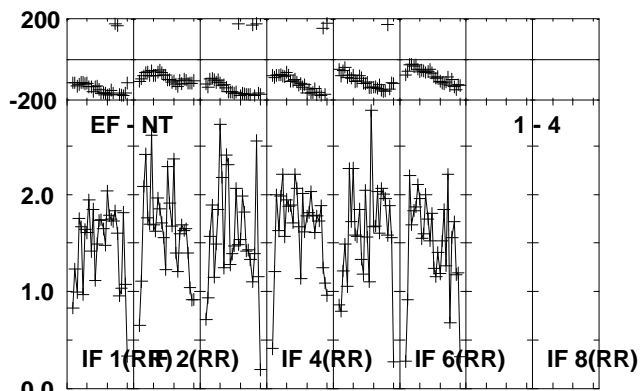
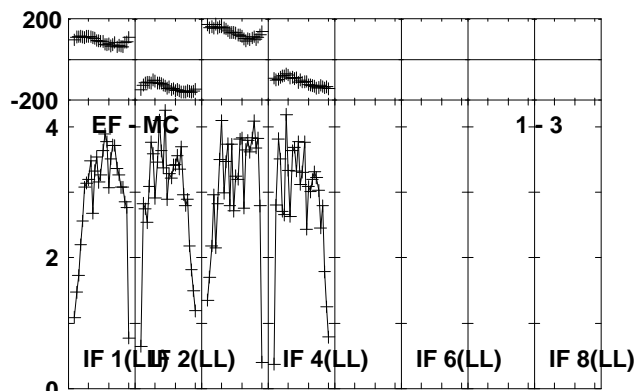
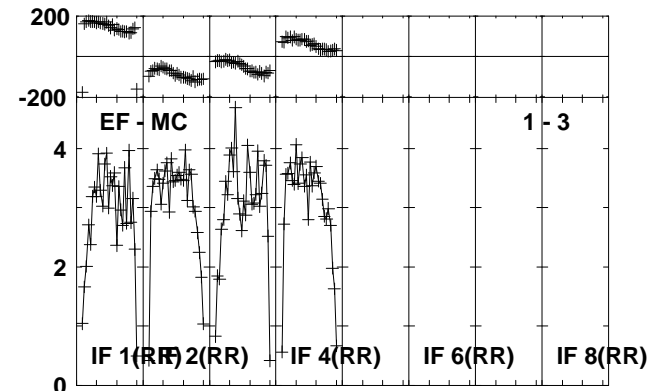
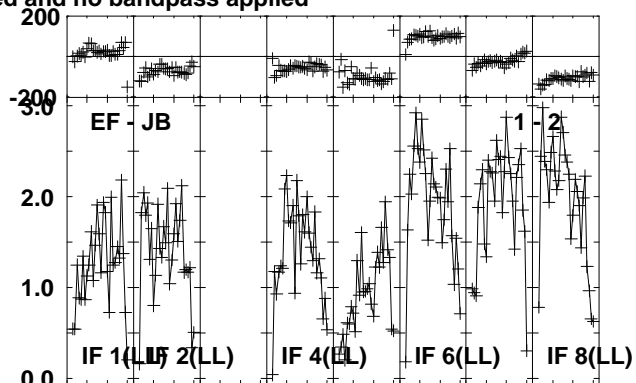
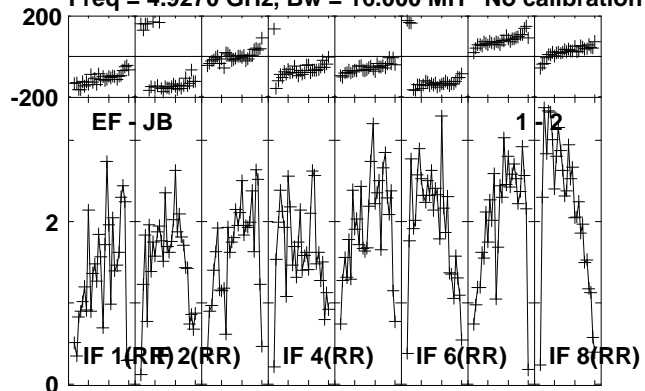

Lower frame: Milli Ampl Jy Top frame: Phas deg
Vector averaged cross-power spectrum Several baselines displayed
Timerange: 00/05:08:37 to 00/05:09:33

Plot file version 242 created 16-OCT-2012 11:57:43

J0645+0541 RO006.UVDATA.1

Freq = 4.9270 GHz, Bw = 16.000 MH No calibration applied and no bandpass applied

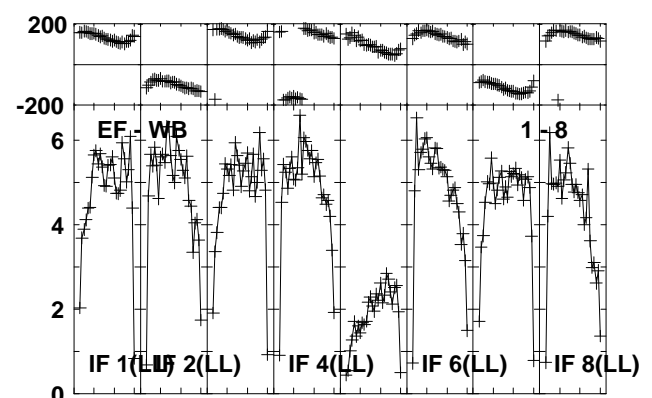
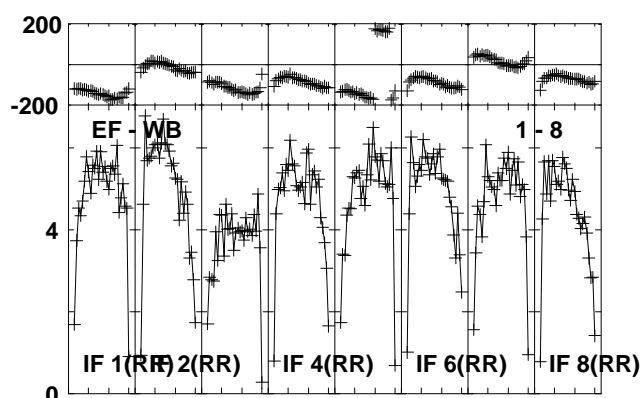
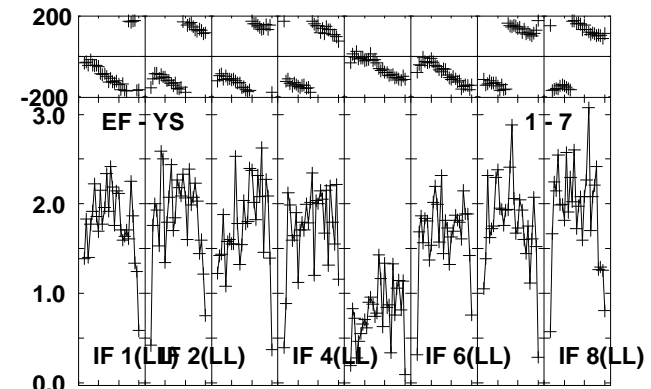
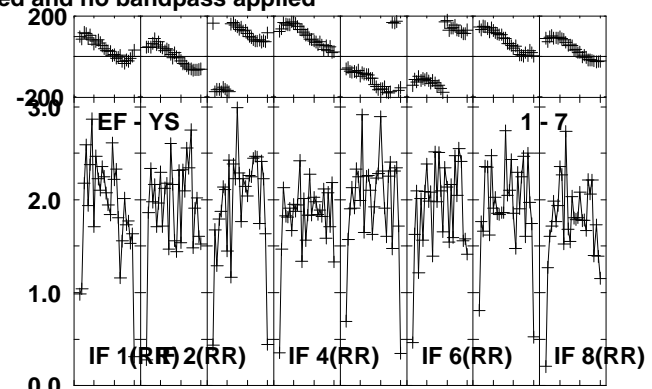
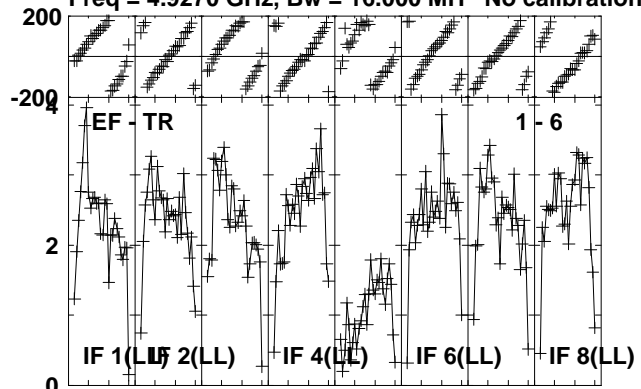

Lower frame: Milli Ampl Jy Top frame: Phas deg
Vector averaged cross-power spectrum Several baselines displayed
Timerange: 00/05:08:37 to 00/05:09:33

Plot file version 243 created 16-OCT-2012 11:57:43

NOVA-MON RO006.UVDATA.1

Freq = 4.9270 GHz, Bw = 16.000 MH No calibration applied and no bandpass applied

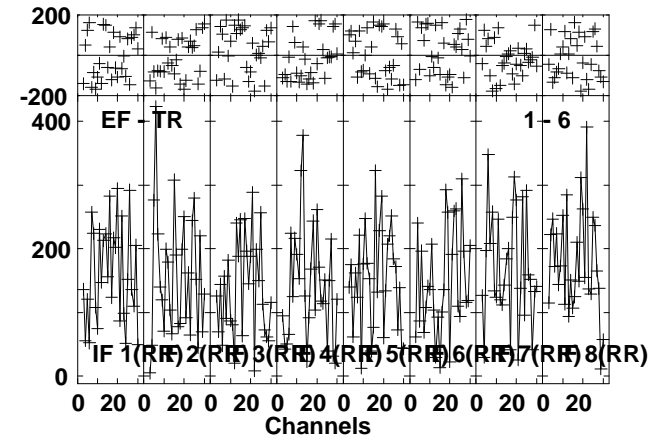
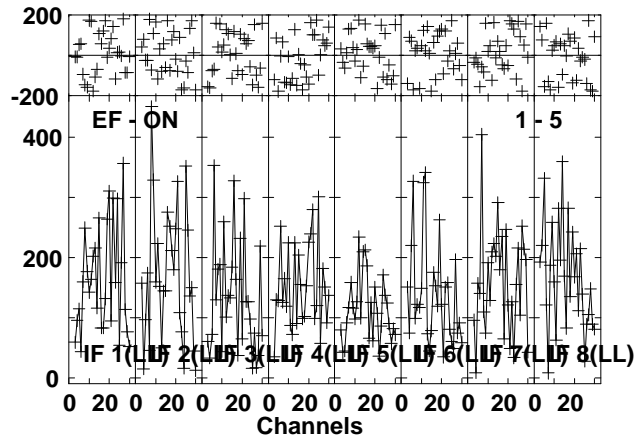
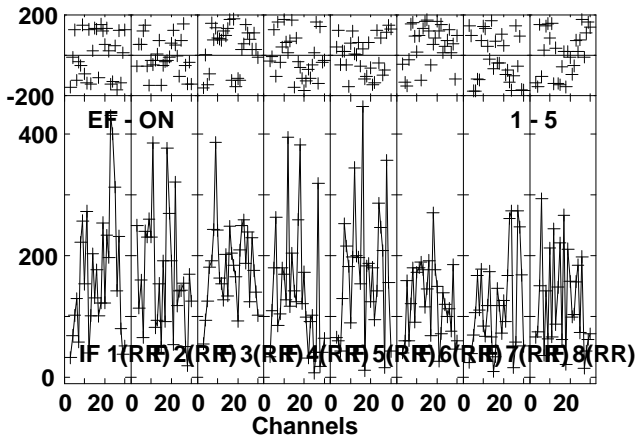
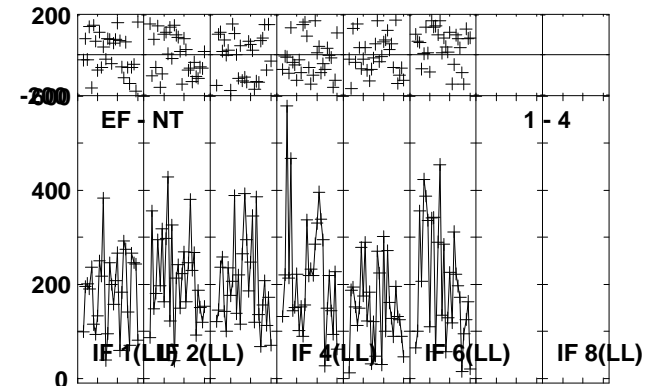
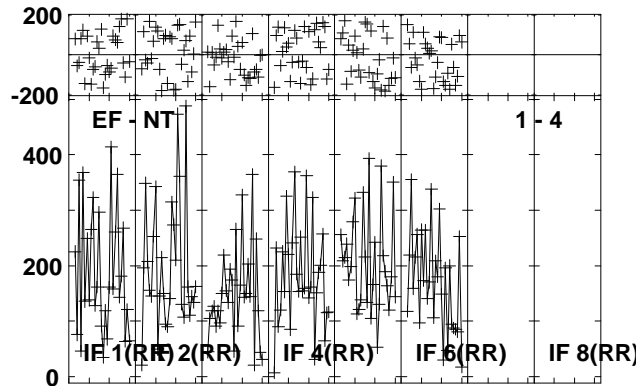
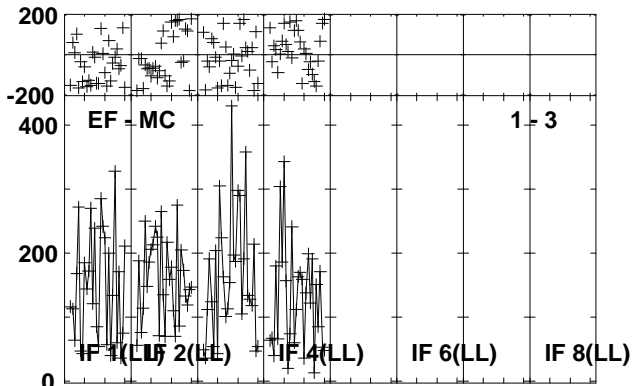
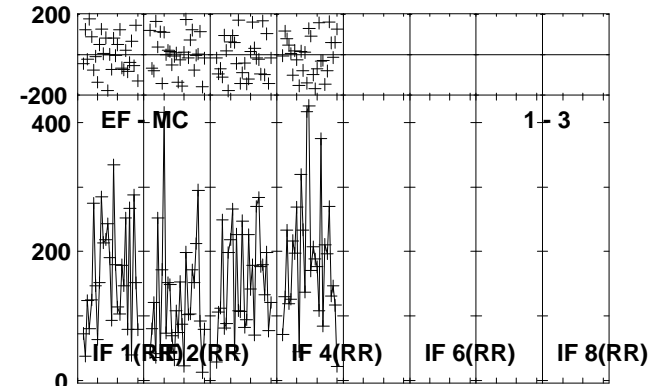
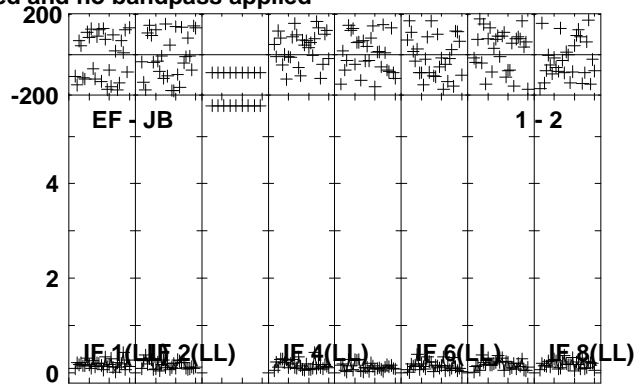
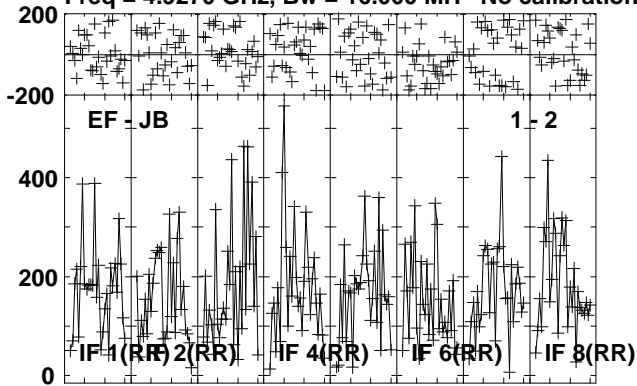

Lower frame: Micro Ampl Jy Top frame: Phas deg
Vector averaged cross-power spectrum Several baselines displayed
Timerange: 00/05:09:37 to 00/05:12:33

Plot file version 244 created 16-OCT-2012 11:57:43

NOVA-MON RO006.UVDATA.1

Freq = 4.9270 GHz, Bw = 16.000 MH No calibration applied and no bandpass applied

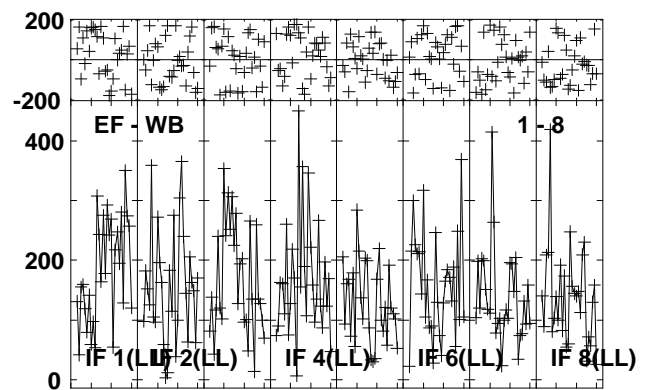
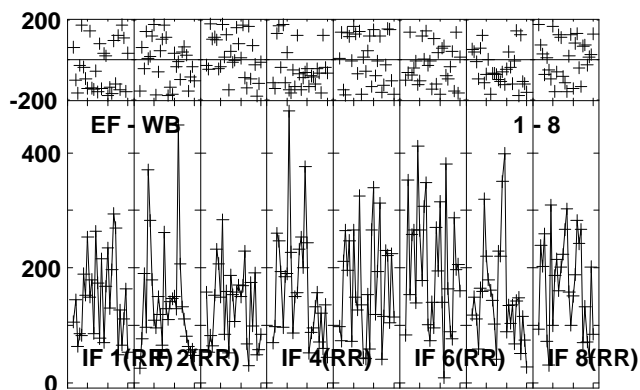
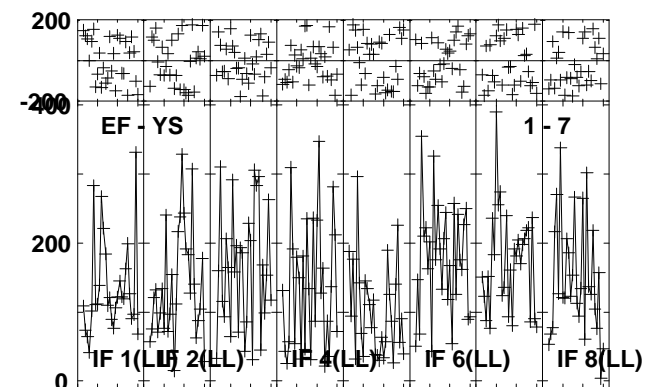
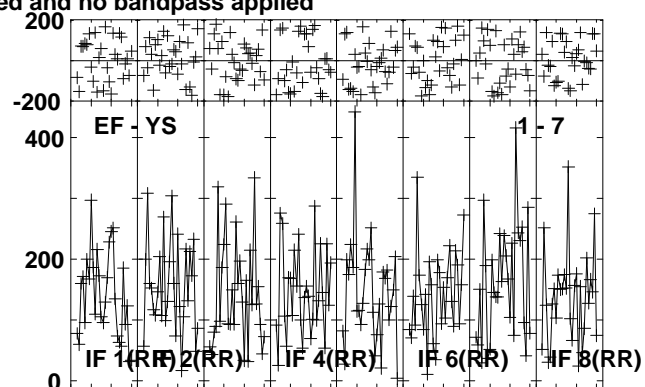
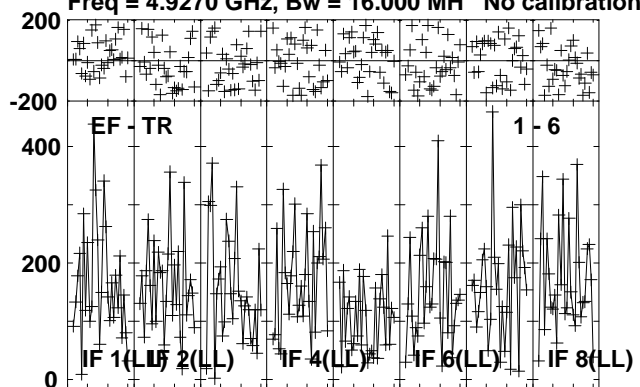

Lower frame: Micro Ampl Jy Top frame: Phas deg
Vector averaged cross-power spectrum Several baselines displayed
Timerange: 00/05:09:37 to 00/05:12:33

Plot file version 245 created 16-OCT-2012 11:57:44

J0639+0601 RO006.UVDATA.1

Freq = 4.9270 GHz, Bw = 16.000 MH No calibration applied and no bandpass applied

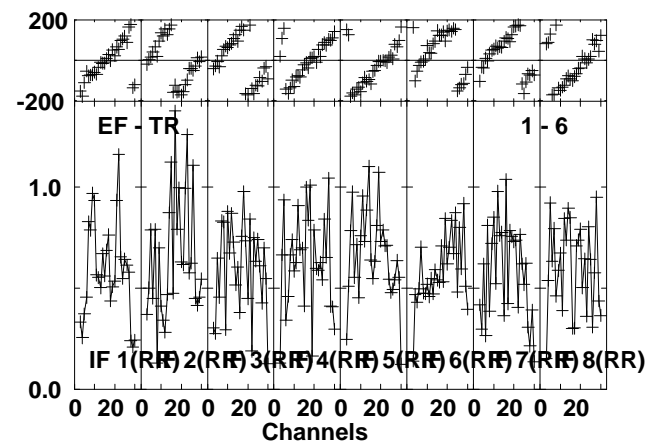
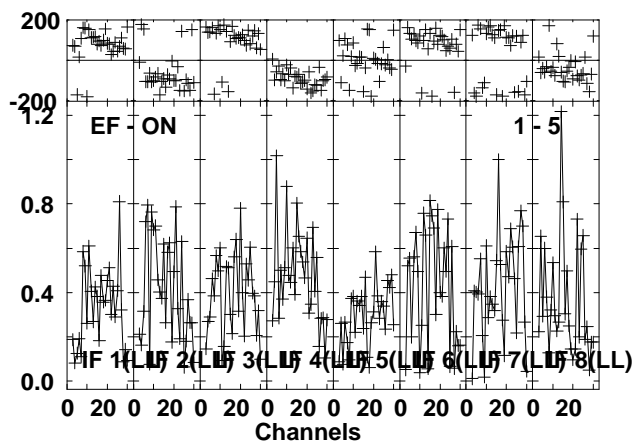
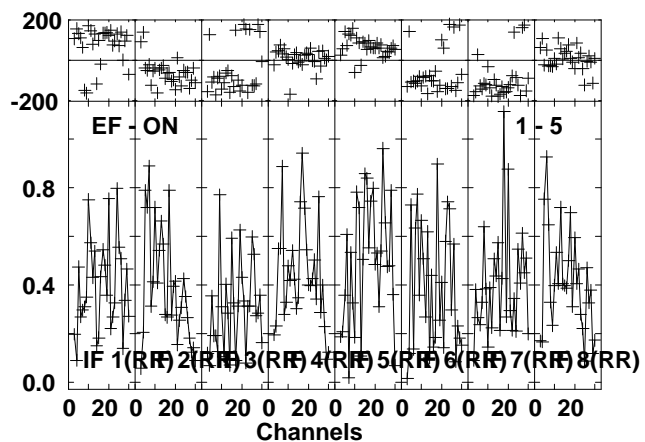
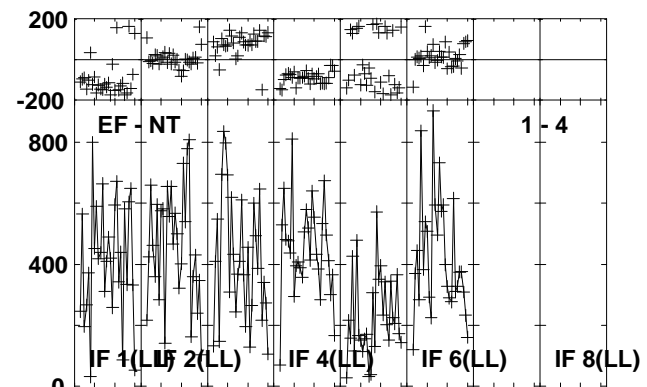
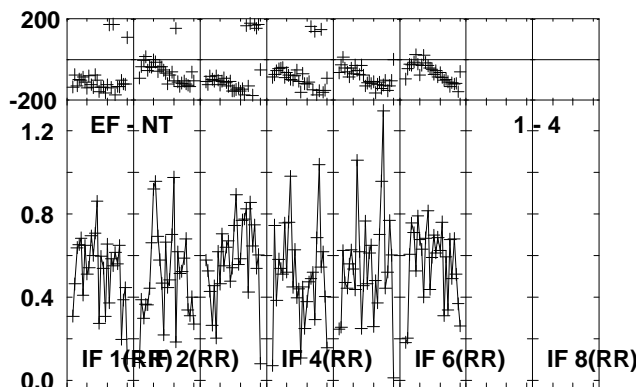
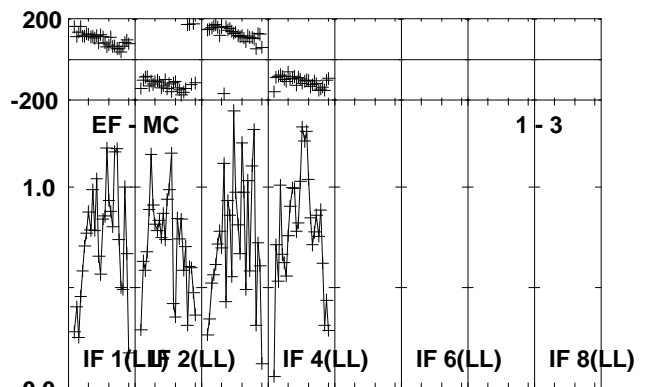
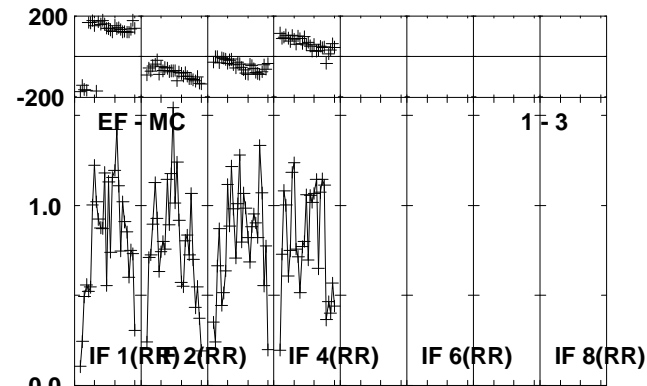
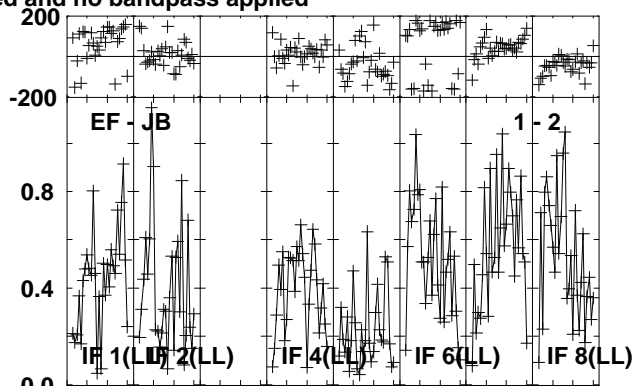
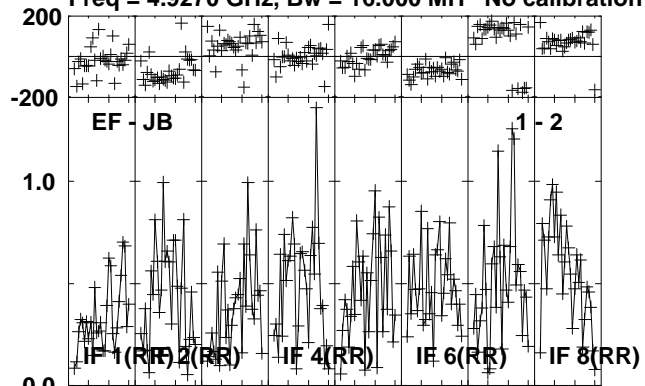

Lower frame: Milli Ampl Jy Top frame: Phas deg
Vector averaged cross-power spectrum Several baselines displayed
Timerange: 00/05:12:37 to 00/05:13:49

Plot file version 246 created 16-OCT-2012 11:57:44

J0639+0601 RO006.UVDATA.1

Freq = 4.9270 GHz, Bw = 16.000 MH No calibration applied and no bandpass applied

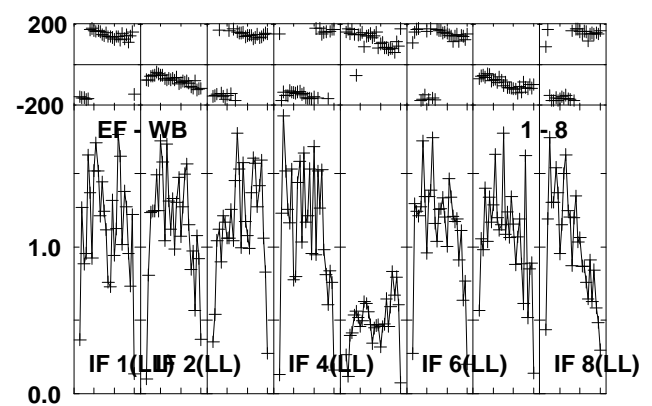
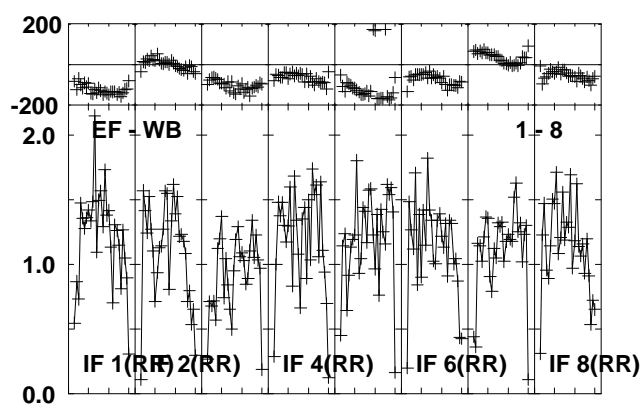
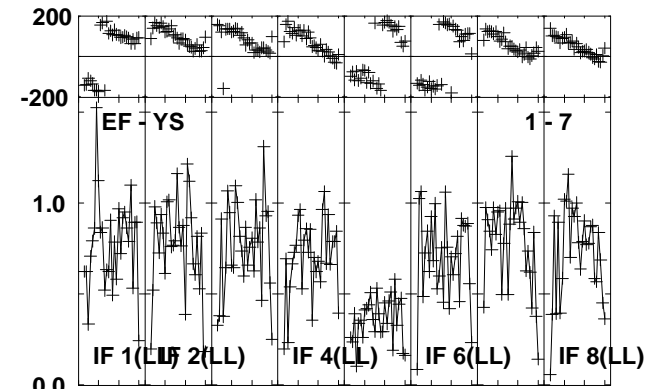
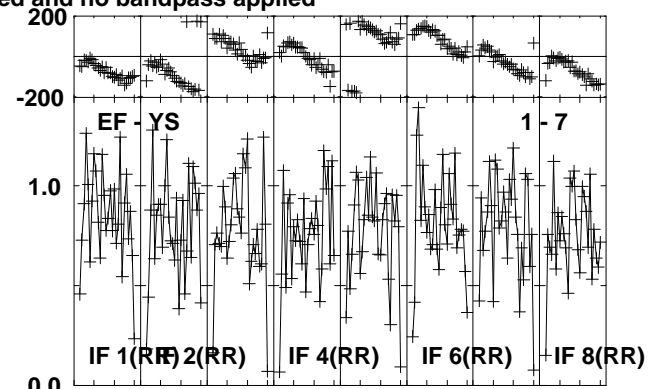
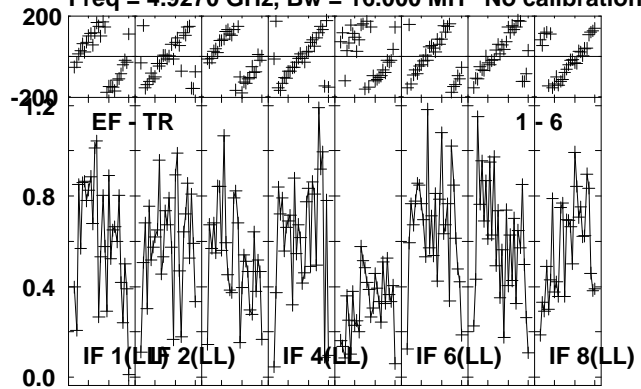

Lower frame: Milli Ampl Jy Top frame: Phas deg
Vector averaged cross-power spectrum Several baselines displayed
Timerange: 00/05:12:37 to 00/05:13:49

Plot file version 247 created 16-OCT-2012 11:57:44

J0645+0541 RO006.UVDATA.1

Freq = 4.9270 GHz, Bw = 16.000 MH No calibration applied and no bandpass applied

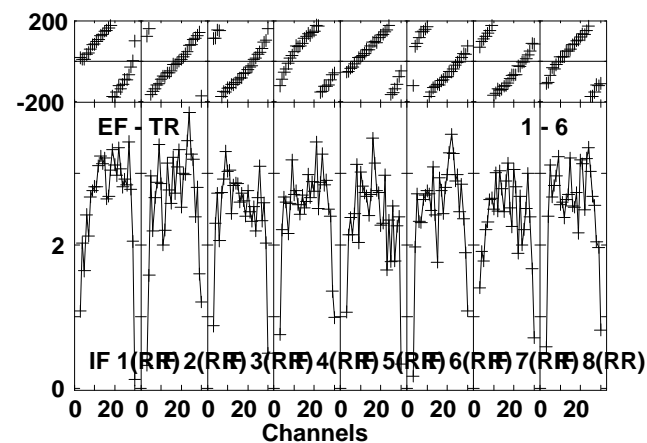
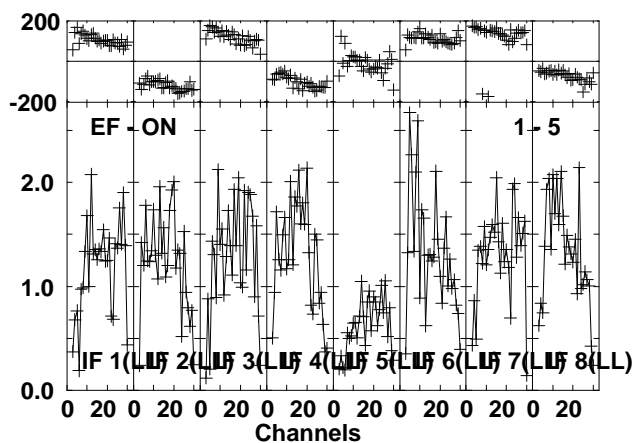
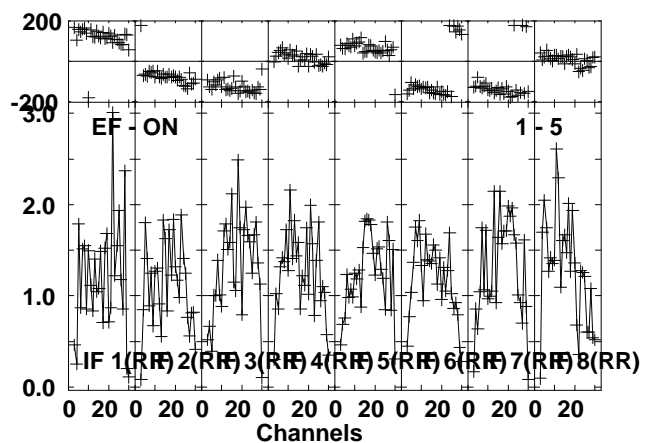
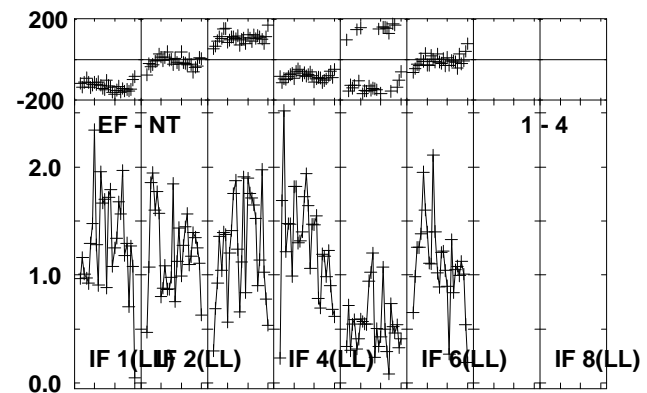
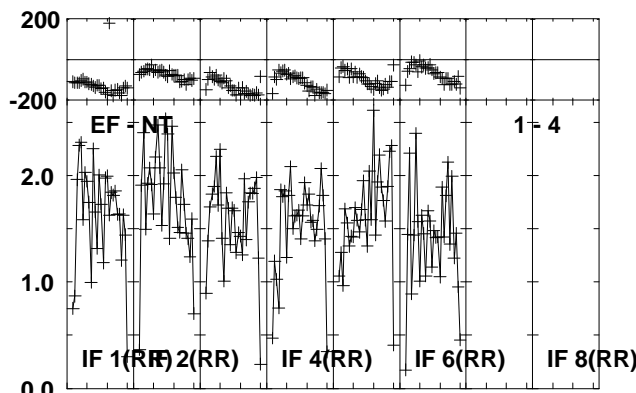
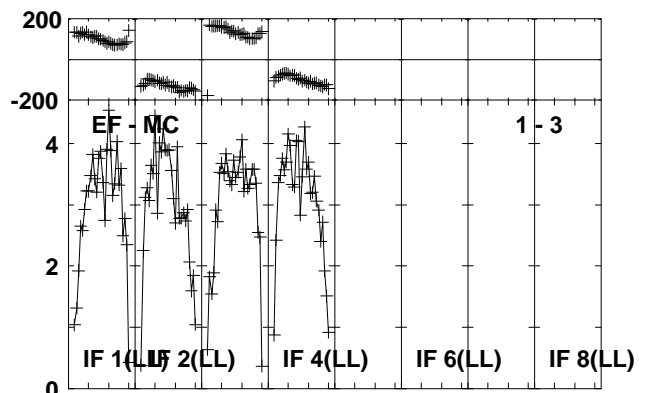
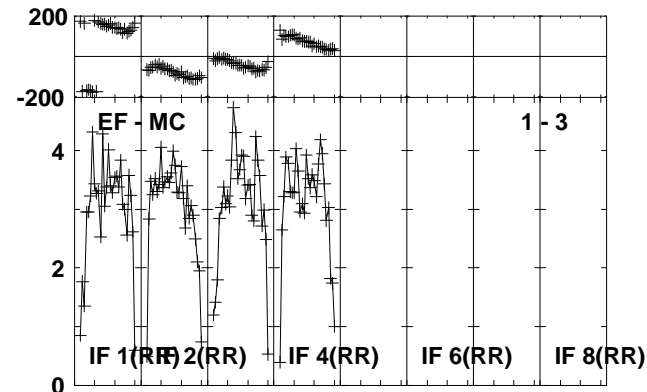
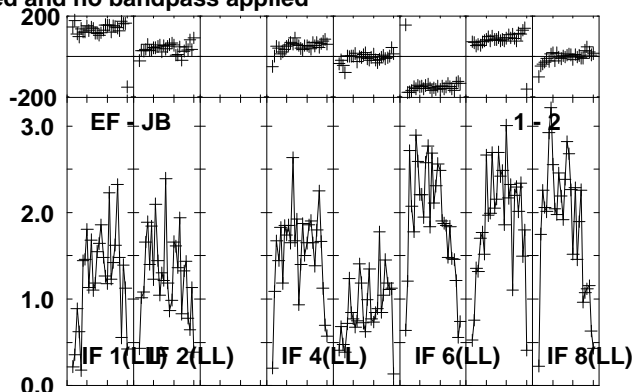
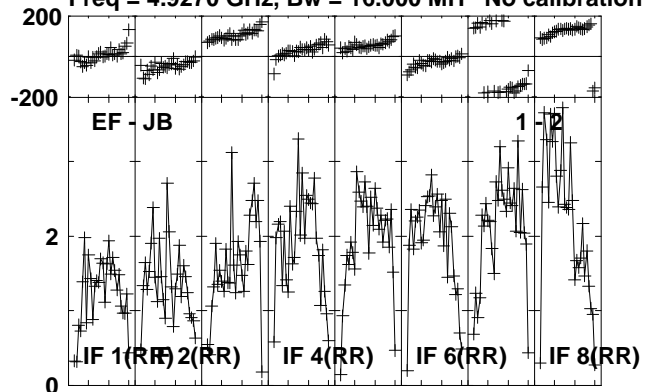

Lower frame: Milli Ampl Jy Top frame: Phas deg
Vector averaged cross-power spectrum Several baselines displayed
Timerange: 00/05:13:53 to 00/05:14:49

Plot file version 248 created 16-OCT-2012 11:57:45

J0645+0541 RO006.UVDATA.1

Freq = 4.9270 GHz, Bw = 16.000 MH No calibration applied and no bandpass applied

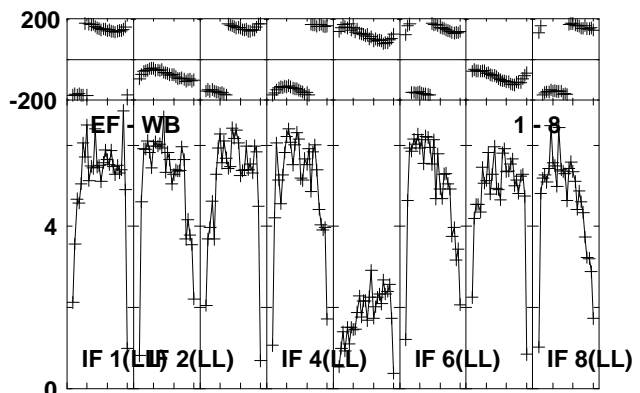
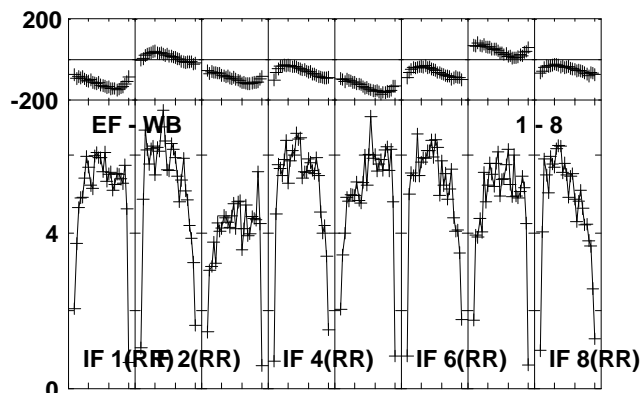
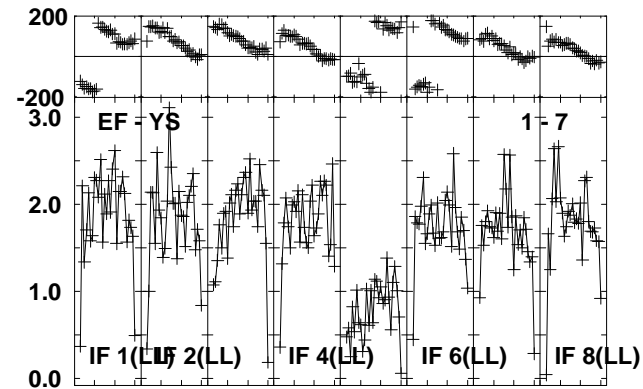
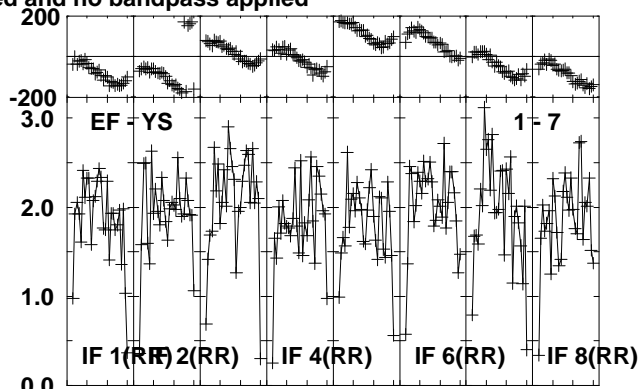
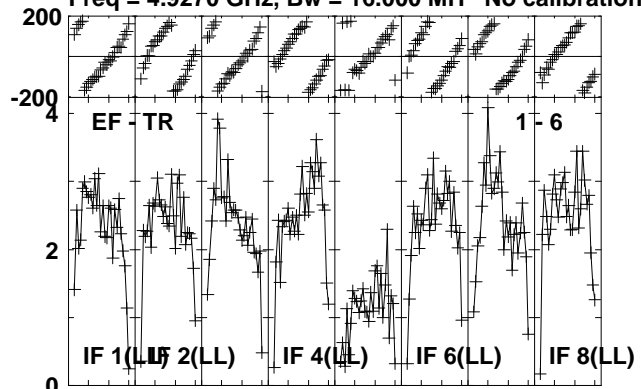

Lower frame: Milli Ampl Jy Top frame: Phas deg
Vector averaged cross-power spectrum Several baselines displayed
Timerange: 00/05:13:53 to 00/05:14:49

Plot file version 249 created 16-OCT-2012 11:57:45

NOVA-MON RO006.UVDATA.1

Freq = 4.9270 GHz, Bw = 16.000 MH No calibration applied and no bandpass applied

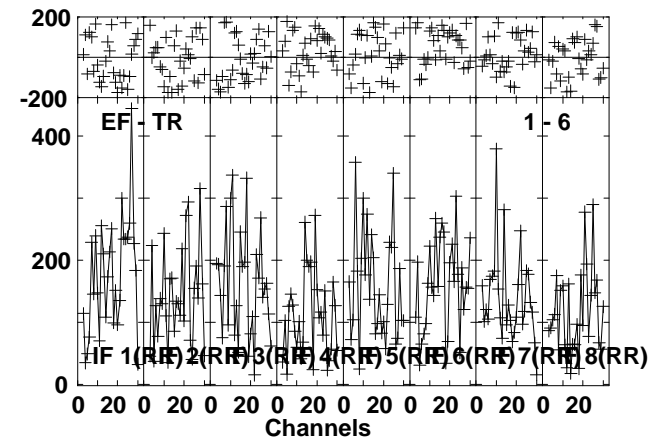
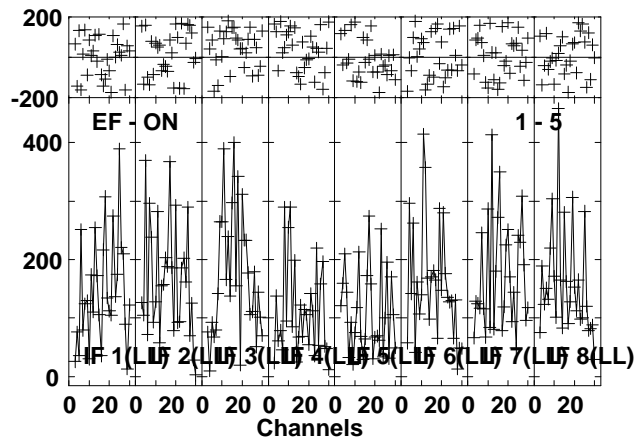
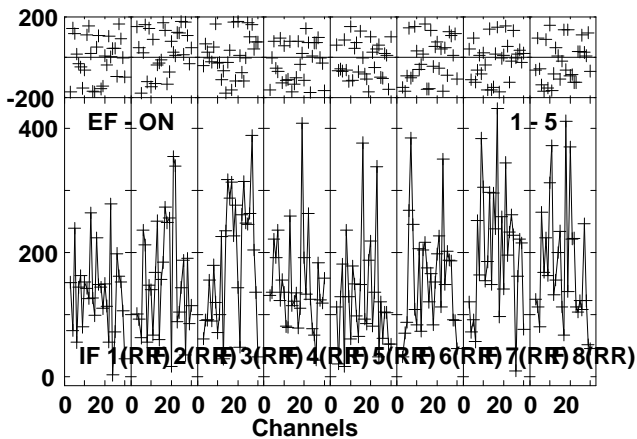
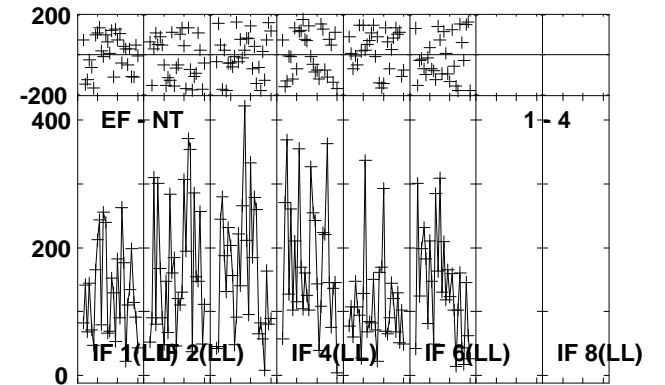
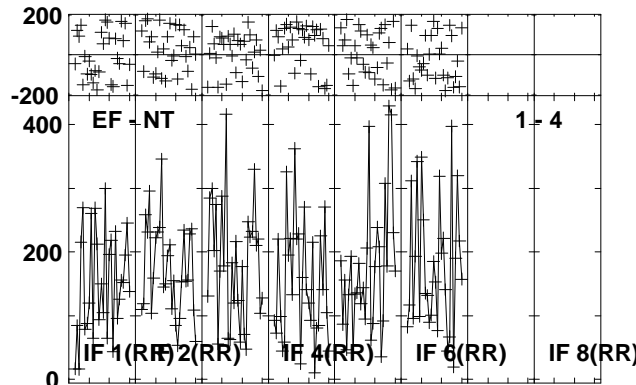
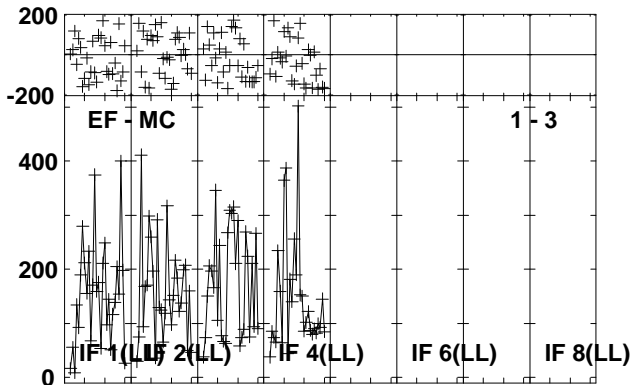
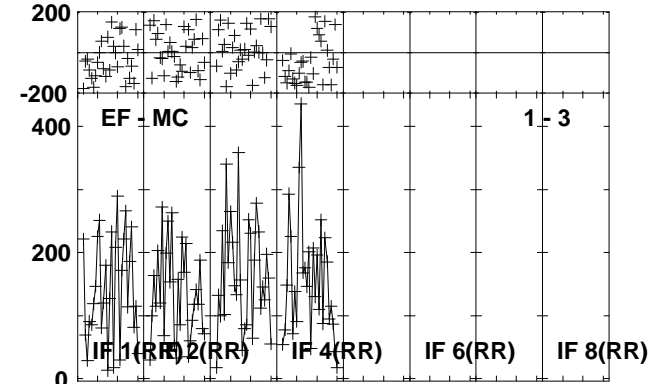
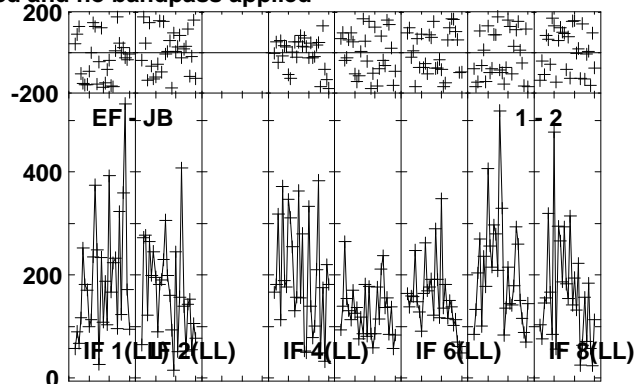
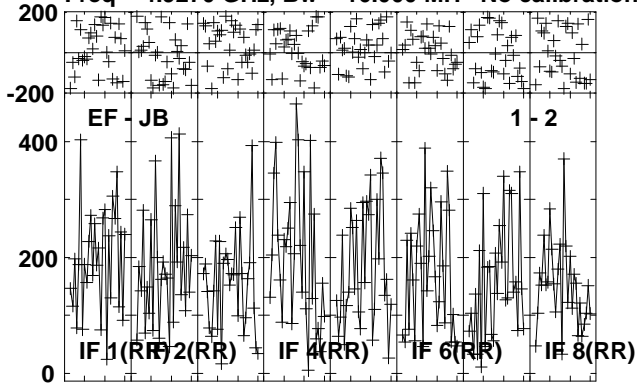

Lower frame: Micro Ampl Jy Top frame: Phas deg
Vector averaged cross-power spectrum Several baselines displayed
Timerange: 00/05:14:53 to 00/05:17:49

Plot file version 250 created 16-OCT-2012 11:57:45

NOVA-MON RO006.UVDATA.1

Freq = 4.9270 GHz, Bw = 16.000 MH No calibration applied and no bandpass applied

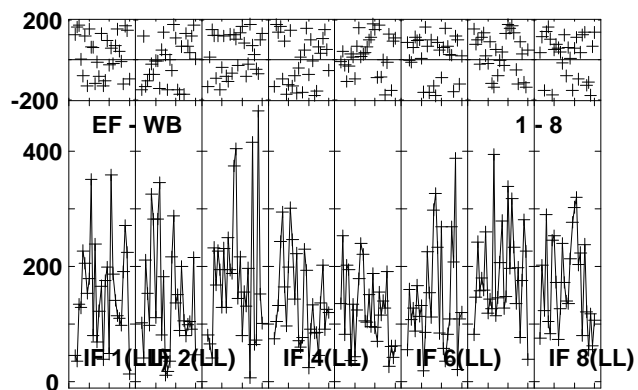
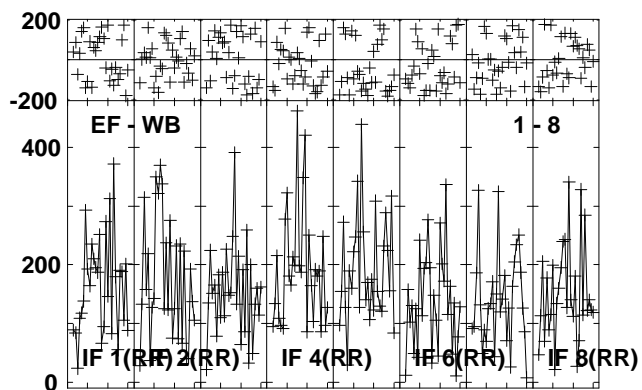
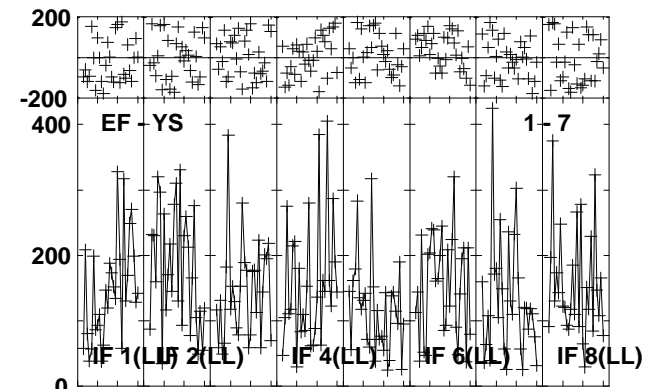
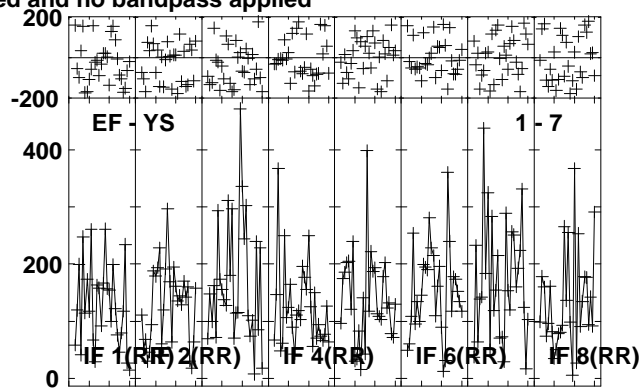
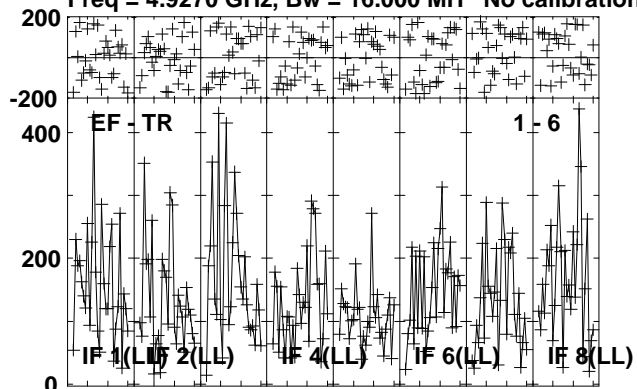

Lower frame: Micro Ampl Jy Top frame: Phas deg
Vector averaged cross-power spectrum Several baselines displayed
Timerange: 00/05:14:53 to 00/05:17:49

Plot file version 251 created 16-OCT-2012 11:57:46

J0639+0601 RO006.UVDATA.1

Freq = 4.9270 GHz, Bw = 16.000 MH No calibration applied and no bandpass applied

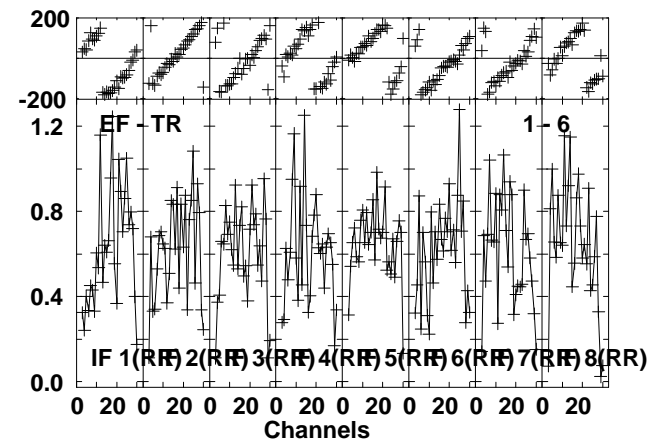
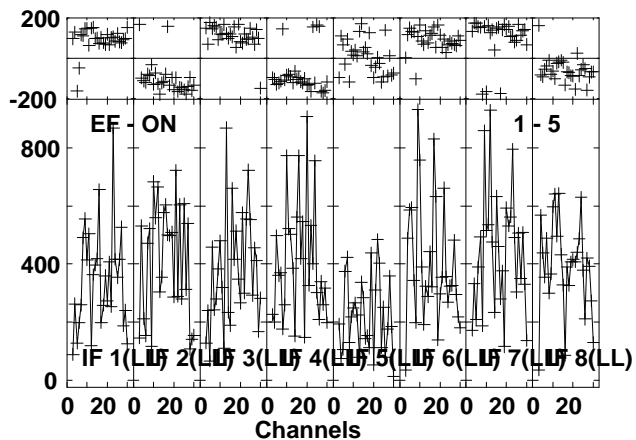
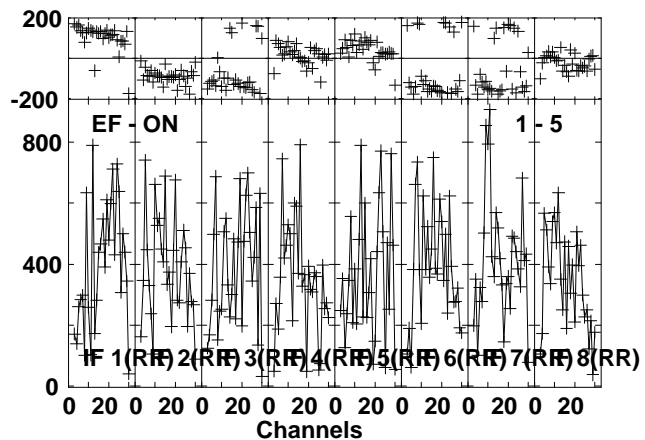
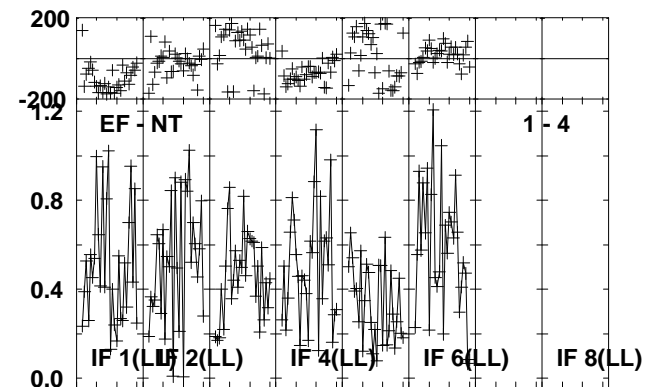
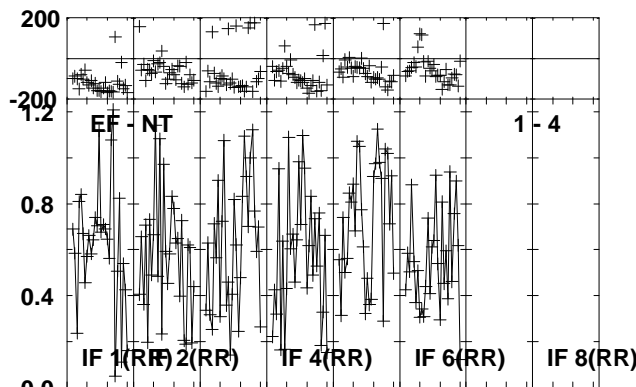
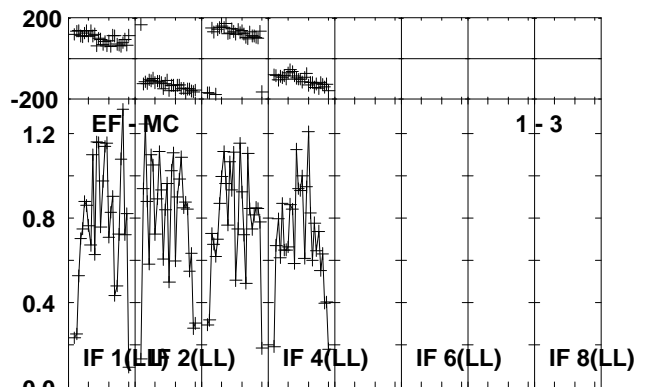
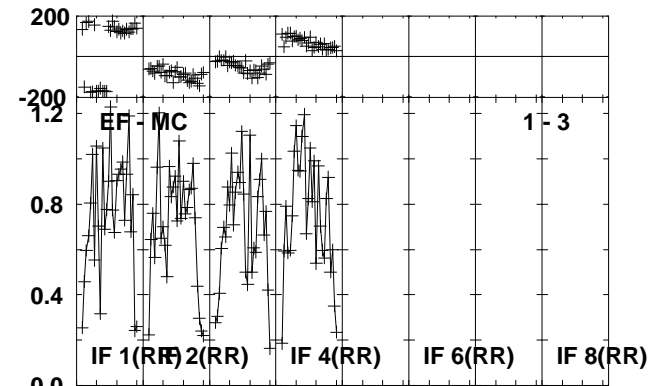
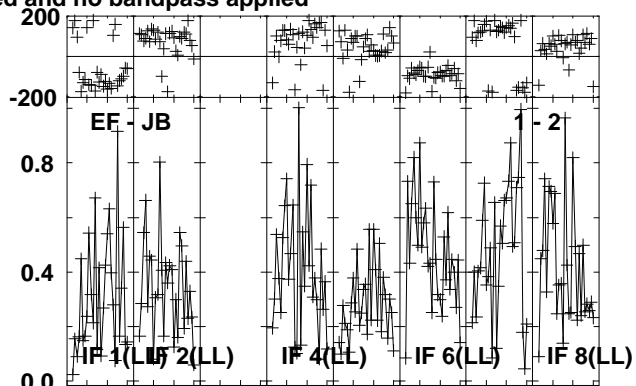
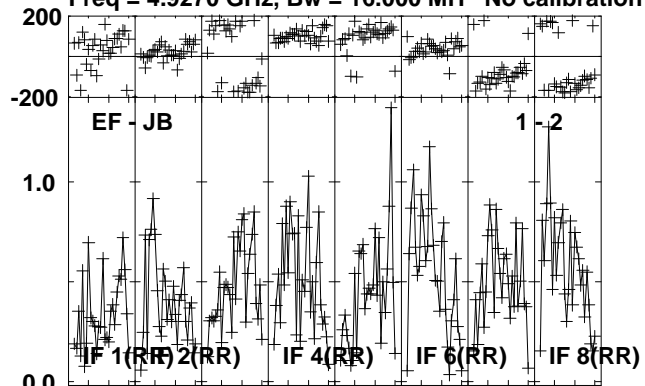

Lower frame: Milli Ampl Jy Top frame: Phas deg
Vector averaged cross-power spectrum Several baselines displayed
Timerange: 00/05:18:17 to 00/05:19:19

Plot file version 252 created 16-OCT-2012 11:57:46
J0639+0601 RO006.UVDATA.1

Freq = 4.9270 GHz, Bw = 16.000 MH No calibration applied and no bandpass applied

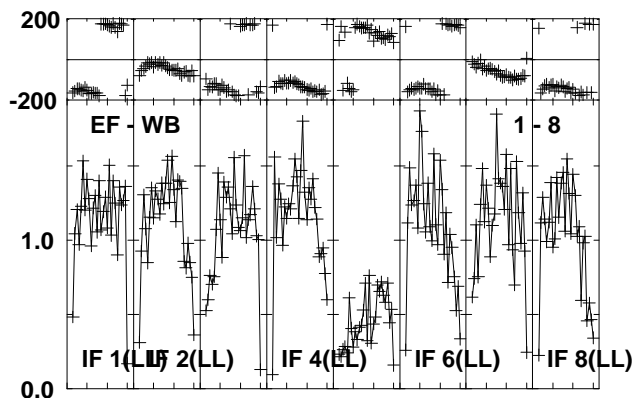
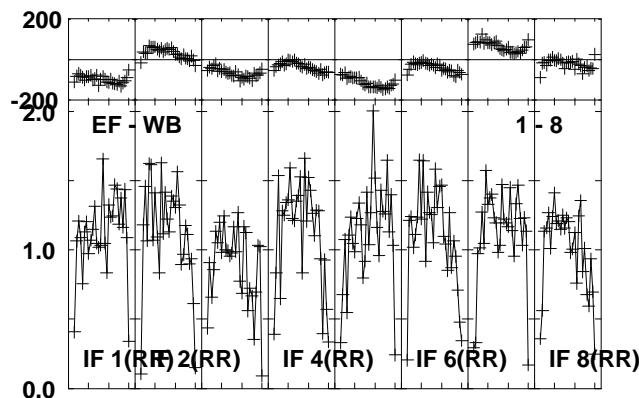
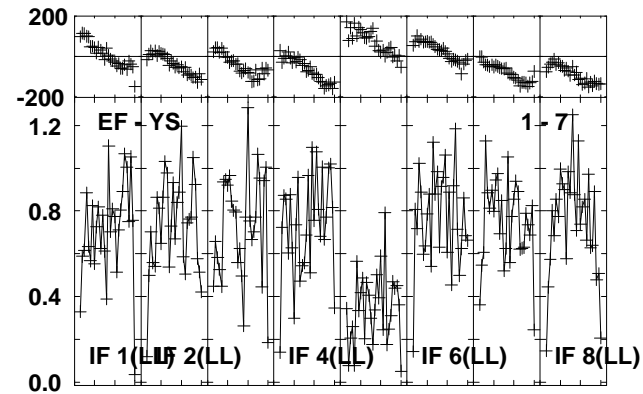
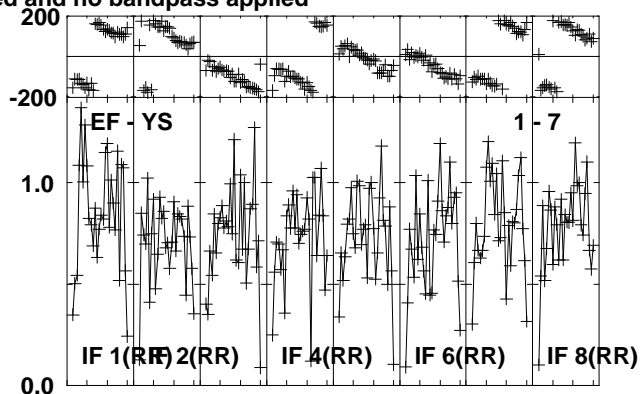
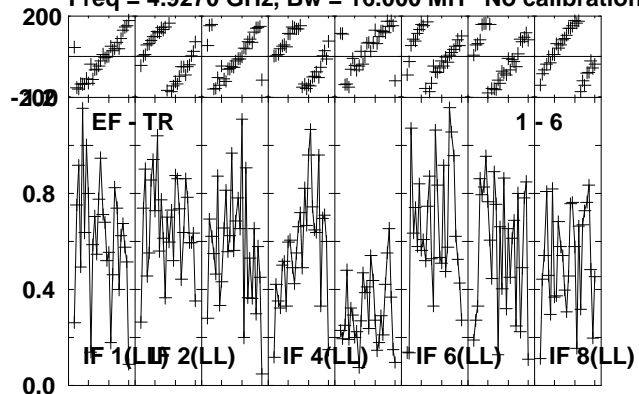

Lower frame: Milli Ampl Jy Top frame: Phas deg
Vector averaged cross-power spectrum Several baselines displayed
Timerange: 00/05:18:17 to 00/05:19:19

Plot file version 253 created 16-OCT-2012 11:57:46

0528+134 RO006.UVDATA.1

Freq = 4.9270 GHz, Bw = 16.000 MH No calibration applied and no bandpass applied

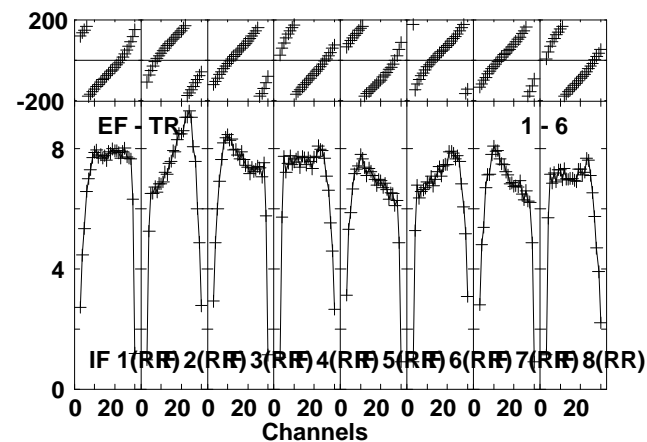
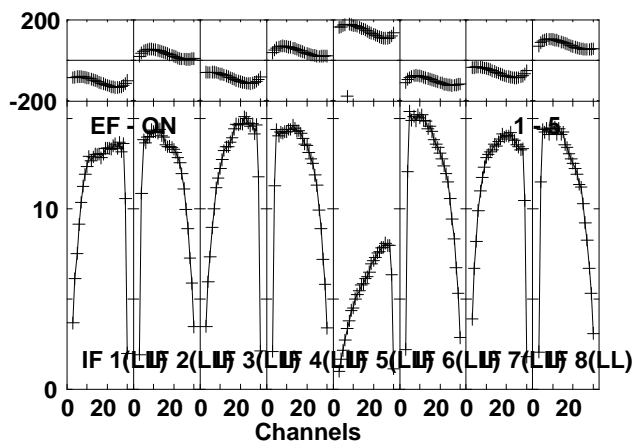
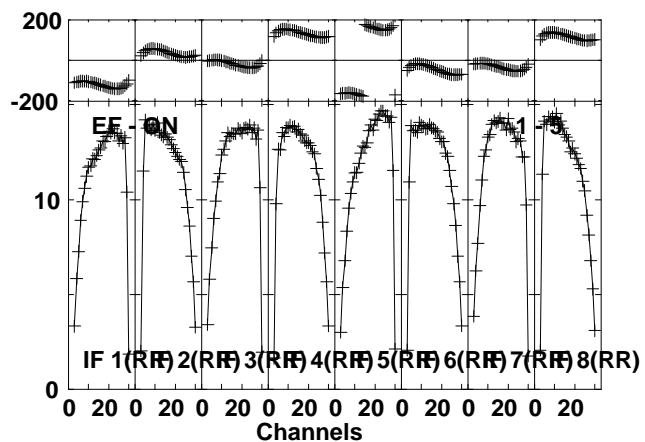
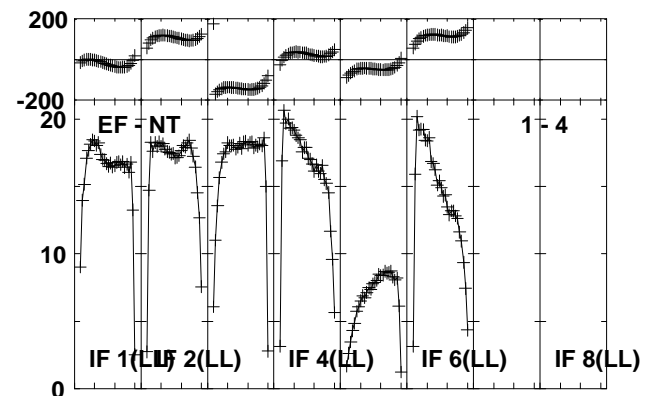
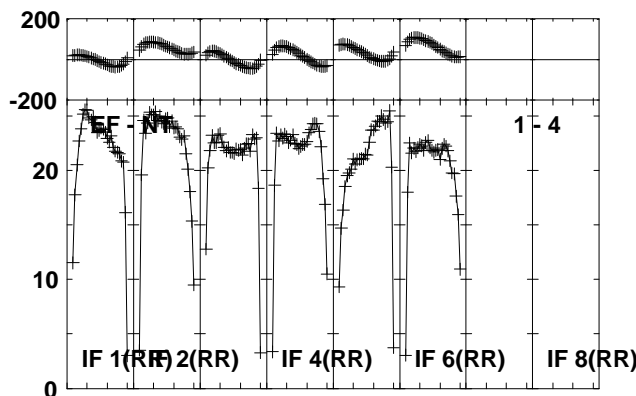
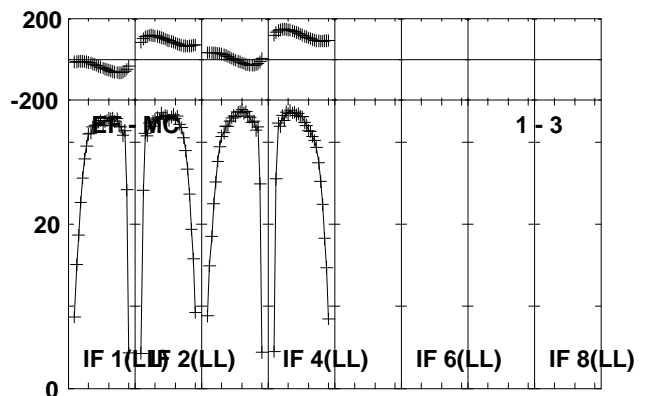
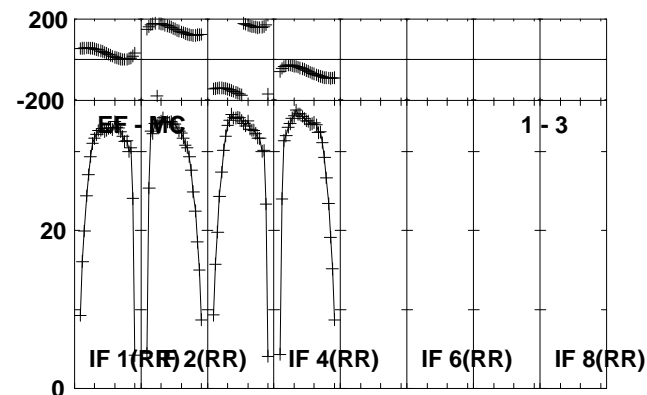
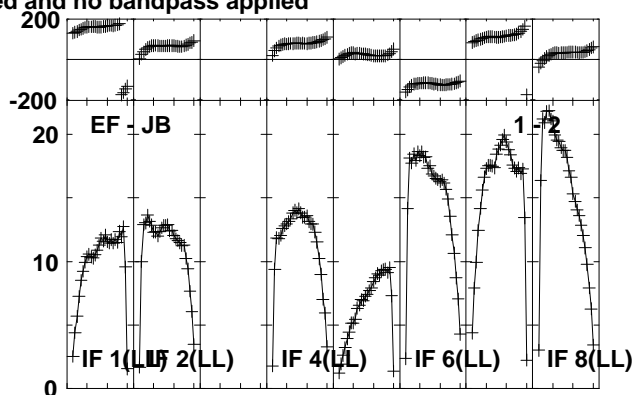
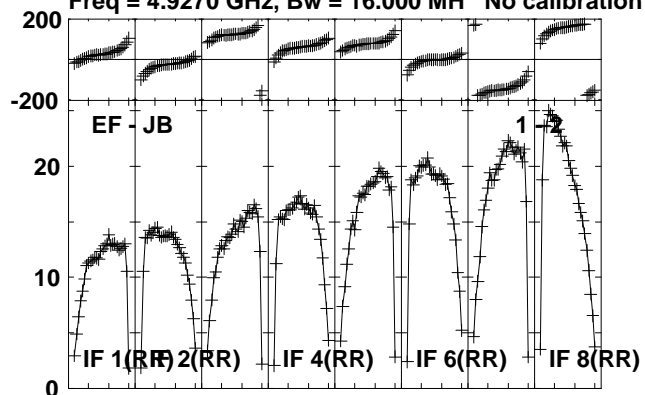

Lower frame: Milli Ampl Jy Top frame: Phas deg
Vector averaged cross-power spectrum Several baselines displayed
Timerange: 00/05:21:17 to 00/05:24:19

Plot file version 254 created 16-OCT-2012 11:57:47

0528+134 RO006.UVDATA.1

Freq = 4.9270 GHz, Bw = 16.000 MH No calibration applied and no bandpass applied

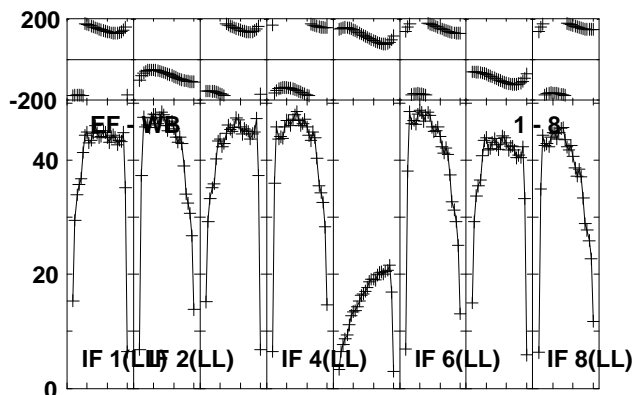
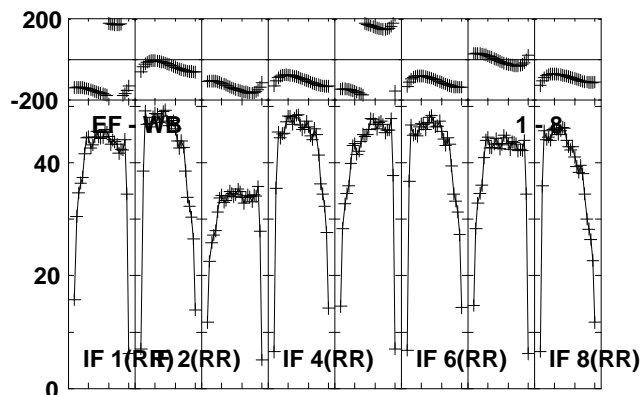
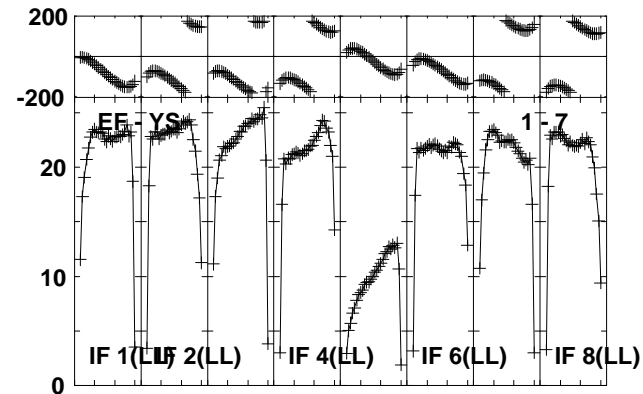
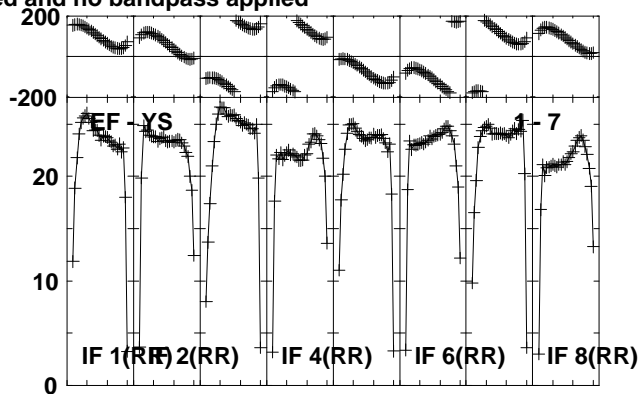
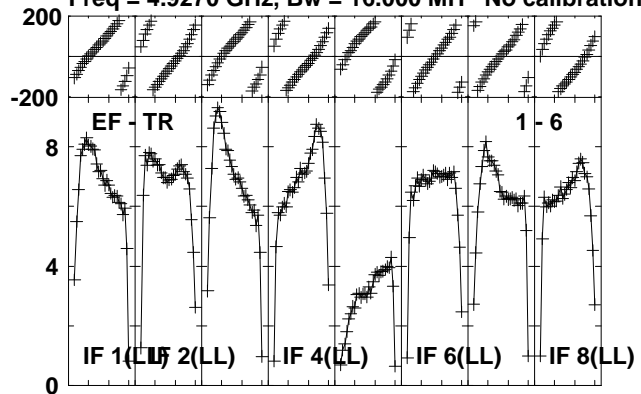

Lower frame: Milli Ampl Jy Top frame: Phas deg
Vector averaged cross-power spectrum Several baselines displayed
Timerange: 00/05:21:17 to 00/05:24:19

Plot file version 255 created 16-OCT-2012 11:57:47

J0645+0541 RO006.UVDATA.1

Freq = 4.9270 GHz, Bw = 16.000 MH No calibration applied and no bandpass applied

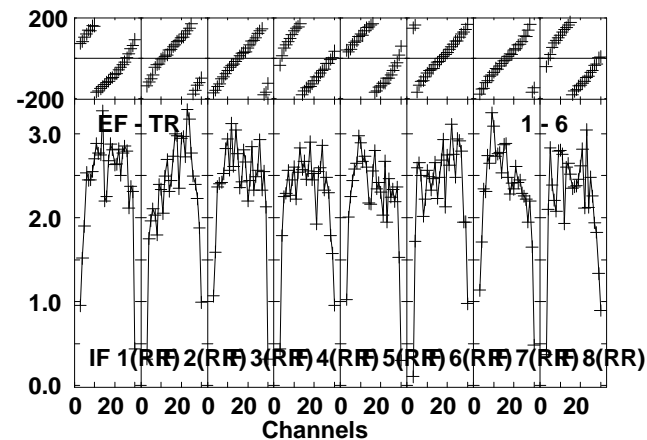
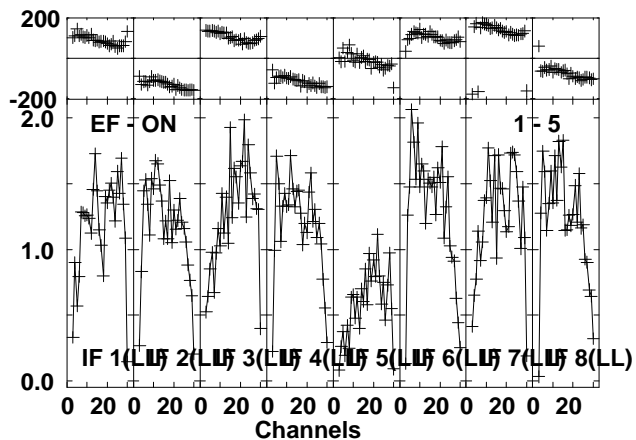
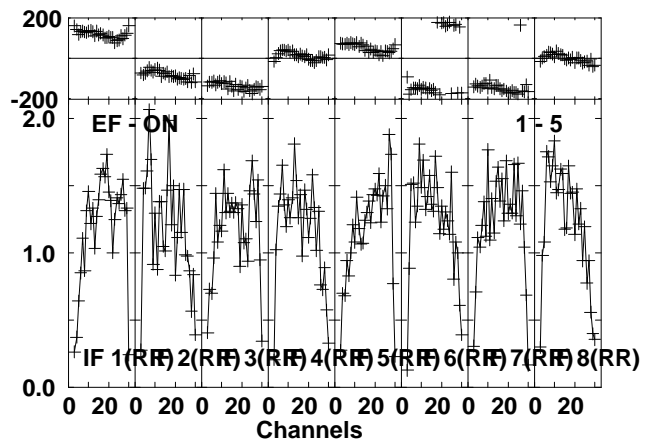
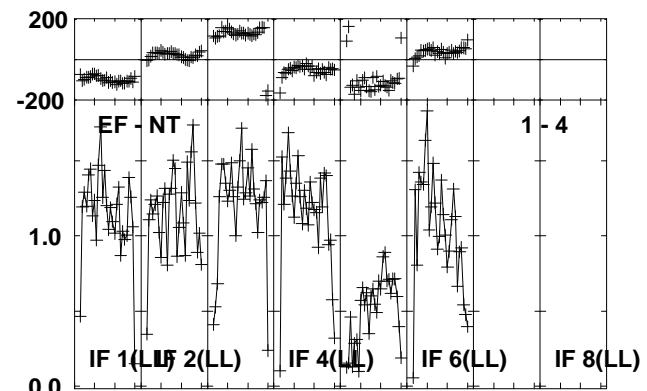
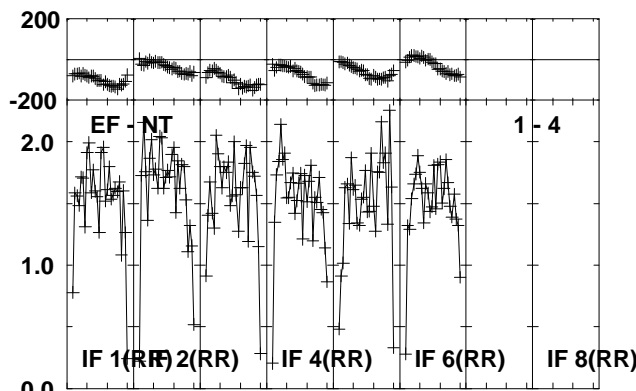
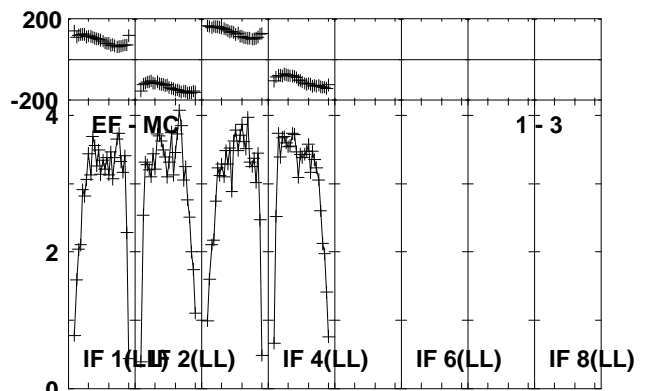
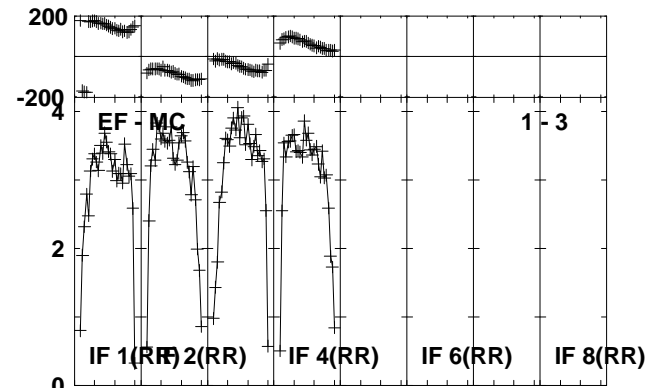
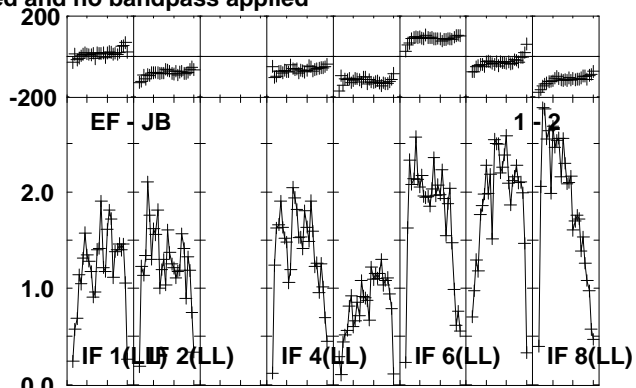
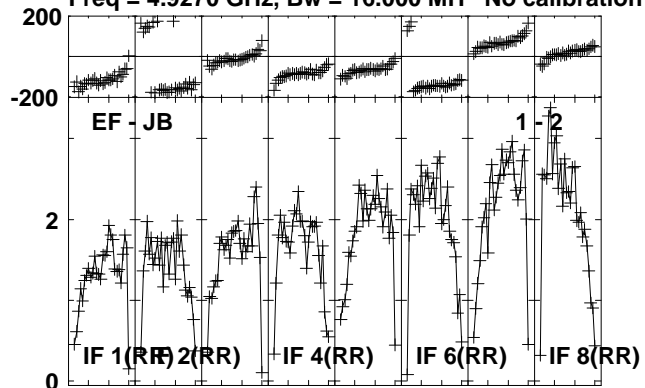

Lower frame: Milli Ampl Jy Top frame: Phas deg
Vector averaged cross-power spectrum Several baselines displayed
Timerange: 00/05:26:17 to 00/05:27:19

Plot file version 256 created 16-OCT-2012 11:57:48

J0645+0541 RO006.UVDATA.1

Freq = 4.9270 GHz, Bw = 16.000 MH No calibration applied and no bandpass applied

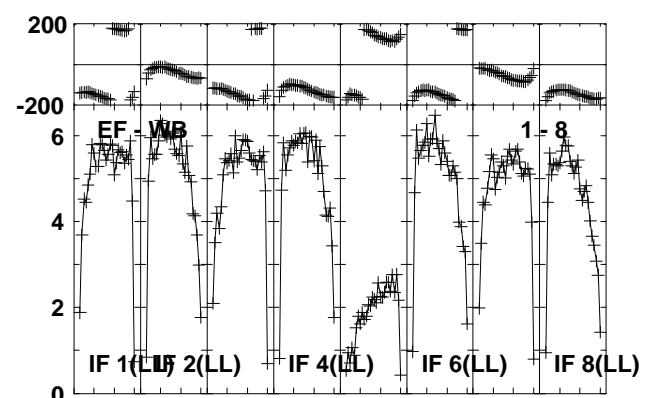
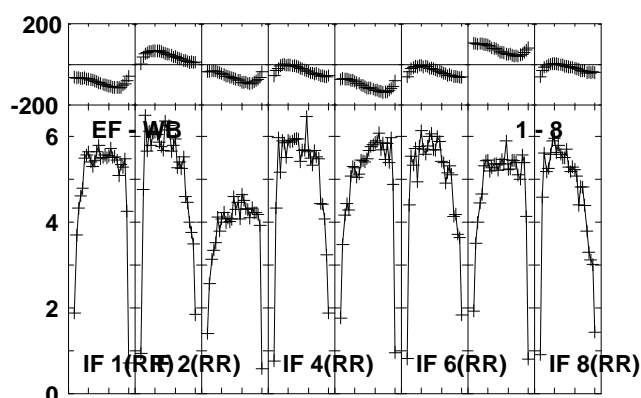
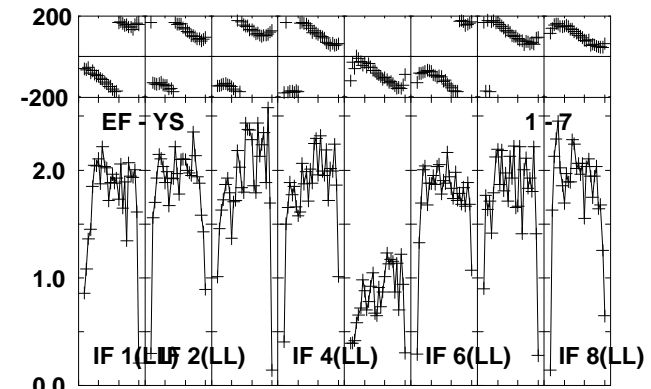
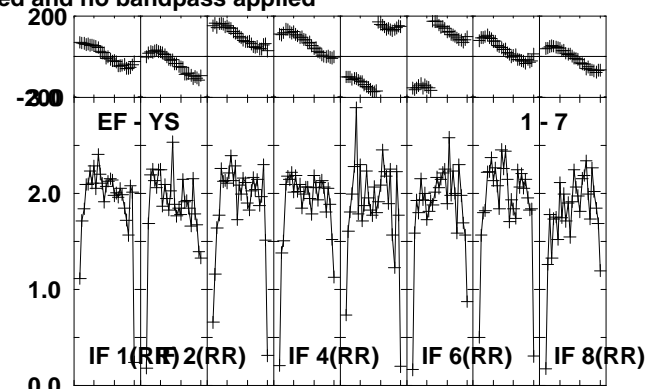
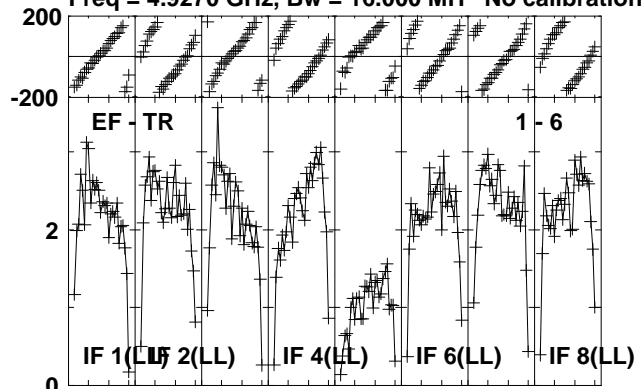

Lower frame: Milli Ampl Jy Top frame: Phas deg
Vector averaged cross-power spectrum Several baselines displayed
Timerange: 00/05:26:17 to 00/05:27:19

Plot file version 257 created 16-OCT-2012 11:57:48

NOVA-MON RO006.UVDATA.1

Freq = 4.9270 GHz, Bw = 16.000 MH No calibration applied and no bandpass applied

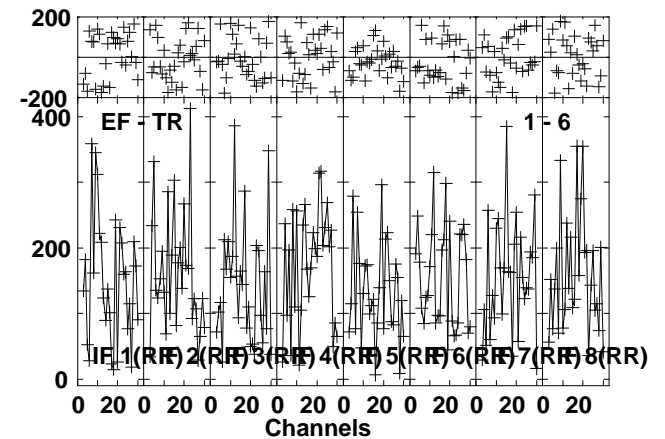
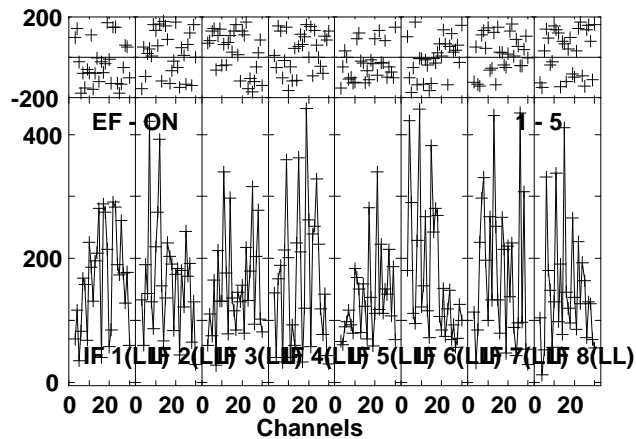
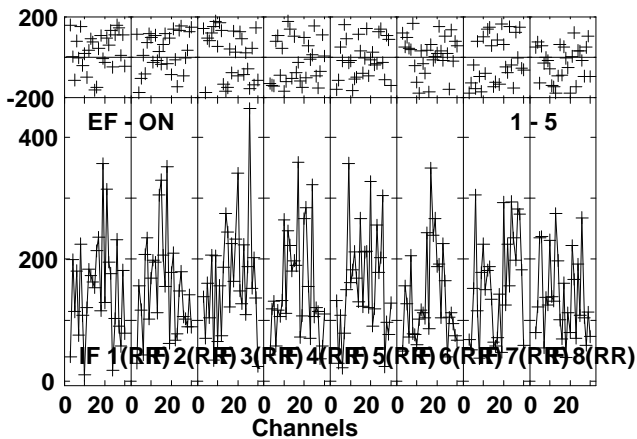
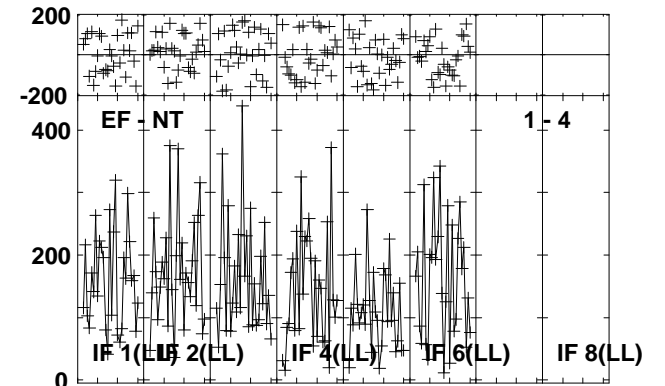
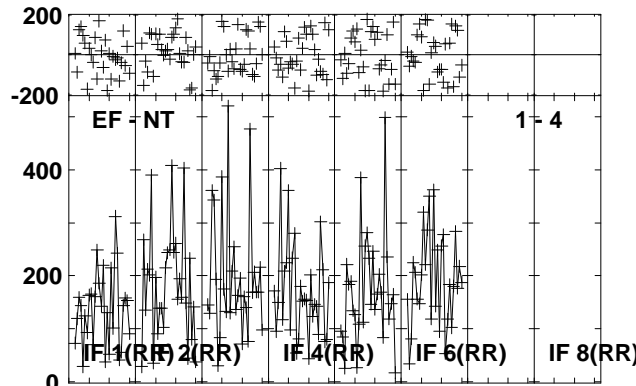
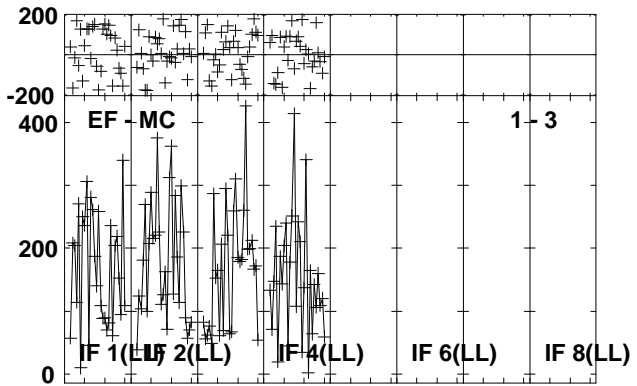
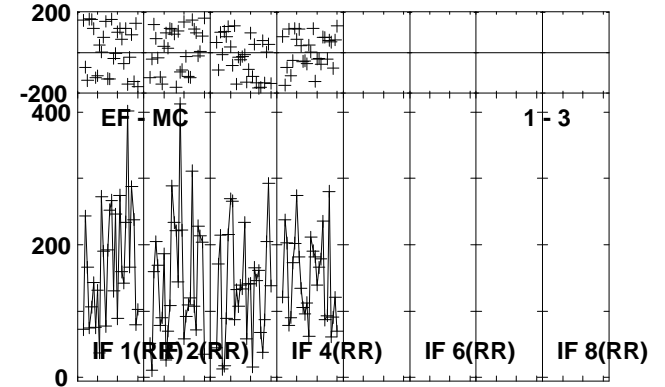
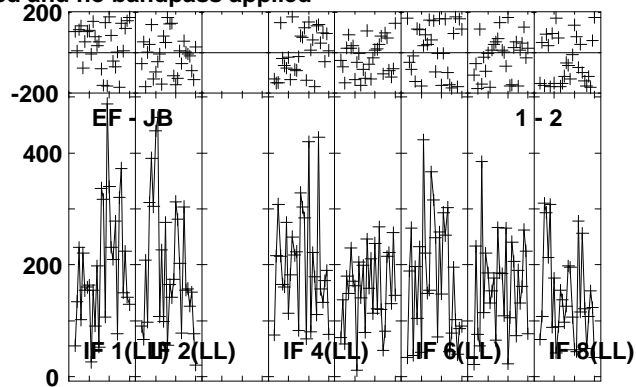
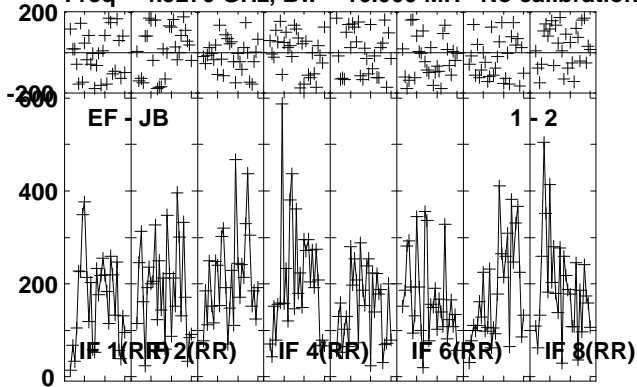

Lower frame: Micro Ampl Jy Top frame: Phas deg
Vector averaged cross-power spectrum Several baselines displayed
Timerange: 00/05:27:23 to 00/05:30:19

Plot file version 258 created 16-OCT-2012 11:57:48

NOVA-MON RO006.UVDATA.1

Freq = 4.9270 GHz, Bw = 16.000 MH No calibration applied and no bandpass applied

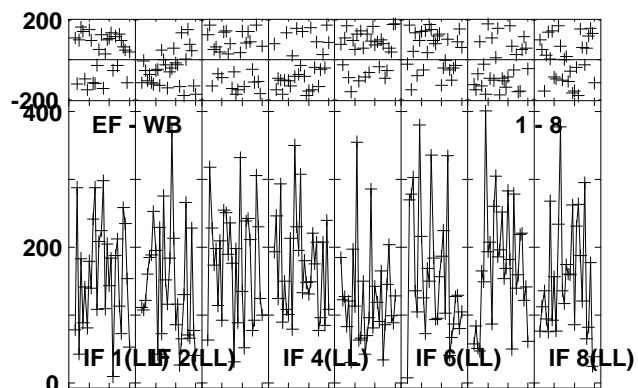
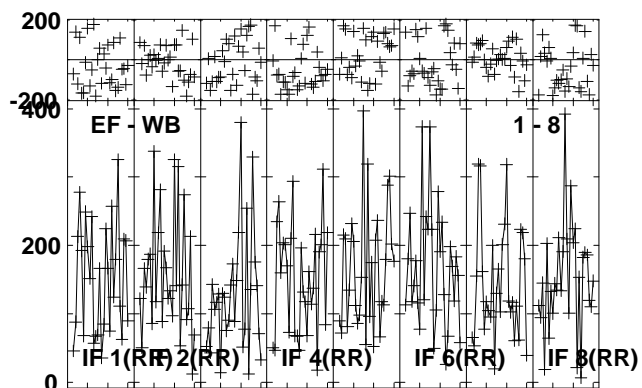
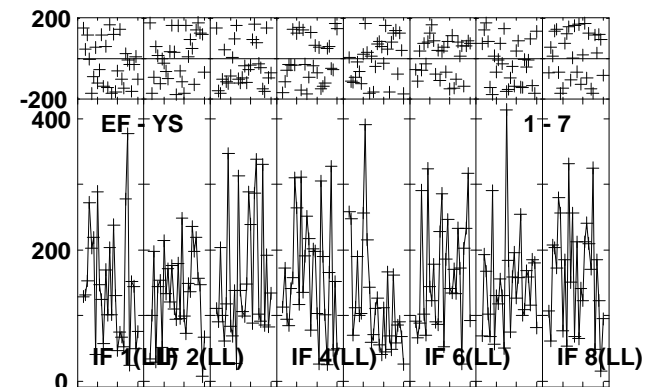
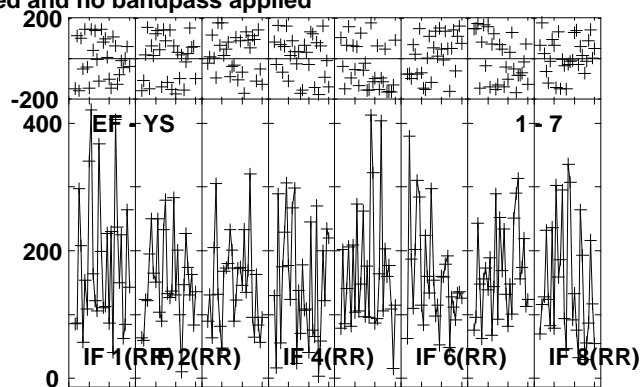
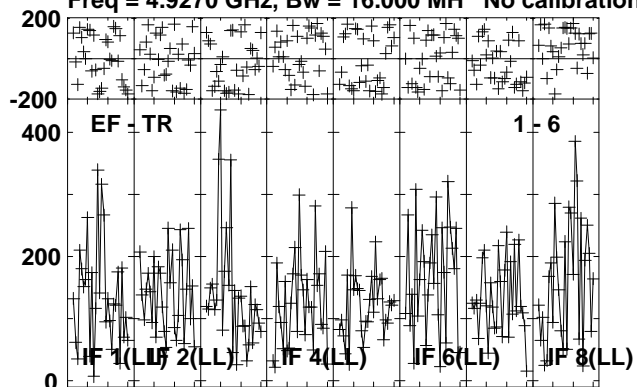

Lower frame: Micro Ampl Jy Top frame: Phas deg
Vector averaged cross-power spectrum Several baselines displayed
Timerange: 00/05:27:23 to 00/05:30:19

Plot file version 259 created 16-OCT-2012 11:57:49

J0639+0601 RO006.UVDATA.1

Freq = 4.9270 GHz, Bw = 16.000 MH No calibration applied and no bandpass applied

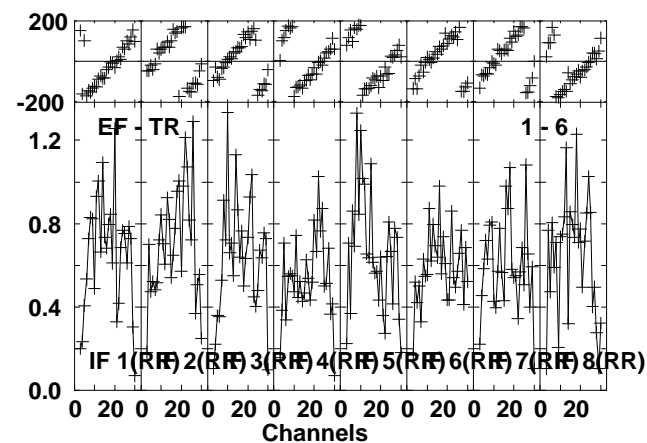
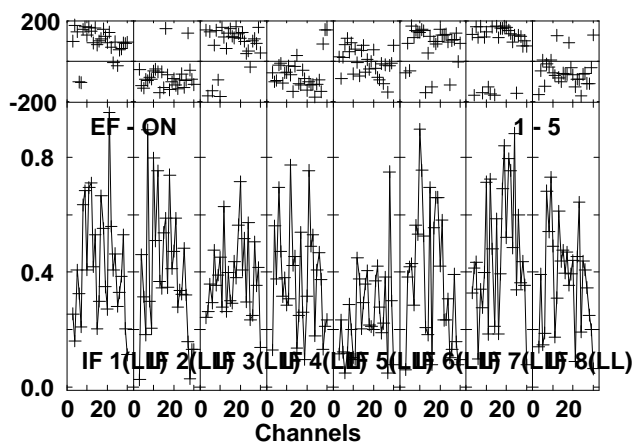
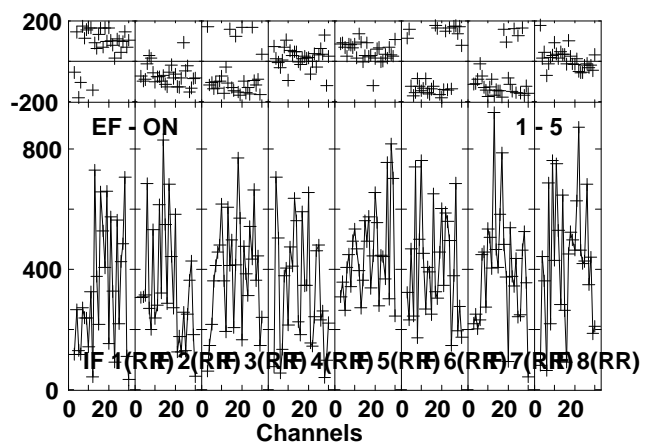
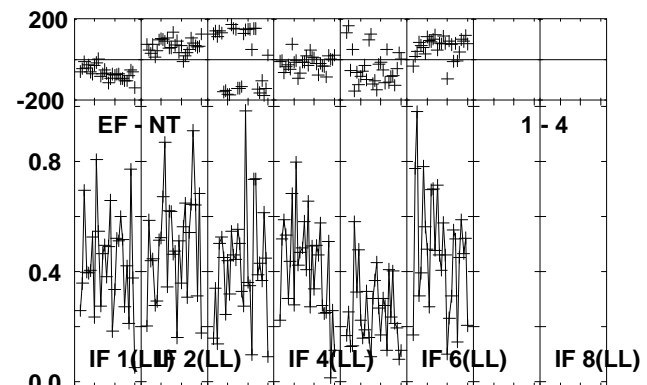
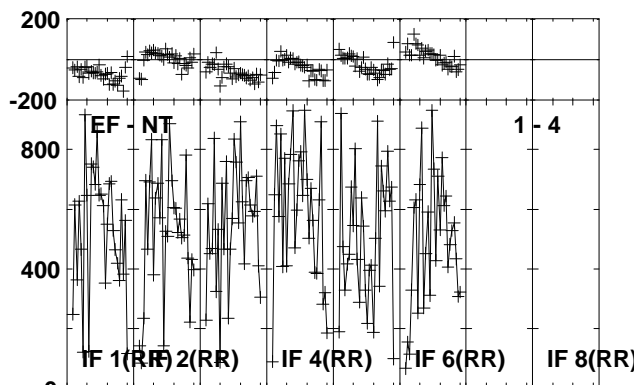
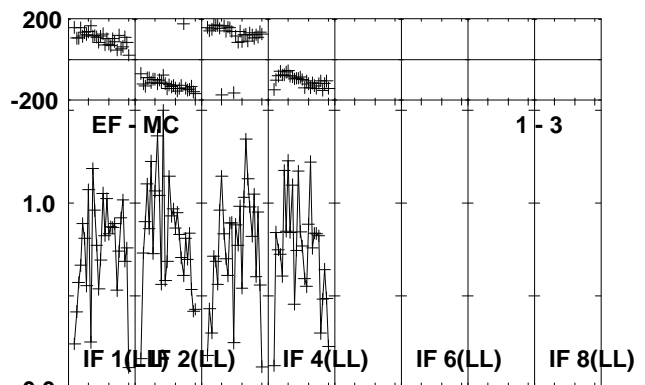
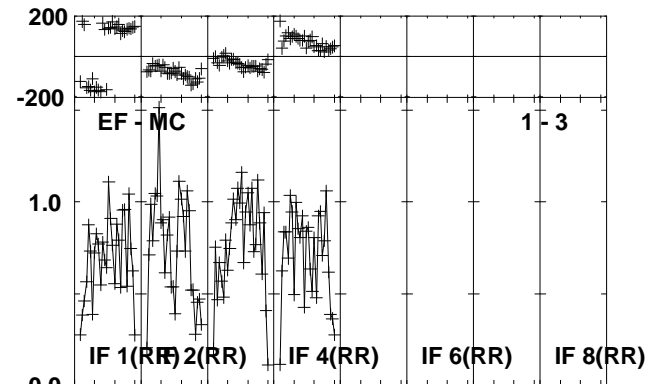
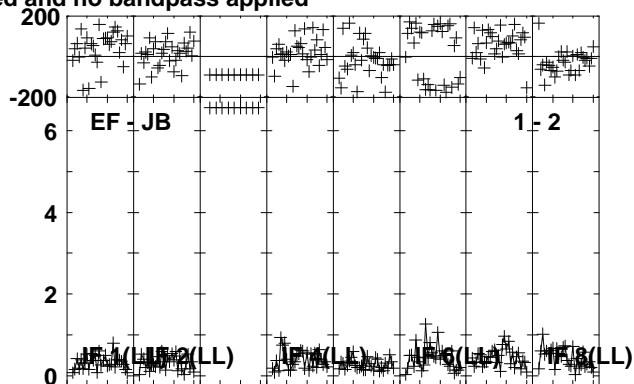
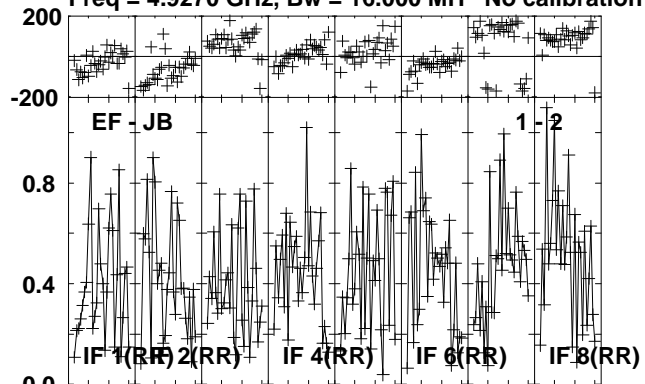

Lower frame: Milli Ampl Jy Top frame: Phas deg
Vector averaged cross-power spectrum Several baselines displayed
Timerange: 00/05:30:23 to 00/05:31:33

Plot file version 260 created 16-OCT-2012 11:57:49

J0639+0601 RO006.UVDATA.1

Freq = 4.9270 GHz, Bw = 16.000 MH No calibration applied and no bandpass applied

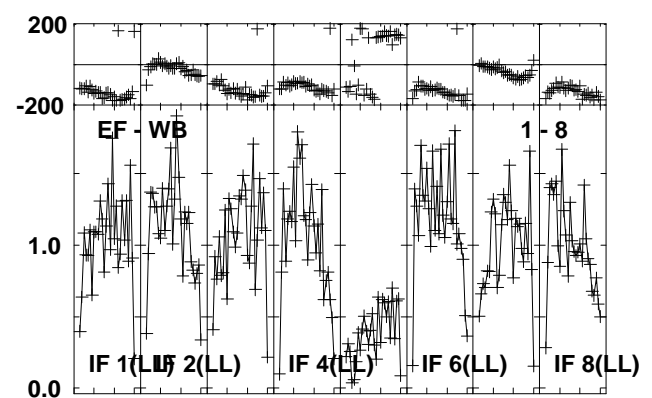
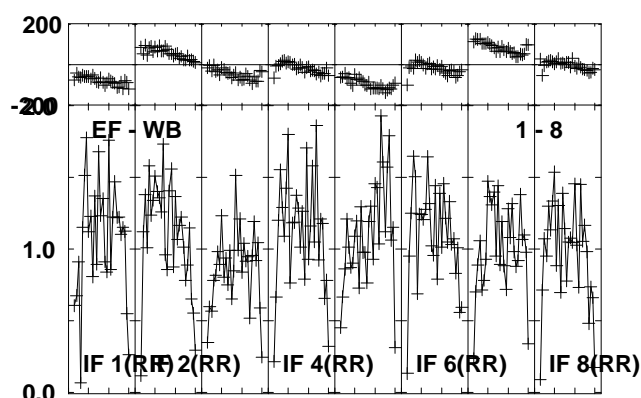
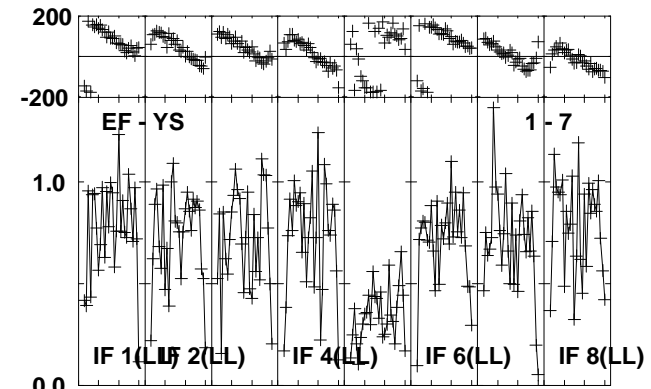
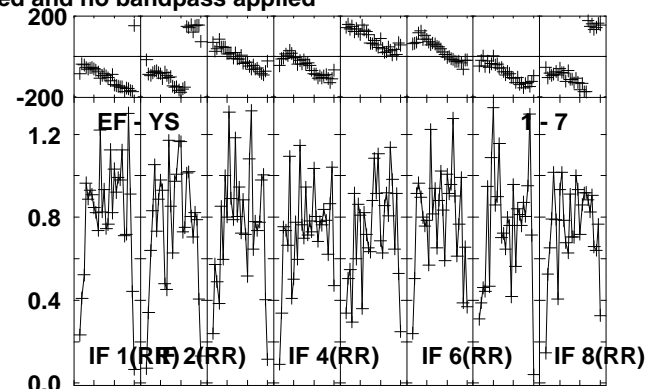
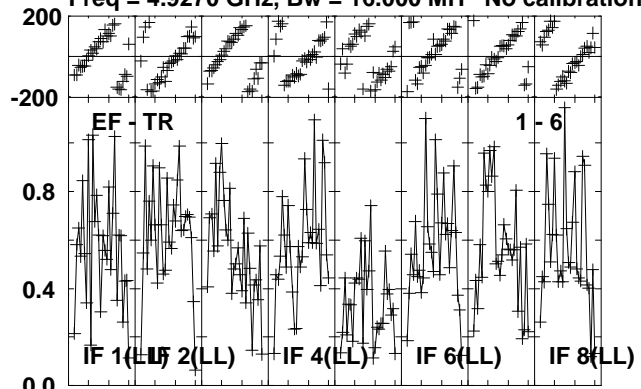

Lower frame: Milli Ampl Jy Top frame: Phas deg
Vector averaged cross-power spectrum Several baselines displayed
Timerange: 00/05:30:23 to 00/05:31:33

Plot file version 261 created 16-OCT-2012 11:57:49

J0645+0541 RO006.UVDATA.1

Freq = 4.9270 GHz, Bw = 16.000 MH No calibration applied and no bandpass applied

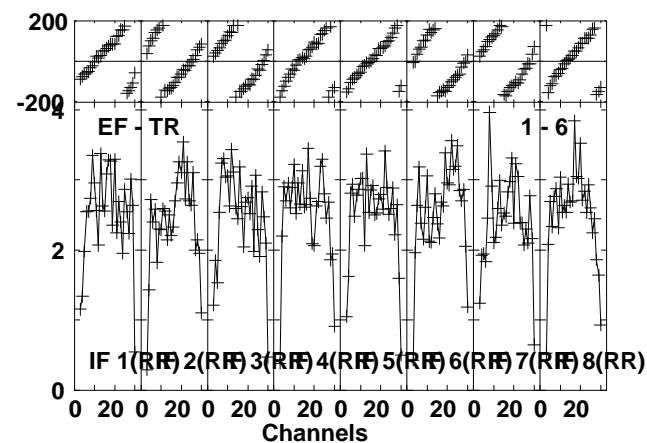
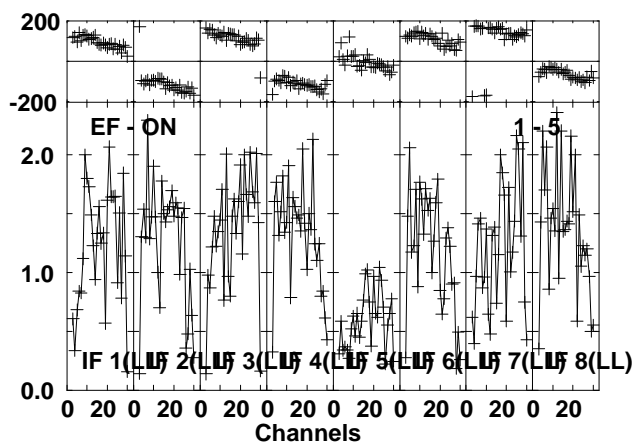
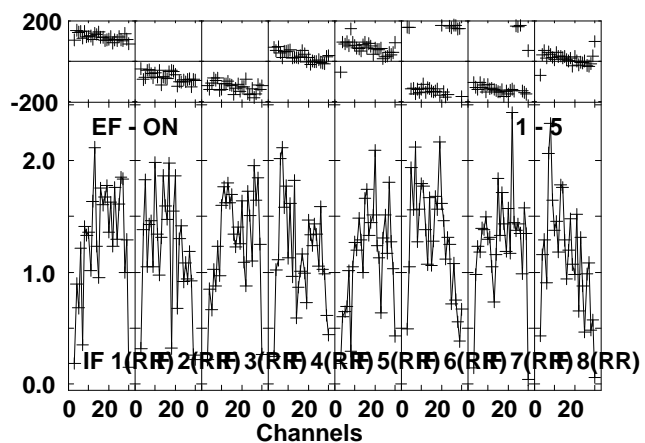
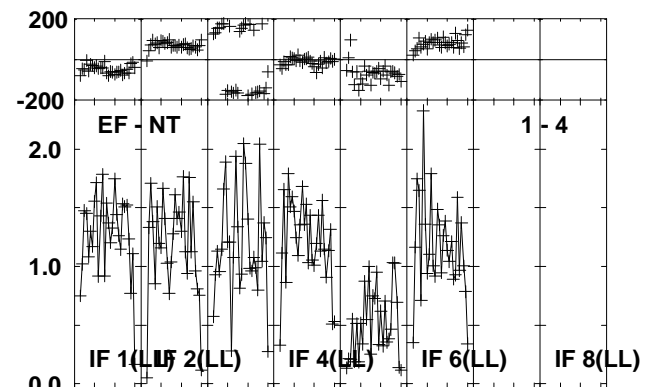
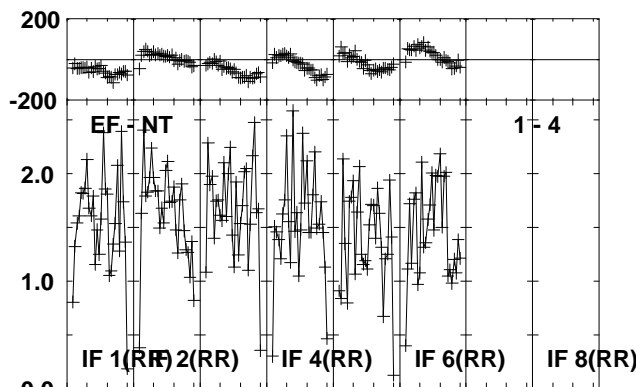
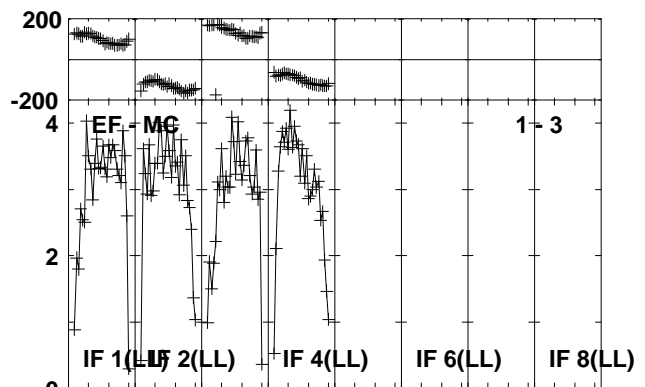
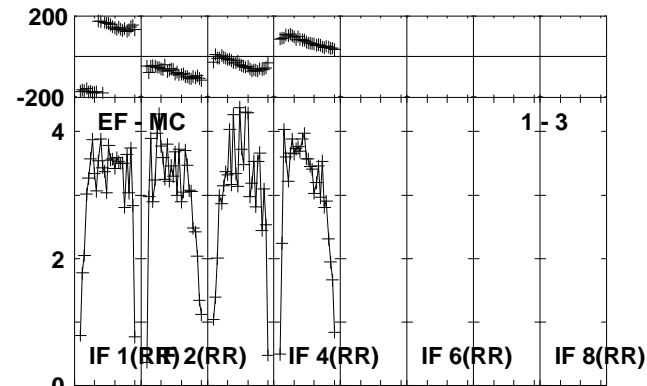
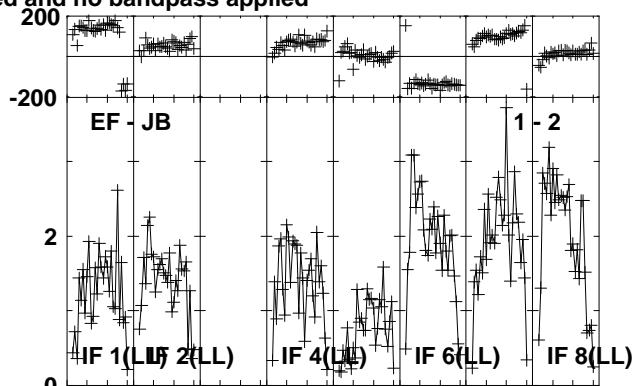
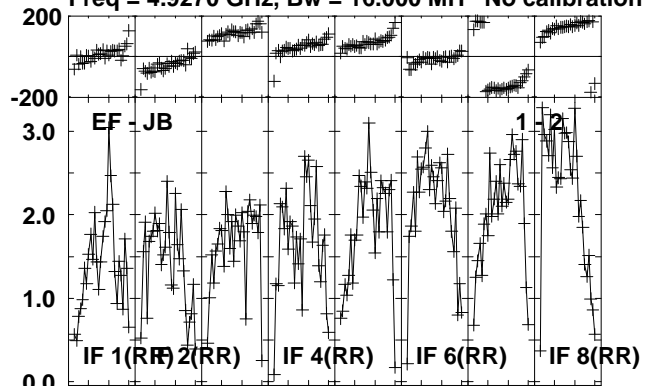

Lower frame: Milli Ampl Jy Top frame: Phas deg
Vector averaged cross-power spectrum Several baselines displayed
Timerange: 00/05:31:37 to 00/05:32:33

Plot file version 262 created 16-OCT-2012 11:57:49
J0645+0541 RO006.UVDATA.1

Freq = 4.9270 GHz, Bw = 16.000 MH No calibration applied and no bandpass applied

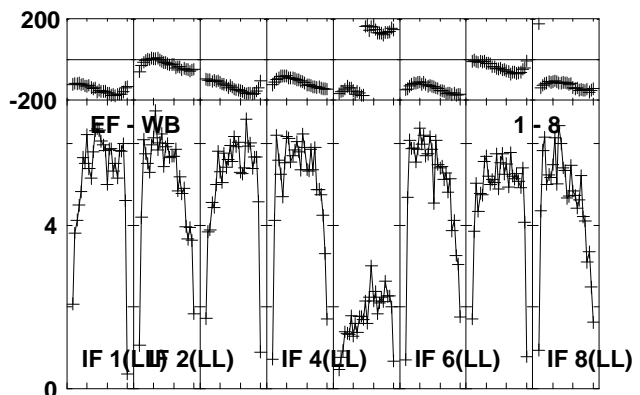
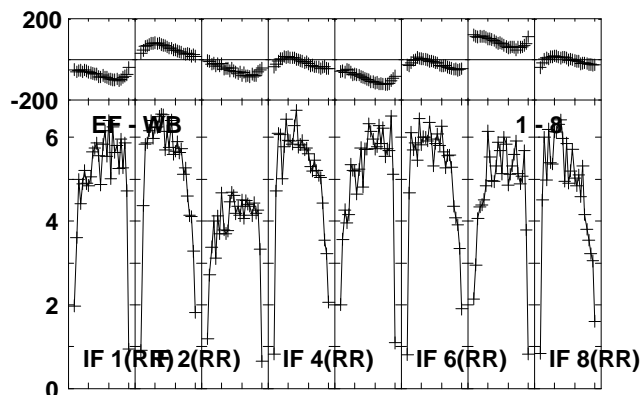
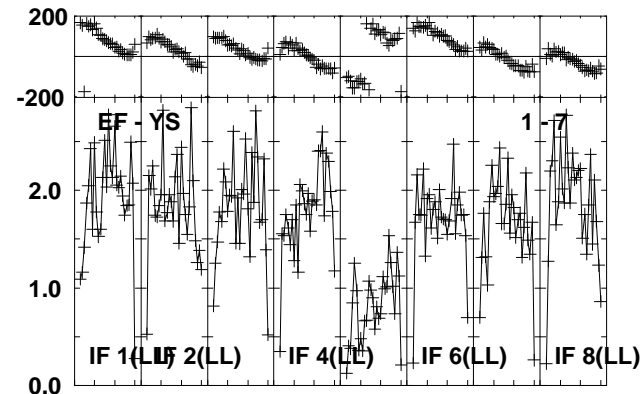
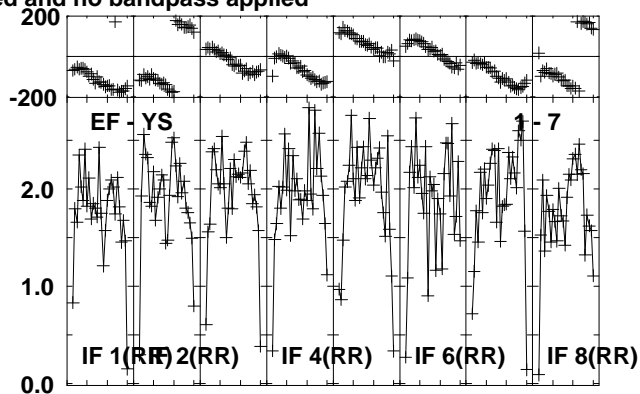
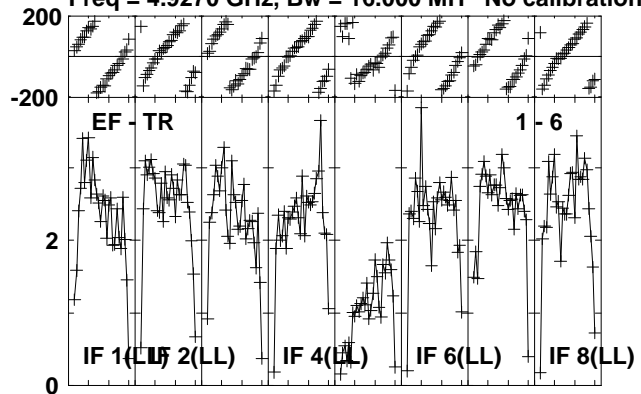

Lower frame: Milli Ampl Jy Top frame: Phas deg
Vector averaged cross-power spectrum Several baselines displayed
Timerange: 00/05:31:37 to 00/05:32:33

Plot file version 263 created 16-OCT-2012 11:57:50

NOVA-MON RO006.UVDATA.1

Freq = 4.9270 GHz, Bw = 16.000 MH No calibration applied and no bandpass applied

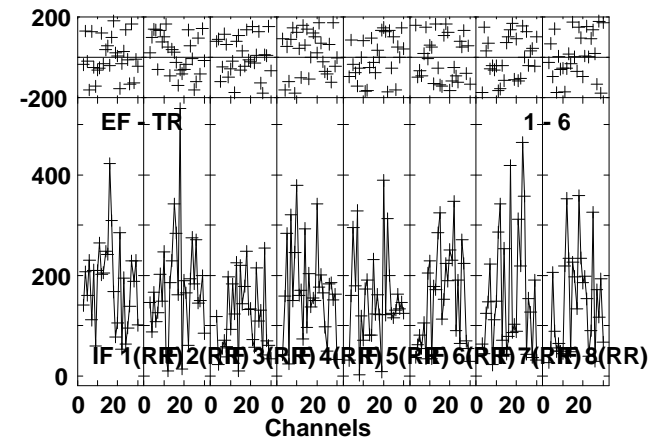
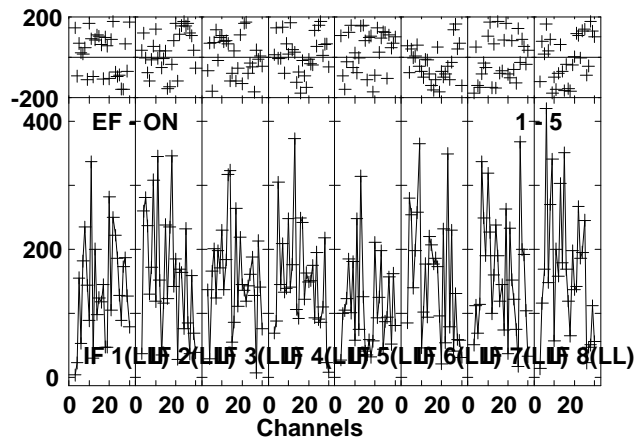
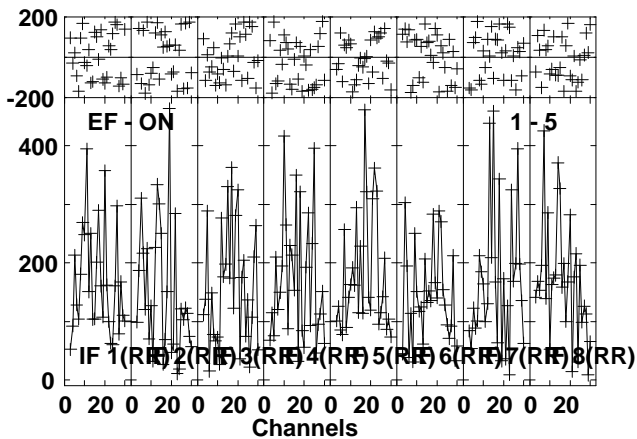
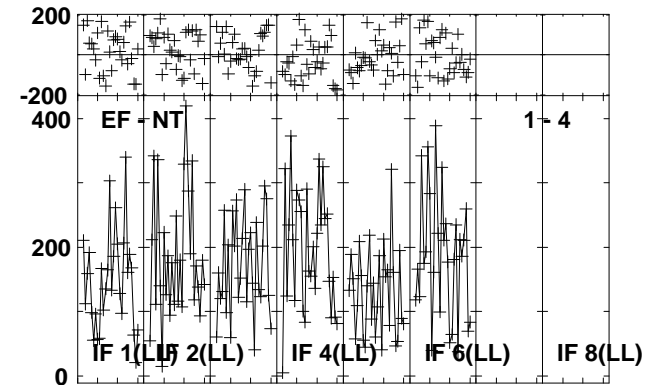
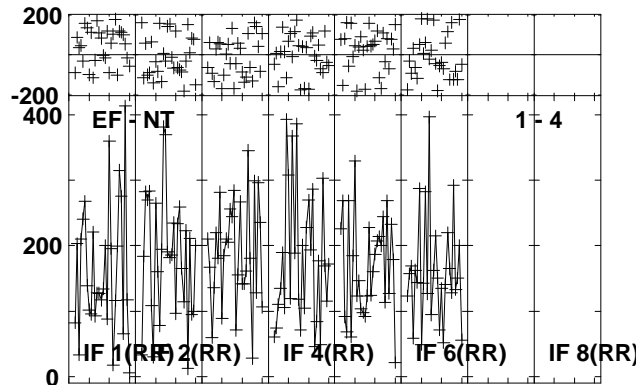
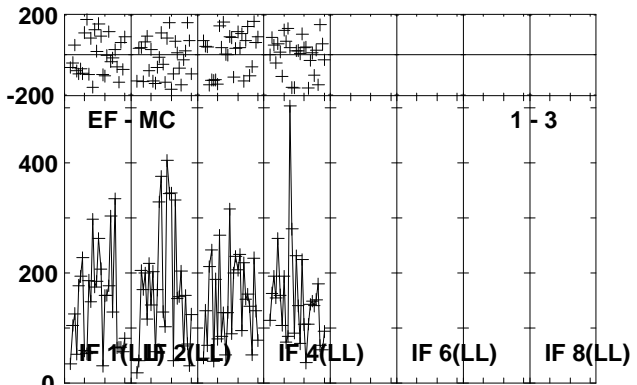
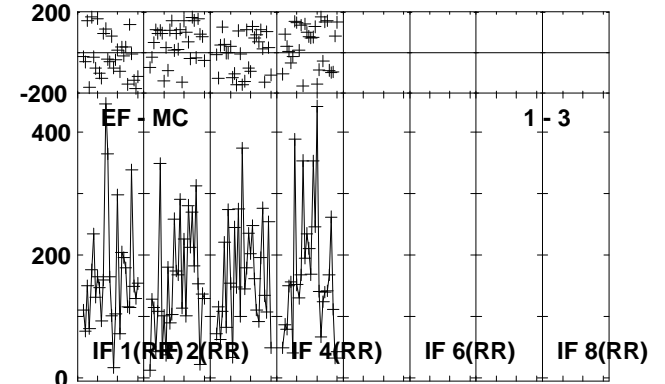
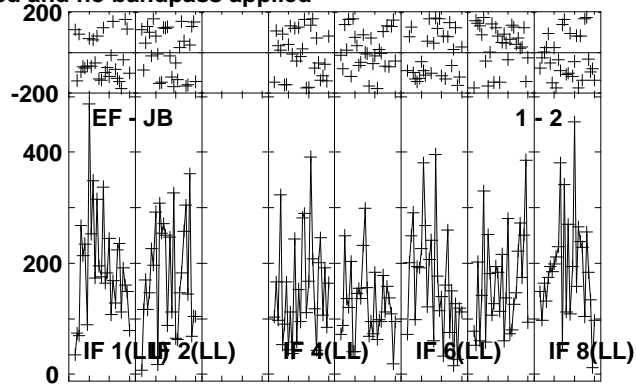
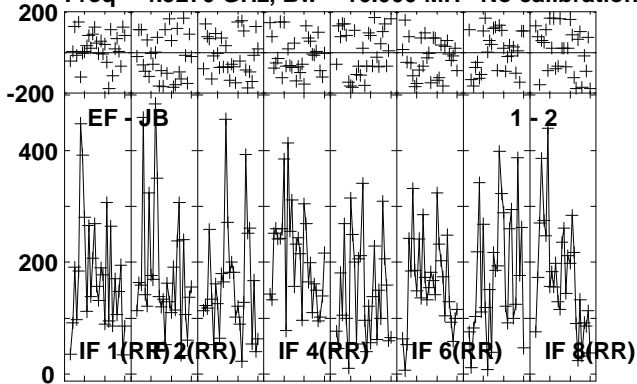

Lower frame: Micro Ampl Jy Top frame: Phas deg
Vector averaged cross-power spectrum Several baselines displayed
Timerange: 00/05:32:37 to 00/05:35:33

Plot file version 264 created 16-OCT-2012 11:57:50

NOVA-MON RO006.UVDATA.1

Freq = 4.9270 GHz, Bw = 16.000 MH No calibration applied and no bandpass applied

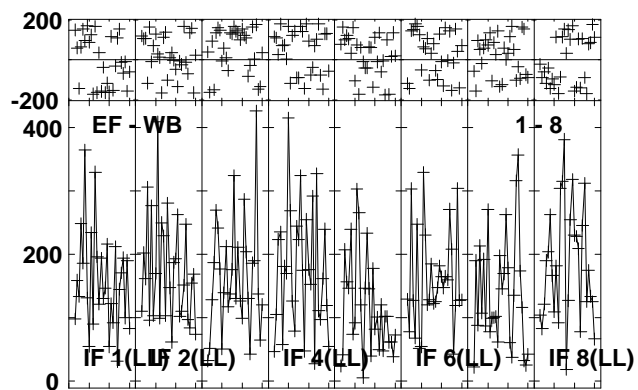
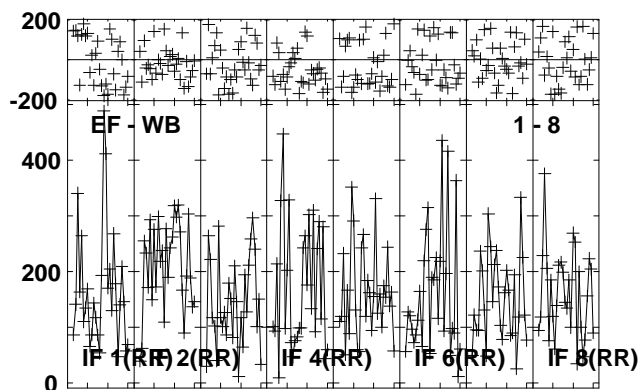
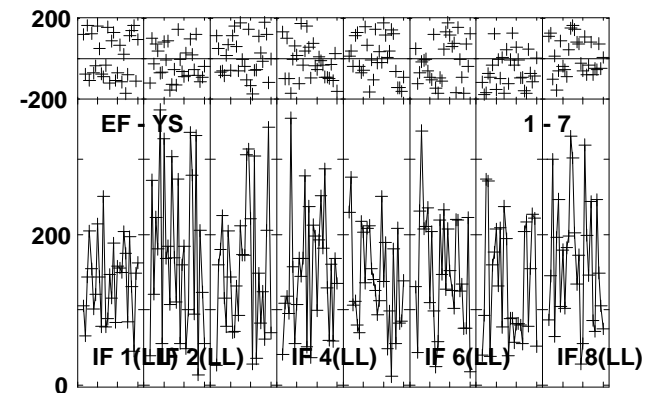
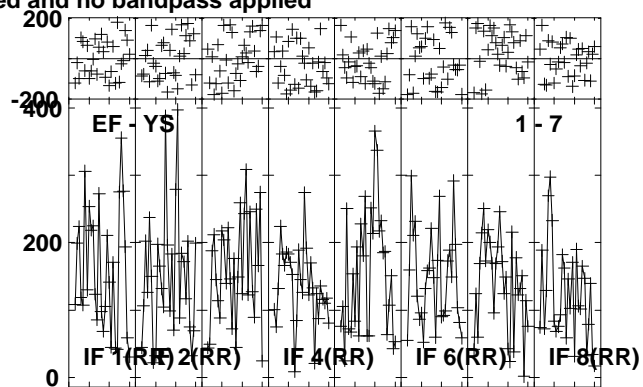
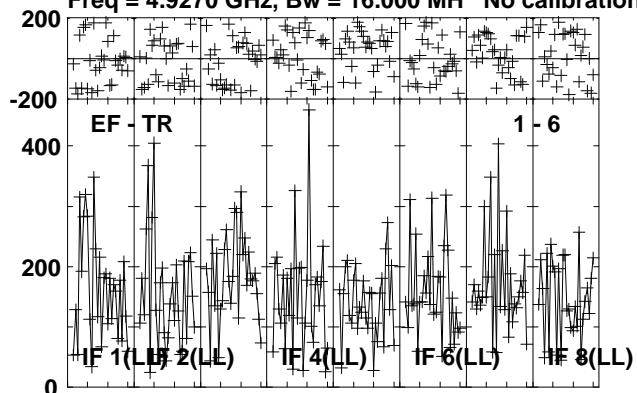

Lower frame: Micro Ampl Jy Top frame: Phas deg
Vector averaged cross-power spectrum Several baselines displayed
Timerange: 00/05:32:37 to 00/05:35:33

Plot file version 265 created 16-OCT-2012 11:57:50

J0639+0601 RO006.UVDATA.1

Freq = 4.9270 GHz, Bw = 16.000 MH No calibration applied and no bandpass applied

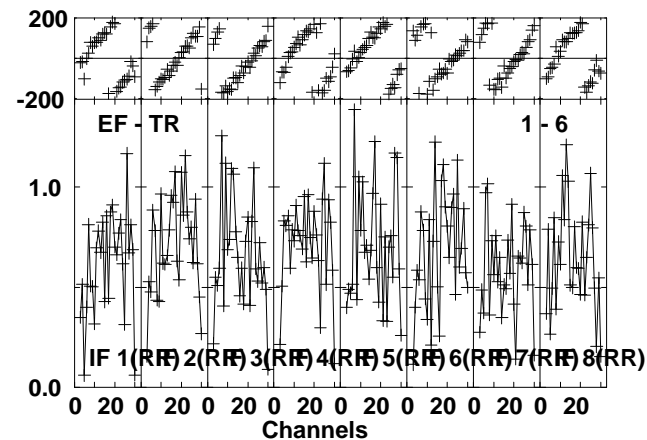
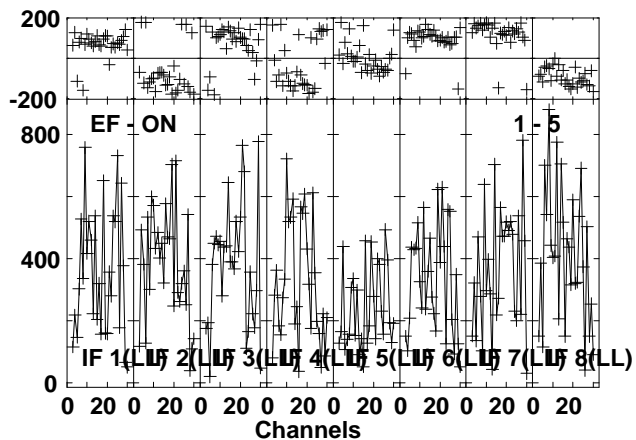
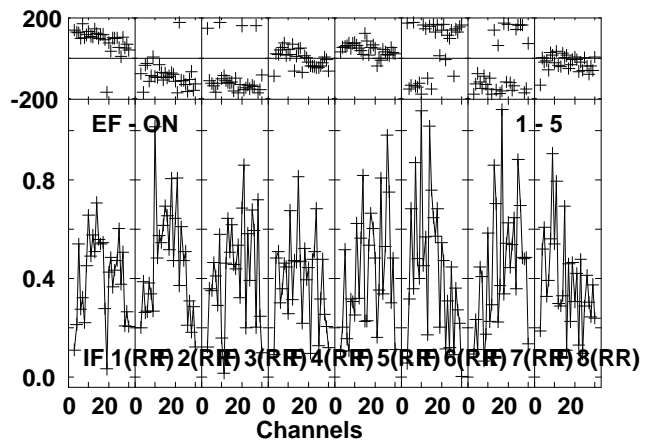
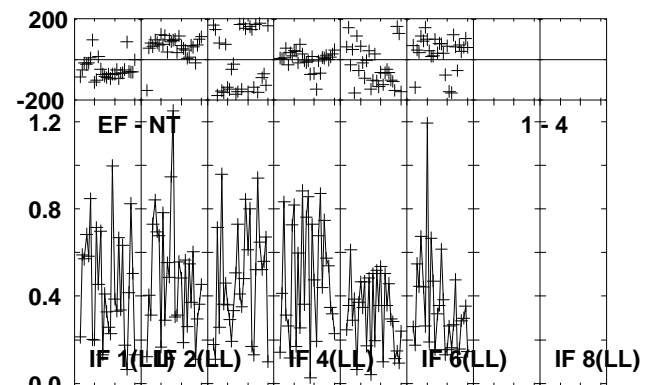
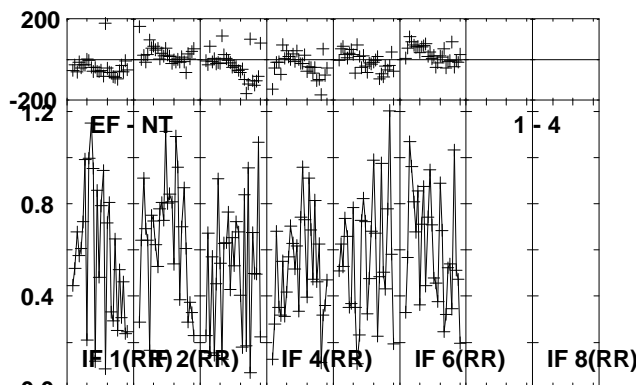
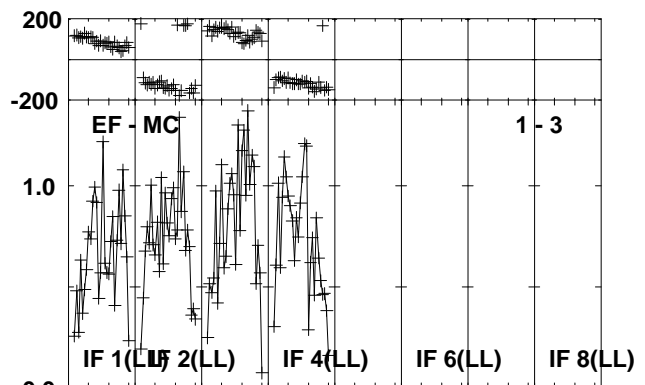
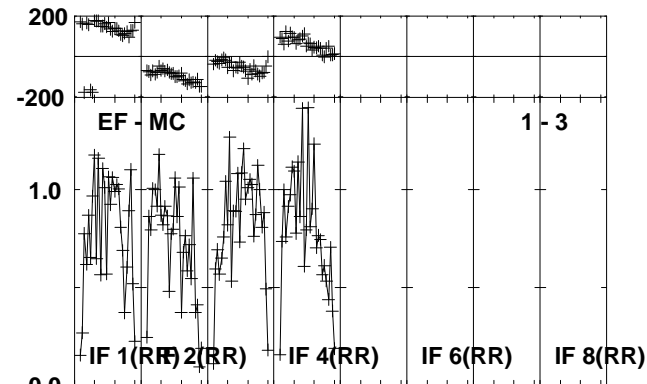
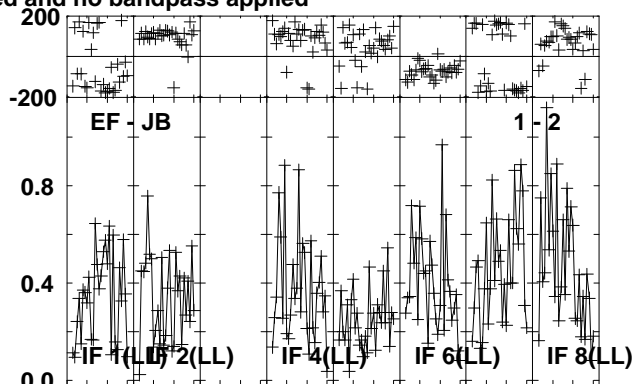
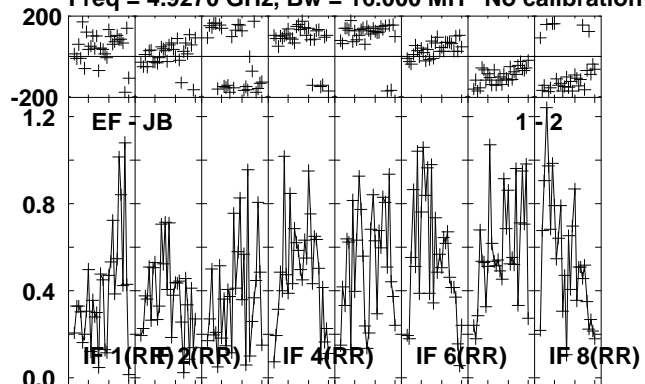

Lower frame: Milli Ampl Jy Top frame: Phas deg
Vector averaged cross-power spectrum Several baselines displayed
Timerange: 00/05:36:03 to 00/05:37:03

Plot file version 266 created 16-OCT-2012 11:57:51

J0639+0601 RO006.UVDATA.1

Freq = 4.9270 GHz, Bw = 16.000 MH No calibration applied and no bandpass applied

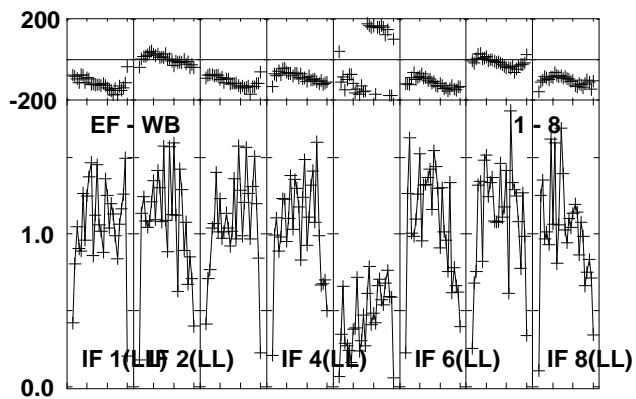
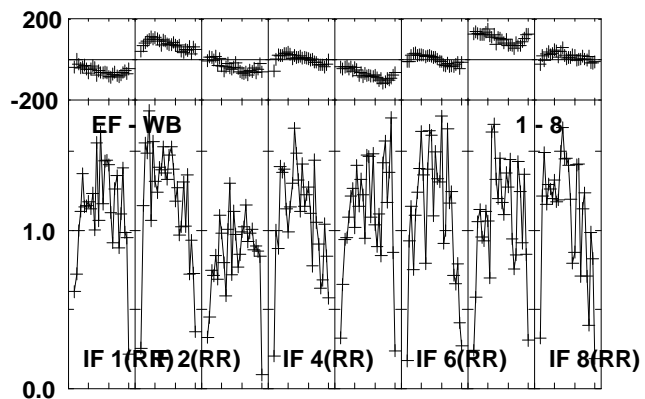
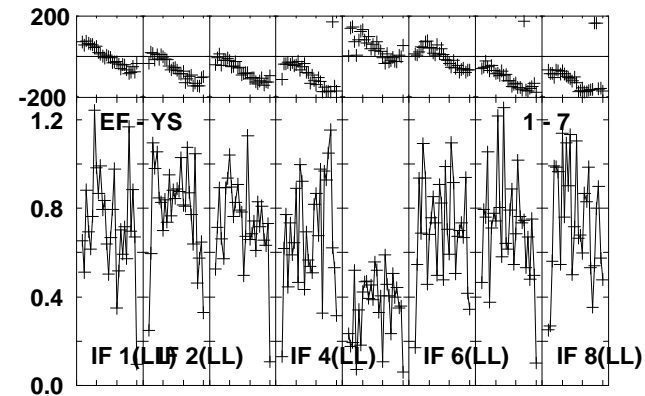
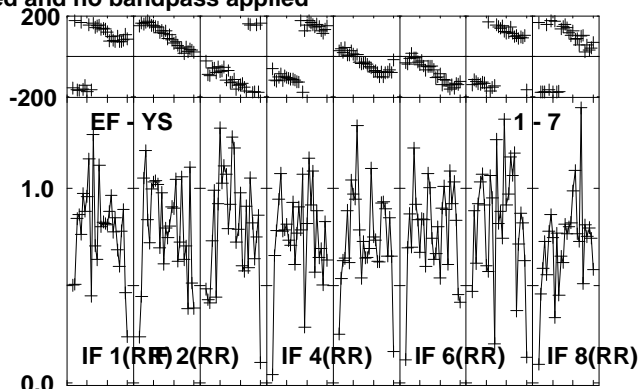
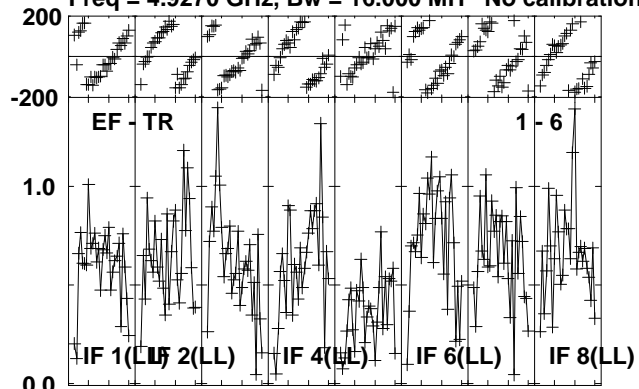

Lower frame: Milli Ampl Jy Top frame: Phas deg
Vector averaged cross-power spectrum Several baselines displayed
Timerange: 00/05:36:03 to 00/05:37:03

Plot file version 267 created 16-OCT-2012 11:57:51

J0645+0541 RO006.UVDATA.1

Freq = 4.9270 GHz, Bw = 16.000 MH No calibration applied and no bandpass applied

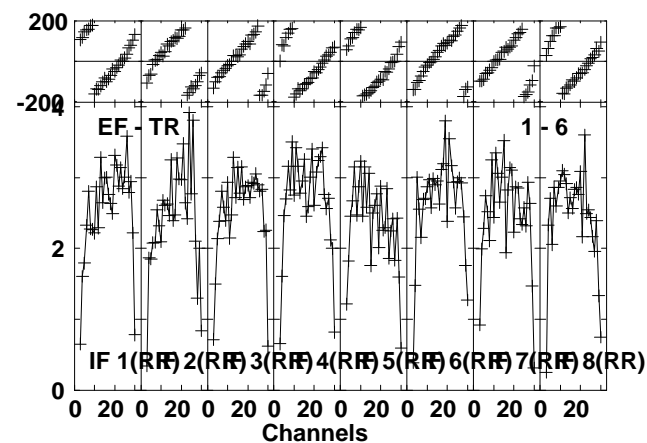
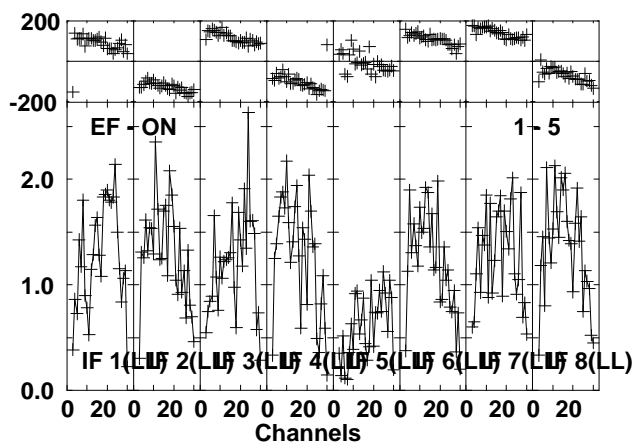
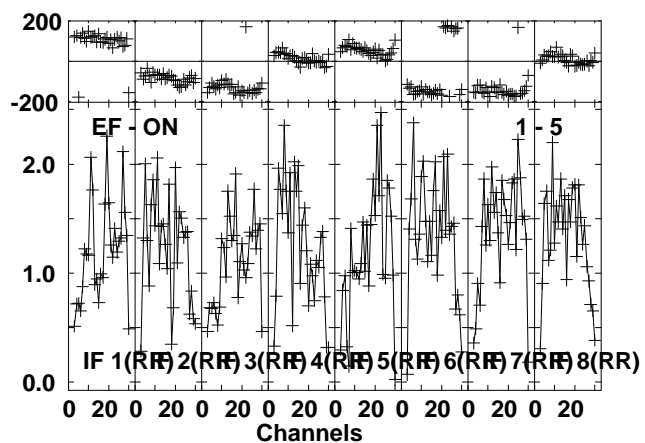
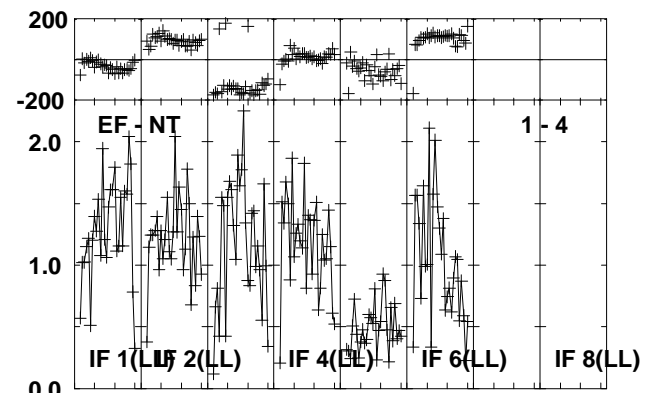
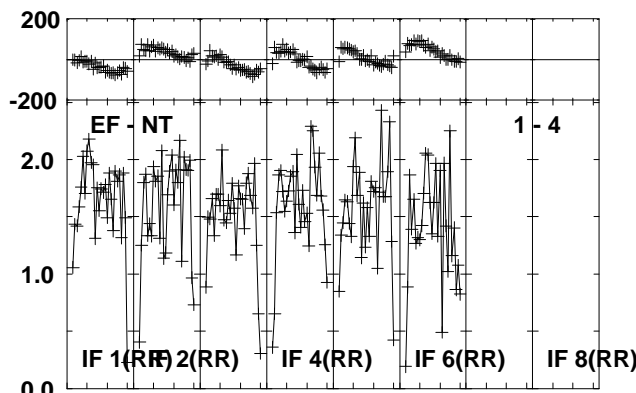
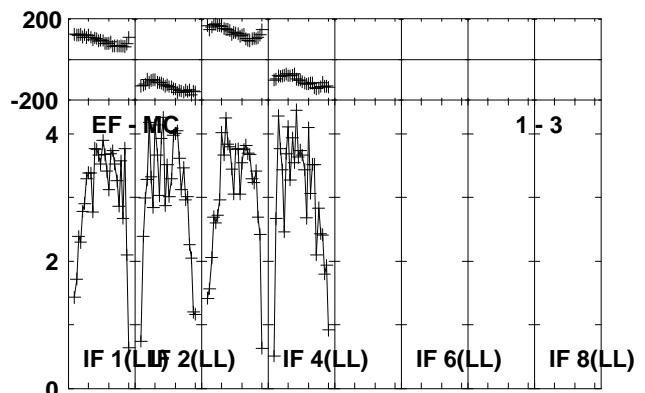
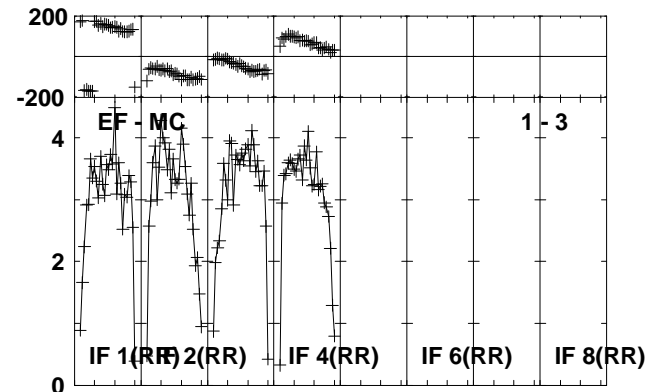
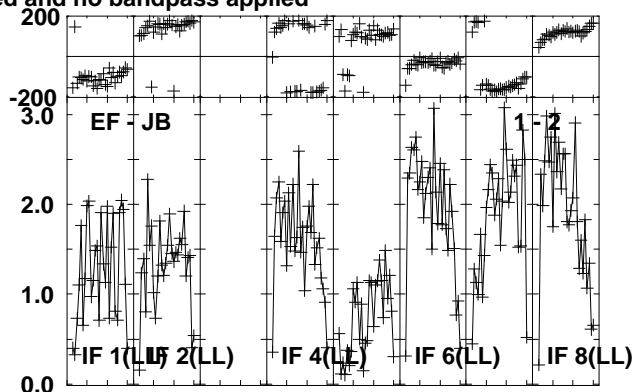
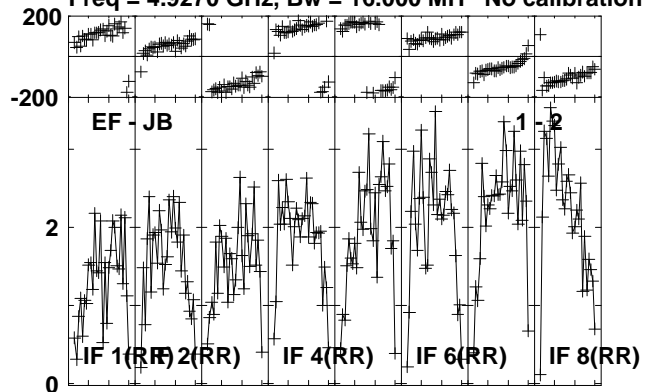

Lower frame: Milli Ampl Jy Top frame: Phas deg
Vector averaged cross-power spectrum Several baselines displayed
Timerange: 00/05:37:07 to 00/05:38:03

Plot file version 268 created 16-OCT-2012 11:57:51

J0645+0541 RO006.UVDATA.1

Freq = 4.9270 GHz, Bw = 16.000 MH No calibration applied and no bandpass applied

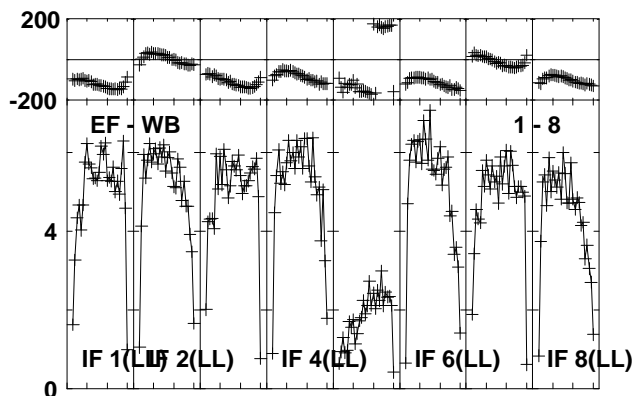
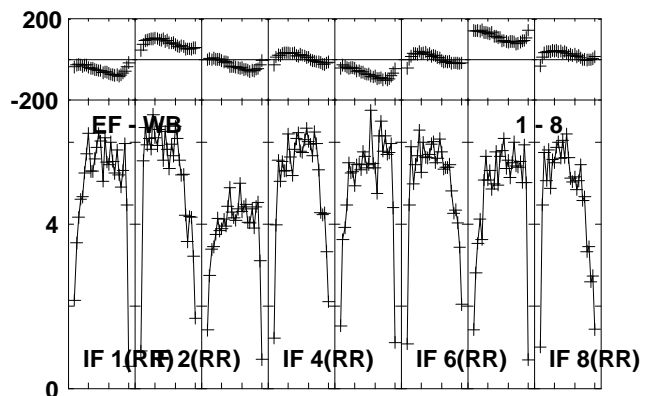
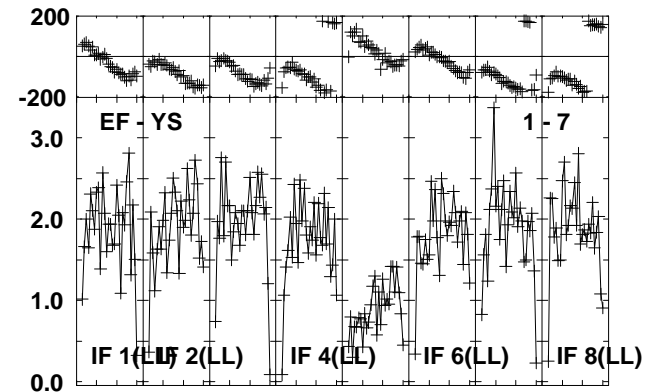
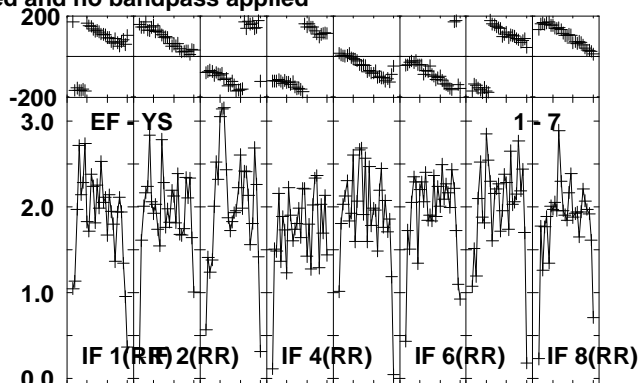
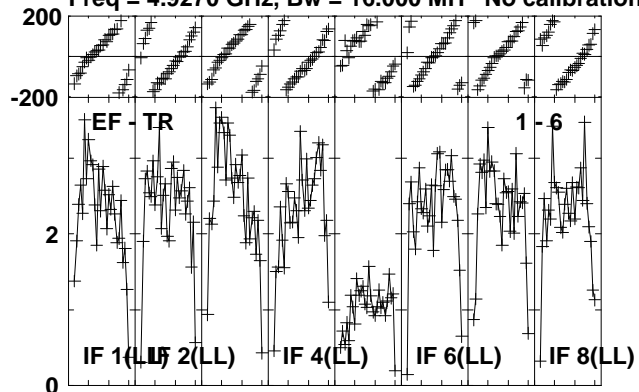

Lower frame: Milli Ampl Jy Top frame: Phas deg
Vector averaged cross-power spectrum Several baselines displayed
Timerange: 00/05:37:07 to 00/05:38:03

Plot file version 269 created 16-OCT-2012 11:57:51

NOVA-MON RO006.UVDATA.1

Freq = 4.9270 GHz, Bw = 16.000 MH No calibration applied and no bandpass applied

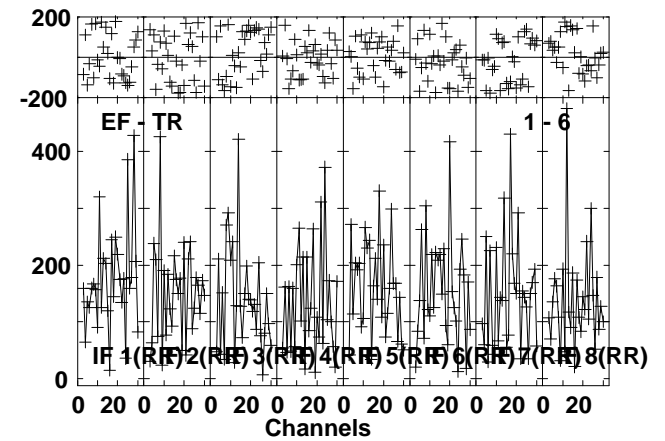
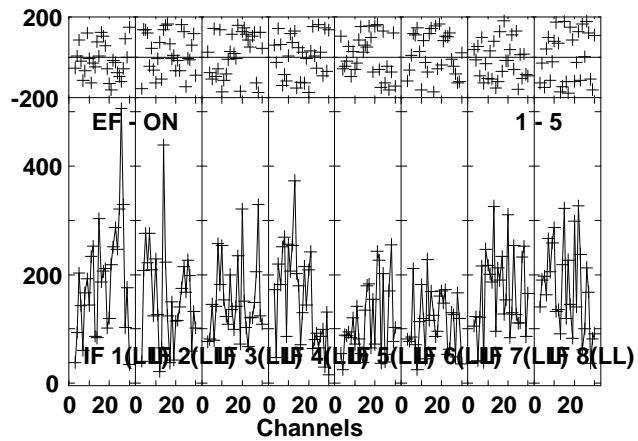
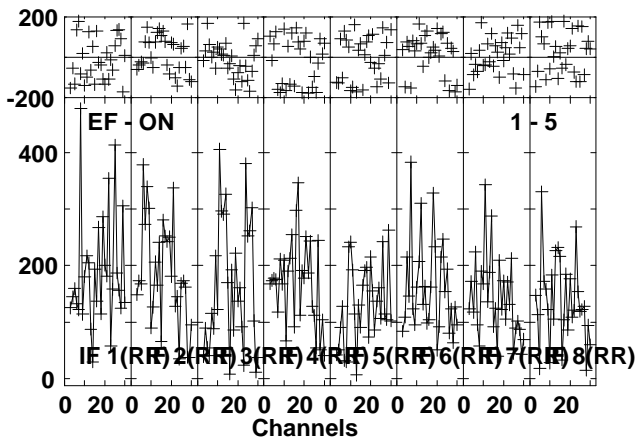
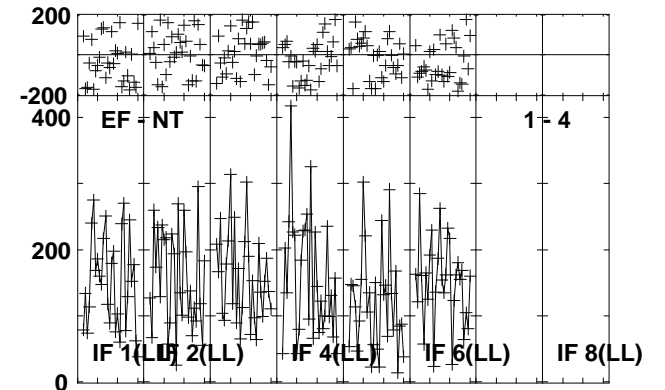
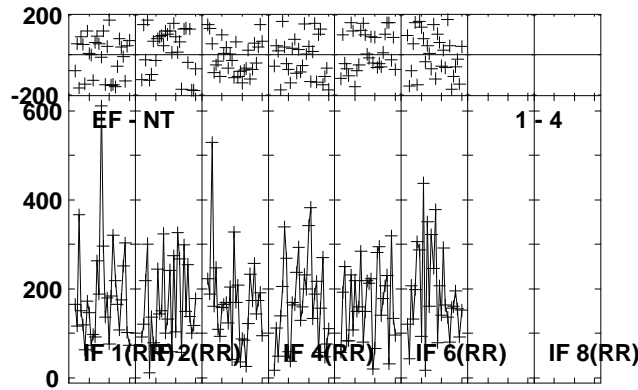
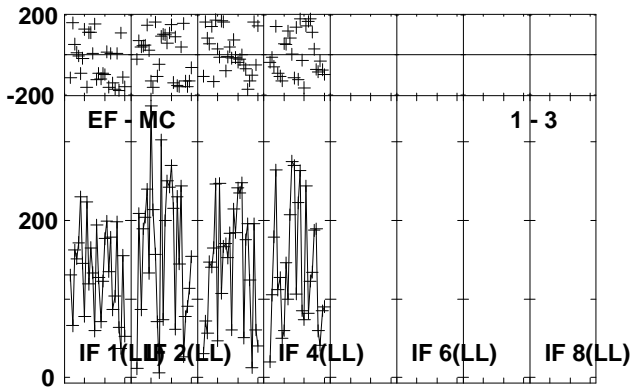
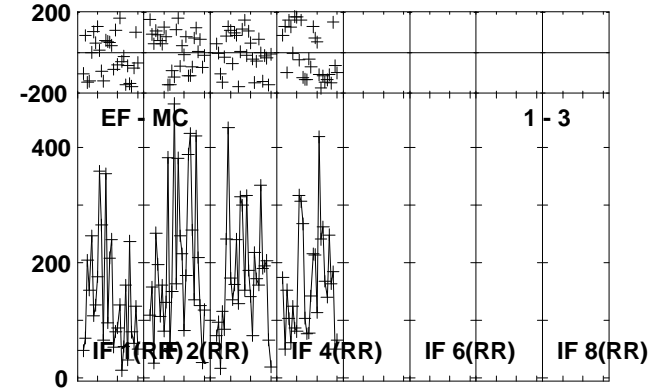
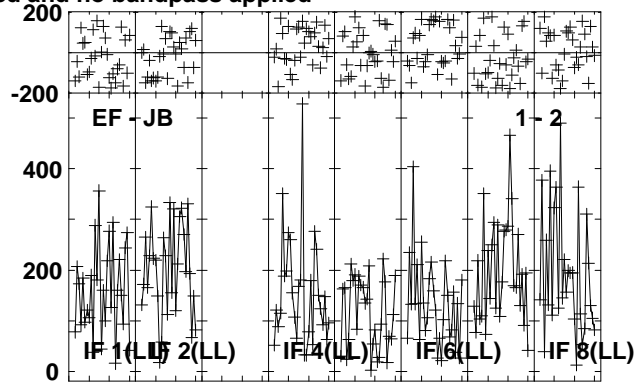
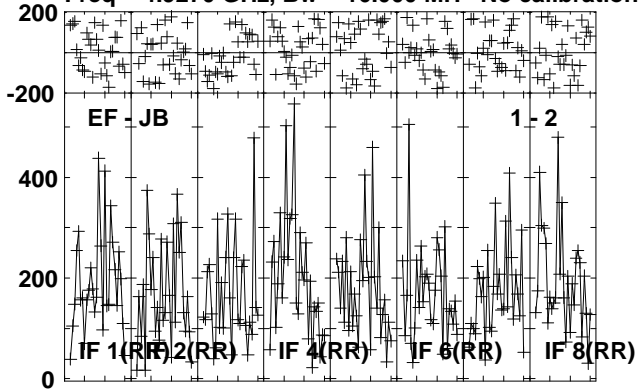

Lower frame: Micro Ampl Jy Top frame: Phas deg
Vector averaged cross-power spectrum Several baselines displayed
Timerange: 00/05:38:07 to 00/05:41:03

Plot file version 270 created 16-OCT-2012 11:57:52

NOVA-MON RO006.UVDATA.1

Freq = 4.9270 GHz, Bw = 16.000 MH No calibration applied and no bandpass applied

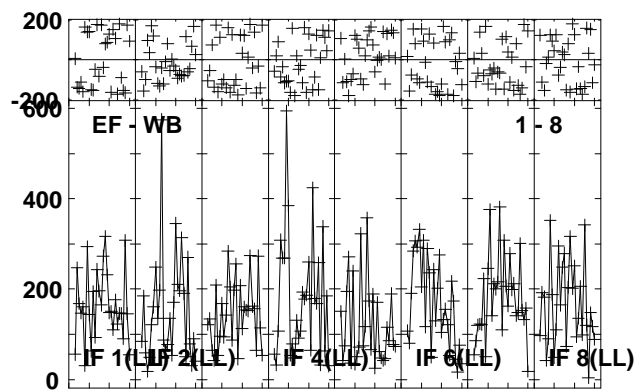
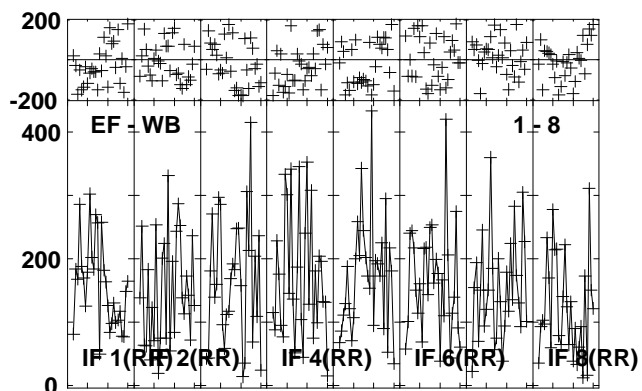
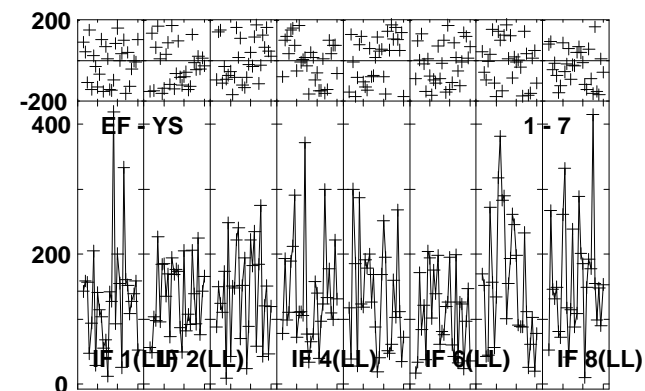
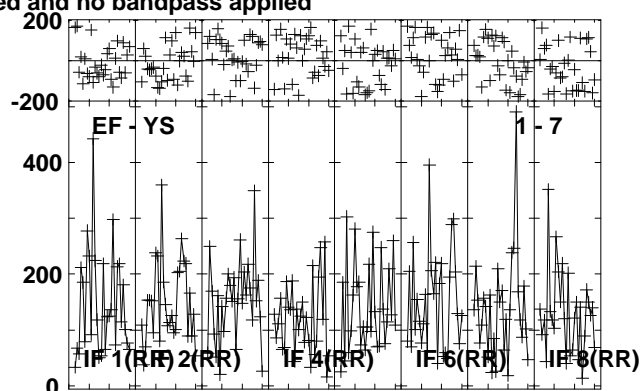
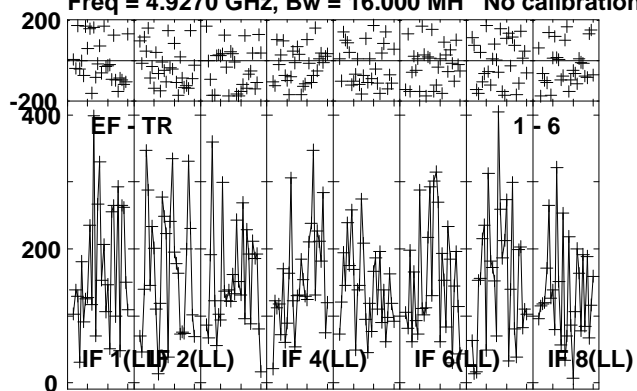

Lower frame: Micro Ampl Jy Top frame: Phas deg
Vector averaged cross-power spectrum Several baselines displayed
Timerange: 00/05:38:07 to 00/05:41:03

Plot file version 271 created 16-OCT-2012 11:57:52

J0639+0601 RO006.UVDATA.1

Freq = 4.9270 GHz, Bw = 16.000 MH No calibration applied and no bandpass applied

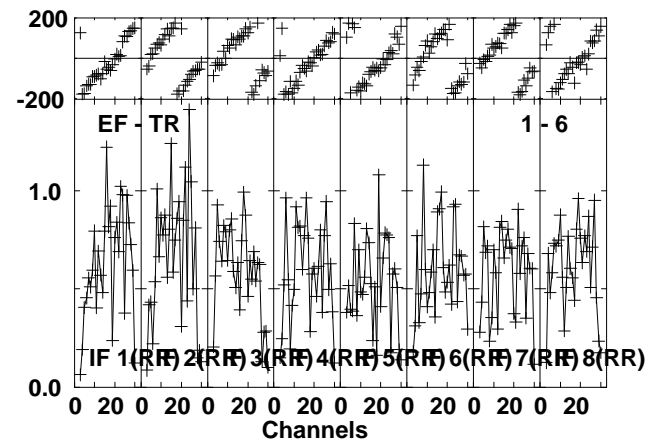
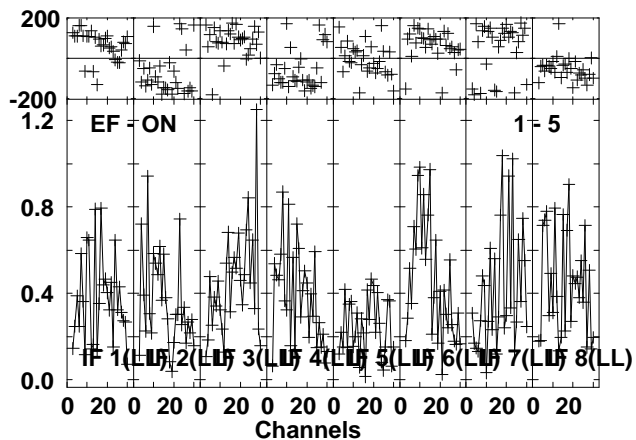
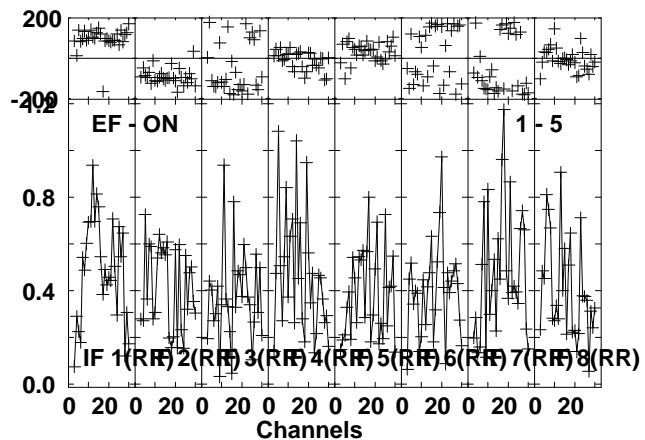
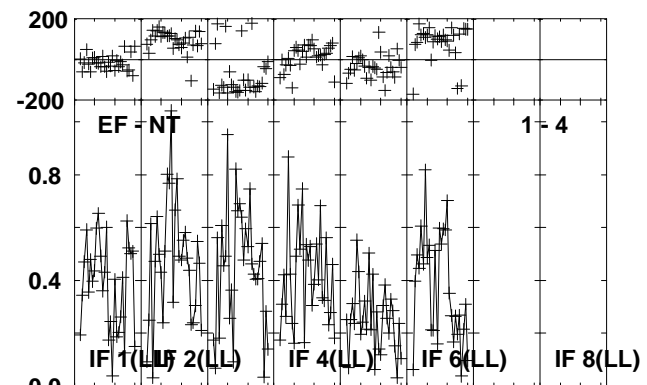
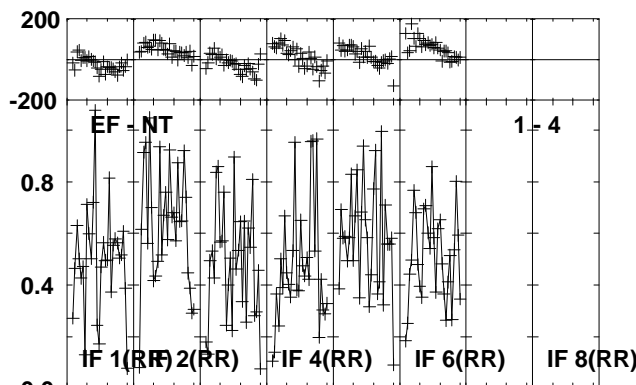
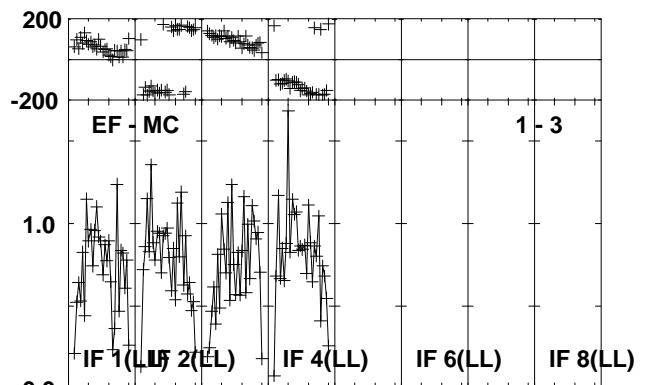
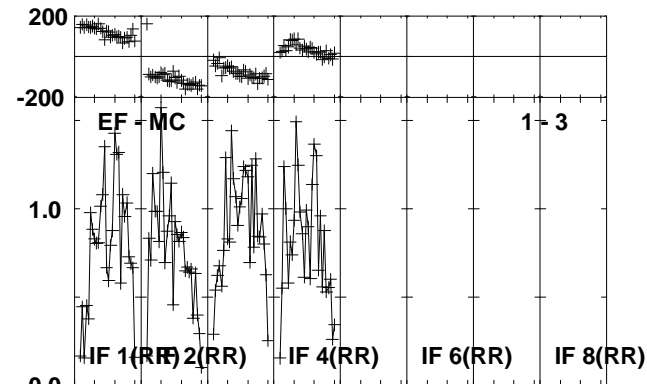
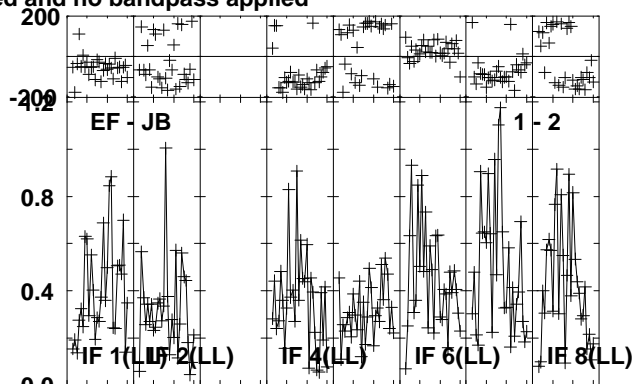
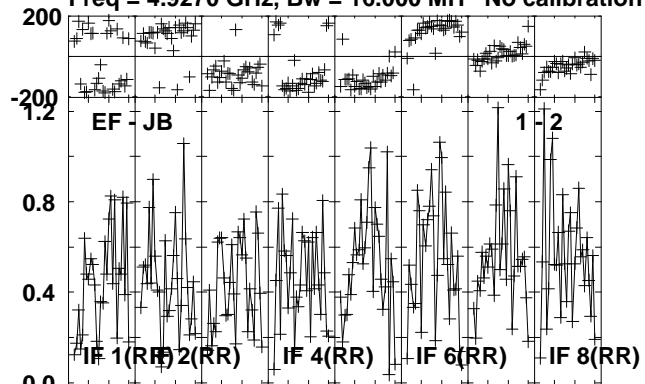

Lower frame: Milli Ampl Jy Top frame: Phas deg
Vector averaged cross-power spectrum Several baselines displayed
Timerange: 00/05:41:07 to 00/05:42:19

Plot file version 272 created 16-OCT-2012 11:57:52

J0639+0601 RO006.UVDATA.1

Freq = 4.9270 GHz, Bw = 16.000 MH No calibration applied and no bandpass applied

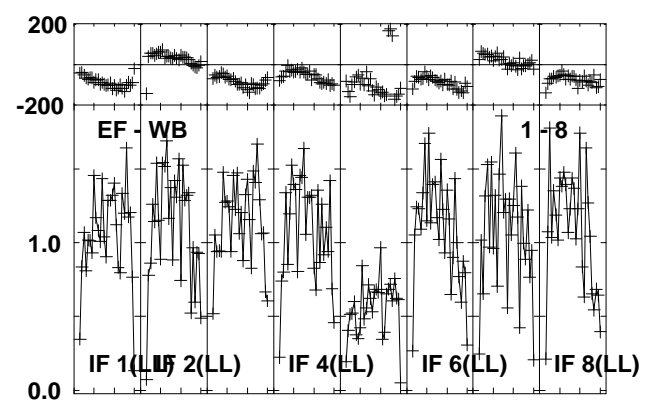
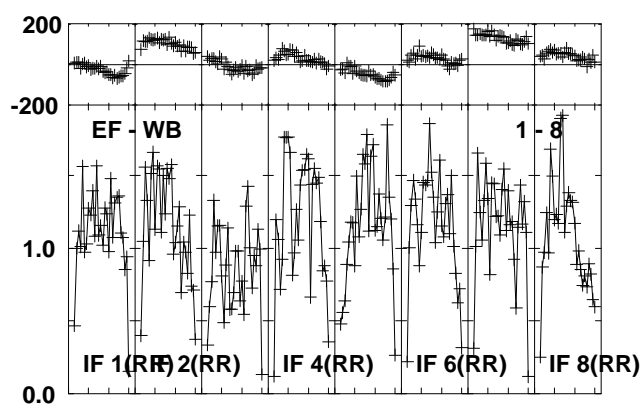
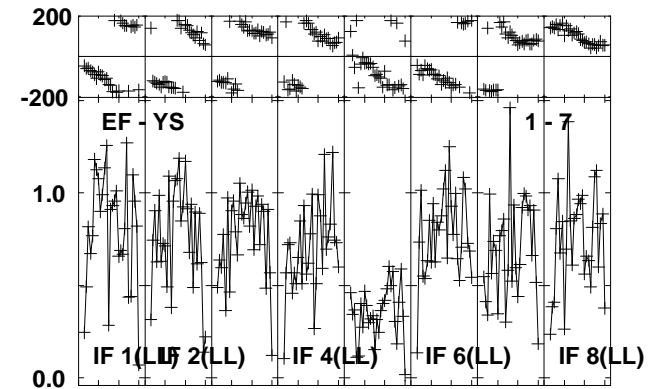
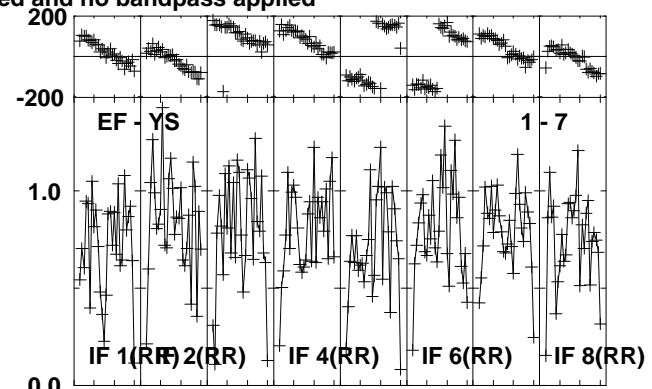
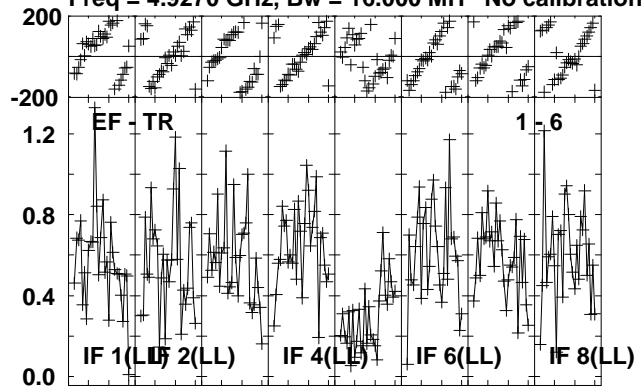

Lower frame: Milli Ampl Jy Top frame: Phas deg
Vector averaged cross-power spectrum Several baselines displayed
Timerange: 00/05:41:07 to 00/05:42:19

Plot file version 273 created 16-OCT-2012 11:57:53

J0645+0541 RO006.UVDATA.1

Freq = 4.9270 GHz, Bw = 16.000 MH No calibration applied and no bandpass applied

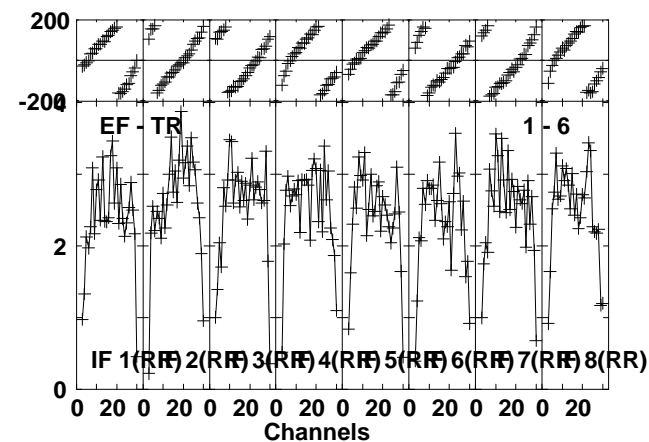
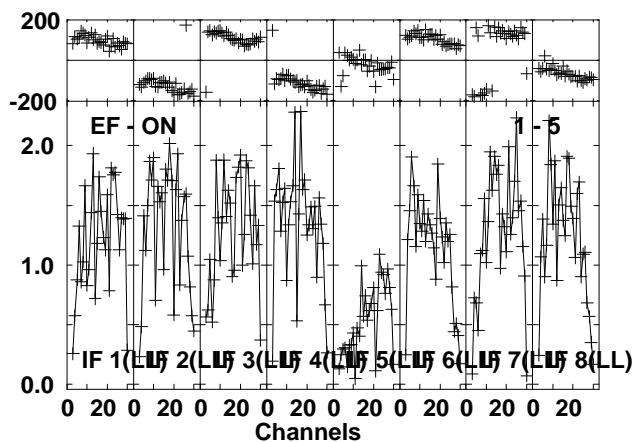
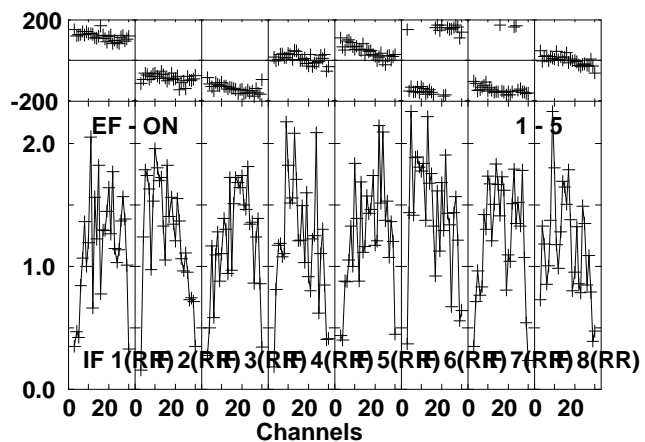
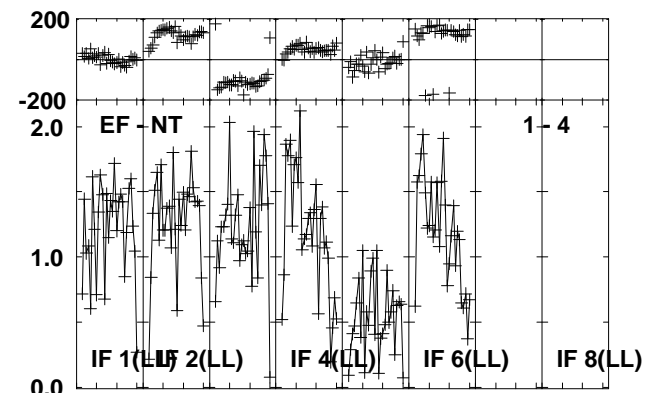
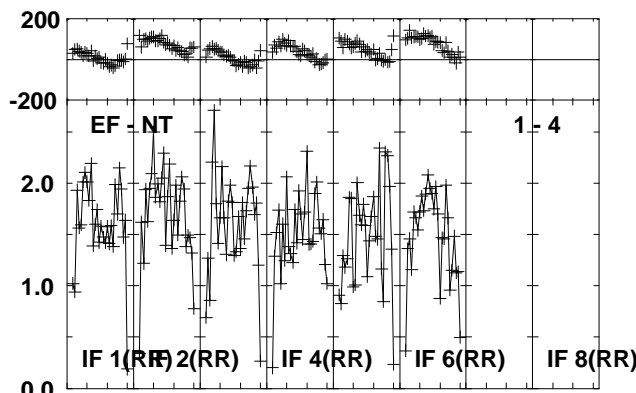
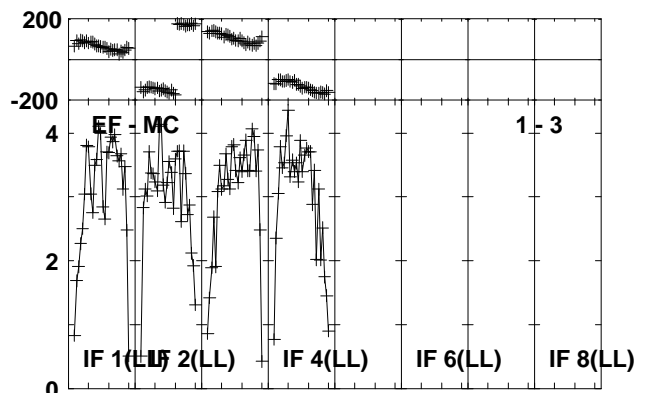
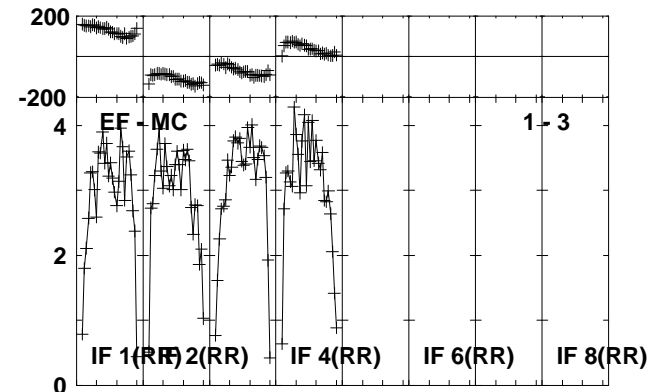
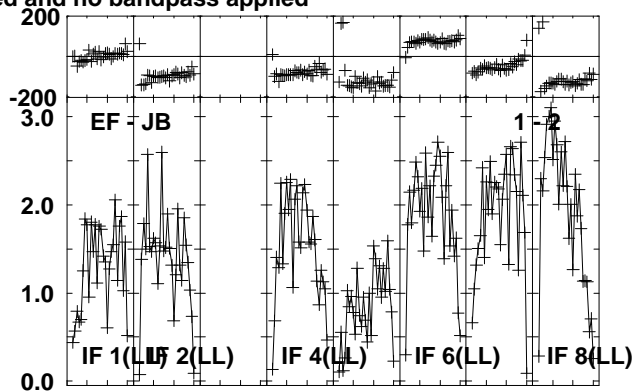
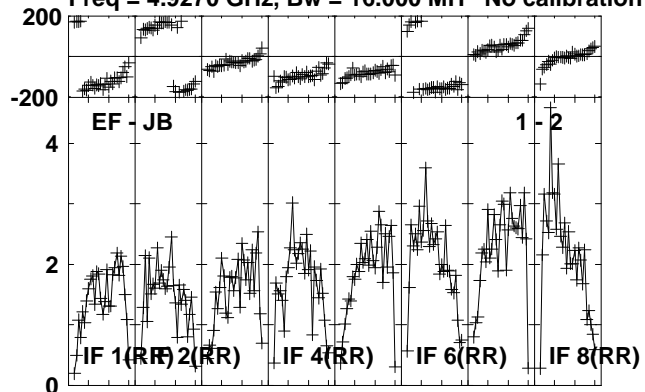

Lower frame: Milli Ampl Jy Top frame: Phas deg
Vector averaged cross-power spectrum Several baselines displayed
Timerange: 00/05:42:23 to 00/05:43:19

Plot file version 274 created 16-OCT-2012 11:57:53

J0645+0541 RO006.UVDATA.1

Freq = 4.9270 GHz, Bw = 16.000 MH No calibration applied and no bandpass applied

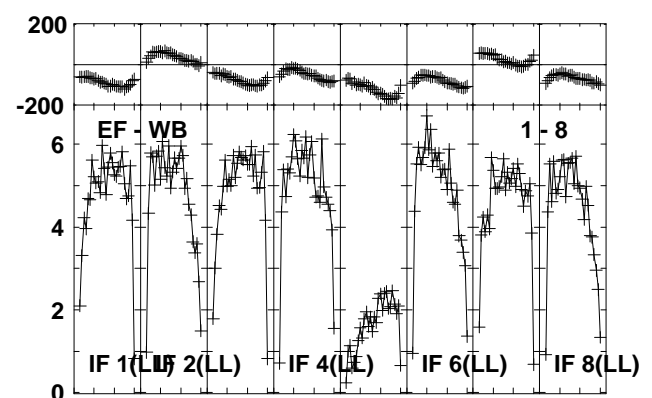
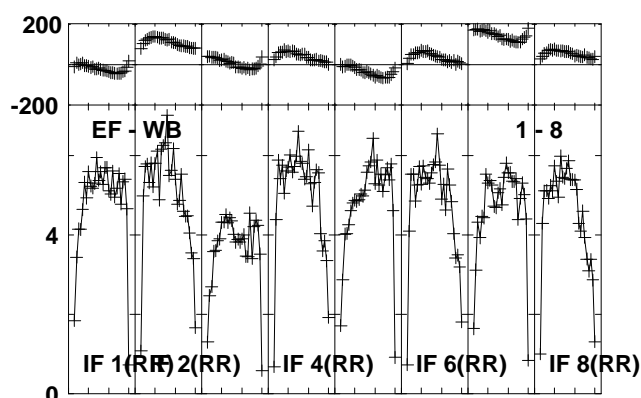
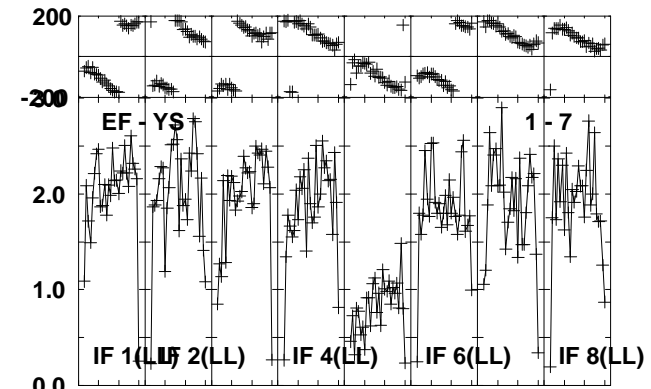
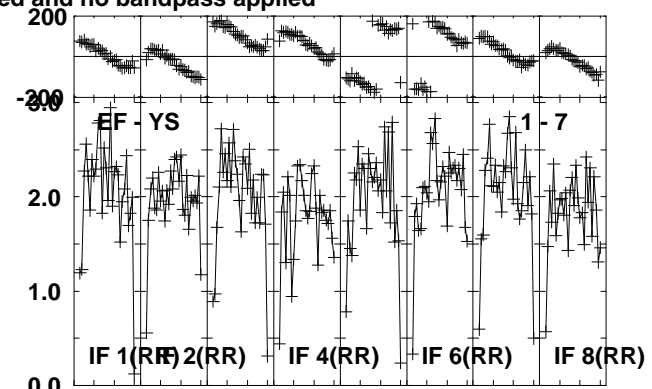
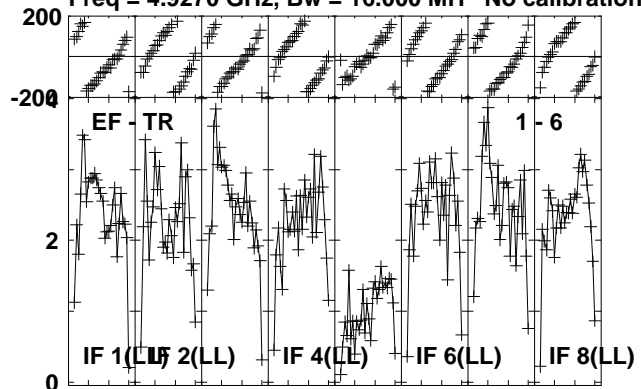

Lower frame: Milli Ampl Jy Top frame: Phas deg
Vector averaged cross-power spectrum Several baselines displayed
Timerange: 00/05:42:23 to 00/05:43:19

Plot file version 275 created 16-OCT-2012 11:57:53

NOVA-MON RO006.UVDATA.1

Freq = 4.9270 GHz, Bw = 16.000 MH No calibration applied and no bandpass applied

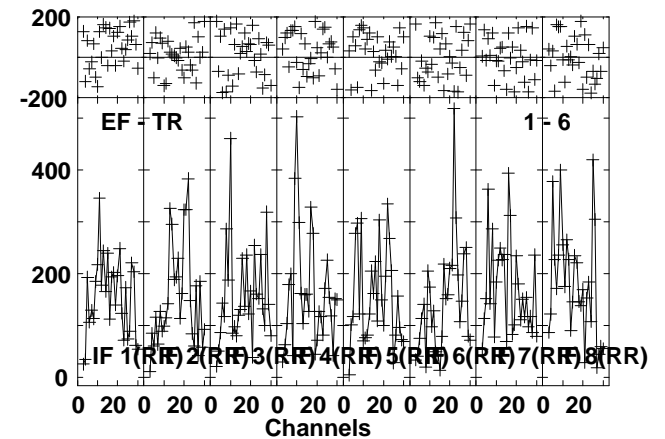
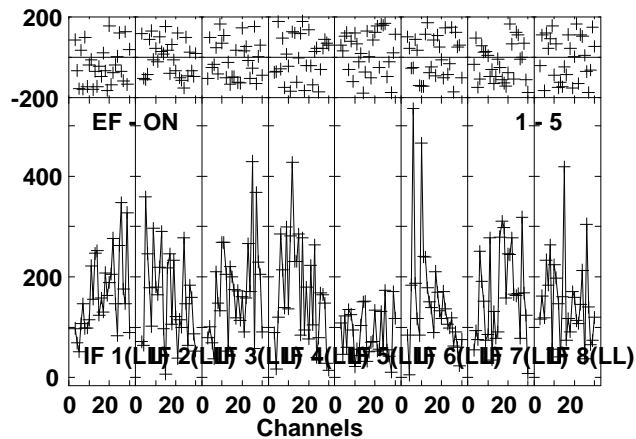
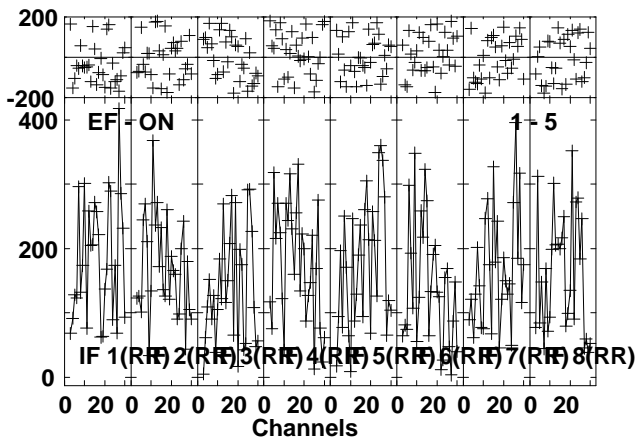
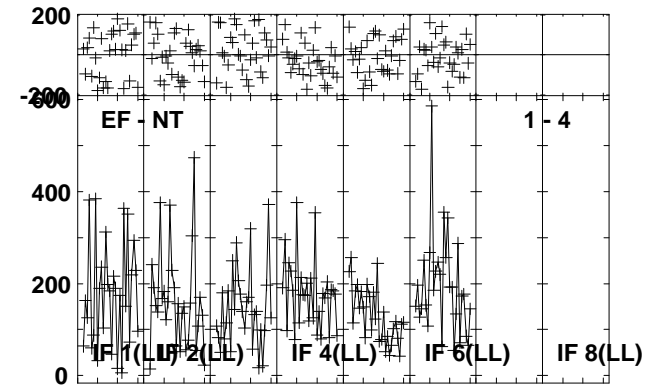
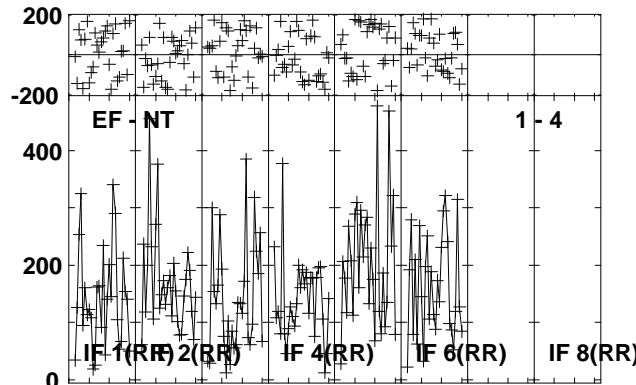
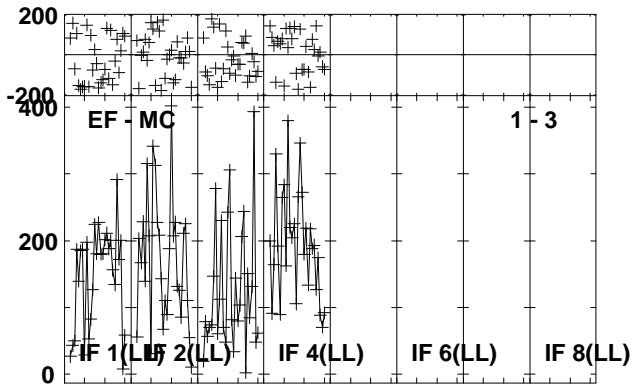
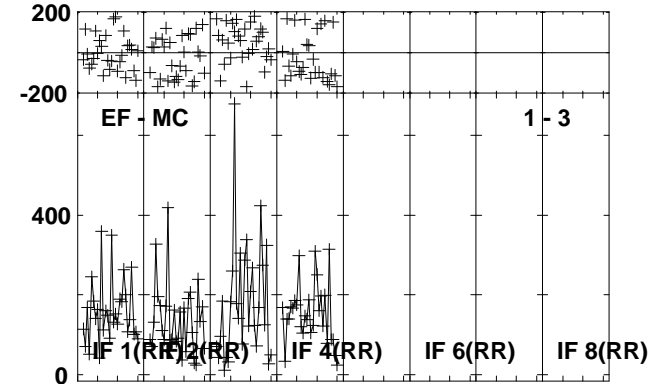
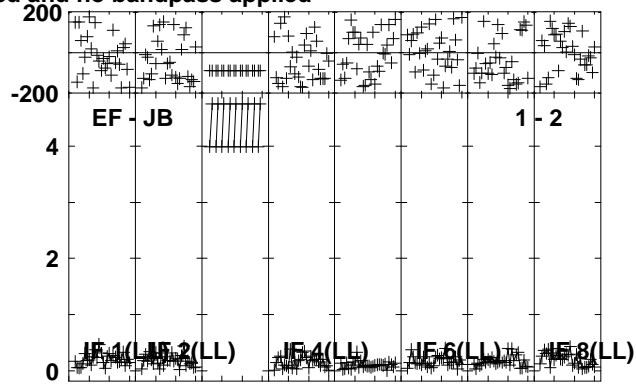
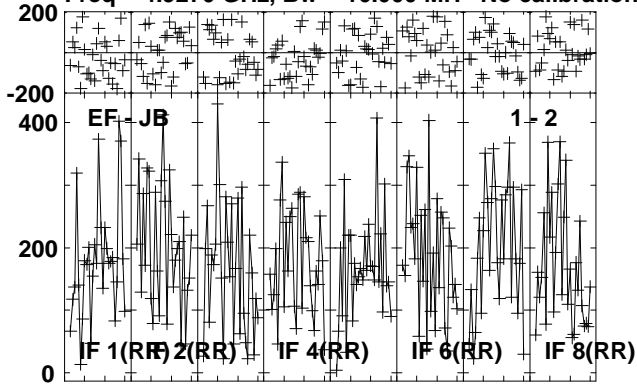

Lower frame: Micro Ampl Jy Top frame: Phas deg
Vector averaged cross-power spectrum Several baselines displayed
Timerange: 00/05:43:23 to 00/05:46:19

Plot file version 276 created 16-OCT-2012 11:57:54

NOVA-MON RO006.UVDATA.1

Freq = 4.9270 GHz, Bw = 16.000 MH No calibration applied and no bandpass applied

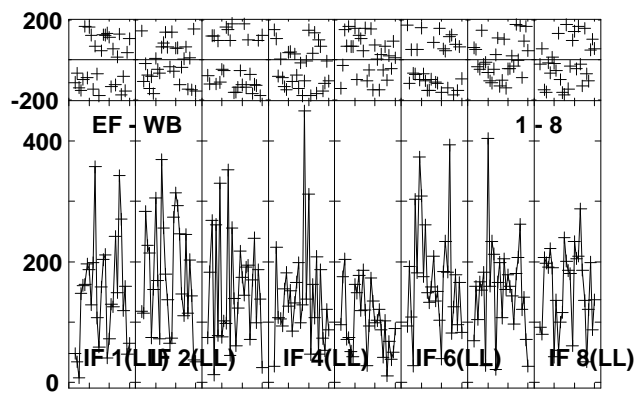
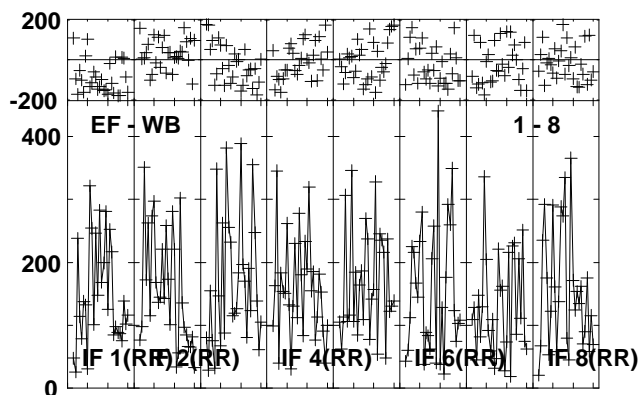
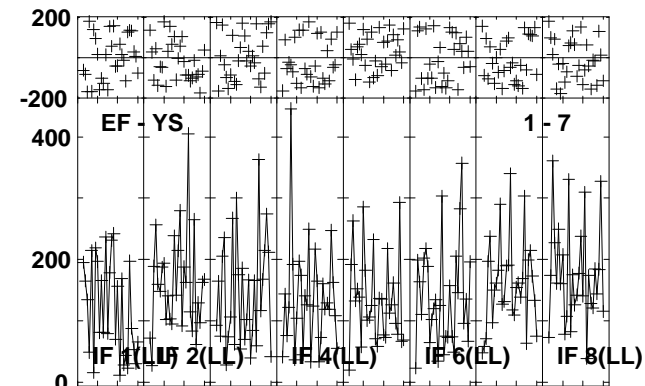
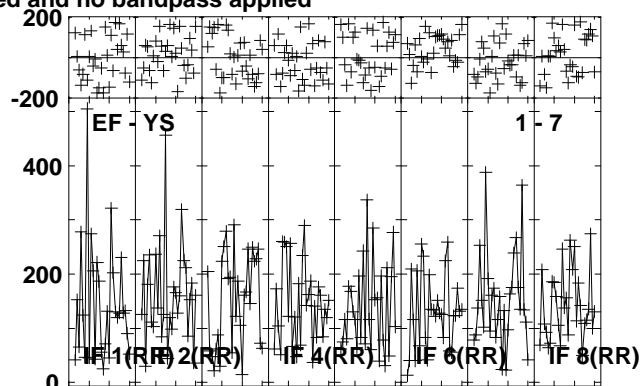
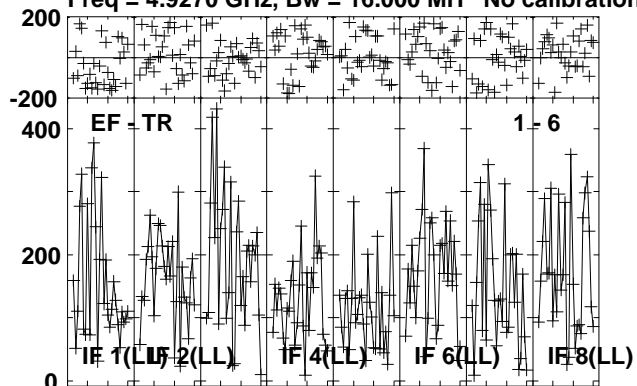

Lower frame: Micro Ampl Jy Top frame: Phas deg
Vector averaged cross-power spectrum Several baselines displayed
Timerange: 00/05:43:23 to 00/05:46:19

Plot file version 278 created 16-OCT-2012 11:57:54

J0639+0601 RO006.UVDATA.1

Freq = 4.9270 GHz, Bw = 16.000 MH No calibration applied and no bandpass applied

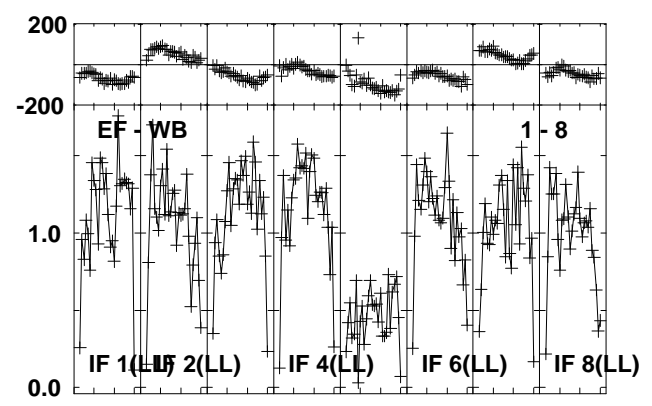
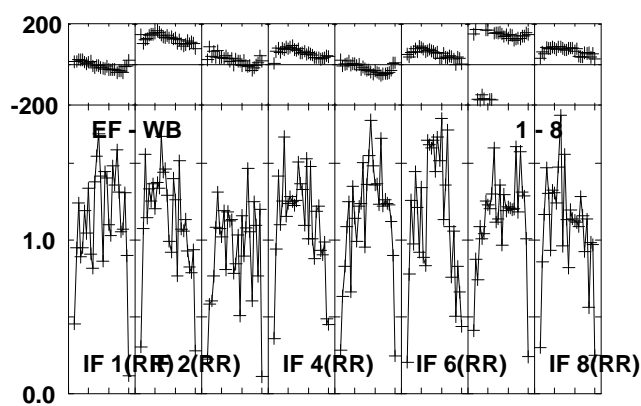
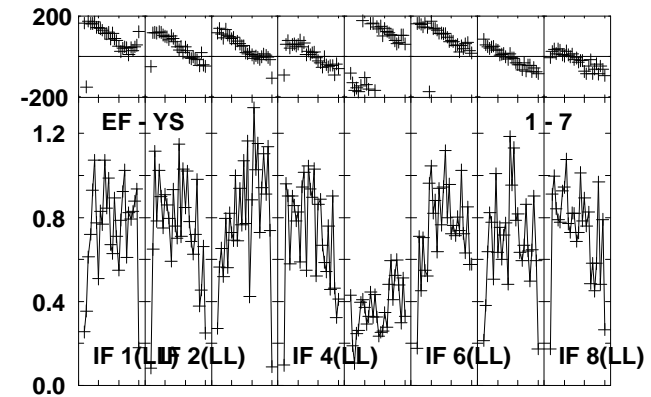
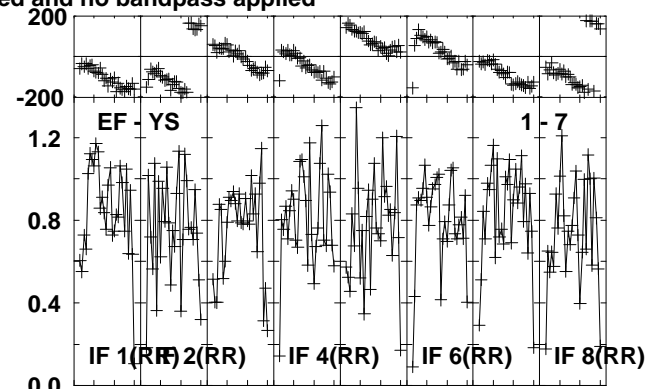
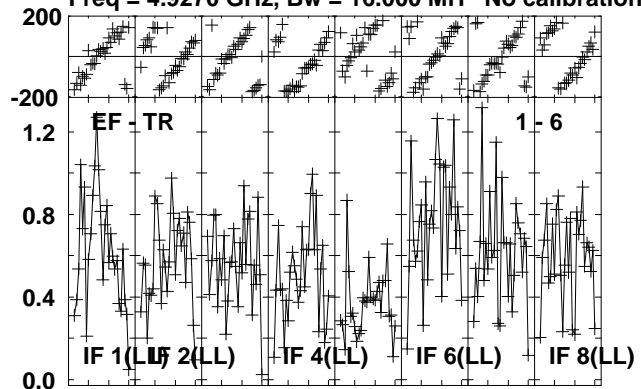

Lower frame: Milli Ampl Jy Top frame: Phas deg
Vector averaged cross-power spectrum Several baselines displayed
Timerange: 00/05:46:47 to 00/05:47:49

Plot file version 279 created 16-OCT-2012 11:57:54

J0645+0541 RO006.UVDATA.1

Freq = 4.9270 GHz, Bw = 16.000 MH No calibration applied and no bandpass applied

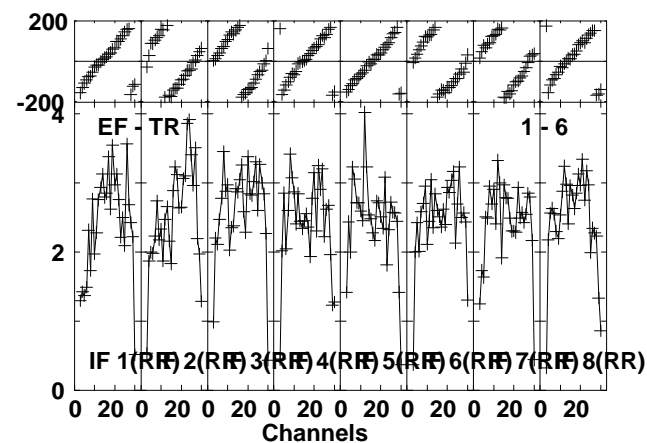
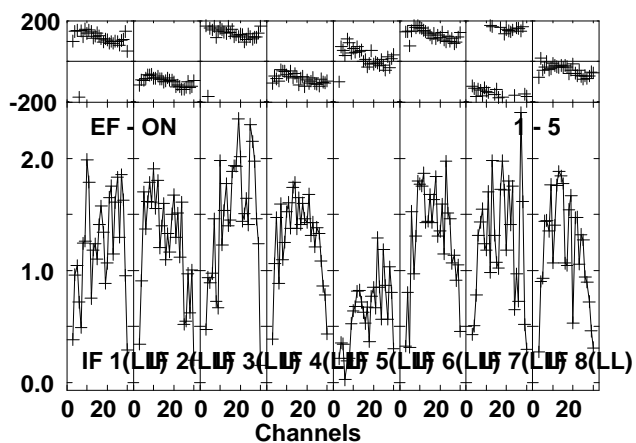
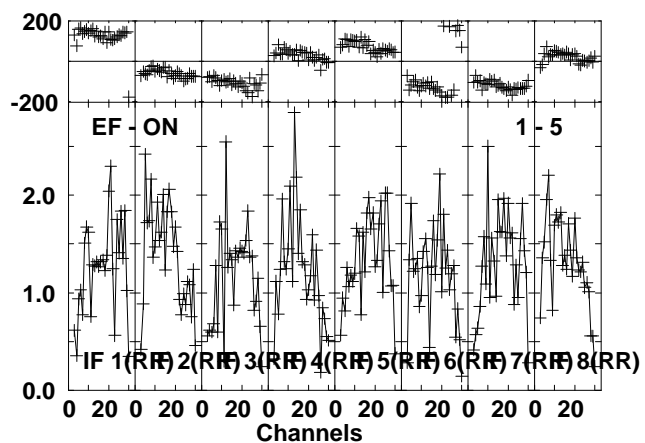
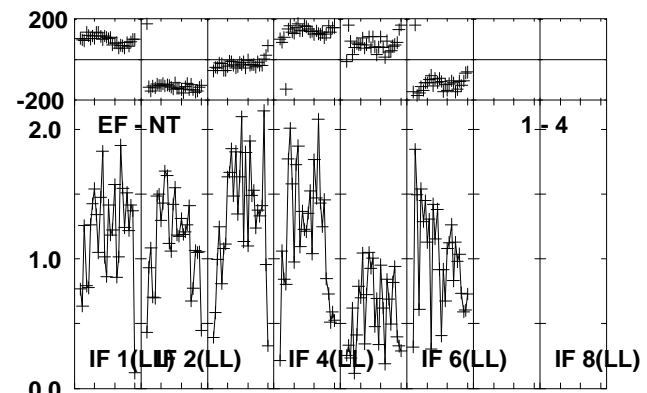
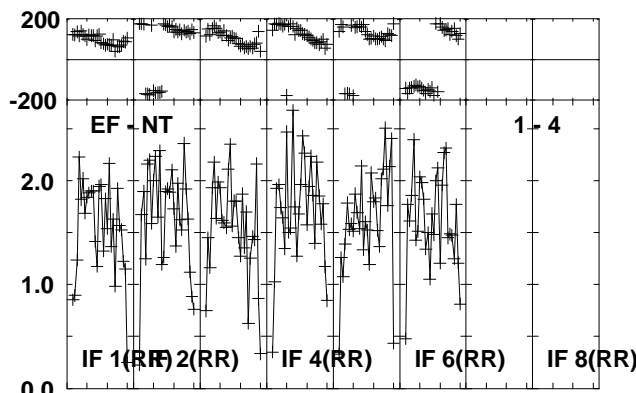
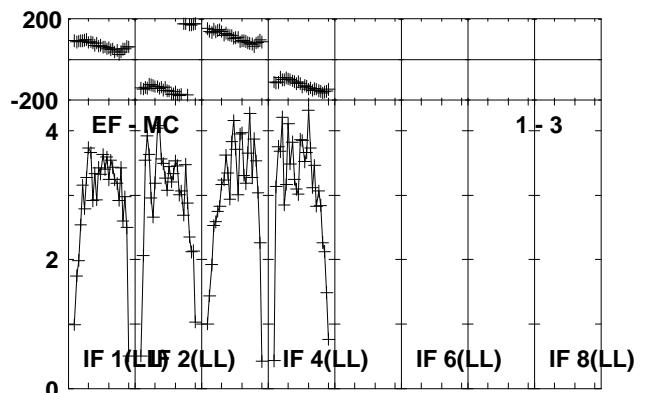
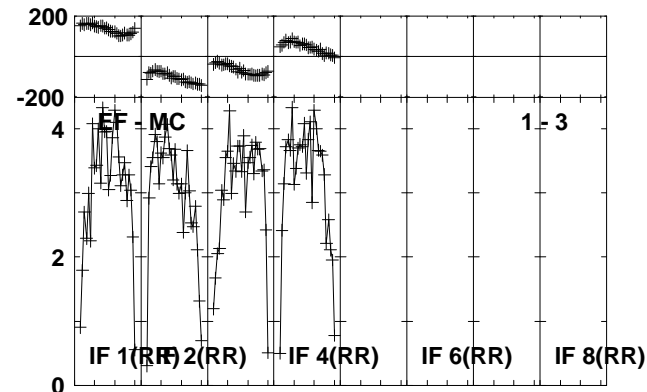
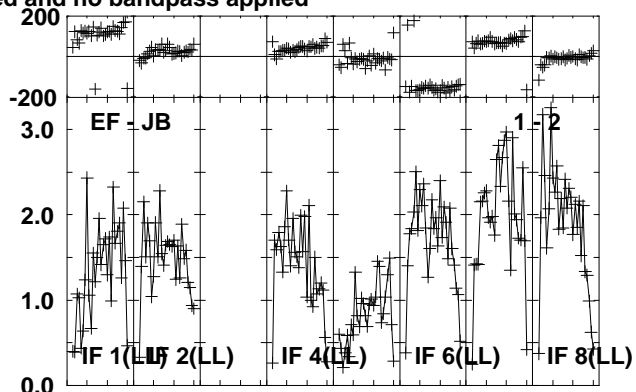
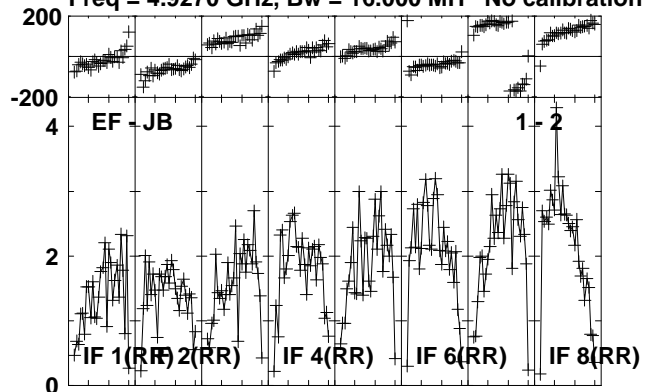

Lower frame: Milli Ampl Jy Top frame: Phas deg
Vector averaged cross-power spectrum Several baselines displayed
Timerange: 00/05:47:53 to 00/05:48:49

Plot file version 280 created 16-OCT-2012 11:57:54

J0645+0541 RO006.UVDATA.1

Freq = 4.9270 GHz, Bw = 16.000 MH No calibration applied and no bandpass applied

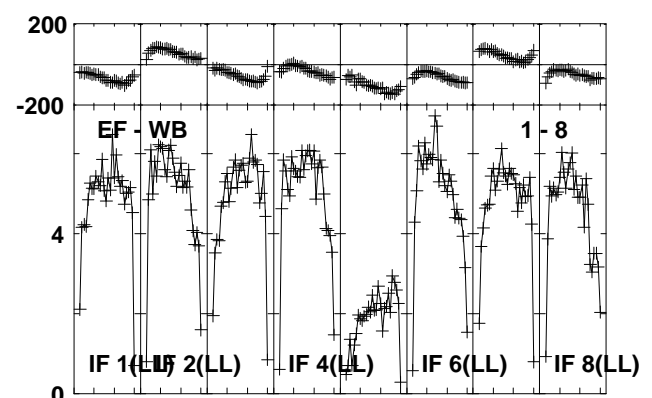
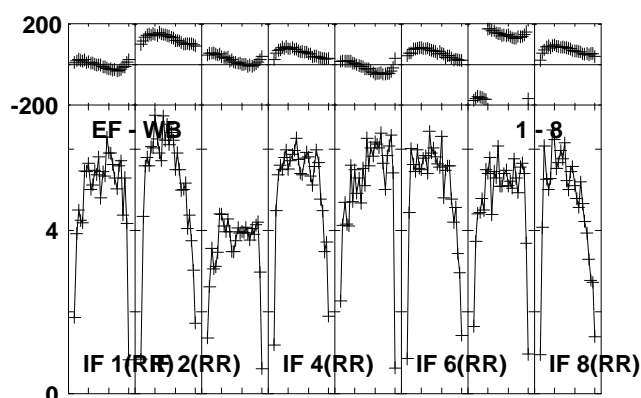
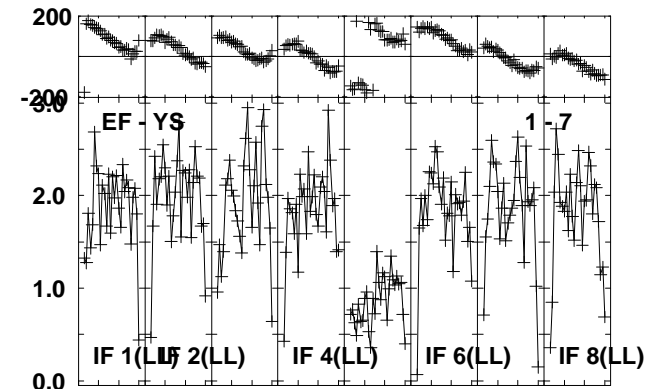
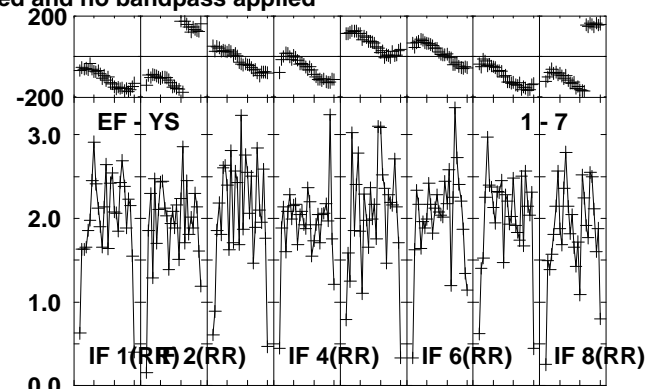
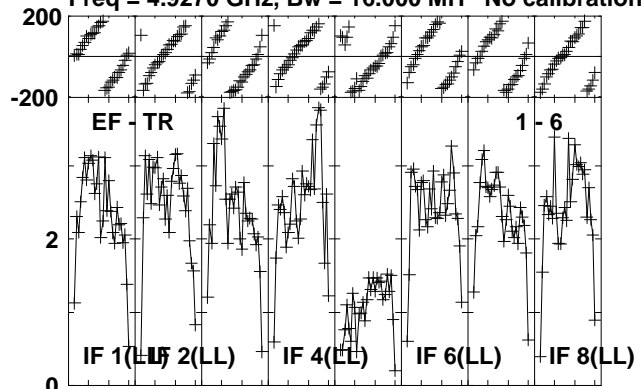

Lower frame: Milli Ampl Jy Top frame: Phas deg
Vector averaged cross-power spectrum Several baselines displayed
Timerange: 00/05:47:53 to 00/05:48:49

Plot file version 281 created 16-OCT-2012 11:57:55

NOVA-MON RO006.UVDATA.1

Freq = 4.9270 GHz, Bw = 16.000 MH No calibration applied and no bandpass applied

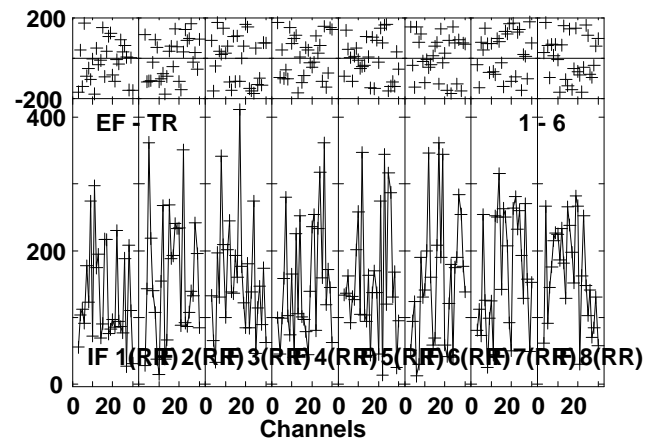
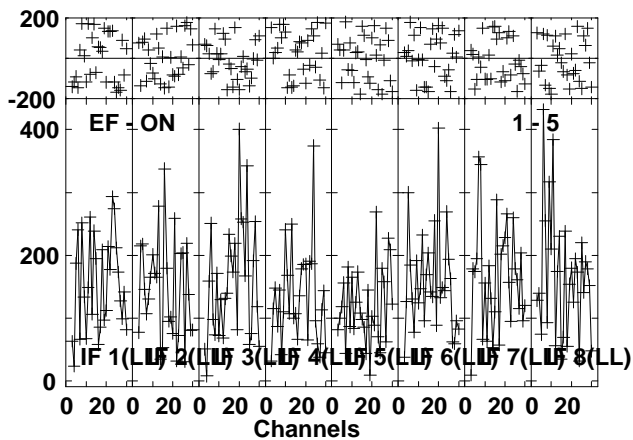
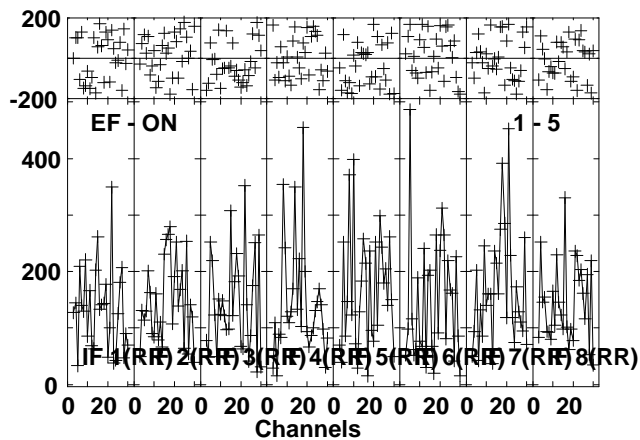
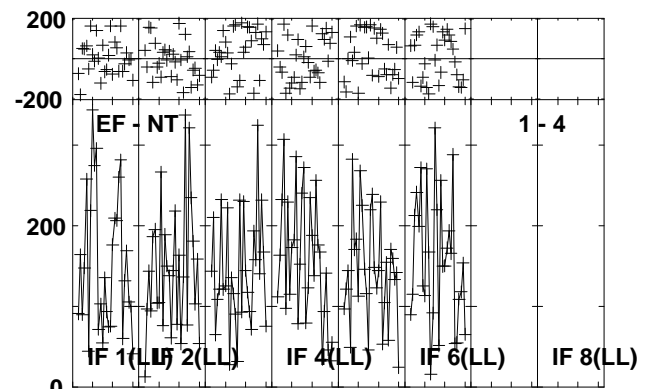
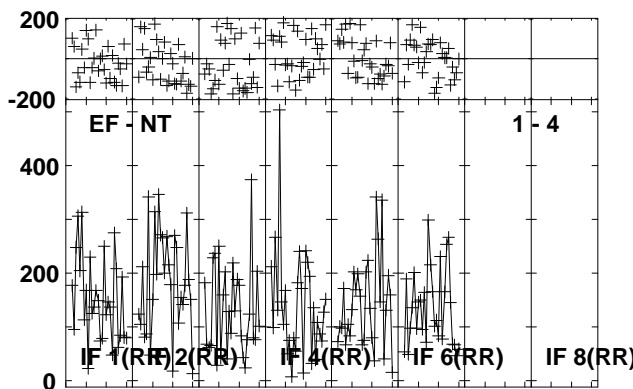
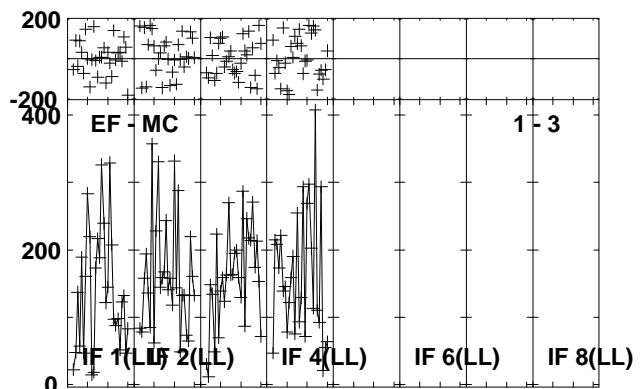
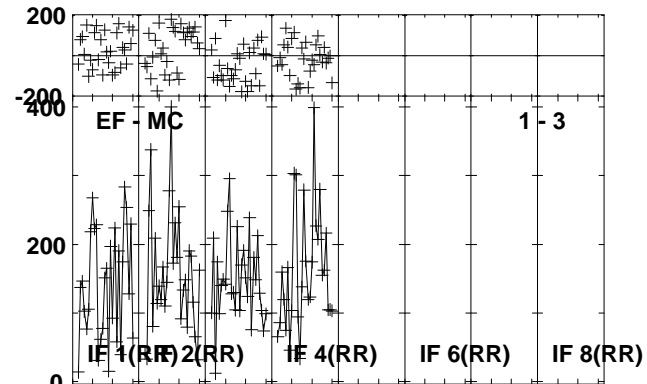
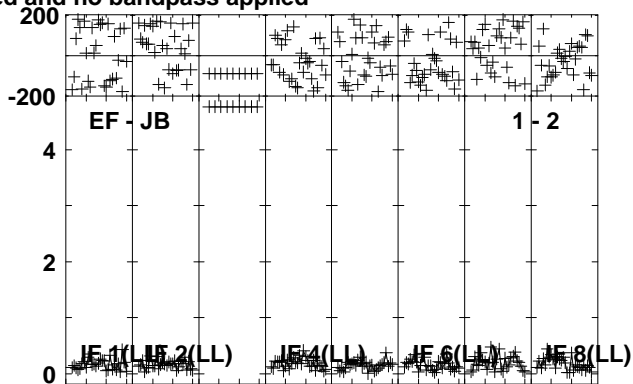
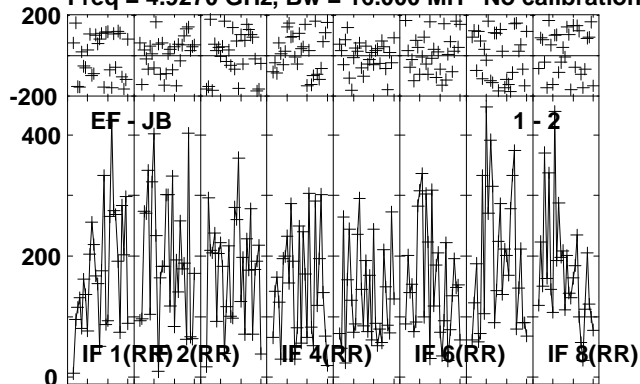

Lower frame: Micro Ampl Jy Top frame: Phas deg
Vector averaged cross-power spectrum Several baselines displayed
Timerange: 00/05:48:53 to 00/05:51:49

Plot file version 282 created 16-OCT-2012 11:57:55

NOVA-MON RO006.UVDATA.1

Freq = 4.9270 GHz, Bw = 16.000 MH No calibration applied and no bandpass applied

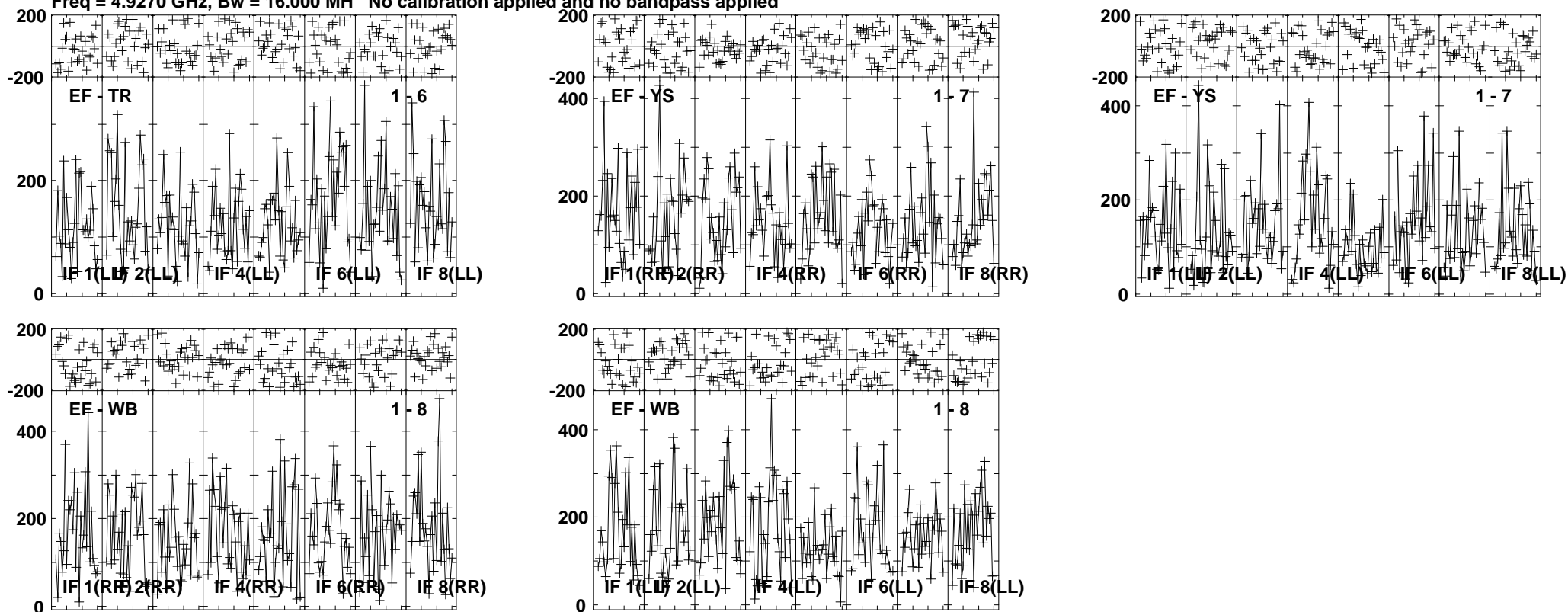

Lower frame: Micro Ampl Jy Top frame: Phas deg
Vector averaged cross-power spectrum Several baselines displayed
Timerange: 00/05:48:53 to 00/05:51:49

Plot file version 283 created 16-OCT-2012 11:57:56

J0639+0601 RO006.UVDATA.1

Freq = 4.9270 GHz, Bw = 16.000 MH No calibration applied and no bandpass applied

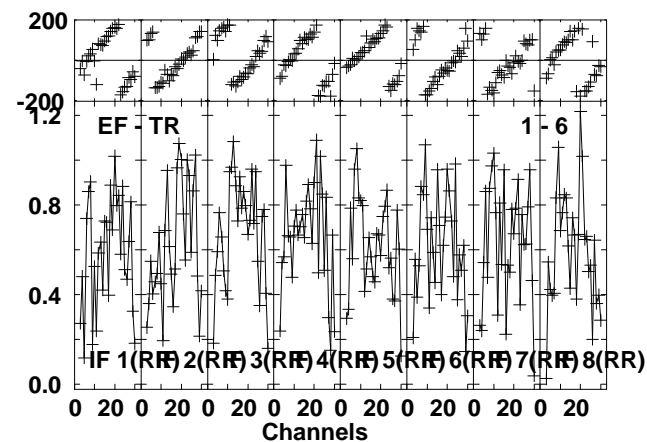
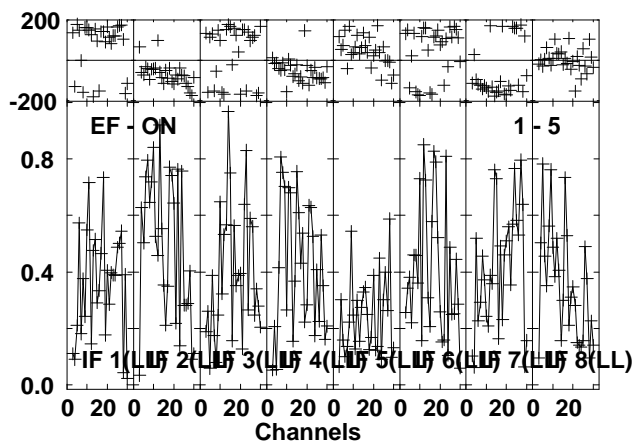
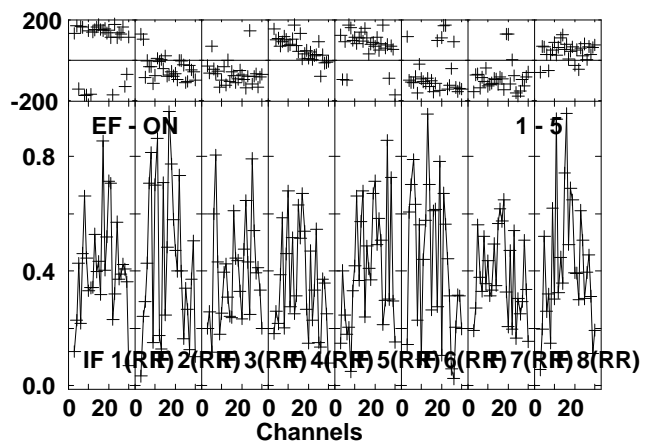
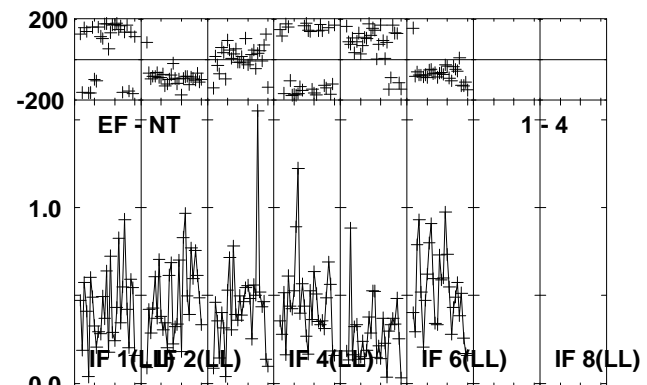
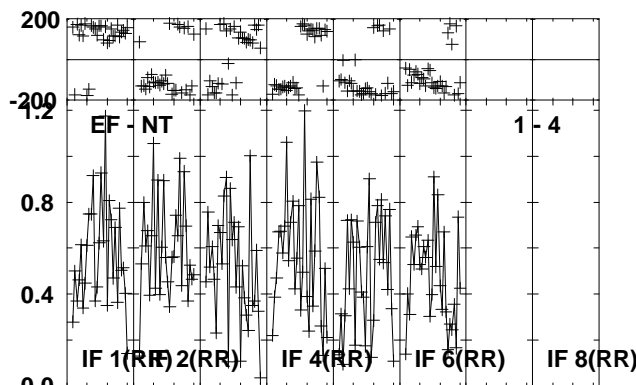
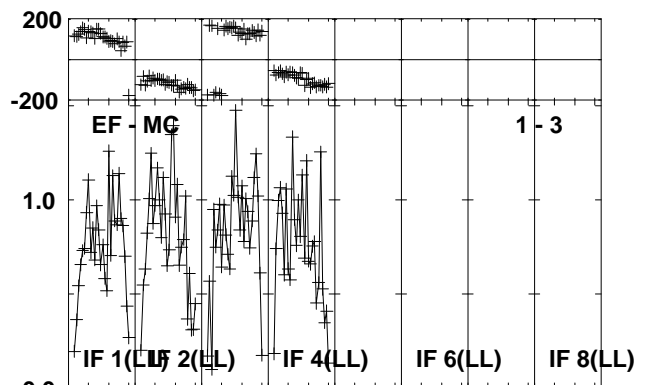
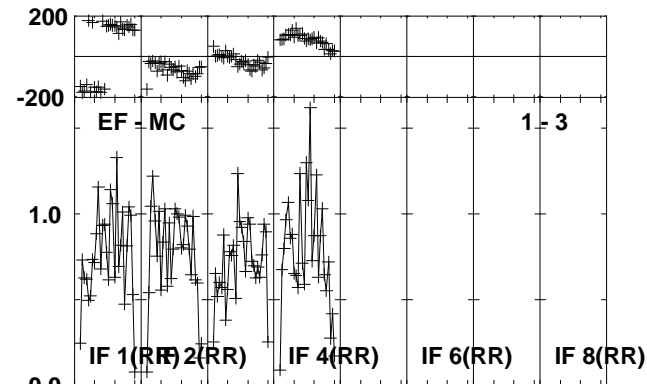
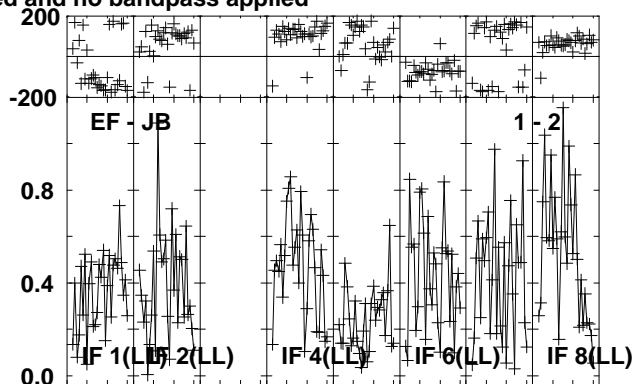
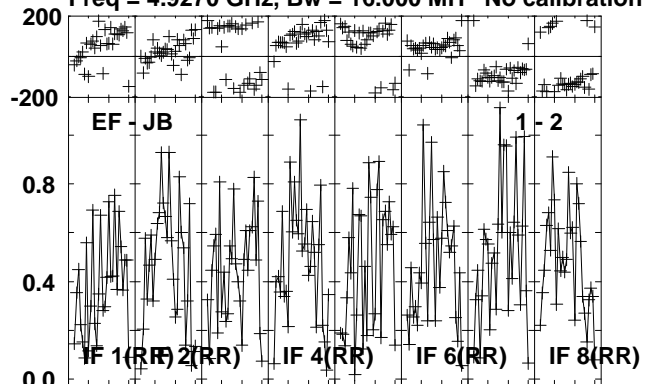

Lower frame: Milli Ampl Jy Top frame: Phas deg
Vector averaged cross-power spectrum Several baselines displayed
Timerange: 00/05:51:53 to 00/05:53:03

Plot file version 284 created 16-OCT-2012 11:57:56

J0639+0601 RO006.UVDATA.1

Freq = 4.9270 GHz, Bw = 16.000 MH No calibration applied and no bandpass applied

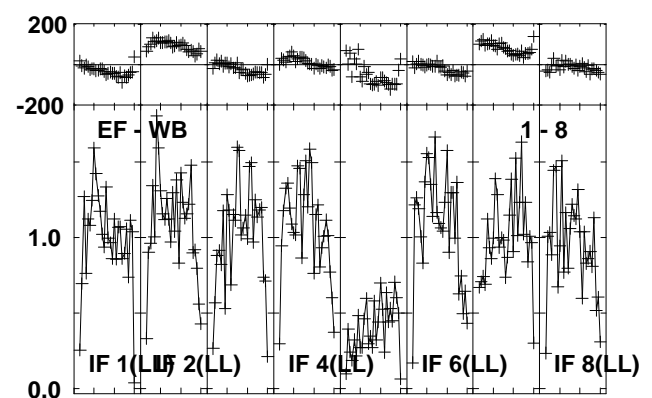
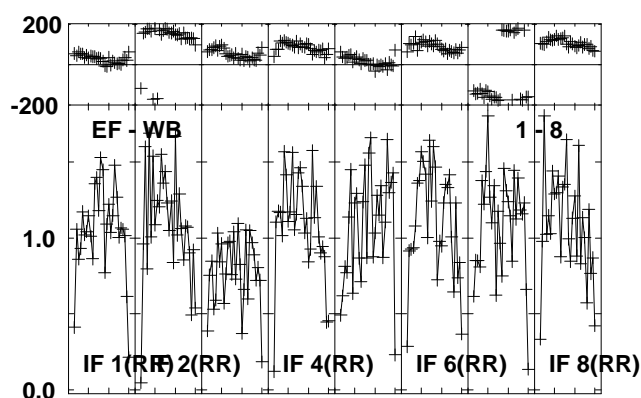
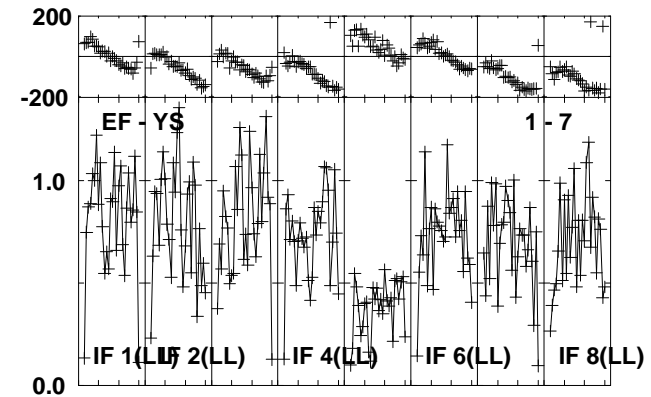
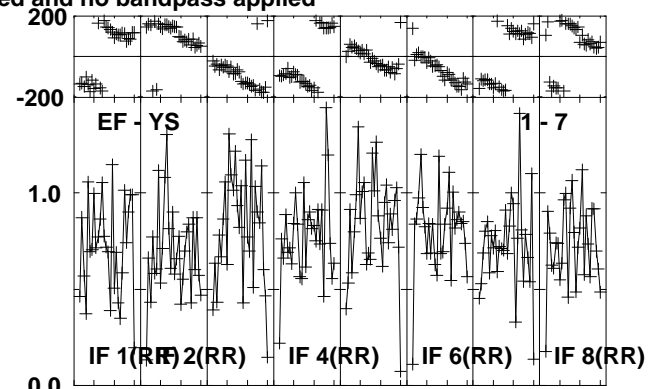
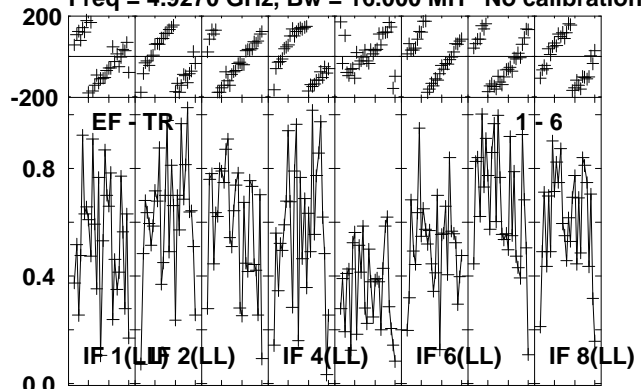

Lower frame: Milli Ampl Jy Top frame: Phas deg
Vector averaged cross-power spectrum Several baselines displayed
Timerange: 00/05:51:53 to 00/05:53:03

Plot file version 285 created 16-OCT-2012 11:57:56

J0645+0541 RO006.UVDATA.1

Freq = 4.9270 GHz, Bw = 16.000 MH No calibration applied and no bandpass applied

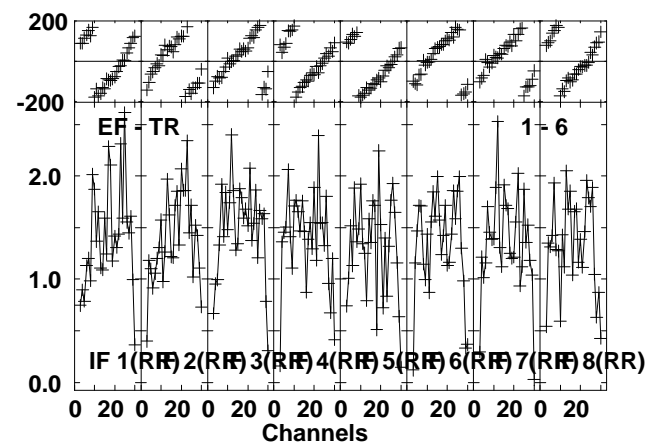
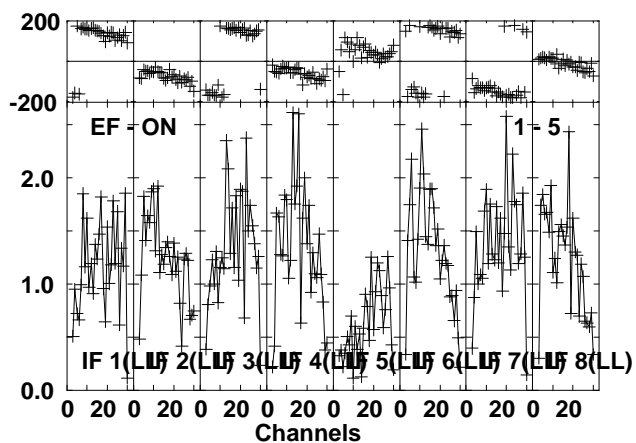
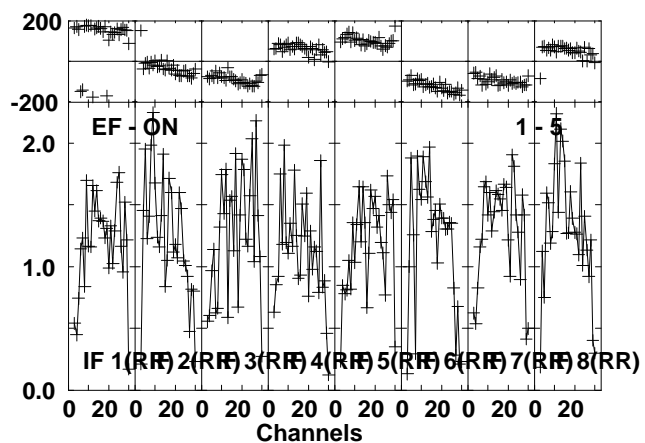
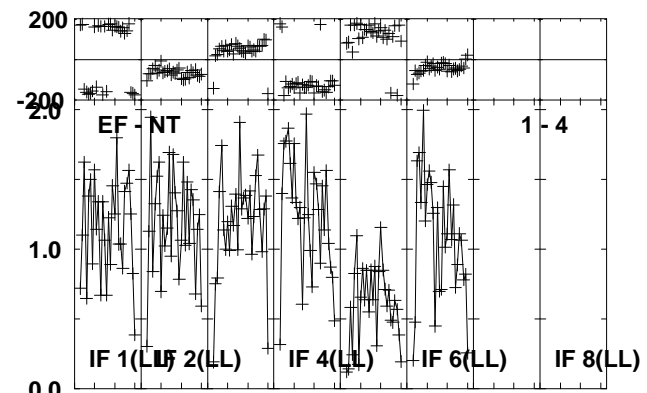
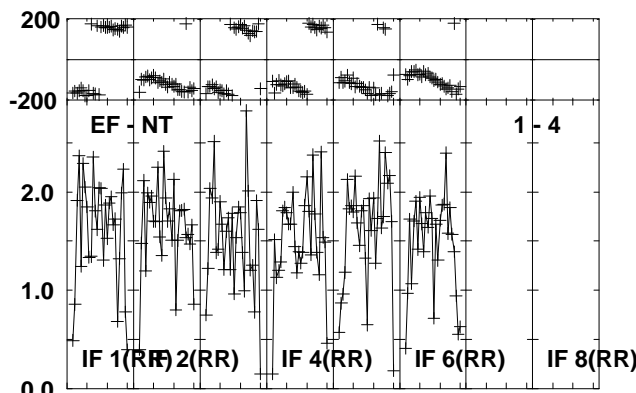
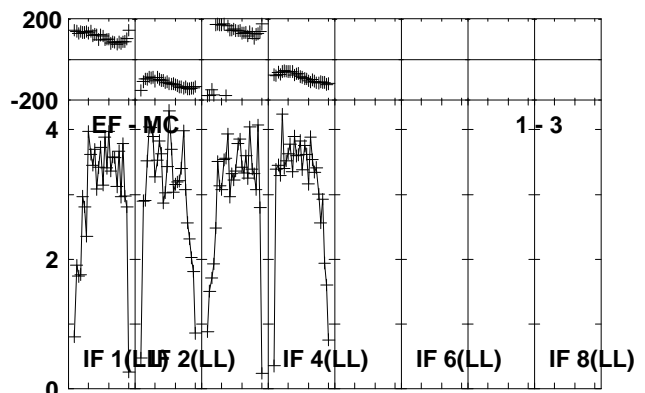
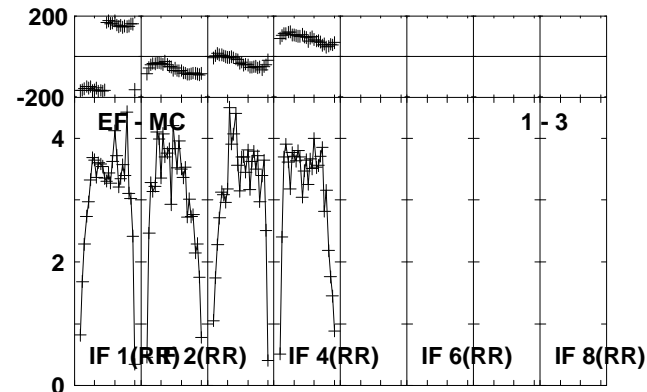
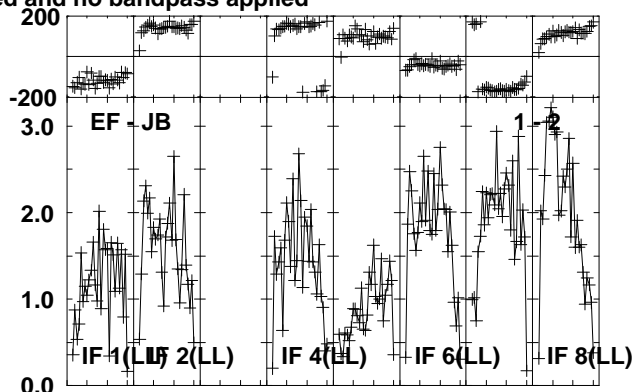
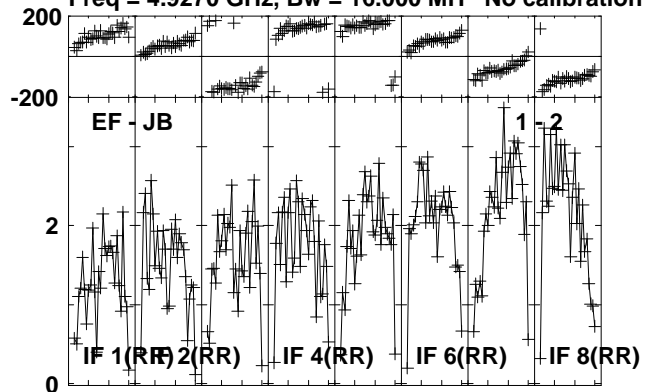

Lower frame: Milli Ampl Jy Top frame: Phas deg
Vector averaged cross-power spectrum Several baselines displayed
Timerange: 00/05:53:07 to 00/05:54:03

Plot file version 286 created 16-OCT-2012 11:57:56

J0645+0541 RO006.UVDATA.1

Freq = 4.9270 GHz, Bw = 16.000 MH No calibration applied and no bandpass applied

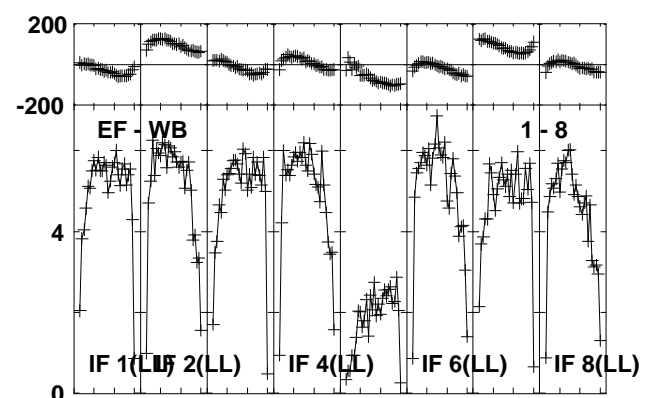
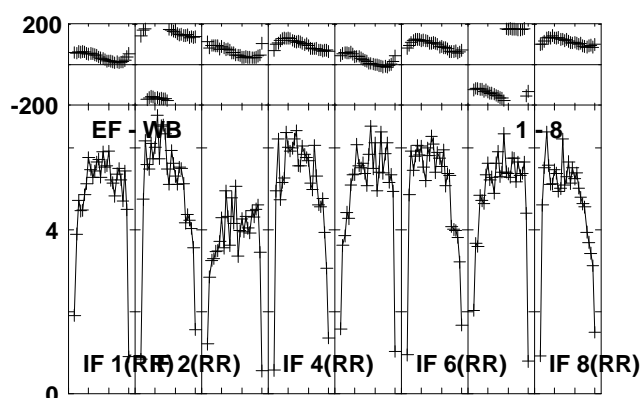
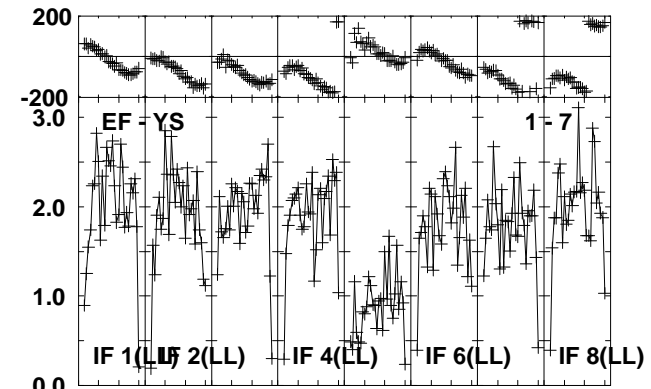
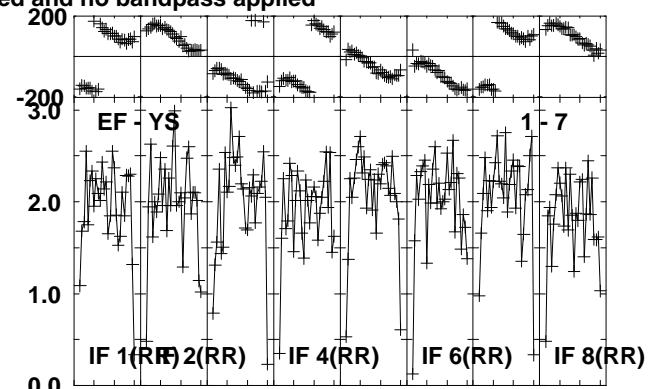
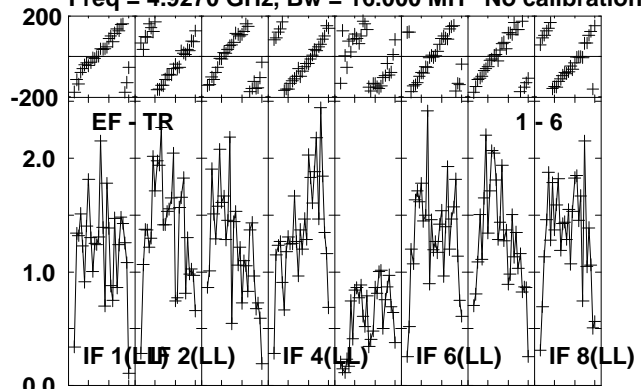

Lower frame: Milli Ampl Jy Top frame: Phas deg
Vector averaged cross-power spectrum Several baselines displayed
Timerange: 00/05:53:07 to 00/05:54:03

Plot file version 287 created 16-OCT-2012 11:57:56

NOVA-MON RO006.UVDATA.1

Freq = 4.9270 GHz, Bw = 16.000 MH No calibration applied and no bandpass applied

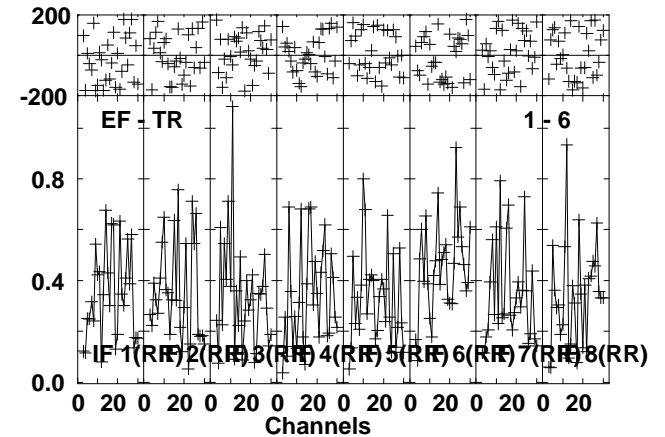
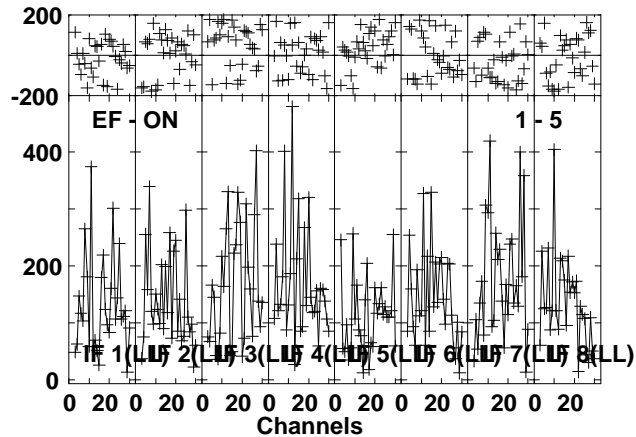
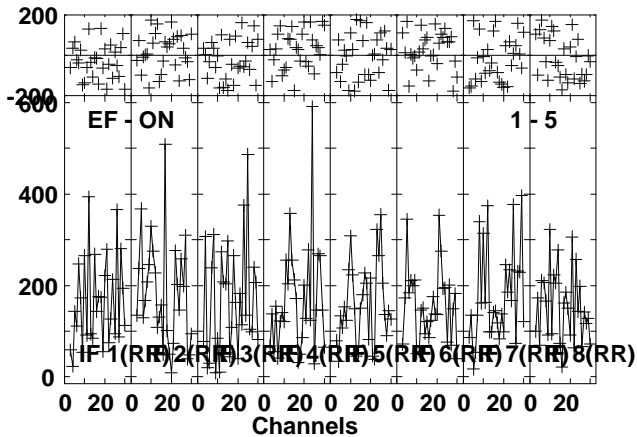
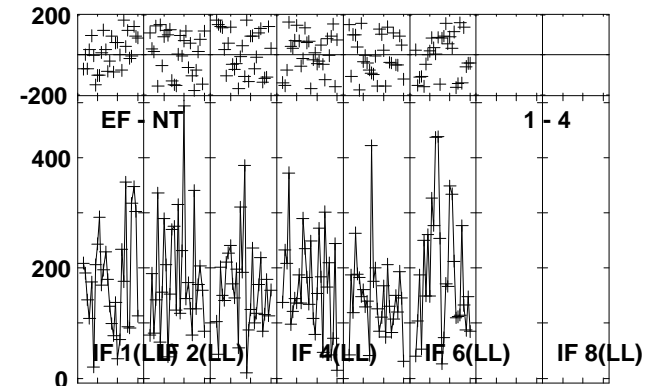
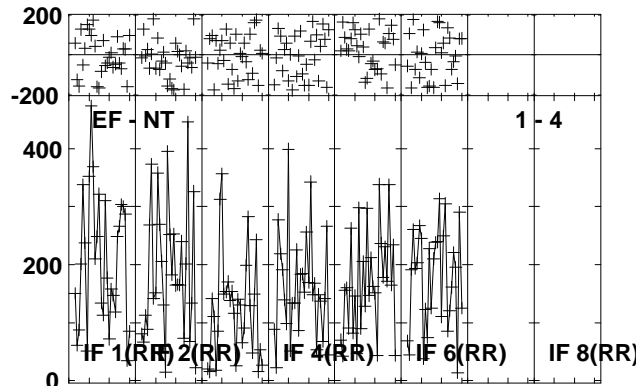
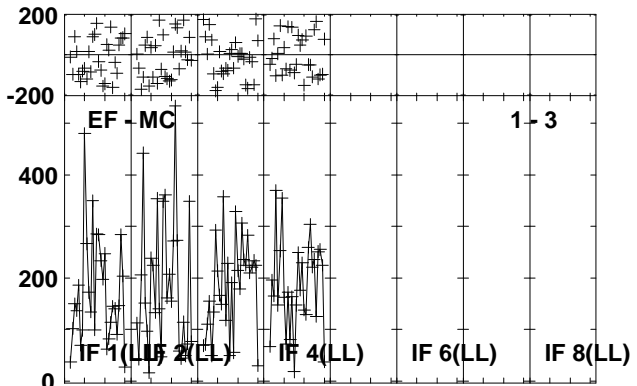
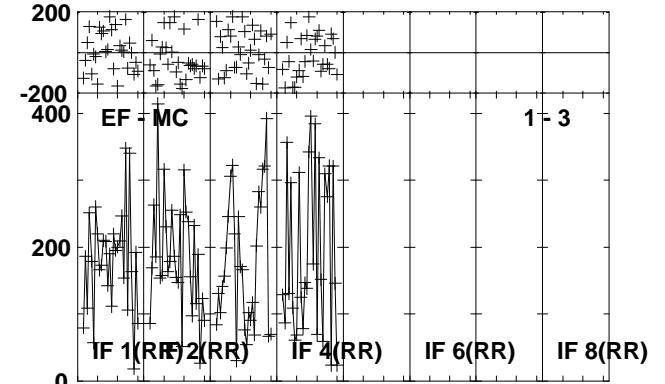
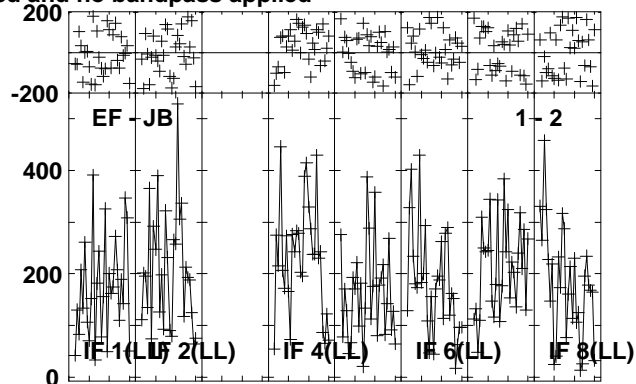
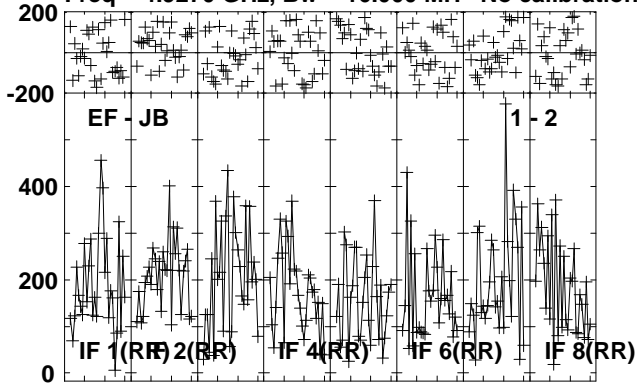

Lower frame: Micro Ampl Jy Top frame: Phas deg
Vector averaged cross-power spectrum Several baselines displayed
Timerange: 00/05:54:07 to 00/05:57:03

Plot file version 288 created 16-OCT-2012 11:57:57

NOVA-MON RO006.UVDATA.1

Freq = 4.9270 GHz, Bw = 16.000 MH No calibration applied and no bandpass applied

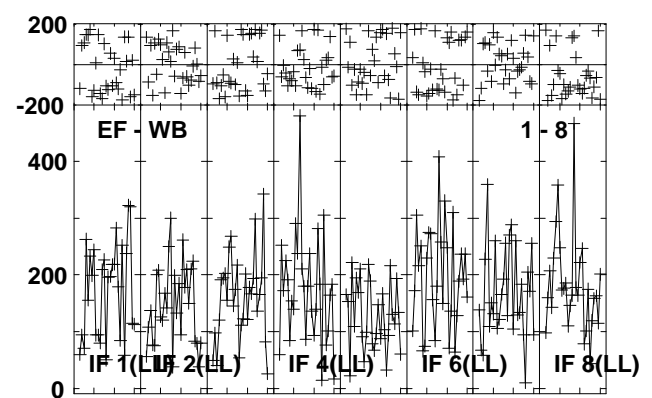
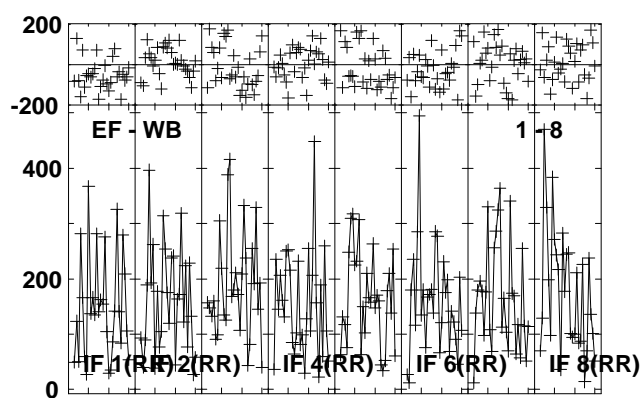
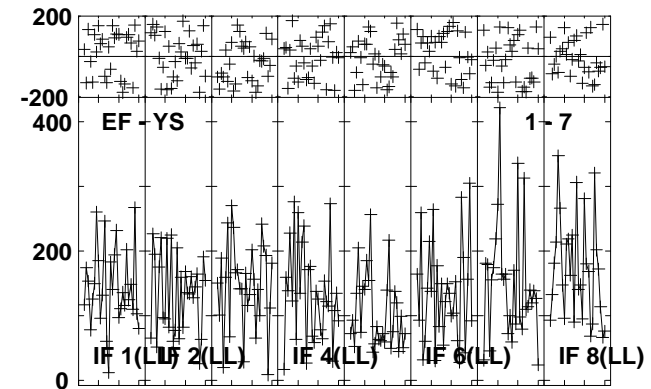
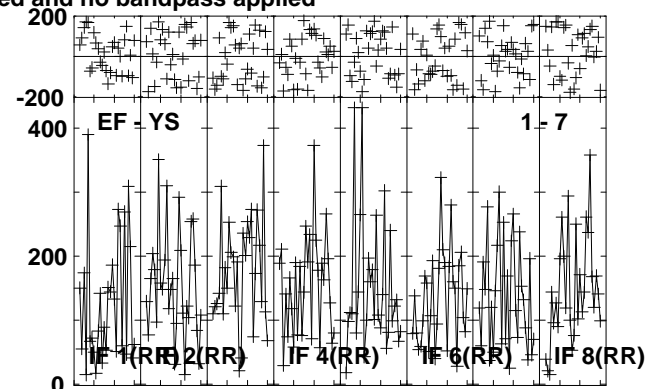
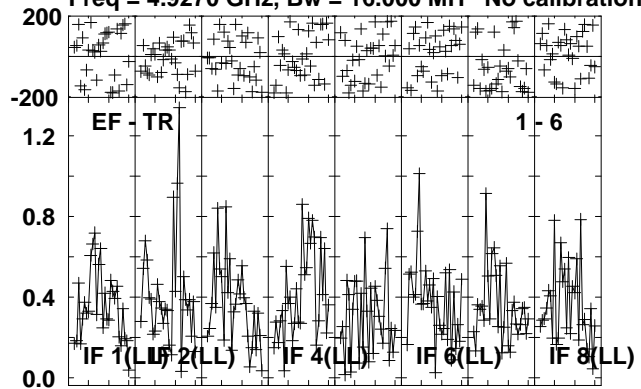

Lower frame: Milli Ampl Jy Top frame: Phas deg
Vector averaged cross-power spectrum Several baselines displayed
Timerange: 00/05:54:07 to 00/05:57:03

Plot file version 289 created 16-OCT-2012 11:57:57

J0639+0601 RO006.UVDATA.1

Freq = 4.9270 GHz, Bw = 16.000 MH No calibration applied and no bandpass applied

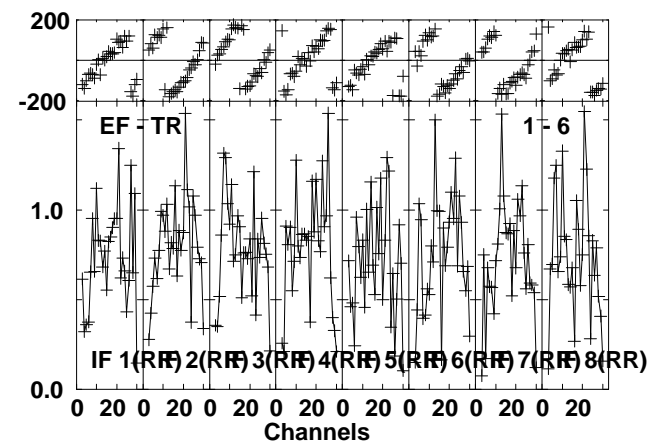
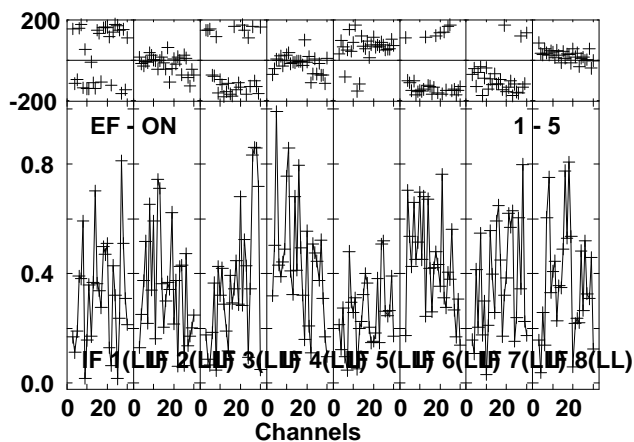
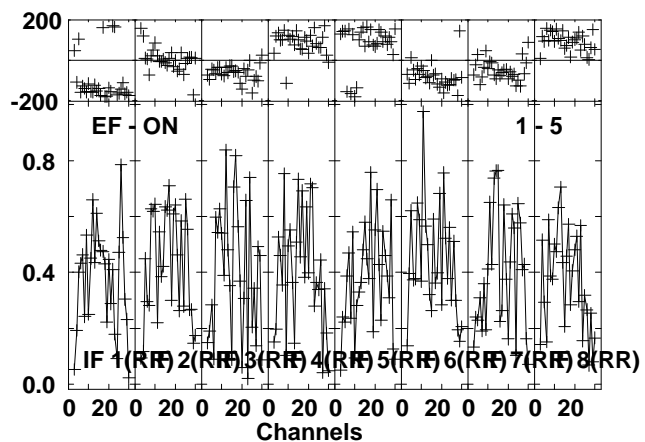
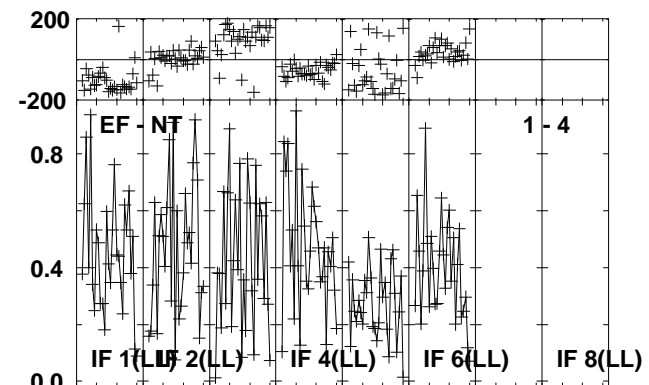
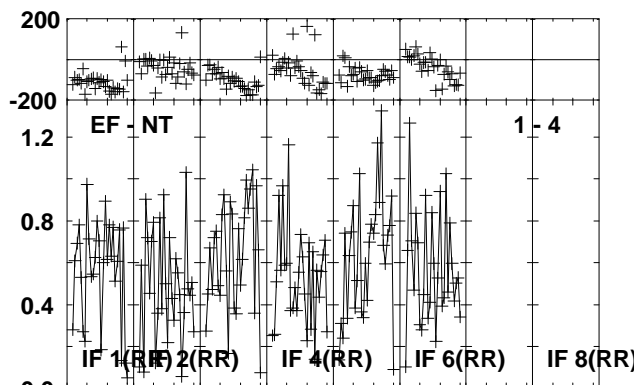
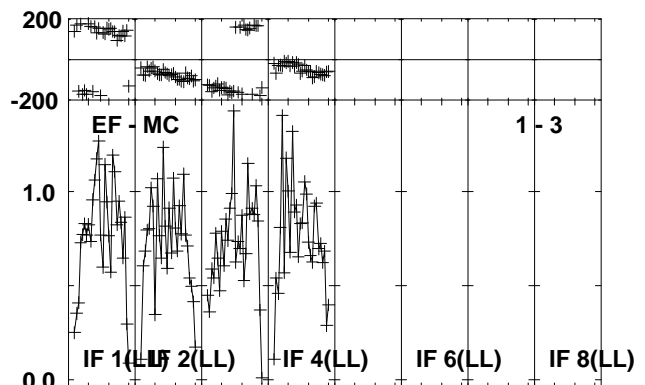
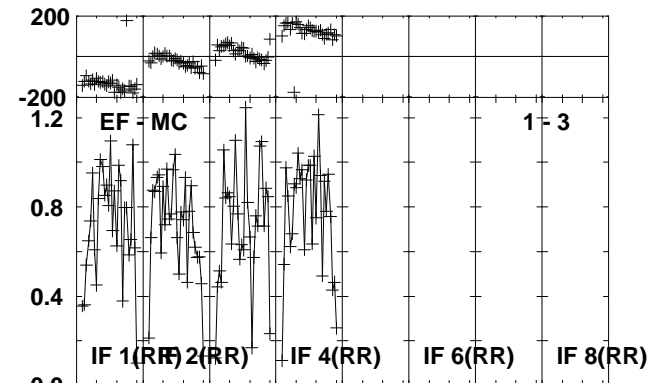
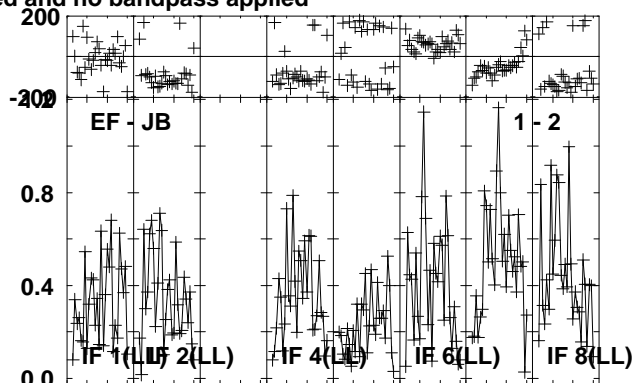
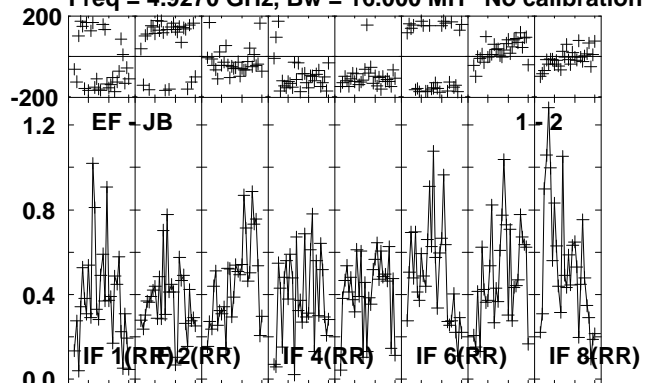

Lower frame: Milli Ampl Jy Top frame: Phas deg
Vector averaged cross-power spectrum Several baselines displayed
Timerange: 00/05:57:33 to 00/05:58:33

Plot file version 290 created 16-OCT-2012 11:57:57

J0639+0601 RO006.UVDATA.1

Freq = 4.9270 GHz, Bw = 16.000 MH No calibration applied and no bandpass applied

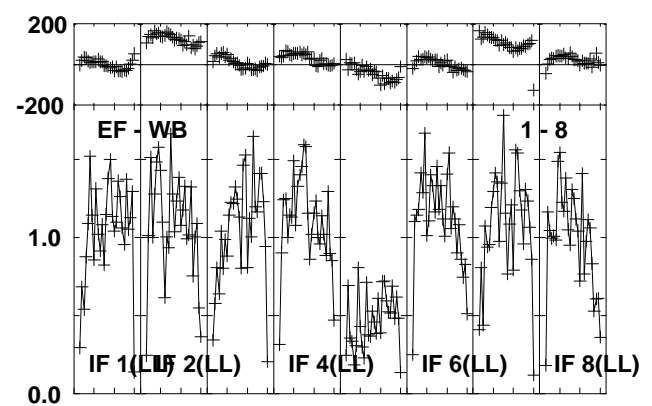
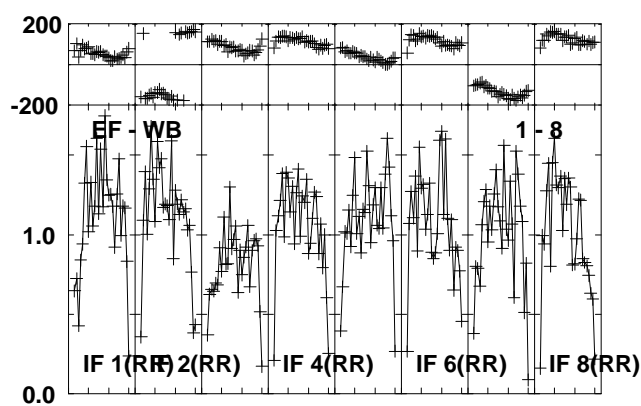
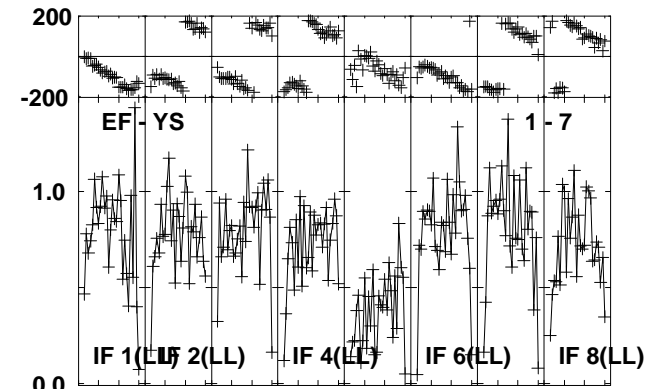
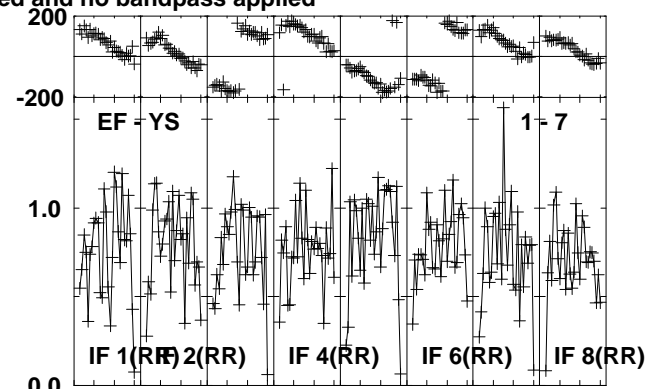
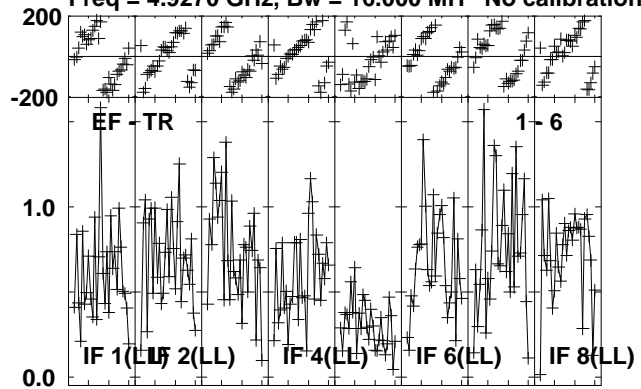

Lower frame: Milli Ampl Jy Top frame: Phas deg
Vector averaged cross-power spectrum Several baselines displayed
Timerange: 00/05:57:33 to 00/05:58:33

Plot file version 291 created 16-OCT-2012 11:57:57

J0645+0541 RO006.UVDATA.1

Freq = 4.9270 GHz, Bw = 16.000 MH No calibration applied and no bandpass applied

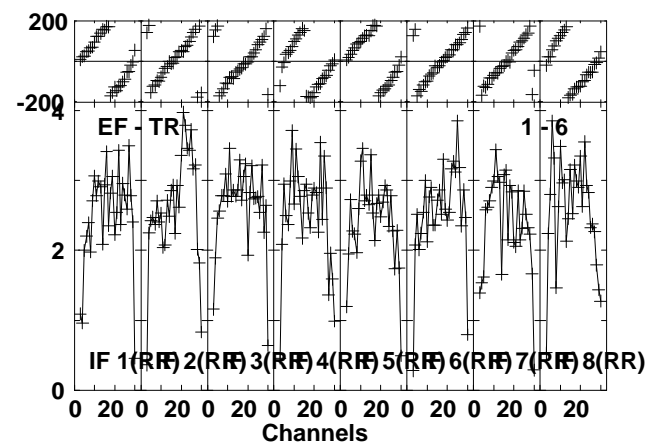
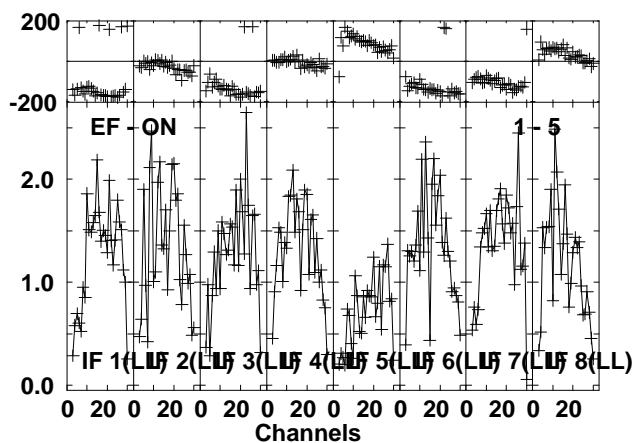
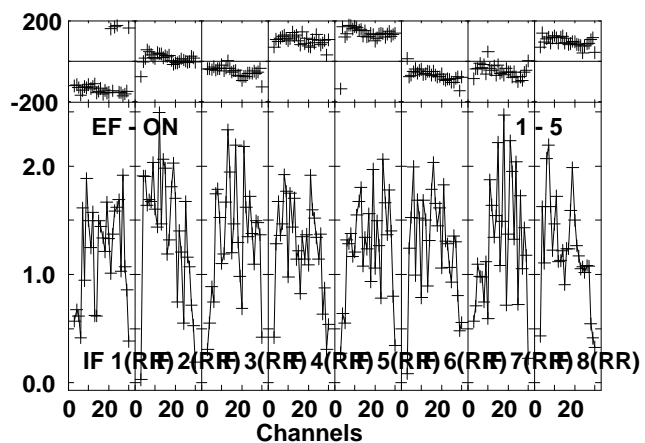
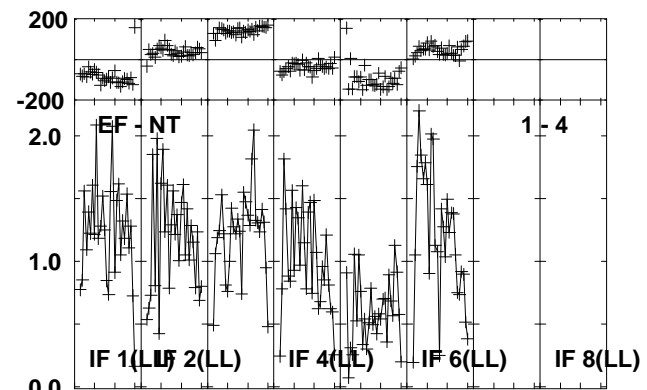
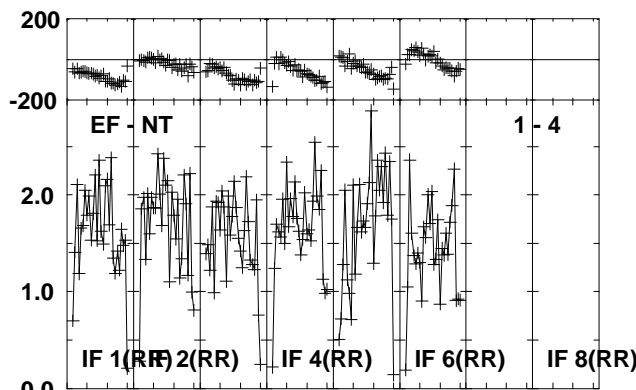
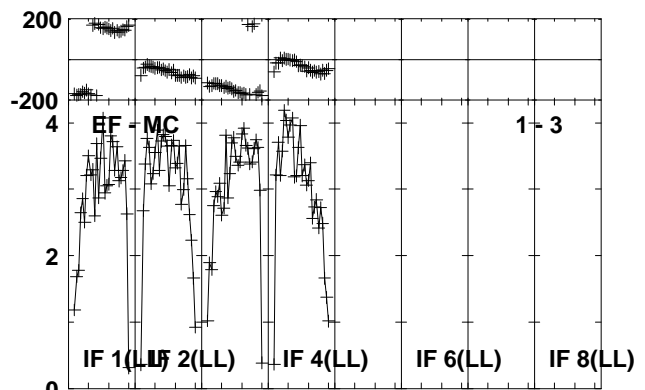
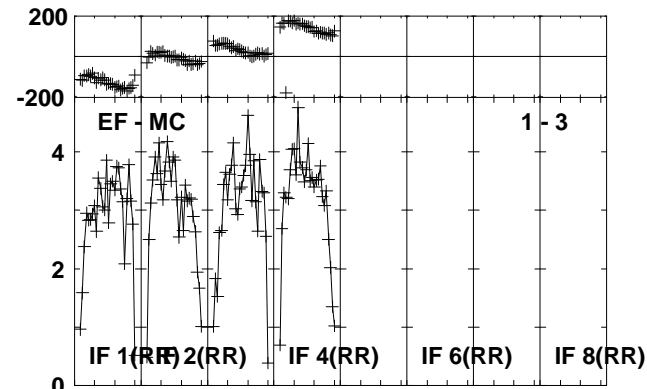
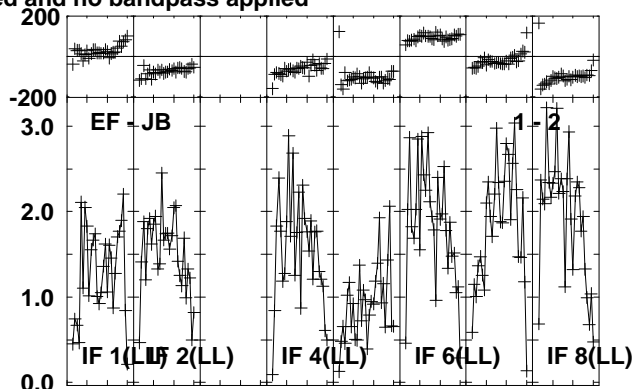
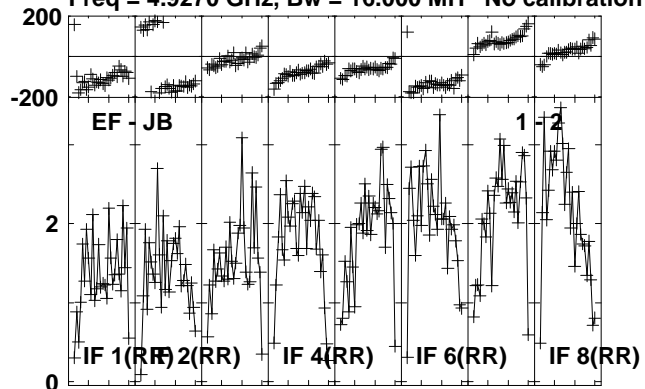

Lower frame: Milli Ampl Jy Top frame: Phas deg
Vector averaged cross-power spectrum Several baselines displayed
Timerange: 00/05:58:37 to 00/05:59:33

Plot file version 292 created 16-OCT-2012 11:57:58

J0645+0541 RO006.UVDATA.1

Freq = 4.9270 GHz, Bw = 16.000 MH No calibration applied and no bandpass applied

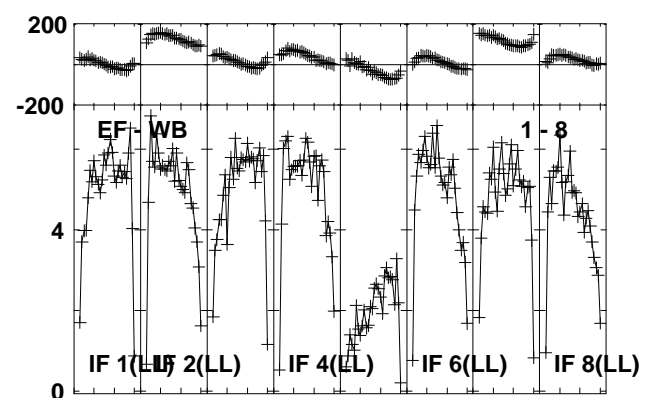
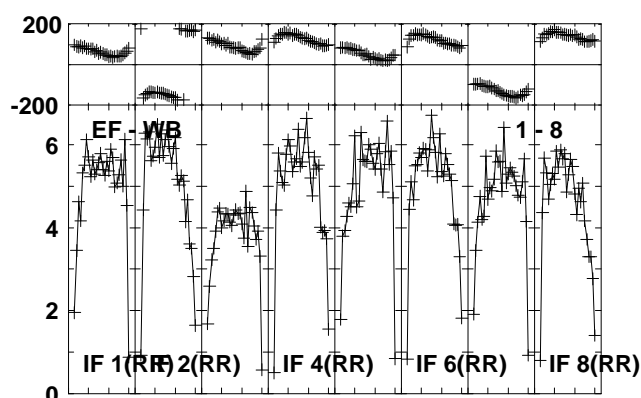
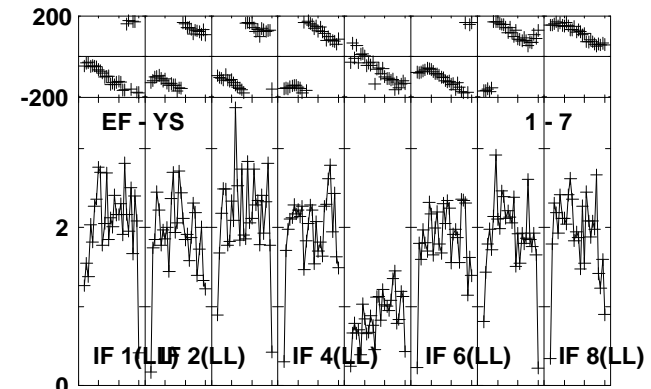
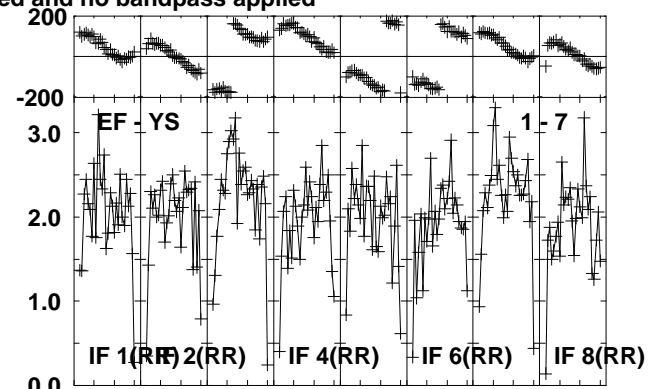
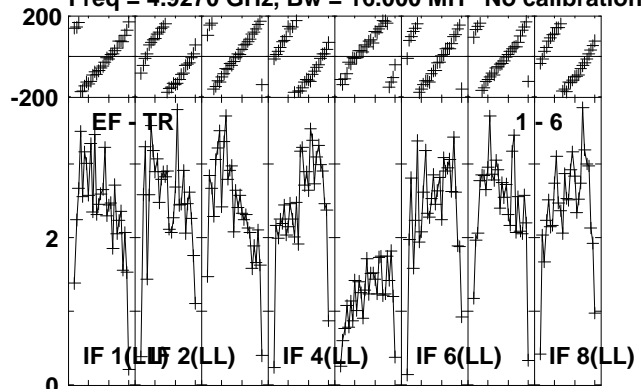

Lower frame: Milli Ampl Jy Top frame: Phas deg
Vector averaged cross-power spectrum Several baselines displayed
Timerange: 00/05:58:37 to 00/05:59:33

Plot file version 293 created 16-OCT-2012 11:57:58

NOVA-MON RO006.UVDATA.1

Freq = 4.9270 GHz, Bw = 16.000 MH No calibration applied and no bandpass applied

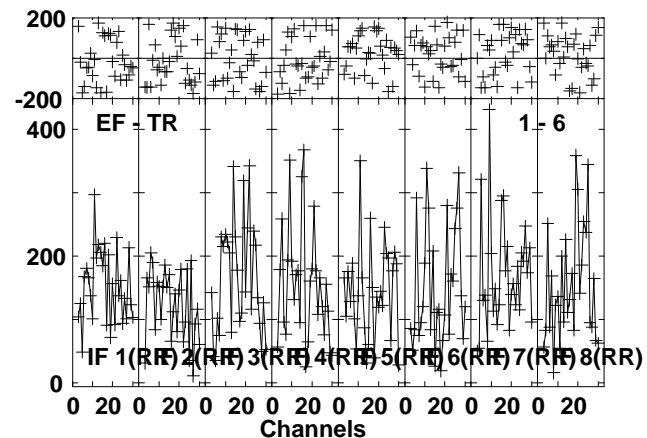
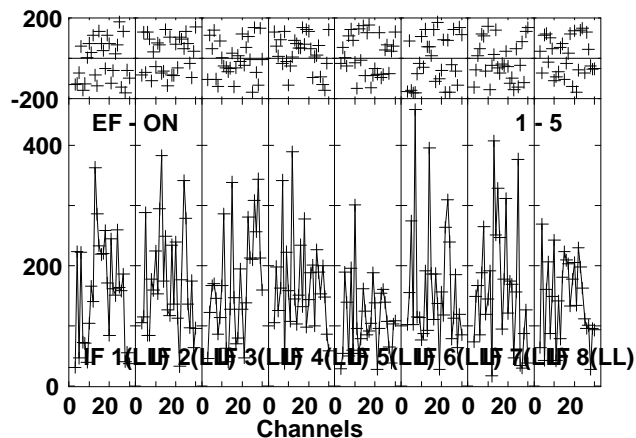
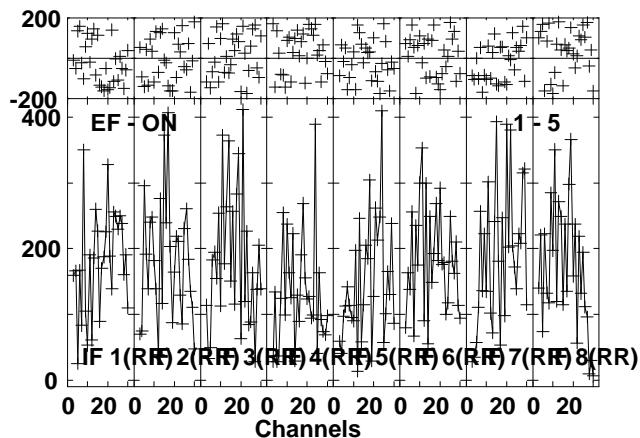
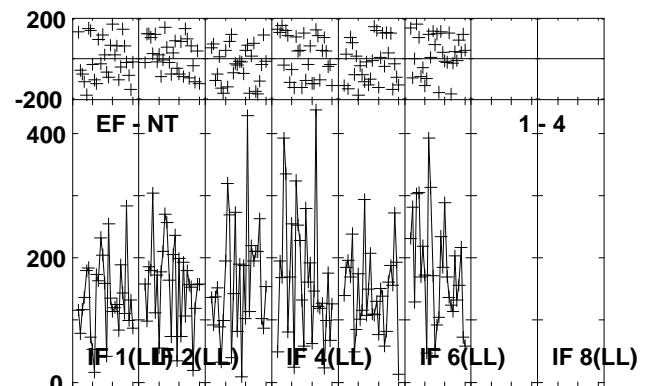
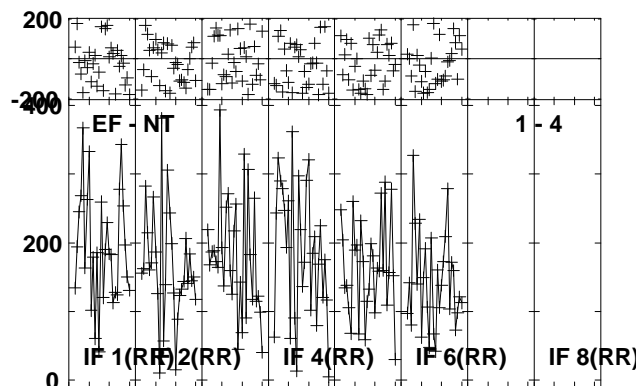
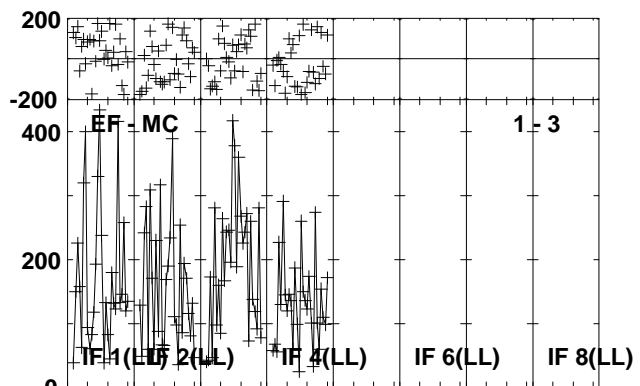
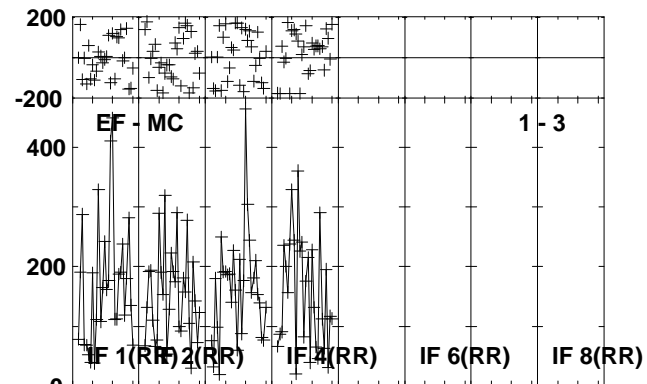
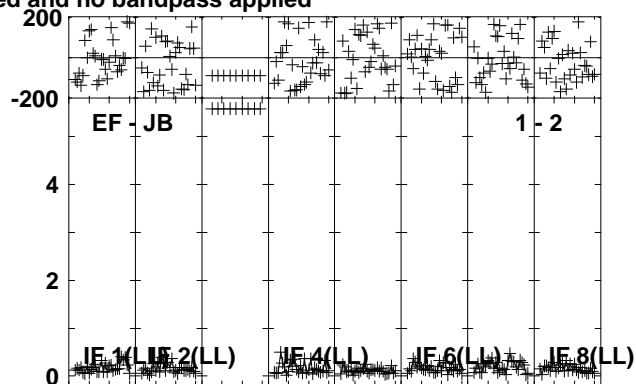
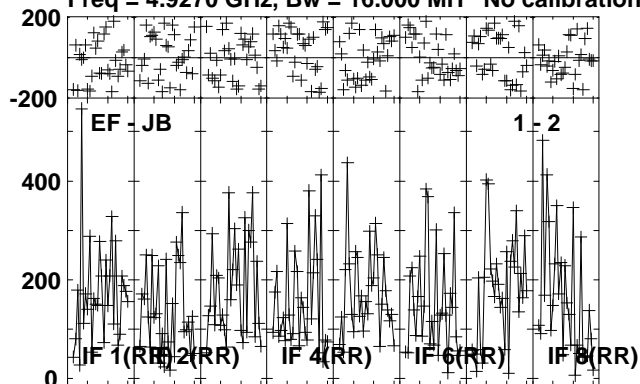

Lower frame: Micro Ampl Jy Top frame: Phas deg
Vector averaged cross-power spectrum Several baselines displayed
Timerange: 00/05:59:37 to 00/06:02:33

Plot file version 294 created 16-OCT-2012 11:57:58

NOVA-MON RO006.UVDATA.1

Freq = 4.9270 GHz, Bw = 16.000 MH No calibration applied and no bandpass applied

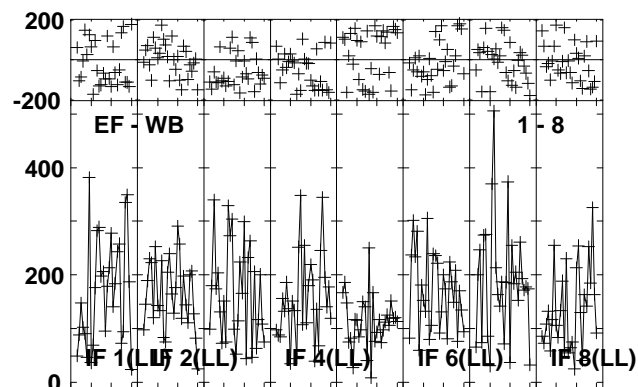
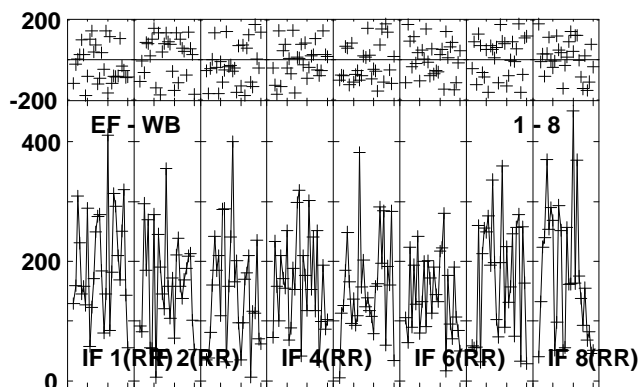
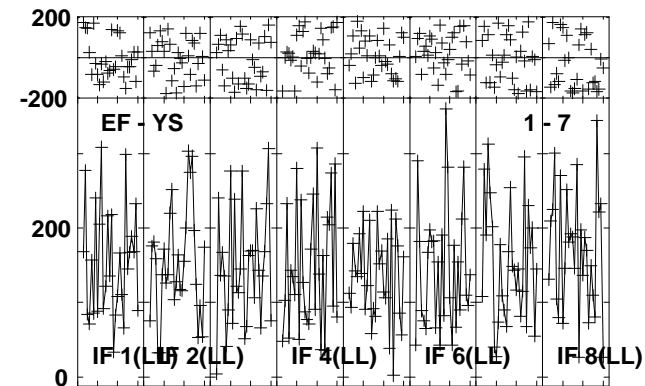
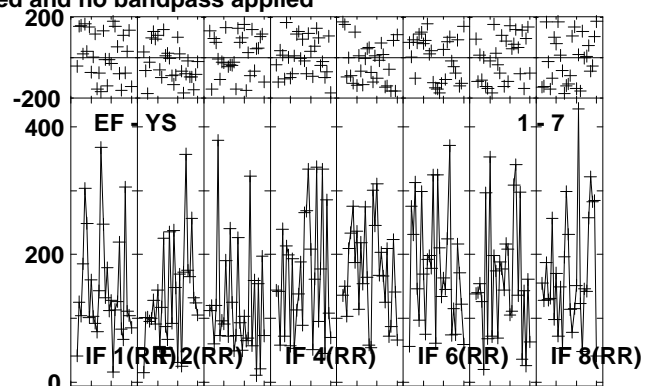
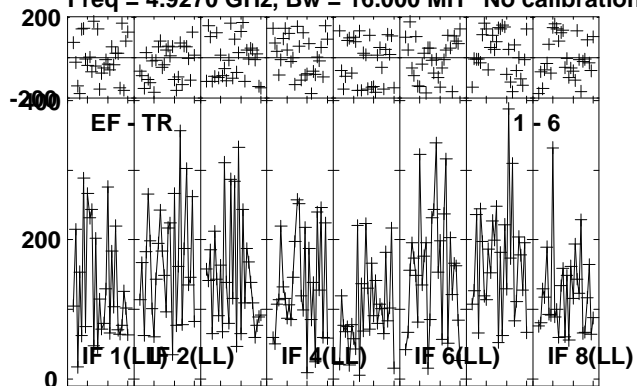

Lower frame: Micro Ampl Jy Top frame: Phas deg
Vector averaged cross-power spectrum Several baselines displayed
Timerange: 00/05:59:37 to 00/06:02:33

Plot file version 295 created 16-OCT-2012 11:57:59

J0639+0601 RO006.UVDATA.1

Freq = 4.9270 GHz, Bw = 16.000 MH No calibration applied and no bandpass applied

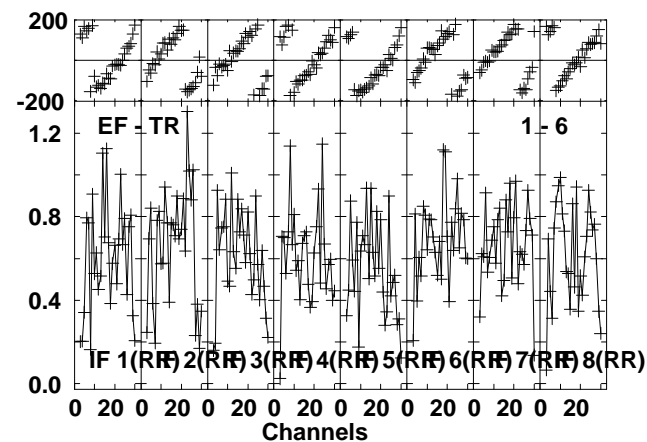
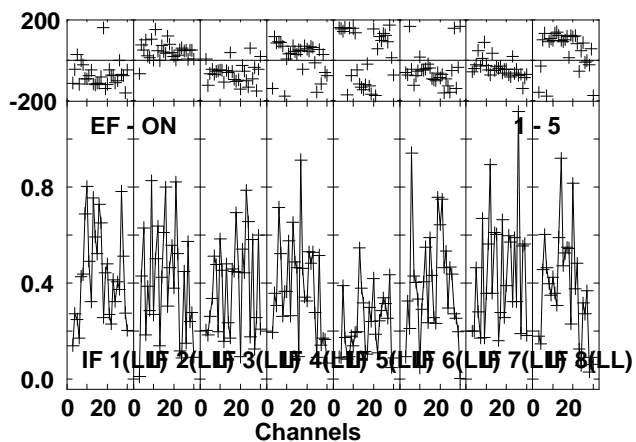
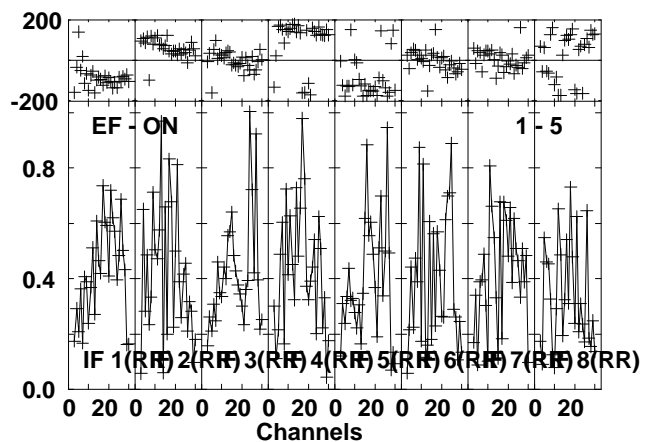
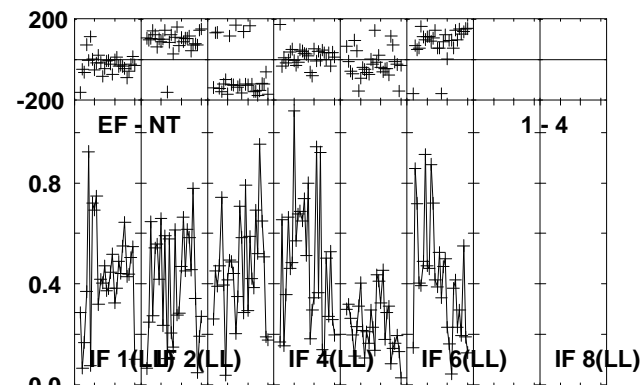
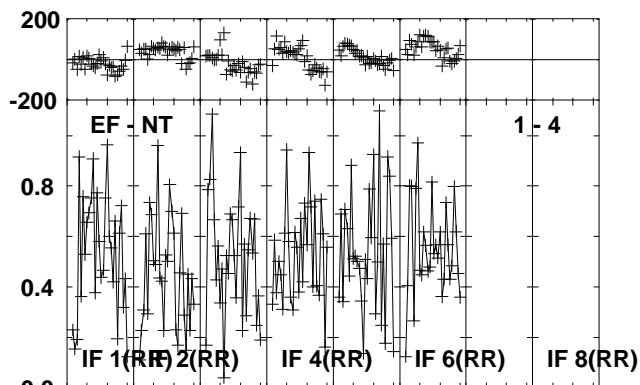
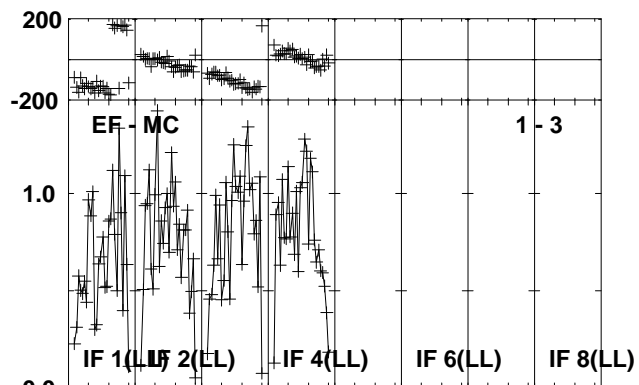
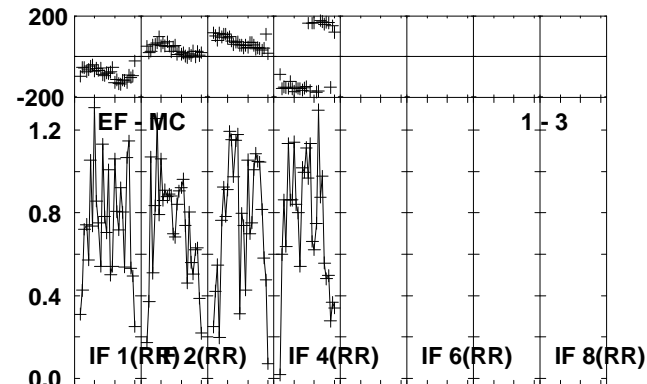
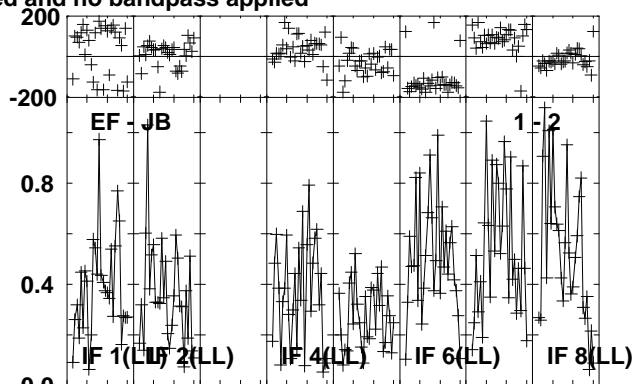
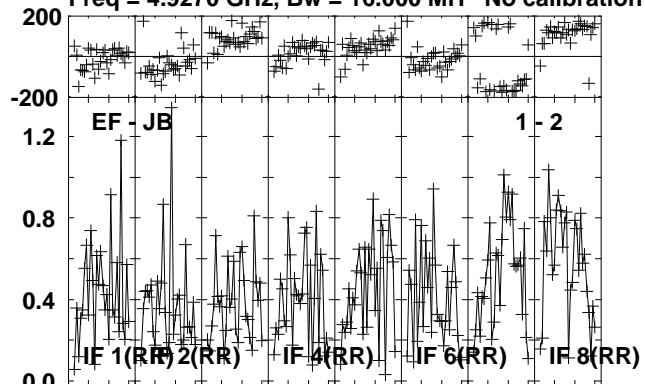

Lower frame: Milli Ampl Jy Top frame: Phas deg
Vector averaged cross-power spectrum Several baselines displayed
Timerange: 00/06:02:37 to 00/06:03:49

Plot file version 296 created 16-OCT-2012 11:57:59

J0639+0601 RO006.UVDATA.1

Freq = 4.9270 GHz, Bw = 16.000 MH No calibration applied and no bandpass applied

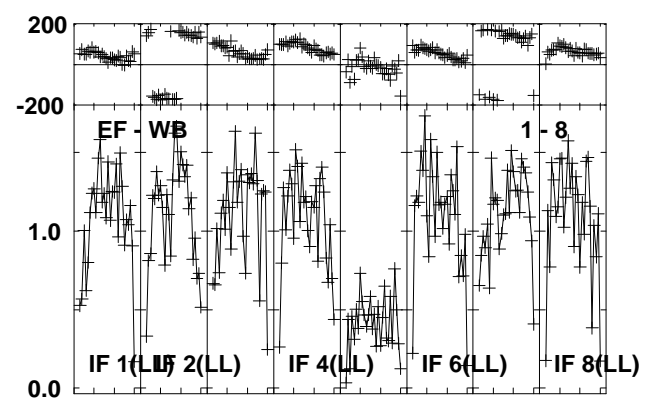
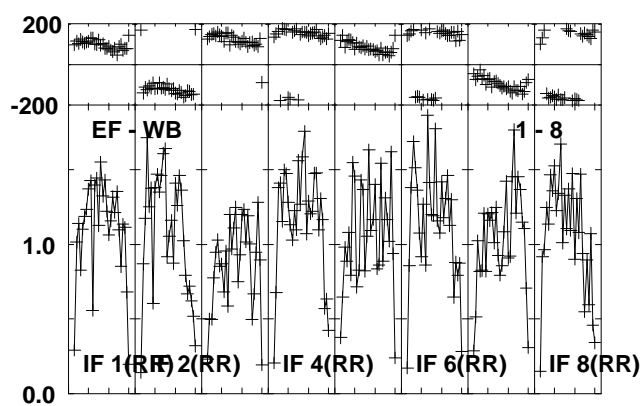
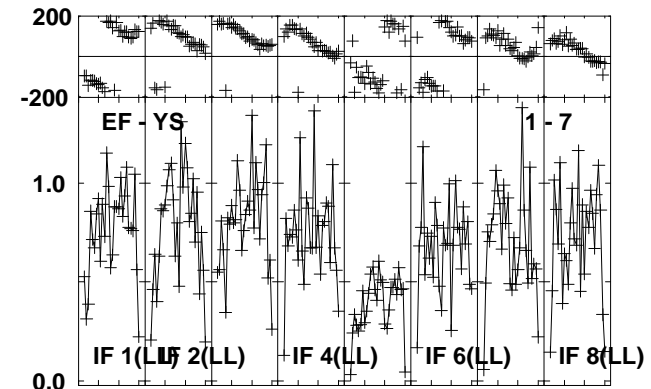
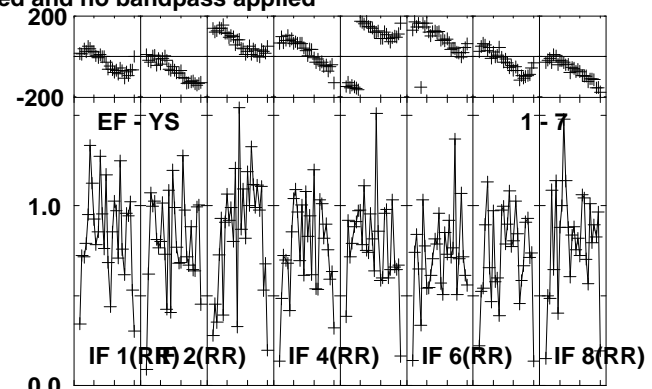
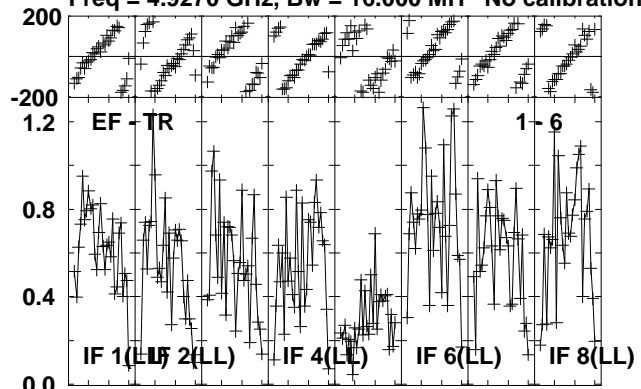

Lower frame: Milli Ampl Jy Top frame: Phas deg
Vector averaged cross-power spectrum Several baselines displayed
Timerange: 00/06:02:37 to 00/06:03:49

Plot file version 297 created 16-OCT-2012 11:57:59

J0645+0541 RO006.UVDATA.1

Freq = 4.9270 GHz, Bw = 16.000 MH No calibration applied and no bandpass applied

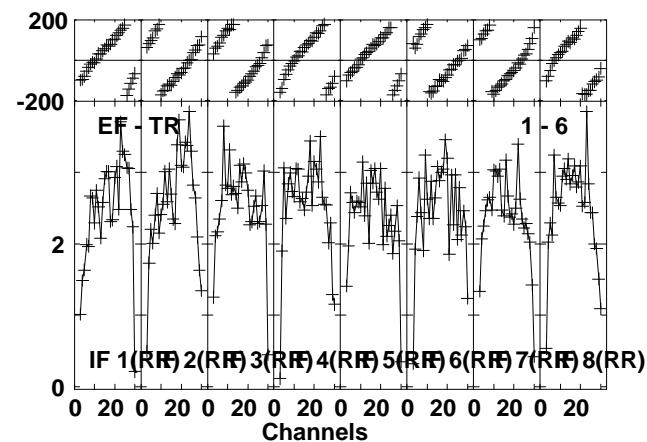
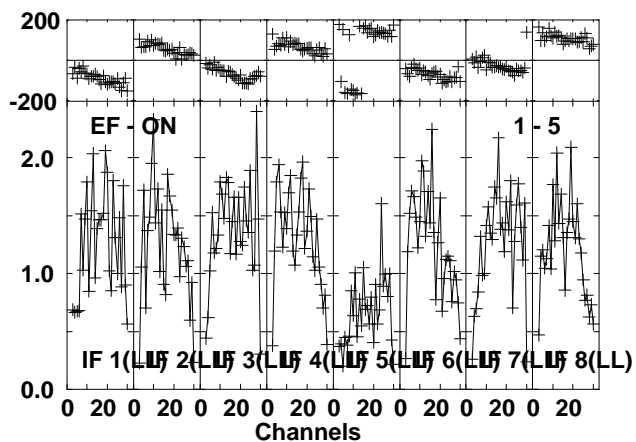
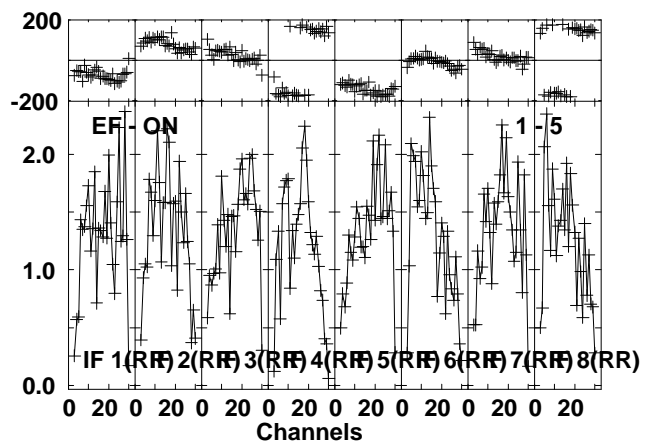
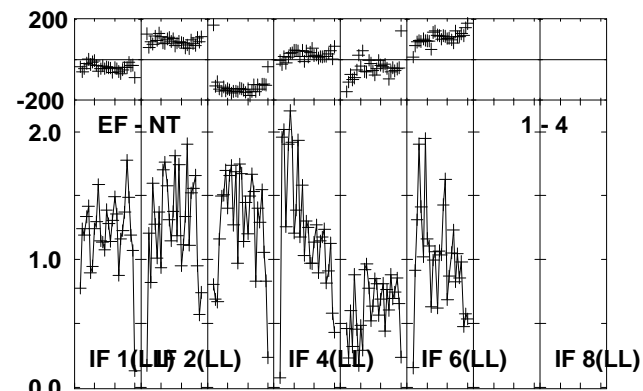
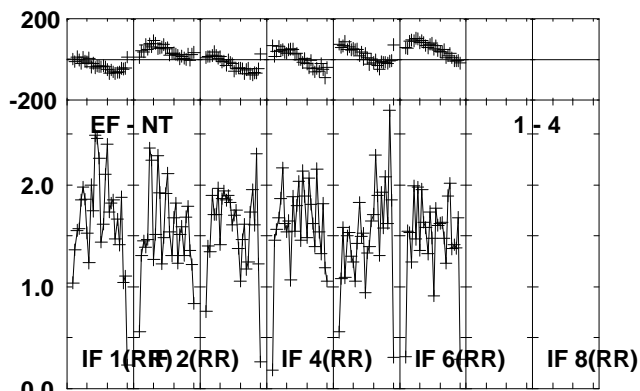
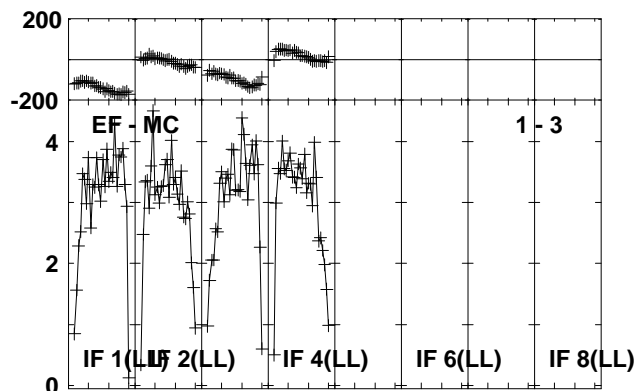
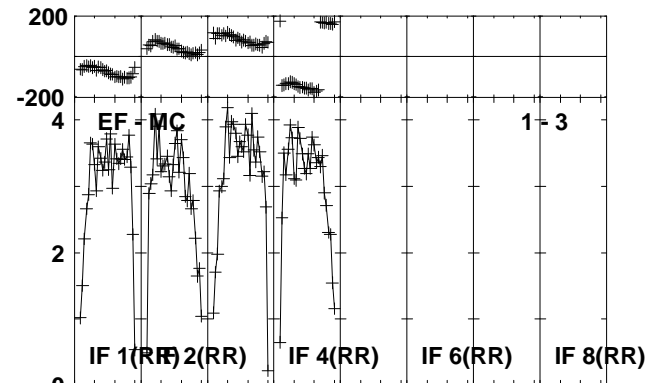
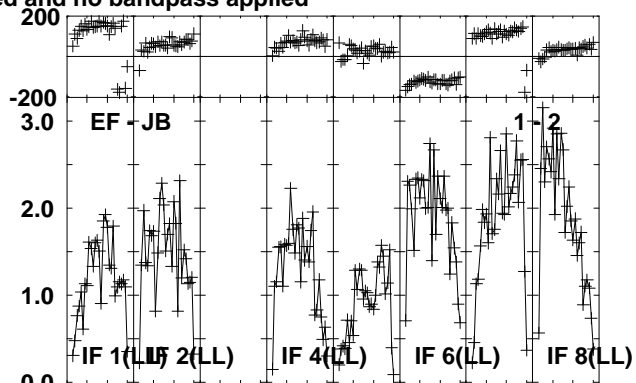
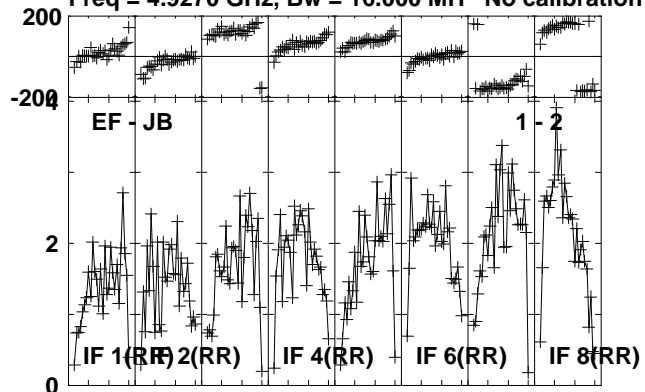

Lower frame: Milli Ampl Jy Top frame: Phas deg
Vector averaged cross-power spectrum Several baselines displayed
Timerange: 00/06:03:53 to 00/06:04:49

Plot file version 298 created 16-OCT-2012 11:57:59

J0645+0541 RO006.UVDATA.1

Freq = 4.9270 GHz, Bw = 16.000 MH No calibration applied and no bandpass applied

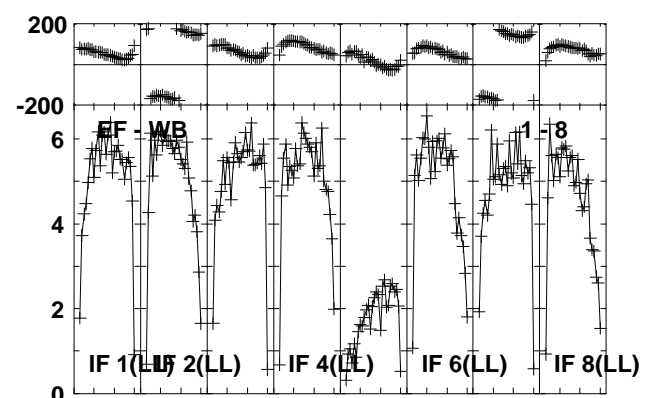
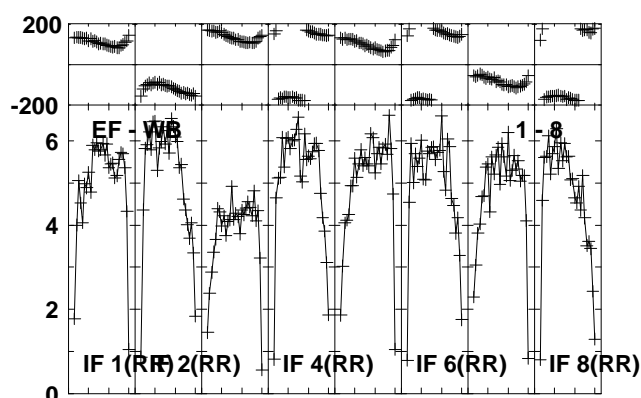
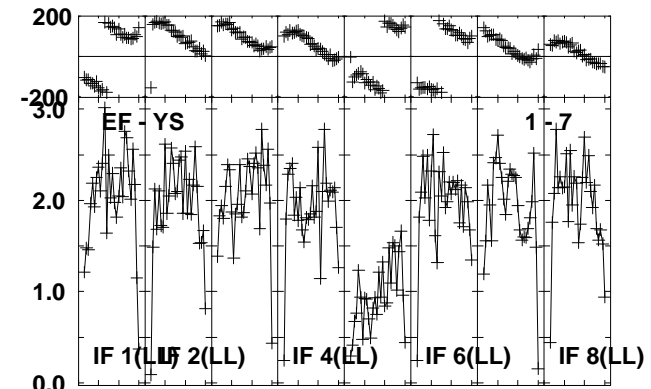
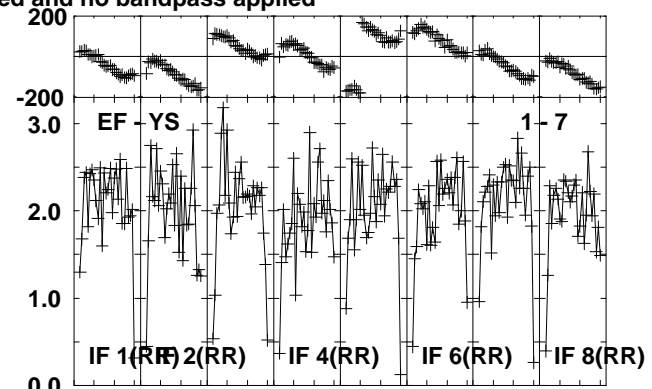
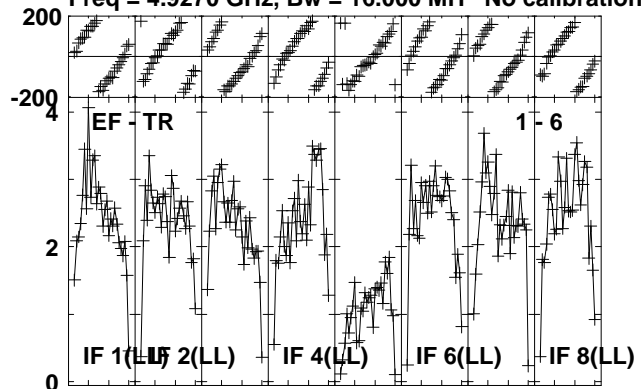

Lower frame: Milli Ampl Jy Top frame: Phas deg
Vector averaged cross-power spectrum Several baselines displayed
Timerange: 00/06:03:53 to 00/06:04:49

Plot file version 299 created 16-OCT-2012 11:58:00

NOVA-MON RO006.UVDATA.1

Freq = 4.9270 GHz, Bw = 16.000 MH No calibration applied and no bandpass applied

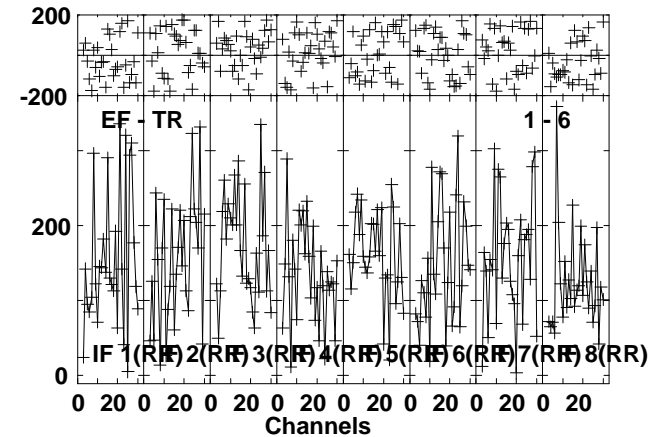
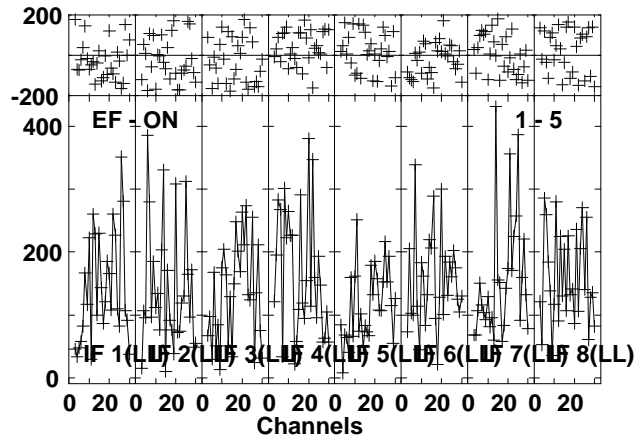
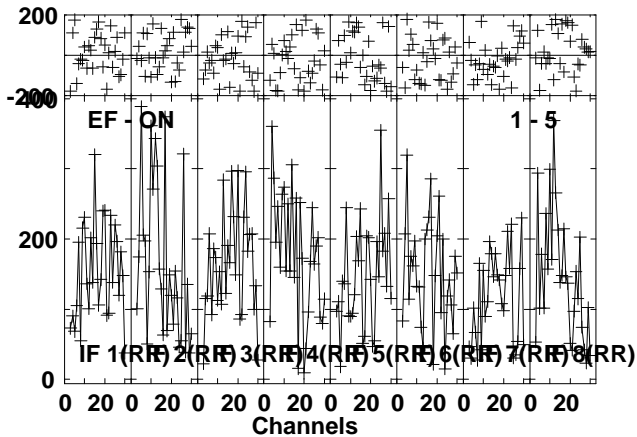
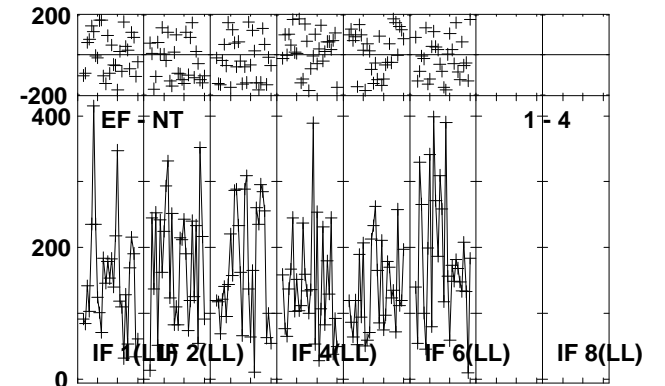
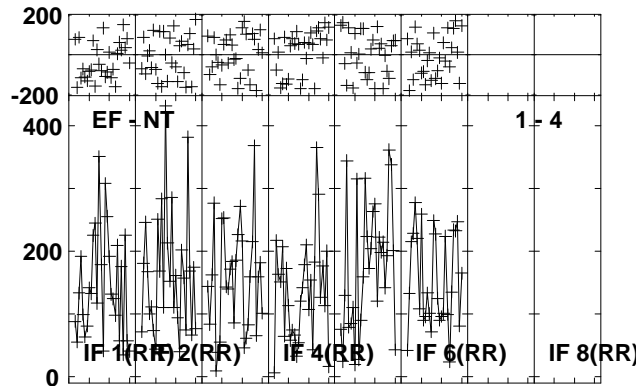
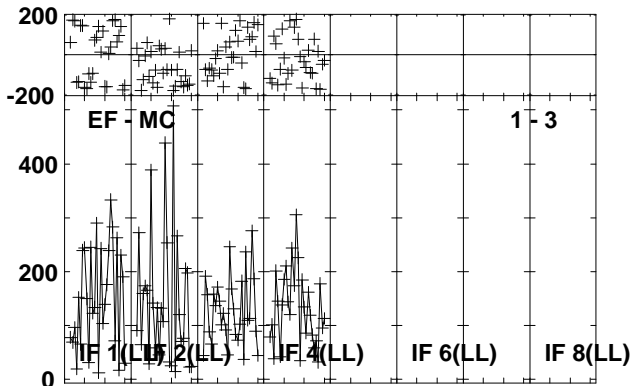
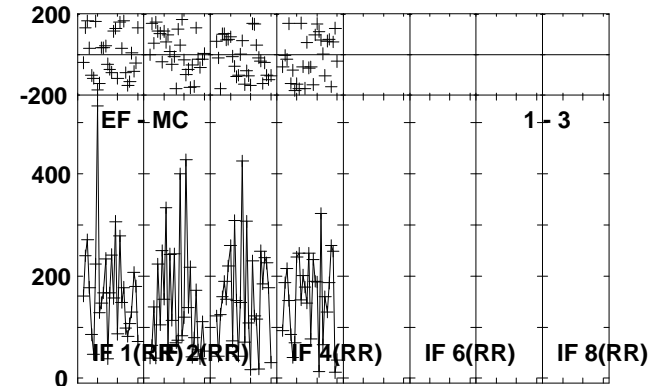
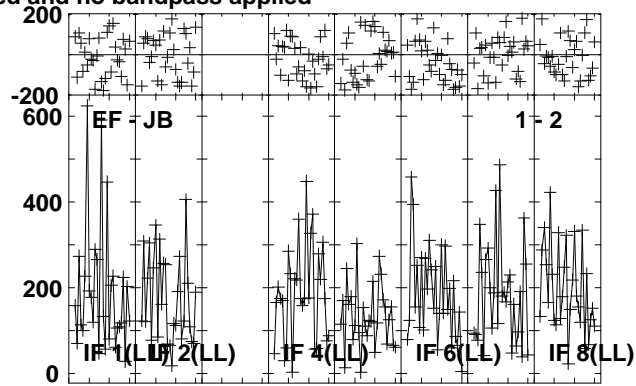
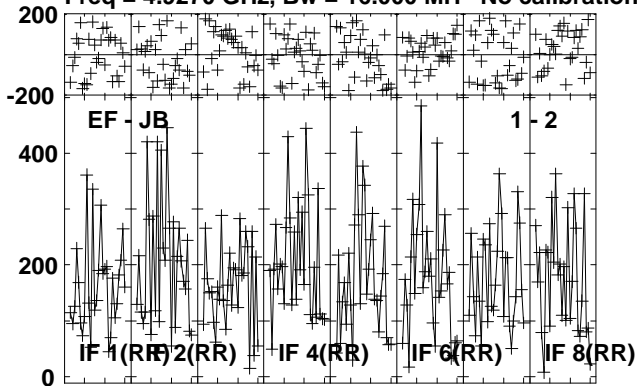

Lower frame: Micro Ampl Jy Top frame: Phas deg
Vector averaged cross-power spectrum Several baselines displayed
Timerange: 00/06:04:53 to 00/06:07:49

Plot file version 300 created 16-OCT-2012 11:58:00

NOVA-MON RO006.UVDATA.1

Freq = 4.9270 GHz, Bw = 16.000 MH No calibration applied and no bandpass applied

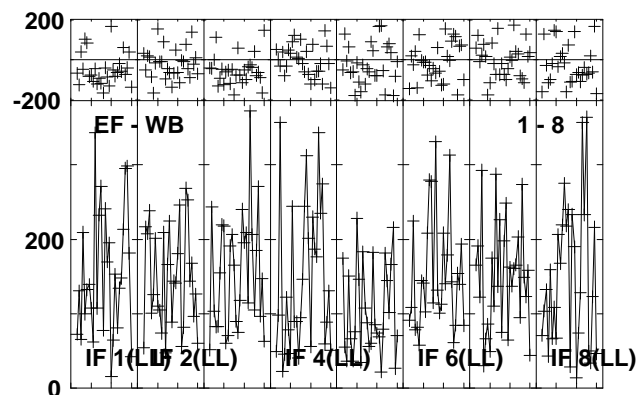
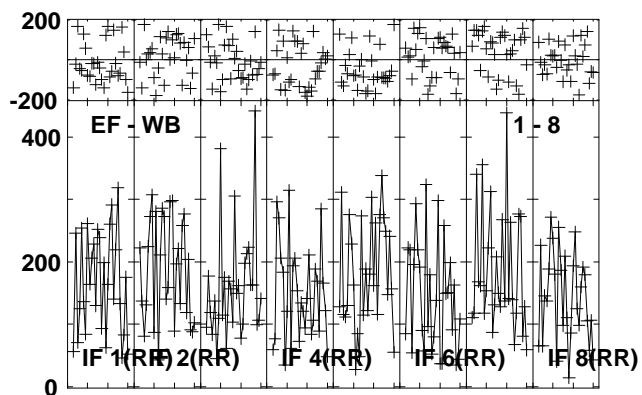
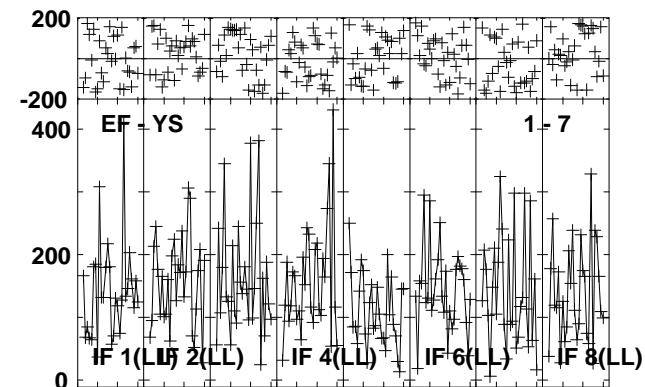
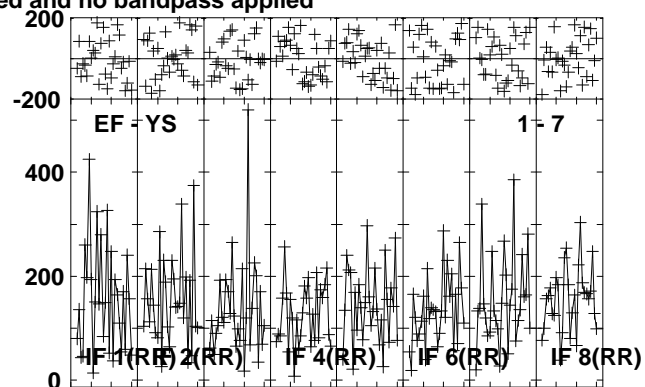
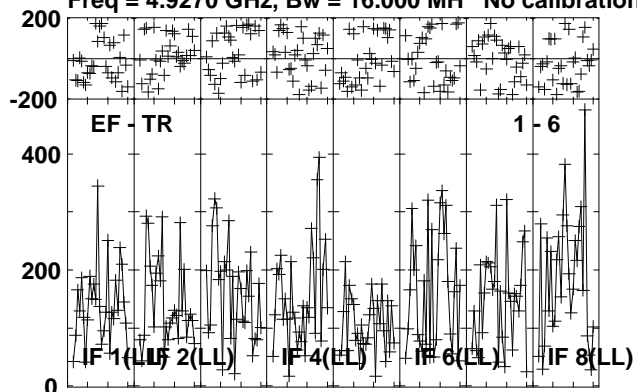

Lower frame: Micro Ampl Jy Top frame: Phas deg
Vector averaged cross-power spectrum Several baselines displayed
Timerange: 00/06:04:53 to 00/06:07:49

Plot file version 301 created 16-OCT-2012 11:58:00

J0639+0601 RO006.UVDATA.1

Freq = 4.9270 GHz, Bw = 16.000 MH No calibration applied and no bandpass applied

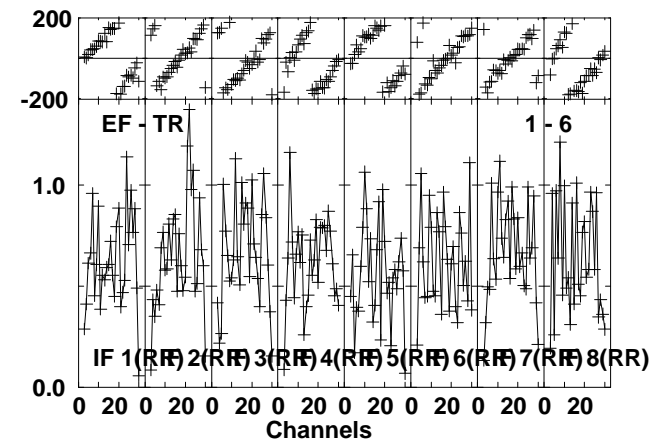
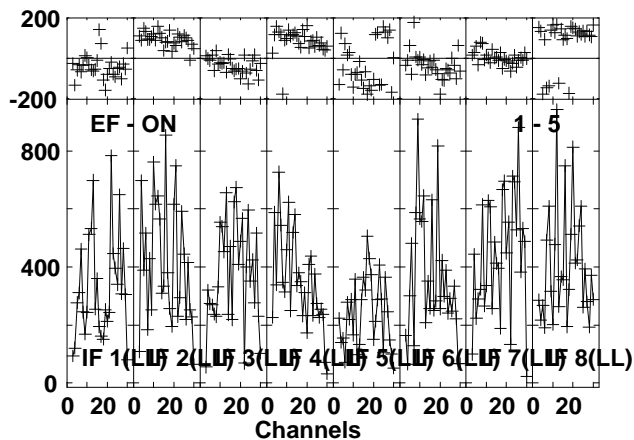
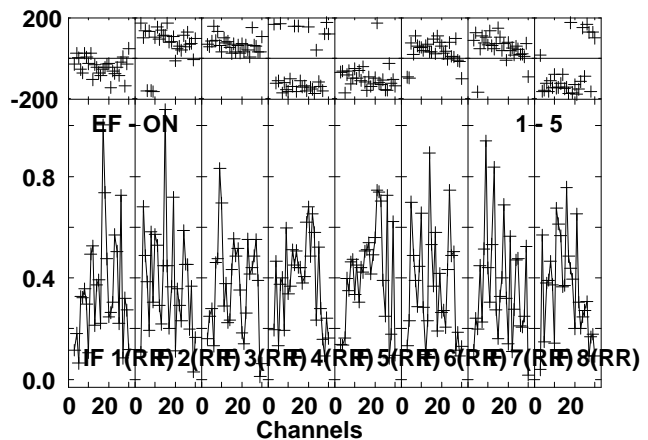
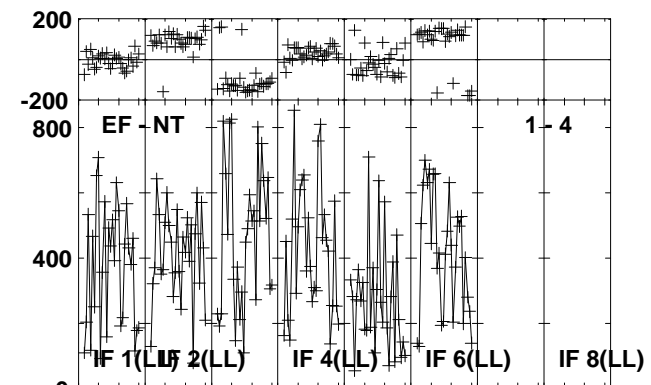
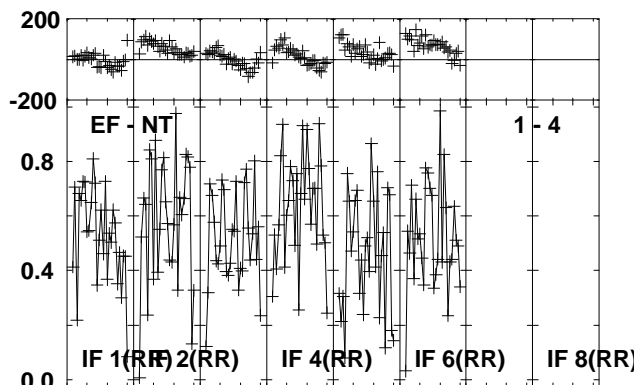
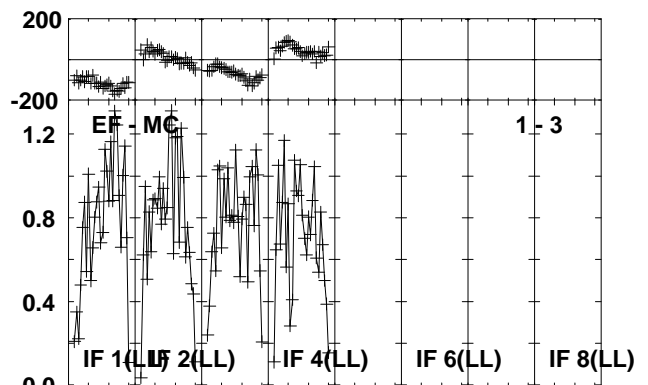
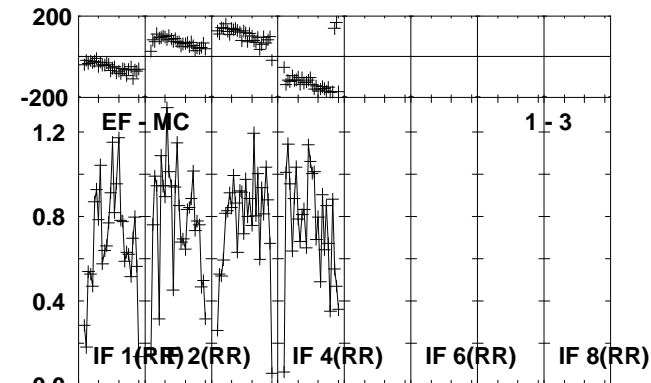
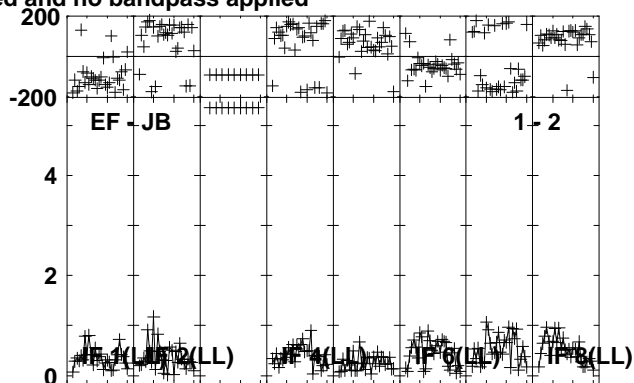
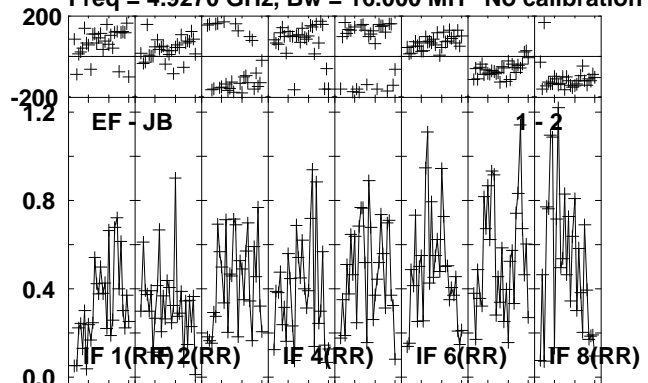

Lower frame: Milli Ampl Jy Top frame: Phas deg
Vector averaged cross-power spectrum Several baselines displayed
Timerange: 00/06:08:17 to 00/06:09:19

Plot file version 302 created 16-OCT-2012 11:58:01

J0639+0601 RO006.UVDATA.1

Freq = 4.9270 GHz, Bw = 16.000 MH No calibration applied and no bandpass applied

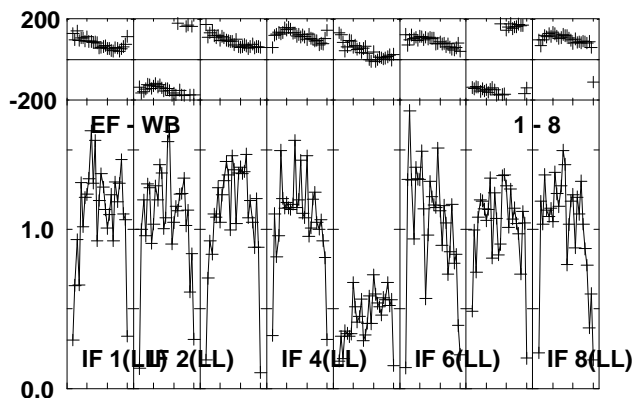
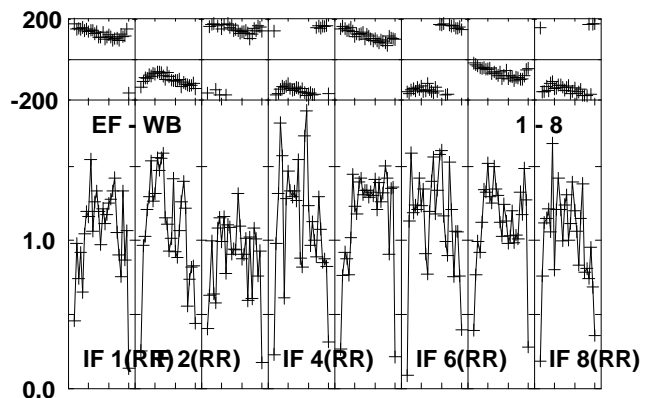
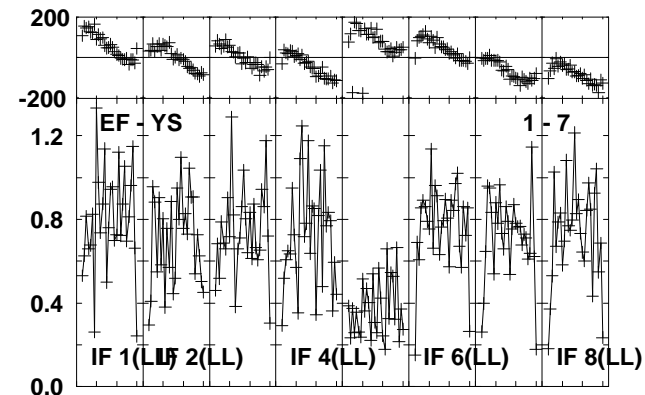
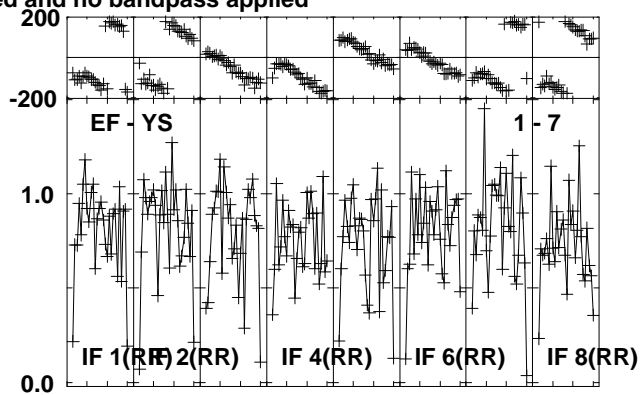
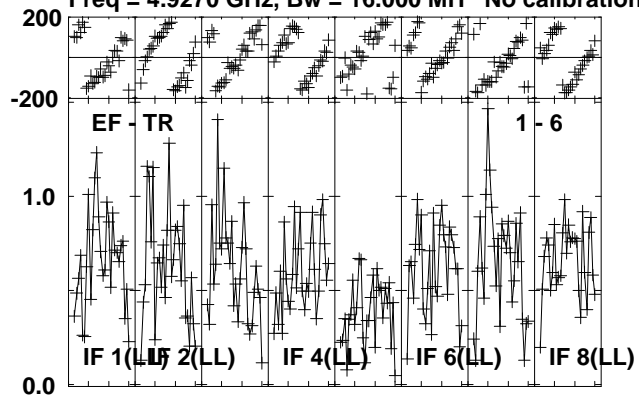

Lower frame: Milli Ampl Jy Top frame: Phas deg
Vector averaged cross-power spectrum Several baselines displayed
Timerange: 00/06:08:17 to 00/06:09:19

Plot file version 303 created 16-OCT-2012 11:58:01

0528+134 RO006.UVDATA.1

Freq = 4.9270 GHz, Bw = 16.000 MH No calibration applied and no bandpass applied

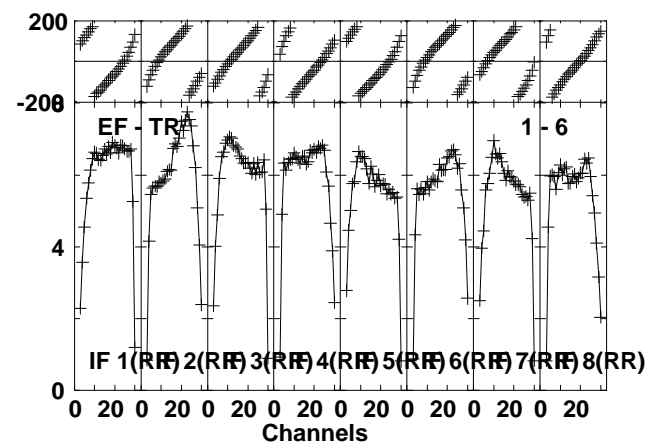
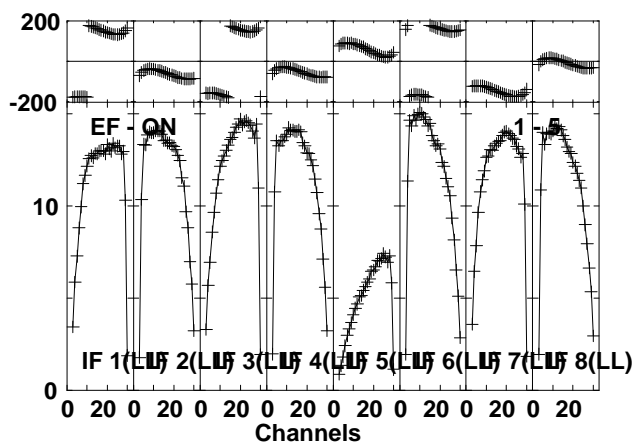
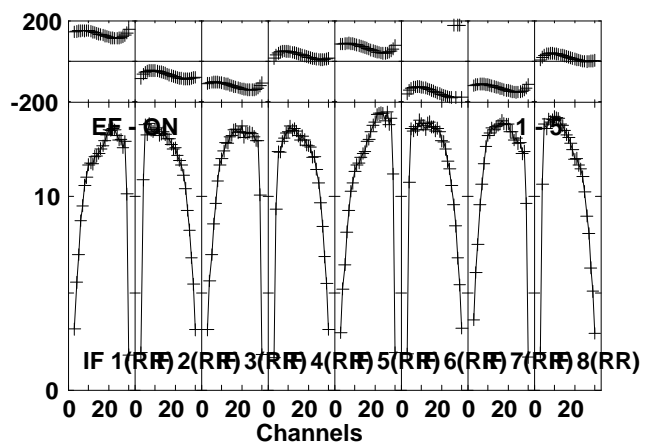
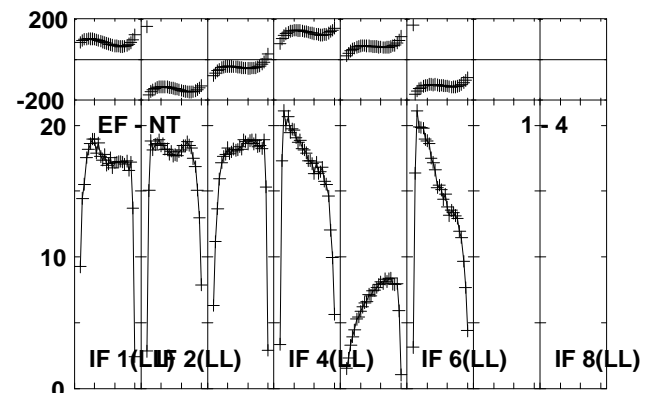
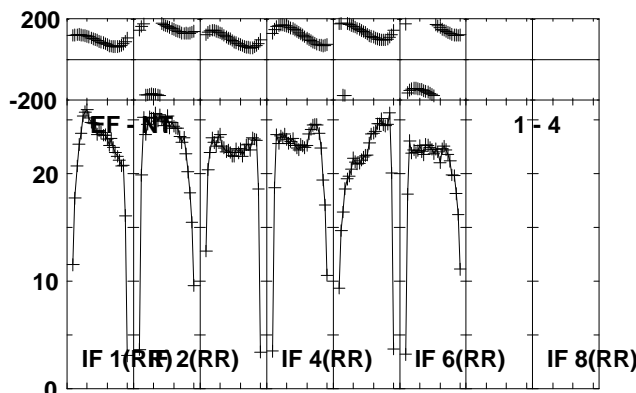
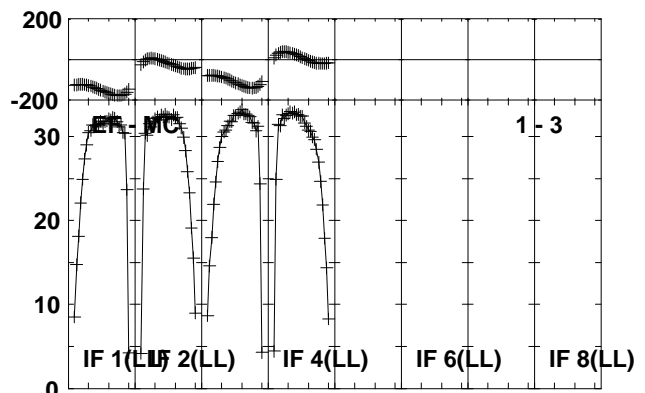
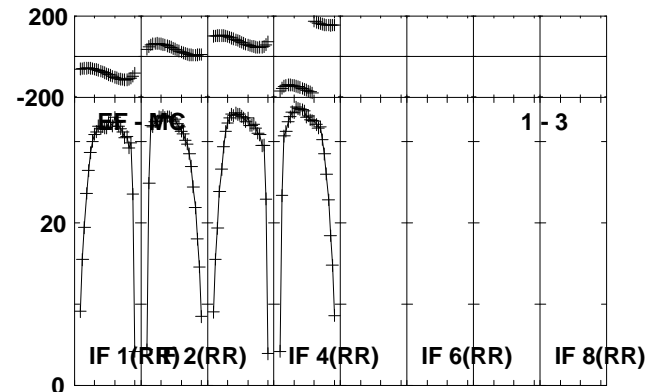
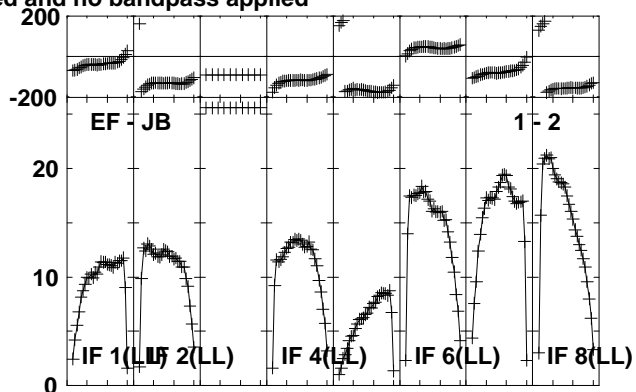
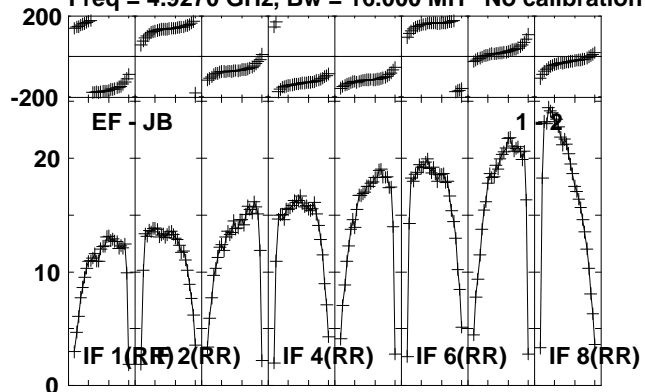

Lower frame: Milli Ampl Jy Top frame: Phas deg
Vector averaged cross-power spectrum Several baselines displayed
Timerange: 00/06:11:17 to 00/06:14:19

Plot file version 304 created 16-OCT-2012 11:58:01

0528+134 RO006.UVDATA.1

Freq = 4.9270 GHz, Bw = 16.000 MH No calibration applied and no bandpass applied

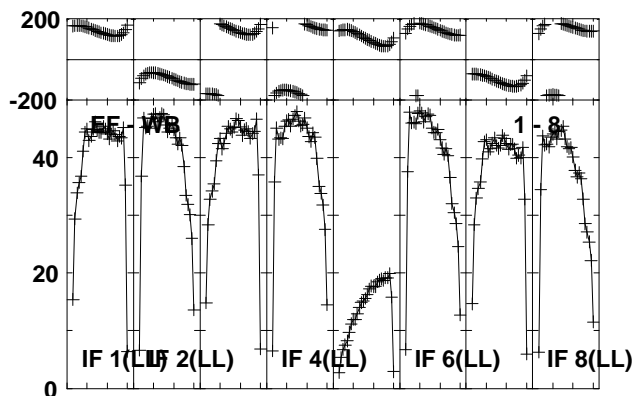
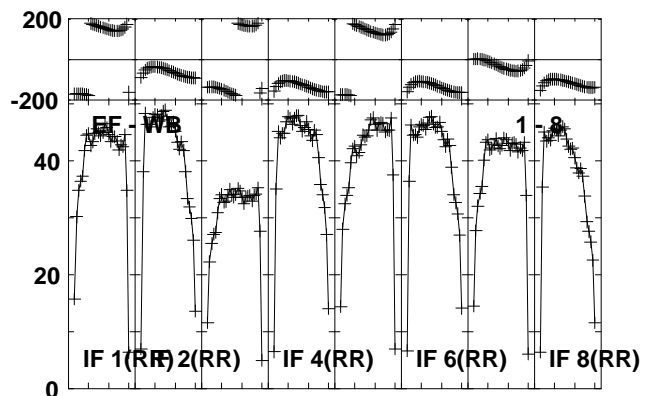
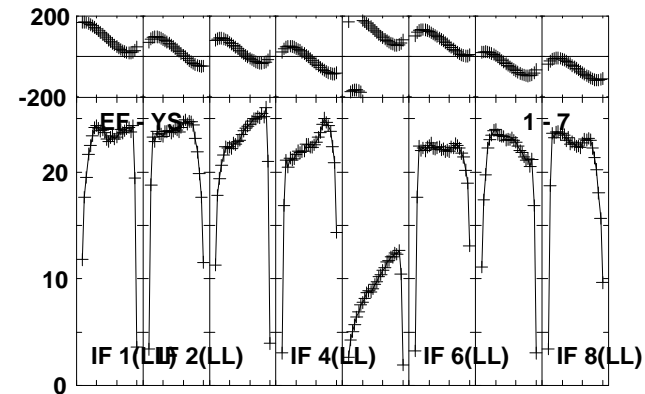
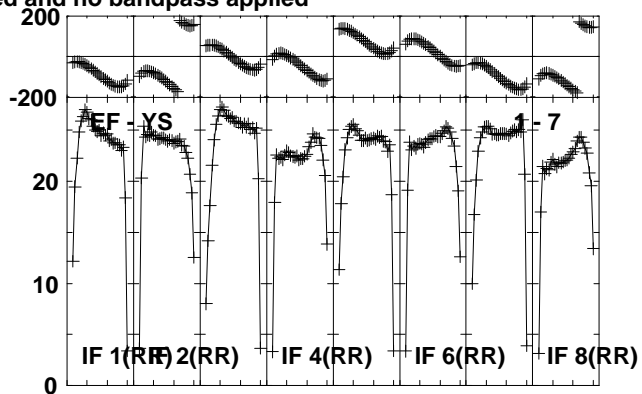
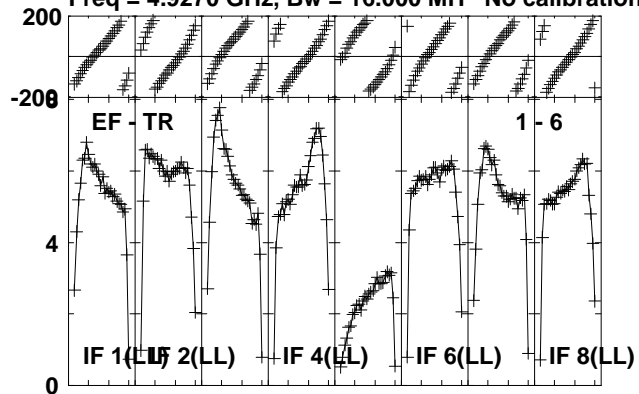

Lower frame: Milli Ampl Jy Top frame: Phas deg
Vector averaged cross-power spectrum Several baselines displayed
Timerange: 00/06:11:17 to 00/06:14:19

Plot file version 305 created 16-OCT-2012 11:58:02

J0645+0541 RO006.UVDATA.1

Freq = 4.9270 GHz, Bw = 16.000 MH No calibration applied and no bandpass applied

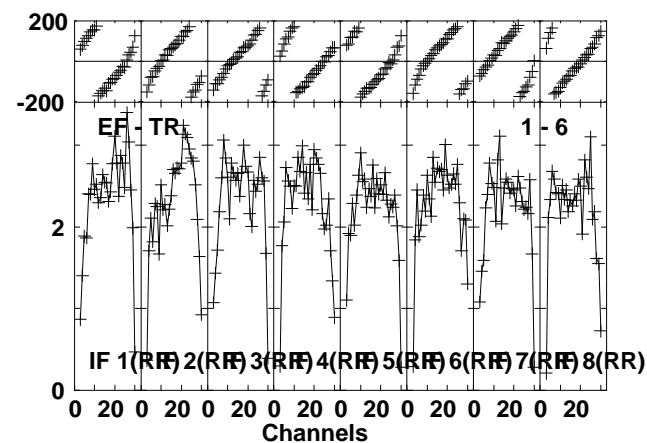
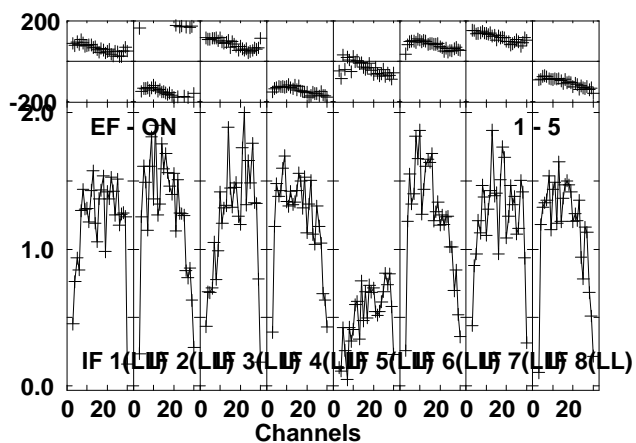
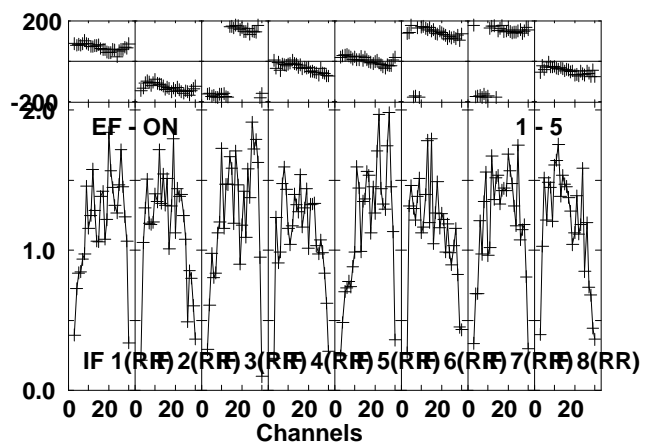
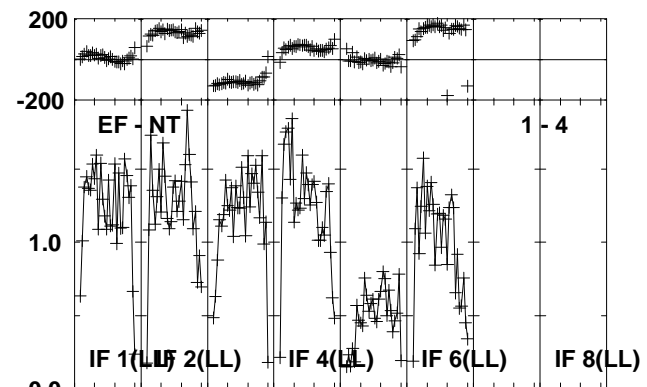
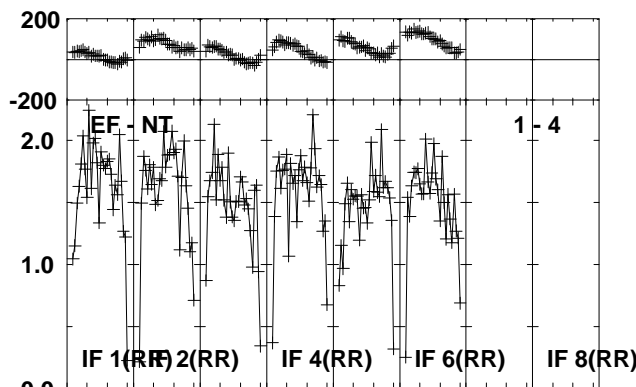
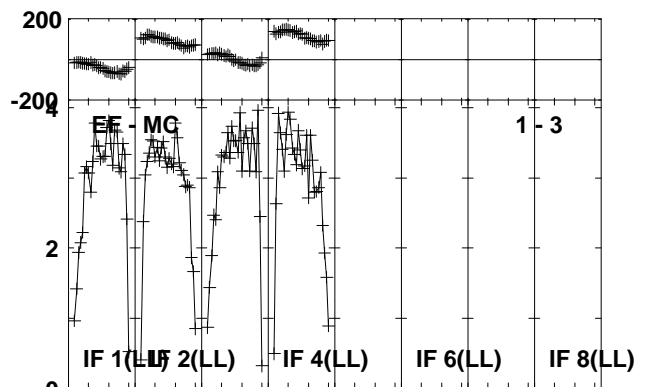
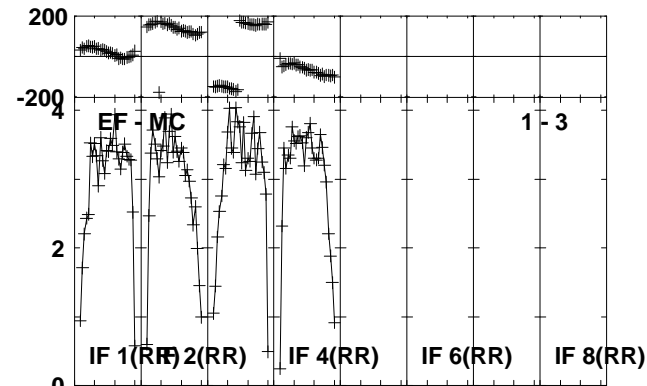
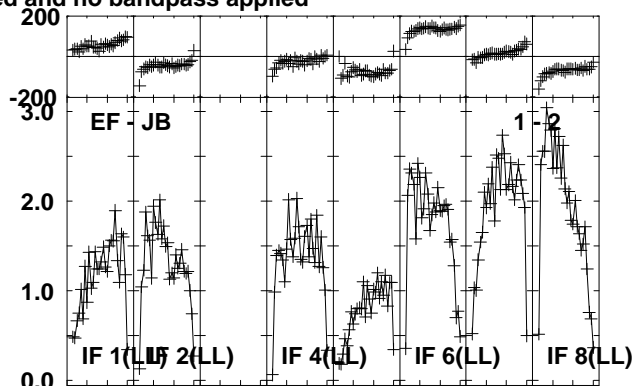
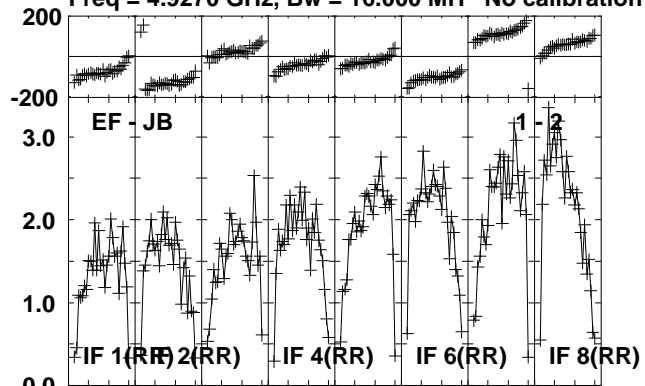

Lower frame: Milli Ampl Jy Top frame: Phas deg
Vector averaged cross-power spectrum Several baselines displayed
Timerange: 00/06:16:17 to 00/06:17:19

Plot file version 306 created 16-OCT-2012 11:58:02

J0645+0541 RO006.UVDATA.1

Freq = 4.9270 GHz, Bw = 16.000 MH No calibration applied and no bandpass applied

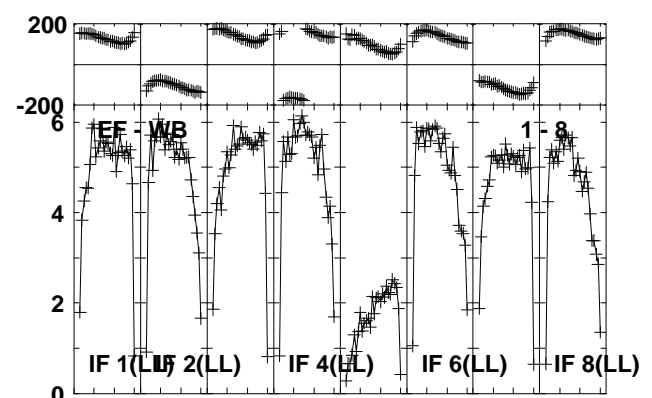
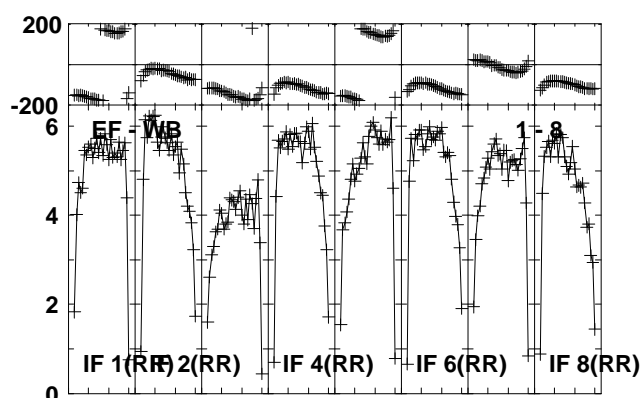
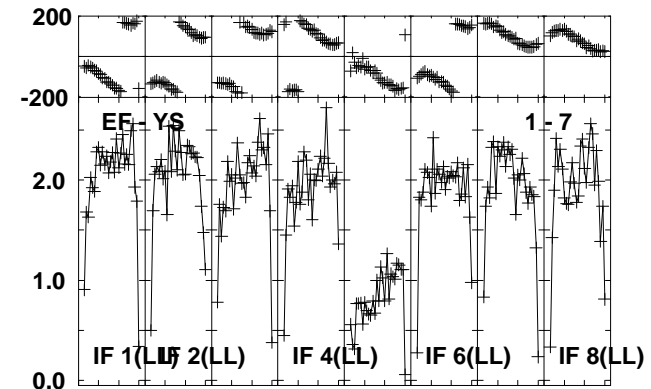
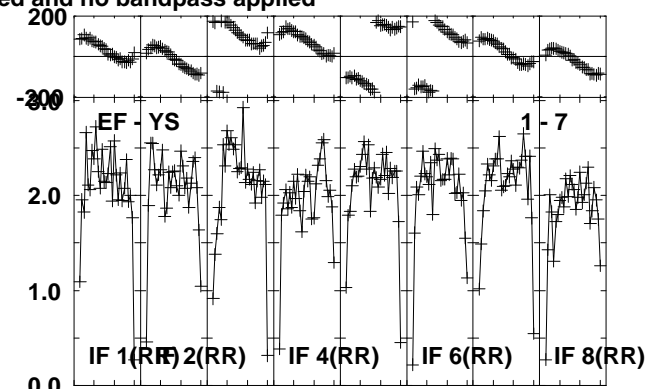
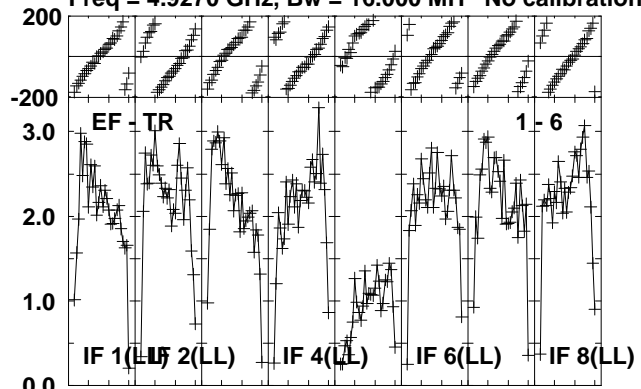

Lower frame: Milli Ampl Jy Top frame: Phas deg
Vector averaged cross-power spectrum Several baselines displayed
Timerange: 00/06:16:17 to 00/06:17:19

Plot file version 308 created 16-OCT-2012 11:58:03

NOVA-MON RO006.UVDATA.1

Freq = 4.9270 GHz, Bw = 16.000 MH No calibration applied and no bandpass applied

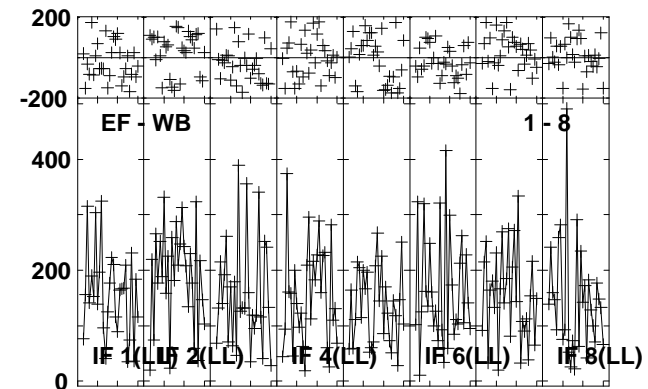
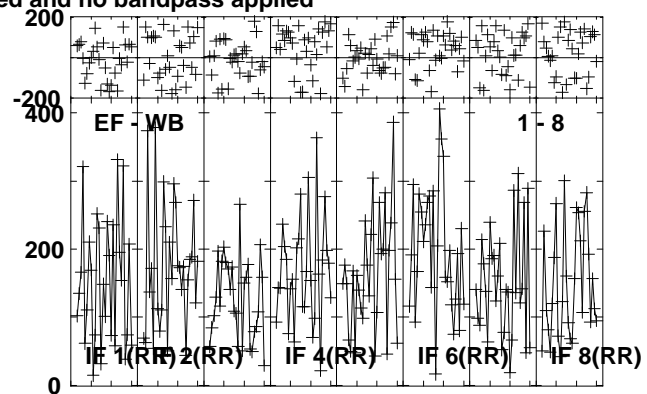
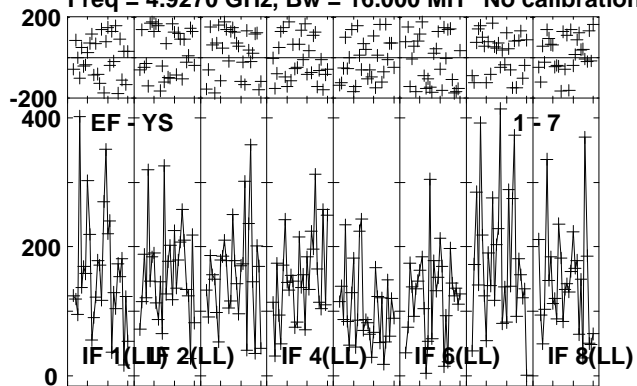

Lower frame: Micro Ampl Jy Top frame: Phas deg
Vector averaged cross-power spectrum Several baselines displayed
Timerange: 00/06:17:23 to 00/06:20:19

Plot file version 309 created 16-OCT-2012 11:58:03

J0639+0601 RO006.UVDATA.1

Freq = 4.9270 GHz, Bw = 16.000 MH No calibration applied and no bandpass applied

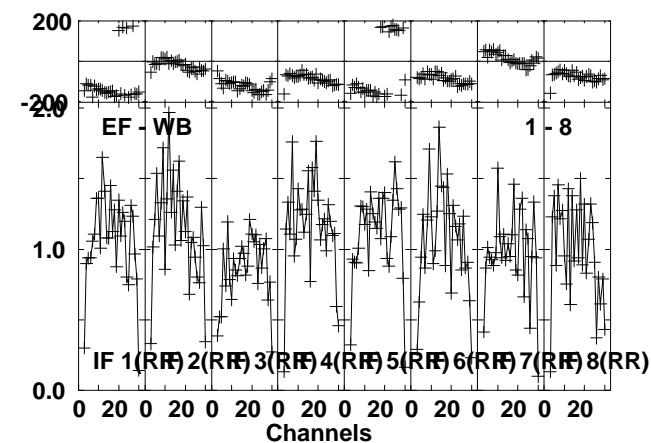
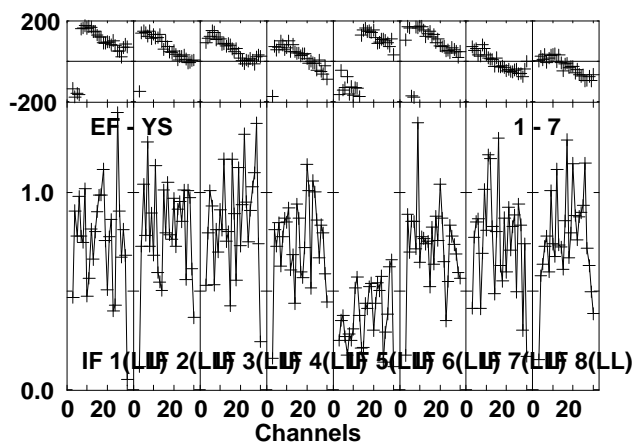
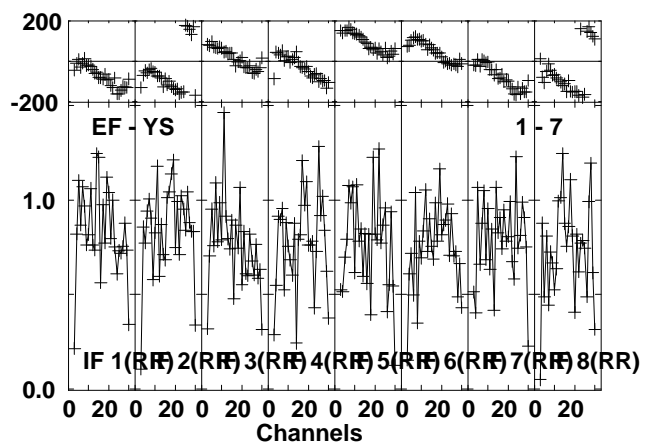
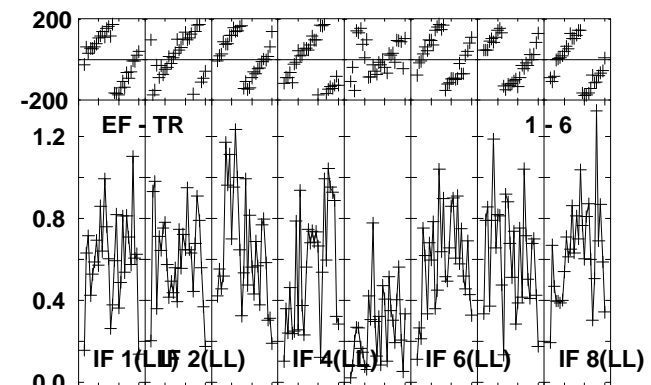
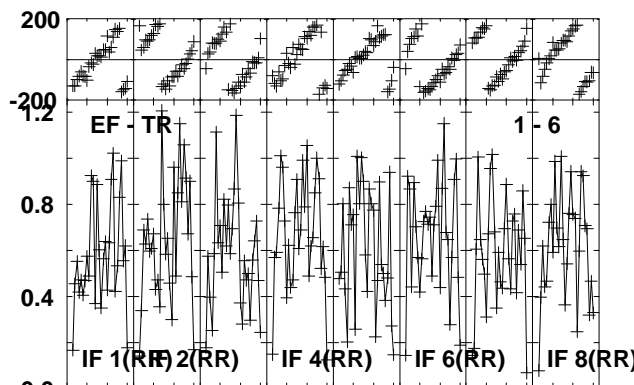
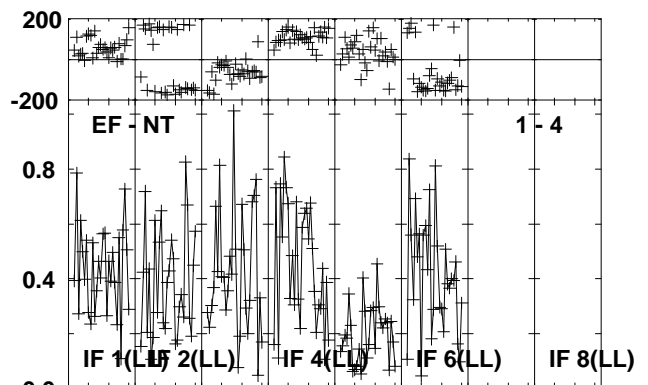
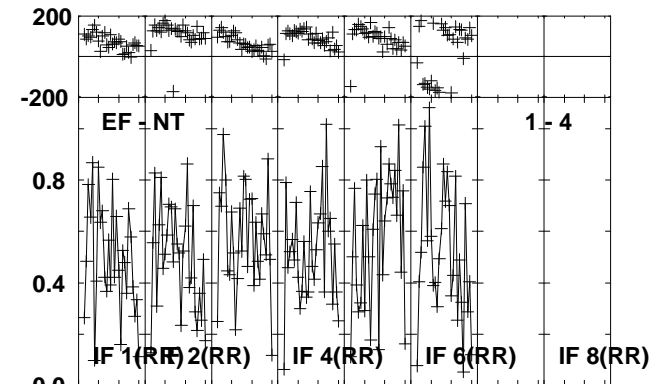
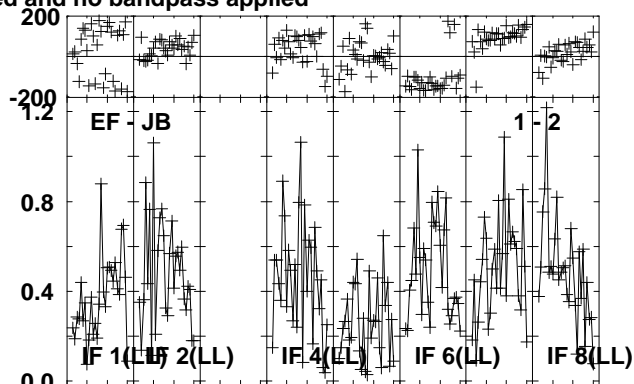
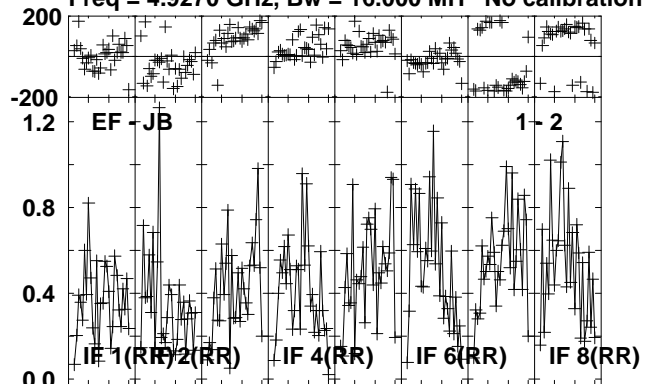

Lower frame: Milli Ampl Jy Top frame: Phas deg
Vector averaged cross-power spectrum Several baselines displayed
Timerange: 00/06:20:23 to 00/06:21:33

Plot file version 310 created 16-OCT-2012 11:58:04

J0639+0601 RO006.UVDATA.1

Freq = 4.9270 GHz, Bw = 16.000 MH No calibration applied and no bandpass applied

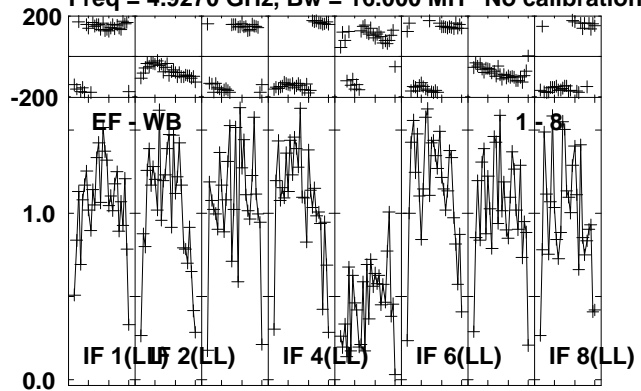

Lower frame: Milli Ampl Jy Top frame: Phas deg
Vector averaged cross-power spectrum Several baselines displayed
Timerange: 00/06:20:23 to 00/06:21:33

Plot file version 311 created 16-OCT-2012 11:58:04

J0645+0541 RO006.UVDATA.1

Freq = 4.9270 GHz, Bw = 16.000 MH No calibration applied and no bandpass applied

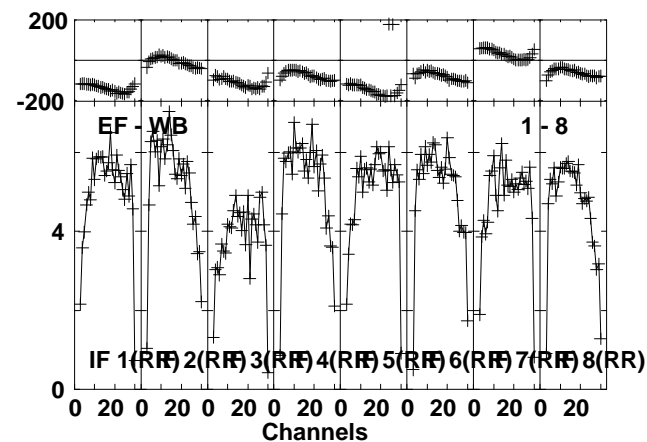
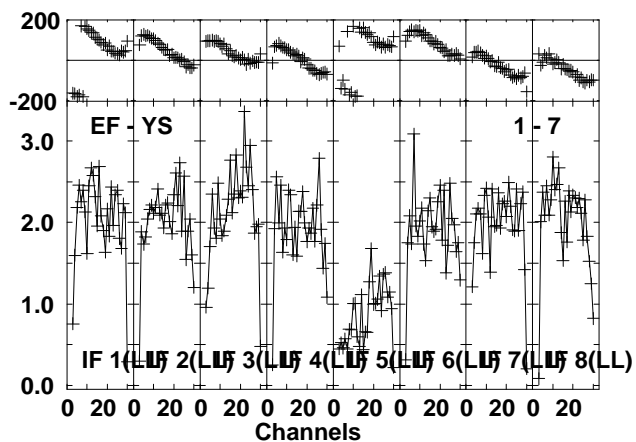
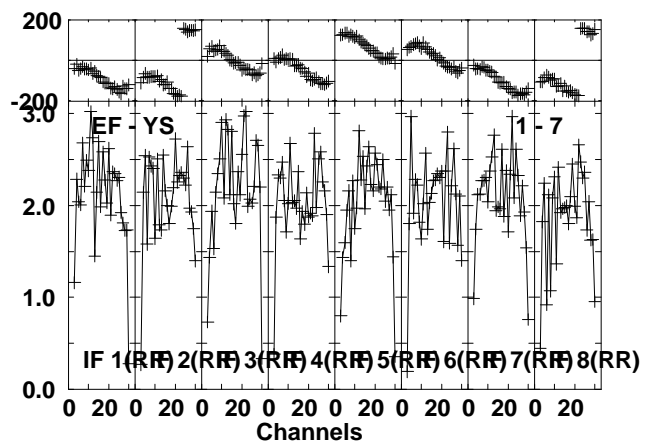
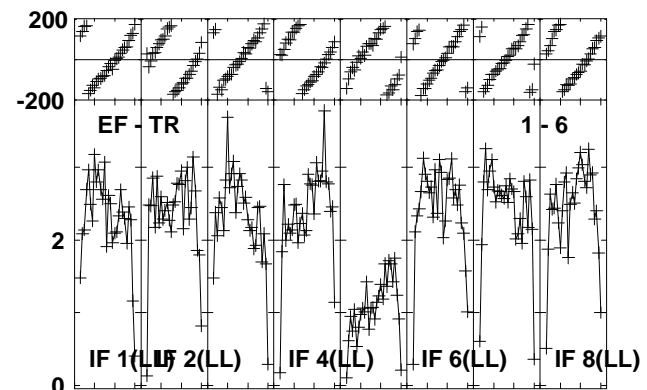
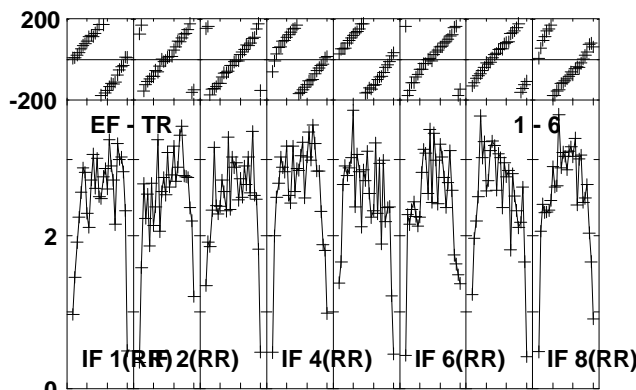
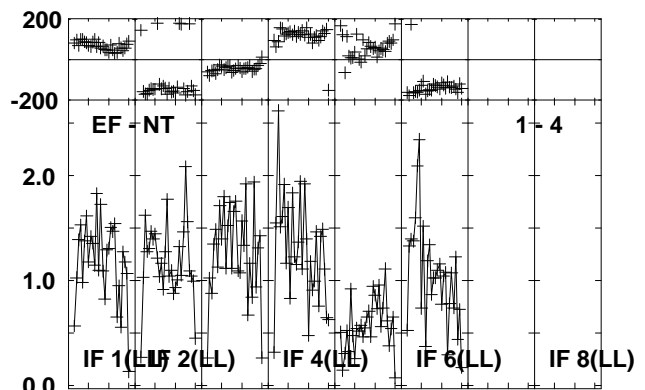
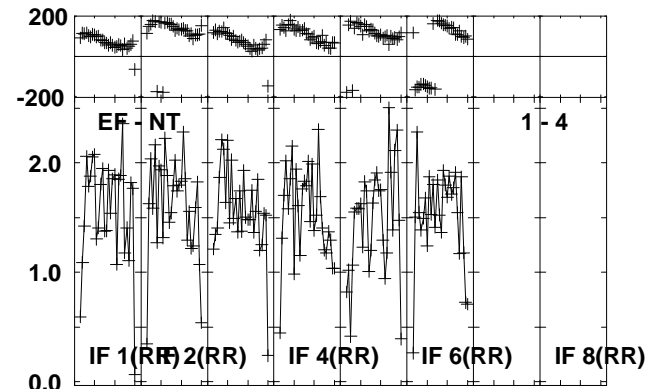
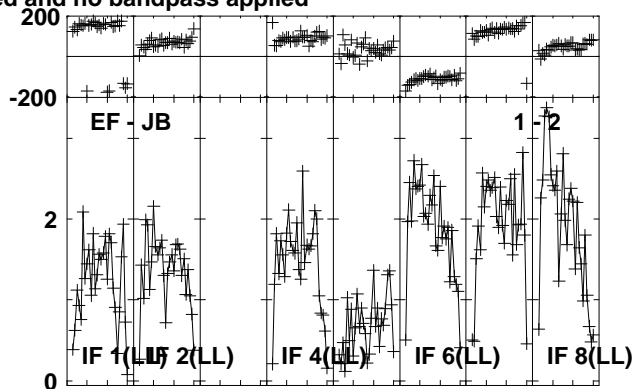
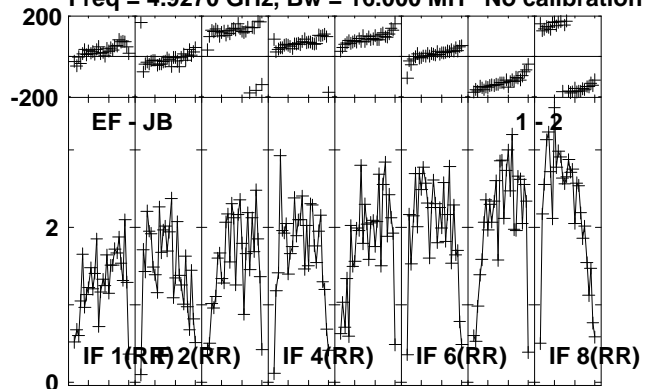

Lower frame: Milli Ampl Jy Top frame: Phas deg
Vector averaged cross-power spectrum Several baselines displayed
Timerange: 00/06:21:37 to 00/06:22:33

Plot file version 312 created 16-OCT-2012 11:58:04

J0645+0541 RO006.UVDATA.1

Freq = 4.9270 GHz, Bw = 16.000 MH No calibration applied and no bandpass applied

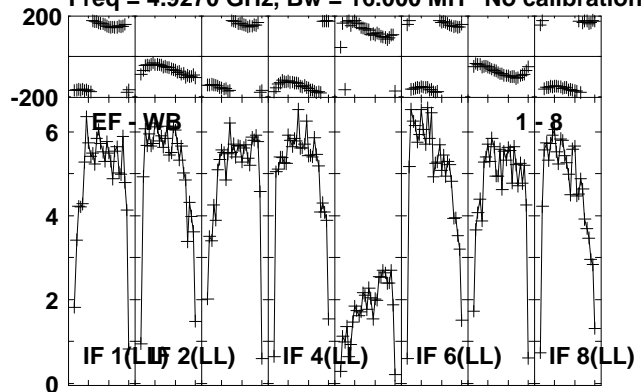

Lower frame: Milli Ampl Jy Top frame: Phas deg
Vector averaged cross-power spectrum Several baselines displayed
Timerange: 00/06:21:37 to 00/06:22:33

Plot file version 313 created 16-OCT-2012 11:58:04

NOVA-MON RO006.UVDATA.1

Freq = 4.9270 GHz, Bw = 16.000 MH No calibration applied and no bandpass applied

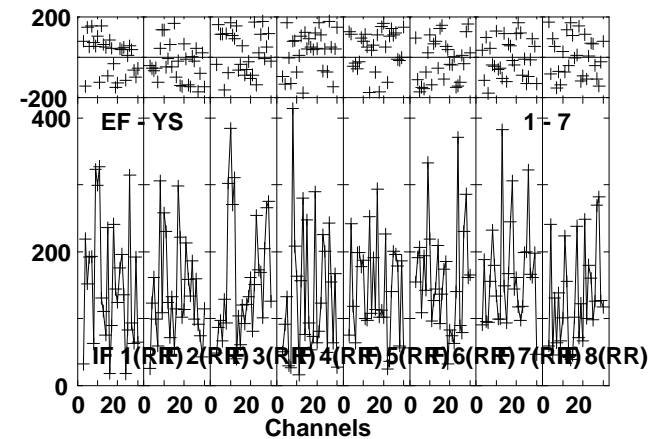
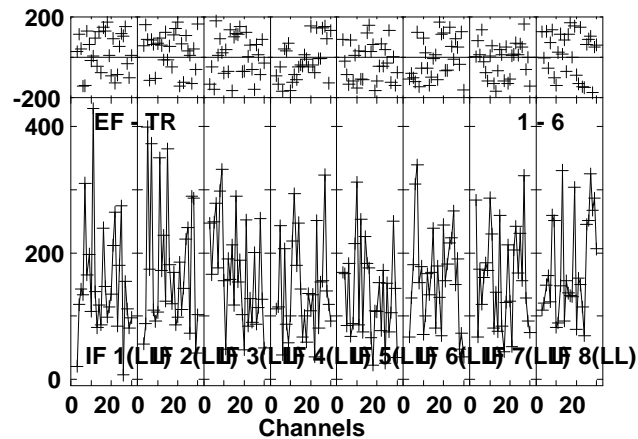
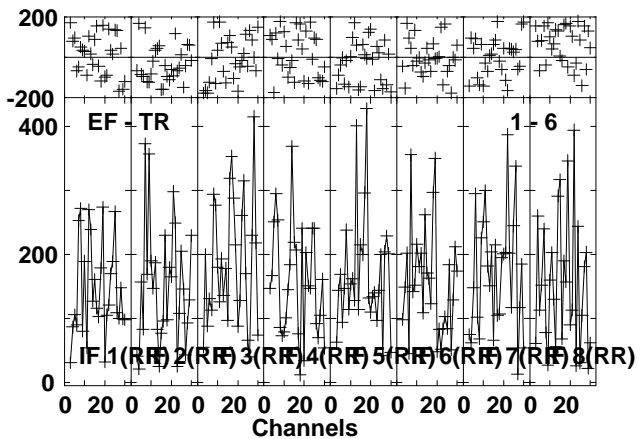
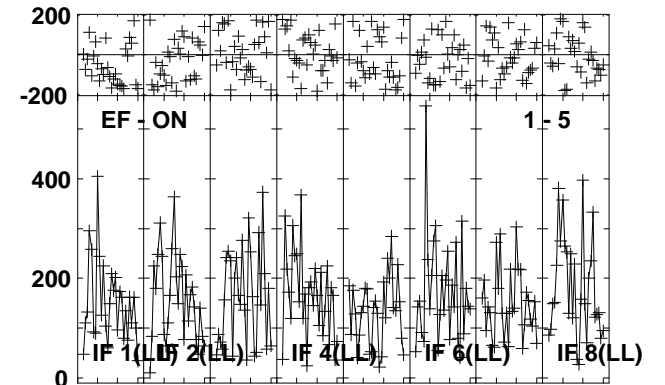
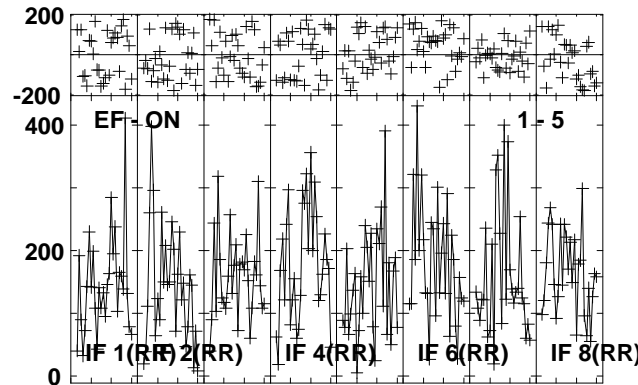
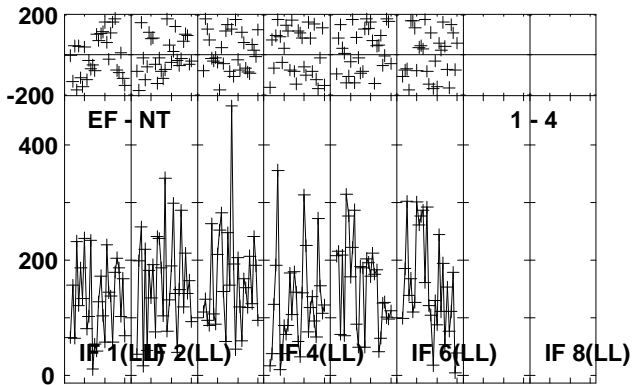
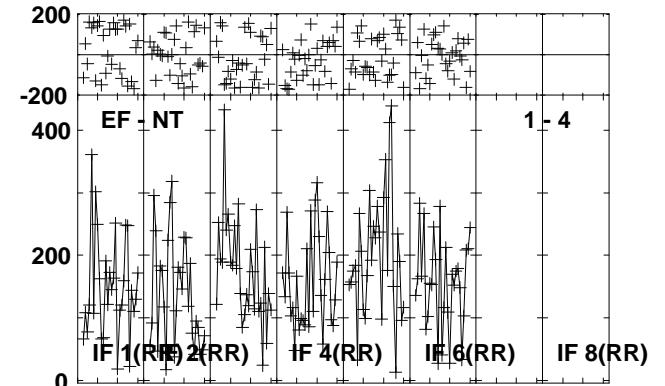
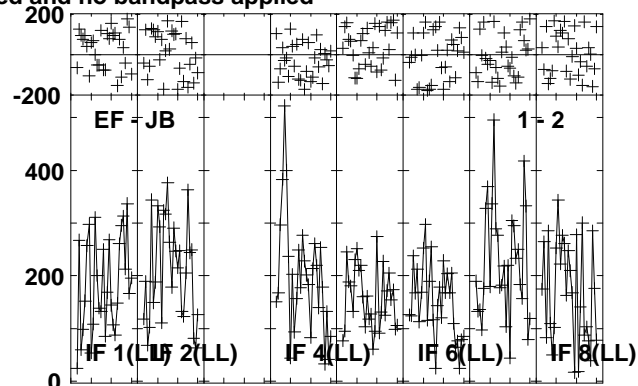
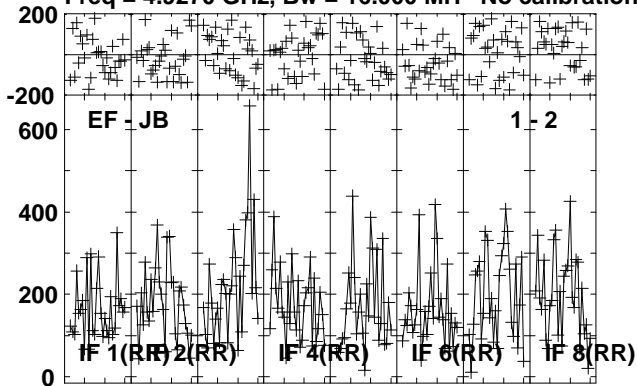

Lower frame: Micro Ampl Jy Top frame: Phas deg
Vector averaged cross-power spectrum Several baselines displayed
Timerange: 00/06:22:37 to 00/06:25:33

Plot file version 314 created 16-OCT-2012 11:58:04

NOVA-MON RO006.UVDATA.1

Freq = 4.9270 GHz, Bw = 16.000 MH No calibration applied and no bandpass applied

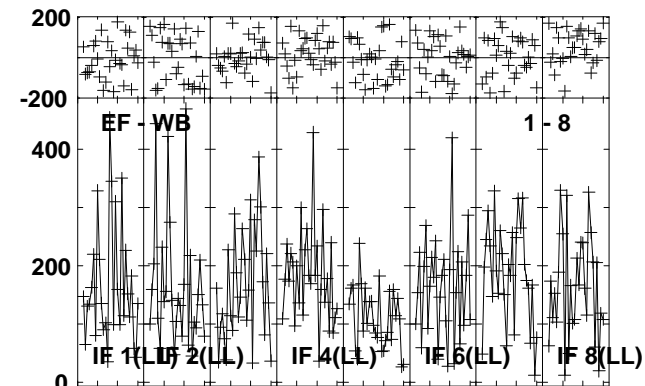
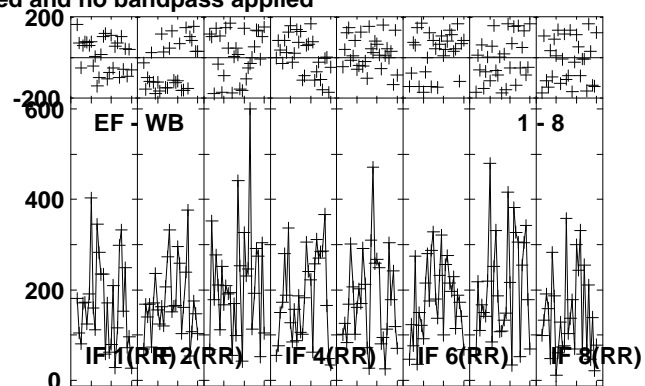
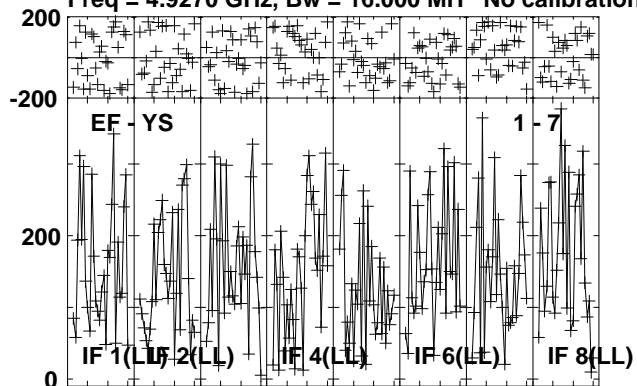

Lower frame: Micro Ampl Jy Top frame: Phas deg
Vector averaged cross-power spectrum Several baselines displayed
Timerange: 00/06:22:37 to 00/06:25:33

Plot file version 315 created 16-OCT-2012 11:58:05

J0639+0601 RO006.UVDATA.1

Freq = 4.9270 GHz, Bw = 16.000 MH No calibration applied and no bandpass applied

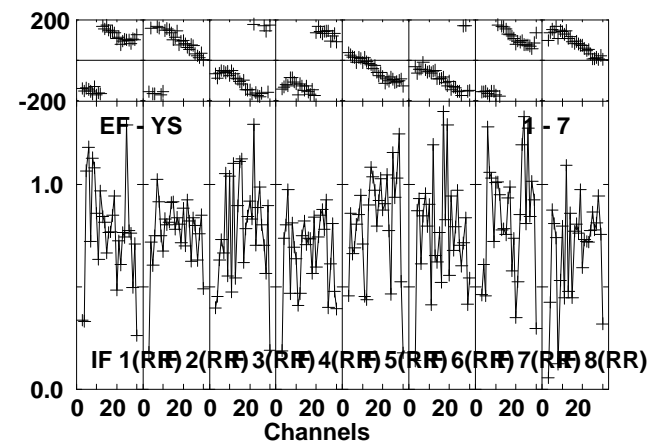
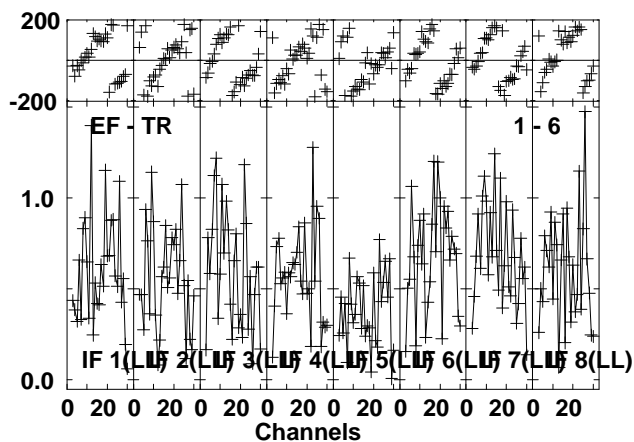
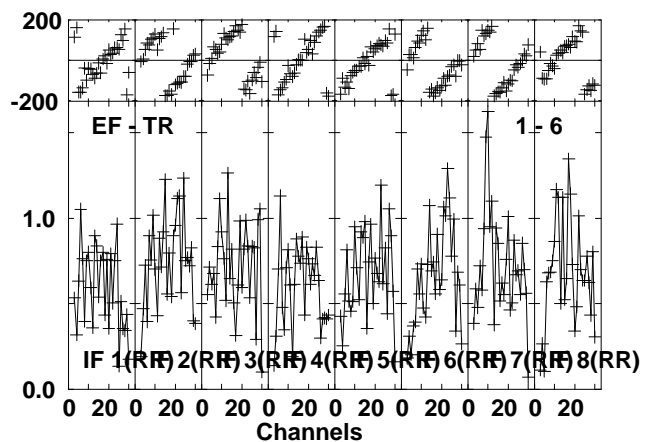
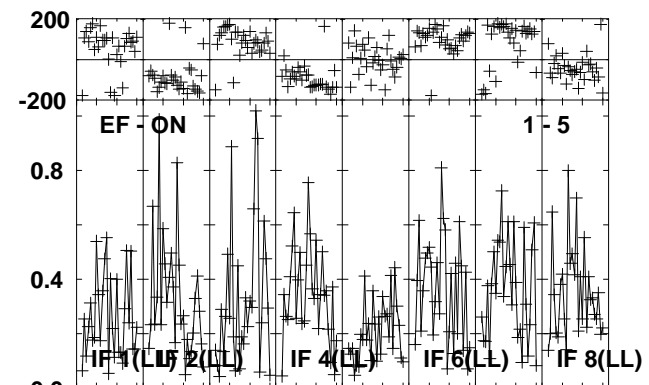
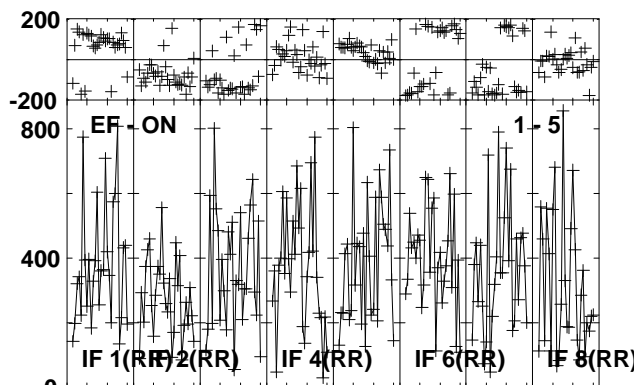
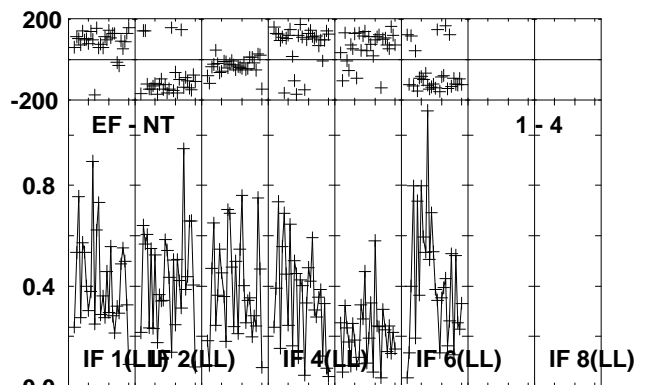
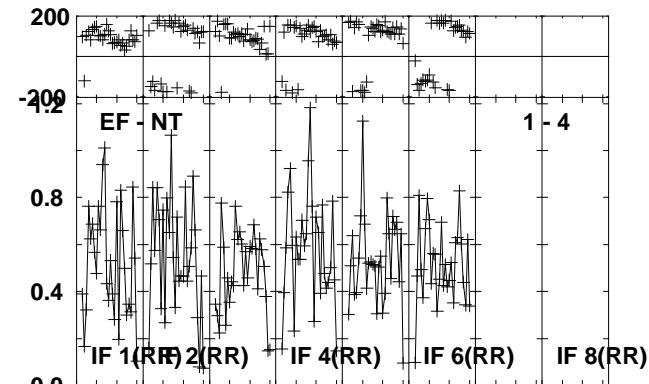
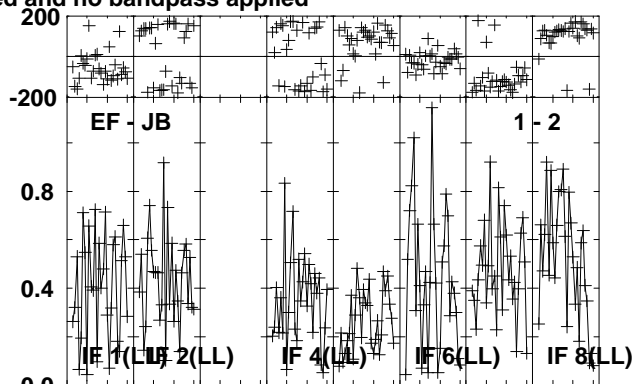
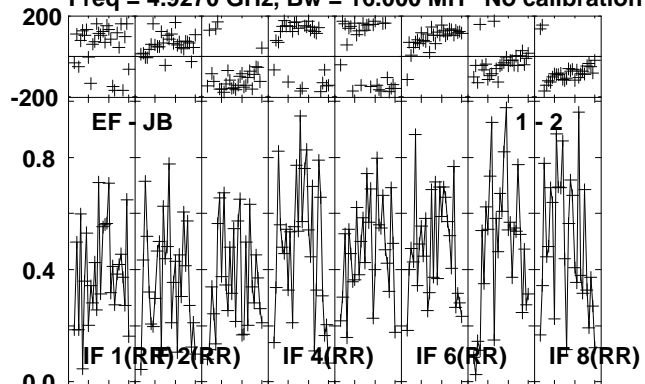

Lower frame: Milli Ampl Jy Top frame: Phas deg
Vector averaged cross-power spectrum Several baselines displayed
Timerange: 00/06:26:03 to 00/06:27:03

Plot file version 316 created 16-OCT-2012 11:58:05

J0639+0601 RO006.UVDATA.1

Freq = 4.9270 GHz, Bw = 16.000 MH No calibration applied and no bandpass applied

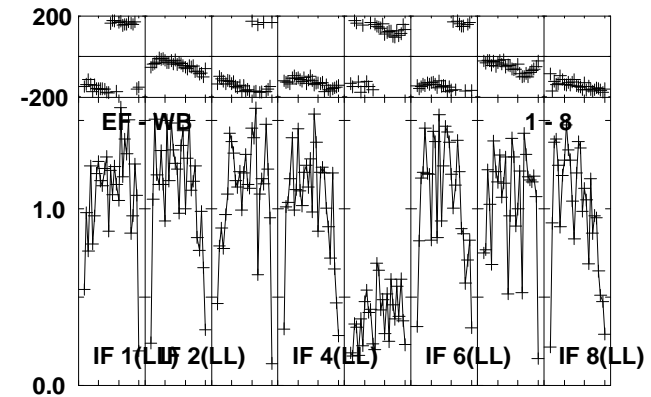
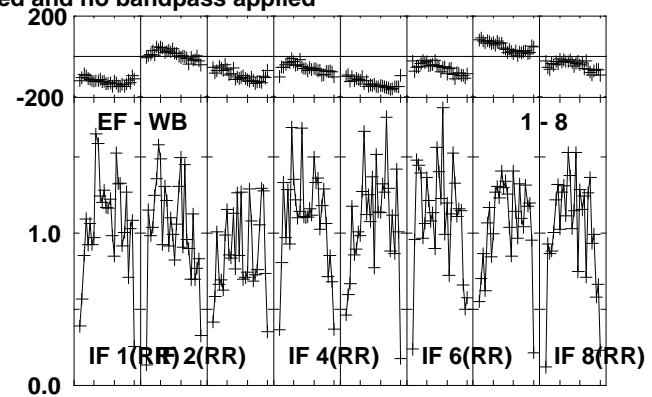
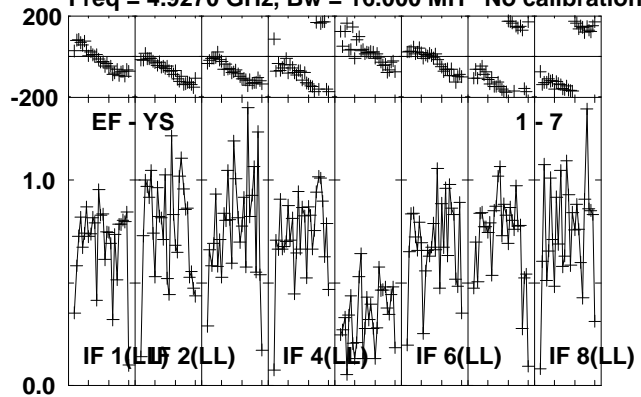

Lower frame: Milli Ampl Jy Top frame: Phas deg
Vector averaged cross-power spectrum Several baselines displayed
Timerange: 00/06:26:03 to 00/06:27:03

Plot file version 317 created 16-OCT-2012 11:58:05

J0645+0541 RO006.UVDATA.1

Freq = 4.9270 GHz, Bw = 16.000 MH No calibration applied and no bandpass applied

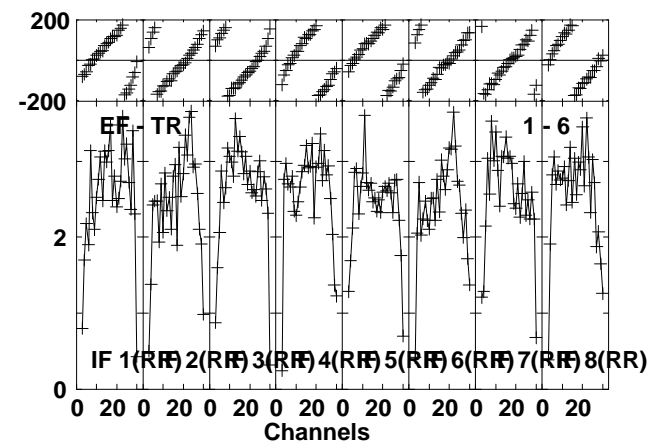
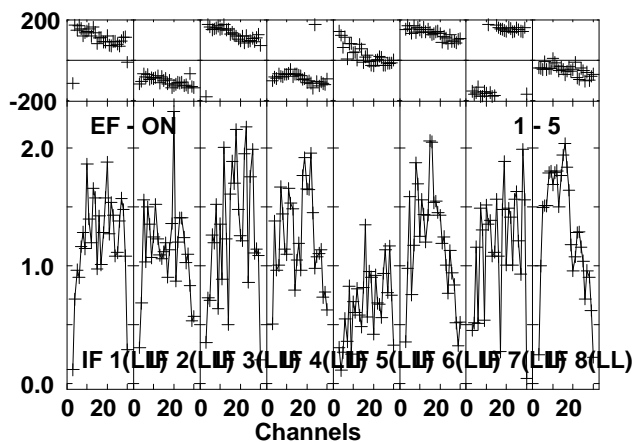
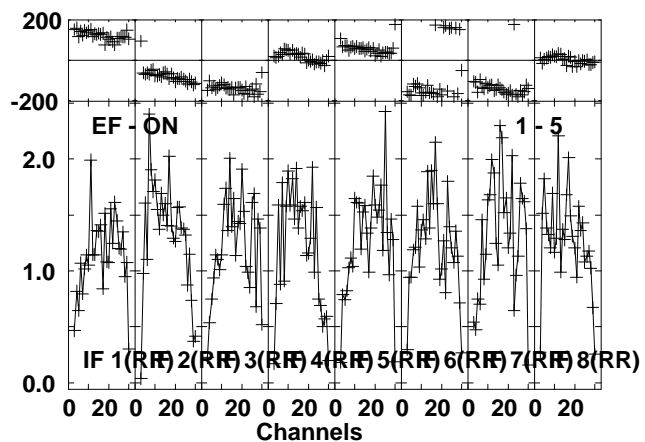
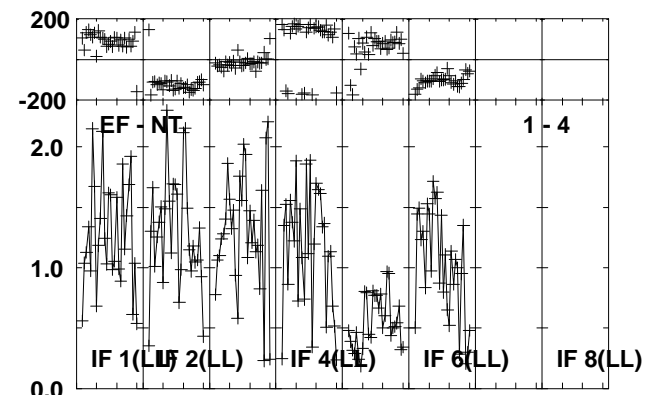
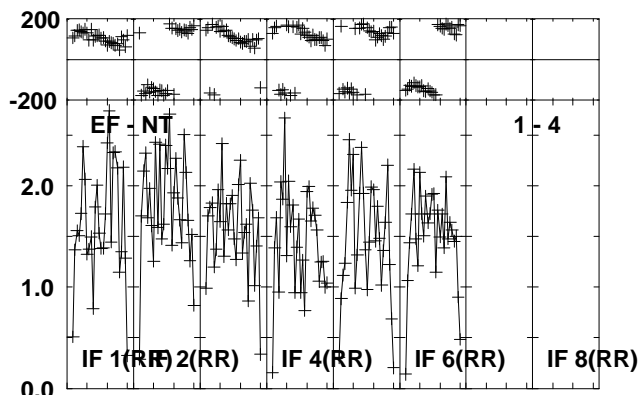
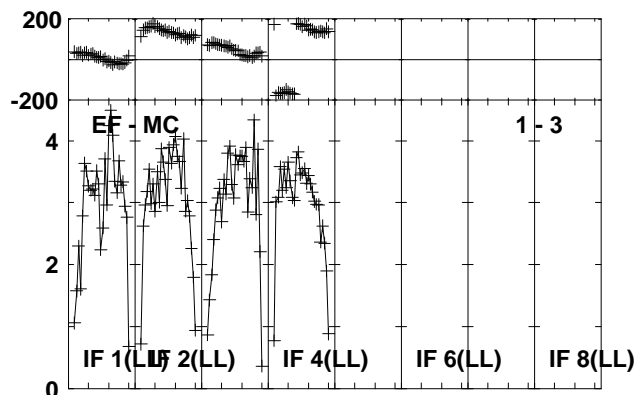
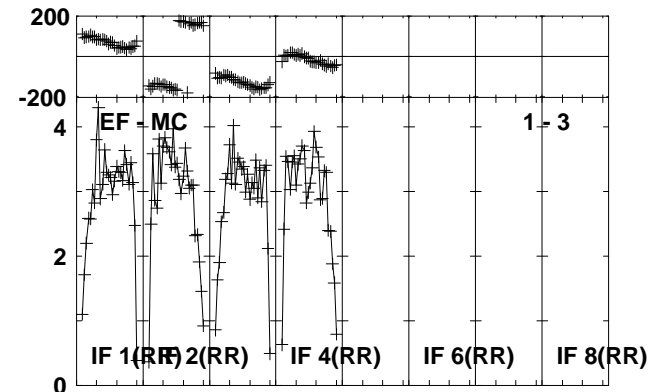
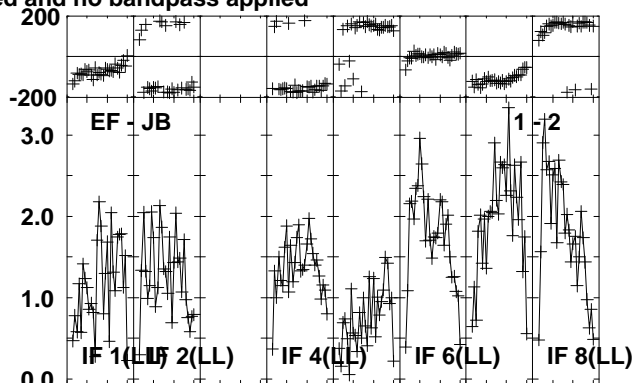
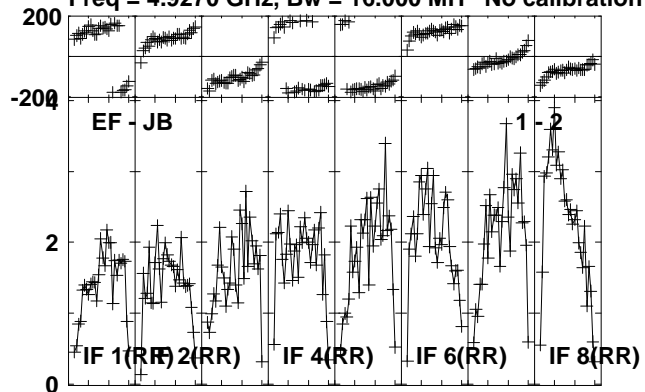

Lower frame: Milli Ampl Jy Top frame: Phas deg
Vector averaged cross-power spectrum Several baselines displayed
Timerange: 00/06:27:07 to 00/06:28:03

Plot file version 318 created 16-OCT-2012 11:58:05

J0645+0541 RO006.UVDATA.1

Freq = 4.9270 GHz, Bw = 16.000 MH No calibration applied and no bandpass applied

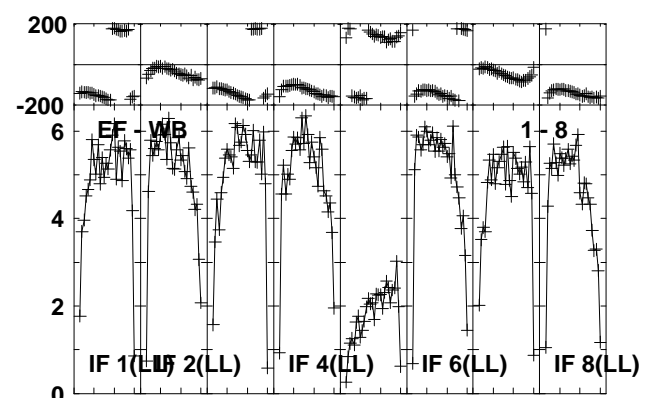
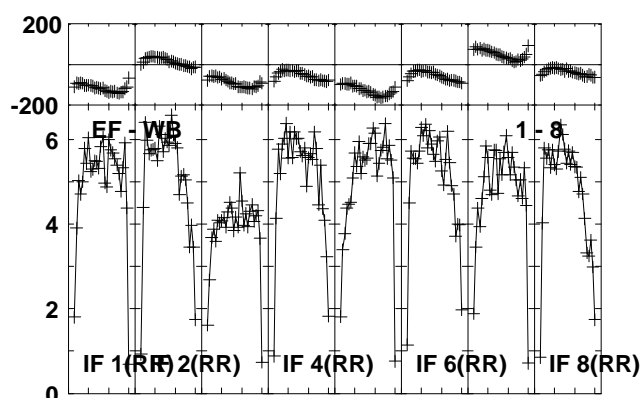
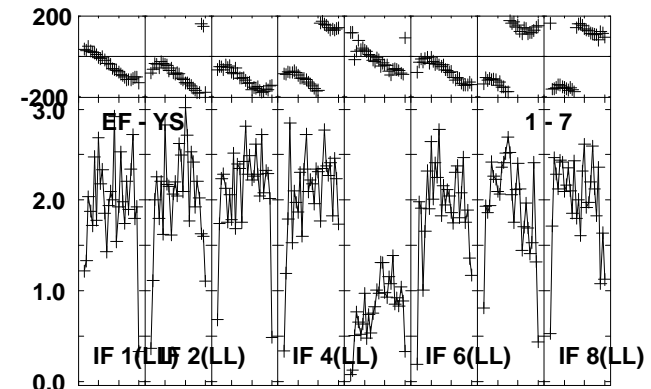
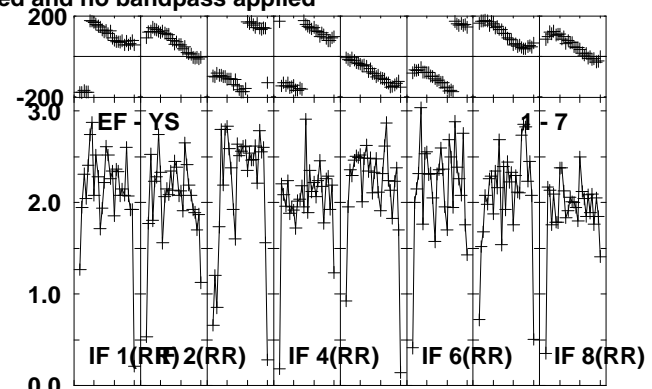
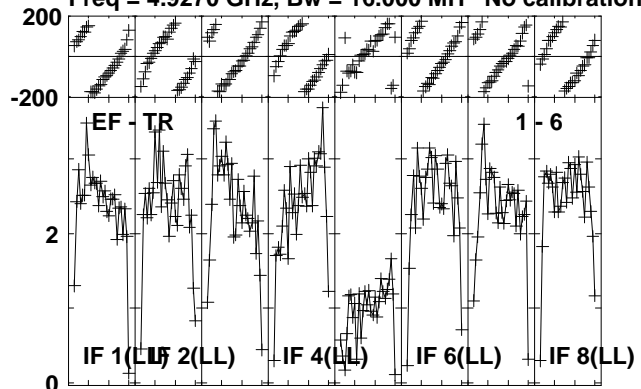

Lower frame: Milli Ampl Jy Top frame: Phas deg
Vector averaged cross-power spectrum Several baselines displayed
Timerange: 00/06:27:07 to 00/06:28:03

Plot file version 319 created 16-OCT-2012 11:58:05

NOVA-MON RO006.UVDATA.1

Freq = 4.9270 GHz, Bw = 16.000 MH No calibration applied and no bandpass applied

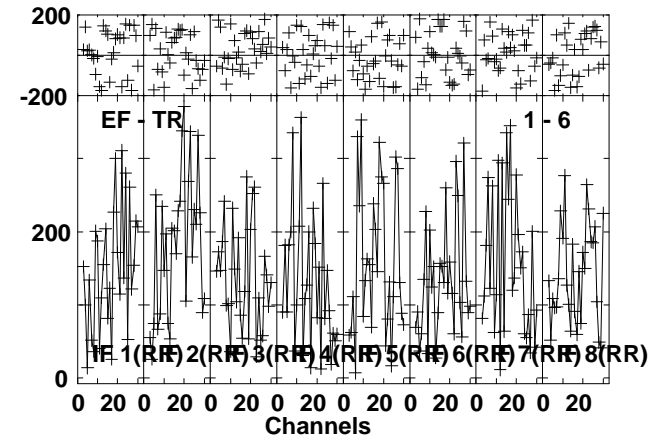
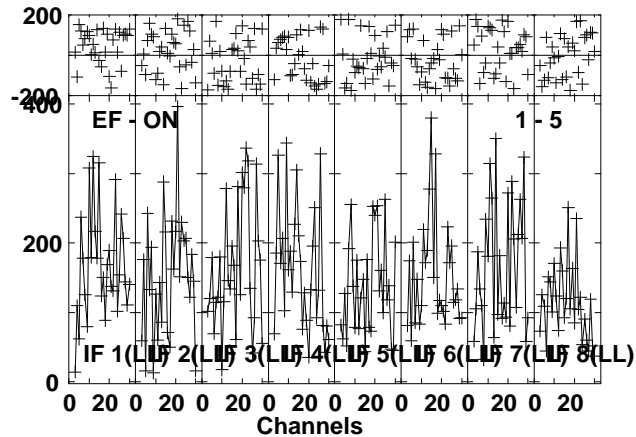
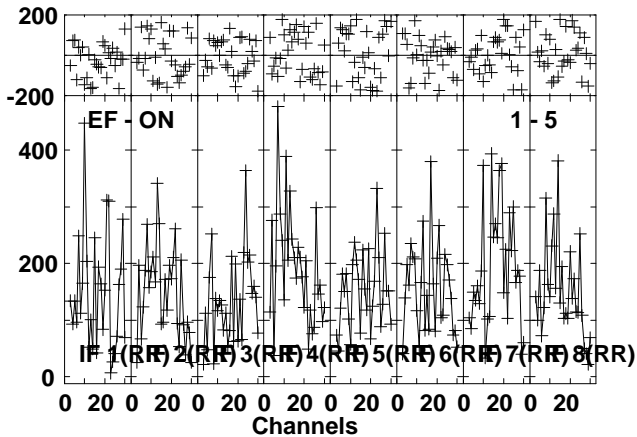
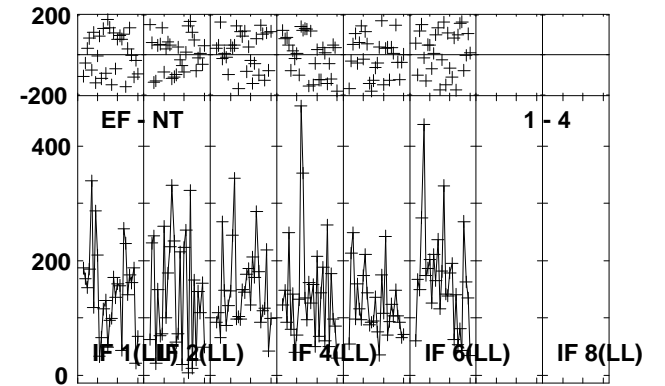
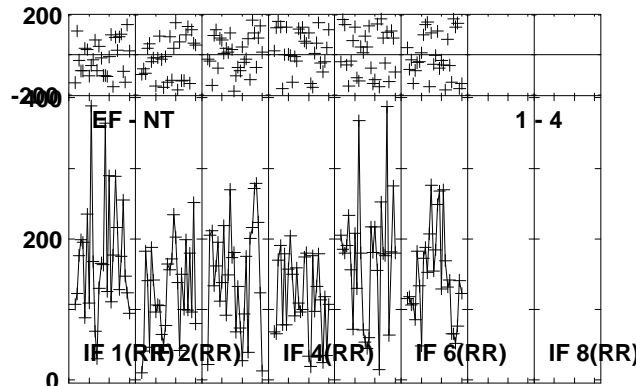
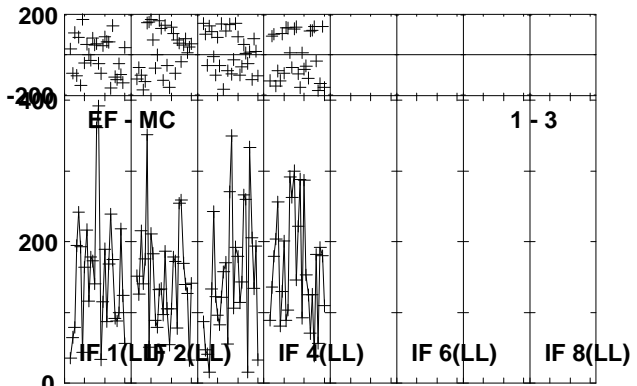
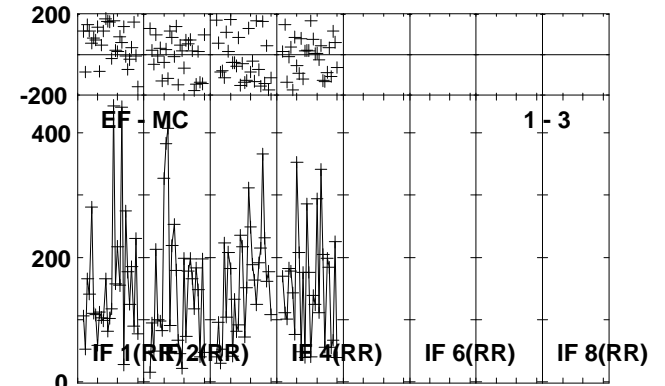
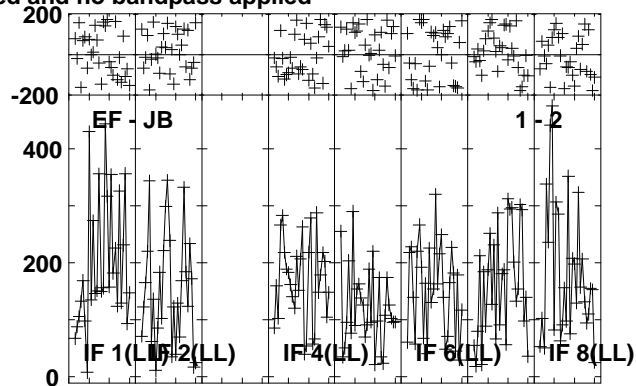
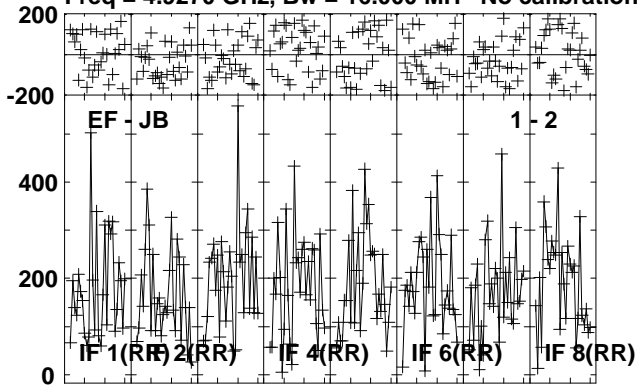

Lower frame: Micro Ampl Jy Top frame: Phas deg
Vector averaged cross-power spectrum Several baselines displayed
Timerange: 00/06:28:07 to 00/06:31:03

Plot file version 320 created 16-OCT-2012 11:58:06

NOVA-MON RO006.UVDATA.1

Freq = 4.9270 GHz, Bw = 16.000 MH No calibration applied and no bandpass applied

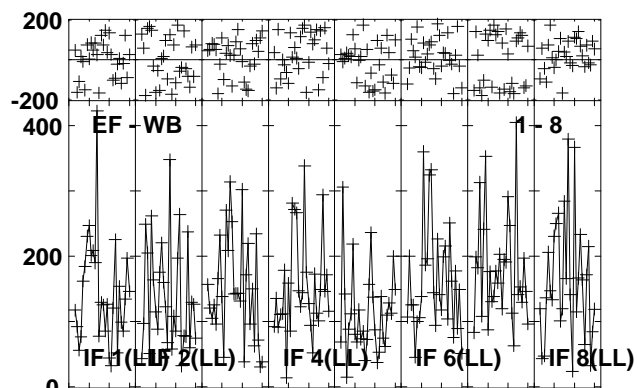
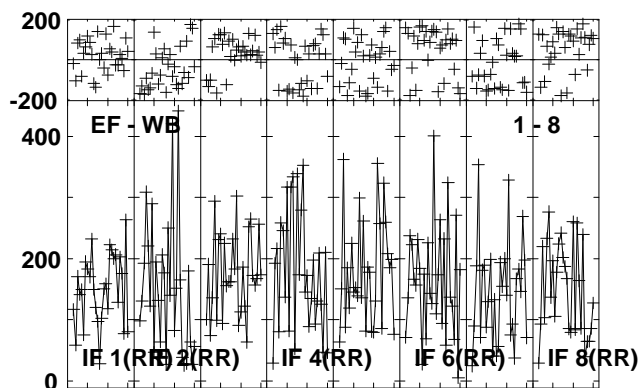
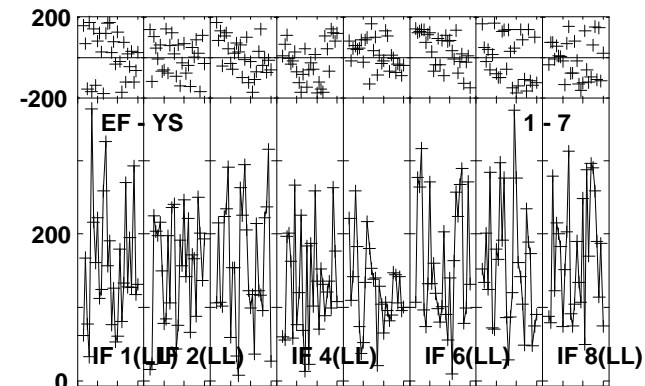
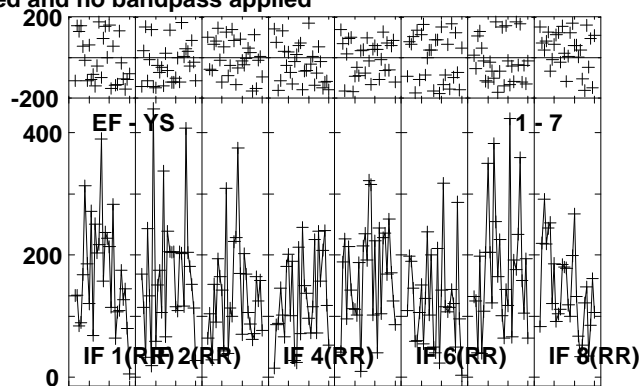
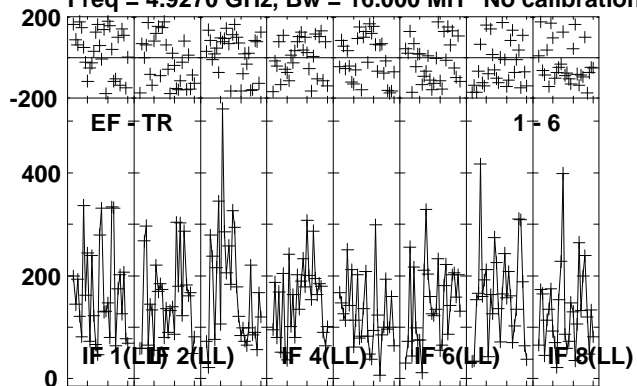

Lower frame: Micro Ampl Jy Top frame: Phas deg
Vector averaged cross-power spectrum Several baselines displayed
Timerange: 00/06:28:07 to 00/06:31:03

Plot file version 321 created 16-OCT-2012 11:58:06

J0639+0601 RO006.UVDATA.1

Freq = 4.9270 GHz, Bw = 16.000 MH No calibration applied and no bandpass applied

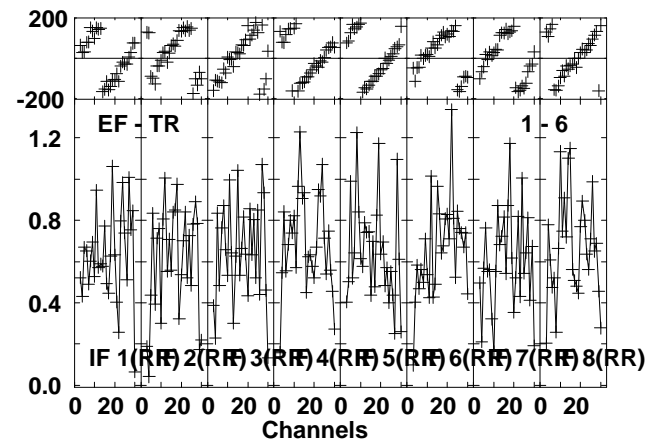
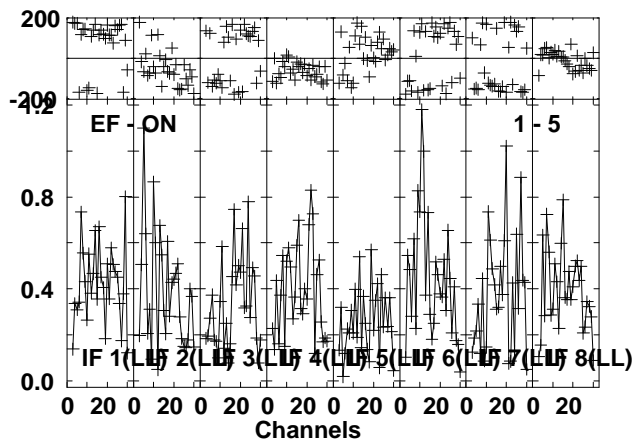
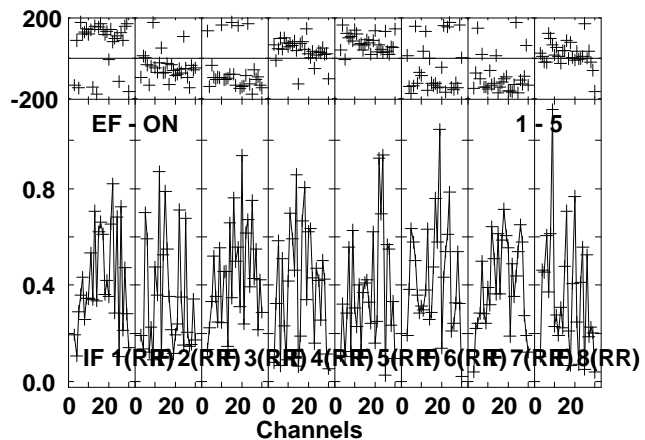
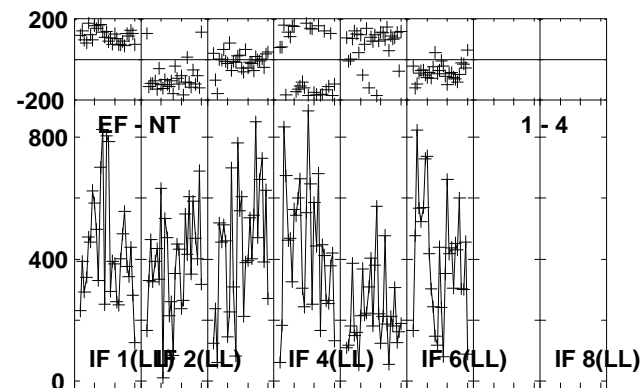
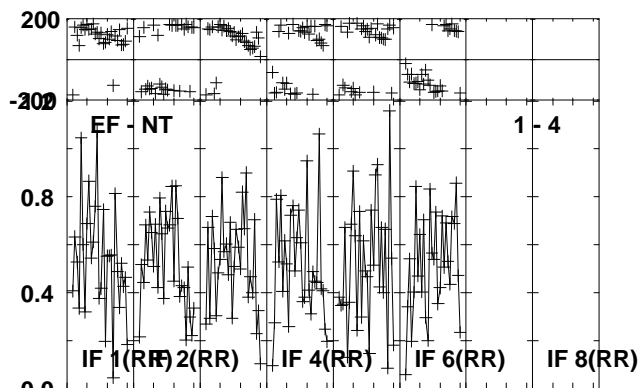
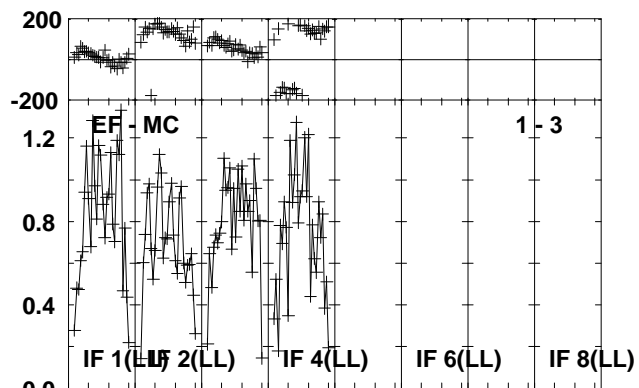
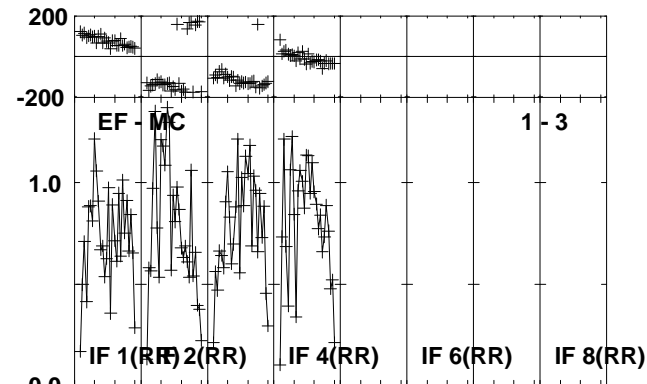
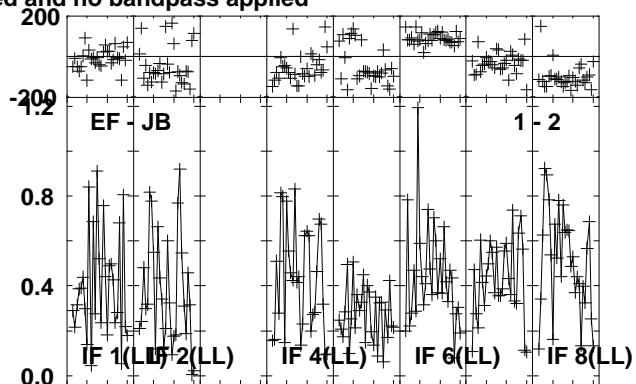
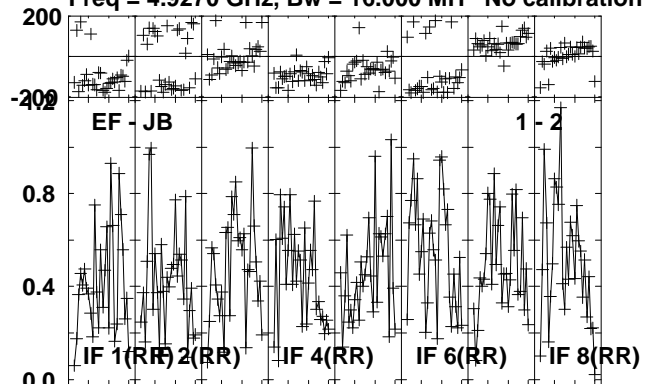

Lower frame: Milli Ampl Jy Top frame: Phas deg
Vector averaged cross-power spectrum Several baselines displayed
Timerange: 00/06:31:07 to 00/06:32:19

Plot file version 322 created 16-OCT-2012 11:58:06

J0639+0601 RO006.UVDATA.1

Freq = 4.9270 GHz, Bw = 16.000 MH No calibration applied and no bandpass applied

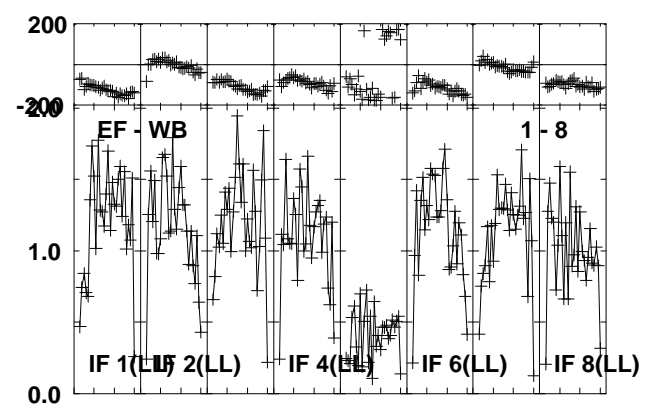
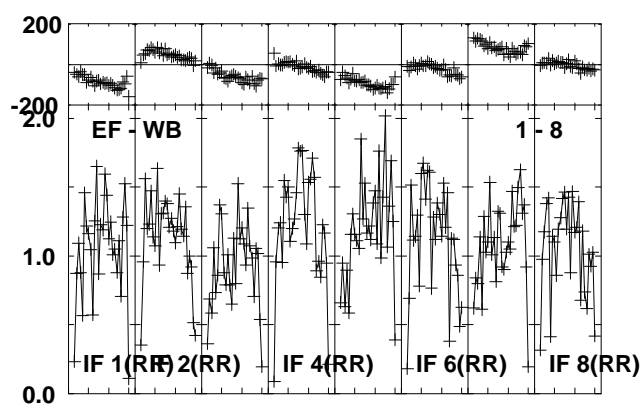
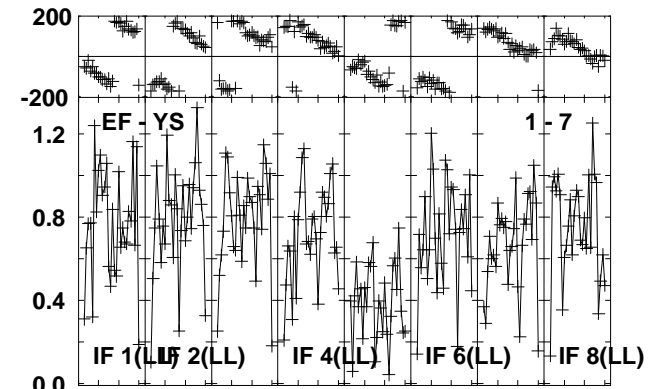
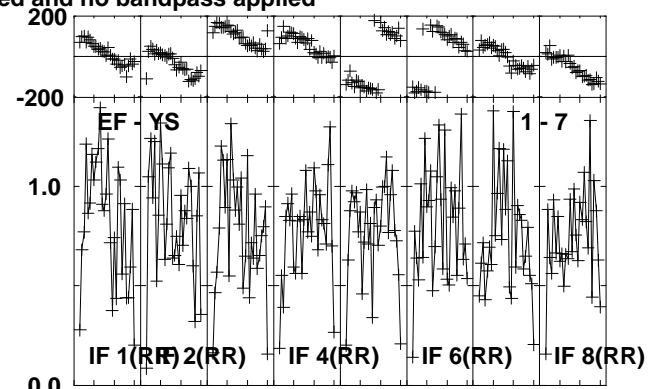
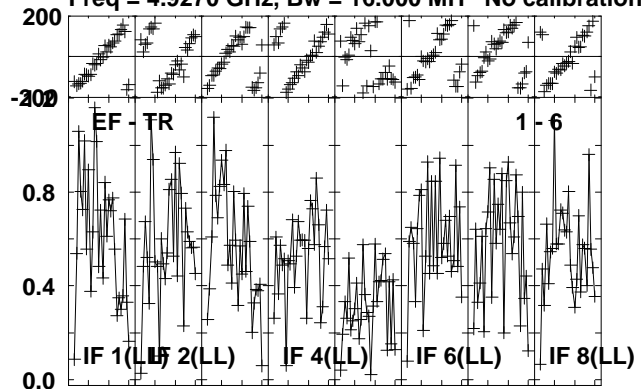

Lower frame: Milli Ampl Jy Top frame: Phas deg
Vector averaged cross-power spectrum Several baselines displayed
Timerange: 00/06:31:07 to 00/06:32:19

Plot file version 323 created 16-OCT-2012 11:58:07

J0645+0541 RO006.UVDATA.1

Freq = 4.9270 GHz, Bw = 16.000 MH No calibration applied and no bandpass applied

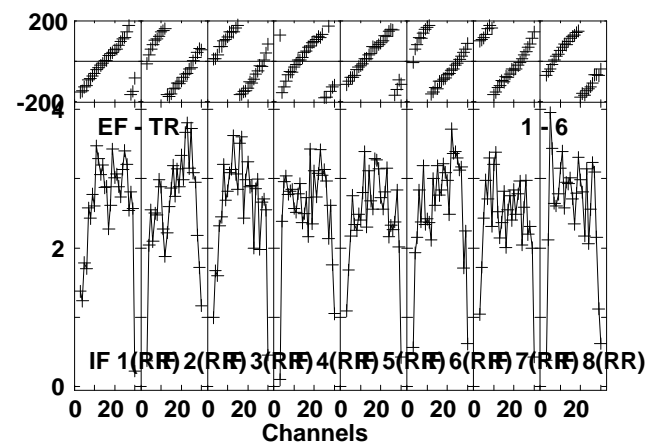
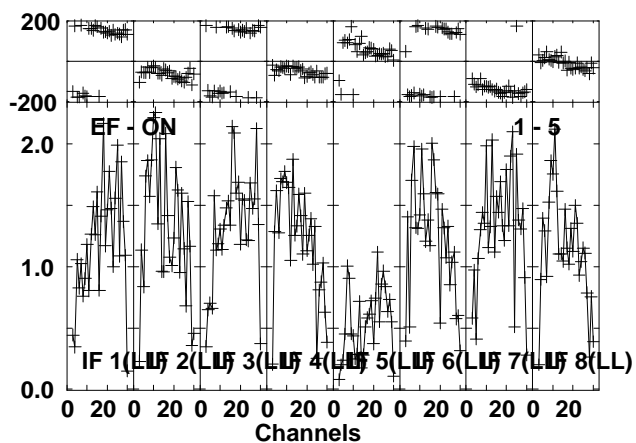
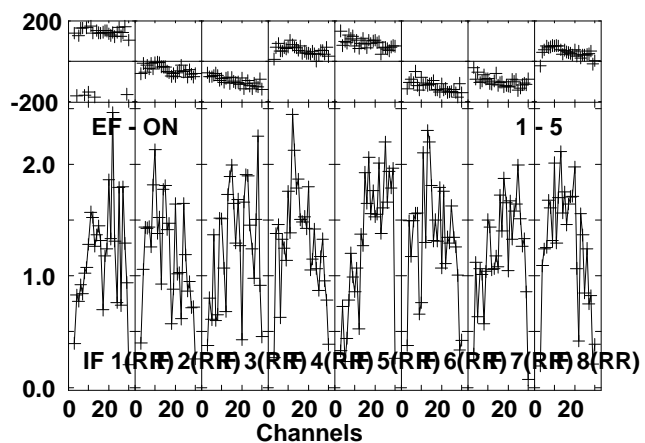
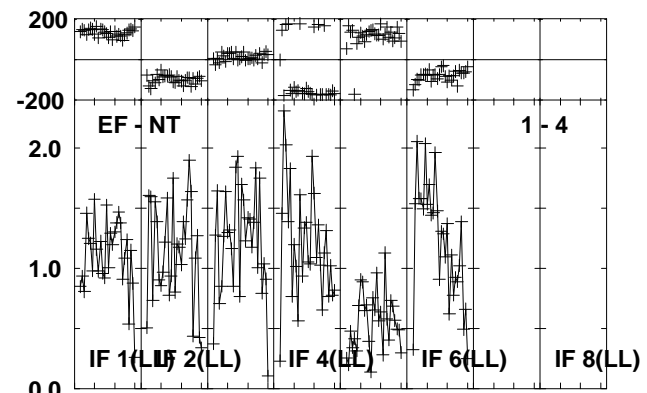
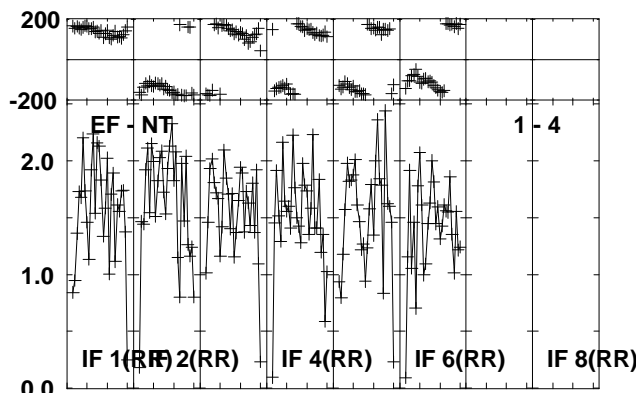
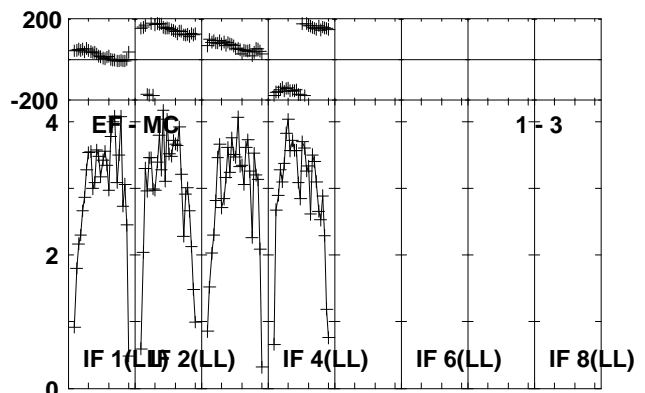
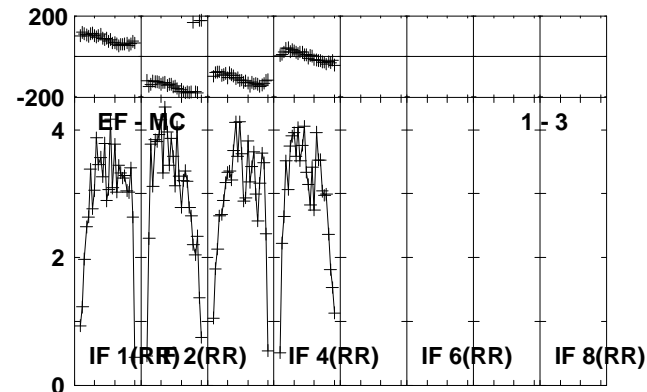
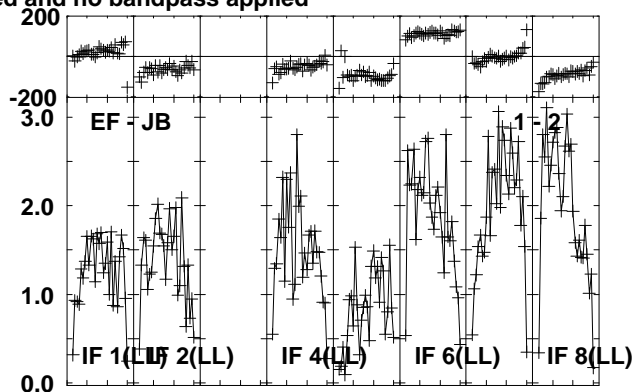
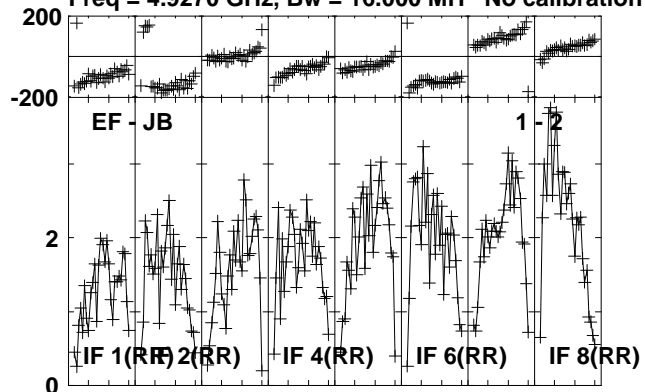

Lower frame: Milli Ampl Jy Top frame: Phas deg
Vector averaged cross-power spectrum Several baselines displayed
Timerange: 00/06:32:23 to 00/06:33:19

Plot file version 324 created 16-OCT-2012 11:58:07

J0645+0541 RO006.UVDATA.1

Freq = 4.9270 GHz, Bw = 16.000 MH No calibration applied and no bandpass applied

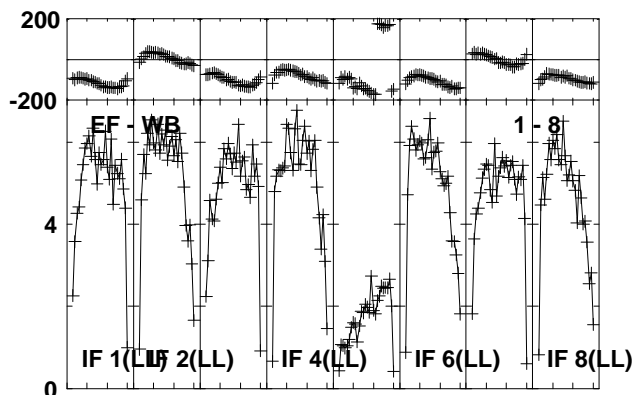
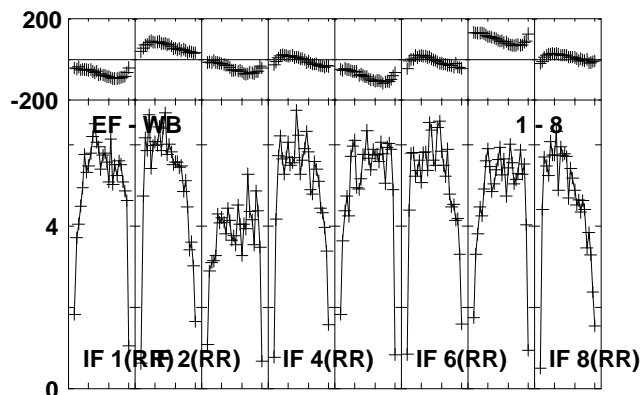
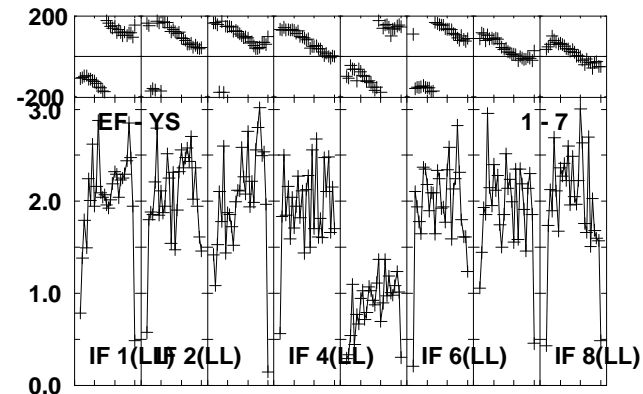
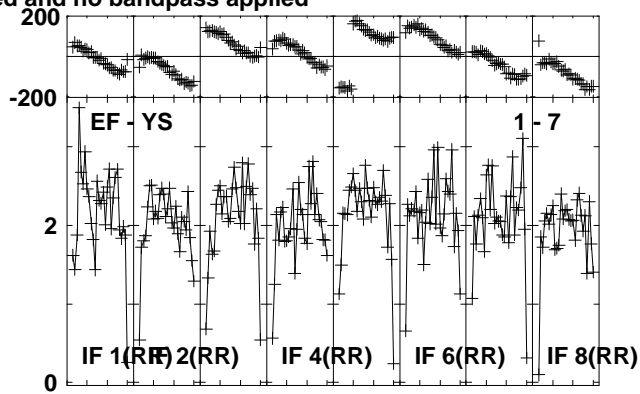
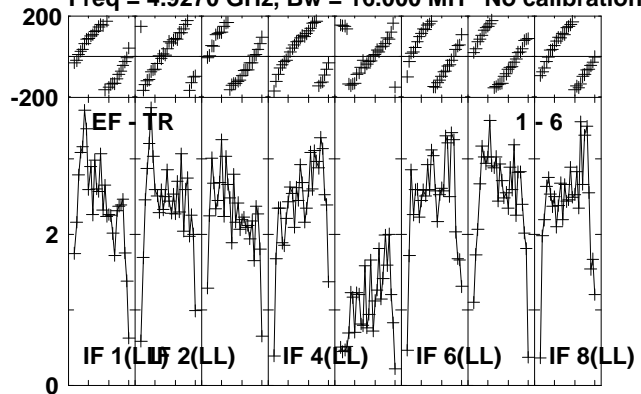

Lower frame: Milli Ampl Jy Top frame: Phas deg
Vector averaged cross-power spectrum Several baselines displayed
Timerange: 00/06:32:23 to 00/06:33:19

Plot file version 325 created 16-OCT-2012 11:58:07

NOVA-MON RO006.UVDATA.1

Freq = 4.9270 GHz, Bw = 16.000 MH No calibration applied and no bandpass applied

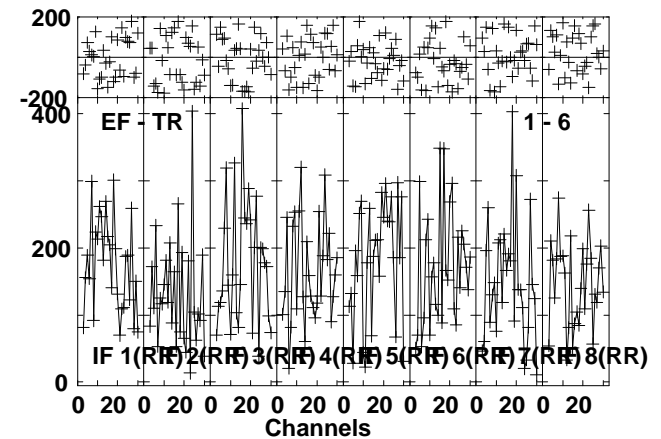
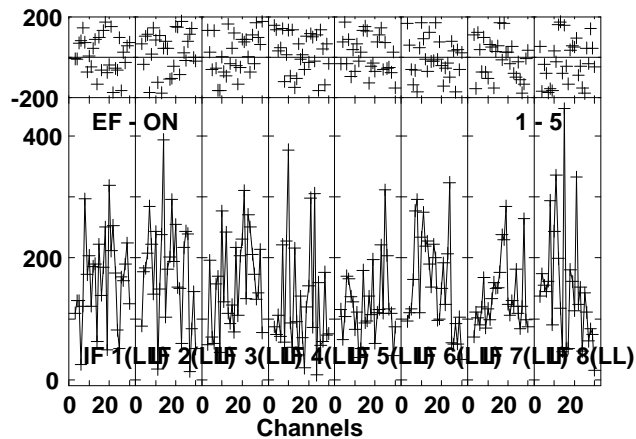
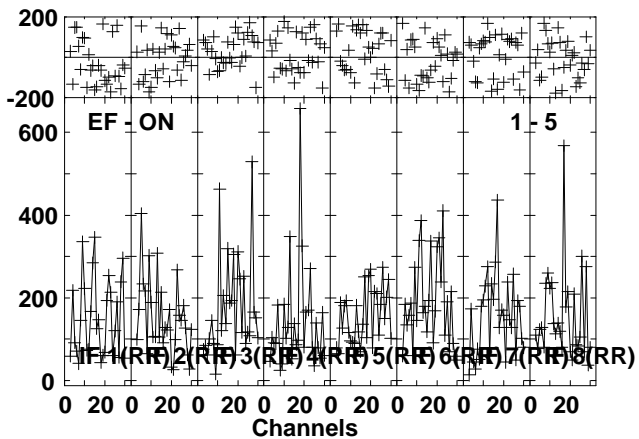
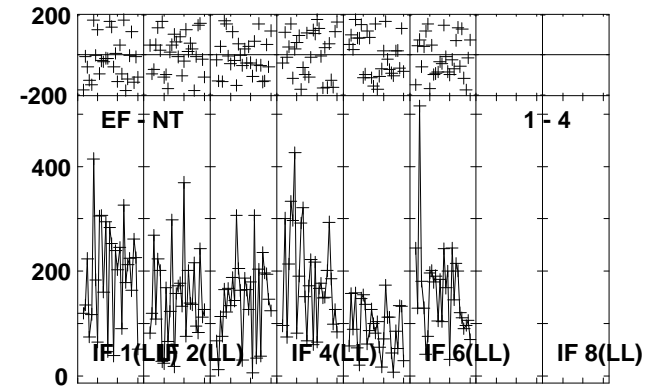
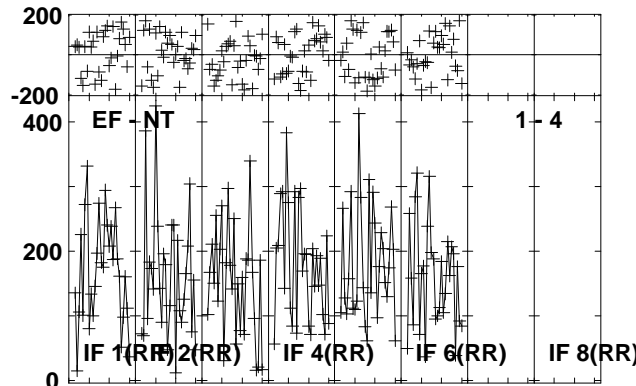
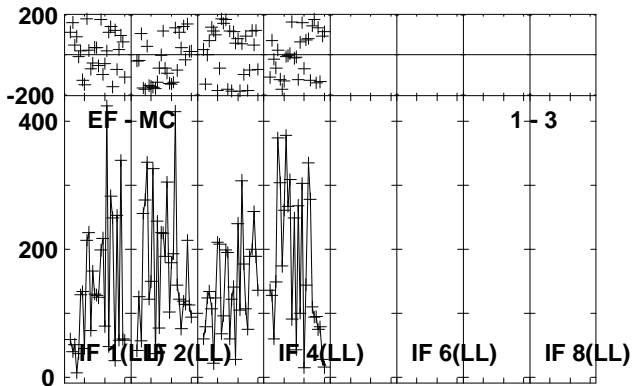
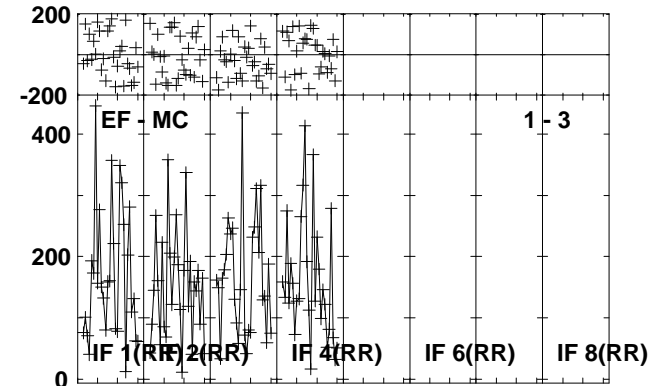
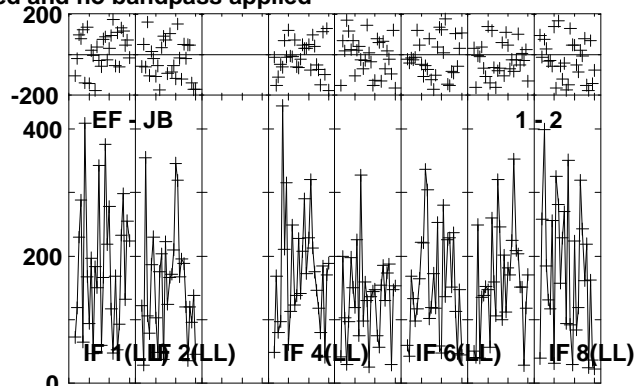
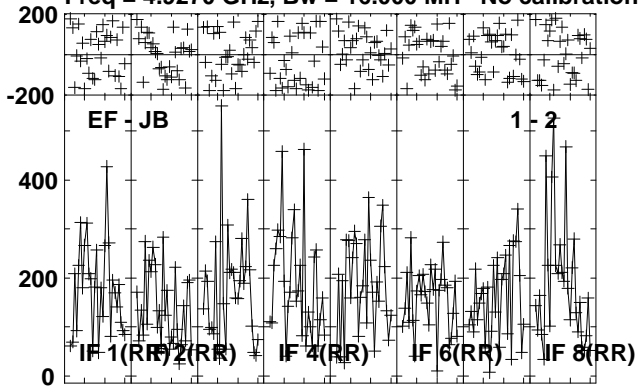

Lower frame: Micro Ampl Jy Top frame: Phas deg
Vector averaged cross-power spectrum Several baselines displayed
Timerange: 00/06:33:23 to 00/06:36:19

Plot file version 326 created 16-OCT-2012 11:58:08

NOVA-MON RO006.UVDATA.1

Freq = 4.9270 GHz, Bw = 16.000 MH No calibration applied and no bandpass applied

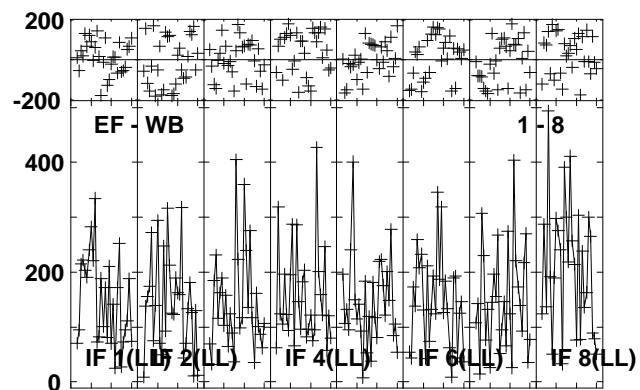
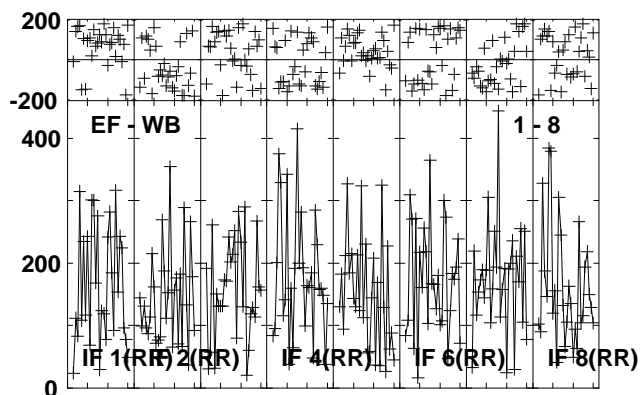
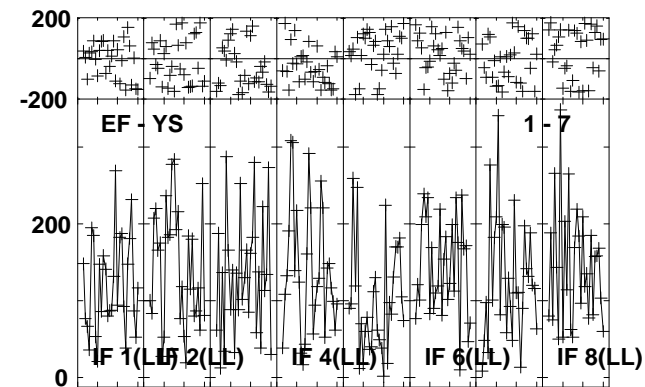
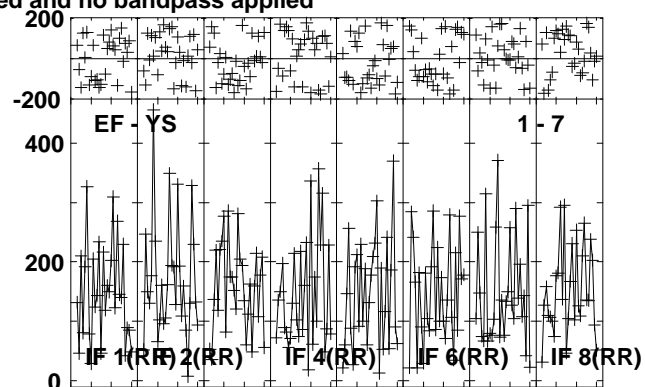
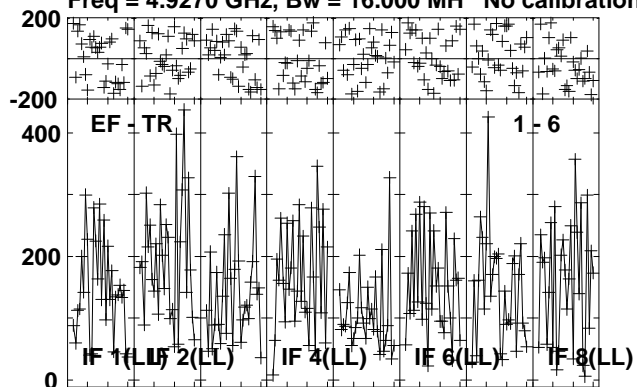

Lower frame: Micro Ampl Jy Top frame: Phas deg
Vector averaged cross-power spectrum Several baselines displayed
Timerange: 00/06:33:23 to 00/06:36:19

Plot file version 327 created 16-OCT-2012 11:58:08

J0639+0601 RO006.UVDATA.1

Freq = 4.9270 GHz, Bw = 16.000 MH No calibration applied and no bandpass applied

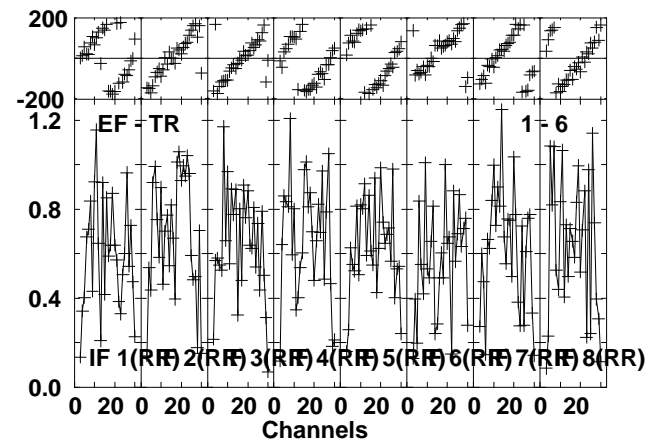
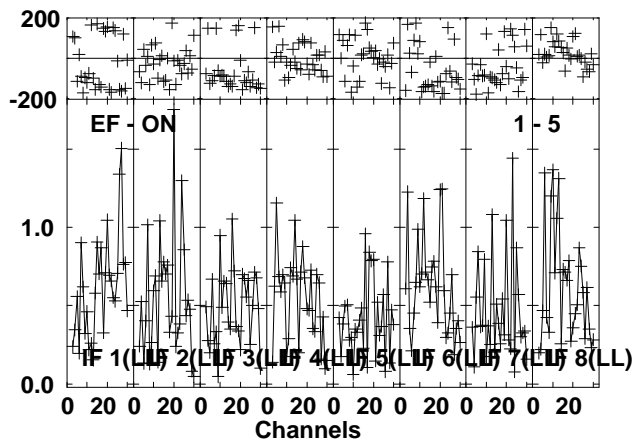
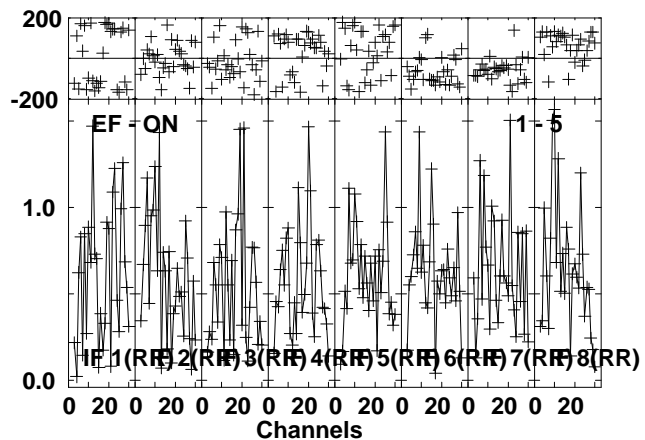
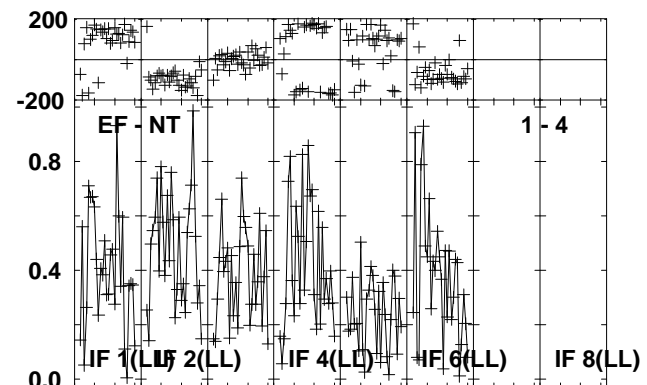
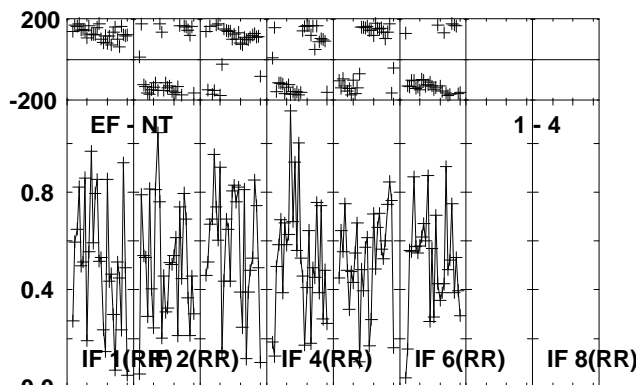
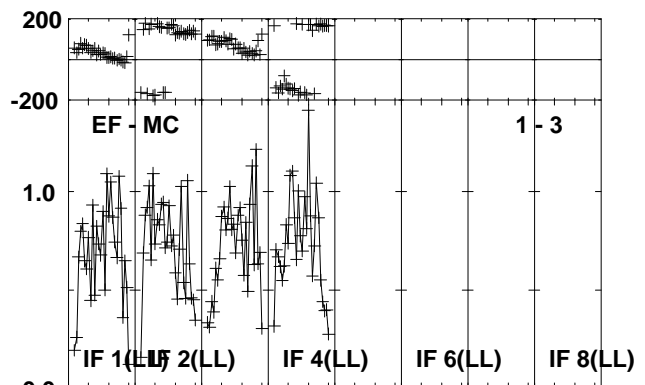
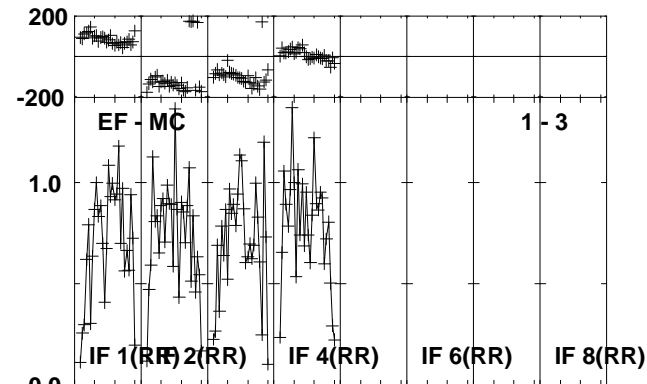
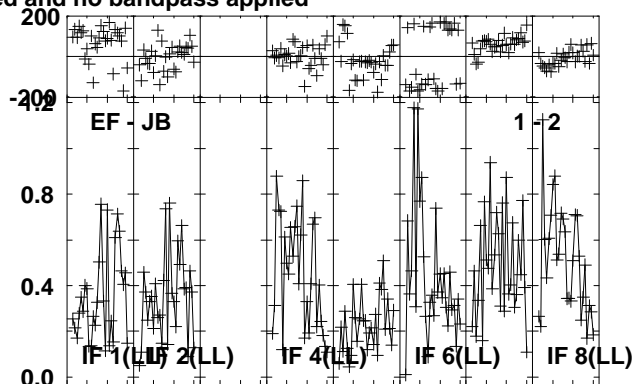
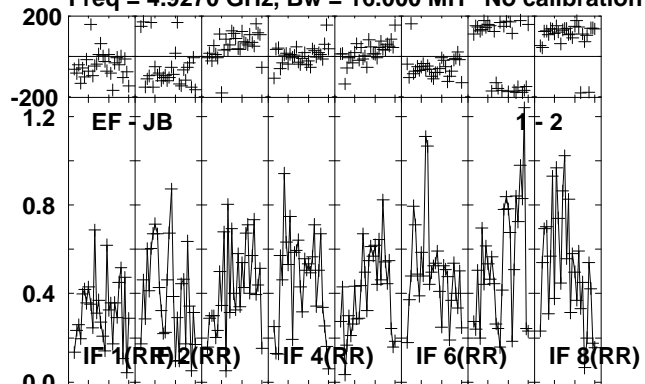

Lower frame: Milli Ampl Jy Top frame: Phas deg
Vector averaged cross-power spectrum Several baselines displayed
Timerange: 00/06:36:47 to 00/06:37:49

Plot file version 328 created 16-OCT-2012 11:58:08

J0639+0601 RO006.UVDATA.1

Freq = 4.9270 GHz, Bw = 16.000 MH No calibration applied and no bandpass applied

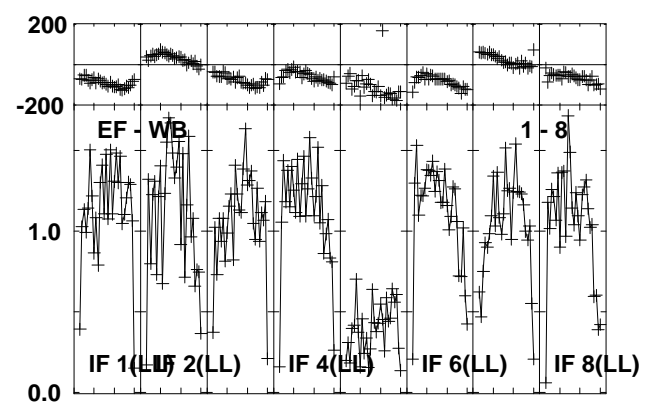
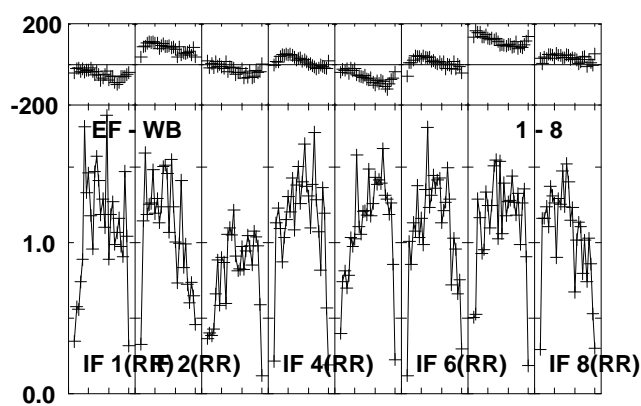
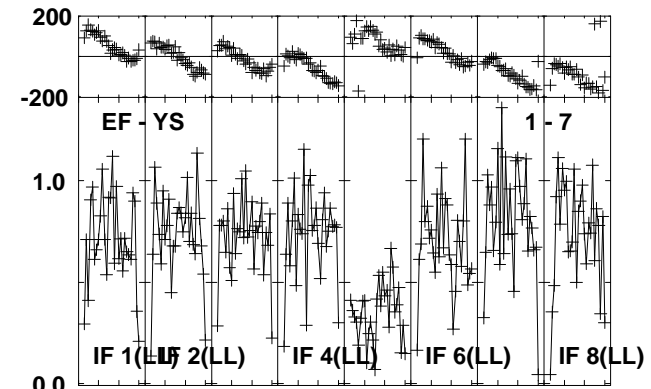
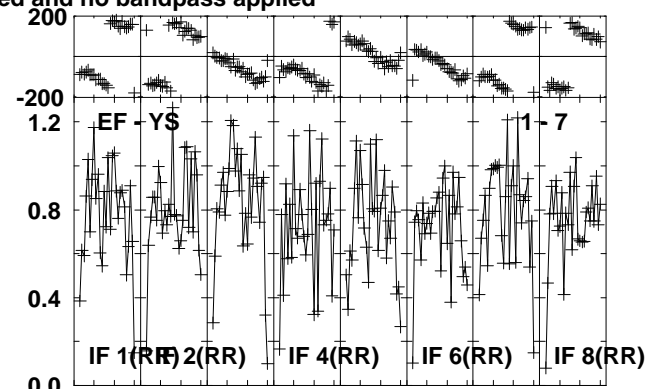
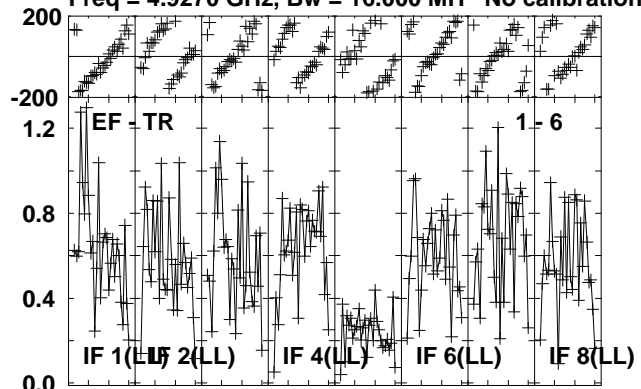

Lower frame: Milli Ampl Jy Top frame: Phas deg
Vector averaged cross-power spectrum Several baselines displayed
Timerange: 00/06:36:47 to 00/06:37:49

Plot file version 329 created 16-OCT-2012 11:58:09

J0645+0541 RO006.UVDATA.1

Freq = 4.9270 GHz, Bw = 16.000 MH No calibration applied and no bandpass applied

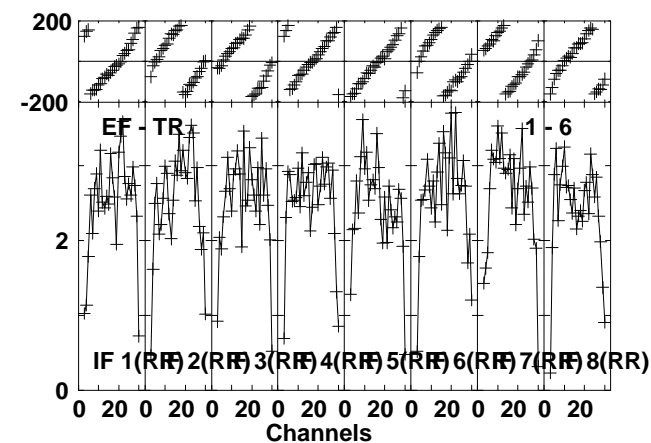
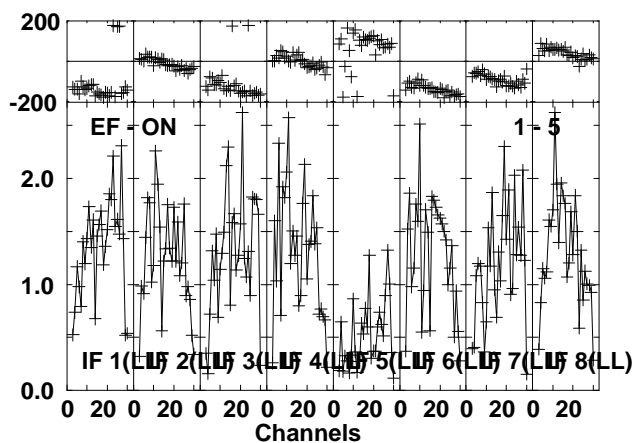
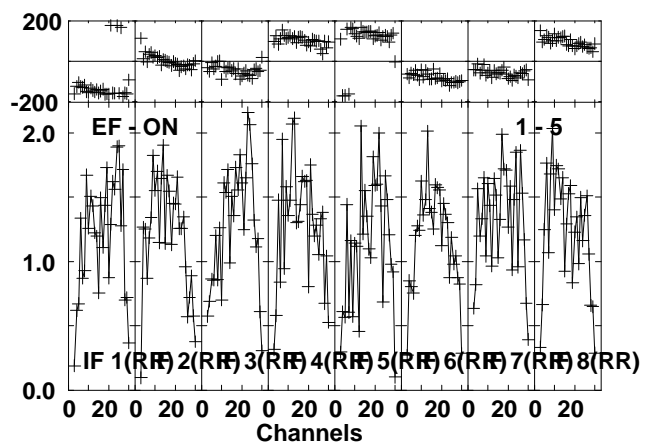
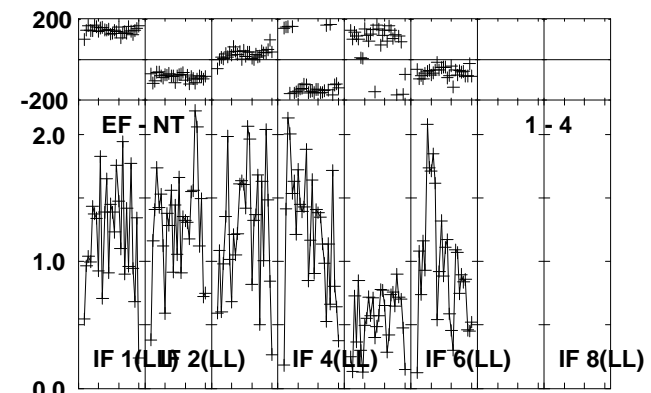
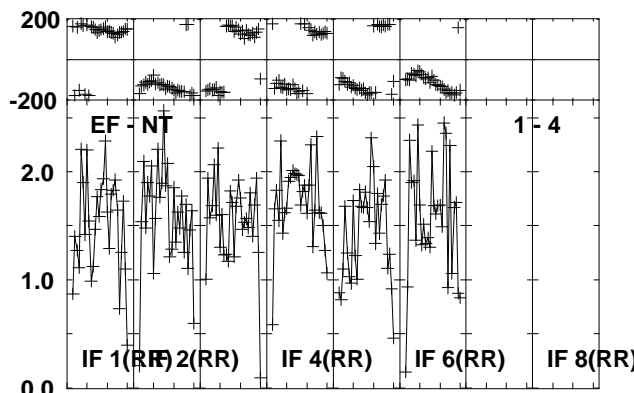
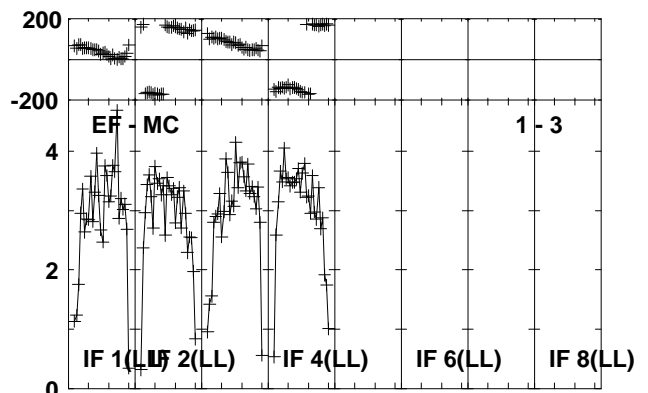
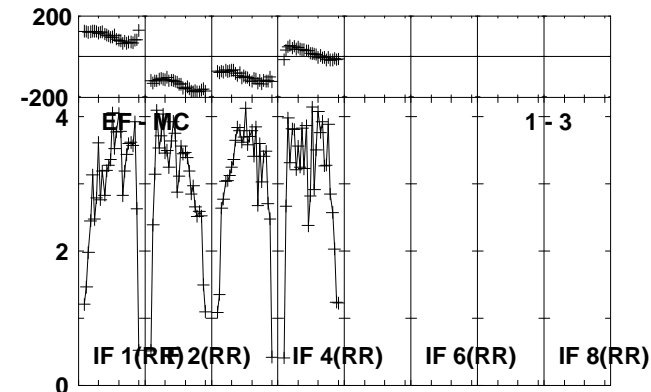
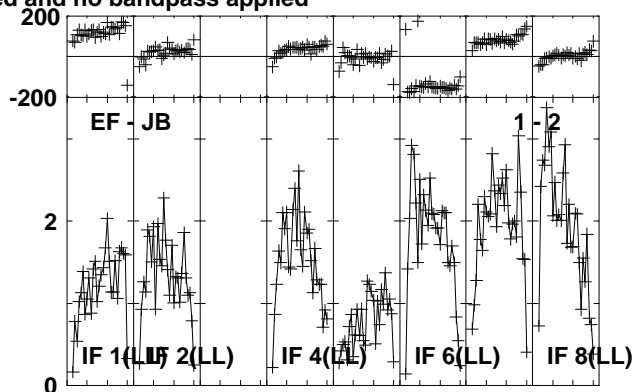
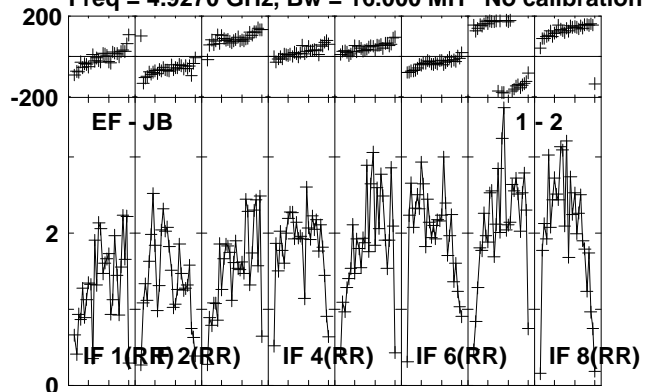

Lower frame: Milli Ampl Jy Top frame: Phas deg
Vector averaged cross-power spectrum Several baselines displayed
Timerange: 00/06:37:53 to 00/06:38:49

Plot file version 330 created 16-OCT-2012 11:58:09

J0645+0541 RO006.UVDATA.1

Freq = 4.9270 GHz, Bw = 16.000 MH No calibration applied and no bandpass applied

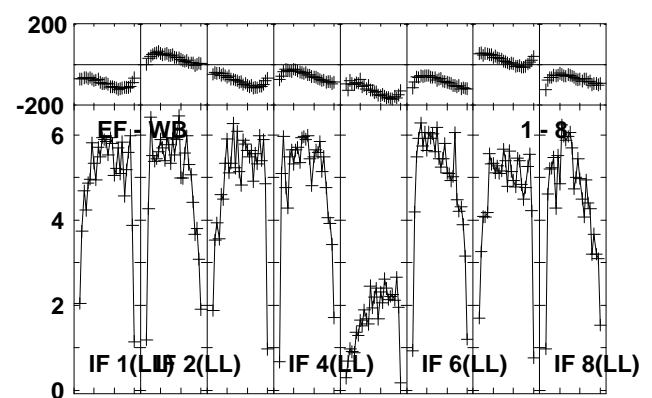
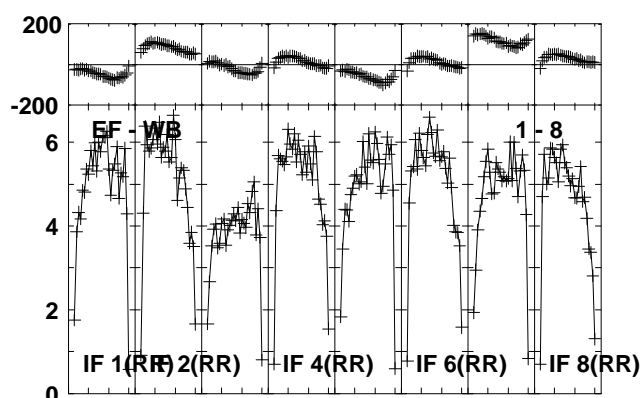
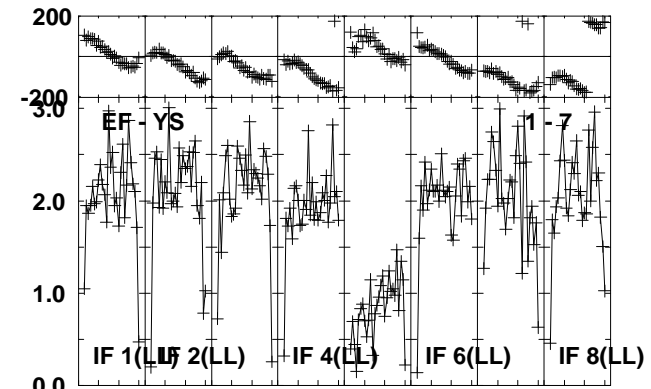
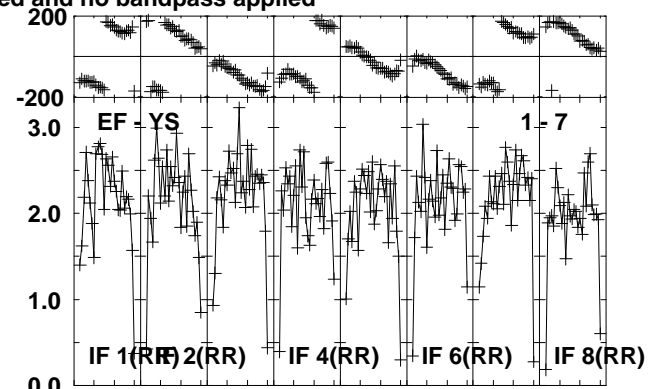
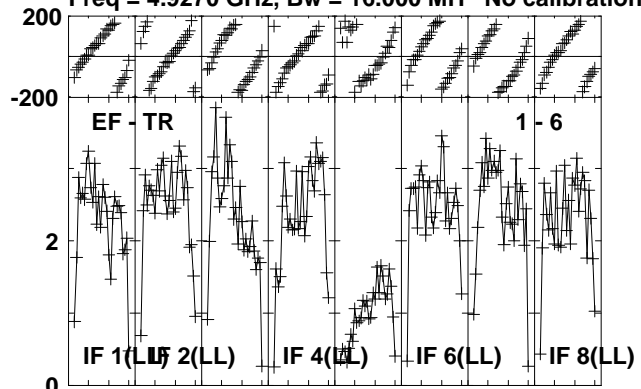

Lower frame: Milli Ampl Jy Top frame: Phas deg
Vector averaged cross-power spectrum Several baselines displayed
Timerange: 00/06:37:53 to 00/06:38:49

Plot file version 332 created 16-OCT-2012 11:58:09

NOVA-MON RO006.UVDATA.1

Freq = 4.9270 GHz, Bw = 16.000 MH No calibration applied and no bandpass applied

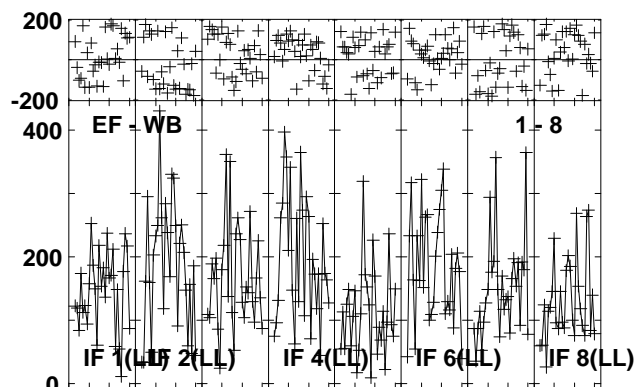
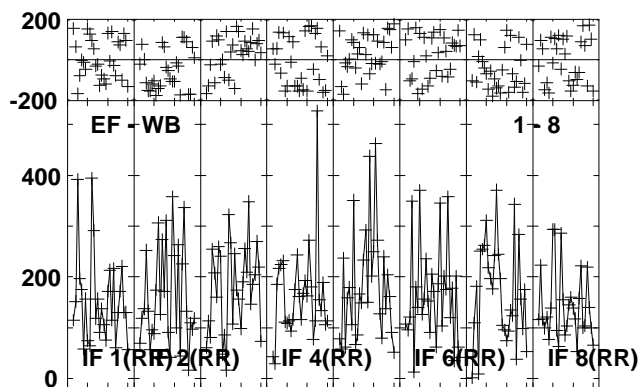
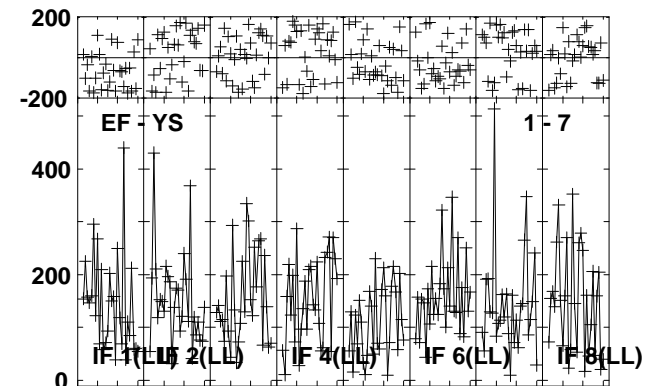
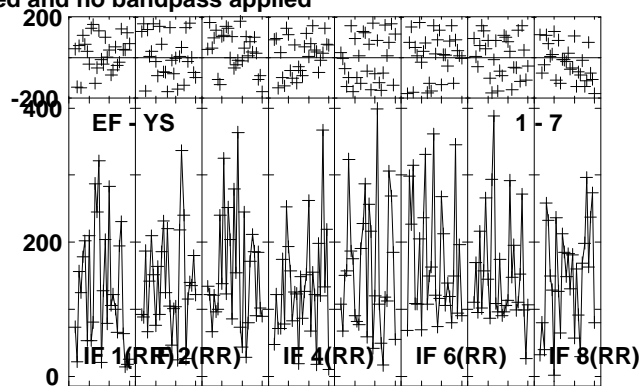
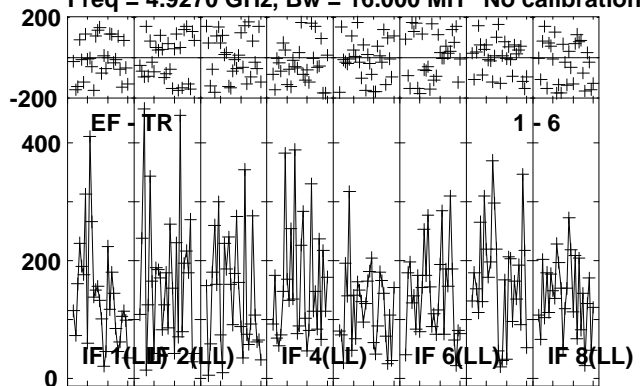

Lower frame: Micro Ampl Jy Top frame: Phas deg
Vector averaged cross-power spectrum Several baselines displayed
Timerange: 00/06:38:53 to 00/06:41:49

Plot file version 333 created 16-OCT-2012 11:58:10

J0639+0601 RO006.UVDATA.1

Freq = 4.9270 GHz, Bw = 16.000 MH No calibration applied and no bandpass applied

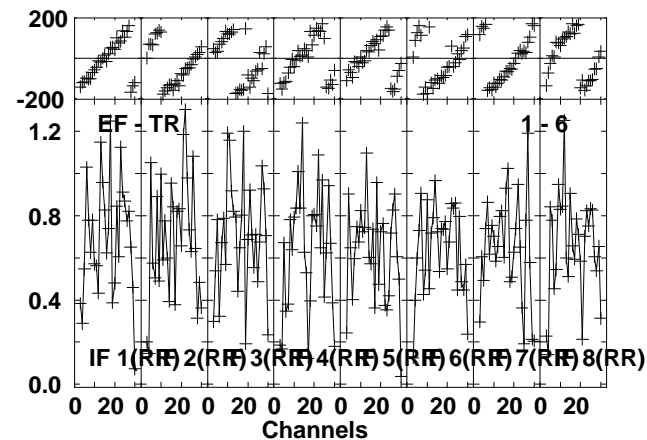
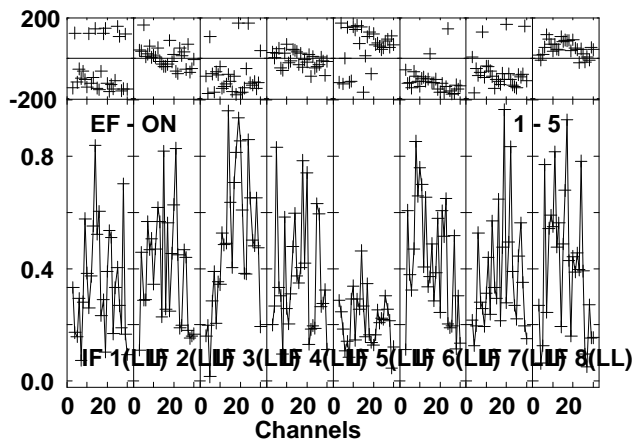
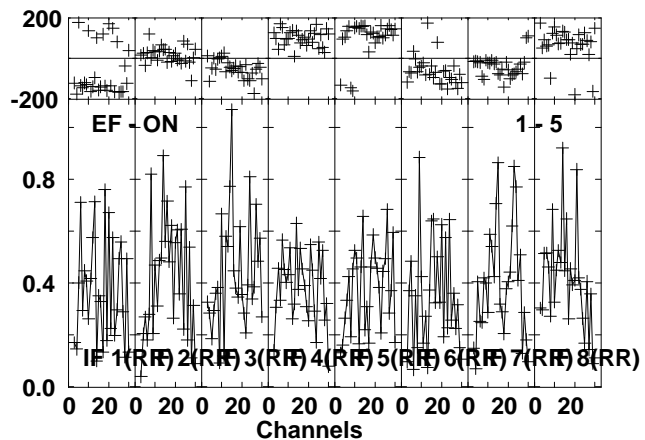
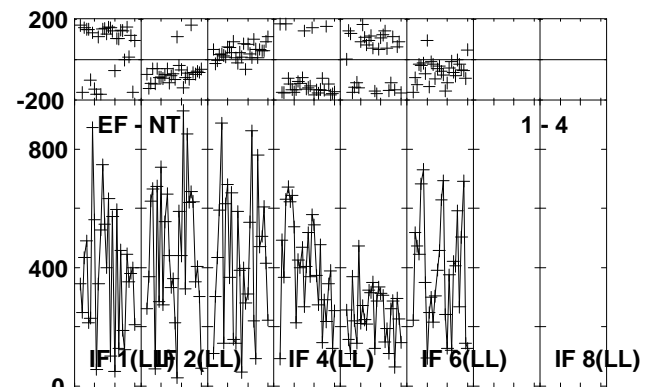
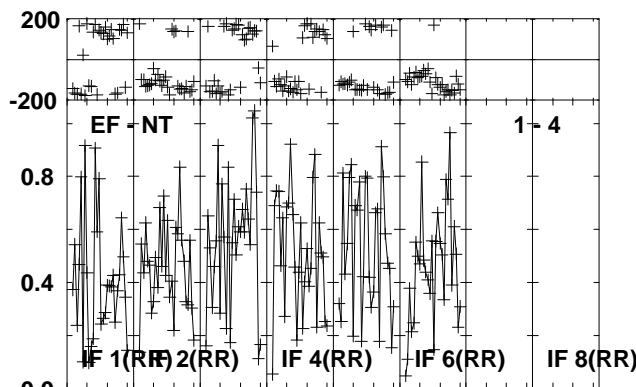
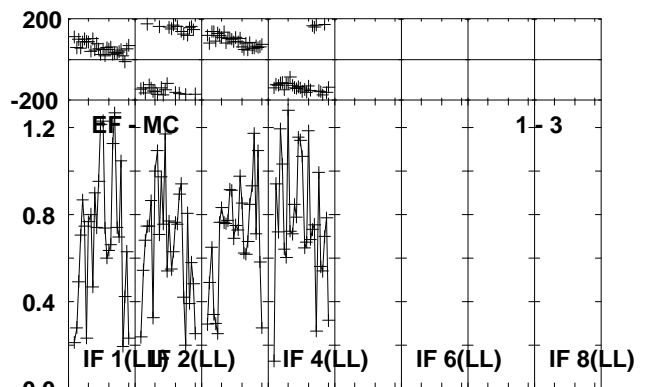
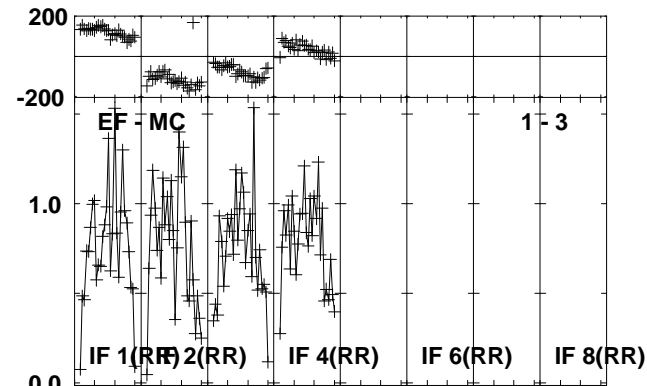
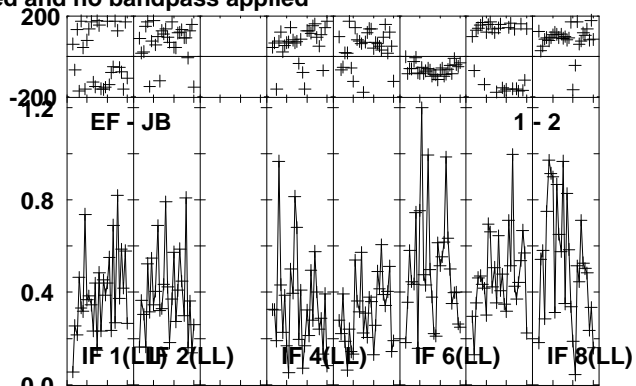
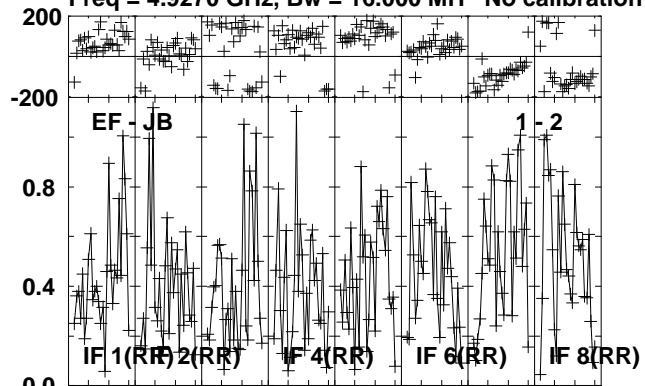

Lower frame: Milli Ampl Jy Top frame: Phas deg
Vector averaged cross-power spectrum Several baselines displayed
Timerange: 00/06:41:53 to 00/06:43:03

Plot file version 334 created 16-OCT-2012 11:58:10

J0639+0601 RO006.UVDATA.1

Freq = 4.9270 GHz, Bw = 16.000 MH No calibration applied and no bandpass applied

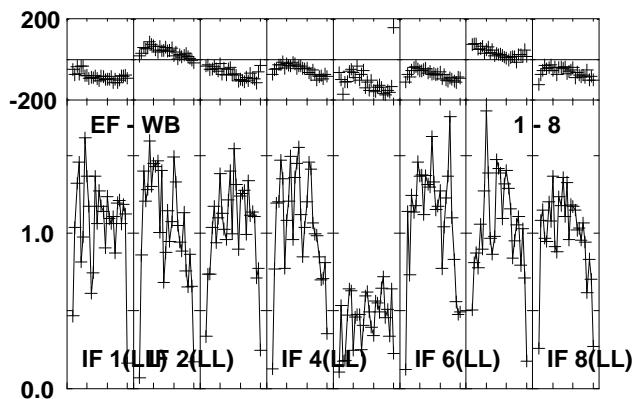
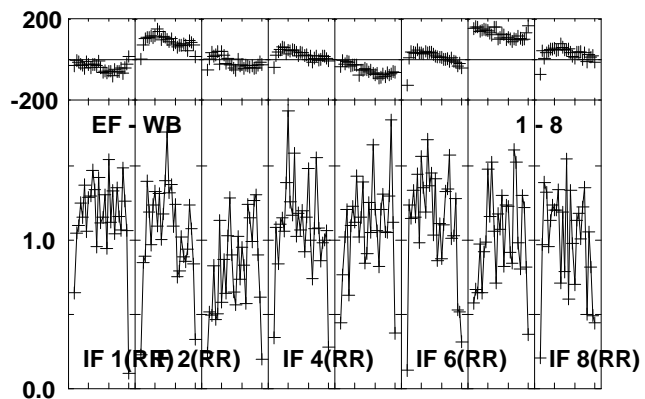
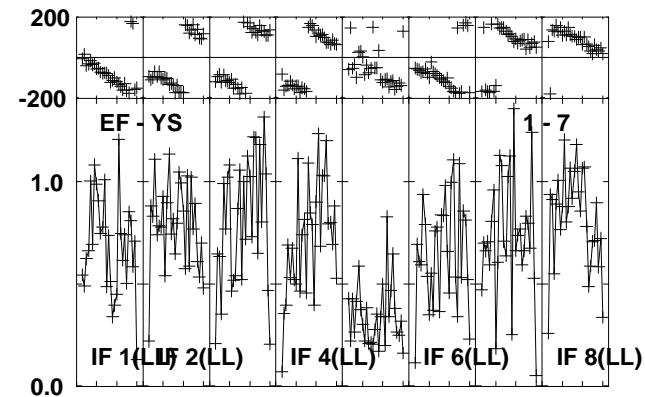
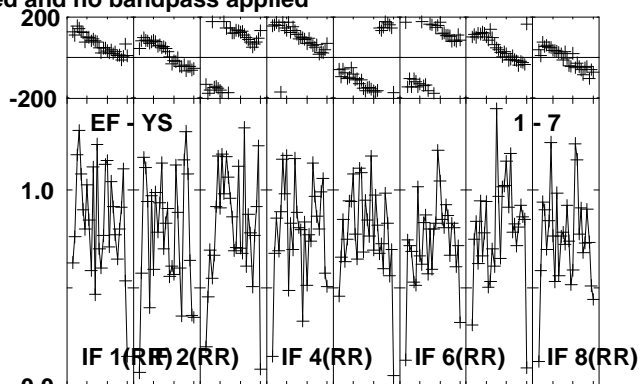
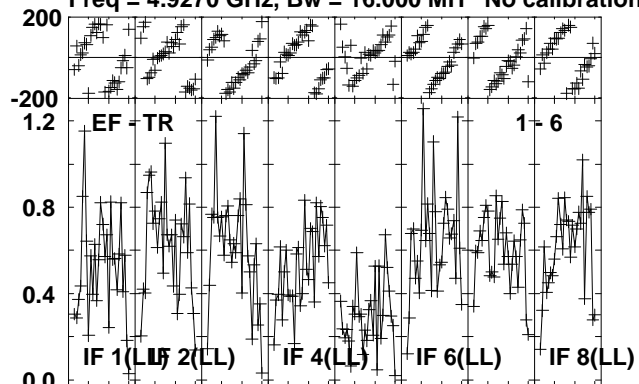

Lower frame: Milli Ampl Jy Top frame: Phas deg
Vector averaged cross-power spectrum Several baselines displayed
Timerange: 00/06:41:53 to 00/06:43:03

Plot file version 336 created 16-OCT-2012 11:58:10

J0645+0541 RO006.UVDATA.1

Freq = 4.9270 GHz, Bw = 16.000 MH No calibration applied and no bandpass applied

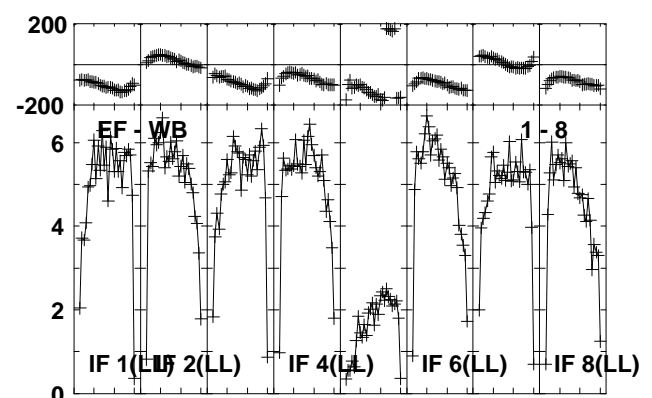
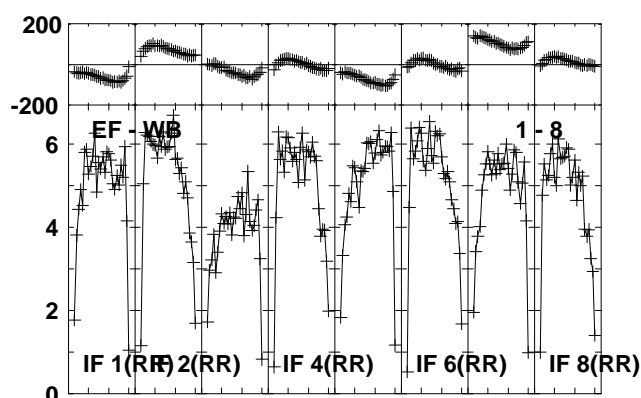
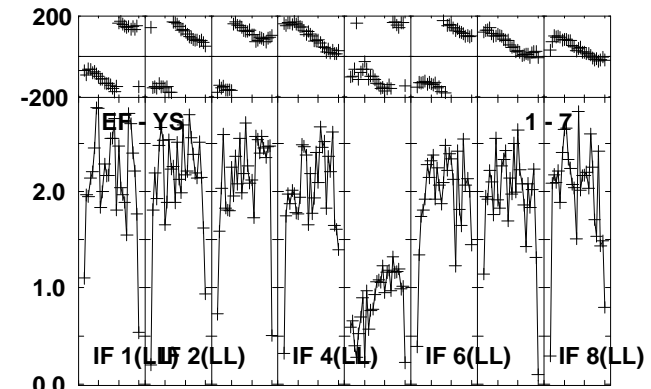
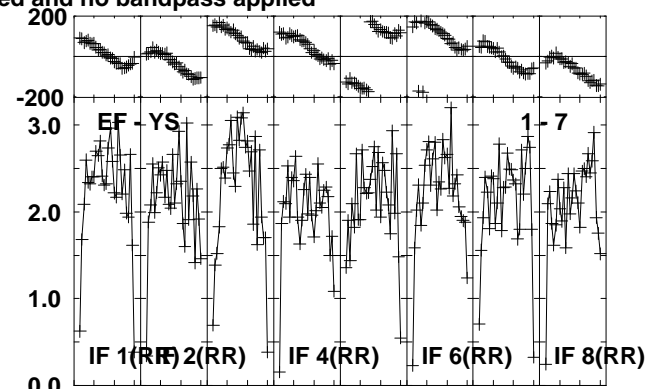
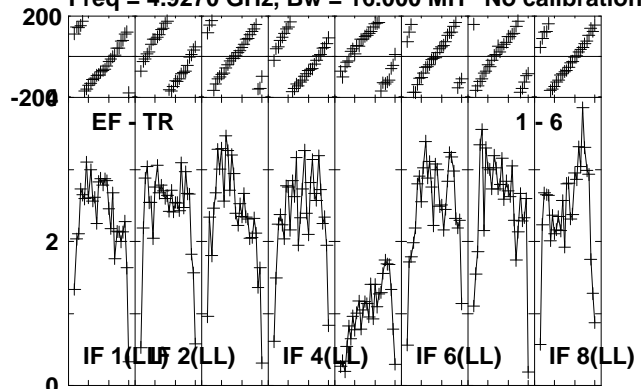

Lower frame: Milli Ampl Jy Top frame: Phas deg
Vector averaged cross-power spectrum Several baselines displayed
Timerange: 00/06:43:07 to 00/06:44:03

Plot file version 338 created 16-OCT-2012 11:58:11

NOVA-MON RO006.UVDATA.1

Freq = 4.9270 GHz, Bw = 16.000 MH No calibration applied and no bandpass applied

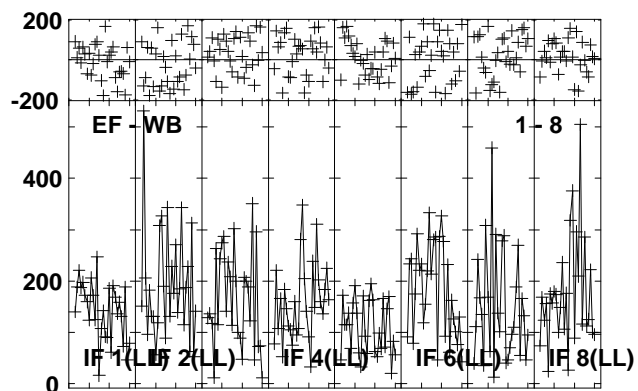
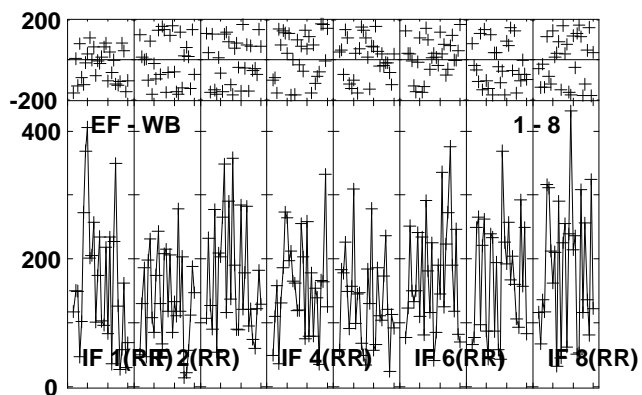
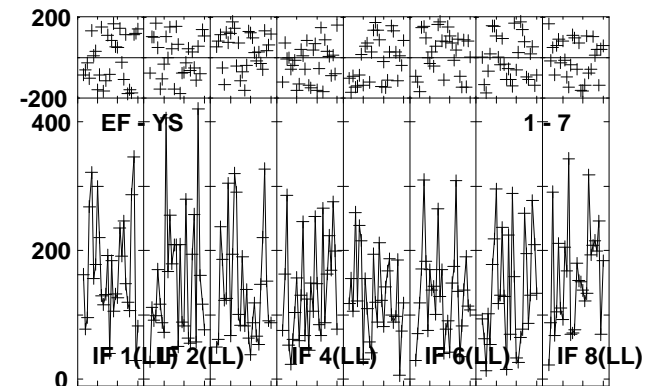
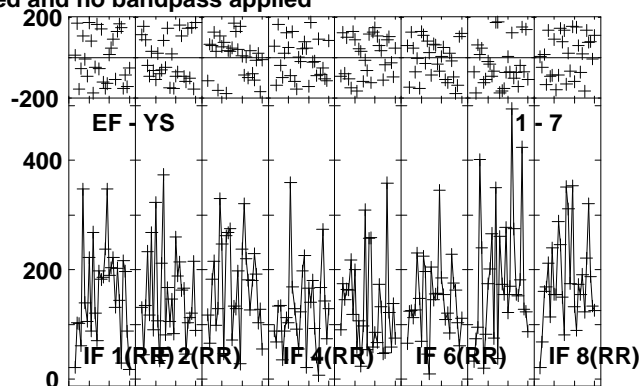
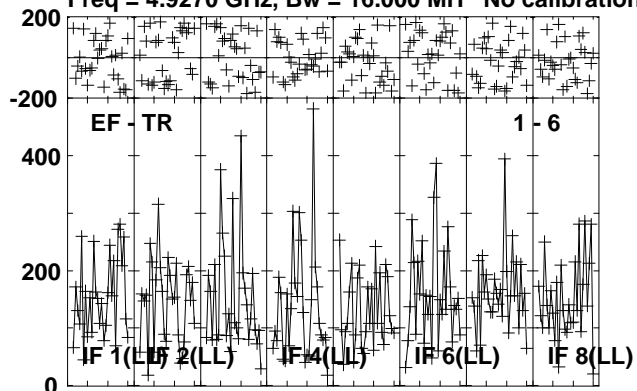

Lower frame: Micro Ampl Jy Top frame: Phas deg
Vector averaged cross-power spectrum Several baselines displayed
Timerange: 00/06:44:07 to 00/06:47:03

Plot file version 339 created 16-OCT-2012 11:58:12

J0639+0601 RO006.UVDATA.1

Freq = 4.9270 GHz, Bw = 16.000 MH No calibration applied and no bandpass applied

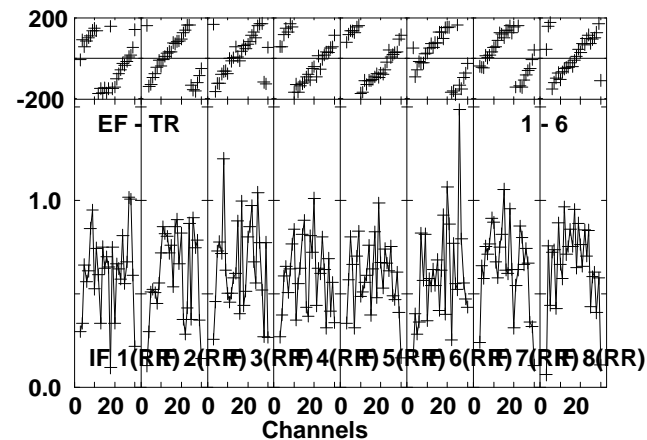
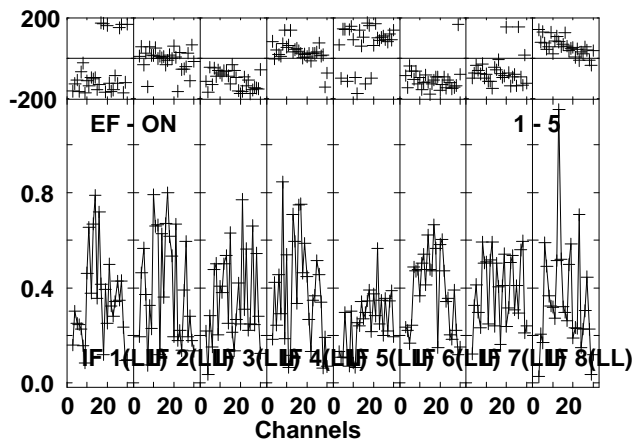
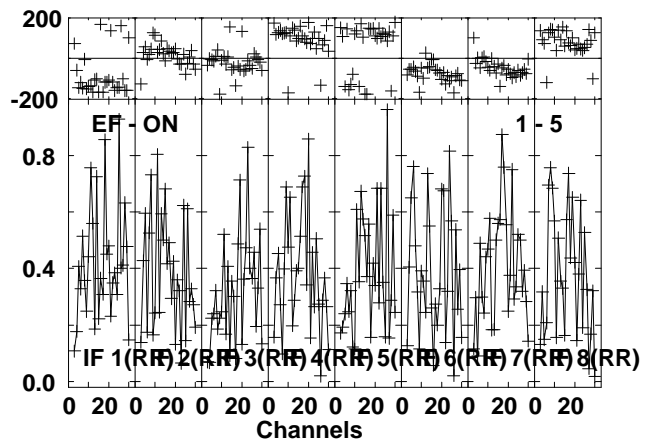
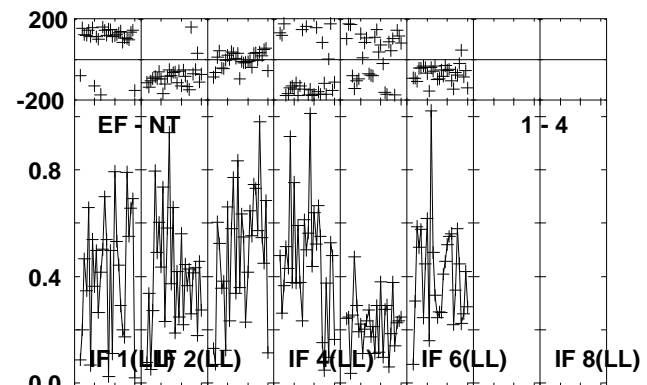
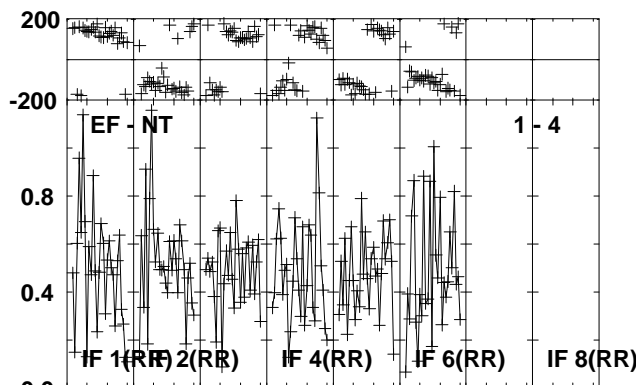
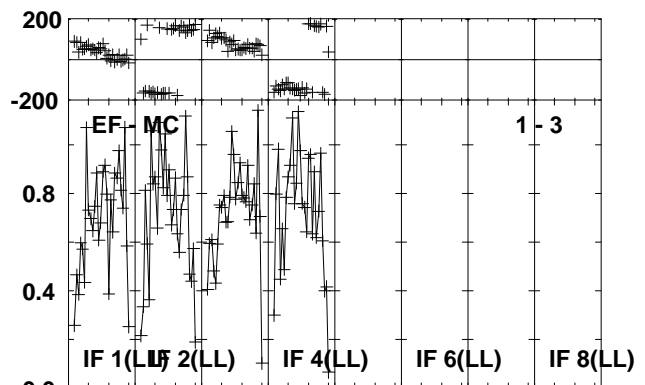
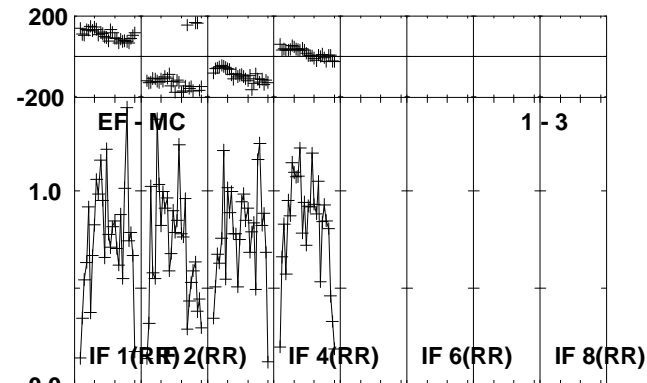
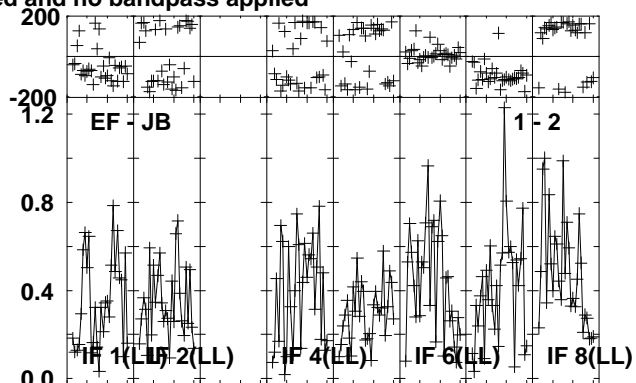
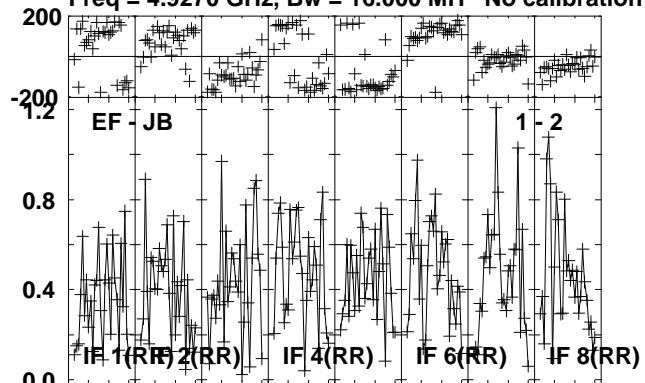

Lower frame: Milli Ampl Jy Top frame: Phas deg
Vector averaged cross-power spectrum Several baselines displayed
Timerange: 00/06:47:33 to 00/06:48:33

Plot file version 340 created 16-OCT-2012 11:58:12

J0639+0601 RO006.UVDATA.1

Freq = 4.9270 GHz, Bw = 16.000 MH No calibration applied and no bandpass applied

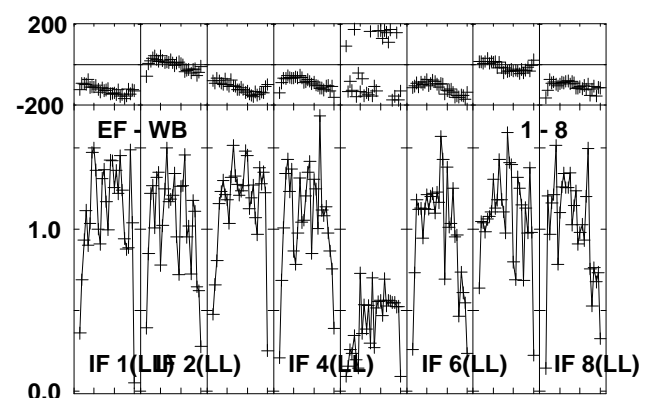
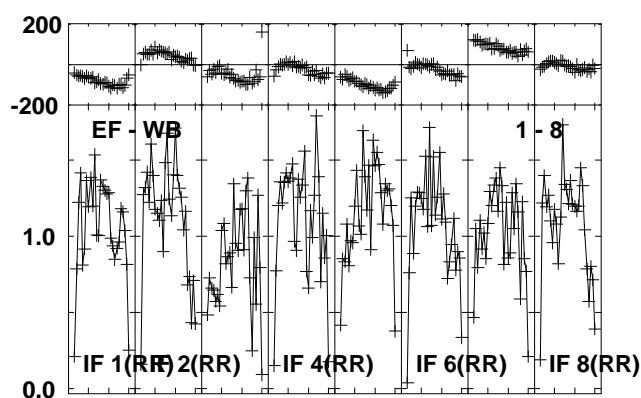
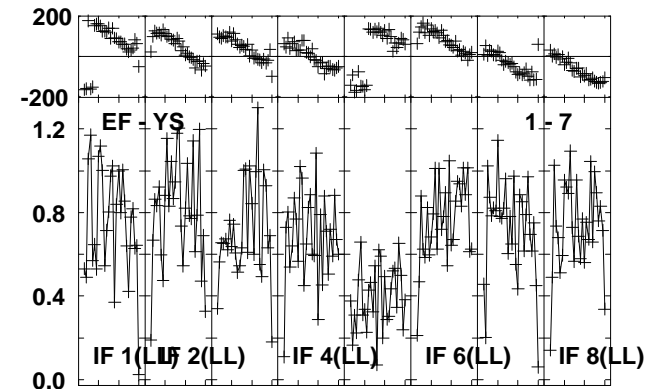
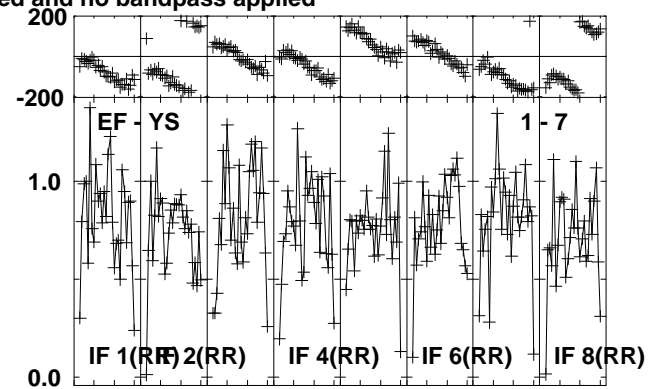
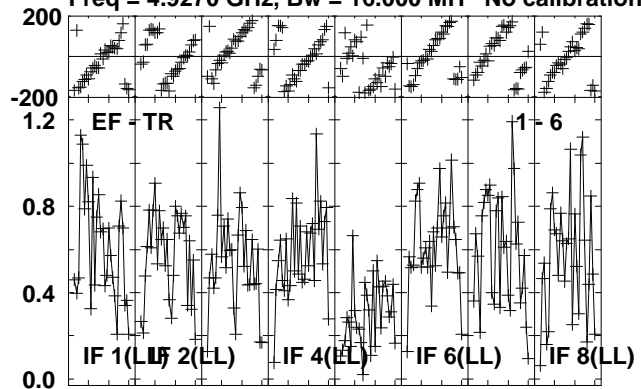

Lower frame: Milli Ampl Jy Top frame: Phas deg
Vector averaged cross-power spectrum Several baselines displayed
Timerange: 00/06:47:33 to 00/06:48:33

Plot file version 341 created 16-OCT-2012 11:58:12

J0645+0541 RO006.UVDATA.1

Freq = 4.9270 GHz, Bw = 16.000 MH No calibration applied and no bandpass applied

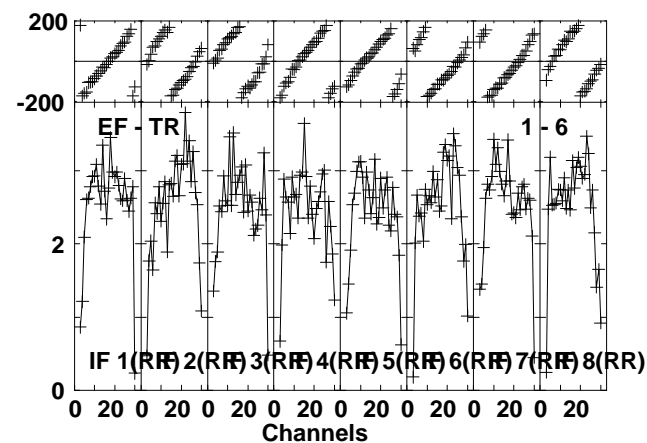
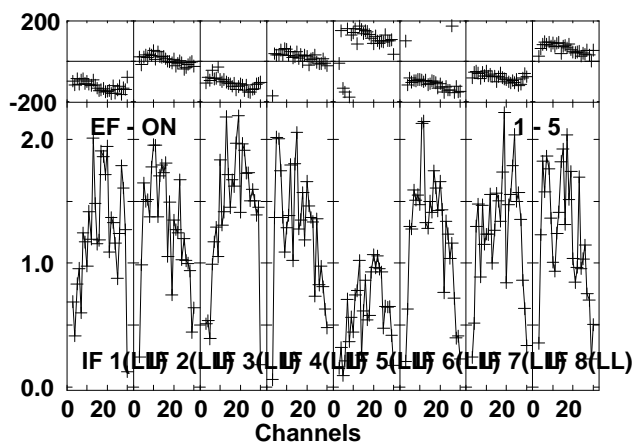
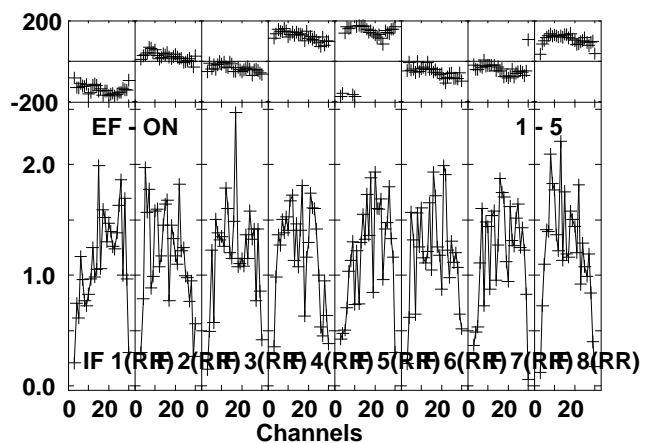
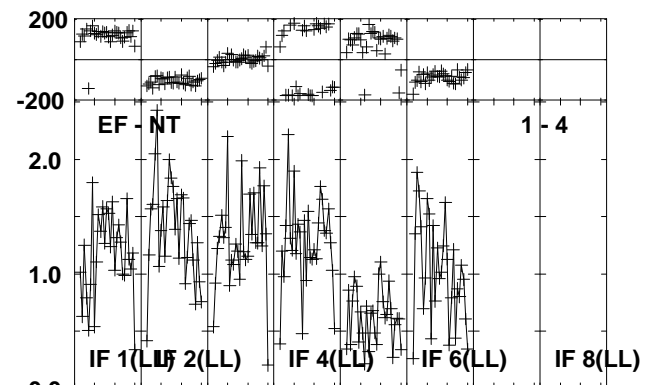
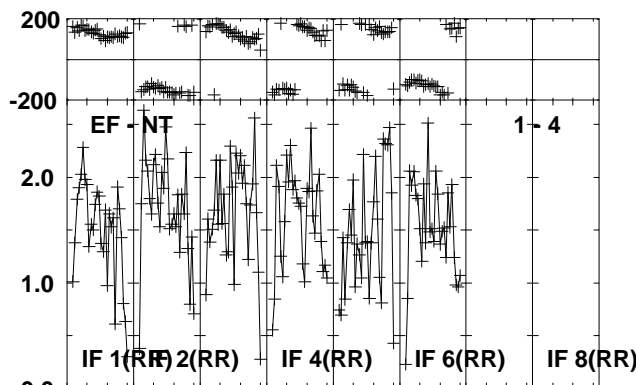
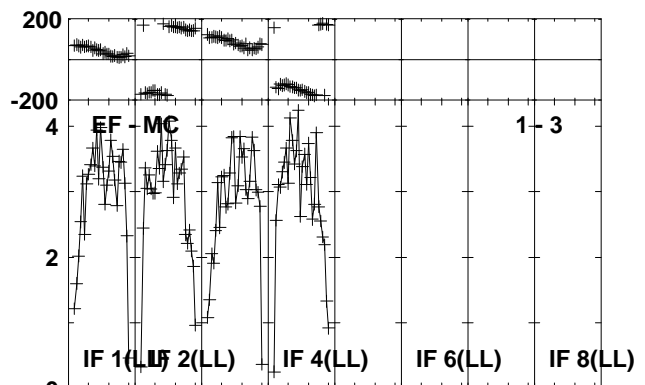
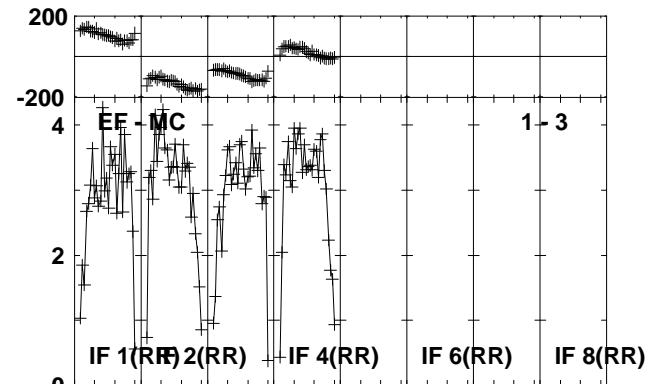
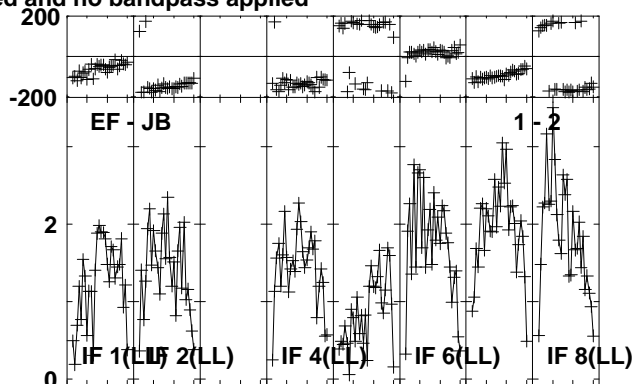
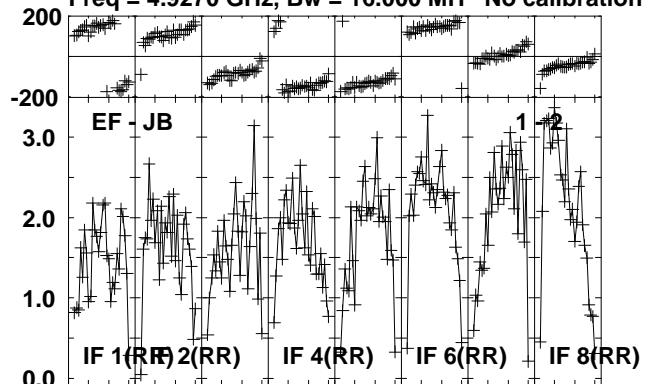

Lower frame: Milli Ampl Jy Top frame: Phas deg
Vector averaged cross-power spectrum Several baselines displayed
Timerange: 00/06:48:37 to 00/06:49:33

Plot file version 342 created 16-OCT-2012 11:58:12

J0645+0541 RO006.UVDATA.1

Freq = 4.9270 GHz, Bw = 16.000 MH No calibration applied and no bandpass applied

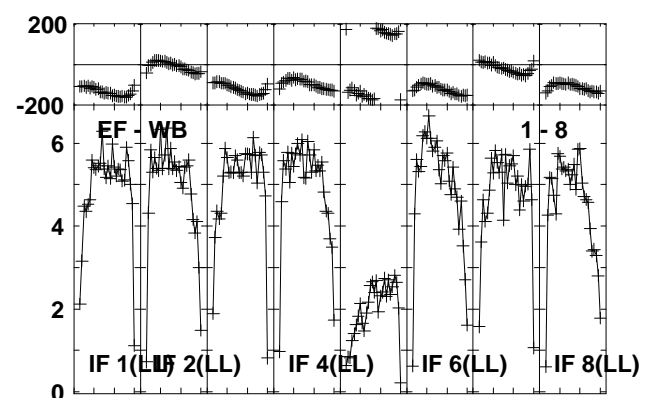
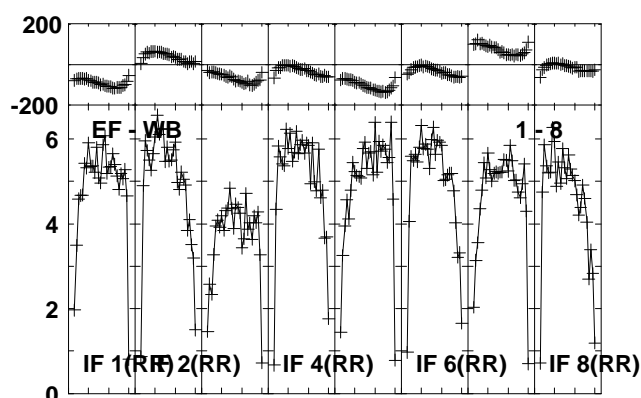
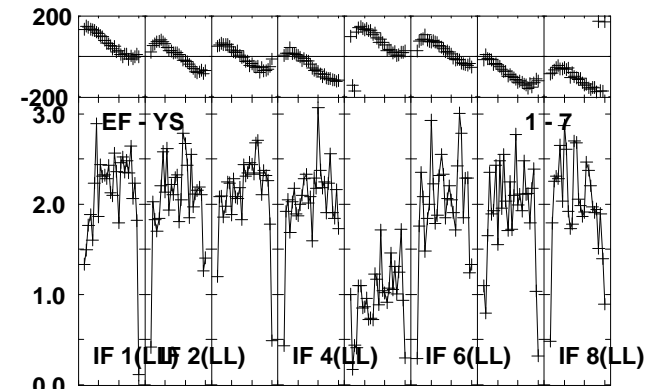
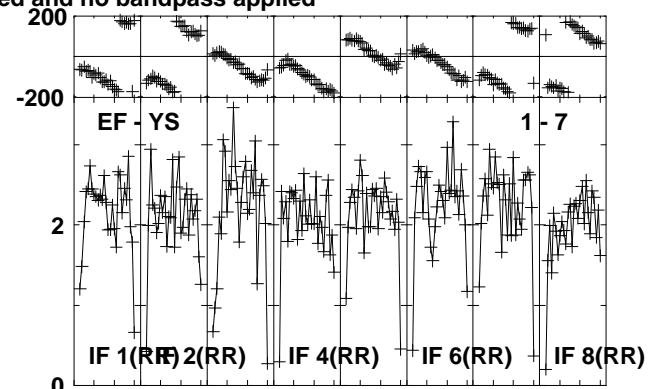
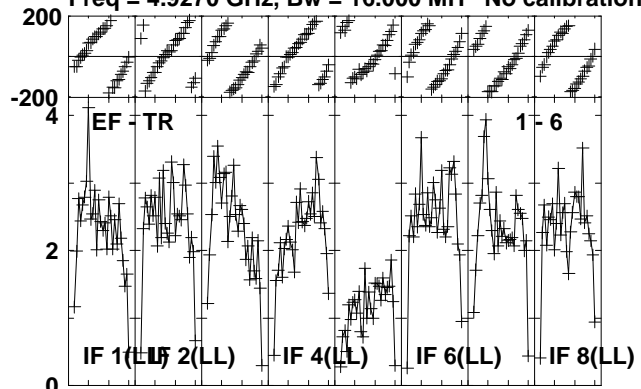

Lower frame: Milli Ampl Jy Top frame: Phas deg
Vector averaged cross-power spectrum Several baselines displayed
Timerange: 00/06:48:37 to 00/06:49:33

Plot file version 343 created 16-OCT-2012 11:58:12

NOVA-MON RO006.UVDATA.1

Freq = 4.9270 GHz, Bw = 16.000 MH No calibration applied and no bandpass applied

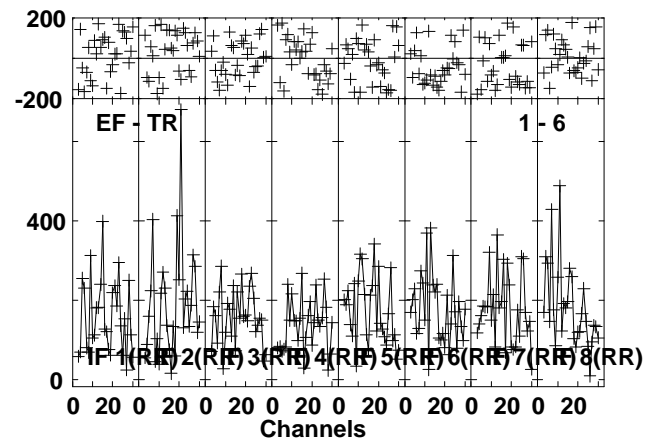
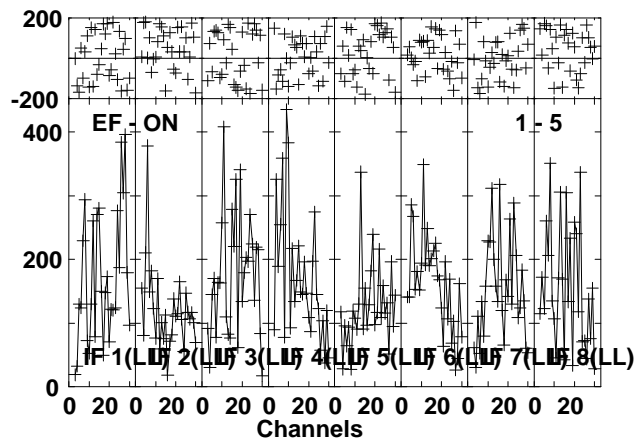
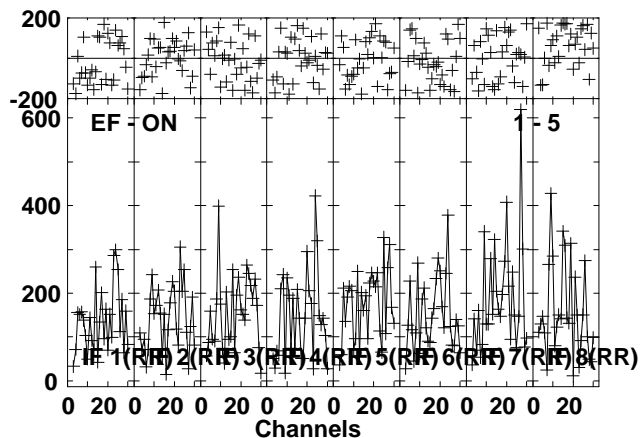
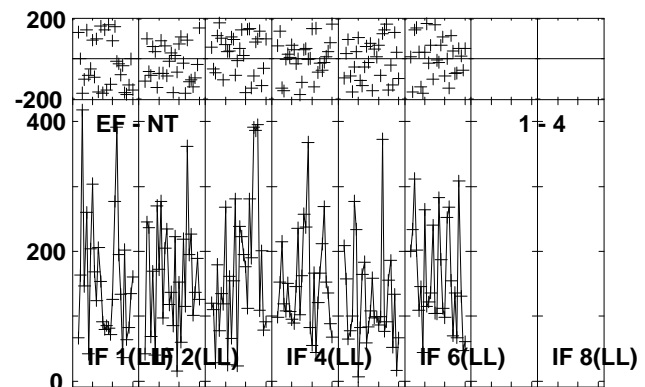
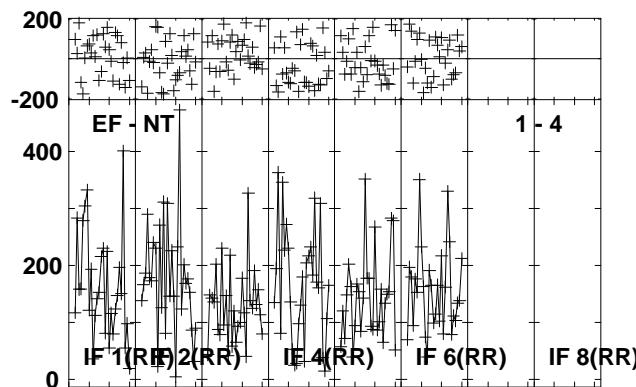
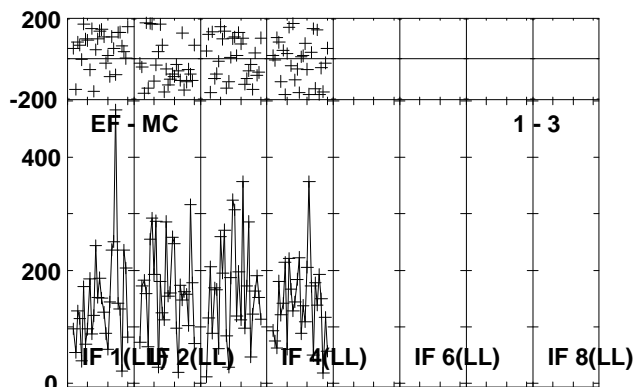
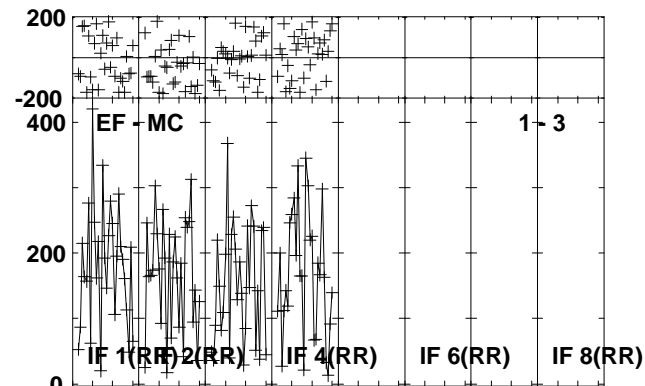
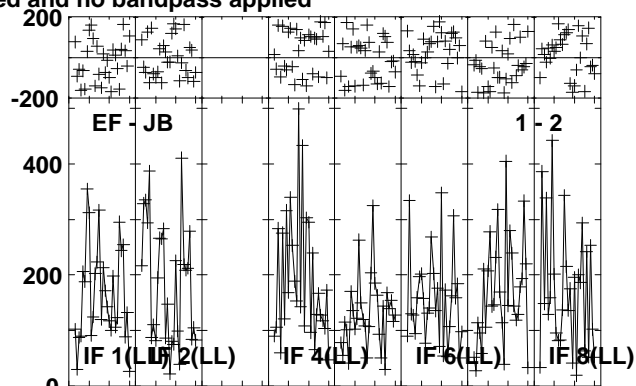
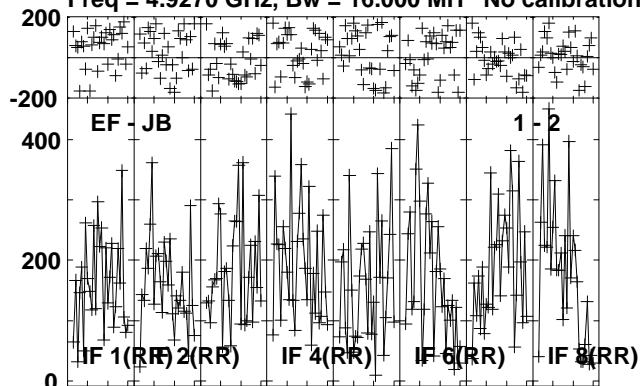

Lower frame: Micro Ampl Jy Top frame: Phas deg
Vector averaged cross-power spectrum Several baselines displayed
Timerange: 00/06:49:37 to 00/06:52:33

Plot file version 344 created 16-OCT-2012 11:58:13

NOVA-MON RO006.UVDATA.1

Freq = 4.9270 GHz, Bw = 16.000 MH No calibration applied and no bandpass applied

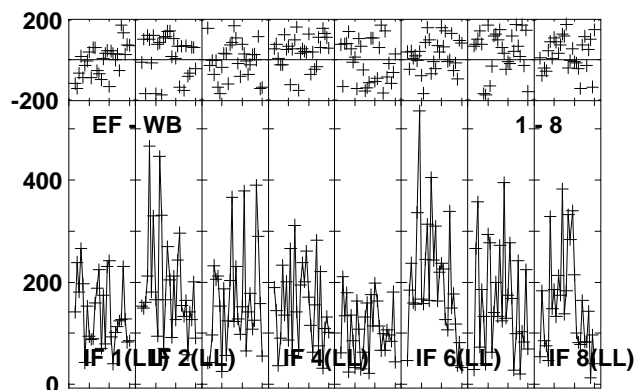
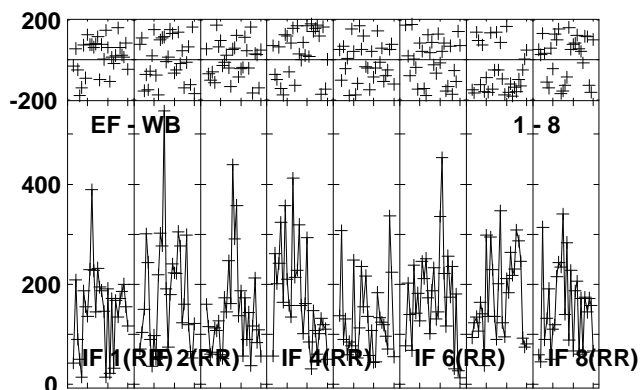
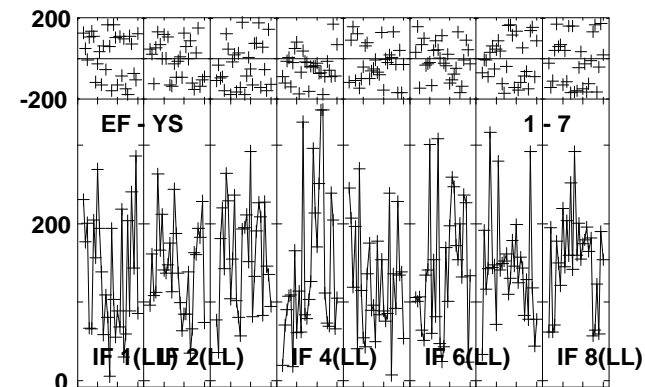
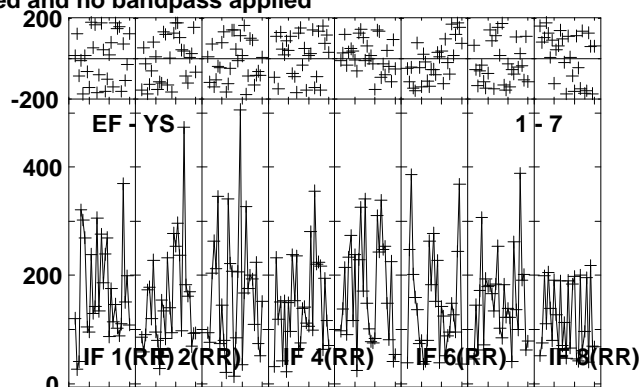
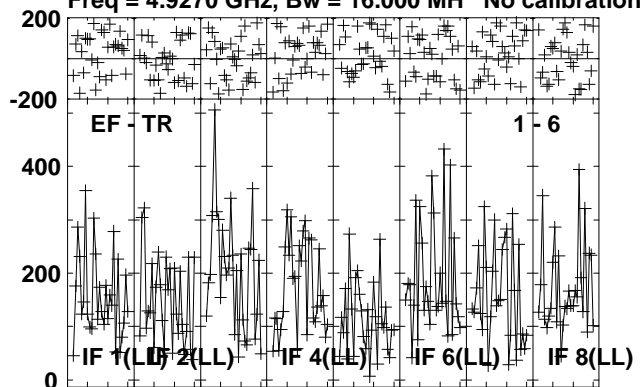

Lower frame: Micro Ampl Jy Top frame: Phas deg
Vector averaged cross-power spectrum Several baselines displayed
Timerange: 00/06:49:37 to 00/06:52:33

Plot file version 345 created 16-OCT-2012 11:58:13

J0639+0601 RO006.UVDATA.1

Freq = 4.9270 GHz, Bw = 16.000 MH No calibration applied and no bandpass applied

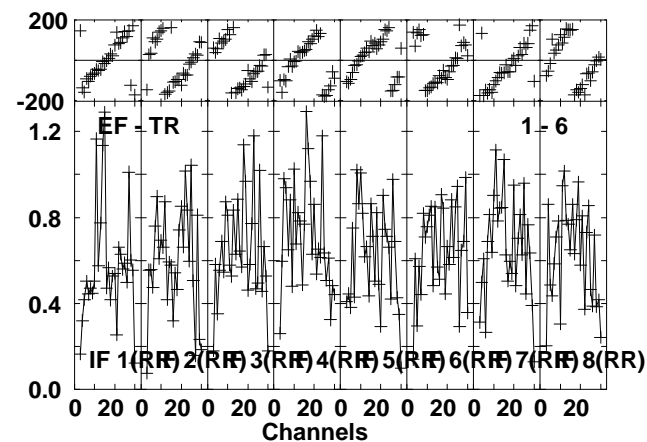
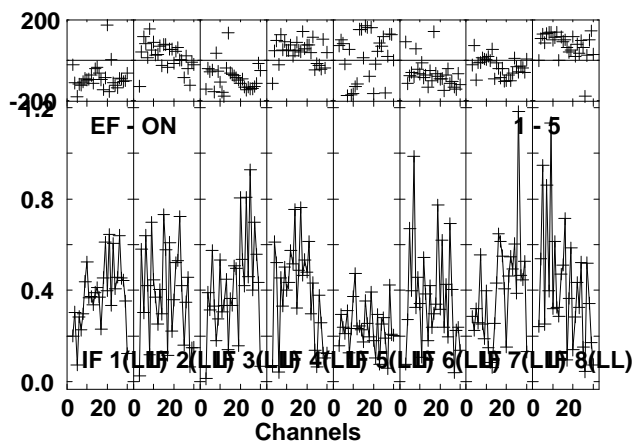
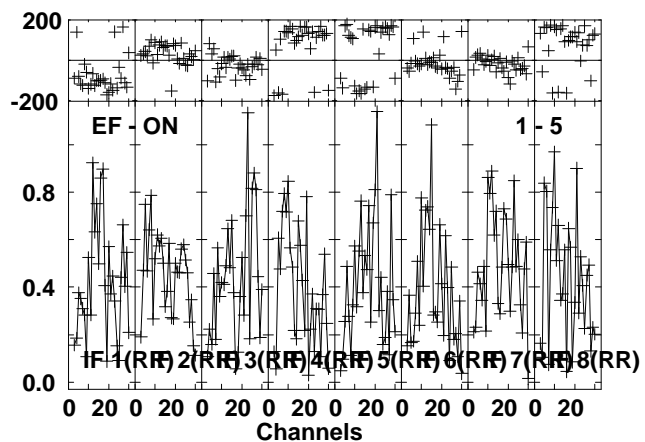
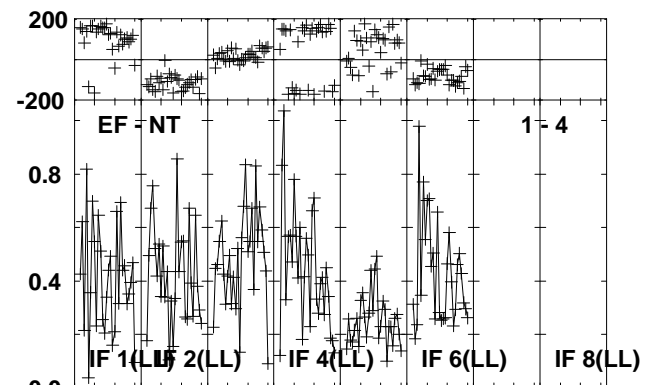
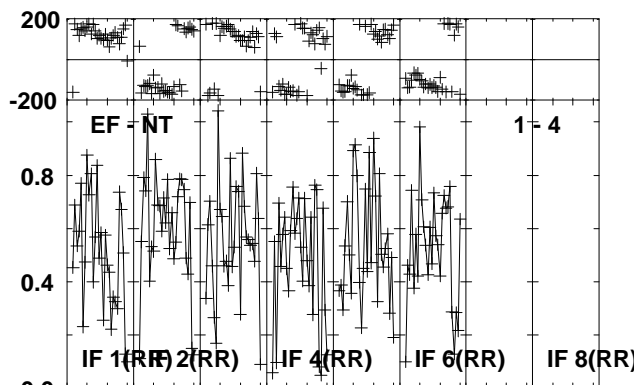
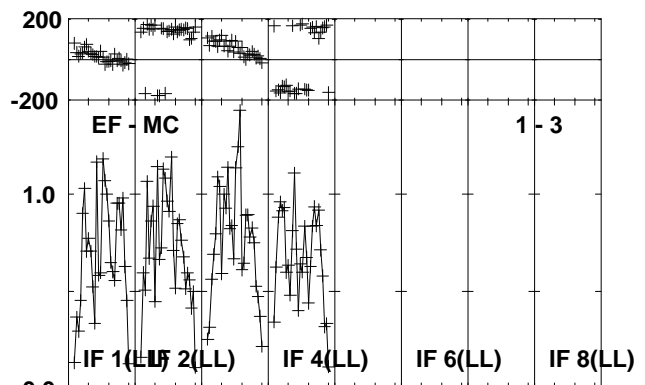
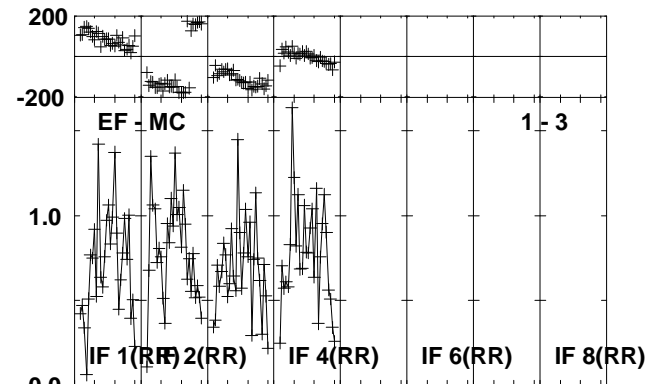
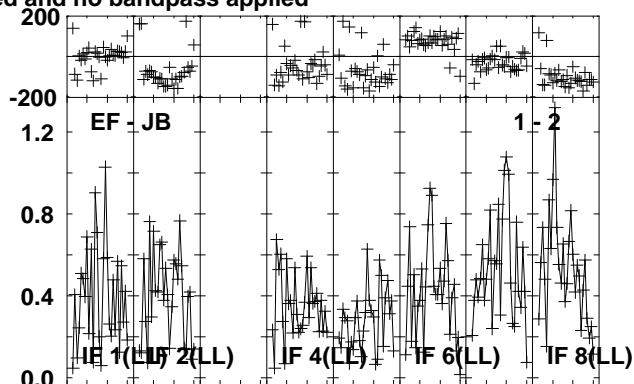
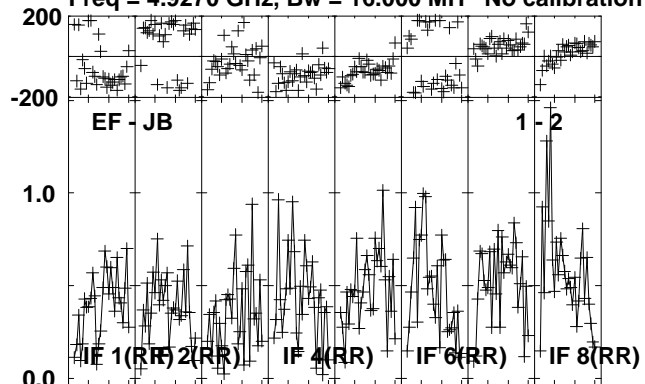

Lower frame: Milli Ampl Jy Top frame: Phas deg
Vector averaged cross-power spectrum Several baselines displayed
Timerange: 00/06:52:37 to 00/06:53:49

Plot file version 346 created 16-OCT-2012 11:58:14

J0639+0601 RO006.UVDATA.1

Freq = 4.9270 GHz, Bw = 16.000 MH No calibration applied and no bandpass applied

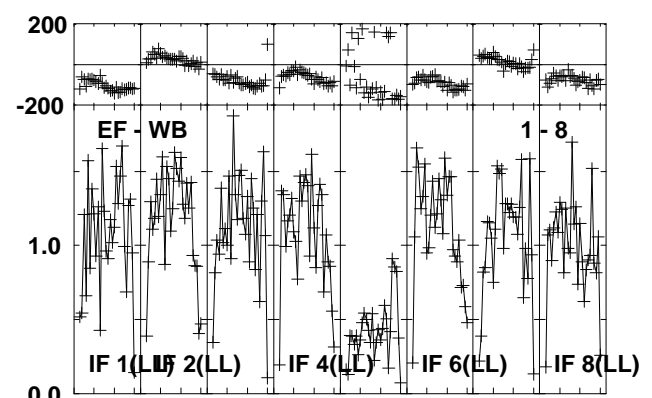
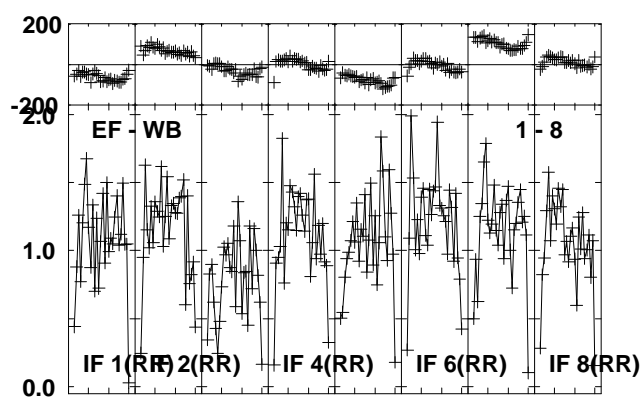
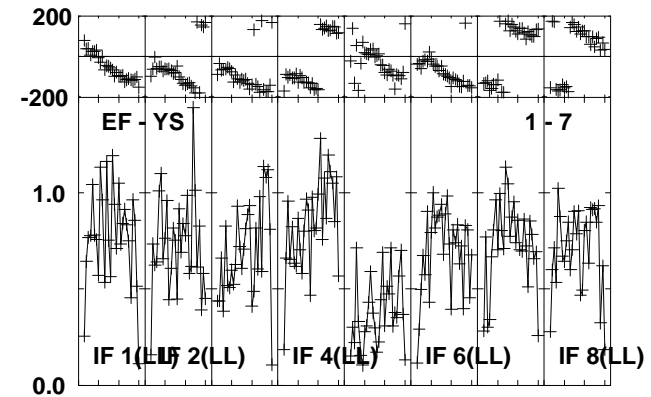
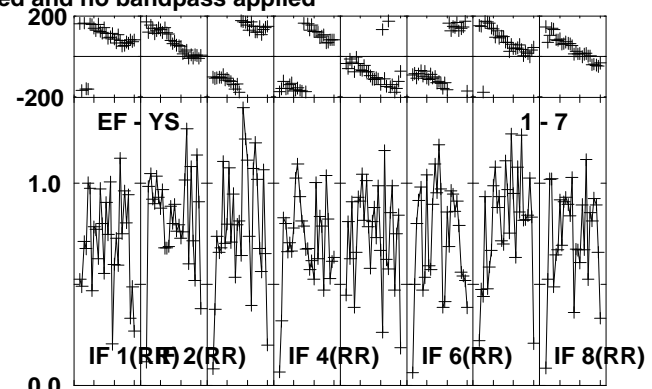
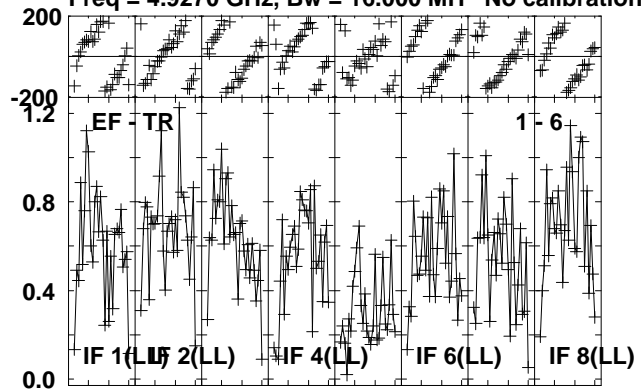

Lower frame: Milli Ampl Jy Top frame: Phas deg
Vector averaged cross-power spectrum Several baselines displayed
Timerange: 00/06:52:37 to 00/06:53:49

Plot file version 347 created 16-OCT-2012 11:58:14

J0645+0541 RO006.UVDATA.1

Freq = 4.9270 GHz, Bw = 16.000 MH No calibration applied and no bandpass applied

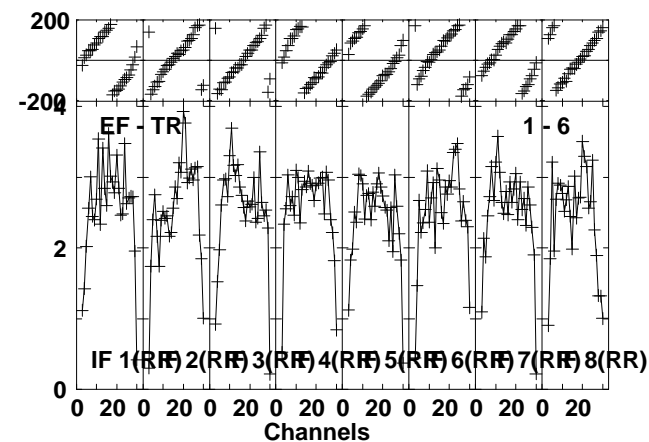
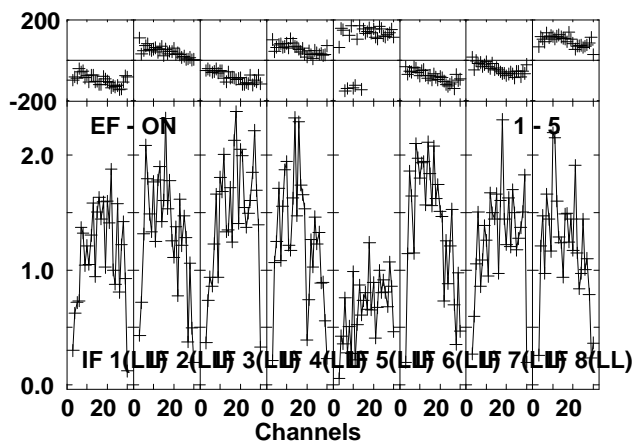
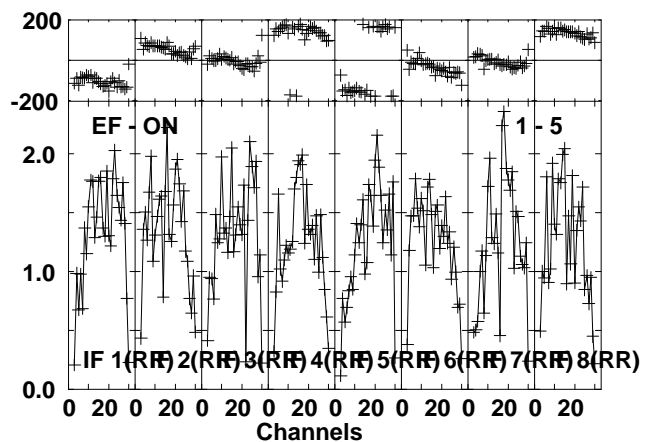
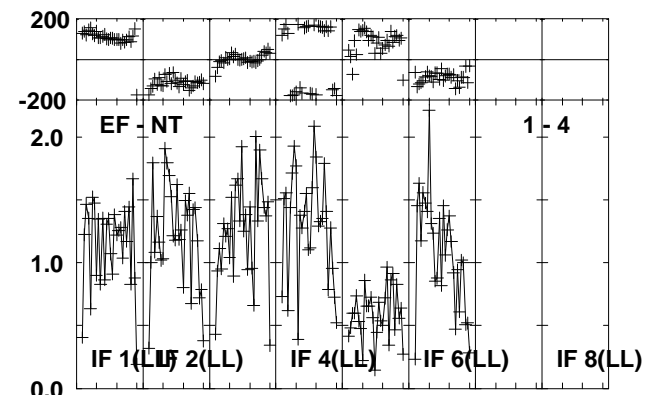
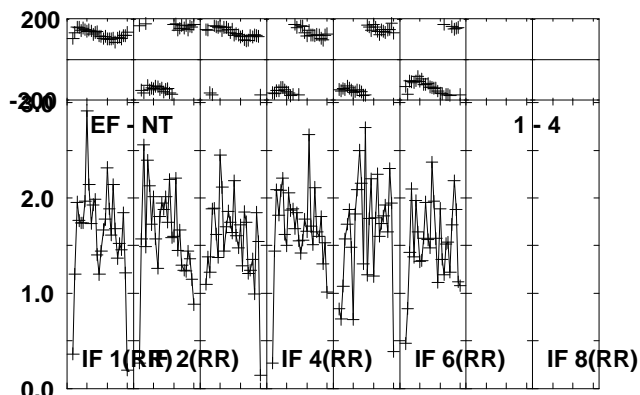
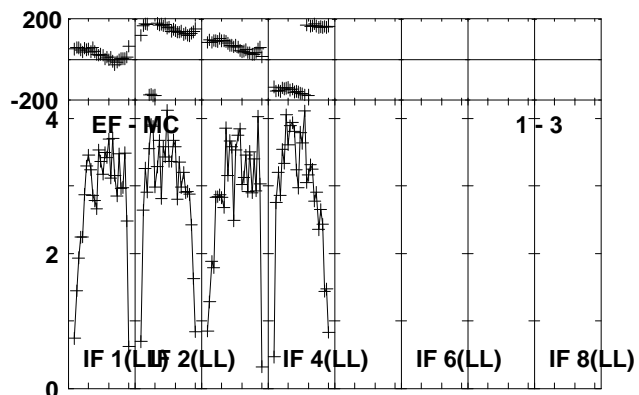
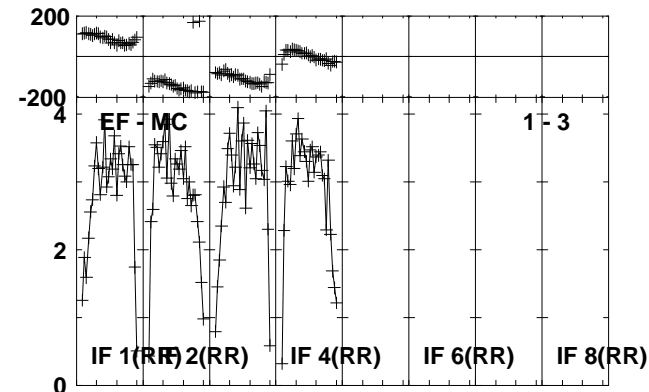
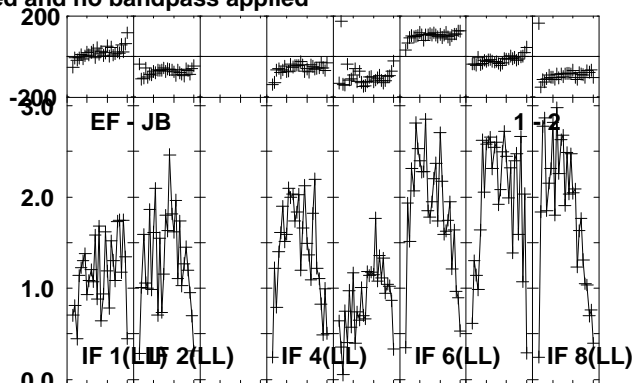
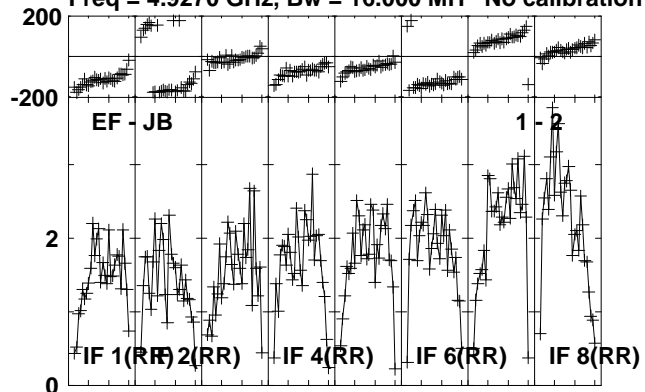

Lower frame: Milli Ampl Jy Top frame: Phas deg
Vector averaged cross-power spectrum Several baselines displayed
Timerange: 00/06:53:53 to 00/06:54:49

Plot file version 348 created 16-OCT-2012 11:58:14

J0645+0541 RO006.UVDATA.1

Freq = 4.9270 GHz, Bw = 16.000 MH No calibration applied and no bandpass applied

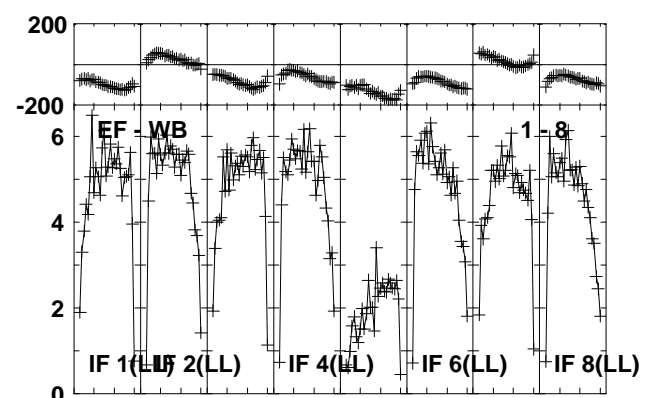
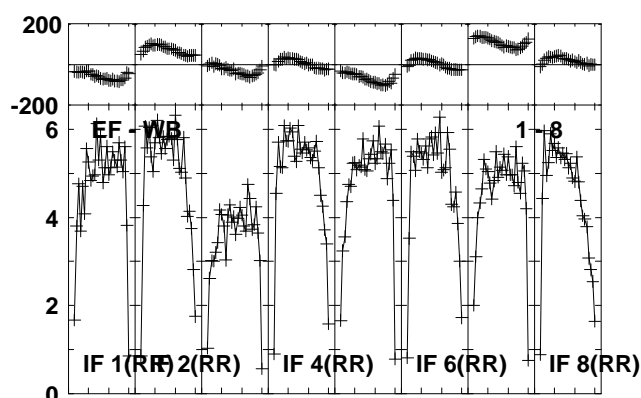
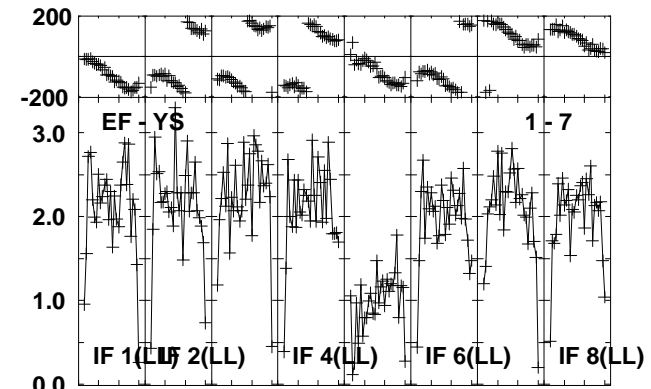
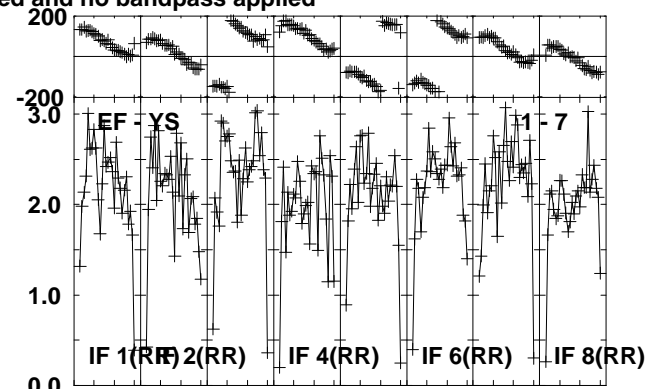
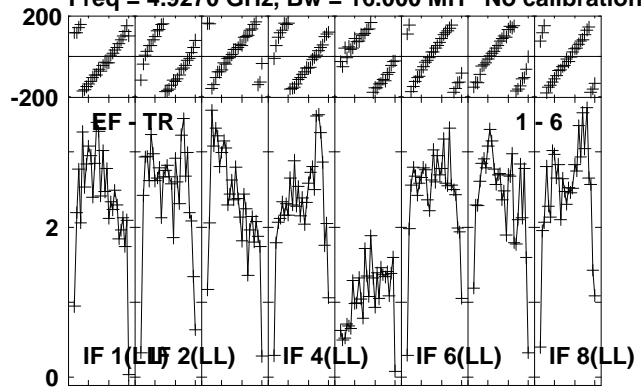

Lower frame: Milli Ampl Jy Top frame: Phas deg
Vector averaged cross-power spectrum Several baselines displayed
Timerange: 00/06:53:53 to 00/06:54:49

Plot file version 349 created 16-OCT-2012 11:58:14

NOVA-MON RO006.UVDATA.1

Freq = 4.9270 GHz, Bw = 16.000 MH No calibration applied and no bandpass applied

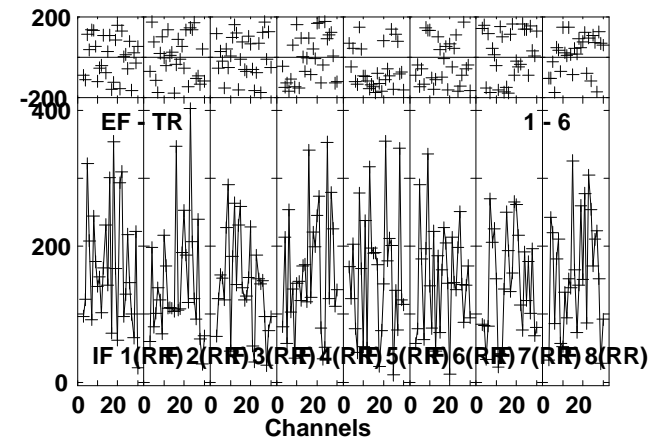
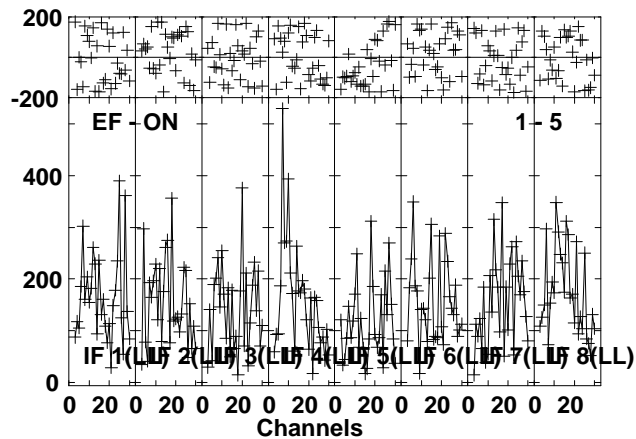
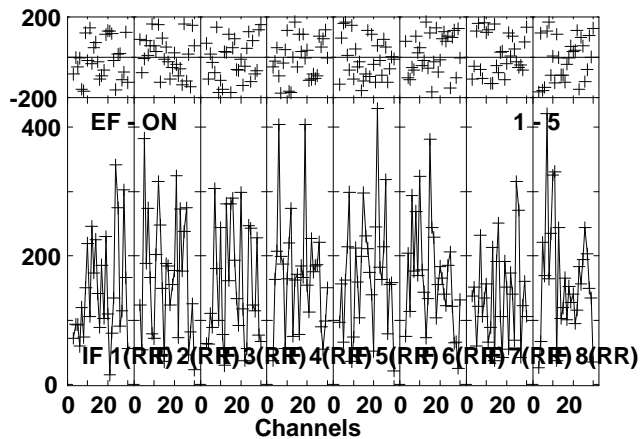
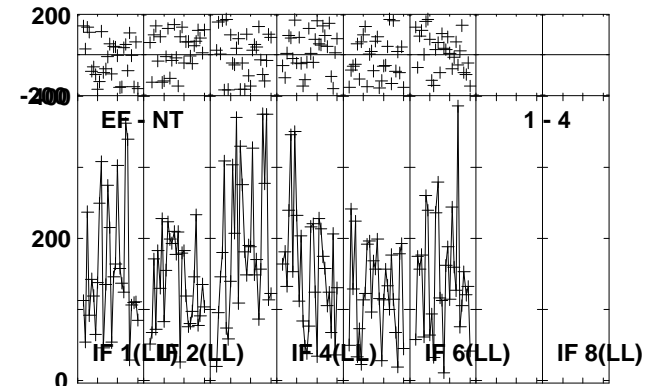
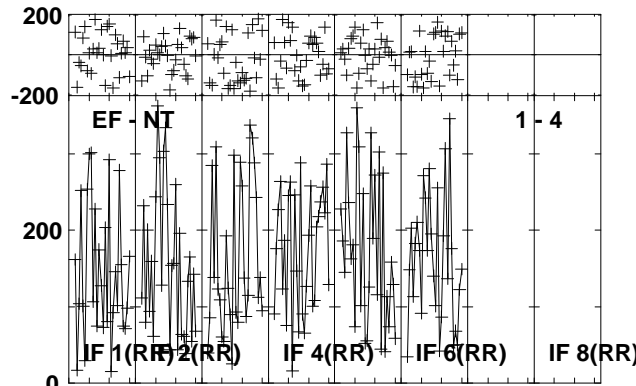
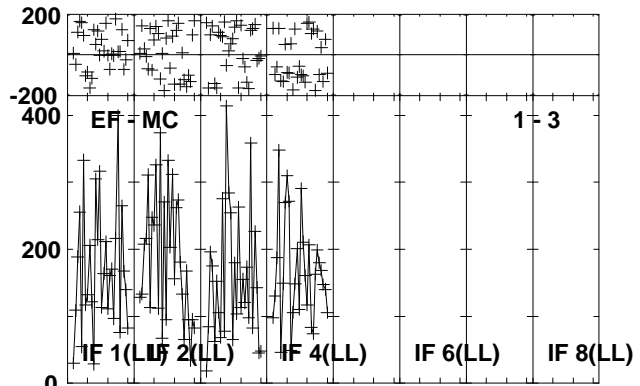
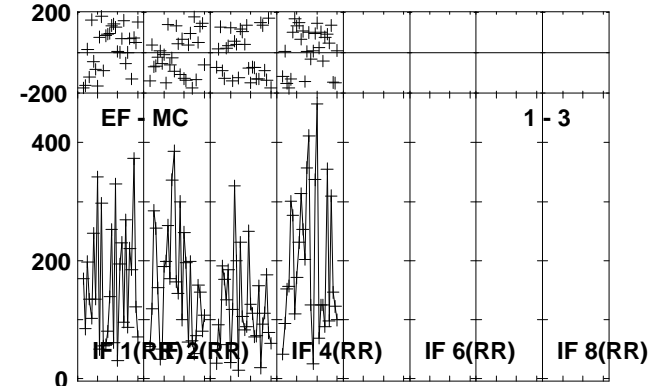
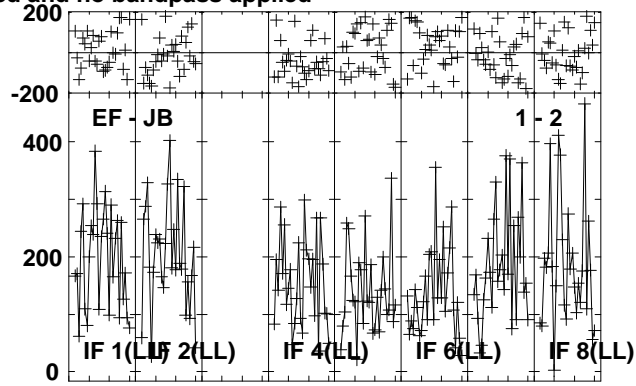
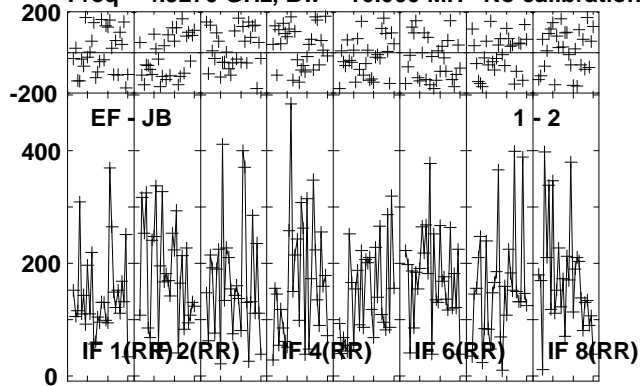

Lower frame: Micro Ampl Jy Top frame: Phas deg
Vector averaged cross-power spectrum Several baselines displayed
Timerange: 00/06:54:53 to 00/06:57:49

Plot file version 350 created 16-OCT-2012 11:58:15

NOVA-MON RO006.UVDATA.1

Freq = 4.9270 GHz, Bw = 16.000 MH No calibration applied and no bandpass applied

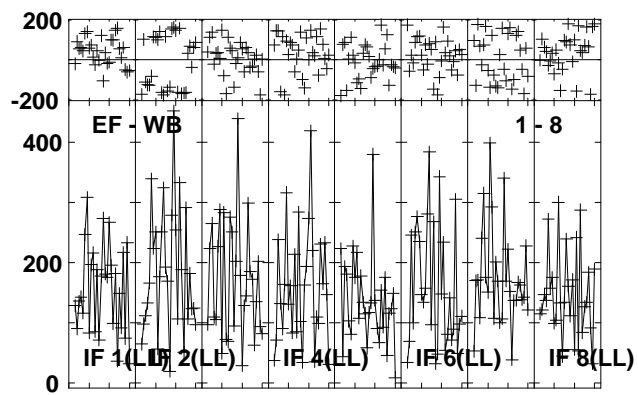
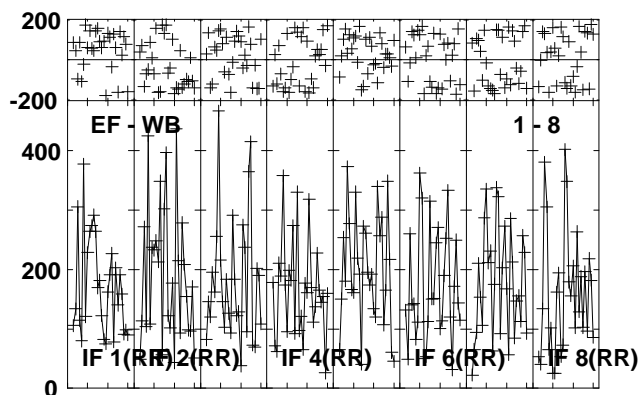
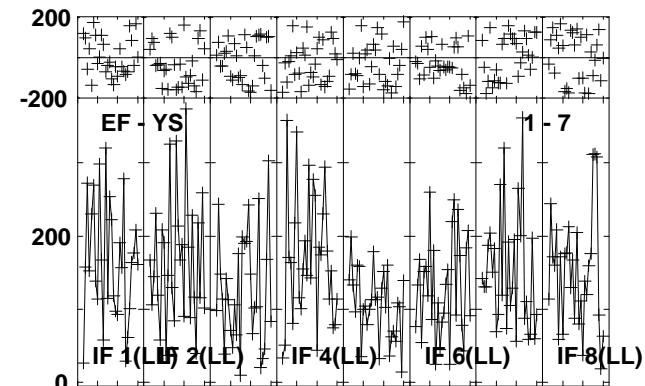
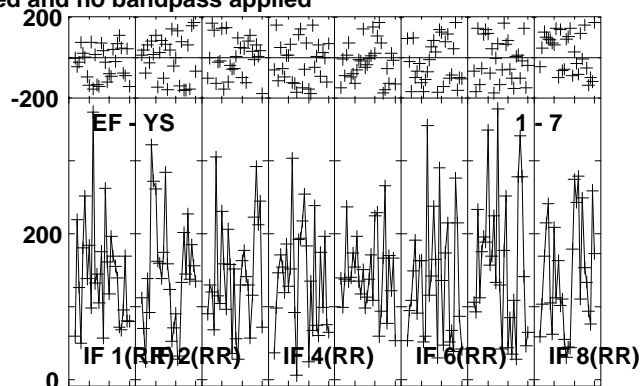
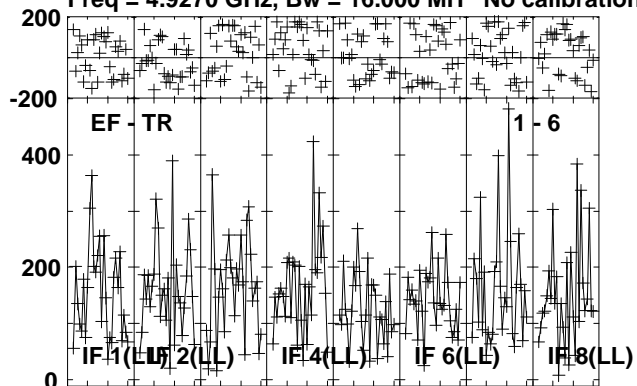

Lower frame: Micro Ampl Jy Top frame: Phas deg
Vector averaged cross-power spectrum Several baselines displayed
Timerange: 00/06:54:53 to 00/06:57:49

Plot file version 351 created 16-OCT-2012 11:58:15

J0639+0601 RO006.UVDATA.1

Freq = 4.9270 GHz, Bw = 16.000 MH No calibration applied and no bandpass applied

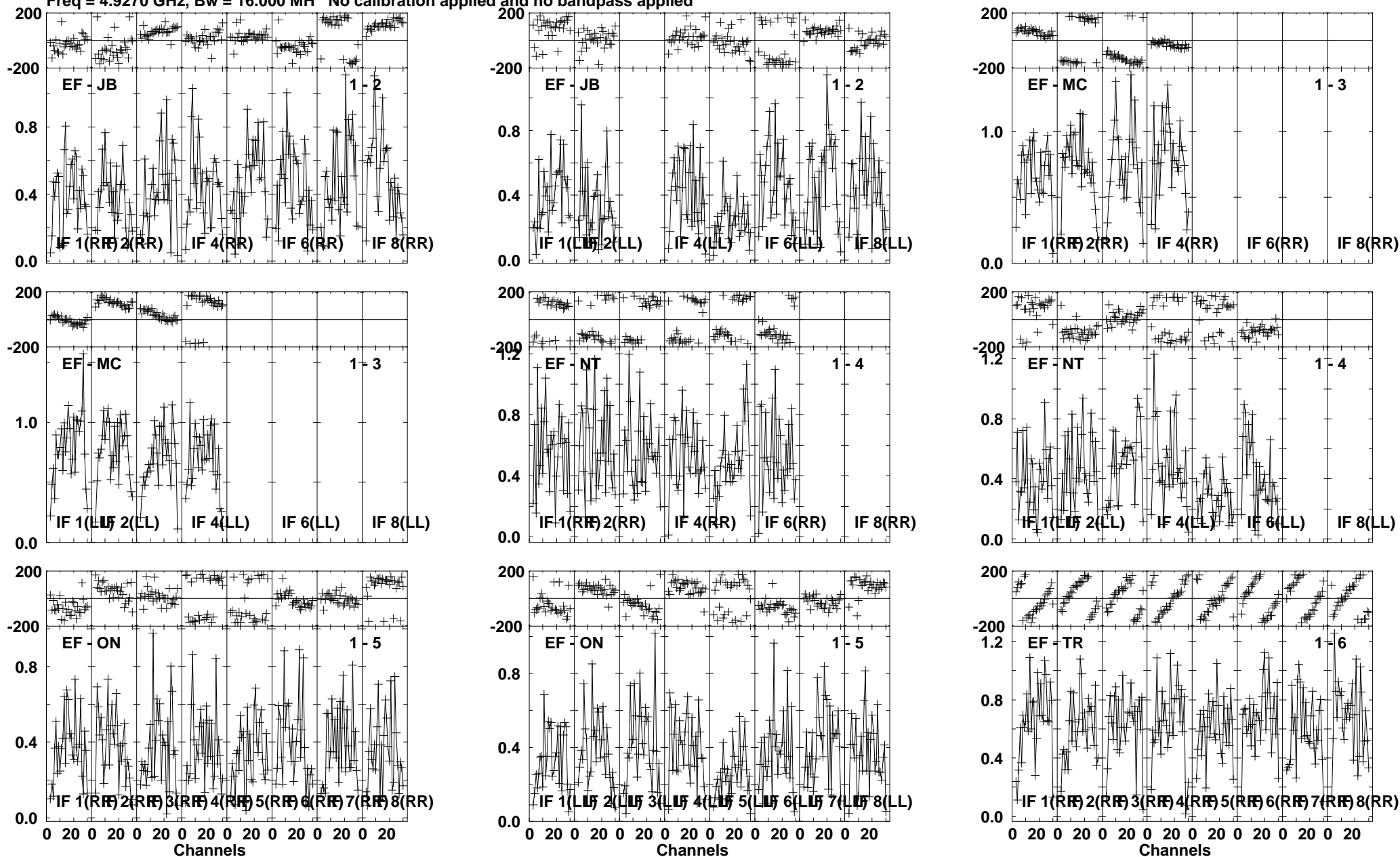

Lower frame: Milli Ampl Jy Top frame: Phas deg
Vector averaged cross-power spectrum Several baselines displayed
Timerange: 00/06:58:17 to 00/06:59:19

Plot file version 352 created 16-OCT-2012 11:58:15
J0639+0601 RO006.UVDATA.1

Freq = 4.9270 GHz, Bw = 16.000 MH No calibration applied and no bandpass applied

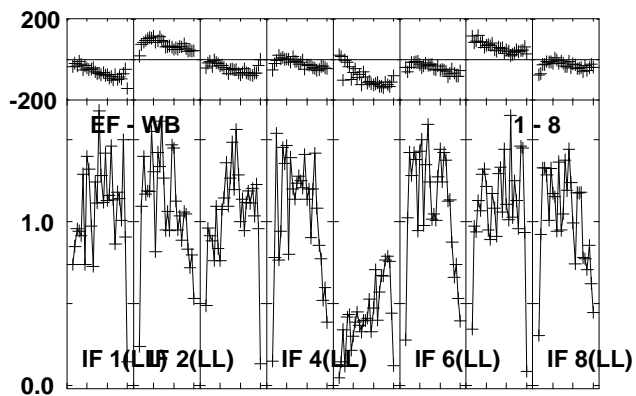
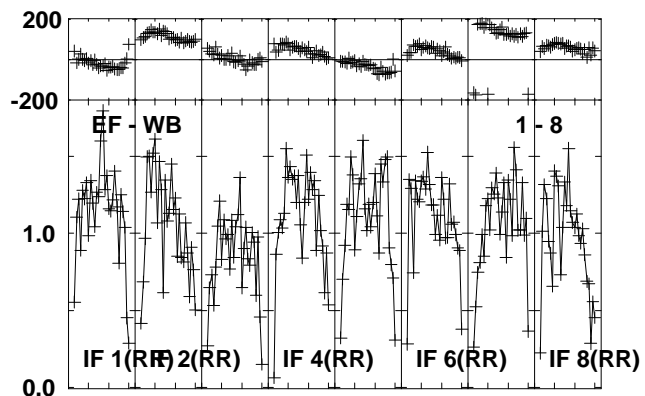
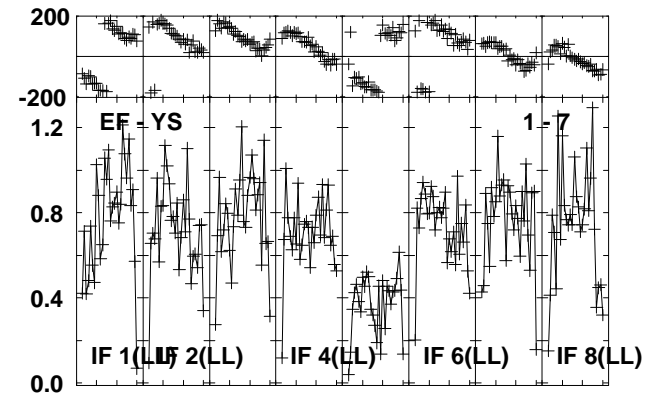
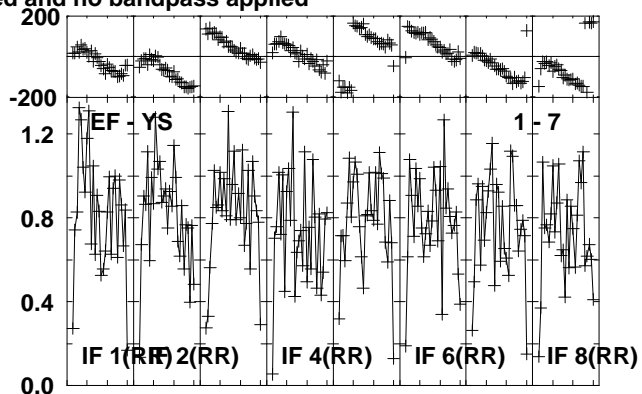
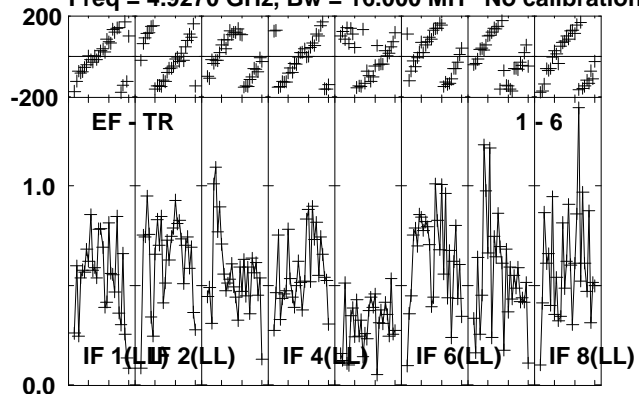

Lower frame: Milli Ampl Jy Top frame: Phas deg
Vector averaged cross-power spectrum Several baselines displayed
Timerange: 00/06:58:17 to 00/06:59:19

Plot file version 353 created 16-OCT-2012 11:58:16

0528+134 RO006.UVDATA.1

Freq = 4.9270 GHz, Bw = 16.000 MH No calibration applied and no bandpass applied

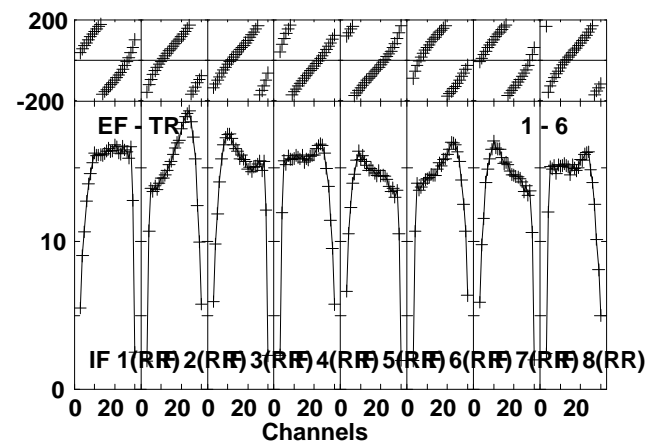
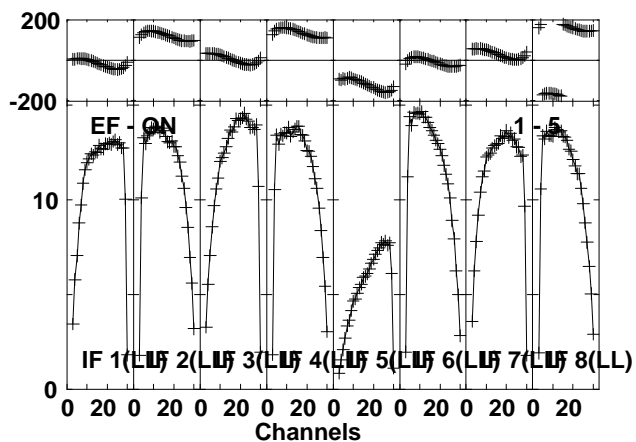
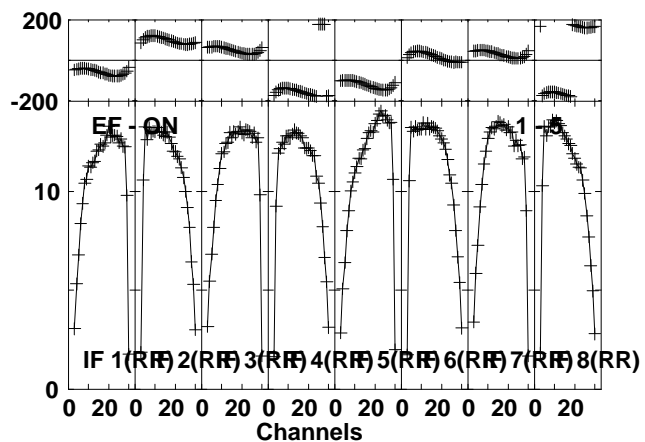
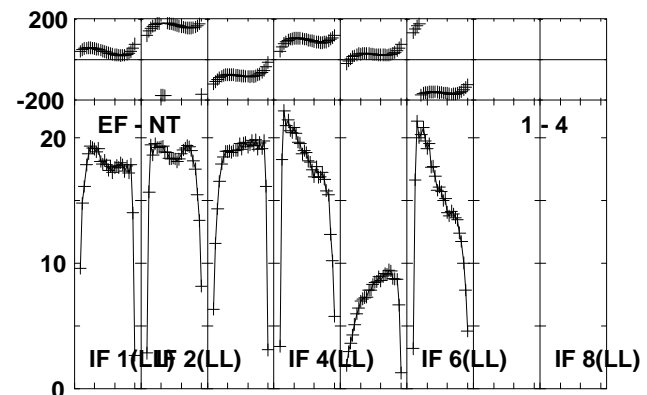
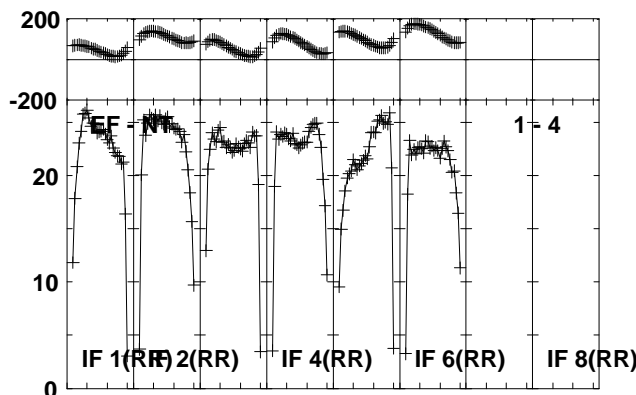
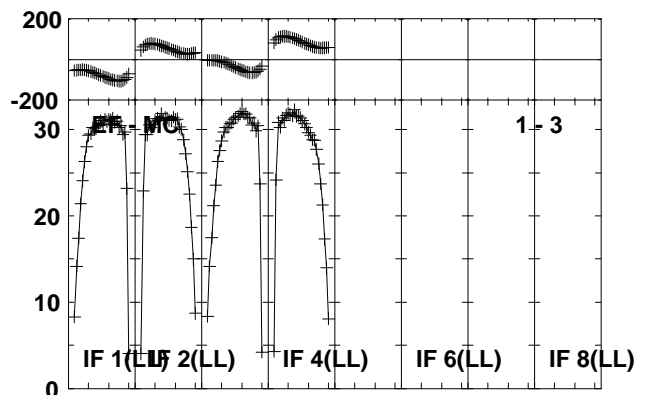
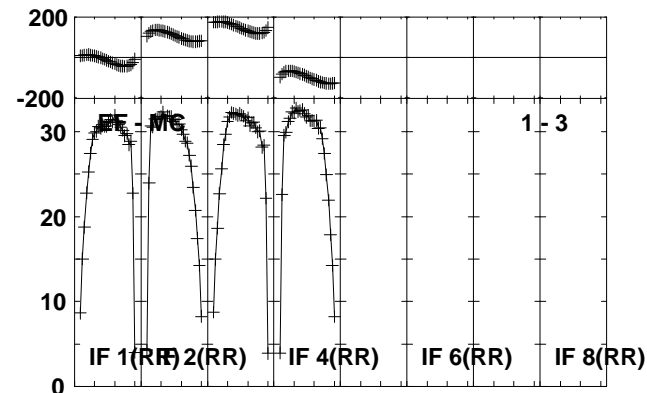
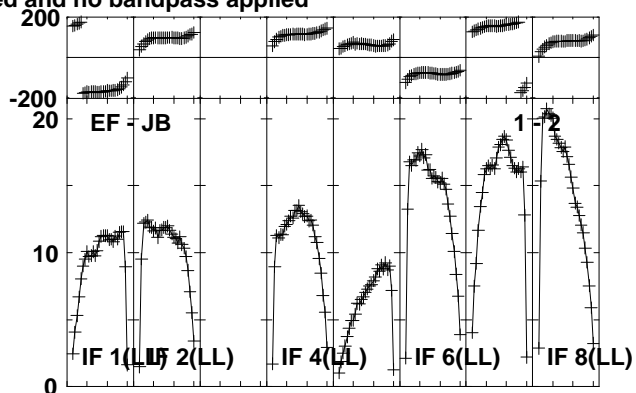
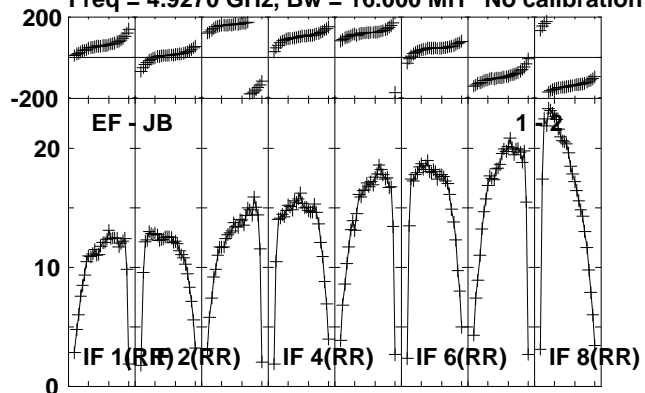

Lower frame: Milli Ampl Jy Top frame: Phas deg
Vector averaged cross-power spectrum Several baselines displayed
Timerange: 00/07:01:17 to 00/07:04:19

Plot file version 354 created 16-OCT-2012 11:58:16

0528+134 RO006.UVDATA.1

Freq = 4.9270 GHz, Bw = 16.000 MH No calibration applied and no bandpass applied

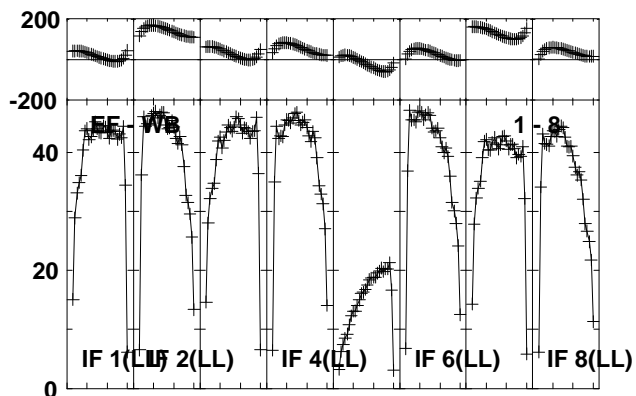
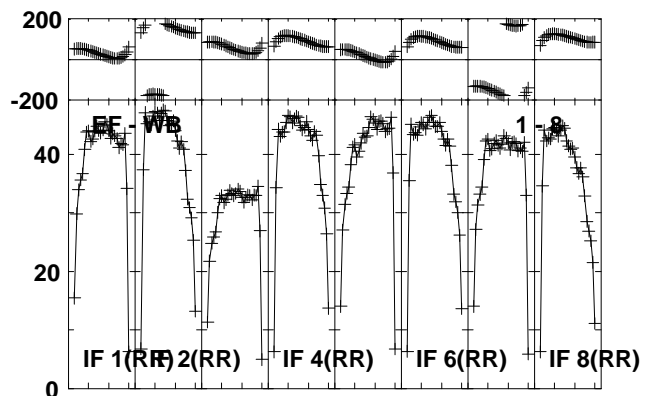
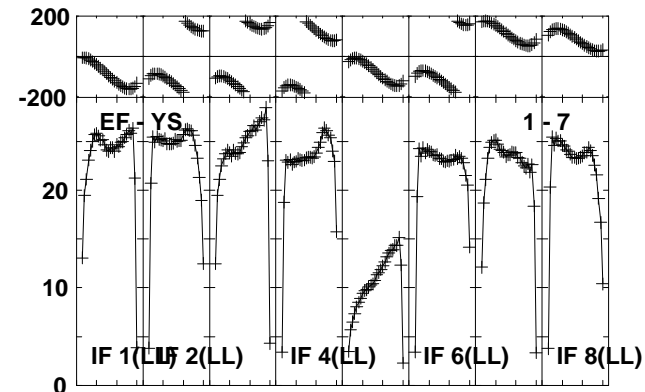
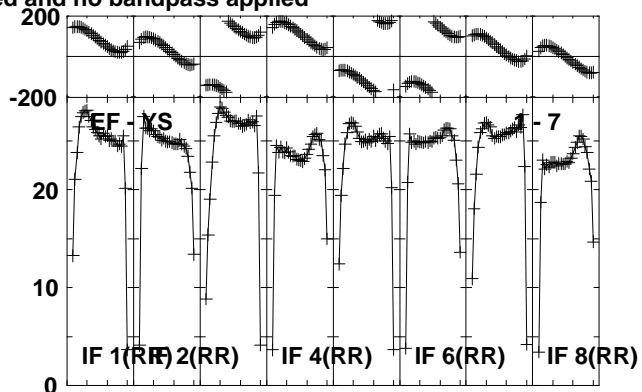
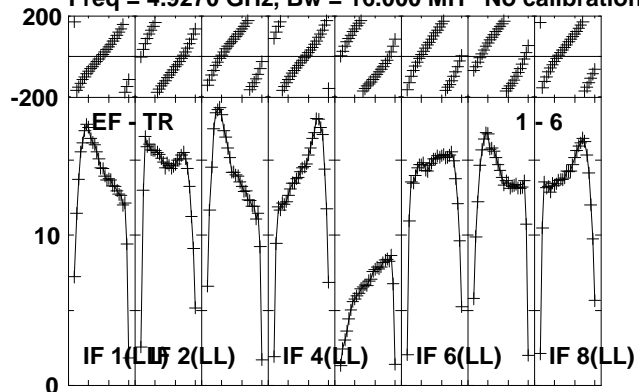

Lower frame: Milli Ampl Jy Top frame: Phas deg
Vector averaged cross-power spectrum Several baselines displayed
Timerange: 00/07:01:17 to 00/07:04:19

Plot file version 355 created 16-OCT-2012 11:58:16

J0645+0541 RO006.UVDATA.1

Freq = 4.9270 GHz, Bw = 16.000 MH No calibration applied and no bandpass applied

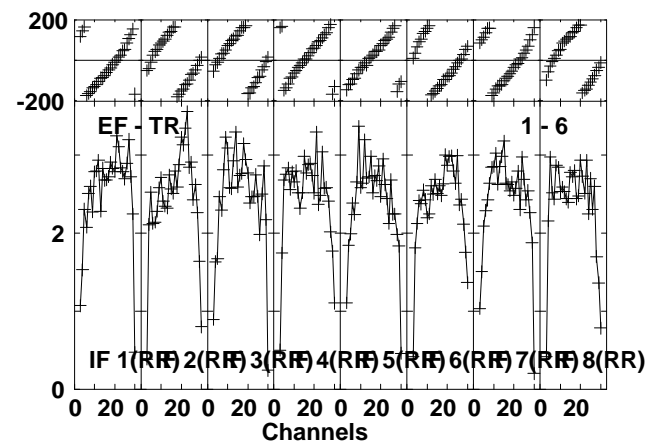
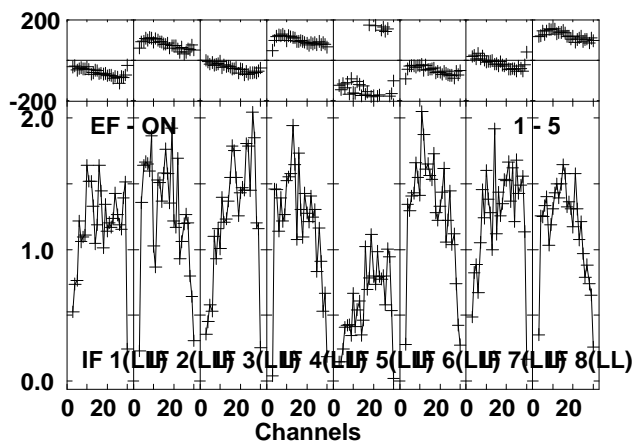
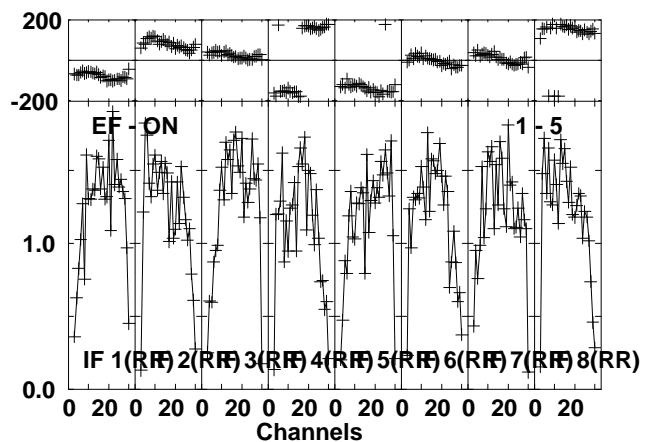
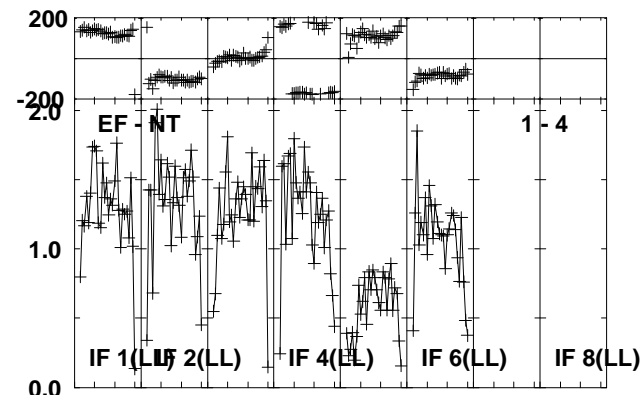
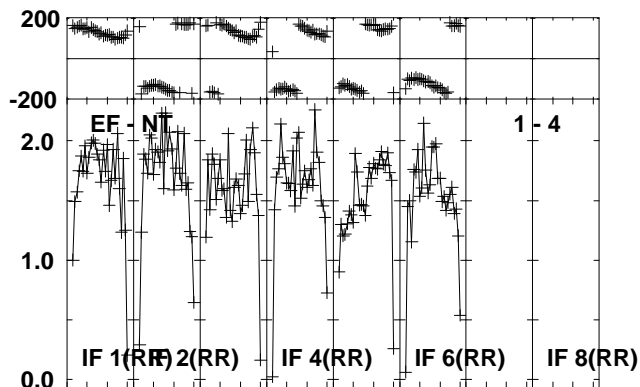
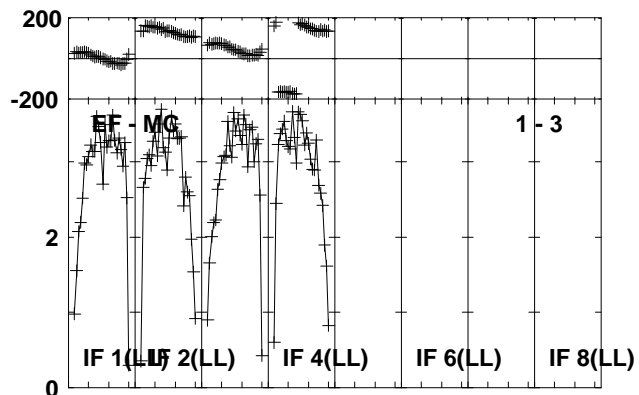
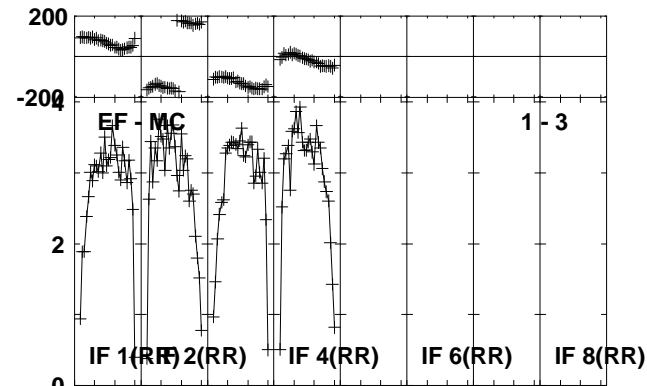
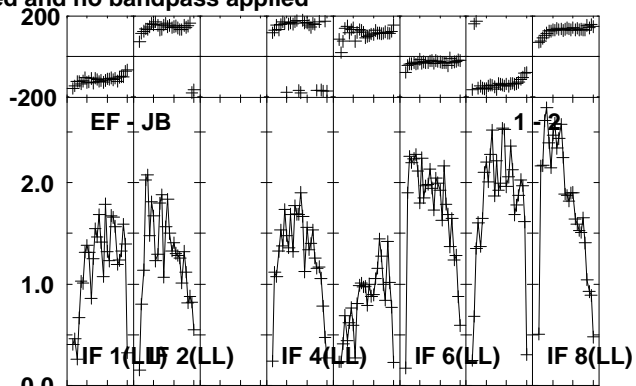
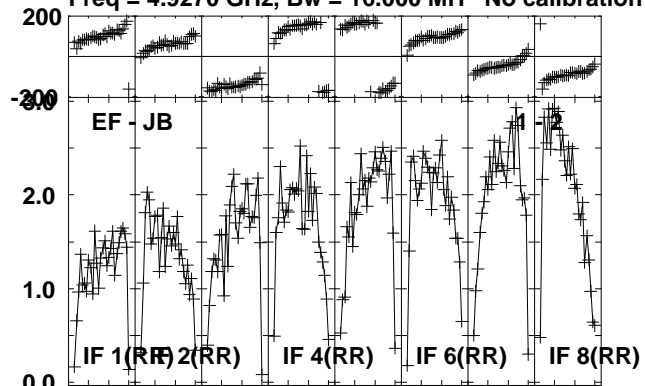

Lower frame: Milli Ampl Jy Top frame: Phas deg
Vector averaged cross-power spectrum Several baselines displayed
Timerange: 00/07:06:17 to 00/07:07:19

Plot file version 356 created 16-OCT-2012 11:58:17

J0645+0541 RO006.UVDATA.1

Freq = 4.9270 GHz, Bw = 16.000 MH No calibration applied and no bandpass applied

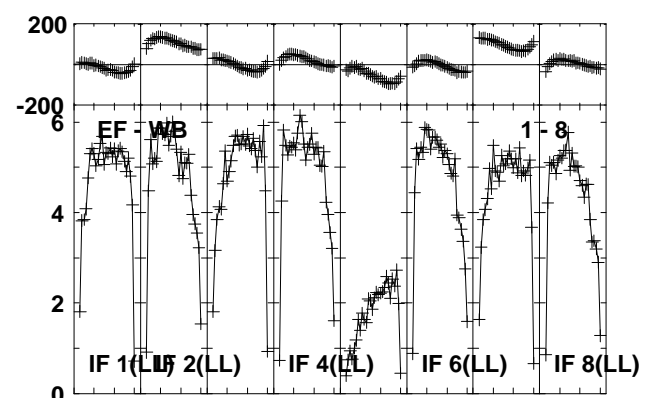
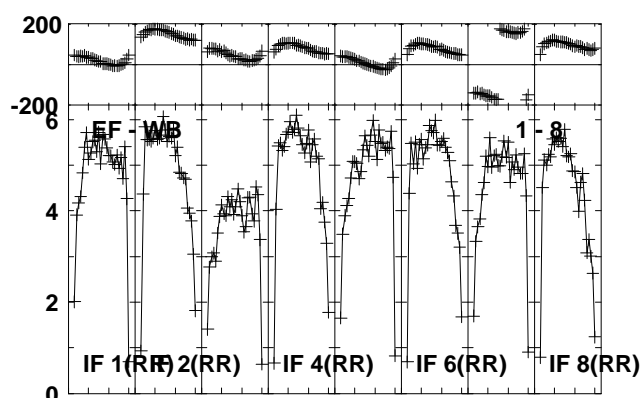
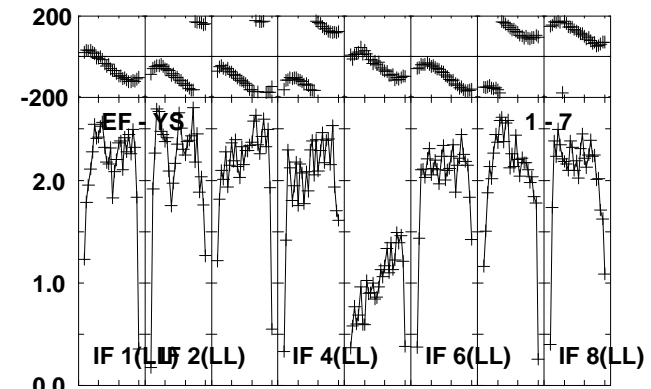
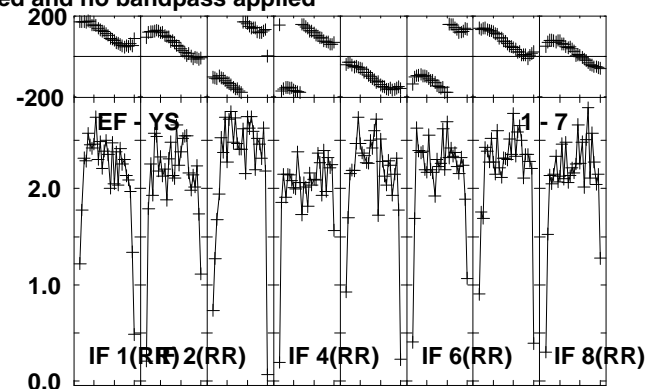
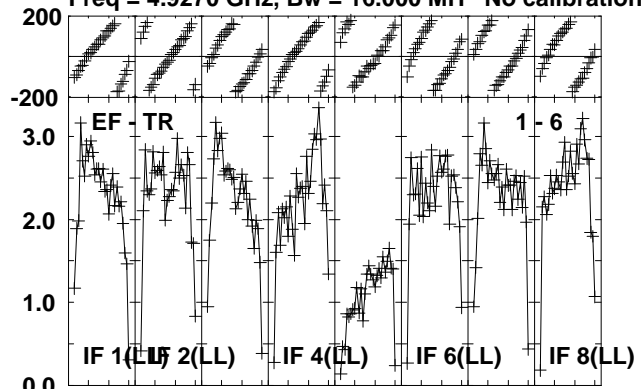

Lower frame: Milli Ampl Jy Top frame: Phas deg
Vector averaged cross-power spectrum Several baselines displayed
Timerange: 00/07:06:17 to 00/07:07:19

Plot file version 357 created 16-OCT-2012 11:58:17

NOVA-MON RO006.UVDATA.1

Freq = 4.9270 GHz, Bw = 16.000 MH No calibration applied and no bandpass applied

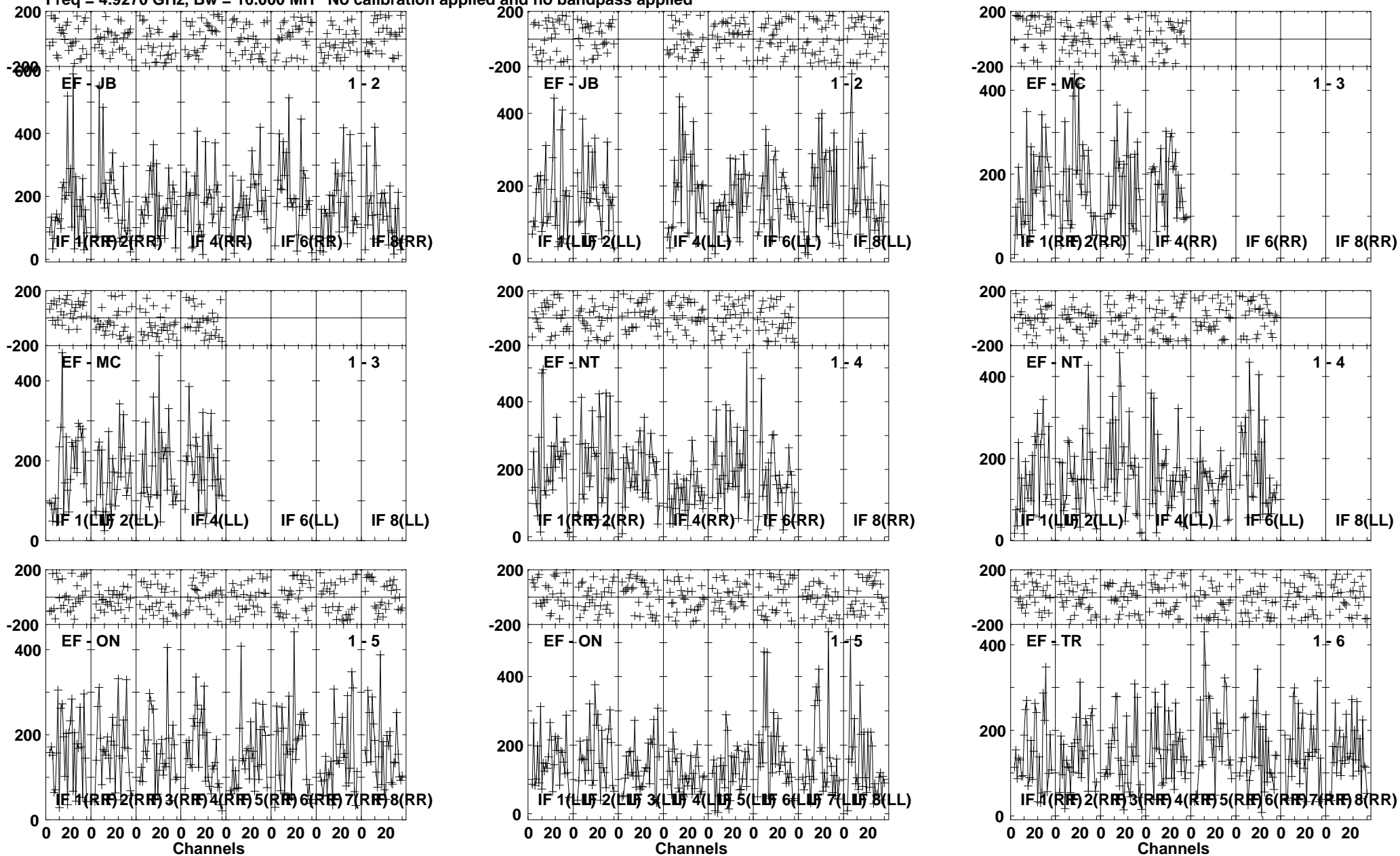

Lower frame: Micro Ampl Jy Top frame: Phas deg
Vector averaged cross-power spectrum Several baselines displayed
Timerange: 00/07:07:23 to 00/07:10:19

Plot file version 358 created 16-OCT-2012 11:58:17

NOVA-MON RO006.UVDATA.1

Freq = 4.9270 GHz, Bw = 16.000 MH No calibration applied and no bandpass applied

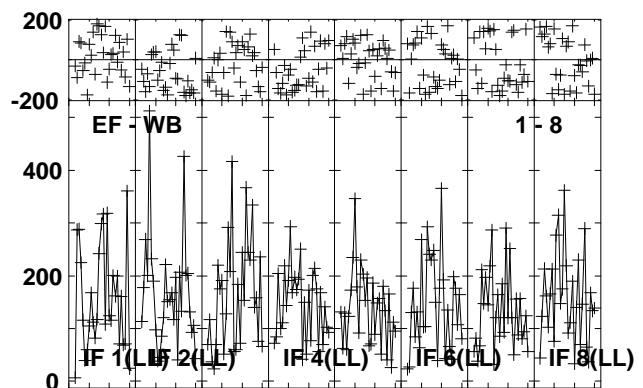
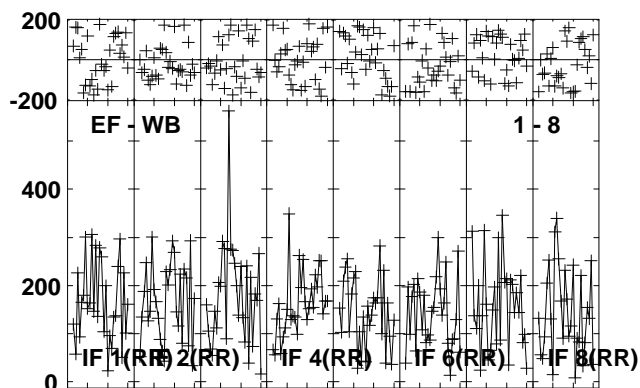
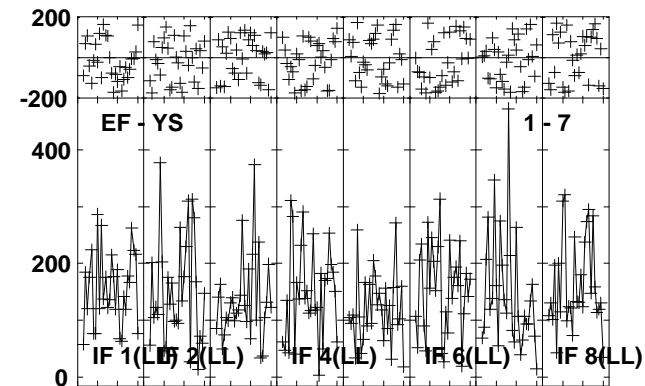
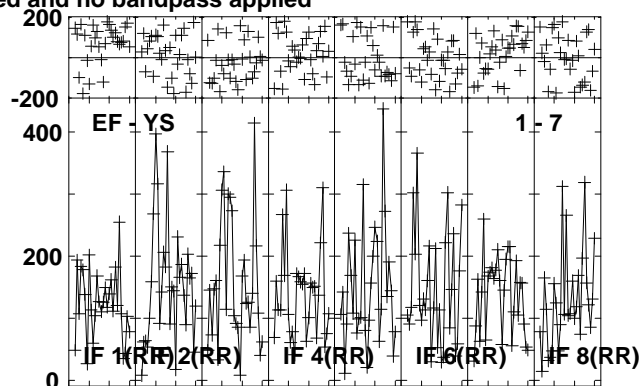
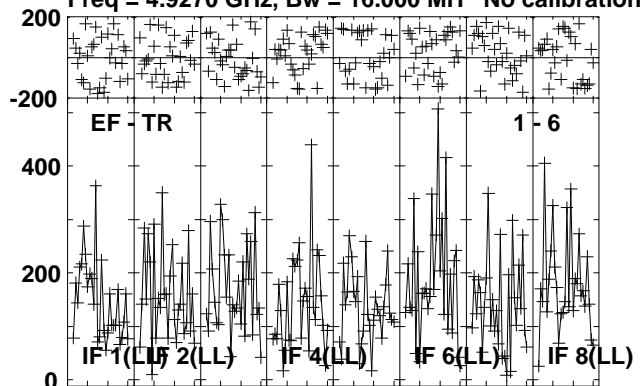

Lower frame: Micro Ampl Jy Top frame: Phas deg
Vector averaged cross-power spectrum Several baselines displayed
Timerange: 00/07:07:23 to 00/07:10:19

Plot file version 359 created 16-OCT-2012 11:58:18

J0639+0601 RO006.UVDATA.1

Freq = 4.9270 GHz, Bw = 16.000 MH No calibration applied and no bandpass applied

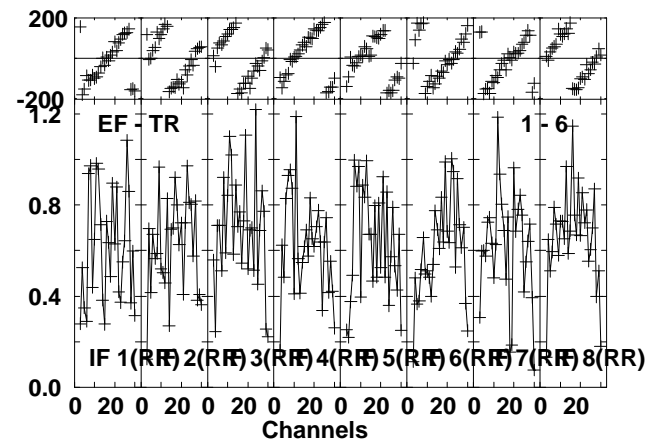
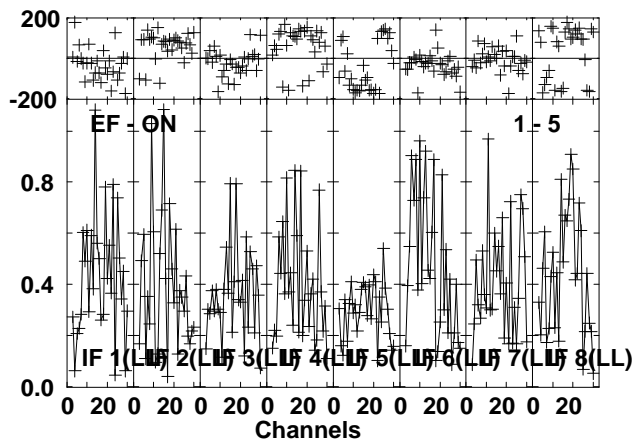
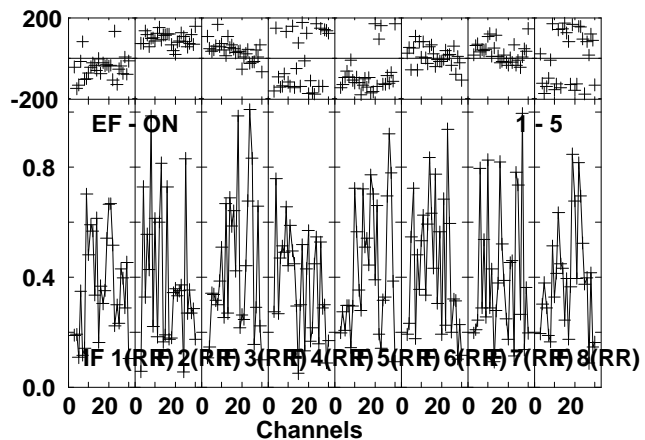
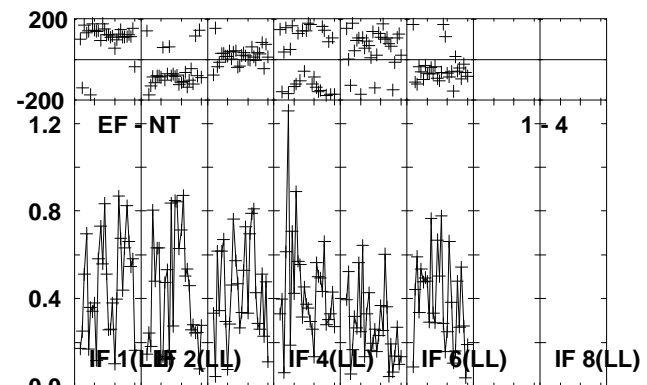
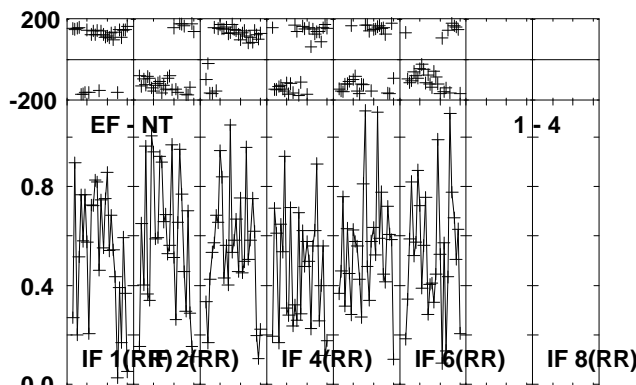
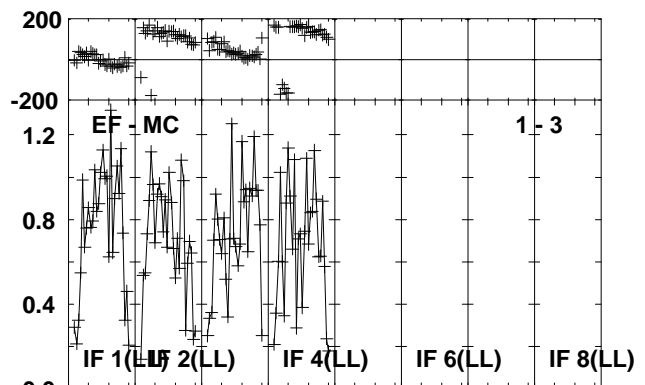
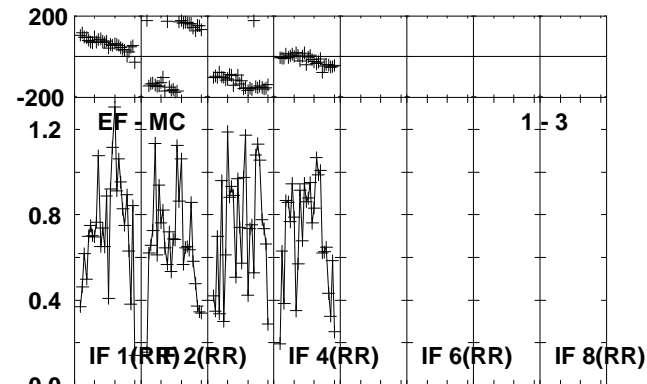
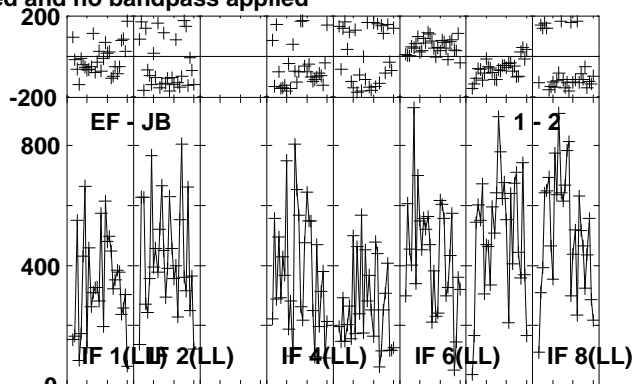
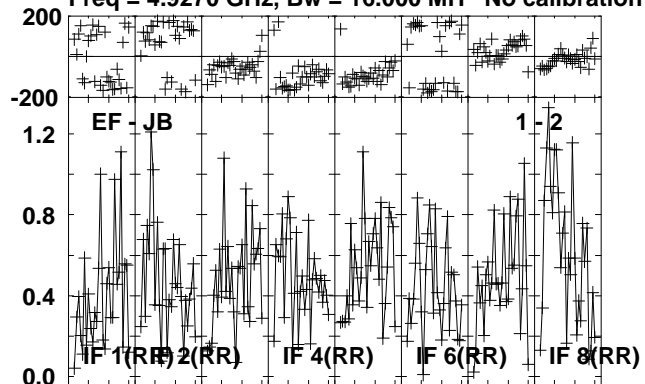

Lower frame: Milli Ampl Jy Top frame: Phas deg
Vector averaged cross-power spectrum Several baselines displayed
Timerange: 00/07:10:23 to 00/07:11:33

Plot file version 360 created 16-OCT-2012 11:58:18

J0639+0601 RO006.UVDATA.1

Freq = 4.9270 GHz, Bw = 16.000 MH No calibration applied and no bandpass applied

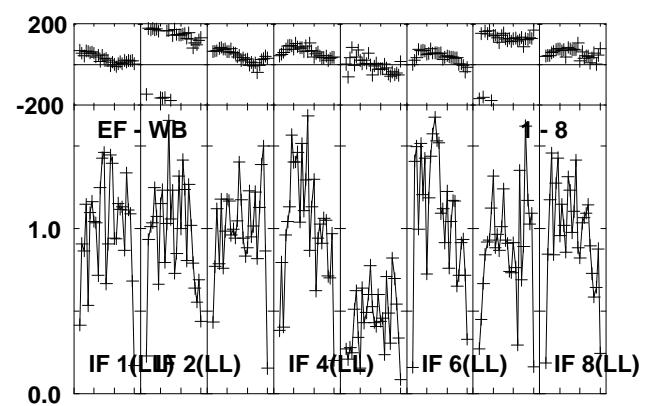
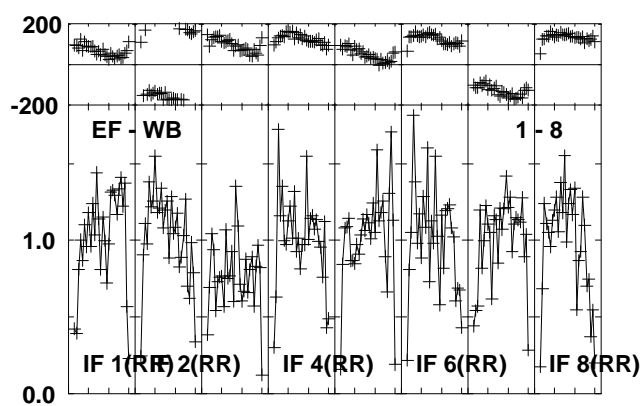
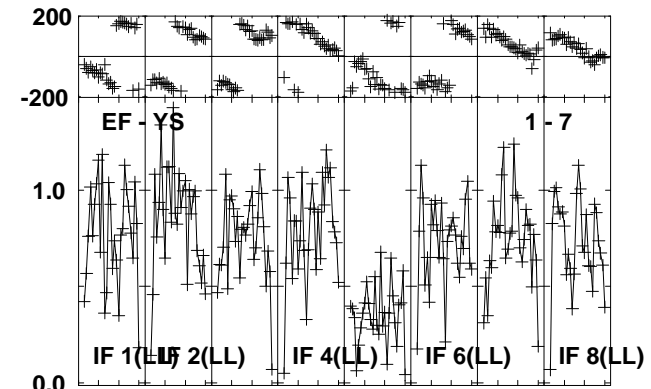
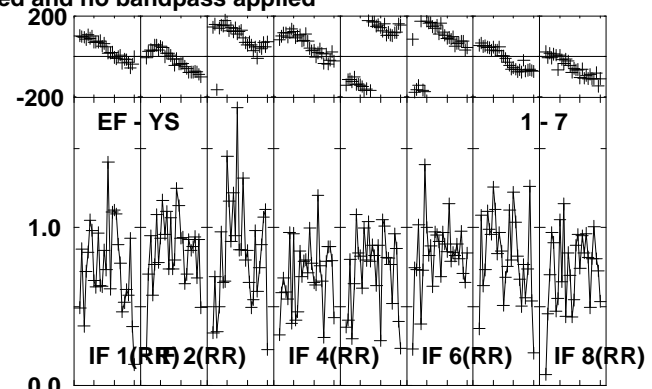
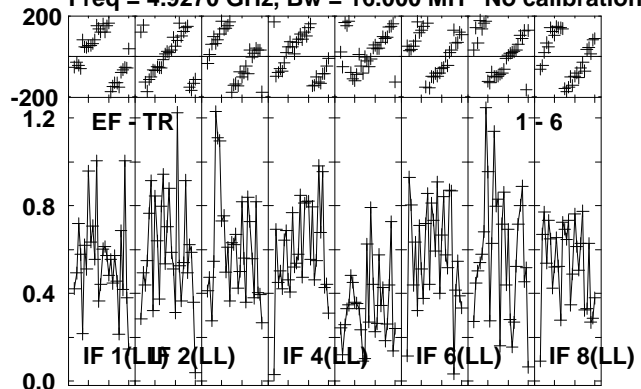

Lower frame: Milli Ampl Jy Top frame: Phas deg
Vector averaged cross-power spectrum Several baselines displayed
Timerange: 00/07:10:23 to 00/07:11:33

Plot file version 361 created 16-OCT-2012 11:58:18

J0645+0541 RO006.UVDATA.1

Freq = 4.9270 GHz, Bw = 16.000 MH No calibration applied and no bandpass applied

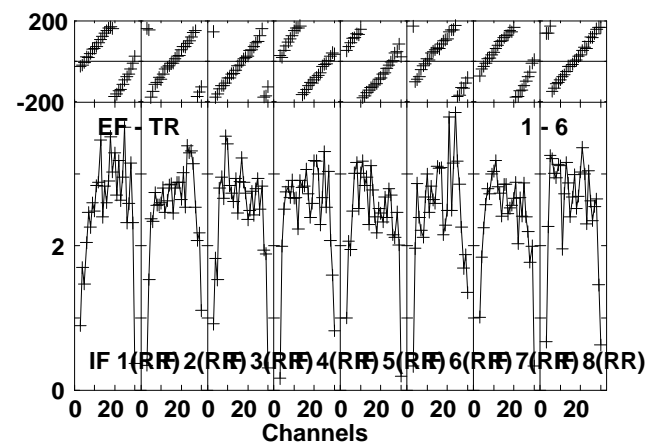
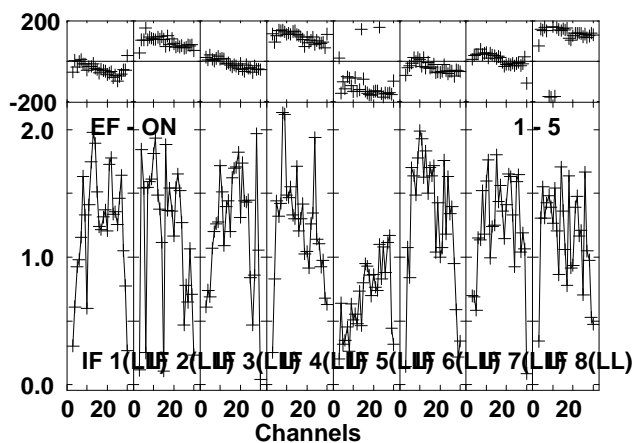
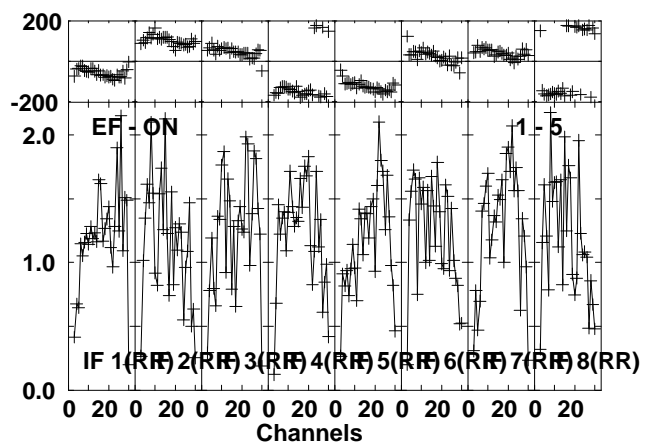
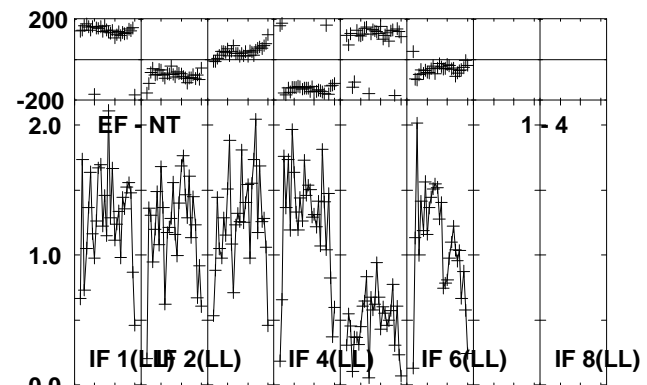
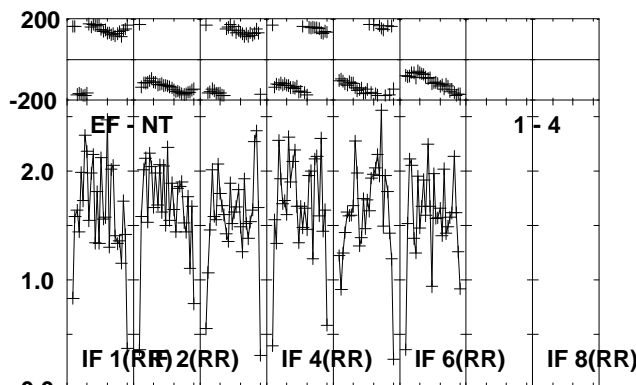
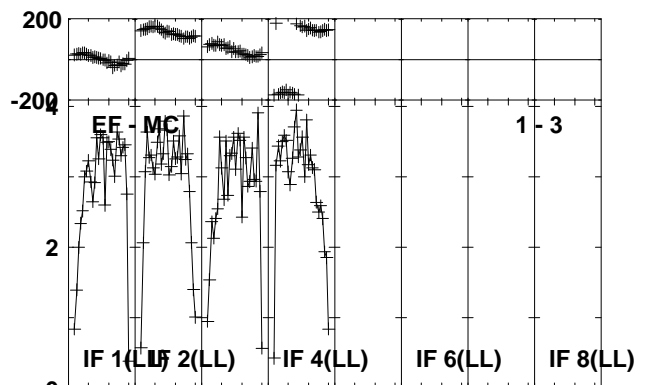
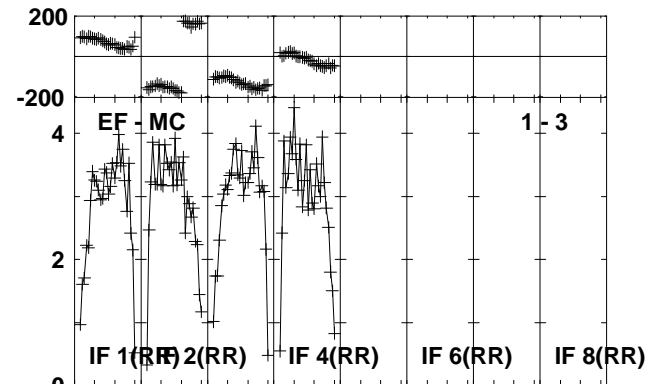
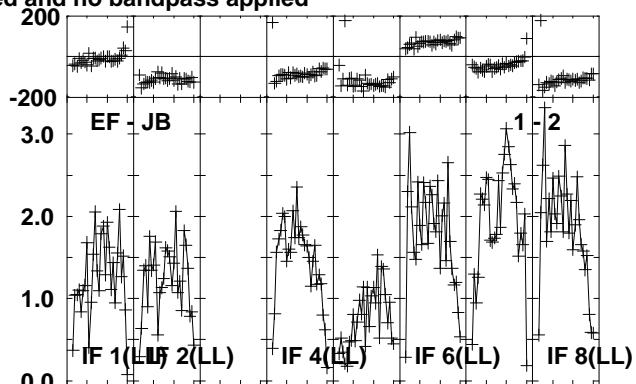
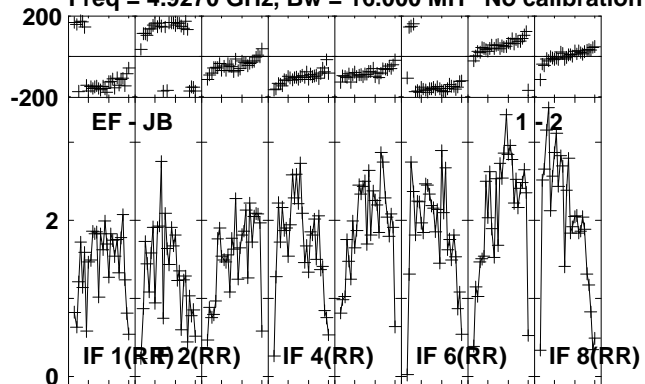

Lower frame: Milli Ampl Jy Top frame: Phas deg
Vector averaged cross-power spectrum Several baselines displayed
Timerange: 00/07:11:37 to 00/07:12:33

Plot file version 362 created 16-OCT-2012 11:58:18

J0645+0541 RO006.UVDATA.1

Freq = 4.9270 GHz, Bw = 16.000 MH No calibration applied and no bandpass applied

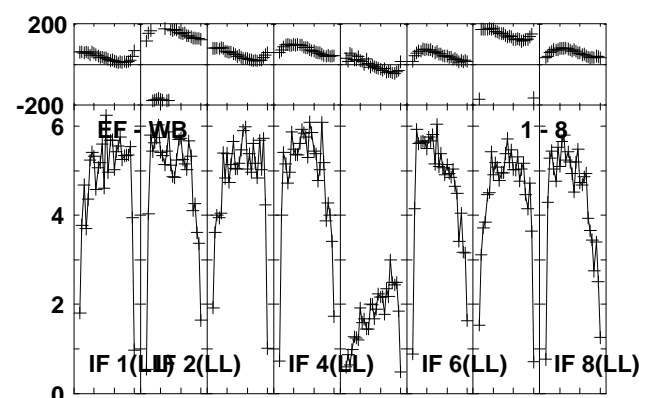
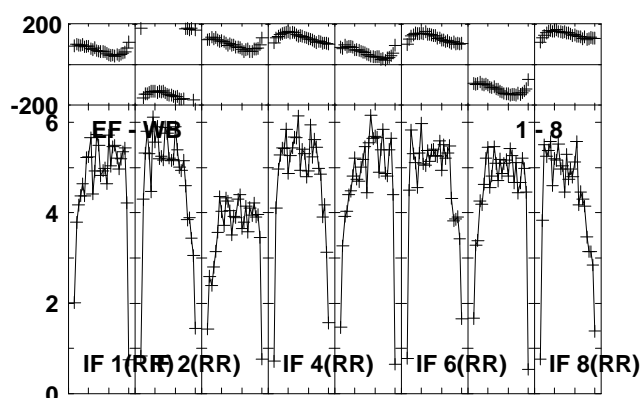
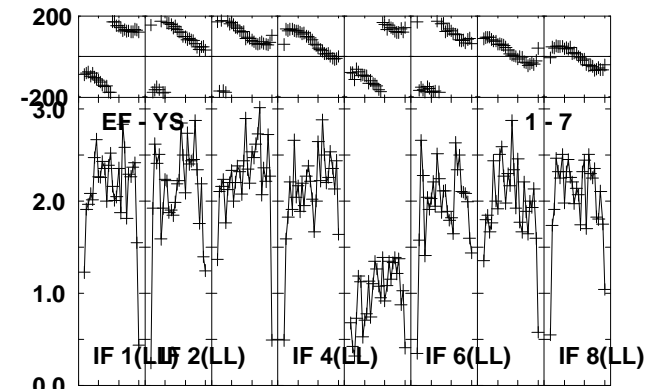
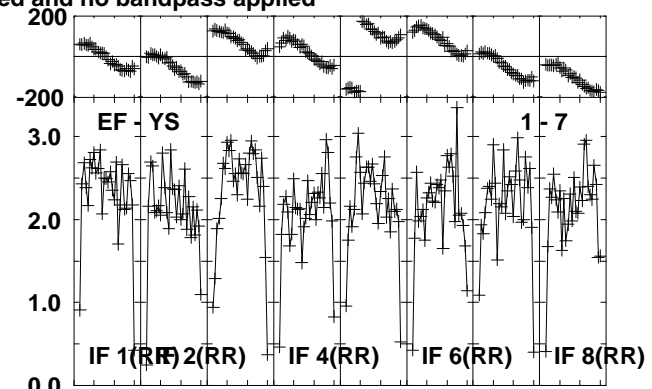
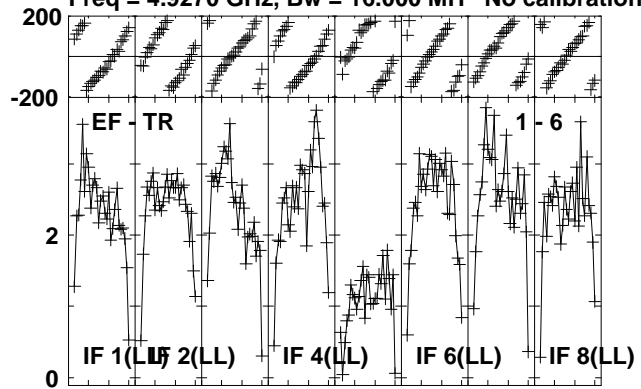

Lower frame: Milli Ampl Jy Top frame: Phas deg
Vector averaged cross-power spectrum Several baselines displayed
Timerange: 00/07:11:37 to 00/07:12:33

Plot file version 363 created 16-OCT-2012 11:58:19

NOVA-MON RO006.UVDATA.1

Freq = 4.9270 GHz, Bw = 16.000 MH No calibration applied and no bandpass applied

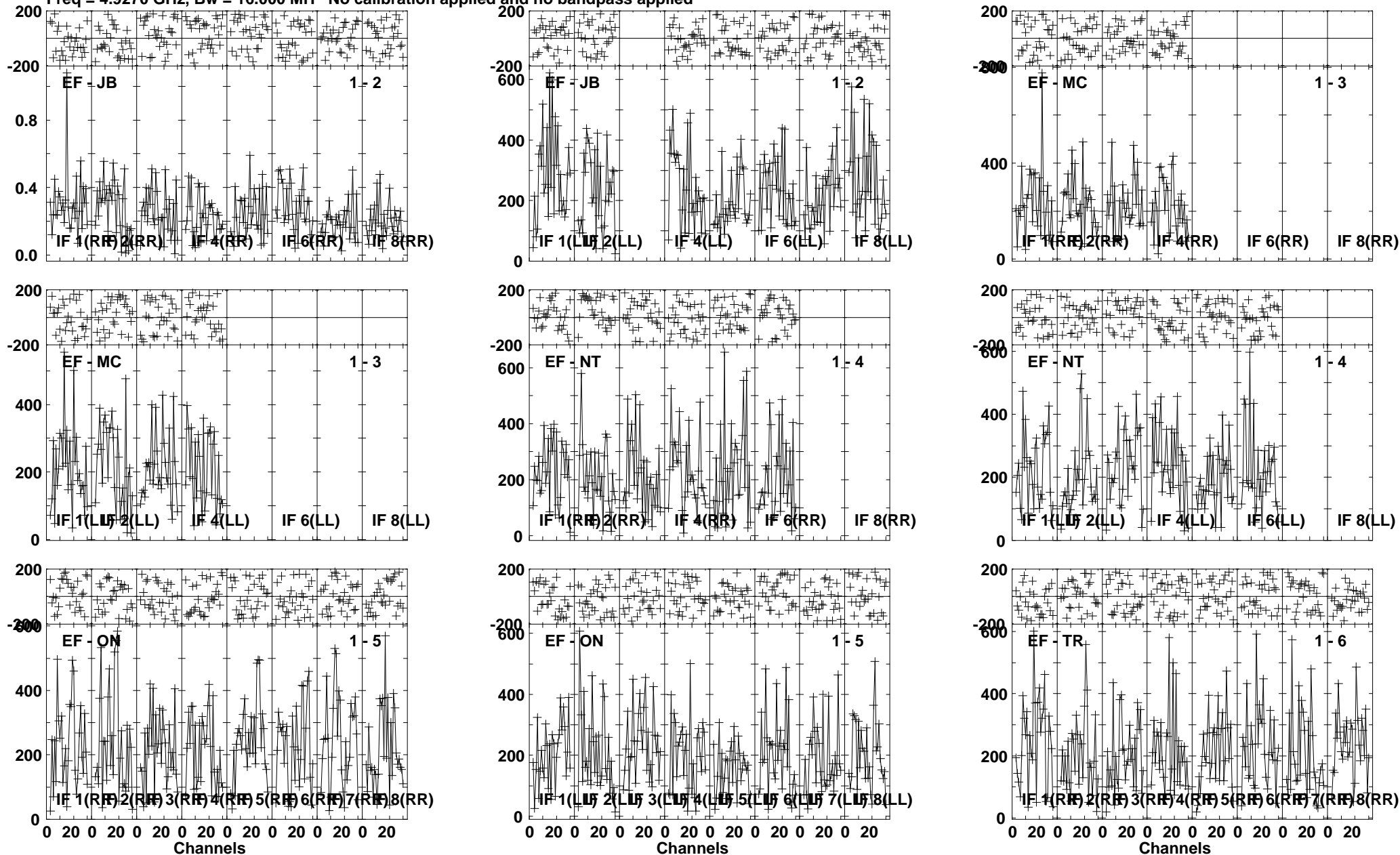

Lower frame: Milli Ampl Jy Top frame: Phas deg
Vector averaged cross-power spectrum Several baselines displayed
Timerange: 00/07:12:37 to 00/07:15:33

Plot file version 364 created 16-OCT-2012 11:58:19

NOVA-MON RO006.UVDATA.1

Freq = 4.9270 GHz, Bw = 16.000 MH No calibration applied and no bandpass applied

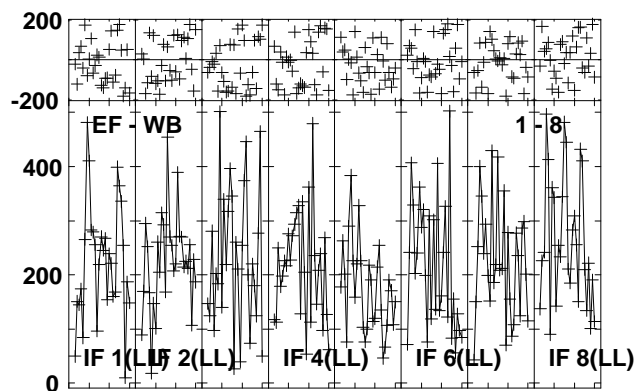
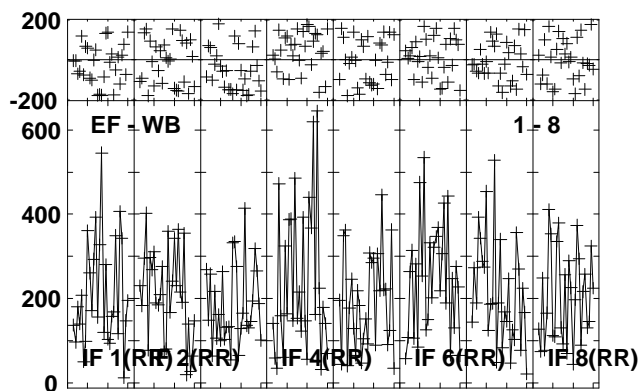
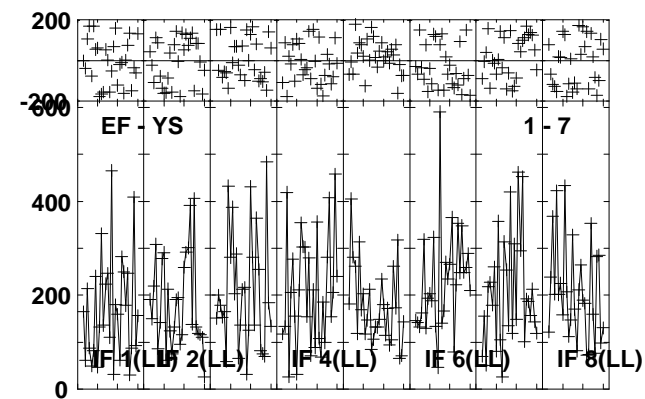
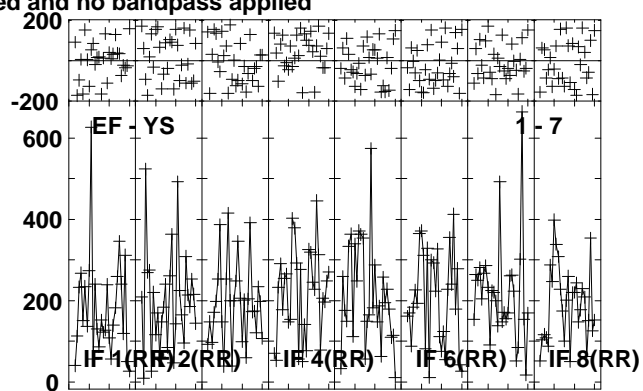
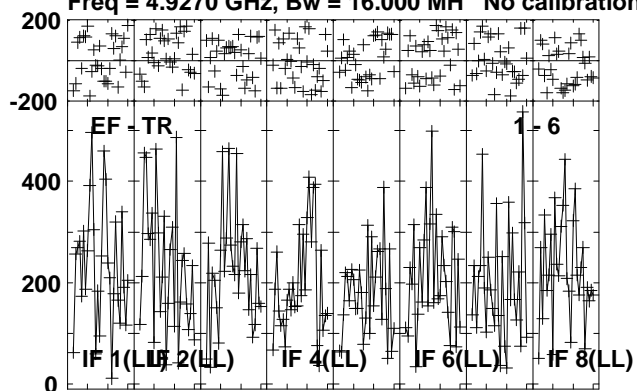

Lower frame: Micro Ampl Jy Top frame: Phas deg
Vector averaged cross-power spectrum Several baselines displayed
Timerange: 00/07:12:37 to 00/07:15:33

Plot file version 365 created 16-OCT-2012 11:58:20

J0639+0601 RO006.UVDATA.1

Freq = 4.9270 GHz, Bw = 16.000 MH No calibration applied and no bandpass applied

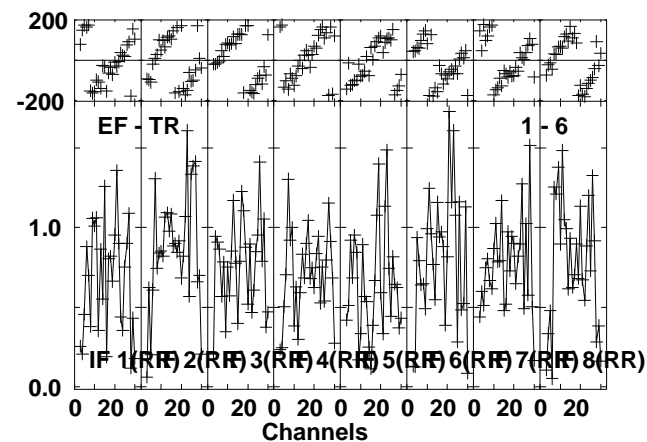
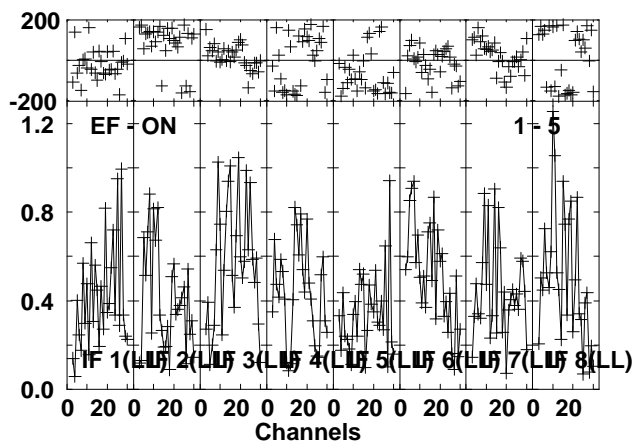
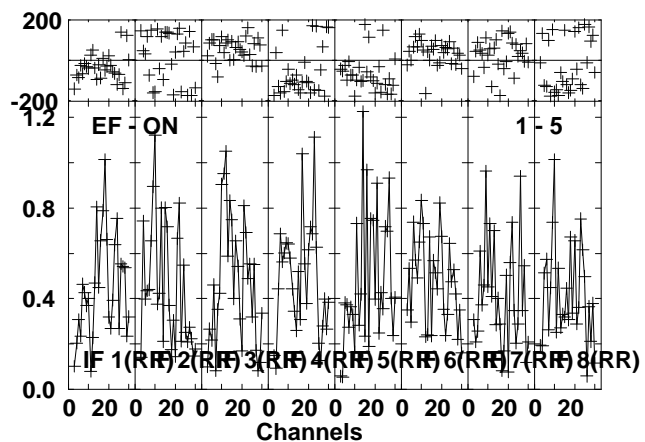
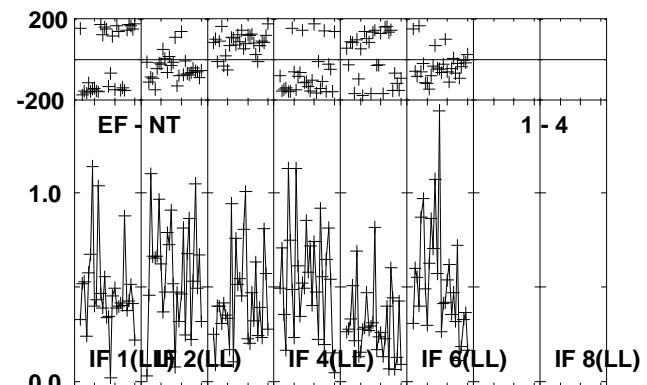
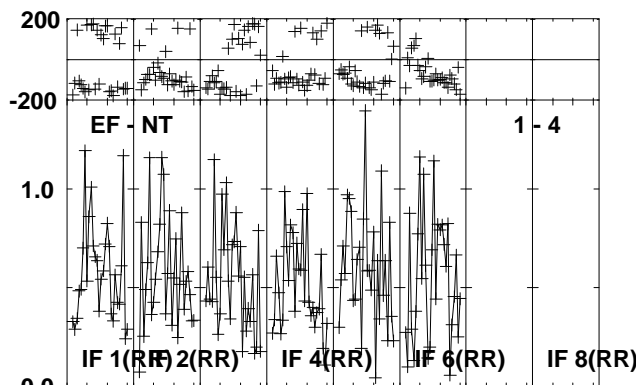
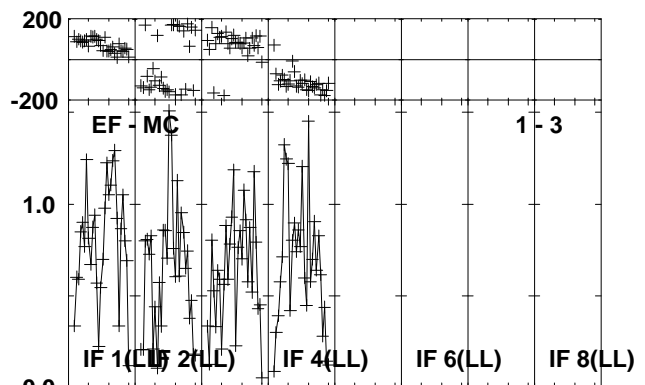
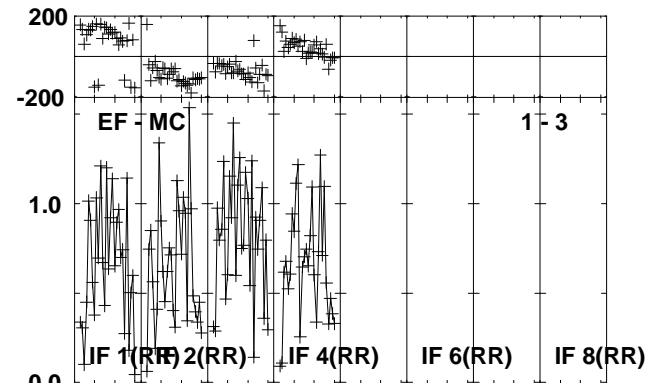
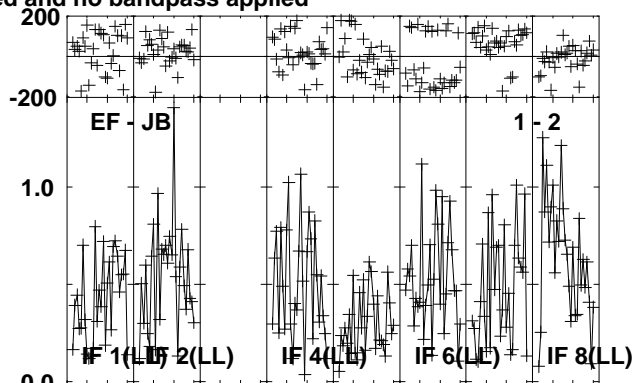
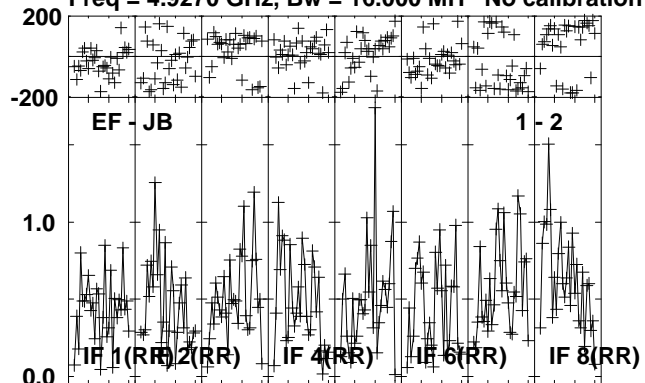

Lower frame: Milli Ampl Jy Top frame: Phas deg
Vector averaged cross-power spectrum Several baselines displayed
Timerange: 00/07:16:03 to 00/07:17:03

Plot file version 366 created 16-OCT-2012 11:58:20

J0639+0601 RO006.UVDATA.1

Freq = 4.9270 GHz, Bw = 16.000 MH No calibration applied and no bandpass applied

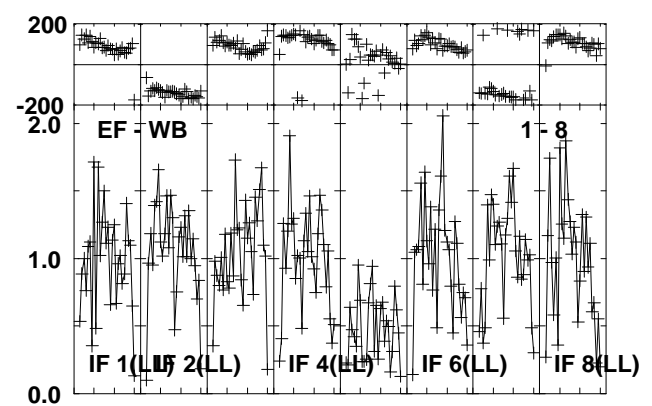
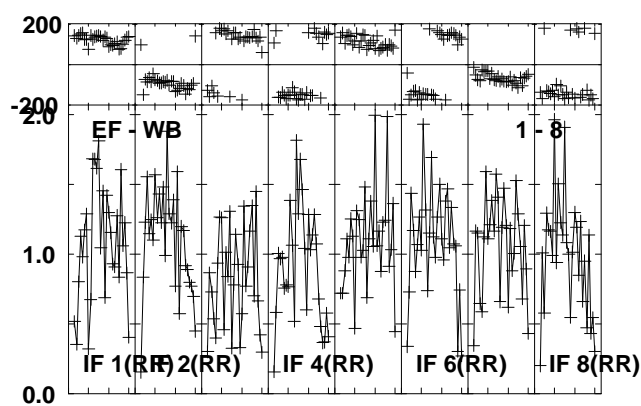
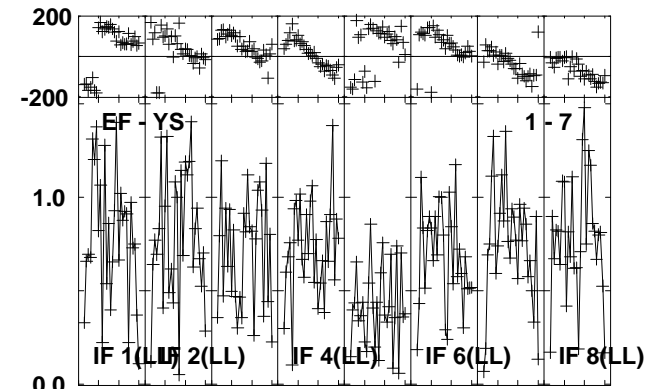
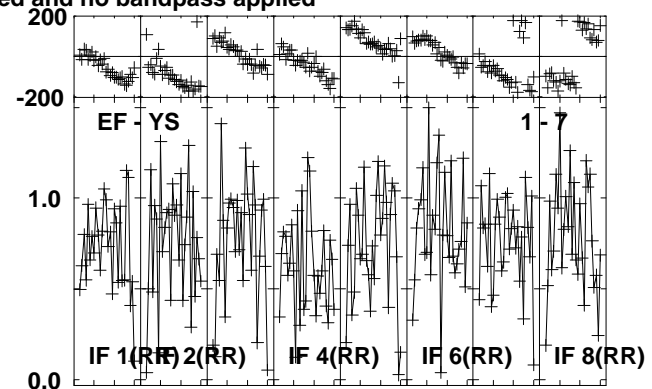
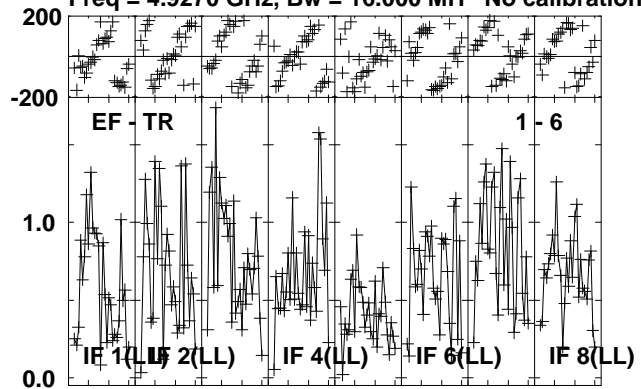

Lower frame: Milli Ampl Jy Top frame: Phas deg
Vector averaged cross-power spectrum Several baselines displayed
Timerange: 00/07:16:03 to 00/07:17:03

Plot file version 367 created 16-OCT-2012 11:58:20

J0645+0541 RO006.UVDATA.1

Freq = 4.9270 GHz, Bw = 16.000 MH No calibration applied and no bandpass applied

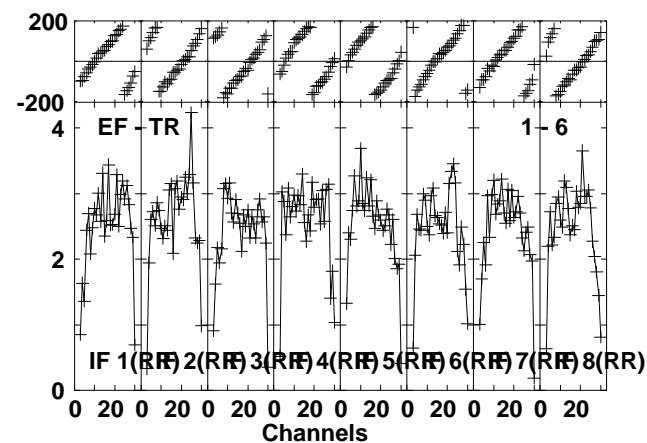
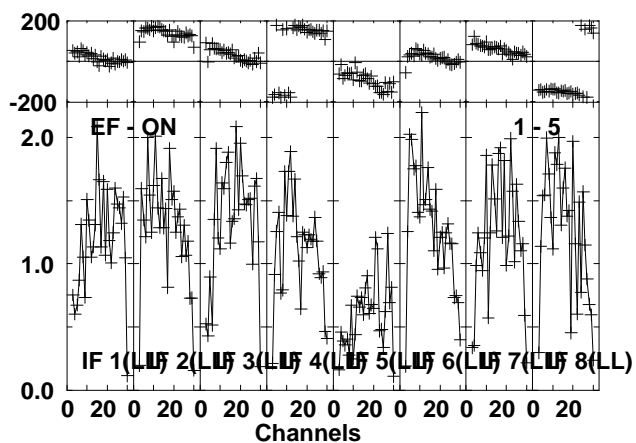
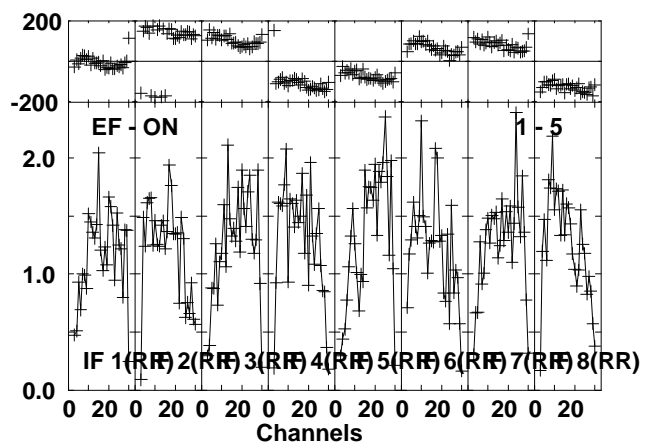
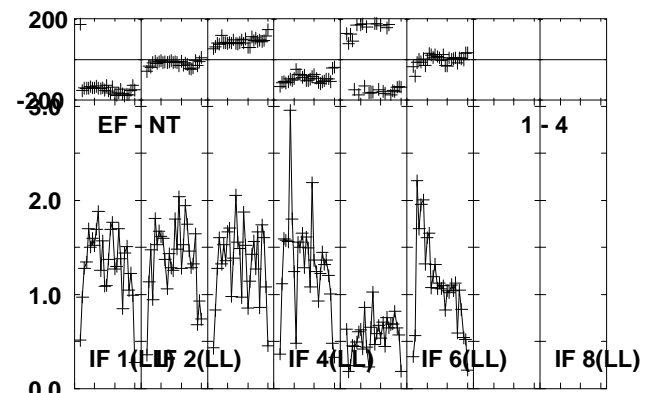
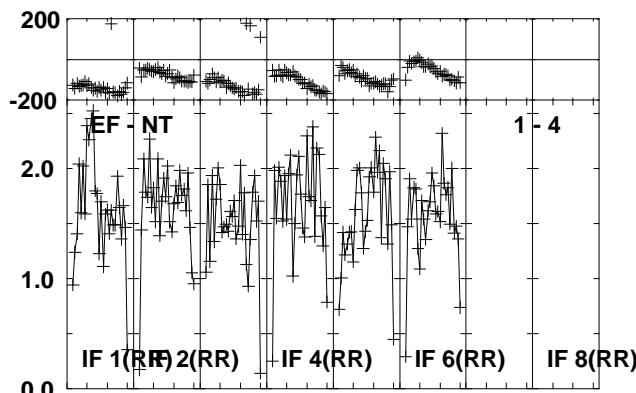
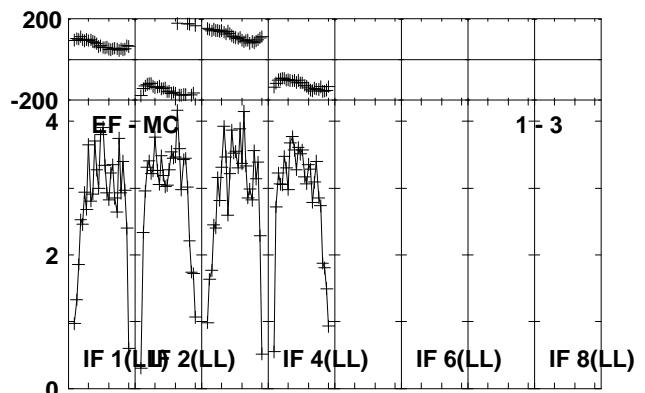
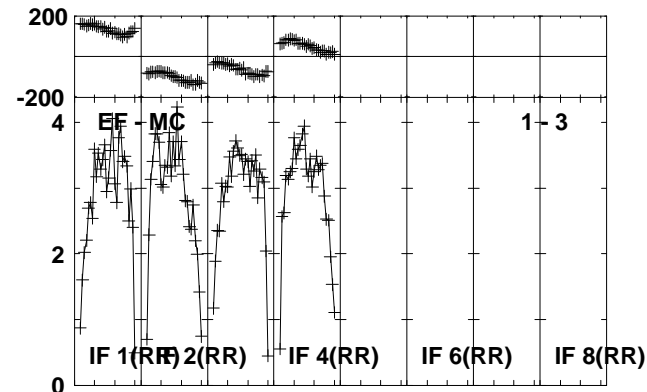
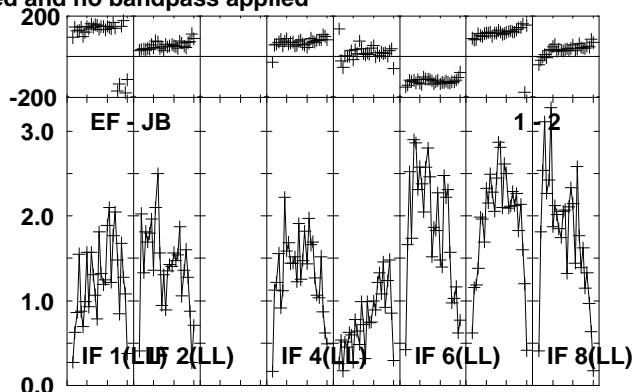
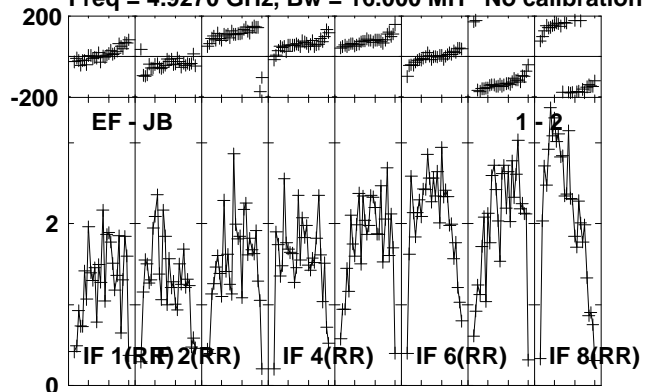

Lower frame: Milli Ampl Jy Top frame: Phas deg
Vector averaged cross-power spectrum Several baselines displayed
Timerange: 00/07:17:07 to 00/07:18:03

Plot file version 368 created 16-OCT-2012 11:58:20

J0645+0541 RO006.UVDATA.1

Freq = 4.9270 GHz, Bw = 16.000 MH No calibration applied and no bandpass applied

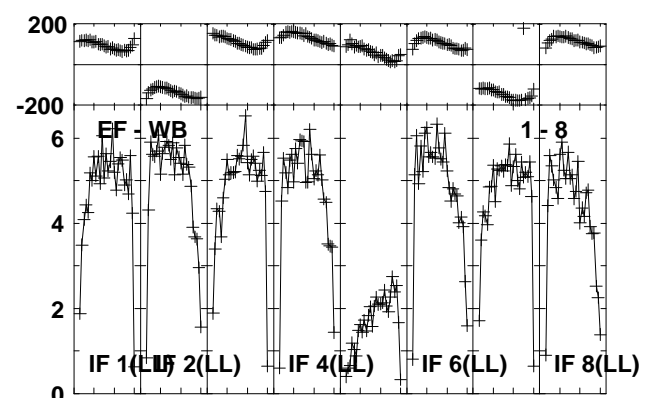
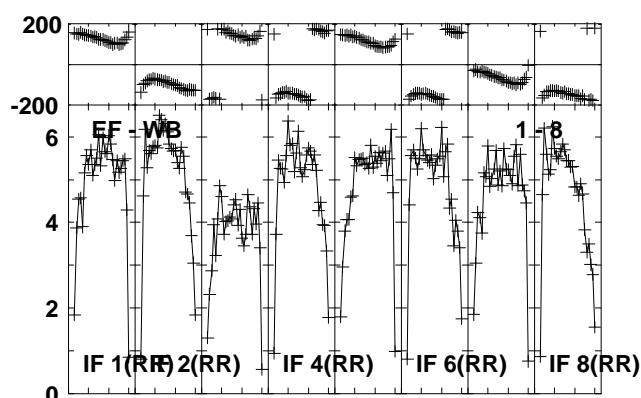
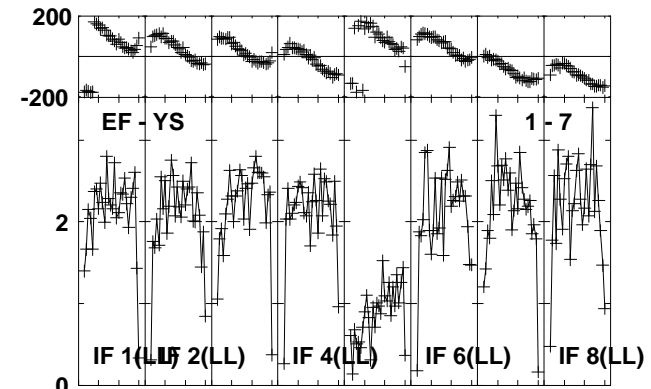
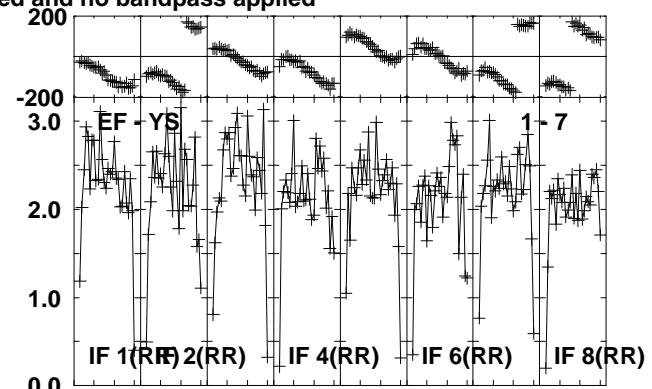
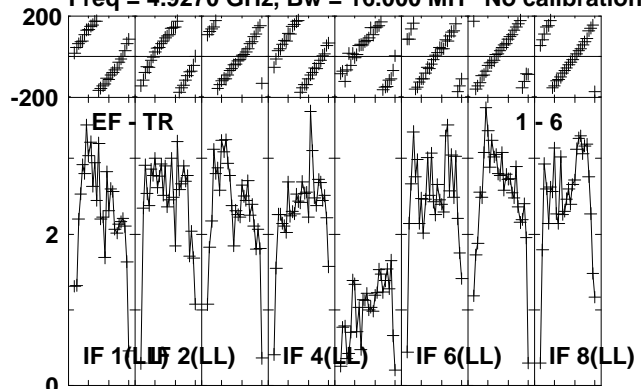

Lower frame: Milli Ampl Jy Top frame: Phas deg
Vector averaged cross-power spectrum Several baselines displayed
Timerange: 00/07:17:07 to 00/07:18:03

Plot file version 369 created 16-OCT-2012 11:58:20

NOVA-MON RO006.UVDATA.1

Freq = 4.9270 GHz, Bw = 16.000 MH No calibration applied and no bandpass applied

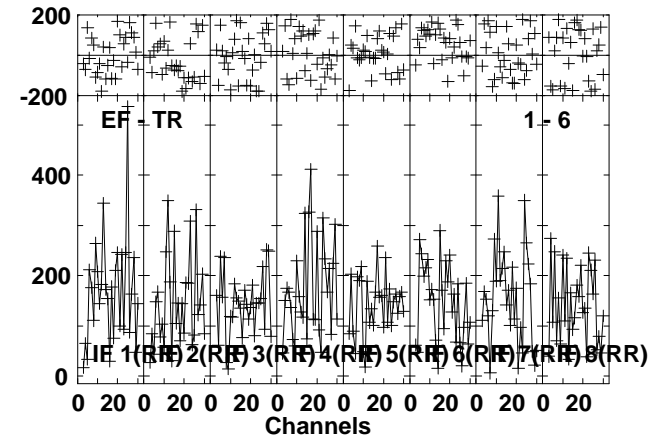
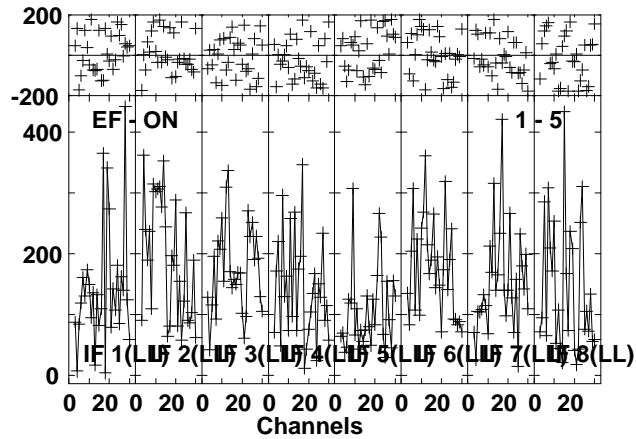
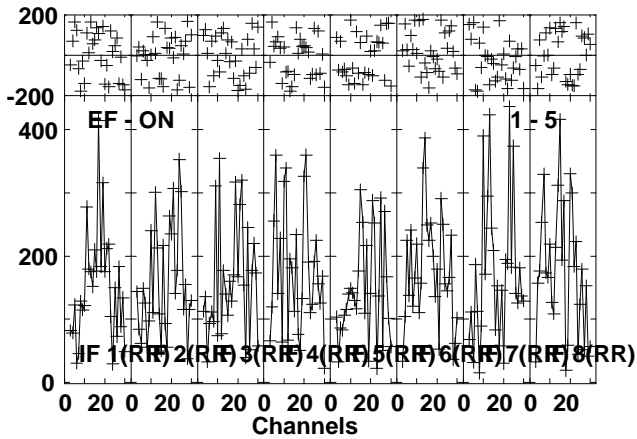
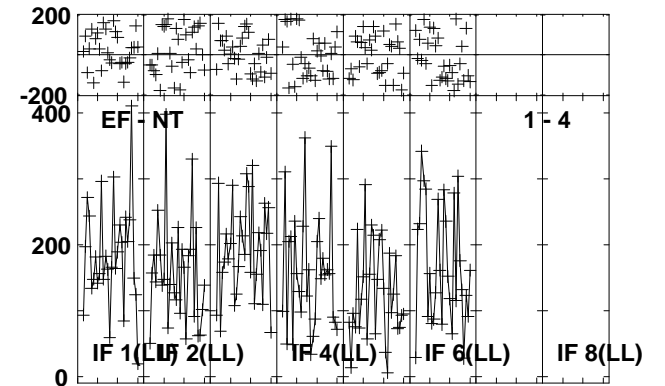
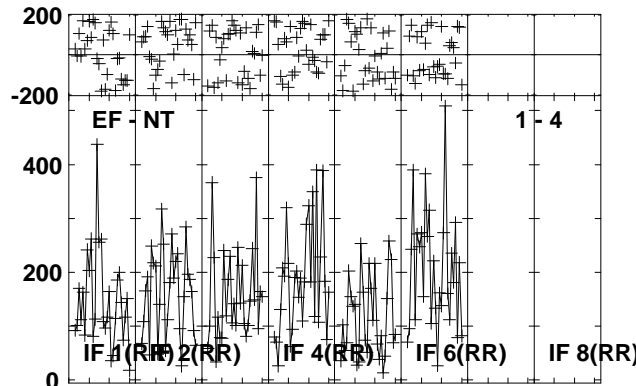
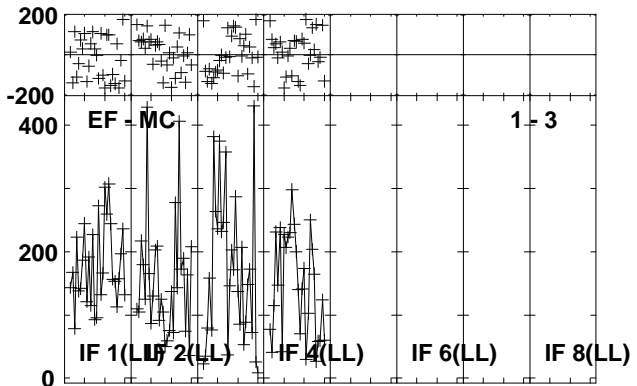
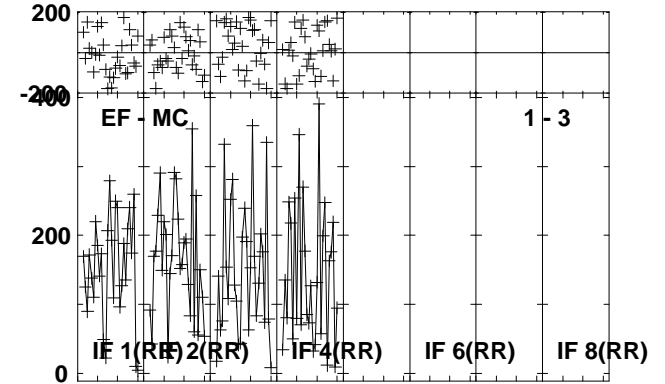
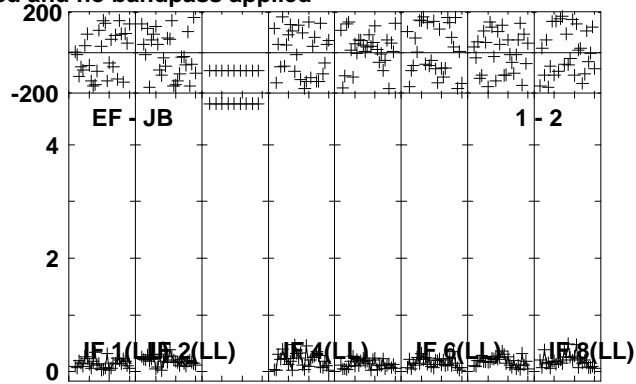
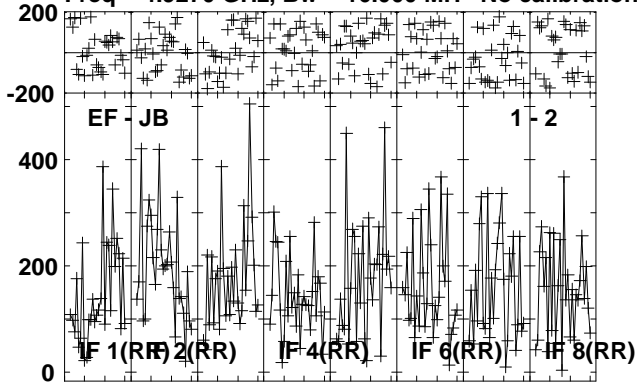

Lower frame: Micro Ampl Jy Top frame: Phas deg
Vector averaged cross-power spectrum Several baselines displayed
Timerange: 00/07:18:07 to 00/07:21:03

Plot file version 370 created 16-OCT-2012 11:58:21

NOVA-MON RO006.UVDATA.1

Freq = 4.9270 GHz, Bw = 16.000 MH No calibration applied and no bandpass applied

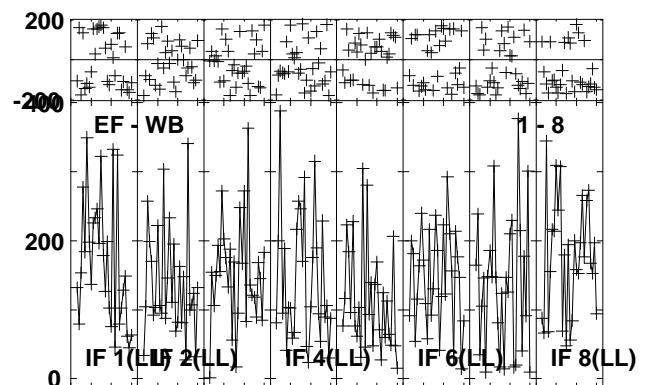
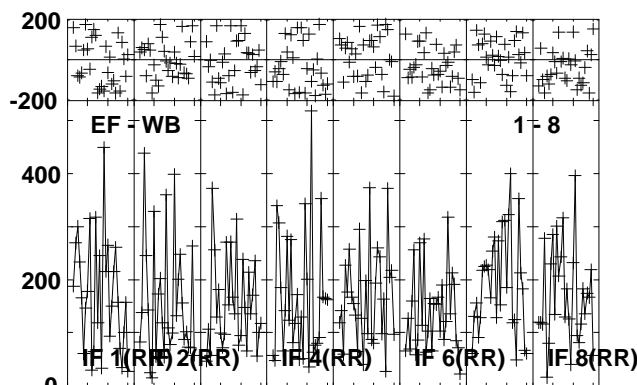
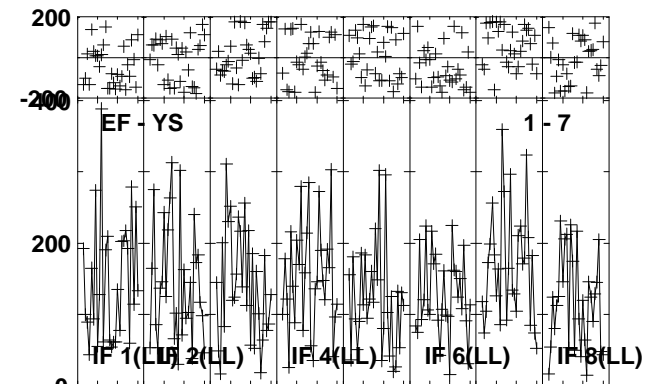
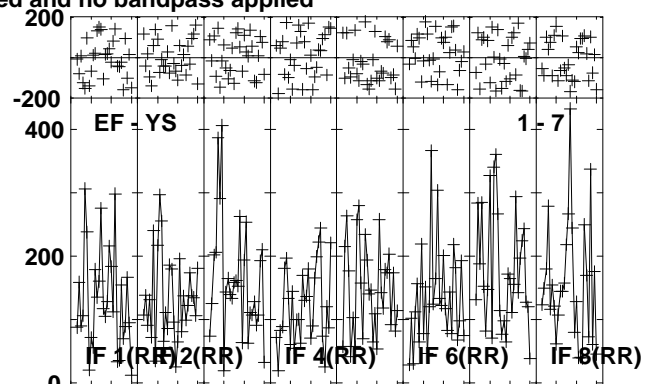
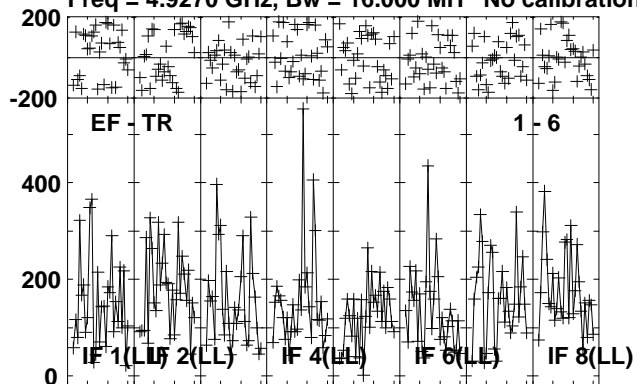

Lower frame: Micro Ampl Jy Top frame: Phas deg
Vector averaged cross-power spectrum Several baselines displayed
Timerange: 00/07:18:07 to 00/07:21:03

Plot file version 371 created 16-OCT-2012 11:58:21

J0639+0601 RO006.UVDATA.1

Freq = 4.9270 GHz, Bw = 16.000 MH No calibration applied and no bandpass applied

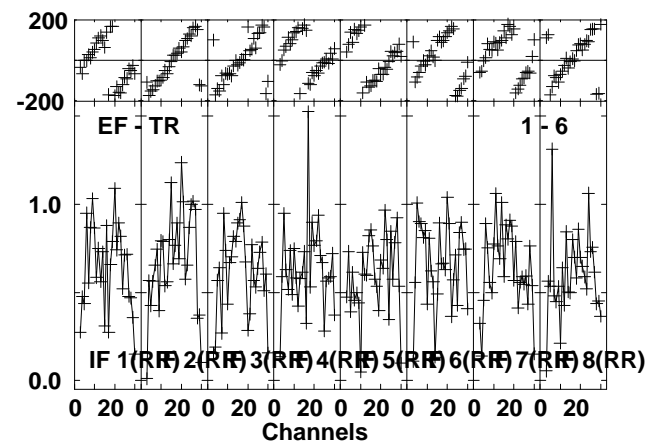
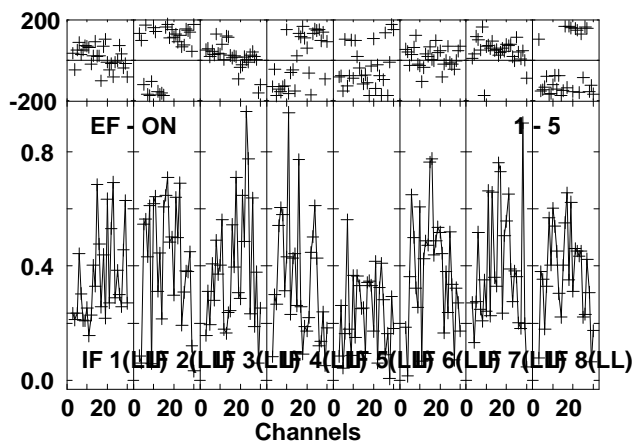
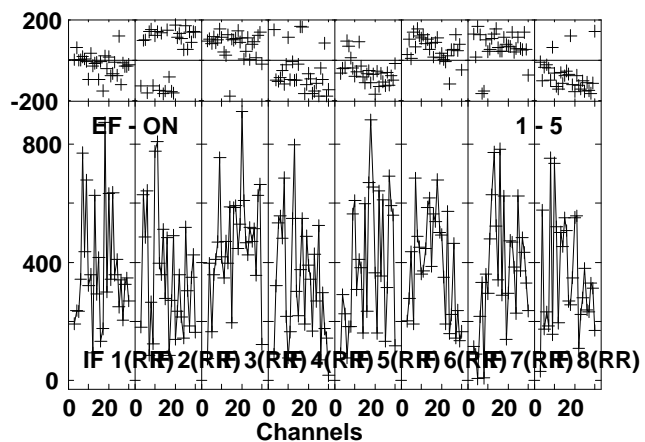
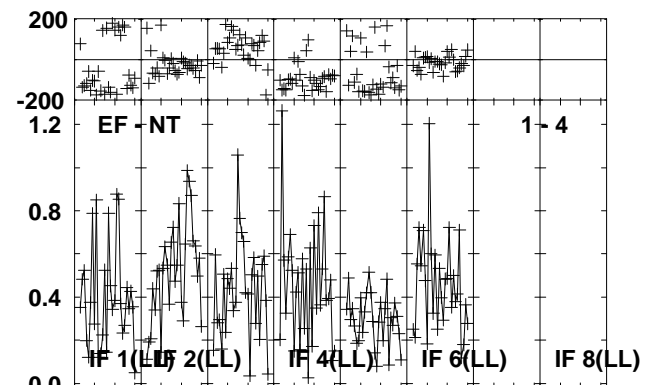
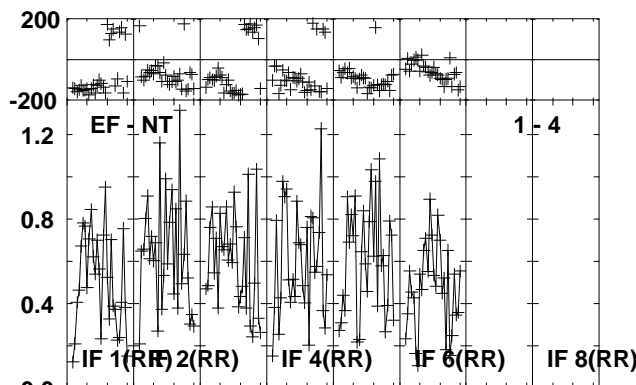
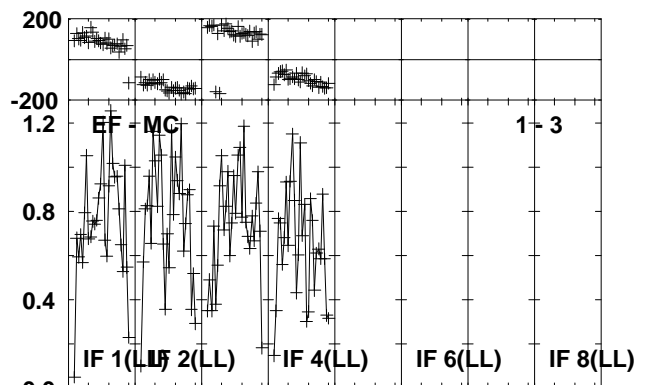
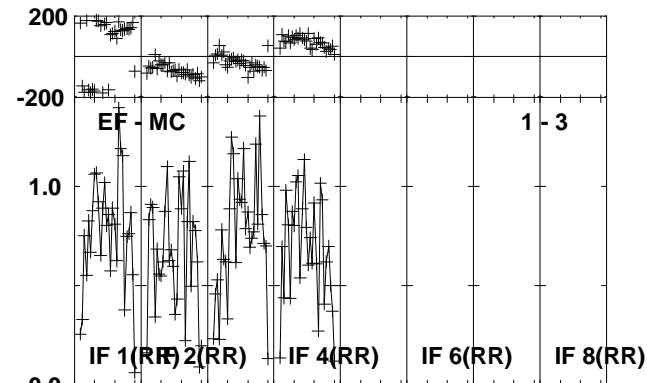
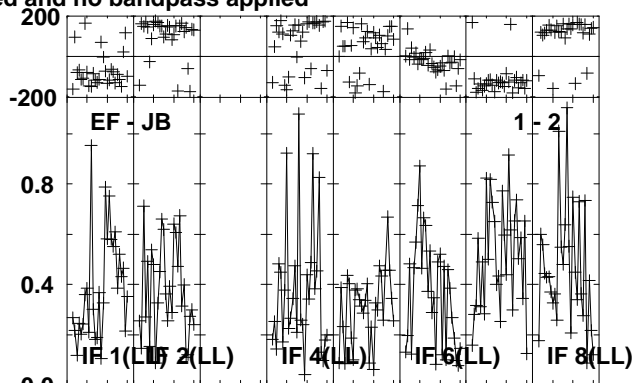
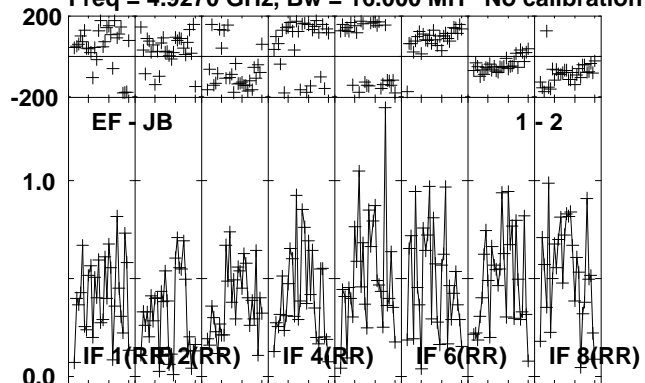

Lower frame: Milli Ampl Jy Top frame: Phas deg
Vector averaged cross-power spectrum Several baselines displayed
Timerange: 00/07:21:07 to 00/07:22:19

Plot file version 372 created 16-OCT-2012 11:58:21

J0639+0601 RO006.UVDATA.1

Freq = 4.9270 GHz, Bw = 16.000 MH No calibration applied and no bandpass applied

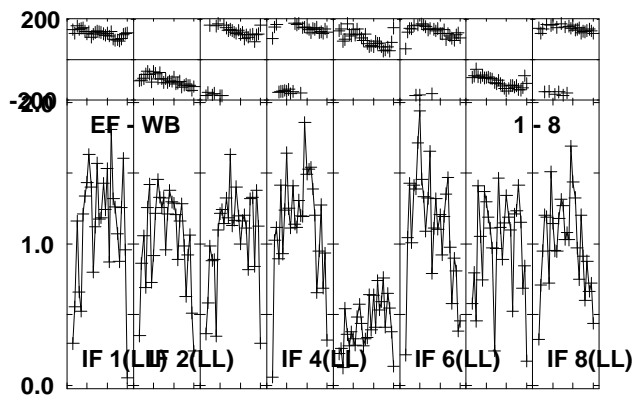
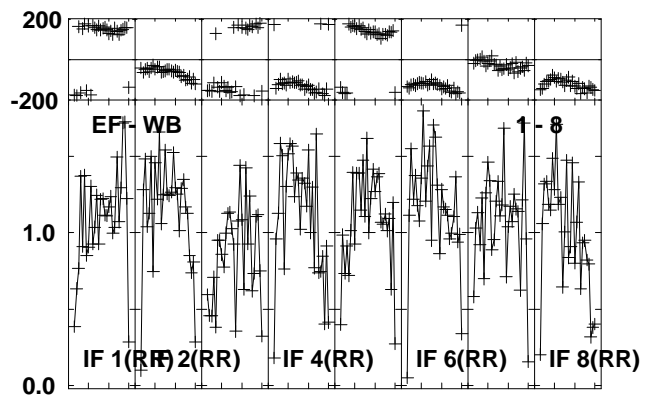
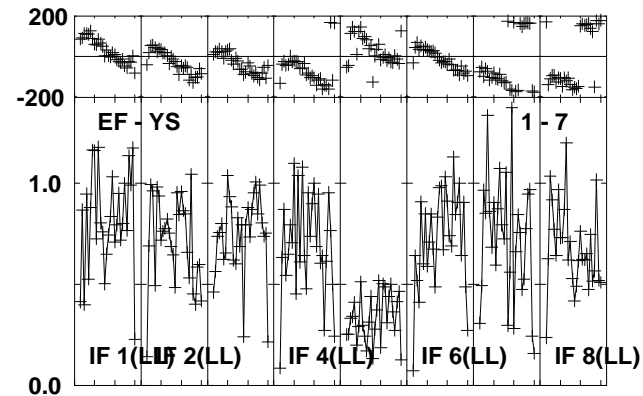
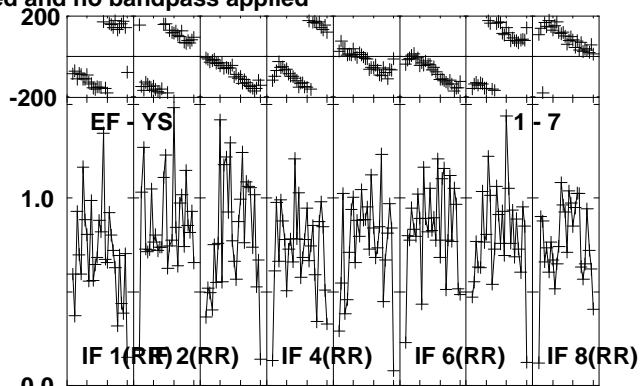
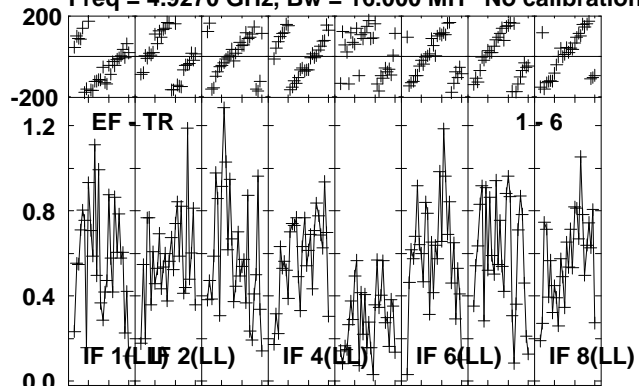

Lower frame: Milli Ampl Jy Top frame: Phas deg
Vector averaged cross-power spectrum Several baselines displayed
Timerange: 00/07:21:07 to 00/07:22:19

Plot file version 373 created 16-OCT-2012 11:58:22

J0645+0541 RO006.UVDATA.1

Freq = 4.9270 GHz, Bw = 16.000 MH No calibration applied and no bandpass applied

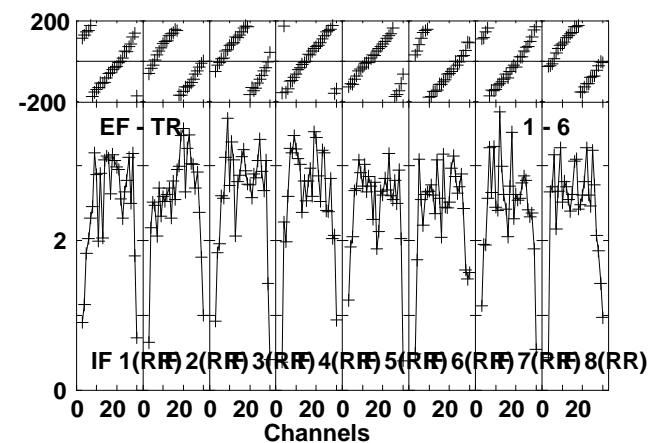
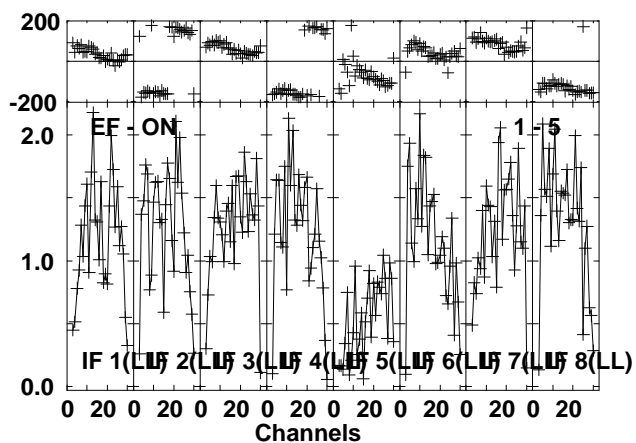
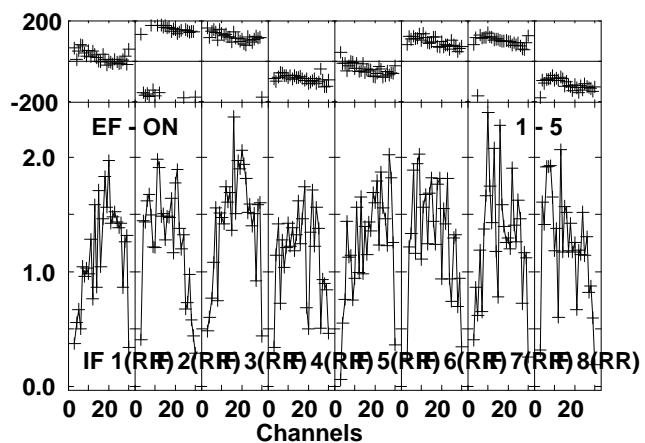
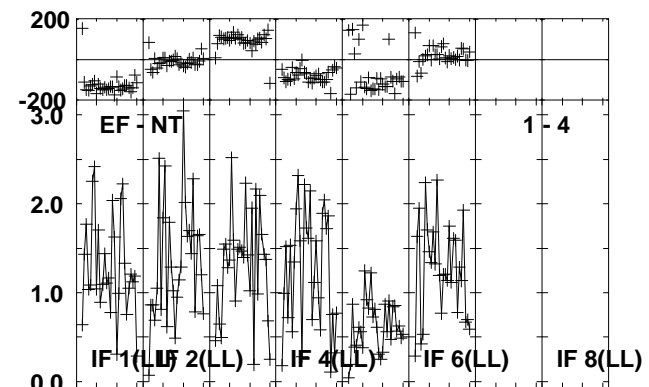
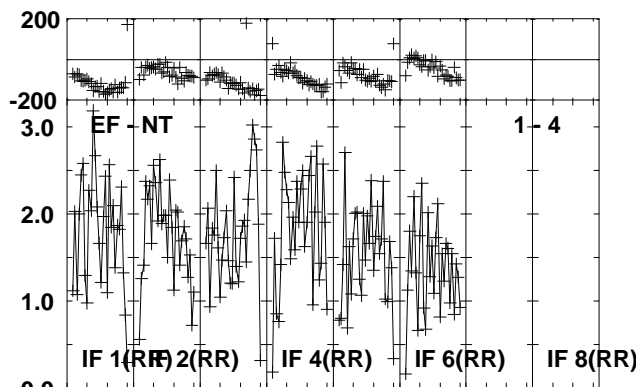
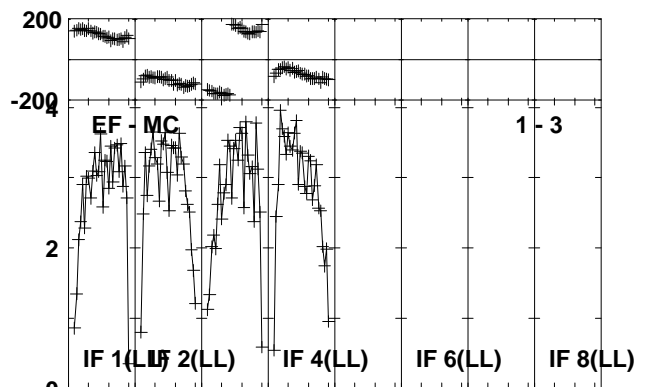
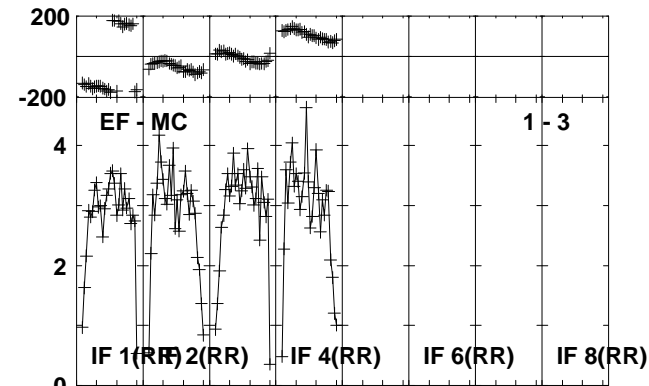
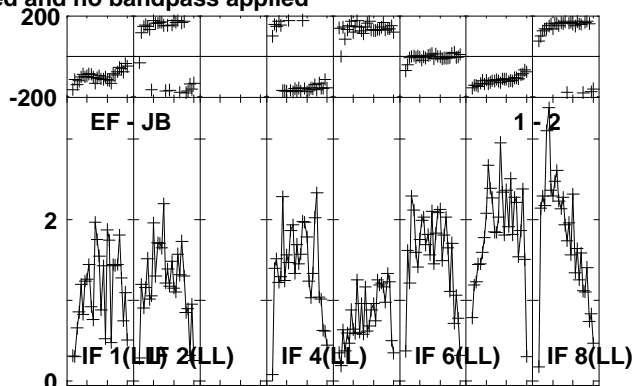
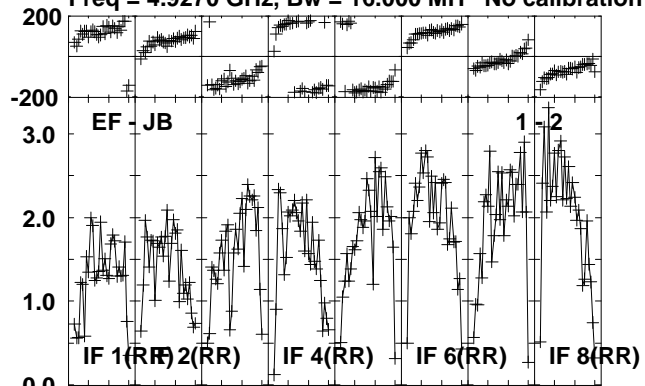

Lower frame: Milli Ampl Jy Top frame: Phas deg
Vector averaged cross-power spectrum Several baselines displayed
Timerange: 00/07:22:23 to 00/07:23:19

Plot file version 374 created 16-OCT-2012 11:58:22

J0645+0541 RO006.UVDATA.1

Freq = 4.9270 GHz, Bw = 16.000 MH No calibration applied and no bandpass applied

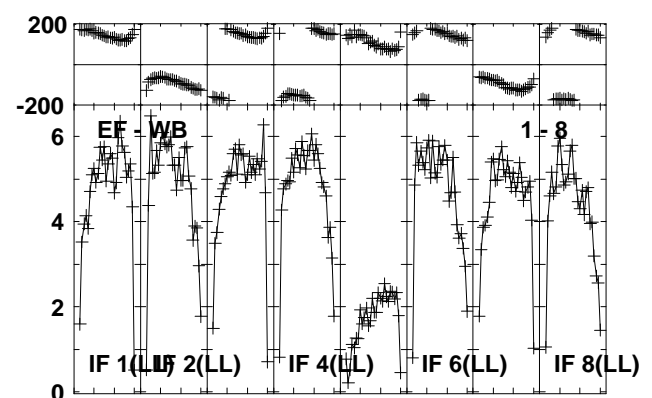
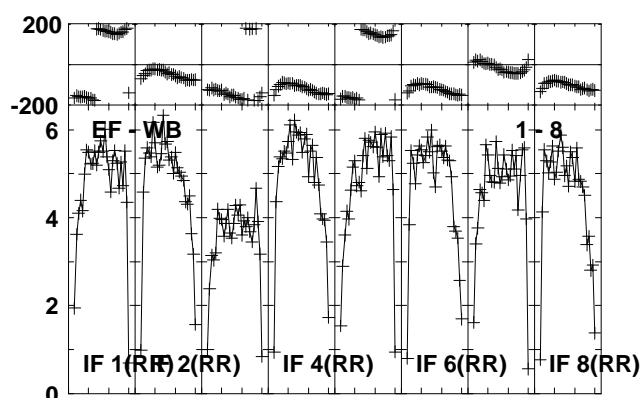
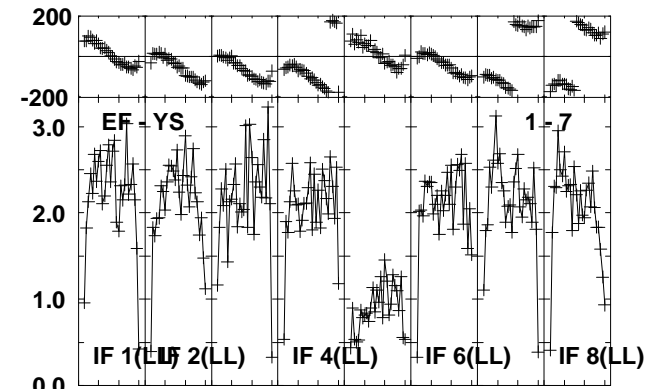
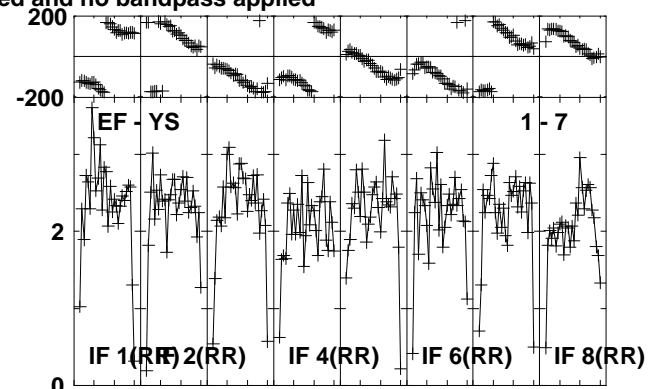
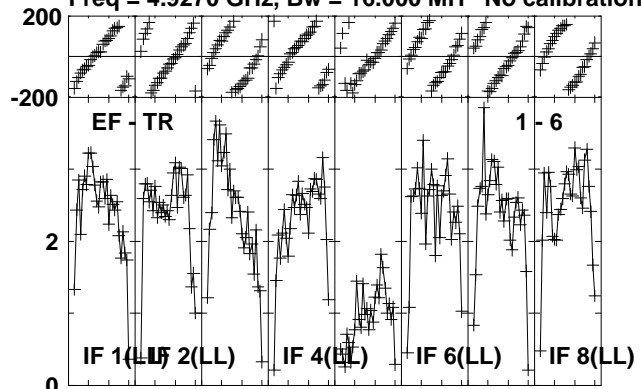

Lower frame: Milli Ampl Jy Top frame: Phas deg
Vector averaged cross-power spectrum Several baselines displayed
Timerange: 00/07:22:23 to 00/07:23:19

Plot file version 375 created 16-OCT-2012 11:58:22

NOVA-MON RO006.UVDATA.1

Freq = 4.9270 GHz, Bw = 16.000 MH No calibration applied and no bandpass applied

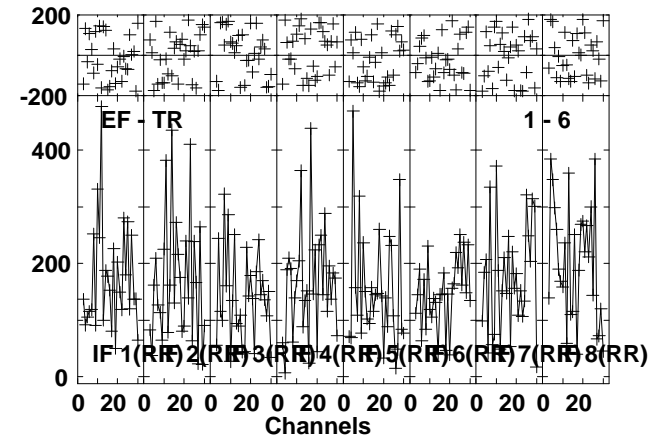
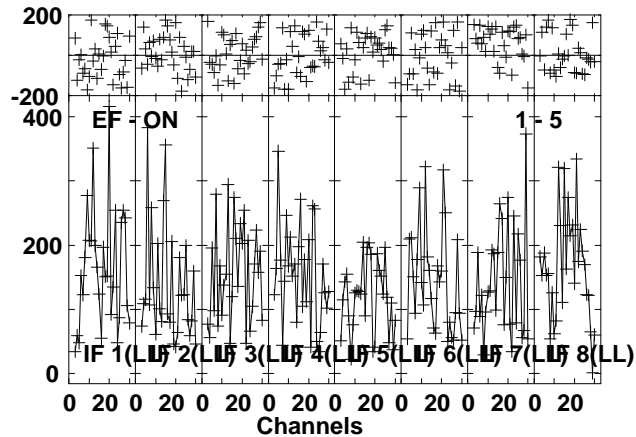
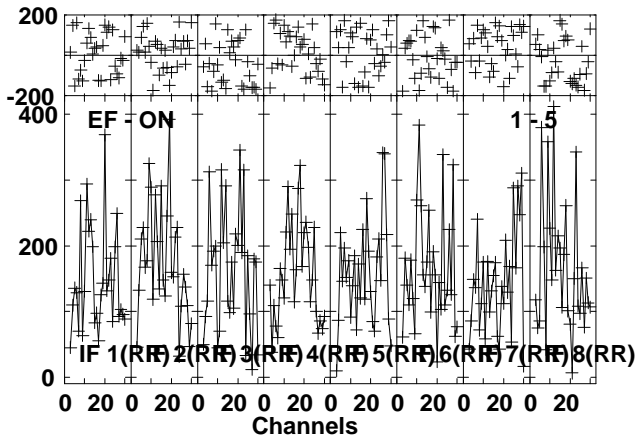
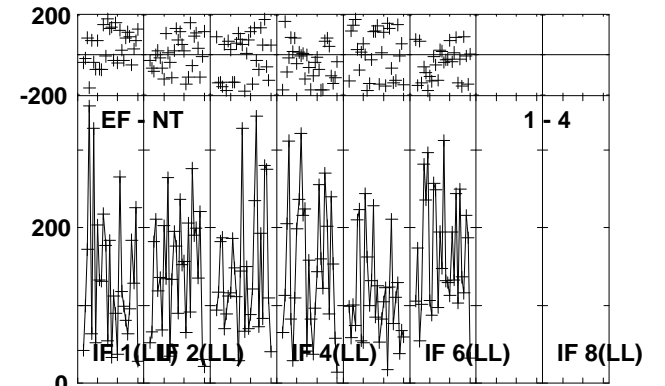
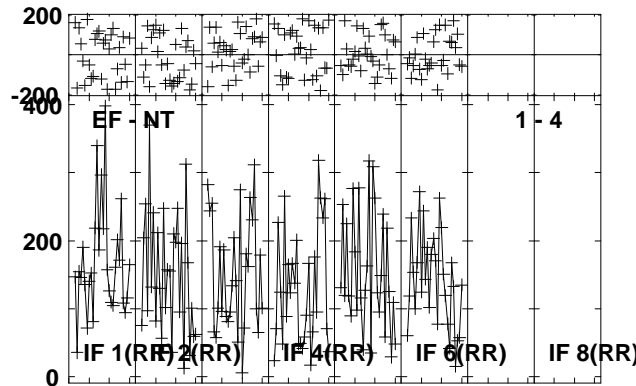
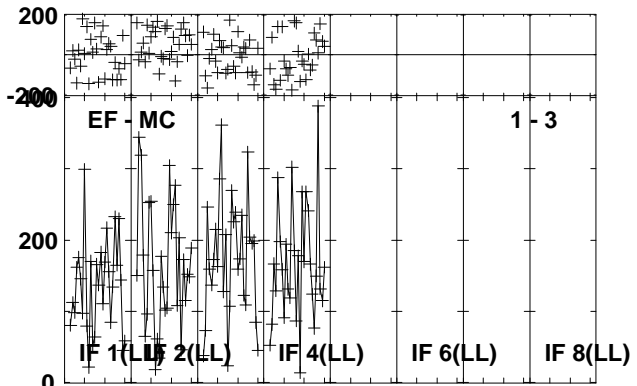
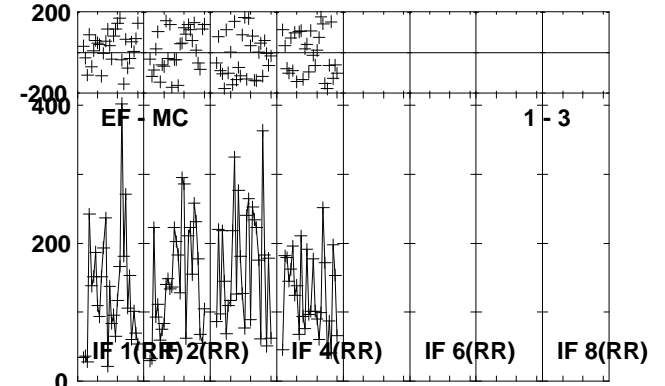
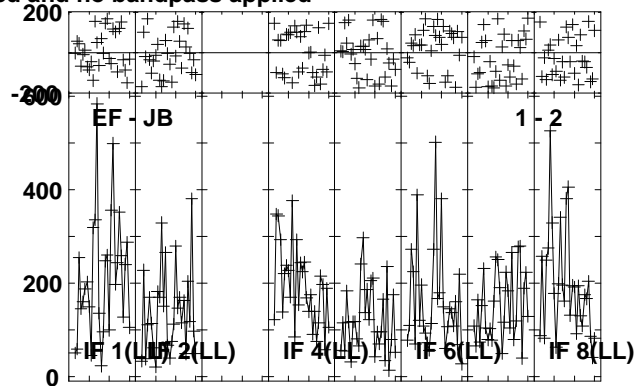
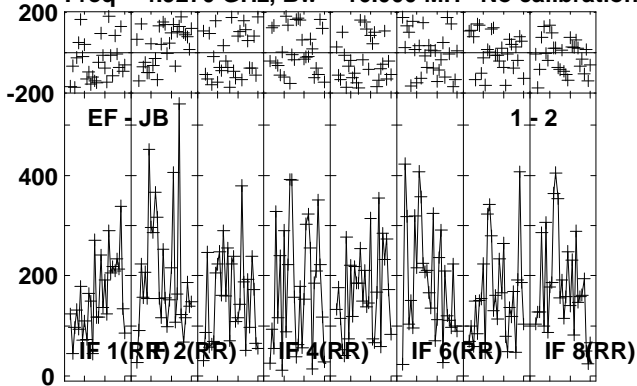

Lower frame: Micro Ampl Jy Top frame: Phas deg
Vector averaged cross-power spectrum Several baselines displayed
Timerange: 00/07:23:23 to 00/07:26:19

Plot file version 376 created 16-OCT-2012 11:58:22

NOVA-MON RO006.UVDATA.1

Freq = 4.9270 GHz, Bw = 16.000 MH No calibration applied and no bandpass applied

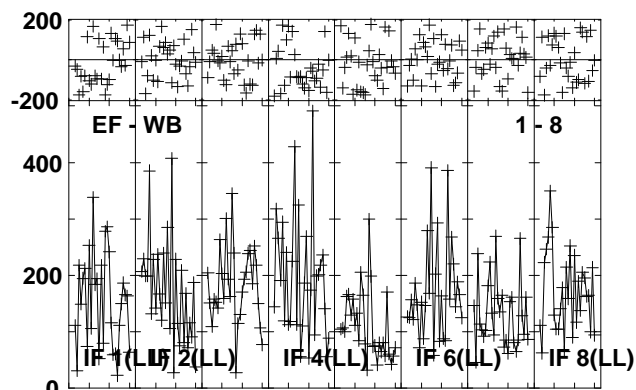
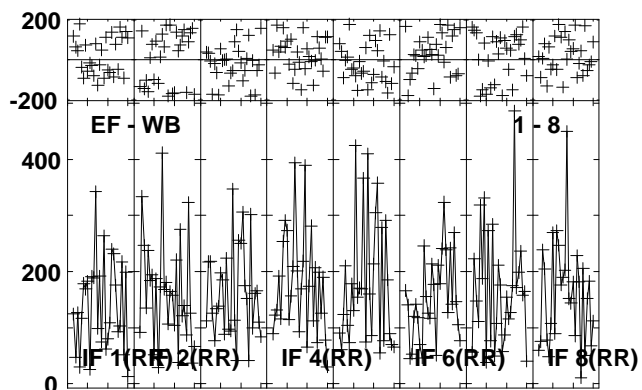
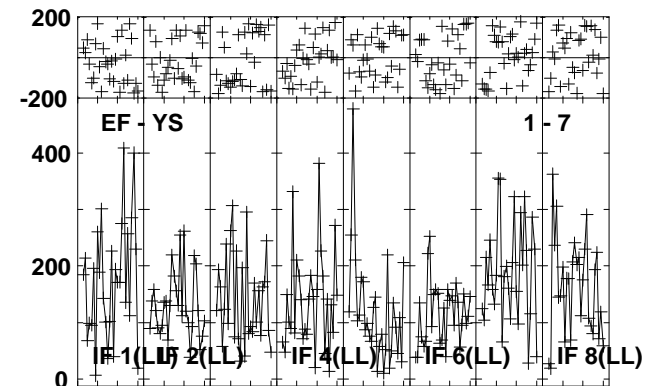
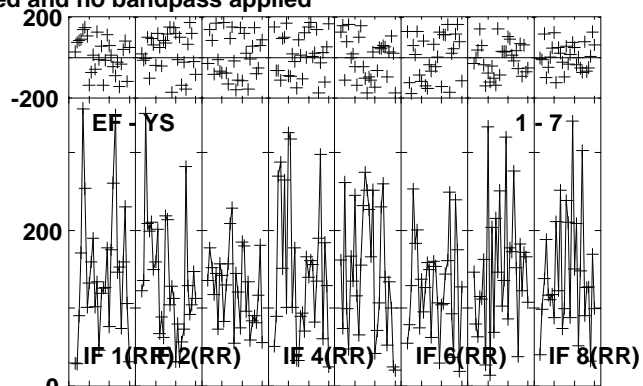
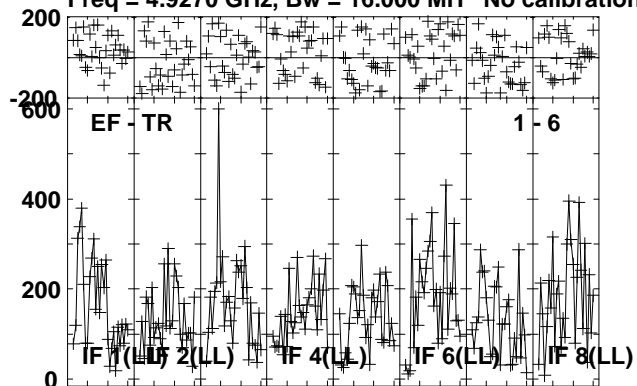

Lower frame: Micro Ampl Jy Top frame: Phas deg
Vector averaged cross-power spectrum Several baselines displayed
Timerange: 00/07:23:23 to 00/07:26:19

Plot file version 377 created 16-OCT-2012 11:58:23

J0639+0601 RO006.UVDATA.1

Freq = 4.9270 GHz, Bw = 16.000 MH No calibration applied and no bandpass applied

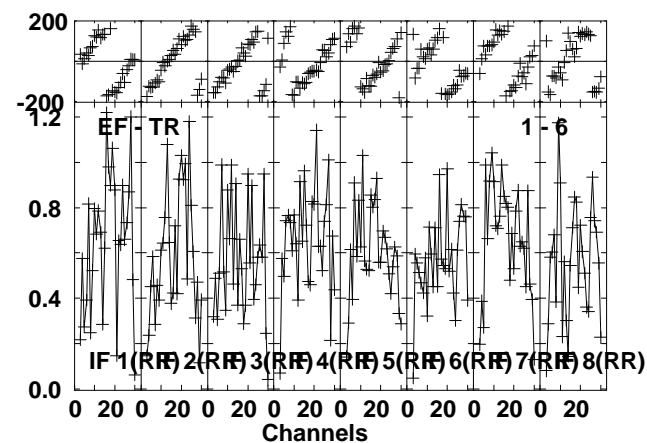
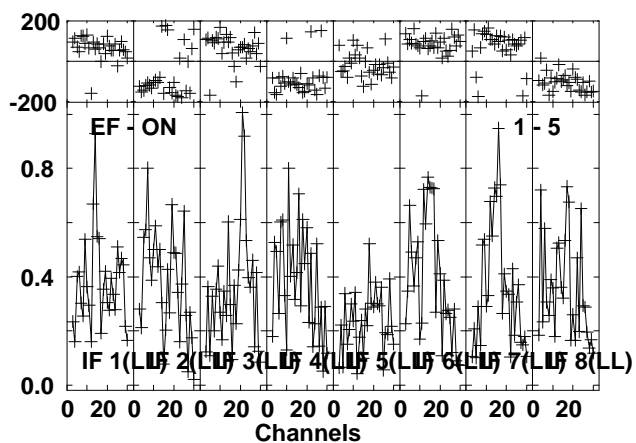
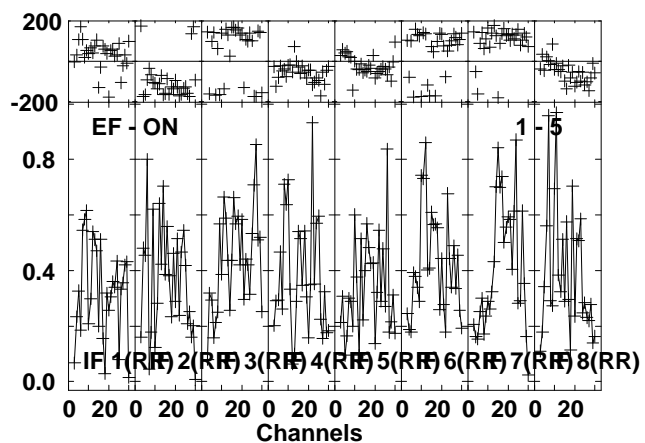
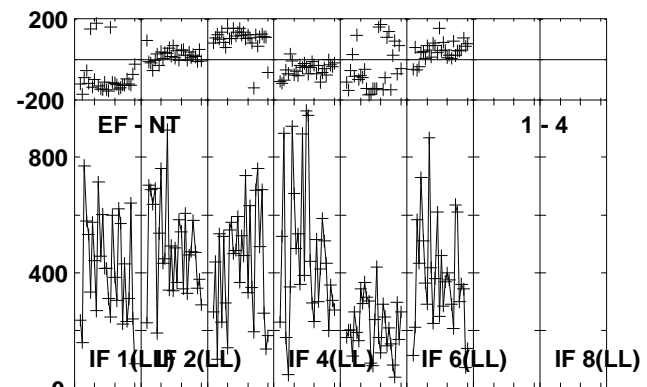
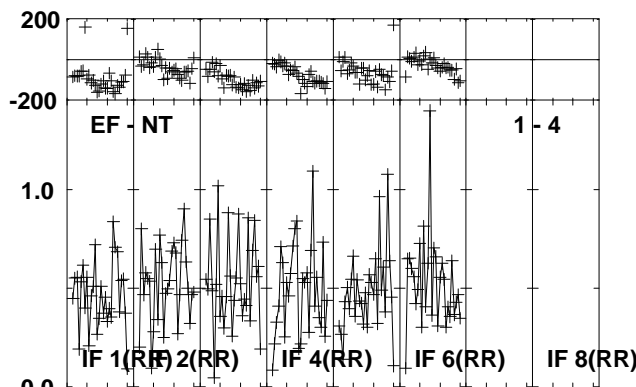
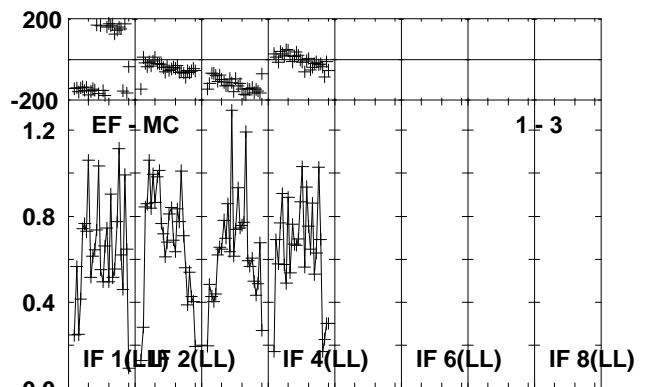
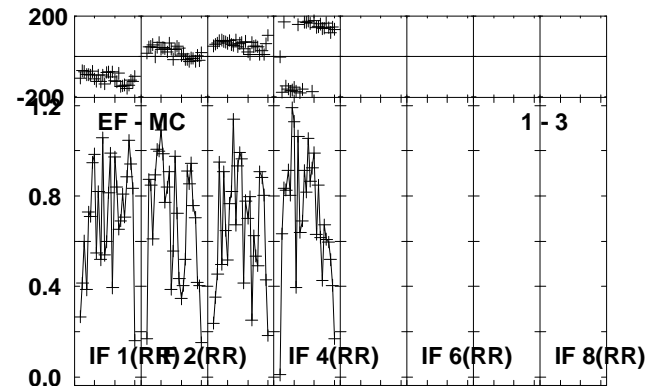
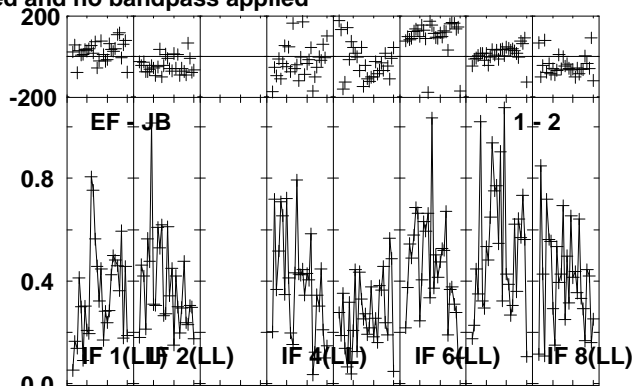
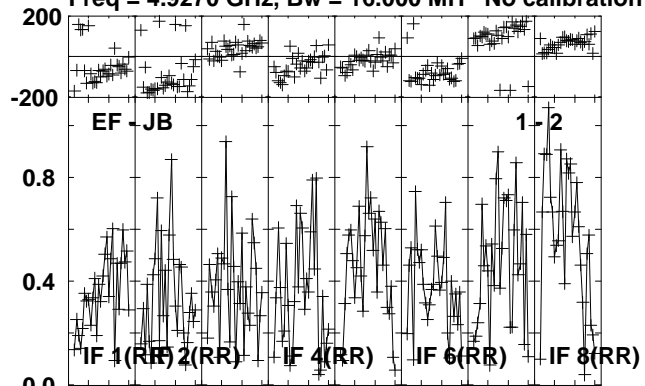

Lower frame: Milli Ampl Jy Top frame: Phas deg
Vector averaged cross-power spectrum Several baselines displayed
Timerange: 00/07:26:47 to 00/07:27:49

Plot file version 378 created 16-OCT-2012 11:58:23

J0639+0601 RO006.UVDATA.1

Freq = 4.9270 GHz, Bw = 16.000 MH No calibration applied and no bandpass applied

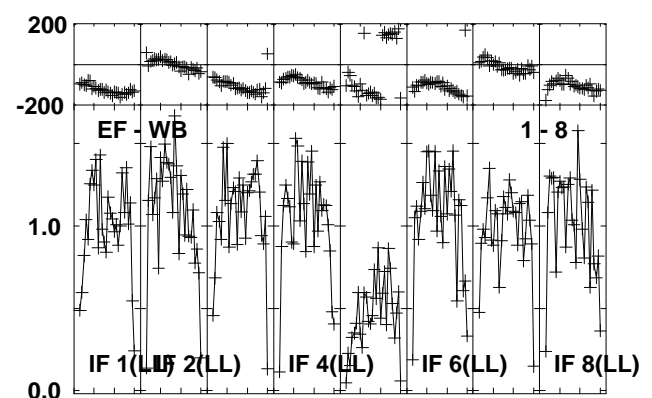
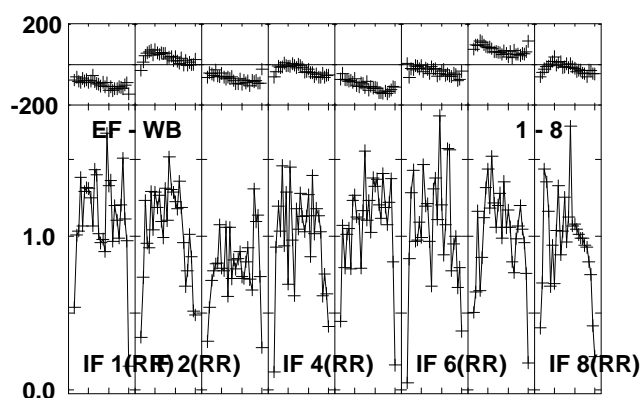
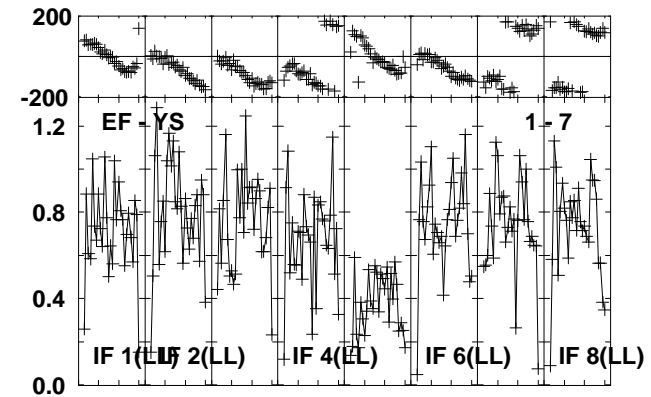
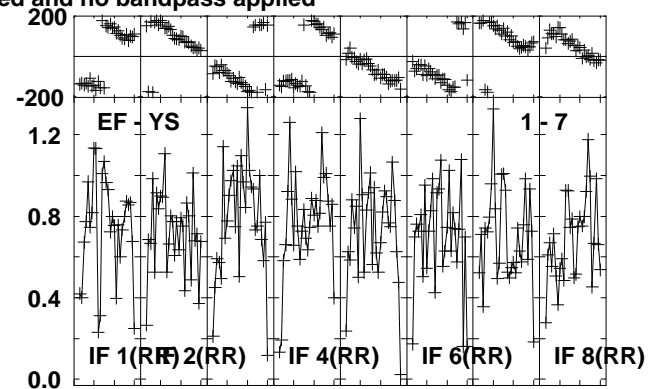
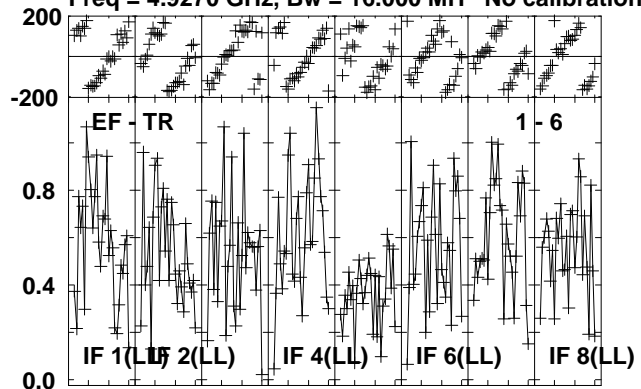

Lower frame: Milli Ampl Jy Top frame: Phas deg
Vector averaged cross-power spectrum Several baselines displayed
Timerange: 00/07:26:47 to 00/07:27:49

Plot file version 379 created 16-OCT-2012 11:58:23

J0645+0541 RO006.UVDATA.1

Freq = 4.9270 GHz, Bw = 16.000 MH No calibration applied and no bandpass applied

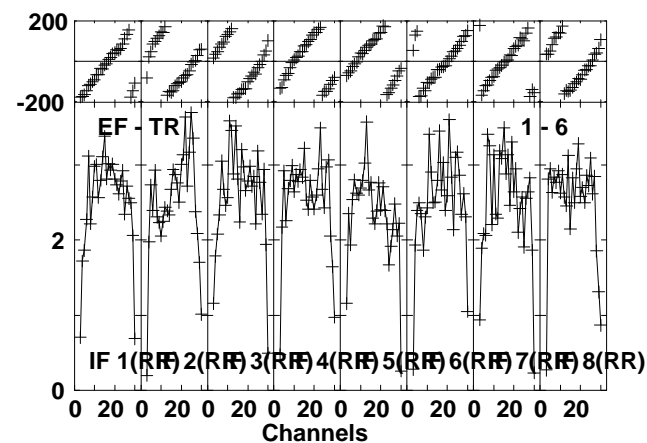
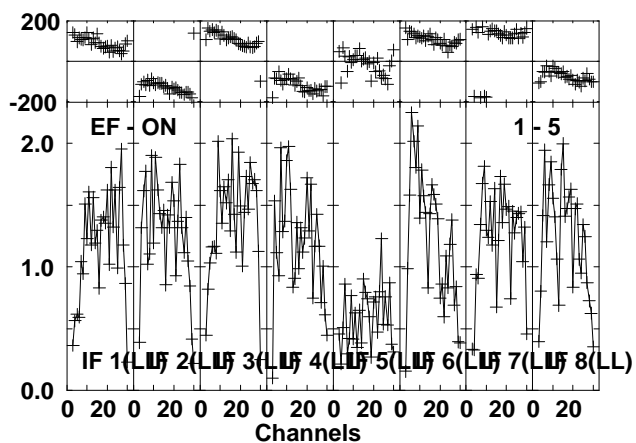
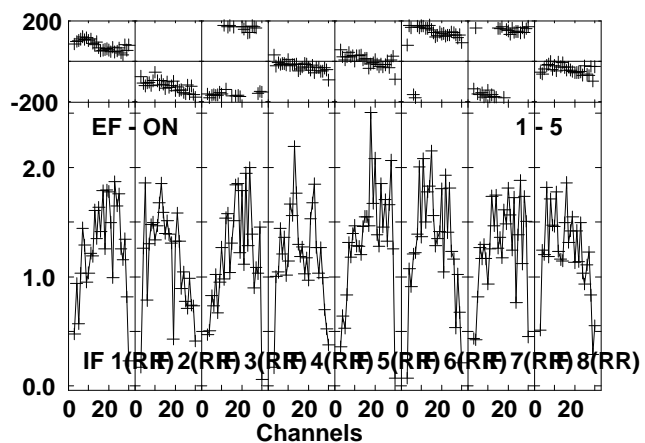
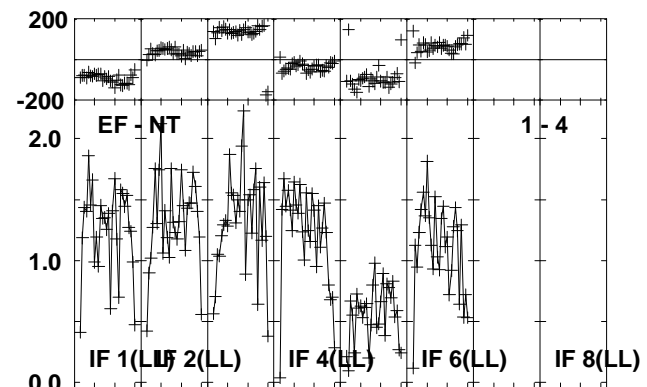
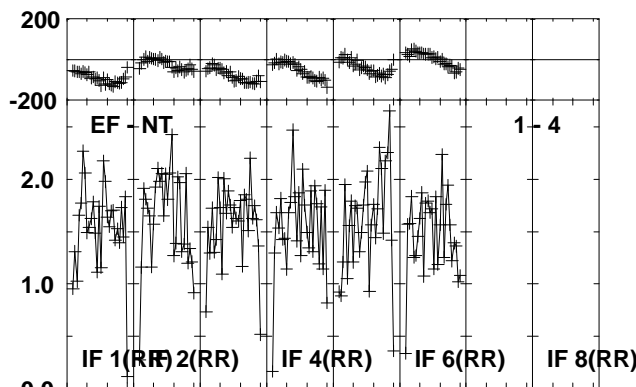
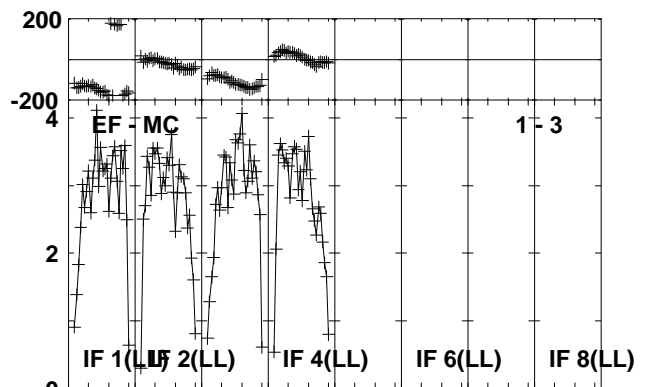
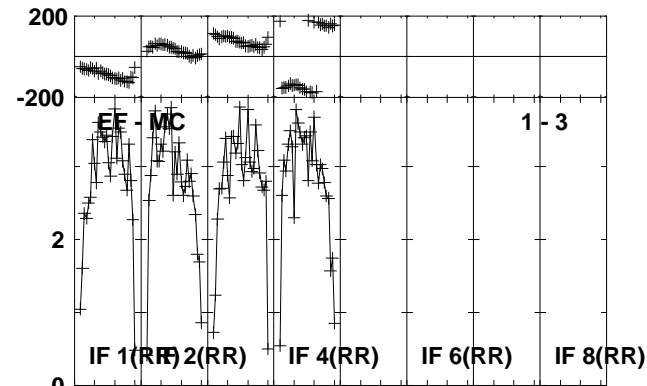
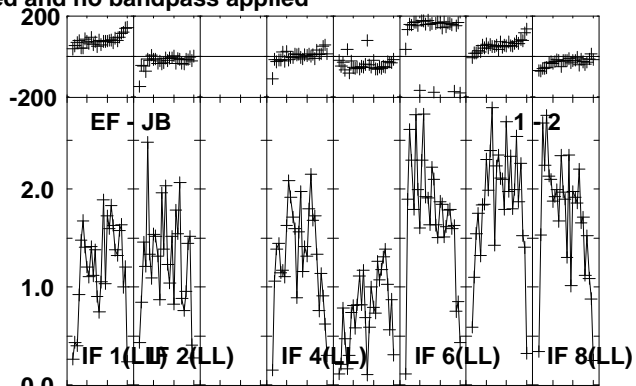
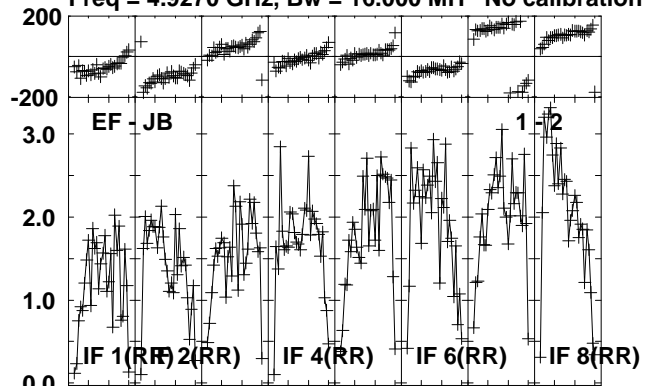

Lower frame: Milli Ampl Jy Top frame: Phas deg
Vector averaged cross-power spectrum Several baselines displayed
Timerange: 00/07:27:53 to 00/07:28:49

Plot file version 380 created 16-OCT-2012 11:58:24
J0645+0541 RO006.UVDATA.1

Freq = 4.9270 GHz, Bw = 16.000 MH No calibration applied and no bandpass applied

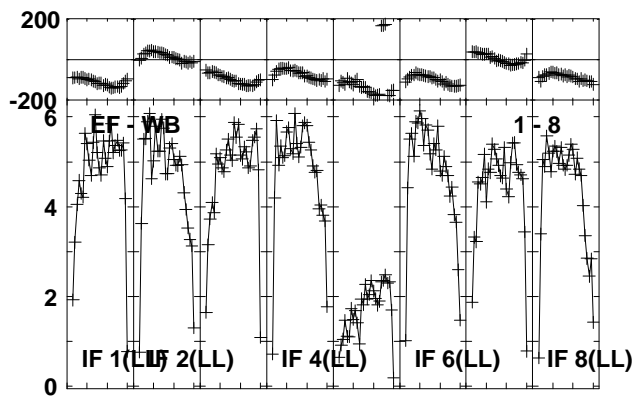
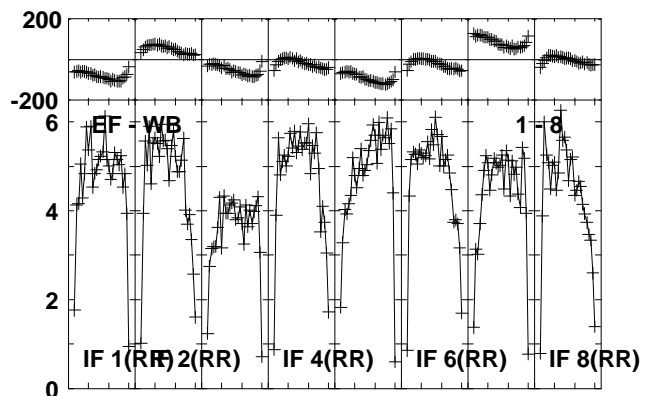
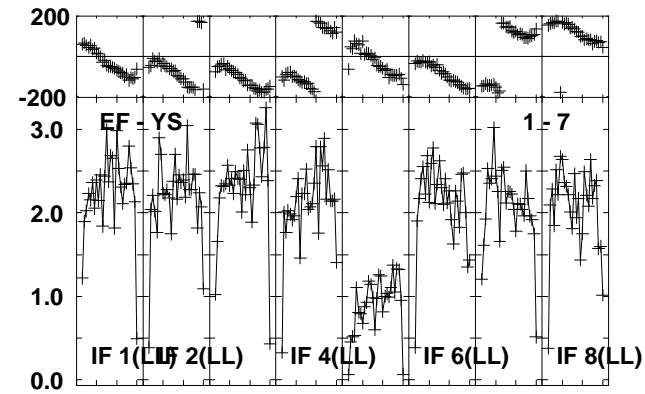
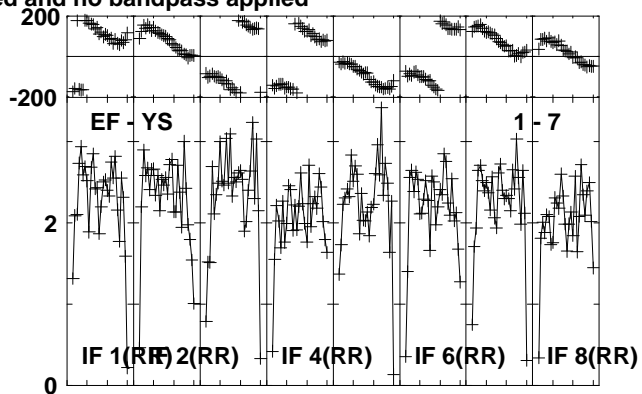
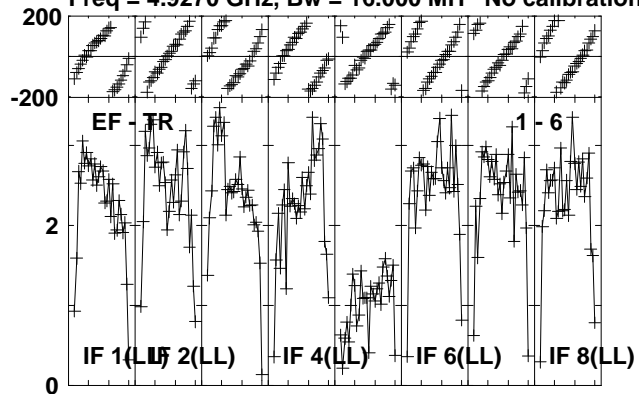

Lower frame: Milli Ampl Jy Top frame: Phas deg
Vector averaged cross-power spectrum Several baselines displayed
Timerange: 00/07:27:53 to 00/07:28:49

Plot file version 381 created 16-OCT-2012 11:58:24

NOVA-MON RO006.UVDATA.1

Freq = 4.9270 GHz, Bw = 16.000 MH No calibration applied and no bandpass applied

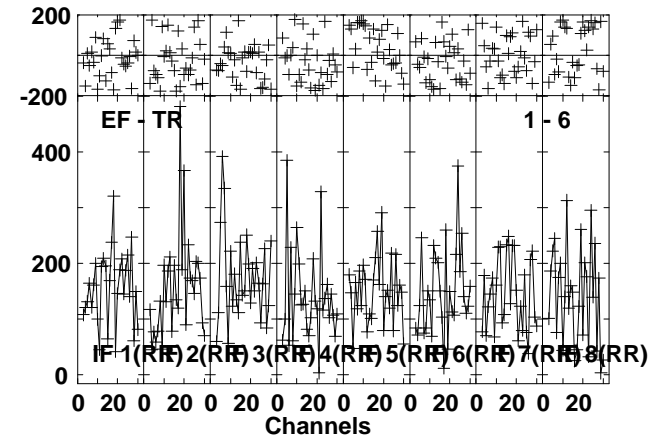
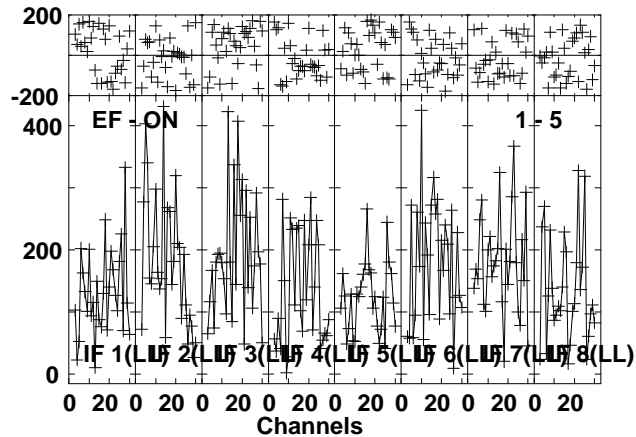
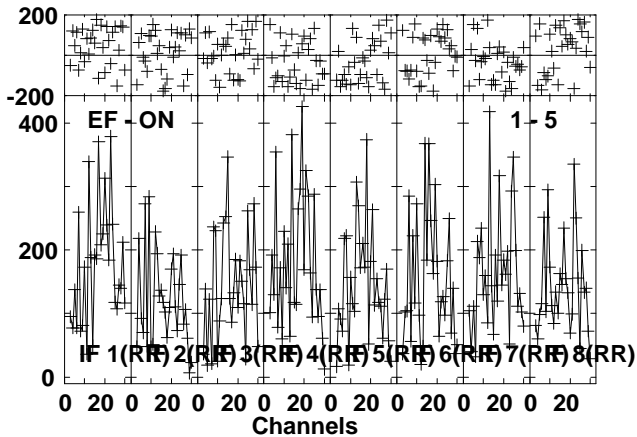
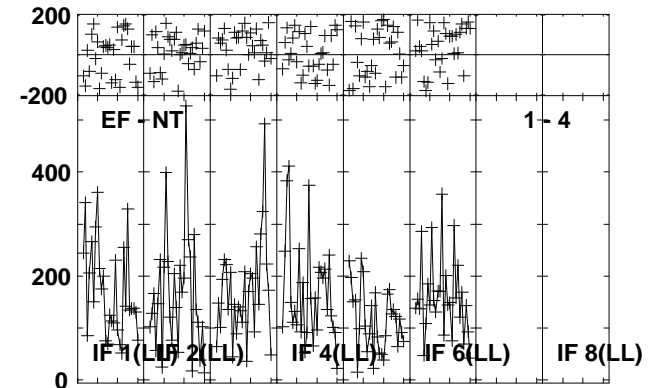
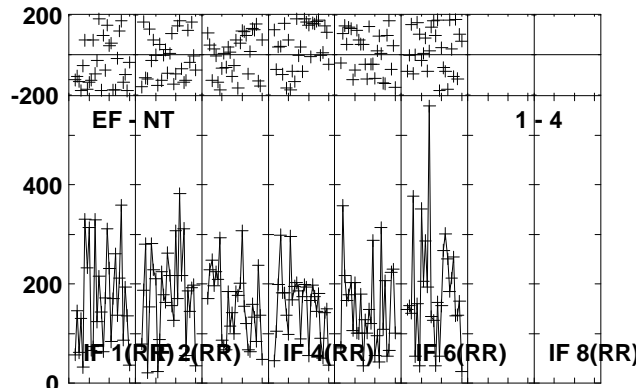
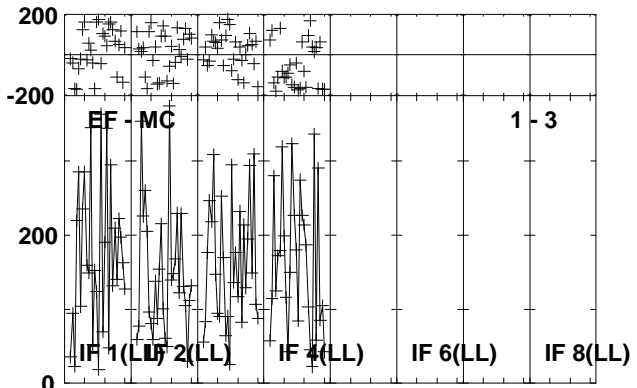
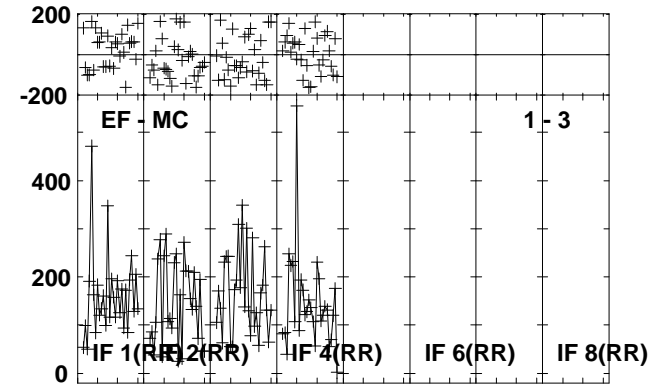
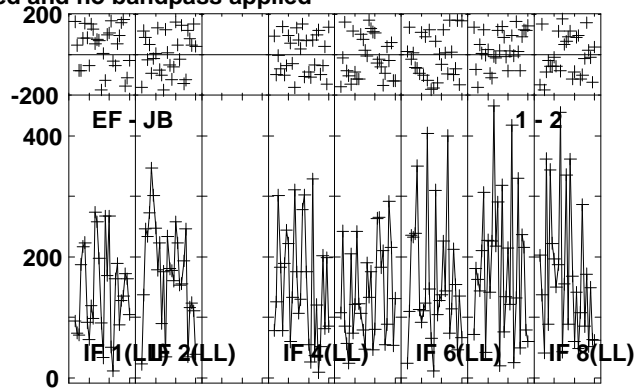
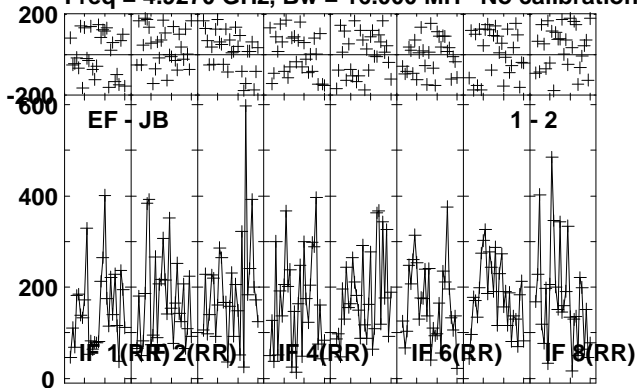

Lower frame: Micro Ampl Jy Top frame: Phas deg
Vector averaged cross-power spectrum Several baselines displayed
Timerange: 00/07:28:53 to 00/07:31:49

Plot file version 382 created 16-OCT-2012 11:58:24

NOVA-MON RO006.UVDATA.1

Freq = 4.9270 GHz, Bw = 16.000 MH No calibration applied and no bandpass applied

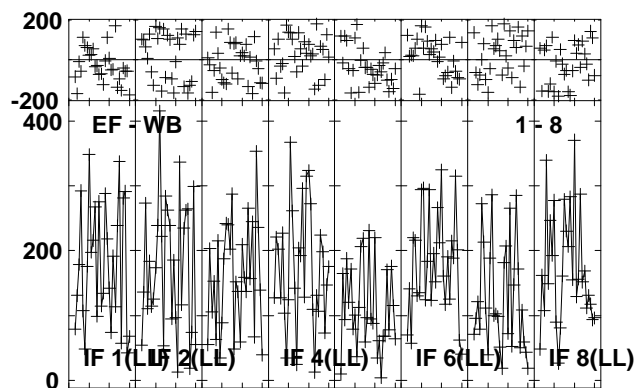
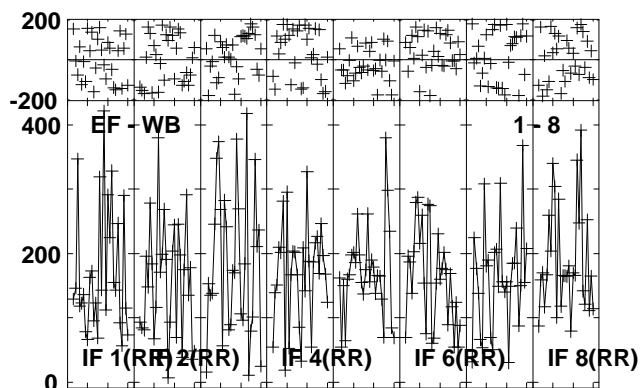
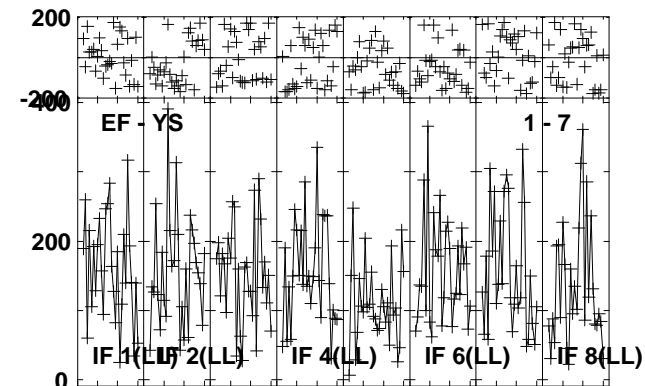
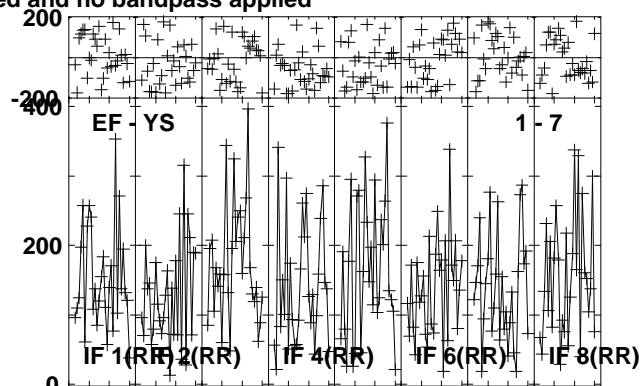
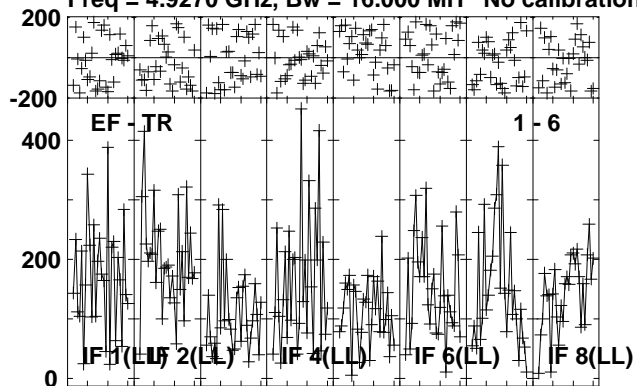

Lower frame: Micro Ampl Jy Top frame: Phas deg
Vector averaged cross-power spectrum Several baselines displayed
Timerange: 00/07:28:53 to 00/07:31:49

Plot file version 383 created 16-OCT-2012 11:58:25

J0639+0601 RO006.UVDATA.1

Freq = 4.9270 GHz, Bw = 16.000 MH No calibration applied and no bandpass applied

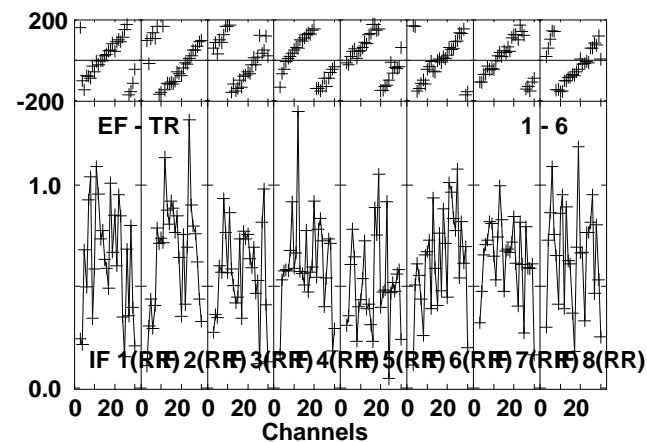
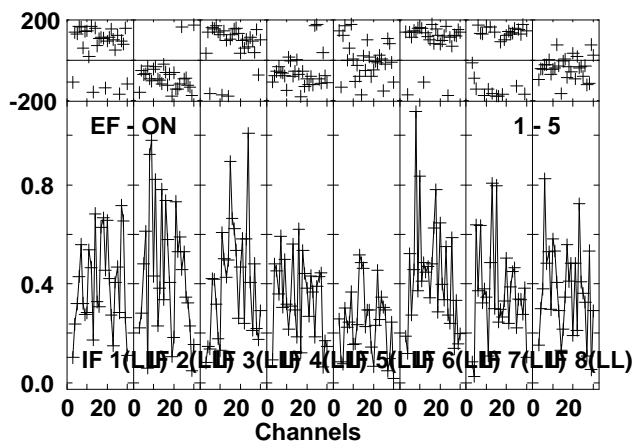
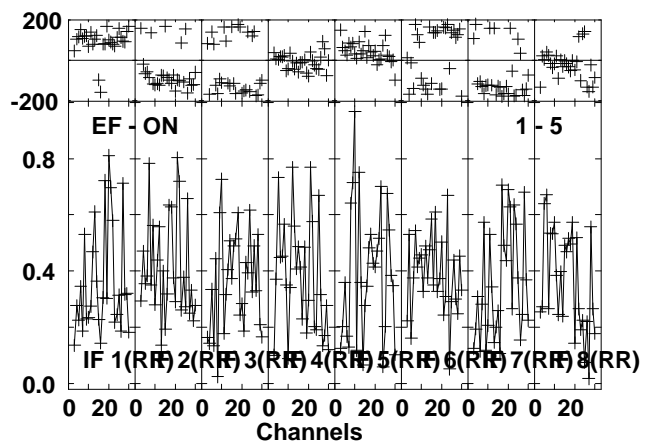
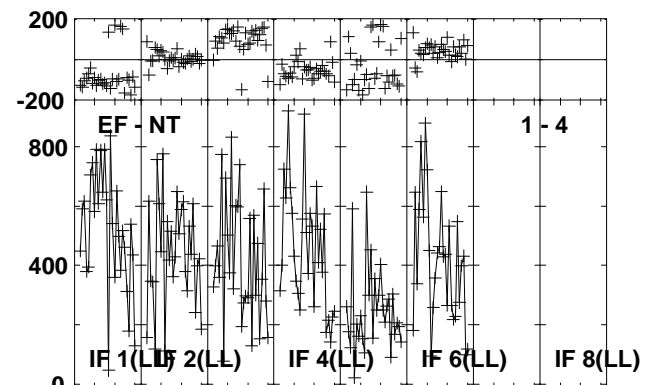
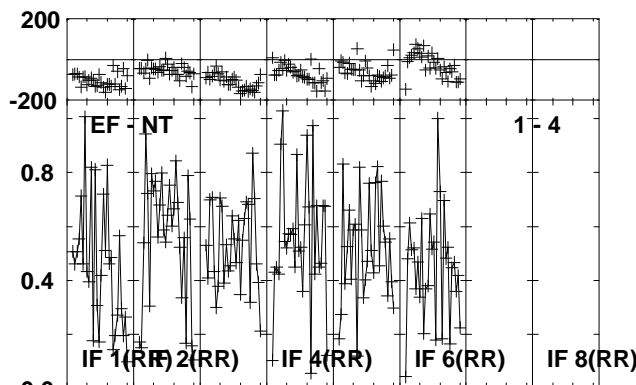
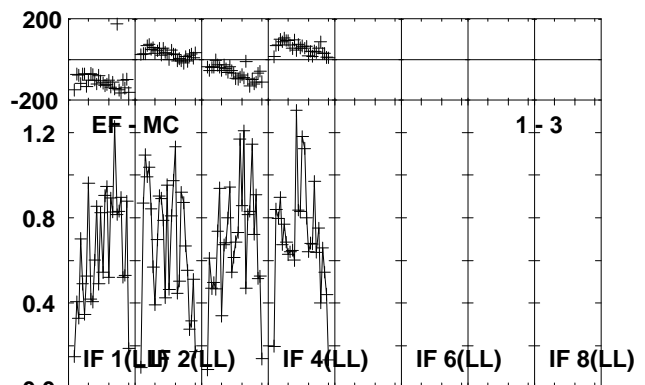
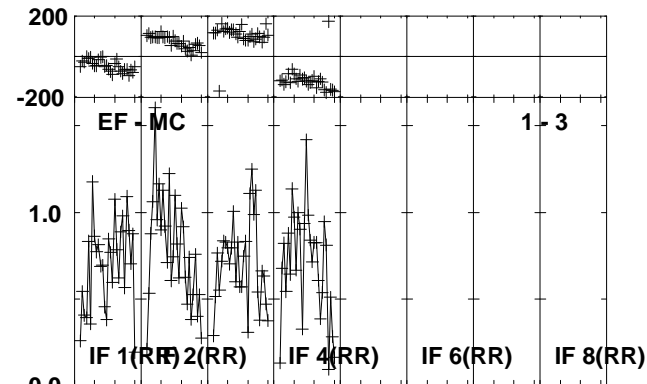
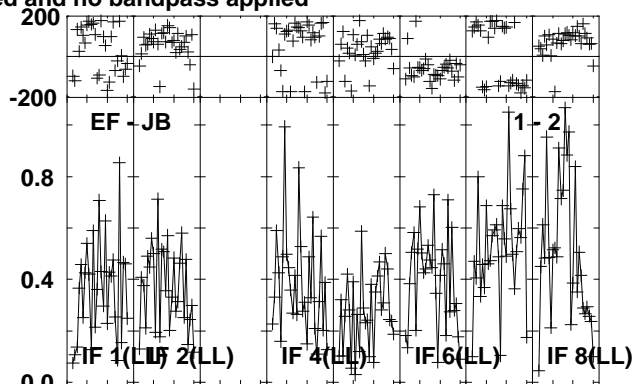
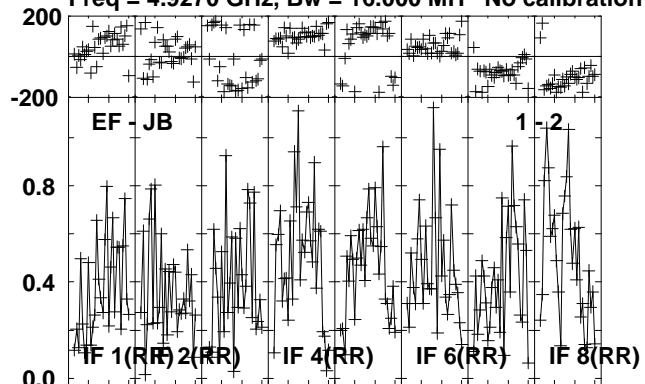

Lower frame: Milli Ampl Jy Top frame: Phas deg
Vector averaged cross-power spectrum Several baselines displayed
Timerange: 00/07:31:53 to 00/07:33:03

Plot file version 384 created 16-OCT-2012 11:58:25

J0639+0601 RO006.UVDATA.1

Freq = 4.9270 GHz, Bw = 16.000 MH No calibration applied and no bandpass applied

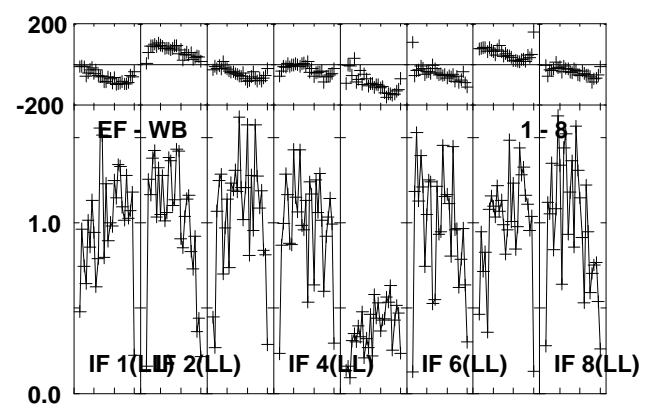
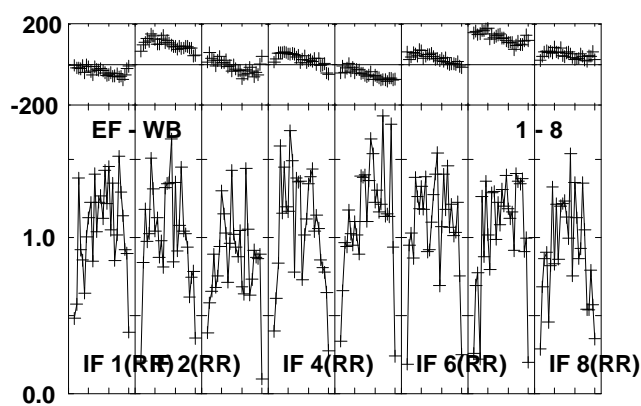
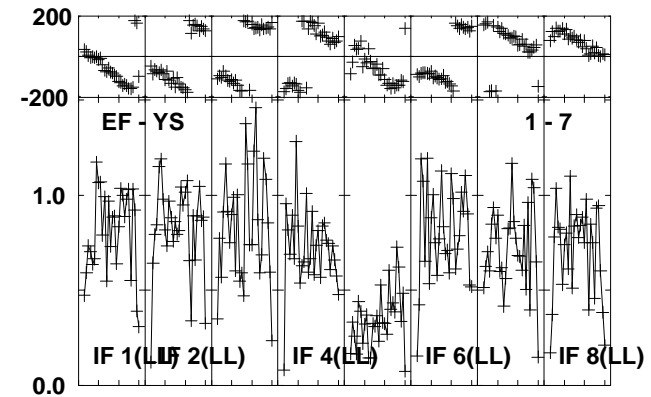
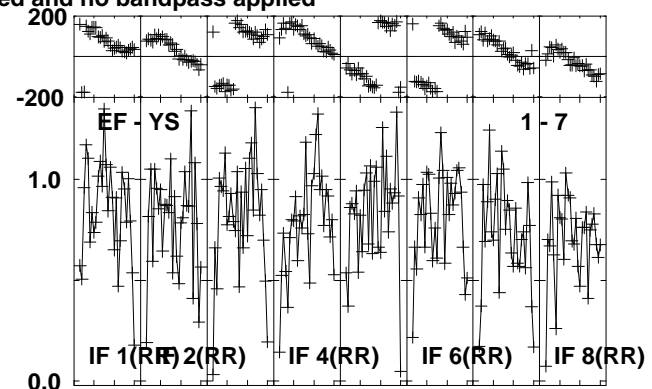
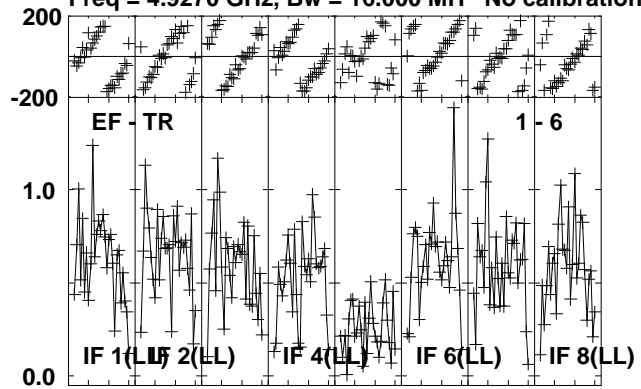

Lower frame: Milli Ampl Jy Top frame: Phas deg
Vector averaged cross-power spectrum Several baselines displayed
Timerange: 00/07:31:53 to 00/07:33:03

Plot file version 385 created 16-OCT-2012 11:58:25

J0645+0541 RO006.UVDATA.1

Freq = 4.9270 GHz, Bw = 16.000 MH No calibration applied and no bandpass applied

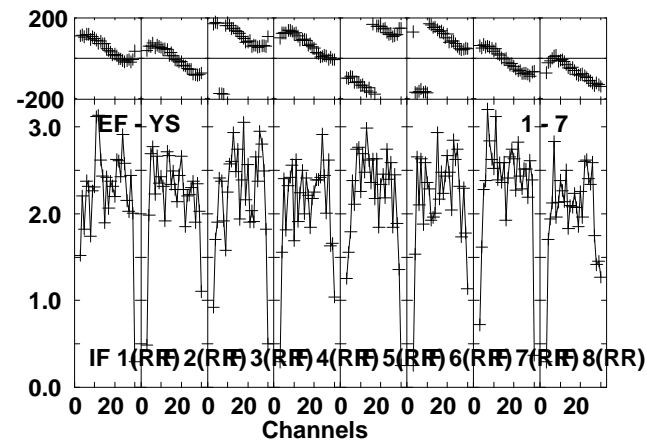
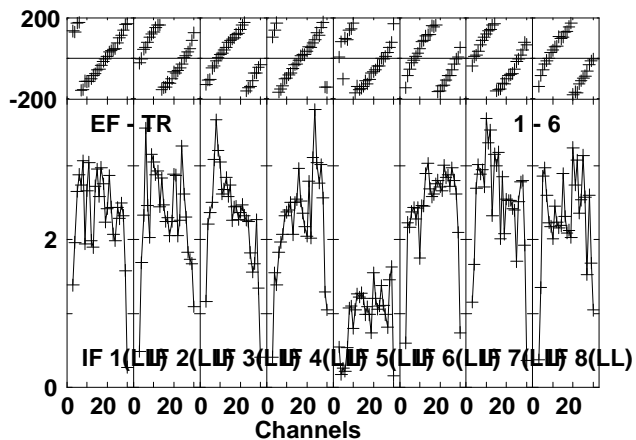
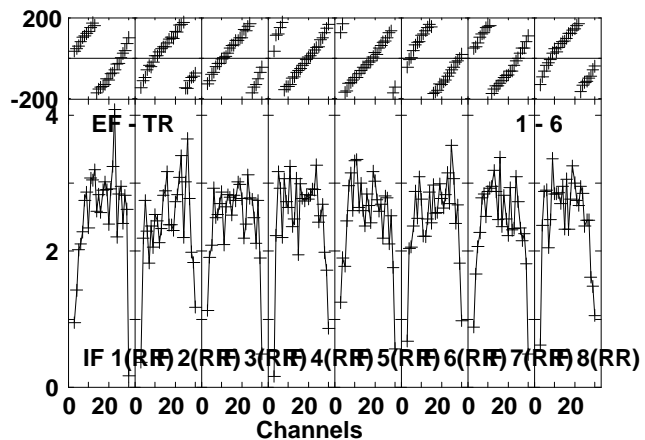
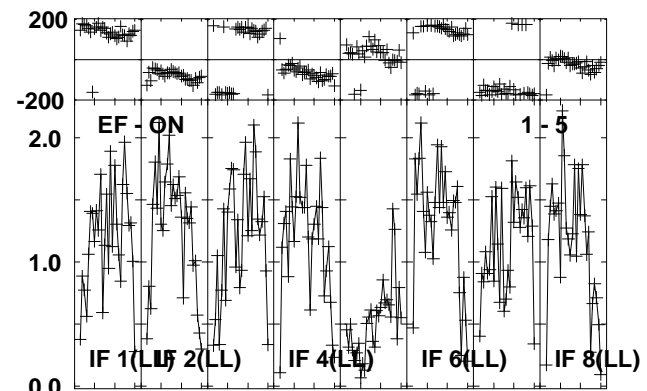
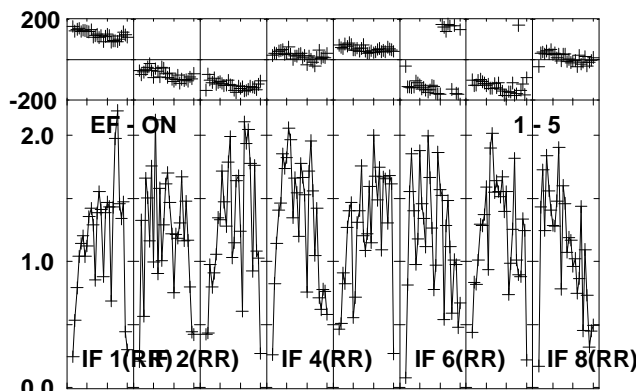
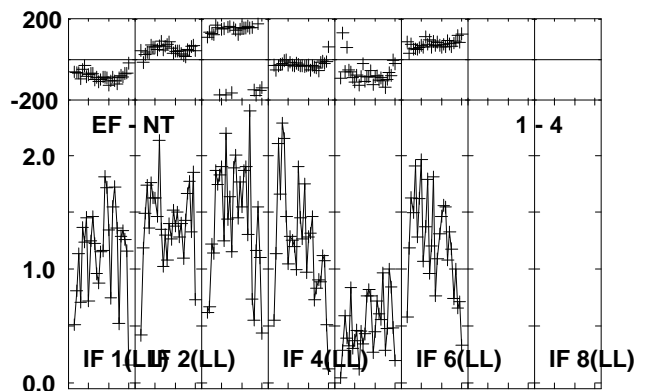
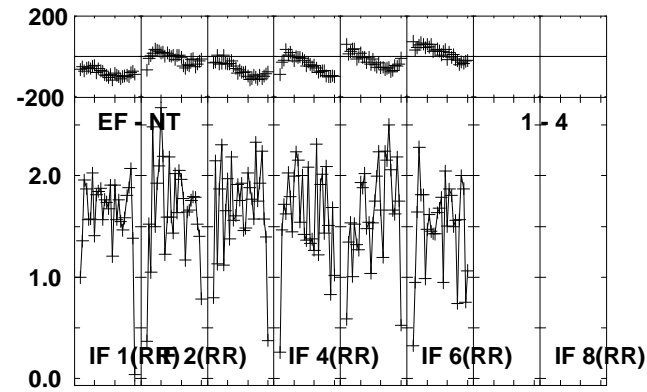
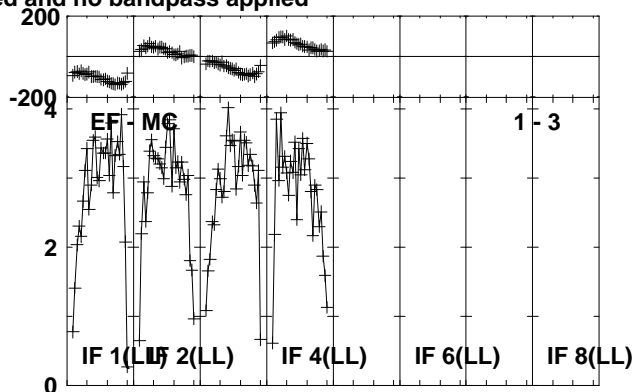
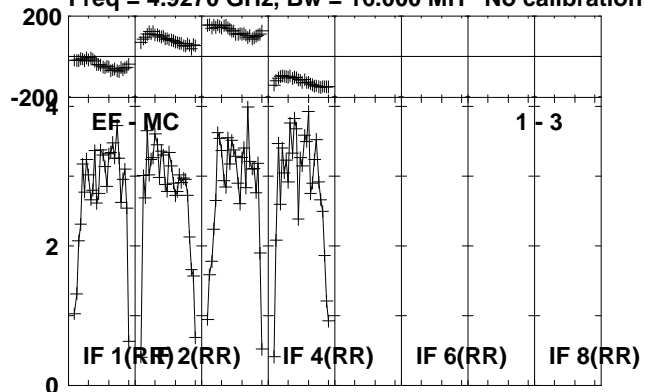

Lower frame: Milli Ampl Jy Top frame: Phas deg
Vector averaged cross-power spectrum Several baselines displayed
Timerange: 00/07:33:07 to 00/07:34:03

Plot file version 386 created 16-OCT-2012 11:58:25

J0645+0541 RO006.UVDATA.1

Freq = 4.9270 GHz, Bw = 16.000 MH No calibration applied and no bandpass applied

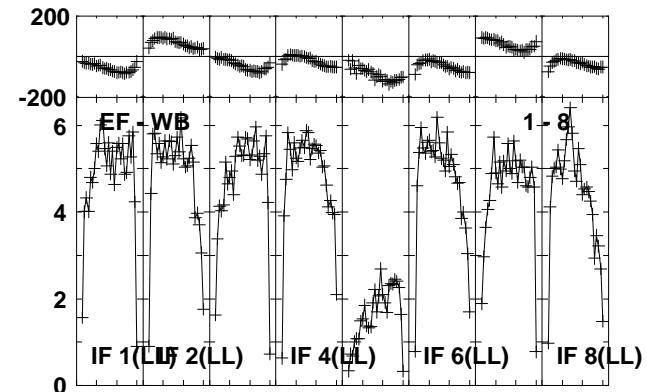
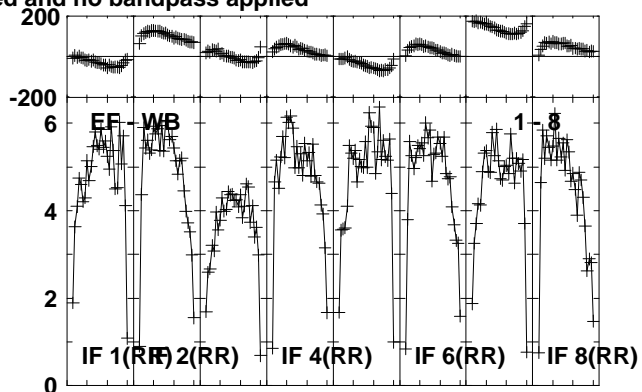
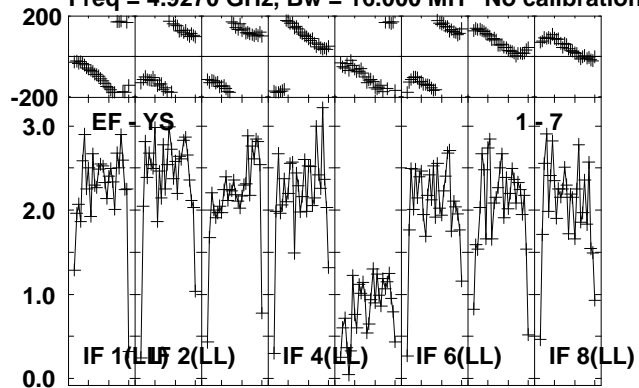

Lower frame: Milli Ampl Jy Top frame: Phas deg
Vector averaged cross-power spectrum Several baselines displayed
Timerange: 00/07:33:07 to 00/07:34:03

Plot file version 387 created 16-OCT-2012 11:58:26

NOVA-MON RO006.UVDATA.1

Freq = 4.9270 GHz, Bw = 16.000 MH No calibration applied and no bandpass applied

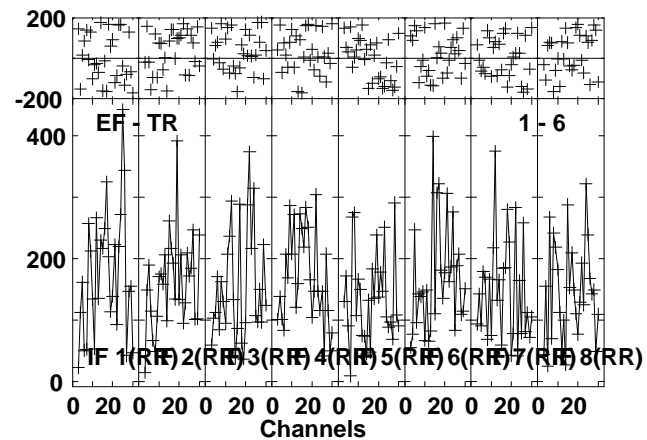
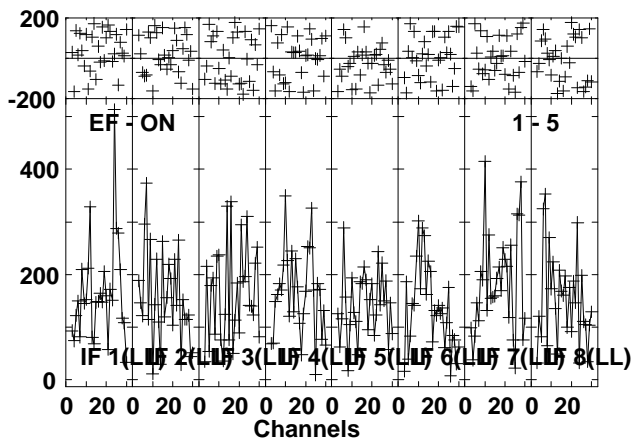
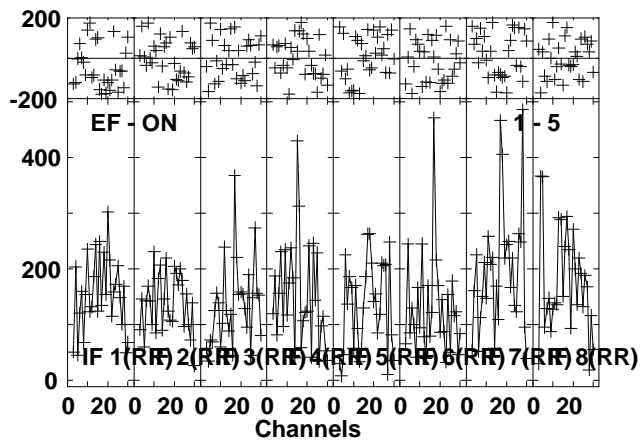
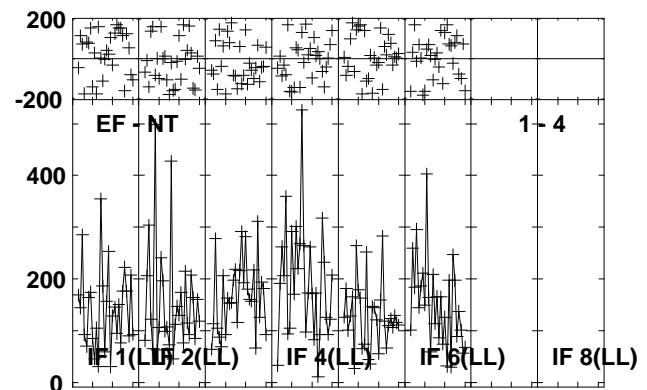
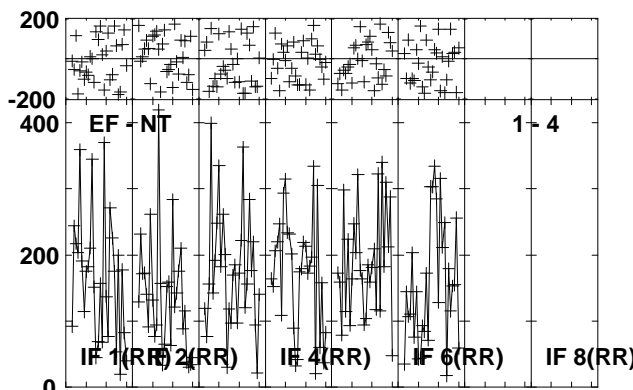
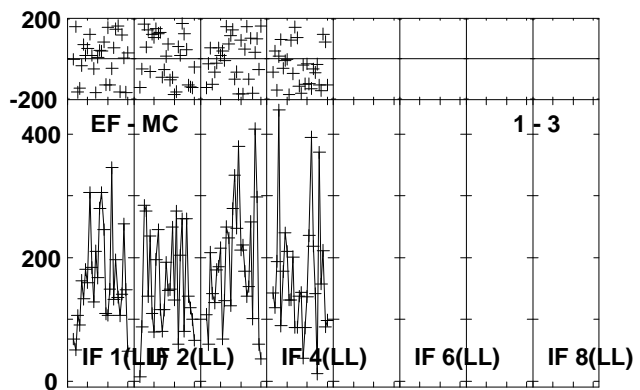
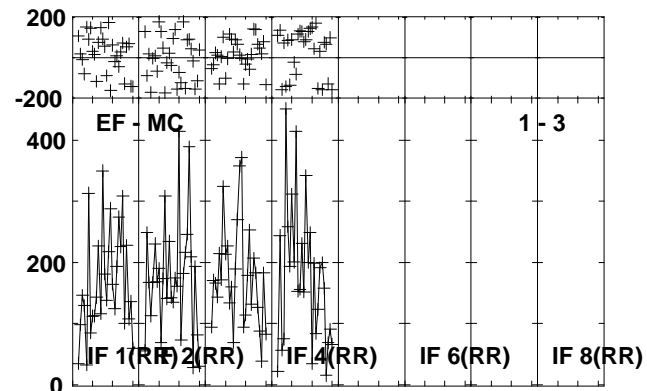
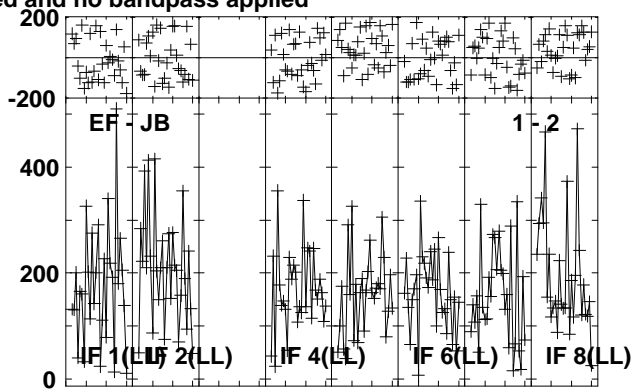
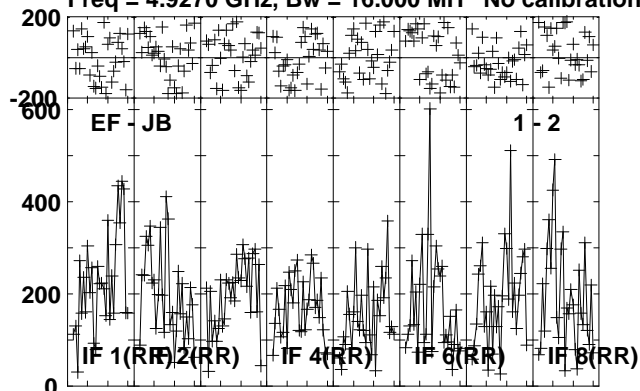

Lower frame: Micro Ampl Jy Top frame: Phas deg
Vector averaged cross-power spectrum Several baselines displayed
Timerange: 00/07:34:07 to 00/07:37:03

Plot file version 388 created 16-OCT-2012 11:58:26

NOVA-MON RO006.UVDATA.1

Freq = 4.9270 GHz, Bw = 16.000 MH No calibration applied and no bandpass applied

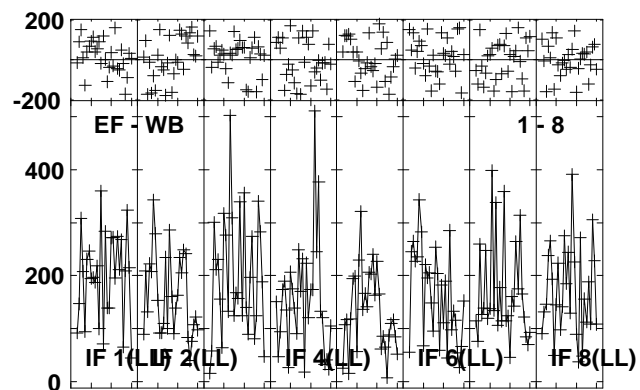
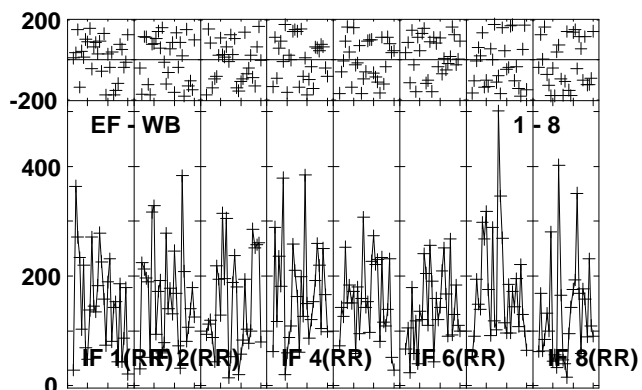
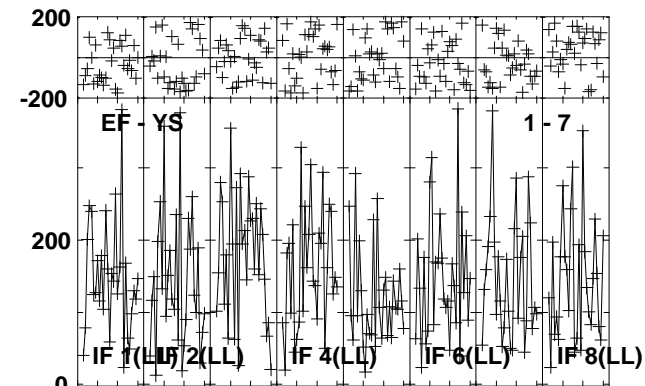
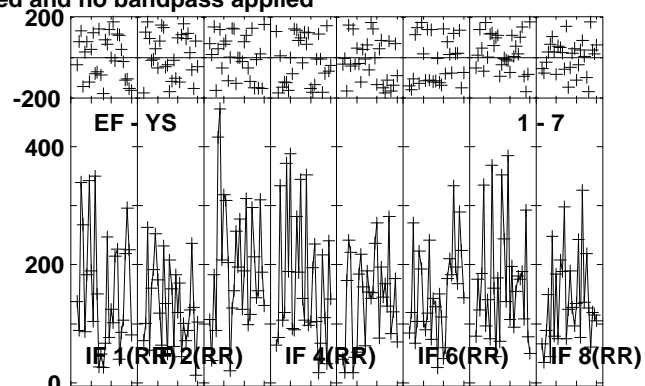
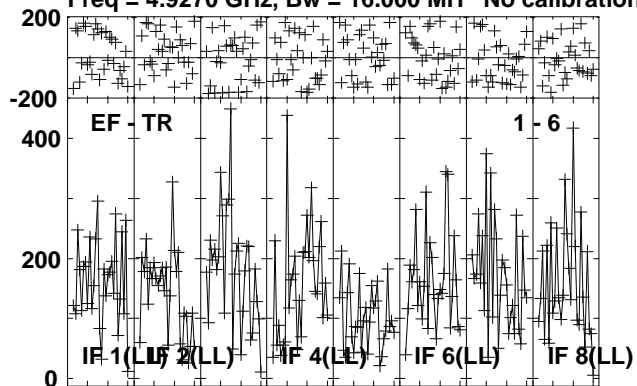

Lower frame: Micro Ampl Jy Top frame: Phas deg
Vector averaged cross-power spectrum Several baselines displayed
Timerange: 00/07:34:07 to 00/07:37:03

Plot file version 389 created 16-OCT-2012 11:58:26

J0639+0601 RO006.UVDATA.1

Freq = 4.9270 GHz, Bw = 16.000 MH No calibration applied and no bandpass applied

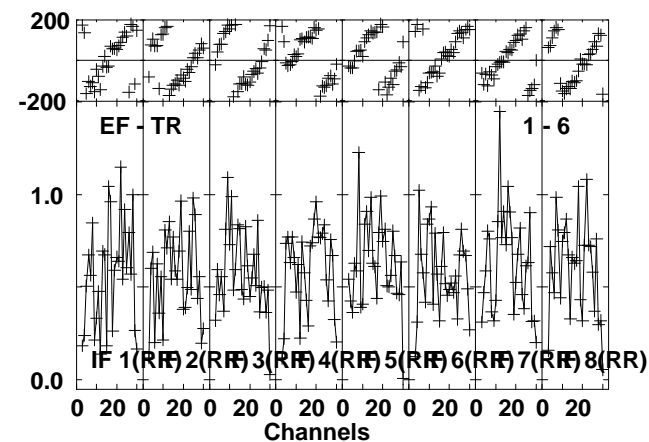
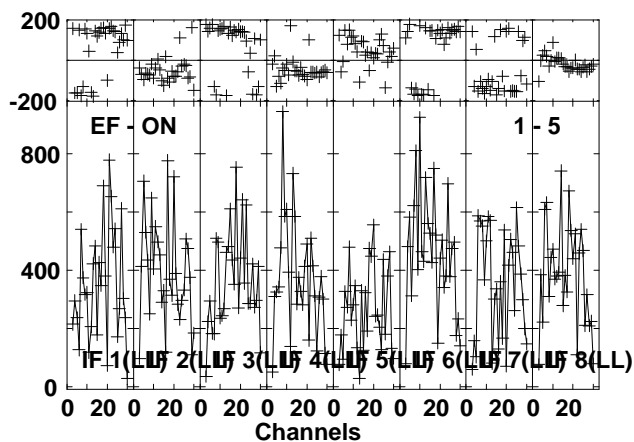
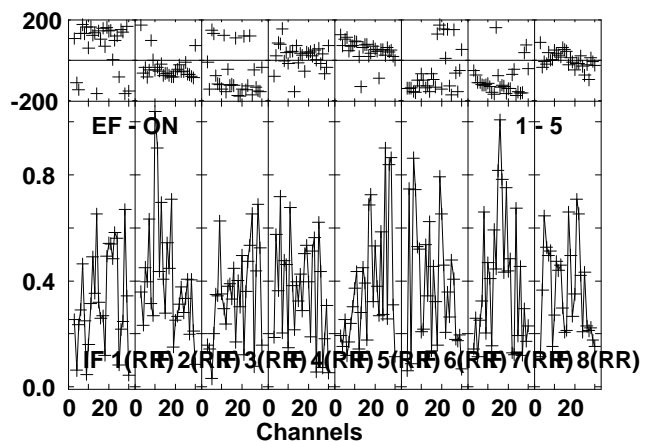
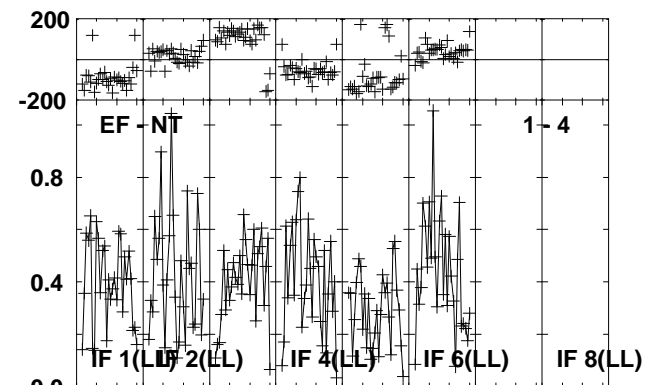
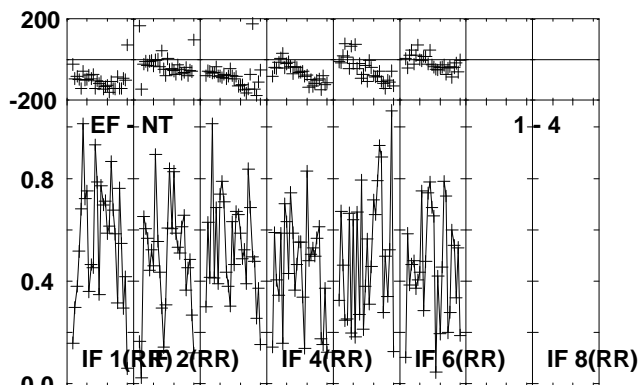
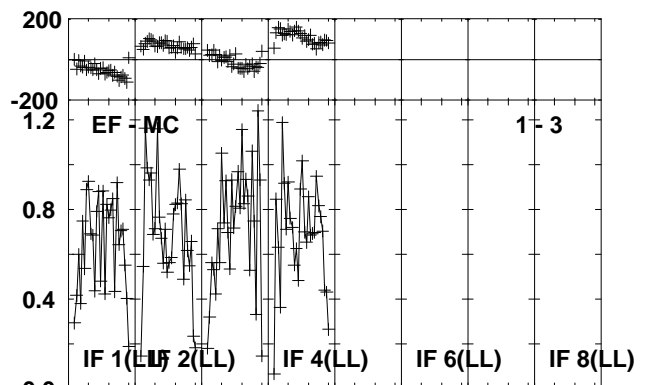
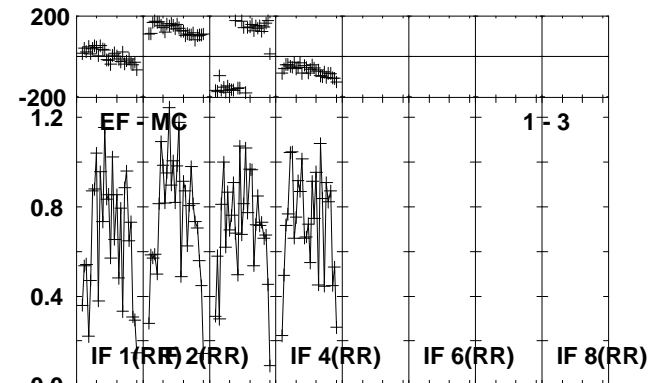
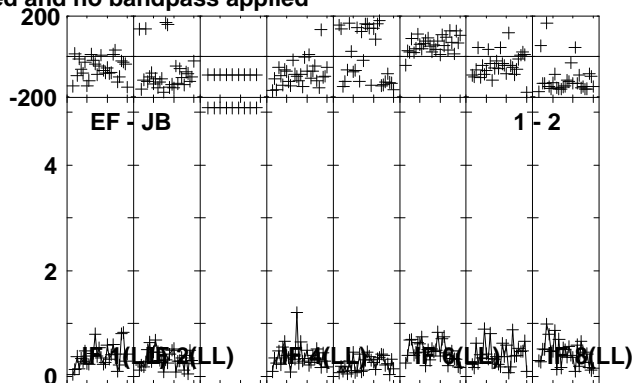
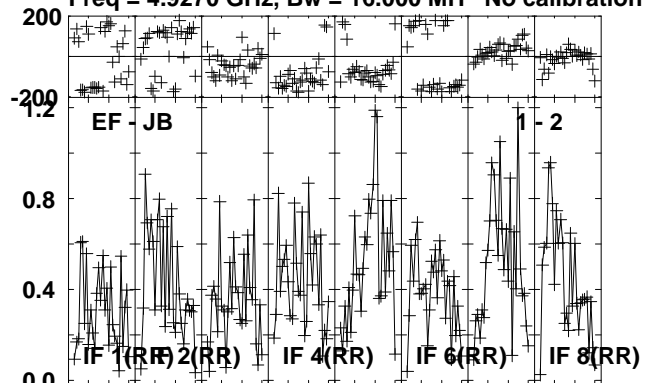

Lower frame: Milli Ampl Jy Top frame: Phas deg
Vector averaged cross-power spectrum Several baselines displayed
Timerange: 00/07:37:33 to 00/07:38:33

Plot file version 390 created 16-OCT-2012 11:58:27

J0639+0601 RO006.UVDATA.1

Freq = 4.9270 GHz, Bw = 16.000 MH No calibration applied and no bandpass applied

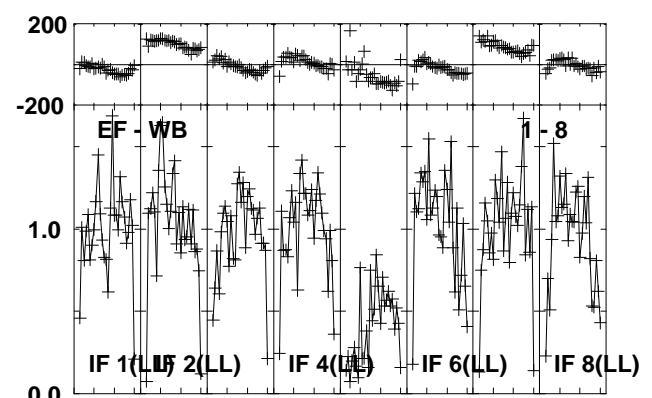
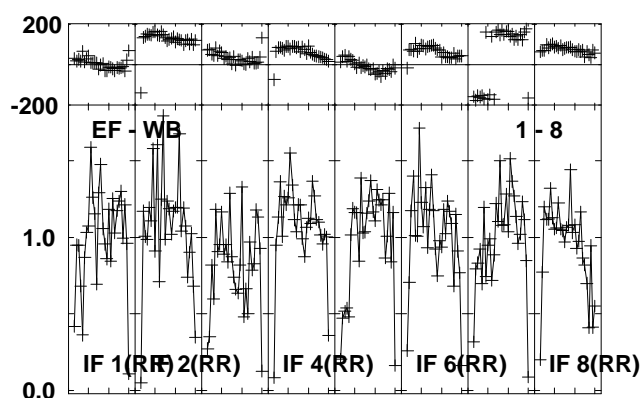
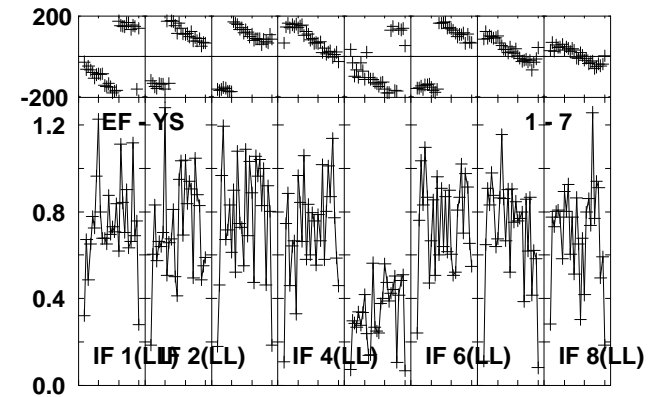
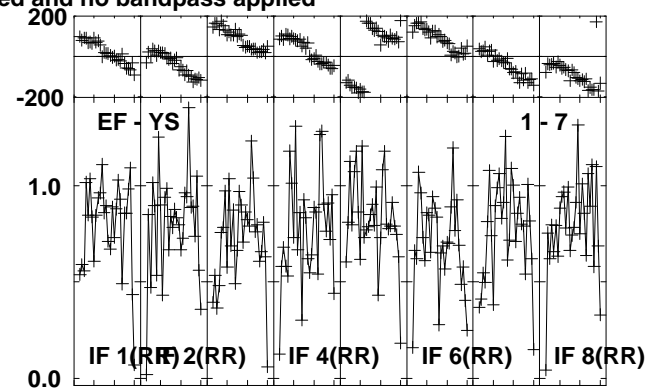
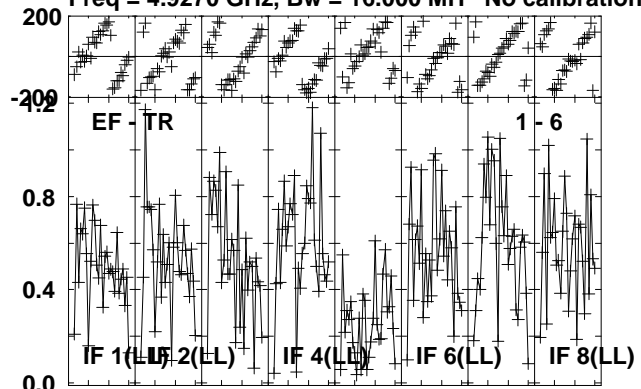

Lower frame: Milli Ampl Jy Top frame: Phas deg
Vector averaged cross-power spectrum Several baselines displayed
Timerange: 00/07:37:33 to 00/07:38:33

Plot file version 391 created 16-OCT-2012 11:58:27

J0645+0541 RO006.UVDATA.1

Freq = 4.9270 GHz, Bw = 16.000 MH No calibration applied and no bandpass applied

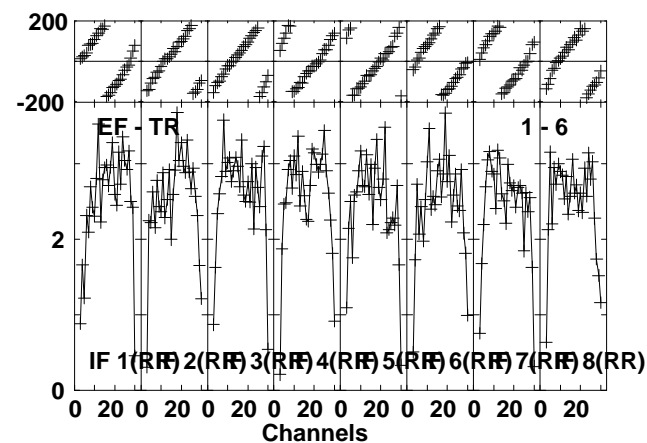
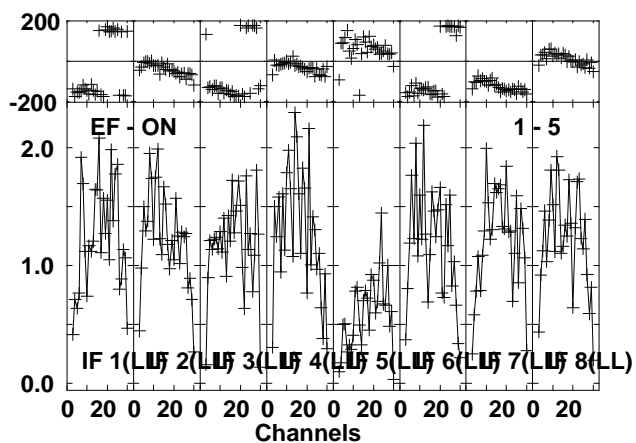
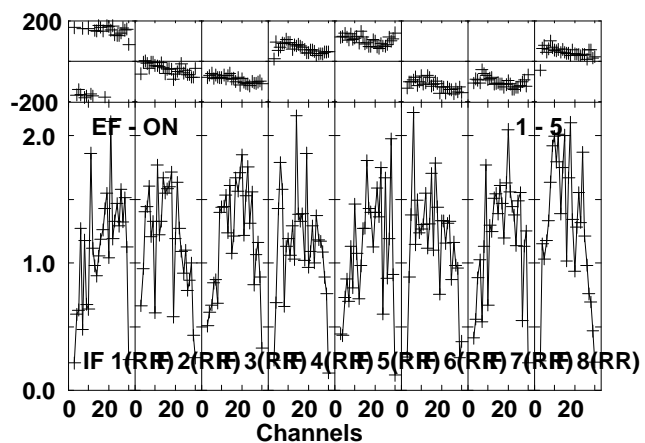
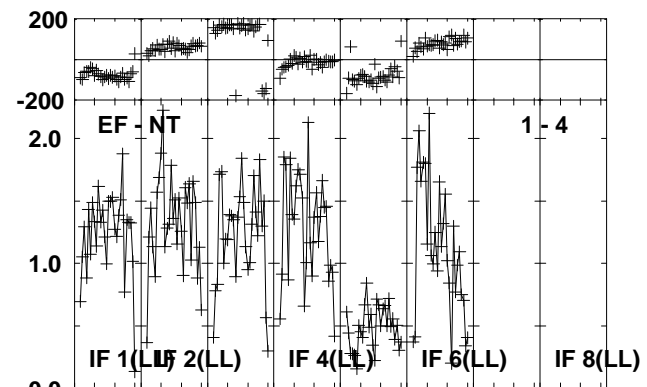
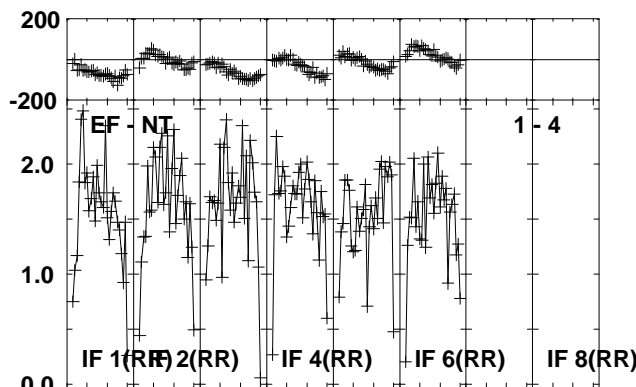
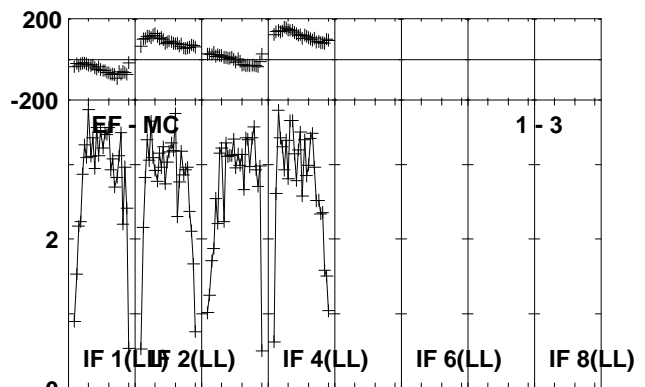
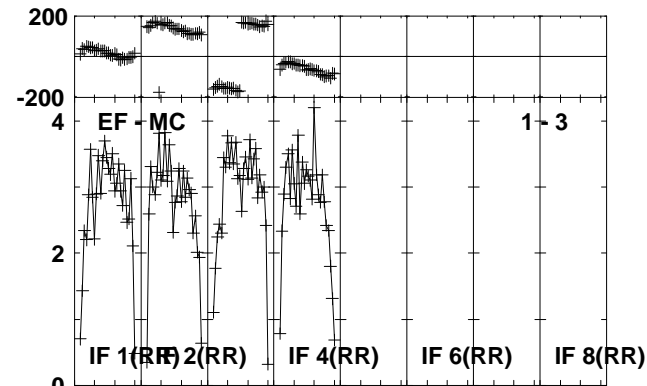
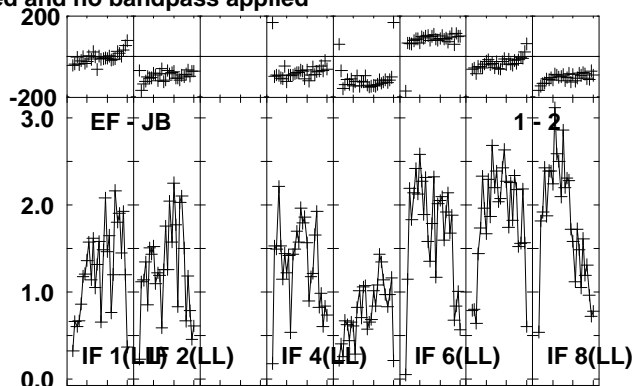
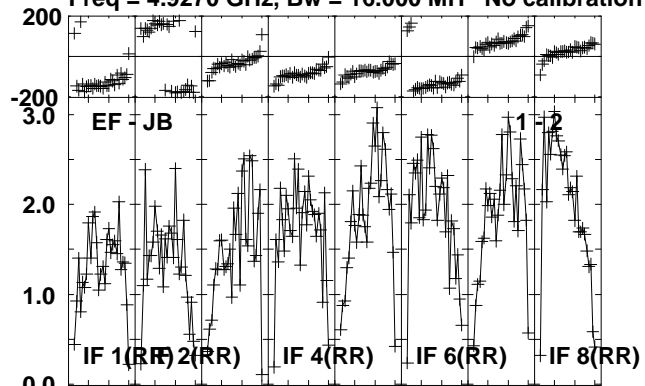

Lower frame: Milli Ampl Jy Top frame: Phas deg
Vector averaged cross-power spectrum Several baselines displayed
Timerange: 00/07:38:37 to 00/07:39:33

Plot file version 392 created 16-OCT-2012 11:58:27

J0645+0541 RO006.UVDATA.1

Freq = 4.9270 GHz, Bw = 16.000 MH No calibration applied and no bandpass applied

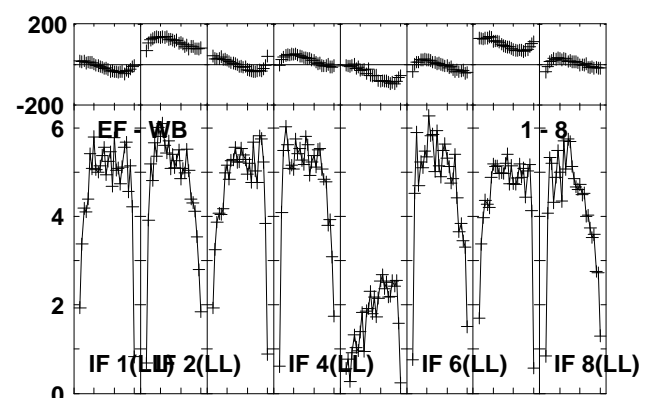
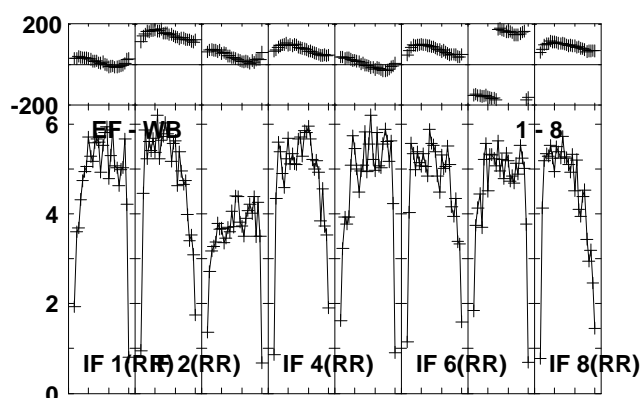
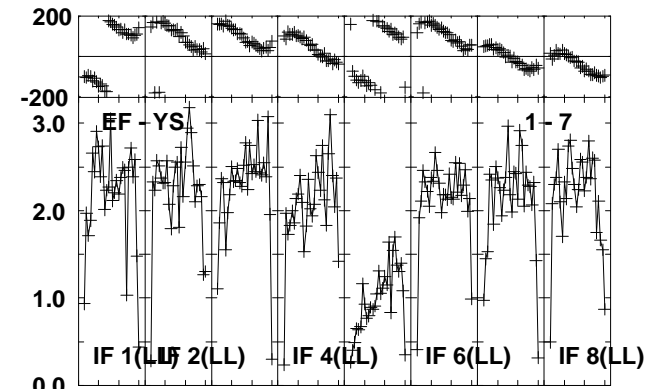
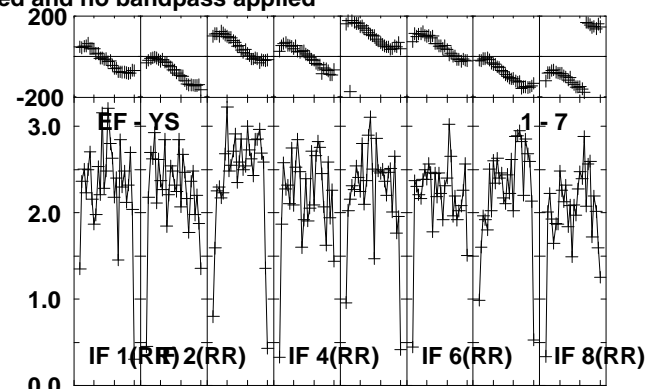
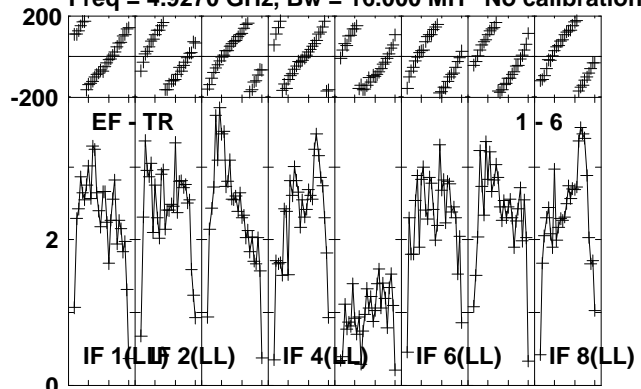

Lower frame: Milli Ampl Jy Top frame: Phas deg
Vector averaged cross-power spectrum Several baselines displayed
Timerange: 00/07:38:37 to 00/07:39:33

Plot file version 394 created 16-OCT-2012 11:58:28

NOVA-MON RO006.UVDATA.1

Freq = 4.9270 GHz, Bw = 16.000 MH No calibration applied and no bandpass applied

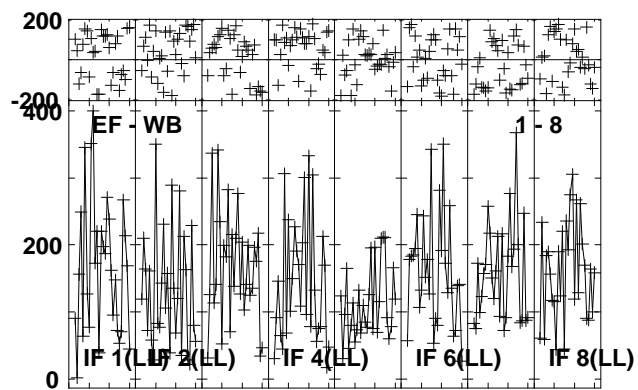
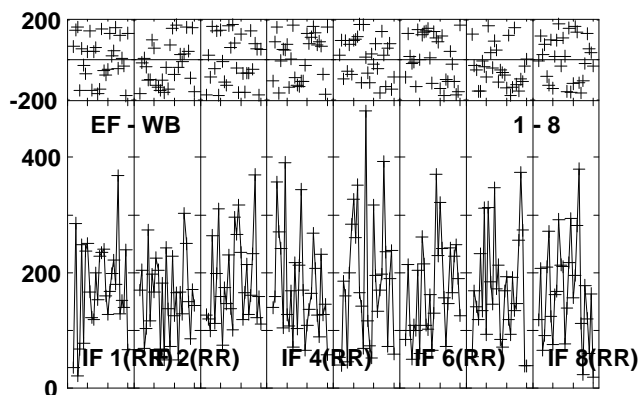
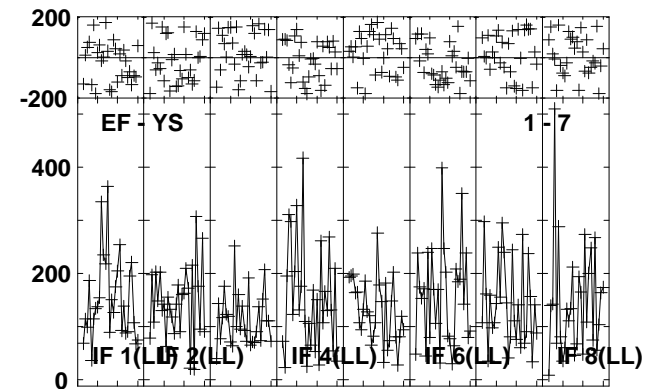
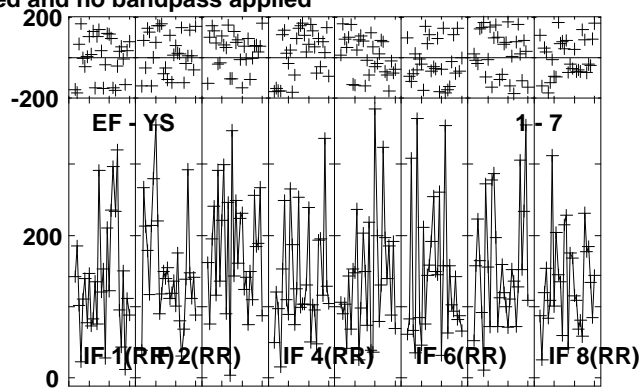
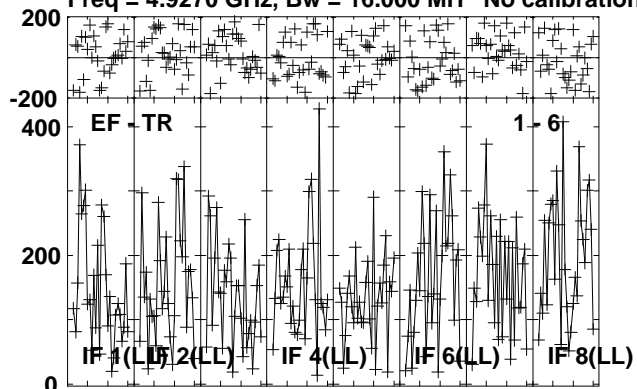

Lower frame: Micro Ampl Jy Top frame: Phas deg
Vector averaged cross-power spectrum Several baselines displayed
Timerange: 00/07:39:37 to 00/07:42:33

Plot file version 395 created 16-OCT-2012 11:58:28

J0639+0601 RO006.UVDATA.1

Freq = 4.9270 GHz, Bw = 16.000 MH No calibration applied and no bandpass applied

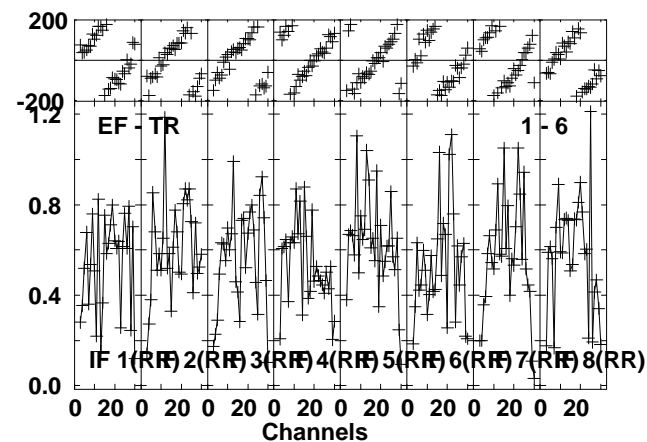
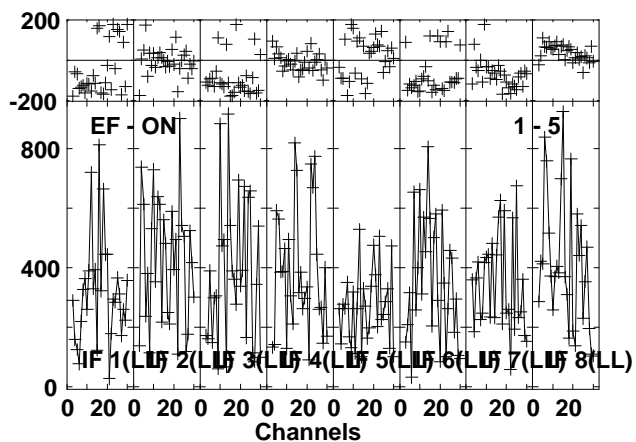
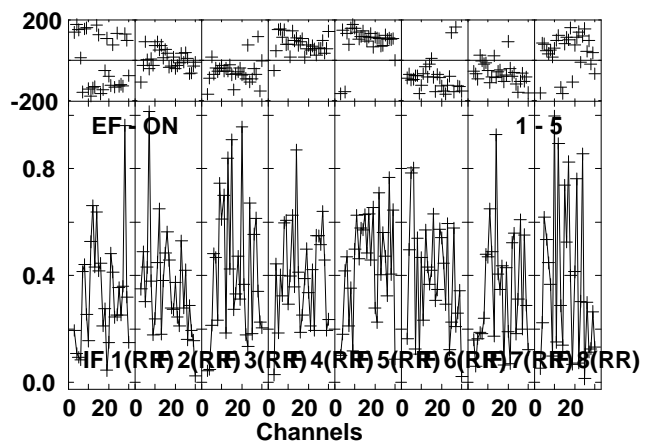
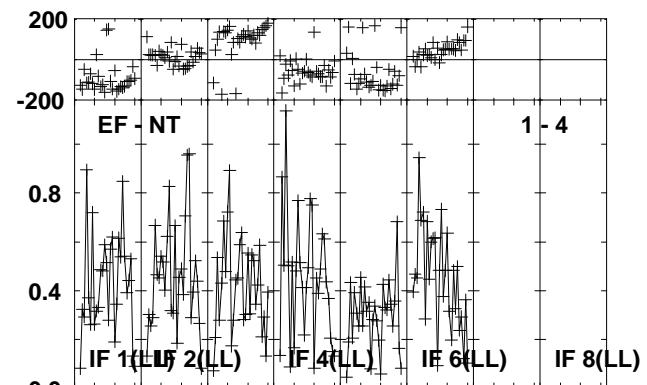
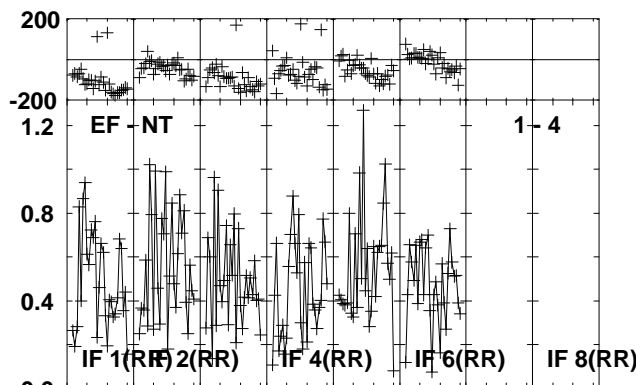
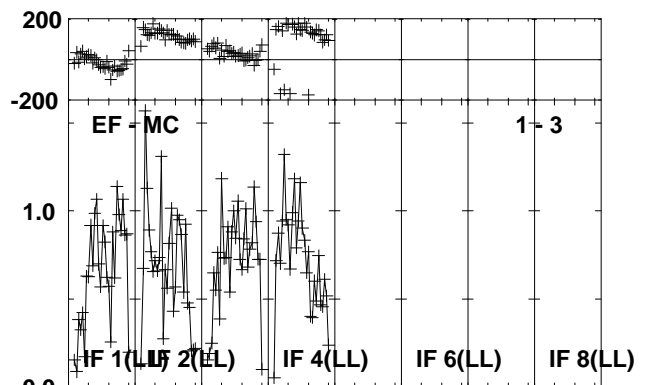
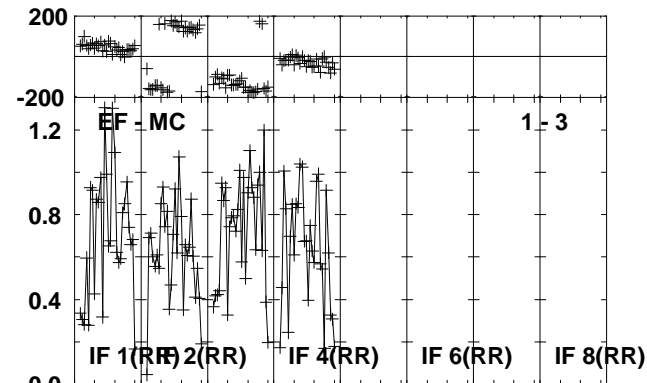
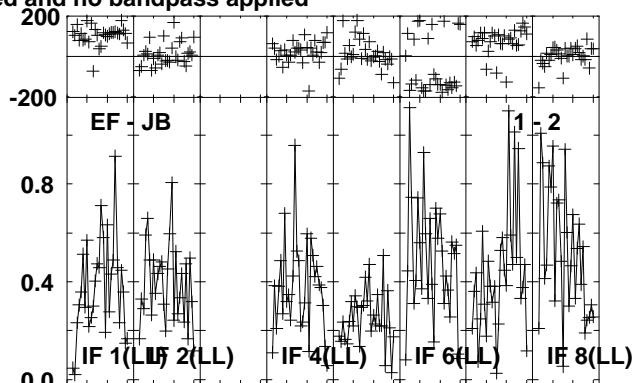
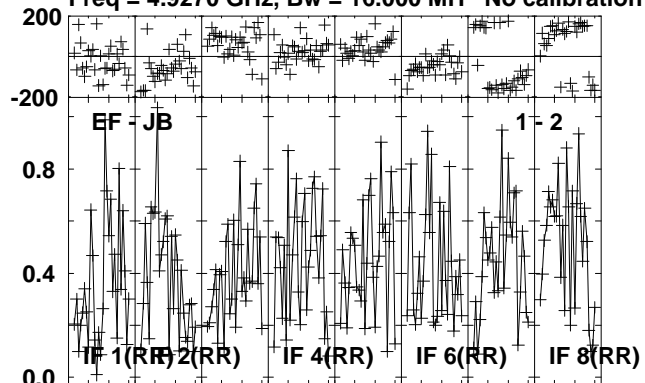

Lower frame: Milli Ampl Jy Top frame: Phas deg
Vector averaged cross-power spectrum Several baselines displayed
Timerange: 00/07:42:37 to 00/07:43:49

Plot file version 396 created 16-OCT-2012 11:58:29

J0639+0601 RO006.UVDATA.1

Freq = 4.9270 GHz, Bw = 16.000 MH No calibration applied and no bandpass applied

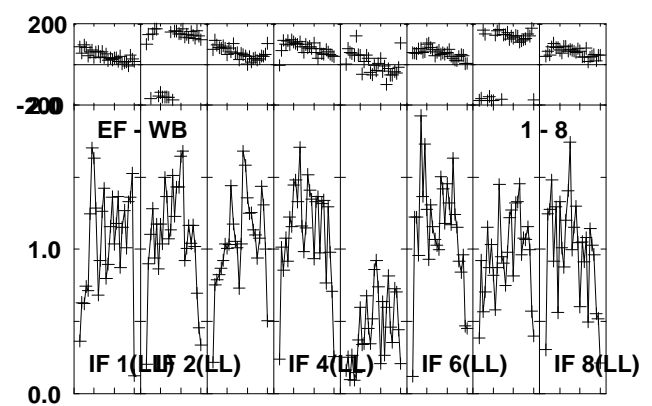
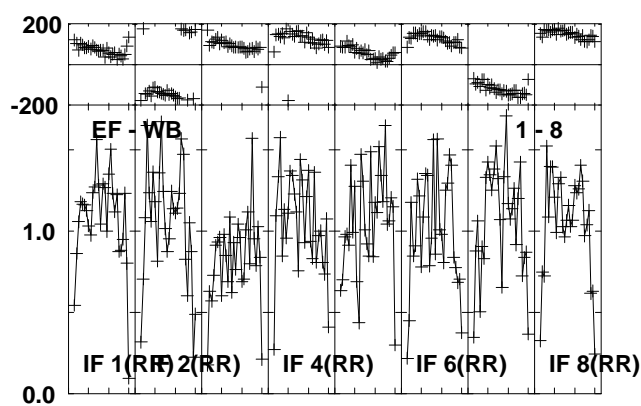
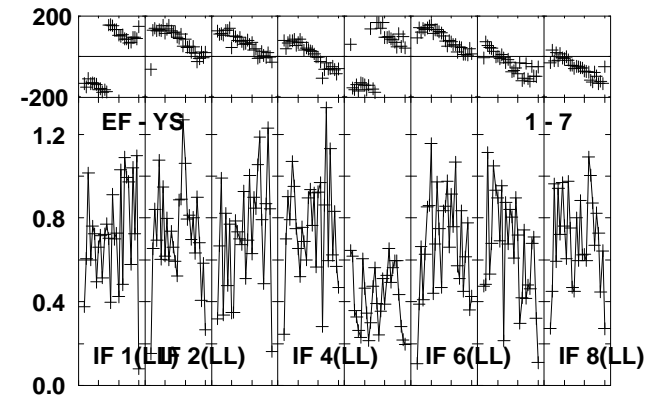
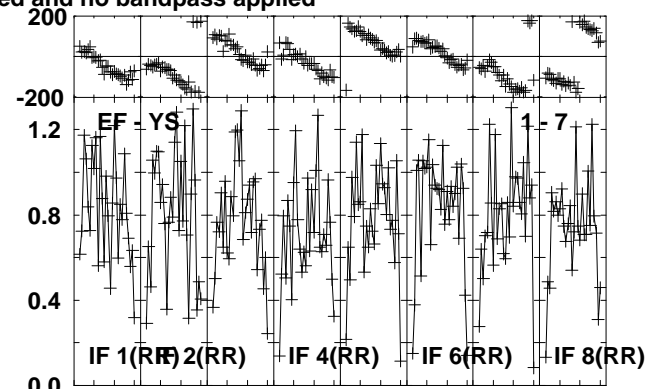
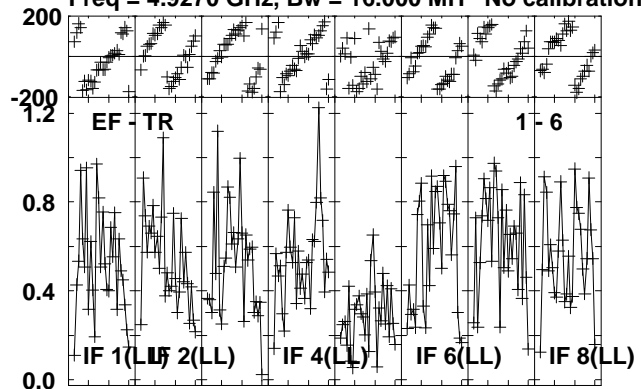

Lower frame: Milli Ampl Jy Top frame: Phas deg
Vector averaged cross-power spectrum Several baselines displayed
Timerange: 00/07:42:37 to 00/07:43:49

Plot file version 397 created 16-OCT-2012 11:58:29

J0645+0541 RO006.UVDATA.1

Freq = 4.9270 GHz, Bw = 16.000 MH No calibration applied and no bandpass applied

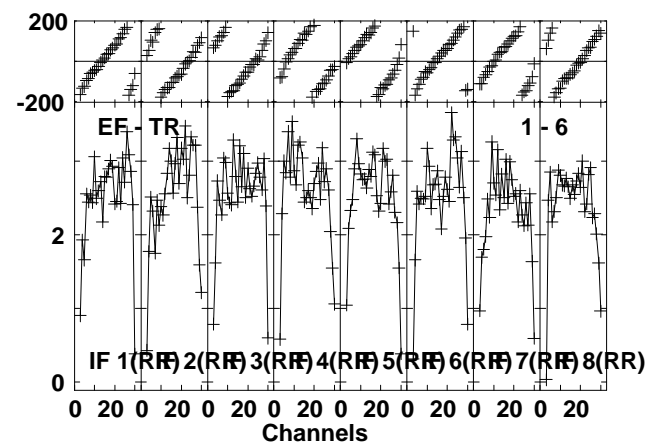
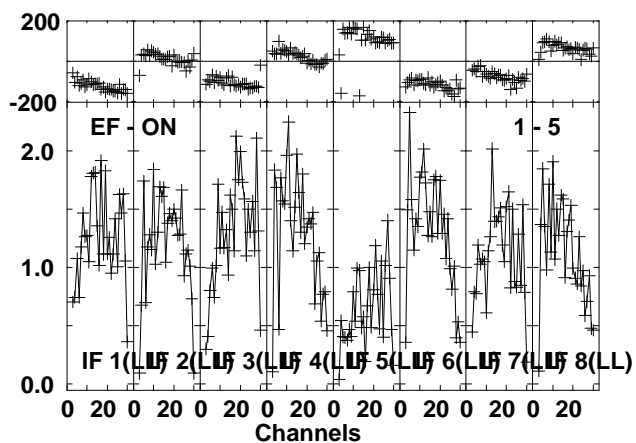
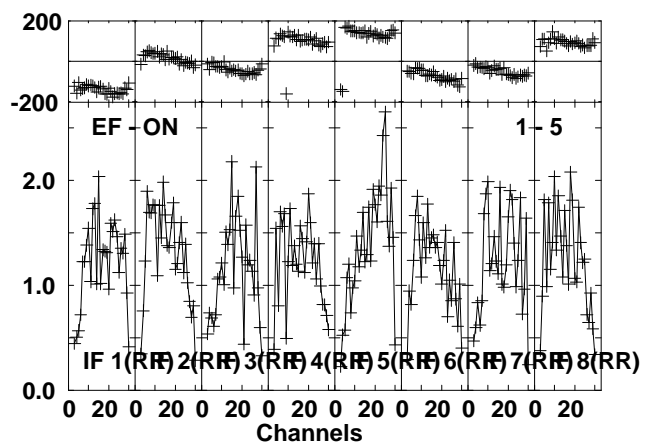
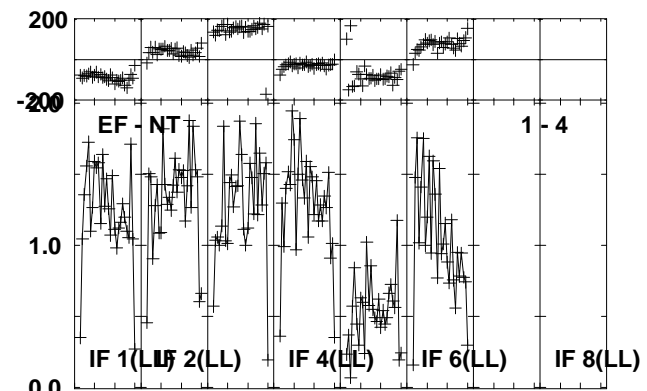
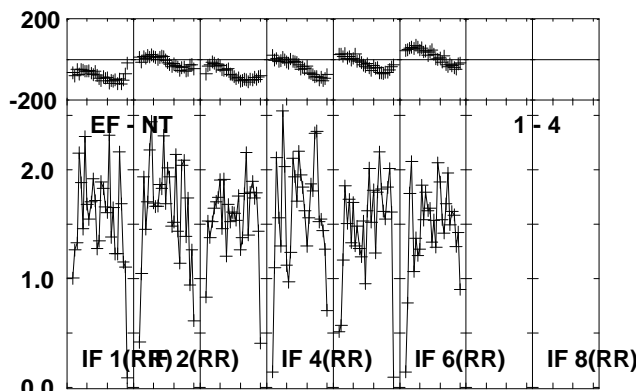
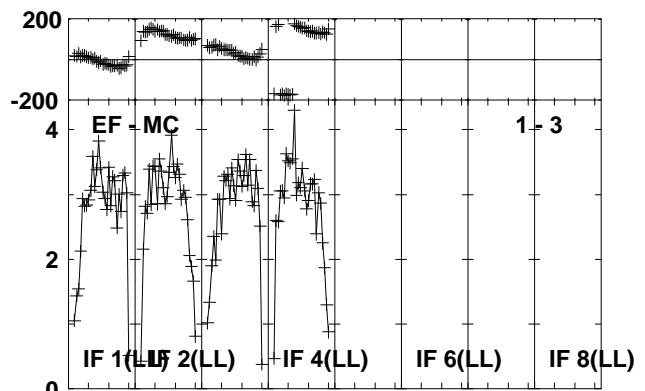
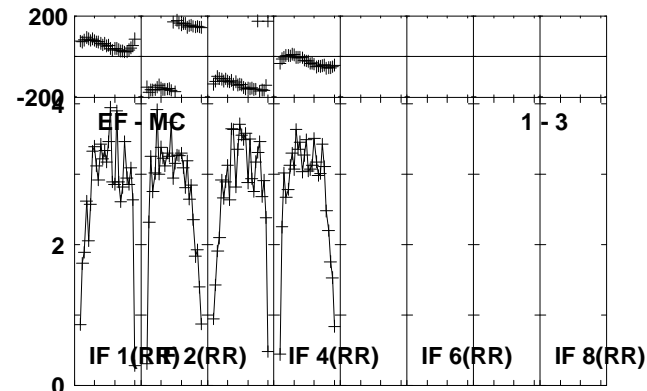
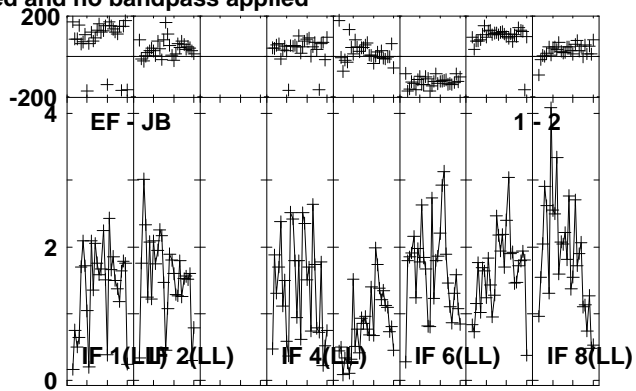
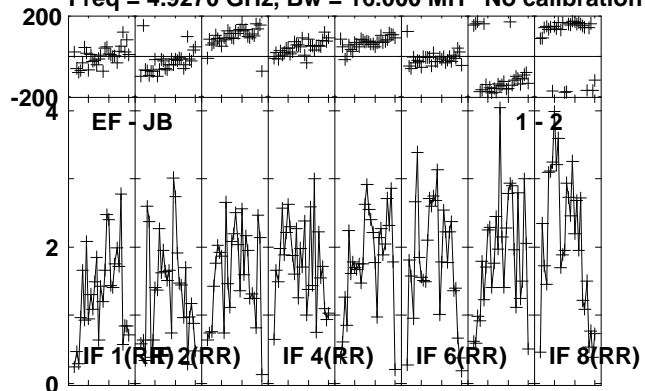

Lower frame: Milli Ampl Jy Top frame: Phas deg
Vector averaged cross-power spectrum Several baselines displayed
Timerange: 00/07:43:53 to 00/07:44:49

Plot file version 398 created 16-OCT-2012 11:58:29

J0645+0541 RO006.UVDATA.1

Freq = 4.9270 GHz, Bw = 16.000 MH No calibration applied and no bandpass applied

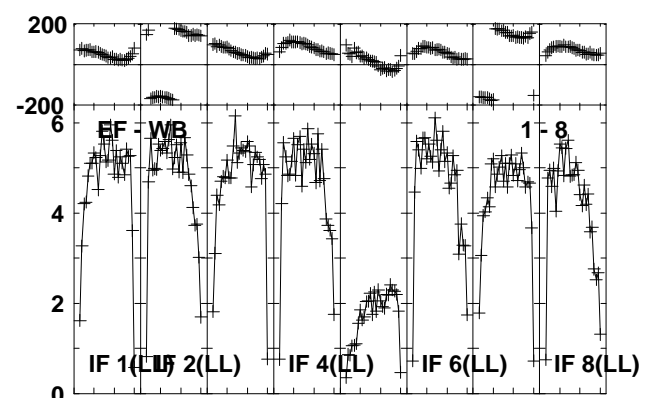
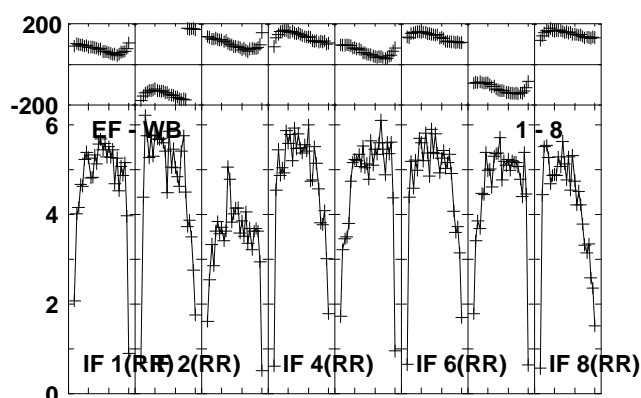
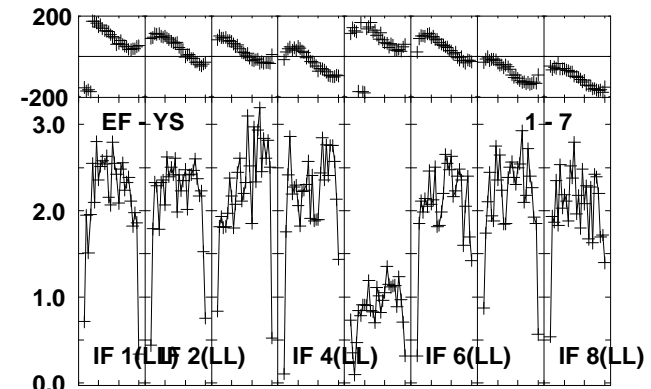
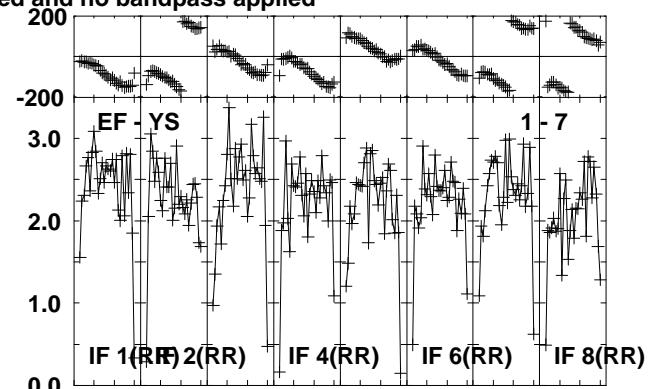
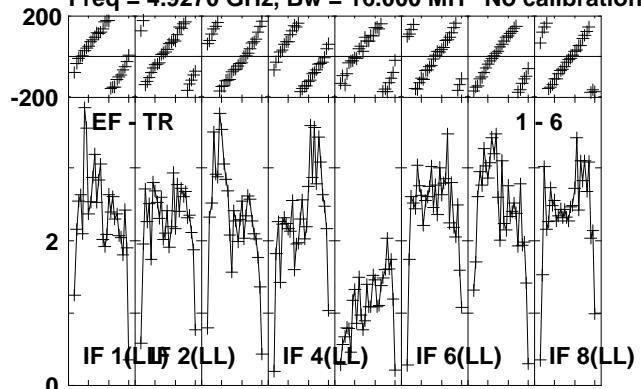

Lower frame: Milli Ampl Jy Top frame: Phas deg
Vector averaged cross-power spectrum Several baselines displayed
Timerange: 00/07:43:53 to 00/07:44:49

Plot file version 399 created 16-OCT-2012 11:58:29

NOVA-MON RO006.UVDATA.1

Freq = 4.9270 GHz, Bw = 16.000 MH No calibration applied and no bandpass applied

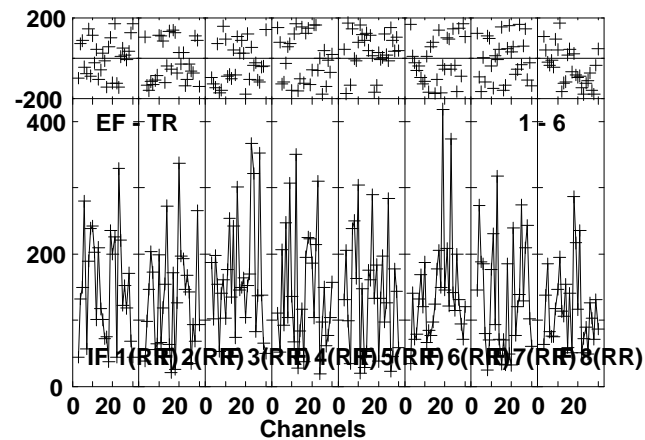
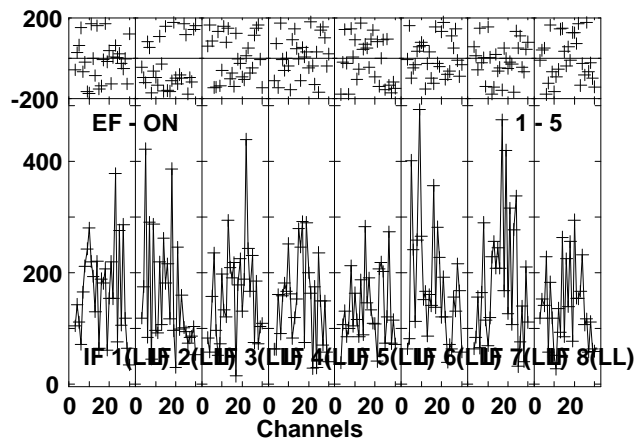
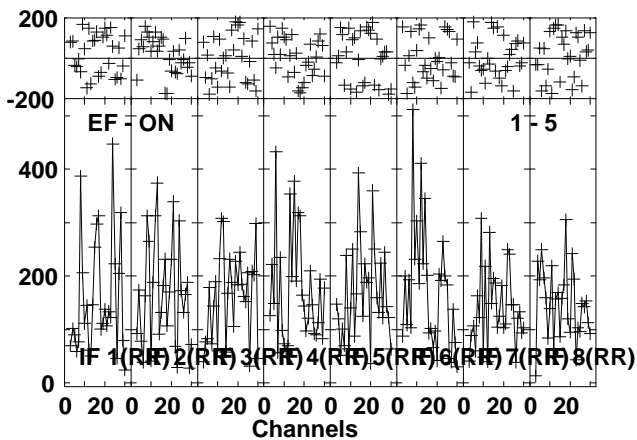
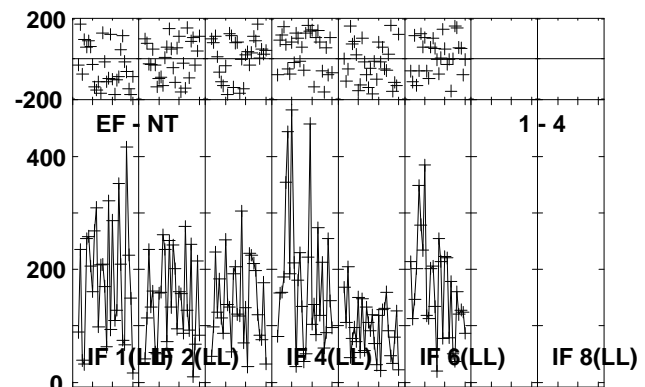
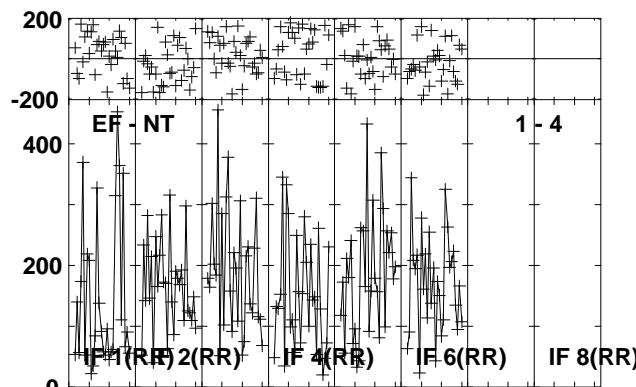
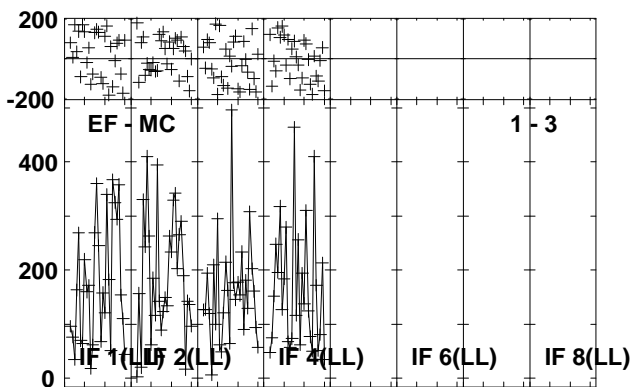
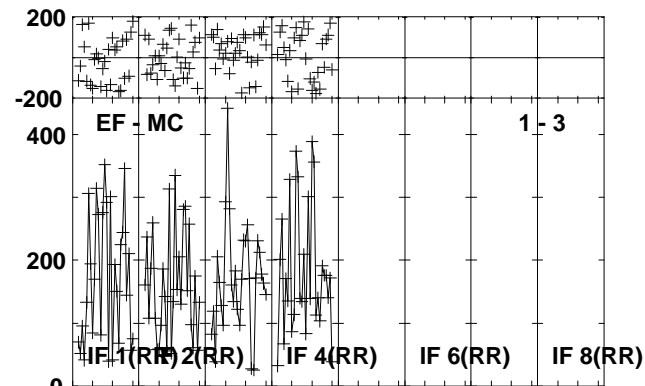
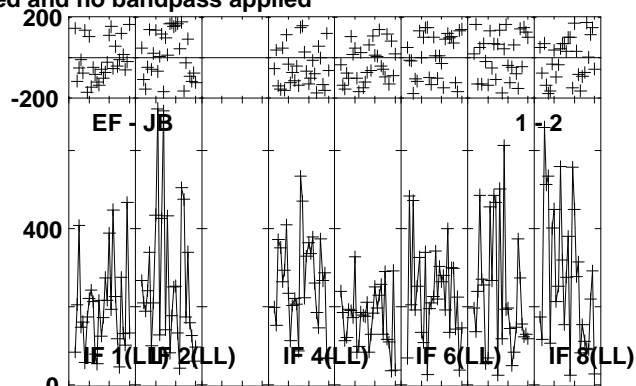
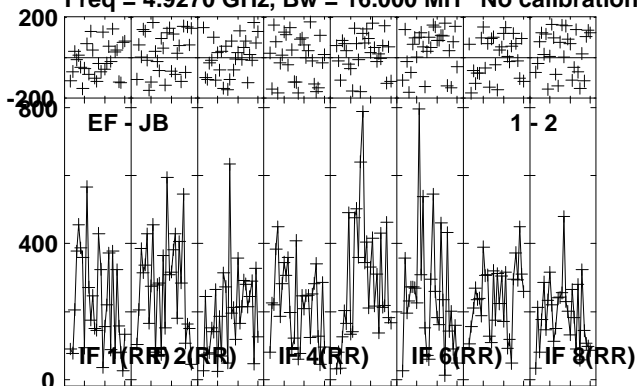

Lower frame: Micro Ampl Jy Top frame: Phas deg
Vector averaged cross-power spectrum Several baselines displayed
Timerange: 00/07:44:53 to 00/07:47:49

Plot file version 400 created 16-OCT-2012 11:58:30

NOVA-MON RO006.UVDATA.1

Freq = 4.9270 GHz, Bw = 16.000 MH No calibration applied and no bandpass applied

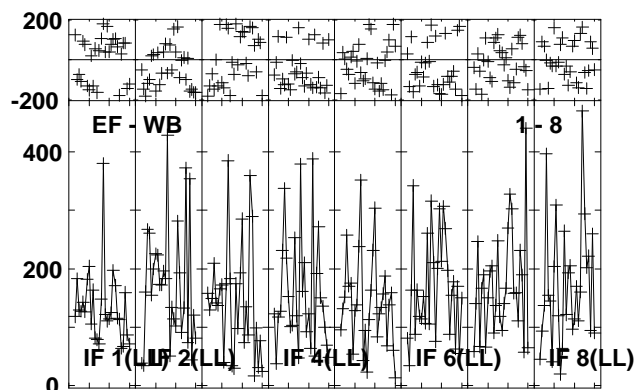
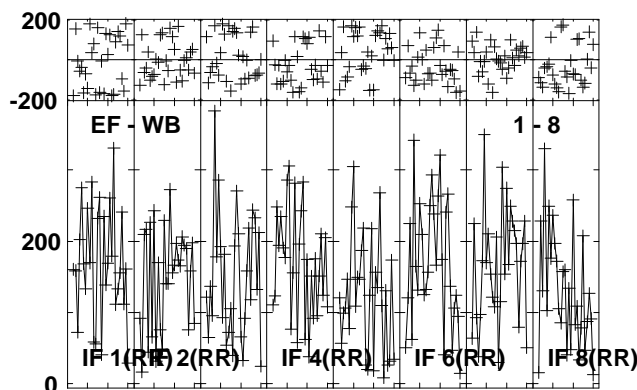
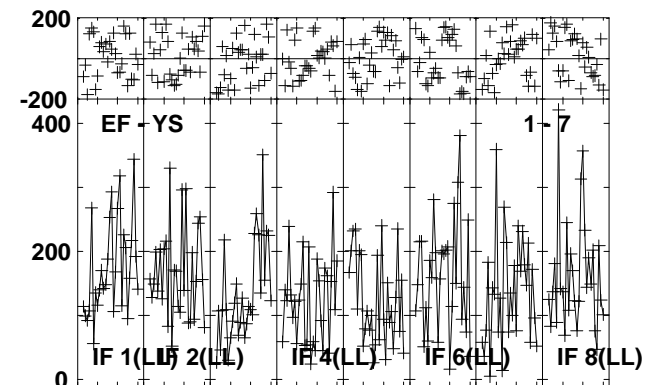
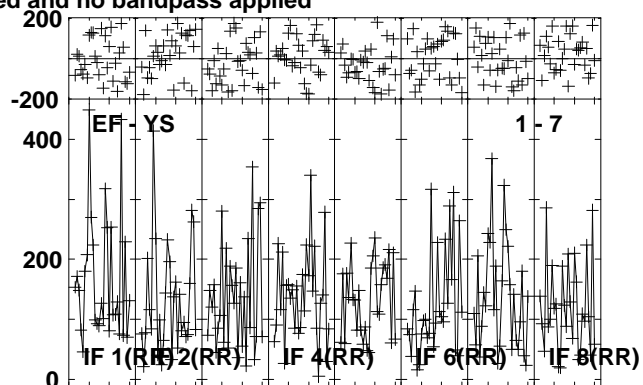
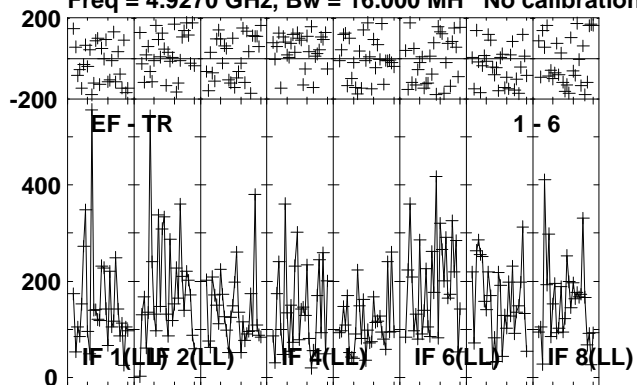

Lower frame: Micro Ampl Jy Top frame: Phas deg
Vector averaged cross-power spectrum Several baselines displayed
Timerange: 00/07:44:53 to 00/07:47:49

Plot file version 402 created 16-OCT-2012 11:58:30

J0639+0601 RO006.UVDATA.1

Freq = 4.9270 GHz, Bw = 16.000 MH No calibration applied and no bandpass applied

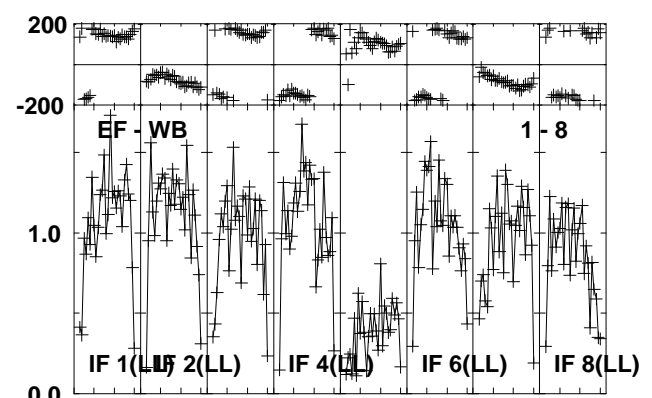
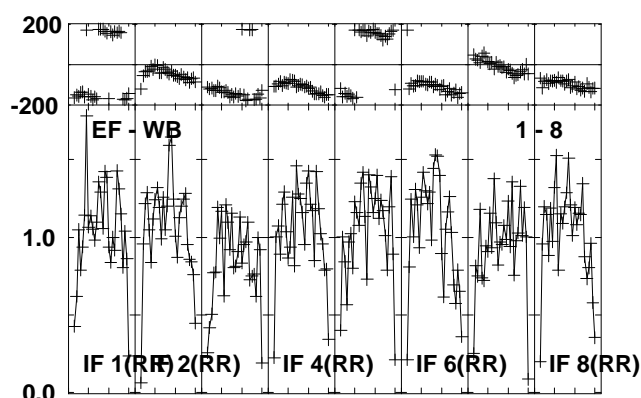
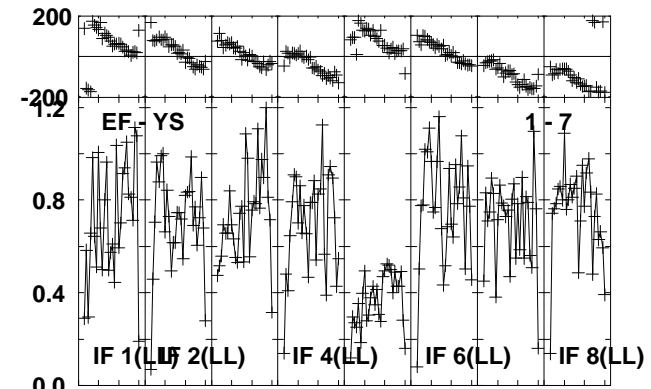
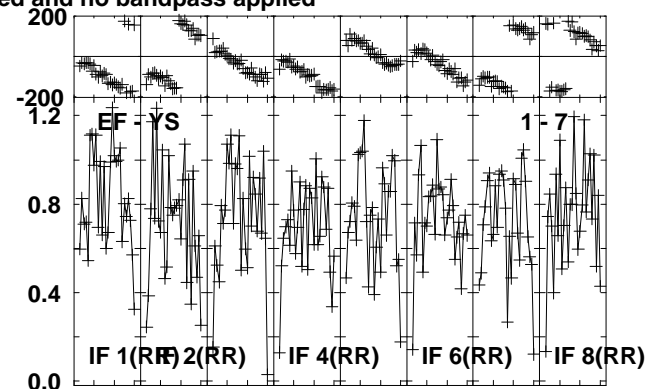
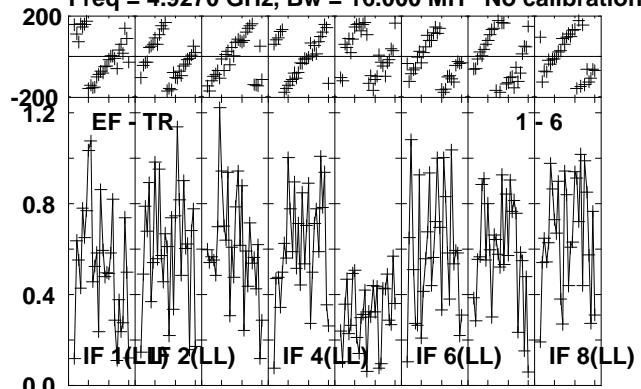

Lower frame: Milli Ampl Jy Top frame: Phas deg
Vector averaged cross-power spectrum Several baselines displayed
Timerange: 00/07:48:17 to 00/07:49:19

Plot file version 403 created 16-OCT-2012 11:58:30

0528+134 RO006.UVDATA.1

Freq = 4.9270 GHz, Bw = 16.000 MH No calibration applied and no bandpass applied

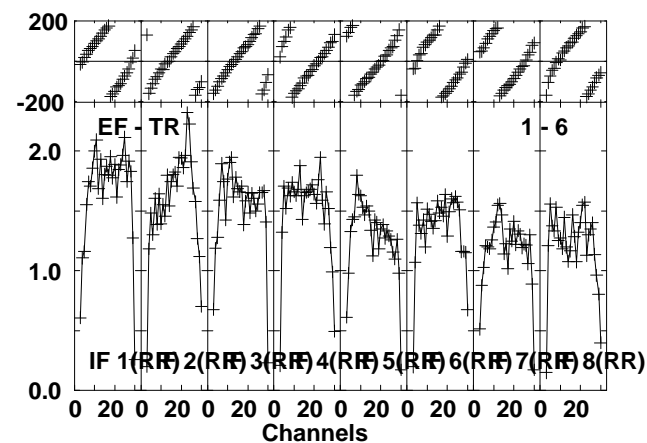
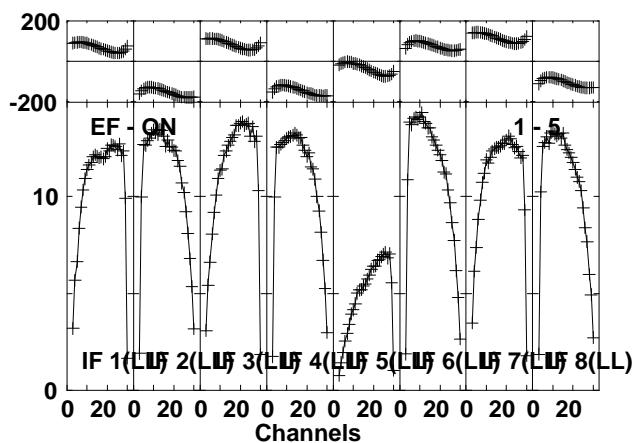
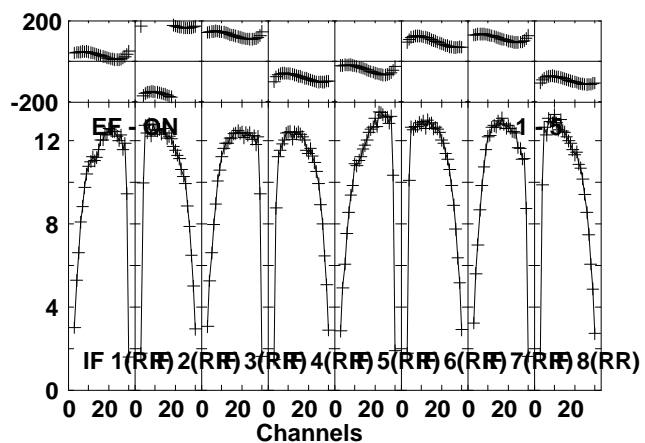
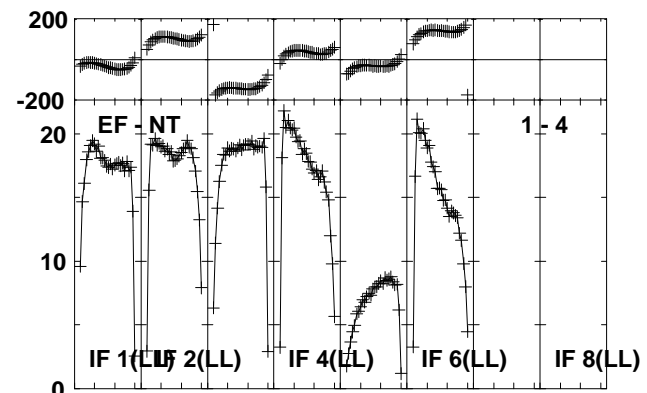
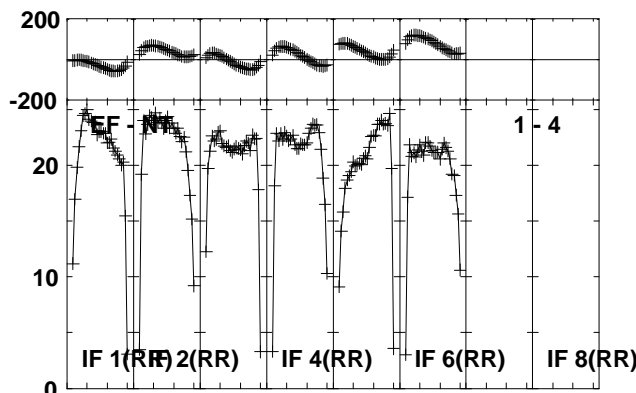
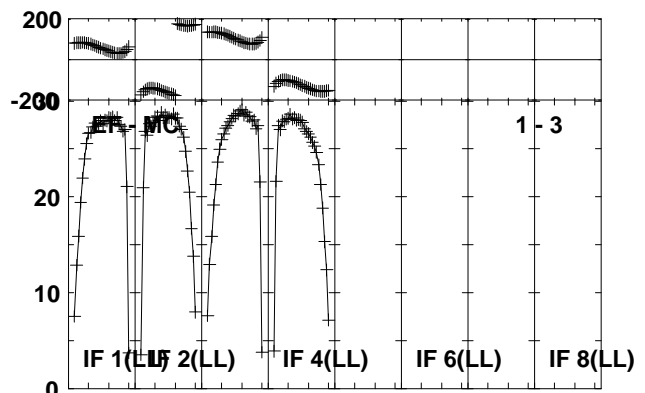
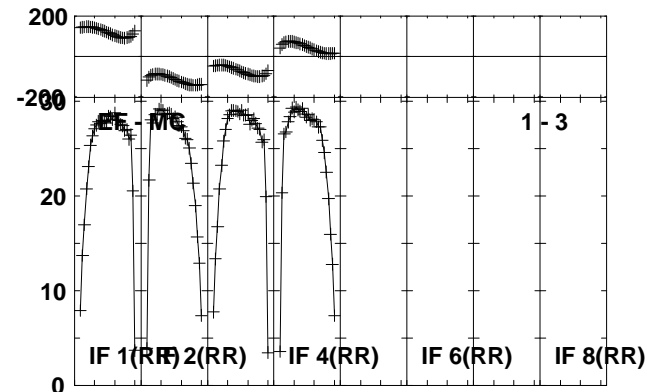
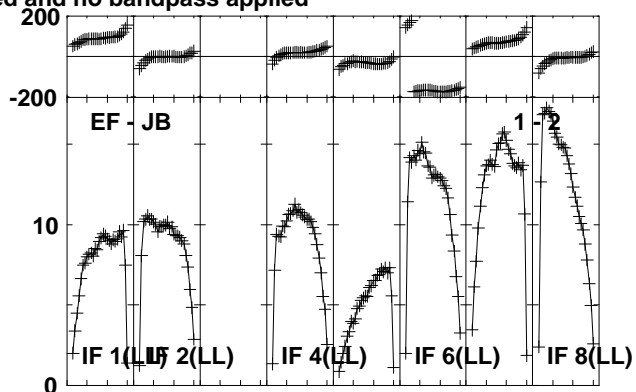
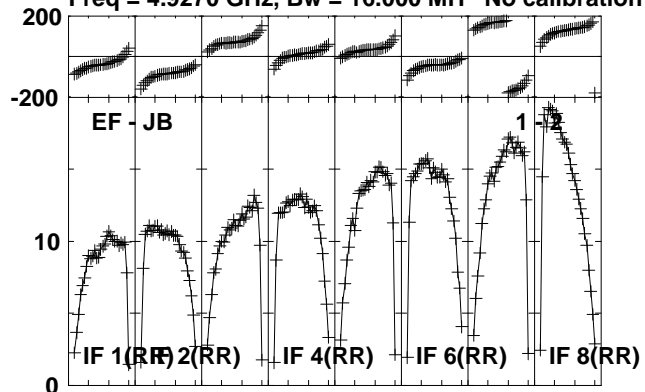

Lower frame: Milli Ampl Jy Top frame: Phas deg
Vector averaged cross-power spectrum Several baselines displayed
Timerange: 00/07:51:17 to 00/07:54:19

Plot file version 404 created 16-OCT-2012 11:58:31

0528+134 RO006.UVDATA.1

Freq = 4.9270 GHz, Bw = 16.000 MH No calibration applied and no bandpass applied

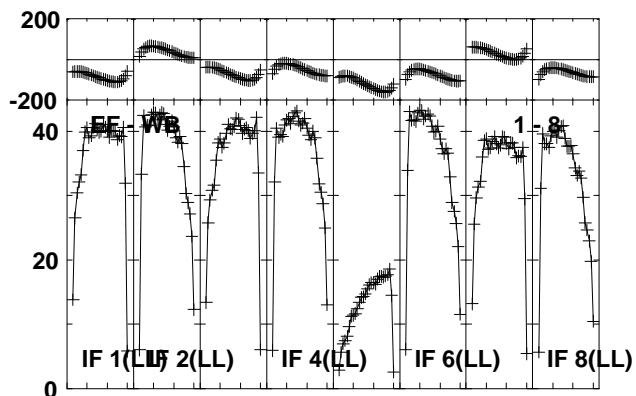
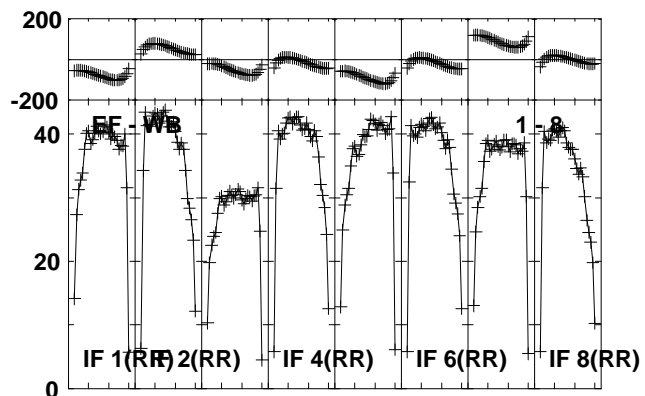
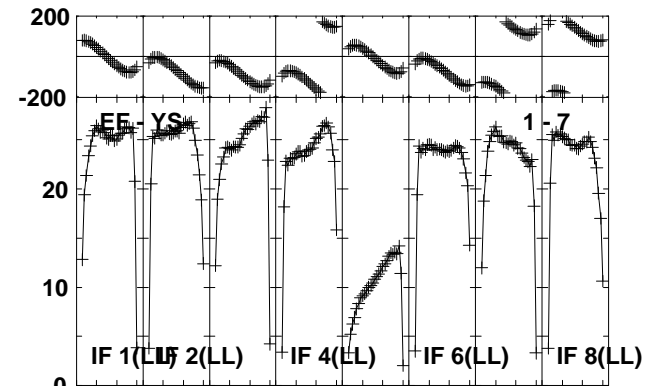
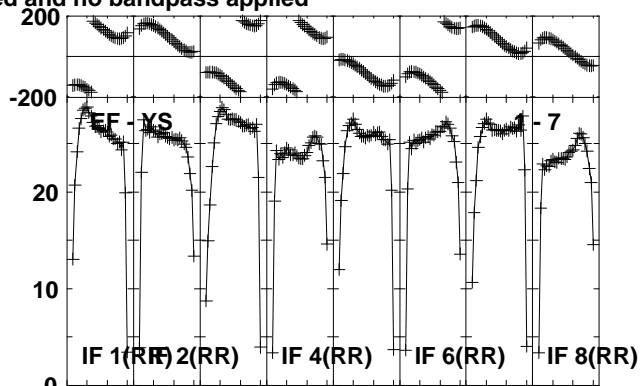
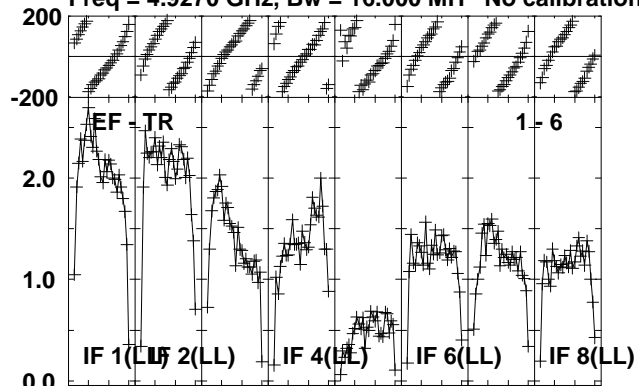

Lower frame: Milli Ampl Jy Top frame: Phas deg
Vector averaged cross-power spectrum Several baselines displayed
Timerange: 00/07:51:17 to 00/07:54:19

Plot file version 405 created 16-OCT-2012 11:58:32

1156+295 RO006.UVDATA.1

Freq = 4.9270 GHz, Bw = 16.000 MH No calibration applied and no bandpass applied

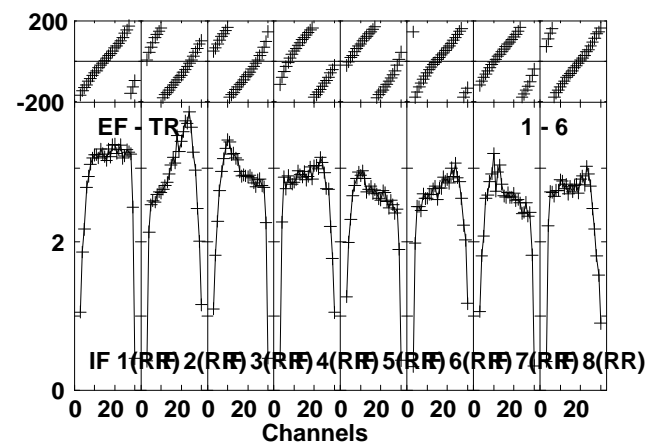
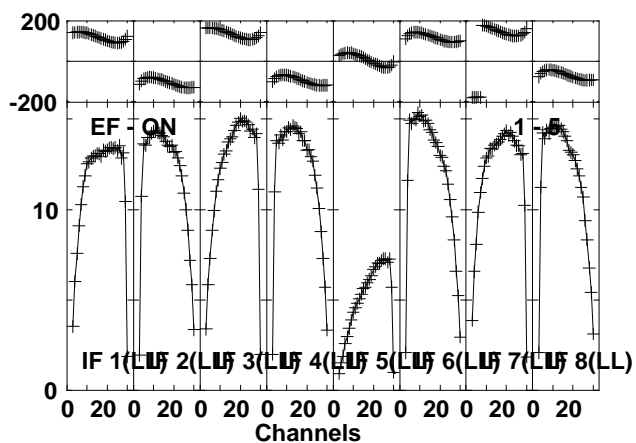
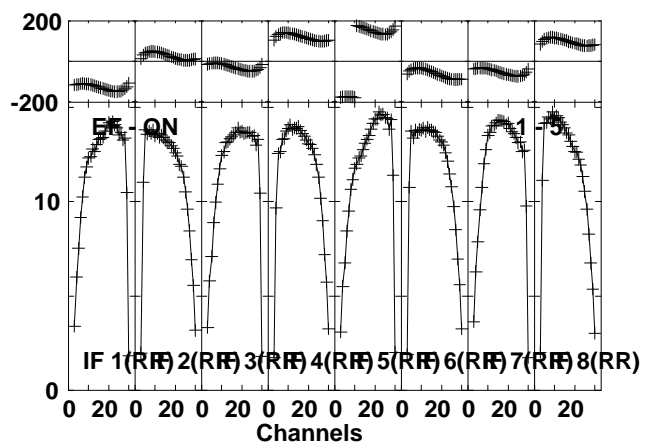
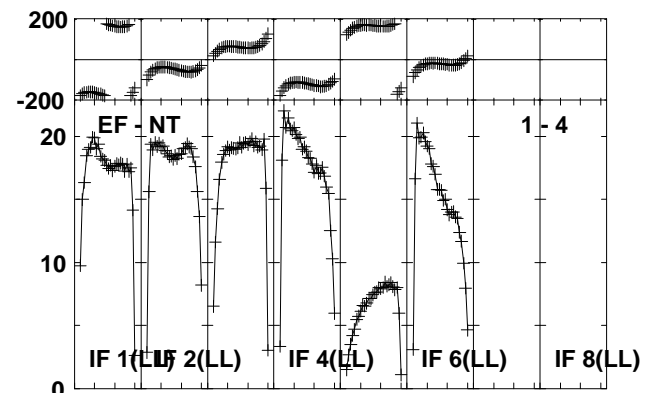
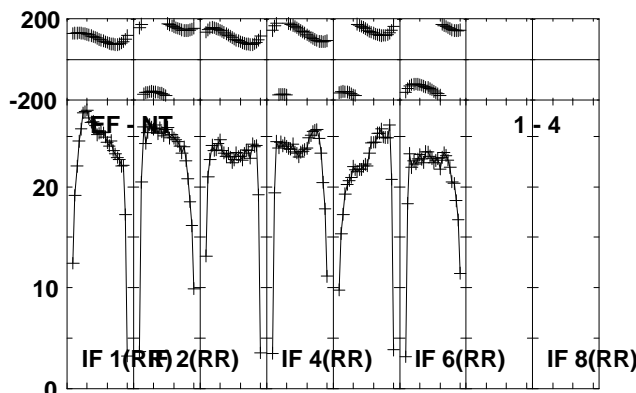
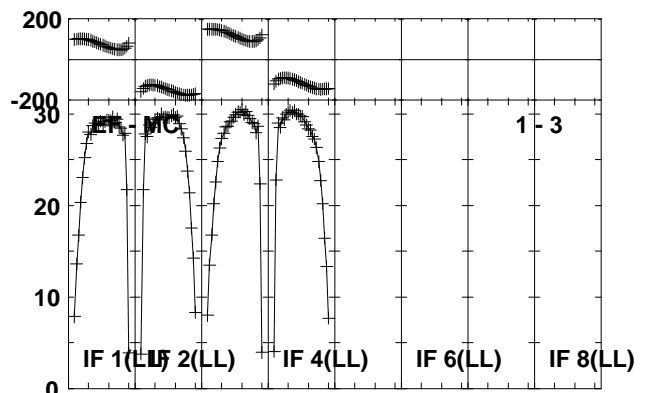
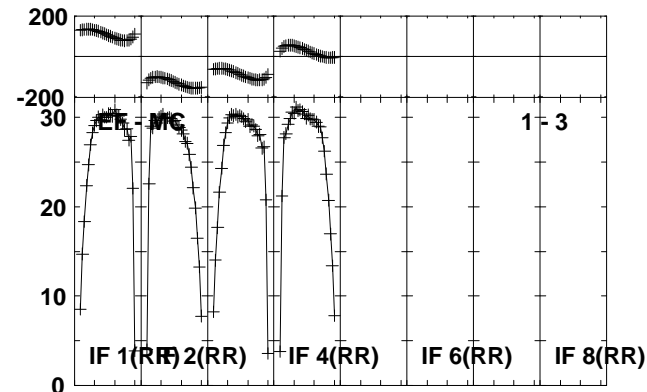
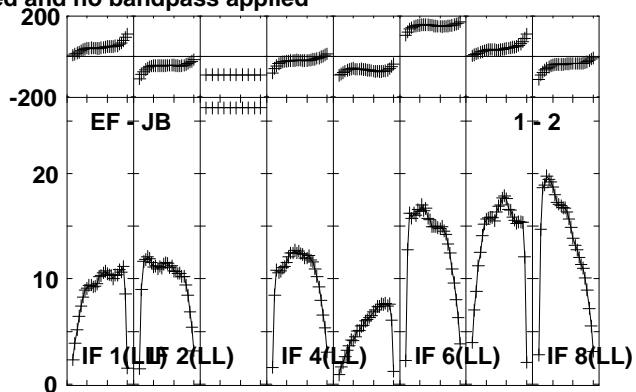
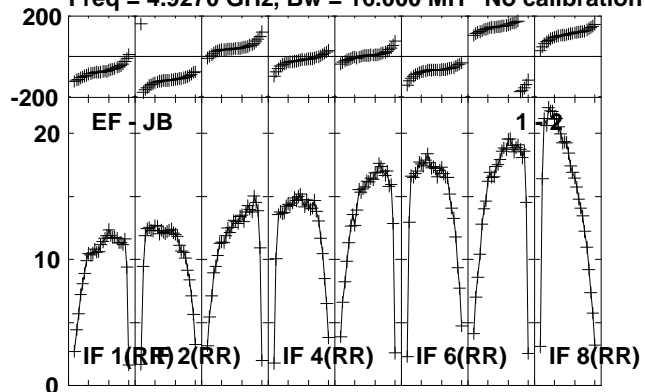

Lower frame: Milli Ampl Jy Top frame: Phas deg
Vector averaged cross-power spectrum Several baselines displayed
Timerange: 00/07:59:36 to 00/08:08:18

Plot file version 406 created 16-OCT-2012 11:58:33

1156+295 RO006.UVDATA.1

Freq = 4.9270 GHz, Bw = 16.000 MH No calibration applied and no bandpass applied

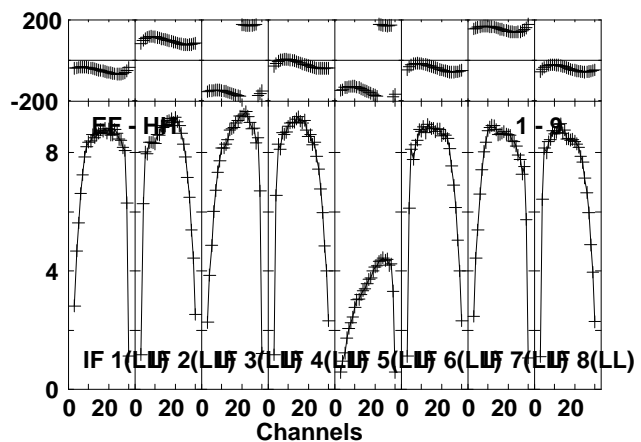
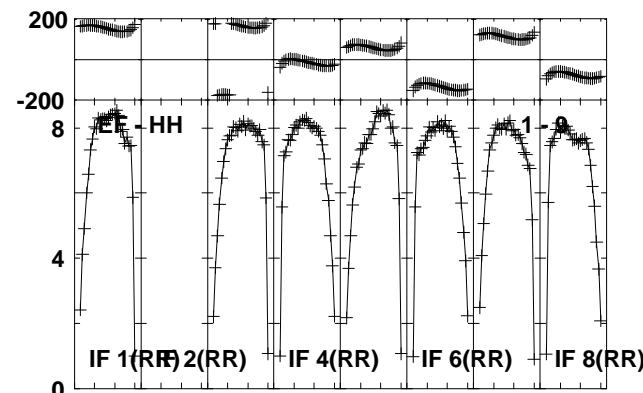
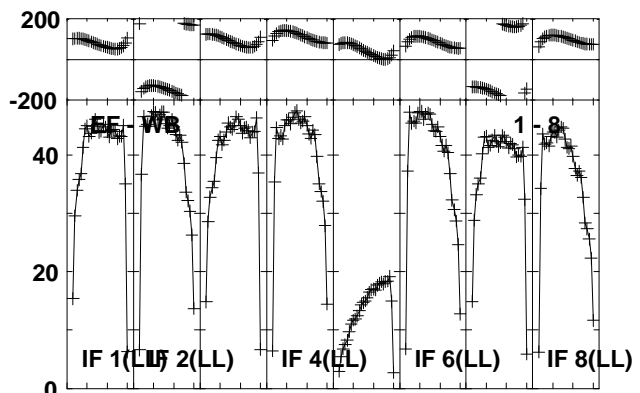
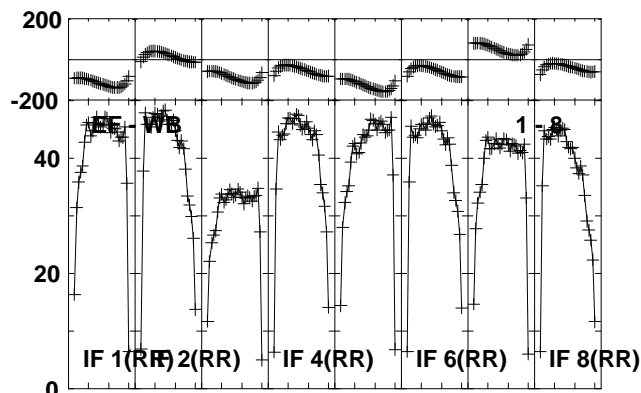
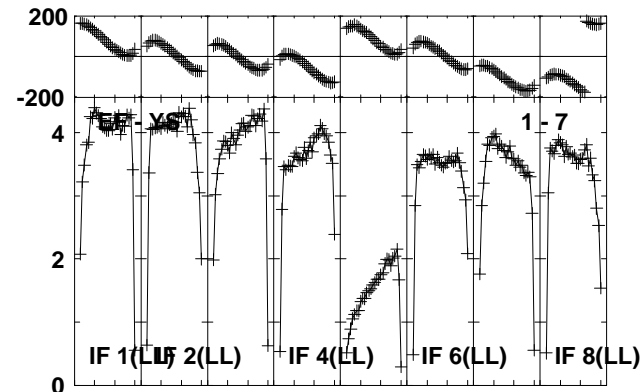
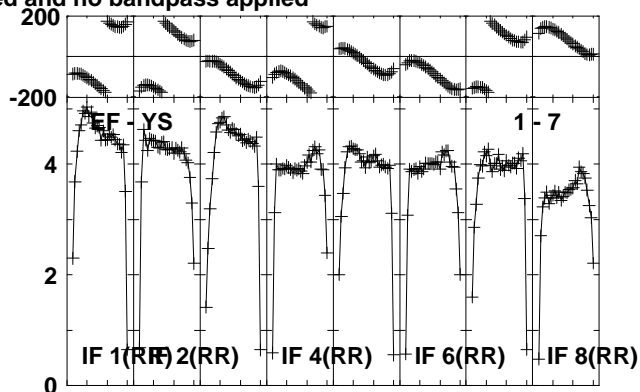
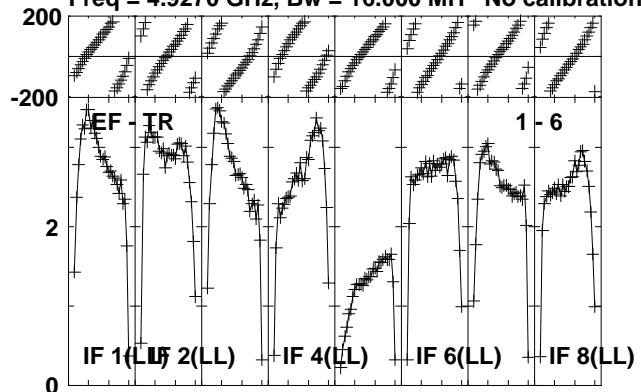

Lower frame: Milli Ampl Jy Top frame: Phas deg
Vector averaged cross-power spectrum Several baselines displayed
Timerange: 00/07:59:36 to 00/08:08:18

Plot file version 407 created 16-OCT-2012 11:58:35

1156+295 RO006.UVDATA.1

Freq = 4.9270 GHz, Bw = 16.000 MH No calibration applied and no bandpass applied

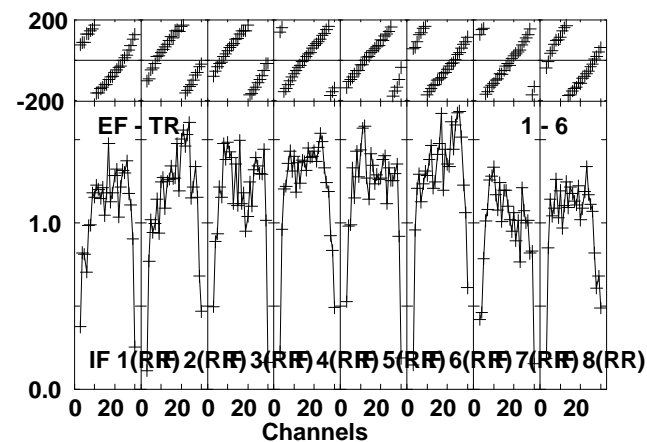
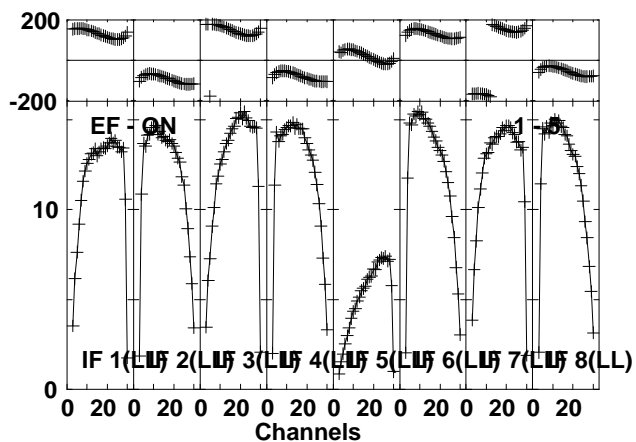
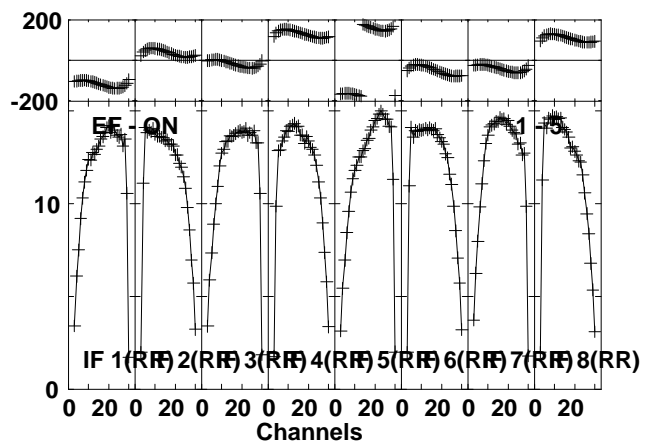
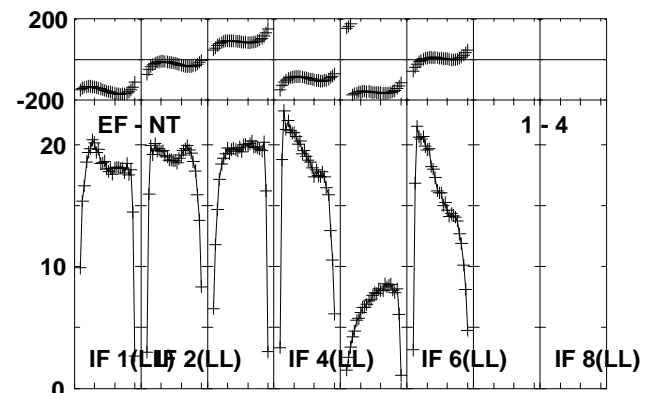
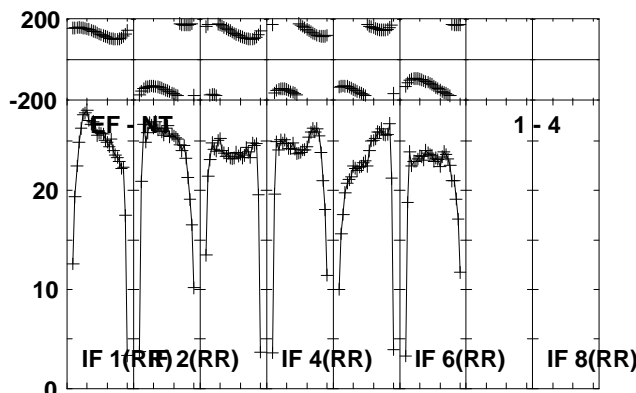
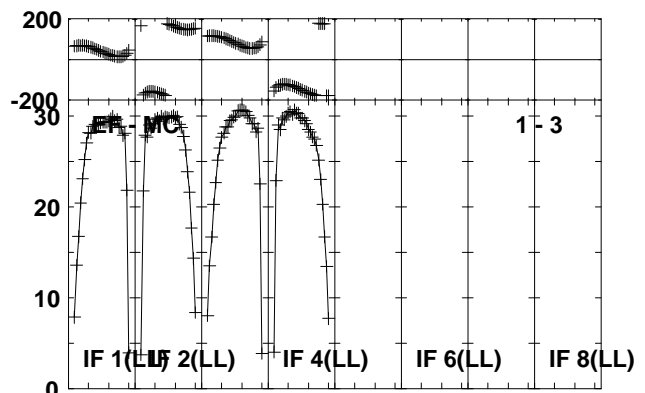
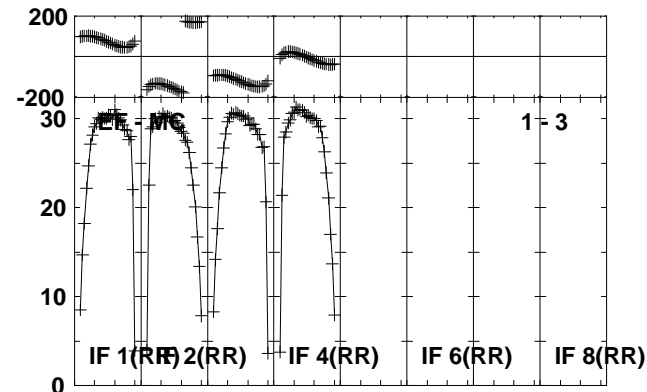
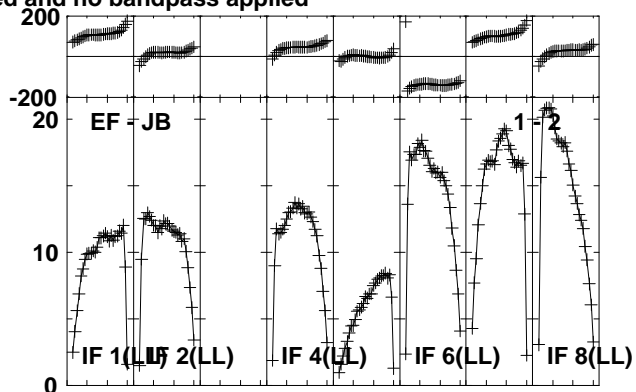
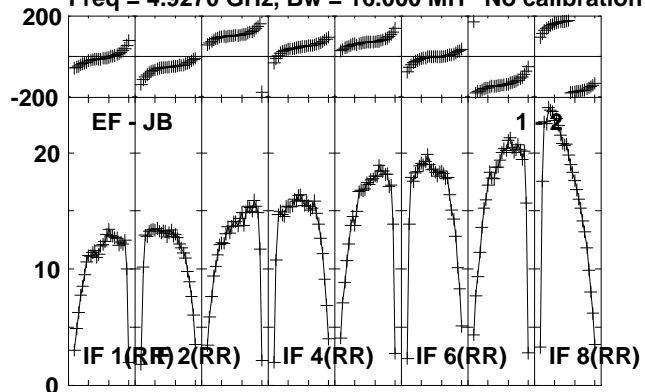

Lower frame: Milli Ampl Jy Top frame: Phas deg
Vector averaged cross-power spectrum Several baselines displayed
Timerange: 00/08:08:58 to 00/08:12:58

Plot file version 408 created 16-OCT-2012 11:58:36

1156+295 RO006.UVDATA.1

Freq = 4.9270 GHz, Bw = 16.000 MH No calibration applied and no bandpass applied

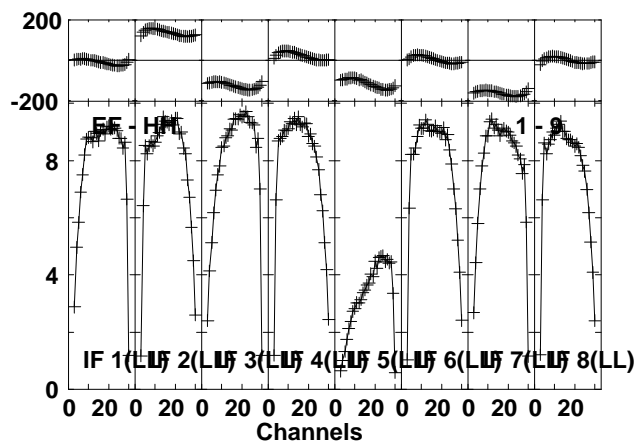
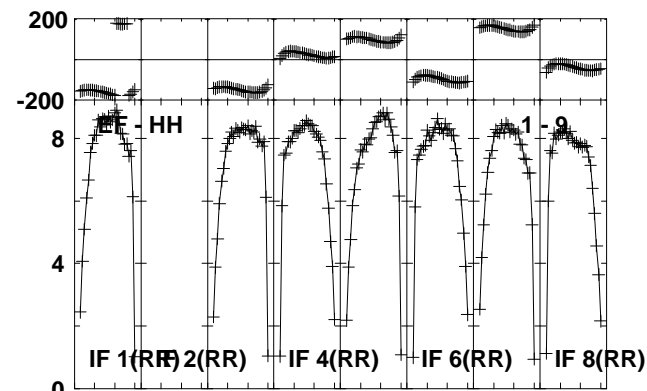
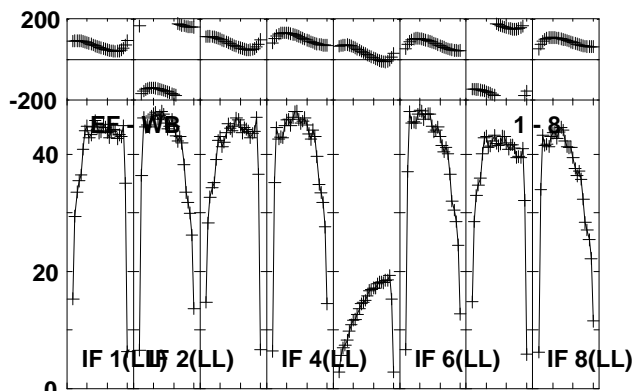
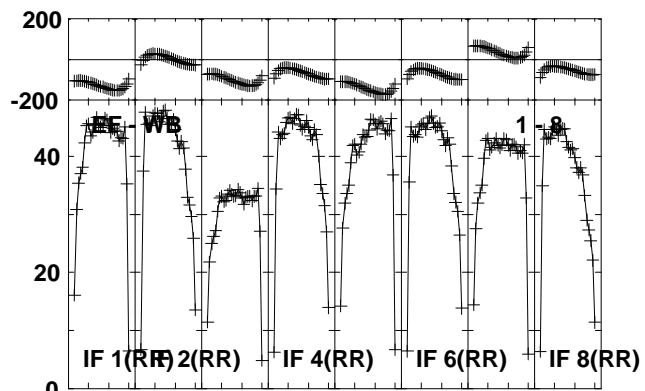
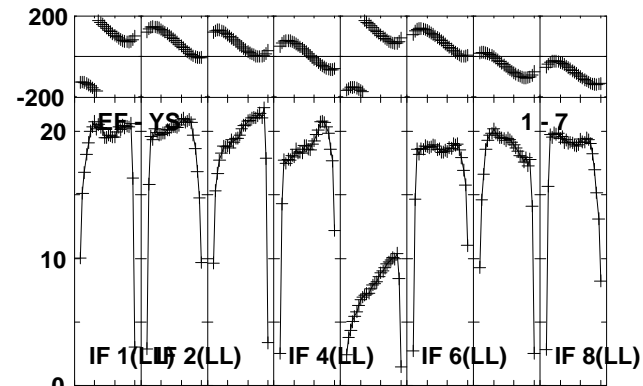
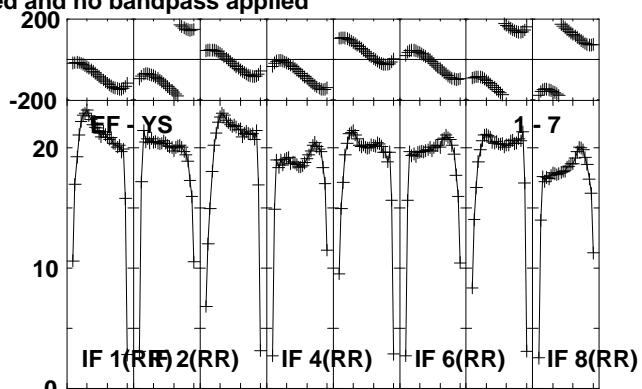
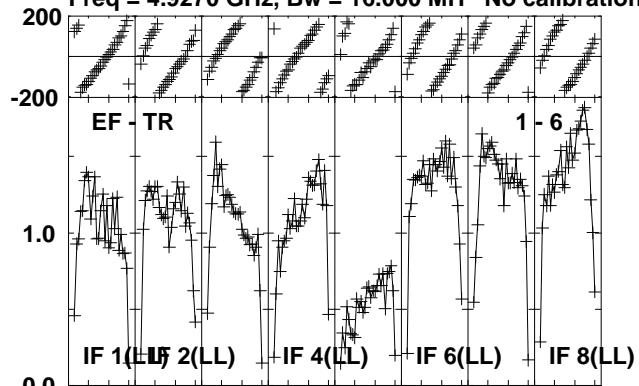

Lower frame: Milli Ampl Jy Top frame: Phas deg
Vector averaged cross-power spectrum Several baselines displayed
Timerange: 00/08:08:58 to 00/08:12:58