

Plot file version 1 created 20-OCT-2009 14:47:24

0133+476 RP015C.UVDATA.1

Freq = 1.6270 GHz, Bw = 8.000 MH No calibration applied and no bandpass applied

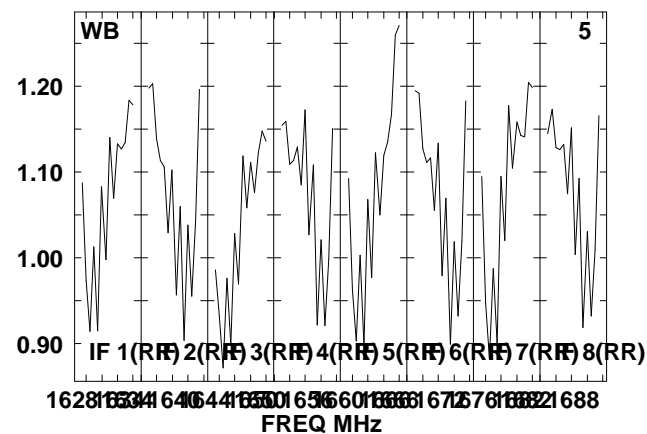
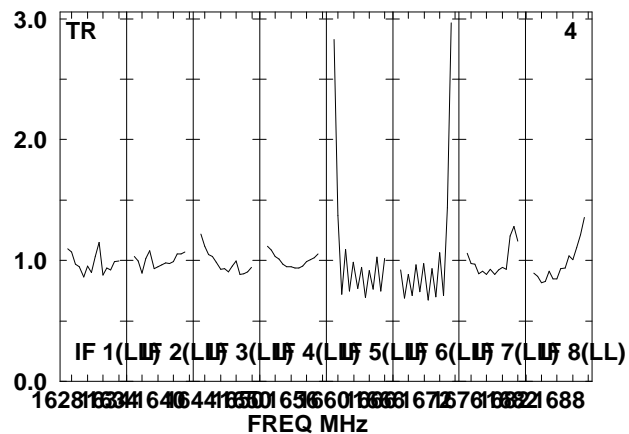
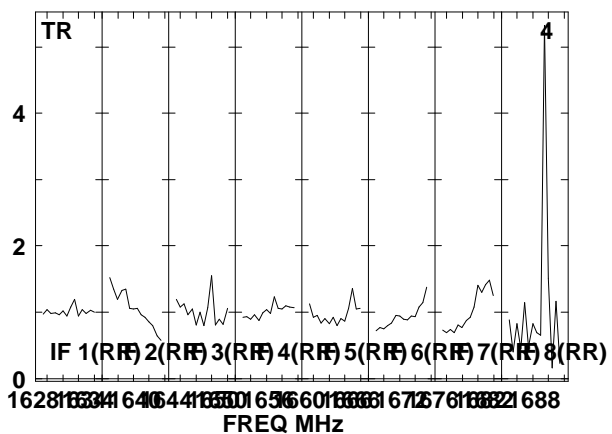
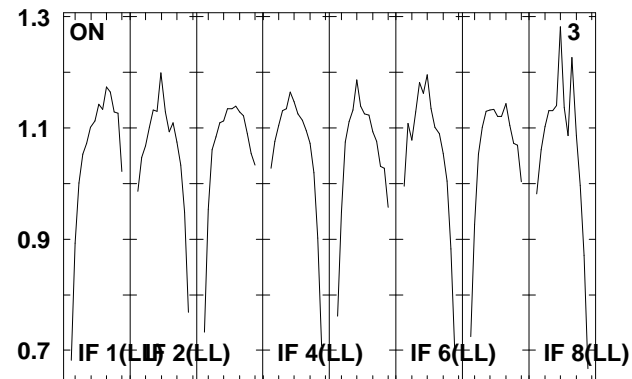
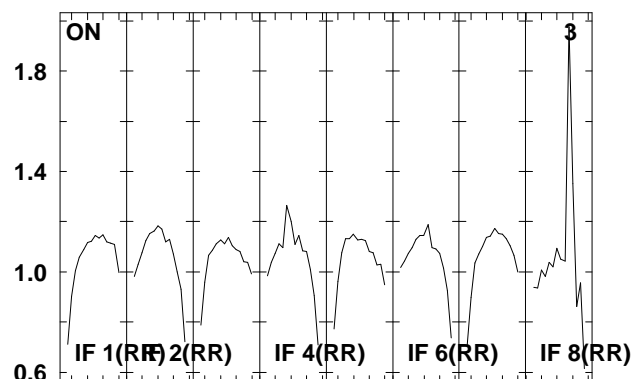
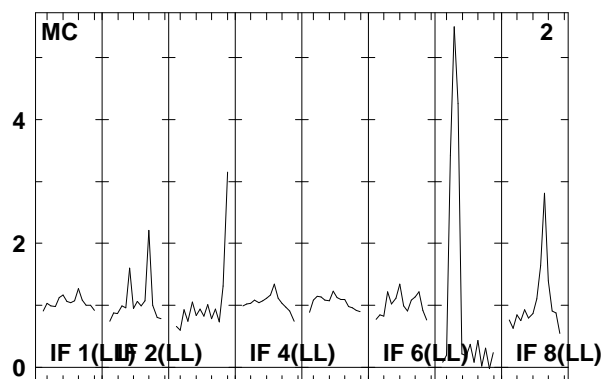
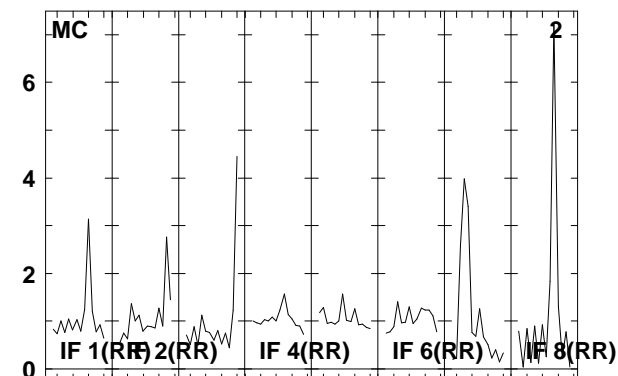
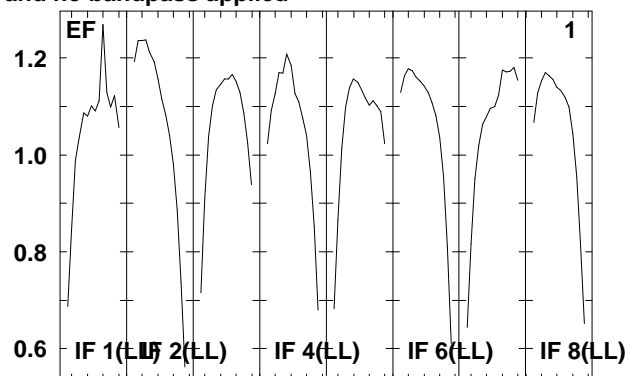
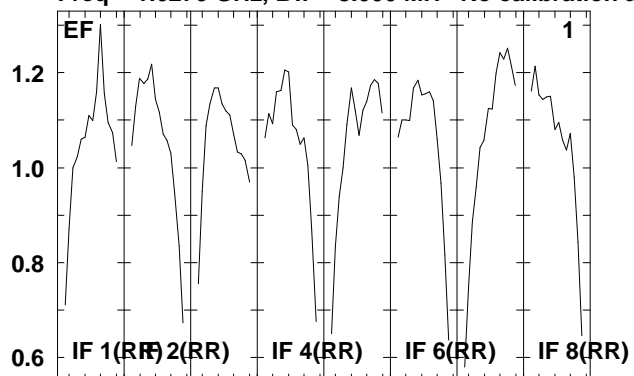

Lower frame: Real Jy  
Total-power spectrum Antenna: \*  
Timerange: 00/23:13:03 to 00/23:35:02

Plot file version 2 created 20-OCT-2009 14:47:29

0133+476 RP015C.UVDATA.1

Freq = 1.6270 GHz, Bw = 8.000 MH No calibration applied and no bandpass applied

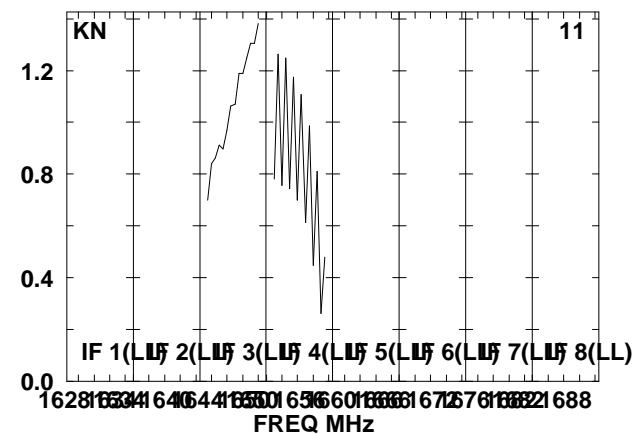
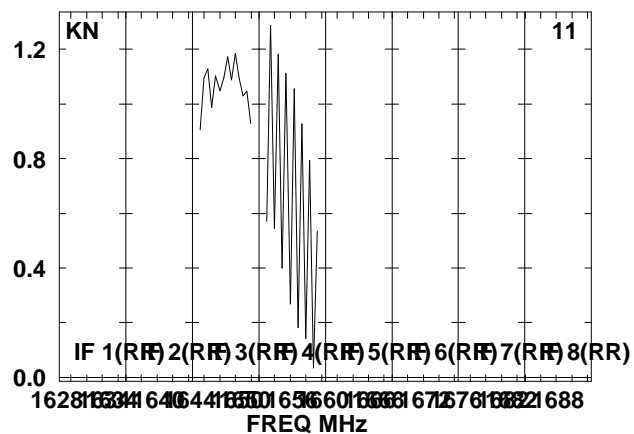
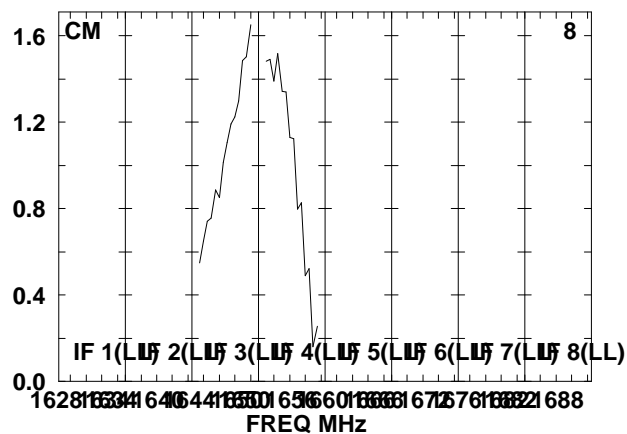
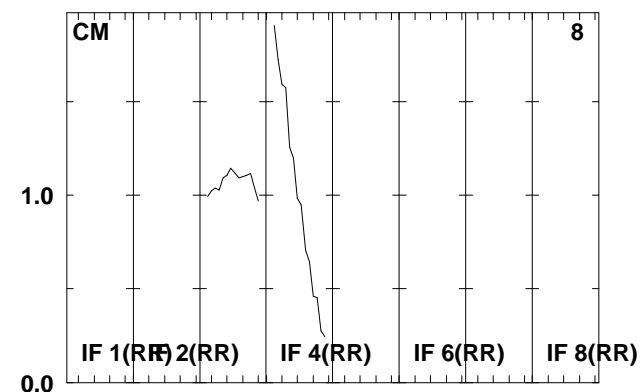
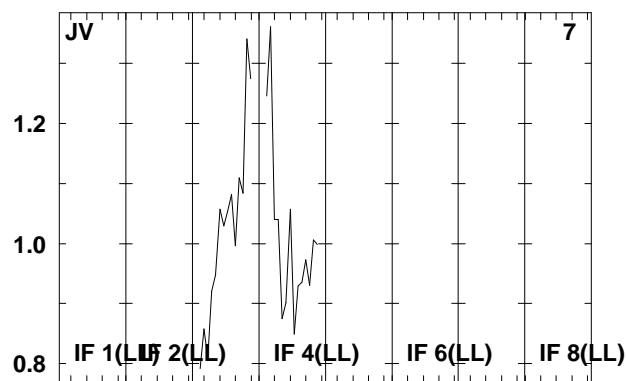
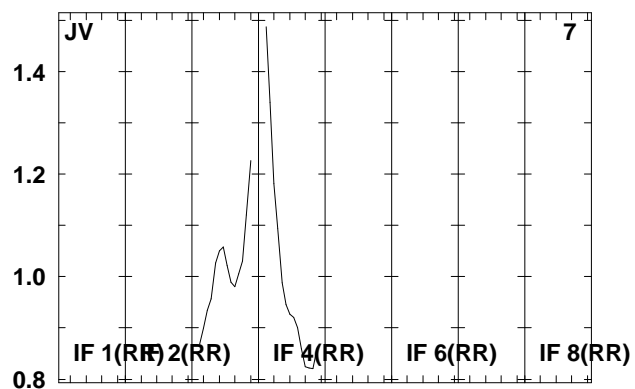
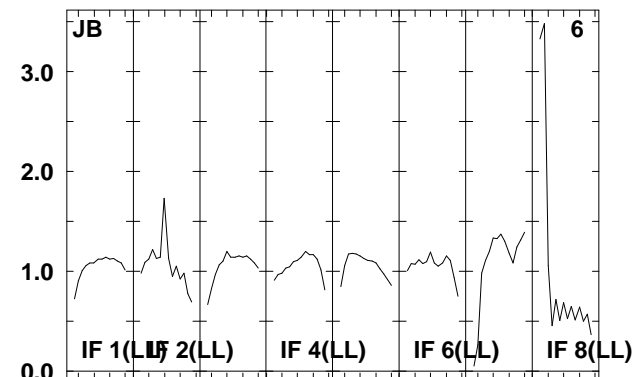
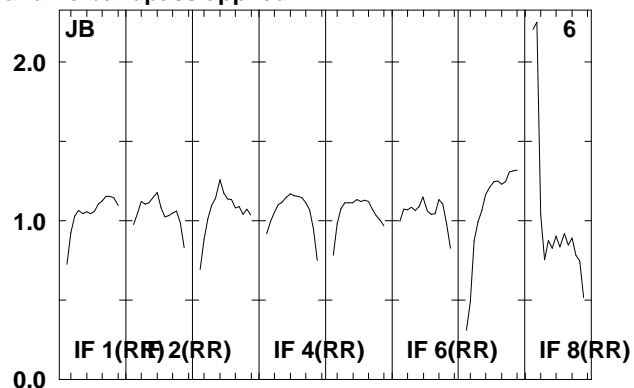
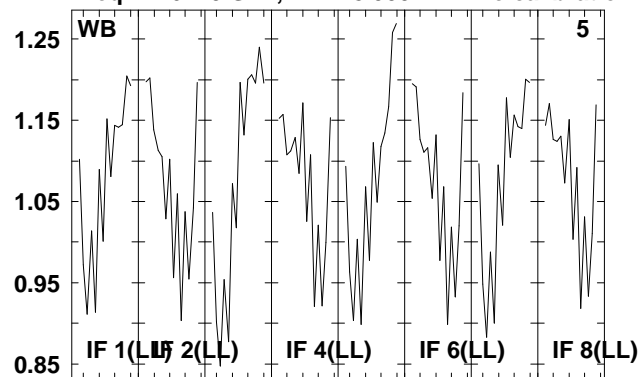

Lower frame: Real Jy

Total-power spectrum Antenna: \*

Timerange: 00/23:13:03 to 00/23:35:02

Plot file version 3 created 20-OCT-2009 14:47:41

0133+476 RP015C.UVDATA.1

Freq = 1.6270 GHz, Bw = 8.000 MH No calibration applied and no bandpass applied

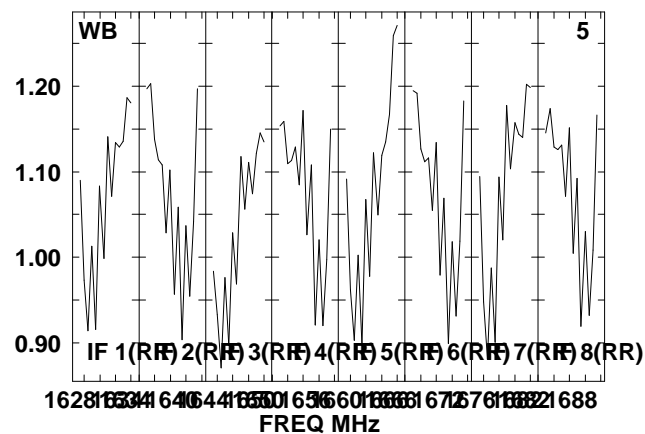
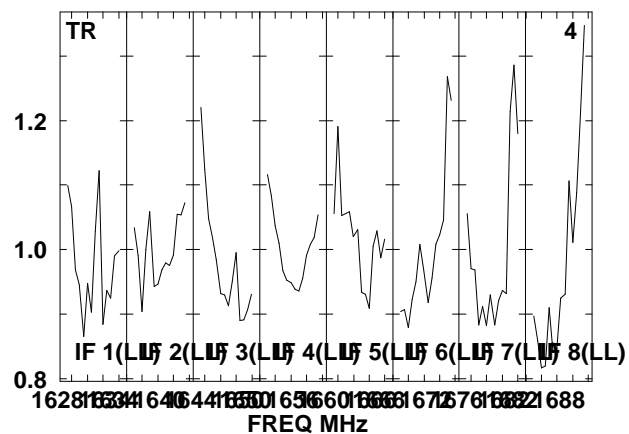
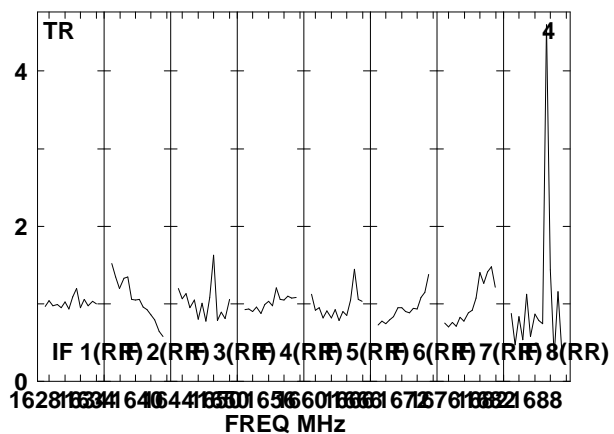
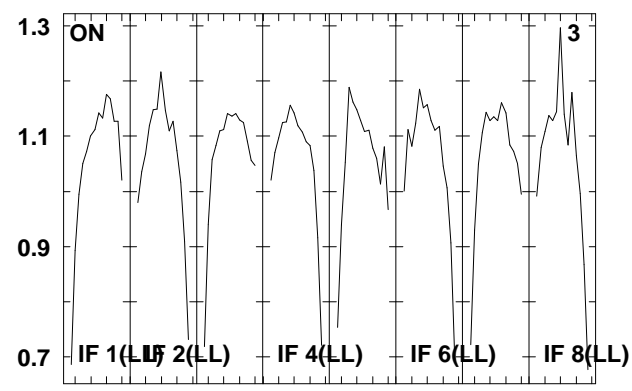
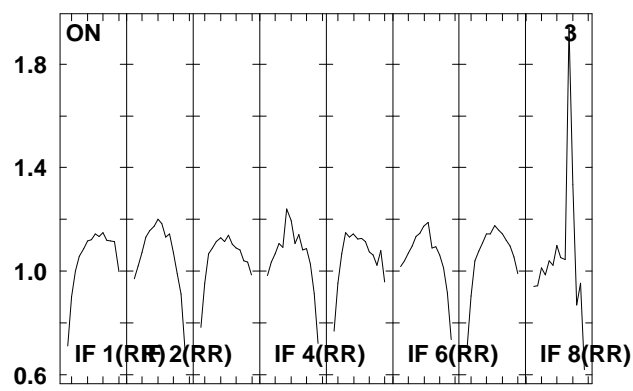
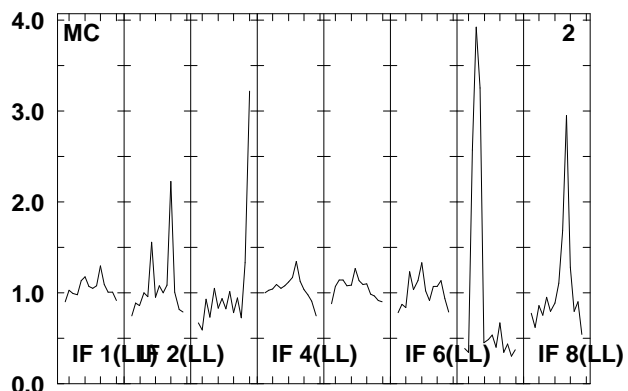
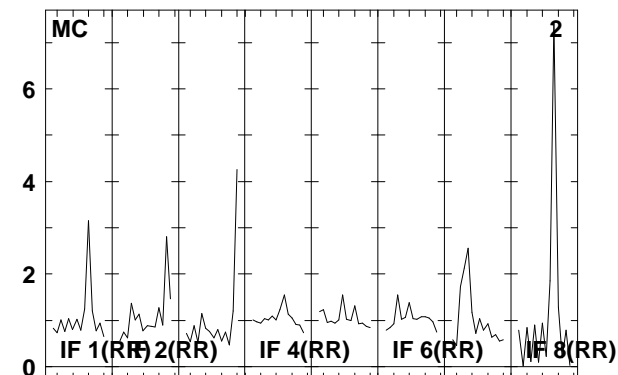
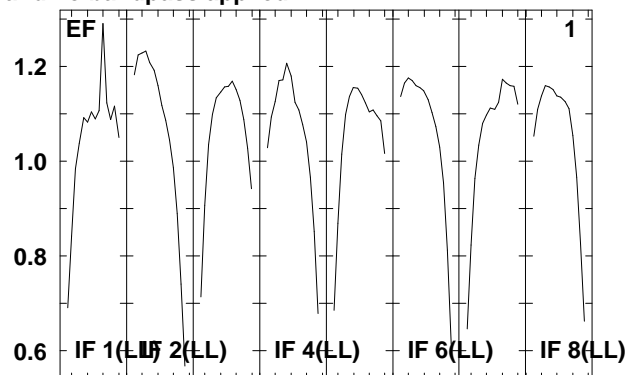
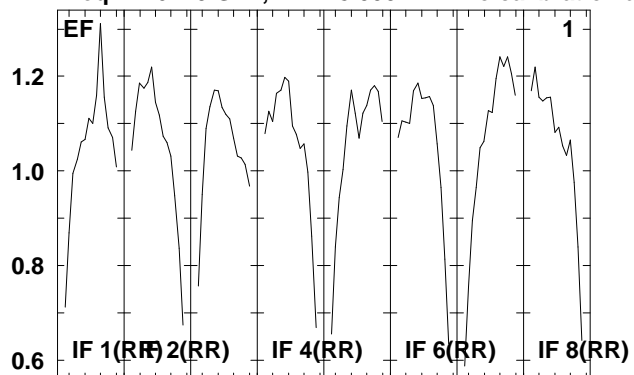

Lower frame: Real Jy  
Total-power spectrum Antenna: \*  
Timerange: 00/23:35:04 to 00/23:57:03

Plot file version 4 created 20-OCT-2009 14:47:46

0133+476 RP015C.UVDATA.1

Freq = 1.6270 GHz, Bw = 8.000 MH No calibration applied and no bandpass applied

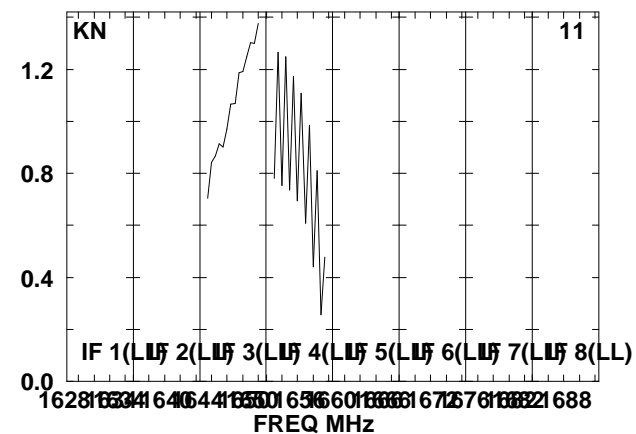
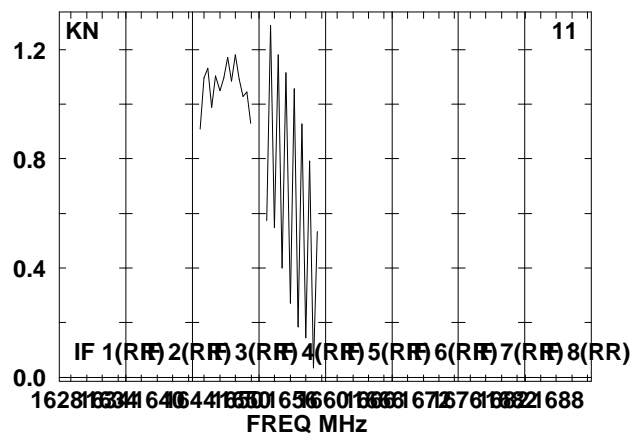
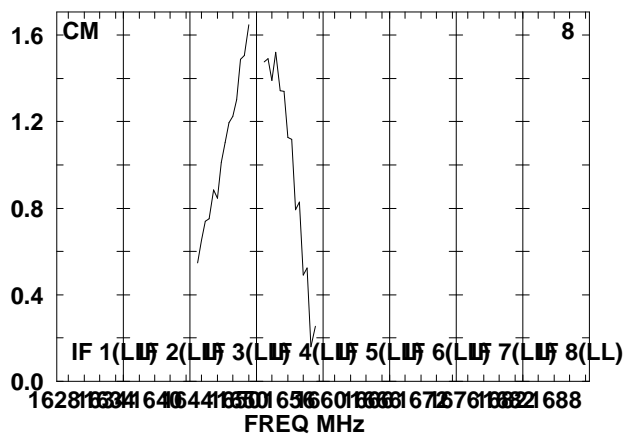
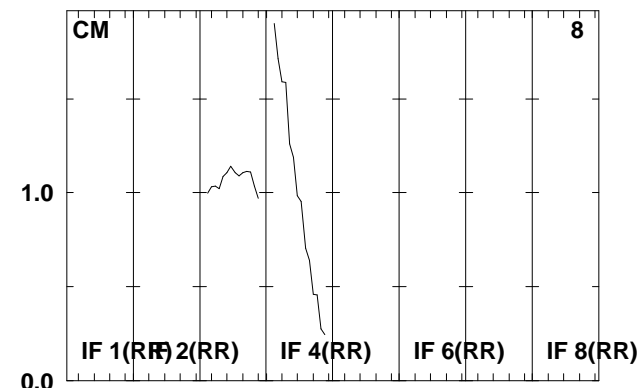
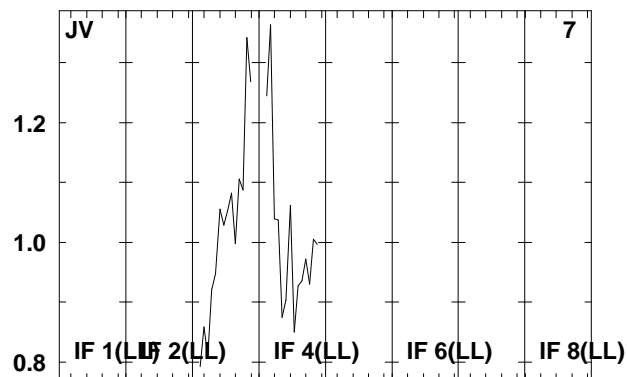
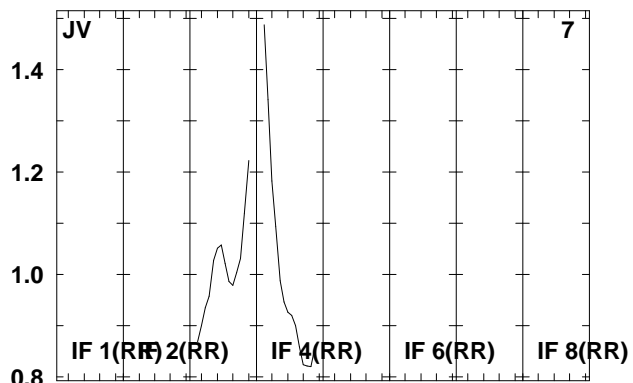
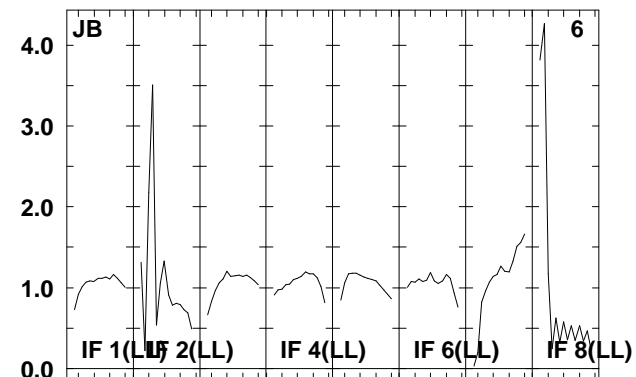
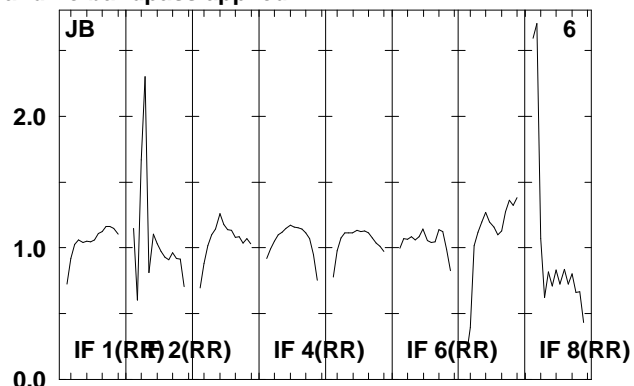
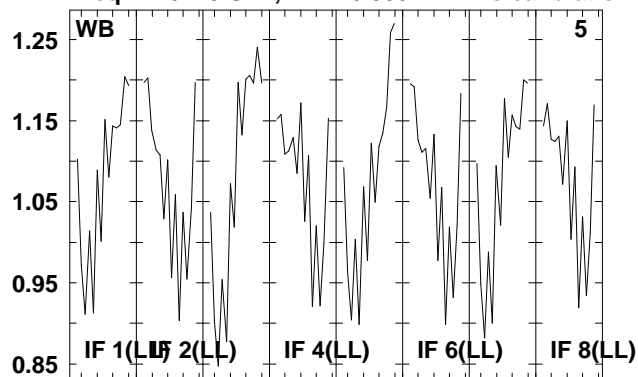

Lower frame: Real Jy

Total-power spectrum Antenna: \*

Timerange: 00/23:35:04 to 00/23:57:03

Plot file version 5 created 20-OCT-2009 14:47:56

0133+476 RP015C.UVDATA.1

Freq = 1.6270 GHz, Bw = 8.000 MH No calibration applied and no bandpass applied

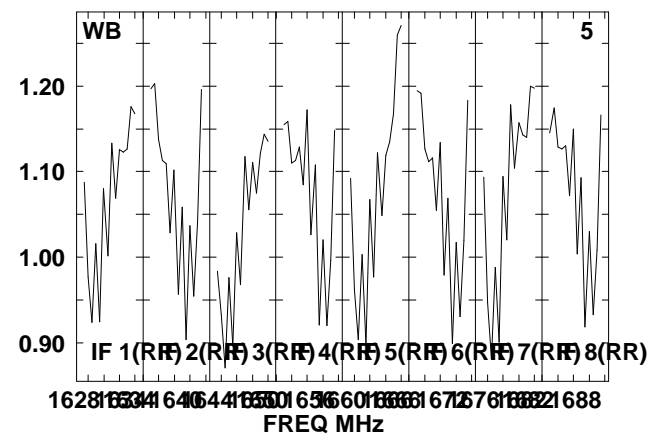
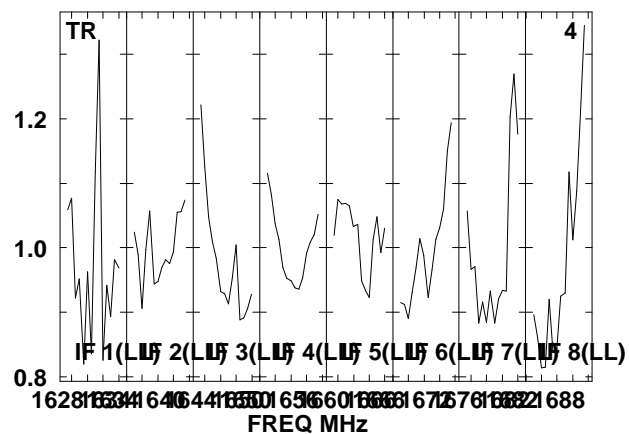
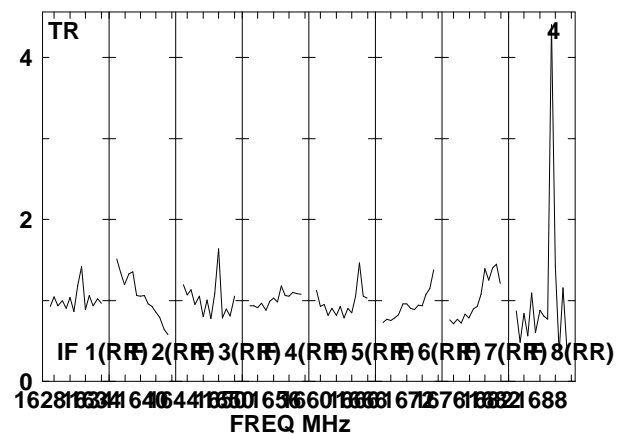
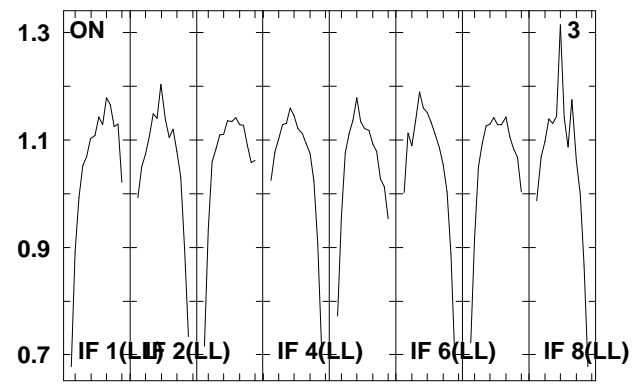
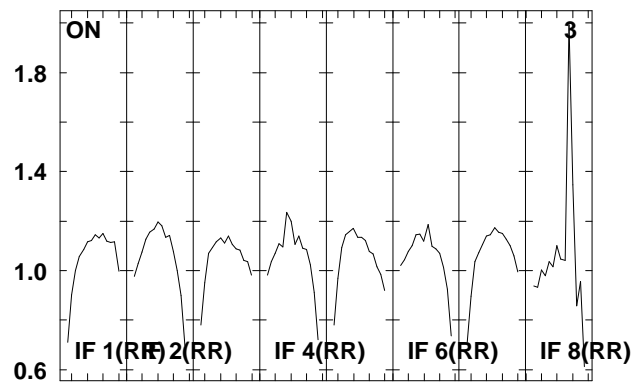
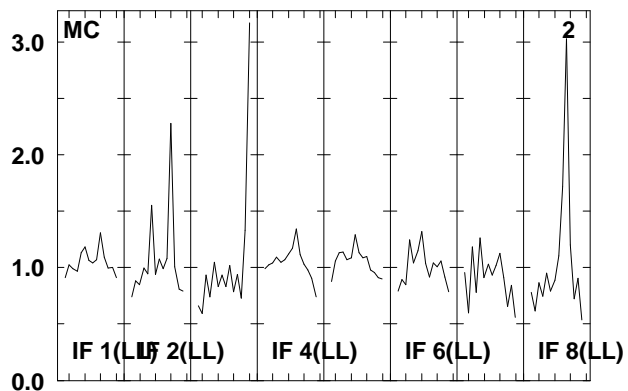
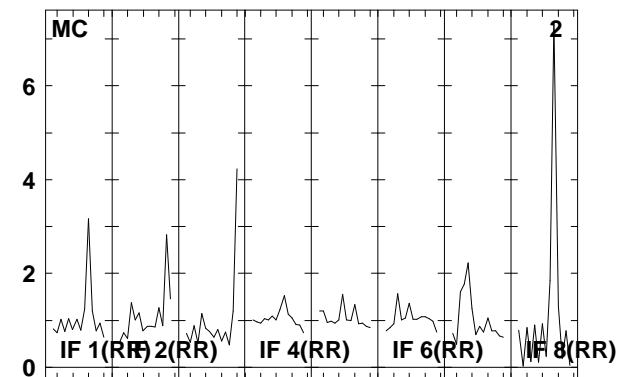
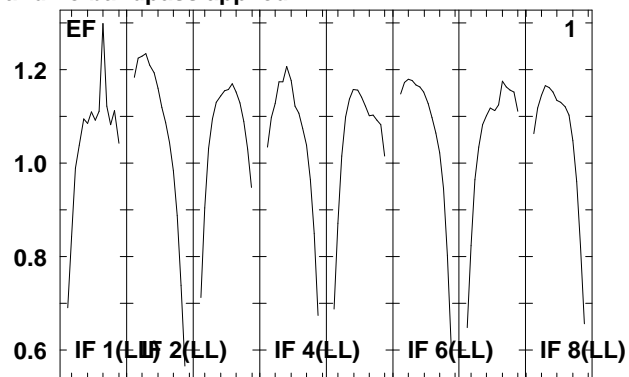
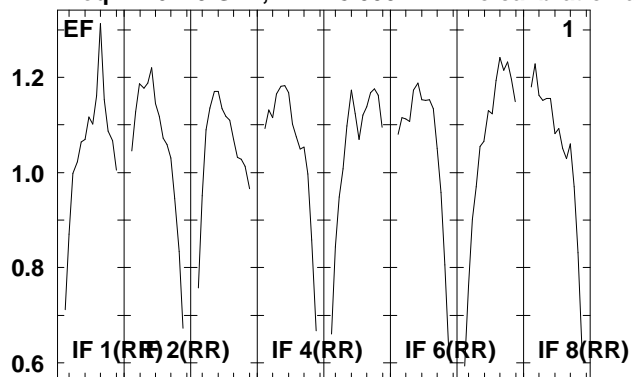

Lower frame: Real Jy  
Total-power spectrum Antenna: \*  
Timerange: 00/23:57:04 to 00/23:59:20

Plot file version 6 created 20-OCT-2009 14:47:57

0133+476 RP015C.UVDATA.1

Freq = 1.6270 GHz, Bw = 8.000 MH No calibration applied and no bandpass applied

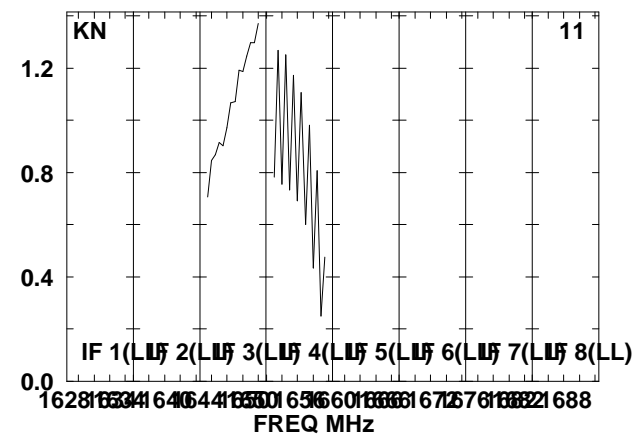
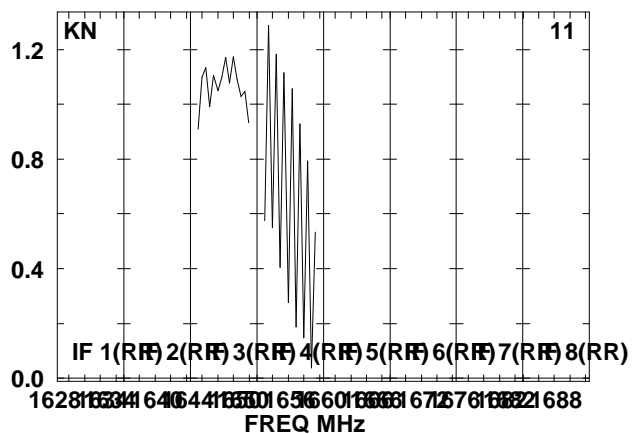
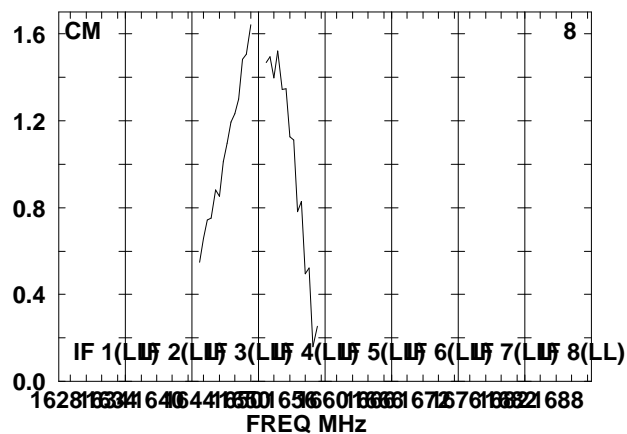
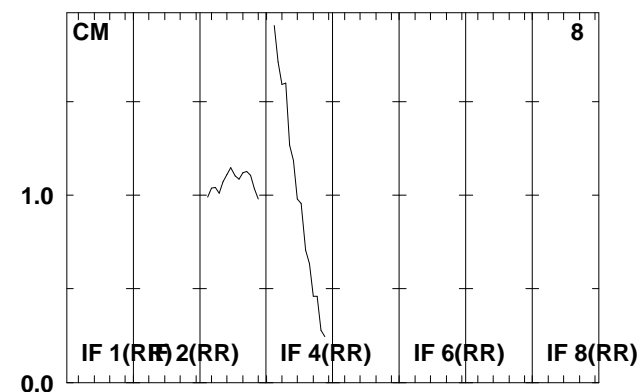
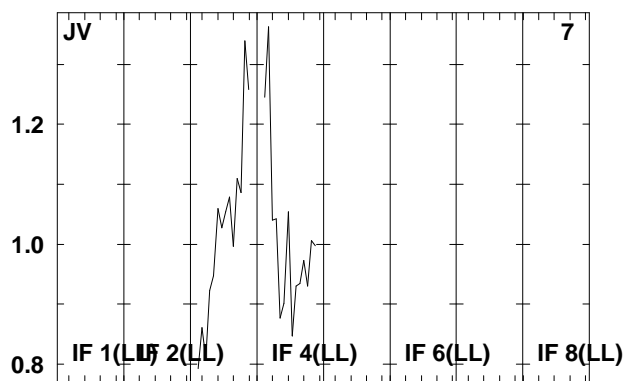
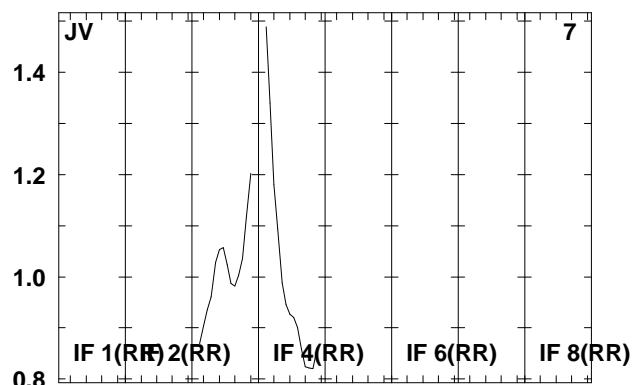
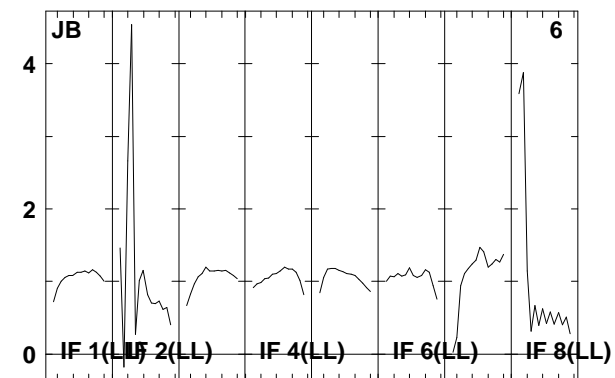
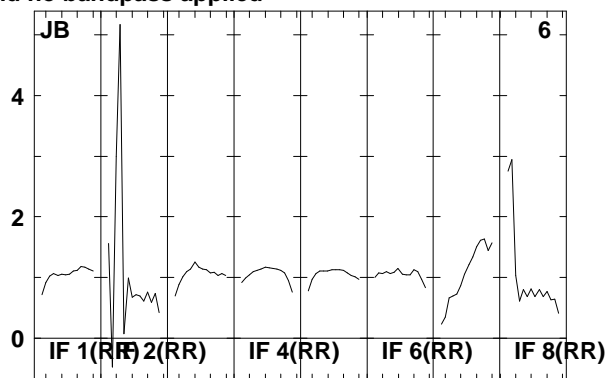
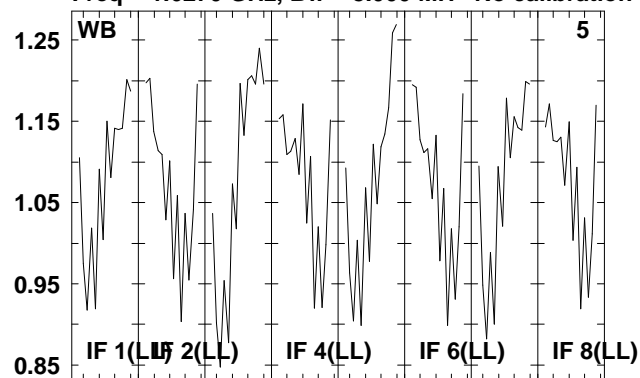

Lower frame: Real Jy

Total-power spectrum Antenna: \*

Timerange: 00/23:57:04 to 00/23:59:20

Plot file version 7 created 20-OCT-2009 14:47:59

3C138 RP015C.UVDATA.1

Freq = 1.6270 GHz, Bw = 8.000 MH No calibration applied and no bandpass applied

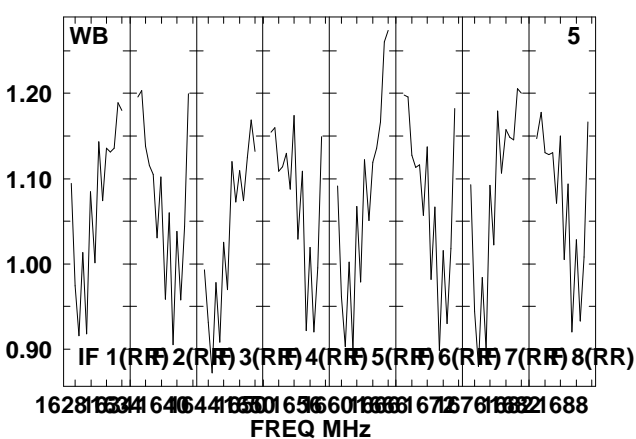
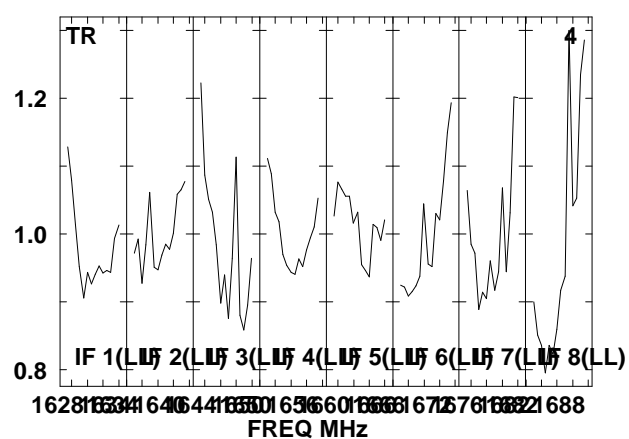
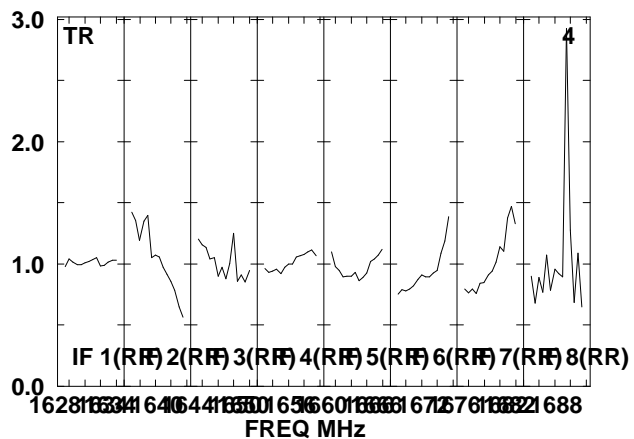
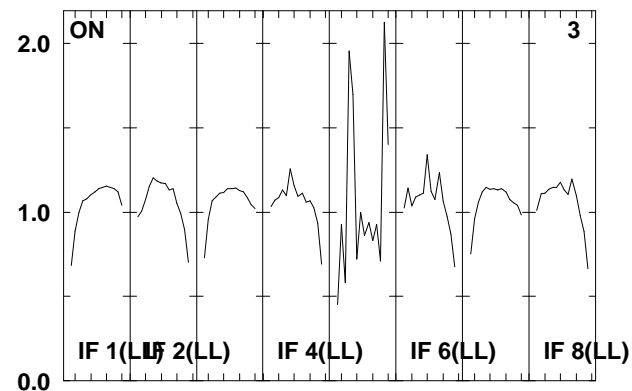
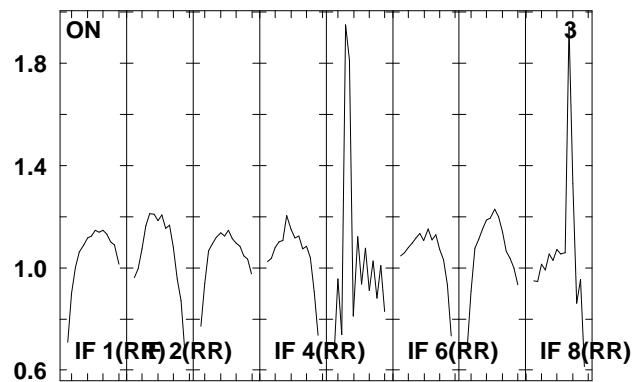
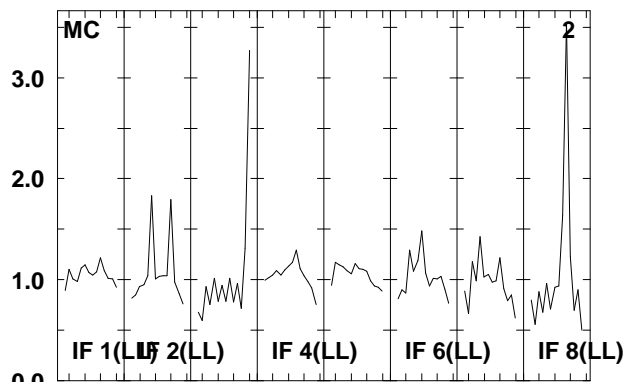
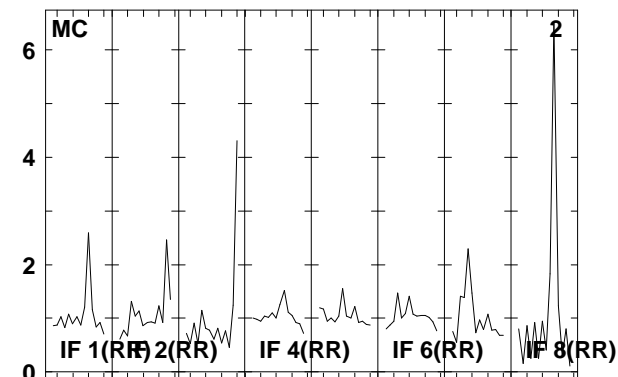
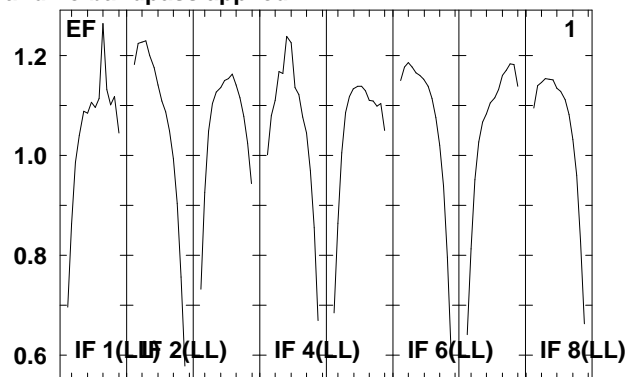
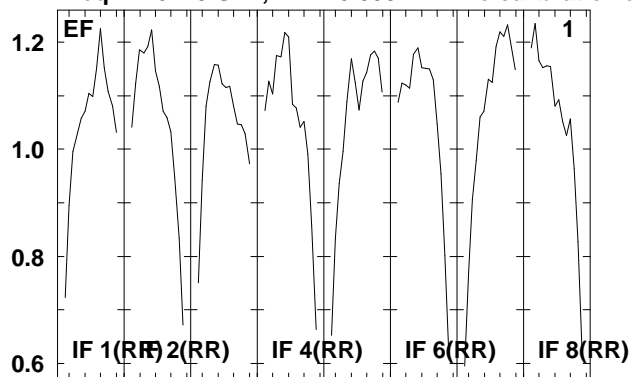

Lower frame: Real Jy

Total-power spectrum Antenna: \*

Timerange: 01/00:00:01 to 01/00:14:19

Plot file version 8 created 20-OCT-2009 14:48:04

3C138 RP015C.UVDATA.1

Freq = 1.6270 GHz, Bw = 8.000 MH No calibration applied and no bandpass applied

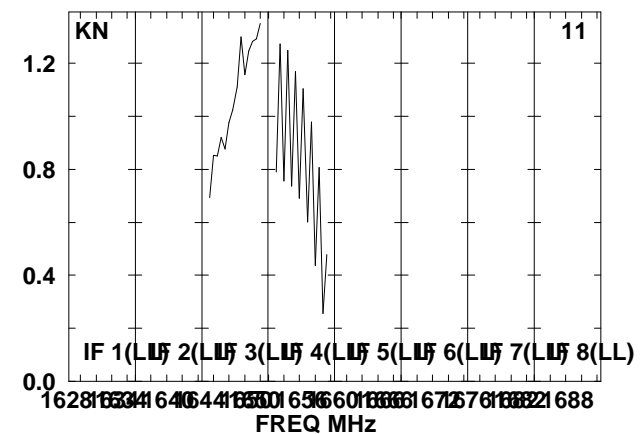
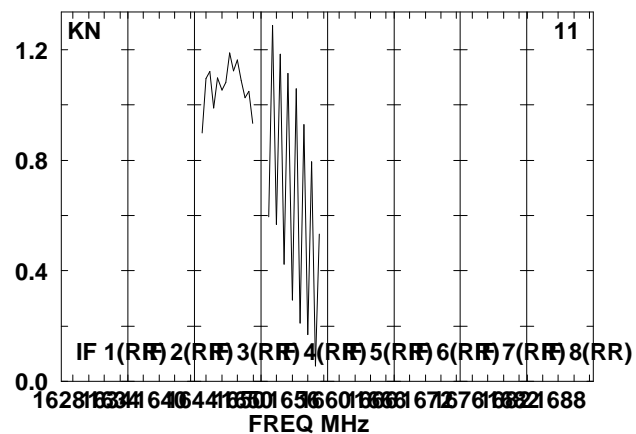
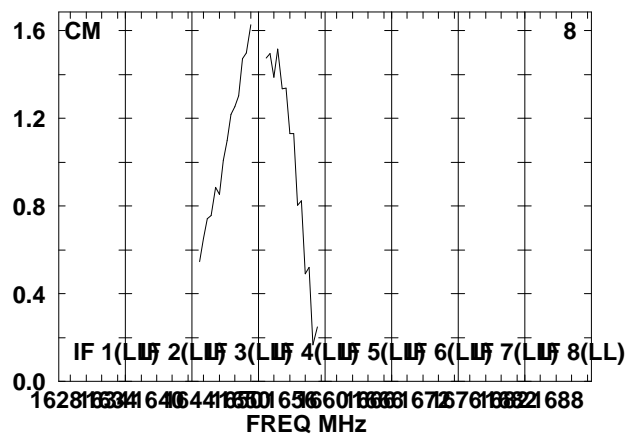
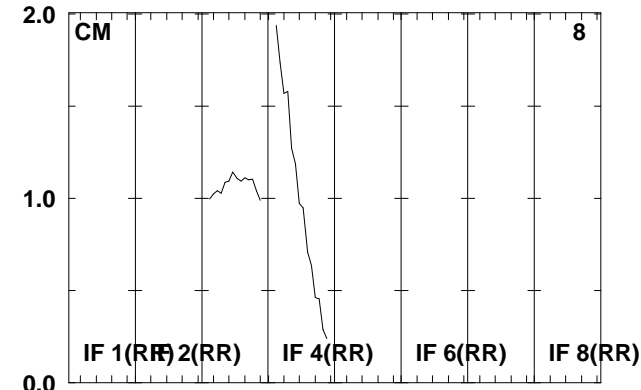
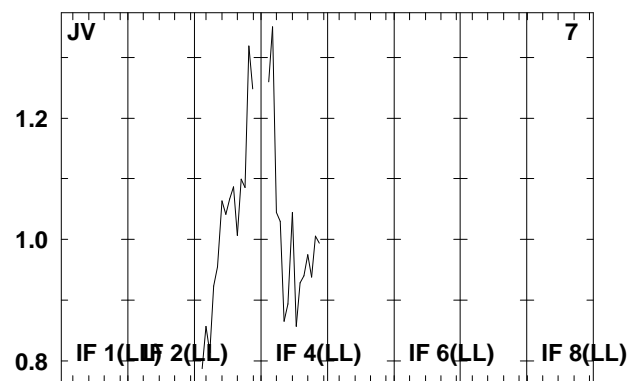
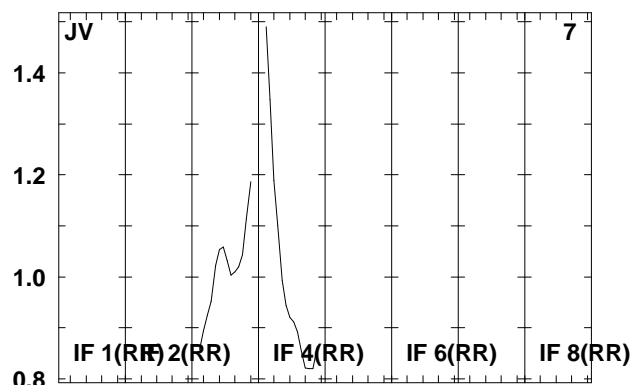
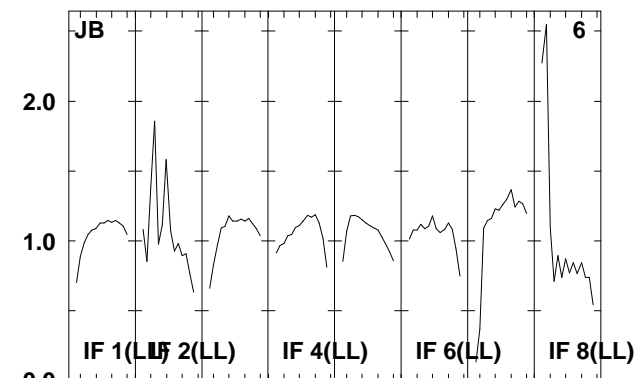
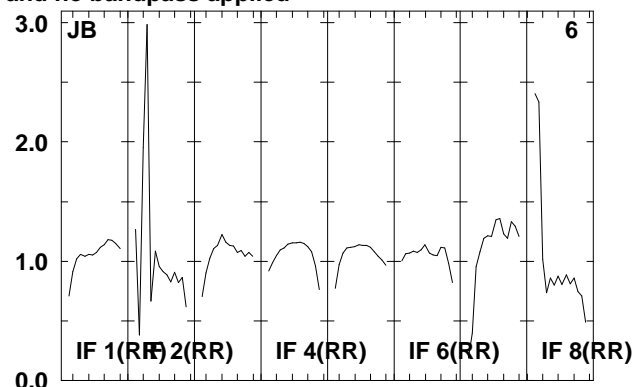
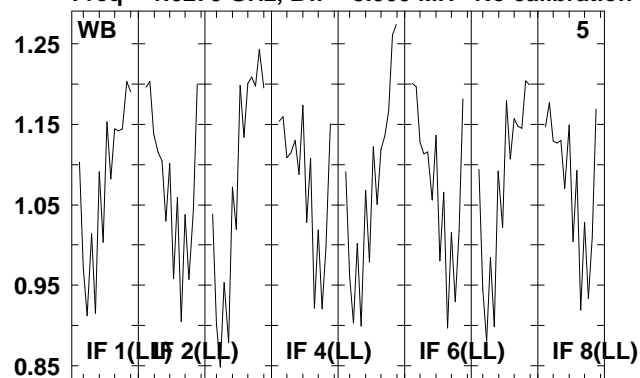

Lower frame: Real Jy

Total-power spectrum Antenna: \*

Timerange: 01/00:00:01 to 01/00:14:19



Plot file version 9 created 20-OCT-2009 14:48:12

3C84 RP015C.UVDATA.1

Freq = 1.6270 GHz, Bw = 8.000 MH No calibration applied and no bandpass applied

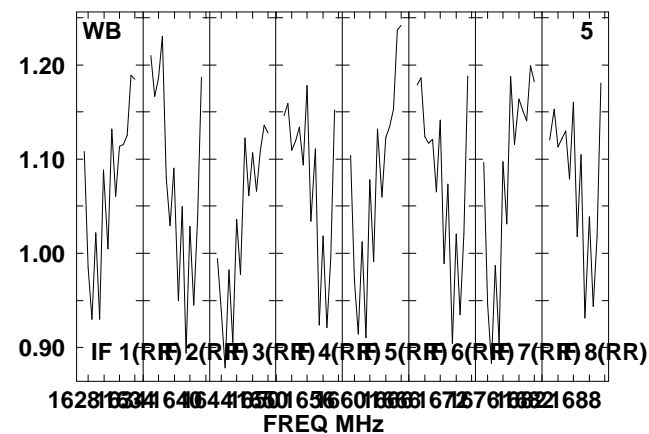
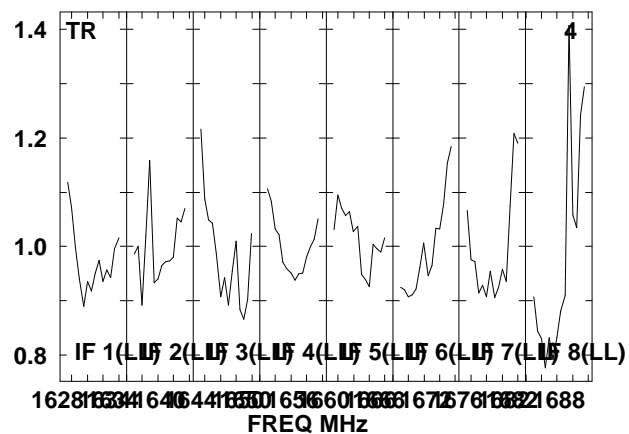
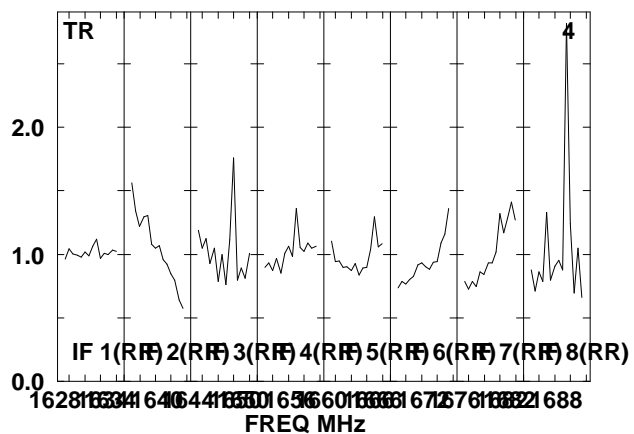
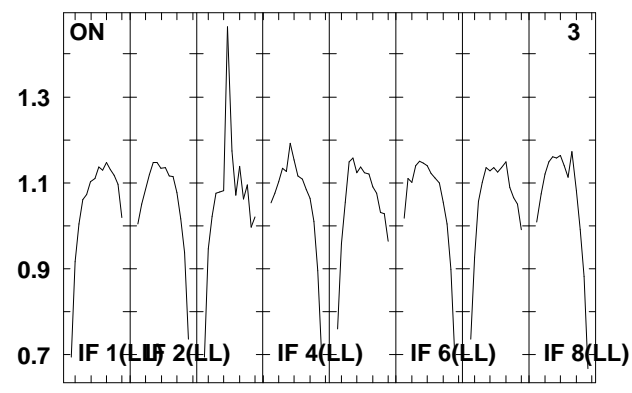
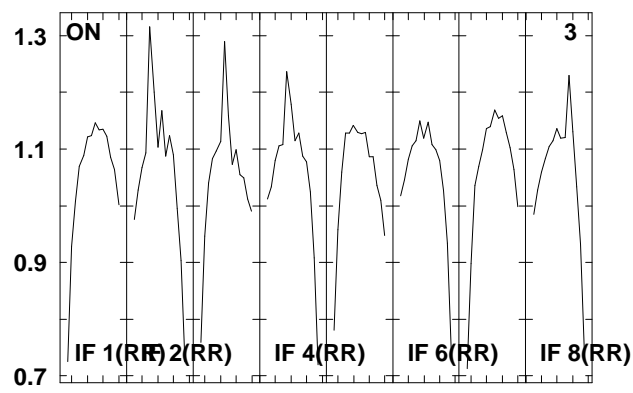
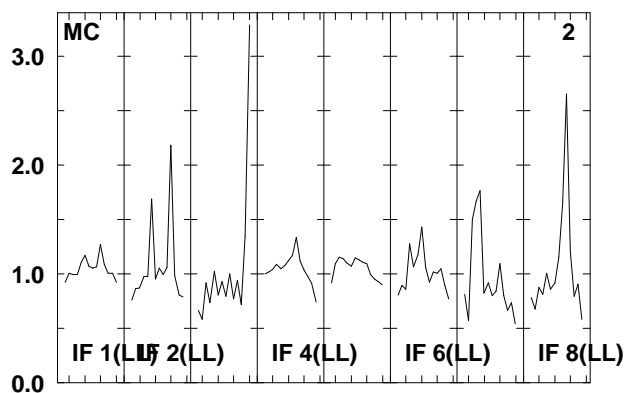
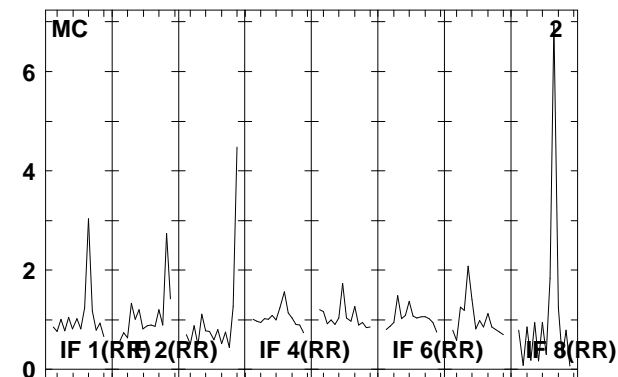
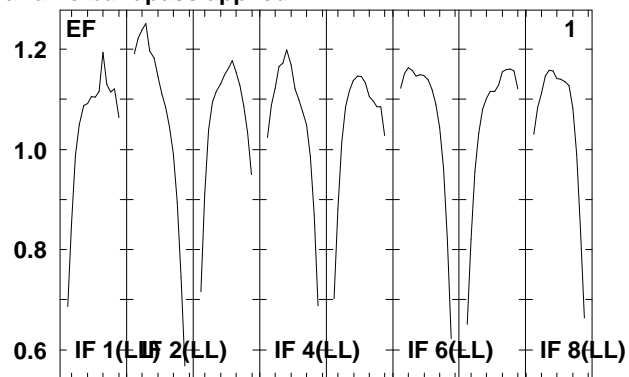
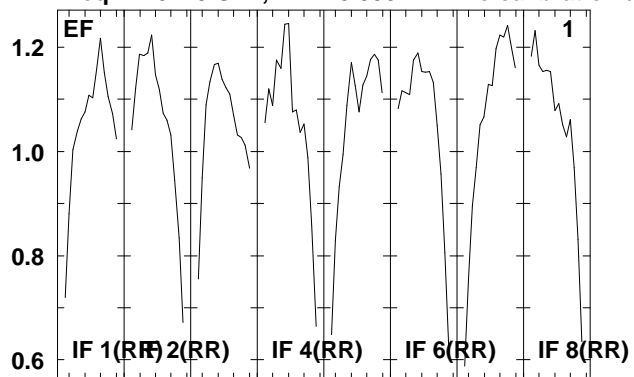

Lower frame: Real Jy

Total-power spectrum Antenna: \*

Timerange: 01/00:15:01 to 01/00:29:19

Plot file version 10 created 20-OCT-2009 14:48:15

3C84 RP015C.UVDATA.1

Freq = 1.6270 GHz, Bw = 8.000 MH No calibration applied and no bandpass applied

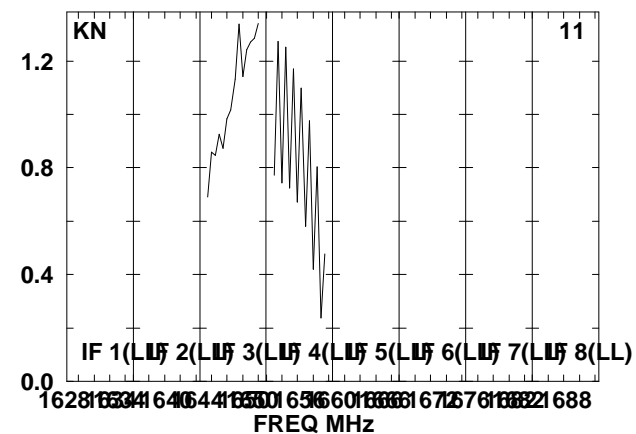
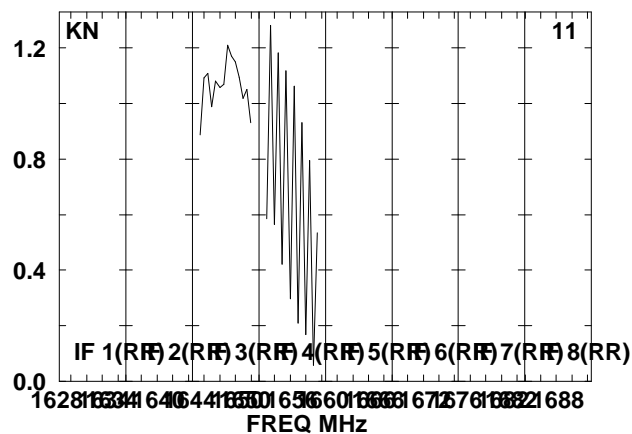
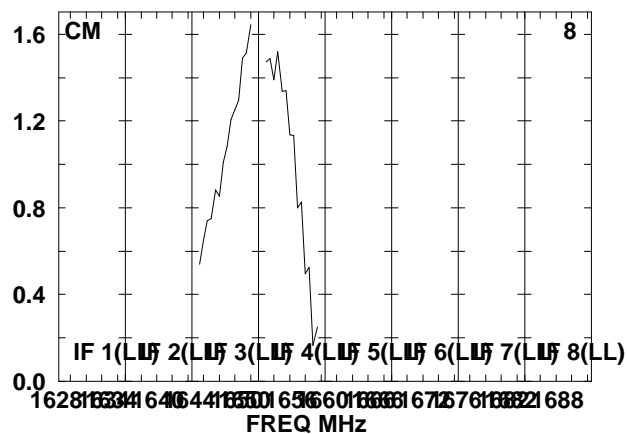
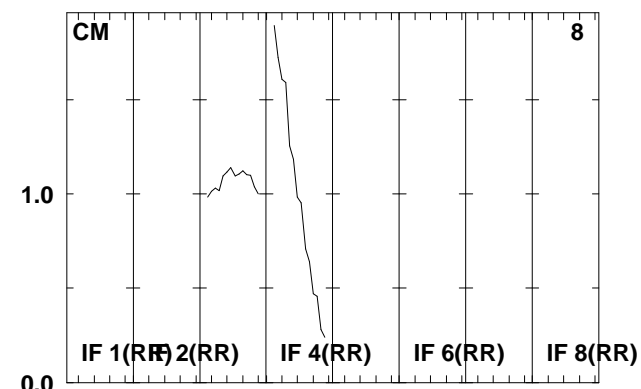
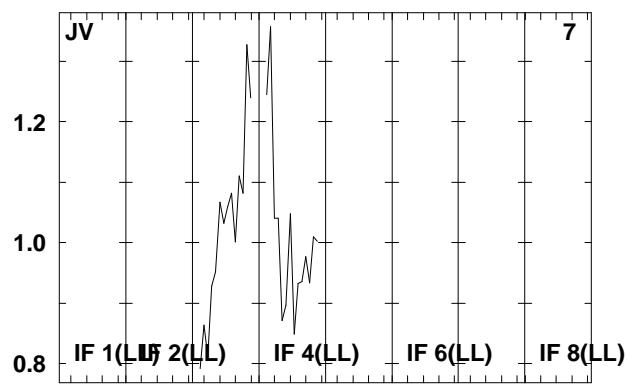
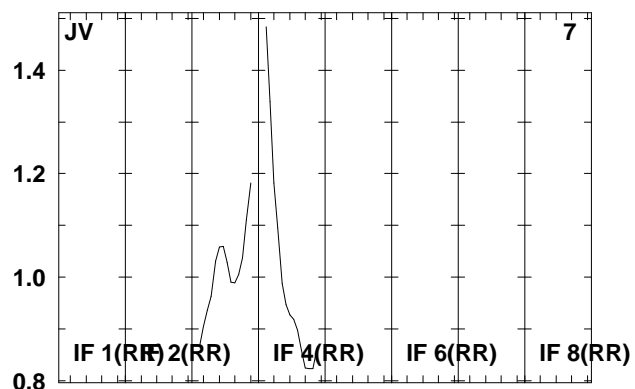
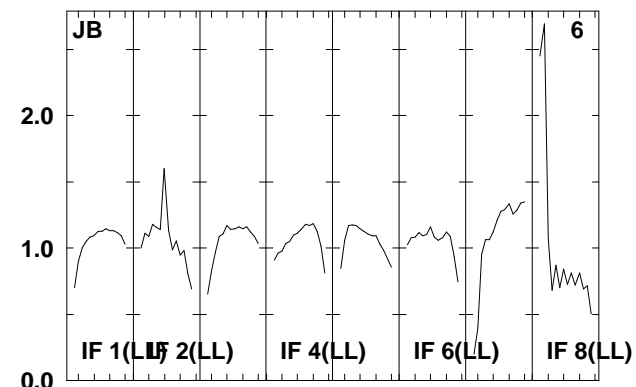
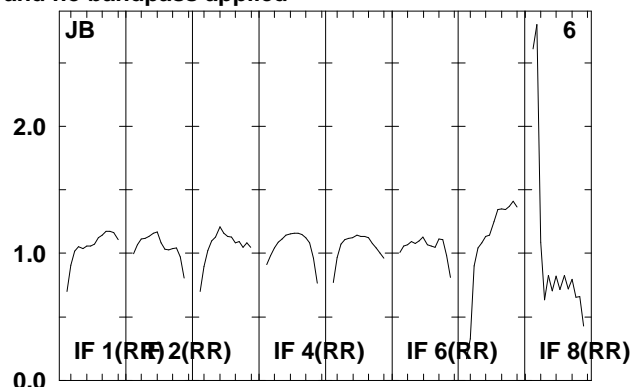
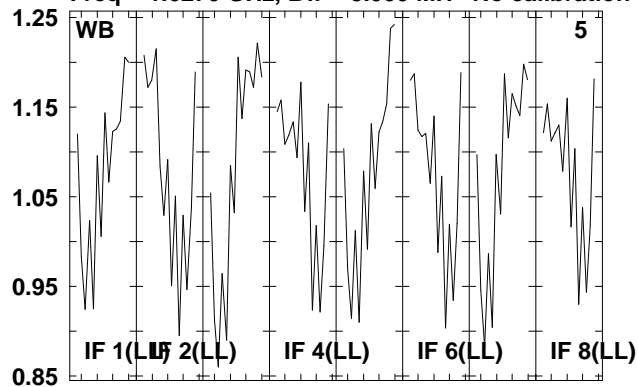

Lower frame: Real Jy

Total-power spectrum Antenna: \*

Timerange: 01/00:15:01 to 01/00:29:19

Plot file version 11 created 20-OCT-2009 14:48:23

J0137+31 RP015C.UVDATA.1

Freq = 1.6270 GHz, Bw = 8.000 MH No calibration applied and no bandpass applied

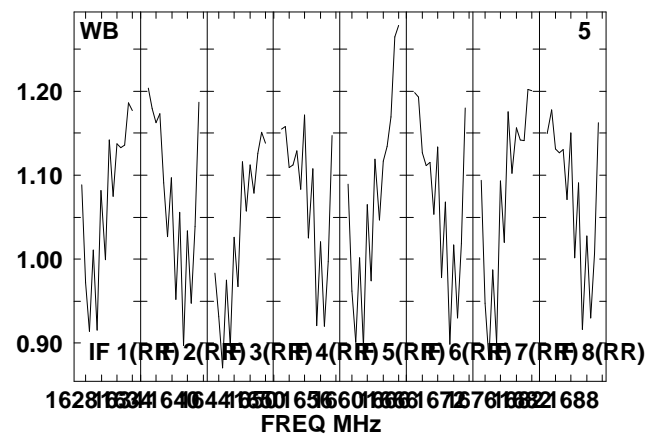
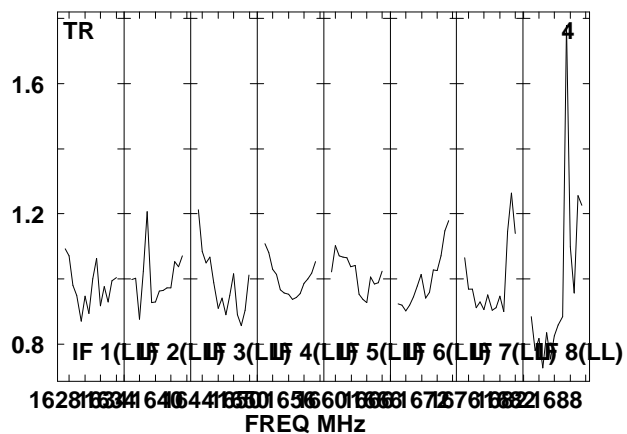
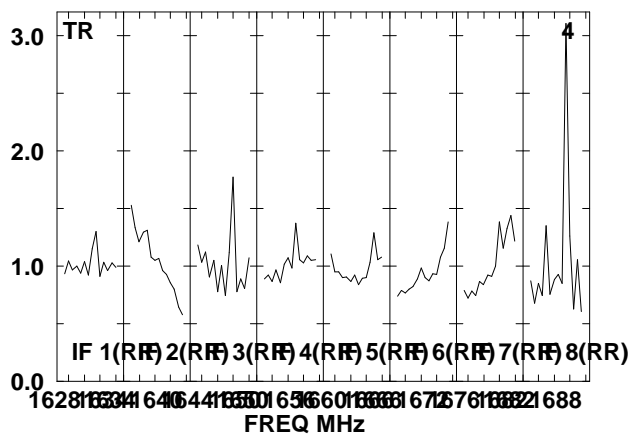
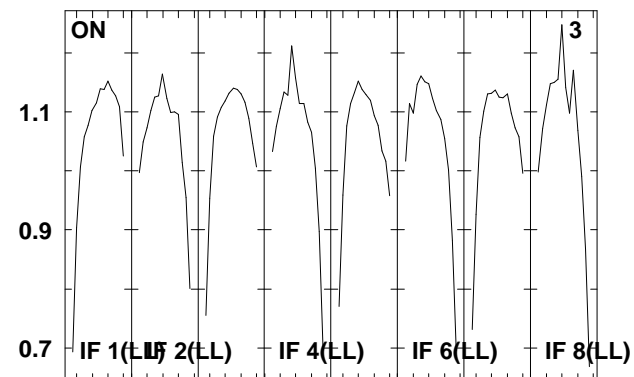
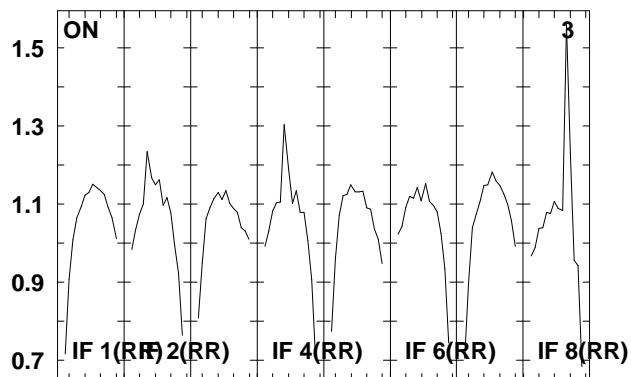
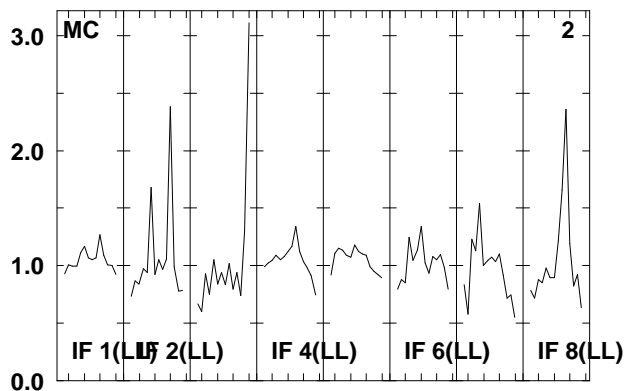
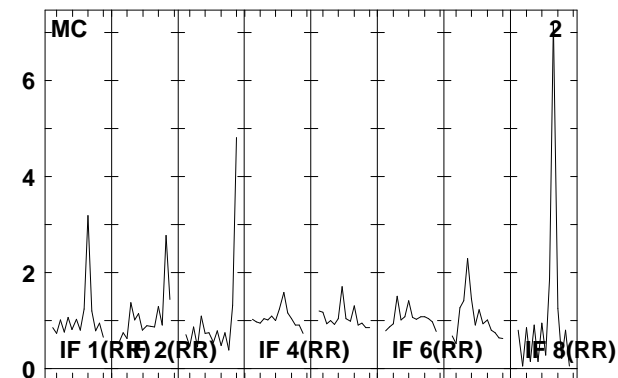
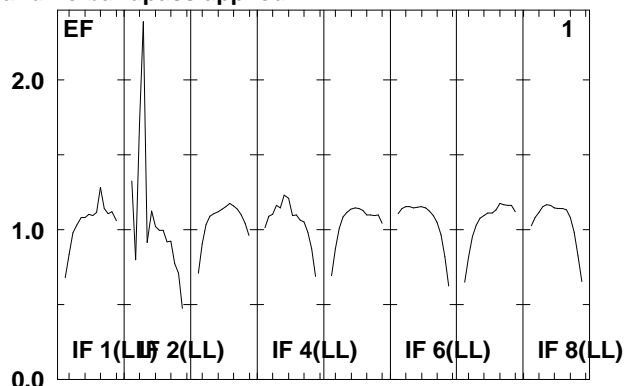
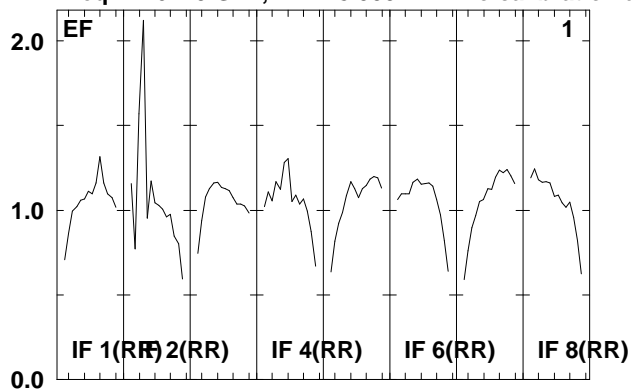

Lower frame: Real Jy  
Total-power spectrum Antenna: \*  
Timerange: 01/00:31:20 to 01/00:46:00

Plot file version 12 created 20-OCT-2009 14:48:26

J0137+31 RP015C.UVDATA.1

Freq = 1.6270 GHz, Bw = 8.000 MH No calibration applied and no bandpass applied

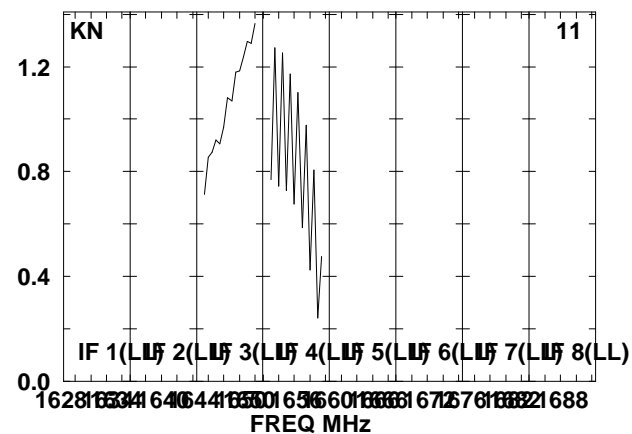
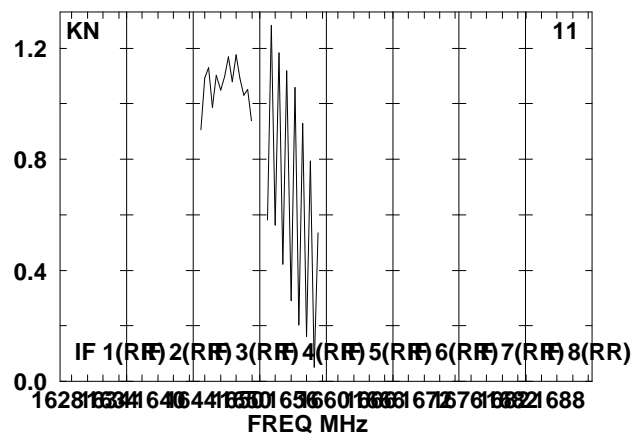
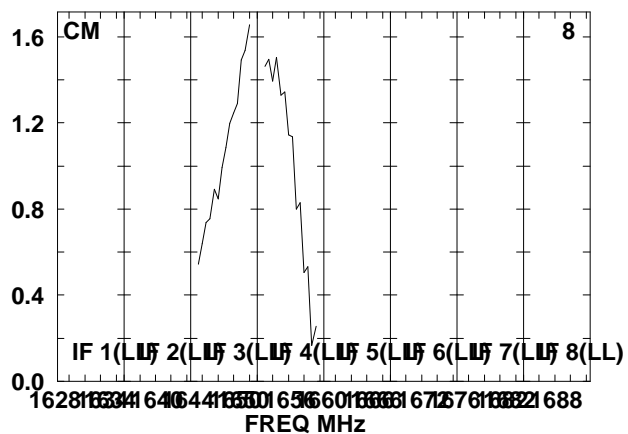
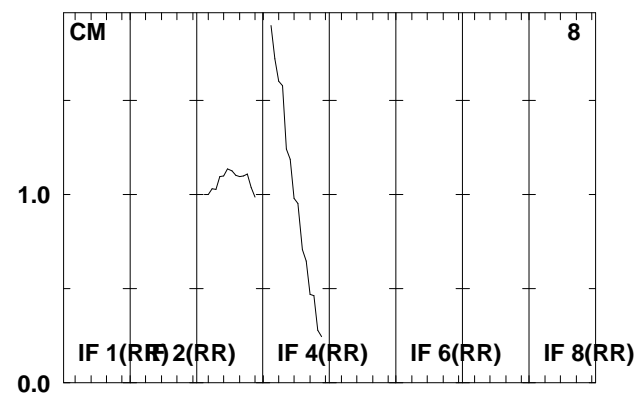
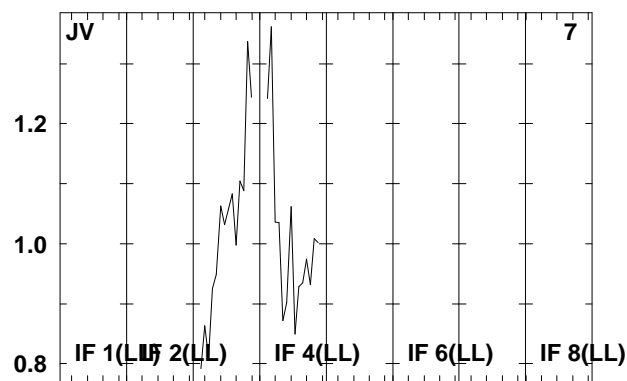
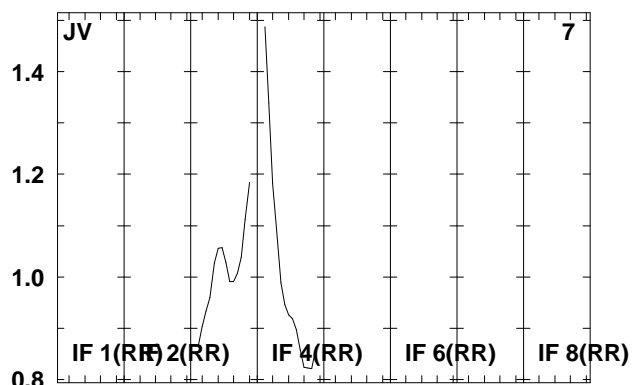
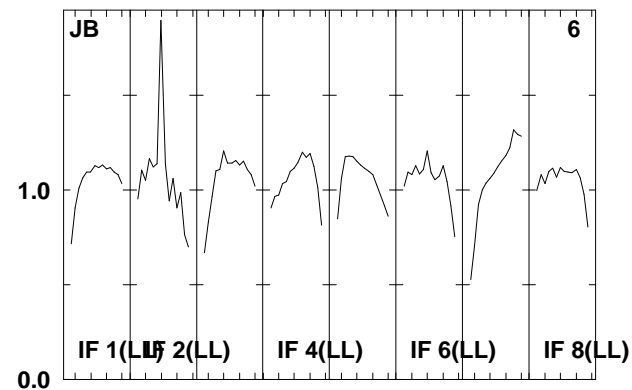
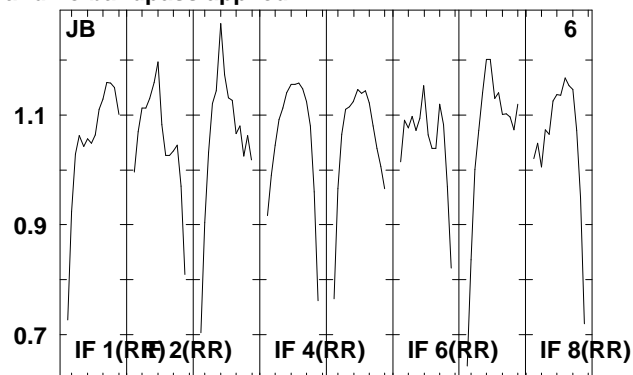
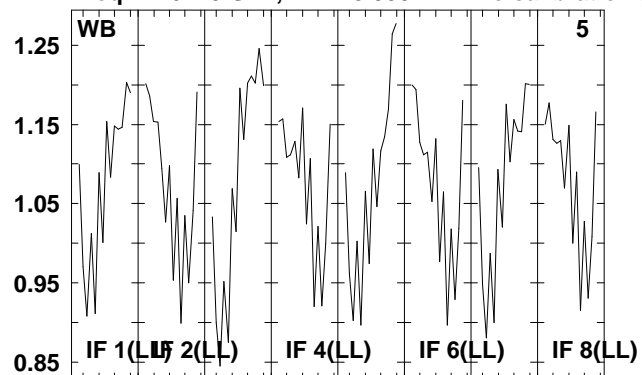

Lower frame: Real Jy  
Total-power spectrum Antenna: \*  
Timerange: 01/00:31:20 to 01/00:46:00

Plot file version 13 created 20-OCT-2009 14:48:32

FAINTCAL RP015C.UVDATA.1

Freq = 1.6270 GHz, Bw = 8.000 MH No calibration applied and no bandpass applied

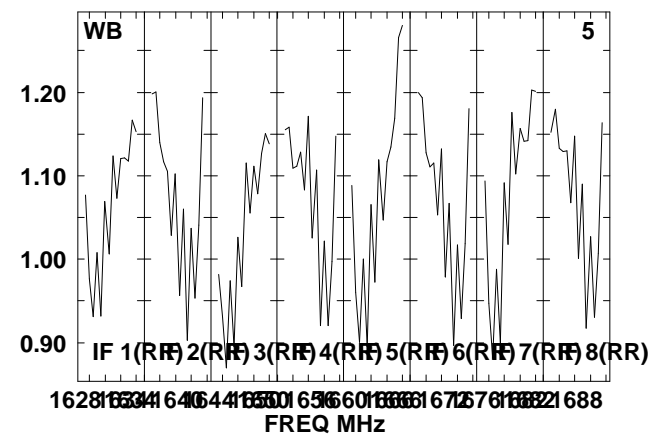
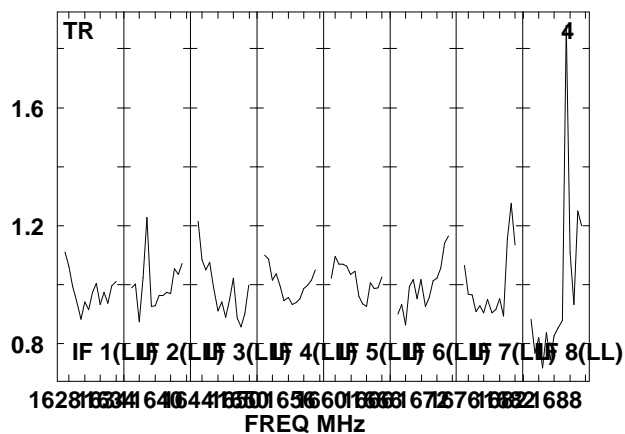
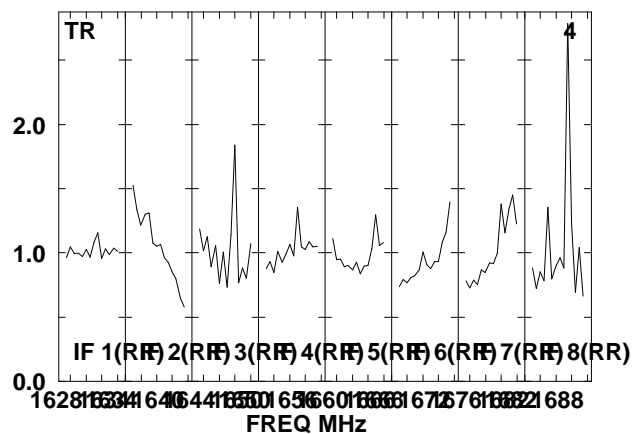
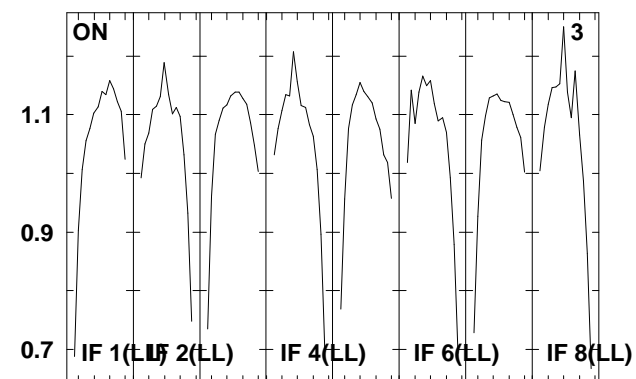
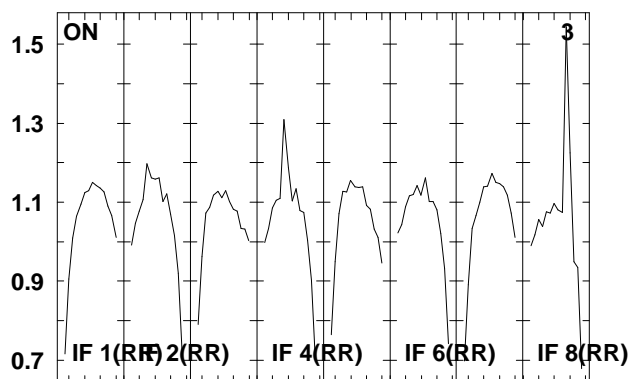
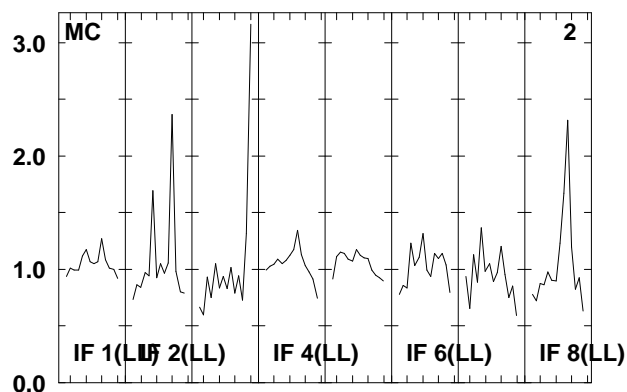
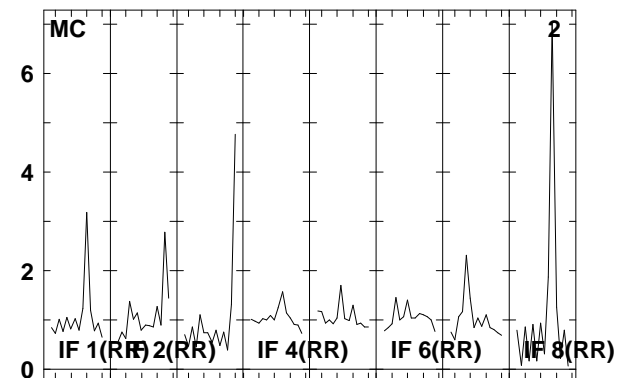
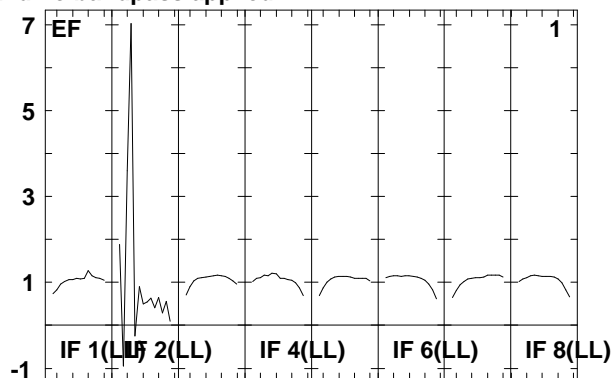
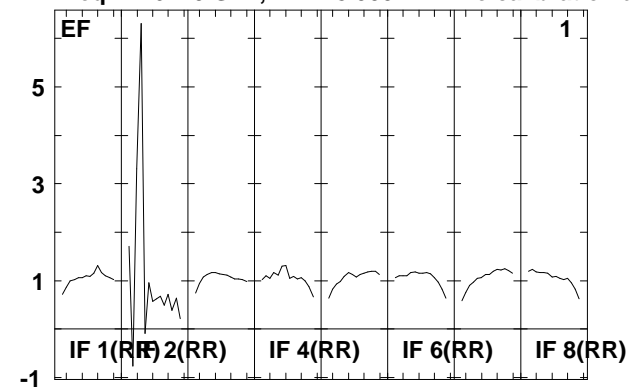

Lower frame: Real Jy

Total-power spectrum Antenna: \*

Timerange: 01/00:46:01 to 01/00:47:19

Plot file version 14 created 20-OCT-2009 14:48:33

FAINTCAL RP015C.UVDATA.1

Freq = 1.6270 GHz, Bw = 8.000 MH No calibration applied and no bandpass applied

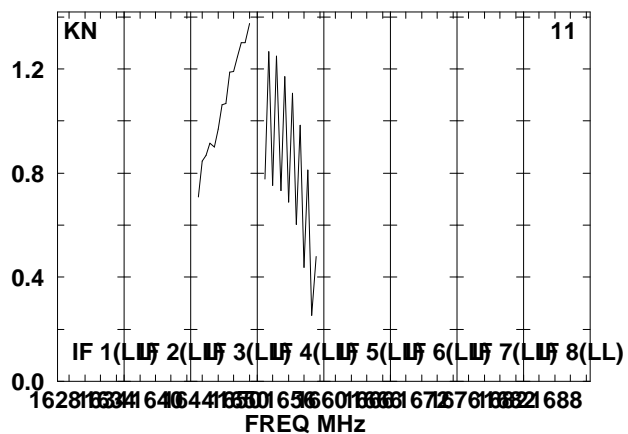
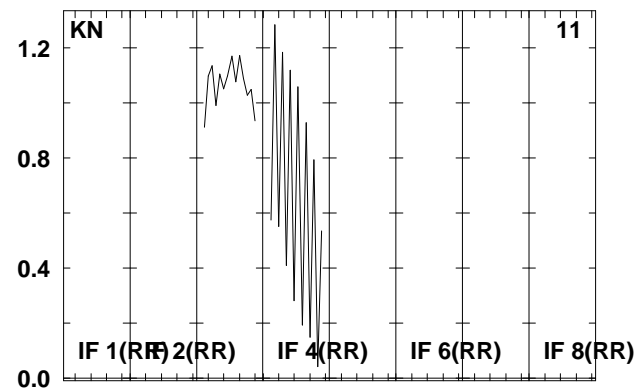
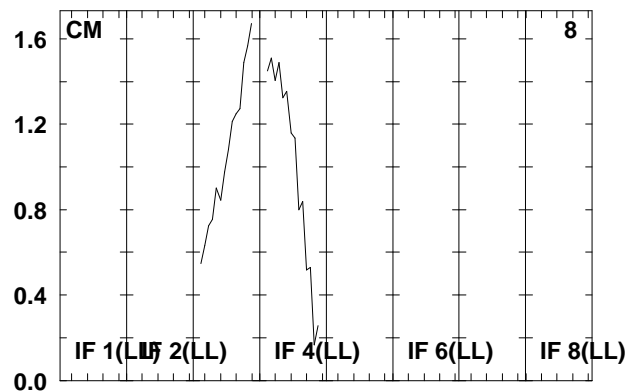
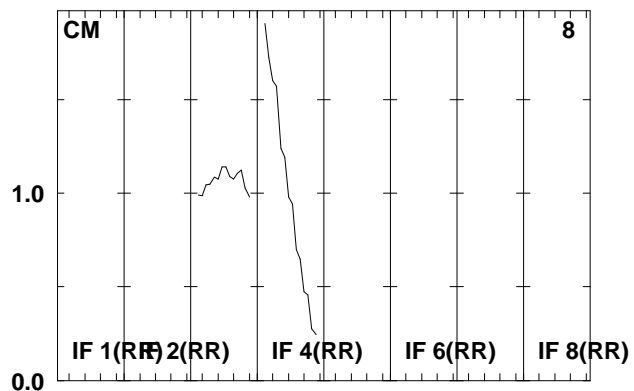
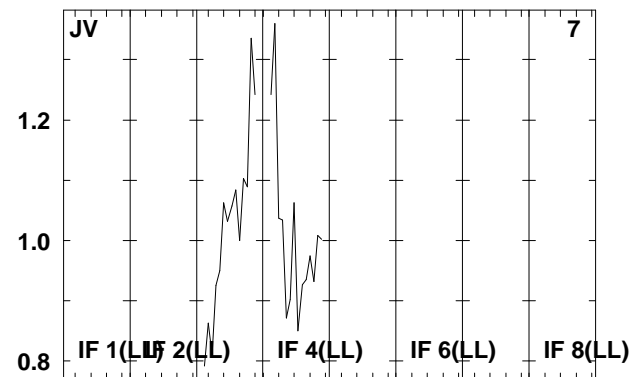
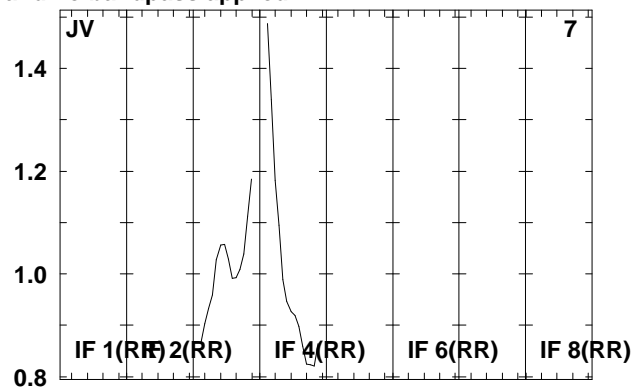
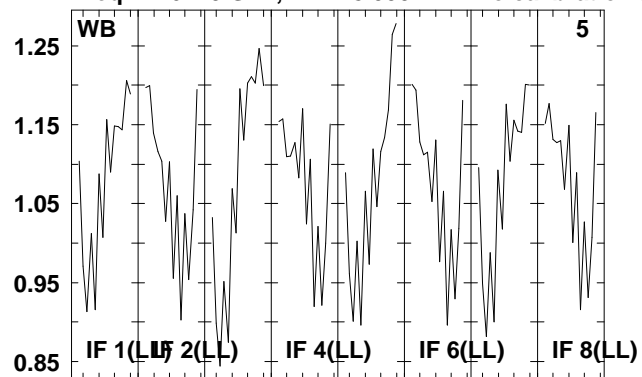

Lower frame: Real Jy

Total-power spectrum Antenna: \*

Timerange: 01/00:46:01 to 01/00:47:19

Plot file version 15 created 20-OCT-2009 14:48:34

M33 RP015C.UVDATA.1

Freq = 1.6270 GHz, Bw = 8.000 MH No calibration applied and no bandpass applied

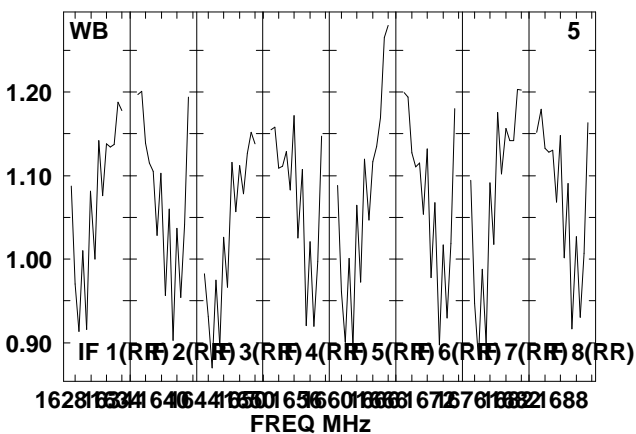
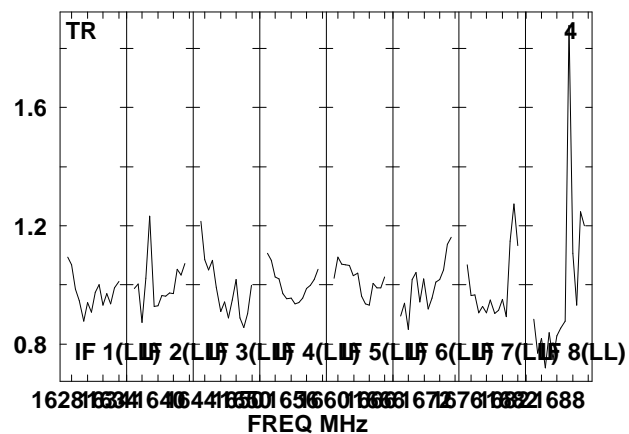
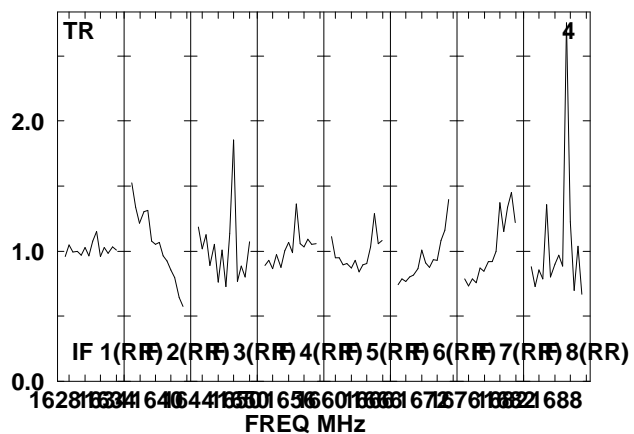
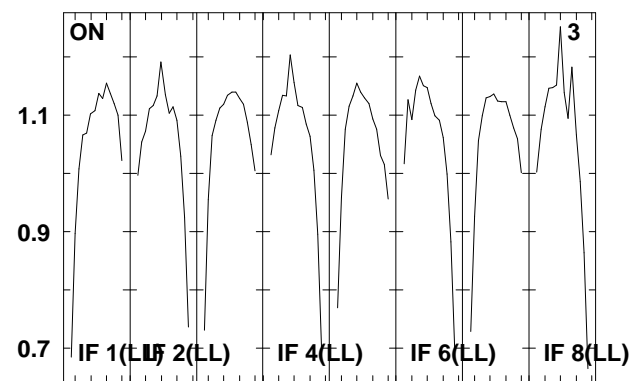
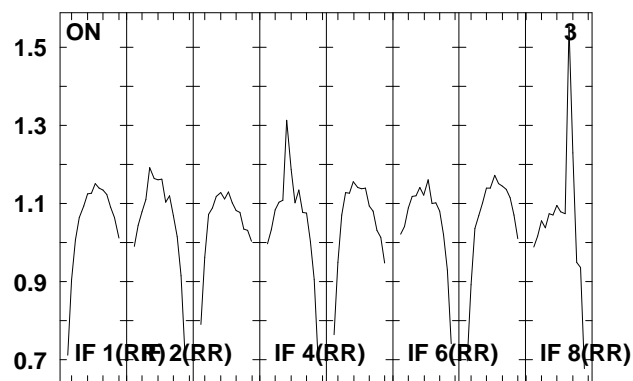
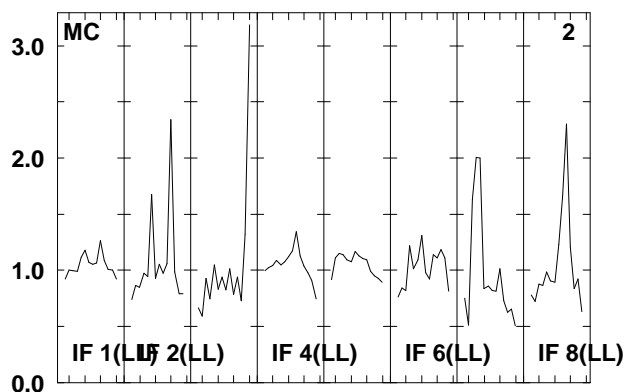
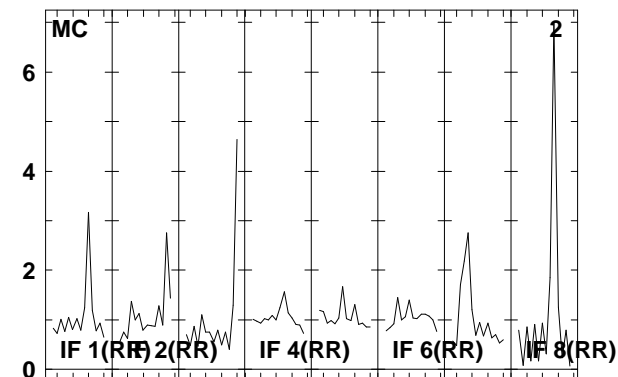
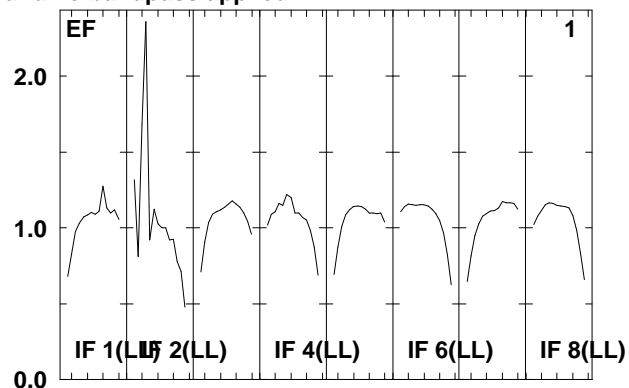
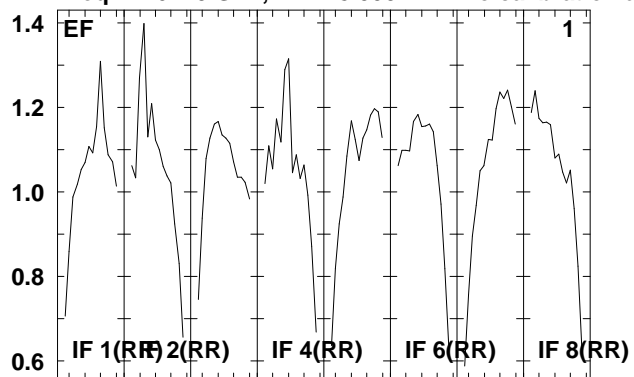

Lower frame: Real Jy

Total-power spectrum Antenna: \*

Timerange: 01/00:47:20 to 01/00:50:19

Plot file version 16 created 20-OCT-2009 14:48:35

M33 RP015C.UVDATA.1

Freq = 1.6270 GHz, Bw = 8.000 MH No calibration applied and no bandpass applied

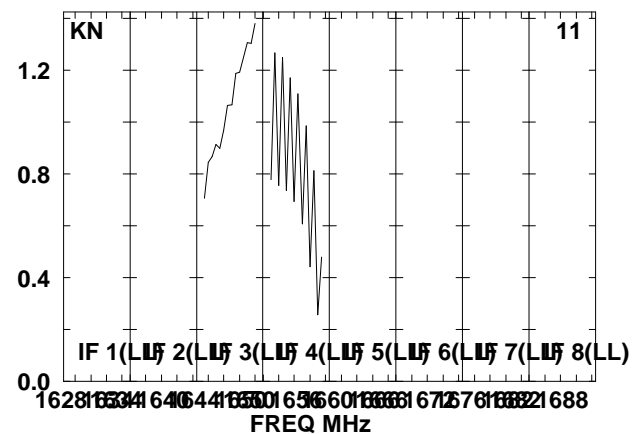
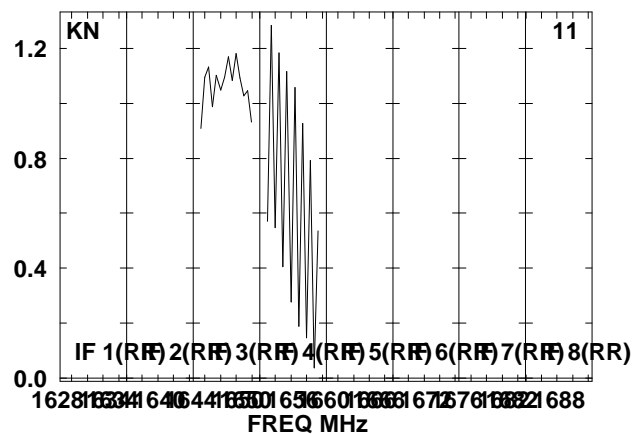
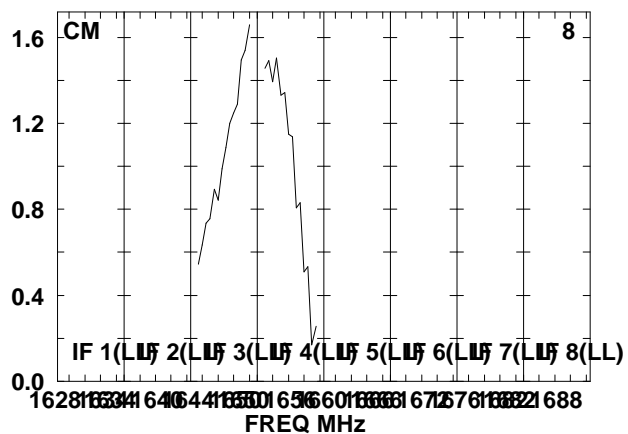
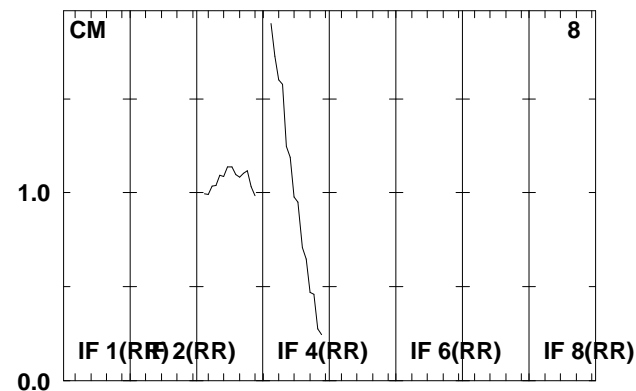
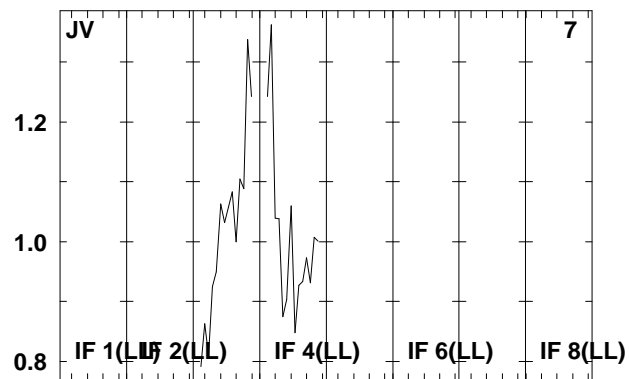
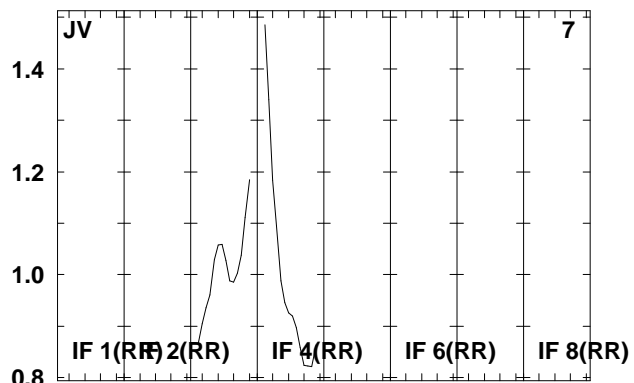
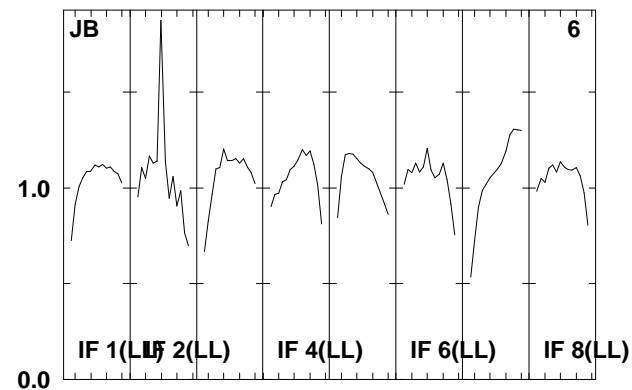
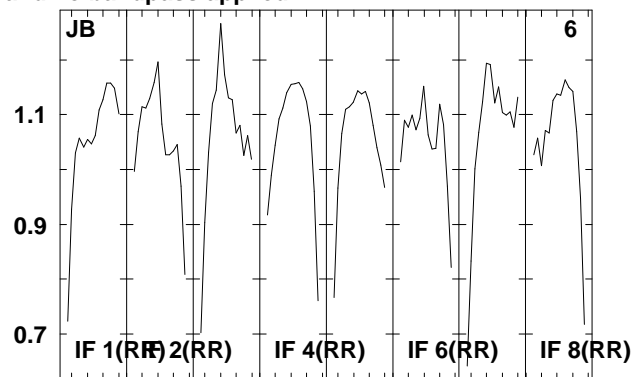
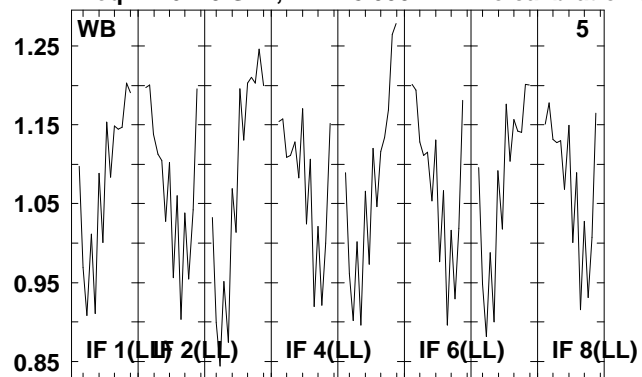

Lower frame: Real Jy  
Total-power spectrum Antenna: \*  
Timerange: 01/00:47:20 to 01/00:50:19



Plot file version 17 created 20-OCT-2009 14:48:36

J0137+31 RP015C.UVDATA.1

Freq = 1.6270 GHz, Bw = 8.000 MH No calibration applied and no bandpass applied

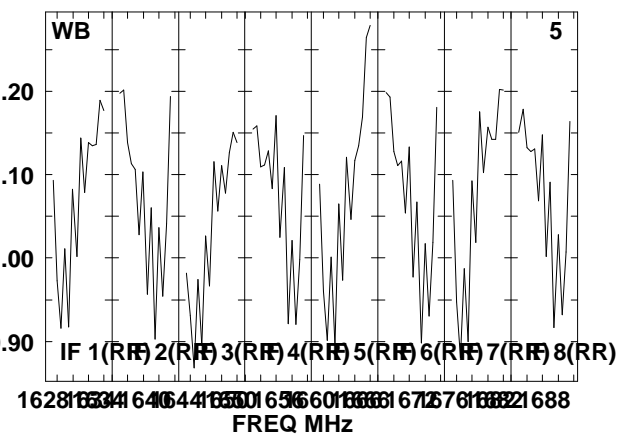
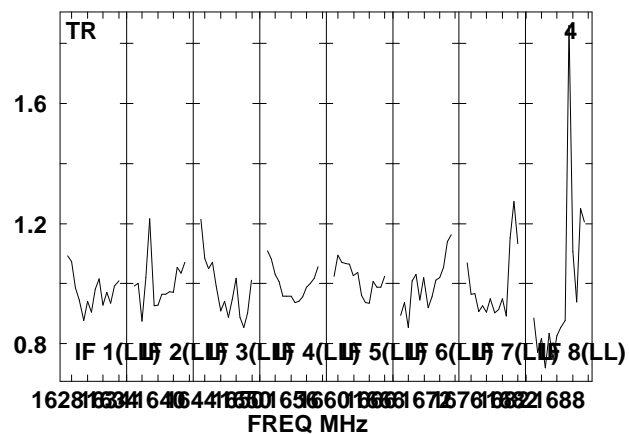
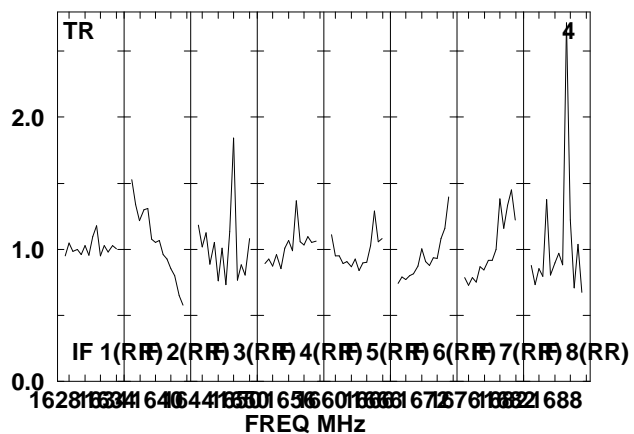
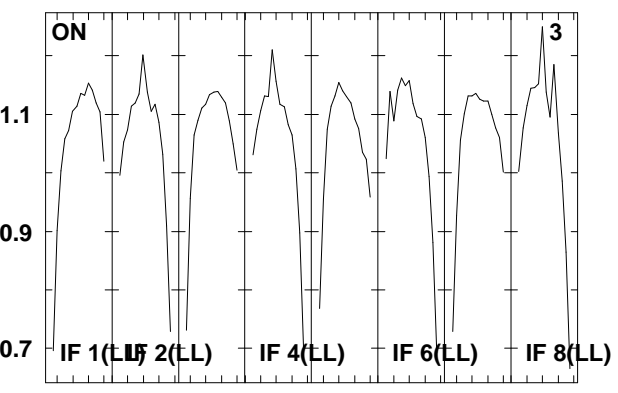
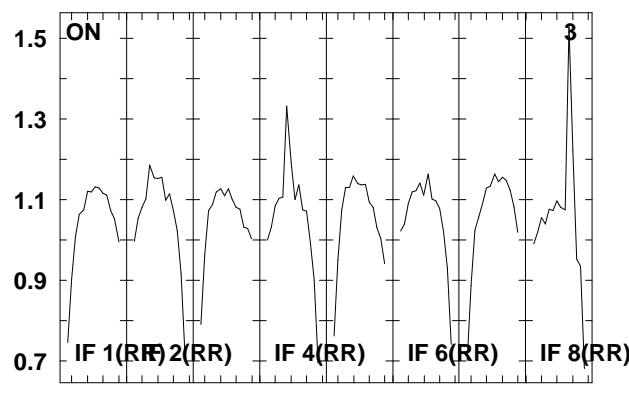
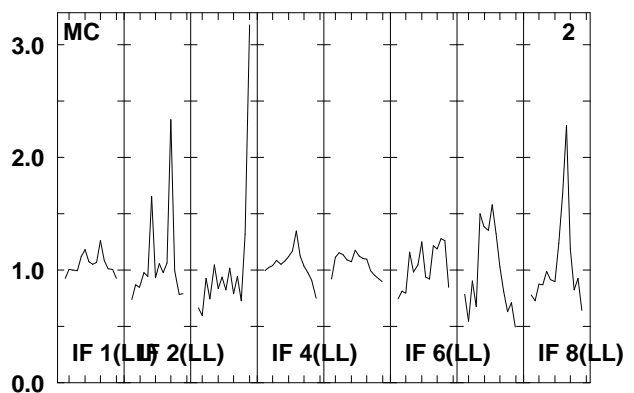
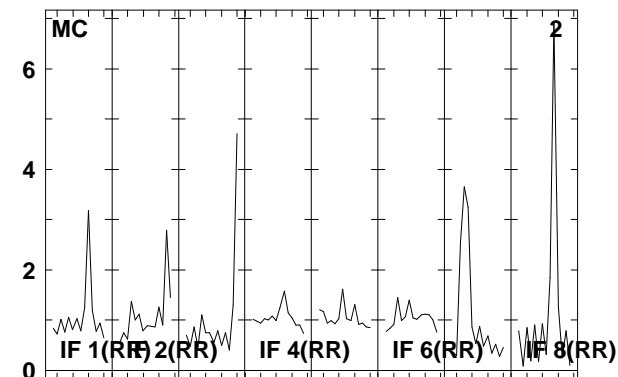
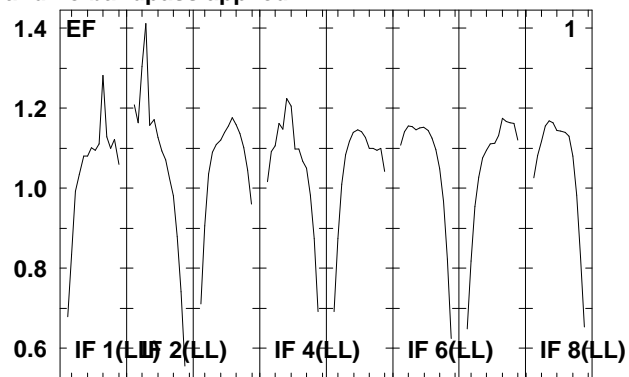
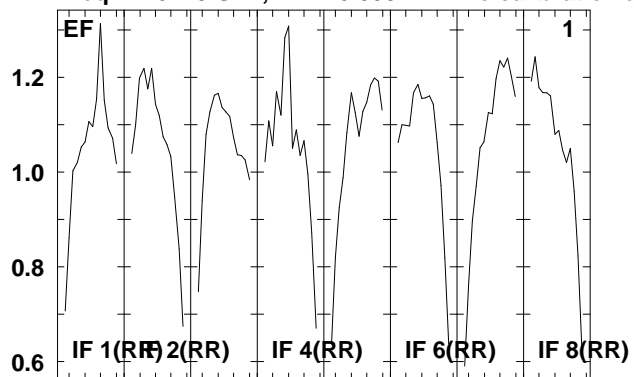

Lower frame: Real Jy  
Total-power spectrum Antenna: \*  
Timerange: 01/00:51:00 to 01/00:51:59

Plot file version 18 created 20-OCT-2009 14:48:36

J0137+31 RP015C.UVDATA.1

Freq = 1.6270 GHz, Bw = 8.000 MH No calibration applied and no bandpass applied

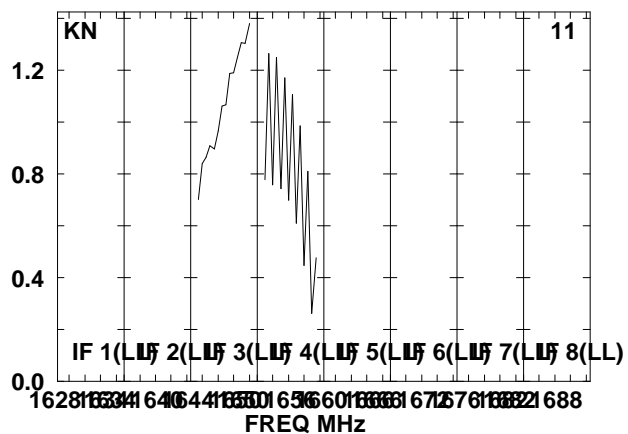
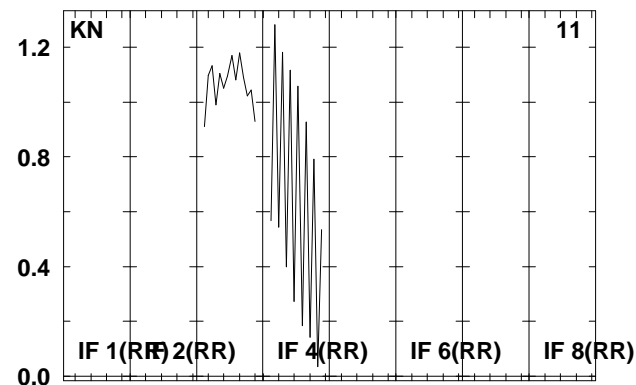
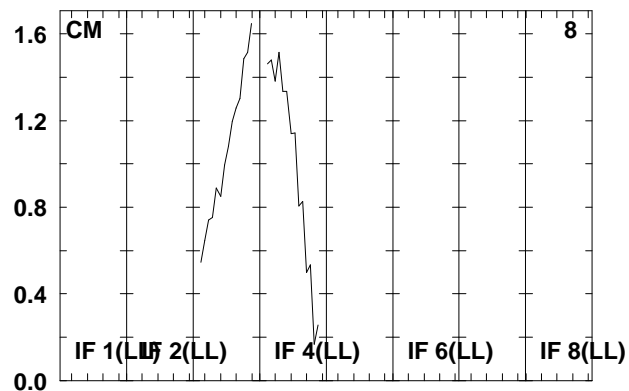
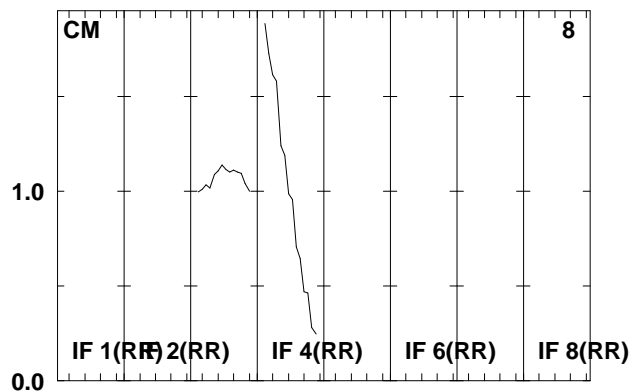
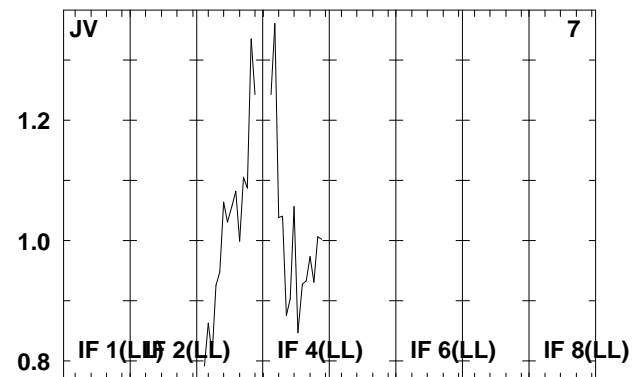
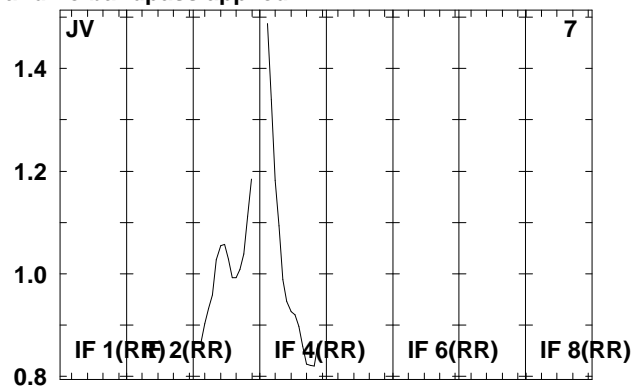
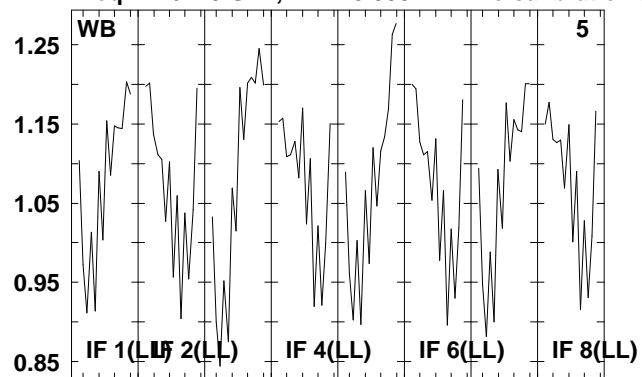

Lower frame: Real Jy

Total-power spectrum Antenna: \*

Timerange: 01/00:51:00 to 01/00:51:59

Plot file version 19 created 20-OCT-2009 14:48:37

FAINTCAL RP015C.UVDATA.1

Freq = 1.6270 GHz, Bw = 8.000 MH No calibration applied and no bandpass applied

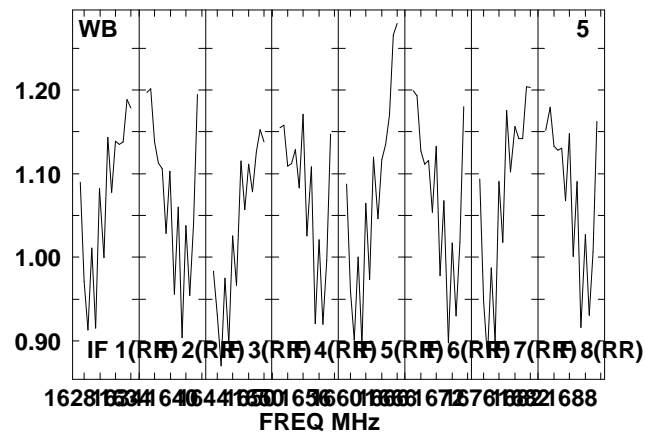
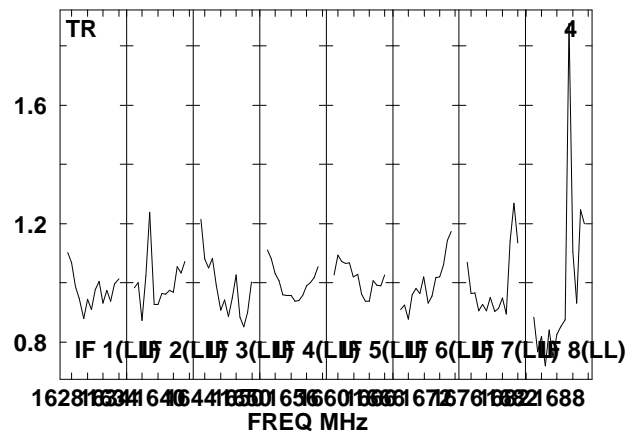
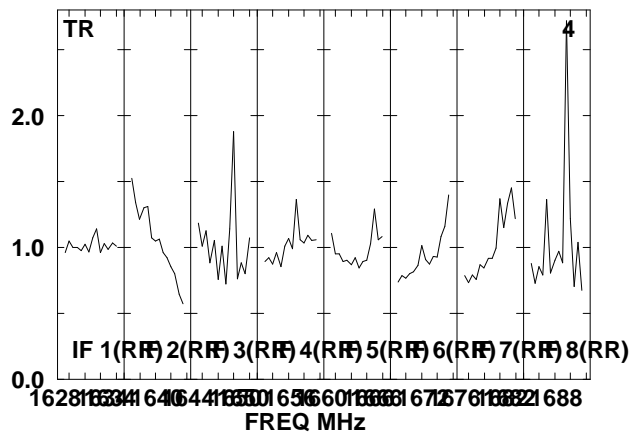
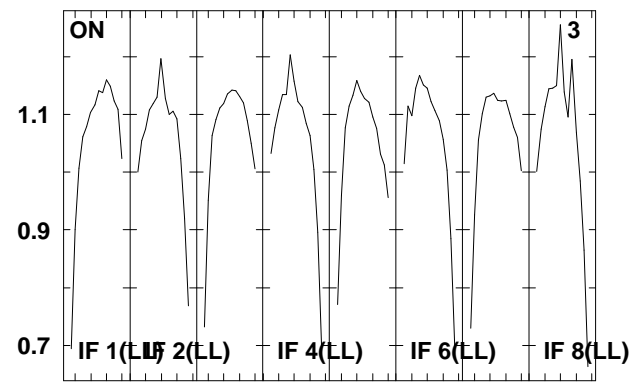
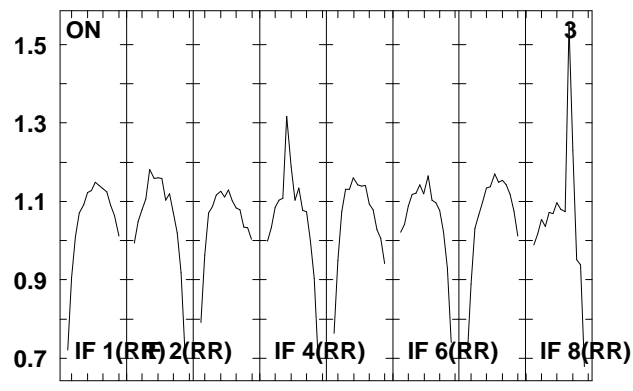
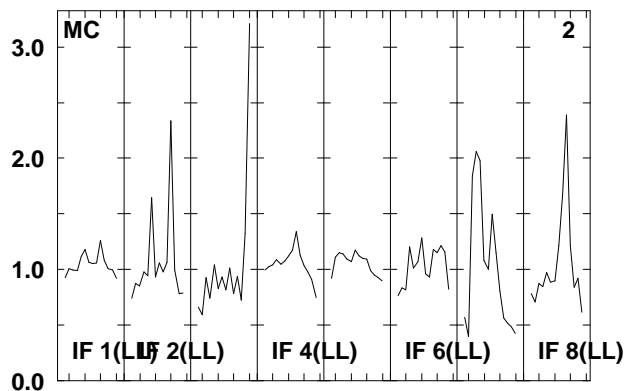
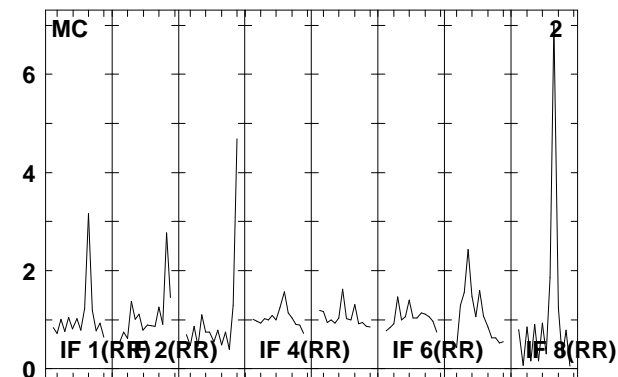
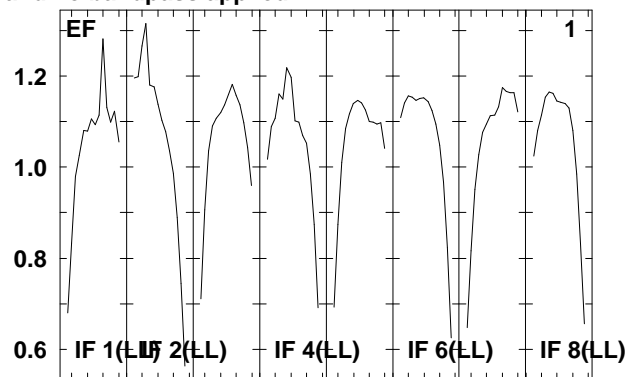
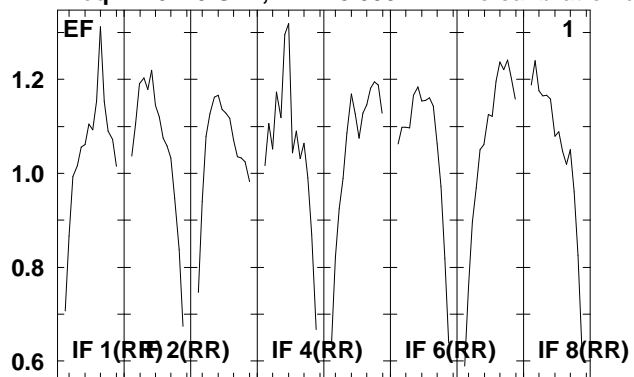

Lower frame: Real Jy  
Total-power spectrum Antenna: \*  
Timerange: 01/00:52:00 to 01/00:53:20

Plot file version 20 created 20-OCT-2009 14:48:37

FAINTCAL RP015C.UVDATA.1

Freq = 1.6270 GHz, Bw = 8.000 MH No calibration applied and no bandpass applied

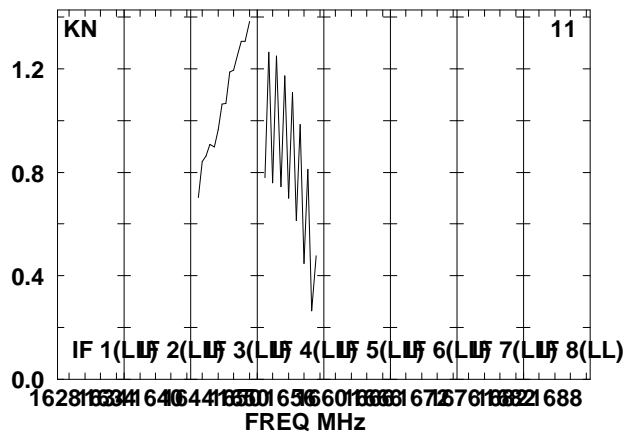
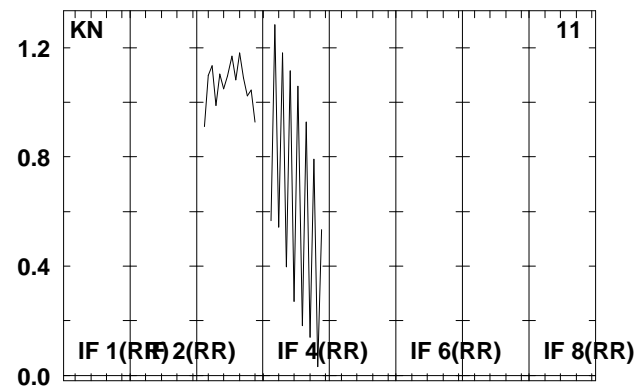
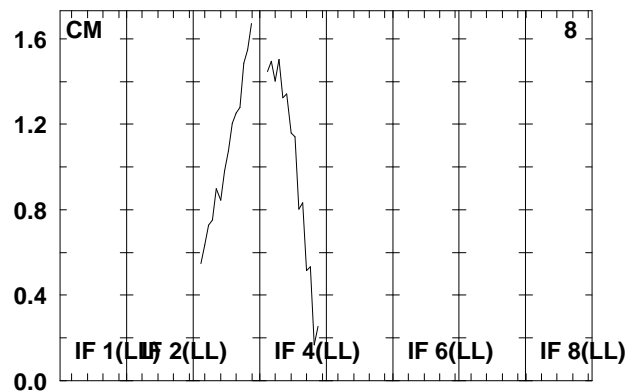
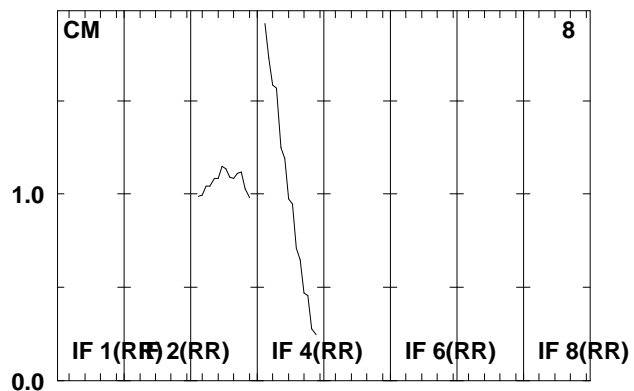
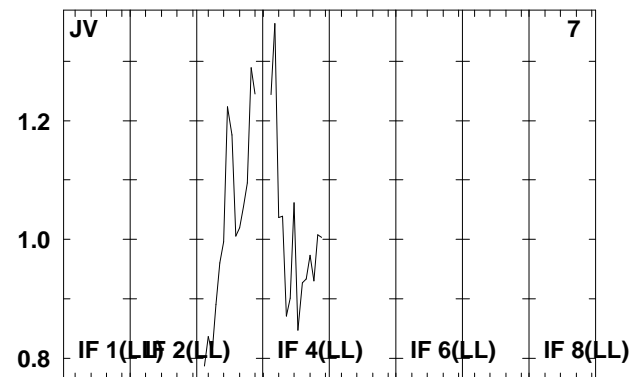
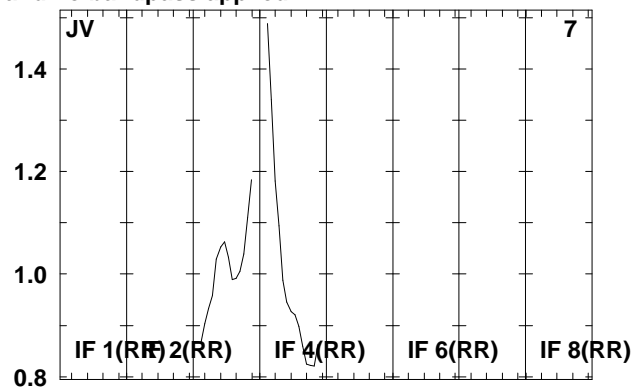
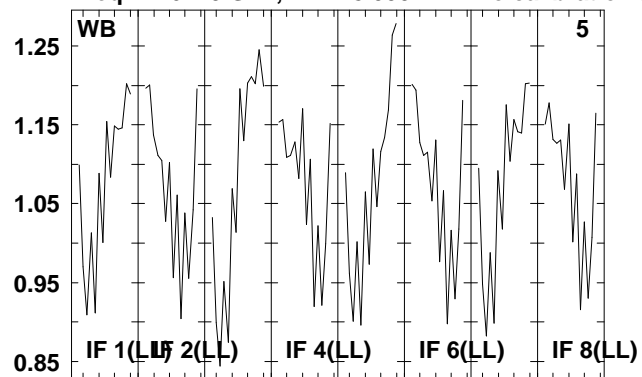

Lower frame: Real Jy

Total-power spectrum Antenna: \*

Timerange: 01/00:52:00 to 01/00:53:20

Plot file version 21 created 20-OCT-2009 14:48:38

M33 RP015C.UVDATA.1

Freq = 1.6270 GHz, Bw = 8.000 MH No calibration applied and no bandpass applied

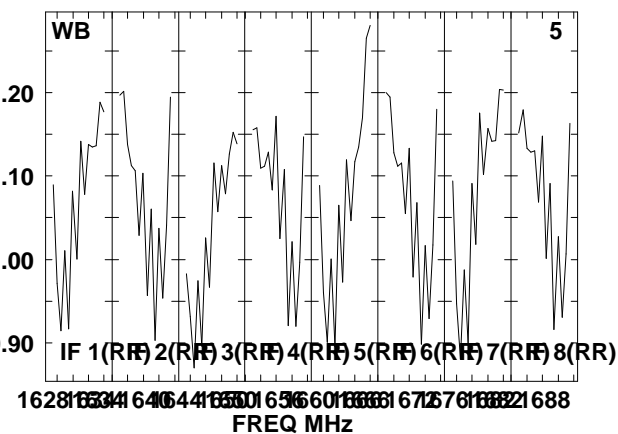
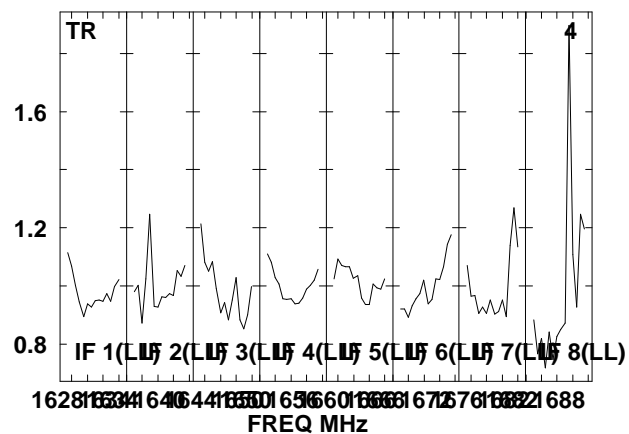
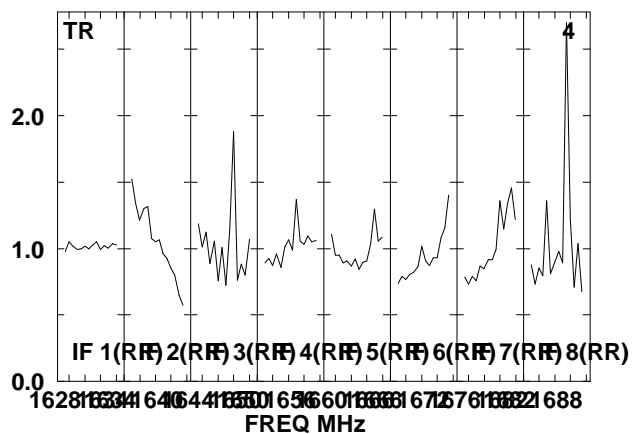
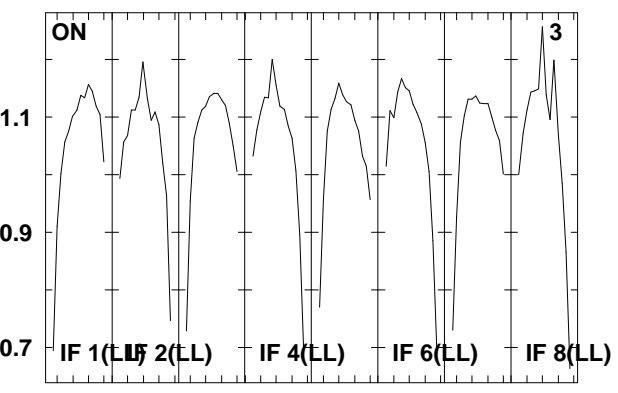
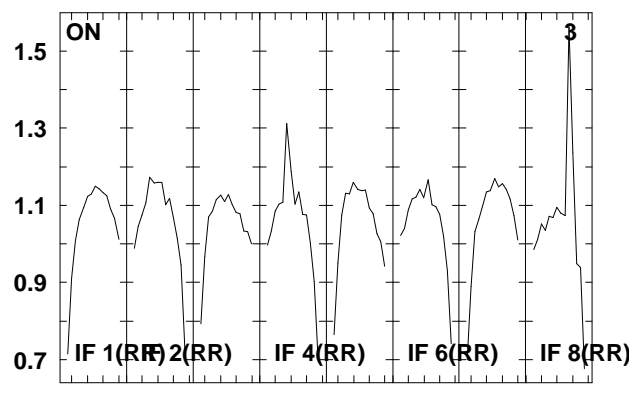
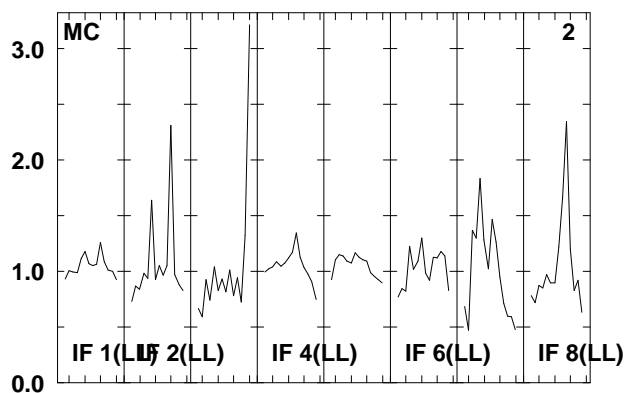
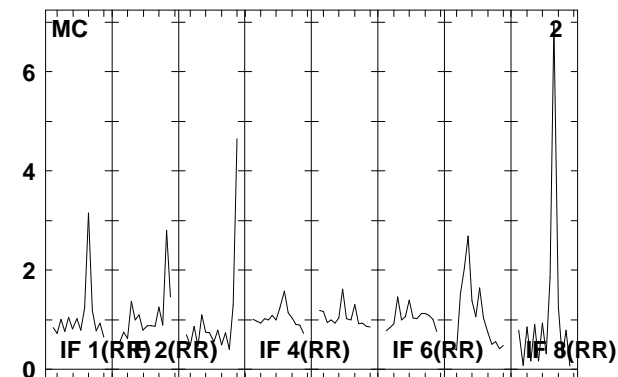
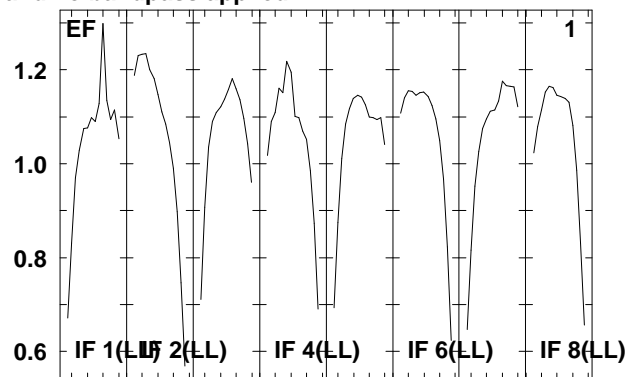
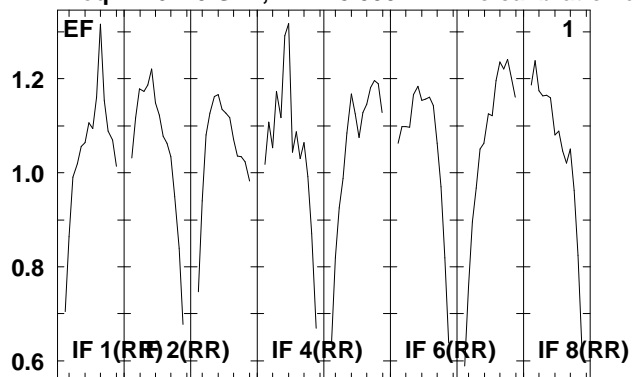

Lower frame: Real Jy  
Total-power spectrum Antenna: \*  
Timerange: 01/00:53:21 to 01/00:56:20

Plot file version 22 created 20-OCT-2009 14:48:39

M33 RP015C.UVDATA.1

Freq = 1.6270 GHz, Bw = 8.000 MH No calibration applied and no bandpass applied

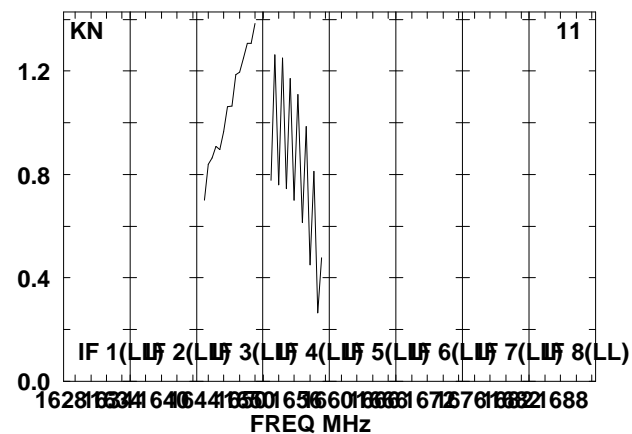
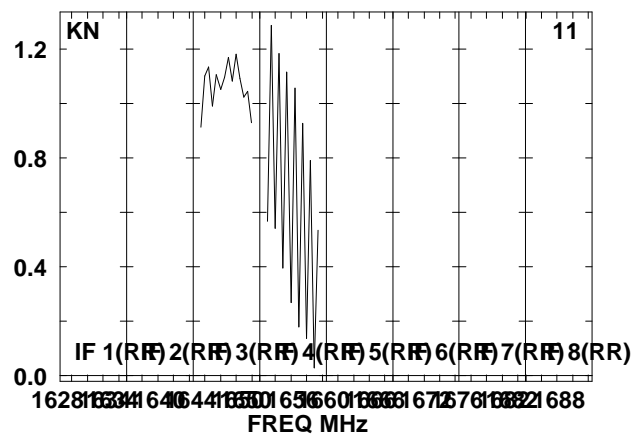
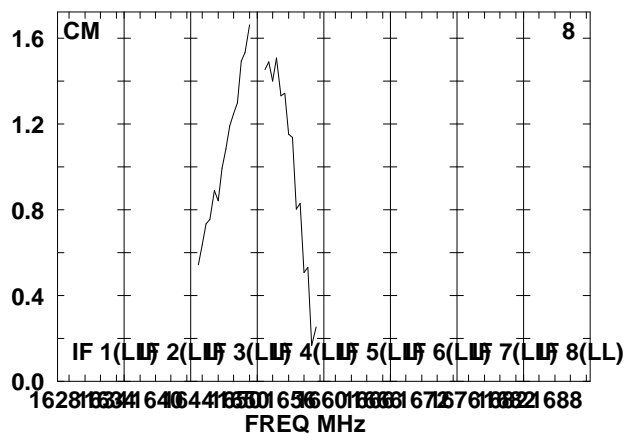
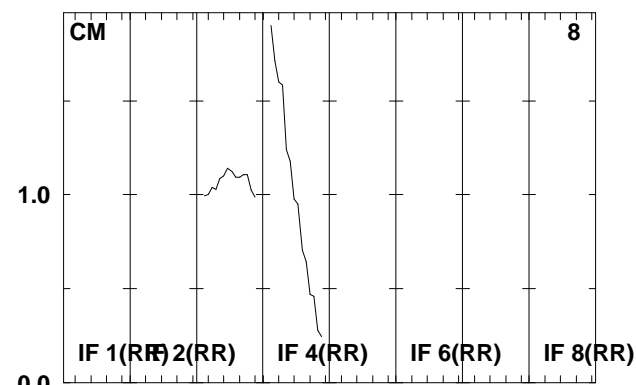
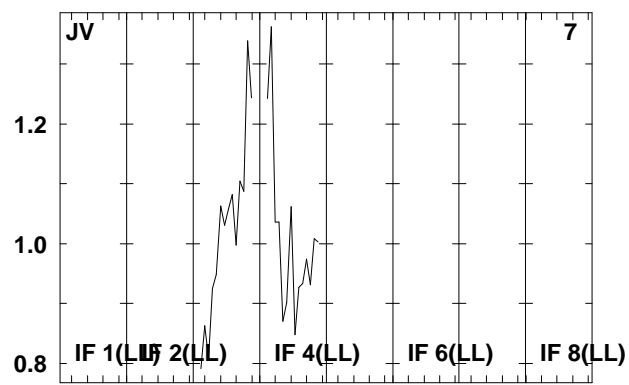
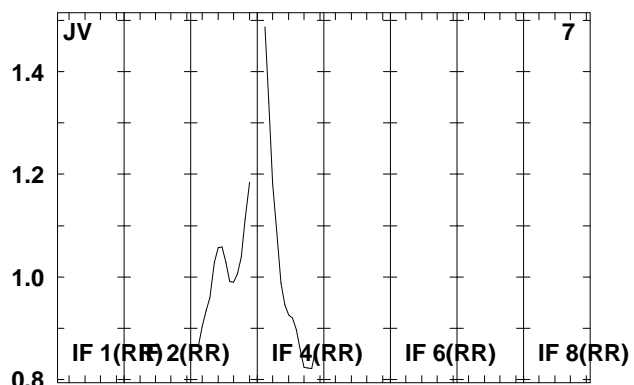
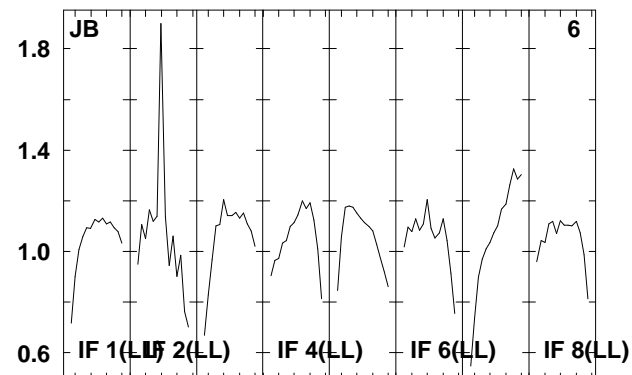
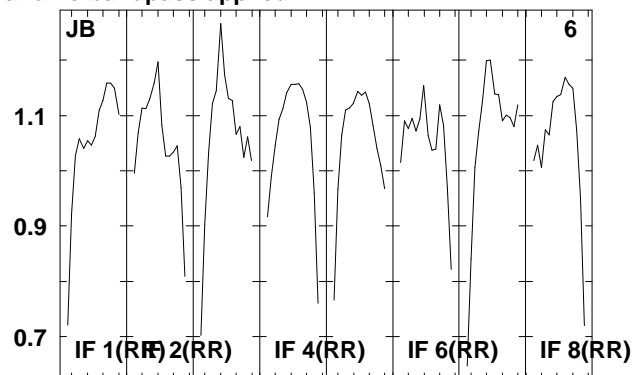
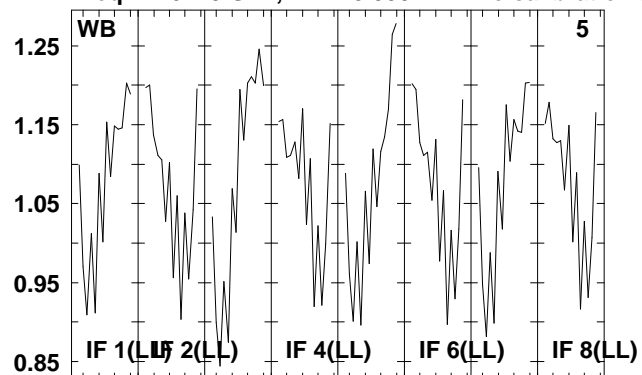

Lower frame: Real Jy  
Total-power spectrum Antenna: \*  
Timerange: 01/00:53:21 to 01/00:56:20

Plot file version 23 created 20-OCT-2009 14:48:41  
 J0137+31 RP015C.UVDATA.1  
 Freq = 1.6270 GHz, Bw = 8.000 MH No calibration applied and no bandpass applied

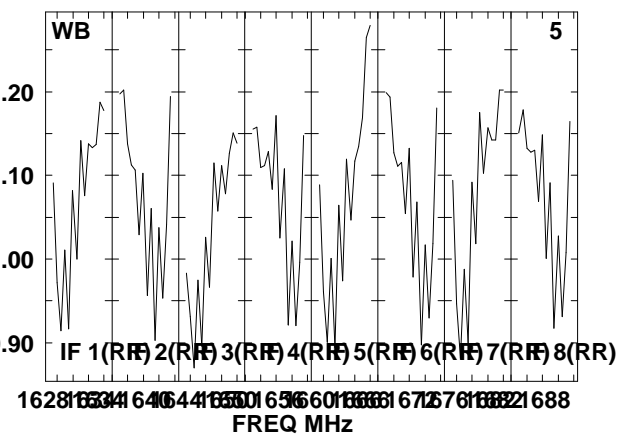
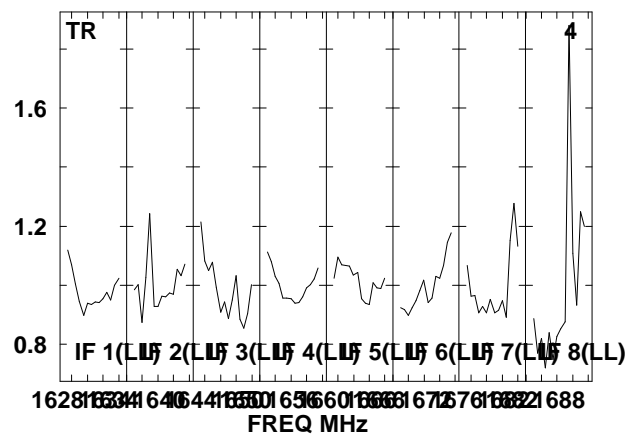
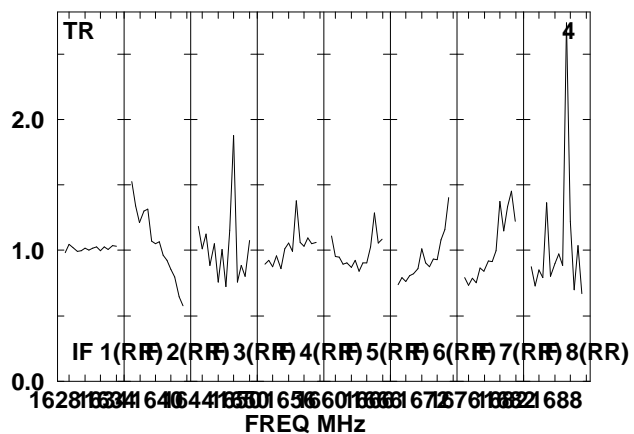
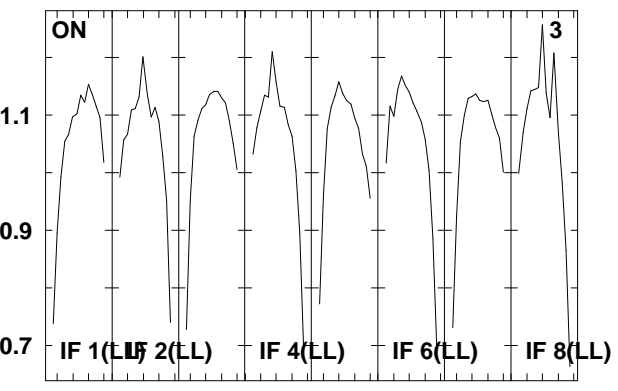
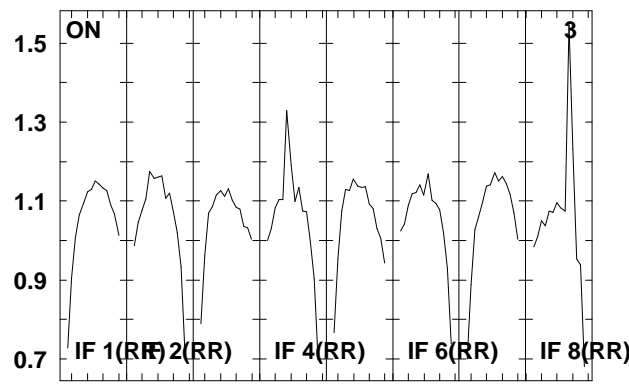
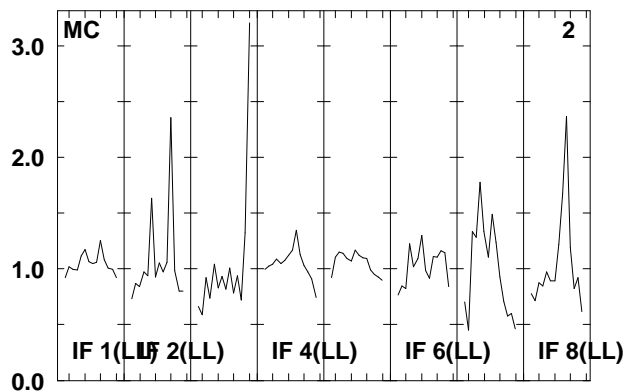
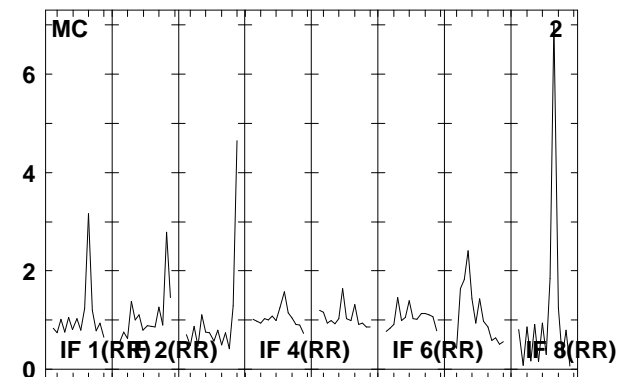
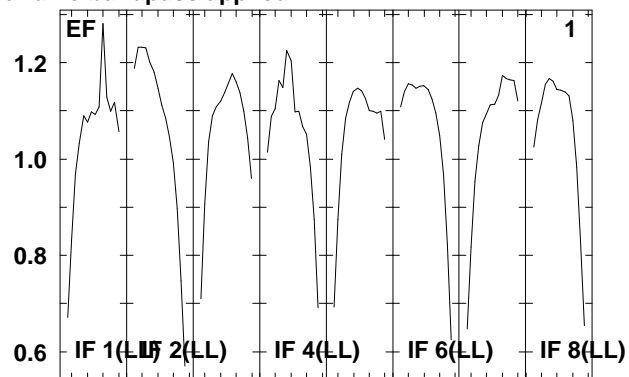
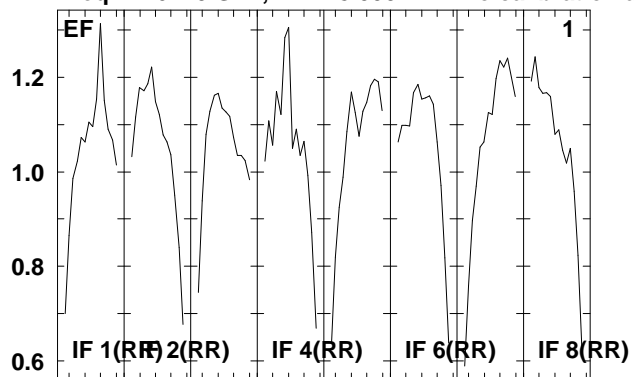

Lower frame: Real Jy  
 Total-power spectrum Antenna: \*  
 Timerange: 01/00:57:01 to 01/00:58:00

Plot file version 24 created 20-OCT-2009 14:48:41

J0137+31 RP015C.UVDATA.1

Freq = 1.6270 GHz, Bw = 8.000 MH No calibration applied and no bandpass applied

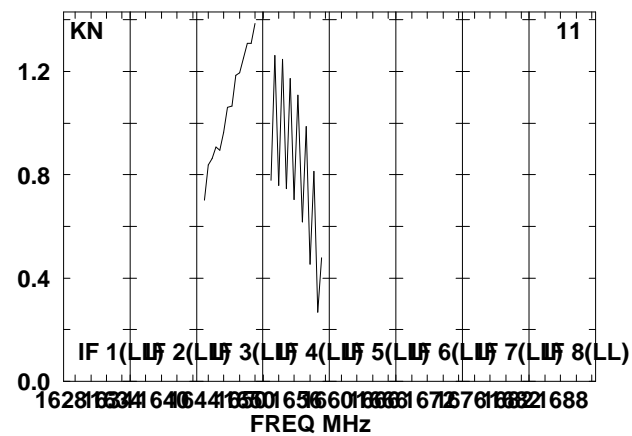
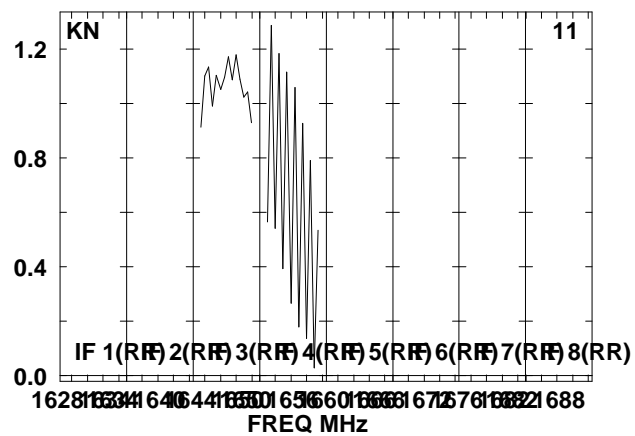
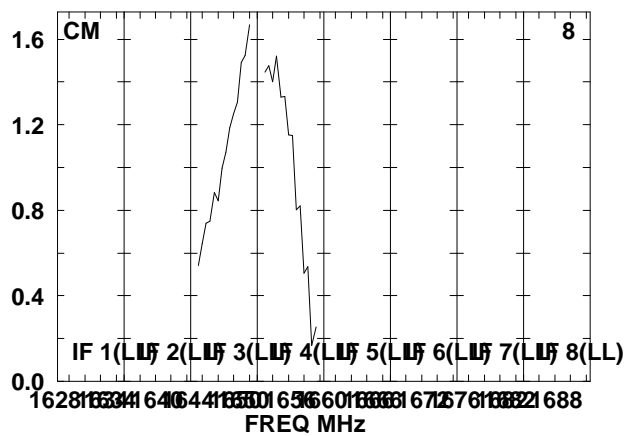
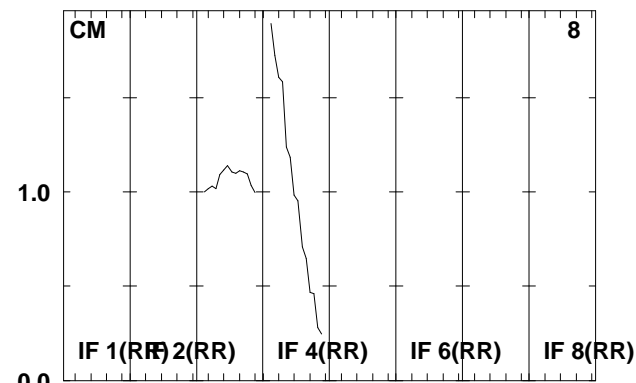
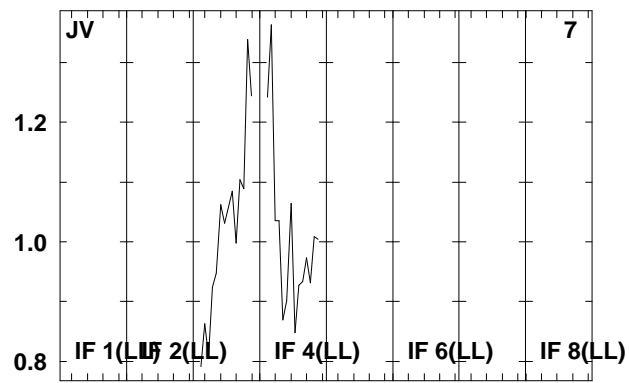
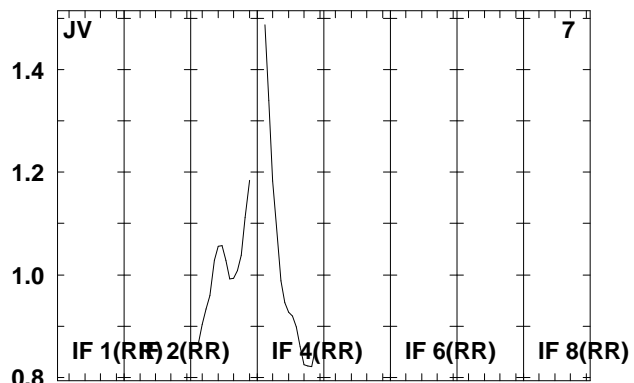
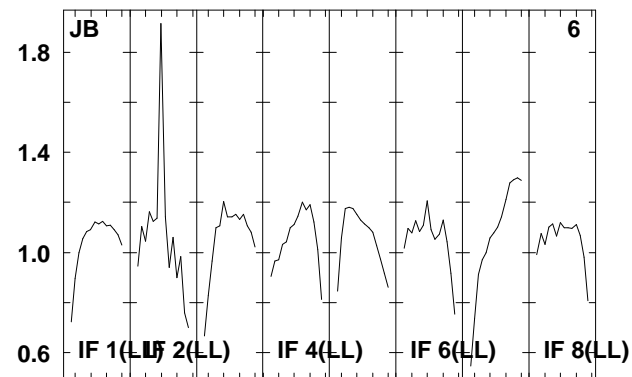
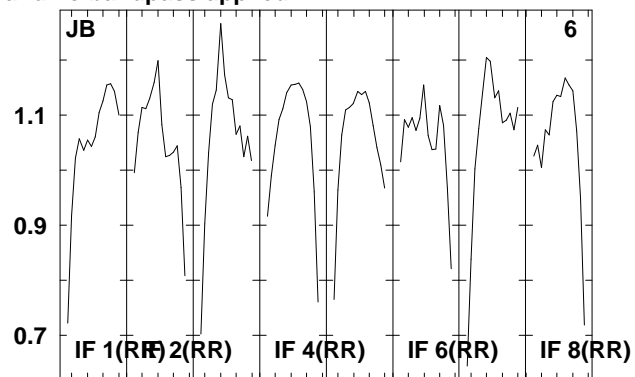
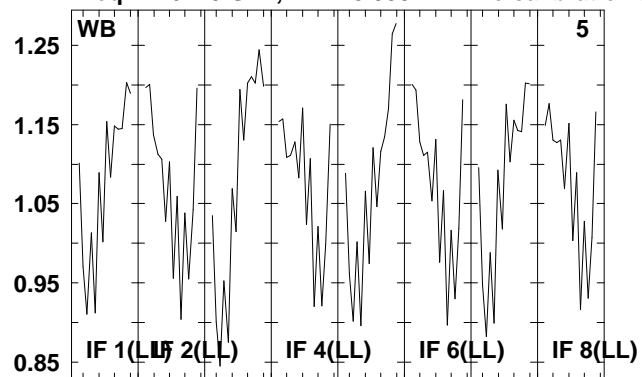

Lower frame: Real Jy  
Total-power spectrum Antenna: \*  
Timerange: 01/00:57:01 to 01/00:58:00



Plot file version 25 created 20-OCT-2009 14:48:42

FAINTCAL RP015C.UVDATA.1

Freq = 1.6270 GHz, Bw = 8.000 MH No calibration applied and no bandpass applied

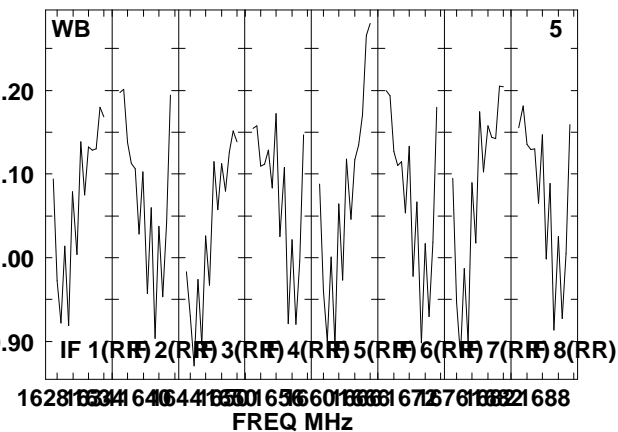
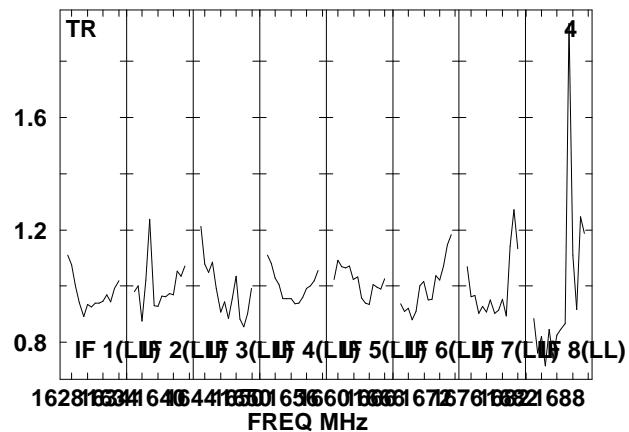
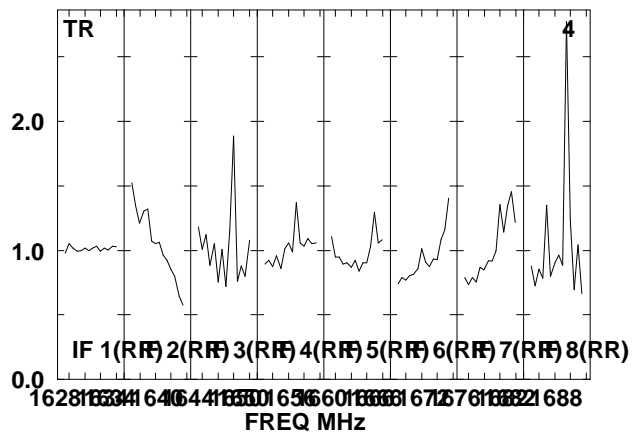
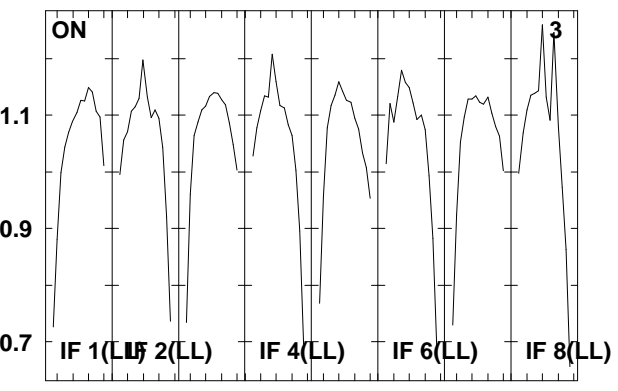
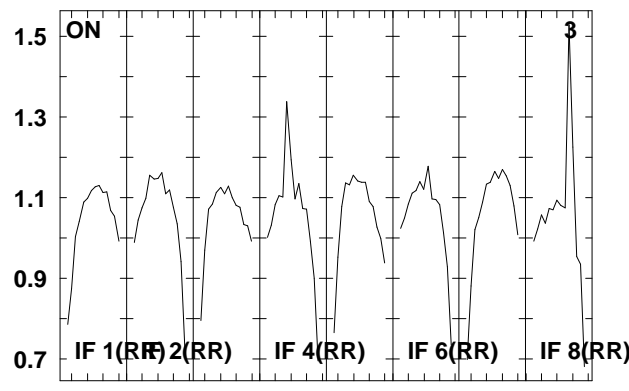
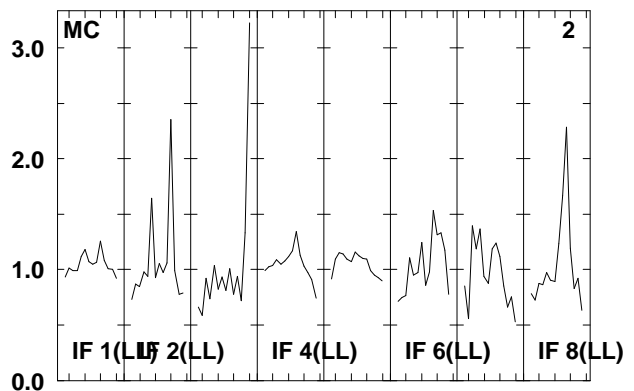
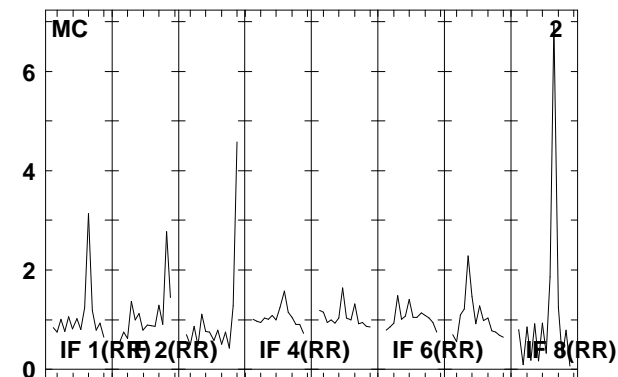
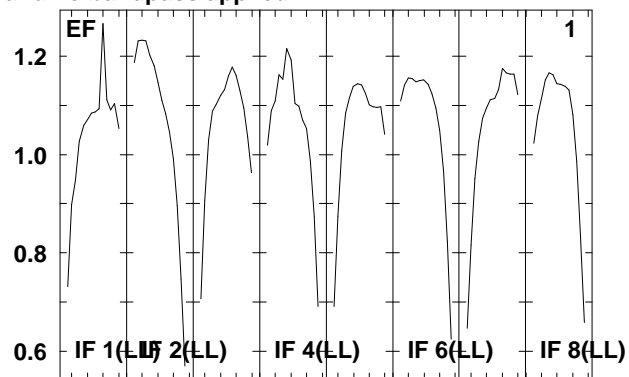
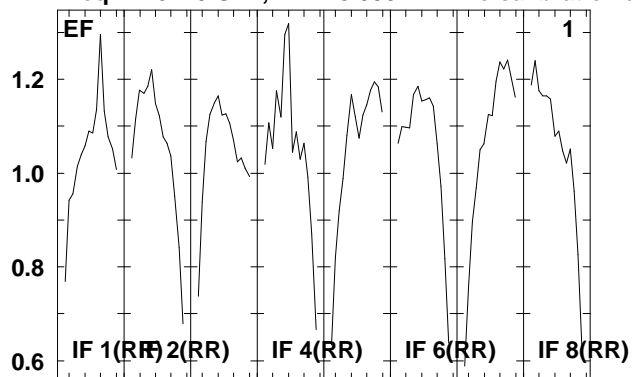

Lower frame: Real Jy  
Total-power spectrum Antenna: \*  
Timerange: 01/00:58:00 to 01/00:59:19

Plot file version 26 created 20-OCT-2009 14:48:42

FAINTCAL RP015C.UVDATA.1

Freq = 1.6270 GHz, Bw = 8.000 MH No calibration applied and no bandpass applied

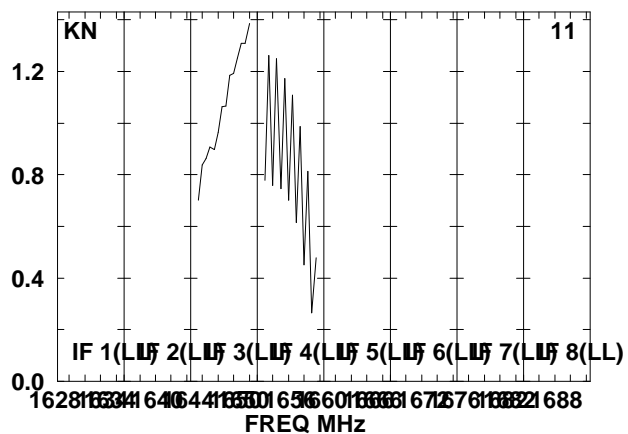
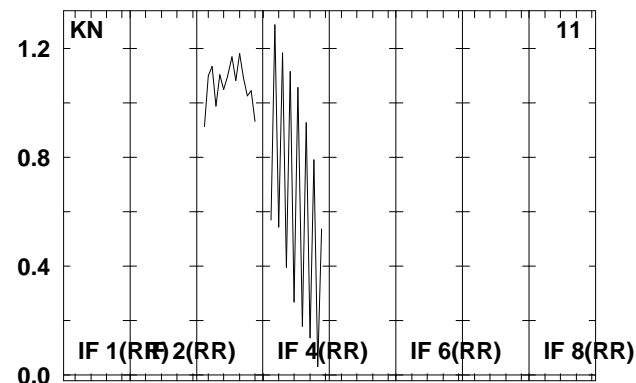
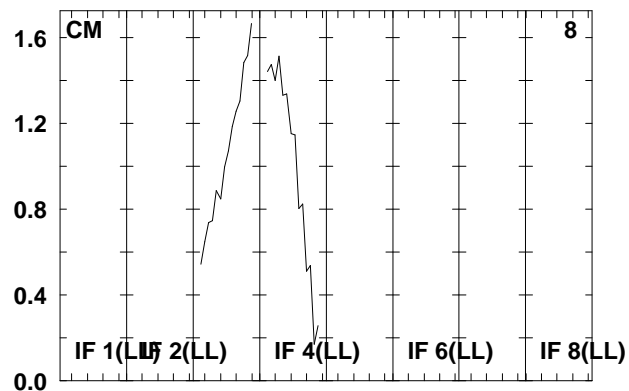
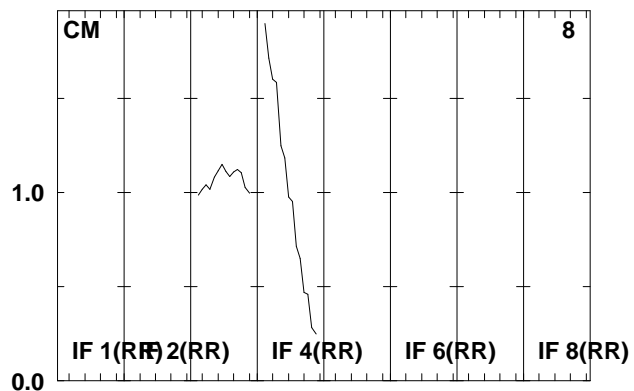
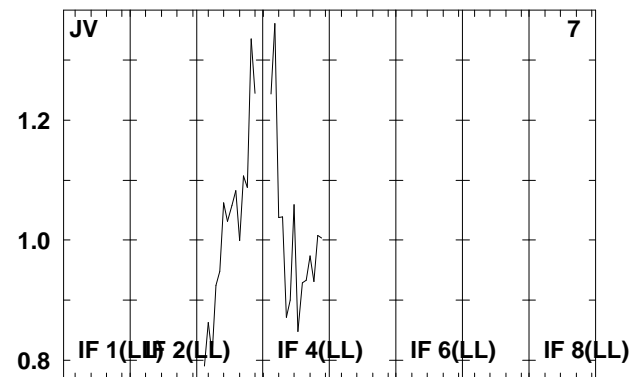
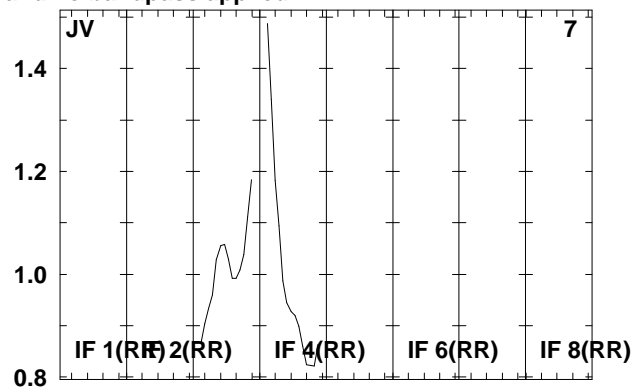
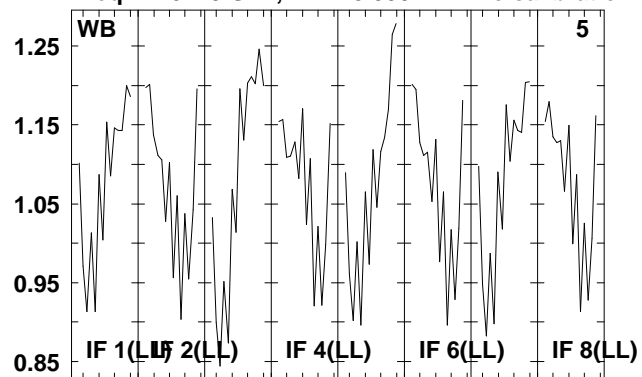

Lower frame: Real Jy

Total-power spectrum Antenna: \*

Timerange: 01/00:58:00 to 01/00:59:19

Plot file version 27 created 20-OCT-2009 14:48:43

M33 RP015C.UVDATA.1

Freq = 1.6270 GHz, Bw = 8.000 MH No calibration applied and no bandpass applied

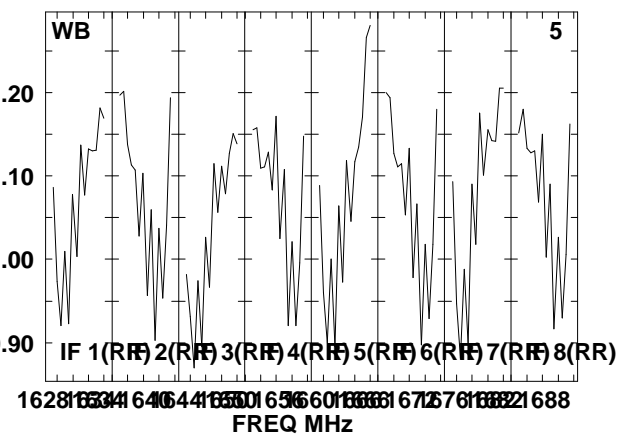
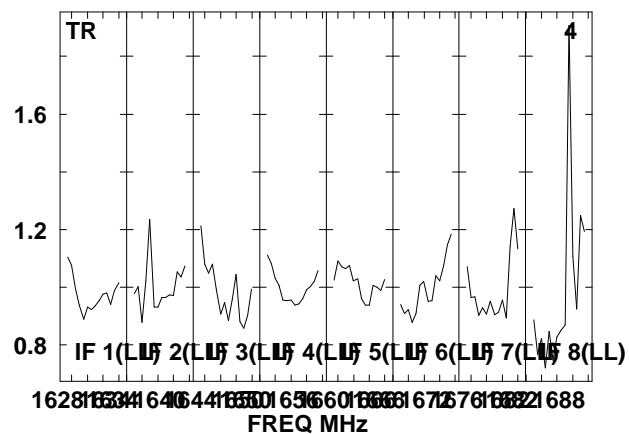
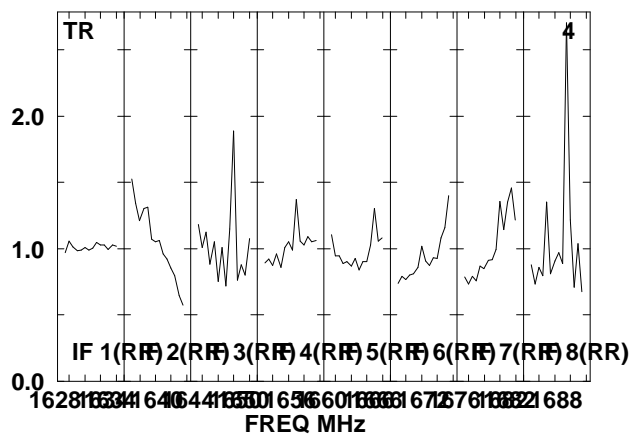
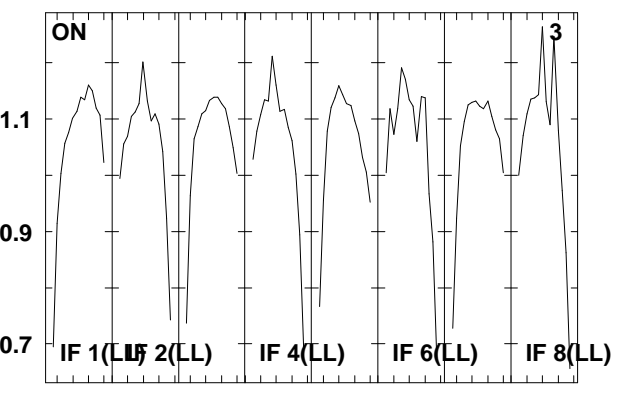
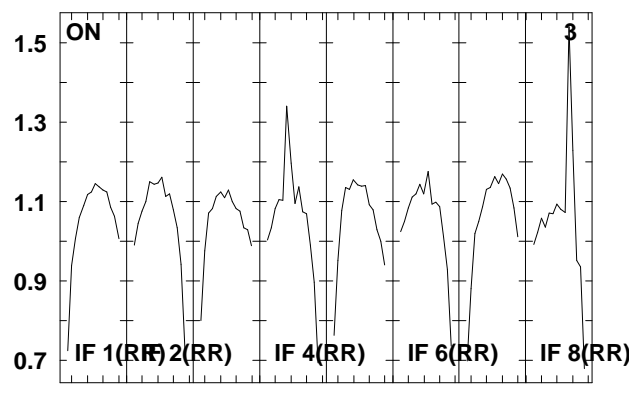
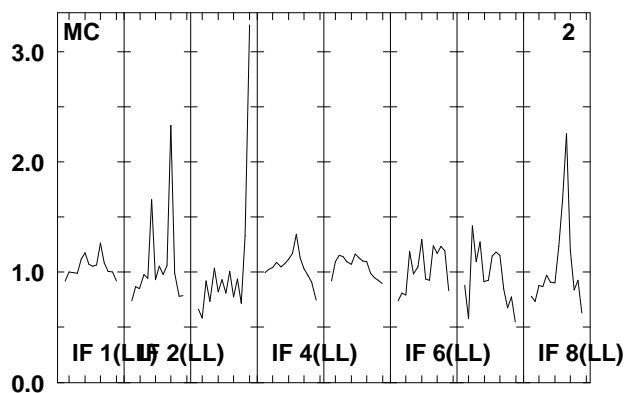
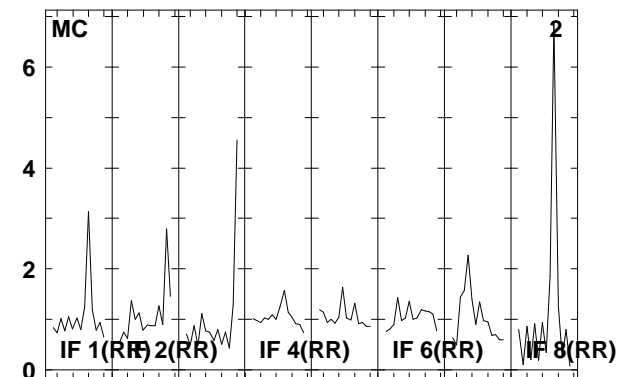
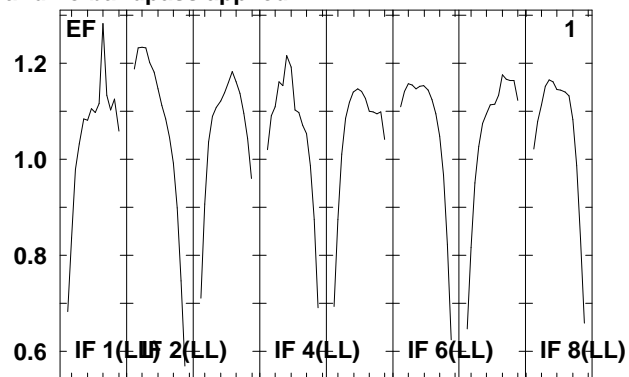
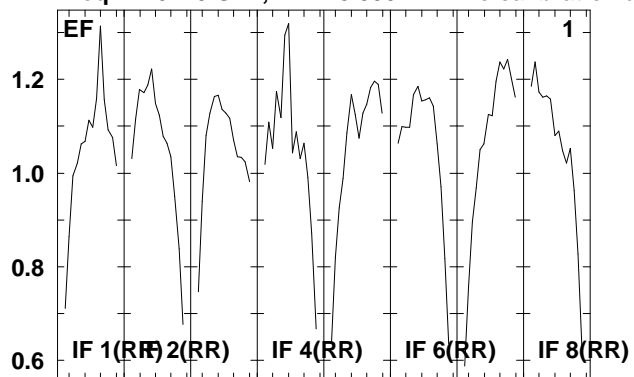

Lower frame: Real Jy  
Total-power spectrum Antenna: \*  
Timerange: 01/00:59:20 to 01/01:02:20

Plot file version 28 created 20-OCT-2009 14:48:43

M33 RP015C.UVDATA.1

Freq = 1.6270 GHz, Bw = 8.000 MH No calibration applied and no bandpass applied

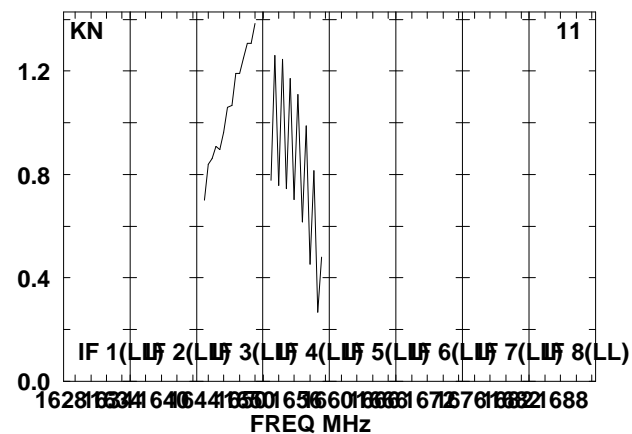
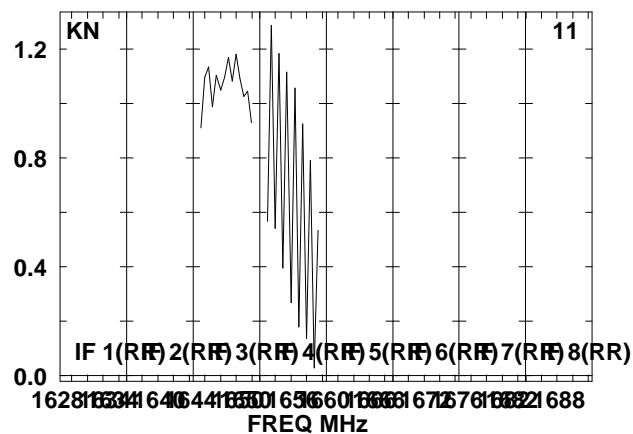
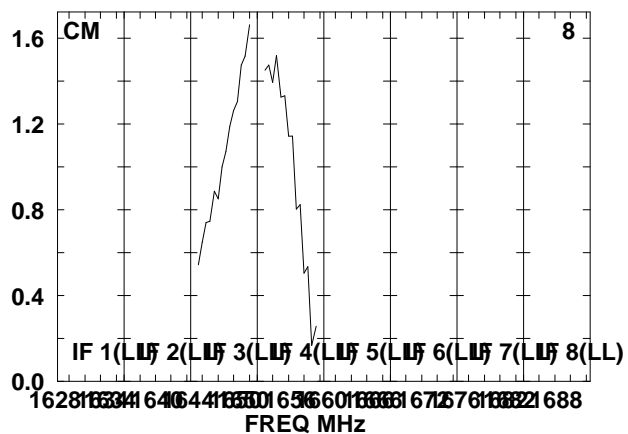
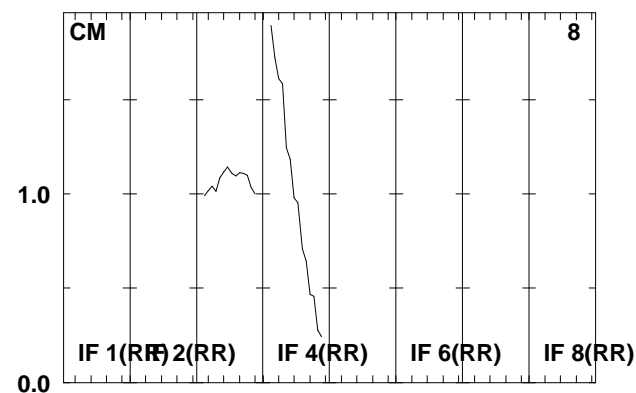
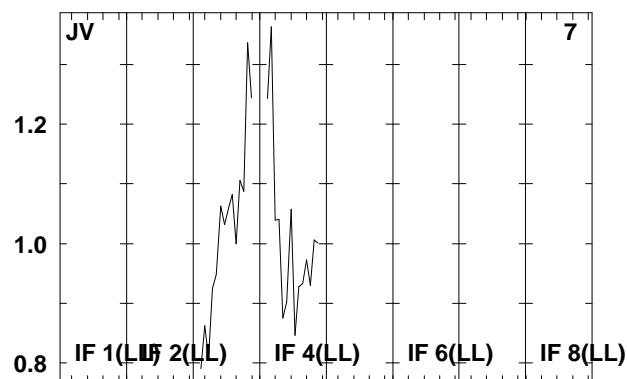
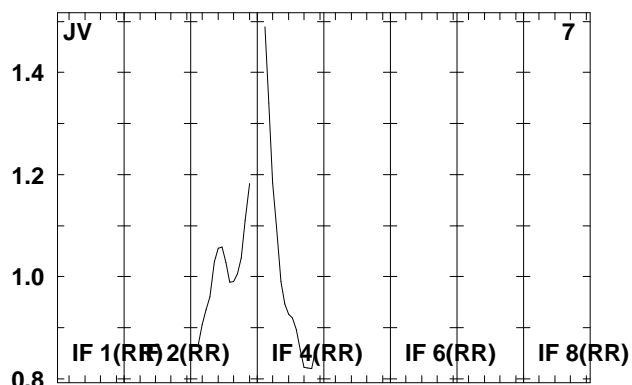
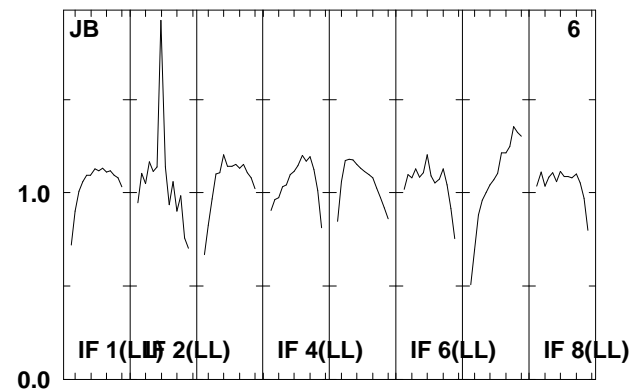
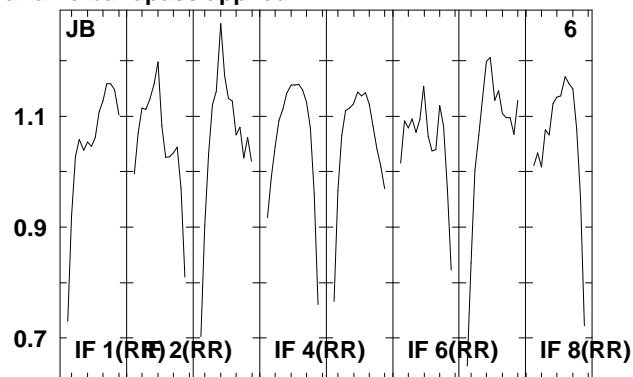
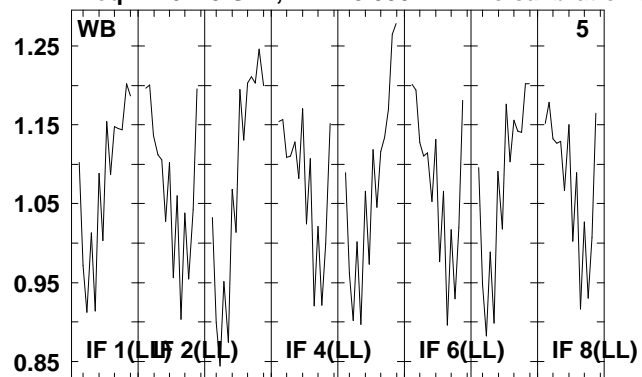

Lower frame: Real Jy  
Total-power spectrum Antenna: \*  
Timerange: 01/00:59:20 to 01/01:02:20

Plot file version 29 created 20-OCT-2009 14:48:45  
 J0137+31 RP015C.UVDATA.1  
 Freq = 1.6270 GHz, Bw = 8.000 MH No calibration applied and no bandpass applied

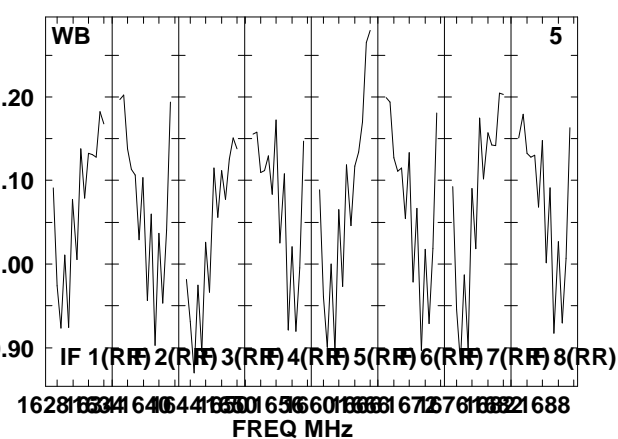
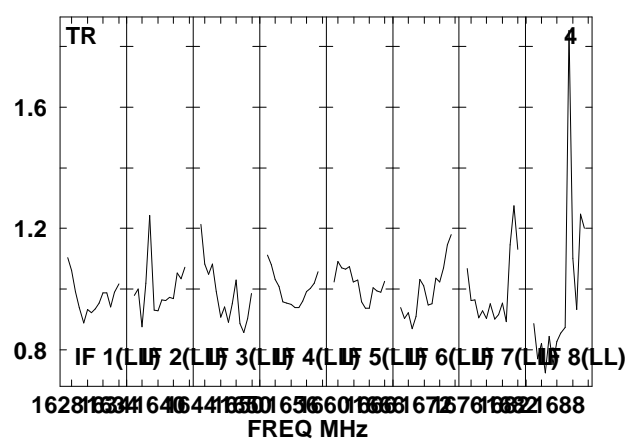
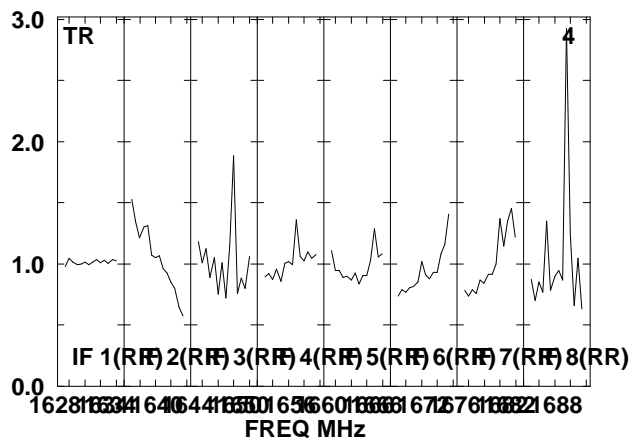
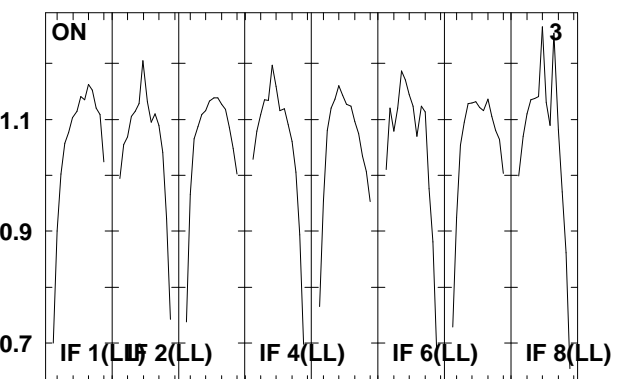
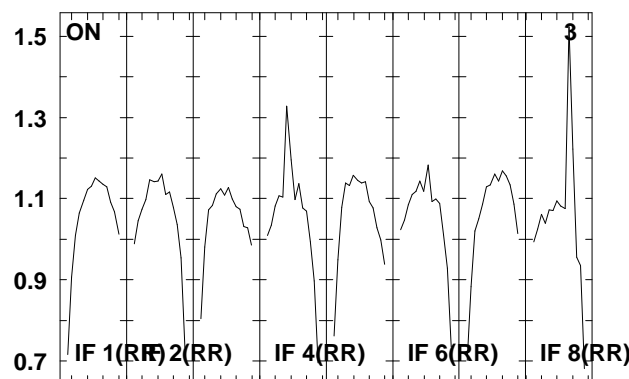
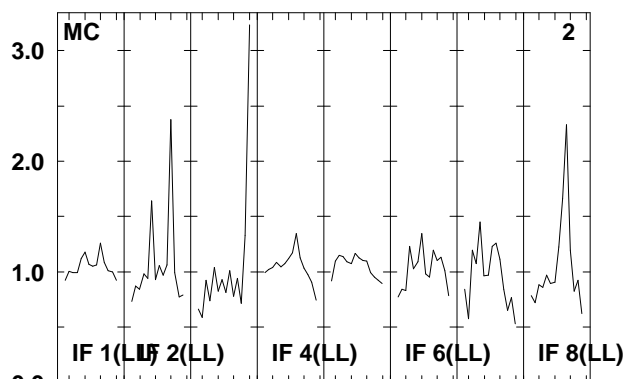
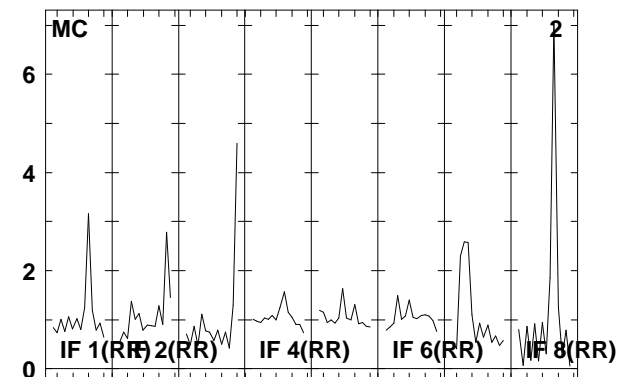
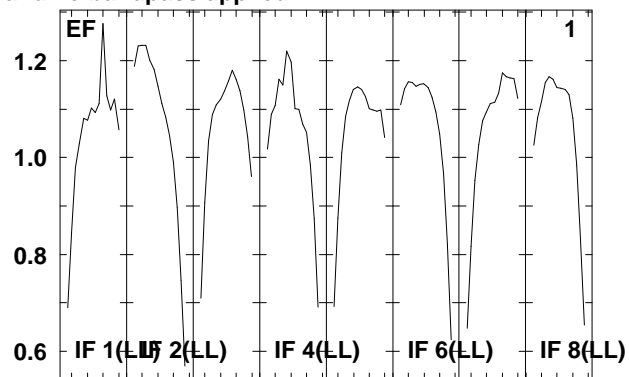
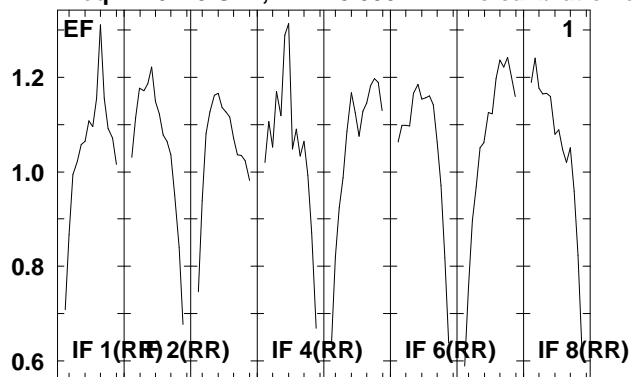

Lower frame: Real Jy  
 Total-power spectrum Antenna: \*  
 Timerange: 01/01:03:00 to 01/01:03:59

Plot file version 30 created 20-OCT-2009 14:48:45  
 J0137+31 RP015C.UVDATA.1  
 Freq = 1.6270 GHz, Bw = 8.000 MH No calibration applied and no bandpass applied

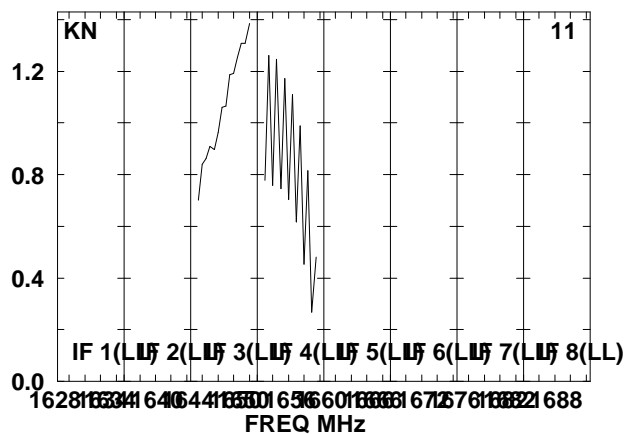
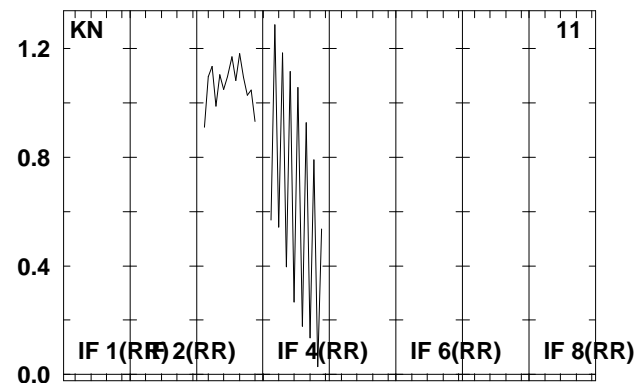
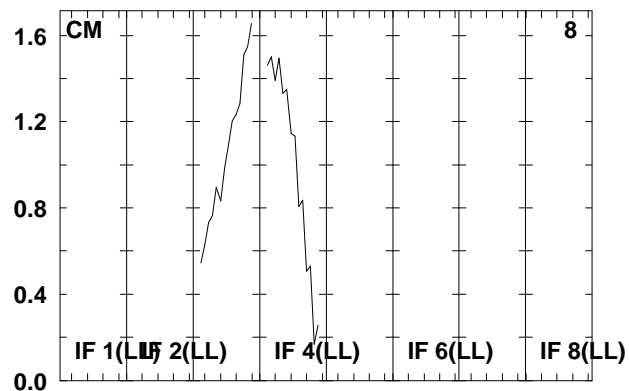
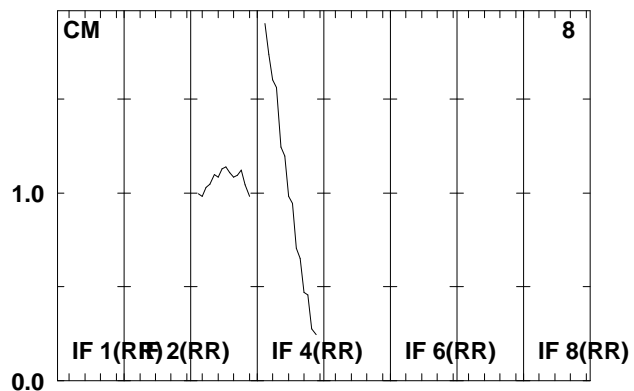
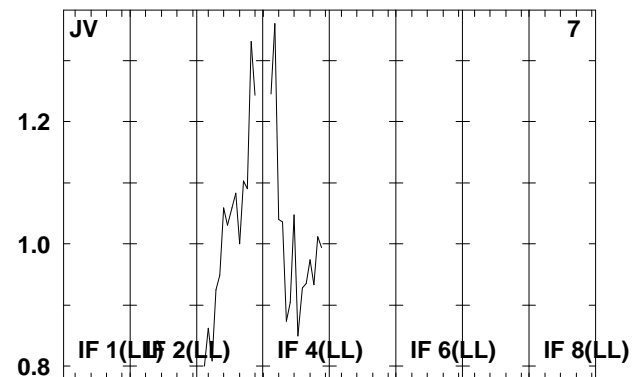
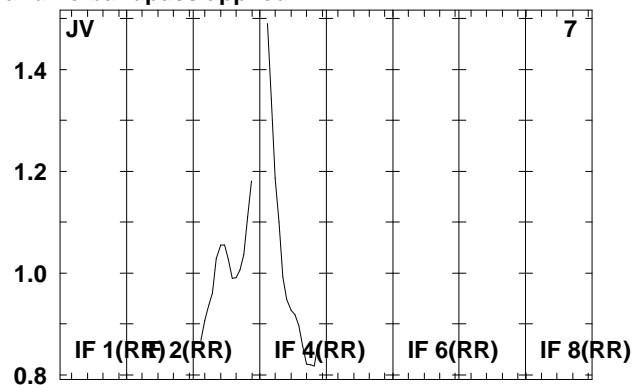
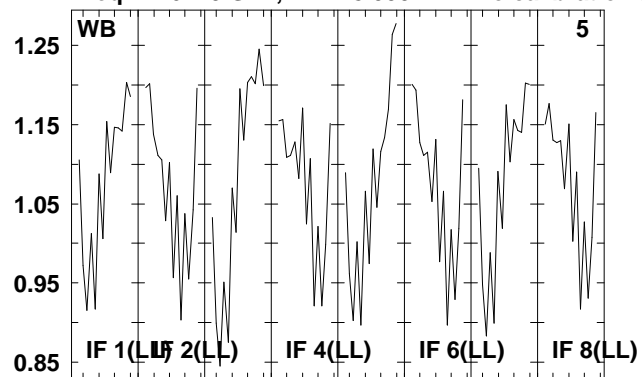

Lower frame: Real Jy  
 Total-power spectrum Antenna: \*  
 Timerange: 01/01:03:00 to 01/01:03:59

Plot file version 31 created 20-OCT-2009 14:48:46

FAINTCAL RP015C.UVDATA.1

Freq = 1.6270 GHz, Bw = 8.000 MH No calibration applied and no bandpass applied

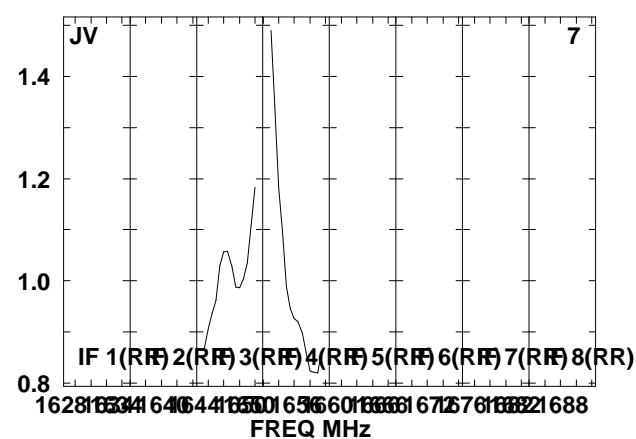
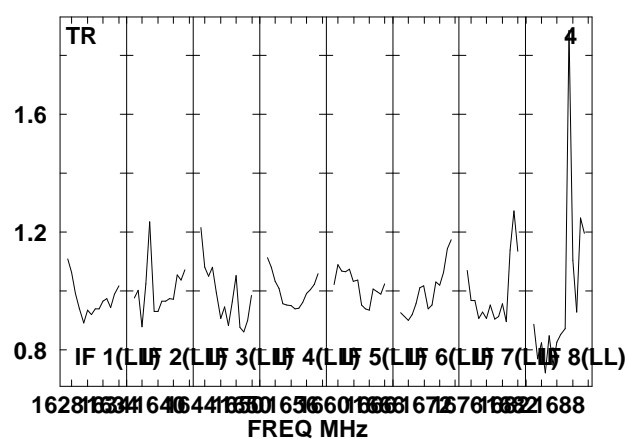
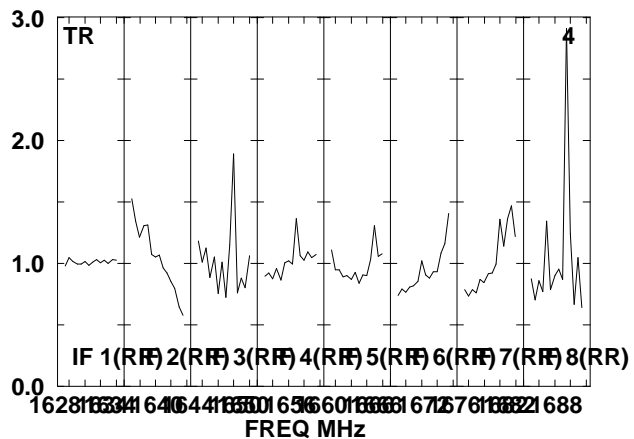
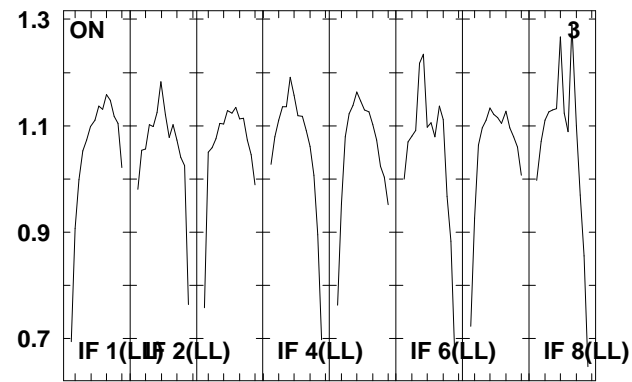
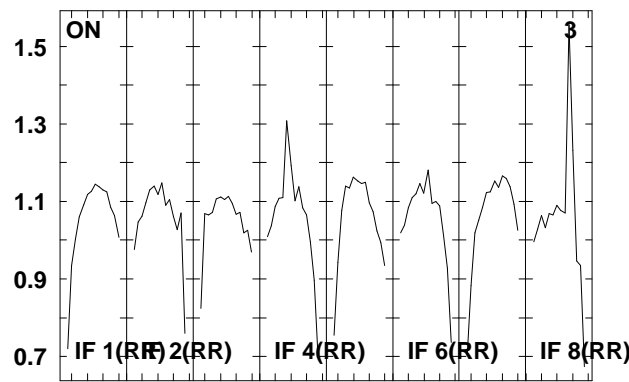
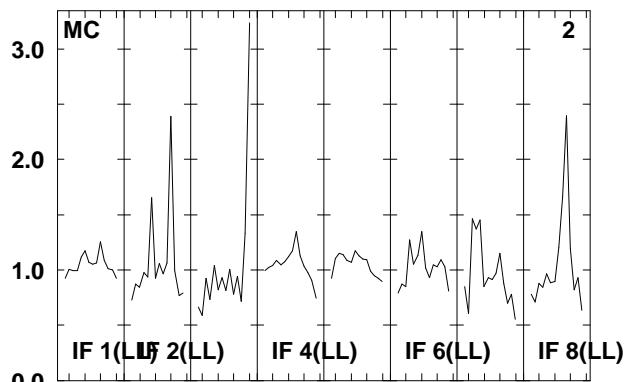
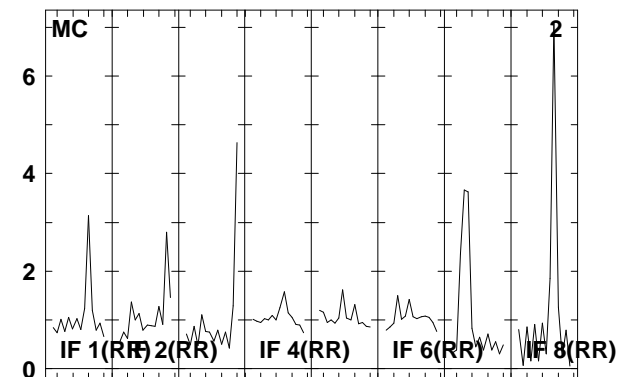
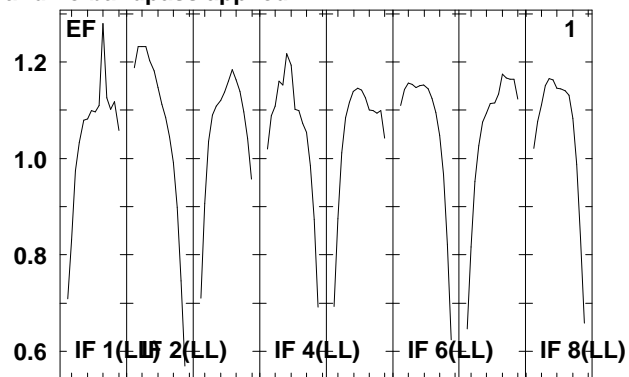
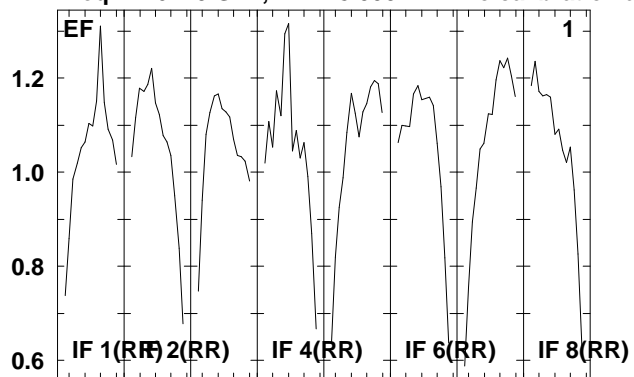

Lower frame: Real Jy  
Total-power spectrum Antenna: \*  
Timerange: 01/01:04:01 to 01/01:05:20

Plot file version 32 created 20-OCT-2009 14:48:47

FAINTCAL RP015C.UVDATA.1

Freq = 1.6270 GHz, Bw = 8.000 MH No calibration applied and no bandpass applied

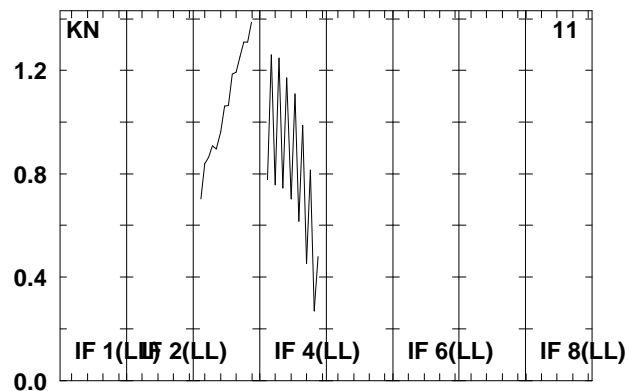
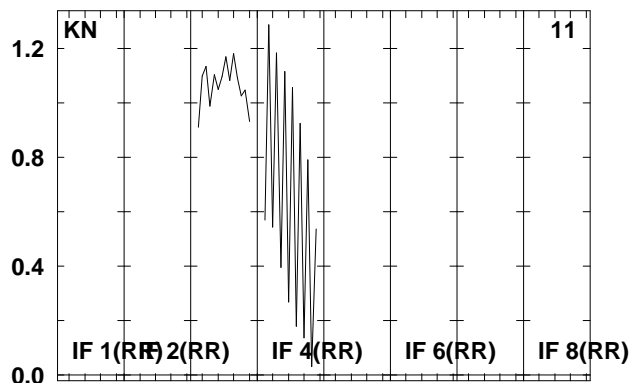
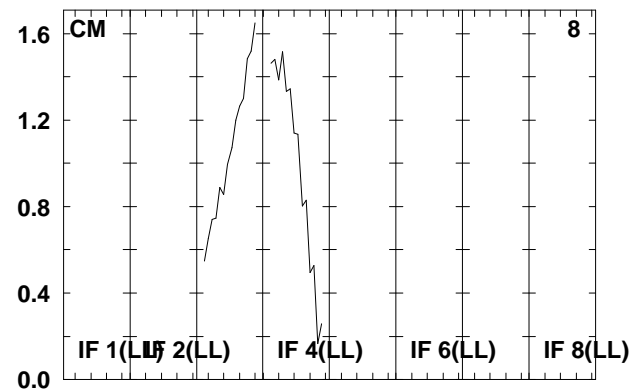
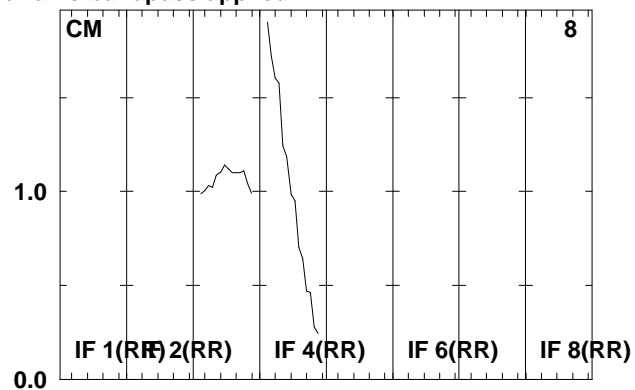
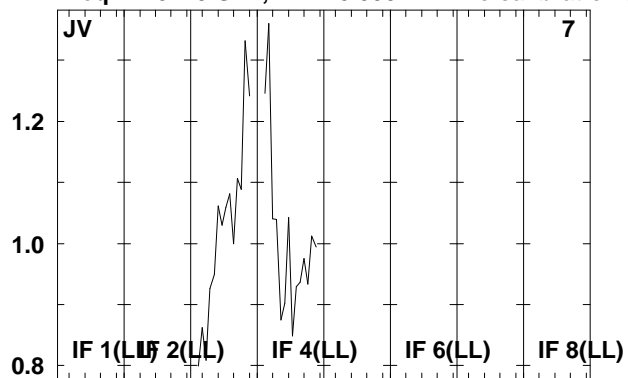

Lower frame: Real Jy  
Total-power spectrum Antenna: \*  
Timerange: 01/01:04:01 to 01/01:05:20



Plot file version 33 created 20-OCT-2009 14:48:47

M33 RP015C.UVDATA.1

Freq = 1.6270 GHz, Bw = 8.000 MH No calibration applied and no bandpass applied

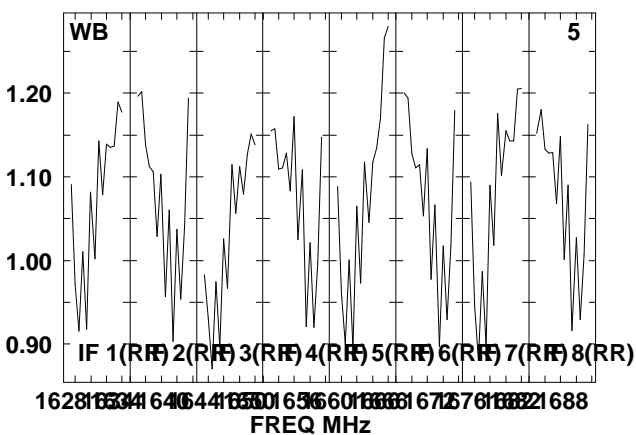
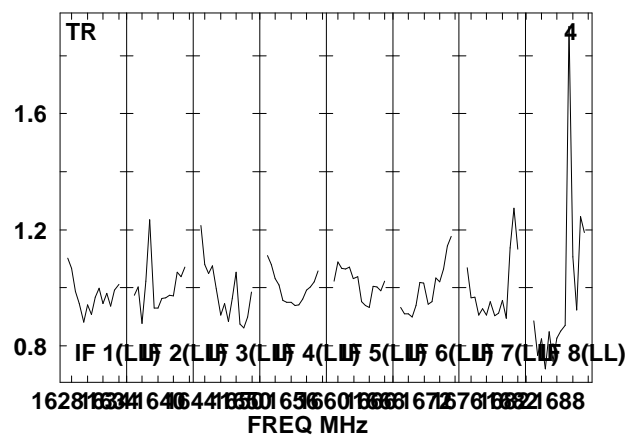
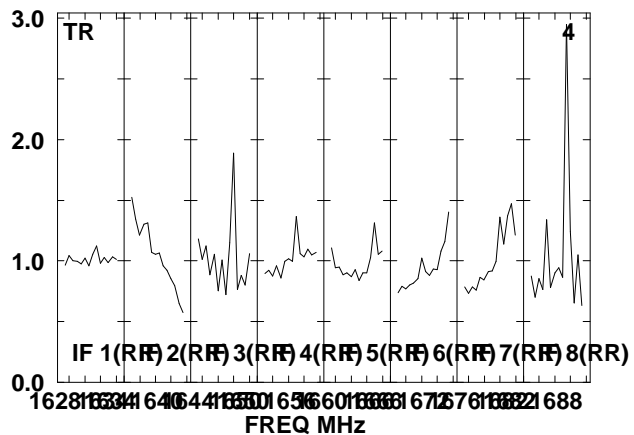
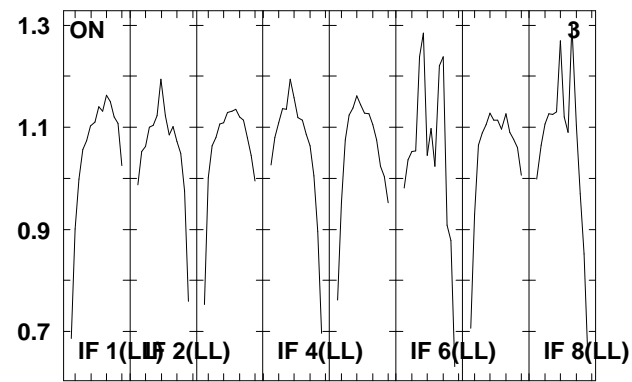
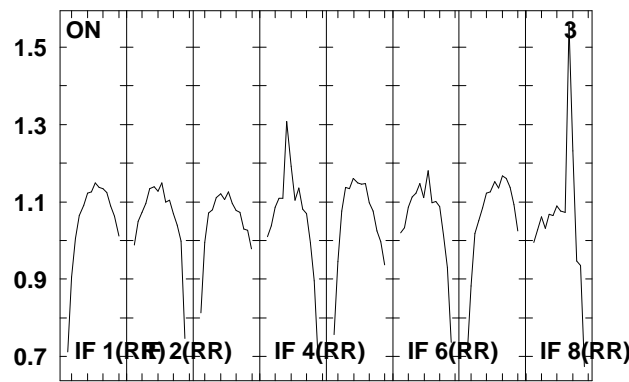
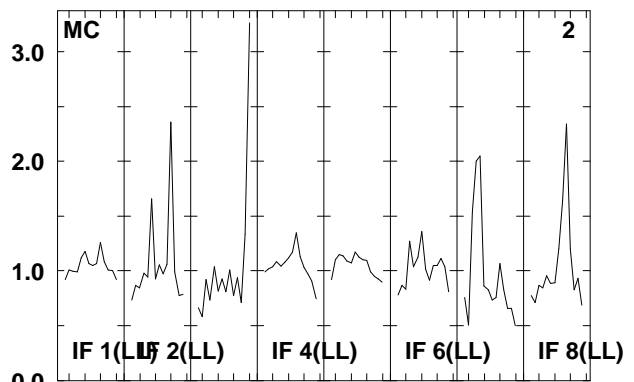
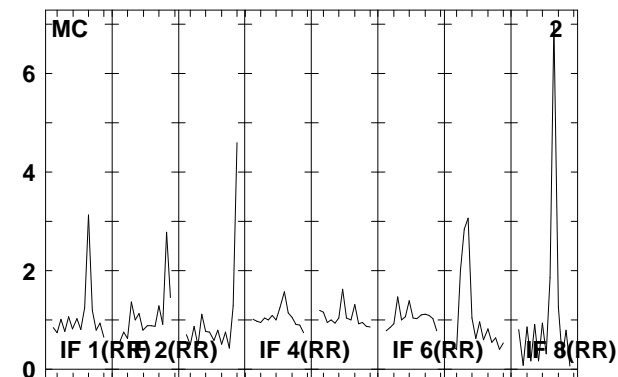
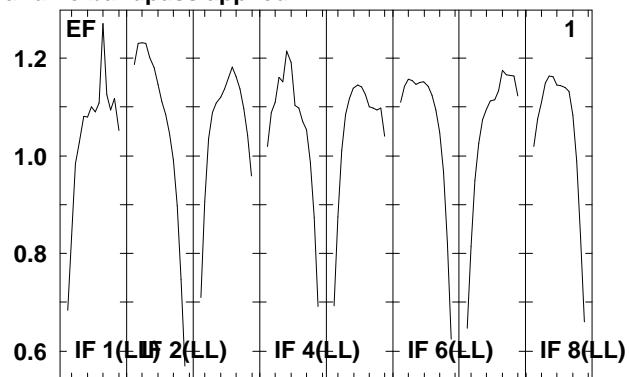
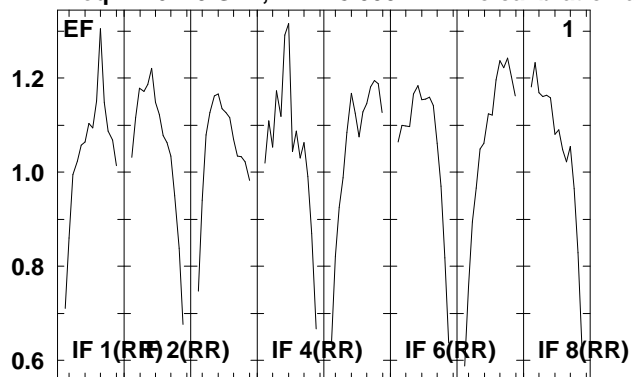

Lower frame: Real Jy  
Total-power spectrum Antenna: \*  
Timerange: 01/01:05:20 to 01/01:08:20

Plot file version 34 created 20-OCT-2009 14:48:48  
 M33 RP015C.UVDATA.1  
 Freq = 1.6270 GHz, Bw = 8.000 MH No calibration applied and no bandpass applied

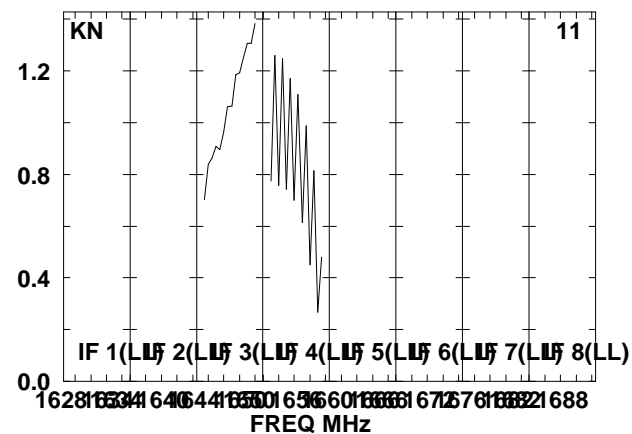
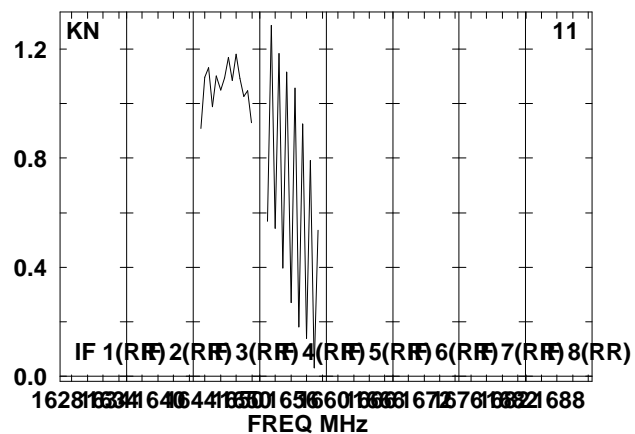
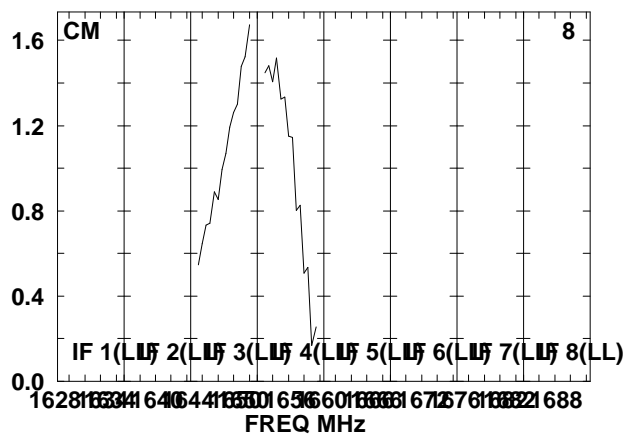
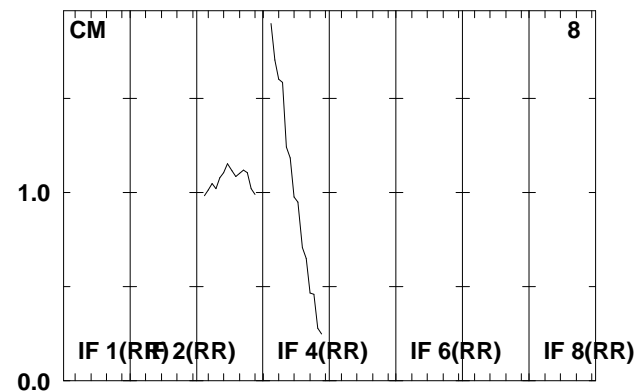
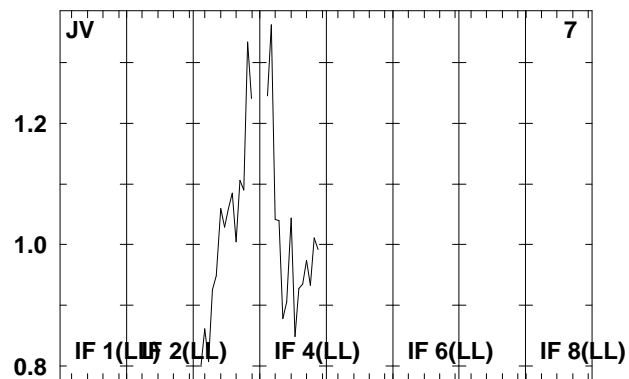
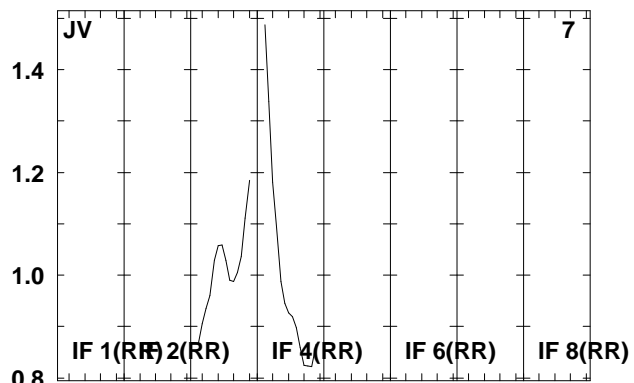
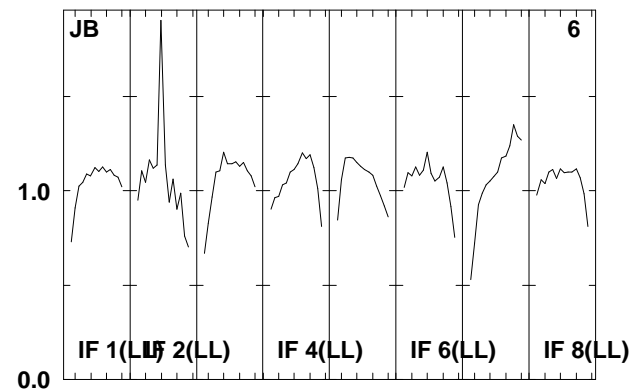
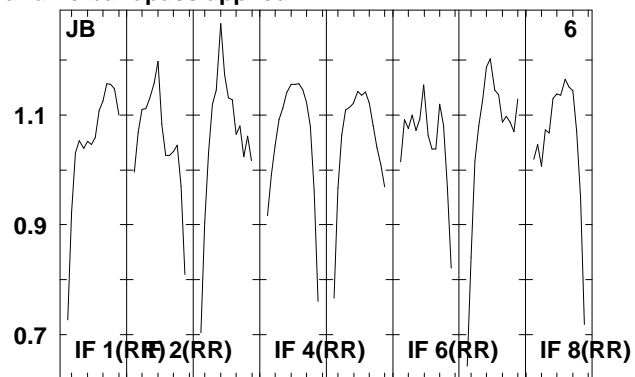
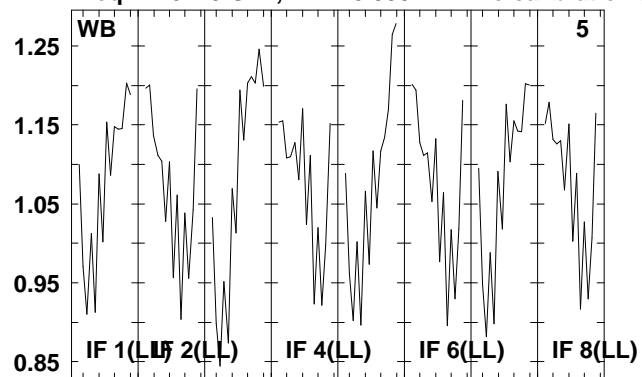

Lower frame: Real Jy  
 Total-power spectrum Antenna: \*  
 Timerange: 01/01:05:20 to 01/01:08:20

Plot file version 35 created 20-OCT-2009 14:48:52  
 J0137+31 RP015C.UVDATA.1  
 Freq = 1.6270 GHz, Bw = 8.000 MH No calibration applied and no bandpass applied

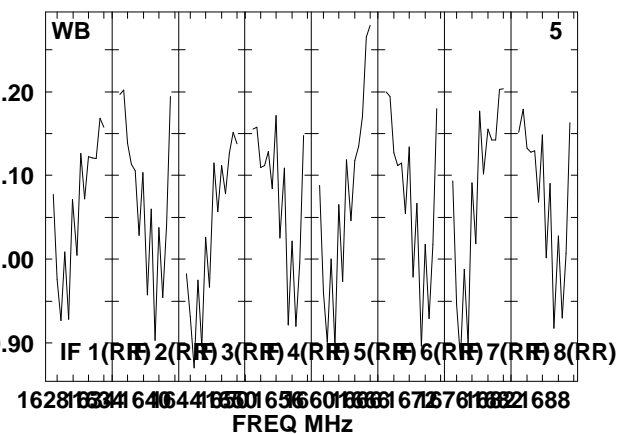
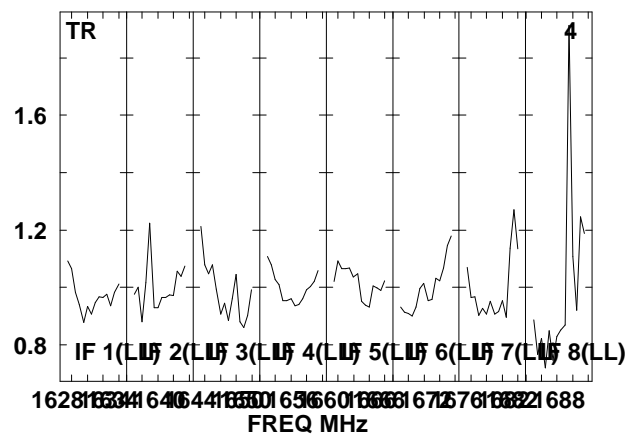
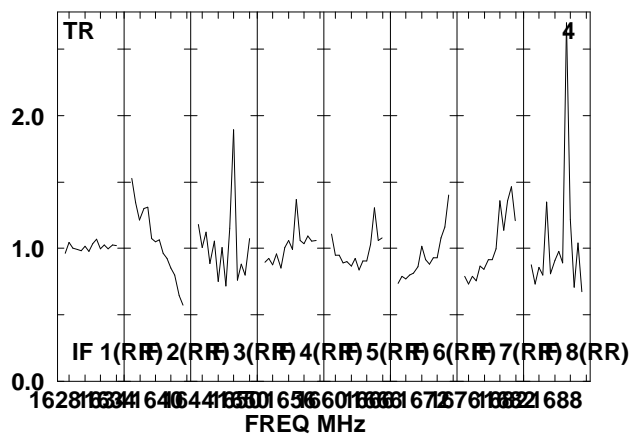
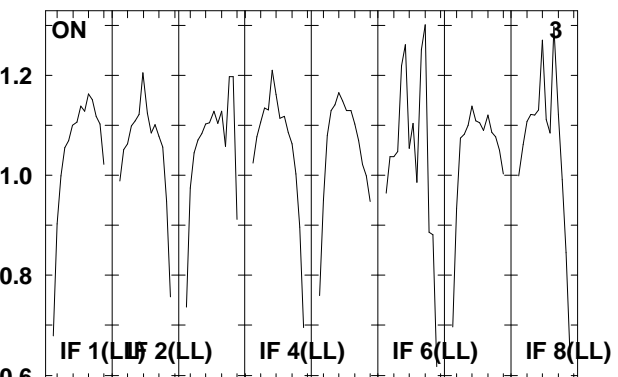
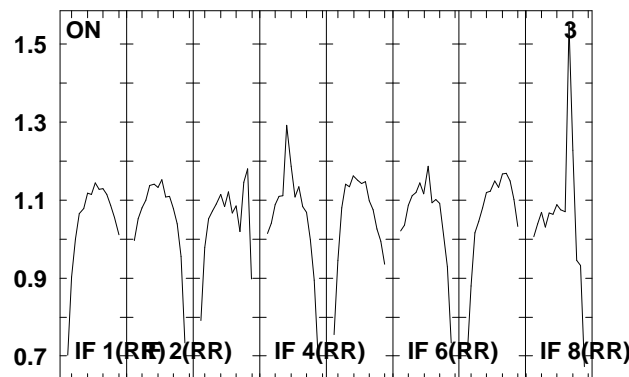
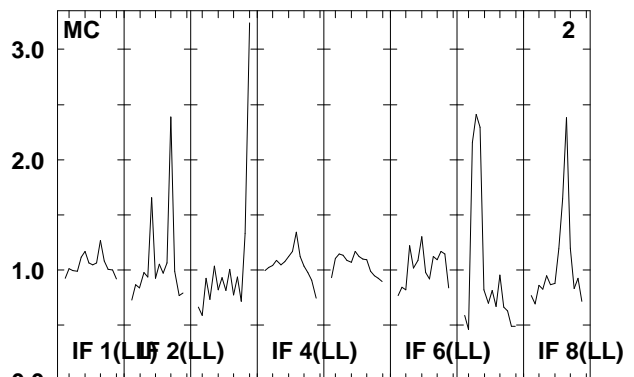
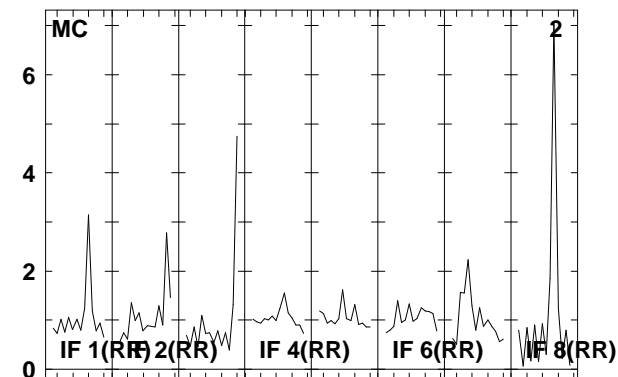
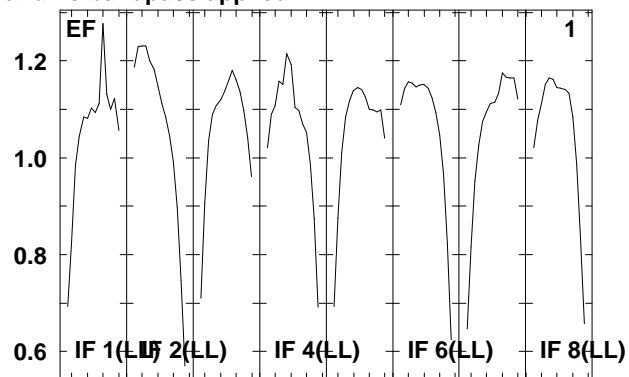
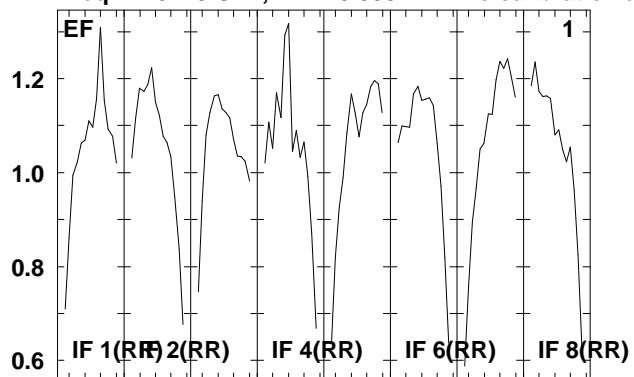

Lower frame: Real Jy  
 Total-power spectrum Antenna: \*  
 Timerange: 01/01:09:01 to 01/01:09:59

Plot file version 36 created 20-OCT-2009 14:48:52  
 J0137+31 RP015C.UVDATA.1  
 Freq = 1.6270 GHz, Bw = 8.000 MH No calibration applied and no bandpass applied

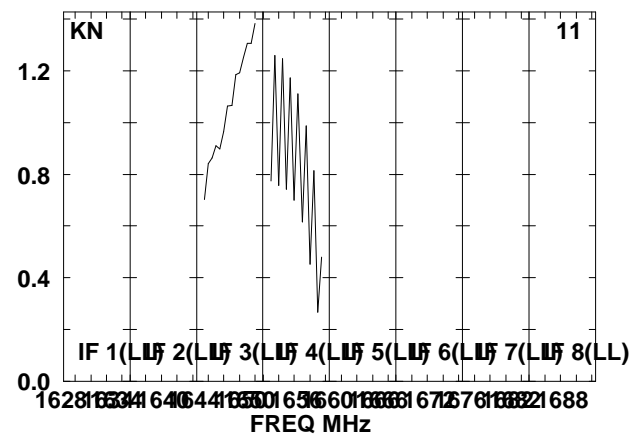
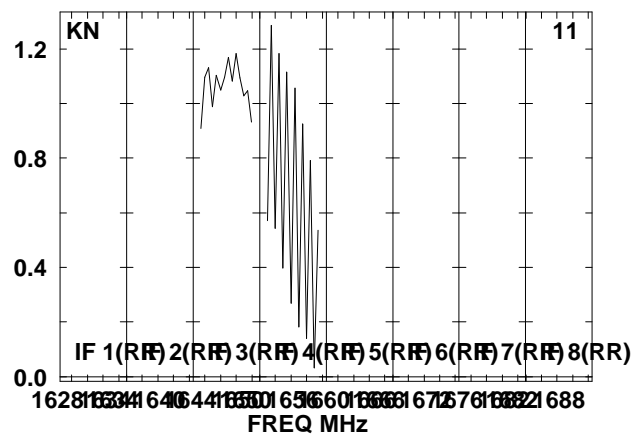
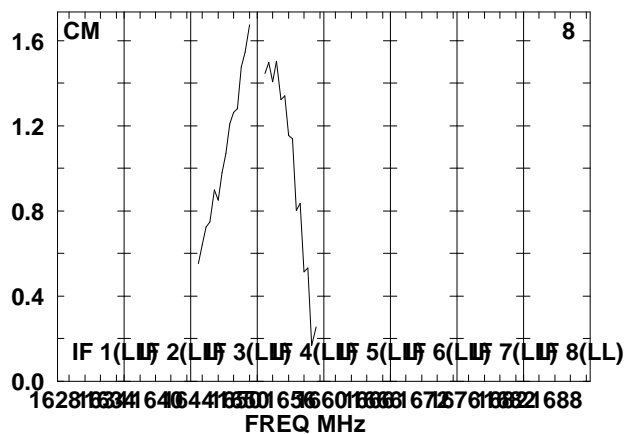
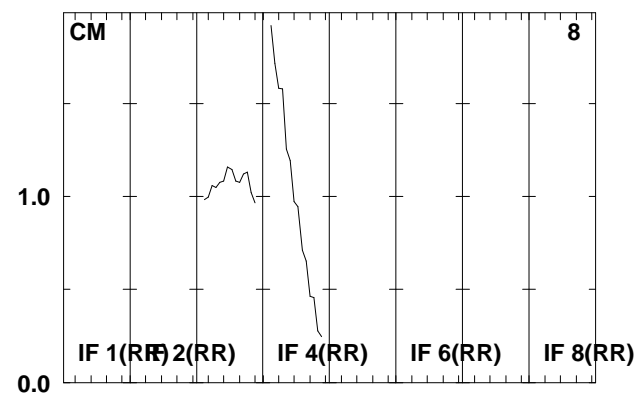
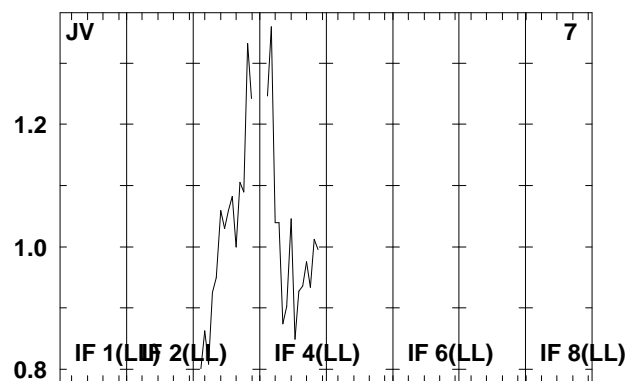
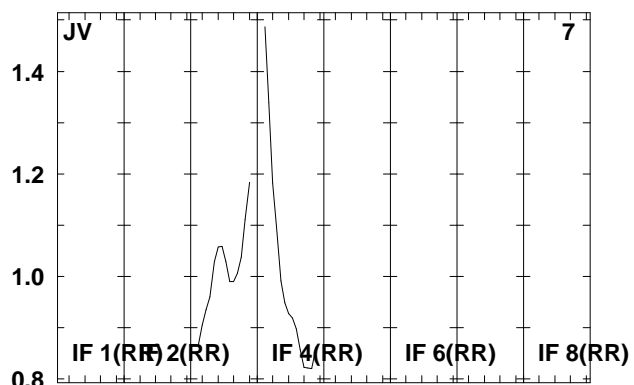
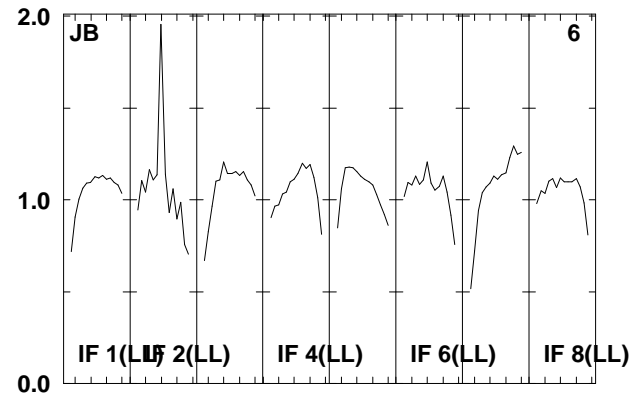
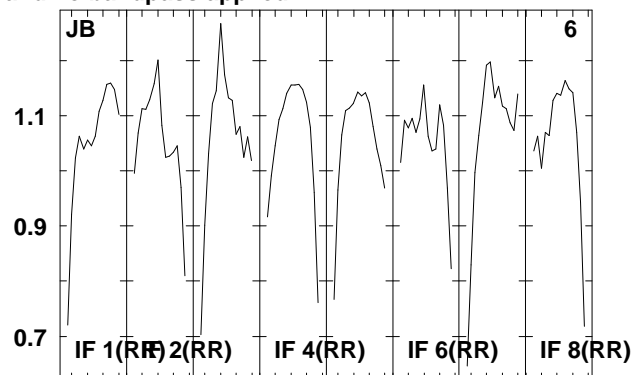
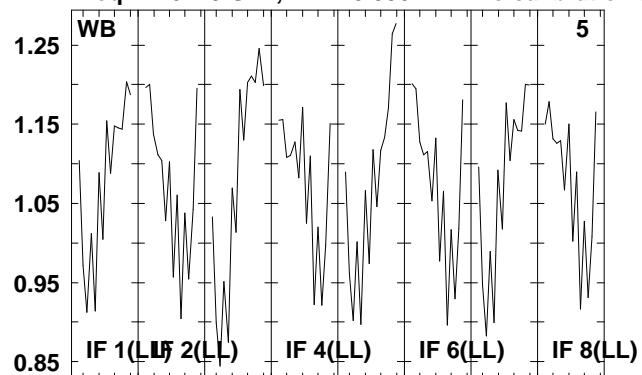

Lower frame: Real Jy  
 Total-power spectrum Antenna: \*  
 Timerange: 01/01:09:01 to 01/01:09:59

Plot file version 37 created 20-OCT-2009 14:48:53

FAINTCAL RP015C.UVDATA.1

Freq = 1.6270 GHz, Bw = 8.000 MH No calibration applied and no bandpass applied

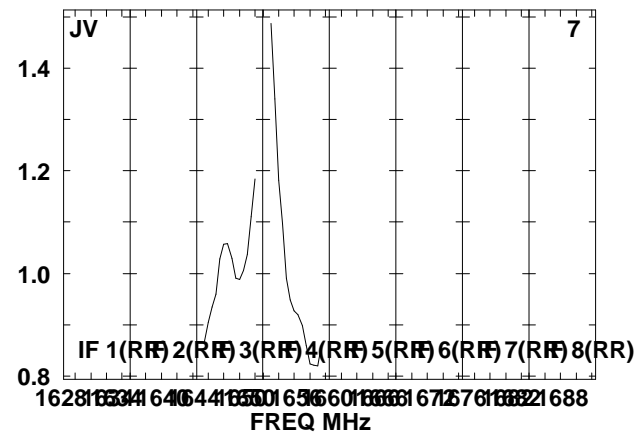
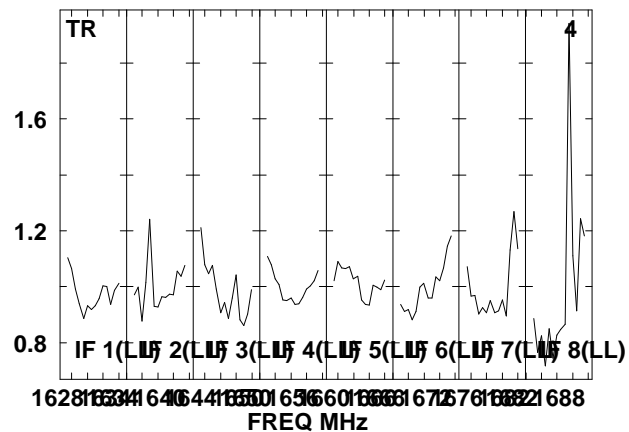
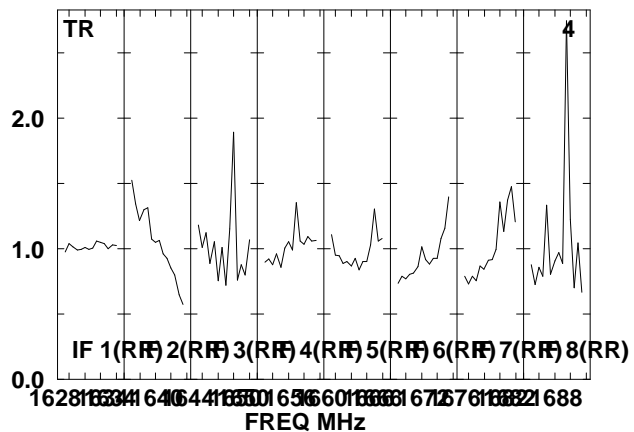
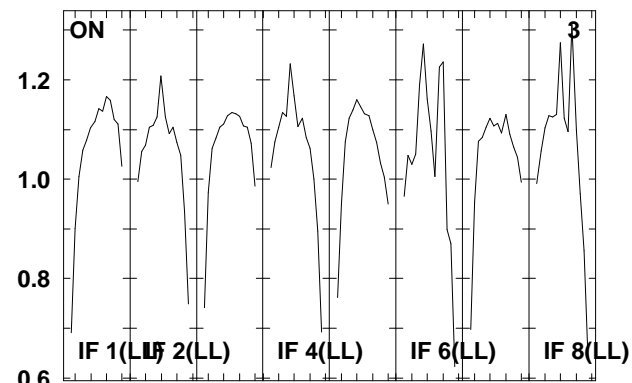
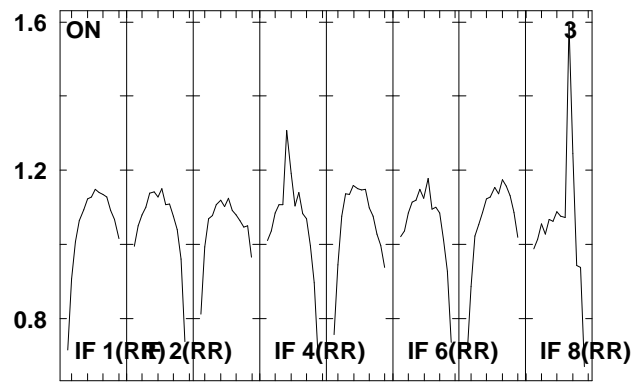
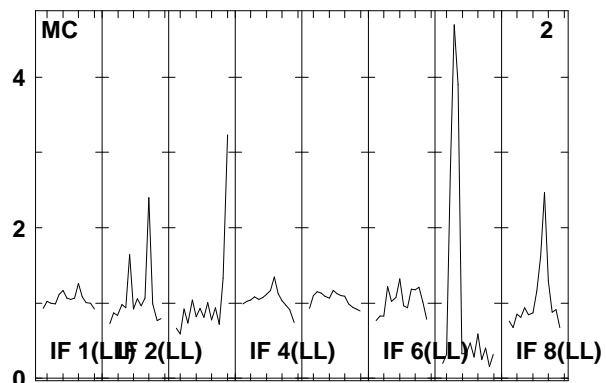
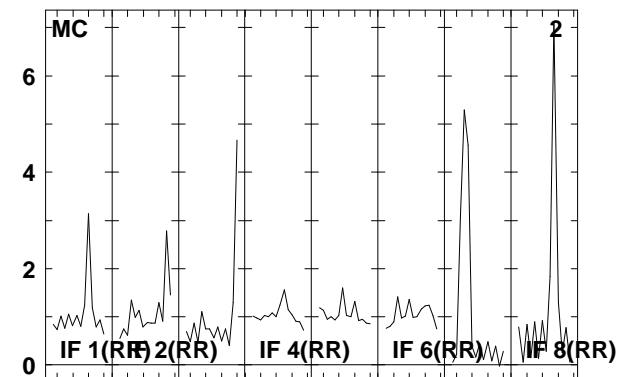
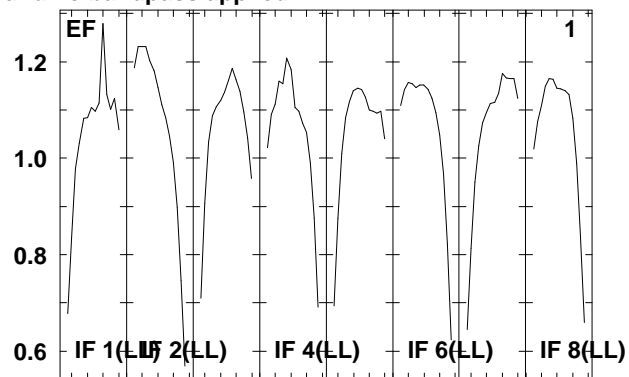
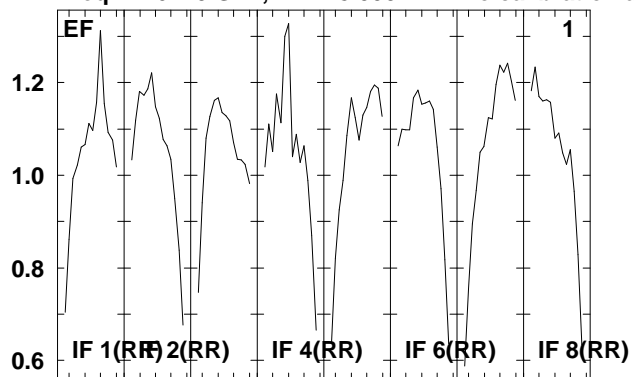

Lower frame: Real Jy

Total-power spectrum Antenna: \*

Timerange: 01/01:10:00 to 01/01:11:19

Plot file version 38 created 20-OCT-2009 14:48:53

FAINTCAL RP015C.UVDATA.1

Freq = 1.6270 GHz, Bw = 8.000 MH No calibration applied and no bandpass applied

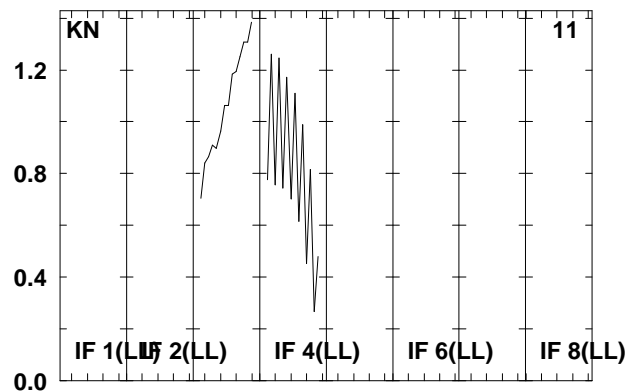
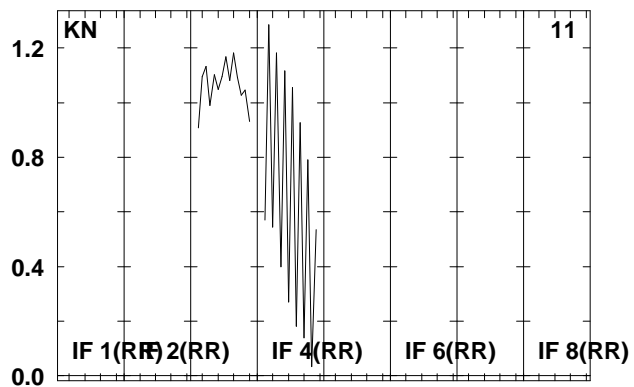
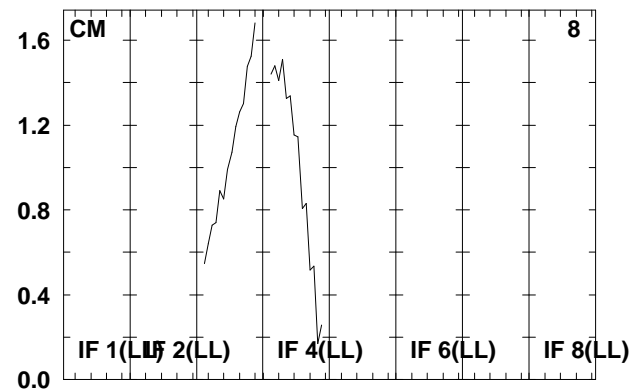
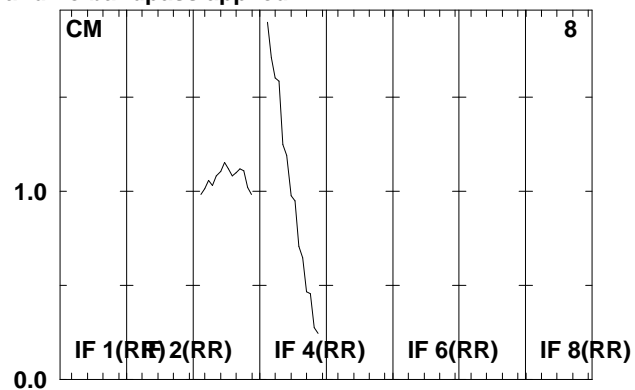
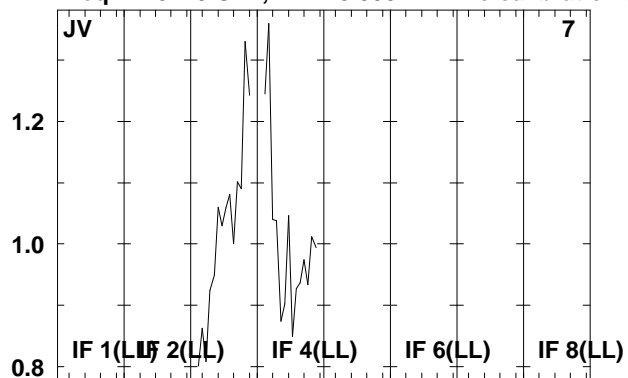

Lower frame: Real Jy  
Total-power spectrum Antenna: \*  
Timerange: 01/01:10:00 to 01/01:11:19

Plot file version 39 created 20-OCT-2009 14:48:54

M33 RP015C.UVDATA.1

Freq = 1.6270 GHz, Bw = 8.000 MH No calibration applied and no bandpass applied

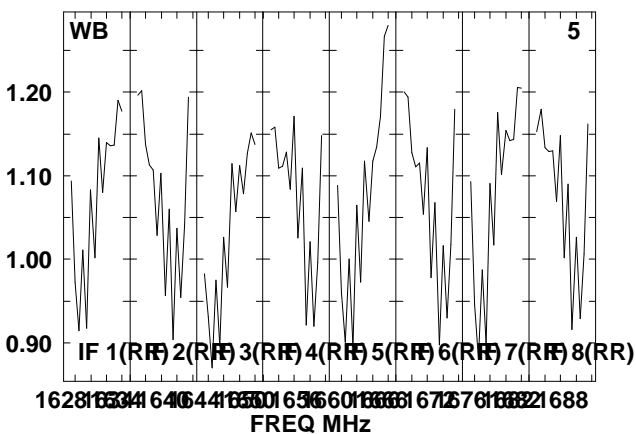
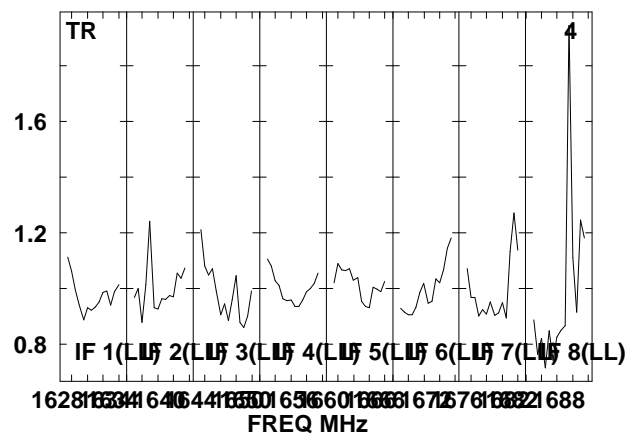
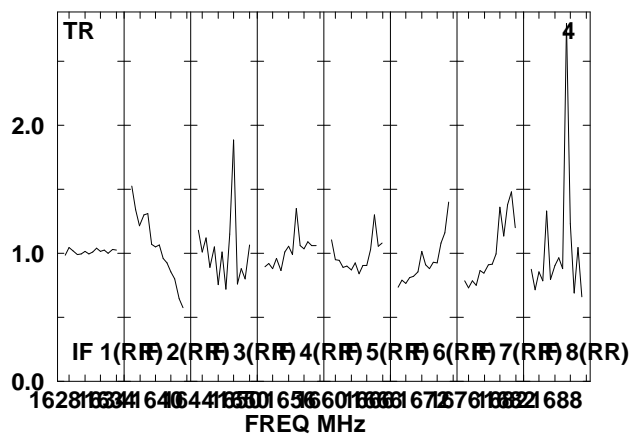
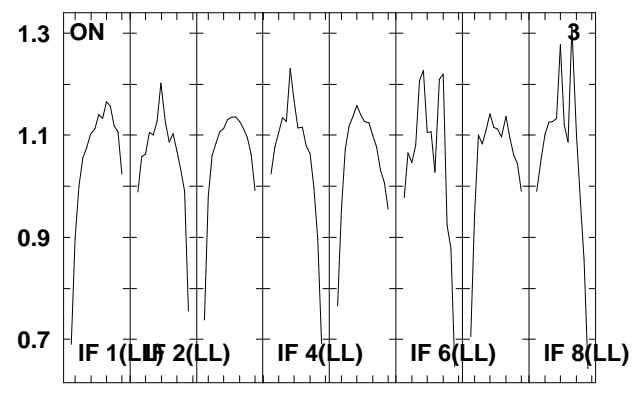
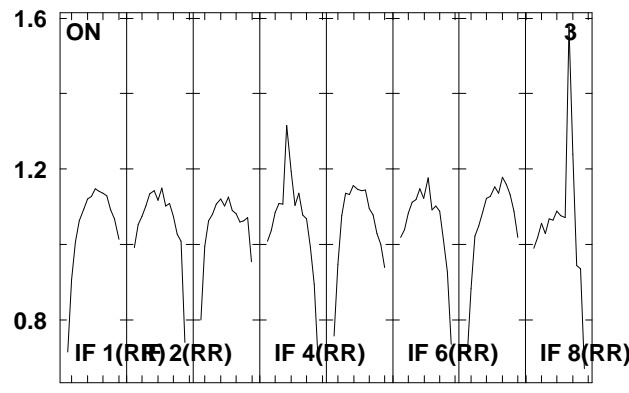
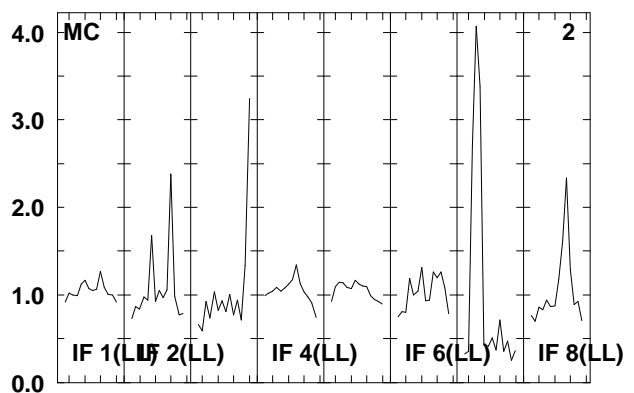
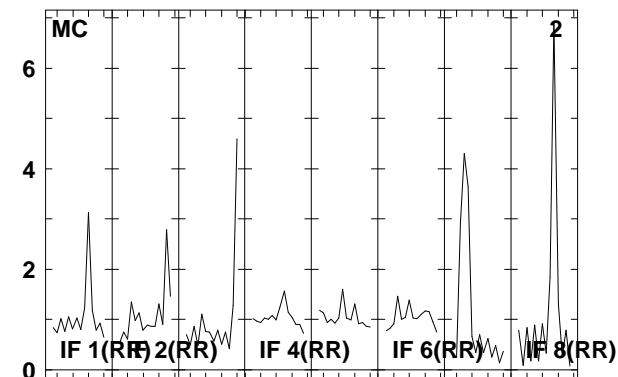
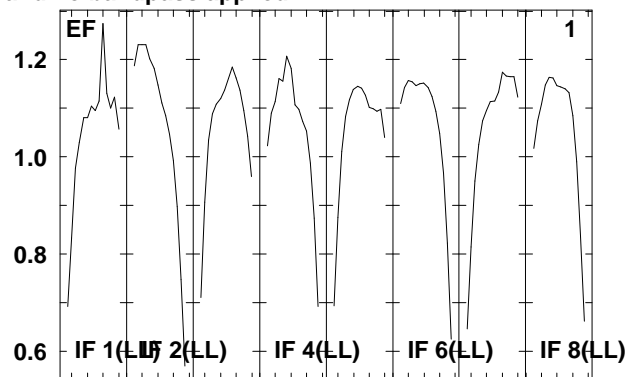
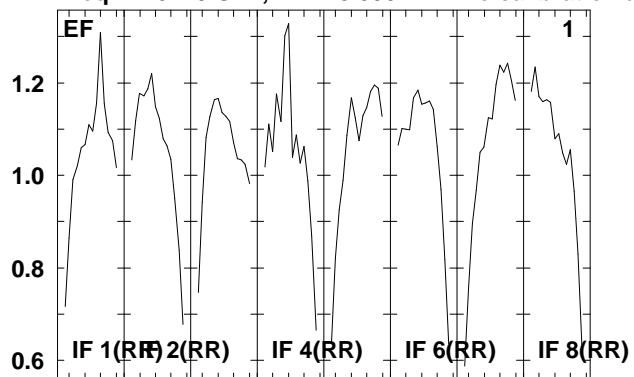

Lower frame: Real Jy

Total-power spectrum Antenna: \*

Timerange: 01/01:11:20 to 01/01:14:19

Plot file version 40 created 20-OCT-2009 14:48:55

M33 RP015C.UVDATA.1

Freq = 1.6270 GHz, Bw = 8.000 MH No calibration applied and no bandpass applied

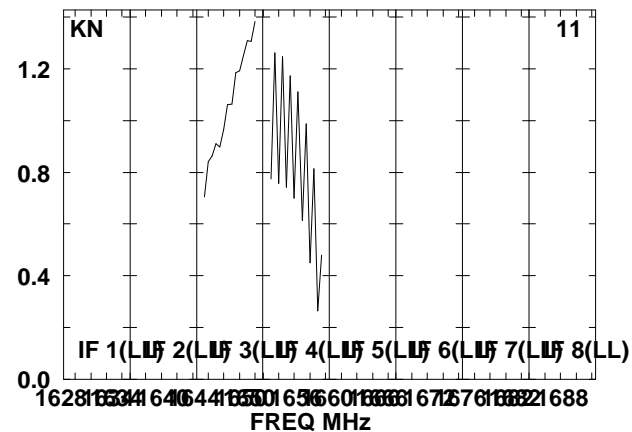
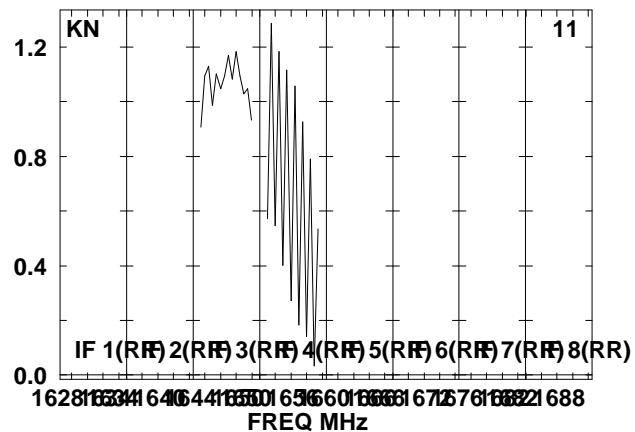
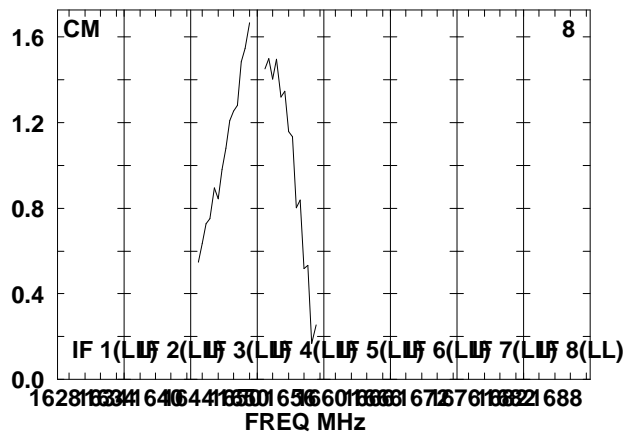
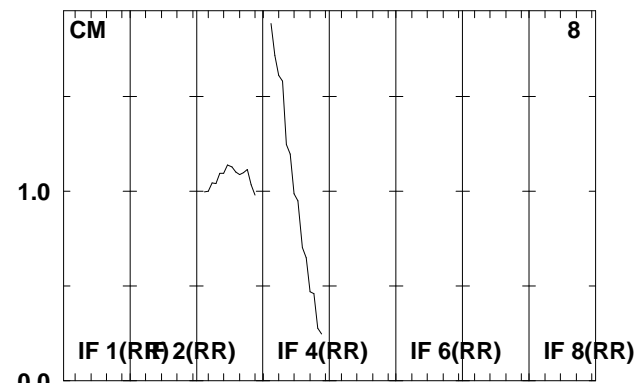
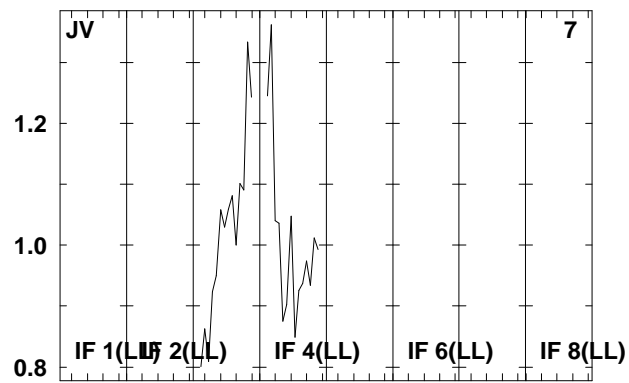
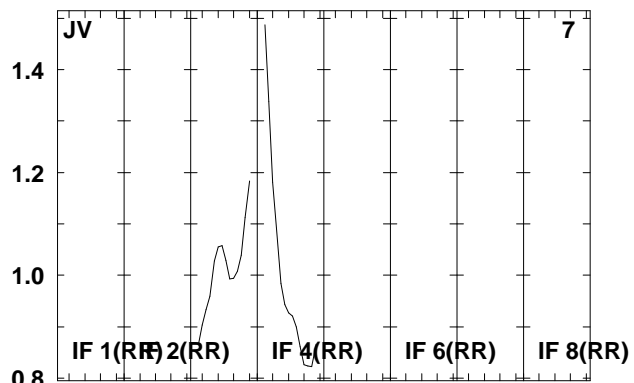
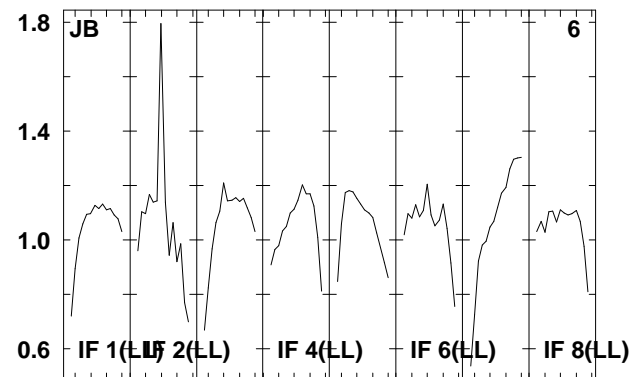
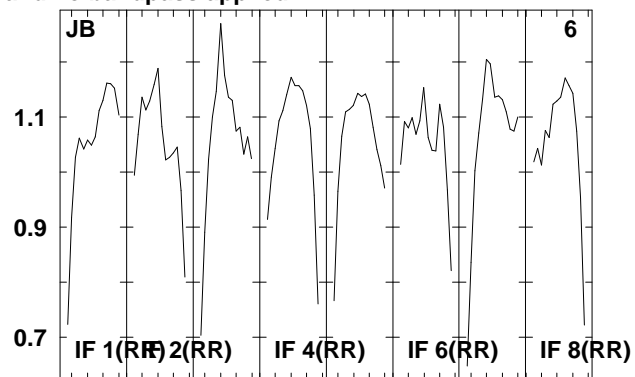
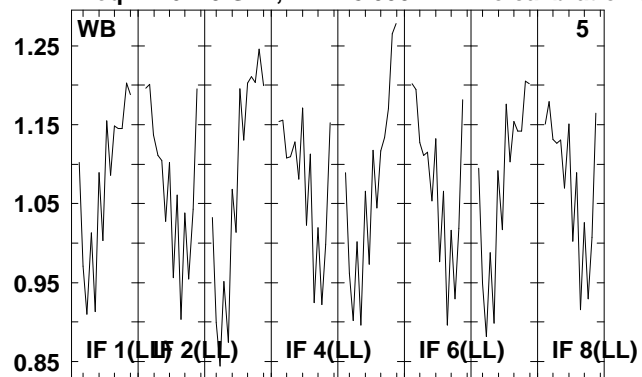

Lower frame: Real Jy  
Total-power spectrum Antenna: \*  
Timerange: 01/01:11:20 to 01/01:14:19



Plot file version 41 created 20-OCT-2009 14:48:56

J0137+31 RP015C.UVDATA.1

Freq = 1.6270 GHz, Bw = 8.000 MH No calibration applied and no bandpass applied

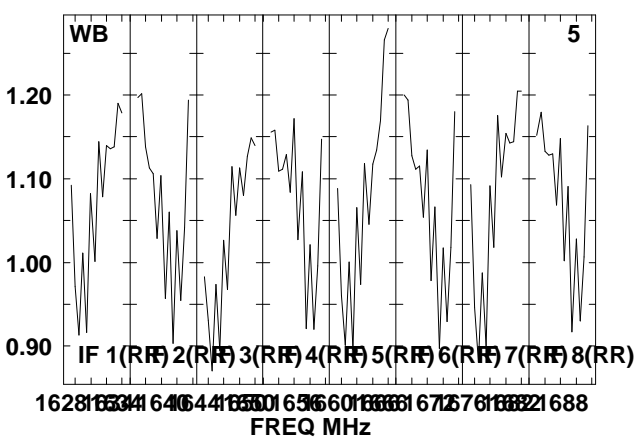
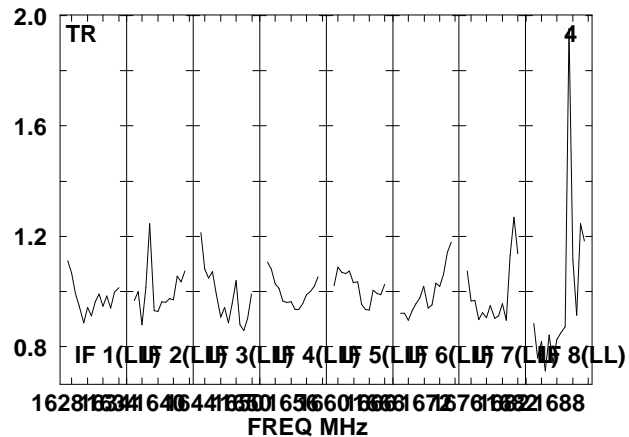
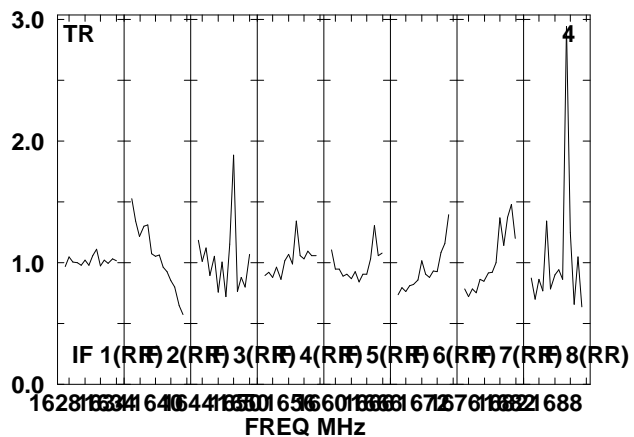
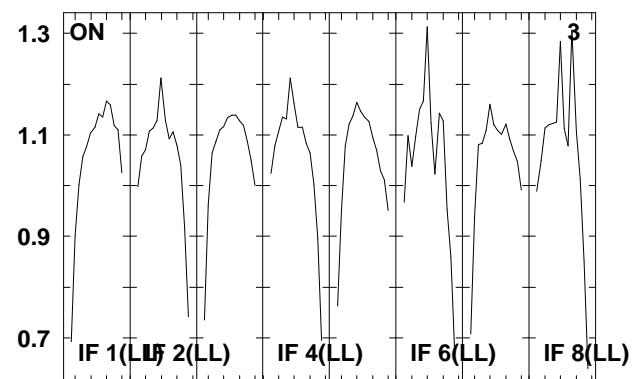
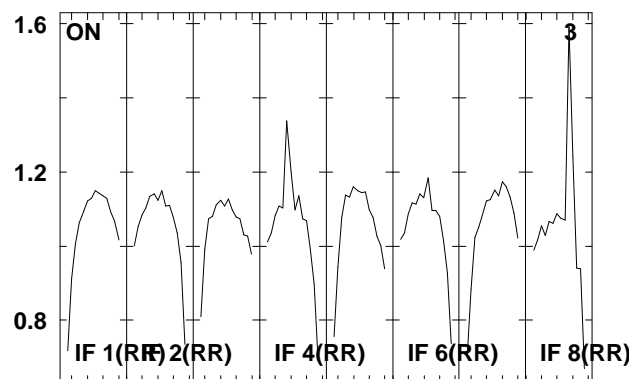
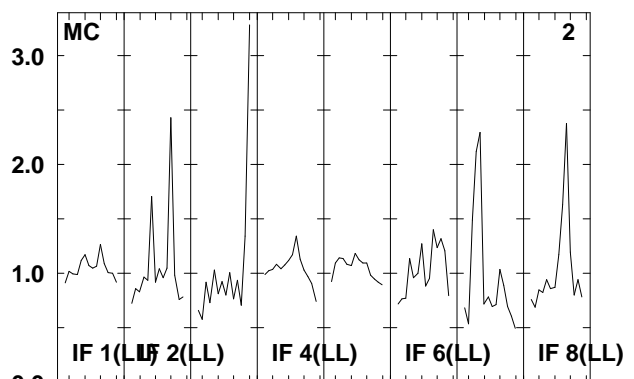
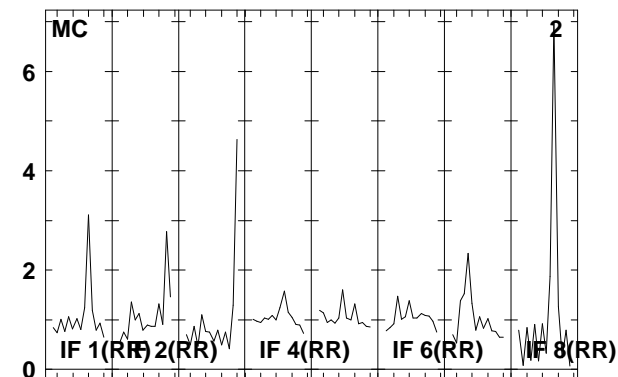
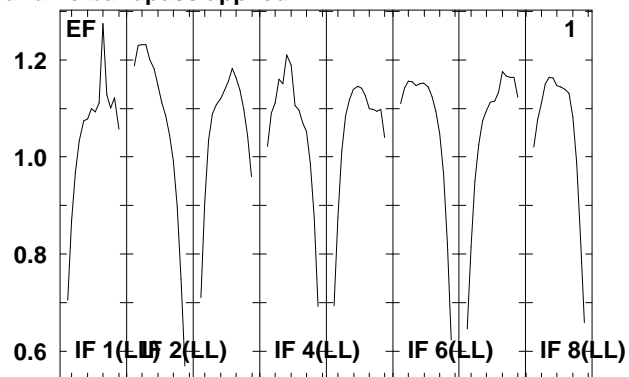
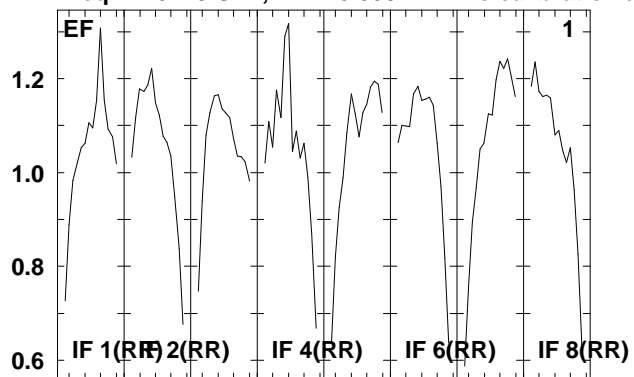

Lower frame: Real Jy  
Total-power spectrum Antenna: \*  
Timerange: 01/01:15:01 to 01/01:16:00

Plot file version 42 created 20-OCT-2009 14:48:57

J0137+31 RP015C.UVDATA.1

Freq = 1.6270 GHz, Bw = 8.000 MH No calibration applied and no bandpass applied

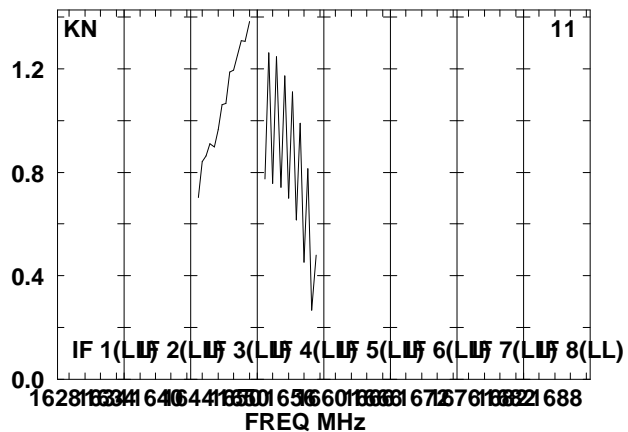
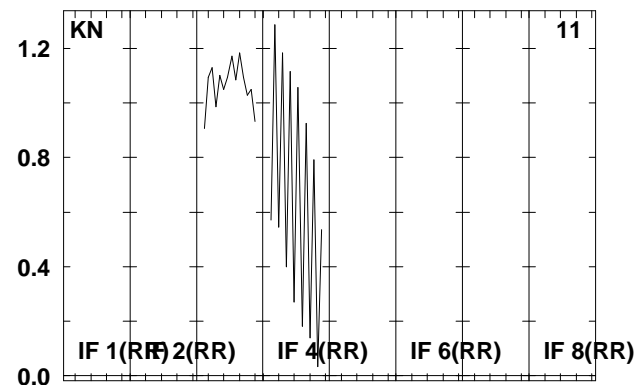
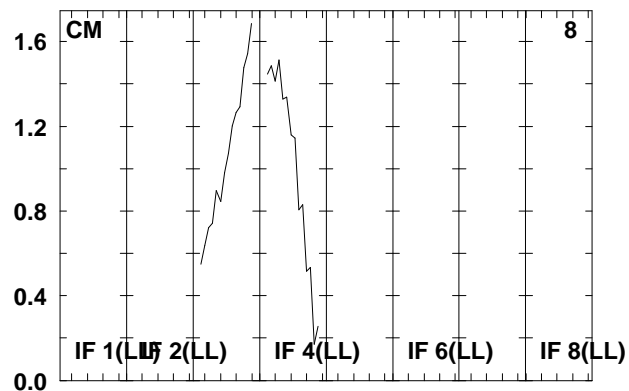
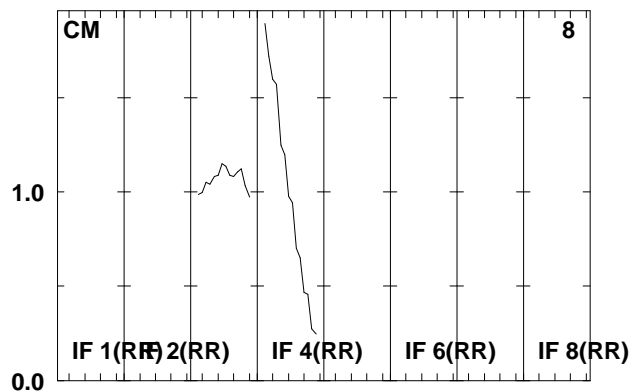
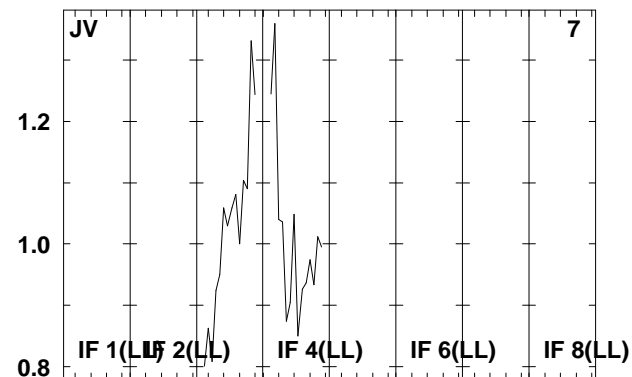
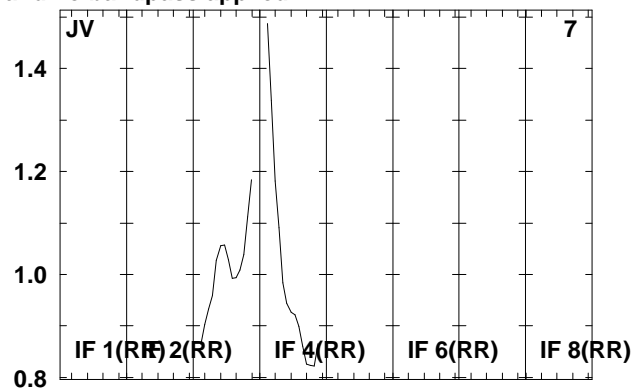
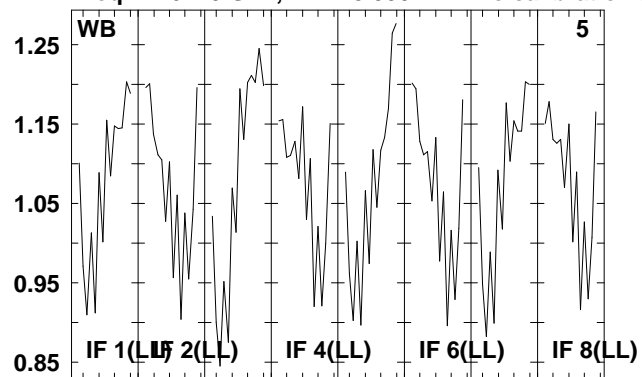

Lower frame: Real Jy

Total-power spectrum Antenna: \*

Timerange: 01/01:15:01 to 01/01:16:00

Plot file version 43 created 20-OCT-2009 14:48:57

FAINTCAL RP015C.UVDATA.1

Freq = 1.6270 GHz, Bw = 8.000 MH No calibration applied and no bandpass applied

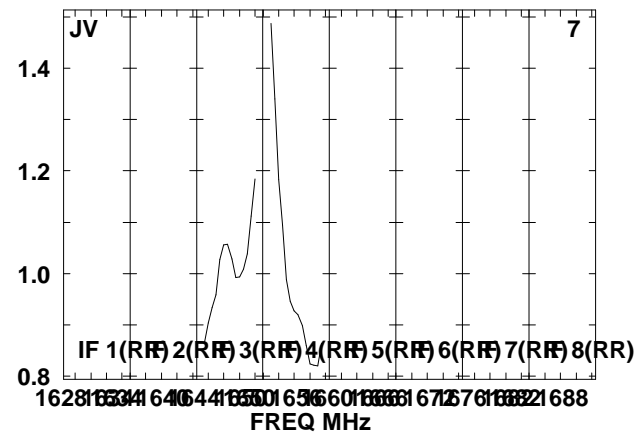
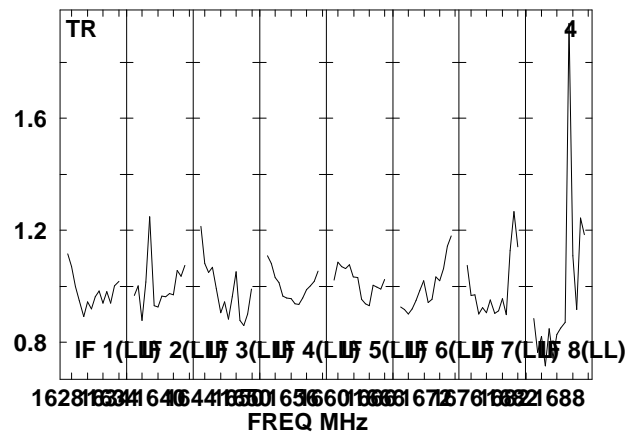
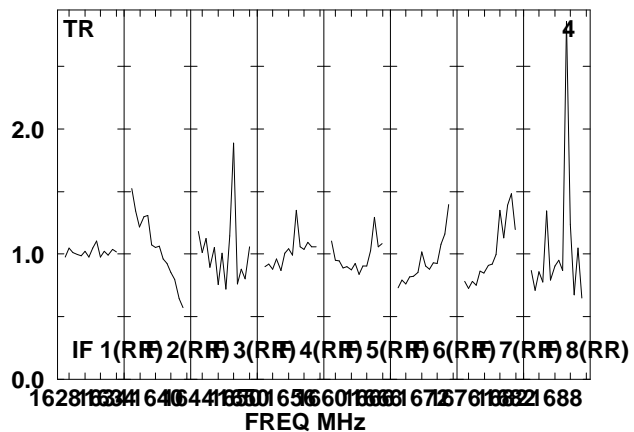
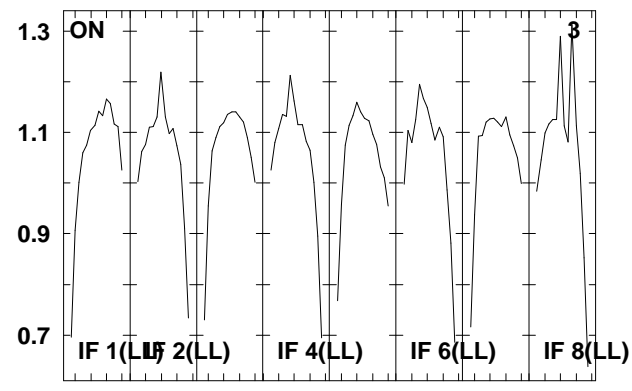
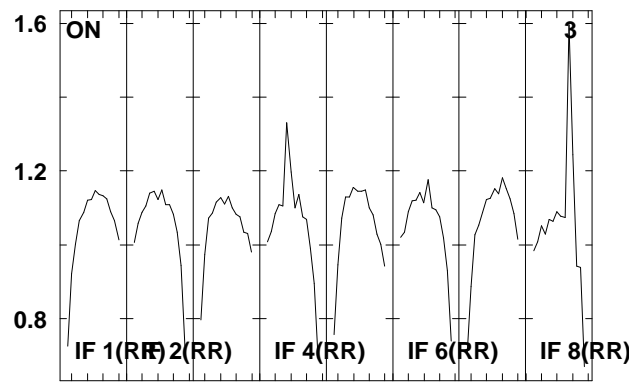
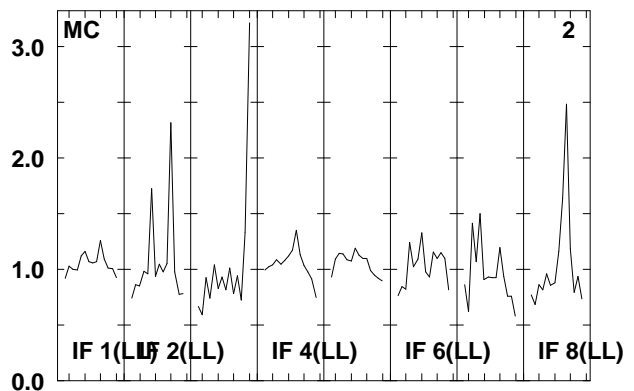
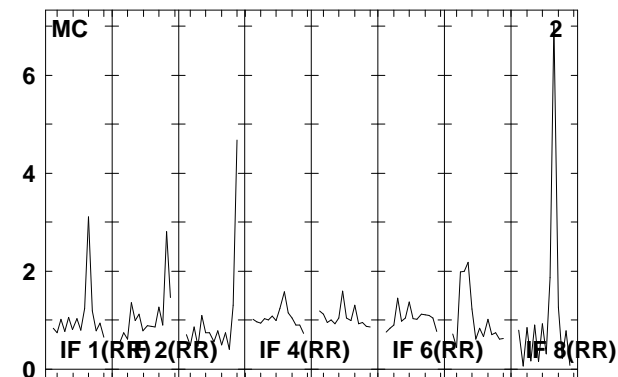
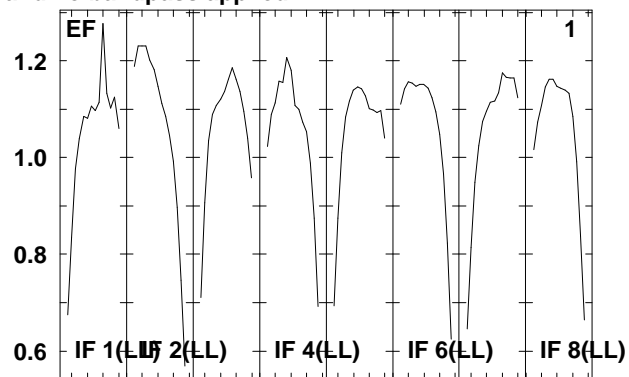
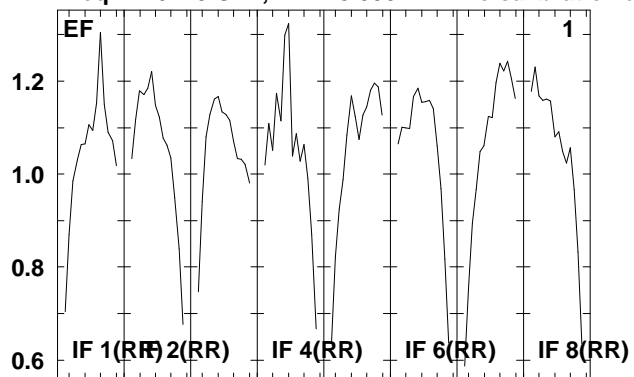

Lower frame: Real Jy  
Total-power spectrum Antenna: \*  
Timerange: 01/01:16:01 to 01/01:17:20

Plot file version 44 created 20-OCT-2009 14:48:58

FAINTCAL RP015C.UVDATA.1

Freq = 1.6270 GHz, Bw = 8.000 MH No calibration applied and no bandpass applied

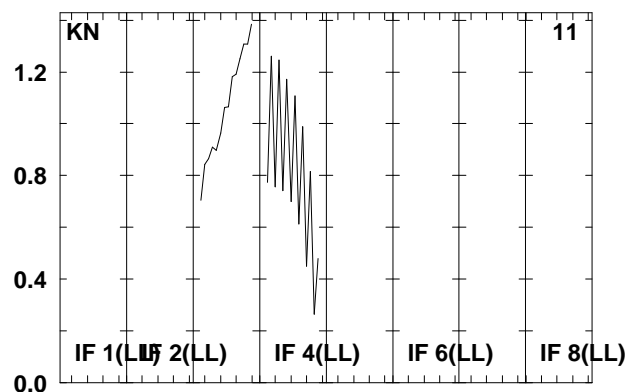
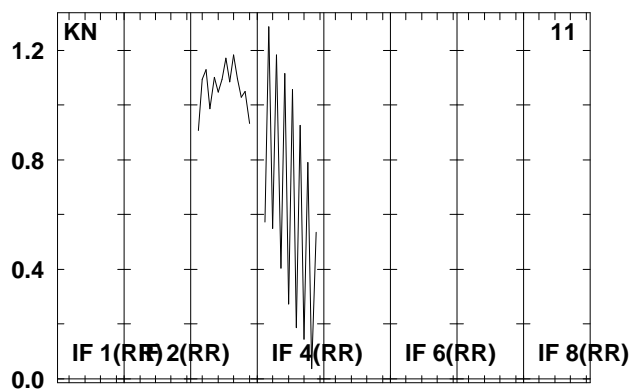
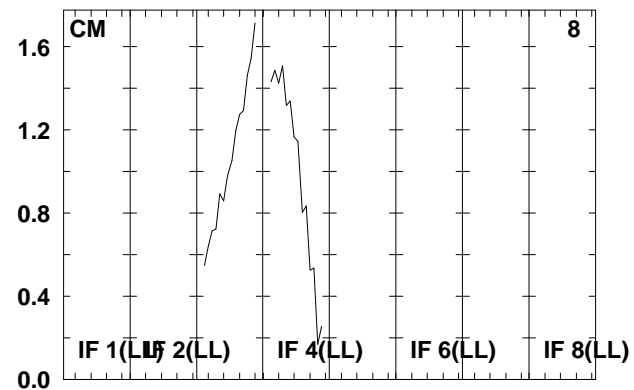
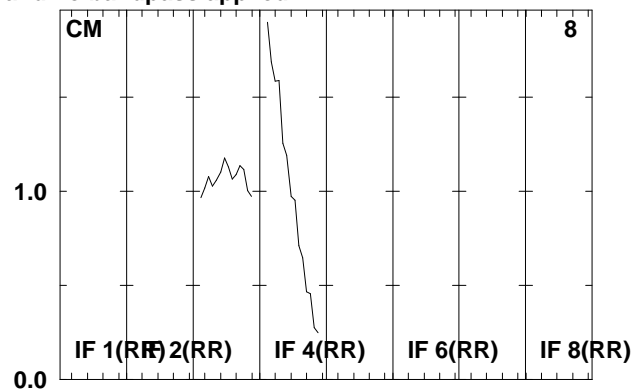
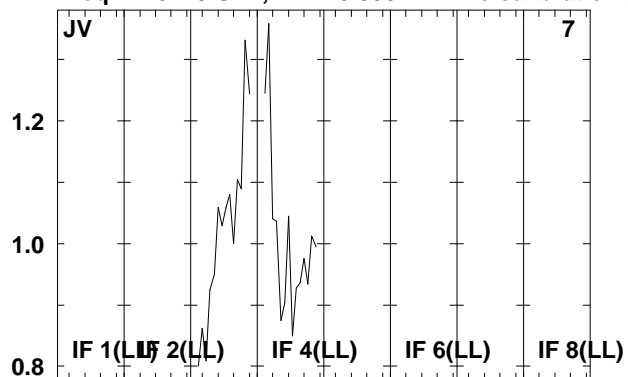

Lower frame: Real Jy  
Total-power spectrum Antenna: \*  
Timerange: 01/01:16:01 to 01/01:17:20

Plot file version 45 created 20-OCT-2009 14:48:58

M33 RP015C.UVDATA.1

Freq = 1.6270 GHz, Bw = 8.000 MH No calibration applied and no bandpass applied

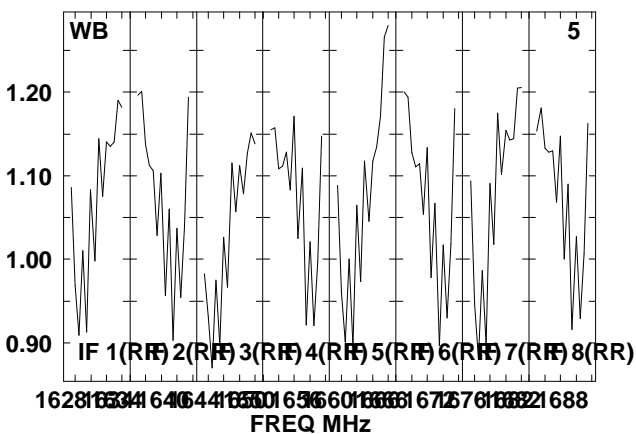
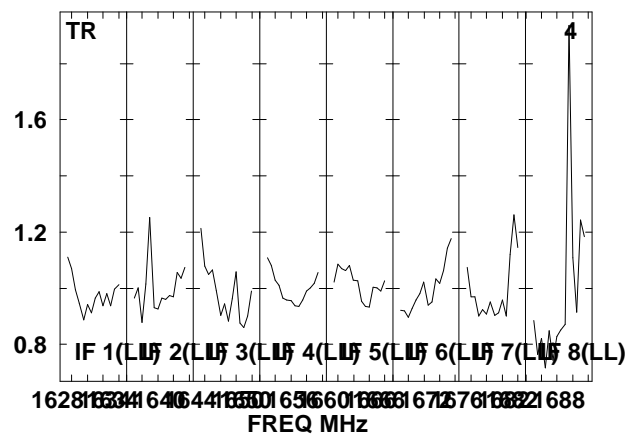
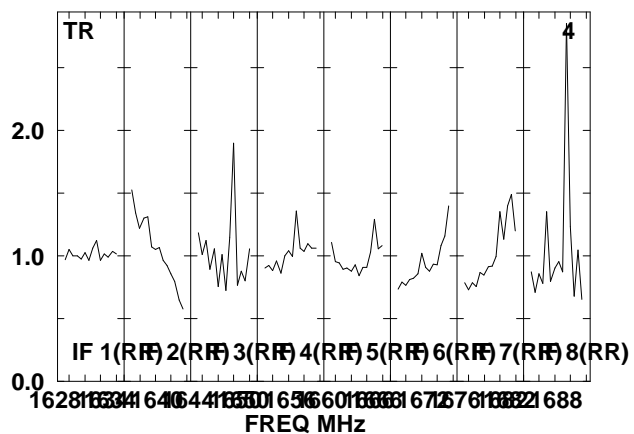
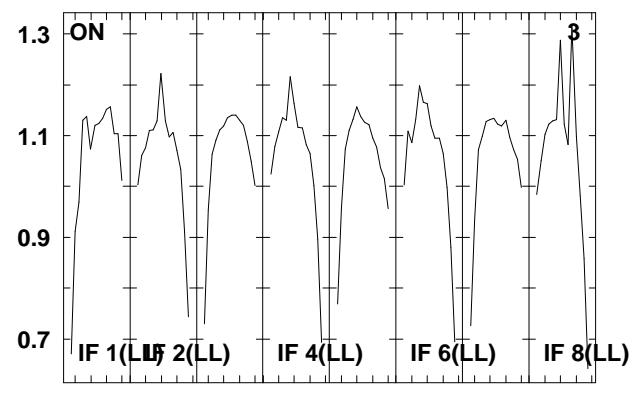
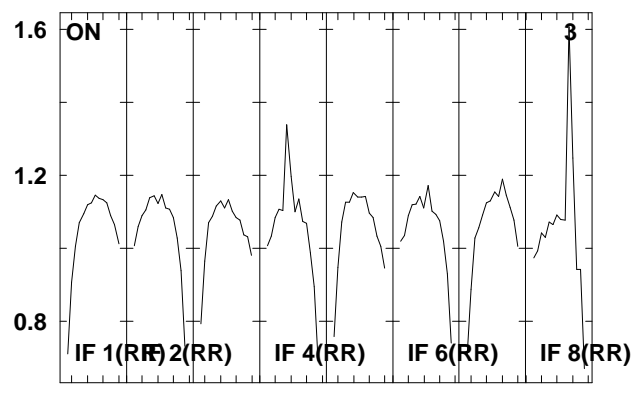
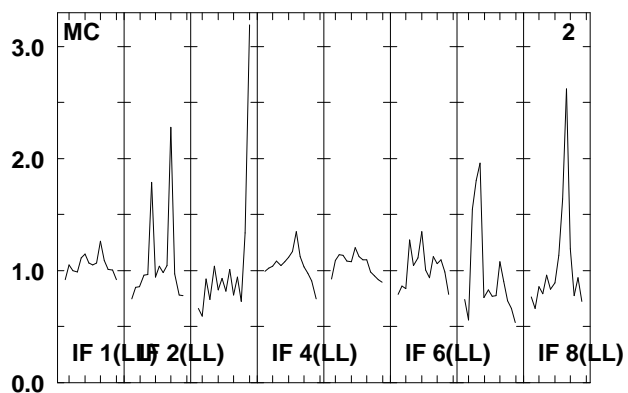
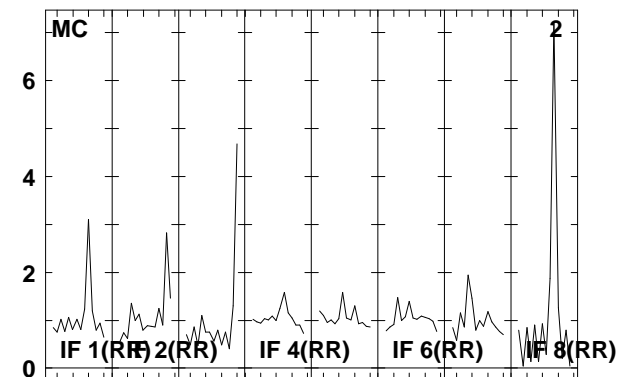
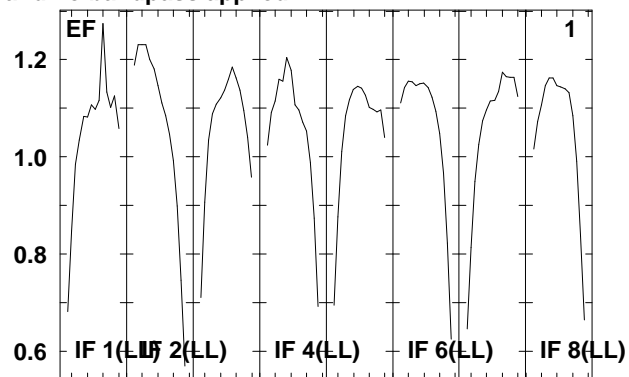
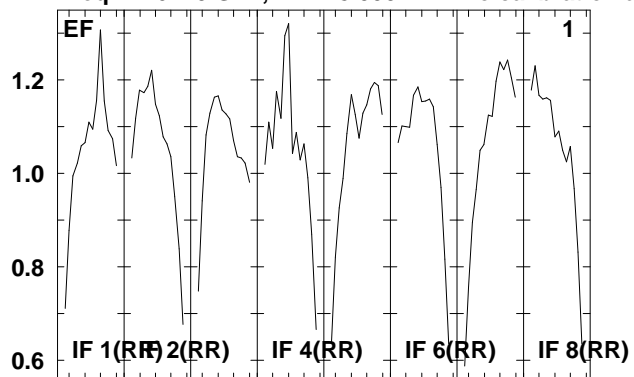

Lower frame: Real Jy

Total-power spectrum Antenna: \*

Timerange: 01/01:17:21 to 01/01:20:20

Plot file version 46 created 20-OCT-2009 14:48:59

M33 RP015C.UVDATA.1

Freq = 1.6270 GHz, Bw = 8.000 MH No calibration applied and no bandpass applied

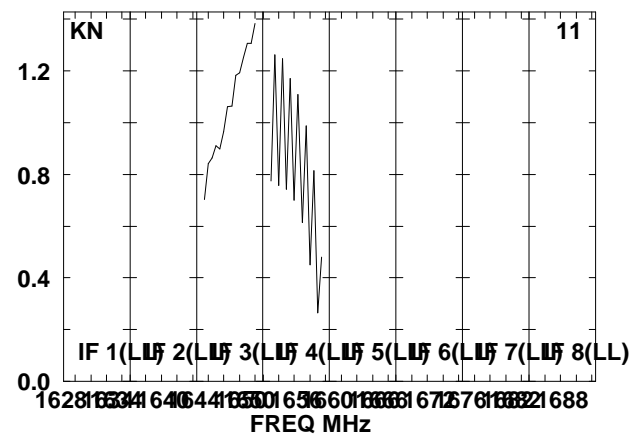
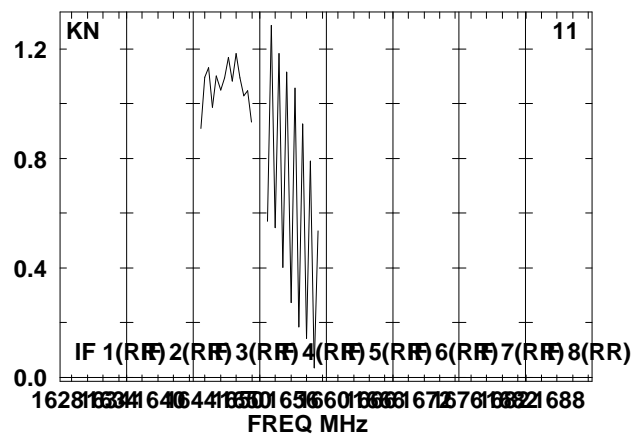
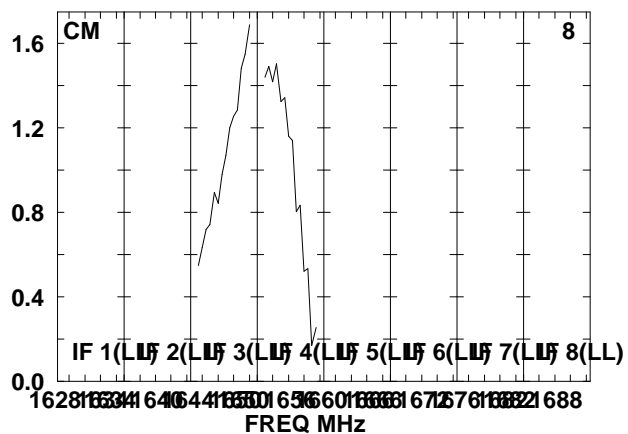
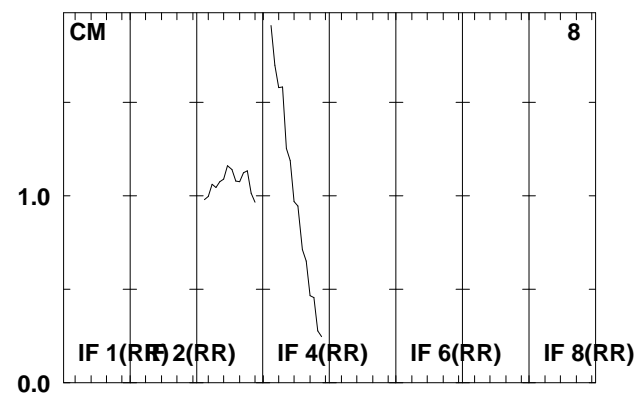
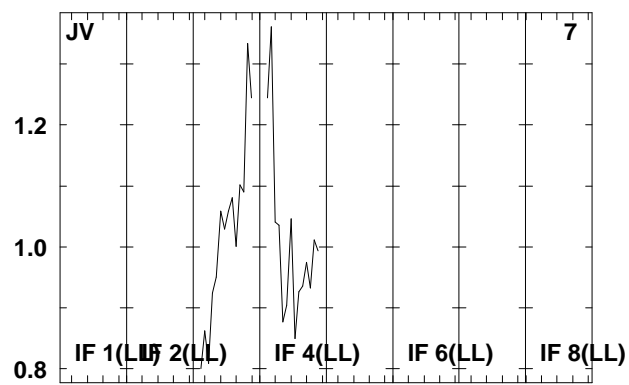
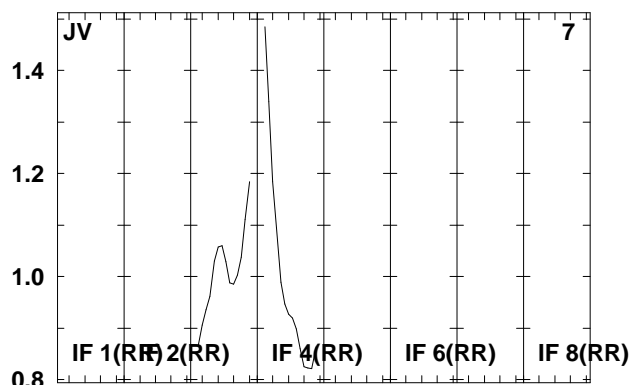
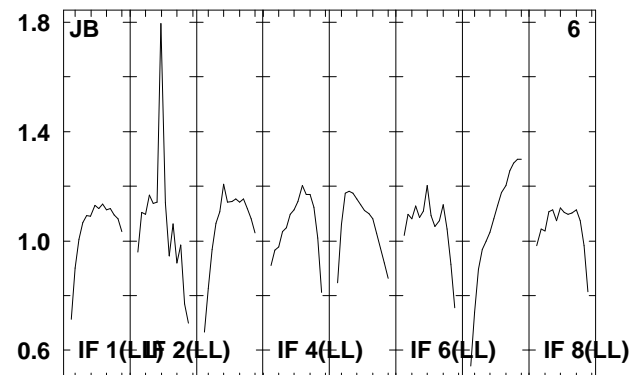
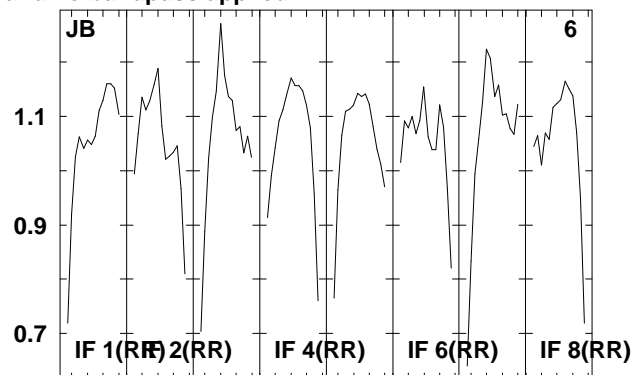
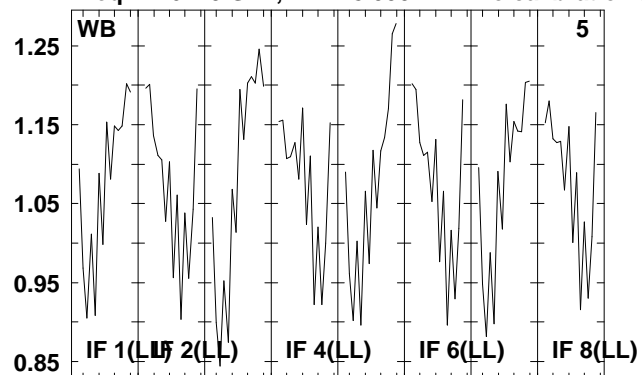

Lower frame: Real Jy  
Total-power spectrum Antenna: \*  
Timerange: 01/01:17:21 to 01/01:20:20

Plot file version 47 created 20-OCT-2009 14:49:01  
 J0137+31 RP015C.UVDATA.1  
 Freq = 1.6270 GHz, Bw = 8.000 MH No calibration applied and no bandpass applied

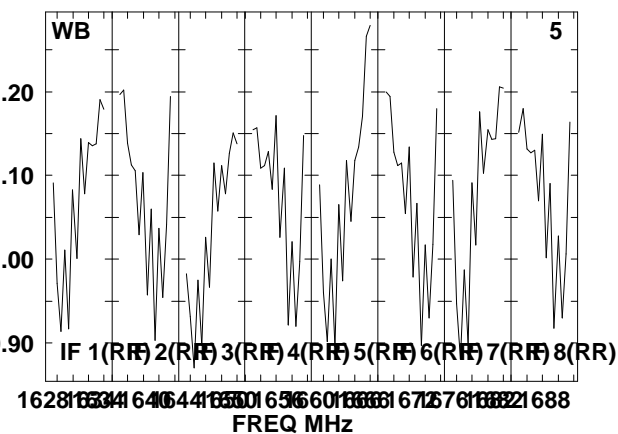
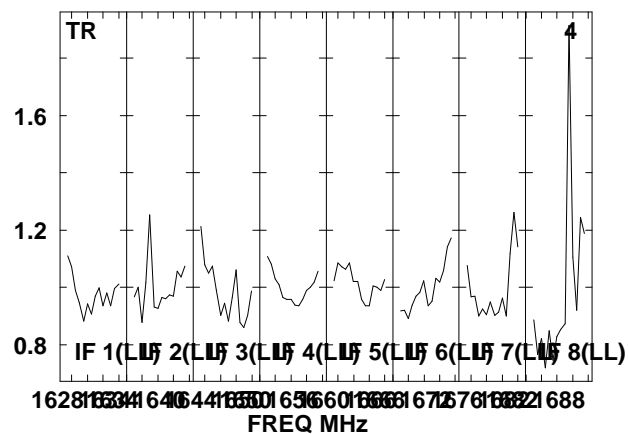
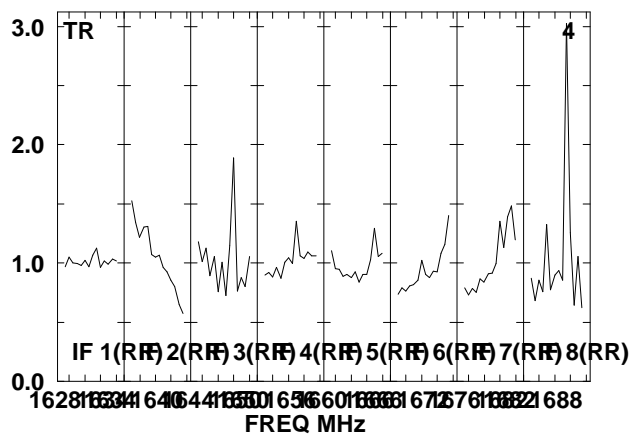
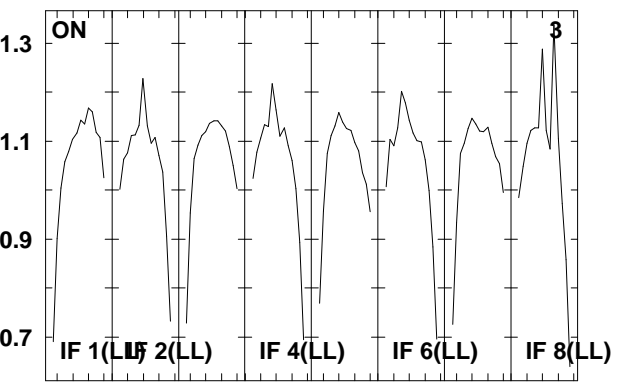
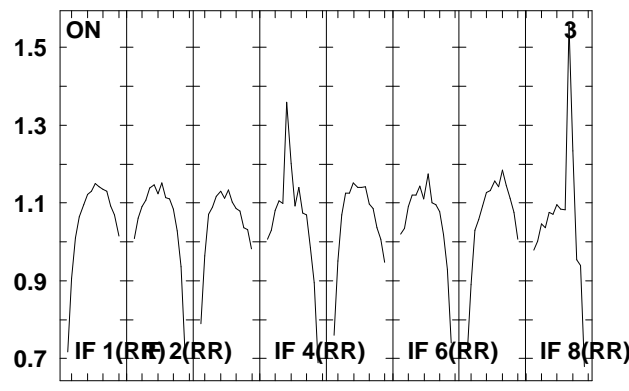
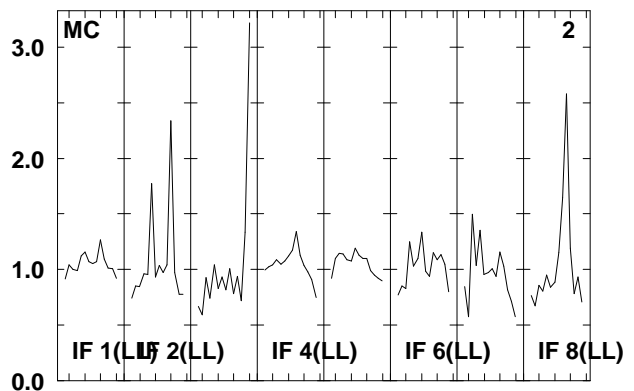
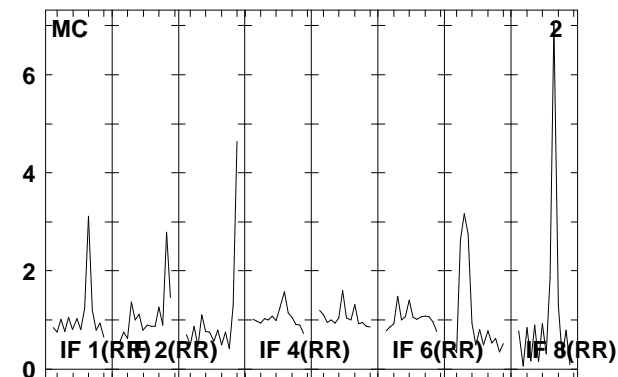
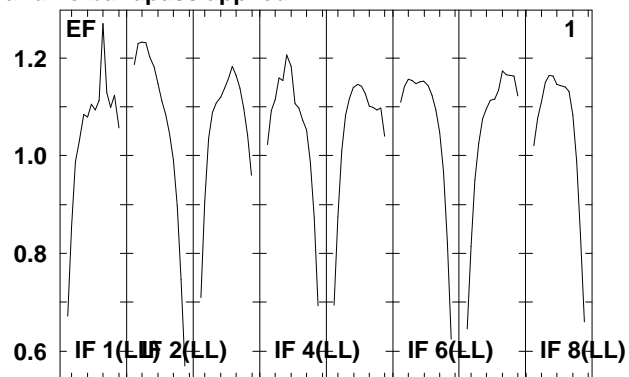
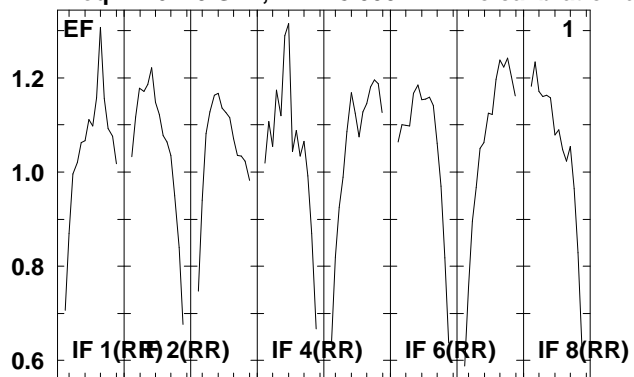

Lower frame: Real Jy  
 Total-power spectrum Antenna: \*  
 Timerange: 01/01:21:01 to 01/01:21:59

Plot file version 48 created 20-OCT-2009 14:49:01  
 J0137+31 RP015C.UVDATA.1  
 Freq = 1.6270 GHz, Bw = 8.000 MH No calibration applied and no bandpass applied

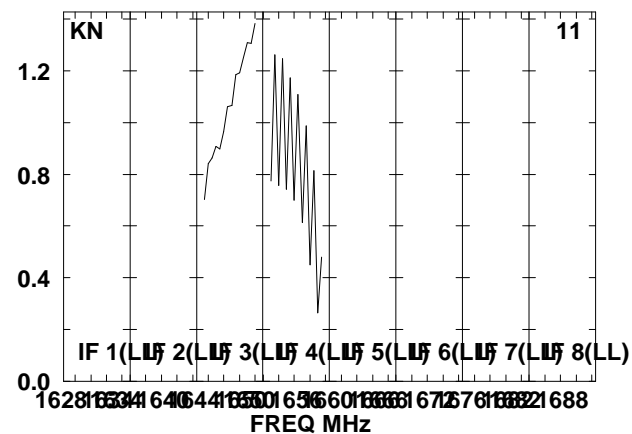
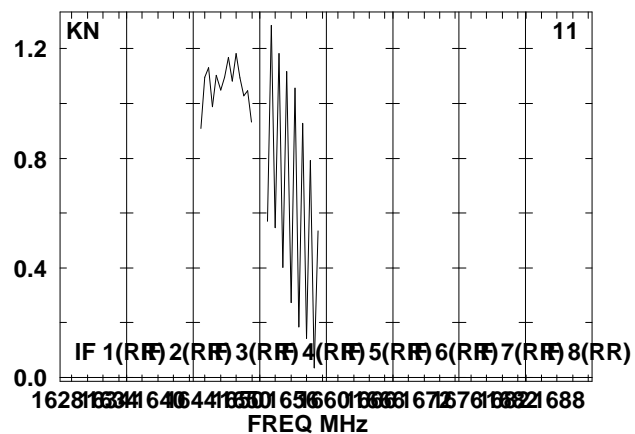
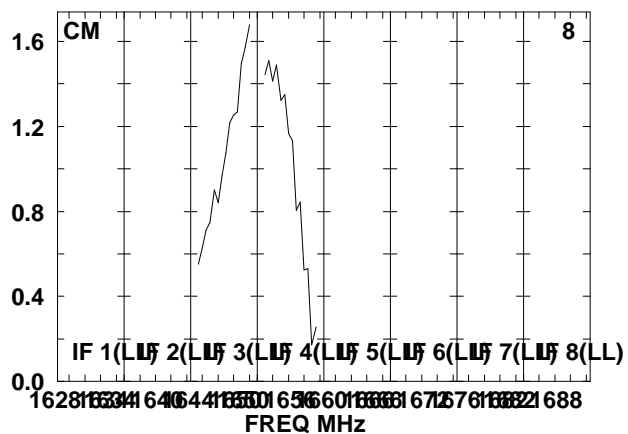
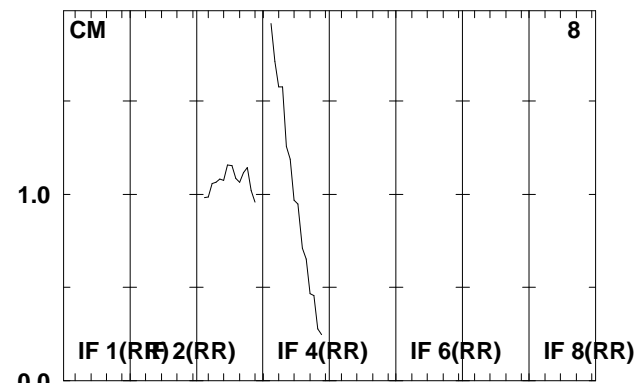
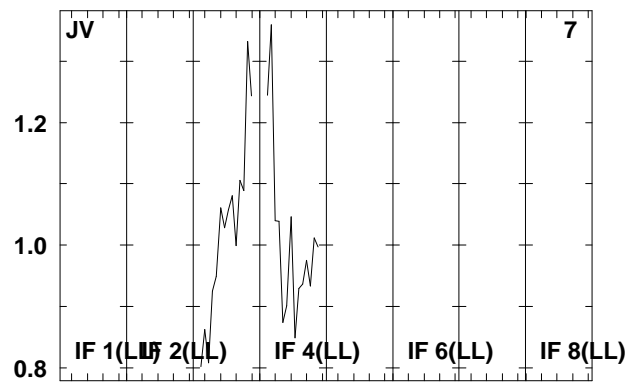
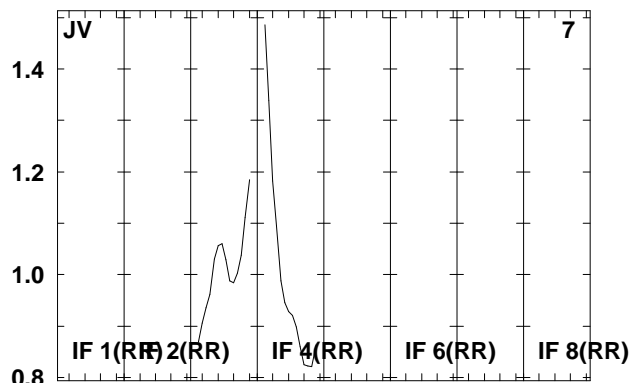
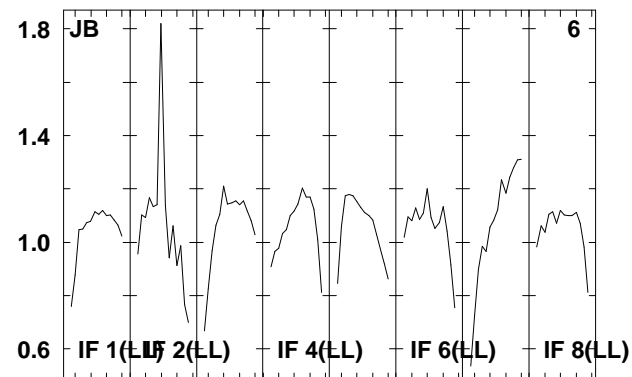
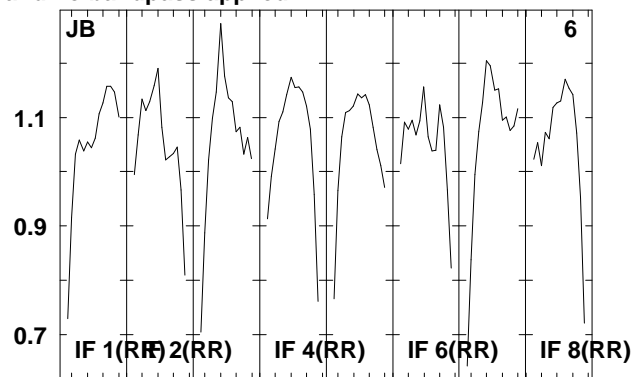
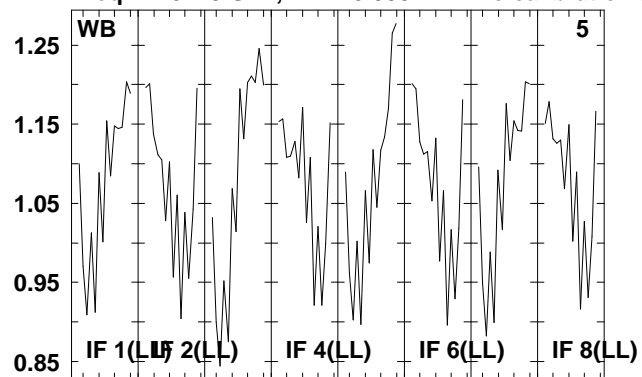

Lower frame: Real Jy  
 Total-power spectrum Antenna: \*  
 Timerange: 01/01:21:01 to 01/01:21:59



Plot file version 49 created 20-OCT-2009 14:49:02

FAINTCAL RP015C.UVDATA.1

Freq = 1.6270 GHz, Bw = 8.000 MH No calibration applied and no bandpass applied

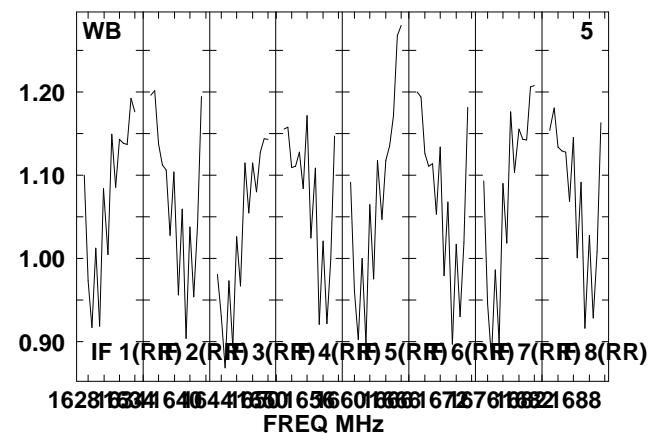
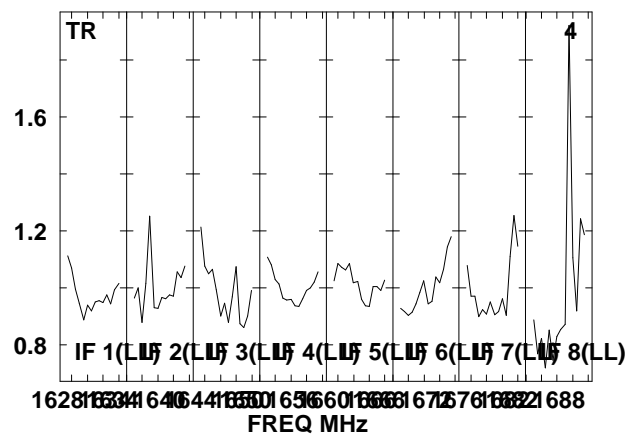
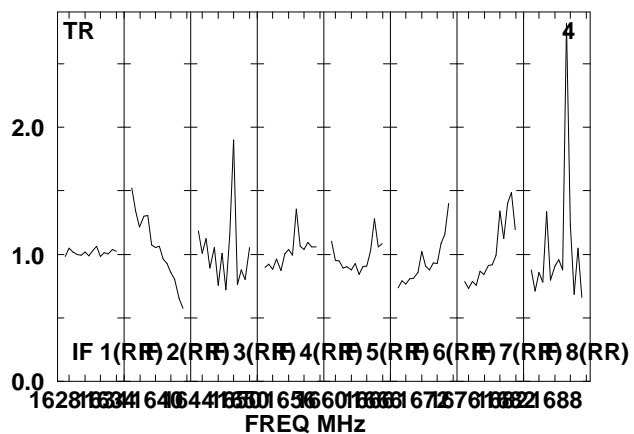
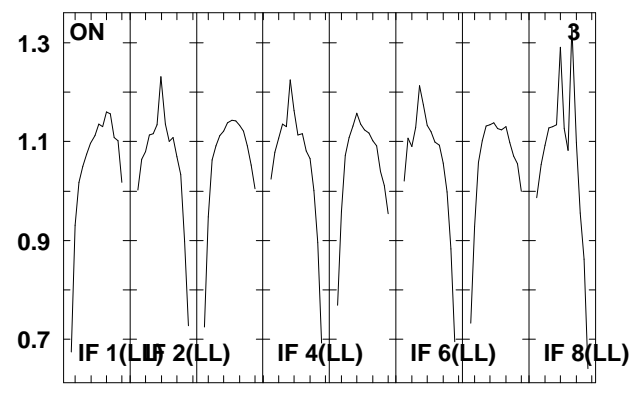
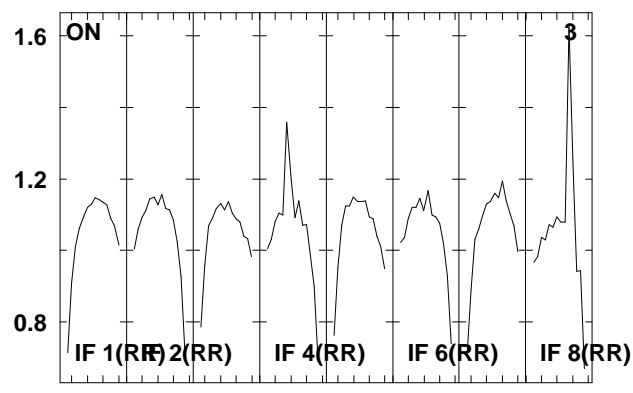
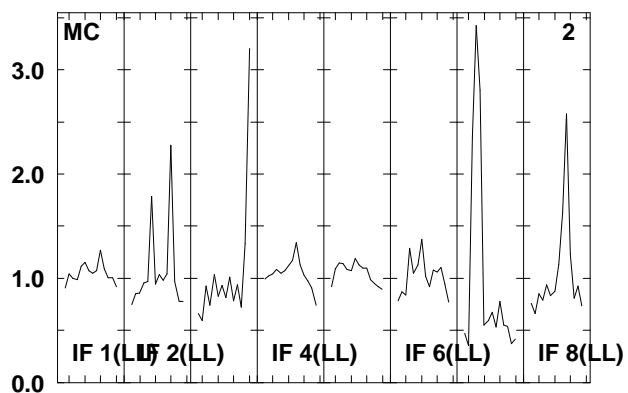
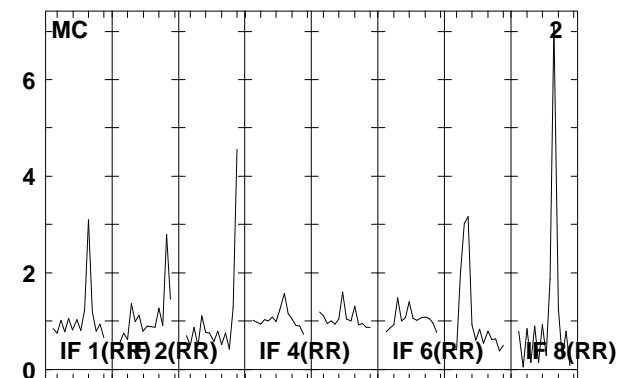
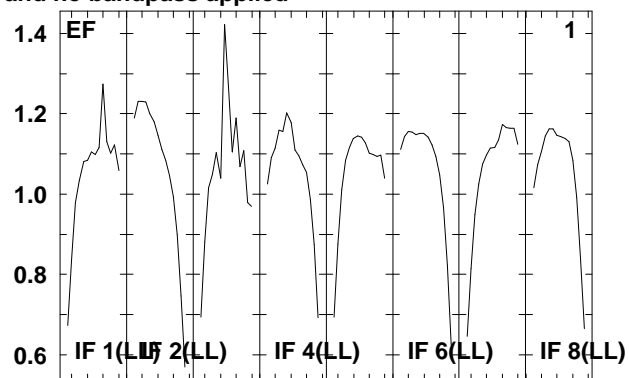
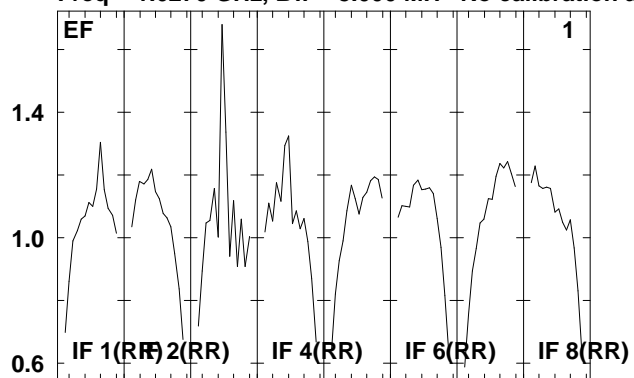

Lower frame: Real Jy

Total-power spectrum Antenna: \*

Timerange: 01/01:22:00 to 01/01:23:19

Plot file version 50 created 20-OCT-2009 14:49:02

FAINTCAL RP015C.UVDATA.1

Freq = 1.6270 GHz, Bw = 8.000 MH No calibration applied and no bandpass applied

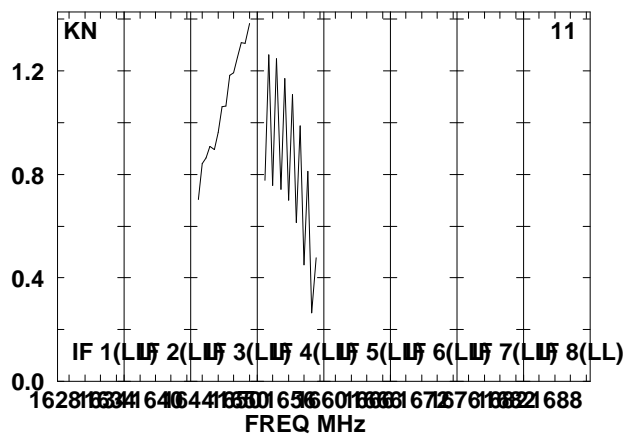
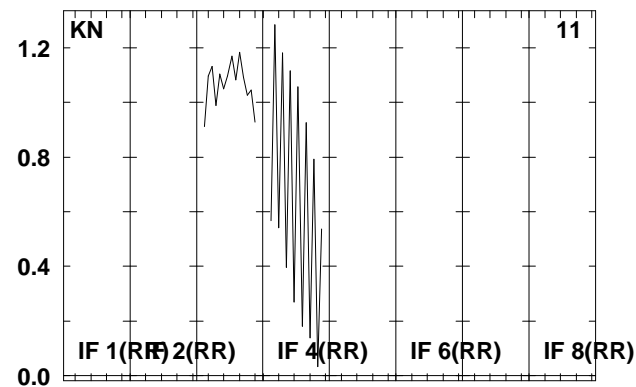
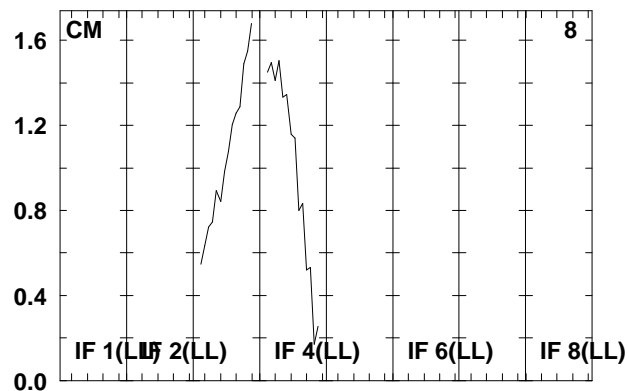
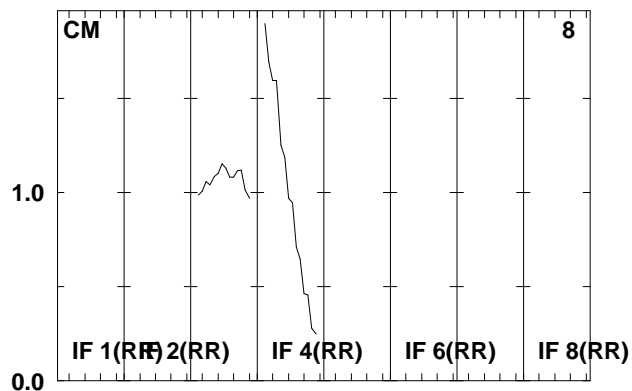
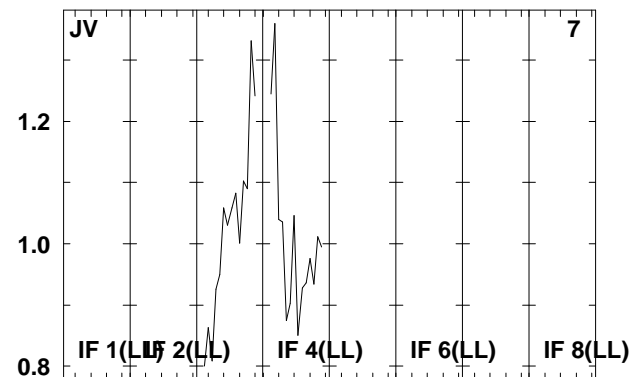
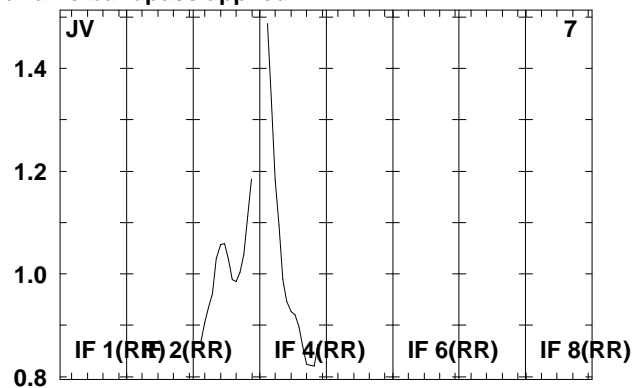
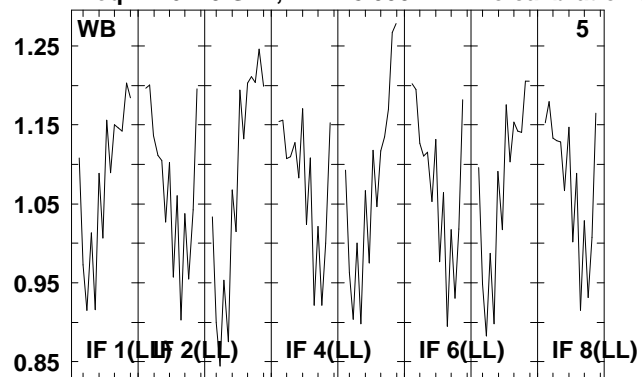

Lower frame: Real Jy

Total-power spectrum Antenna: \*

Timerange: 01/01:22:00 to 01/01:23:19

Plot file version 51 created 20-OCT-2009 14:49:03

M33 RP015C.UVDATA.1

Freq = 1.6270 GHz, Bw = 8.000 MH No calibration applied and no bandpass applied

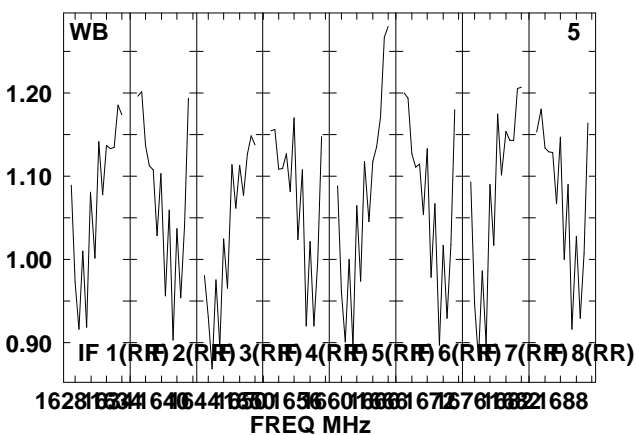
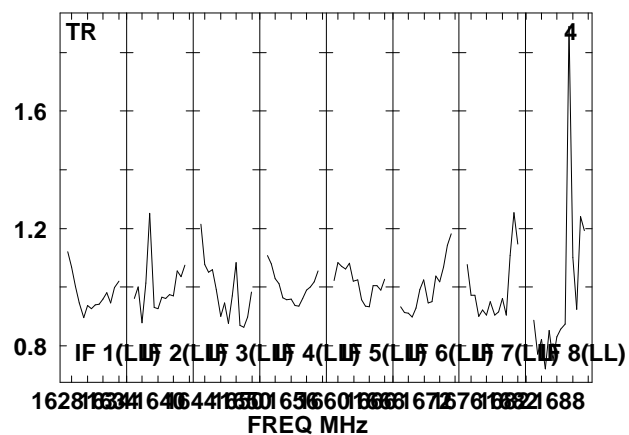
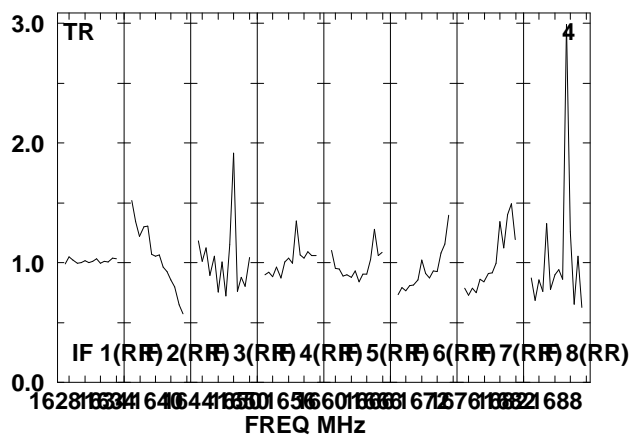
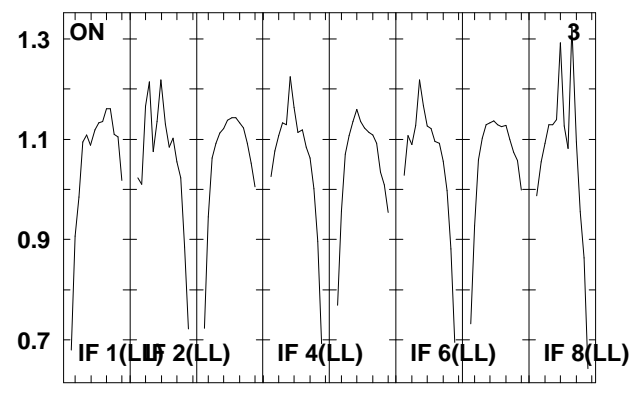
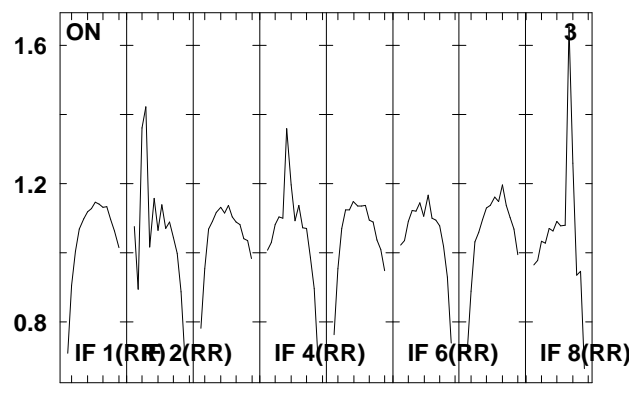
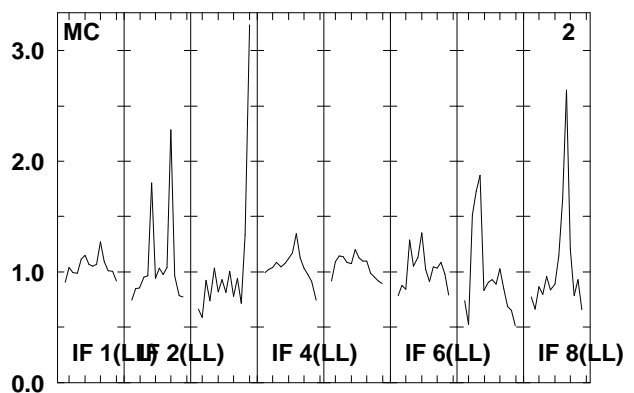
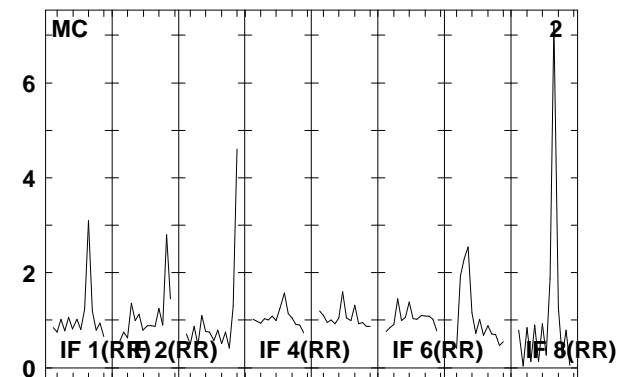
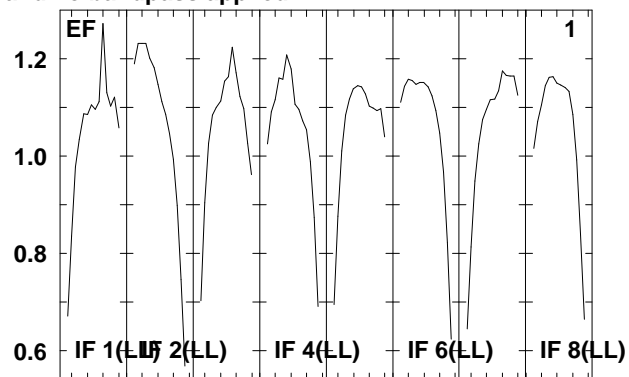
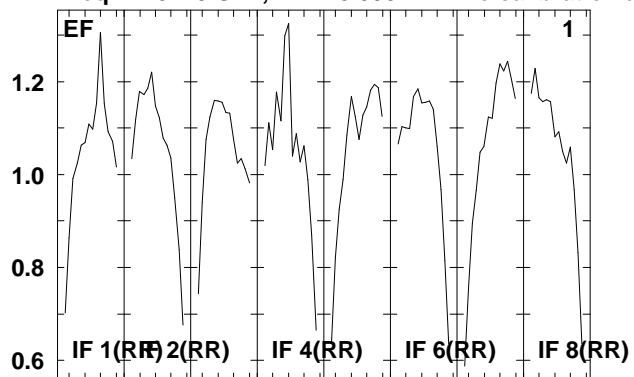

Lower frame: Real Jy  
Total-power spectrum Antenna: \*  
Timerange: 01/01:23:20 to 01/01:26:20

Plot file version 52 created 20-OCT-2009 14:49:03

M33 RP015C.UVDATA.1

Freq = 1.6270 GHz, Bw = 8.000 MH No calibration applied and no bandpass applied

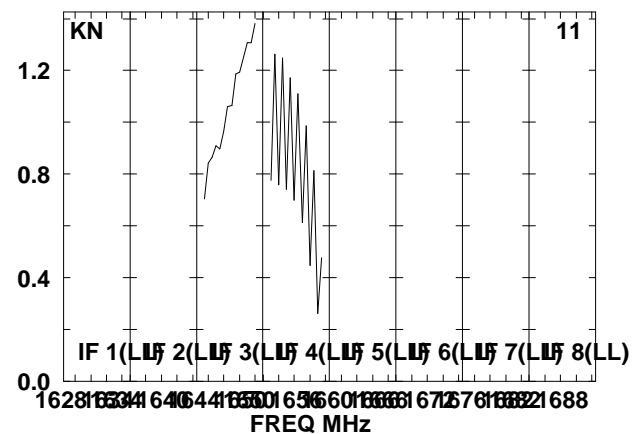
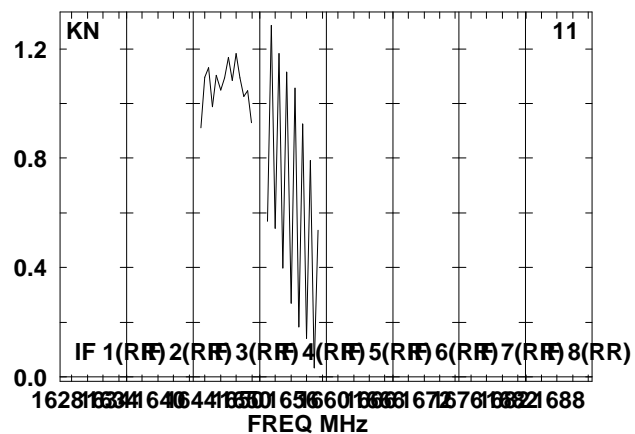
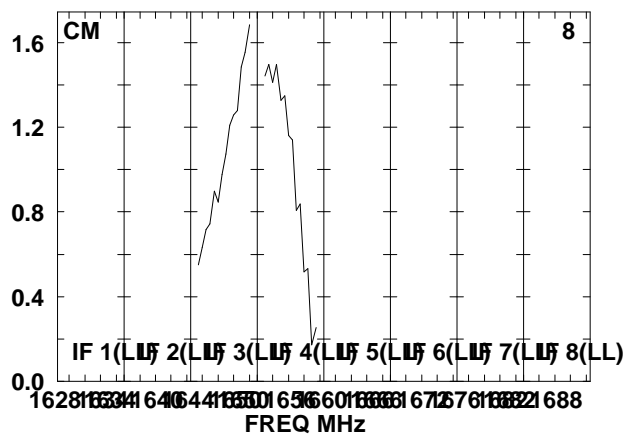
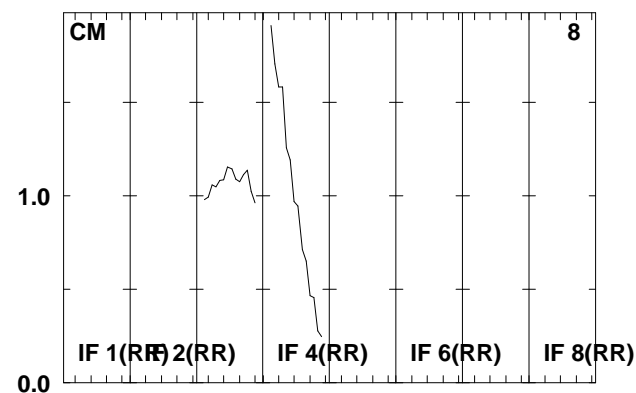
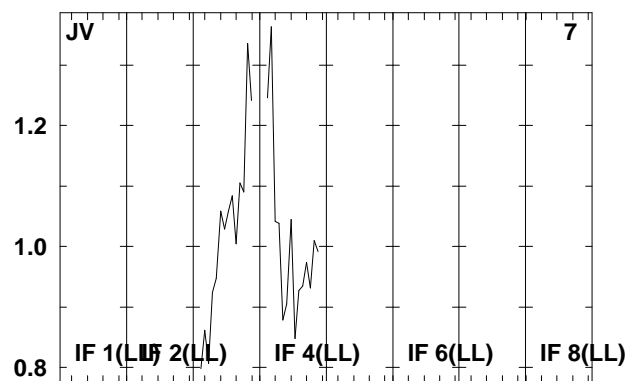
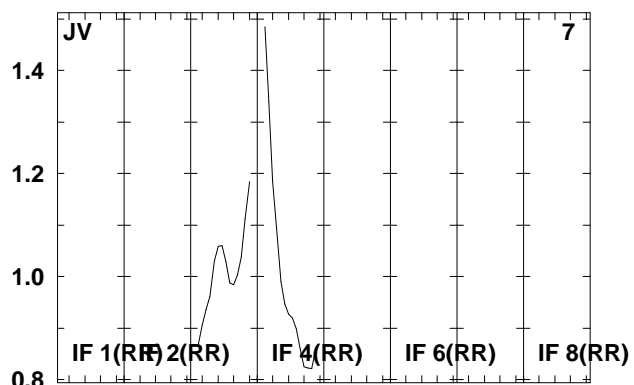
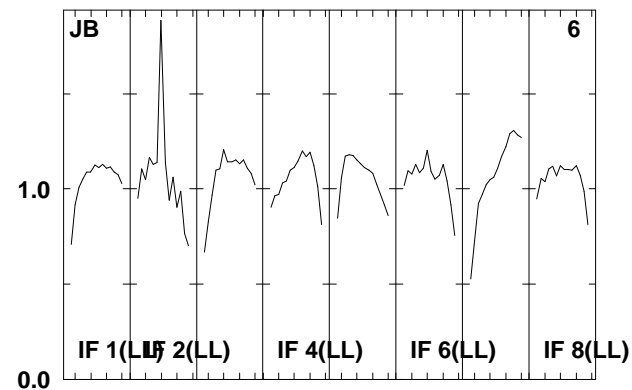
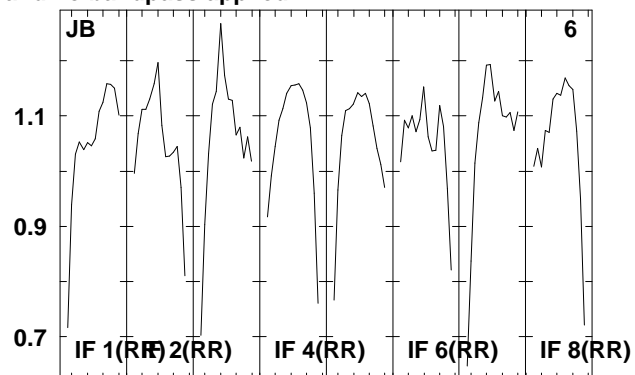
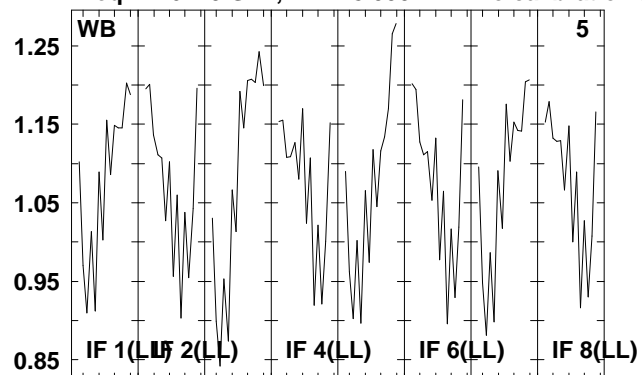

Lower frame: Real Jy  
Total-power spectrum Antenna: \*  
Timerange: 01/01:23:20 to 01/01:26:20

Plot file version 53 created 20-OCT-2009 14:49:05

J0137+31 RP015C.UVDATA.1

Freq = 1.6270 GHz, Bw = 8.000 MH No calibration applied and no bandpass applied

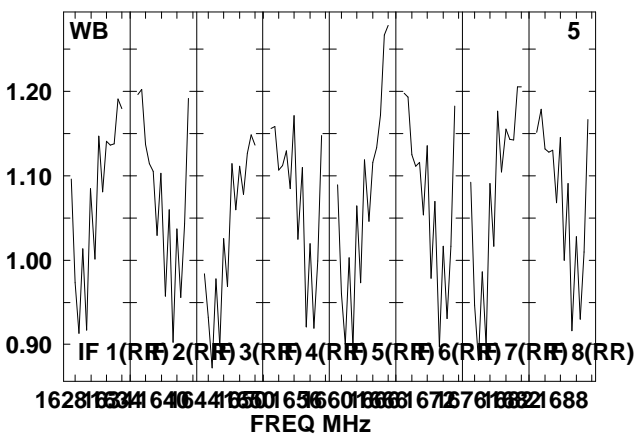
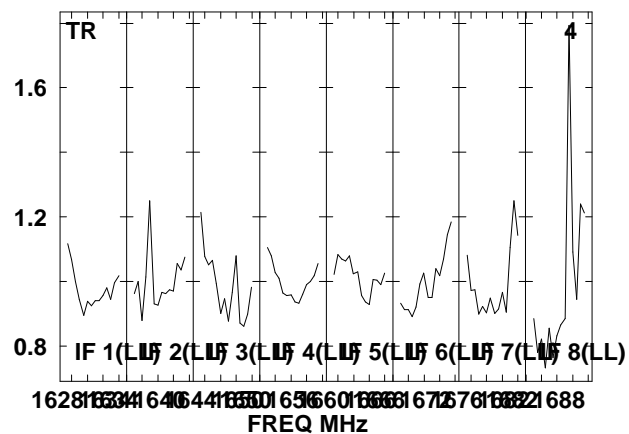
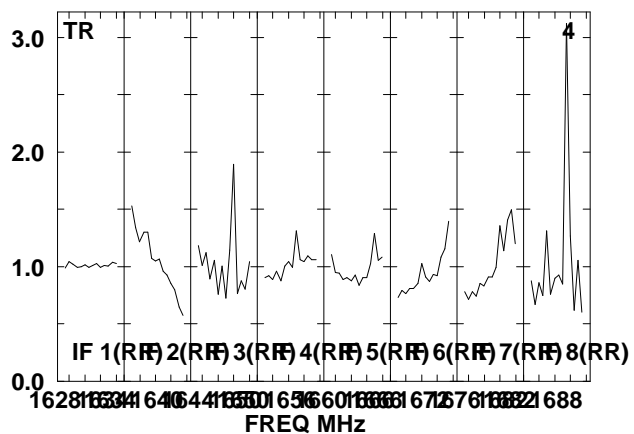
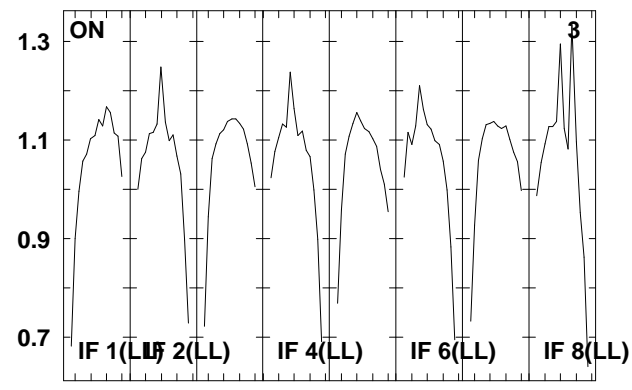
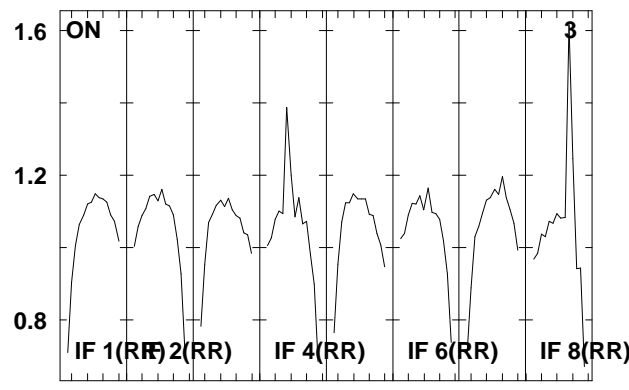
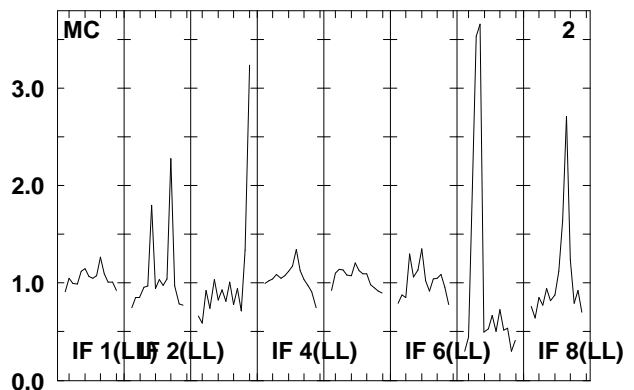
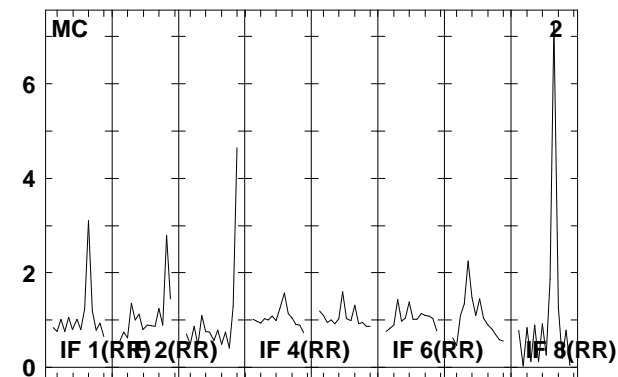
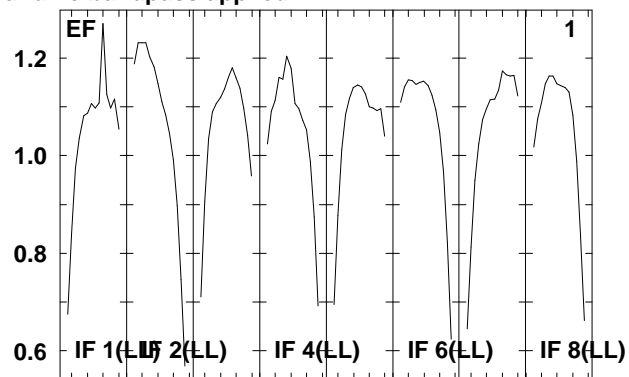
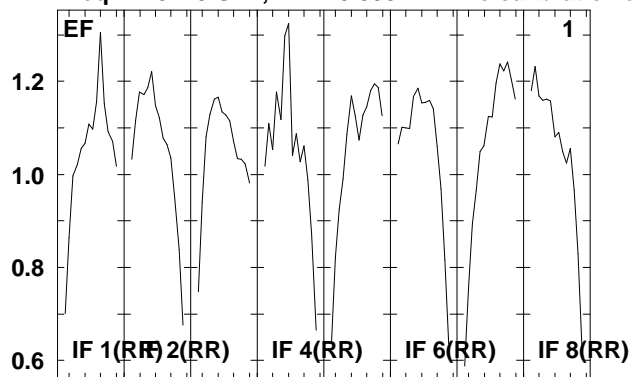

Lower frame: Real Jy  
Total-power spectrum Antenna: \*  
Timerange: 01/01:27:00 to 01/01:27:59

Plot file version 54 created 20-OCT-2009 14:49:05  
 J0137+31 RP015C.UVDATA.1  
 Freq = 1.6270 GHz, Bw = 8.000 MH No calibration applied and no bandpass applied

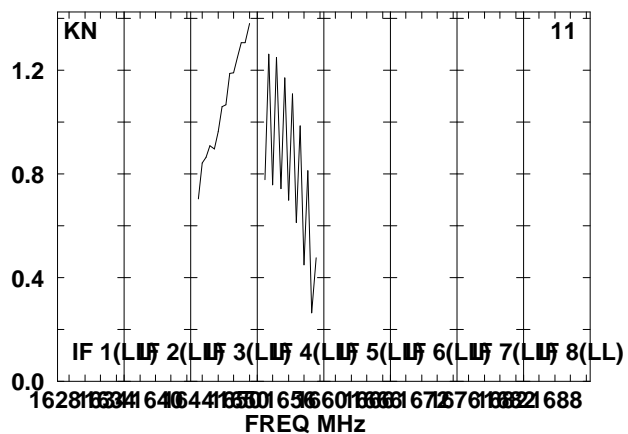
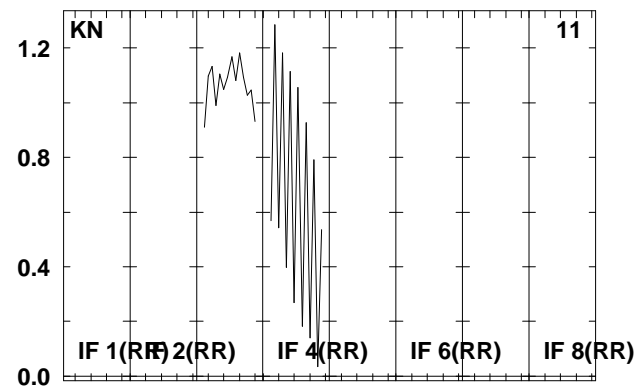
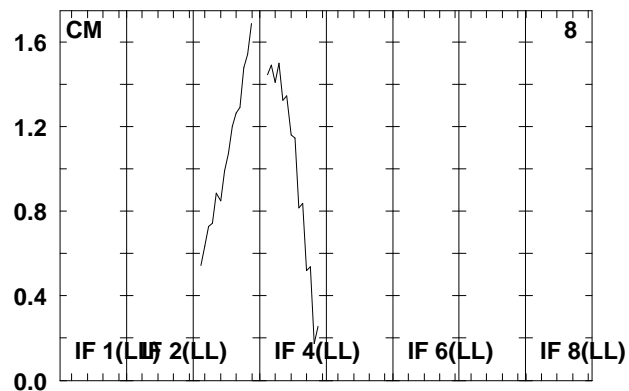
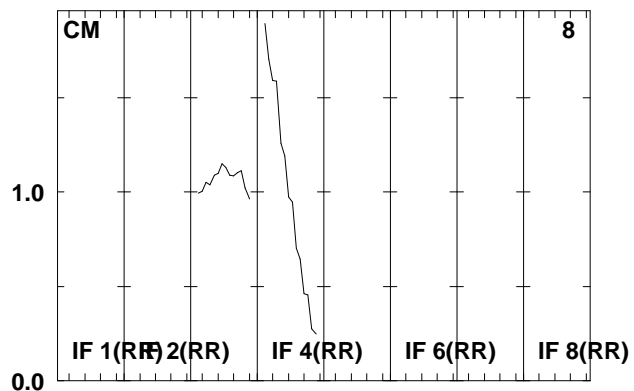
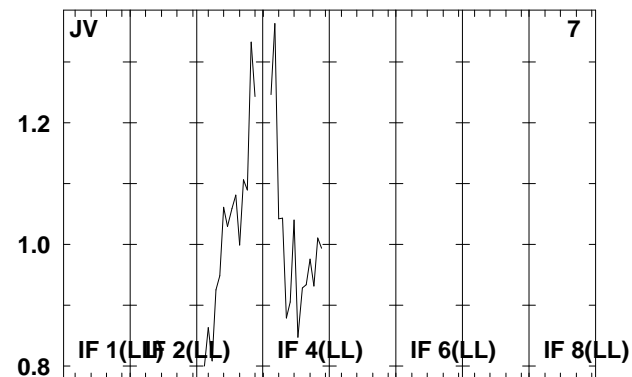
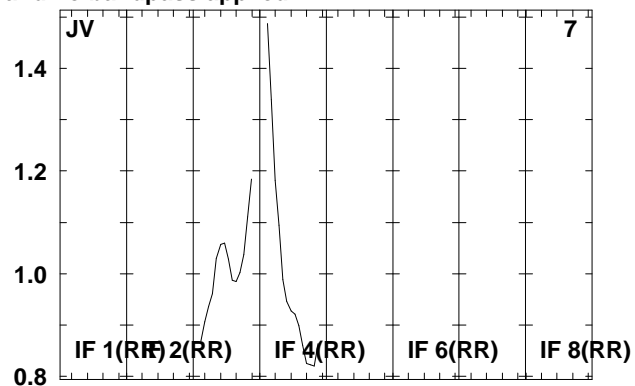
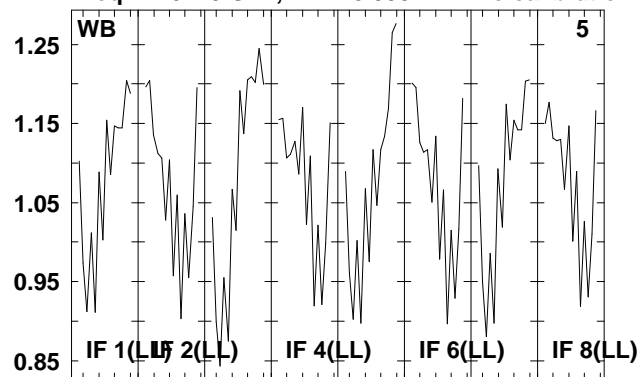

Lower frame: Real Jy  
 Total-power spectrum Antenna: \*  
 Timerange: 01/01:27:00 to 01/01:27:59

Plot file version 55 created 20-OCT-2009 14:49:06

FAINTCAL RP015C.UVDATA.1

Freq = 1.6270 GHz, Bw = 8.000 MH No calibration applied and no bandpass applied

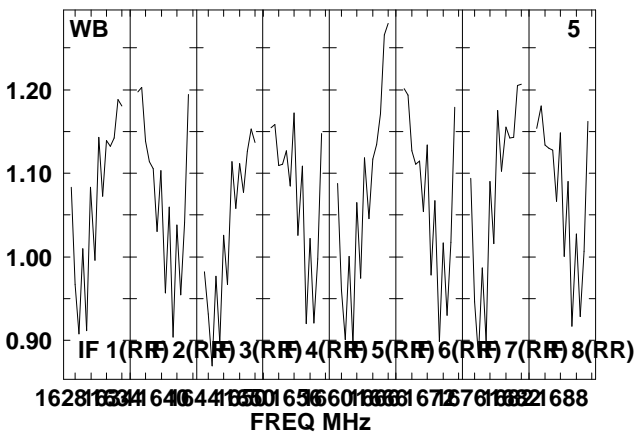
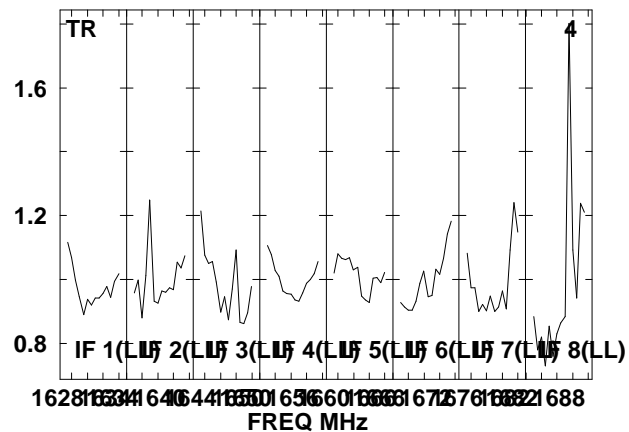
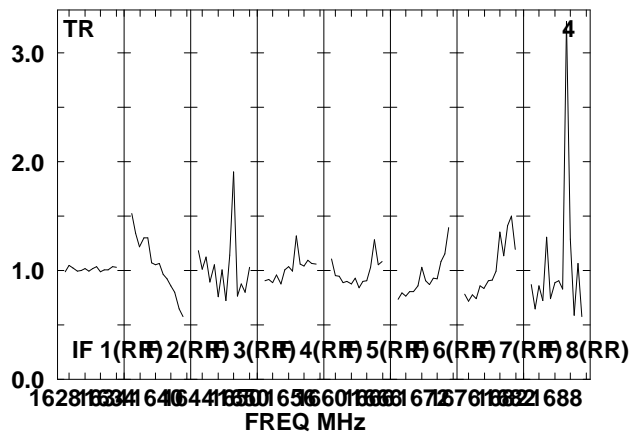
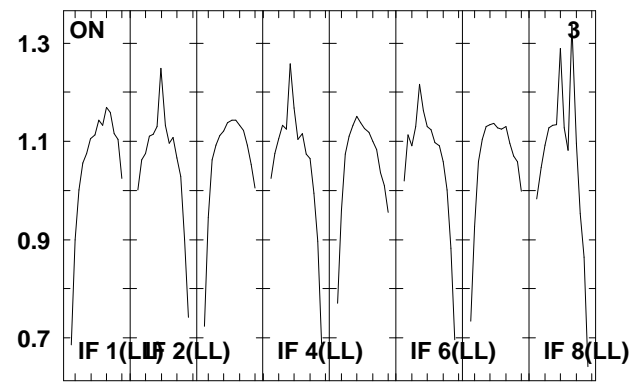
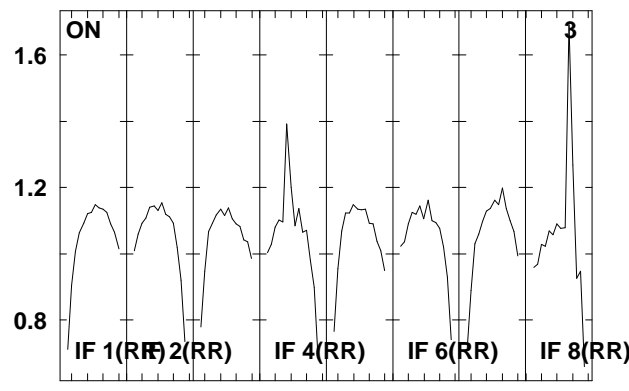
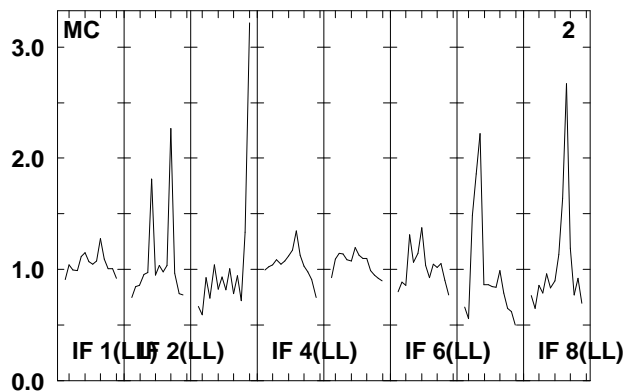
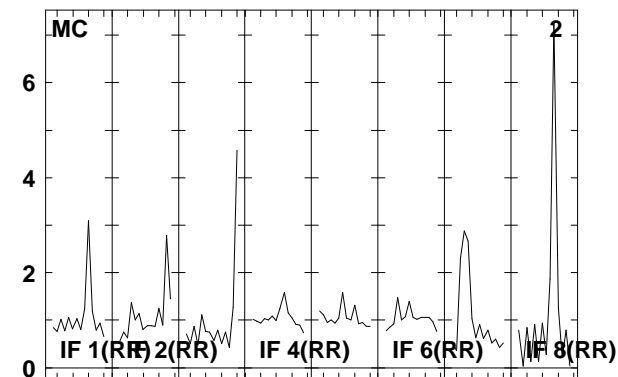
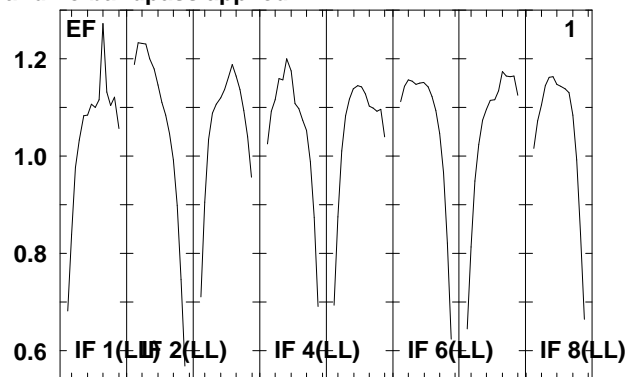
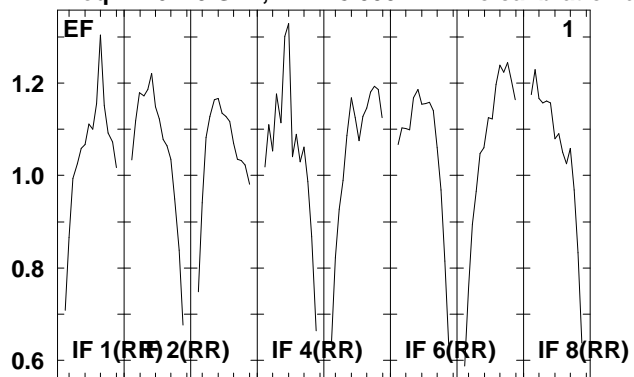

Lower frame: Real Jy  
Total-power spectrum Antenna: \*  
Timerange: 01/01:28:01 to 01/01:29:20

Plot file version 56 created 20-OCT-2009 14:49:06

FAINTCAL RP015C.UVDATA.1

Freq = 1.6270 GHz, Bw = 8.000 MH No calibration applied and no bandpass applied

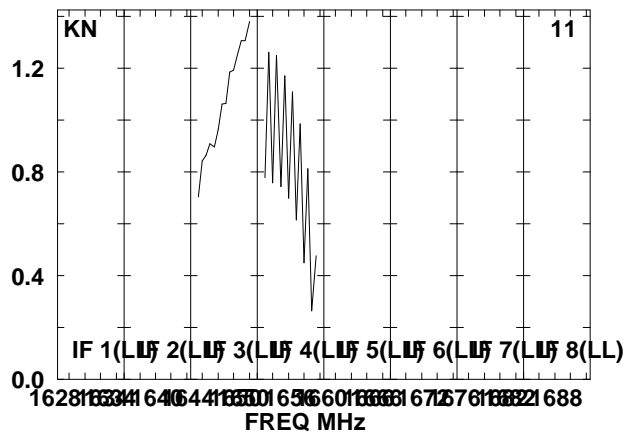
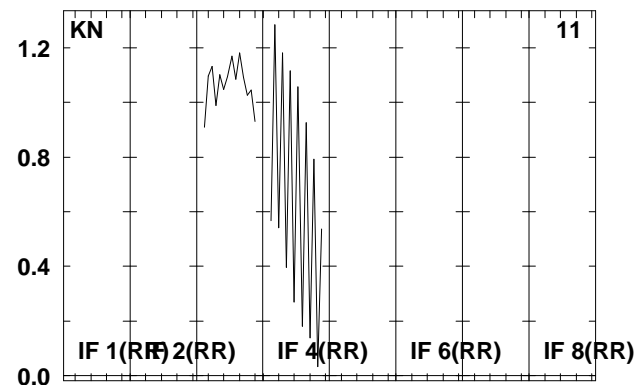
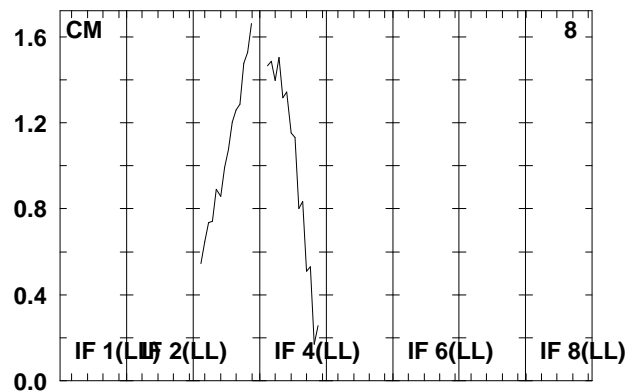
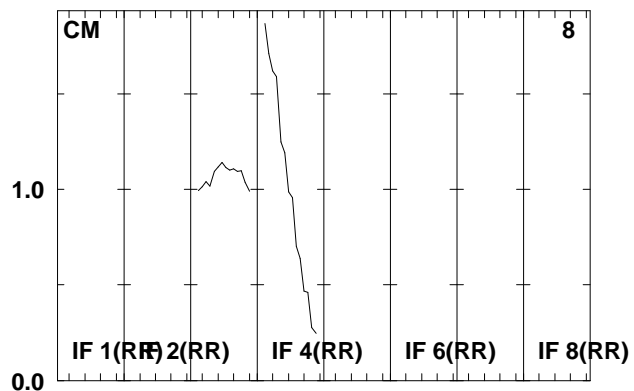
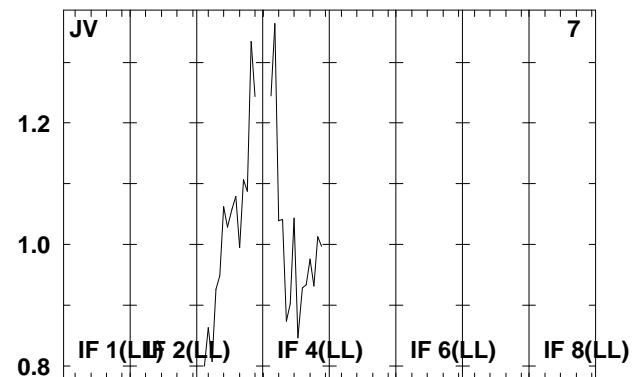
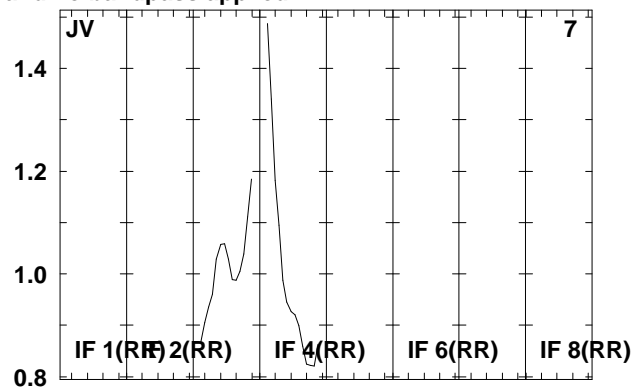
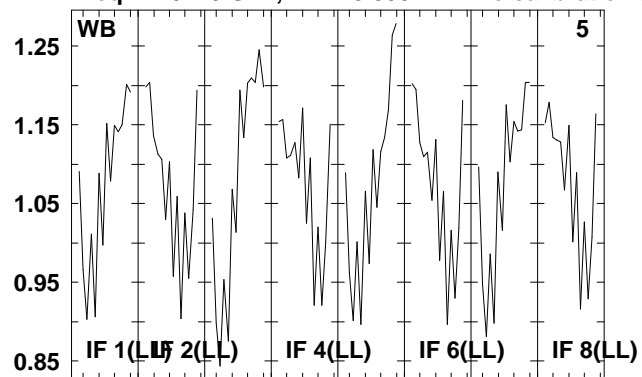

Lower frame: Real Jy

Total-power spectrum Antenna: \*

Timerange: 01/01:28:01 to 01/01:29:20



Plot file version 57 created 20-OCT-2009 14:49:07

M33 RP015C.UVDATA.1

Freq = 1.6270 GHz, Bw = 8.000 MH No calibration applied and no bandpass applied

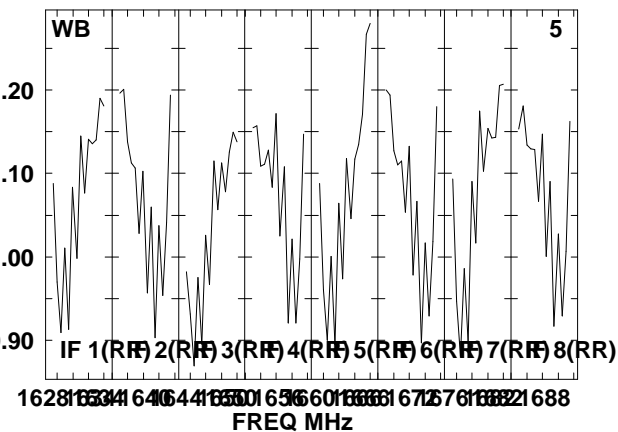
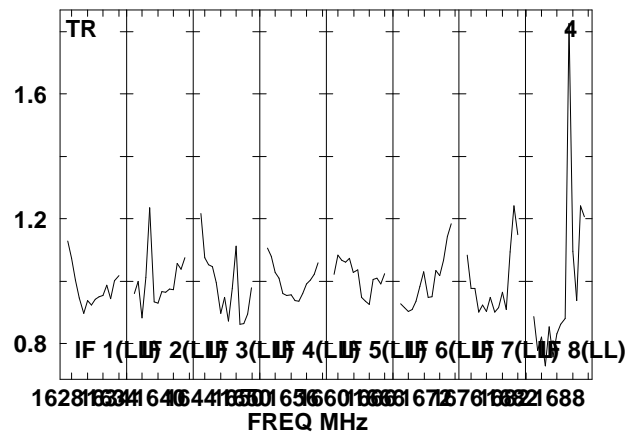
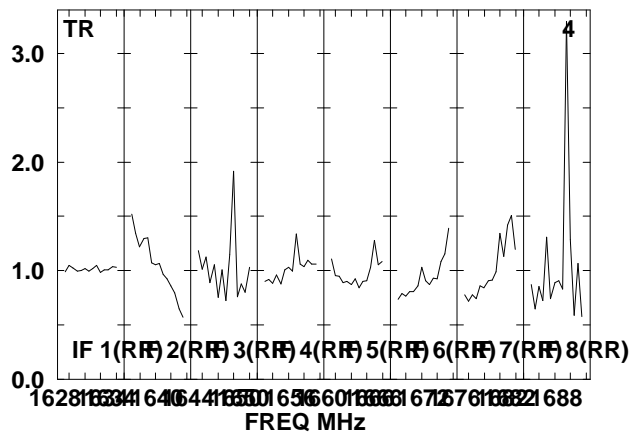
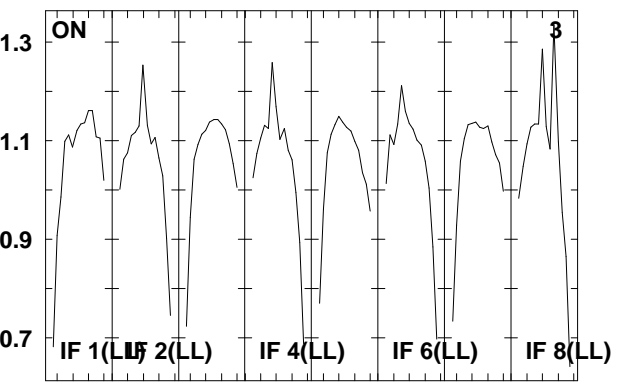
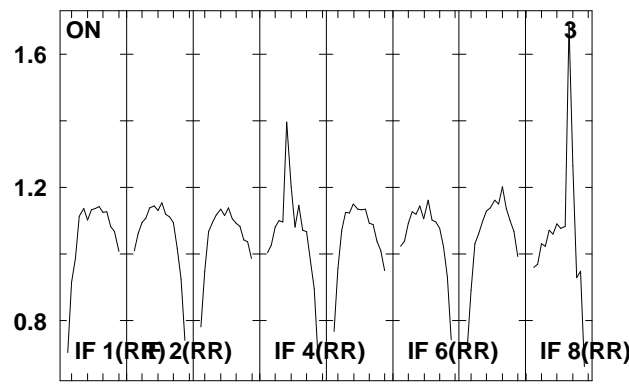
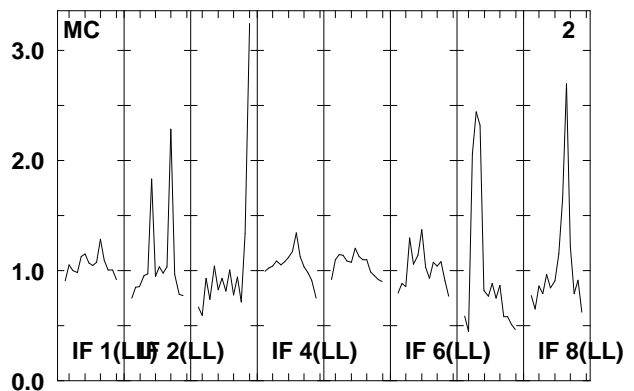
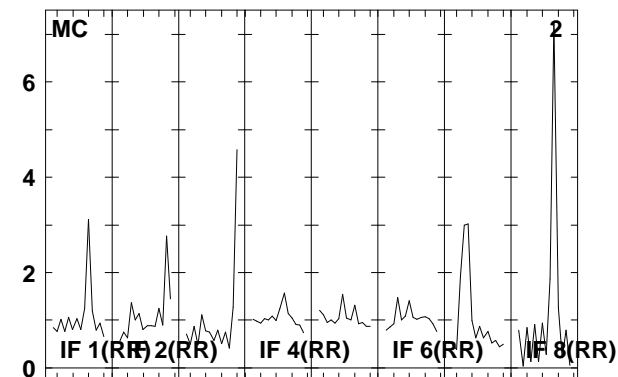
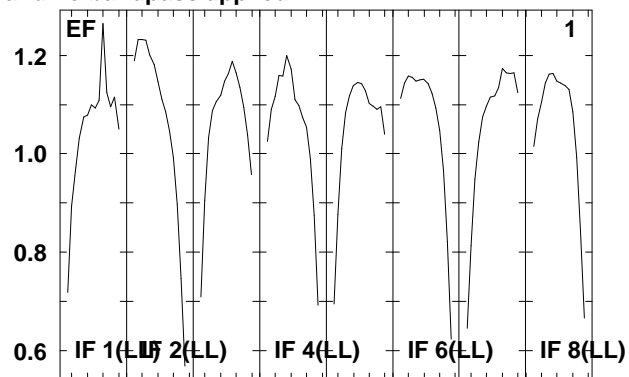
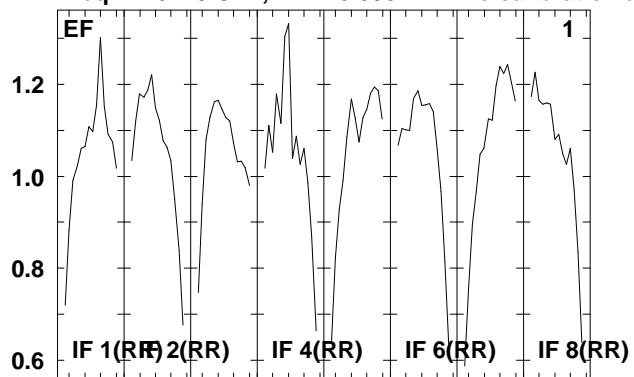

Lower frame: Real Jy  
Total-power spectrum Antenna: \*  
Timerange: 01/01:29:20 to 01/01:32:19

Plot file version 58 created 20-OCT-2009 14:49:08

M33 RP015C.UVDATA.1

Freq = 1.6270 GHz, Bw = 8.000 MH No calibration applied and no bandpass applied

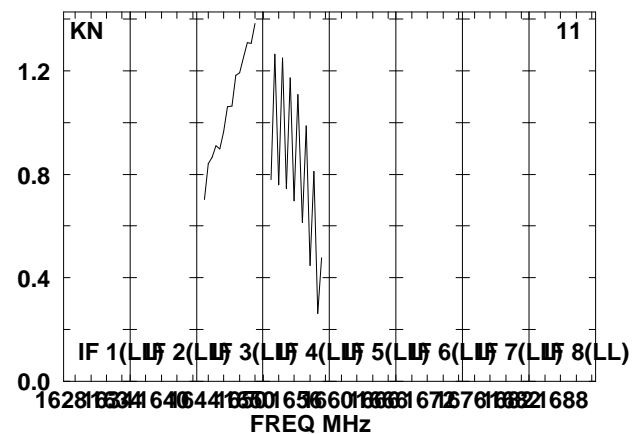
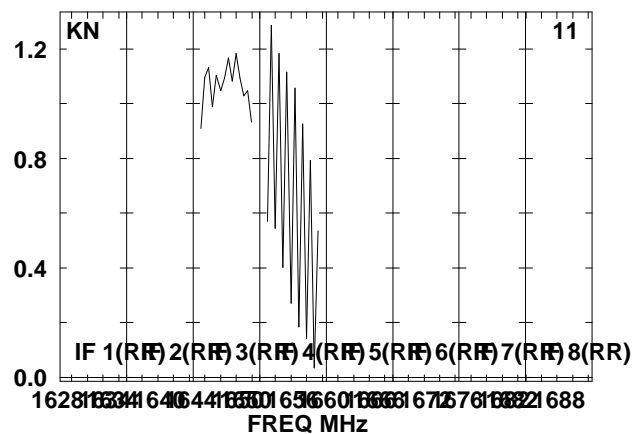
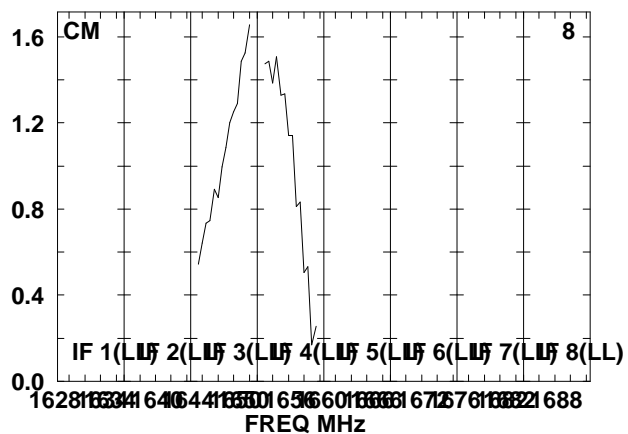
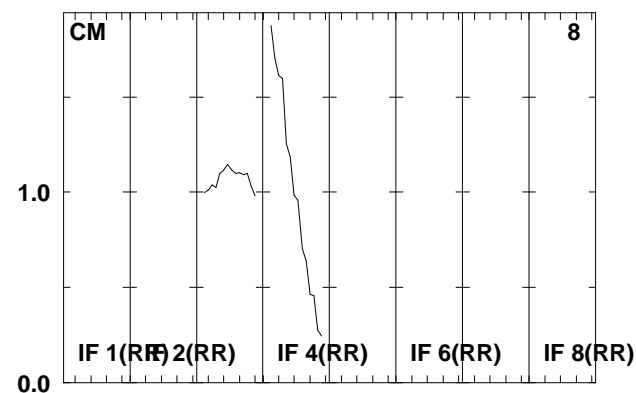
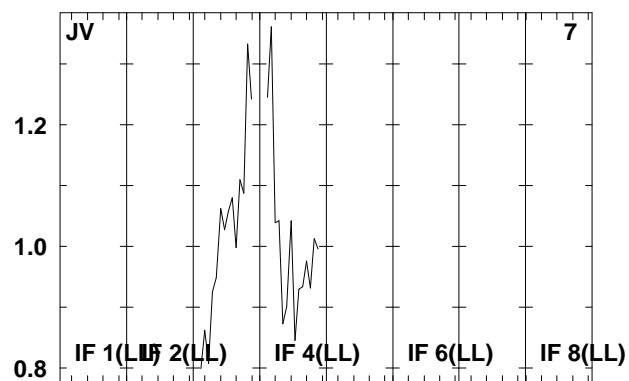
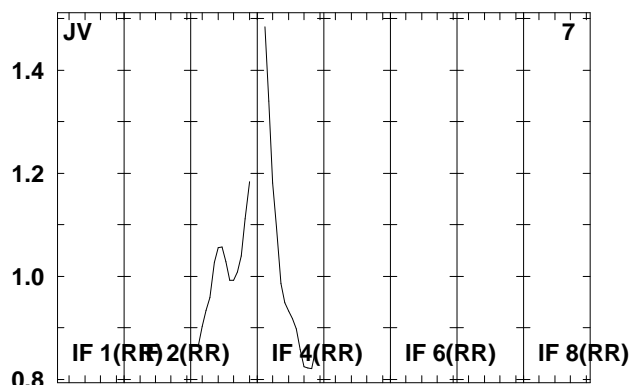
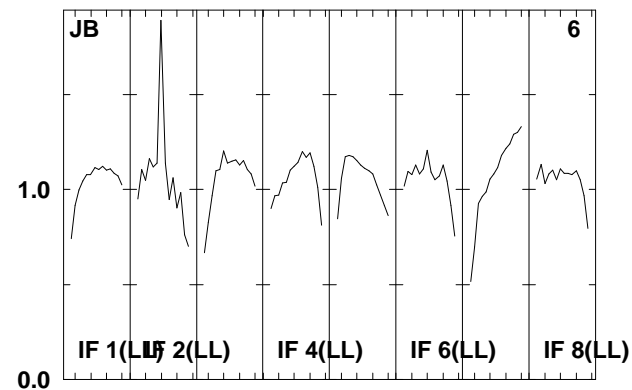
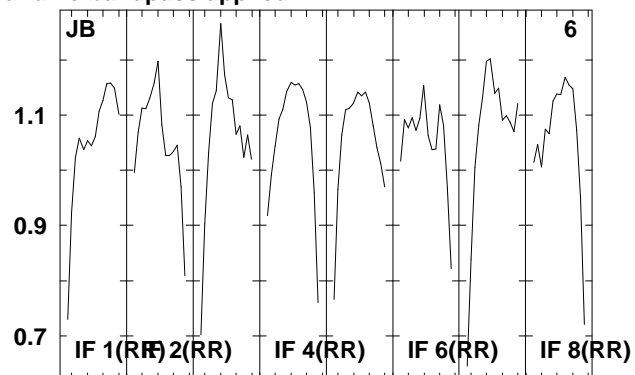
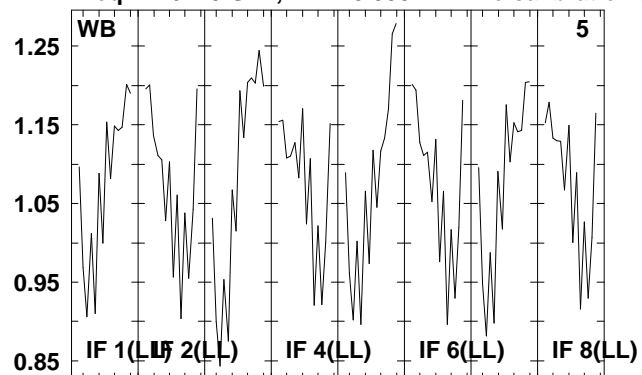

Lower frame: Real Jy

Total-power spectrum Antenna: \*

Timerange: 01/01:29:20 to 01/01:32:19

Plot file version 59 created 20-OCT-2009 14:49:09

J0137+31 RP015C.UVDATA.1

Freq = 1.6270 GHz, Bw = 8.000 MH No calibration applied and no bandpass applied

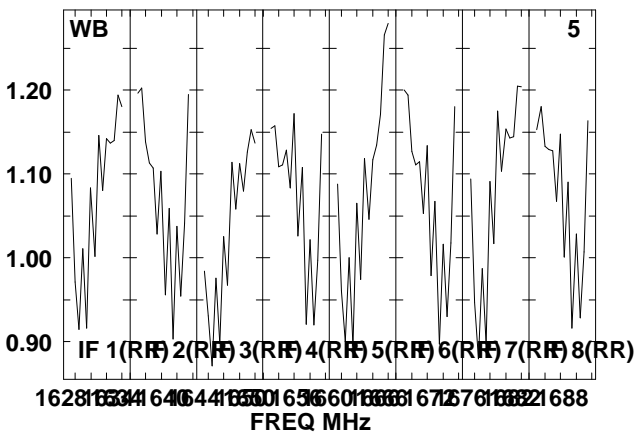
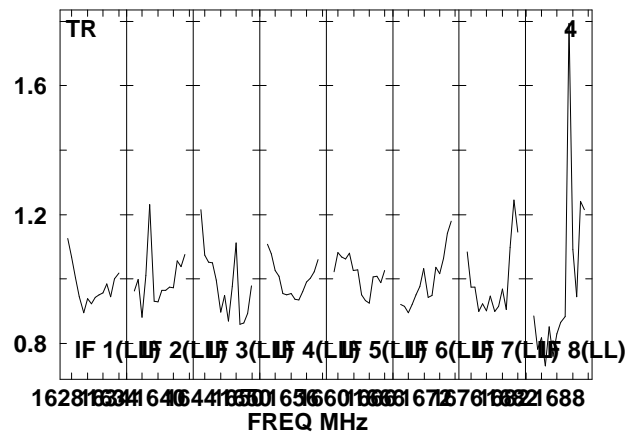
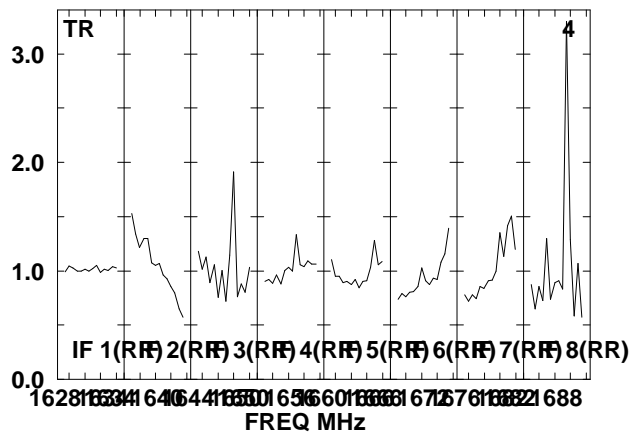
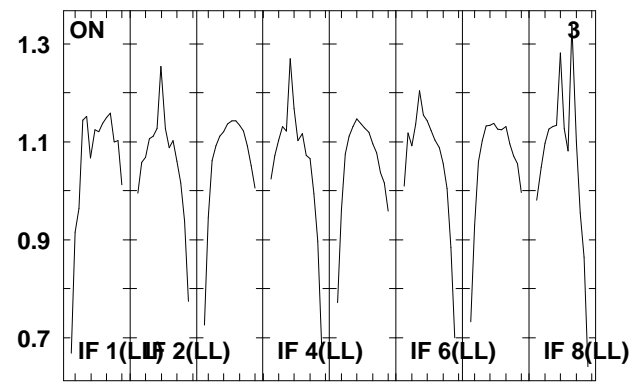
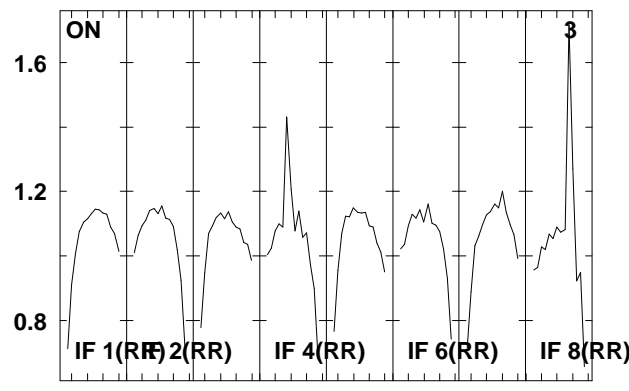
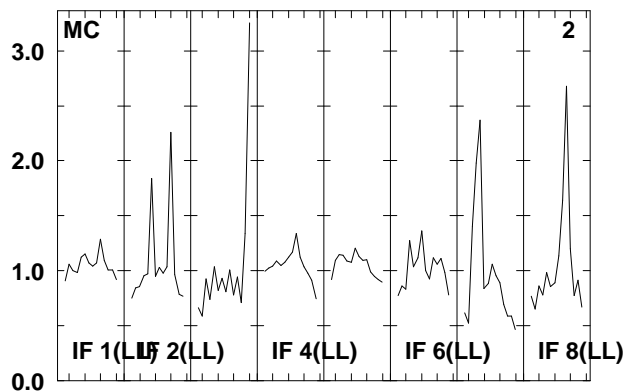
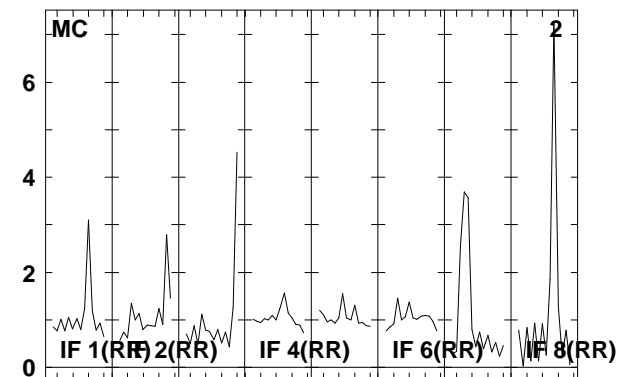
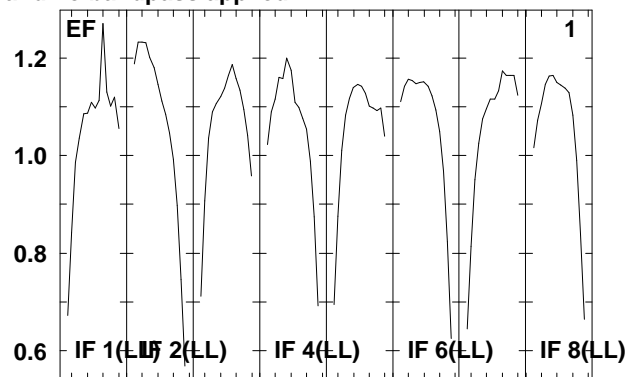
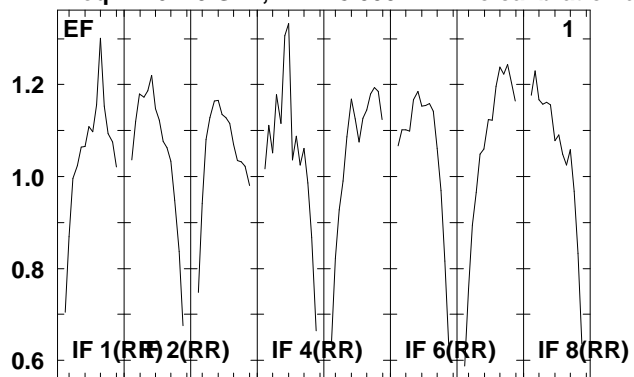

Lower frame: Real Jy  
Total-power spectrum Antenna: \*  
Timerange: 01/01:33:01 to 01/01:33:59

Plot file version 60 created 20-OCT-2009 14:49:10  
 J0137+31 RP015C.UVDATA.1  
 Freq = 1.6270 GHz, Bw = 8.000 MH No calibration applied and no bandpass applied

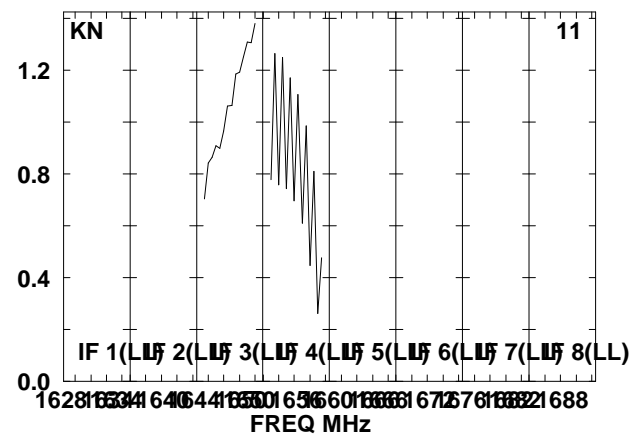
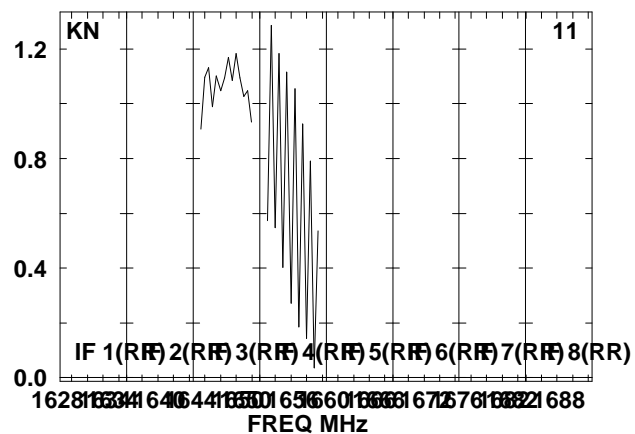
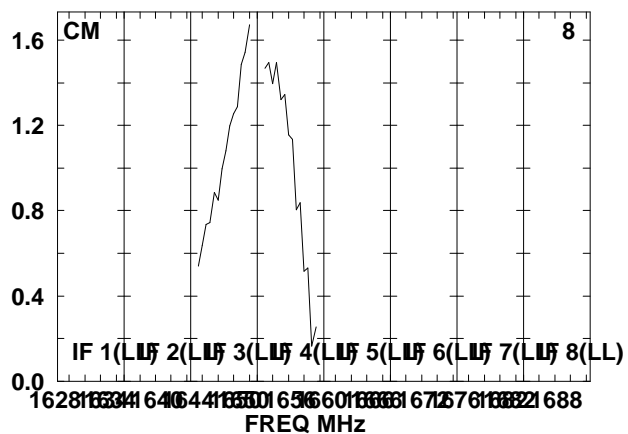
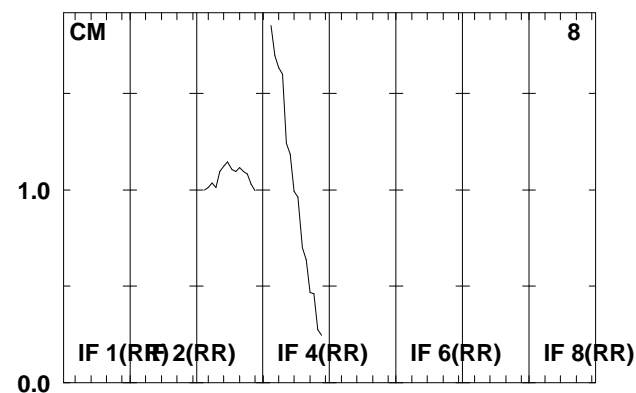
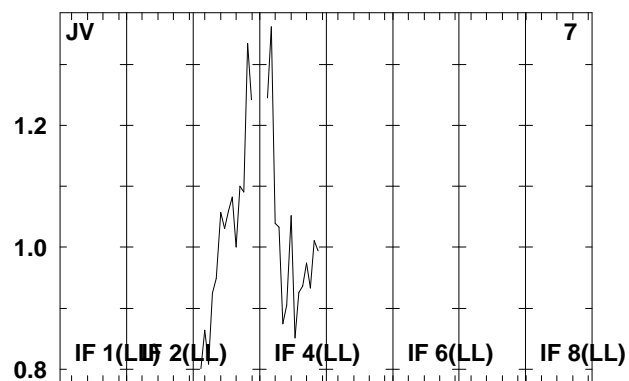
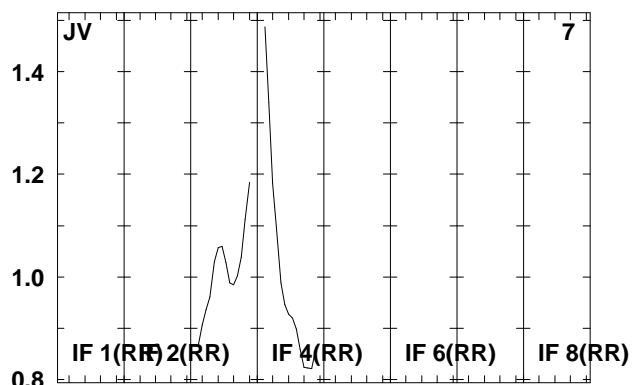
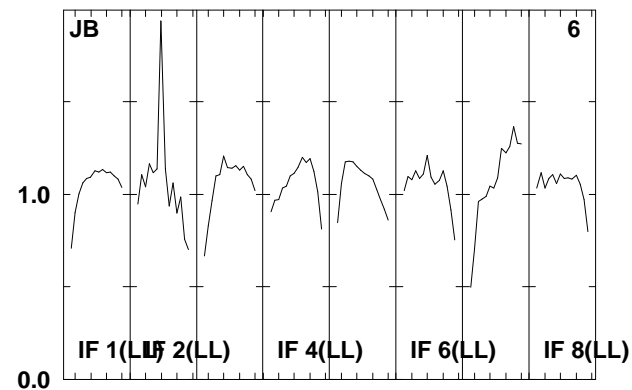
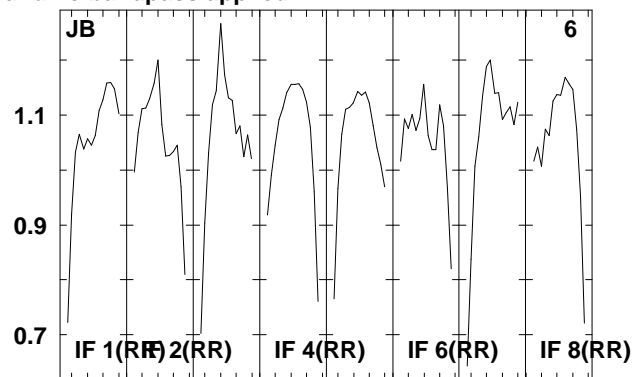
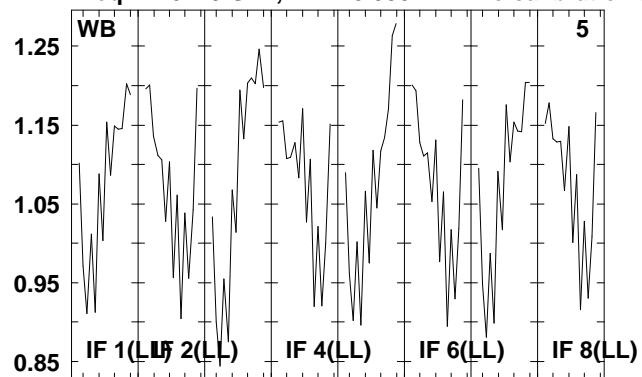

Lower frame: Real Jy  
 Total-power spectrum Antenna: \*  
 Timerange: 01/01:33:01 to 01/01:33:59

Plot file version 61 created 20-OCT-2009 14:49:10

FAINTCAL RP015C.UVDATA.1

Freq = 1.6270 GHz, Bw = 8.000 MH No calibration applied and no bandpass applied

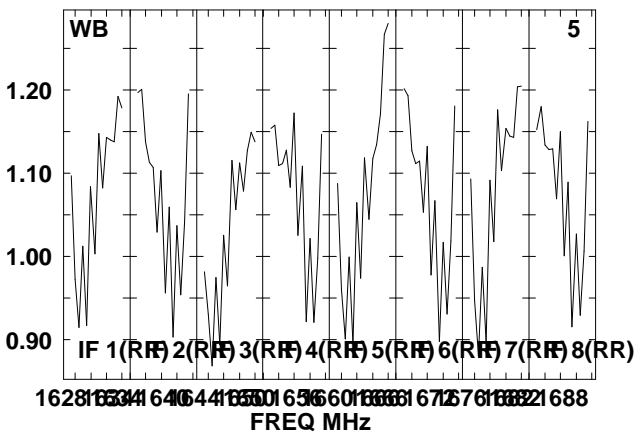
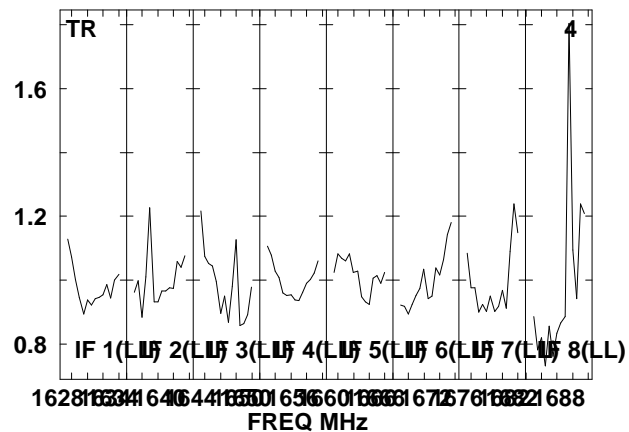
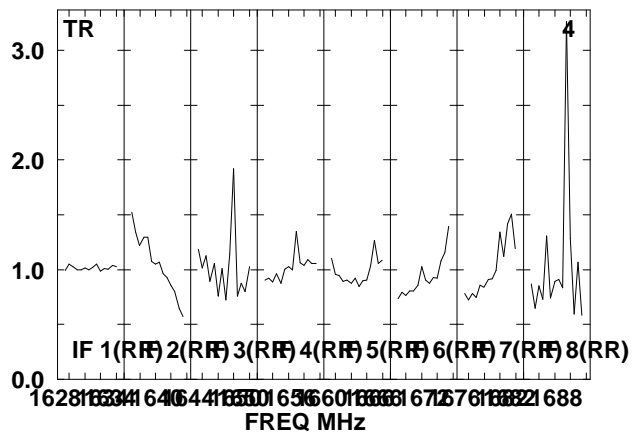
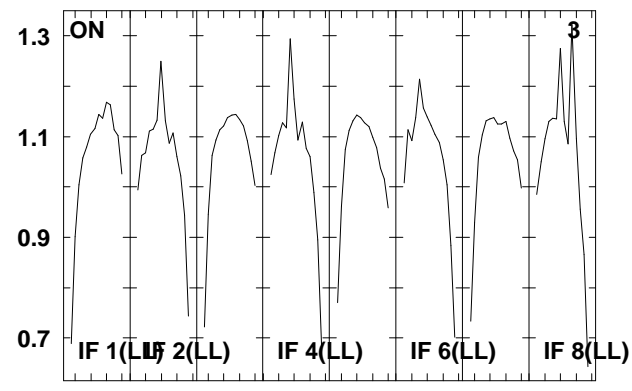
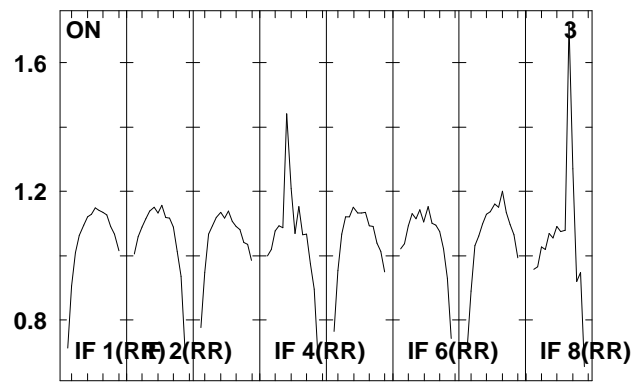
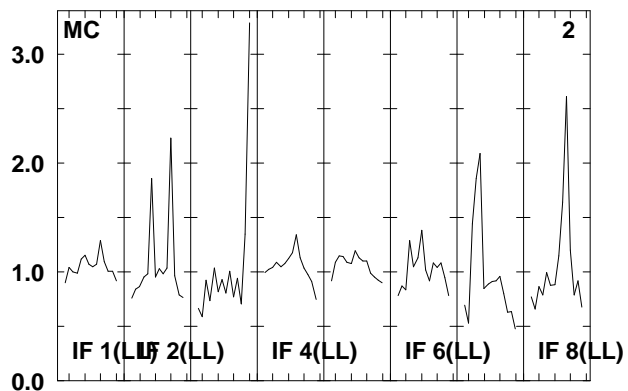
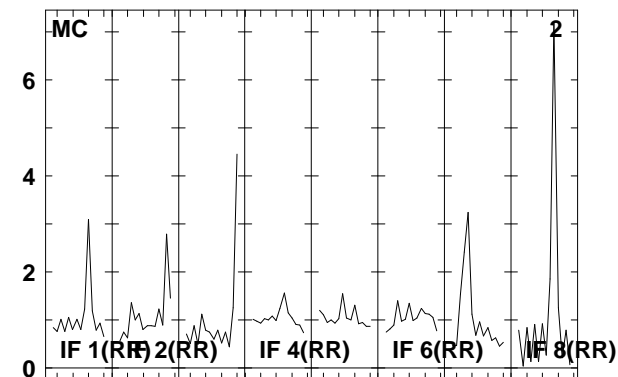
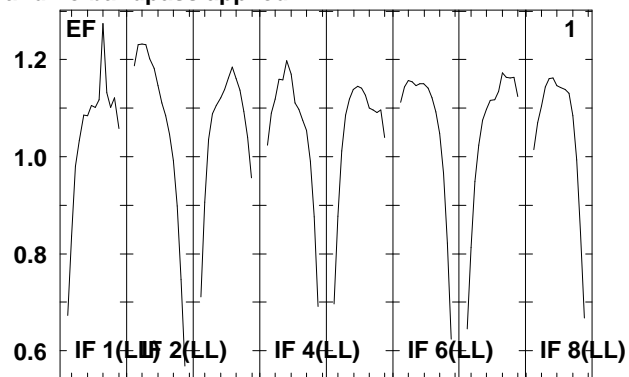
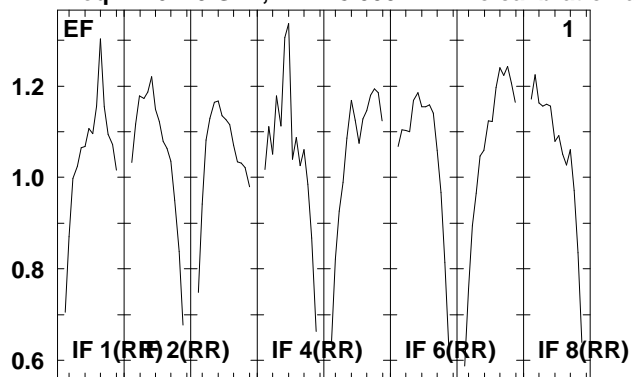

Lower frame: Real Jy  
Total-power spectrum Antenna: \*  
Timerange: 01/01:34:00 to 01/01:35:19

Plot file version 62 created 20-OCT-2009 14:49:11

FAINTCAL RP015C.UVDATA.1

Freq = 1.6270 GHz, Bw = 8.000 MH No calibration applied and no bandpass applied

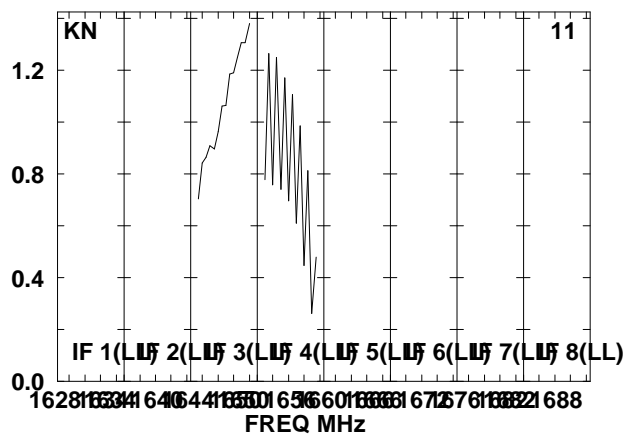
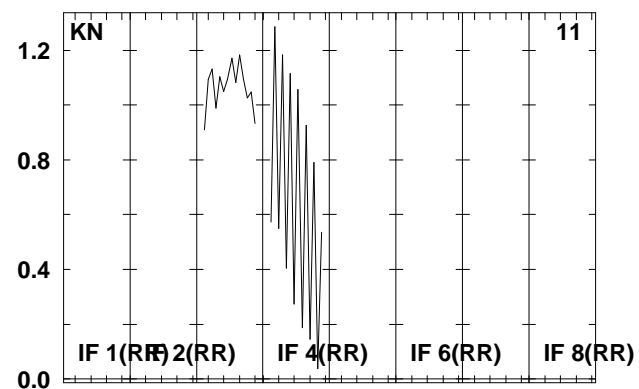
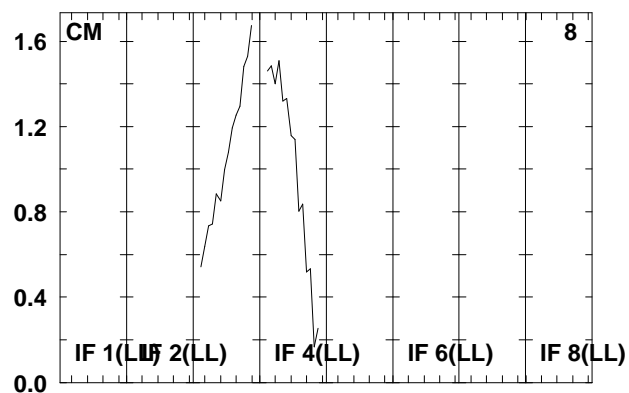
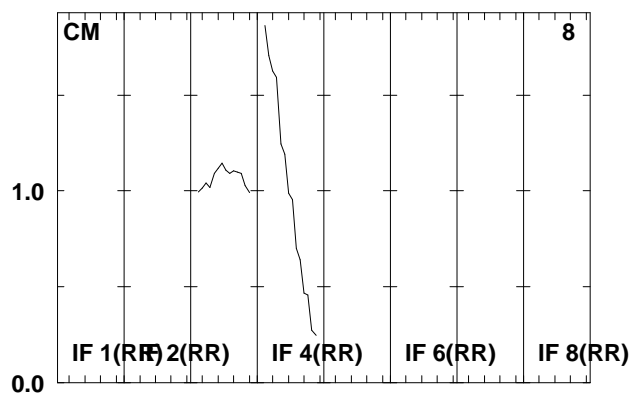
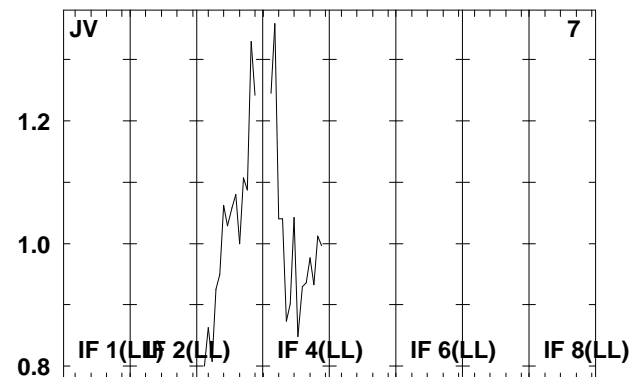
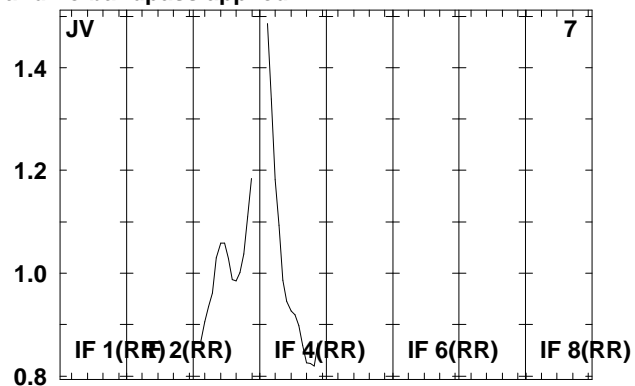
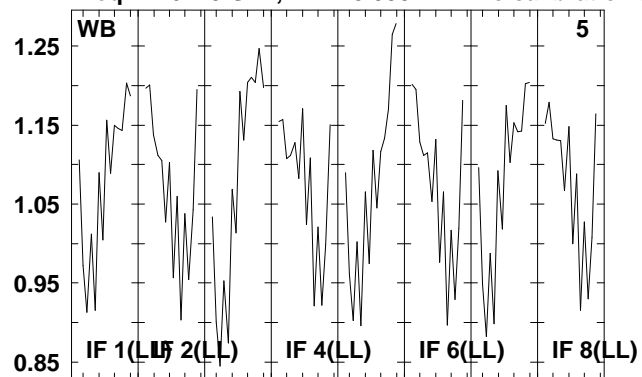

Lower frame: Real Jy

Total-power spectrum Antenna: \*

Timerange: 01/01:34:00 to 01/01:35:19

Plot file version 63 created 20-OCT-2009 14:49:11

M33 RP015C.UVDATA.1

Freq = 1.6270 GHz, Bw = 8.000 MH No calibration applied and no bandpass applied

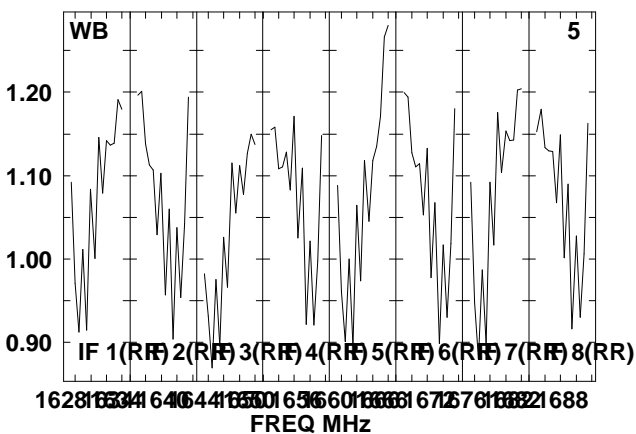
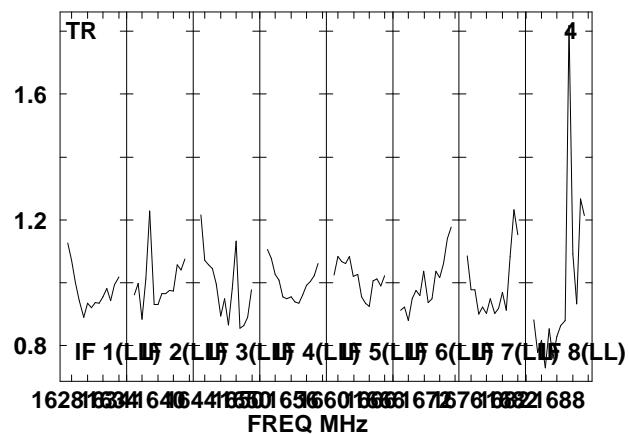
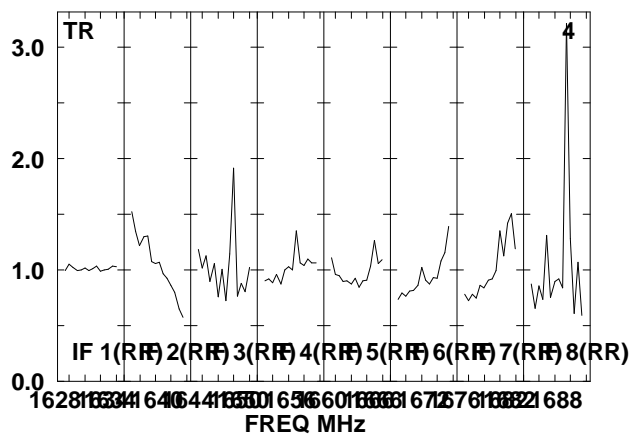
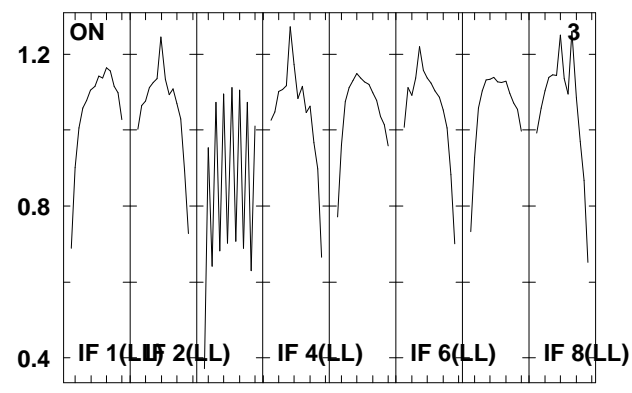
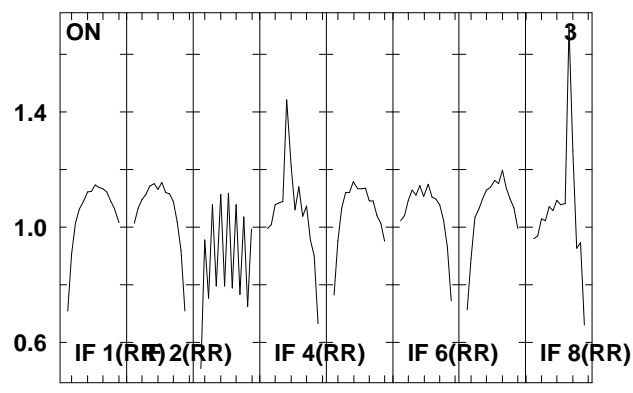
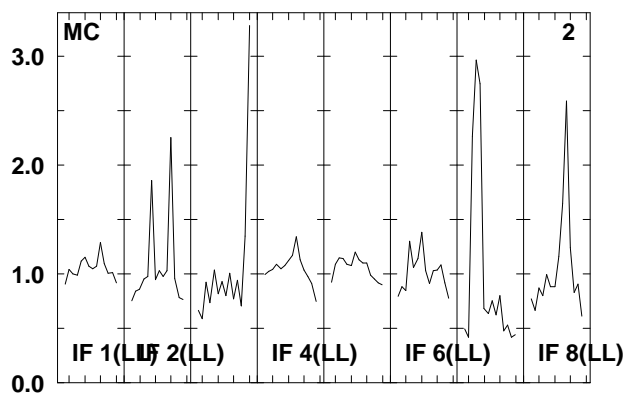
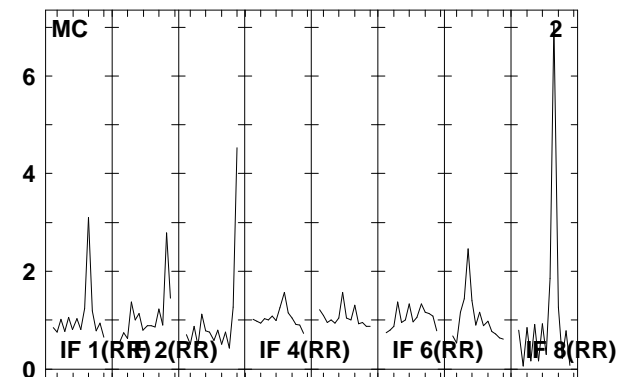
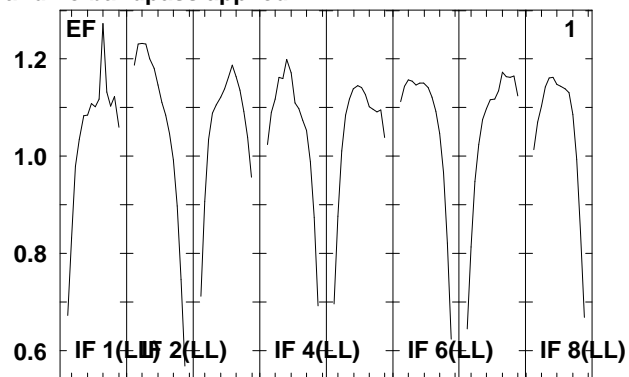
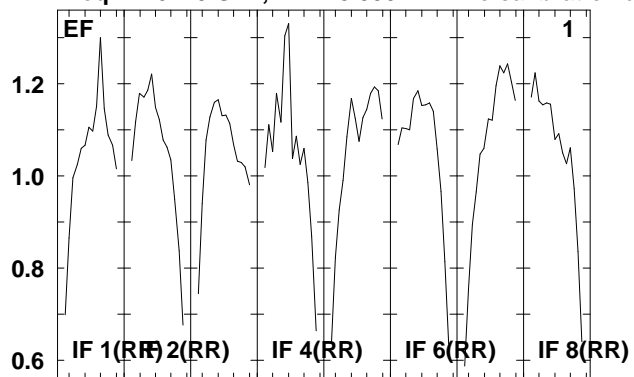

Lower frame: Real Jy

Total-power spectrum Antenna: \*

Timerange: 01/01:35:20 to 01/01:38:20

Plot file version 64 created 20-OCT-2009 14:49:12

M33 RP015C.UVDATA.1

Freq = 1.6270 GHz, Bw = 8.000 MH No calibration applied and no bandpass applied

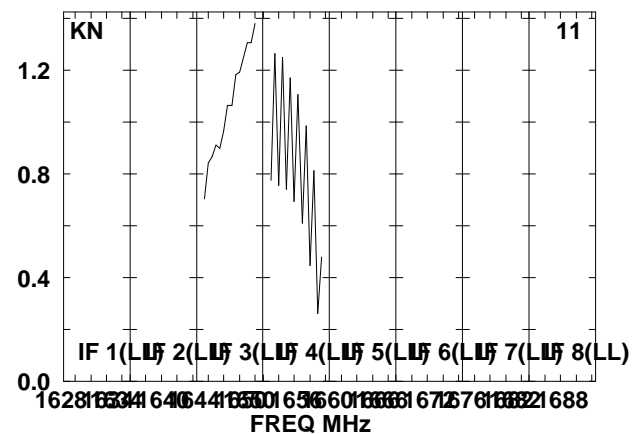
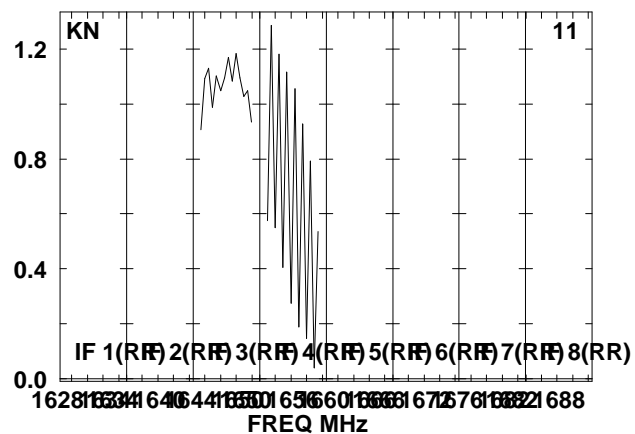
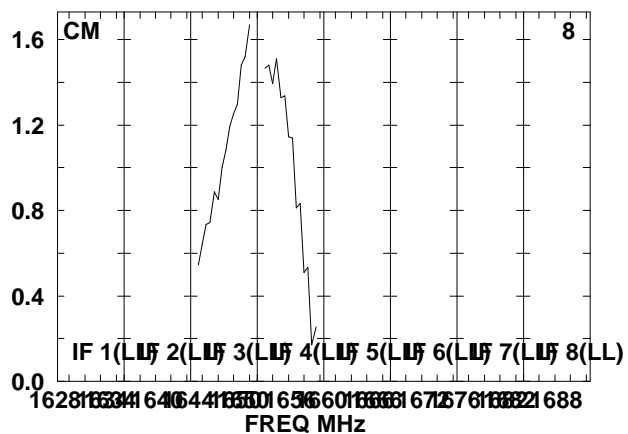
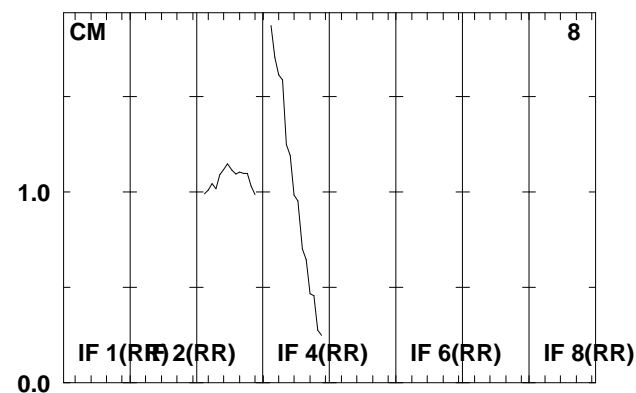
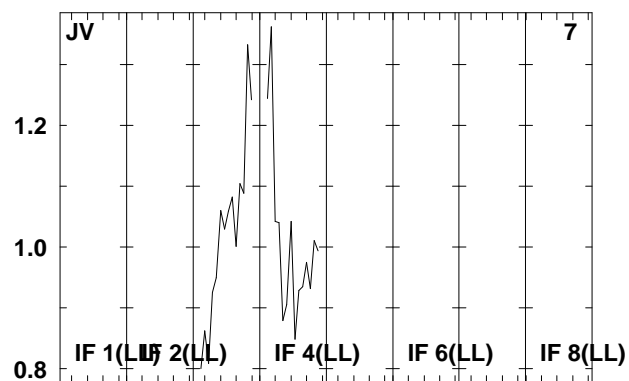
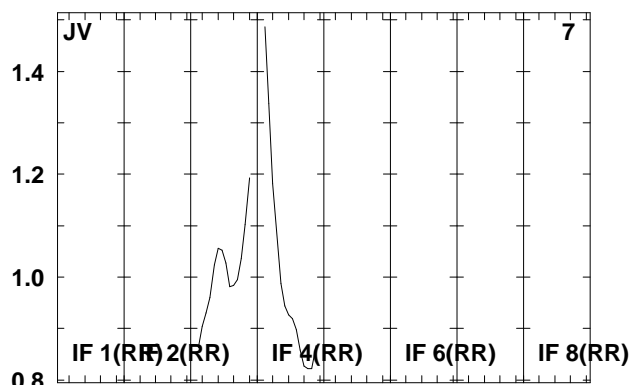
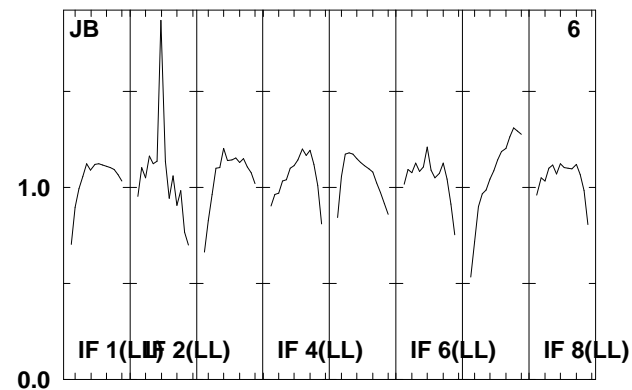
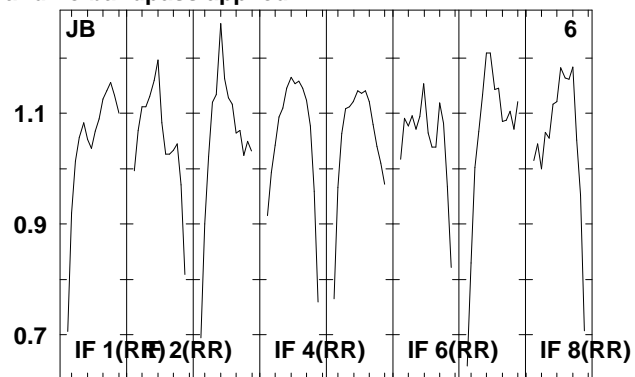
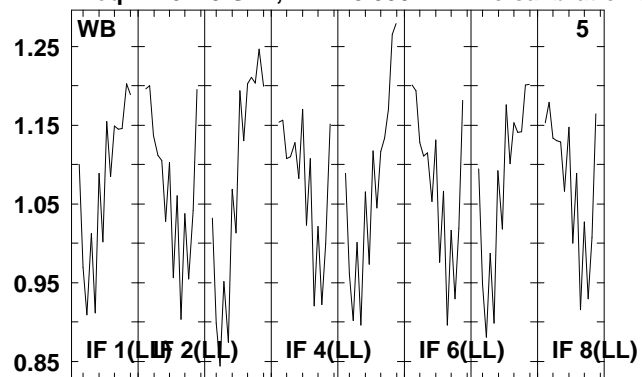

Lower frame: Real Jy  
Total-power spectrum Antenna: \*  
Timerange: 01/01:35:20 to 01/01:38:20



Plot file version 65 created 20-OCT-2009 14:49:14

J0137+31 RP015C.UVDATA.1

Freq = 1.6270 GHz, Bw = 8.000 MH No calibration applied and no bandpass applied

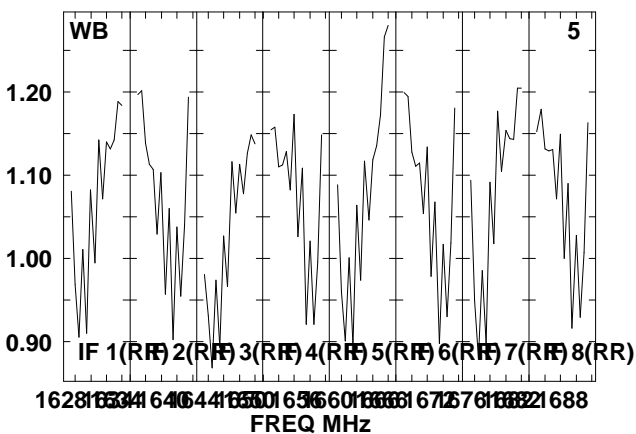
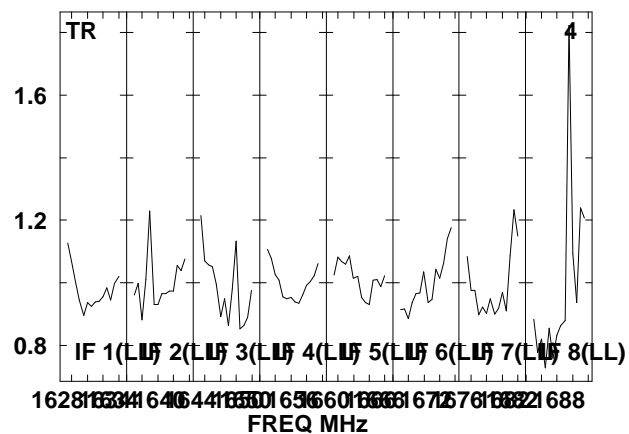
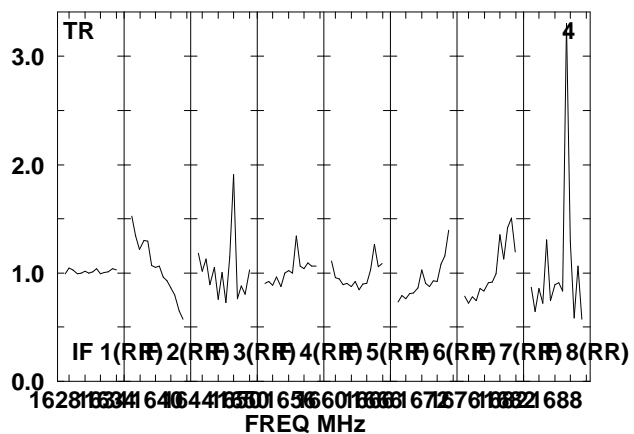
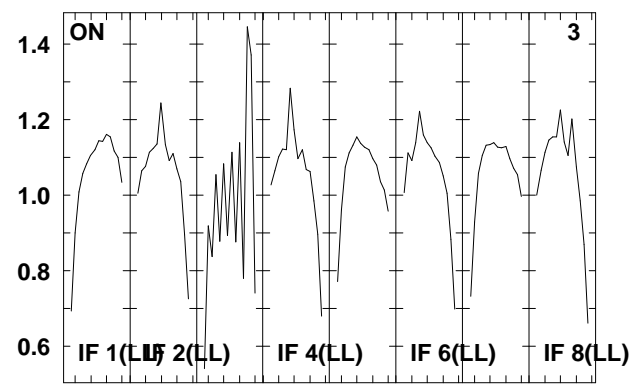
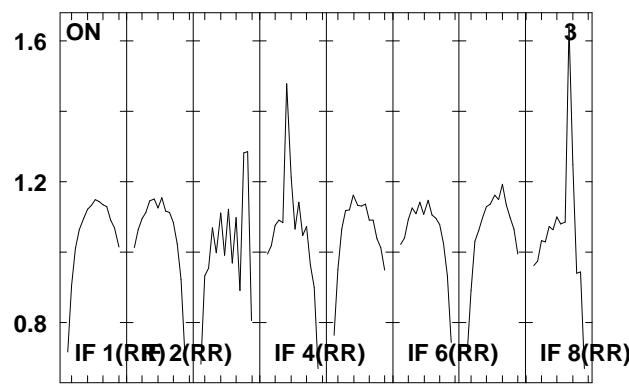
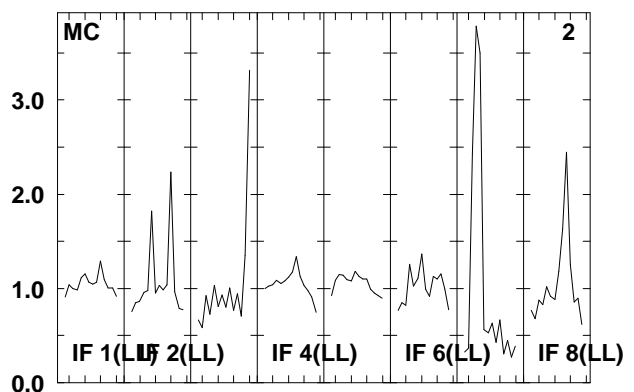
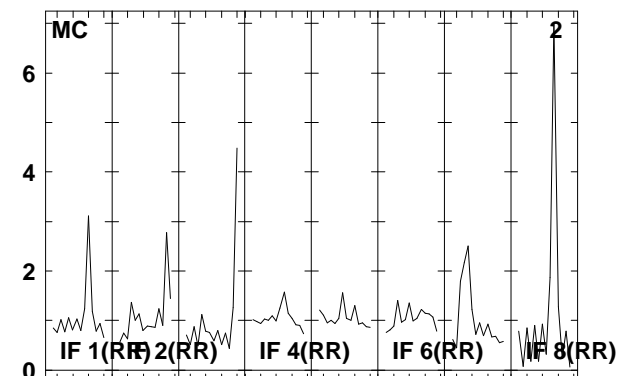
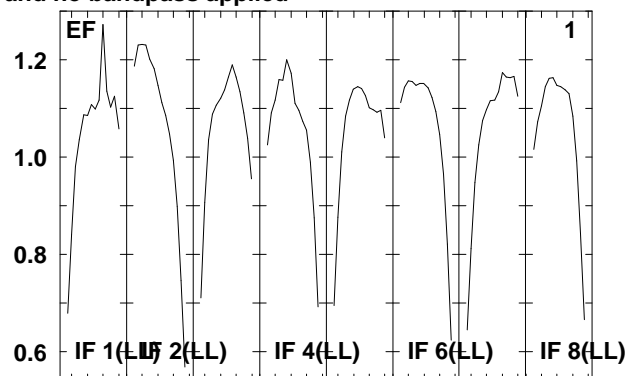
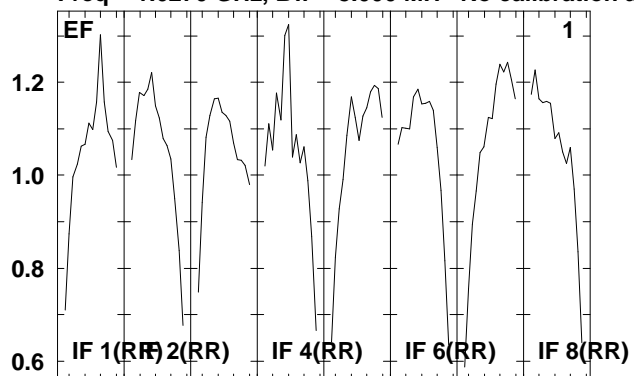

Lower frame: Real Jy  
Total-power spectrum Antenna: \*  
Timerange: 01/01:39:01 to 01/01:40:00

Plot file version 66 created 20-OCT-2009 14:49:14  
 J0137+31 RP015C.UVDATA.1  
 Freq = 1.6270 GHz, Bw = 8.000 MH No calibration applied and no bandpass applied

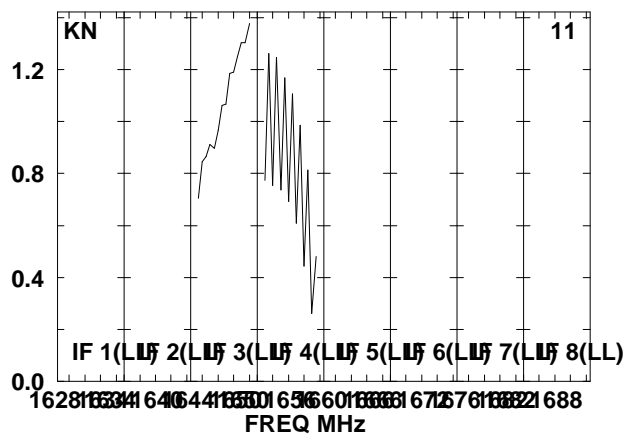
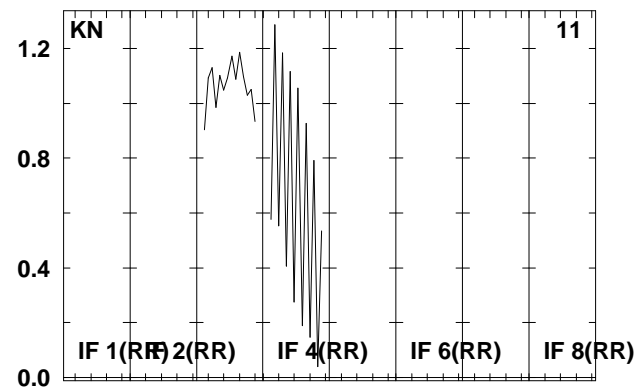
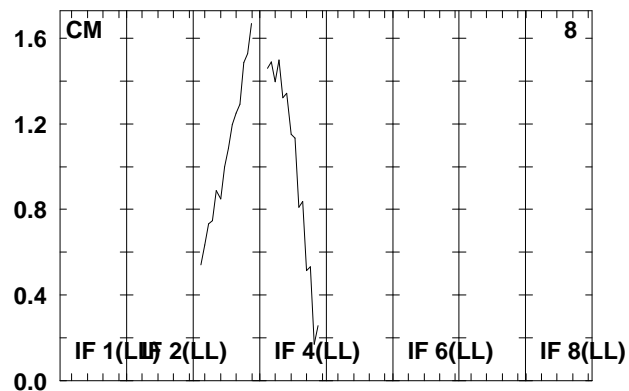
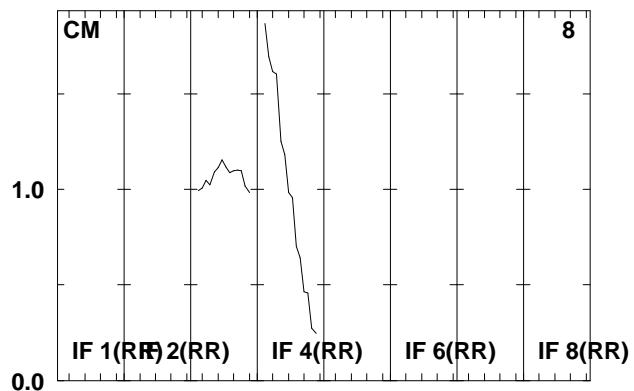
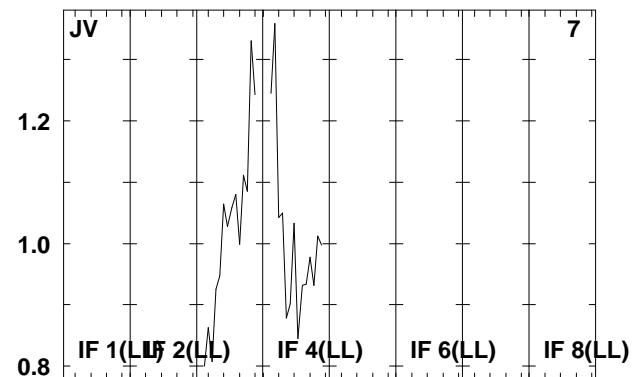
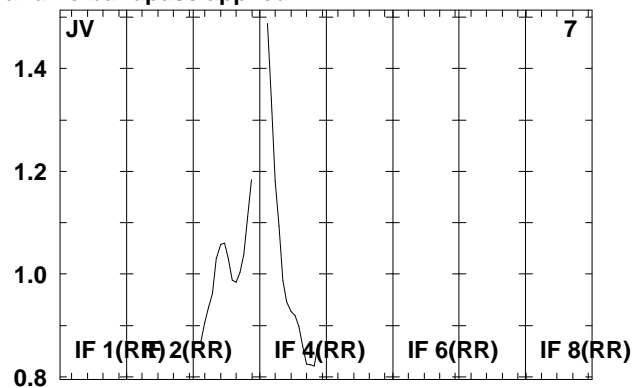
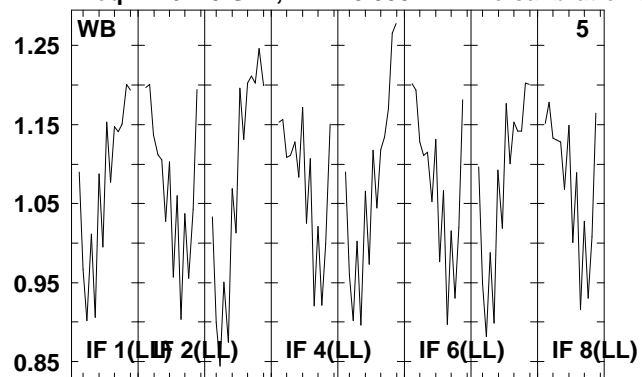

Lower frame: Real Jy  
 Total-power spectrum Antenna: \*  
 Timerange: 01/01:39:01 to 01/01:40:00

Plot file version 67 created 20-OCT-2009 14:49:15

FAINTCAL RP015C.UVDATA.1

Freq = 1.6270 GHz, Bw = 8.000 MH No calibration applied and no bandpass applied

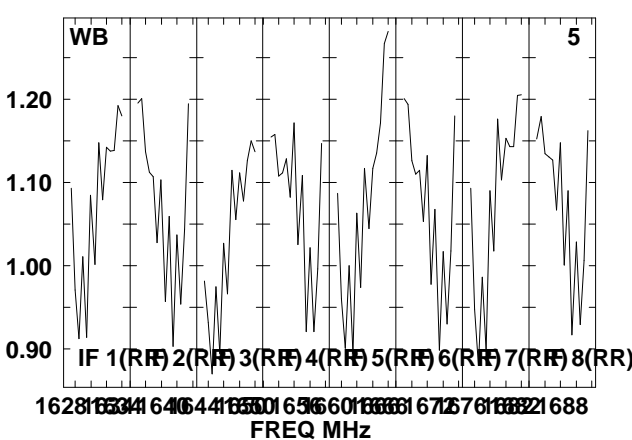
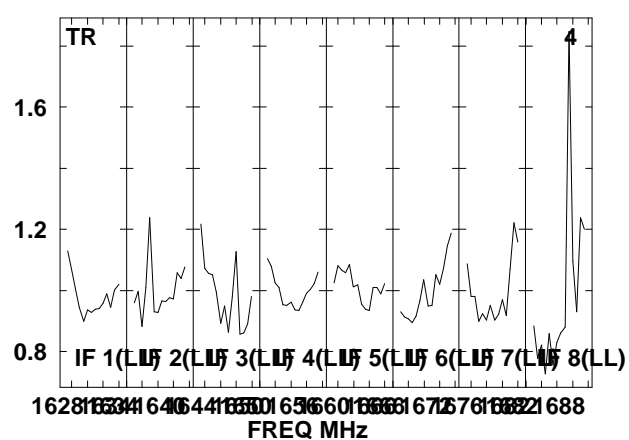
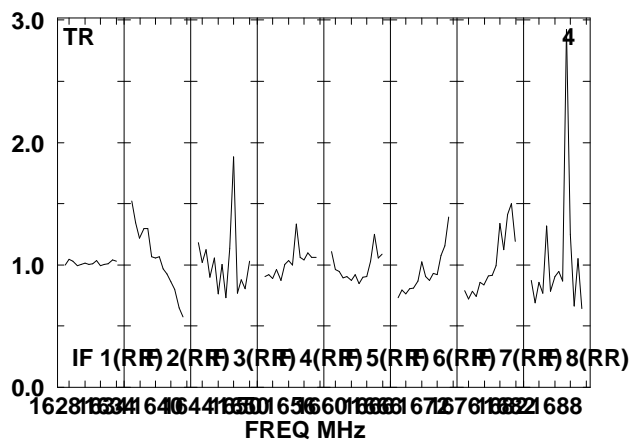
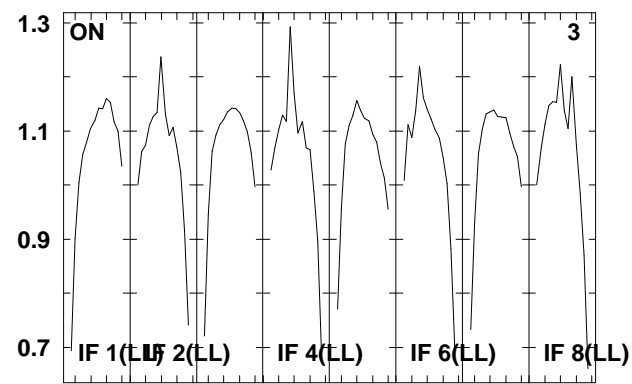
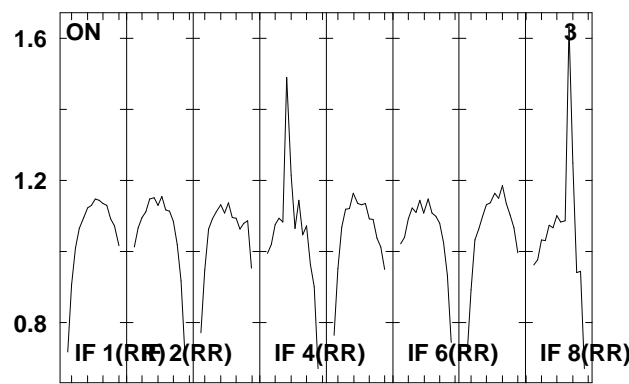
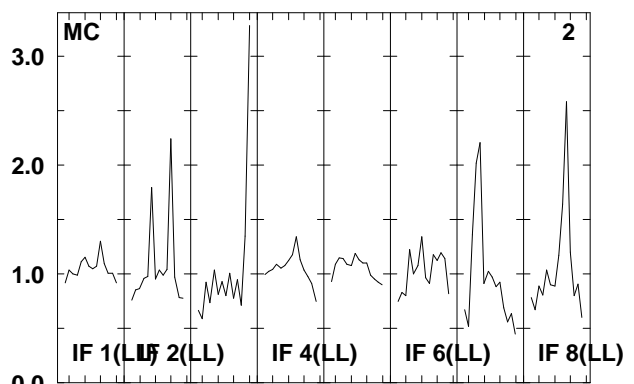
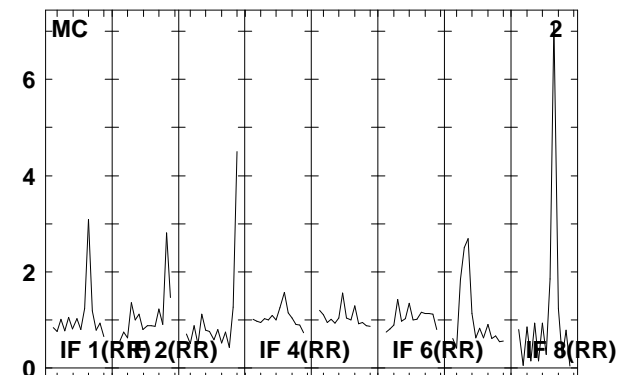
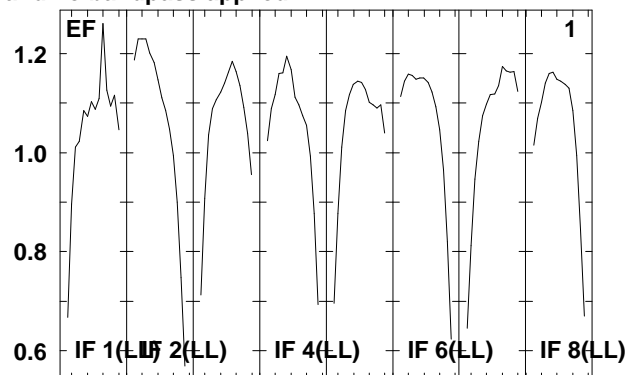
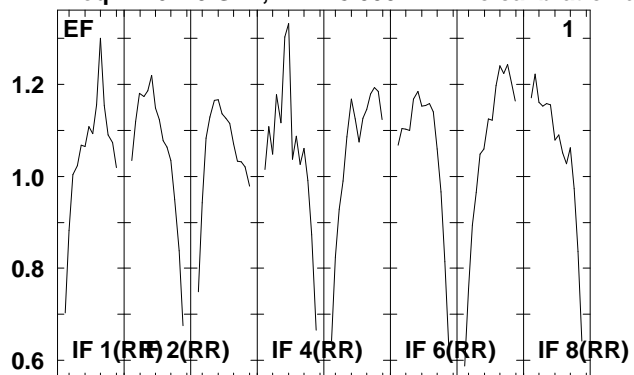

Lower frame: Real Jy  
Total-power spectrum Antenna: \*  
Timerange: 01/01:40:01 to 01/01:41:20

Plot file version 68 created 20-OCT-2009 14:49:15

FAINTCAL RP015C.UVDATA.1

Freq = 1.6270 GHz, Bw = 8.000 MH No calibration applied and no bandpass applied

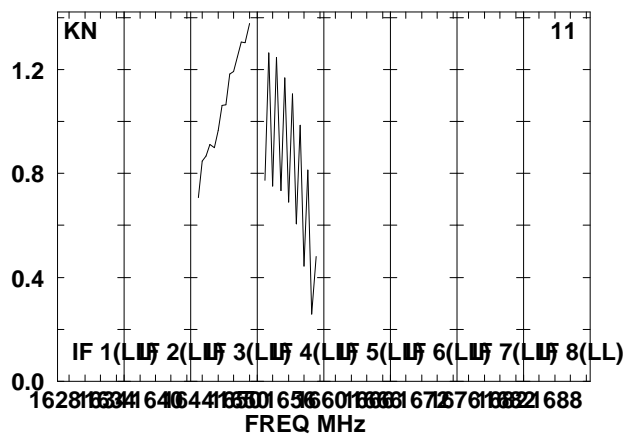
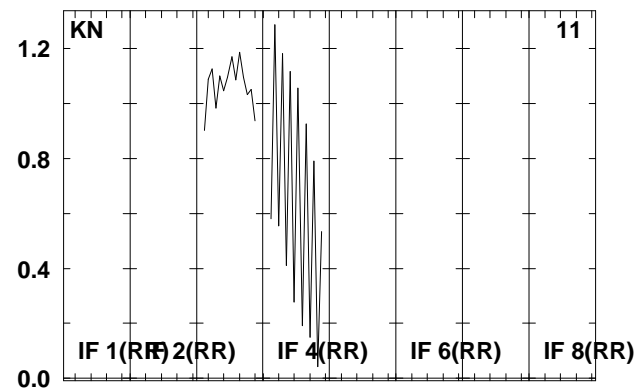
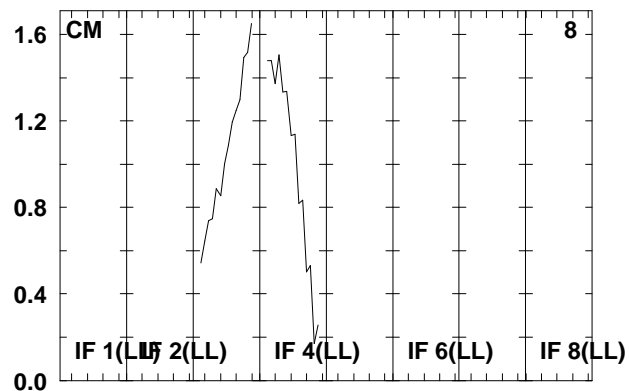
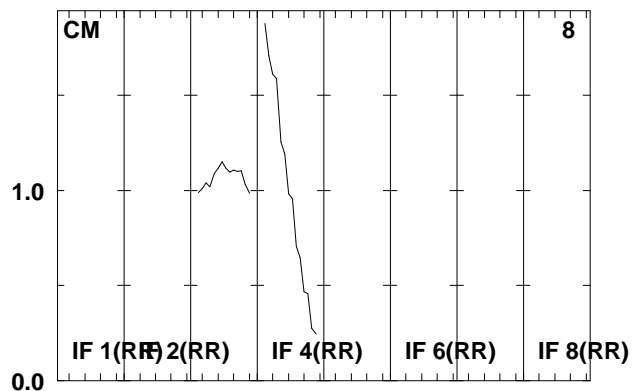
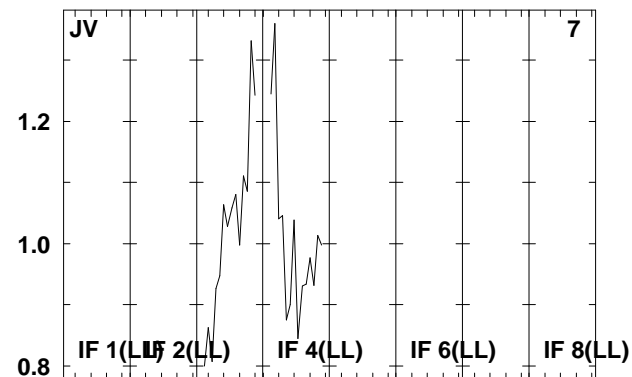
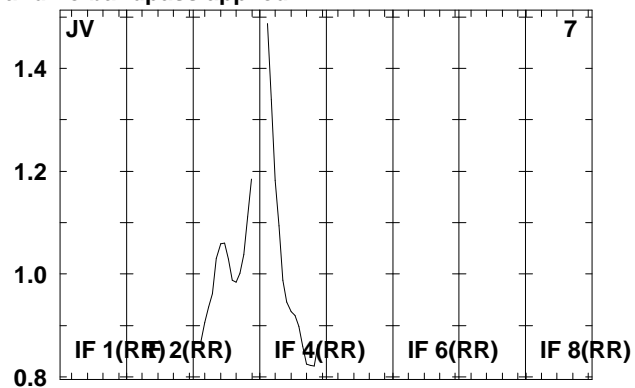
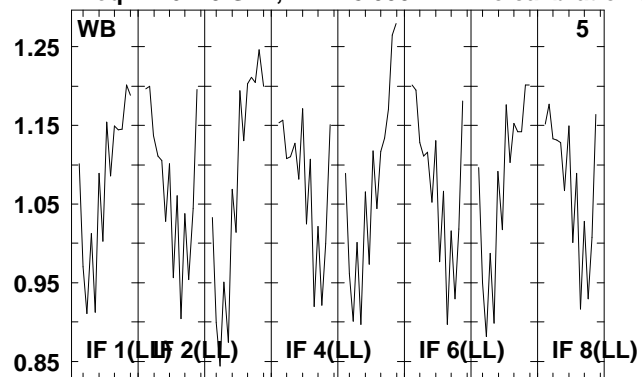

Lower frame: Real Jy

Total-power spectrum Antenna: \*

Timerange: 01/01:40:01 to 01/01:41:20

Plot file version 69 created 20-OCT-2009 14:49:16

M33 RP015C.UVDATA.1

Freq = 1.6270 GHz, Bw = 8.000 MH No calibration applied and no bandpass applied

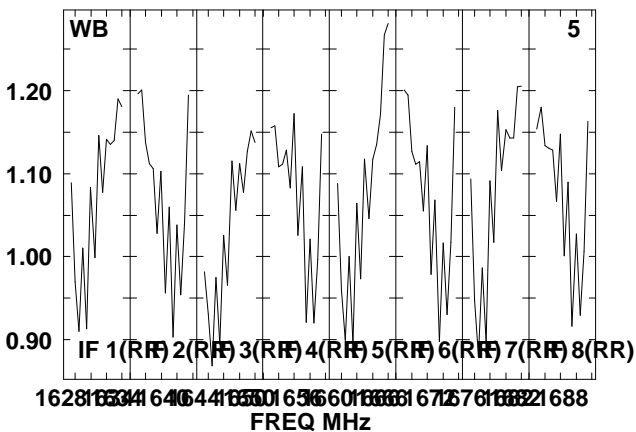
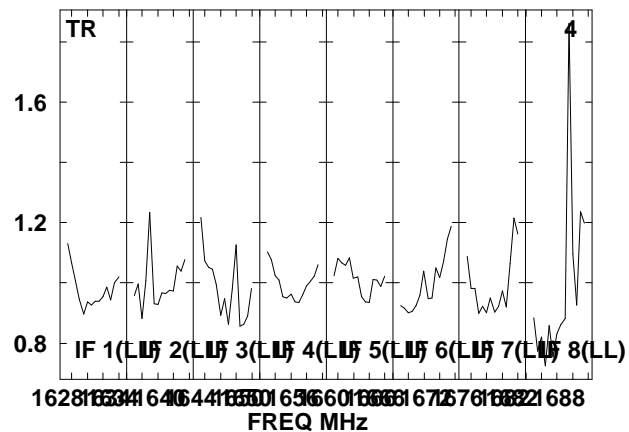
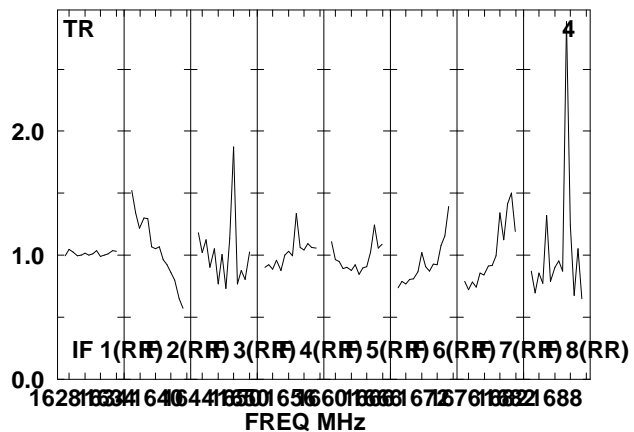
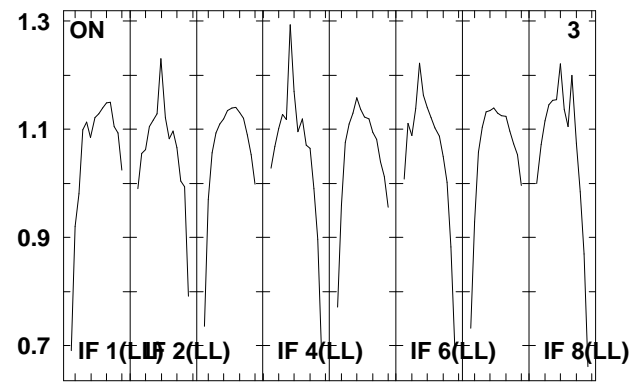
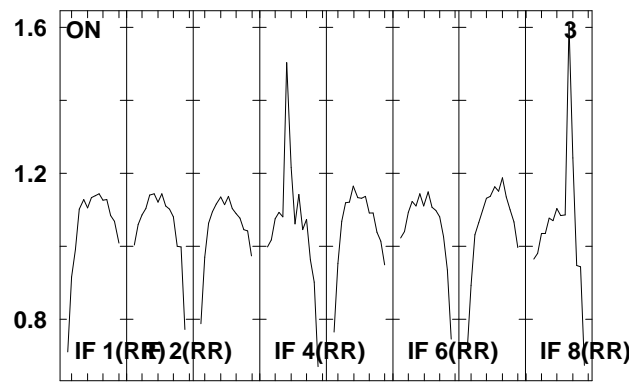
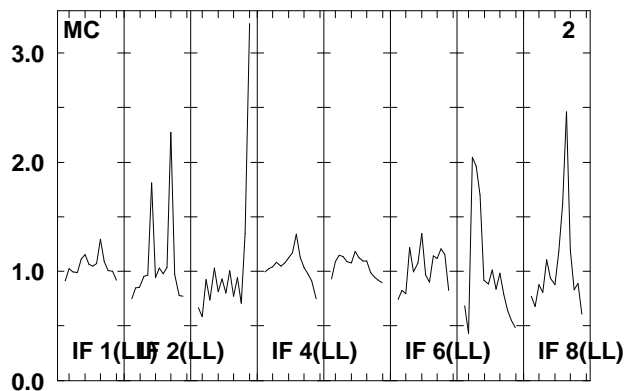
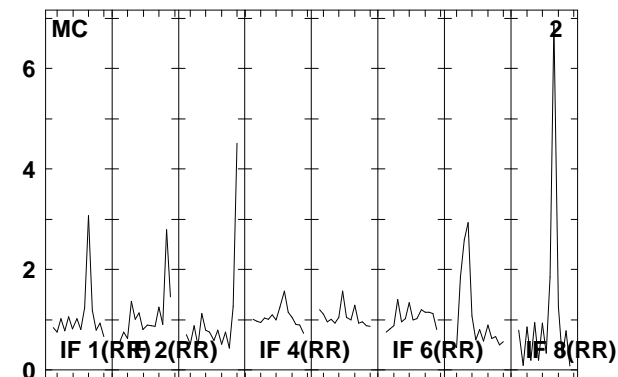
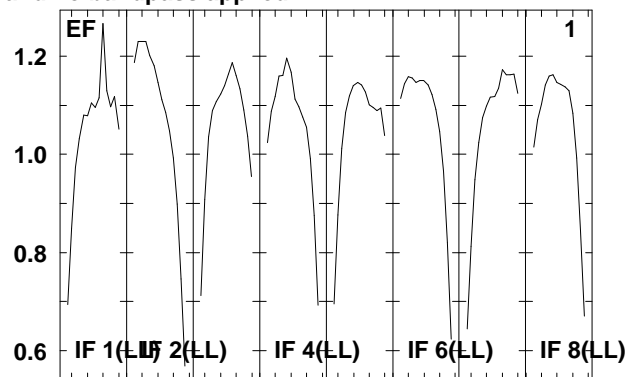
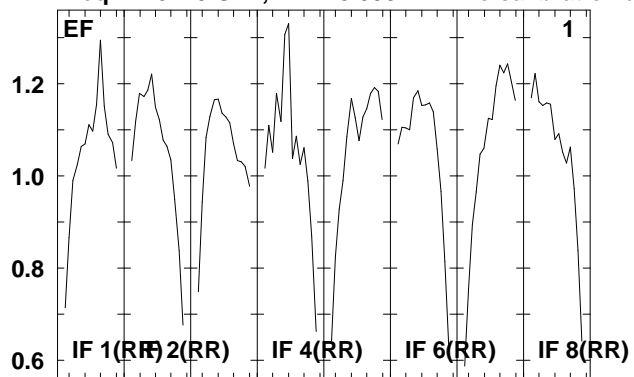

Lower frame: Real Jy  
Total-power spectrum Antenna: \*  
Timerange: 01/01:41:21 to 01/01:44:20

Plot file version 70 created 20-OCT-2009 14:49:17

M33 RP015C.UVDATA.1

Freq = 1.6270 GHz, Bw = 8.000 MH No calibration applied and no bandpass applied

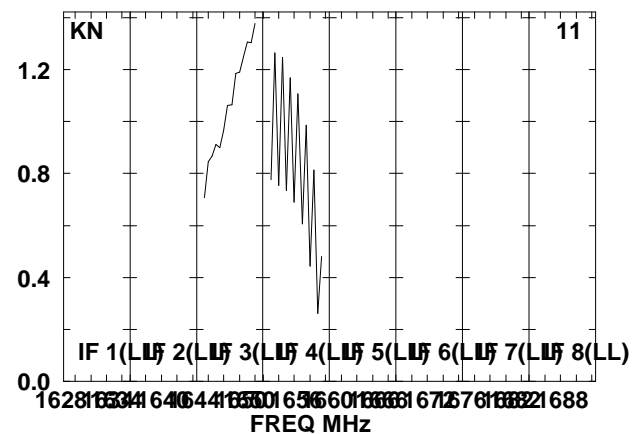
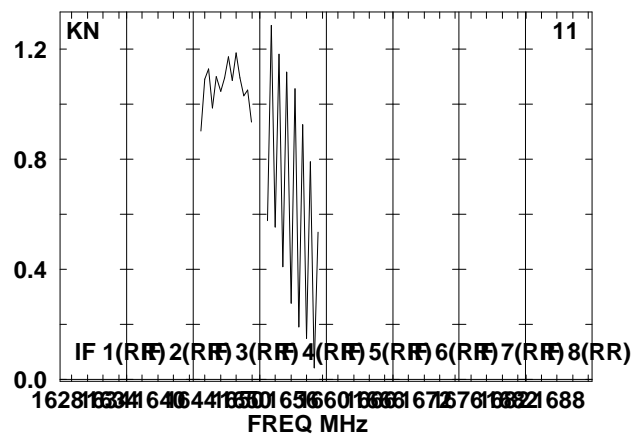
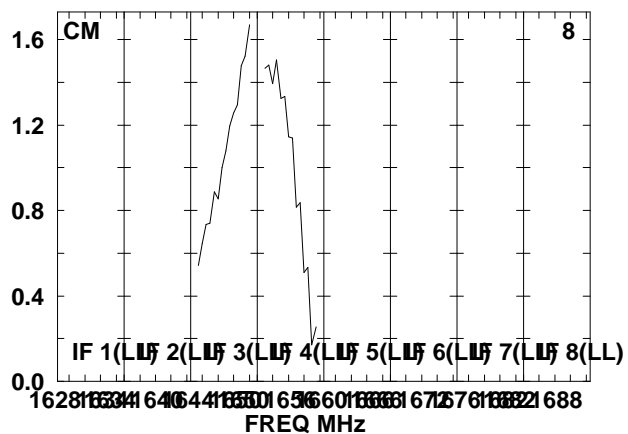
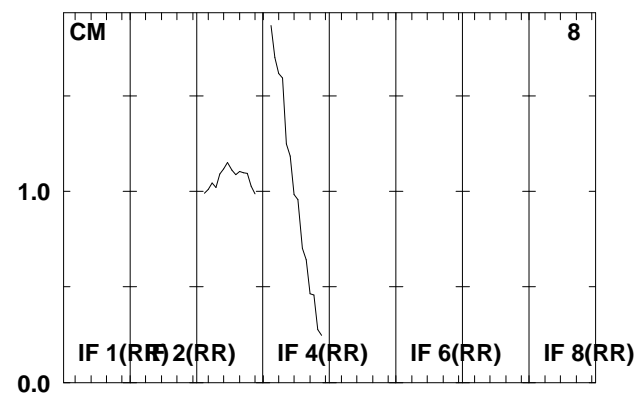
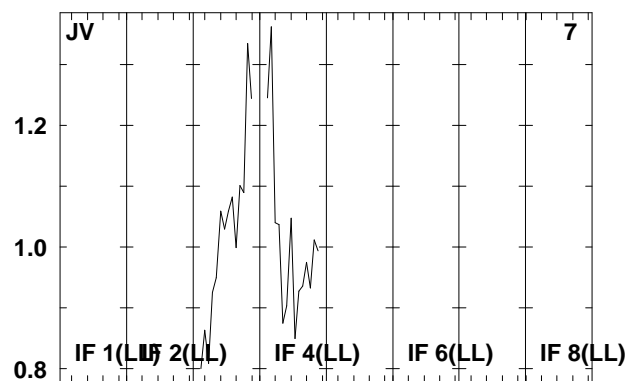
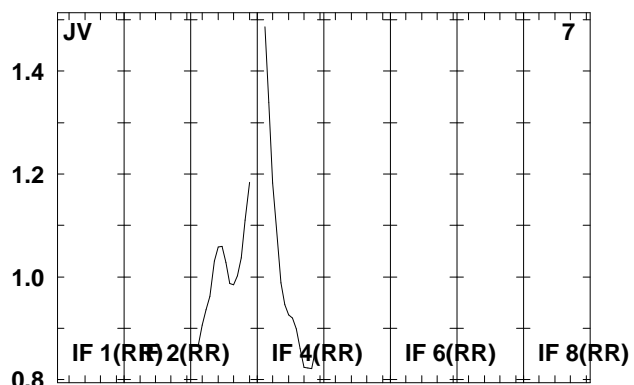
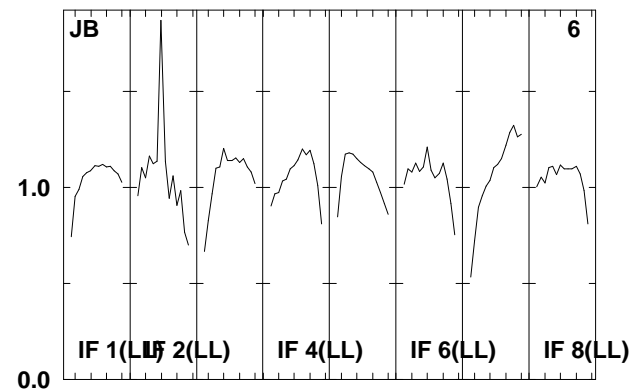
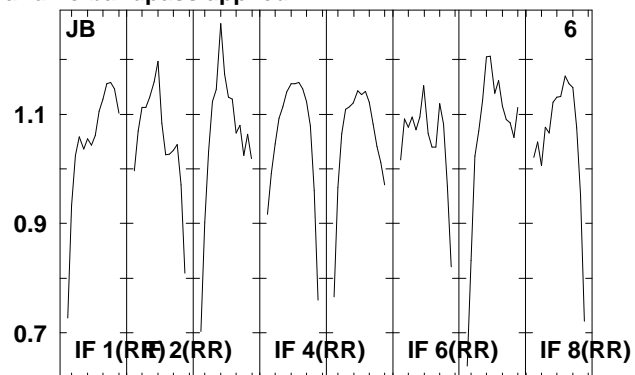
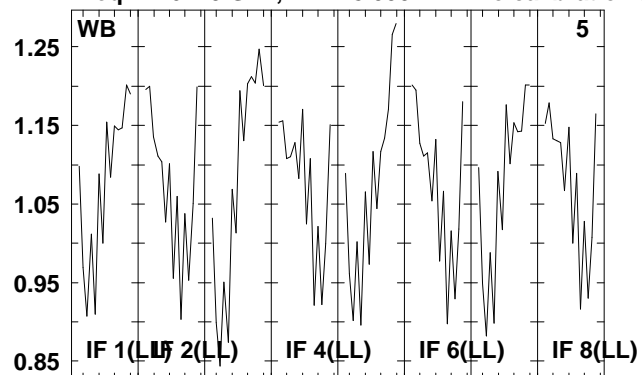

Lower frame: Real Jy  
Total-power spectrum Antenna: \*  
Timerange: 01/01:41:21 to 01/01:44:20

Plot file version 71 created 20-OCT-2009 14:49:18

J0137+31 RP015C.UVDATA.1

Freq = 1.6270 GHz, Bw = 8.000 MH No calibration applied and no bandpass applied

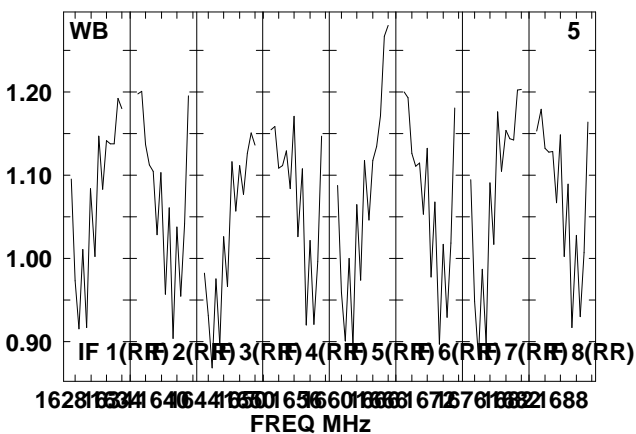
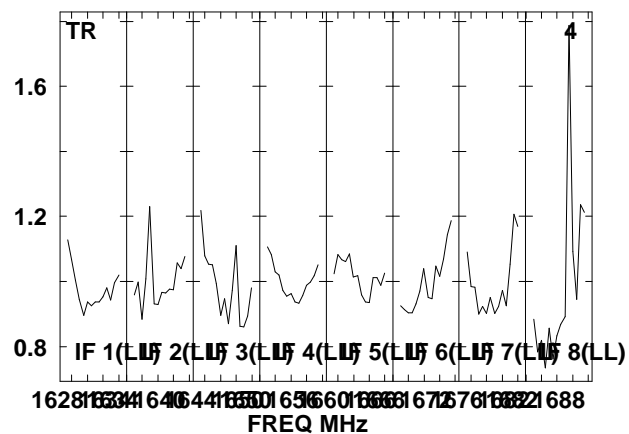
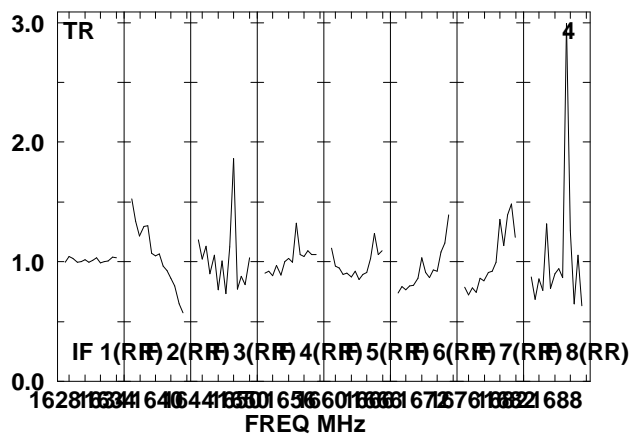
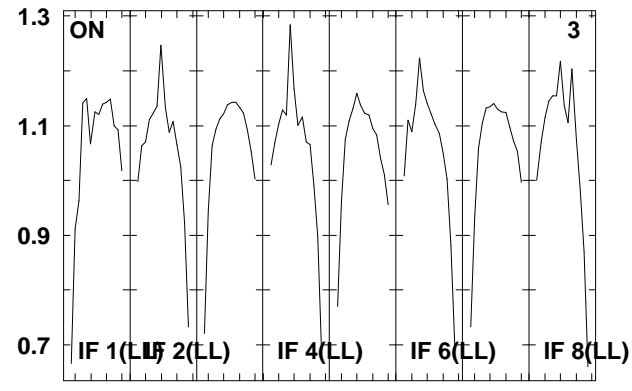
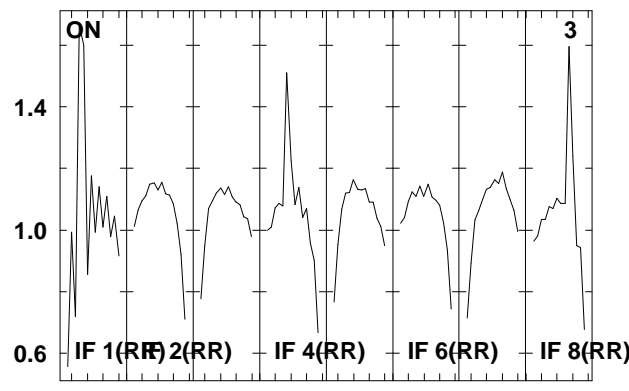
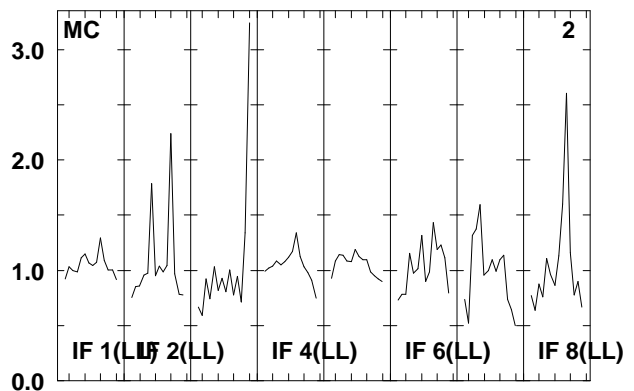
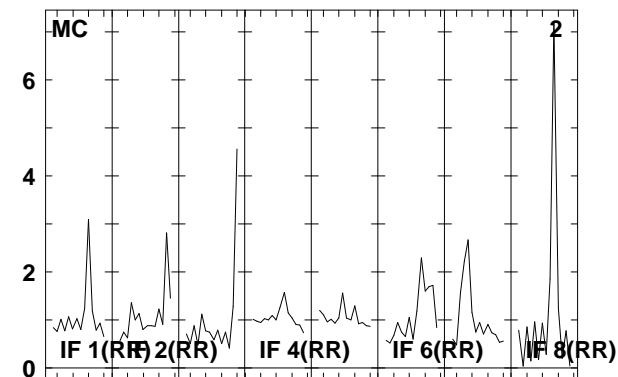
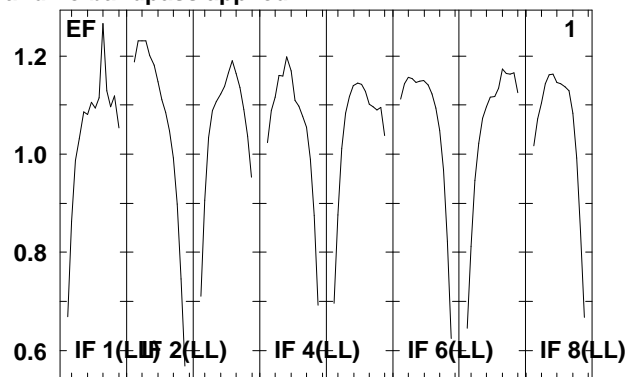
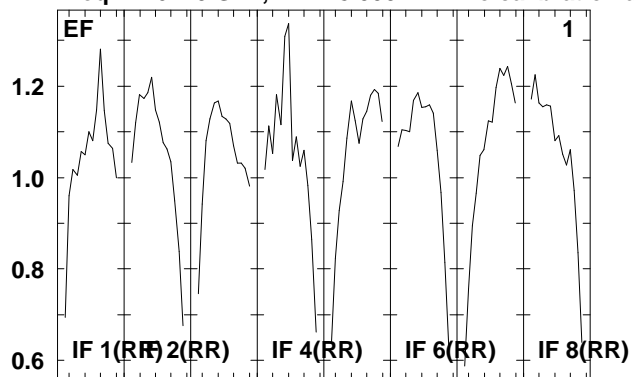

Lower frame: Real Jy  
Total-power spectrum Antenna: \*  
Timerange: 01/01:45:01 to 01/01:45:59

Plot file version 72 created 20-OCT-2009 14:49:19

J0137+31 RP015C.UVDATA.1

Freq = 1.6270 GHz, Bw = 8.000 MH No calibration applied and no bandpass applied

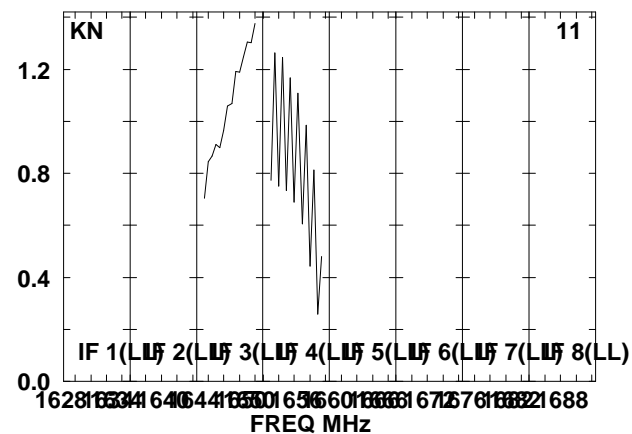
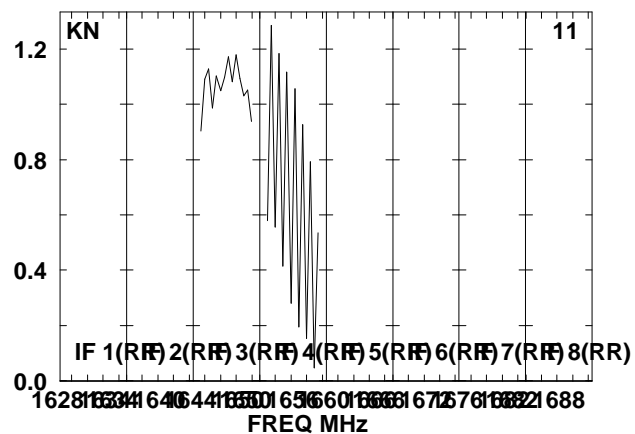
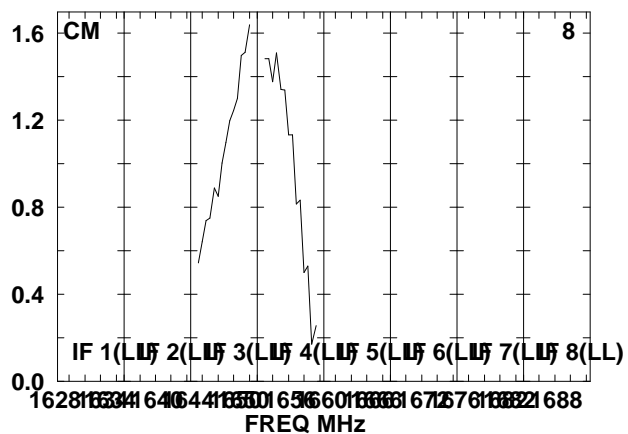
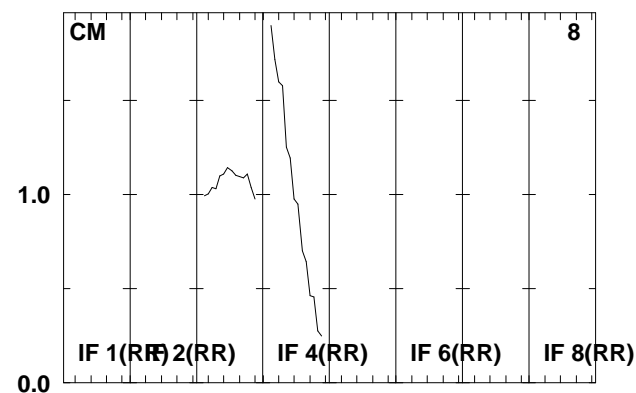
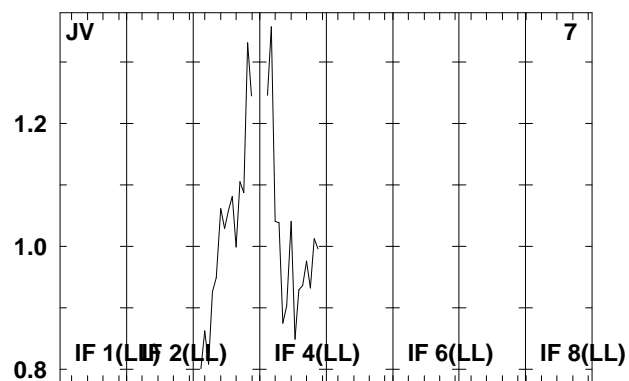
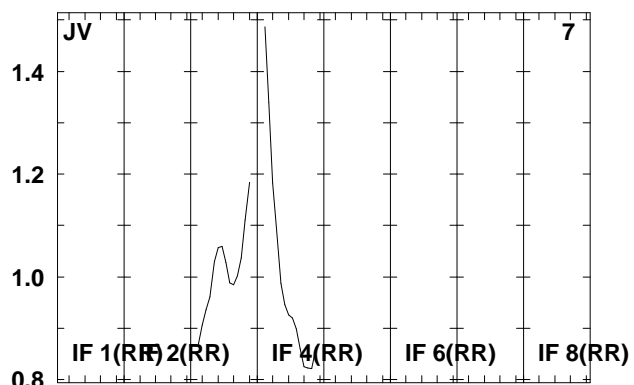
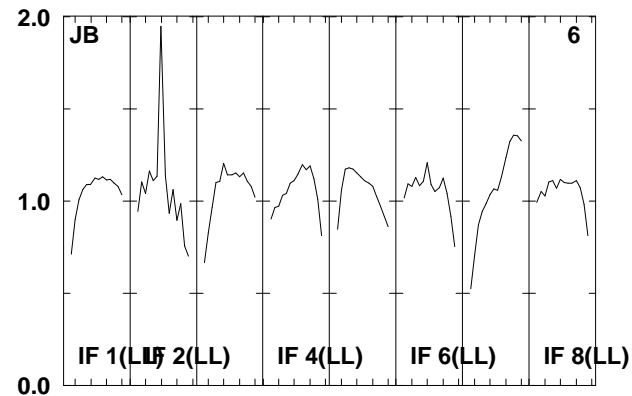
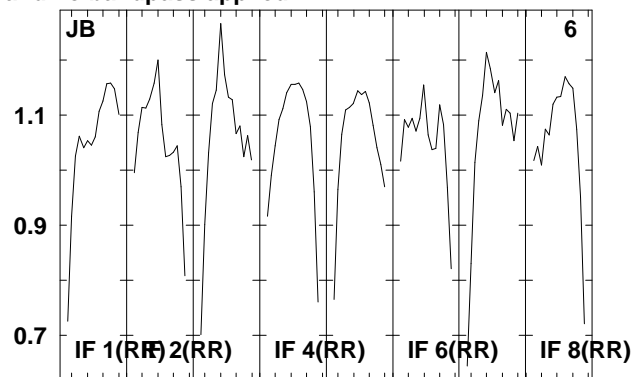
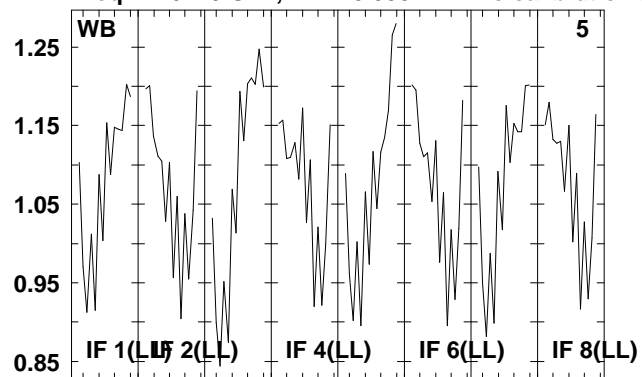

Lower frame: Real Jy

Total-power spectrum Antenna: \*

Timerange: 01/01:45:01 to 01/01:45:59



Plot file version 73 created 20-OCT-2009 14:49:19

FAINTCAL RP015C.UVDATA.1

Freq = 1.6270 GHz, Bw = 8.000 MH No calibration applied and no bandpass applied

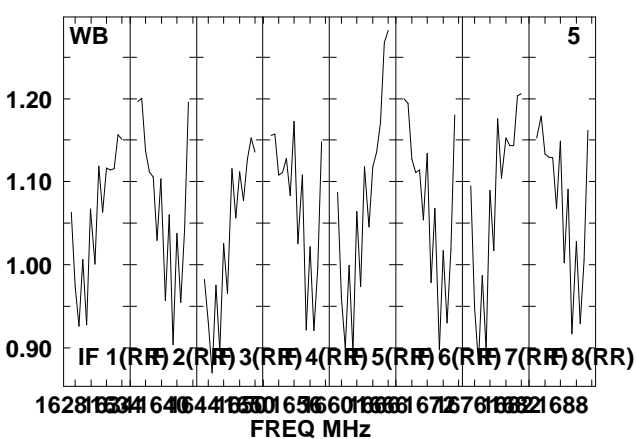
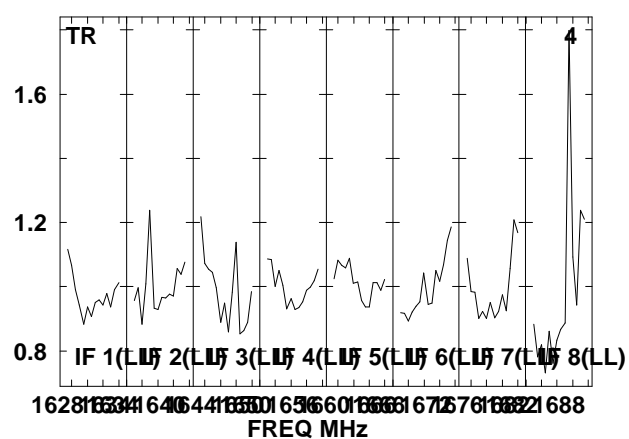
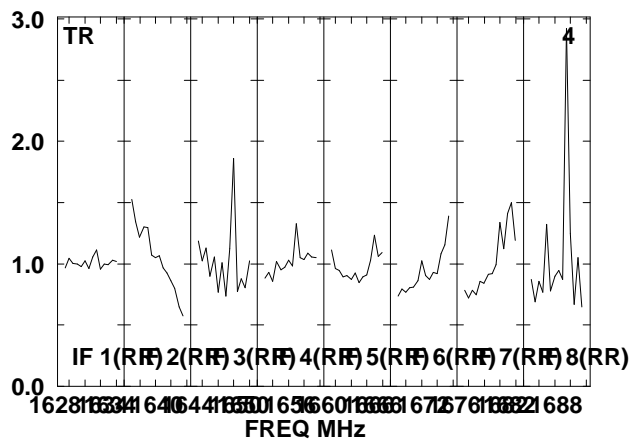
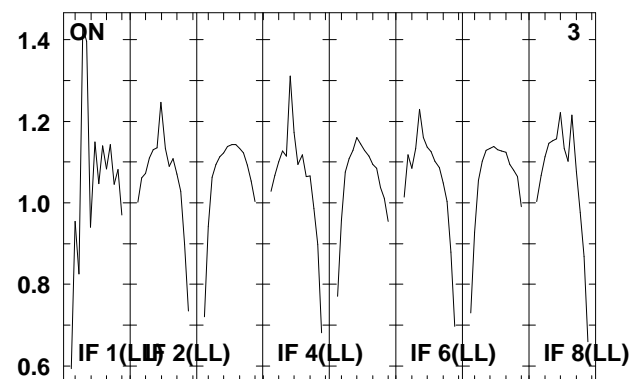
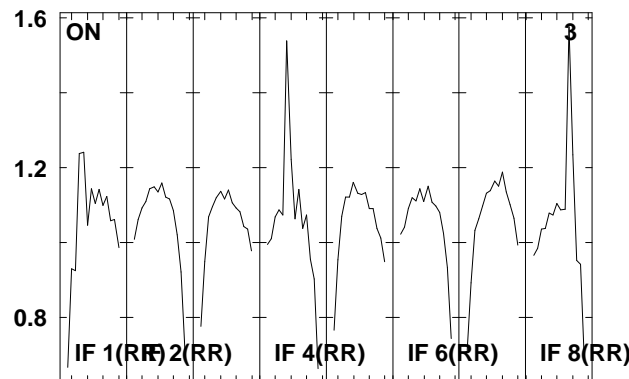
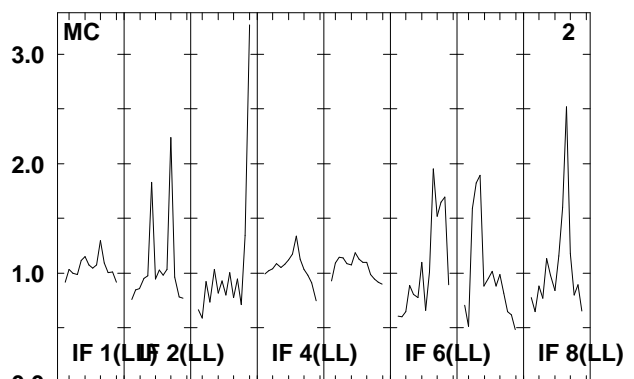
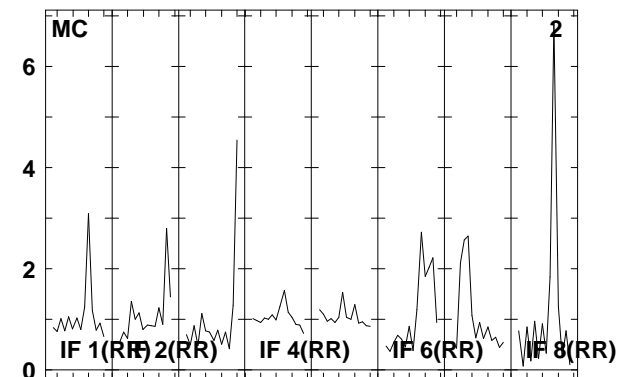
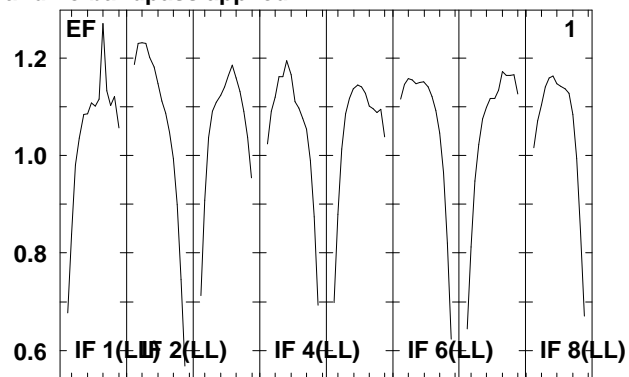
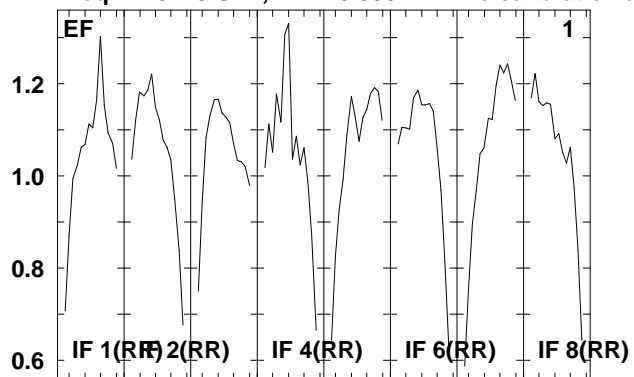

Lower frame: Real Jy  
Total-power spectrum Antenna: \*  
Timerange: 01/01:46:00 to 01/01:47:19

Plot file version 74 created 20-OCT-2009 14:49:20

FAINTCAL RP015C.UVDATA.1

Freq = 1.6270 GHz, Bw = 8.000 MH No calibration applied and no bandpass applied

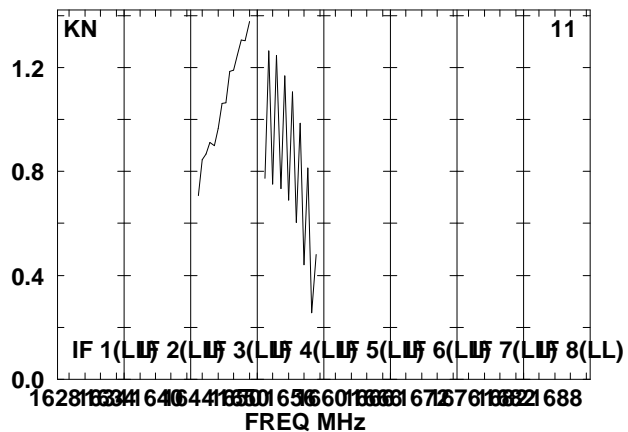
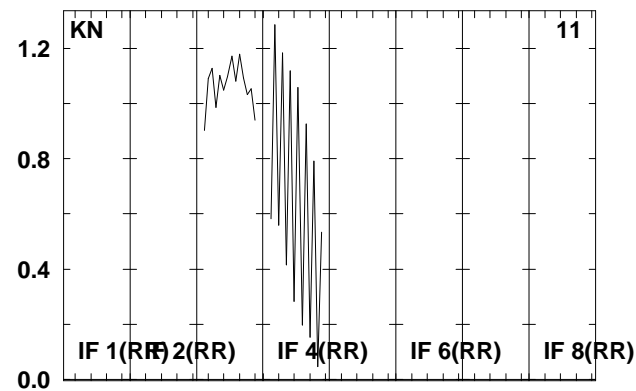
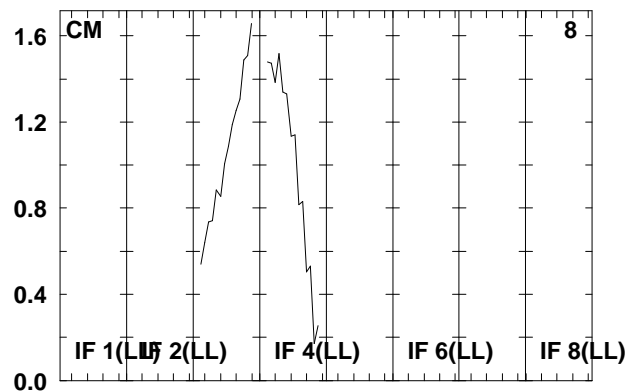
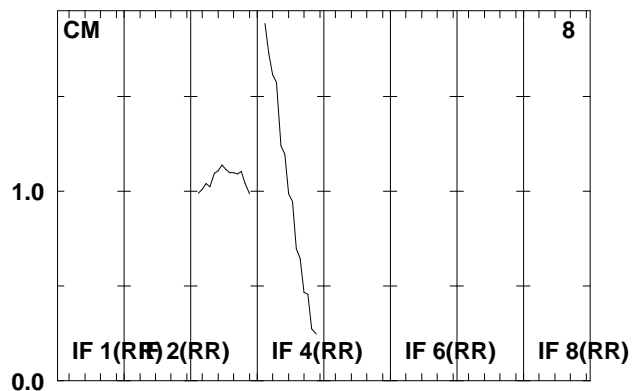
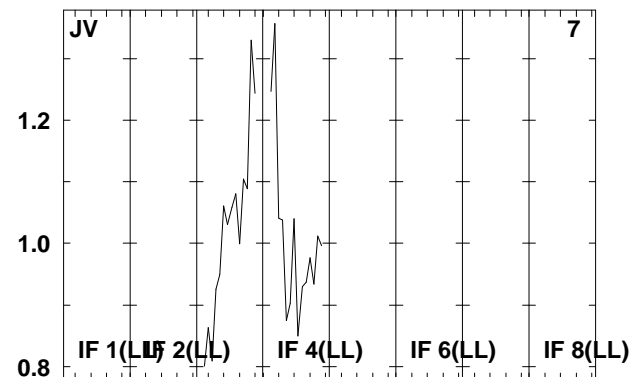
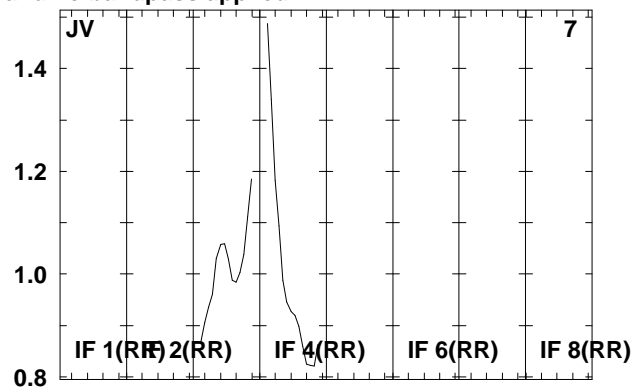
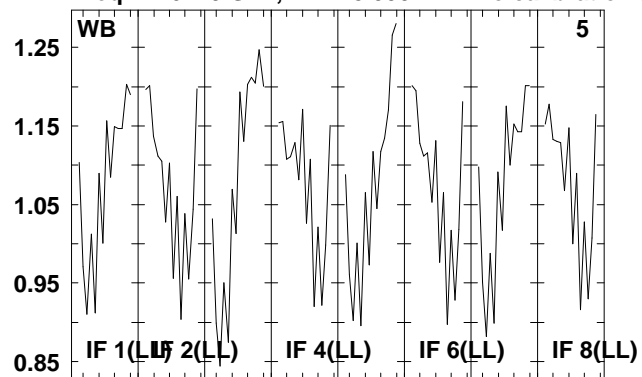

Lower frame: Real Jy

Total-power spectrum Antenna: \*

Timerange: 01/01:46:00 to 01/01:47:19

Plot file version 75 created 20-OCT-2009 14:49:21

M33 RP015C.UVDATA.1

Freq = 1.6270 GHz, Bw = 8.000 MH No calibration applied and no bandpass applied

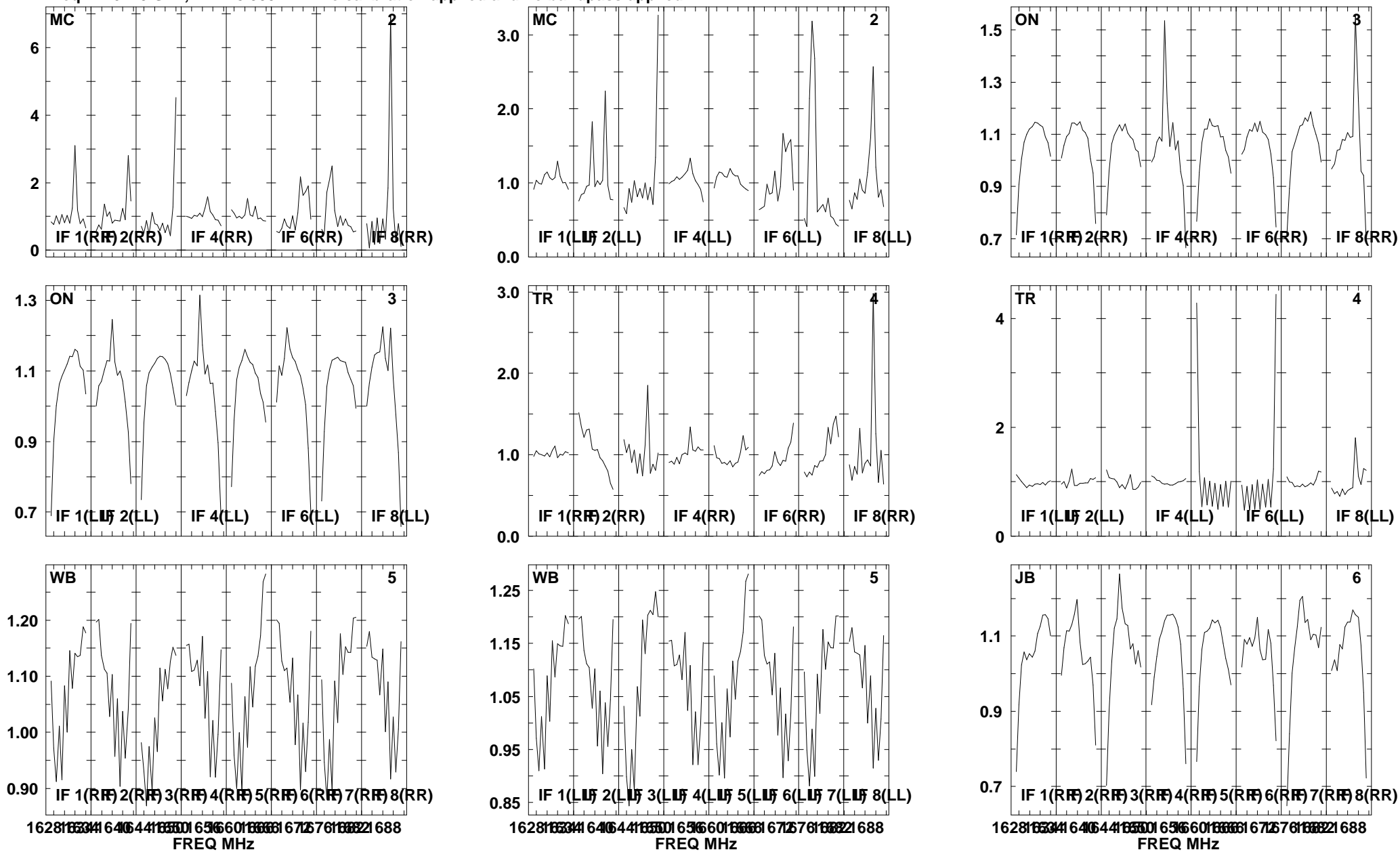

Lower frame: Real Jy  
Total-power spectrum Antenna: \*  
Timerange: 01/01:47:20 to 01/01:50:20

Plot file version 76 created 20-OCT-2009 14:49:21  
 M33 RP015C.UVDATA.1  
 Freq = 1.6270 GHz, Bw = 8.000 MH No calibration applied and no bandpass applied

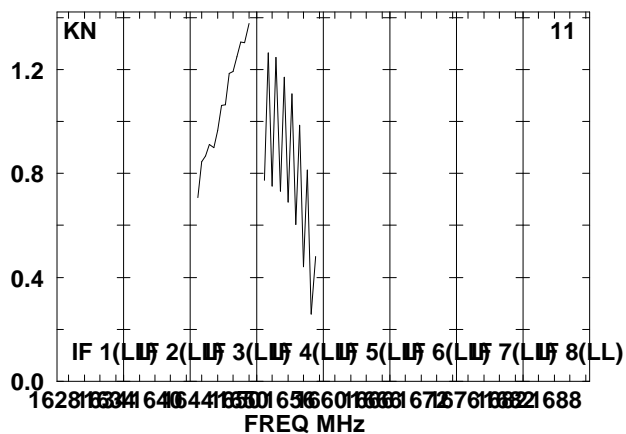
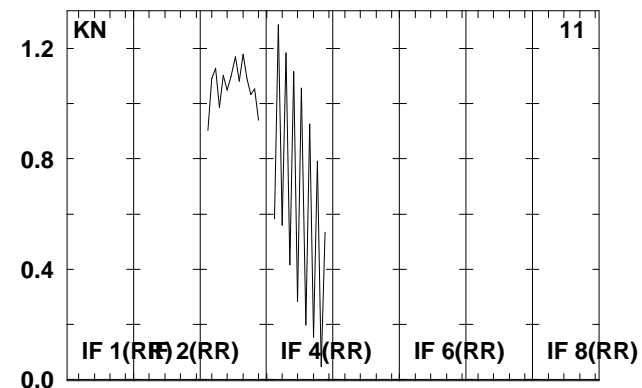
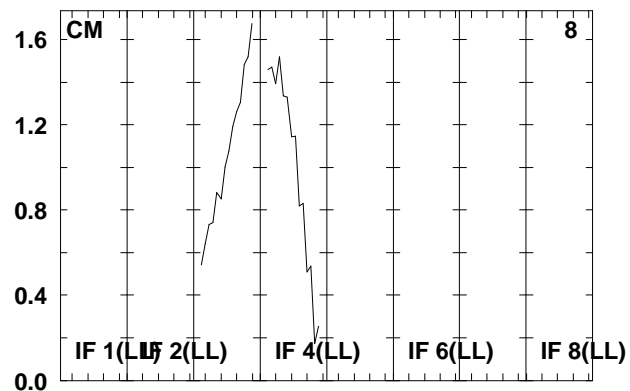
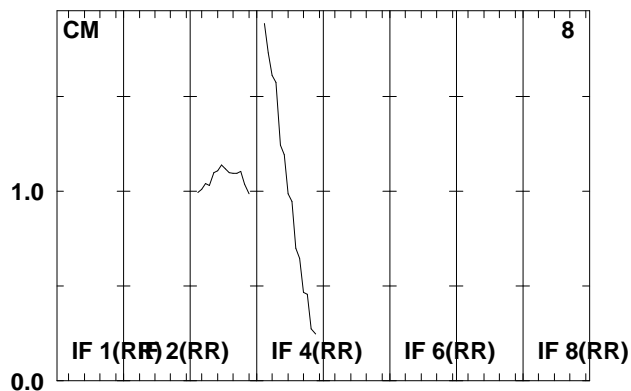
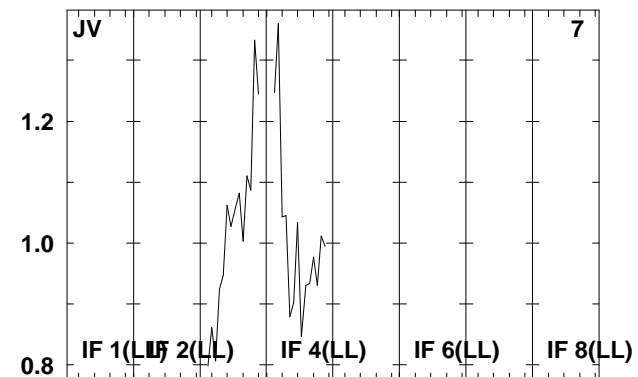
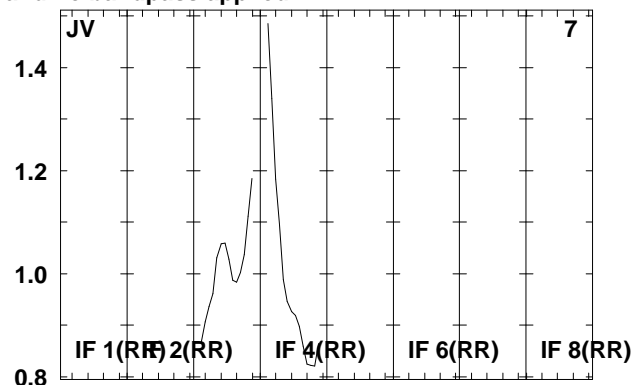
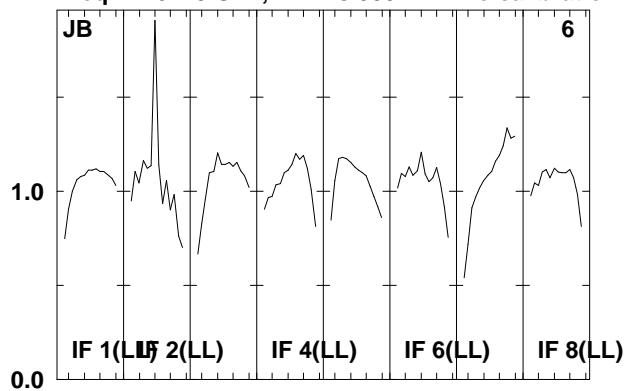

Lower frame: Real Jy  
 Total-power spectrum Antenna: \*  
 Timerange: 01/01:47:20 to 01/01:50:20

Plot file version 77 created 20-OCT-2009 14:49:22

J0137+31 RP015C.UVDATA.1

Freq = 1.6270 GHz, Bw = 8.000 MH No calibration applied and no bandpass applied

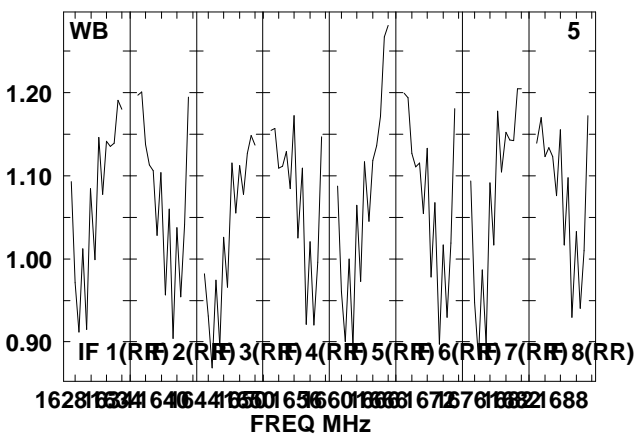
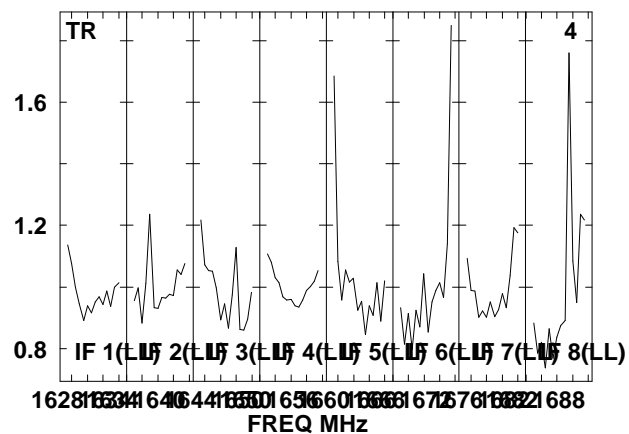
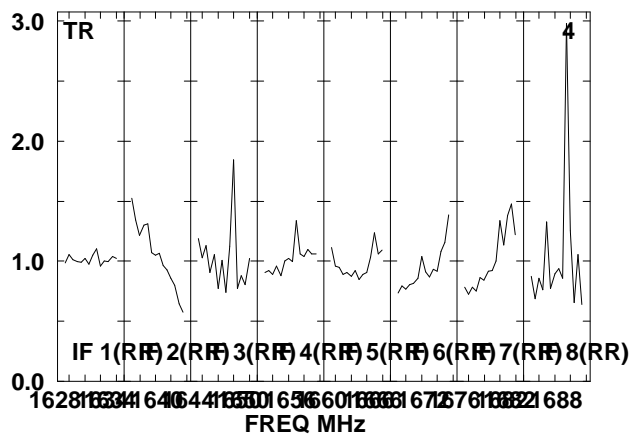
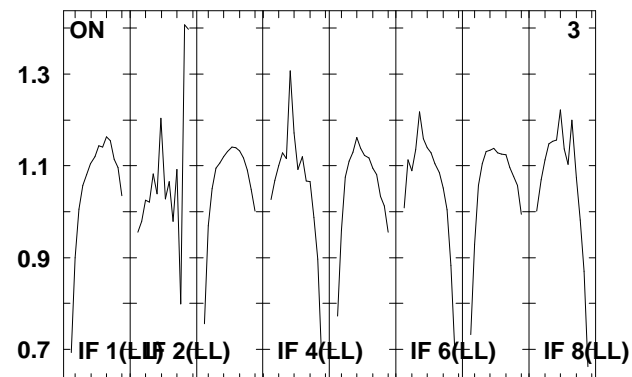
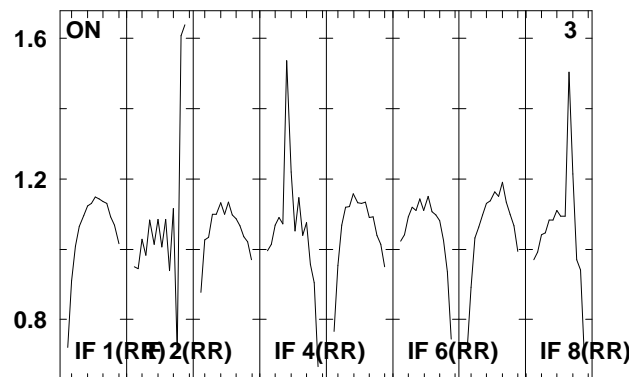
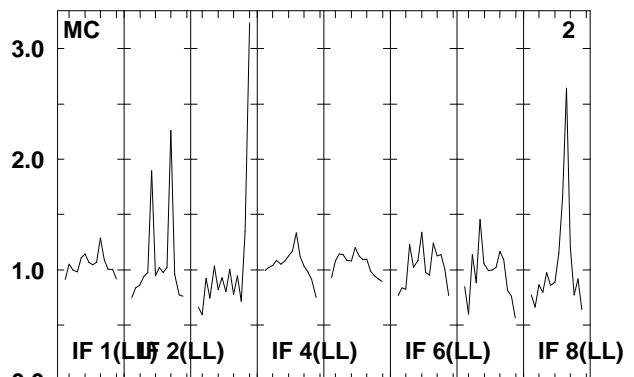
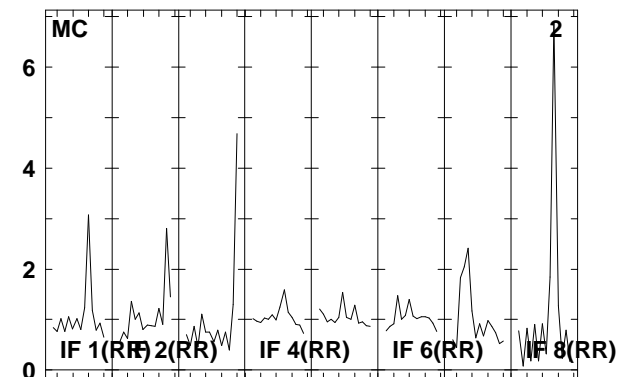
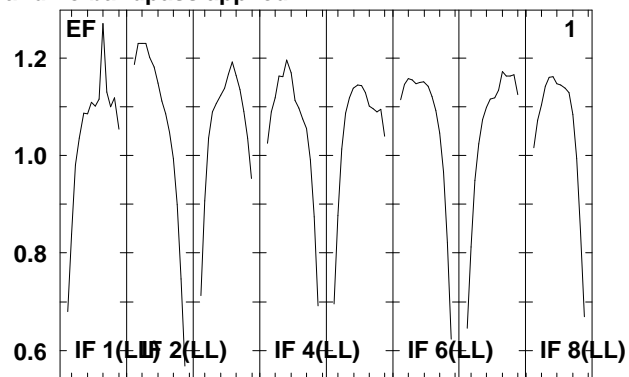
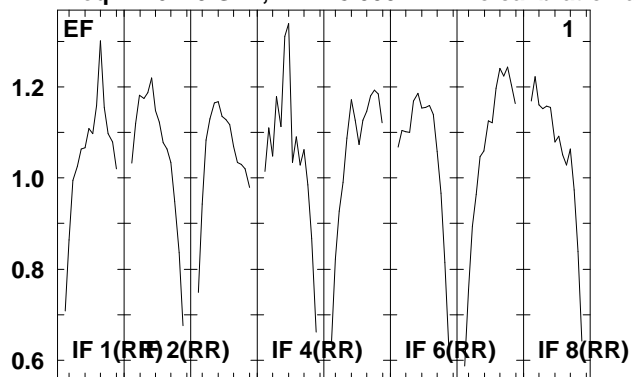

Lower frame: Real Jy  
Total-power spectrum Antenna: \*  
Timerange: 01/01:51:00 to 01/01:51:59

Plot file version 78 created 20-OCT-2009 14:49:23  
 J0137+31 RP015C.UVDATA.1  
 Freq = 1.6270 GHz, Bw = 8.000 MH No calibration applied and no bandpass applied

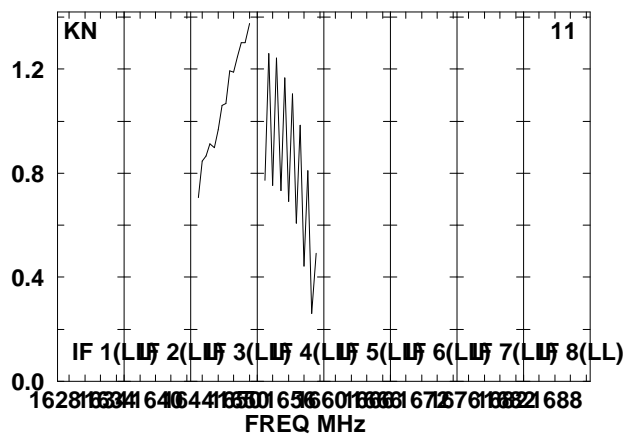
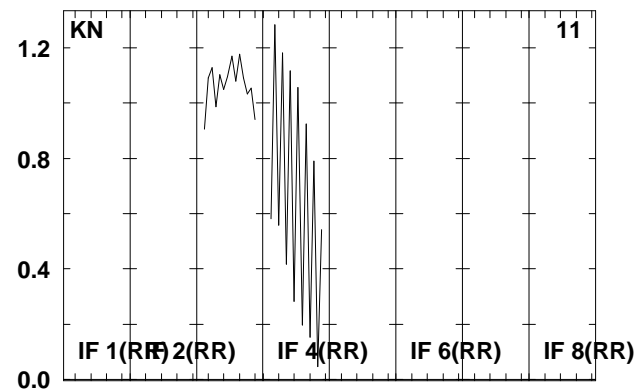
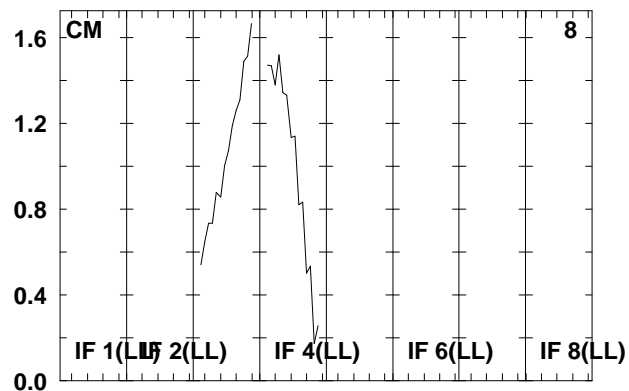
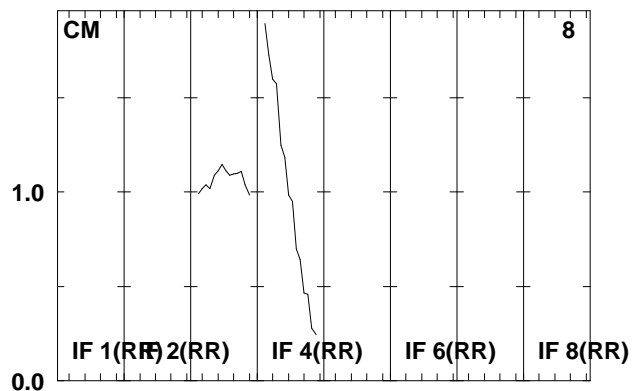
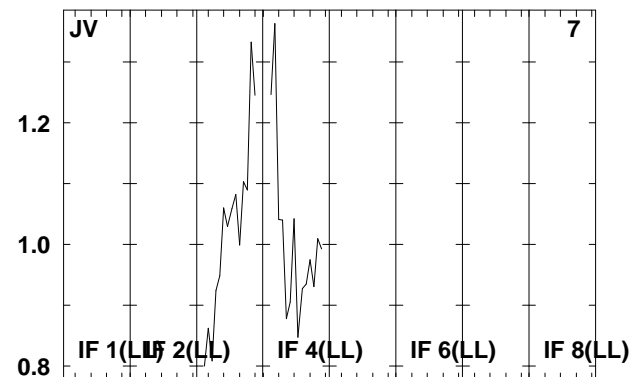
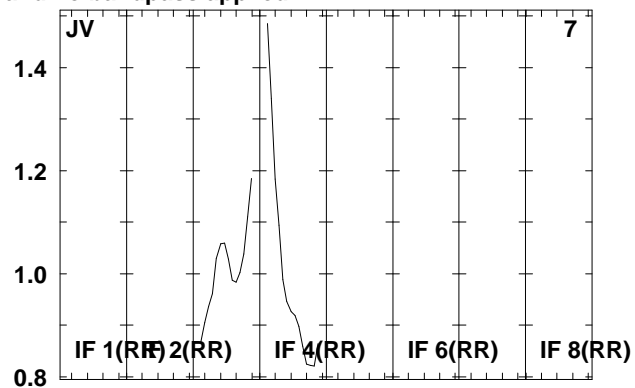
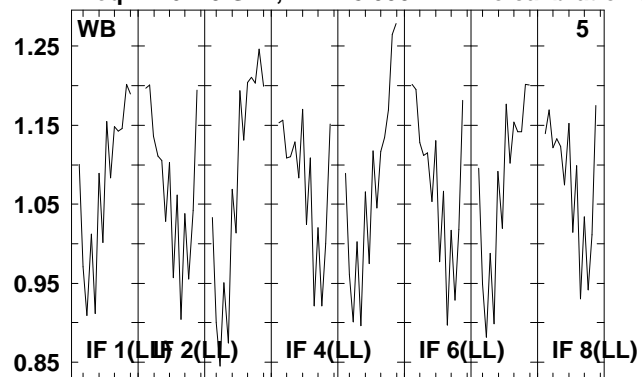

Lower frame: Real Jy  
 Total-power spectrum Antenna: \*  
 Timerange: 01/01:51:00 to 01/01:51:59

Plot file version 79 created 20-OCT-2009 14:49:23

FAINTCAL RP015C.UVDATA.1

Freq = 1.6270 GHz, Bw = 8.000 MH No calibration applied and no bandpass applied

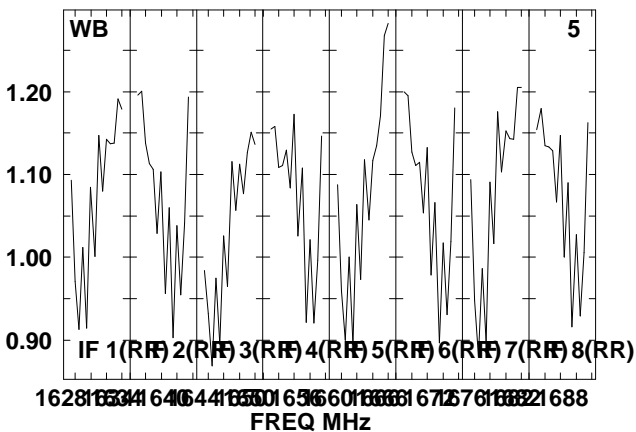
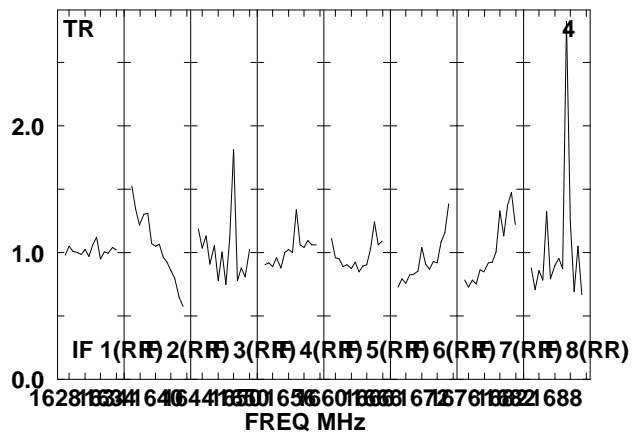
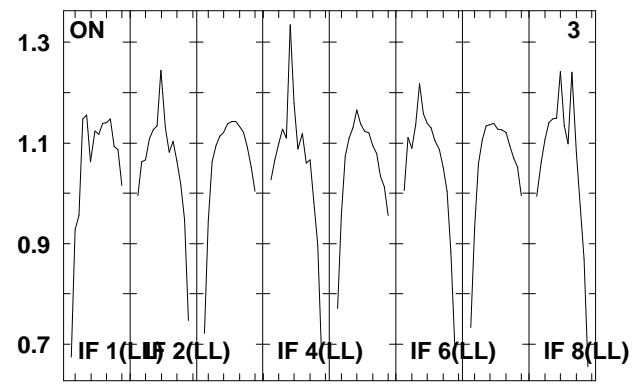
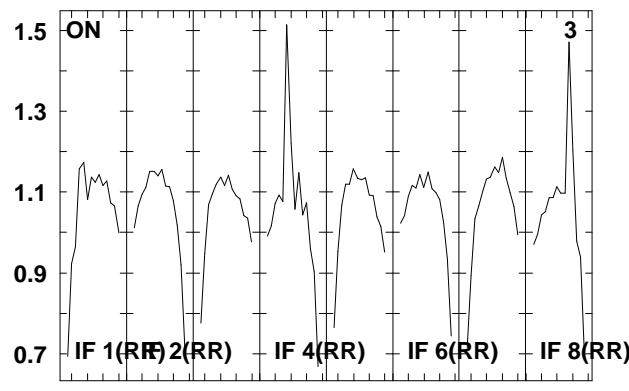
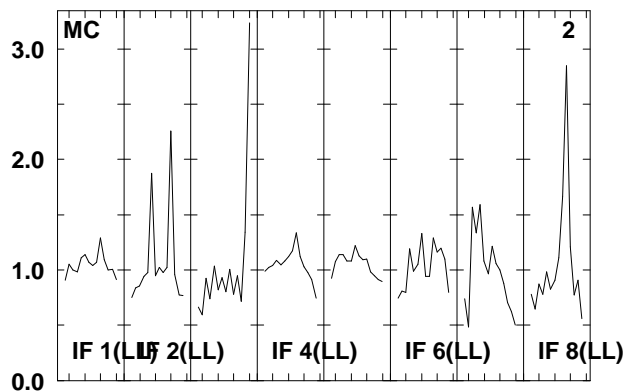
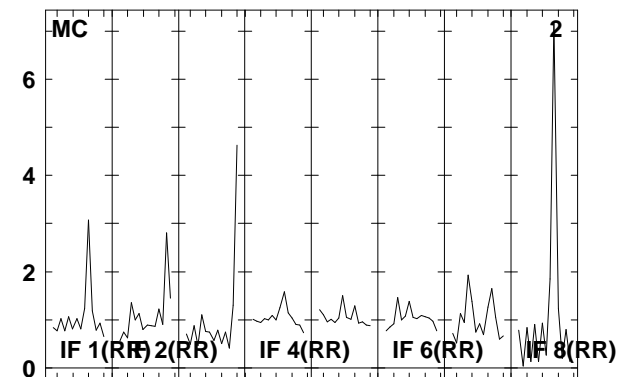
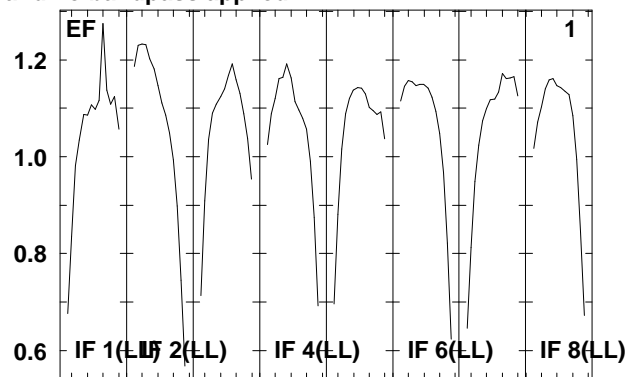
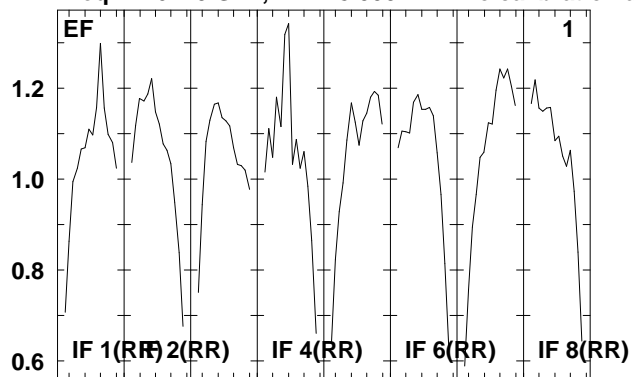

Lower frame: Real Jy  
Total-power spectrum Antenna: \*  
Timerange: 01/01:52:01 to 01/01:53:20

Plot file version 80 created 20-OCT-2009 14:49:24

FAINTCAL RP015C.UVDATA.1

Freq = 1.6270 GHz, Bw = 8.000 MH No calibration applied and no bandpass applied

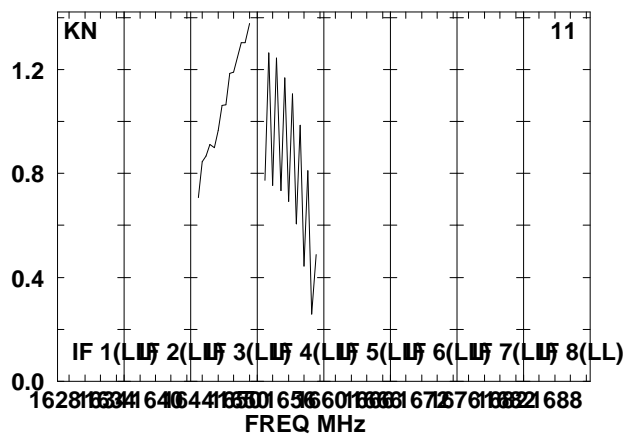
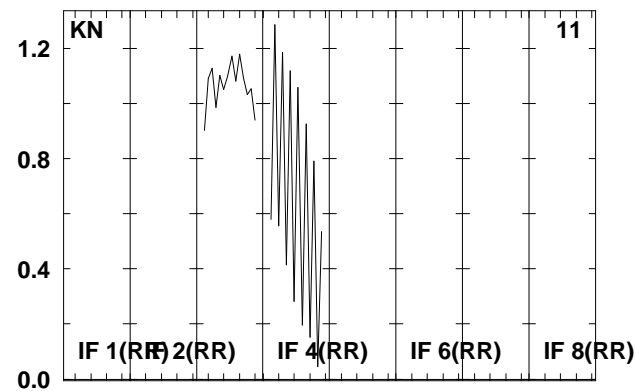
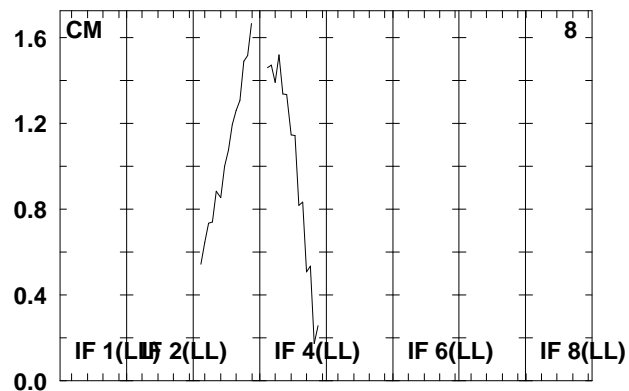
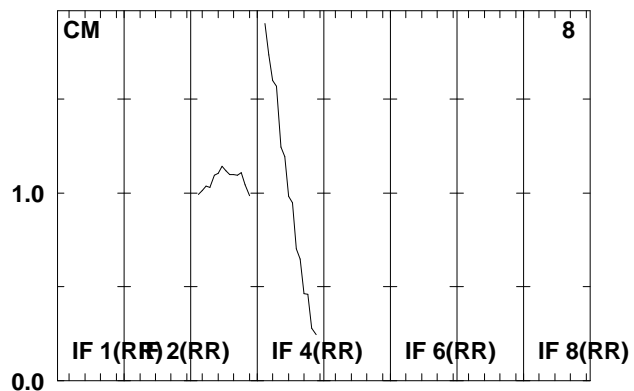
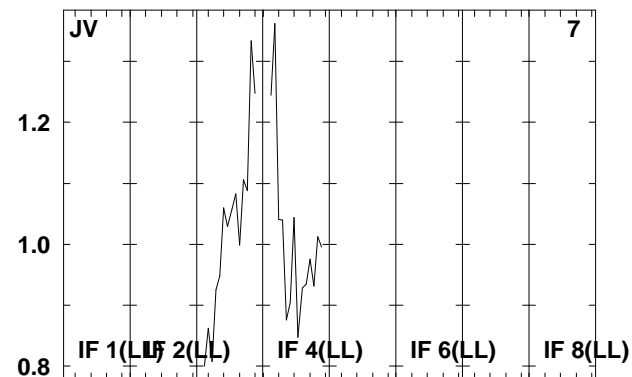
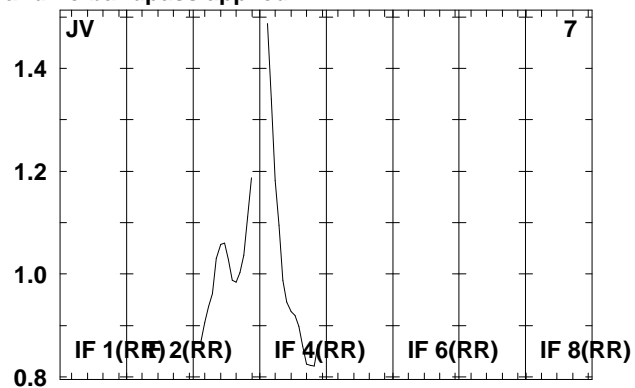
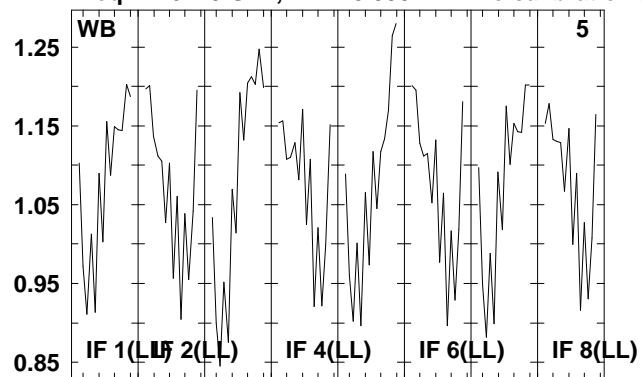

Lower frame: Real Jy

Total-power spectrum Antenna: \*

Timerange: 01/01:52:01 to 01/01:53:20



Plot file version 81 created 20-OCT-2009 14:49:24

M33 RP015C.UVDATA.1

Freq = 1.6270 GHz, Bw = 8.000 MH No calibration applied and no bandpass applied

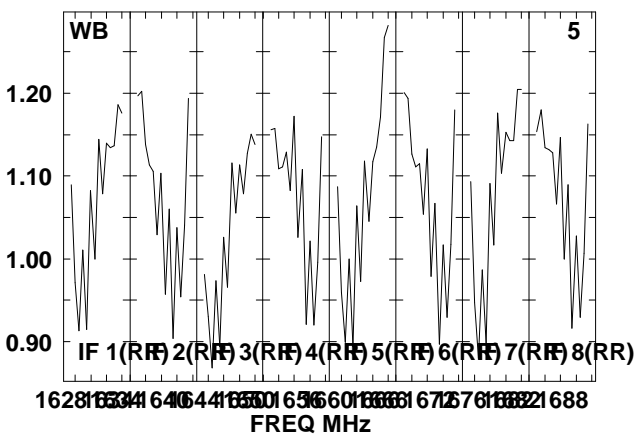
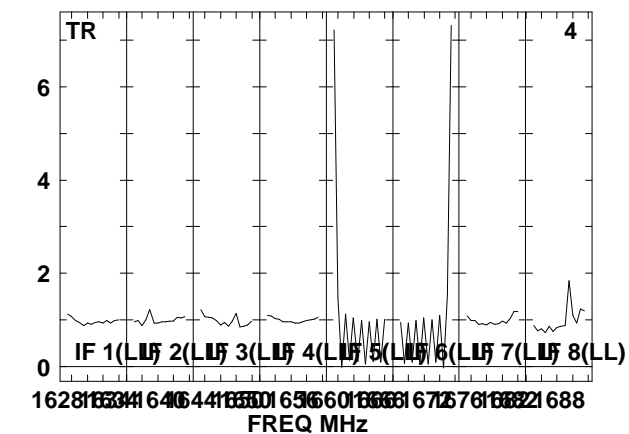
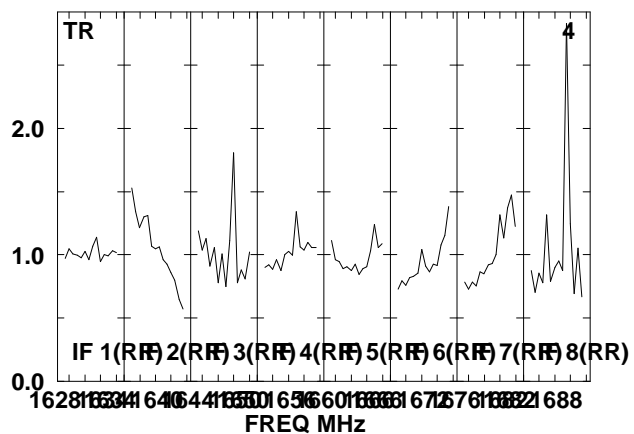
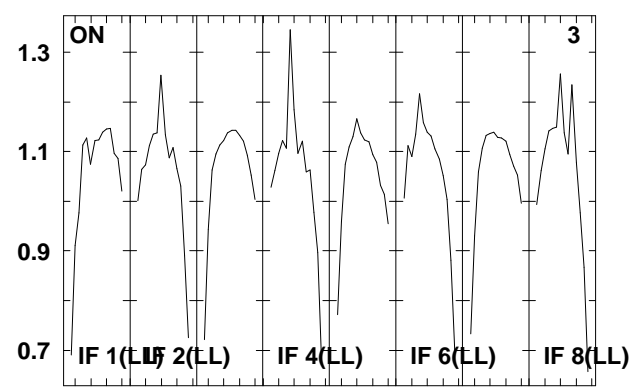
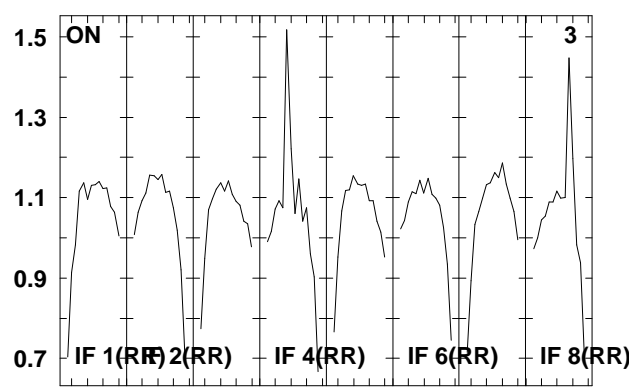
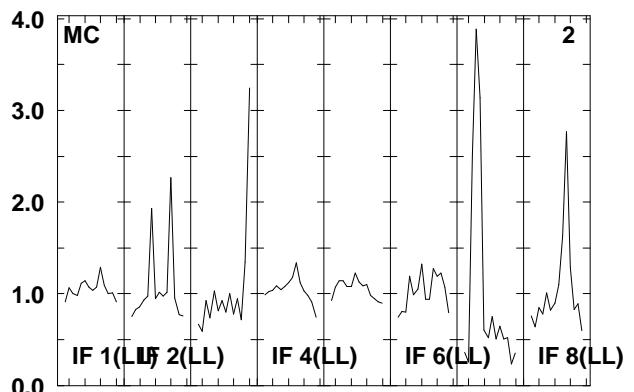
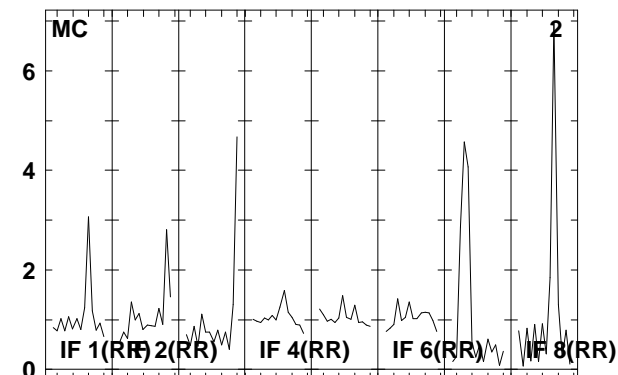
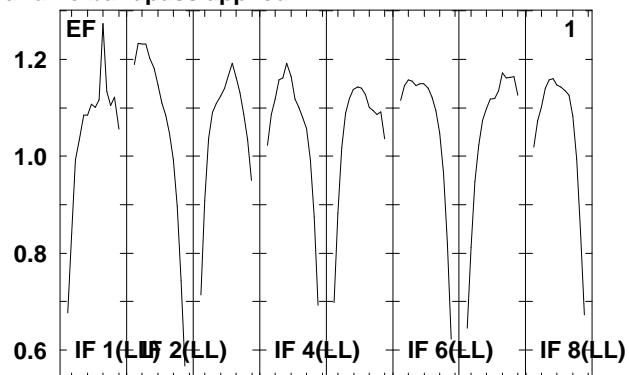
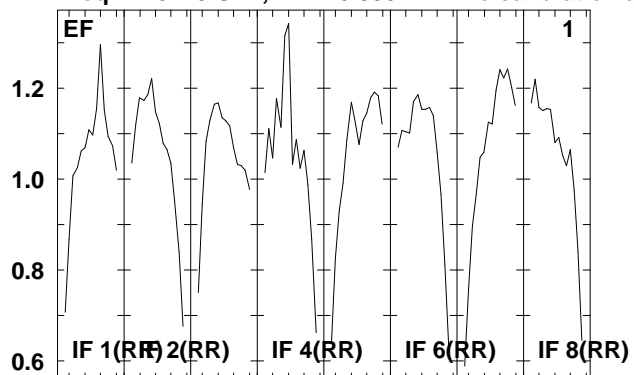

Lower frame: Real Jy  
Total-power spectrum Antenna: \*  
Timerange: 01/01:53:20 to 01/01:56:19

Plot file version 82 created 20-OCT-2009 14:49:25

M33 RP015C.UVDATA.1

Freq = 1.6270 GHz, Bw = 8.000 MH No calibration applied and no bandpass applied

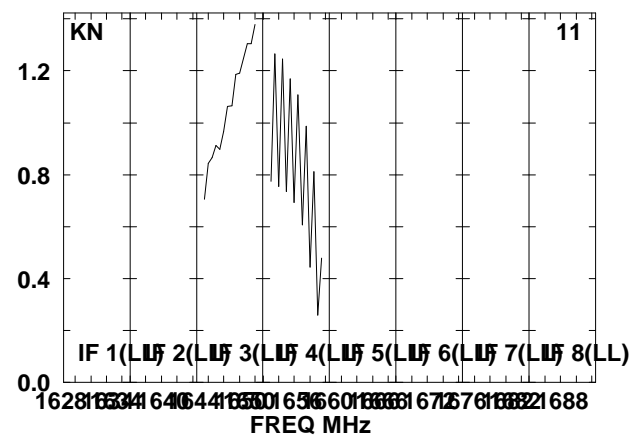
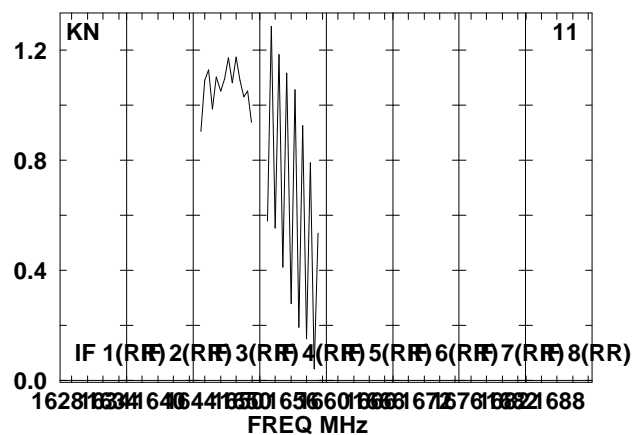
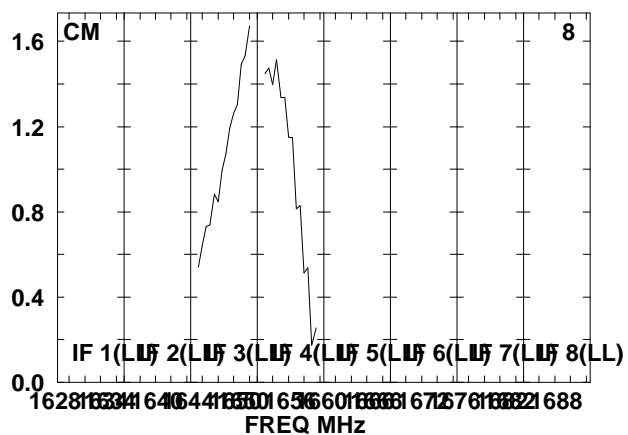
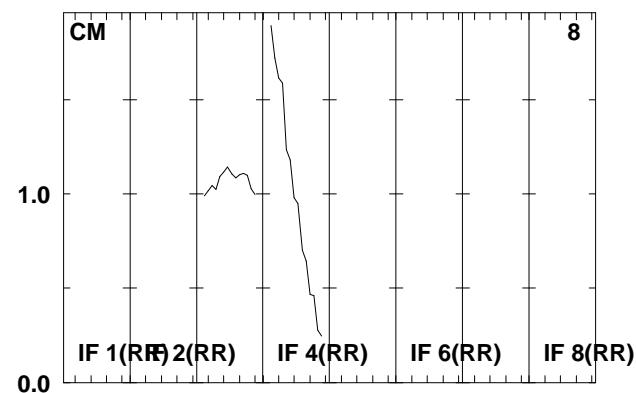
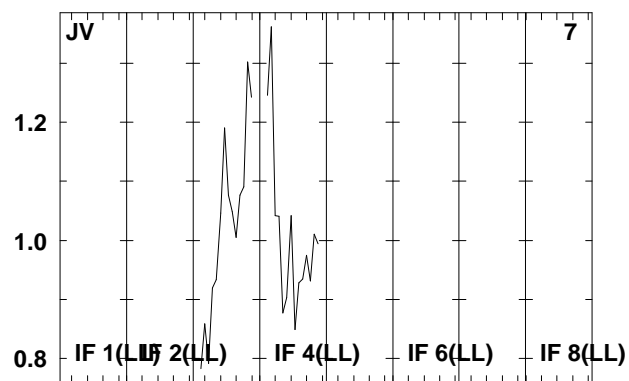
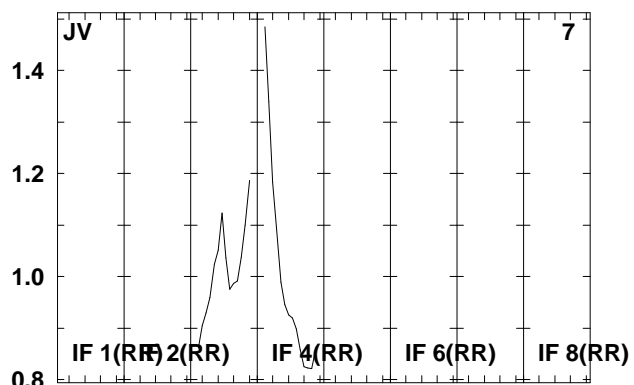
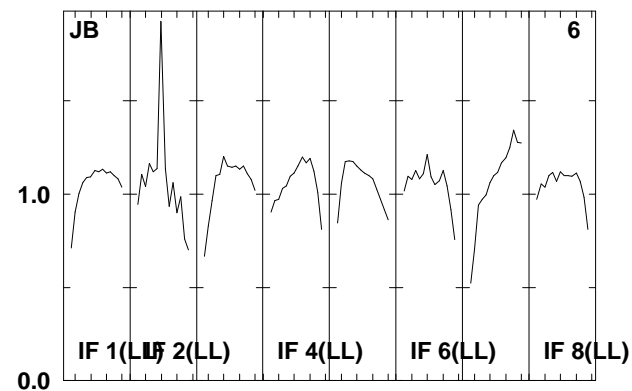
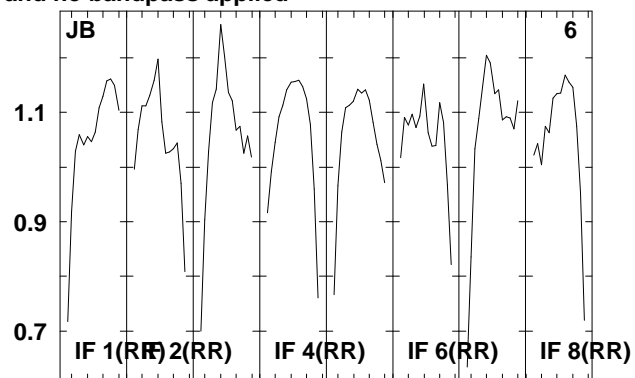
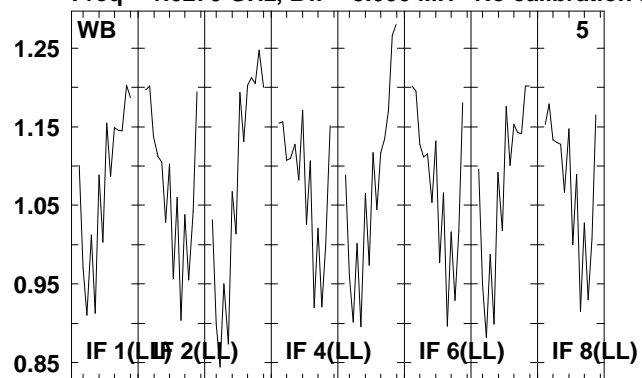

Lower frame: Real Jy  
Total-power spectrum Antenna: \*  
Timerange: 01/01:53:20 to 01/01:56:19

Plot file version 83 created 20-OCT-2009 14:49:27

J0137+31 RP015C.UVDATA.1

Freq = 1.6270 GHz, Bw = 8.000 MH No calibration applied and no bandpass applied

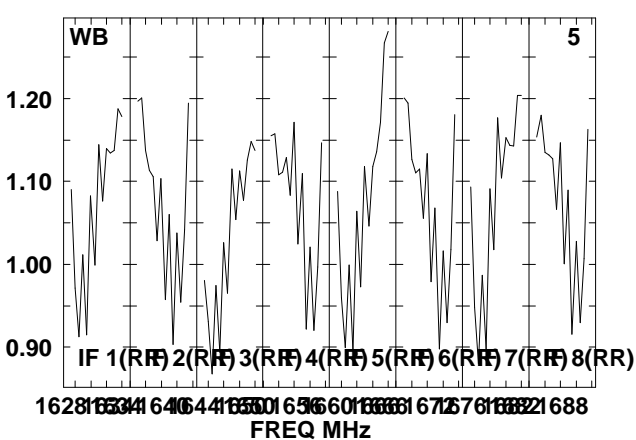
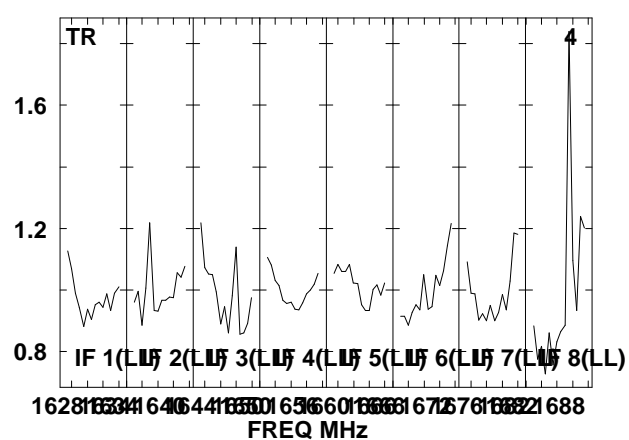
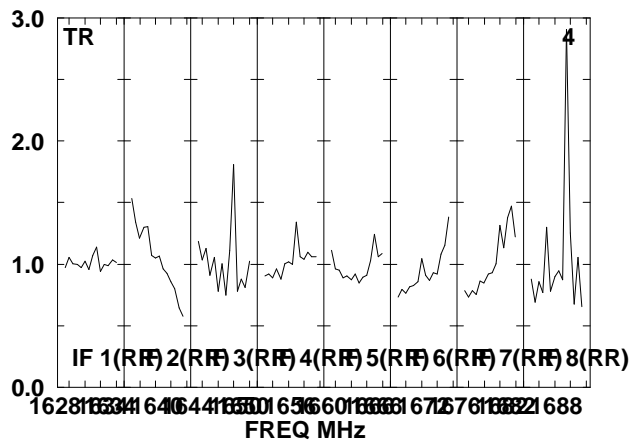
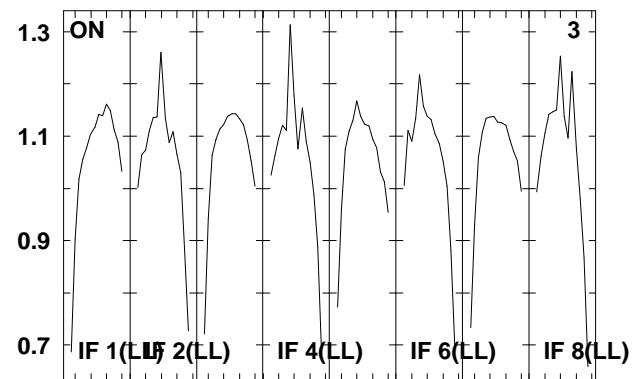
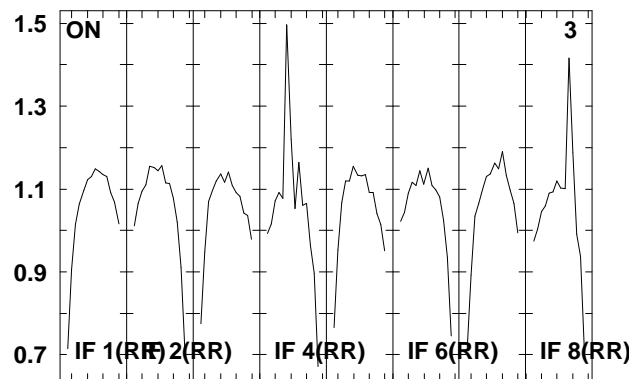
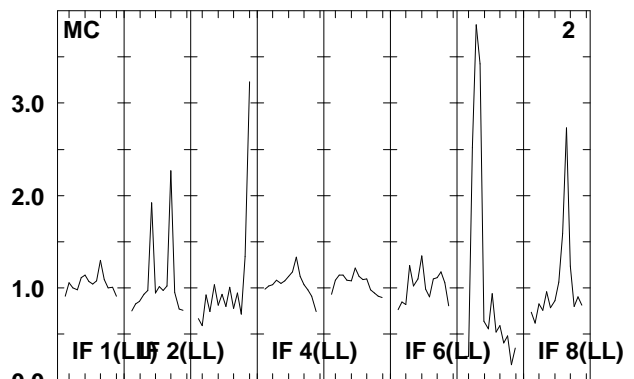
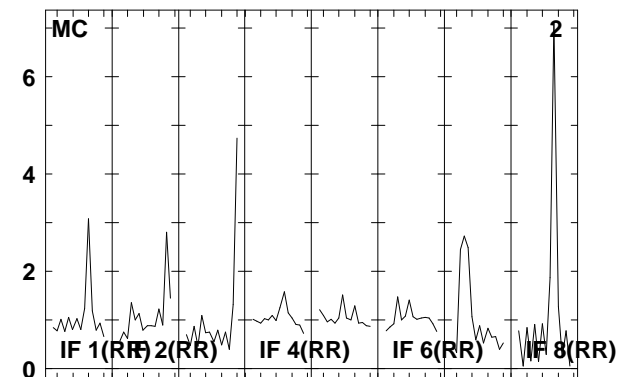
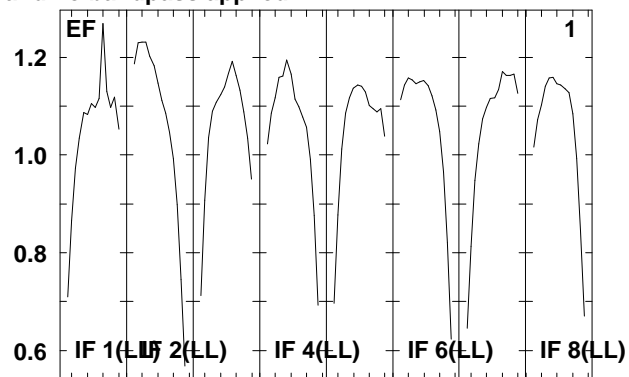
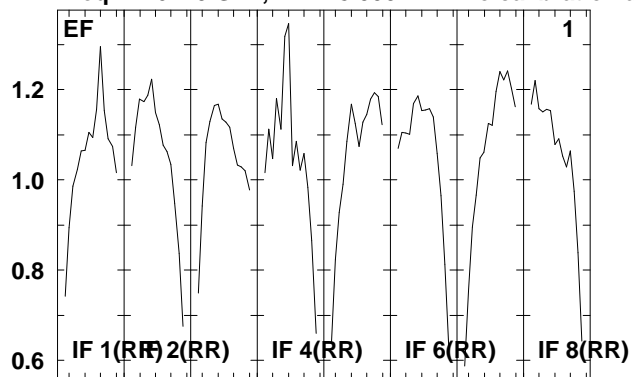

Lower frame: Real Jy  
Total-power spectrum Antenna: \*  
Timerange: 01/01:57:01 to 01/01:57:59

Plot file version 84 created 20-OCT-2009 14:49:27

J0137+31 RP015C.UVDATA.1

Freq = 1.6270 GHz, Bw = 8.000 MH No calibration applied and no bandpass applied

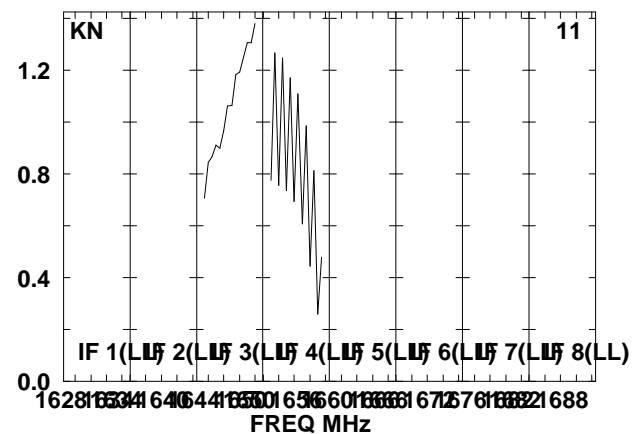
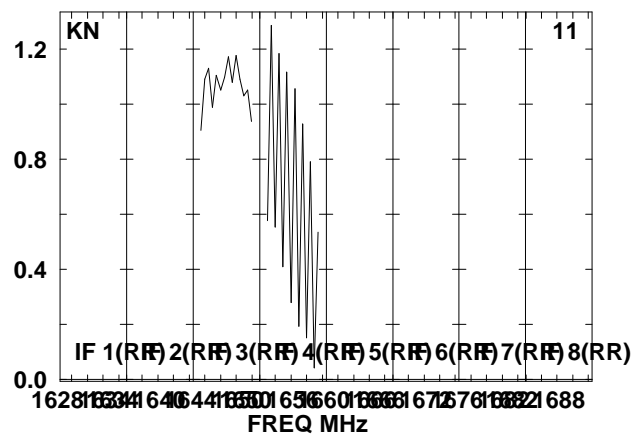
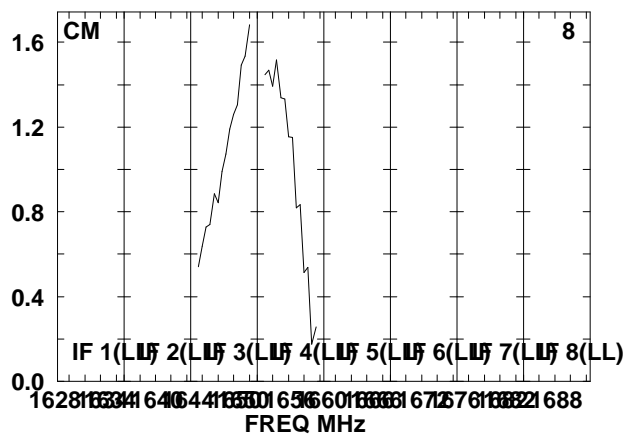
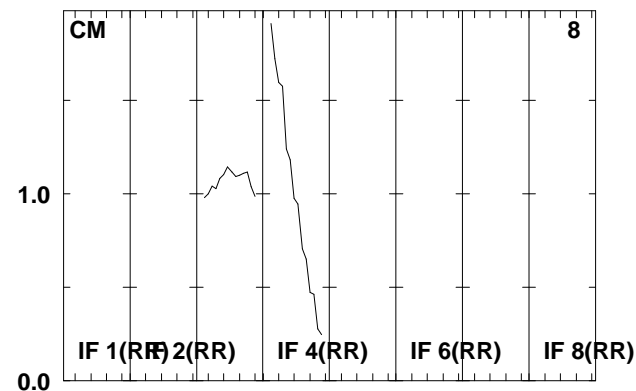
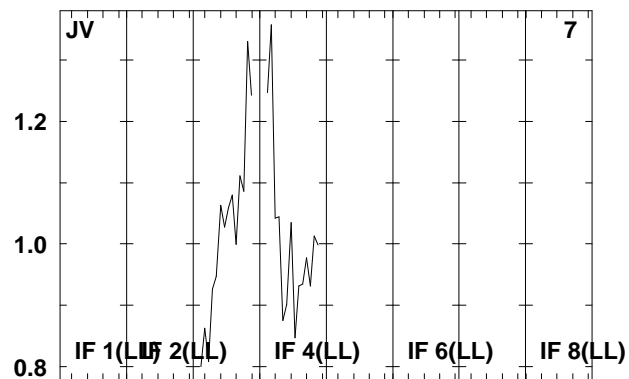
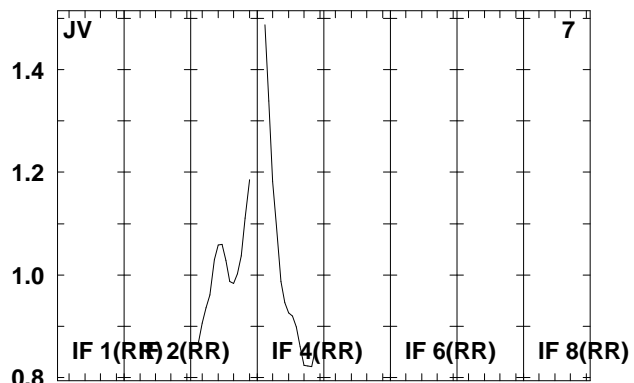
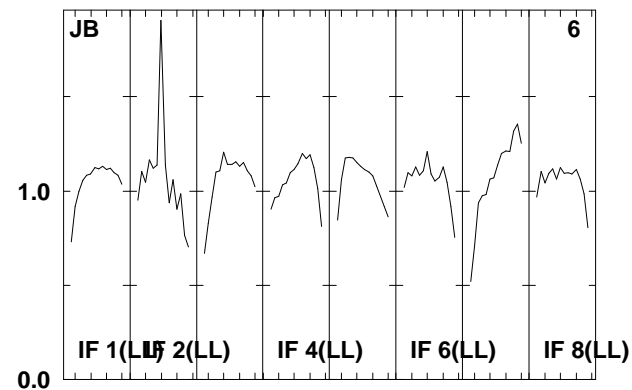
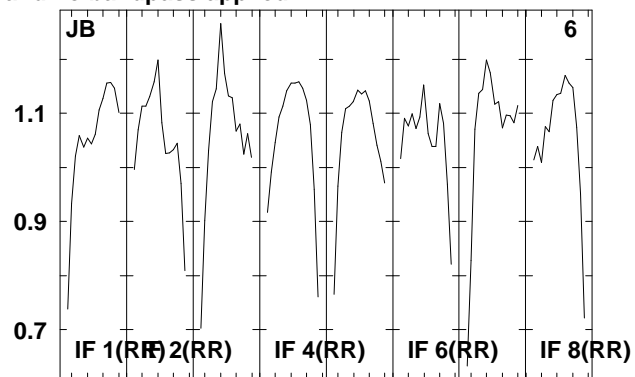
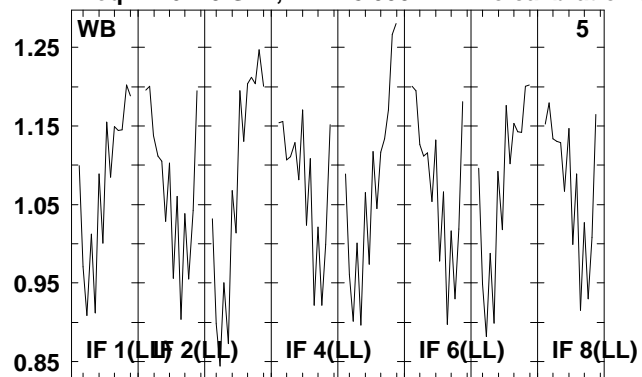

Lower frame: Real Jy  
Total-power spectrum Antenna: \*  
Timerange: 01/01:57:01 to 01/01:57:59

Plot file version 85 created 20-OCT-2009 14:49:28

FAINTCAL RP015C.UVDATA.1

Freq = 1.6270 GHz, Bw = 8.000 MH No calibration applied and no bandpass applied

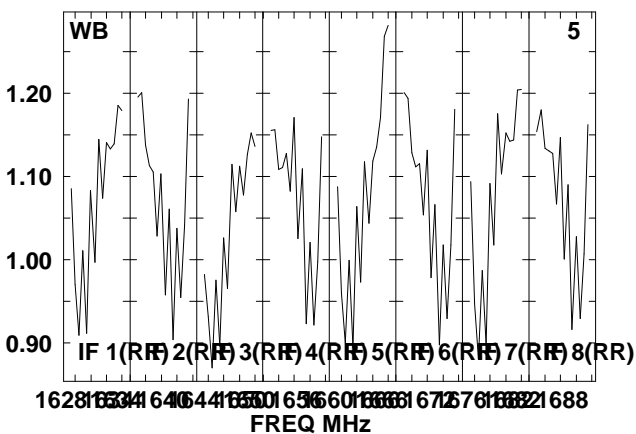
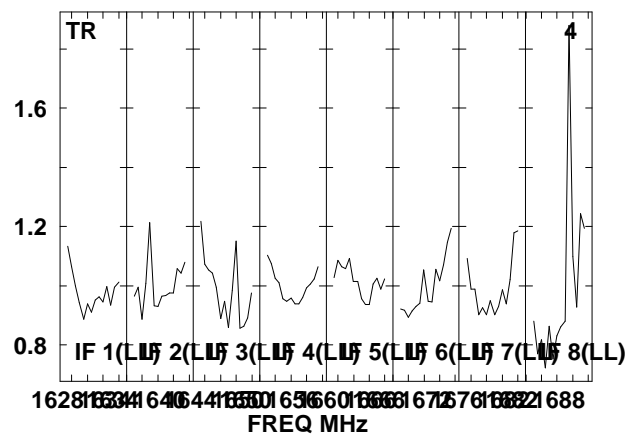
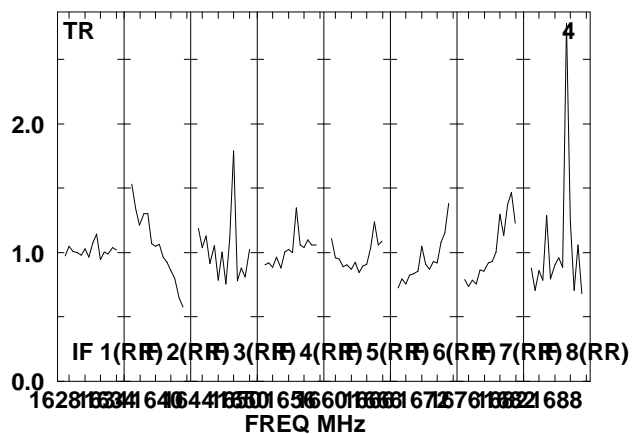
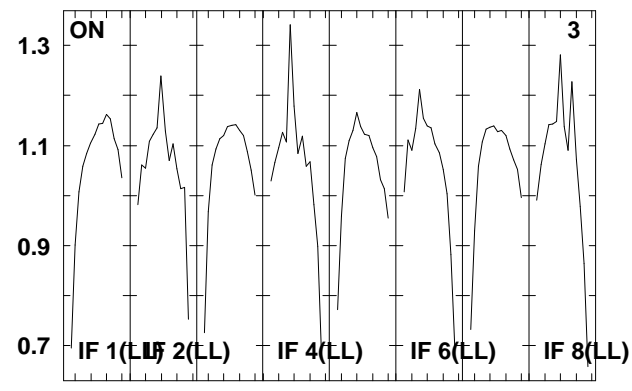
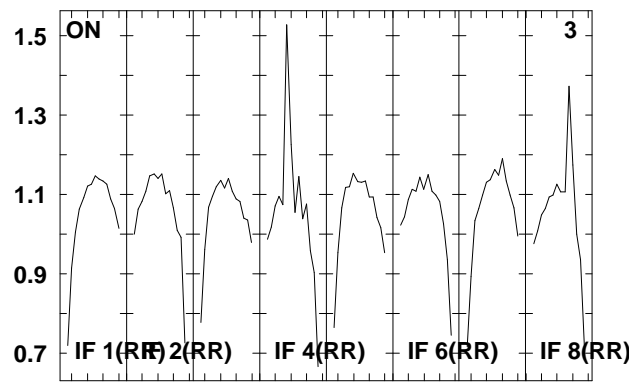
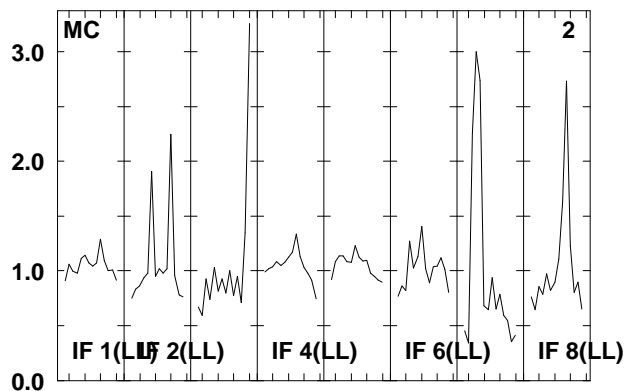
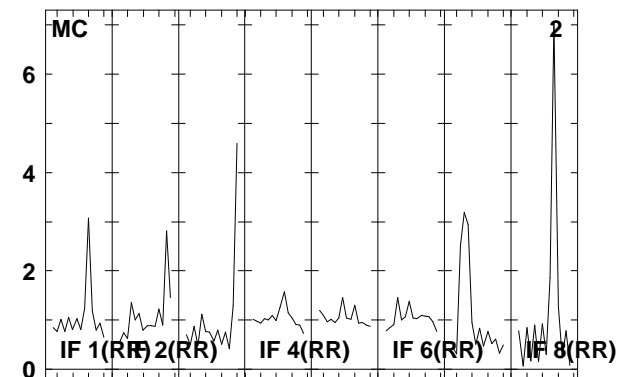
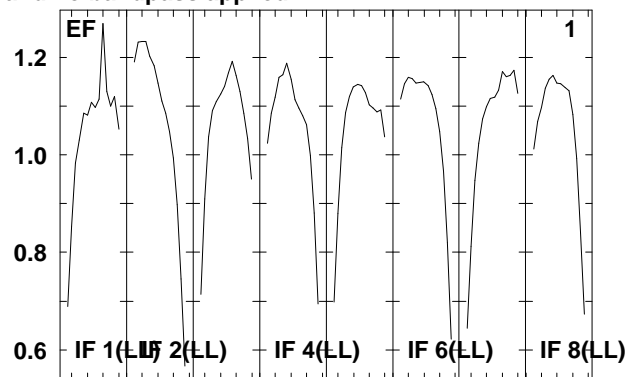
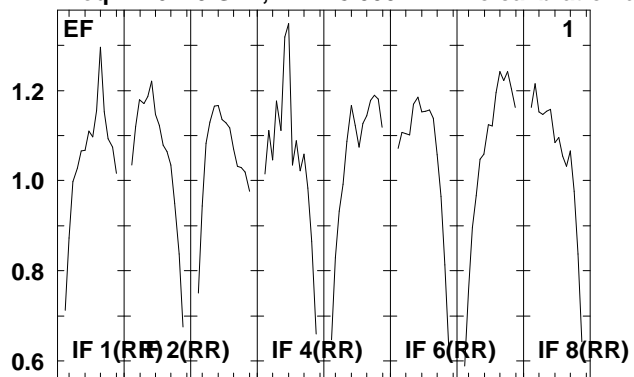

Lower frame: Real Jy  
Total-power spectrum Antenna: \*  
Timerange: 01/01:58:00 to 01/01:59:19

Plot file version 86 created 20-OCT-2009 14:49:28

FAINTCAL RP015C.UVDATA.1

Freq = 1.6270 GHz, Bw = 8.000 MH No calibration applied and no bandpass applied

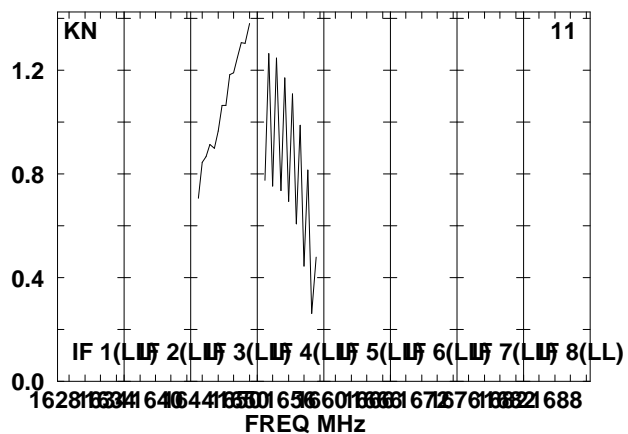
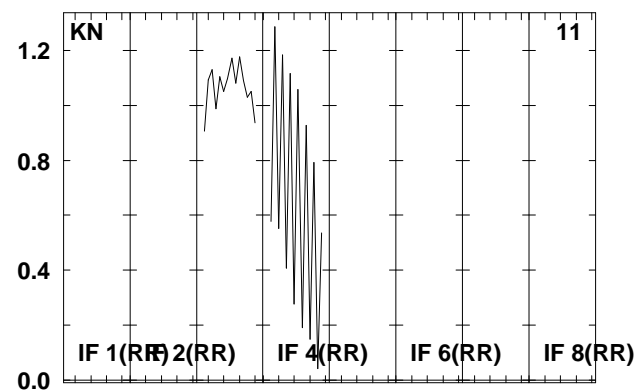
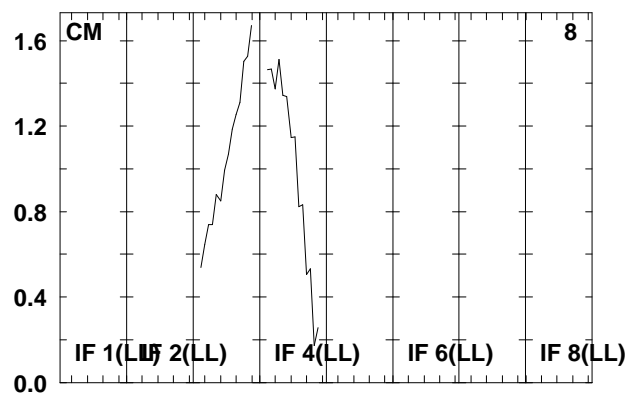
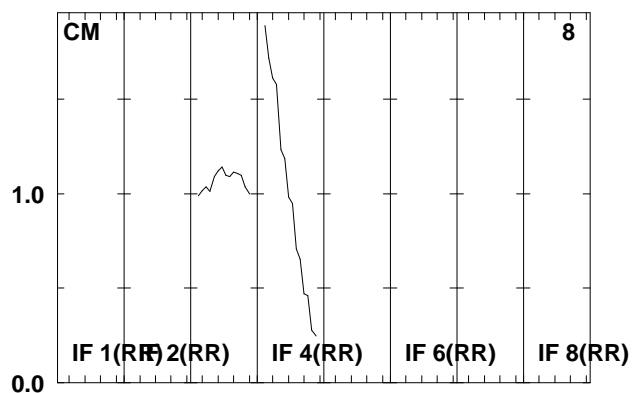
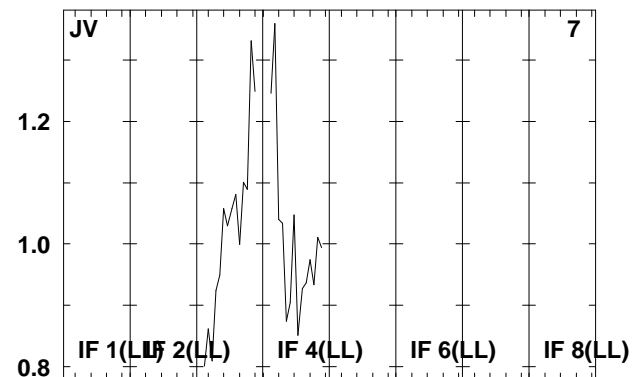
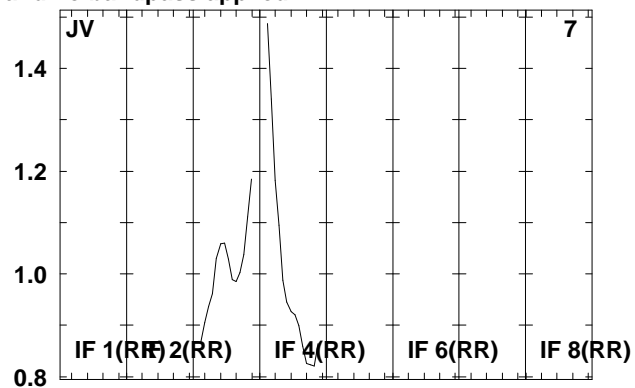
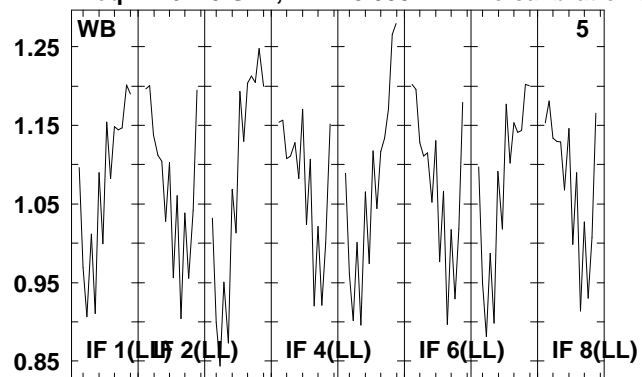

Lower frame: Real Jy

Total-power spectrum Antenna: \*

Timerange: 01/01:58:00 to 01/01:59:19

Plot file version 87 created 20-OCT-2009 14:49:29

M33 RP015C.UVDATA.1

Freq = 1.6270 GHz, Bw = 8.000 MH No calibration applied and no bandpass applied

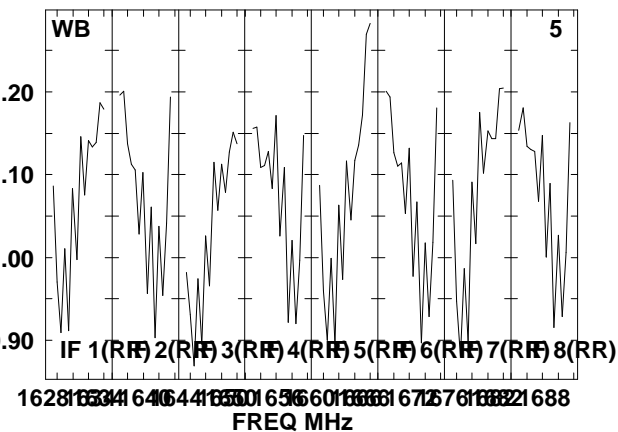
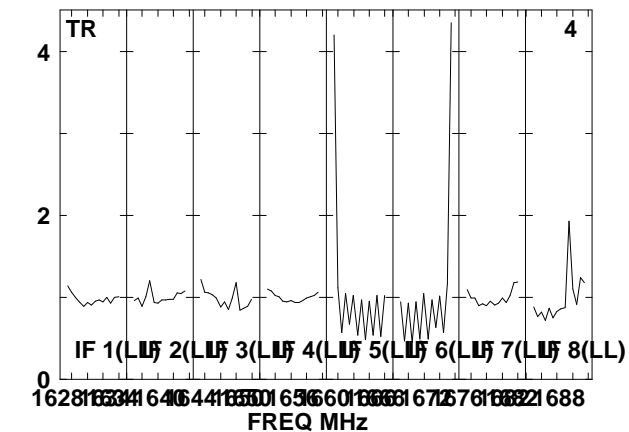
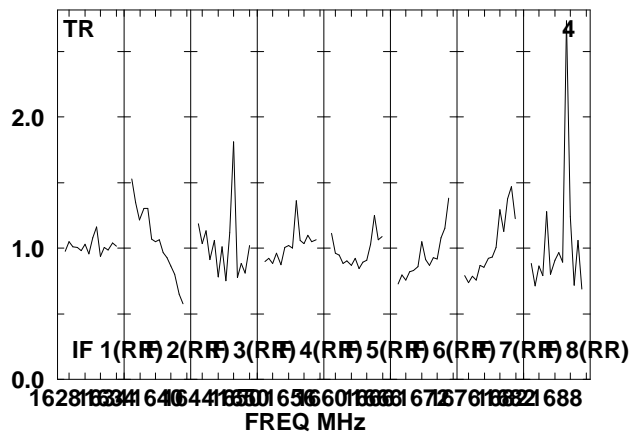
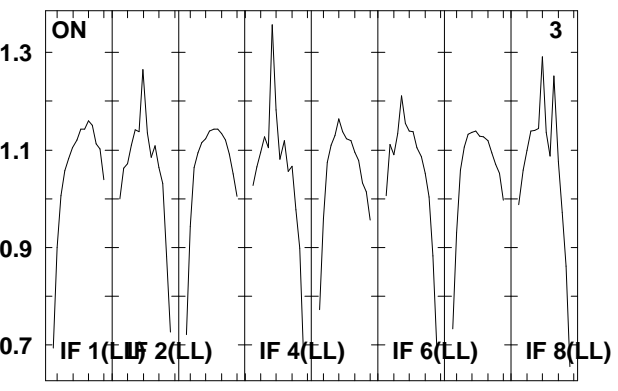
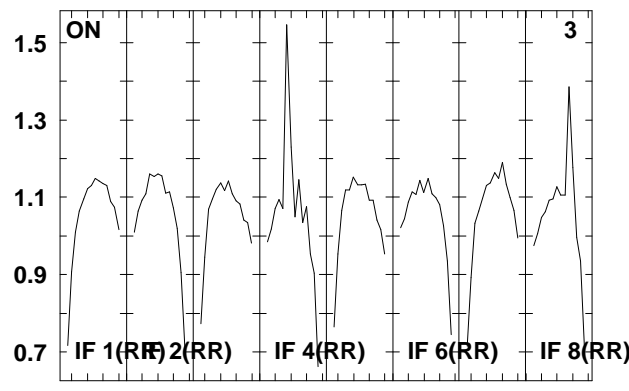
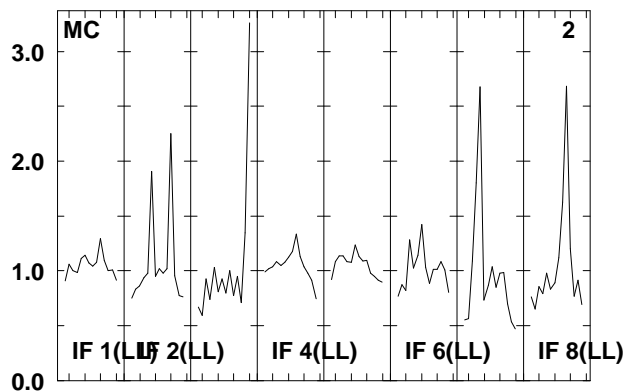
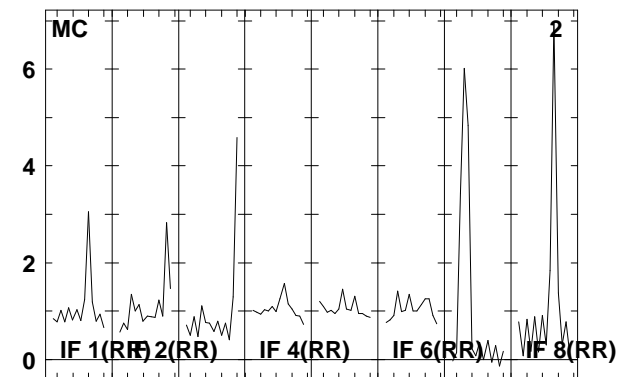
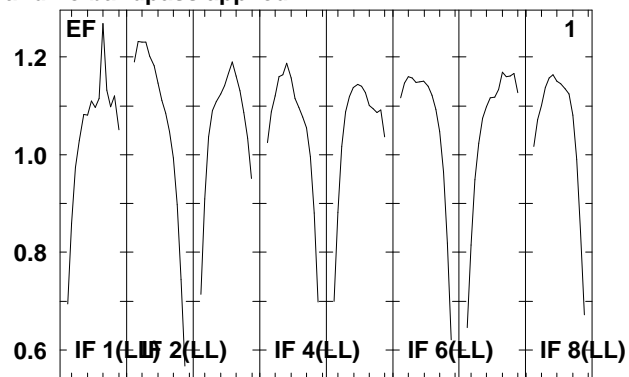
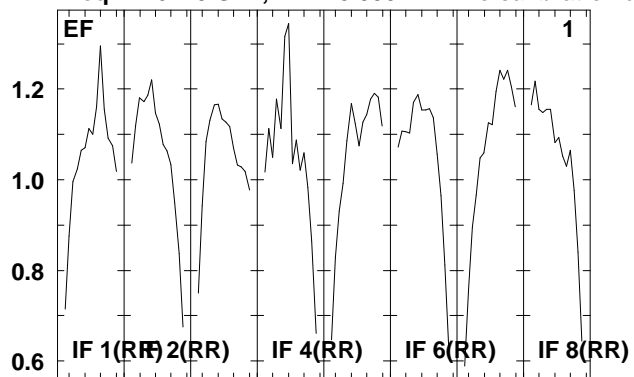

Lower frame: Real Jy  
Total-power spectrum Antenna: \*  
Timerange: 01/01:59:21 to 01/02:02:20

Plot file version 88 created 20-OCT-2009 14:49:30

M33 RP015C.UVDATA.1

Freq = 1.6270 GHz, Bw = 8.000 MH No calibration applied and no bandpass applied

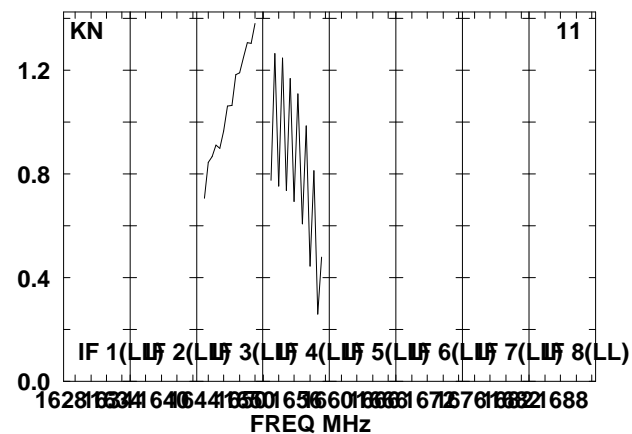
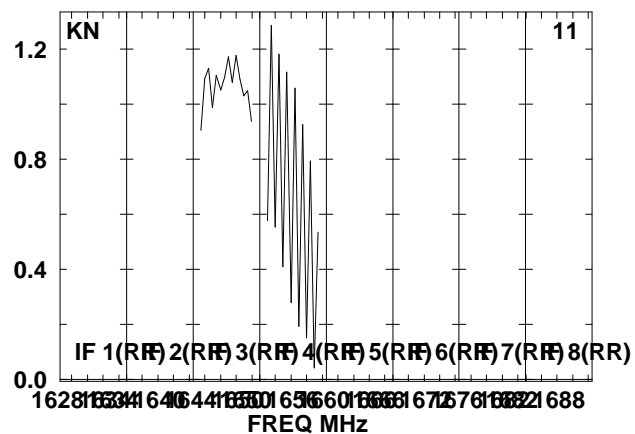
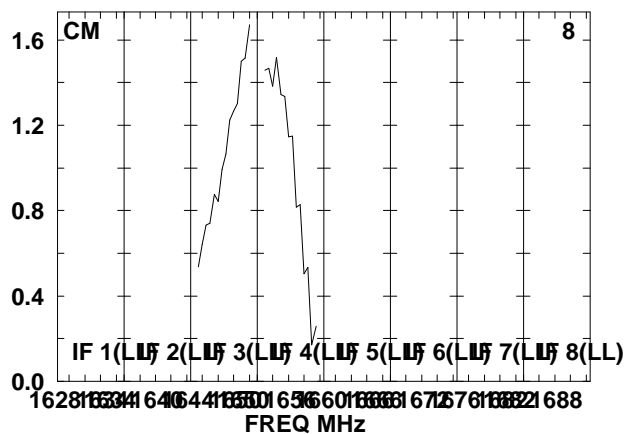
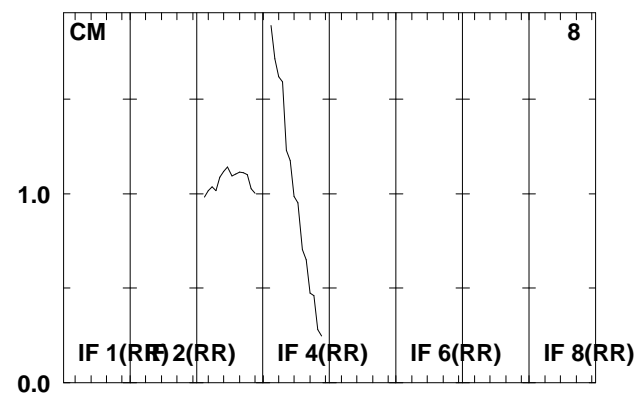
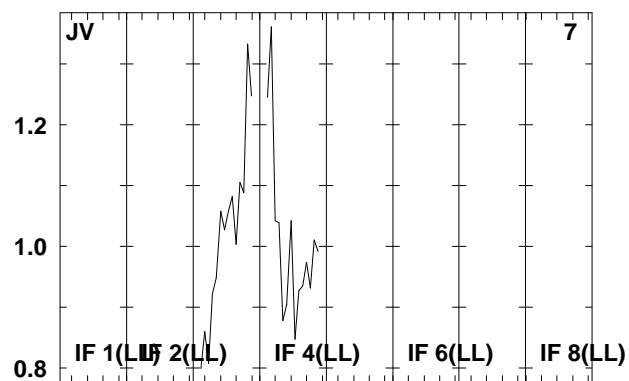
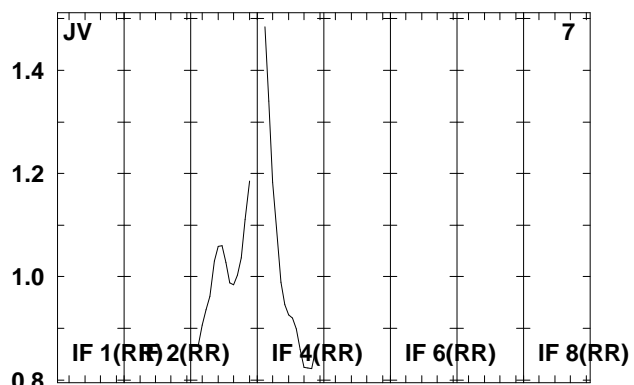
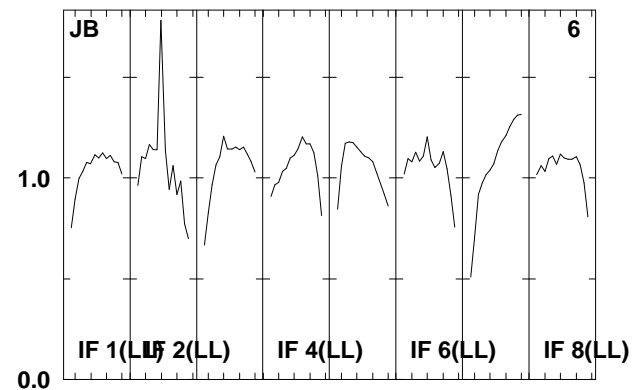
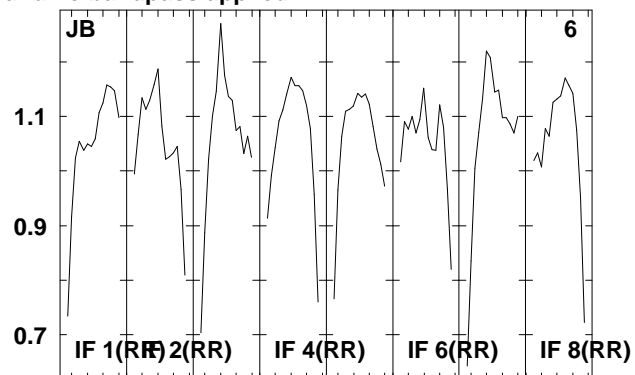
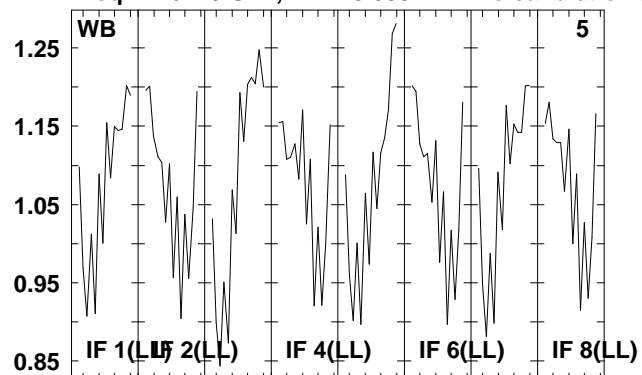

Lower frame: Real Jy  
Total-power spectrum Antenna: \*  
Timerange: 01/01:59:21 to 01/02:02:20



Plot file version 89 created 20-OCT-2009 14:49:31

J0137+31 RP015C.UVDATA.1

Freq = 1.6270 GHz, Bw = 8.000 MH No calibration applied and no bandpass applied

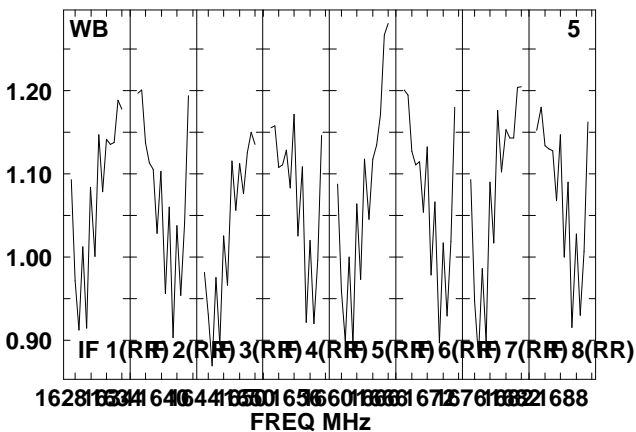
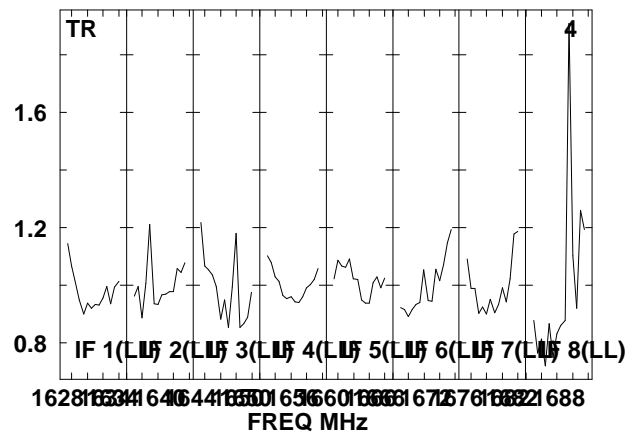
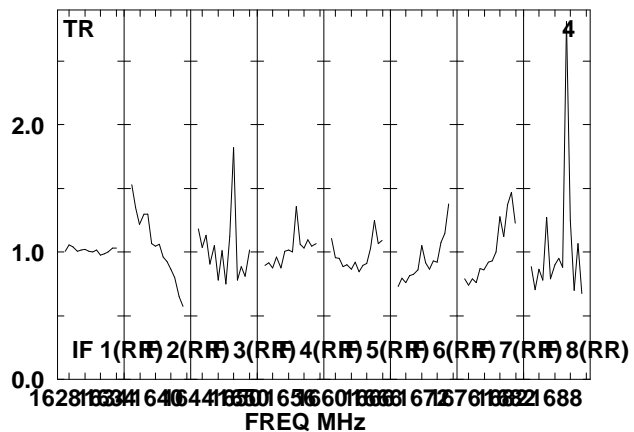
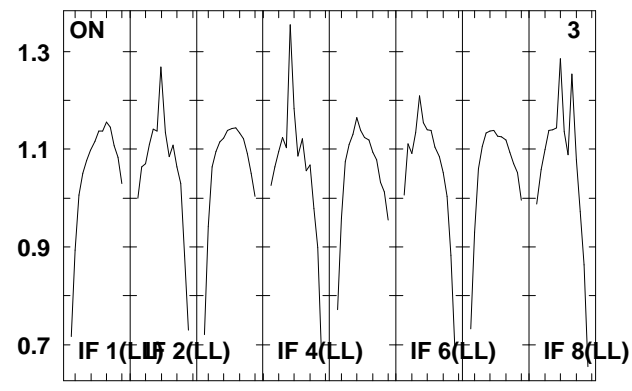
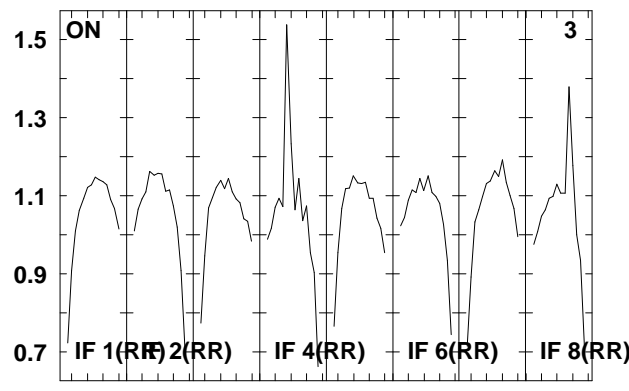
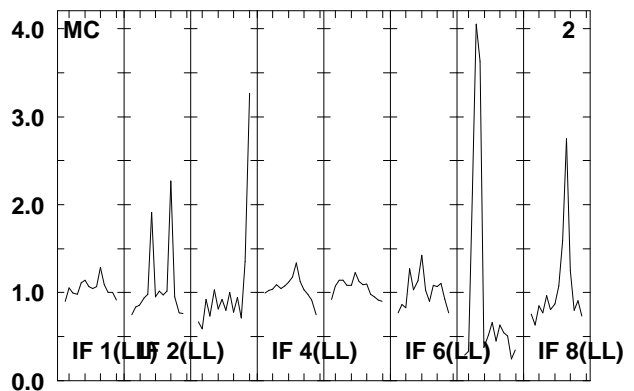
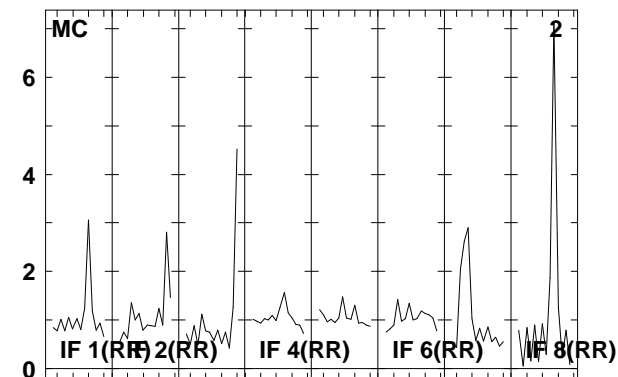
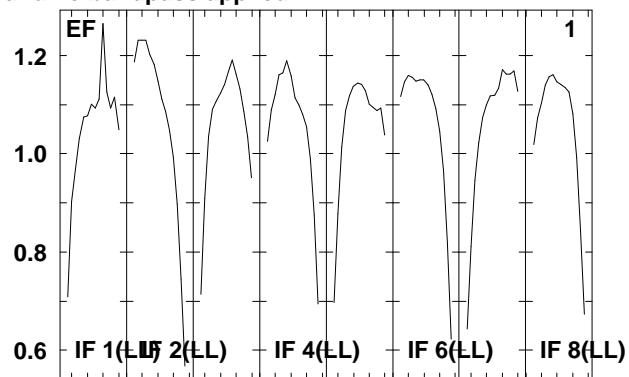
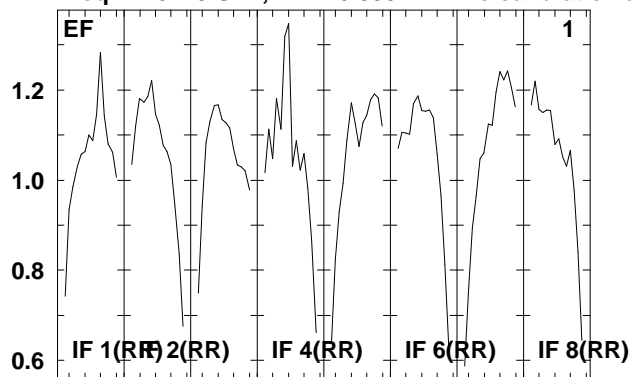

Lower frame: Real Jy  
Total-power spectrum Antenna: \*  
Timerange: 01/02:03:01 to 01/02:04:00

Plot file version 90 created 20-OCT-2009 14:49:31  
 J0137+31 RP015C.UVDATA.1  
 Freq = 1.6270 GHz, Bw = 8.000 MH No calibration applied and no bandpass applied

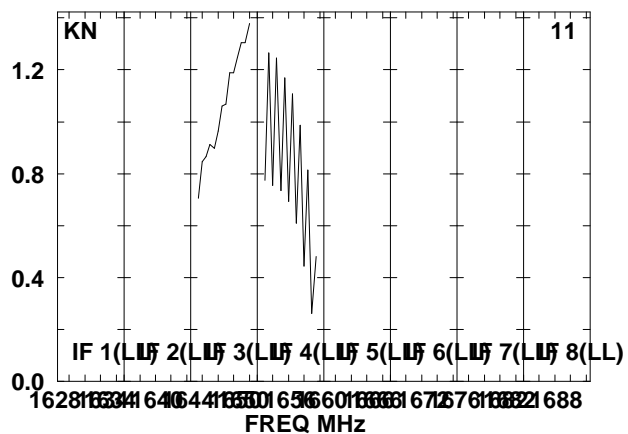
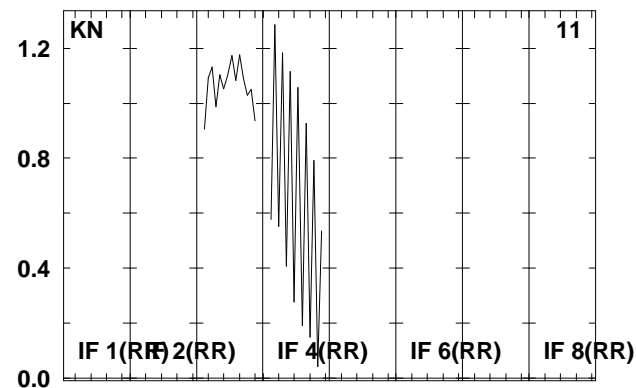
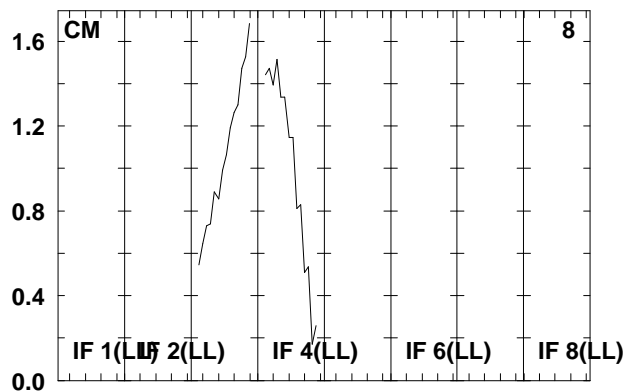
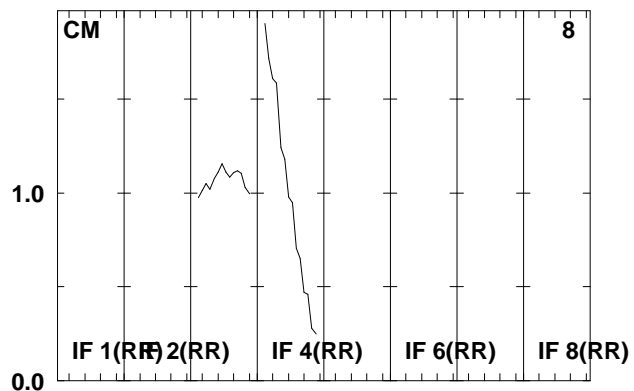
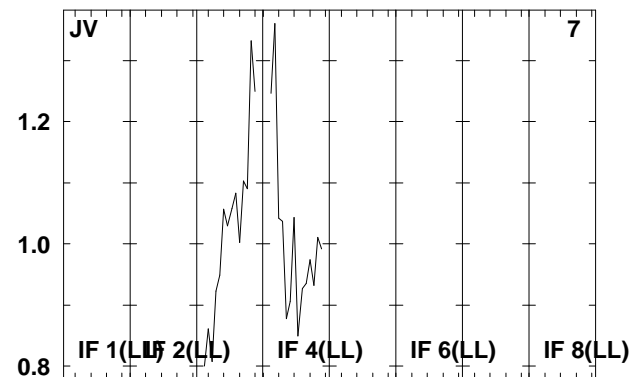
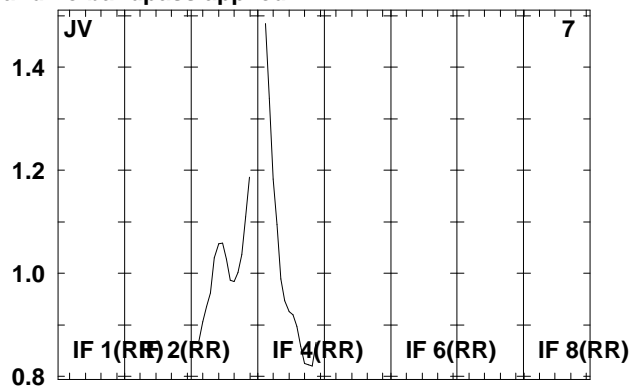
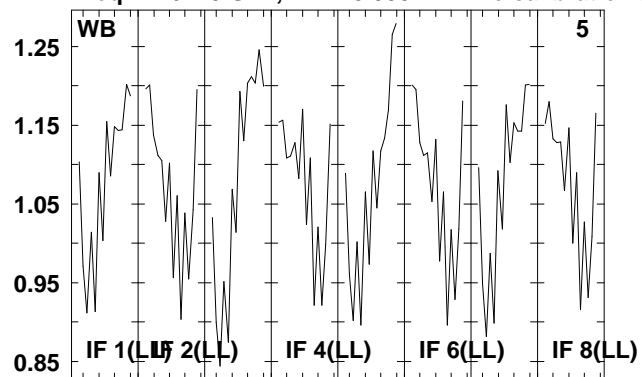

Lower frame: Real Jy  
 Total-power spectrum Antenna: \*  
 Timerange: 01/02:03:01 to 01/02:04:00

Plot file version 91 created 20-OCT-2009 14:49:32

FAINTCAL RP015C.UVDATA.1

Freq = 1.6270 GHz, Bw = 8.000 MH No calibration applied and no bandpass applied

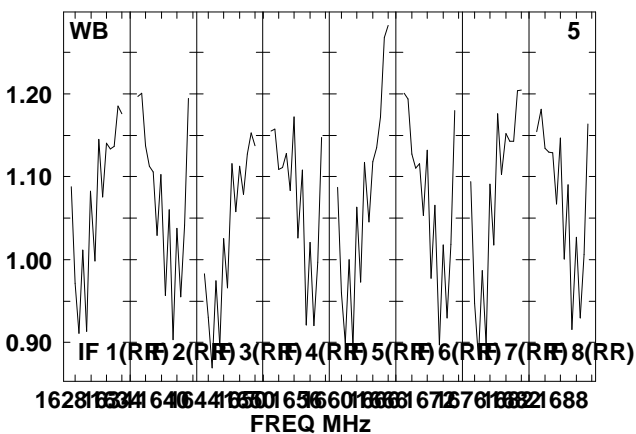
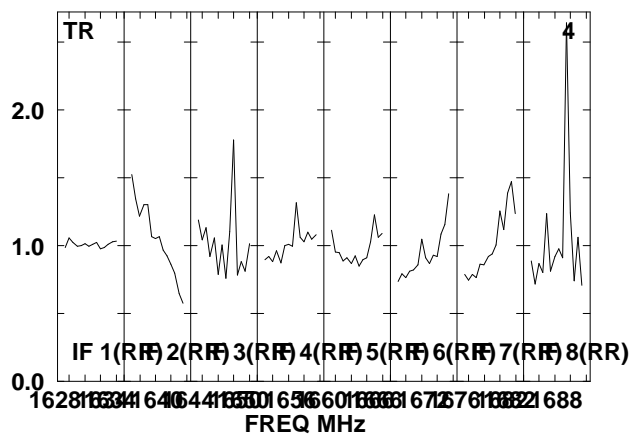
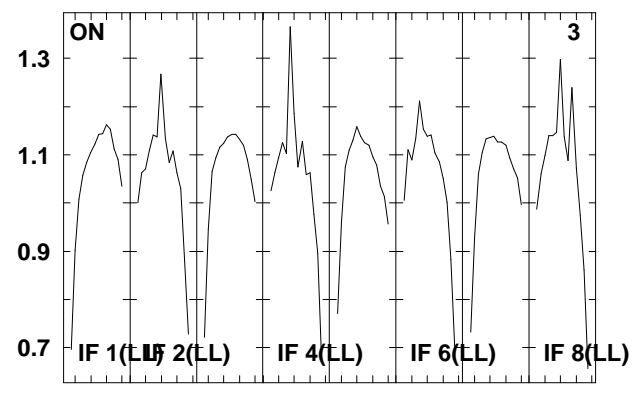
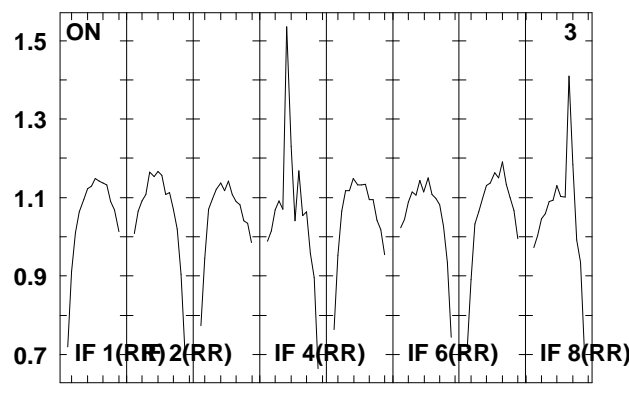
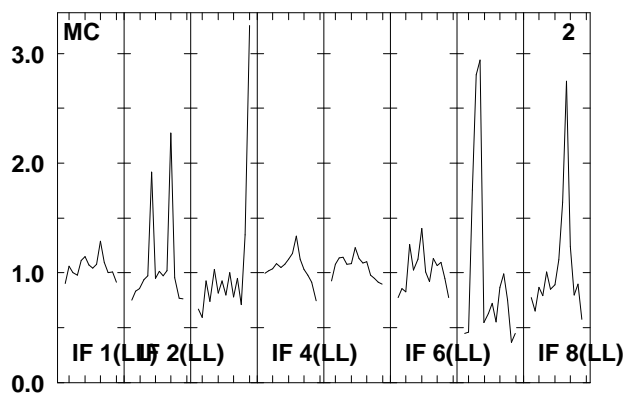
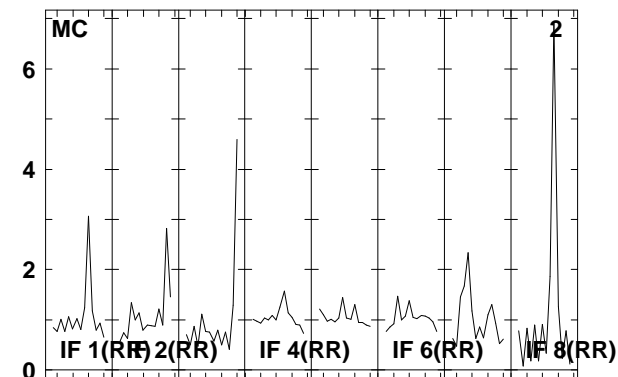
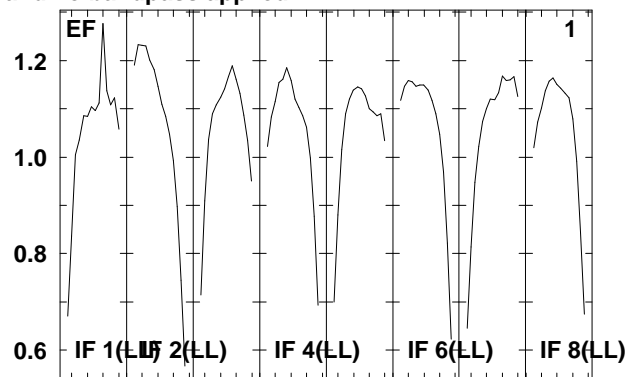
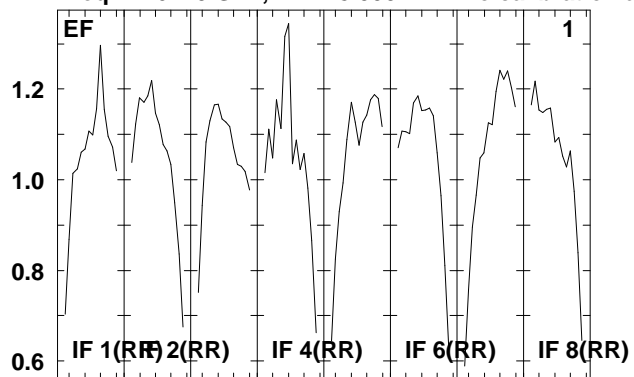

Lower frame: Real Jy  
Total-power spectrum Antenna: \*  
Timerange: 01/02:04:01 to 01/02:05:19

Plot file version 92 created 20-OCT-2009 14:49:32

FAINTCAL RP015C.UVDATA.1

Freq = 1.6270 GHz, Bw = 8.000 MH No calibration applied and no bandpass applied

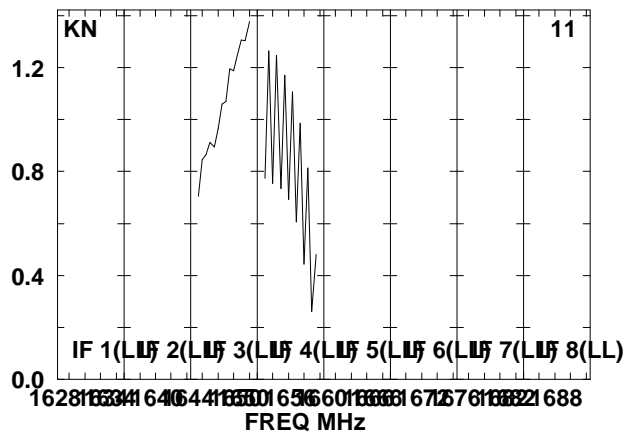
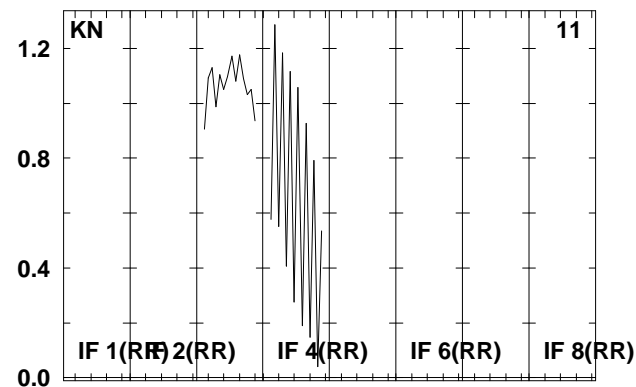
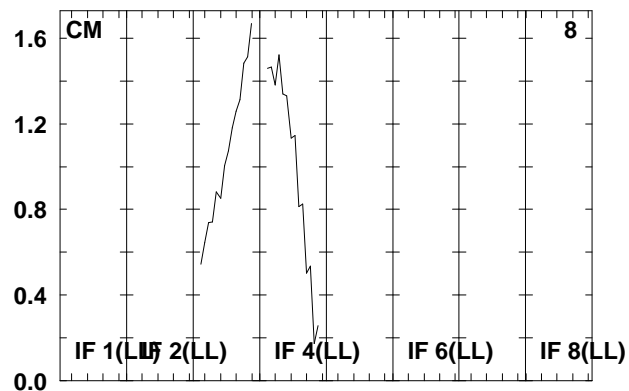
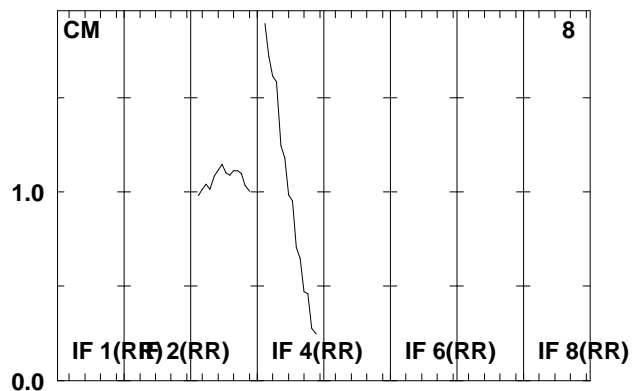
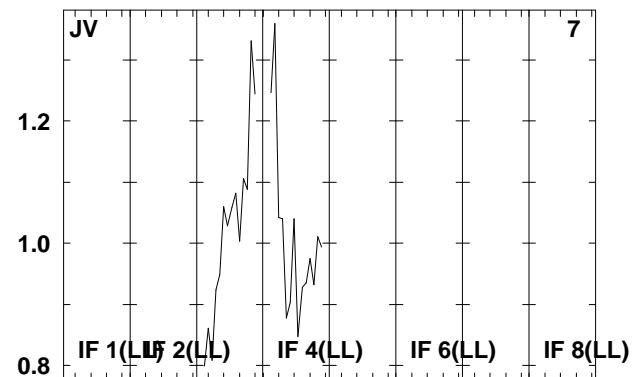
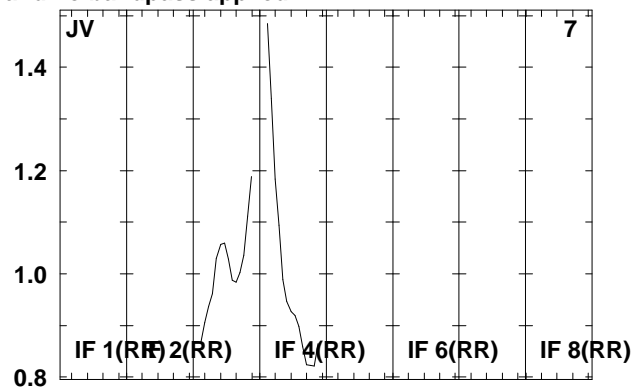
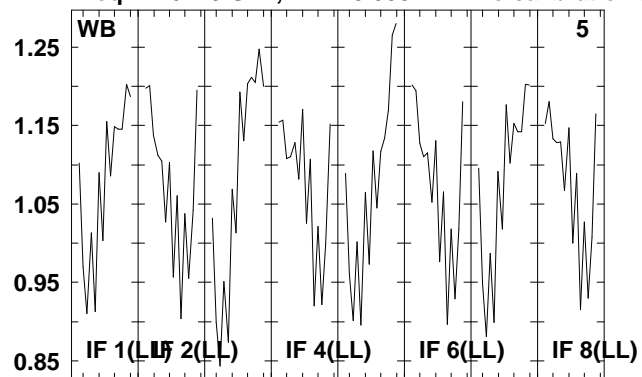

Lower frame: Real Jy

Total-power spectrum Antenna: \*

Timerange: 01/02:04:01 to 01/02:05:19

Plot file version 93 created 20-OCT-2009 14:49:33

M33 RP015C.UVDATA.1

Freq = 1.6270 GHz, Bw = 8.000 MH No calibration applied and no bandpass applied

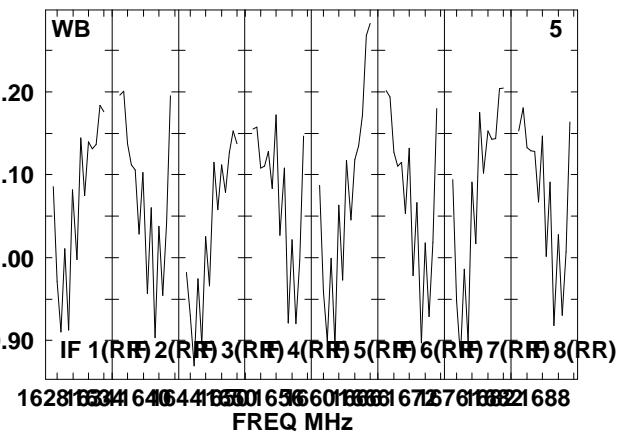
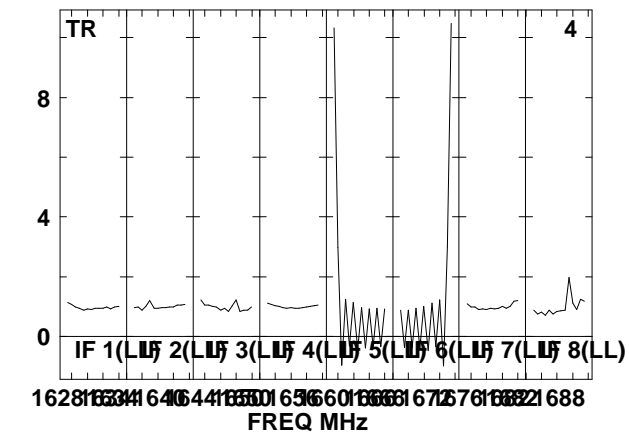
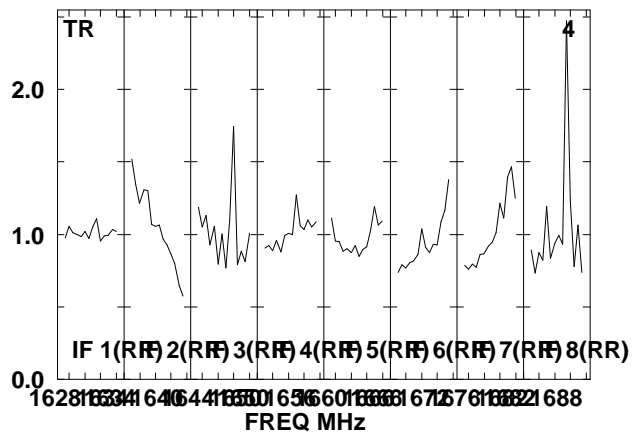
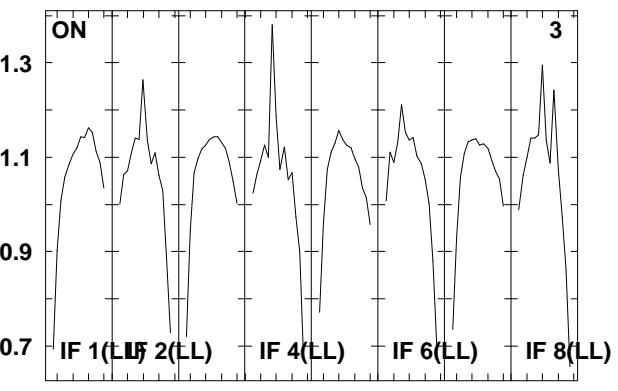
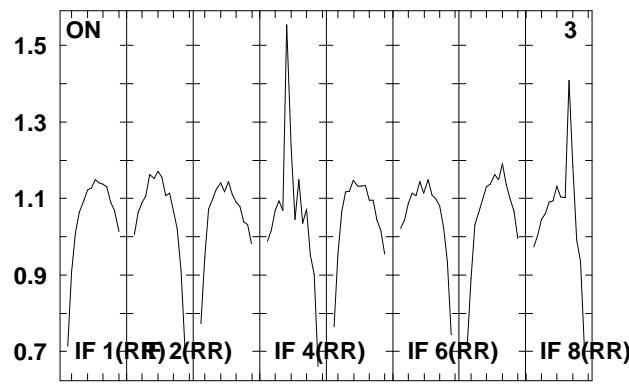
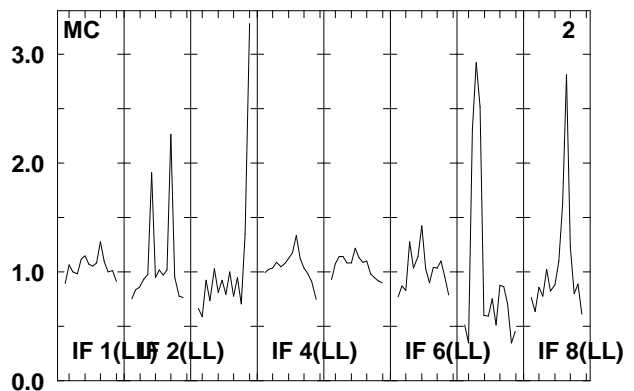
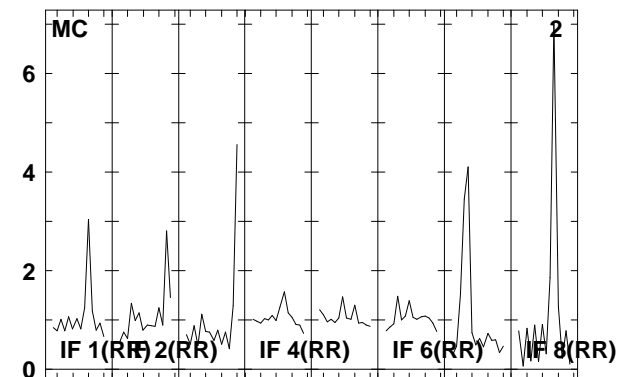
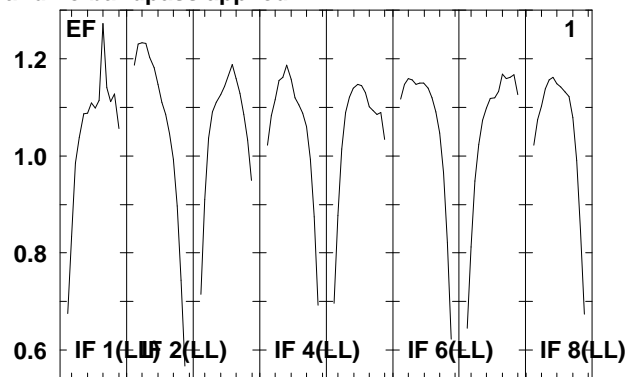
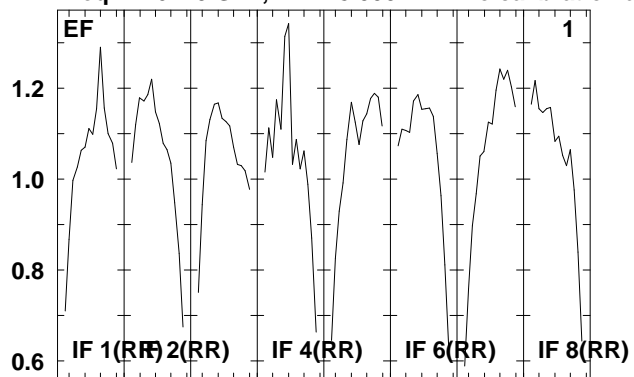

Lower frame: Real Jy  
Total-power spectrum Antenna: \*  
Timerange: 01/02:05:20 to 01/02:08:20

Plot file version 94 created 20-OCT-2009 14:49:34

M33 RP015C.UVDATA.1

Freq = 1.6270 GHz, Bw = 8.000 MH No calibration applied and no bandpass applied

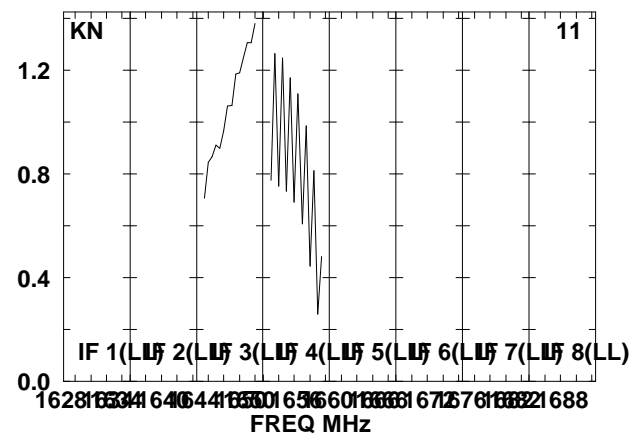
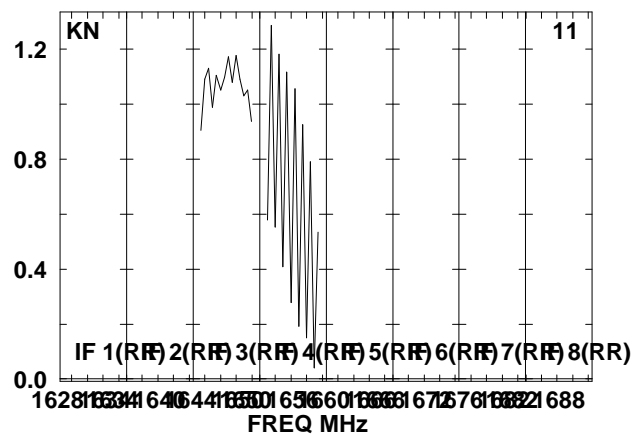
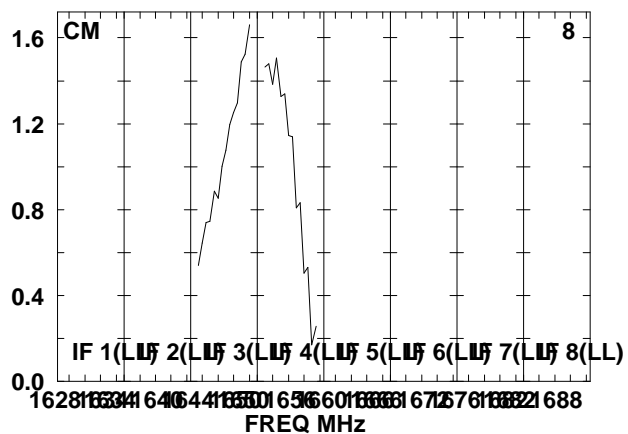
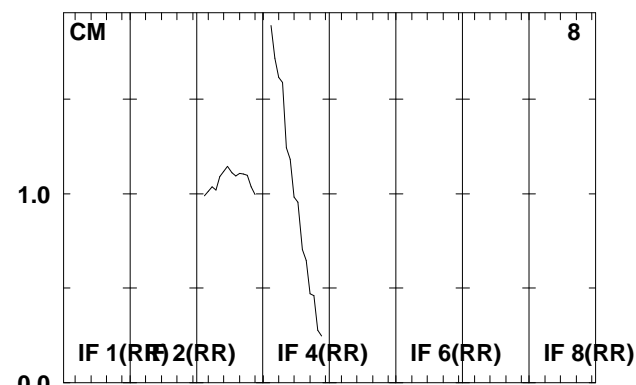
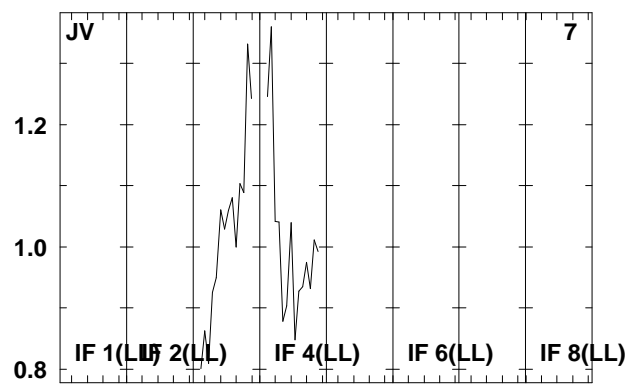
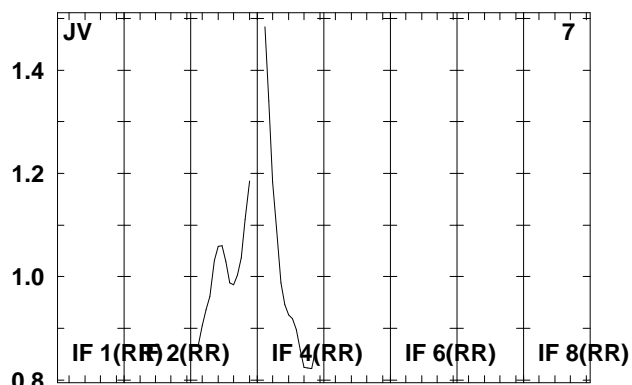
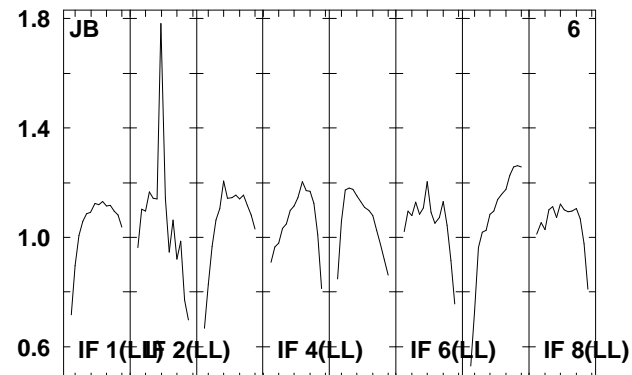
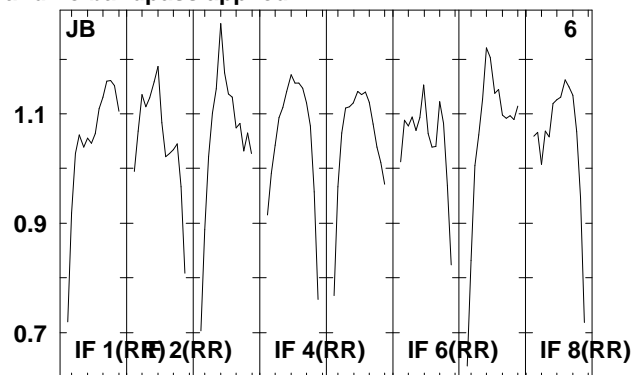
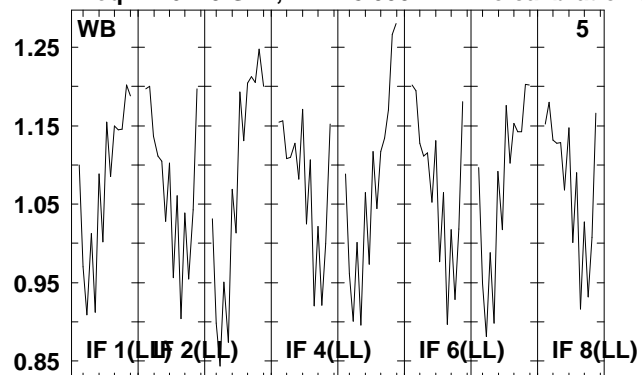

Lower frame: Real Jy  
Total-power spectrum Antenna: \*  
Timerange: 01/02:05:20 to 01/02:08:20

Plot file version 95 created 20-OCT-2009 14:49:35

J0137+31 RP015C.UVDATA.1

Freq = 1.6270 GHz, Bw = 8.000 MH No calibration applied and no bandpass applied

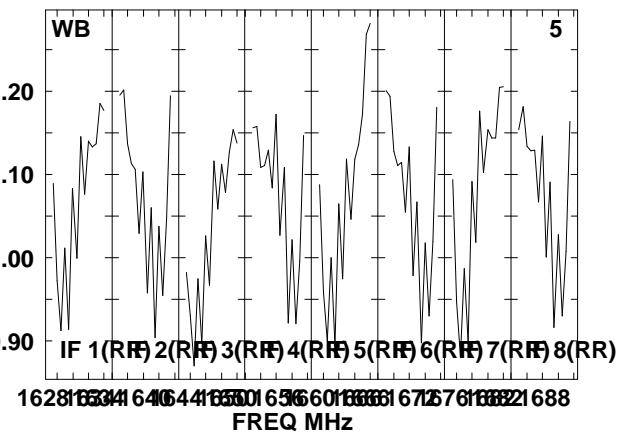
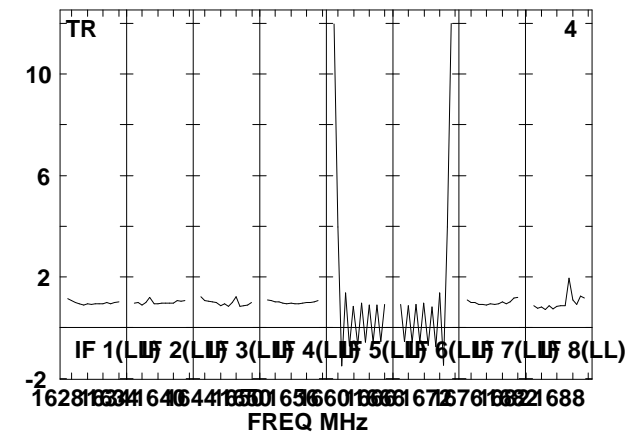
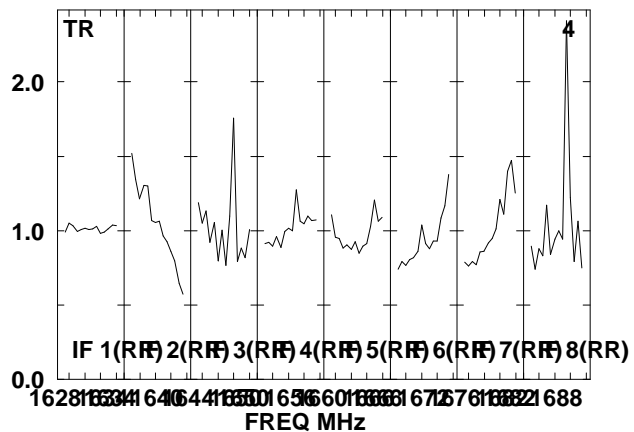
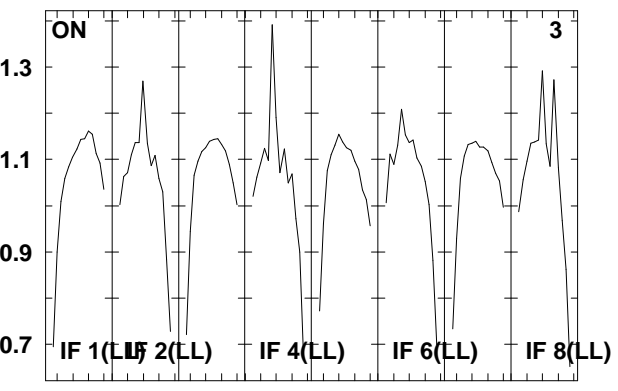
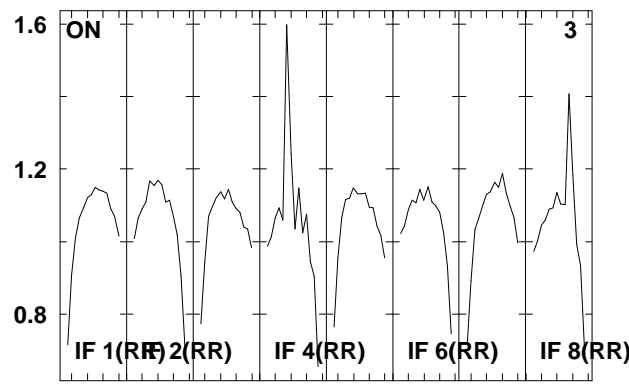
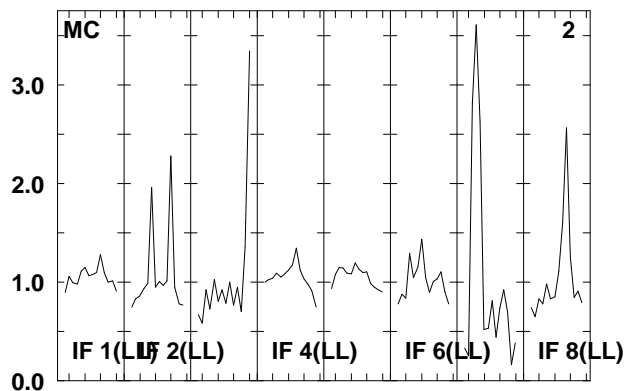
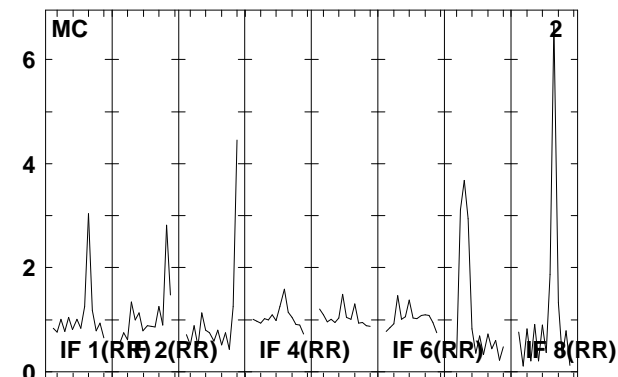
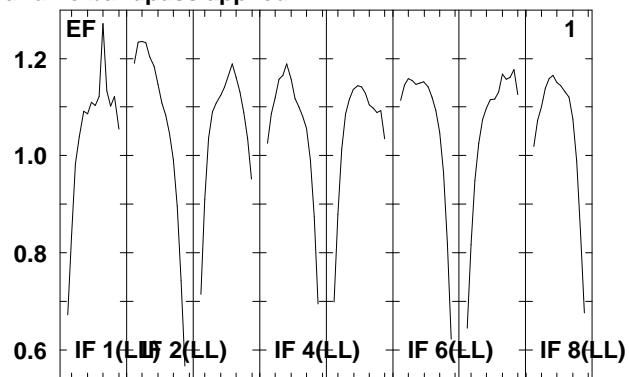
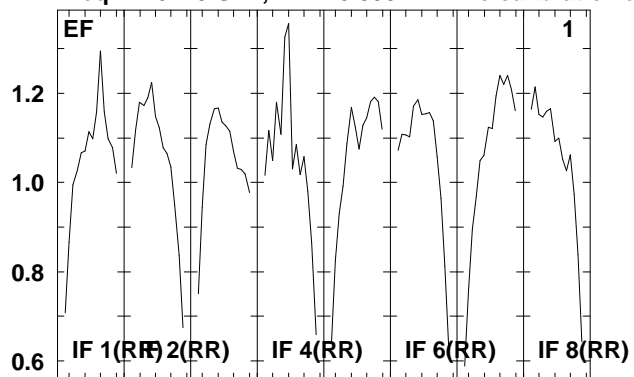

Lower frame: Real Jy  
Total-power spectrum Antenna: \*  
Timerange: 01/02:09:00 to 01/02:09:59

Plot file version 96 created 20-OCT-2009 14:49:36

J0137+31 RP015C.UVDATA.1

Freq = 1.6270 GHz, Bw = 8.000 MH No calibration applied and no bandpass applied

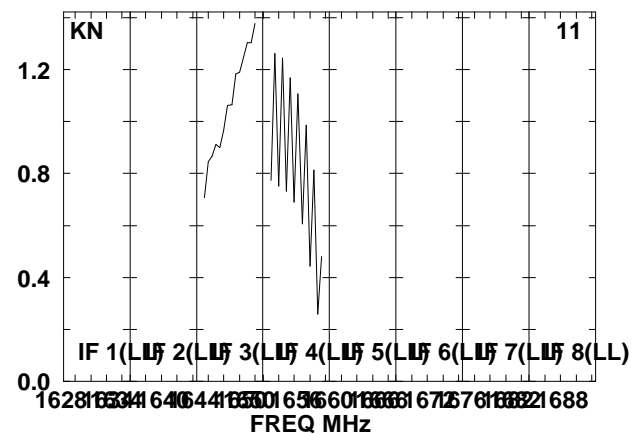
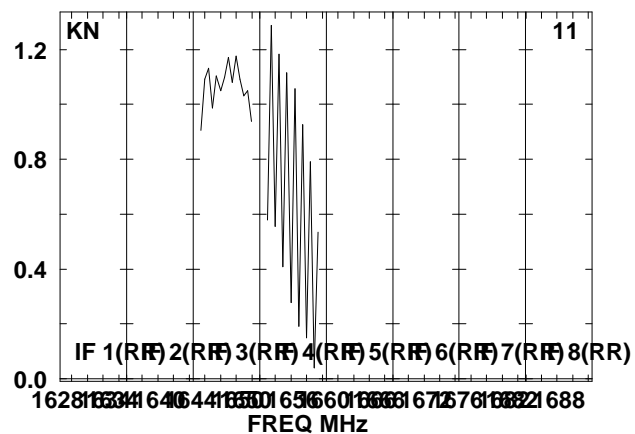
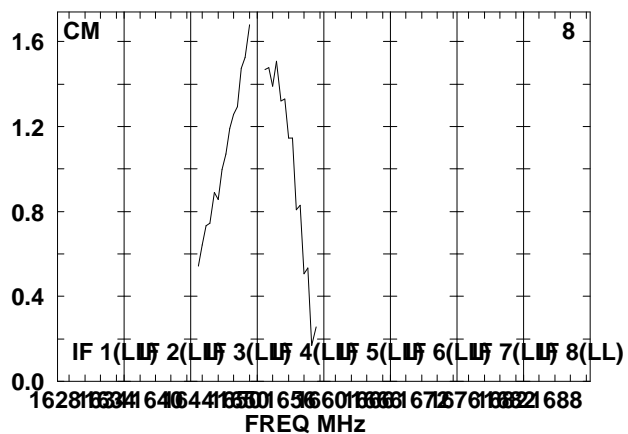
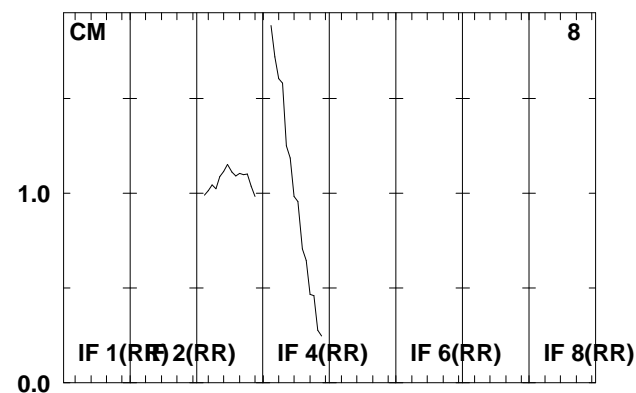
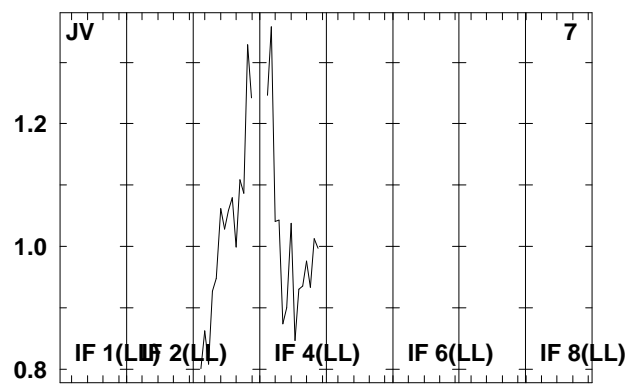
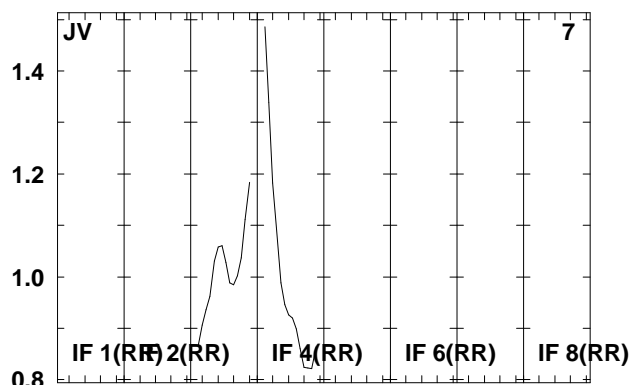
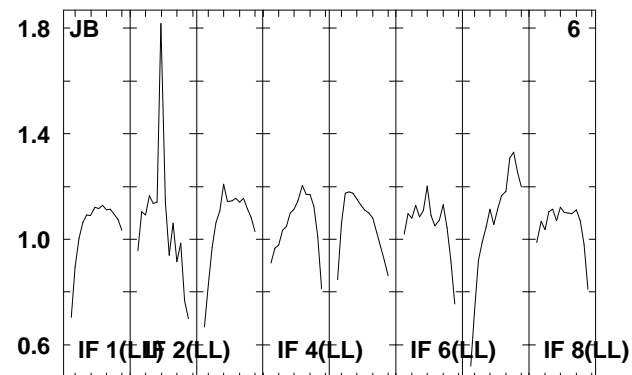
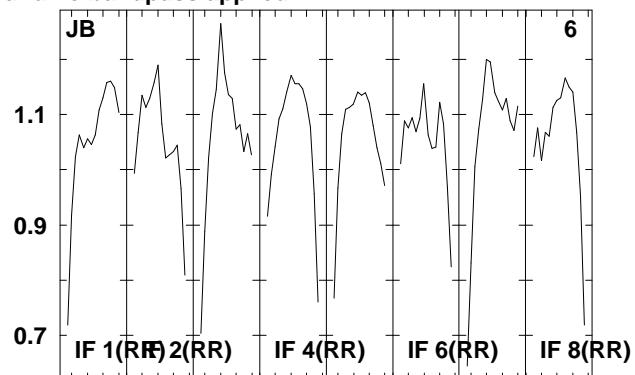
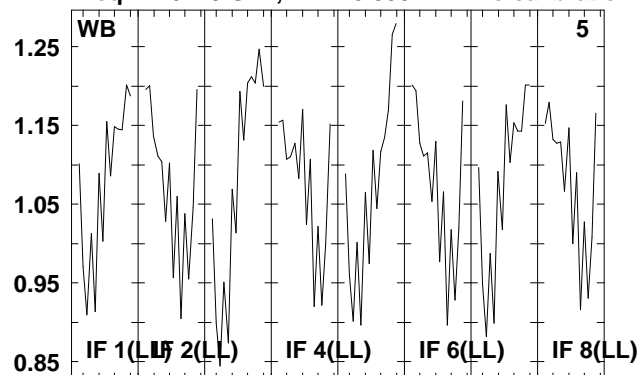

Lower frame: Real Jy

Total-power spectrum Antenna: \*

Timerange: 01/02:09:00 to 01/02:09:59



Plot file version 97 created 20-OCT-2009 14:49:36

FAINTCAL RP015C.UVDATA.1

Freq = 1.6270 GHz, Bw = 8.000 MH No calibration applied and no bandpass applied

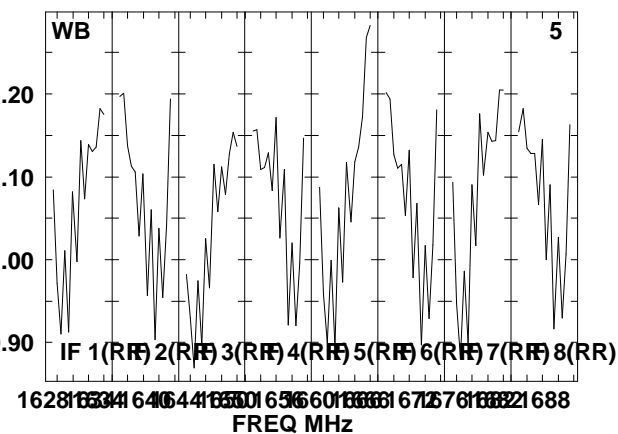
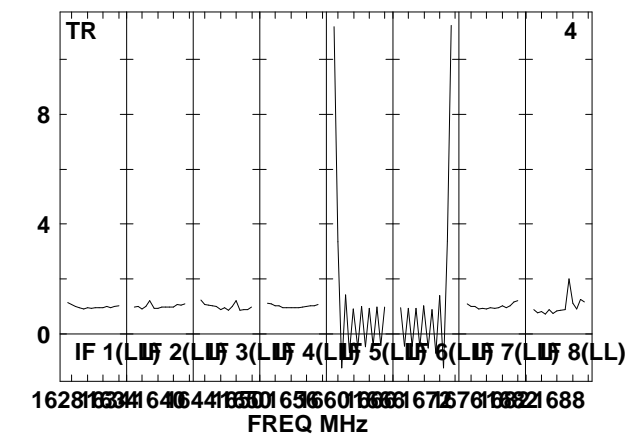
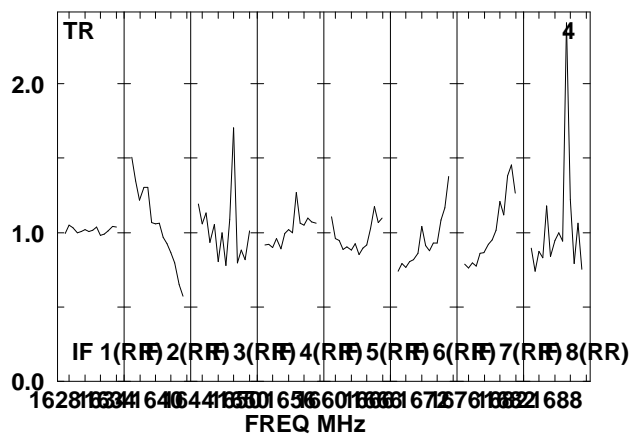
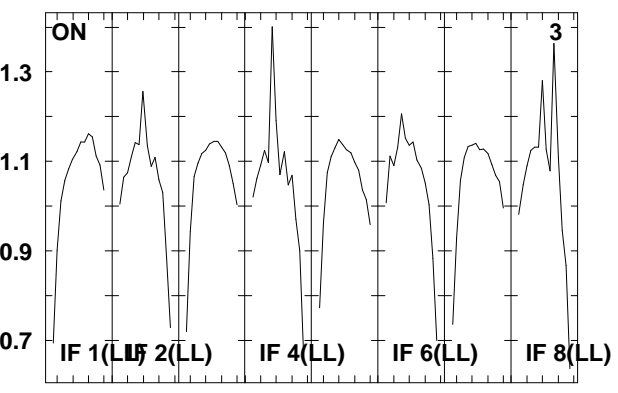
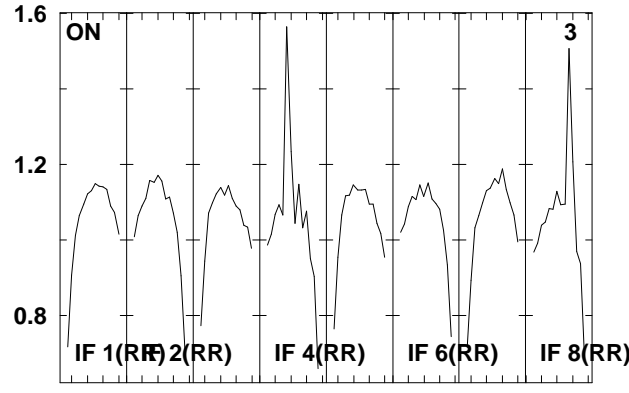
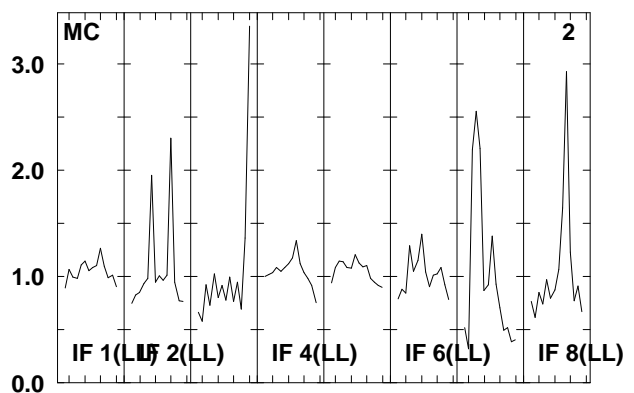
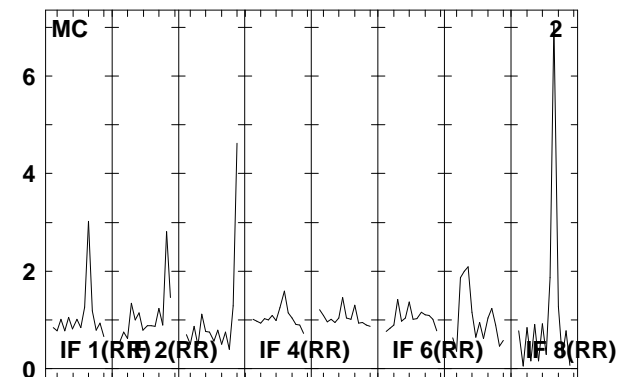
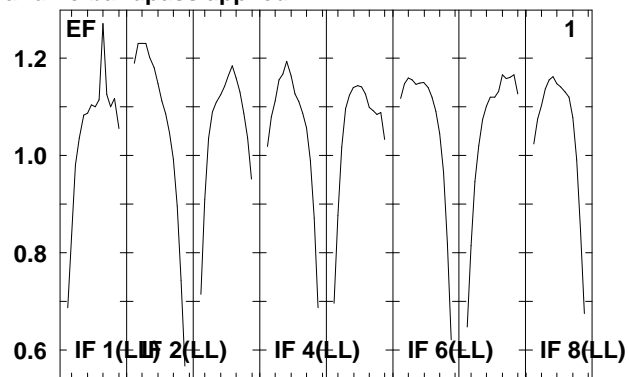
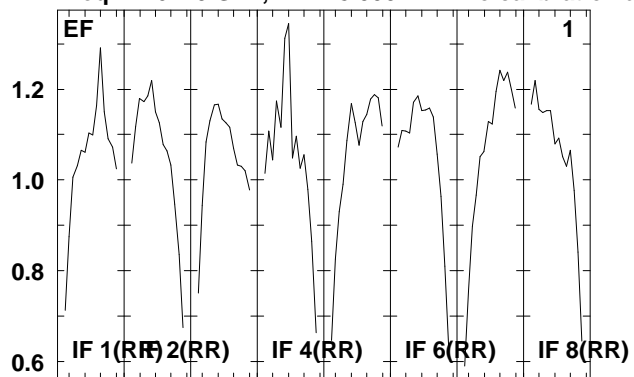

Lower frame: Real Jy  
Total-power spectrum Antenna: \*  
Timerange: 01/02:10:00 to 01/02:11:20

Plot file version 98 created 20-OCT-2009 14:49:37

FAINTCAL RP015C.UVDATA.1

Freq = 1.6270 GHz, Bw = 8.000 MH No calibration applied and no bandpass applied

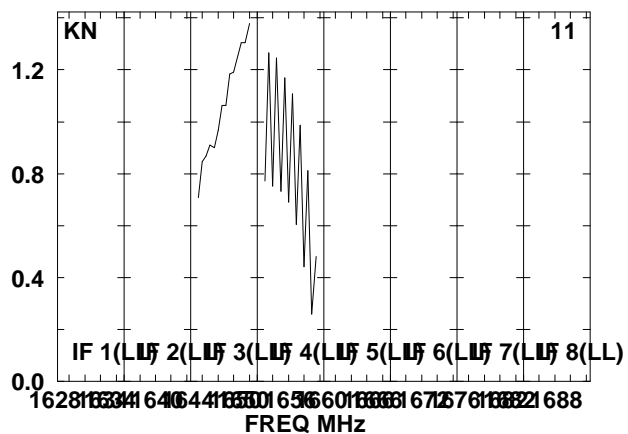
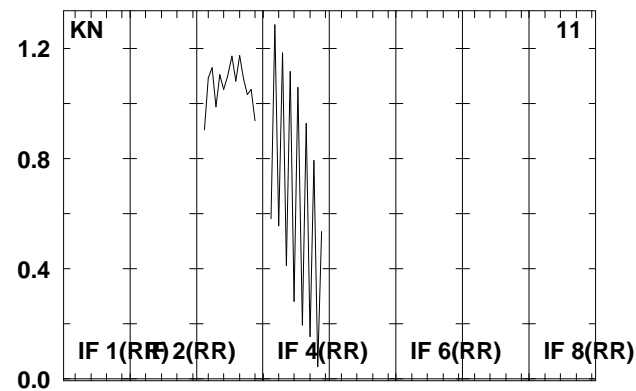
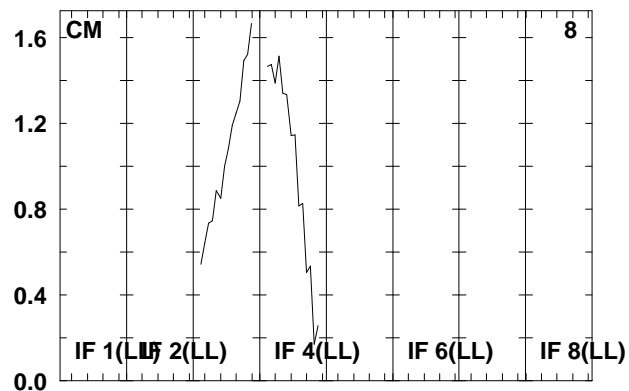
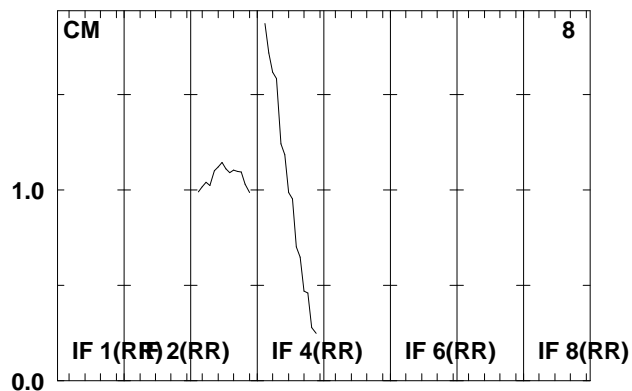
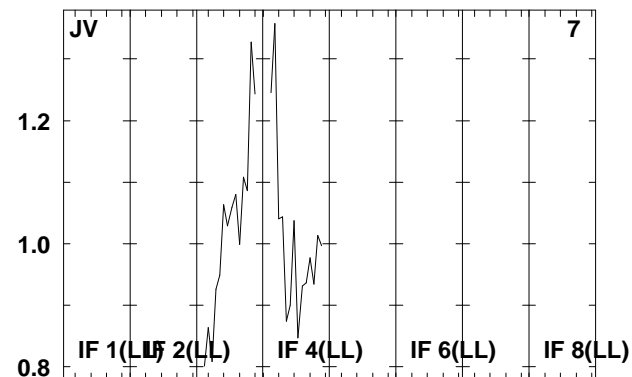
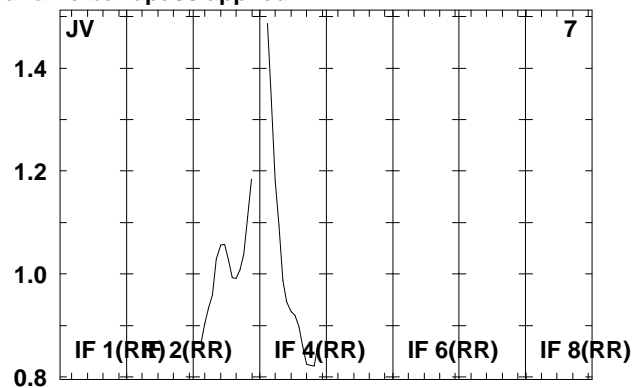
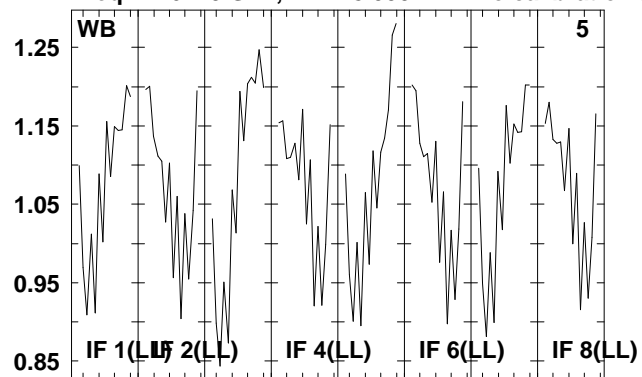

Lower frame: Real Jy

Total-power spectrum Antenna: \*

Timerange: 01/02:10:00 to 01/02:11:20

Plot file version 99 created 20-OCT-2009 14:49:38

M33 RP015C.UVDATA.1

Freq = 1.6270 GHz, Bw = 8.000 MH No calibration applied and no bandpass applied

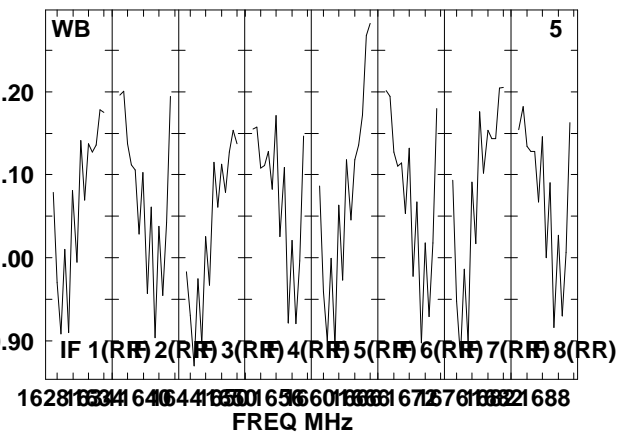
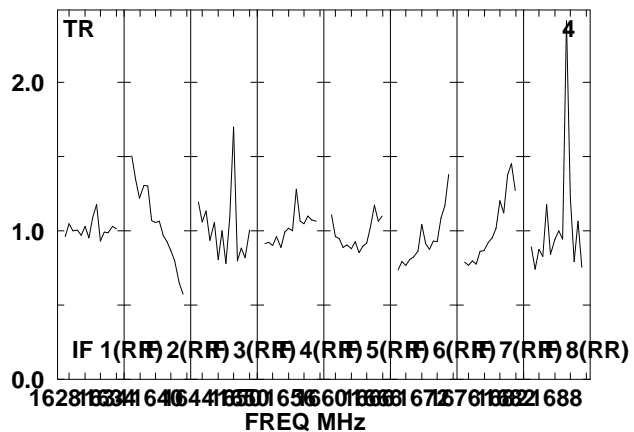
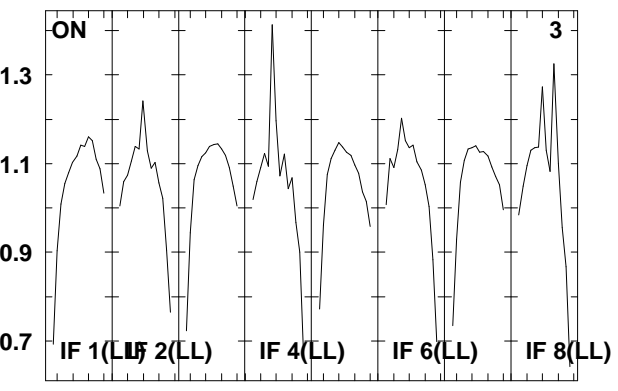
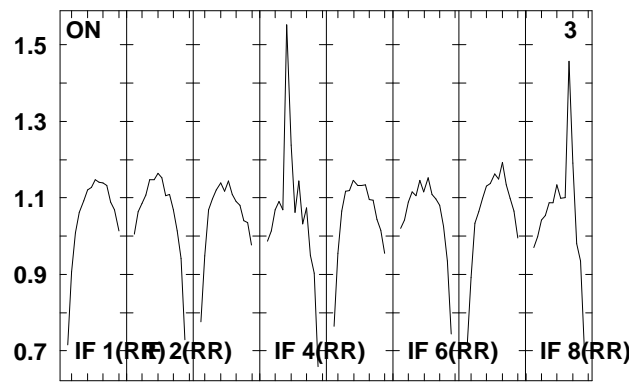
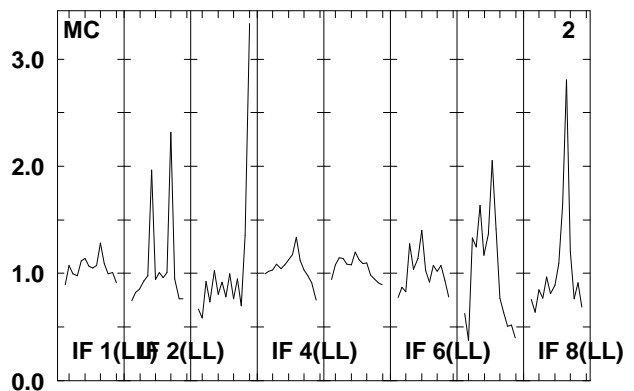
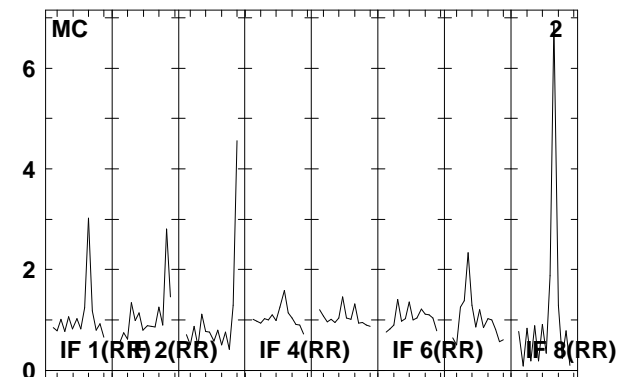
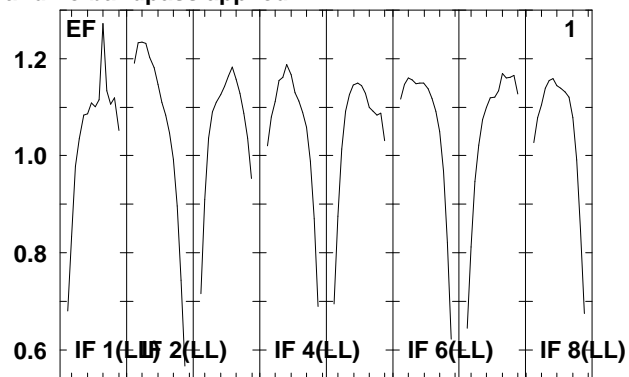
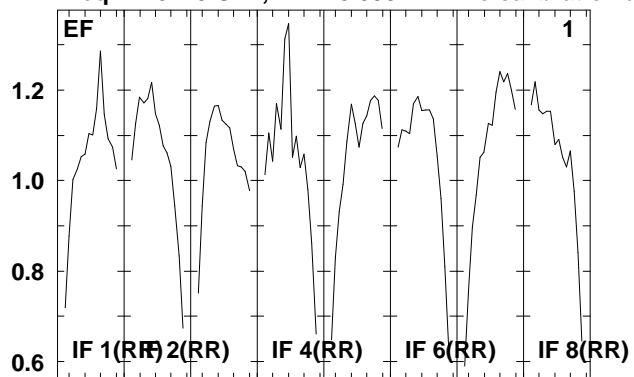

Lower frame: Real Jy

Total-power spectrum Antenna: \*

Timerange: 01/02:11:20 to 01/02:14:20

Plot file version 100 created 20-OCT-2009 14:49:38  
 M33 RP015C.UVDATA.1  
 Freq = 1.6270 GHz, Bw = 8.000 MH No calibration applied and no bandpass applied

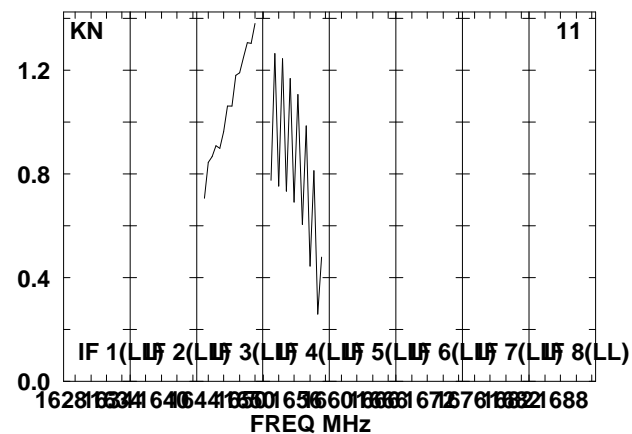
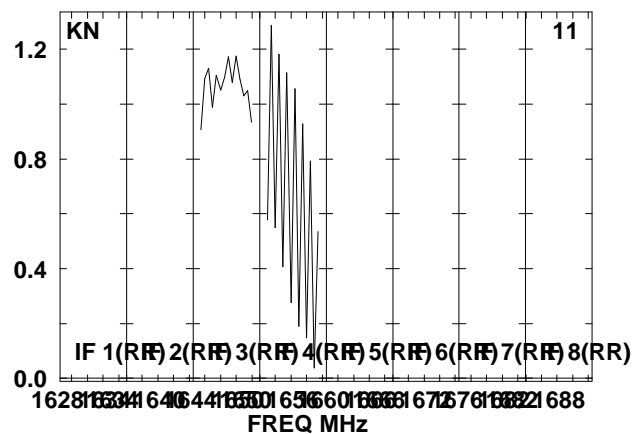
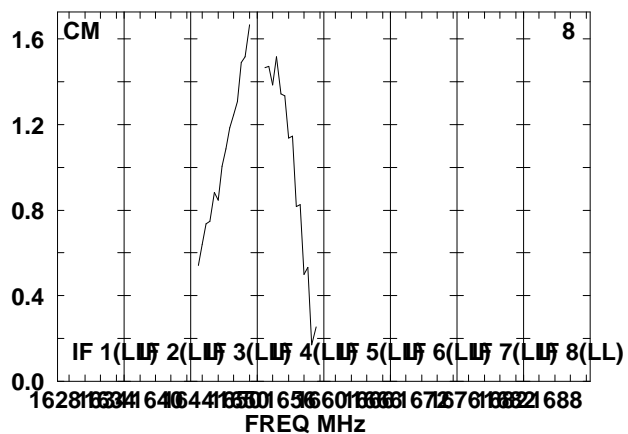
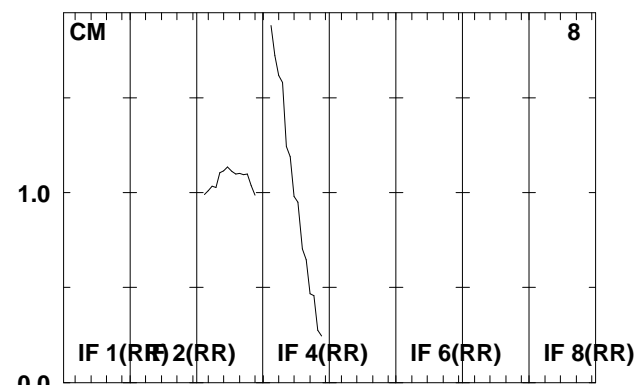
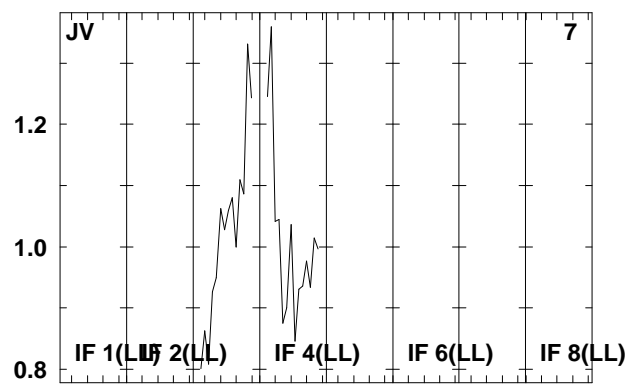
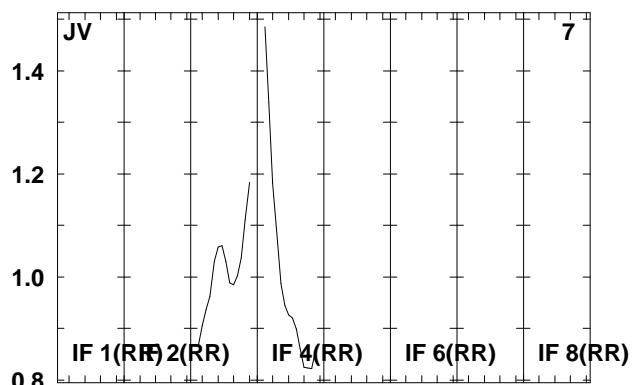
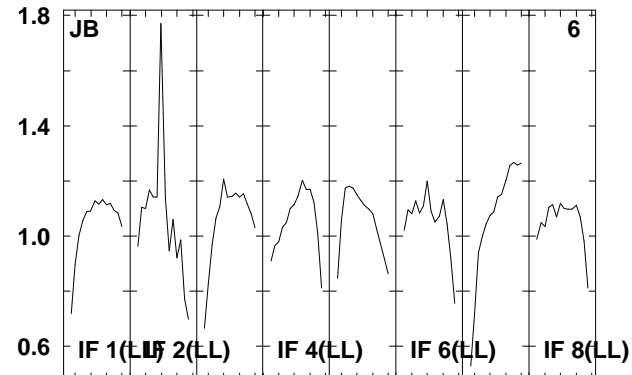
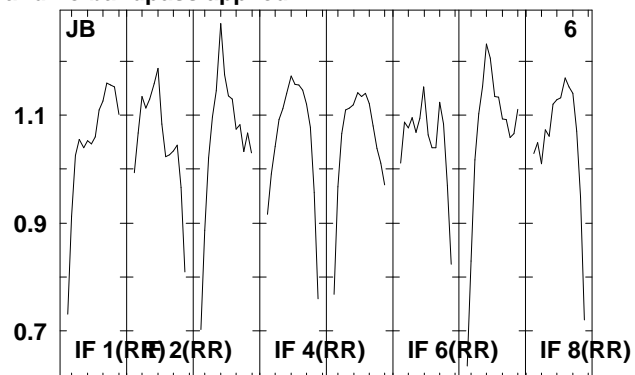
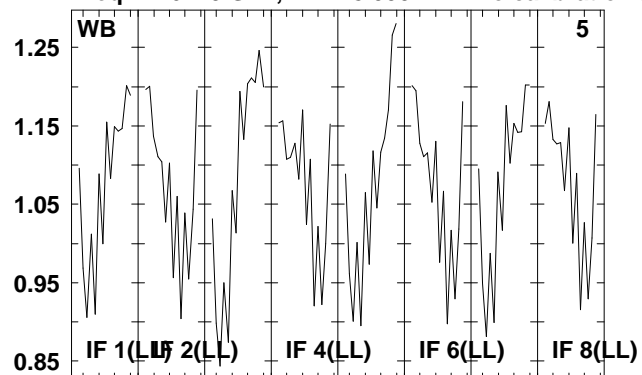

Lower frame: Real Jy  
 Total-power spectrum Antenna: \*  
 Timerange: 01/02:11:20 to 01/02:14:20

Plot file version 101 created 20-OCT-2009 14:49:40

J0137+31 RP015C.UVDATA.1

Freq = 1.6270 GHz, Bw = 8.000 MH No calibration applied and no bandpass applied

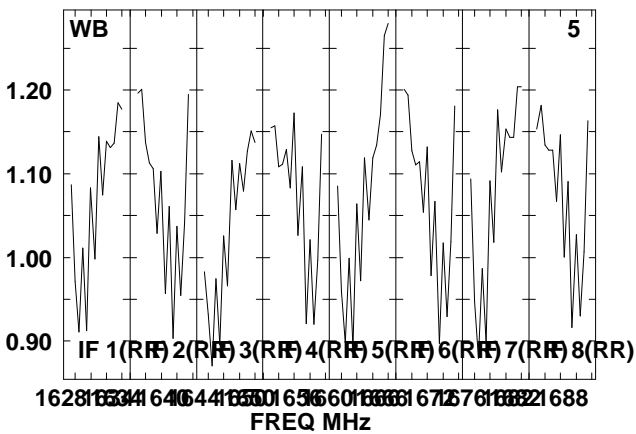
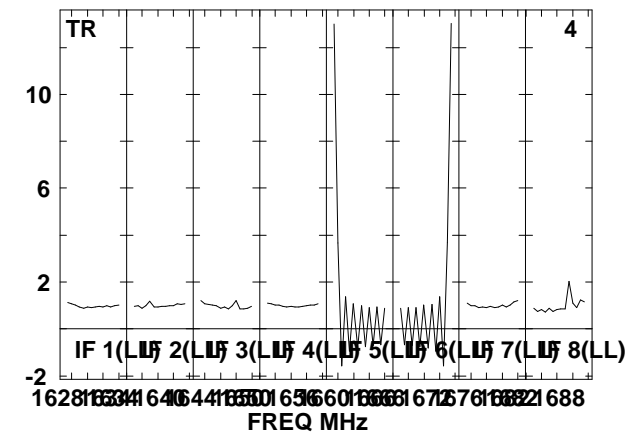
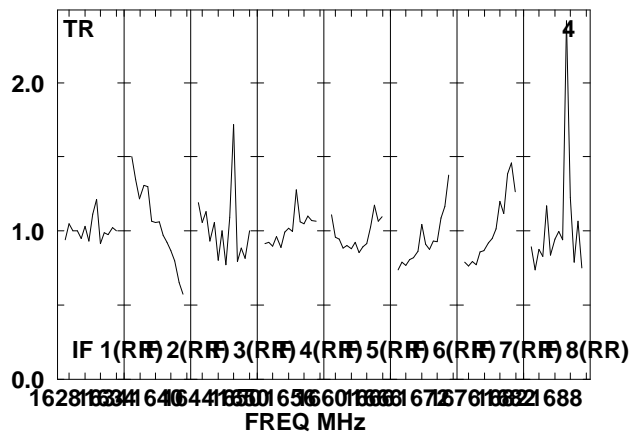
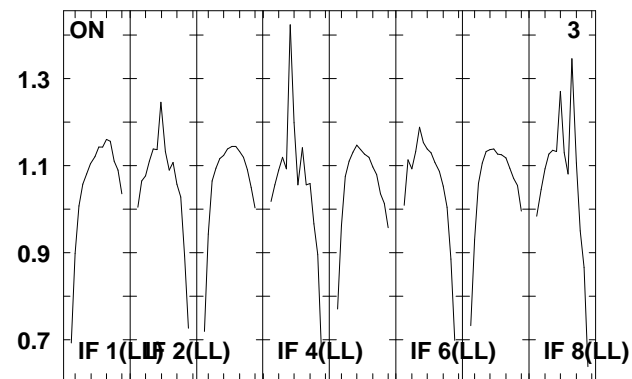
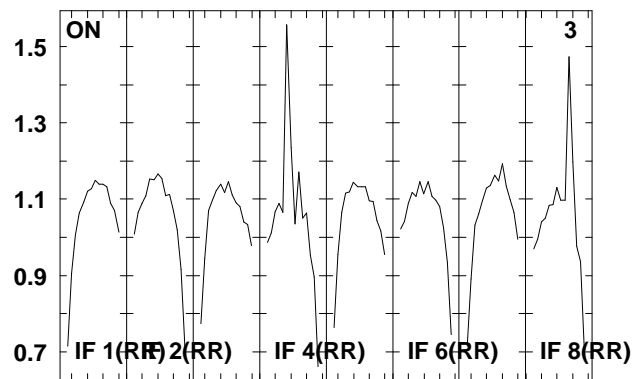
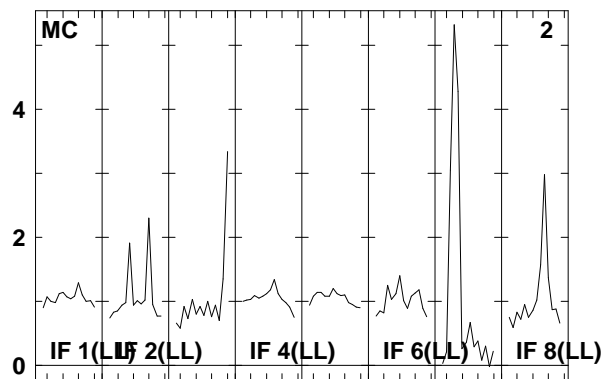
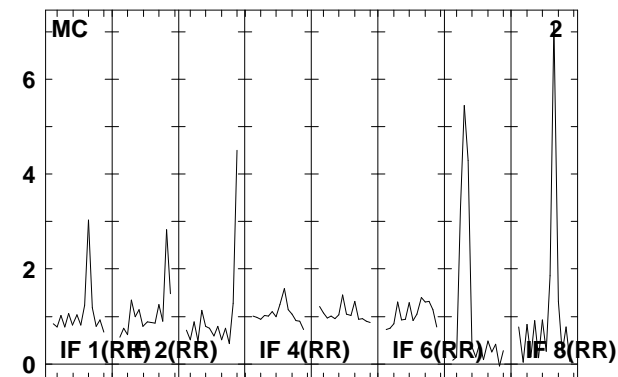
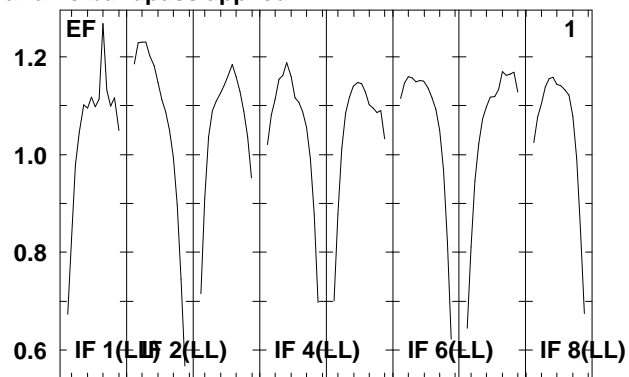
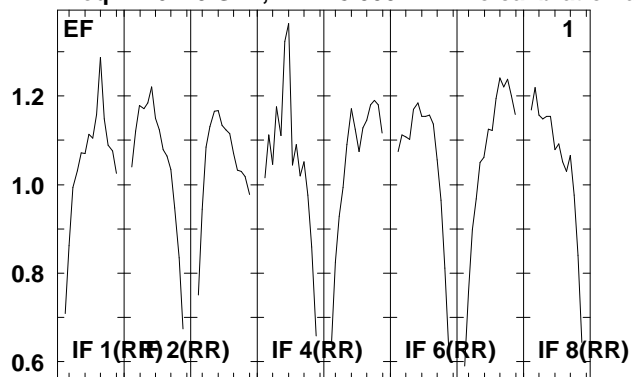

Lower frame: Real Jy

Total-power spectrum Antenna: \*

Timerange: 01/02:15:01 to 01/02:16:00

Plot file version 102 created 20-OCT-2009 14:49:41  
 J0137+31 RP015C.UVDATA.1  
 Freq = 1.6270 GHz, Bw = 8.000 MH No calibration applied and no bandpass applied

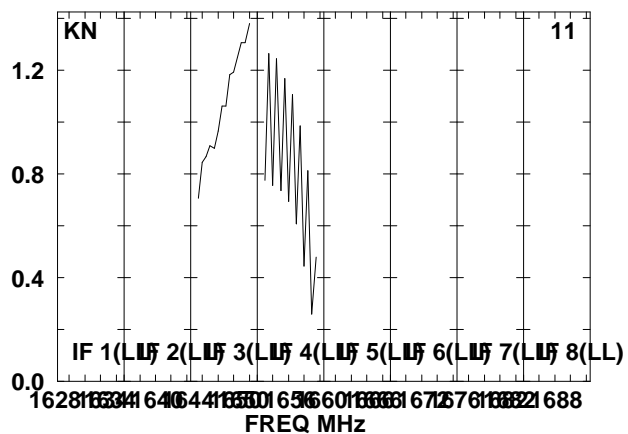
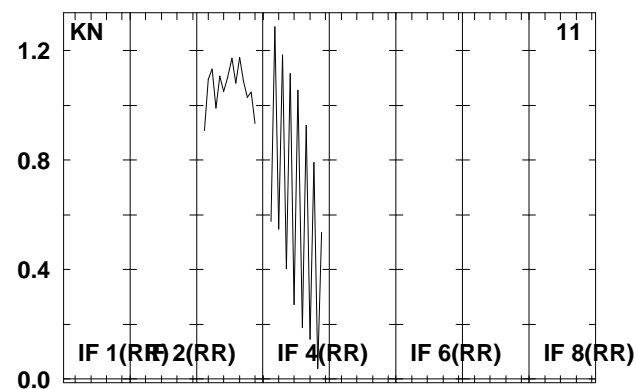
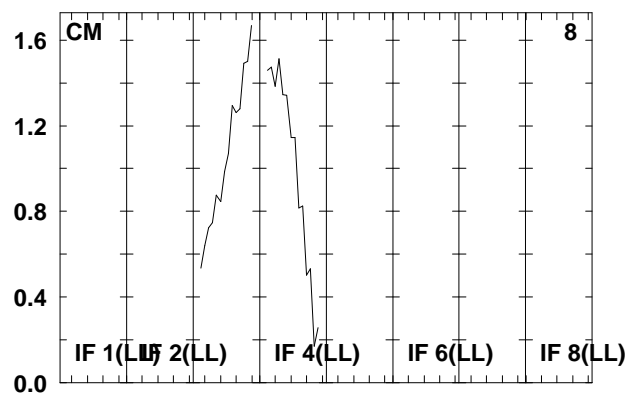
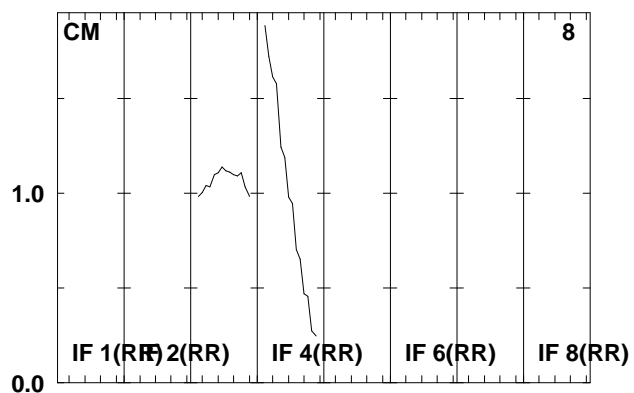
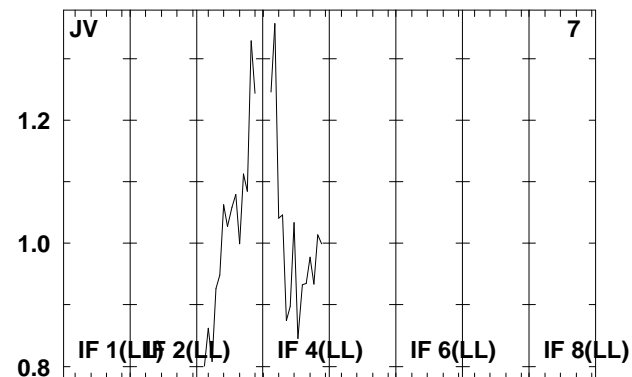
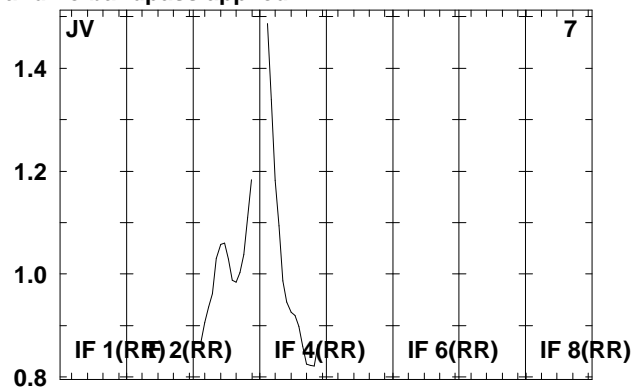
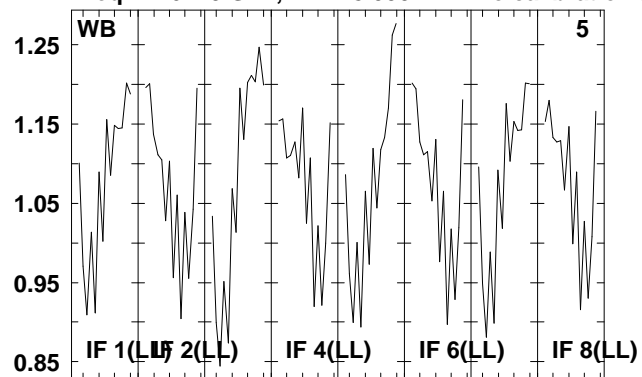

Lower frame: Real Jy  
 Total-power spectrum Antenna: \*  
 Timerange: 01/02:15:01 to 01/02:16:00

Plot file version 103 created 20-OCT-2009 14:49:41

FAINTCAL RP015C.UVDATA.1

Freq = 1.6270 GHz, Bw = 8.000 MH No calibration applied and no bandpass applied

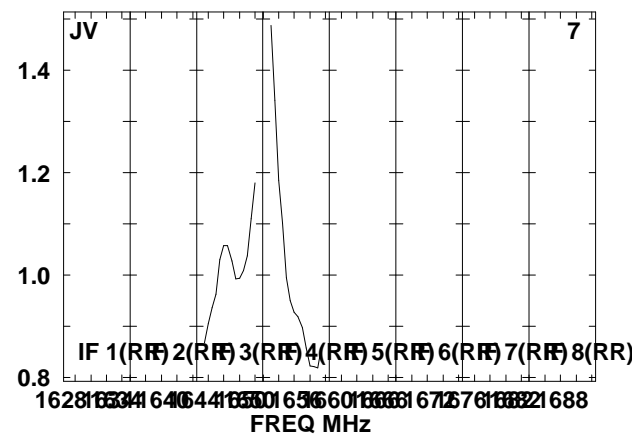
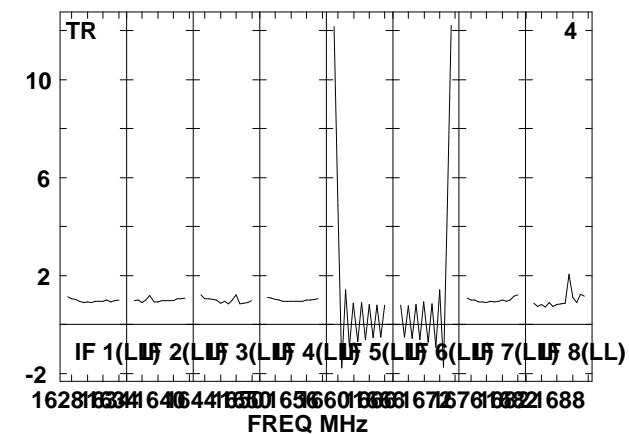
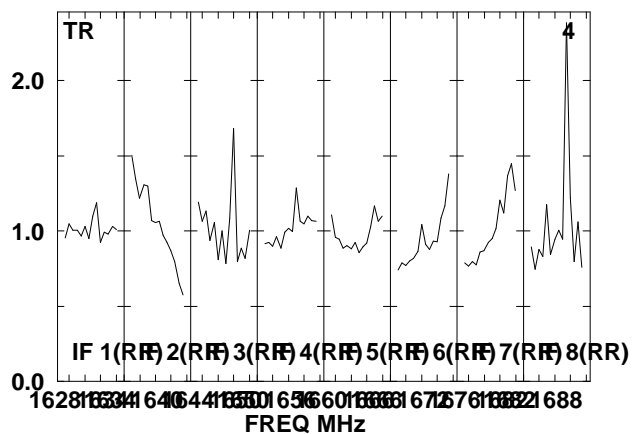
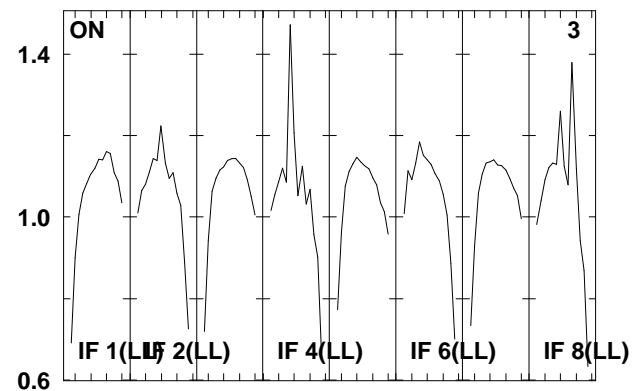
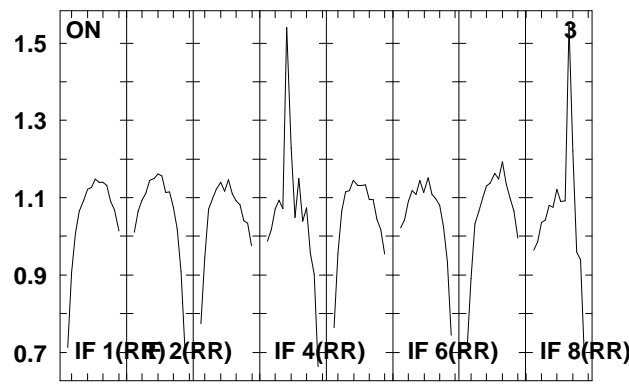
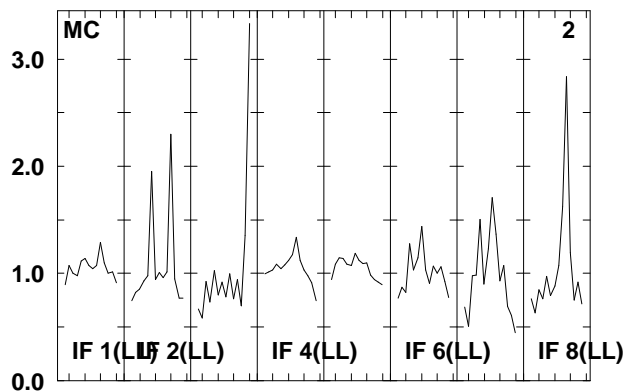
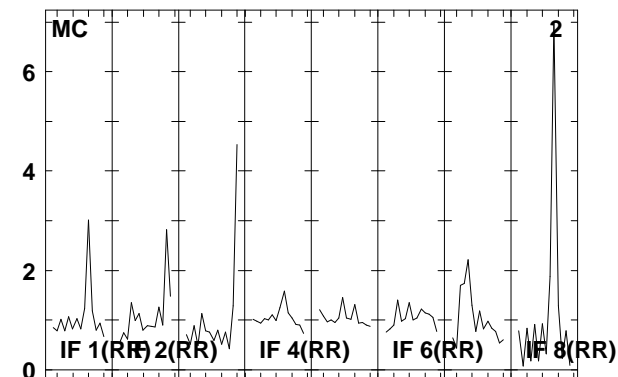
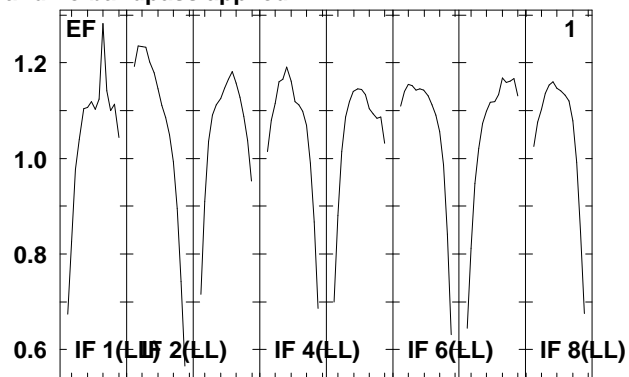
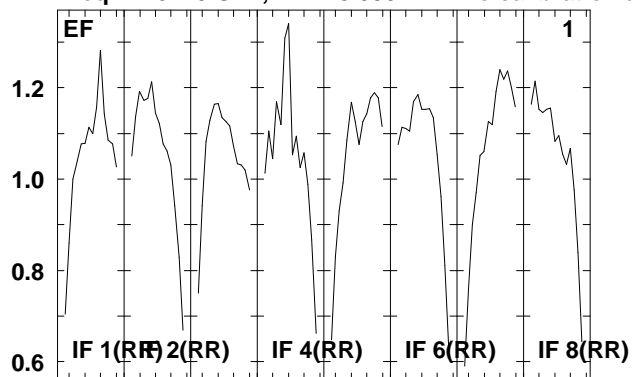

Lower frame: Real Jy

Total-power spectrum Antenna: \*

Timerange: 01/02:16:01 to 01/02:17:19

Plot file version 104 created 20-OCT-2009 14:49:42

FAINTCAL RP015C.UVDATA.1

Freq = 1.6270 GHz, Bw = 8.000 MH No calibration applied and no bandpass applied

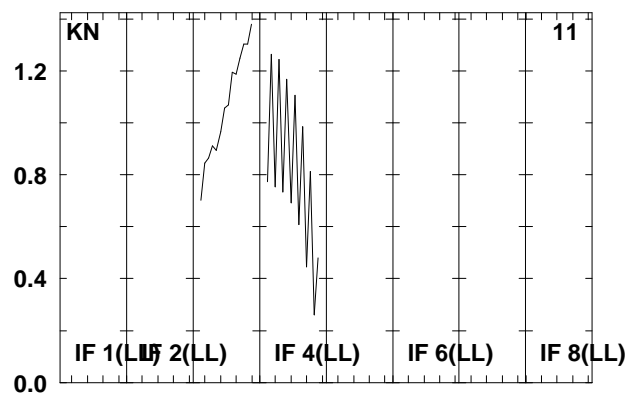
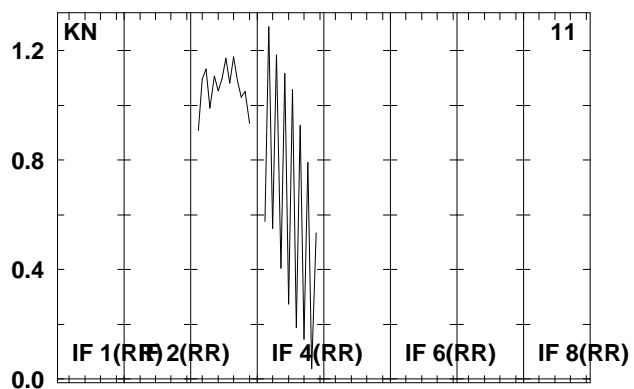
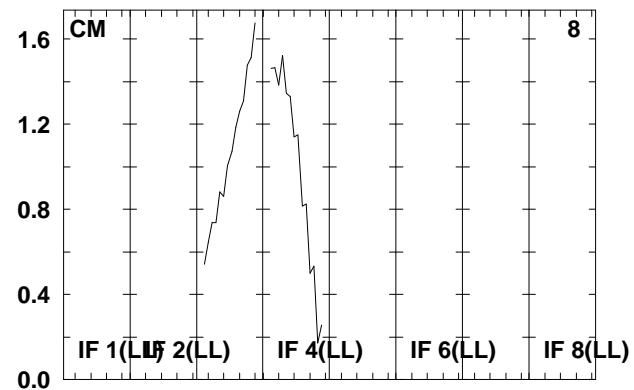
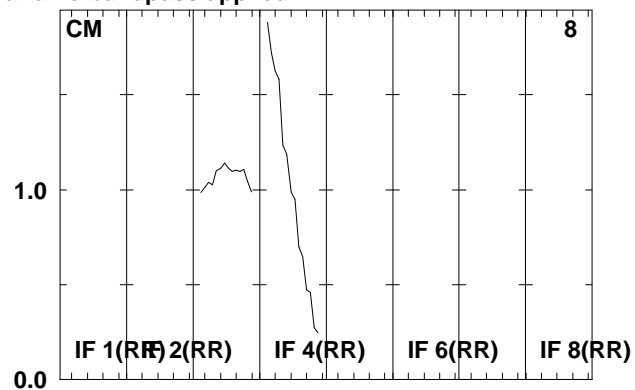
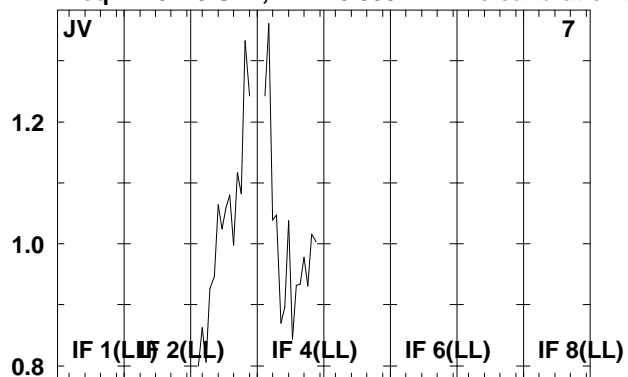

Lower frame: Real Jy  
Total-power spectrum Antenna: \*  
Timerange: 01/02:16:01 to 01/02:17:19



Plot file version 105 created 20-OCT-2009 14:49:42

M33 RP015C.UVDATA.1

Freq = 1.6270 GHz, Bw = 8.000 MH No calibration applied and no bandpass applied

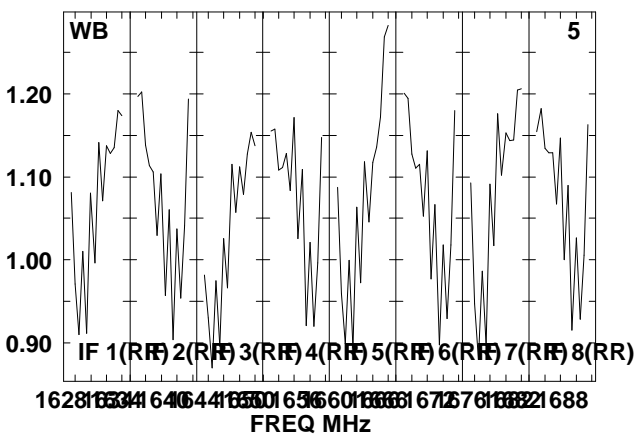
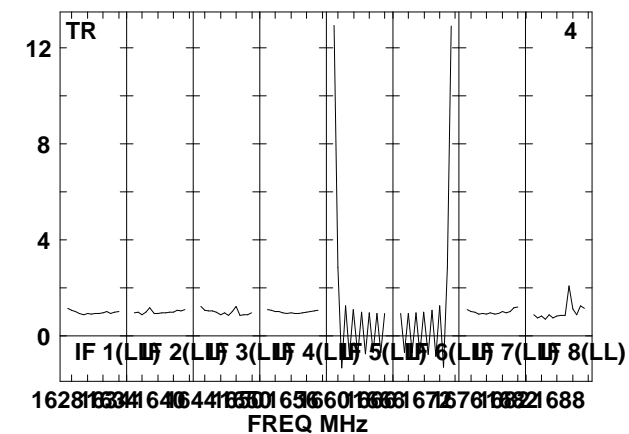
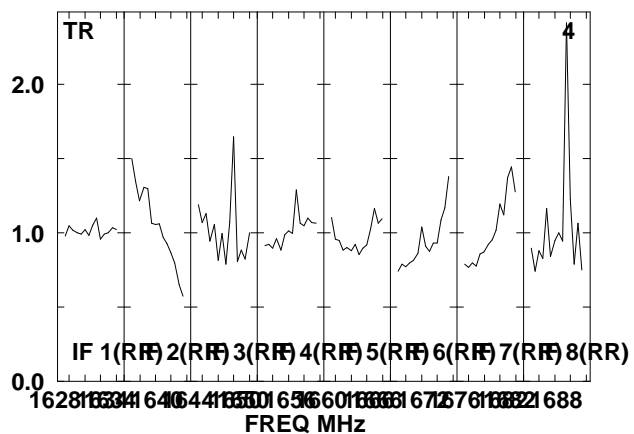
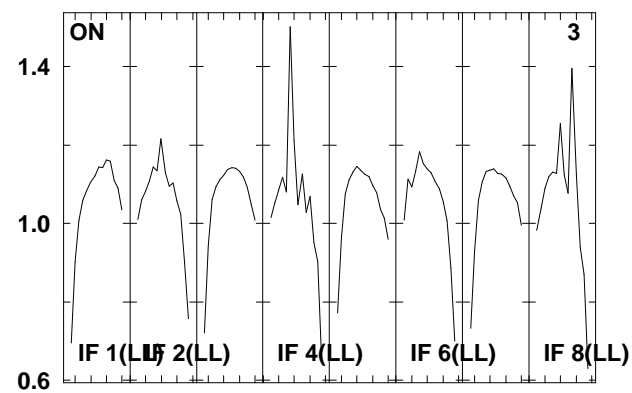
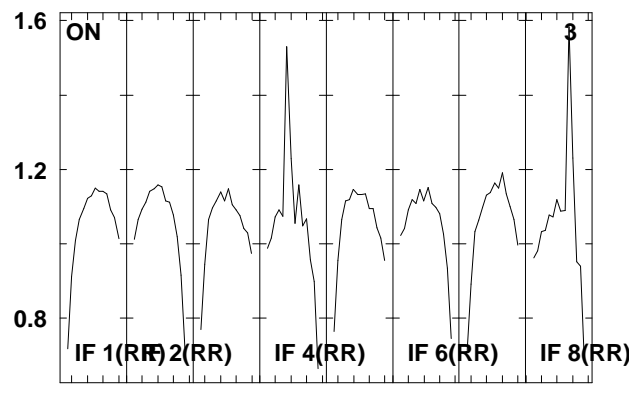
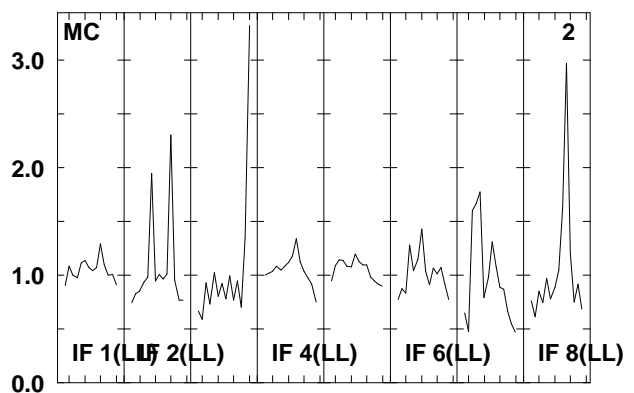
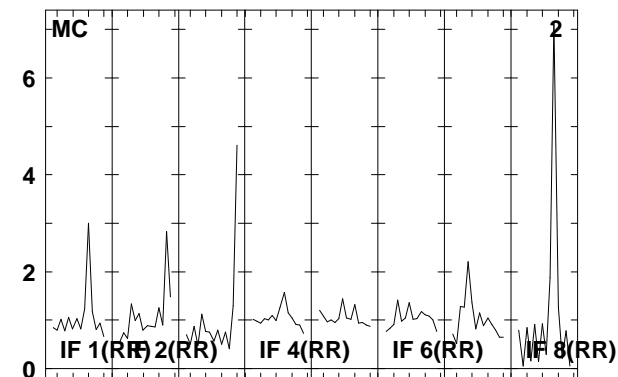
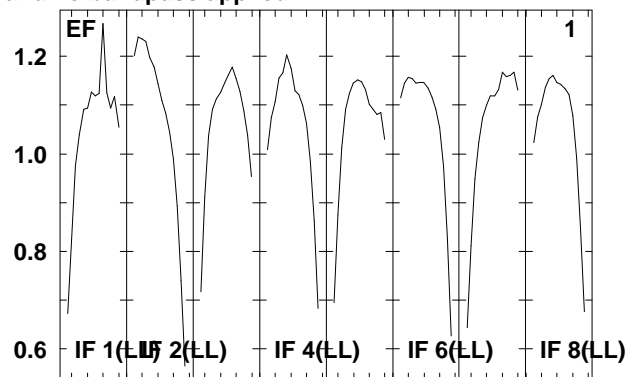
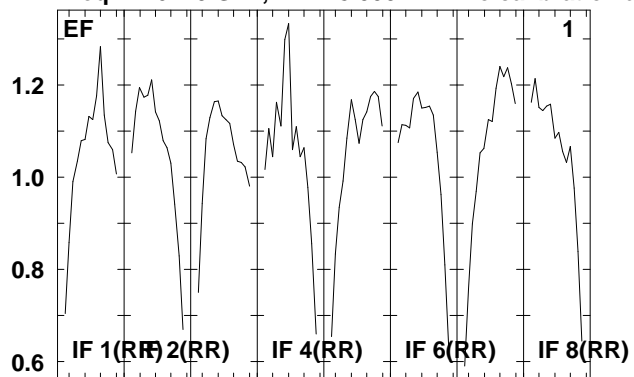

Lower frame: Real Jy  
Total-power spectrum Antenna: \*  
Timerange: 01/02:17:20 to 01/02:20:19

Plot file version 106 created 20-OCT-2009 14:49:43  
 M33 RP015C.UVDATA.1  
 Freq = 1.6270 GHz, Bw = 8.000 MH No calibration applied and no bandpass applied

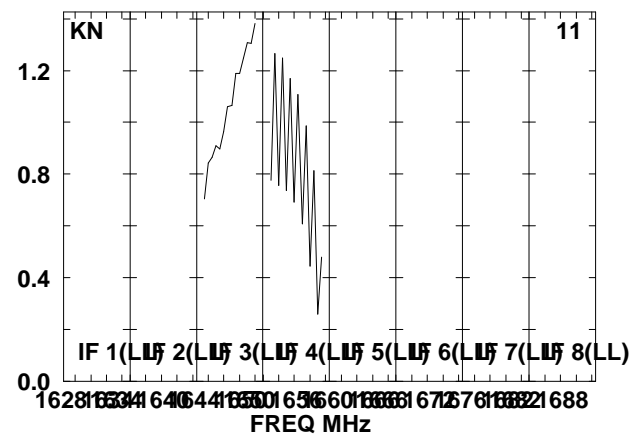
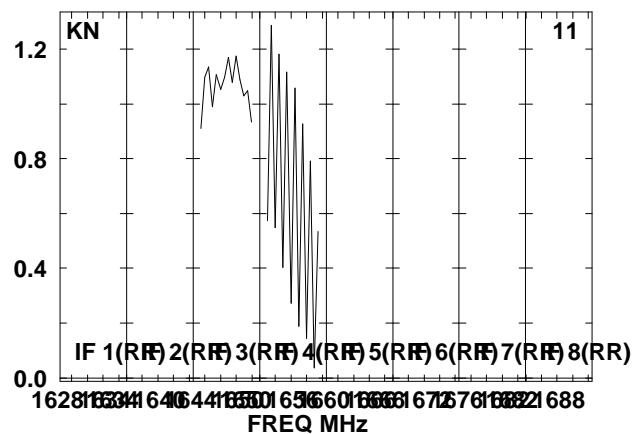
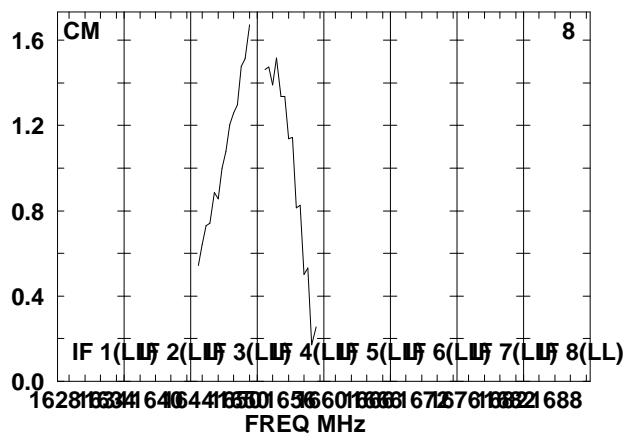
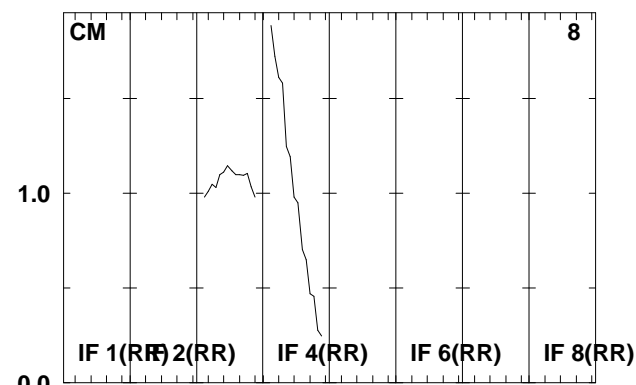
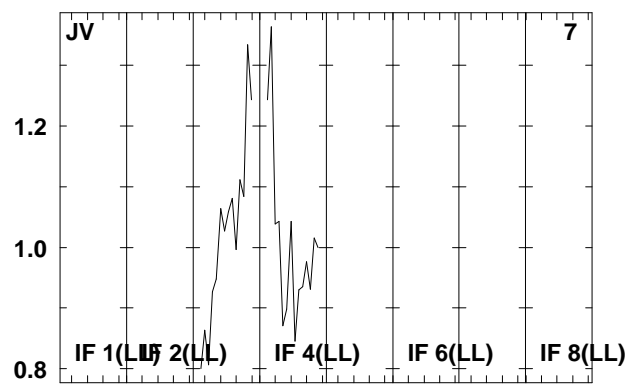
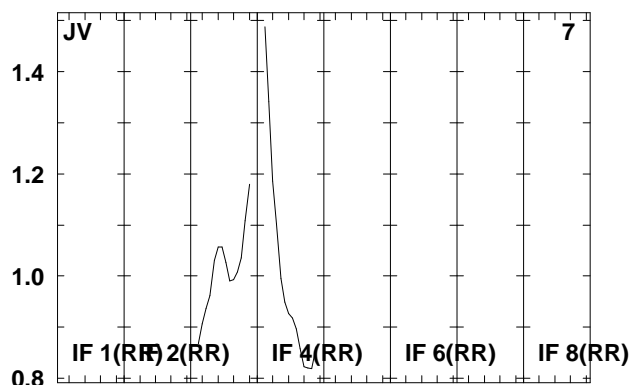
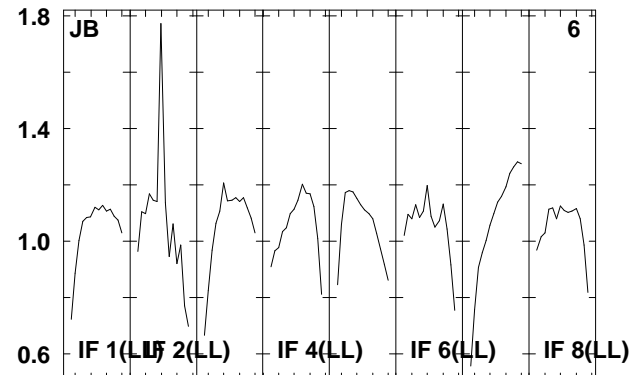
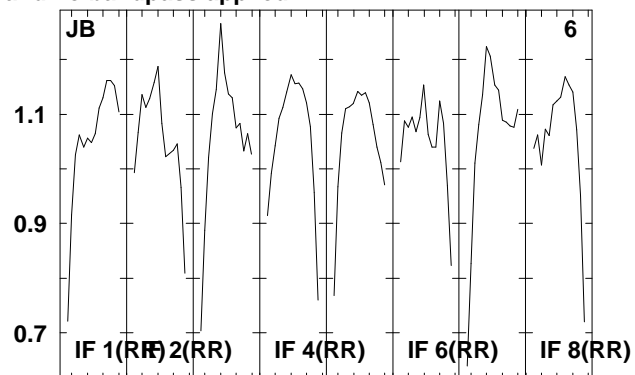
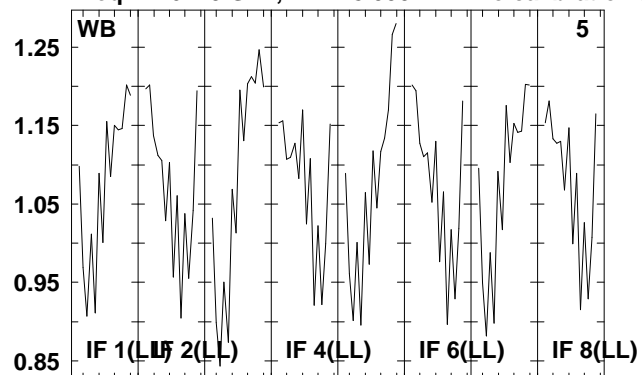

Lower frame: Real Jy  
 Total-power spectrum Antenna: \*  
 Timerange: 01/02:17:20 to 01/02:20:19

Plot file version 107 created 20-OCT-2009 14:49:45

J0137+31 RP015C.UVDATA.1

Freq = 1.6270 GHz, Bw = 8.000 MH No calibration applied and no bandpass applied

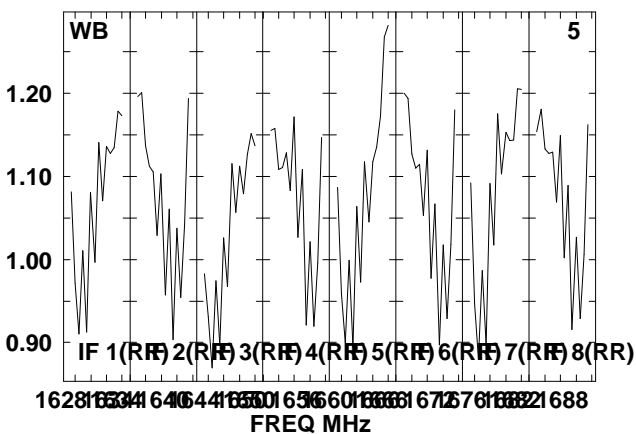
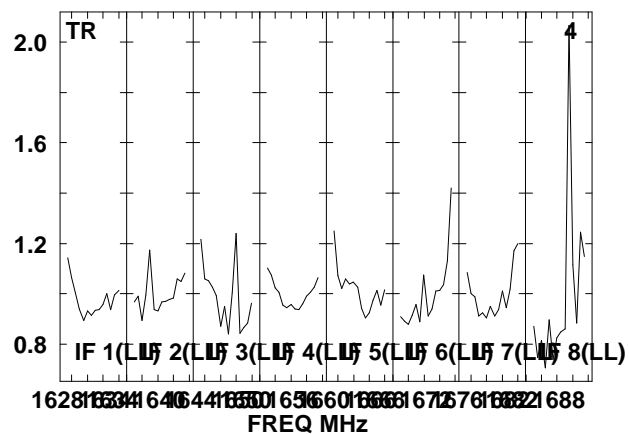
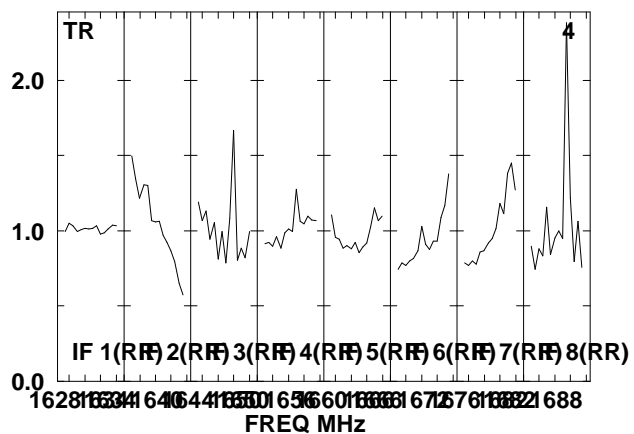
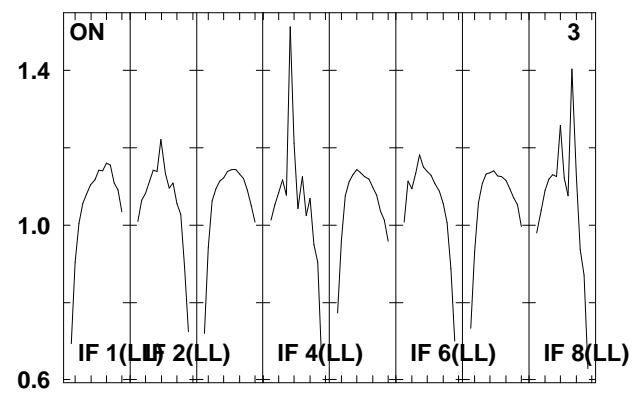
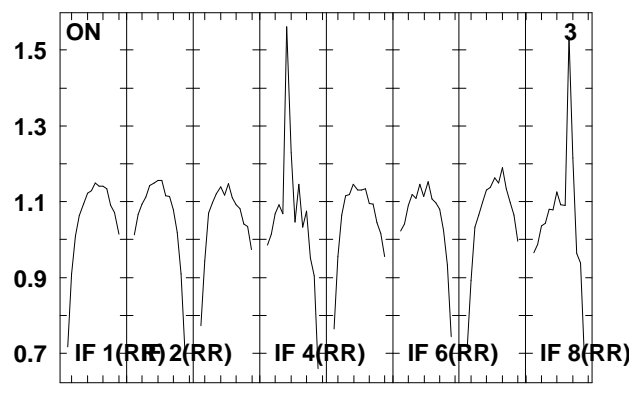
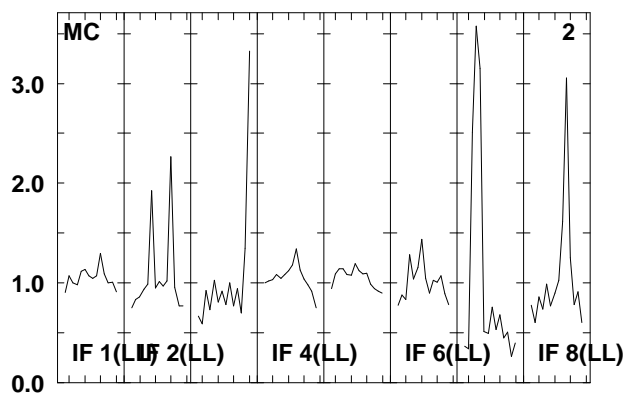
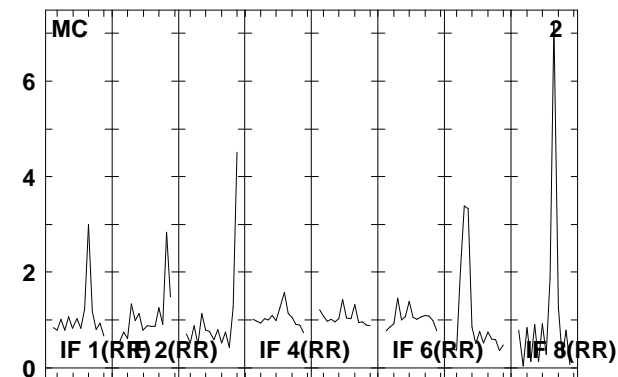
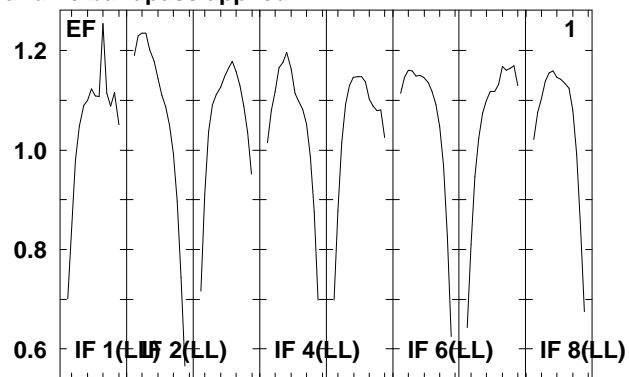
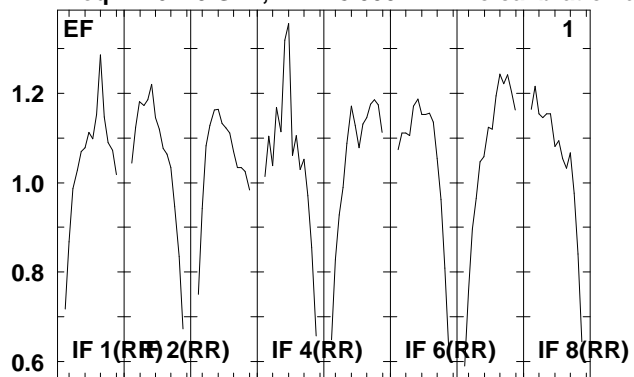

Lower frame: Real Jy

Total-power spectrum Antenna: \*

Timerange: 01/02:21:00 to 01/02:21:59

Plot file version 108 created 20-OCT-2009 14:49:45

J0137+31 RP015C.UVDATA.1

Freq = 1.6270 GHz, Bw = 8.000 MH No calibration applied and no bandpass applied

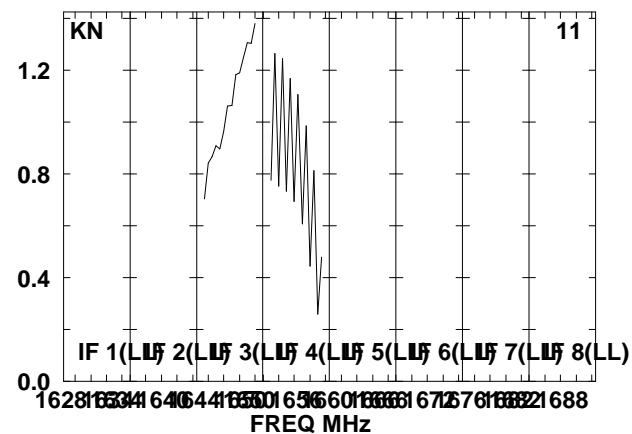
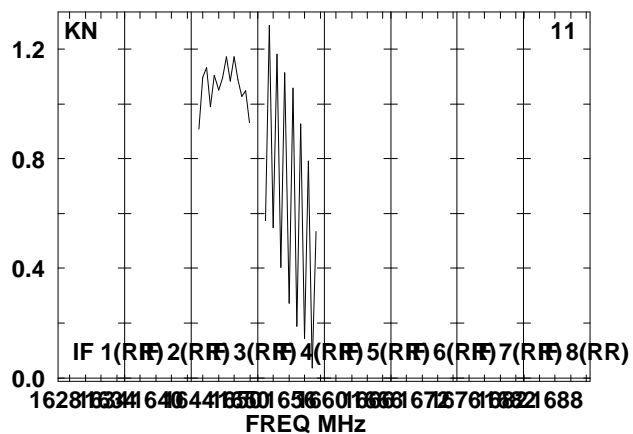
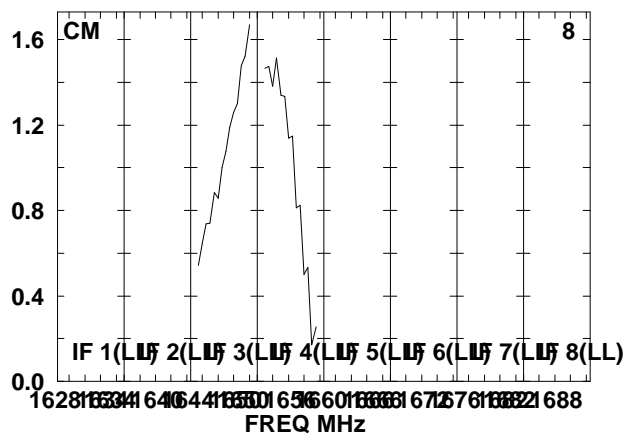
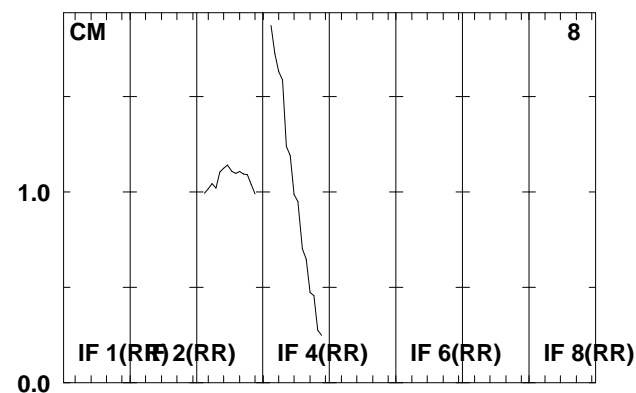
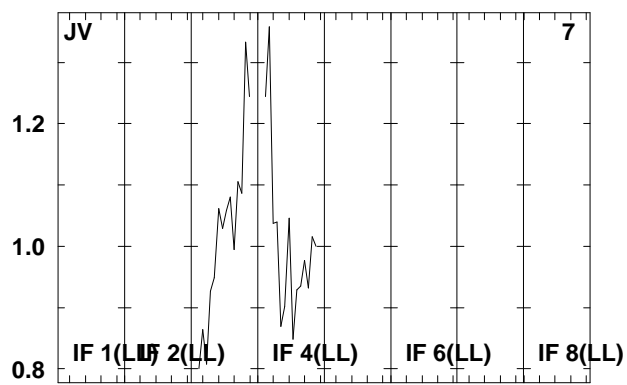
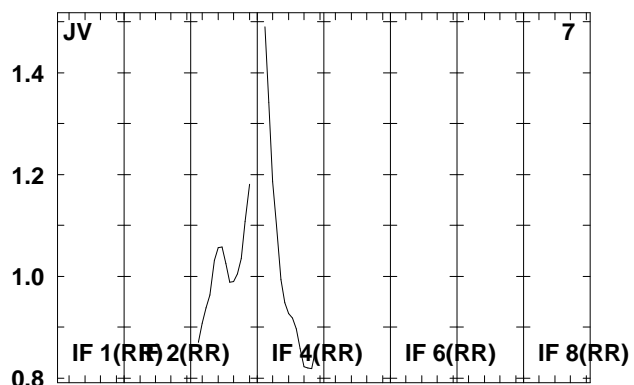
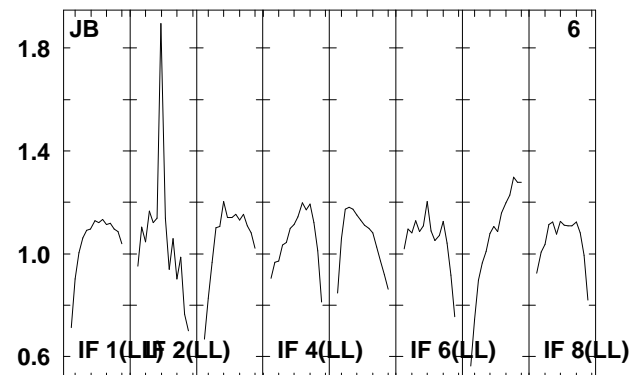
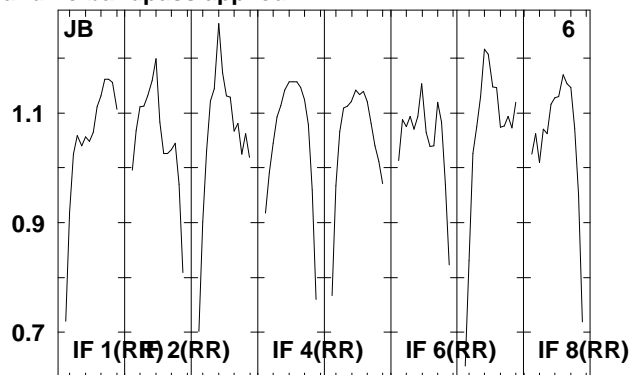
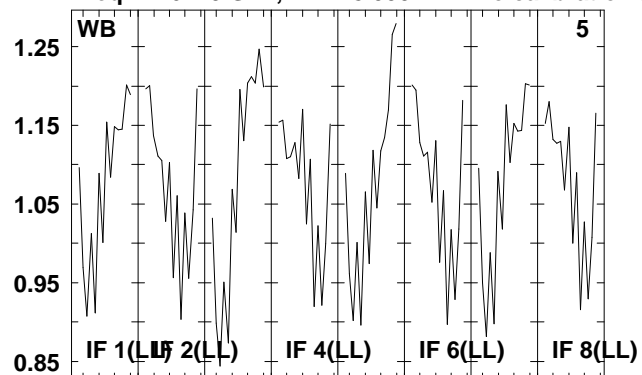

Lower frame: Real Jy

Total-power spectrum Antenna: \*

Timerange: 01/02:21:00 to 01/02:21:59

Plot file version 109 created 20-OCT-2009 14:49:46

FAINTCAL RP015C.UVDATA.1

Freq = 1.6270 GHz, Bw = 8.000 MH No calibration applied and no bandpass applied

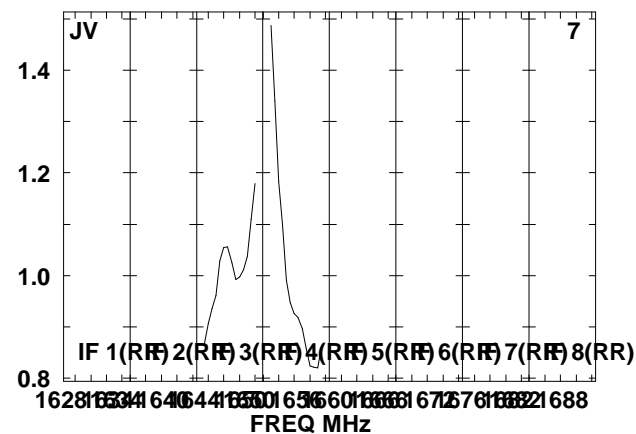
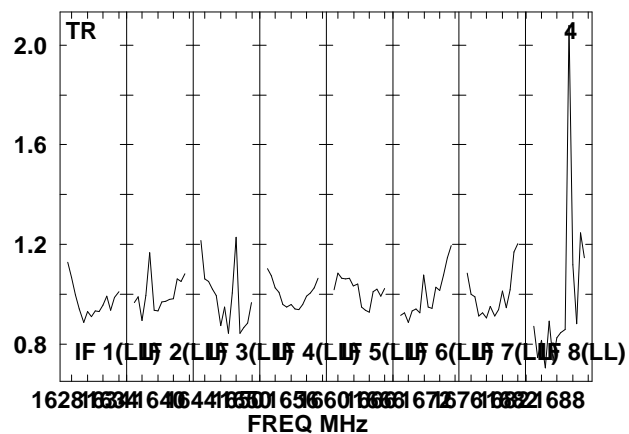
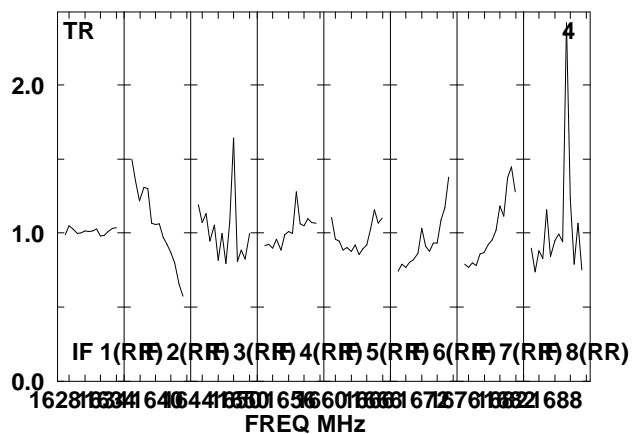
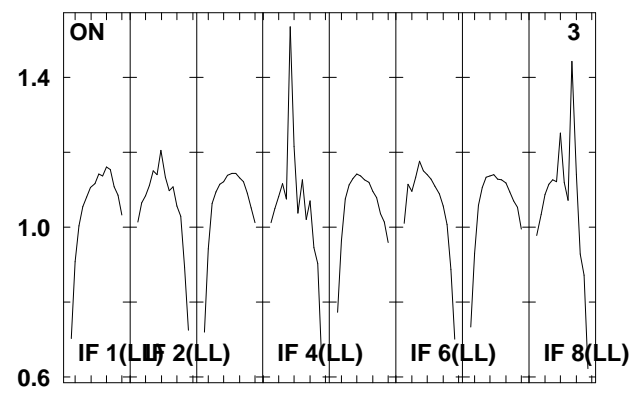
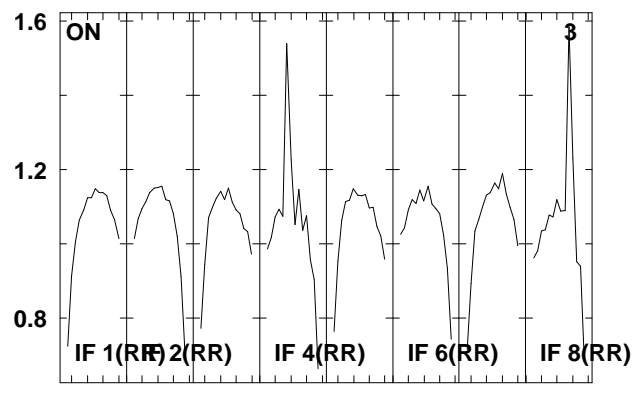
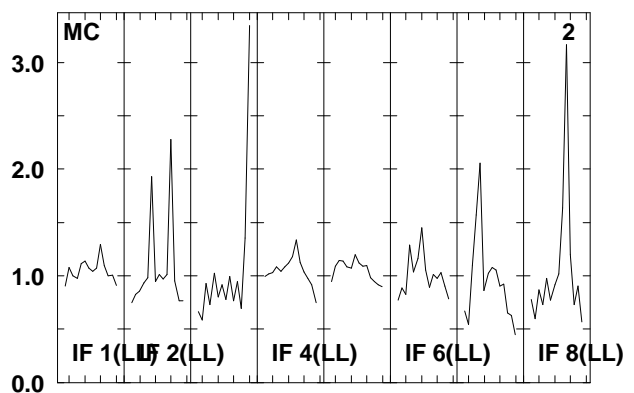
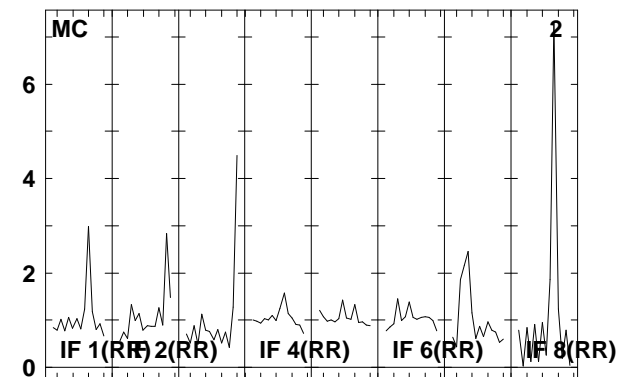
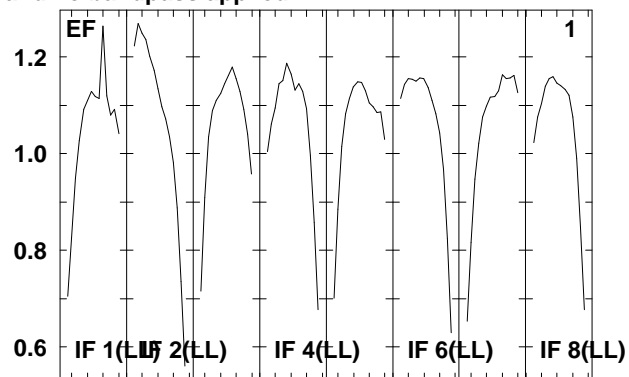
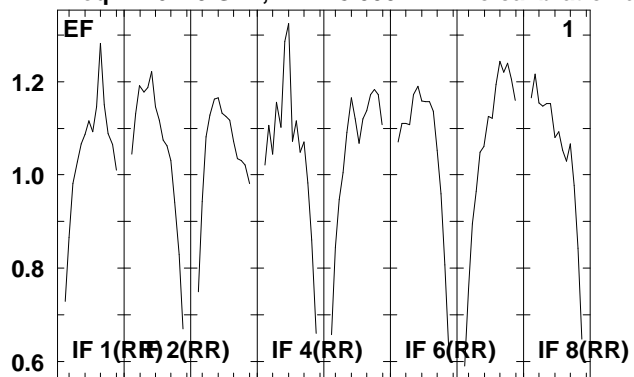

Lower frame: Real Jy

Total-power spectrum Antenna: \*

Timerange: 01/02:22:00 to 01/02:23:20

Plot file version 110 created 20-OCT-2009 14:49:46

FAINTCAL RP015C.UVDATA.1

Freq = 1.6270 GHz, Bw = 8.000 MH No calibration applied and no bandpass applied

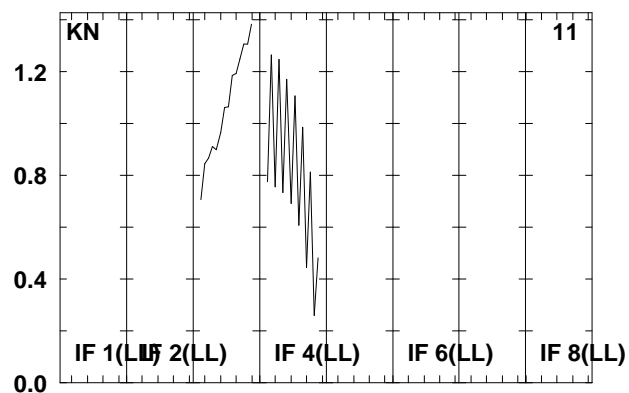
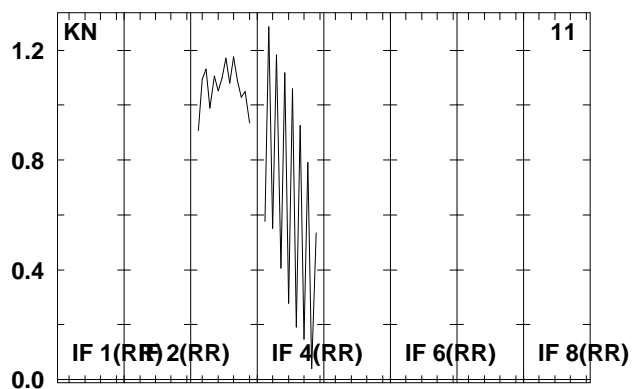
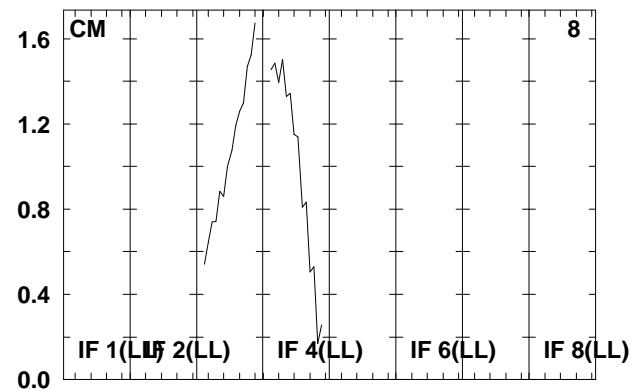
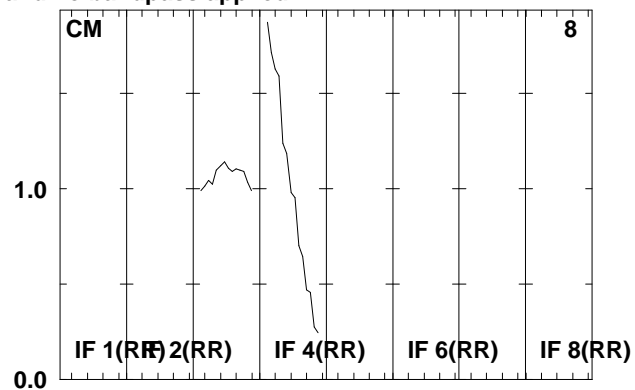
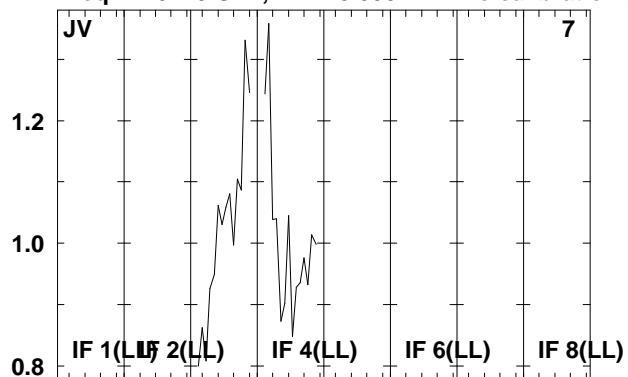

Lower frame: Real Jy  
Total-power spectrum Antenna: \*  
Timerange: 01/02:22:00 to 01/02:23:20

Plot file version 111 created 20-OCT-2009 14:49:47

M33 RP015C.UVDATA.1

Freq = 1.6270 GHz, Bw = 8.000 MH No calibration applied and no bandpass applied

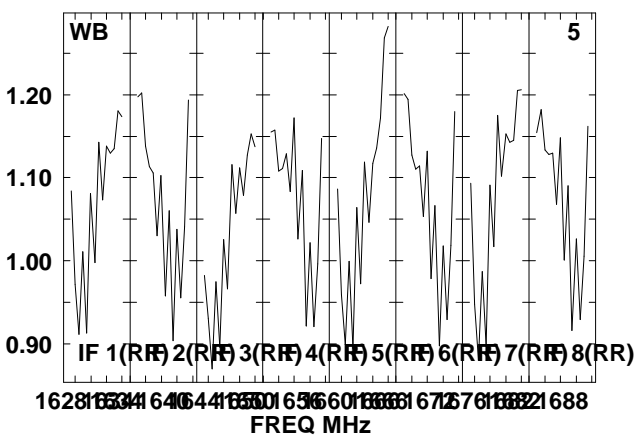
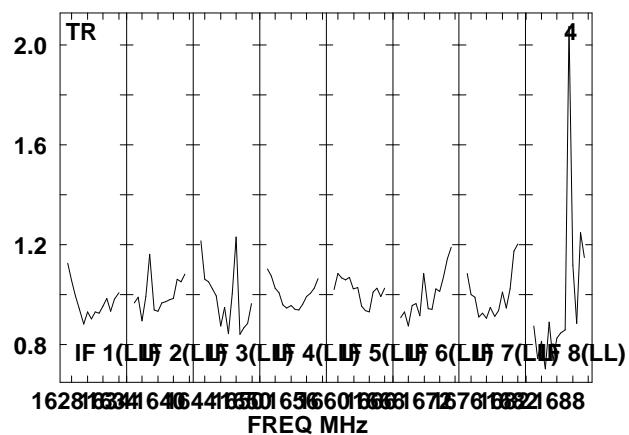
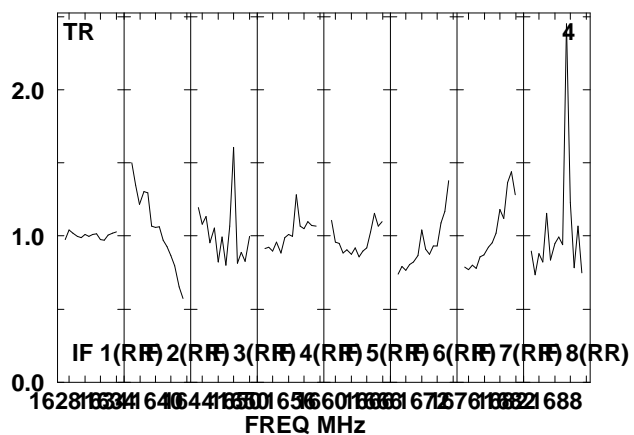
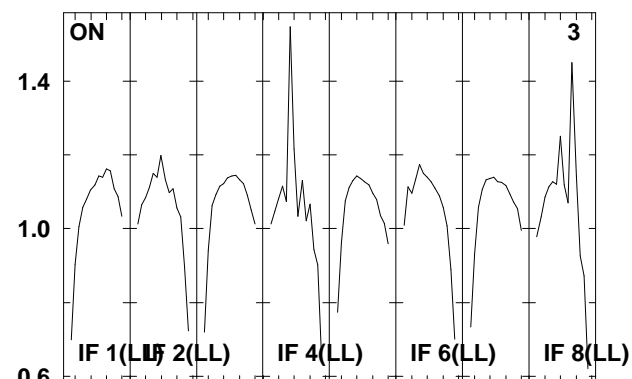
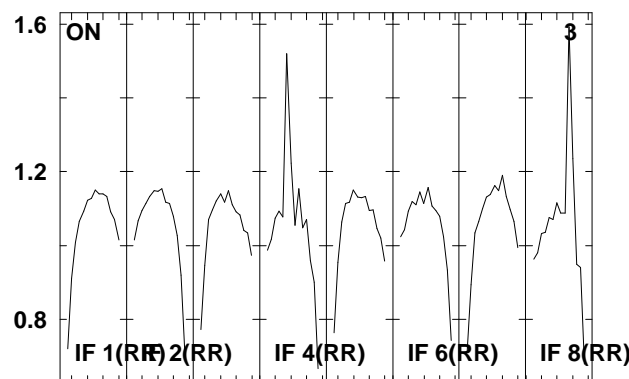
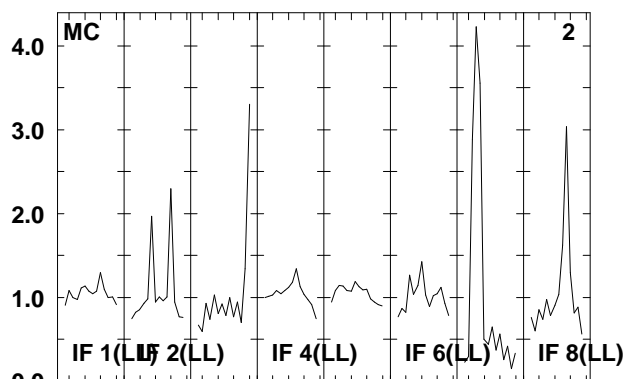
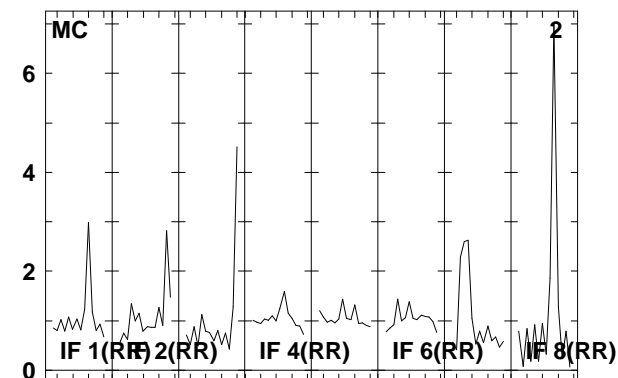
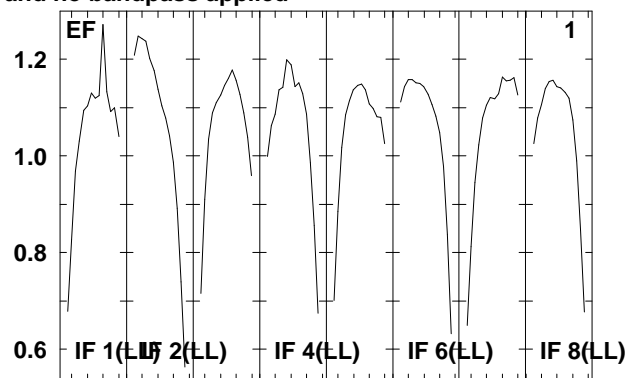
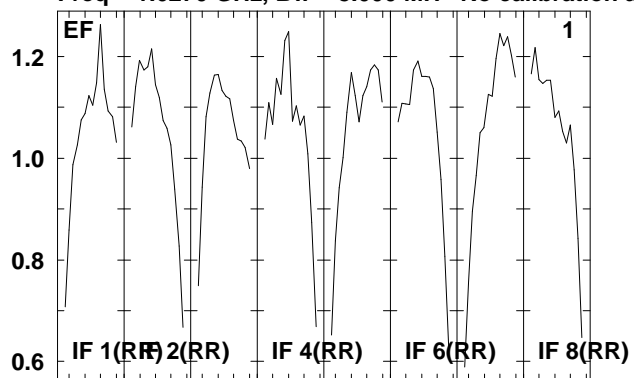

Lower frame: Real Jy  
Total-power spectrum Antenna: \*  
Timerange: 01/02:23:21 to 01/02:26:20

Plot file version 112 created 20-OCT-2009 14:49:48

M33 RP015C.UVDATA.1

Freq = 1.6270 GHz, Bw = 8.000 MH No calibration applied and no bandpass applied

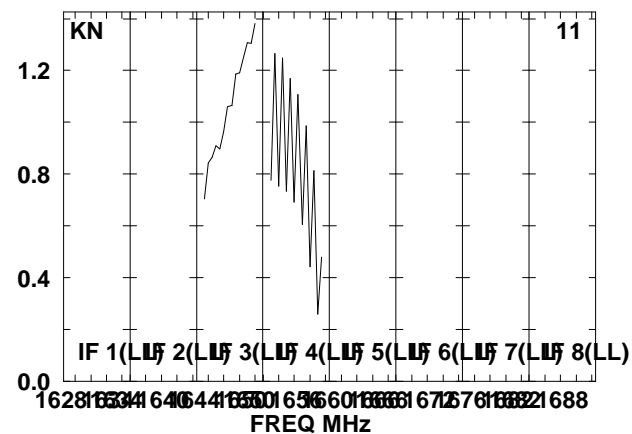
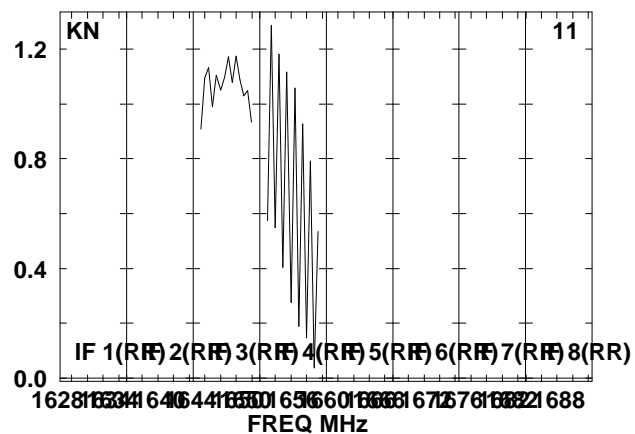
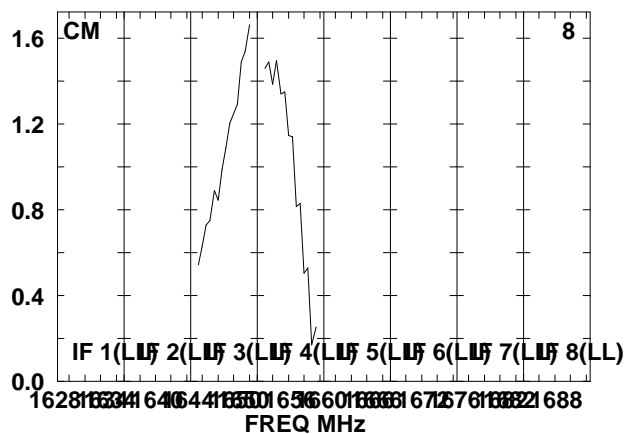
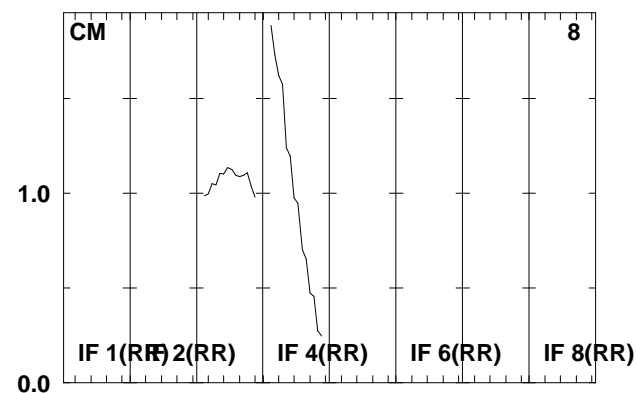
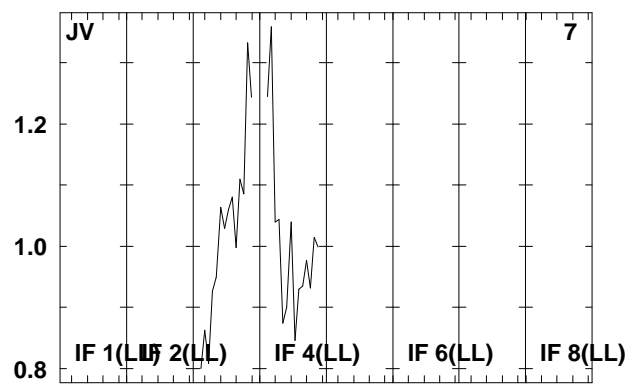
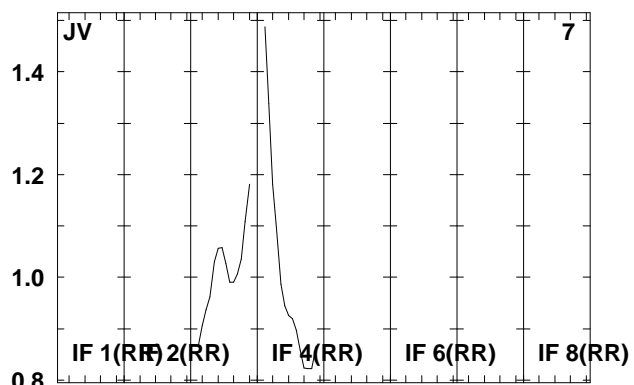
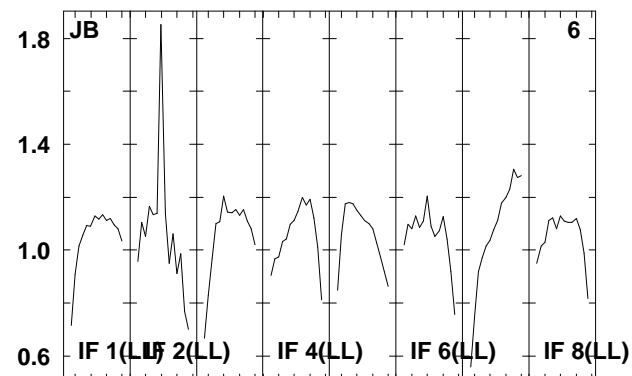
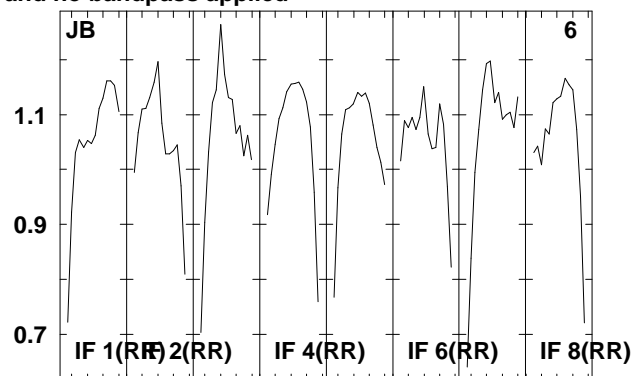
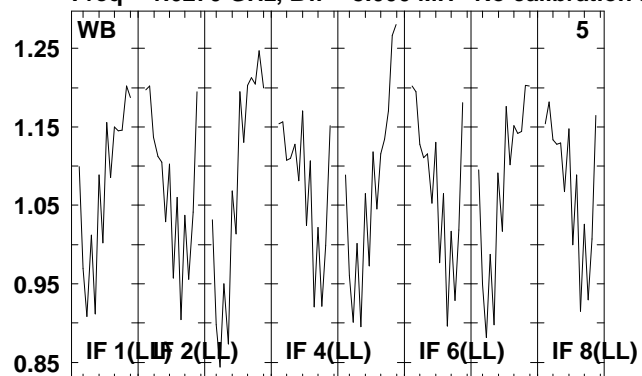

Lower frame: Real Jy  
Total-power spectrum Antenna: \*  
Timerange: 01/02:23:21 to 01/02:26:20



Plot file version 113 created 20-OCT-2009 14:49:49

J0137+31 RP015C.UVDATA.1

Freq = 1.6270 GHz, Bw = 8.000 MH No calibration applied and no bandpass applied

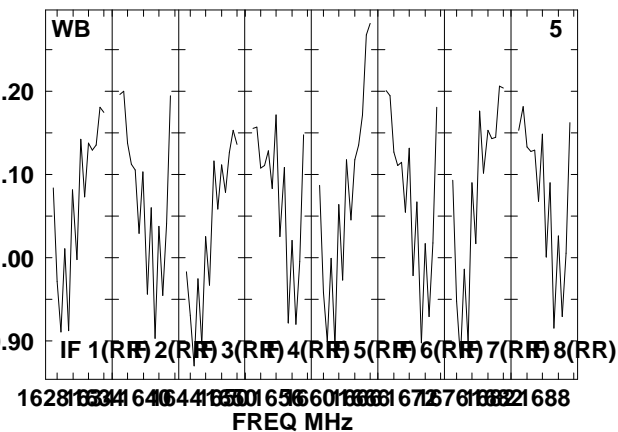
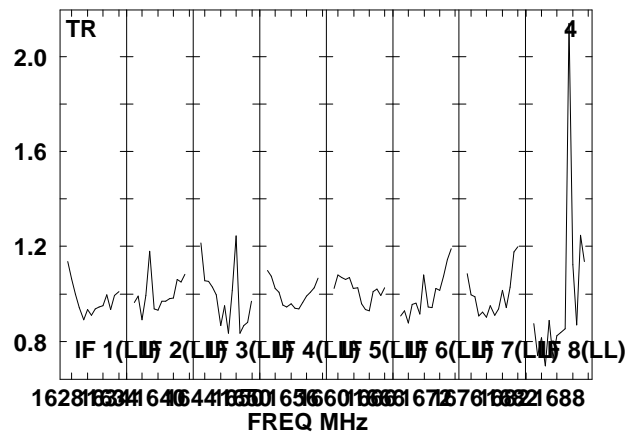
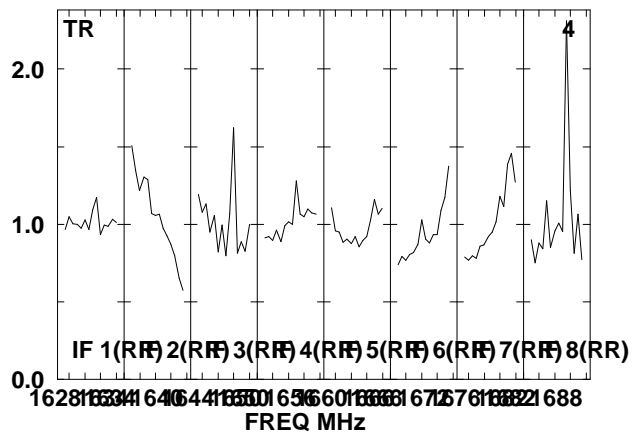
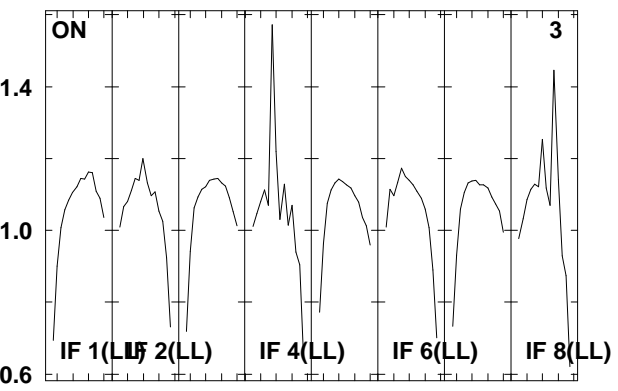
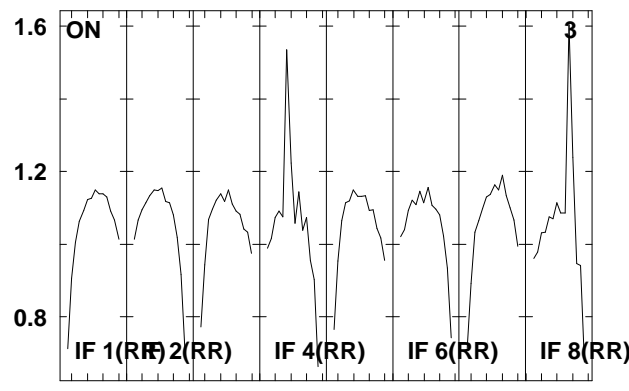
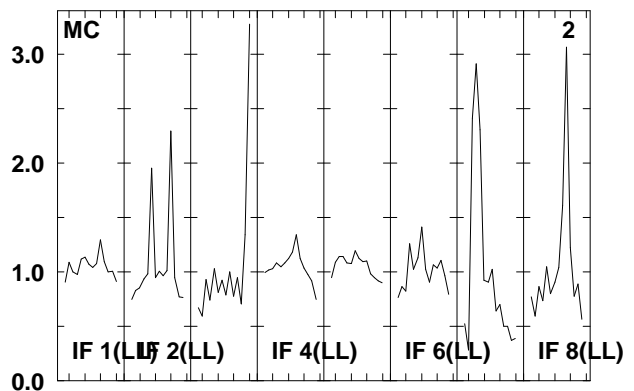
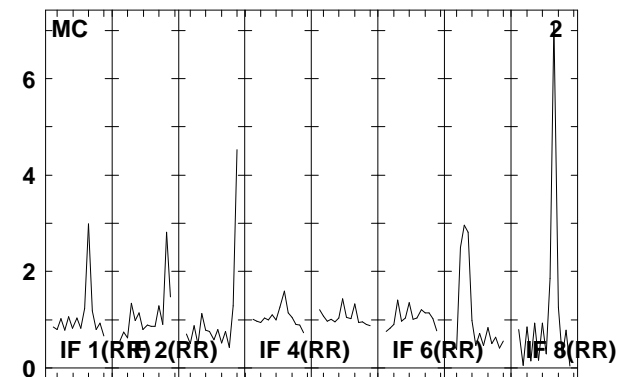
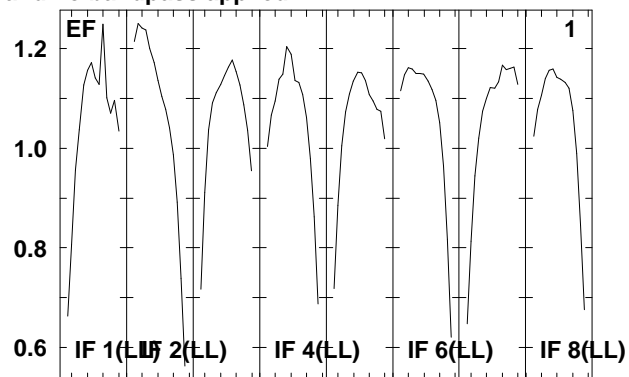
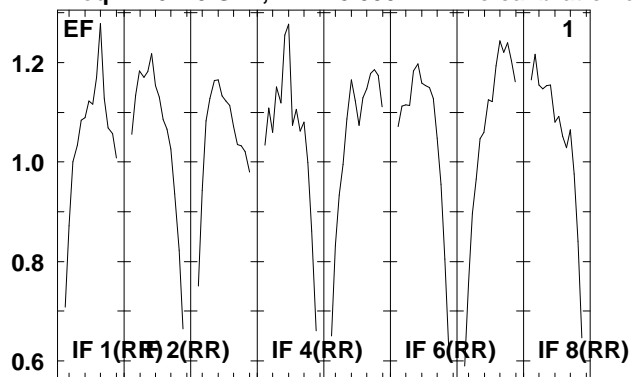

Lower frame: Real Jy  
Total-power spectrum Antenna: \*  
Timerange: 01/02:27:01 to 01/02:28:00

Plot file version 114 created 20-OCT-2009 14:49:49

J0137+31 RP015C.UVDATA.1

Freq = 1.6270 GHz, Bw = 8.000 MH No calibration applied and no bandpass applied

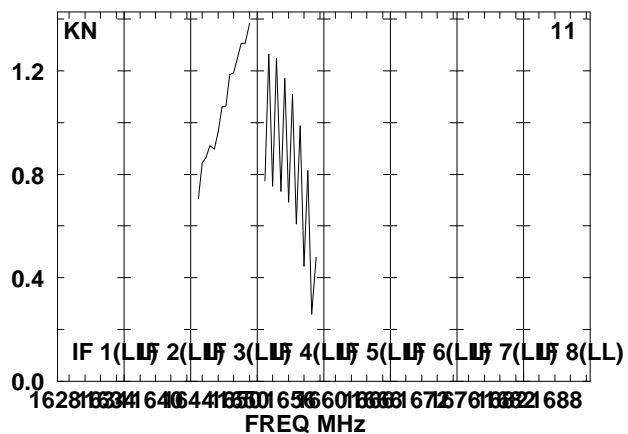
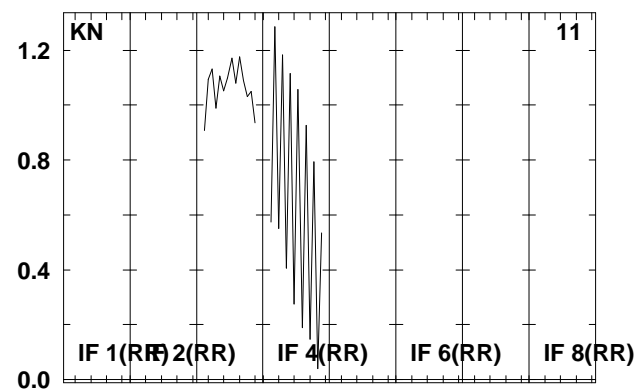
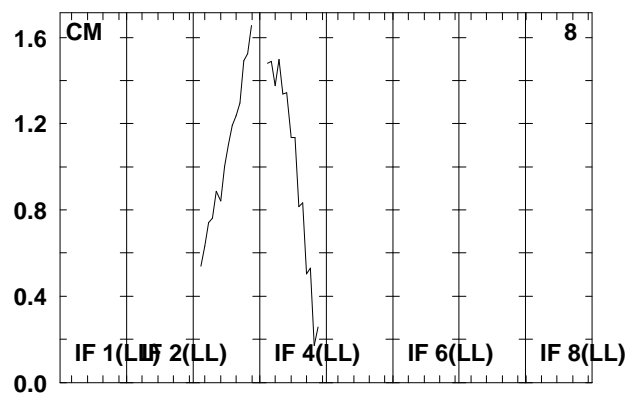
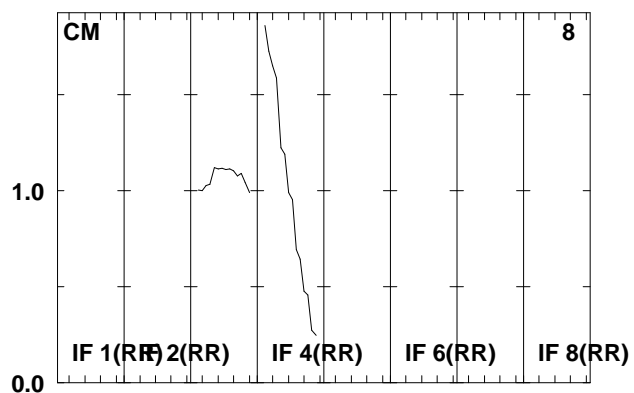
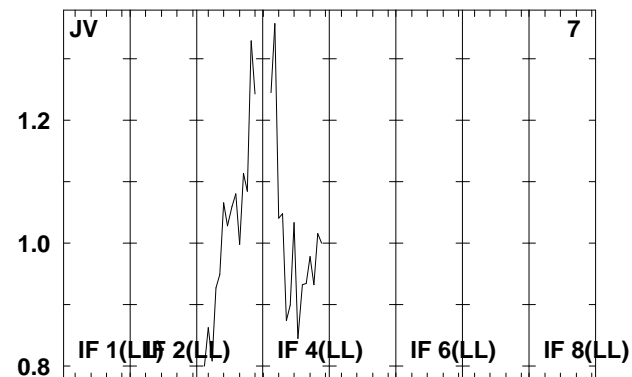
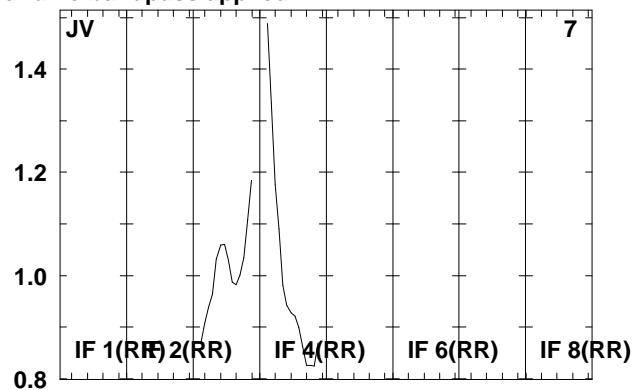
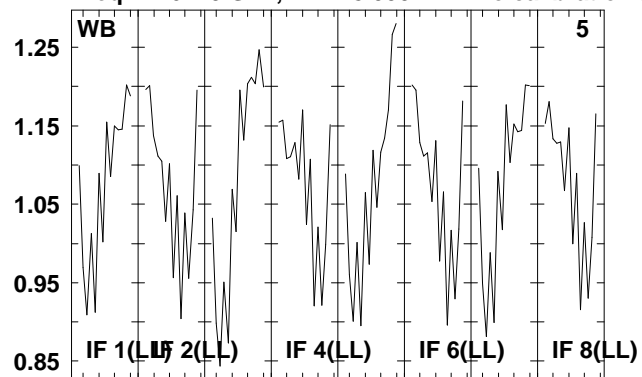

Lower frame: Real Jy

Total-power spectrum Antenna: \*

Timerange: 01/02:27:01 to 01/02:28:00

Plot file version 115 created 20-OCT-2009 14:49:50

FAINTCAL RP015C.UVDATA.1

Freq = 1.6270 GHz, Bw = 8.000 MH No calibration applied and no bandpass applied

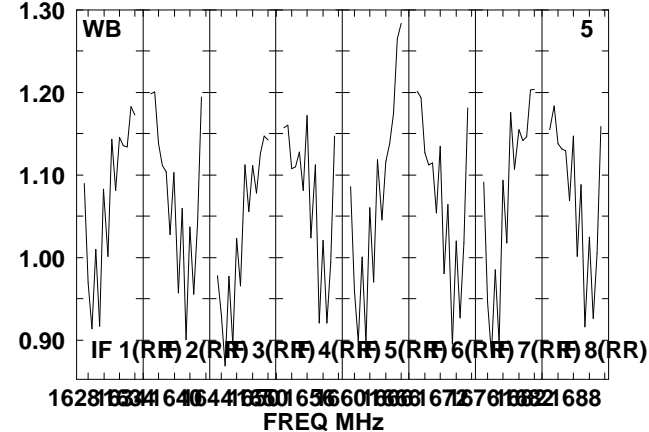
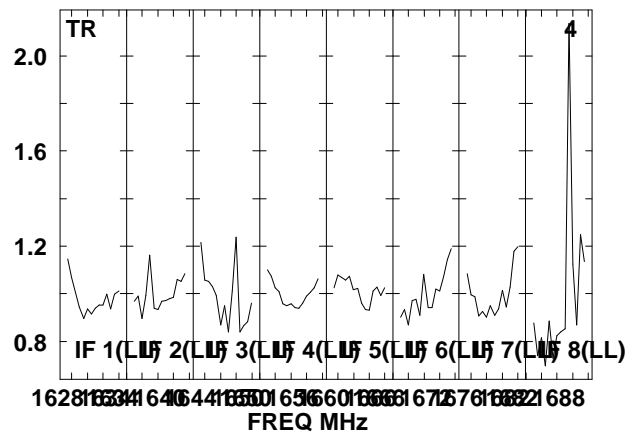
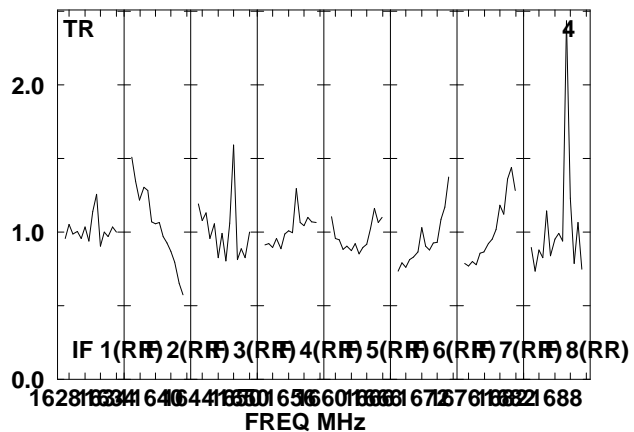
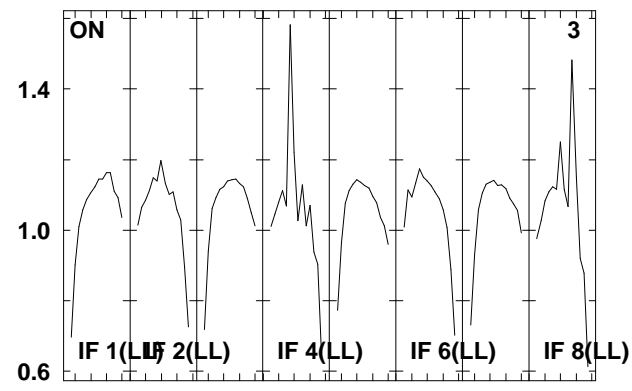
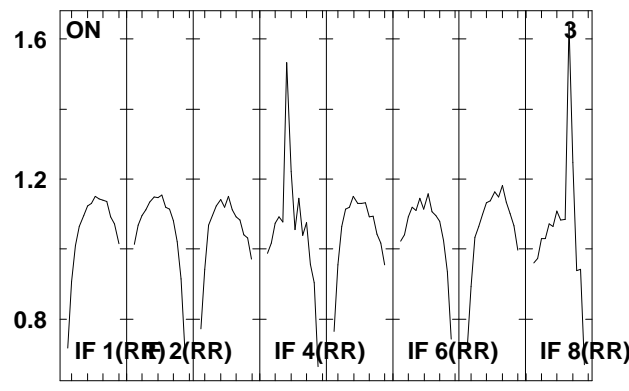
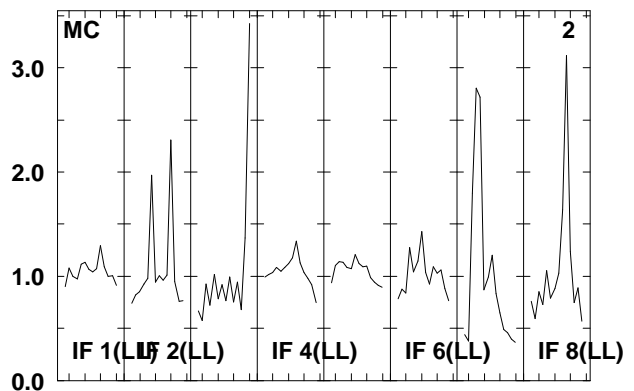
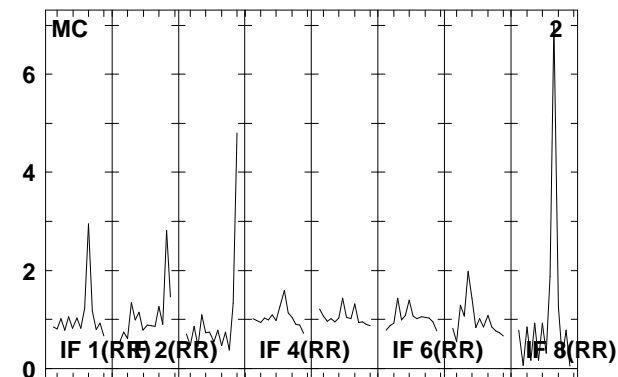
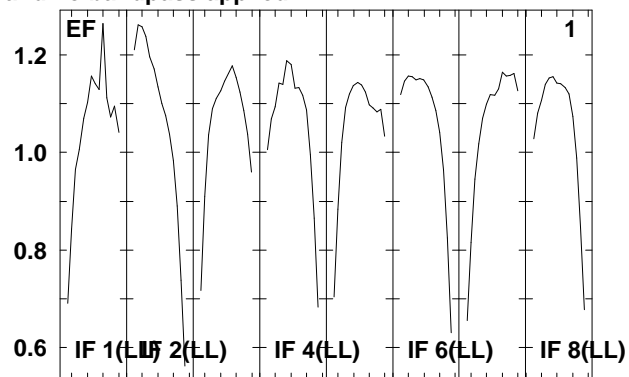
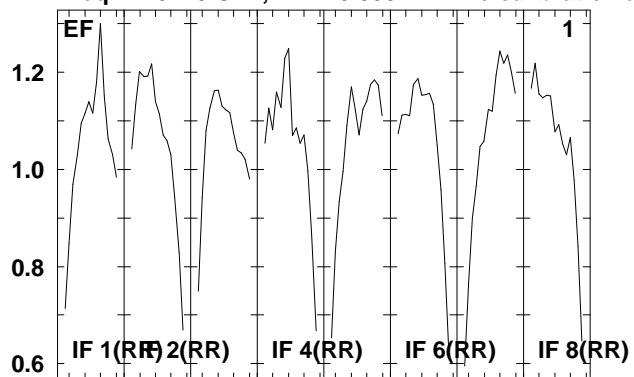

Lower frame: Real Jy  
Total-power spectrum Antenna: \*  
Timerange: 01/02:28:00 to 01/02:29:19

Plot file version 116 created 20-OCT-2009 14:49:50

FAINTCAL RP015C.UVDATA.1

Freq = 1.6270 GHz, Bw = 8.000 MH No calibration applied and no bandpass applied

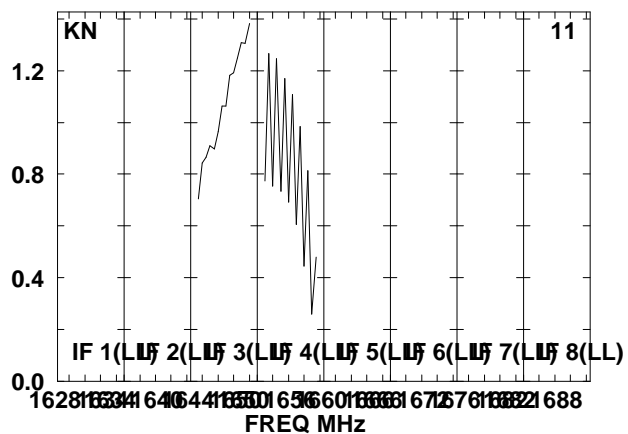
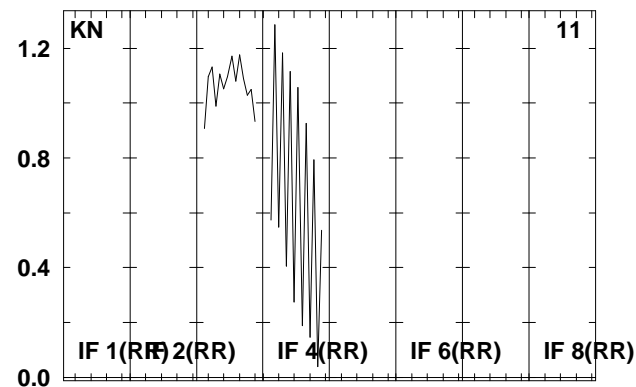
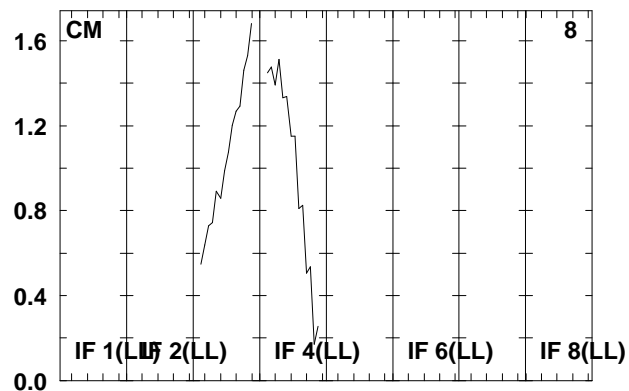
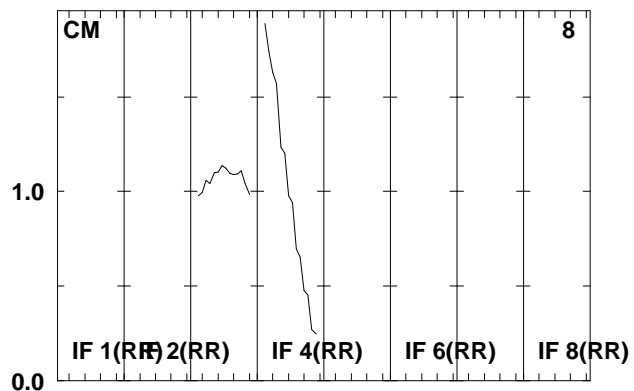
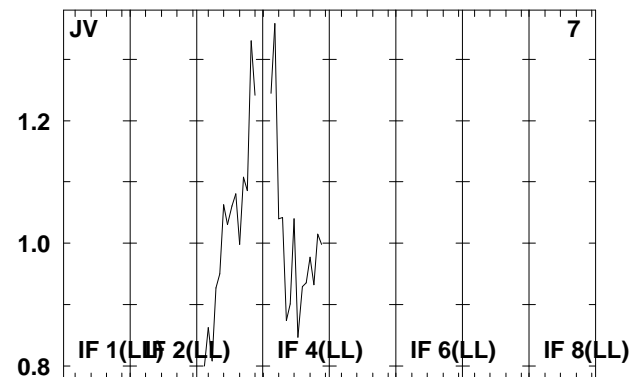
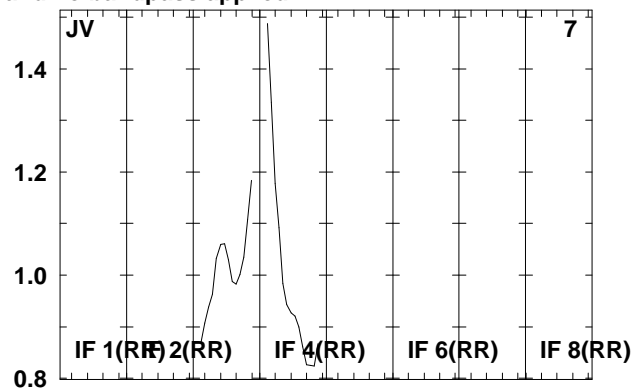
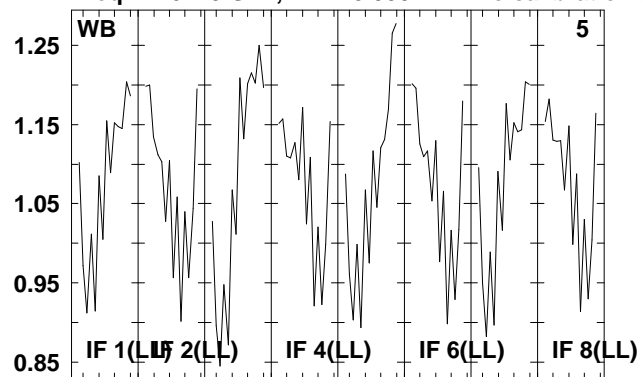

Lower frame: Real Jy

Total-power spectrum Antenna: \*

Timerange: 01/02:28:00 to 01/02:29:19

Plot file version 117 created 20-OCT-2009 14:49:51

M33 RP015C.UVDATA.1

Freq = 1.6270 GHz, Bw = 8.000 MH No calibration applied and no bandpass applied

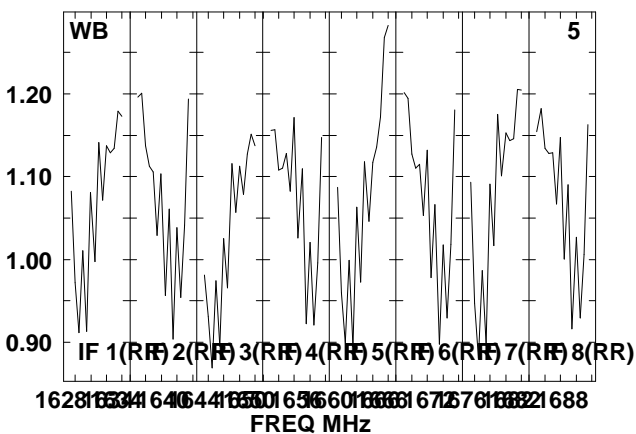
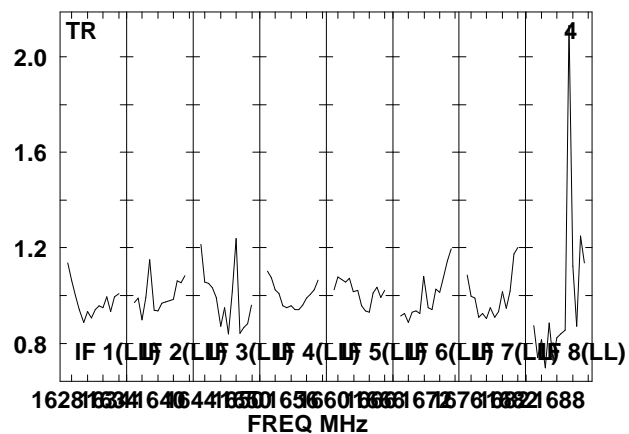
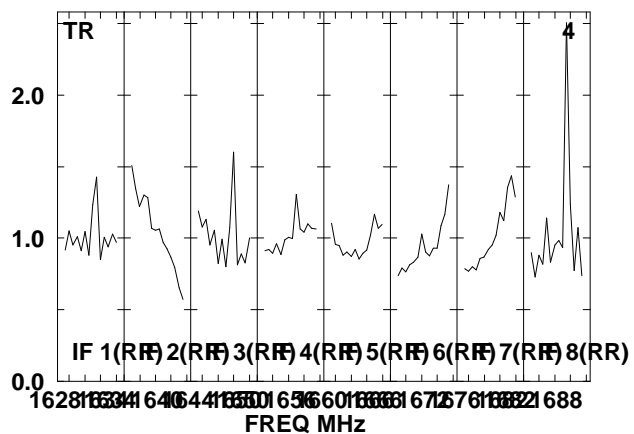
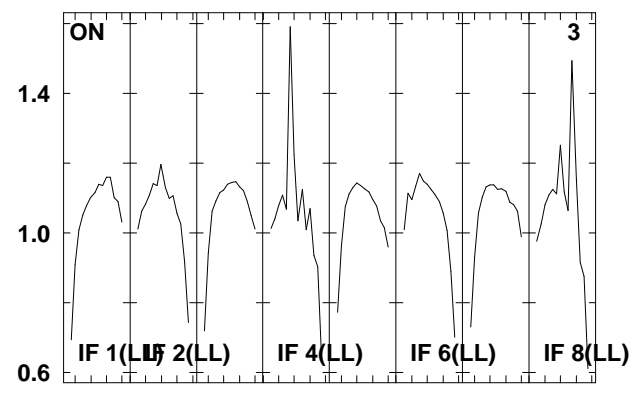
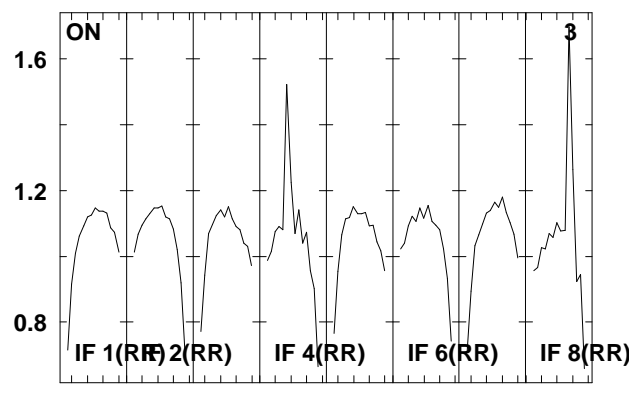
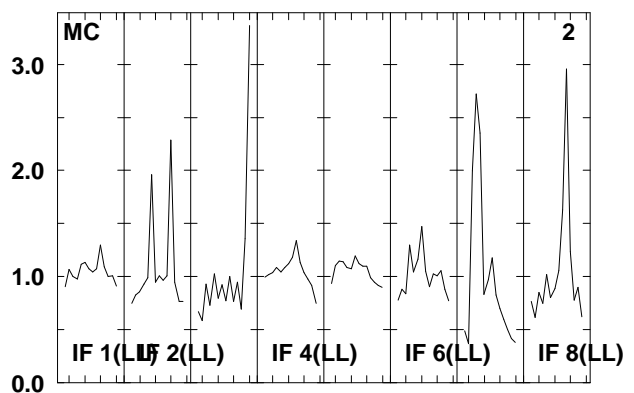
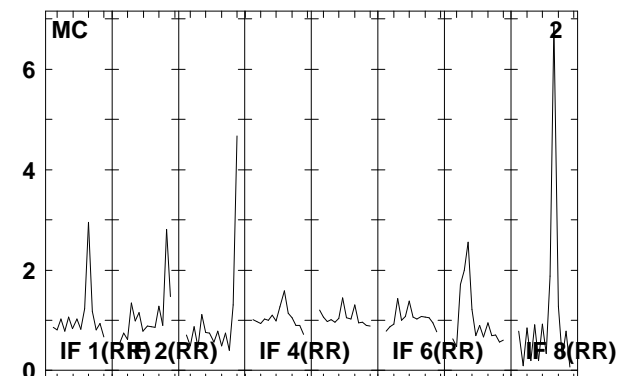
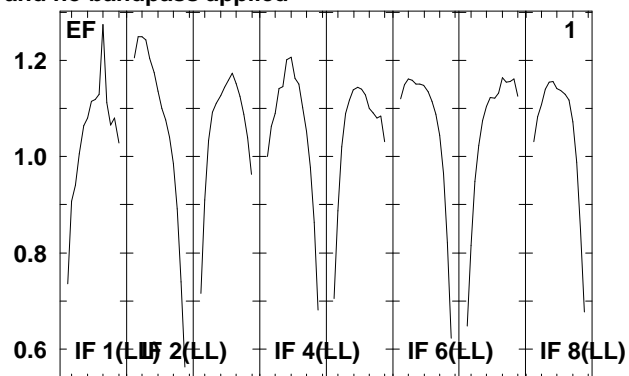
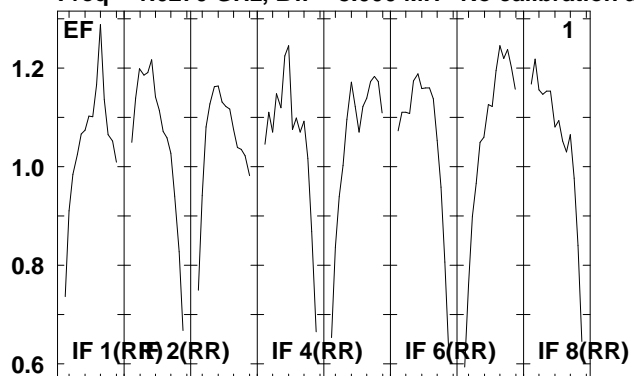

Lower frame: Real Jy

Total-power spectrum Antenna: \*

Timerange: 01/02:29:20 to 01/02:32:20

Plot file version 118 created 20-OCT-2009 14:49:52  
 M33 RP015C.UVDATA.1  
 Freq = 1.6270 GHz, Bw = 8.000 MH No calibration applied and no bandpass applied

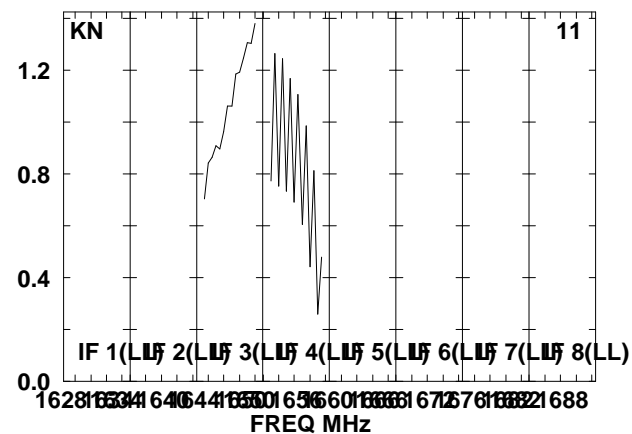
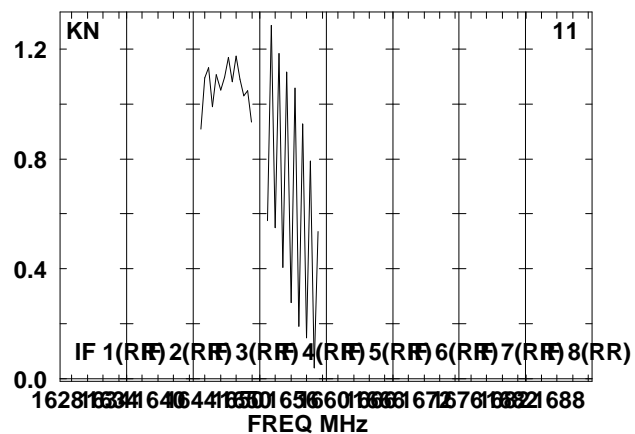
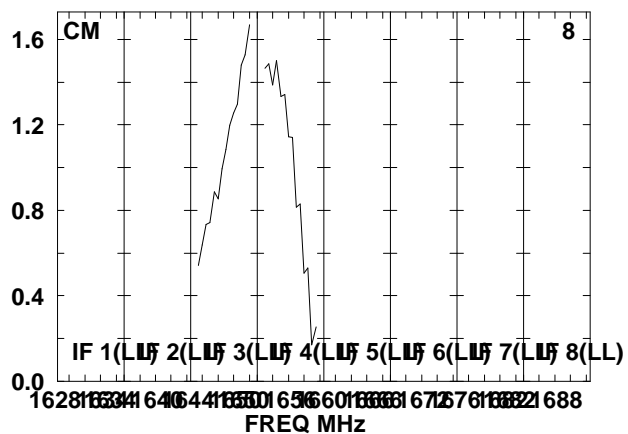
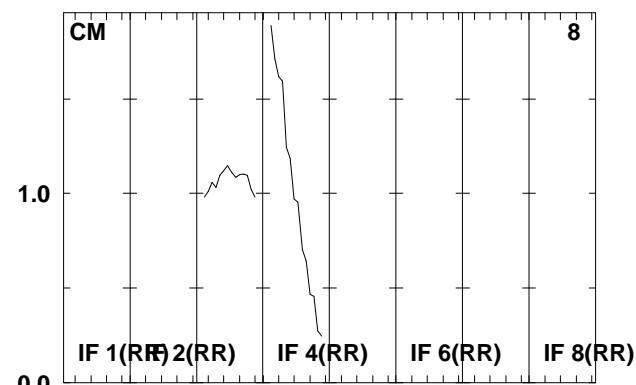
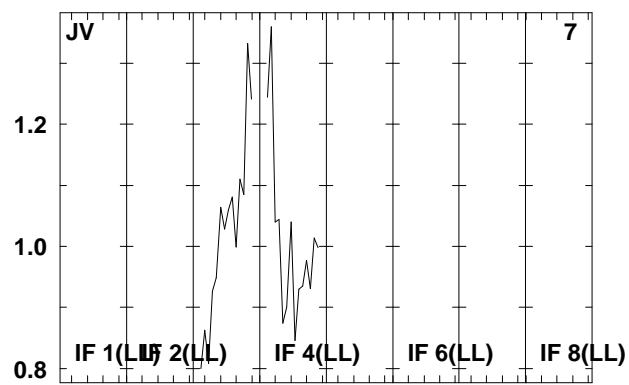
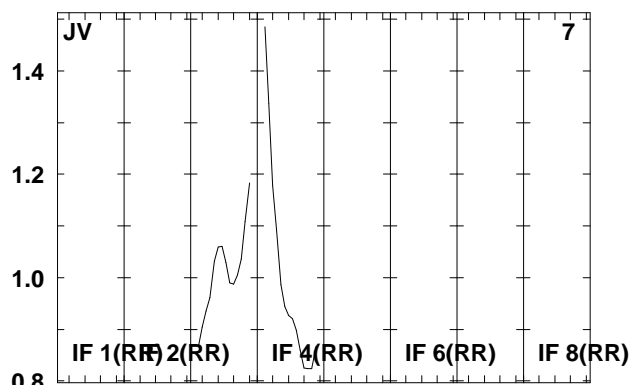
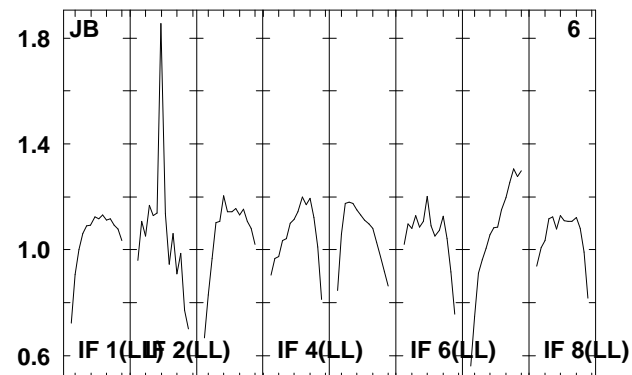
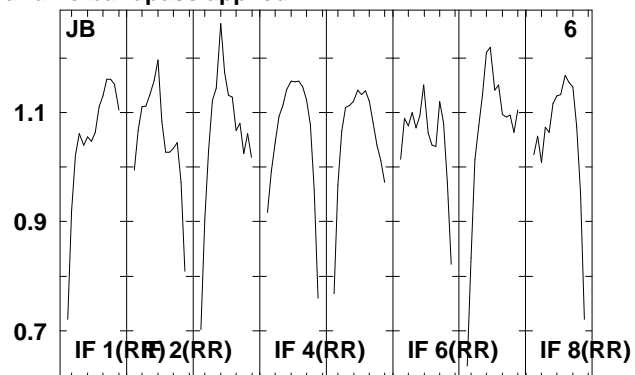
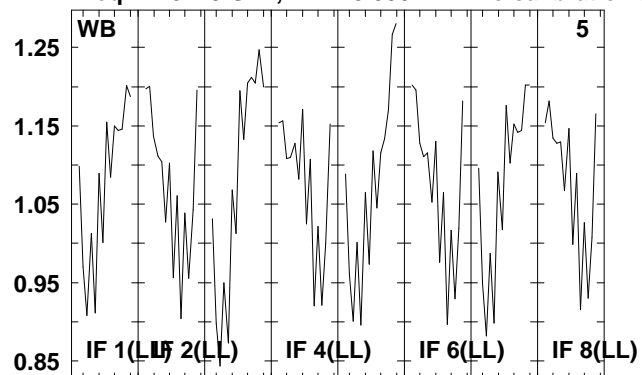

Lower frame: Real Jy  
 Total-power spectrum Antenna: \*  
 Timerange: 01/02:29:20 to 01/02:32:20

Plot file version 119 created 20-OCT-2009 14:49:53

J0137+31 RP015C.UVDATA.1

Freq = 1.6270 GHz, Bw = 8.000 MH No calibration applied and no bandpass applied

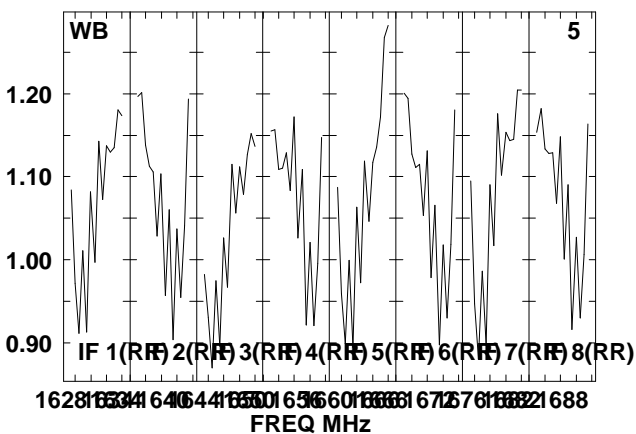
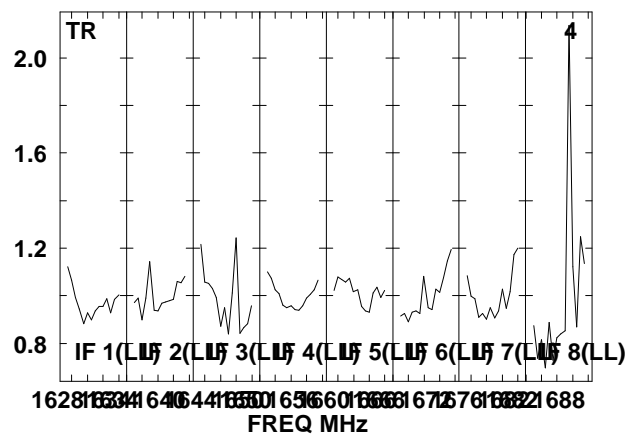
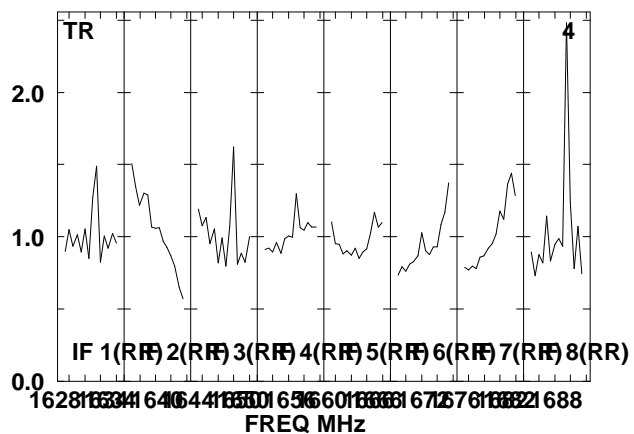
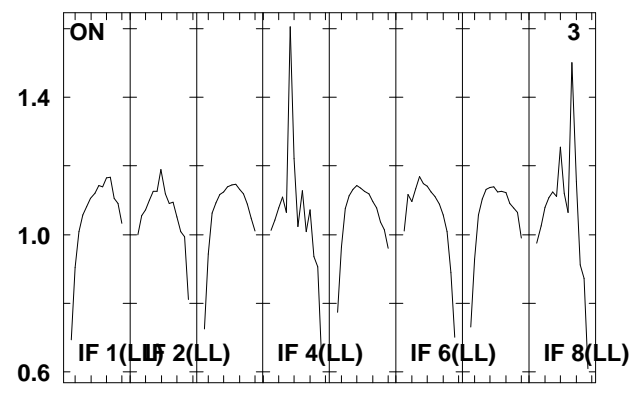
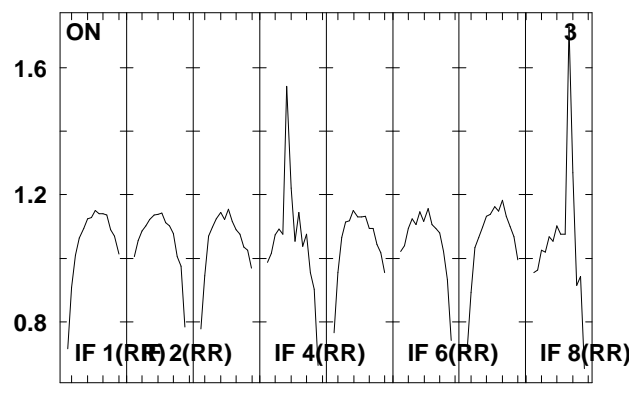
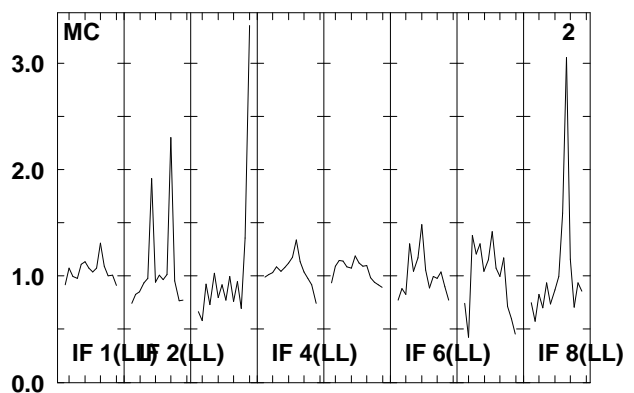
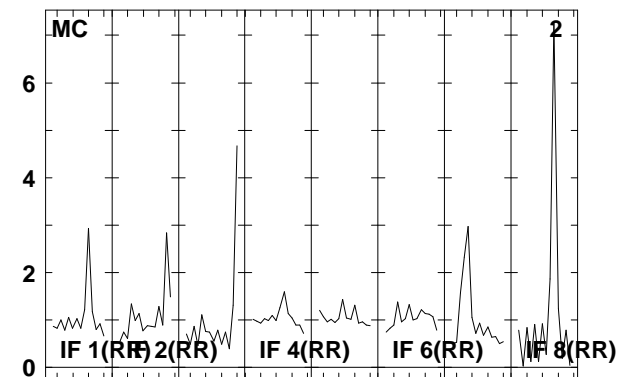
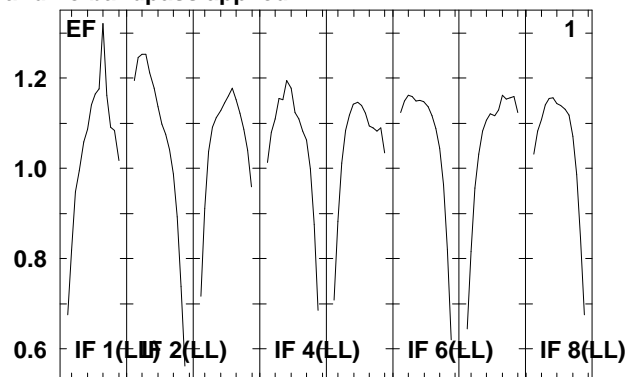
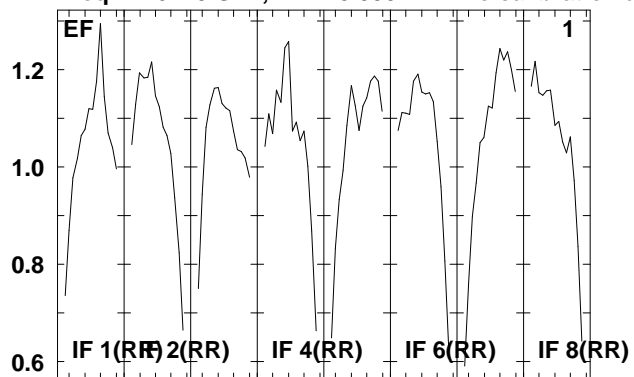

Lower frame: Real Jy  
Total-power spectrum Antenna: \*  
Timerange: 01/02:33:00 to 01/02:33:59

Plot file version 120 created 20-OCT-2009 14:49:54

J0137+31 RP015C.UVDATA.1

Freq = 1.6270 GHz, Bw = 8.000 MH No calibration applied and no bandpass applied

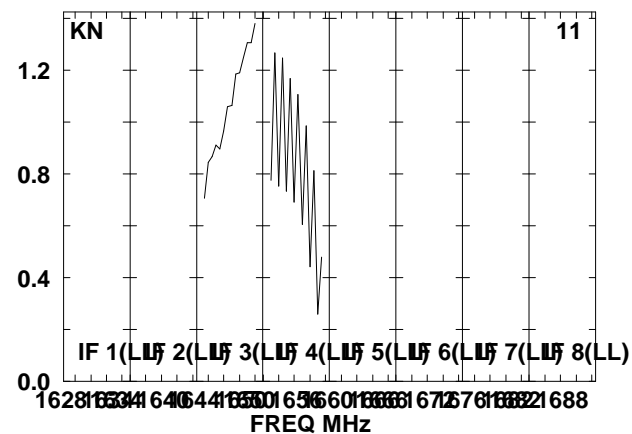
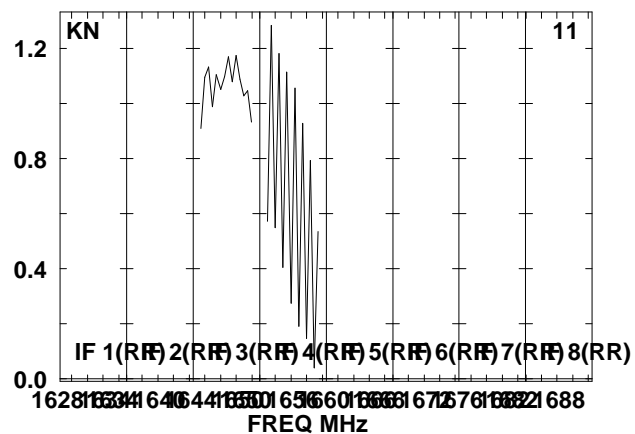
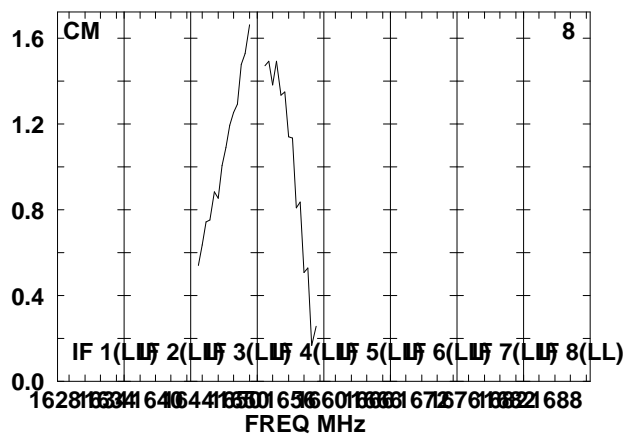
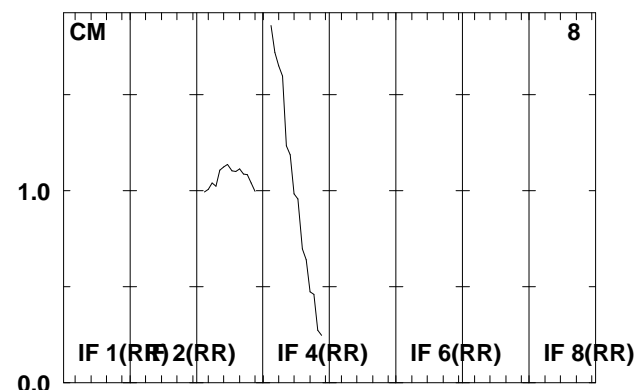
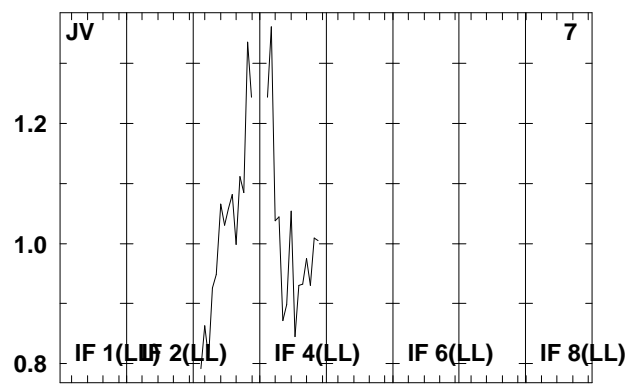
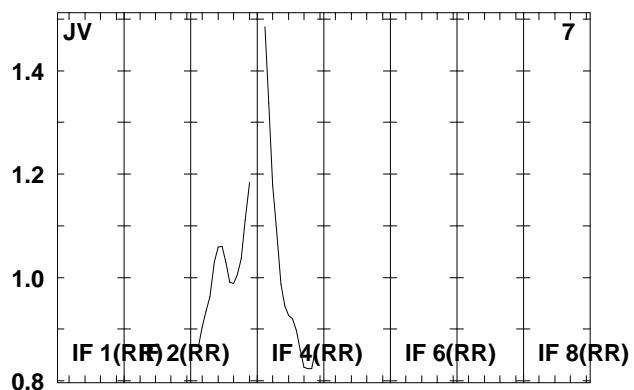
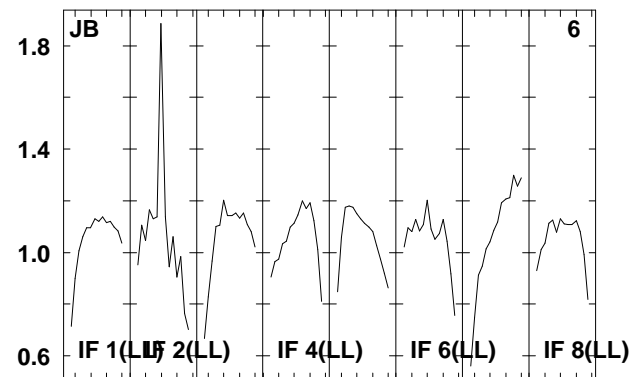
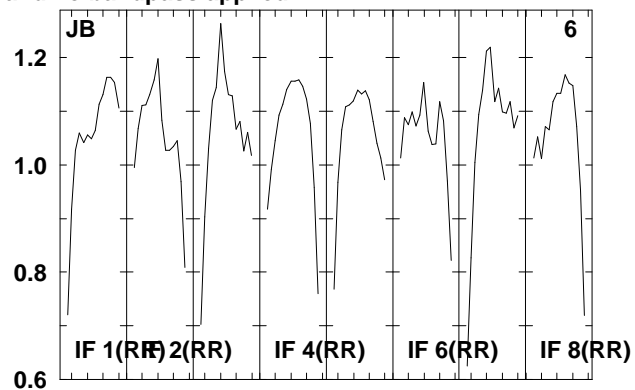
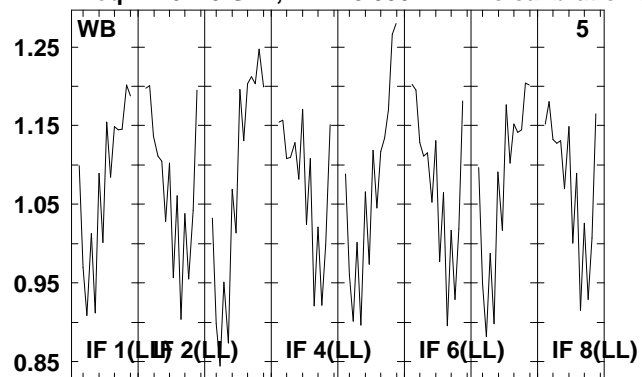

Lower frame: Real Jy

Total-power spectrum Antenna: \*

Timerange: 01/02:33:00 to 01/02:33:59



Plot file version 121 created 20-OCT-2009 14:49:54

FAINTCAL RP015C.UVDATA.1

Freq = 1.6270 GHz, Bw = 8.000 MH No calibration applied and no bandpass applied

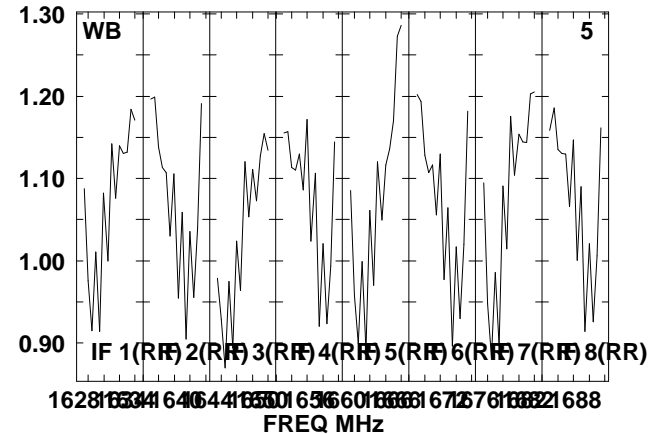
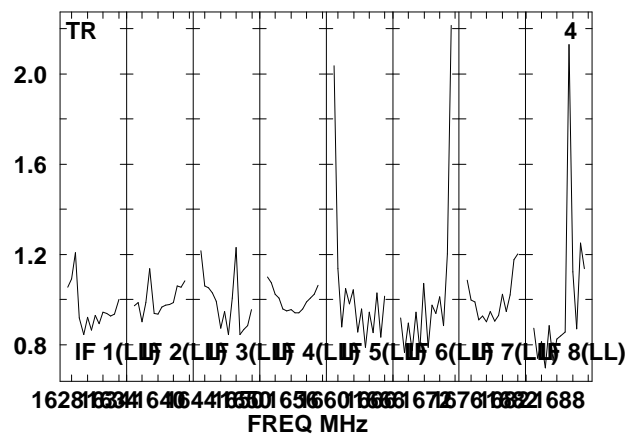
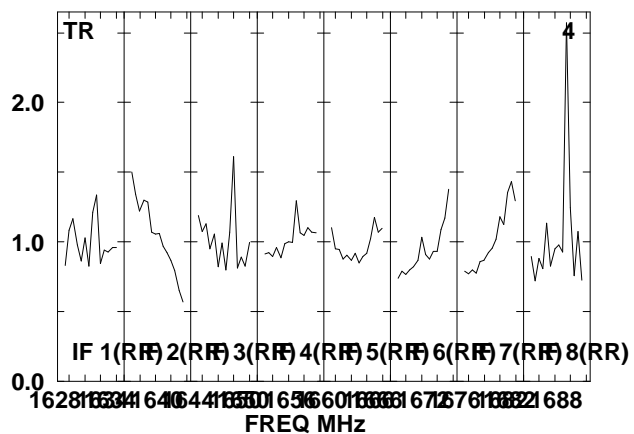
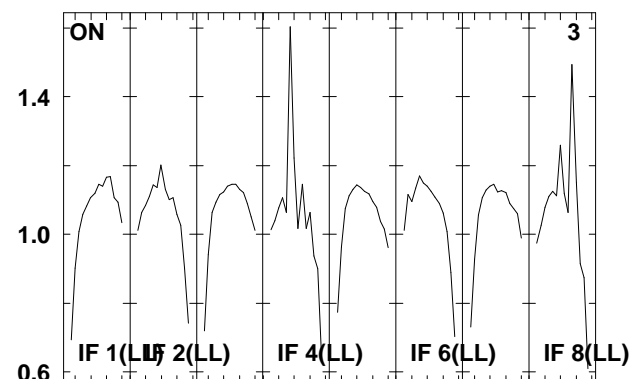
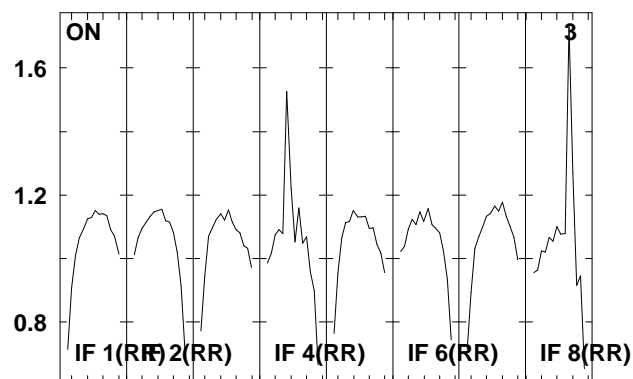
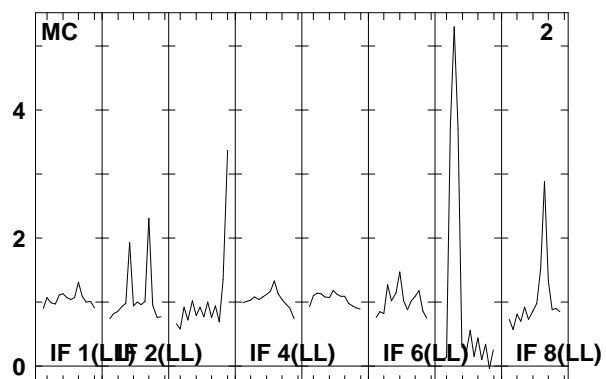
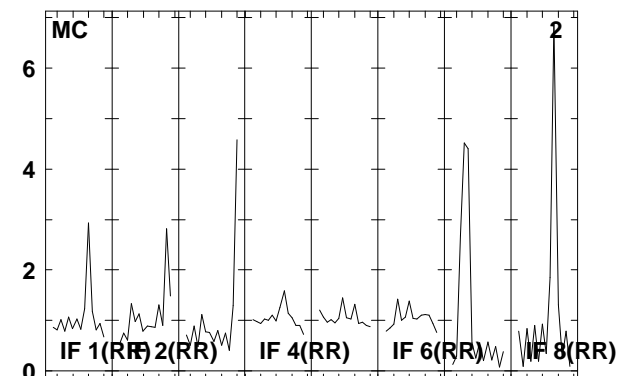
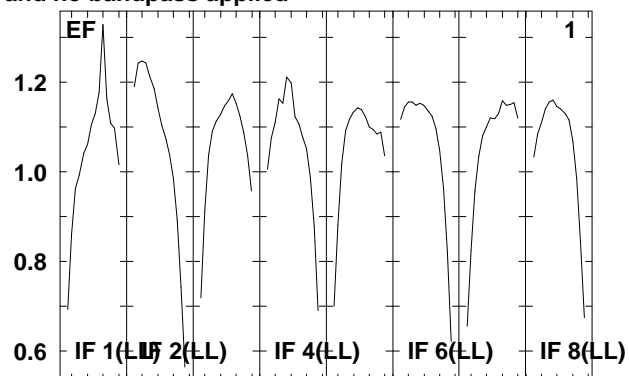
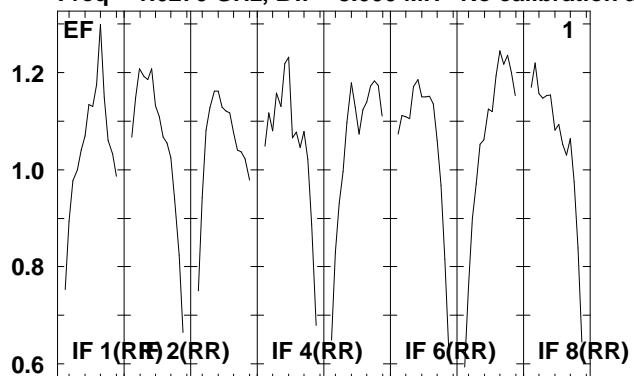

Lower frame: Real Jy  
Total-power spectrum Antenna: \*  
Timerange: 01/02:34:01 to 01/02:35:20

Plot file version 122 created 20-OCT-2009 14:49:55

FAINTCAL RP015C.UVDATA.1

Freq = 1.6270 GHz, Bw = 8.000 MH No calibration applied and no bandpass applied

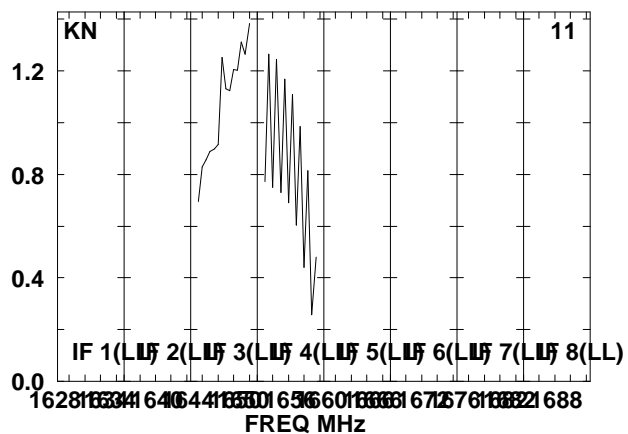
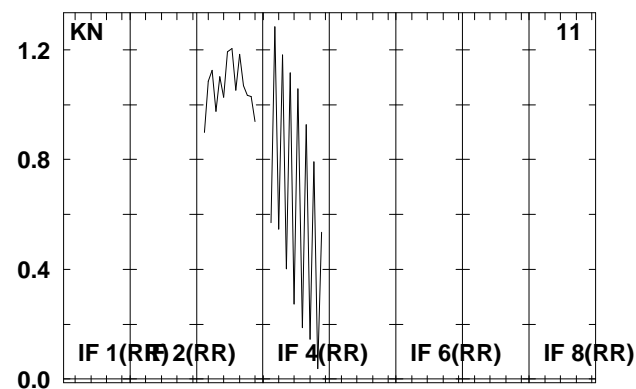
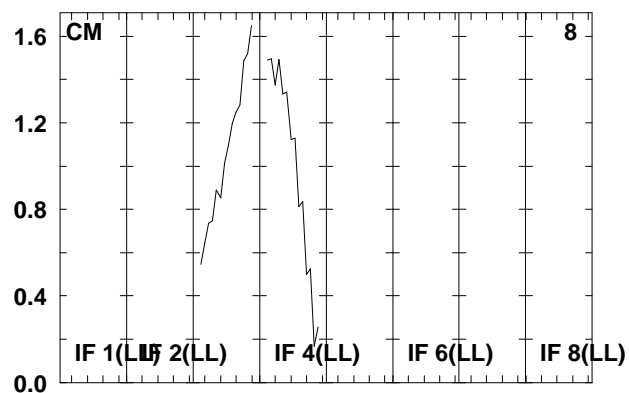
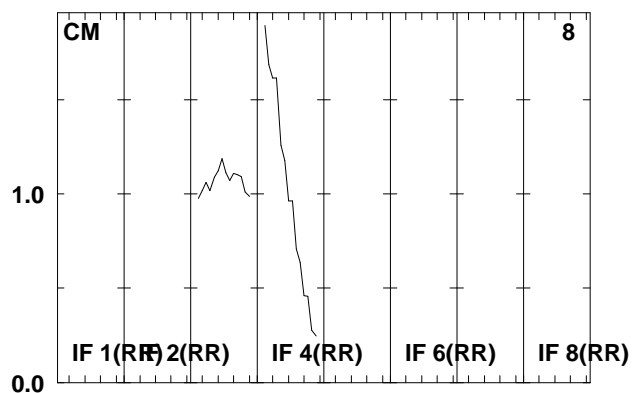
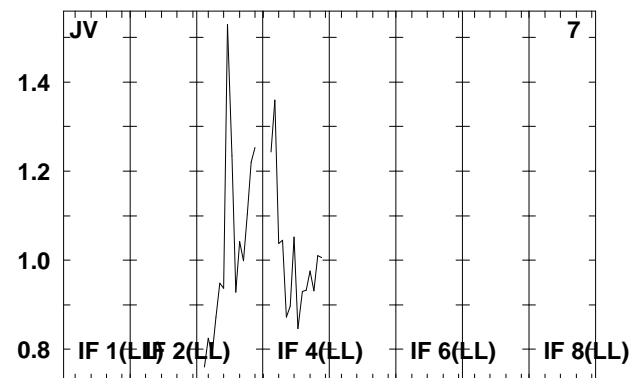
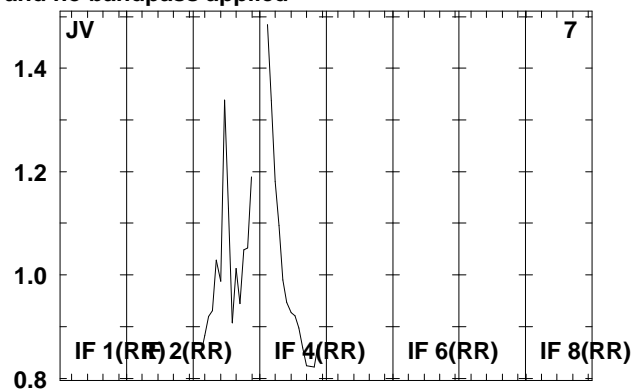
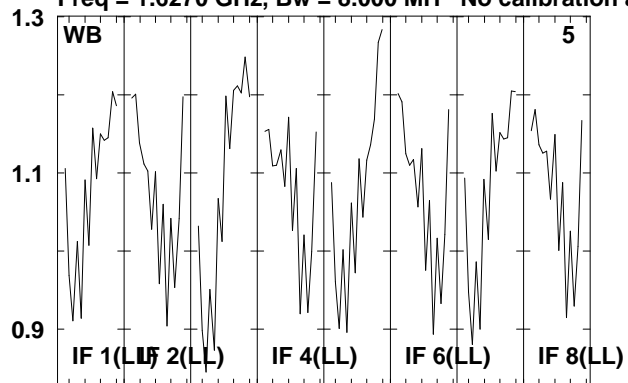

Lower frame: Real Jy

Total-power spectrum Antenna: \*

Timerange: 01/02:34:01 to 01/02:35:20

Plot file version 123 created 20-OCT-2009 14:49:56

M33 RP015C.UVDATA.1

Freq = 1.6270 GHz, Bw = 8.000 MH No calibration applied and no bandpass applied

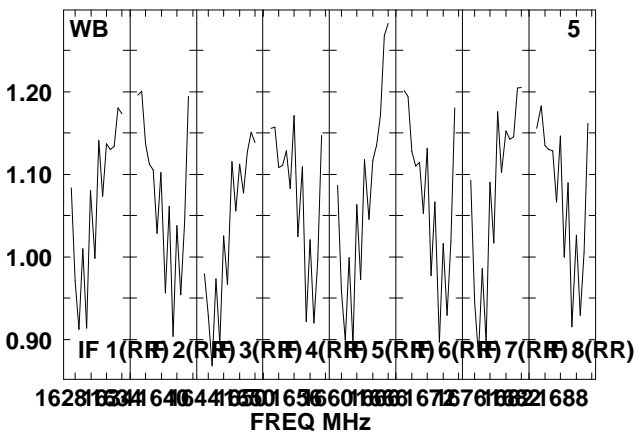
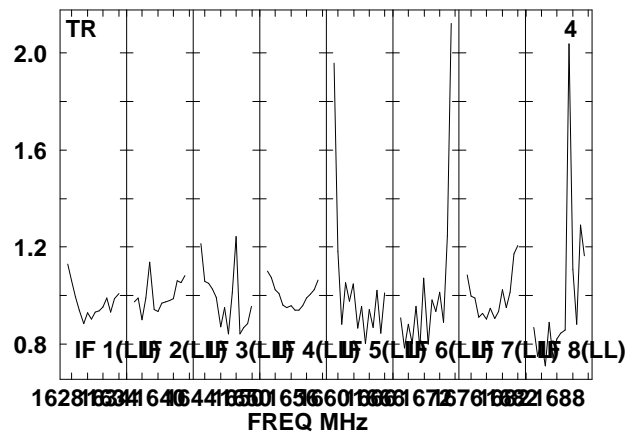
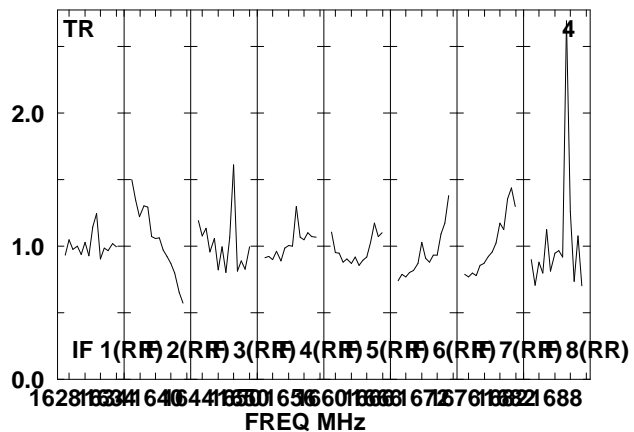
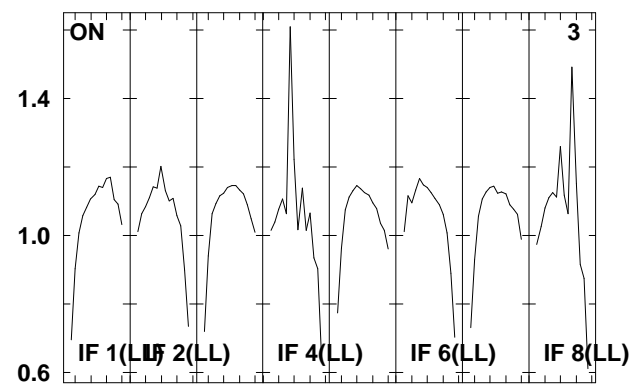
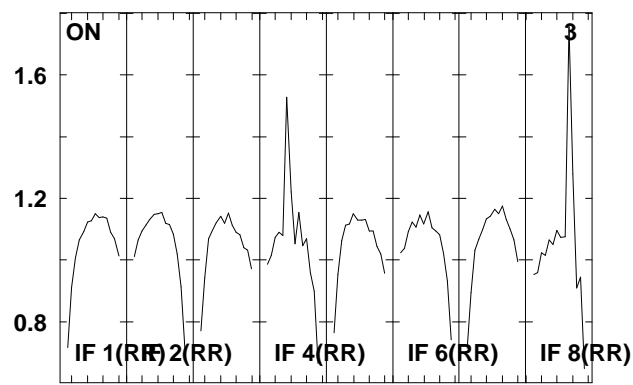
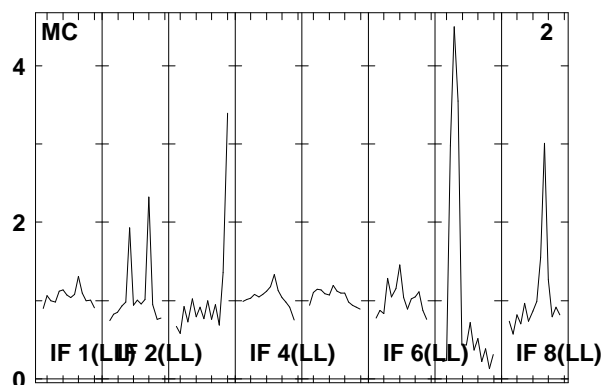
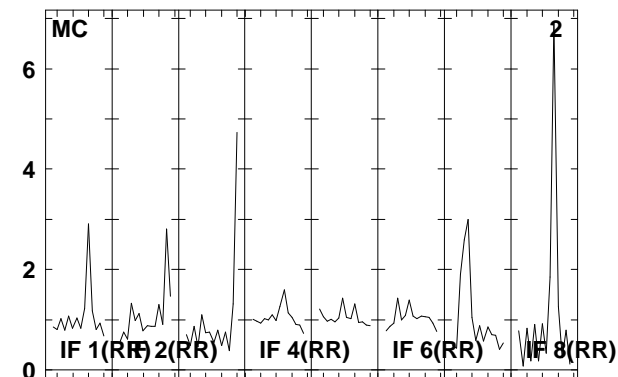
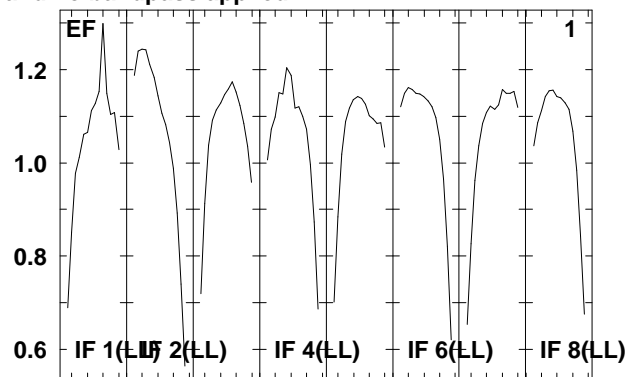
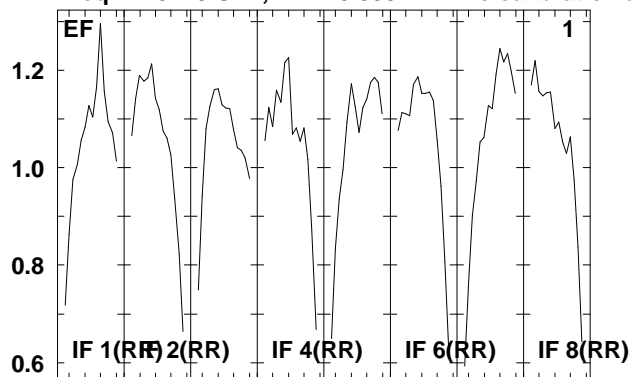

Lower frame: Real Jy

Total-power spectrum Antenna: \*

Timerange: 01/02:35:20 to 01/02:38:20

Plot file version 124 created 20-OCT-2009 14:49:56

M33 RP015C.UVDATA.1

Freq = 1.6270 GHz, Bw = 8.000 MH No calibration applied and no bandpass applied

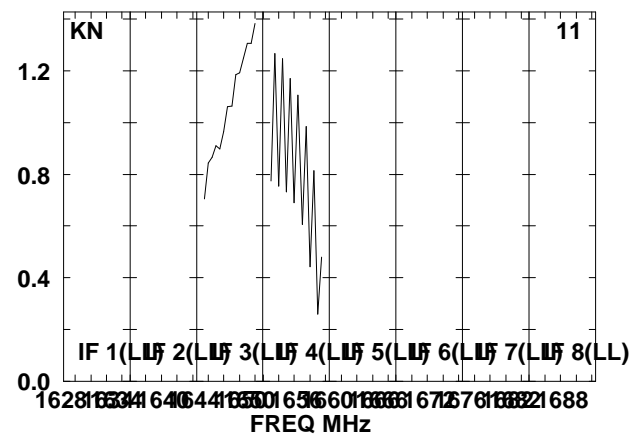
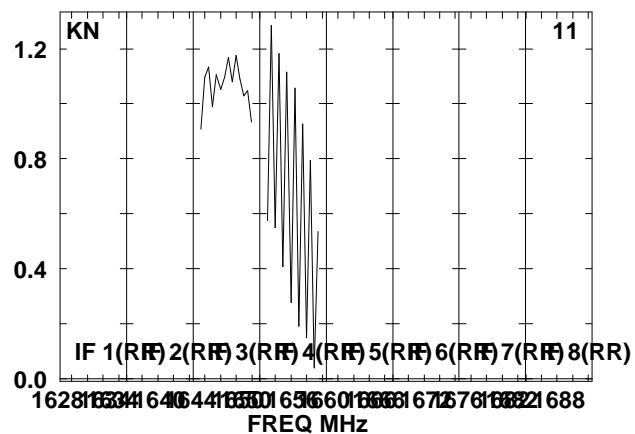
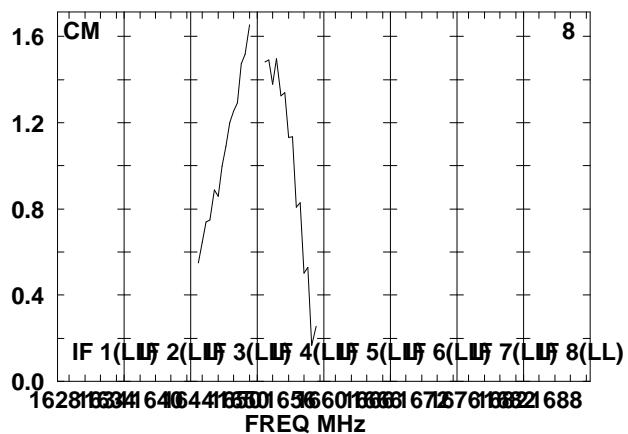
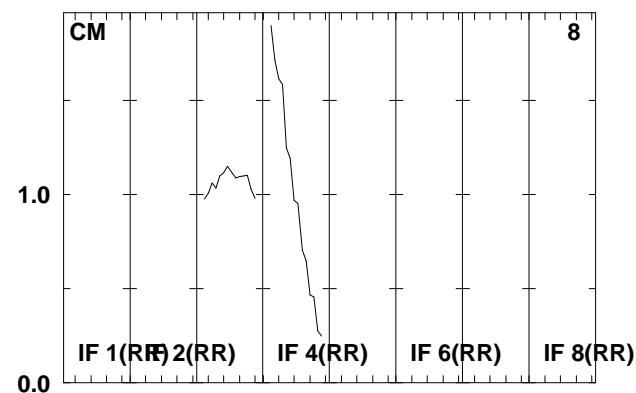
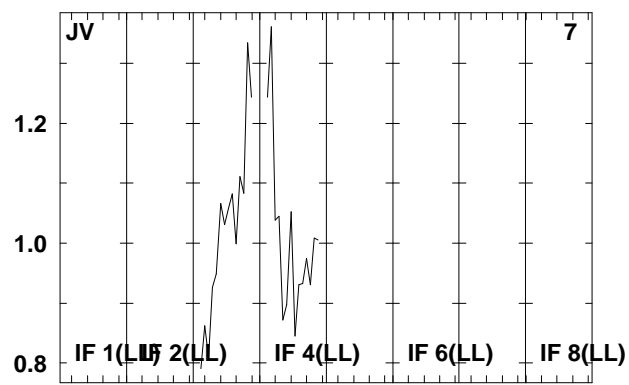
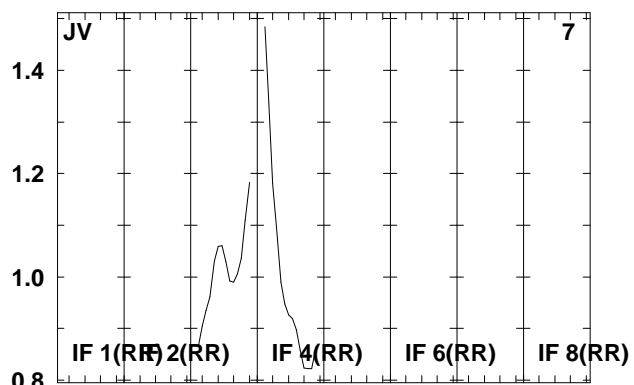
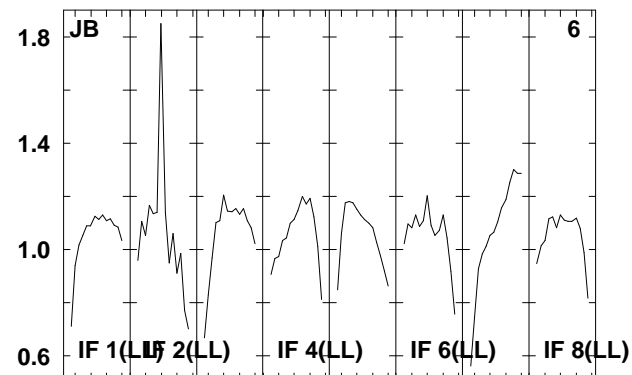
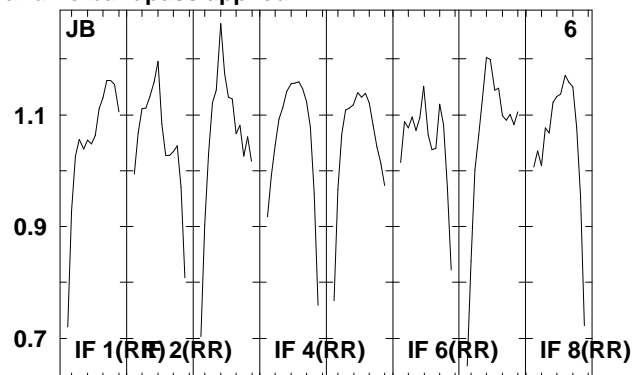
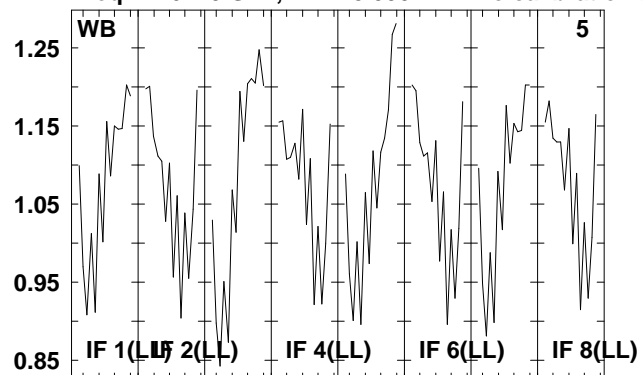

Lower frame: Real Jy

Total-power spectrum Antenna: \*

Timerange: 01/02:35:20 to 01/02:38:20

Plot file version 125 created 20-OCT-2009 14:49:58

J0137+31 RP015C.UVDATA.1

Freq = 1.6270 GHz, Bw = 8.000 MH No calibration applied and no bandpass applied

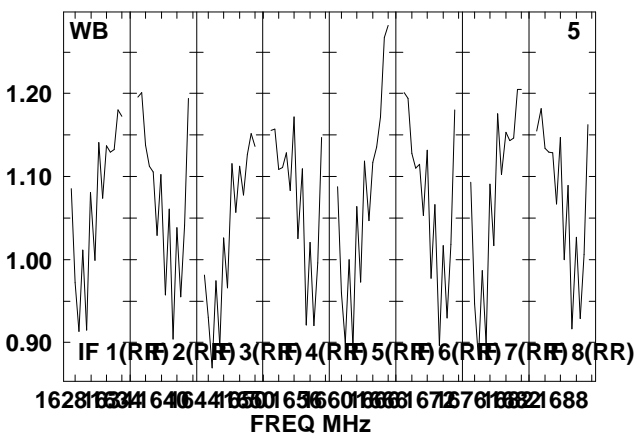
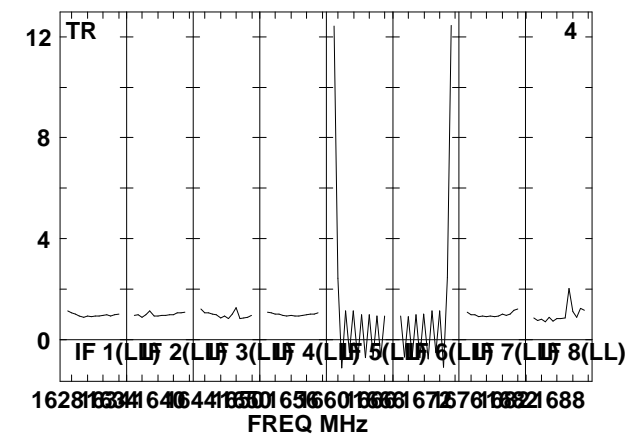
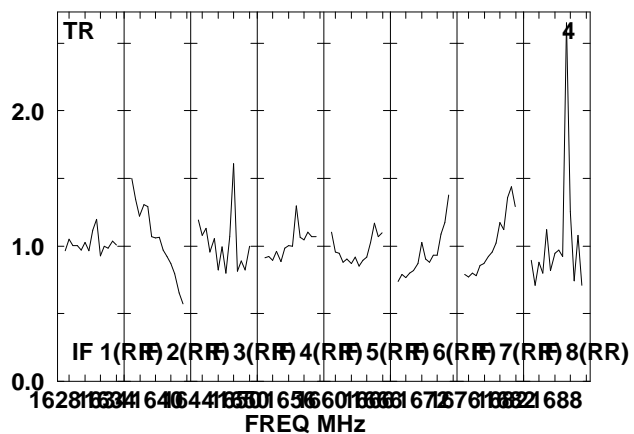
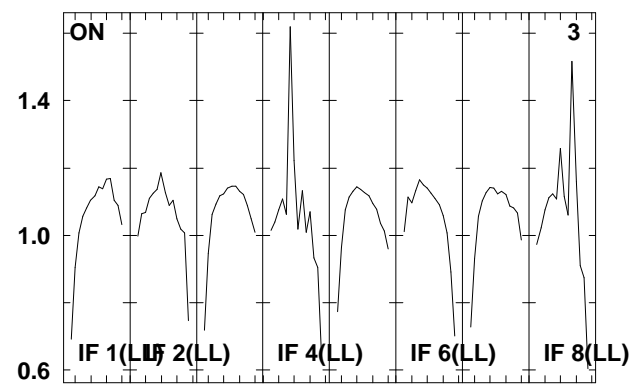
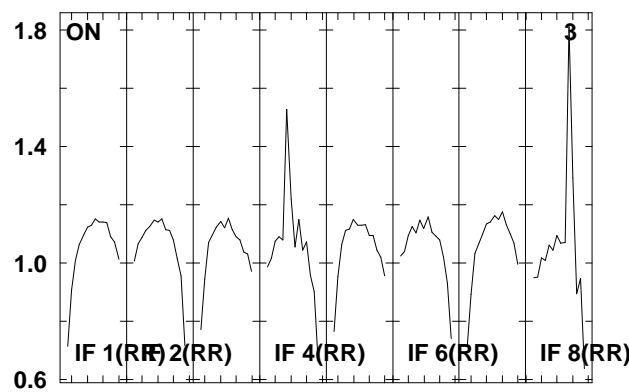
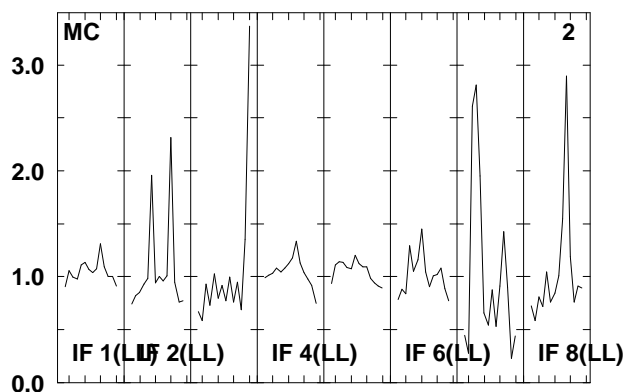
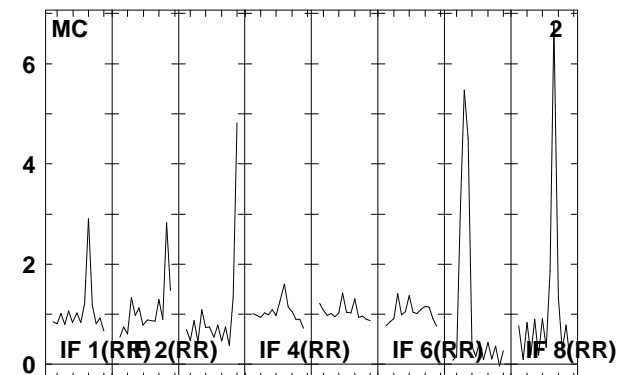
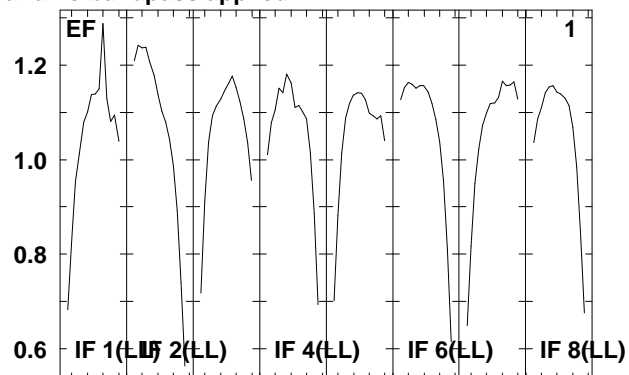
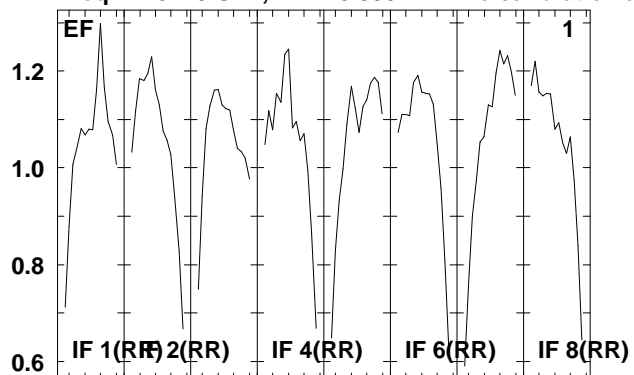

Lower frame: Real Jy  
Total-power spectrum Antenna: \*  
Timerange: 01/02:39:01 to 01/02:39:59

Plot file version 126 created 20-OCT-2009 14:49:58

J0137+31 RP015C.UVDATA.1

Freq = 1.6270 GHz, Bw = 8.000 MH No calibration applied and no bandpass applied

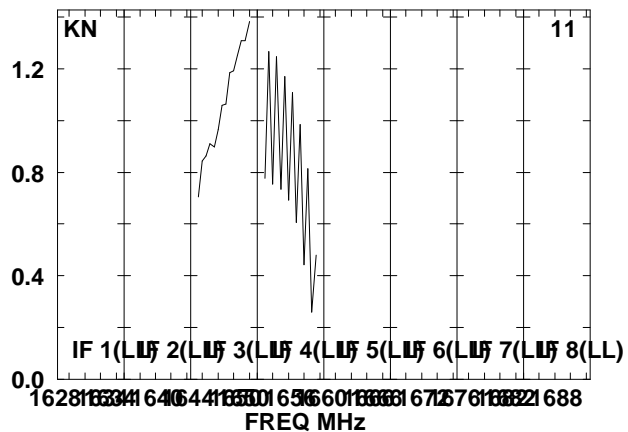
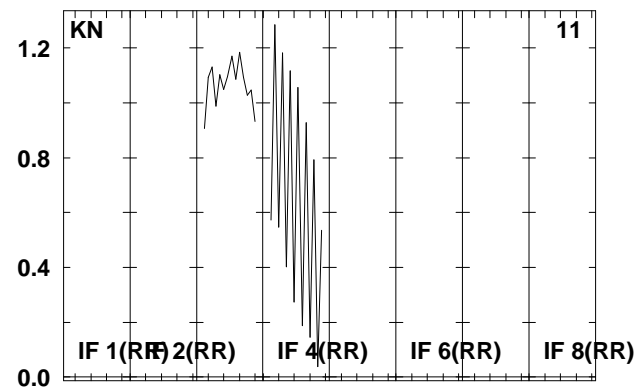
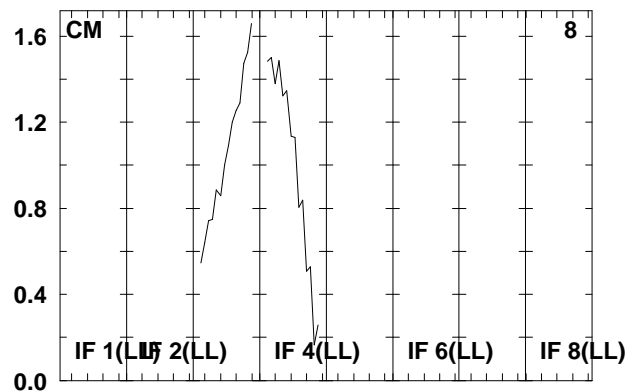
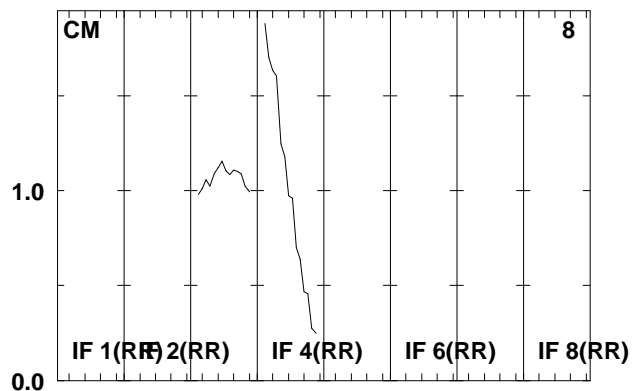
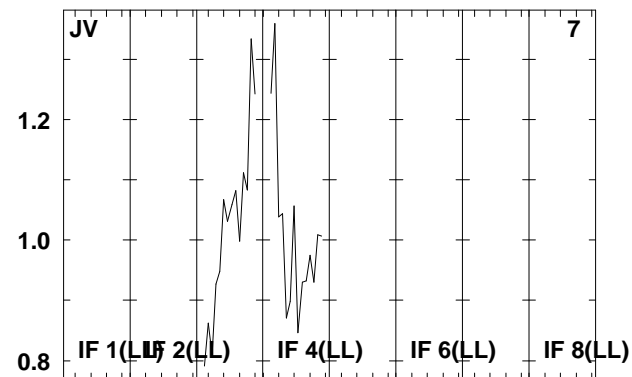
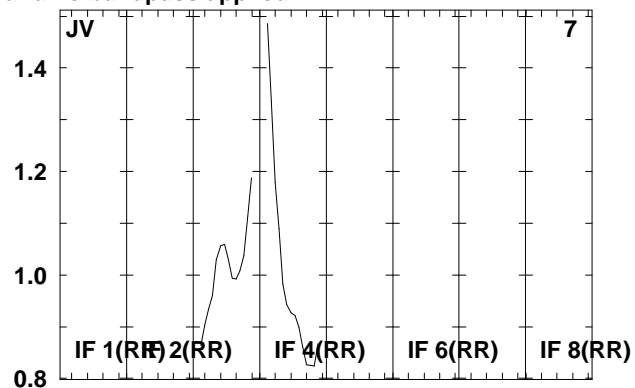
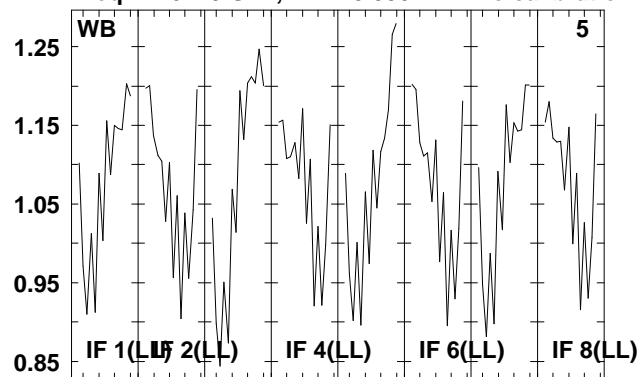

Lower frame: Real Jy

Total-power spectrum Antenna: \*

Timerange: 01/02:39:01 to 01/02:39:59

Plot file version 127 created 20-OCT-2009 14:49:59

FAINTCAL RP015C.UVDATA.1

Freq = 1.6270 GHz, Bw = 8.000 MH No calibration applied and no bandpass applied

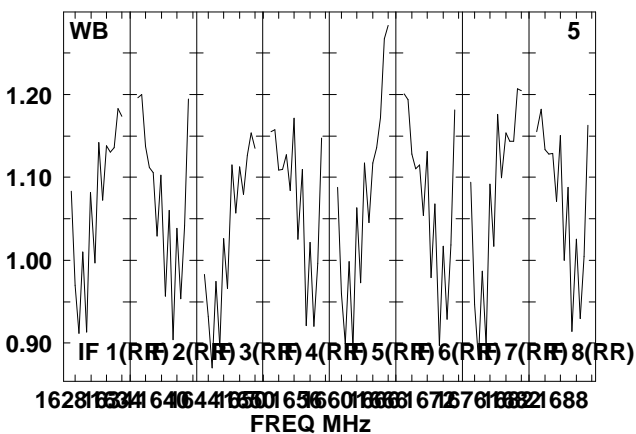
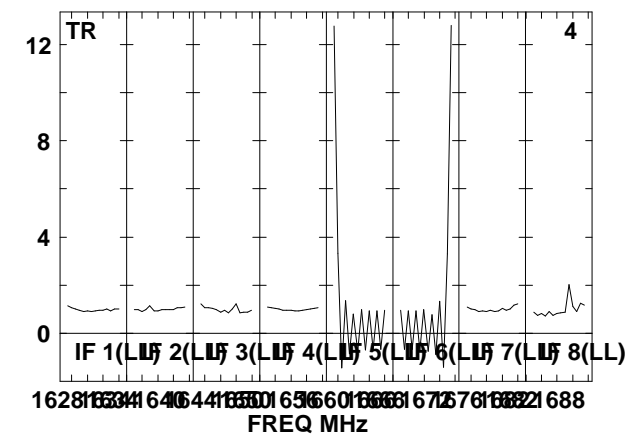
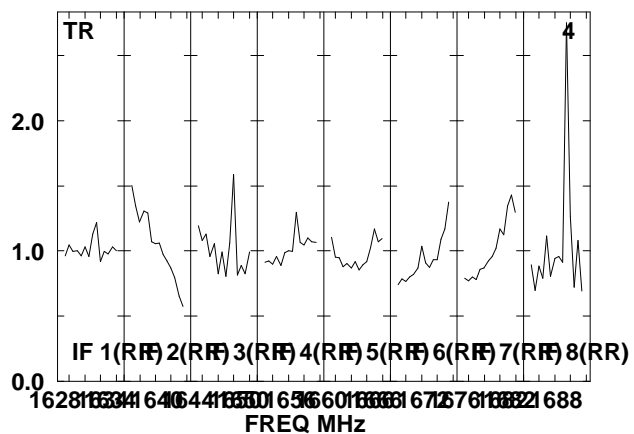
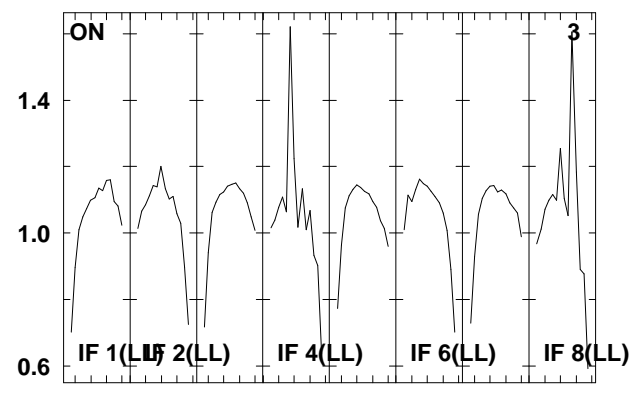
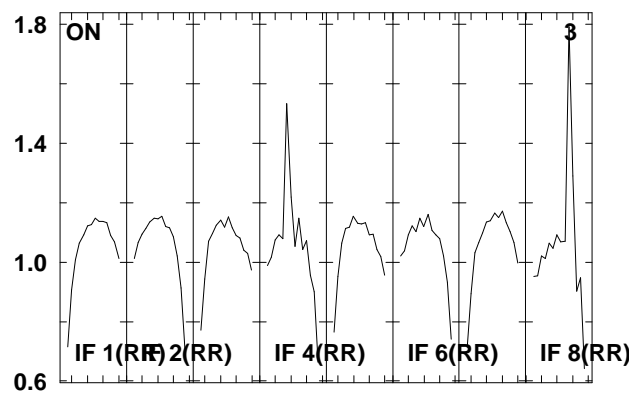
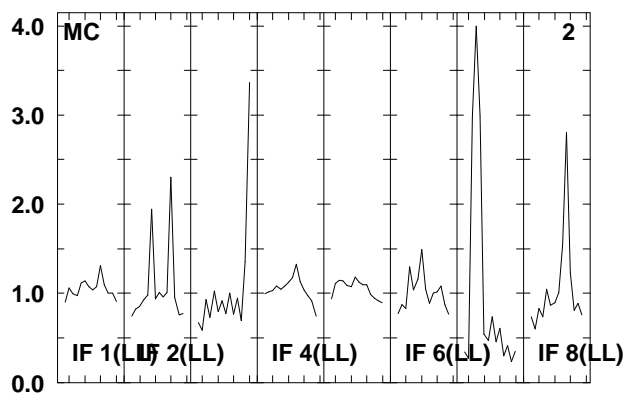
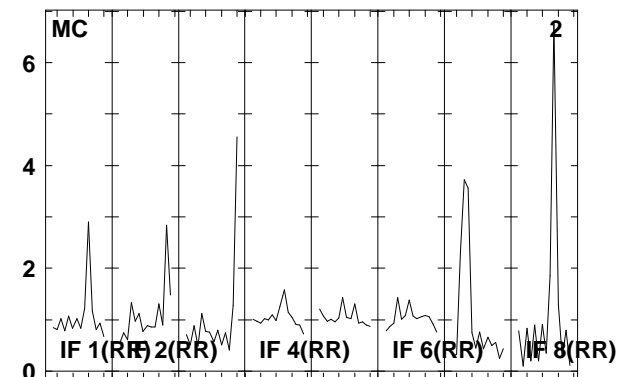
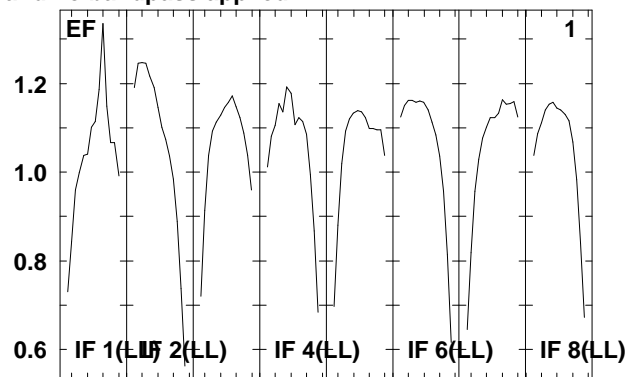
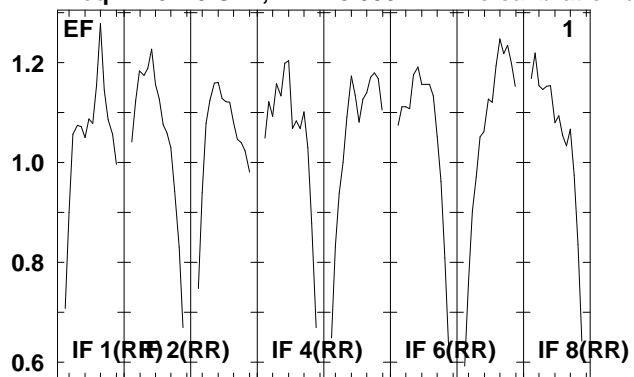

Lower frame: Real Jy  
Total-power spectrum Antenna: \*  
Timerange: 01/02:40:00 to 01/02:41:19

Plot file version 128 created 20-OCT-2009 14:49:59

FAINTCAL RP015C.UVDATA.1

Freq = 1.6270 GHz, Bw = 8.000 MH No calibration applied and no bandpass applied

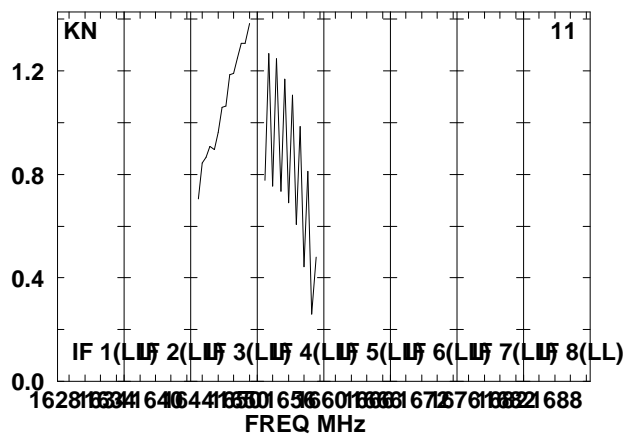
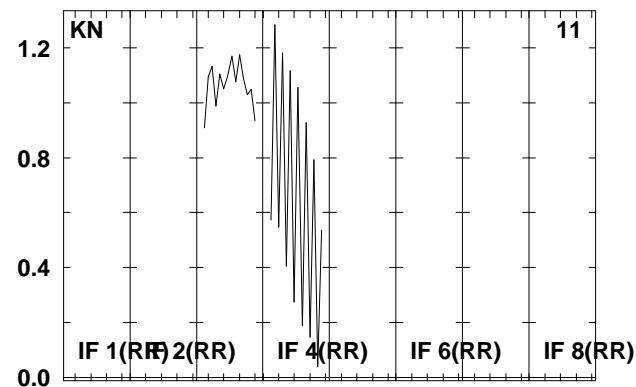
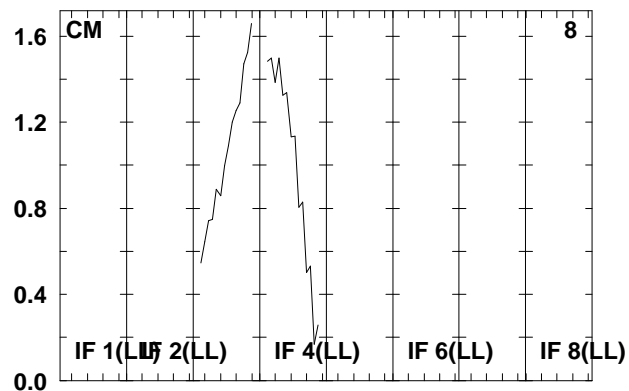
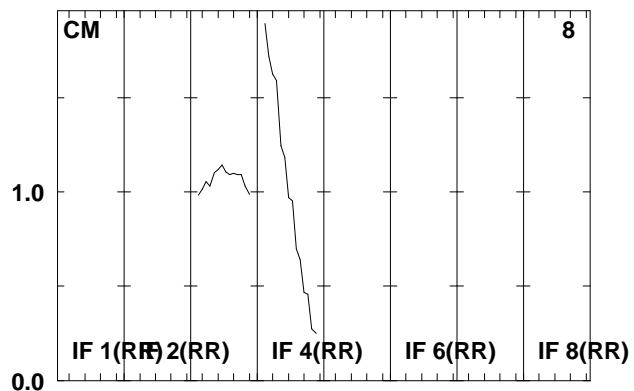
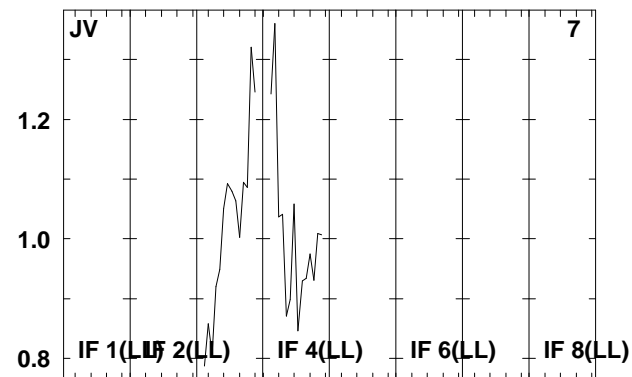
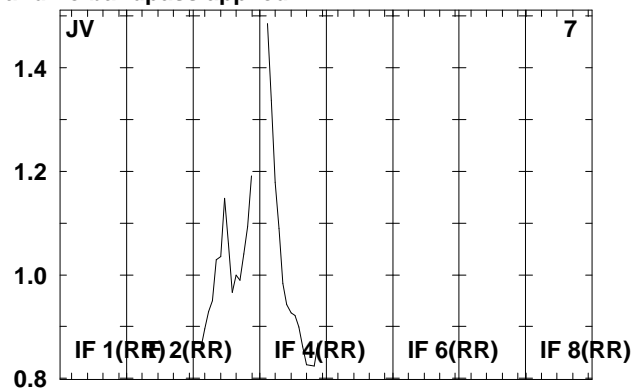
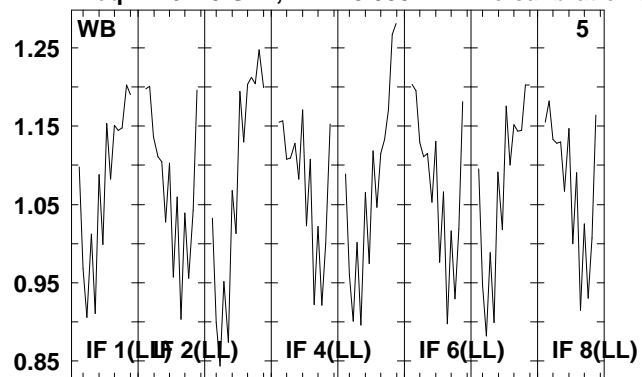

Lower frame: Real Jy

Total-power spectrum Antenna: \*

Timerange: 01/02:40:00 to 01/02:41:19



Plot file version 129 created 20-OCT-2009 14:50:00

M33 RP015C.UVDATA.1

Freq = 1.6270 GHz, Bw = 8.000 MH No calibration applied and no bandpass applied

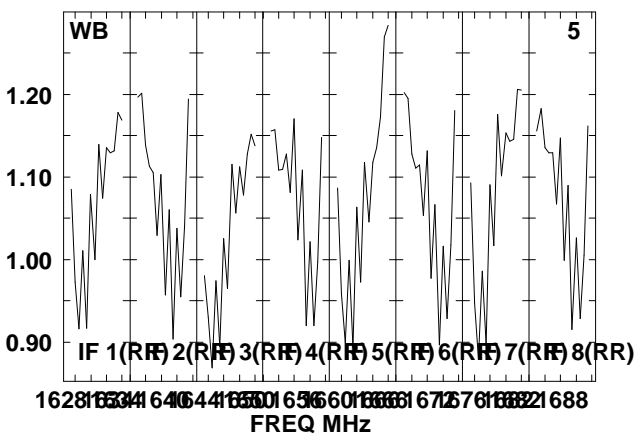
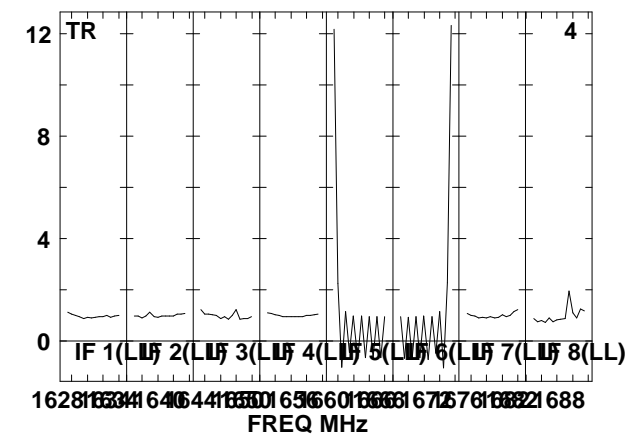
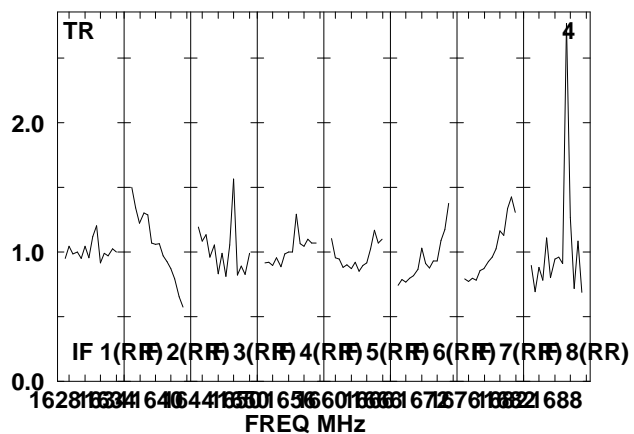
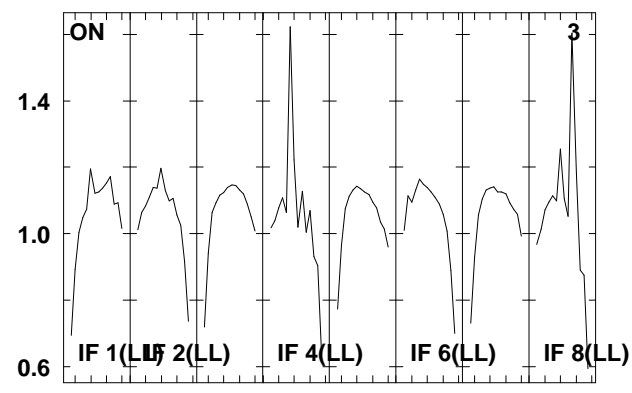
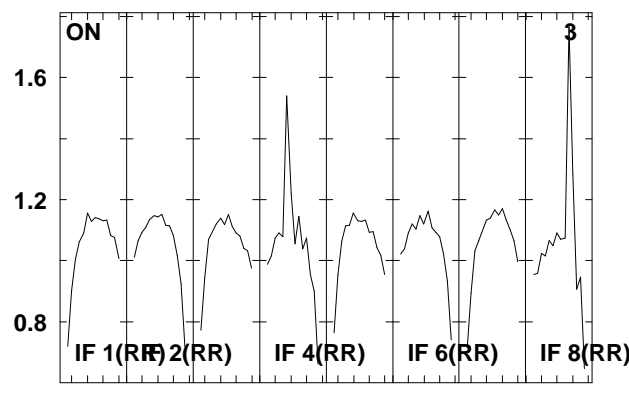
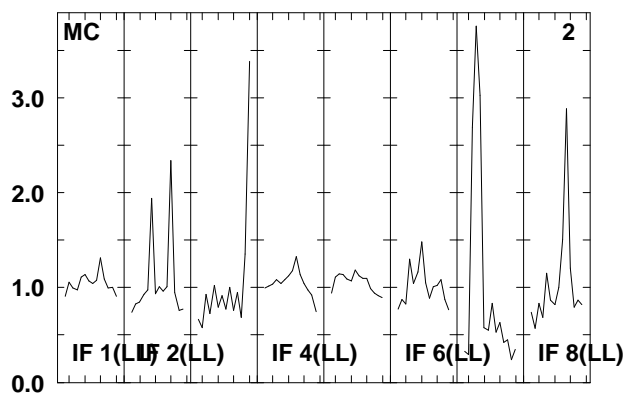
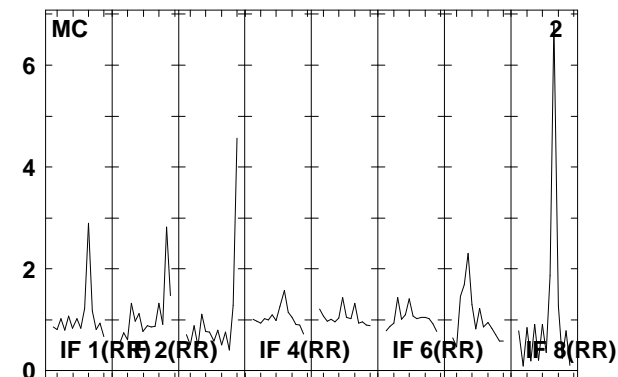
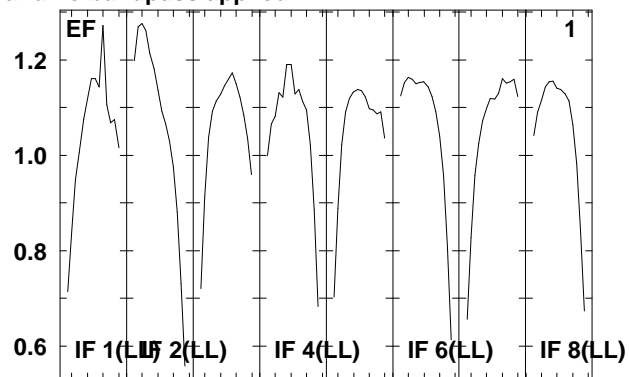
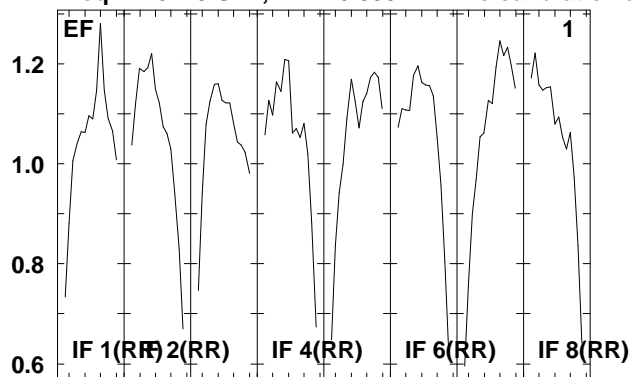

Lower frame: Real Jy

Total-power spectrum Antenna: \*

Timerange: 01/02:41:20 to 01/02:44:19

Plot file version 130 created 20-OCT-2009 14:50:01  
 M33 RP015C.UVDATA.1  
 Freq = 1.6270 GHz, Bw = 8.000 MH No calibration applied and no bandpass applied

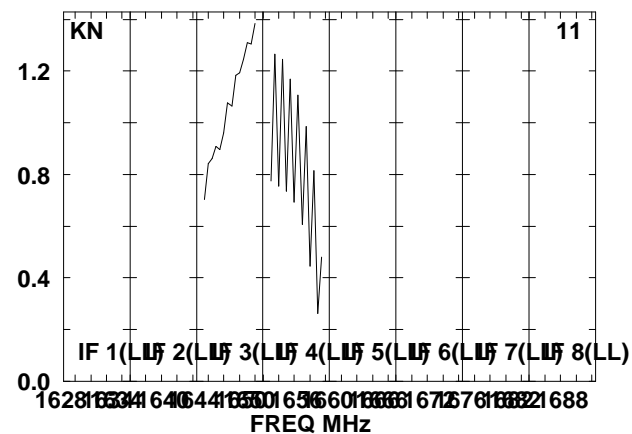
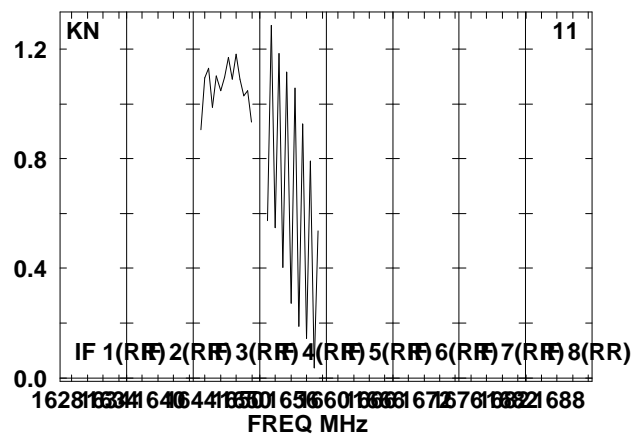
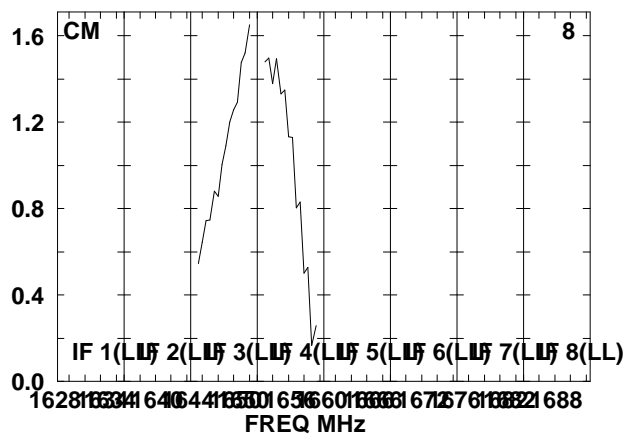
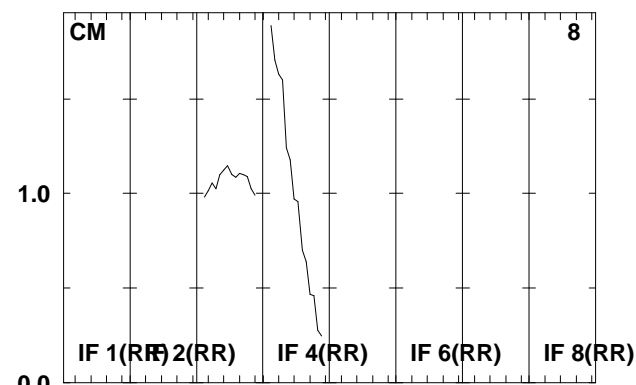
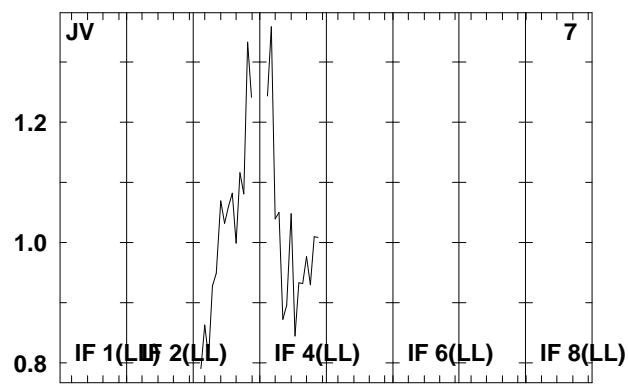
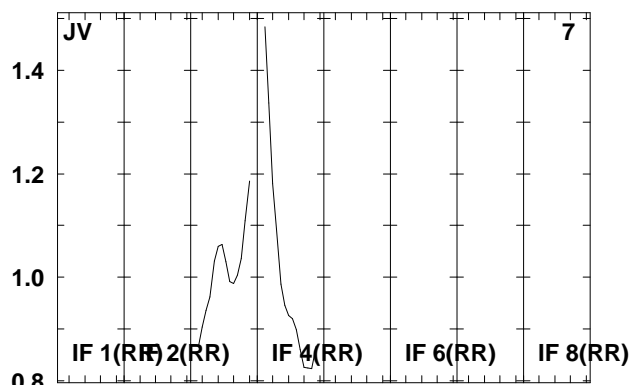
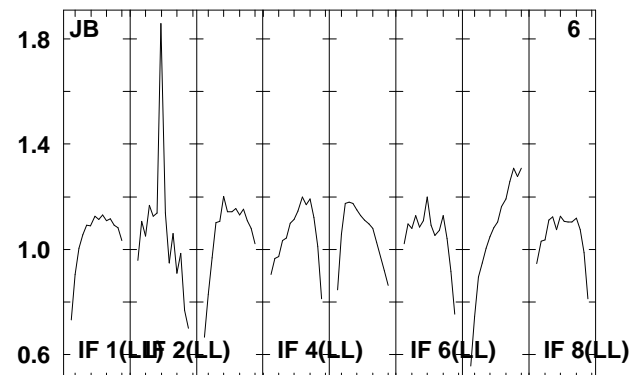
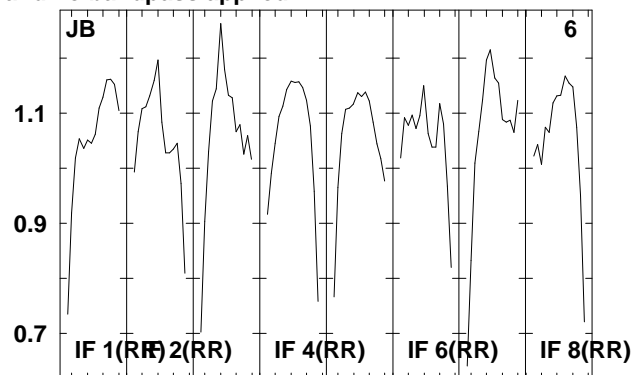
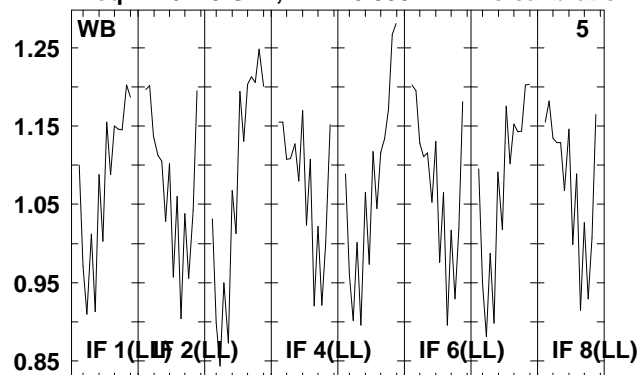

Lower frame: Real Jy  
 Total-power spectrum Antenna: \*  
 Timerange: 01/02:41:20 to 01/02:44:19

Plot file version 131 created 20-OCT-2009 14:50:02

J0137+31 RP015C.UVDATA.1

Freq = 1.6270 GHz, Bw = 8.000 MH No calibration applied and no bandpass applied

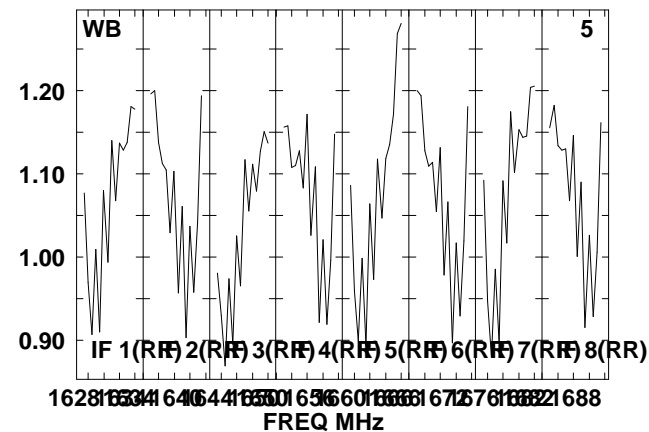
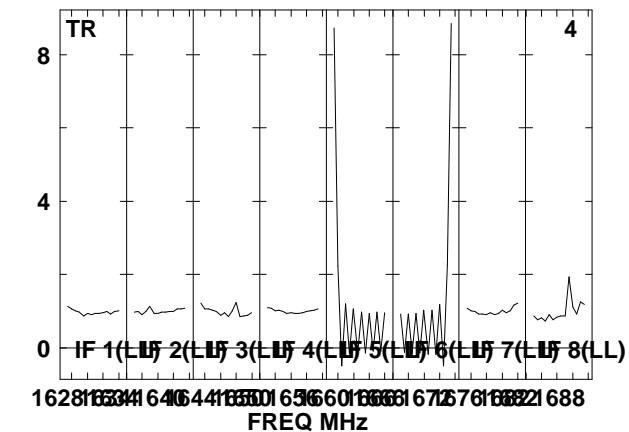
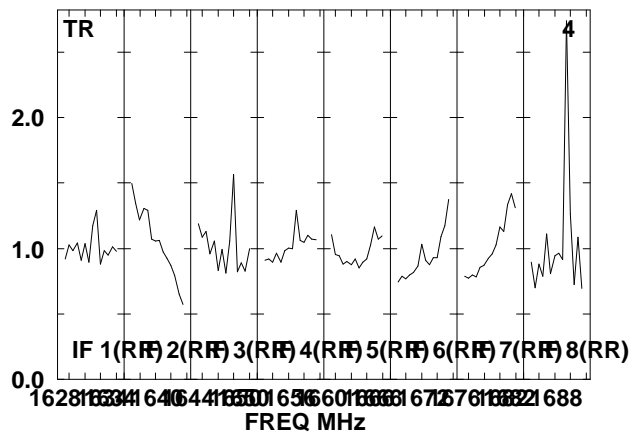
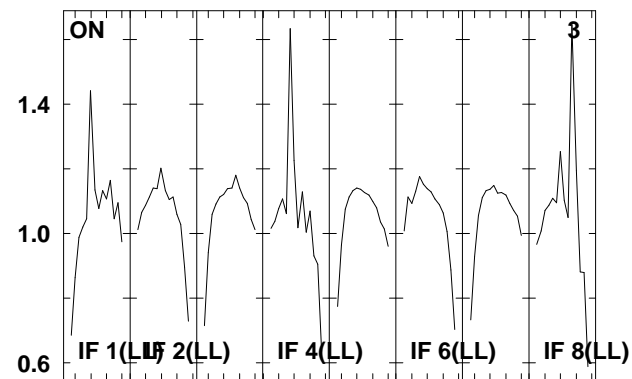
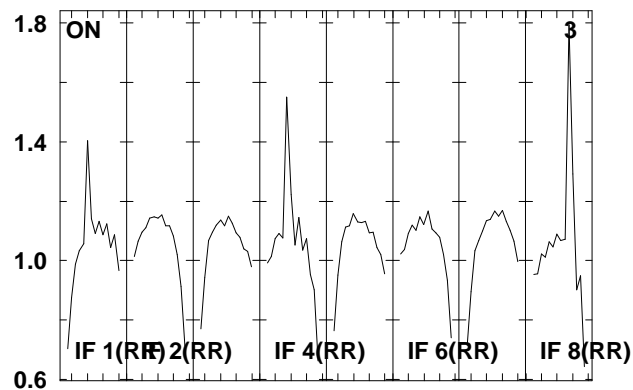
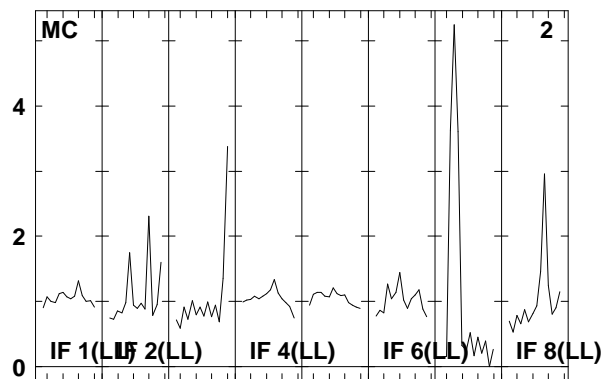
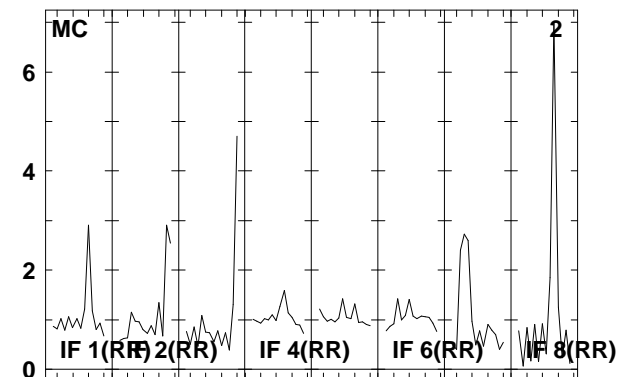
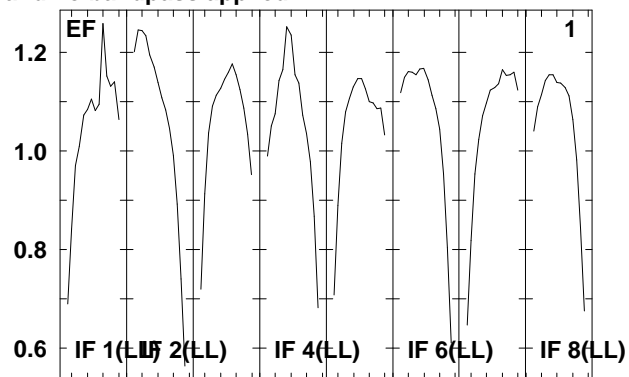
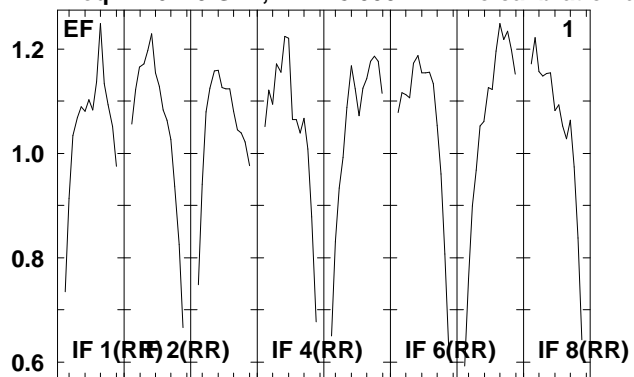

Lower frame: Real Jy  
Total-power spectrum Antenna: \*  
Timerange: 01/02:45:01 to 01/02:46:00

Plot file version 132 created 20-OCT-2009 14:50:03

J0137+31 RP015C.UVDATA.1

Freq = 1.6270 GHz, Bw = 8.000 MH No calibration applied and no bandpass applied

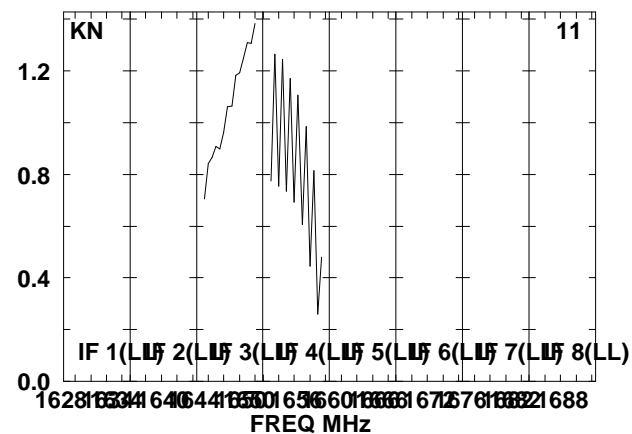
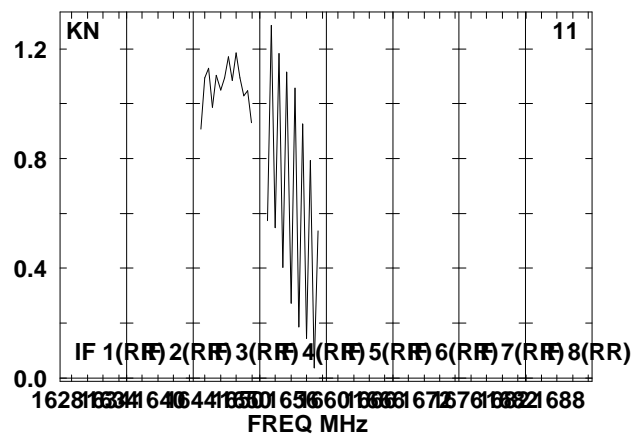
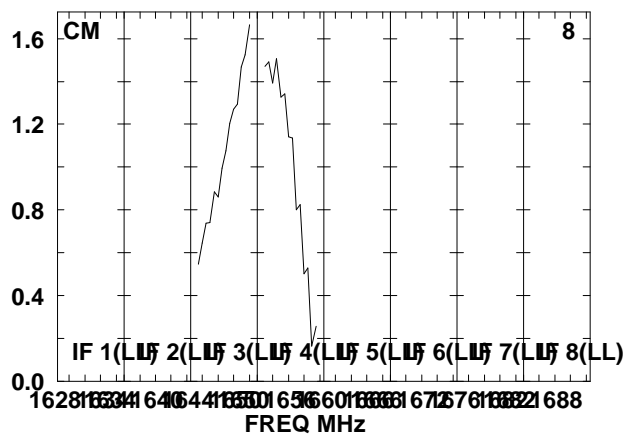
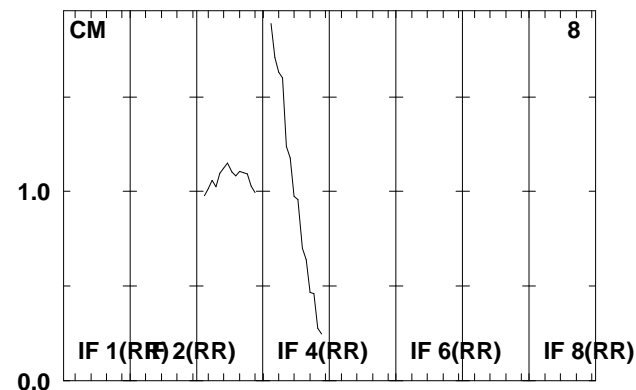
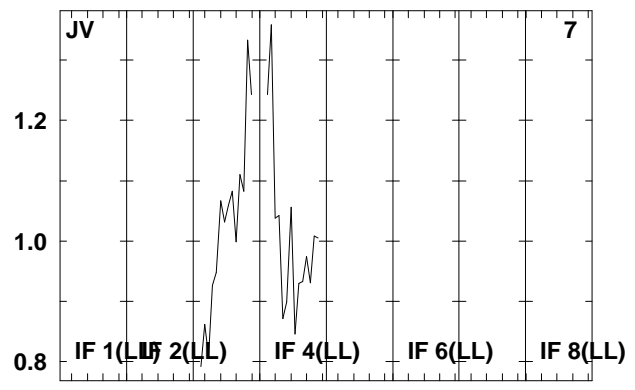
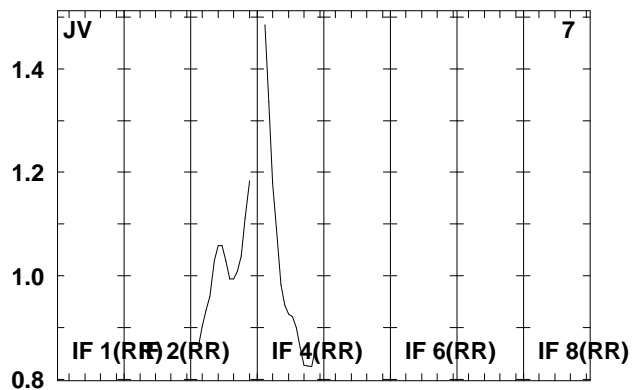
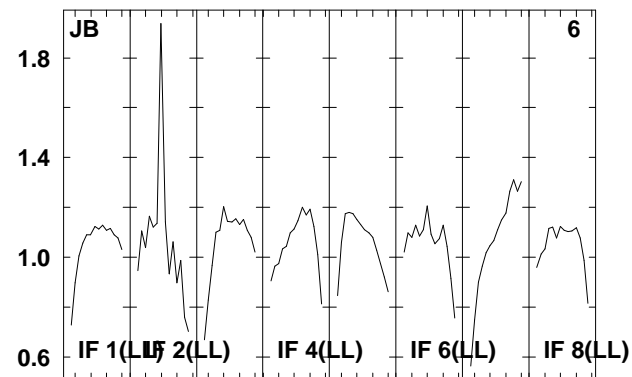
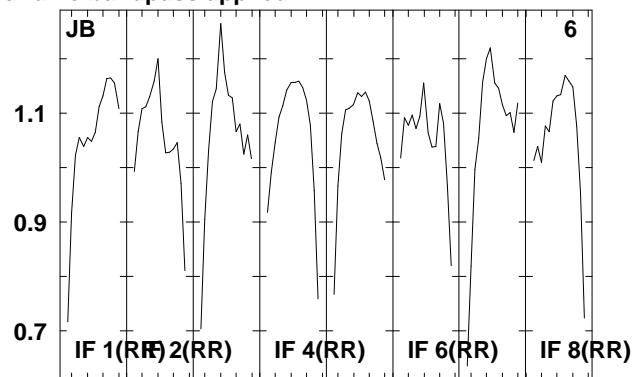
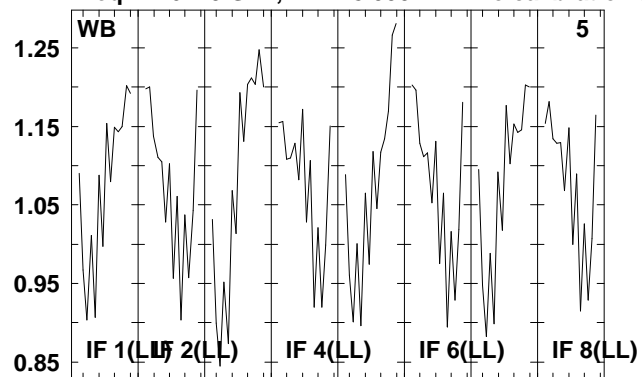

Lower frame: Real Jy  
Total-power spectrum Antenna: \*  
Timerange: 01/02:45:01 to 01/02:46:00

Plot file version 133 created 20-OCT-2009 14:50:03

FAINTCAL RP015C.UVDATA.1

Freq = 1.6270 GHz, Bw = 8.000 MH No calibration applied and no bandpass applied

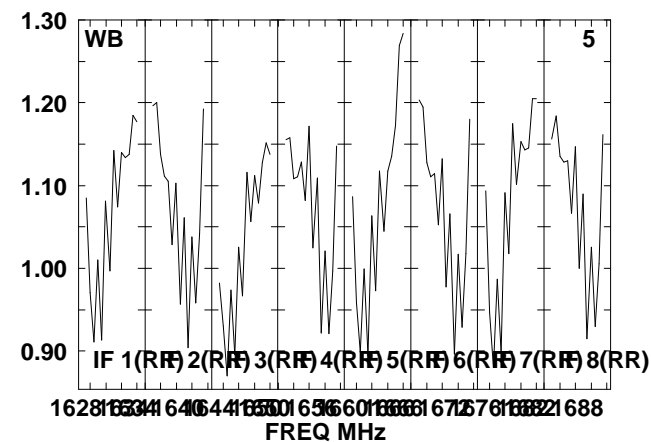
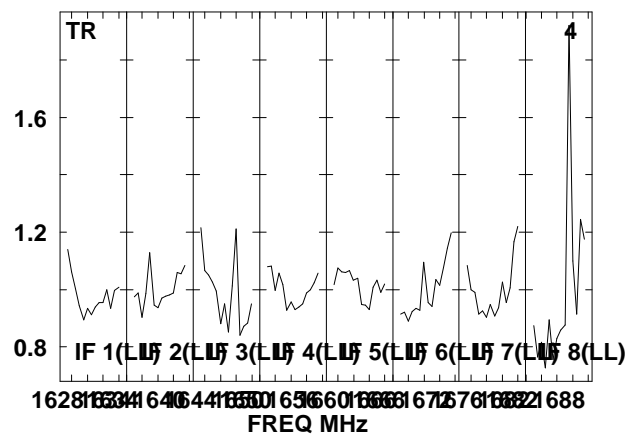
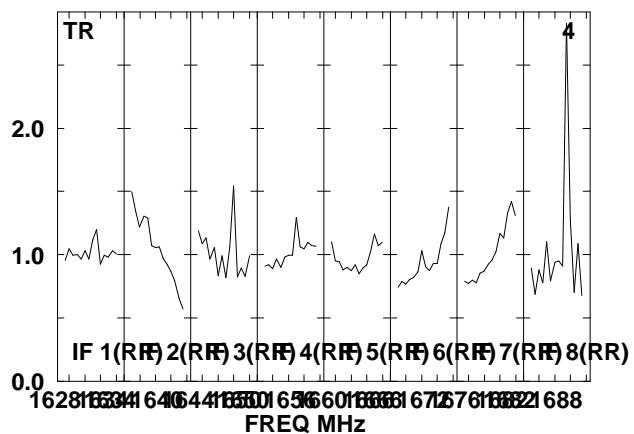
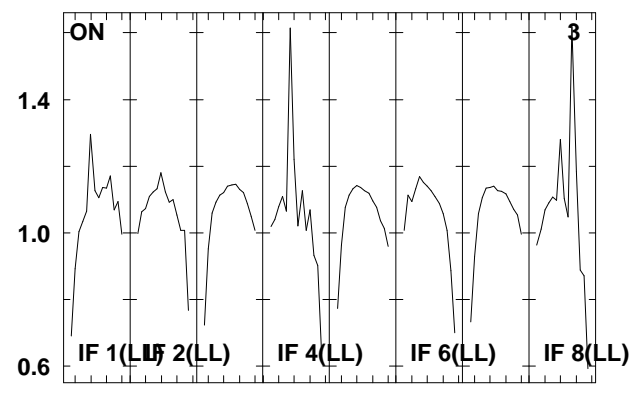
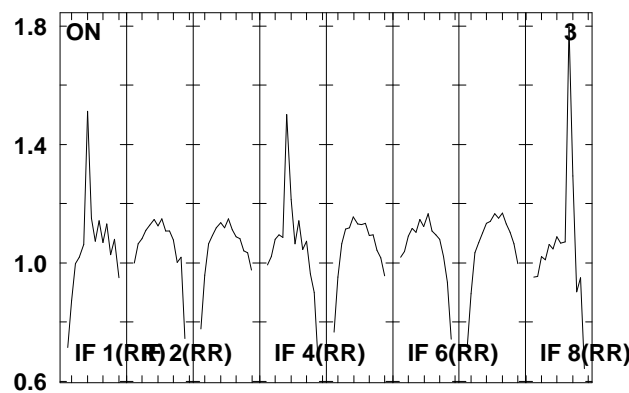
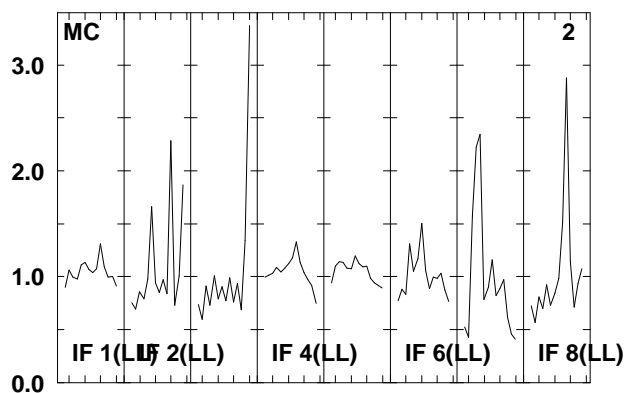
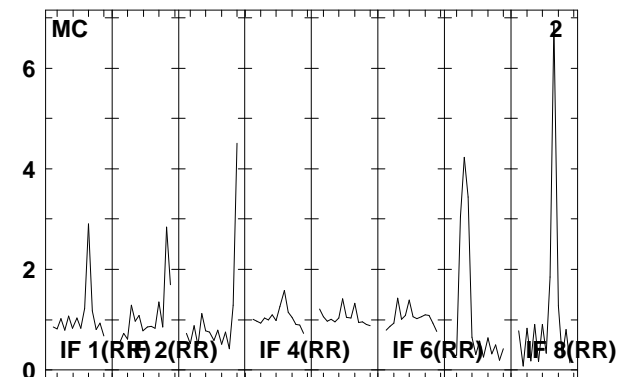
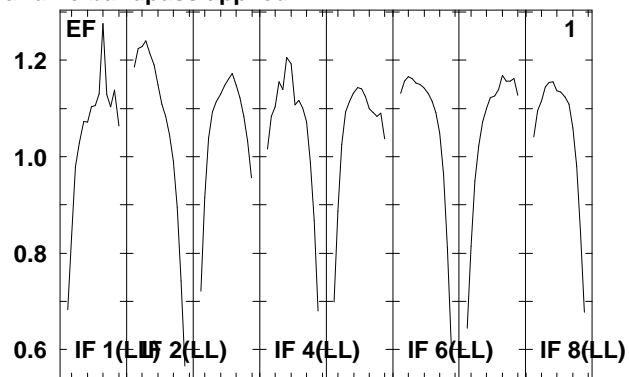
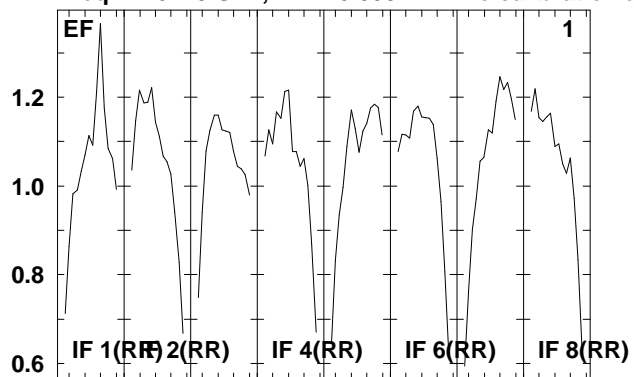

Lower frame: Real Jy  
Total-power spectrum Antenna: \*  
Timerange: 01/02:46:01 to 01/02:47:20

Plot file version 134 created 20-OCT-2009 14:50:04

FAINTCAL RP015C.UVDATA.1

Freq = 1.6270 GHz, Bw = 8.000 MH No calibration applied and no bandpass applied

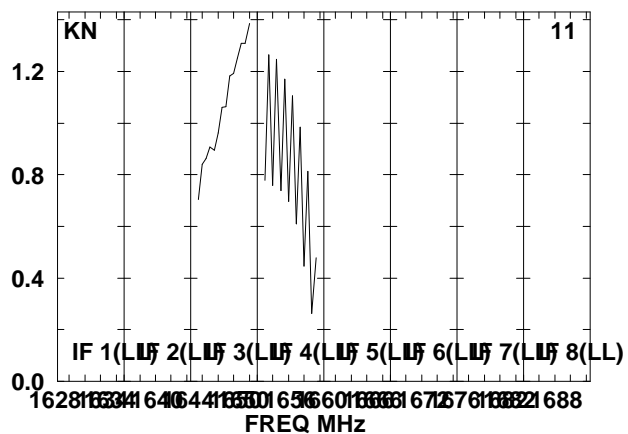
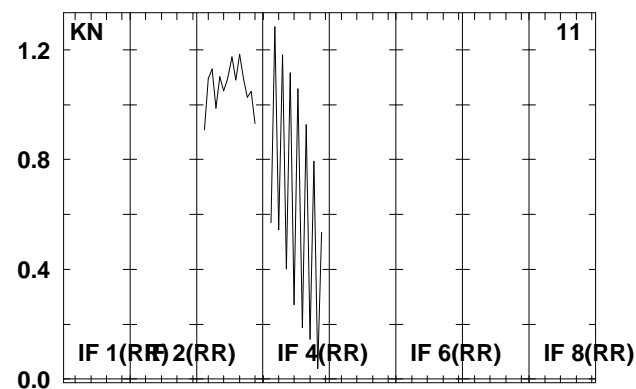
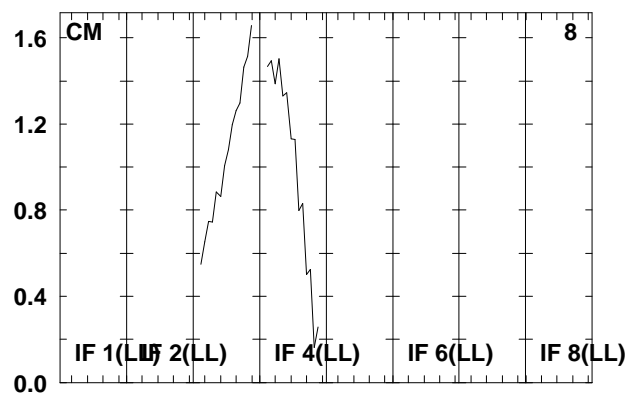
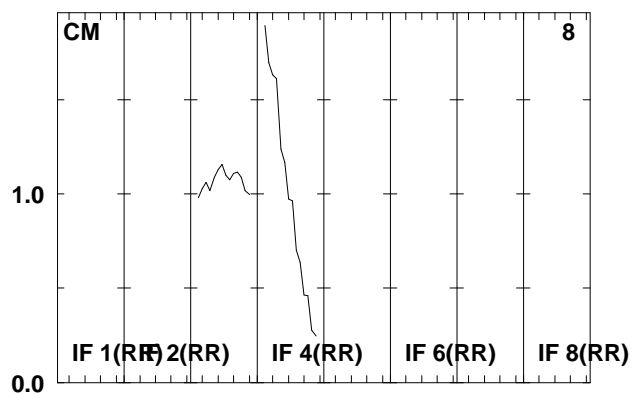
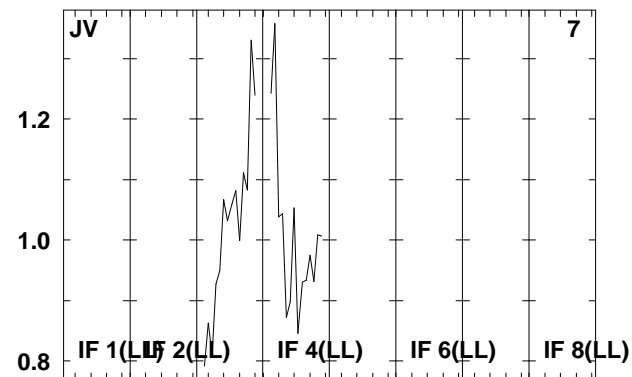
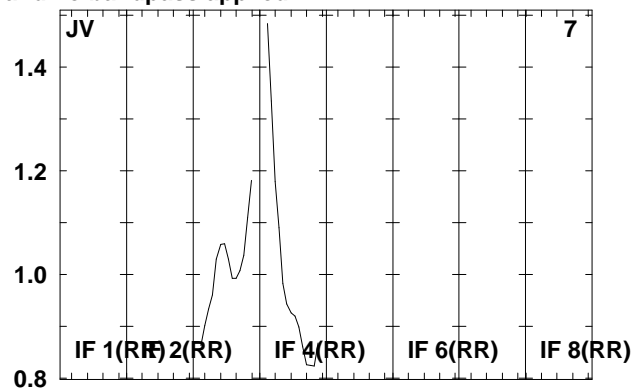
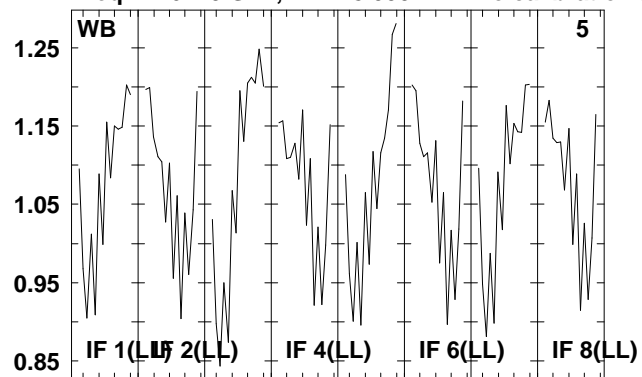

Lower frame: Real Jy

Total-power spectrum Antenna: \*

Timerange: 01/02:46:01 to 01/02:47:20

Plot file version 135 created 20-OCT-2009 14:50:04

M33 RP015C.UVDATA.1

Freq = 1.6270 GHz, Bw = 8.000 MH No calibration applied and no bandpass applied

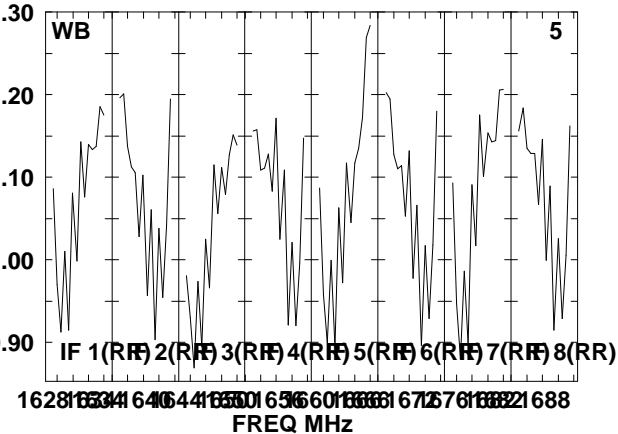
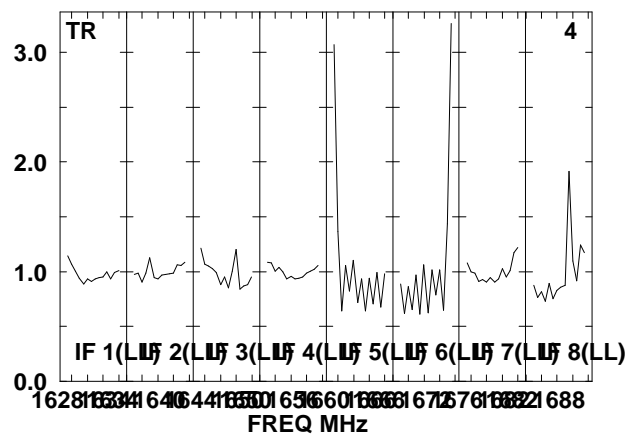
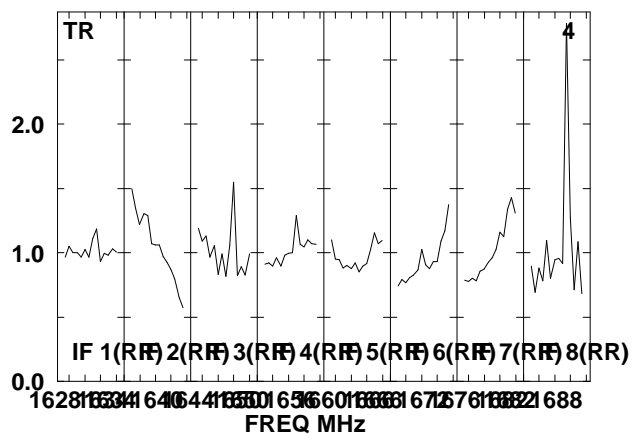
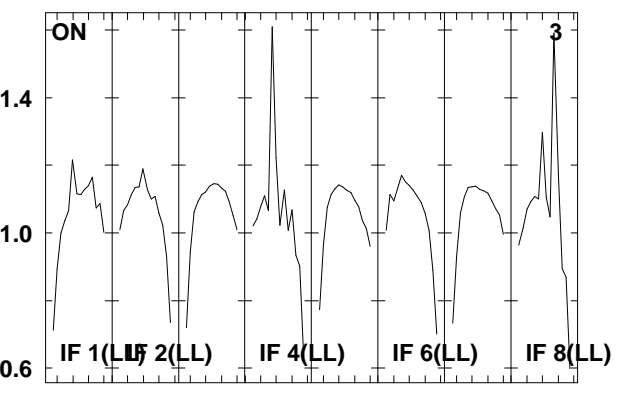
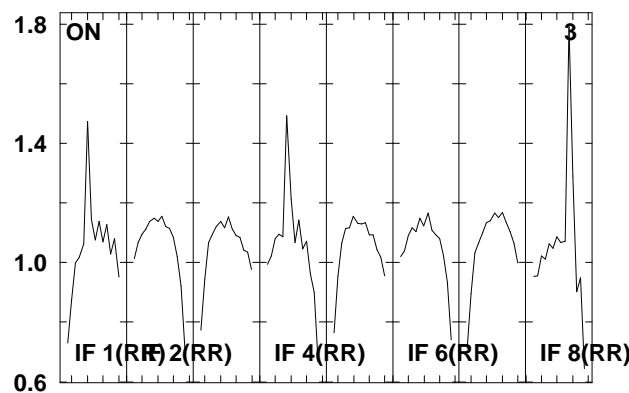
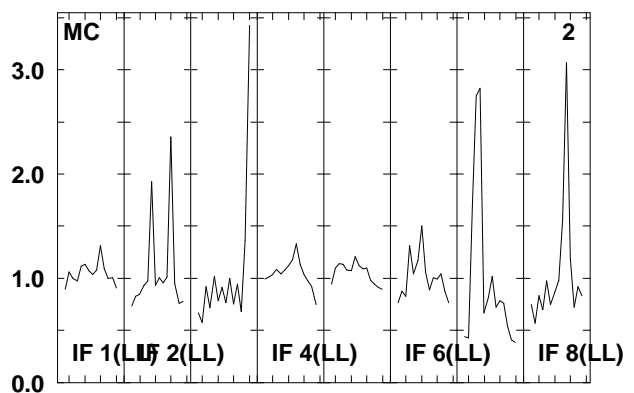
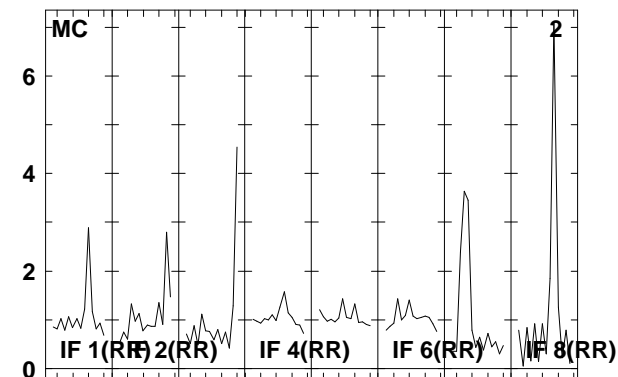
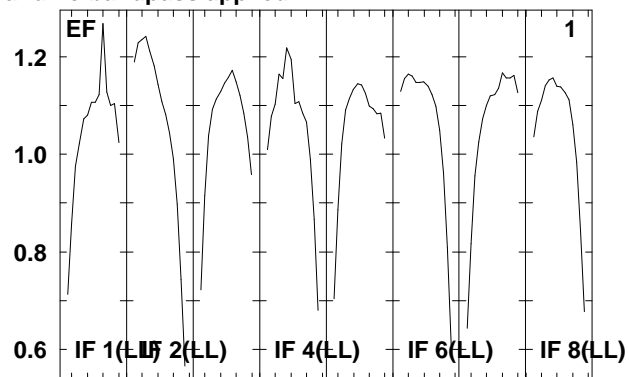
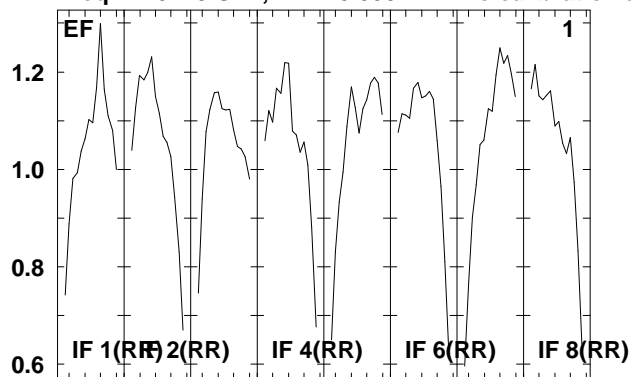

Lower frame: Real Jy  
Total-power spectrum Antenna: \*  
Timerange: 01/02:47:21 to 01/02:50:20

Plot file version 136 created 20-OCT-2009 14:50:05

M33 RP015C.UVDATA.1

Freq = 1.6270 GHz, Bw = 8.000 MH No calibration applied and no bandpass applied

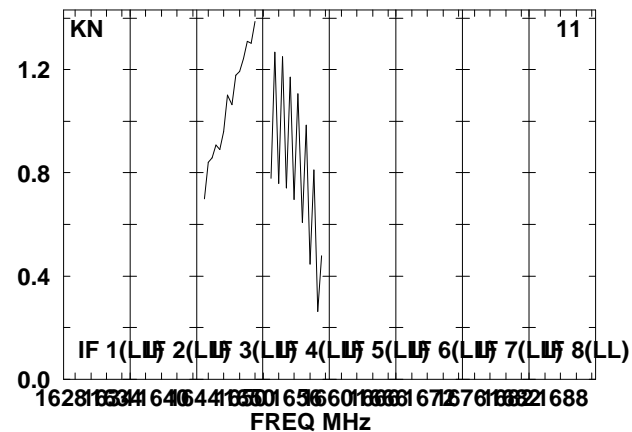
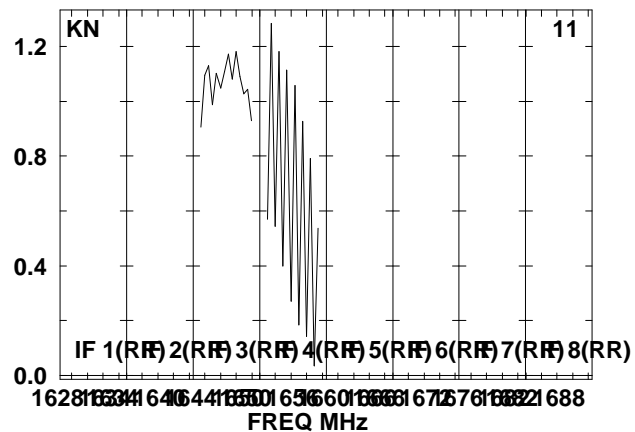
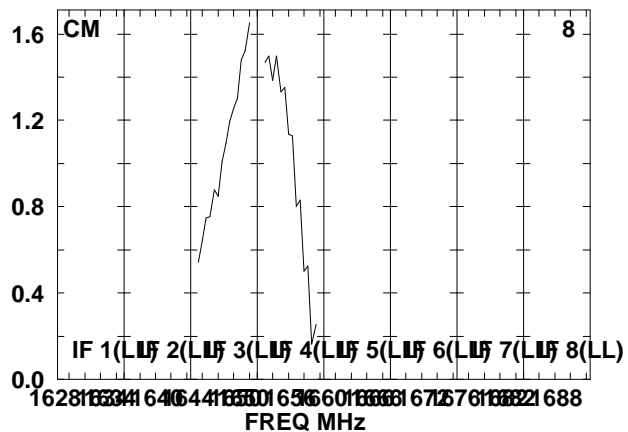
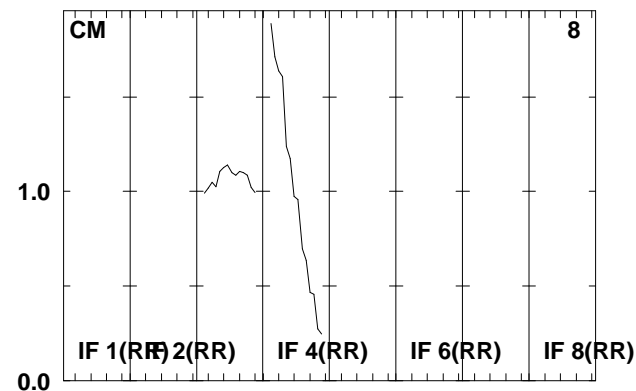
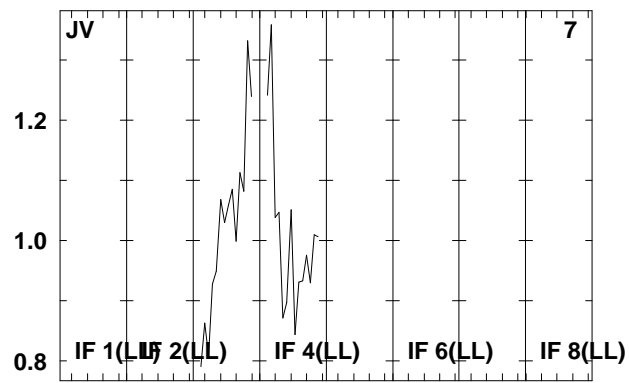
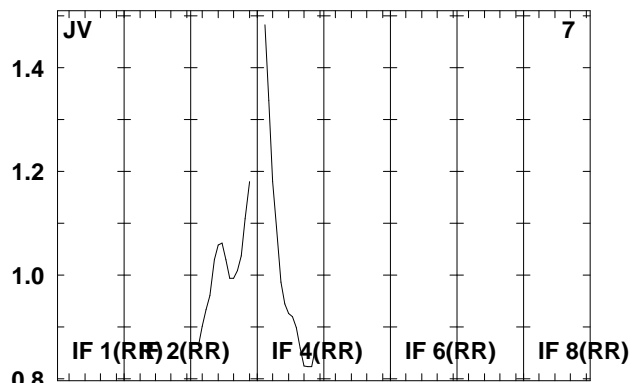
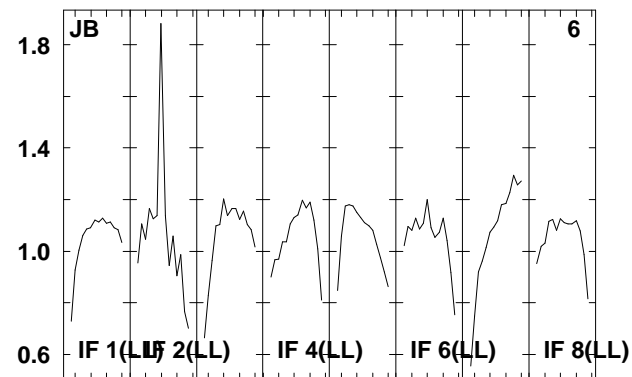
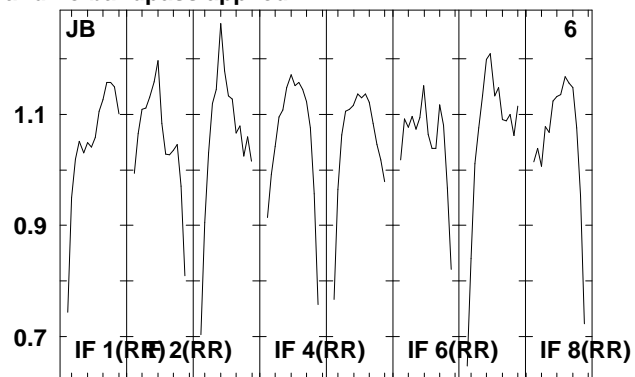
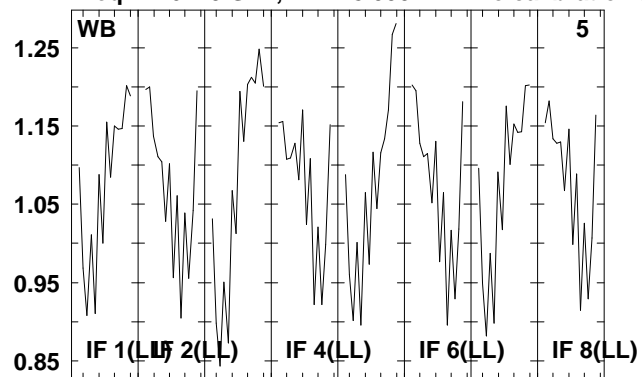

Lower frame: Real Jy  
Total-power spectrum Antenna: \*  
Timerange: 01/02:47:21 to 01/02:50:20



Plot file version 137 created 20-OCT-2009 14:50:07

J0137+31 RP015C.UVDATA.1

Freq = 1.6270 GHz, Bw = 8.000 MH No calibration applied and no bandpass applied

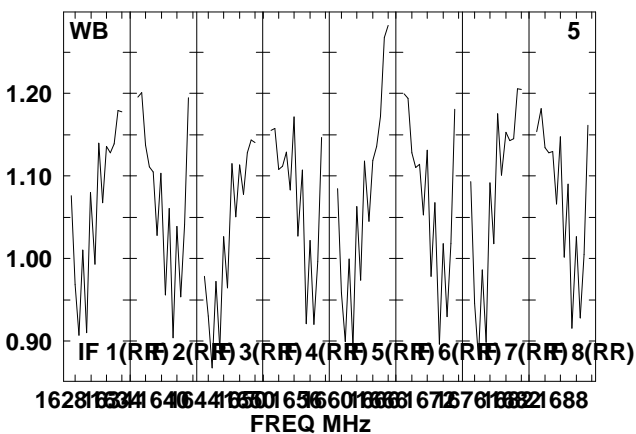
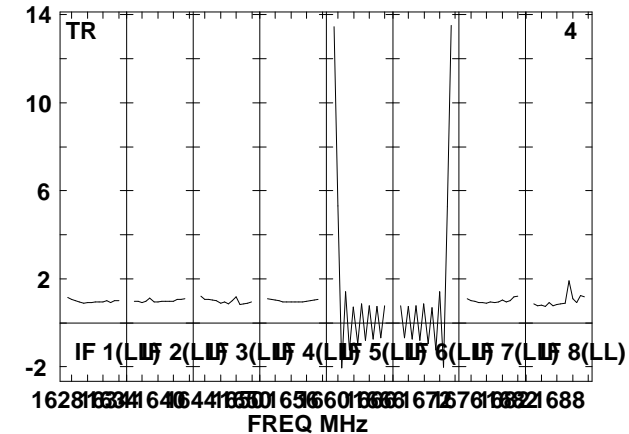
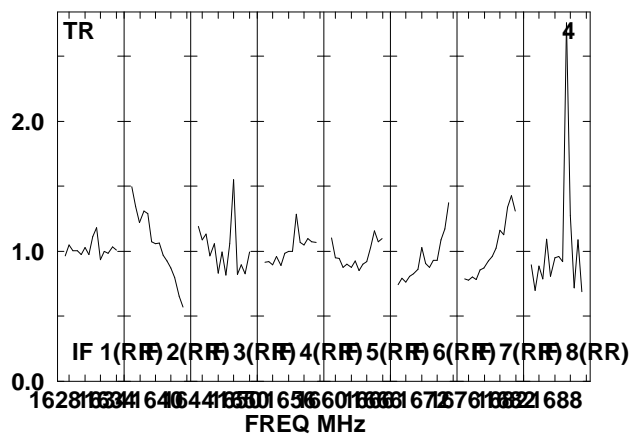
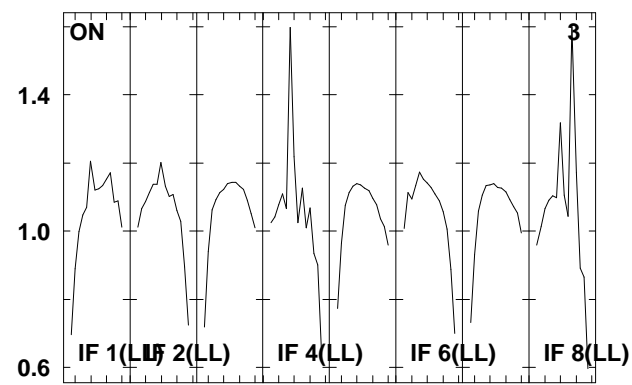
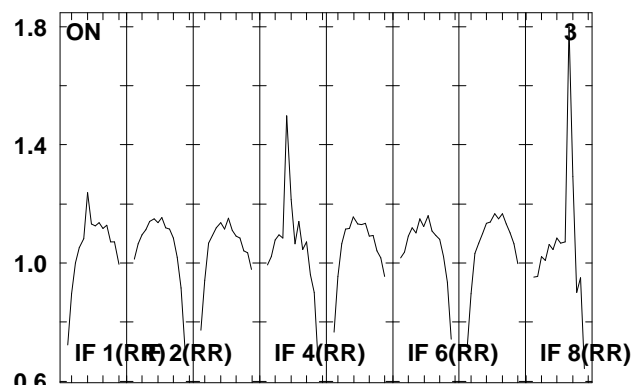
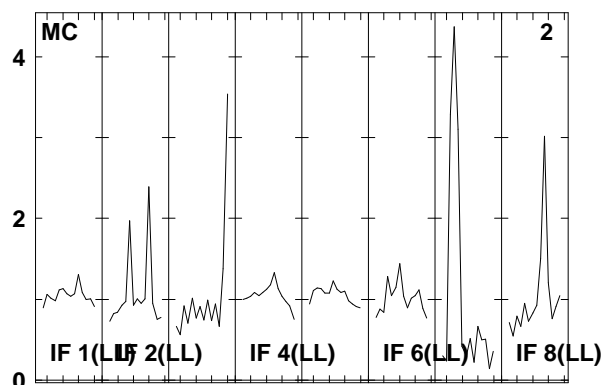
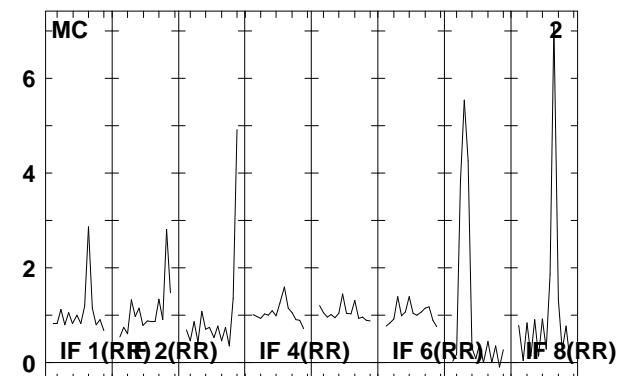
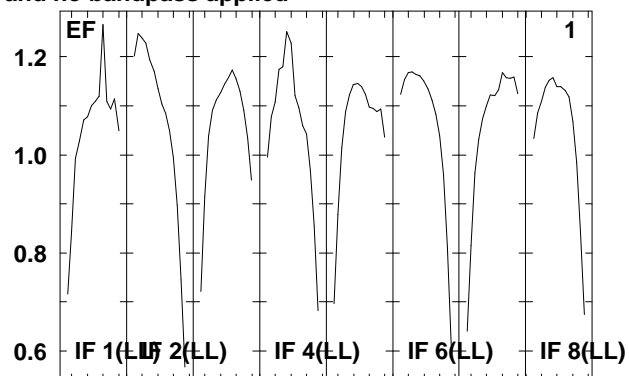
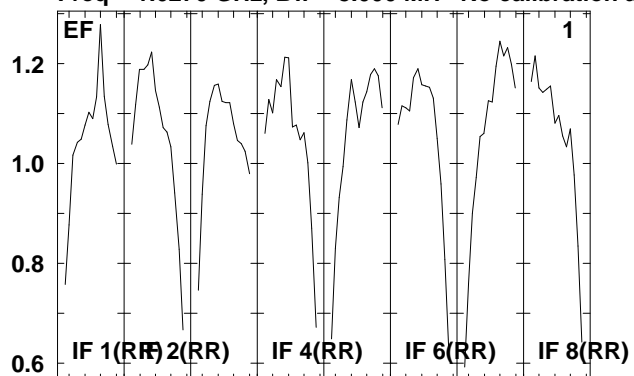

Lower frame: Real Jy

Total-power spectrum Antenna: \*

Timerange: 01/02:51:01 to 01/02:51:59

Plot file version 138 created 20-OCT-2009 14:50:07

J0137+31 RP015C.UVDATA.1

Freq = 1.6270 GHz, Bw = 8.000 MH No calibration applied and no bandpass applied

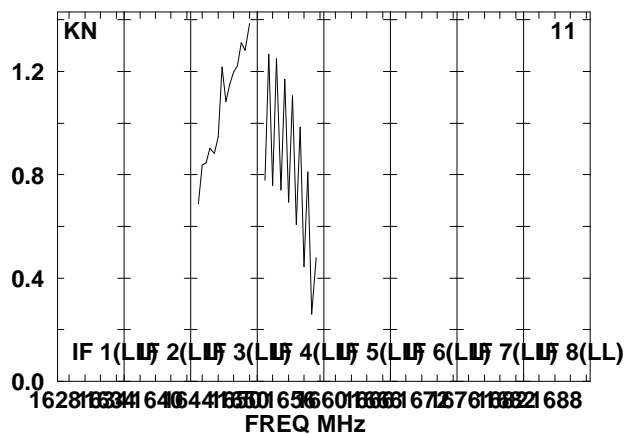
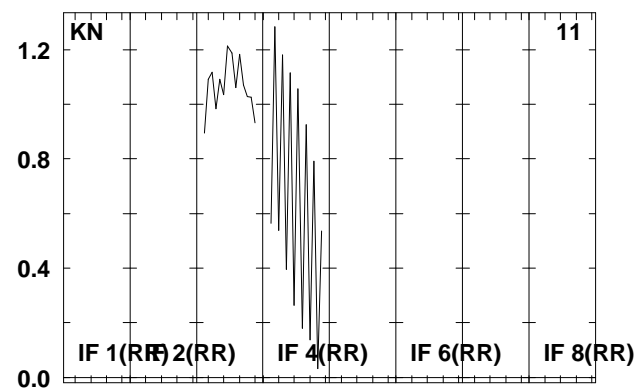
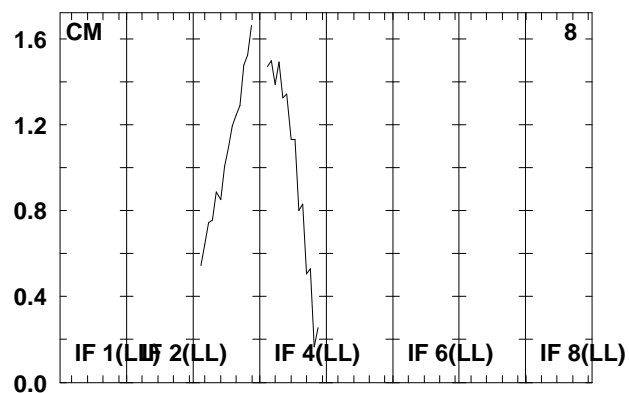
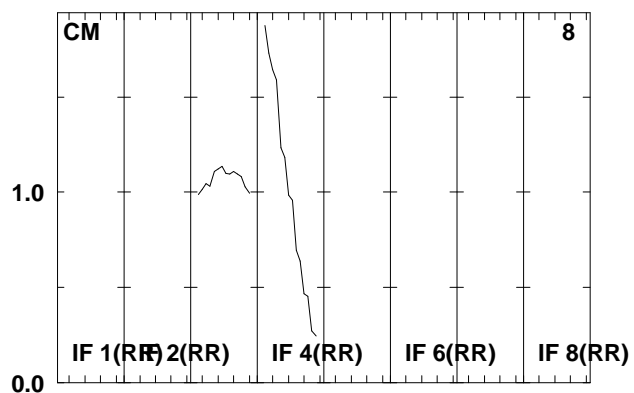
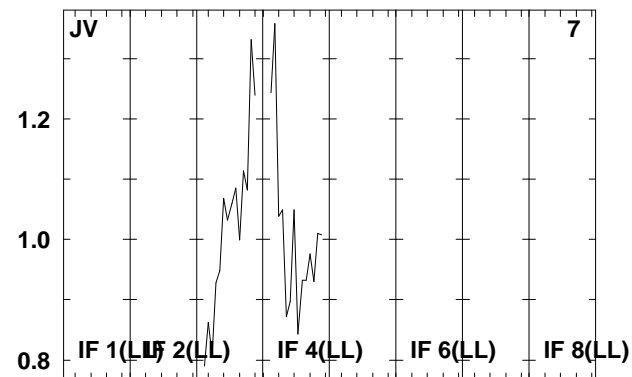
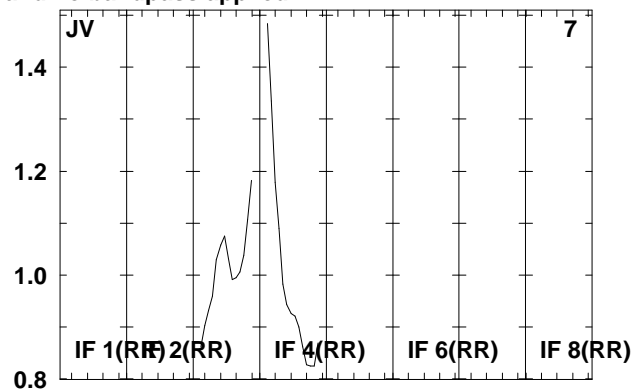
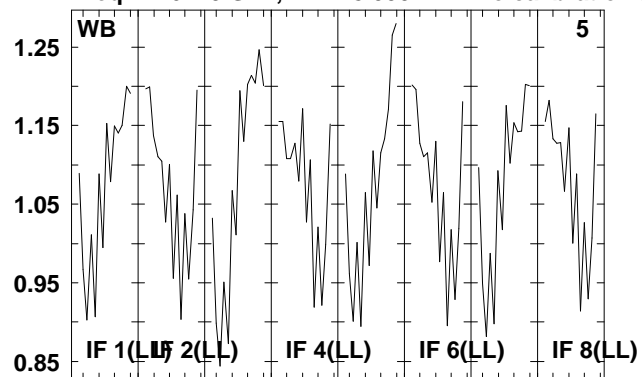

Lower frame: Real Jy

Total-power spectrum Antenna: \*

Timerange: 01/02:51:01 to 01/02:51:59

Plot file version 139 created 20-OCT-2009 14:50:08

FAINTCAL RP015C.UVDATA.1

Freq = 1.6270 GHz, Bw = 8.000 MH No calibration applied and no bandpass applied

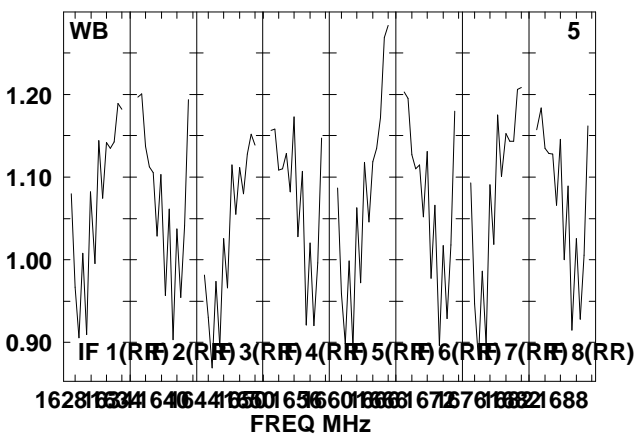
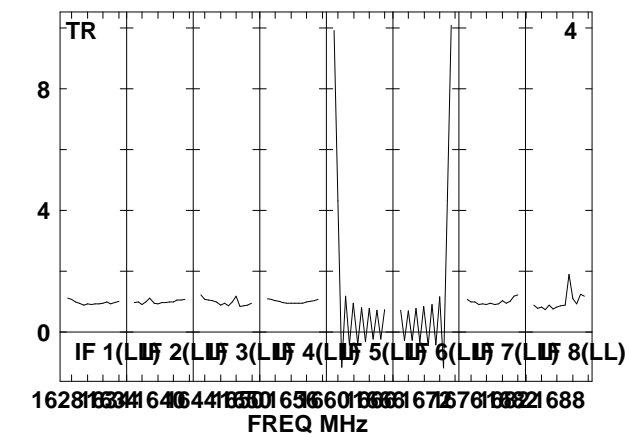
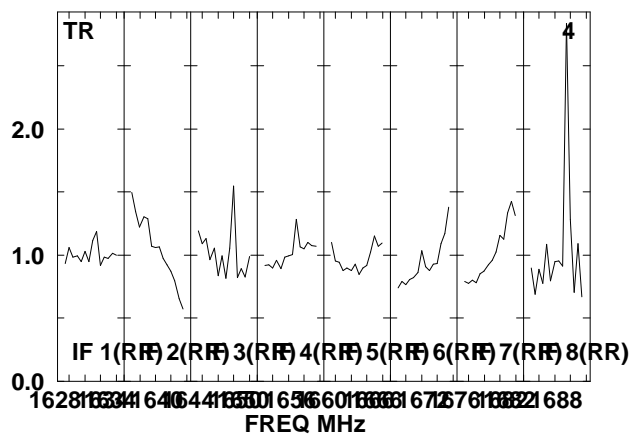
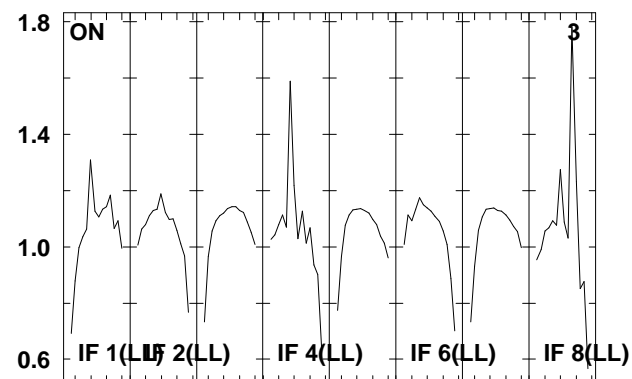
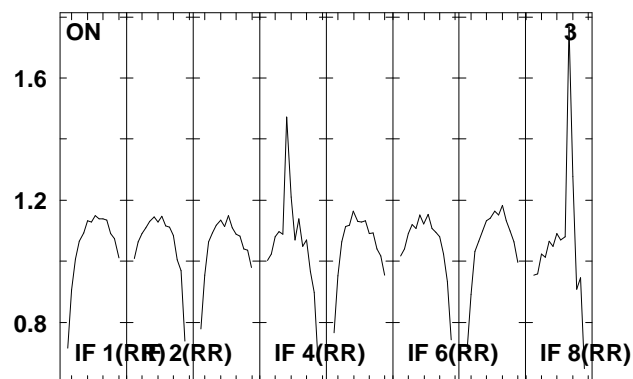
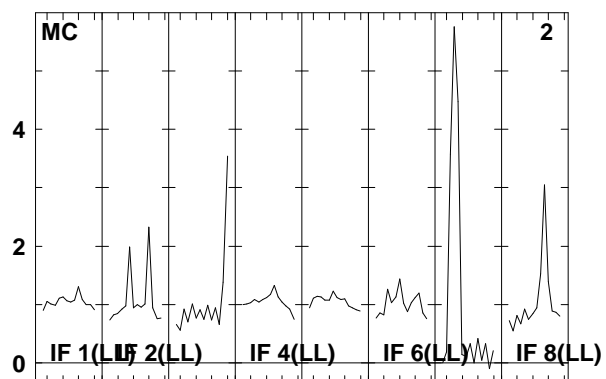
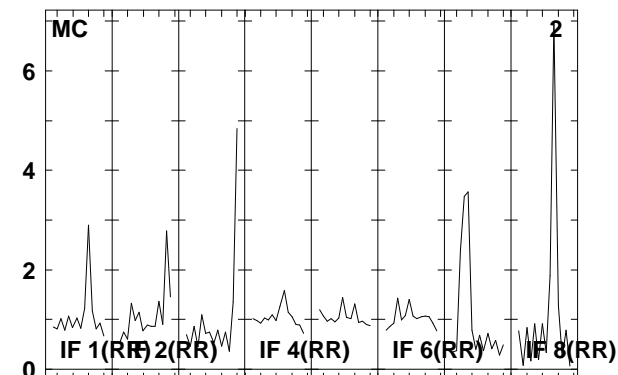
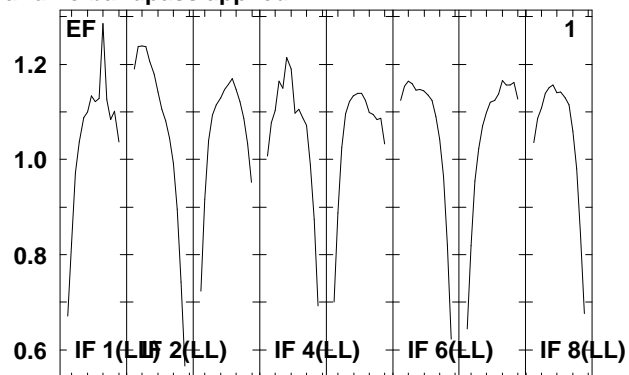
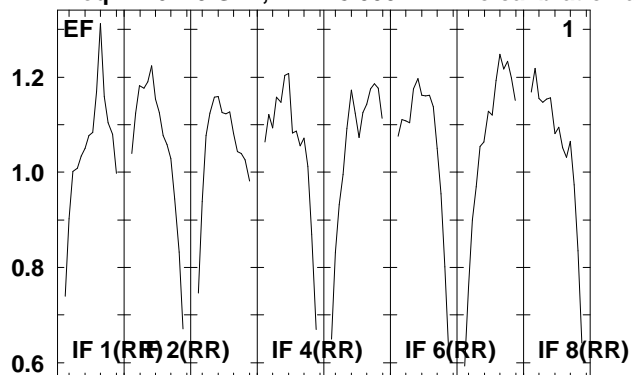

Lower frame: Real Jy

Total-power spectrum Antenna: \*

Timerange: 01/02:52:00 to 01/02:53:19

Plot file version 140 created 20-OCT-2009 14:50:08

FAINTCAL RP015C.UVDATA.1

Freq = 1.6270 GHz, Bw = 8.000 MH No calibration applied and no bandpass applied

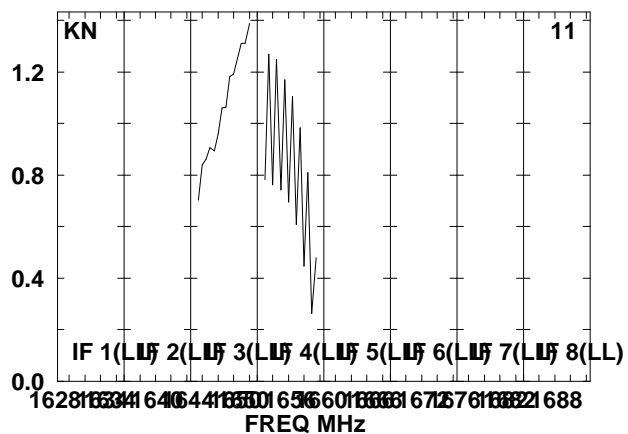
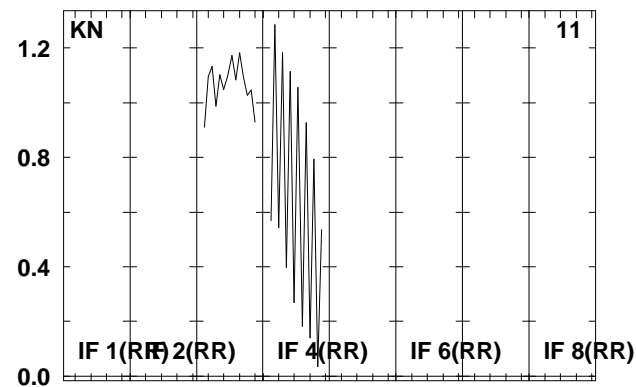
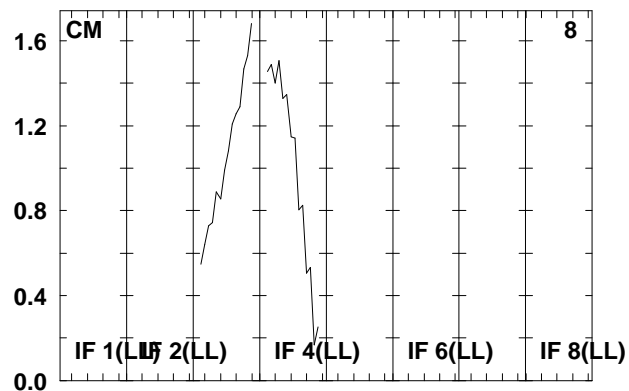
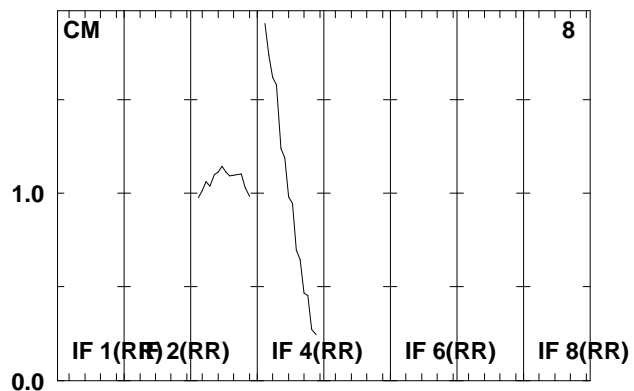
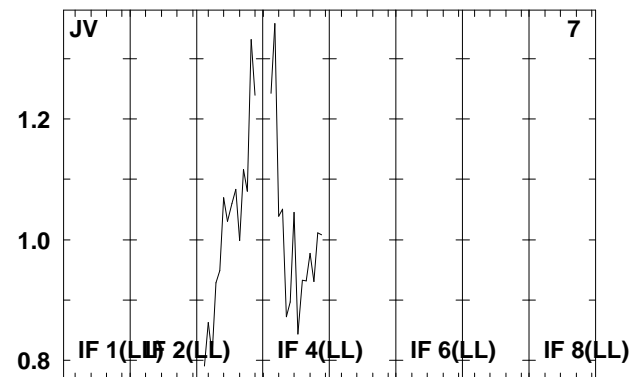
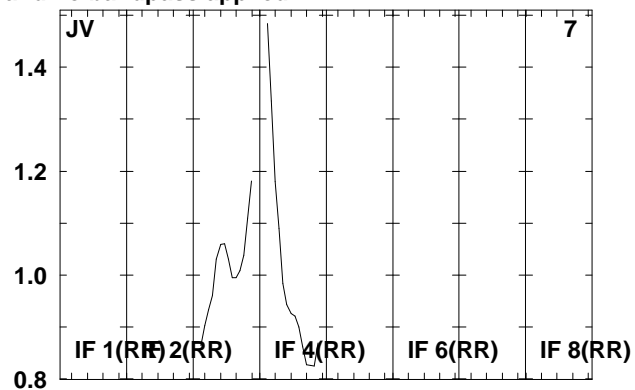
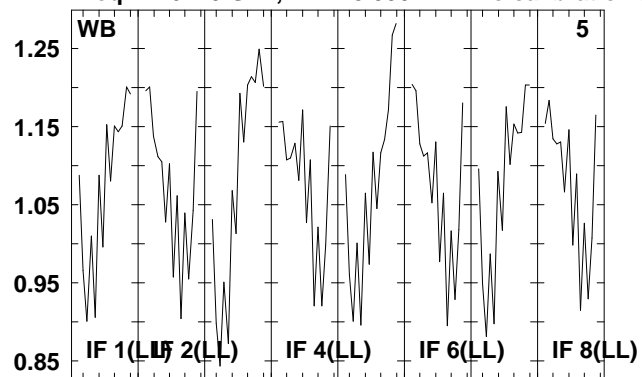

Lower frame: Real Jy

Total-power spectrum Antenna: \*

Timerange: 01/02:52:00 to 01/02:53:19

Plot file version 141 created 20-OCT-2009 14:50:09

M33 RP015C.UVDATA.1

Freq = 1.6270 GHz, Bw = 8.000 MH No calibration applied and no bandpass applied

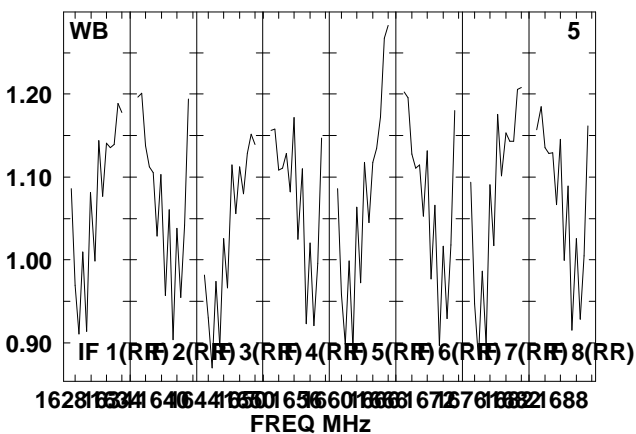
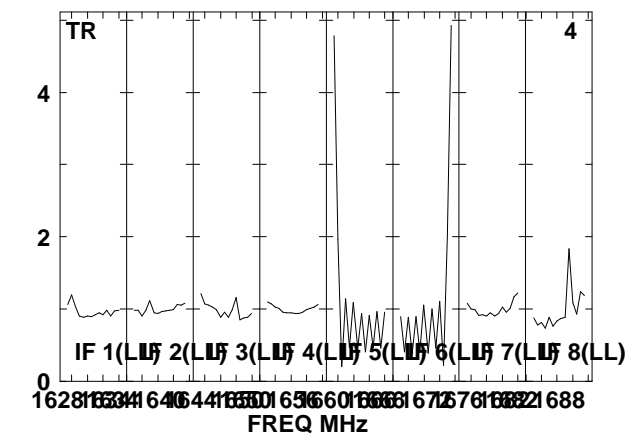
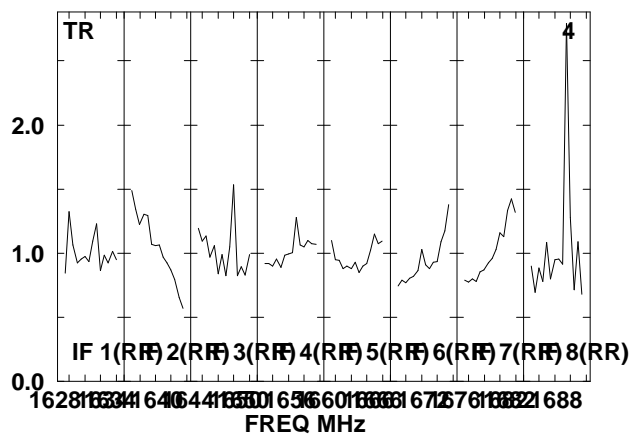
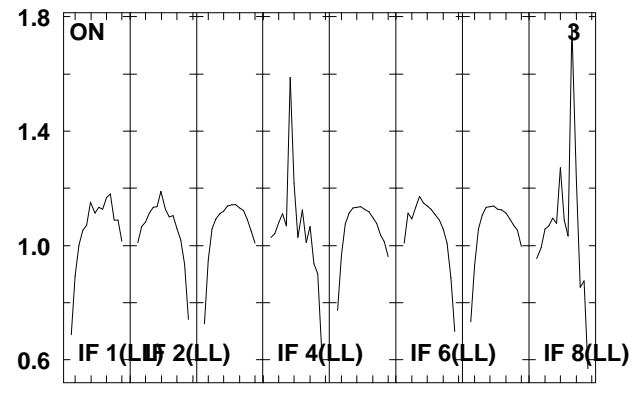
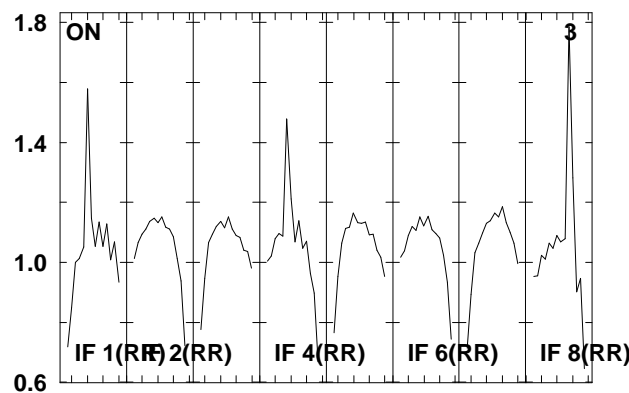
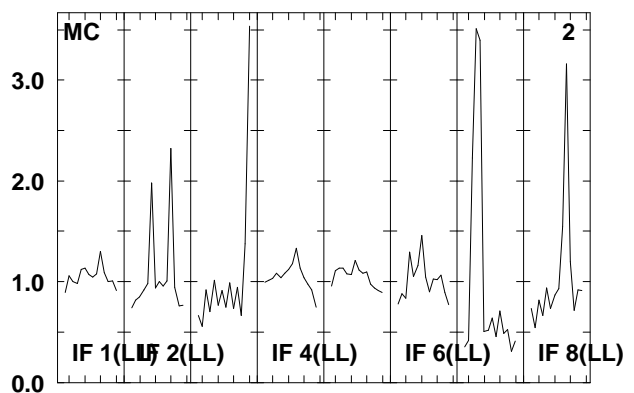
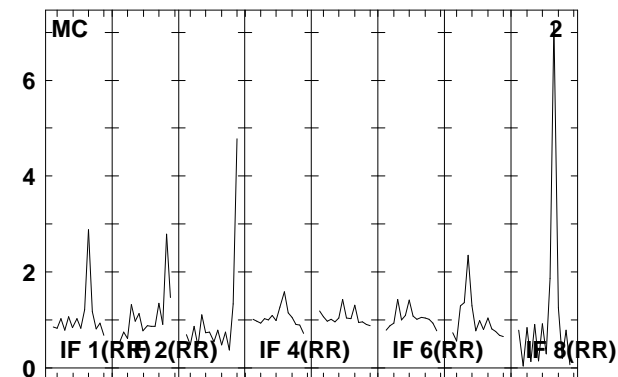
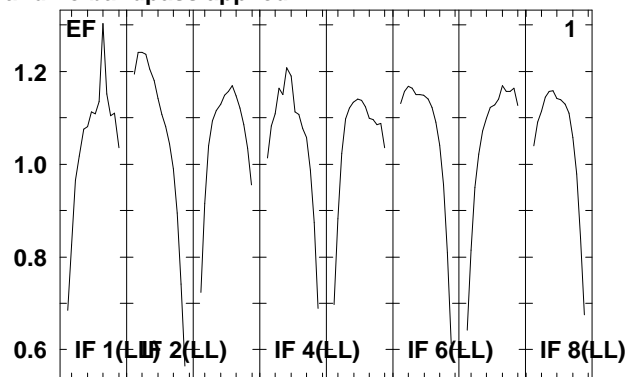
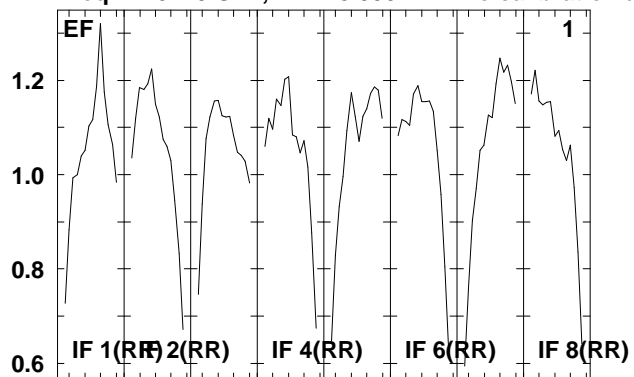

Lower frame: Real Jy  
Total-power spectrum Antenna: \*  
Timerange: 01/02:53:20 to 01/02:56:20

Plot file version 142 created 20-OCT-2009 14:50:10

M33 RP015C.UVDATA.1

Freq = 1.6270 GHz, Bw = 8.000 MH No calibration applied and no bandpass applied

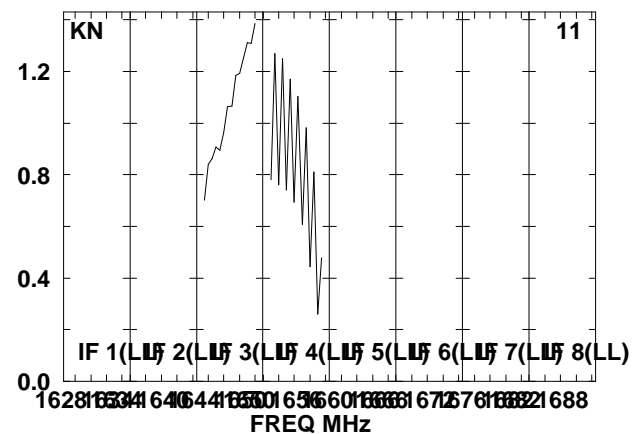
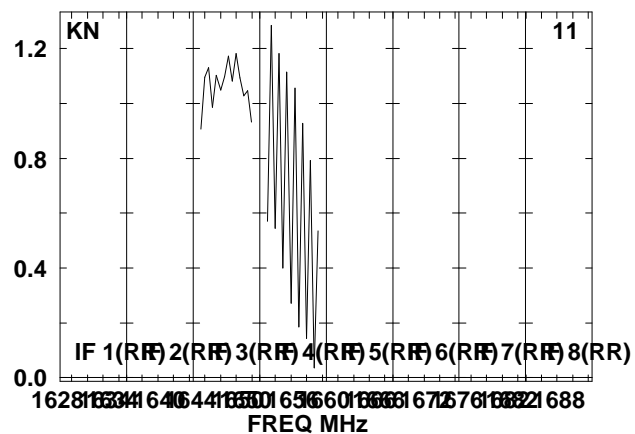
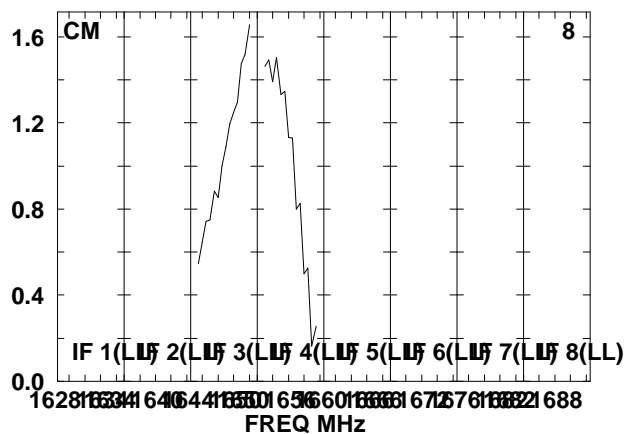
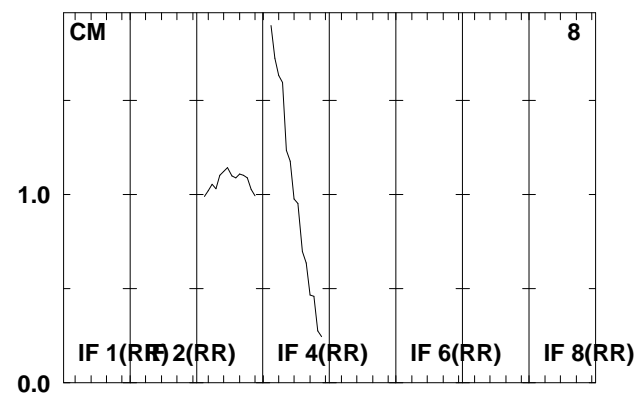
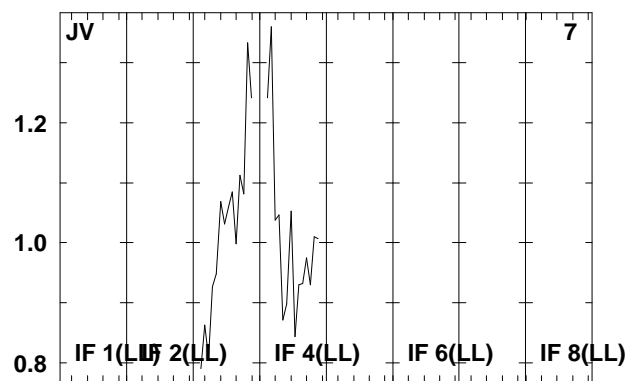
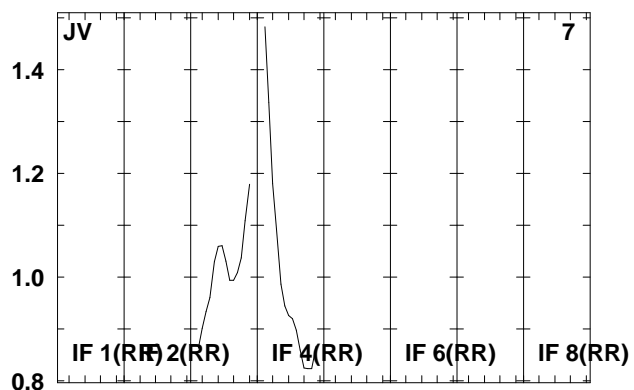
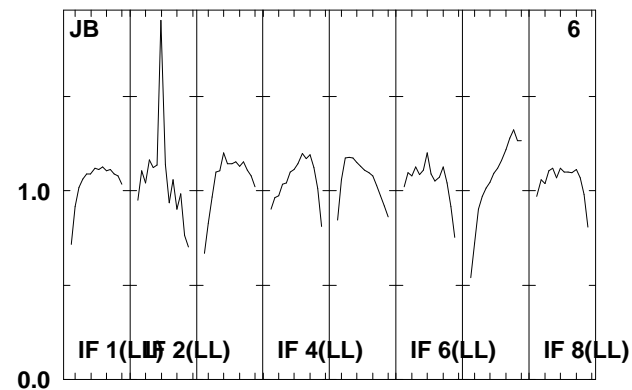
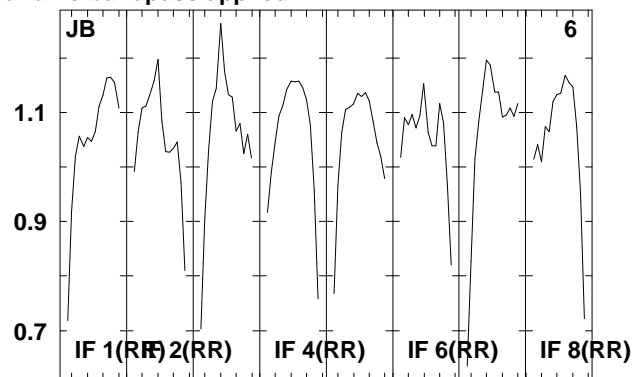
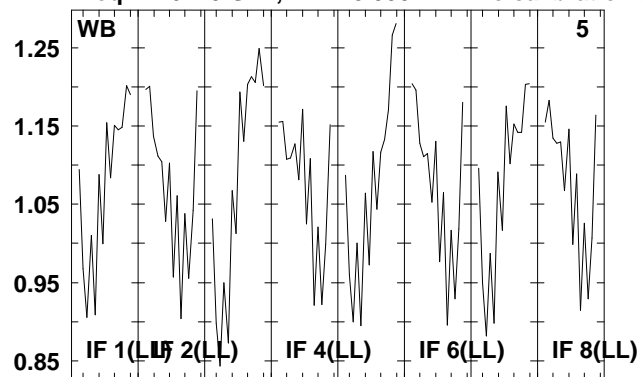

Lower frame: Real Jy  
Total-power spectrum Antenna: \*  
Timerange: 01/02:53:20 to 01/02:56:20

Plot file version 143 created 20-OCT-2009 14:50:11

J0137+31 RP015C.UVDATA.1

Freq = 1.6270 GHz, Bw = 8.000 MH No calibration applied and no bandpass applied

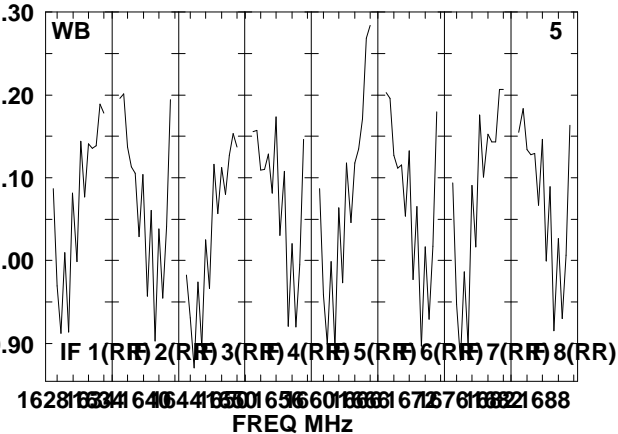
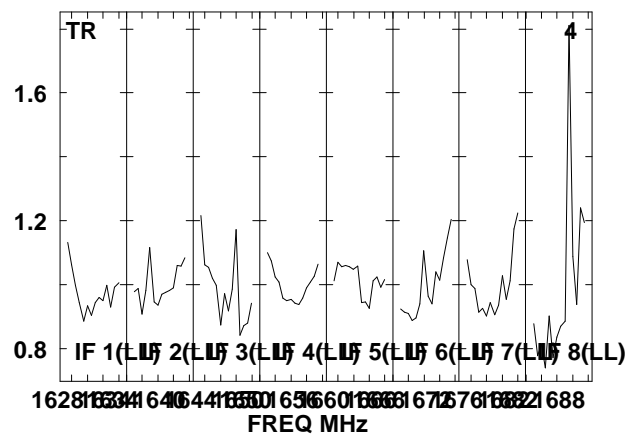
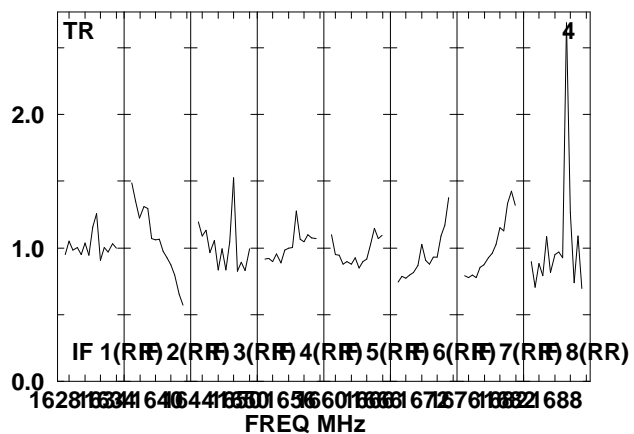
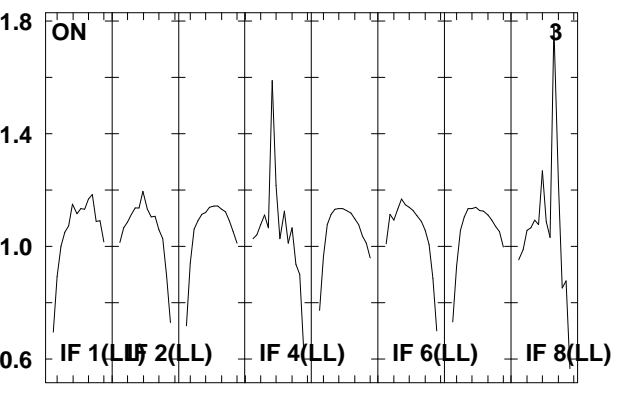
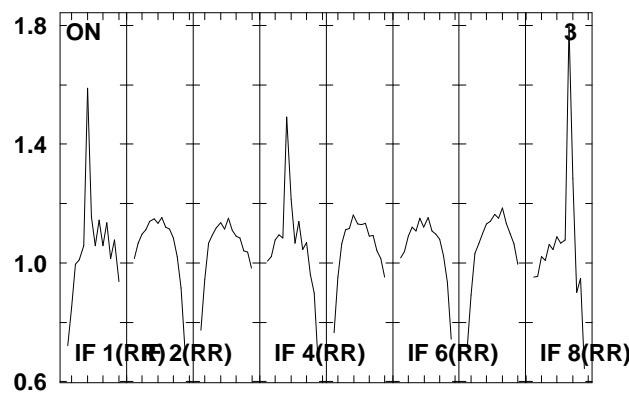
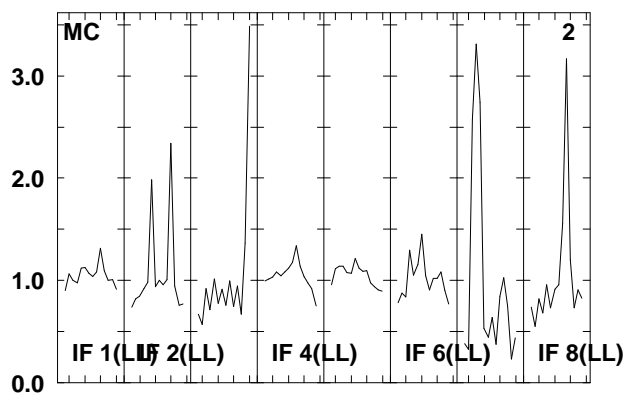
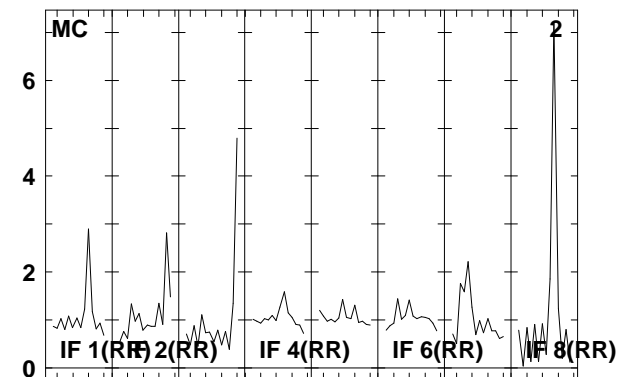
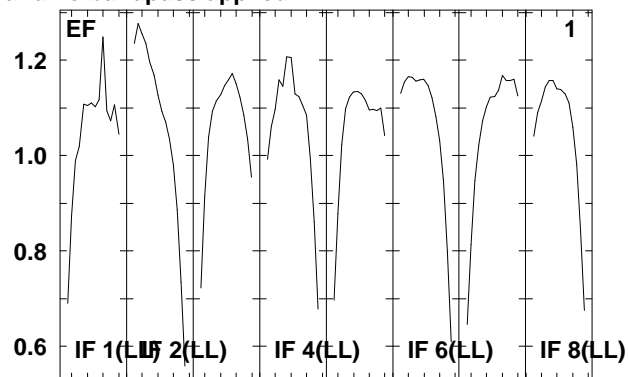
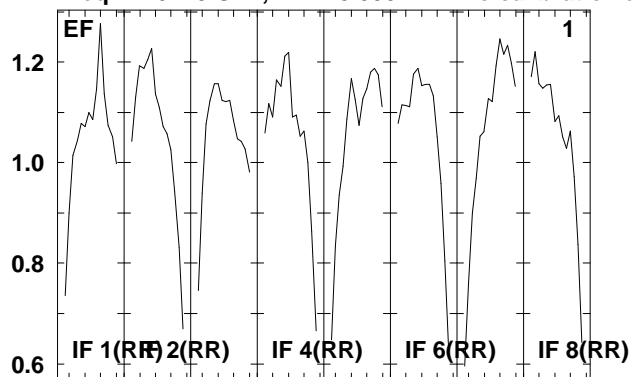

Lower frame: Real Jy  
Total-power spectrum Antenna: \*  
Timerange: 01/02:57:00 to 01/02:57:59

Plot file version 144 created 20-OCT-2009 14:50:11

J0137+31 RP015C.UVDATA.1

Freq = 1.6270 GHz, Bw = 8.000 MH No calibration applied and no bandpass applied

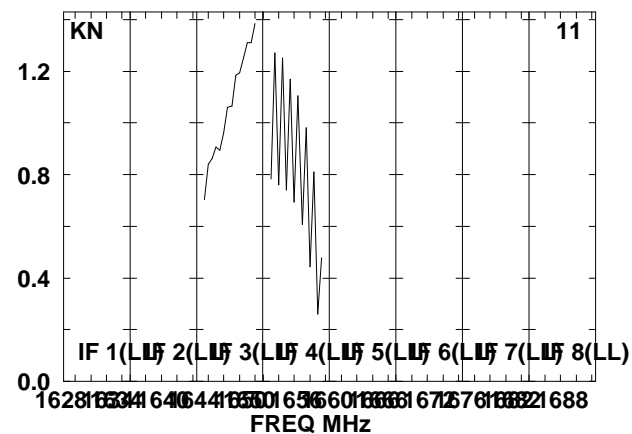
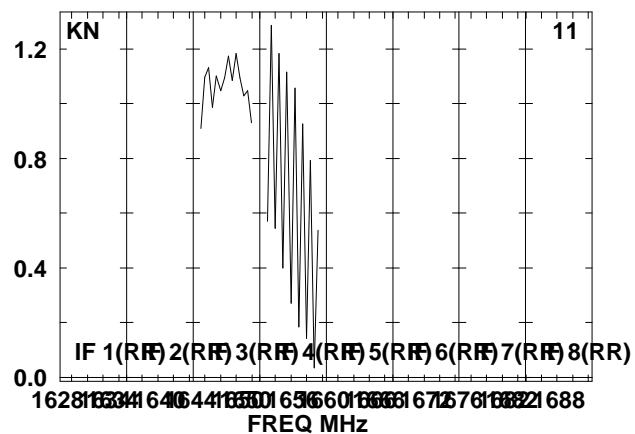
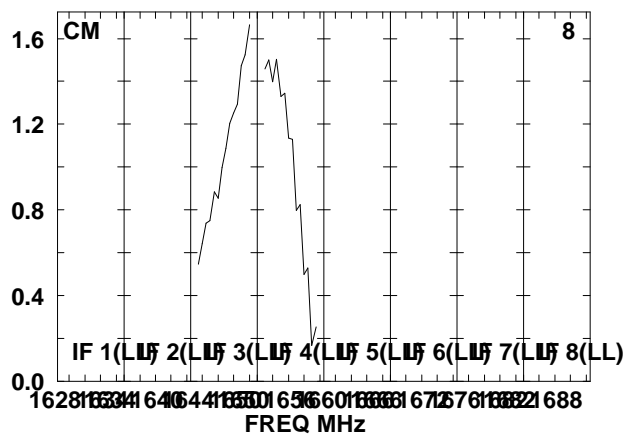
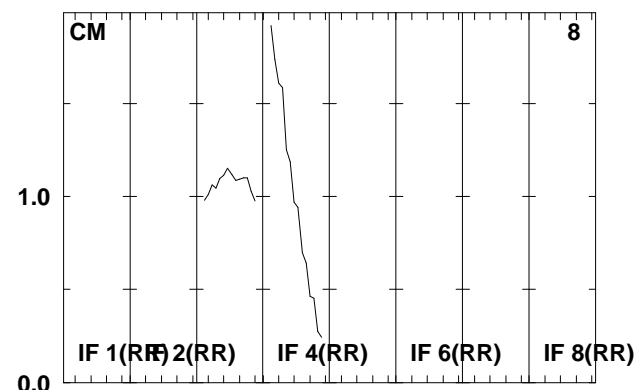
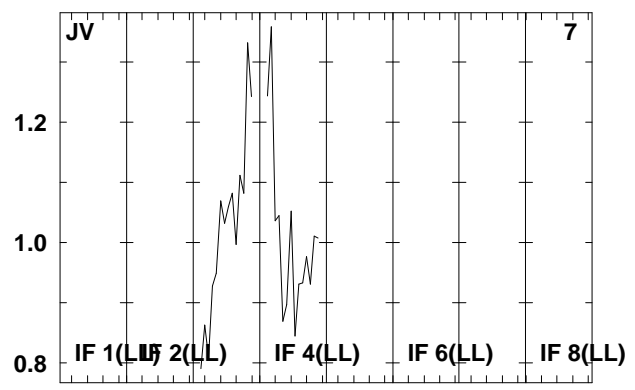
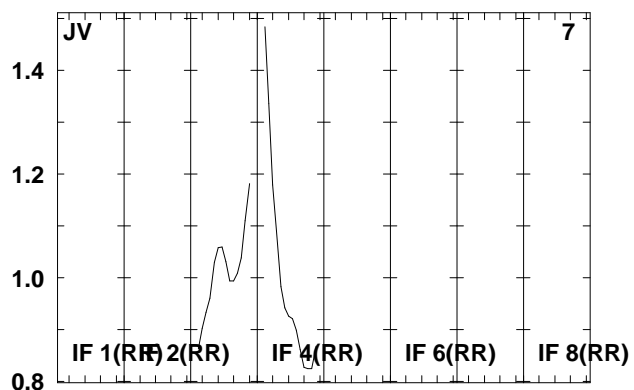
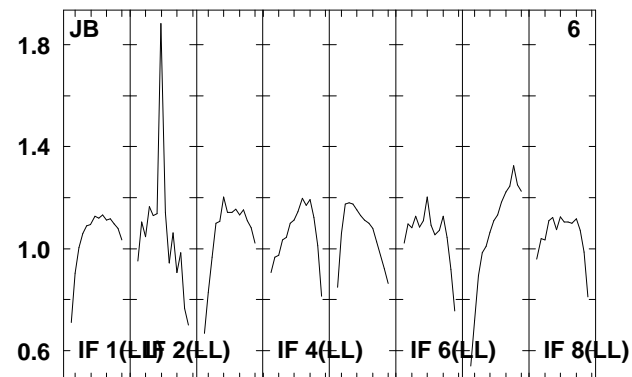
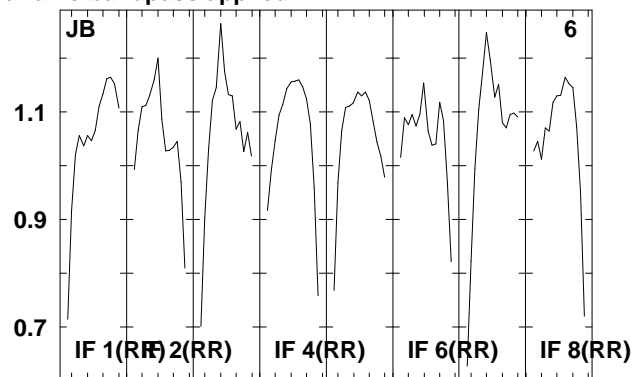
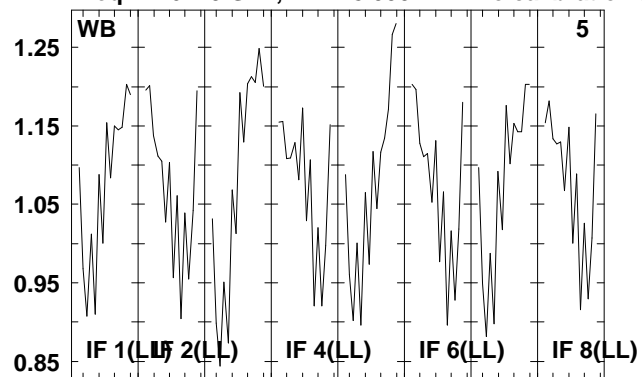

Lower frame: Real Jy  
Total-power spectrum Antenna: \*  
Timerange: 01/02:57:00 to 01/02:57:59



Plot file version 145 created 20-OCT-2009 14:50:12

FAINTCAL RP015C.UVDATA.1

Freq = 1.6270 GHz, Bw = 8.000 MH No calibration applied and no bandpass applied

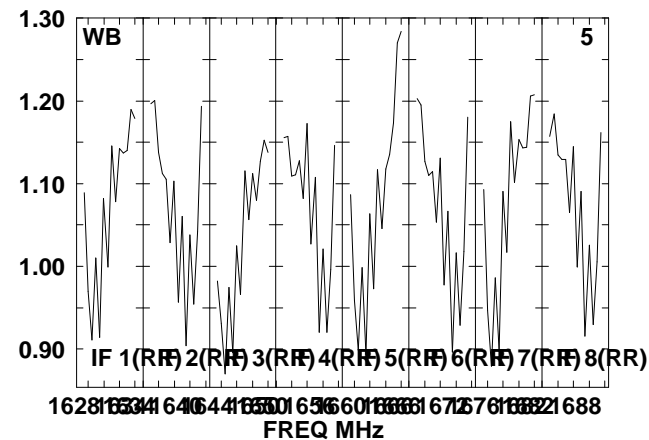
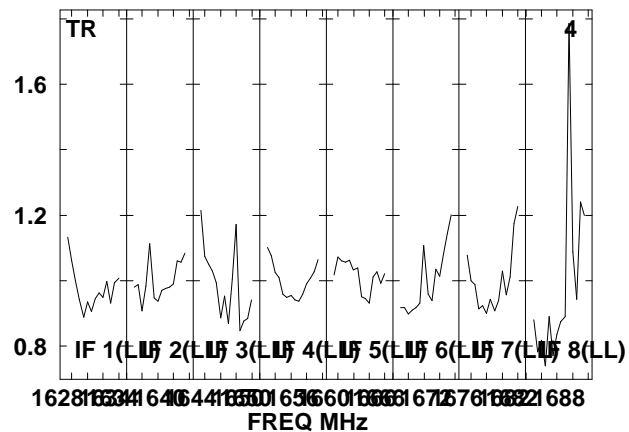
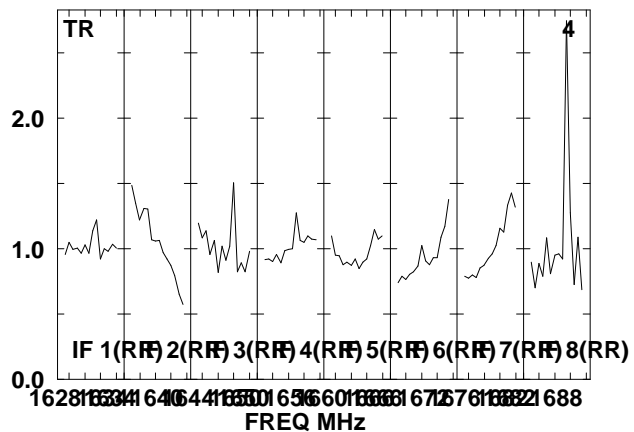
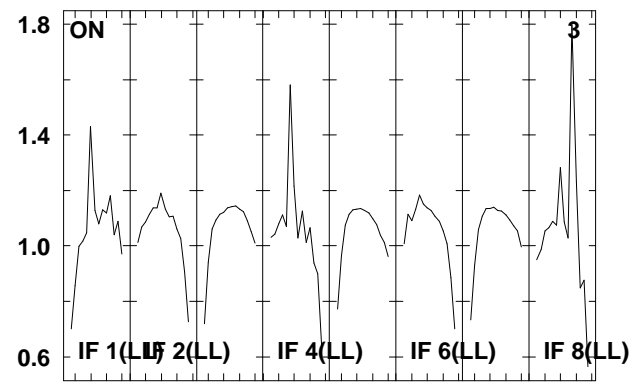
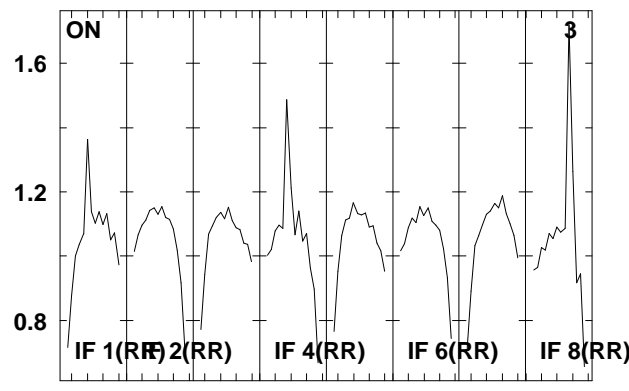
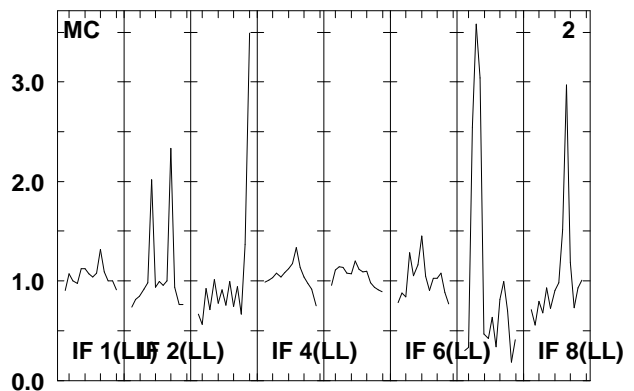
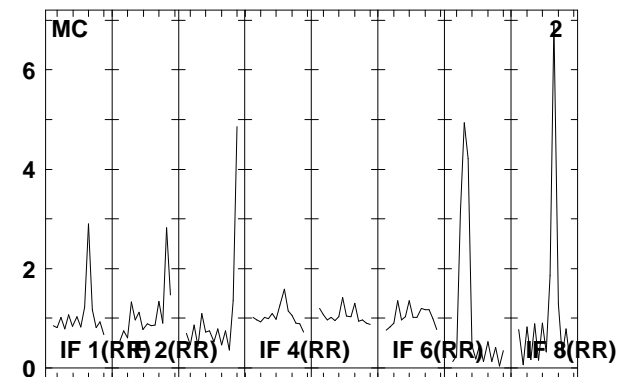
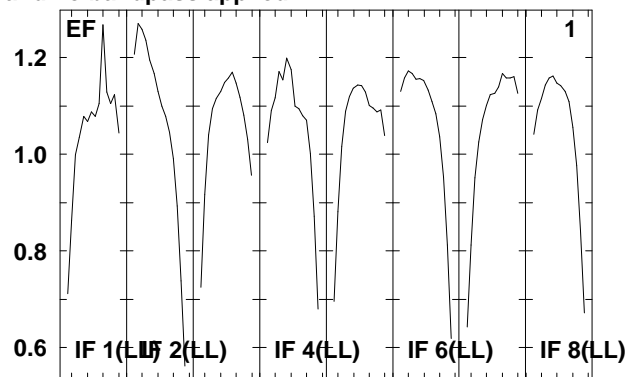
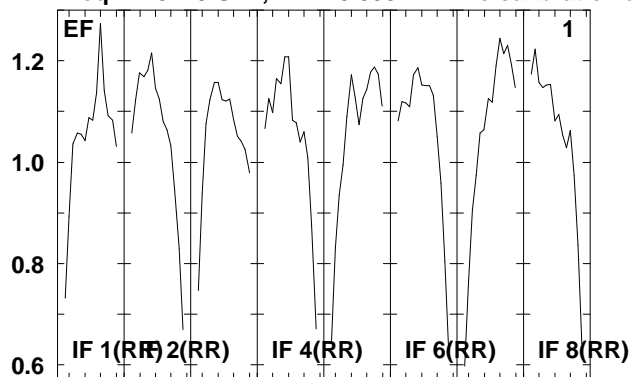

Lower frame: Real Jy  
Total-power spectrum Antenna: \*  
Timerange: 01/02:58:01 to 01/02:59:20

Plot file version 146 created 20-OCT-2009 14:50:12

FAINTCAL RP015C.UVDATA.1

Freq = 1.6270 GHz, Bw = 8.000 MH No calibration applied and no bandpass applied

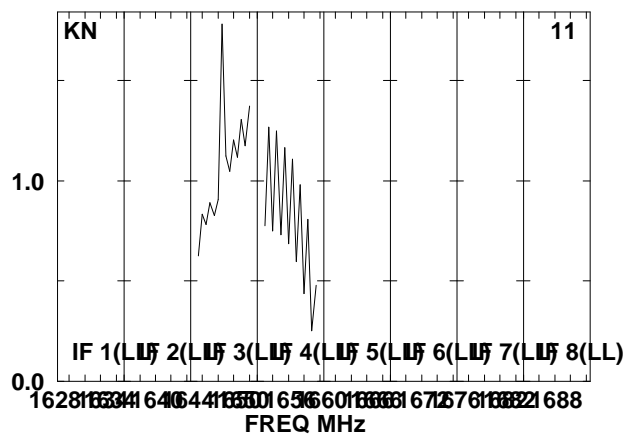
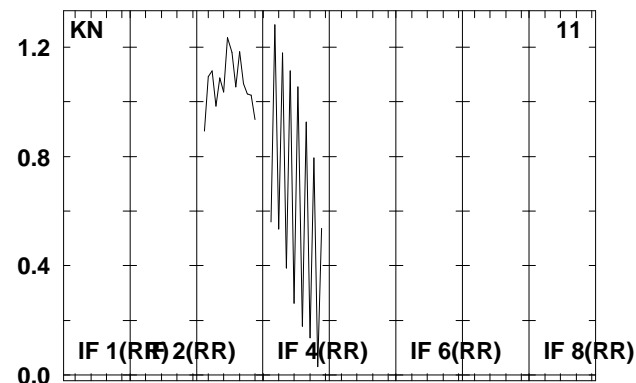
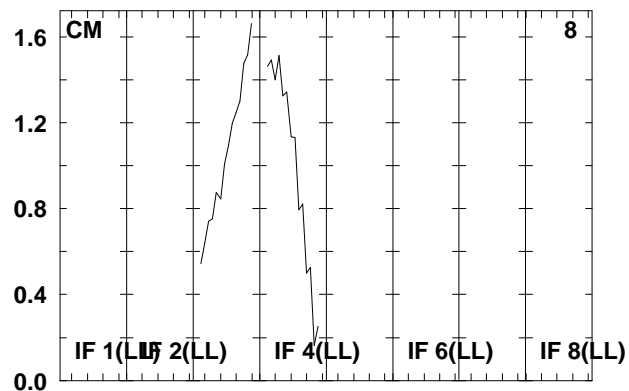
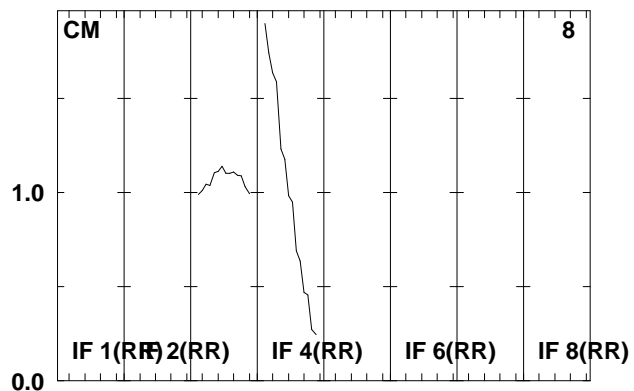
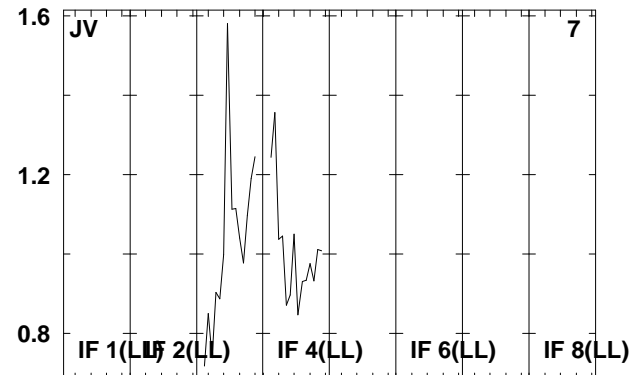
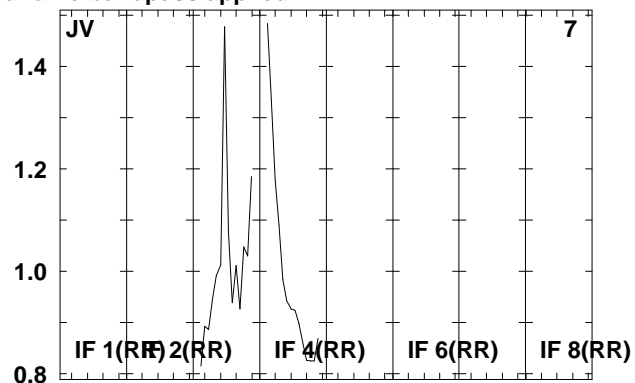
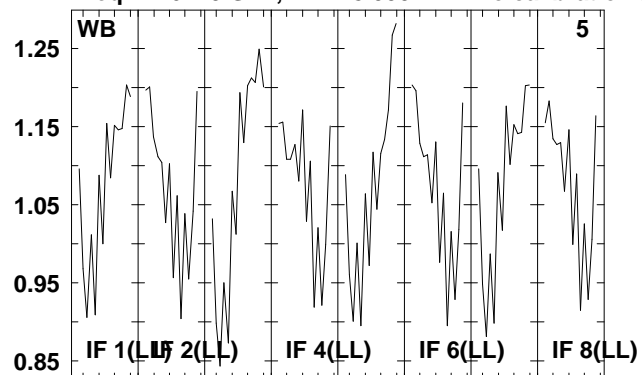

Lower frame: Real Jy

Total-power spectrum Antenna: \*

Timerange: 01/02:58:01 to 01/02:59:20

Plot file version 147 created 20-OCT-2009 14:50:13

M33 RP015C.UVDATA.1

Freq = 1.6270 GHz, Bw = 8.000 MH No calibration applied and no bandpass applied

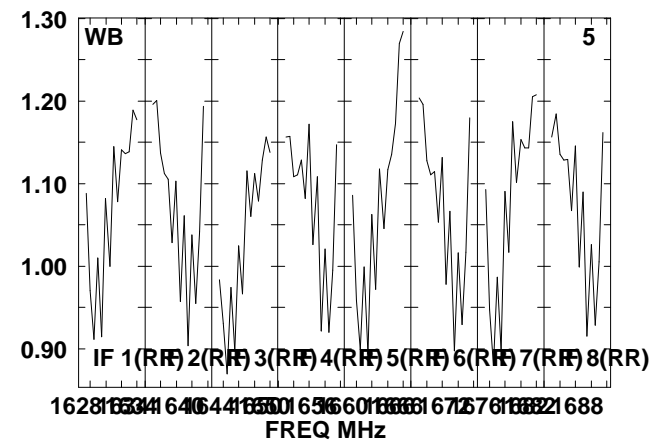
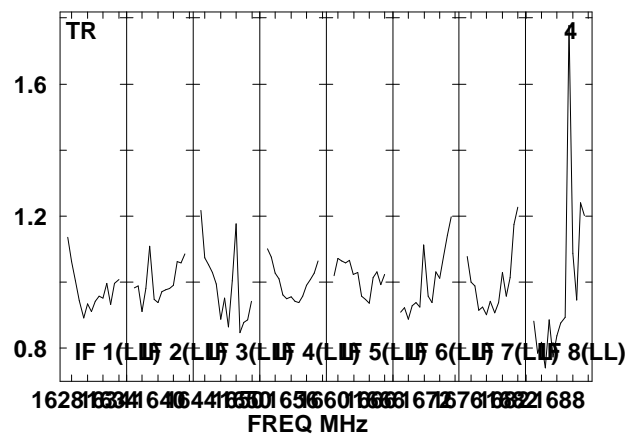
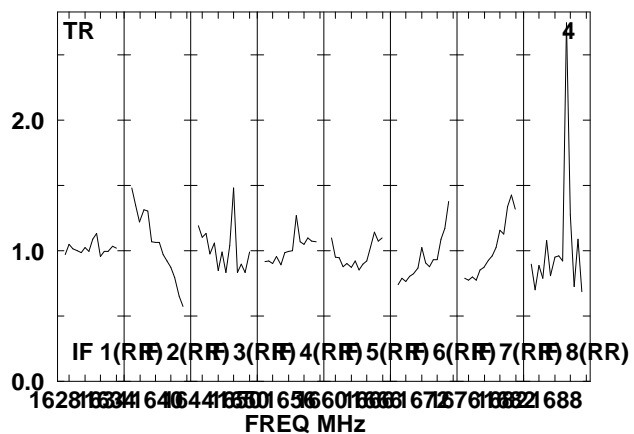
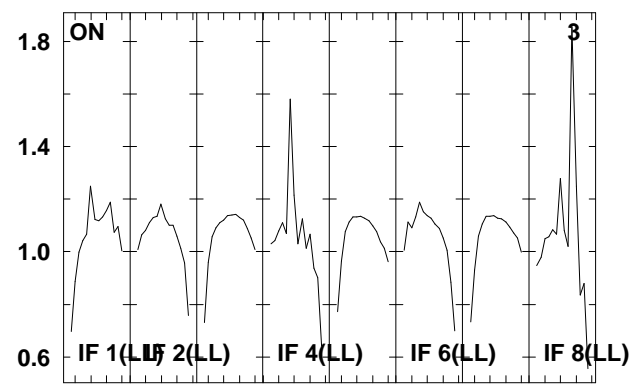
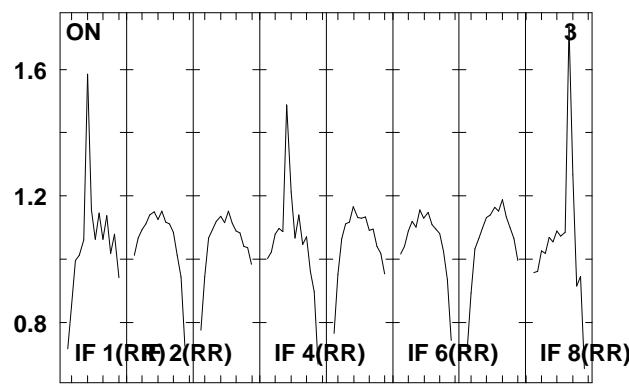
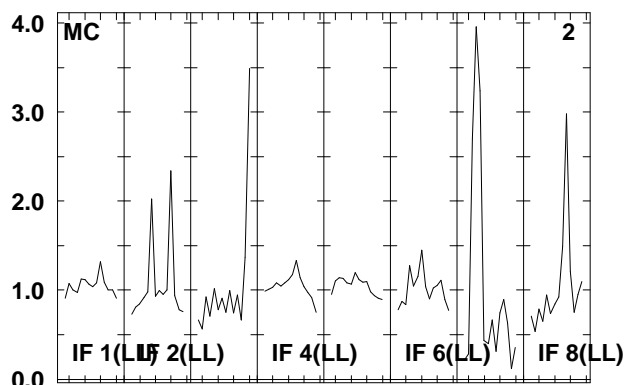
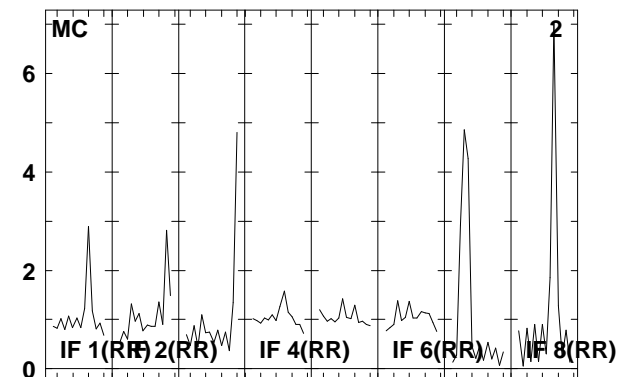
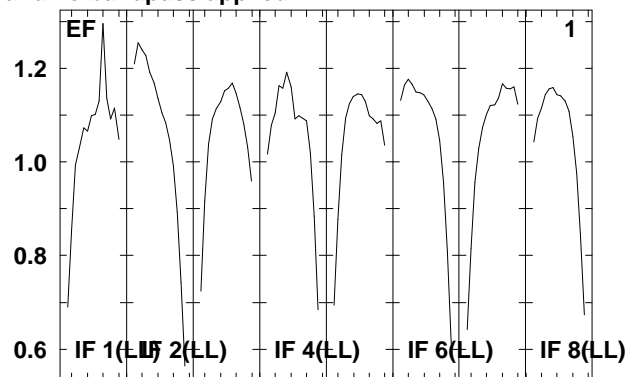
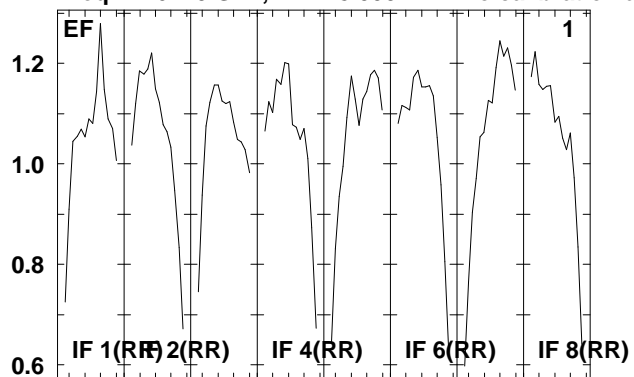

Lower frame: Real Jy

Total-power spectrum Antenna: \*

Timerange: 01/02:59:20 to 01/03:02:19

Plot file version 148 created 20-OCT-2009 14:50:14

M33 RP015C.UVDATA.1

Freq = 1.6270 GHz, Bw = 8.000 MH No calibration applied and no bandpass applied

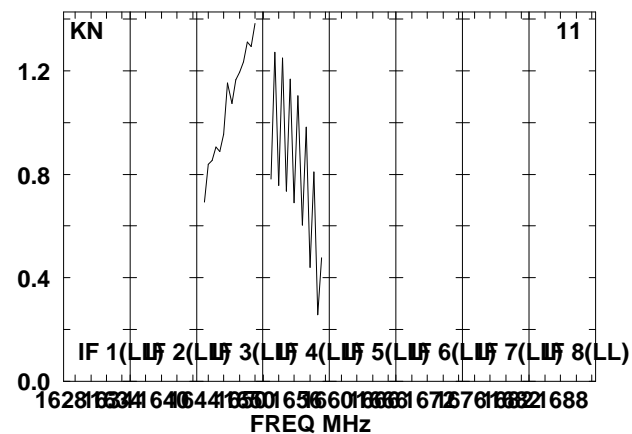
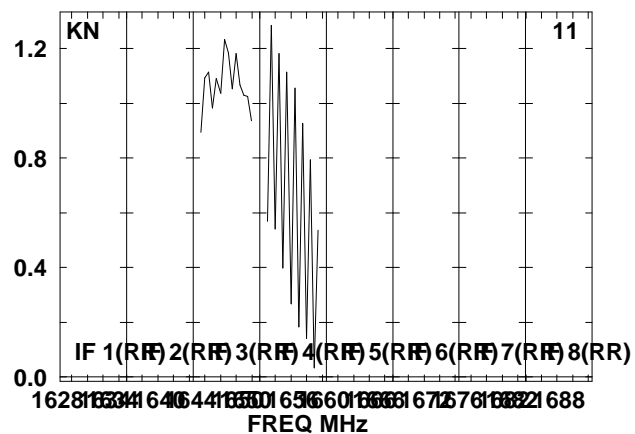
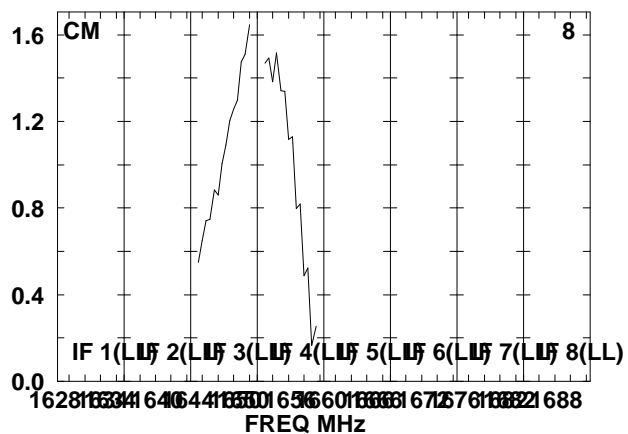
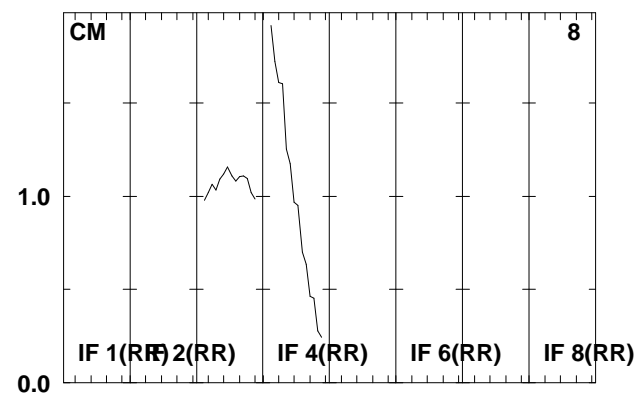
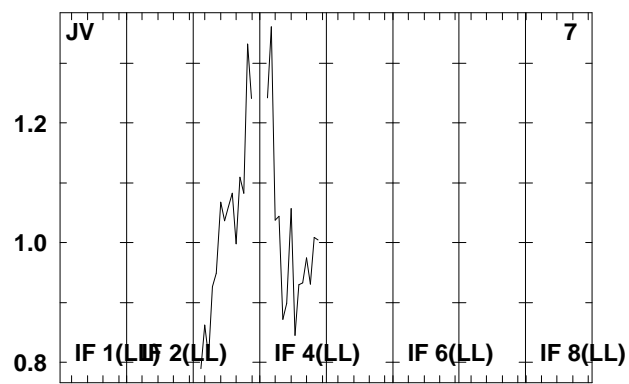
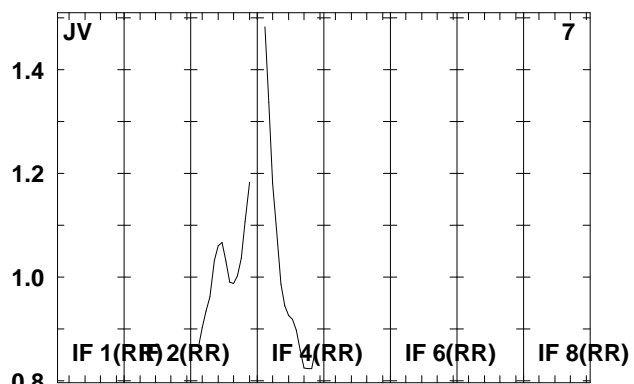
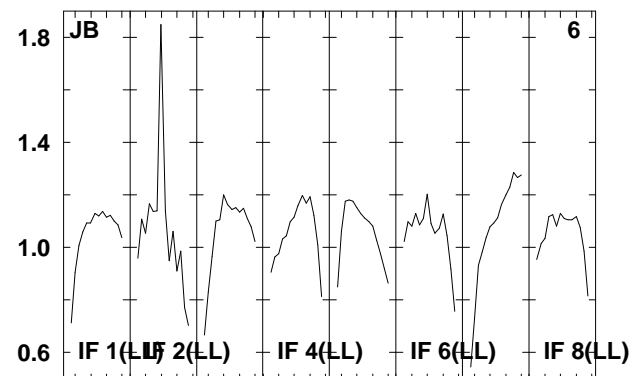
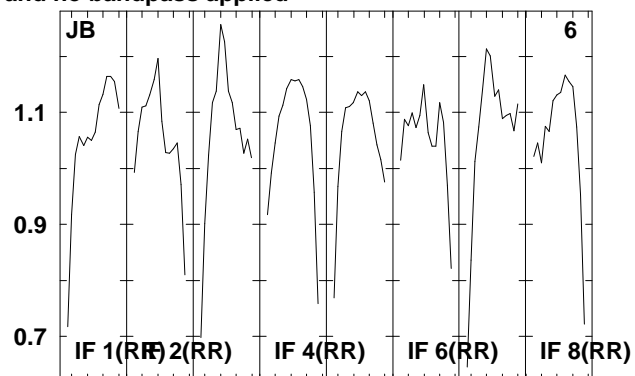
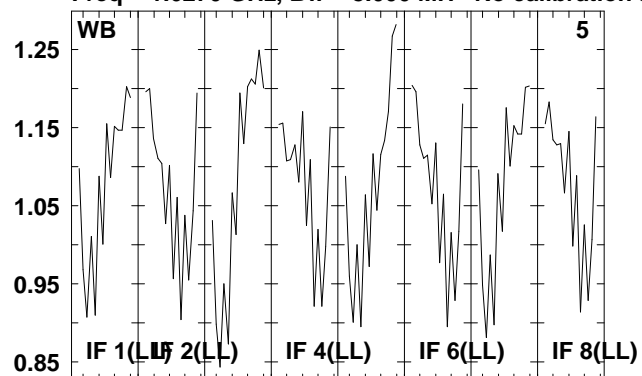

Lower frame: Real Jy

Total-power spectrum Antenna: \*

Timerange: 01/02:59:20 to 01/03:02:19

Plot file version 149 created 20-OCT-2009 14:50:16

J0137+31 RP015C.UVDATA.1

Freq = 1.6270 GHz, Bw = 8.000 MH No calibration applied and no bandpass applied

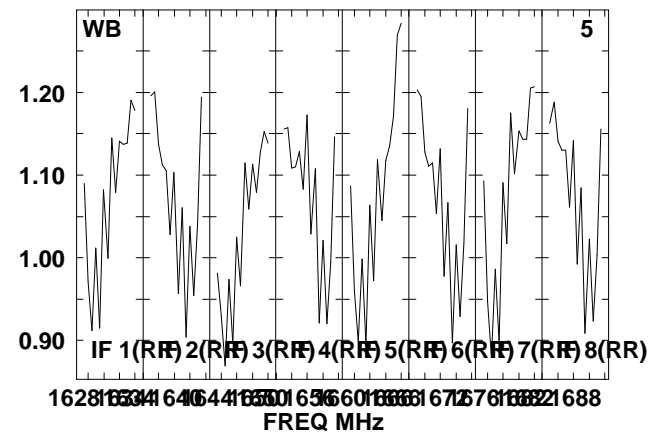
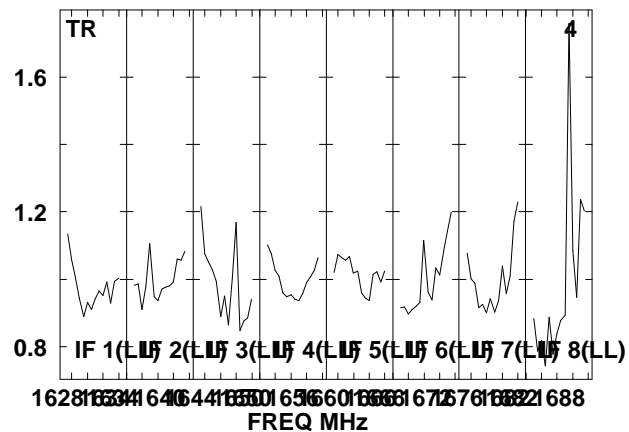
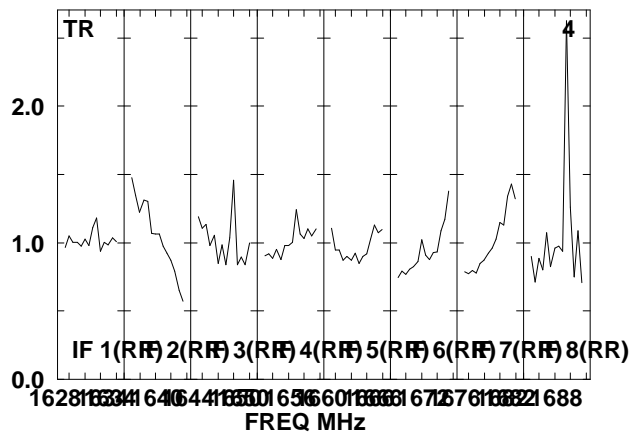
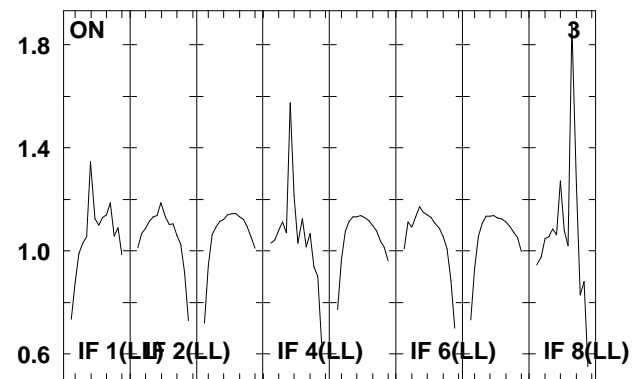
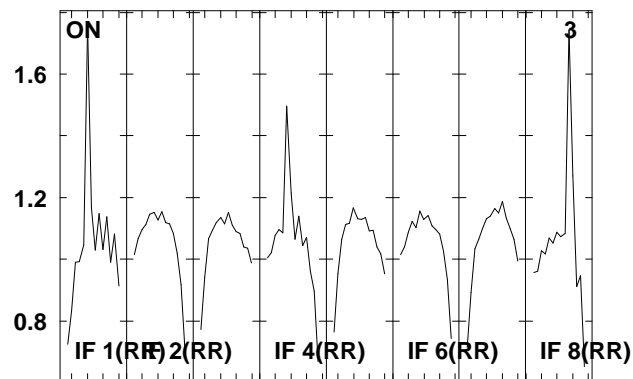
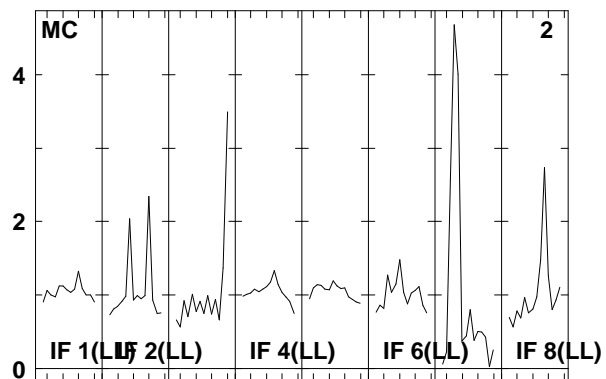
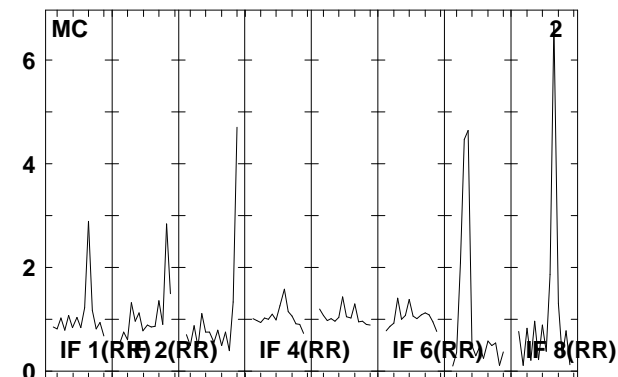
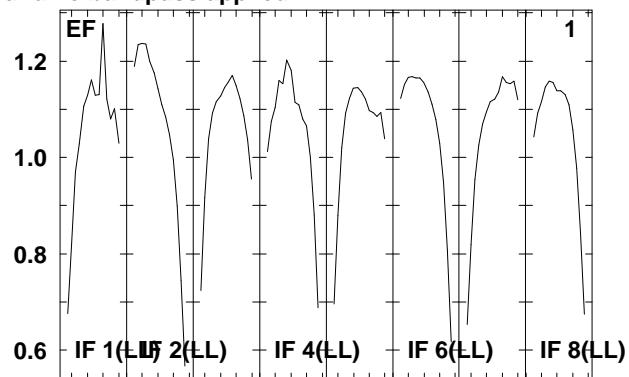
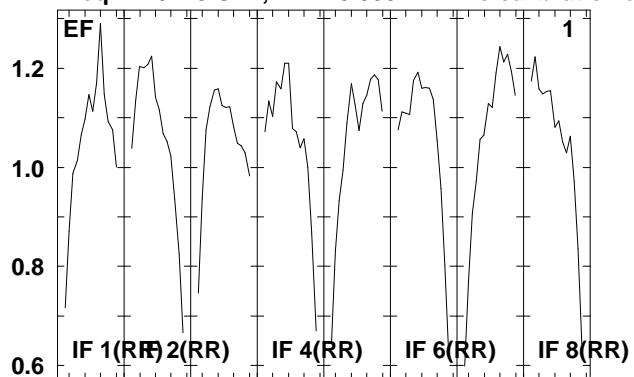

Lower frame: Real Jy

Total-power spectrum Antenna: \*

Timerange: 01/03:03:01 to 01/03:03:59

Plot file version 150 created 20-OCT-2009 14:50:16

J0137+31 RP015C.UVDATA.1

Freq = 1.6270 GHz, Bw = 8.000 MH No calibration applied and no bandpass applied

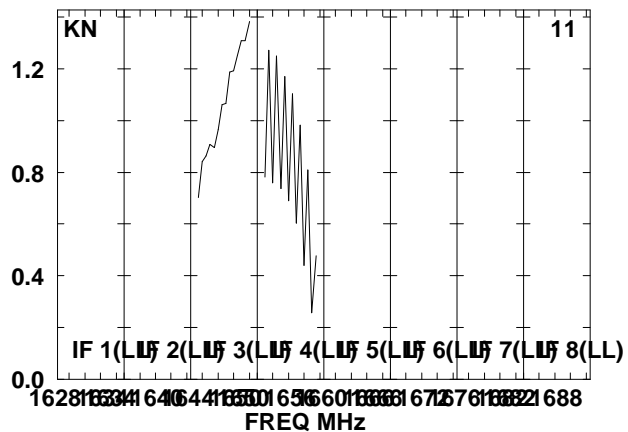
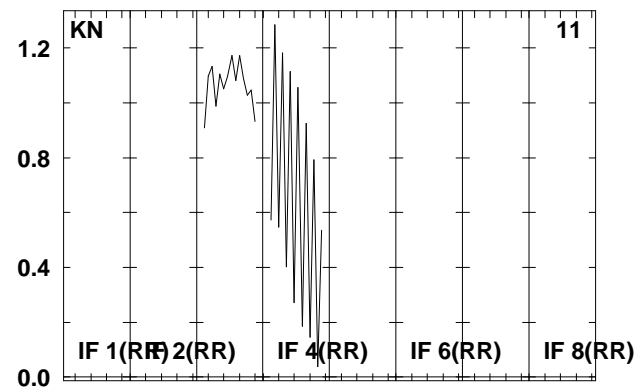
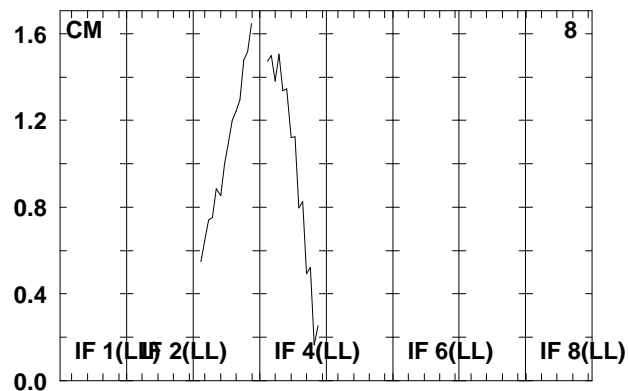
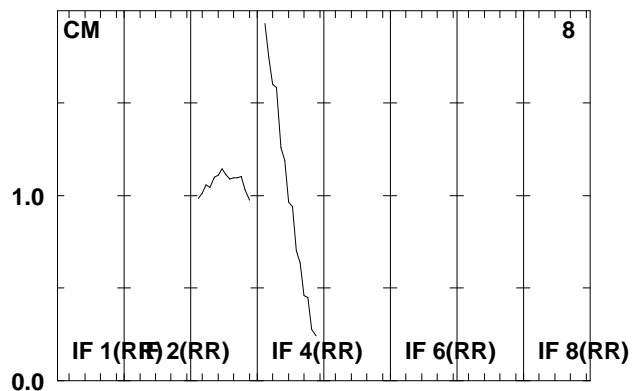
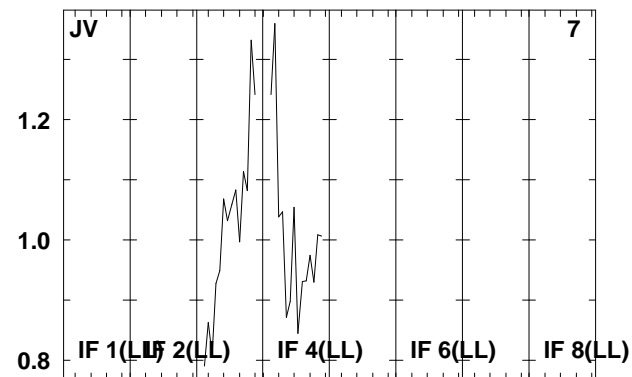
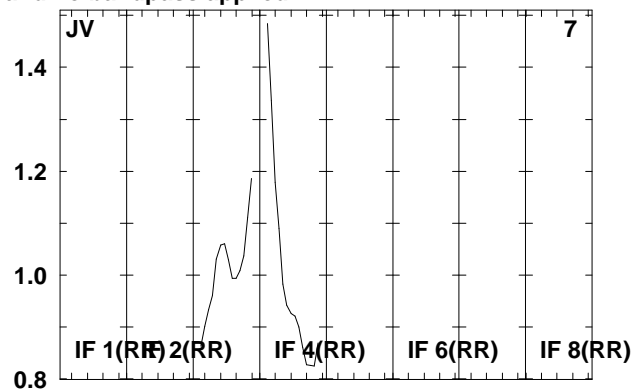
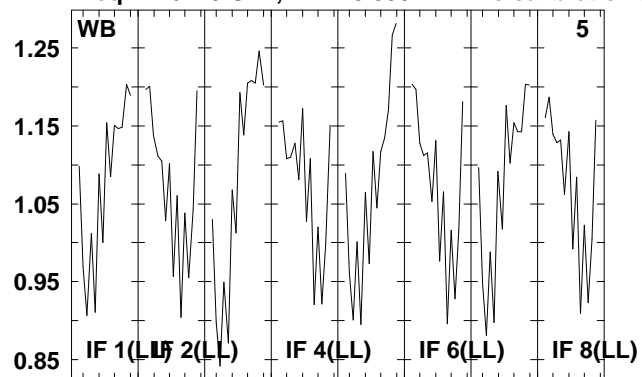

Lower frame: Real Jy

Total-power spectrum Antenna: \*

Timerange: 01/03:03:01 to 01/03:03:59

Plot file version 151 created 20-OCT-2009 14:50:17

FAINTCAL RP015C.UVDATA.1

Freq = 1.6270 GHz, Bw = 8.000 MH No calibration applied and no bandpass applied

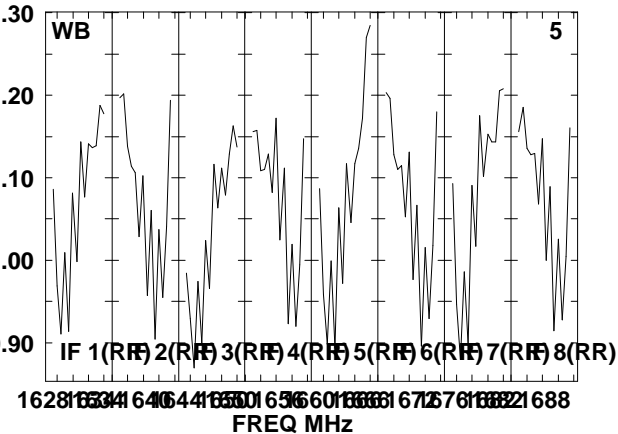
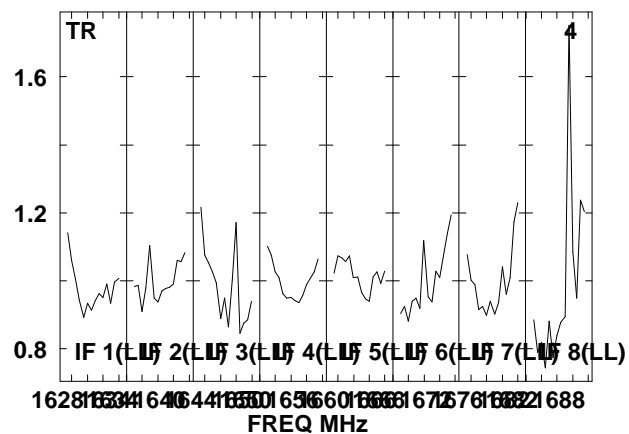
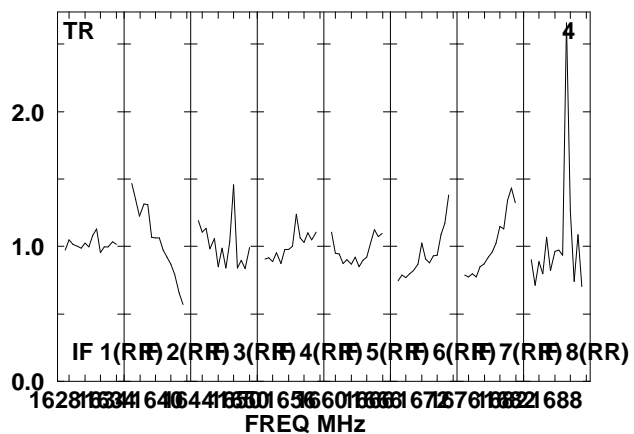
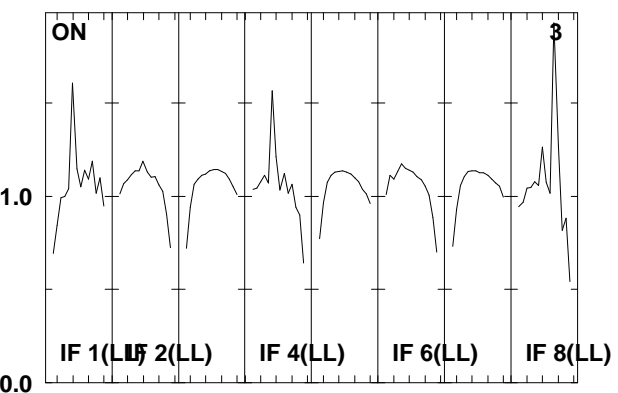
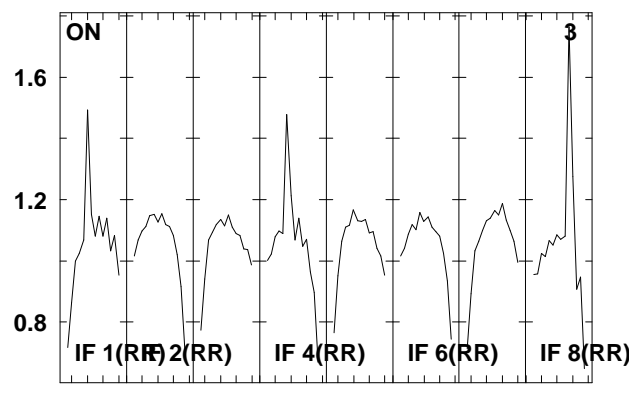
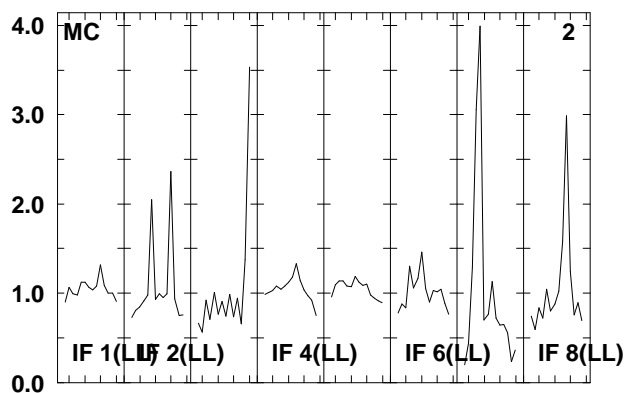
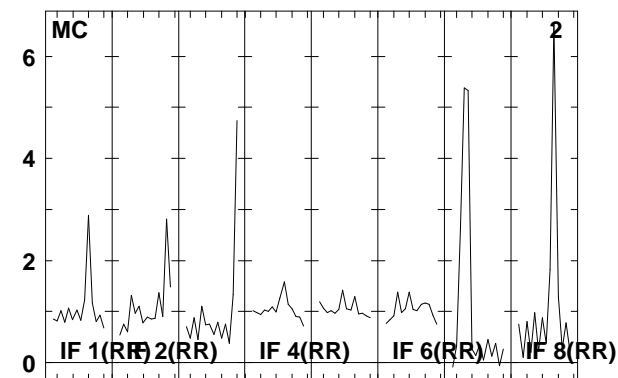
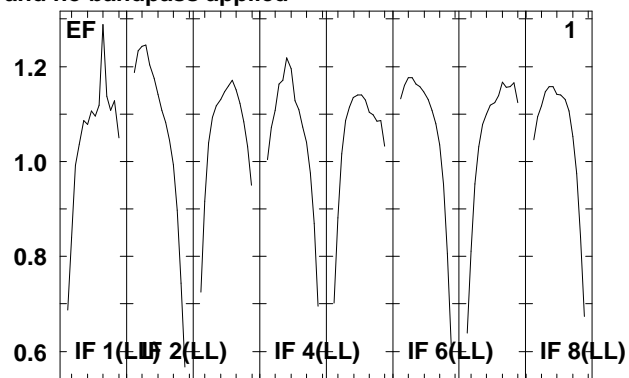
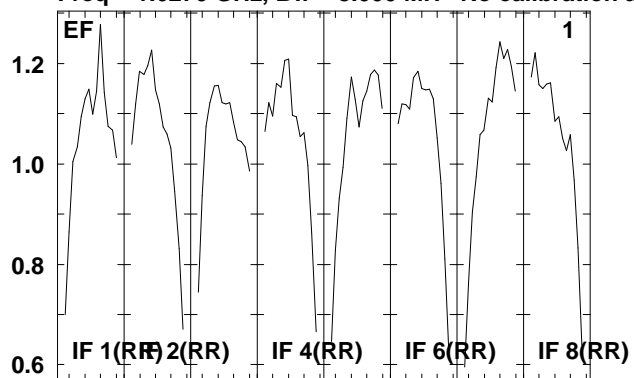

Lower frame: Real Jy  
Total-power spectrum Antenna: \*  
Timerange: 01/03:04:00 to 01/03:05:19

Plot file version 152 created 20-OCT-2009 14:50:17

FAINTCAL RP015C.UVDATA.1

Freq = 1.6270 GHz, Bw = 8.000 MH No calibration applied and no bandpass applied

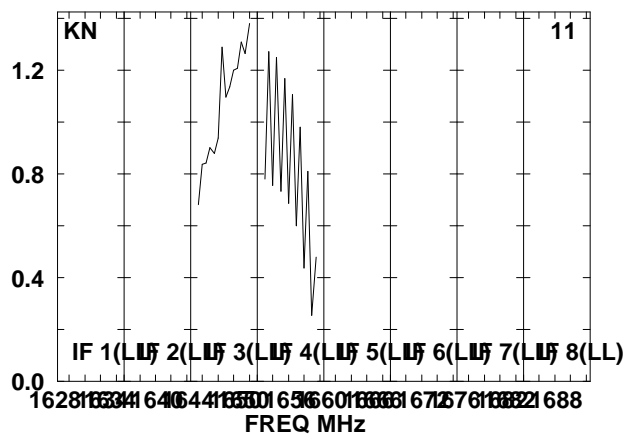
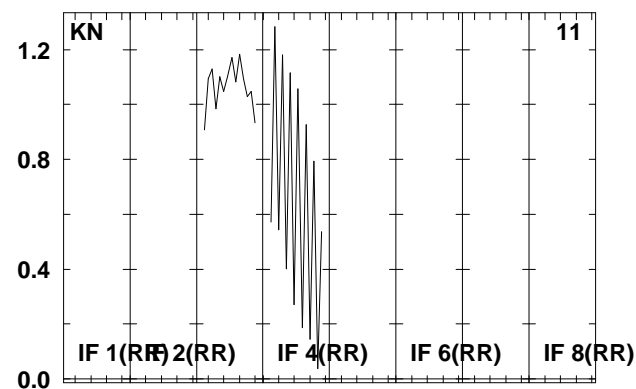
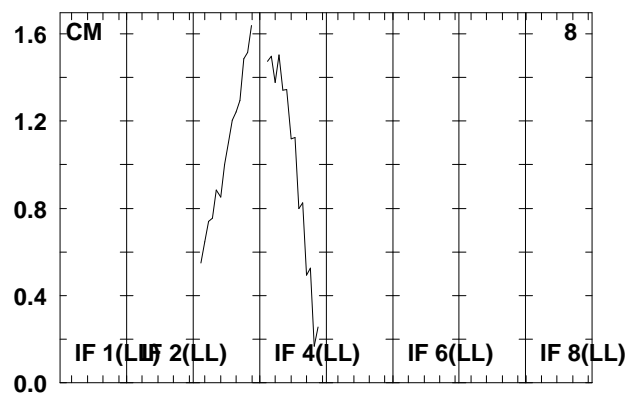
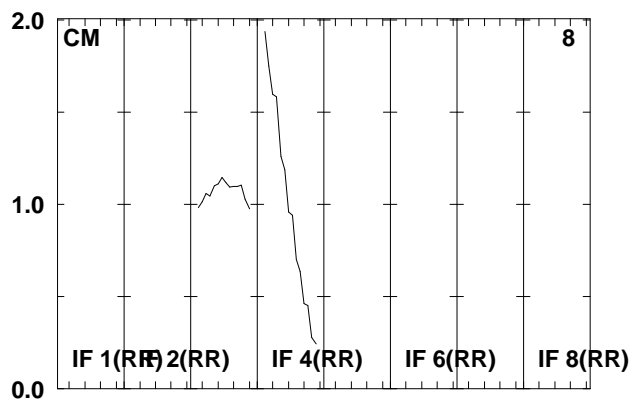
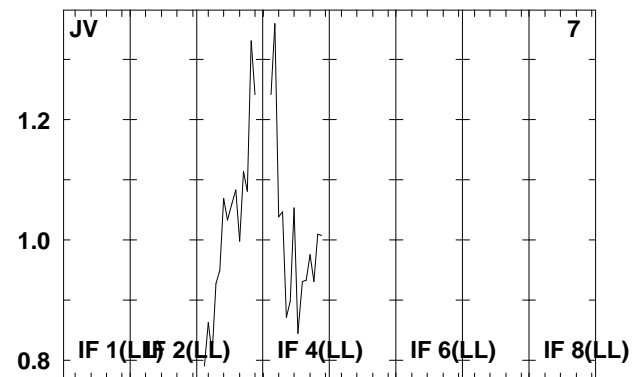
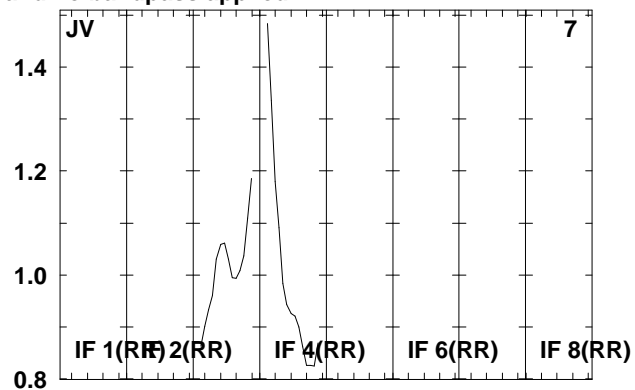
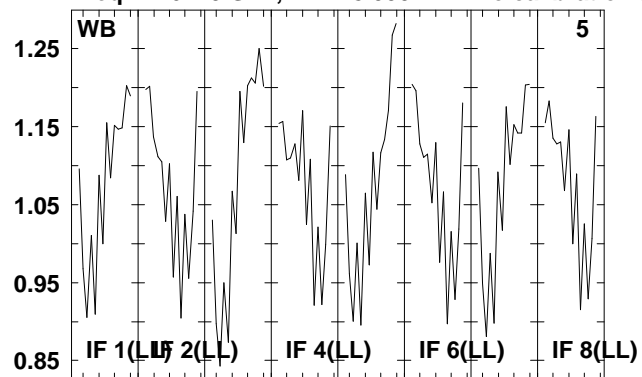

Lower frame: Real Jy

Total-power spectrum Antenna: \*

Timerange: 01/03:04:00 to 01/03:05:19



Plot file version 153 created 20-OCT-2009 14:50:18

M33 RP015C.UVDATA.1

Freq = 1.6270 GHz, Bw = 8.000 MH No calibration applied and no bandpass applied

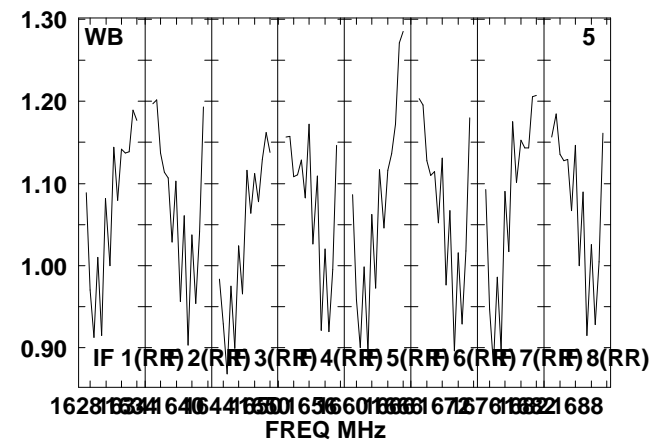
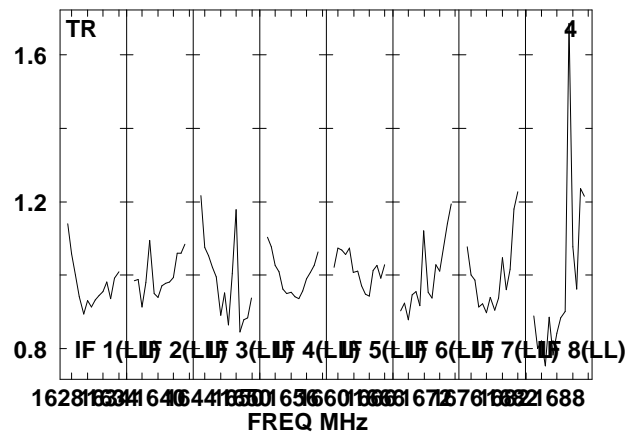
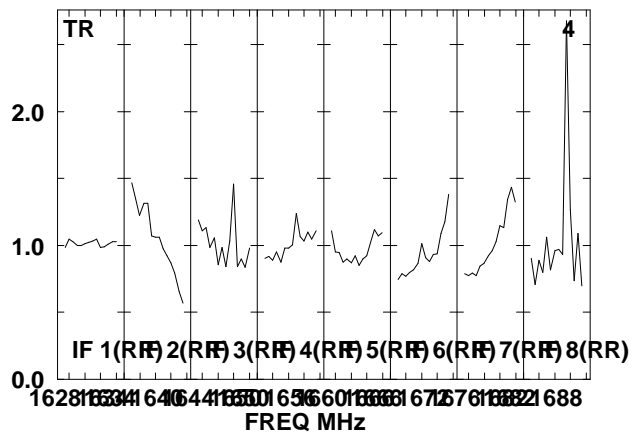
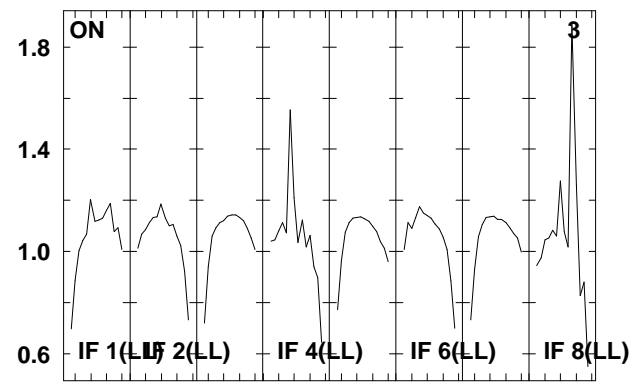
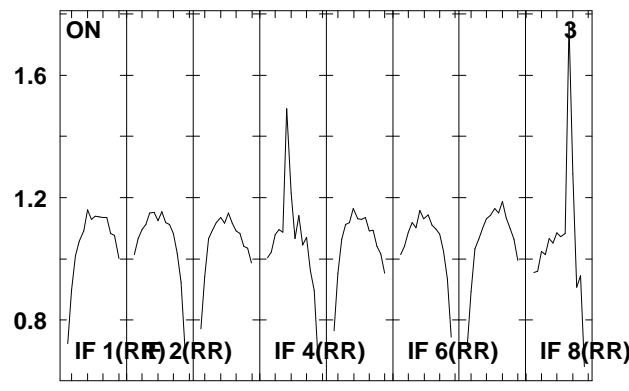
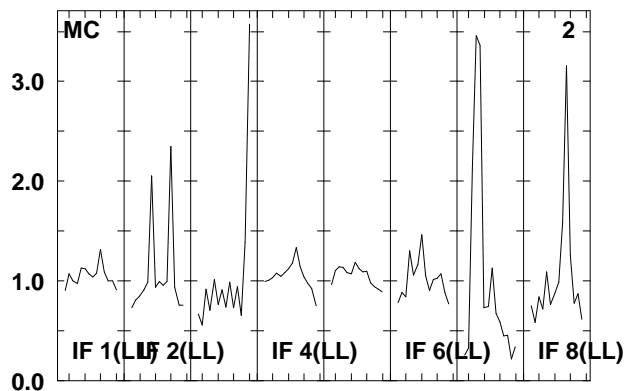
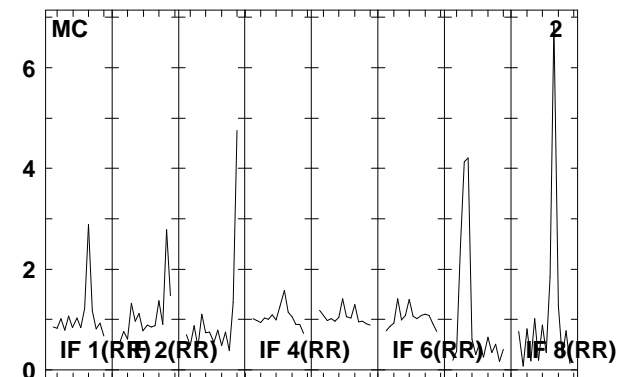
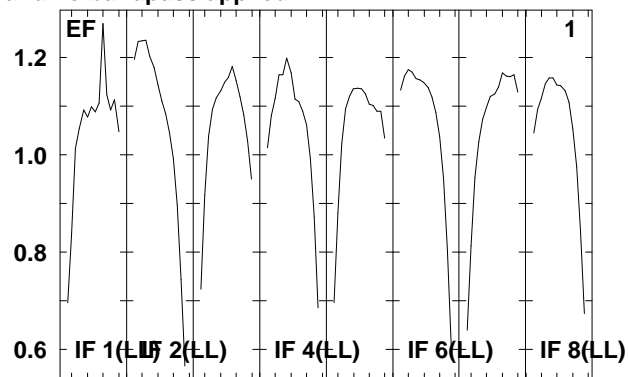
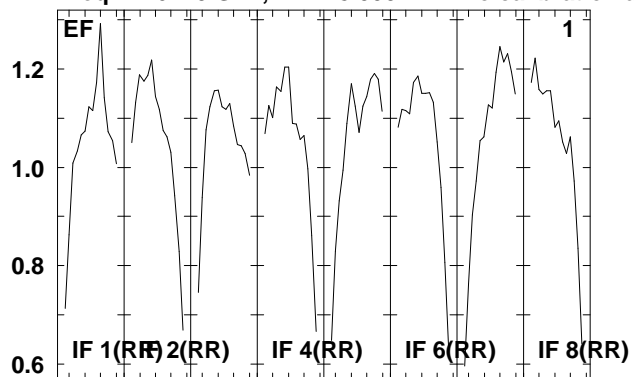

Lower frame: Real Jy  
Total-power spectrum Antenna: \*  
Timerange: 01/03:05:21 to 01/03:08:20

Plot file version 154 created 20-OCT-2009 14:50:19

M33 RP015C.UVDATA.1

Freq = 1.6270 GHz, Bw = 8.000 MH No calibration applied and no bandpass applied

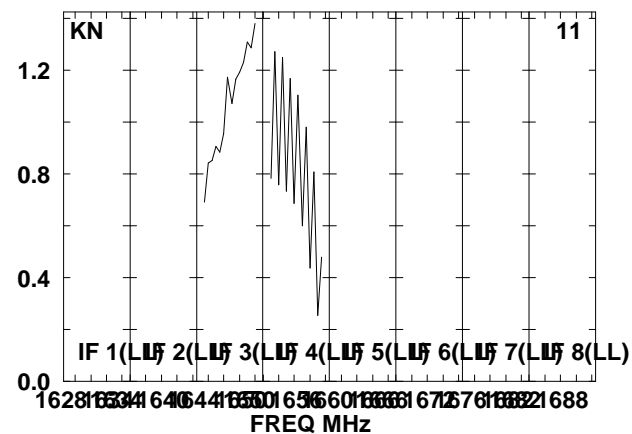
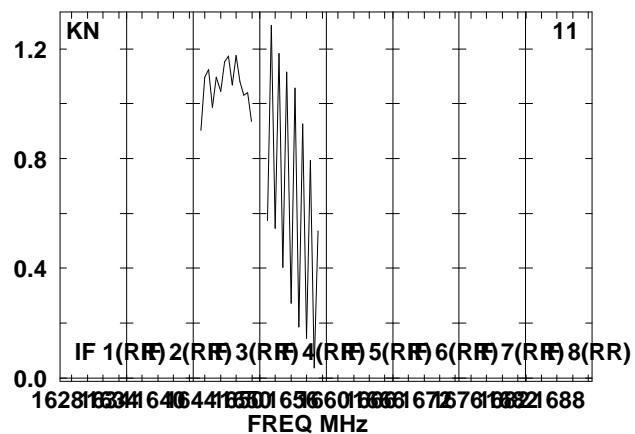
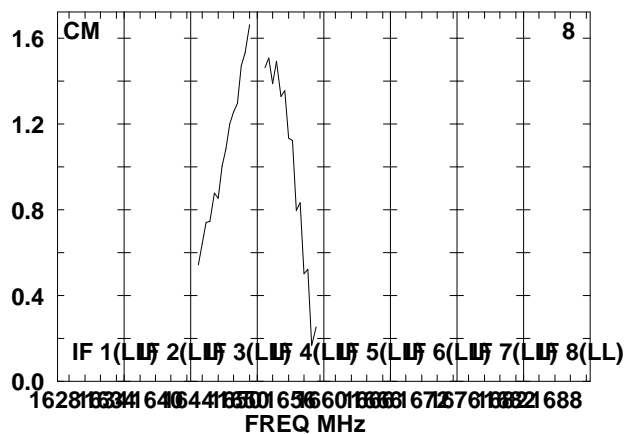
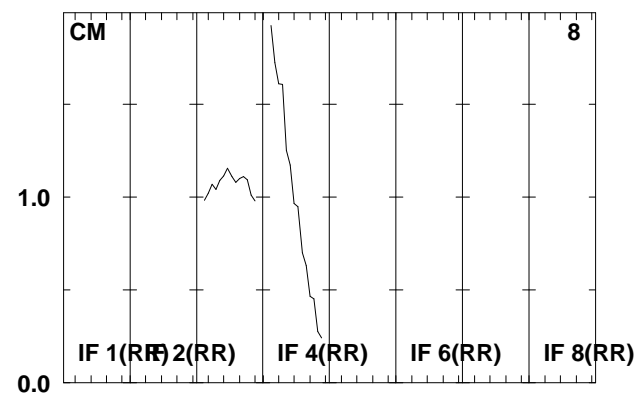
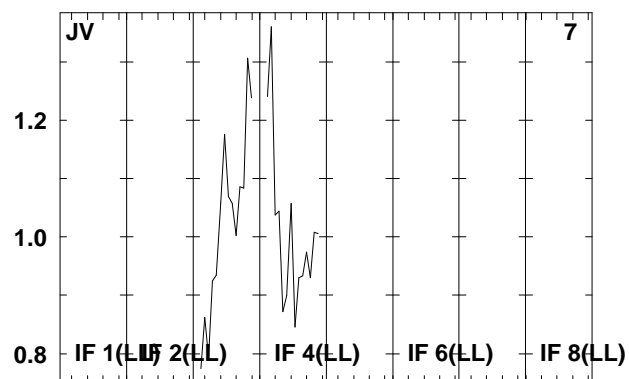
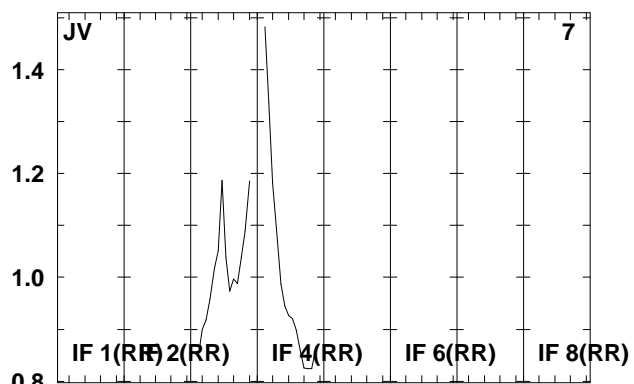
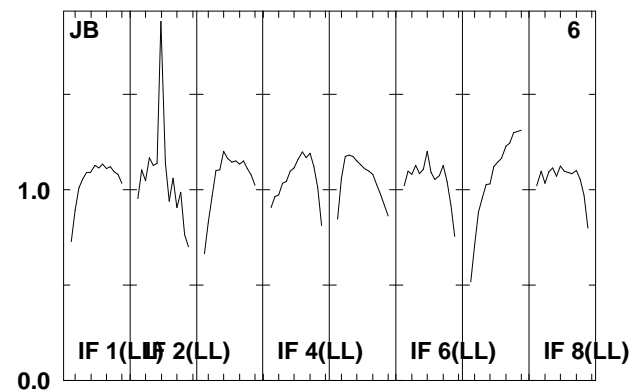
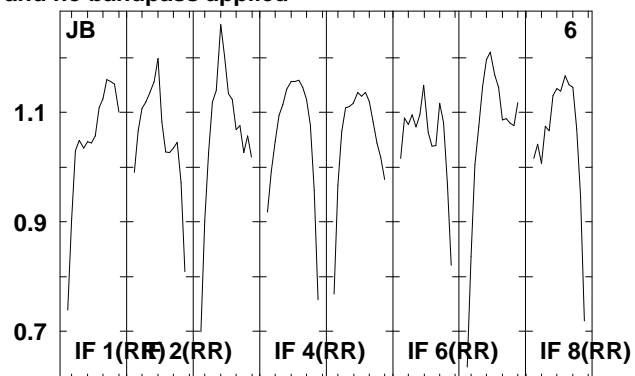
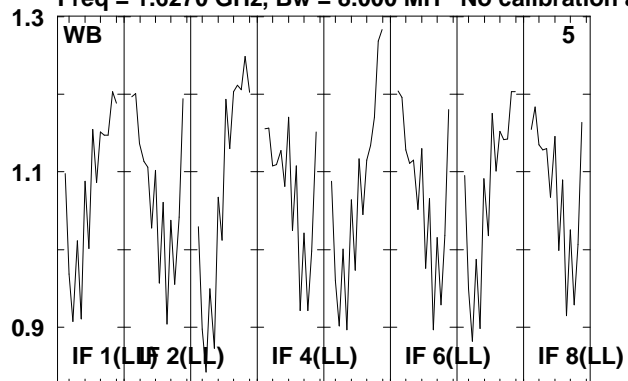

Lower frame: Real Jy

Total-power spectrum Antenna: \*

Timerange: 01/03:05:21 to 01/03:08:20

Plot file version 155 created 20-OCT-2009 14:50:20

J0137+31 RP015C.UVDATA.1

Freq = 1.6270 GHz, Bw = 8.000 MH No calibration applied and no bandpass applied

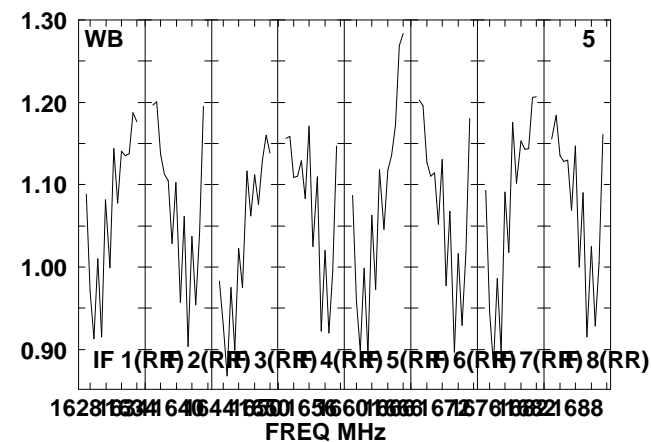
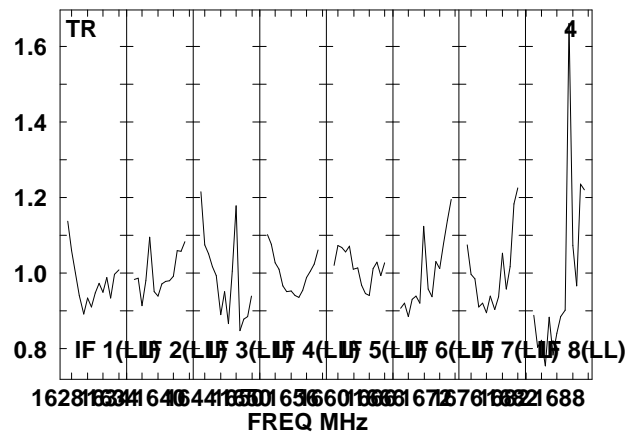
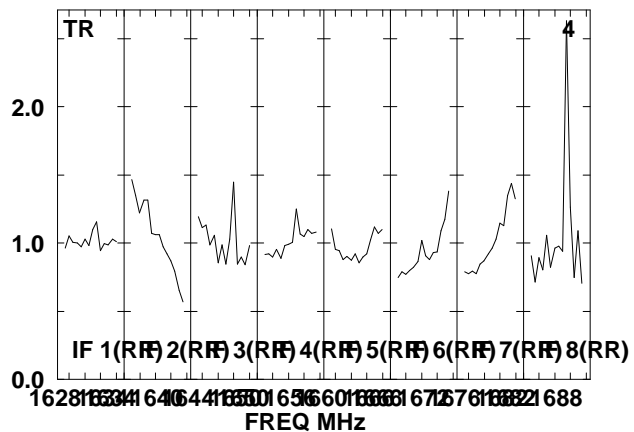
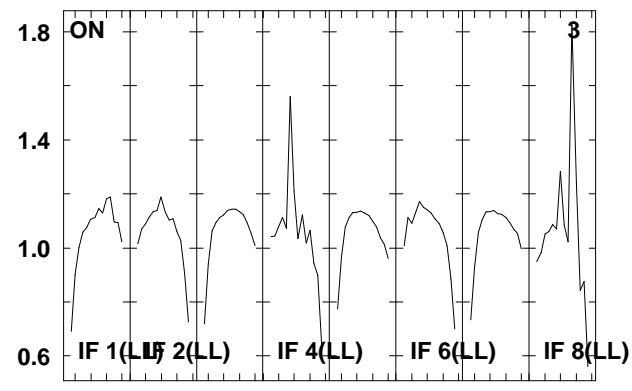
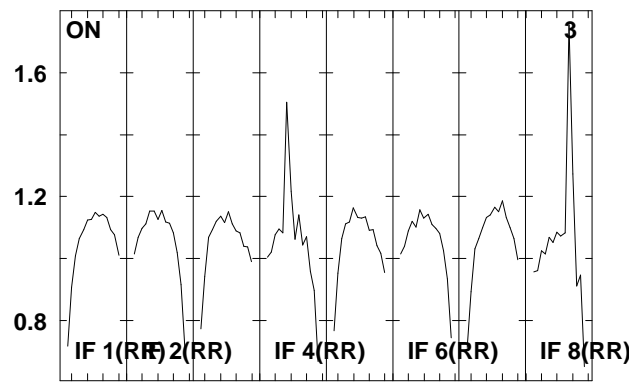
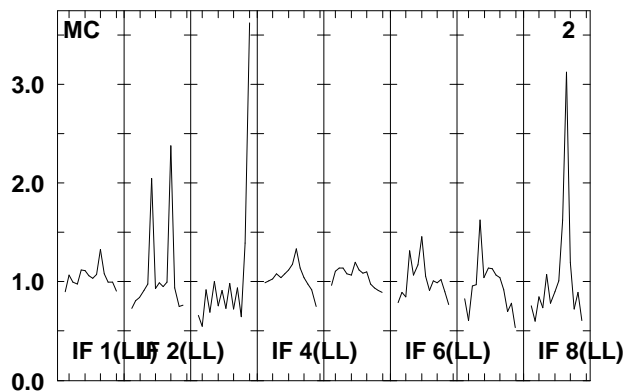
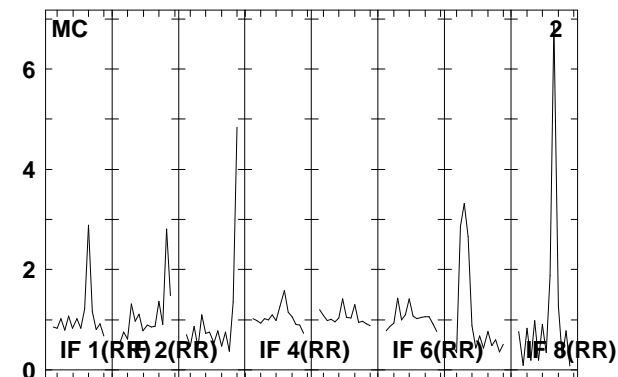
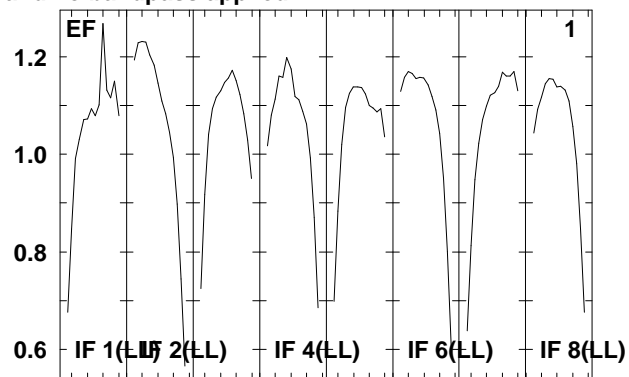
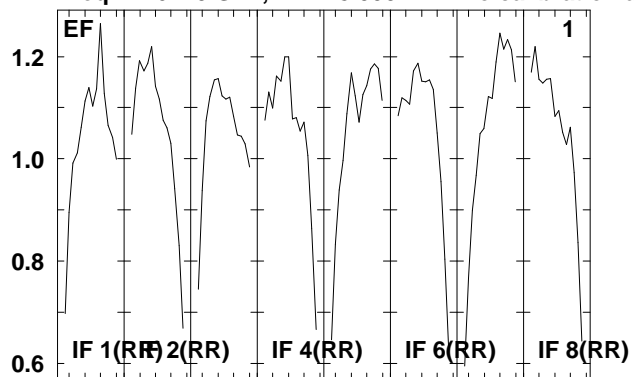

Lower frame: Real Jy  
Total-power spectrum Antenna: \*  
Timerange: 01/03:09:01 to 01/03:10:00

Plot file version 156 created 20-OCT-2009 14:50:20

J0137+31 RP015C.UVDATA.1

Freq = 1.6270 GHz, Bw = 8.000 MH No calibration applied and no bandpass applied

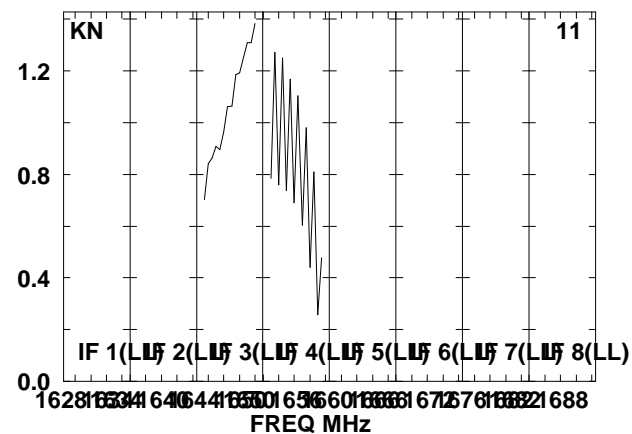
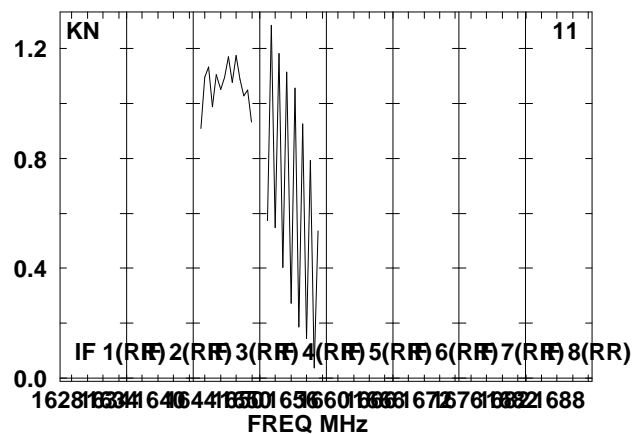
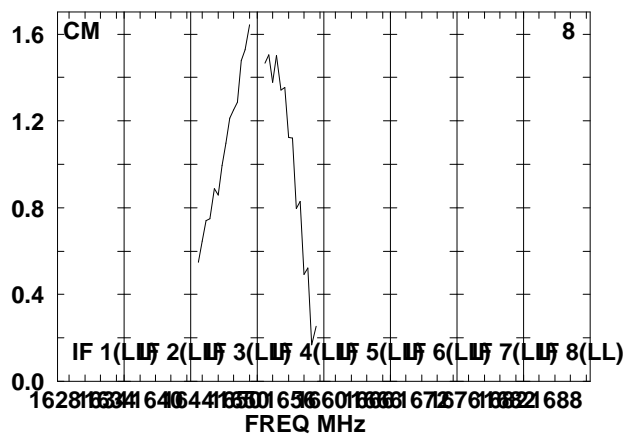
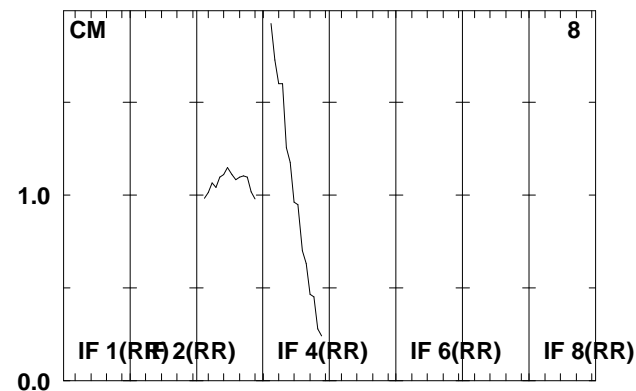
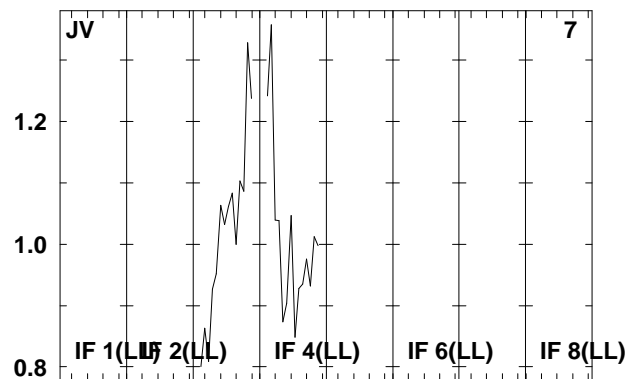
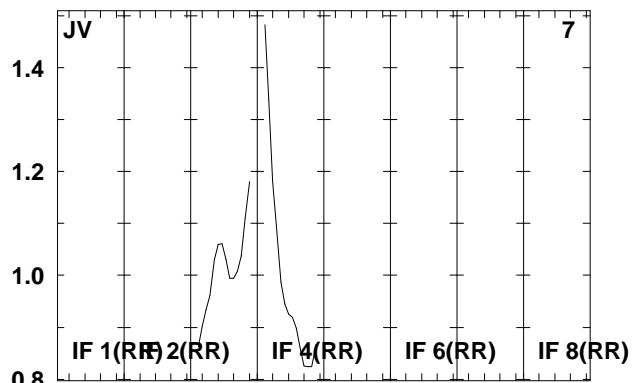
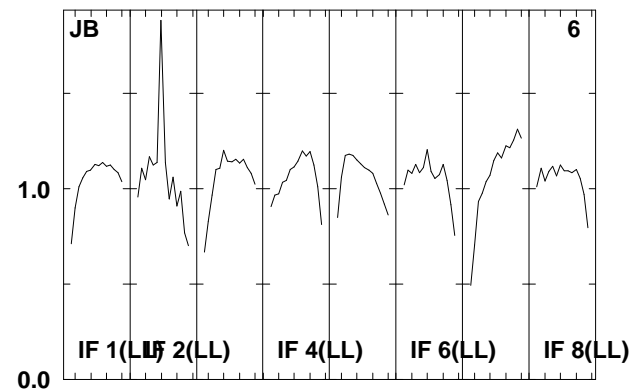
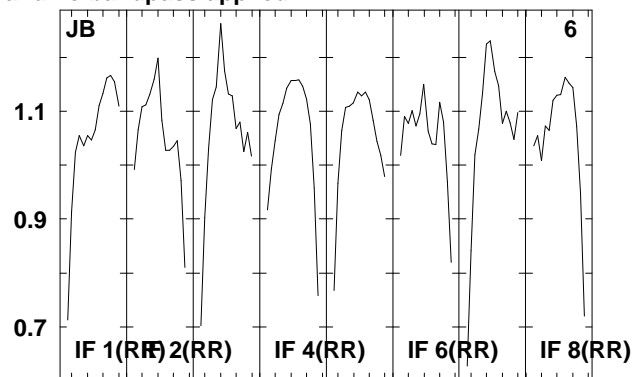
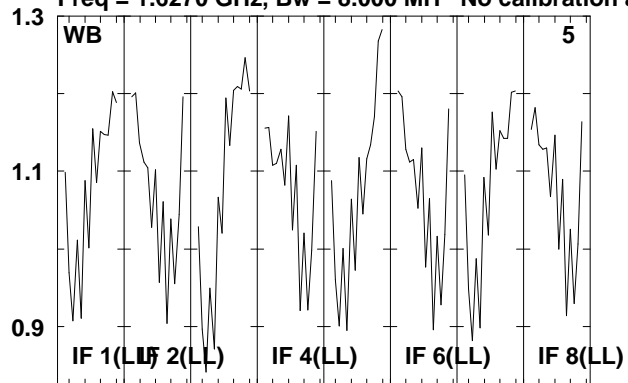

Lower frame: Real Jy  
Total-power spectrum Antenna: \*  
Timerange: 01/03:09:01 to 01/03:10:00

Plot file version 157 created 20-OCT-2009 14:50:21

FAINTCAL RP015C.UVDATA.1

Freq = 1.6270 GHz, Bw = 8.000 MH No calibration applied and no bandpass applied

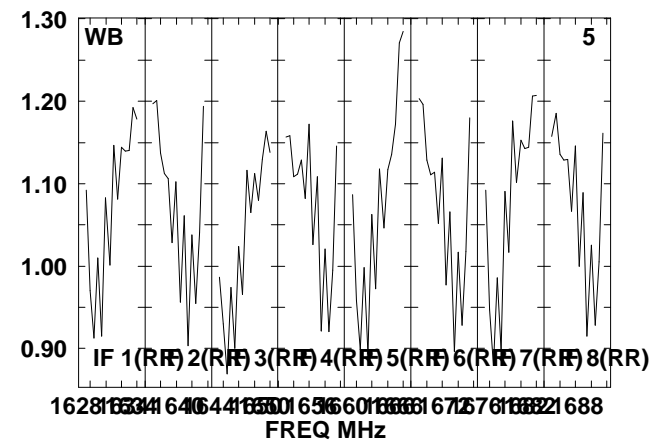
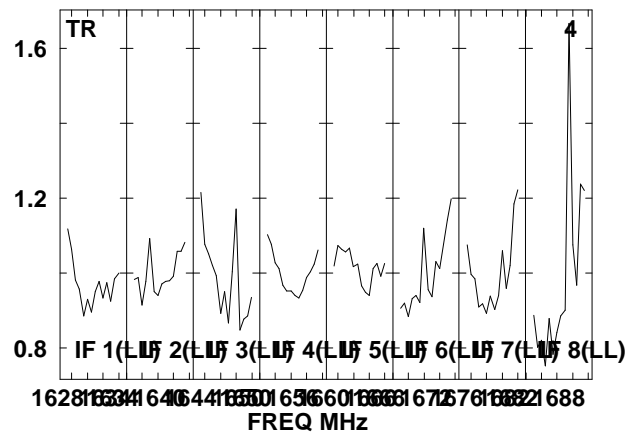
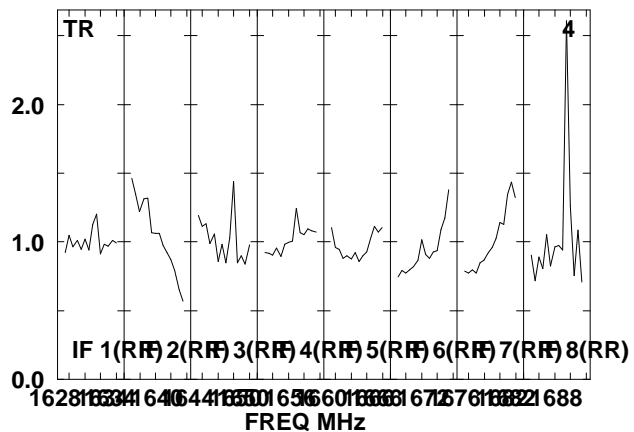
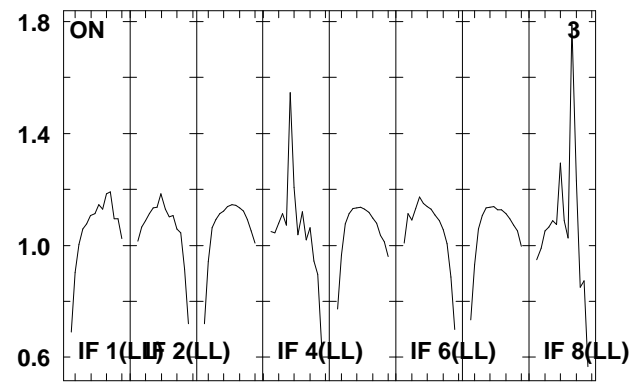
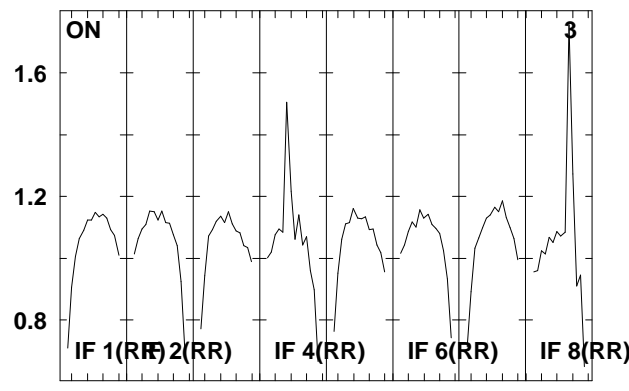
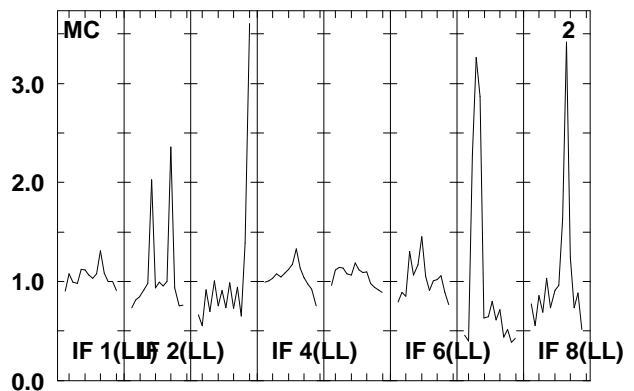
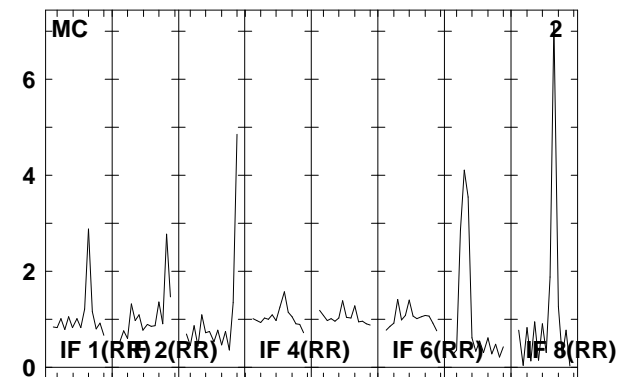
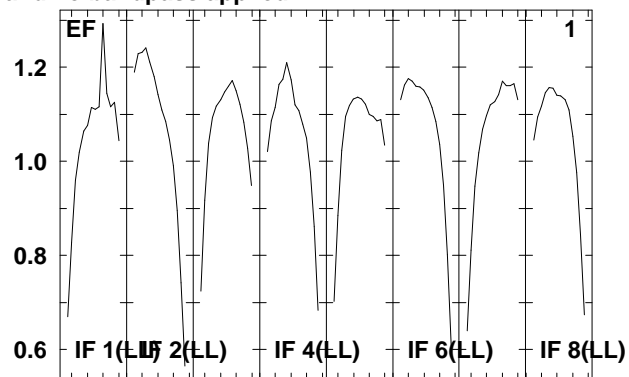
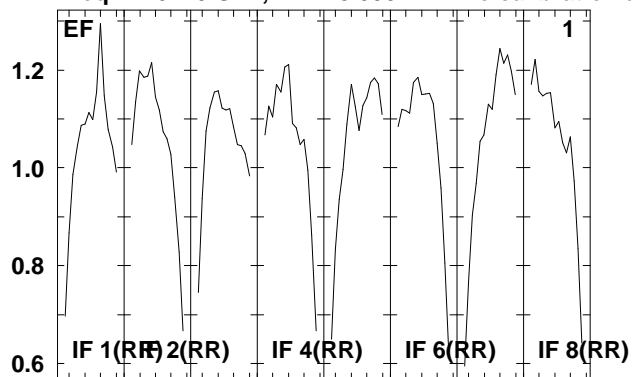

Lower frame: Real Jy

Total-power spectrum Antenna: \*

Timerange: 01/03:10:01 to 01/03:11:20

Plot file version 158 created 20-OCT-2009 14:50:21

FAINTCAL RP015C.UVDATA.1

Freq = 1.6270 GHz, Bw = 8.000 MH No calibration applied and no bandpass applied

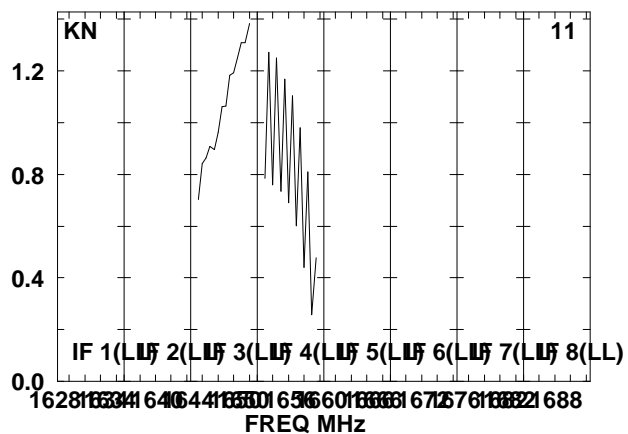
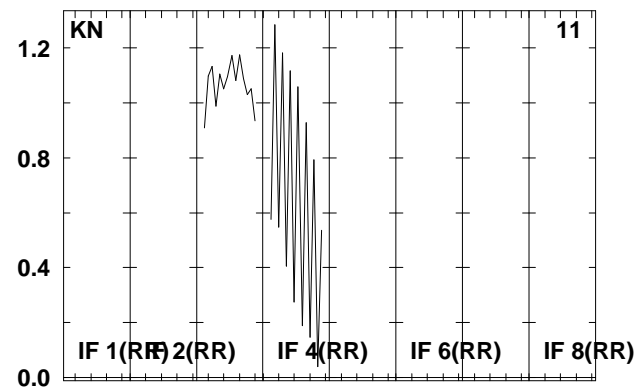
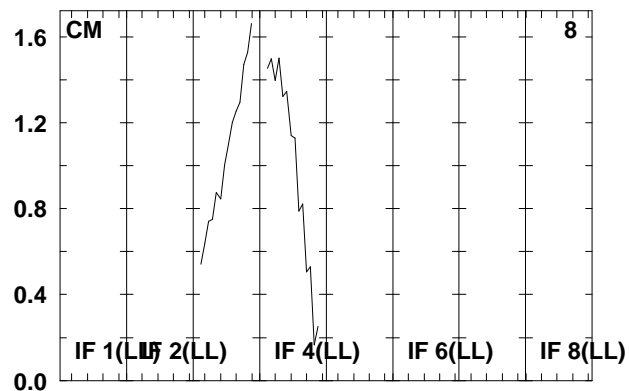
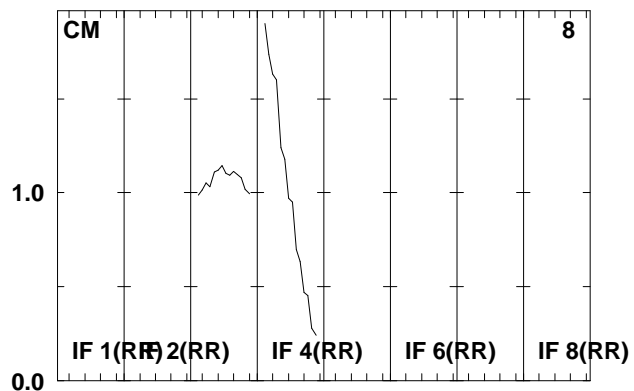
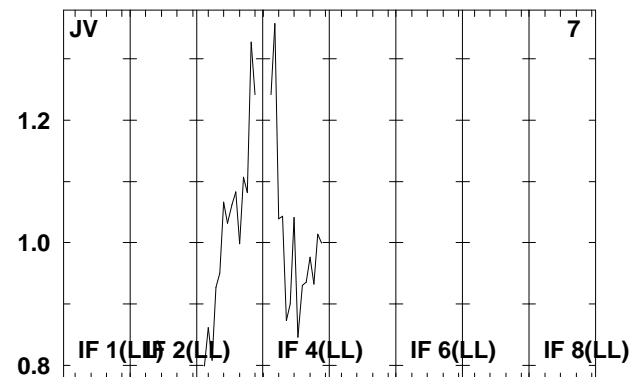
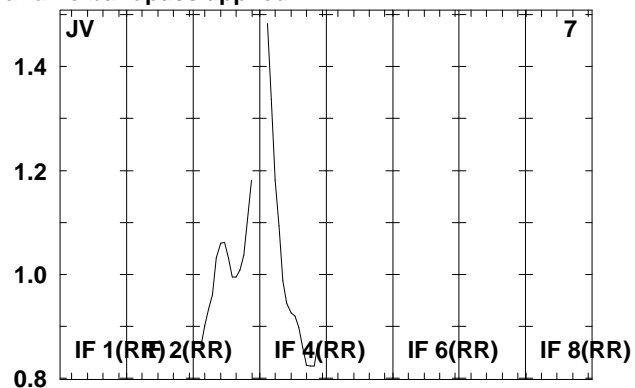
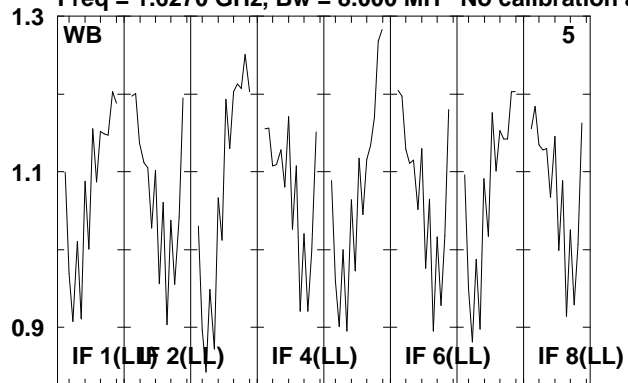

Lower frame: Real Jy

Total-power spectrum Antenna: \*

Timerange: 01/03:10:01 to 01/03:11:20

Plot file version 159 created 20-OCT-2009 14:50:22

M33 RP015C.UVDATA.1

Freq = 1.6270 GHz, Bw = 8.000 MH No calibration applied and no bandpass applied

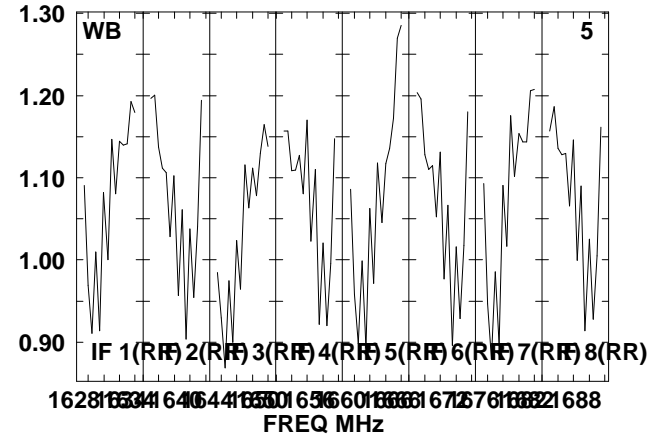
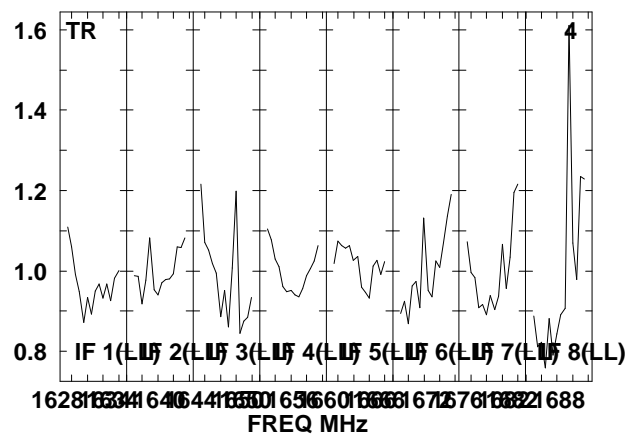
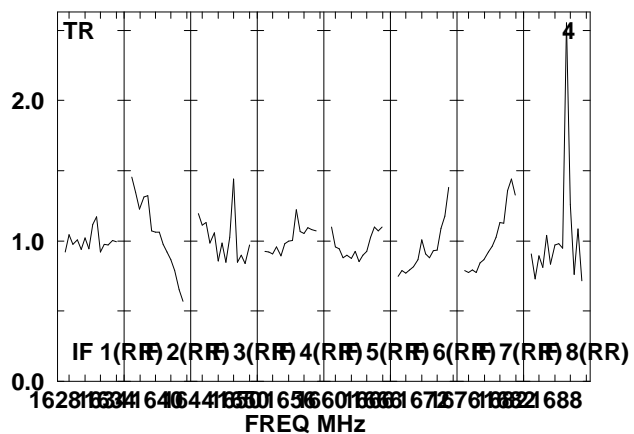
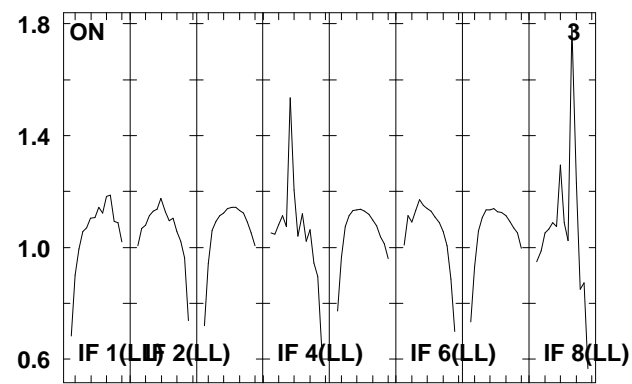
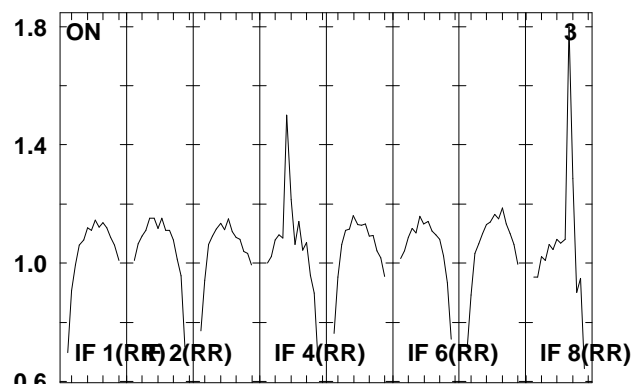
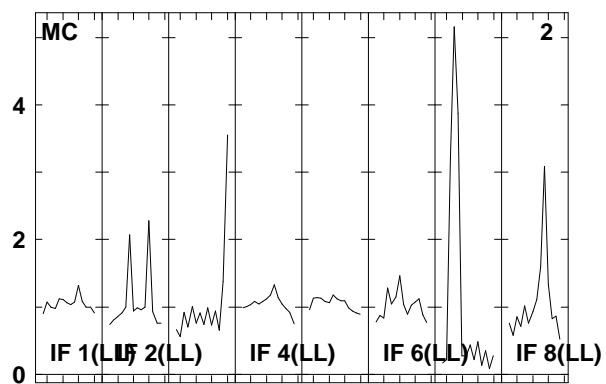
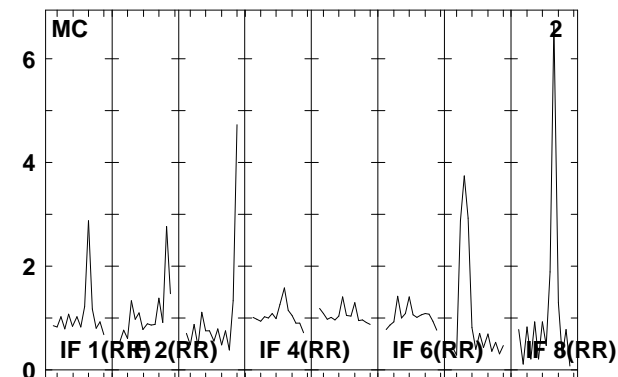
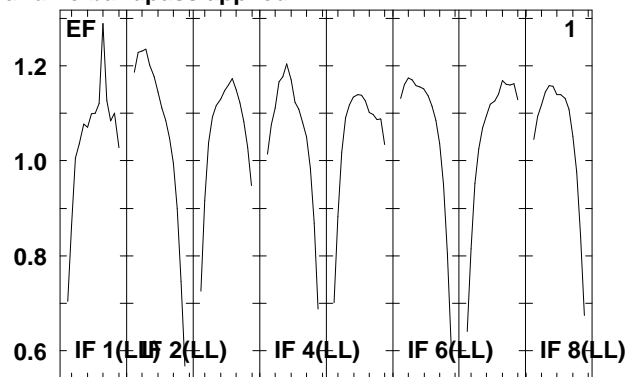
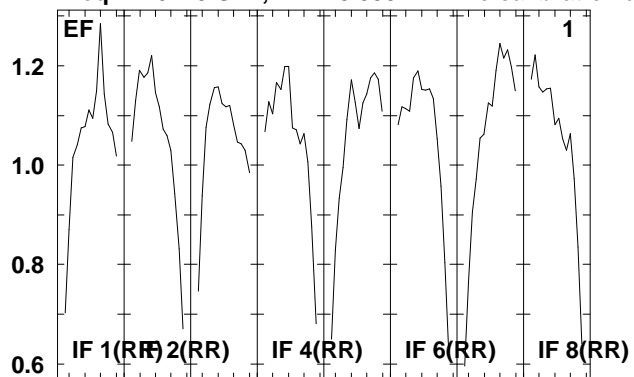

Lower frame: Real Jy

Total-power spectrum Antenna: \*

Timerange: 01/03:11:21 to 01/03:14:20

Plot file version 160 created 20-OCT-2009 14:50:23

M33 RP015C.UVDATA.1

Freq = 1.6270 GHz, Bw = 8.000 MH No calibration applied and no bandpass applied

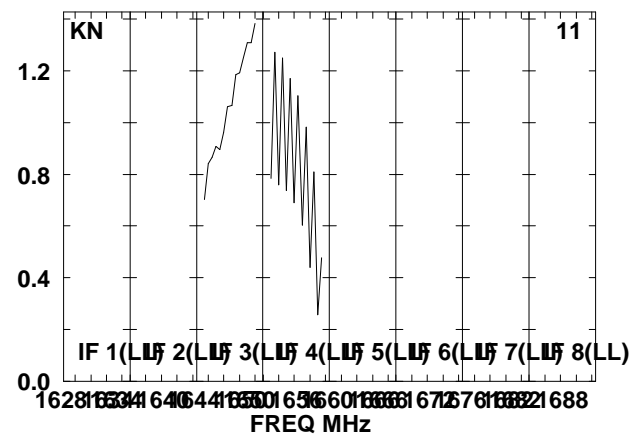
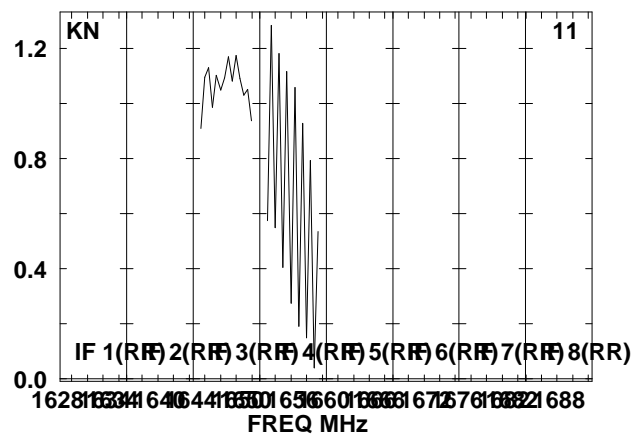
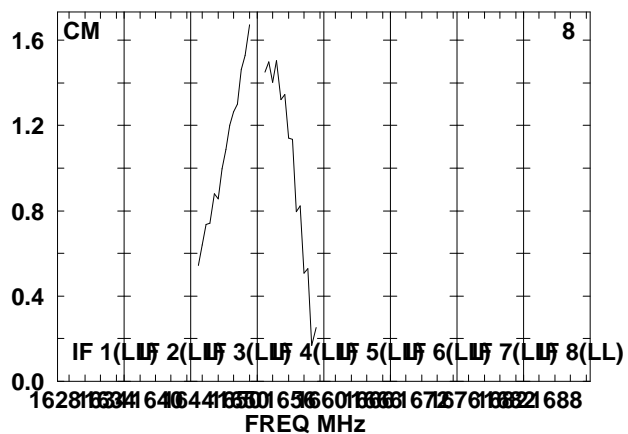
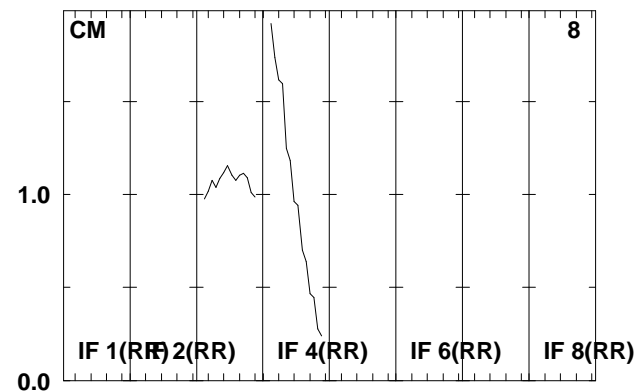
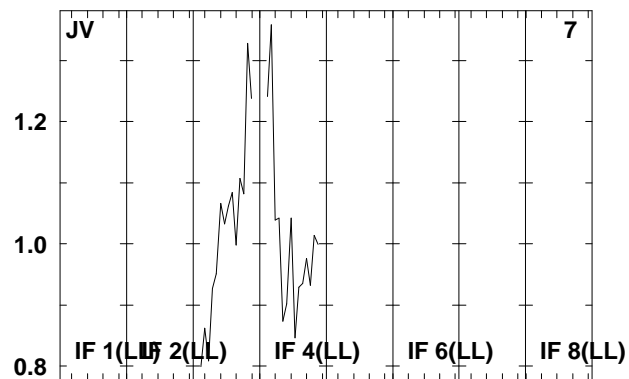
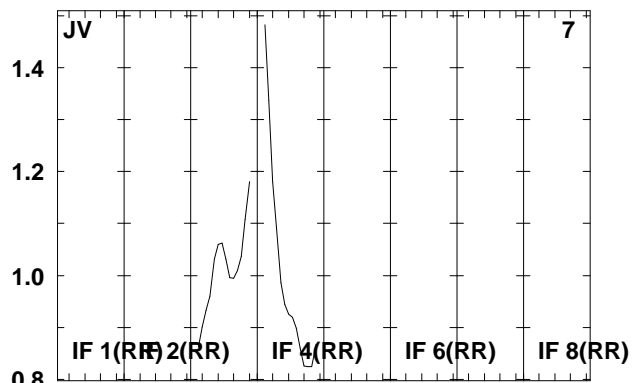
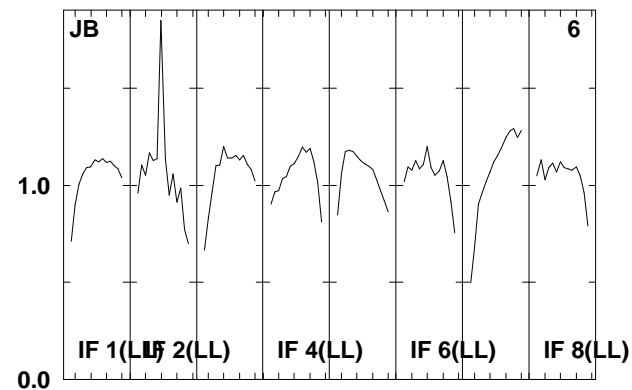
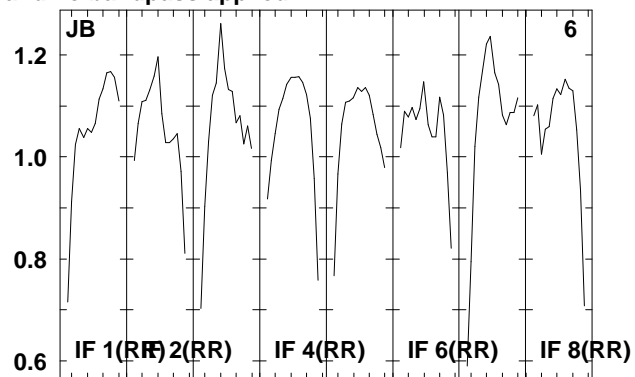
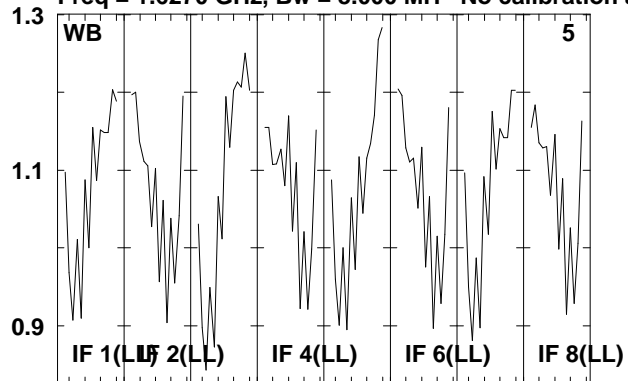

Lower frame: Real Jy  
Total-power spectrum Antenna: \*  
Timerange: 01/03:11:21 to 01/03:14:20



Plot file version 161 created 20-OCT-2009 14:50:25

J0137+31 RP015C.UVDATA.1

Freq = 1.6270 GHz, Bw = 8.000 MH No calibration applied and no bandpass applied

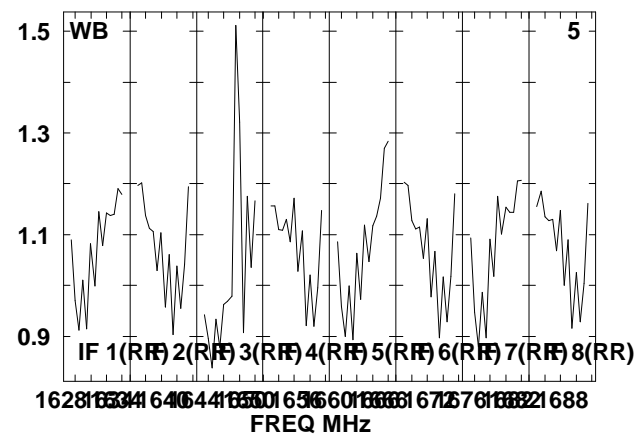
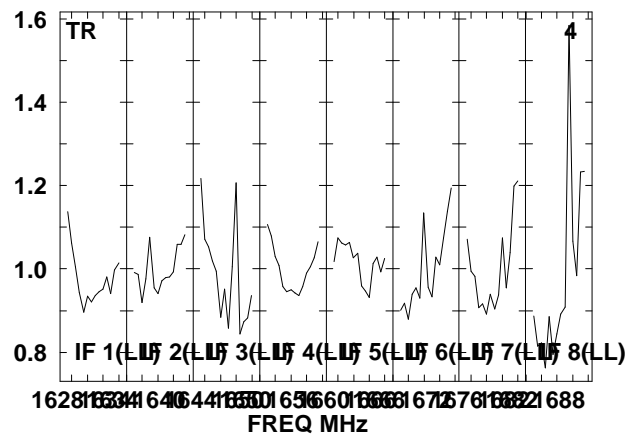
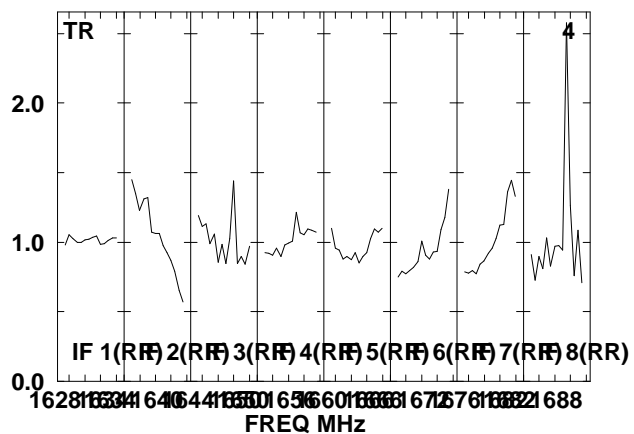
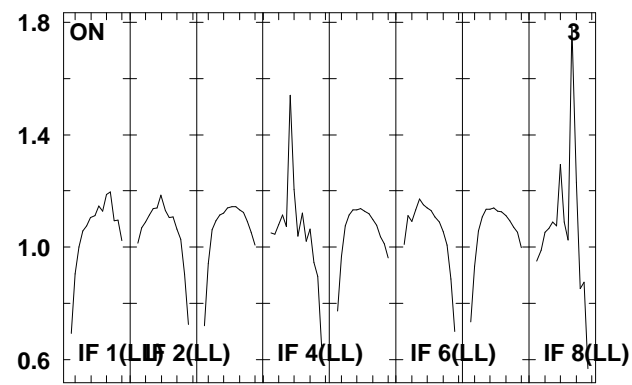
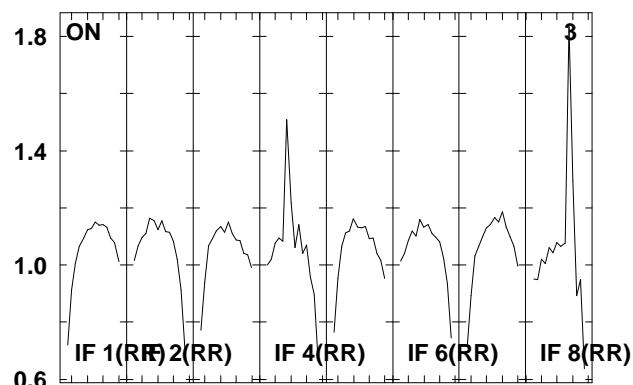
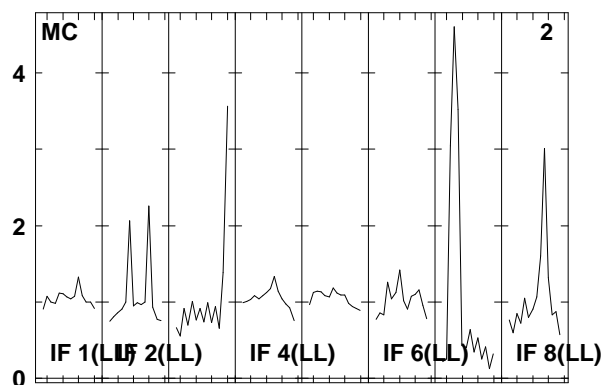
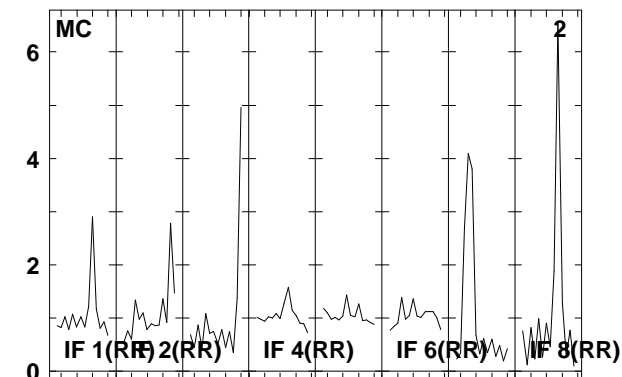
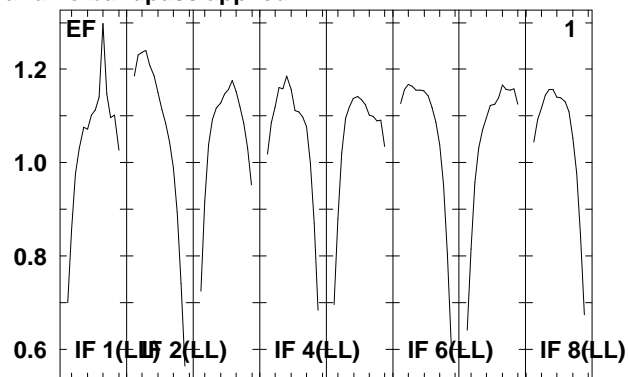
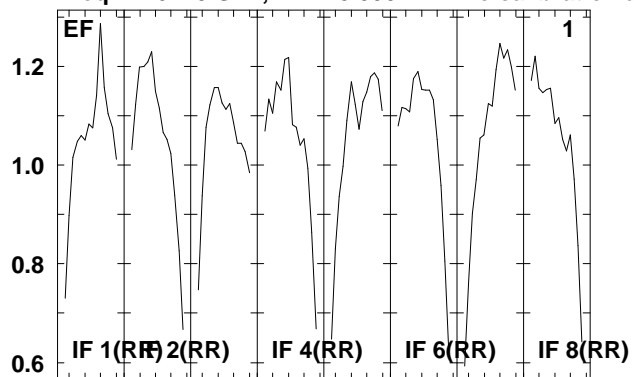

Lower frame: Real Jy

Total-power spectrum Antenna: \*

Timerange: 01/03:15:01 to 01/03:15:59

Plot file version 162 created 20-OCT-2009 14:50:25

J0137+31 RP015C.UVDATA.1

Freq = 1.6270 GHz, Bw = 8.000 MH No calibration applied and no bandpass applied

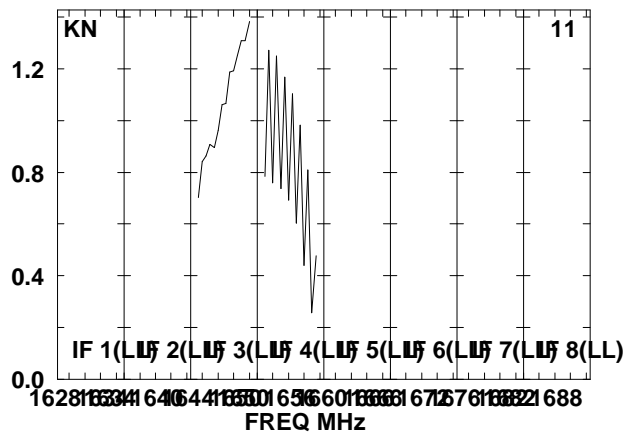
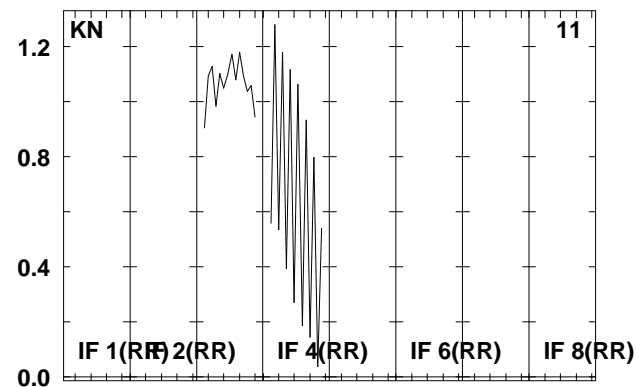
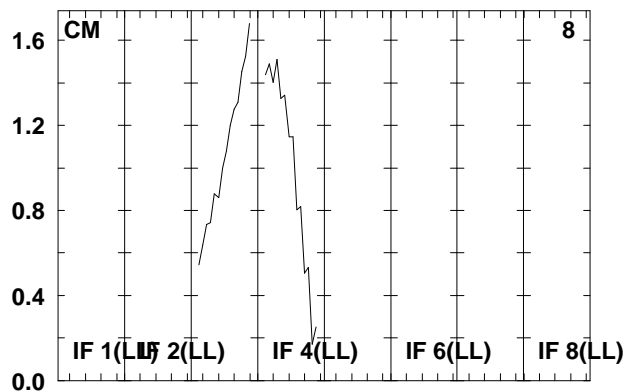
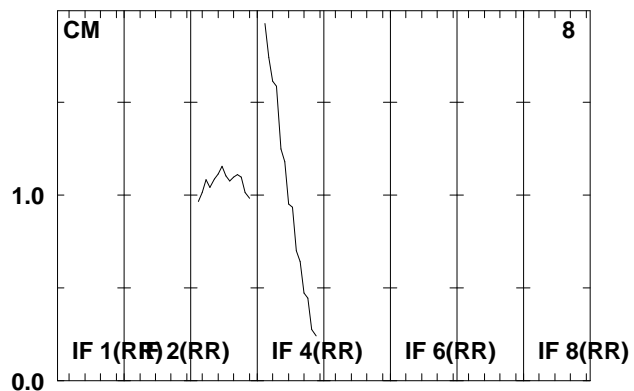
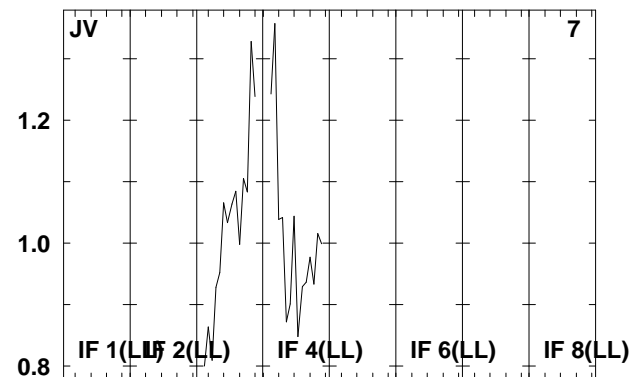
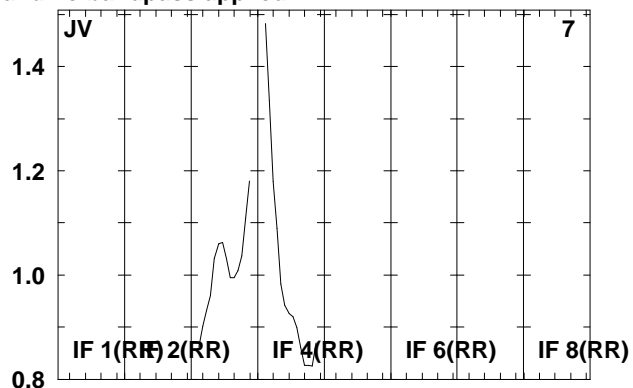
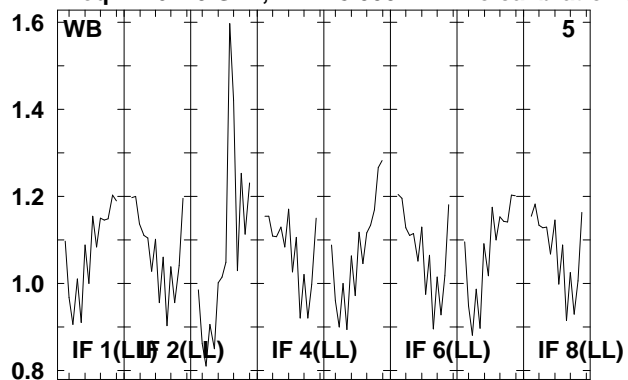

Lower frame: Real Jy

Total-power spectrum Antenna: \*

Timerange: 01/03:15:01 to 01/03:15:59

Plot file version 163 created 20-OCT-2009 14:50:25

FAINTCAL RP015C.UVDATA.1

Freq = 1.6270 GHz, Bw = 8.000 MH No calibration applied and no bandpass applied

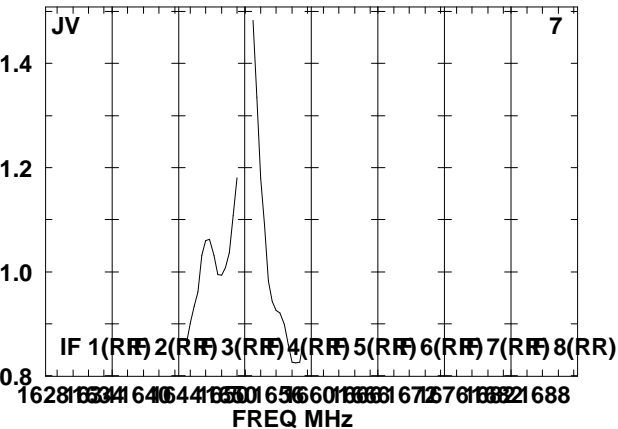
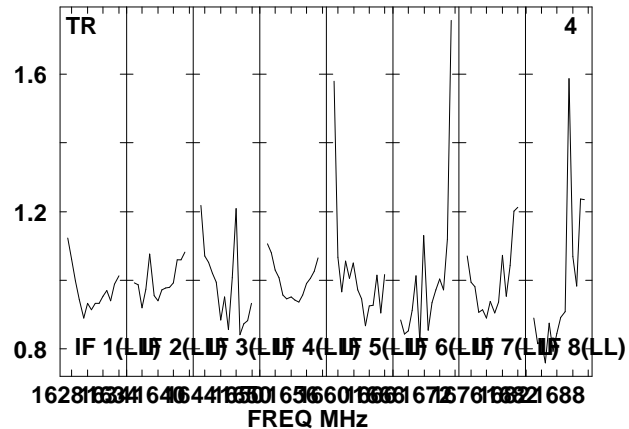
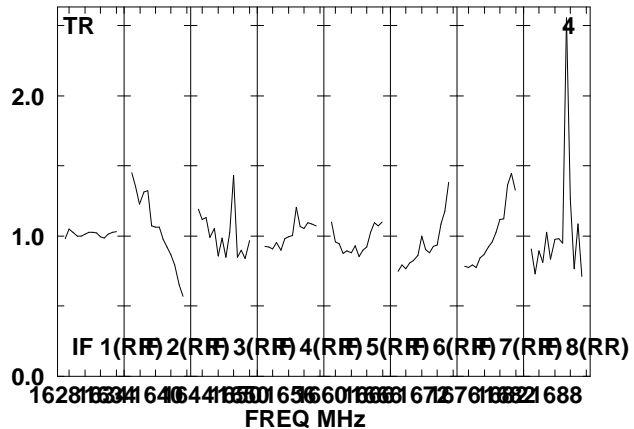
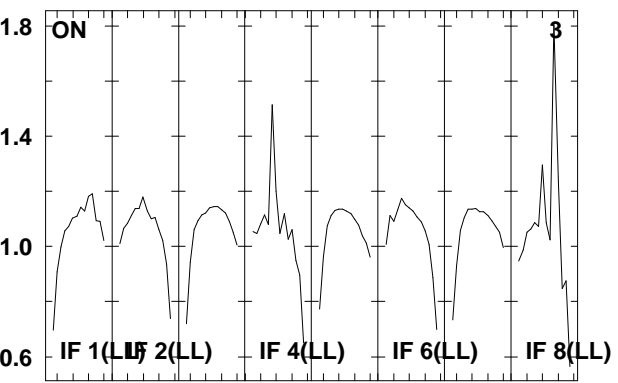
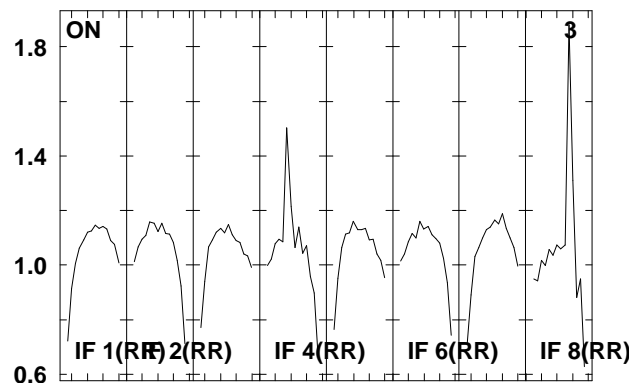
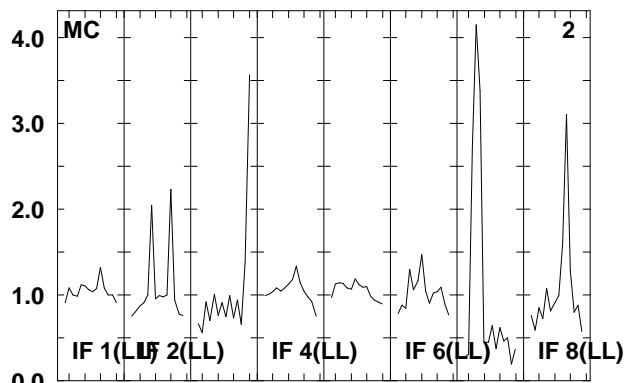
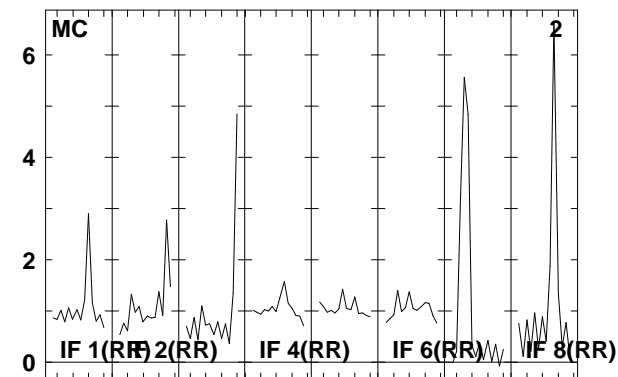
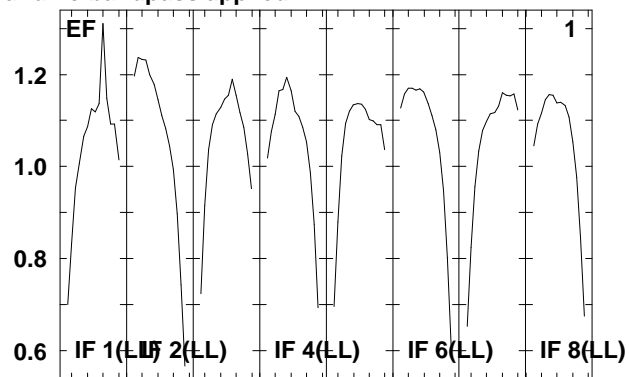
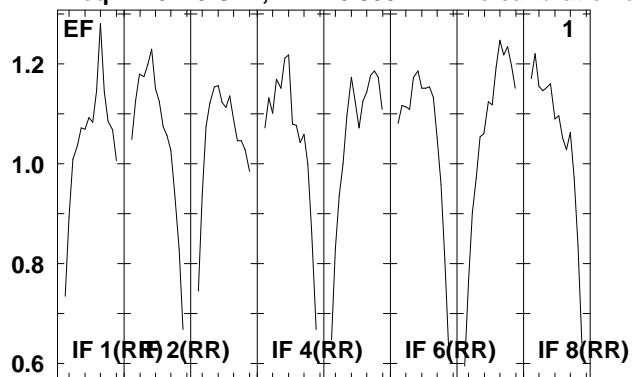

Lower frame: Real Jy  
Total-power spectrum Antenna: \*  
Timerange: 01/03:16:00 to 01/03:17:20

Plot file version 164 created 20-OCT-2009 14:50:26

FAINTCAL RP015C.UVDATA.1

Freq = 1.6270 GHz, Bw = 8.000 MH No calibration applied and no bandpass applied

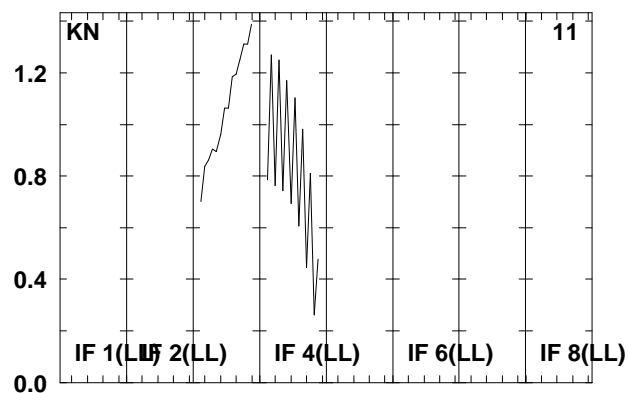
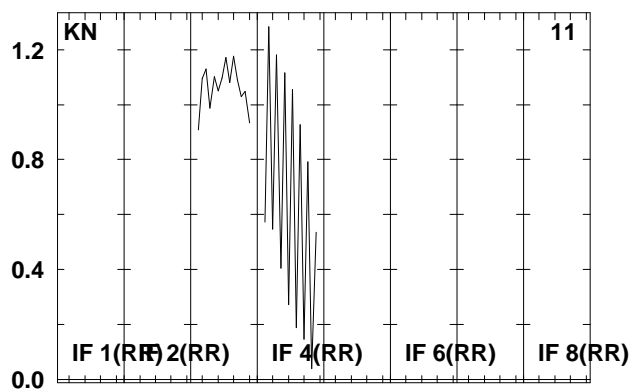
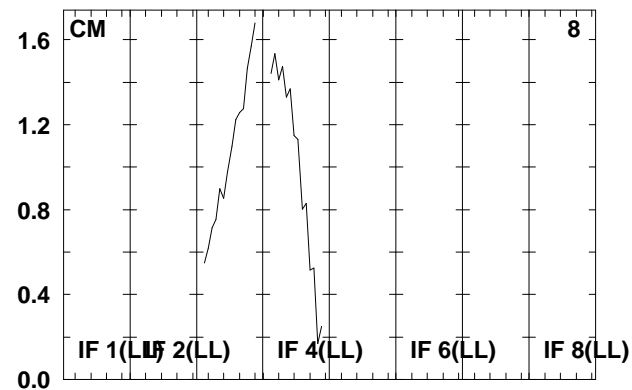
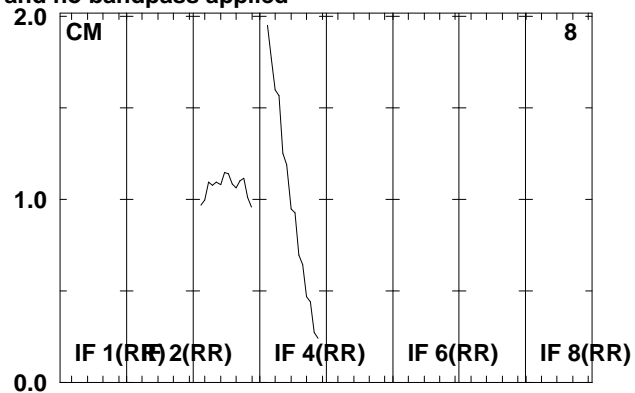
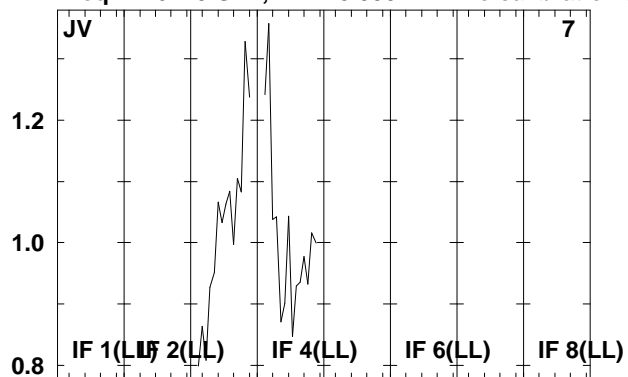

Lower frame: Real Jy  
Total-power spectrum Antenna: \*  
Timerange: 01/03:16:00 to 01/03:17:20

Plot file version 165 created 20-OCT-2009 14:50:27

M33 RP015C.UVDATA.1

Freq = 1.6270 GHz, Bw = 8.000 MH No calibration applied and no bandpass applied

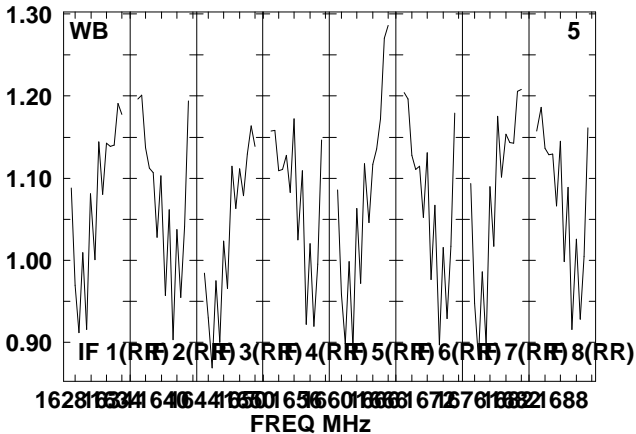
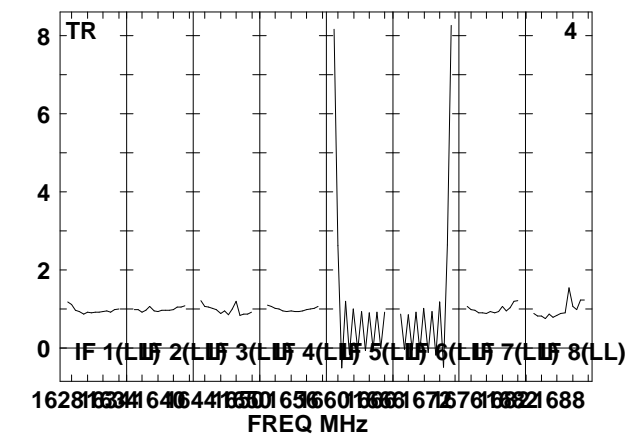
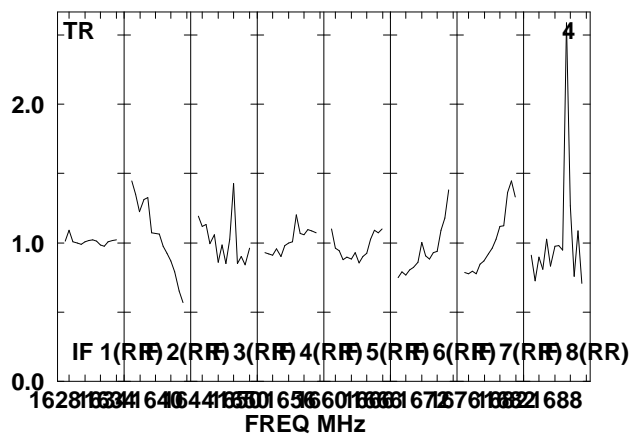
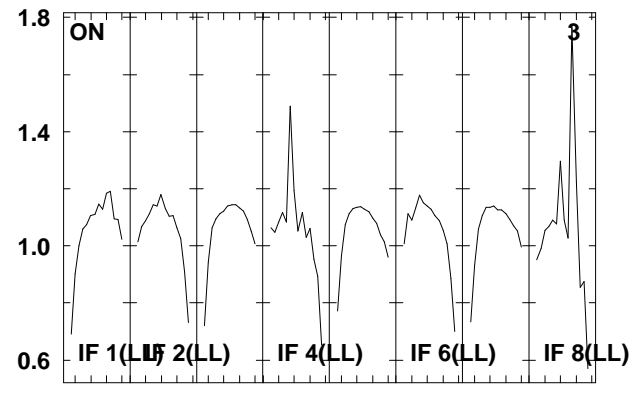
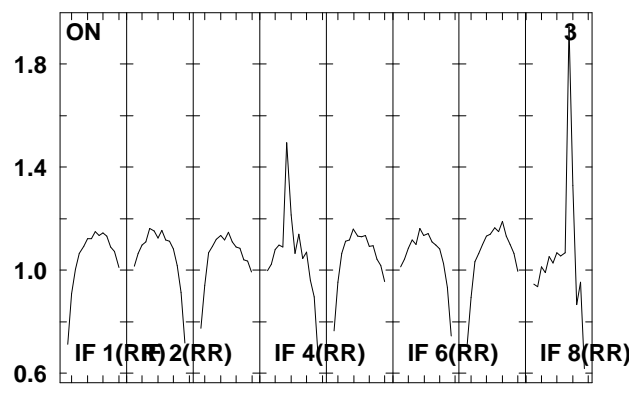
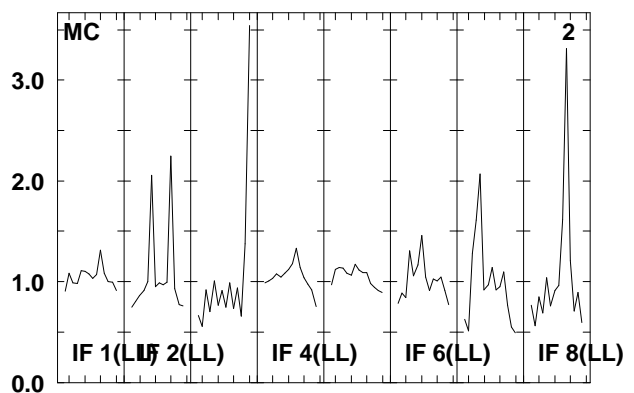
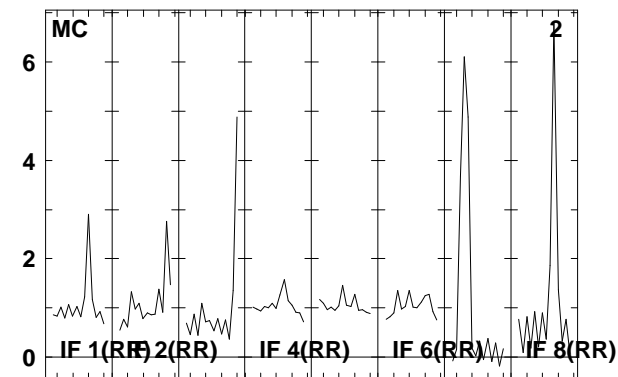
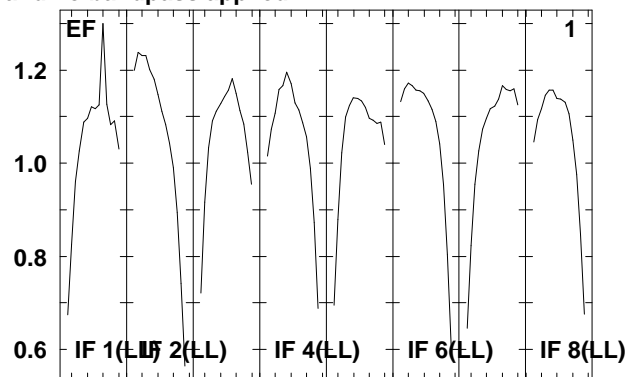
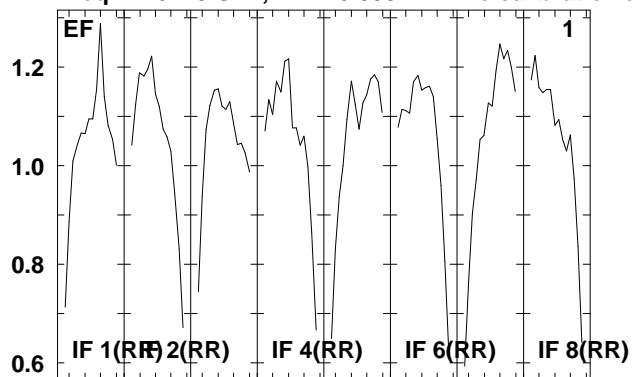

Lower frame: Real Jy

Total-power spectrum Antenna: \*

Timerange: 01/03:17:20 to 01/03:20:20

Plot file version 166 created 20-OCT-2009 14:50:27

M33 RP015C.UVDATA.1

Freq = 1.6270 GHz, Bw = 8.000 MH No calibration applied and no bandpass applied

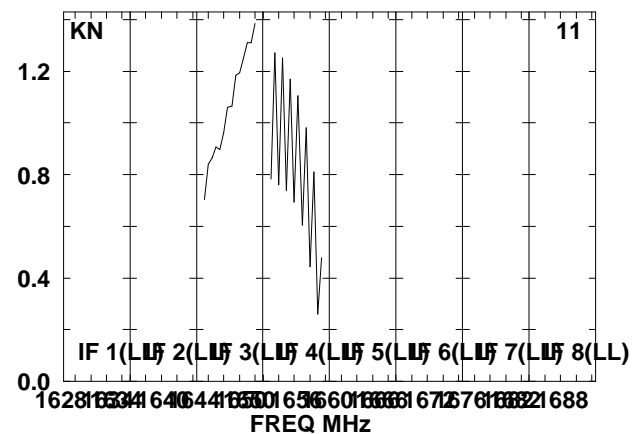
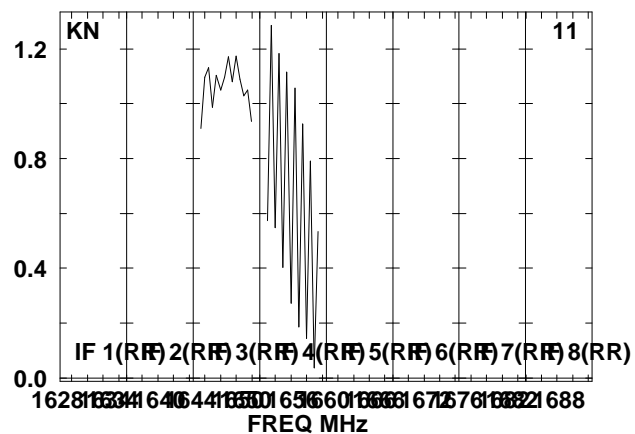
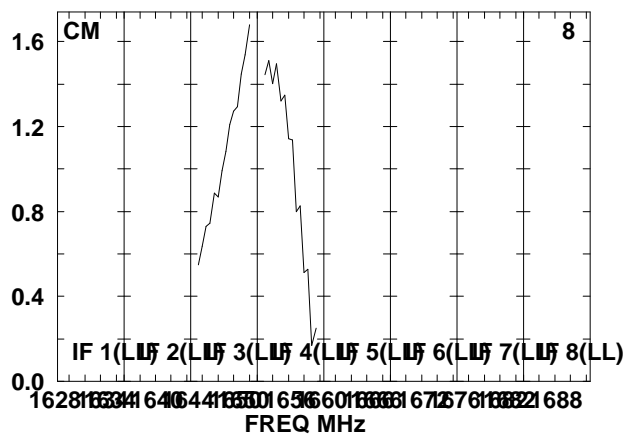
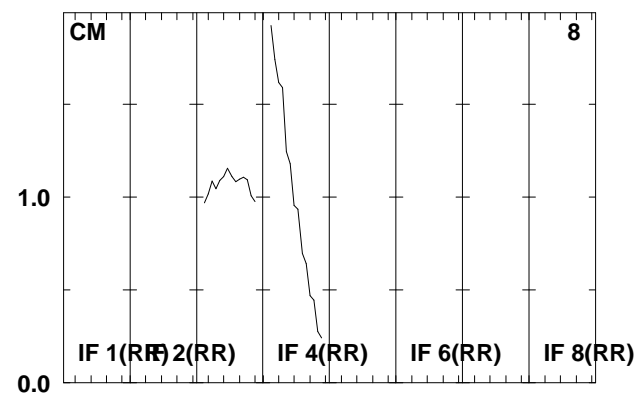
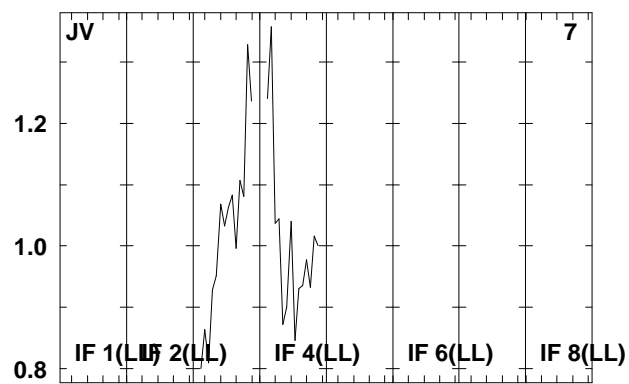
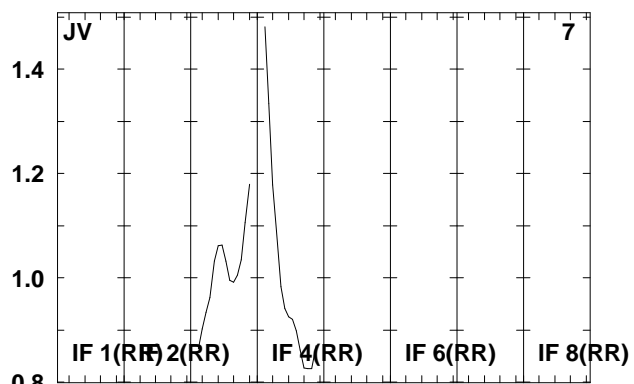
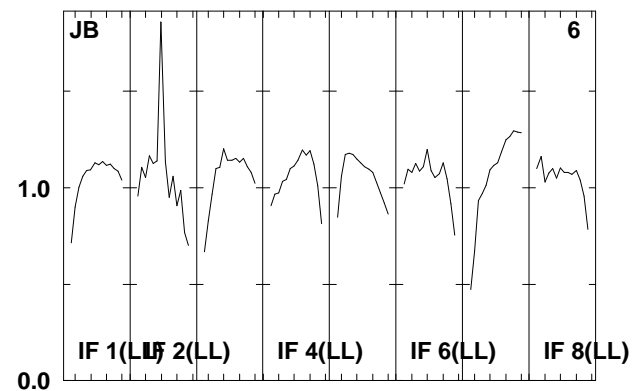
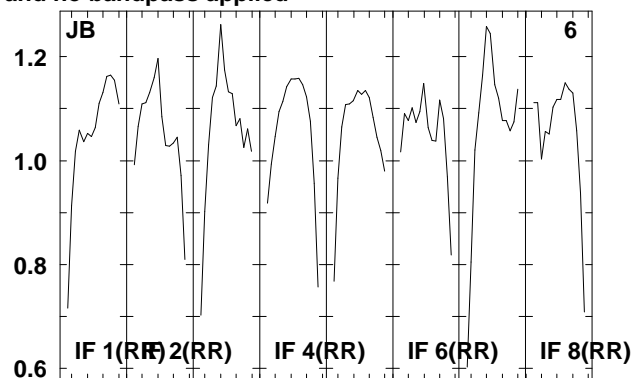
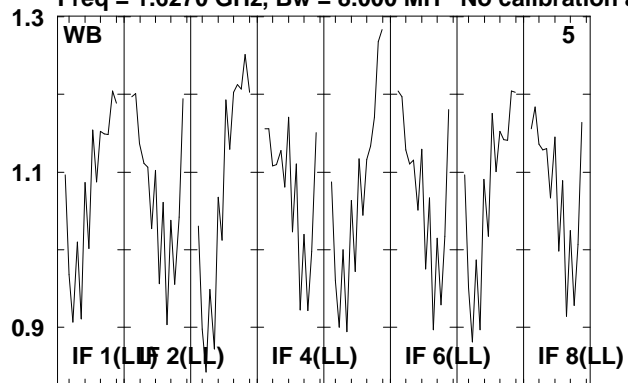

Lower frame: Real Jy  
Total-power spectrum Antenna: \*  
Timerange: 01/03:17:20 to 01/03:20:20

Plot file version 167 created 20-OCT-2009 14:50:29

J0137+31 RP015C.UVDATA.1

Freq = 1.6270 GHz, Bw = 8.000 MH No calibration applied and no bandpass applied

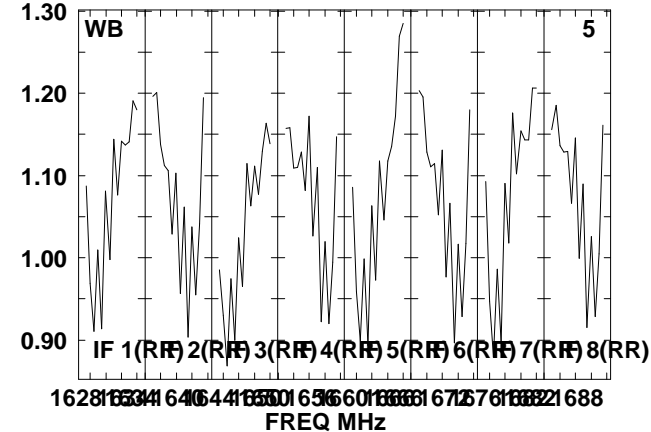
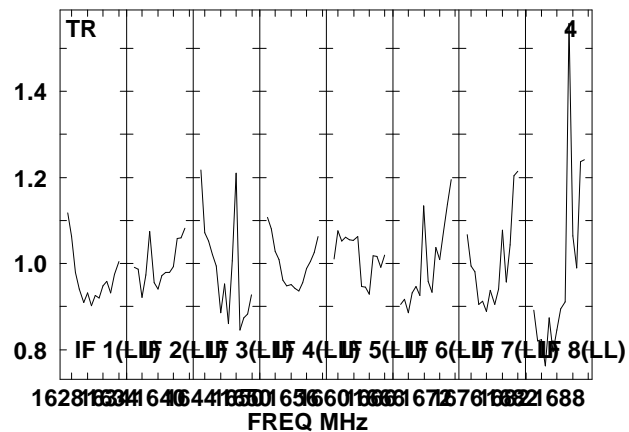
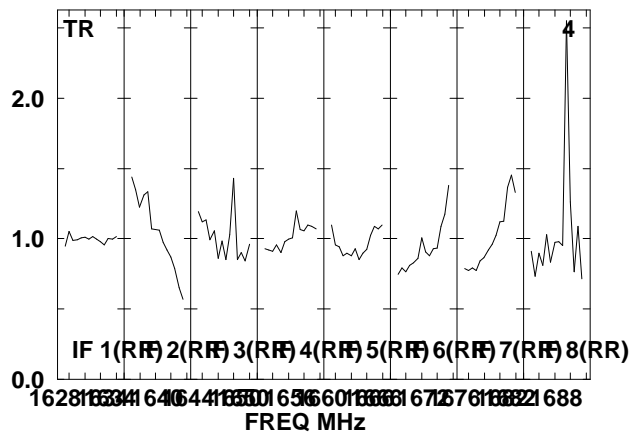
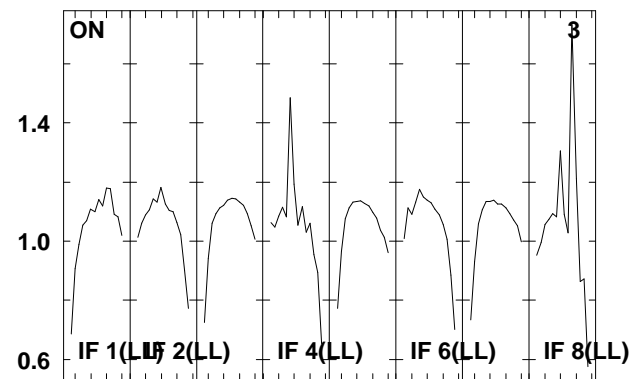
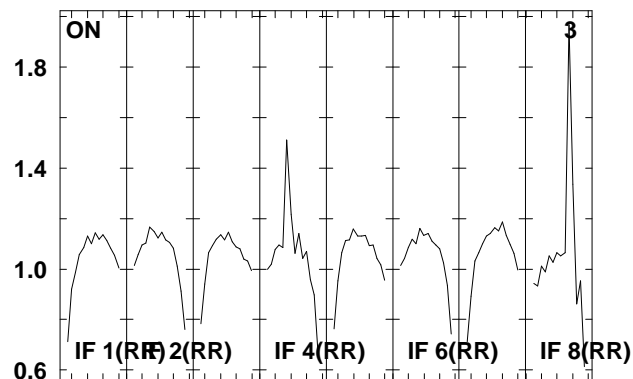
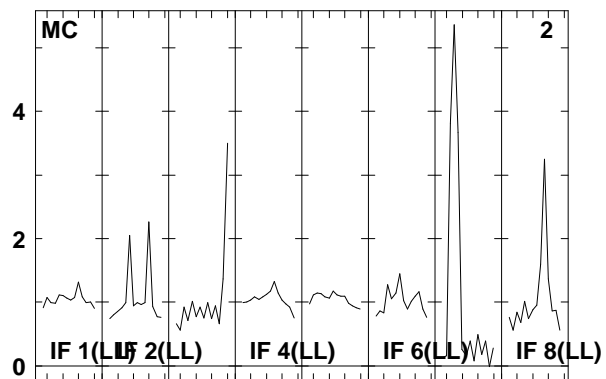
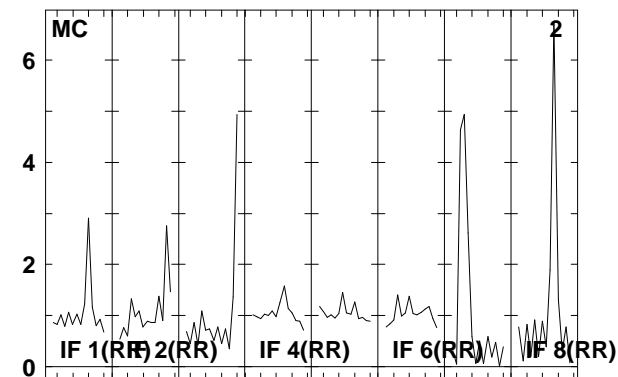
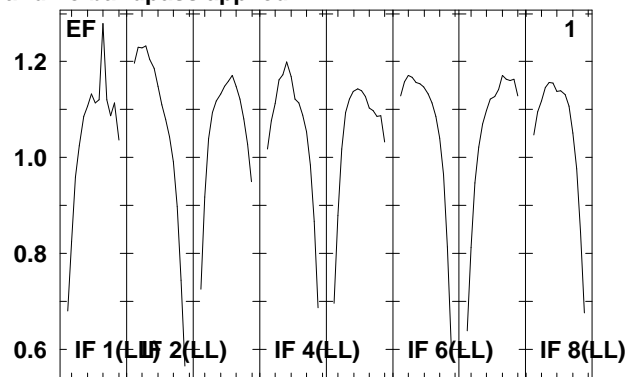
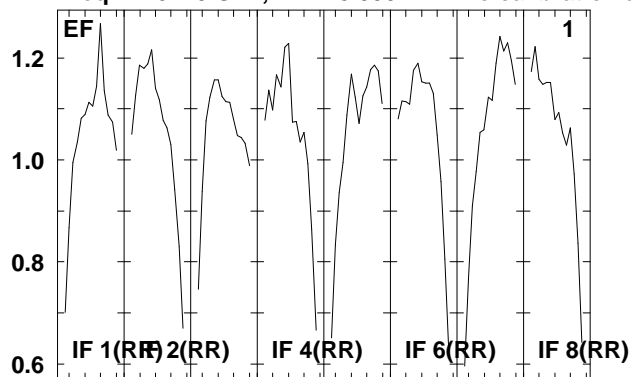

Lower frame: Real Jy  
Total-power spectrum Antenna: \*  
Timerange: 01/03:21:00 to 01/03:21:59

Plot file version 168 created 20-OCT-2009 14:50:29

J0137+31 RP015C.UVDATA.1

Freq = 1.6270 GHz, Bw = 8.000 MH No calibration applied and no bandpass applied

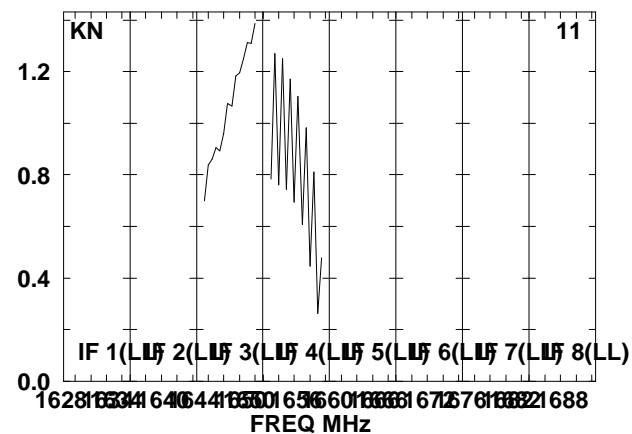
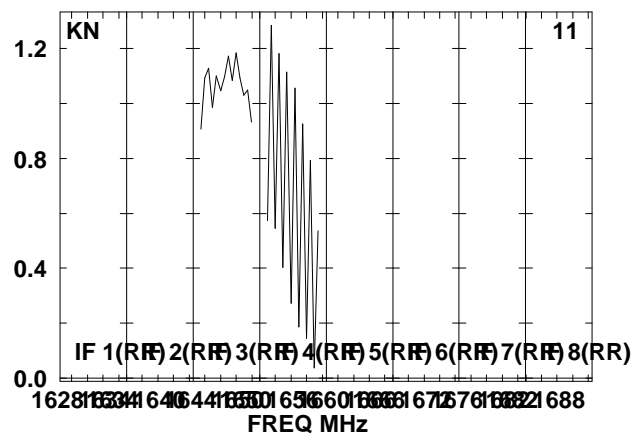
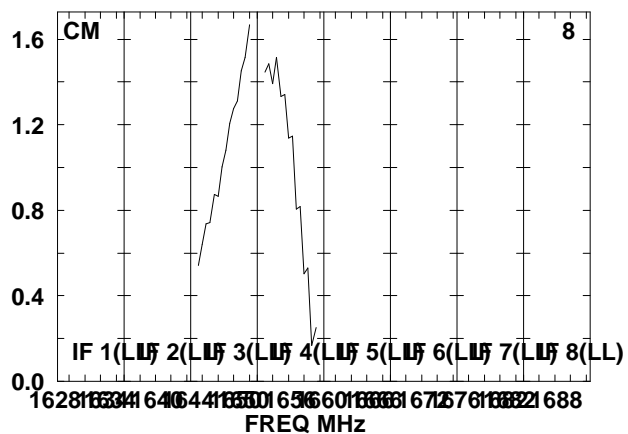
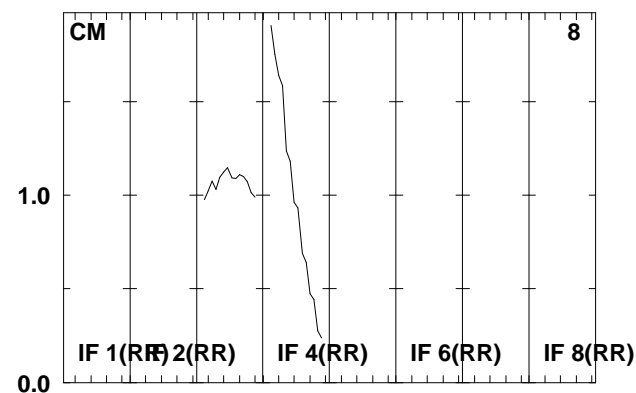
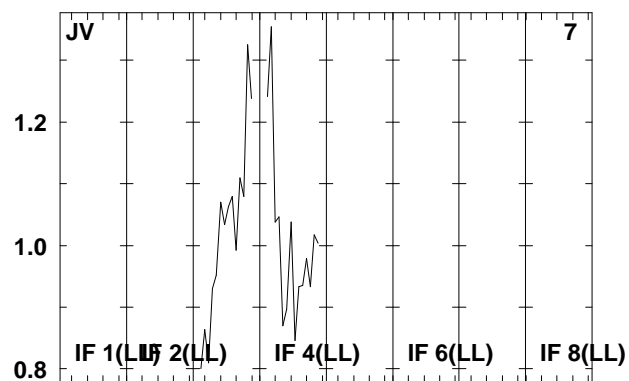
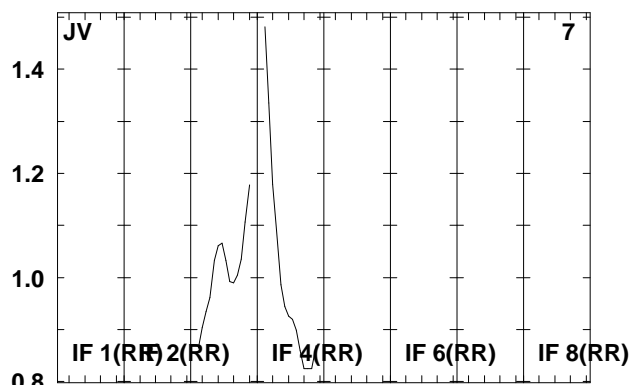
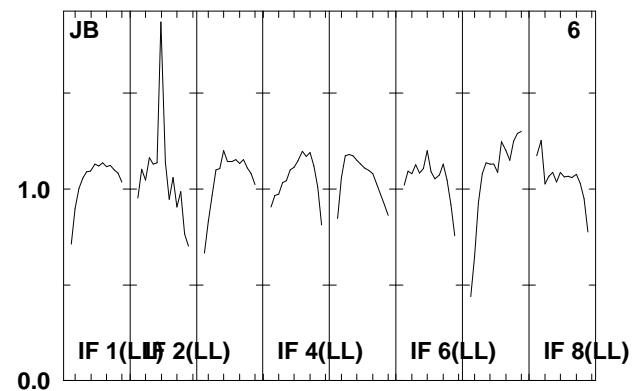
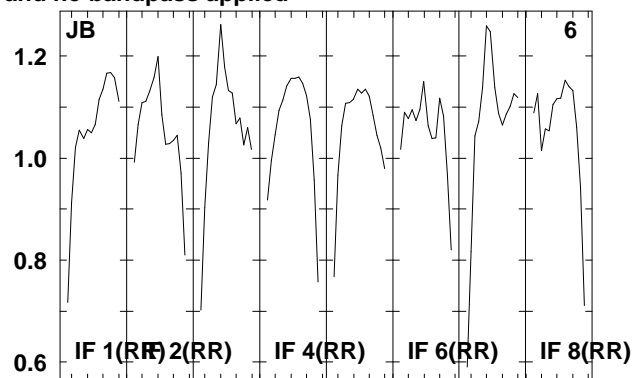
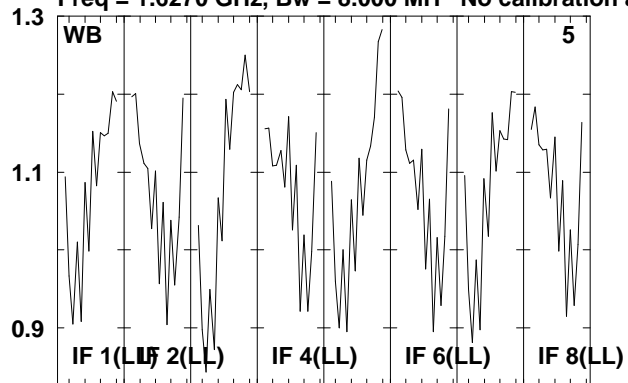

Lower frame: Real Jy  
Total-power spectrum Antenna: \*  
Timerange: 01/03:21:00 to 01/03:21:59



Plot file version 169 created 20-OCT-2009 14:50:30

FAINTCAL RP015C.UVDATA.1

Freq = 1.6270 GHz, Bw = 8.000 MH No calibration applied and no bandpass applied

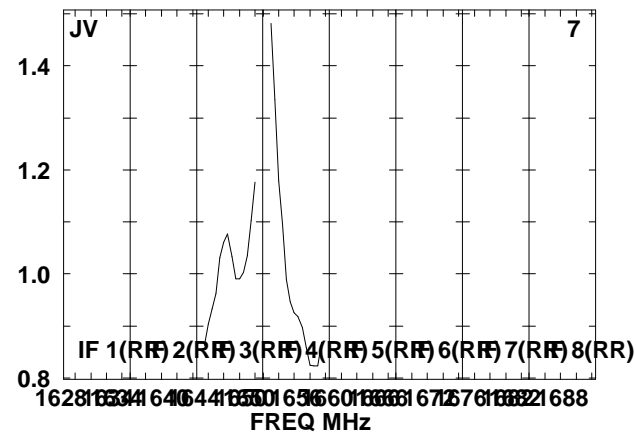
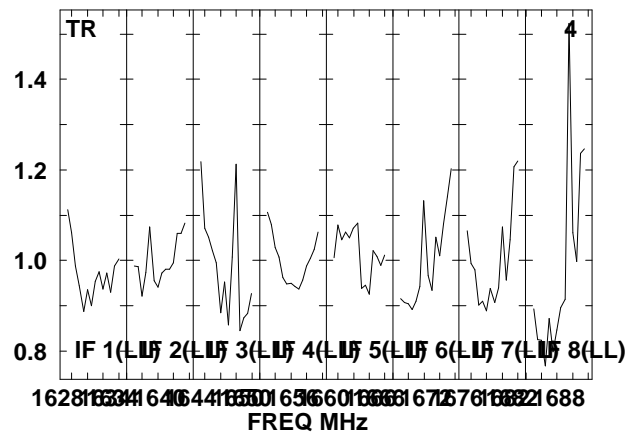
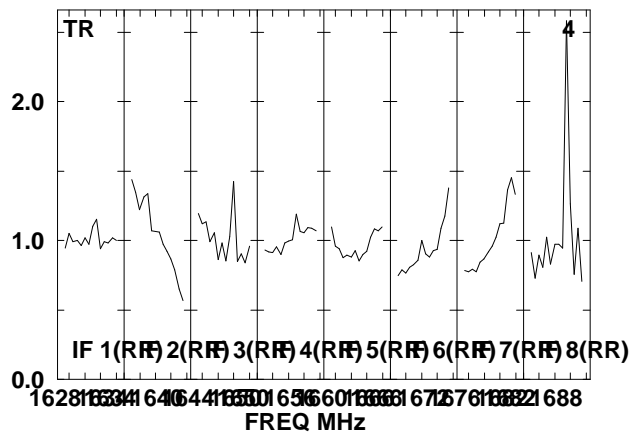
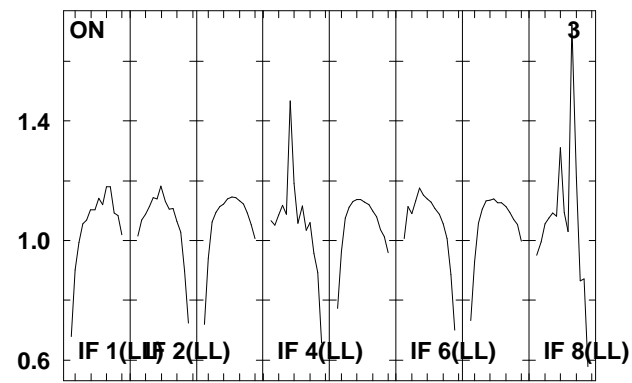
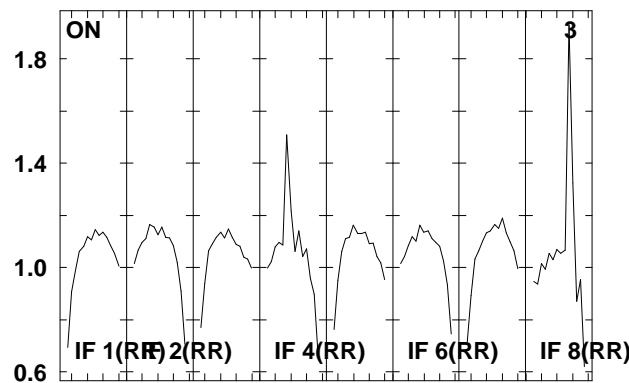
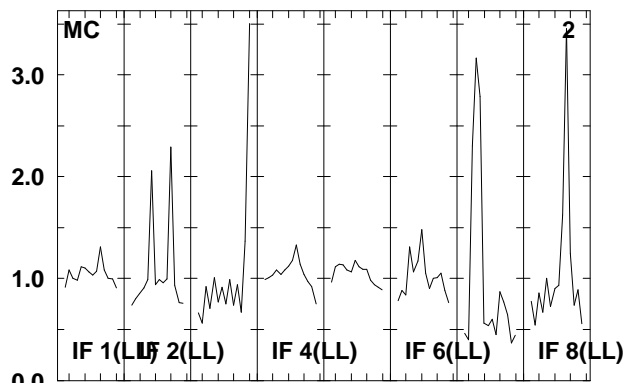
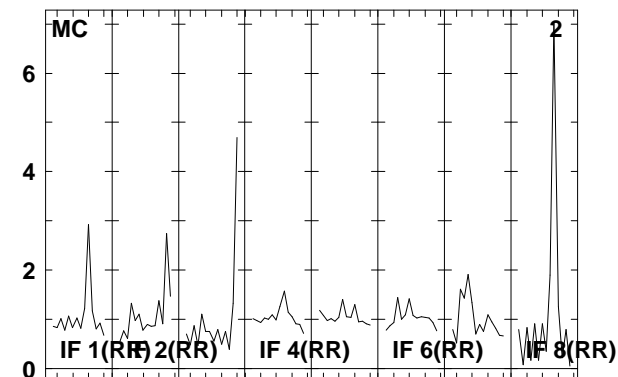
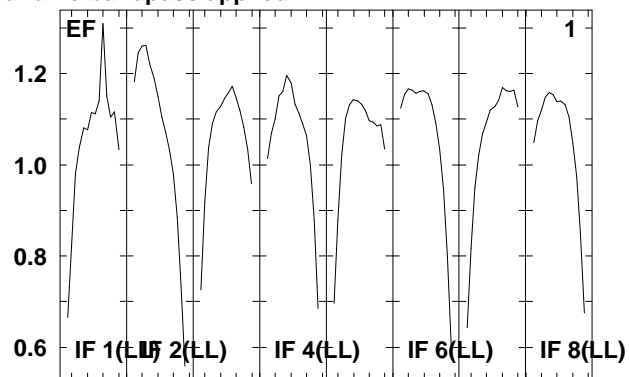
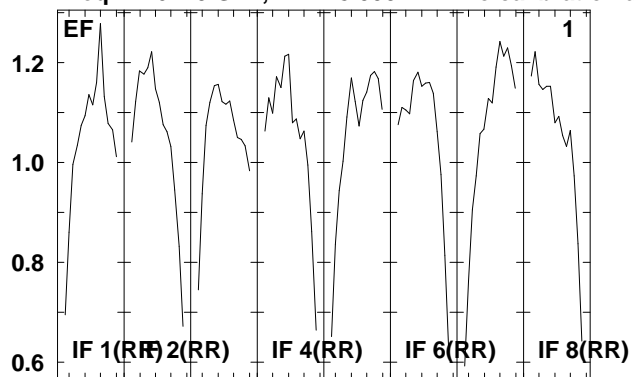

Lower frame: Real Jy

Total-power spectrum Antenna: \*

Timerange: 01/03:22:01 to 01/03:23:20

Plot file version 170 created 20-OCT-2009 14:50:30

FAINTCAL RP015C.UVDATA.1

Freq = 1.6270 GHz, Bw = 8.000 MH No calibration applied and no bandpass applied

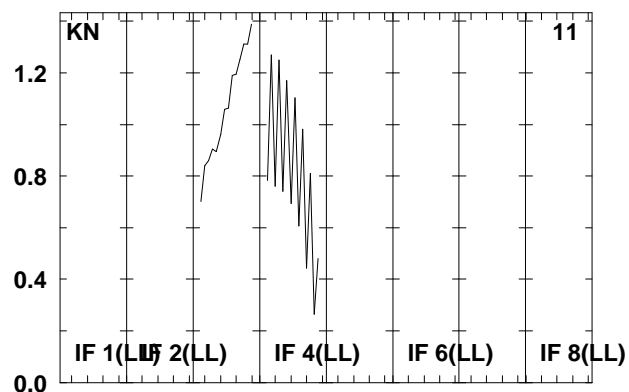
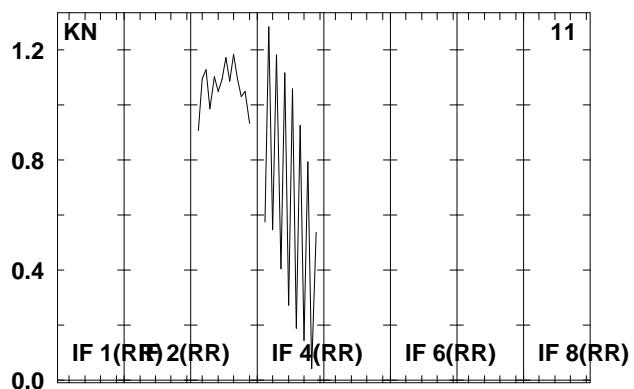
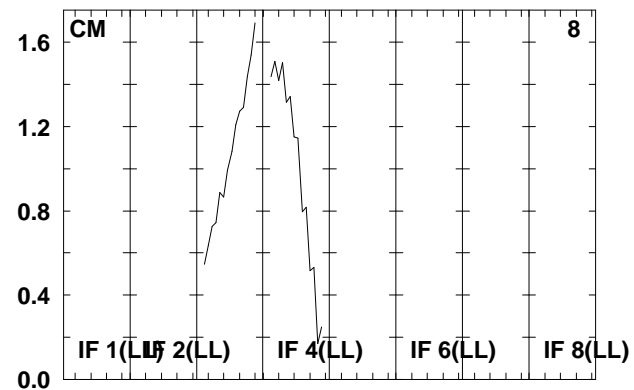
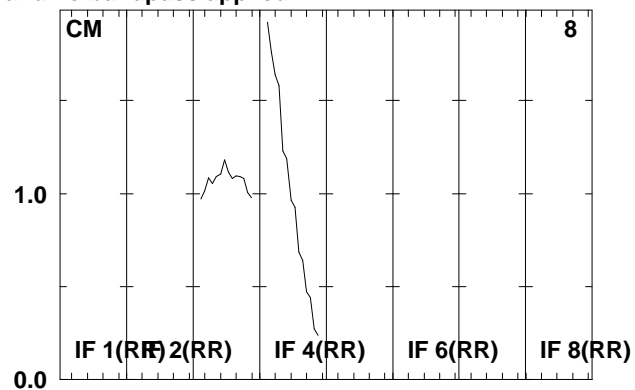
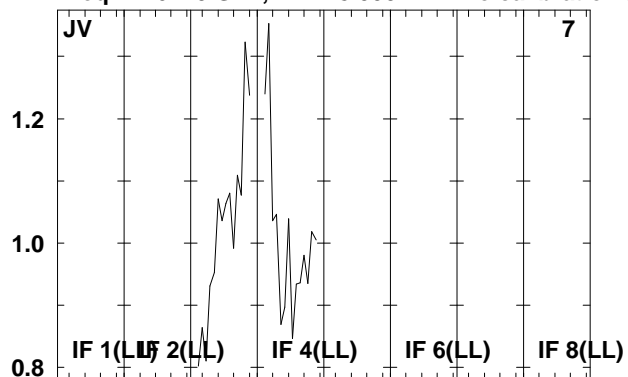

Lower frame: Real Jy  
Total-power spectrum Antenna: \*  
Timerange: 01/03:22:01 to 01/03:23:20

Plot file version 171 created 20-OCT-2009 14:50:31

M33 RP015C.UVDATA.1

Freq = 1.6270 GHz, Bw = 8.000 MH No calibration applied and no bandpass applied

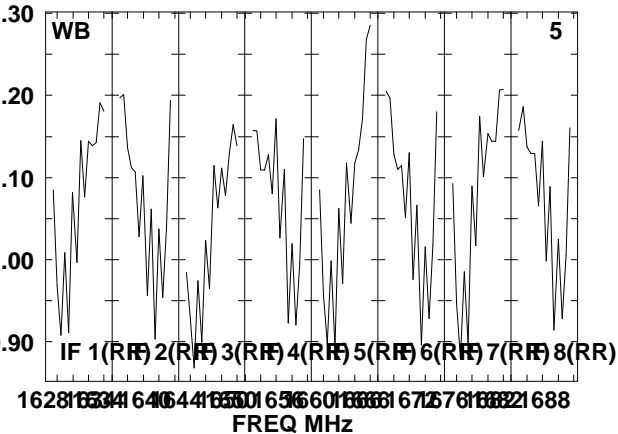
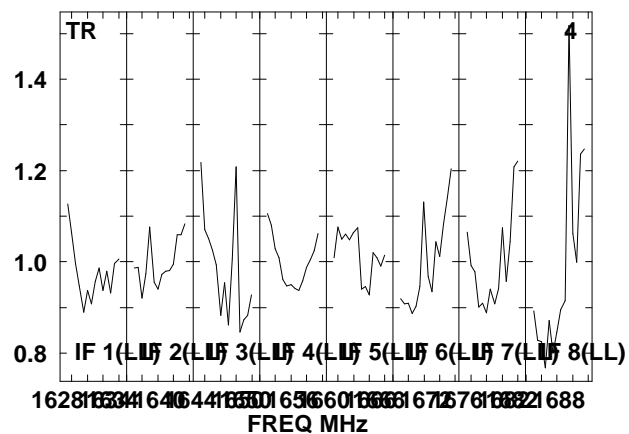
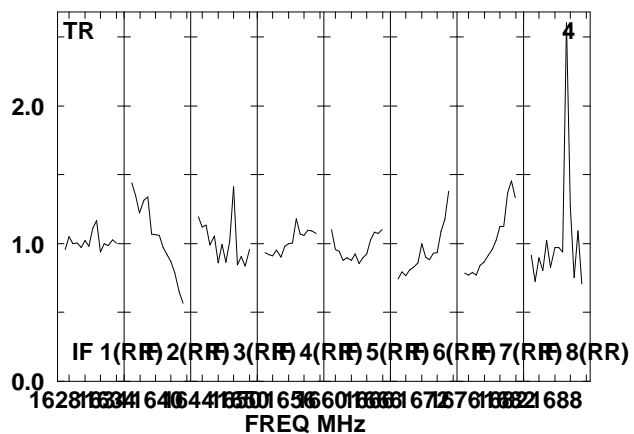
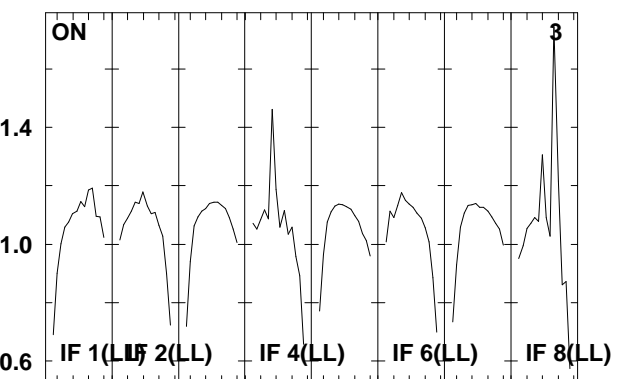
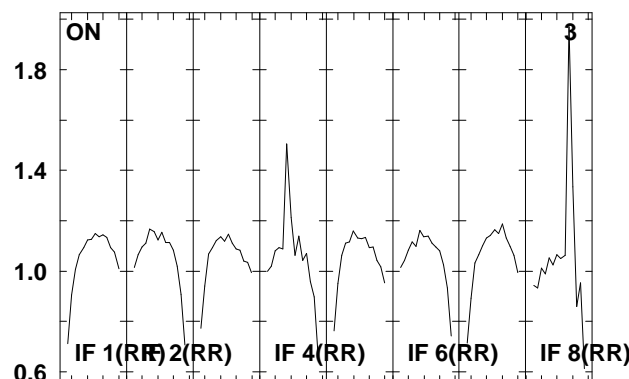
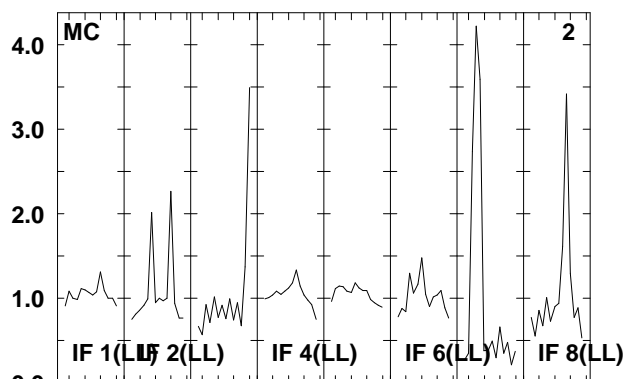
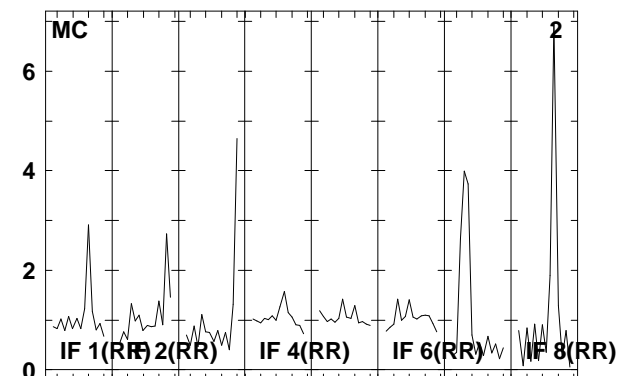
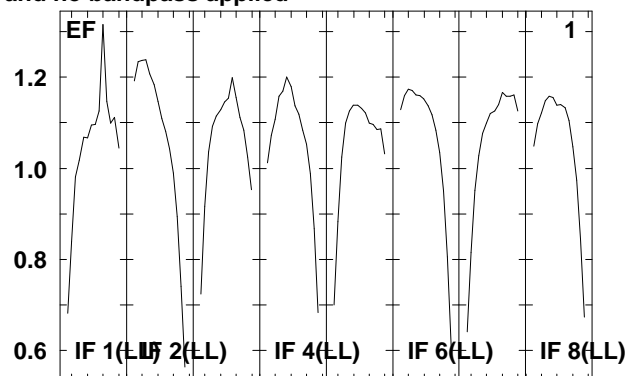
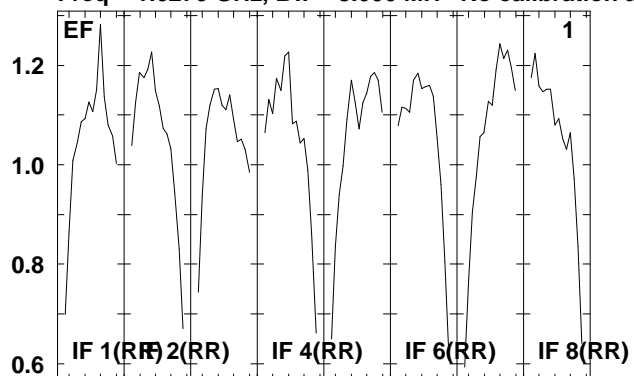

Lower frame: Real Jy  
Total-power spectrum Antenna: \*  
Timerange: 01/03:23:20 to 01/03:26:19

Plot file version 172 created 20-OCT-2009 14:50:32

M33 RP015C.UVDATA.1

Freq = 1.6270 GHz, Bw = 8.000 MH No calibration applied and no bandpass applied

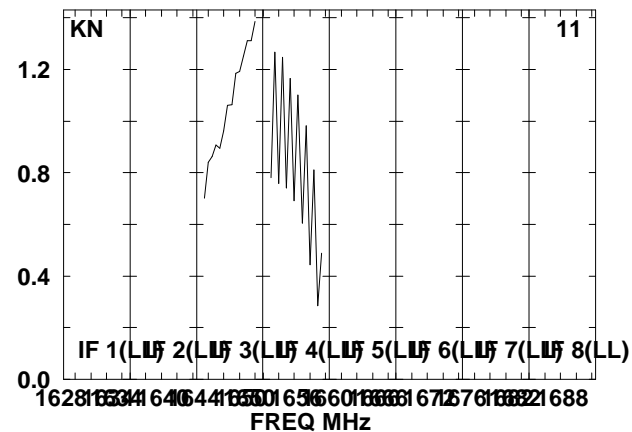
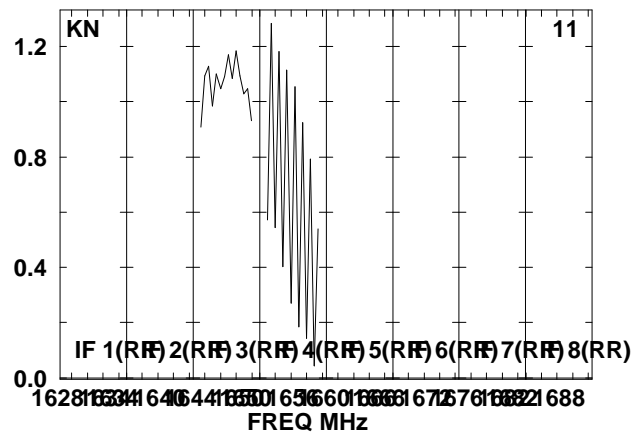
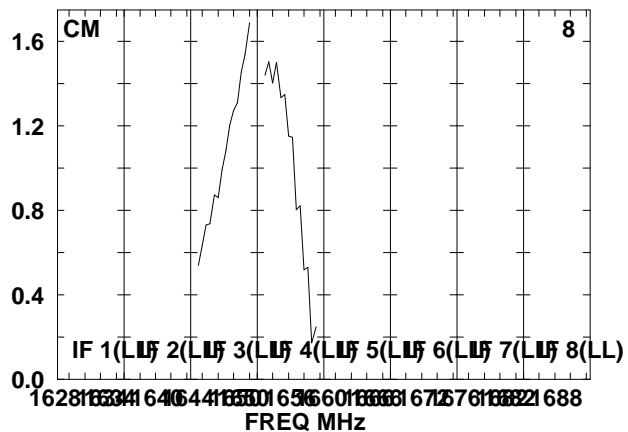
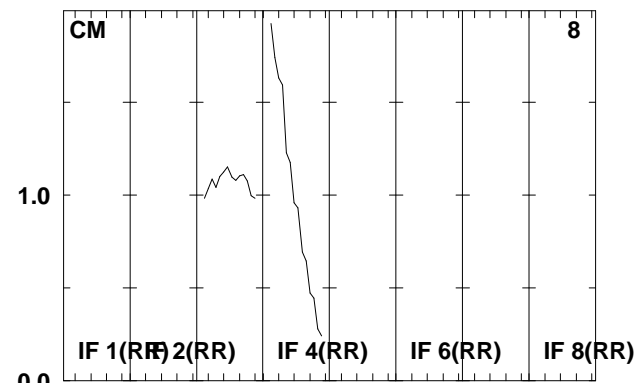
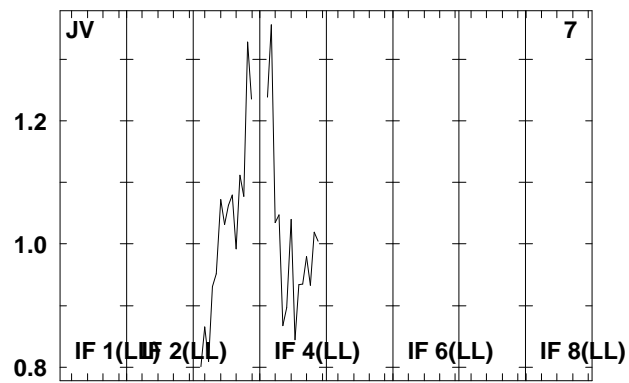
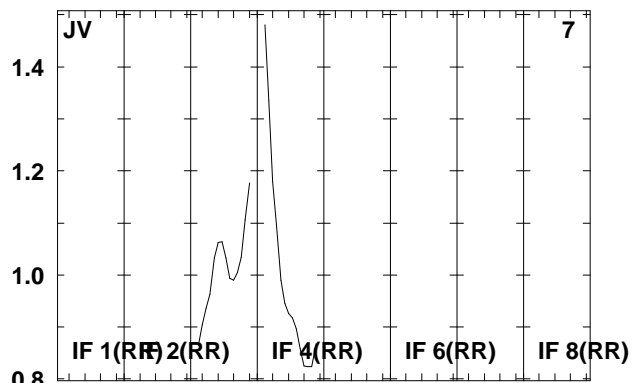
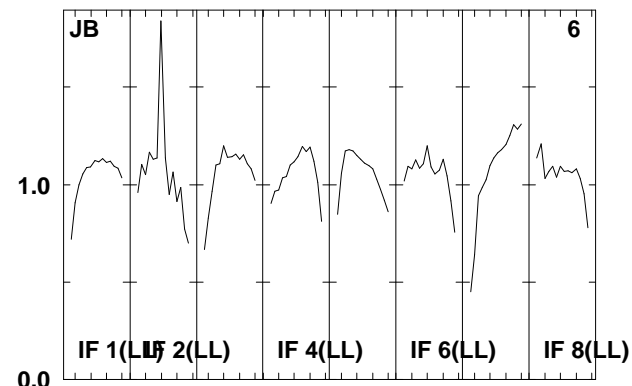
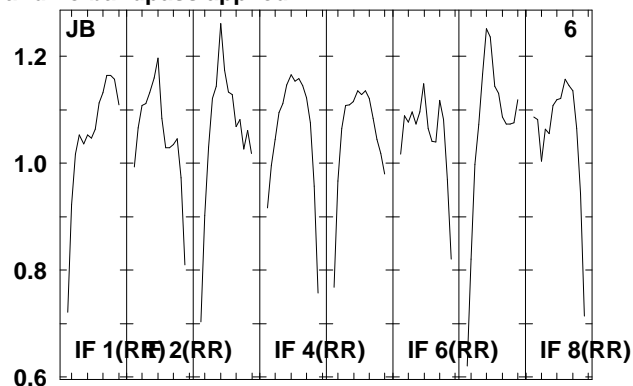
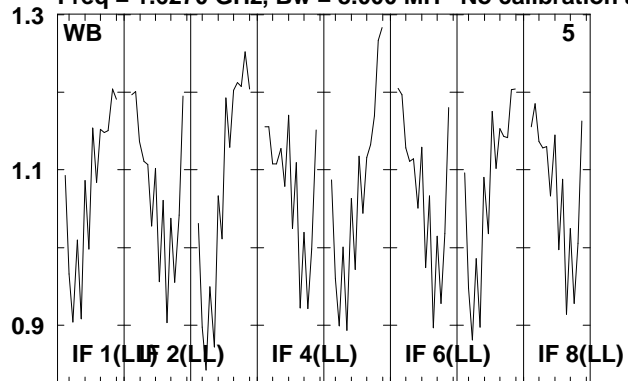

Lower frame: Real Jy  
Total-power spectrum Antenna: \*  
Timerange: 01/03:23:20 to 01/03:26:19

Plot file version 173 created 20-OCT-2009 14:50:33

J0137+31 RP015C.UVDATA.1

Freq = 1.6270 GHz, Bw = 8.000 MH No calibration applied and no bandpass applied

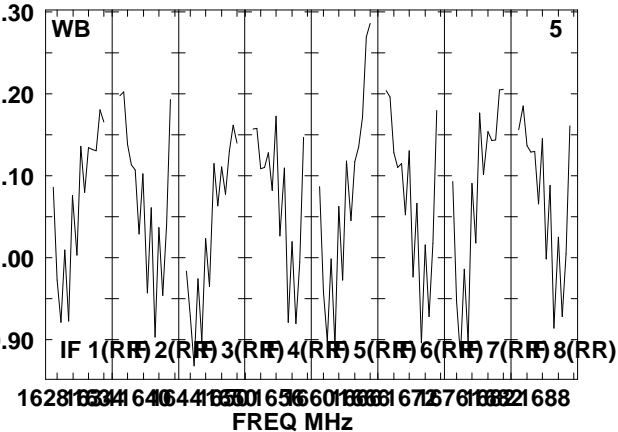
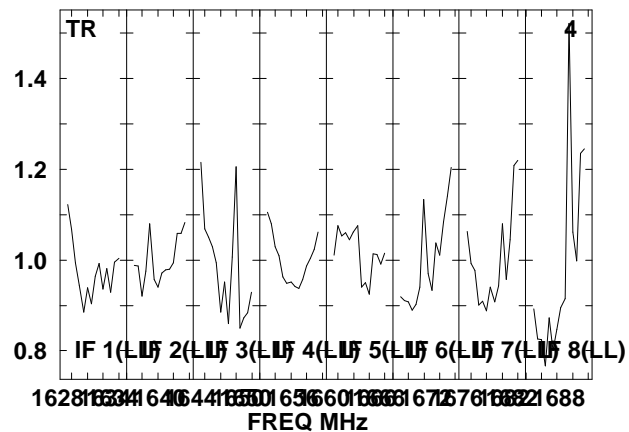
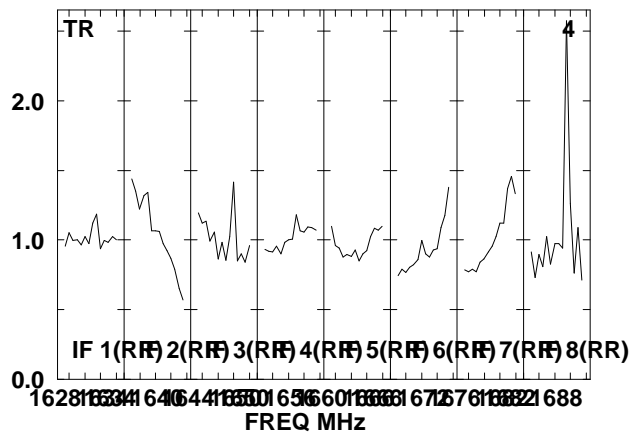
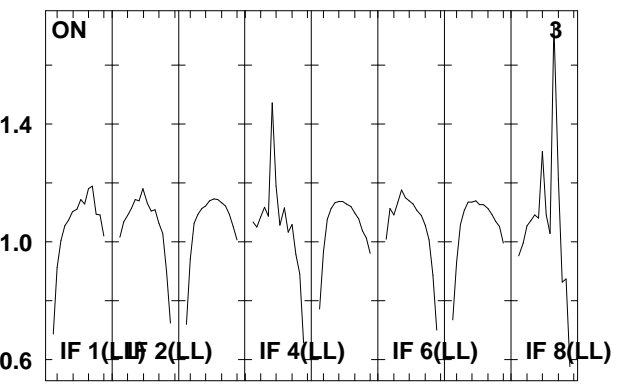
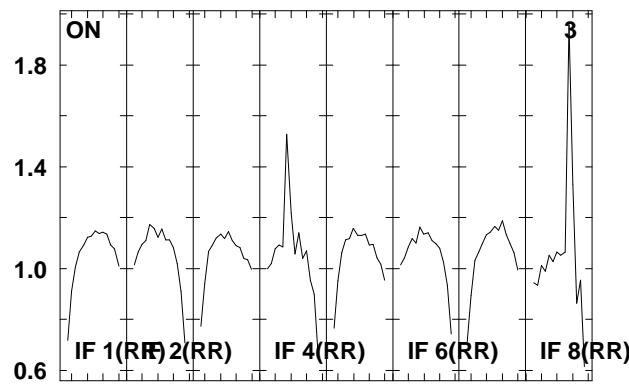
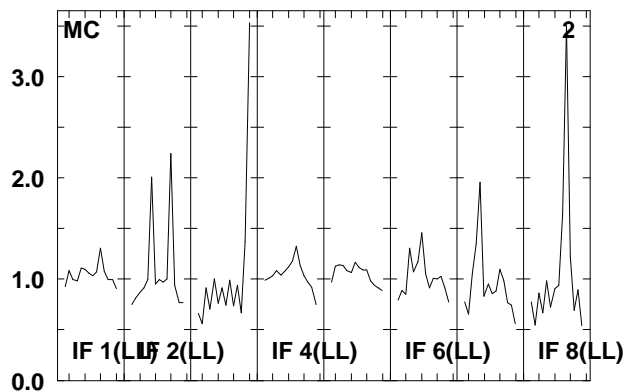
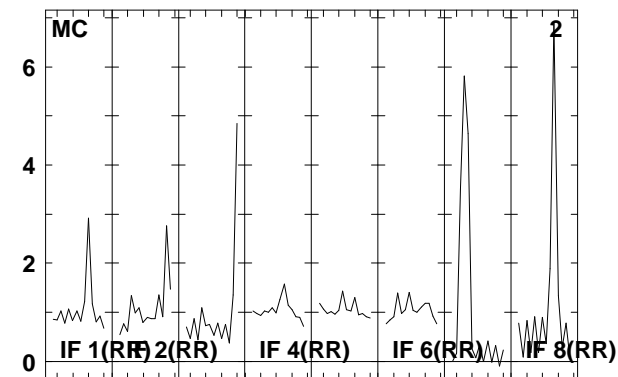
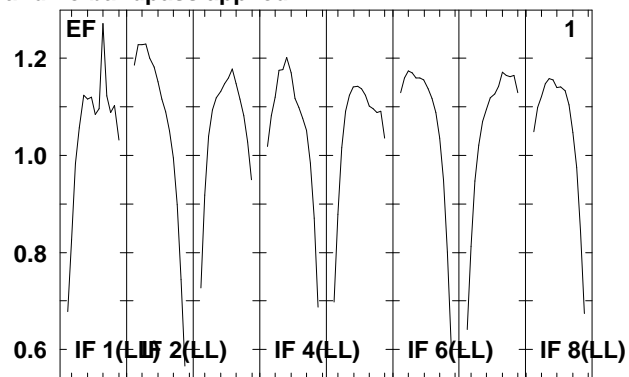
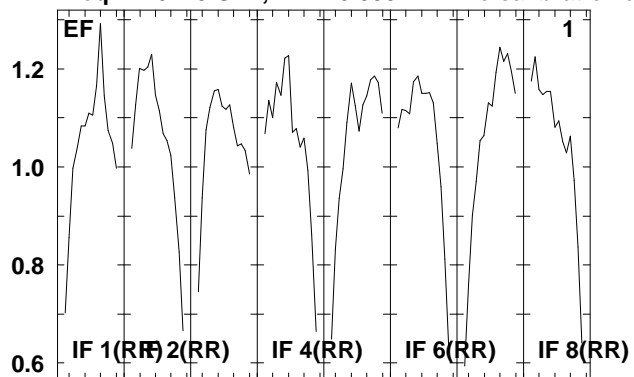

Lower frame: Real Jy  
Total-power spectrum Antenna: \*  
Timerange: 01/03:27:01 to 01/03:27:59

Plot file version 174 created 20-OCT-2009 14:50:33

J0137+31 RP015C.UVDATA.1

Freq = 1.6270 GHz, Bw = 8.000 MH No calibration applied and no bandpass applied

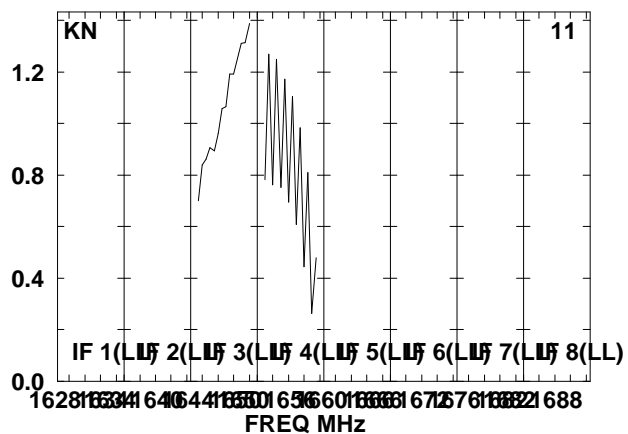
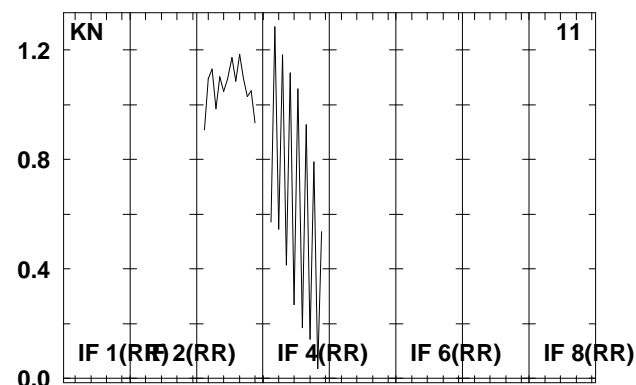
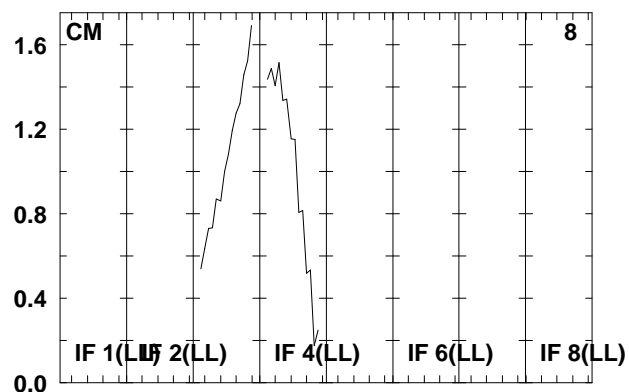
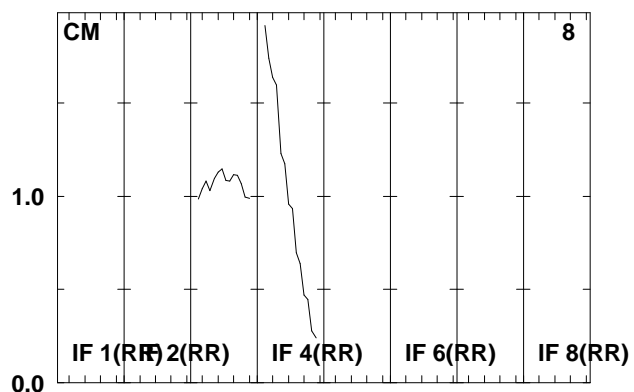
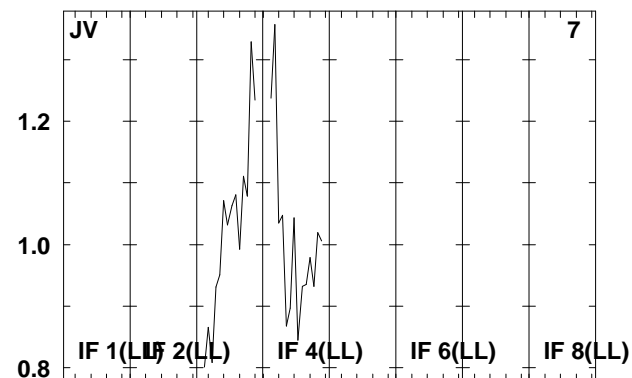
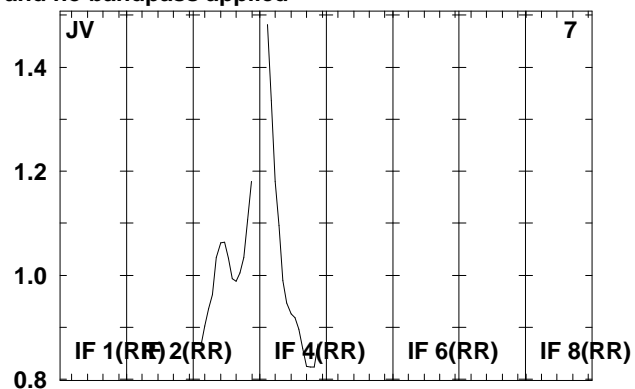
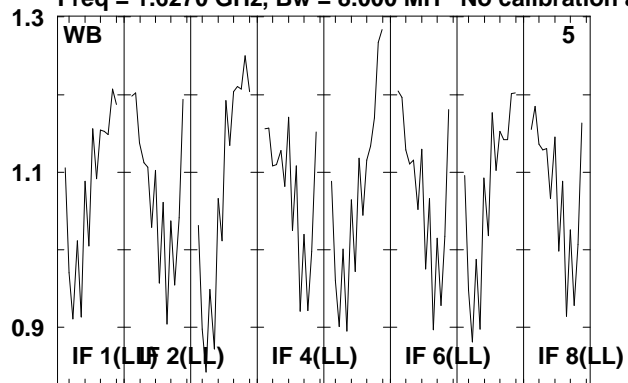

Lower frame: Real Jy

Total-power spectrum Antenna: \*

Timerange: 01/03:27:01 to 01/03:27:59

Plot file version 175 created 20-OCT-2009 14:50:34

FAINTCAL RP015C.UVDATA.1

Freq = 1.6270 GHz, Bw = 8.000 MH No calibration applied and no bandpass applied

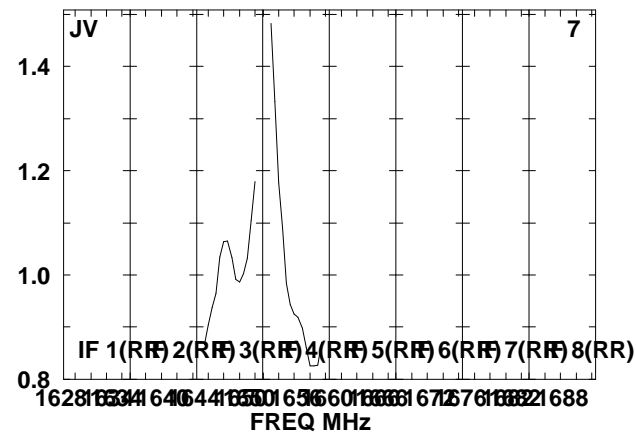
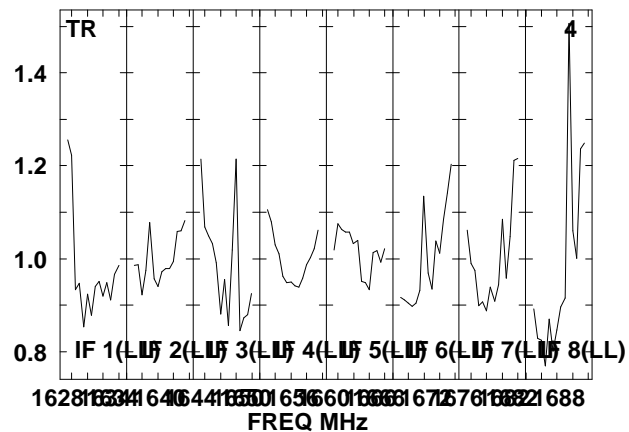
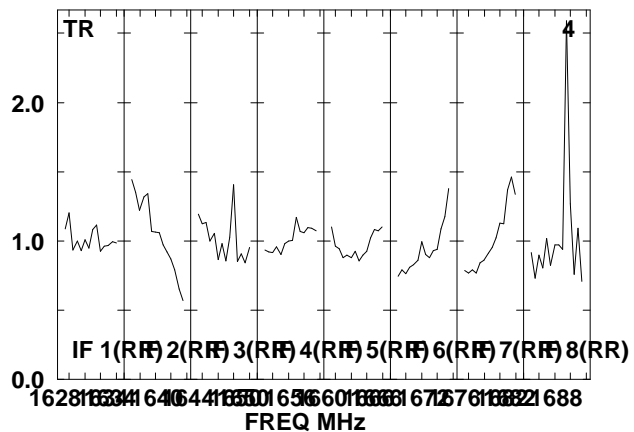
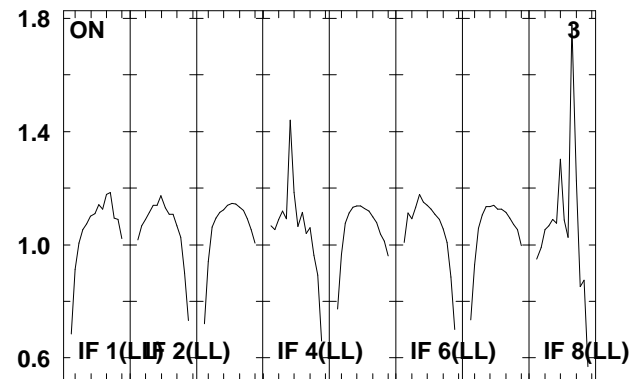
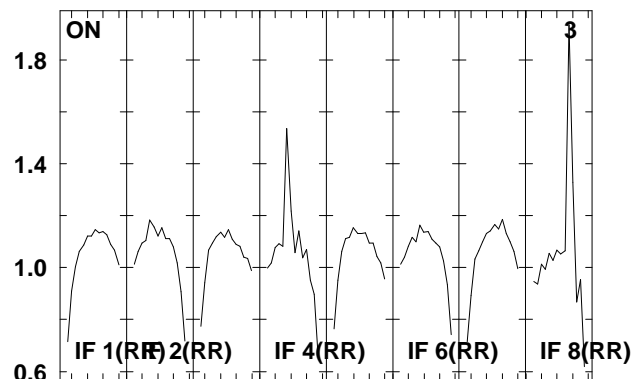
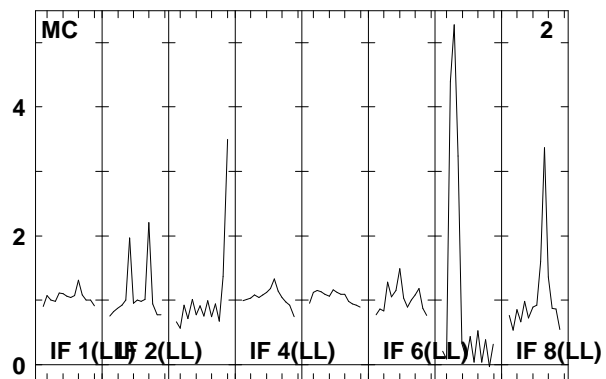
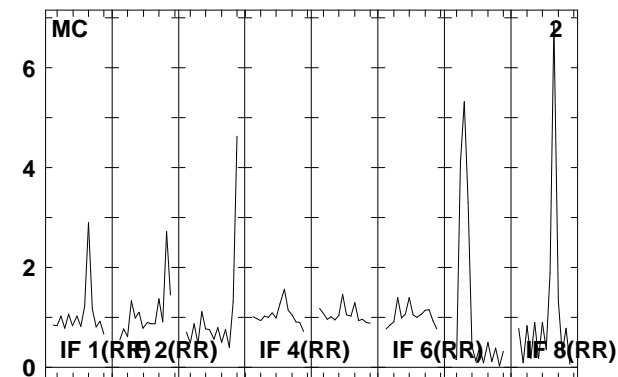
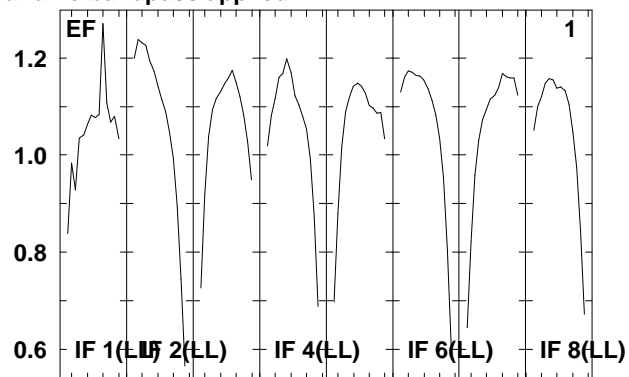
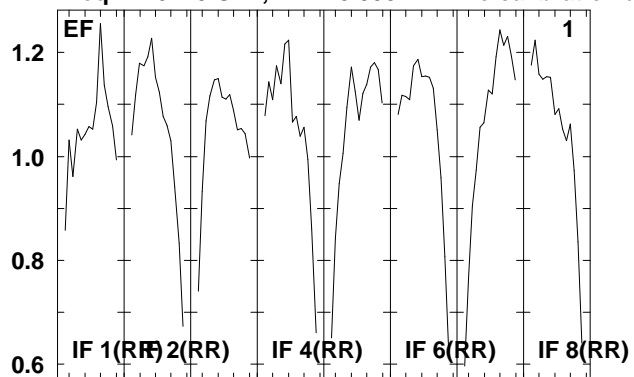

Lower frame: Real Jy  
Total-power spectrum Antenna: \*  
Timerange: 01/03:28:00 to 01/03:29:19

Plot file version 176 created 20-OCT-2009 14:50:35

FAINTCAL RP015C.UVDATA.1

Freq = 1.6270 GHz, Bw = 8.000 MH No calibration applied and no bandpass applied

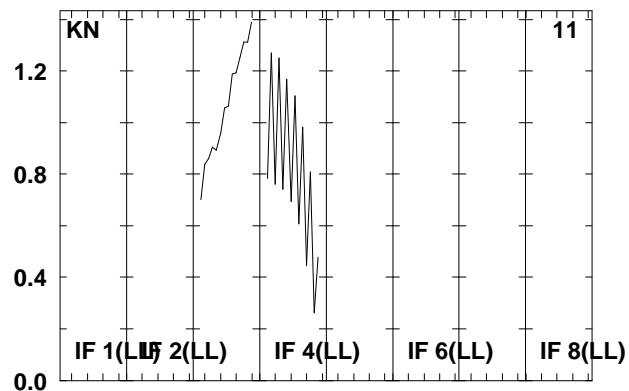
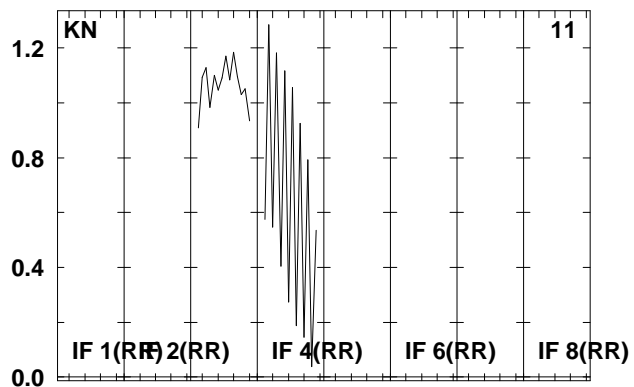
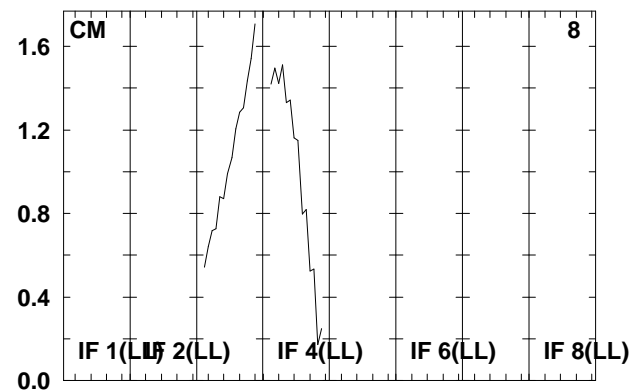
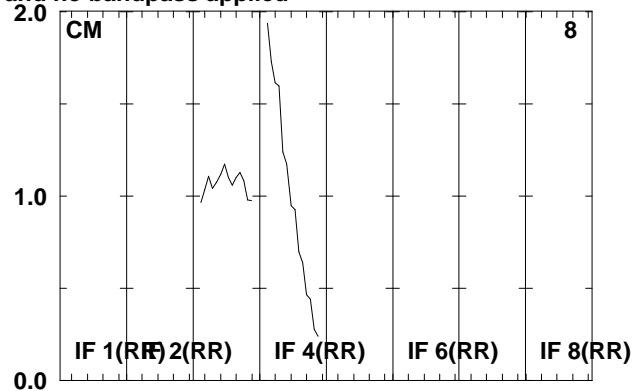
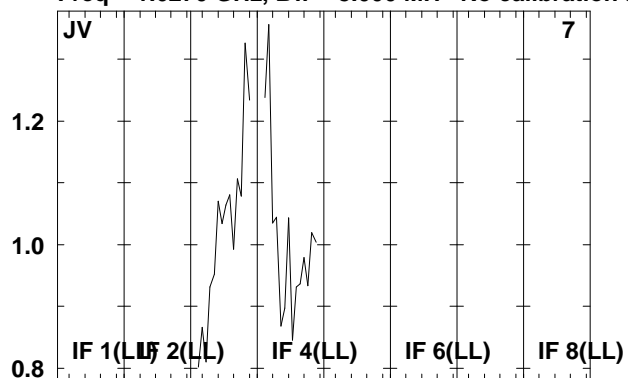

Lower frame: Real Jy  
Total-power spectrum Antenna: \*  
Timerange: 01/03:28:00 to 01/03:29:19



Plot file version 177 created 20-OCT-2009 14:50:35

M33 RP015C.UVDATA.1

Freq = 1.6270 GHz, Bw = 8.000 MH No calibration applied and no bandpass applied

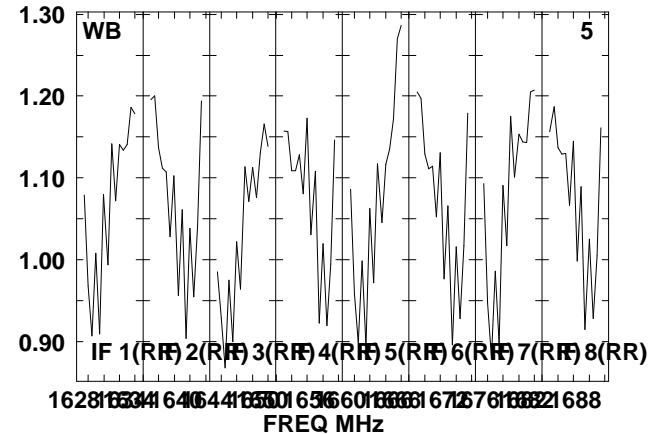
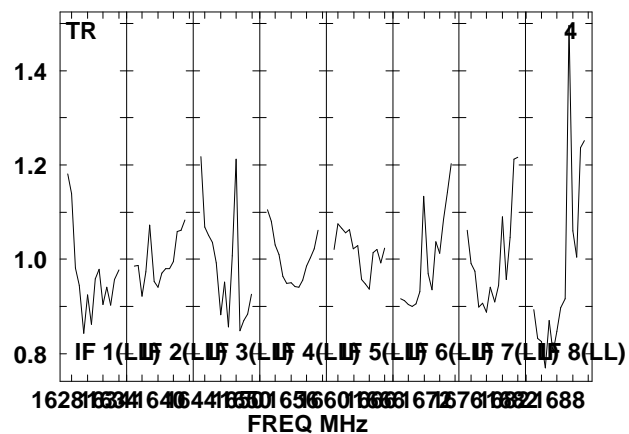
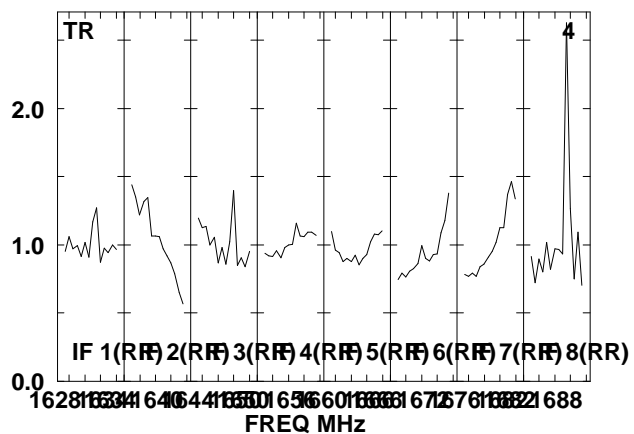
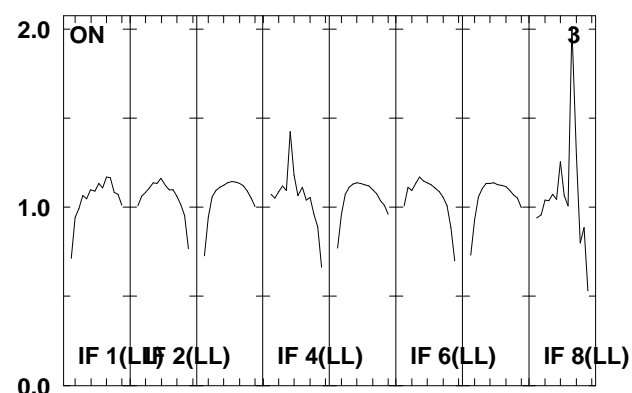
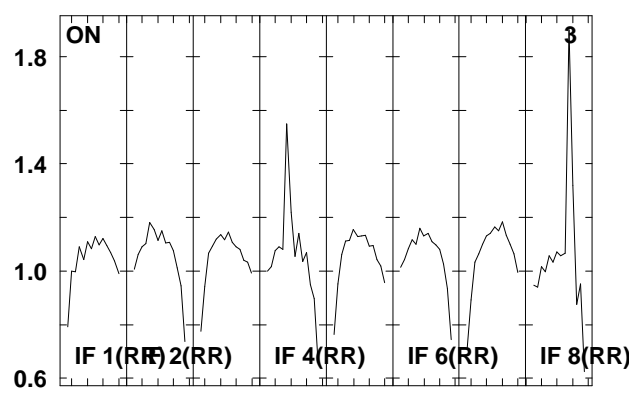
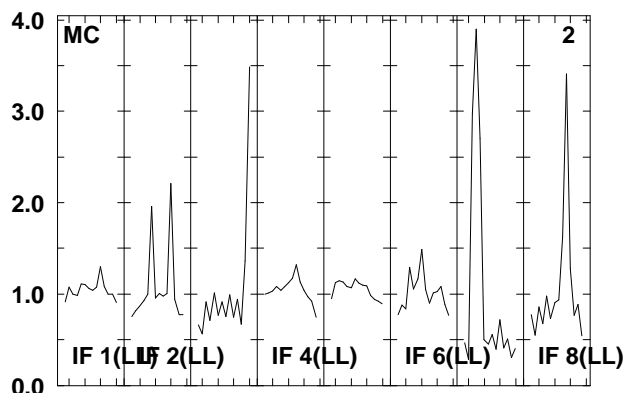
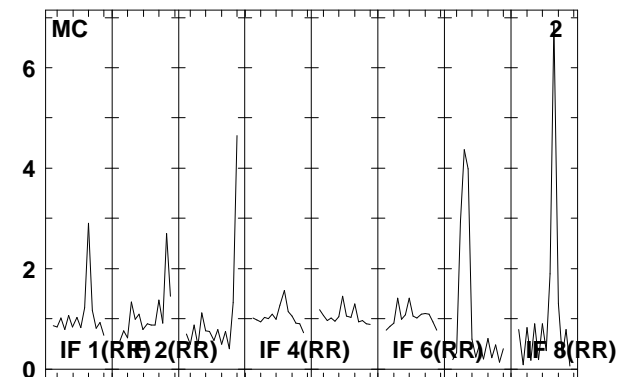
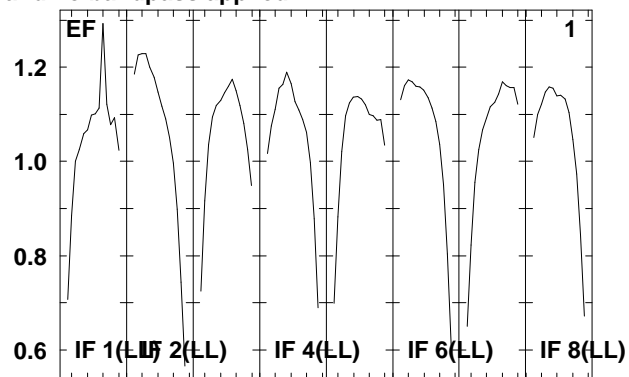
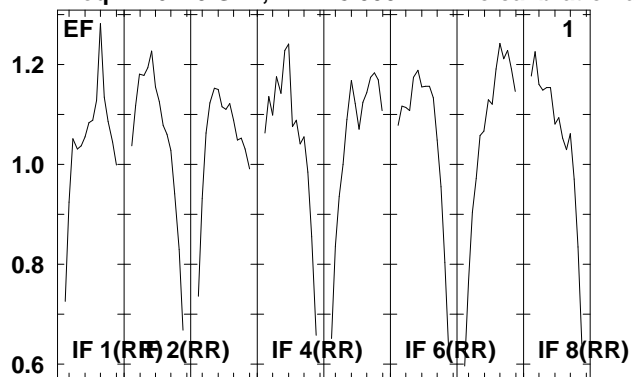

Lower frame: Real Jy  
Total-power spectrum Antenna: \*  
Timerange: 01/03:29:21 to 01/03:32:20

Plot file version 178 created 20-OCT-2009 14:50:36

M33 RP015C.UVDATA.1

Freq = 1.6270 GHz, Bw = 8.000 MH No calibration applied and no bandpass applied

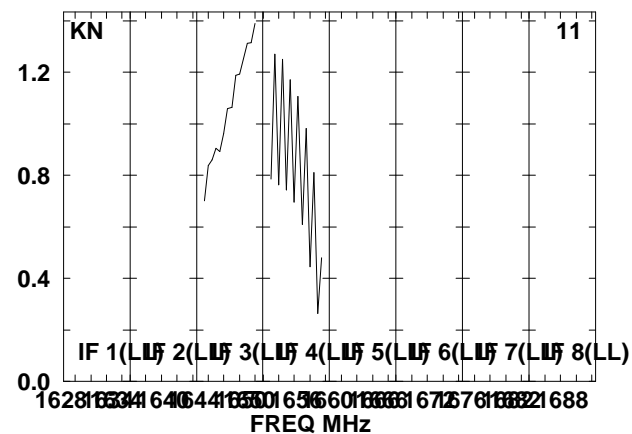
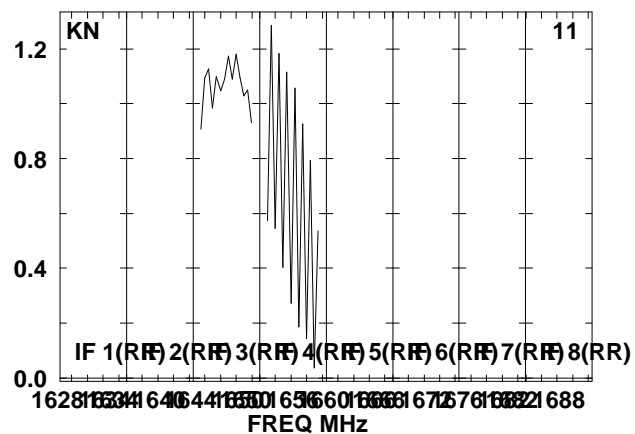
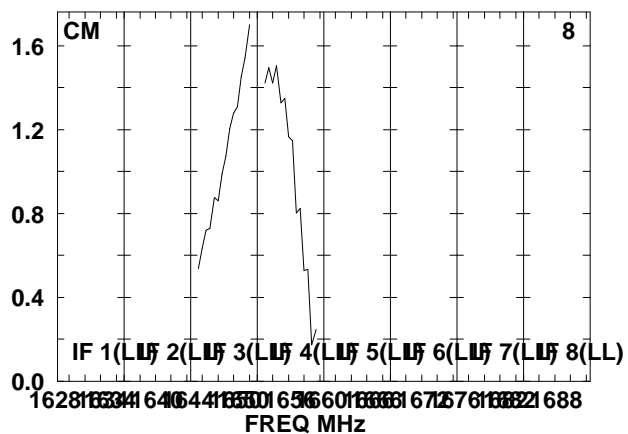
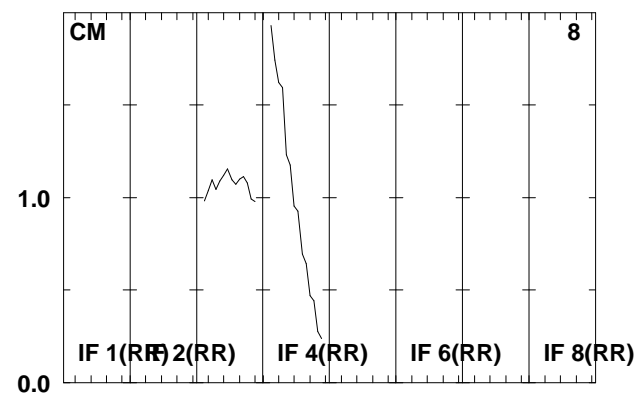
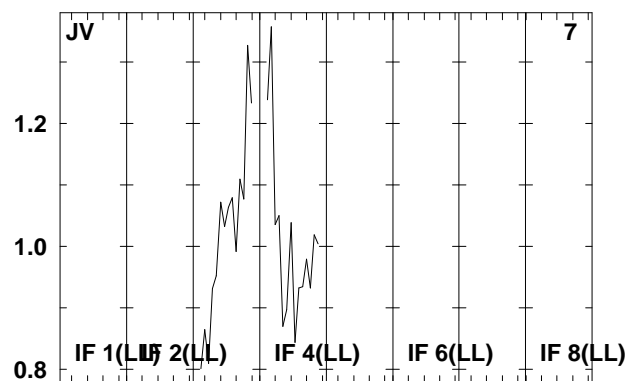
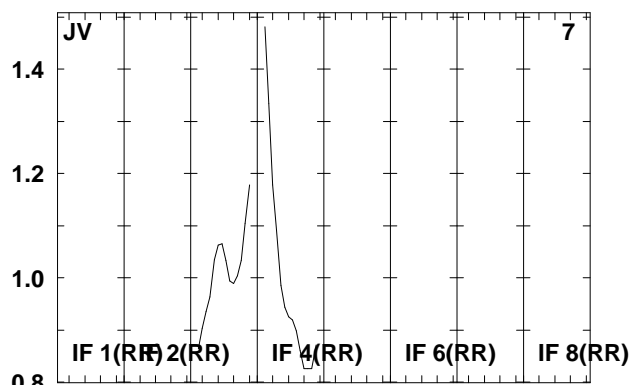
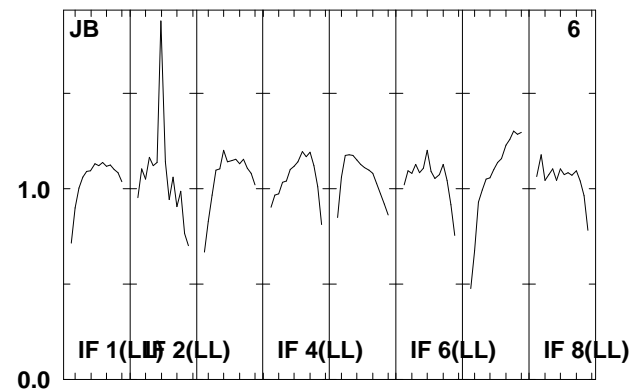
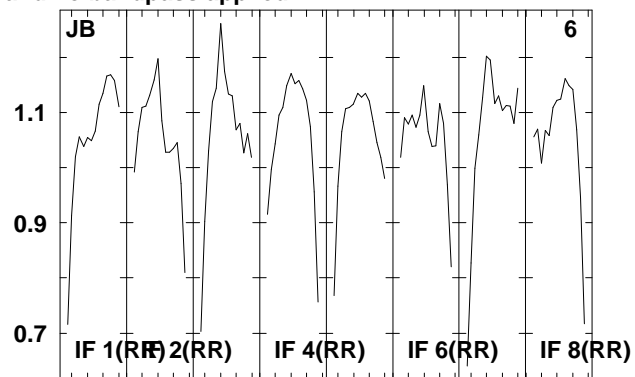
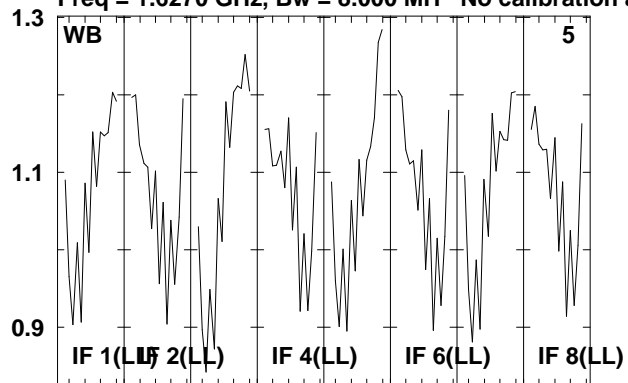

Lower frame: Real Jy  
Total-power spectrum Antenna: \*  
Timerange: 01/03:29:21 to 01/03:32:20

Plot file version 179 created 20-OCT-2009 14:50:38

J0137+31 RP015C.UVDATA.1

Freq = 1.6270 GHz, Bw = 8.000 MH No calibration applied and no bandpass applied

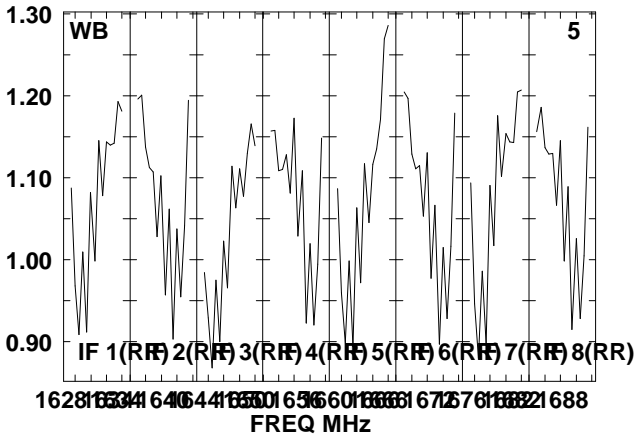
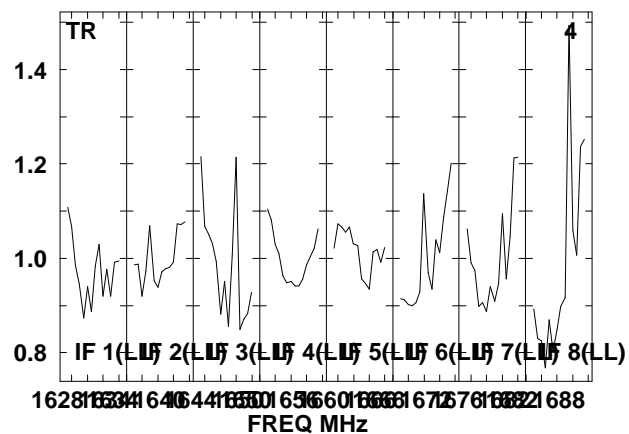
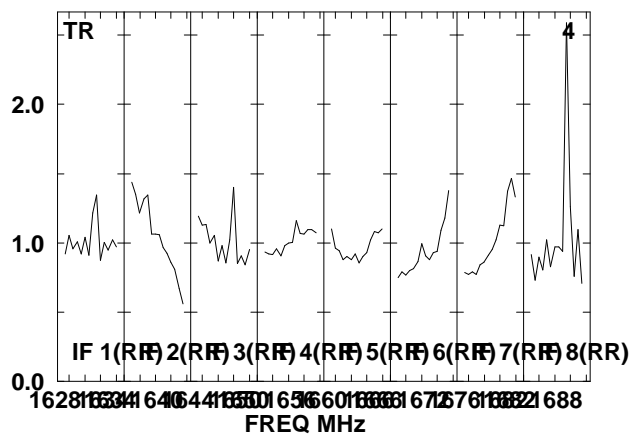
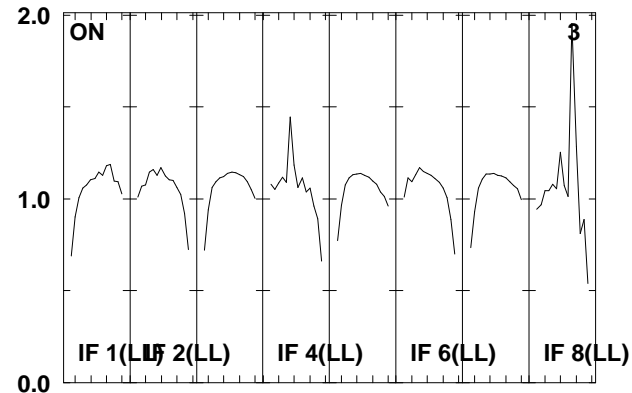
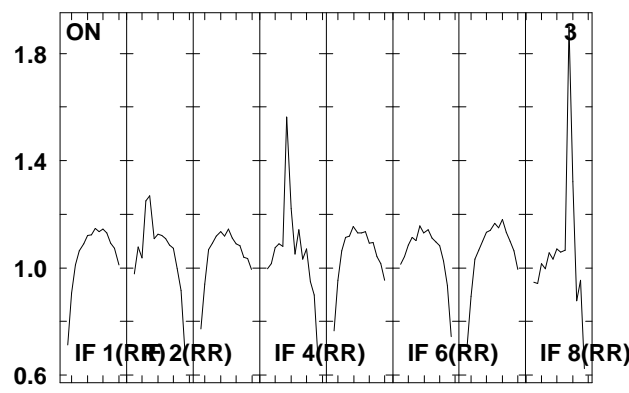
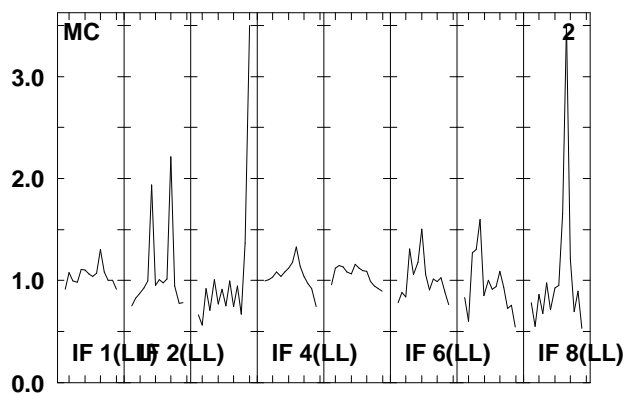
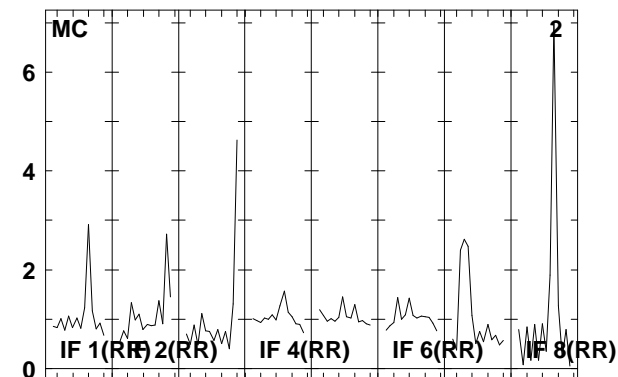
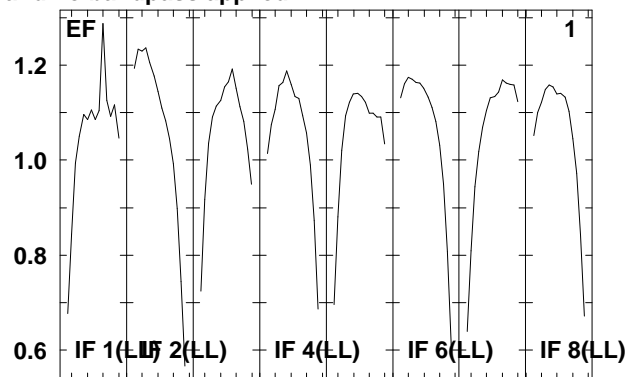
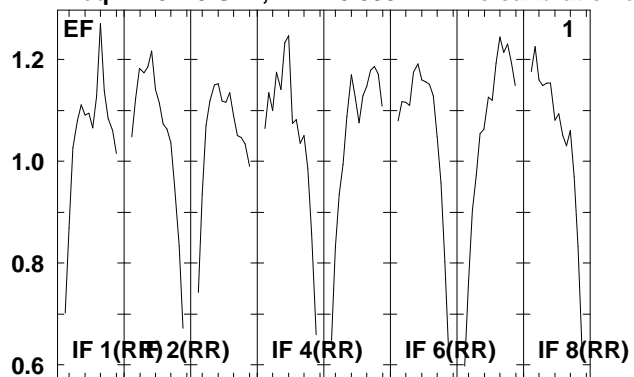

Lower frame: Real Jy  
Total-power spectrum Antenna: \*  
Timerange: 01/03:33:01 to 01/03:34:00

Plot file version 180 created 20-OCT-2009 14:50:38

J0137+31 RP015C.UVDATA.1

Freq = 1.6270 GHz, Bw = 8.000 MH No calibration applied and no bandpass applied

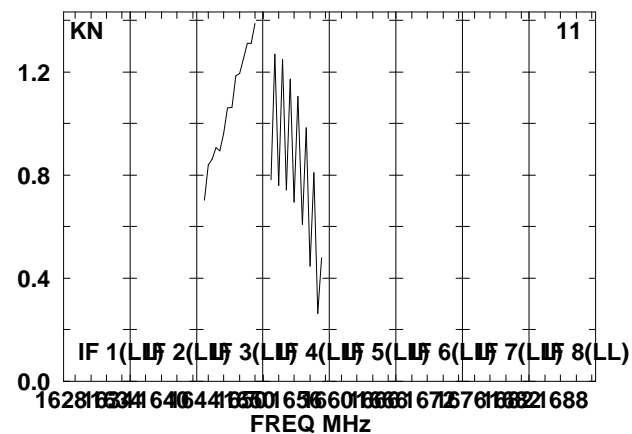
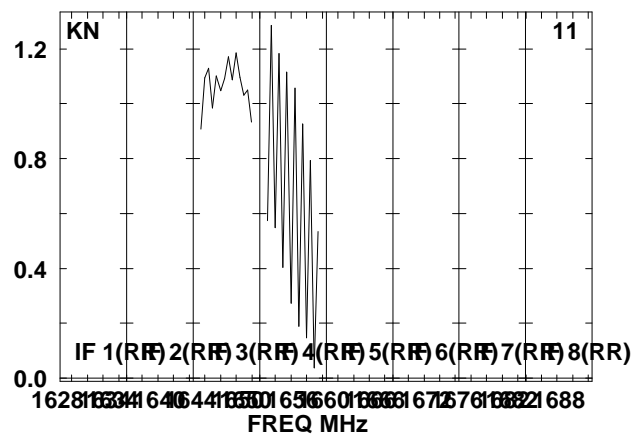
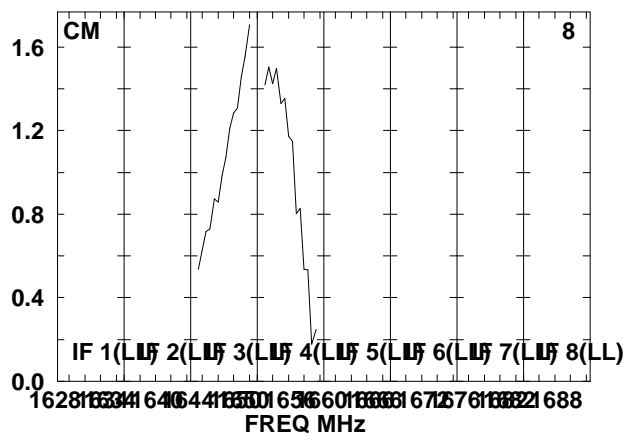
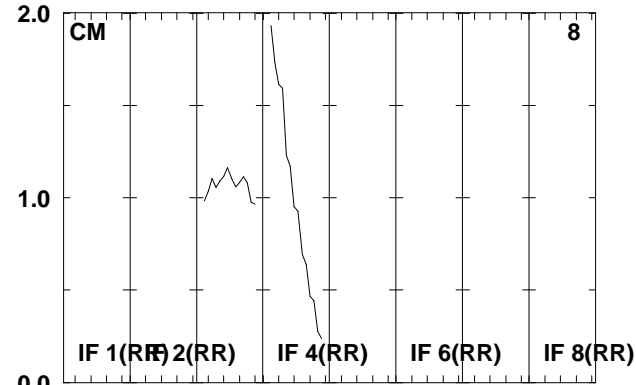
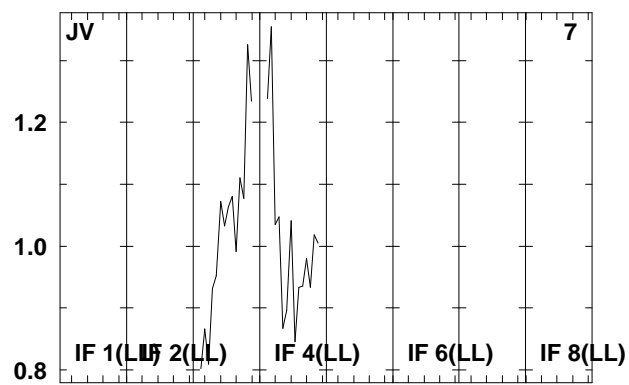
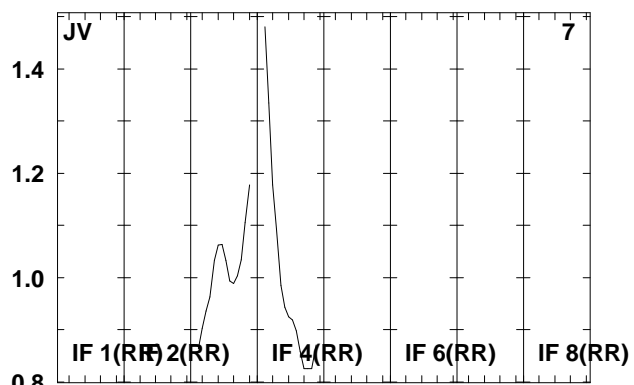
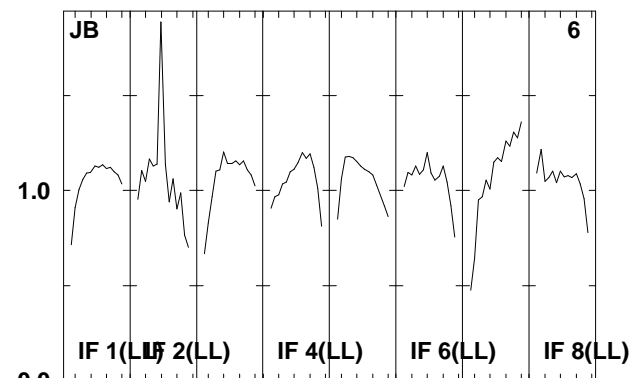
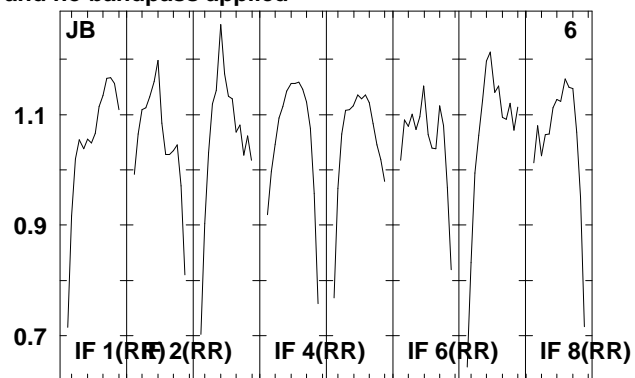
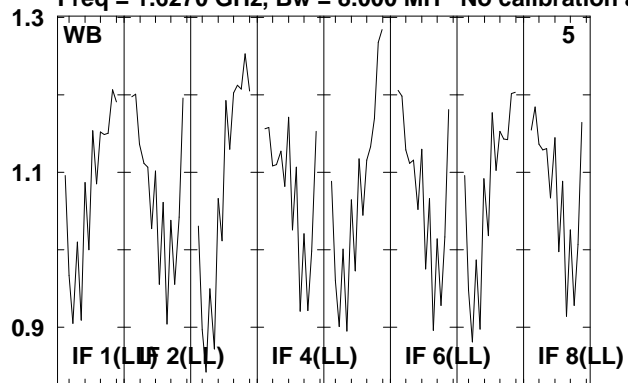

Lower frame: Real Jy  
Total-power spectrum Antenna: \*  
Timerange: 01/03:33:01 to 01/03:34:00

Plot file version 181 created 20-OCT-2009 14:50:39

FAINTCAL RP015C.UVDATA.1

Freq = 1.6270 GHz, Bw = 8.000 MH No calibration applied and no bandpass applied

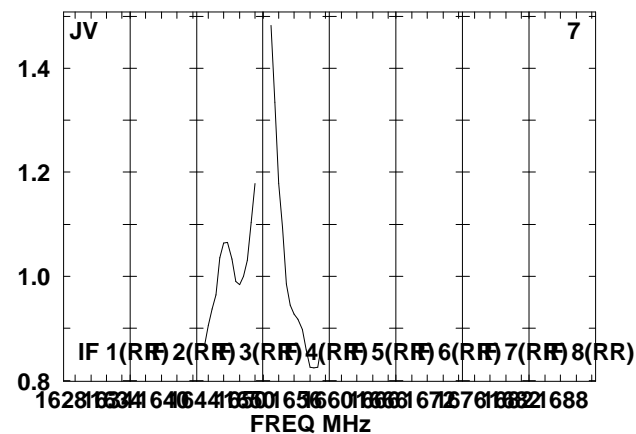
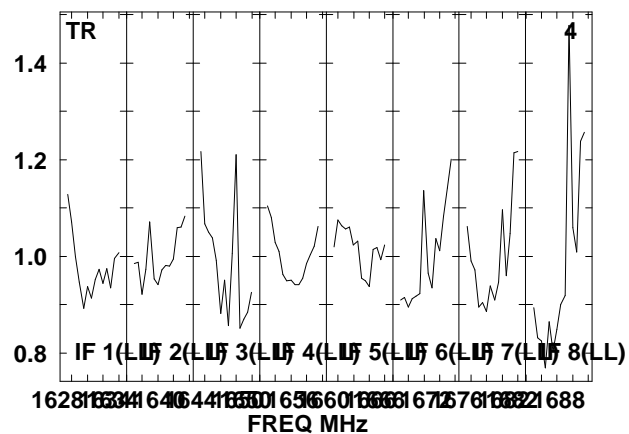
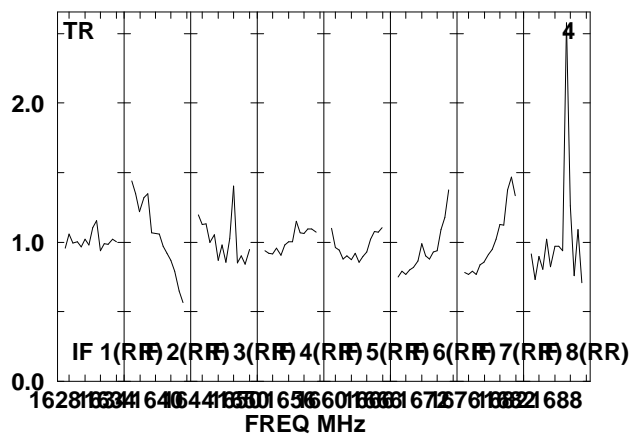
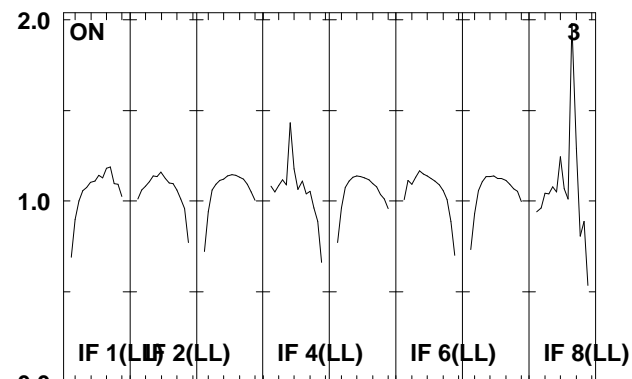
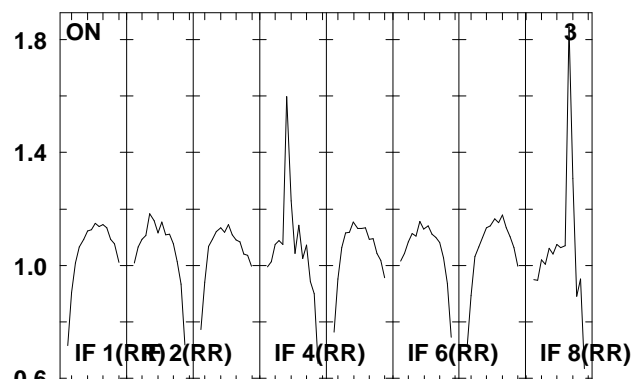
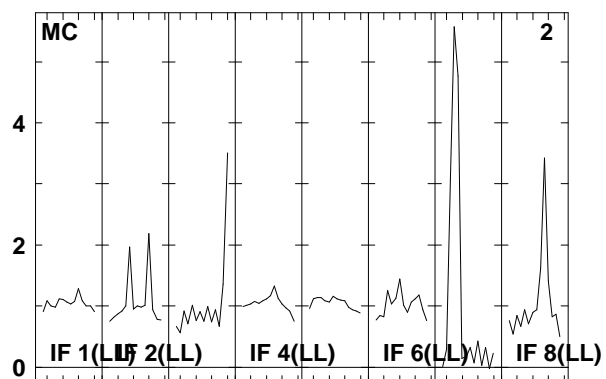
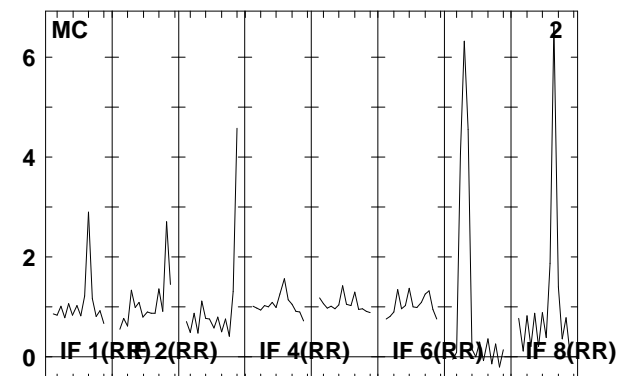
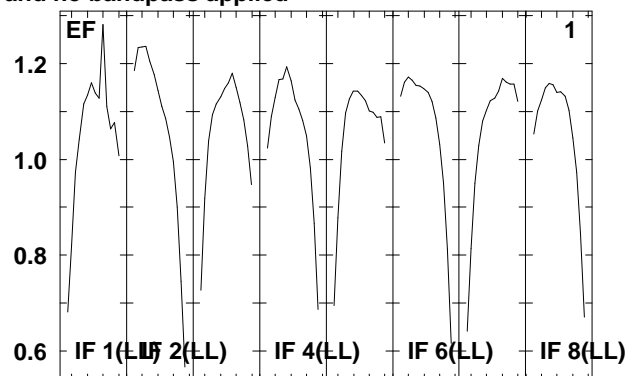
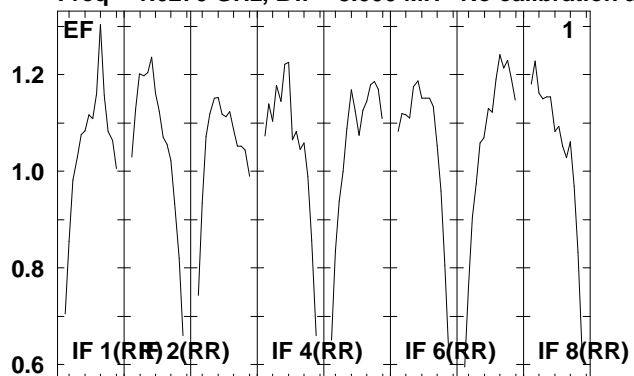

Lower frame: Real Jy  
Total-power spectrum Antenna: \*  
Timerange: 01/03:34:01 to 01/03:35:19

Plot file version 182 created 20-OCT-2009 14:50:39

FAINTCAL RP015C.UVDATA.1

Freq = 1.6270 GHz, Bw = 8.000 MH No calibration applied and no bandpass applied

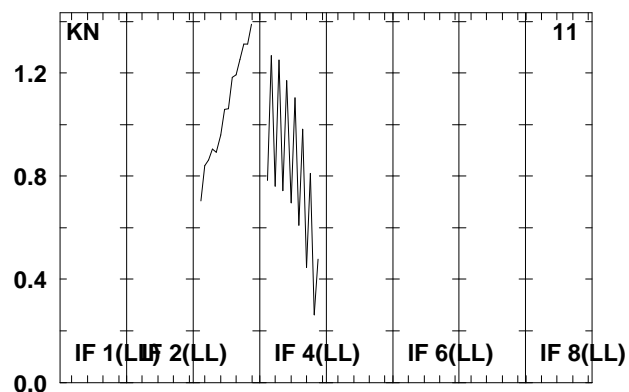
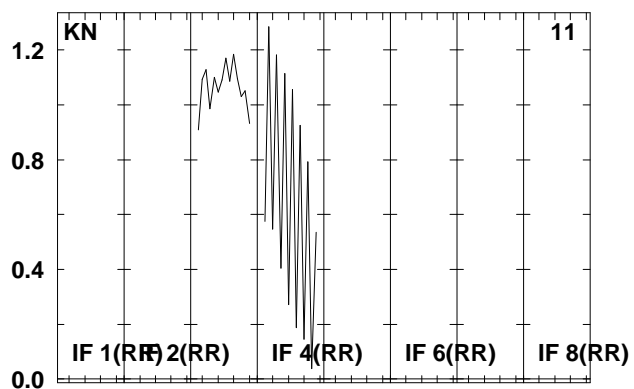
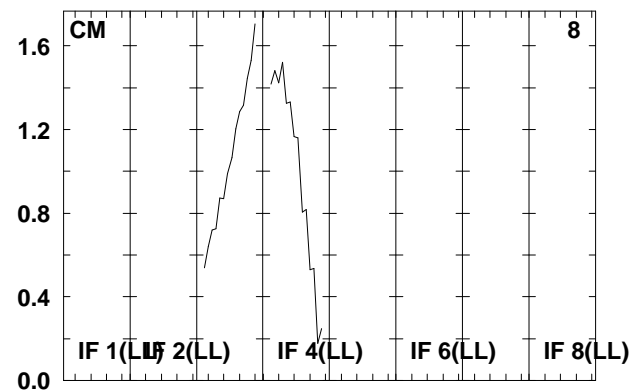
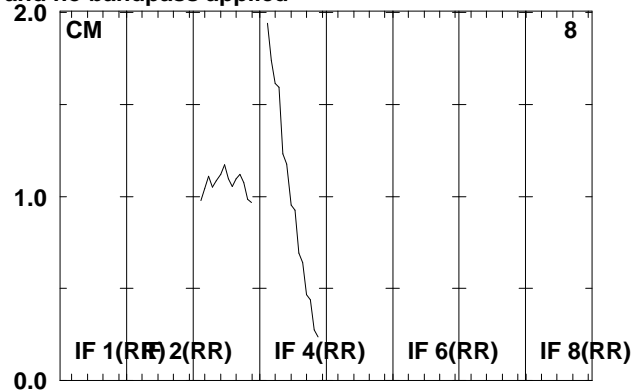
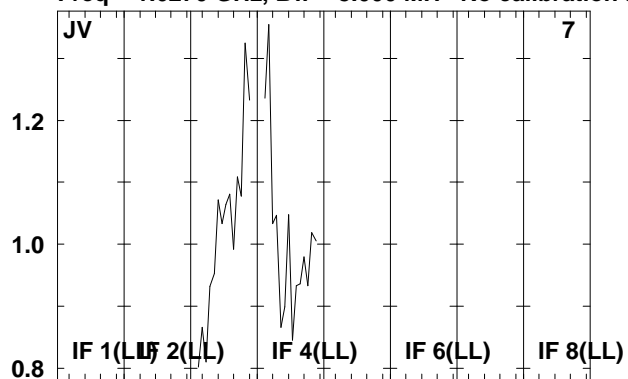

Lower frame: Real Jy  
Total-power spectrum Antenna: \*  
Timerange: 01/03:34:01 to 01/03:35:19

Plot file version 183 created 20-OCT-2009 14:50:40

M33 RP015C.UVDATA.1

Freq = 1.6270 GHz, Bw = 8.000 MH No calibration applied and no bandpass applied

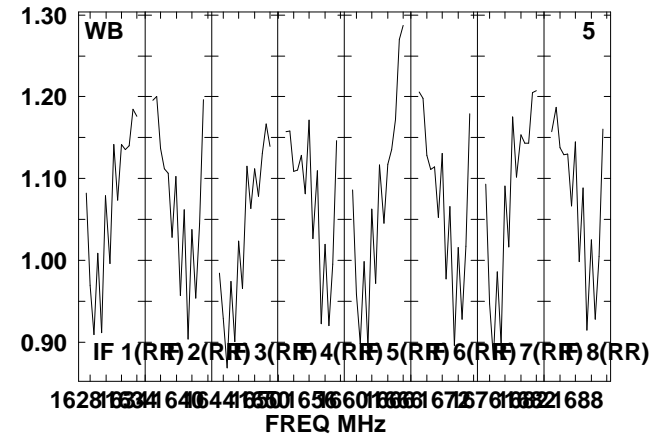
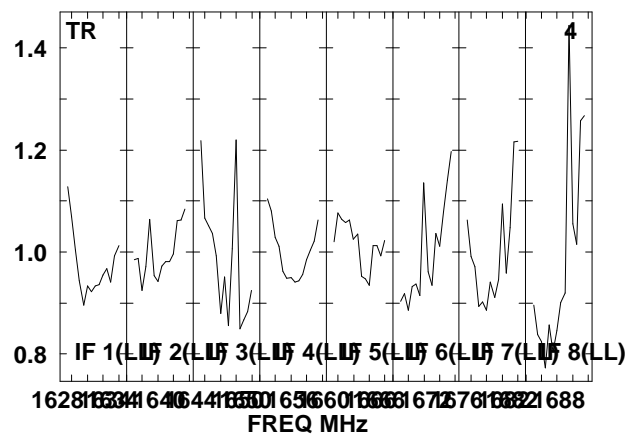
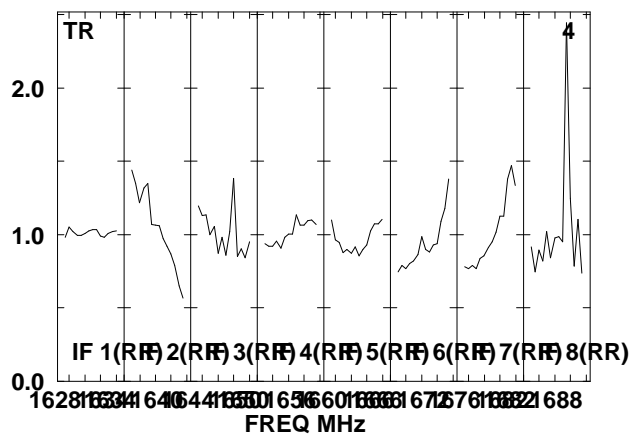
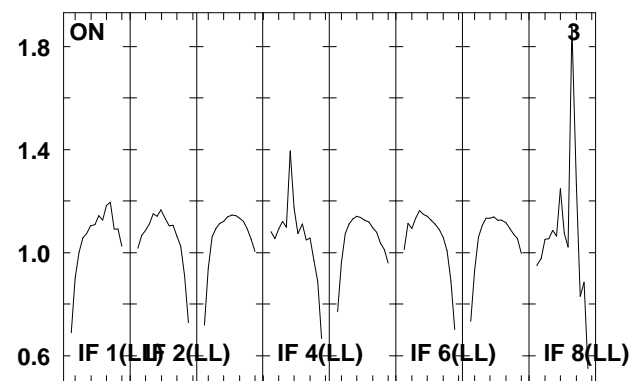
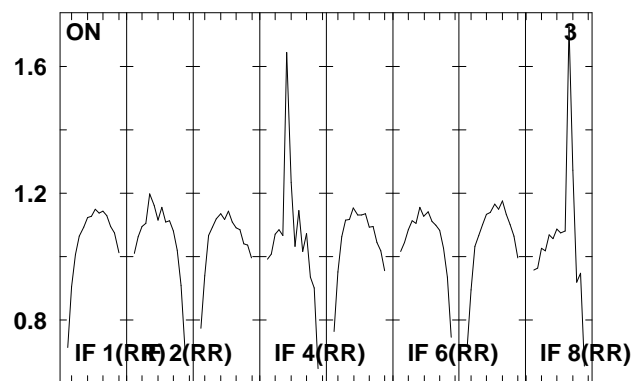
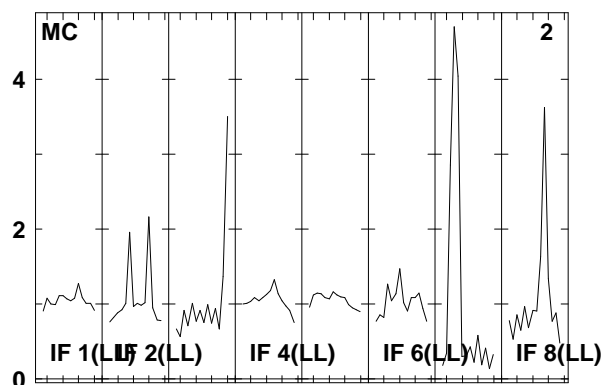
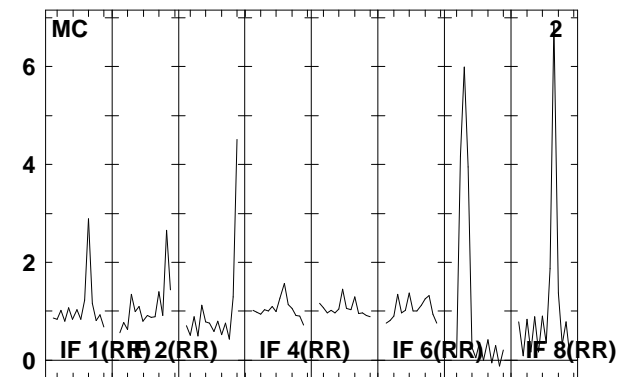
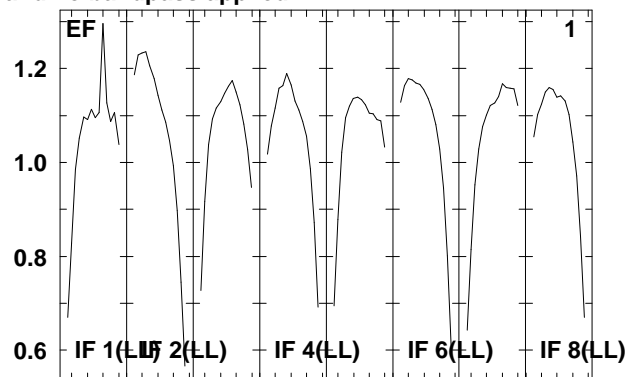
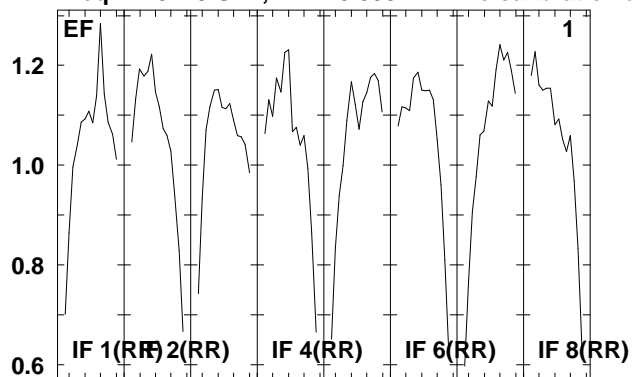

Lower frame: Real Jy  
Total-power spectrum Antenna: \*  
Timerange: 01/03:35:20 to 01/03:38:20

Plot file version 184 created 20-OCT-2009 14:50:40

M33 RP015C.UVDATA.1

Freq = 1.6270 GHz, Bw = 8.000 MH No calibration applied and no bandpass applied

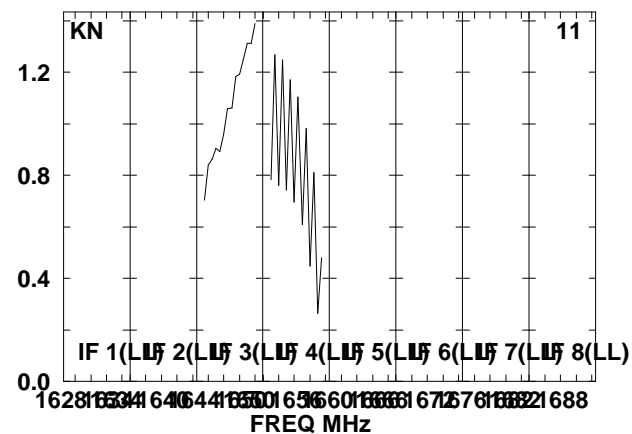
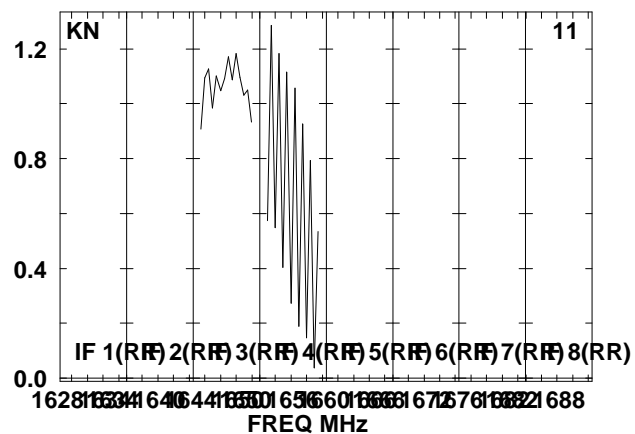
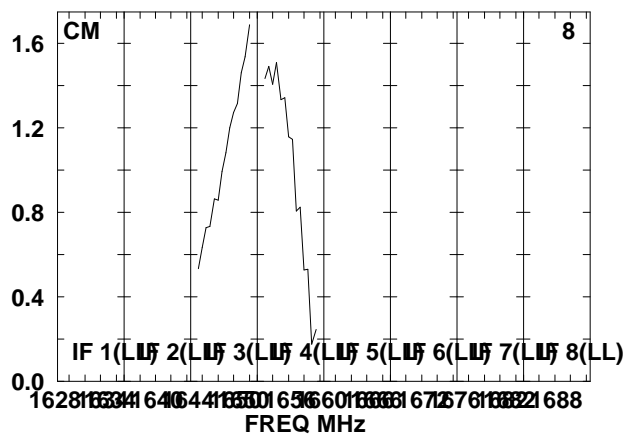
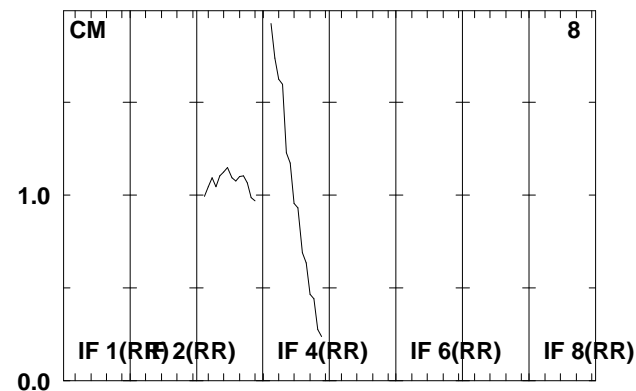
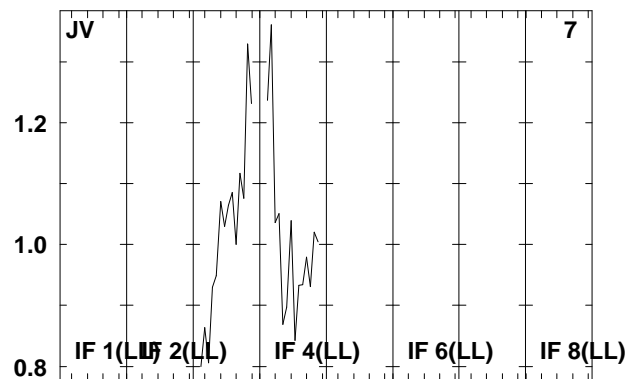
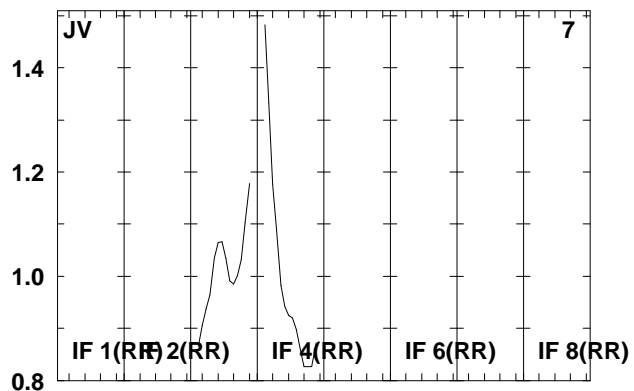
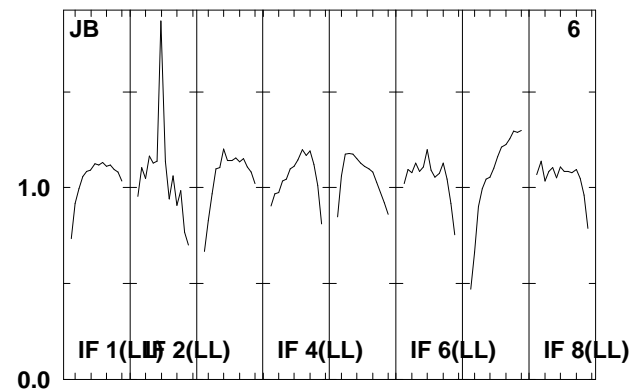
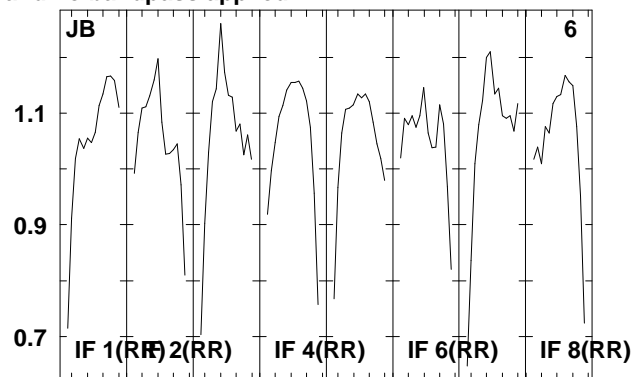
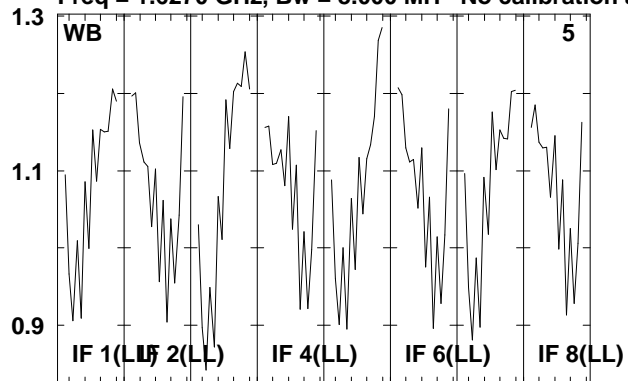

Lower frame: Real Jy  
Total-power spectrum Antenna: \*  
Timerange: 01/03:35:20 to 01/03:38:20



Plot file version 185 created 20-OCT-2009 14:50:42

J0137+31 RP015C.UVDATA.1

Freq = 1.6270 GHz, Bw = 8.000 MH No calibration applied and no bandpass applied

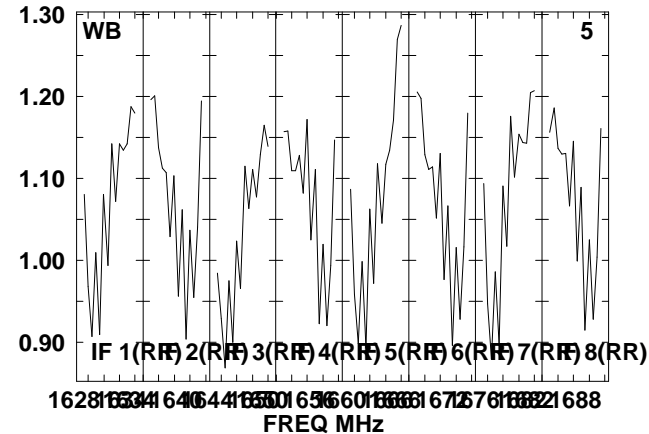
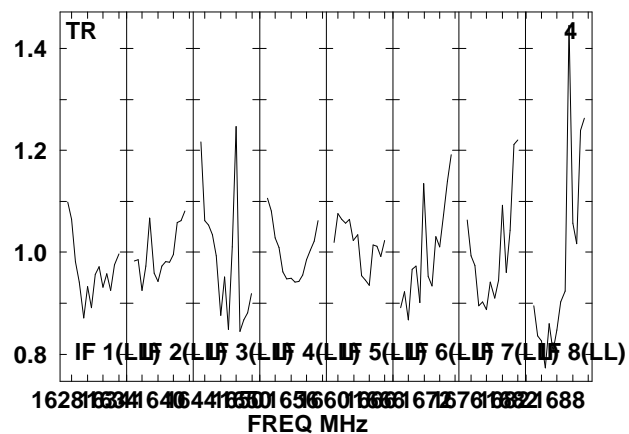
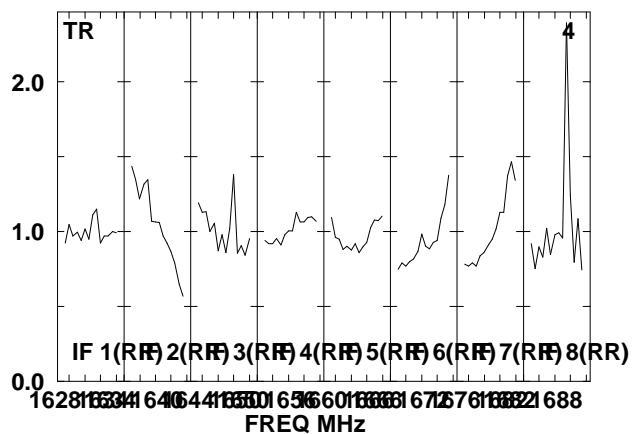
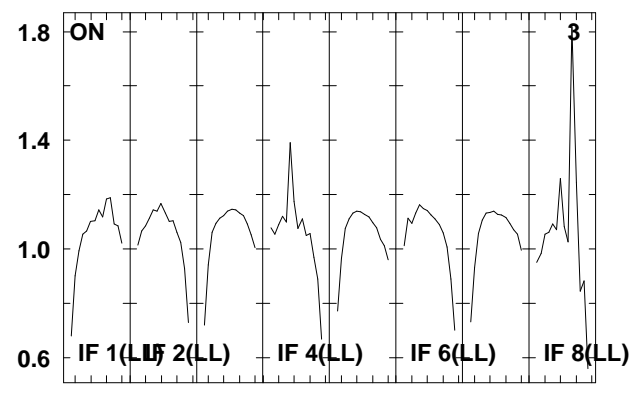
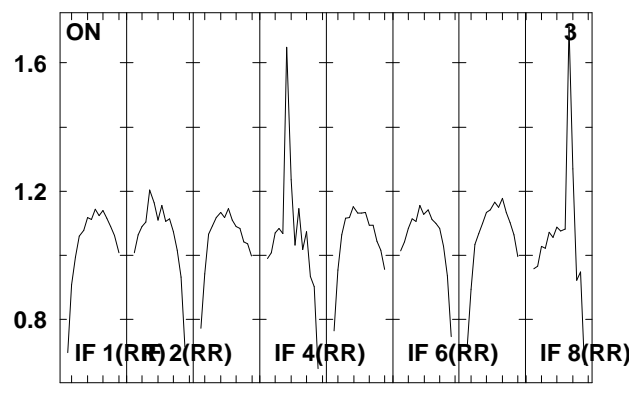
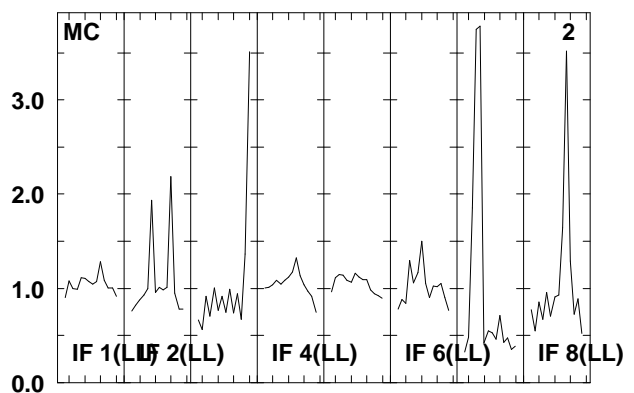
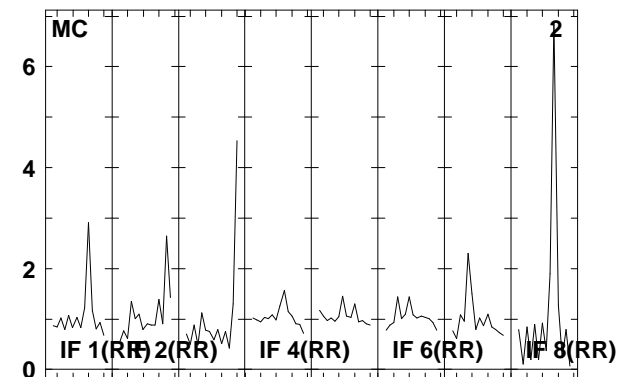
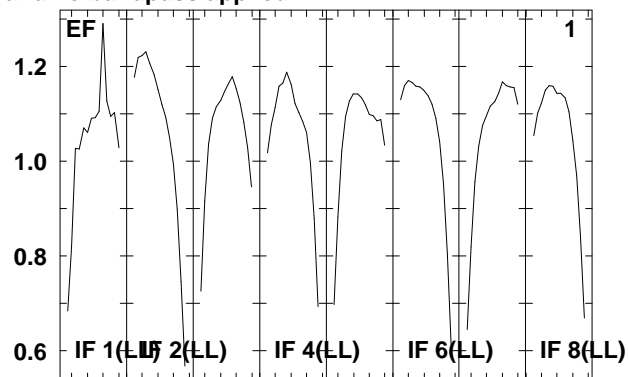
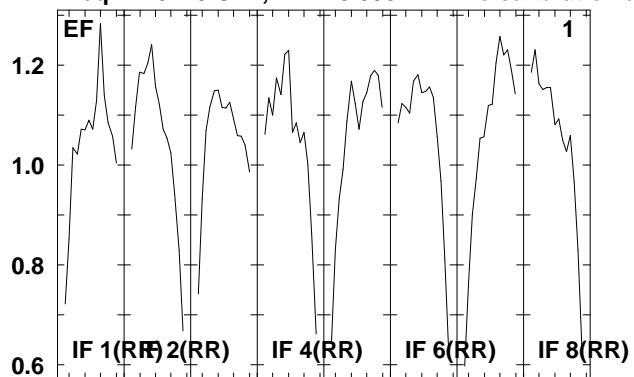

Lower frame: Real Jy

Total-power spectrum Antenna: \*

Timerange: 01/03:39:00 to 01/03:39:59

Plot file version 186 created 20-OCT-2009 14:50:43

J0137+31 RP015C.UVDATA.1

Freq = 1.6270 GHz, Bw = 8.000 MH No calibration applied and no bandpass applied

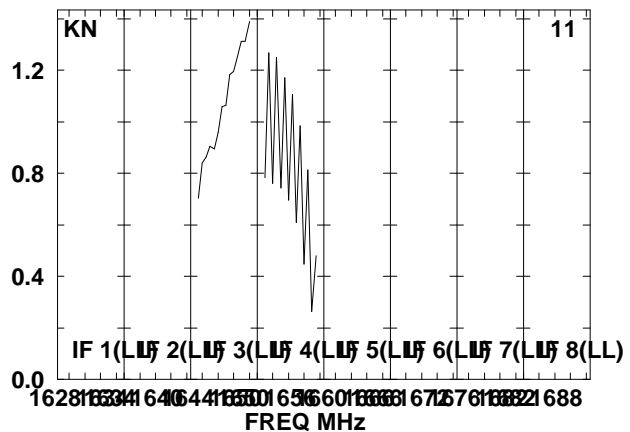
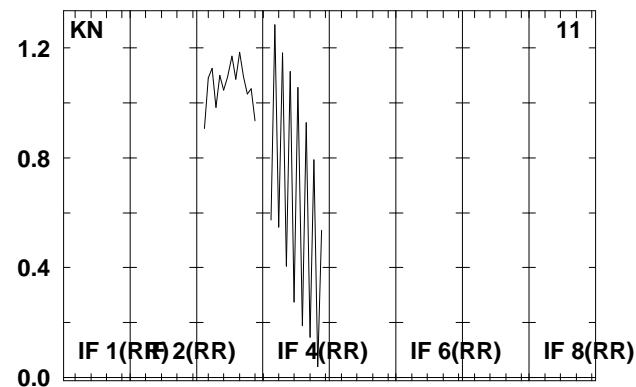
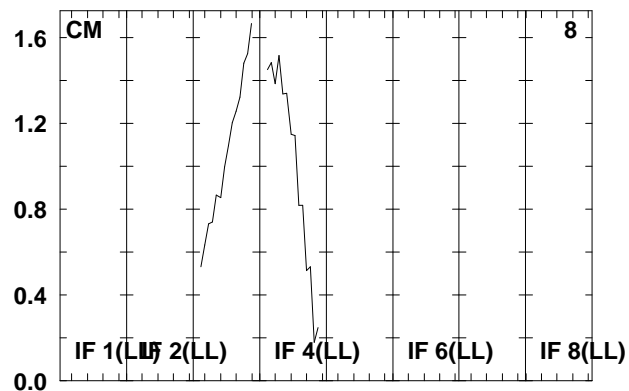
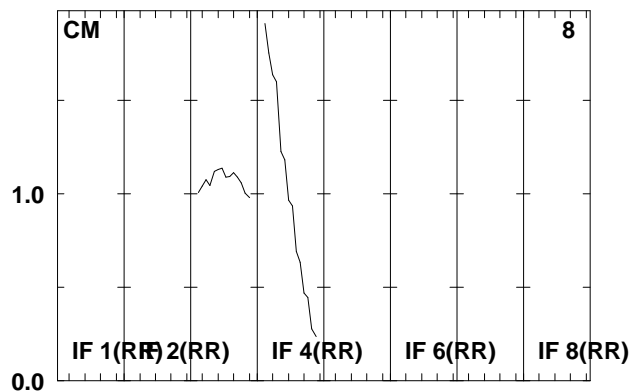
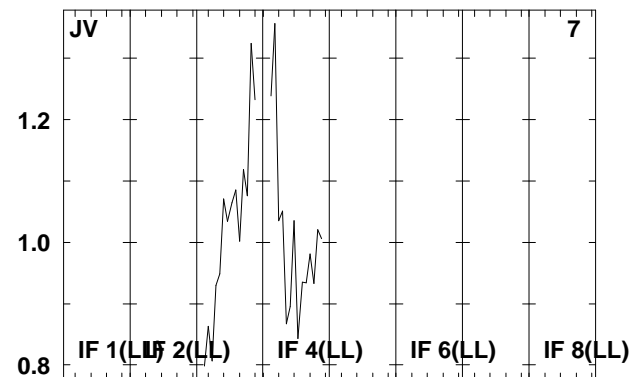
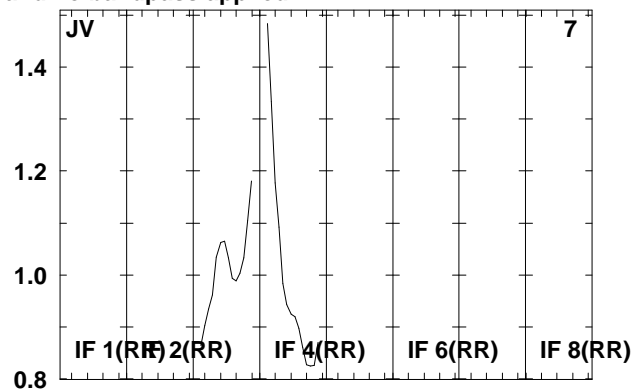
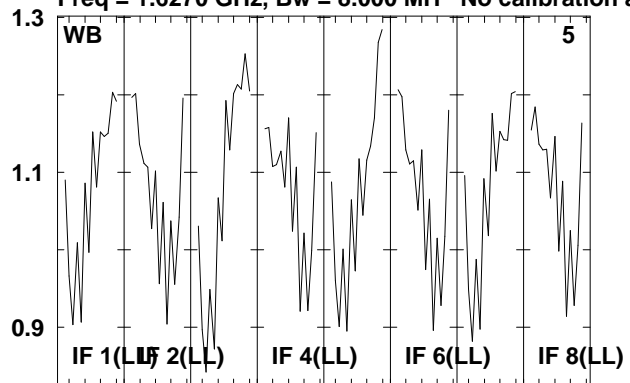

Lower frame: Real Jy

Total-power spectrum Antenna: \*

Timerange: 01/03:39:00 to 01/03:39:59

Plot file version 187 created 20-OCT-2009 14:50:43

FAINTCAL RP015C.UVDATA.1

Freq = 1.6270 GHz, Bw = 8.000 MH No calibration applied and no bandpass applied

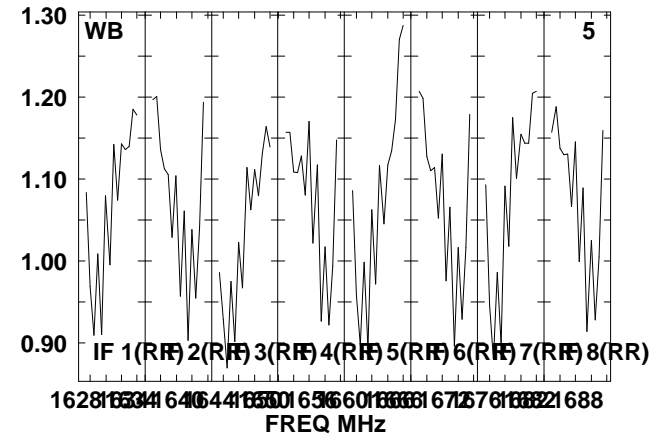
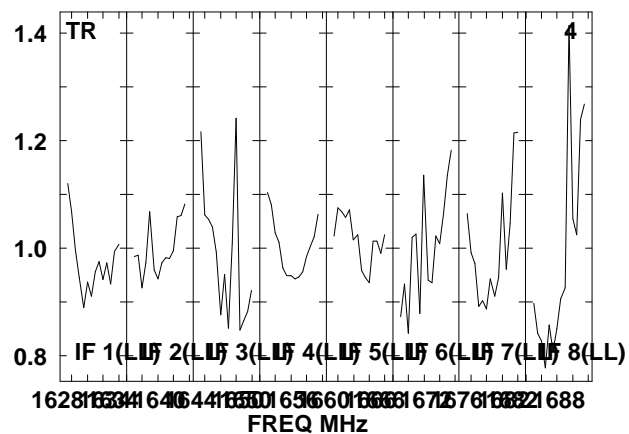
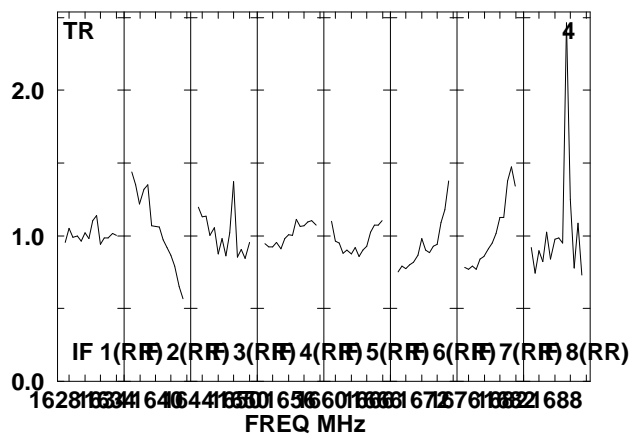
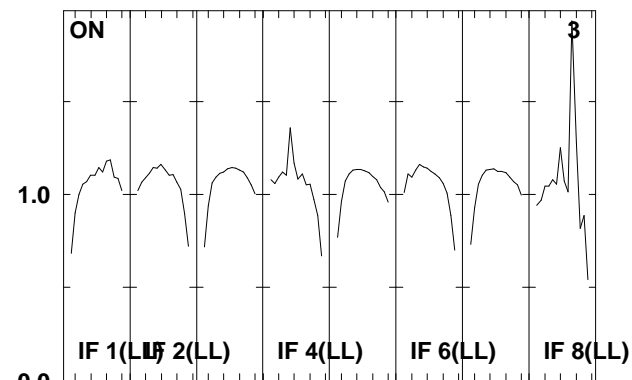
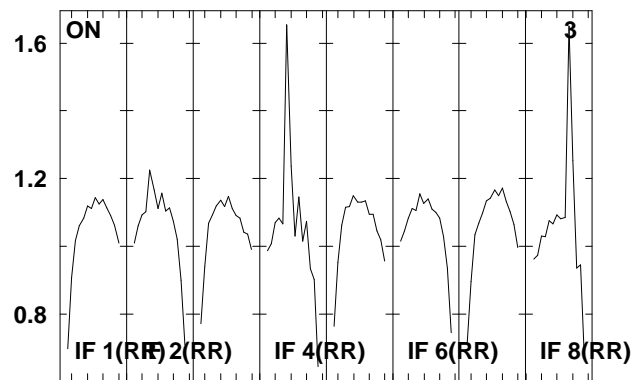
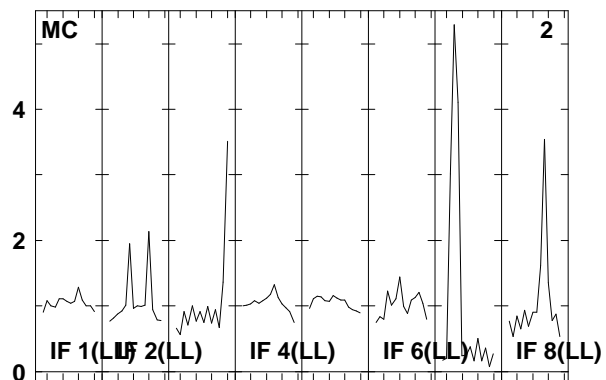
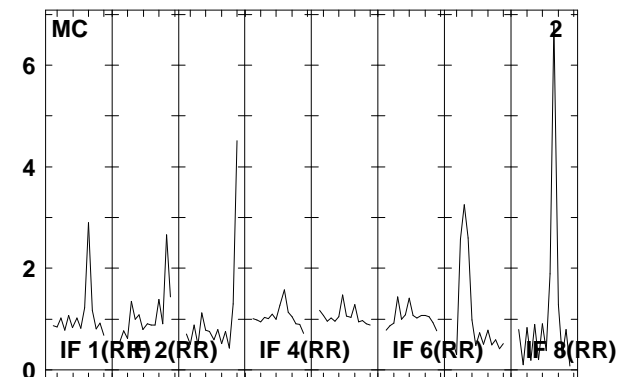
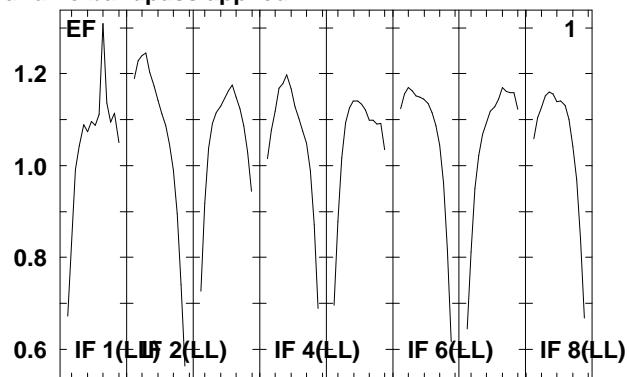
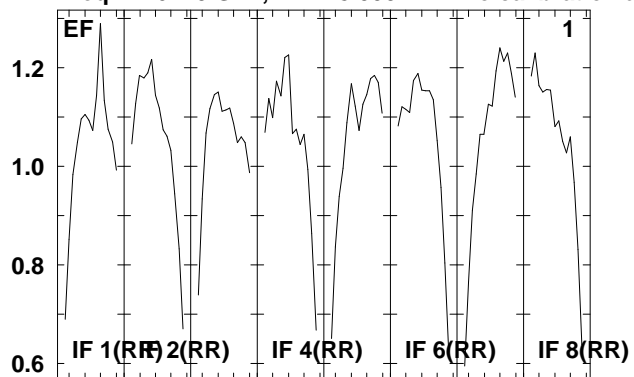

Lower frame: Real Jy

Total-power spectrum Antenna: \*

Timerange: 01/03:40:00 to 01/03:41:20

Plot file version 188 created 20-OCT-2009 14:50:44

FAINTCAL RP015C.UVDATA.1

Freq = 1.6270 GHz, Bw = 8.000 MH No calibration applied and no bandpass applied

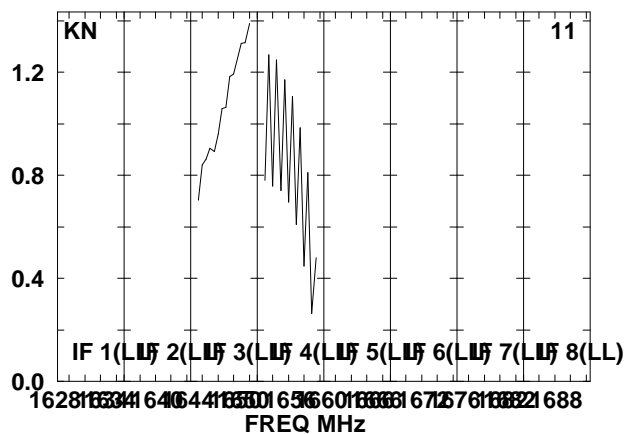
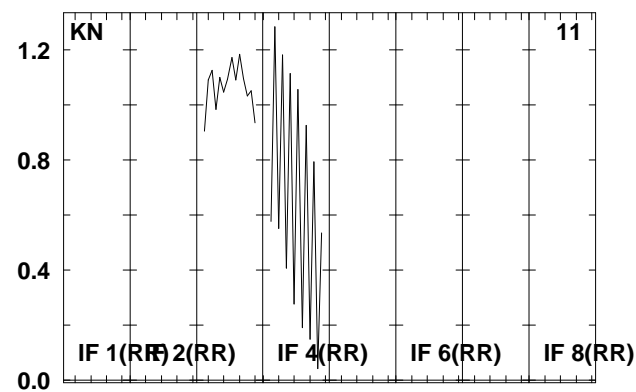
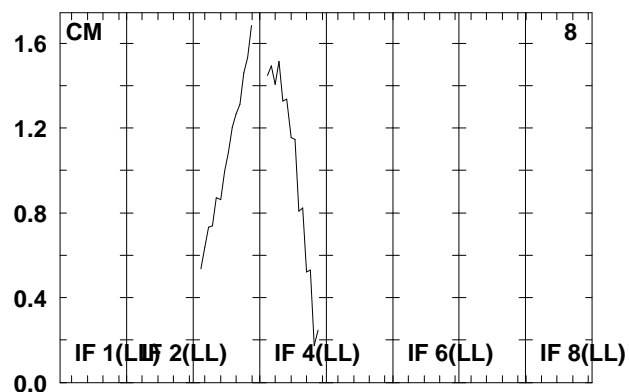
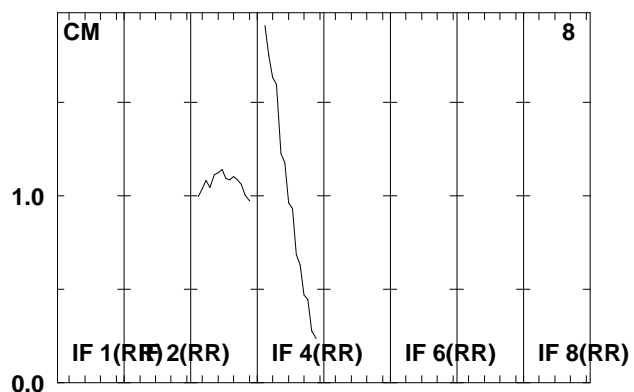
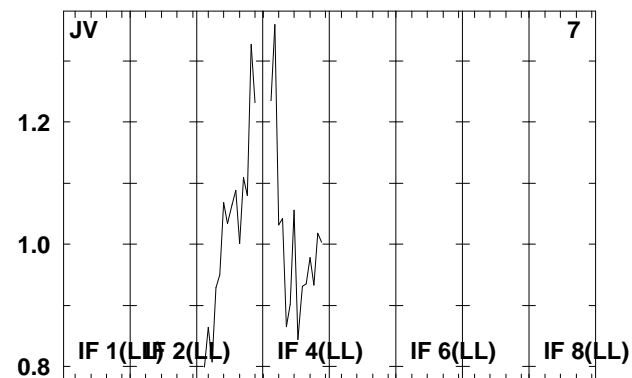
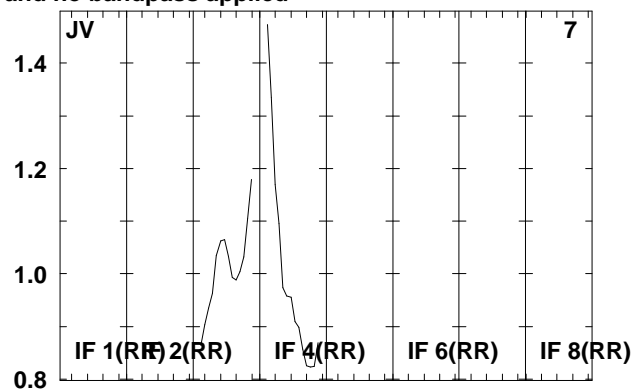
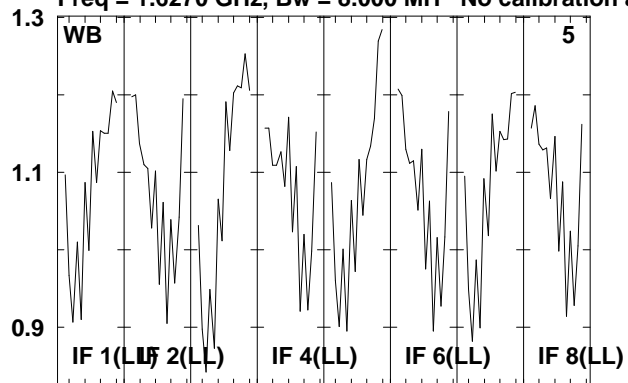

Lower frame: Real Jy

Total-power spectrum Antenna: \*

Timerange: 01/03:40:00 to 01/03:41:20

Plot file version 189 created 20-OCT-2009 14:50:44

M33 RP015C.UVDATA.1

Freq = 1.6270 GHz, Bw = 8.000 MH No calibration applied and no bandpass applied

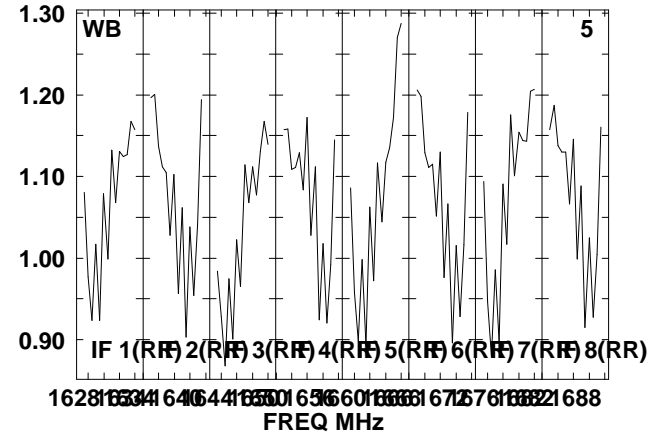
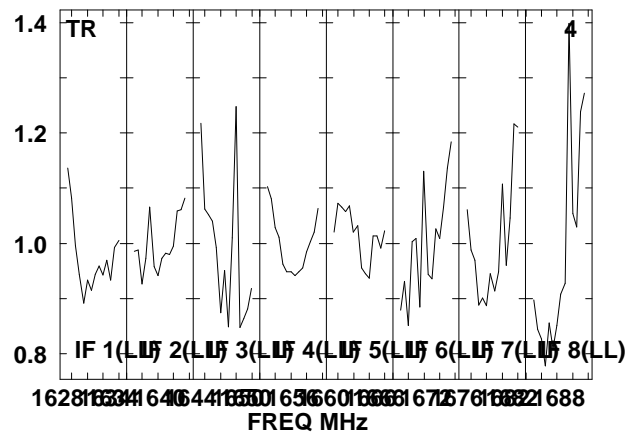
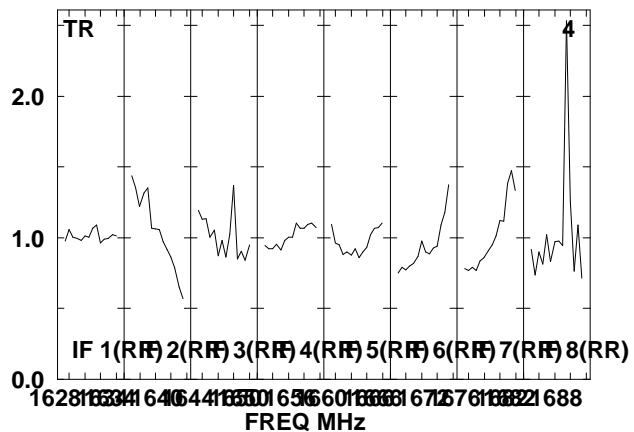
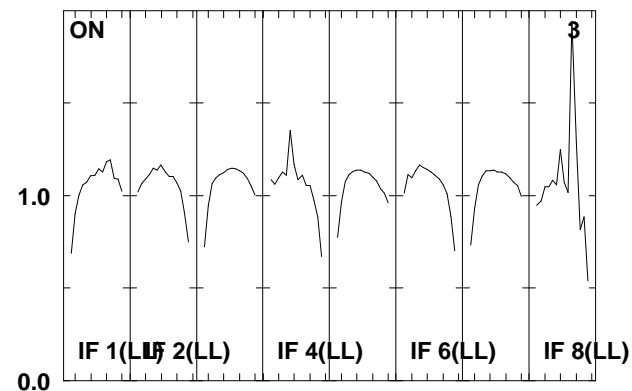
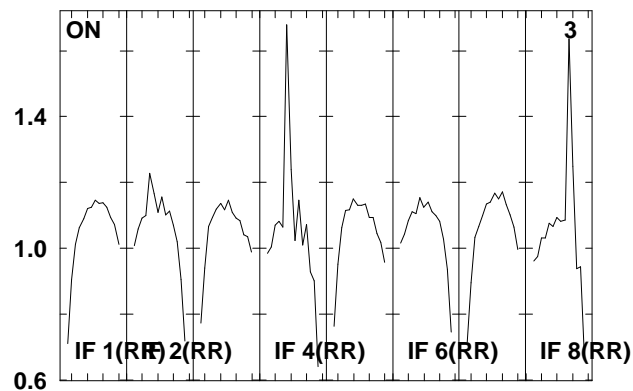
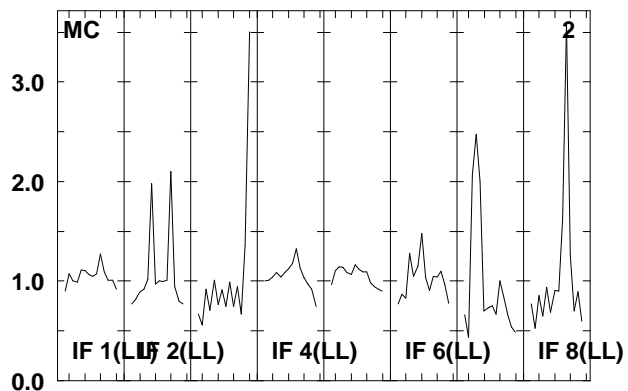
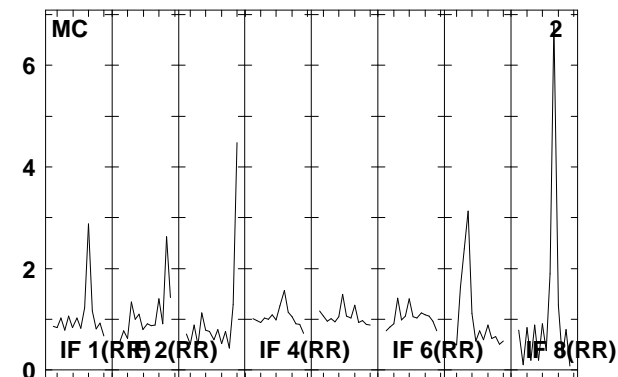
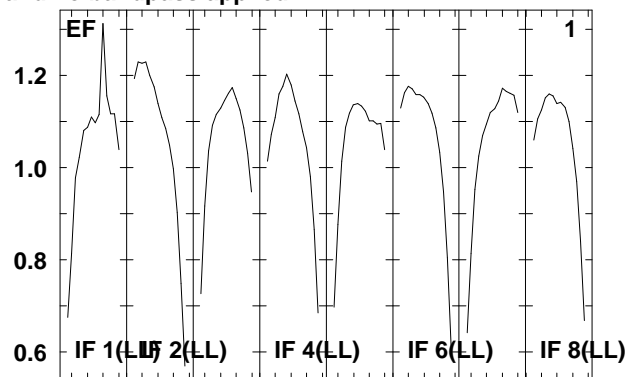
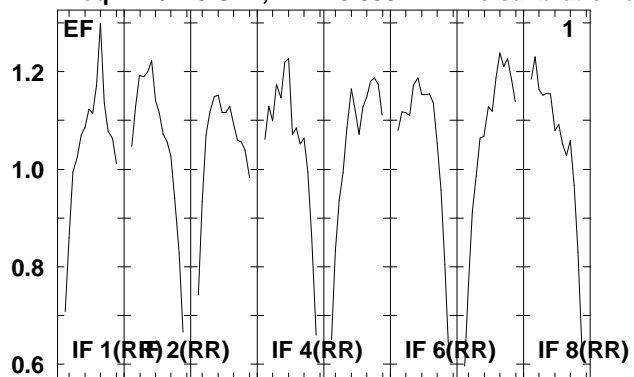

Lower frame: Real Jy

Total-power spectrum Antenna: \*

Timerange: 01/03:41:20 to 01/03:44:20

Plot file version 190 created 20-OCT-2009 14:50:45

M33 RP015C.UVDATA.1

Freq = 1.6270 GHz, Bw = 8.000 MH No calibration applied and no bandpass applied

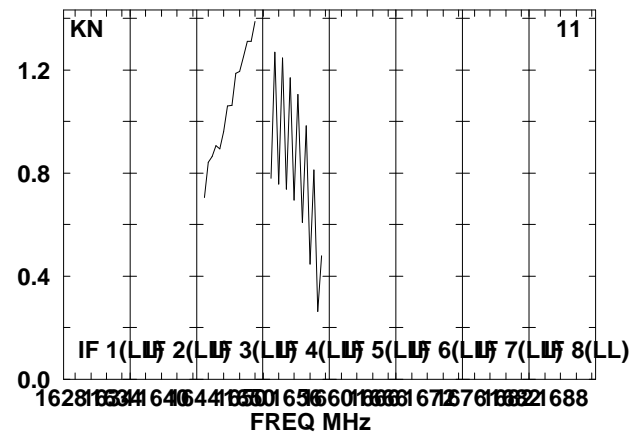
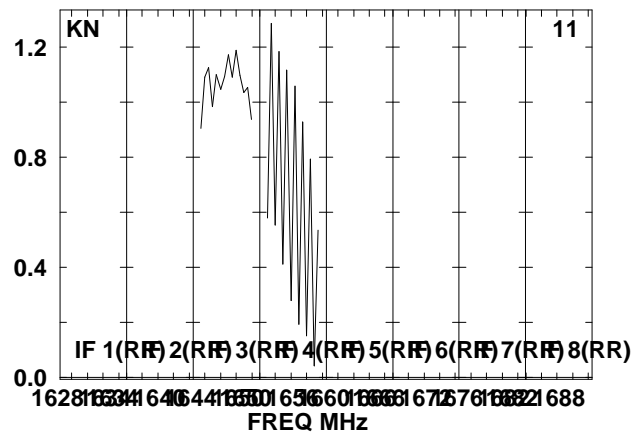
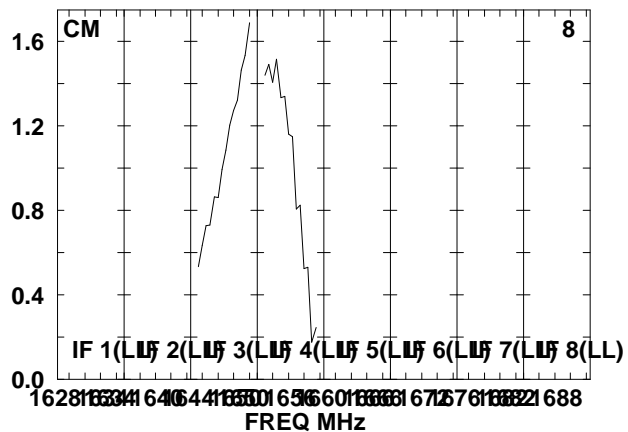
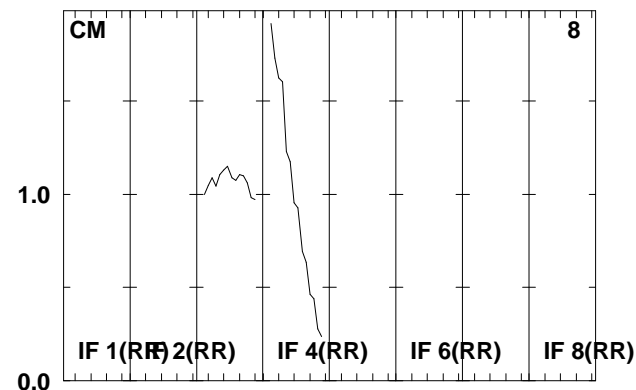
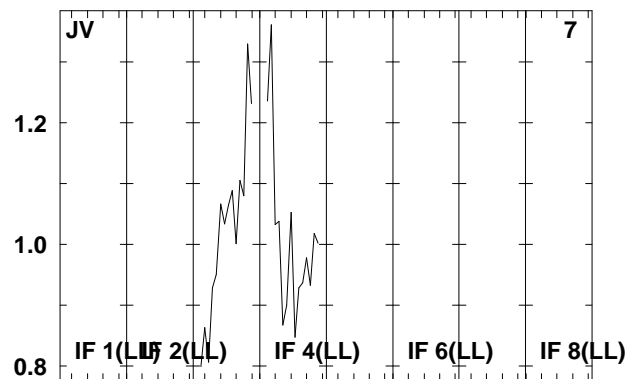
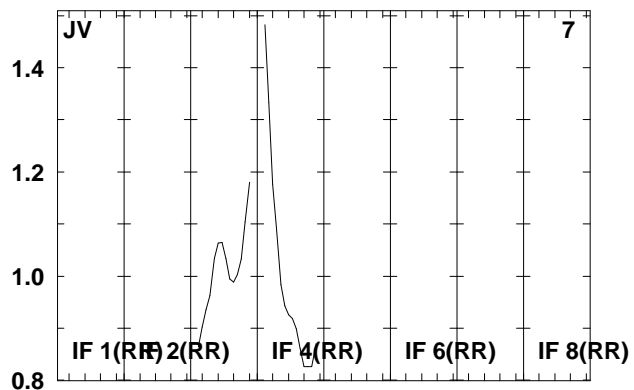
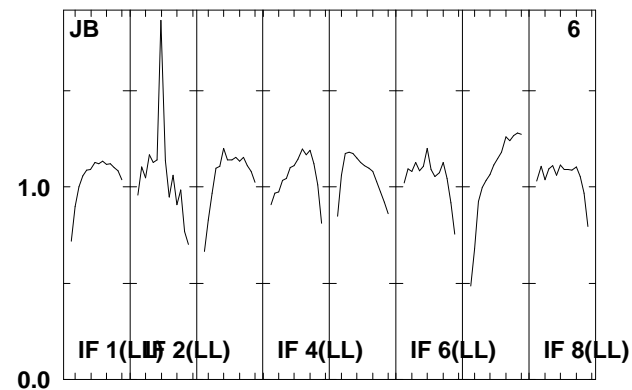
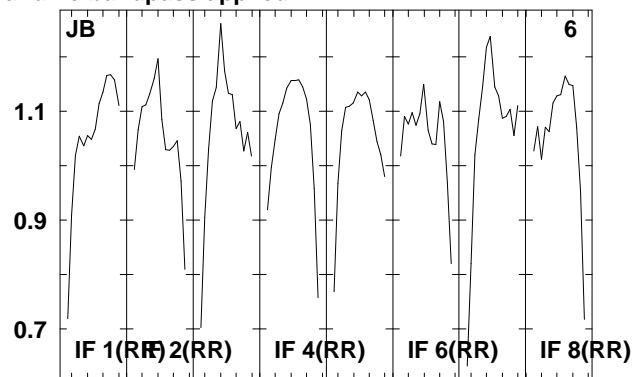
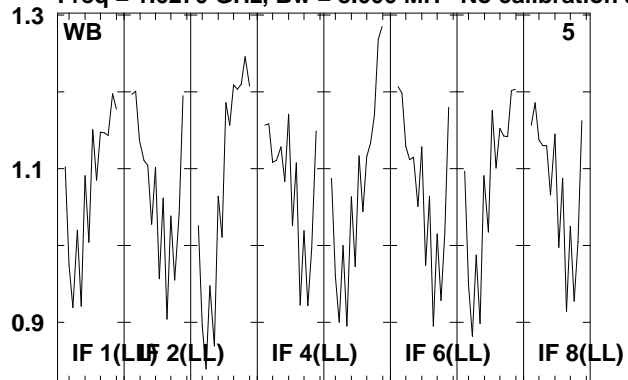

Lower frame: Real Jy

Total-power spectrum Antenna: \*

Timerange: 01/03:41:20 to 01/03:44:20

Plot file version 191 created 20-OCT-2009 14:50:47

J0137+31 RP015C.UVDATA.1

Freq = 1.6270 GHz, Bw = 8.000 MH No calibration applied and no bandpass applied

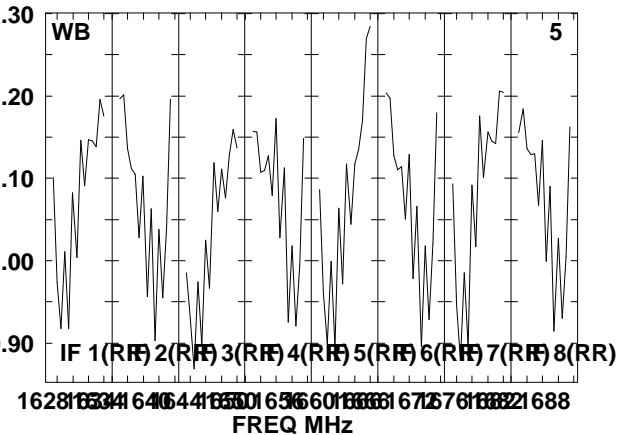
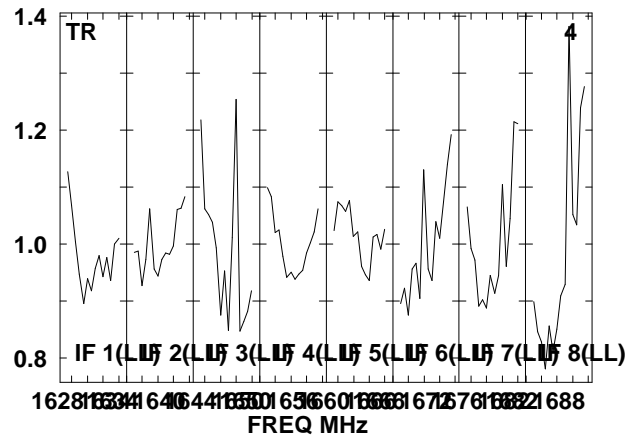
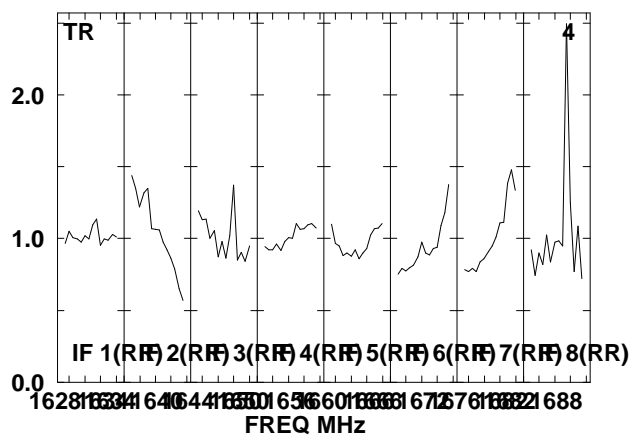
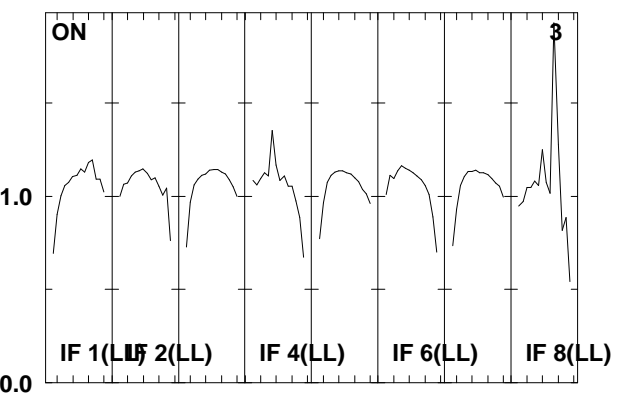
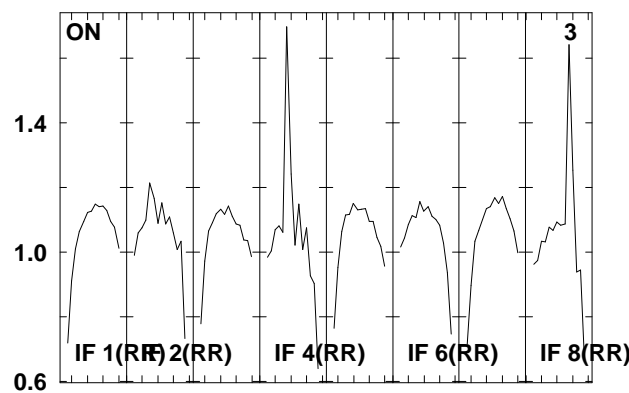
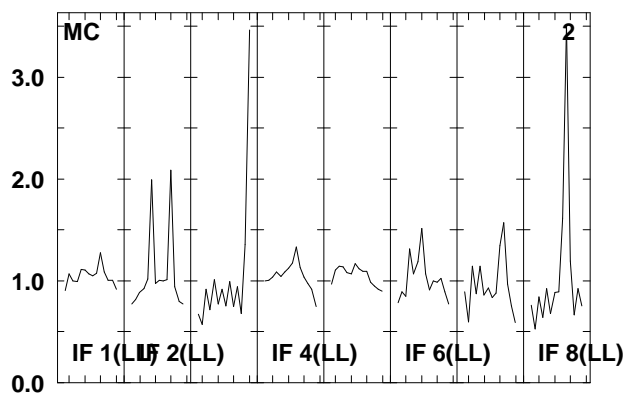
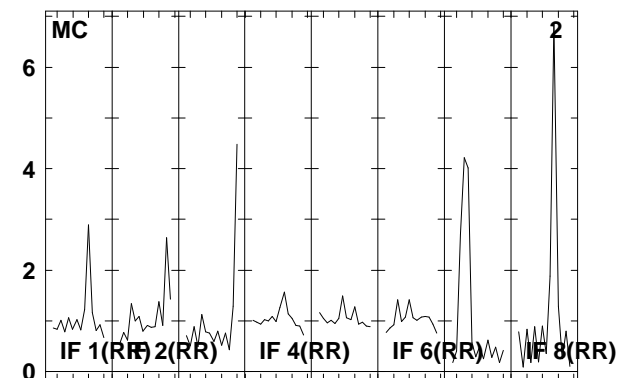
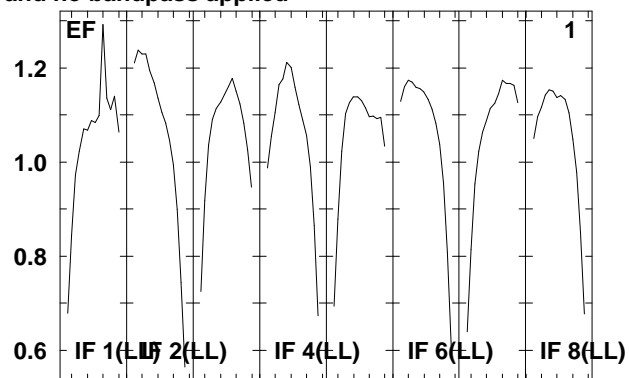
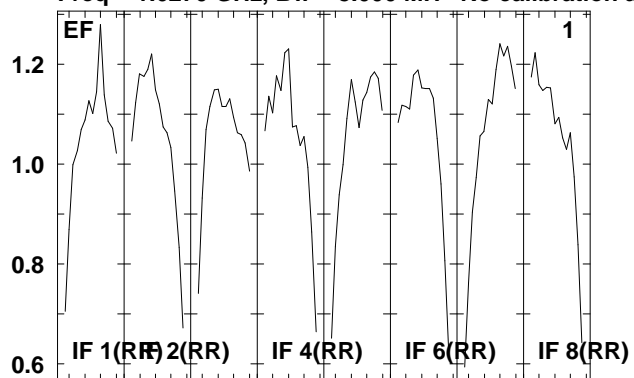

Lower frame: Real Jy  
Total-power spectrum Antenna: \*  
Timerange: 01/03:45:00 to 01/03:45:59

Plot file version 192 created 20-OCT-2009 14:50:47

J0137+31 RP015C.UVDATA.1

Freq = 1.6270 GHz, Bw = 8.000 MH No calibration applied and no bandpass applied

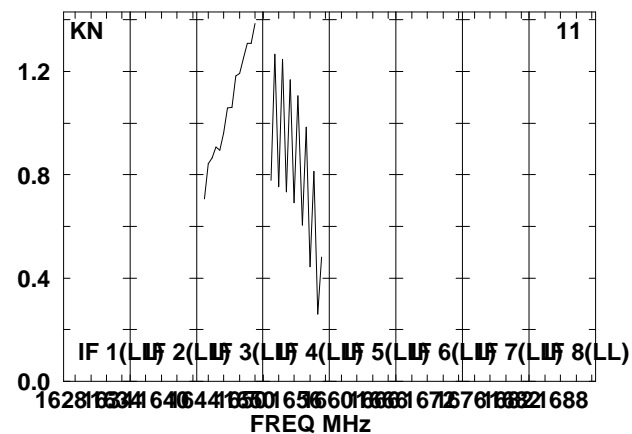
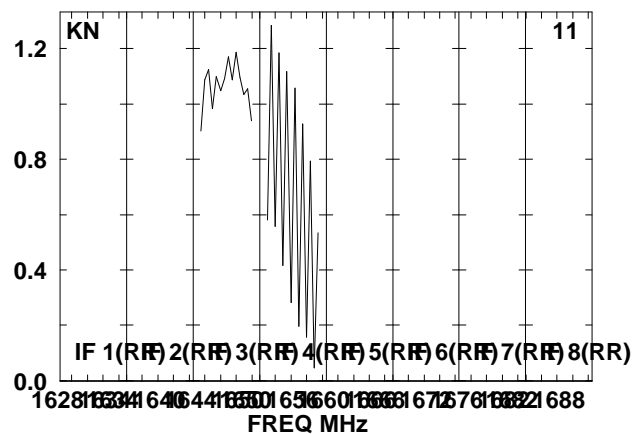
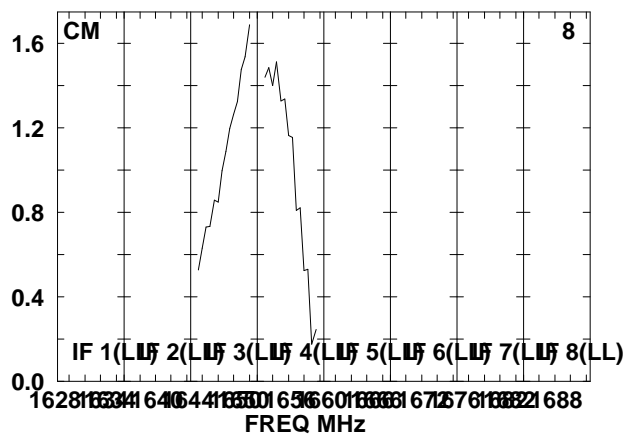
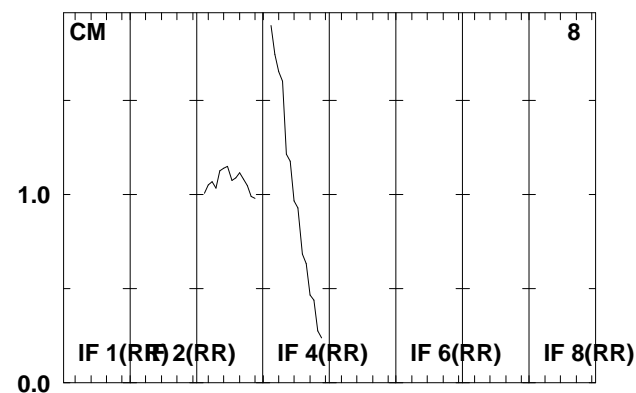
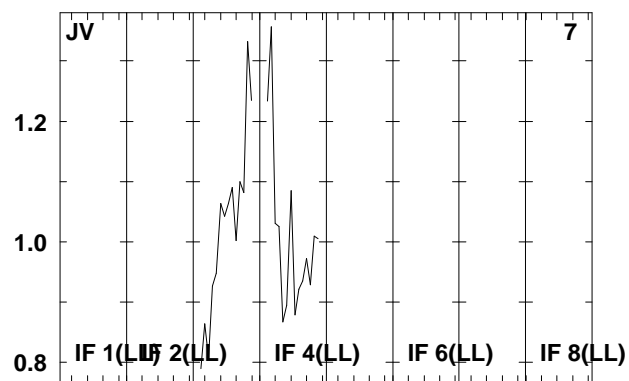
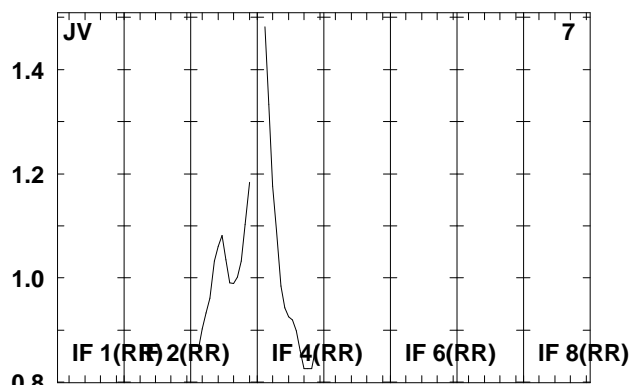
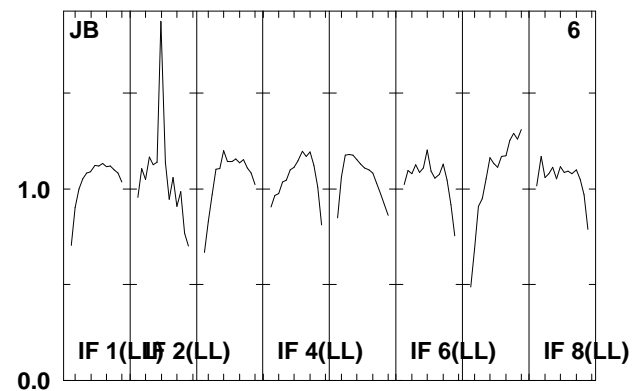
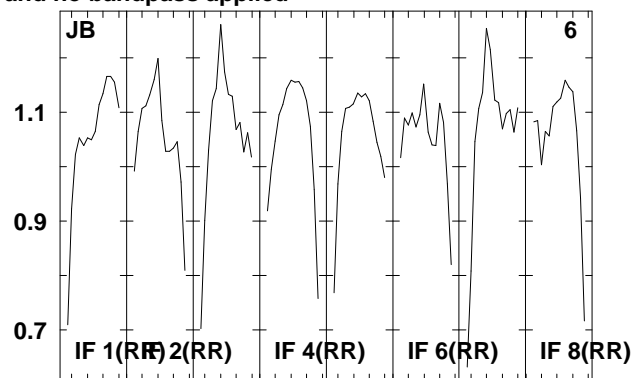
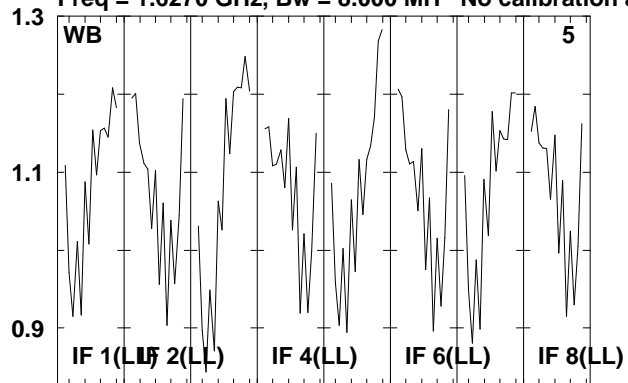

Lower frame: Real Jy

Total-power spectrum Antenna: \*

Timerange: 01/03:45:00 to 01/03:45:59



Plot file version 193 created 20-OCT-2009 14:50:48

FAINTCAL RP015C.UVDATA.1

Freq = 1.6270 GHz, Bw = 8.000 MH No calibration applied and no bandpass applied

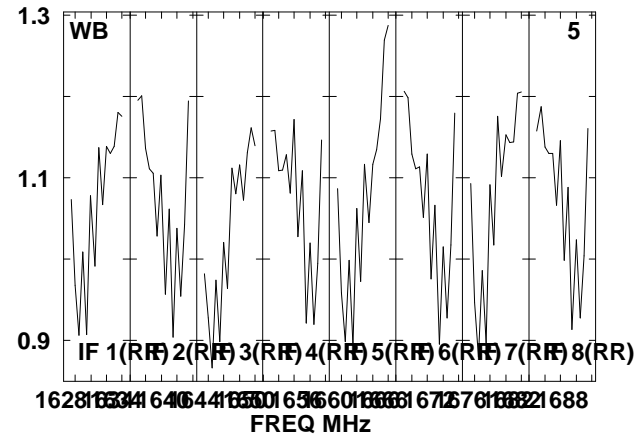
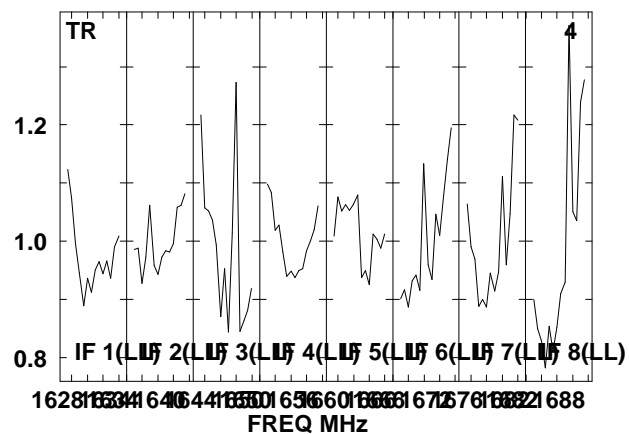
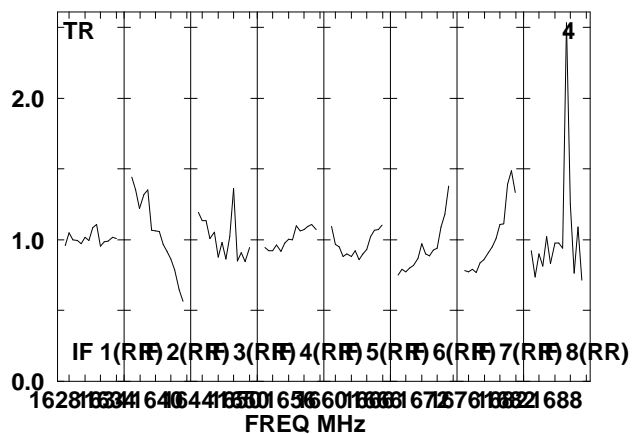
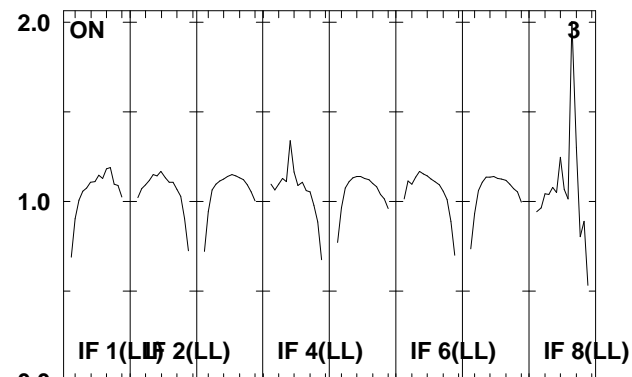
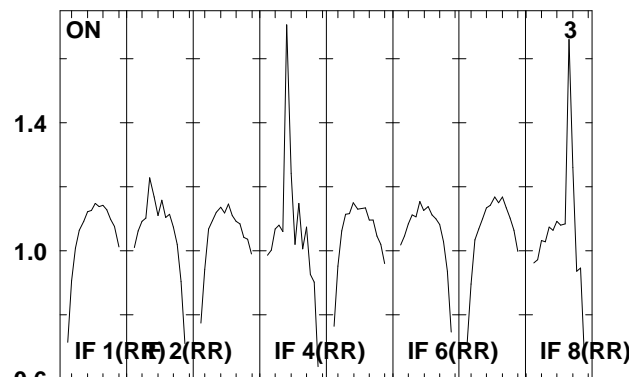
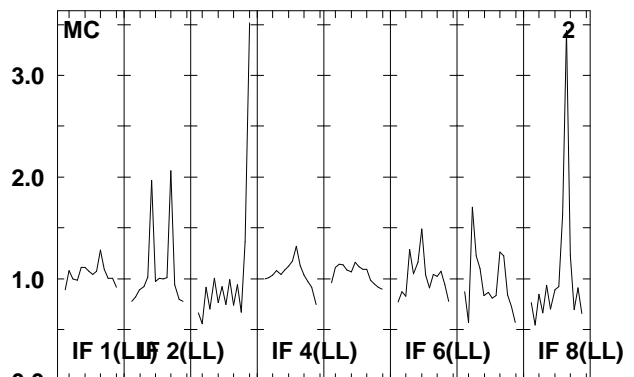
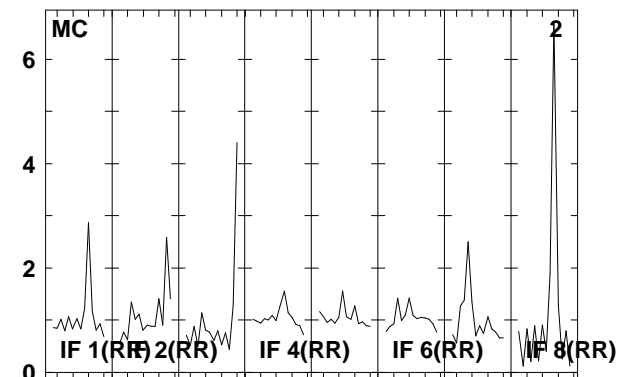
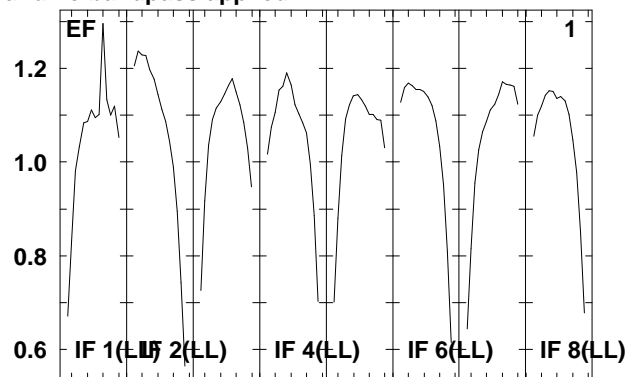
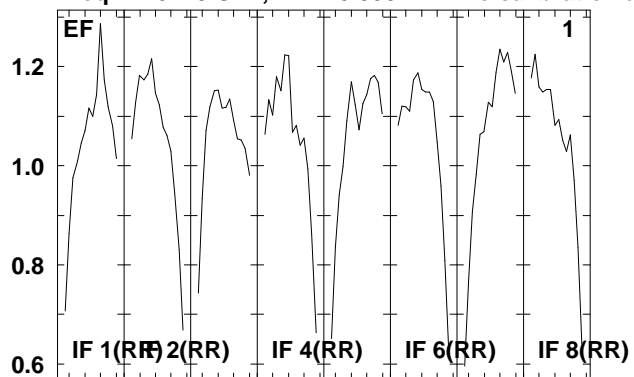

Lower frame: Real Jy

Total-power spectrum Antenna: \*

Timerange: 01/03:46:01 to 01/03:47:19

Plot file version 194 created 20-OCT-2009 14:50:48

FAINTCAL RP015C.UVDATA.1

Freq = 1.6270 GHz, Bw = 8.000 MH No calibration applied and no bandpass applied

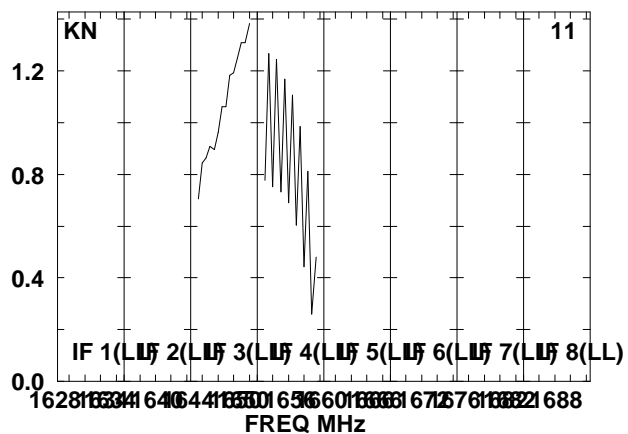
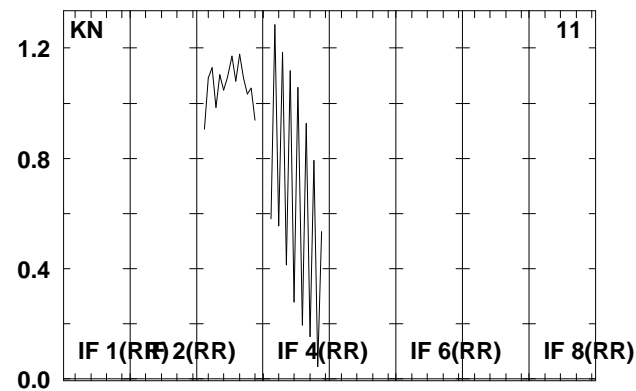
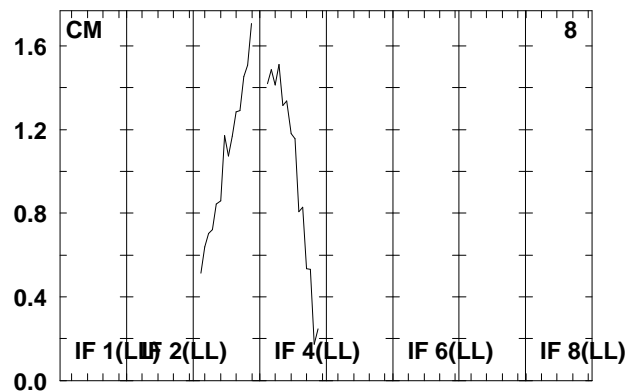
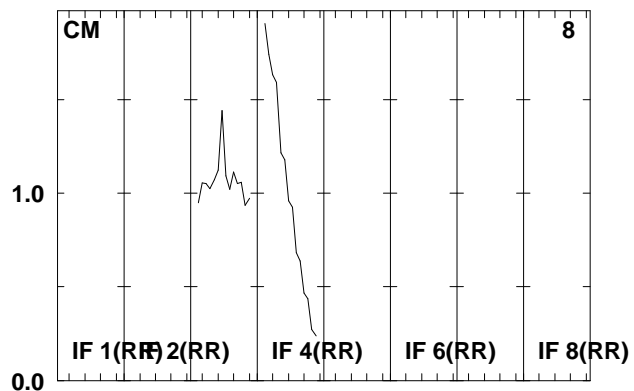
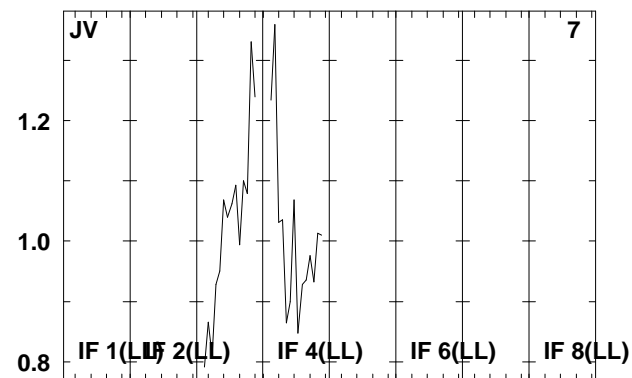
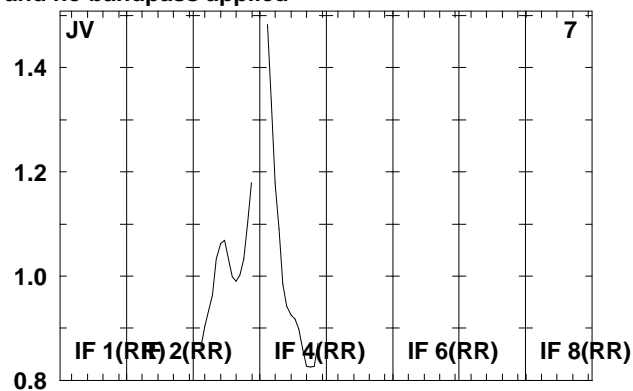
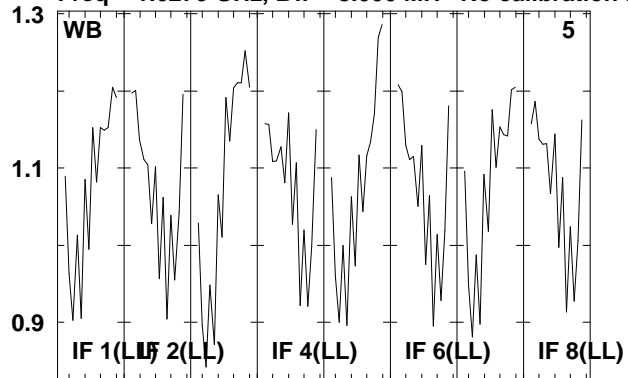

Lower frame: Real Jy

Total-power spectrum Antenna: \*

Timerange: 01/03:46:01 to 01/03:47:19

Plot file version 195 created 20-OCT-2009 14:50:49

M33 RP015C.UVDATA.1

Freq = 1.6270 GHz, Bw = 8.000 MH No calibration applied and no bandpass applied

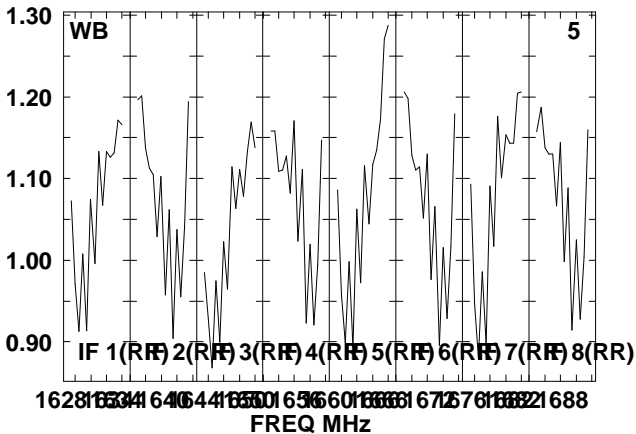
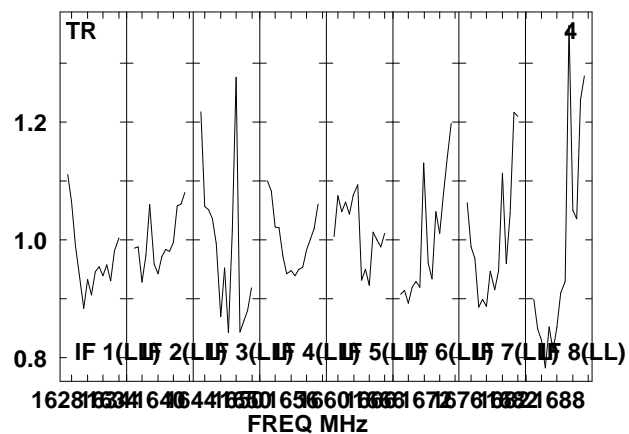
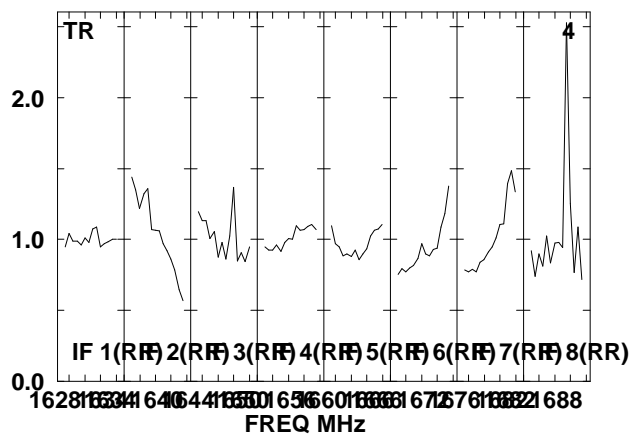
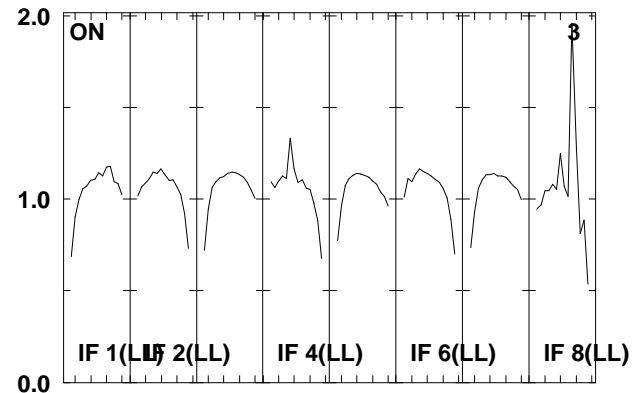
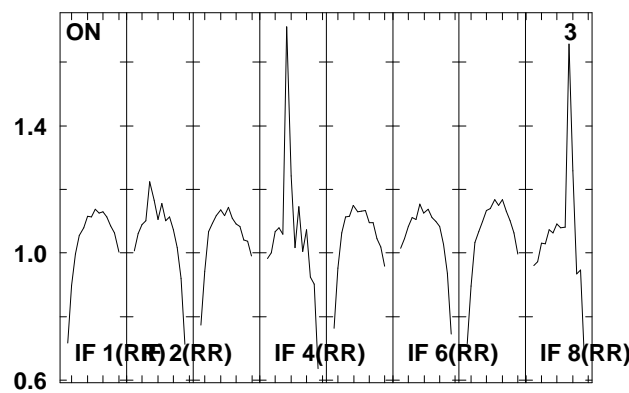
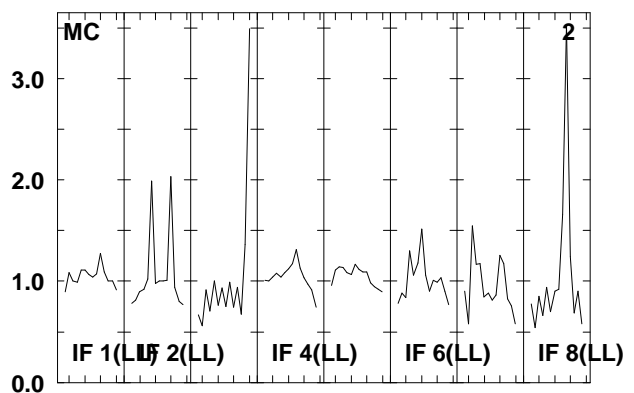
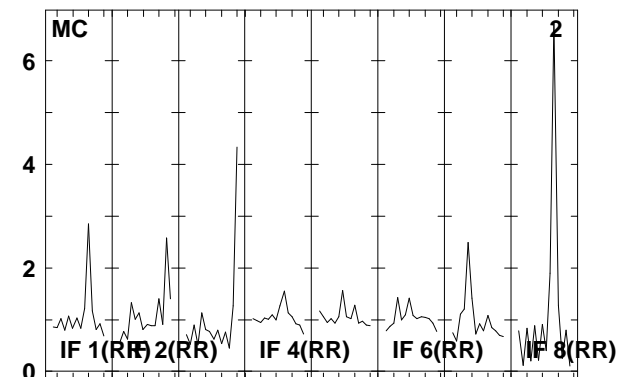
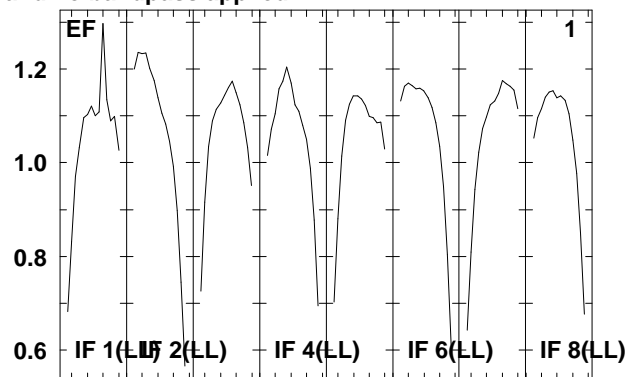
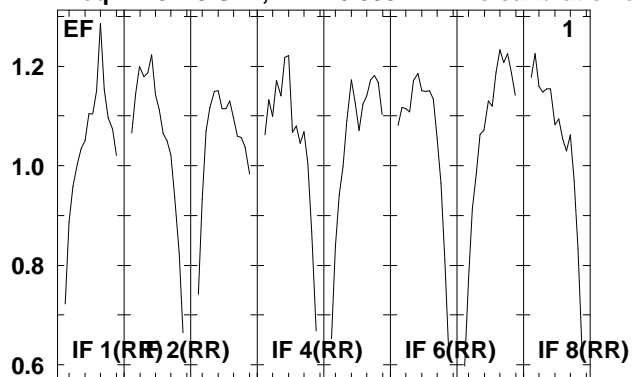

Lower frame: Real Jy

Total-power spectrum Antenna: \*

Timerange: 01/03:47:20 to 01/03:50:19

Plot file version 196 created 20-OCT-2009 14:50:50

M33 RP015C.UVDATA.1

Freq = 1.6270 GHz, Bw = 8.000 MH No calibration applied and no bandpass applied

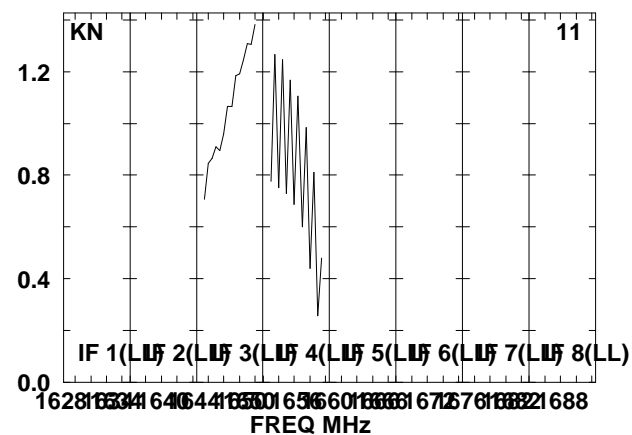
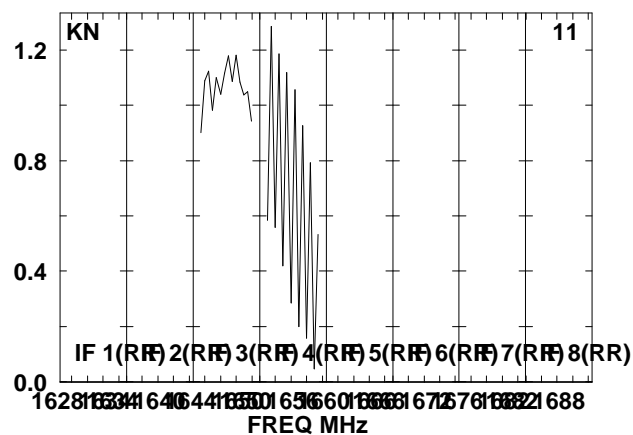
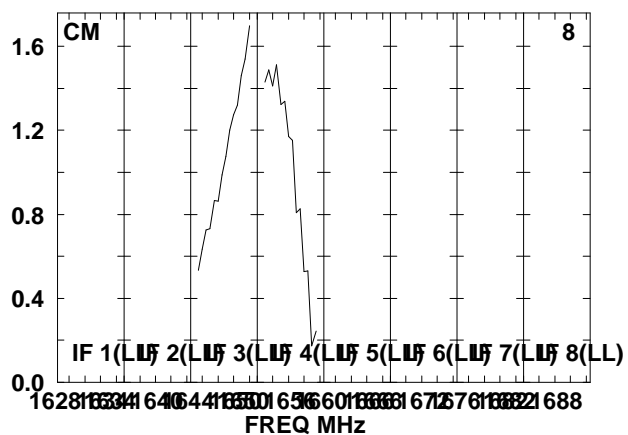
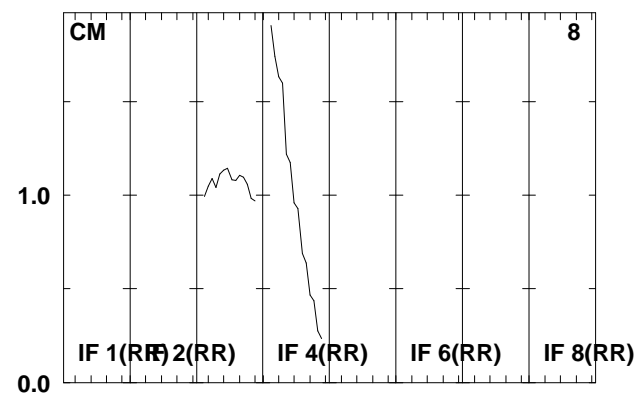
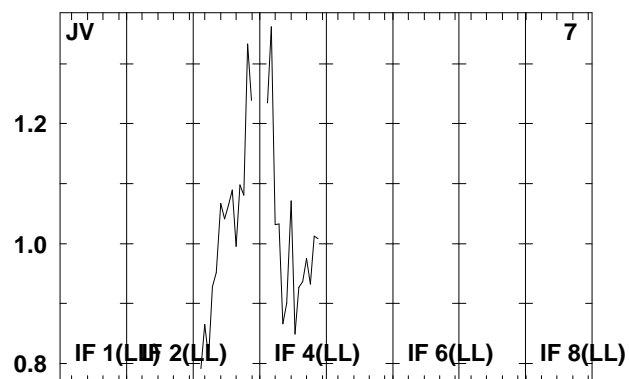
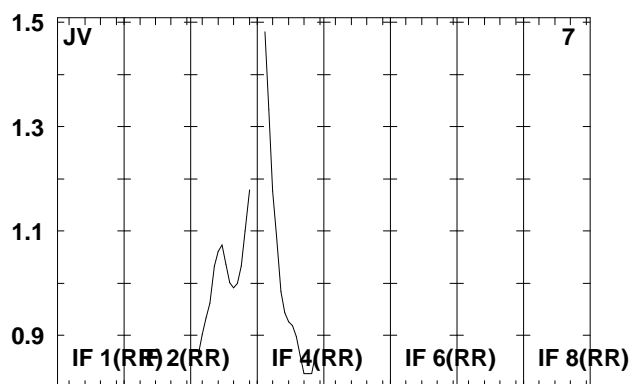
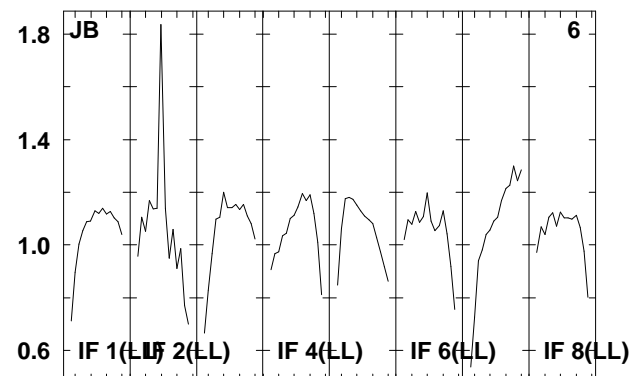
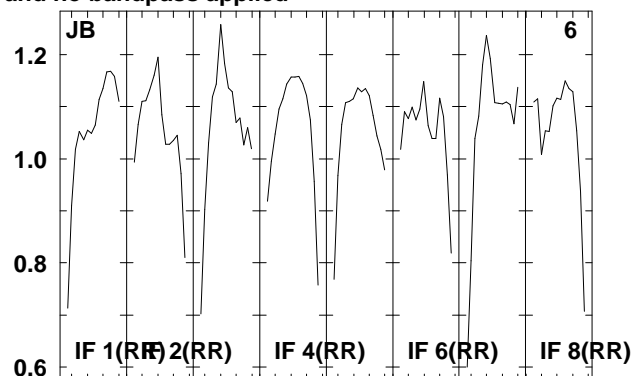
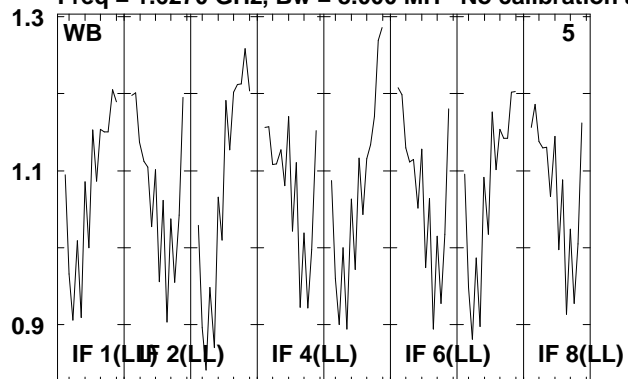

Lower frame: Real Jy  
Total-power spectrum Antenna: \*  
Timerange: 01/03:47:20 to 01/03:50:19

Plot file version 197 created 20-OCT-2009 14:50:51

J0137+31 RP015C.UVDATA.1

Freq = 1.6270 GHz, Bw = 8.000 MH No calibration applied and no bandpass applied

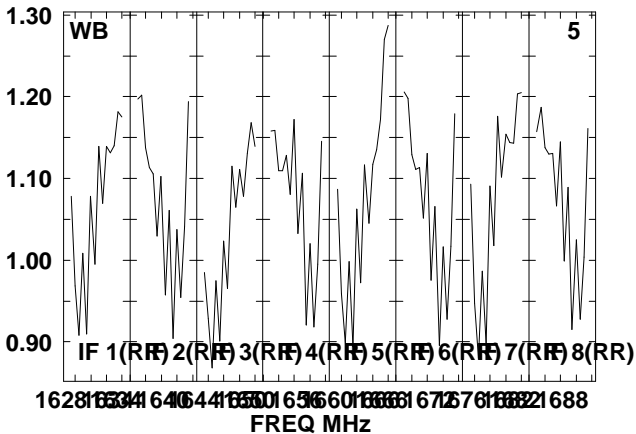
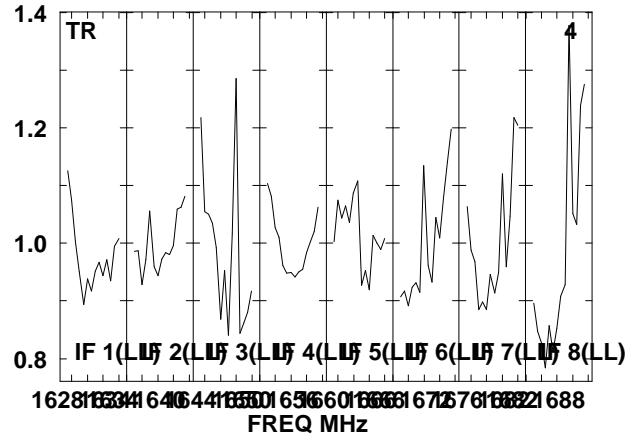
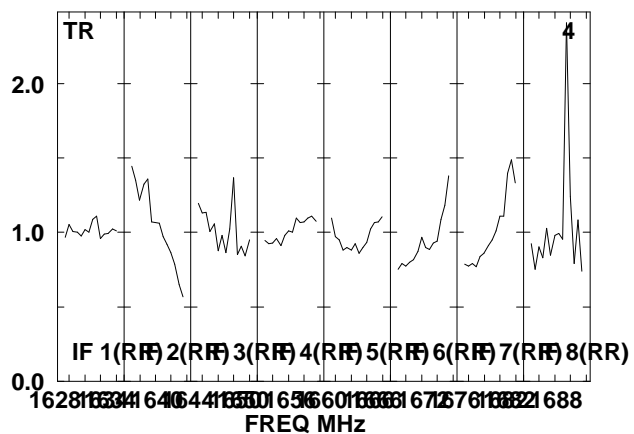
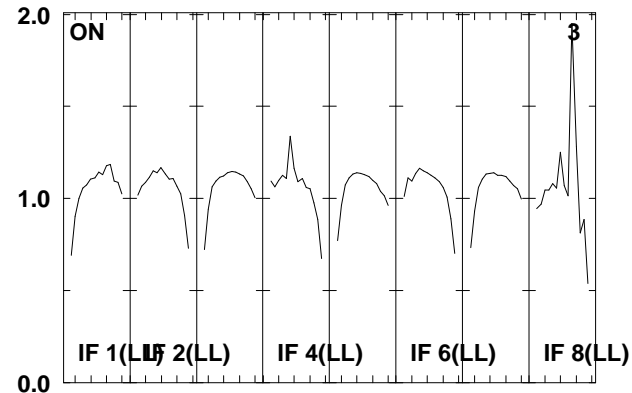
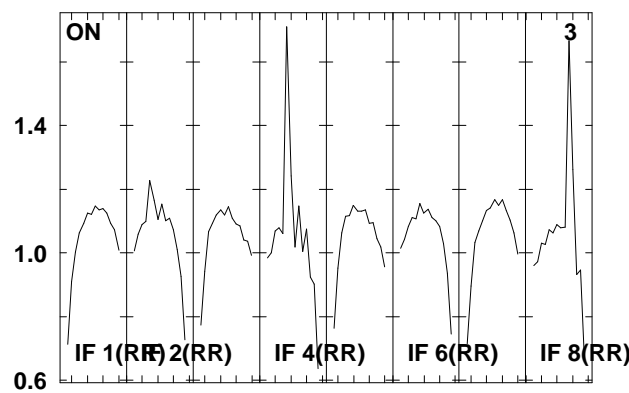
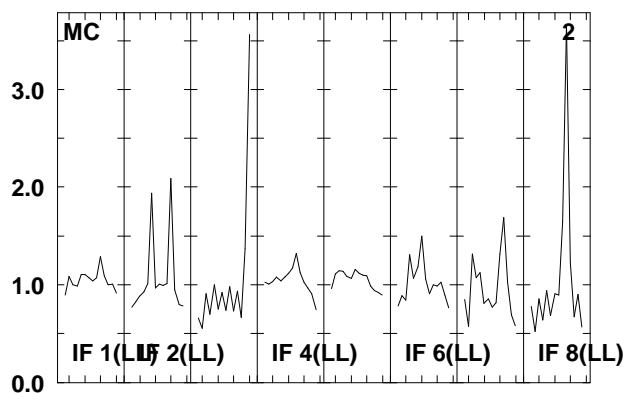
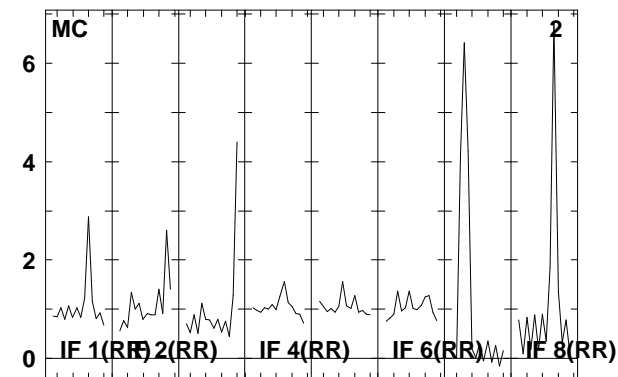
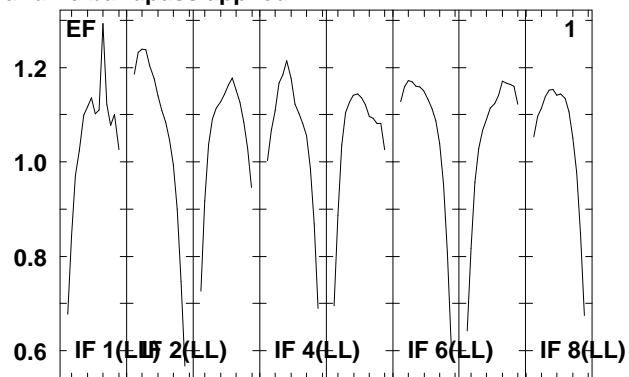
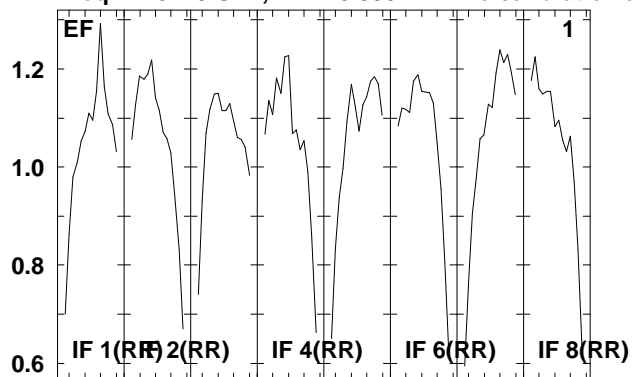

Lower frame: Real Jy

Total-power spectrum Antenna: \*

Timerange: 01/03:51:00 to 01/03:51:59

Plot file version 198 created 20-OCT-2009 14:50:51

J0137+31 RP015C.UVDATA.1

Freq = 1.6270 GHz, Bw = 8.000 MH No calibration applied and no bandpass applied

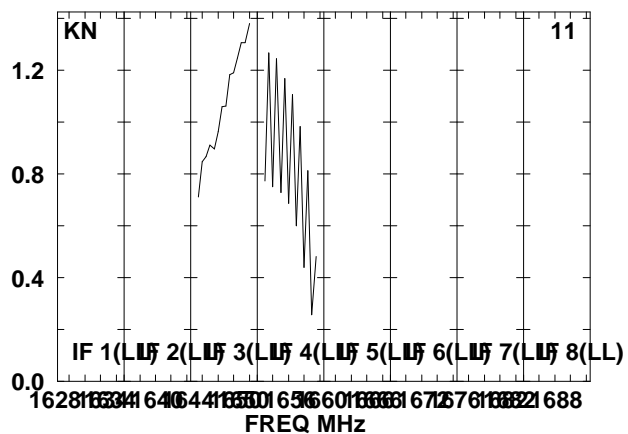
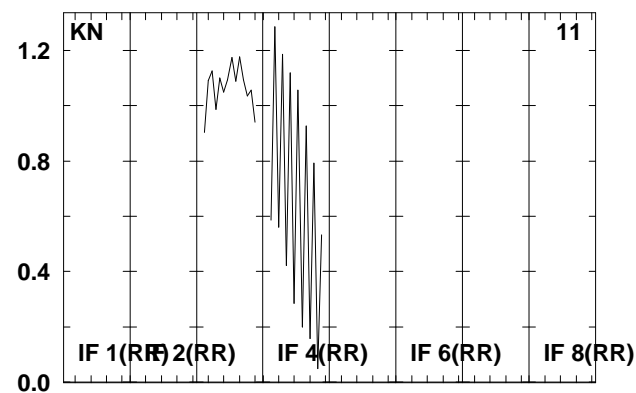
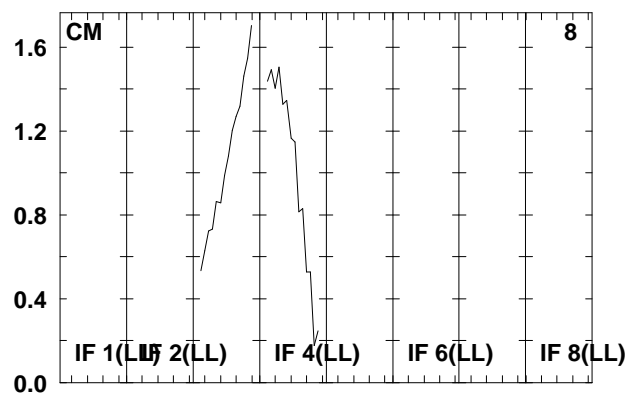
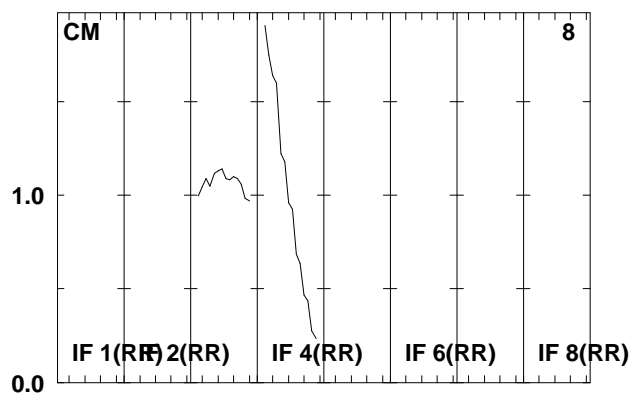
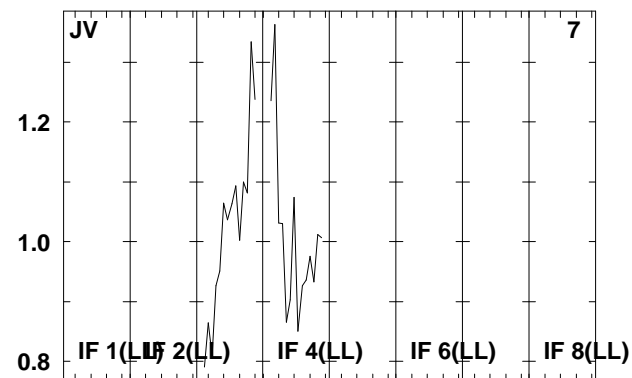
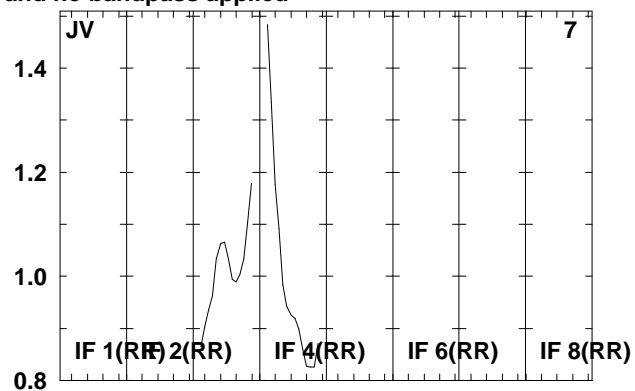
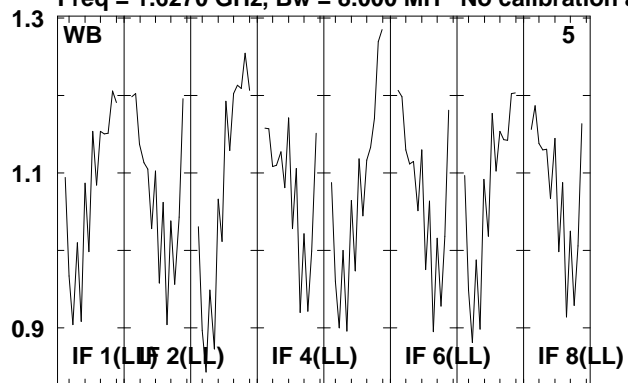

Lower frame: Real Jy

Total-power spectrum Antenna: \*

Timerange: 01/03:51:00 to 01/03:51:59

Plot file version 199 created 20-OCT-2009 14:50:52

FAINTCAL RP015C.UVDATA.1

Freq = 1.6270 GHz, Bw = 8.000 MH No calibration applied and no bandpass applied

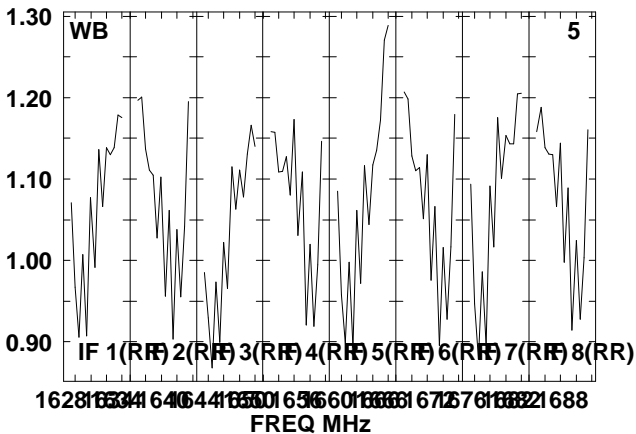
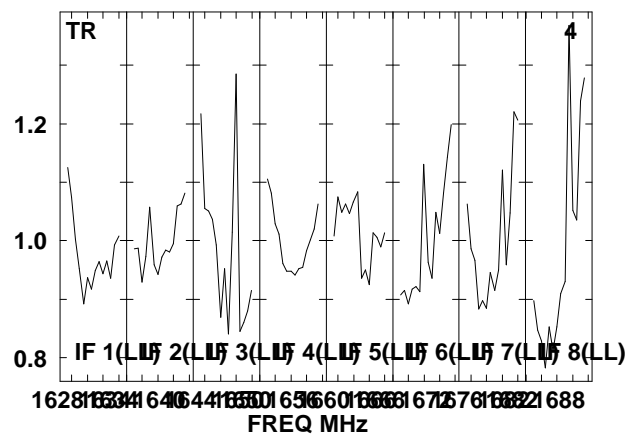
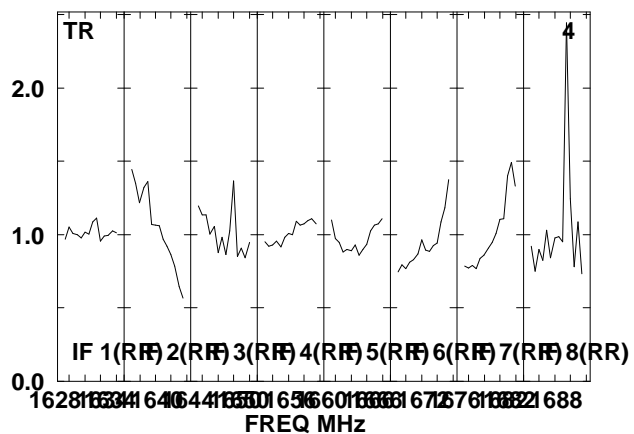
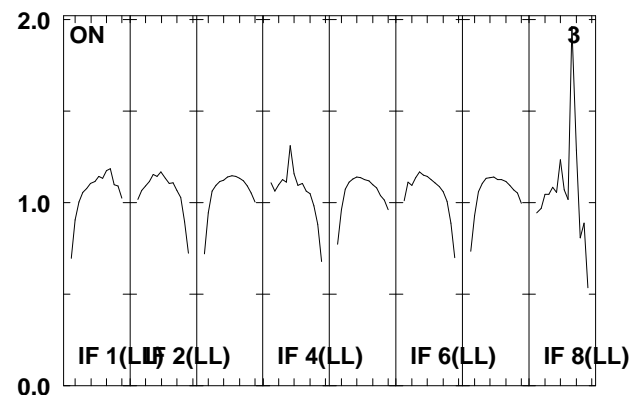
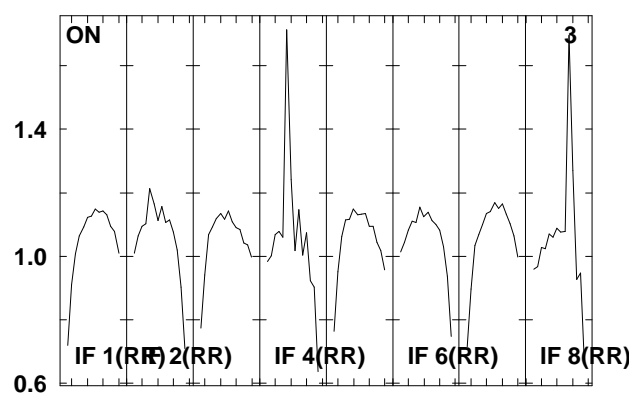
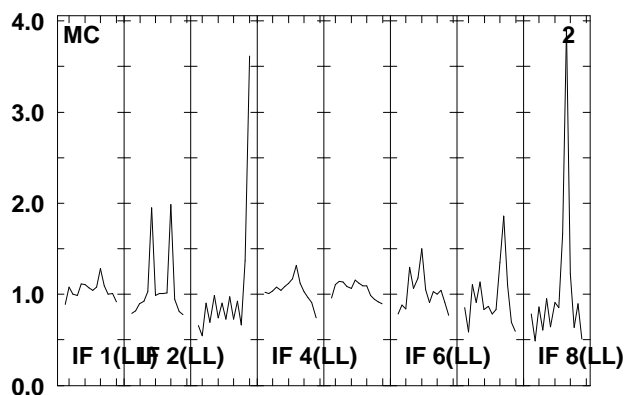
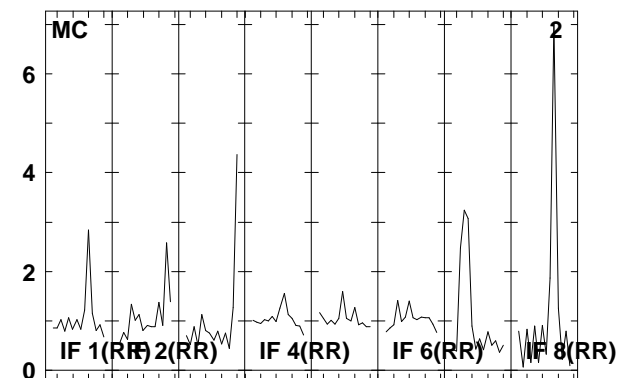
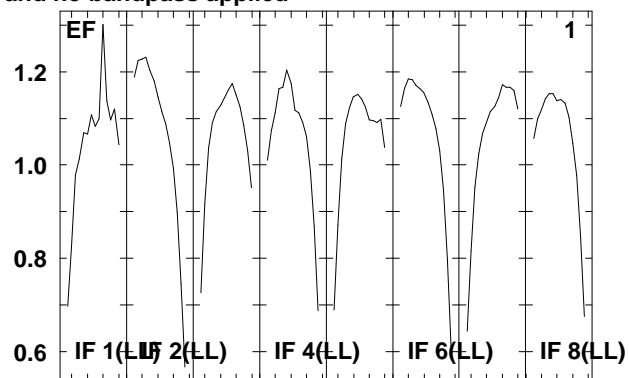
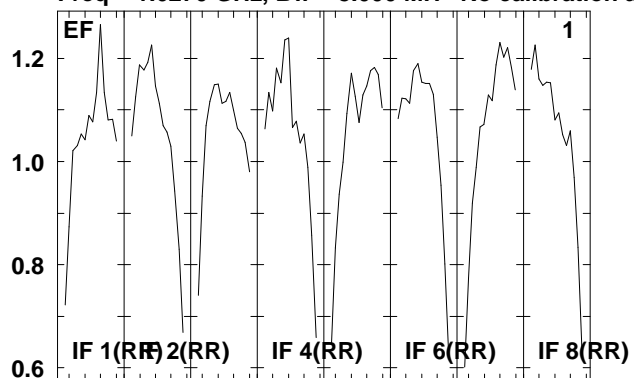

Lower frame: Real Jy  
Total-power spectrum Antenna: \*  
Timerange: 01/03:52:00 to 01/03:53:20

Plot file version 200 created 20-OCT-2009 14:50:52

FAINTCAL RP015C.UVDATA.1

Freq = 1.6270 GHz, Bw = 8.000 MH No calibration applied and no bandpass applied

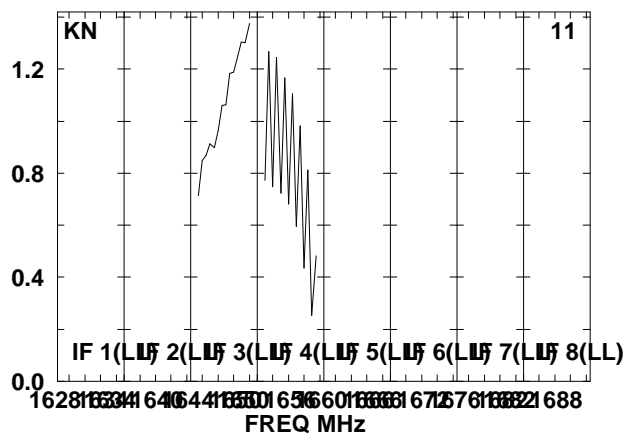
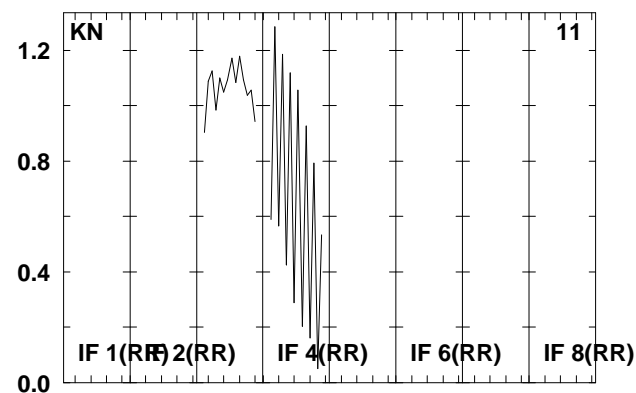
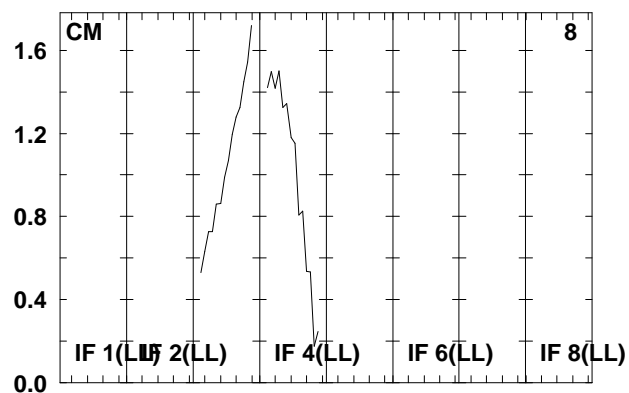
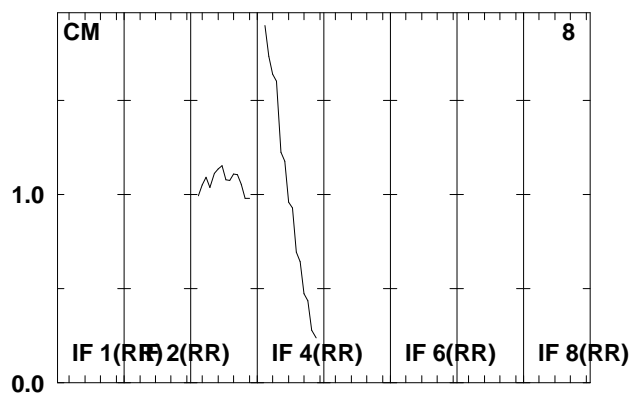
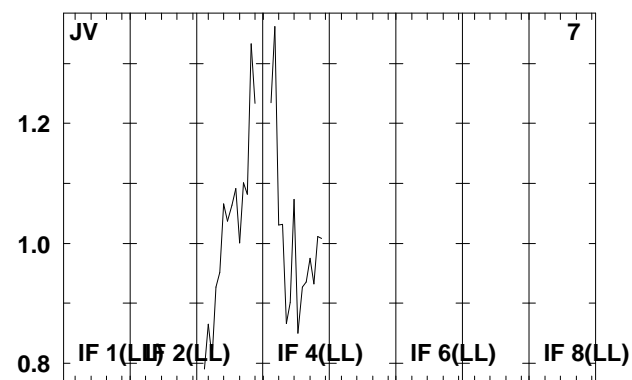
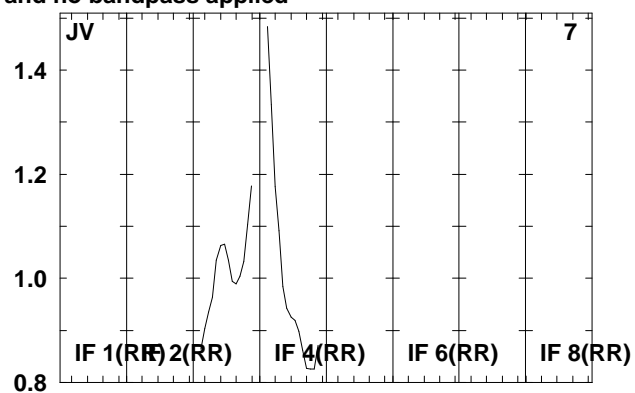
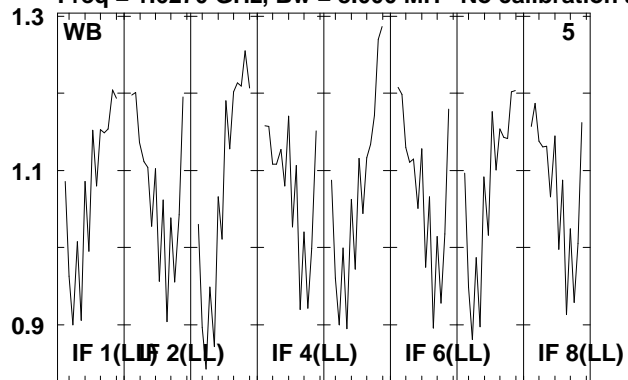

Lower frame: Real Jy

Total-power spectrum Antenna: \*

Timerange: 01/03:52:00 to 01/03:53:20



Plot file version 201 created 20-OCT-2009 14:50:53

M33 RP015C.UVDATA.1

Freq = 1.6270 GHz, Bw = 8.000 MH No calibration applied and no bandpass applied

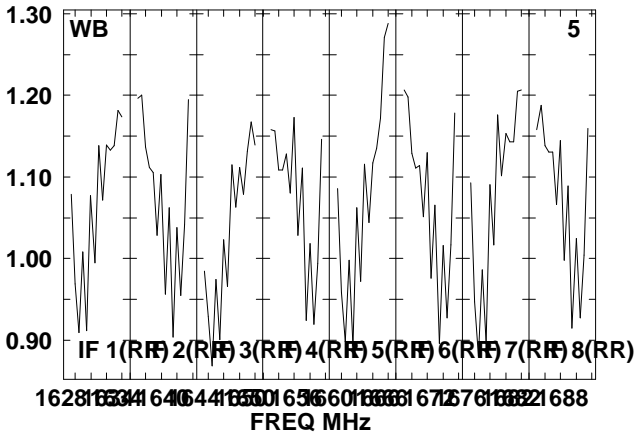
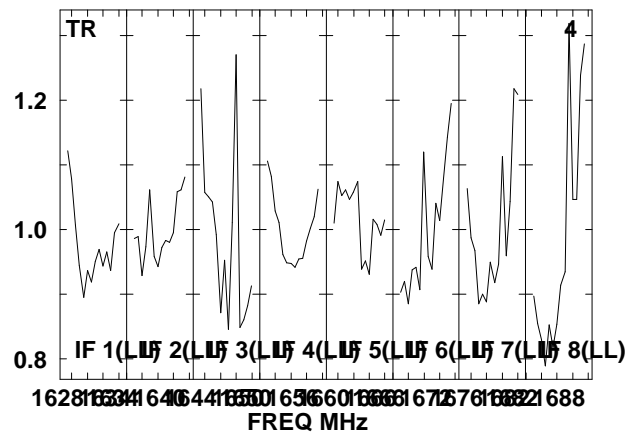
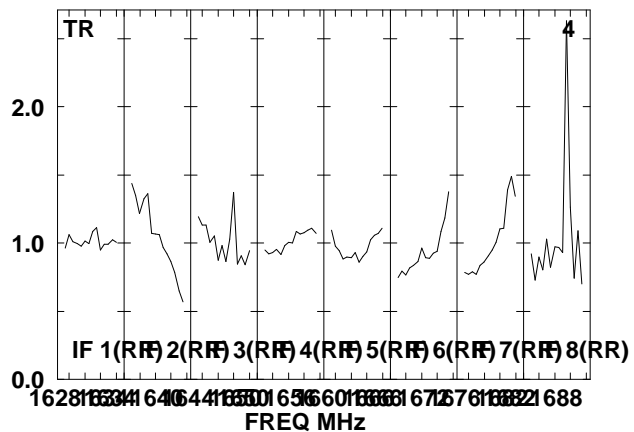
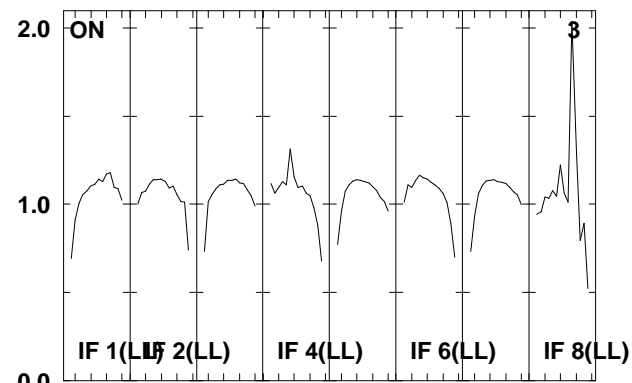
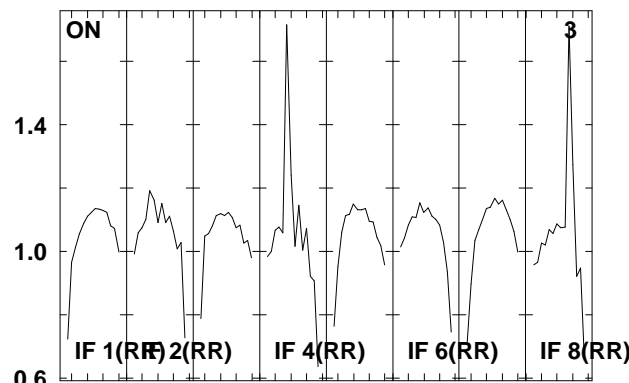
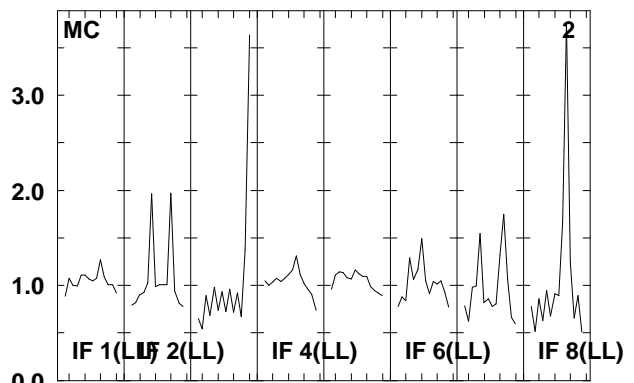
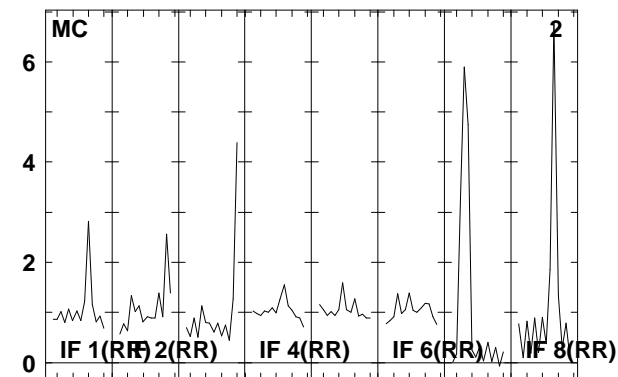
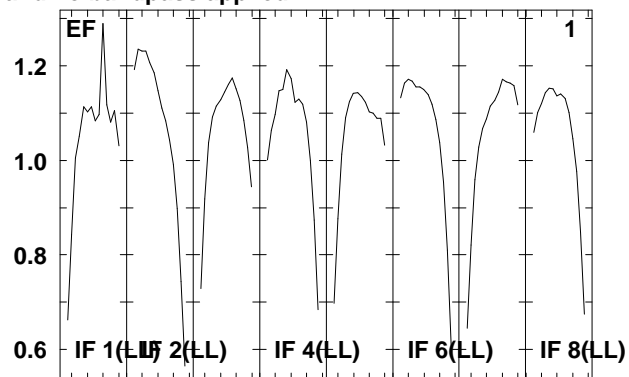
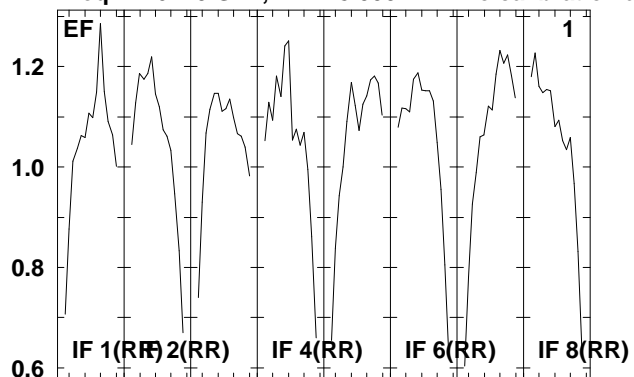

Lower frame: Real Jy

Total-power spectrum Antenna: \*

Timerange: 01/03:53:21 to 01/03:56:20

Plot file version 202 created 20-OCT-2009 14:50:54

M33 RP015C.UVDATA.1

Freq = 1.6270 GHz, Bw = 8.000 MH No calibration applied and no bandpass applied

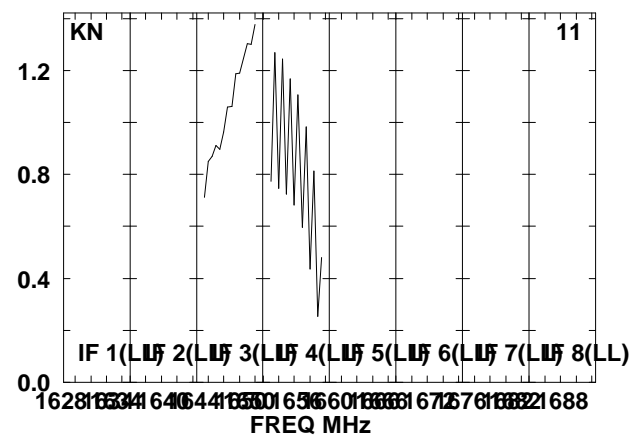
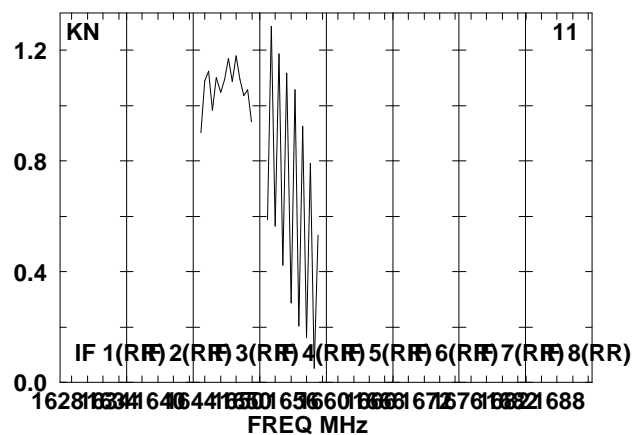
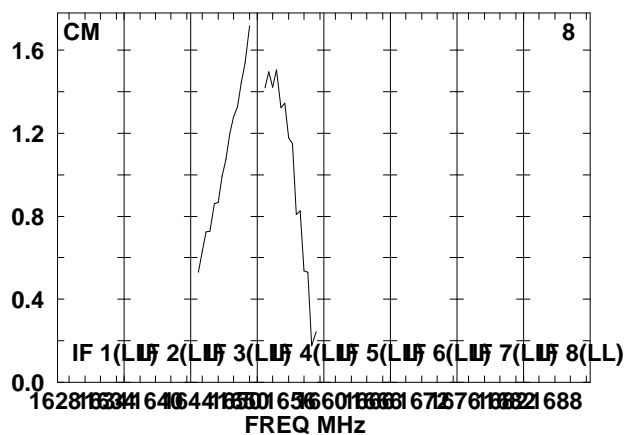
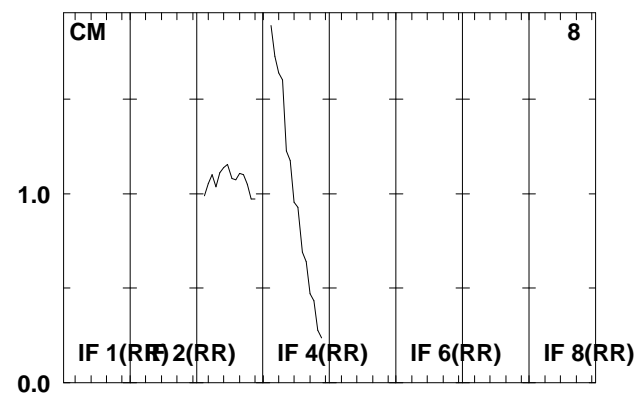
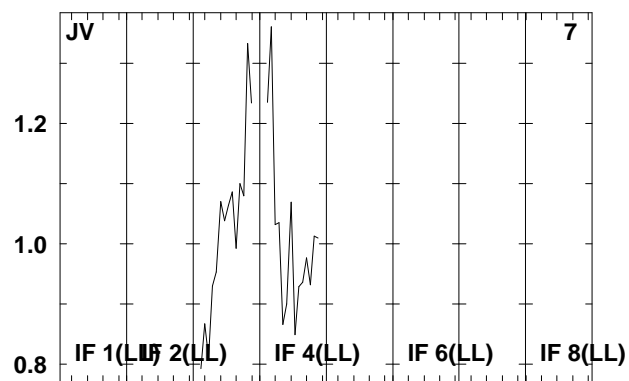
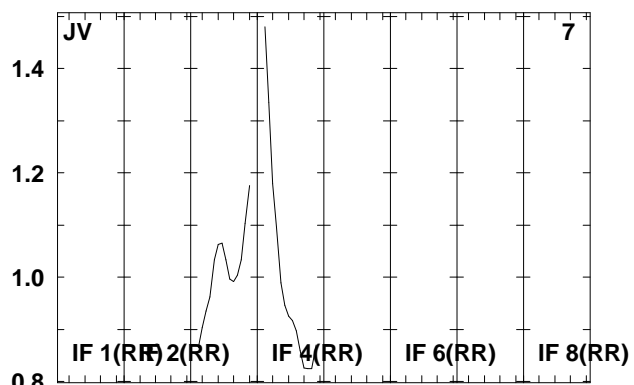
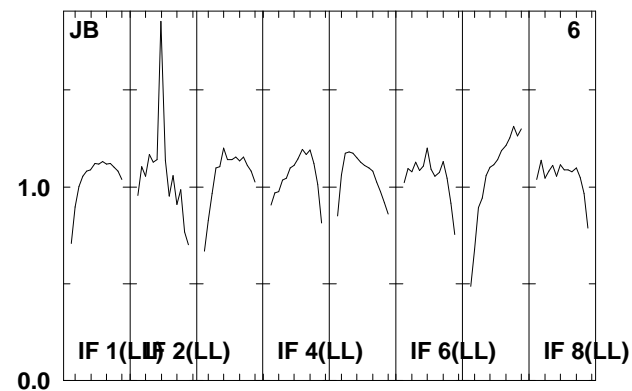
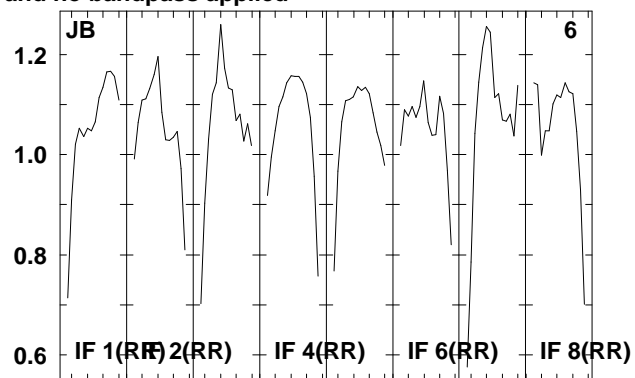
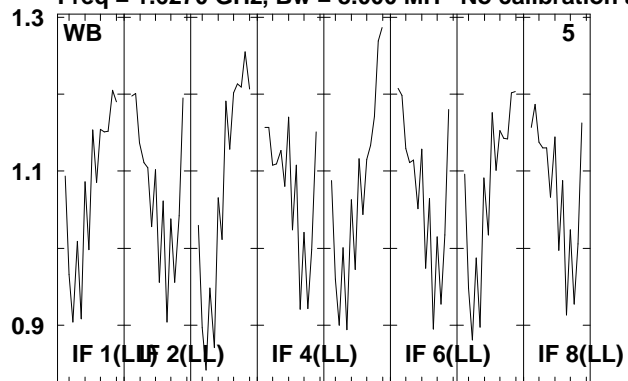

Lower frame: Real Jy  
Total-power spectrum Antenna: \*  
Timerange: 01/03:53:21 to 01/03:56:20

Plot file version 203 created 20-OCT-2009 14:50:56

J0137+31 RP015C.UVDATA.1

Freq = 1.6270 GHz, Bw = 8.000 MH No calibration applied and no bandpass applied

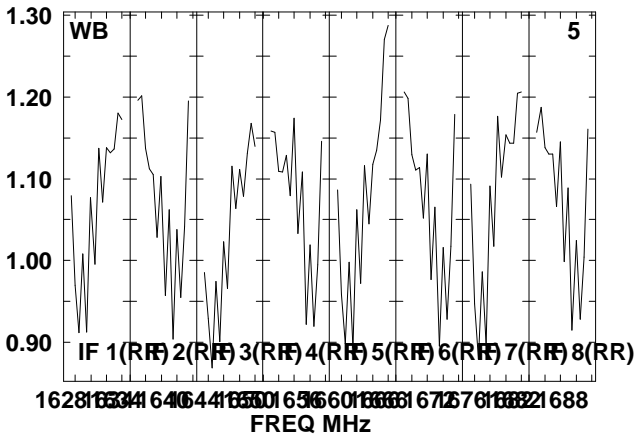
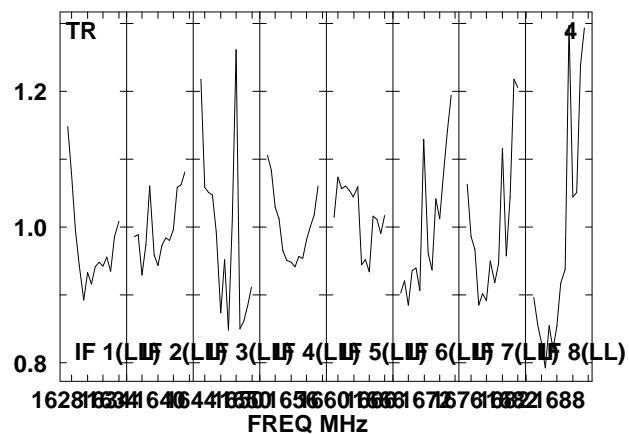
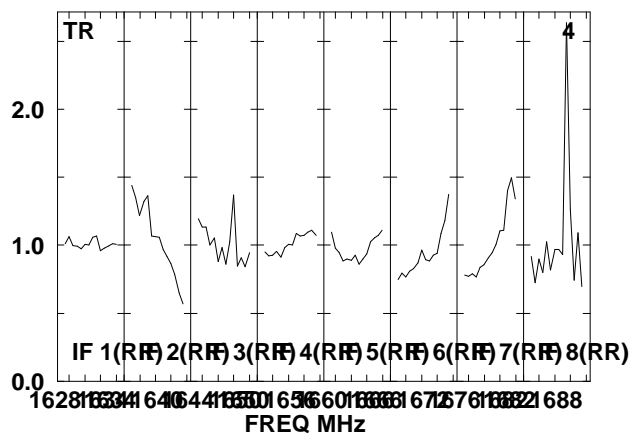
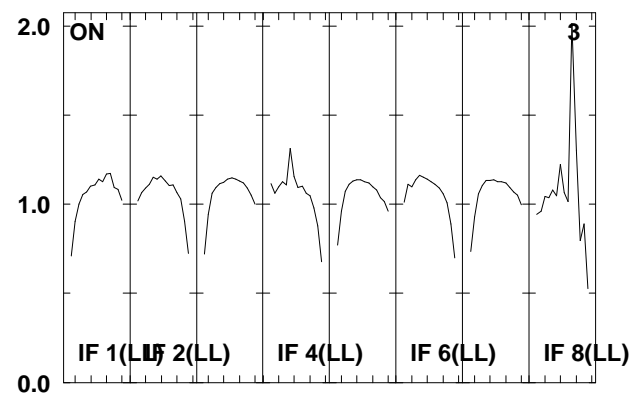
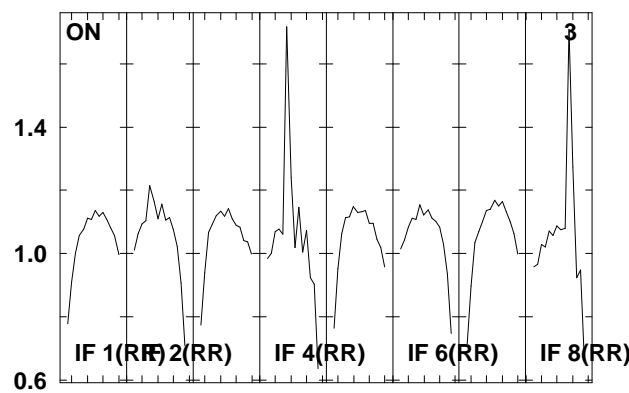
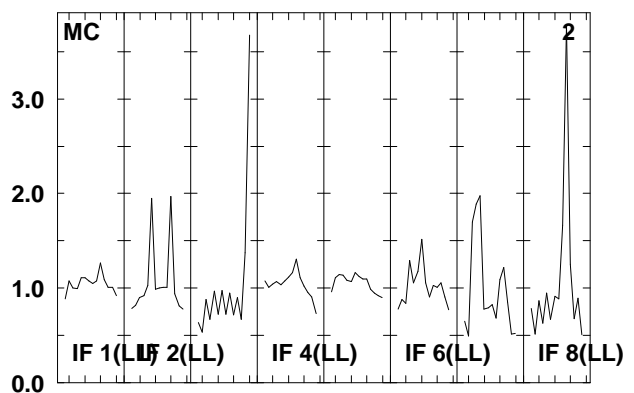
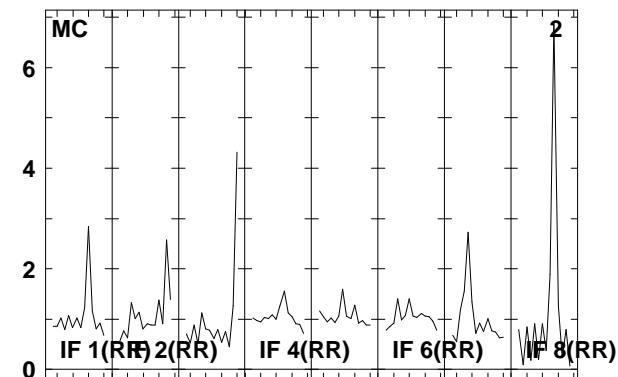
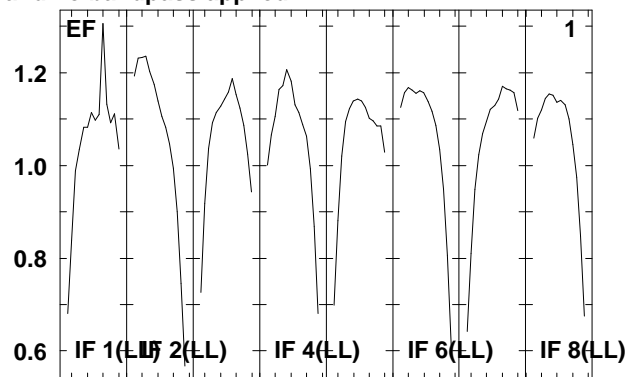
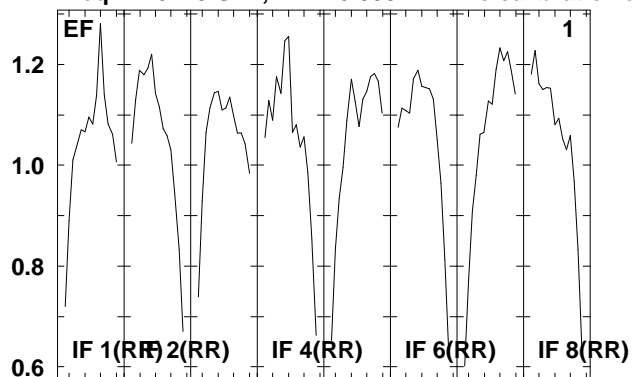

Lower frame: Real Jy  
Total-power spectrum Antenna: \*  
Timerange: 01/03:57:01 to 01/04:01:19

Plot file version 204 created 20-OCT-2009 14:50:57

J0137+31 RP015C.UVDATA.1

Freq = 1.6270 GHz, Bw = 8.000 MH No calibration applied and no bandpass applied

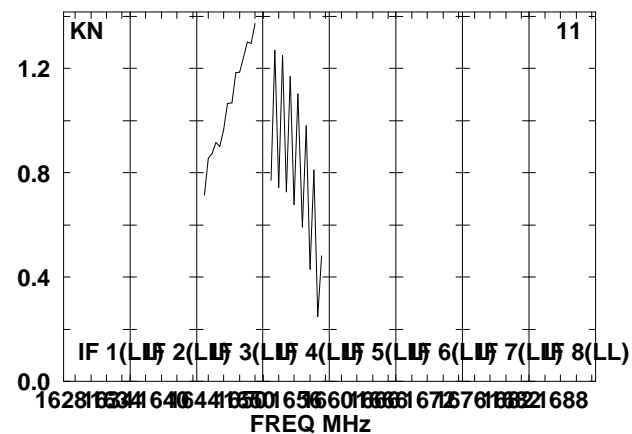
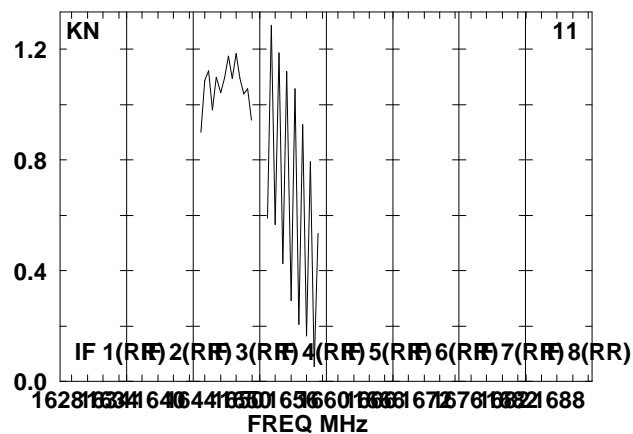
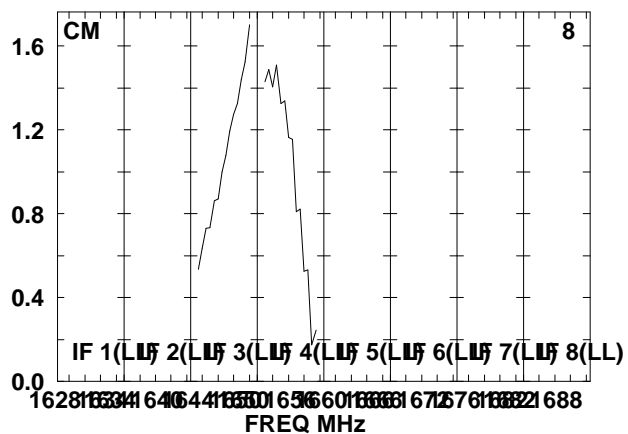
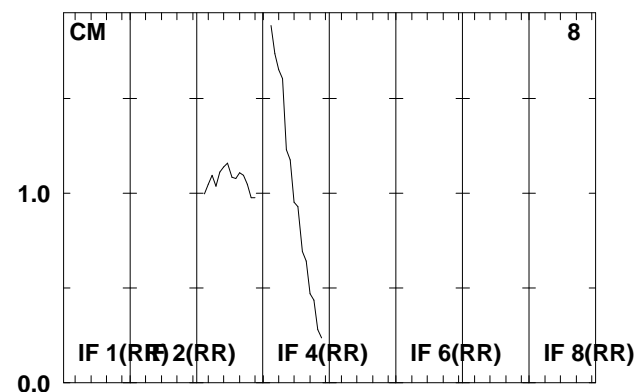
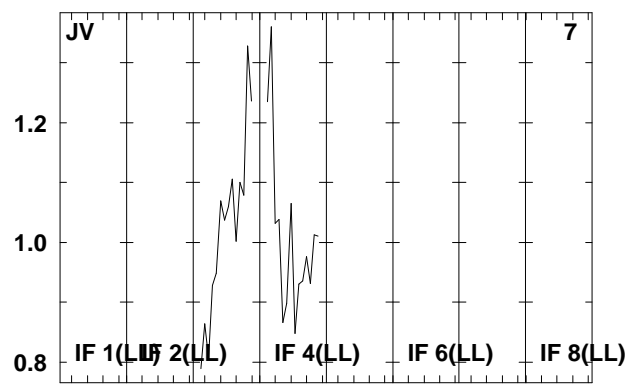
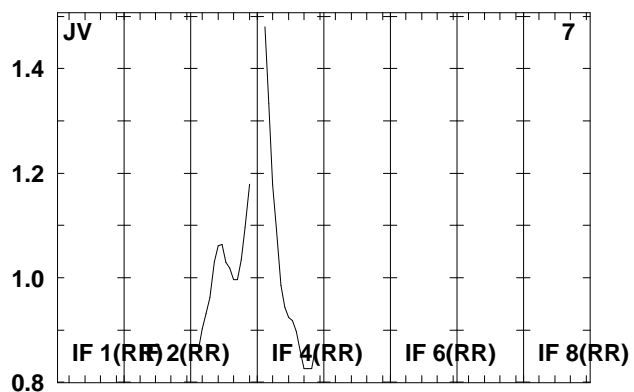
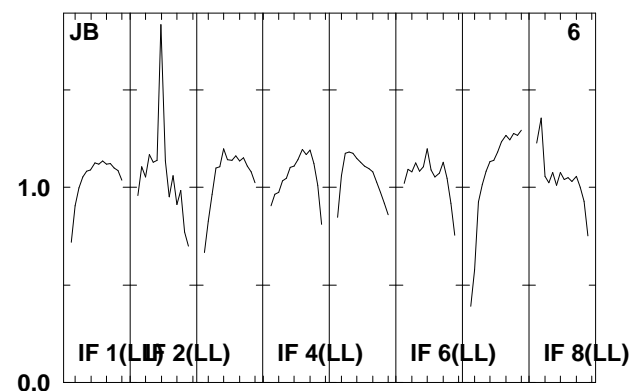
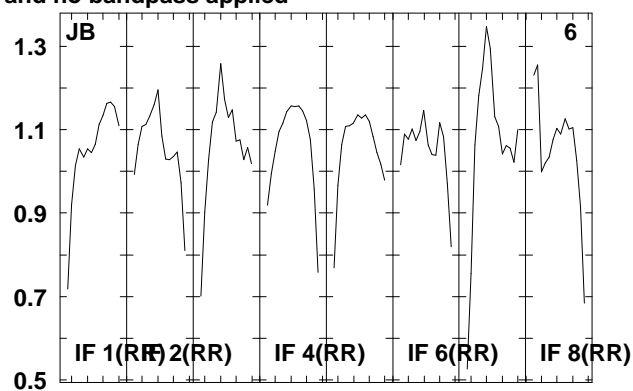
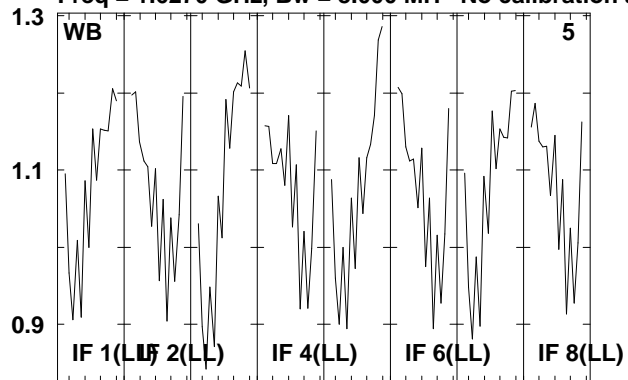

Lower frame: Real Jy  
Total-power spectrum Antenna: \*  
Timerange: 01/03:57:01 to 01/04:01:19

Plot file version 205 created 20-OCT-2009 14:50:59

J0137+31 RP015C.UVDATA.1

Freq = 1.6270 GHz, Bw = 8.000 MH No calibration applied and no bandpass applied

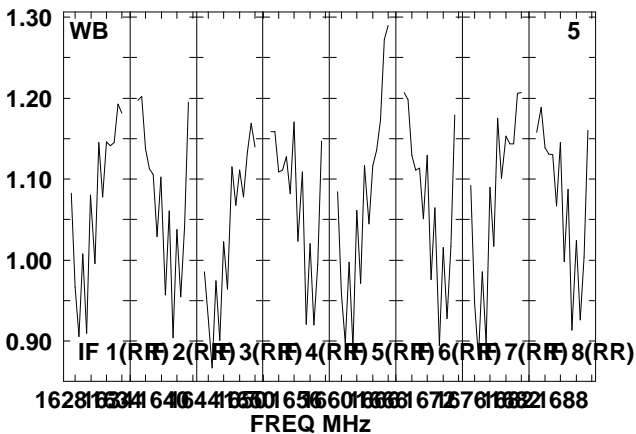
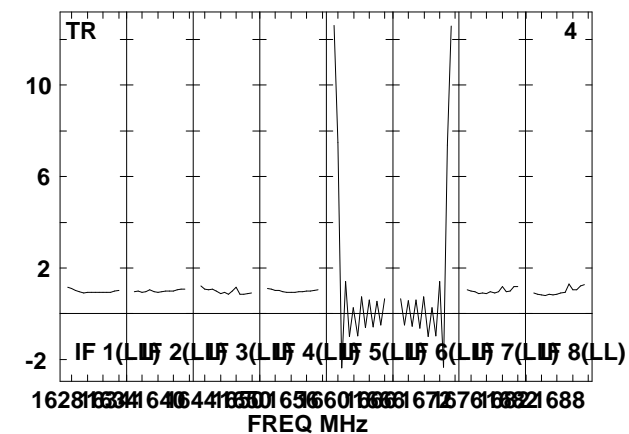
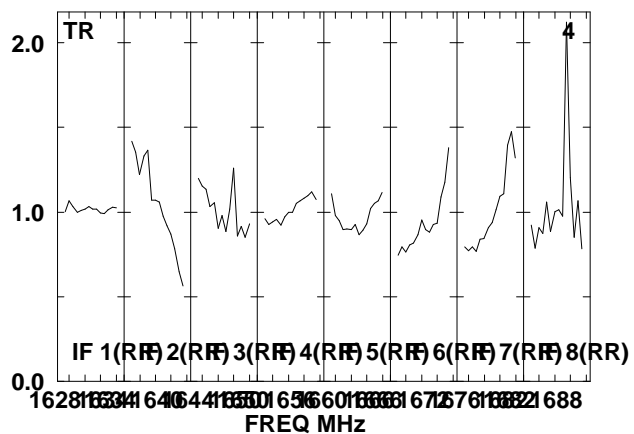
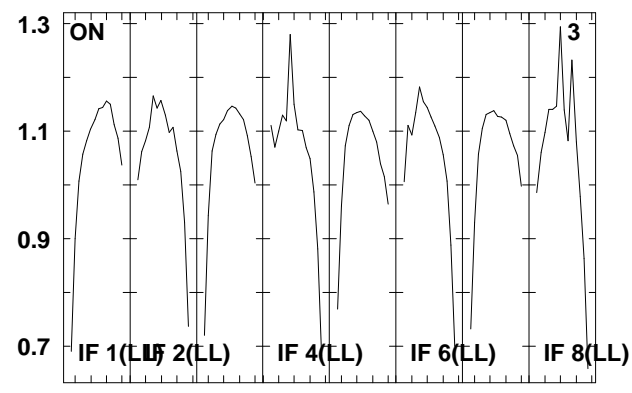
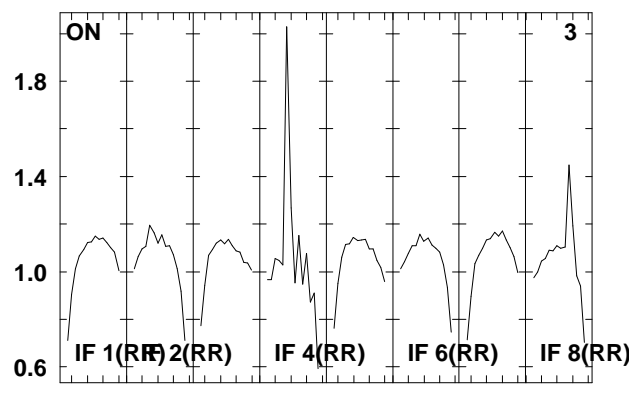
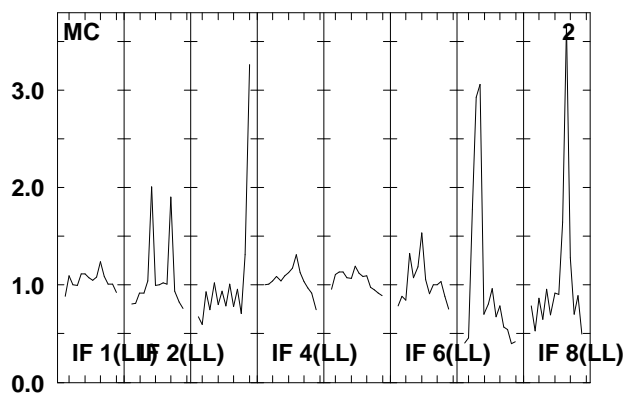
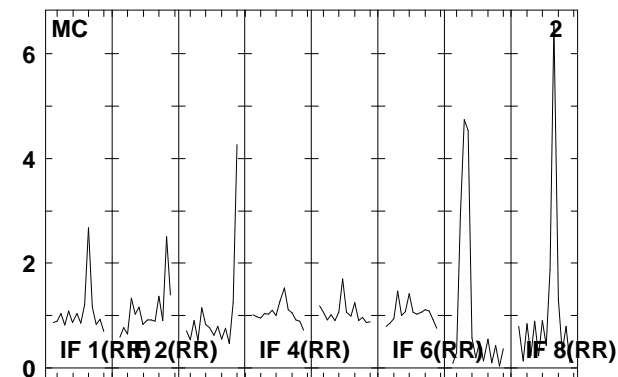
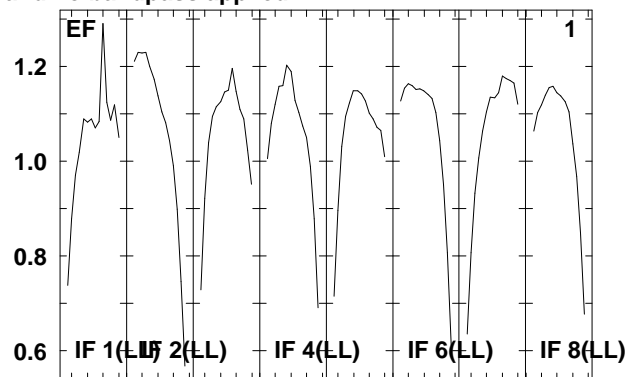
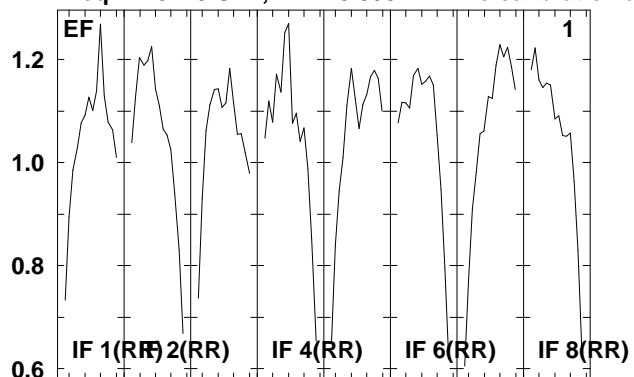

Lower frame: Real Jy  
Total-power spectrum Antenna: \*  
Timerange: 01/04:25:01 to 01/04:26:00

Plot file version 206 created 20-OCT-2009 14:50:59

J0137+31 RP015C.UVDATA.1

Freq = 1.6270 GHz, Bw = 8.000 MH No calibration applied and no bandpass applied

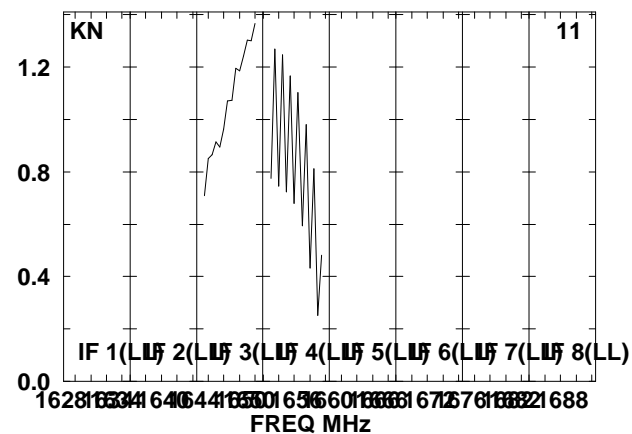
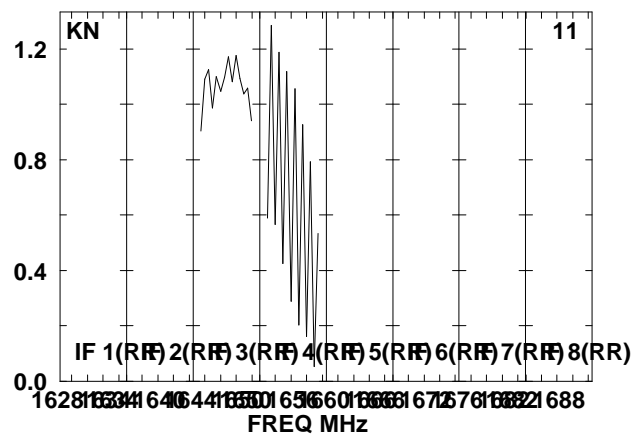
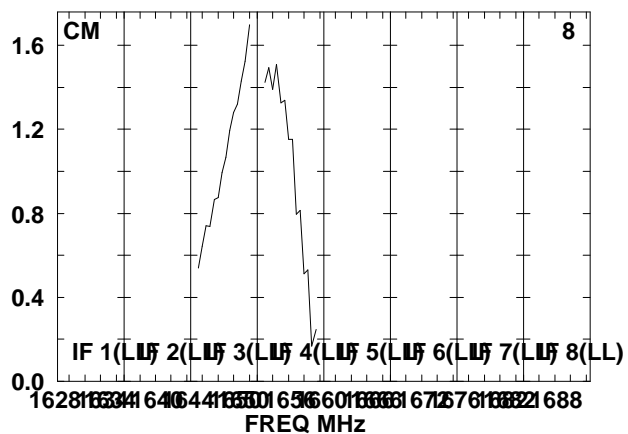
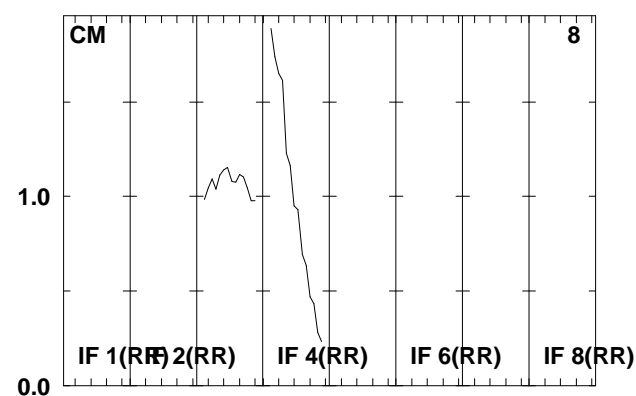
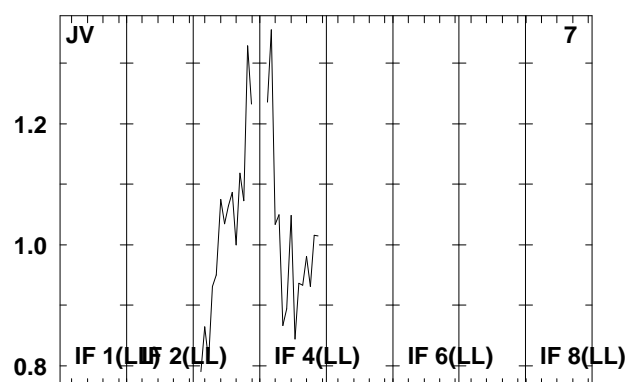
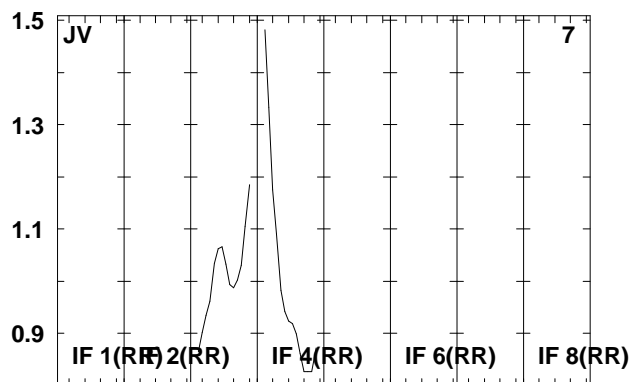
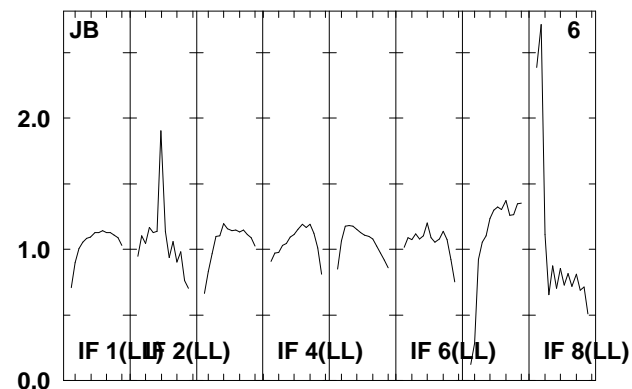
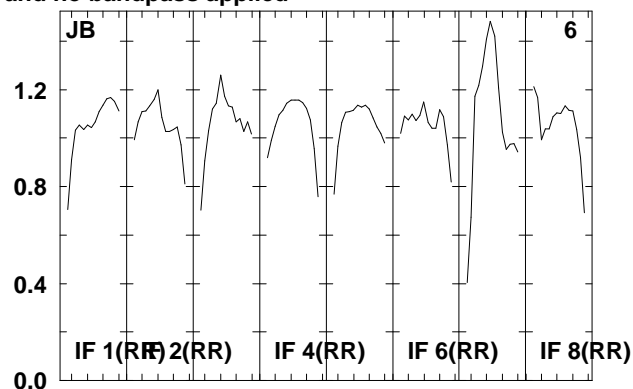
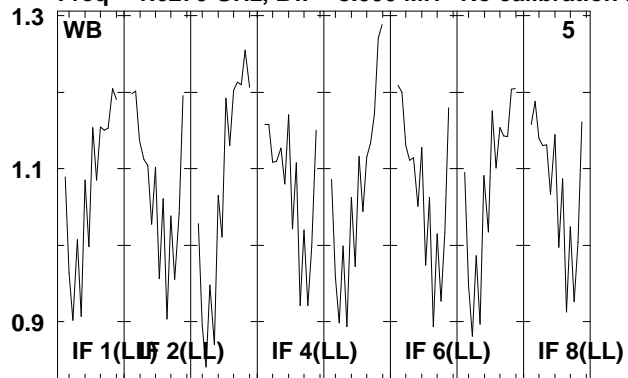

Lower frame: Real Jy

Total-power spectrum Antenna: \*

Timerange: 01/04:25:01 to 01/04:26:00

Plot file version 207 created 20-OCT-2009 14:51:00

J0137+31 RP015C.UVDATA.1

Freq = 1.6270 GHz, Bw = 8.000 MH No calibration applied and no bandpass applied

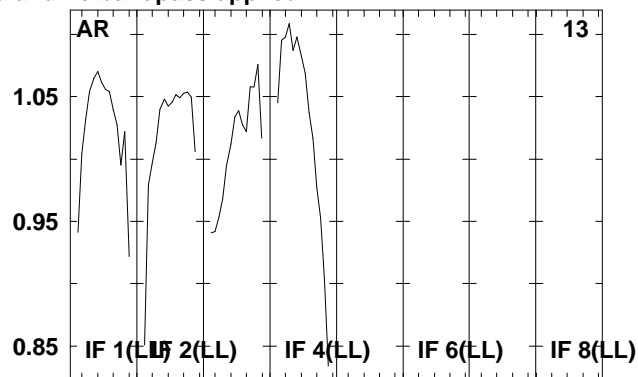
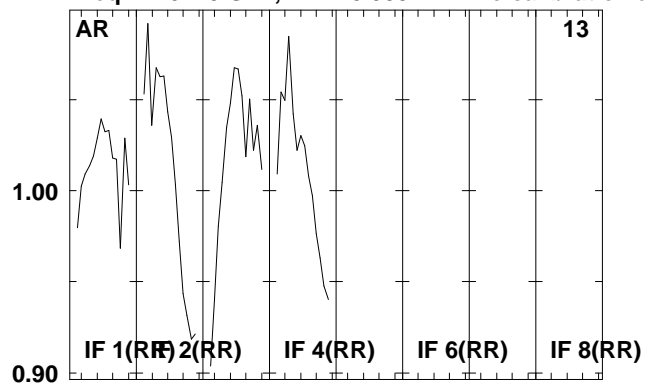

Lower frame: Real Jy  
Total-power spectrum Antenna: \*  
Timerange: 01/04:25:01 to 01/04:26:00

Plot file version 208 created 20-OCT-2009 14:51:00

FAINTCAL RP015C.UVDATA.1

Freq = 1.6270 GHz, Bw = 8.000 MH No calibration applied and no bandpass applied

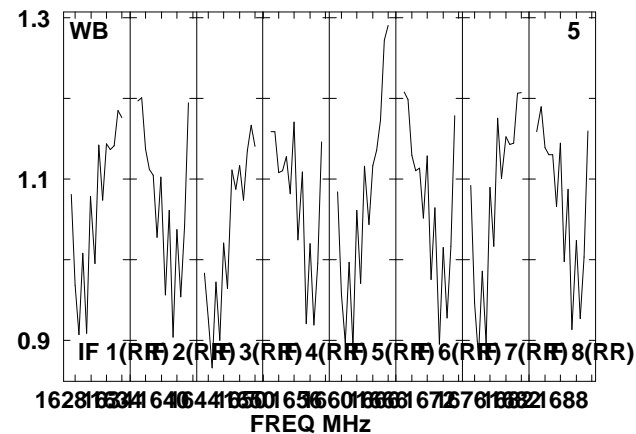
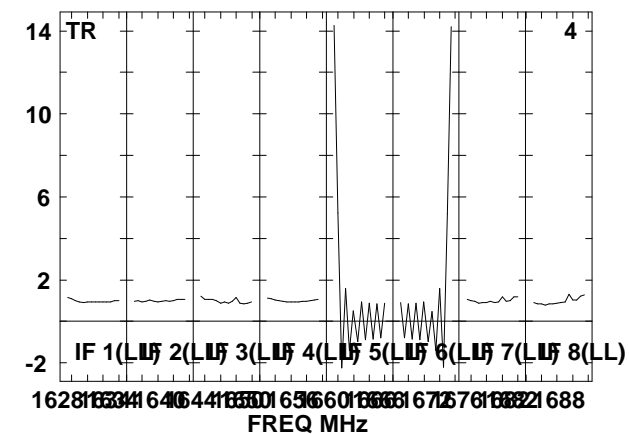
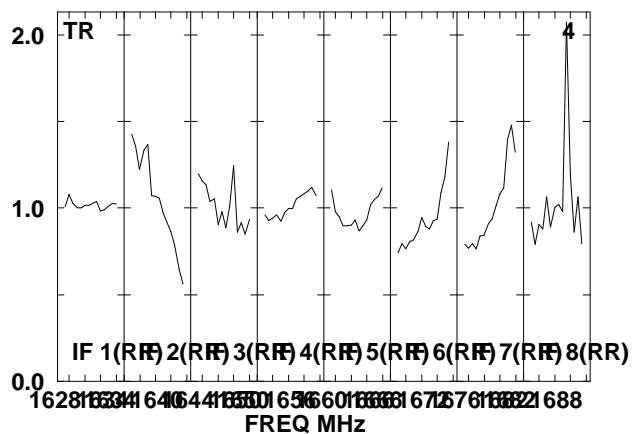
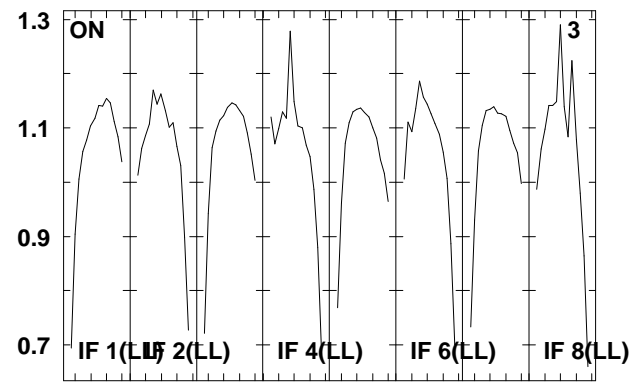
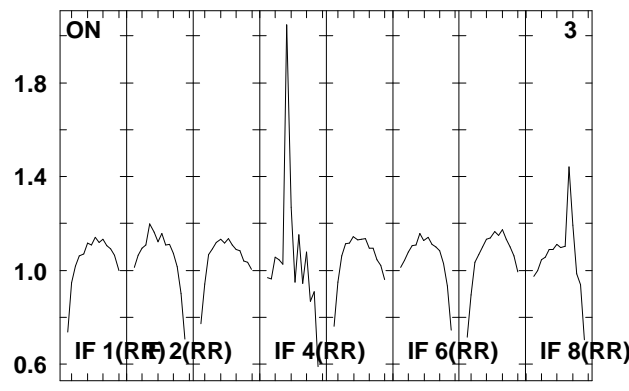
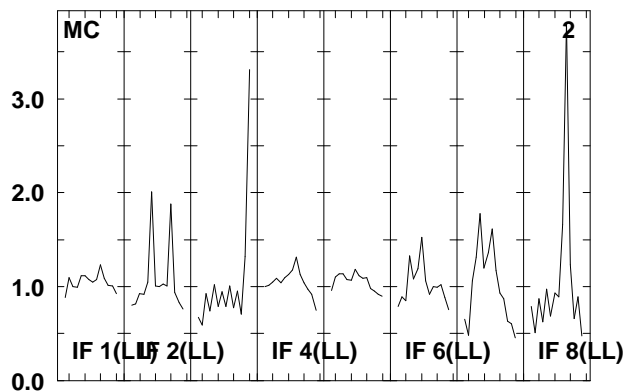
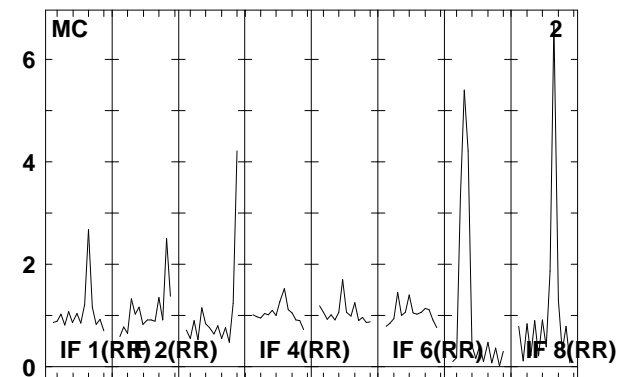
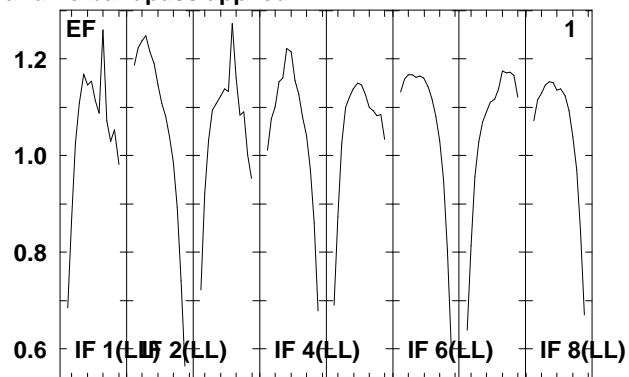
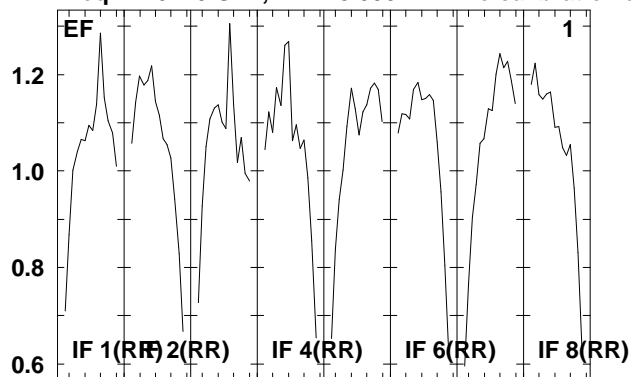

Lower frame: Real Jy  
Total-power spectrum Antenna: \*  
Timerange: 01/04:26:01 to 01/04:27:20



Plot file version 209 created 20-OCT-2009 14:51:01

FAINTCAL RP015C.UVDATA.1

Freq = 1.6270 GHz, Bw = 8.000 MH No calibration applied and no bandpass applied

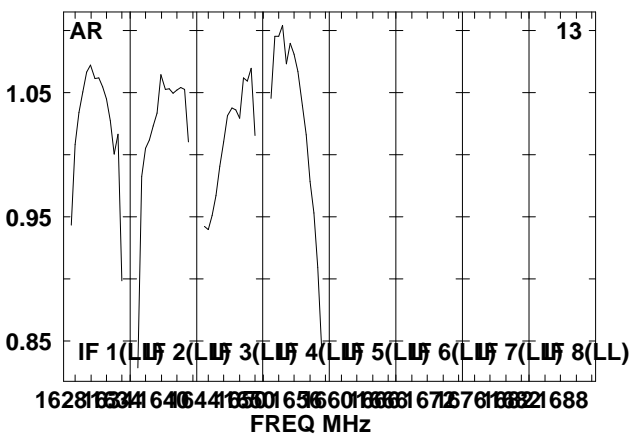
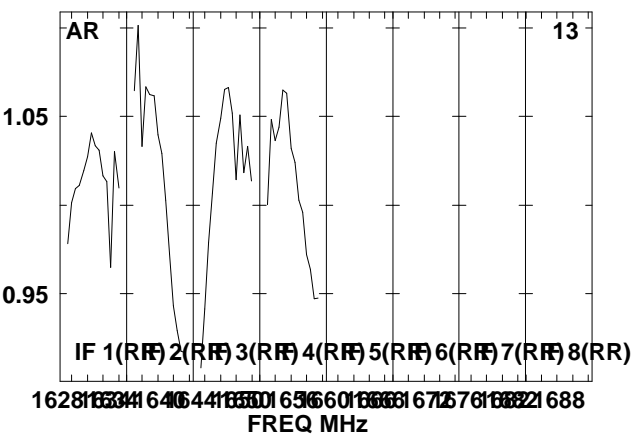
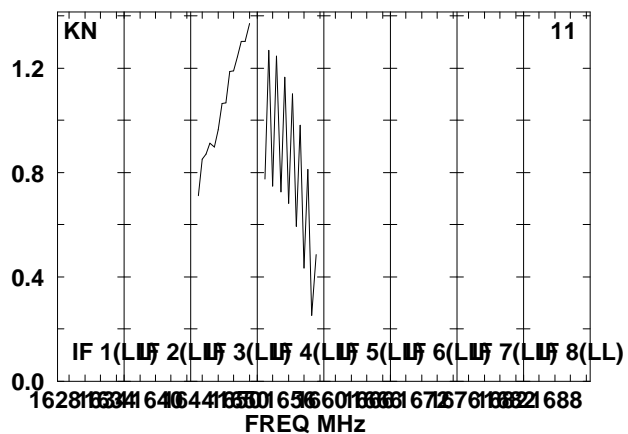
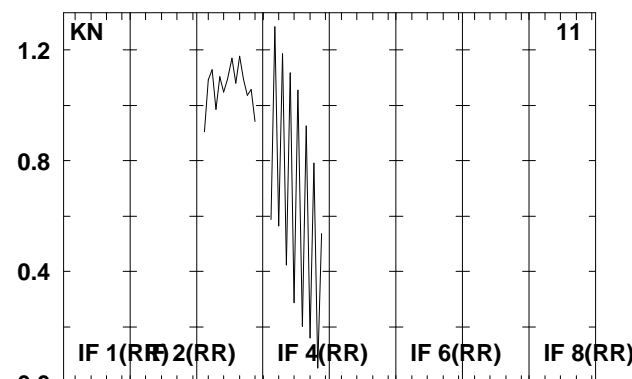
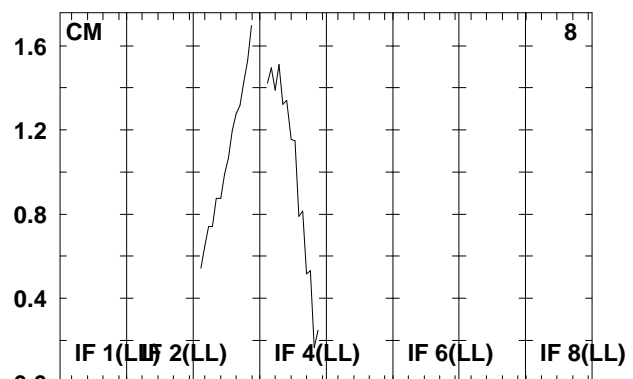
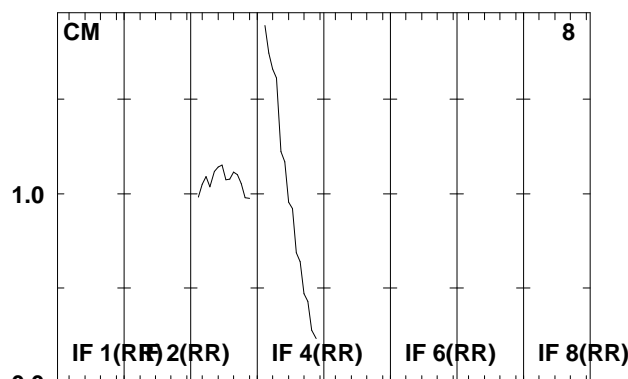
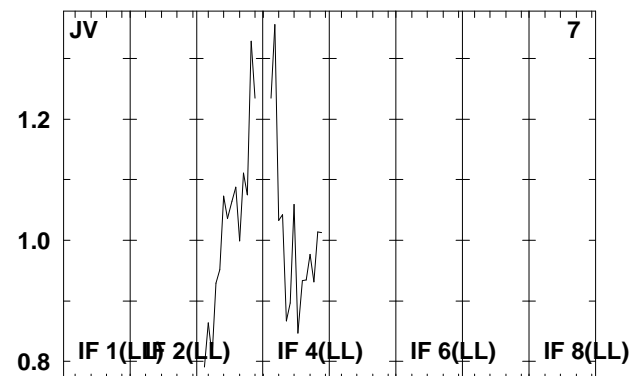
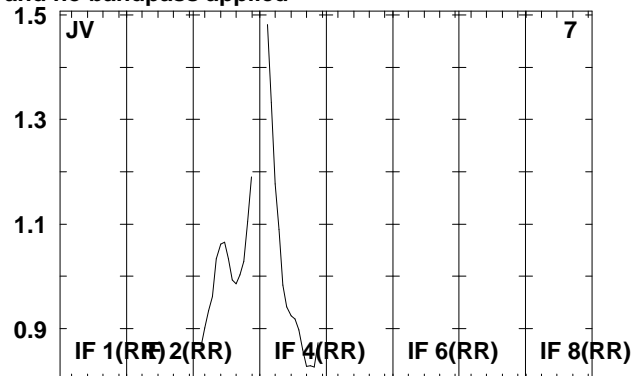
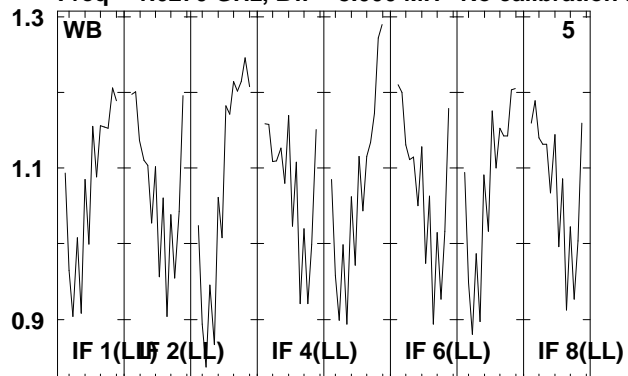

Lower frame: Real Jy  
Total-power spectrum Antenna: \*  
Timerange: 01/04:26:01 to 01/04:27:20

Plot file version 210 created 20-OCT-2009 14:51:02

M33 RP015C.UVDATA.1

Freq = 1.6270 GHz, Bw = 8.000 MH No calibration applied and no bandpass applied

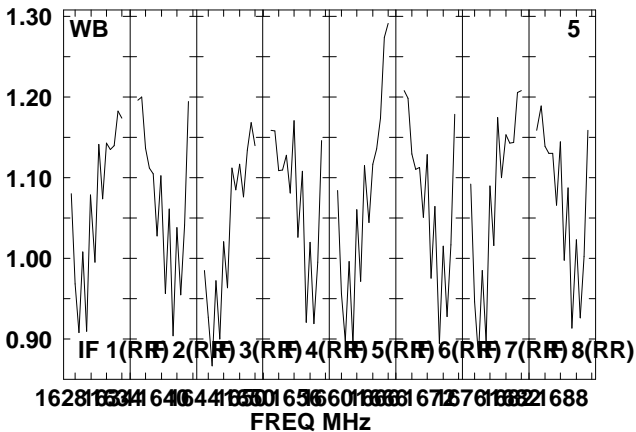
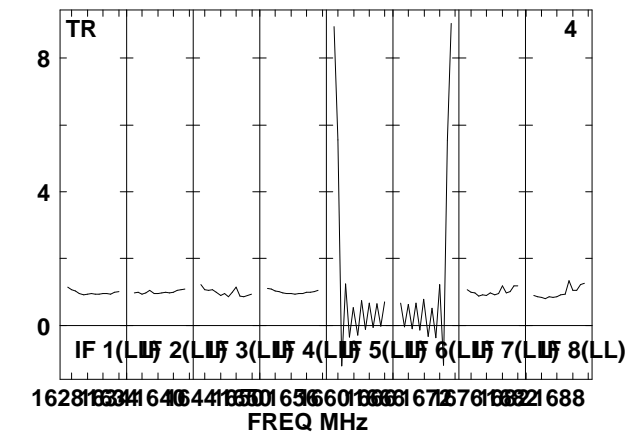
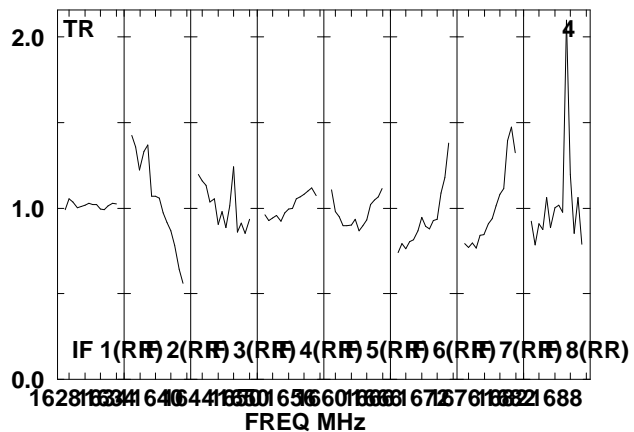
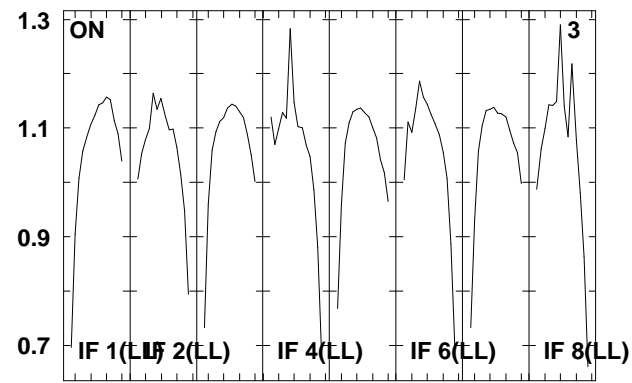
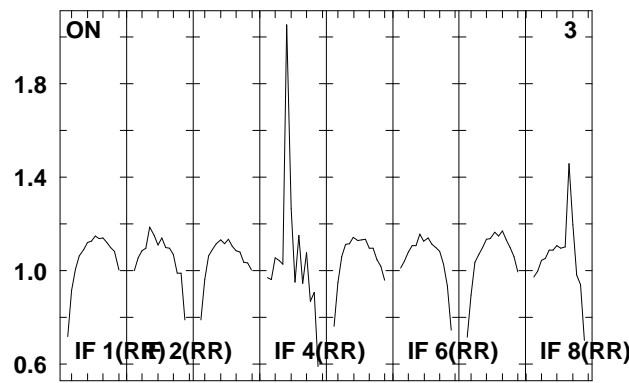
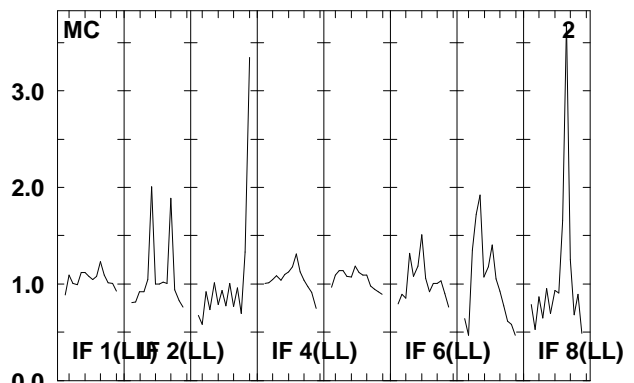
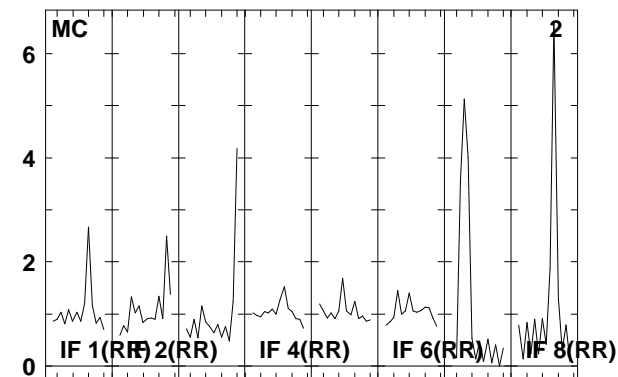
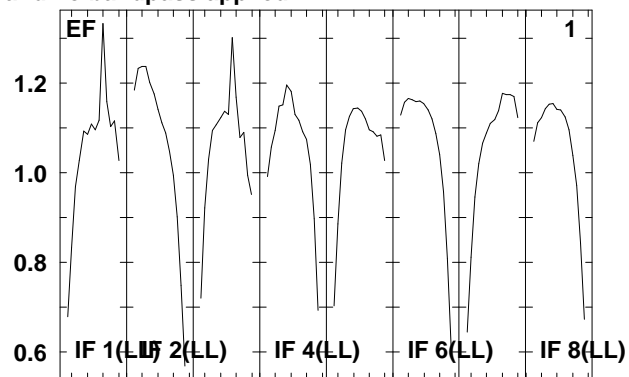
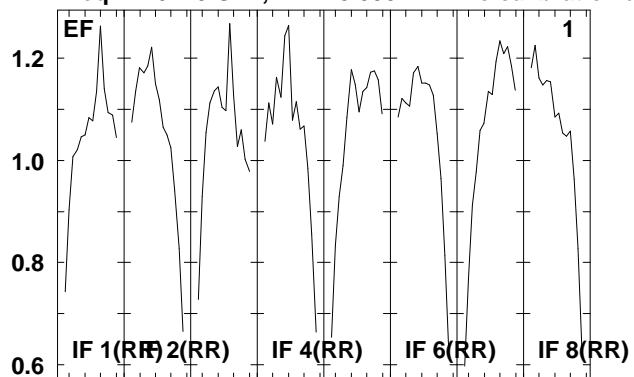

Lower frame: Real Jy  
Total-power spectrum Antenna: \*  
Timerange: 01/04:27:20 to 01/04:30:20

Plot file version 211 created 20-OCT-2009 14:51:03

M33 RP015C.UVDATA.1

Freq = 1.6270 GHz, Bw = 8.000 MH No calibration applied and no bandpass applied

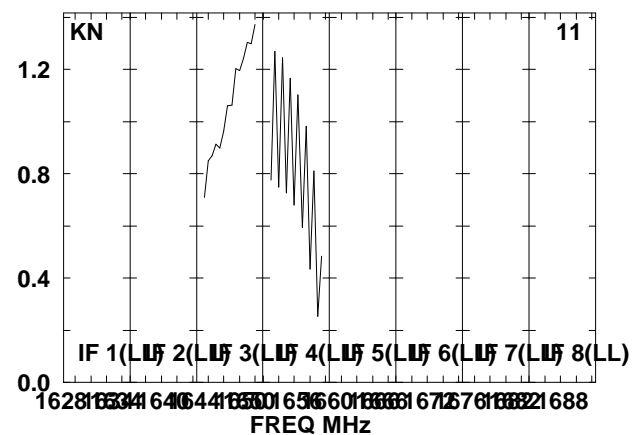
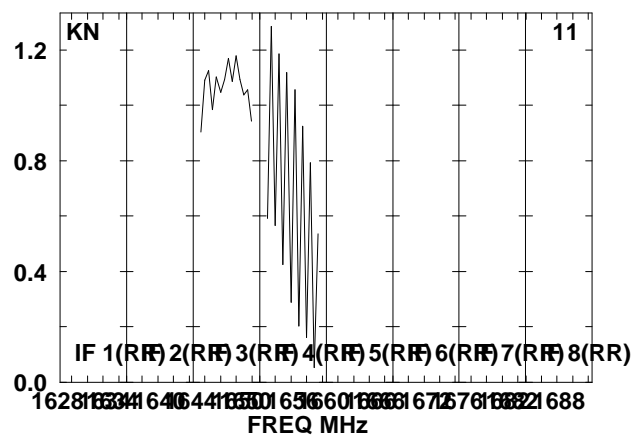
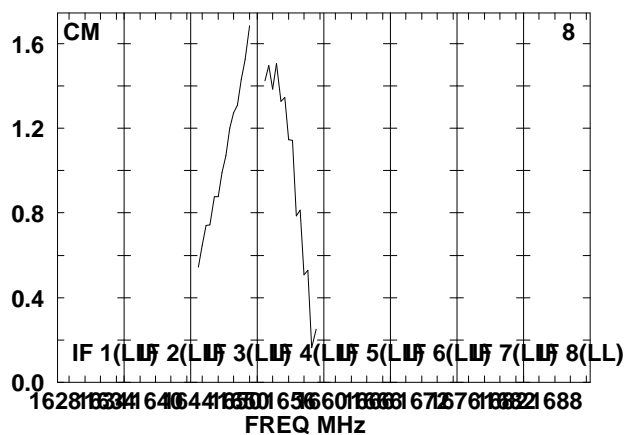
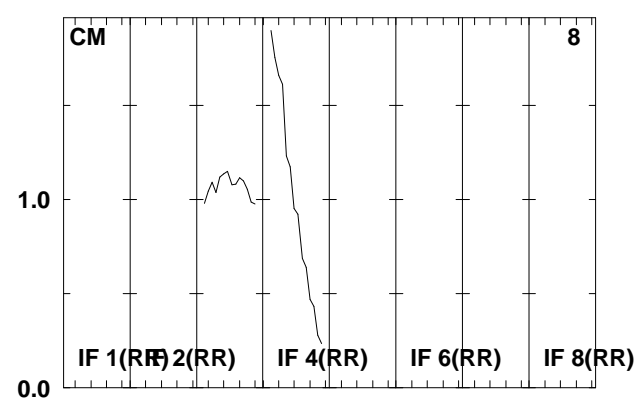
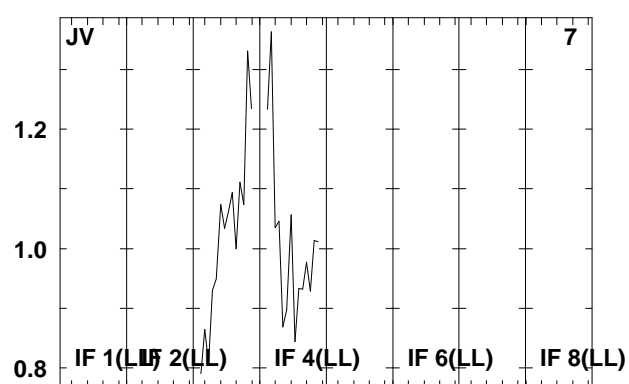
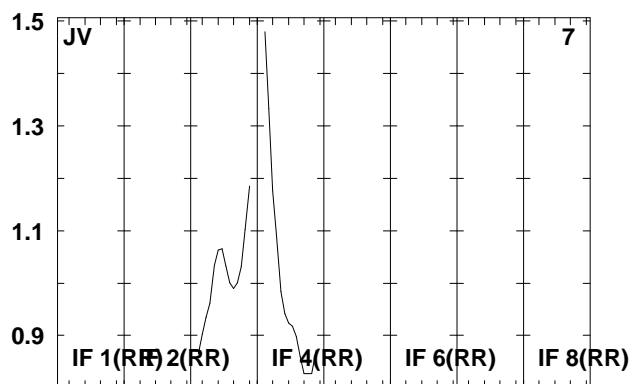
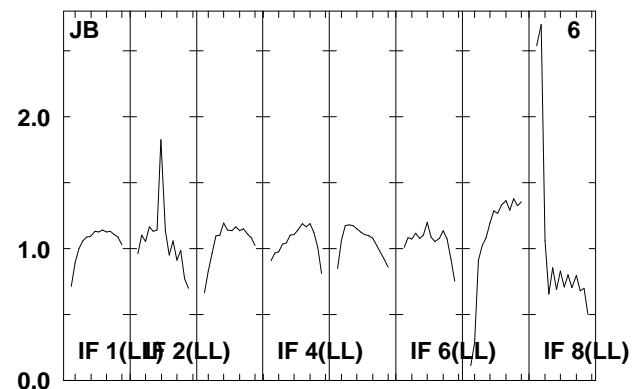
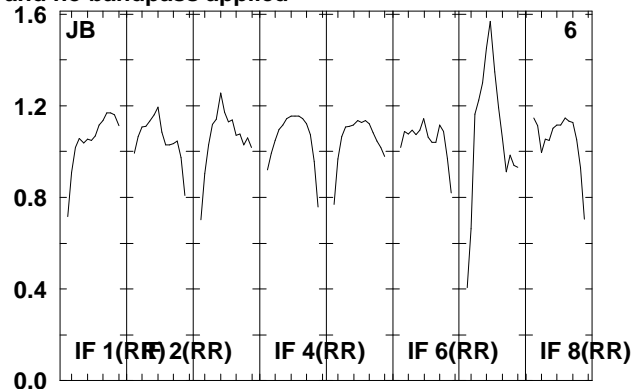
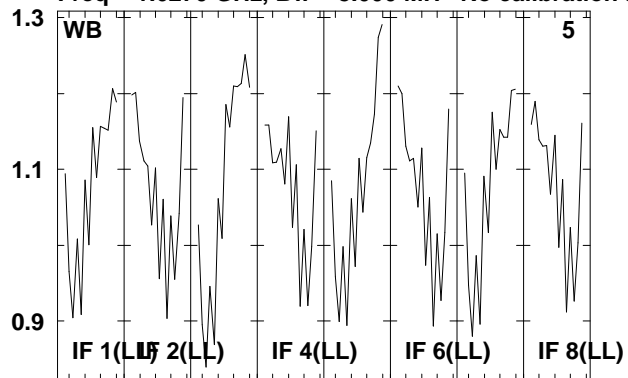

Lower frame: Real Jy

Total-power spectrum Antenna: \*

Timerange: 01/04:27:20 to 01/04:30:20

Plot file version 212 created 20-OCT-2009 14:51:04

M33 RP015C.UVDATA.1

Freq = 1.6270 GHz, Bw = 8.000 MH No calibration applied and no bandpass applied

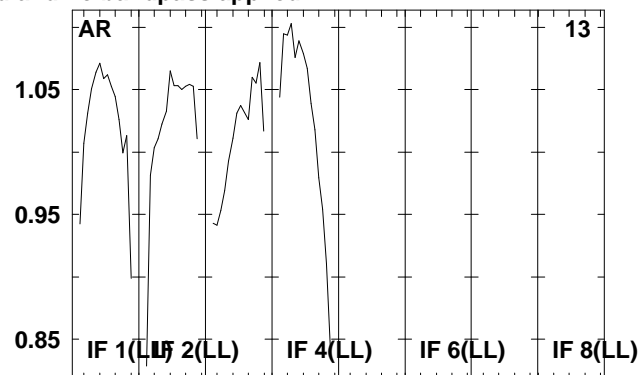
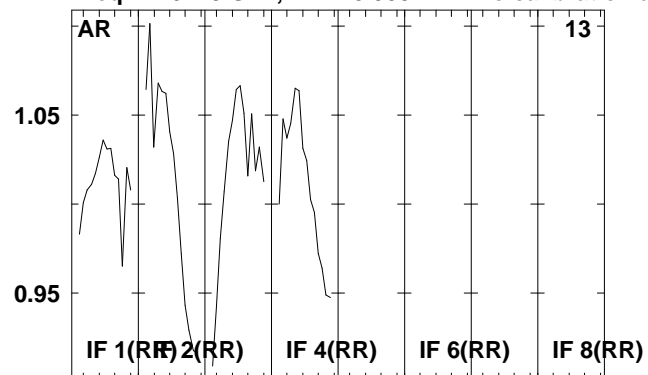

Lower frame: Real Jy  
Total-power spectrum Antenna: \*  
Timerange: 01/04:27:20 to 01/04:30:20

Plot file version 213 created 20-OCT-2009 14:51:04

J0137+31 RP015C.UVDATA.1

Freq = 1.6270 GHz, Bw = 8.000 MH No calibration applied and no bandpass applied

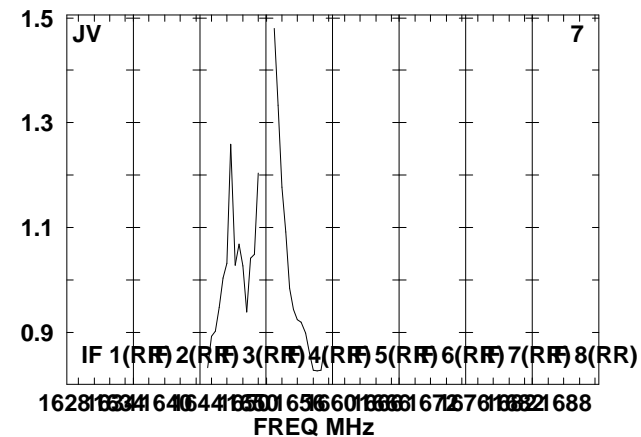
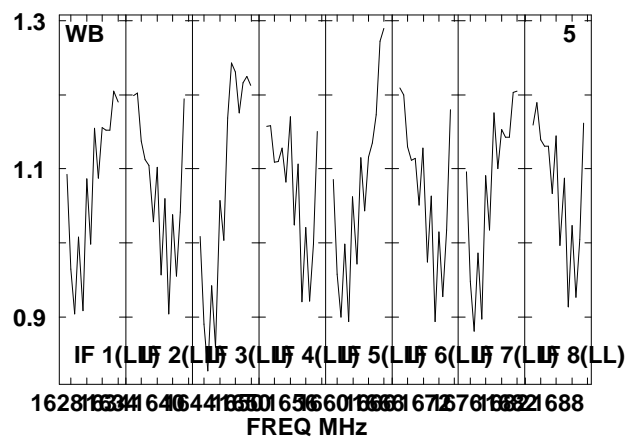
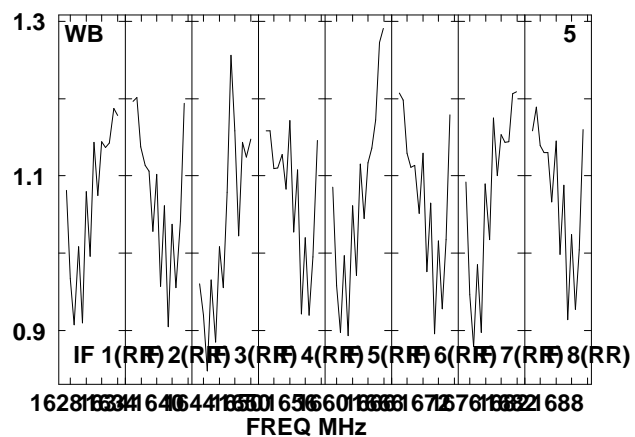
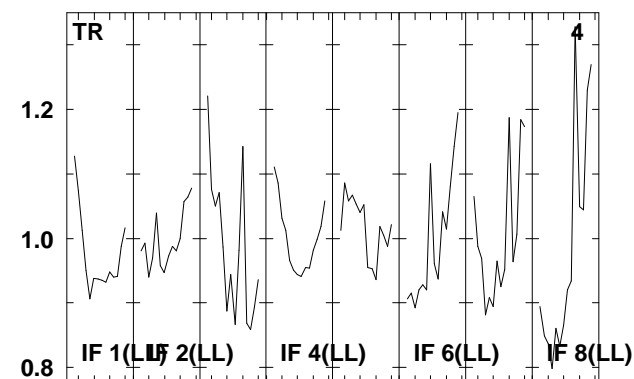
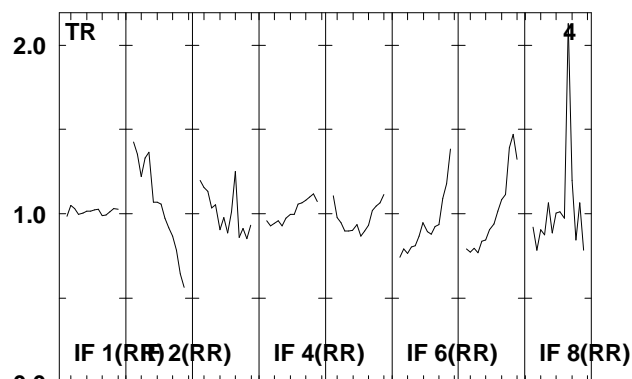
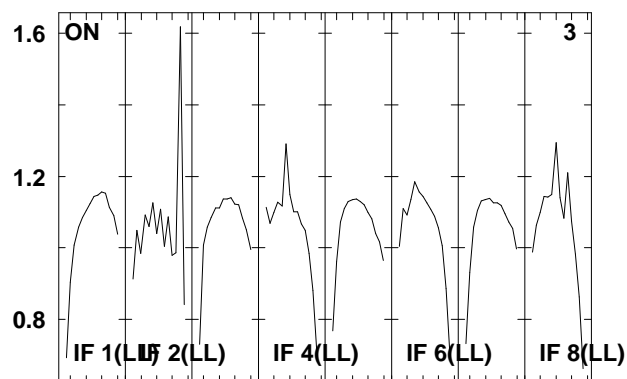
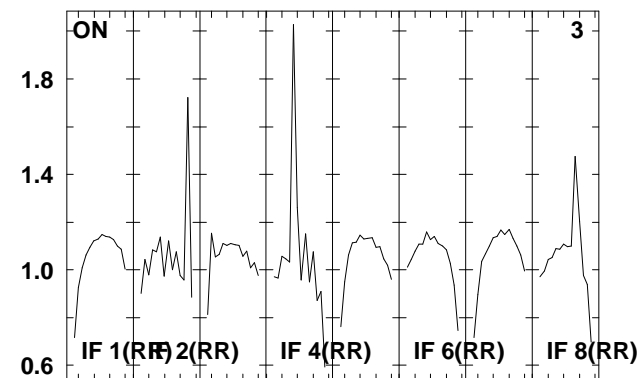
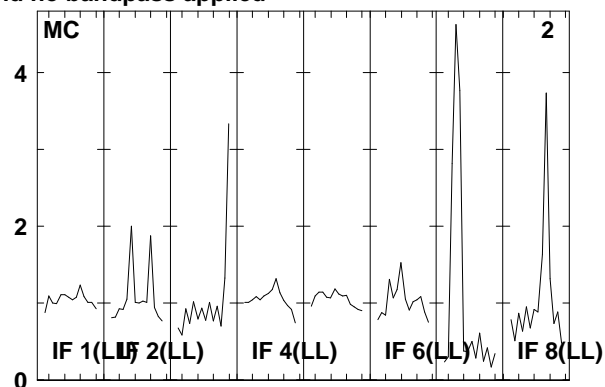
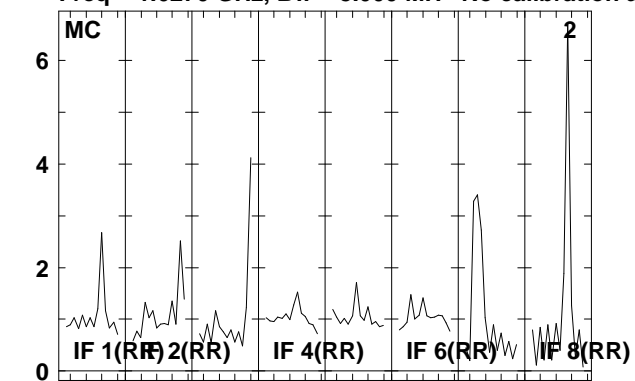

Lower frame: Real Jy  
Total-power spectrum Antenna: \*  
Timerange: 01/04:31:01 to 01/04:31:59

Plot file version 214 created 20-OCT-2009 14:51:05  
 J0137+31 RP015C.UVDATA.1  
 Freq = 1.6270 GHz, Bw = 8.000 MH No calibration applied and no bandpass applied

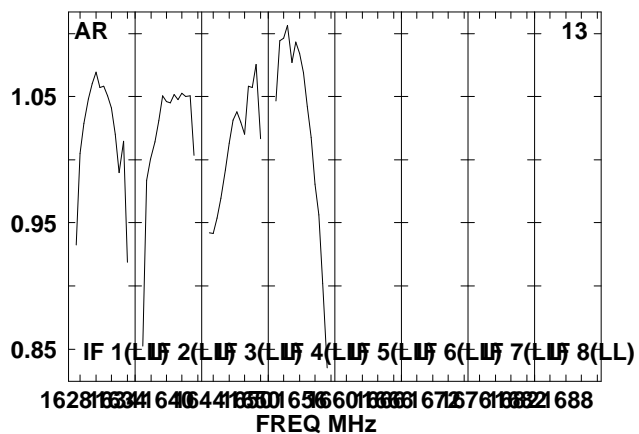
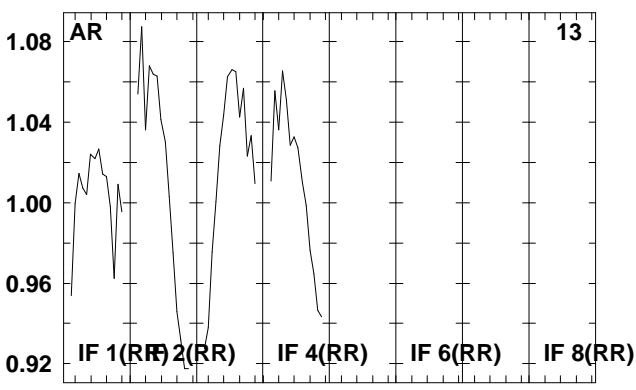
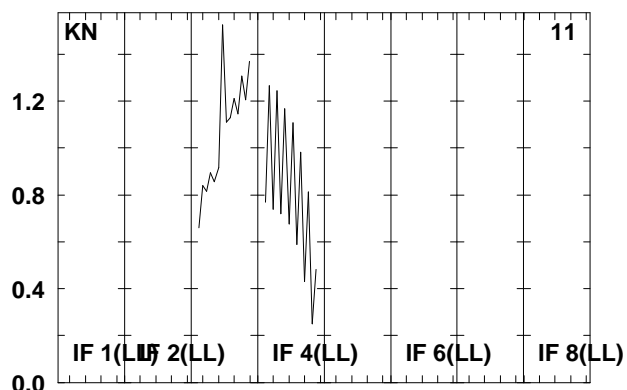
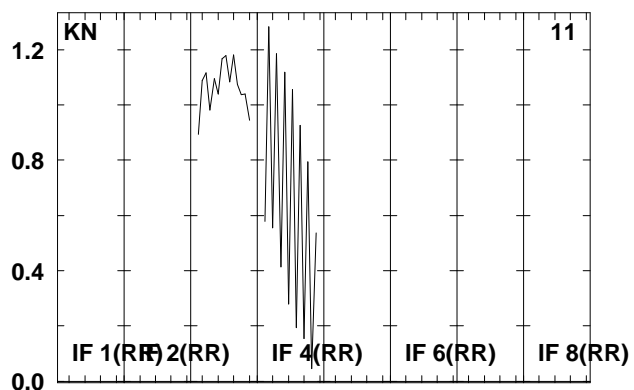
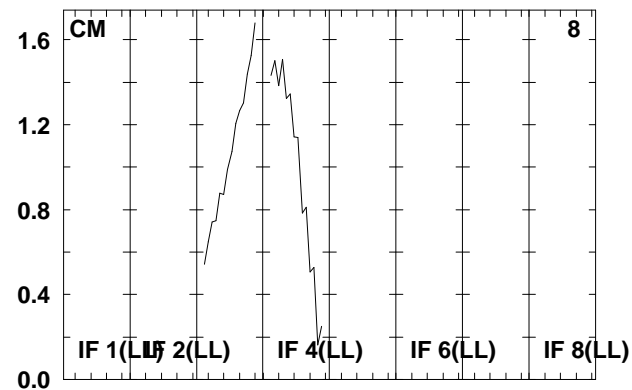
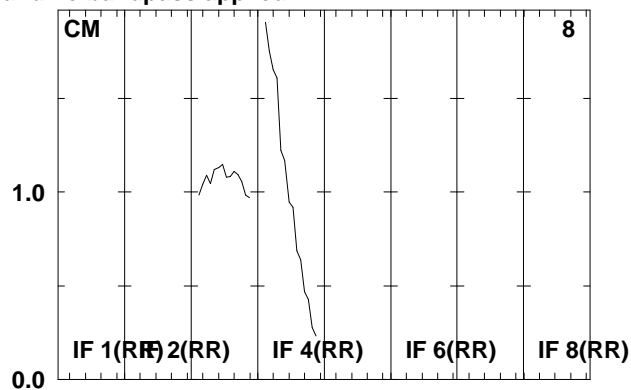
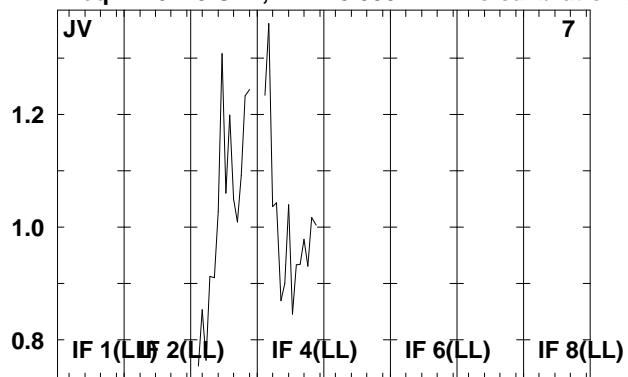

Lower frame: Real Jy  
 Total-power spectrum Antenna: \*  
 Timerange: 01/04:31:01 to 01/04:31:59

Plot file version 215 created 20-OCT-2009 14:51:05  
 FAINTCAL RP015C.UVDATA.1  
 Freq = 1.6270 GHz, Bw = 8.000 MH No calibration applied and no bandpass applied

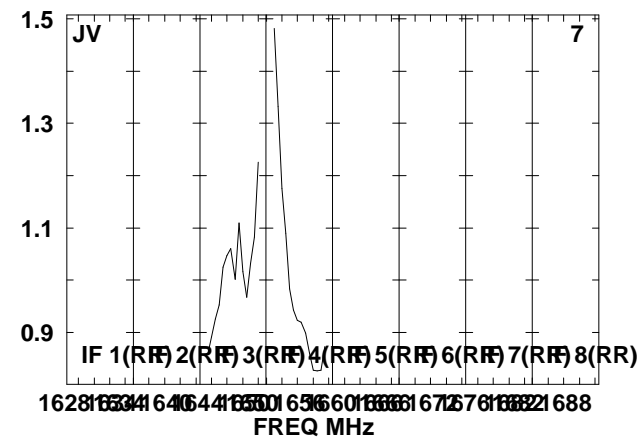
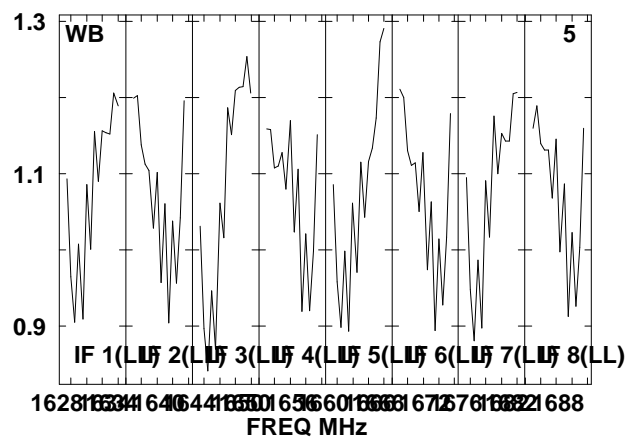
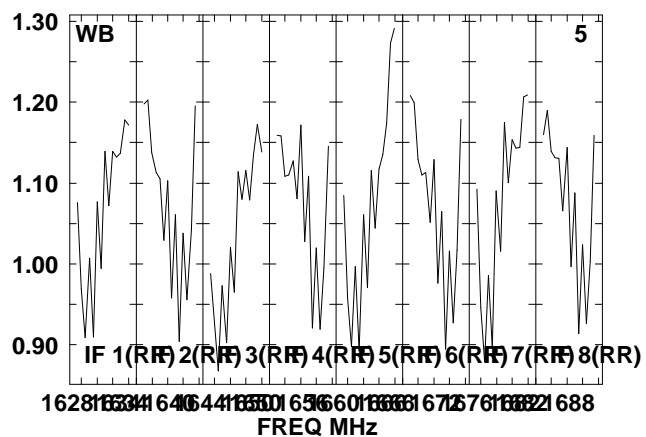
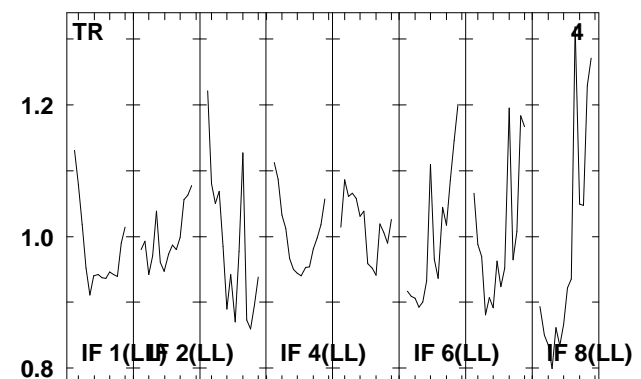
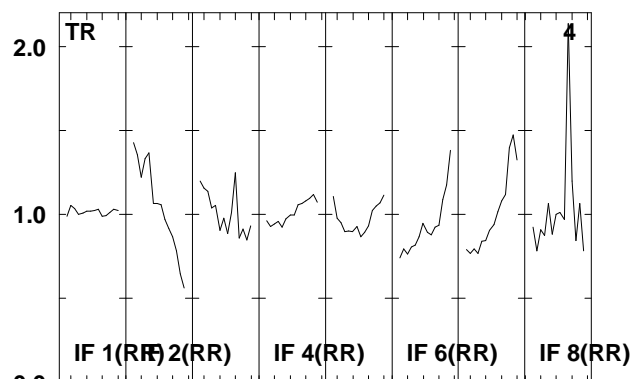
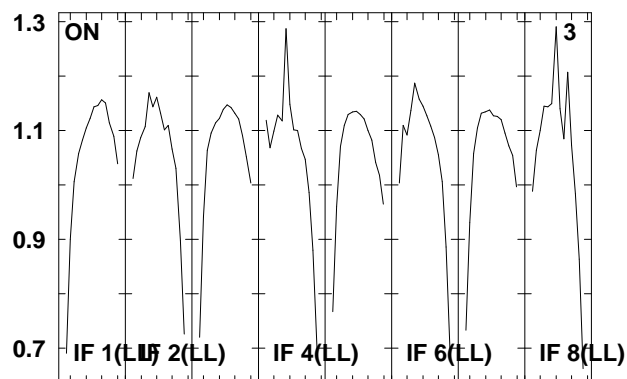
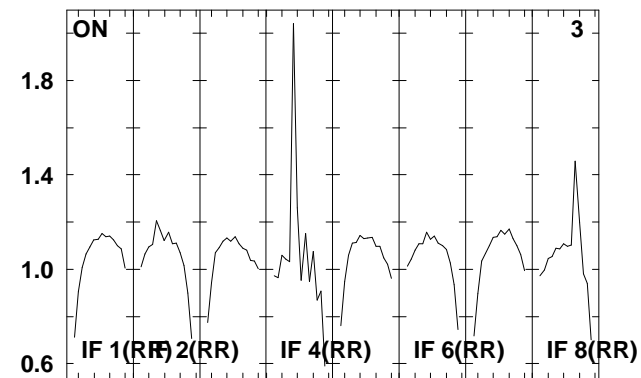
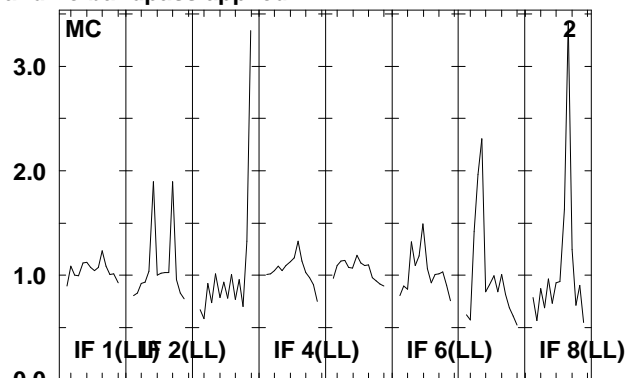
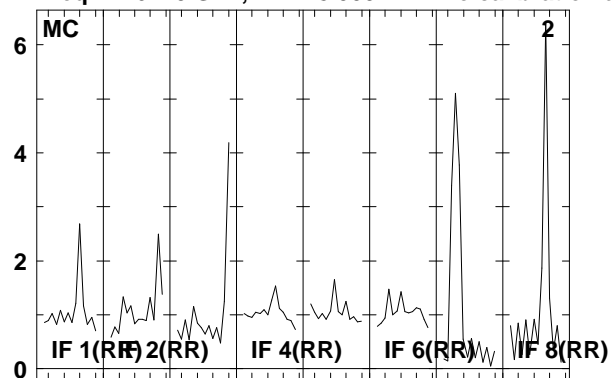

Lower frame: Real Jy  
 Total-power spectrum Antenna: \*  
 Timerange: 01/04:32:00 to 01/04:33:20

Plot file version 216 created 20-OCT-2009 14:51:06

FAINTCAL RP015C.UVDATA.1

Freq = 1.6270 GHz, Bw = 8.000 MH No calibration applied and no bandpass applied

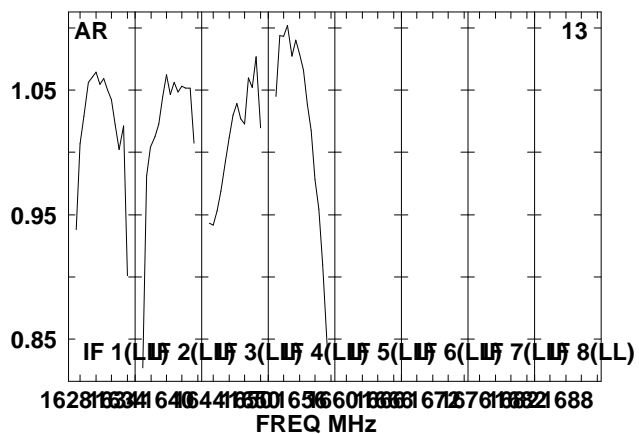
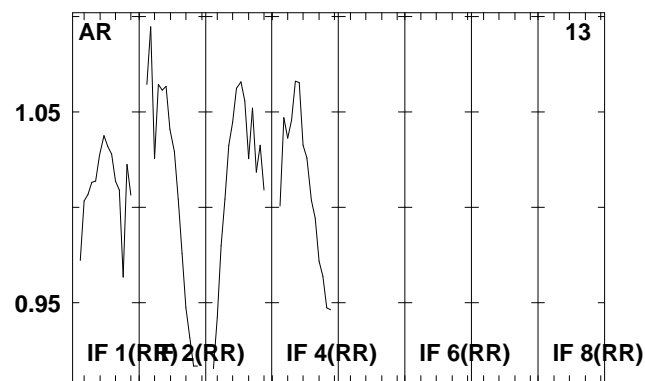
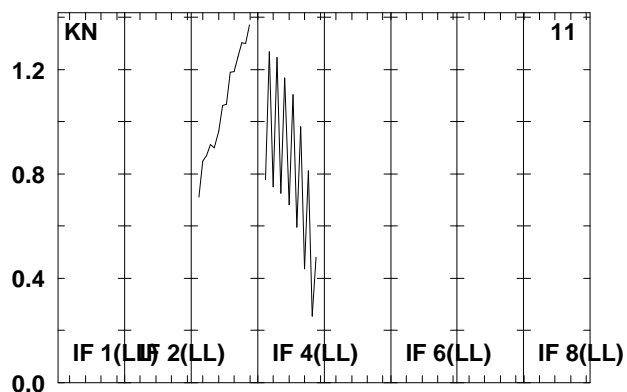
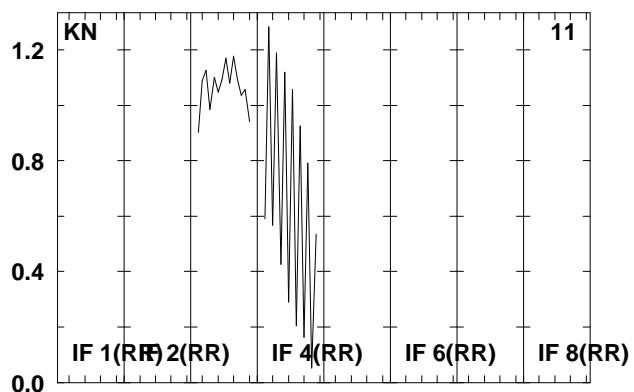
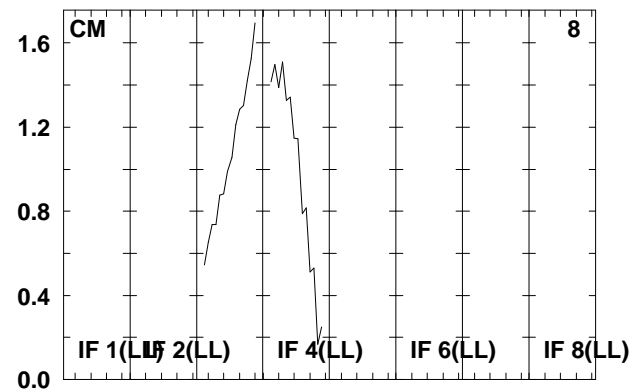
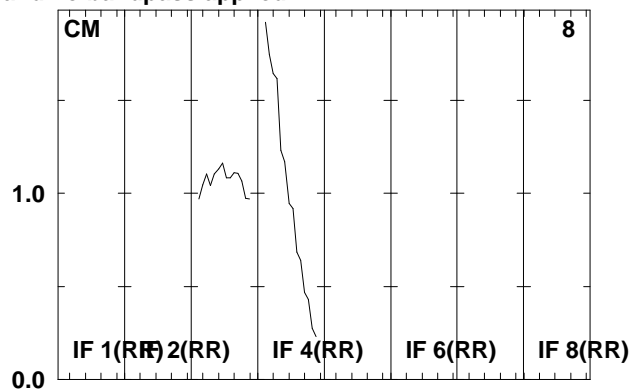
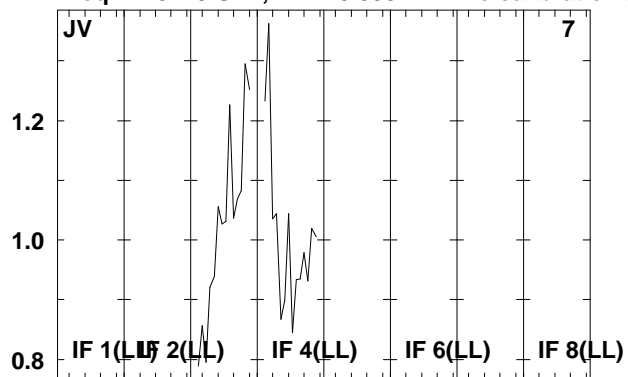

Lower frame: Real Jy

Total-spectrum Antenna: \*

Timerange: 01/04:32:00 to 01/04:33:20



Plot file version 217 created 20-OCT-2009 14:51:06

M33 RP015C.UVDATA.1

Freq = 1.6270 GHz, Bw = 8.000 MH No calibration applied and no bandpass applied

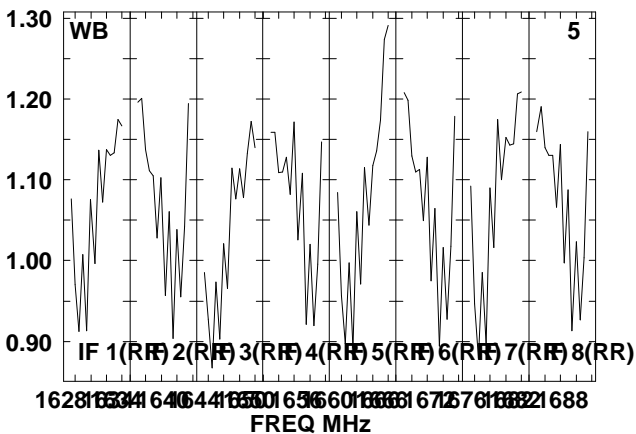
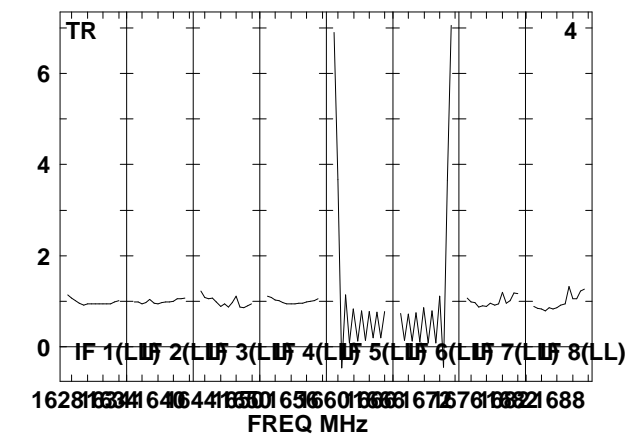
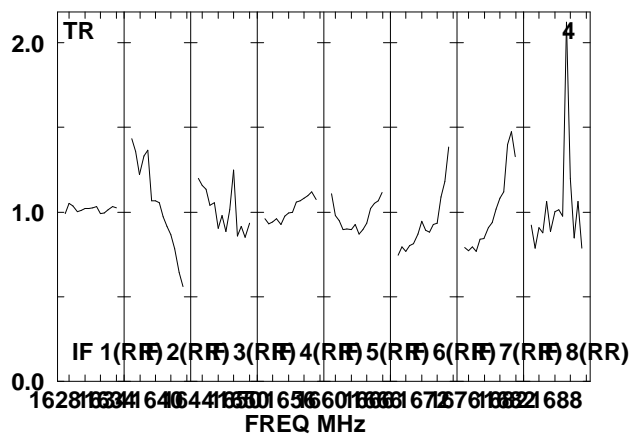
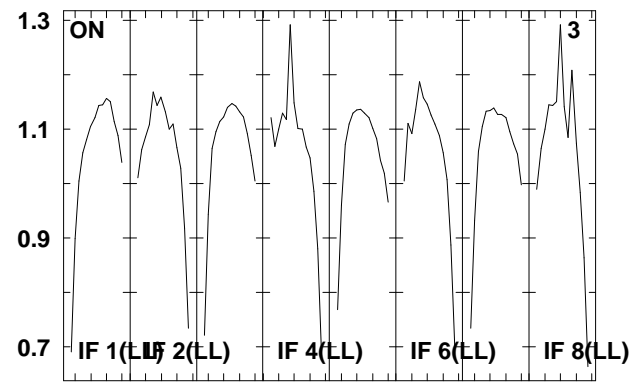
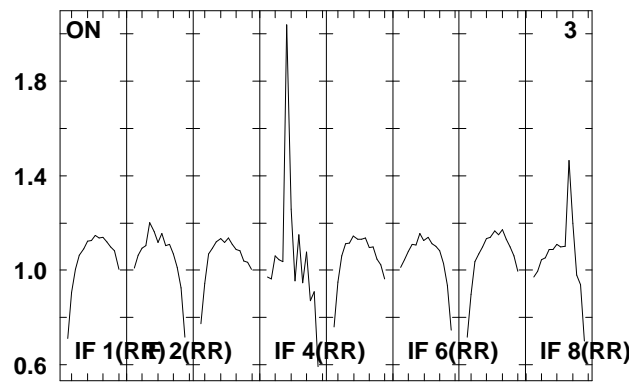
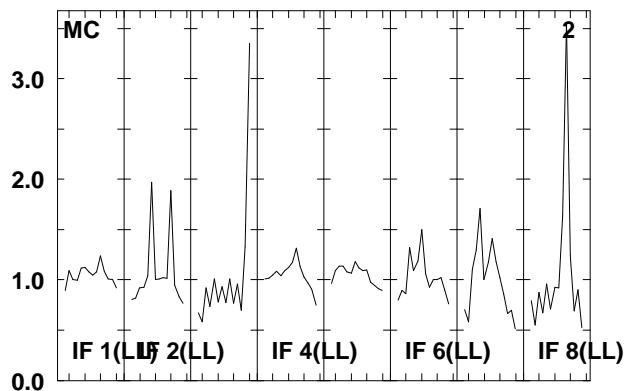
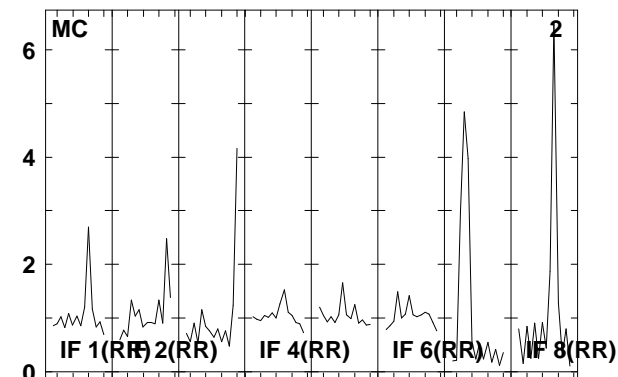
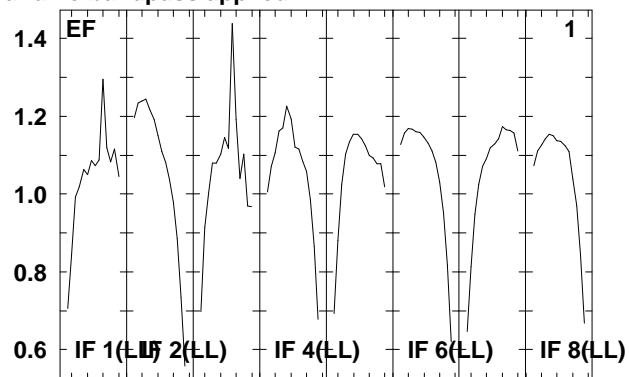
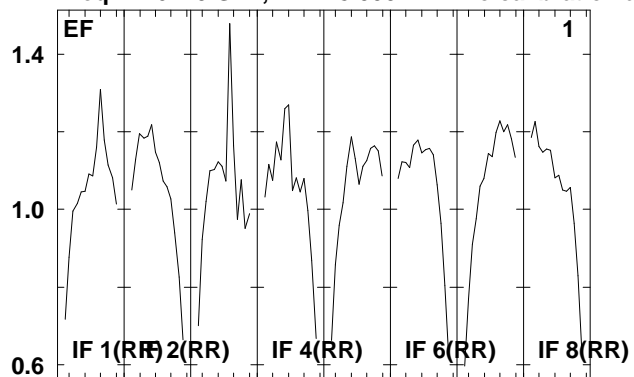

Lower frame: Real Jy  
Total-power spectrum Antenna: \*  
Timerange: 01/04:33:20 to 01/04:36:20

Plot file version 218 created 20-OCT-2009 14:51:07

M33 RP015C.UVDATA.1

Freq = 1.6270 GHz, Bw = 8.000 MH No calibration applied and no bandpass applied

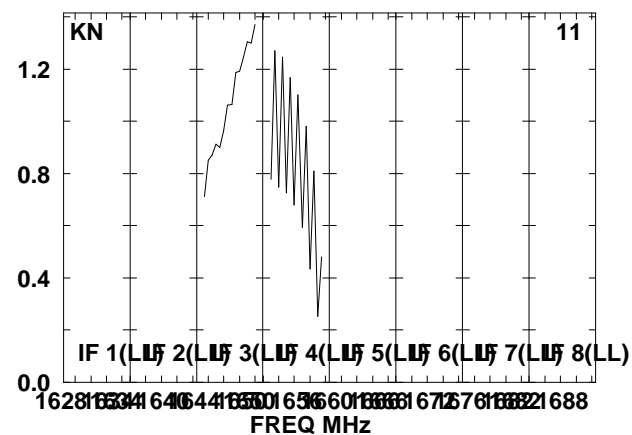
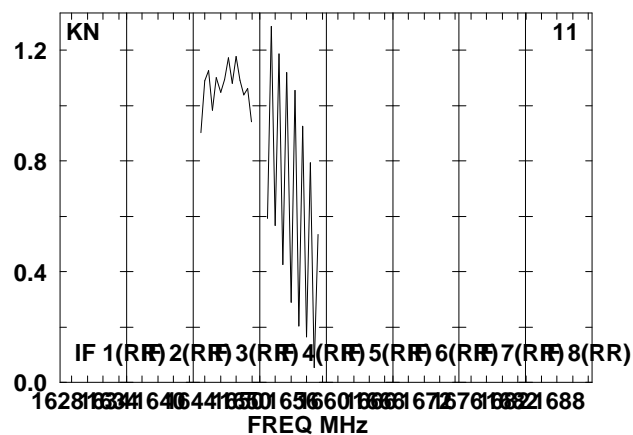
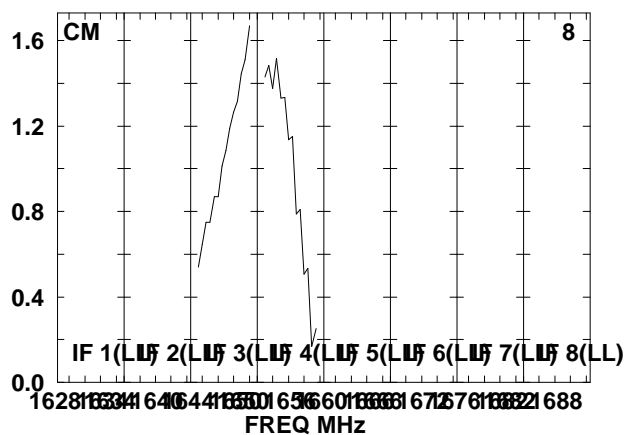
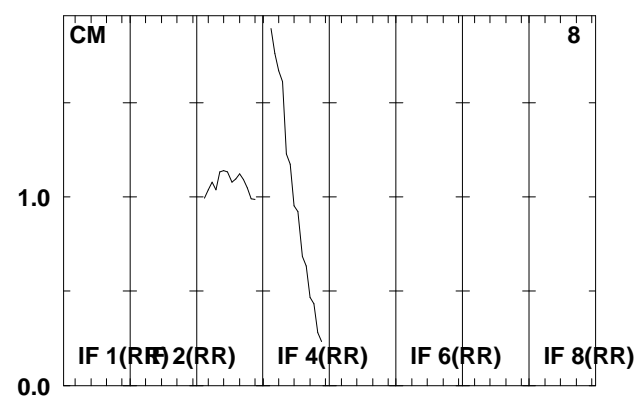
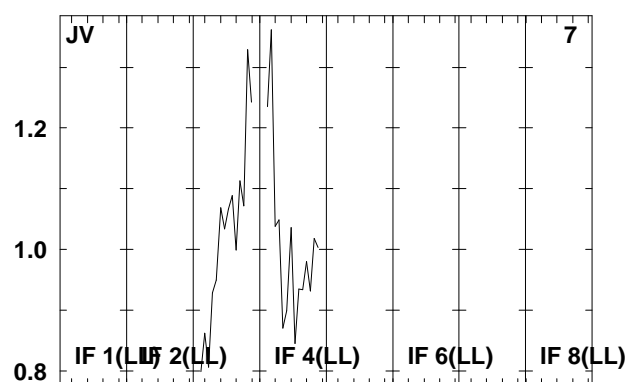
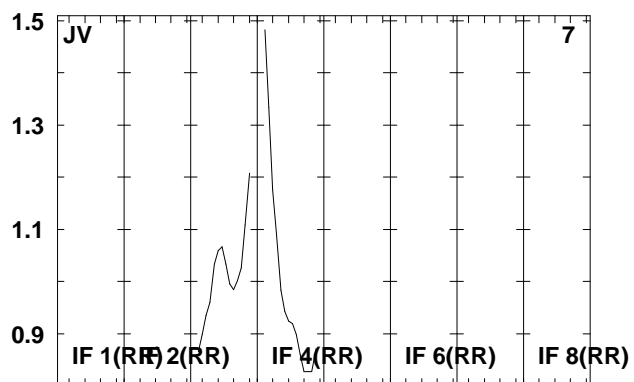
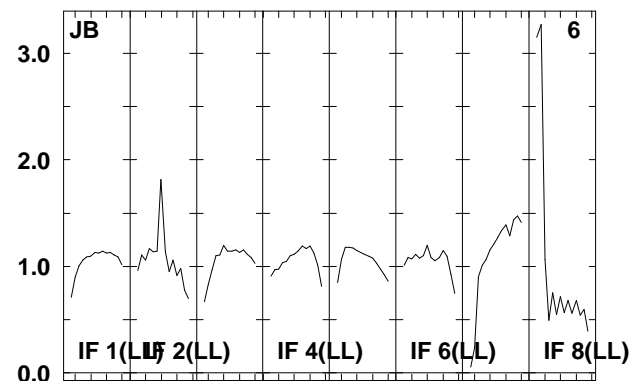
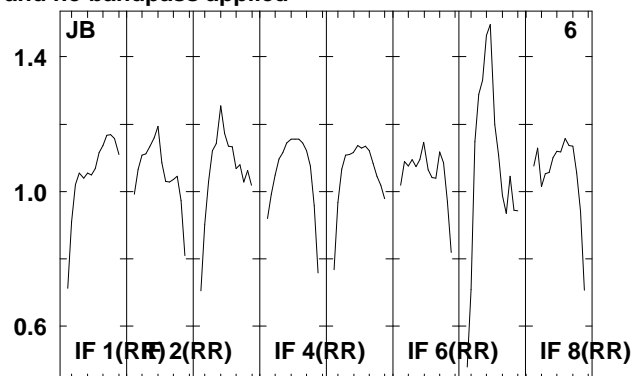
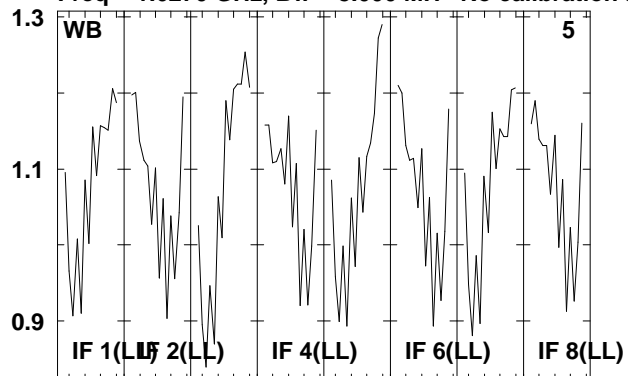

Lower frame: Real Jy

Total-power spectrum Antenna: \*

Timerange: 01/04:33:20 to 01/04:36:20

Plot file version 219 created 20-OCT-2009 14:51:09

M33 RP015C.UVDATA.1

Freq = 1.6270 GHz, Bw = 8.000 MH No calibration applied and no bandpass applied

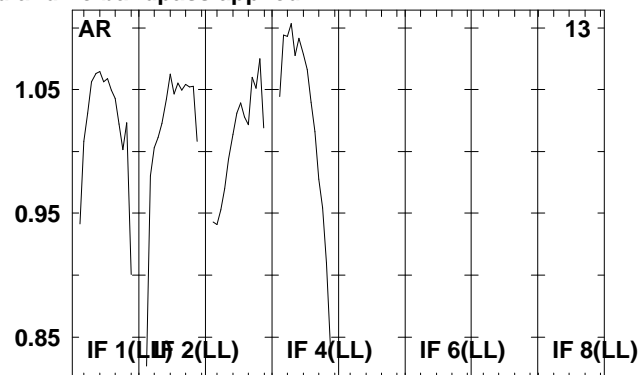
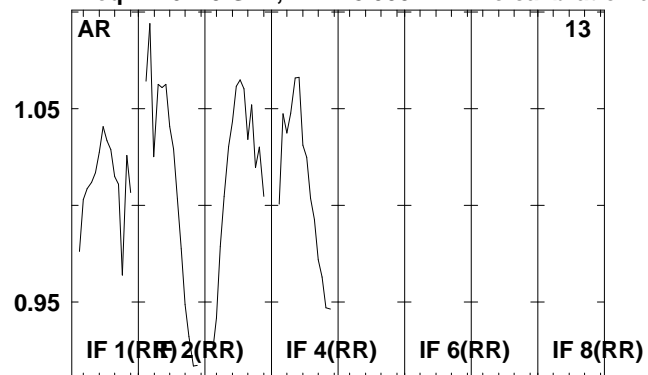

Lower frame: Real Jy  
Total-power spectrum Antenna: \*  
Timerange: 01/04:33:20 to 01/04:36:20

Plot file version 220 created 20-OCT-2009 14:51:09

J0137+31 RP015C.UVDATA.1

Freq = 1.6270 GHz, Bw = 8.000 MH No calibration applied and no bandpass applied

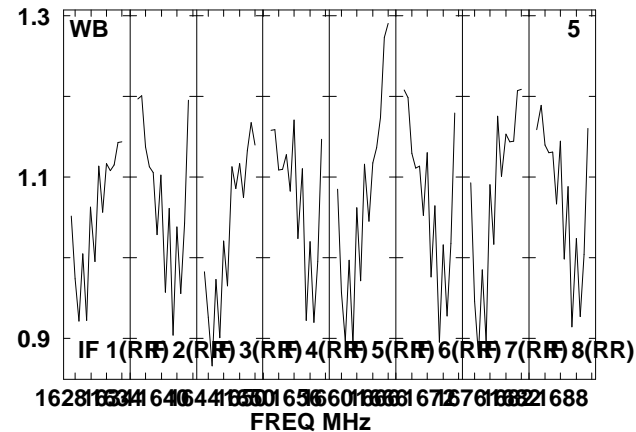
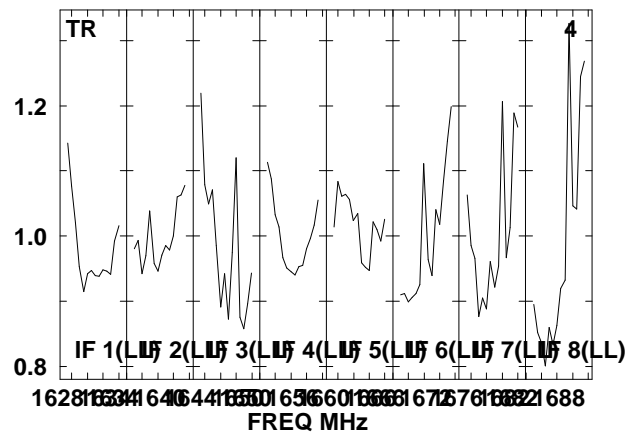
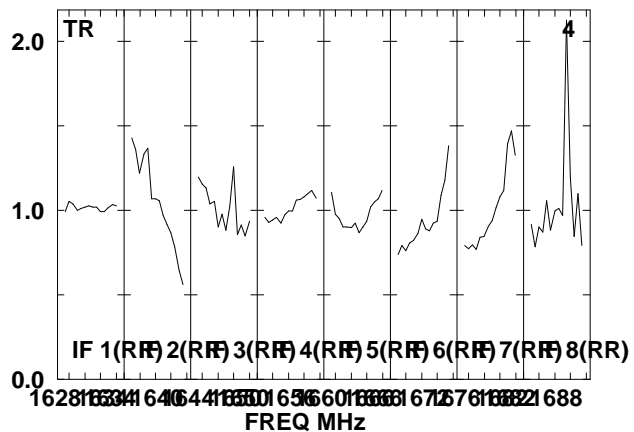
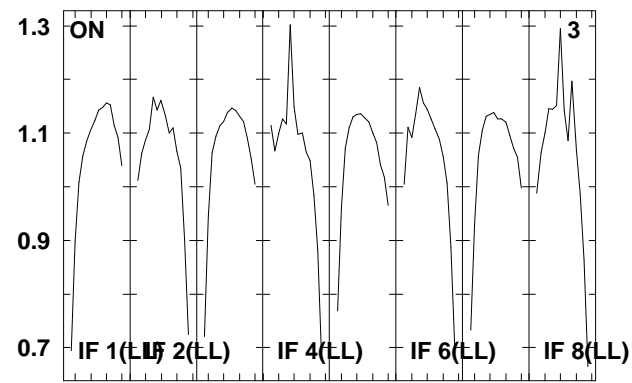
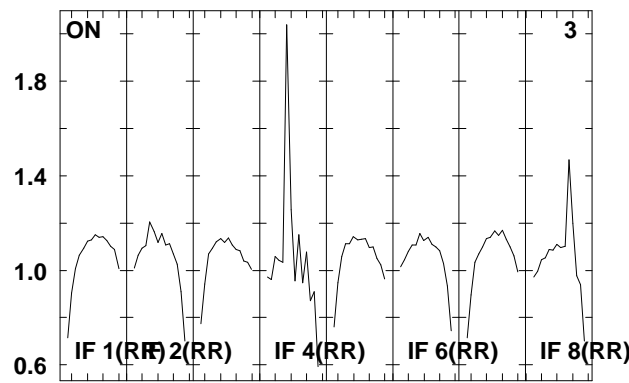
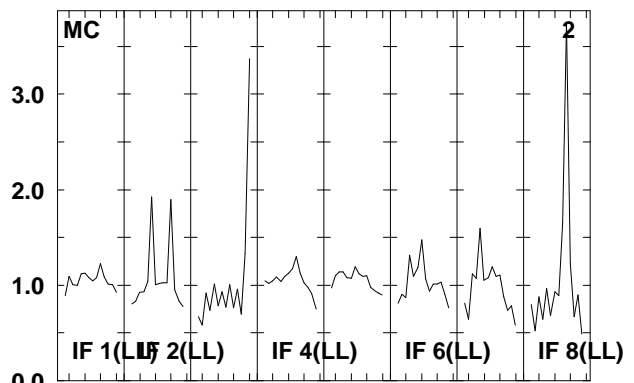
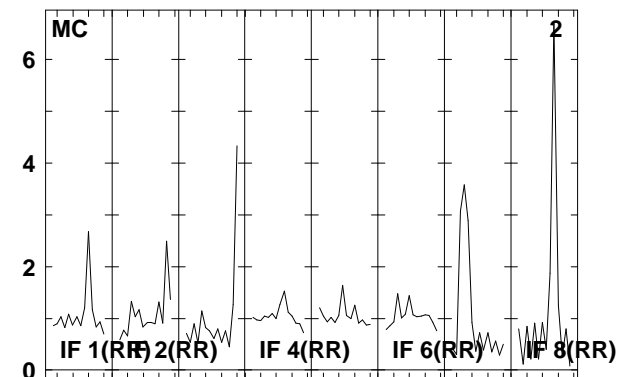
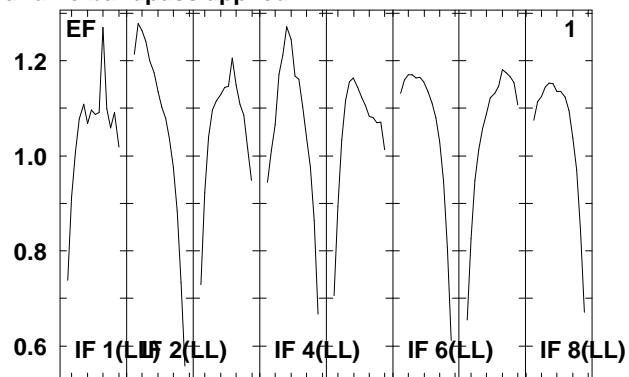
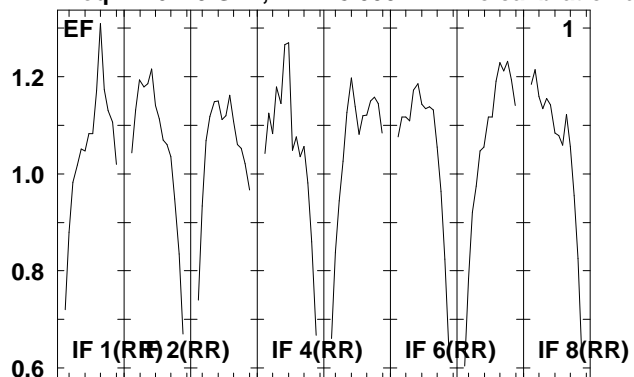

Lower frame: Real Jy  
Total-power spectrum Antenna: \*  
Timerange: 01/04:37:00 to 01/04:37:59

Plot file version 221 created 20-OCT-2009 14:51:09

J0137+31 RP015C.UVDATA.1

Freq = 1.6270 GHz, Bw = 8.000 MH No calibration applied and no bandpass applied

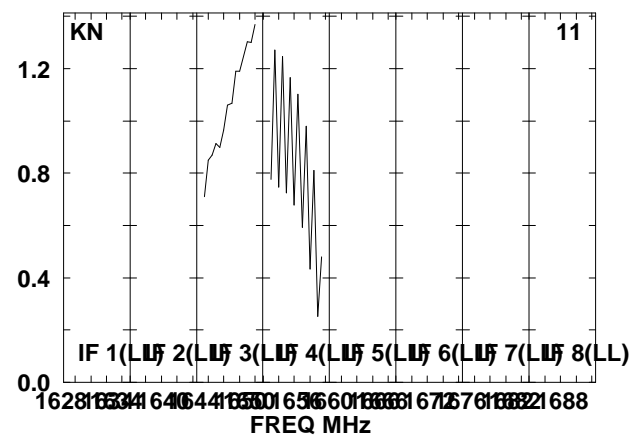
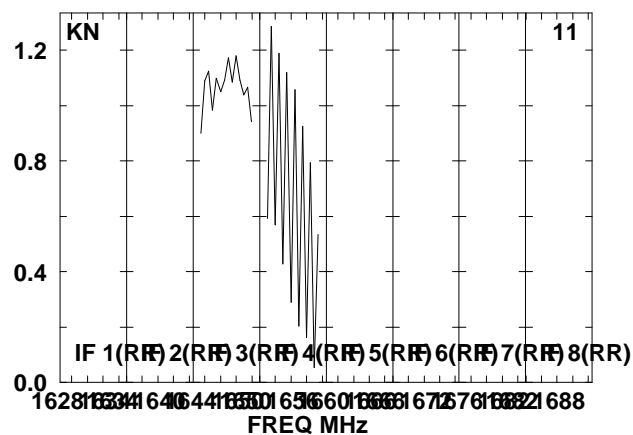
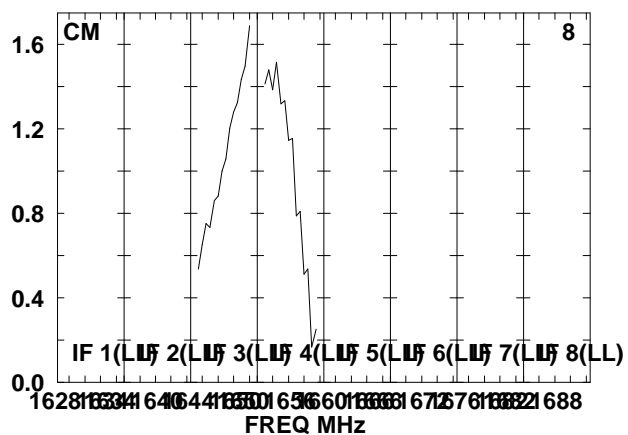
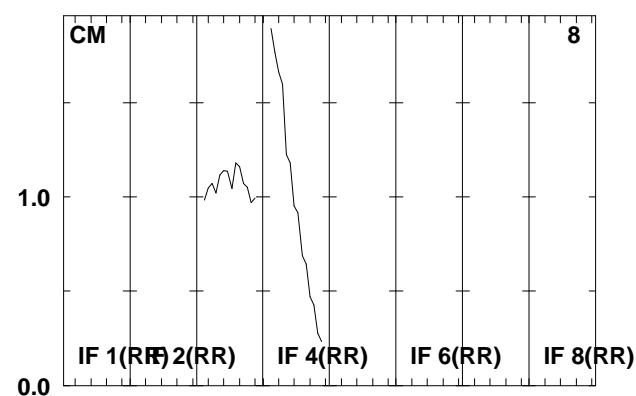
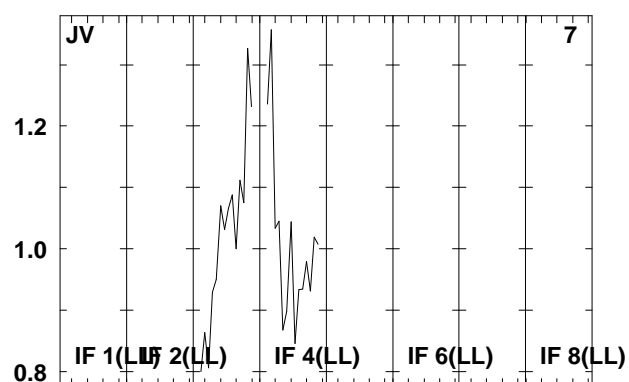
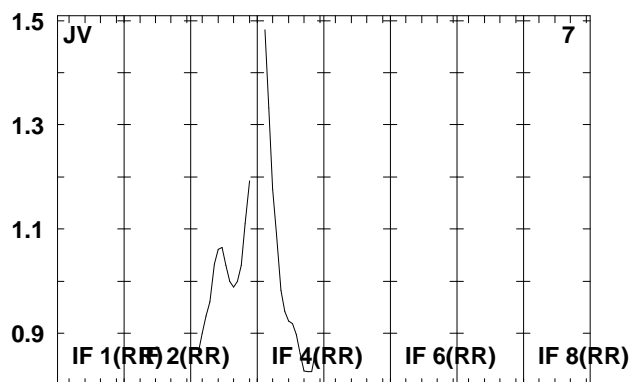
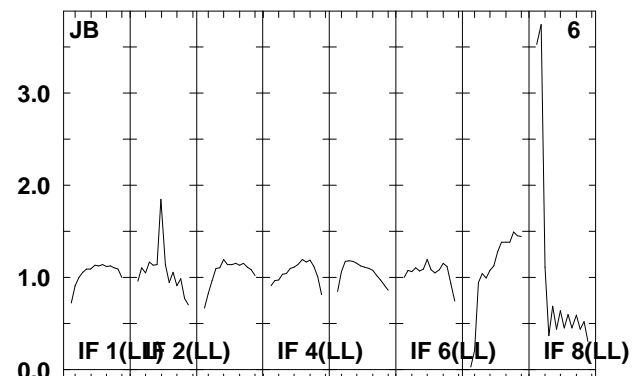
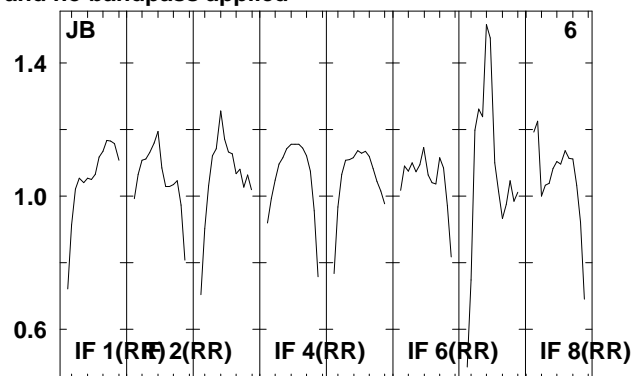
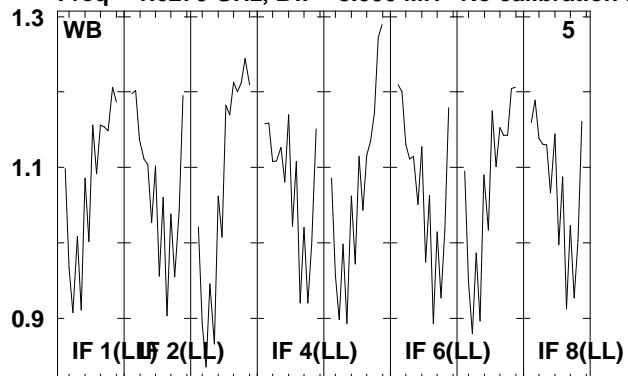

Lower frame: Real Jy  
Total-power spectrum Antenna: \*  
Timerange: 01/04:37:00 to 01/04:37:59

Plot file version 222 created 20-OCT-2009 14:51:10

J0137+31 RP015C.UVDATA.1

Freq = 1.6270 GHz, Bw = 8.000 MH No calibration applied and no bandpass applied

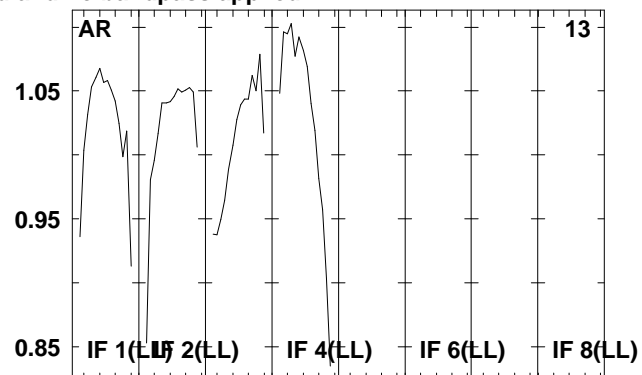
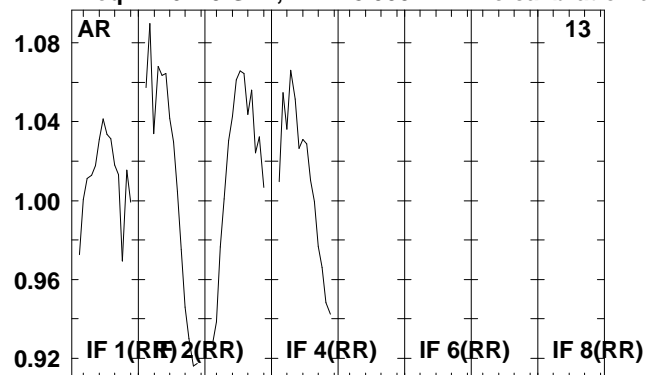

Lower frame: Real Jy  
Total-power spectrum Antenna: \*  
Timerange: 01/04:37:00 to 01/04:37:59

Plot file version 223 created 20-OCT-2009 14:51:10

FAINTCAL RP015C.UVDATA.1

Freq = 1.6270 GHz, Bw = 8.000 MH No calibration applied and no bandpass applied

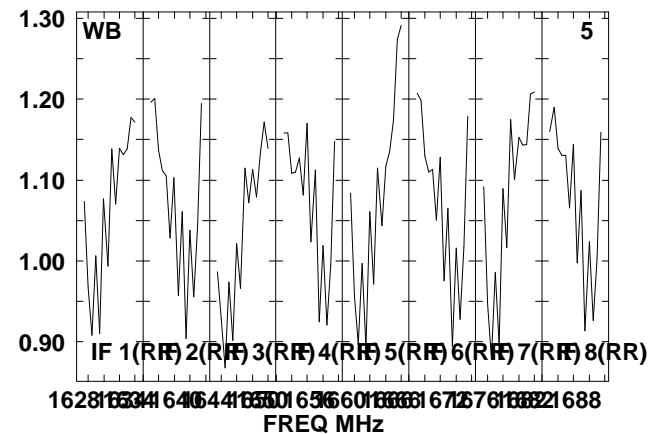
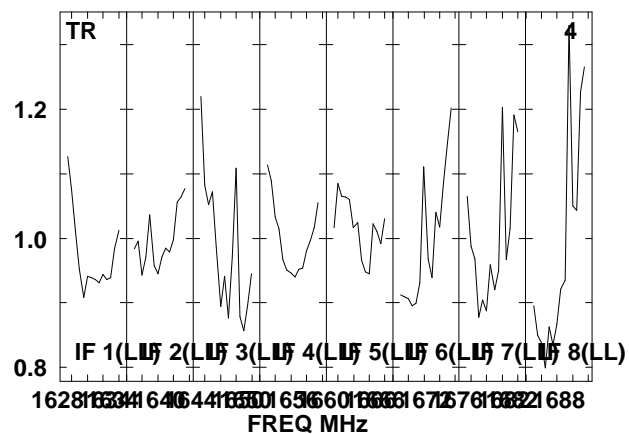
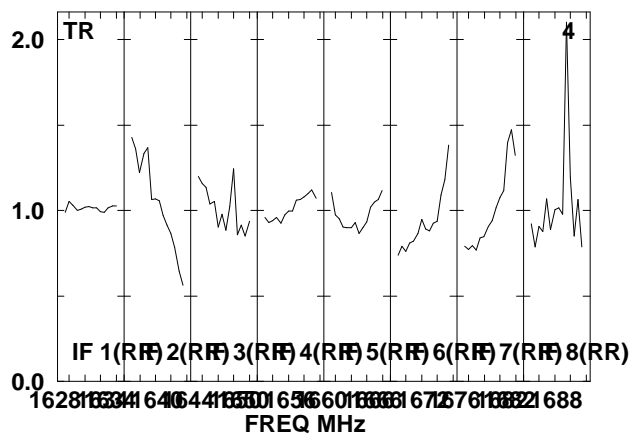
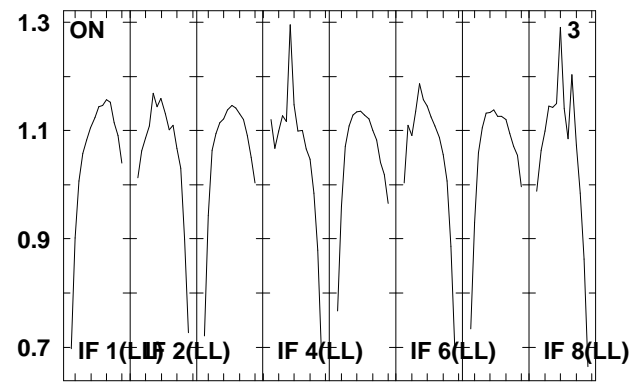
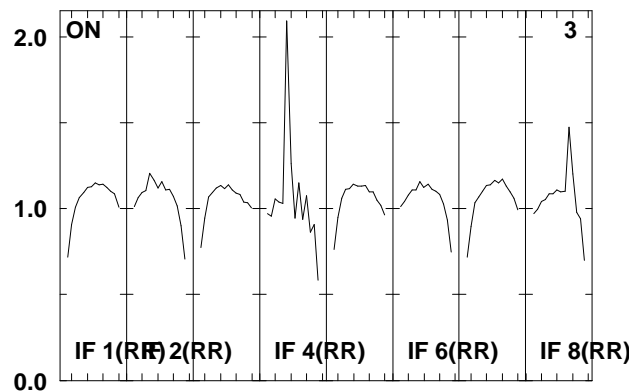
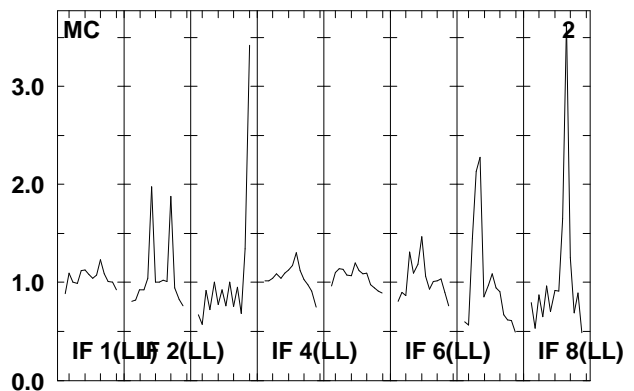
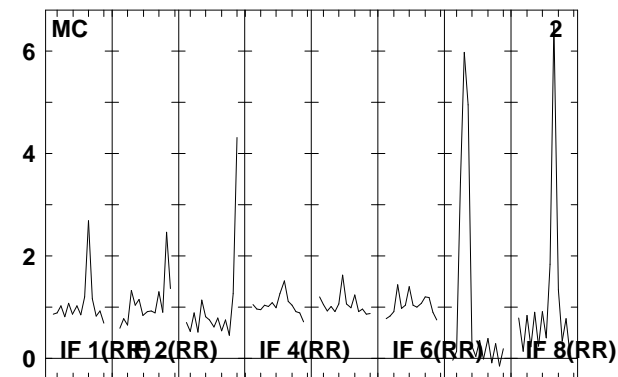
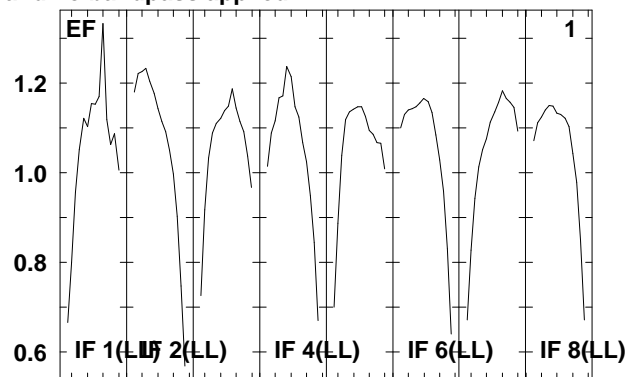
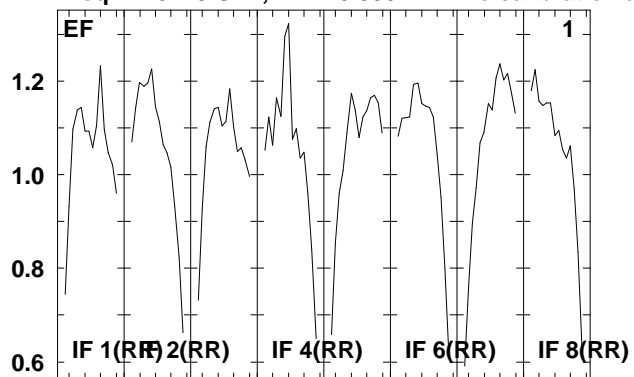

Lower frame: Real Jy  
Total-power spectrum Antenna: \*  
Timerange: 01/04:38:01 to 01/04:39:19

Plot file version 224 created 20-OCT-2009 14:51:10

FAINTCAL RP015C.UVDATA.1

Freq = 1.6270 GHz, Bw = 8.000 MH No calibration applied and no bandpass applied

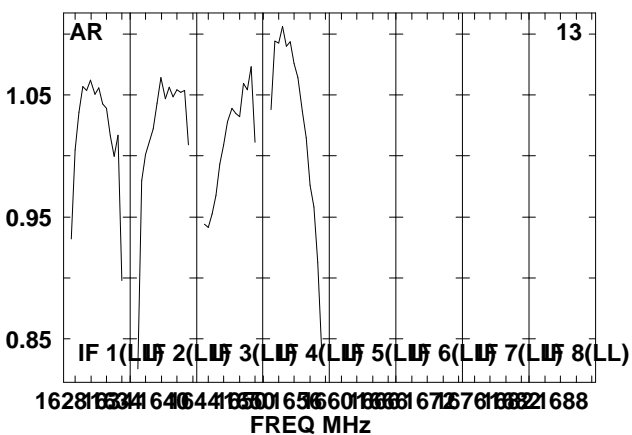
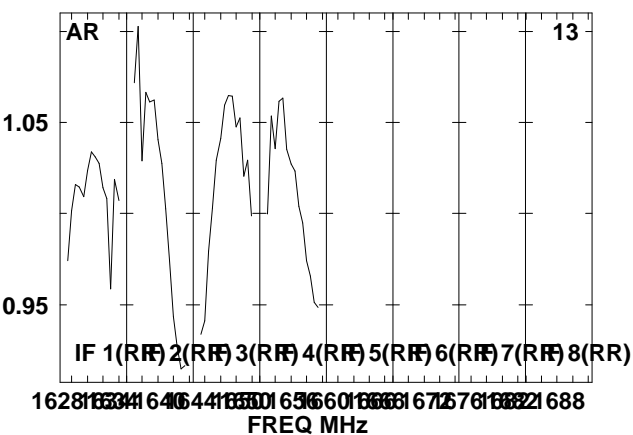
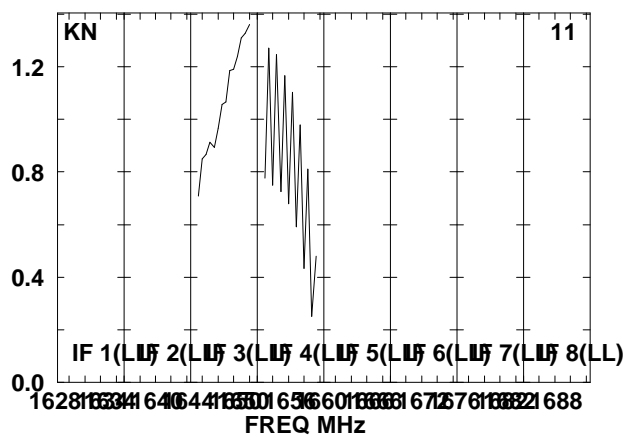
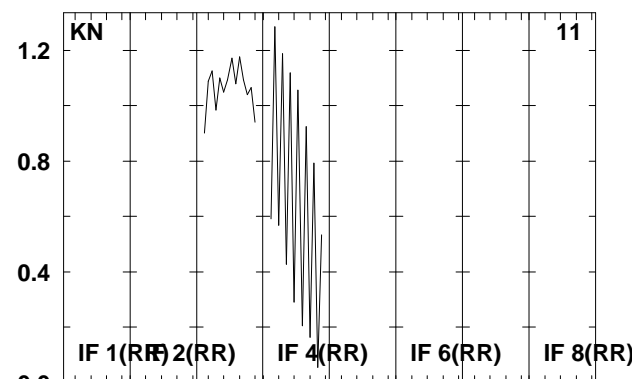
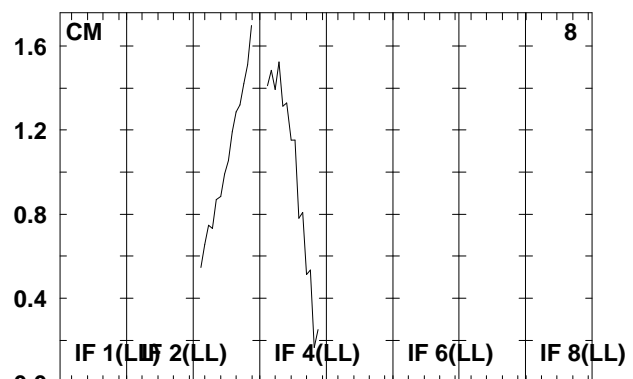
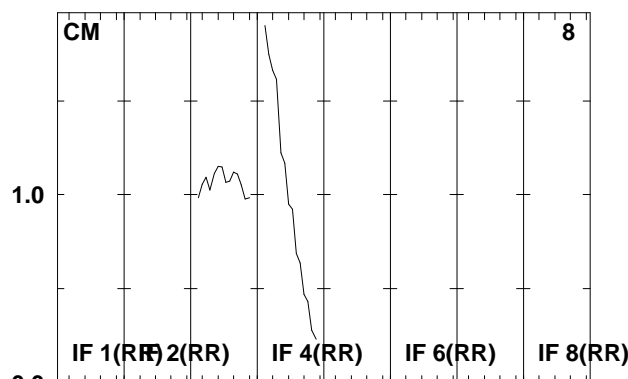
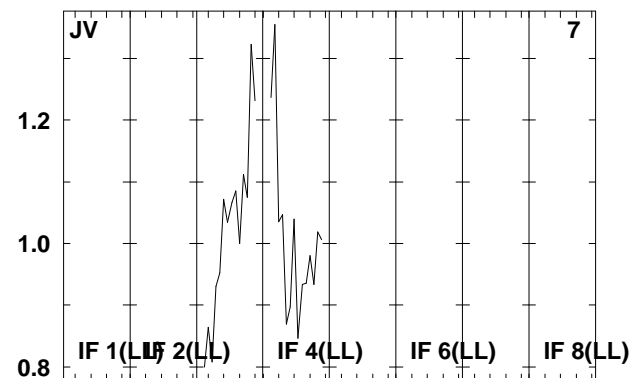
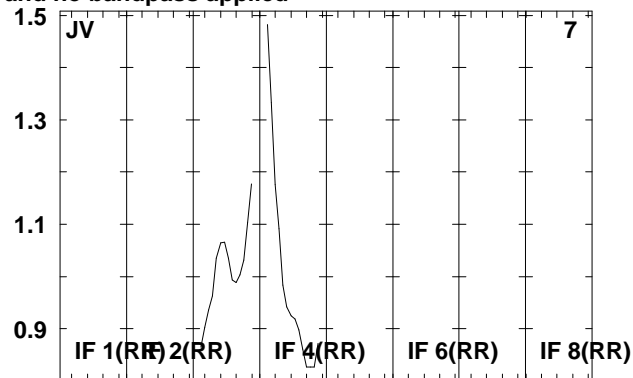
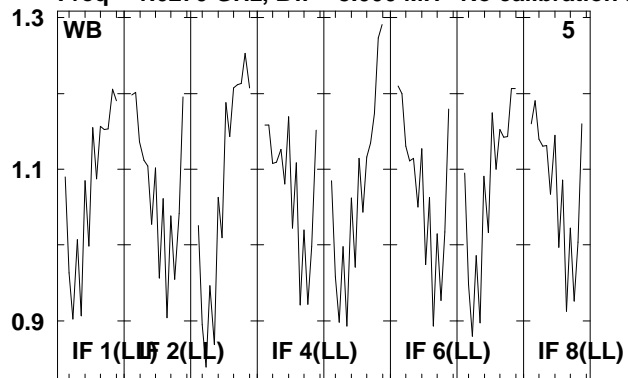

Lower frame: Real Jy  
Total-power spectrum Antenna: \*  
Timerange: 01/04:38:01 to 01/04:39:19



Plot file version 225 created 20-OCT-2009 14:51:11

M33 RP015C.UVDATA.1

Freq = 1.6270 GHz, Bw = 8.000 MH No calibration applied and no bandpass applied

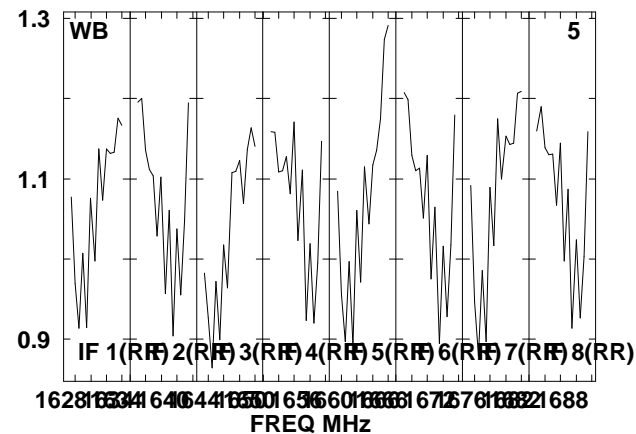
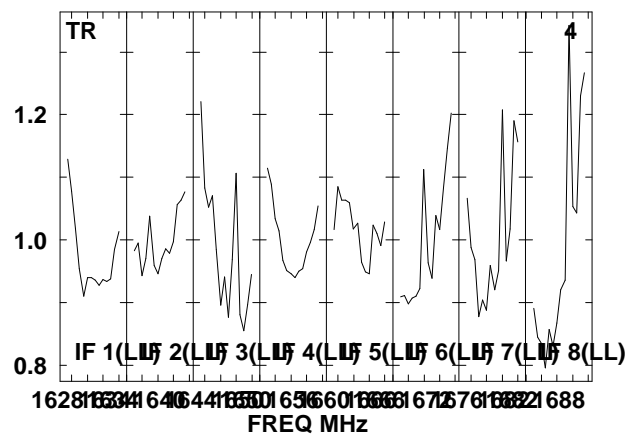
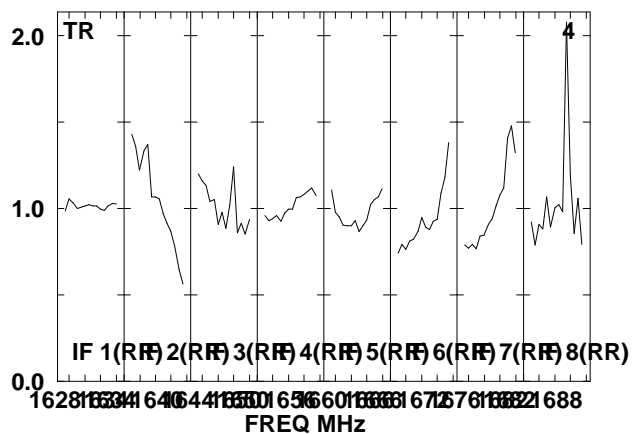
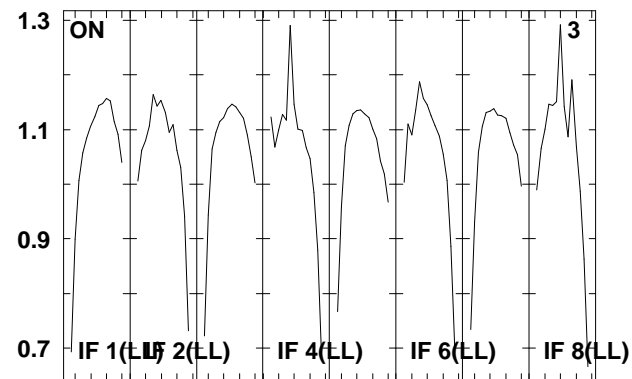
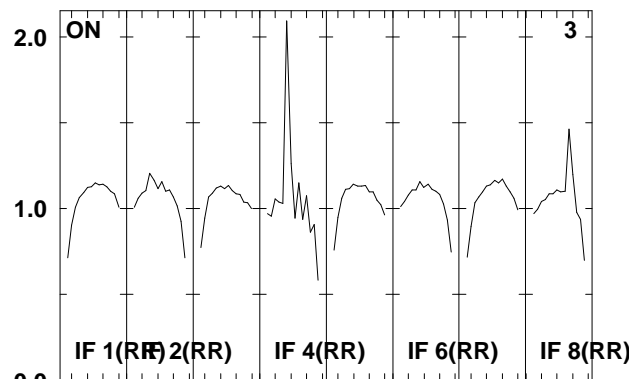
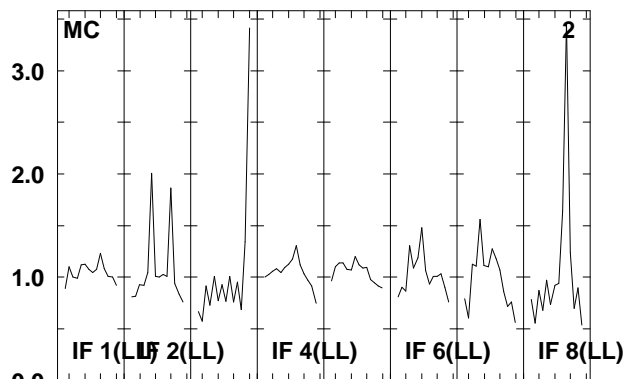
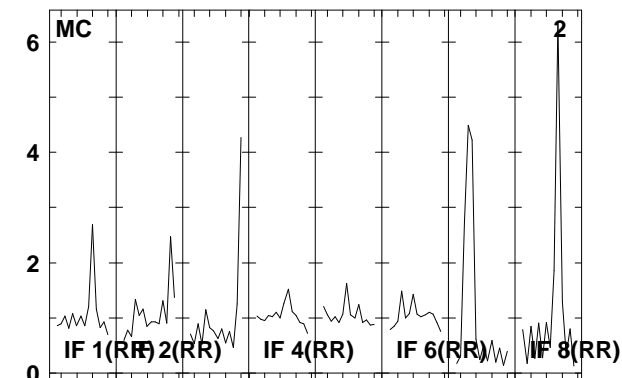
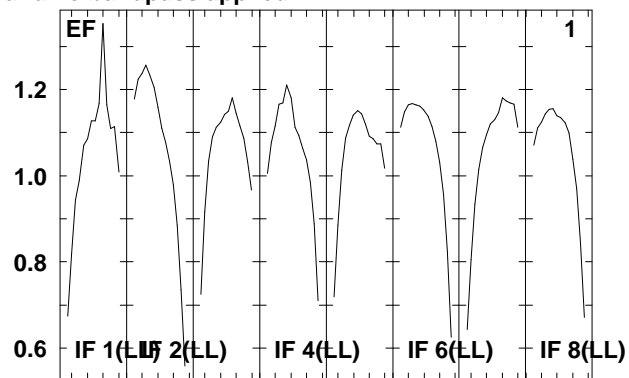
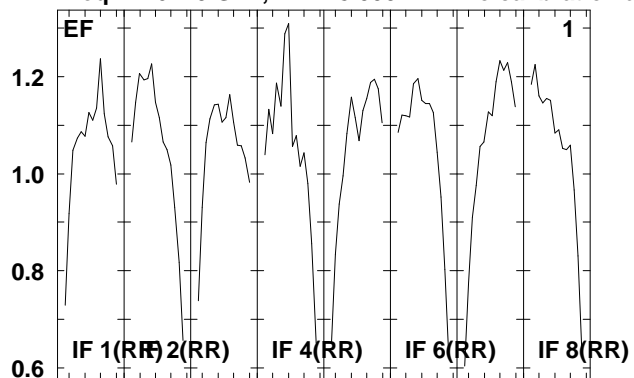

Lower frame: Real Jy  
Total-power spectrum Antenna: \*  
Timerange: 01/04:39:20 to 01/04:42:19

Plot file version 226 created 20-OCT-2009 14:51:12

M33 RP015C.UVDATA.1

Freq = 1.6270 GHz, Bw = 8.000 MH No calibration applied and no bandpass applied

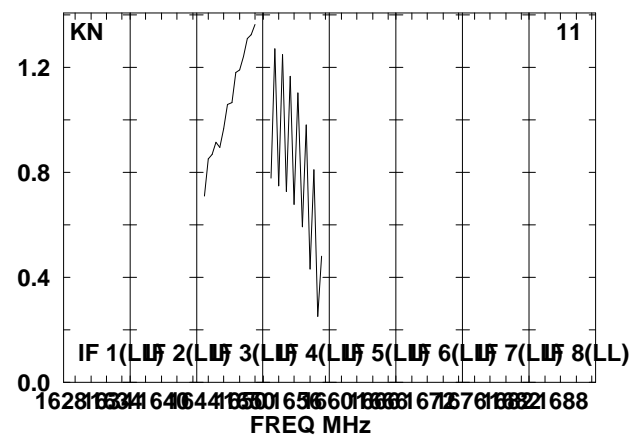
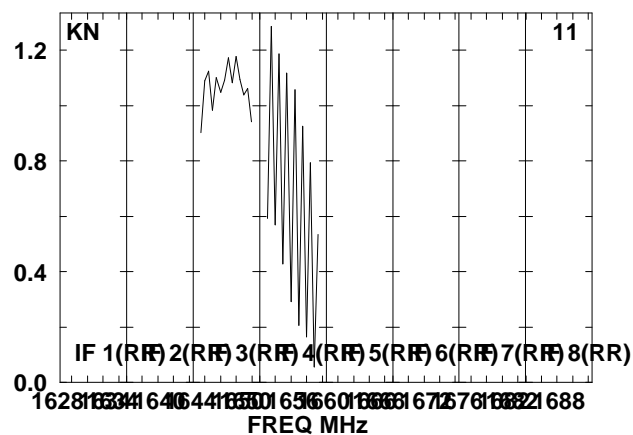
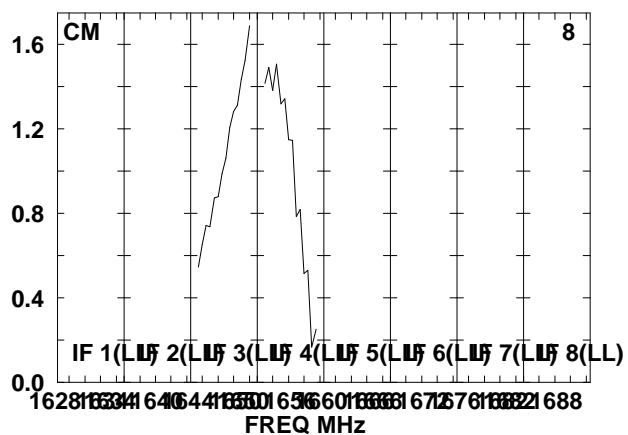
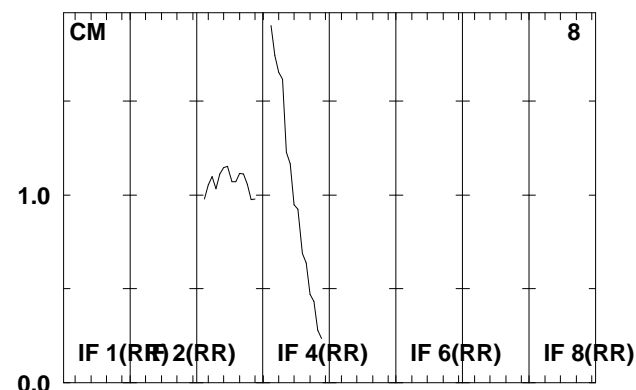
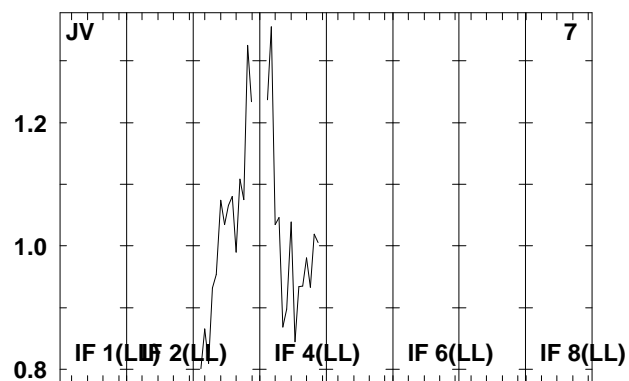
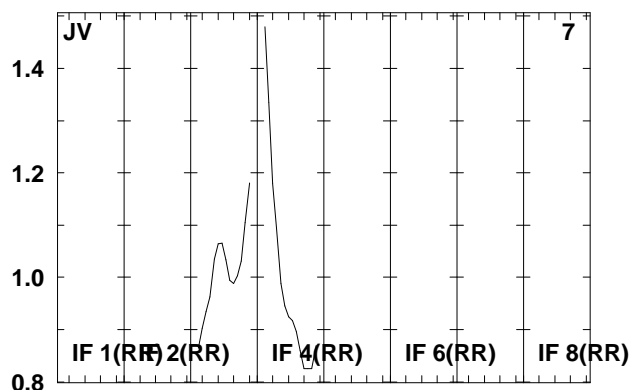
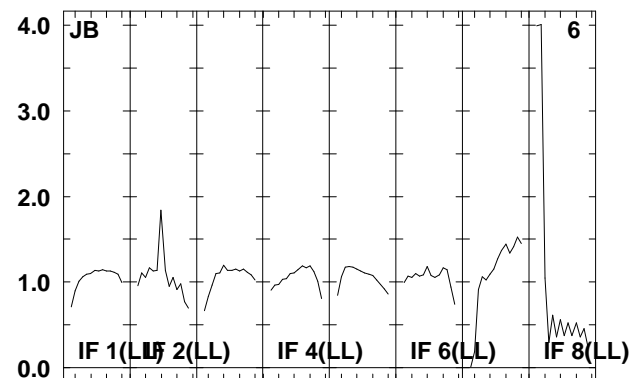
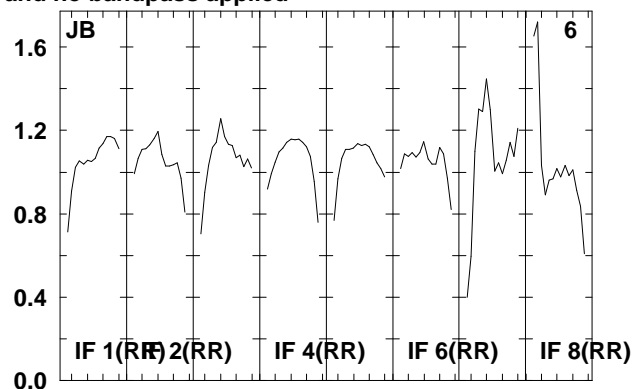
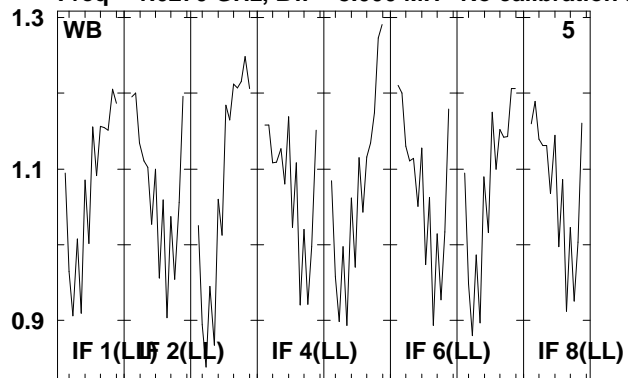

Lower frame: Real Jy

Total-power spectrum Antenna: \*

Timerange: 01/04:39:20 to 01/04:42:19

Plot file version 227 created 20-OCT-2009 14:51:14

M33 RP015C.UVDATA.1

Freq = 1.6270 GHz, Bw = 8.000 MH No calibration applied and no bandpass applied

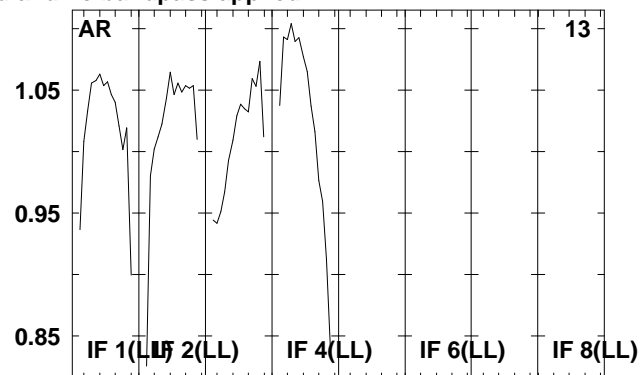
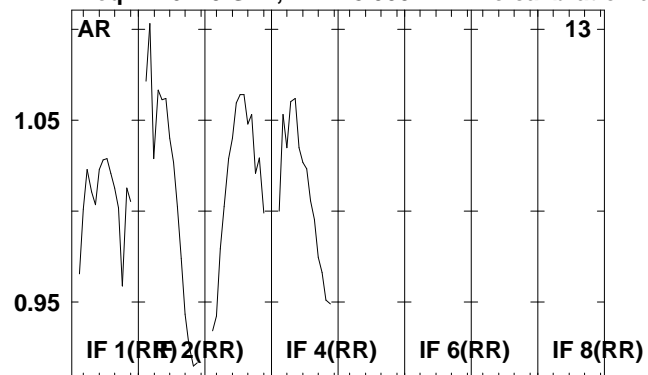

Lower frame: Real Jy  
Total-power spectrum Antenna: \*  
Timerange: 01/04:39:20 to 01/04:42:19

Plot file version 228 created 20-OCT-2009 14:51:14

J0137+31 RP015C.UVDATA.1

Freq = 1.6270 GHz, Bw = 8.000 MH No calibration applied and no bandpass applied

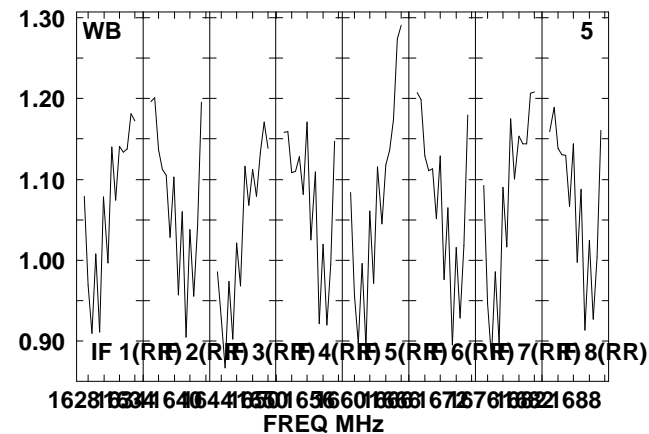
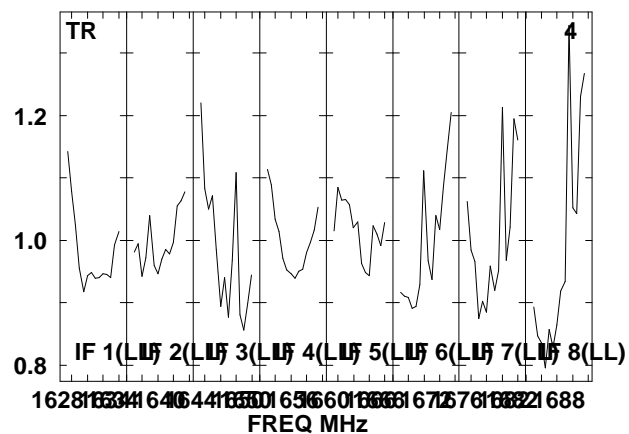
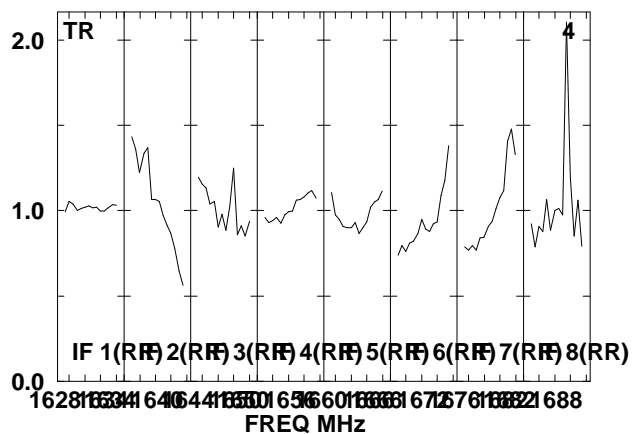
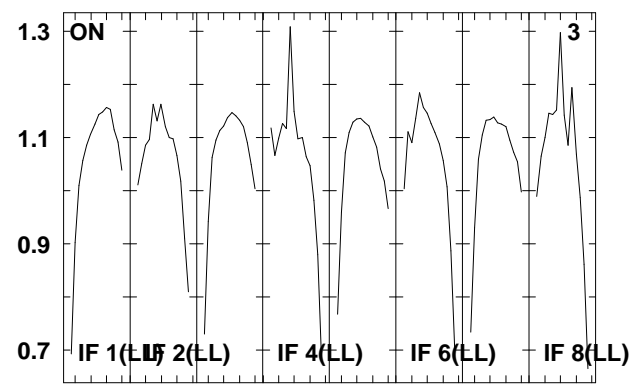
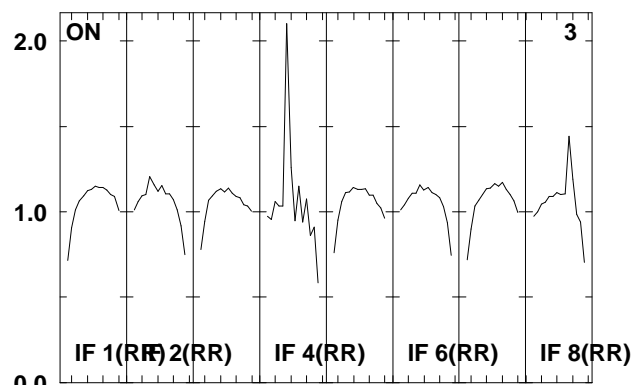
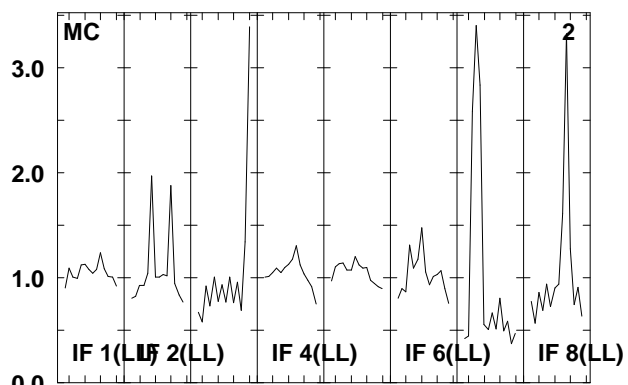
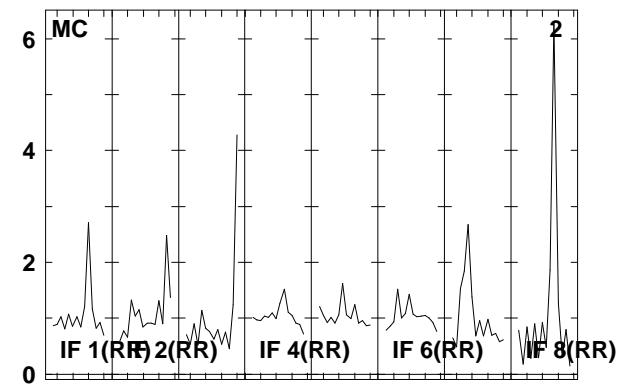
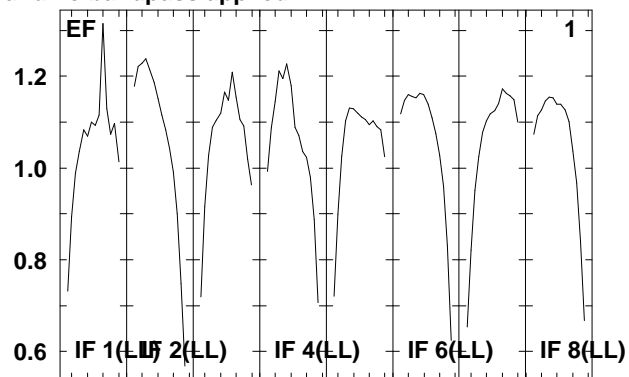
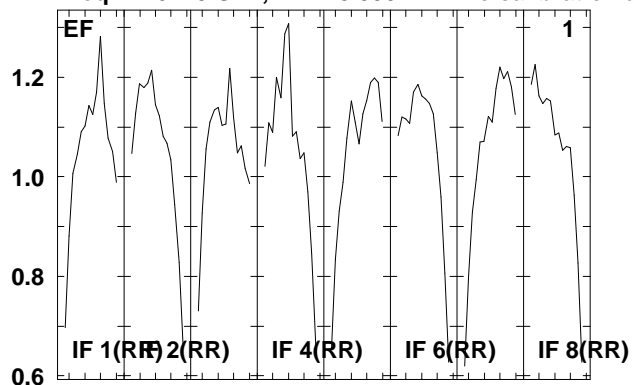

Lower frame: Real Jy  
Total-power spectrum Antenna: \*  
Timerange: 01/04:43:00 to 01/04:43:59

Plot file version 229 created 20-OCT-2009 14:51:14

J0137+31 RP015C.UVDATA.1

Freq = 1.6270 GHz, Bw = 8.000 MH No calibration applied and no bandpass applied

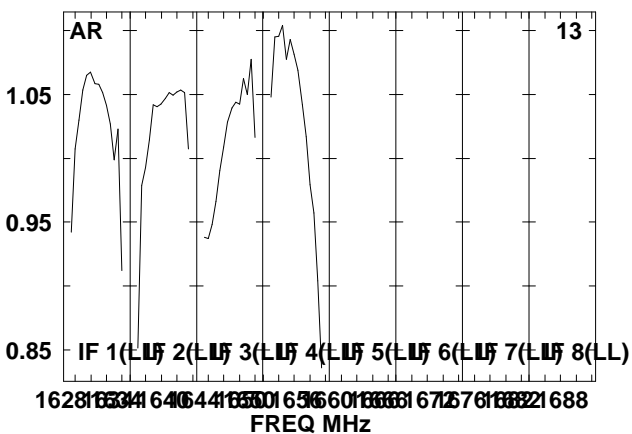
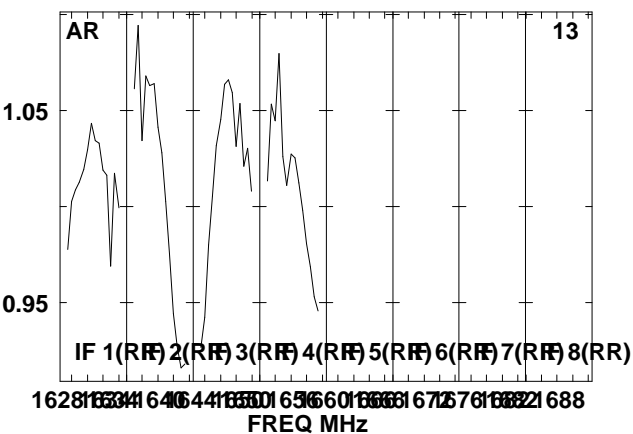
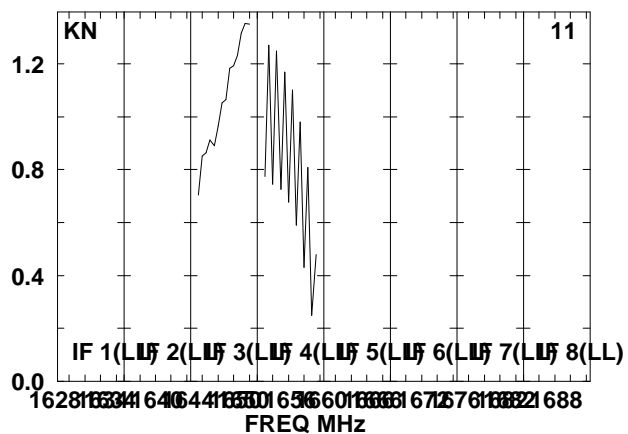
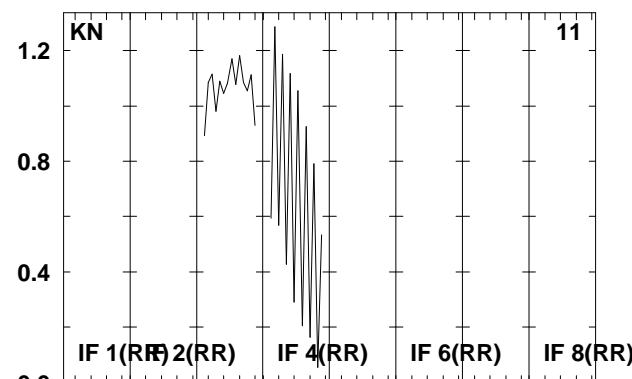
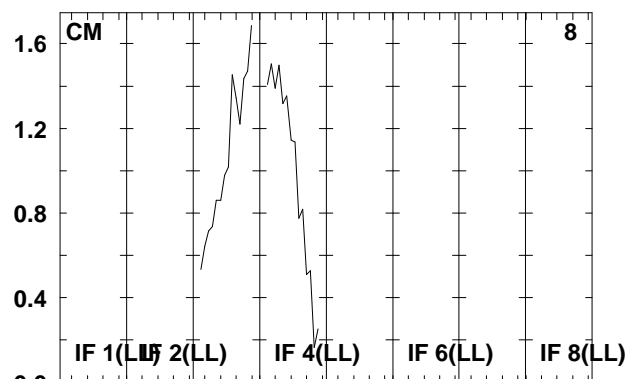
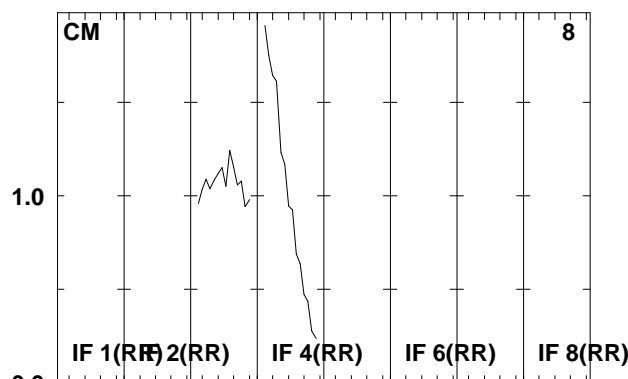
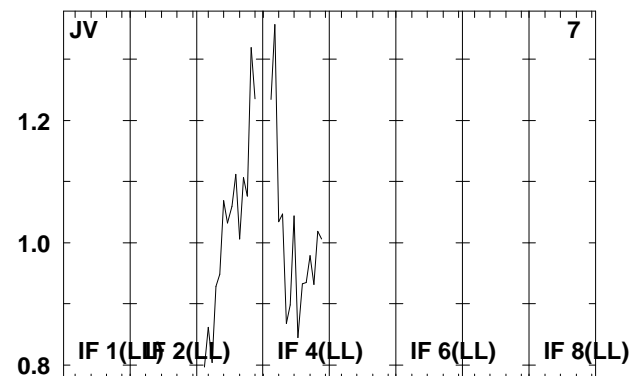
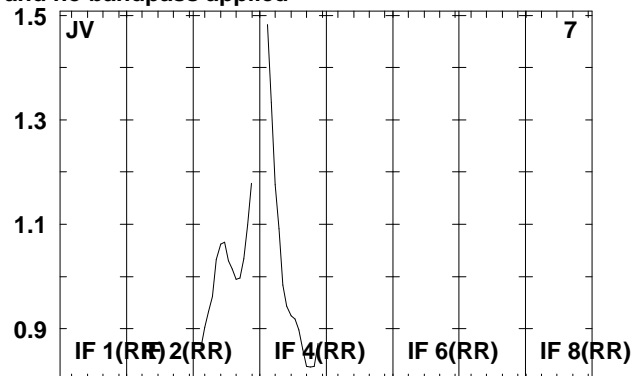
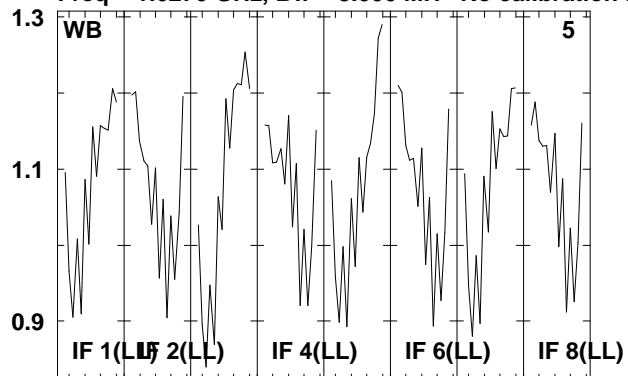

Lower frame: Real Jy  
Total-power spectrum Antenna: \*  
Timerange: 01/04:43:00 to 01/04:43:59

Plot file version 230 created 20-OCT-2009 14:51:15

FAINTCAL RP015C.UVDATA.1

Freq = 1.6270 GHz, Bw = 8.000 MH No calibration applied and no bandpass applied

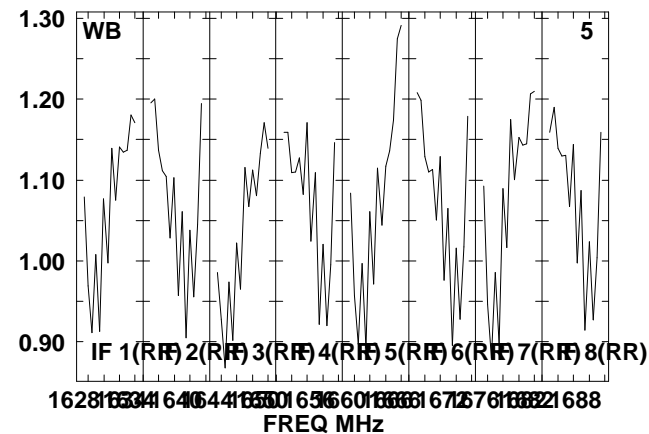
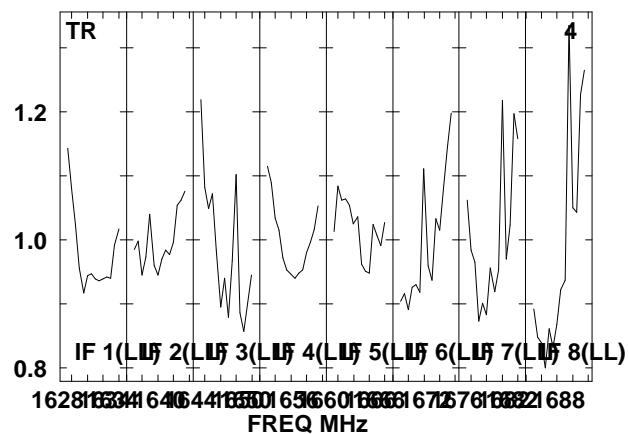
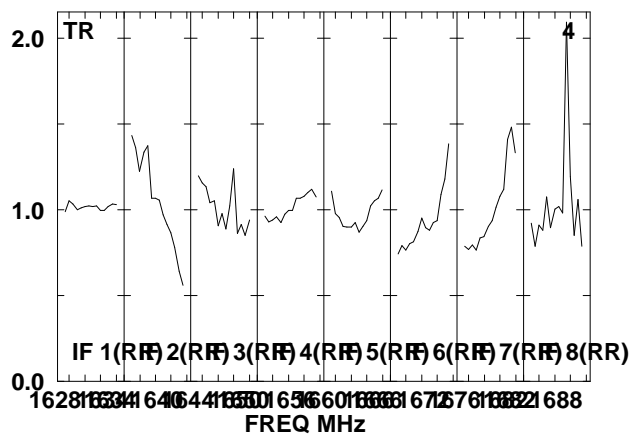
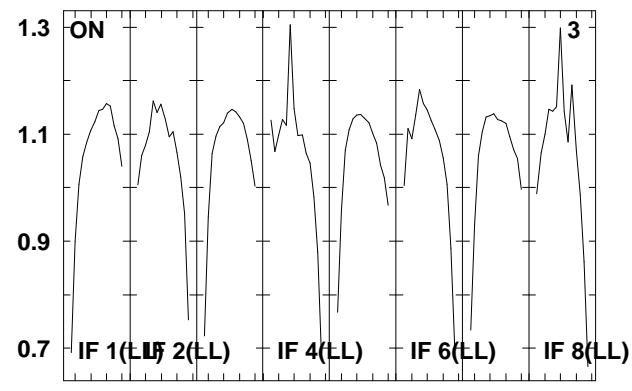
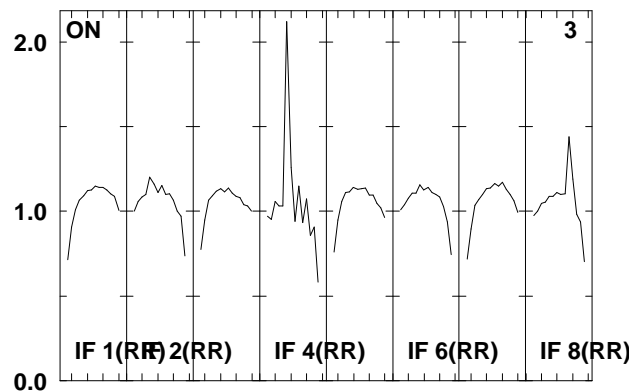
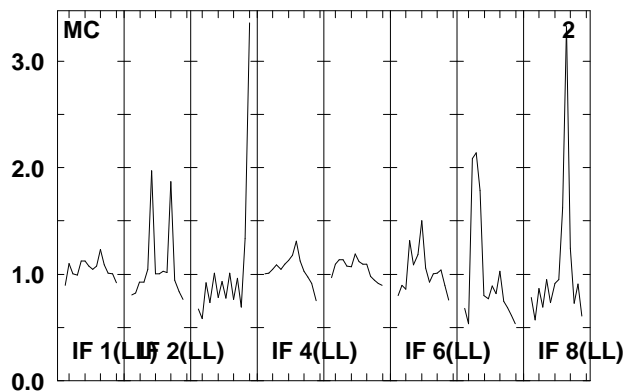
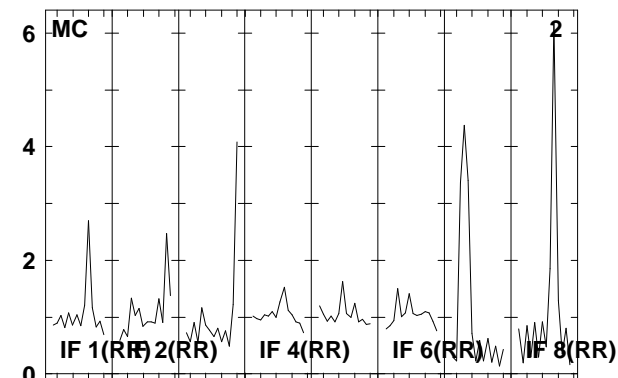
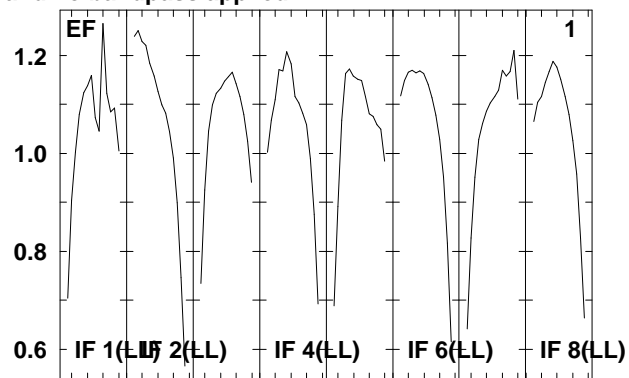
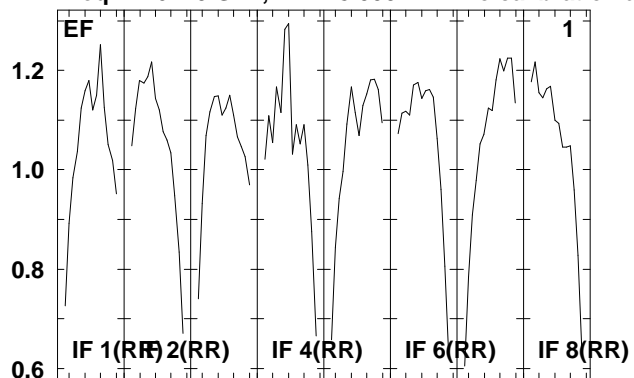

Lower frame: Real Jy  
Total-power spectrum Antenna: \*  
Timerange: 01/04:44:00 to 01/04:45:20

Plot file version 231 created 20-OCT-2009 14:51:15

FAINTCAL RP015C.UVDATA.1

Freq = 1.6270 GHz, Bw = 8.000 MH No calibration applied and no bandpass applied

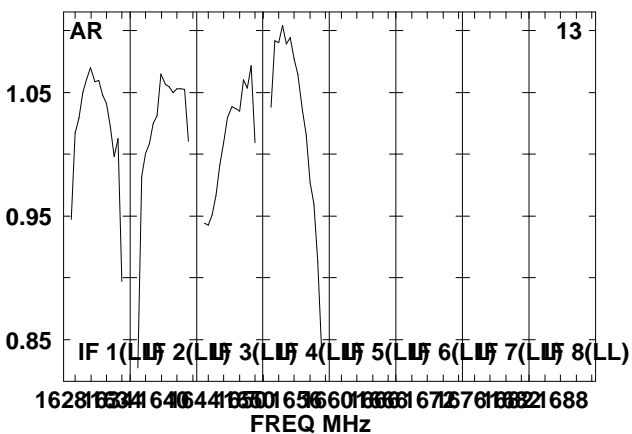
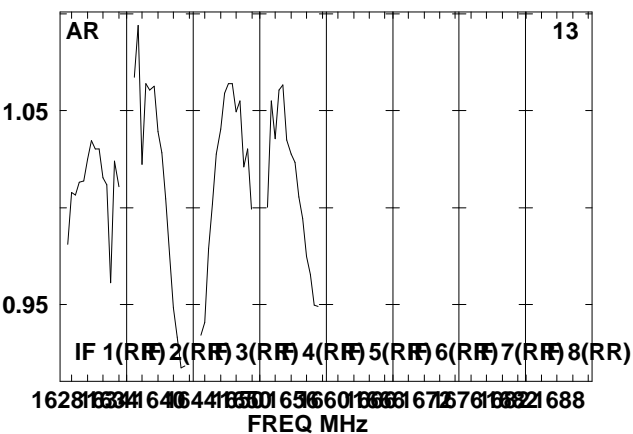
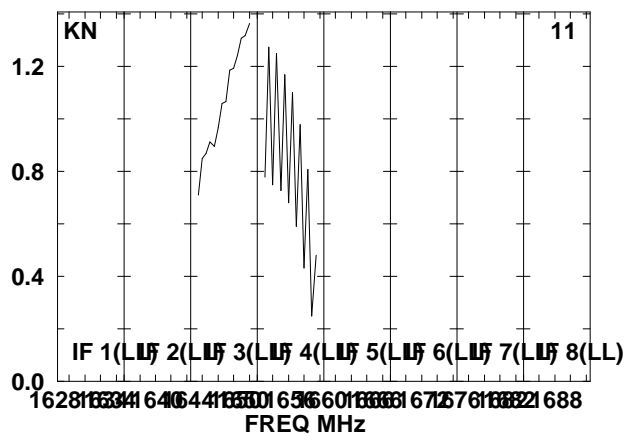
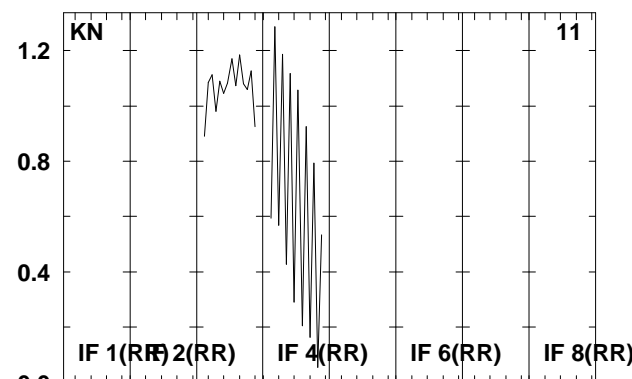
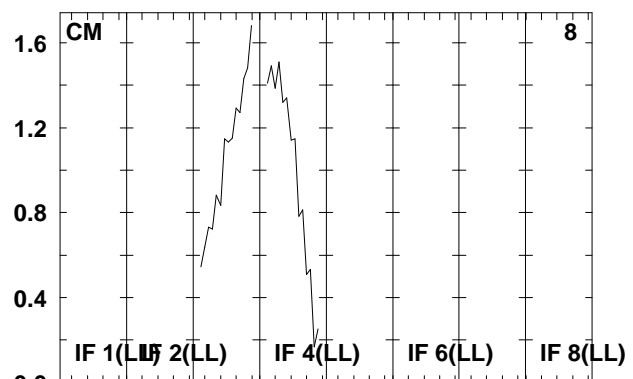
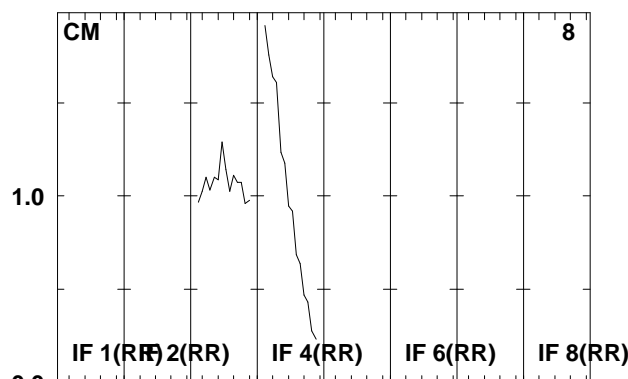
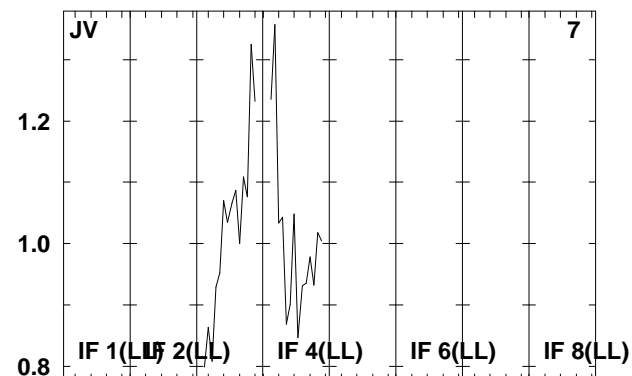
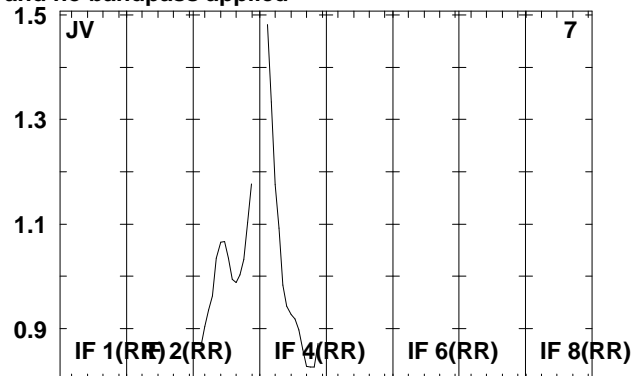
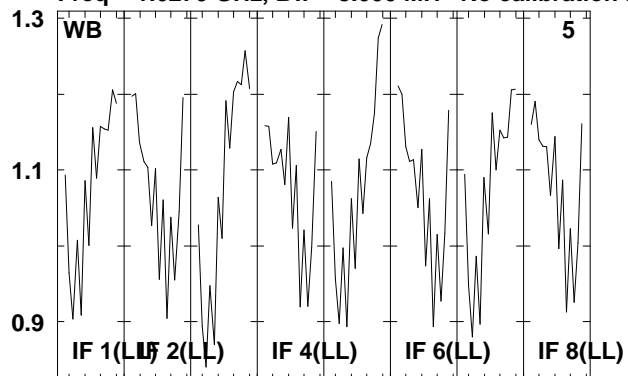

Lower frame: Real Jy  
Total-power spectrum Antenna: \*  
Timerange: 01/04:44:00 to 01/04:45:20

Plot file version 232 created 20-OCT-2009 14:51:16

M33 RP015C.UVDATA.1

Freq = 1.6270 GHz, Bw = 8.000 MH No calibration applied and no bandpass applied

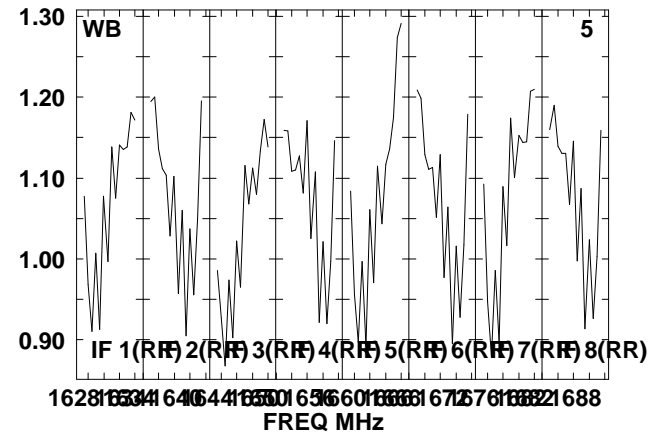
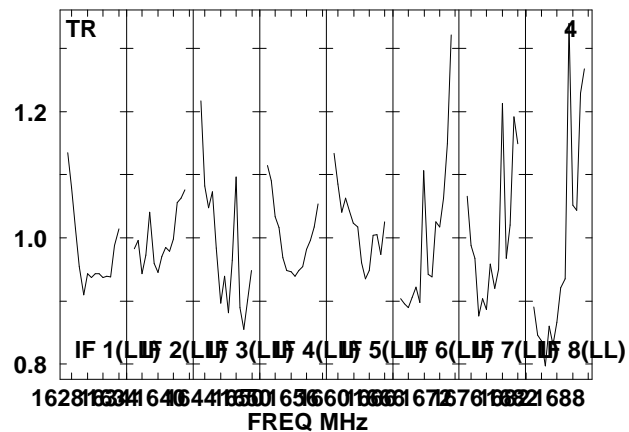
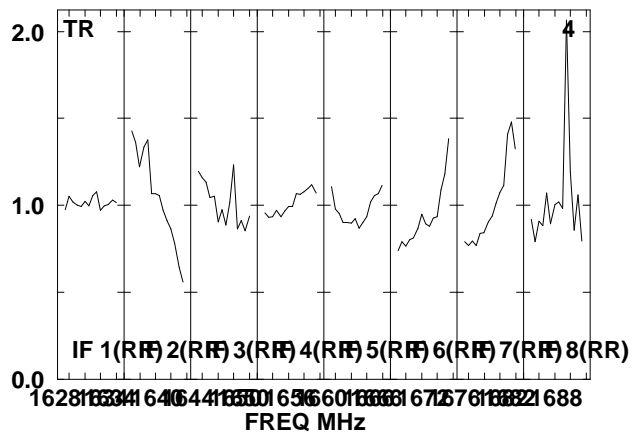
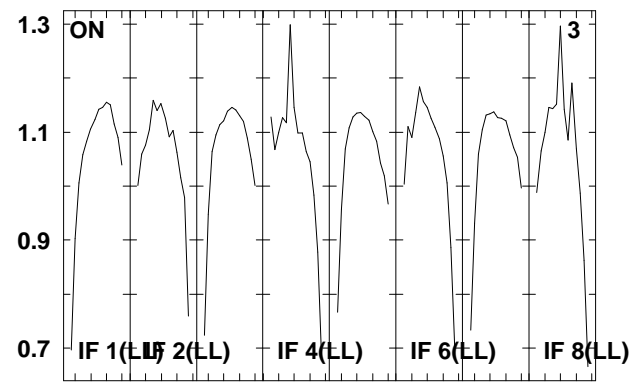
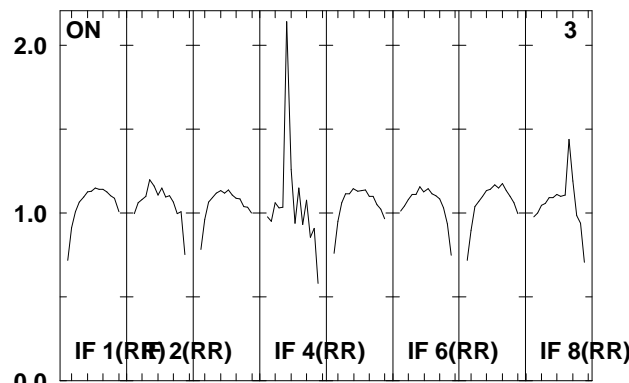
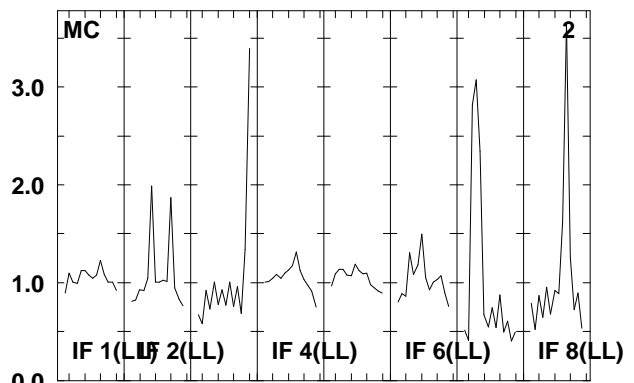
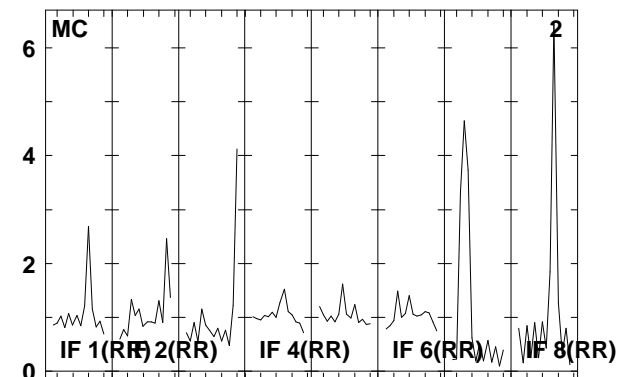
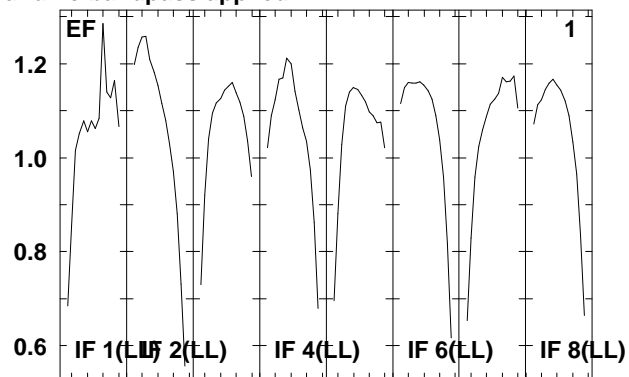
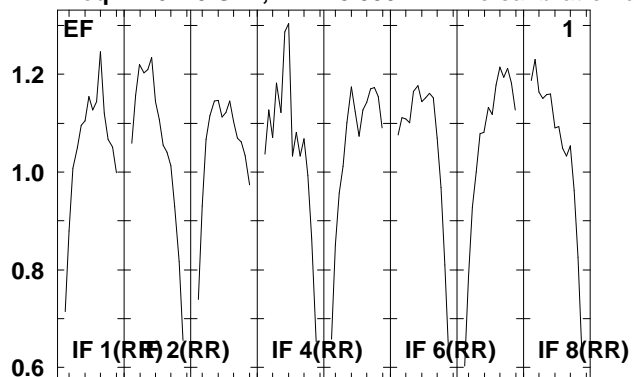

Lower frame: Real Jy

Total-power spectrum Antenna: \*

Timerange: 01/04:45:21 to 01/04:48:20



Plot file version 233 created 20-OCT-2009 14:51:17

M33 RP015C.UVDATA.1

Freq = 1.6270 GHz, Bw = 8.000 MH No calibration applied and no bandpass applied

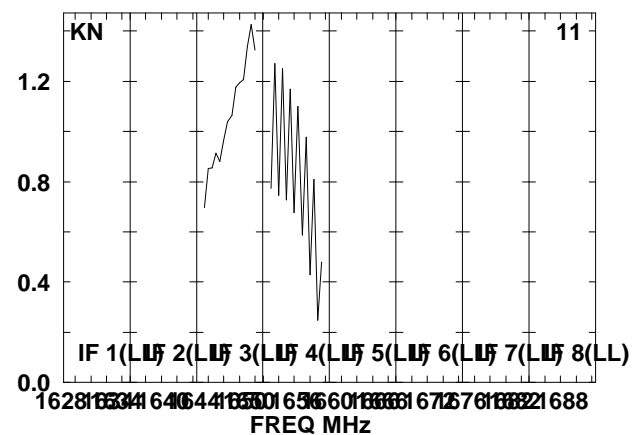
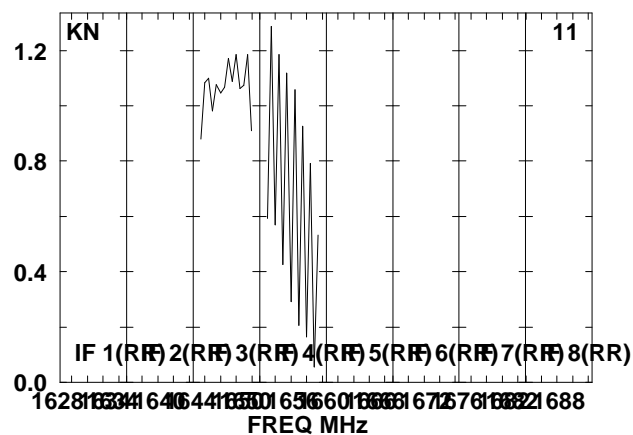
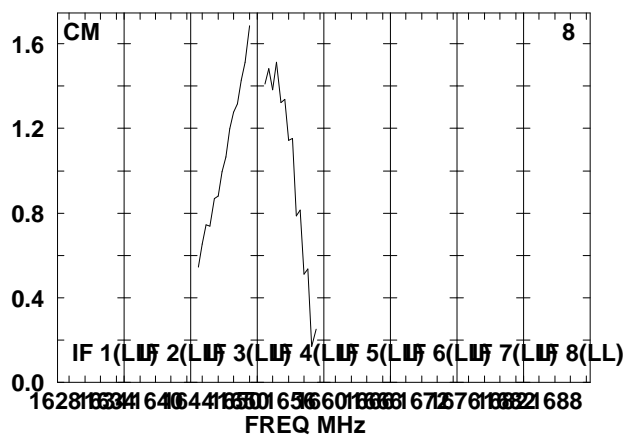
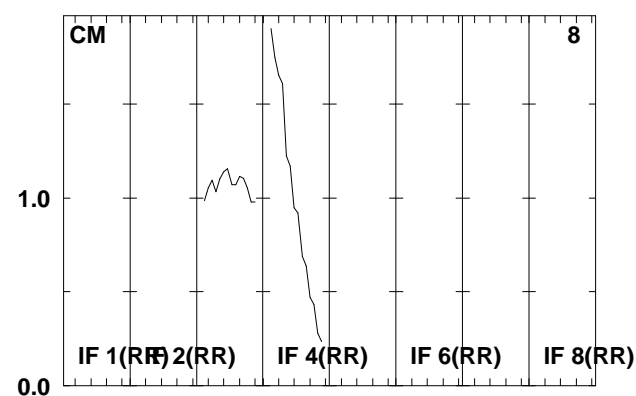
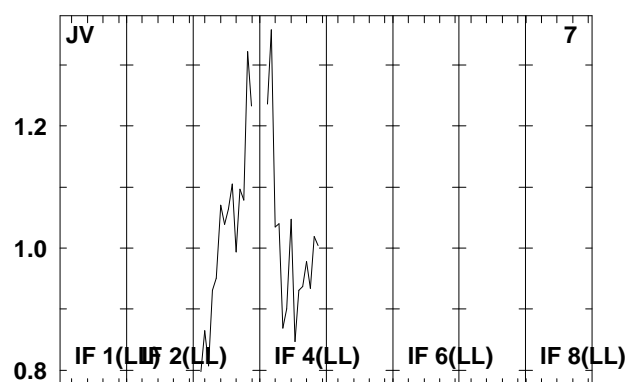
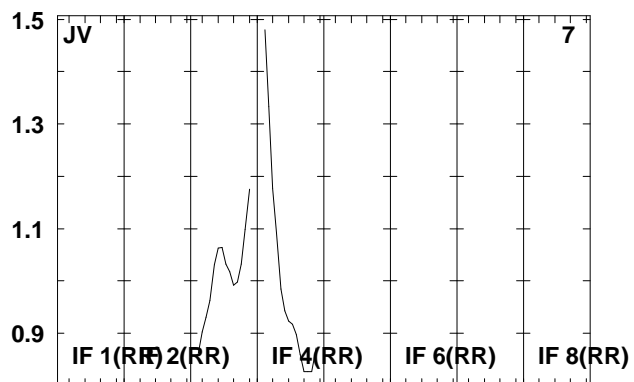
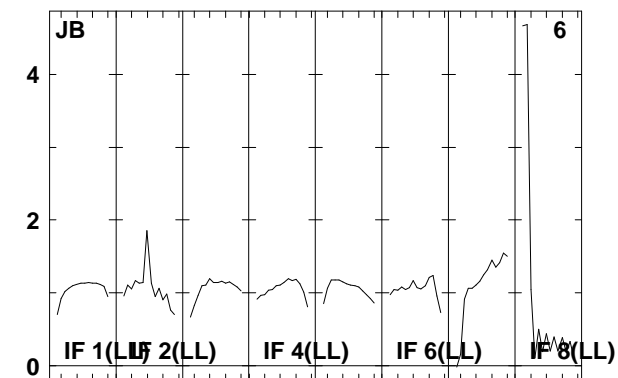
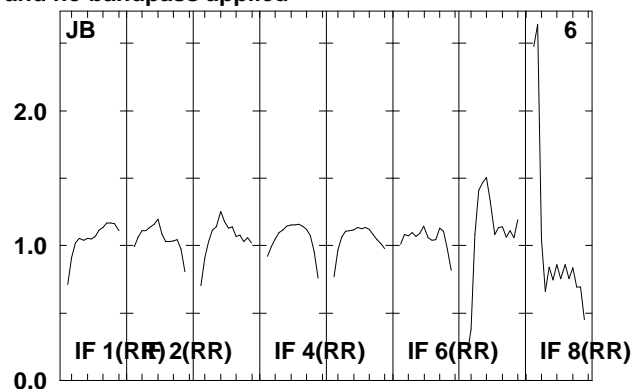
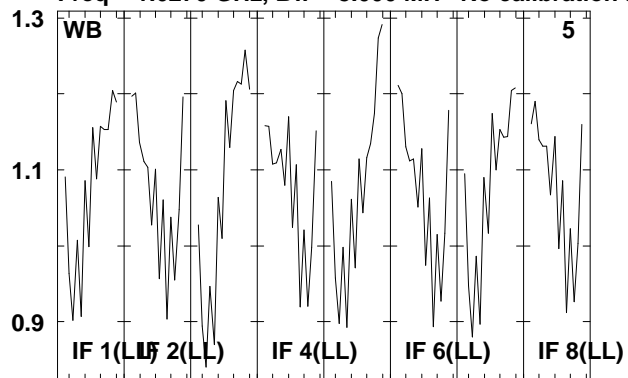

Lower frame: Real Jy

Total-power spectrum Antenna: \*

Timerange: 01/04:45:21 to 01/04:48:20

Plot file version 234 created 20-OCT-2009 14:51:19

M33 RP015C.UVDATA.1

Freq = 1.6270 GHz, Bw = 8.000 MH No calibration applied and no bandpass applied

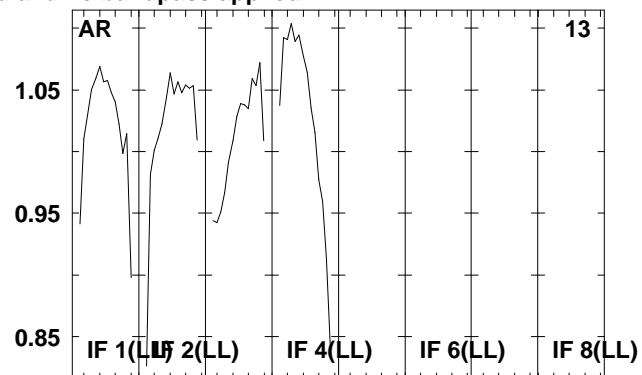
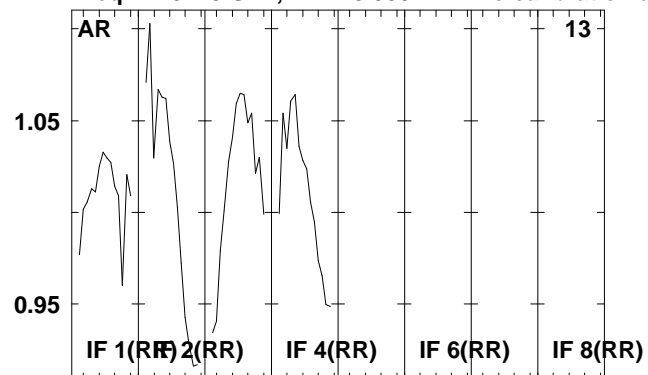

Lower frame: Real Jy  
Total-power spectrum Antenna: \*  
Timerange: 01/04:45:21 to 01/04:48:20

Plot file version 235 created 20-OCT-2009 14:51:19

J0137+31 RP015C.UVDATA.1

Freq = 1.6270 GHz, Bw = 8.000 MH No calibration applied and no bandpass applied

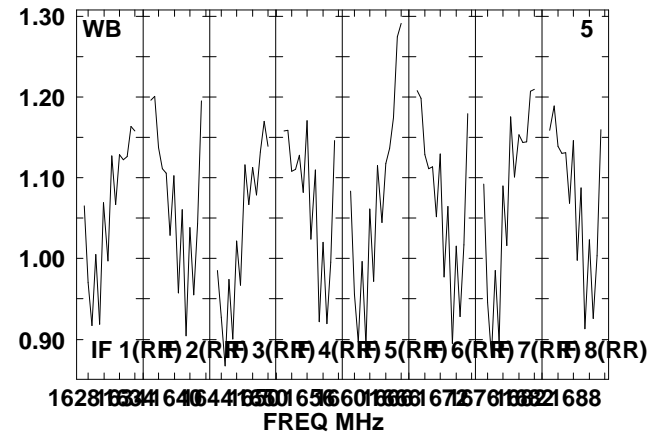
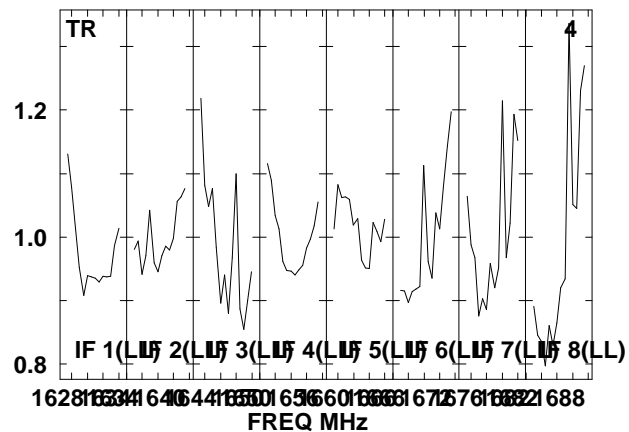
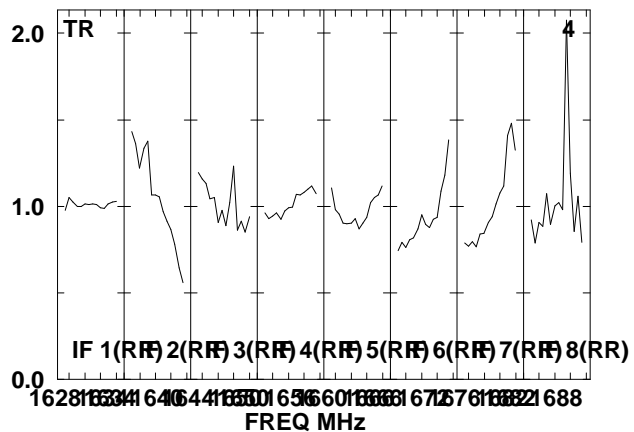
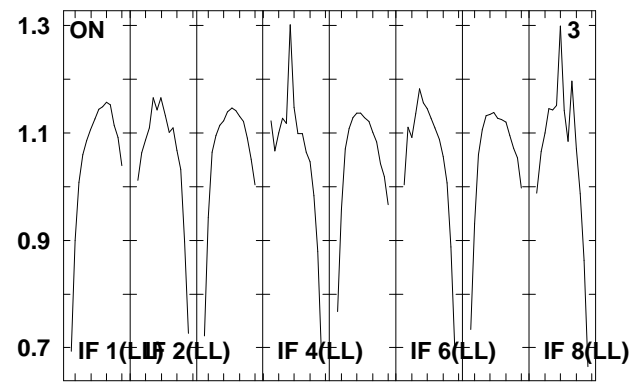
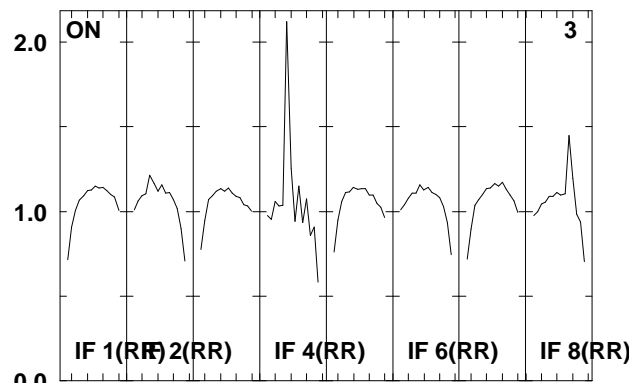
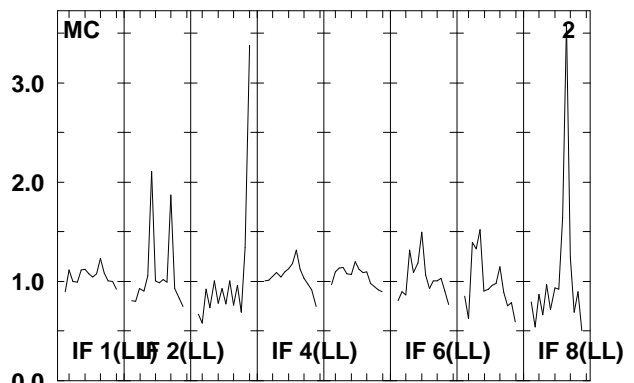
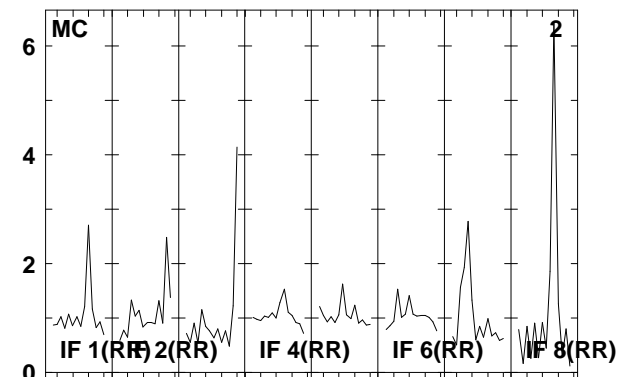
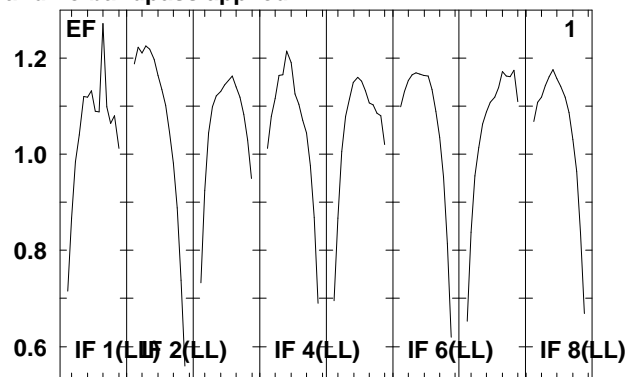
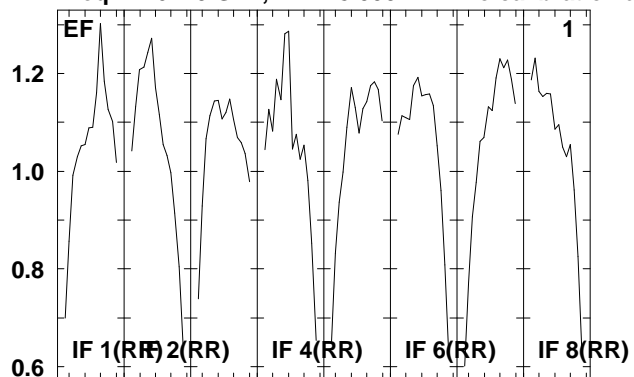

Lower frame: Real Jy  
Total-power spectrum Antenna: \*  
Timerange: 01/04:49:01 to 01/04:50:00

Plot file version 236 created 20-OCT-2009 14:51:19

J0137+31 RP015C.UVDATA.1

Freq = 1.6270 GHz, Bw = 8.000 MH No calibration applied and no bandpass applied

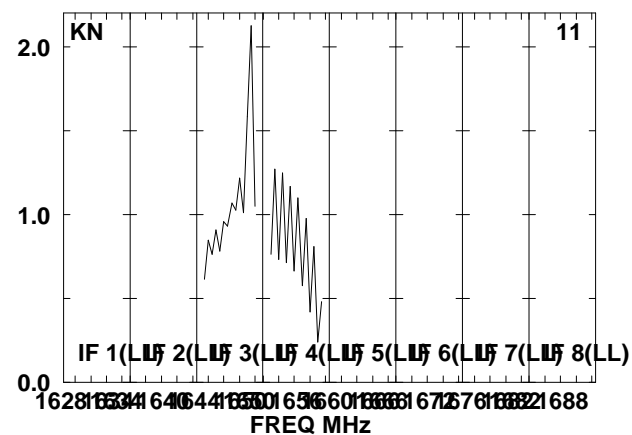
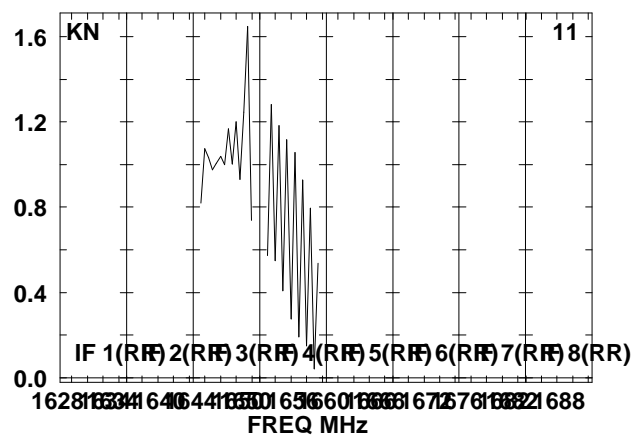
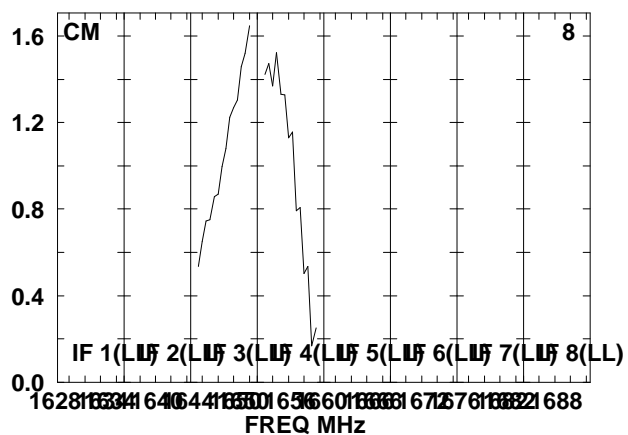
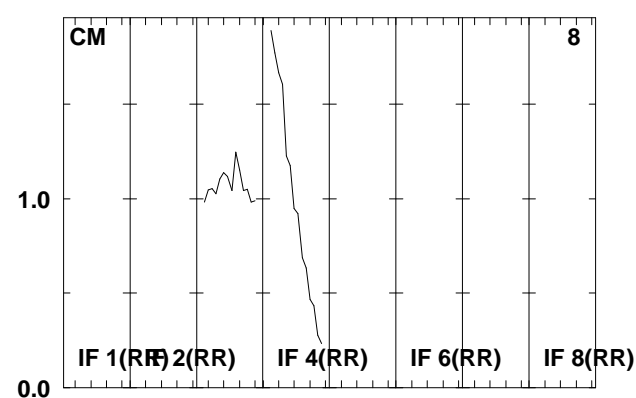
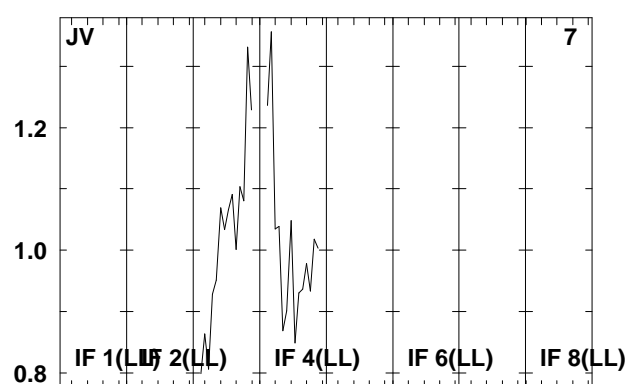
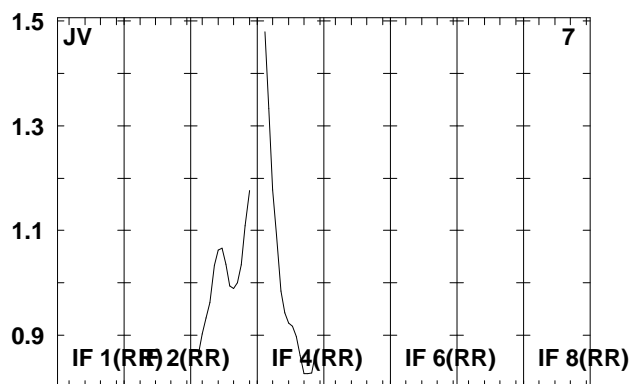
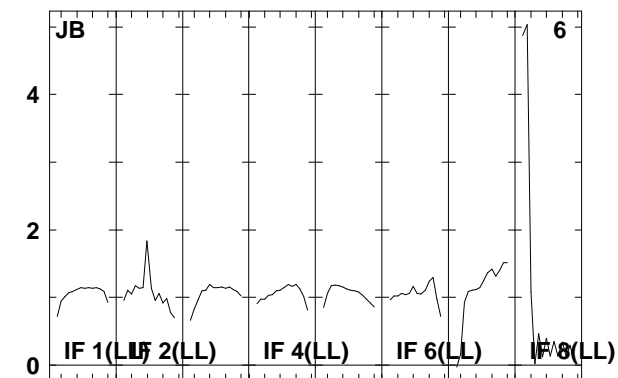
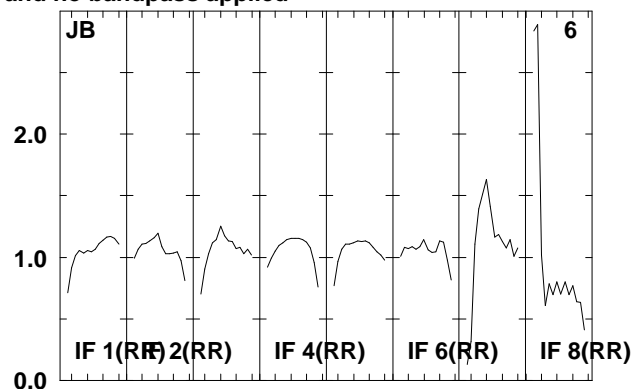
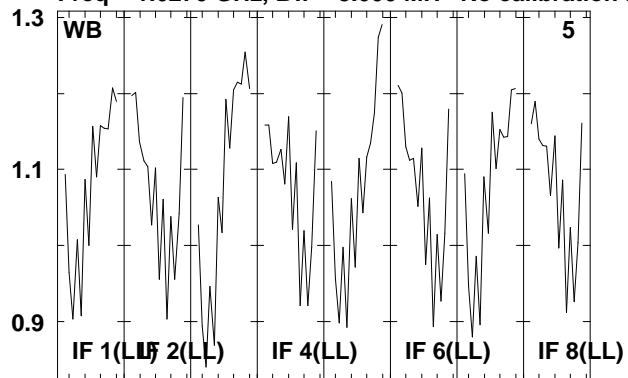

Lower frame: Real Jy  
Total-power spectrum Antenna: \*  
Timerange: 01/04:49:01 to 01/04:50:00

Plot file version 237 created 20-OCT-2009 14:51:20

J0137+31 RP015C.UVDATA.1

Freq = 1.6270 GHz, Bw = 8.000 MH No calibration applied and no bandpass applied

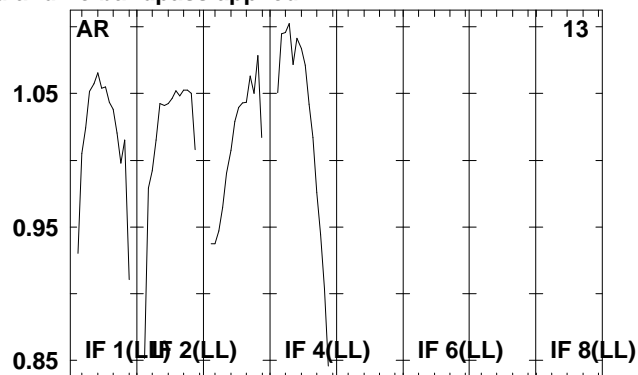
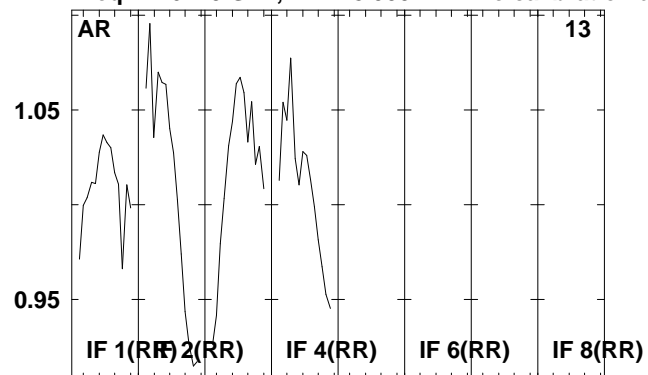

Lower frame: Real Jy  
Total-power spectrum Antenna: \*  
Timerange: 01/04:49:01 to 01/04:50:00

Plot file version 238 created 20-OCT-2009 14:51:20

FAINTCAL RP015C.UVDATA.1

Freq = 1.6270 GHz, Bw = 8.000 MH No calibration applied and no bandpass applied

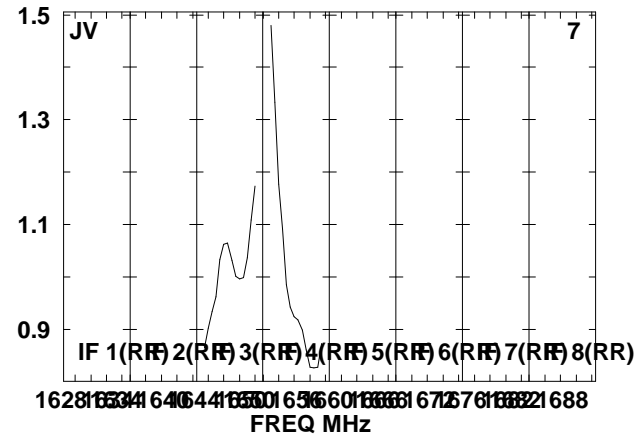
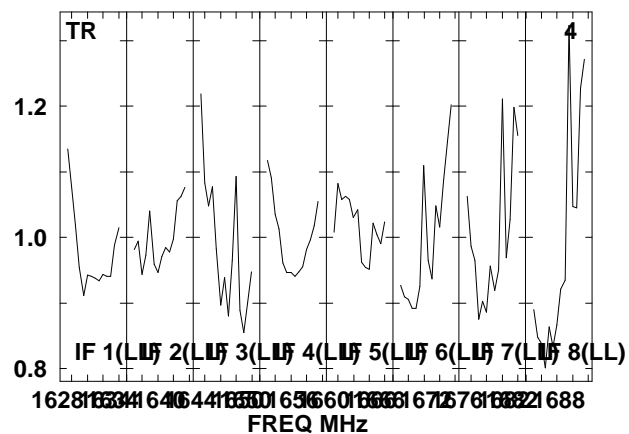
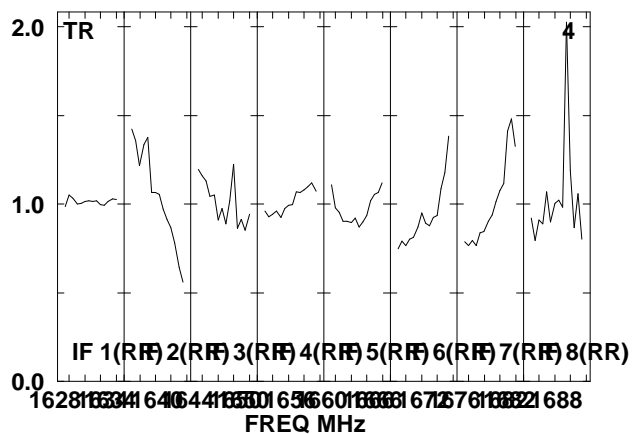
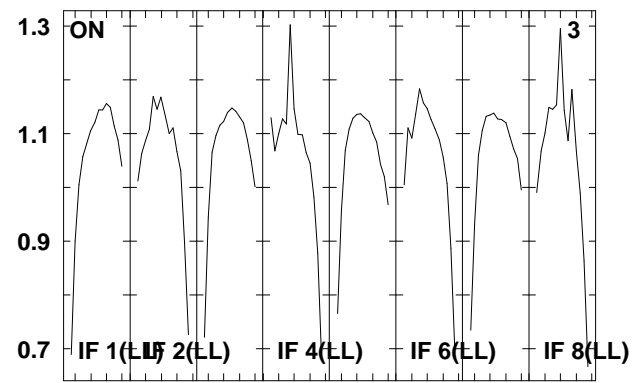
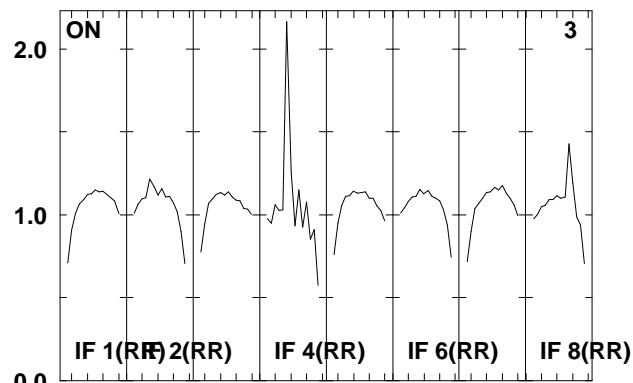
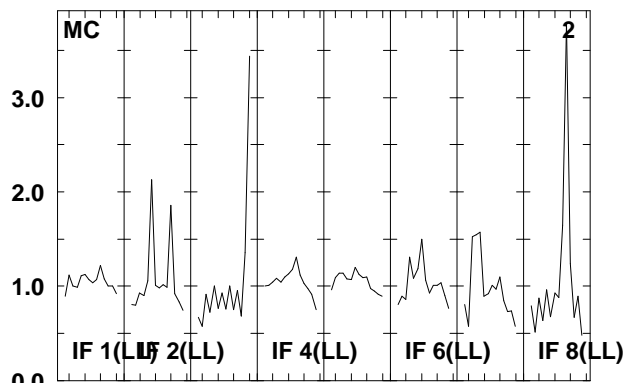
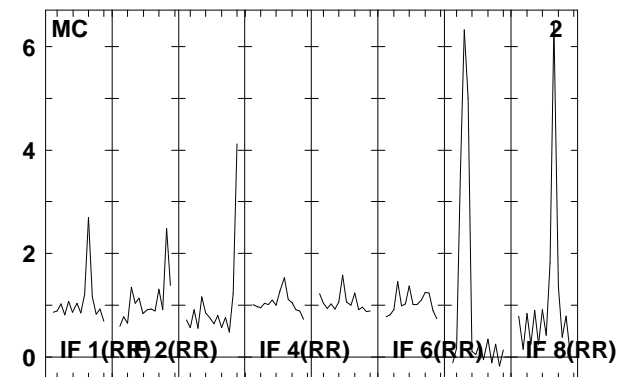
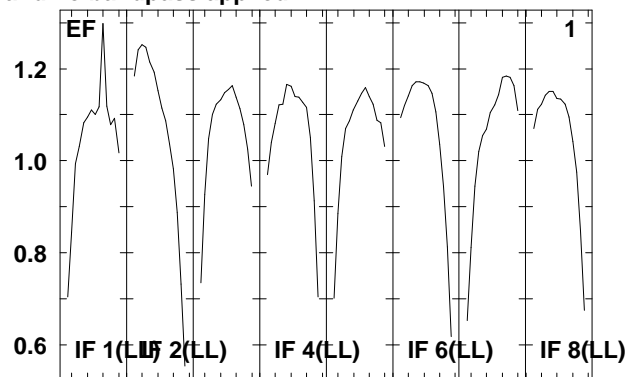
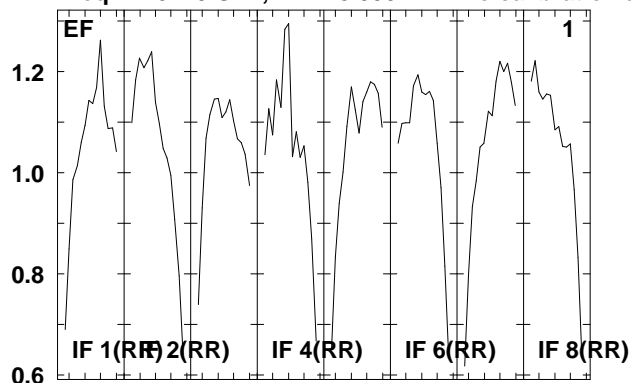

Lower frame: Real Jy  
Total-power spectrum Antenna: \*  
Timerange: 01/04:50:01 to 01/04:51:19

Plot file version 239 created 20-OCT-2009 14:51:20

FAINTCAL RP015C.UVDATA.1

Freq = 1.6270 GHz, Bw = 8.000 MH No calibration applied and no bandpass applied

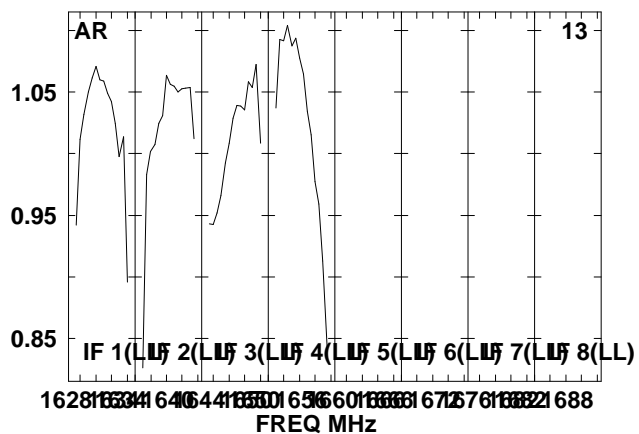
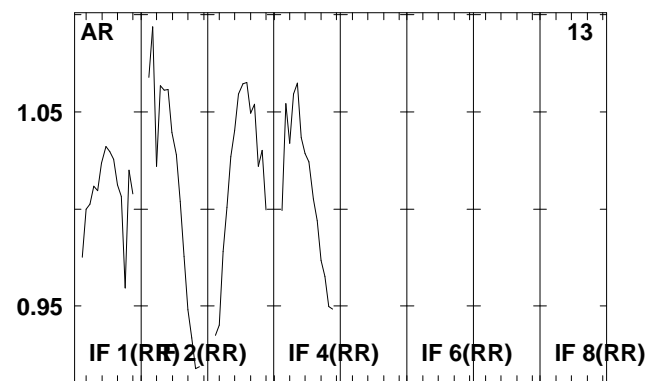
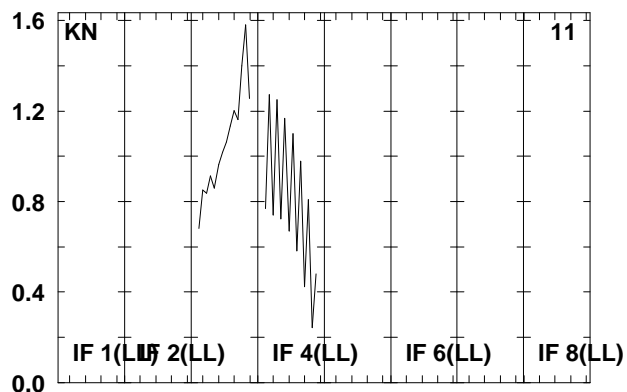
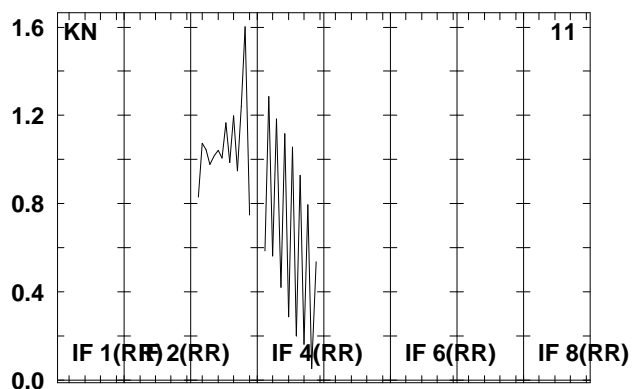
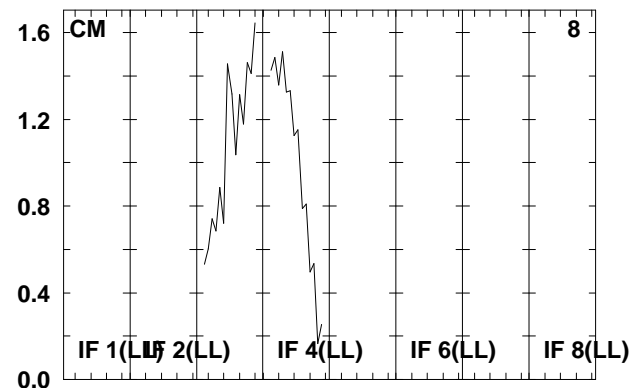
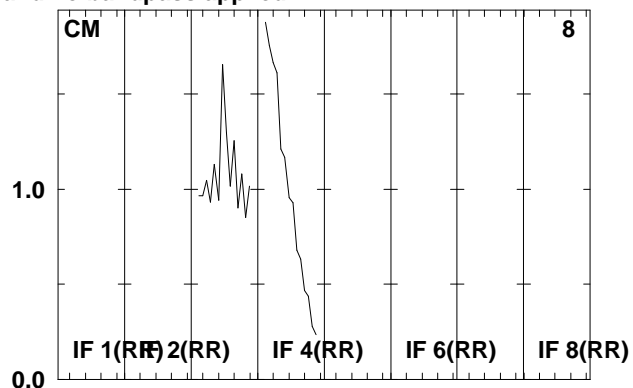
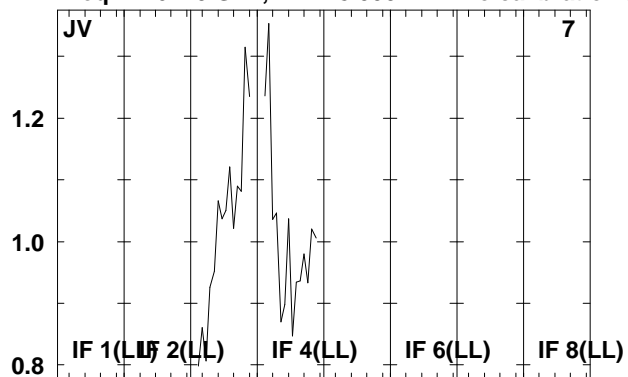

Lower frame: Real Jy

Total-power spectrum Antenna: \*

Timerange: 01/04:50:01 to 01/04:51:19

Plot file version 240 created 20-OCT-2009 14:51:21

M33 RP015C.UVDATA.1

Freq = 1.6270 GHz, Bw = 8.000 MH No calibration applied and no bandpass applied

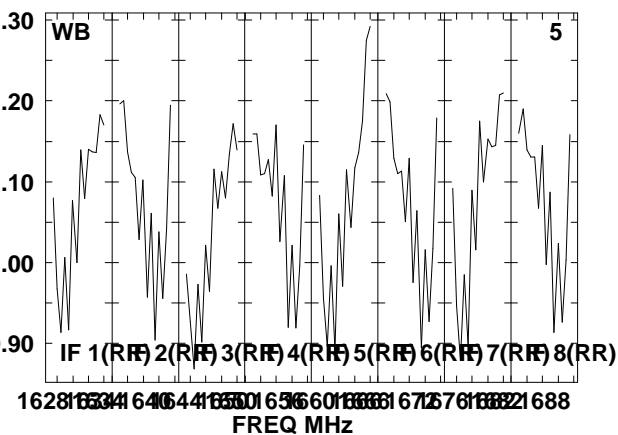
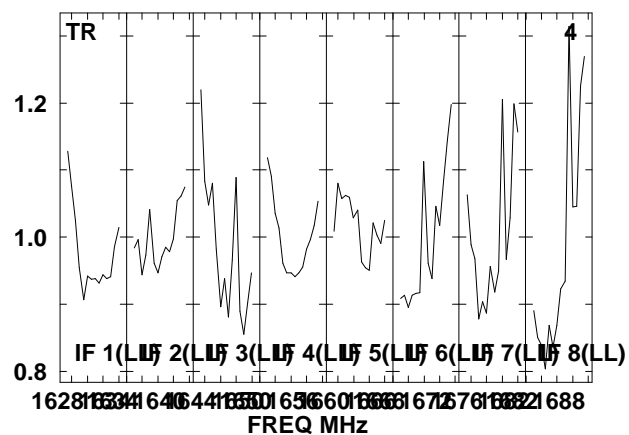
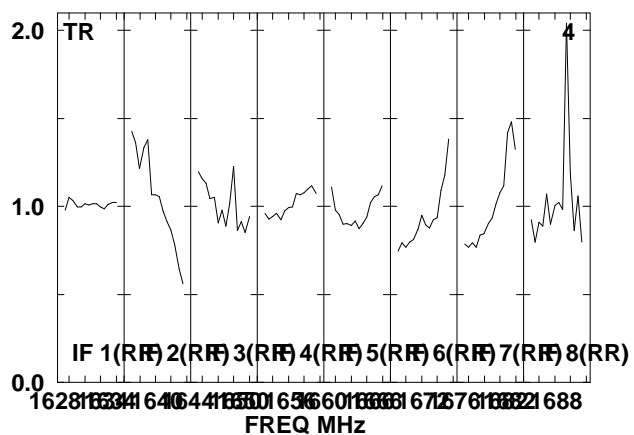
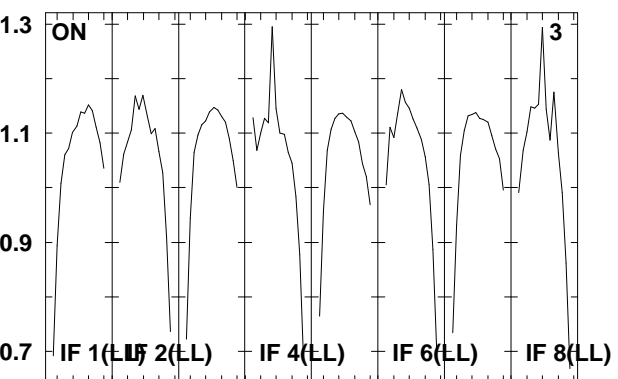
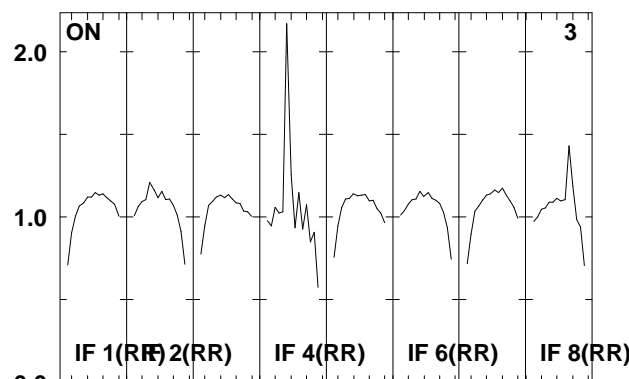
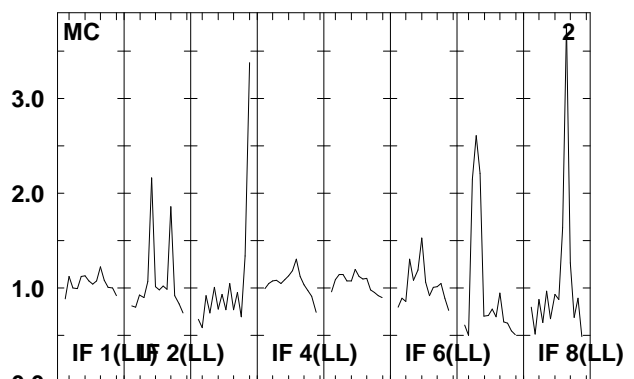
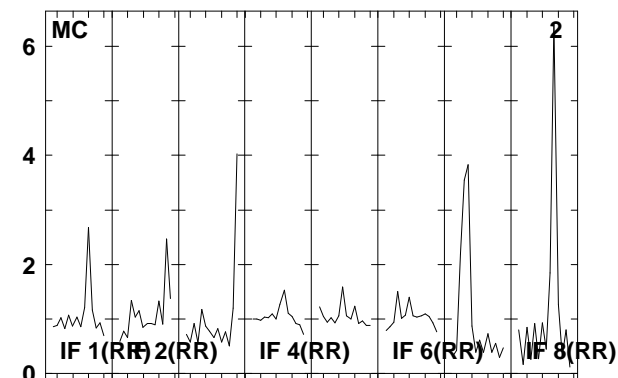
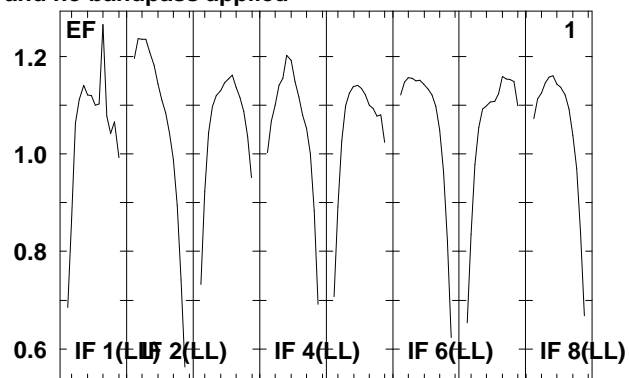
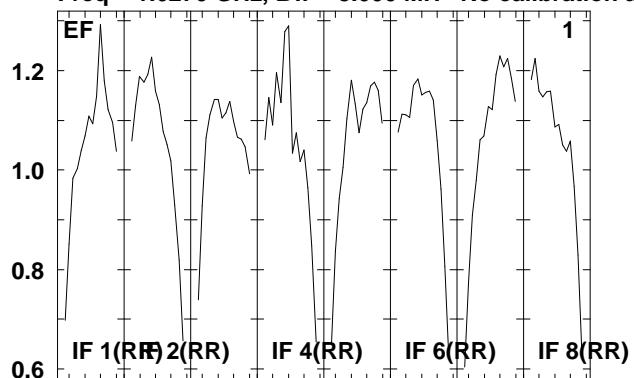

Lower frame: Real Jy

Total-power spectrum Antenna: \*

Timerange: 01/04:51:20 to 01/04:54:20



Plot file version 241 created 20-OCT-2009 14:51:22

M33 RP015C.UVDATA.1

Freq = 1.6270 GHz, Bw = 8.000 MH No calibration applied and no bandpass applied

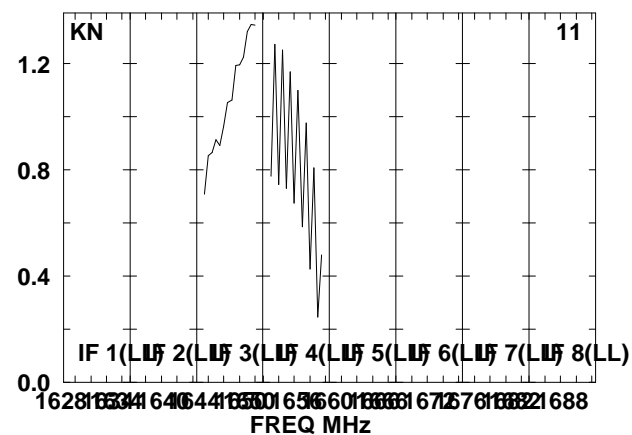
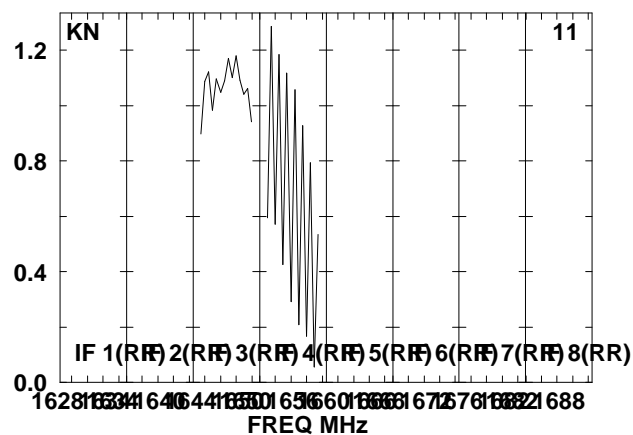
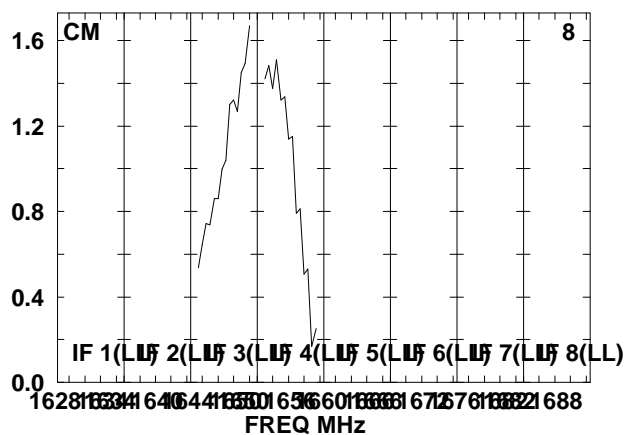
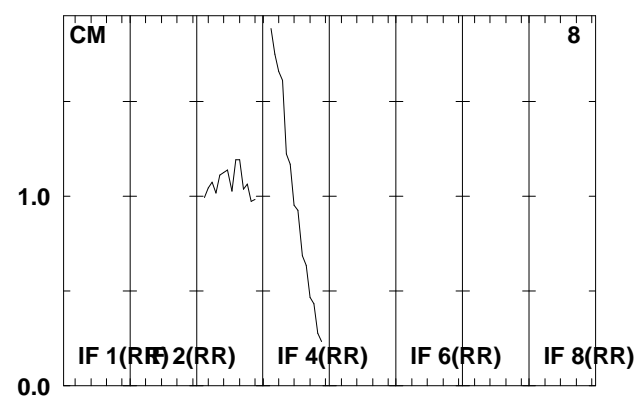
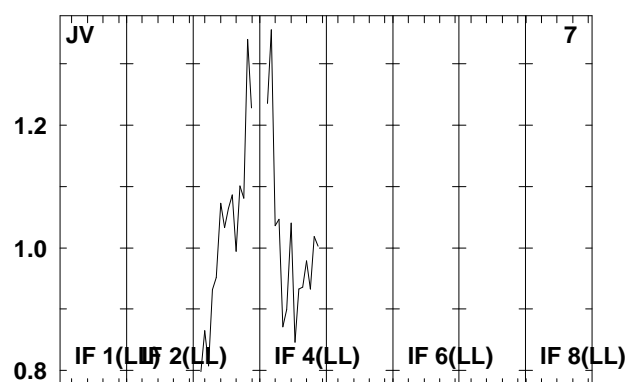
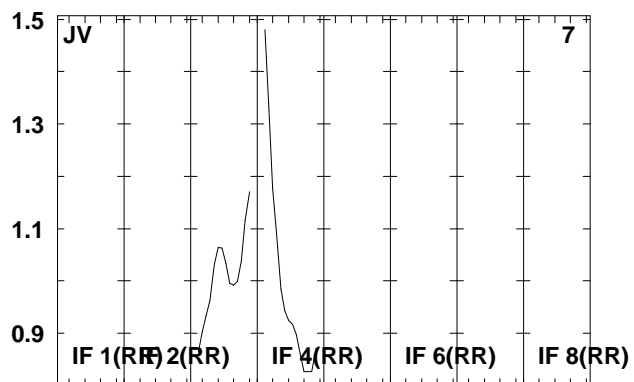
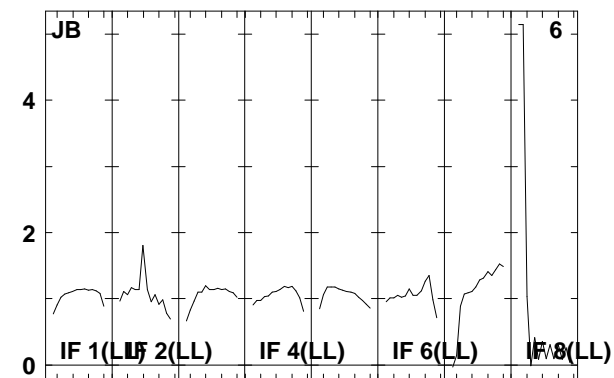
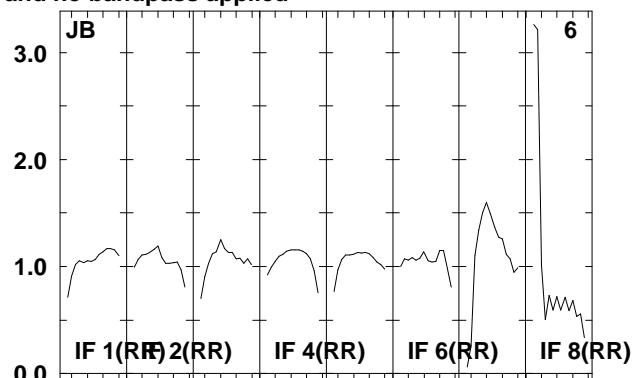
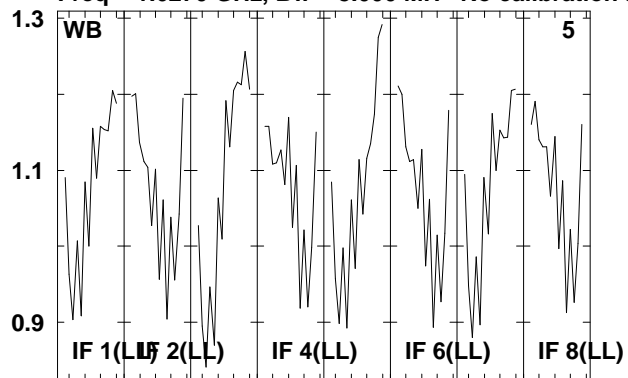

Lower frame: Real Jy

Total-power spectrum Antenna: \*

Timerange: 01/04:51:20 to 01/04:54:20

Plot file version 242 created 20-OCT-2009 14:51:24

M33 RP015C.UVDATA.1

Freq = 1.6270 GHz, Bw = 8.000 MH No calibration applied and no bandpass applied

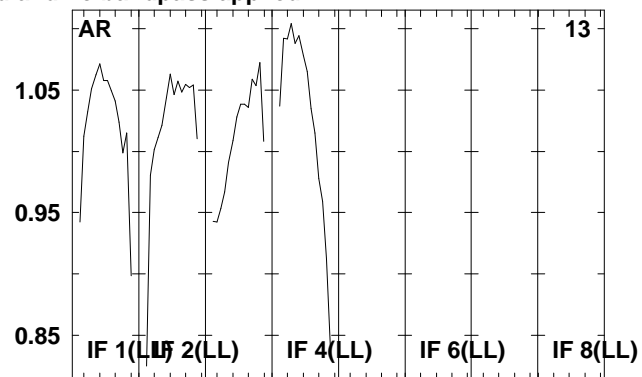
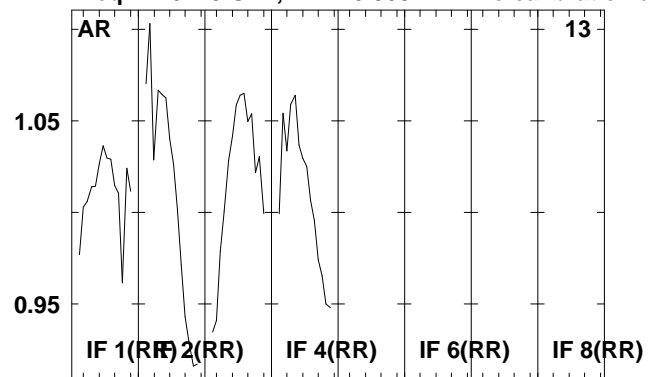

Lower frame: Real Jy  
Total-power spectrum Antenna: \*  
Timerange: 01/04:51:20 to 01/04:54:20

Plot file version 243 created 20-OCT-2009 14:51:24

J0137+31 RP015C.UVDATA.1

Freq = 1.6270 GHz, Bw = 8.000 MH No calibration applied and no bandpass applied

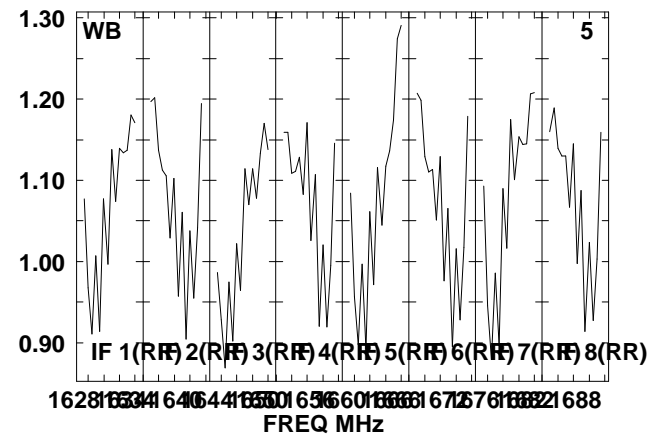
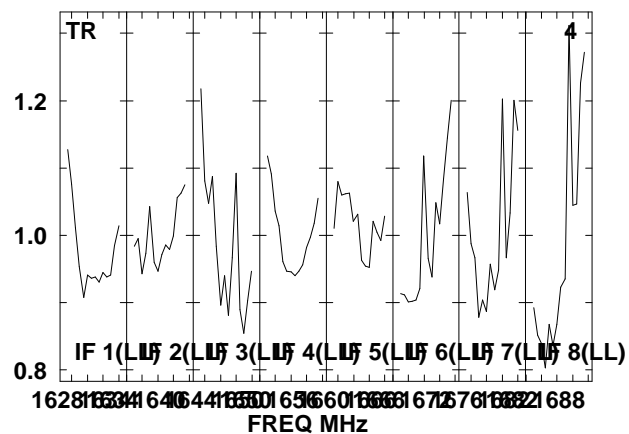
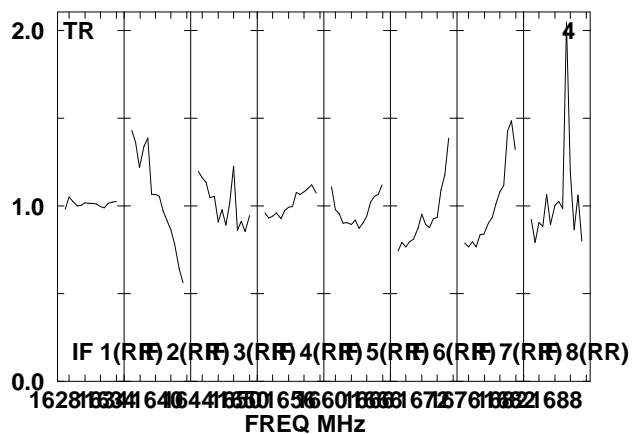
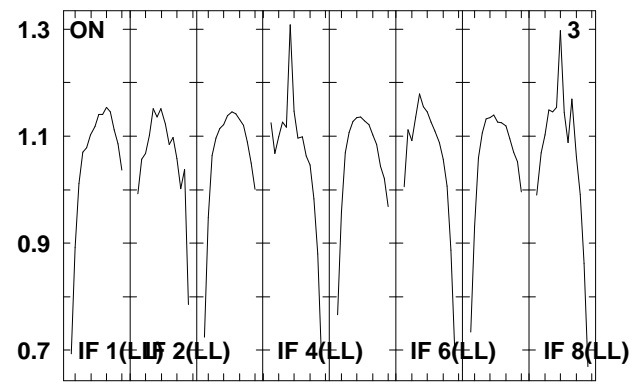
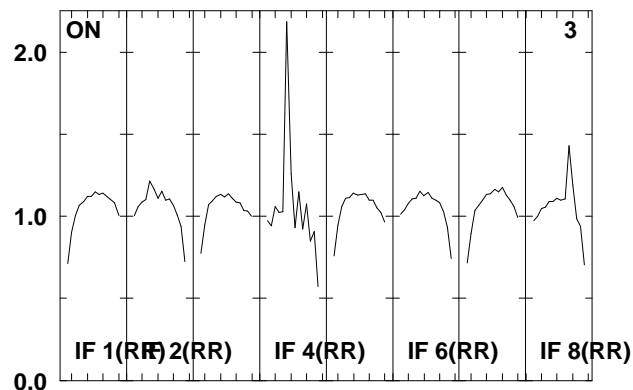
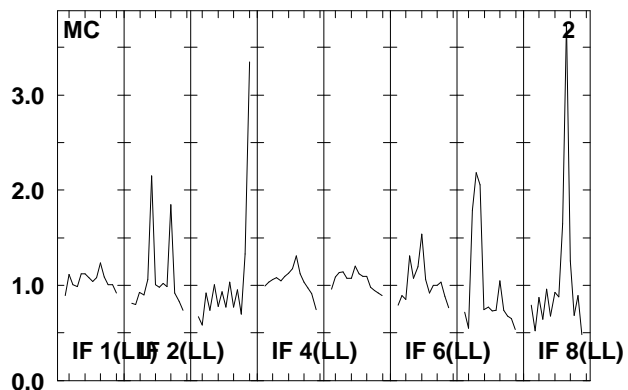
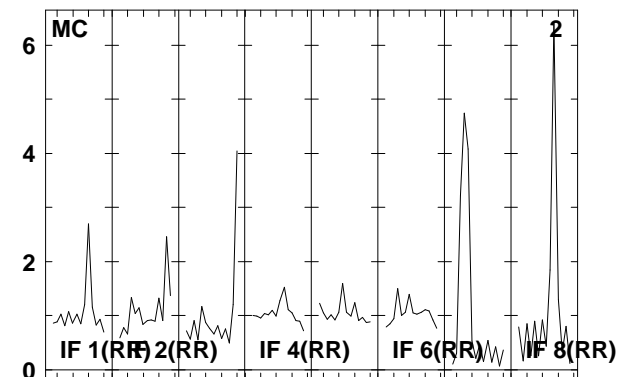
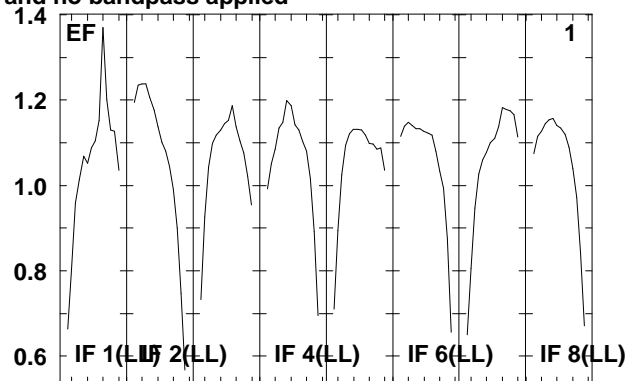
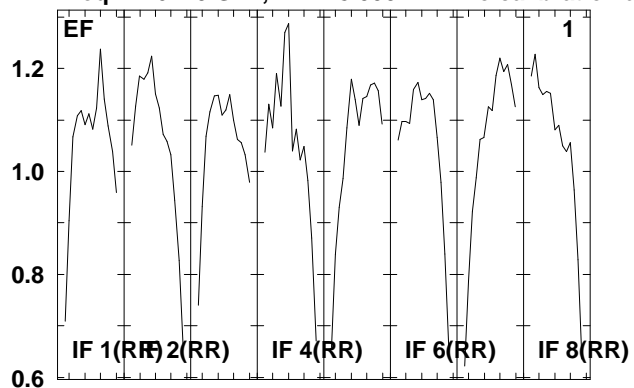

Lower frame: Real Jy

Total-power spectrum Antenna: \*

Timerange: 01/04:55:00 to 01/04:55:59

Plot file version 244 created 20-OCT-2009 14:51:24

J0137+31 RP015C.UVDATA.1

Freq = 1.6270 GHz, Bw = 8.000 MH No calibration applied and no bandpass applied

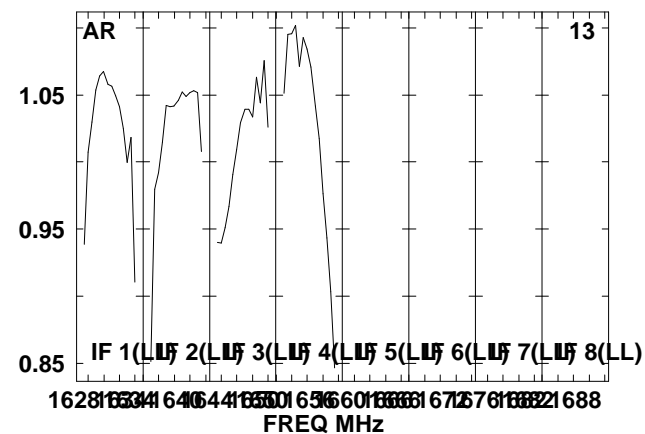
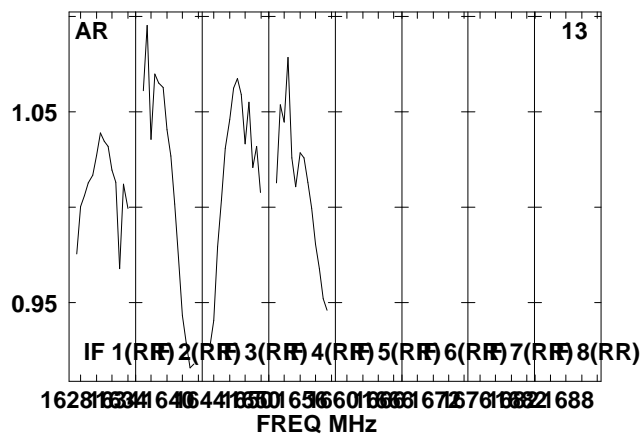
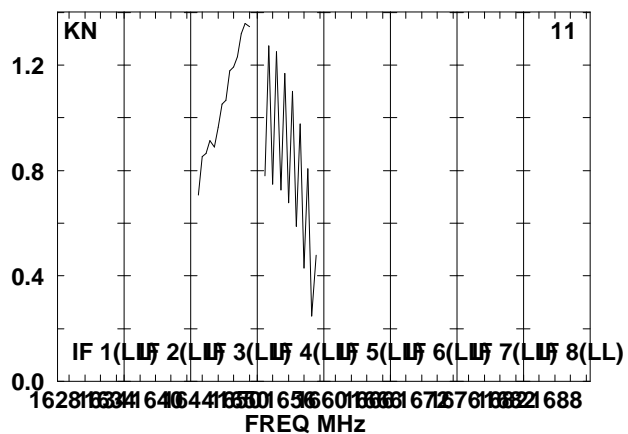
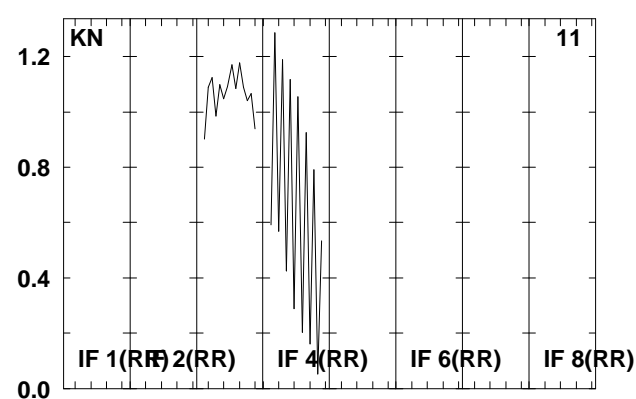
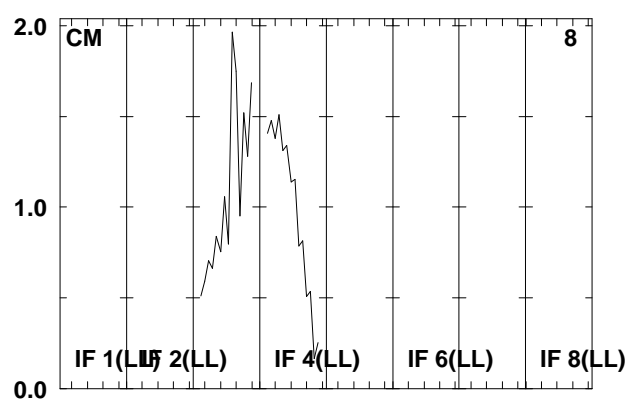
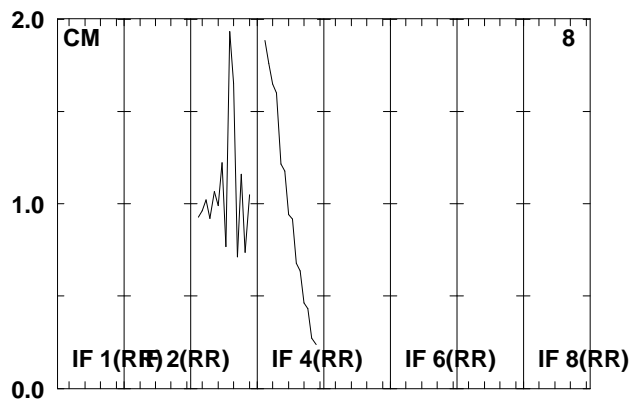
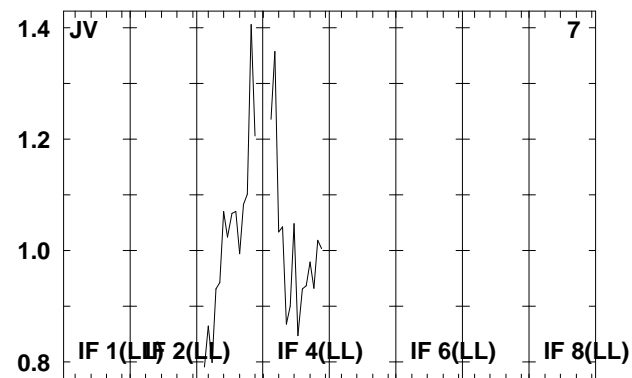
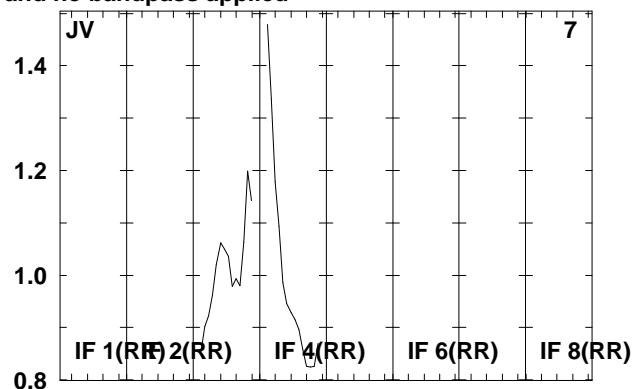
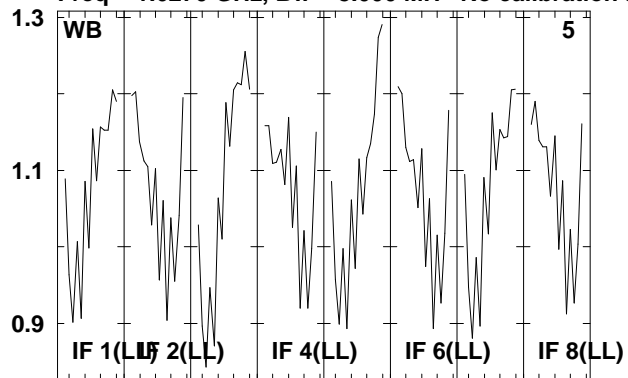

Lower frame: Real Jy  
Total-power spectrum Antenna: \*  
Timerange: 01/04:55:00 to 01/04:55:59

Plot file version 245 created 20-OCT-2009 14:51:25

FAINTCAL RP015C.UVDATA.1

Freq = 1.6270 GHz, Bw = 8.000 MH No calibration applied and no bandpass applied

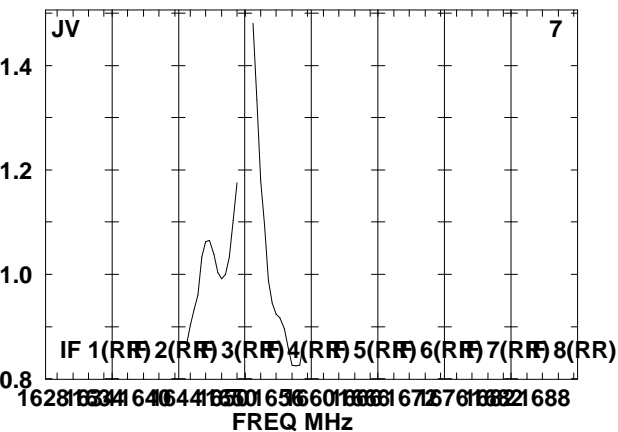
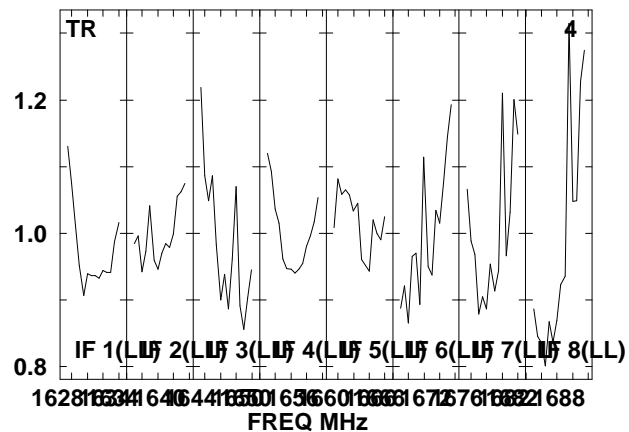
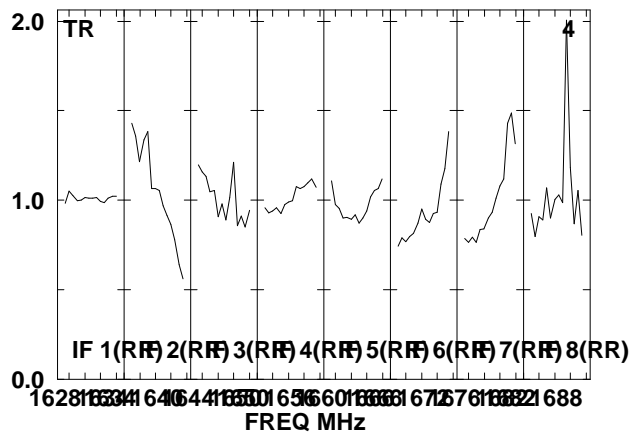
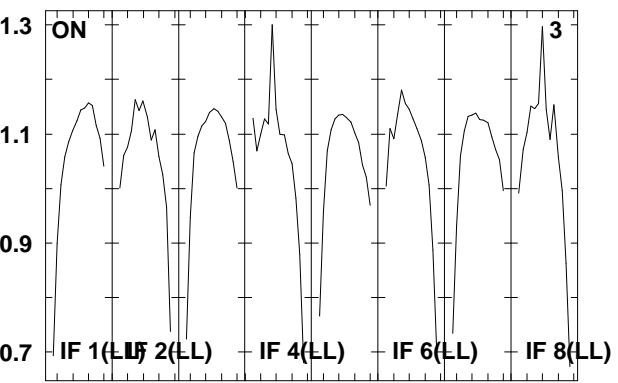
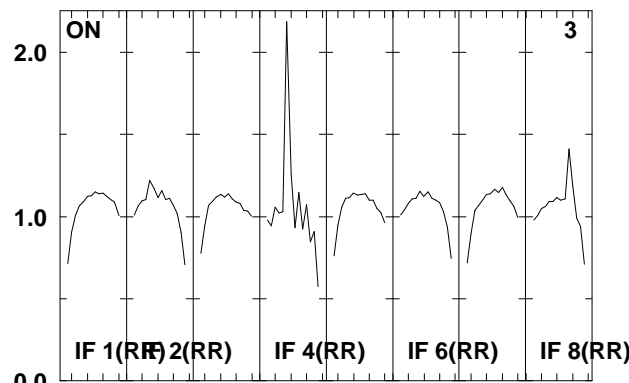
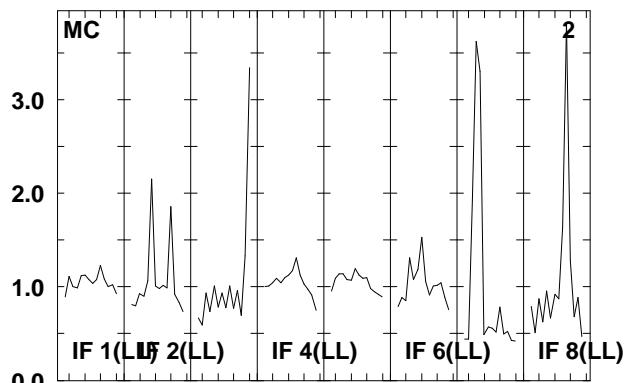
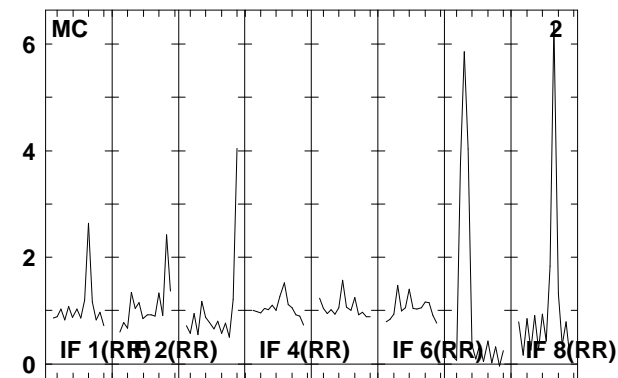
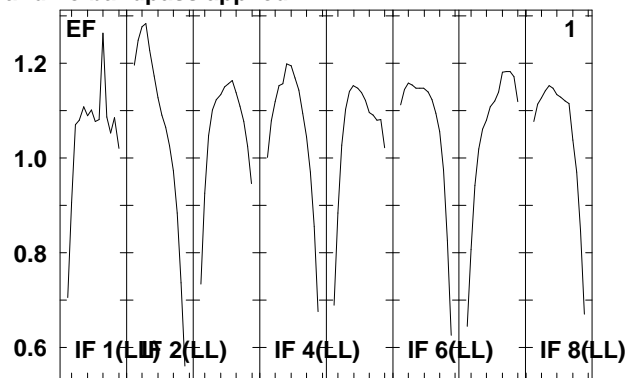
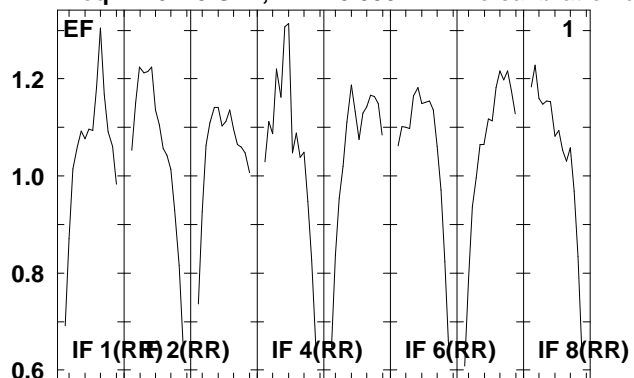

Lower frame: Real Jy  
Total-power spectrum Antenna: \*  
Timerange: 01/04:56:01 to 01/04:57:20

Plot file version 246 created 20-OCT-2009 14:51:25

FAINTCAL RP015C.UVDATA.1

Freq = 1.6270 GHz, Bw = 8.000 MH No calibration applied and no bandpass applied

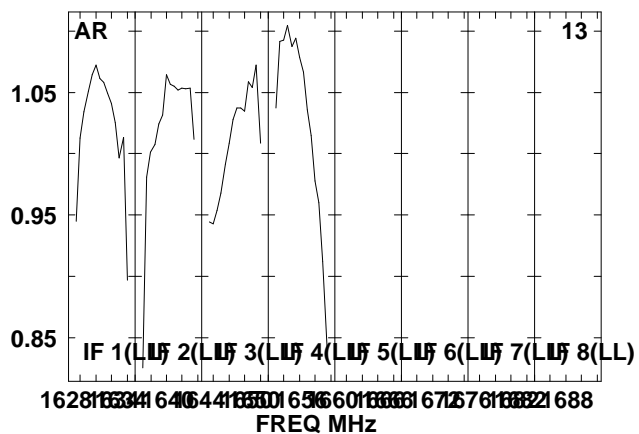
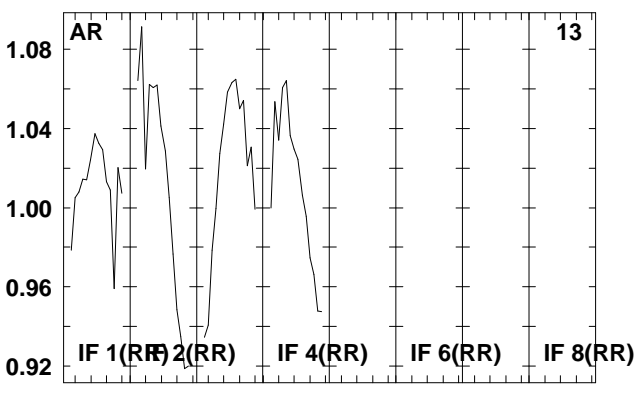
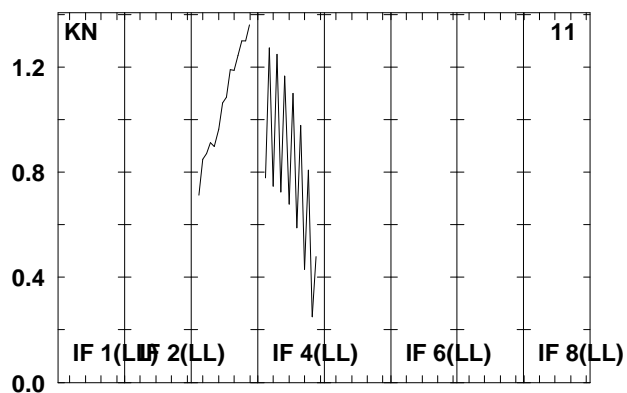
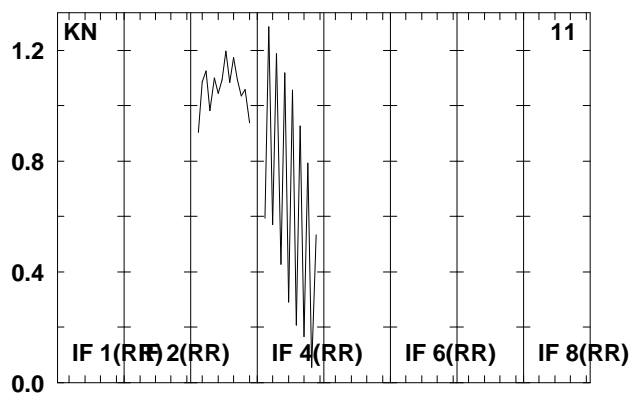
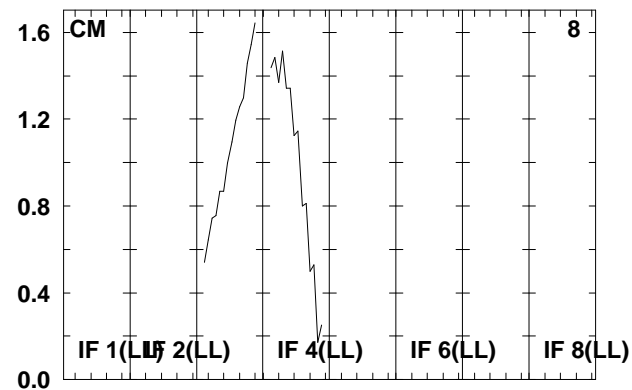
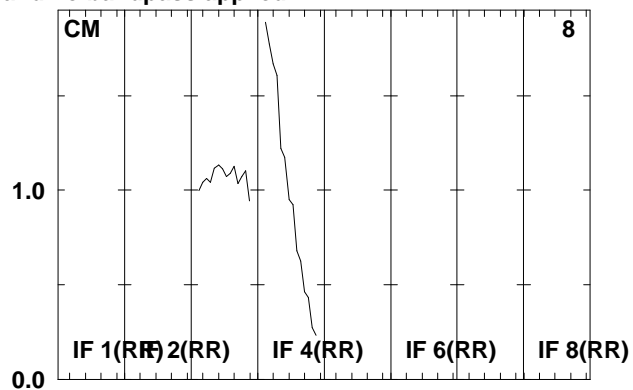
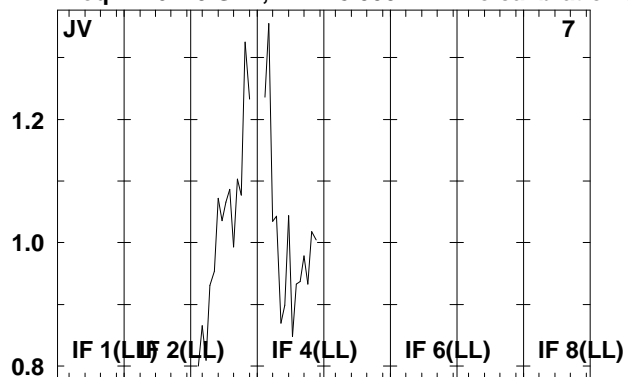

Lower frame: Real Jy

Total-power spectrum Antenna: \*

Timerange: 01/04:56:01 to 01/04:57:20

Plot file version 247 created 20-OCT-2009 14:51:26

M33 RP015C.UVDATA.1

Freq = 1.6270 GHz, Bw = 8.000 MH No calibration applied and no bandpass applied

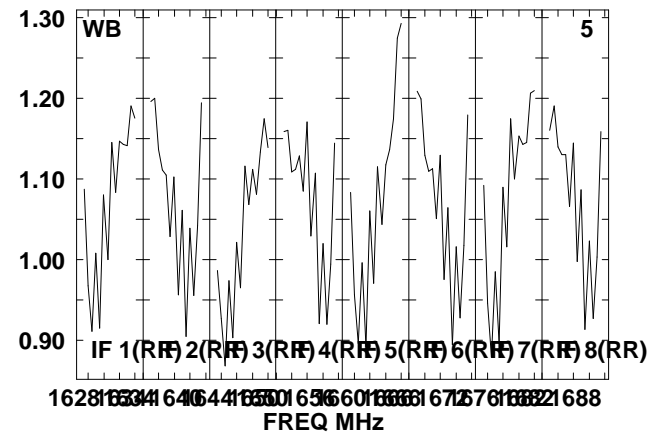
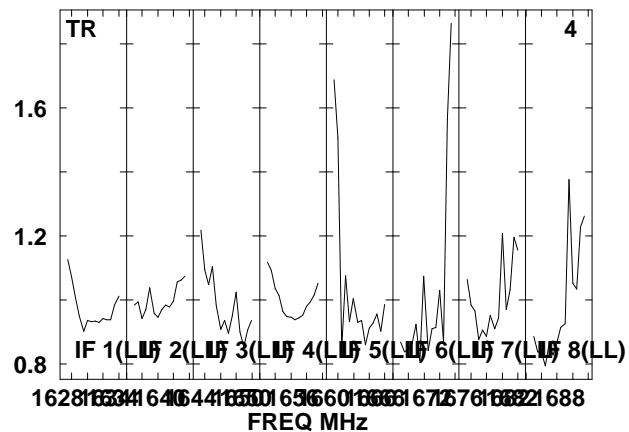
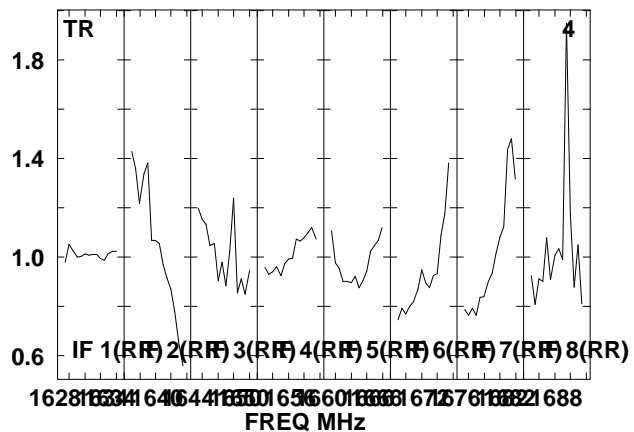
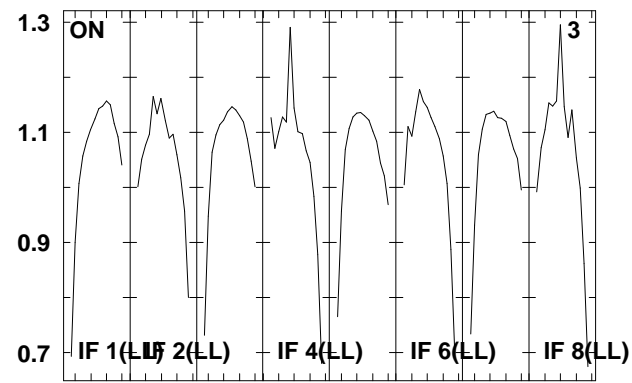
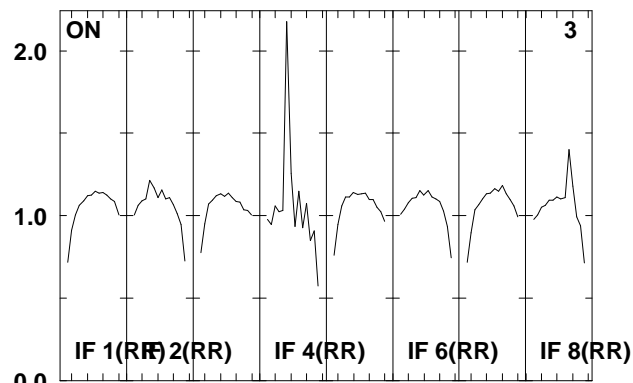
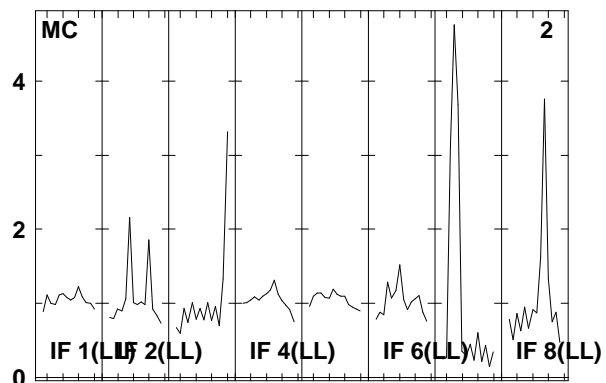
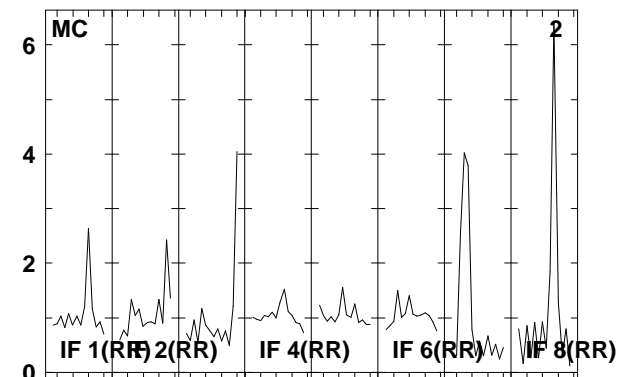
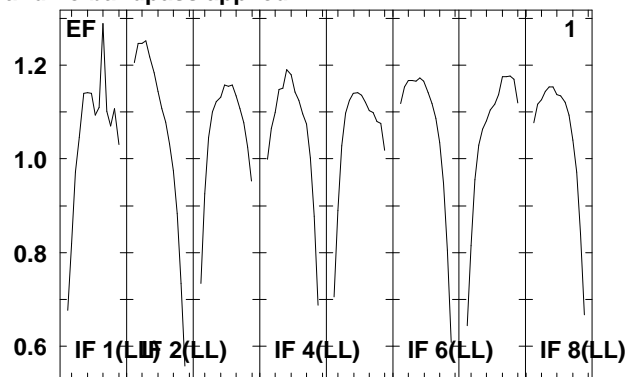
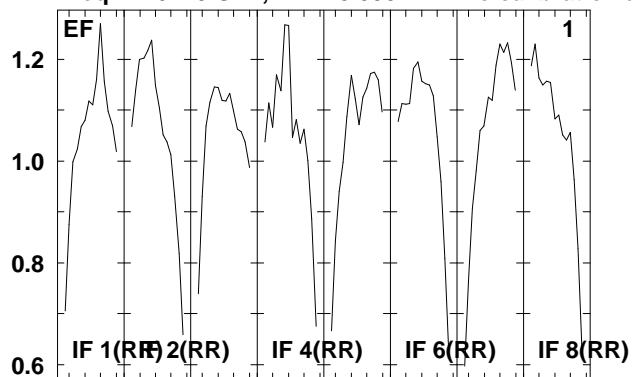

Lower frame: Real Jy

Total-power spectrum Antenna: \*

Timerange: 01/04:57:20 to 01/05:00:20

Plot file version 248 created 20-OCT-2009 14:51:27

M33 RP015C.UVDATA.1

Freq = 1.6270 GHz, Bw = 8.000 MH No calibration applied and no bandpass applied

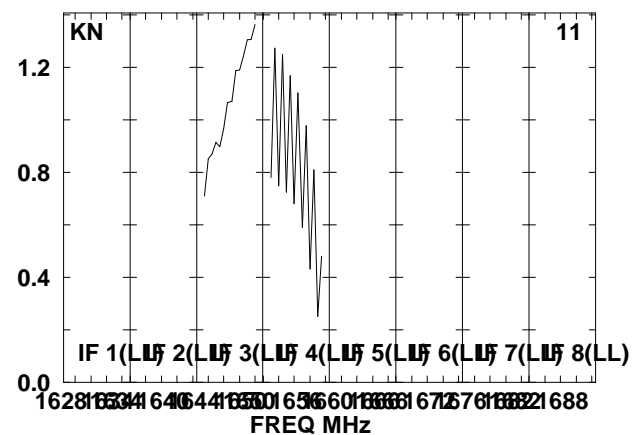
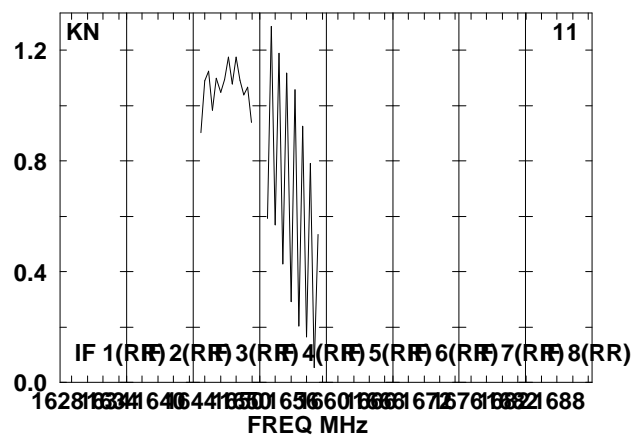
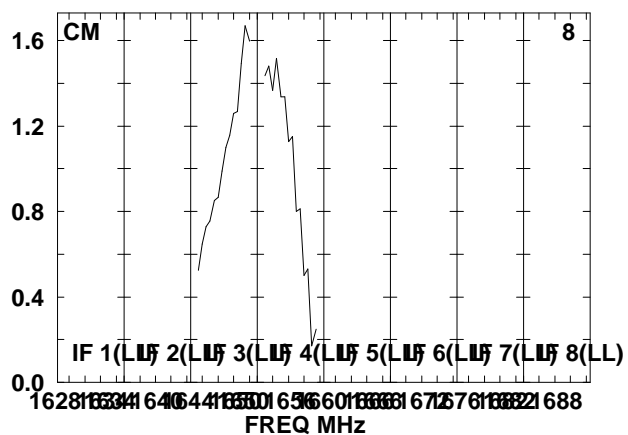
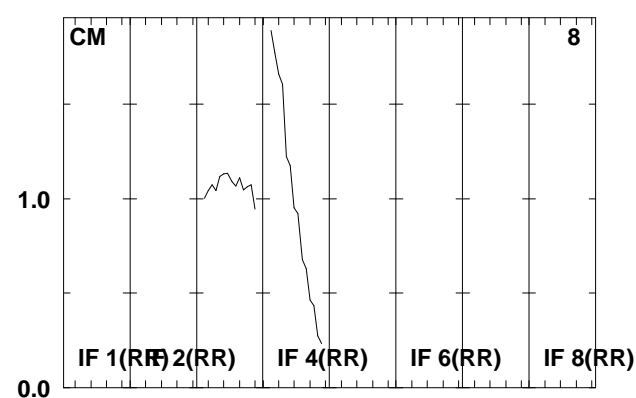
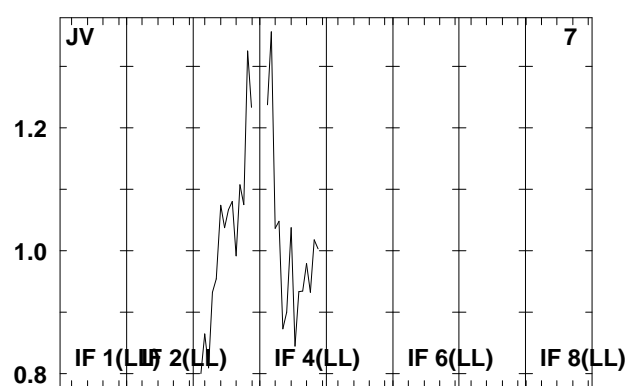
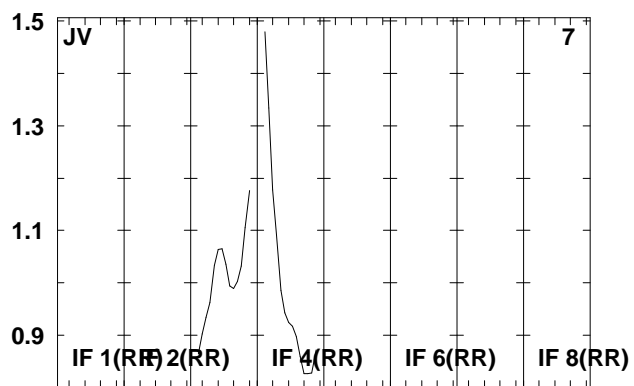
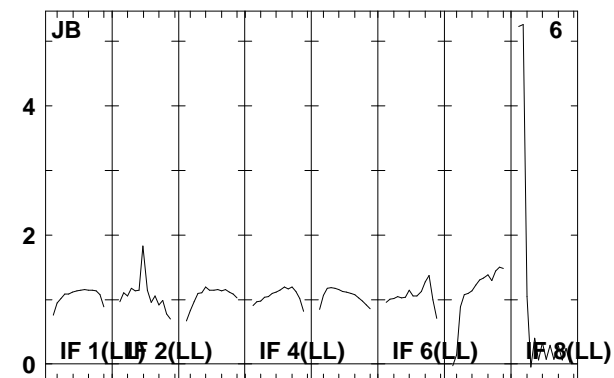
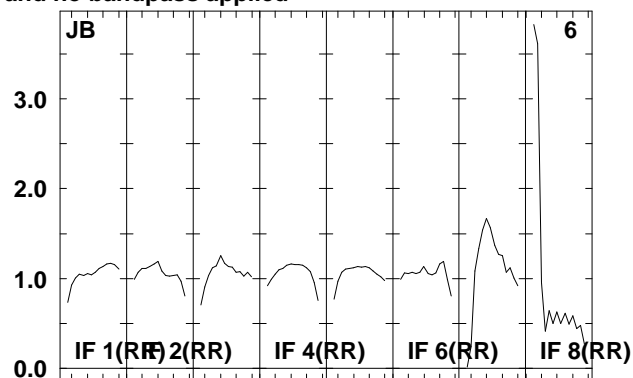
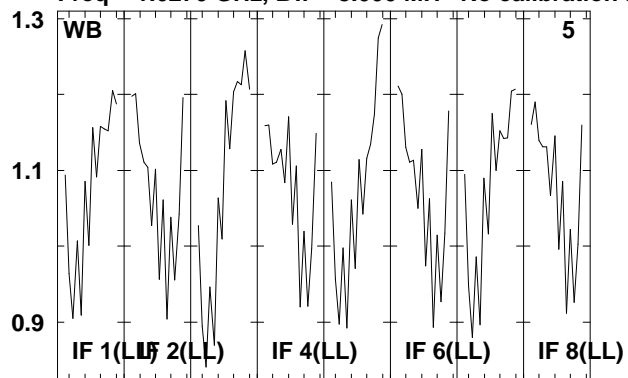

Lower frame: Real Jy  
Total-power spectrum Antenna: \*  
Timerange: 01/04:57:20 to 01/05:00:20



Plot file version 249 created 20-OCT-2009 14:51:29

M33 RP015C.UVDATA.1

Freq = 1.6270 GHz, Bw = 8.000 MH No calibration applied and no bandpass applied

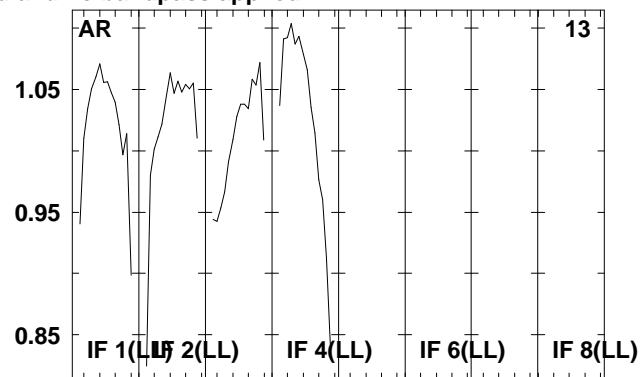
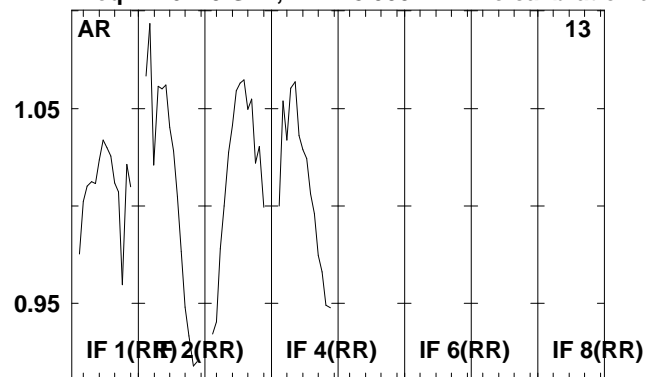

Lower frame: Real Jy  
Total-power spectrum Antenna: \*  
Timerange: 01/04:57:20 to 01/05:00:20

Plot file version 250 created 20-OCT-2009 14:51:29

J0137+31 RP015C.UVDATA.1

Freq = 1.6270 GHz, Bw = 8.000 MH No calibration applied and no bandpass applied

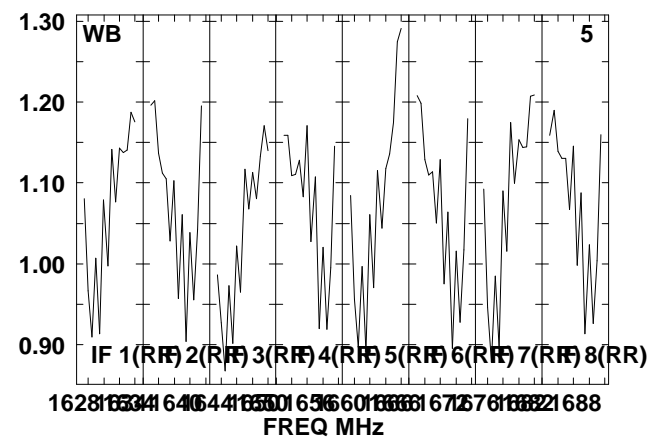
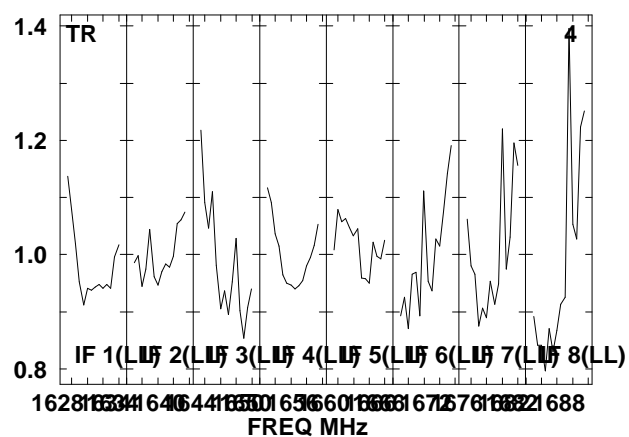
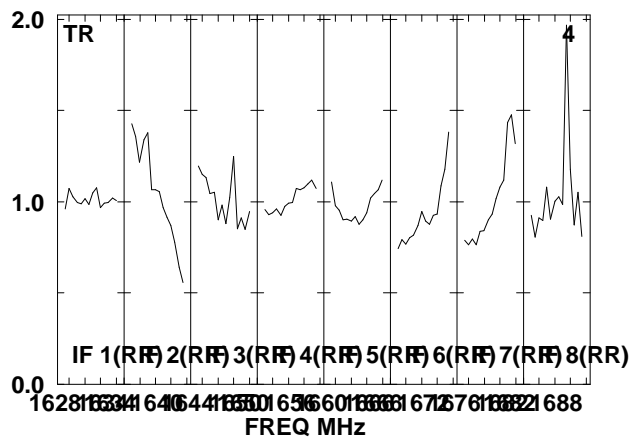
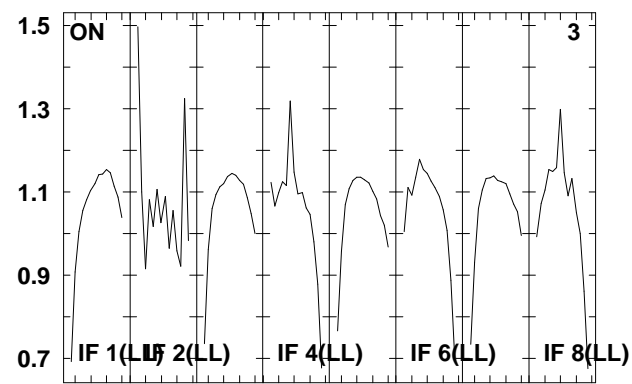
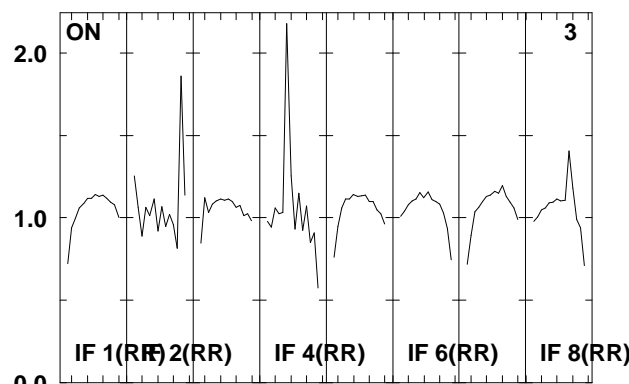
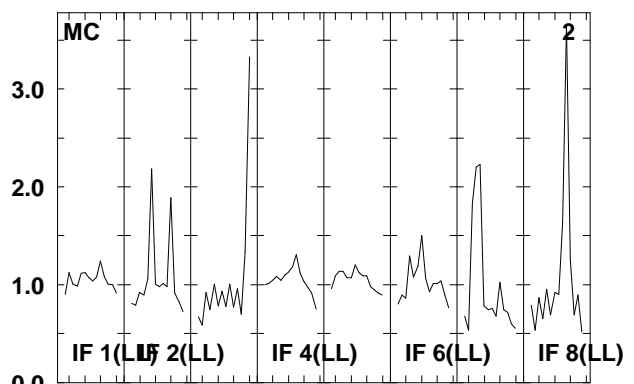
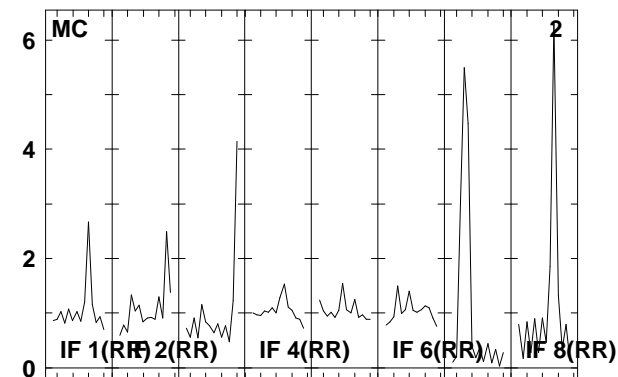
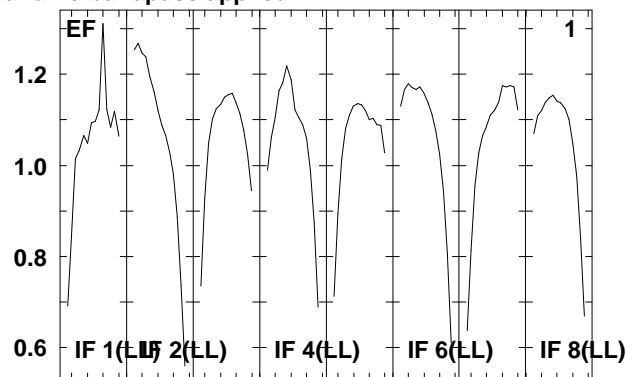
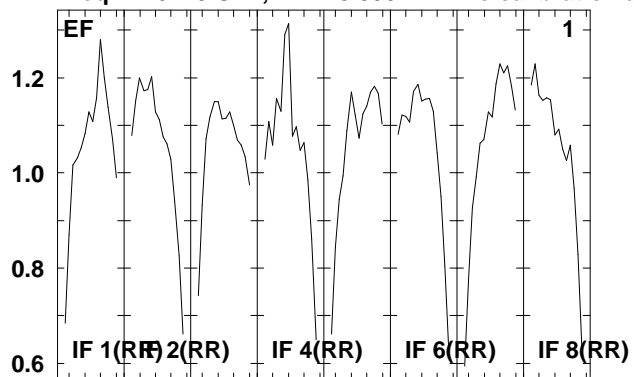

Lower frame: Real Jy

Total-power spectrum Antenna: \*

Timerange: 01/05:01:01 to 01/05:02:00

Plot file version 251 created 20-OCT-2009 14:51:29

J0137+31 RP015C.UVDATA.1

Freq = 1.6270 GHz, Bw = 8.000 MH No calibration applied and no bandpass applied

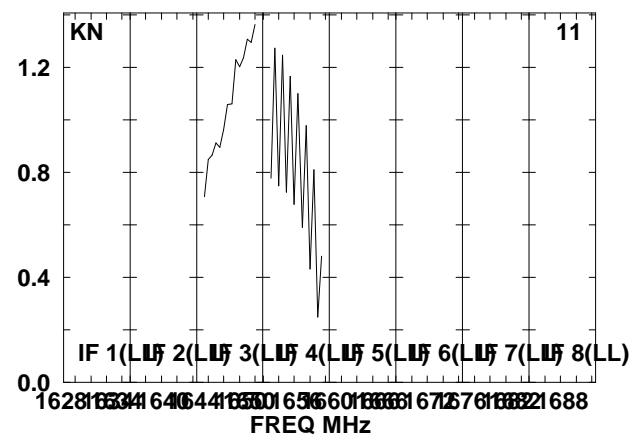
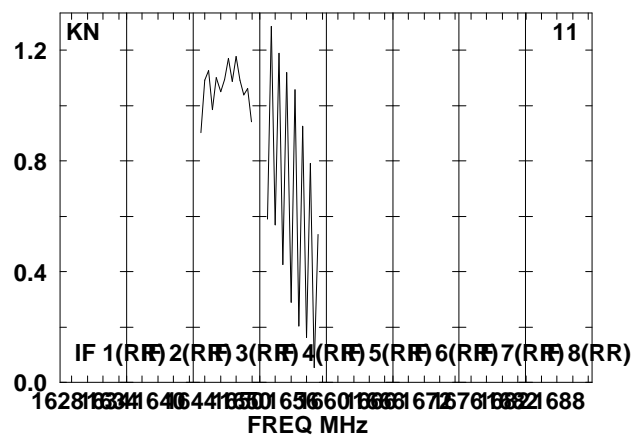
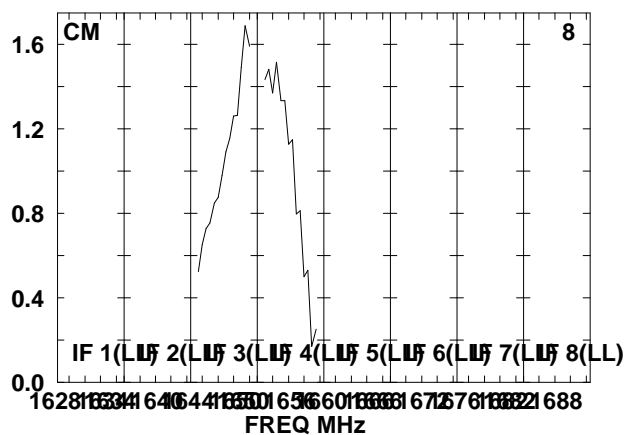
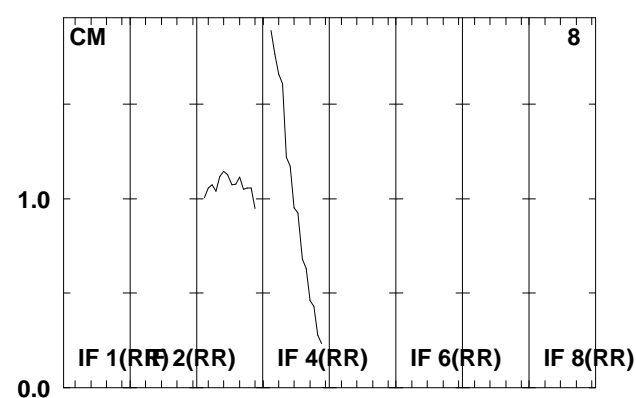
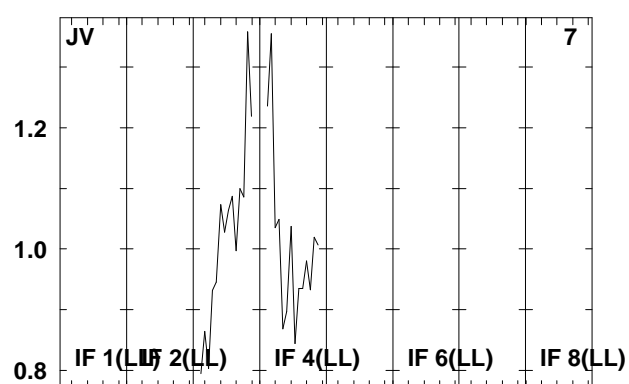
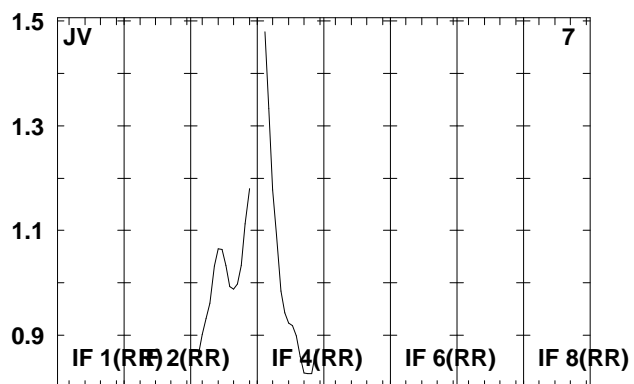
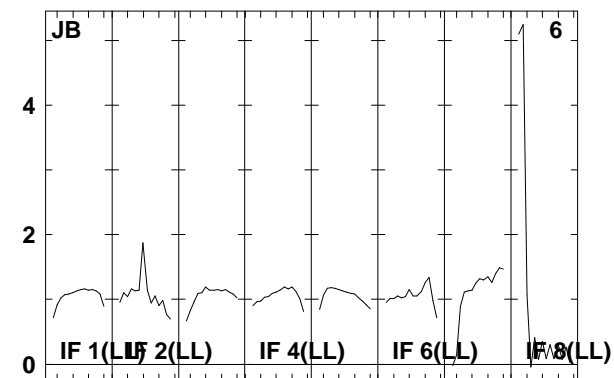
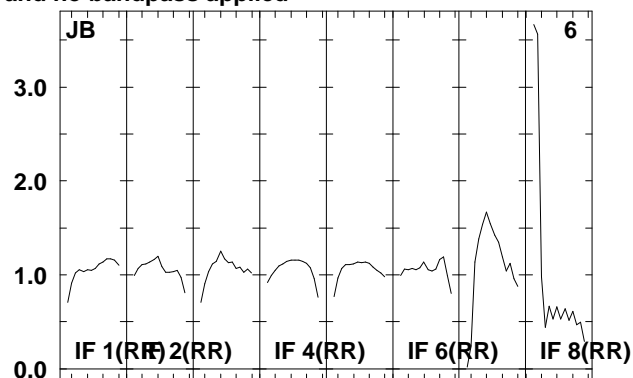
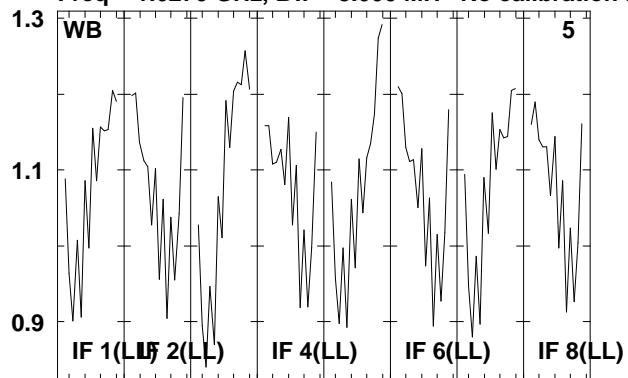

Lower frame: Real Jy  
Total-power spectrum Antenna: \*  
Timerange: 01/05:01:01 to 01/05:02:00

Plot file version 252 created 20-OCT-2009 14:51:30

J0137+31 RP015C.UVDATA.1

Freq = 1.6270 GHz, Bw = 8.000 MH No calibration applied and no bandpass applied

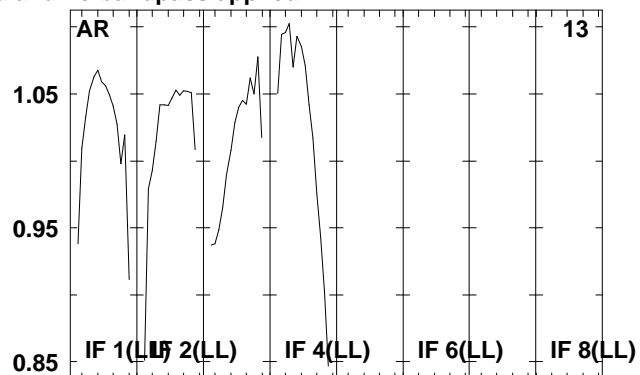
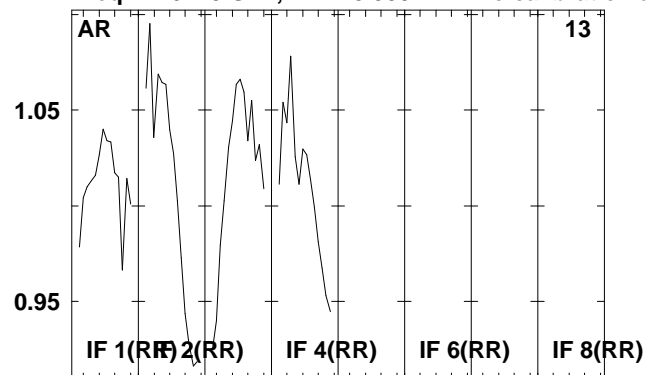

Lower frame: Real Jy  
Total-power spectrum Antenna: \*  
Timerange: 01/05:01:01 to 01/05:02:00

Plot file version 253 created 20-OCT-2009 14:51:30

FAINTCAL RP015C.UVDATA.1

Freq = 1.6270 GHz, Bw = 8.000 MH No calibration applied and no bandpass applied

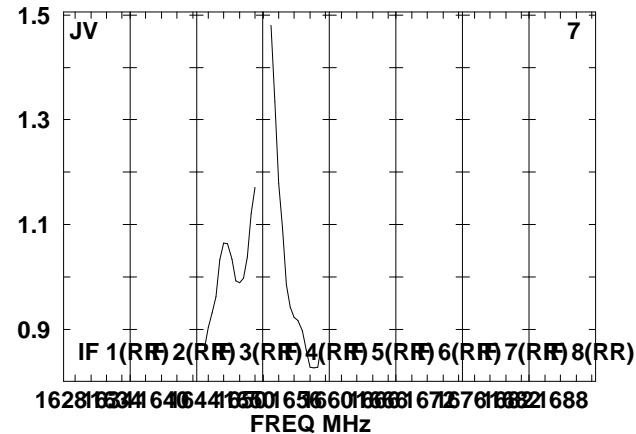
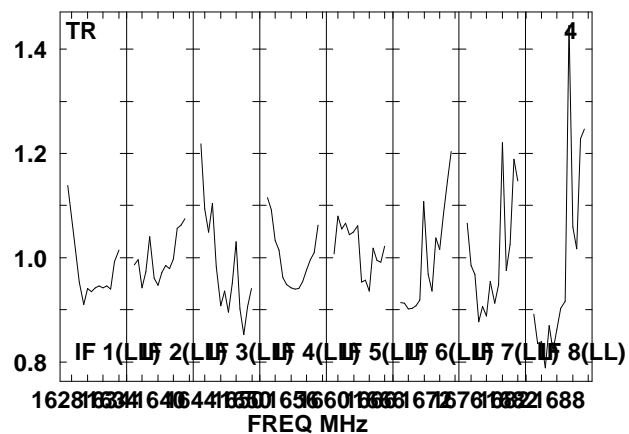
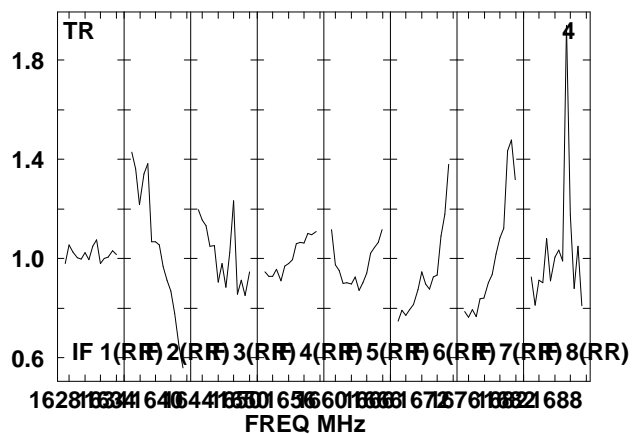
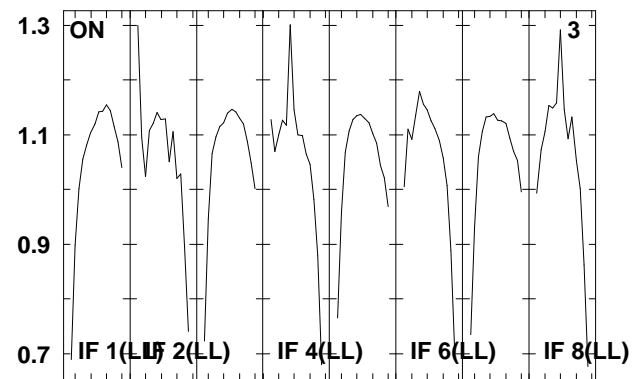
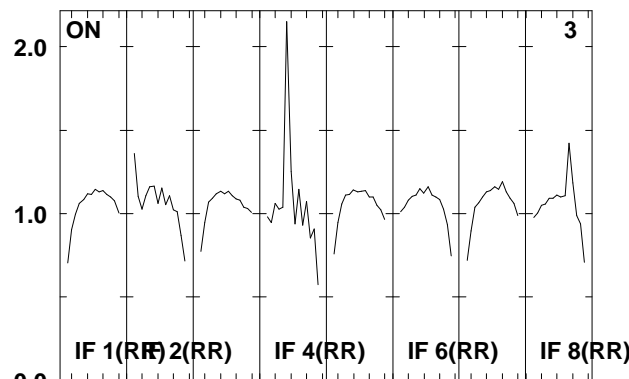
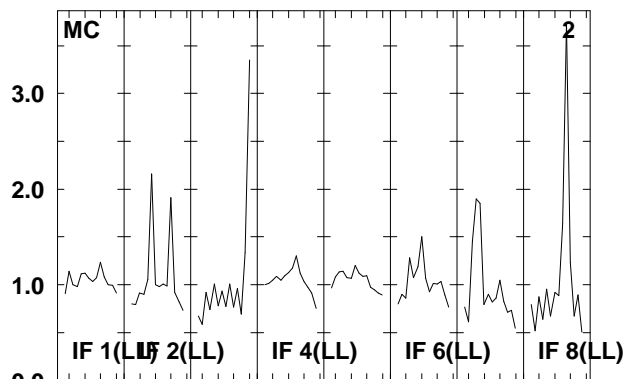
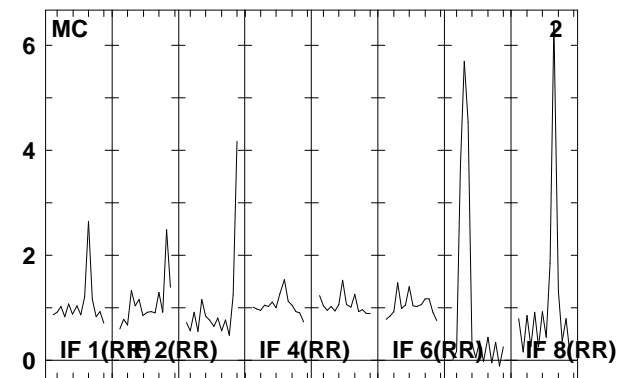
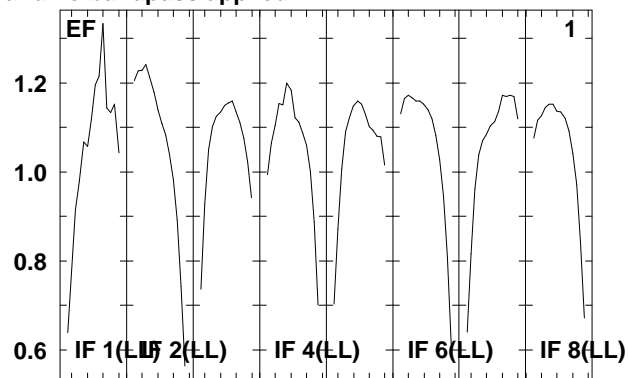
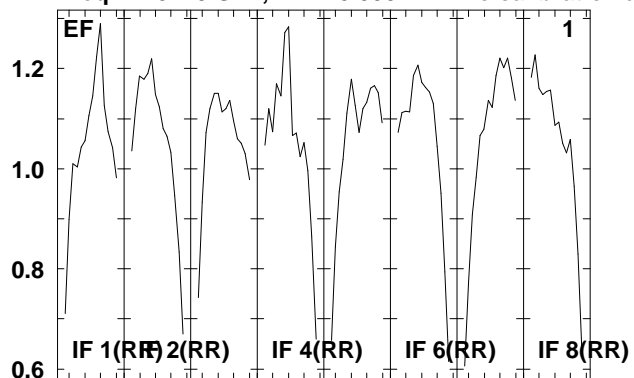

Lower frame: Real Jy  
Total-power spectrum Antenna: \*  
Timerange: 01/05:02:00 to 01/05:03:19

Plot file version 254 created 20-OCT-2009 14:51:30

FAINTCAL RP015C.UVDATA.1

Freq = 1.6270 GHz, Bw = 8.000 MH No calibration applied and no bandpass applied

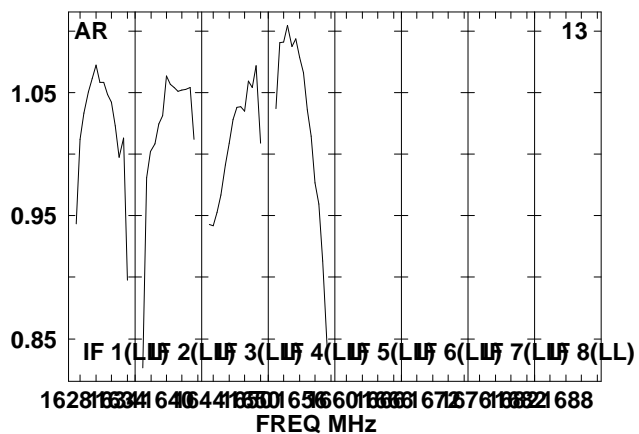
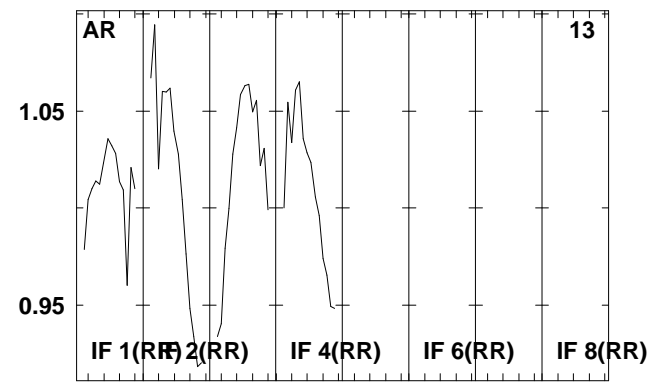
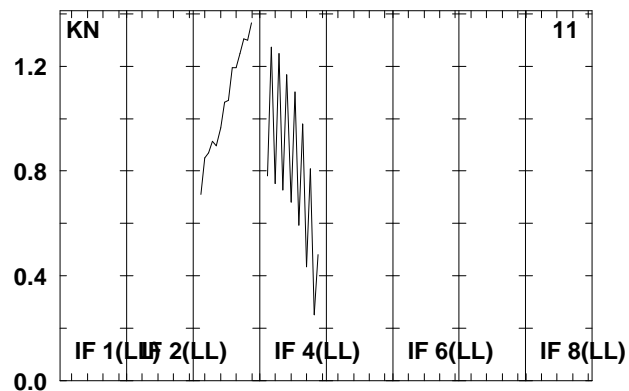
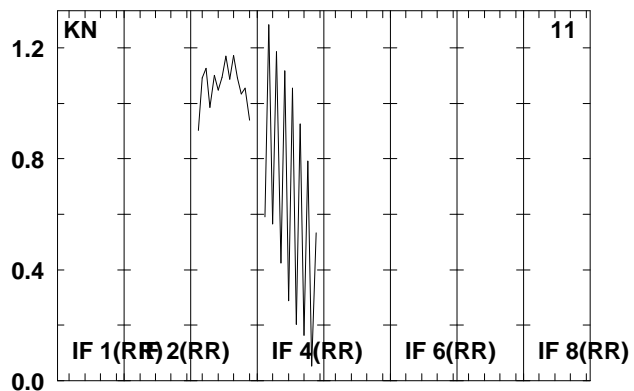
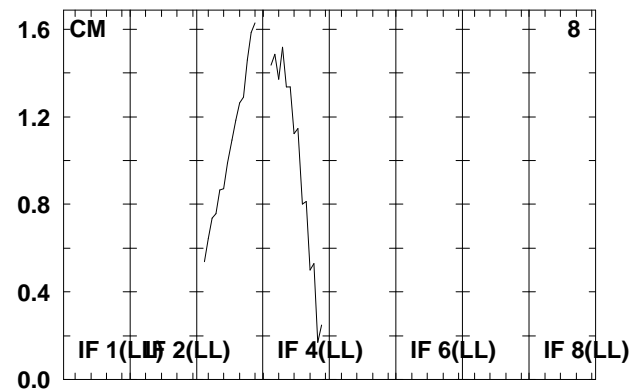
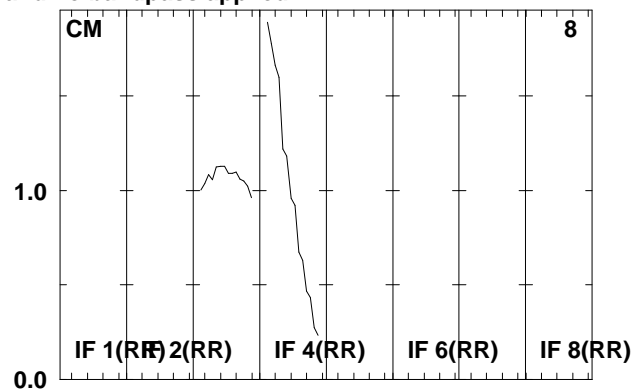
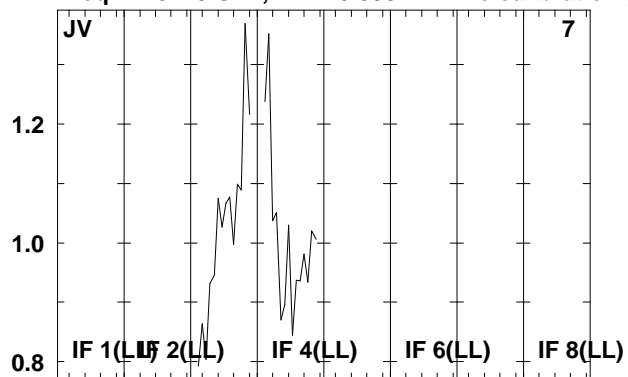

Lower frame: Real Jy

Total-power spectrum Antenna: \*

Timerange: 01/05:02:00 to 01/05:03:19

Plot file version 255 created 20-OCT-2009 14:51:31

M33 RP015C.UVDATA.1

Freq = 1.6270 GHz, Bw = 8.000 MH No calibration applied and no bandpass applied

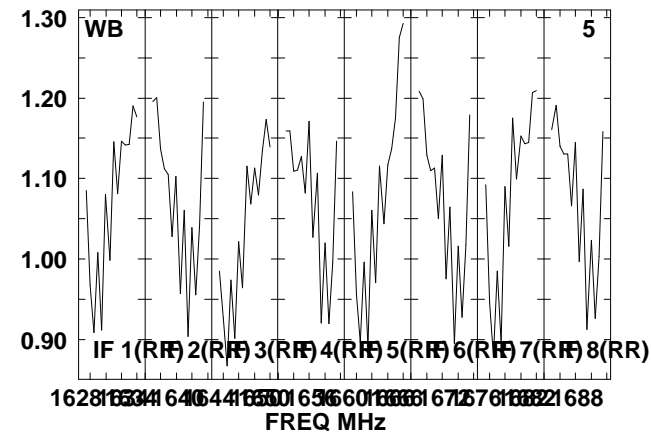
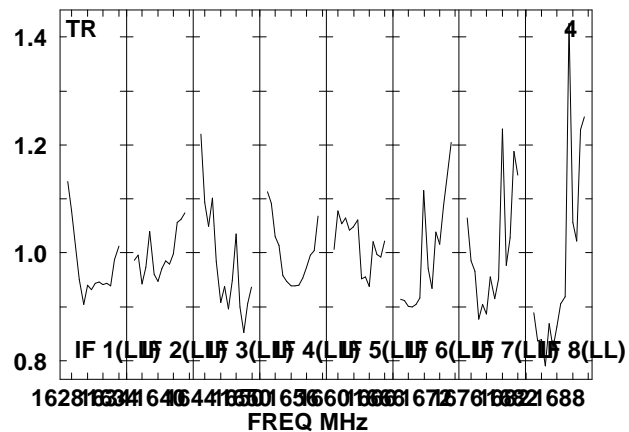
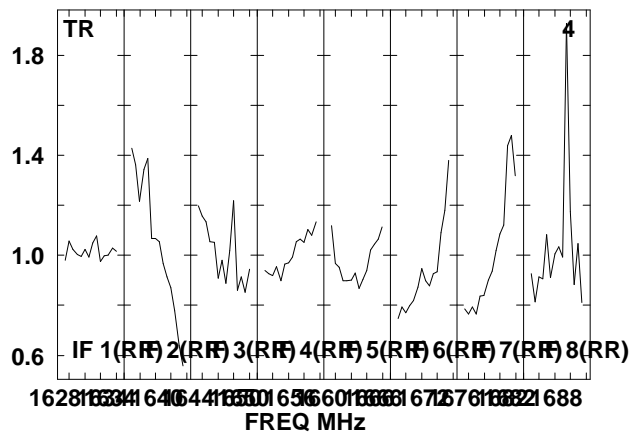
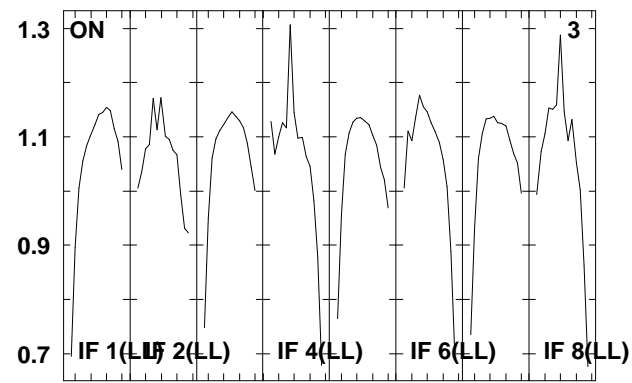
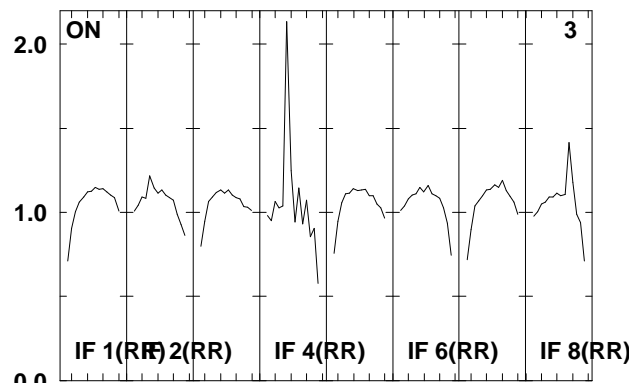
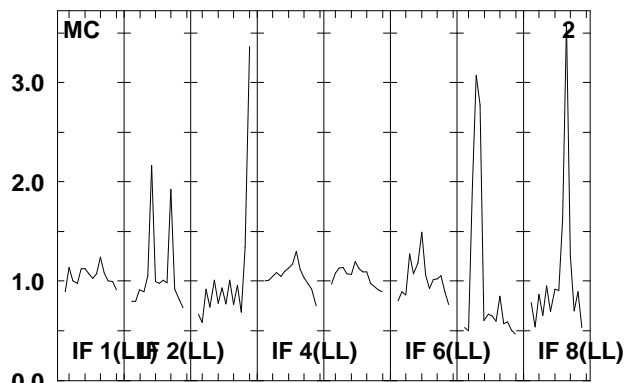
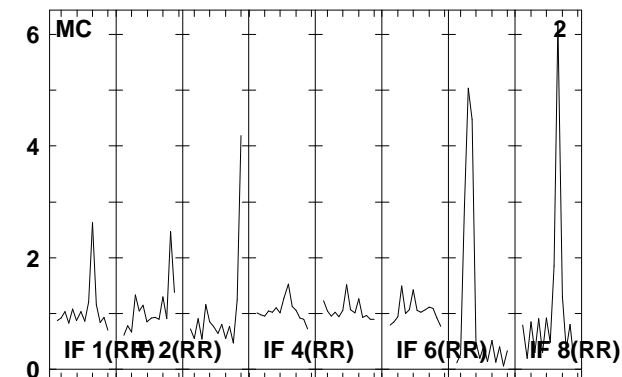
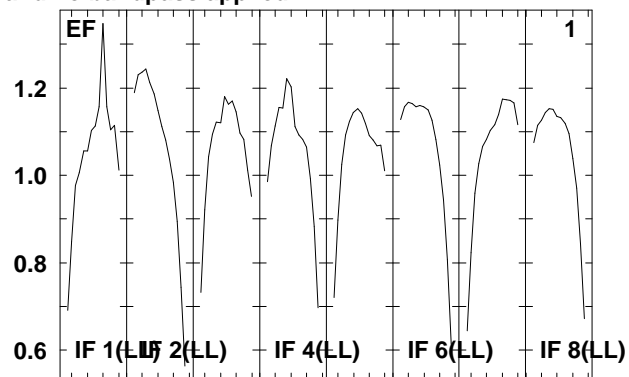
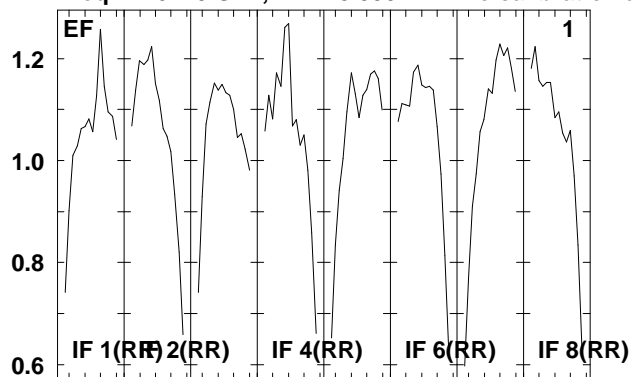

1628 1634 1640 1644 1650 1656 1660 1666 1672 1676 1682 1688  
FREQ MHz

1628 1634 1640 1644 1650 1656 1660 1666 1672 1676 1682 1688  
FREQ MHz

1628 1634 1640 1644 1650 1656 1660 1666 1672 1676 1682 1688  
FREQ MHz

Lower frame: Real Jy  
Total-power spectrum Antenna: \*  
Timerange: 01/05:03:20 to 01/05:06:19

Plot file version 256 created 20-OCT-2009 14:51:32

M33 RP015C.UVDATA.1

Freq = 1.6270 GHz, Bw = 8.000 MH No calibration applied and no bandpass applied

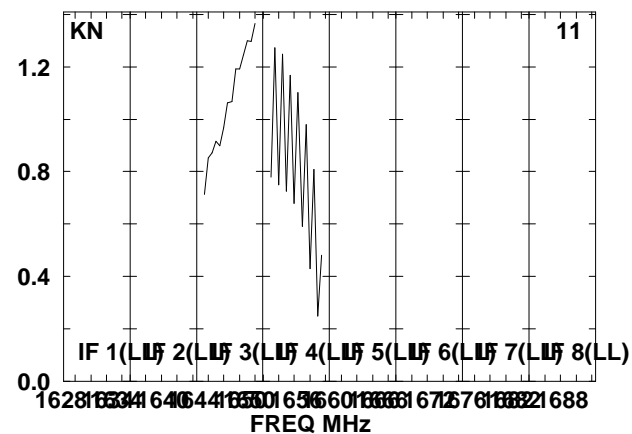
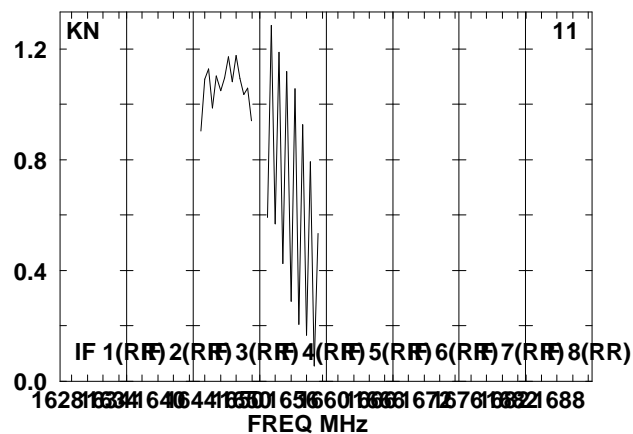
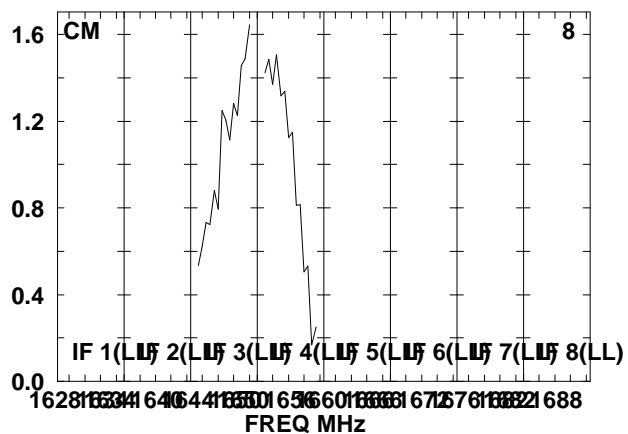
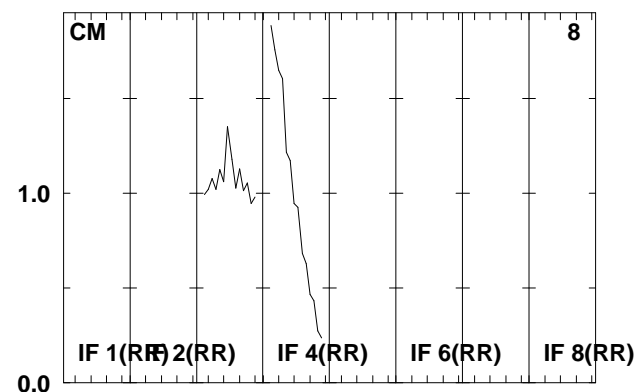
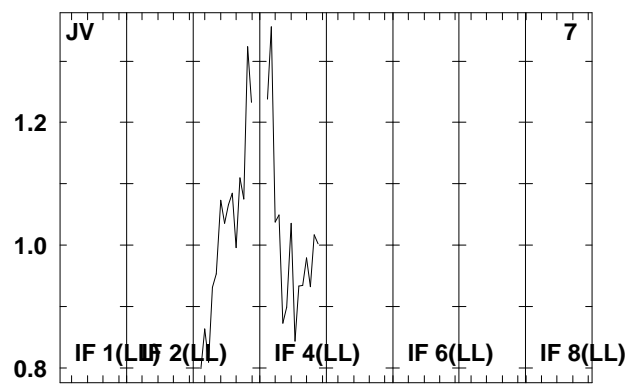
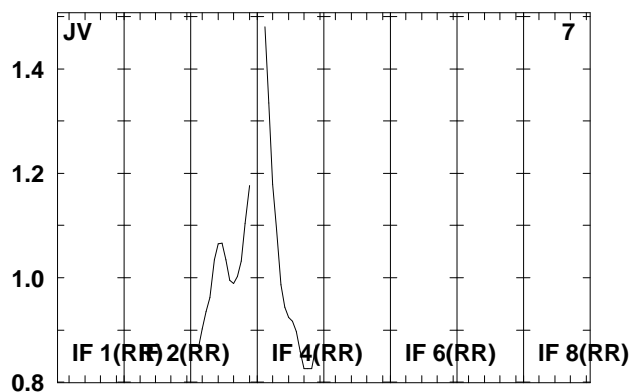
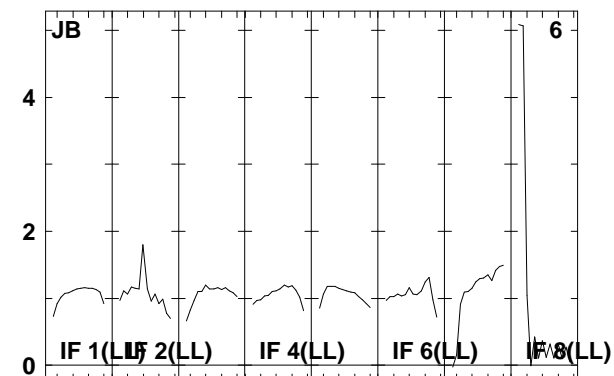
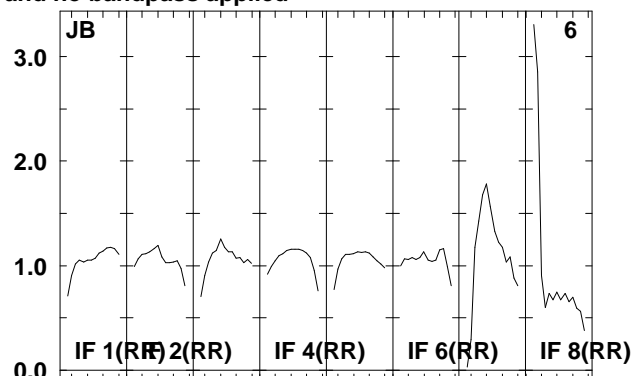
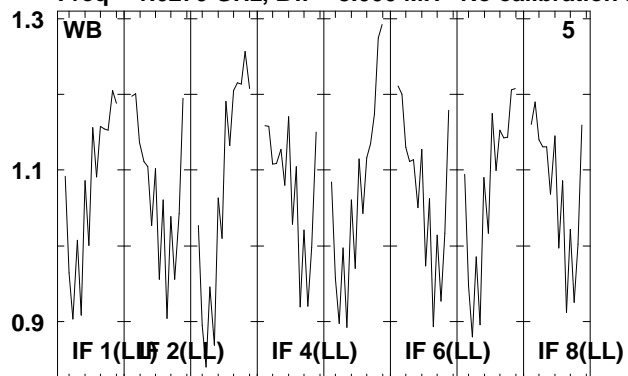

Lower frame: Real Jy

Total-power spectrum Antenna: \*

Timerange: 01/05:03:20 to 01/05:06:19



Plot file version 257 created 20-OCT-2009 14:51:34

M33 RP015C.UVDATA.1

Freq = 1.6270 GHz, Bw = 8.000 MH No calibration applied and no bandpass applied

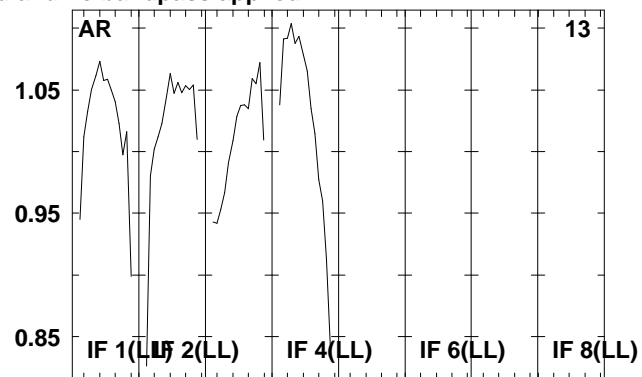
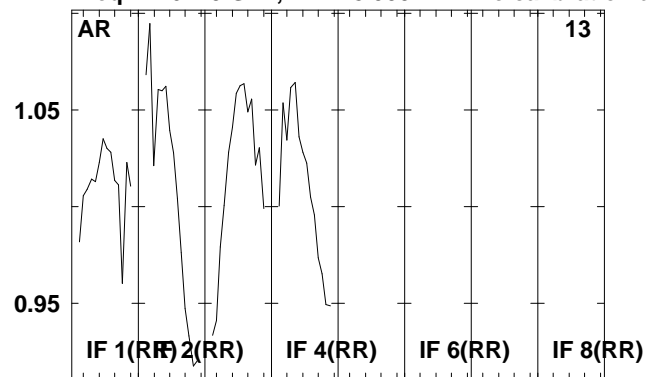

Lower frame: Real Jy  
Total-power spectrum Antenna: \*  
Timerange: 01/05:03:20 to 01/05:06:19

Plot file version 258 created 20-OCT-2009 14:51:34

J0137+31 RP015C.UVDATA.1

Freq = 1.6270 GHz, Bw = 8.000 MH No calibration applied and no bandpass applied

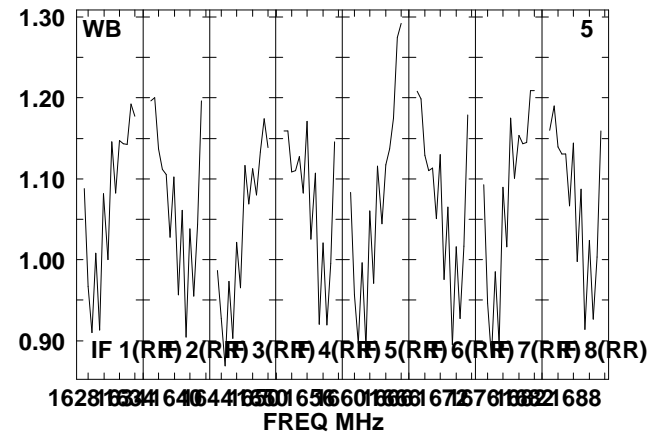
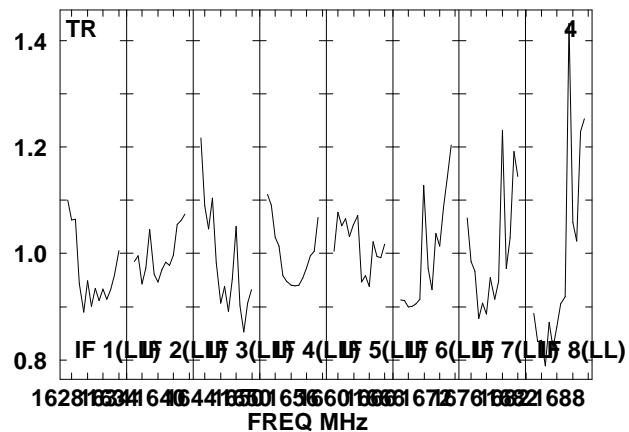
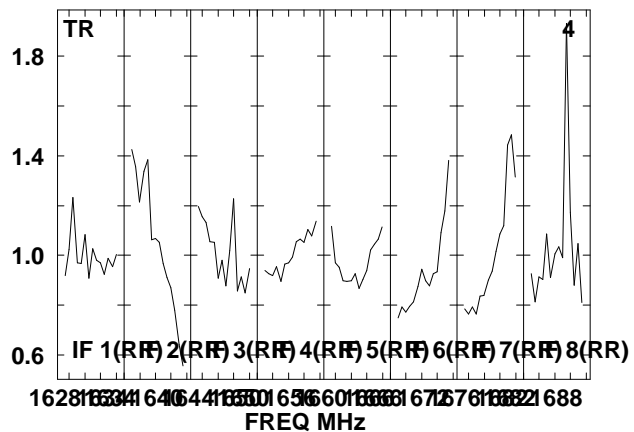
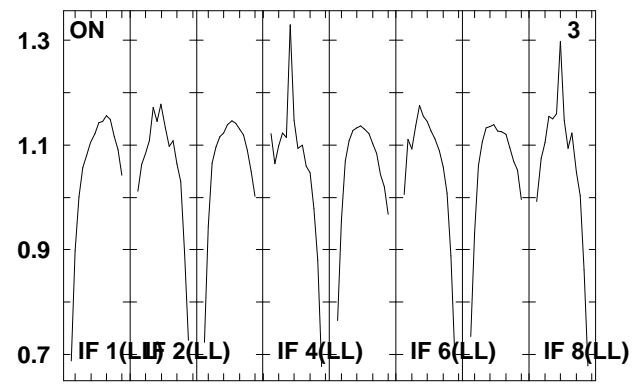
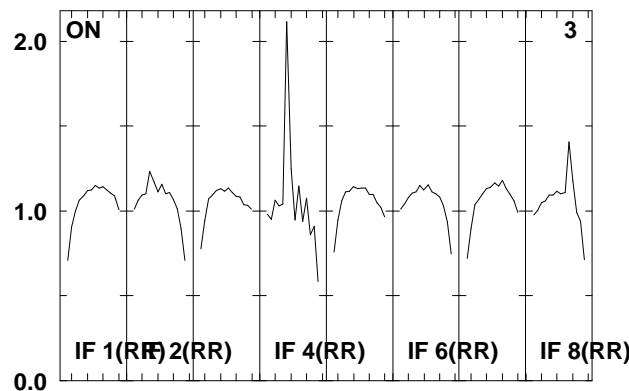
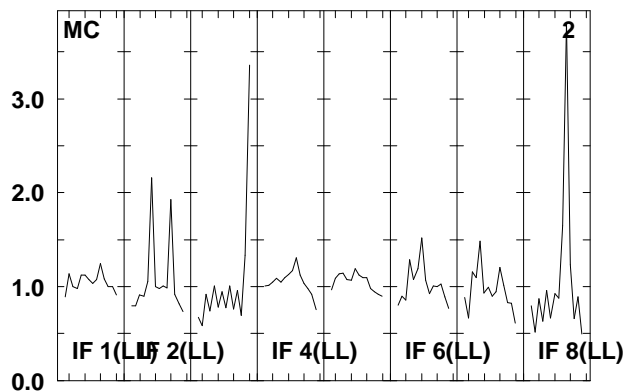
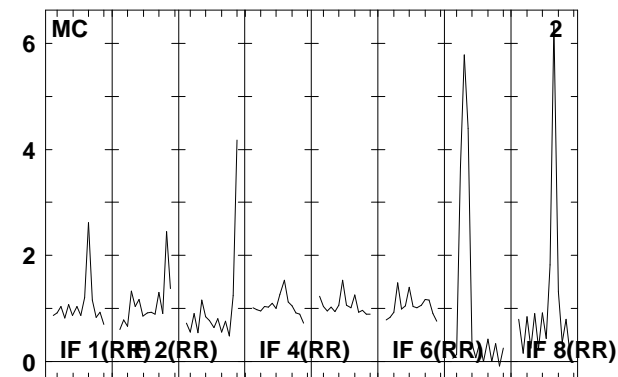
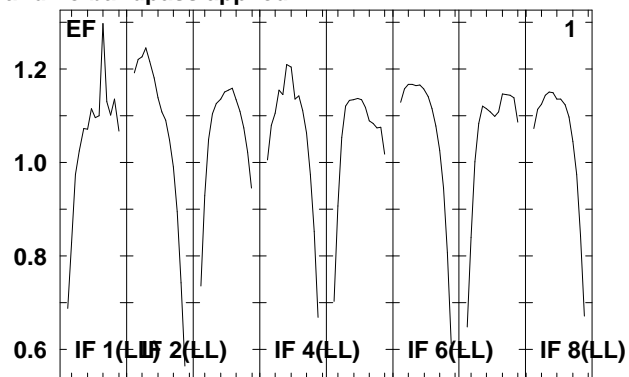
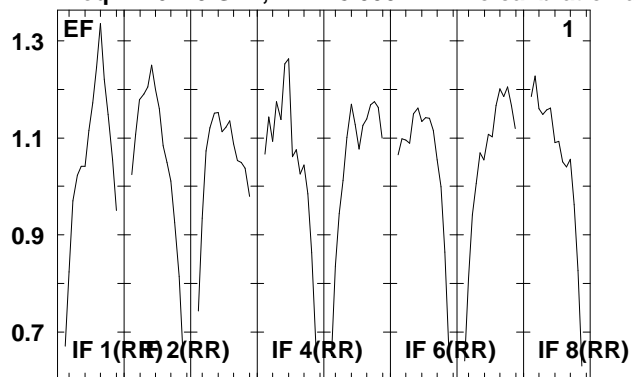

Lower frame: Real Jy  
Total-power spectrum Antenna: \*  
Timerange: 01/05:07:01 to 01/05:08:00

Plot file version 259 created 20-OCT-2009 14:51:34

J0137+31 RP015C.UVDATA.1

Freq = 1.6270 GHz, Bw = 8.000 MH No calibration applied and no bandpass applied

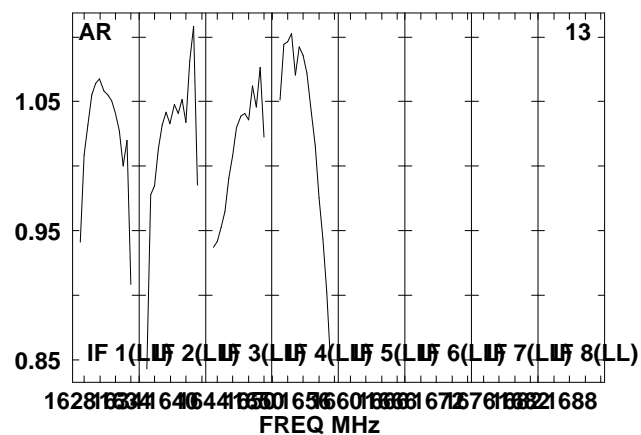
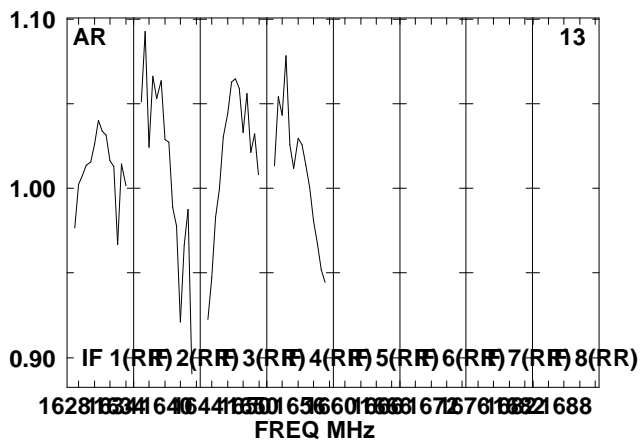
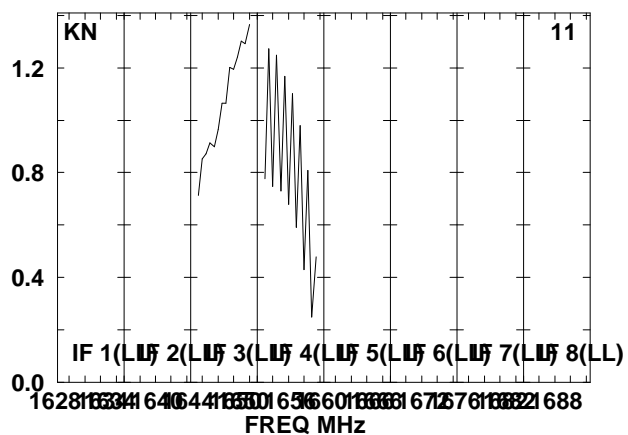
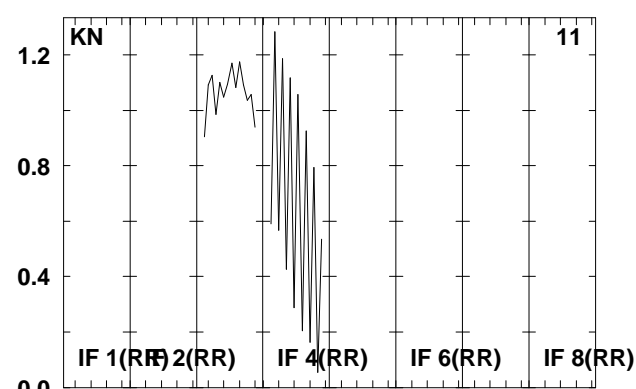
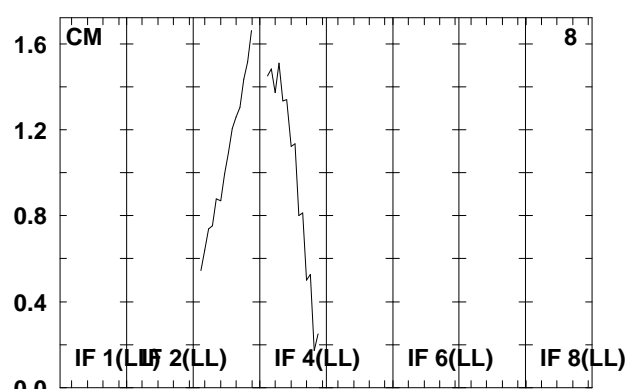
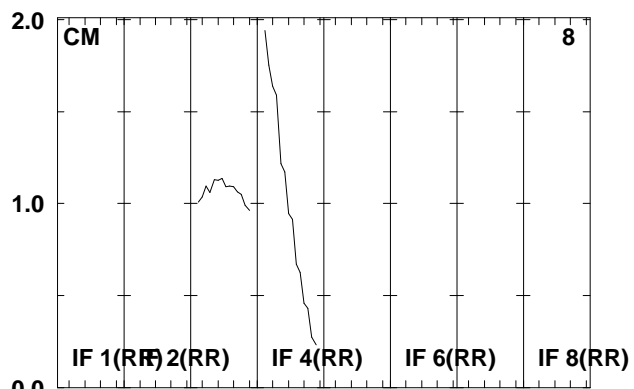
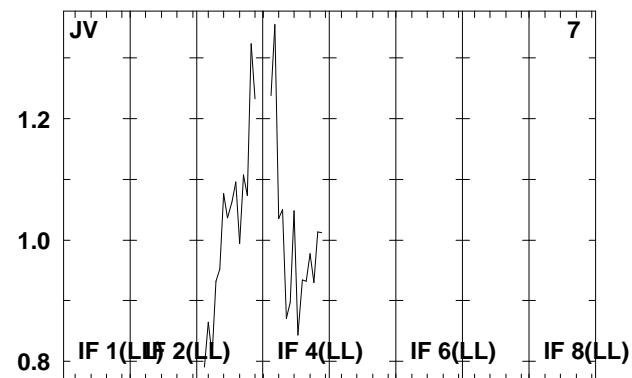
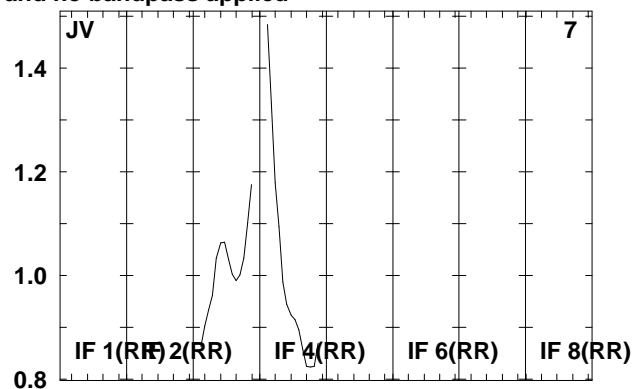
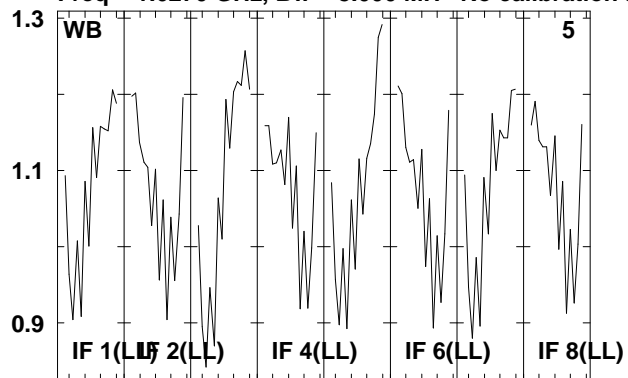

Lower frame: Real Jy  
Total-power spectrum Antenna: \*  
Timerange: 01/05:07:01 to 01/05:08:00

Plot file version 260 created 20-OCT-2009 14:51:35

FAINTCAL RP015C.UVDATA.1

Freq = 1.6270 GHz, Bw = 8.000 MH No calibration applied and no bandpass applied

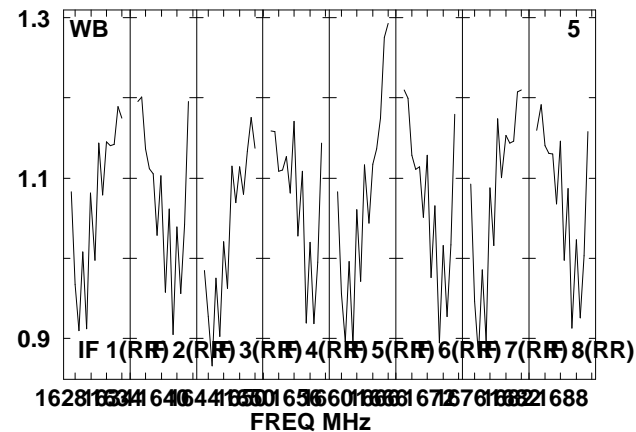
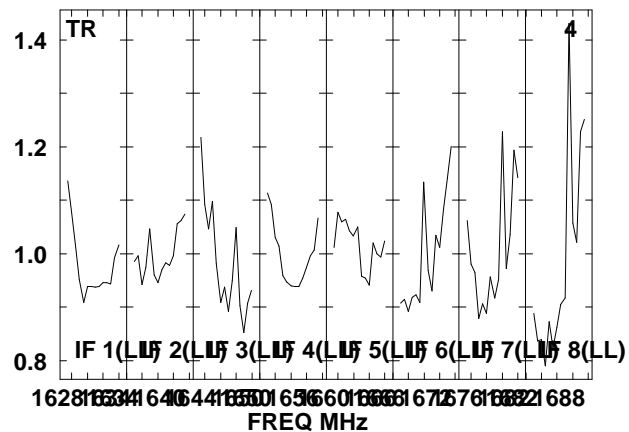
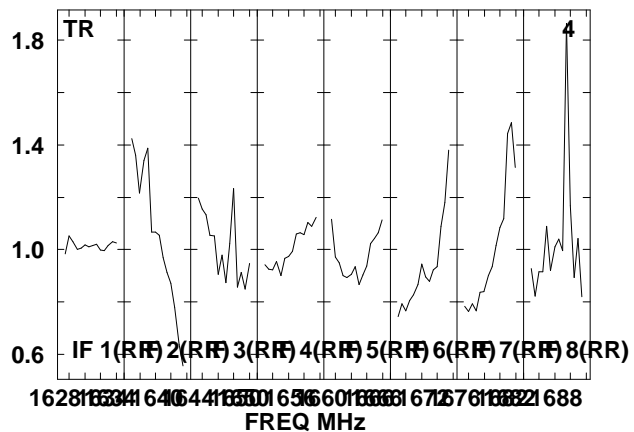
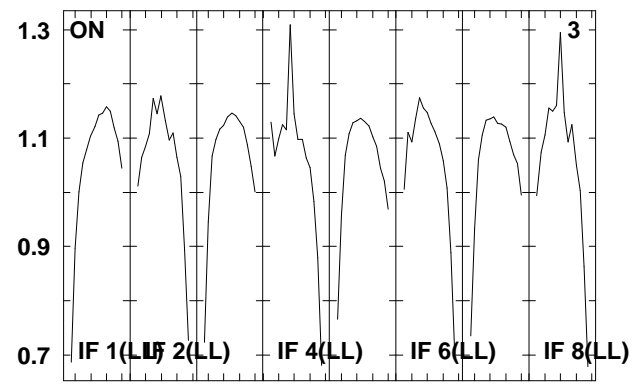
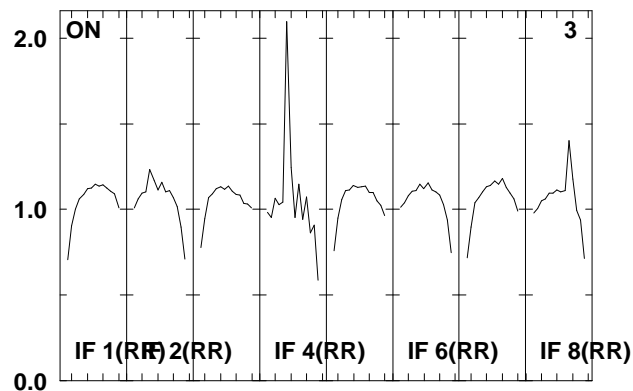
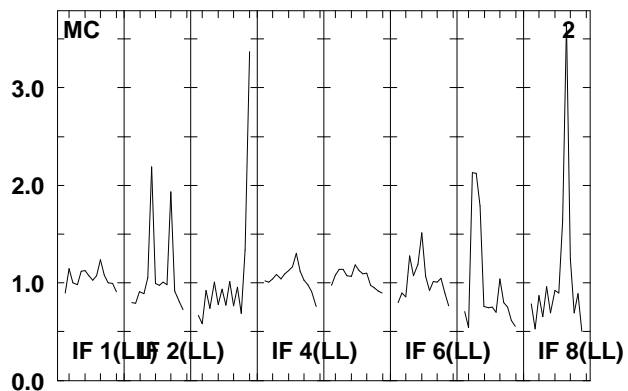
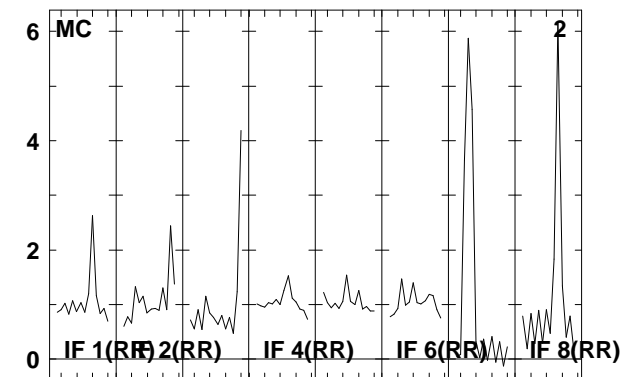
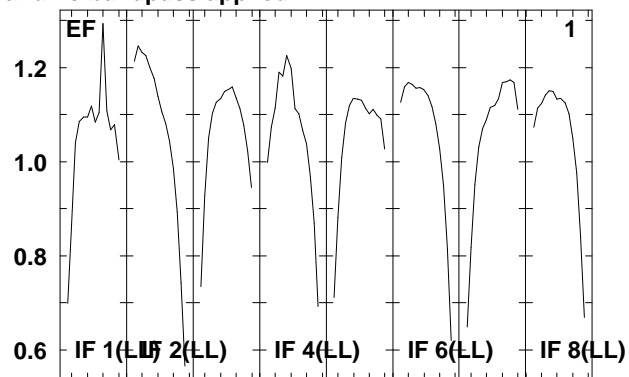
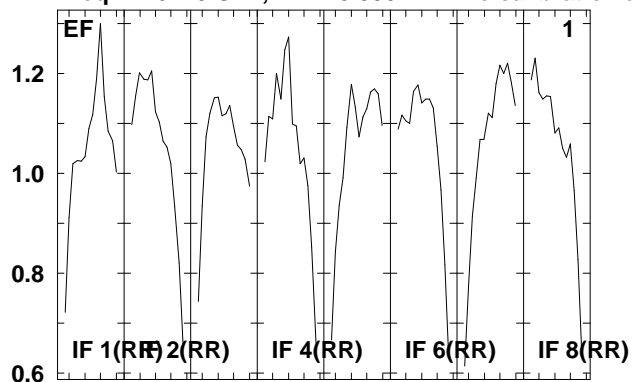

Lower frame: Real Jy  
Total-power spectrum Antenna: \*  
Timerange: 01/05:08:01 to 01/05:09:20

Plot file version 261 created 20-OCT-2009 14:51:35

FAINTCAL RP015C.UVDATA.1

Freq = 1.6270 GHz, Bw = 8.000 MH No calibration applied and no bandpass applied

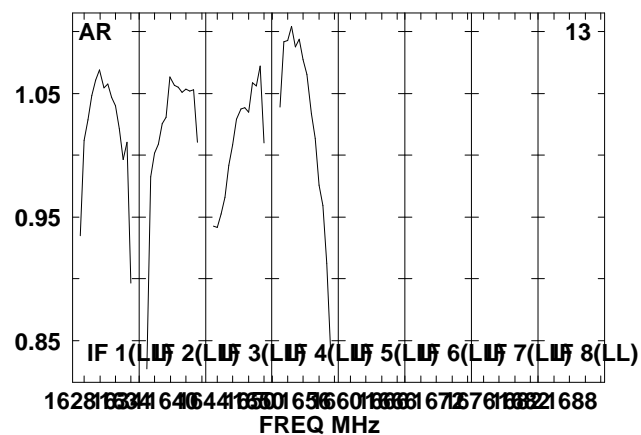
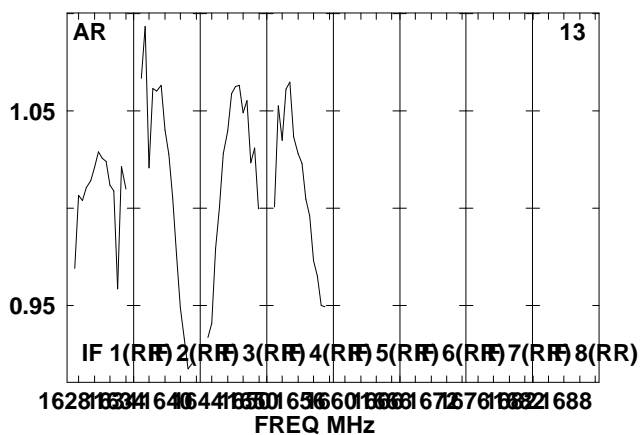
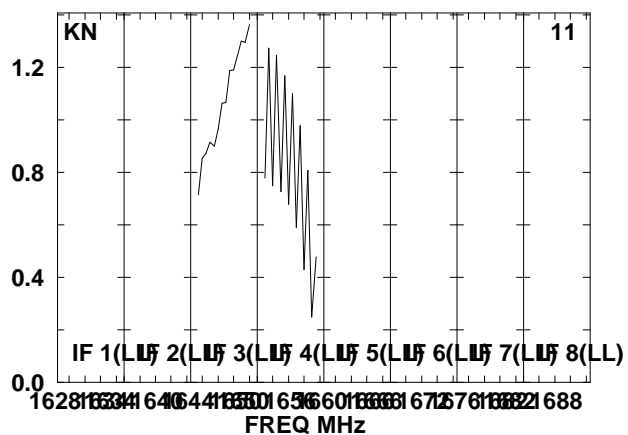
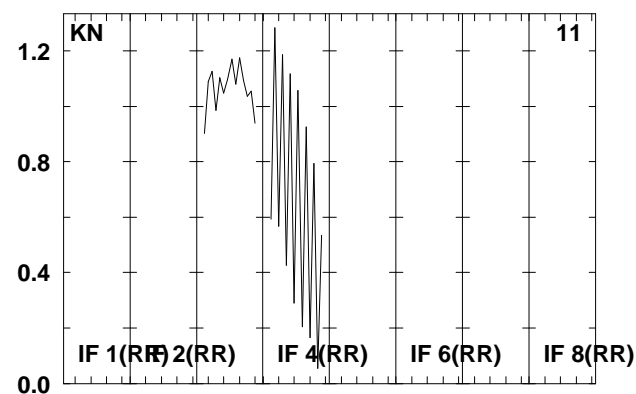
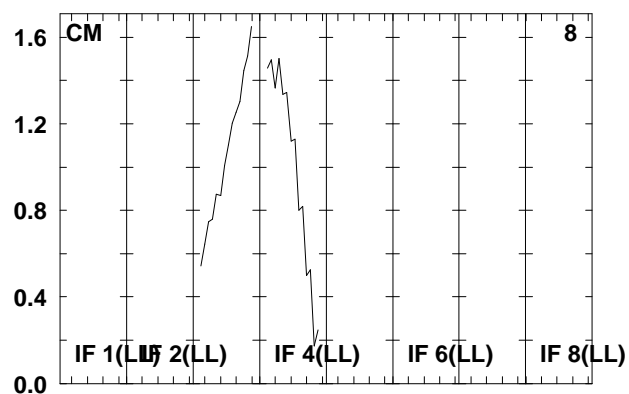
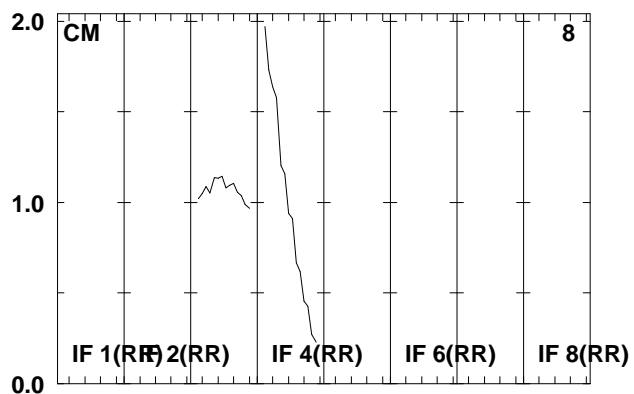
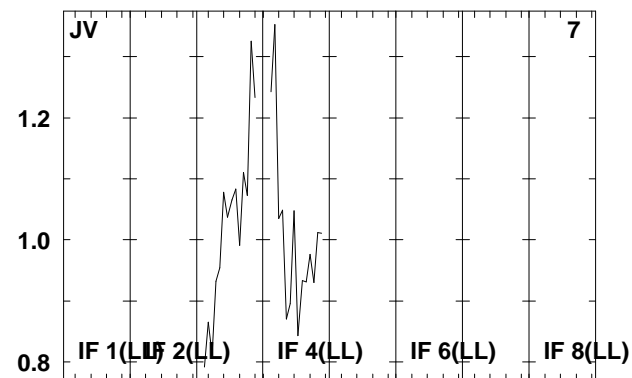
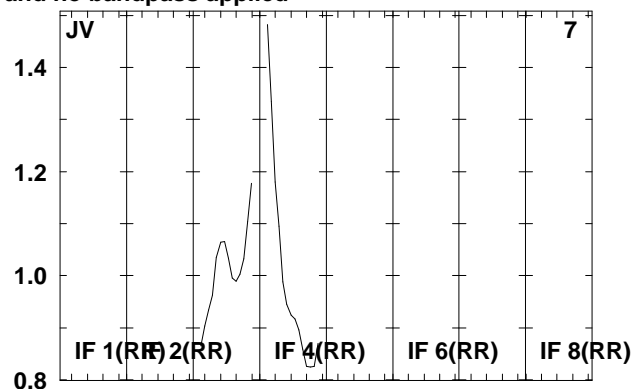
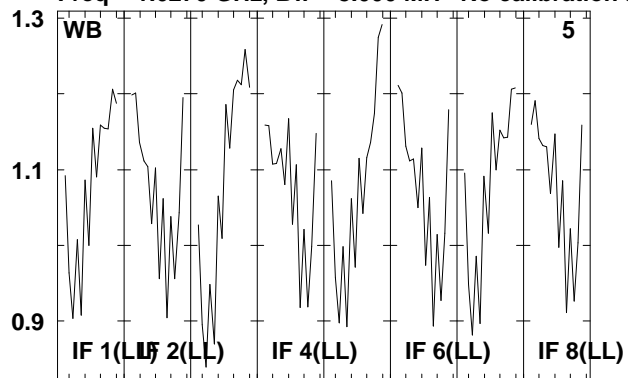

Lower frame: Real Jy

Total-power spectrum Antenna: \*

Timerange: 01/05:08:01 to 01/05:09:20

Plot file version 262 created 20-OCT-2009 14:51:36

M33 RP015C.UVDATA.1

Freq = 1.6270 GHz, Bw = 8.000 MH No calibration applied and no bandpass applied

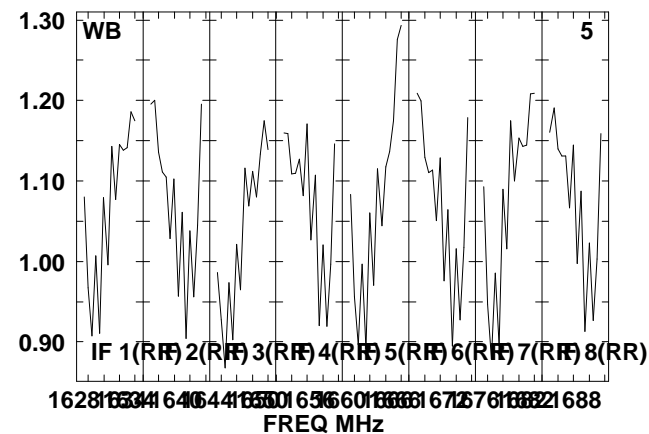
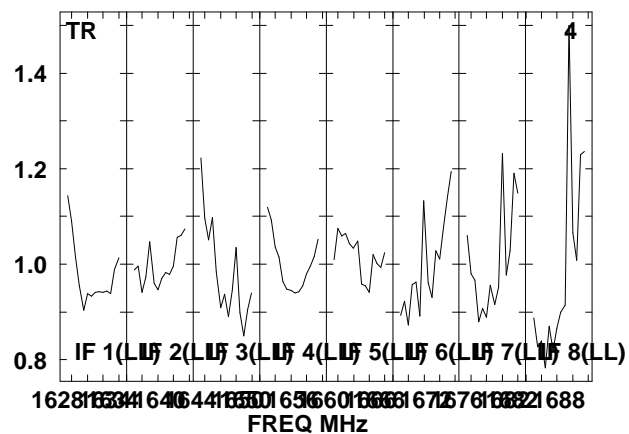
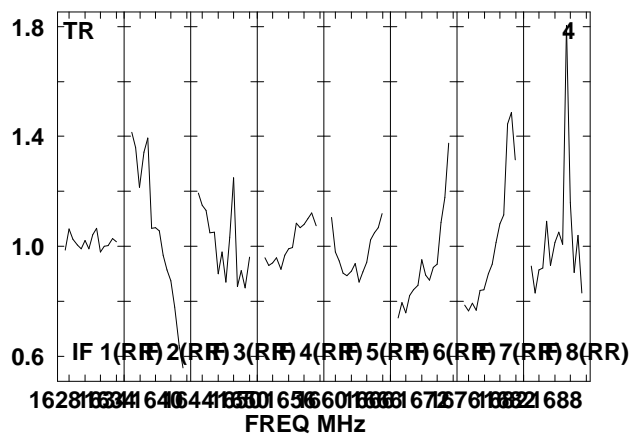
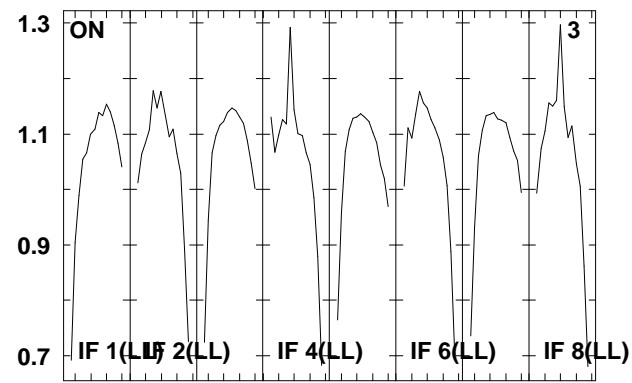
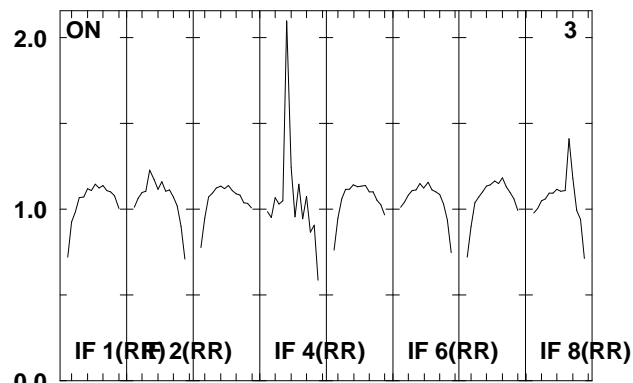
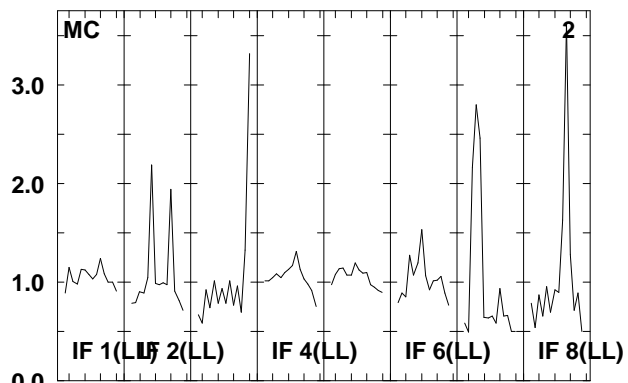
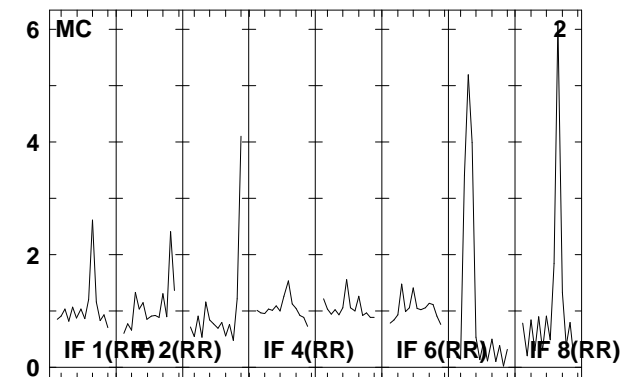
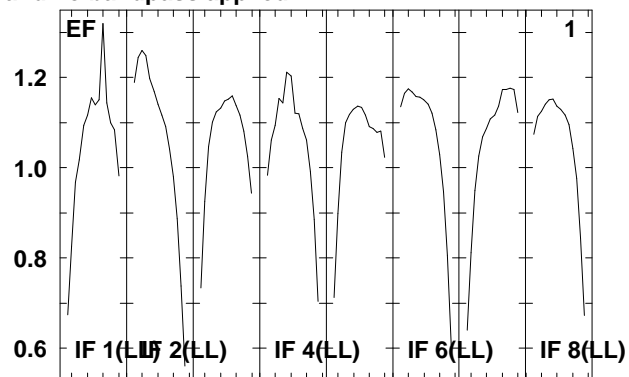
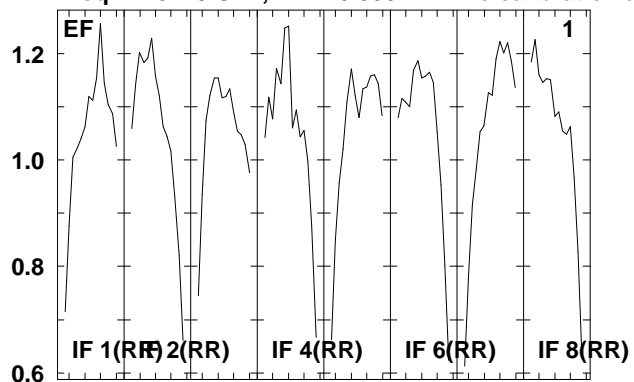

Lower frame: Real Jy  
Total-power spectrum Antenna: \*  
Timerange: 01/05:09:21 to 01/05:12:20

Plot file version 263 created 20-OCT-2009 14:51:38

M33 RP015C.UVDATA.1

Freq = 1.6270 GHz, Bw = 8.000 MH No calibration applied and no bandpass applied

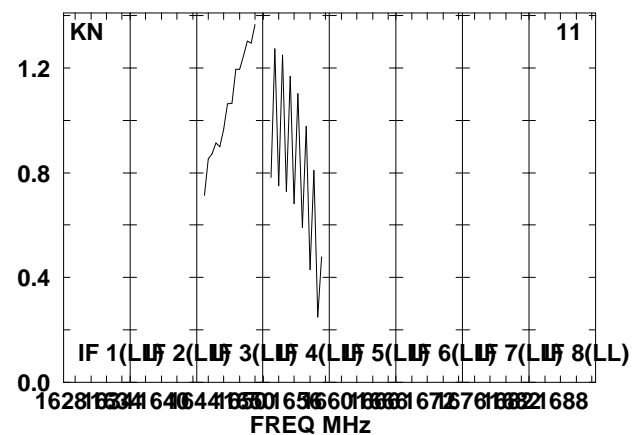
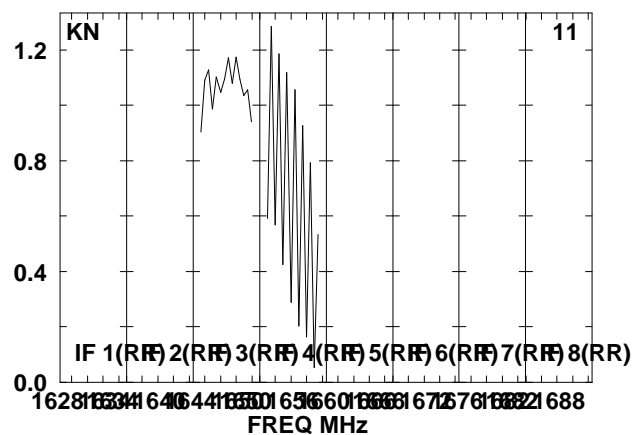
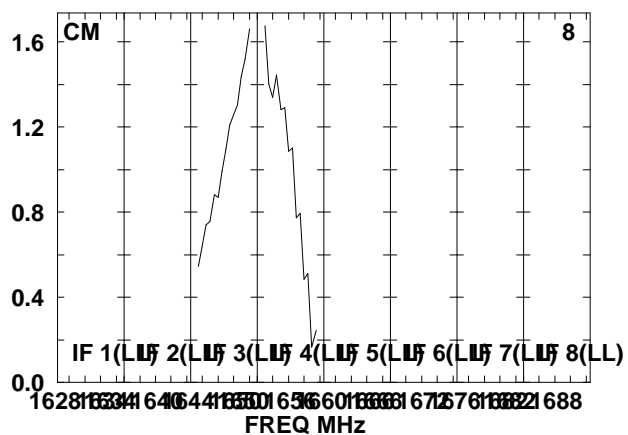
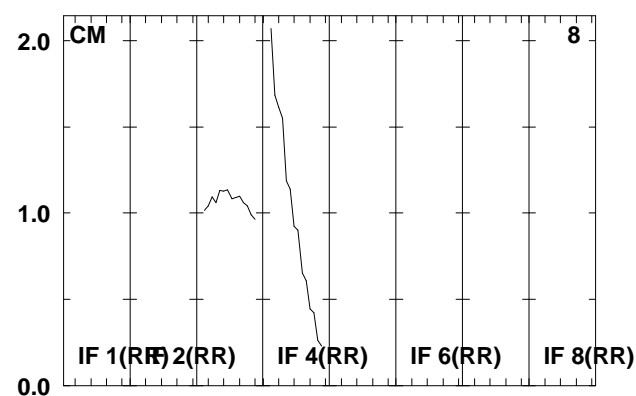
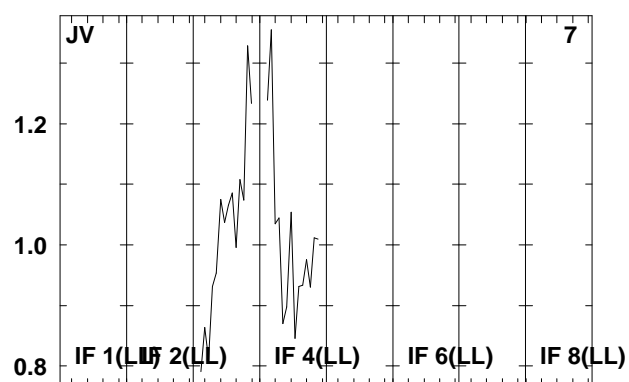
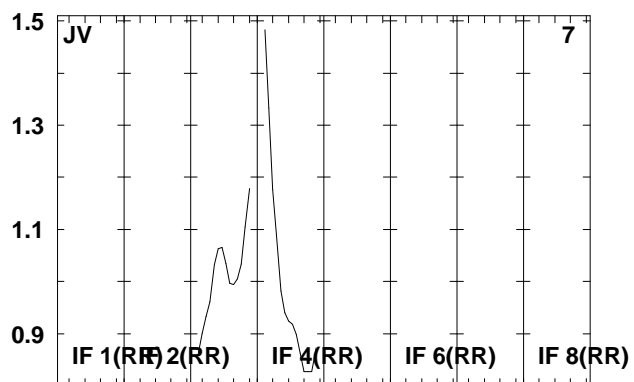
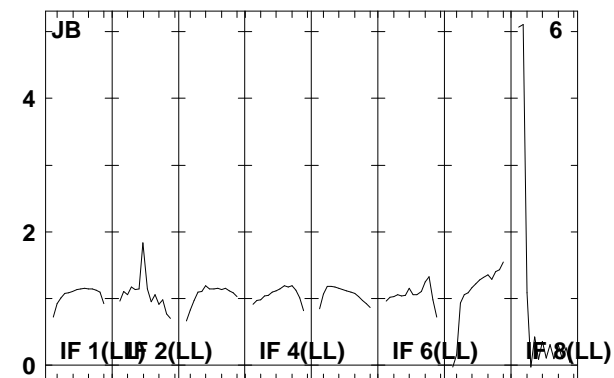
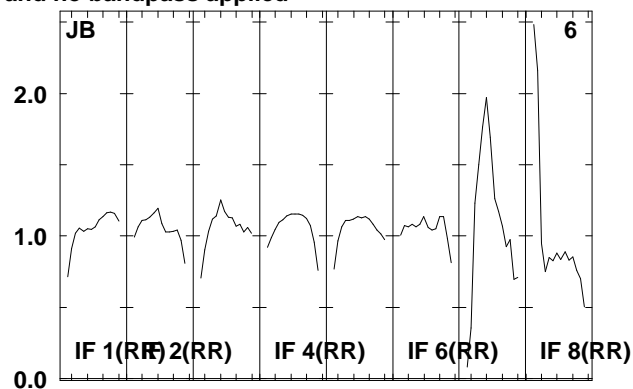
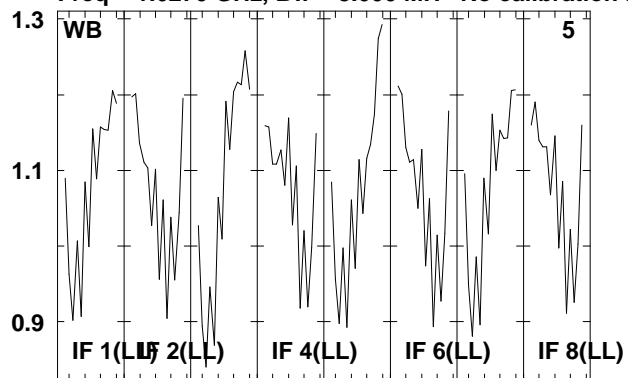

Lower frame: Real Jy

Total-power spectrum Antenna: \*

Timerange: 01/05:09:21 to 01/05:12:20

Plot file version 264 created 20-OCT-2009 14:51:39

M33 RP015C.UVDATA.1

Freq = 1.6270 GHz, Bw = 8.000 MH No calibration applied and no bandpass applied

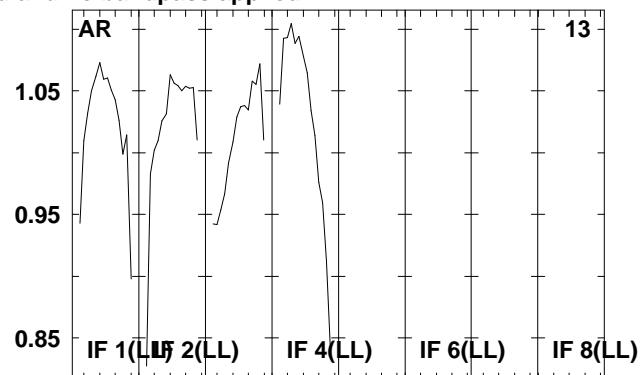
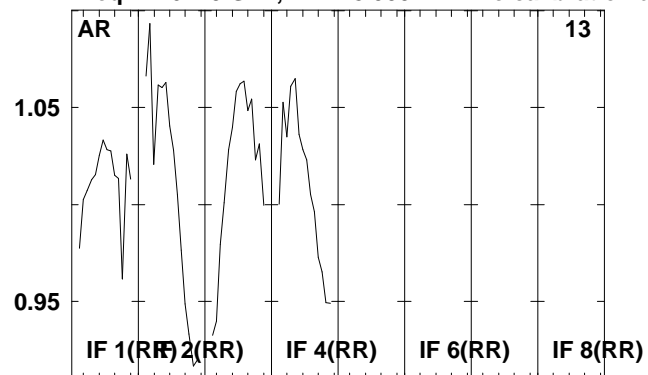

Lower frame: Real Jy  
Total-power spectrum Antenna: \*  
Timerange: 01/05:09:21 to 01/05:12:20



Plot file version 265 created 20-OCT-2009 14:51:40

J0137+31 RP015C.UVDATA.1

Freq = 1.6270 GHz, Bw = 8.000 MH No calibration applied and no bandpass applied

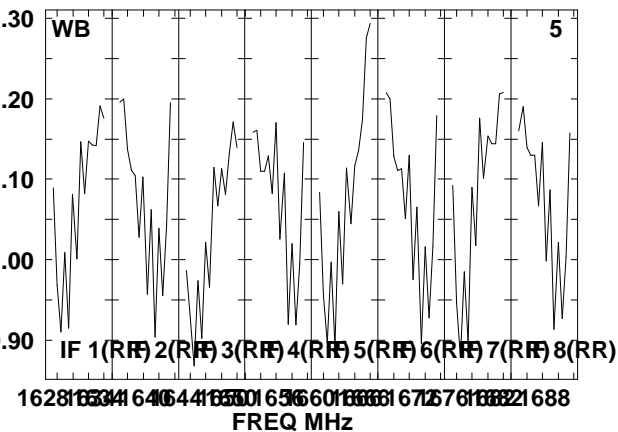
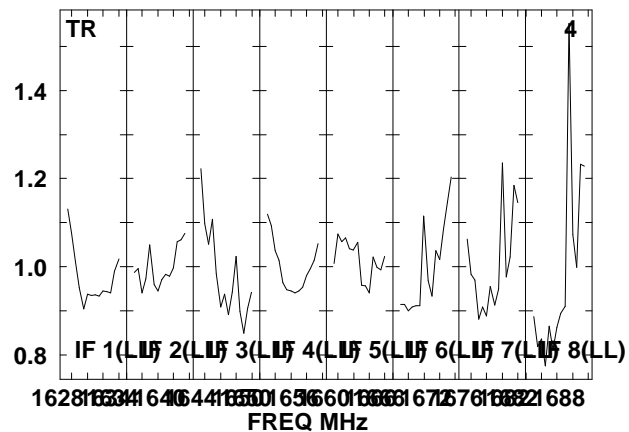
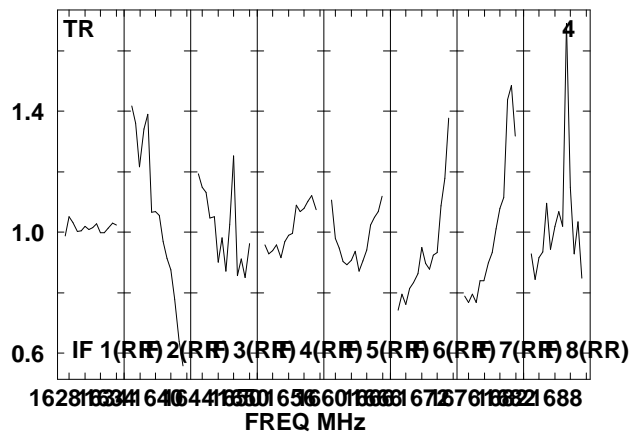
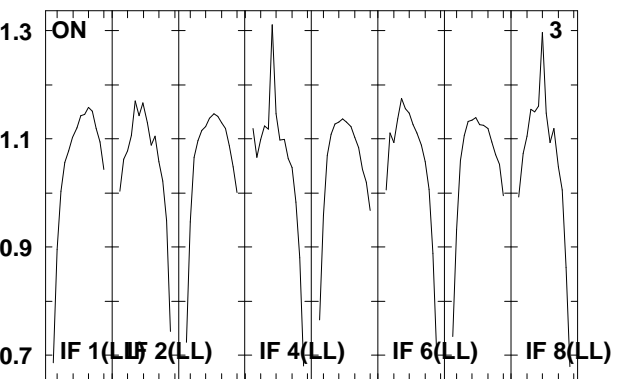
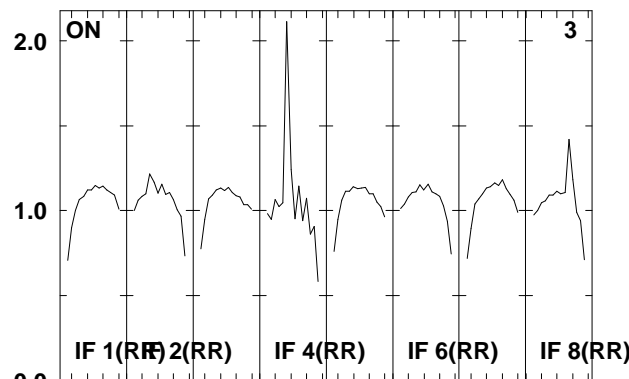
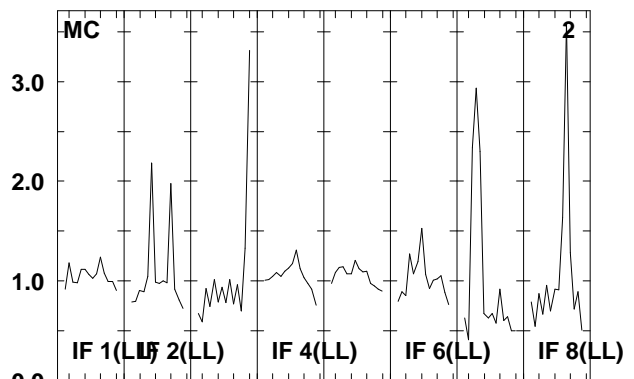
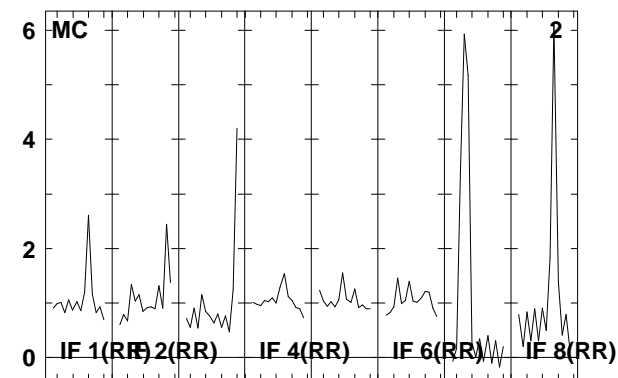
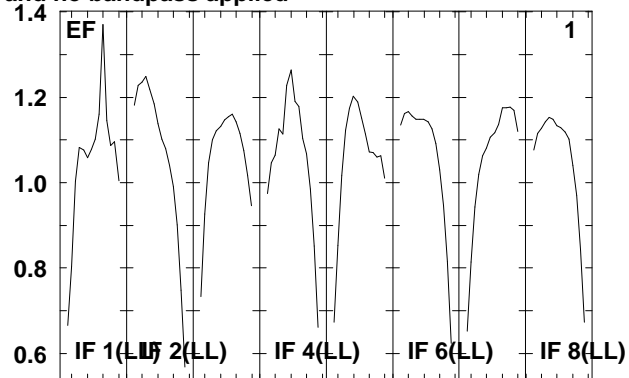
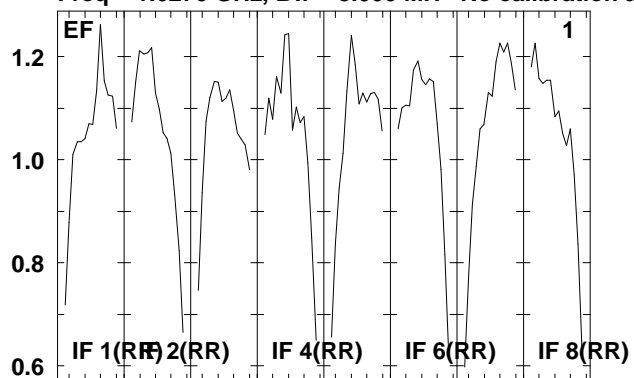

1628 1634 1640 1644 1650 1656 1660 1666 1672 1676 1682 1688  
FREQ MHz

1628 1634 1640 1644 1650 1656 1660 1666 1672 1676 1682 1688  
FREQ MHz

1628 1634 1640 1644 1650 1656 1660 1666 1672 1676 1682 1688  
FREQ MHz

Lower frame: Real Jy  
Total-power spectrum Antenna: \*  
Timerange: 01/05:13:01 to 01/05:13:59

Plot file version 266 created 20-OCT-2009 14:51:40

J0137+31 RP015C.UVDATA.1

Freq = 1.6270 GHz, Bw = 8.000 MH No calibration applied and no bandpass applied

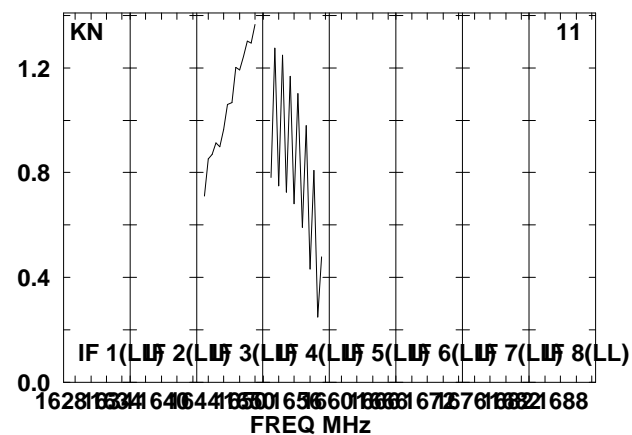
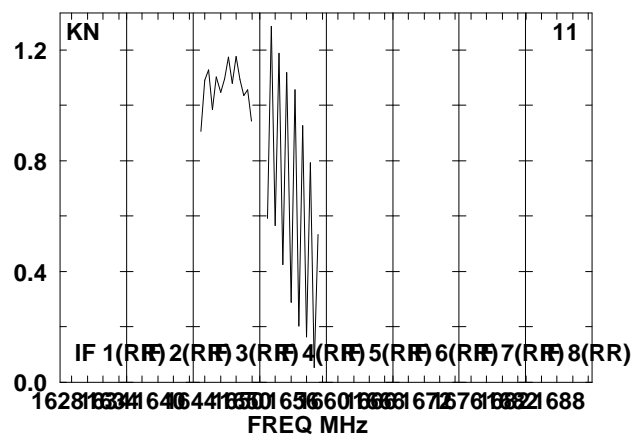
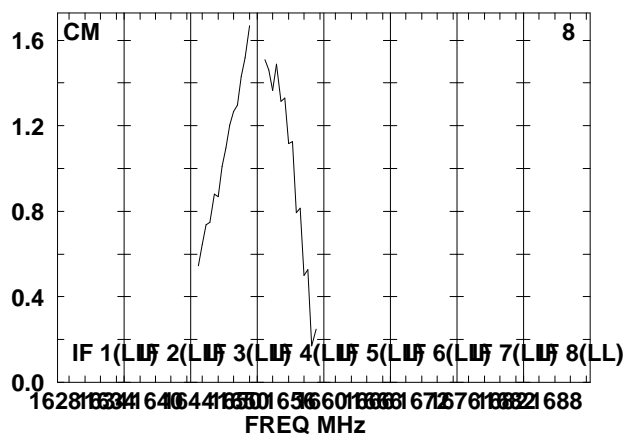
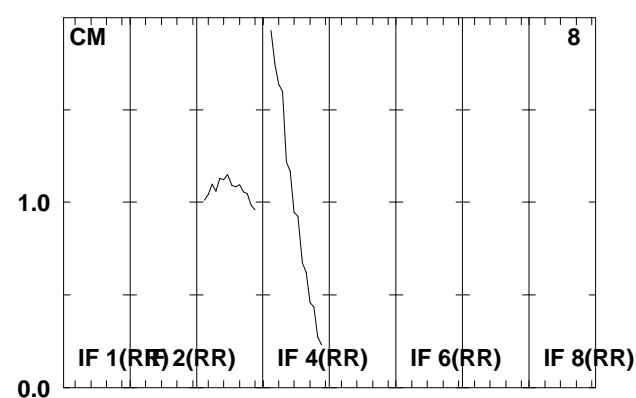
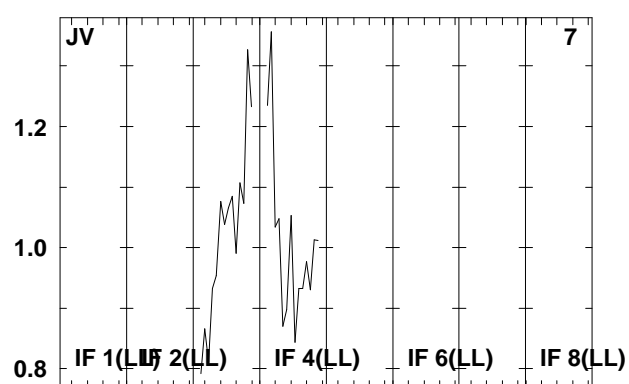
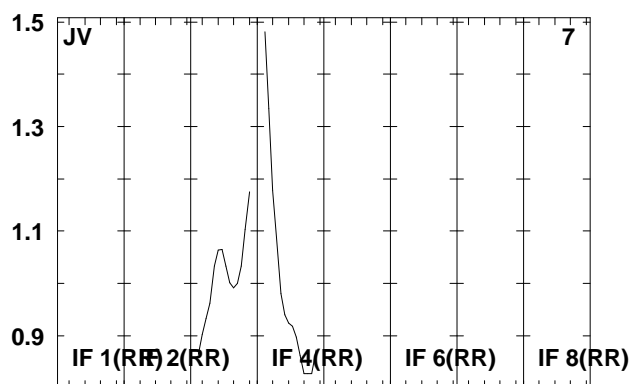
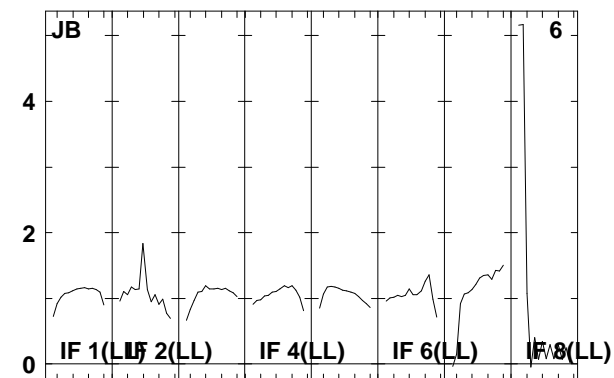
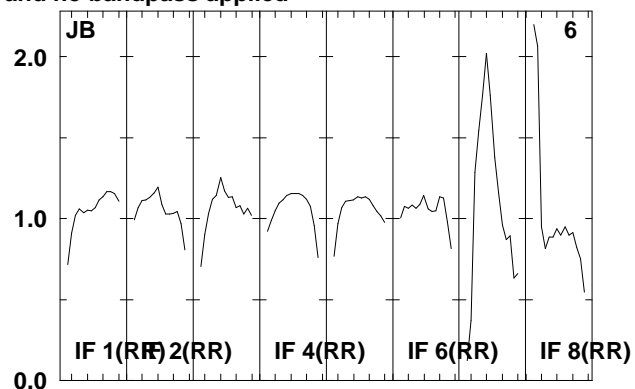
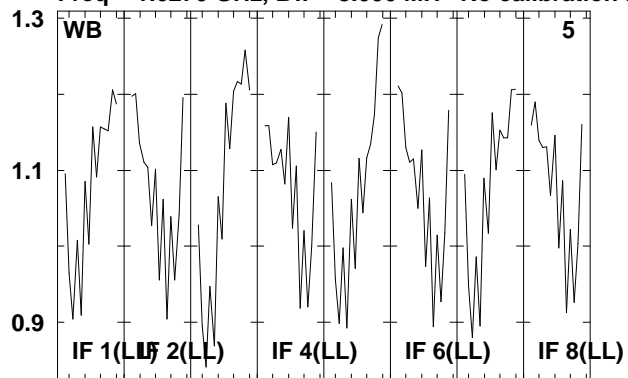

Lower frame: Real Jy

Total-power spectrum Antenna: \*

Timerange: 01/05:13:01 to 01/05:13:59

Plot file version 267 created 20-OCT-2009 14:51:40

J0137+31 RP015C.UVDATA.1

Freq = 1.6270 GHz, Bw = 8.000 MH No calibration applied and no bandpass applied

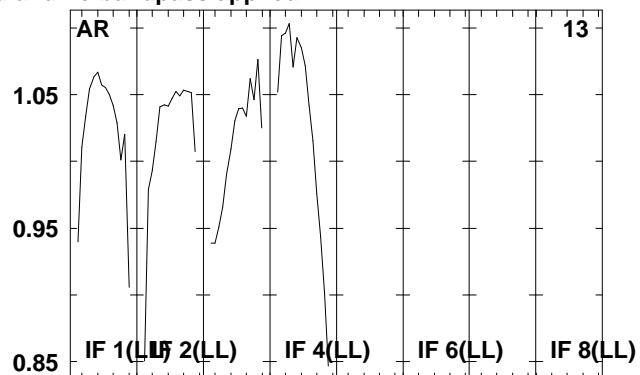
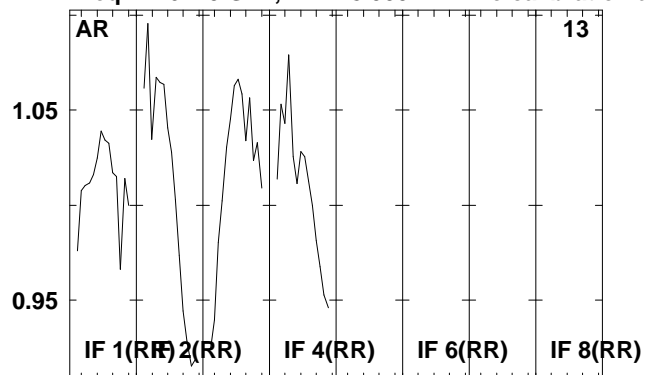

Lower frame: Real Jy  
Total-power spectrum Antenna: \*  
Timerange: 01/05:13:01 to 01/05:13:59

Plot file version 268 created 20-OCT-2009 14:51:41

FAINTCAL RP015C.UVDATA.1

Freq = 1.6270 GHz, Bw = 8.000 MH No calibration applied and no bandpass applied

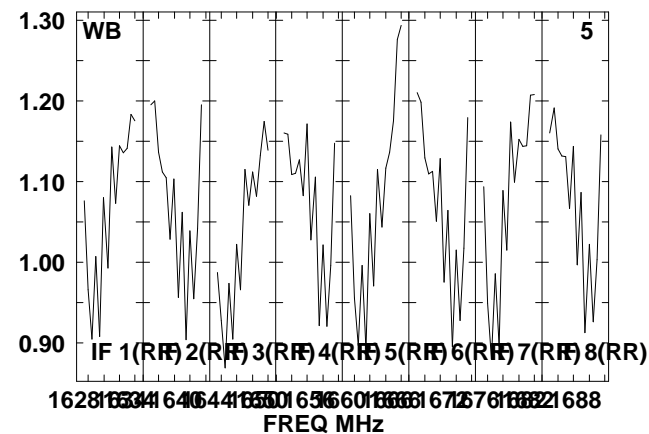
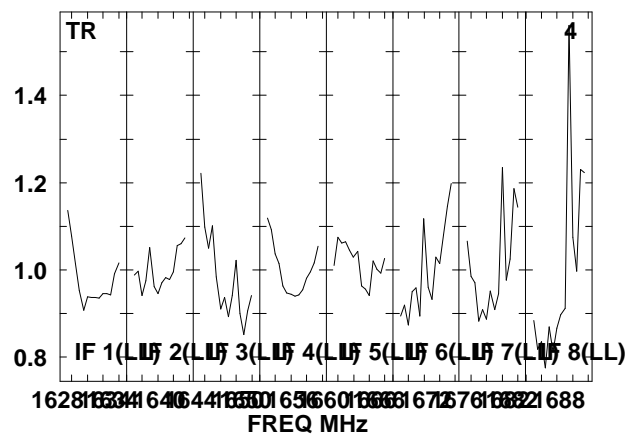
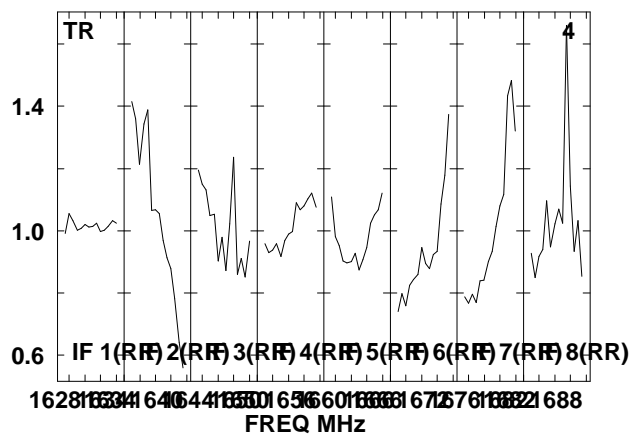
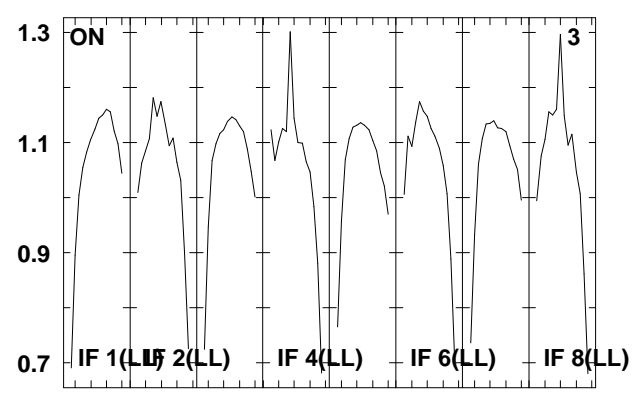
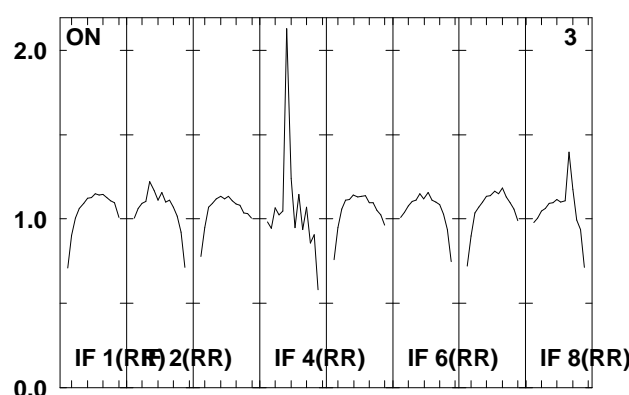
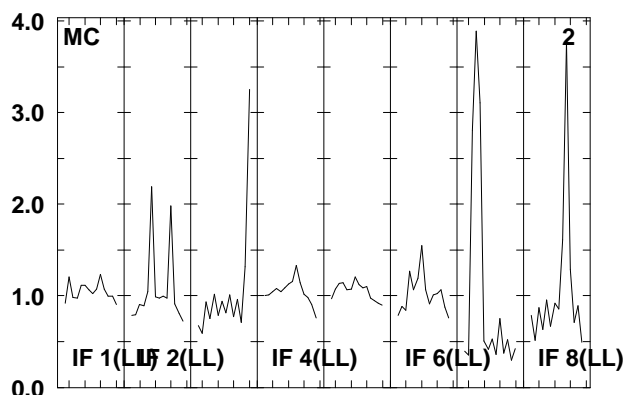
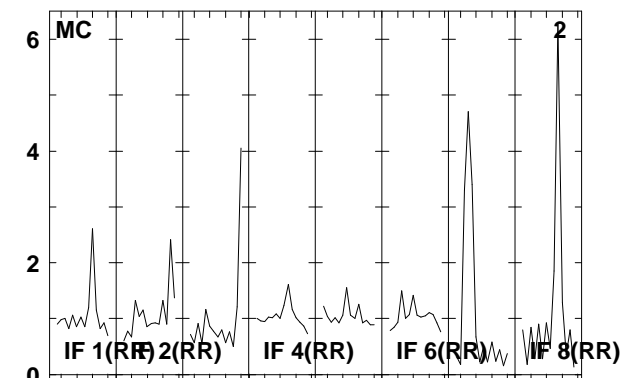
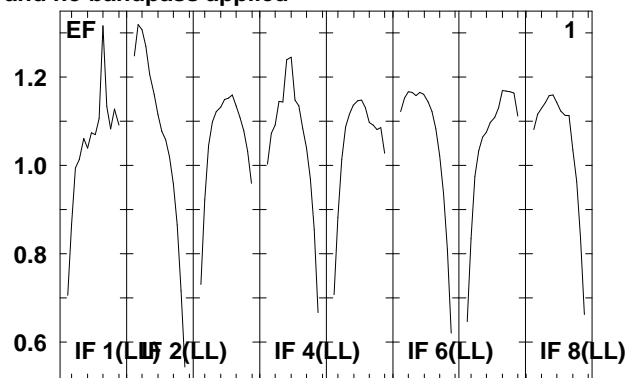
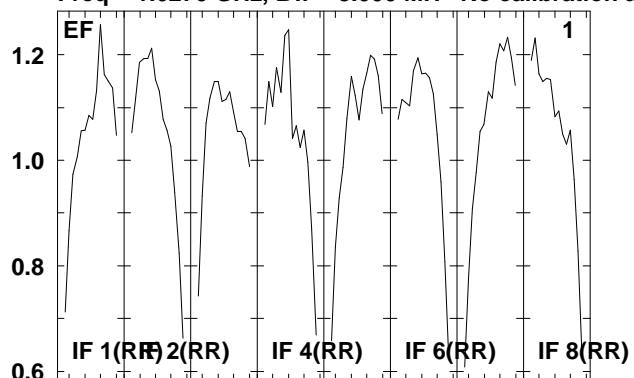

Lower frame: Real Jy

Total-power spectrum Antenna: \*

Timerange: 01/05:14:00 to 01/05:15:19

Plot file version 269 created 20-OCT-2009 14:51:41

FAINTCAL RP015C.UVDATA.1

Freq = 1.6270 GHz, Bw = 8.000 MH No calibration applied and no bandpass applied

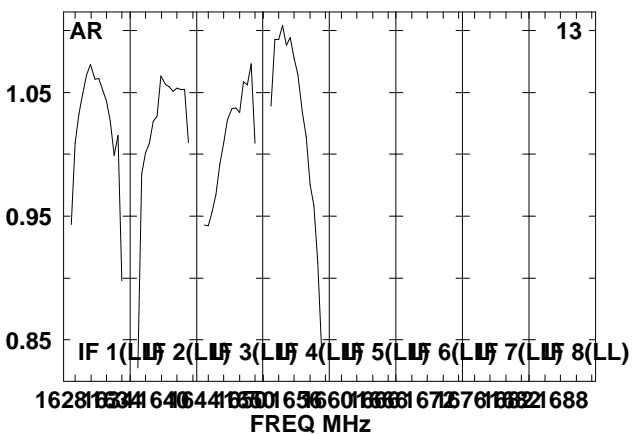
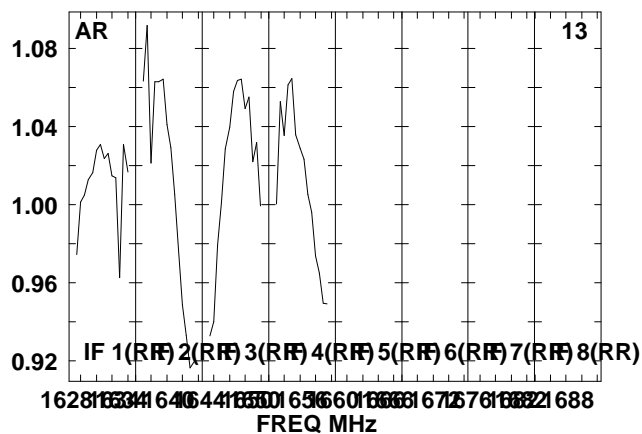
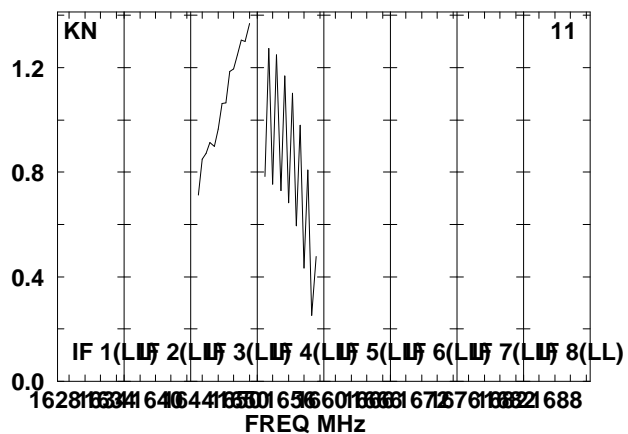
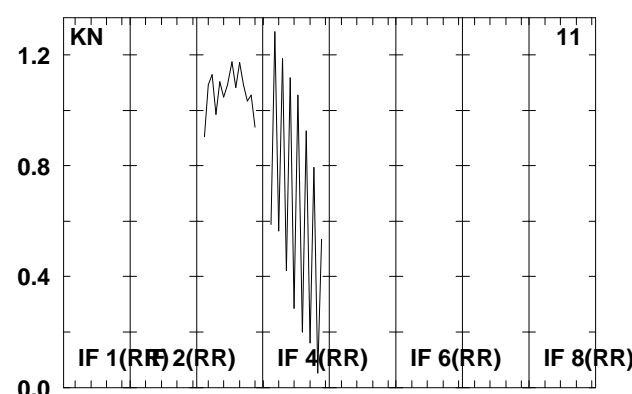
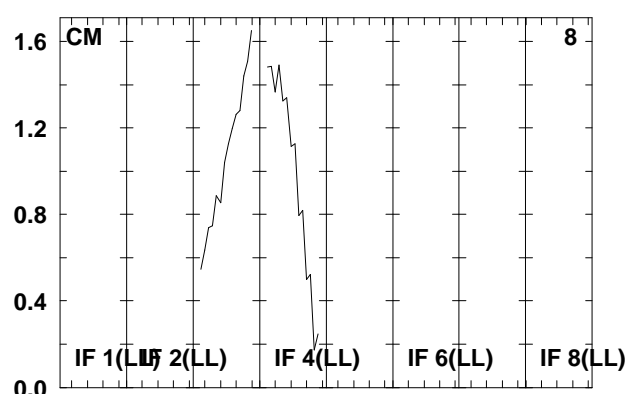
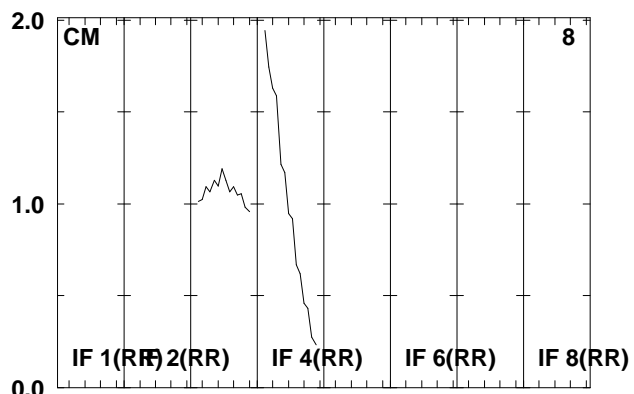
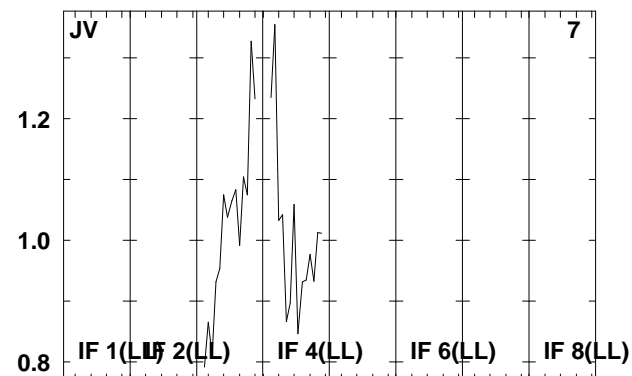
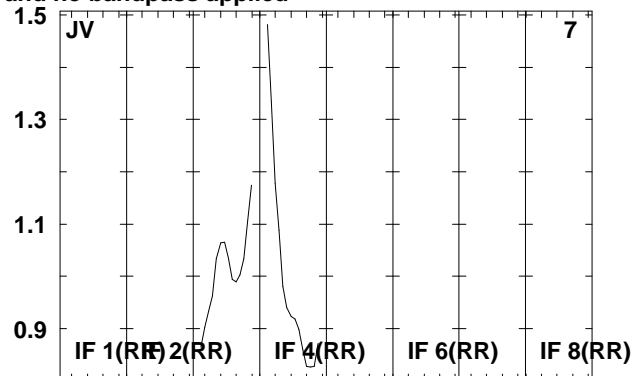
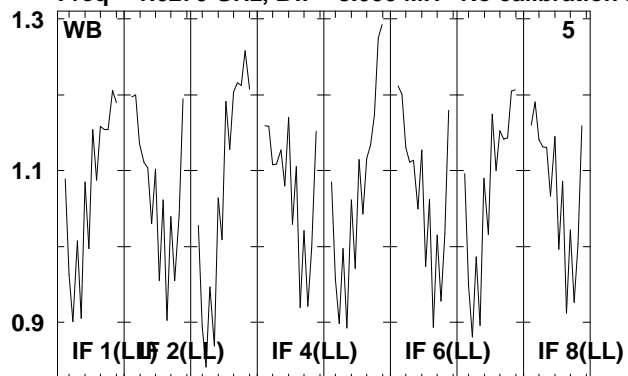

Lower frame: Real Jy

Total-power spectrum Antenna: \*

Timerange: 01/05:14:00 to 01/05:15:19

Plot file version 270 created 20-OCT-2009 14:51:42

M33 RP015C.UVDATA.1

Freq = 1.6270 GHz, Bw = 8.000 MH No calibration applied and no bandpass applied

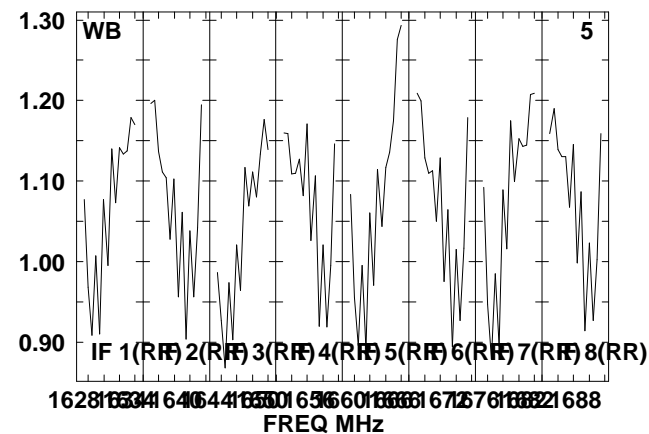
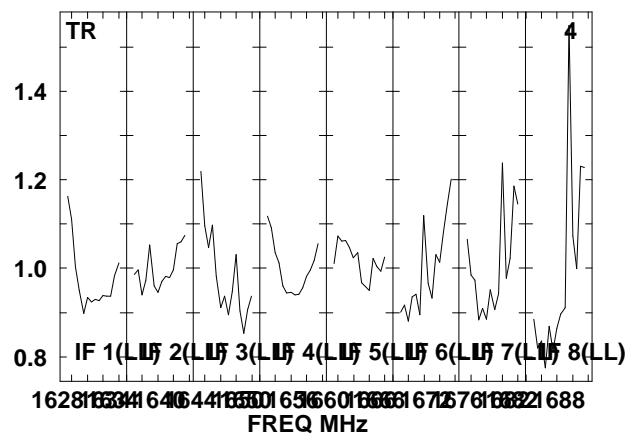
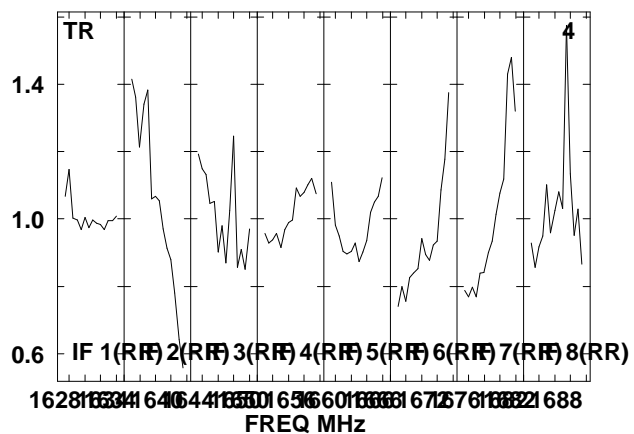
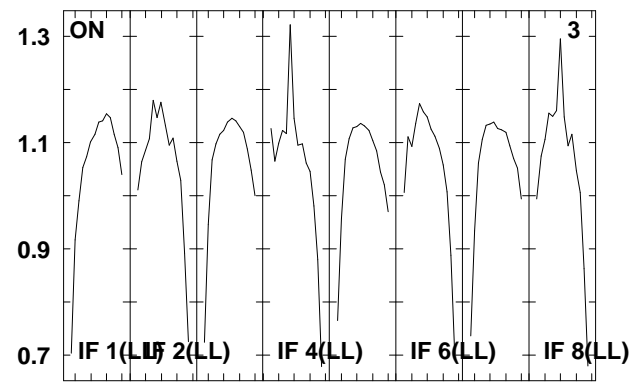
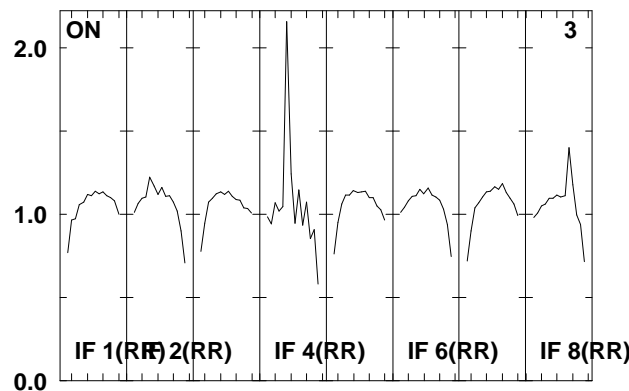
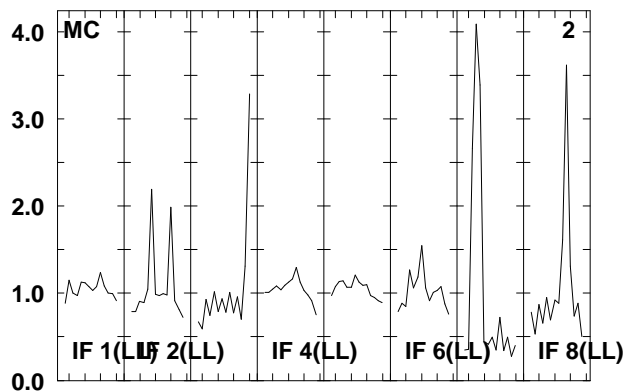
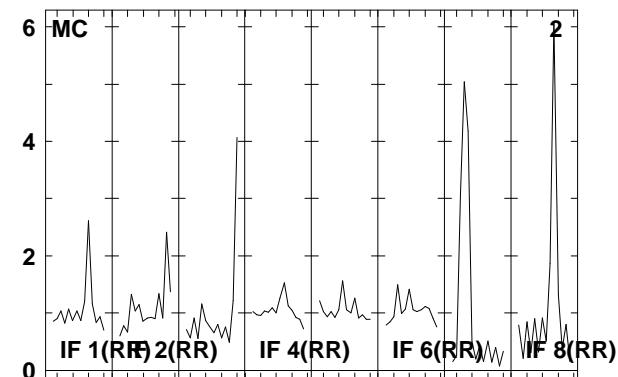
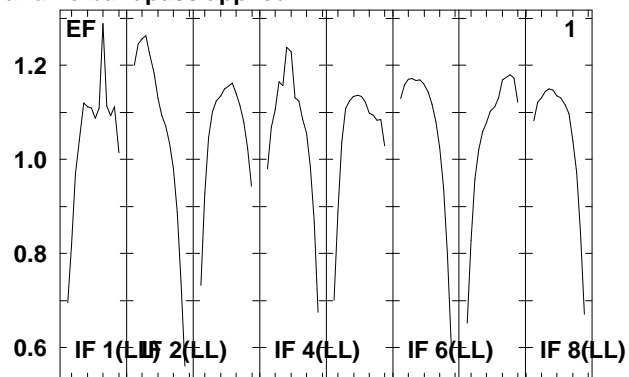
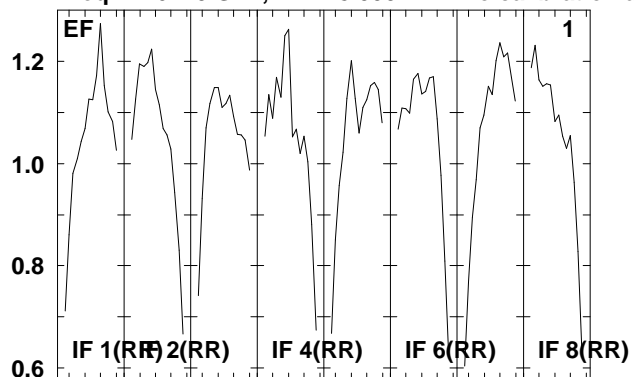

Lower frame: Real Jy

Total-power spectrum Antenna: \*

Timerange: 01/05:15:20 to 01/05:18:20

Plot file version 271 created 20-OCT-2009 14:51:43

M33 RP015C.UVDATA.1

Freq = 1.6270 GHz, Bw = 8.000 MH No calibration applied and no bandpass applied

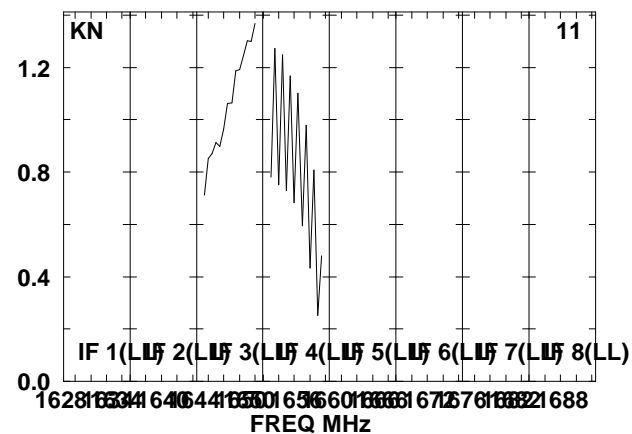
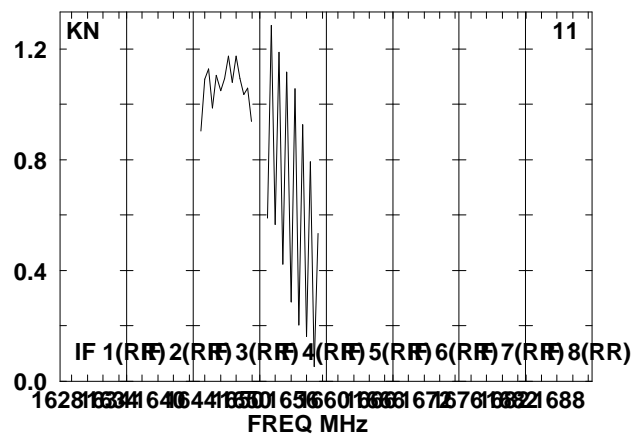
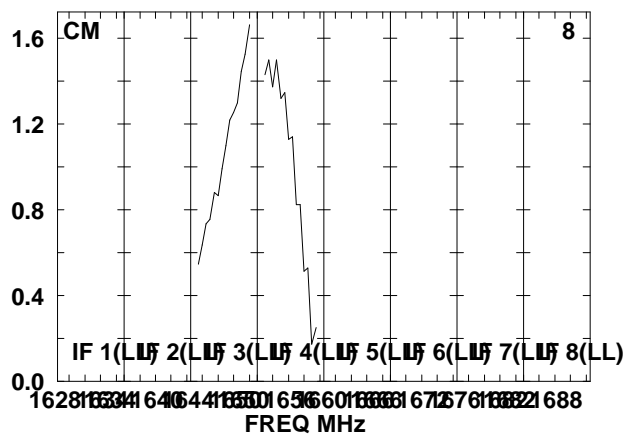
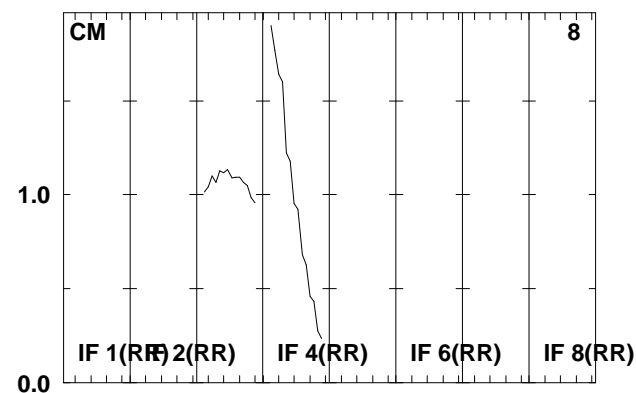
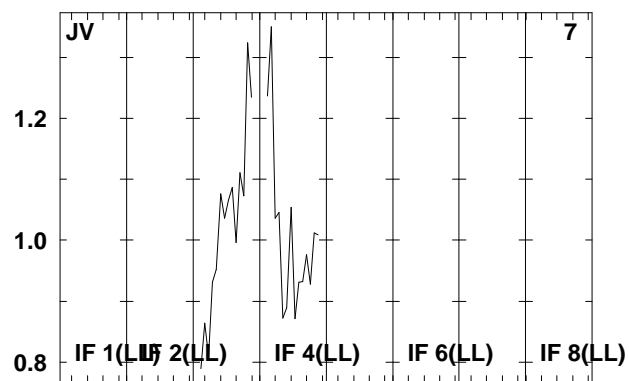
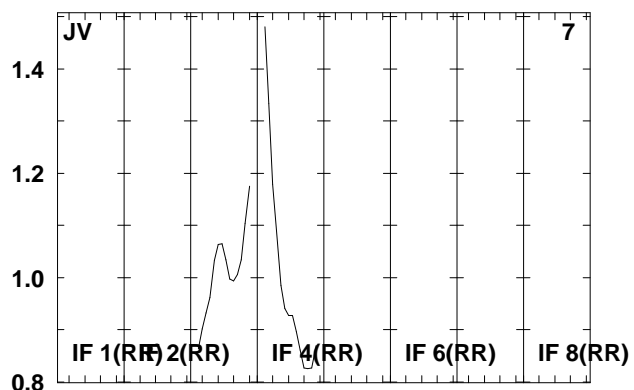
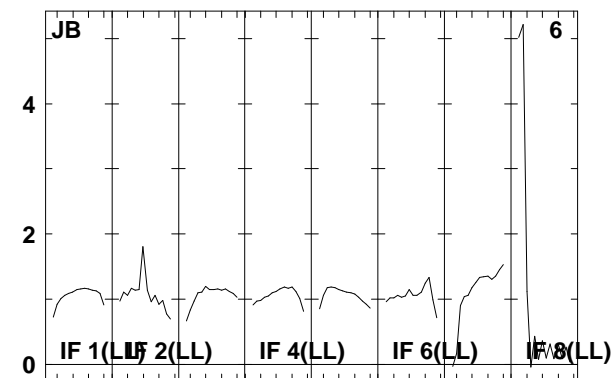
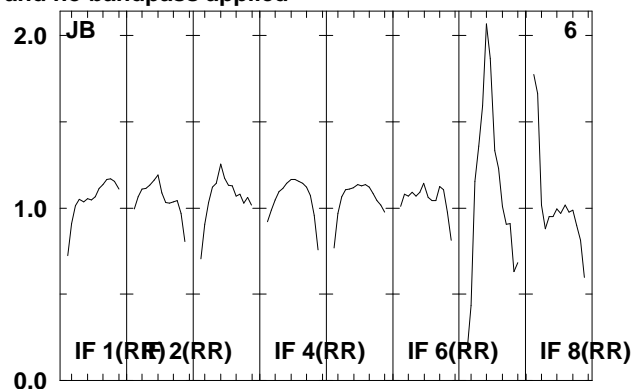
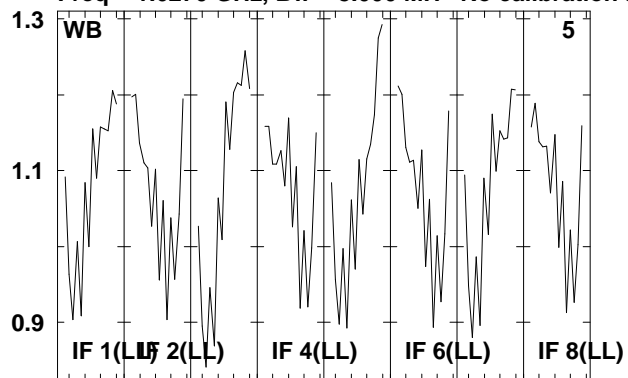

Lower frame: Real Jy  
Total-power spectrum Antenna: \*  
Timerange: 01/05:15:20 to 01/05:18:20

Plot file version 272 created 20-OCT-2009 14:51:45

M33 RP015C.UVDATA.1

Freq = 1.6270 GHz, Bw = 8.000 MH No calibration applied and no bandpass applied

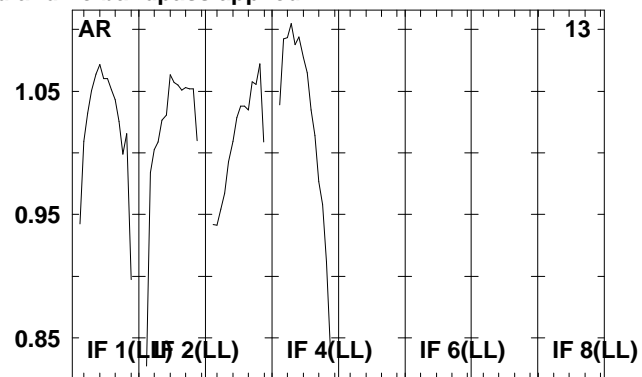
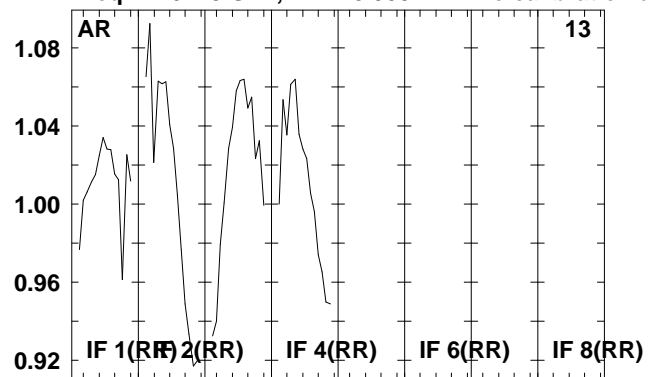

Lower frame: Real Jy  
Total-power spectrum Antenna: \*  
Timerange: 01/05:15:20 to 01/05:18:20



Plot file version 273 created 20-OCT-2009 14:51:45

J0137+31 RP015C.UVDATA.1

Freq = 1.6270 GHz, Bw = 8.000 MH No calibration applied and no bandpass applied

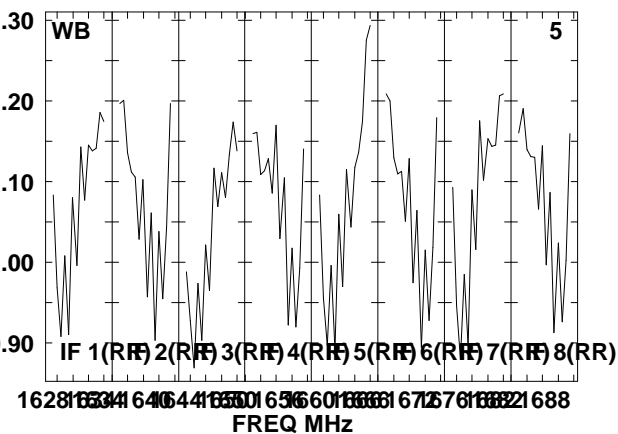
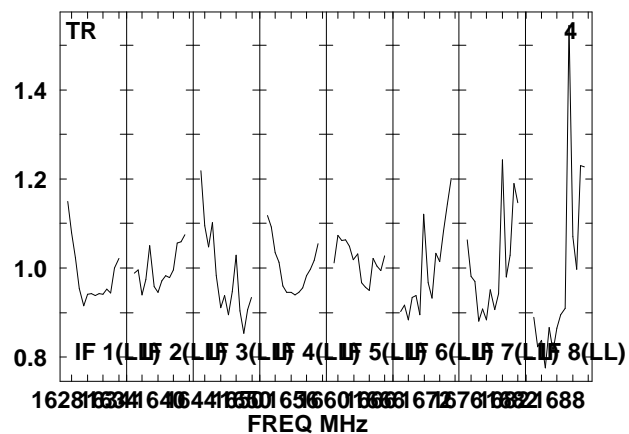
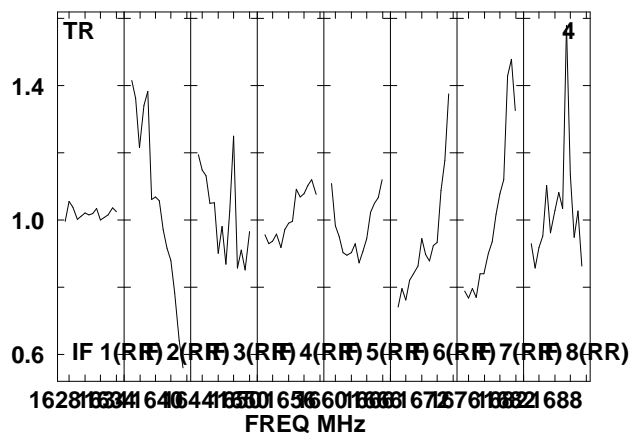
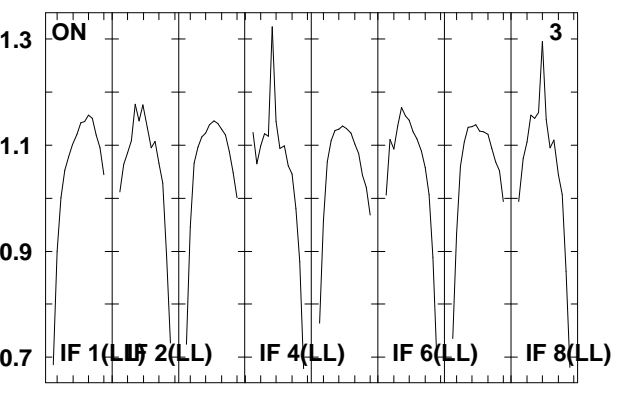
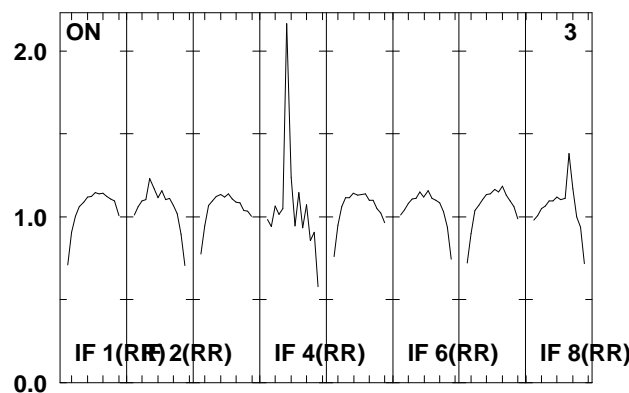
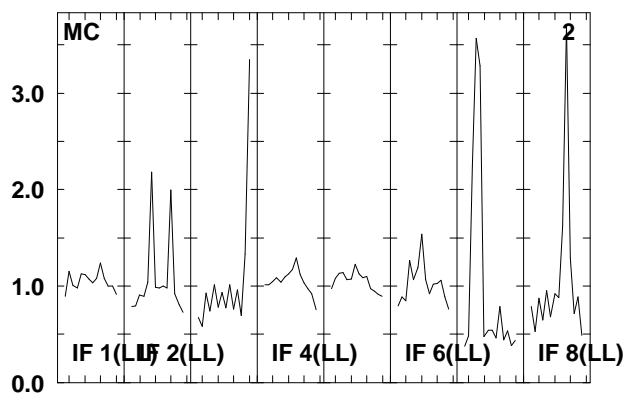
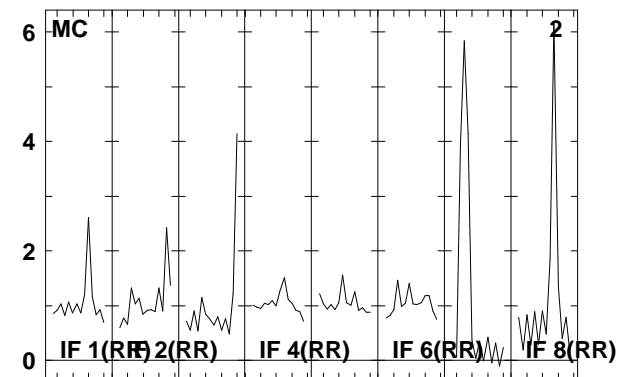
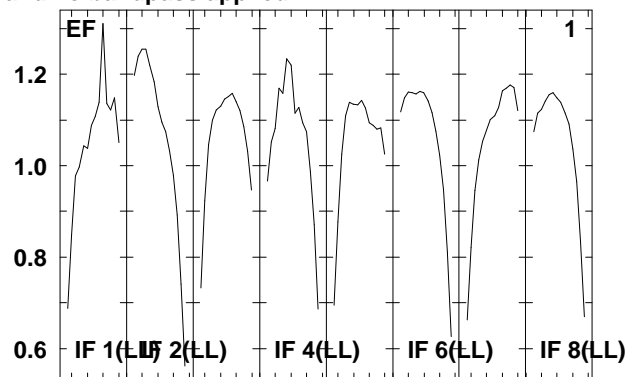
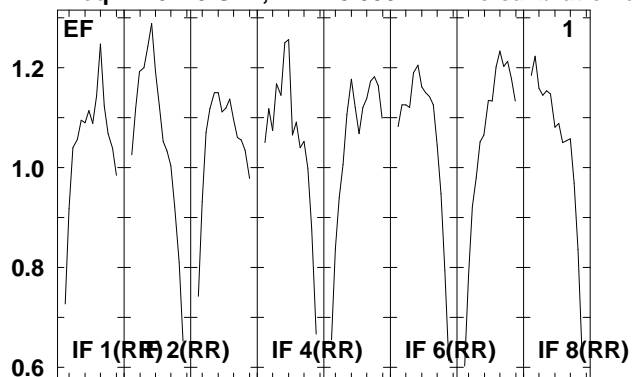

1628 1634 1640 1644 1650 1656 1660 1666 1672 1676 1682 1688  
FREQ MHz

1628 1634 1640 1644 1650 1656 1660 1666 1672 1676 1682 1688  
FREQ MHz

1628 1634 1640 1644 1650 1656 1660 1666 1672 1676 1682 1688  
FREQ MHz

Lower frame: Real Jy  
Total-power spectrum Antenna: \*  
Timerange: 01/05:19:00 to 01/05:19:59

Plot file version 274 created 20-OCT-2009 14:51:45

J0137+31 RP015C.UVDATA.1

Freq = 1.6270 GHz, Bw = 8.000 MH No calibration applied and no bandpass applied

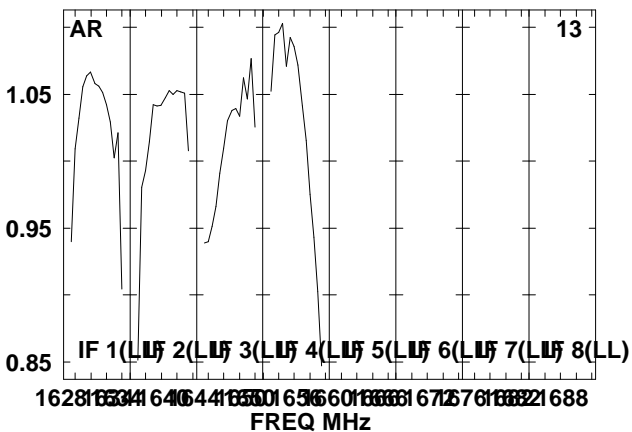
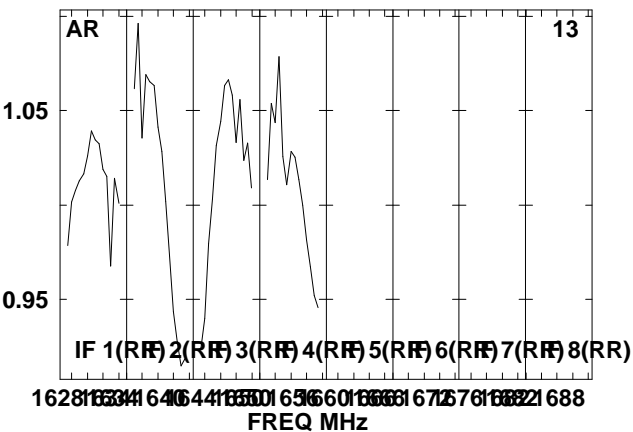
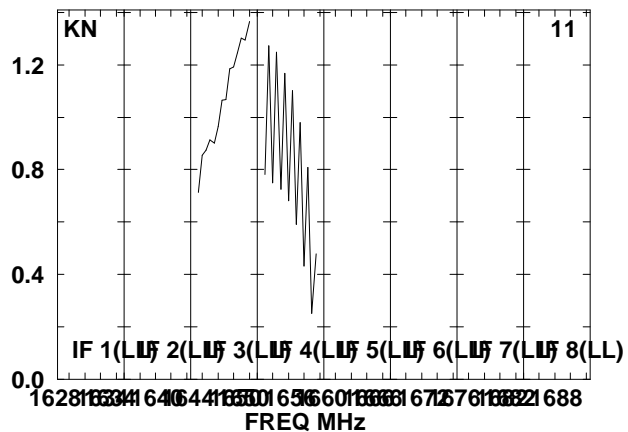
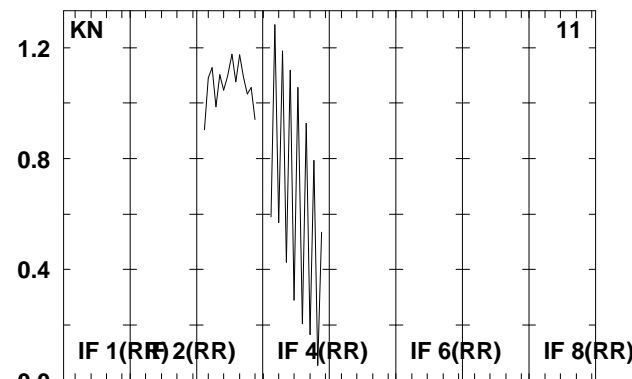
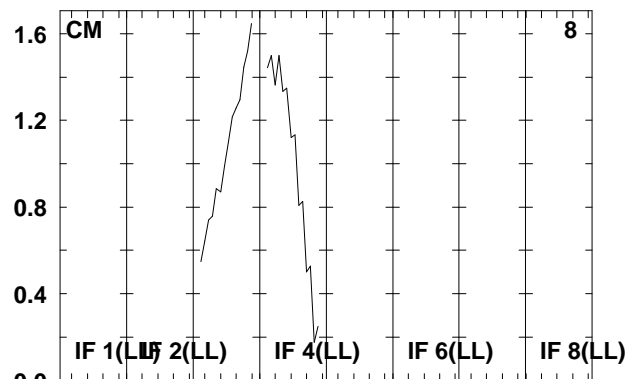
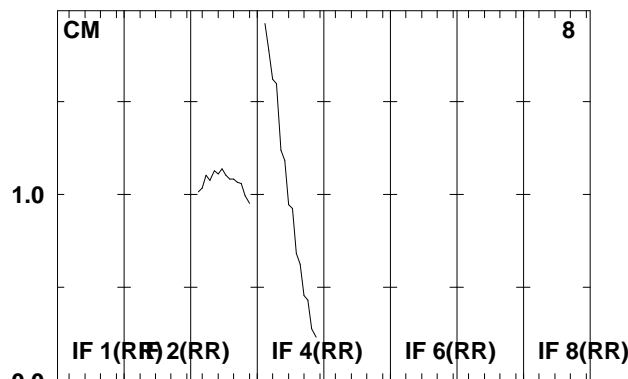
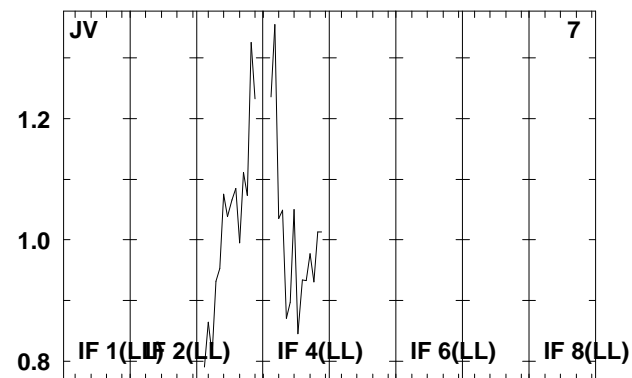
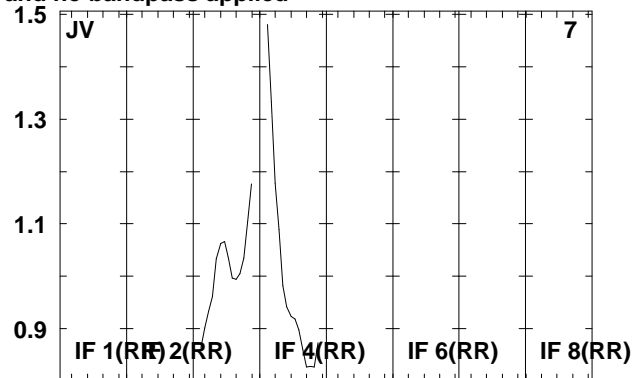
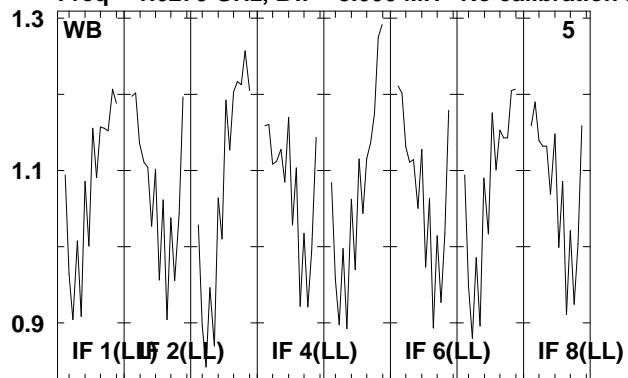

Lower frame: Real Jy  
Total-power spectrum Antenna: \*  
Timerange: 01/05:19:00 to 01/05:19:59

Plot file version 275 created 20-OCT-2009 14:51:46

FAINTCAL RP015C.UVDATA.1

Freq = 1.6270 GHz, Bw = 8.000 MH No calibration applied and no bandpass applied

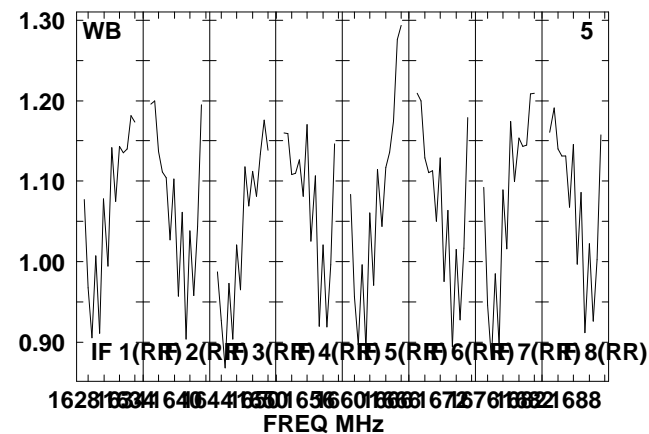
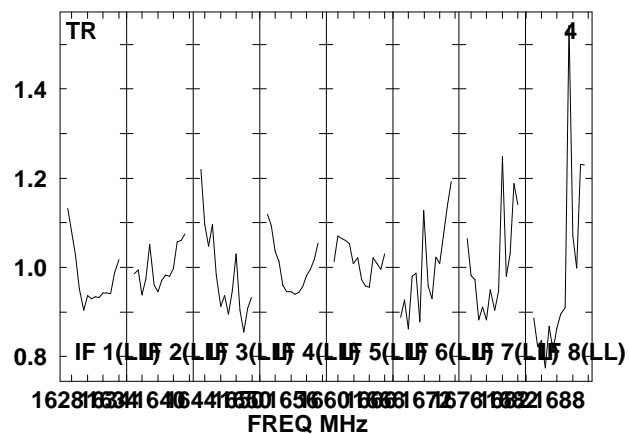
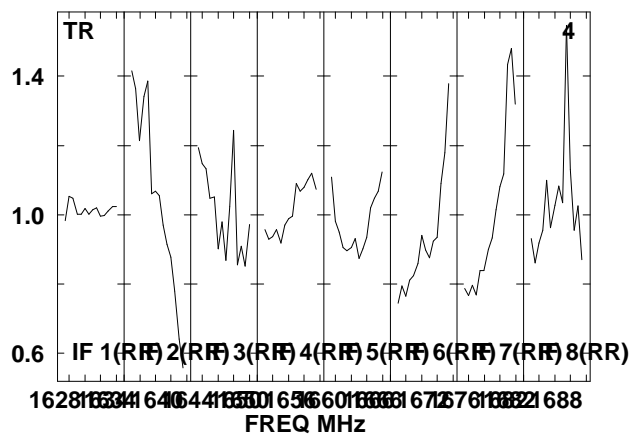
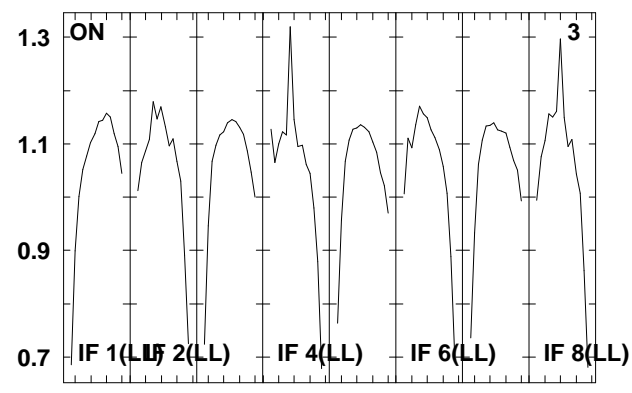
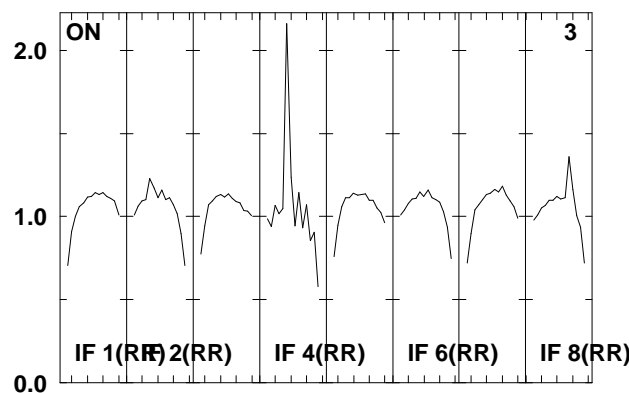
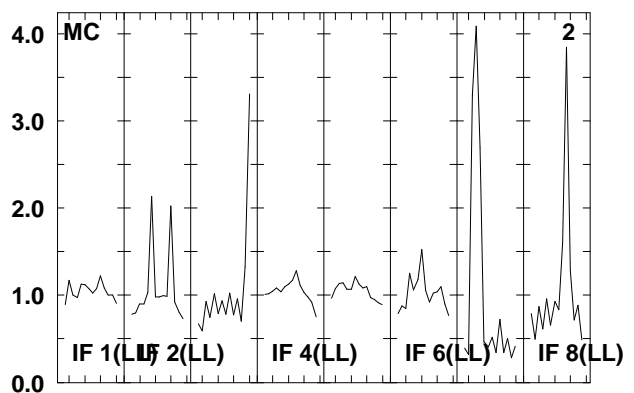
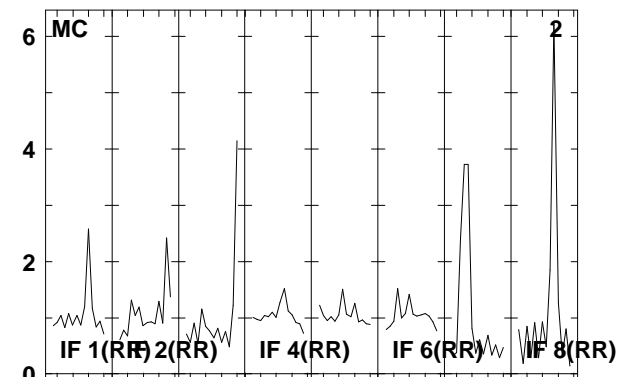
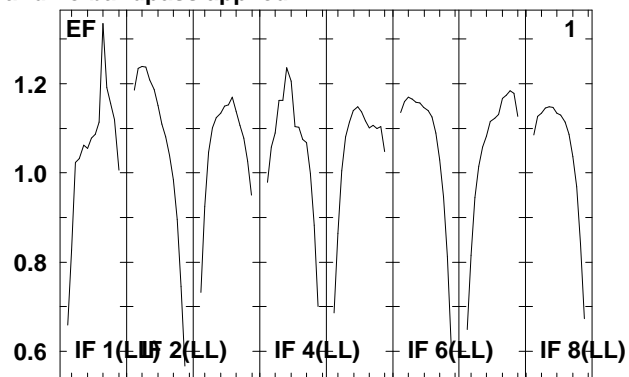
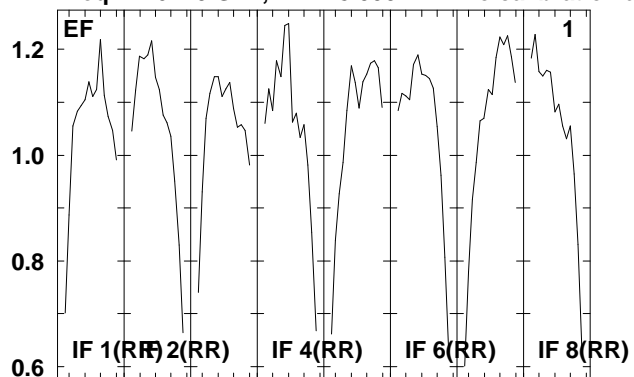

Lower frame: Real Jy

Total-power spectrum Antenna: \*

Timerange: 01/05:20:01 to 01/05:21:20

Plot file version 276 created 20-OCT-2009 14:51:46

FAINTCAL RP015C.UVDATA.1

Freq = 1.6270 GHz, Bw = 8.000 MH No calibration applied and no bandpass applied

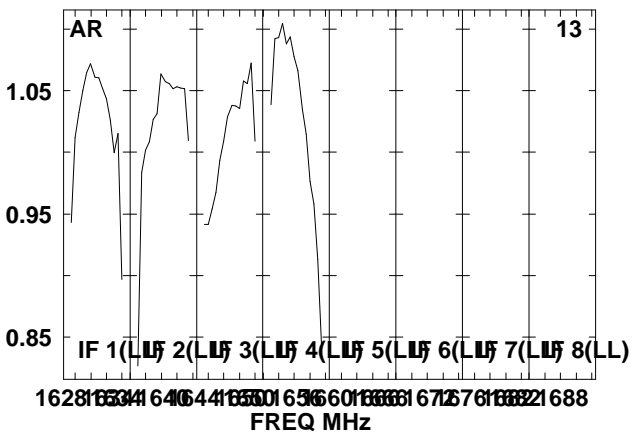
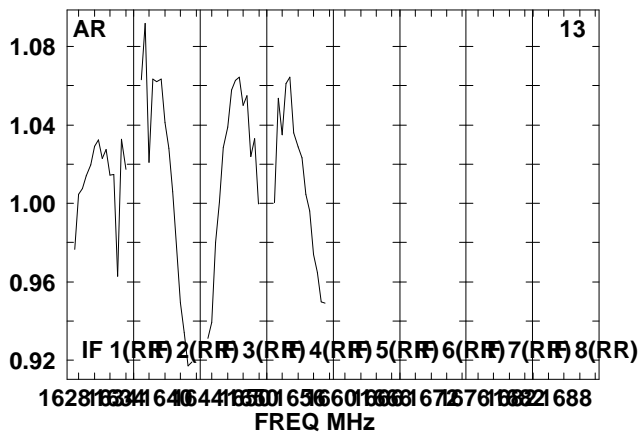
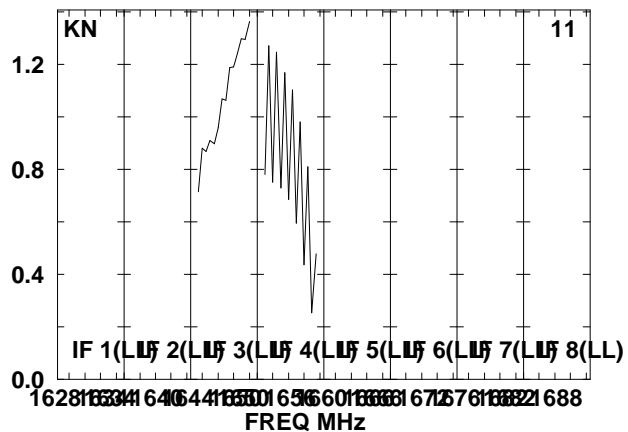
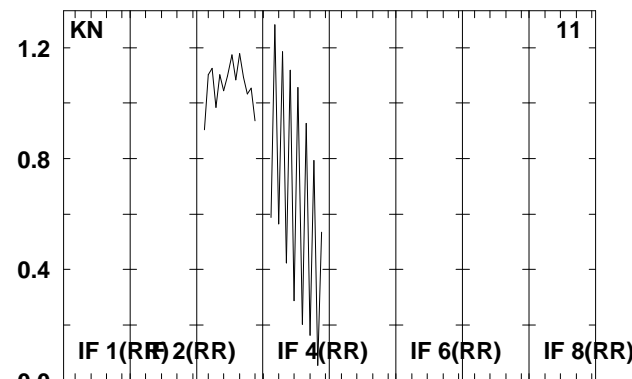
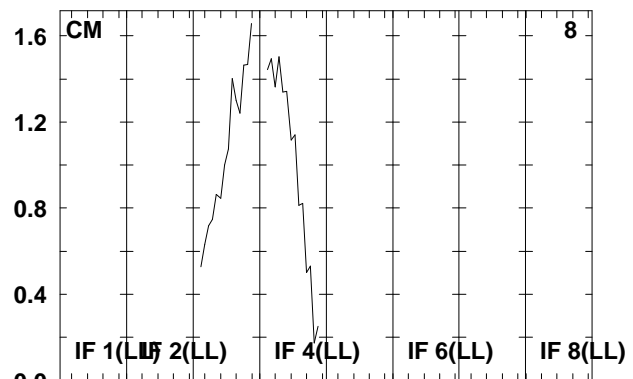
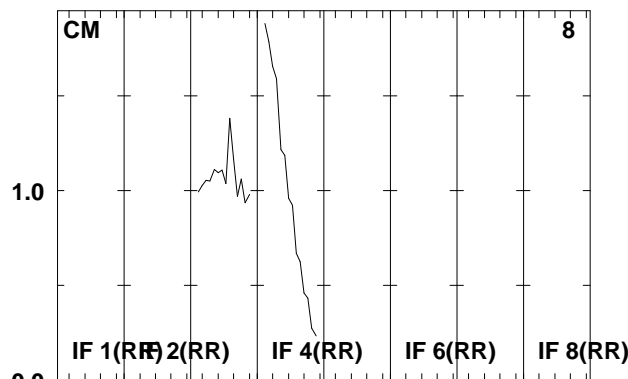
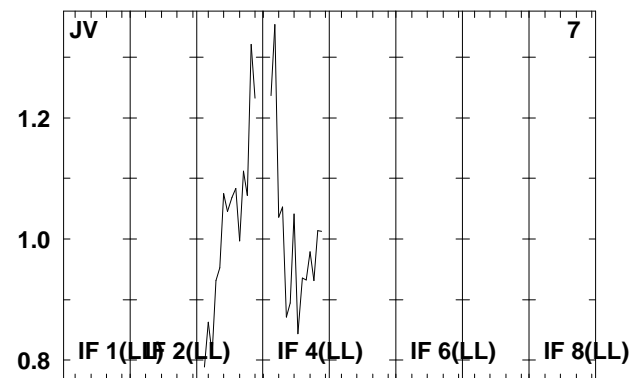
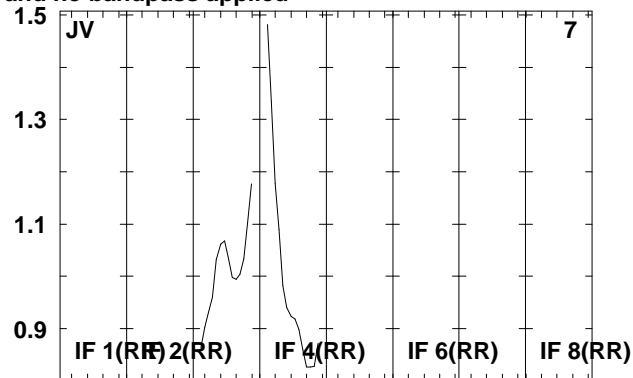
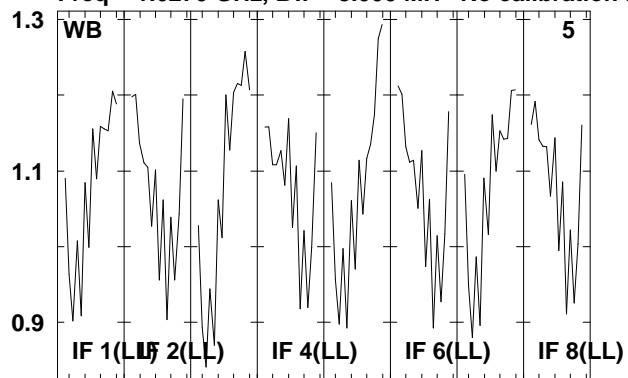

Lower frame: Real Jy  
Total-power spectrum Antenna: \*  
Timerange: 01/05:20:01 to 01/05:21:20

Plot file version 277 created 20-OCT-2009 14:51:47

M33 RP015C.UVDATA.1

Freq = 1.6270 GHz, Bw = 8.000 MH No calibration applied and no bandpass applied

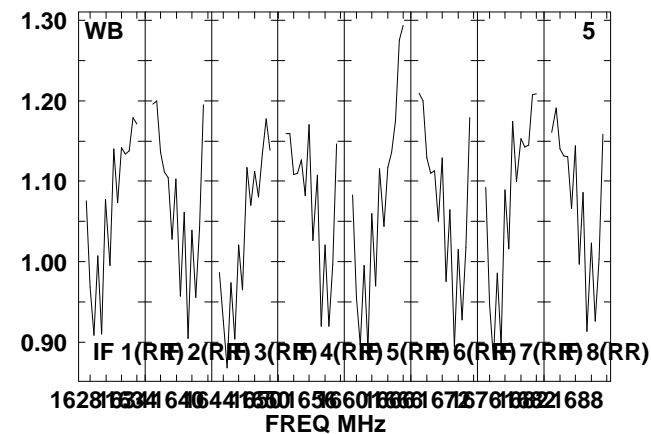
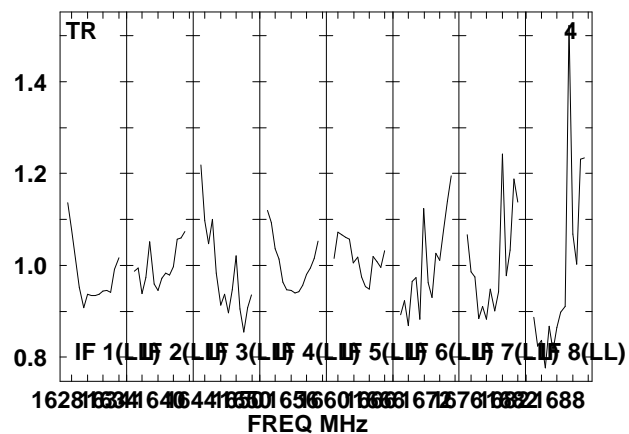
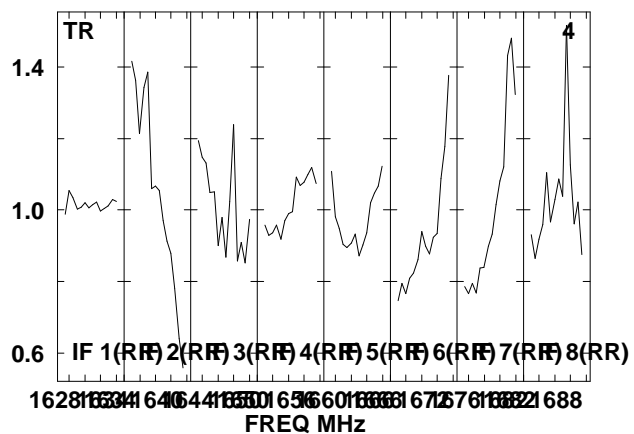
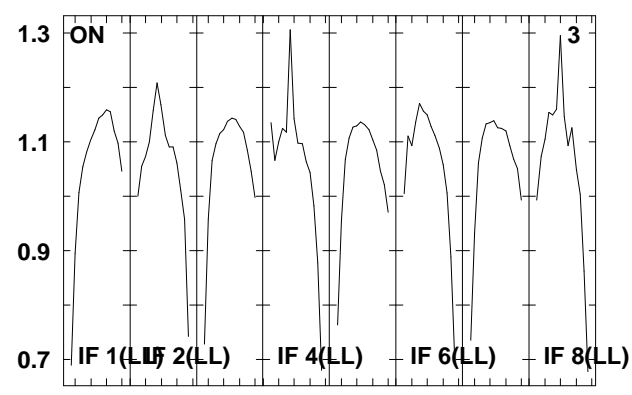
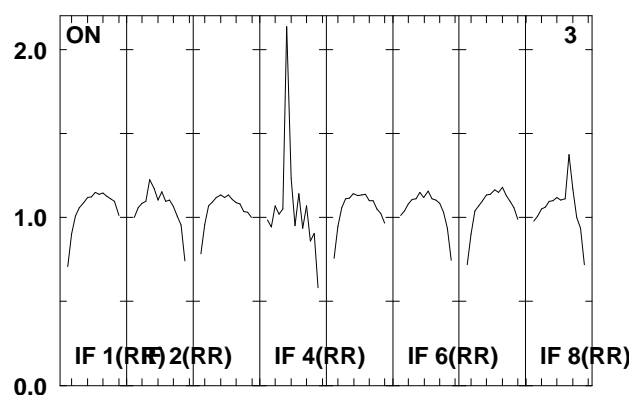
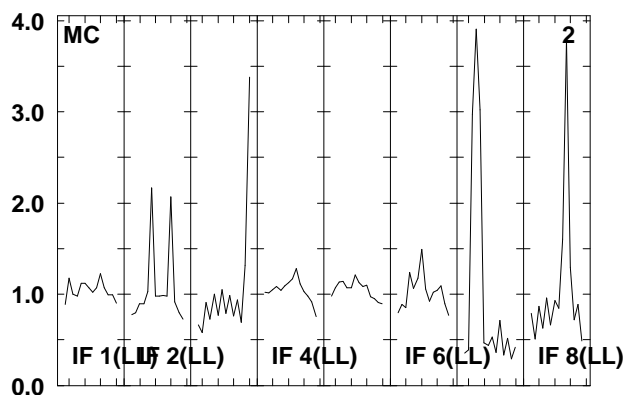
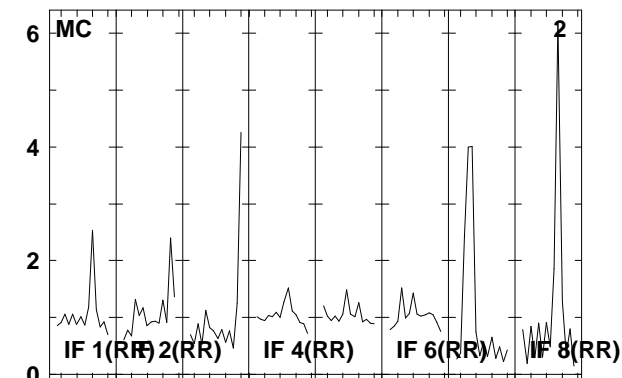
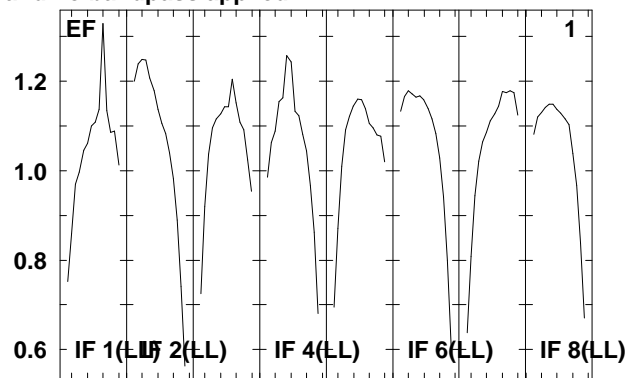
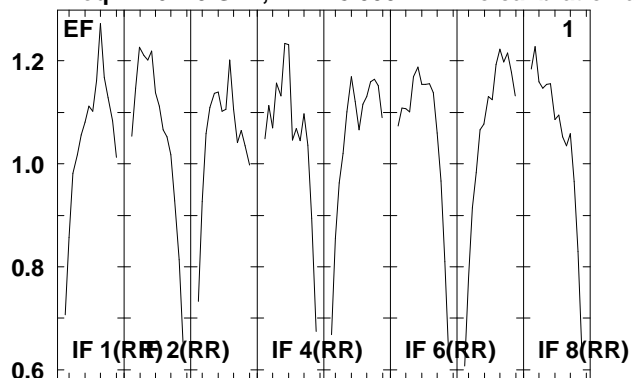

Lower frame: Real Jy  
Total-power spectrum Antenna: \*  
Timerange: 01/05:21:20 to 01/05:24:19

Plot file version 278 created 20-OCT-2009 14:51:48

M33 RP015C.UVDATA.1

Freq = 1.6270 GHz, Bw = 8.000 MH No calibration applied and no bandpass applied

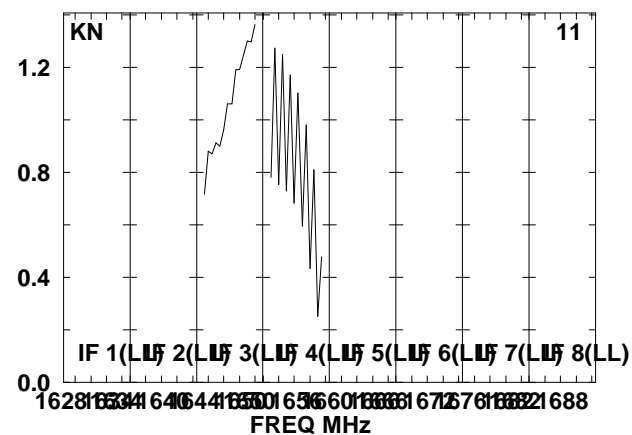
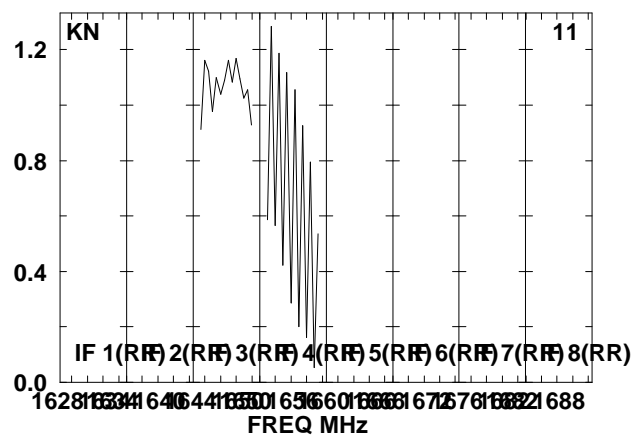
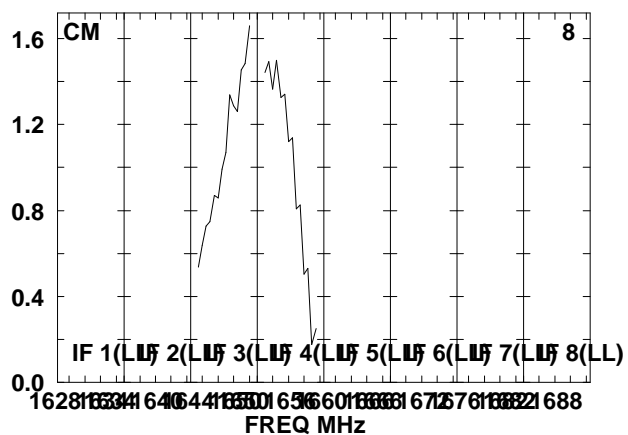
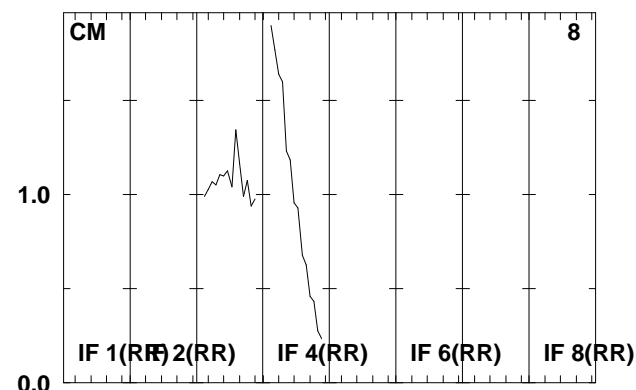
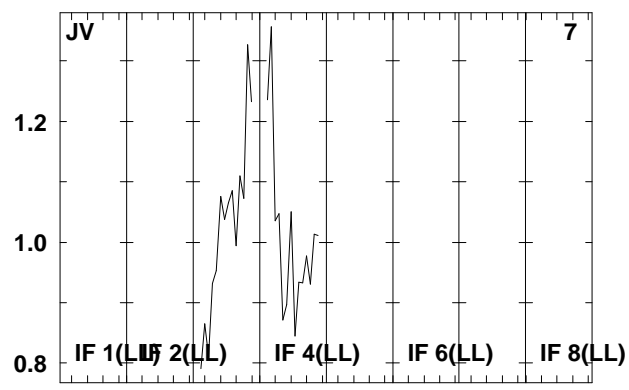
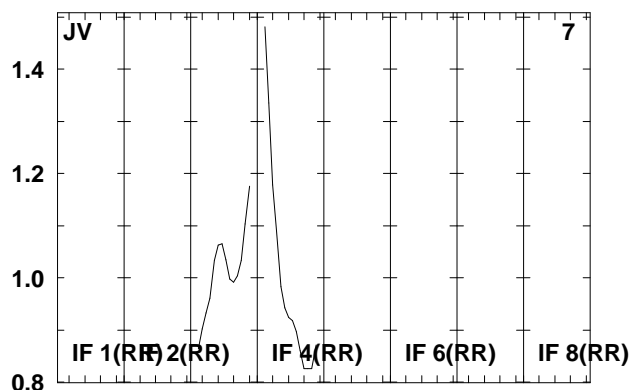
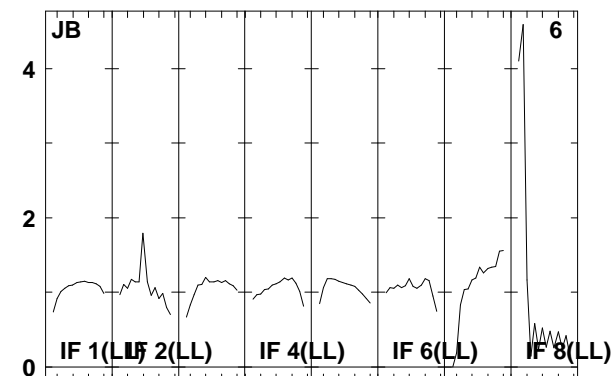
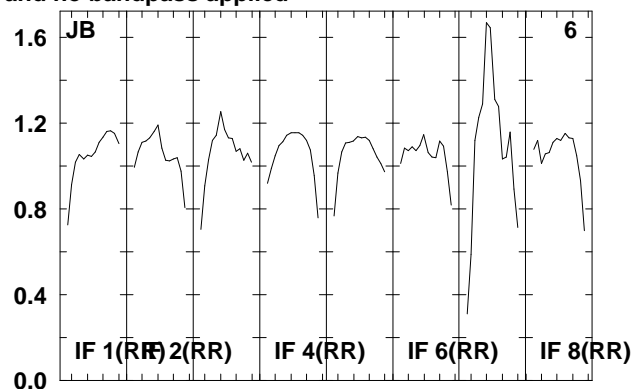
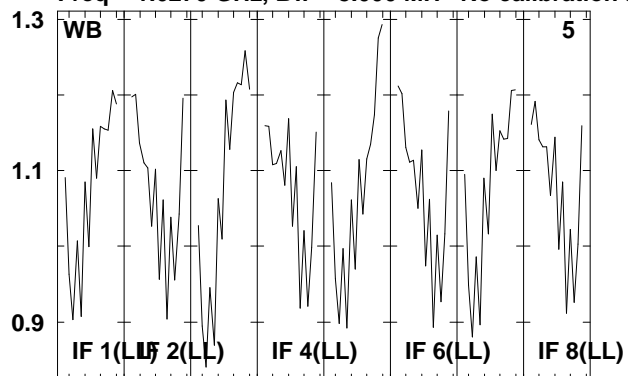

Lower frame: Real Jy

Total-power spectrum Antenna: \*

Timerange: 01/05:21:20 to 01/05:24:19

Plot file version 279 created 20-OCT-2009 14:51:50

M33 RP015C.UVDATA.1

Freq = 1.6270 GHz, Bw = 8.000 MH No calibration applied and no bandpass applied

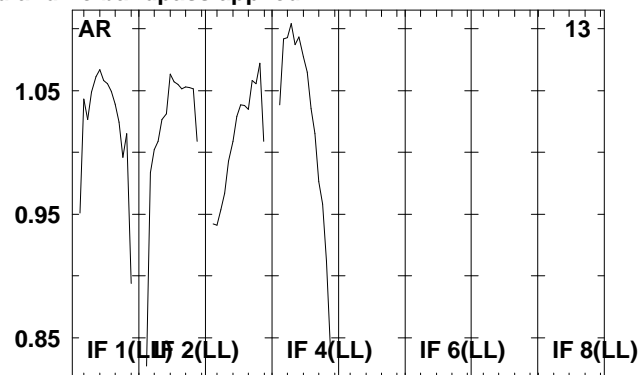
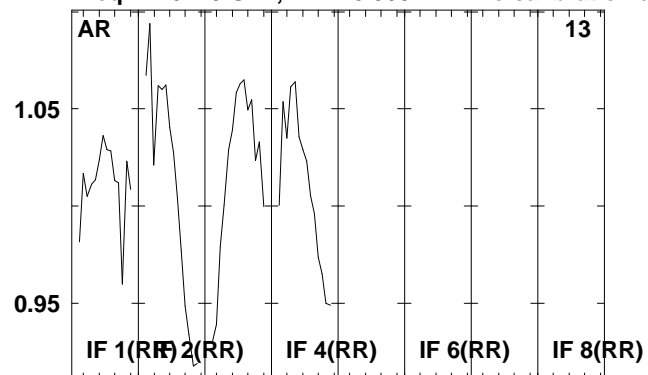

Lower frame: Real Jy  
Total-power spectrum Antenna: \*  
Timerange: 01/05:21:20 to 01/05:24:19

Plot file version 280 created 20-OCT-2009 14:51:50

J0137+31 RP015C.UVDATA.1

Freq = 1.6270 GHz, Bw = 8.000 MH No calibration applied and no bandpass applied

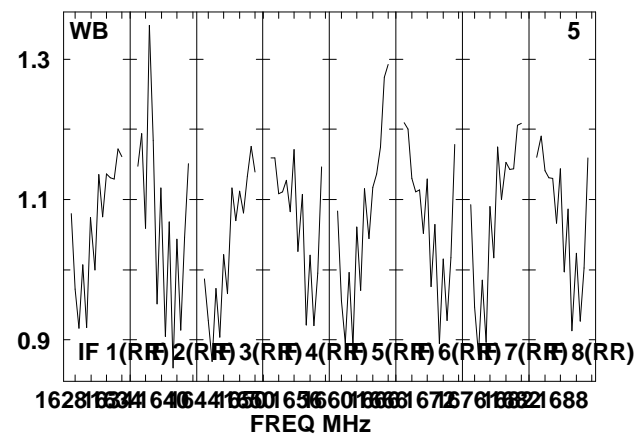
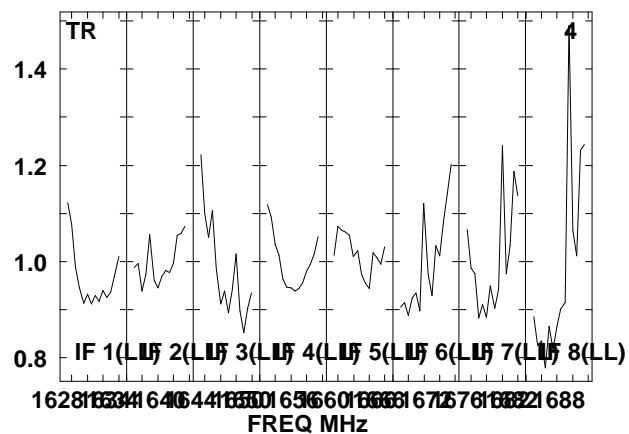
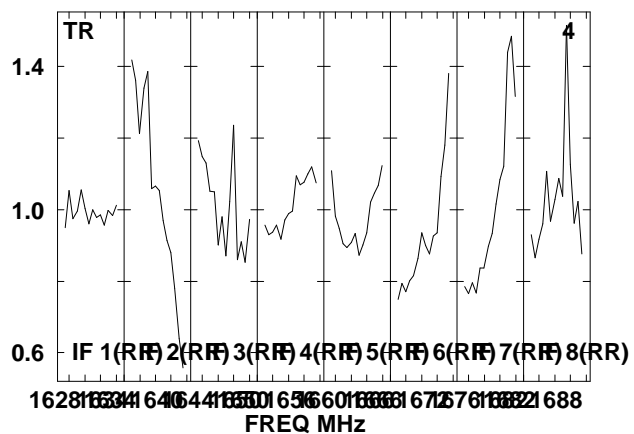
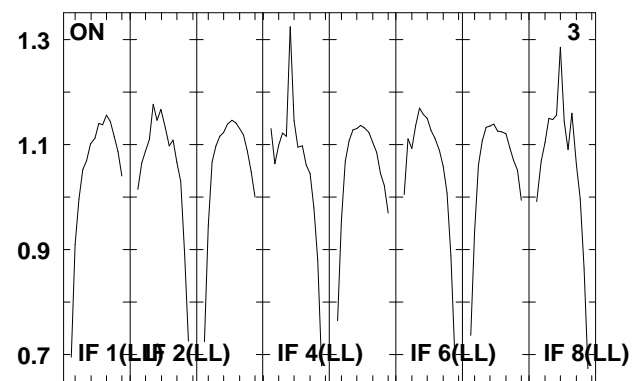
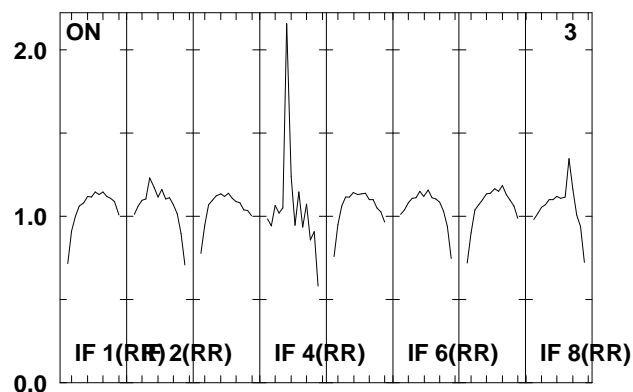
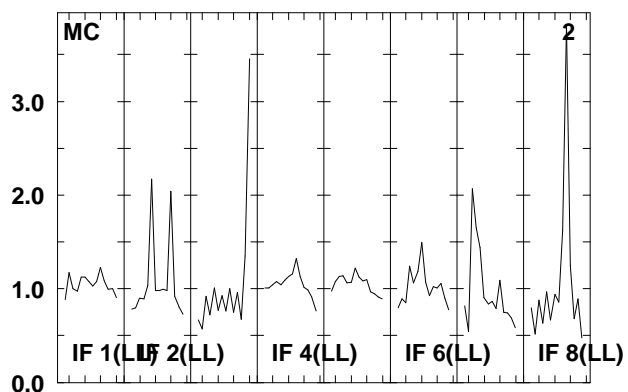
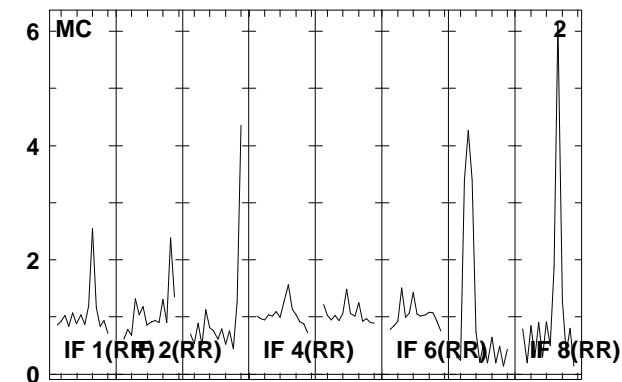
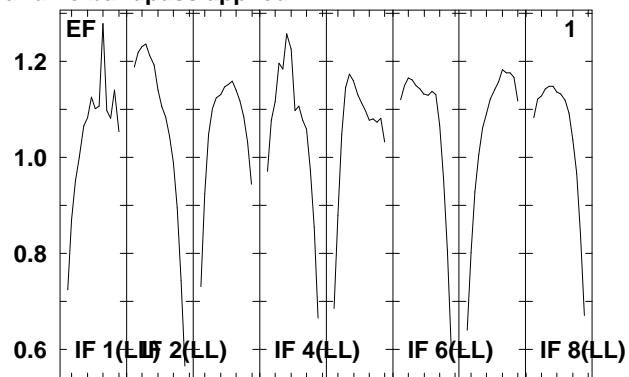
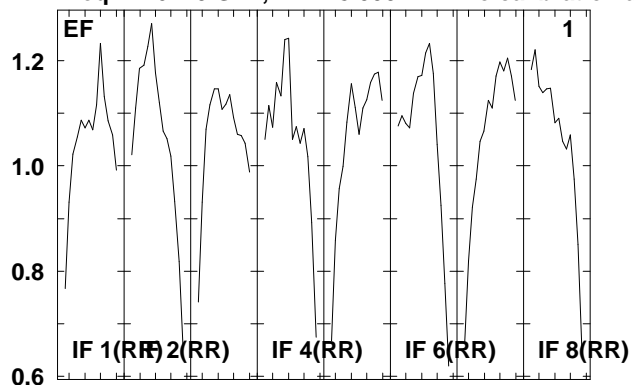

Lower frame: Real Jy

Total-power spectrum Antenna: \*

Timerange: 01/05:25:01 to 01/05:25:59



Plot file version 281 created 20-OCT-2009 14:51:50

J0137+31 RP015C.UVDATA.1

Freq = 1.6270 GHz, Bw = 8.000 MH No calibration applied and no bandpass applied

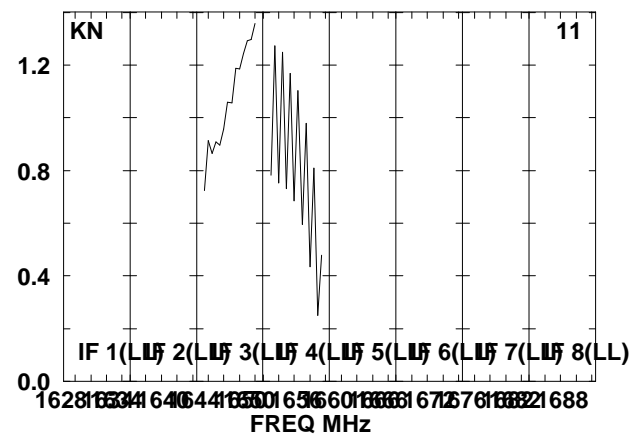
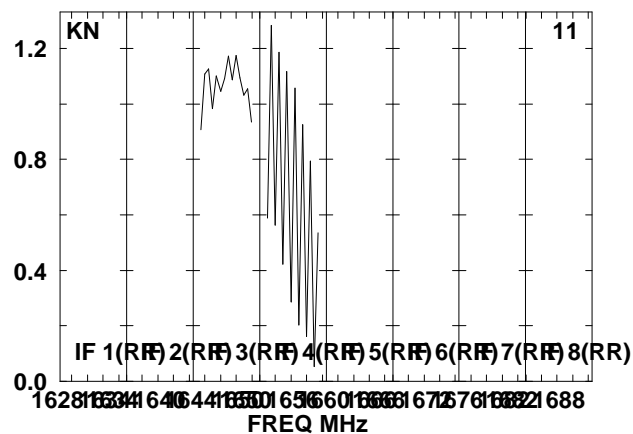
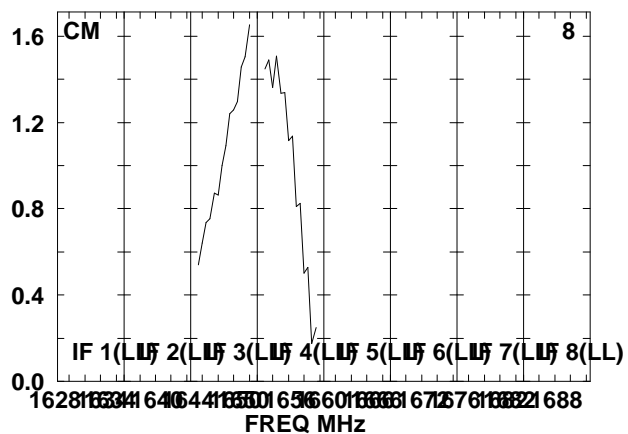
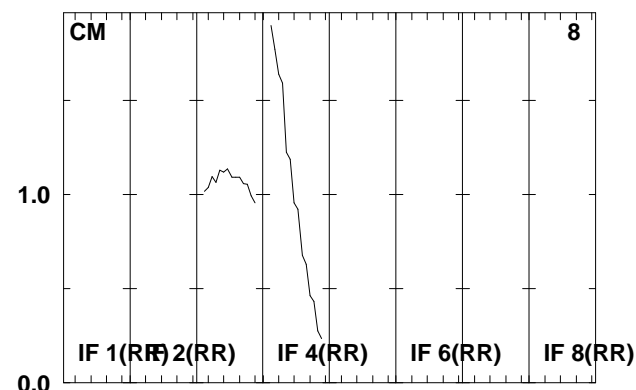
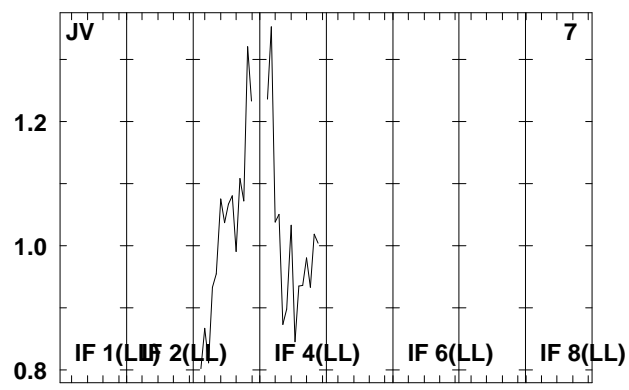
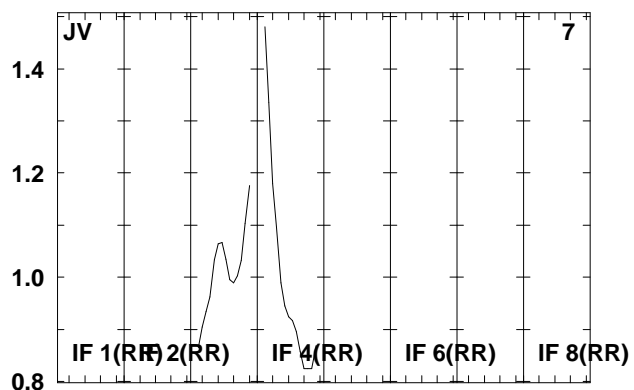
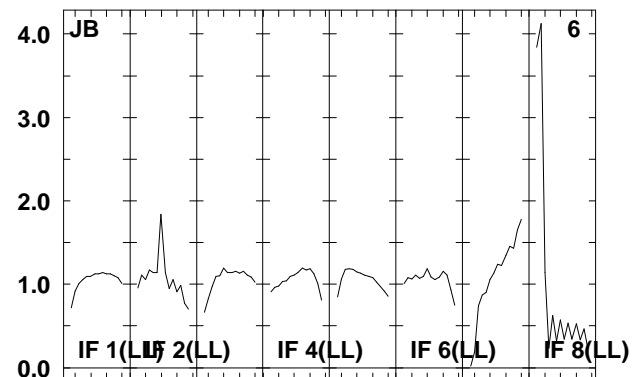
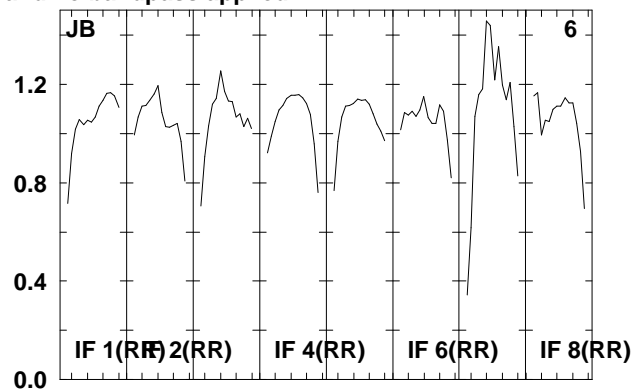
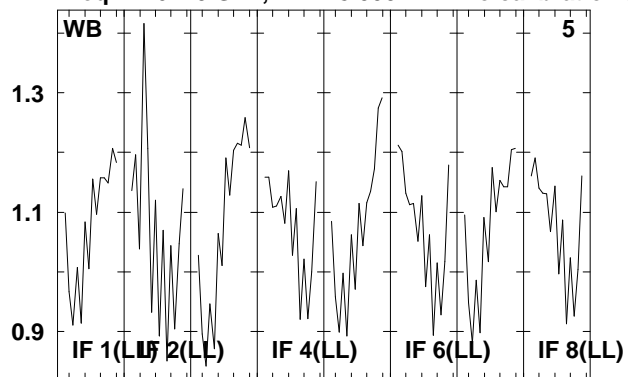

Lower frame: Real Jy

Total-power spectrum Antenna: \*

Timerange: 01/05:25:01 to 01/05:25:59

Plot file version 282 created 20-OCT-2009 14:51:51

J0137+31 RP015C.UVDATA.1

Freq = 1.6270 GHz, Bw = 8.000 MH No calibration applied and no bandpass applied

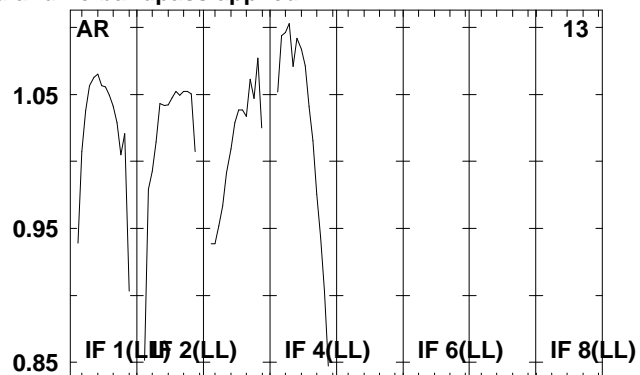
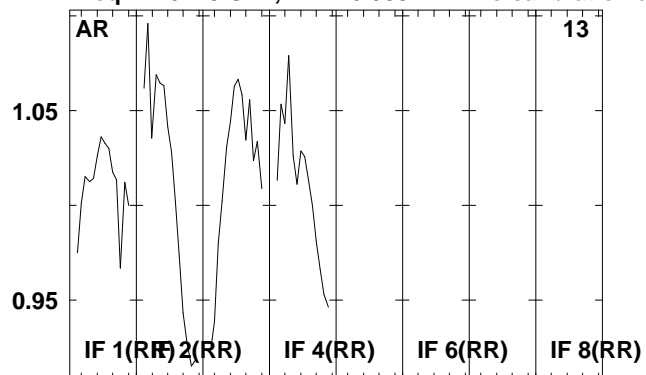

Lower frame: Real Jy  
Total-power spectrum Antenna: \*  
Timerange: 01/05:25:01 to 01/05:25:59

Plot file version 283 created 20-OCT-2009 14:51:51

FAINTCAL RP015C.UVDATA.1

Freq = 1.6270 GHz, Bw = 8.000 MH No calibration applied and no bandpass applied

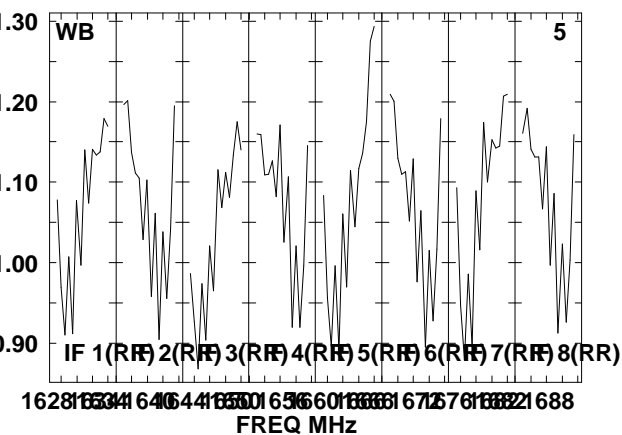
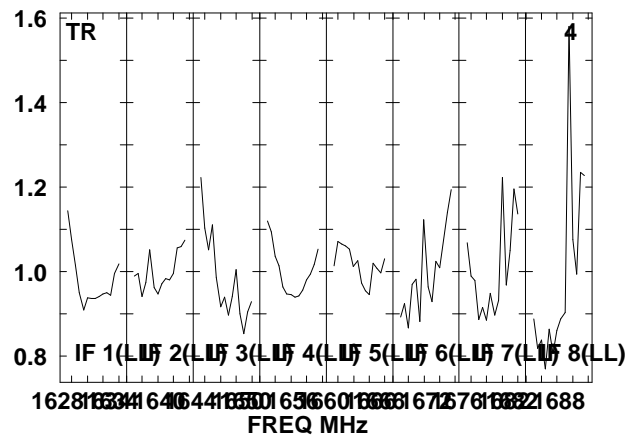
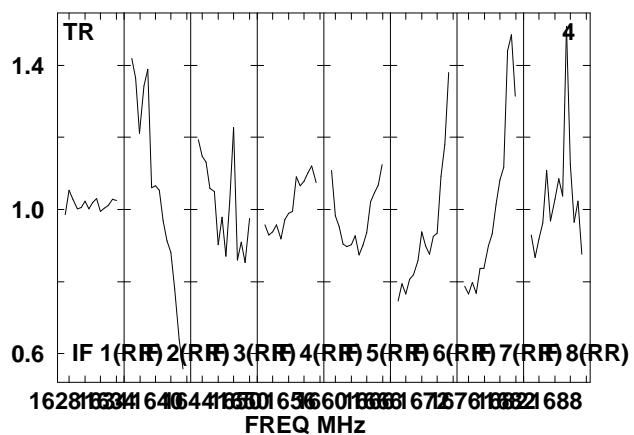
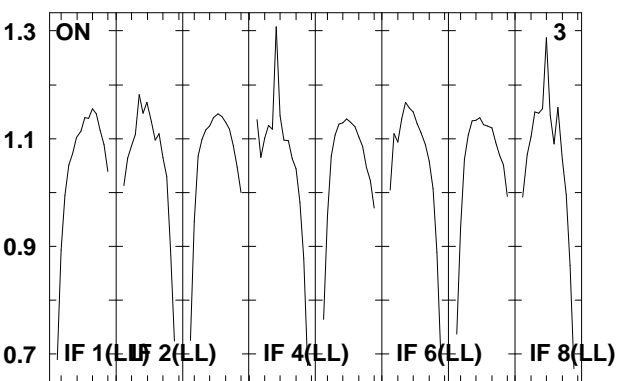
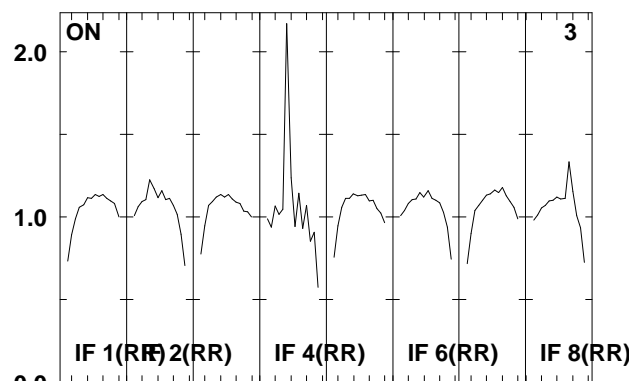
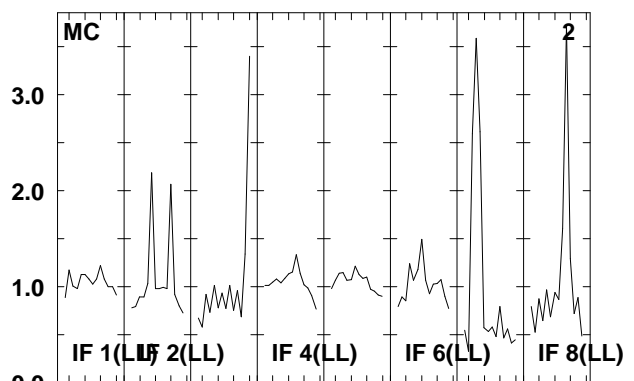
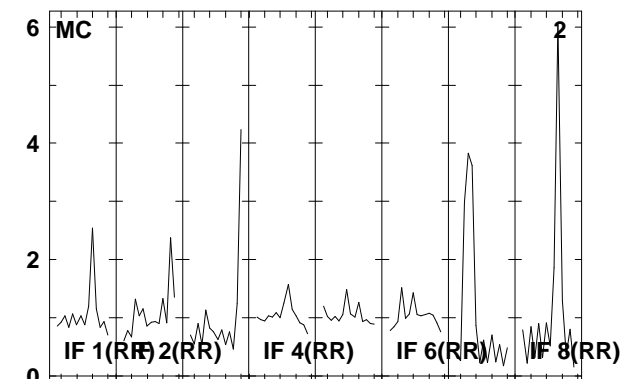
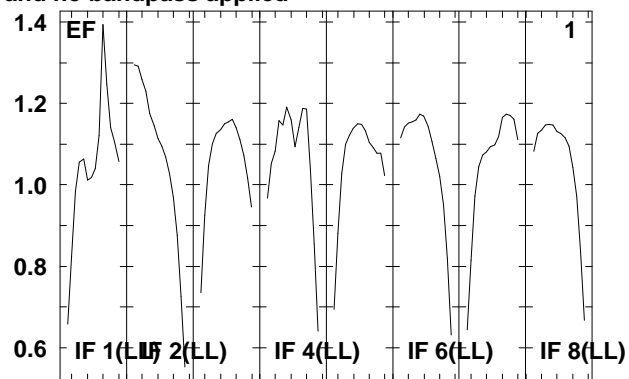
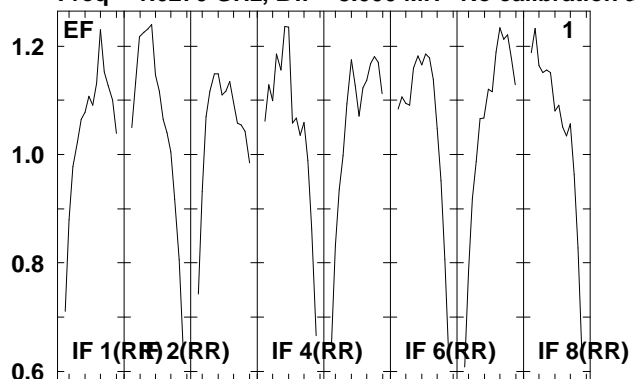

Lower frame: Real Jy

Total-power spectrum Antenna: \*

Timerange: 01/05:26:00 to 01/05:27:19

Plot file version 284 created 20-OCT-2009 14:51:51

FAINTCAL RP015C.UVDATA.1

Freq = 1.6270 GHz, Bw = 8.000 MH No calibration applied and no bandpass applied

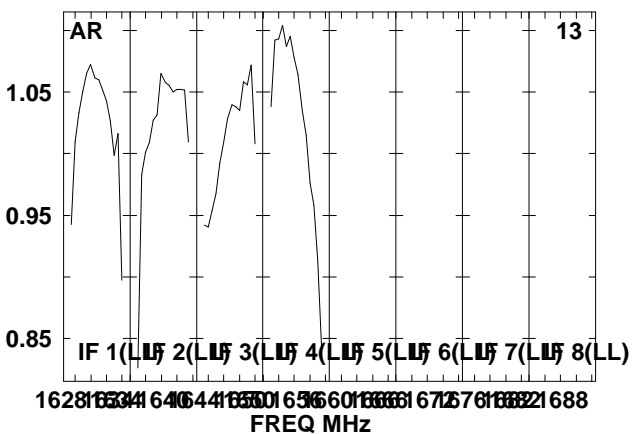
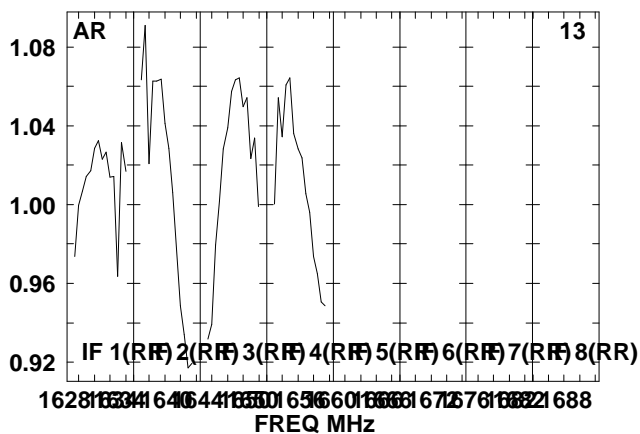
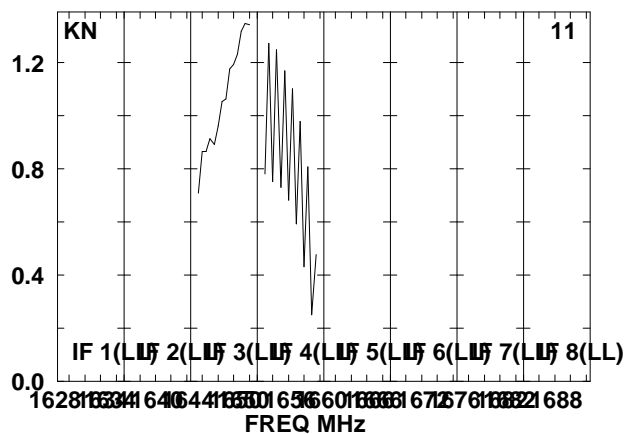
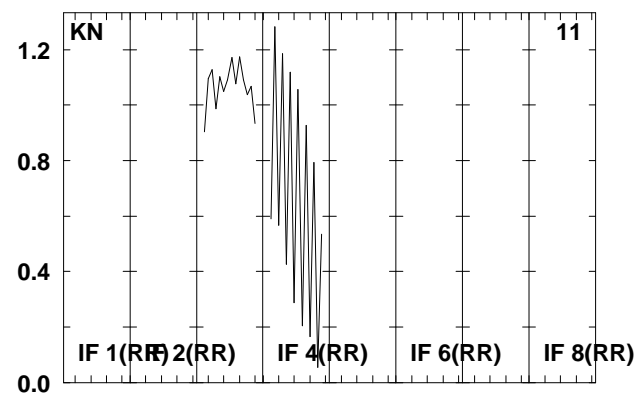
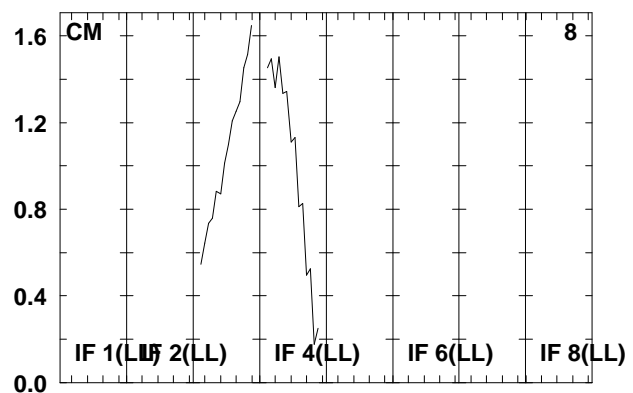
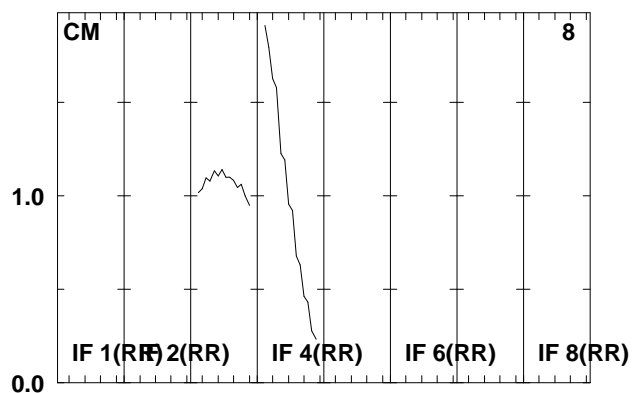
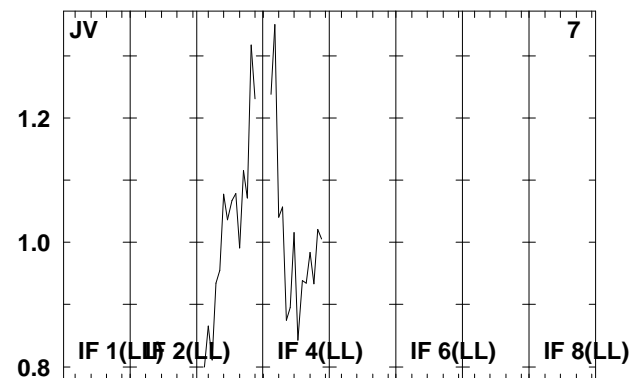
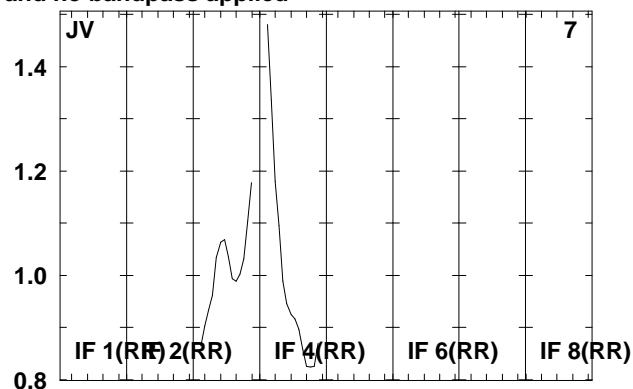
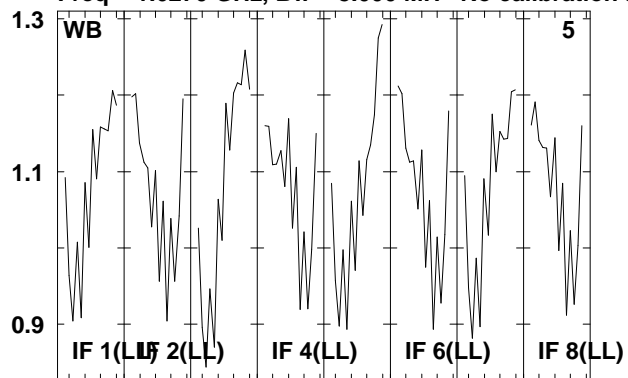

Lower frame: Real Jy

Total-power spectrum Antenna: \*

Timerange: 01/05:26:00 to 01/05:27:19

Plot file version 285 created 20-OCT-2009 14:51:52

M33 RP015C.UVDATA.1

Freq = 1.6270 GHz, Bw = 8.000 MH No calibration applied and no bandpass applied

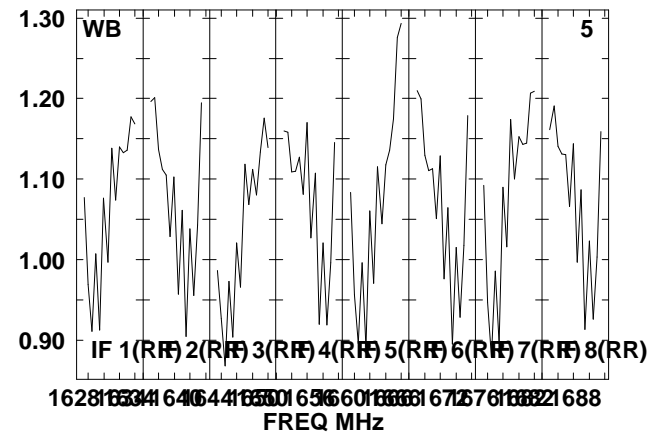
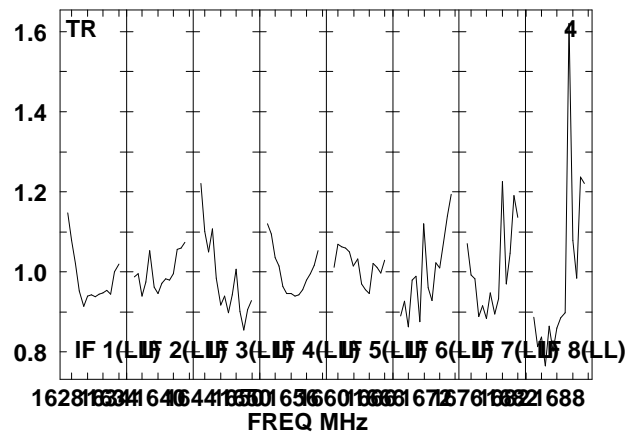
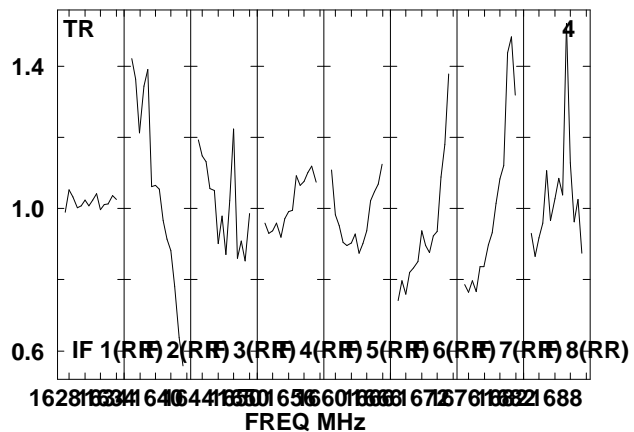
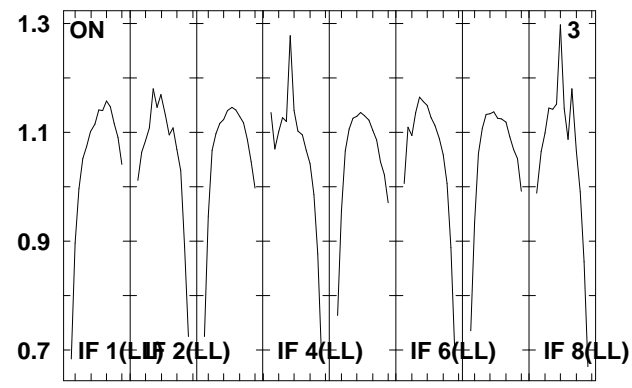
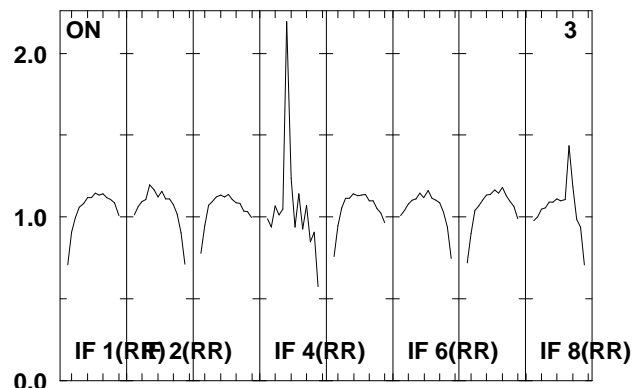
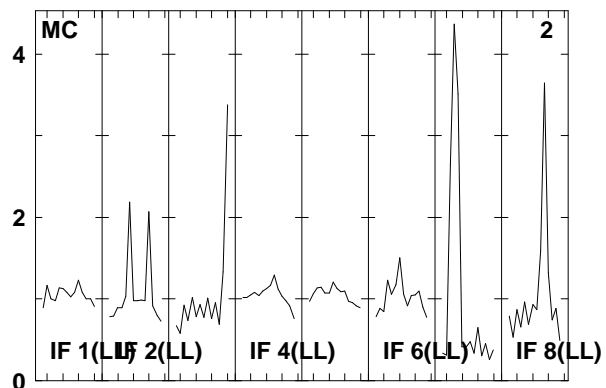
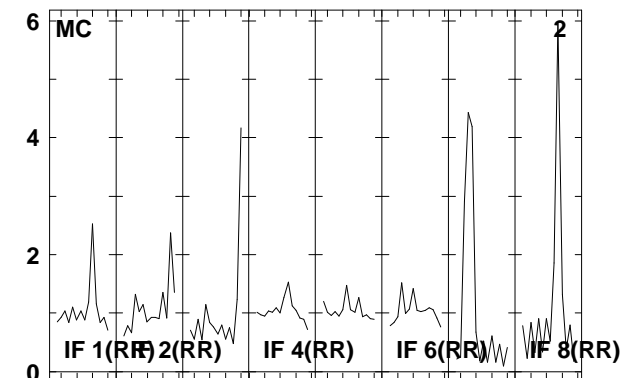
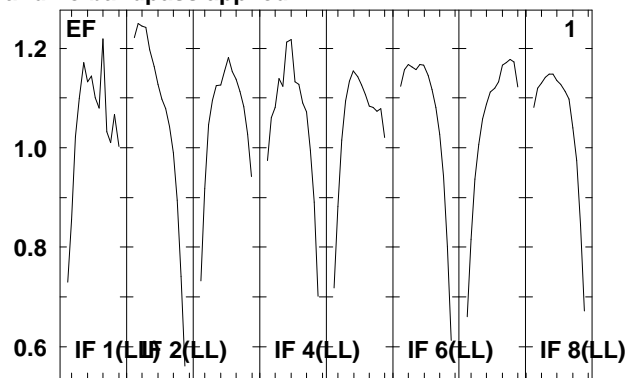
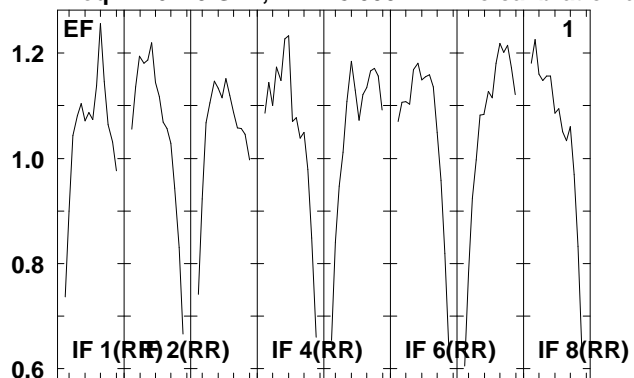

Lower frame: Real Jy

Total-power spectrum Antenna: \*

Timerange: 01/05:27:20 to 01/05:30:20

Plot file version 286 created 20-OCT-2009 14:51:53

M33 RP015C.UVDATA.1

Freq = 1.6270 GHz, Bw = 8.000 MH No calibration applied and no bandpass applied

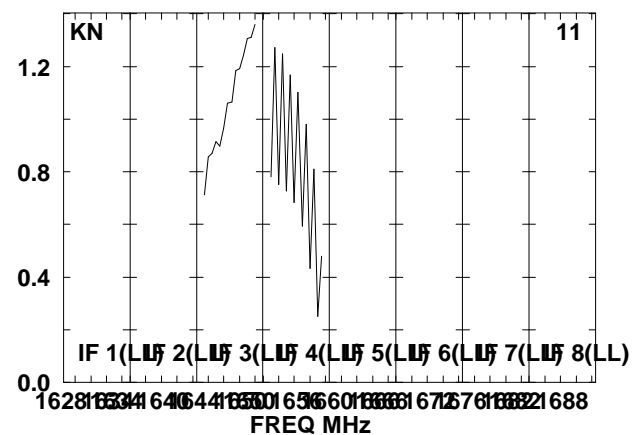
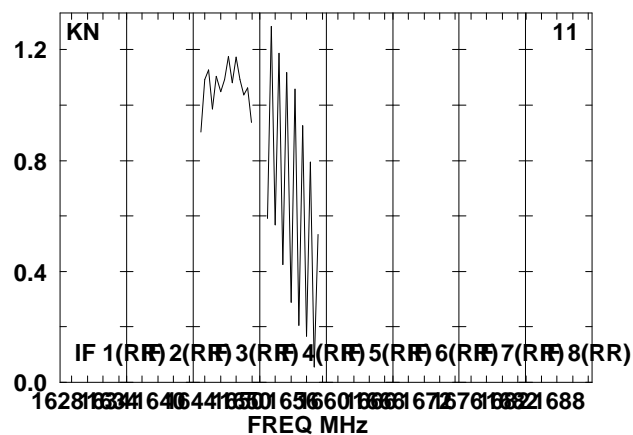
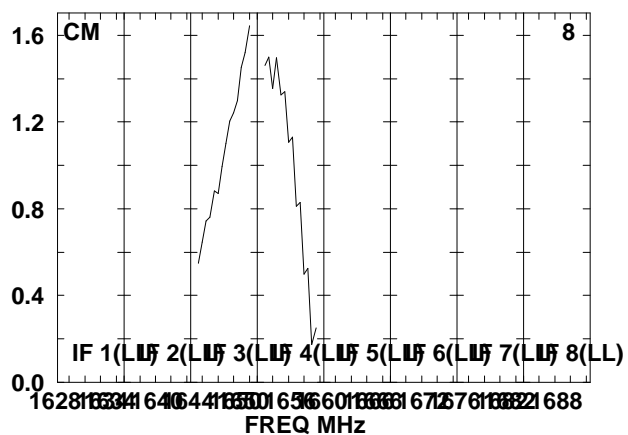
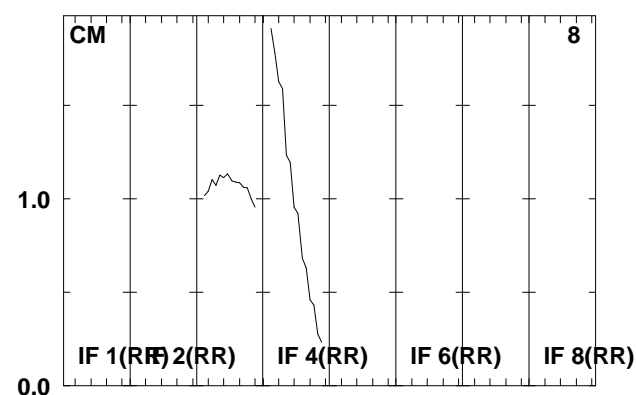
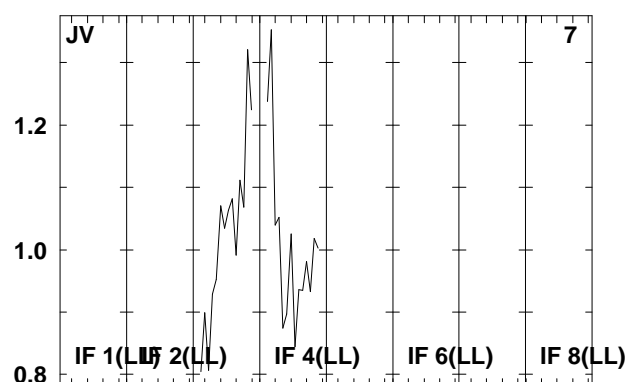
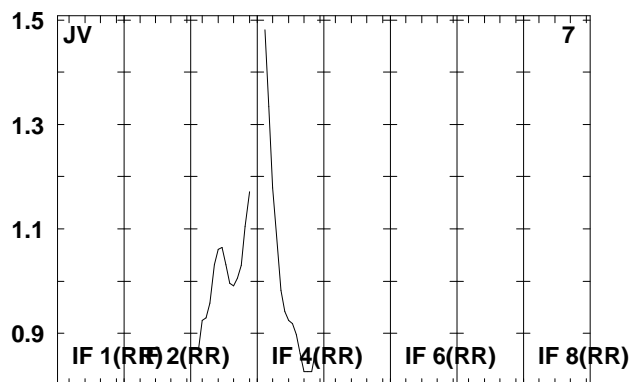
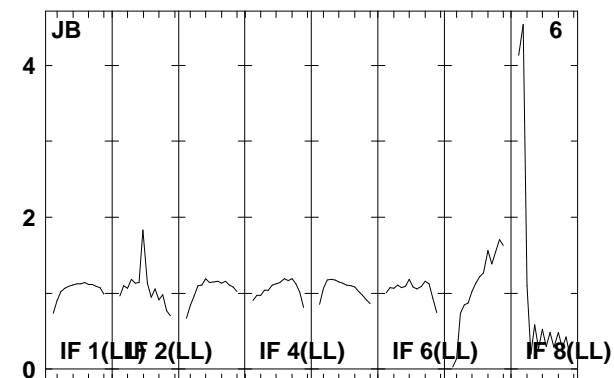
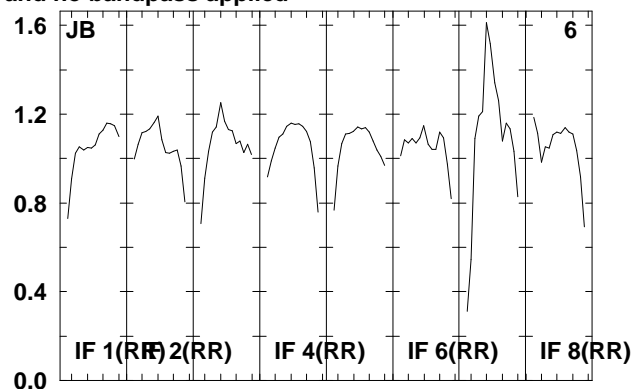
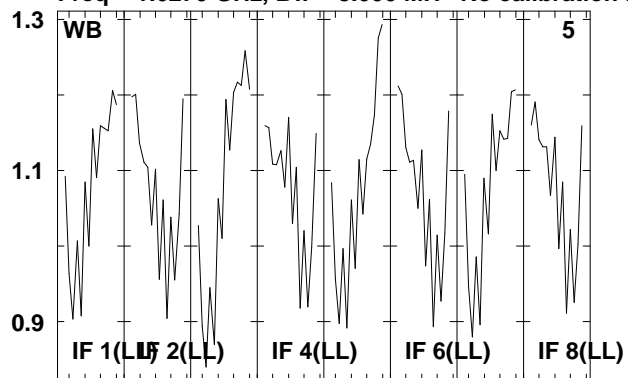

Lower frame: Real Jy  
Total-power spectrum Antenna: \*  
Timerange: 01/05:27:20 to 01/05:30:20

Plot file version 287 created 20-OCT-2009 14:51:55

M33 RP015C.UVDATA.1

Freq = 1.6270 GHz, Bw = 8.000 MH No calibration applied and no bandpass applied

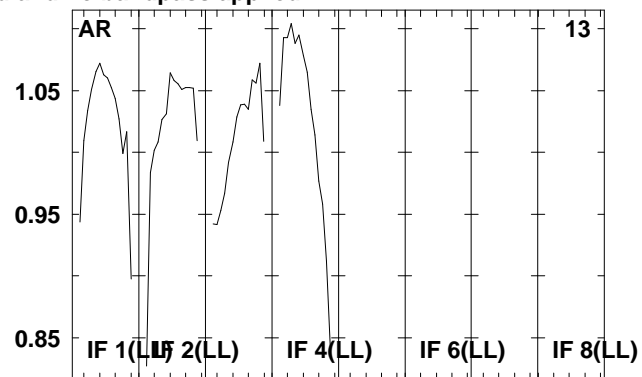
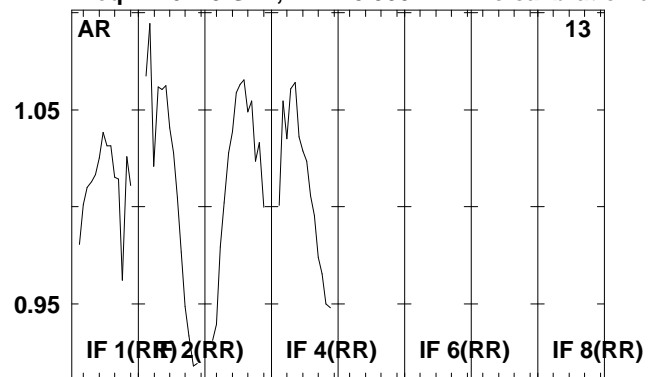

Lower frame: Real Jy  
Total-power spectrum Antenna: \*  
Timerange: 01/05:27:20 to 01/05:30:20

Plot file version 288 created 20-OCT-2009 14:51:55

J0137+31 RP015C.UVDATA.1

Freq = 1.6270 GHz, Bw = 8.000 MH No calibration applied and no bandpass applied

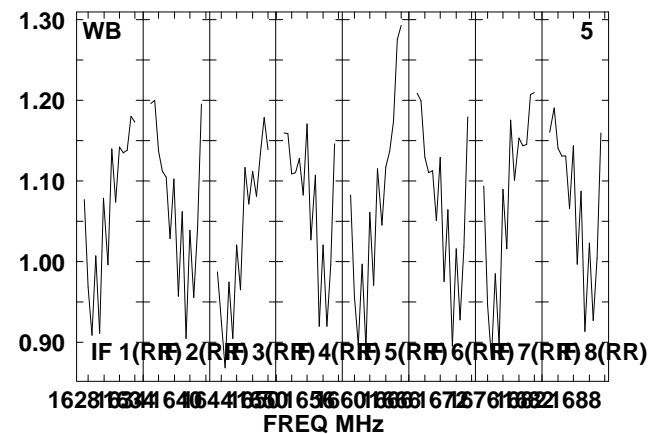
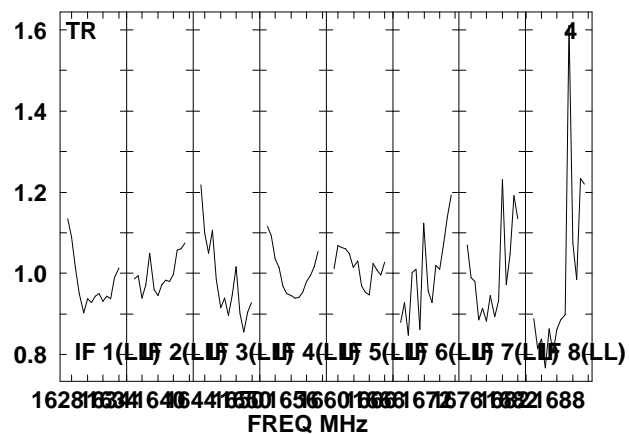
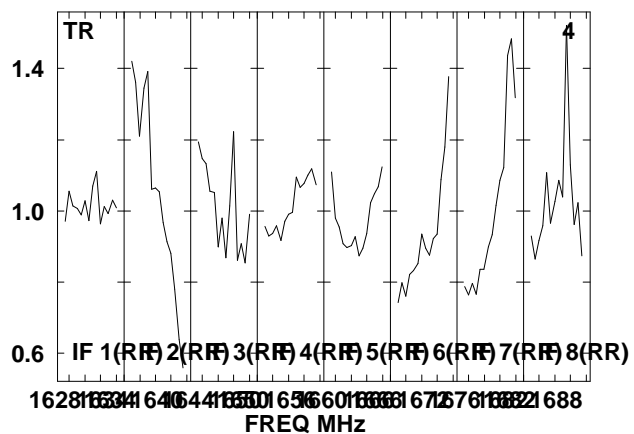
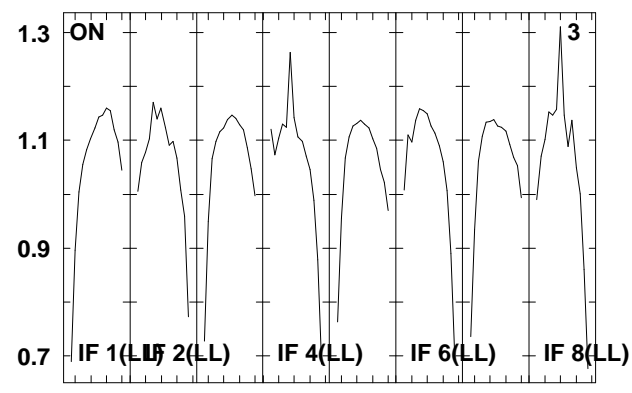
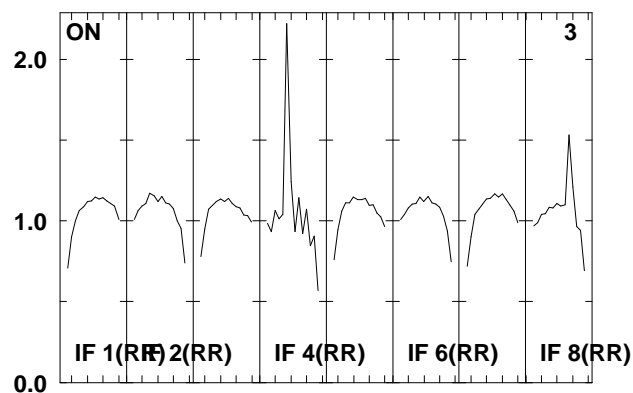
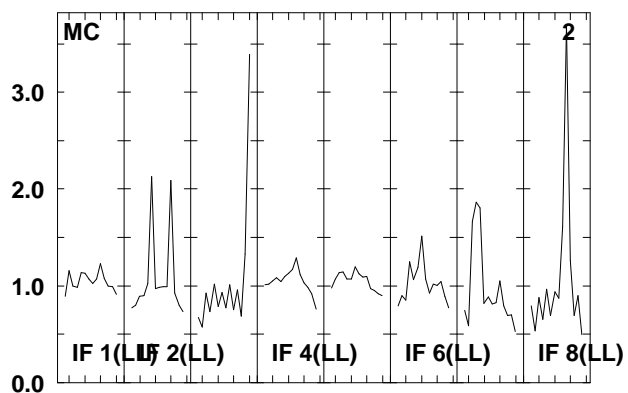
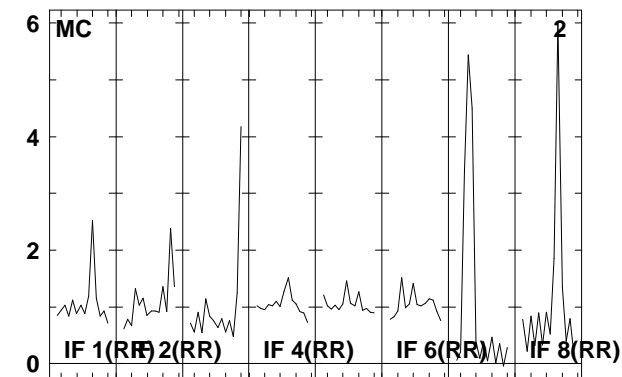
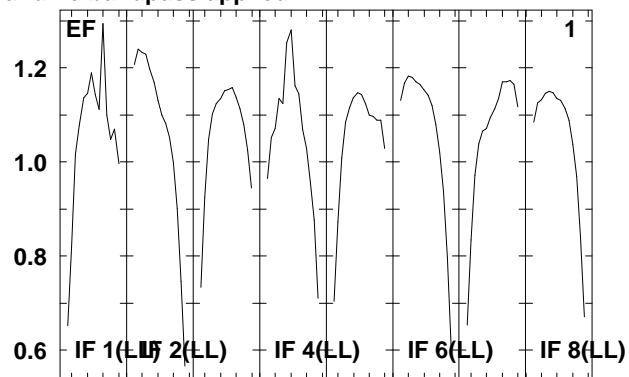
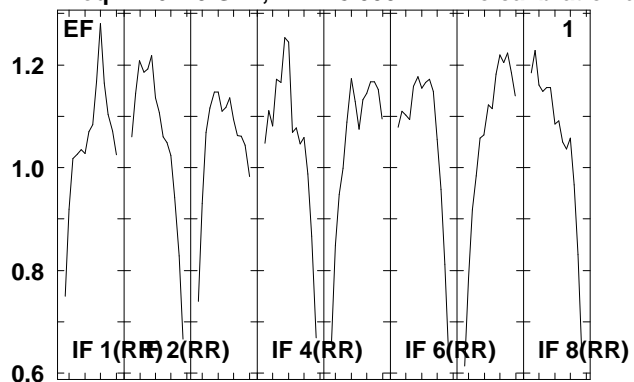

Lower frame: Real Jy

Total-power spectrum Antenna: \*

Timerange: 01/05:31:01 to 01/05:32:00



Plot file version 289 created 20-OCT-2009 14:51:55

J0137+31 RP015C.UVDATA.1

Freq = 1.6270 GHz, Bw = 8.000 MH No calibration applied and no bandpass applied

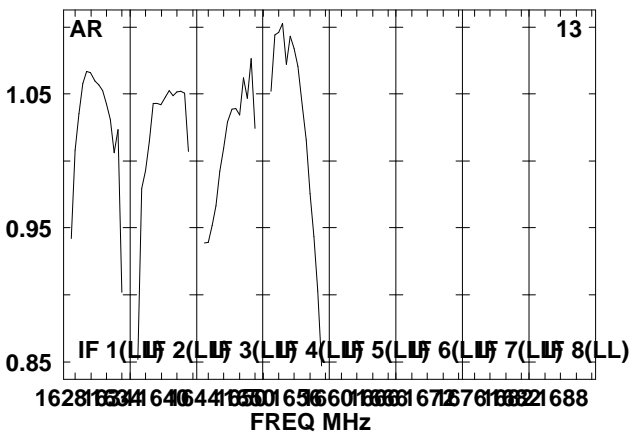
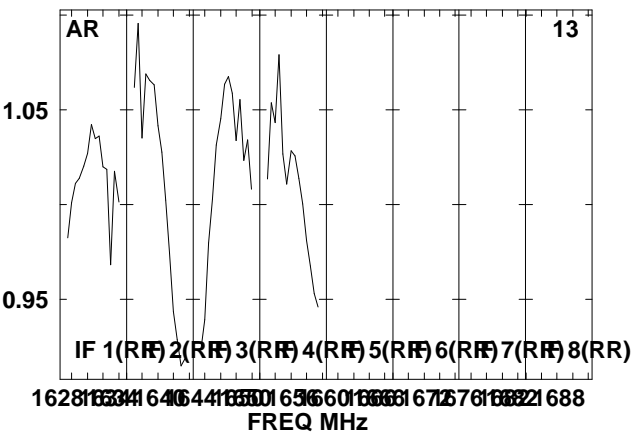
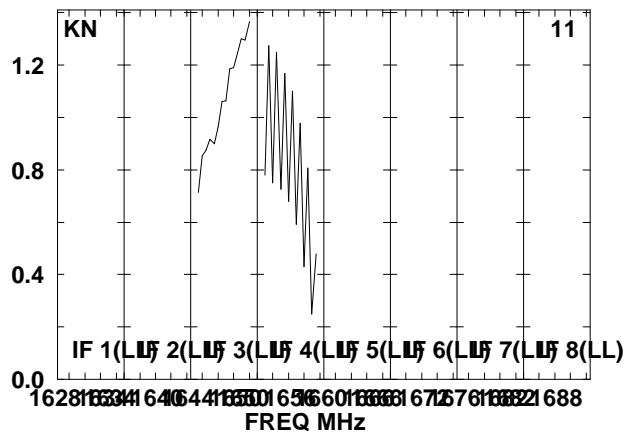
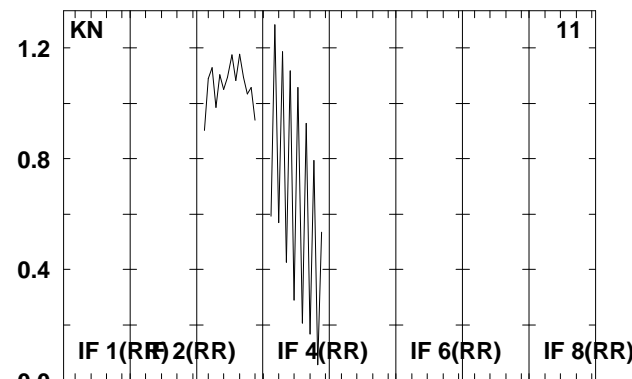
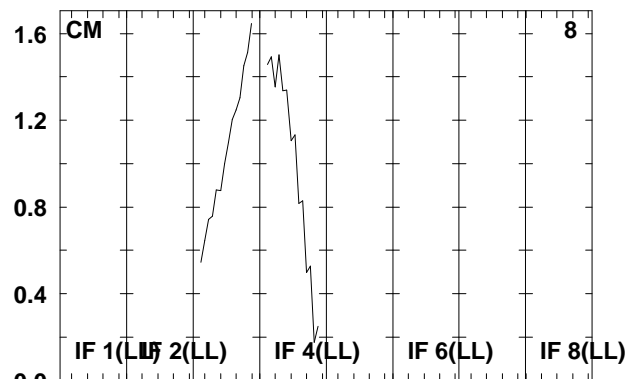
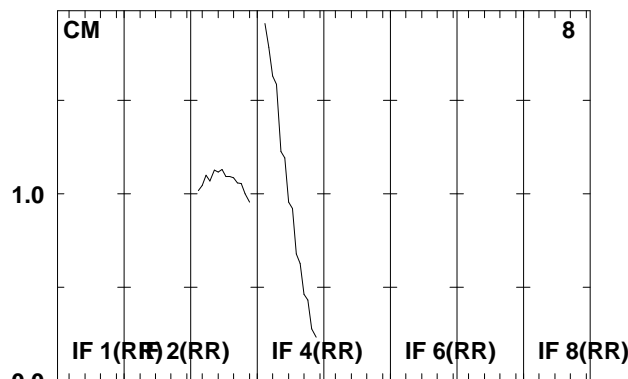
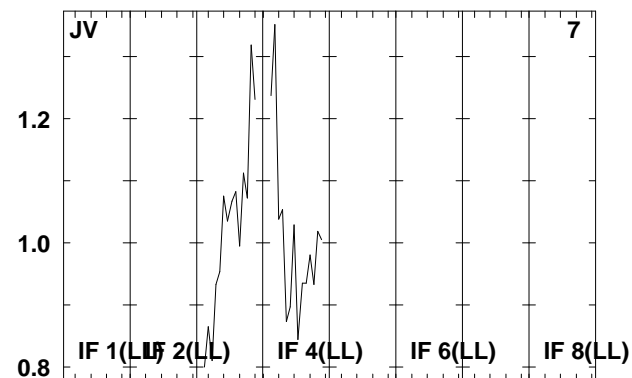
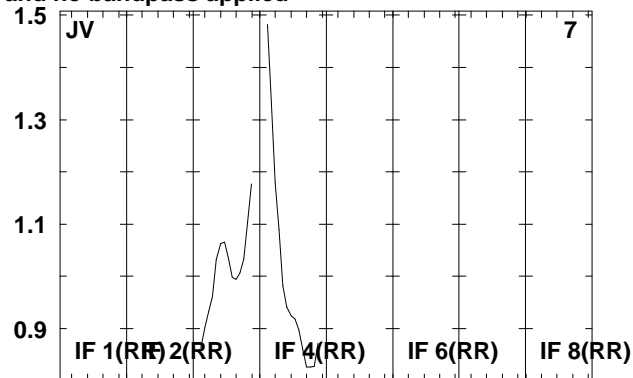
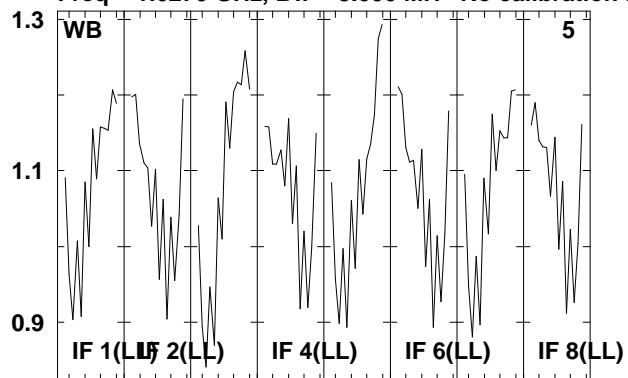

Lower frame: Real Jy  
Total-power spectrum Antenna: \*  
Timerange: 01/05:31:01 to 01/05:32:00

Plot file version 290 created 20-OCT-2009 14:51:56

FAINTCAL RP015C.UVDATA.1

Freq = 1.6270 GHz, Bw = 8.000 MH No calibration applied and no bandpass applied

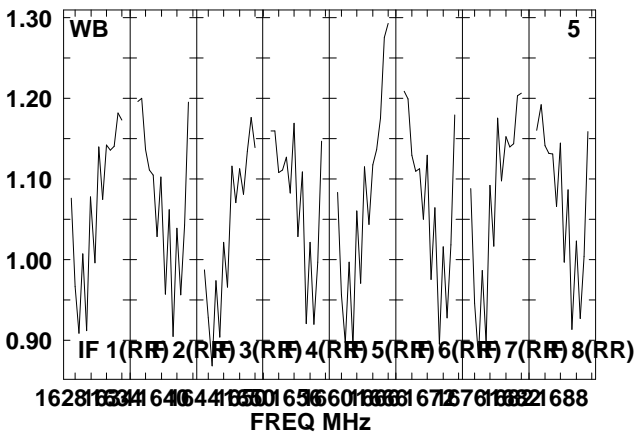
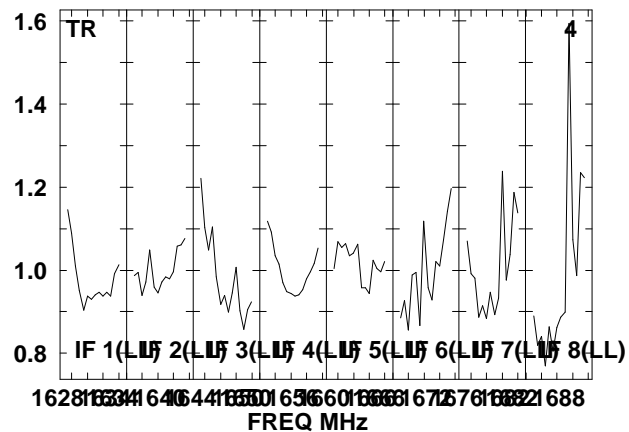
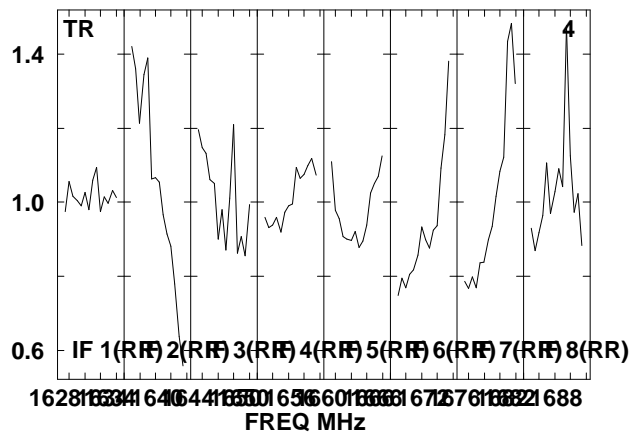
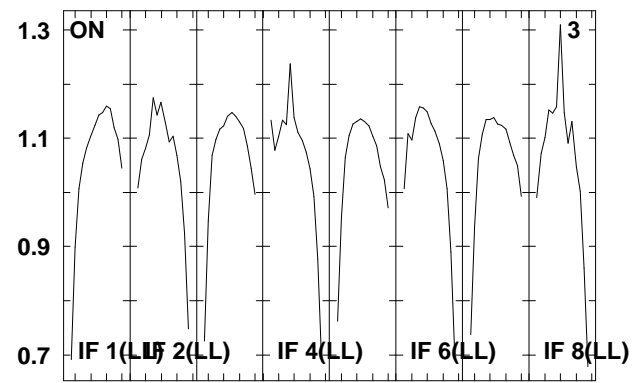
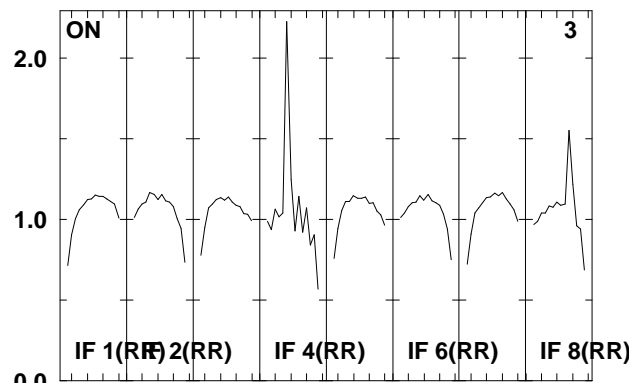
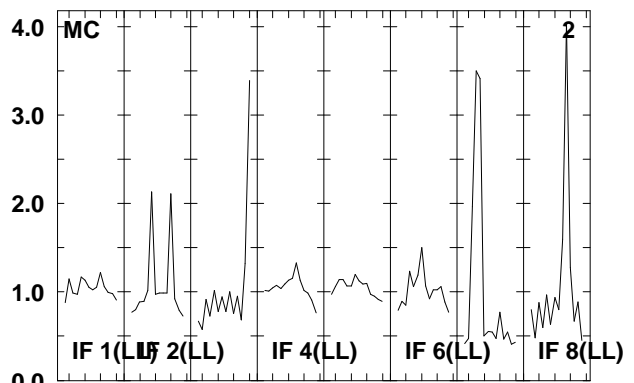
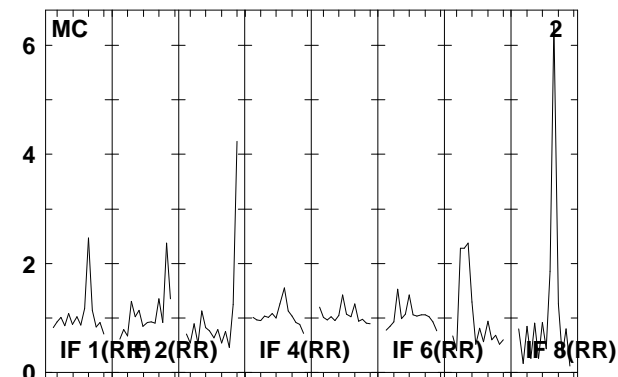
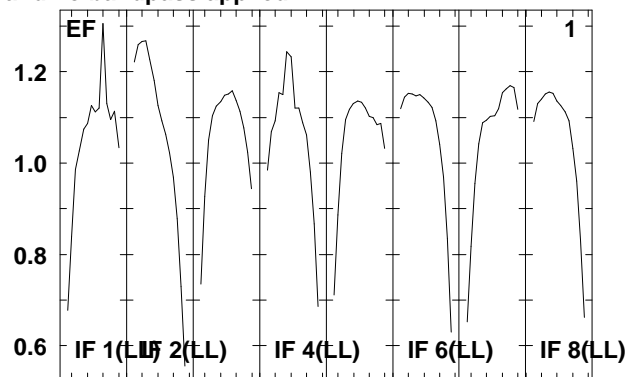
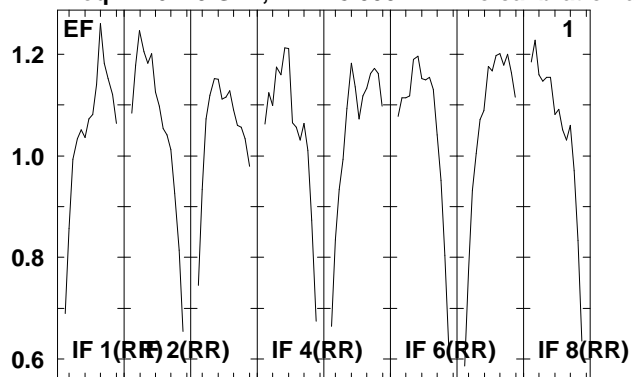

1628 1634 1640 1644 1650 1656 1660 1666 1672 1676 1682 1688  
FREQ MHz

1628 1634 1640 1644 1650 1656 1660 1666 1672 1676 1682 1688  
FREQ MHz

1628 1634 1640 1644 1650 1656 1660 1666 1672 1676 1682 1688  
FREQ MHz

Lower frame: Real Jy  
Total-power spectrum Antenna: \*  
Timerange: 01/05:32:01 to 01/05:33:20

Plot file version 291 created 20-OCT-2009 14:51:56

FAINTCAL RP015C.UVDATA.1

Freq = 1.6270 GHz, Bw = 8.000 MH No calibration applied and no bandpass applied

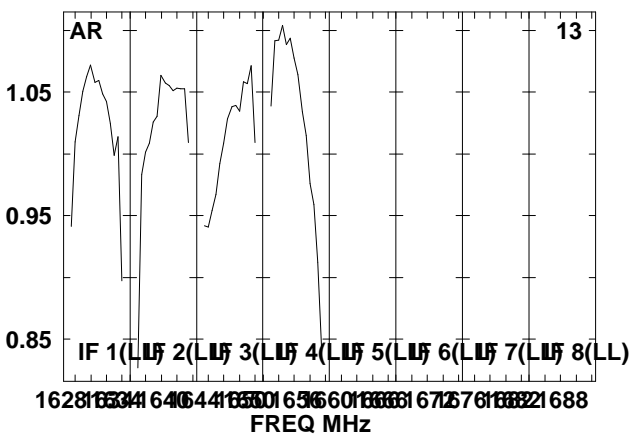
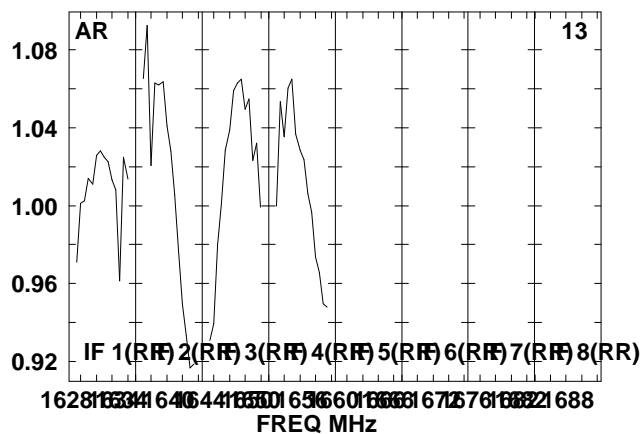
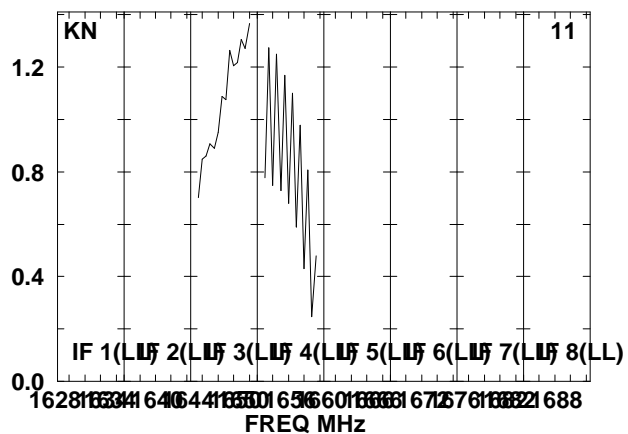
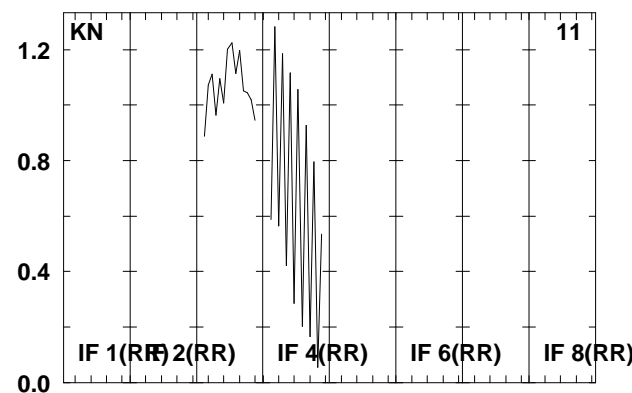
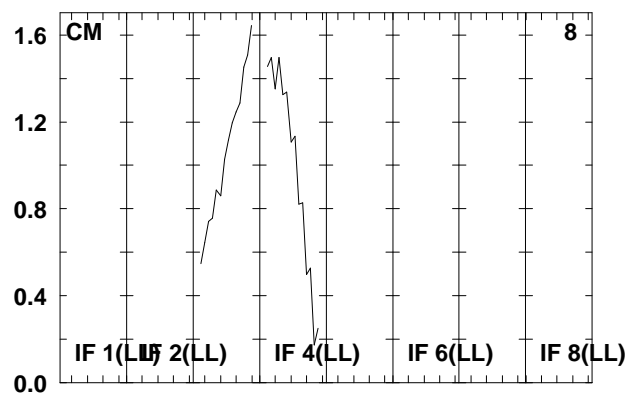
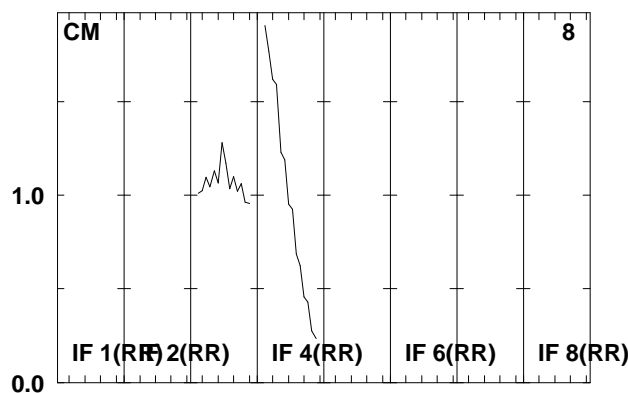
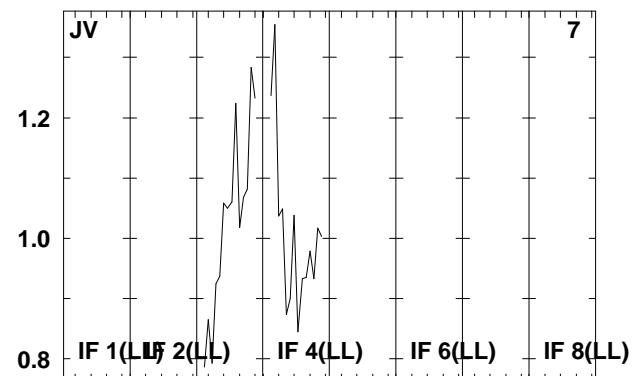
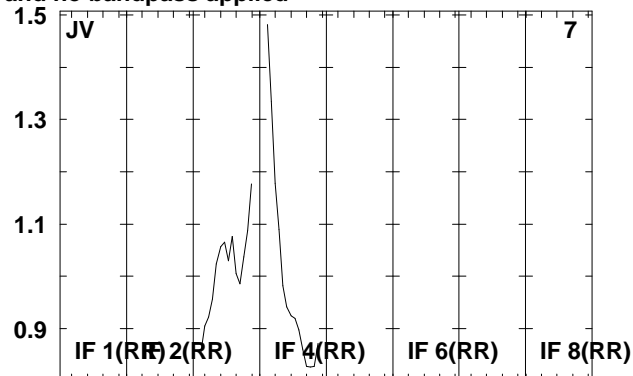
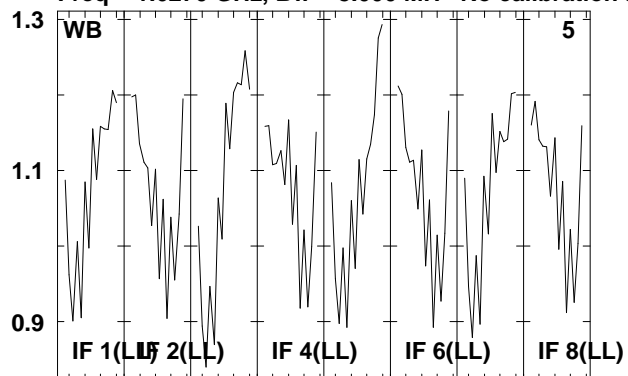

Lower frame: Real Jy

Total-power spectrum Antenna: \*

Timerange: 01/05:32:01 to 01/05:33:20

Plot file version 292 created 20-OCT-2009 14:51:58

M33 RP015C.UVDATA.1

Freq = 1.6270 GHz, Bw = 8.000 MH No calibration applied and no bandpass applied

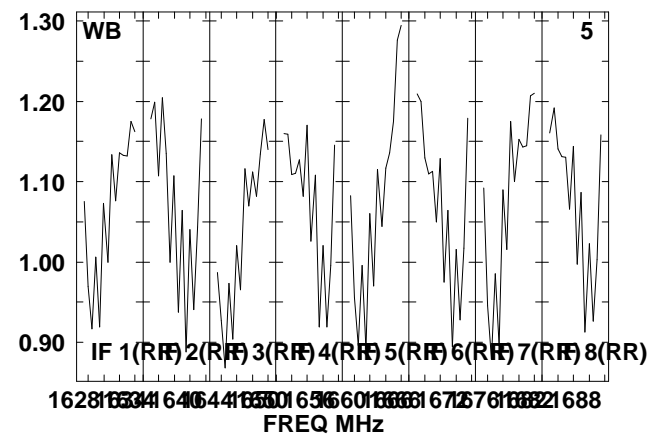
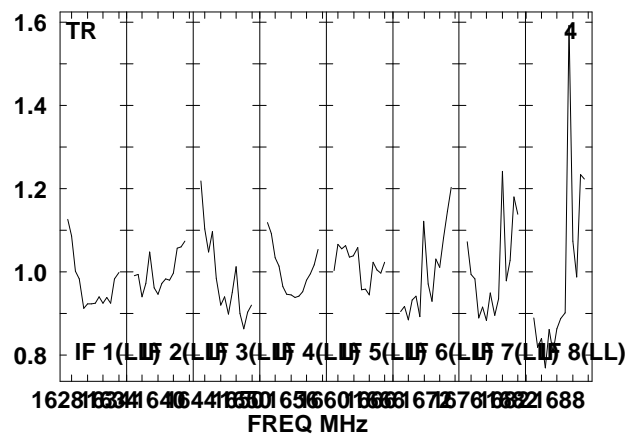
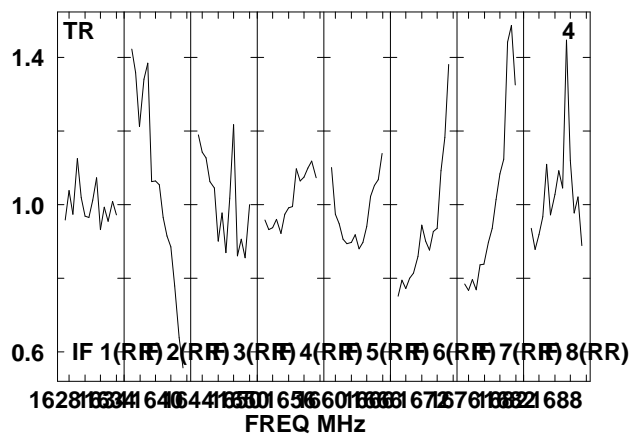
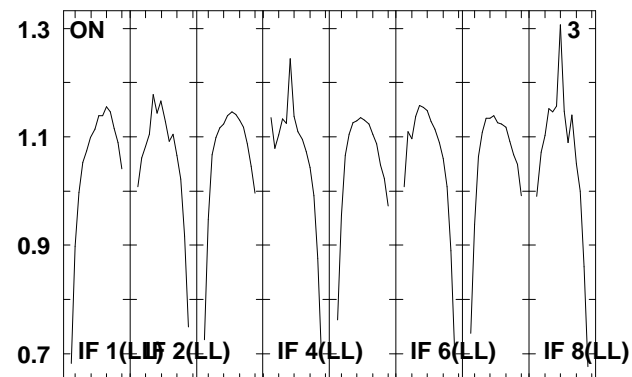
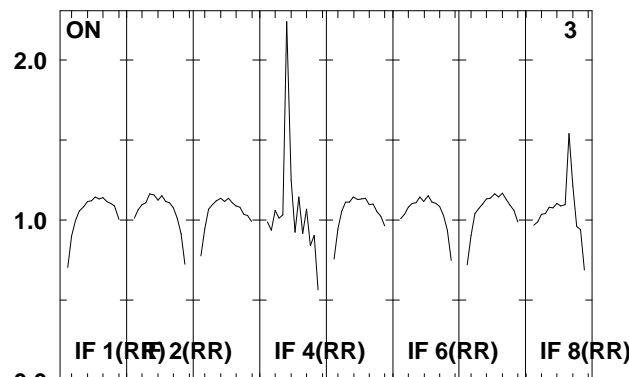
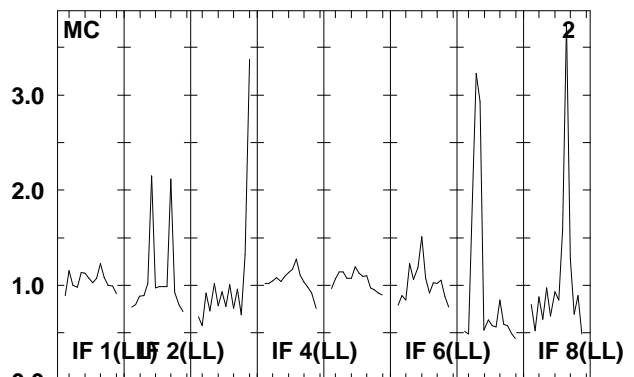
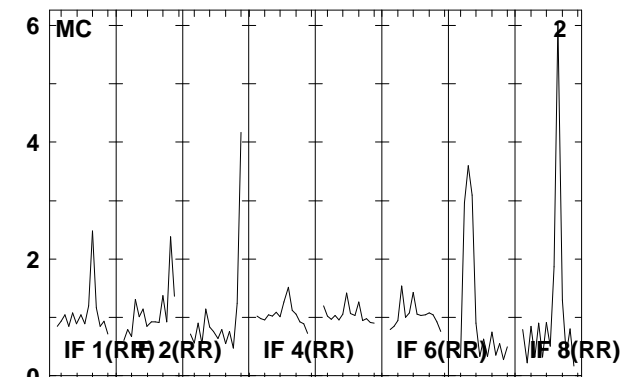
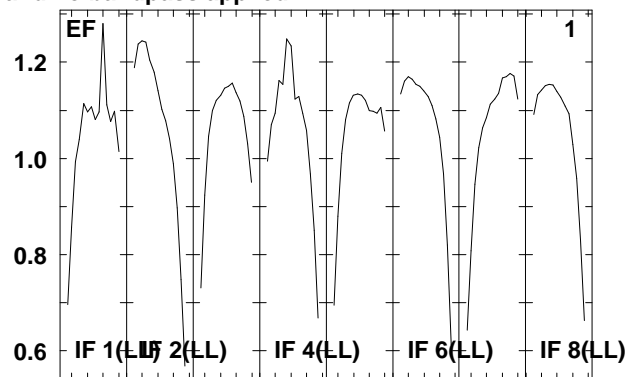
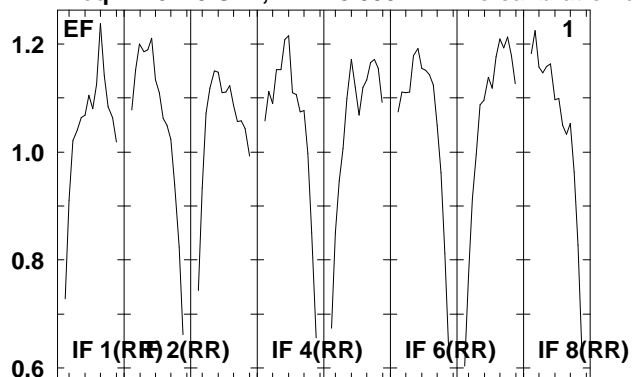

Lower frame: Real Jy

Total-power spectrum Antenna: \*

Timerange: 01/05:33:21 to 01/05:36:20

Plot file version 293 created 20-OCT-2009 14:51:58

M33 RP015C.UVDATA.1

Freq = 1.6270 GHz, Bw = 8.000 MH No calibration applied and no bandpass applied

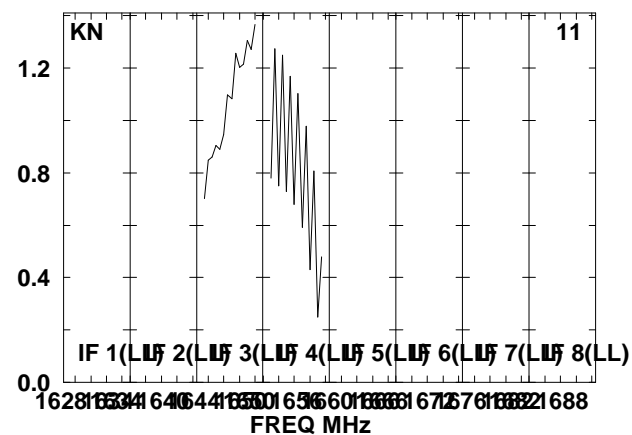
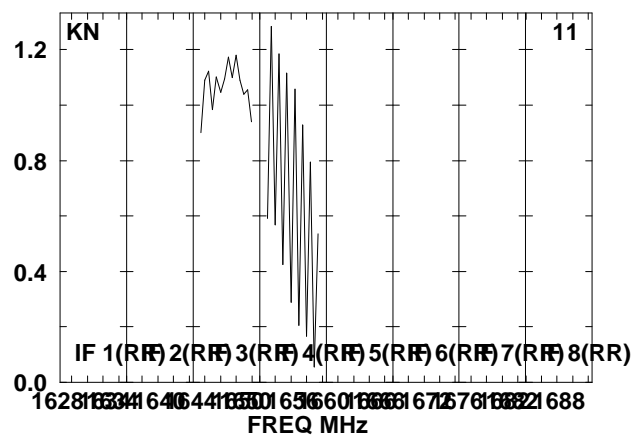
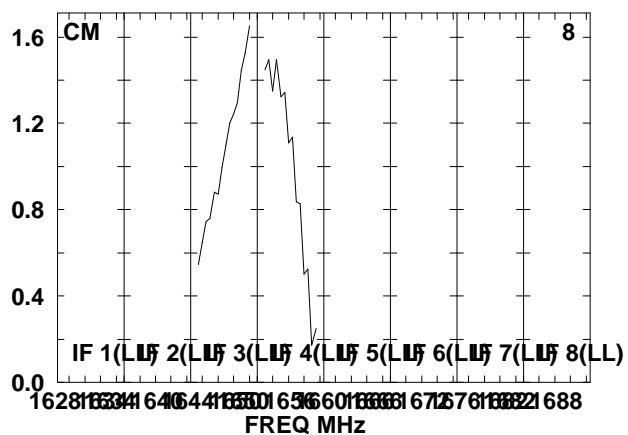
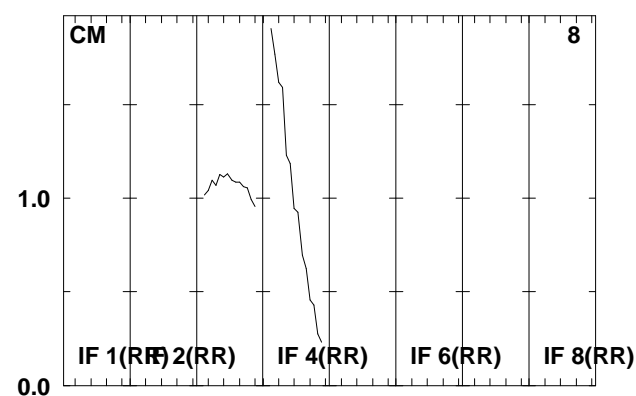
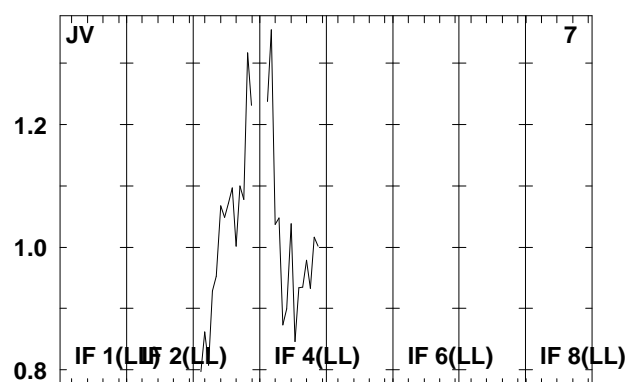
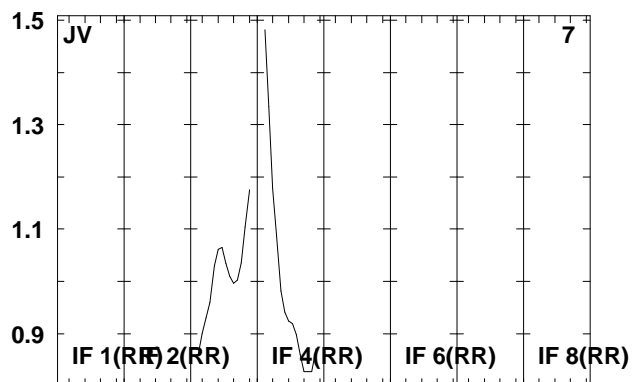
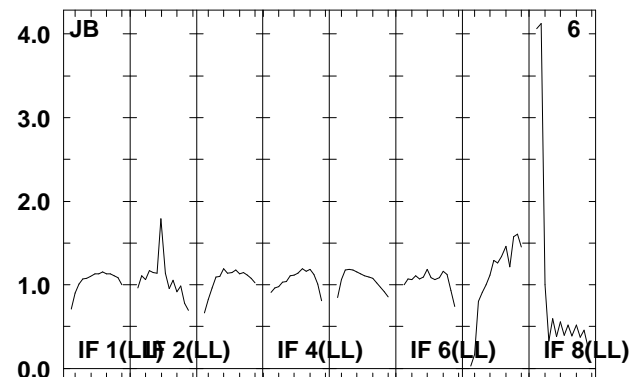
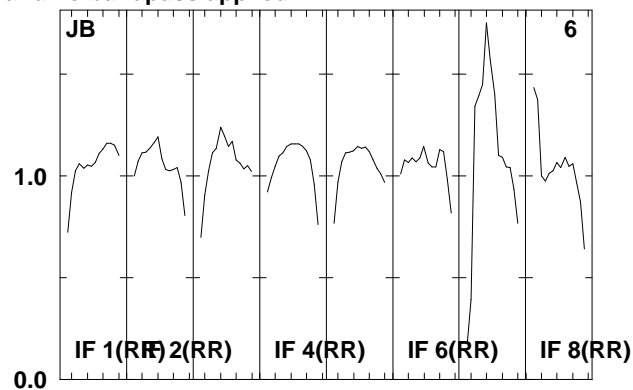
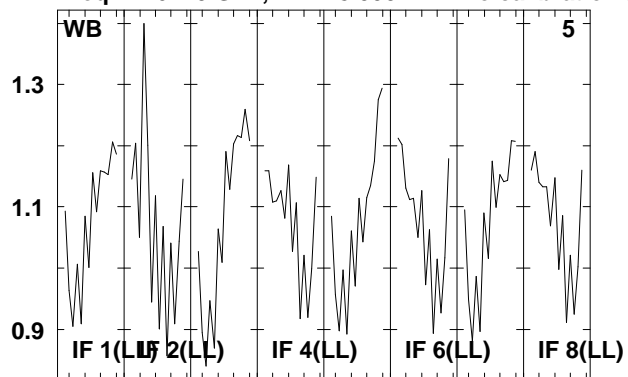

Lower frame: Real Jy

Total-power spectrum Antenna: \*

Timerange: 01/05:33:21 to 01/05:36:20

Plot file version 294 created 20-OCT-2009 14:52:00

M33 RP015C.UVDATA.1

Freq = 1.6270 GHz, Bw = 8.000 MH No calibration applied and no bandpass applied

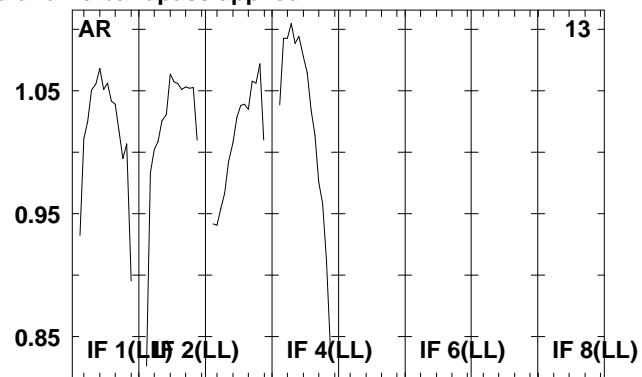
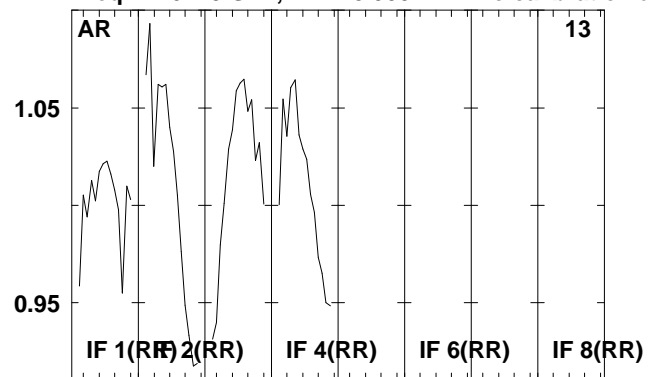

Lower frame: Real Jy  
Total-power spectrum Antenna: \*  
Timerange: 01/05:33:21 to 01/05:36:20

Plot file version 295 created 20-OCT-2009 14:52:00

J0137+31 RP015C.UVDATA.1

Freq = 1.6270 GHz, Bw = 8.000 MH No calibration applied and no bandpass applied

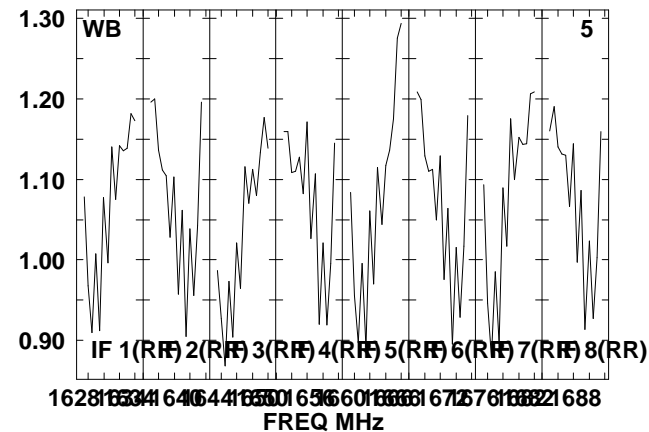
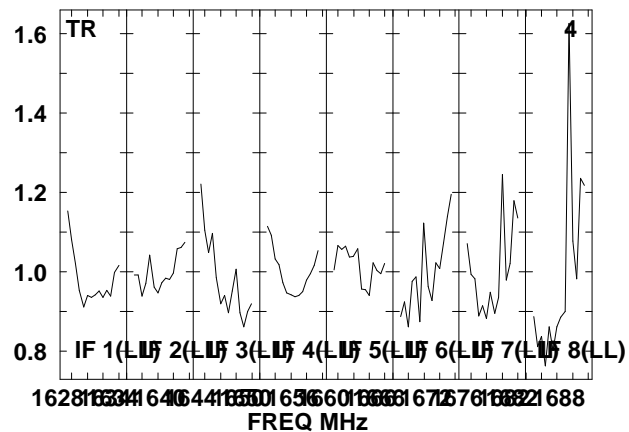
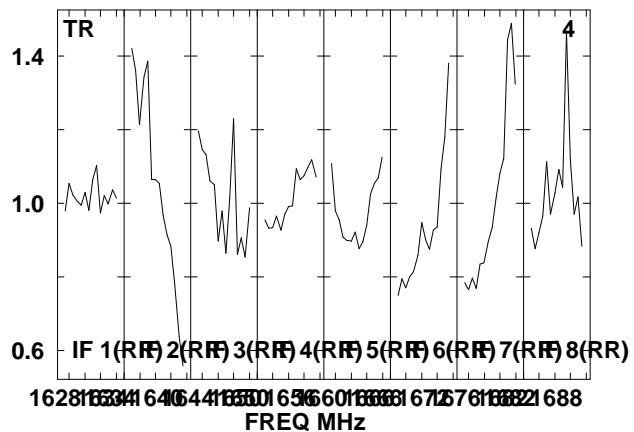
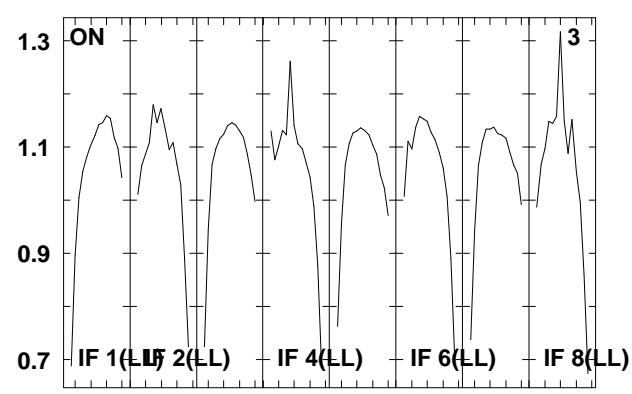
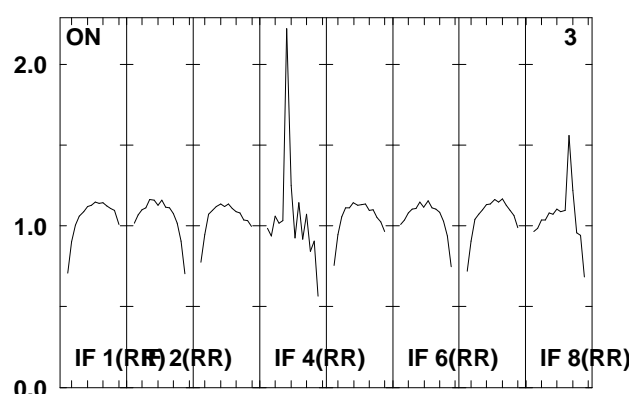
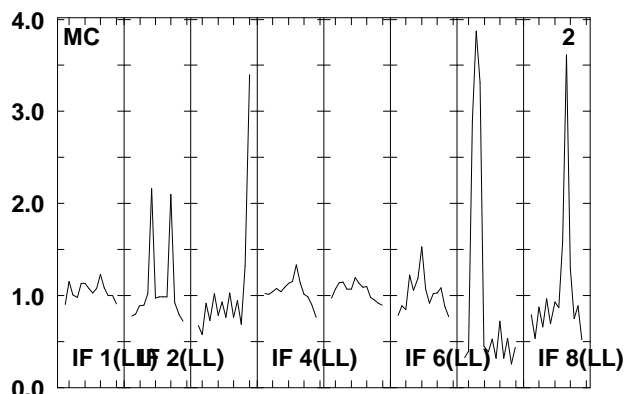
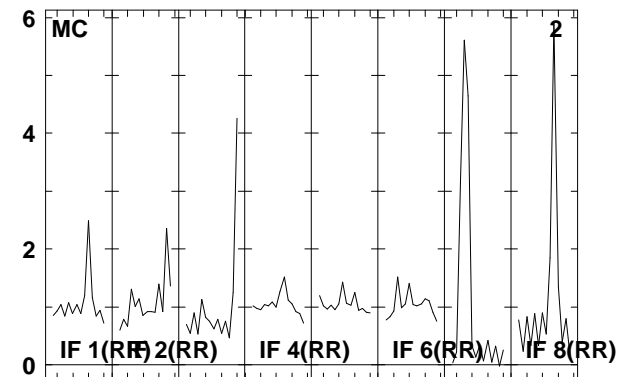
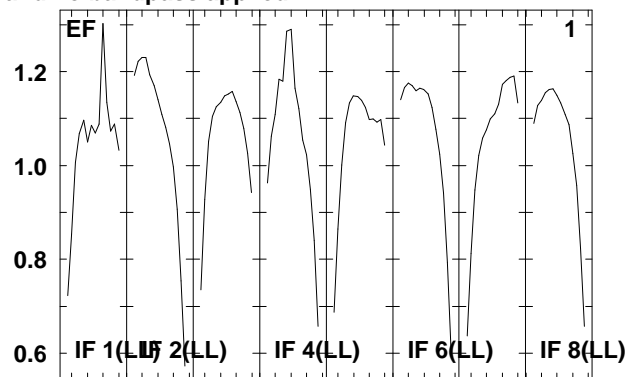
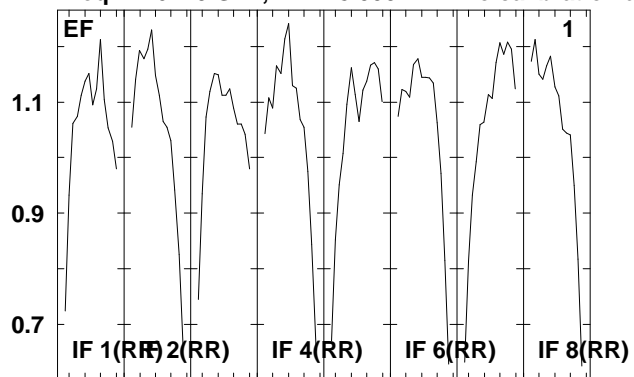

Lower frame: Real Jy

Total-power spectrum Antenna: \*

Timerange: 01/05:37:01 to 01/05:37:59

Plot file version 296 created 20-OCT-2009 14:52:01

J0137+31 RP015C.UVDATA.1

Freq = 1.6270 GHz, Bw = 8.000 MH No calibration applied and no bandpass applied

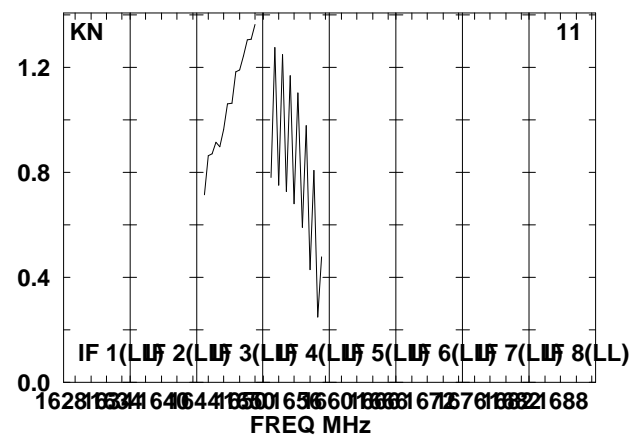
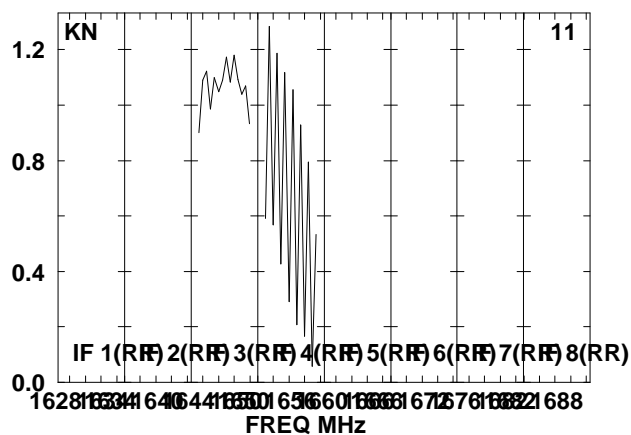
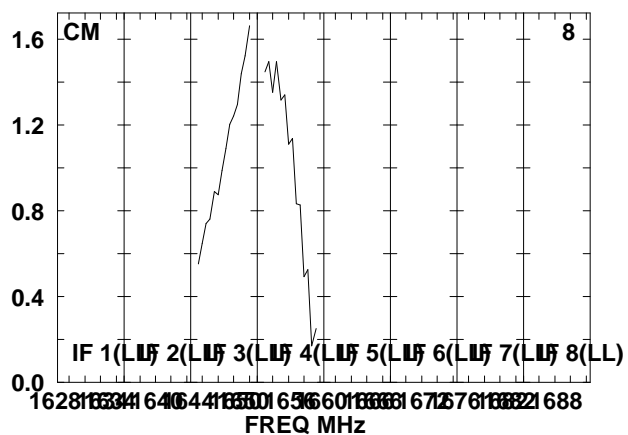
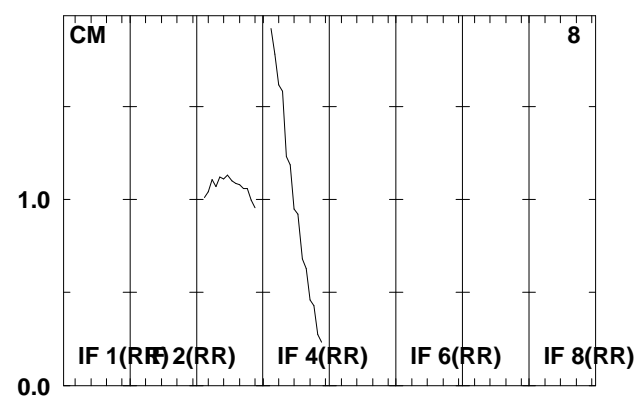
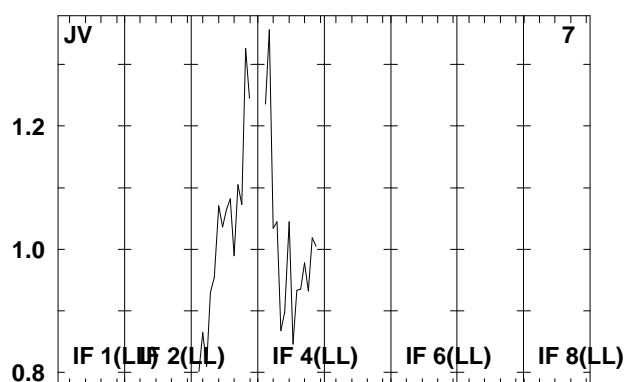
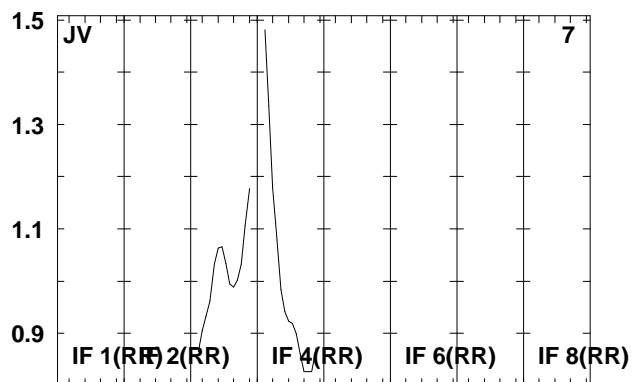
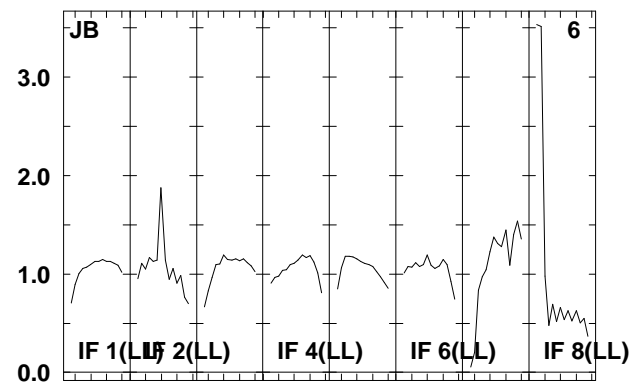
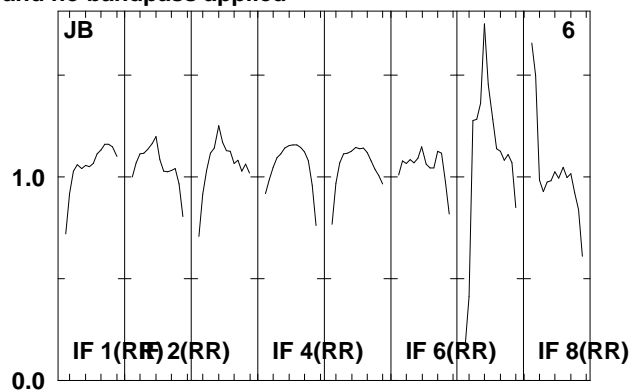
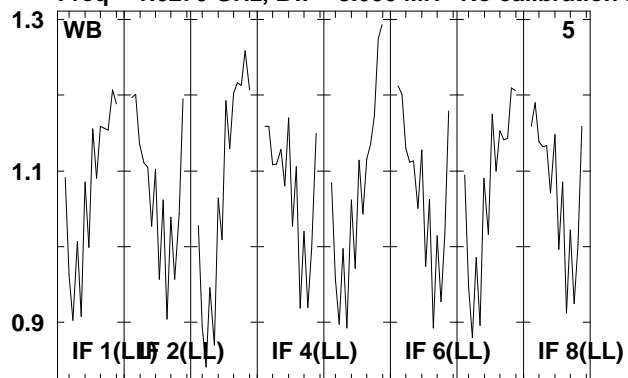

Lower frame: Real Jy

Total-power spectrum Antenna: \*

Timerange: 01/05:37:01 to 01/05:37:59



Plot file version 297 created 20-OCT-2009 14:52:01

J0137+31 RP015C.UVDATA.1

Freq = 1.6270 GHz, Bw = 8.000 MH No calibration applied and no bandpass applied

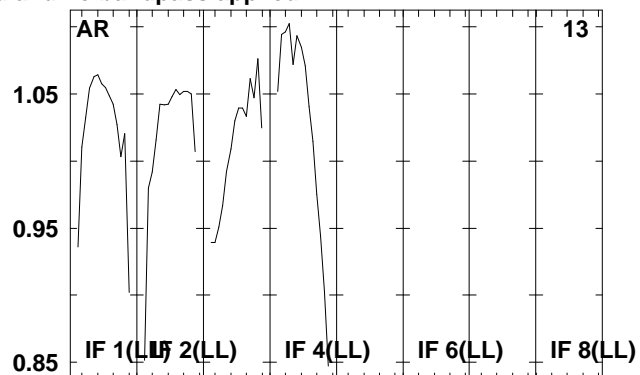
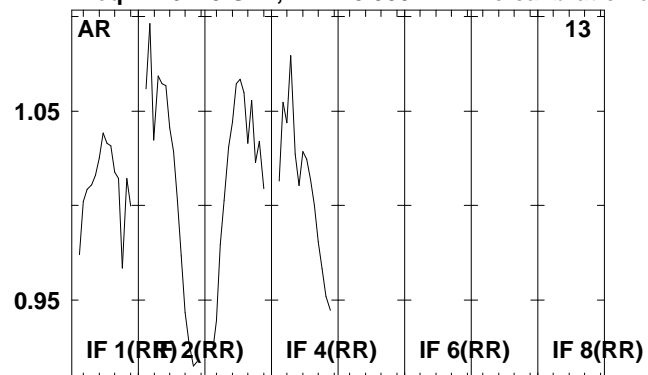

Lower frame: Real Jy  
Total-power spectrum Antenna: \*  
Timerange: 01/05:37:01 to 01/05:37:59

Plot file version 298 created 20-OCT-2009 14:52:01

FAINTCAL RP015C.UVDATA.1

Freq = 1.6270 GHz, Bw = 8.000 MH No calibration applied and no bandpass applied

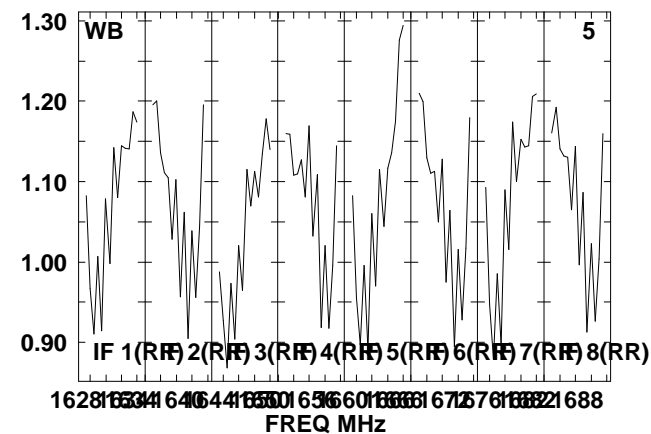
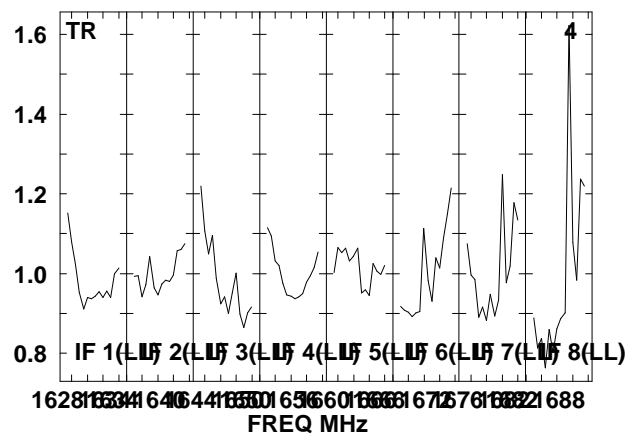
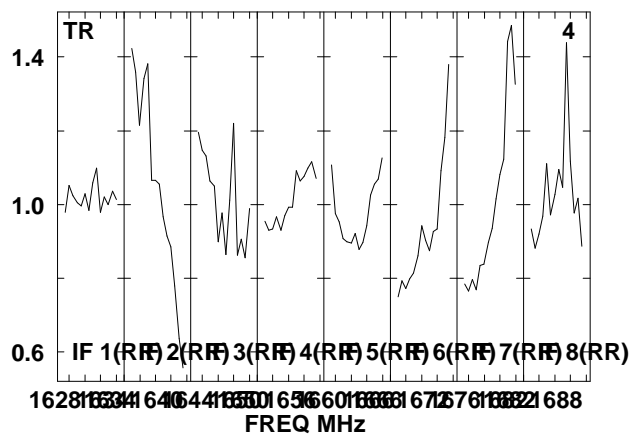
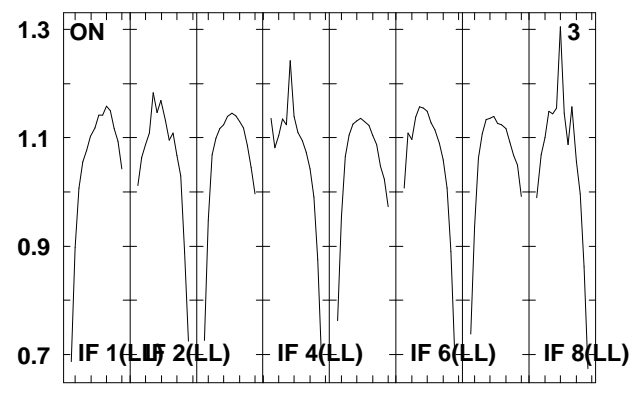
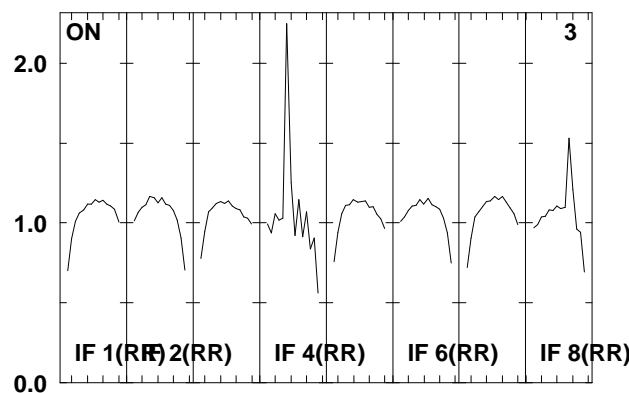
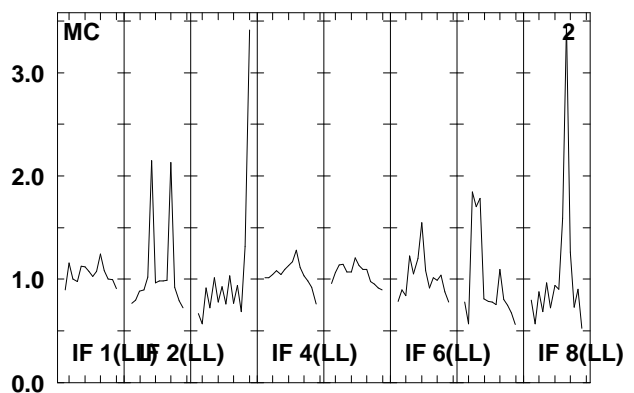
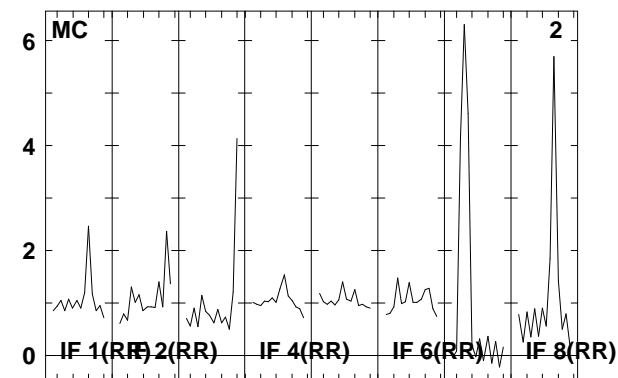
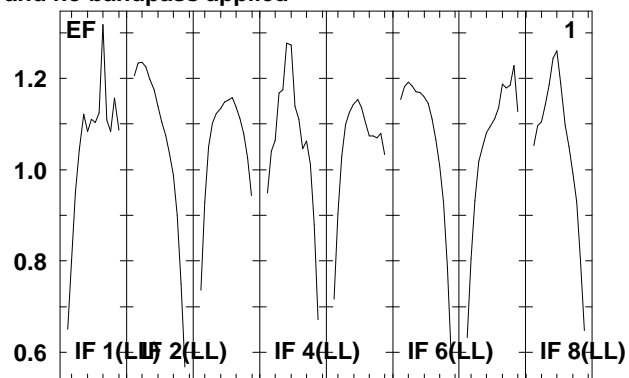
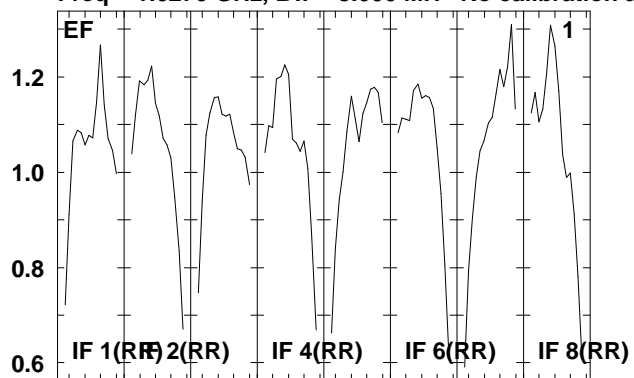

Lower frame: Real Jy  
Total-power spectrum Antenna: \*  
Timerange: 01/05:38:00 to 01/05:39:19

Plot file version 299 created 20-OCT-2009 14:52:02

FAINTCAL RP015C.UVDATA.1

Freq = 1.6270 GHz, Bw = 8.000 MH No calibration applied and no bandpass applied

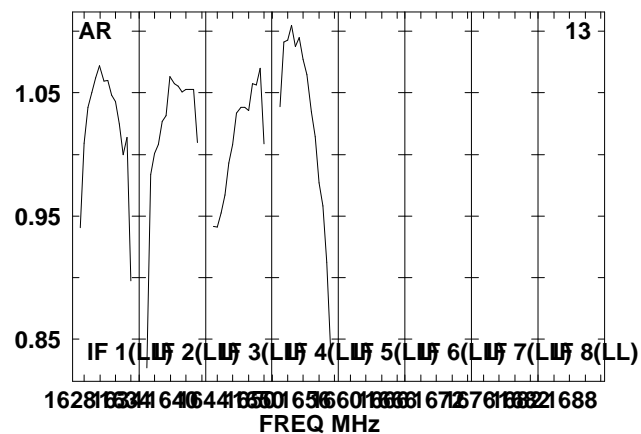
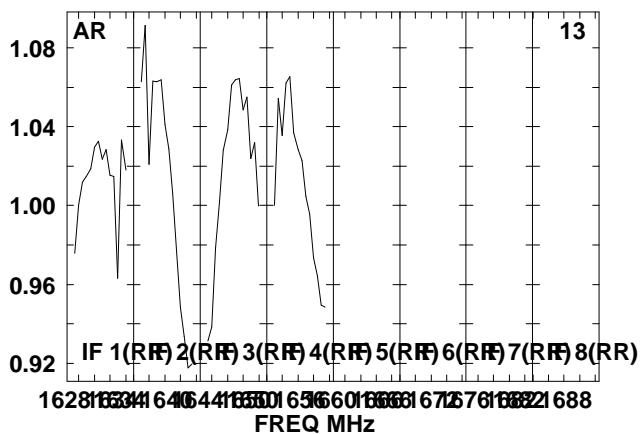
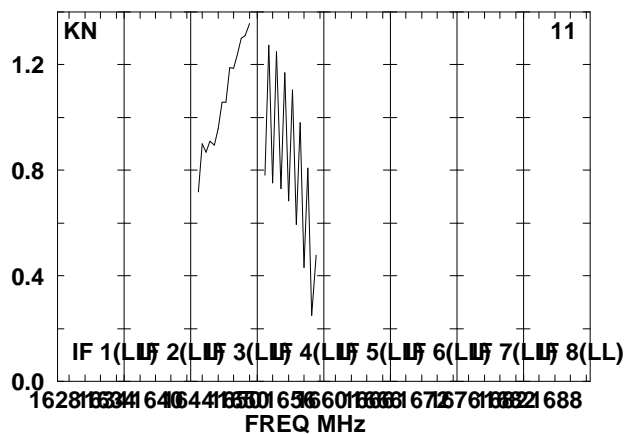
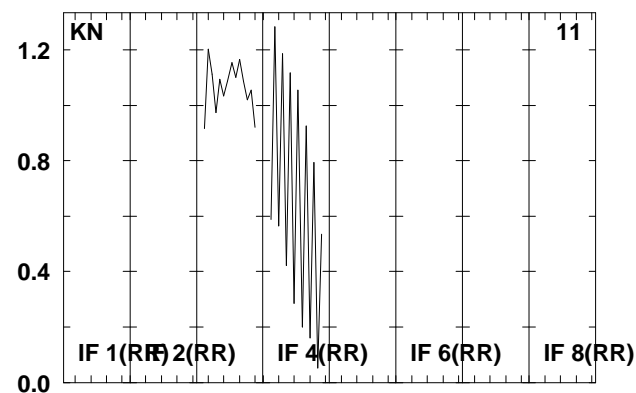
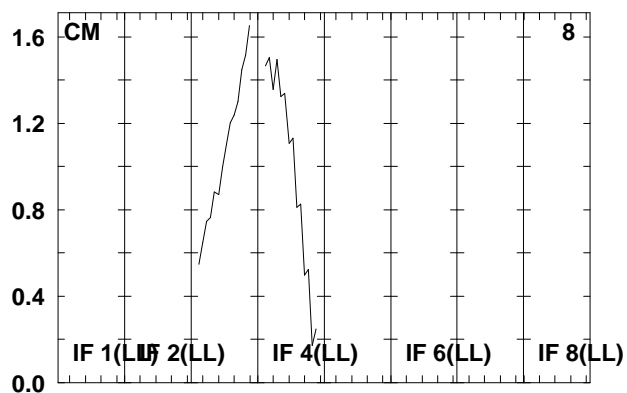
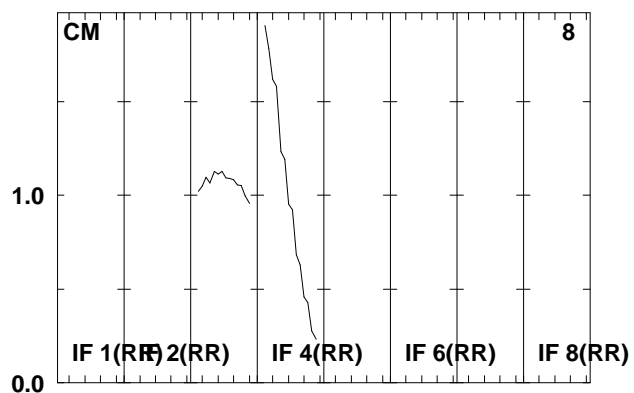
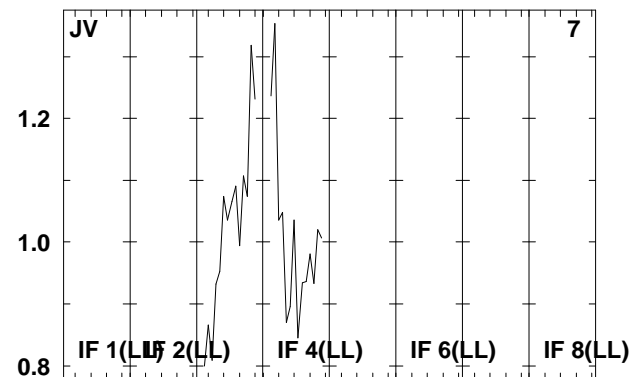
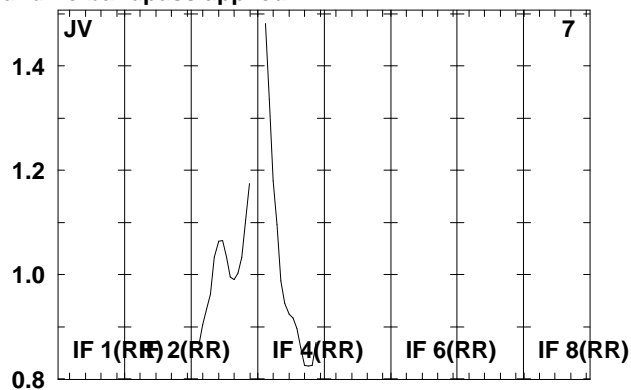
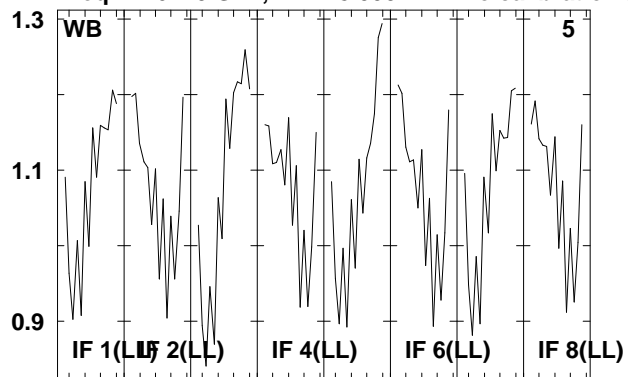

Lower frame: Real Jy

Total-power spectrum Antenna: \*

Timerange: 01/05:38:00 to 01/05:39:19

Plot file version 300 created 20-OCT-2009 14:52:03

M33 RP015C.UVDATA.1

Freq = 1.6270 GHz, Bw = 8.000 MH No calibration applied and no bandpass applied

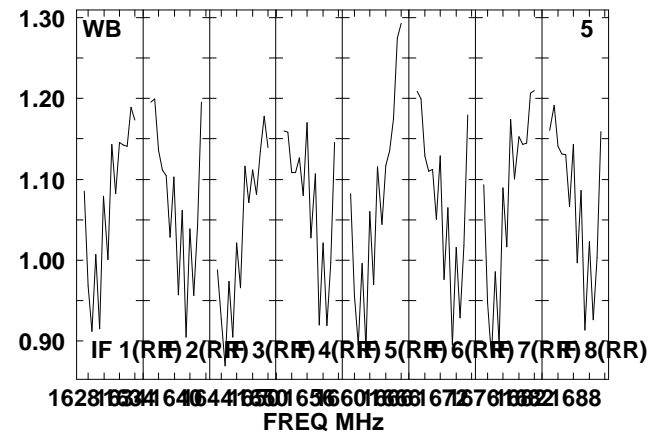
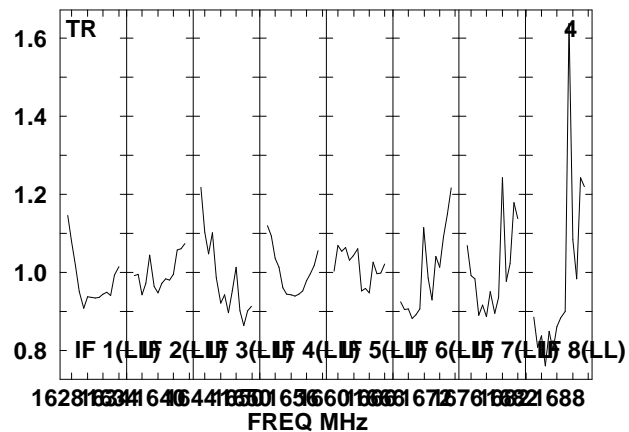
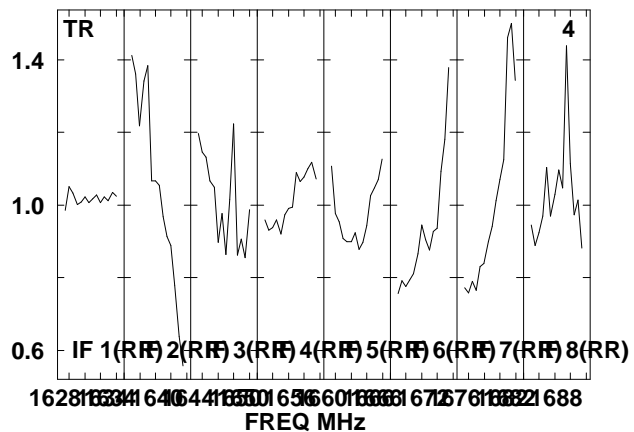
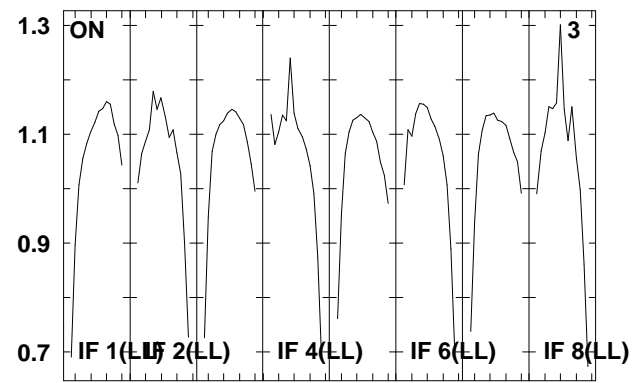
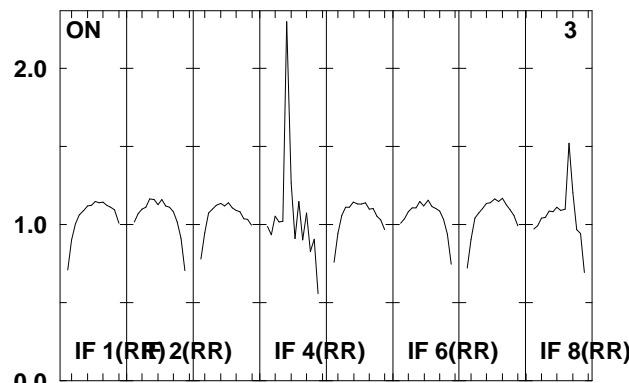
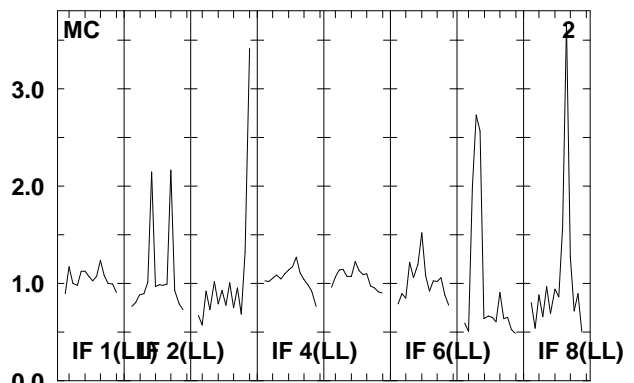
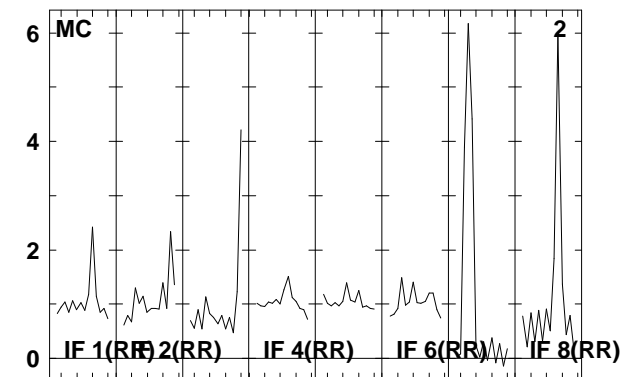
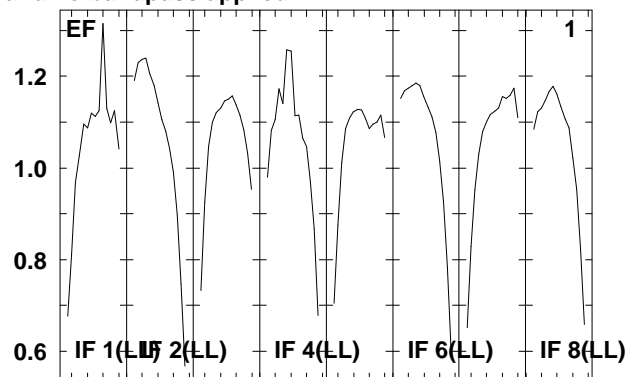
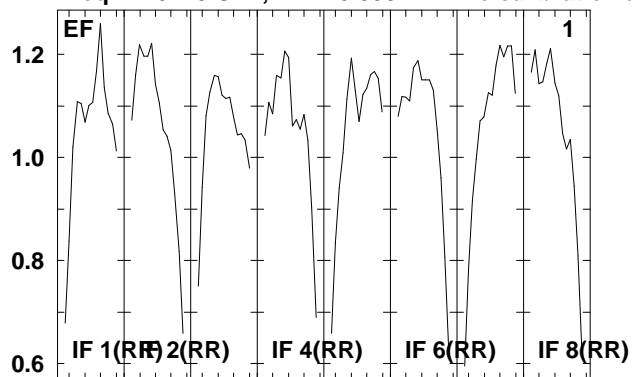

Lower frame: Real Jy  
Total-power spectrum Antenna: \*  
Timerange: 01/05:39:20 to 01/05:42:20

Plot file version 301 created 20-OCT-2009 14:52:04

M33 RP015C.UVDATA.1

Freq = 1.6270 GHz, Bw = 8.000 MH No calibration applied and no bandpass applied

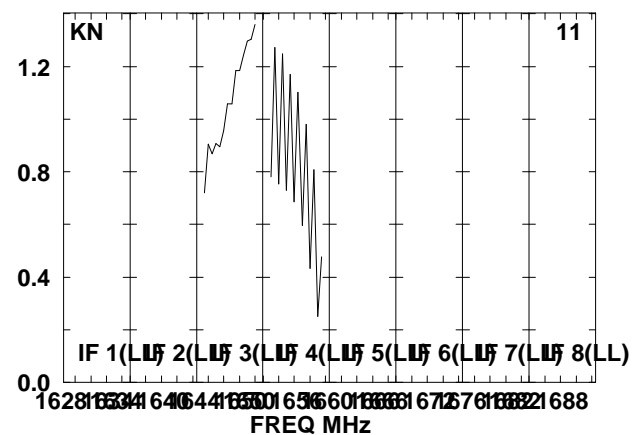
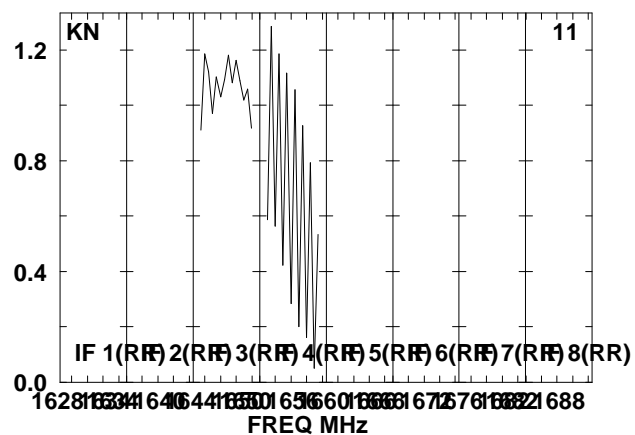
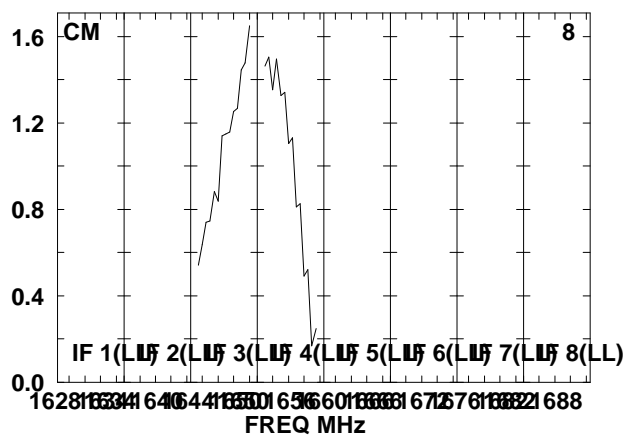
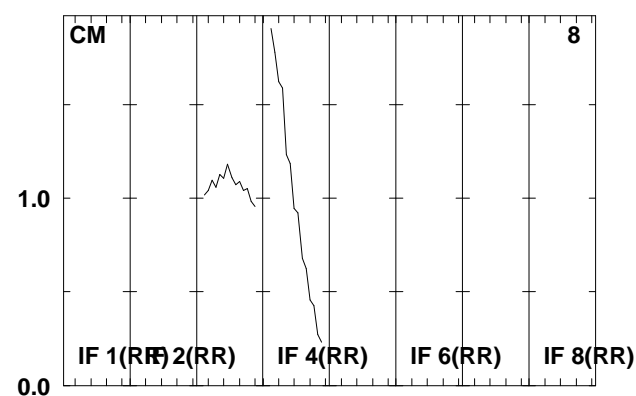
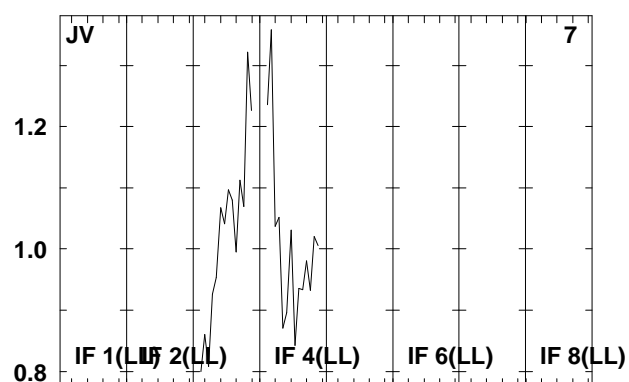
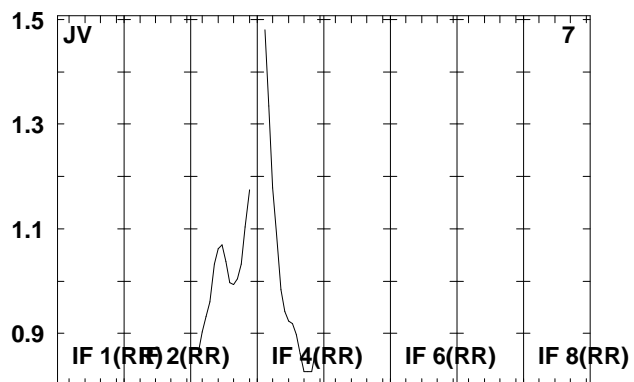
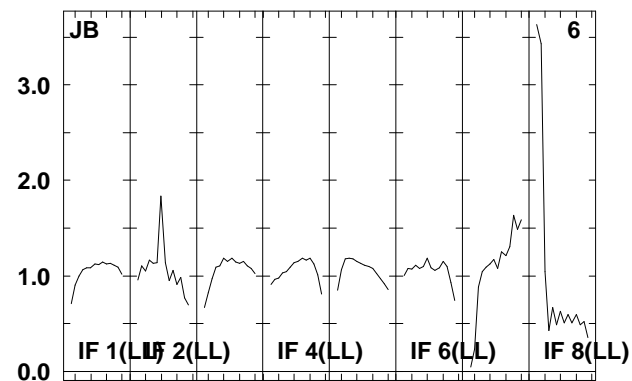
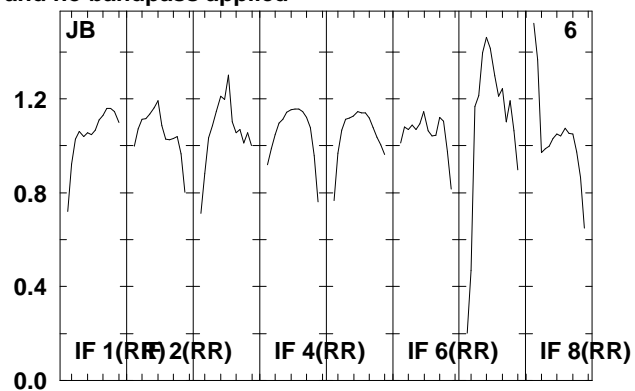
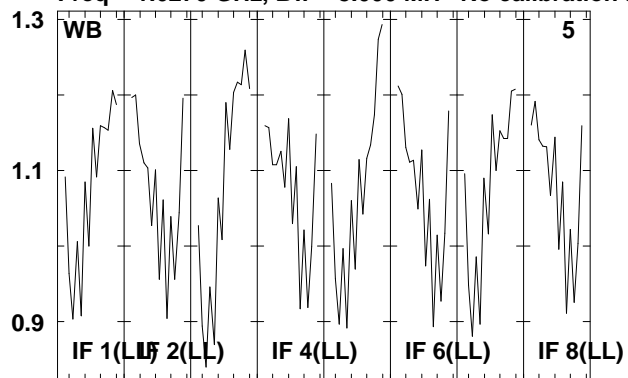

Lower frame: Real Jy

Total-power spectrum Antenna: \*

Timerange: 01/05:39:20 to 01/05:42:20

Plot file version 302 created 20-OCT-2009 14:52:05

M33 RP015C.UVDATA.1

Freq = 1.6270 GHz, Bw = 8.000 MH No calibration applied and no bandpass applied

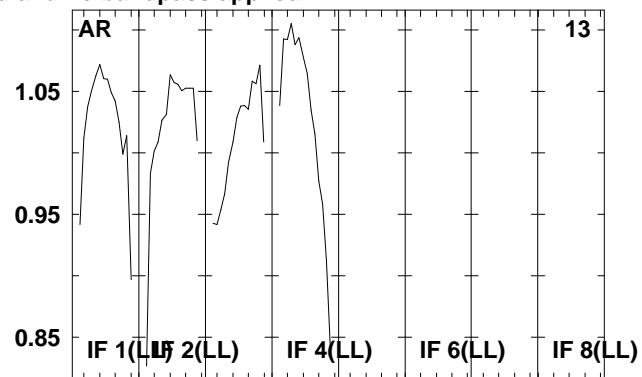
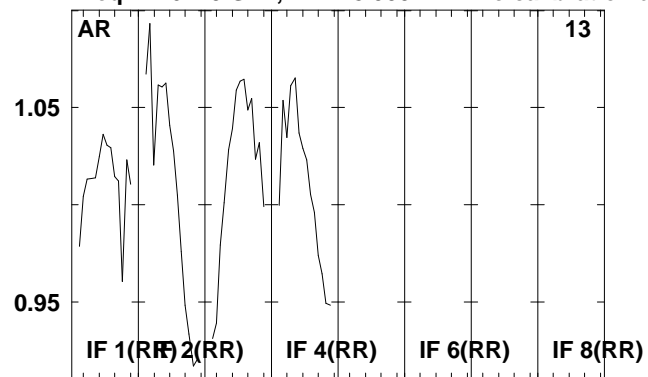

Lower frame: Real Jy  
Total-power spectrum Antenna: \*  
Timerange: 01/05:39:20 to 01/05:42:20

Plot file version 303 created 20-OCT-2009 14:52:05

J0137+31 RP015C.UVDATA.1

Freq = 1.6270 GHz, Bw = 8.000 MH No calibration applied and no bandpass applied

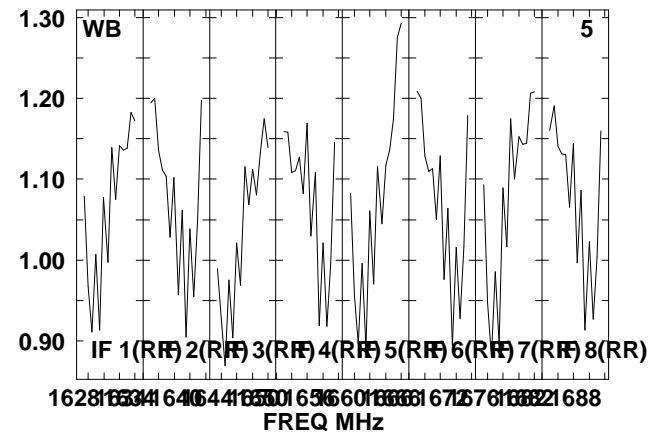
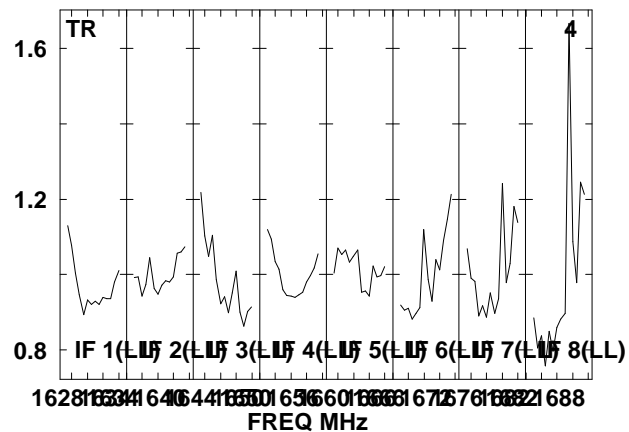
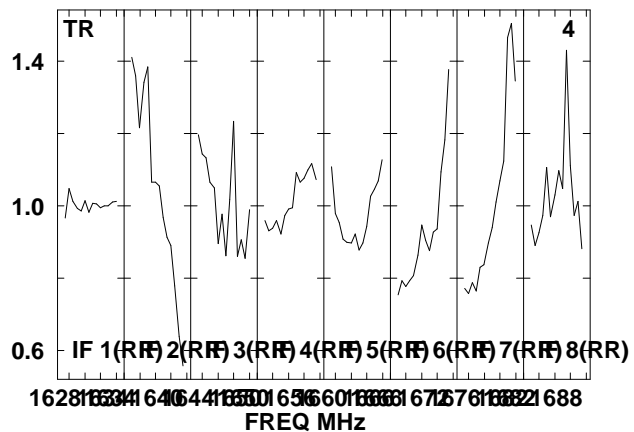
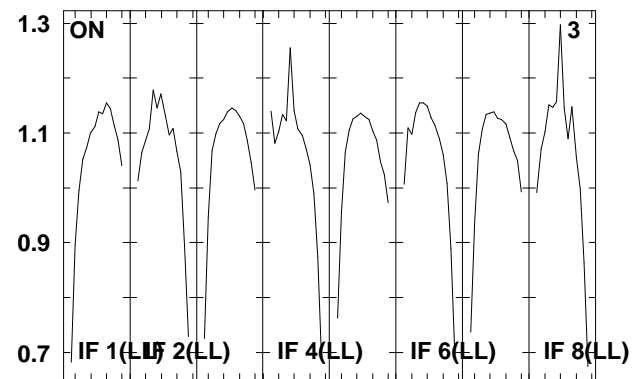
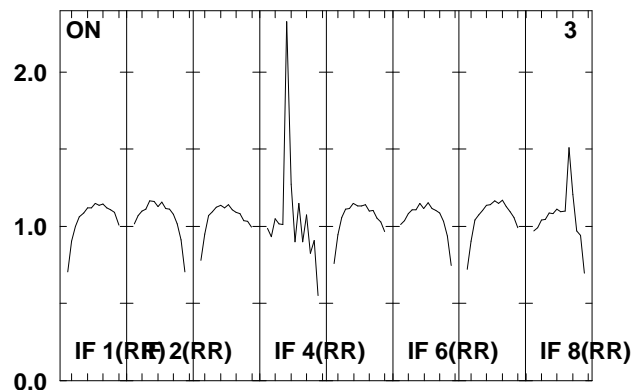
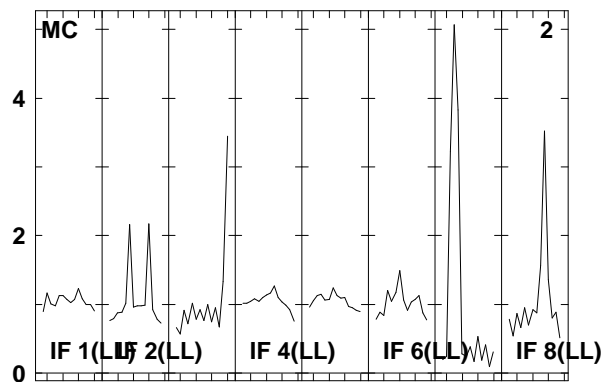
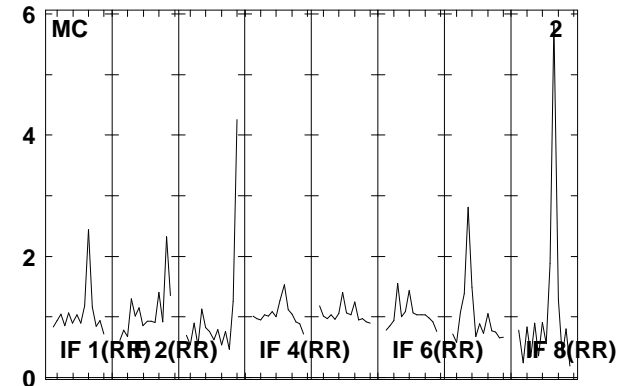
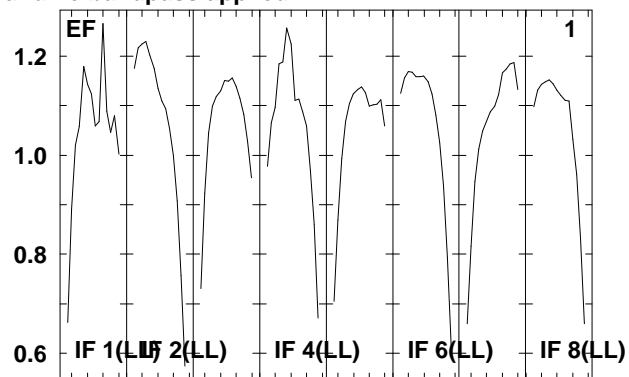
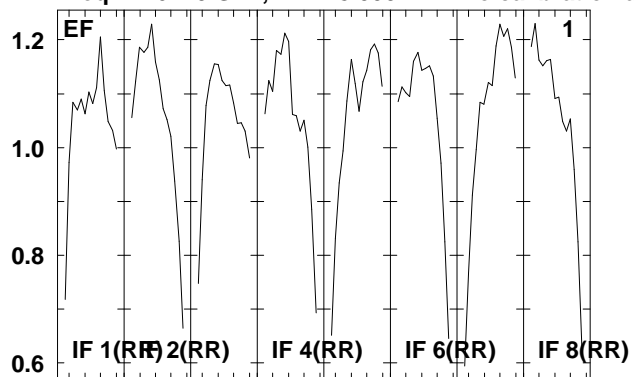

Lower frame: Real Jy

Total-power spectrum Antenna: \*

Timerange: 01/05:43:00 to 01/05:43:59

Plot file version 304 created 20-OCT-2009 14:52:06

J0137+31 RP015C.UVDATA.1

Freq = 1.6270 GHz, Bw = 8.000 MH No calibration applied and no bandpass applied

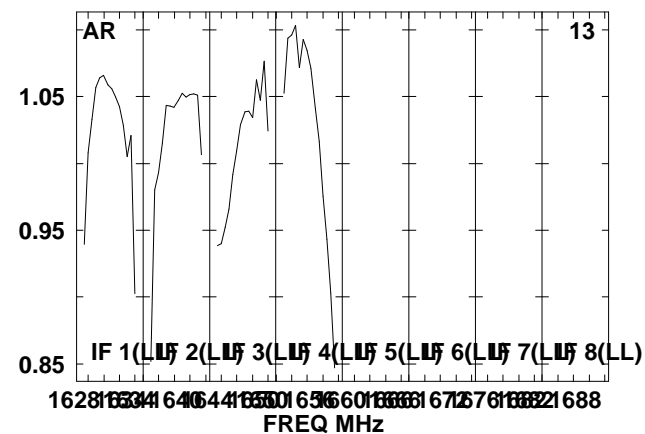
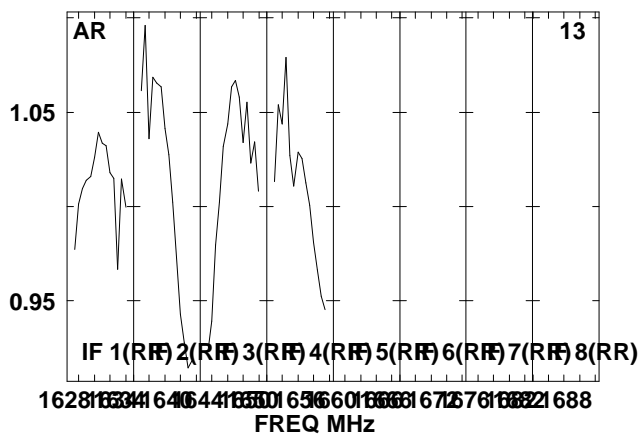
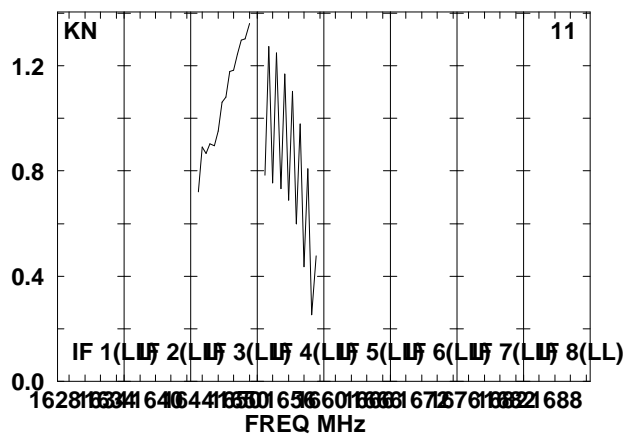
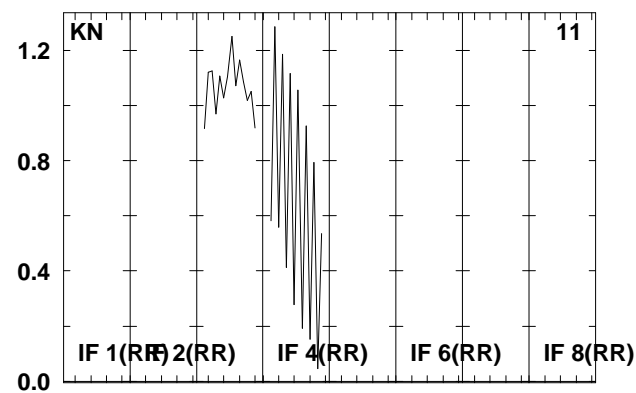
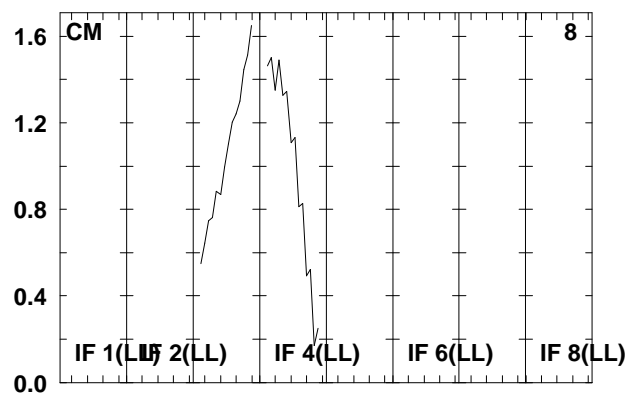
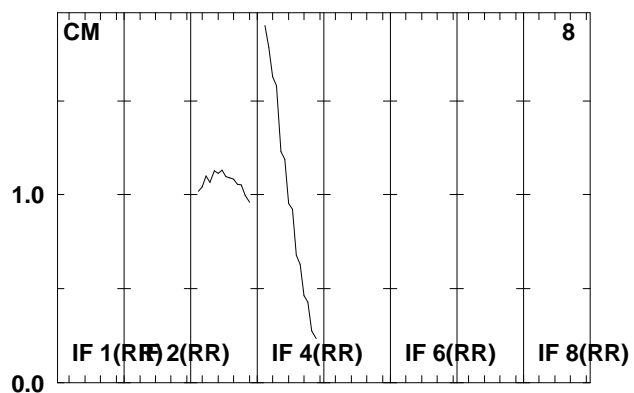
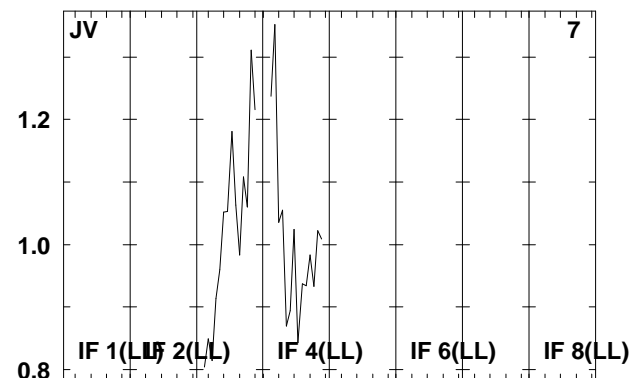
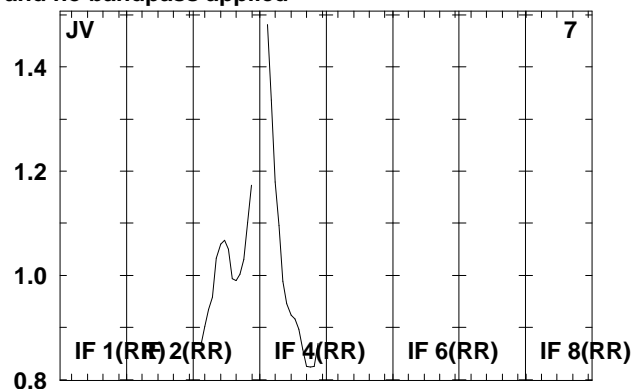
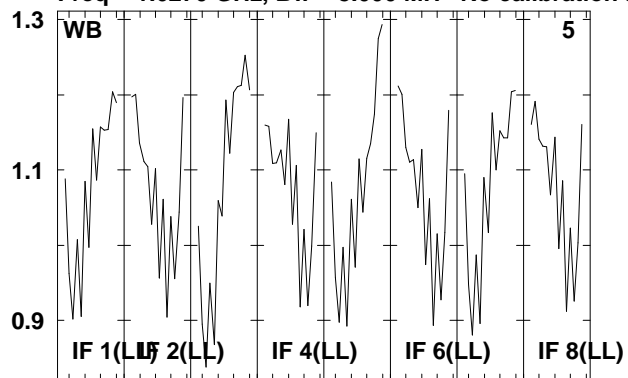

Lower frame: Real Jy

Total-power spectrum Antenna: \*

Timerange: 01/05:43:00 to 01/05:43:59



Plot file version 305 created 20-OCT-2009 14:52:06

FAINTCAL RP015C.UVDATA.1

Freq = 1.6270 GHz, Bw = 8.000 MH No calibration applied and no bandpass applied

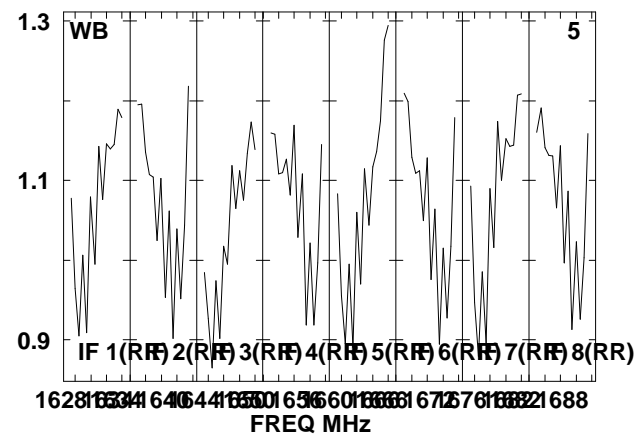
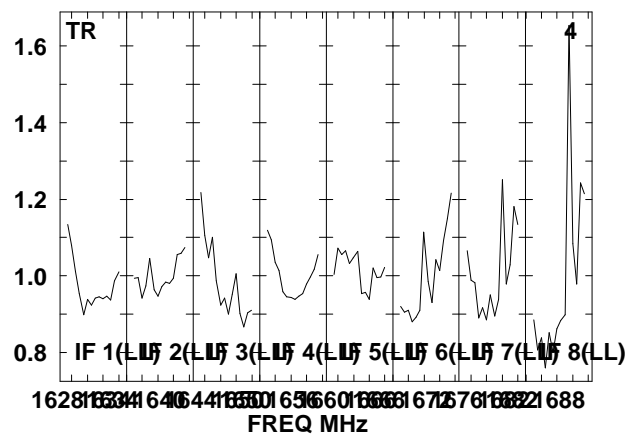
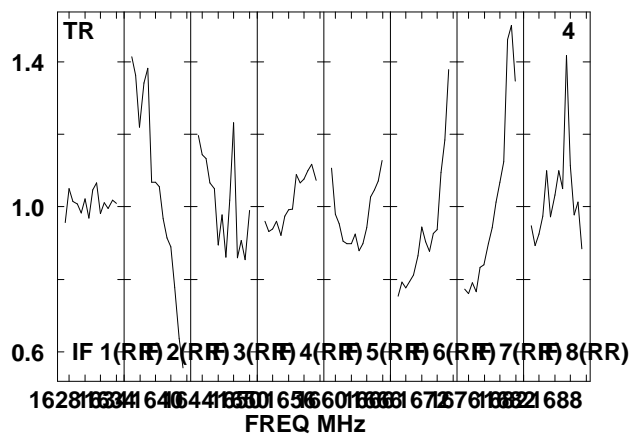
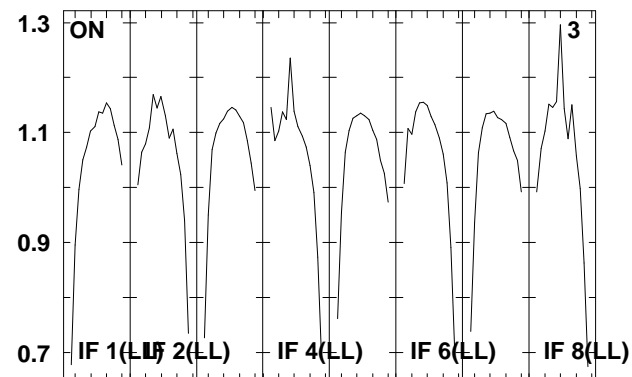
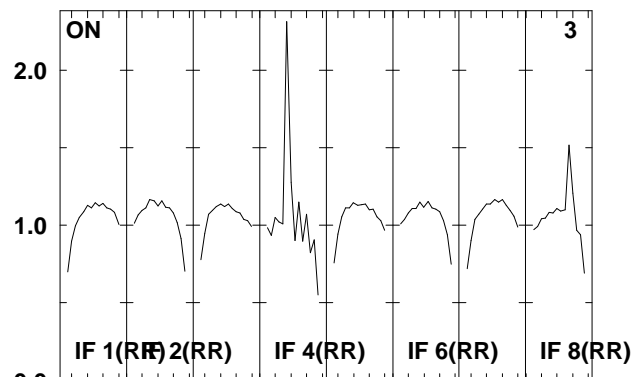
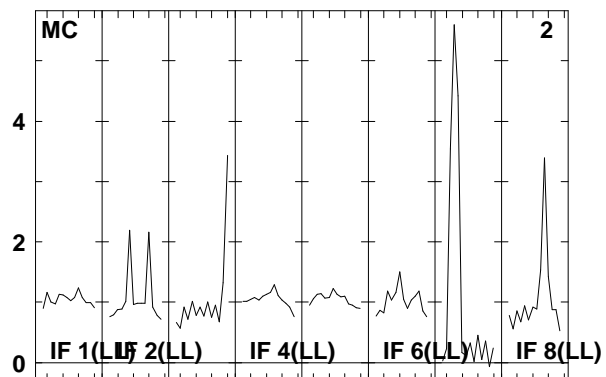
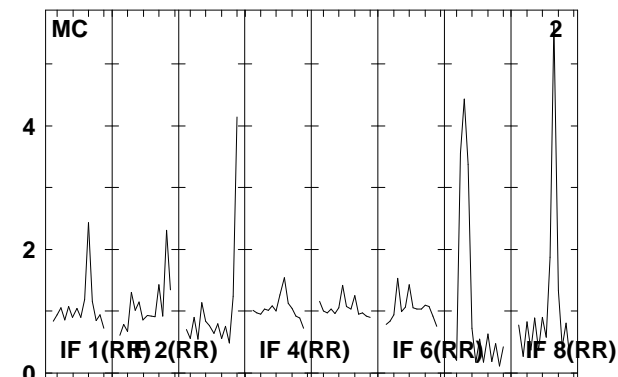
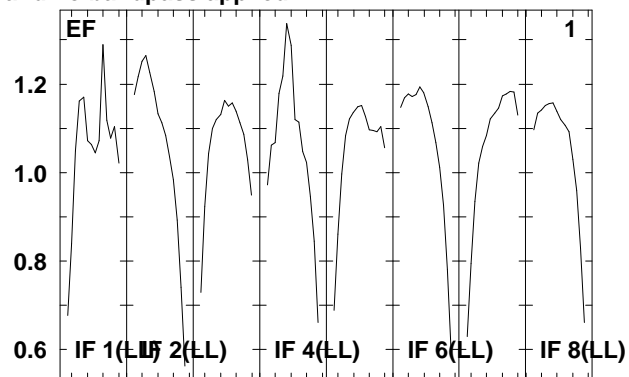
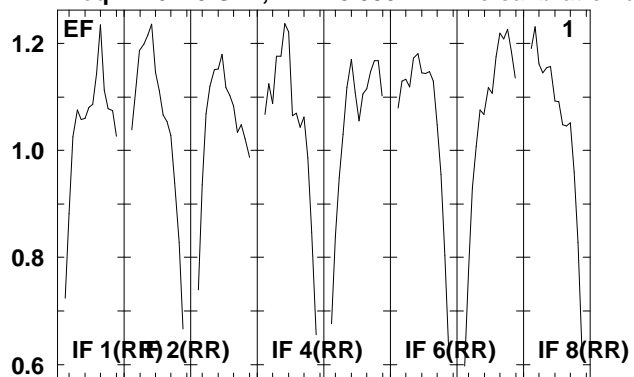

Lower frame: Real Jy  
Total-power spectrum Antenna: \*  
Timerange: 01/05:44:01 to 01/05:45:20

Plot file version 306 created 20-OCT-2009 14:52:07

FAINTCAL RP015C.UVDATA.1

Freq = 1.6270 GHz, Bw = 8.000 MH No calibration applied and no bandpass applied

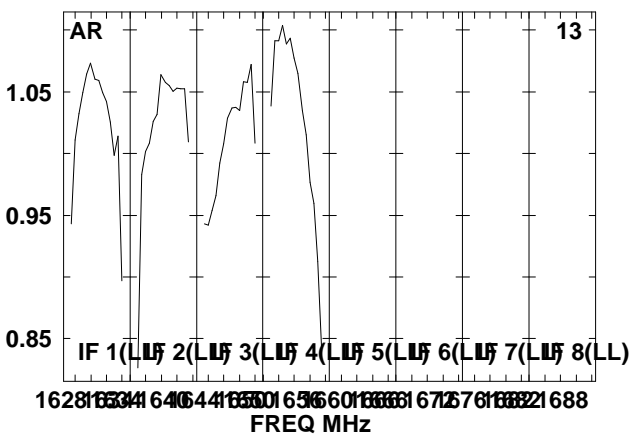
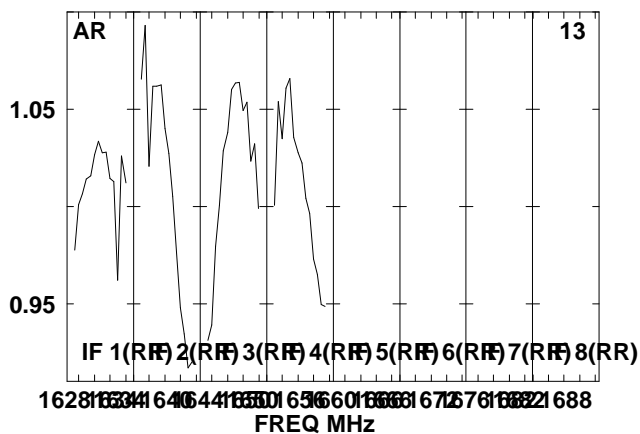
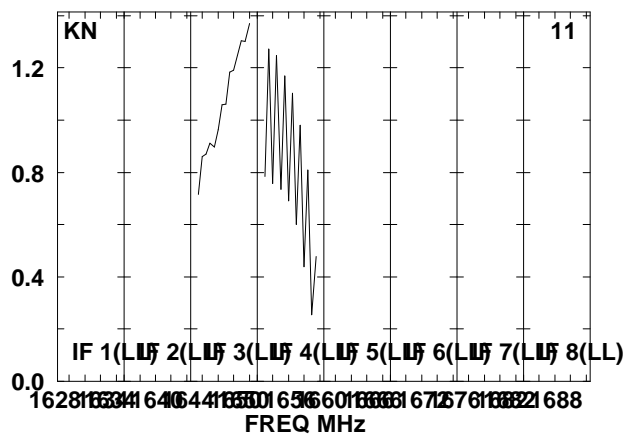
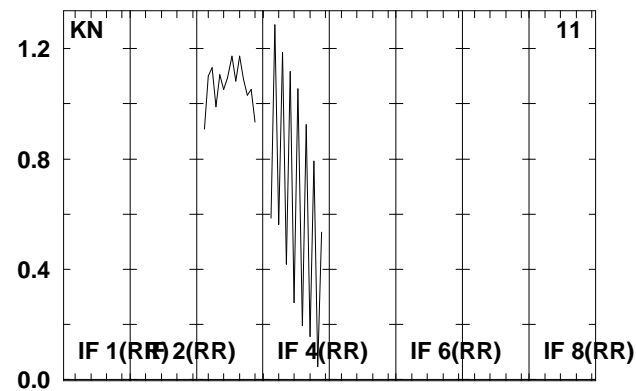
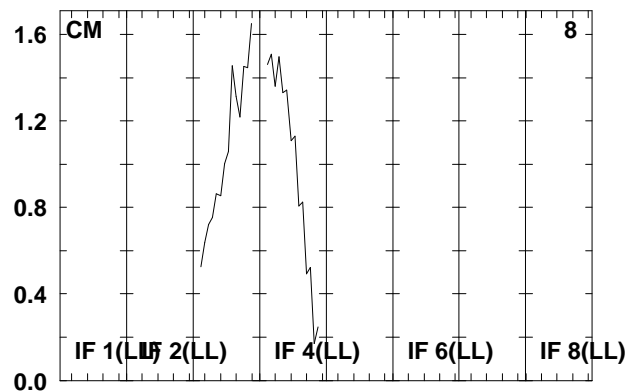
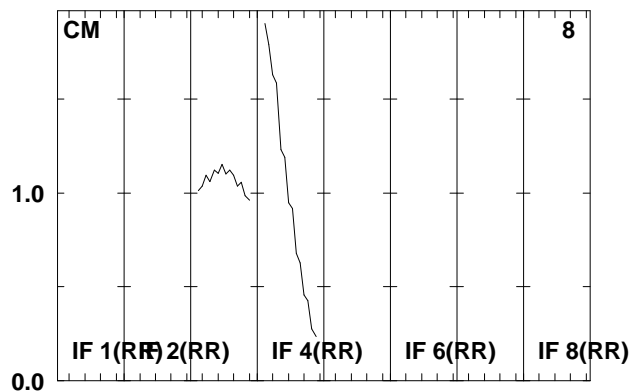
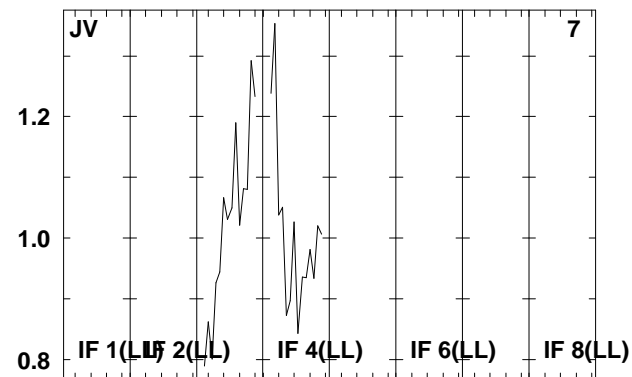
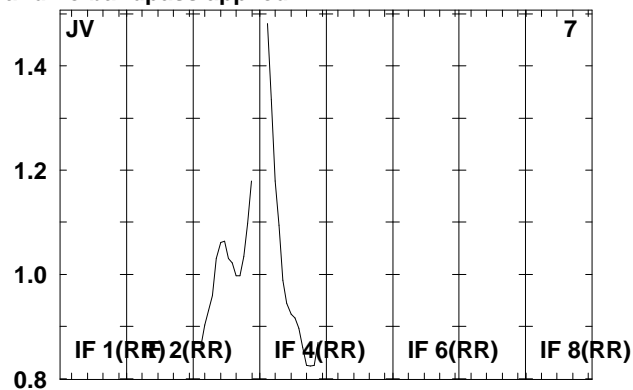
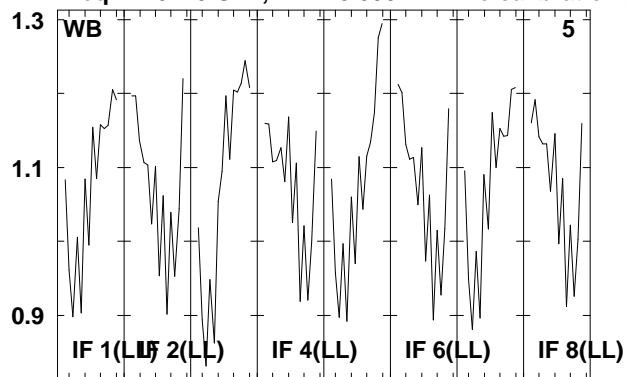

Lower frame: Real Jy  
Total-power spectrum Antenna: \*  
Timerange: 01/05:44:01 to 01/05:45:20

Plot file version 307 created 20-OCT-2009 14:52:08

M33 RP015C.UVDATA.1

Freq = 1.6270 GHz, Bw = 8.000 MH No calibration applied and no bandpass applied

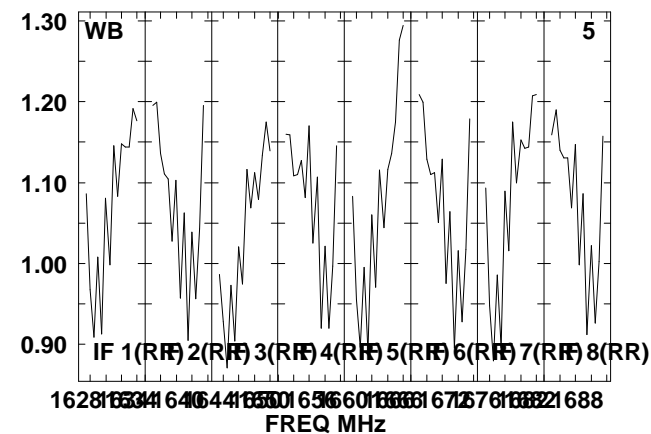
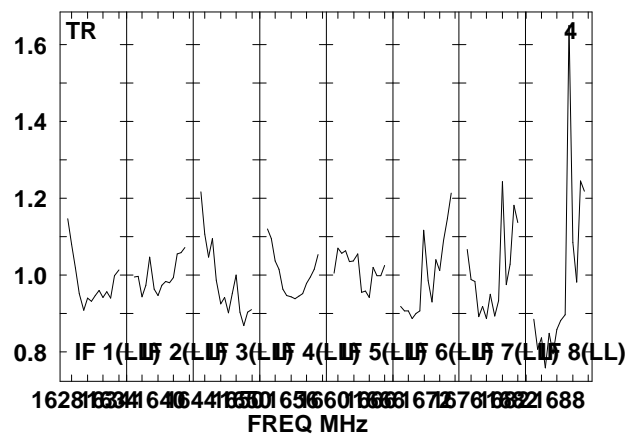
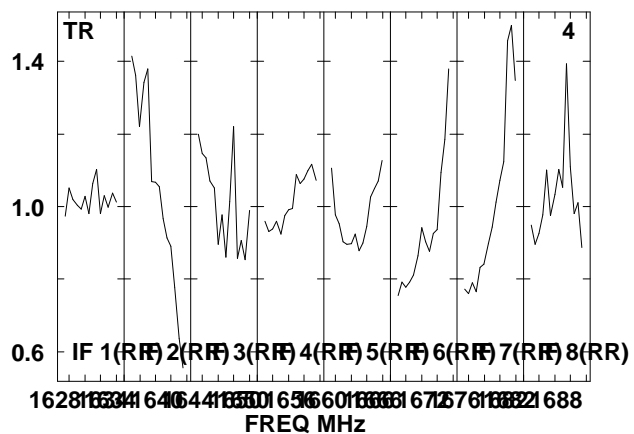
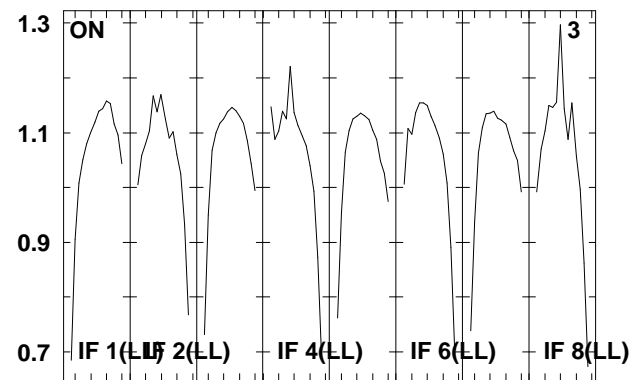
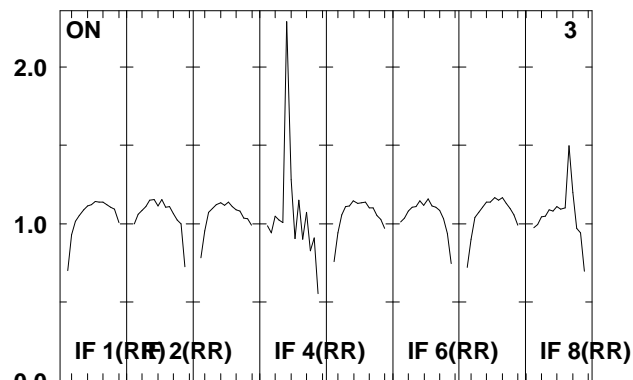
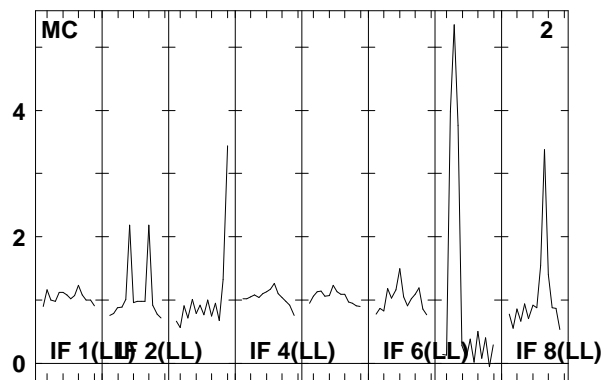
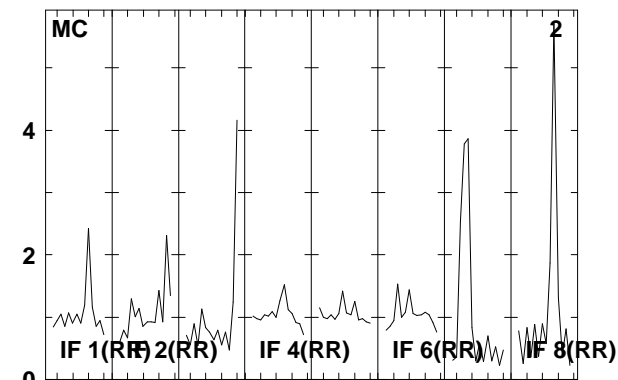
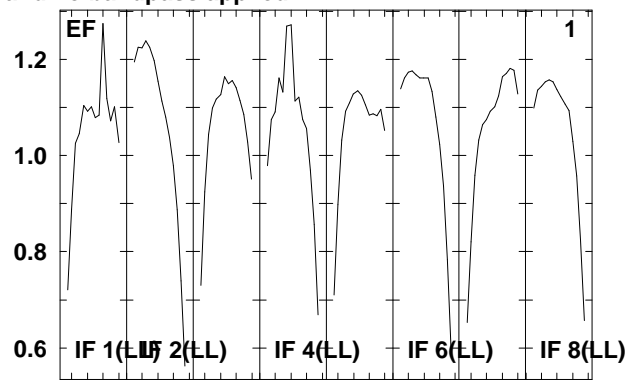
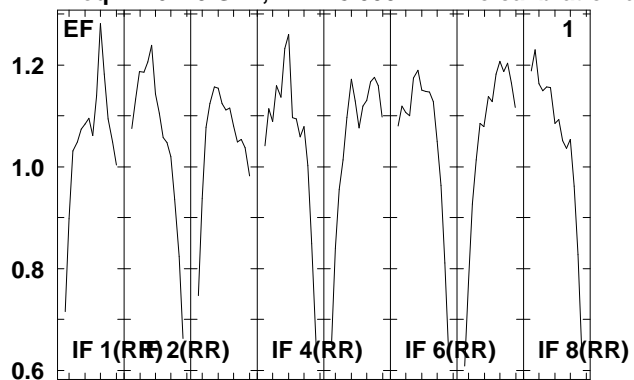

Lower frame: Real Jy  
Total-power spectrum Antenna: \*  
Timerange: 01/05:45:20 to 01/05:48:19

Plot file version 308 created 20-OCT-2009 14:52:09

M33 RP015C.UVDATA.1

Freq = 1.6270 GHz, Bw = 8.000 MH No calibration applied and no bandpass applied

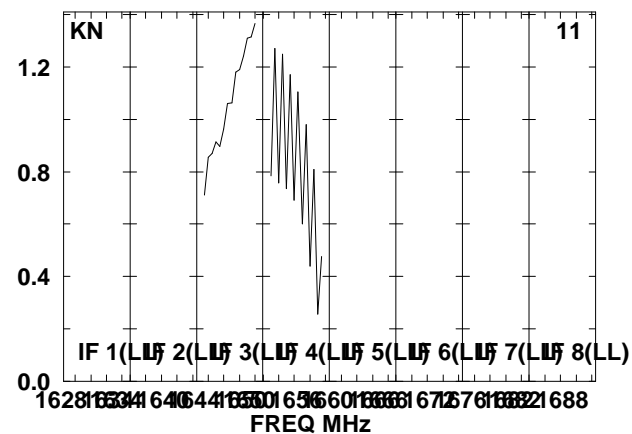
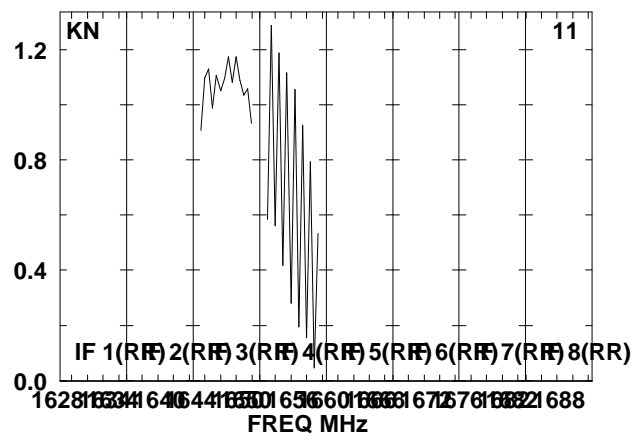
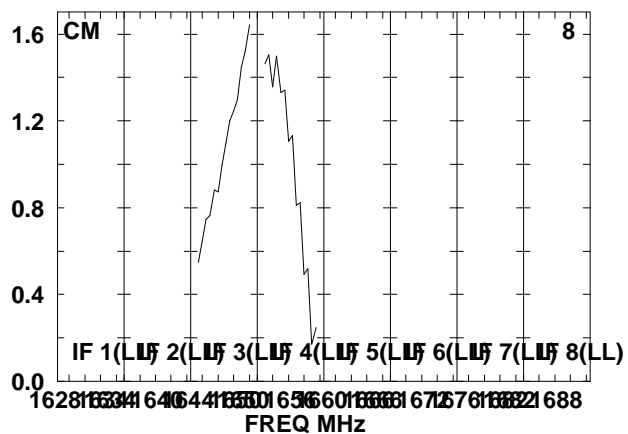
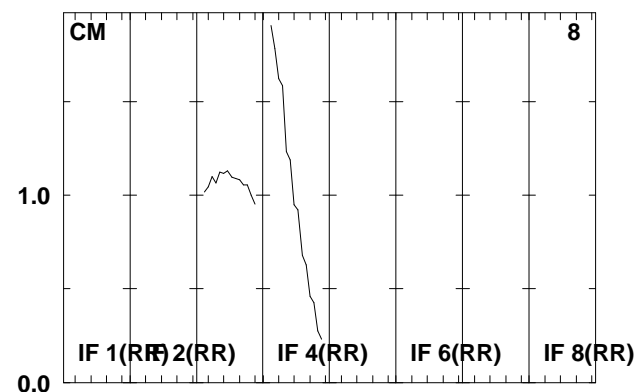
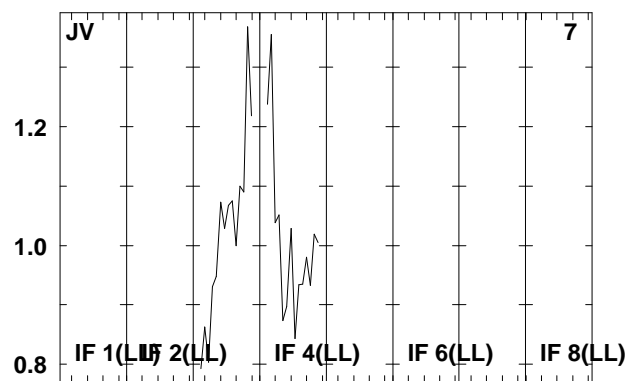
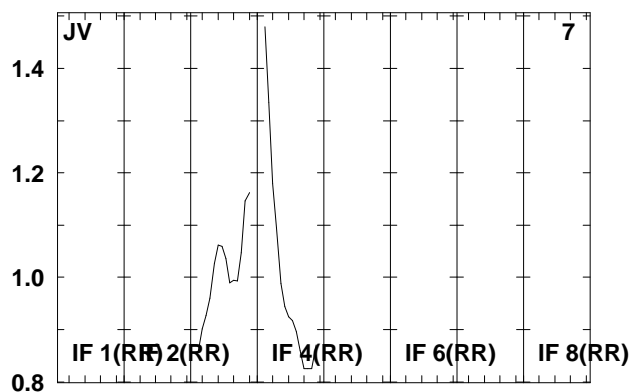
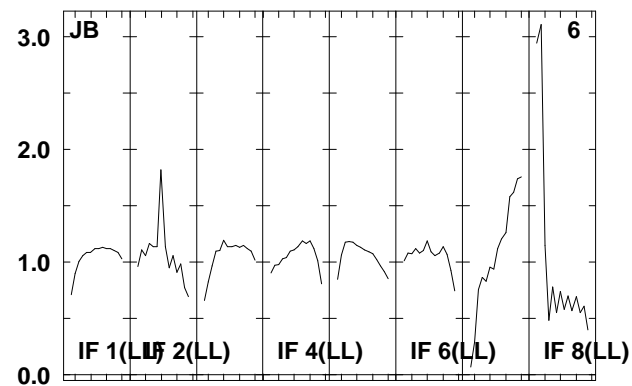
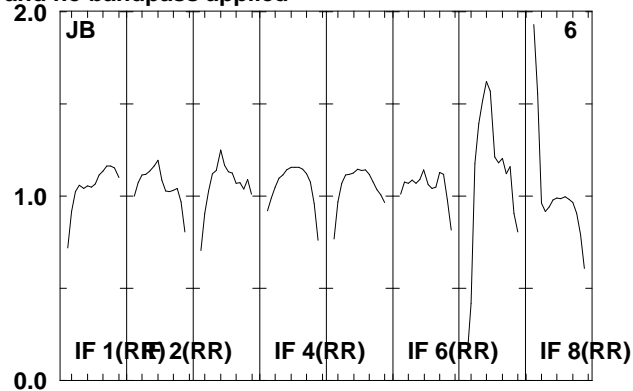
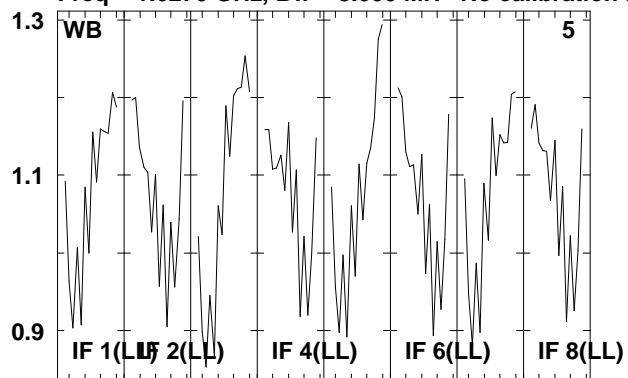

Lower frame: Real Jy

Total-power spectrum Antenna: \*

Timerange: 01/05:45:20 to 01/05:48:19

Plot file version 309 created 20-OCT-2009 14:52:10

M33 RP015C.UVDATA.1

Freq = 1.6270 GHz, Bw = 8.000 MH No calibration applied and no bandpass applied

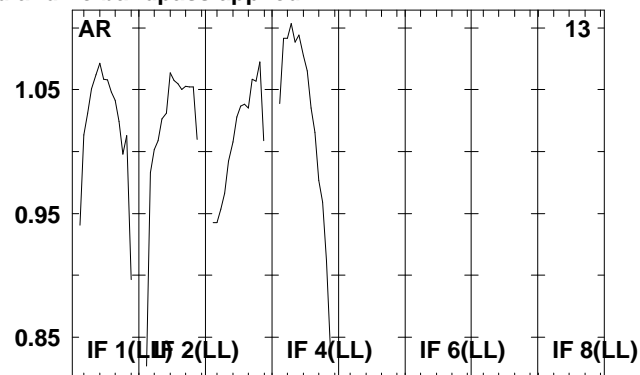
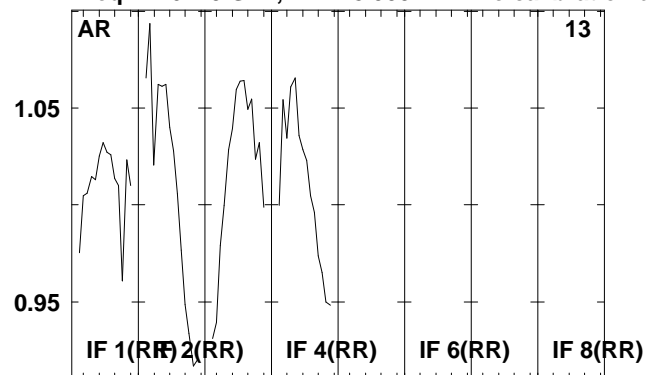

Lower frame: Real Jy  
Total-power spectrum Antenna: \*  
Timerange: 01/05:45:20 to 01/05:48:19

Plot file version 310 created 20-OCT-2009 14:52:10

J0137+31 RP015C.UVDATA.1

Freq = 1.6270 GHz, Bw = 8.000 MH No calibration applied and no bandpass applied

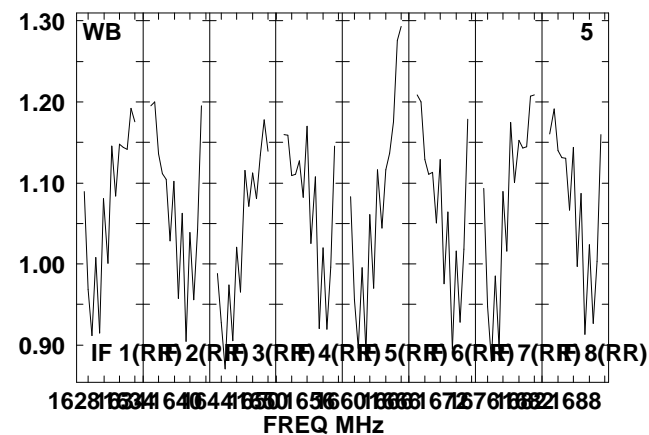
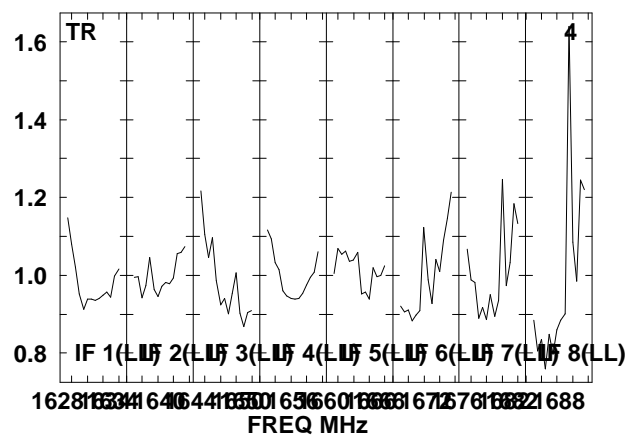
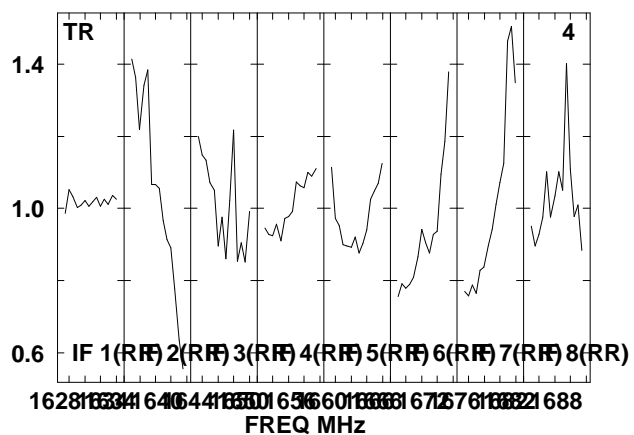
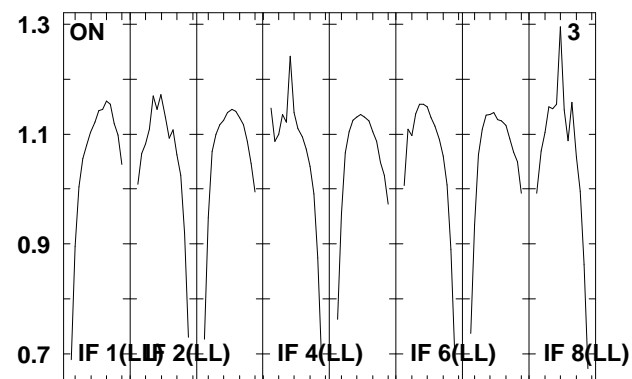
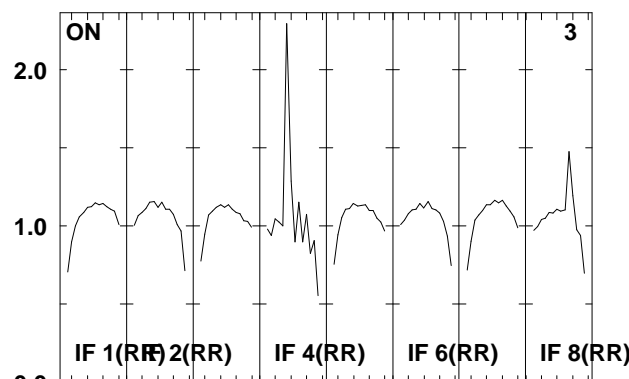
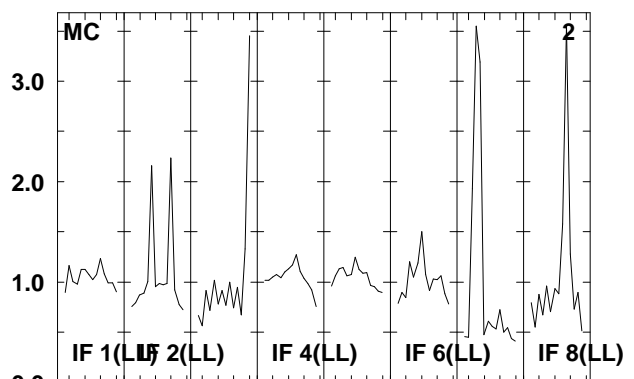
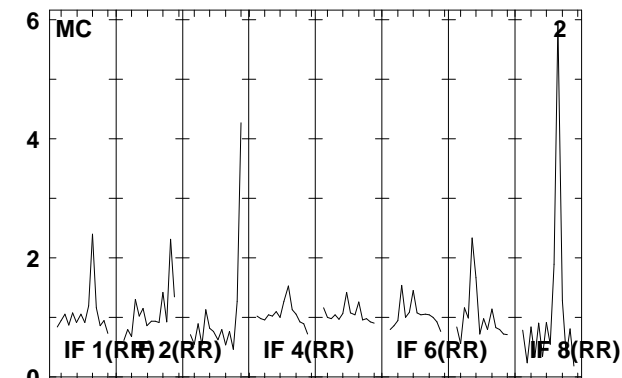
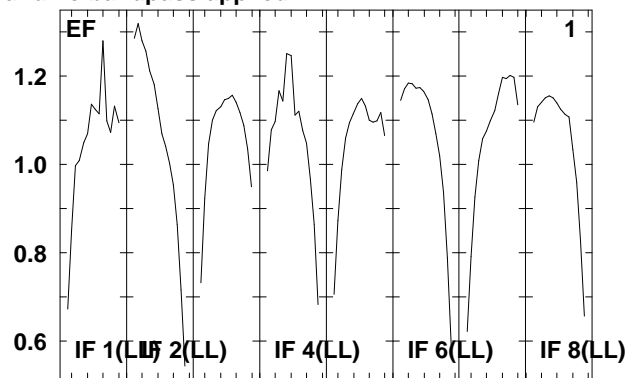
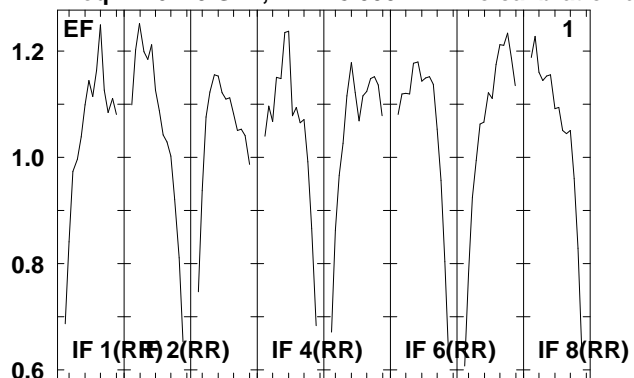

Lower frame: Real Jy

Total-power spectrum Antenna: \*

Timerange: 01/05:49:01 to 01/05:49:59

Plot file version 311 created 20-OCT-2009 14:52:11

J0137+31 RP015C.UVDATA.1

Freq = 1.6270 GHz, Bw = 8.000 MH No calibration applied and no bandpass applied

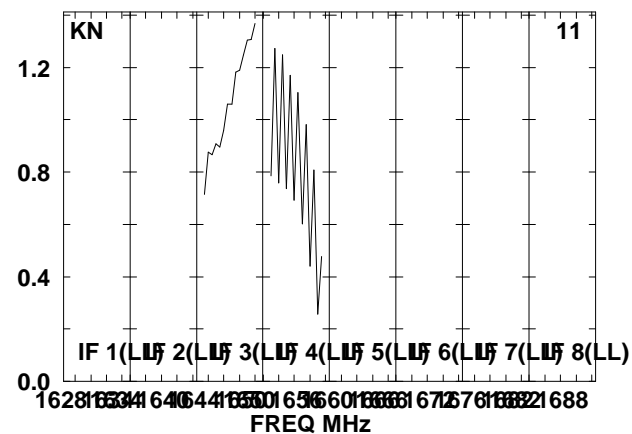
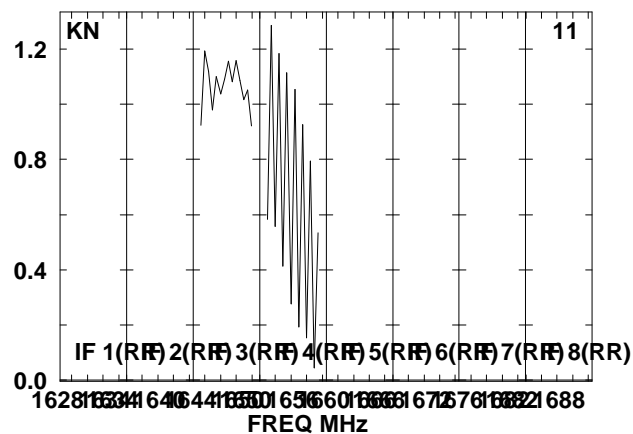
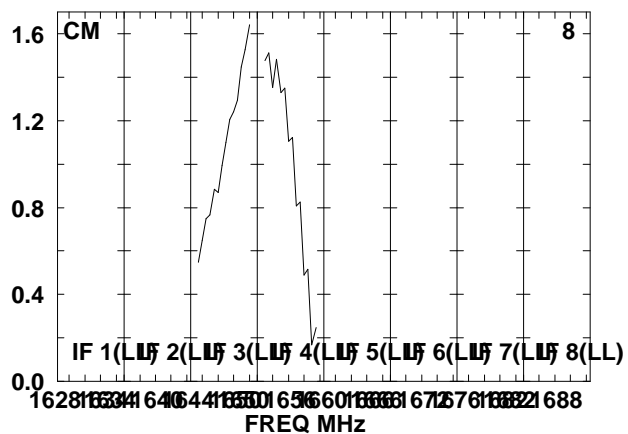
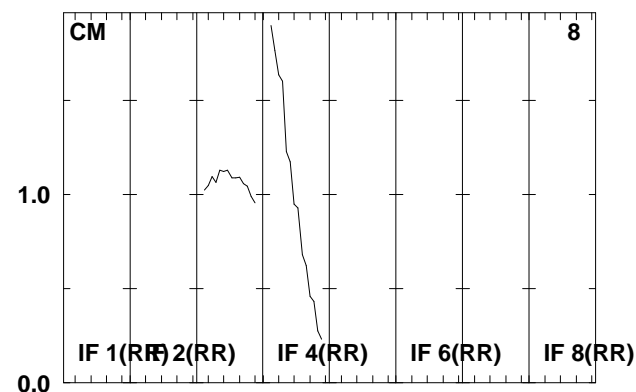
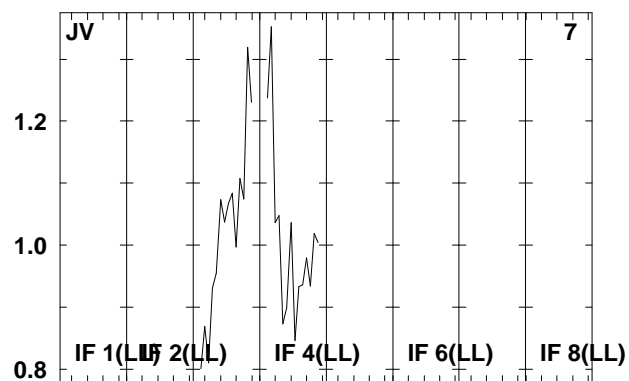
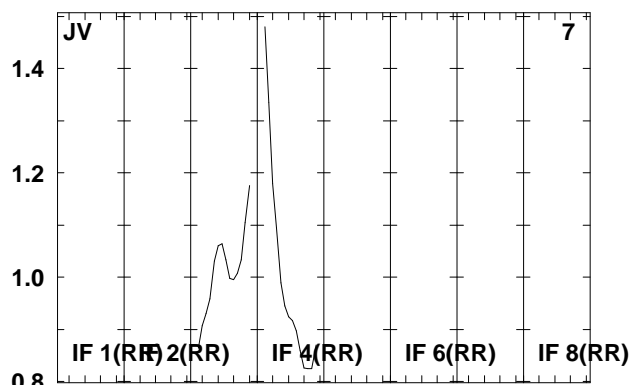
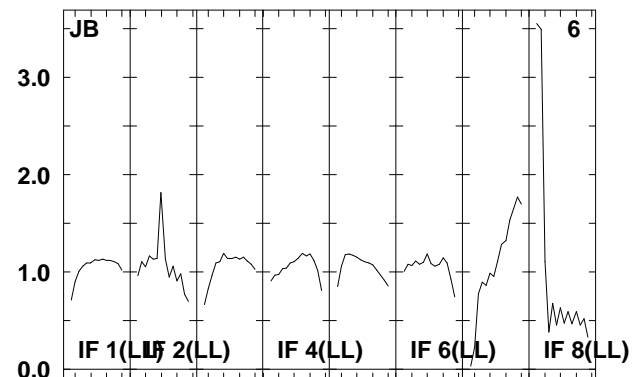
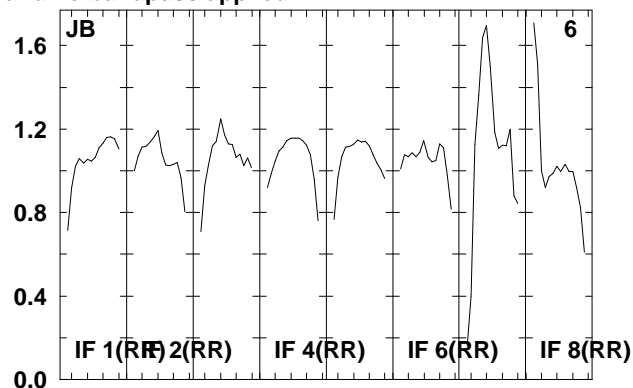
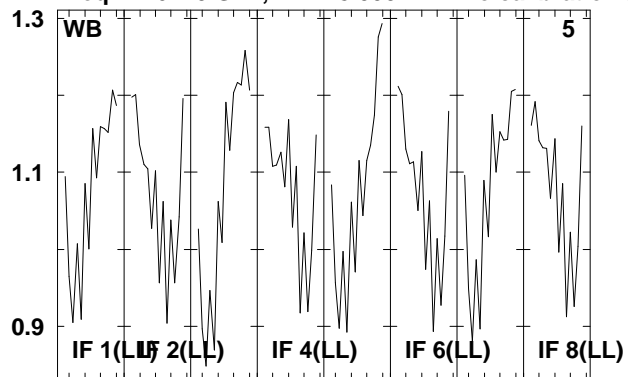

Lower frame: Real Jy  
Total-power spectrum Antenna: \*  
Timerange: 01/05:49:01 to 01/05:49:59

Plot file version 312 created 20-OCT-2009 14:52:11

J0137+31 RP015C.UVDATA.1

Freq = 1.6270 GHz, Bw = 8.000 MH No calibration applied and no bandpass applied

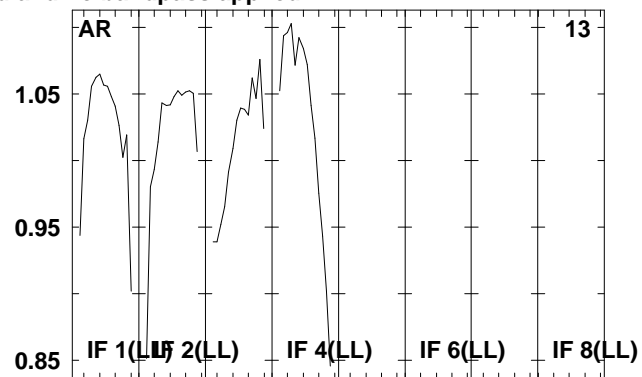
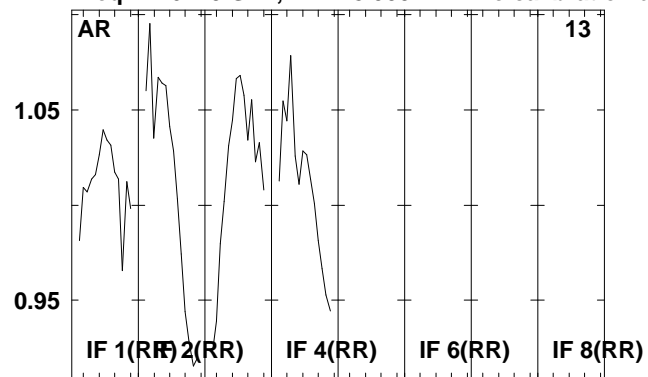

Lower frame: Real Jy  
Total-power spectrum Antenna: \*  
Timerange: 01/05:49:01 to 01/05:49:59



Plot file version 313 created 20-OCT-2009 14:52:11

FAINTCAL RP015C.UVDATA.1

Freq = 1.6270 GHz, Bw = 8.000 MH No calibration applied and no bandpass applied

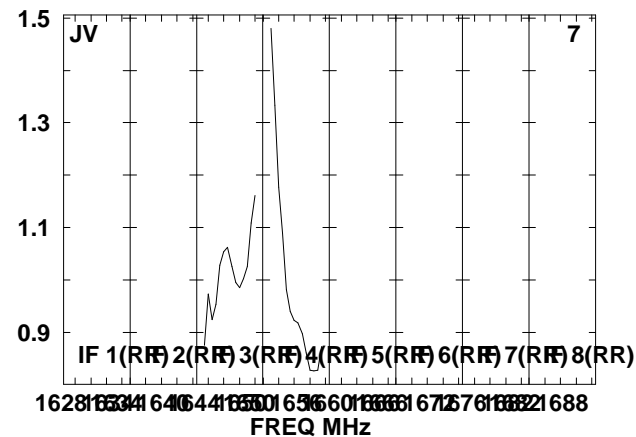
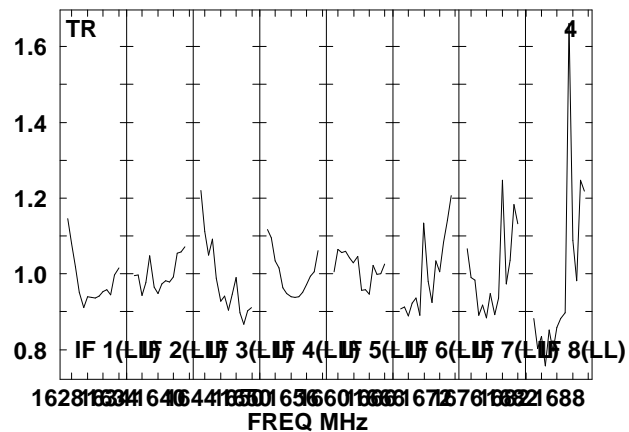
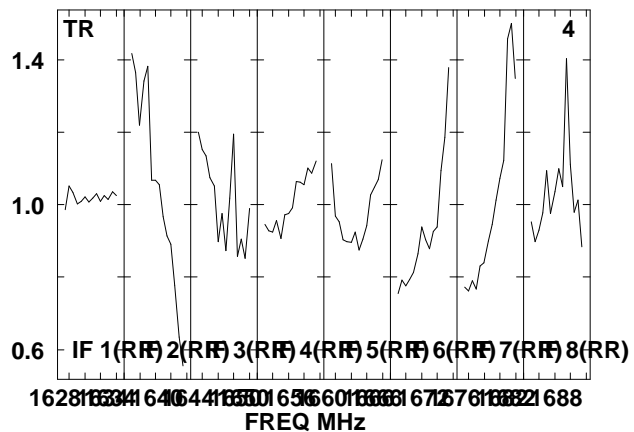
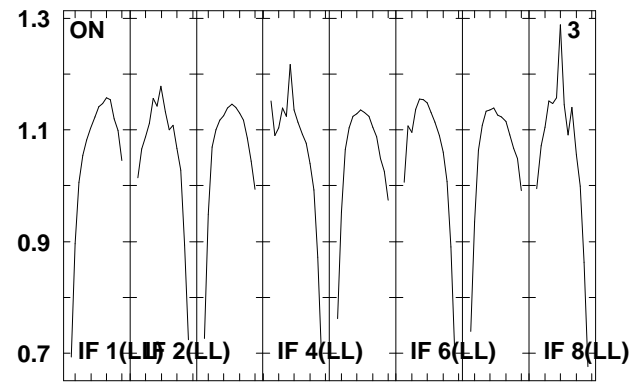
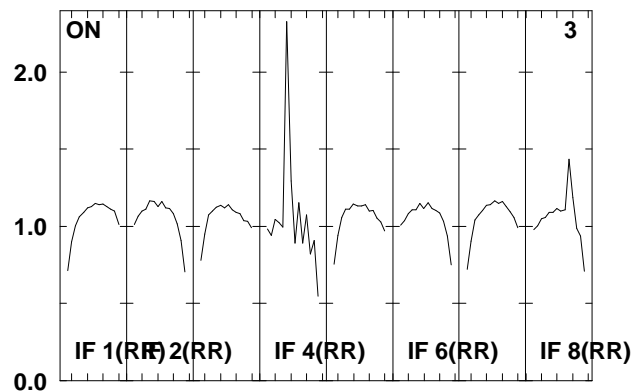
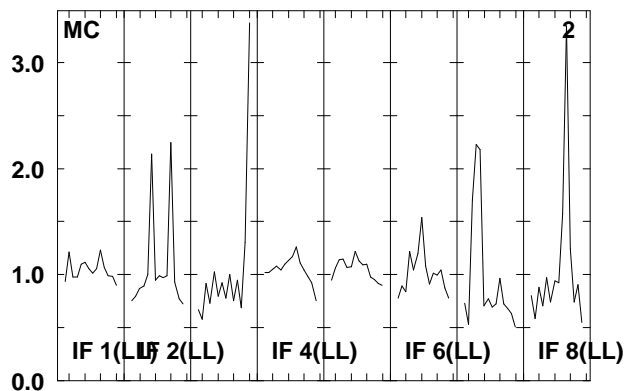
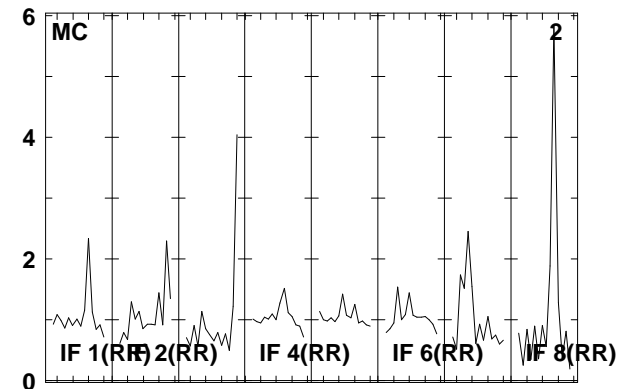
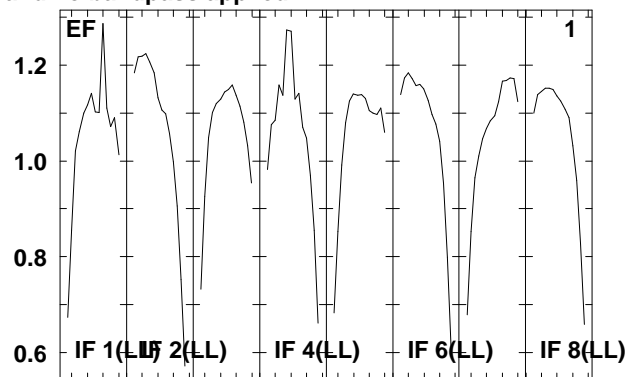
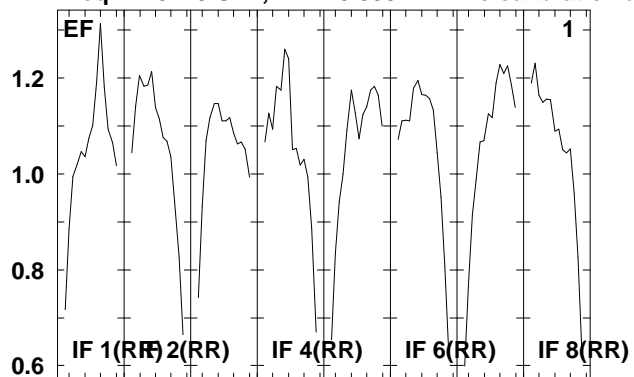

Lower frame: Real Jy

Total-power spectrum Antenna: \*

Timerange: 01/05:50:00 to 01/05:51:19

Plot file version 314 created 20-OCT-2009 14:52:12

FAINTCAL RP015C.UVDATA.1

Freq = 1.6270 GHz, Bw = 8.000 MH No calibration applied and no bandpass applied

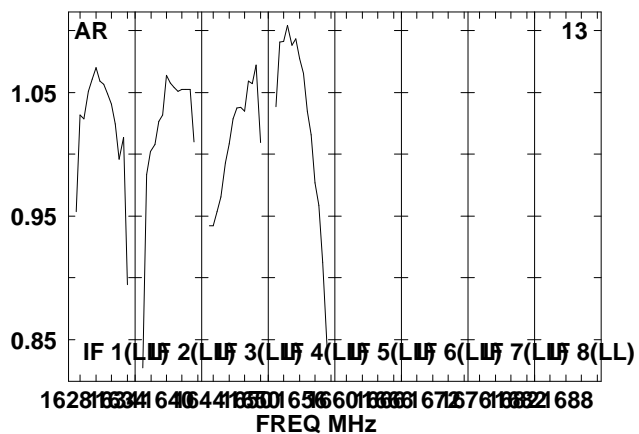
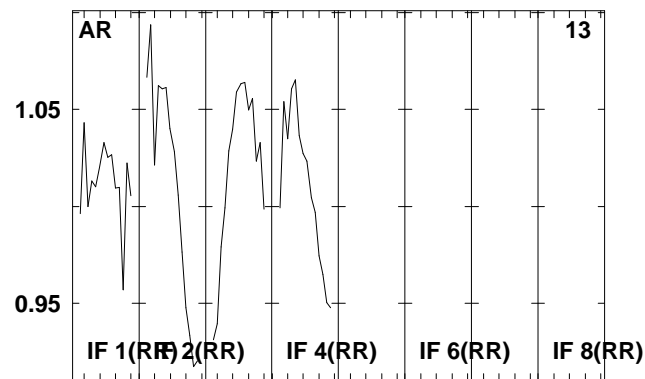
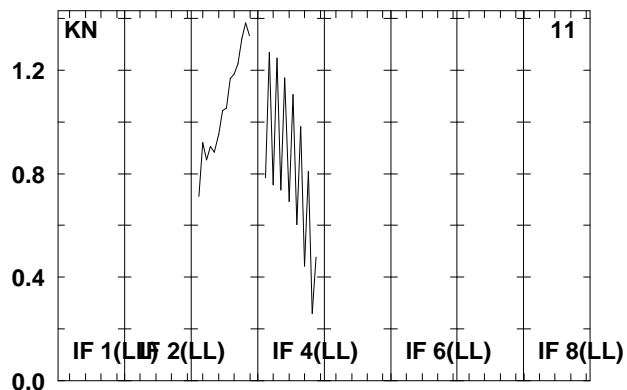
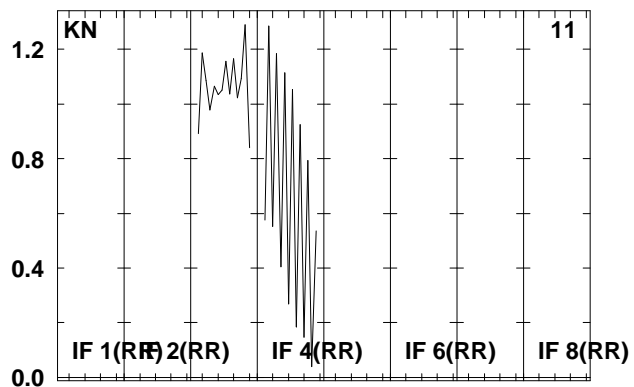
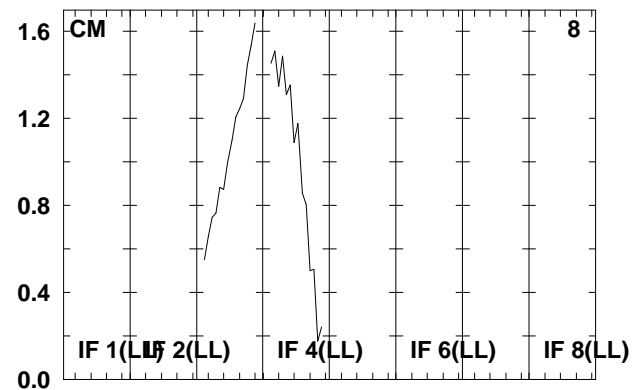
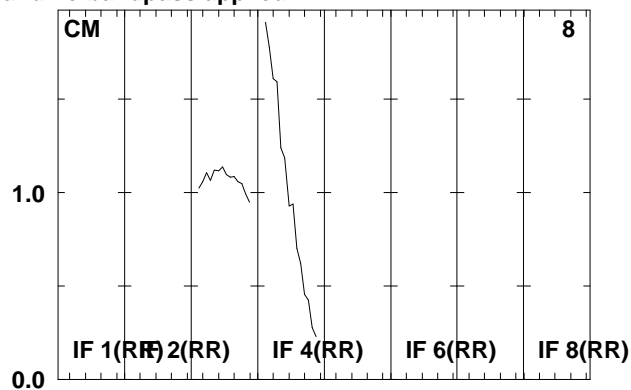
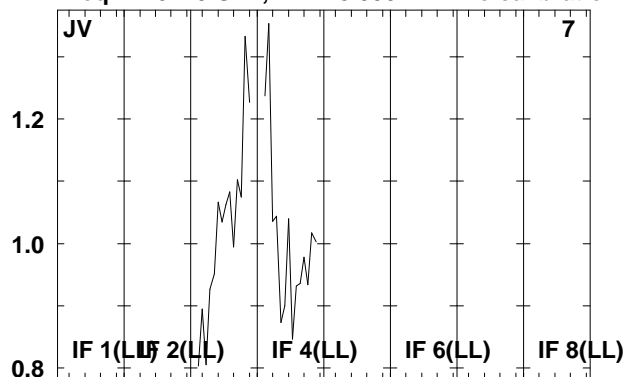

Lower frame: Real Jy

Total-power spectrum Antenna: \*

Timerange: 01/05:50:00 to 01/05:51:19

Plot file version 315 created 20-OCT-2009 14:52:13

M33 RP015C.UVDATA.1

Freq = 1.6270 GHz, Bw = 8.000 MH No calibration applied and no bandpass applied

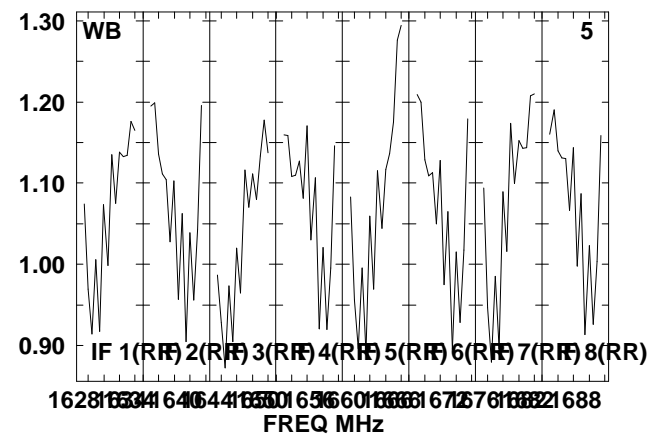
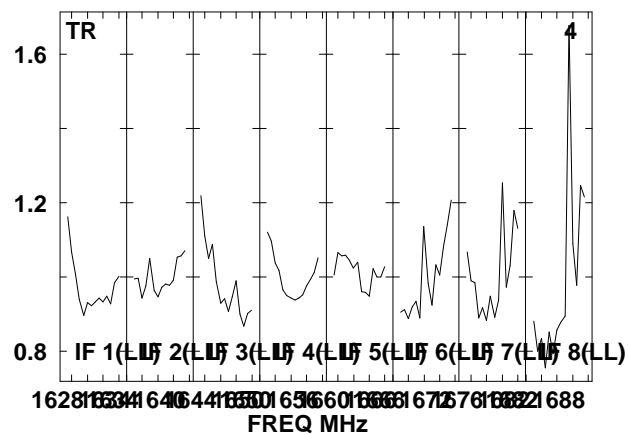
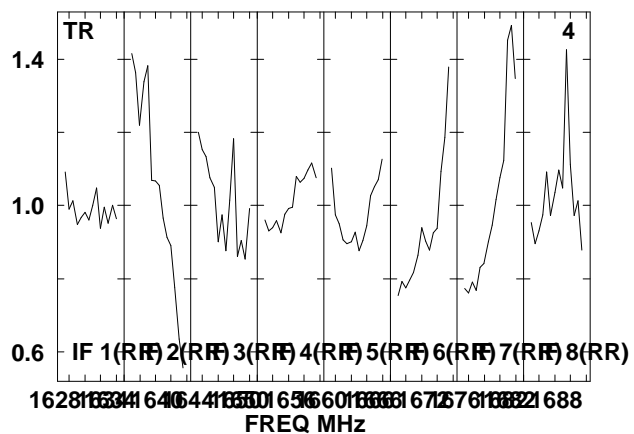
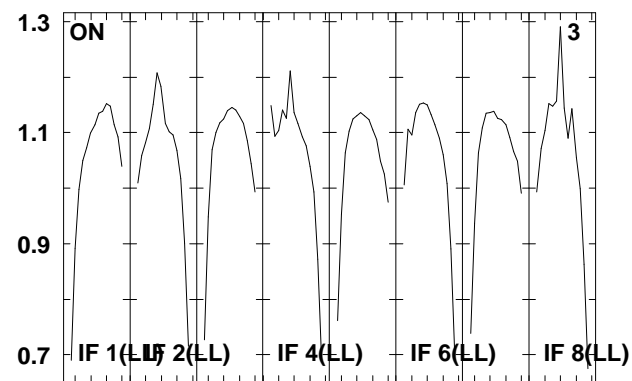
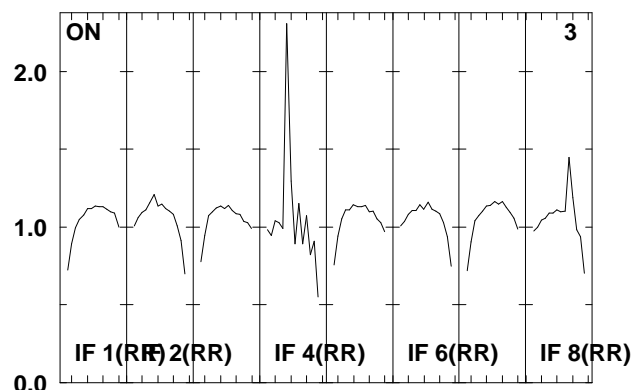
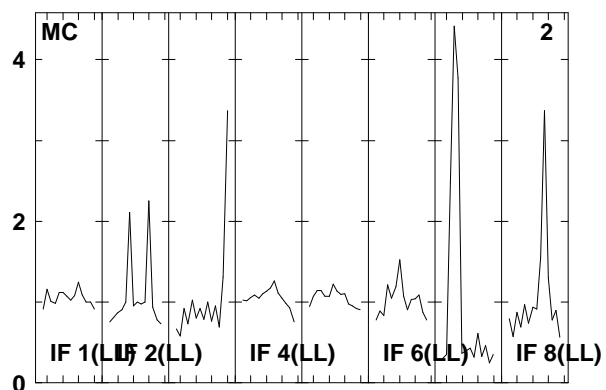
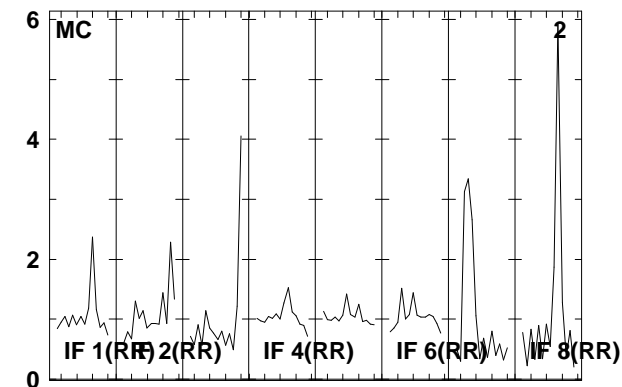
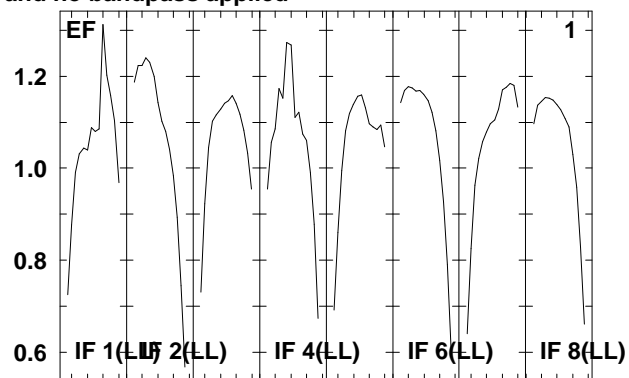
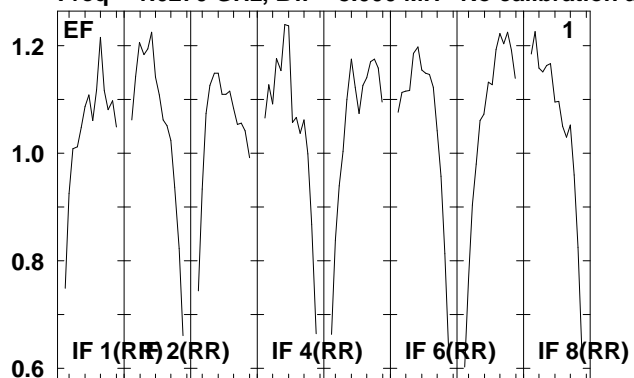

Lower frame: Real Jy

Total-power spectrum Antenna: \*

Timerange: 01/05:51:21 to 01/05:54:20

Plot file version 316 created 20-OCT-2009 14:52:14

M33 RP015C.UVDATA.1

Freq = 1.6270 GHz, Bw = 8.000 MH No calibration applied and no bandpass applied

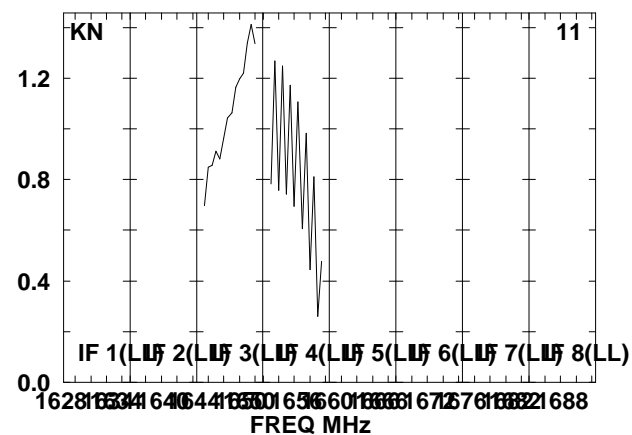
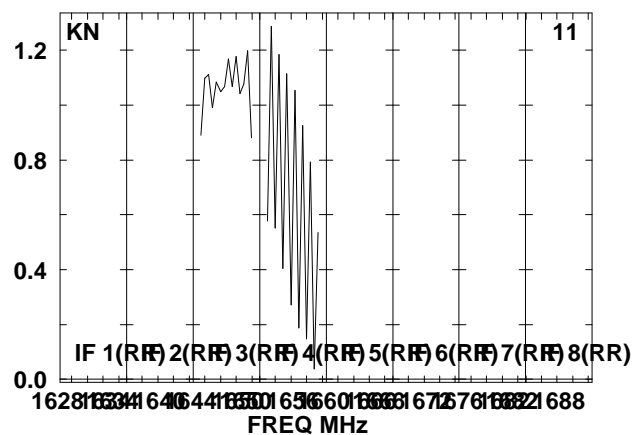
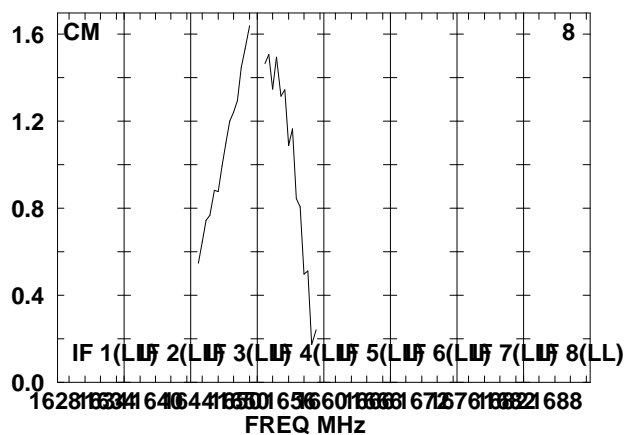
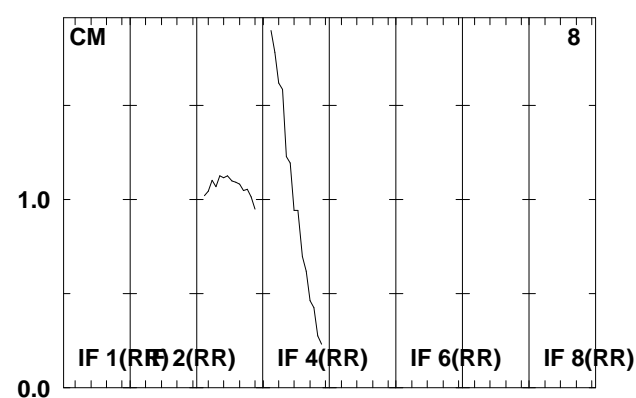
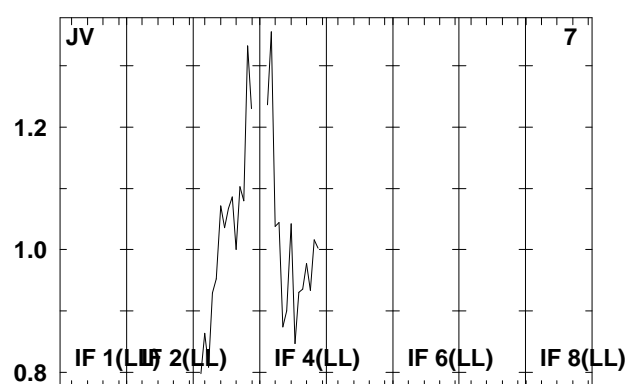
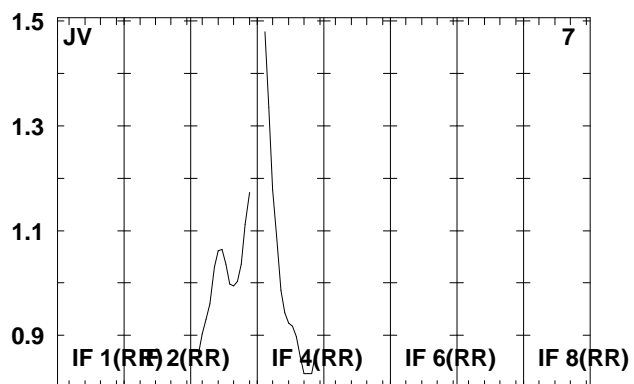
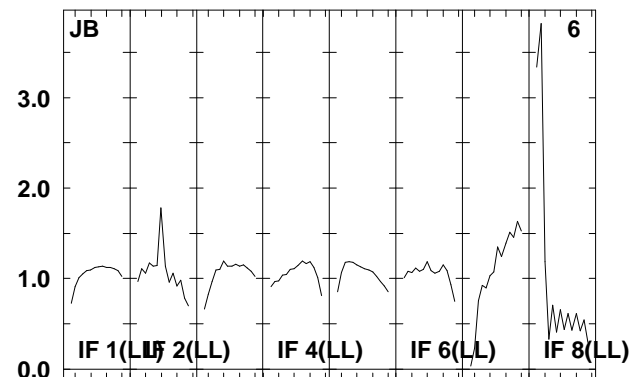
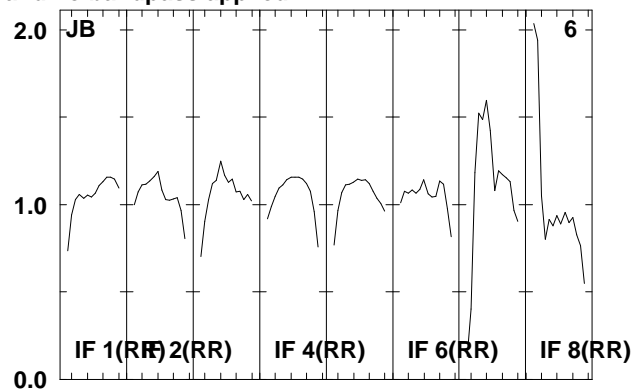
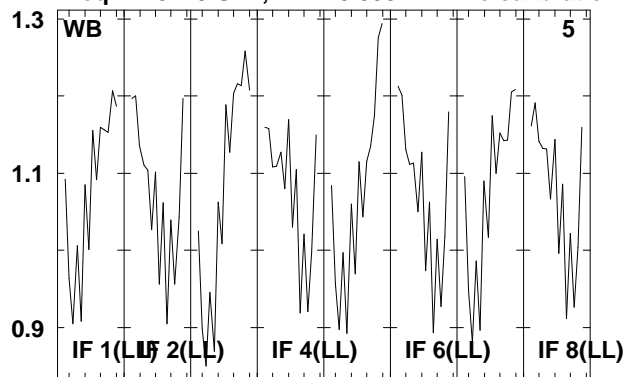

Lower frame: Real Jy

Total-power spectrum Antenna: \*

Timerange: 01/05:51:21 to 01/05:54:20

Plot file version 317 created 20-OCT-2009 14:52:15

M33 RP015C.UVDATA.1

Freq = 1.6270 GHz, Bw = 8.000 MH No calibration applied and no bandpass applied

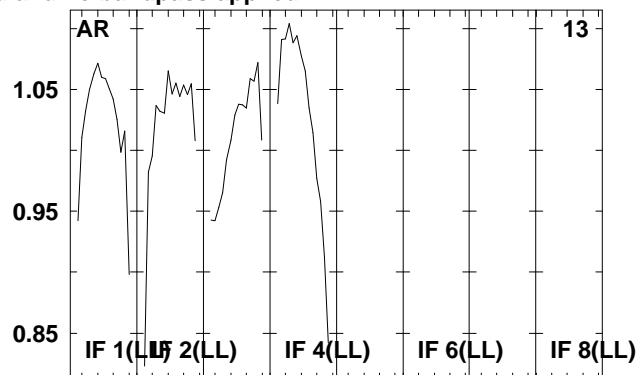
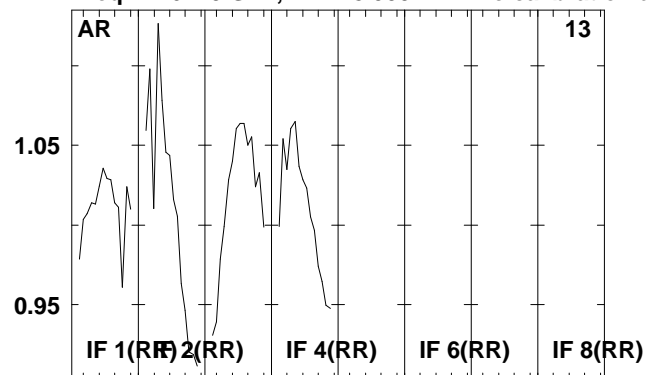

Lower frame: Real Jy  
Total-power spectrum Antenna: \*  
Timerange: 01/05:51:21 to 01/05:54:20

Plot file version 318 created 20-OCT-2009 14:52:15

J0137+31 RP015C.UVDATA.1

Freq = 1.6270 GHz, Bw = 8.000 MH No calibration applied and no bandpass applied

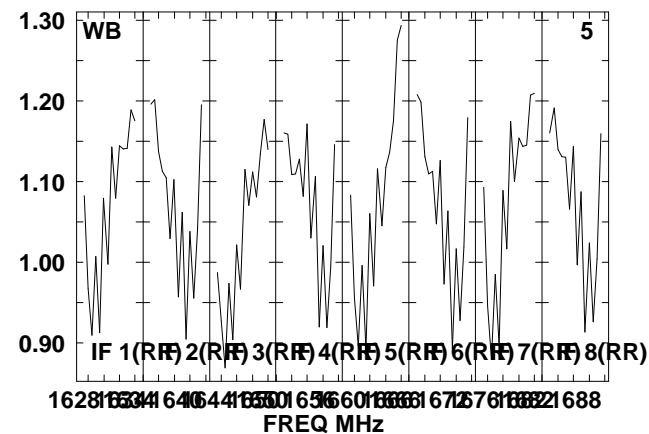
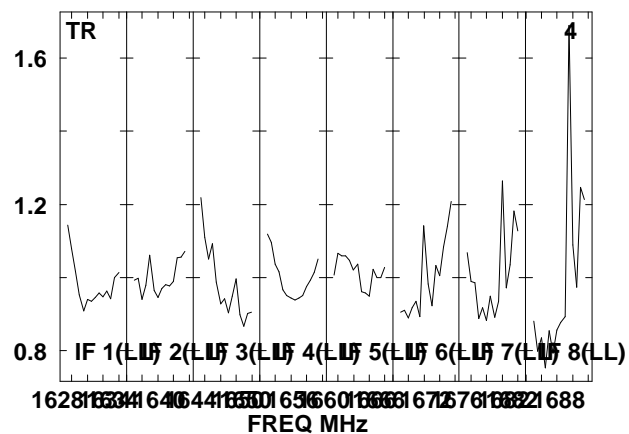
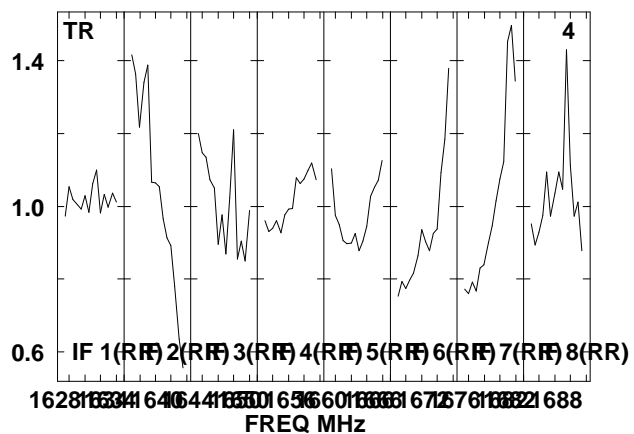
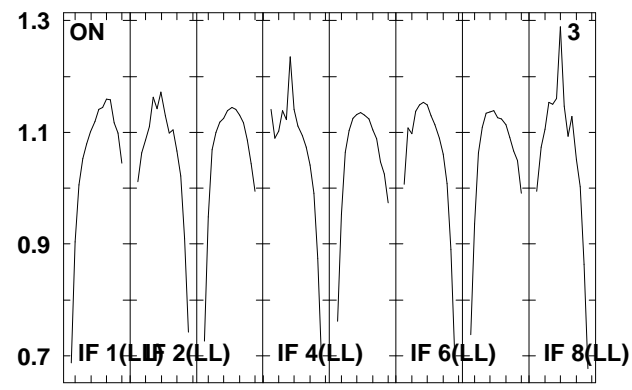
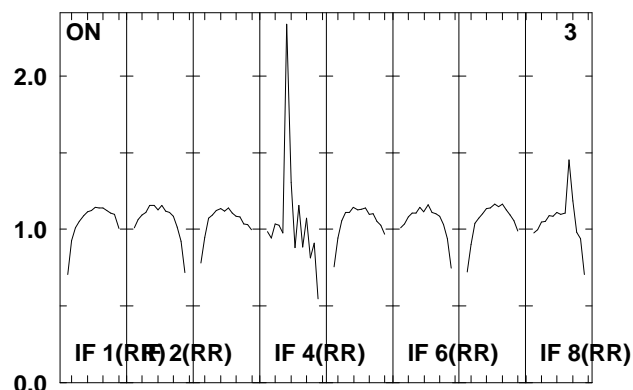
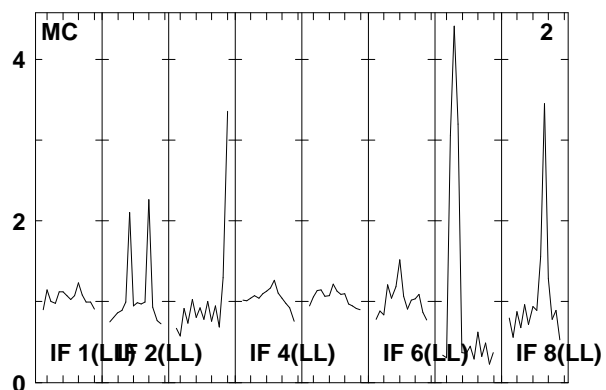
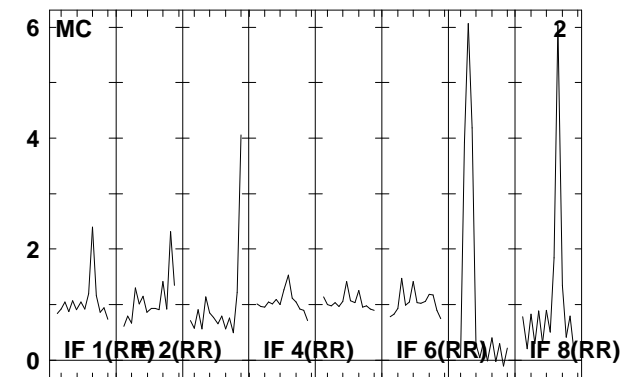
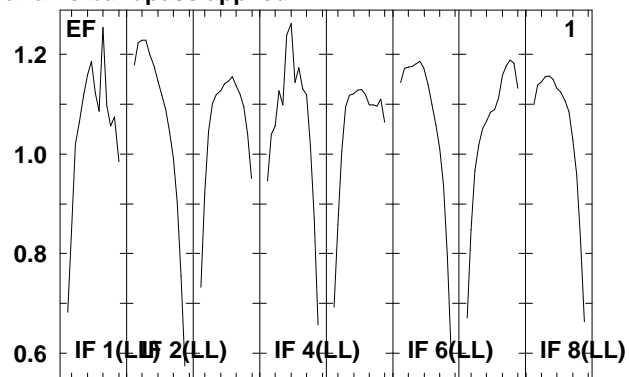
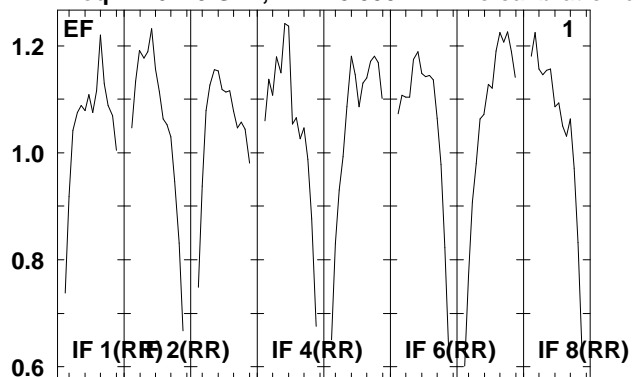

Lower frame: Real Jy

Total-power spectrum Antenna: \*

Timerange: 01/05:55:01 to 01/05:56:00

Plot file version 319 created 20-OCT-2009 14:52:16

J0137+31 RP015C.UVDATA.1

Freq = 1.6270 GHz, Bw = 8.000 MH No calibration applied and no bandpass applied

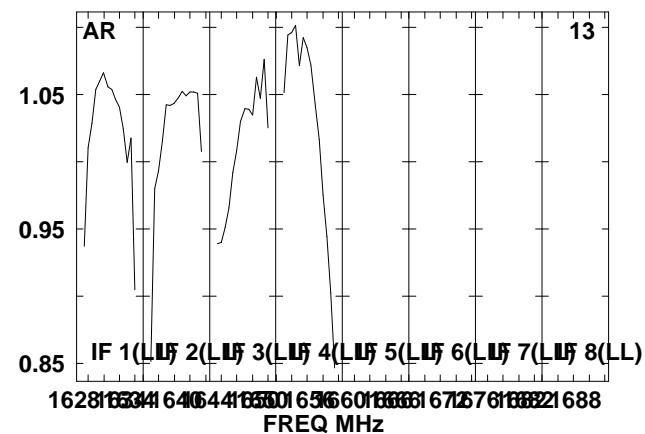
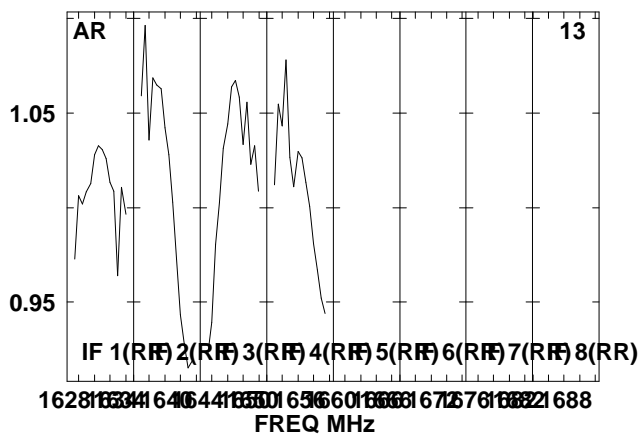
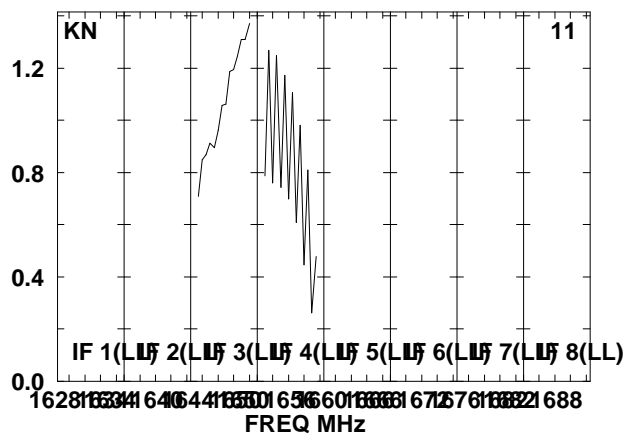
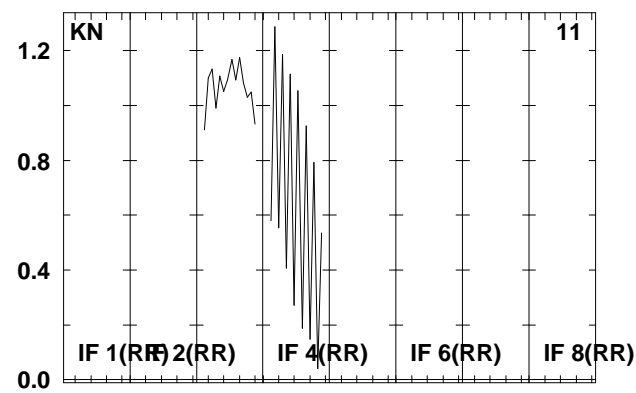
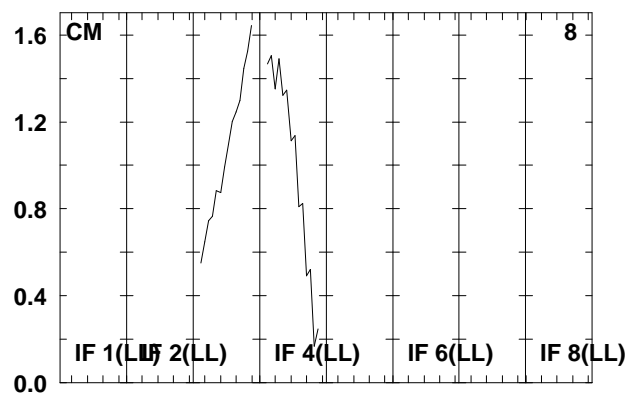
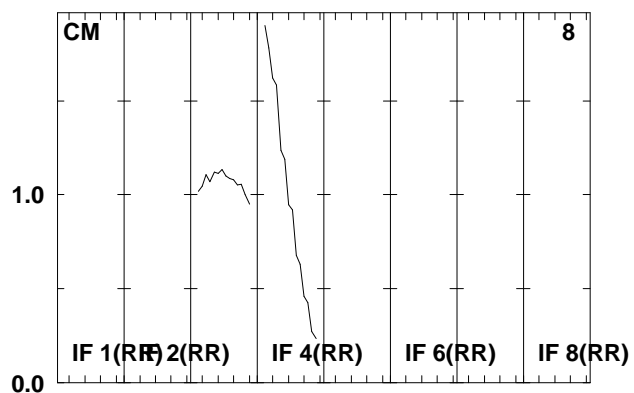
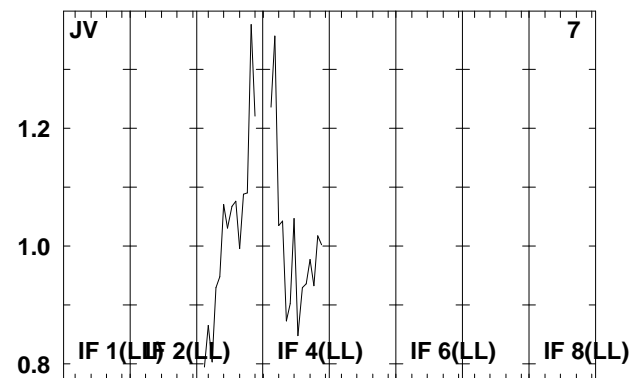
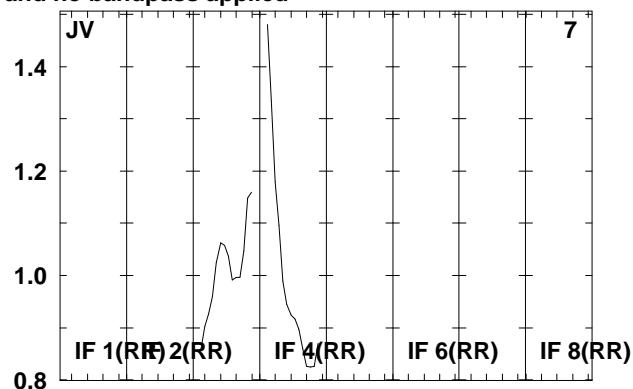
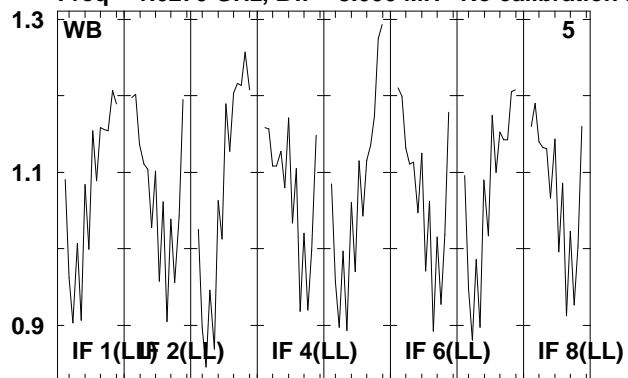

Lower frame: Real Jy  
Total-power spectrum Antenna: \*  
Timerange: 01/05:55:01 to 01/05:56:00

Plot file version 320 created 20-OCT-2009 14:52:16

FAINTCAL RP015C.UVDATA.1

Freq = 1.6270 GHz, Bw = 8.000 MH No calibration applied and no bandpass applied

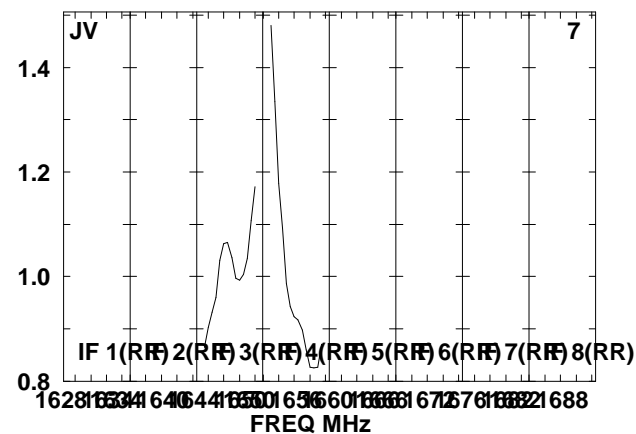
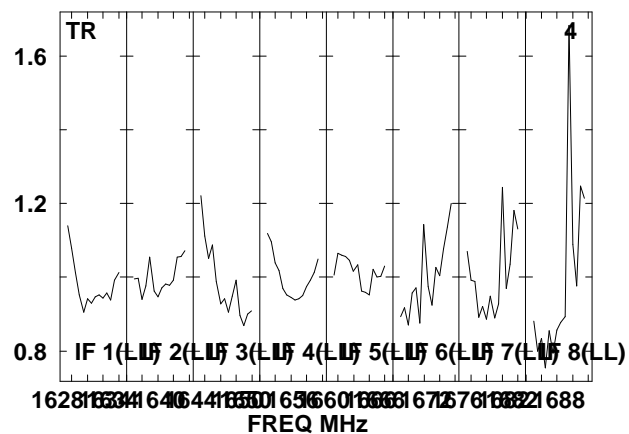
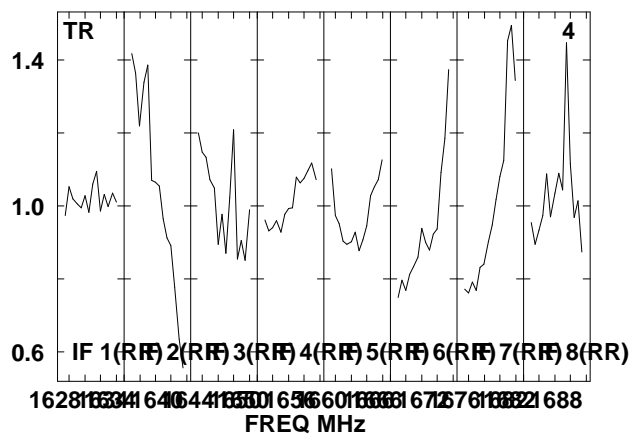
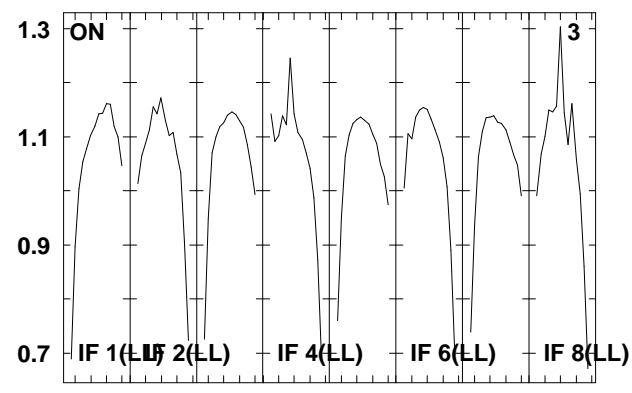
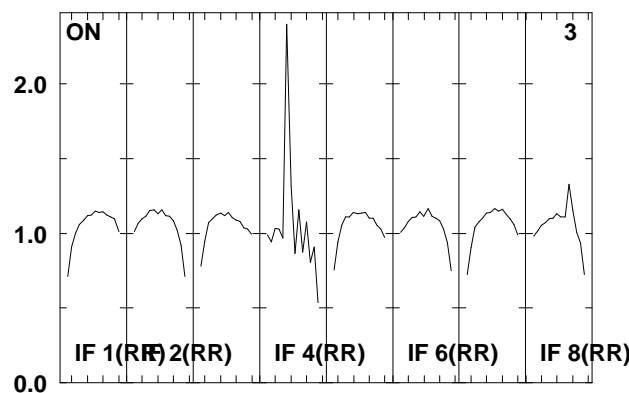
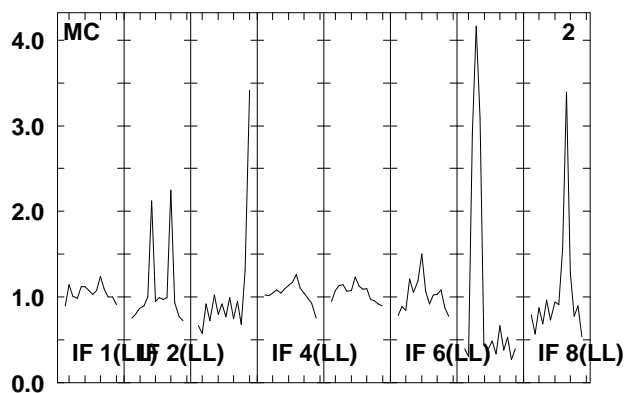
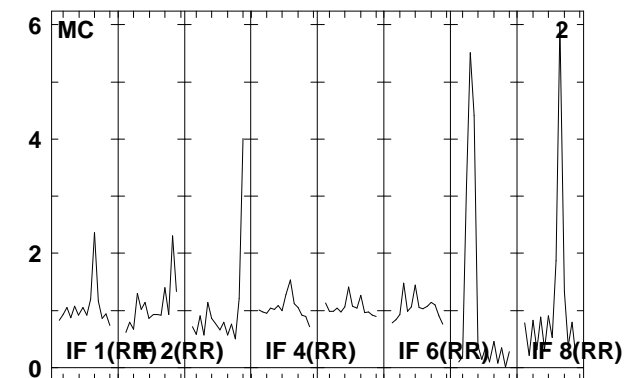
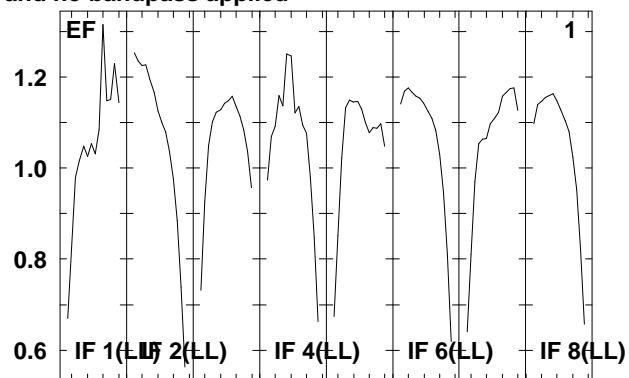
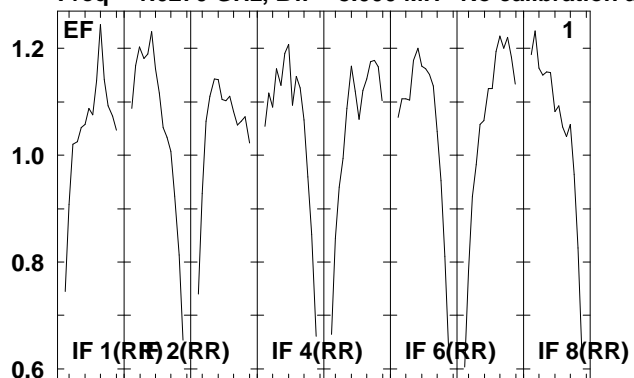

Lower frame: Real Jy  
Total-power spectrum Antenna: \*  
Timerange: 01/05:56:01 to 01/05:57:20



Plot file version 321 created 20-OCT-2009 14:52:17

FAINTCAL RP015C.UVDATA.1

Freq = 1.6270 GHz, Bw = 8.000 MH No calibration applied and no bandpass applied

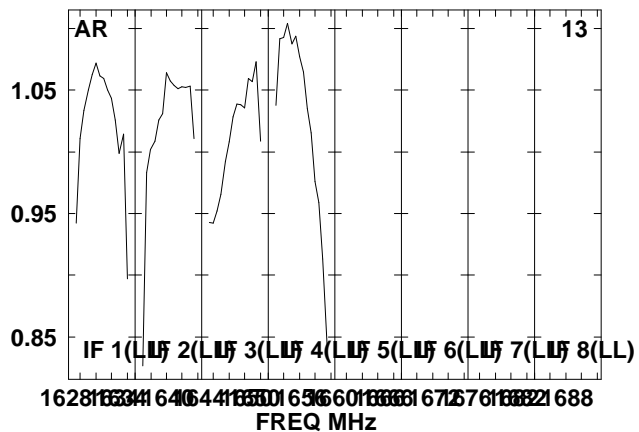
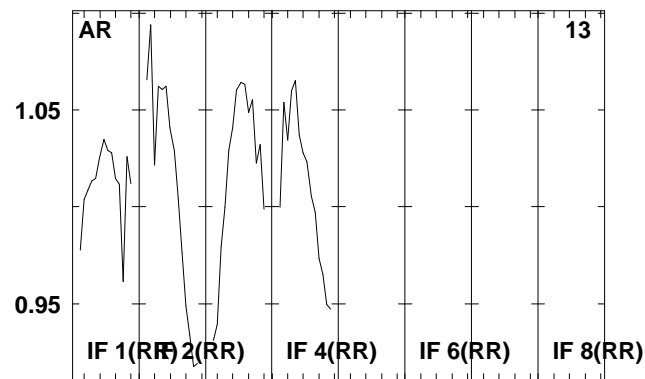
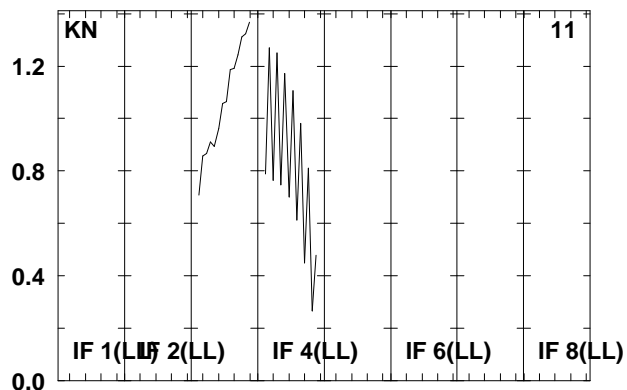
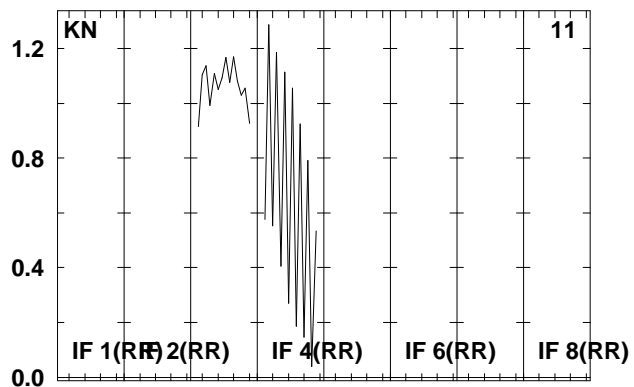
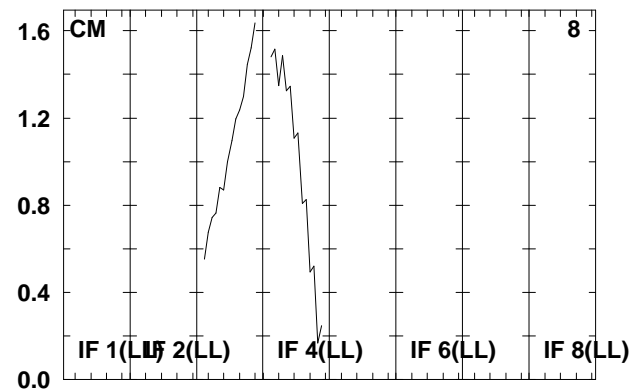
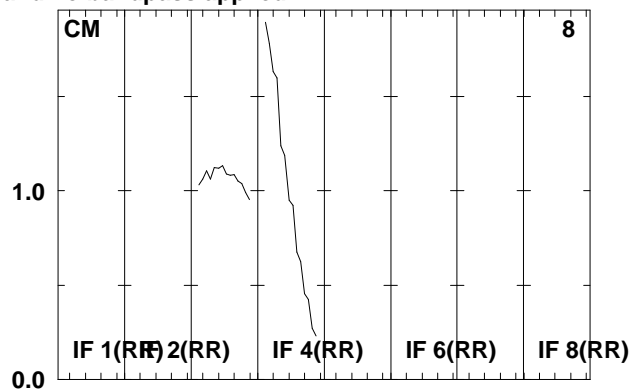
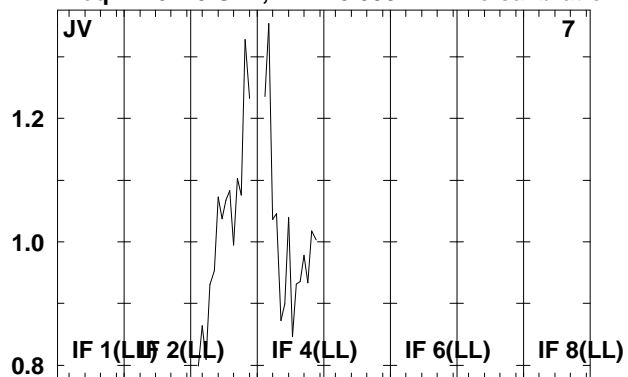

Lower frame: Real Jy

Total-power spectrum Antenna: \*

Timerange: 01/05:56:01 to 01/05:57:20

Plot file version 322 created 20-OCT-2009 14:52:18

M33 RP015C.UVDATA.1

Freq = 1.6270 GHz, Bw = 8.000 MH No calibration applied and no bandpass applied

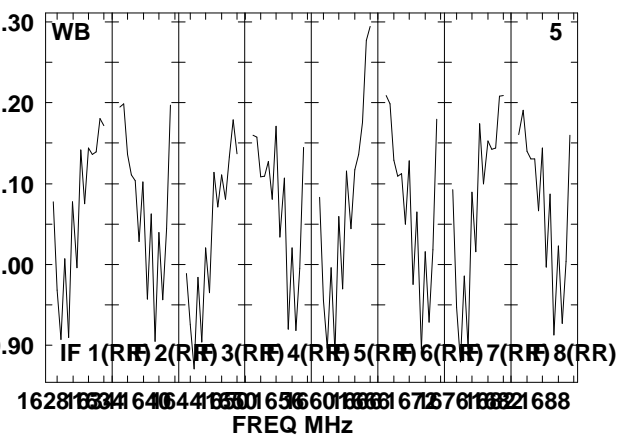
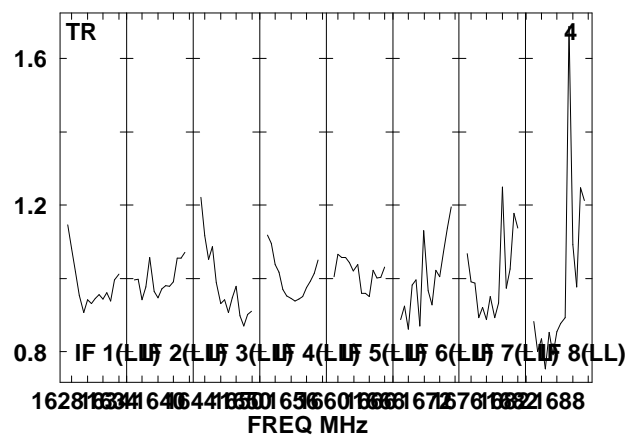
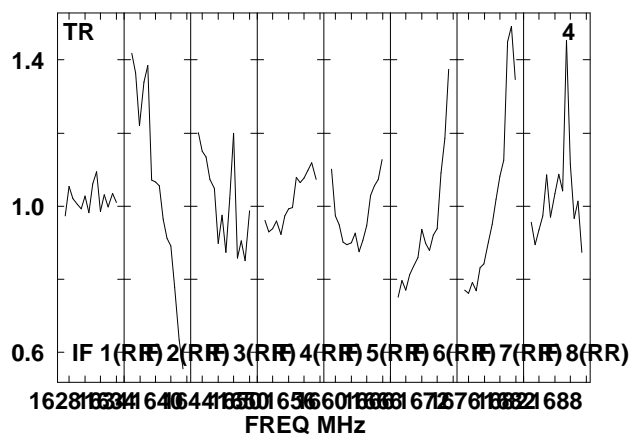
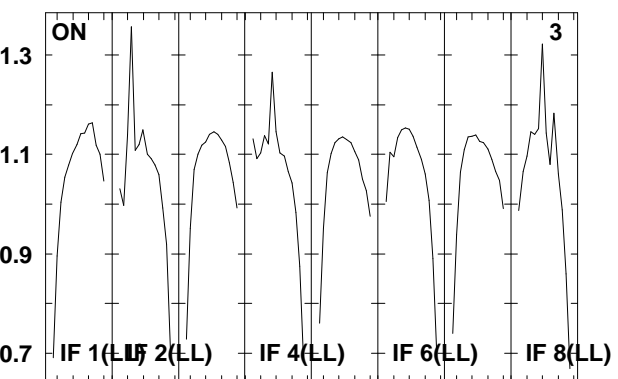
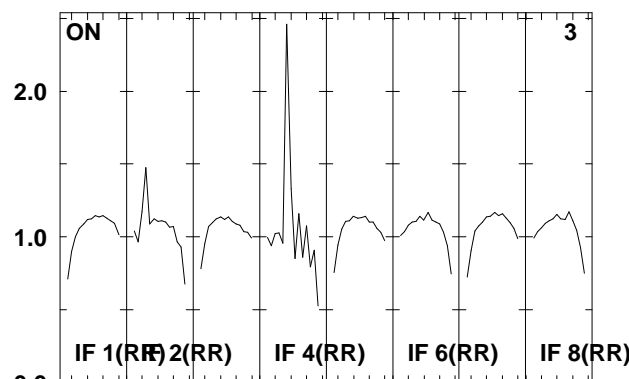
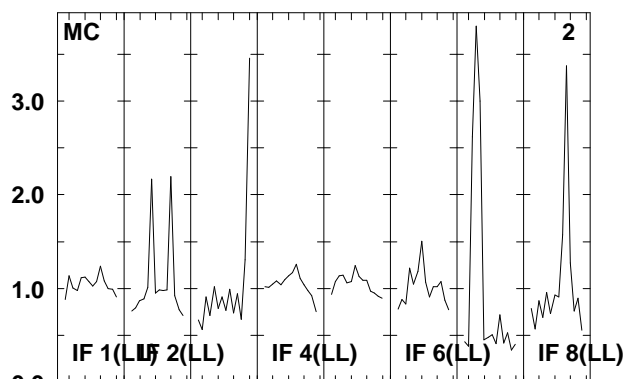
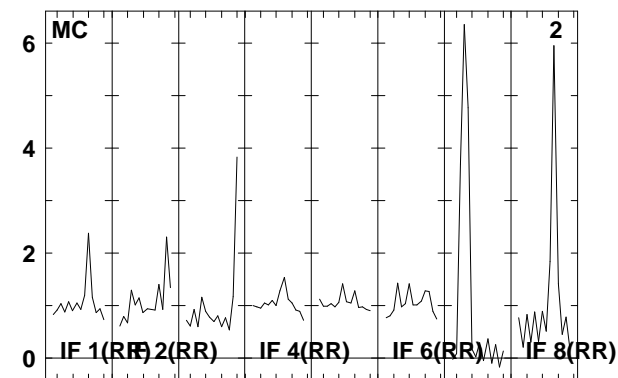
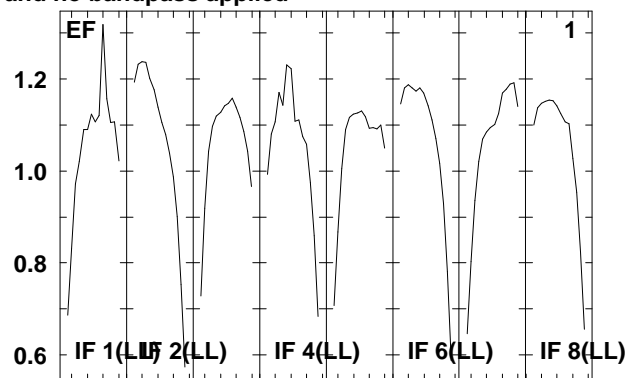
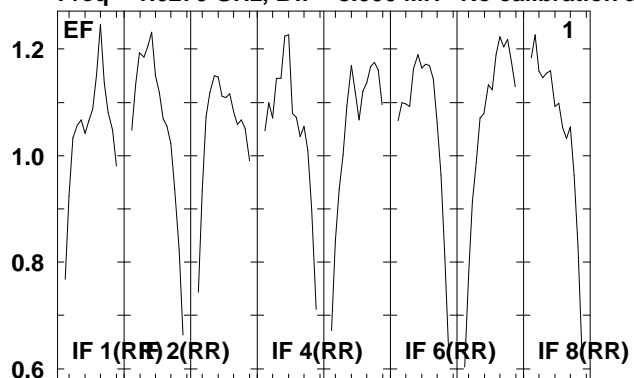

Lower frame: Real Jy  
Total-power spectrum Antenna: \*  
Timerange: 01/05:57:20 to 01/06:00:20

Plot file version 323 created 20-OCT-2009 14:52:19

M33 RP015C.UVDATA.1

Freq = 1.6270 GHz, Bw = 8.000 MH No calibration applied and no bandpass applied

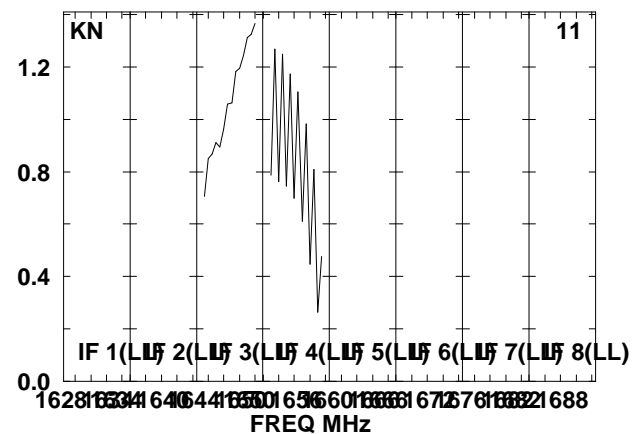
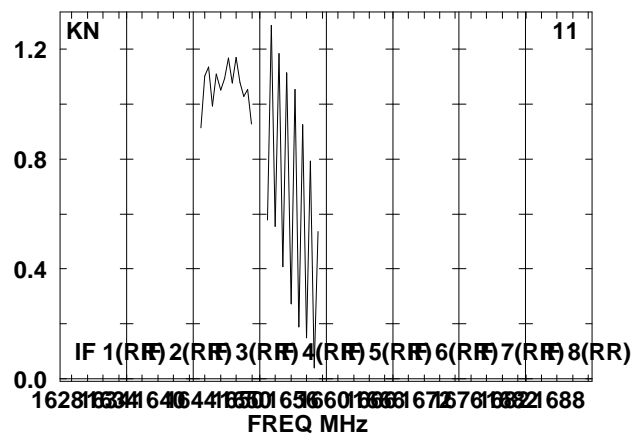
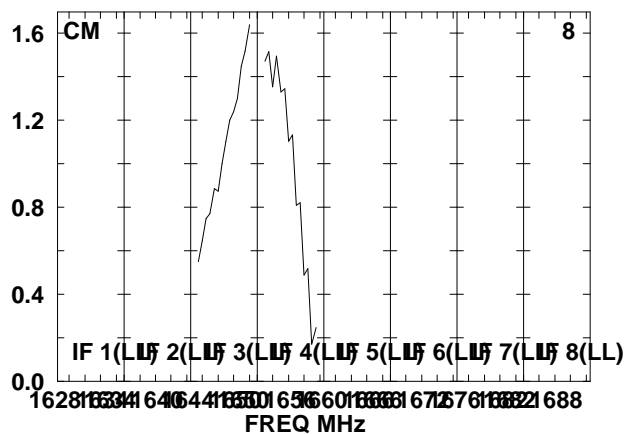
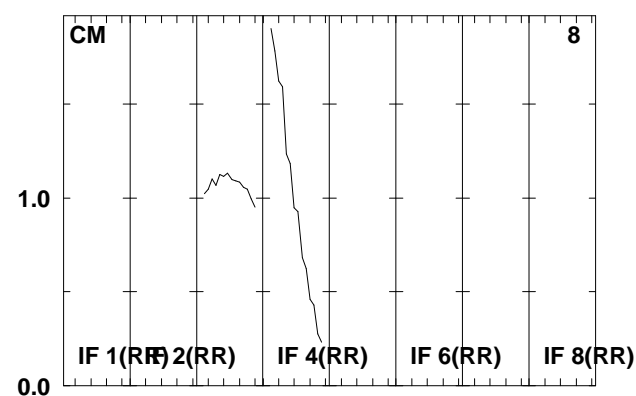
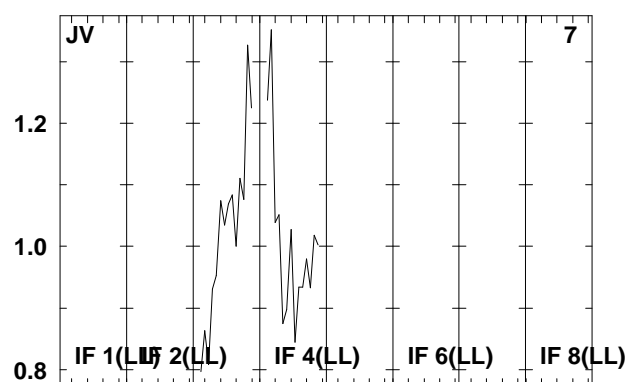
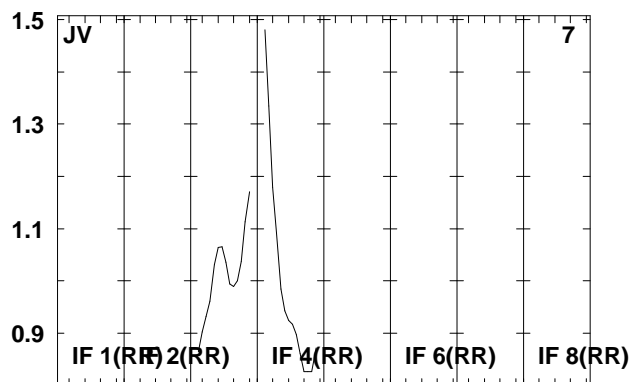
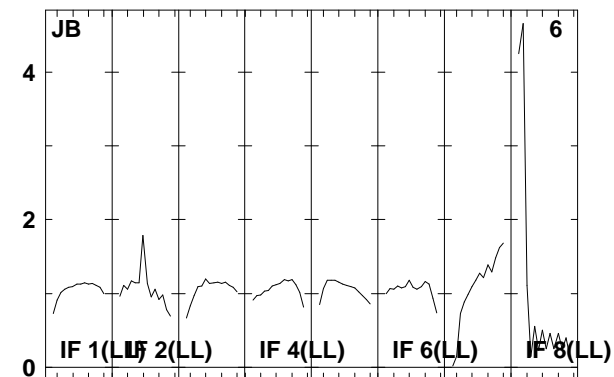
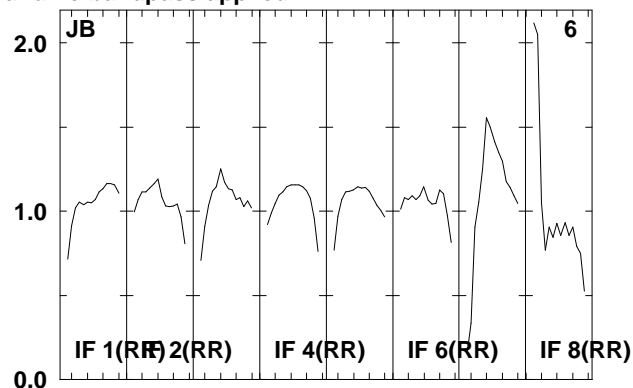
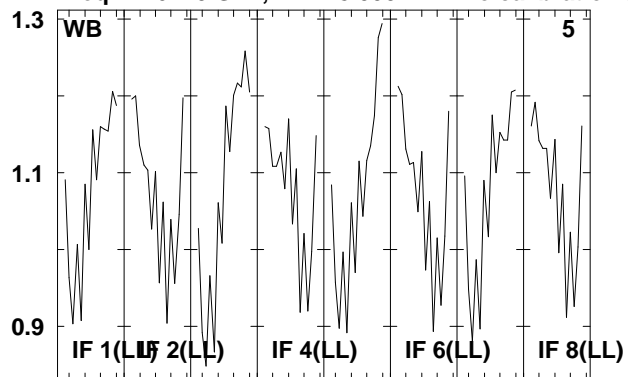

Lower frame: Real Jy  
Total-power spectrum Antenna: \*  
Timerange: 01/05:57:20 to 01/06:00:20

Plot file version 324 created 20-OCT-2009 14:52:20

M33 RP015C.UVDATA.1

Freq = 1.6270 GHz, Bw = 8.000 MH No calibration applied and no bandpass applied

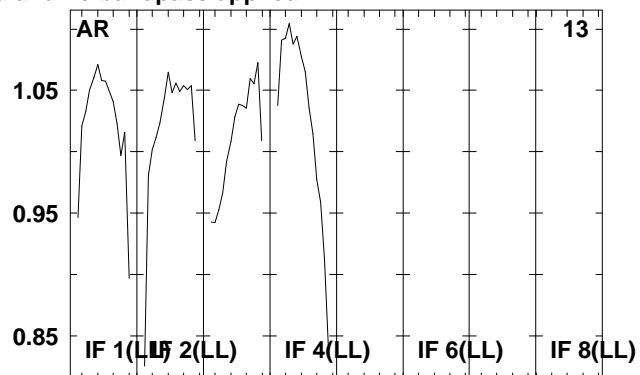
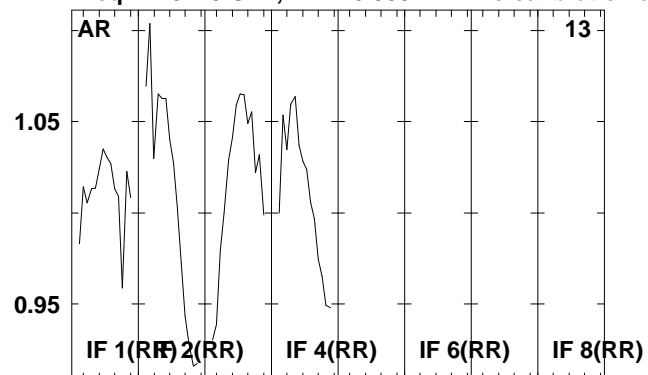

Lower frame: Real Jy  
Total-power spectrum Antenna: \*  
Timerange: 01/05:57:20 to 01/06:00:20

Plot file version 325 created 20-OCT-2009 14:52:20

J0137+31 RP015C.UVDATA.1

Freq = 1.6270 GHz, Bw = 8.000 MH No calibration applied and no bandpass applied

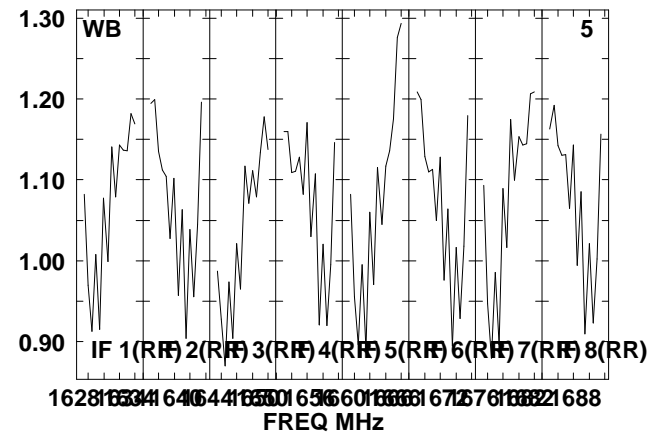
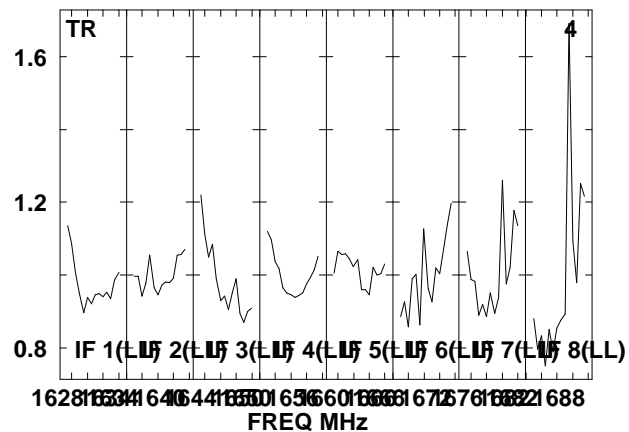
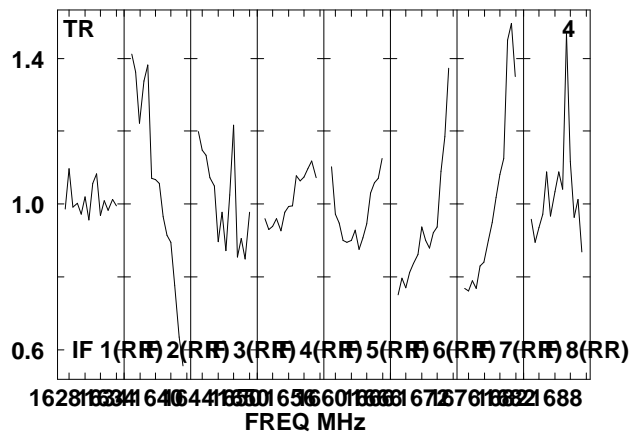
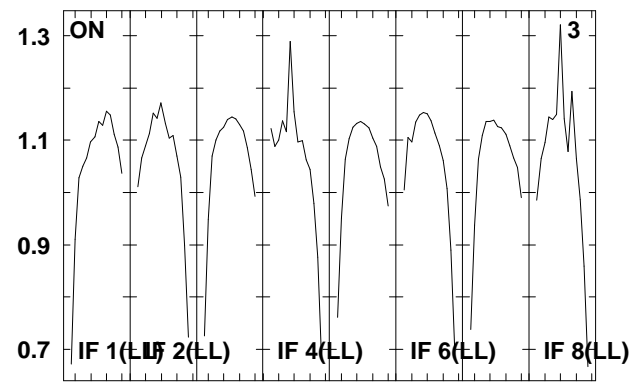
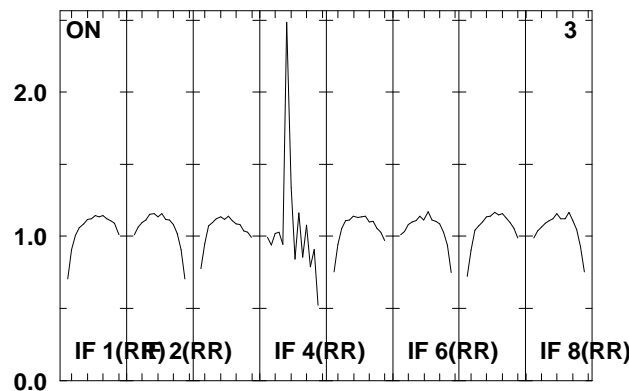
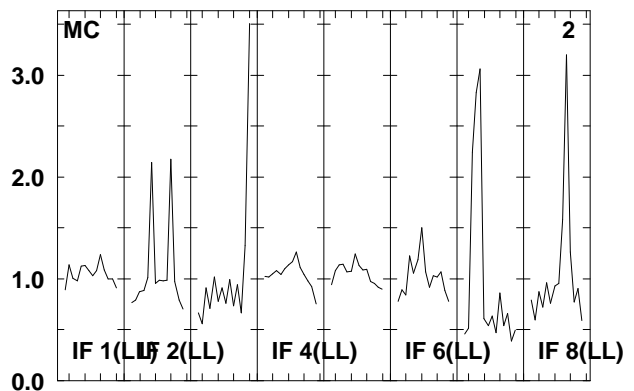
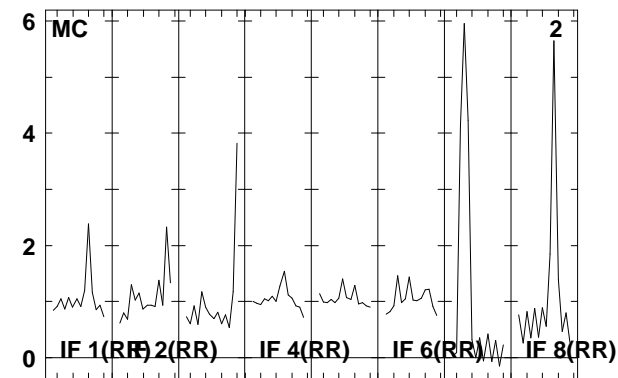
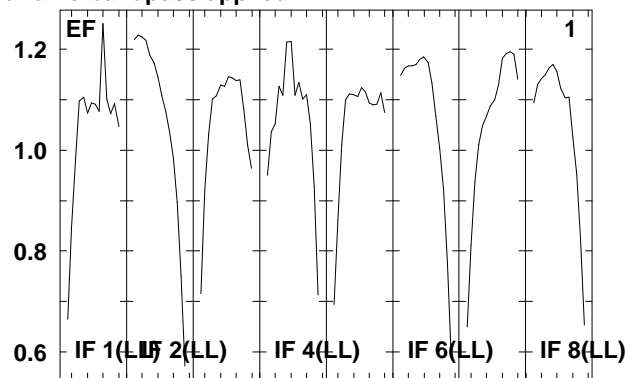
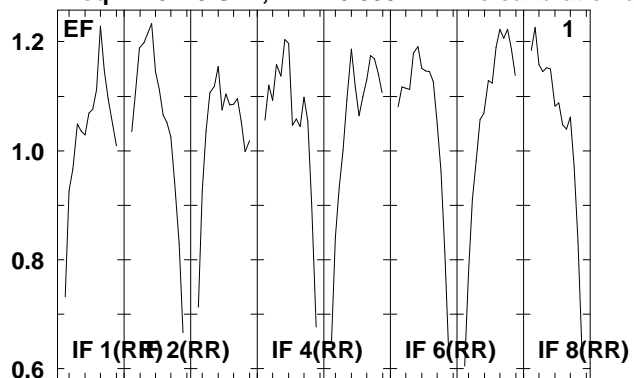

Lower frame: Real Jy  
Total-power spectrum Antenna: \*  
Timerange: 01/06:01:01 to 01/06:01:59

Plot file version 326 created 20-OCT-2009 14:52:21

J0137+31 RP015C.UVDATA.1

Freq = 1.6270 GHz, Bw = 8.000 MH No calibration applied and no bandpass applied

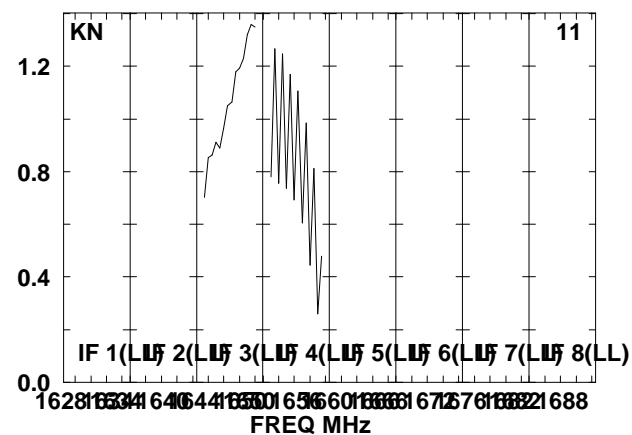
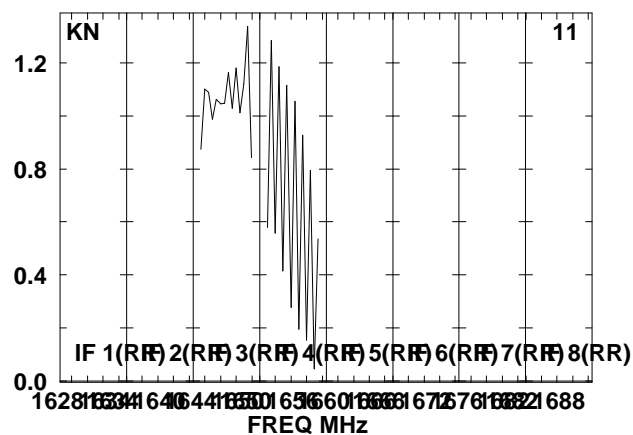
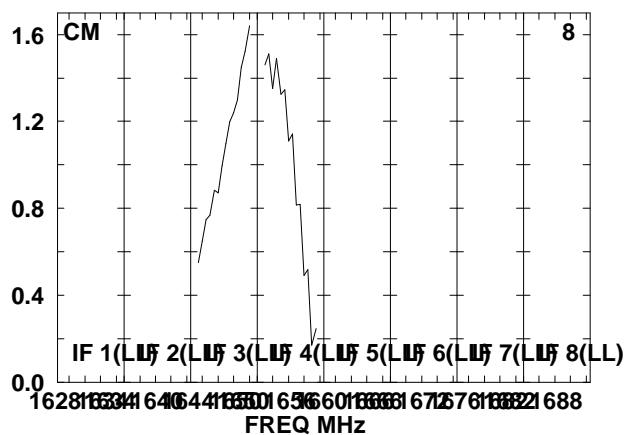
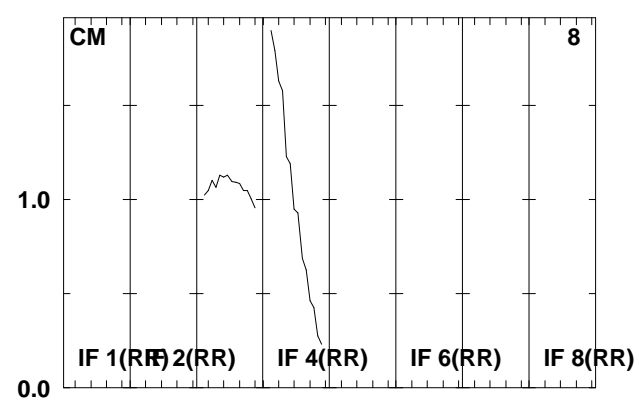
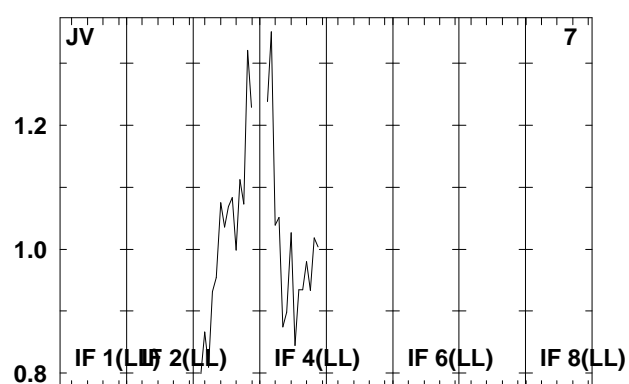
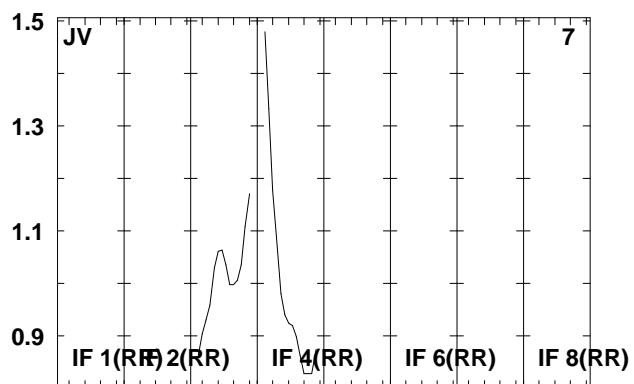
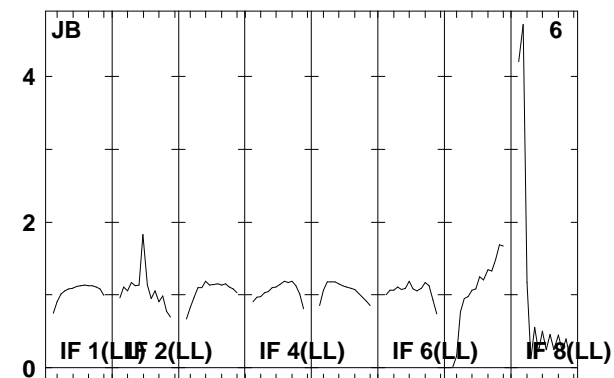
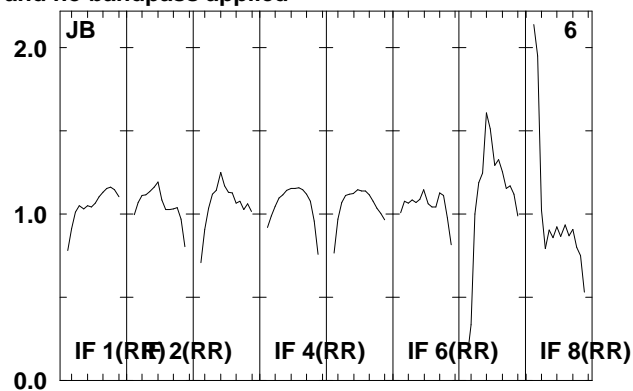
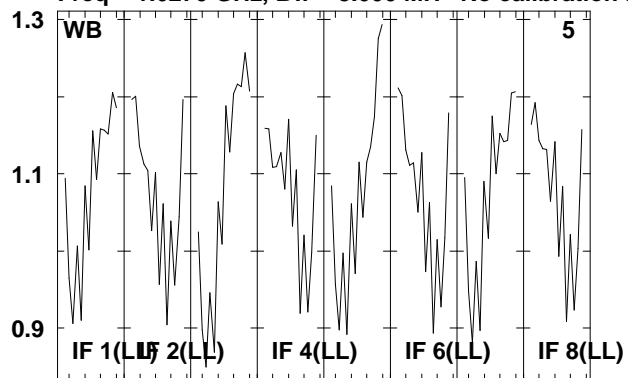

Lower frame: Real Jy  
Total-power spectrum Antenna: \*  
Timerange: 01/06:01:01 to 01/06:01:59

Plot file version 327 created 20-OCT-2009 14:52:21

J0137+31 RP015C.UVDATA.1

Freq = 1.6270 GHz, Bw = 8.000 MH No calibration applied and no bandpass applied

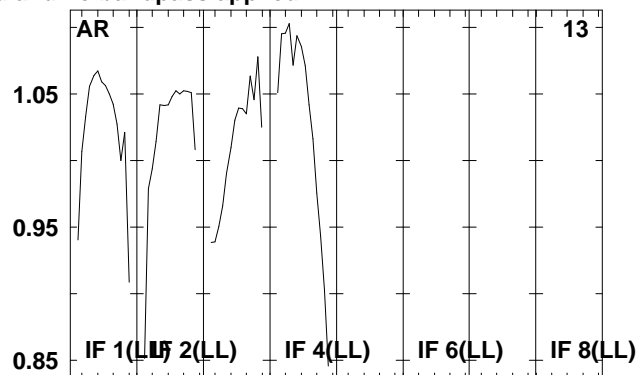
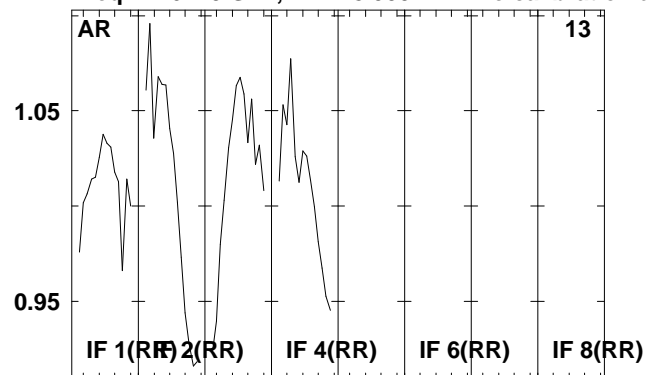

Lower frame: Real Jy  
Total-power spectrum Antenna: \*  
Timerange: 01/06:01:01 to 01/06:01:59

Plot file version 328 created 20-OCT-2009 14:52:21

FAINTCAL RP015C.UVDATA.1

Freq = 1.6270 GHz, Bw = 8.000 MH No calibration applied and no bandpass applied

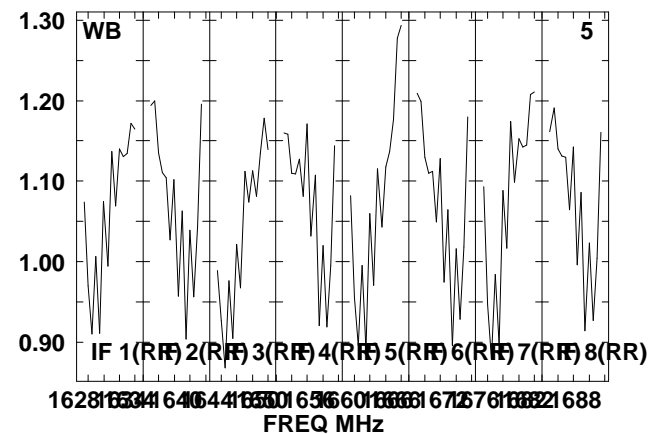
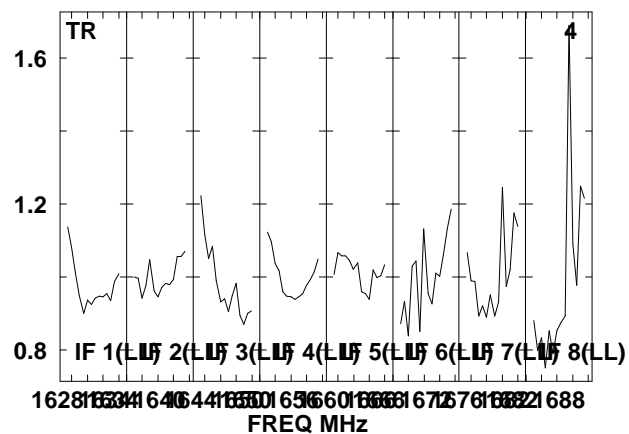
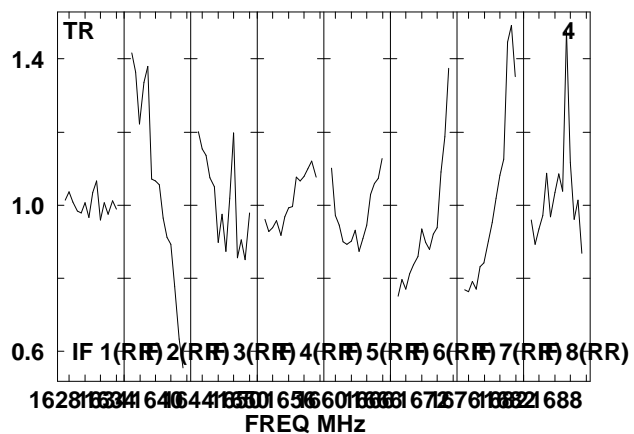
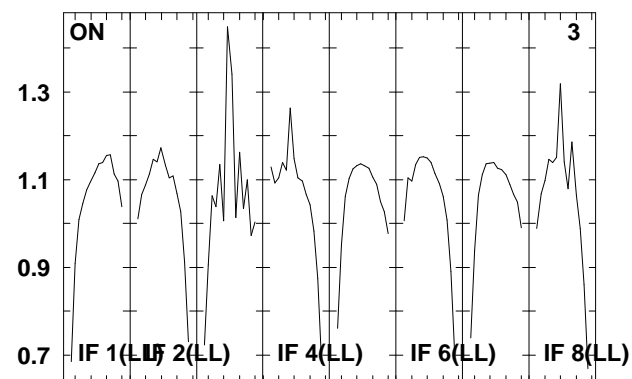
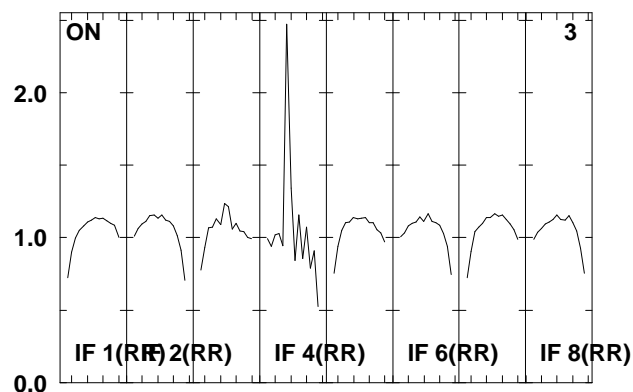
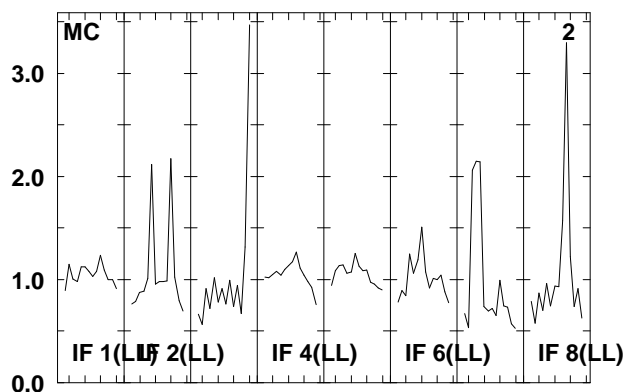
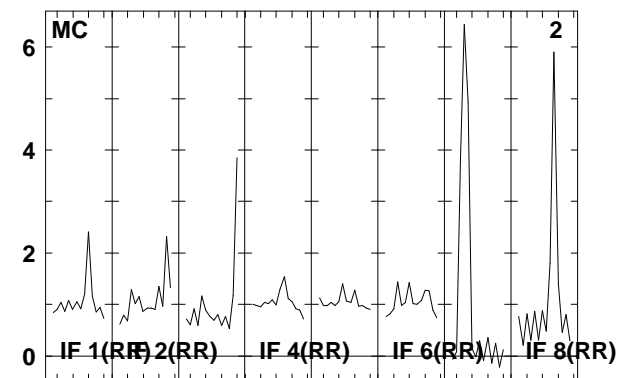
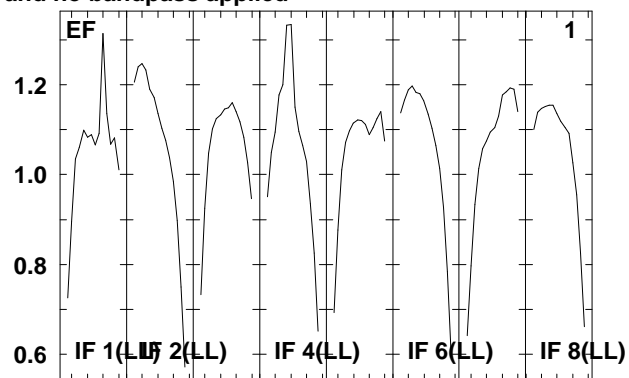
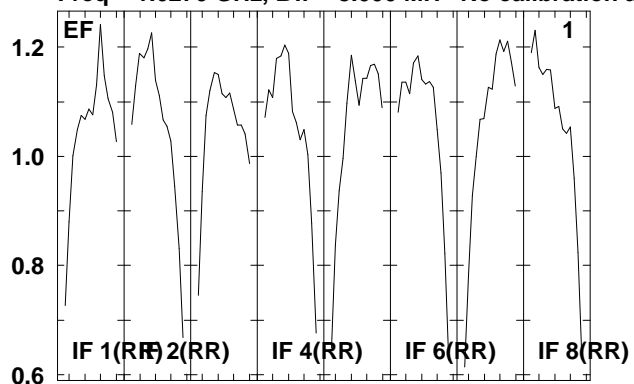

Lower frame: Real Jy

Total-power spectrum Antenna: \*

Timerange: 01/06:02:01 to 01/06:03:20



Plot file version 329 created 20-OCT-2009 14:52:22

FAINTCAL RP015C.UVDATA.1

Freq = 1.6270 GHz, Bw = 8.000 MH No calibration applied and no bandpass applied

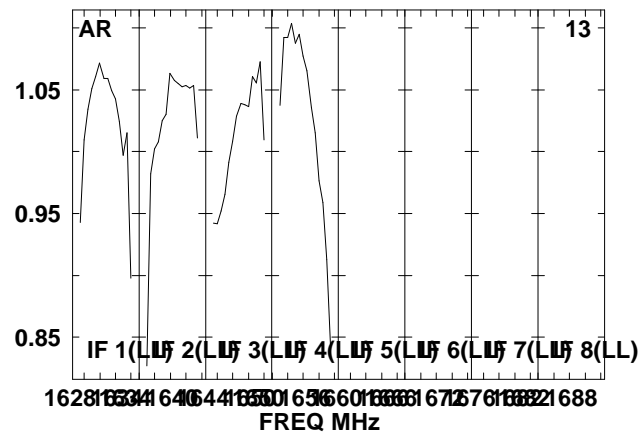
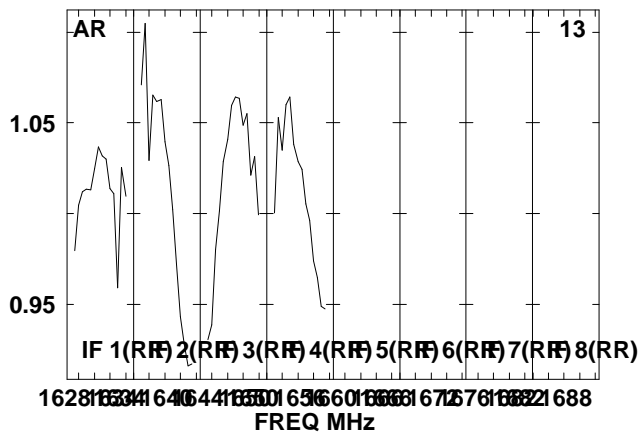
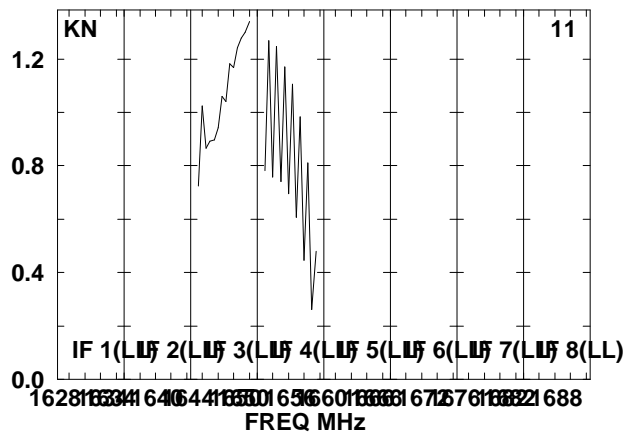
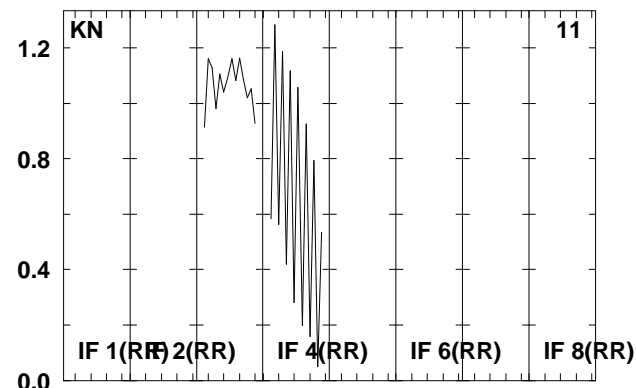
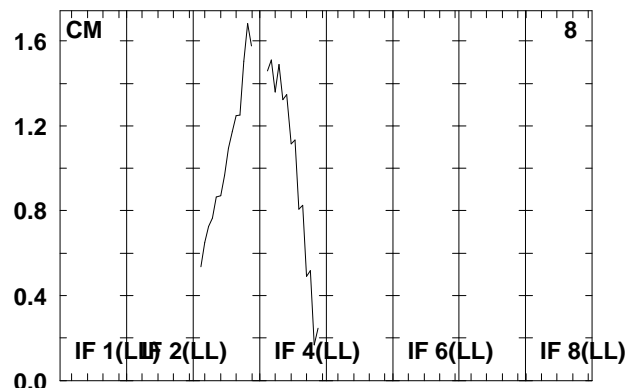
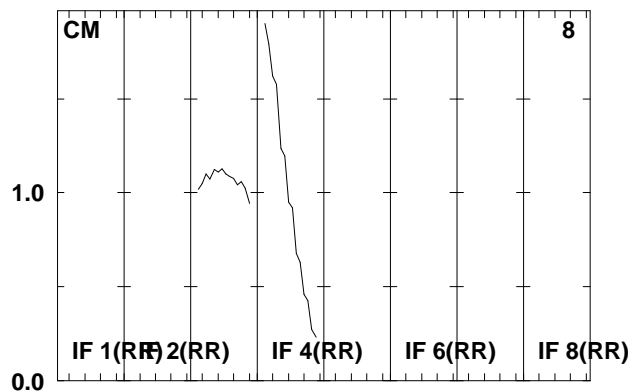
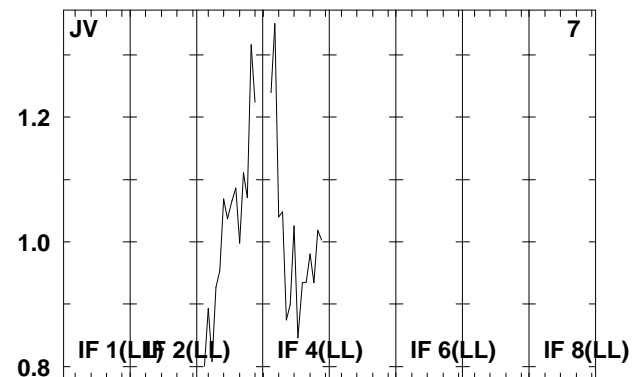
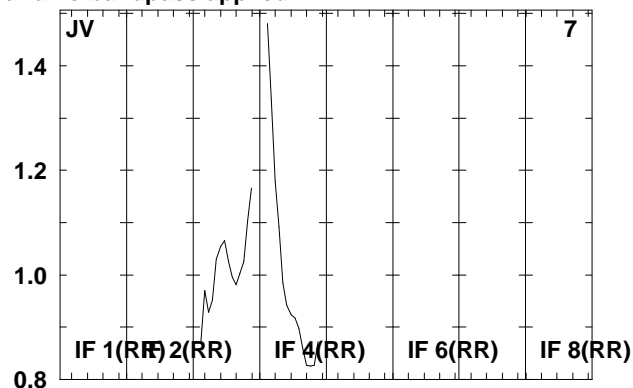
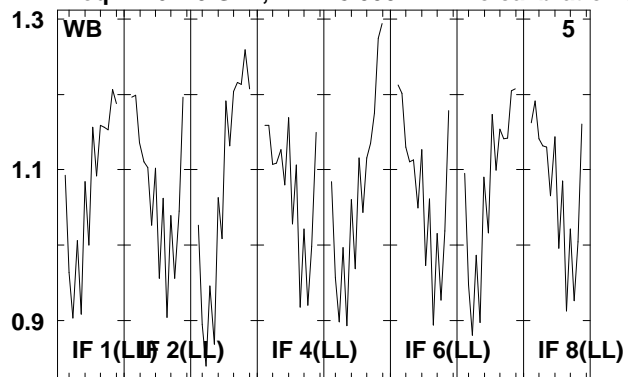

Lower frame: Real Jy

Total-power spectrum Antenna: \*

Timerange: 01/06:02:01 to 01/06:03:20

Plot file version 330 created 20-OCT-2009 14:52:23

M33 RP015C.UVDATA.1

Freq = 1.6270 GHz, Bw = 8.000 MH No calibration applied and no bandpass applied

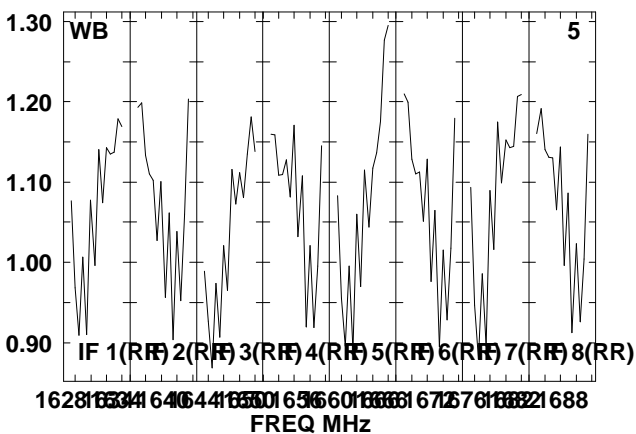
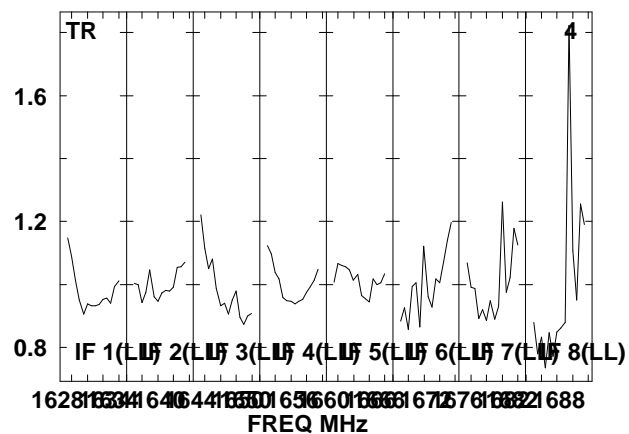
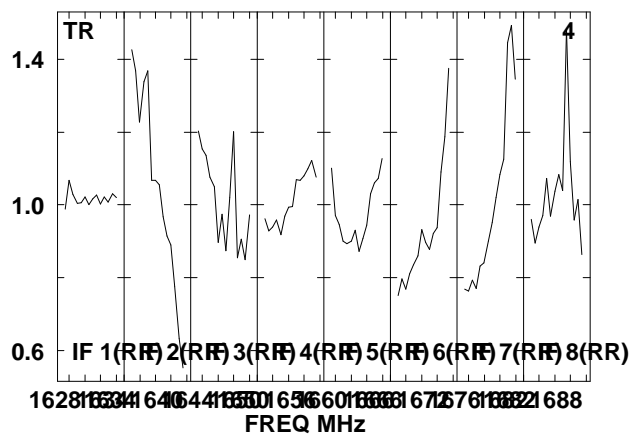
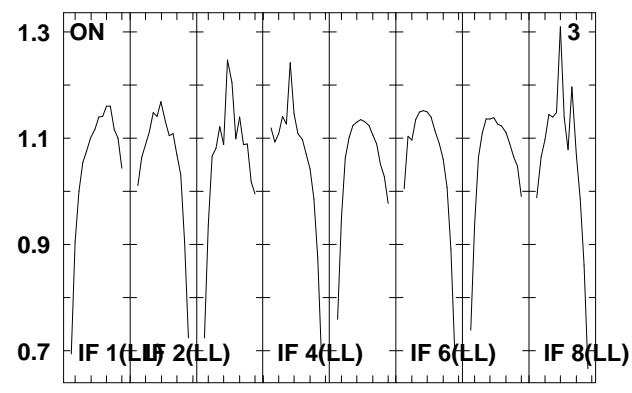
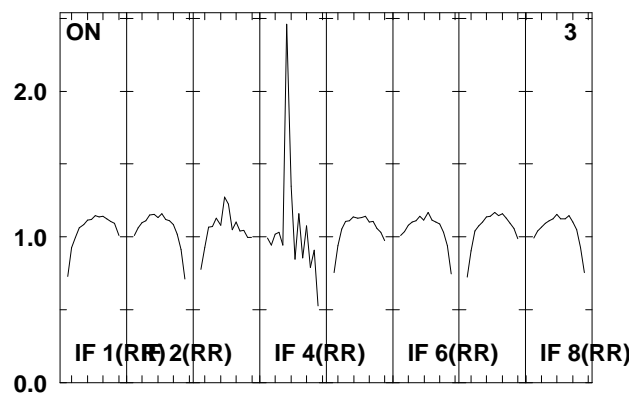
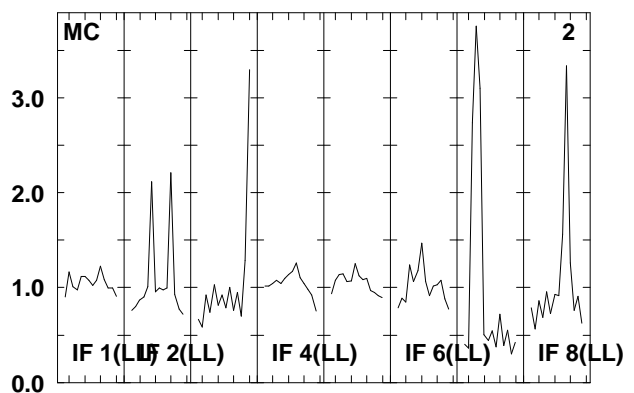
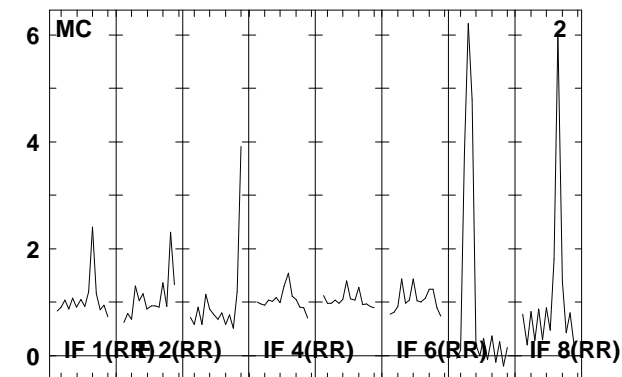
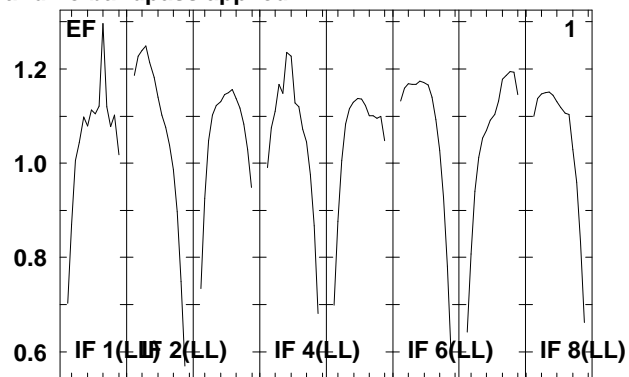
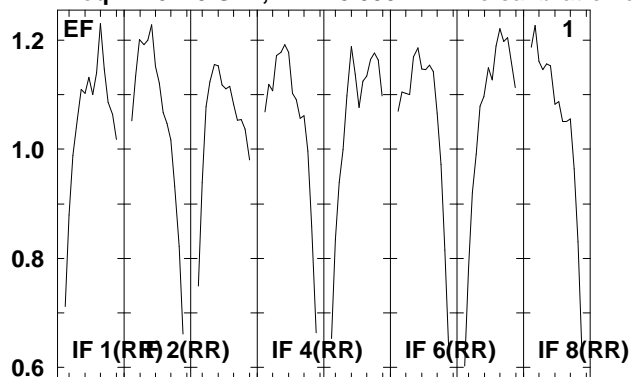

Lower frame: Real Jy

Total-power spectrum Antenna: \*

Timerange: 01/06:03:20 to 01/06:06:20

Plot file version 331 created 20-OCT-2009 14:52:24

M33 RP015C.UVDATA.1

Freq = 1.6270 GHz, Bw = 8.000 MH No calibration applied and no bandpass applied

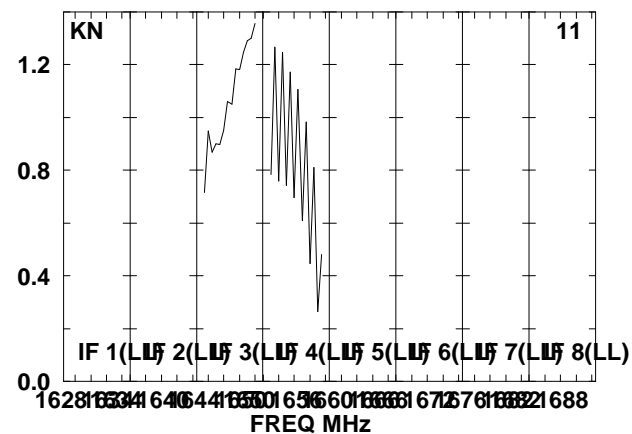
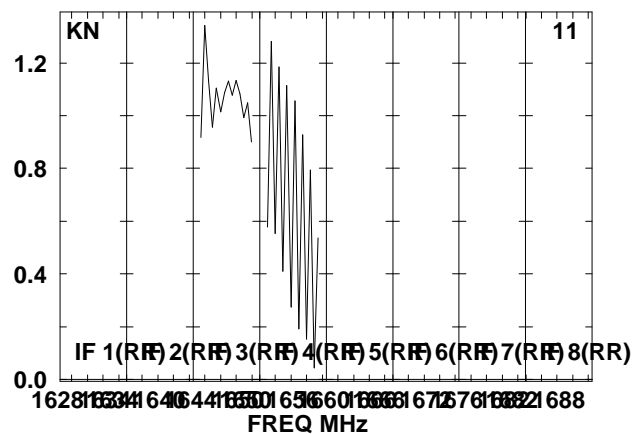
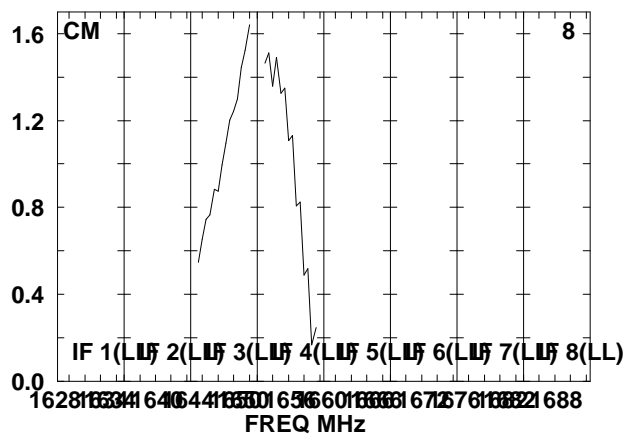
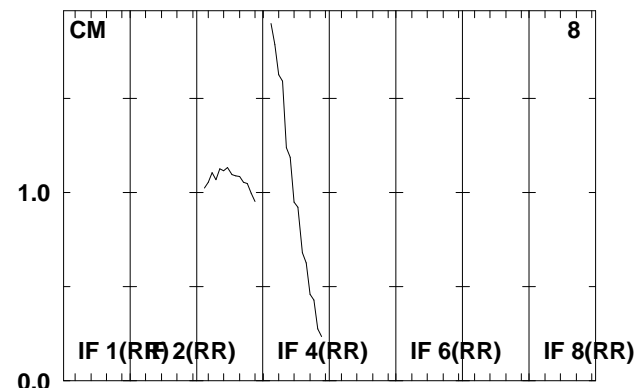
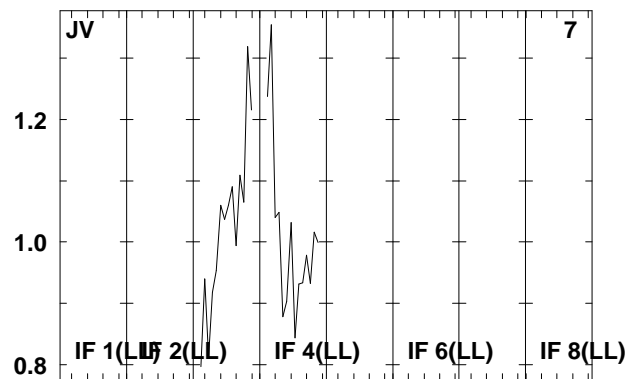
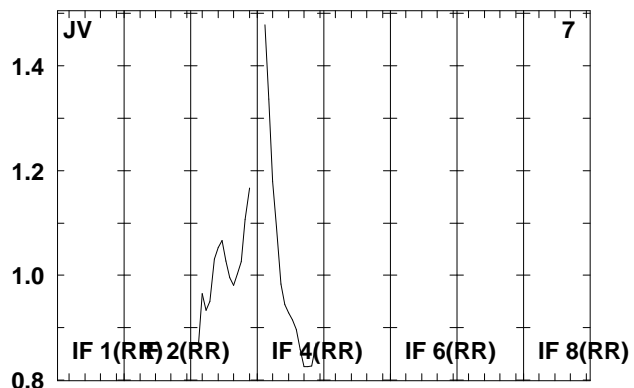
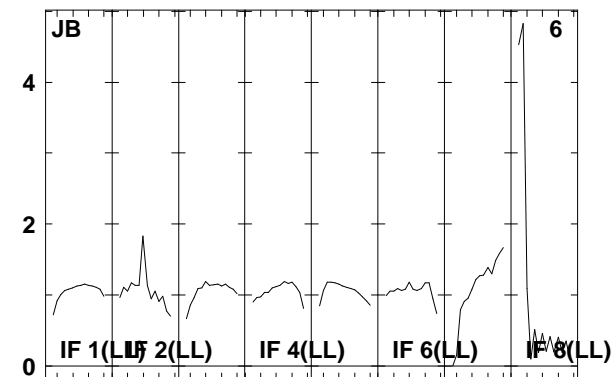
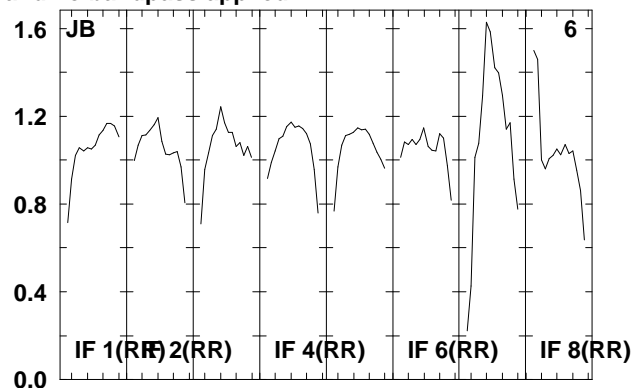
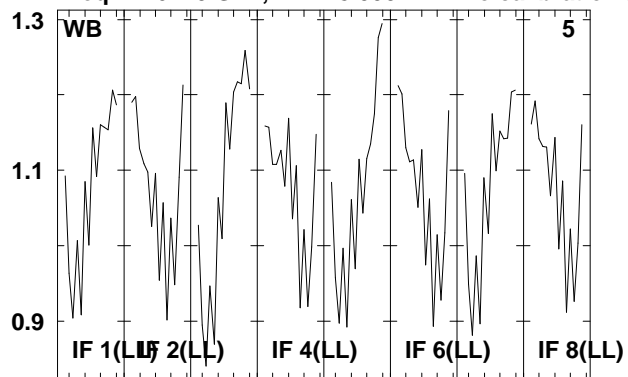

Lower frame: Real Jy

Total-power spectrum Antenna: \*

Timerange: 01/06:03:20 to 01/06:06:20

Plot file version 332 created 20-OCT-2009 14:52:25

M33 RP015C.UVDATA.1

Freq = 1.6270 GHz, Bw = 8.000 MH No calibration applied and no bandpass applied

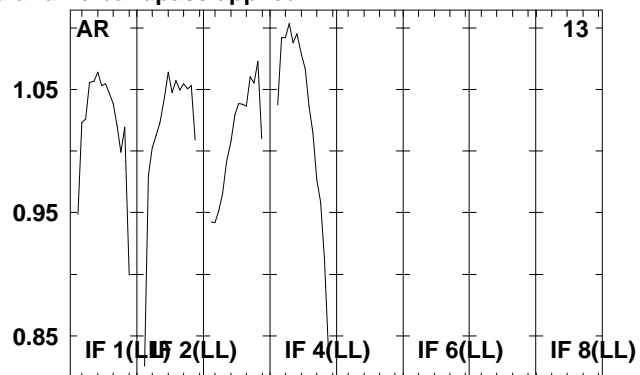
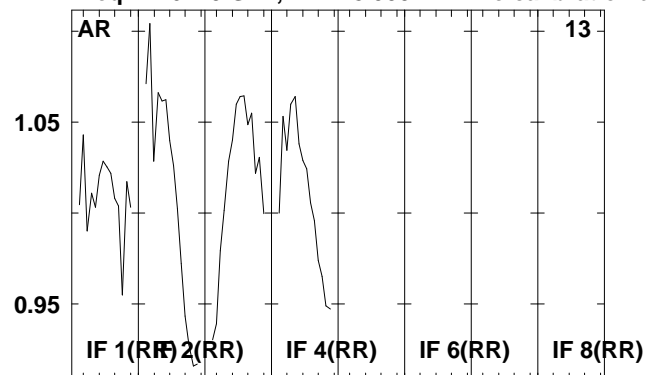

Lower frame: Real Jy  
Total-power spectrum Antenna: \*  
Timerange: 01/06:03:20 to 01/06:06:20

Plot file version 333 created 20-OCT-2009 14:52:25

J0137+31 RP015C.UVDATA.1

Freq = 1.6270 GHz, Bw = 8.000 MH No calibration applied and no bandpass applied

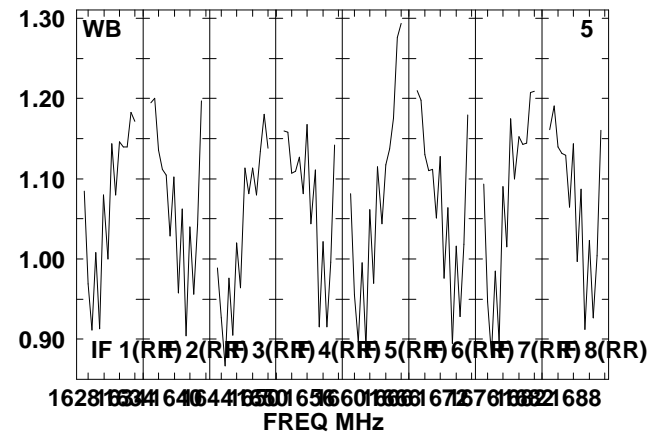
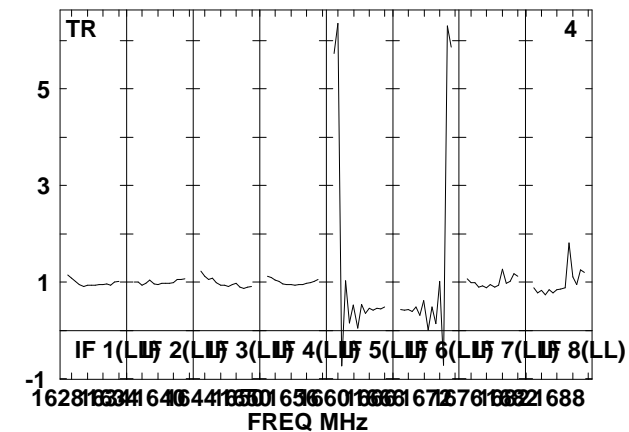
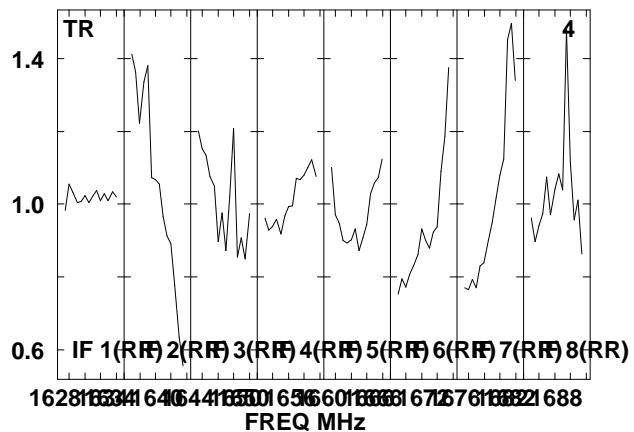
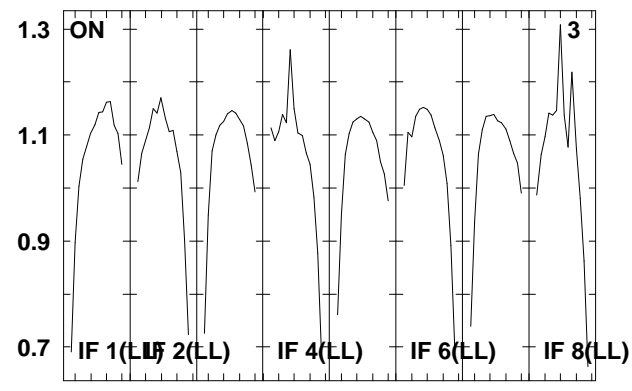
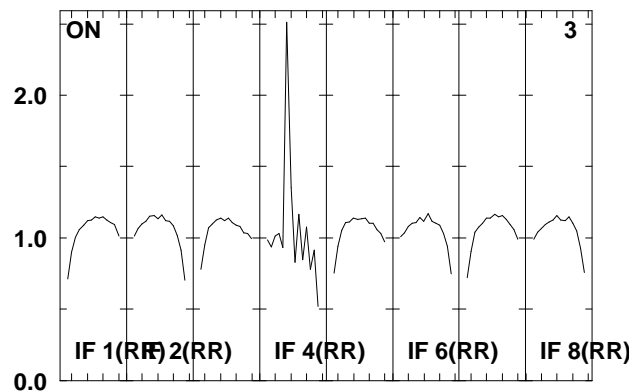
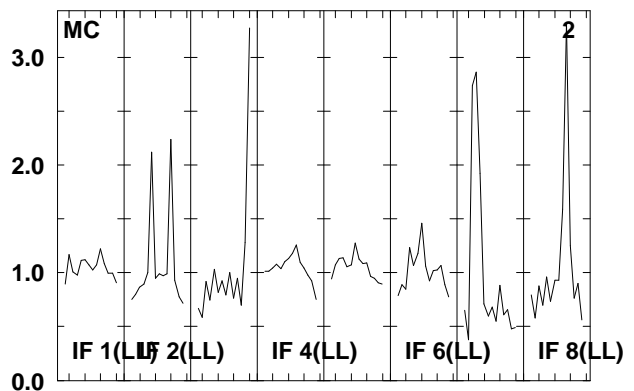
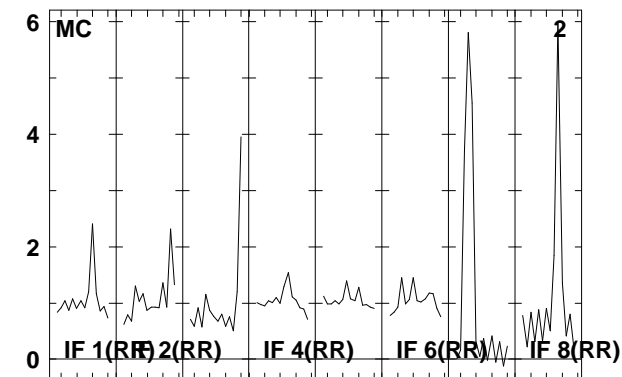
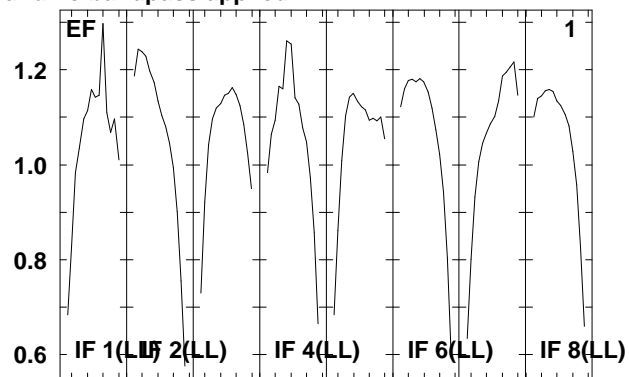
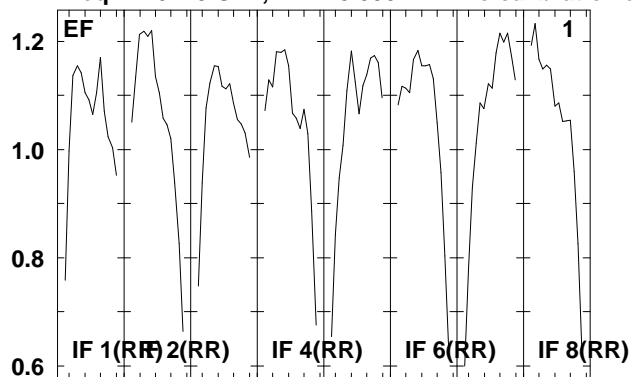

Lower frame: Real Jy

Total-power spectrum Antenna: \*

Timerange: 01/06:07:00 to 01/06:07:59

Plot file version 334 created 20-OCT-2009 14:52:26

J0137+31 RP015C.UVDATA.1

Freq = 1.6270 GHz, Bw = 8.000 MH No calibration applied and no bandpass applied

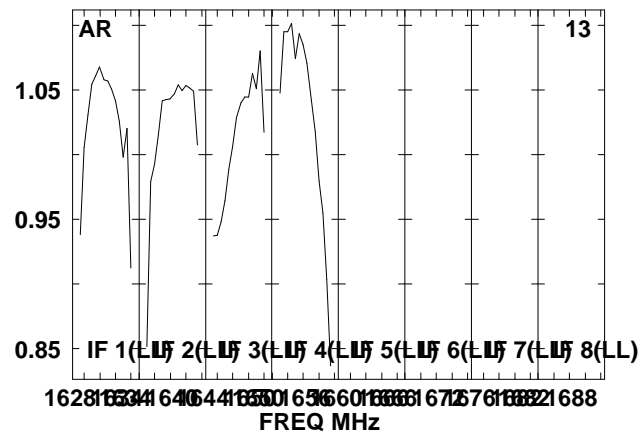
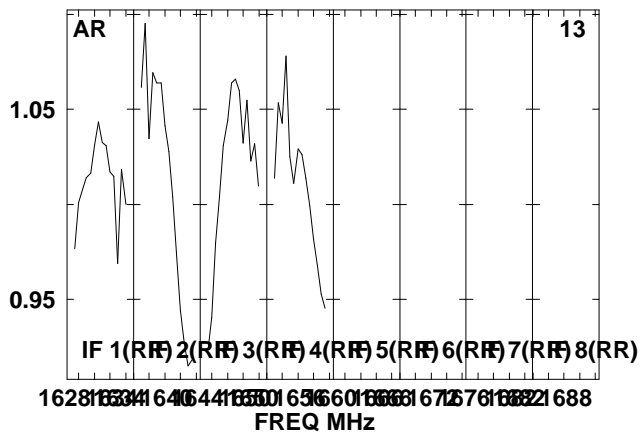
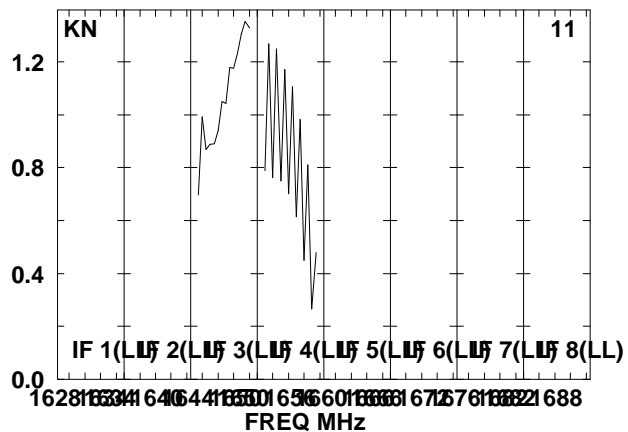
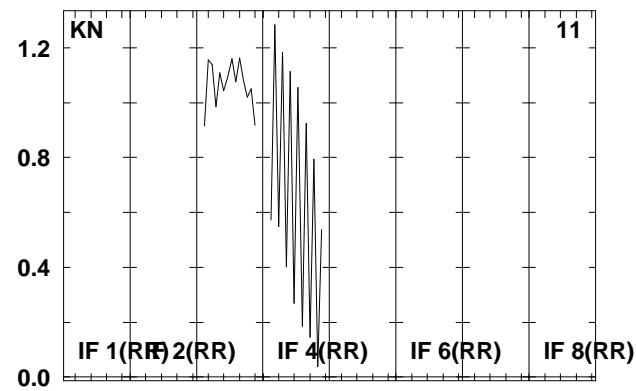
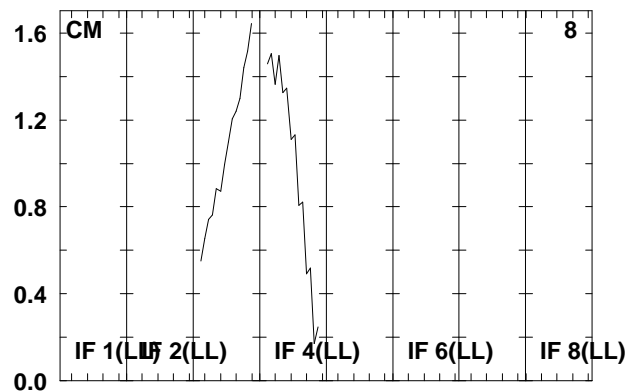
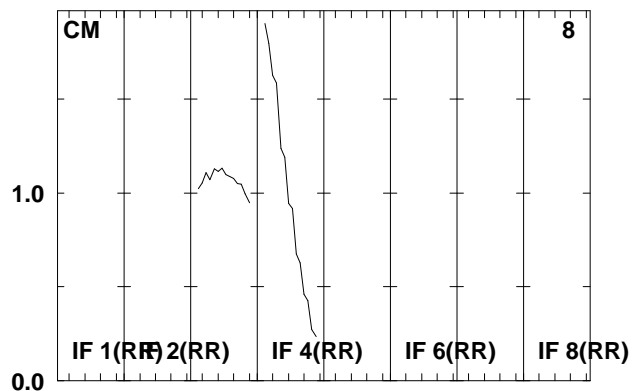
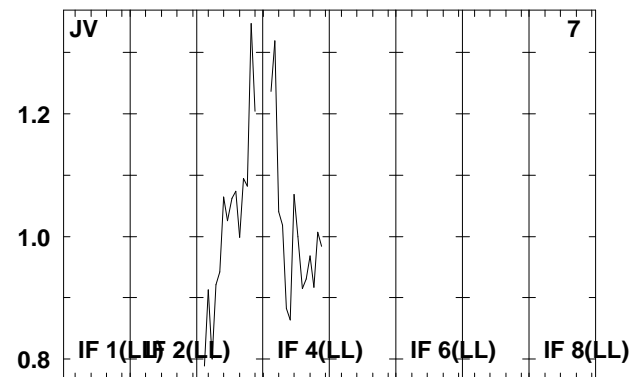
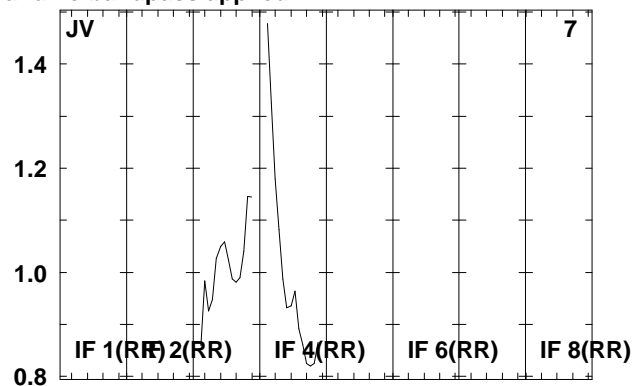
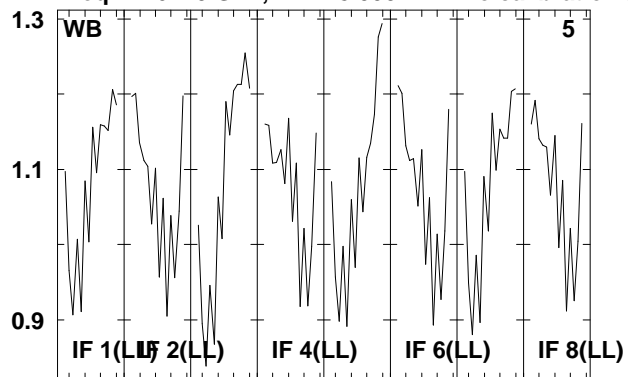

Lower frame: Real Jy

Total-power spectrum Antenna: \*

Timerange: 01/06:07:00 to 01/06:07:59

Plot file version 335 created 20-OCT-2009 14:52:26

FAINTCAL RP015C.UVDATA.1

Freq = 1.6270 GHz, Bw = 8.000 MH No calibration applied and no bandpass applied

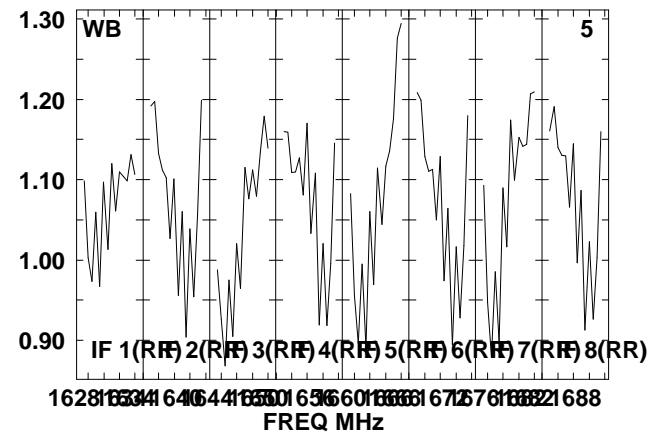
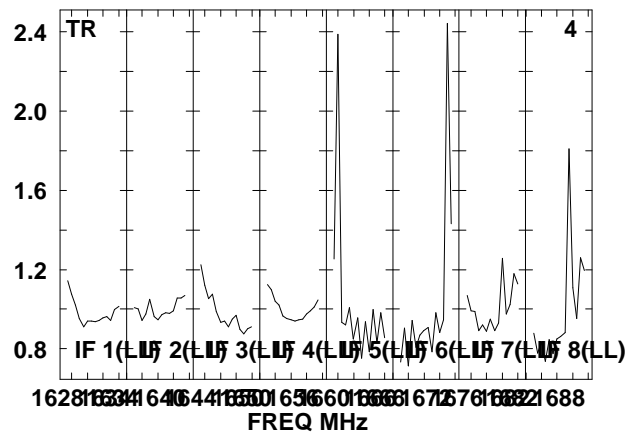
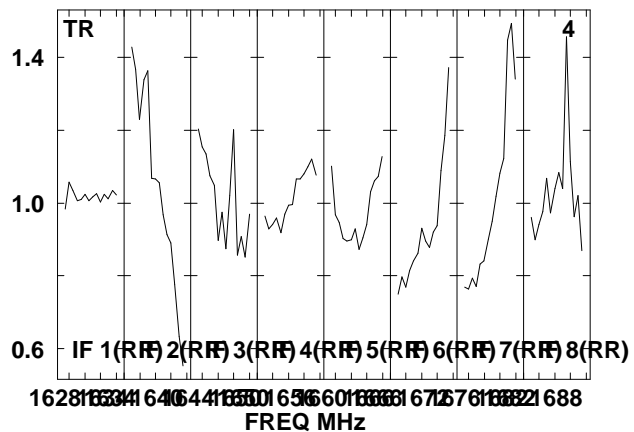
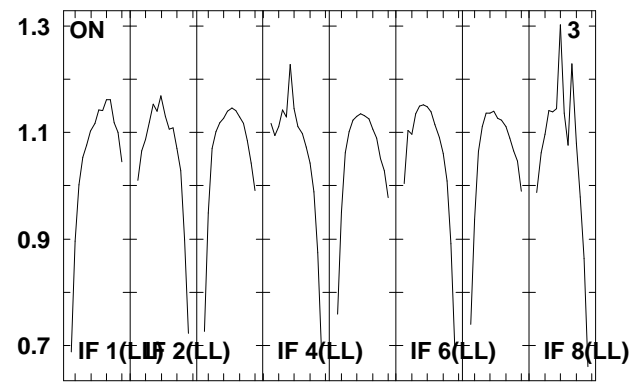
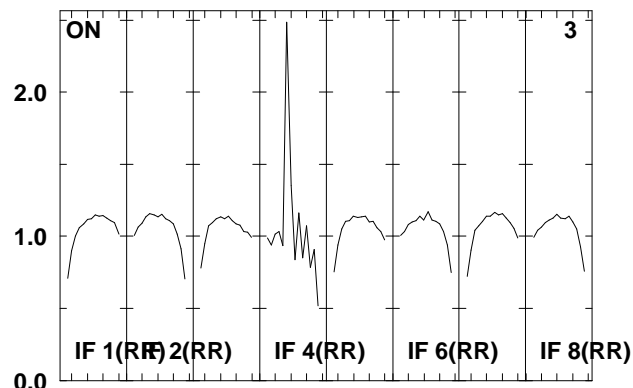
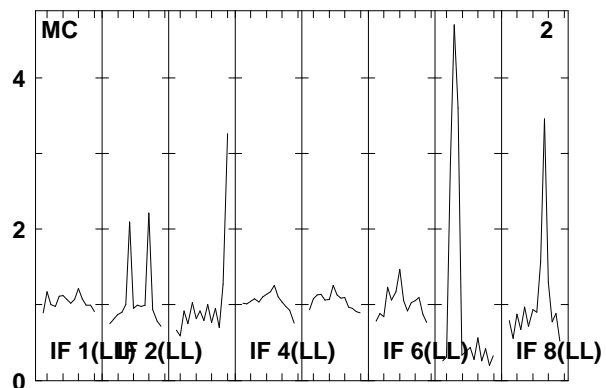
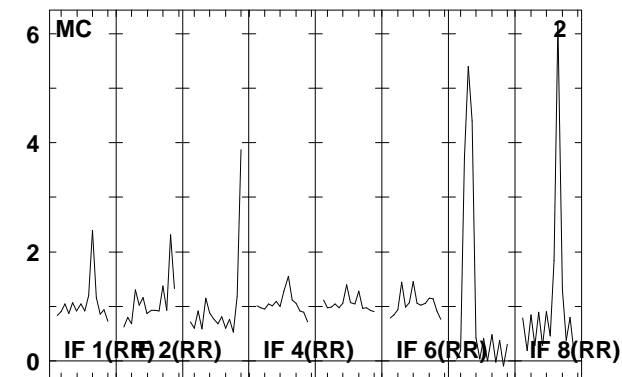
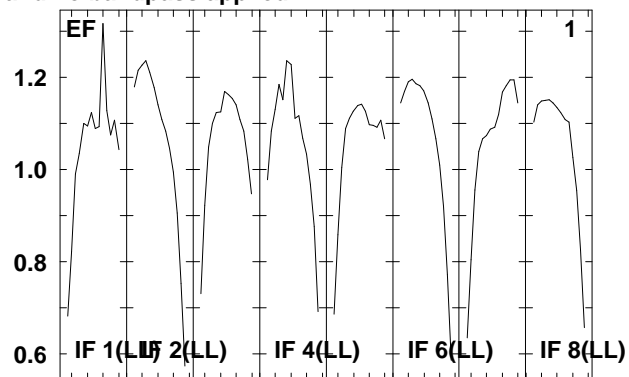
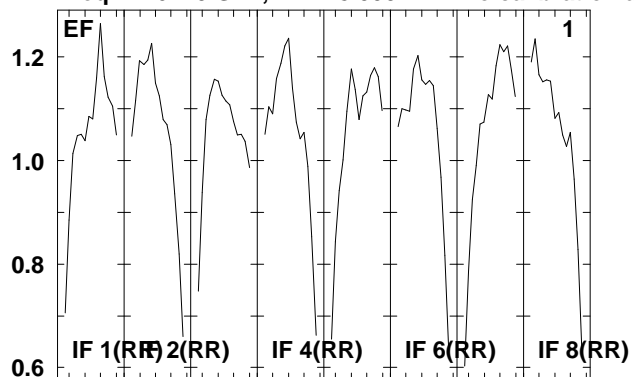

Lower frame: Real Jy

Total-power spectrum Antenna: \*

Timerange: 01/06:08:01 to 01/06:09:19

Plot file version 336 created 20-OCT-2009 14:52:27

FAINTCAL RP015C.UVDATA.1

Freq = 1.6270 GHz, Bw = 8.000 MH No calibration applied and no bandpass applied

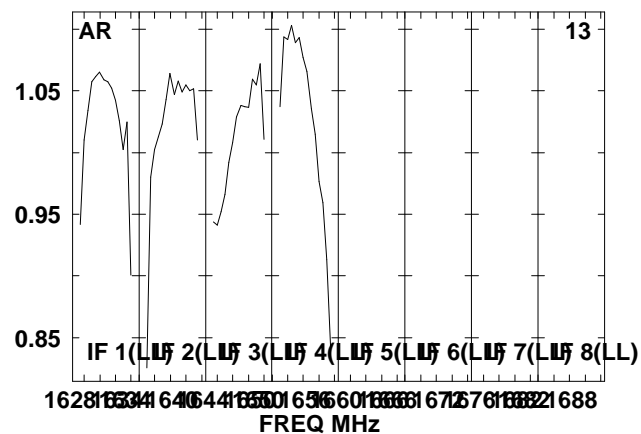
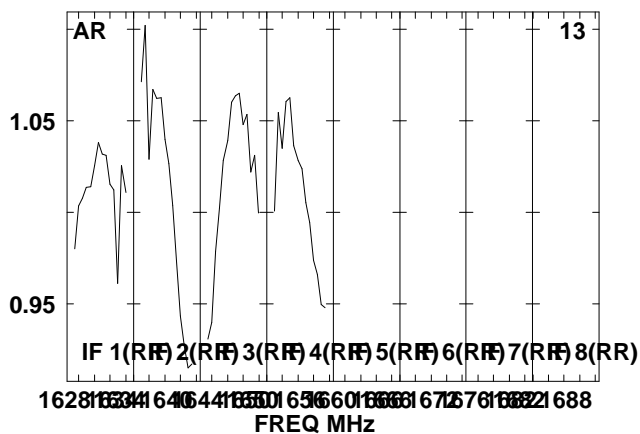
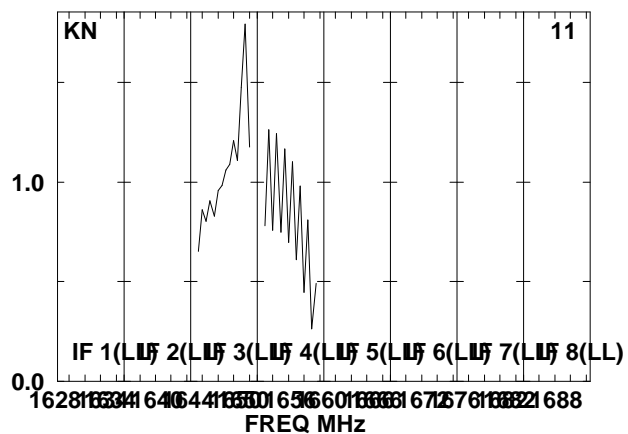
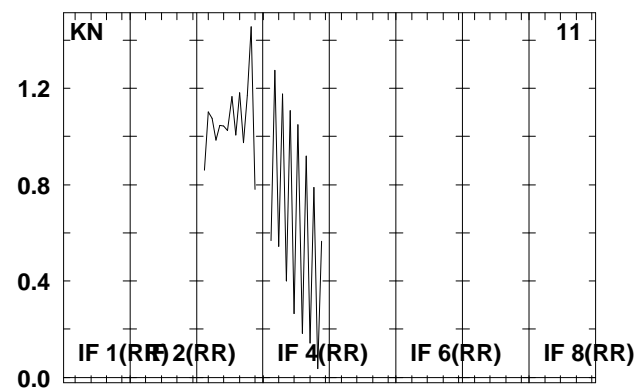
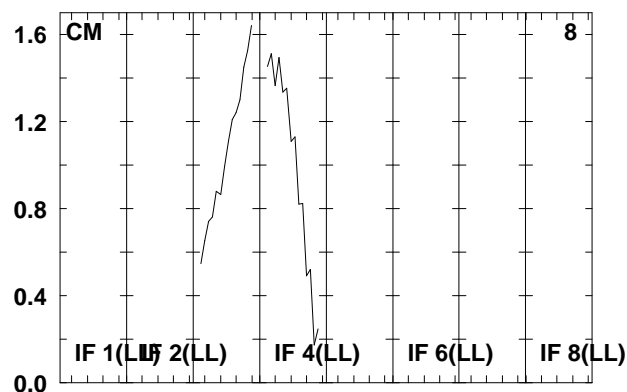
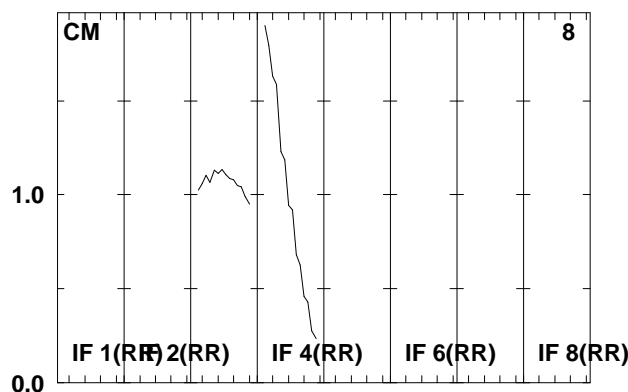
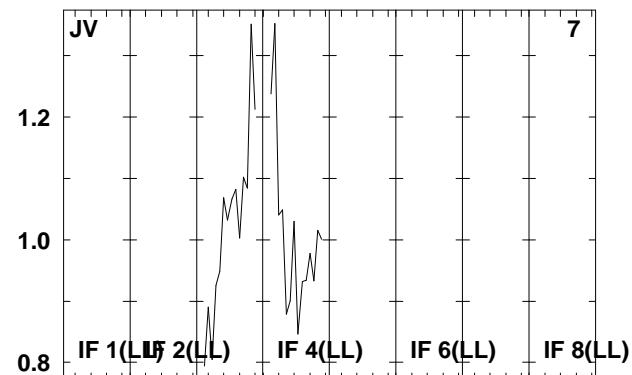
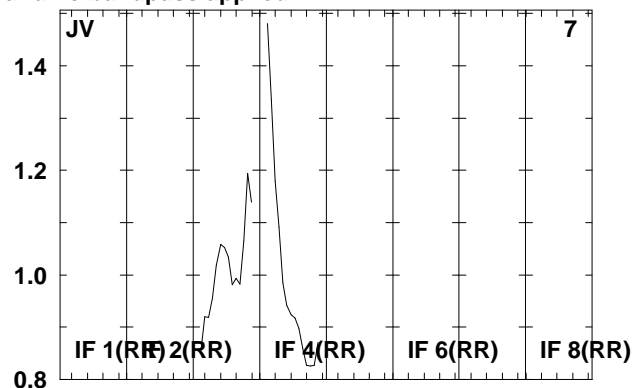
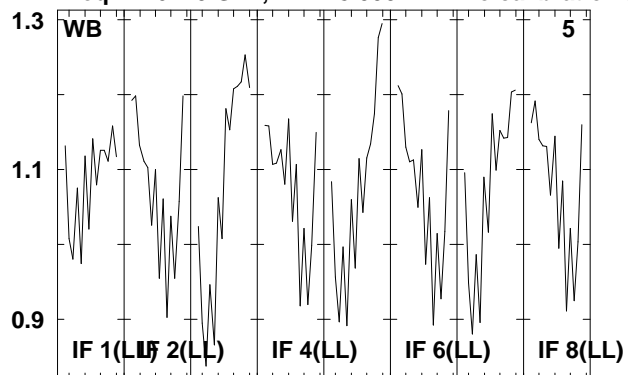

Lower frame: Real Jy  
Total-power spectrum Antenna: \*  
Timerange: 01/06:08:01 to 01/06:09:19



Plot file version 337 created 20-OCT-2009 14:52:28

M33 RP015C.UVDATA.1

Freq = 1.6270 GHz, Bw = 8.000 MH No calibration applied and no bandpass applied

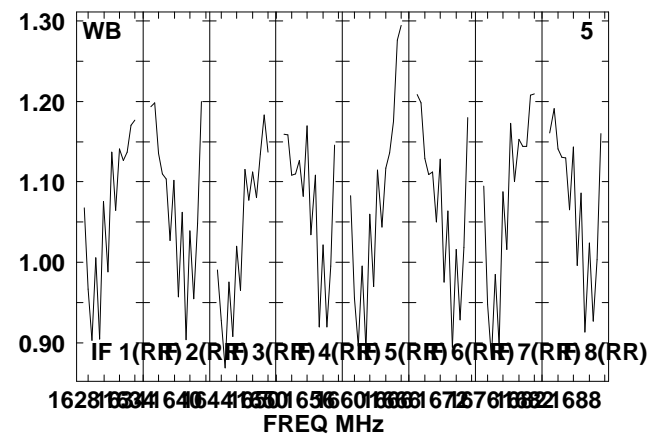
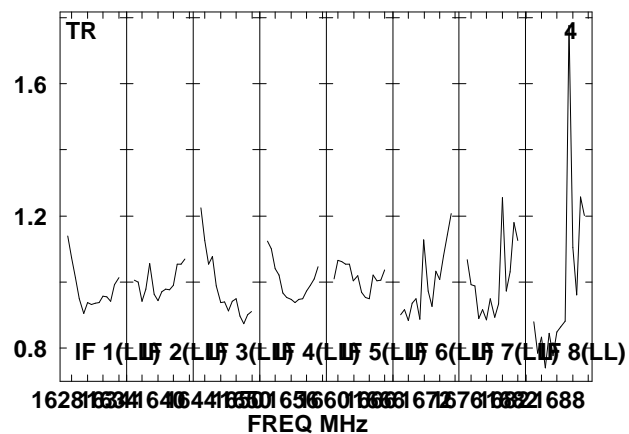
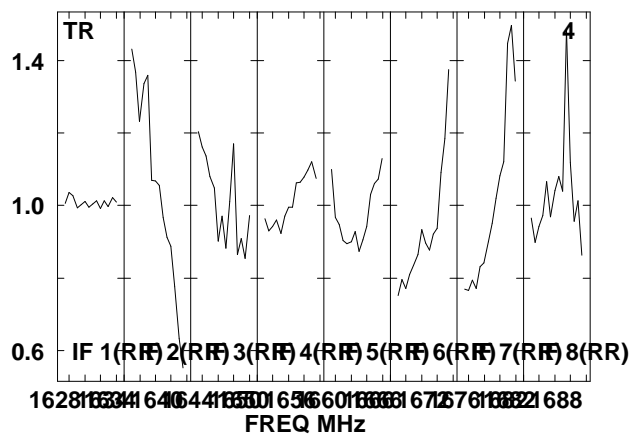
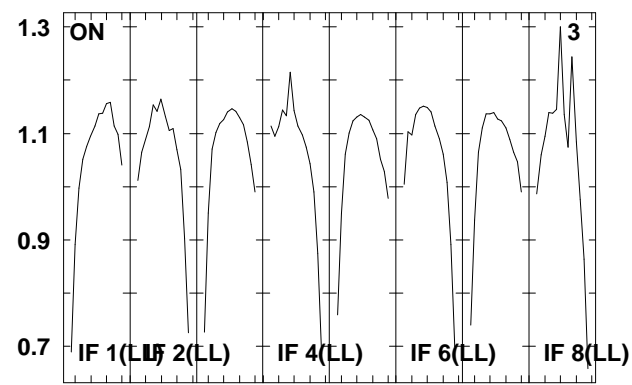
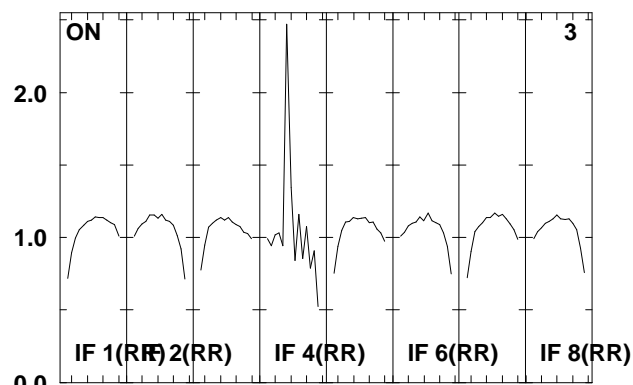
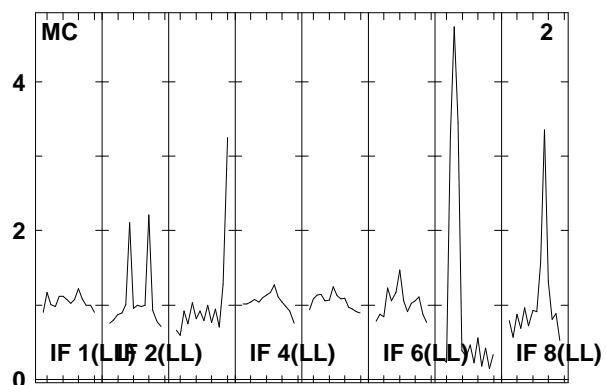
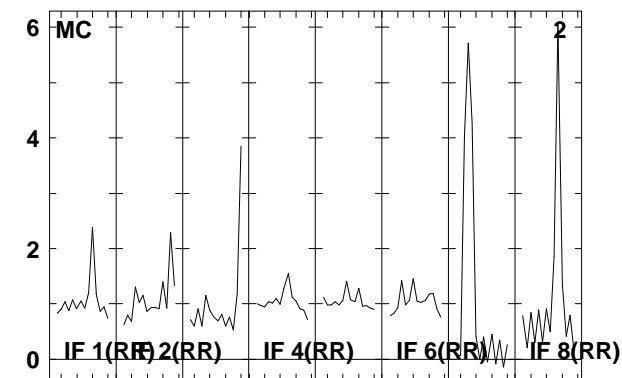
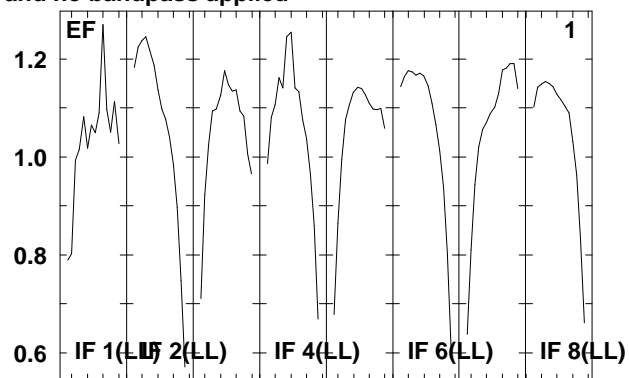
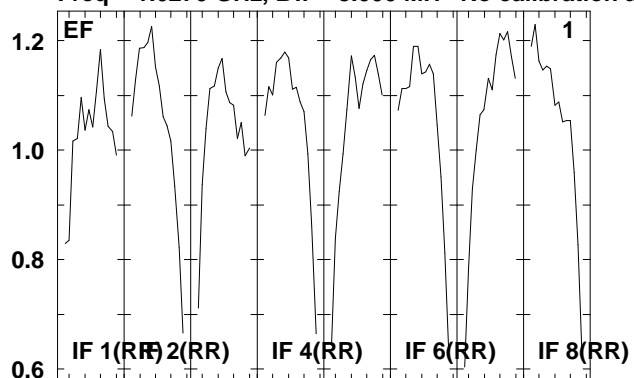

Lower frame: Real Jy

Total-power spectrum Antenna: \*

Timerange: 01/06:09:20 to 01/06:12:19

Plot file version 338 created 20-OCT-2009 14:52:29

M33 RP015C.UVDATA.1

Freq = 1.6270 GHz, Bw = 8.000 MH No calibration applied and no bandpass applied

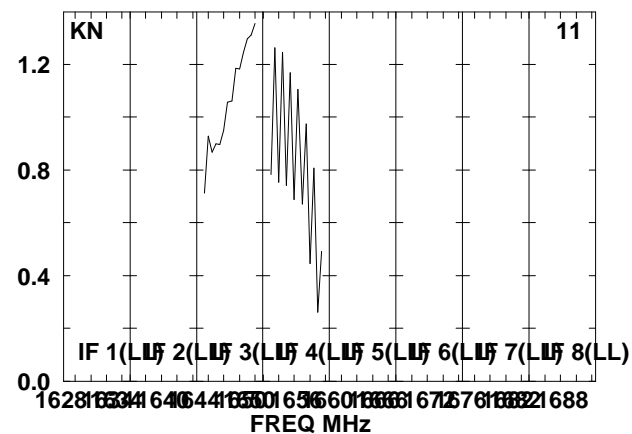
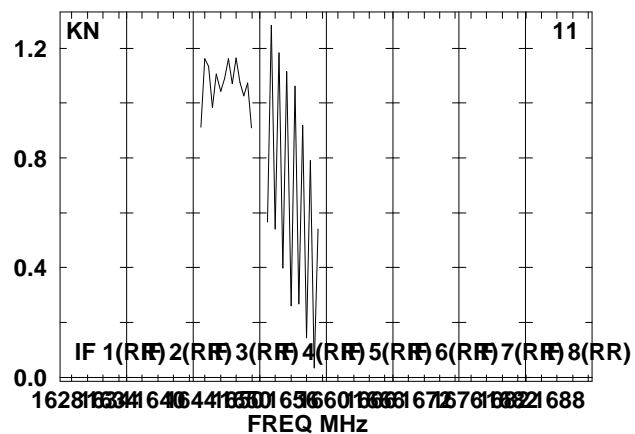
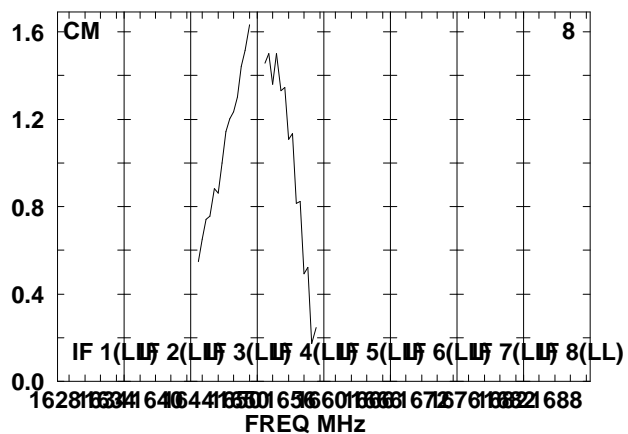
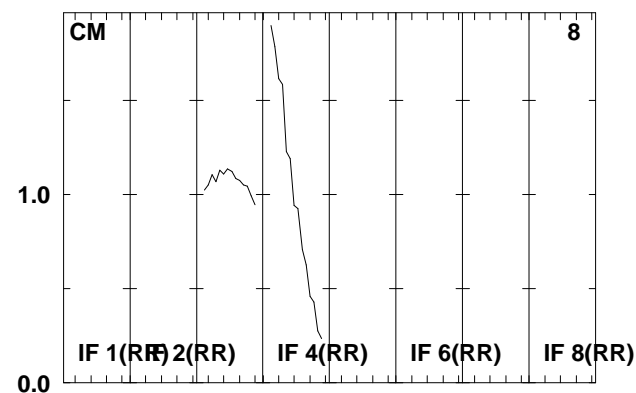
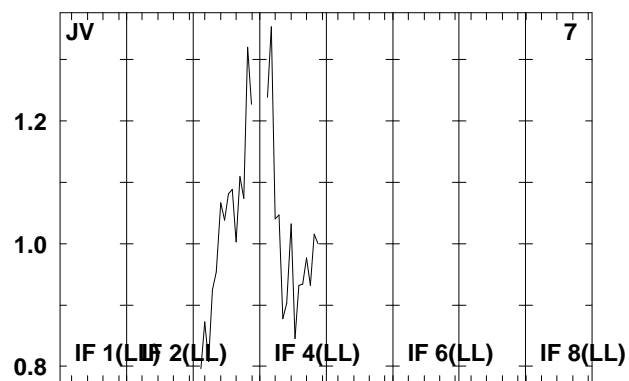
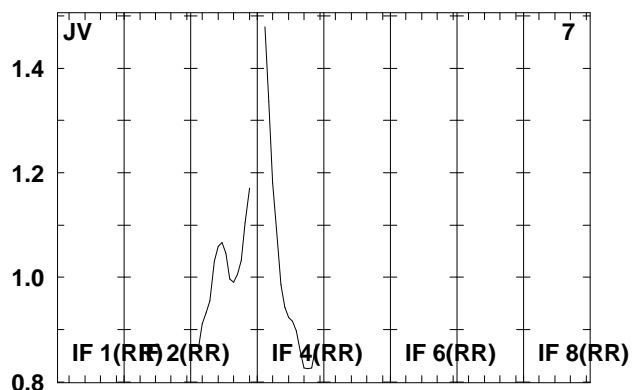
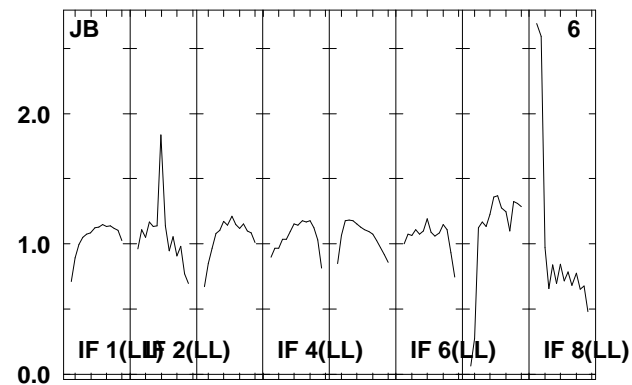
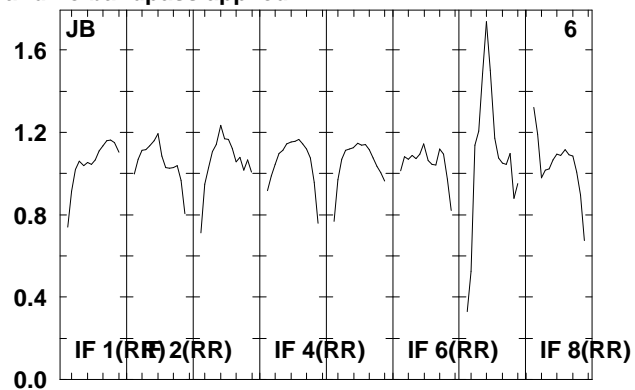
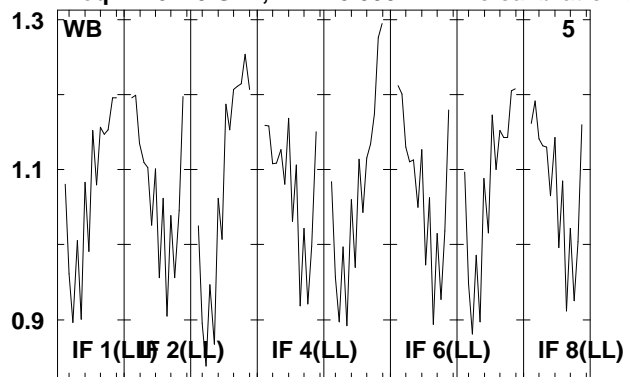

Lower frame: Real Jy

Total-power spectrum Antenna: \*

Timerange: 01/06:09:20 to 01/06:12:19

Plot file version 339 created 20-OCT-2009 14:52:31

M33 RP015C.UVDATA.1

Freq = 1.6270 GHz, Bw = 8.000 MH No calibration applied and no bandpass applied

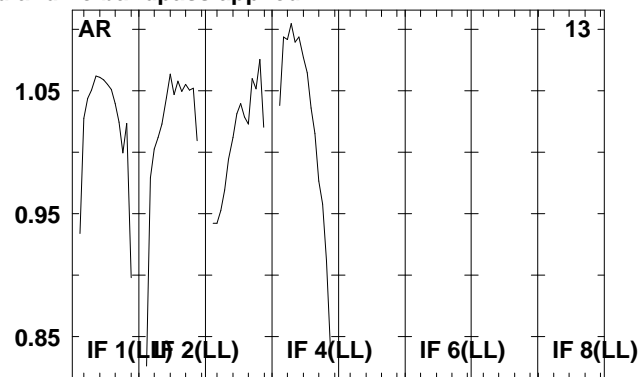
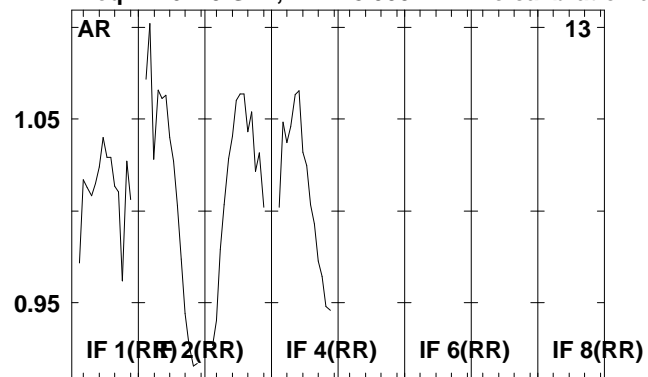

Lower frame: Real Jy  
Total-power spectrum Antenna: \*  
Timerange: 01/06:09:20 to 01/06:12:19

Plot file version 340 created 20-OCT-2009 14:52:31

J0137+31 RP015C.UVDATA.1

Freq = 1.6270 GHz, Bw = 8.000 MH No calibration applied and no bandpass applied

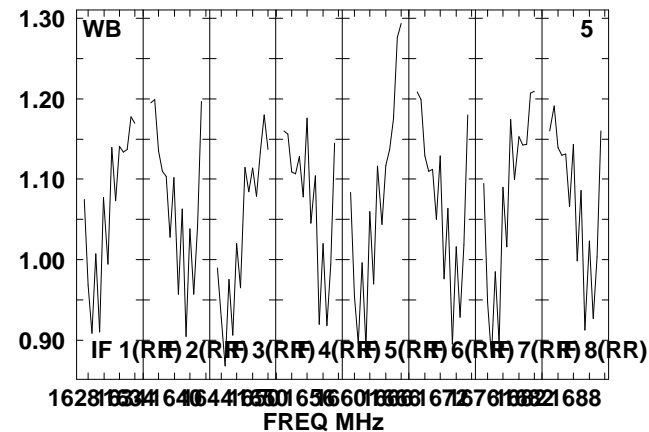
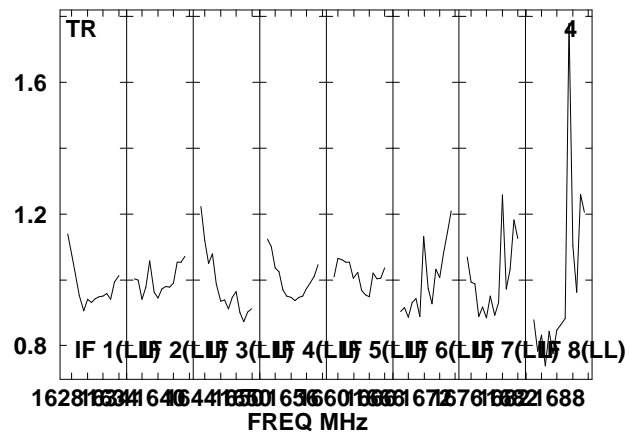
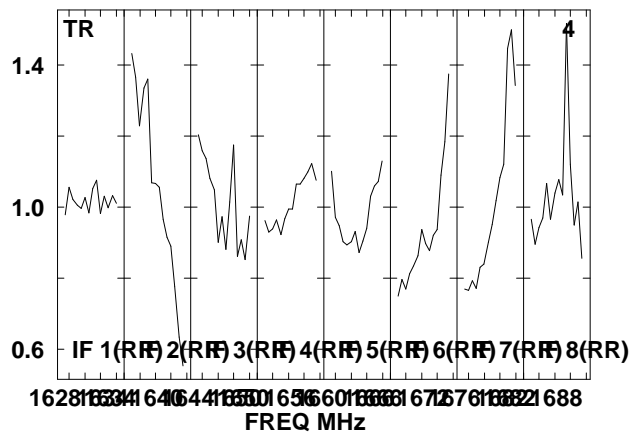
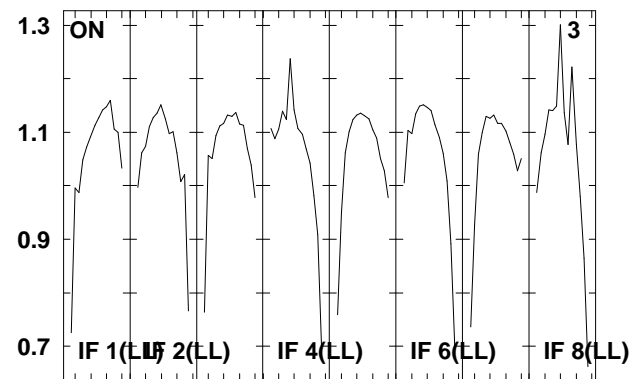
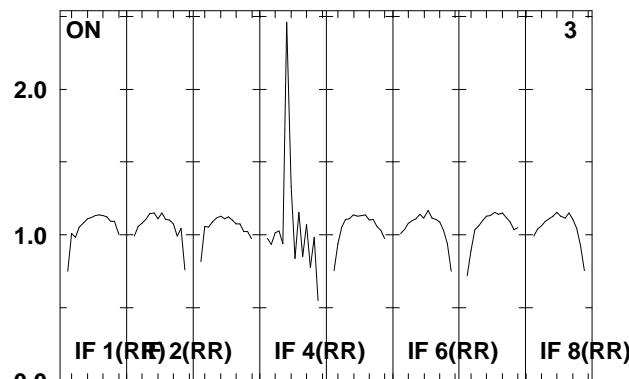
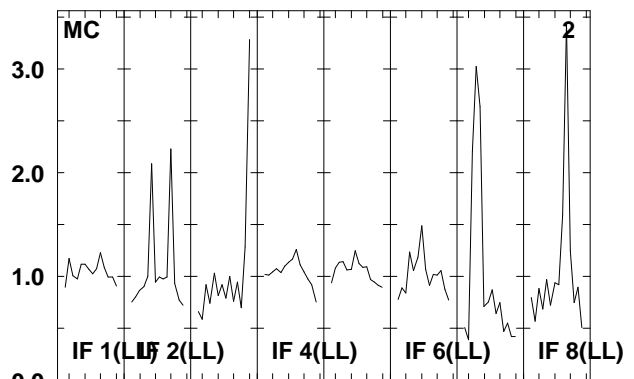
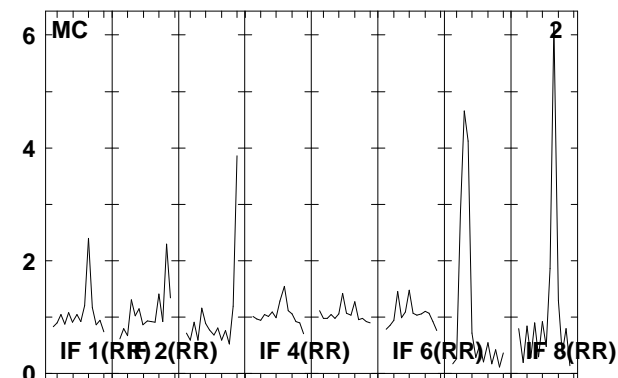
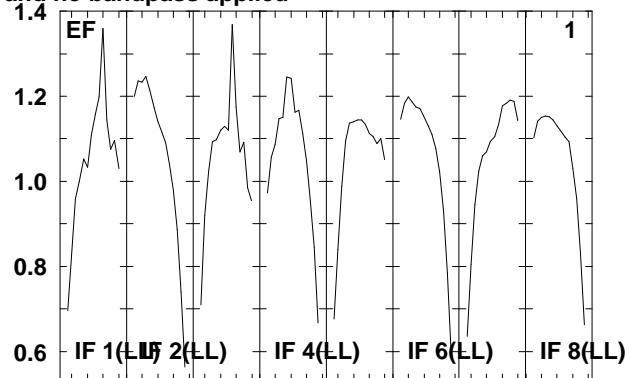
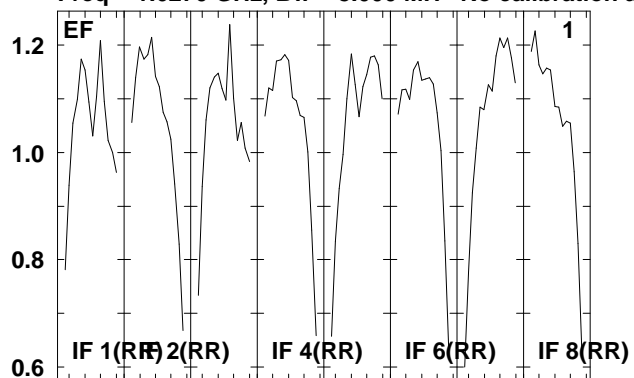

Lower frame: Real Jy

Total-power spectrum Antenna: \*

Timerange: 01/06:13:00 to 01/06:13:59

Plot file version 341 created 20-OCT-2009 14:52:31

J0137+31 RP015C.UVDATA.1

Freq = 1.6270 GHz, Bw = 8.000 MH No calibration applied and no bandpass applied

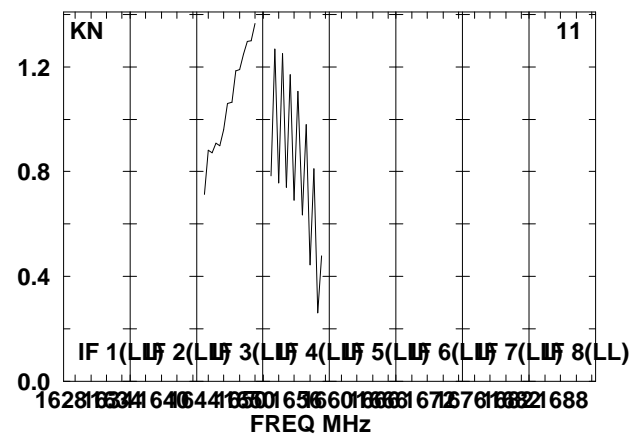
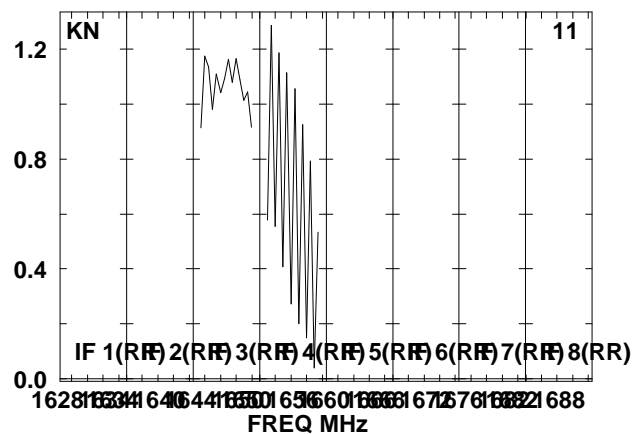
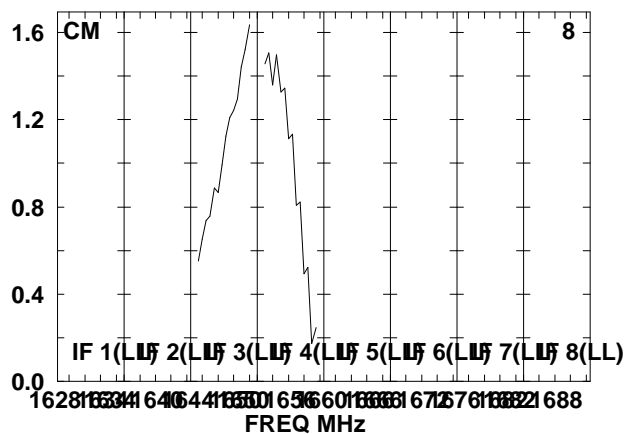
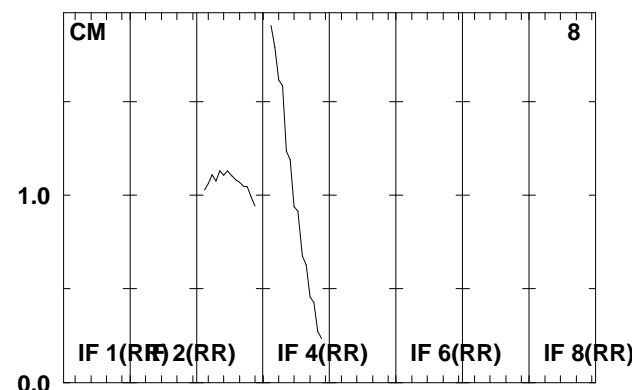
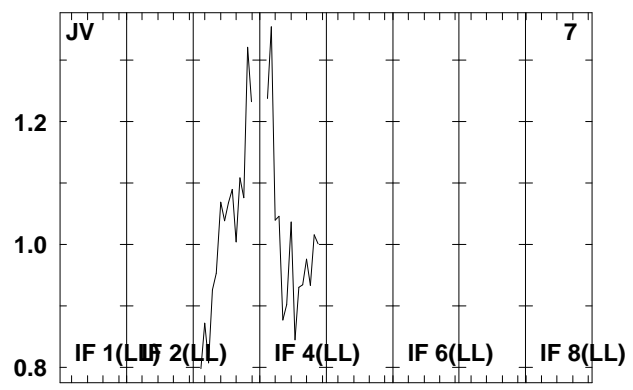
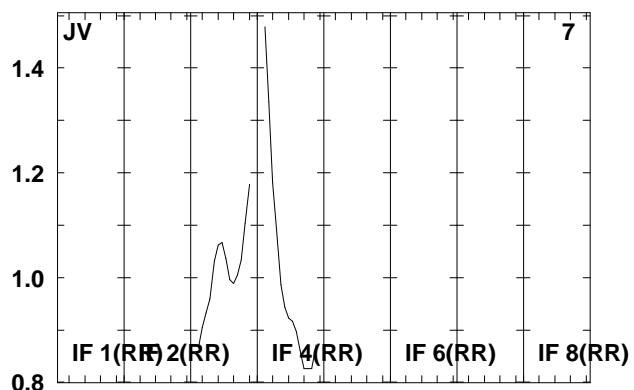
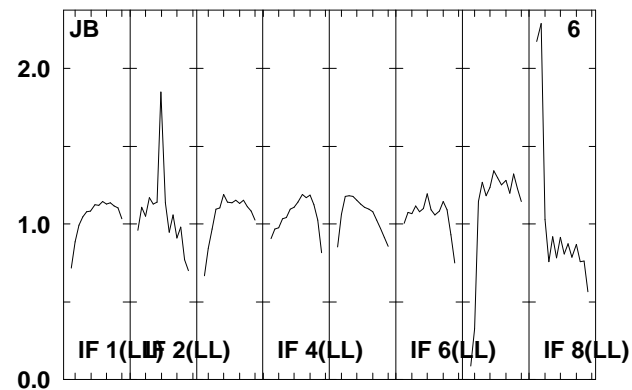
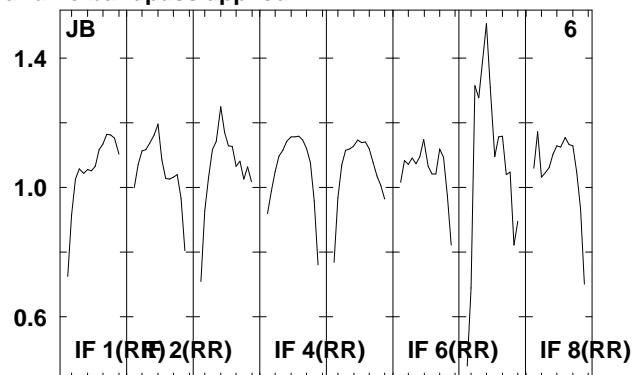
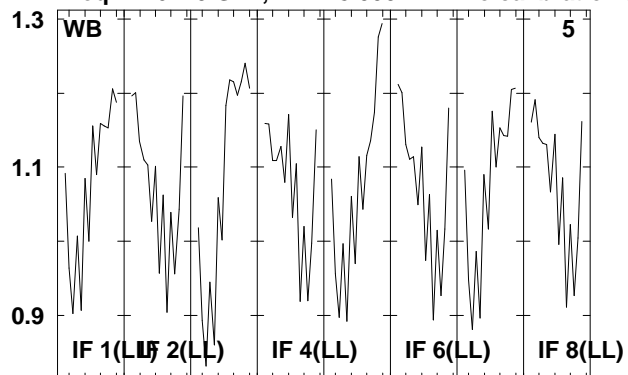

Lower frame: Real Jy  
Total-power spectrum Antenna: \*  
Timerange: 01/06:13:00 to 01/06:13:59

Plot file version 342 created 20-OCT-2009 14:52:32

J0137+31 RP015C.UVDATA.1

Freq = 1.6270 GHz, Bw = 8.000 MH No calibration applied and no bandpass applied

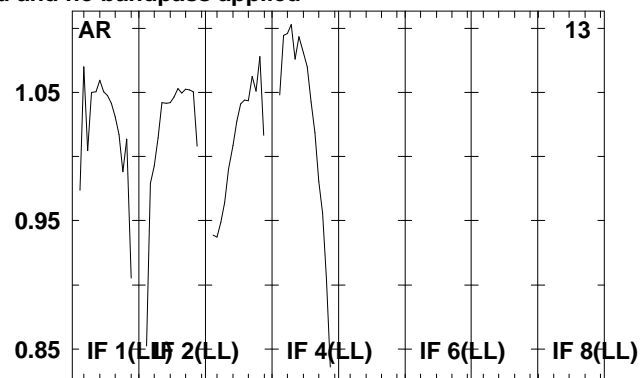
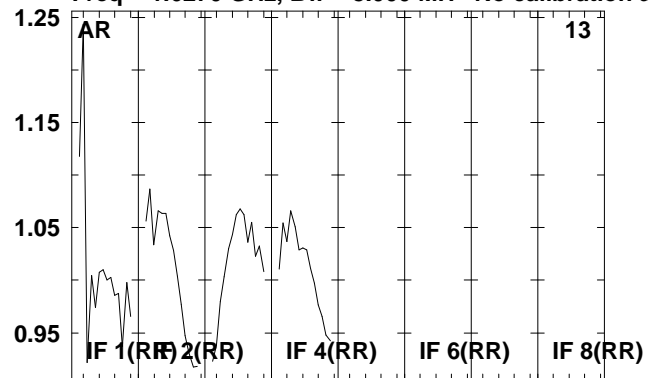

Lower frame: Real Jy  
Total-power spectrum Antenna: \*  
Timerange: 01/06:13:00 to 01/06:13:59

Plot file version 343 created 20-OCT-2009 14:52:32

FAINTCAL RP015C.UVDATA.1

Freq = 1.6270 GHz, Bw = 8.000 MH No calibration applied and no bandpass applied

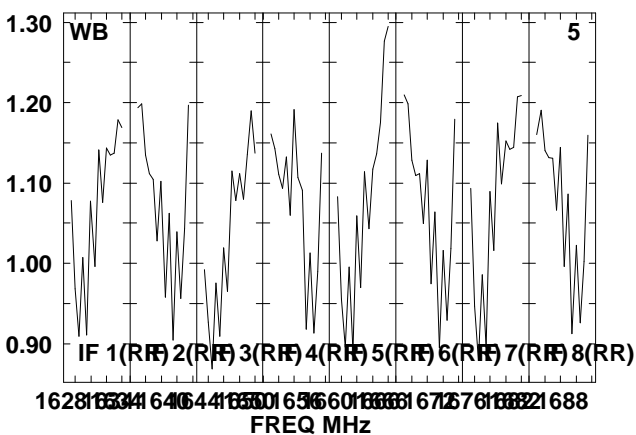
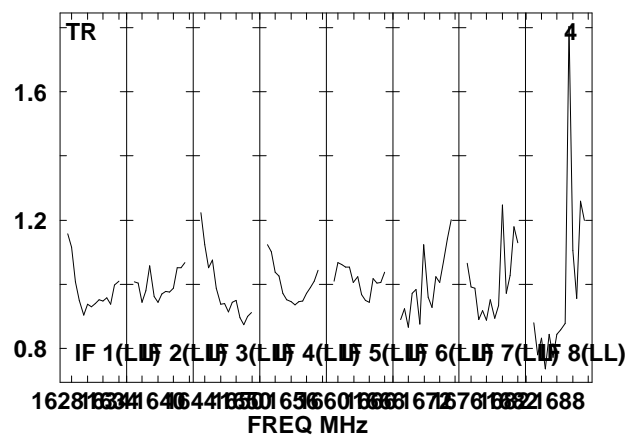
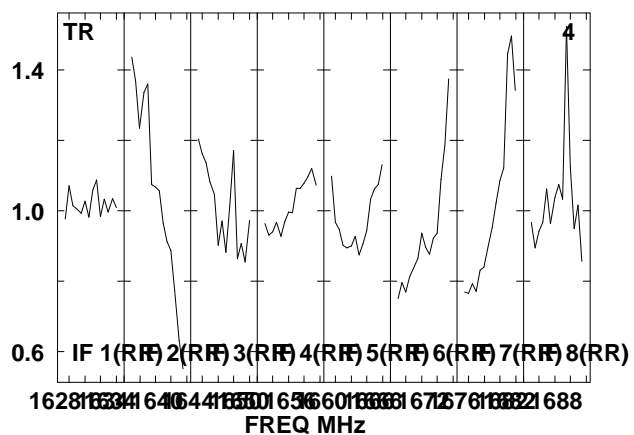
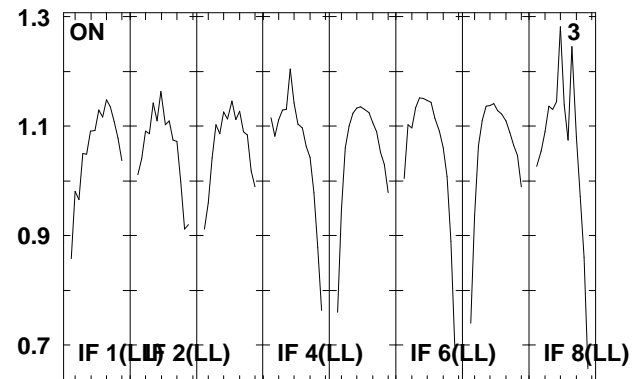
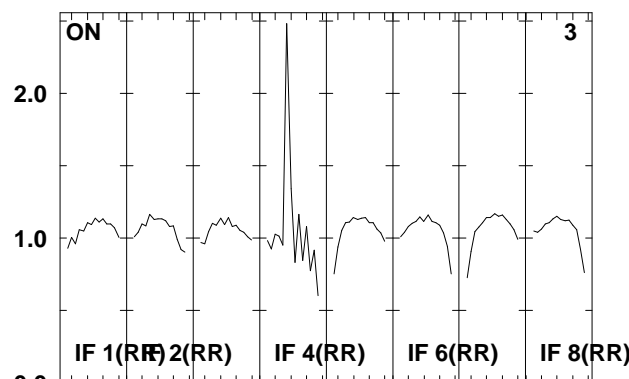
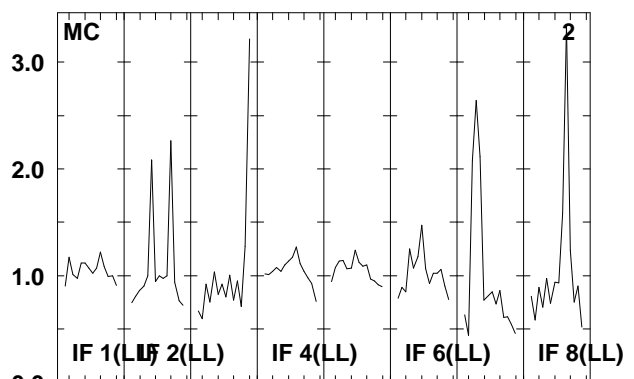
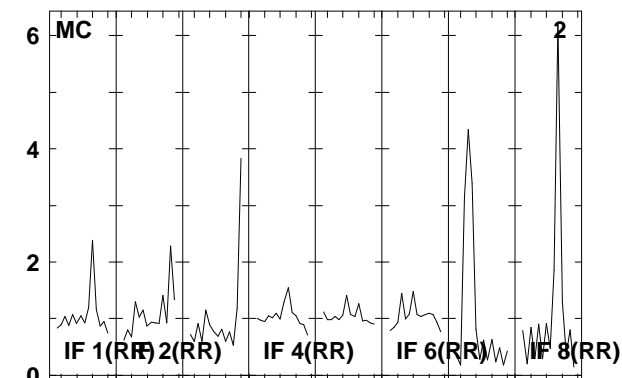
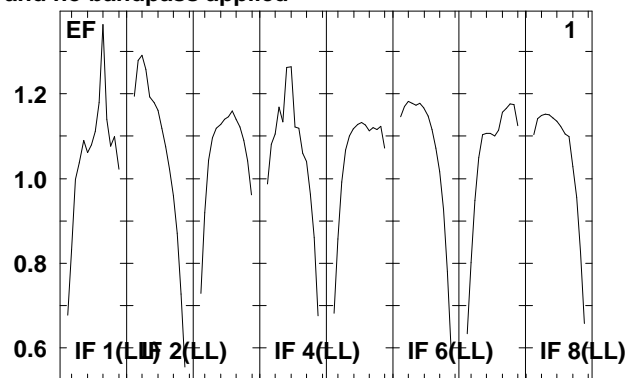
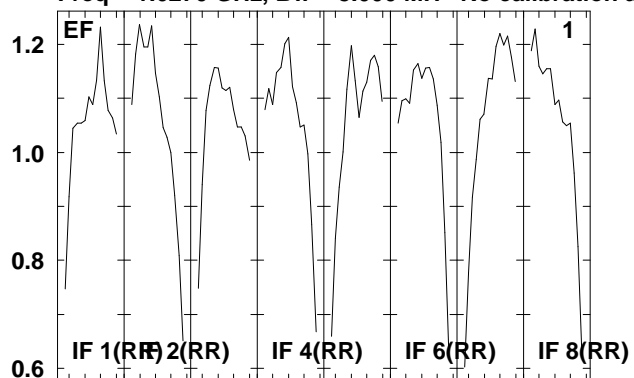

Lower frame: Real Jy

Total-power spectrum Antenna: \*

Timerange: 01/06:14:00 to 01/06:15:19

Plot file version 344 created 20-OCT-2009 14:52:32

FAINTCAL RP015C.UVDATA.1

Freq = 1.6270 GHz, Bw = 8.000 MH No calibration applied and no bandpass applied

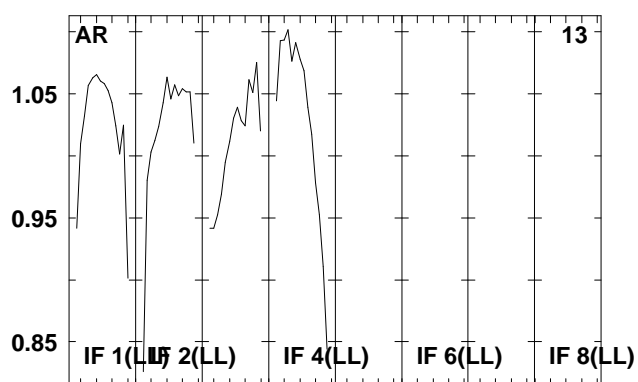
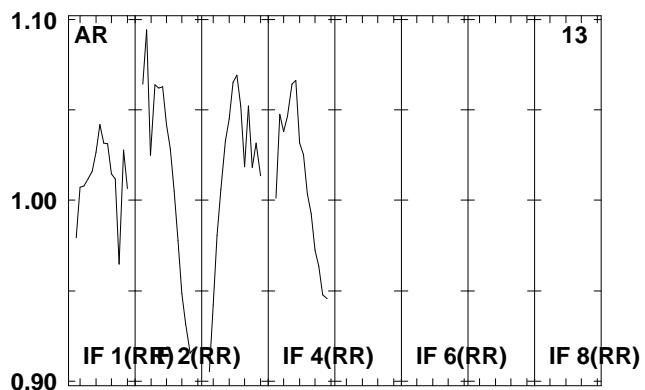
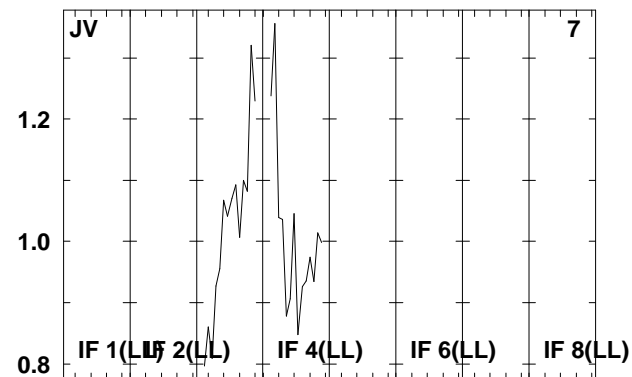
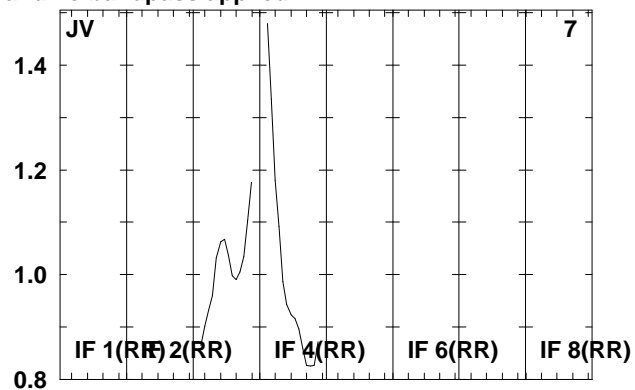
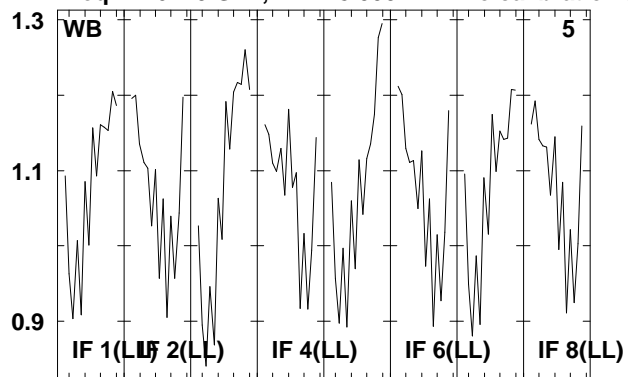

Lower frame: Real Jy  
Total-power spectrum Antenna: \*  
Timerange: 01/06:14:00 to 01/06:15:19



Plot file version 345 created 20-OCT-2009 14:52:33

M33 RP015C.UVDATA.1

Freq = 1.6270 GHz, Bw = 8.000 MH No calibration applied and no bandpass applied

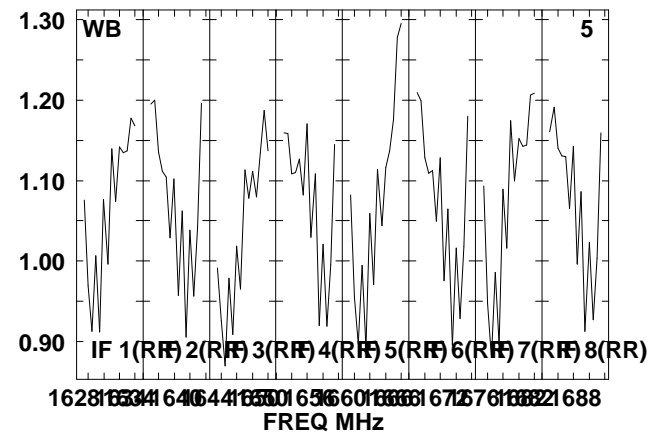
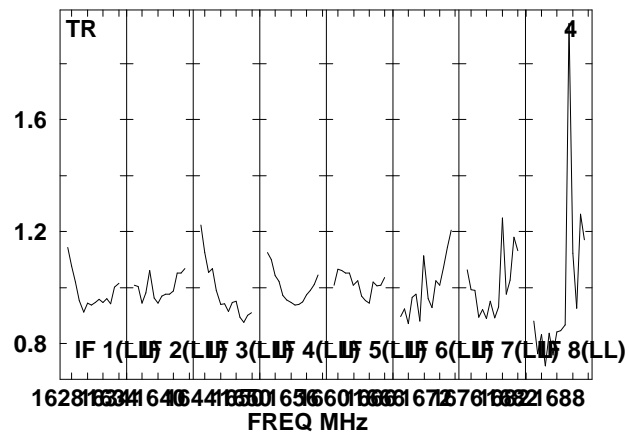
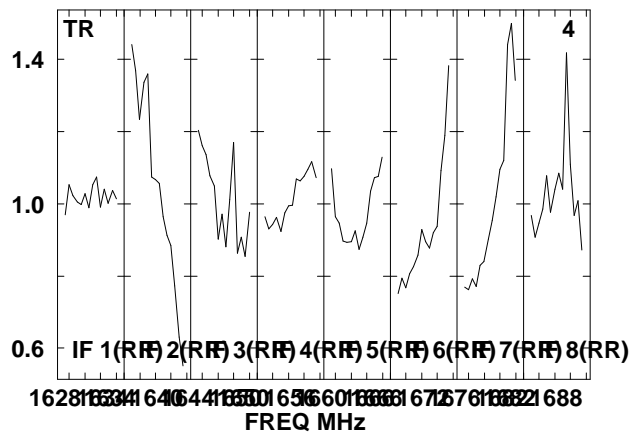
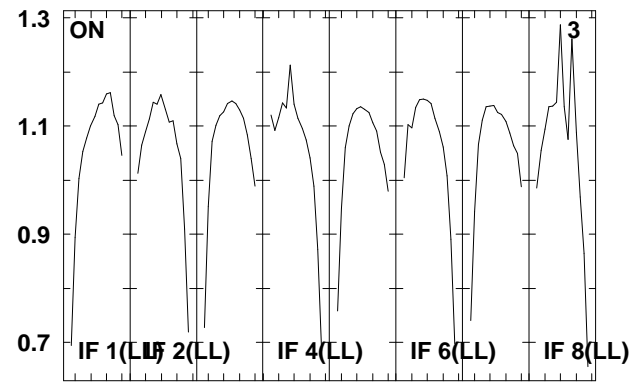
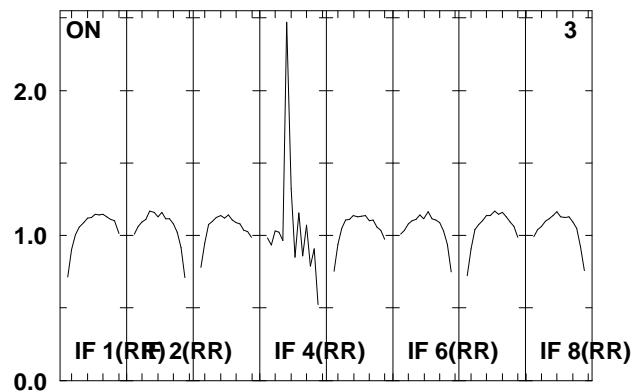
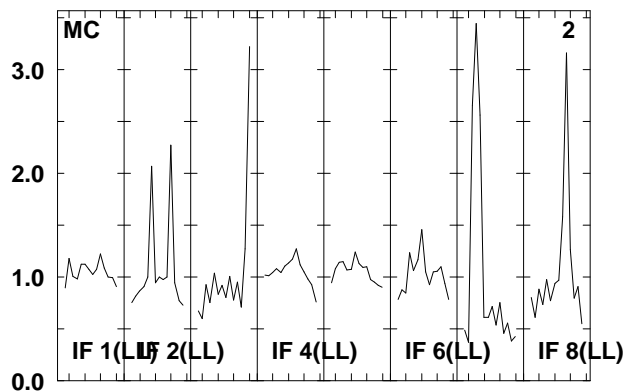
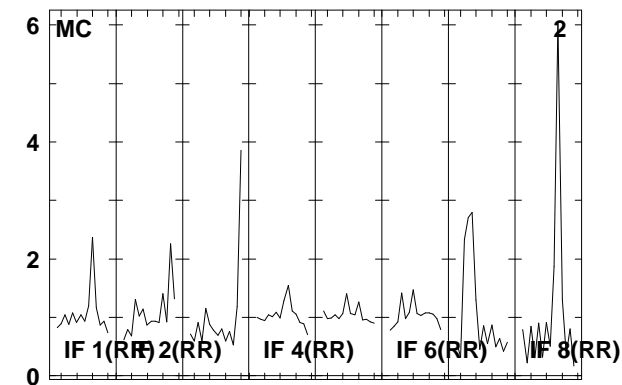
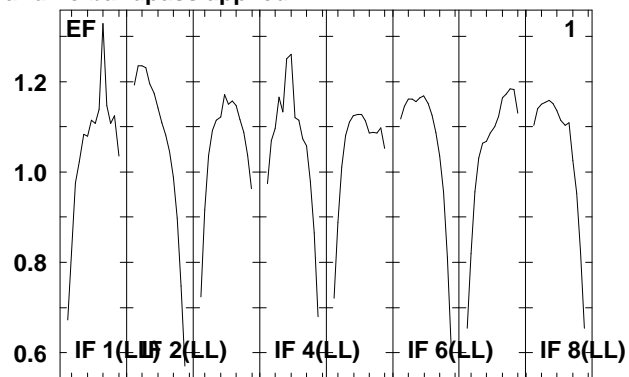
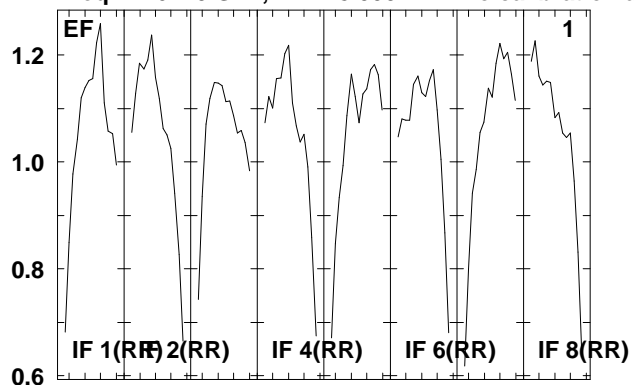

Lower frame: Real Jy

Total-power spectrum Antenna: \*

Timerange: 01/06:15:21 to 01/06:18:20

Plot file version 346 created 20-OCT-2009 14:52:34

M33 RP015C.UVDATA.1

Freq = 1.6270 GHz, Bw = 8.000 MH No calibration applied and no bandpass applied

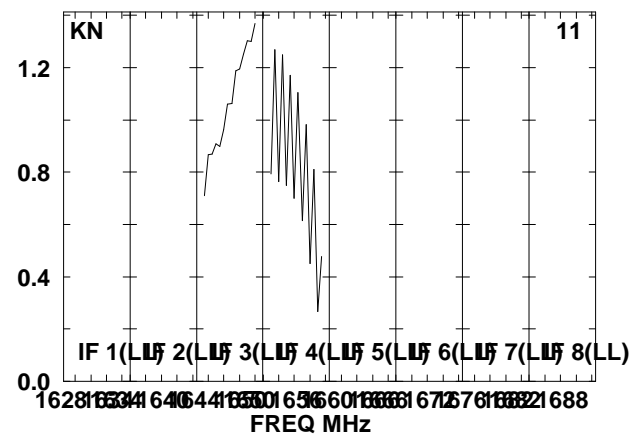
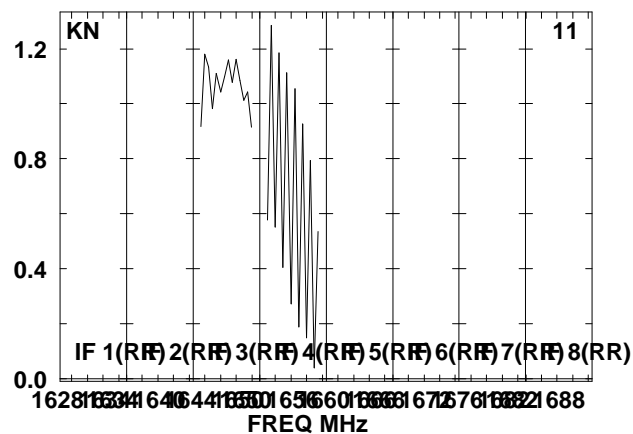
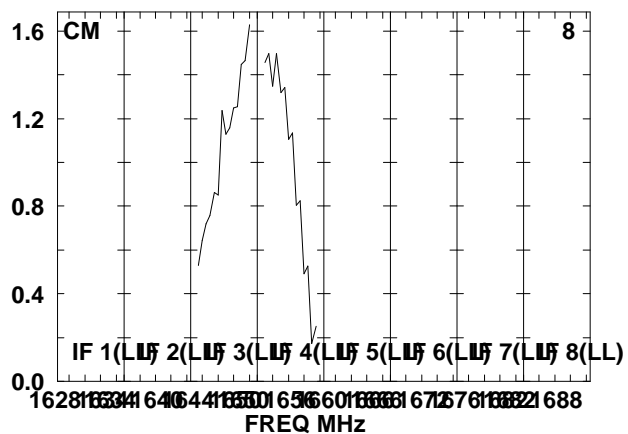
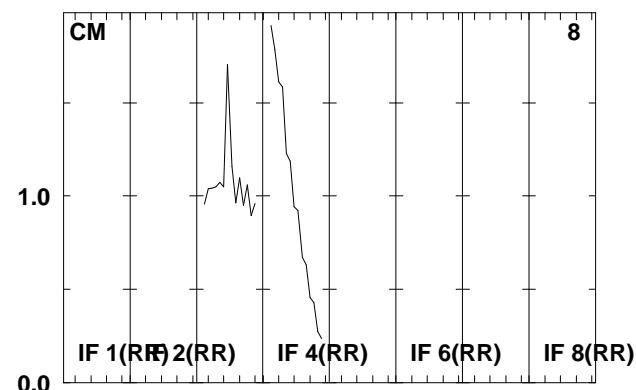
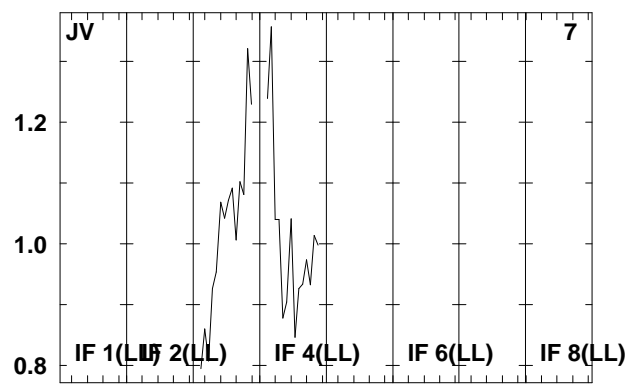
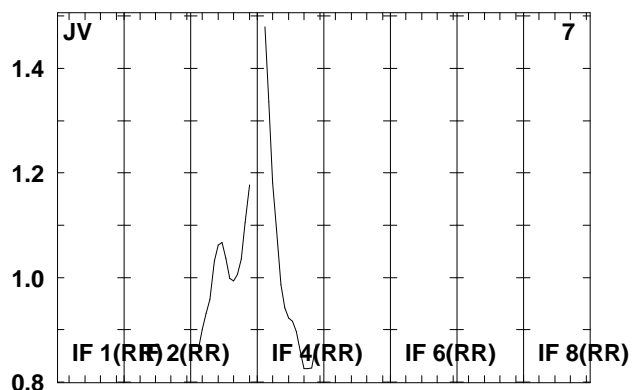
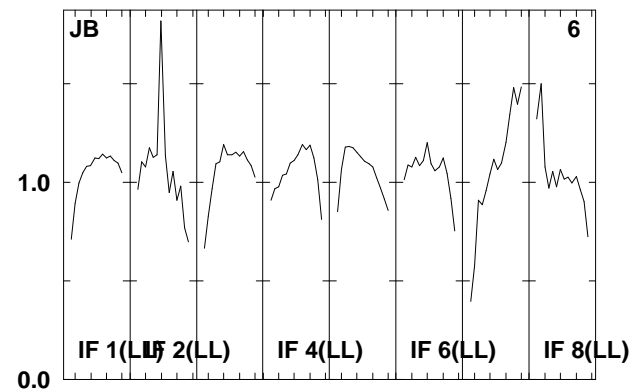
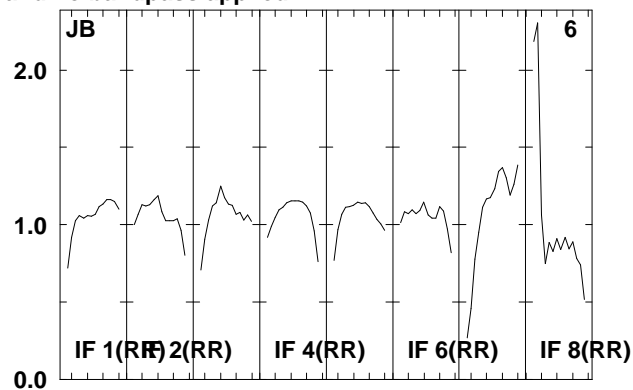
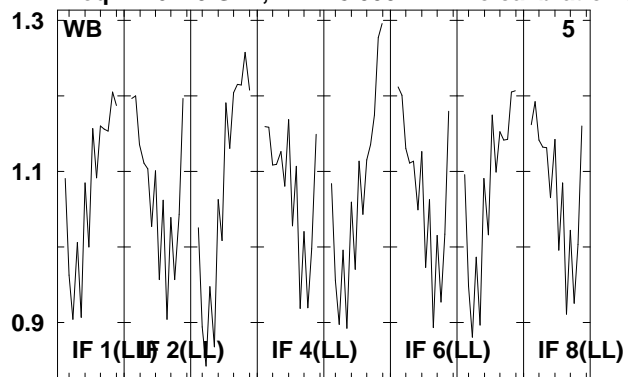

Lower frame: Real Jy

Total-power spectrum Antenna: \*

Timerange: 01/06:15:21 to 01/06:18:20

Plot file version 347 created 20-OCT-2009 14:52:36

M33 RP015C.UVDATA.1

Freq = 1.6270 GHz, Bw = 8.000 MH No calibration applied and no bandpass applied

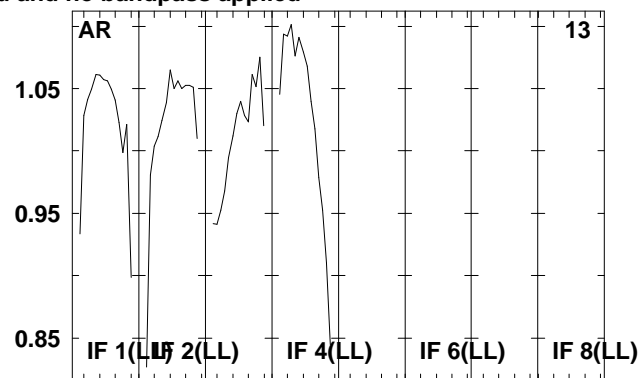
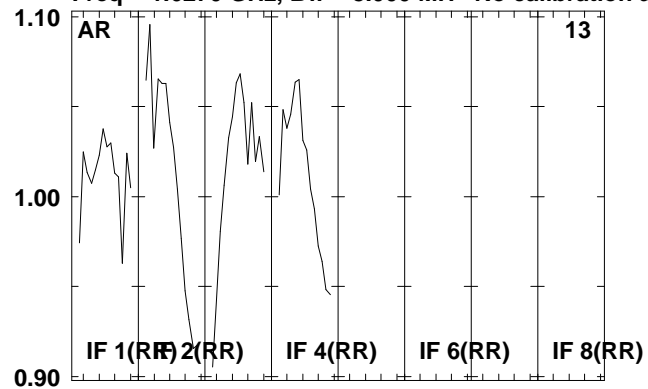

Lower frame: Real Jy  
Total-power spectrum Antenna: \*  
Timerange: 01/06:15:21 to 01/06:18:20

Plot file version 348 created 20-OCT-2009 14:52:36

J0137+31 RP015C.UVDATA.1

Freq = 1.6270 GHz, Bw = 8.000 MH No calibration applied and no bandpass applied

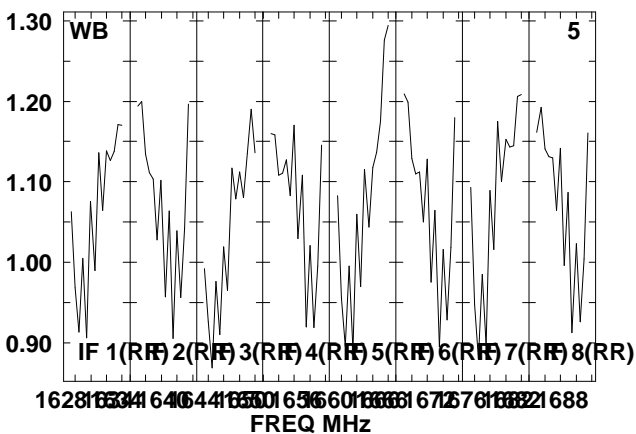
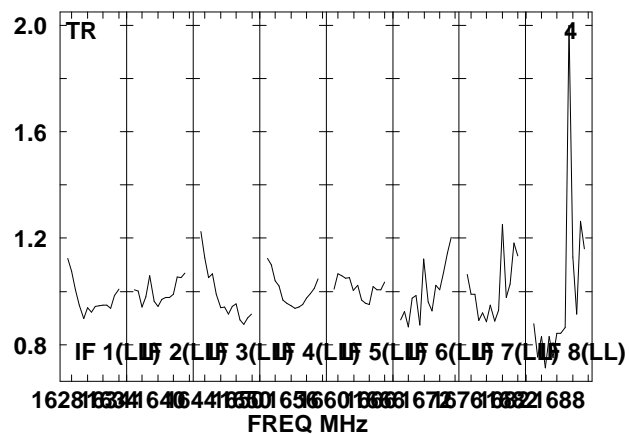
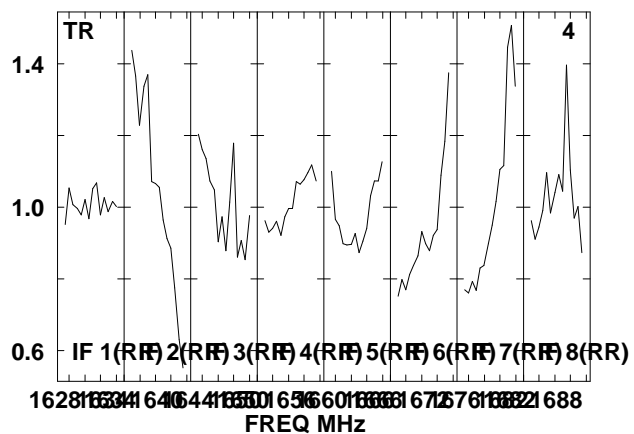
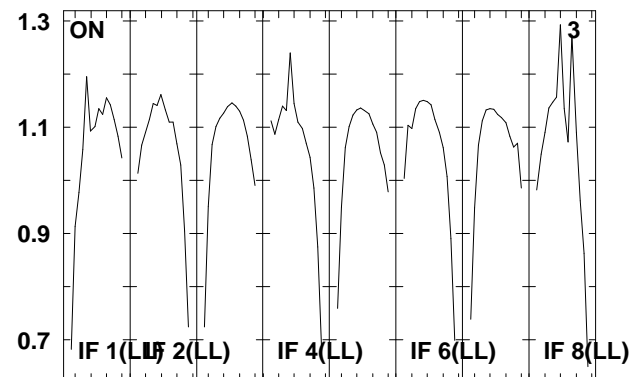
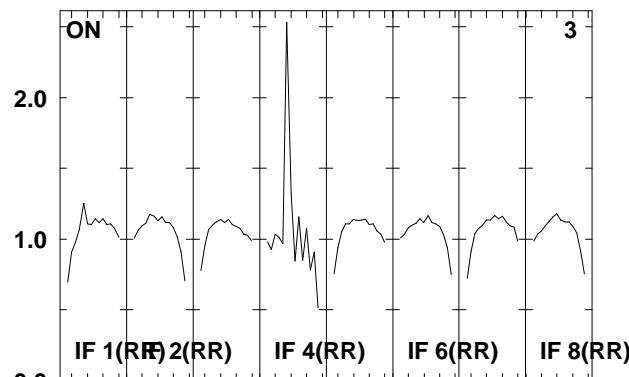
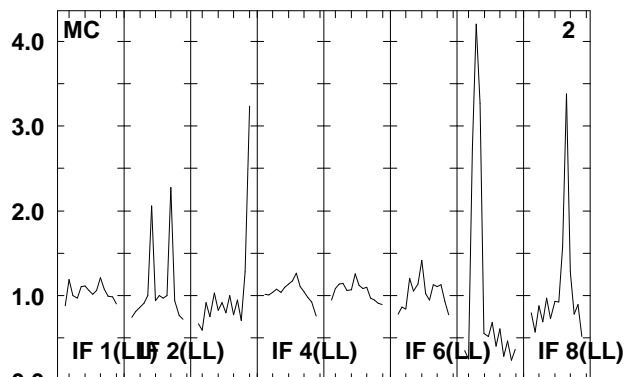
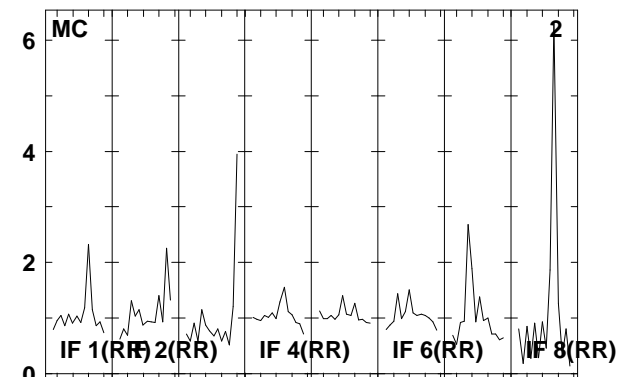
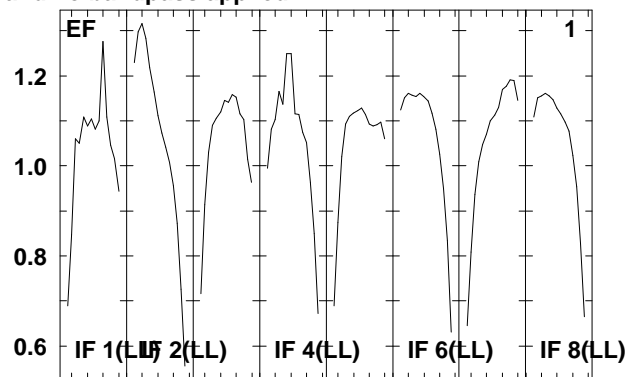
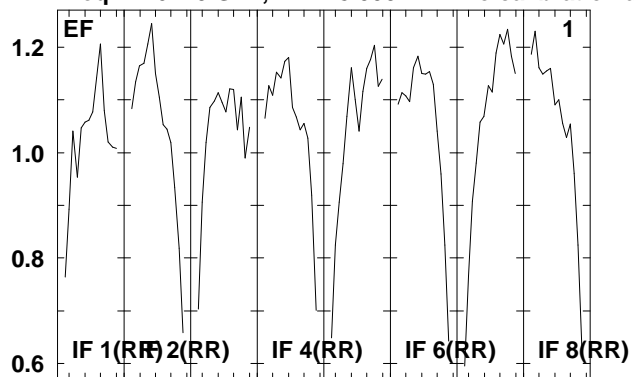

Lower frame: Real Jy  
Total-power spectrum Antenna: \*  
Timerange: 01/06:19:01 to 01/06:20:00

Plot file version 349 created 20-OCT-2009 14:52:36

J0137+31 RP015C.UVDATA.1

Freq = 1.6270 GHz, Bw = 8.000 MH No calibration applied and no bandpass applied

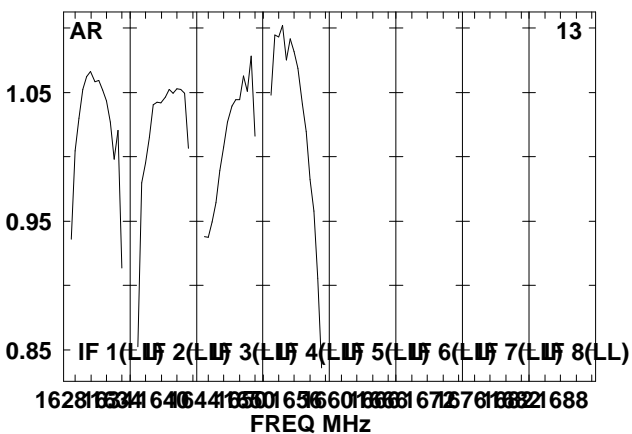
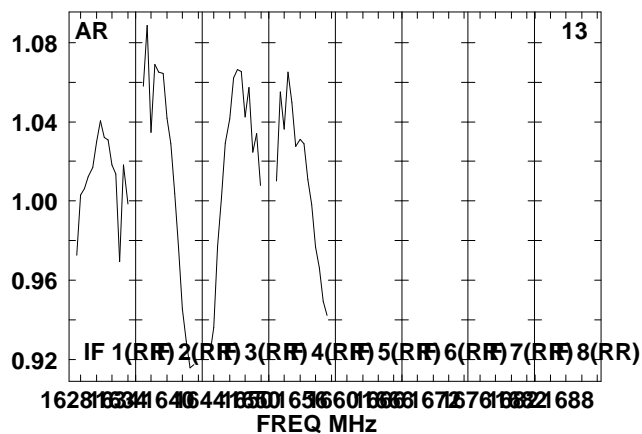
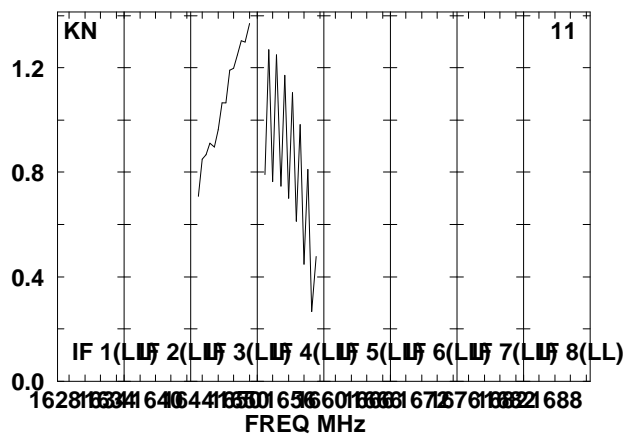
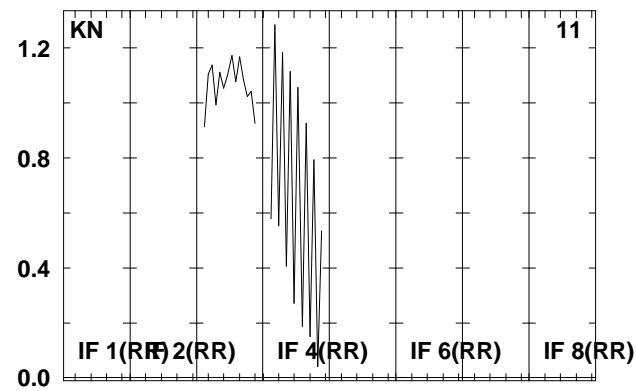
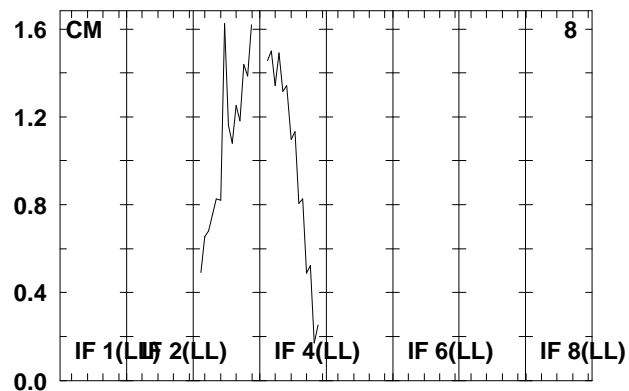
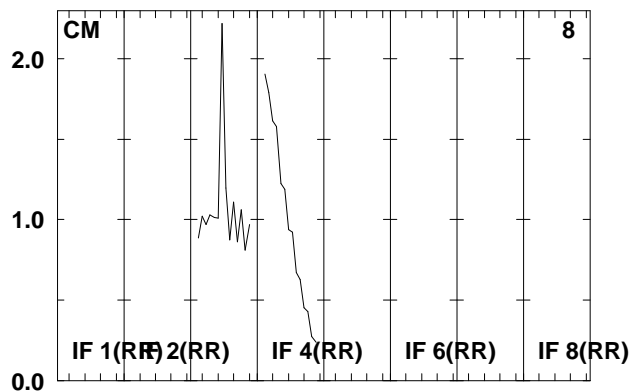
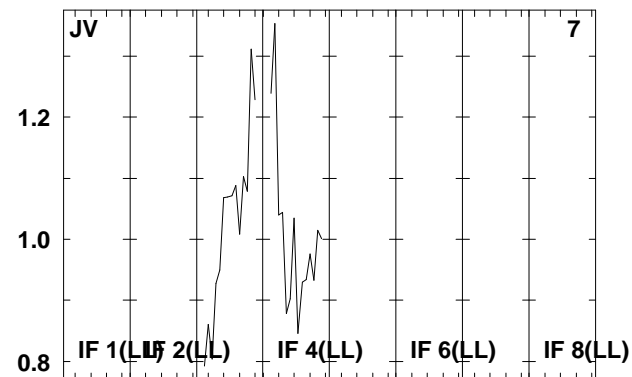
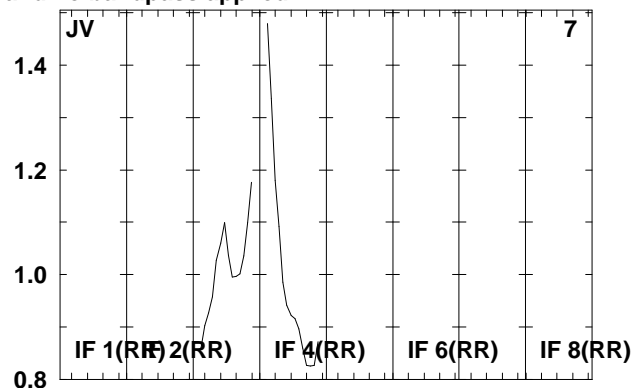
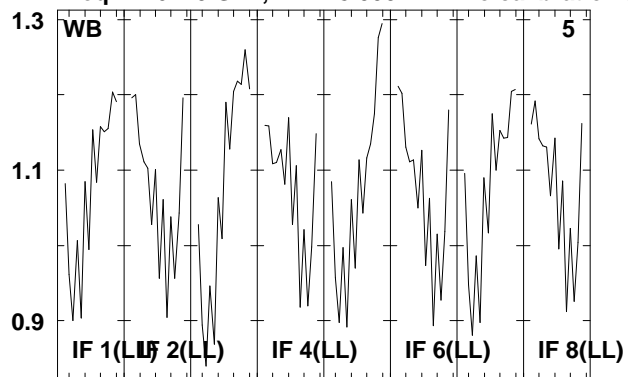

Lower frame: Real Jy  
Total-power spectrum Antenna: \*  
Timerange: 01/06:19:01 to 01/06:20:00

Plot file version 350 created 20-OCT-2009 14:52:37

FAINTCAL RP015C.UVDATA.1

Freq = 1.6270 GHz, Bw = 8.000 MH No calibration applied and no bandpass applied

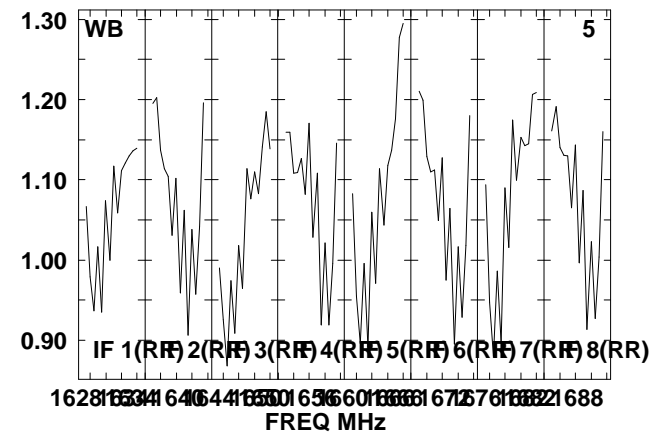
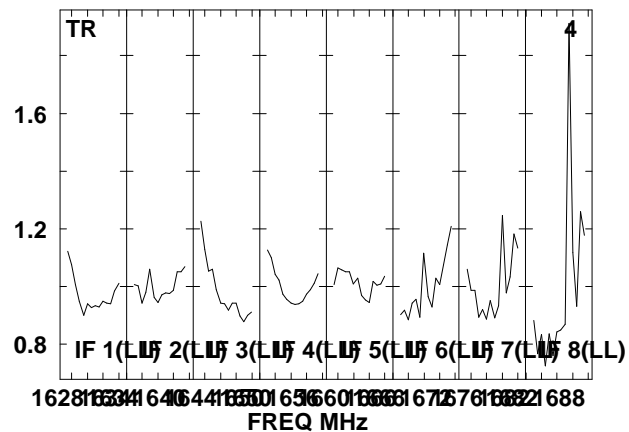
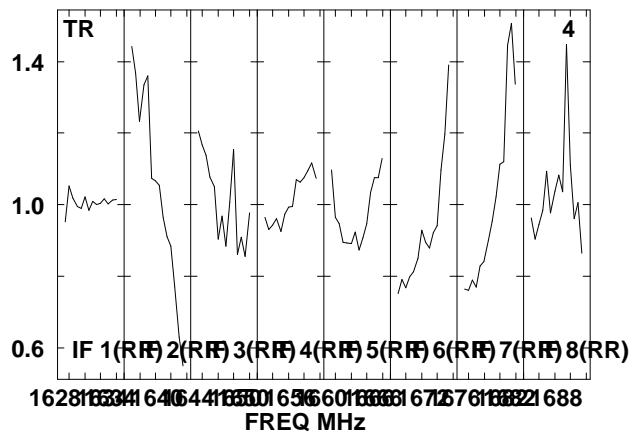
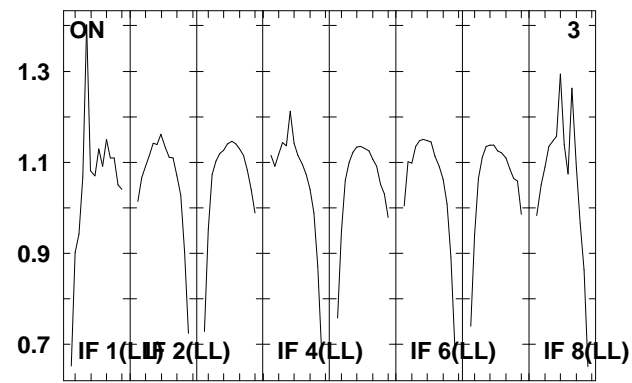
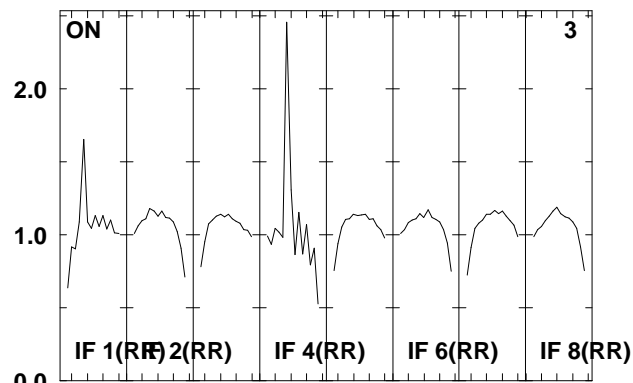
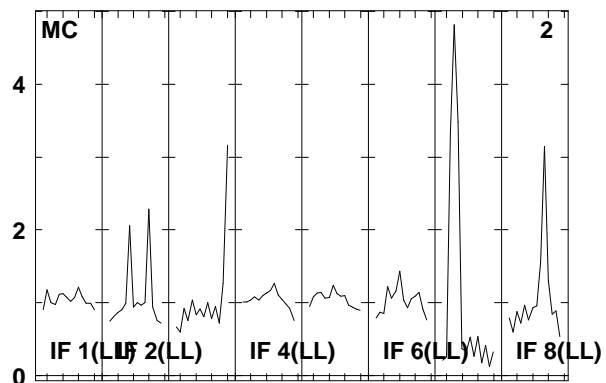
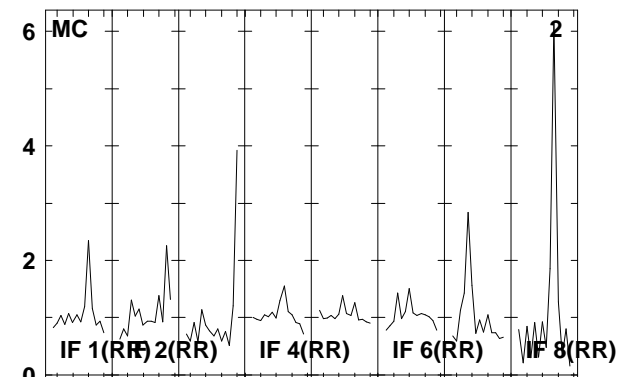
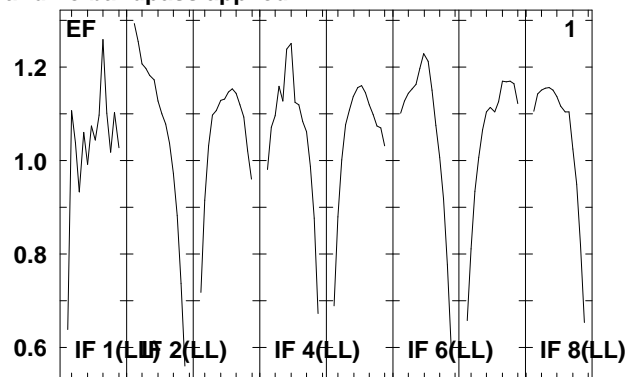
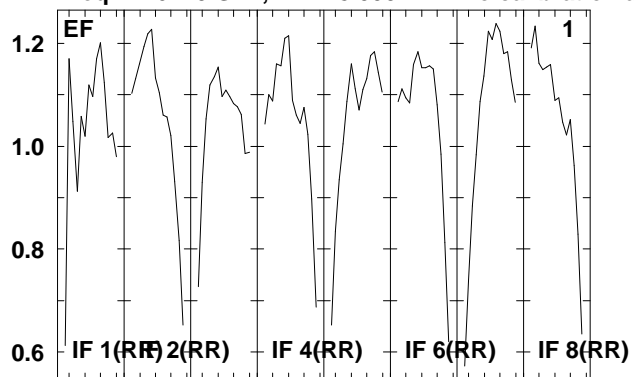

Lower frame: Real Jy

Total-power spectrum Antenna: \*

Timerange: 01/06:20:01 to 01/06:21:19

Plot file version 351 created 20-OCT-2009 14:52:37

FAINTCAL RP015C.UVDATA.1

Freq = 1.6270 GHz, Bw = 8.000 MH No calibration applied and no bandpass applied

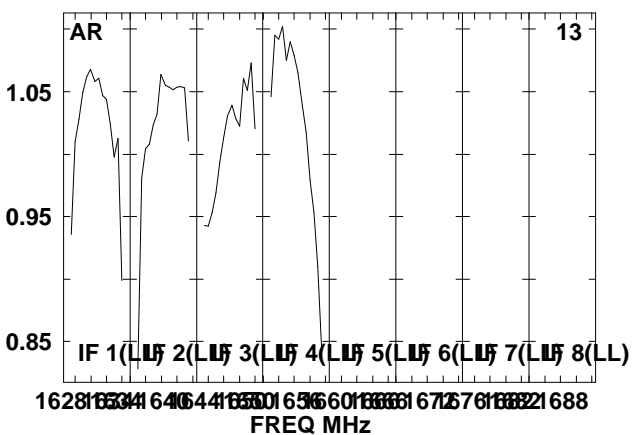
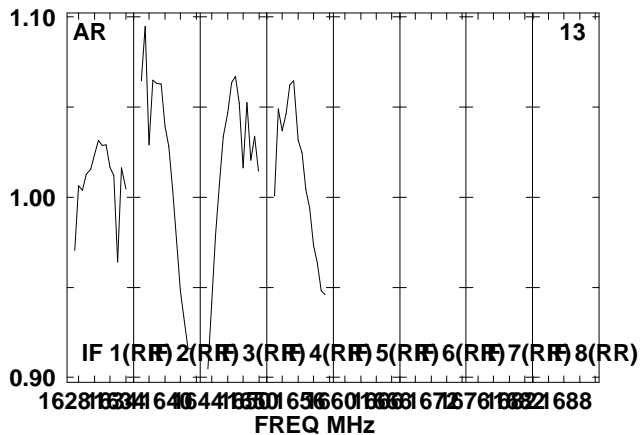
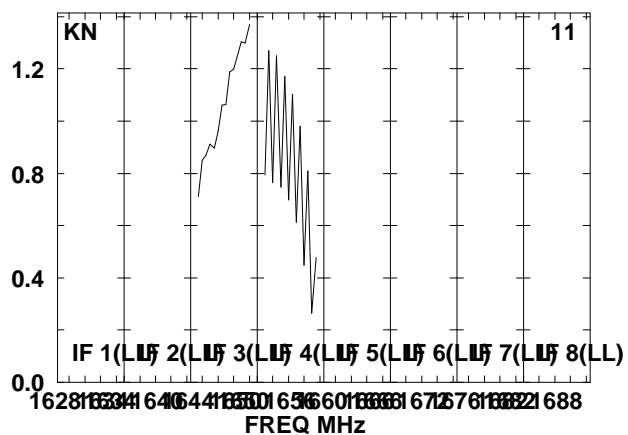
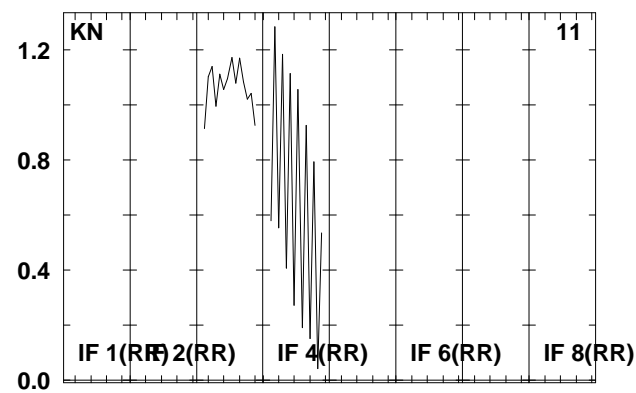
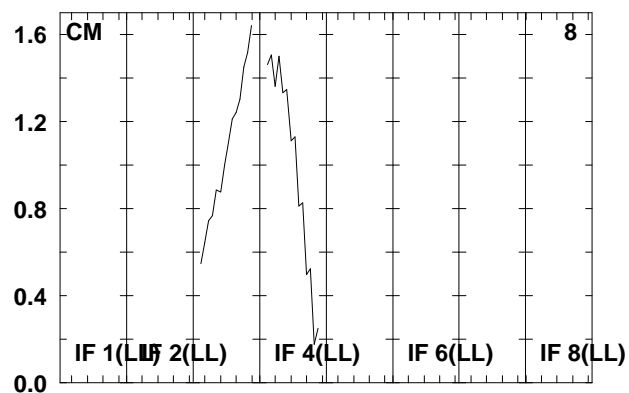
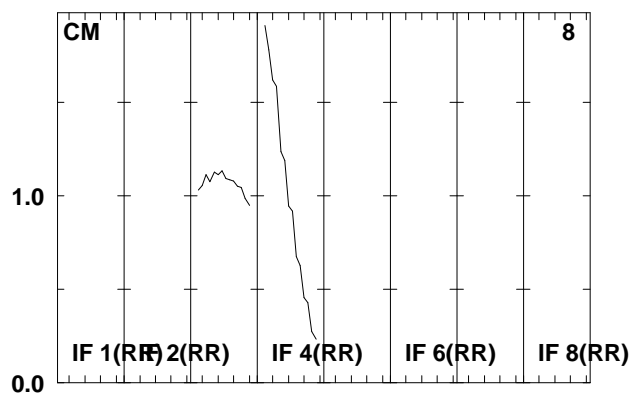
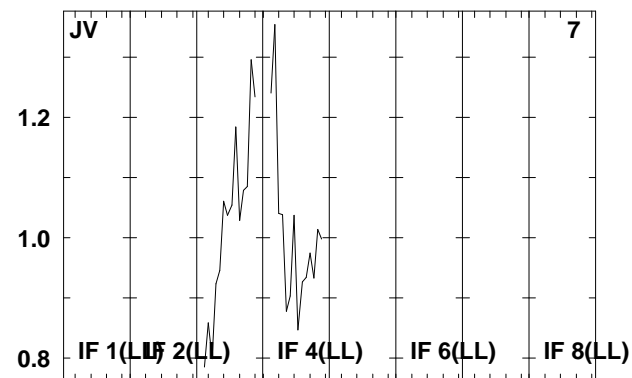
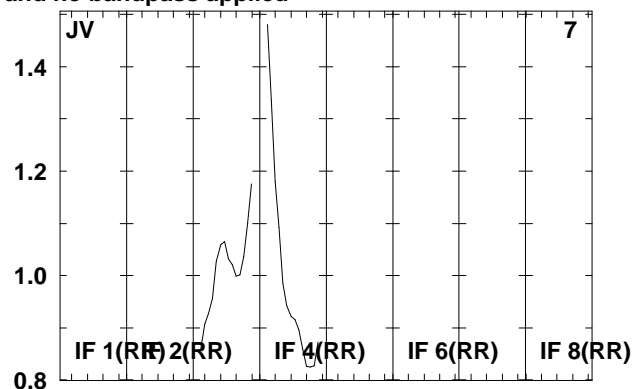
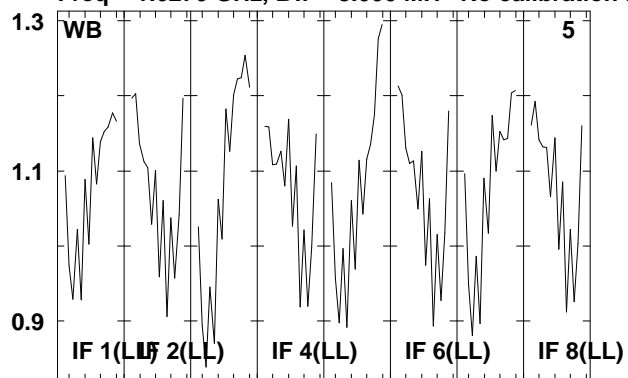

Lower frame: Real Jy

Total-power spectrum Antenna: \*

Timerange: 01/06:20:01 to 01/06:21:19

Plot file version 352 created 20-OCT-2009 14:52:38

M33 RP015C.UVDATA.1

Freq = 1.6270 GHz, Bw = 8.000 MH No calibration applied and no bandpass applied

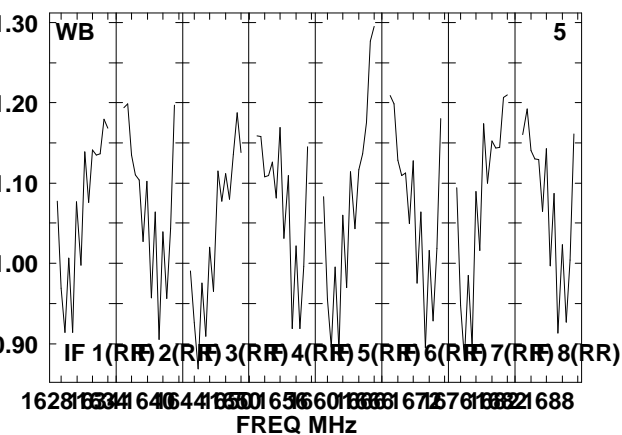
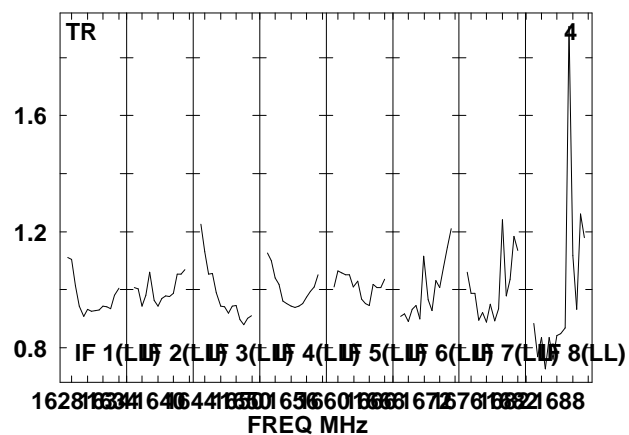
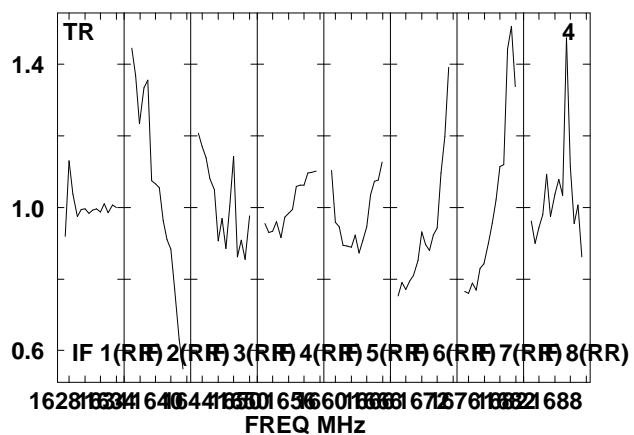
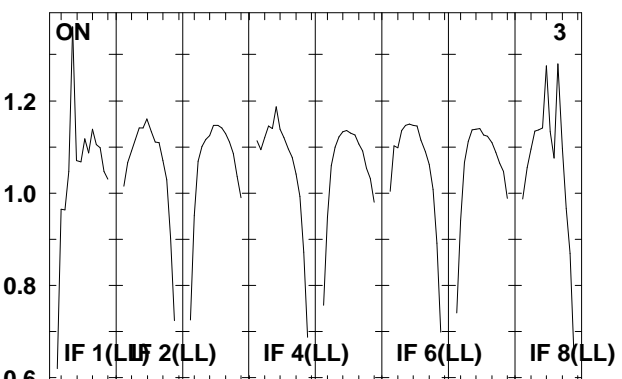
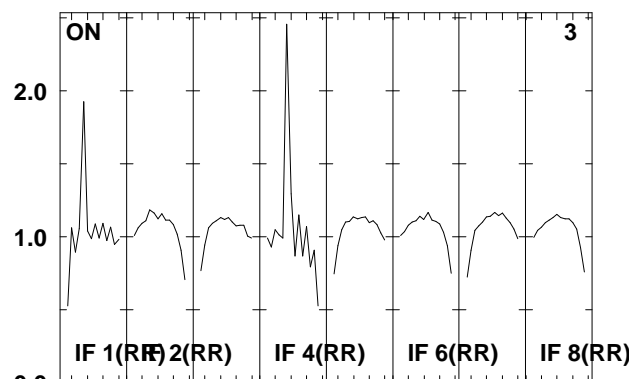
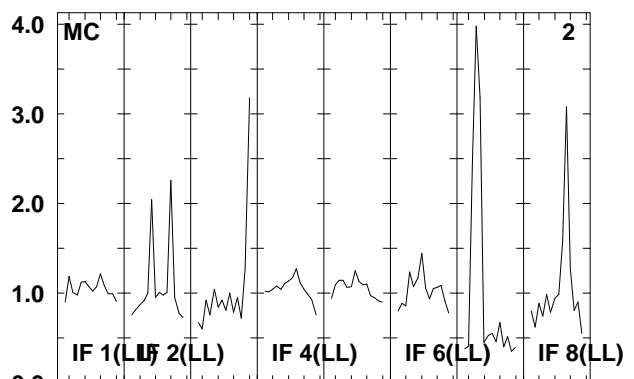
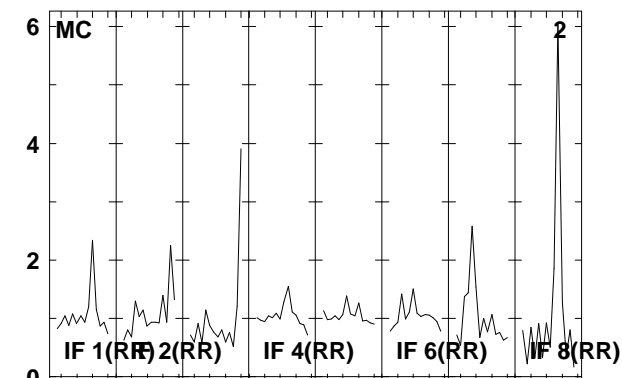
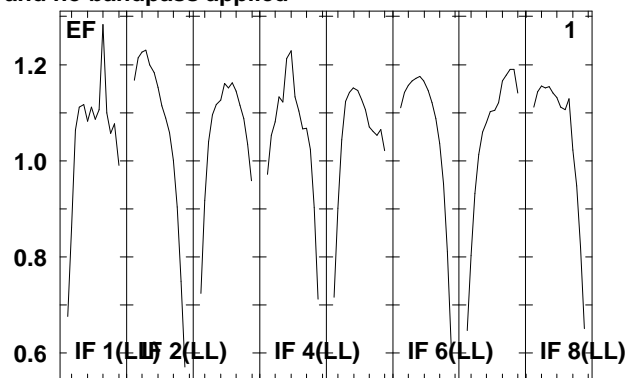
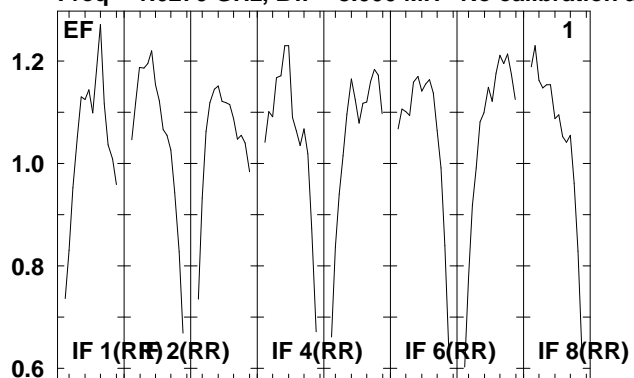

Lower frame: Real Jy

Total-power spectrum Antenna: \*

Timerange: 01/06:21:20 to 01/06:24:20



Plot file version 353 created 20-OCT-2009 14:52:39

M33 RP015C.UVDATA.1

Freq = 1.6270 GHz, Bw = 8.000 MH No calibration applied and no bandpass applied

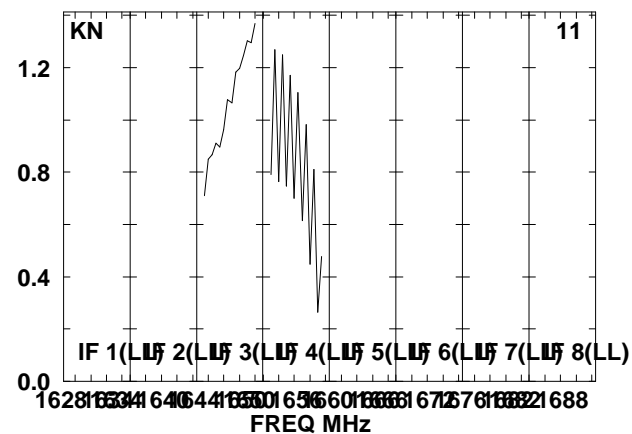
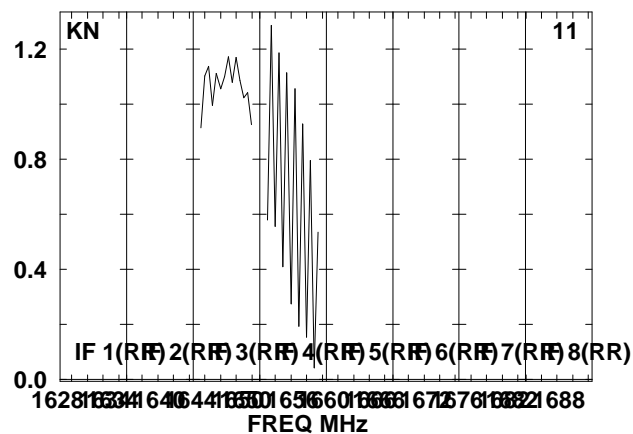
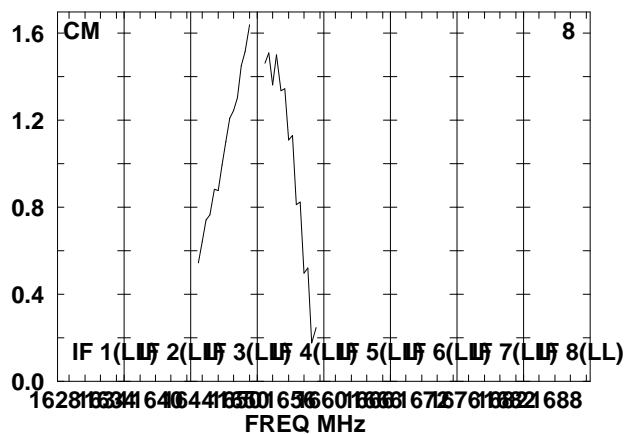
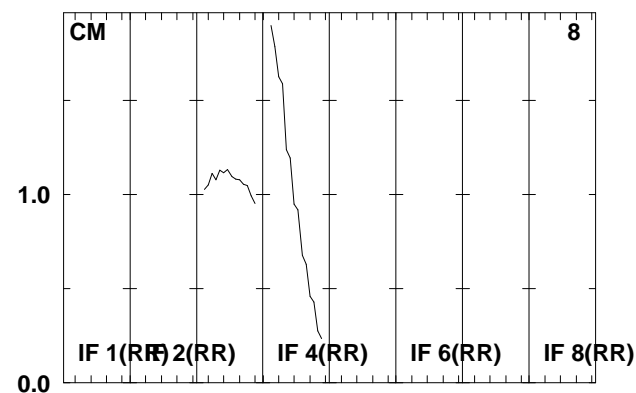
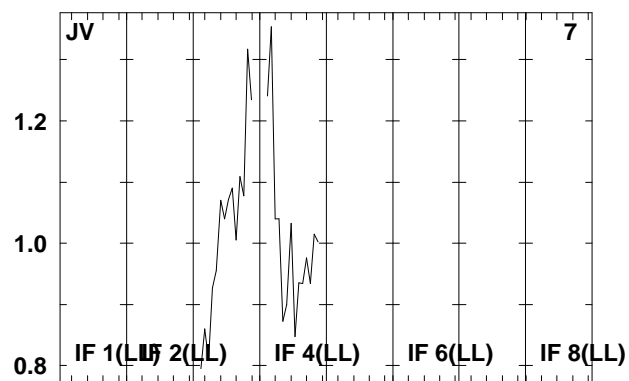
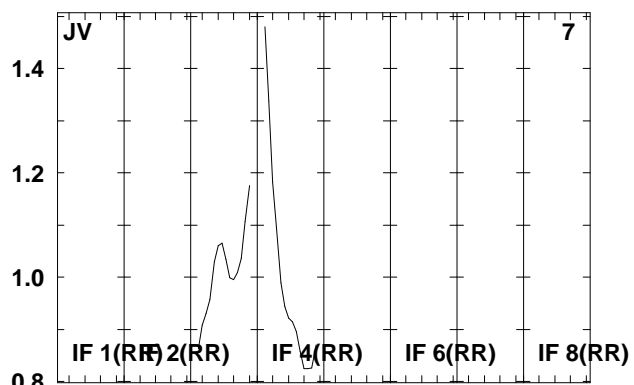
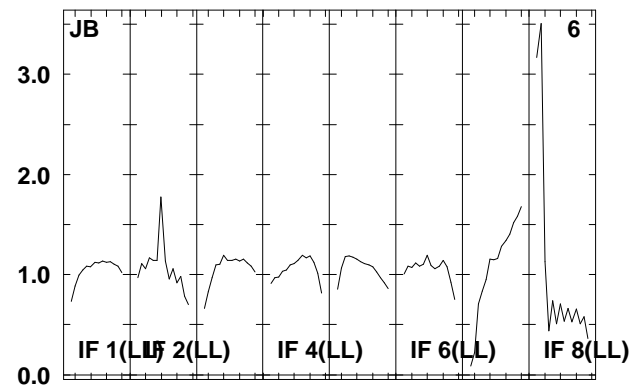
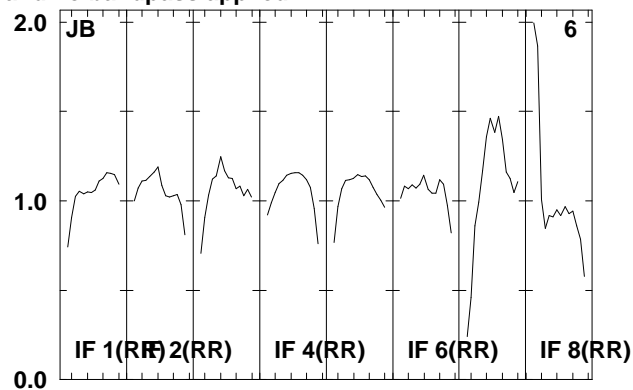
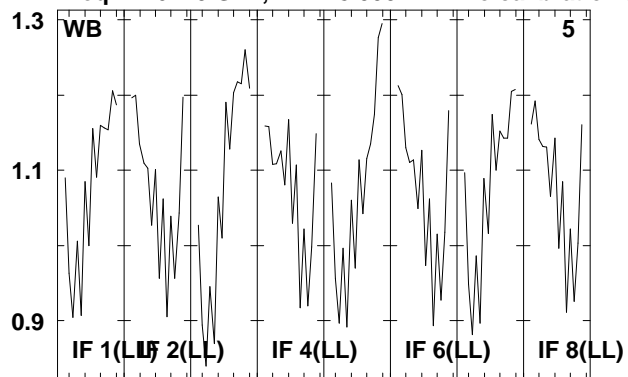

Lower frame: Real Jy

Total-power spectrum Antenna: \*

Timerange: 01/06:21:20 to 01/06:24:20

Plot file version 354 created 20-OCT-2009 14:52:41

M33 RP015C.UVDATA.1

Freq = 1.6270 GHz, Bw = 8.000 MH No calibration applied and no bandpass applied

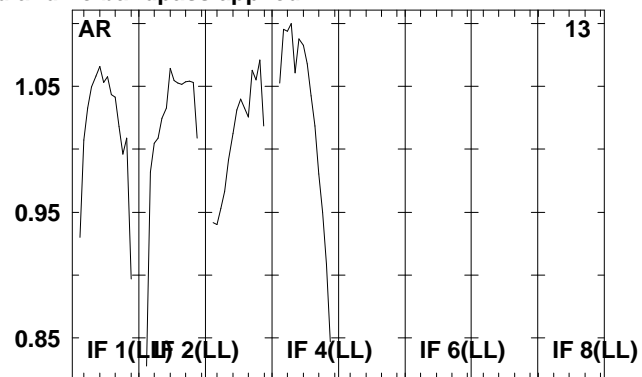
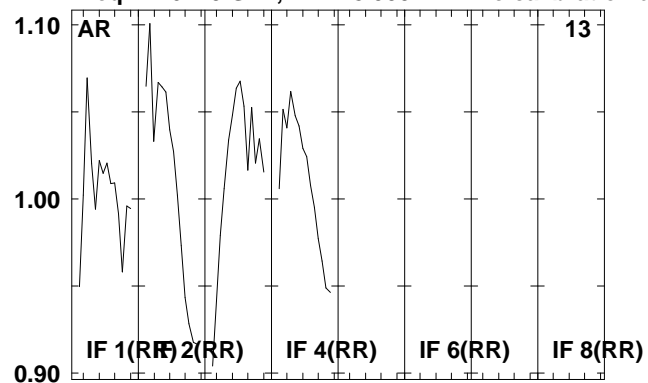

Lower frame: Real Jy  
Total-power spectrum Antenna: \*  
Timerange: 01/06:21:20 to 01/06:24:20

Plot file version 355 created 20-OCT-2009 14:52:41

J0137+31 RP015C.UVDATA.1

Freq = 1.6270 GHz, Bw = 8.000 MH No calibration applied and no bandpass applied

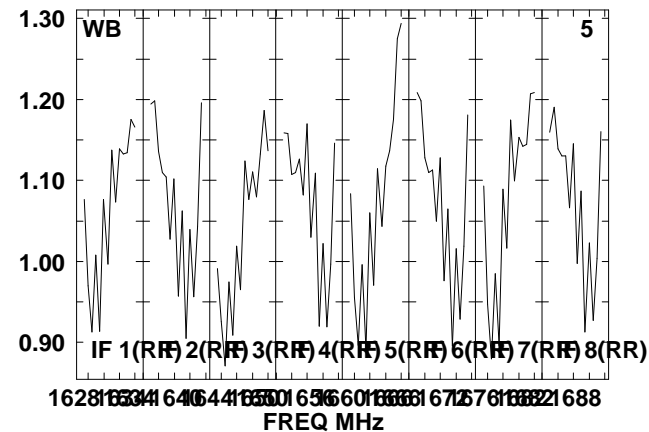
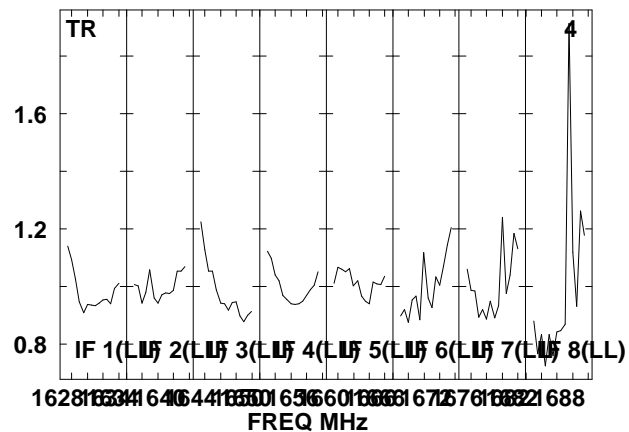
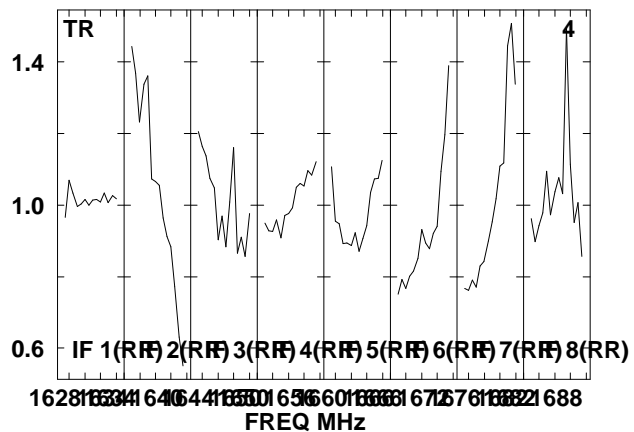
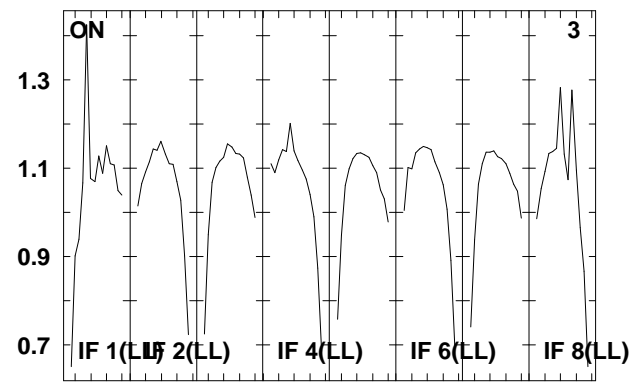
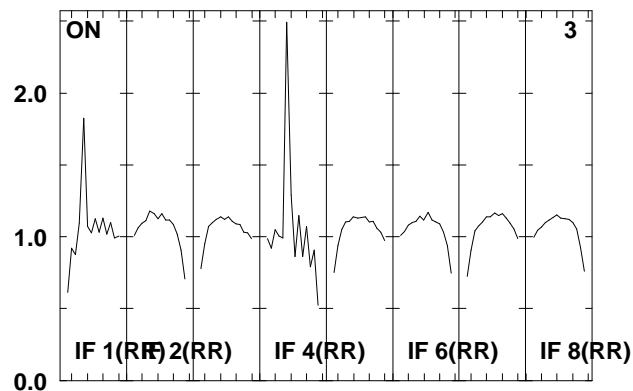
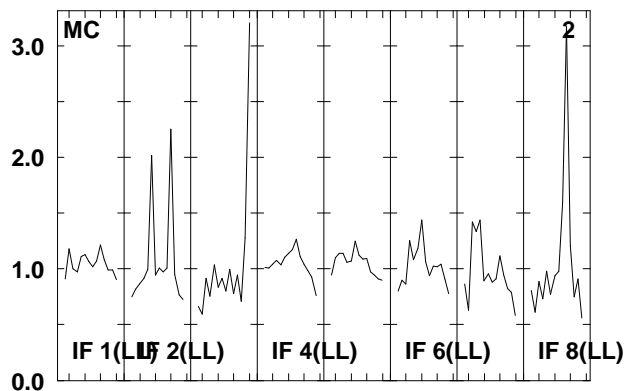
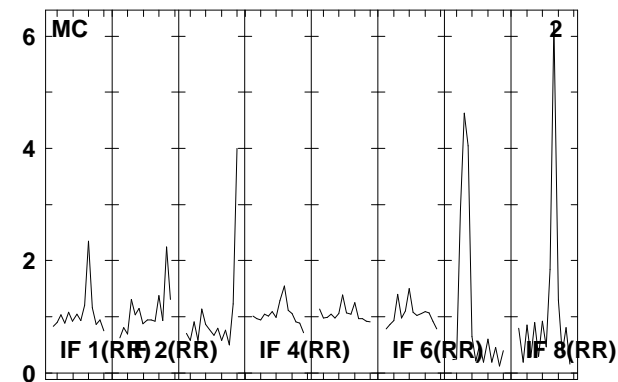
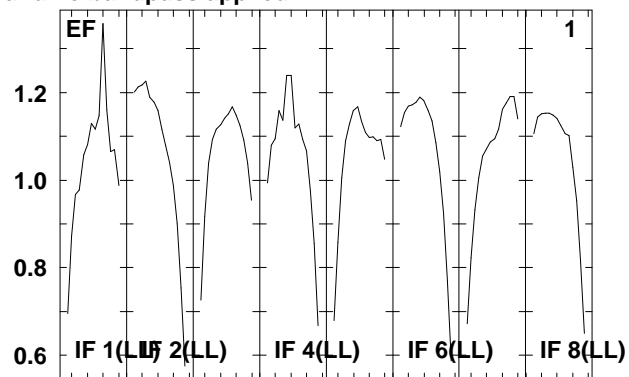
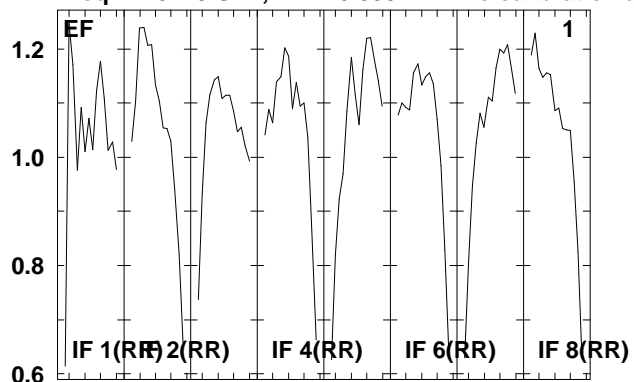

Lower frame: Real Jy

Total-power spectrum Antenna: \*

Timerange: 01/06:25:00 to 01/06:25:59

Plot file version 356 created 20-OCT-2009 14:52:41  
 J0137+31 RP015C.UVDATA.1  
 Freq = 1.6270 GHz, Bw = 8.000 MH No calibration applied and no bandpass applied

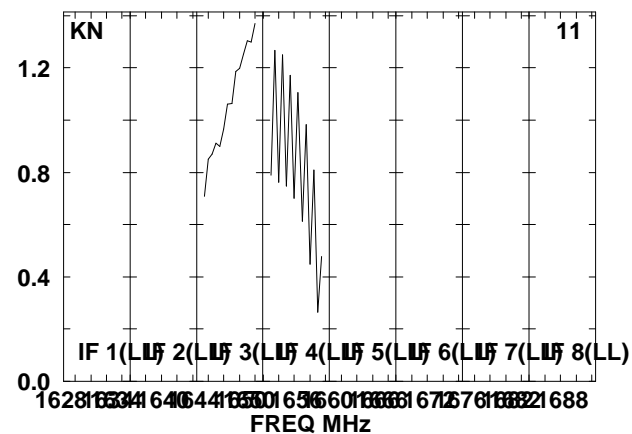
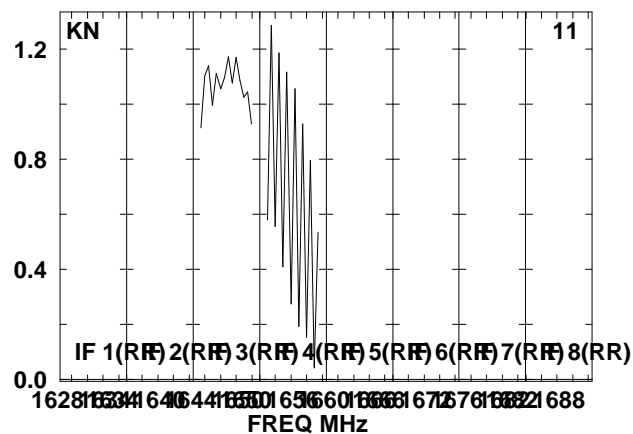
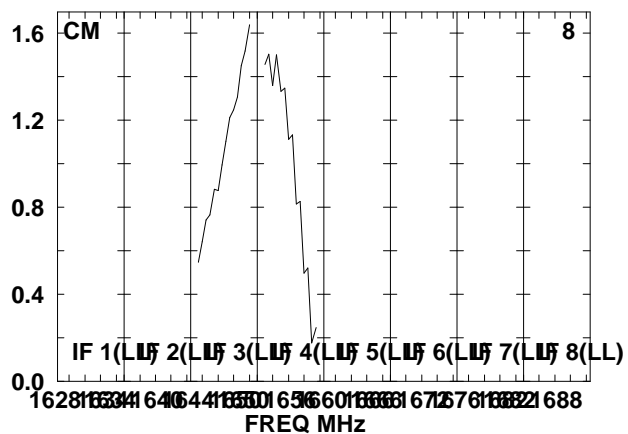
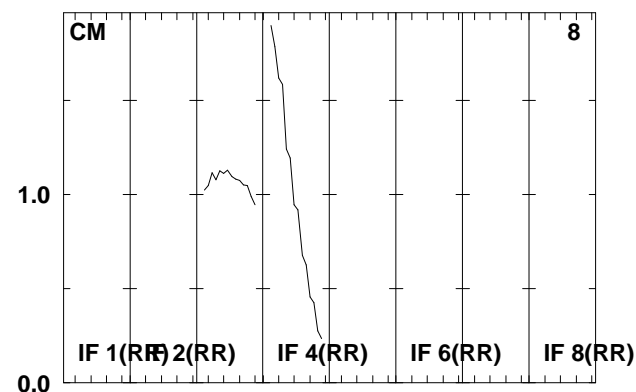
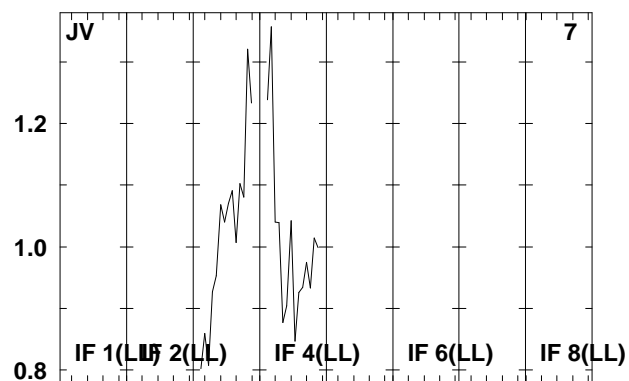
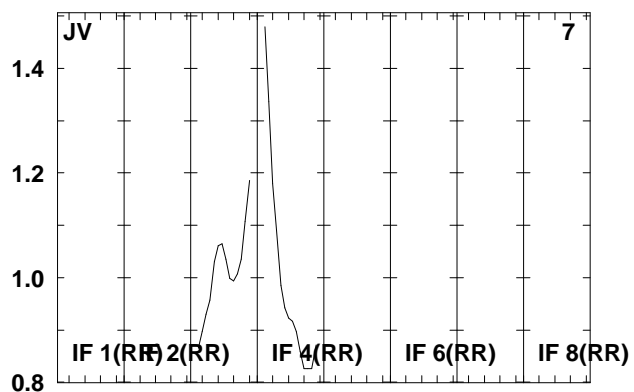
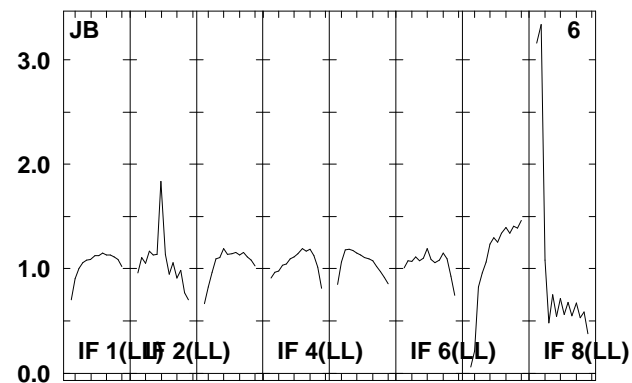
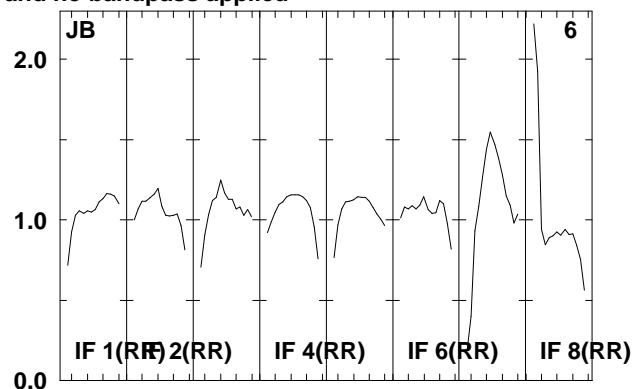
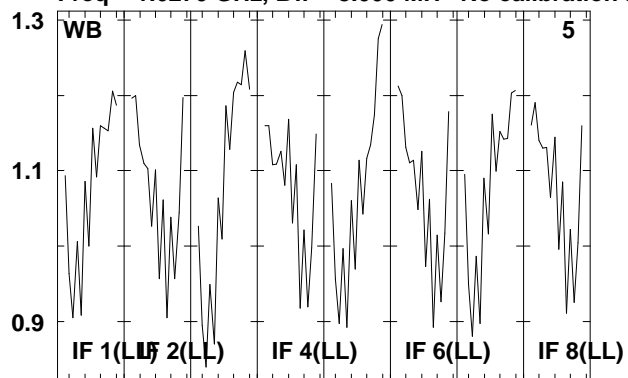

Lower frame: Real Jy  
 Total-power spectrum Antenna: \*  
 Timerange: 01/06:25:00 to 01/06:25:59

Plot file version 357 created 20-OCT-2009 14:52:42

J0137+31 RP015C.UVDATA.1

Freq = 1.6270 GHz, Bw = 8.000 MH No calibration applied and no bandpass applied

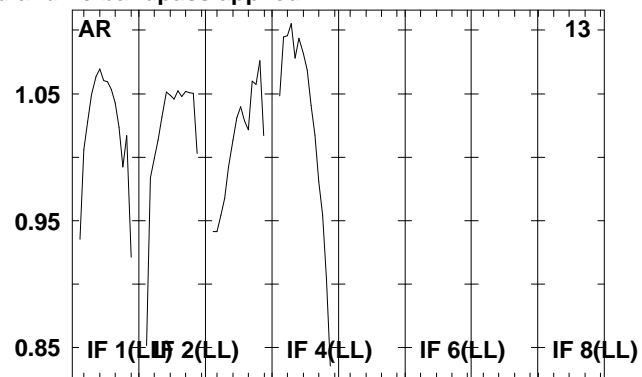
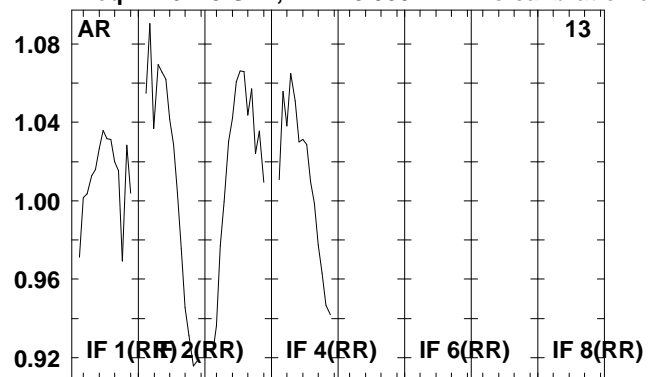

Lower frame: Real Jy  
Total-power spectrum Antenna: \*  
Timerange: 01/06:25:00 to 01/06:25:59

Plot file version 358 created 20-OCT-2009 14:52:42

FAINTCAL RP015C.UVDATA.1

Freq = 1.6270 GHz, Bw = 8.000 MH No calibration applied and no bandpass applied

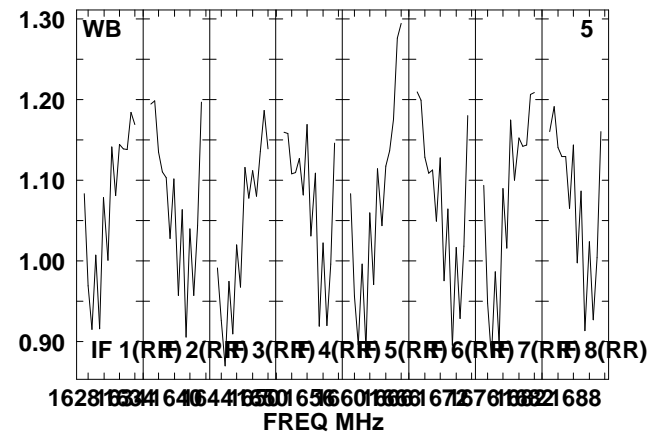
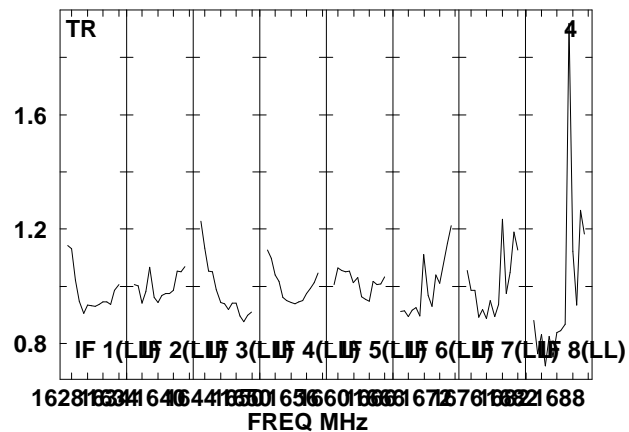
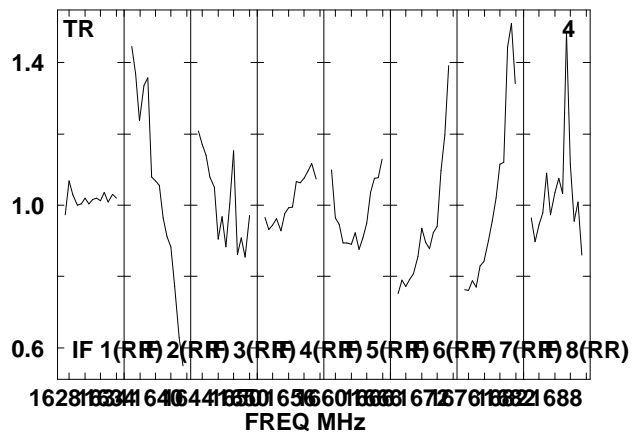
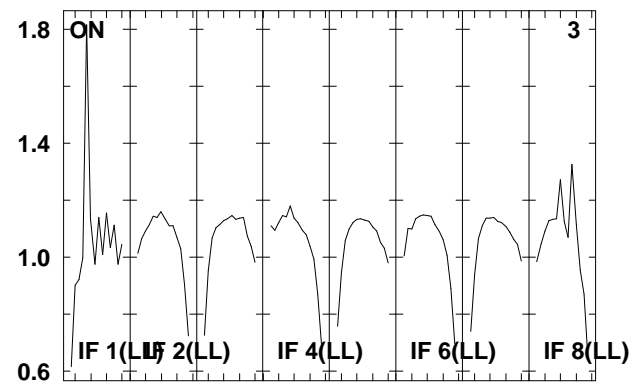
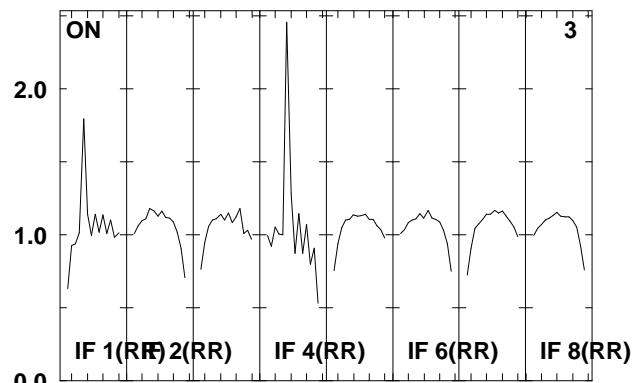
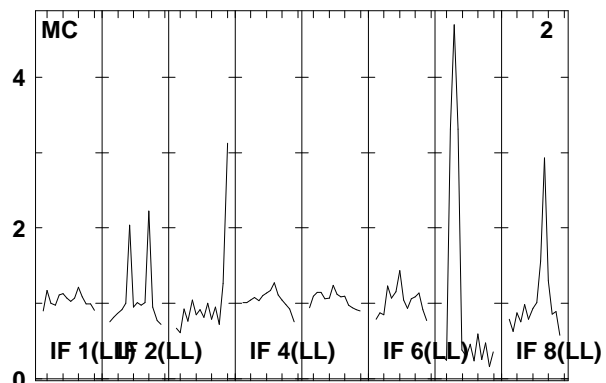
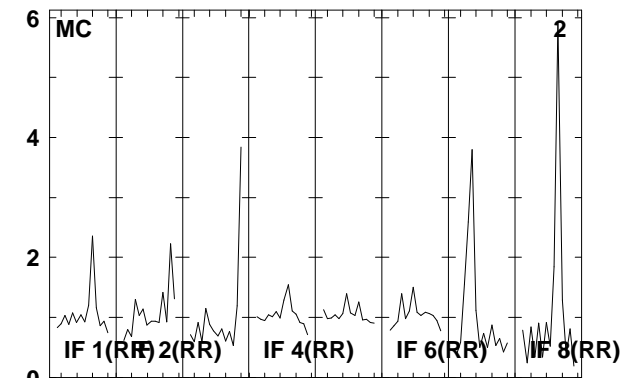
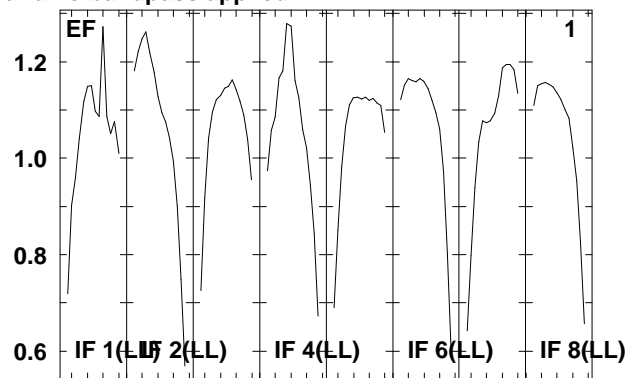
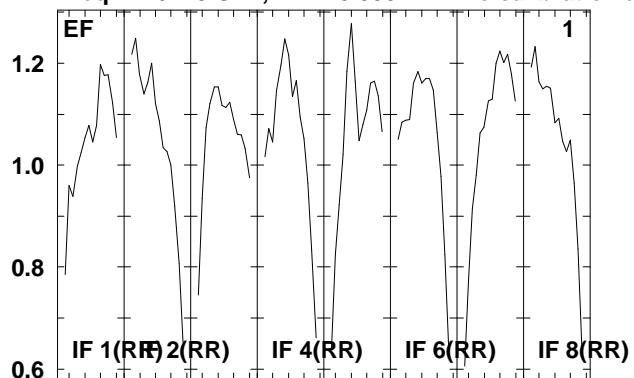

Lower frame: Real Jy

Total-power spectrum Antenna: \*

Timerange: 01/06:26:01 to 01/06:27:20

Plot file version 359 created 20-OCT-2009 14:52:42

FAINTCAL RP015C.UVDATA.1

Freq = 1.6270 GHz, Bw = 8.000 MH No calibration applied and no bandpass applied

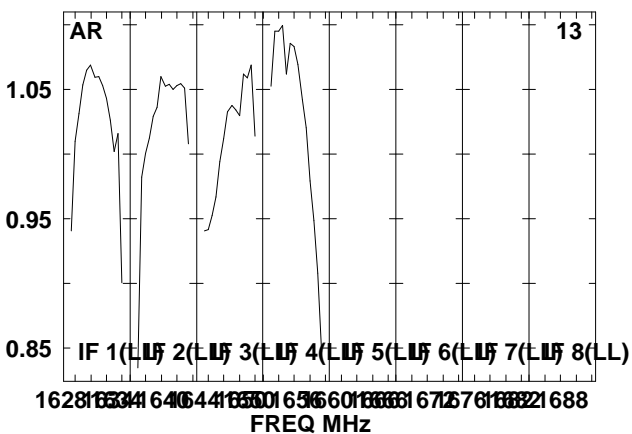
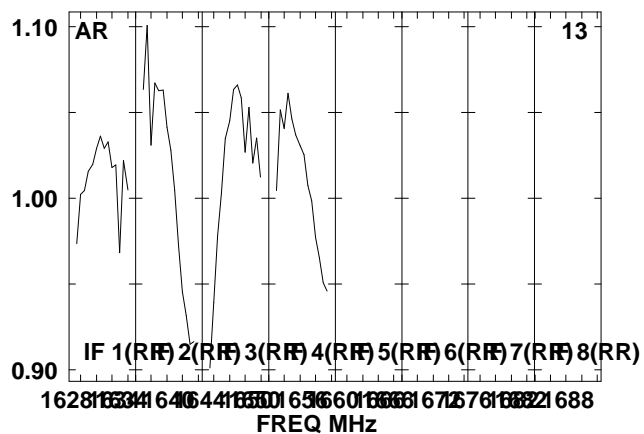
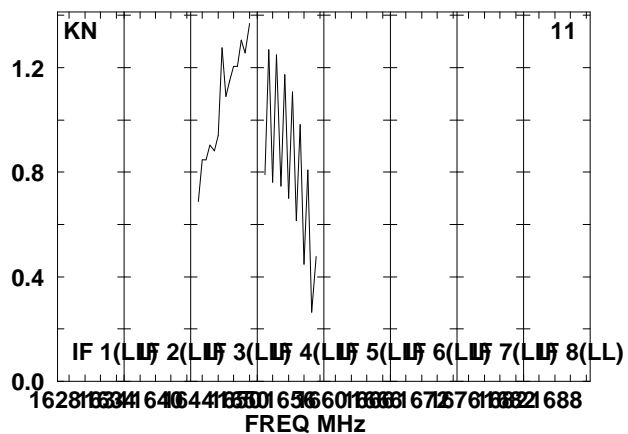
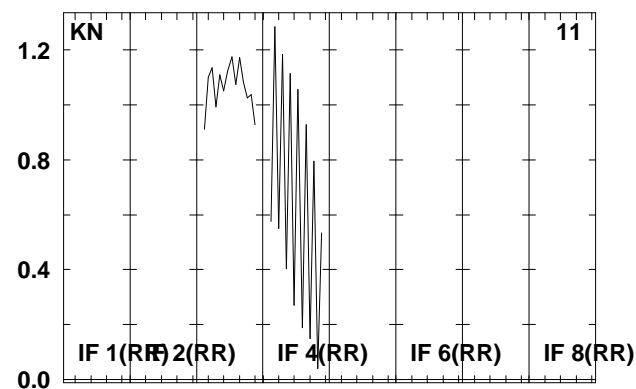
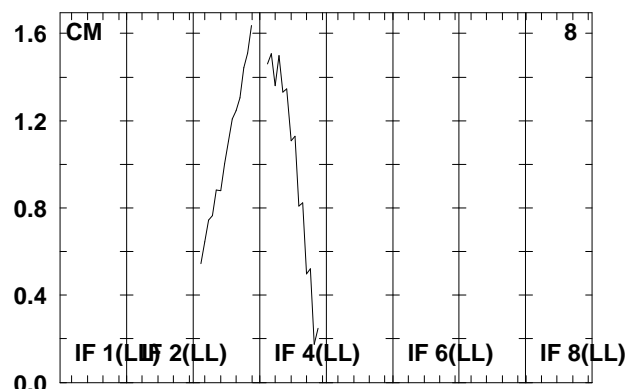
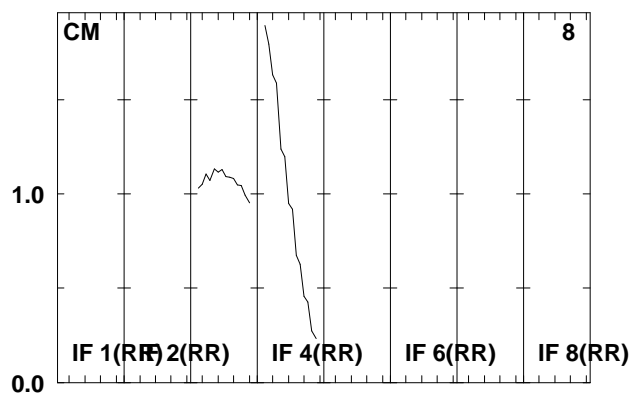
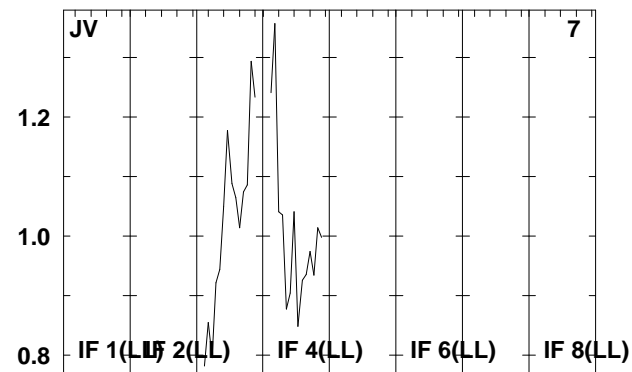
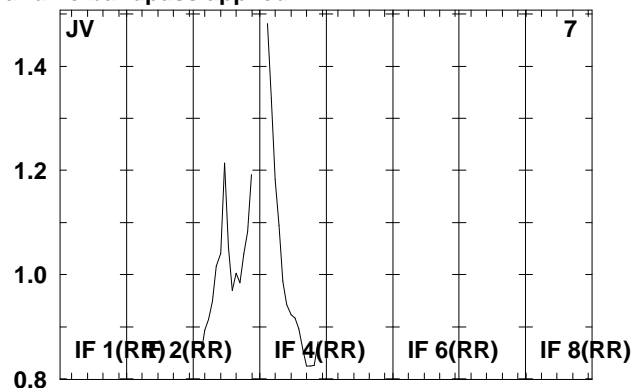
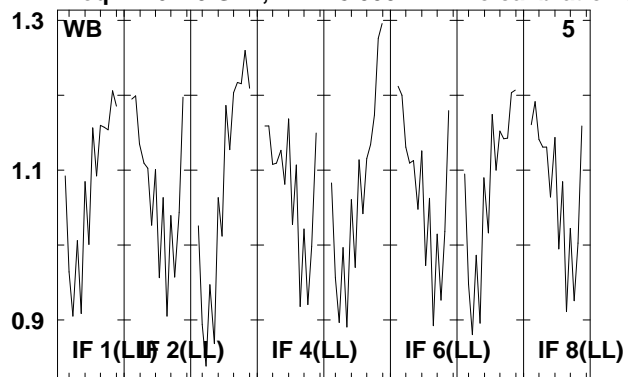

Lower frame: Real Jy

Total-power spectrum Antenna: \*

Timerange: 01/06:26:01 to 01/06:27:20

Plot file version 360 created 20-OCT-2009 14:52:44

M33 RP015C.UVDATA.1

Freq = 1.6270 GHz, Bw = 8.000 MH No calibration applied and no bandpass applied

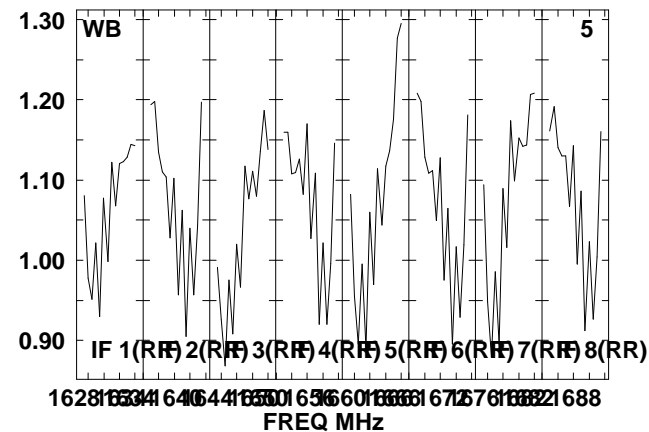
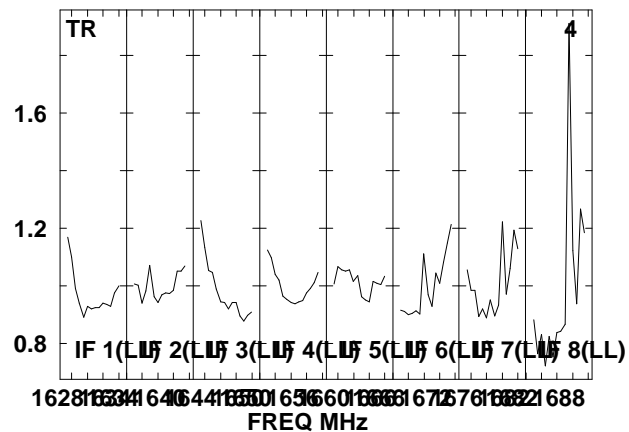
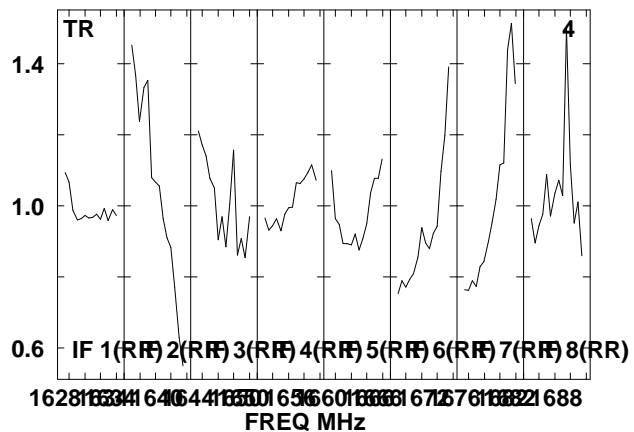
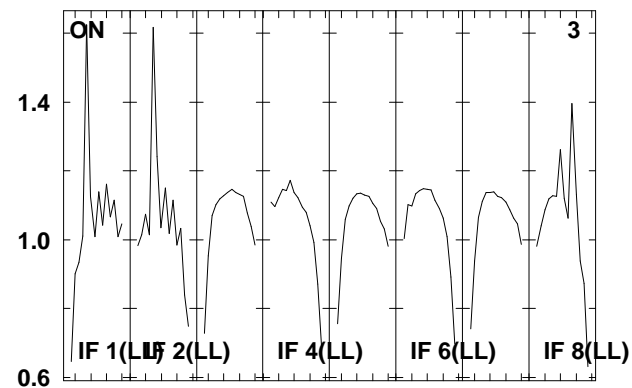
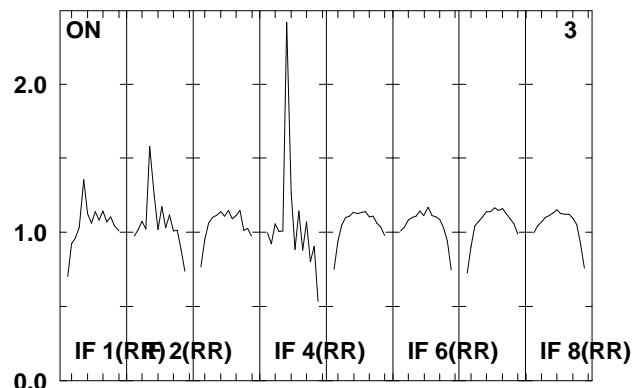
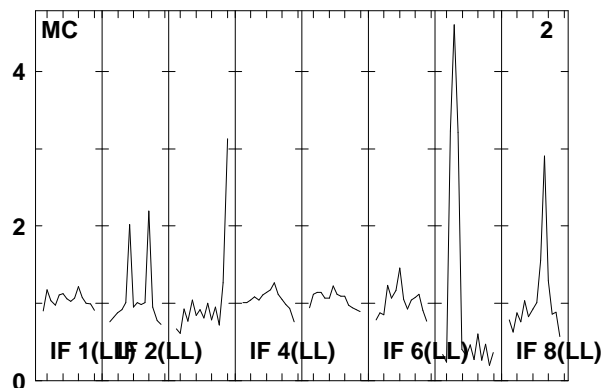
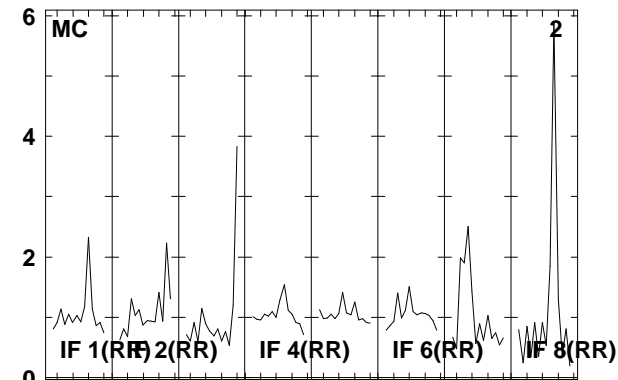
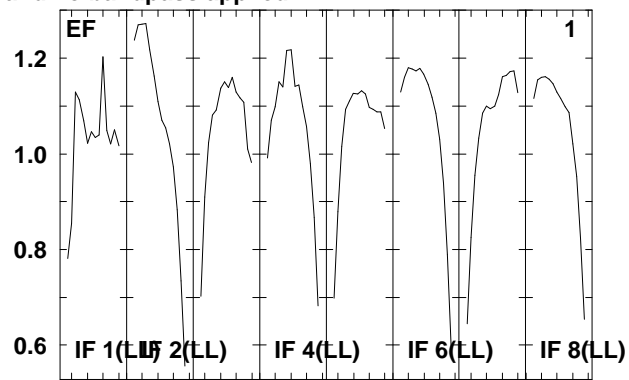
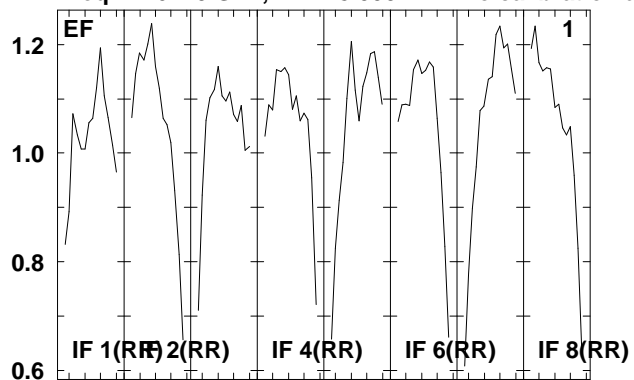

Lower frame: Real Jy

Total-power spectrum Antenna: \*

Timerange: 01/06:27:20 to 01/06:30:20



Plot file version 361 created 20-OCT-2009 14:52:44

M33 RP015C.UVDATA.1

Freq = 1.6270 GHz, Bw = 8.000 MH No calibration applied and no bandpass applied

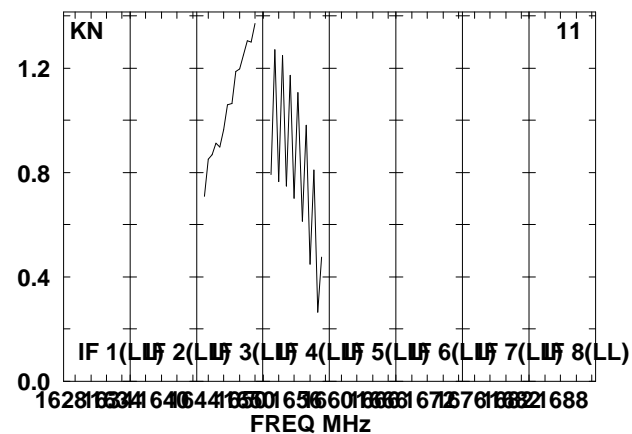
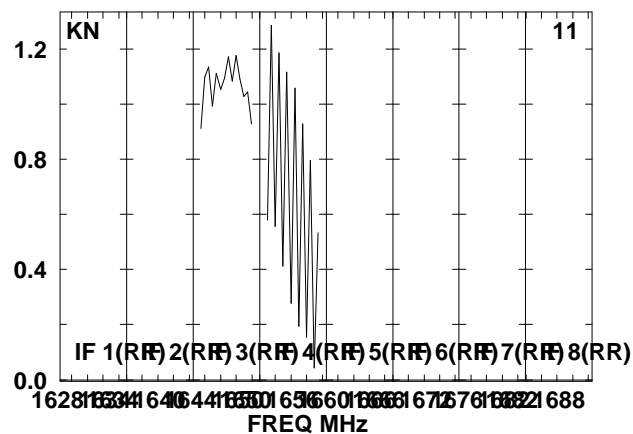
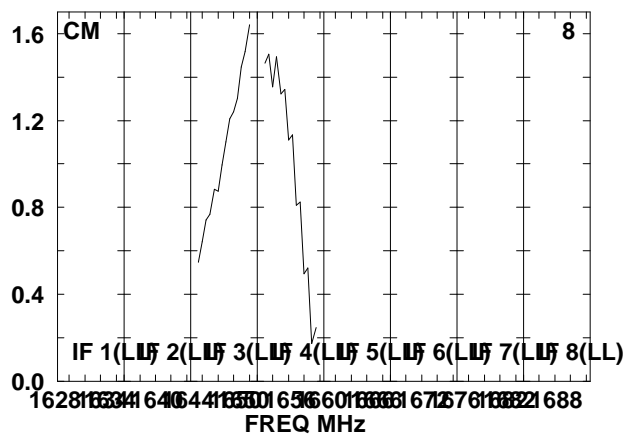
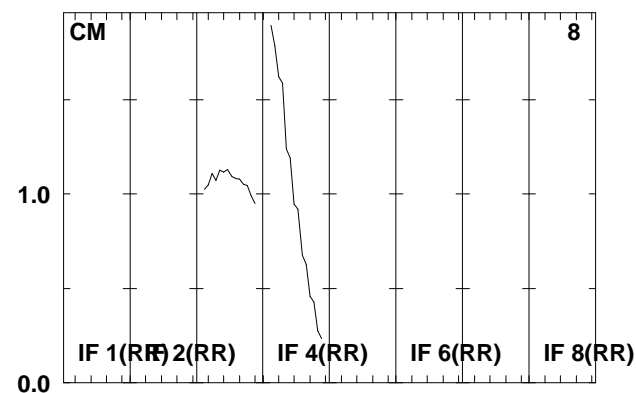
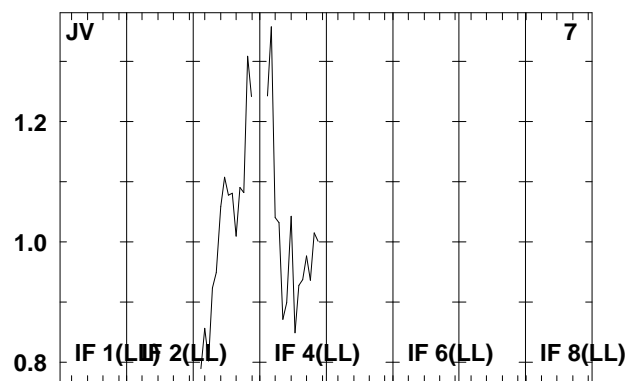
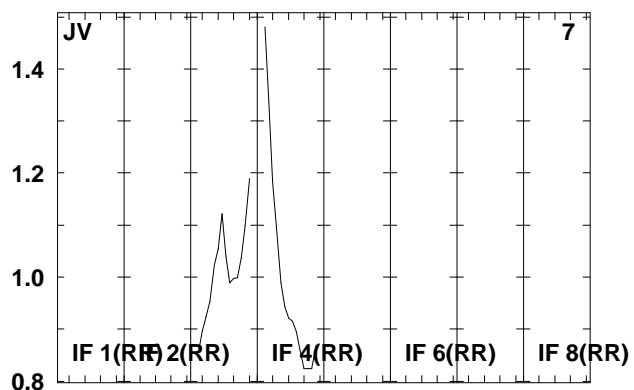
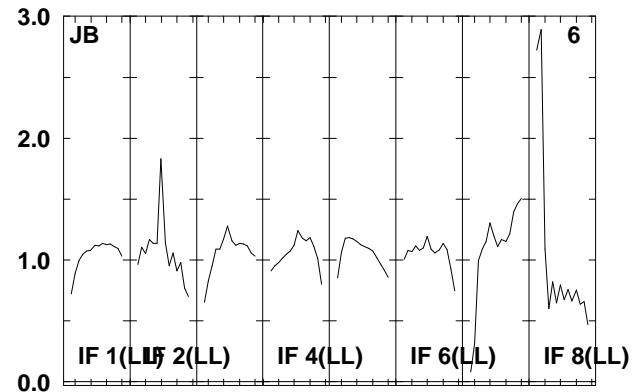
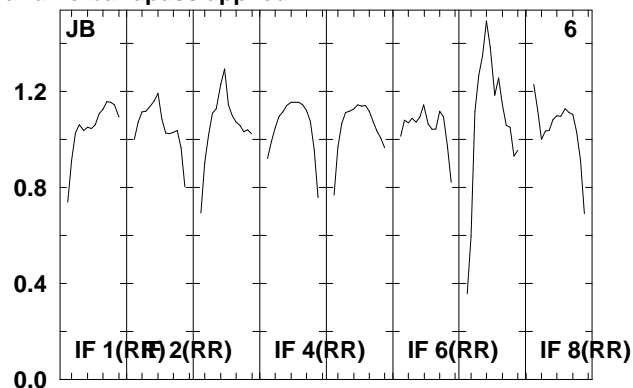
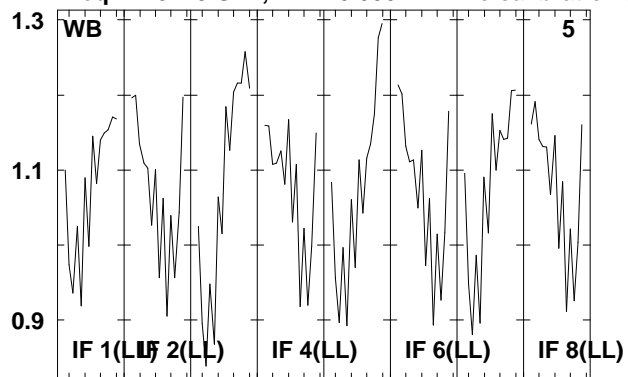

Lower frame: Real Jy

Total-power spectrum Antenna: \*

Timerange: 01/06:27:20 to 01/06:30:20

Plot file version 362 created 20-OCT-2009 14:52:46

M33 RP015C.UVDATA.1

Freq = 1.6270 GHz, Bw = 8.000 MH No calibration applied and no bandpass applied

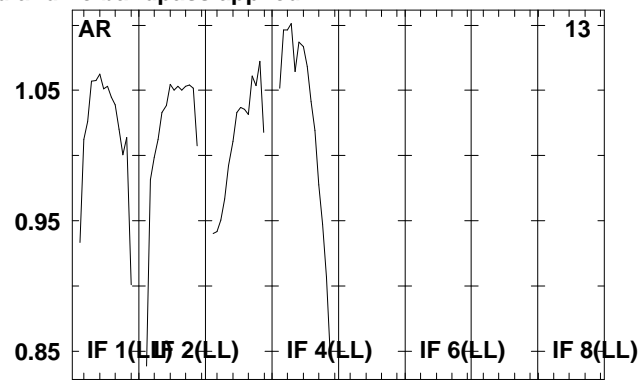
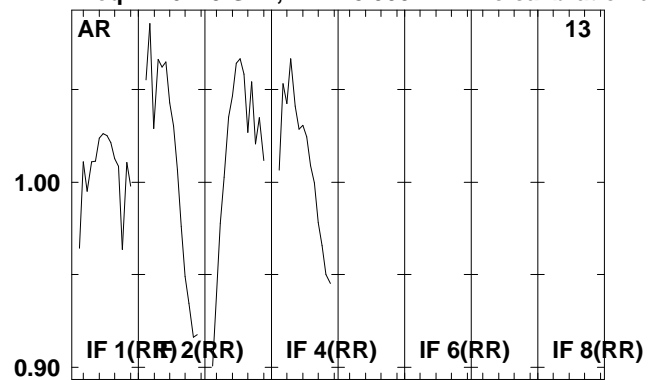

Lower frame: Real Jy  
Total-power spectrum Antenna: \*  
Timerange: 01/06:27:20 to 01/06:30:20

Plot file version 363 created 20-OCT-2009 14:52:47

DA193 RP015C.UVDATA.1

Freq = 1.6270 GHz, Bw = 8.000 MH No calibration applied and no bandpass applied

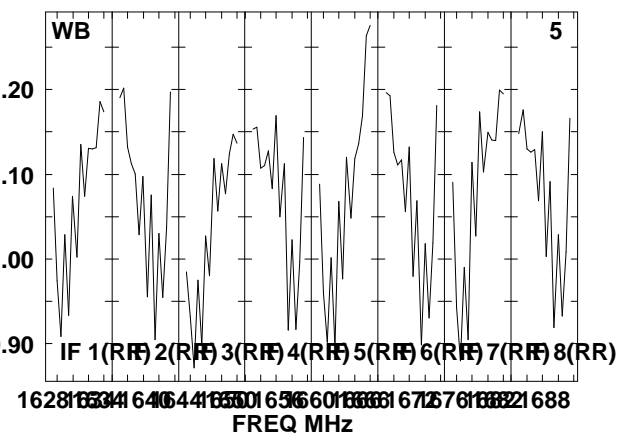
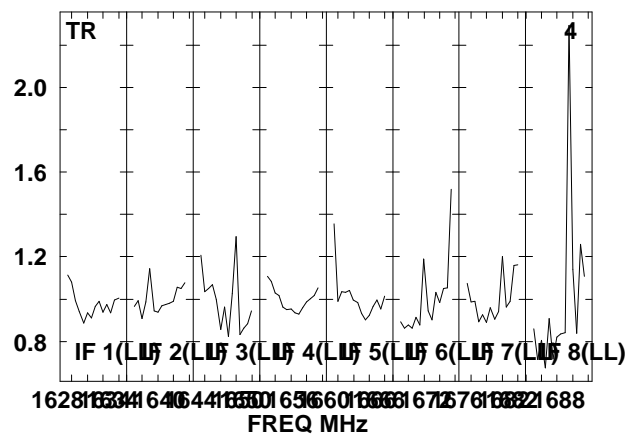
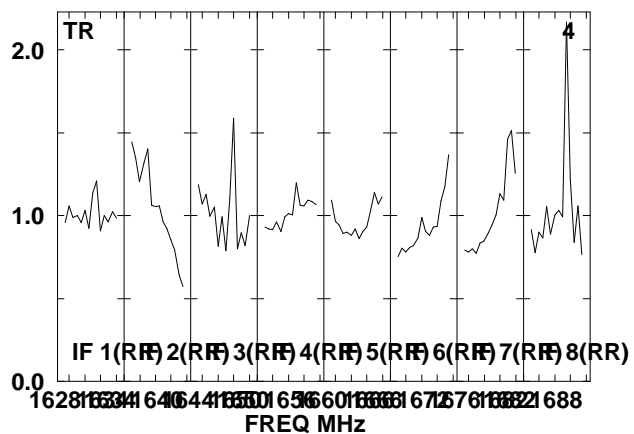
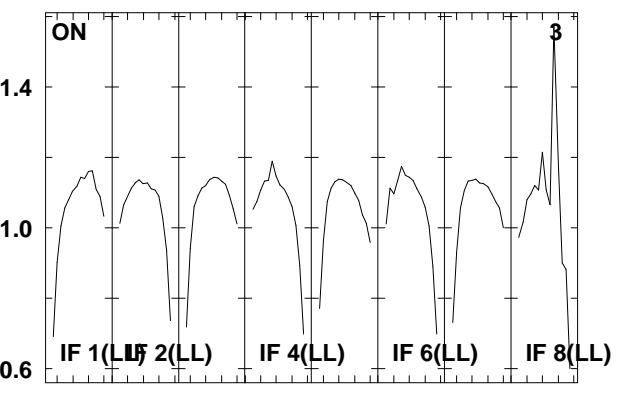
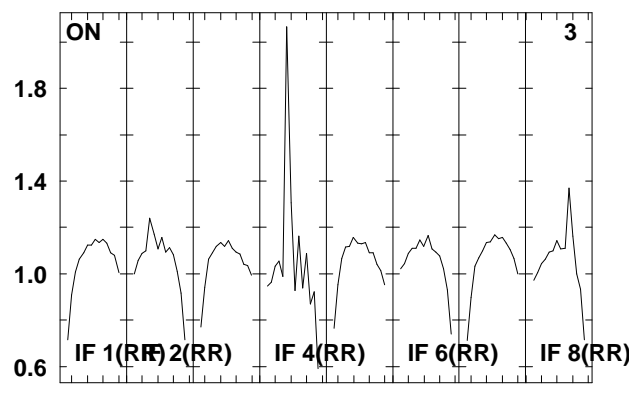
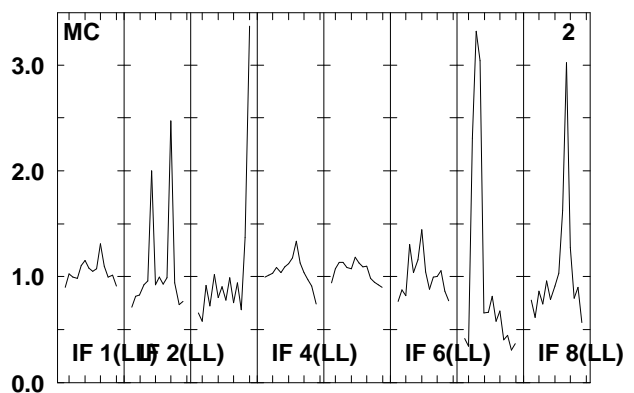
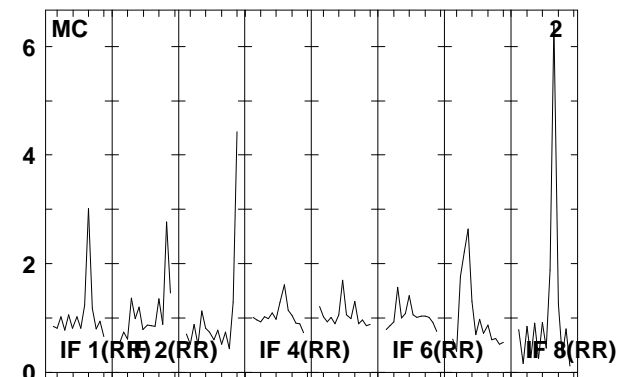
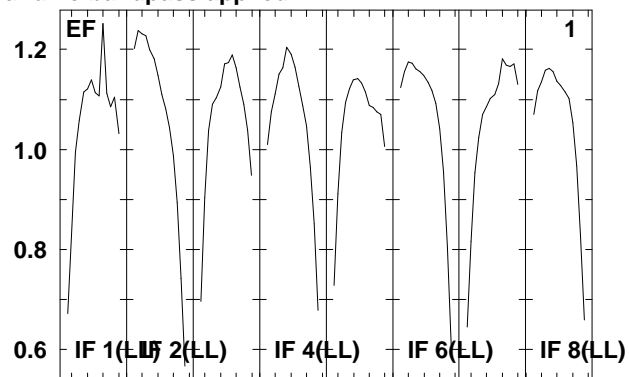
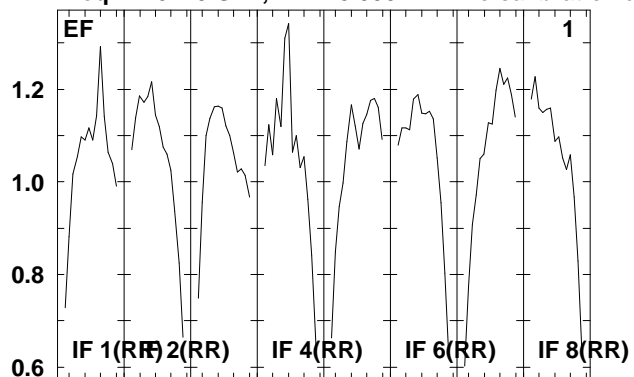

Lower frame: Real Jy

Total-power spectrum Antenna: \*

Timerange: 01/06:37:09 to 01/06:46:59

Plot file version 364 created 20-OCT-2009 14:52:49

DA193 RP015C.UVDATA.1

Freq = 1.6270 GHz, Bw = 8.000 MH No calibration applied and no bandpass applied

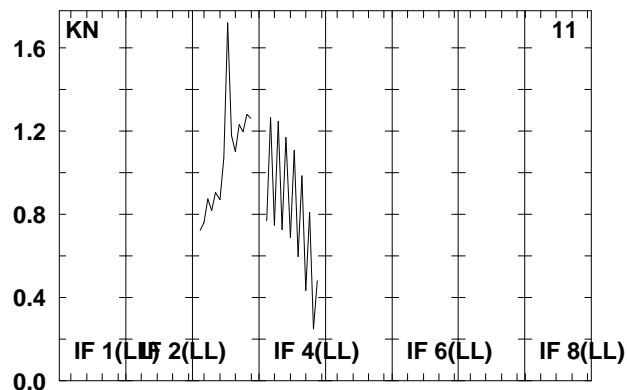
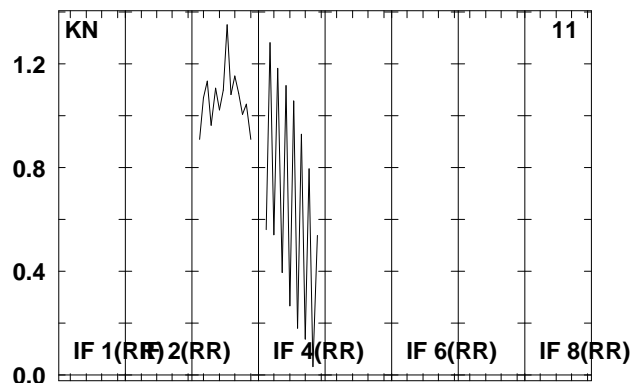
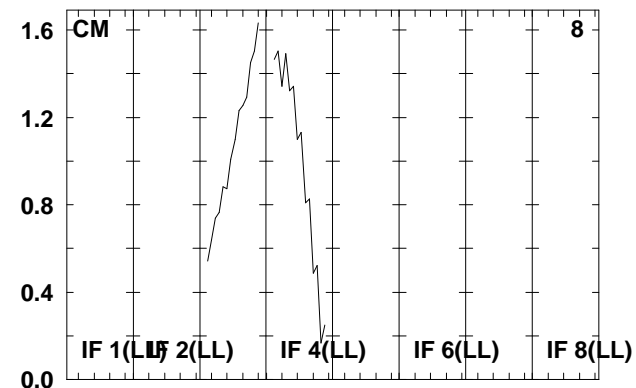
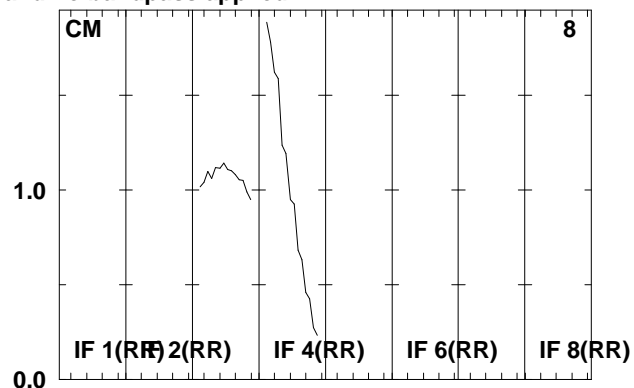
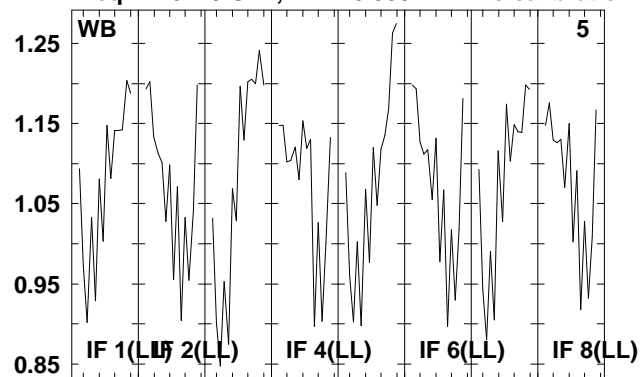

Lower frame: Real Jy  
Total-power spectrum Antenna: \*  
Timerange: 01/06:37:09 to 01/06:46:59