

Plot file version 1 created 04-OCT-2010 10:12:02

1156+295 RP016A.UVDATA.1

Freq = 4.9410 GHz, Bw = 16.000 MH No calibration applied and no bandpass applied

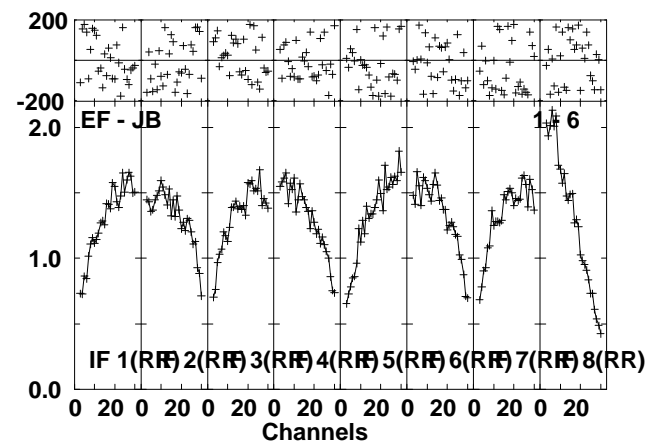
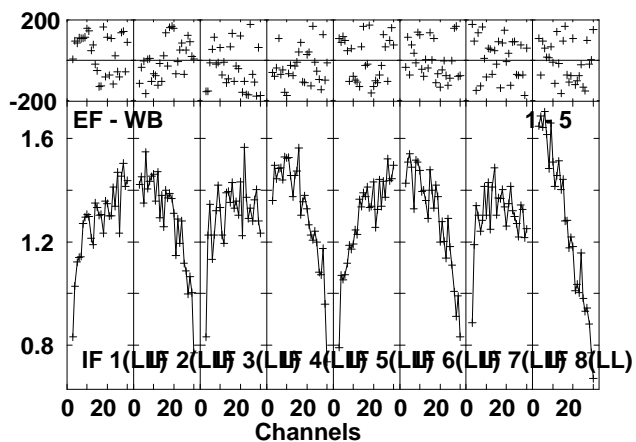
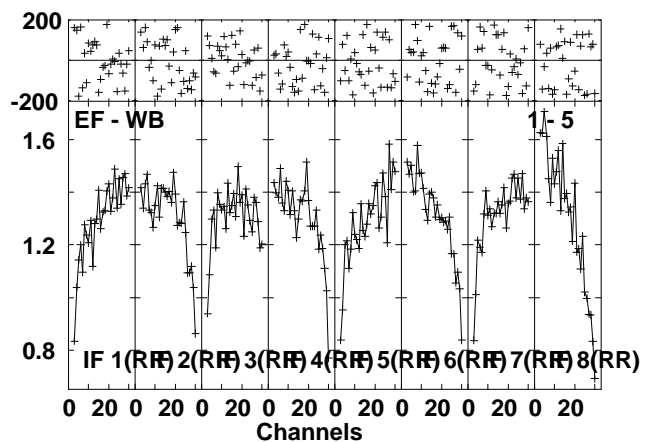
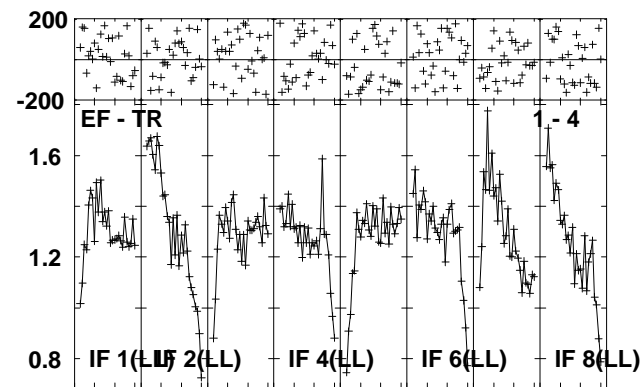
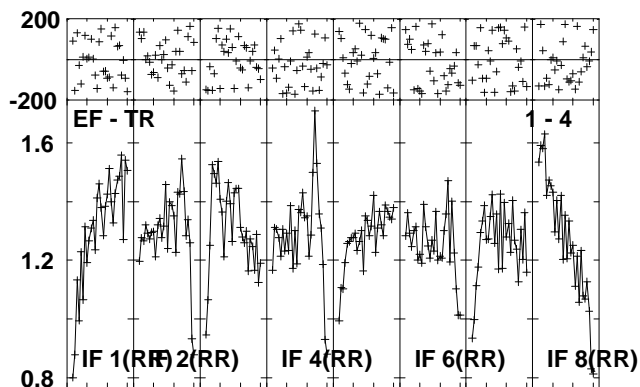
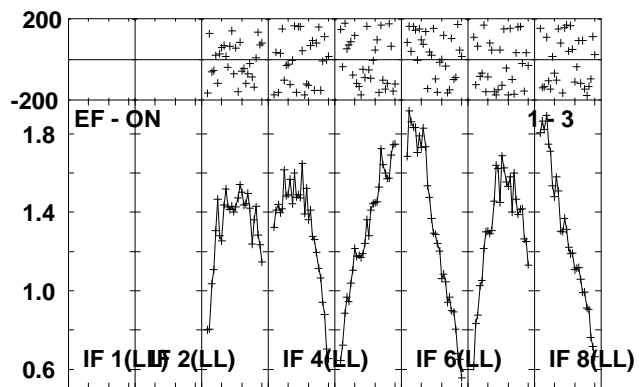
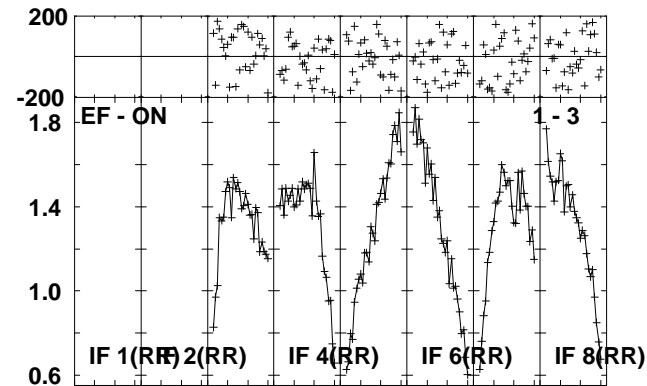
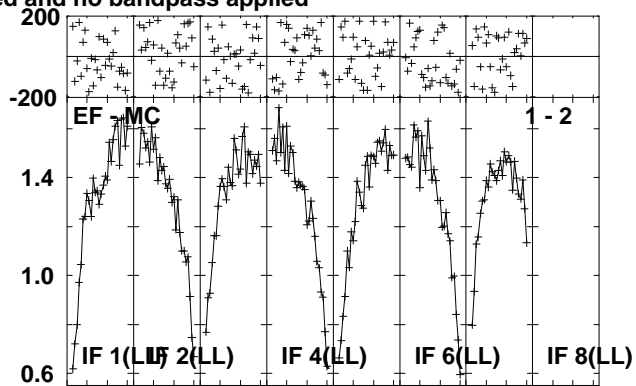
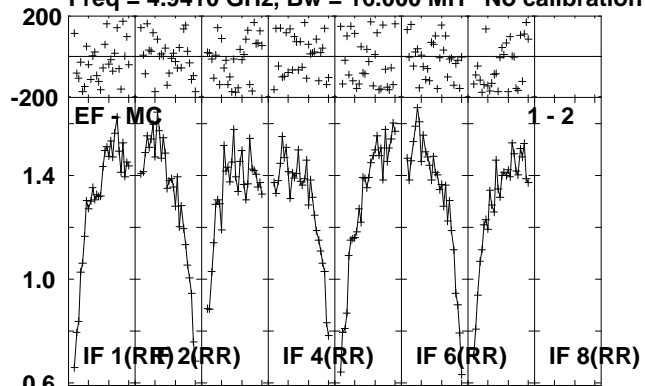

Lower frame: Milli Ampl Jy Top frame: Phas deg
Scalar averaged cross-power spectrum Several baselines displayed
Timerange: 00/12:00:01 to 00/12:21:59

Plot file version 2 created 04-OCT-2010 10:12:15
1156+295 RP016A.UVDATA.1

Freq = 4.9410 GHz, Bw = 16.000 MH No calibration applied and no bandpass applied

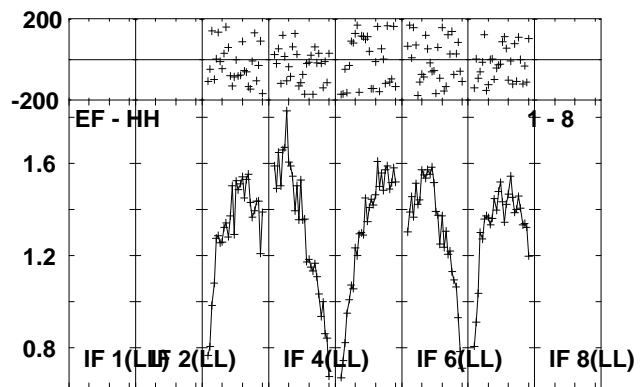
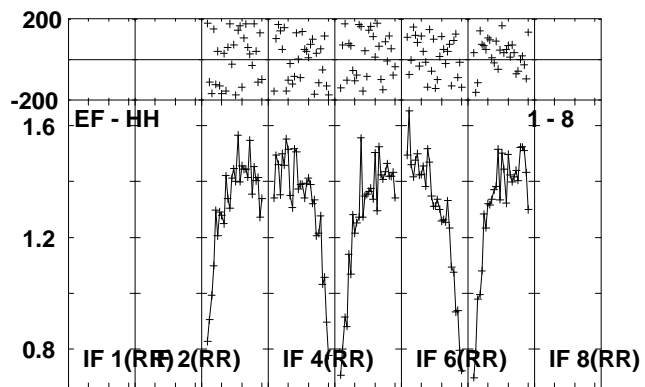
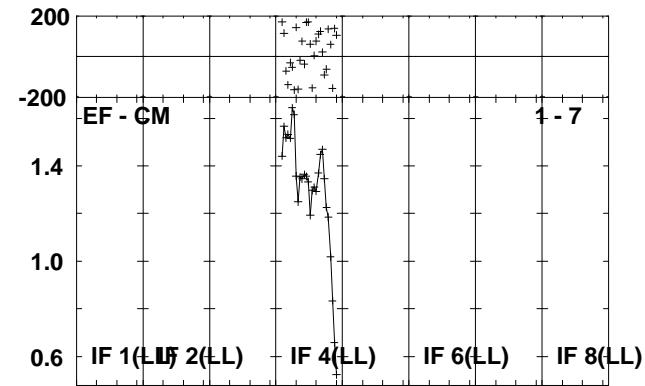
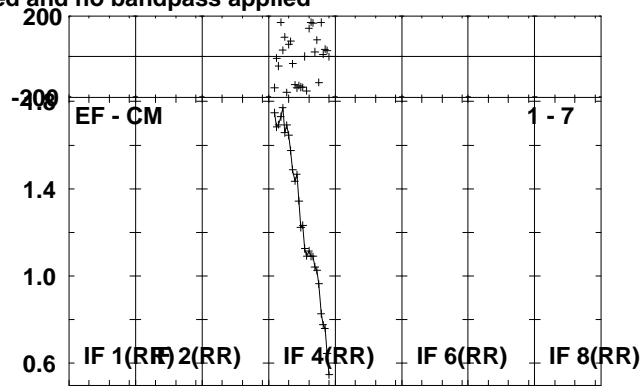
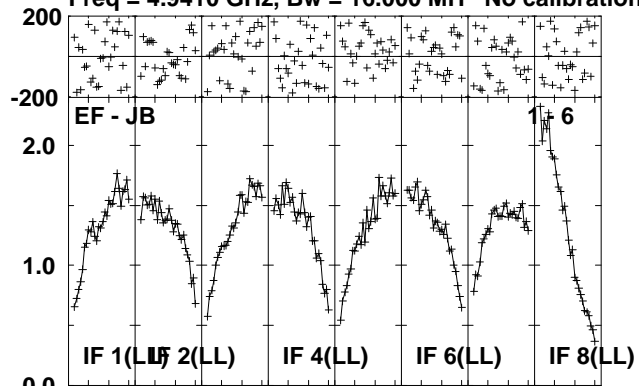

Lower frame: Milli Ampl Jy Top frame: Phas deg
Scalar averaged cross-power spectrum Several baselines displayed
Timerange: 00/12:00:01 to 00/12:21:59

Plot file version 3 created 04-OCT-2010 10:12:23

1156+295 RP016A.UVDATA.1

Freq = 4.9410 GHz, Bw = 16.000 MH No calibration applied and no bandpass applied

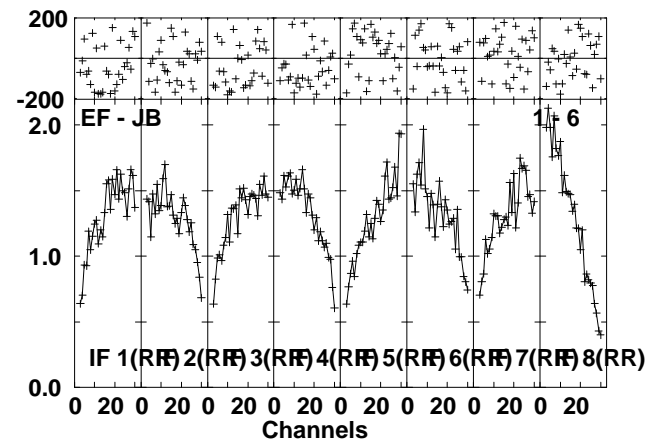
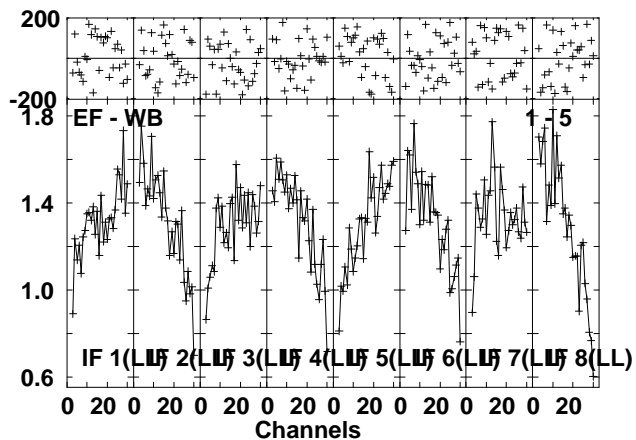
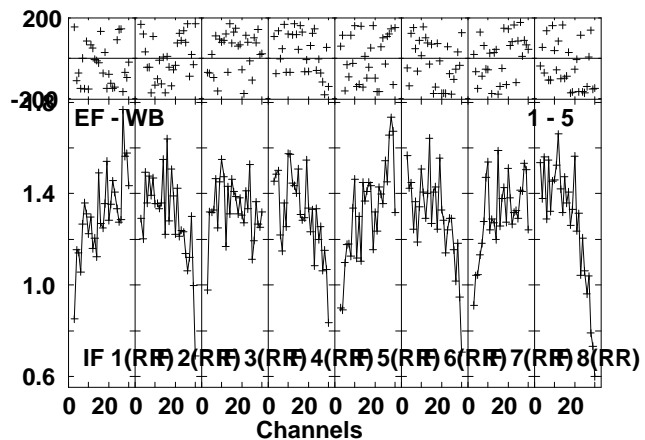
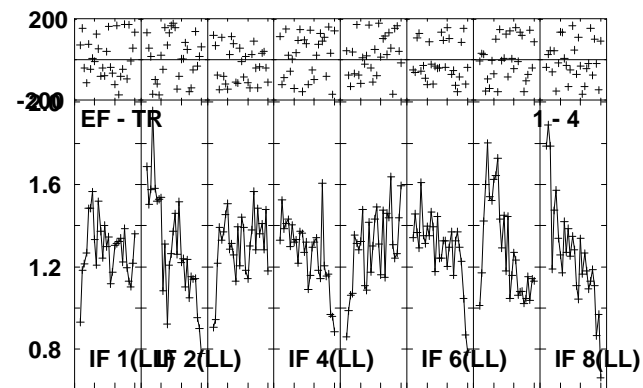
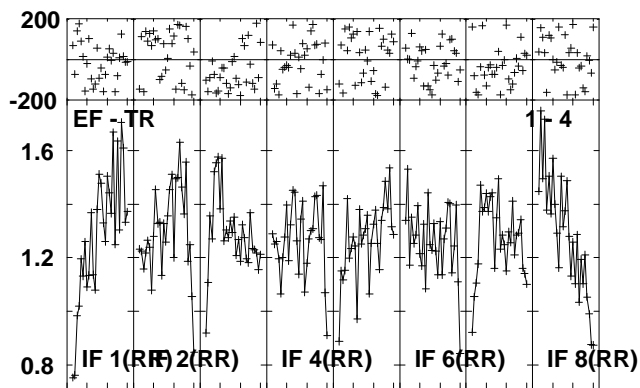
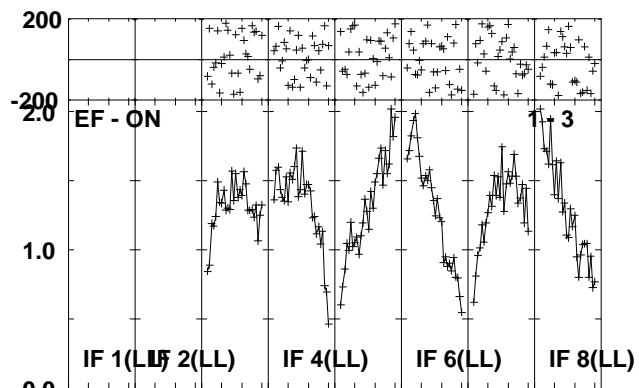
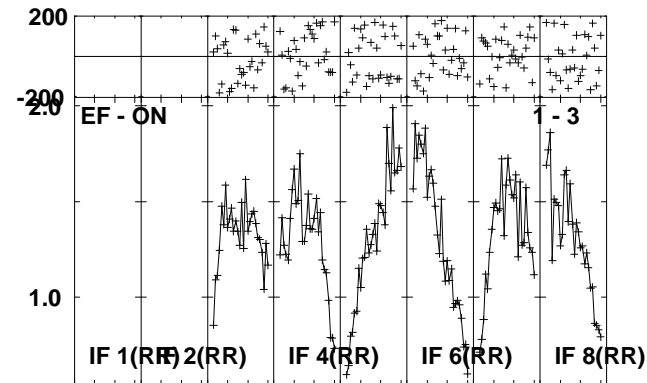
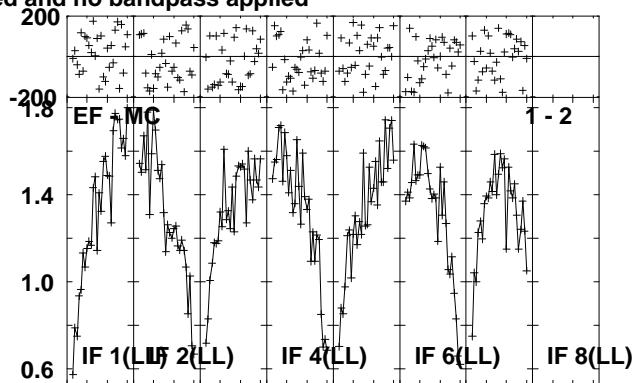
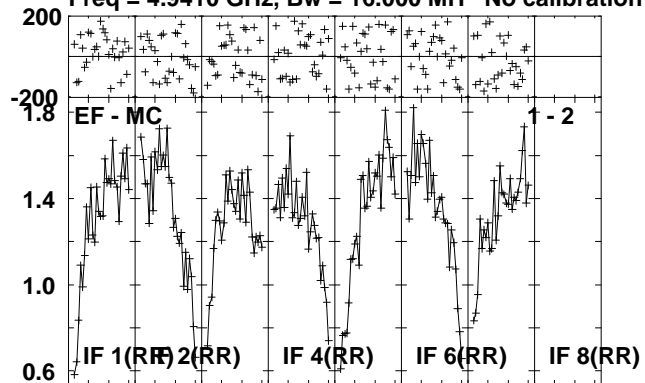

Lower frame: Milli Ampl Jy Top frame: Phas deg
Scalar averaged cross-power spectrum Several baselines displayed
Timerange: 00/12:22:01 to 00/12:27:59

Plot file version 4 created 04-OCT-2010 10:12:27
1156+295 RP016A.UVDATA.1

Freq = 4.9410 GHz, Bw = 16.000 MH No calibration applied and no bandpass applied

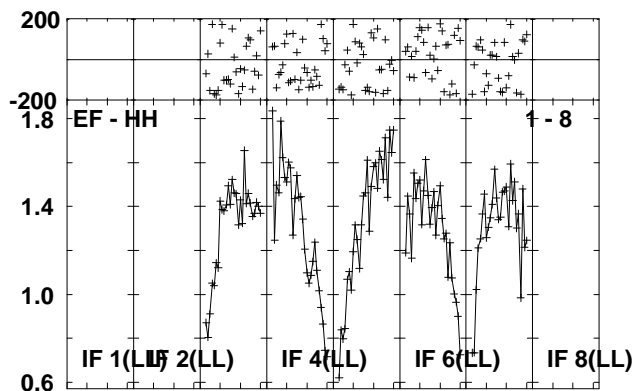
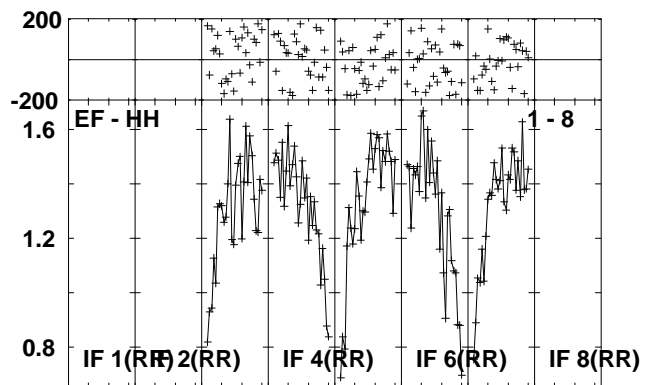
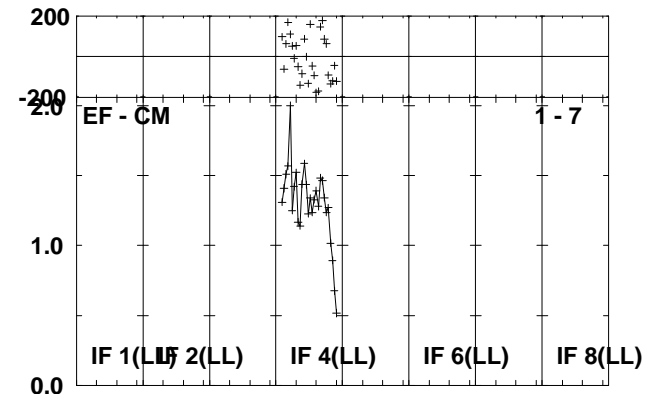
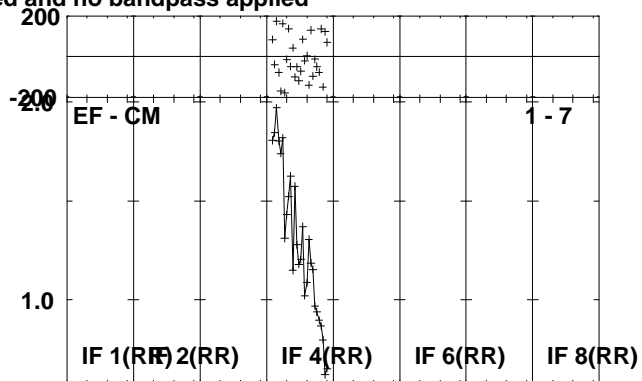
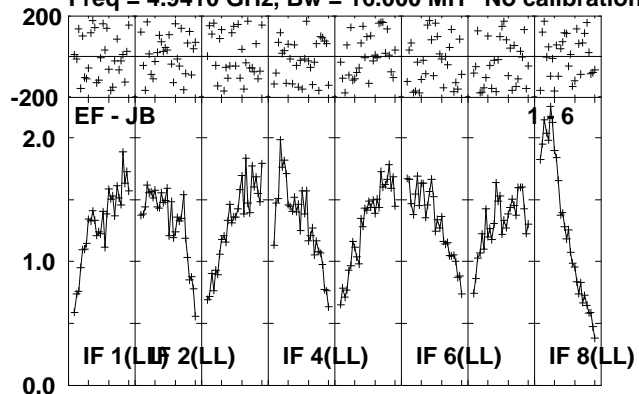

Lower frame: Milli Ampl Jy Top frame: Phas deg
Scalar averaged cross-power spectrum Several baselines displayed
Timerange: 00/12:22:01 to 00/12:27:59

Plot file version 5 created 04-OCT-2010 10:12:31

J1310+32 RP016A.UVDATA.1

Freq = 4.9410 GHz, Bw = 16.000 MH No calibration applied and no bandpass applied

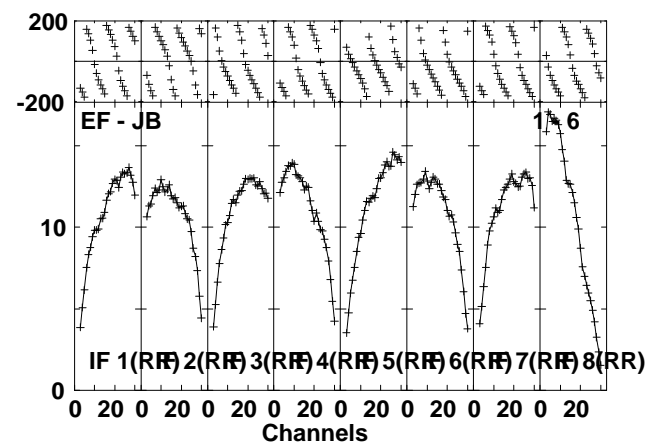
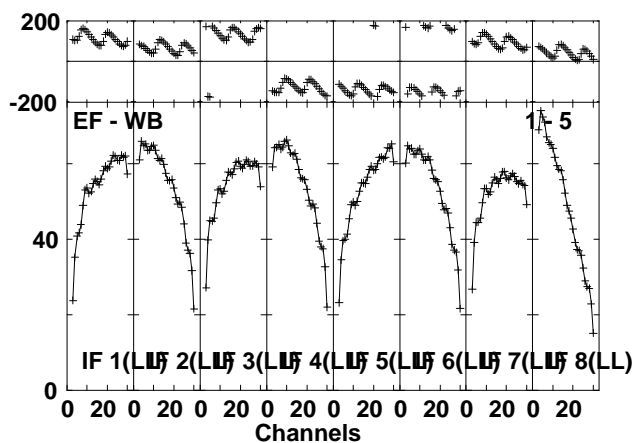
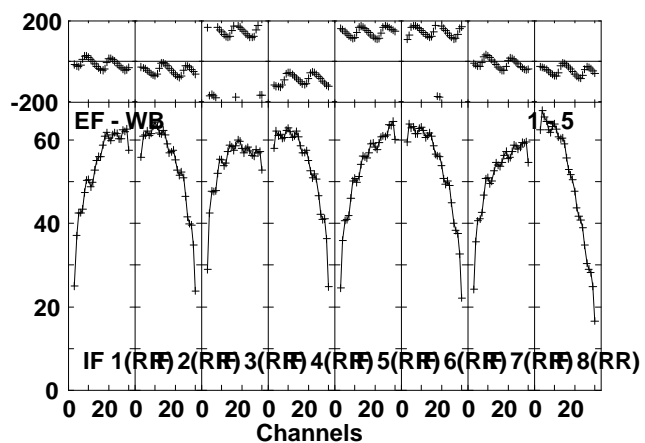
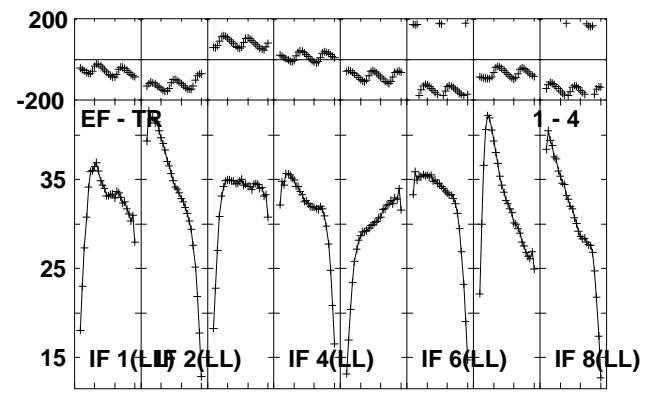
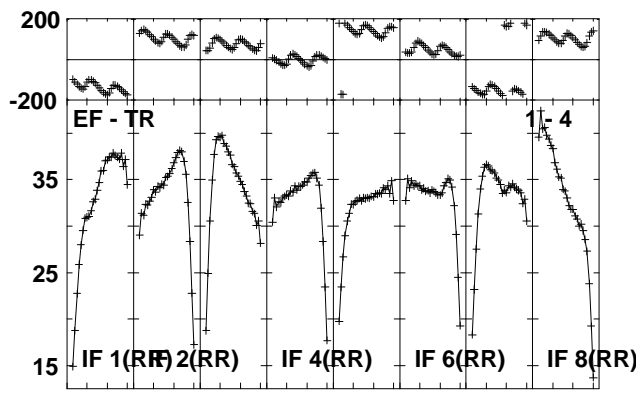
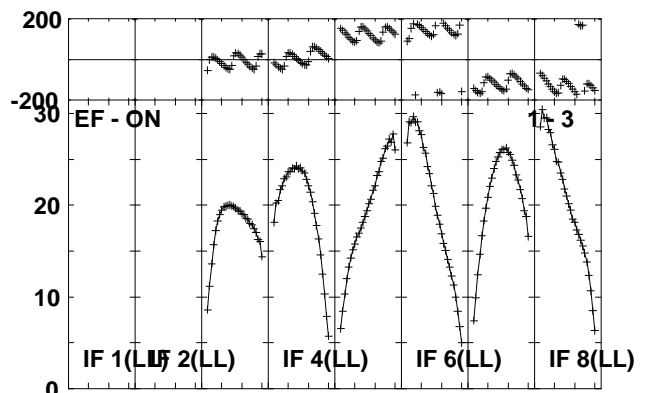
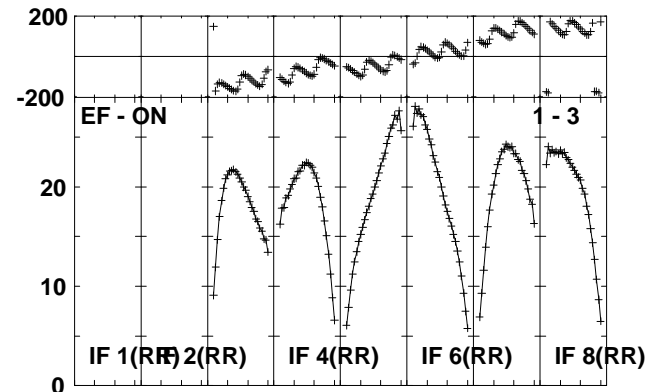
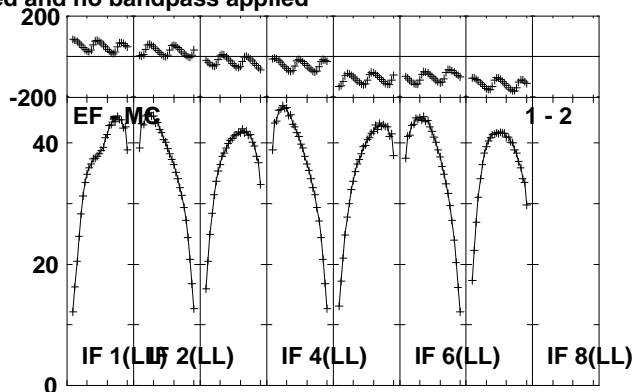
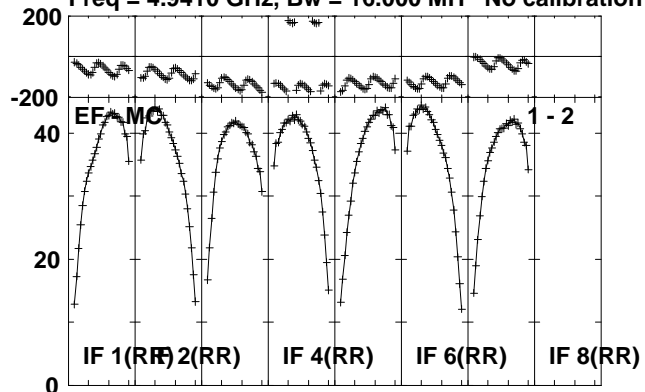

Lower frame: Milli Ampl Jy Top frame: Phas deg
Scalar averaged cross-power spectrum Several baselines displayed
Timerange: 00/12:30:01 to 00/12:52:01

Plot file version 6 created 04-OCT-2010 10:12:40

J1310+32 RP016A.UVDATA.1

Freq = 4.9410 GHz, Bw = 16.000 MH No calibration applied and no bandpass applied

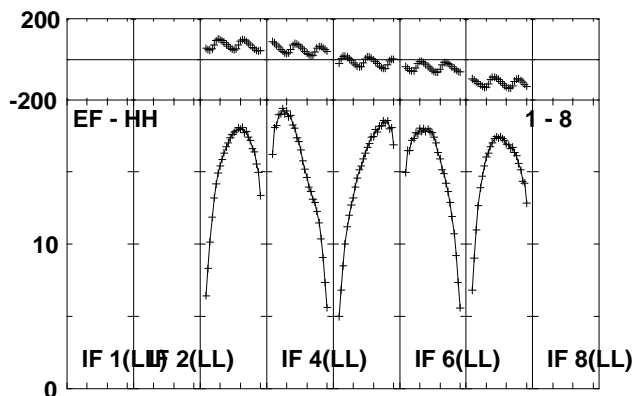
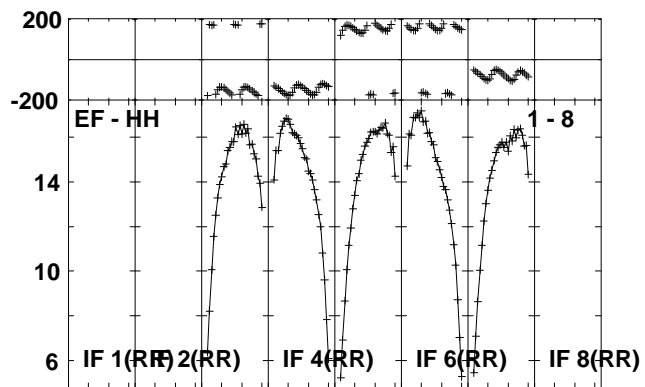
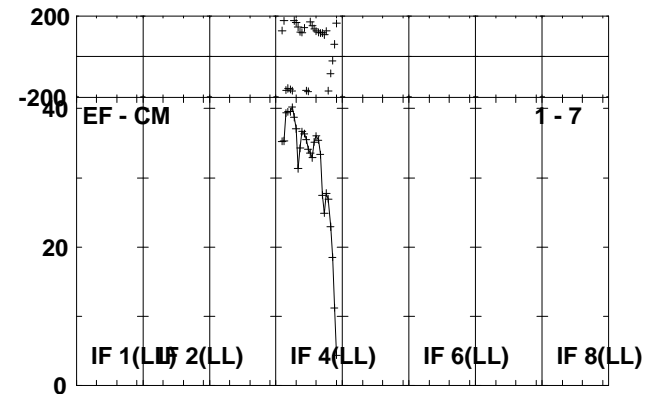
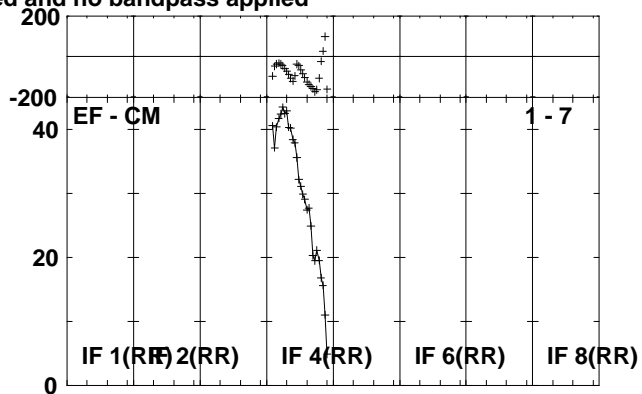
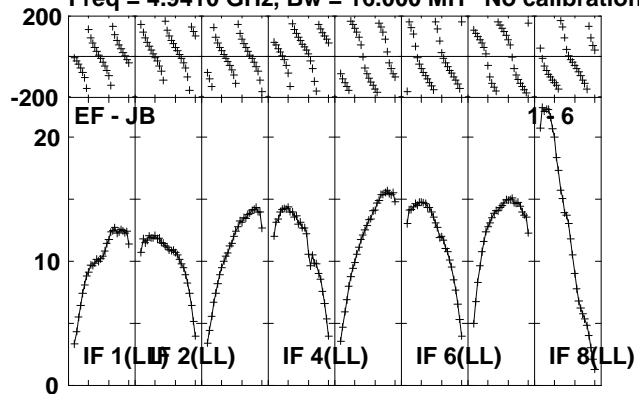

Lower frame: Milli Ampl Jy Top frame: Phas deg
Scalar averaged cross-power spectrum Several baselines displayed
Timerange: 00/12:30:01 to 00/12:52:01

Plot file version 7 created 04-OCT-2010 10:12:46

J1310+32 RP016A.UVDATA.1

Freq = 4.9410 GHz, Bw = 16.000 MH No calibration applied and no bandpass applied

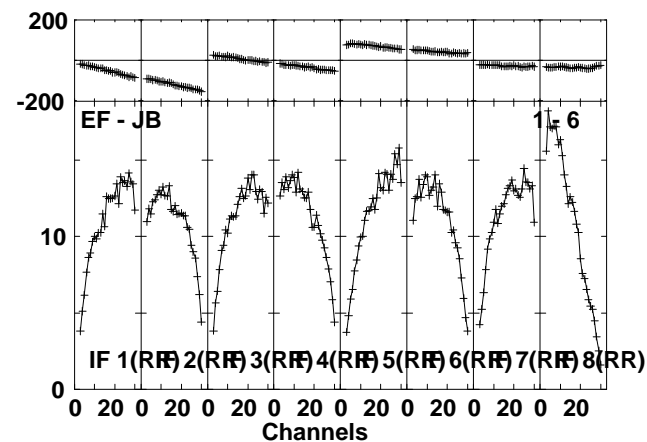
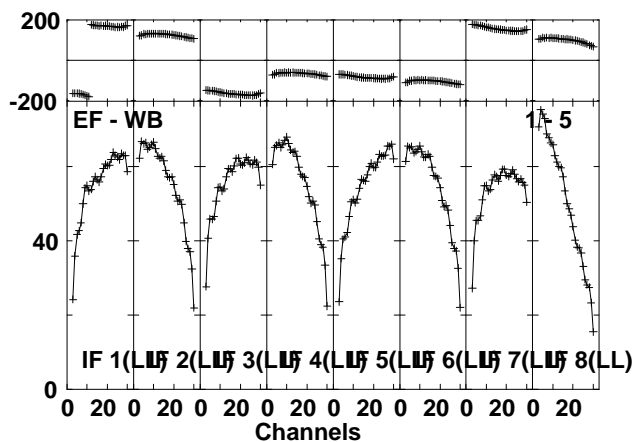
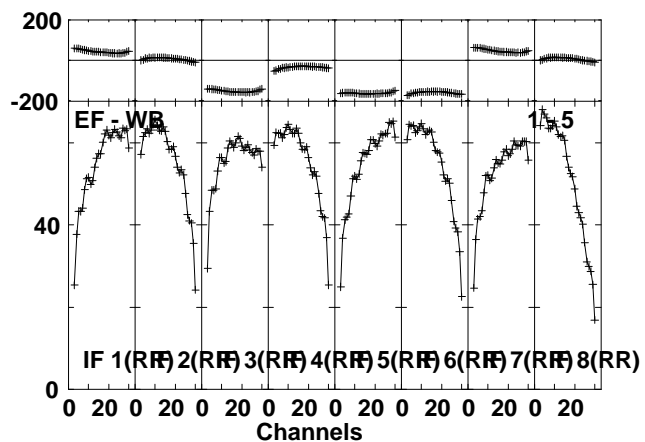
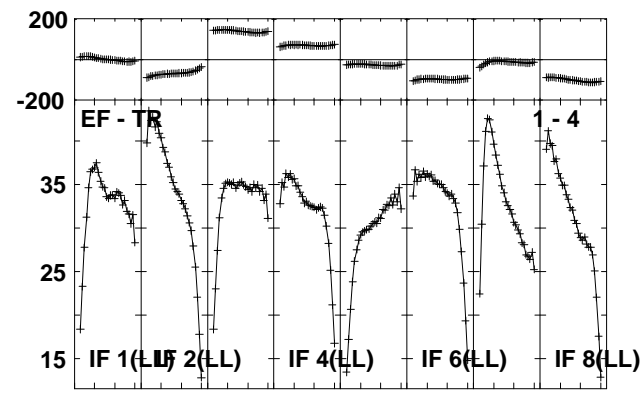
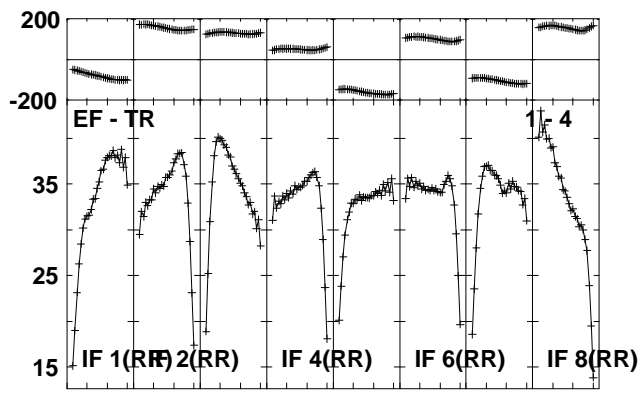
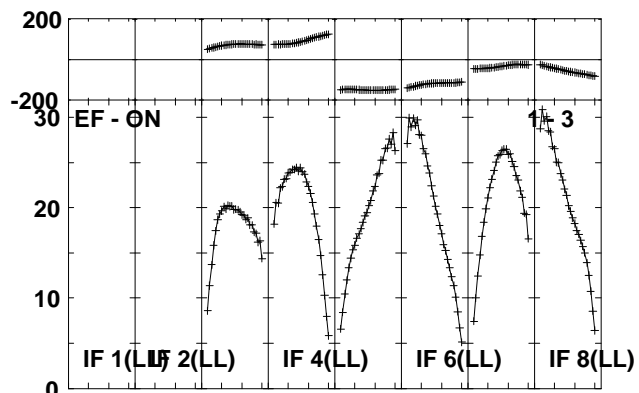
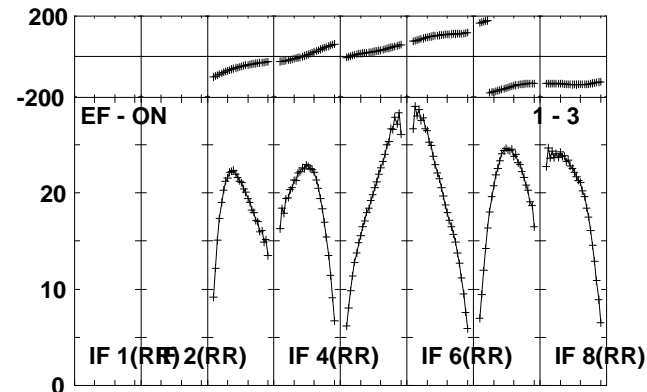
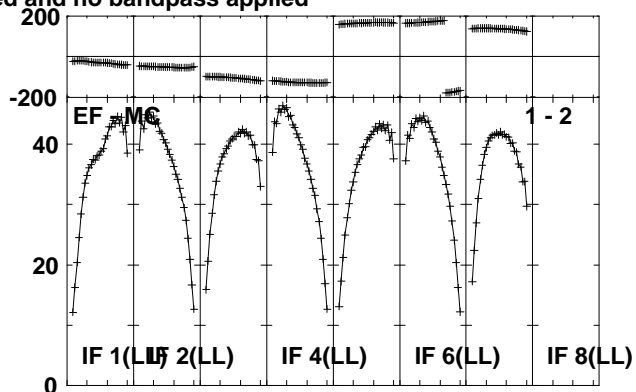
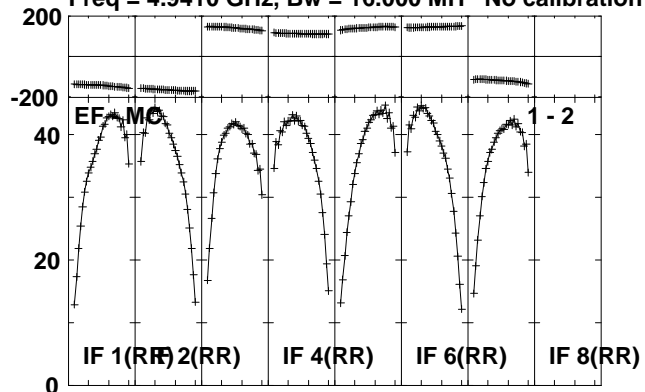

Lower frame: Milli Ampl Jy Top frame: Phas deg
Scalar averaged cross-power spectrum Several baselines displayed
Timerange: 00/12:52:03 to 00/12:57:59

Plot file version 8 created 04-OCT-2010 10:12:49

J1310+32 RP016A.UVDATA.1

Freq = 4.9410 GHz, Bw = 16.000 MH No calibration applied and no bandpass applied

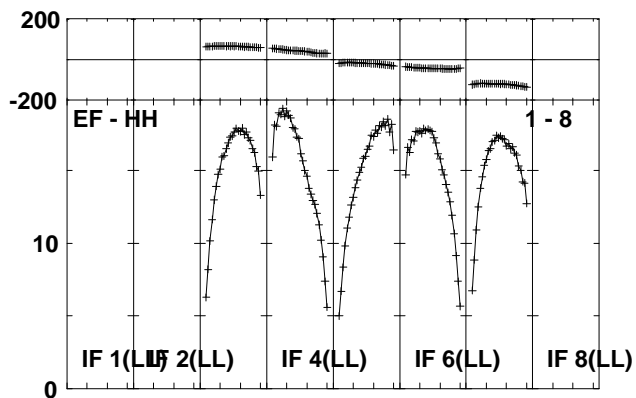
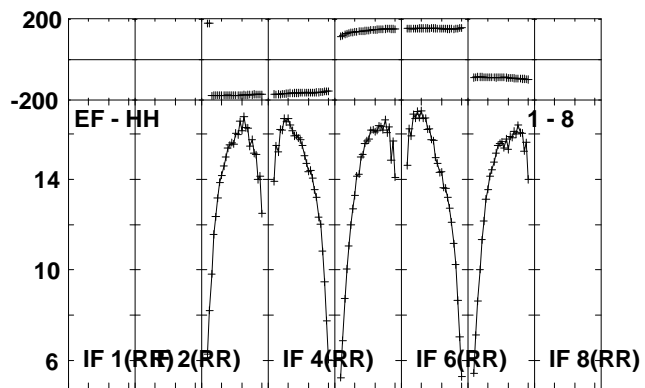
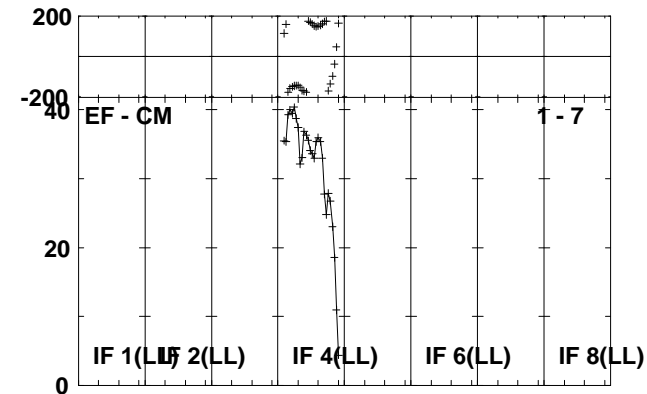
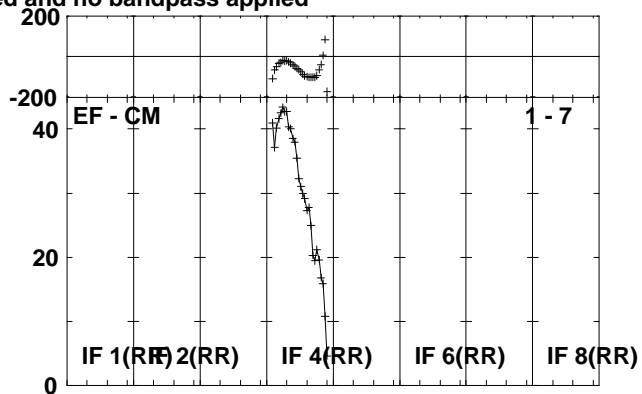
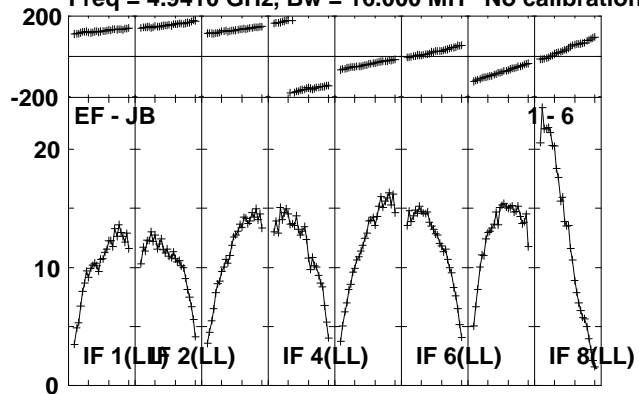

Lower frame: Milli Ampl Jy Top frame: Phas deg
Scalar averaged cross-power spectrum Several baselines displayed
Timerange: 00/12:52:03 to 00/12:57:59

Plot file version 9 created 04-OCT-2010 10:12:54

OQ208 RP016A.UVDATA.1

Freq = 4.9410 GHz, Bw = 16.000 MH No calibration applied and no bandpass applied

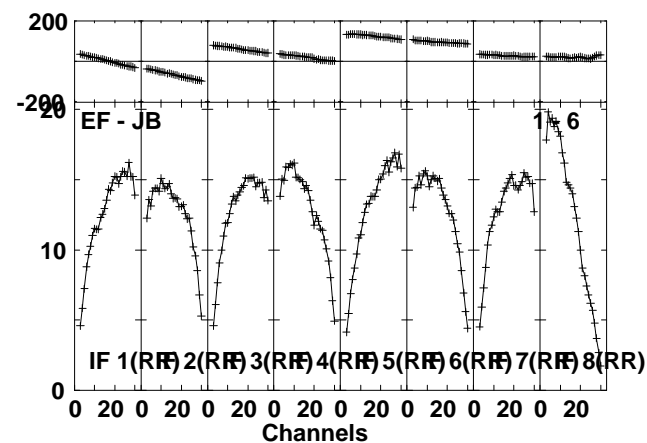
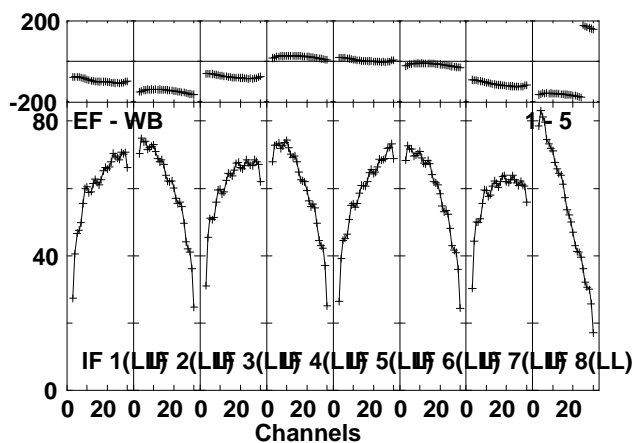
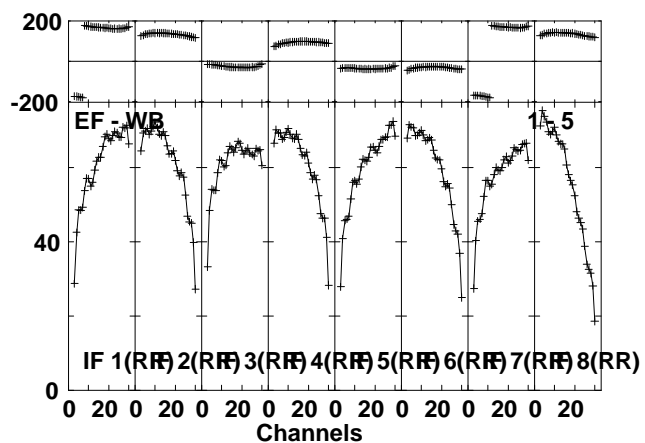
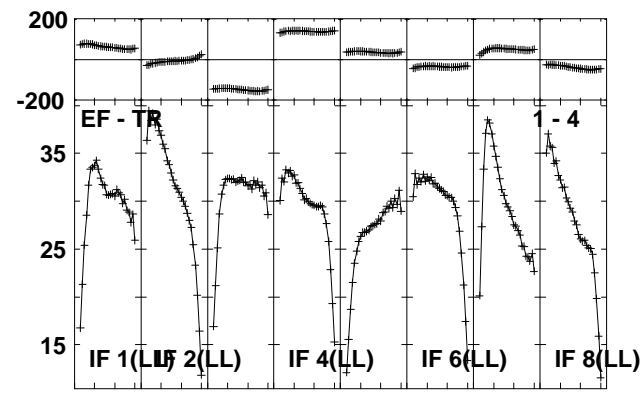
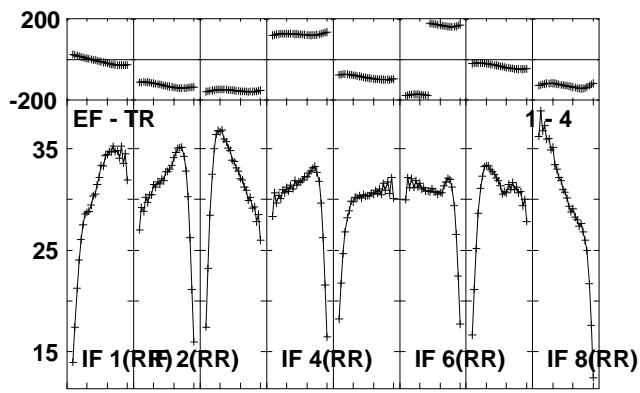
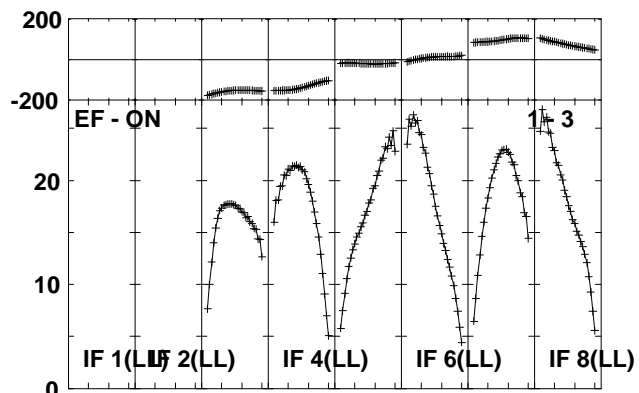
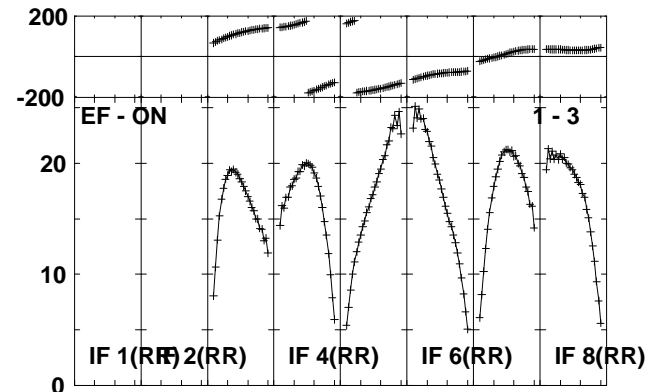
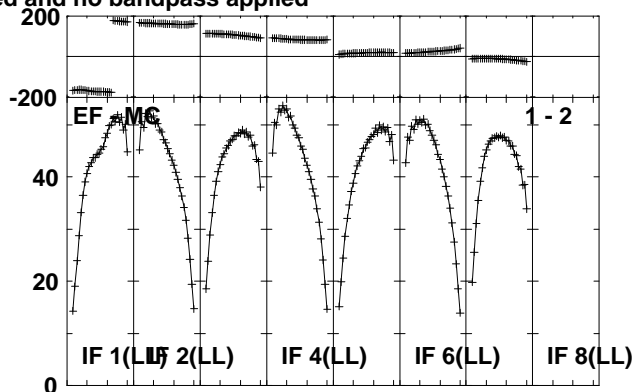
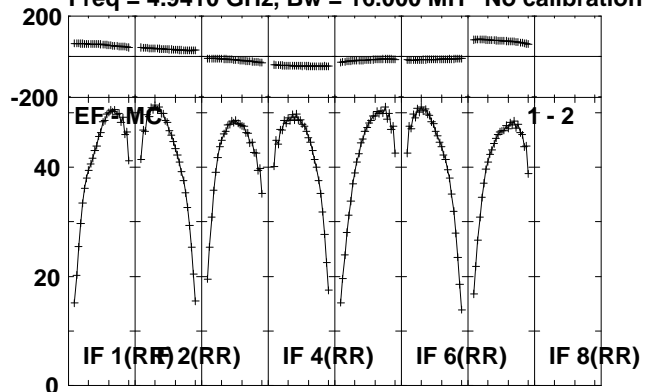

Lower frame: Milli Ampl Jy Top frame: Phas deg
Scalar averaged cross-power spectrum Several baselines displayed
Timerange: 00/13:00:01 to 00/13:22:01

Plot file version 10 created 04-OCT-2010 10:13:08

OQ208 RP016A.UVDATA.1

Freq = 4.9410 GHz, Bw = 16.000 MH No calibration applied and no bandpass applied

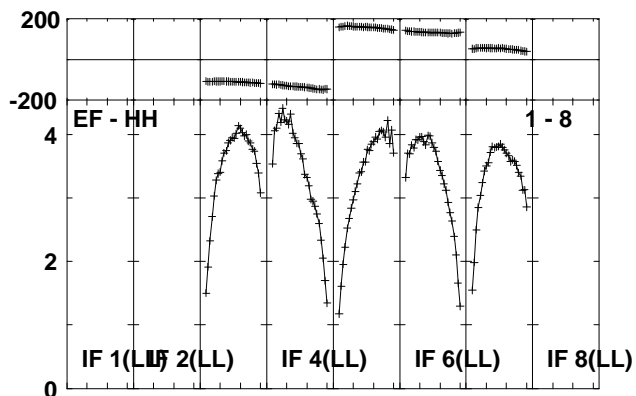
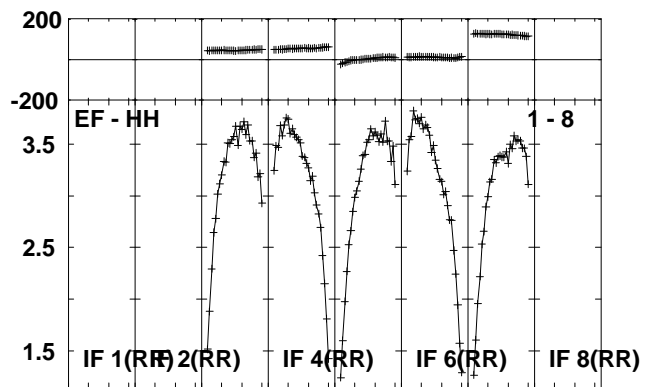
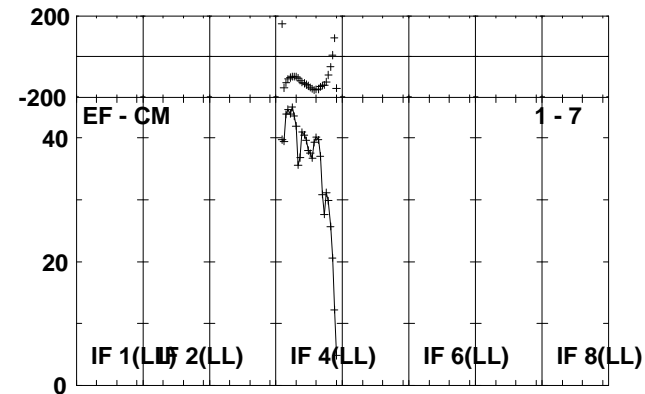
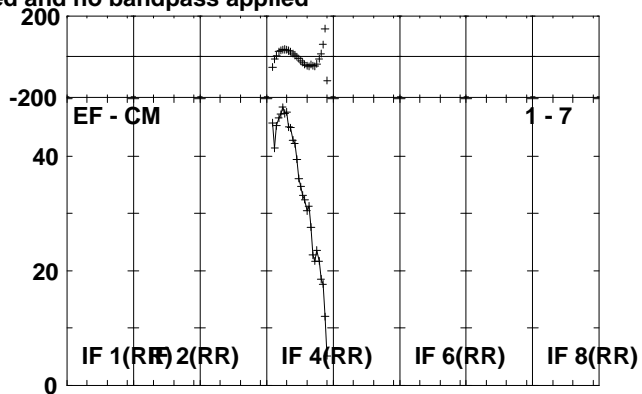
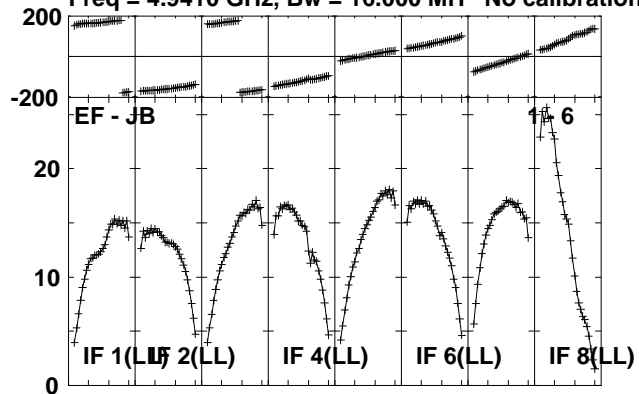

Lower frame: Milli Ampl Jy Top frame: Phas deg
Scalar averaged cross-power spectrum Several baselines displayed
Timerange: 00/13:00:01 to 00/13:22:01

Plot file version 11 created 04-OCT-2010 10:13:16
 OQ208 RP016A.UVDATA.1
 Freq = 4.9410 GHz, Bw = 16.000 MH No calibration applied and no bandpass applied

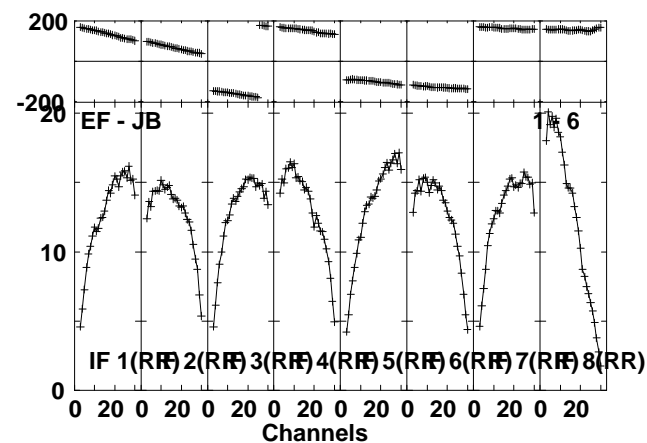
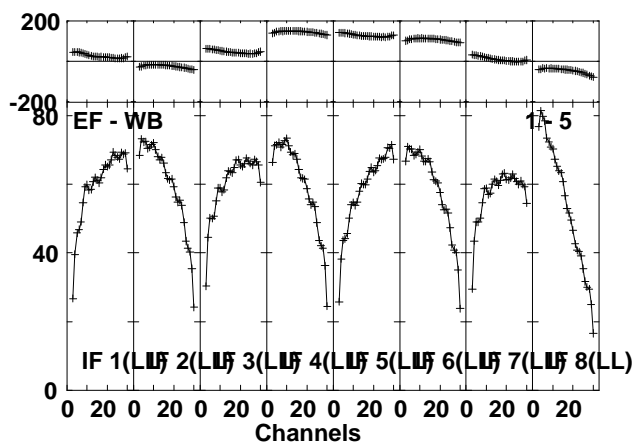
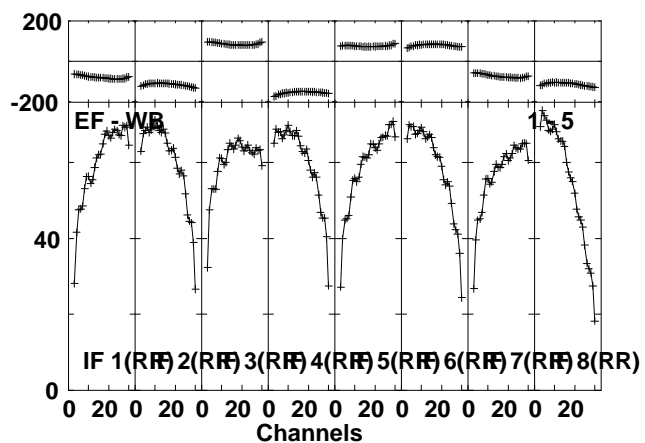
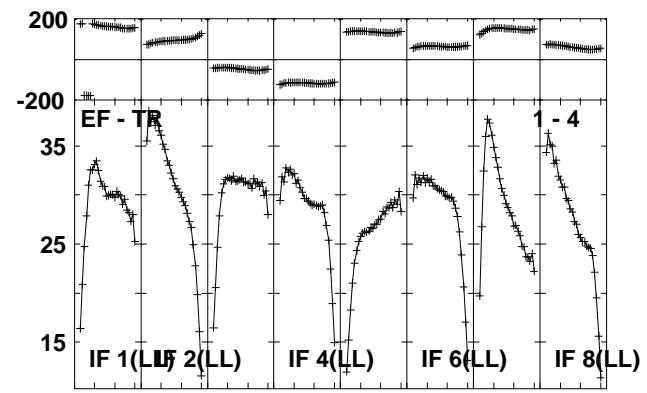
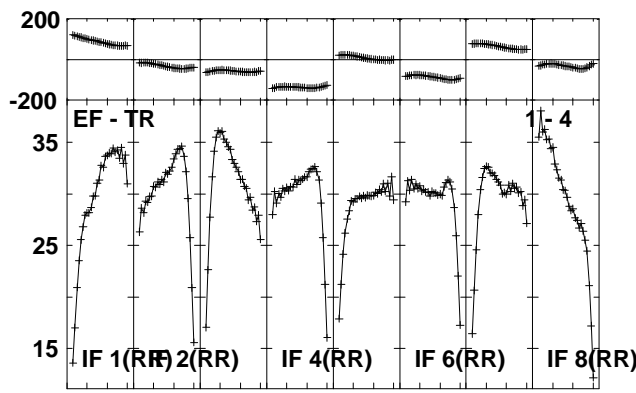
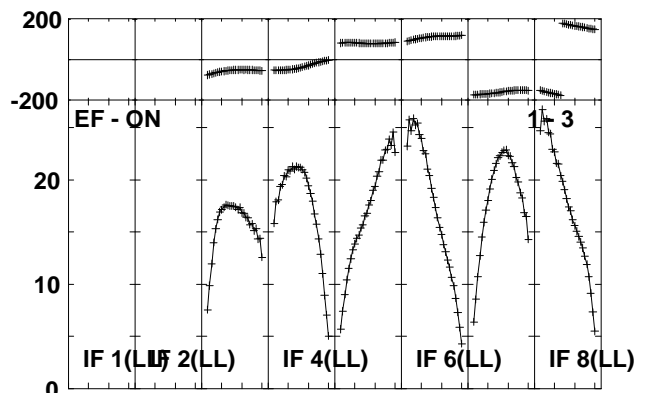
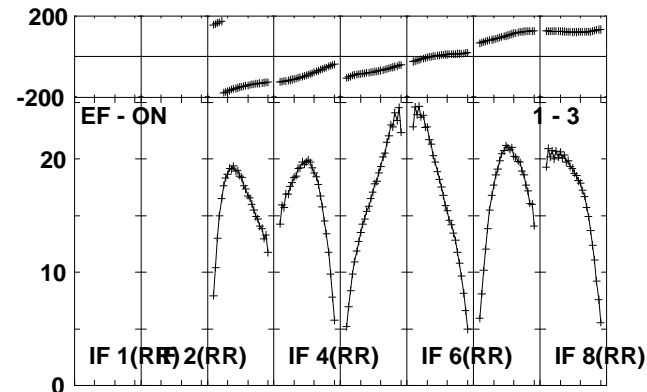
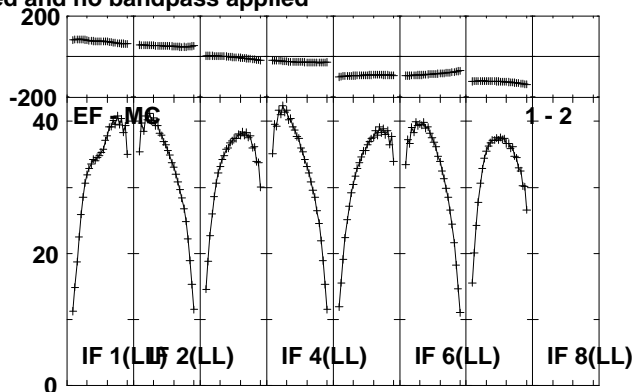
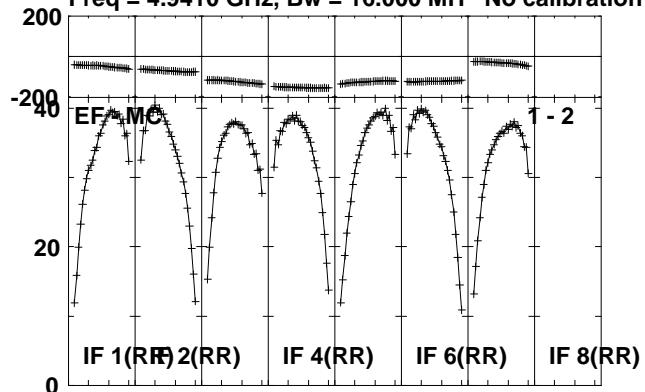

Lower frame: Milli Ampl Jy Top frame: Phas deg
 Scalar averaged cross-power spectrum Several baselines displayed
 Timerange: 00/13:22:03 to 00/13:27:59

Plot file version 12 created 04-OCT-2010 10:13:20

OQ208 RP016A.UVDATA.1

Freq = 4.9410 GHz, Bw = 16.000 MH No calibration applied and no bandpass applied

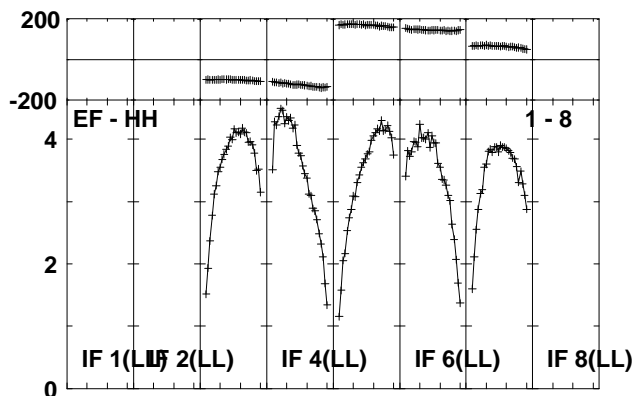
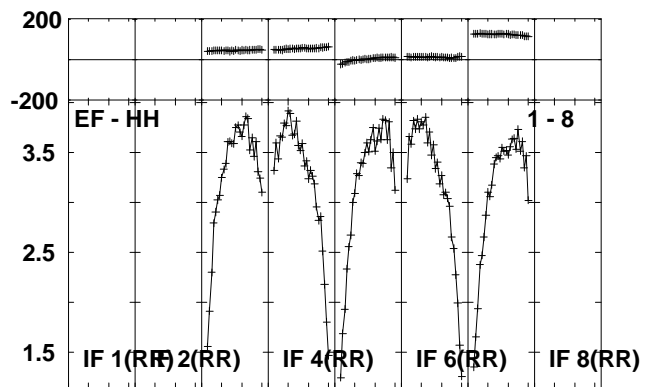
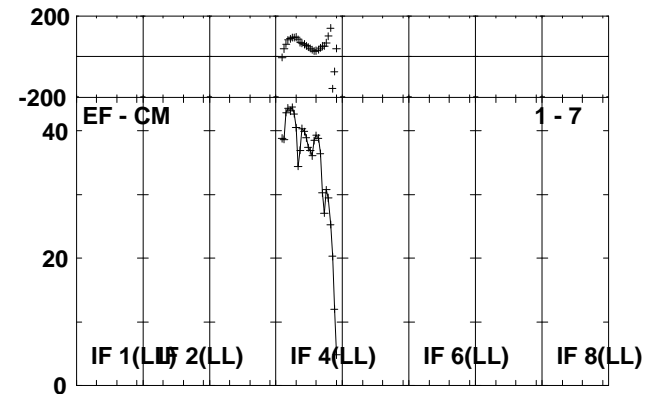
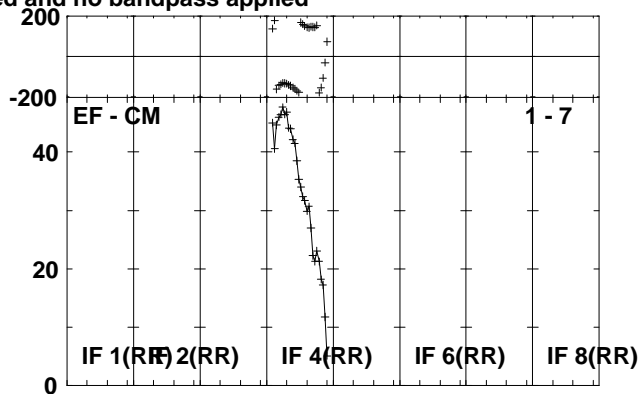
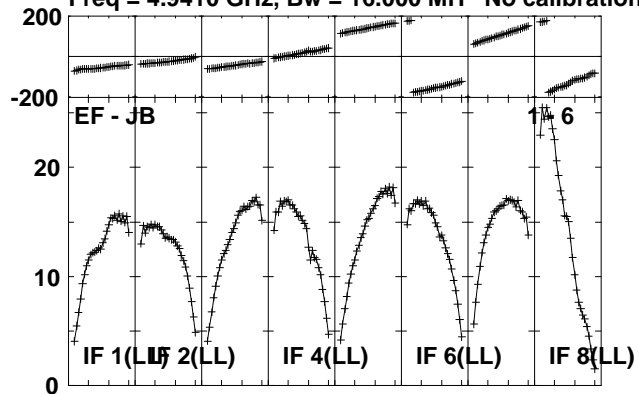

Lower frame: Milli Ampl Jy Top frame: Phas deg
Scalar averaged cross-power spectrum Several baselines displayed
Timerange: 00/13:22:03 to 00/13:27:59

Plot file version 13 created 04-OCT-2010 10:13:25

J1751+09 RP016A.UVDATA.1

Freq = 4.9410 GHz, Bw = 16.000 MH No calibration applied and no bandpass applied

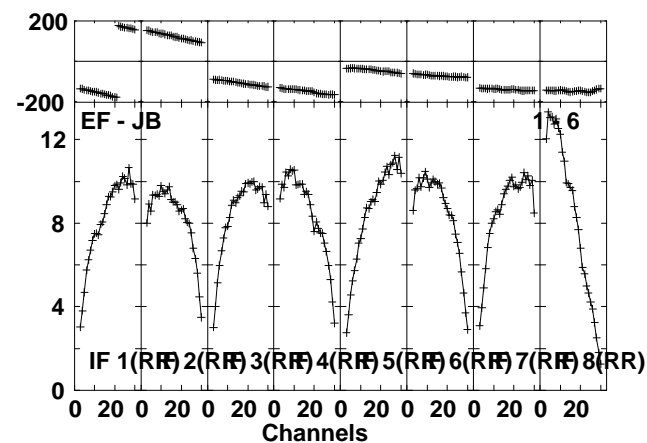
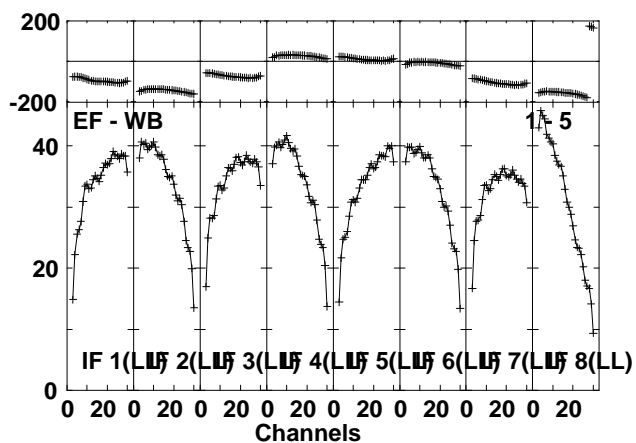
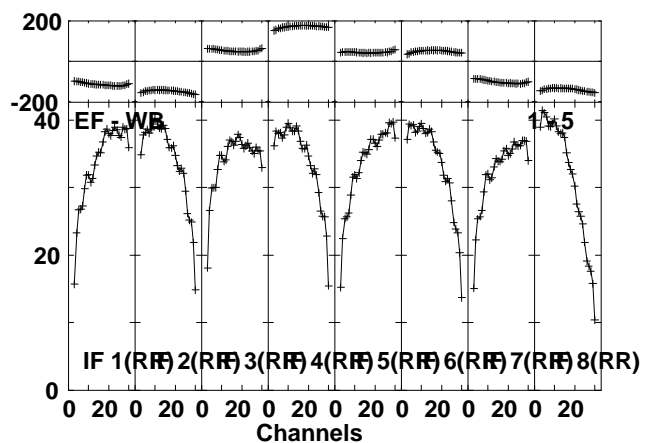
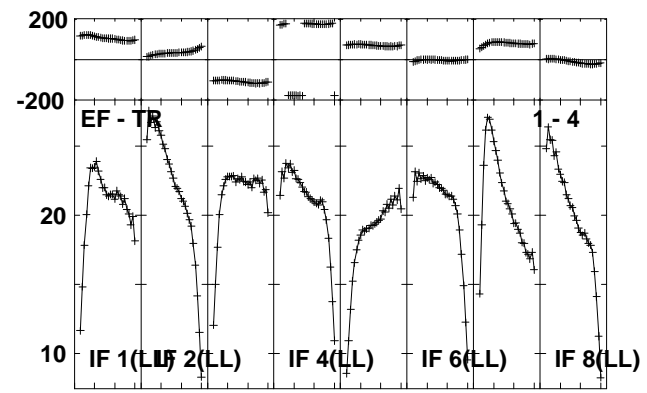
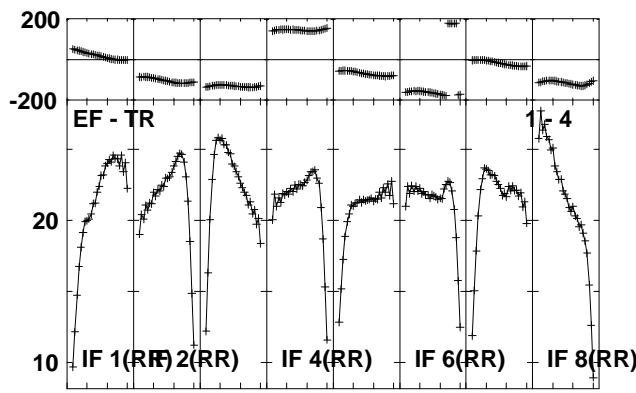
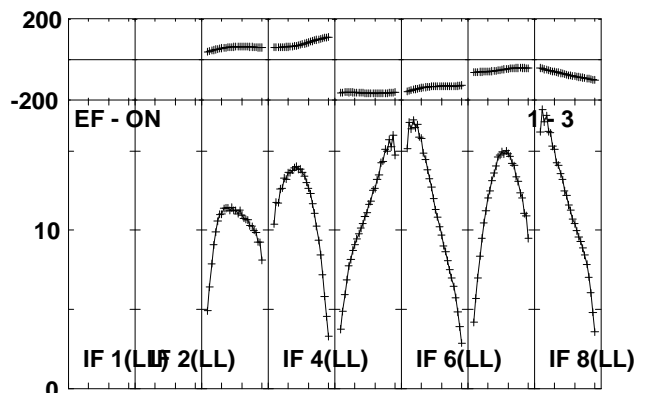
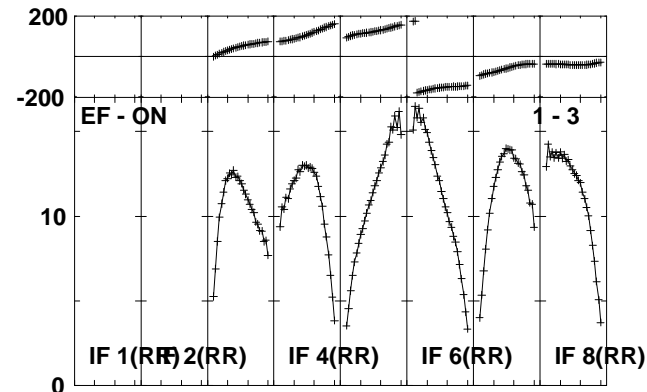
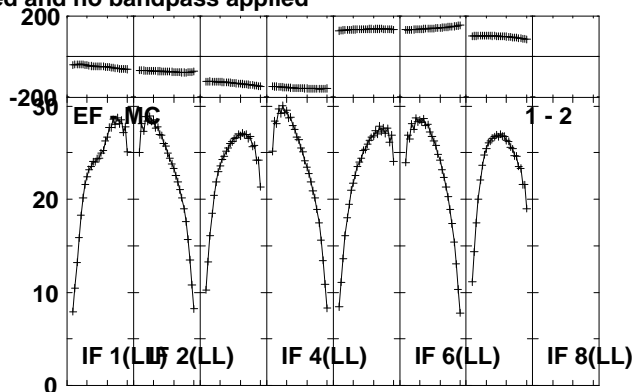
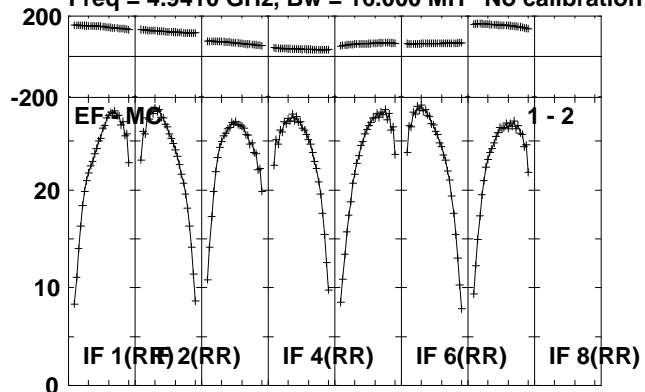

Lower frame: Milli Ampl Jy Top frame: Phas deg
Scalar averaged cross-power spectrum Several baselines displayed
Timerange: 00/13:30:01 to 00/13:42:59

Plot file version 14 created 04-OCT-2010 10:13:33

J1751+09 RP016A.UVDATA.1

Freq = 4.9410 GHz, Bw = 16.000 MH No calibration applied and no bandpass applied

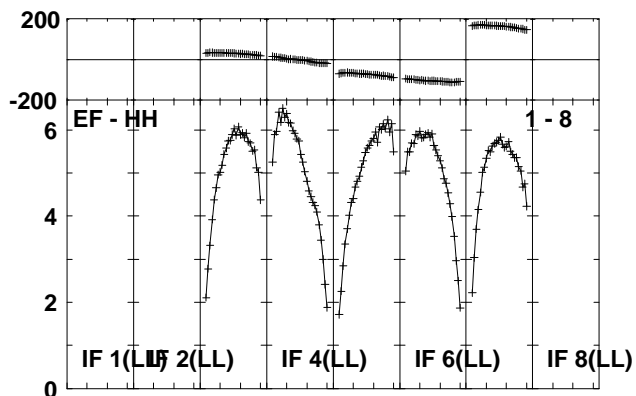
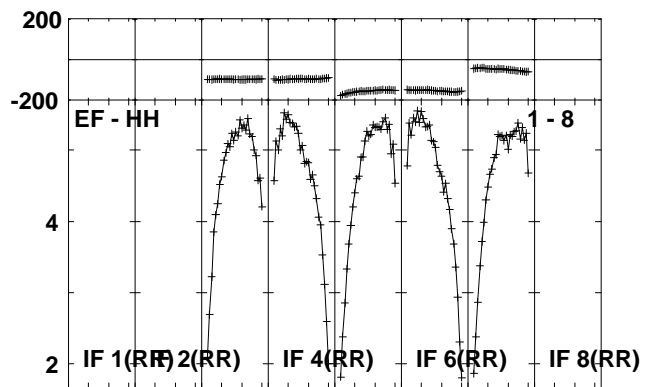
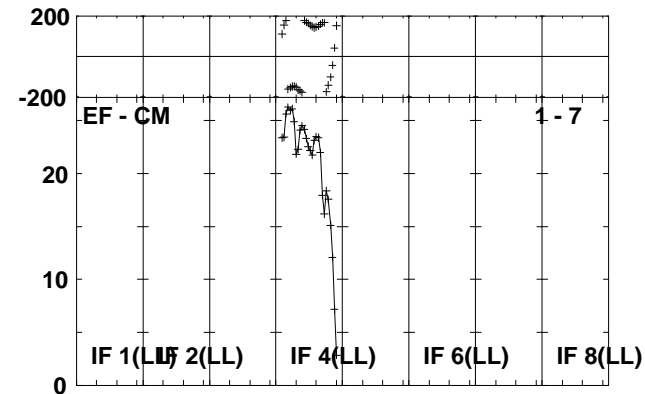
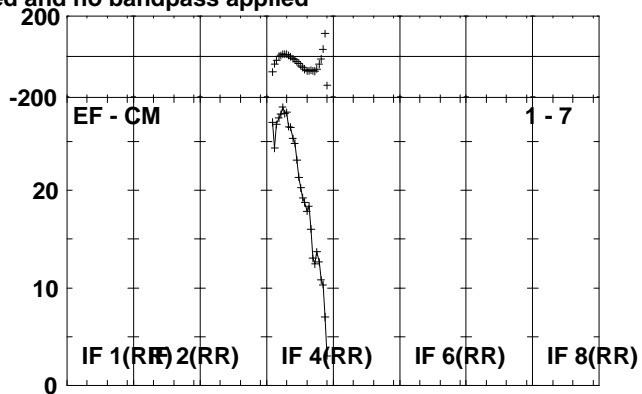
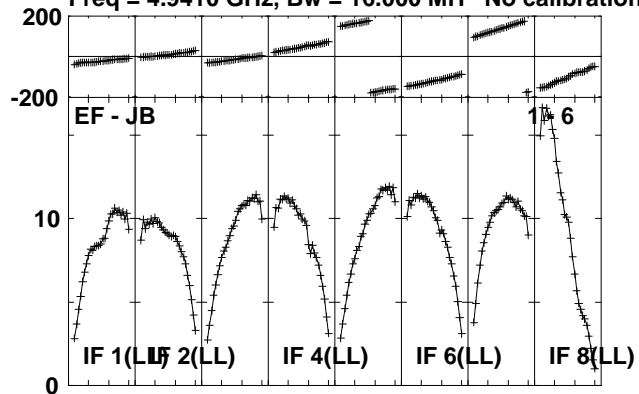

Lower frame: Milli Ampl Jy Top frame: Phas deg
Scalar averaged cross-power spectrum Several baselines displayed
Timerange: 00/13:30:01 to 00/13:42:59

Plot file version 15 created 04-OCT-2010 10:13:40

J1724-14 RP016A.UVDATA.1

Freq = 4.9410 GHz, Bw = 16.000 MH No calibration applied and no bandpass applied

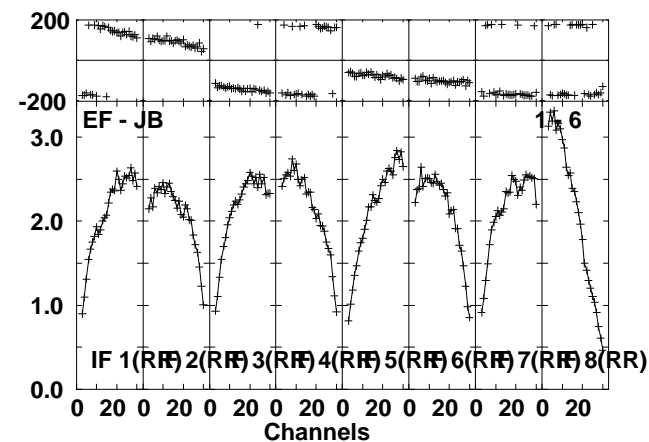
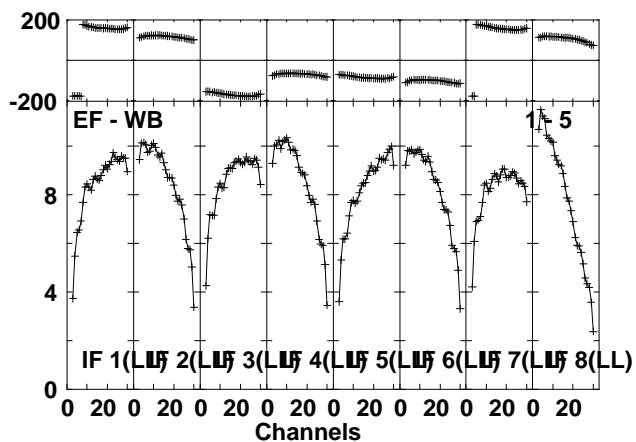
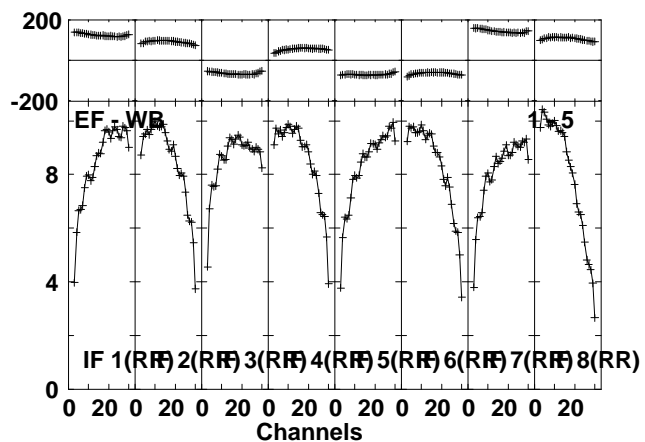
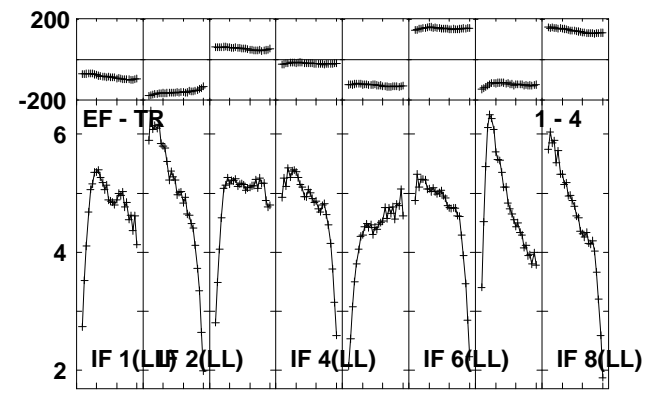
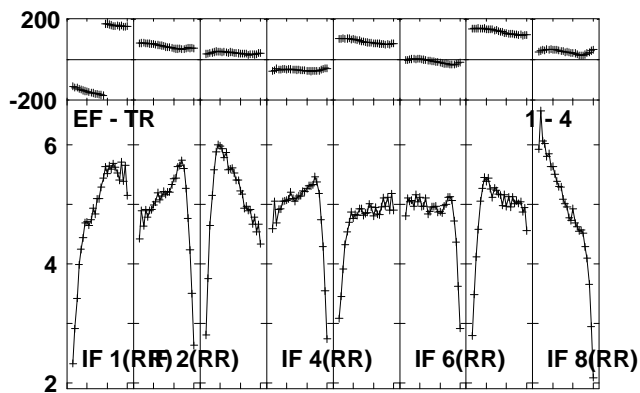
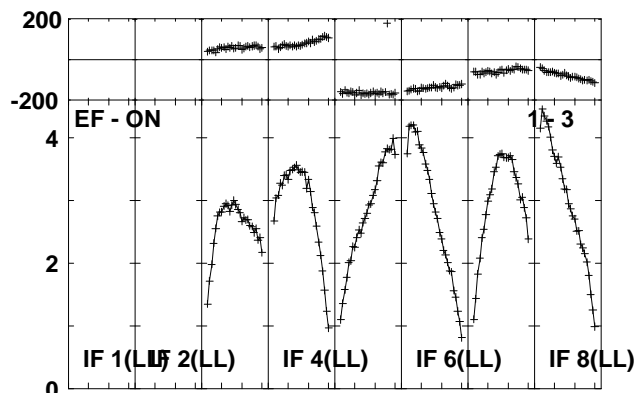
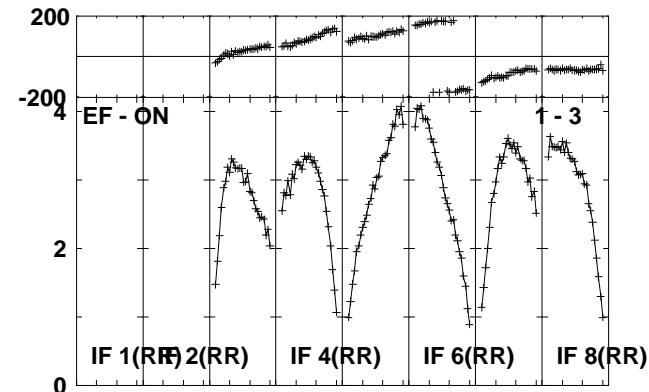
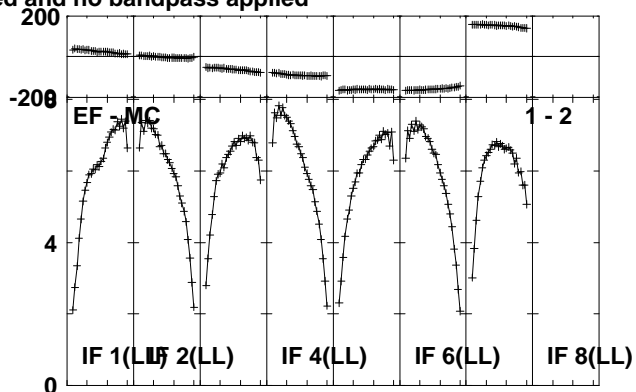
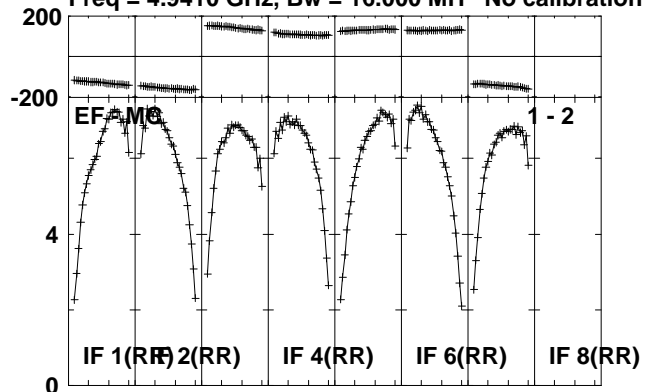

Lower frame: Milli Ampl Jy Top frame: Phas deg
Scalar averaged cross-power spectrum Several baselines displayed
Timerange: 00/13:45:01 to 00/13:57:59

Plot file version 16 created 04-OCT-2010 10:13:48

J1724-14 RP016A.UVDATA.1

Freq = 4.9410 GHz, Bw = 16.000 MH No calibration applied and no bandpass applied

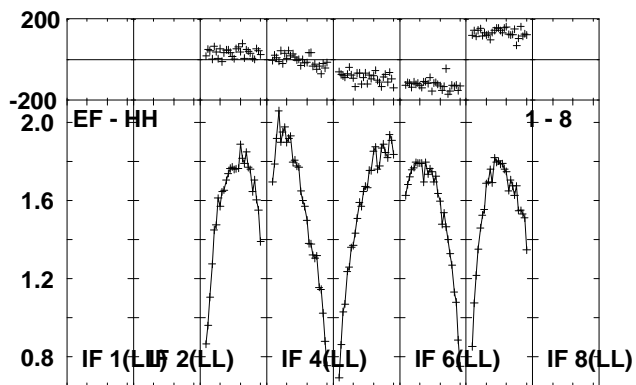
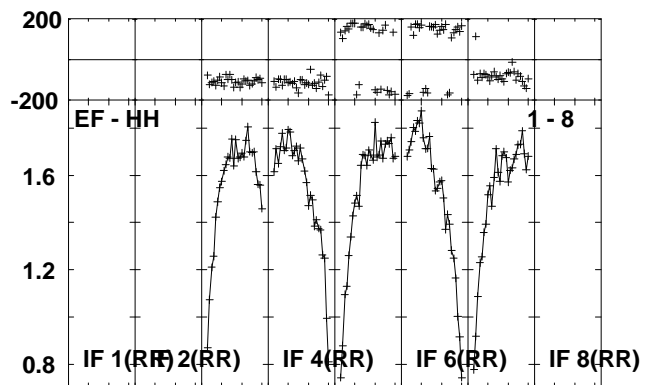
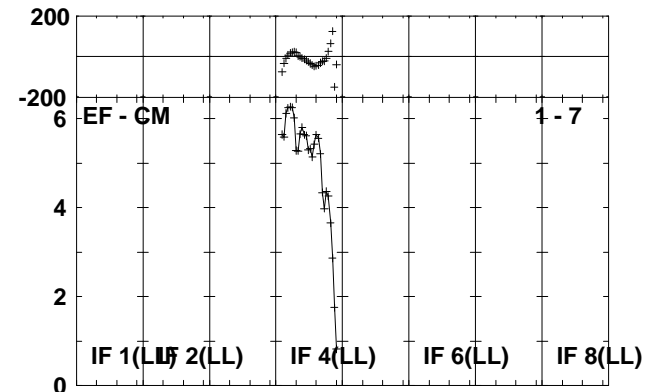
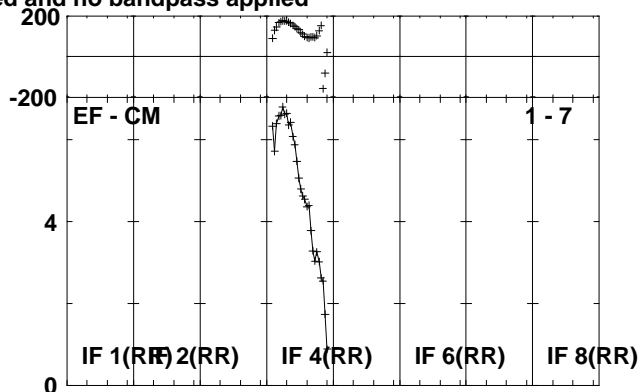
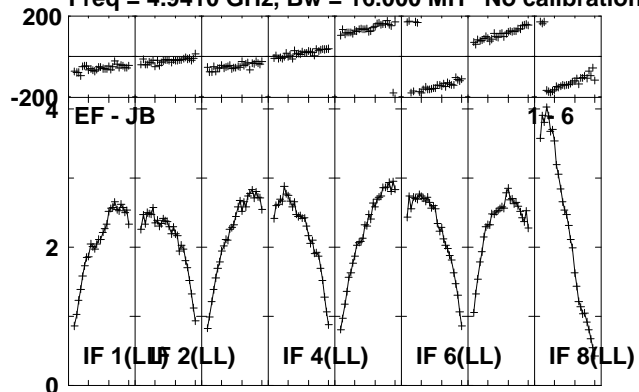

Lower frame: Milli Ampl Jy Top frame: Phas deg
Scalar averaged cross-power spectrum Several baselines displayed
Timerange: 00/13:45:01 to 00/13:57:59

Plot file version 17 created 04-OCT-2010 10:13:52

J1707-14 RP016A.UVDATA.1

Freq = 4.9410 GHz, Bw = 16.000 MH No calibration applied and no bandpass applied

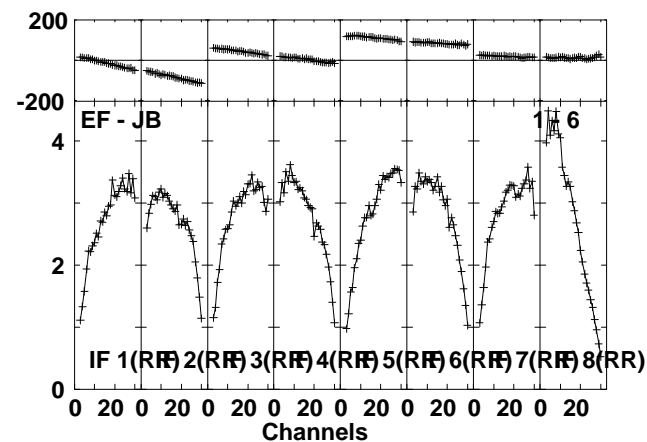
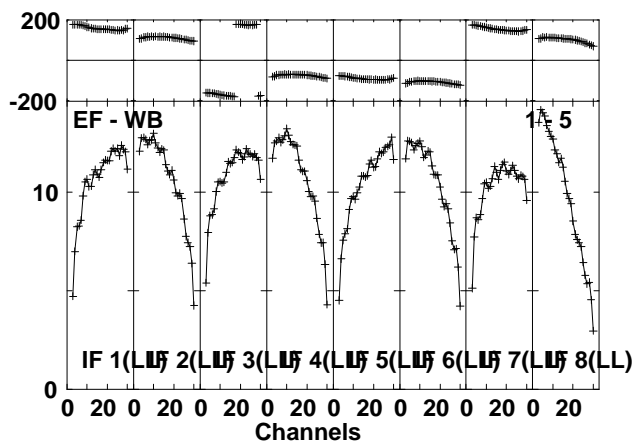
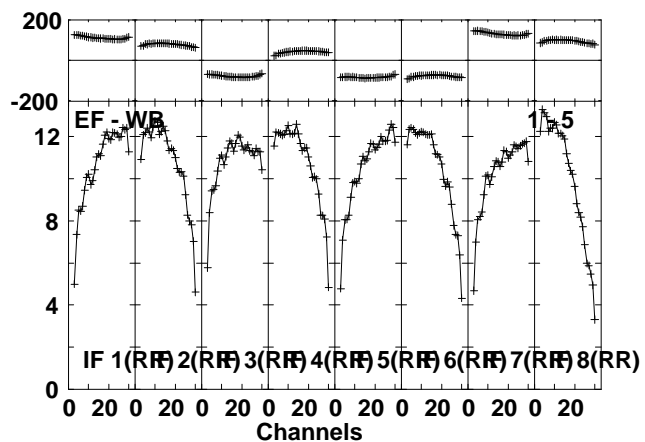
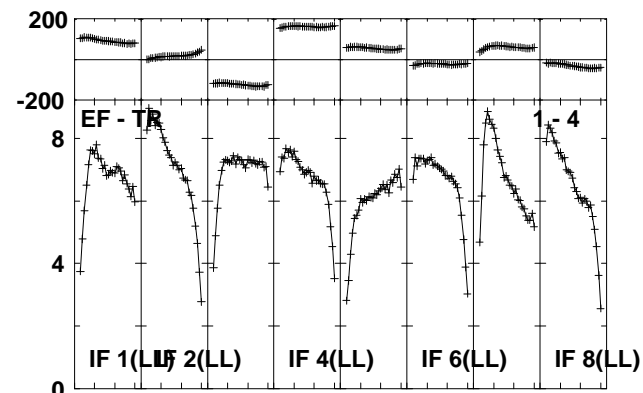
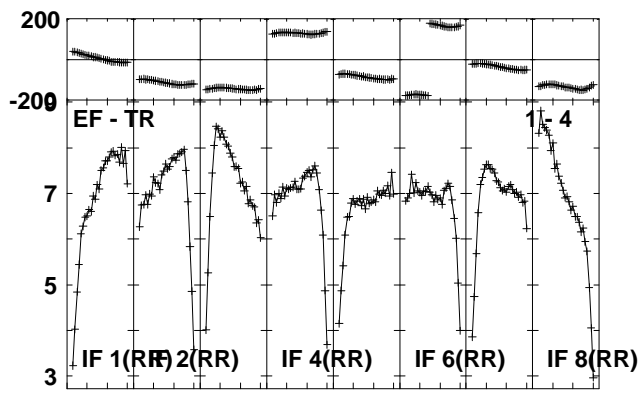
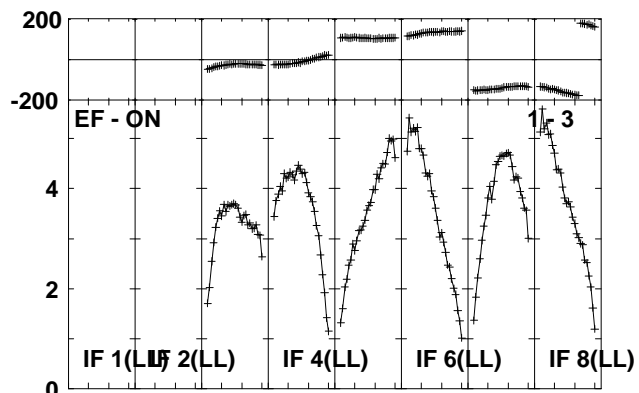
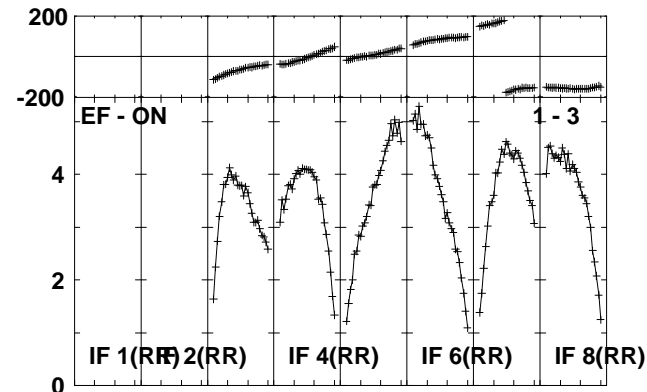
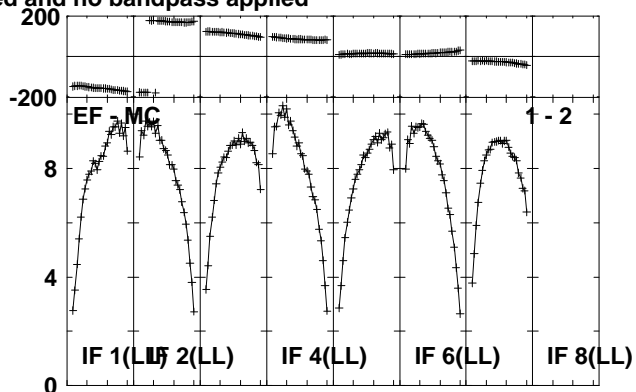
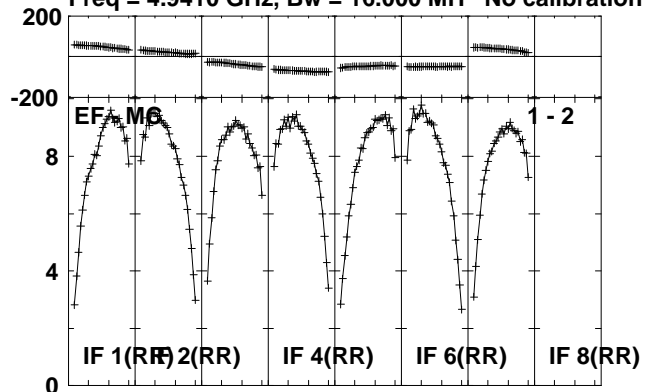

Lower frame: Milli Ampl Jy Top frame: Phas deg
Scalar averaged cross-power spectrum Several baselines displayed
Timerange: 00/13:59:01 to 00/14:03:59

Plot file version 18 created 04-OCT-2010 10:13:56
J1707-14 RP016A.UVDATA.1

Freq = 4.9410 GHz, Bw = 16.000 MH No calibration applied and no bandpass applied

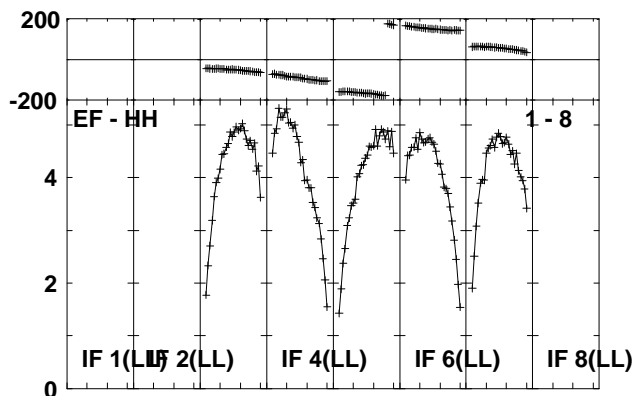
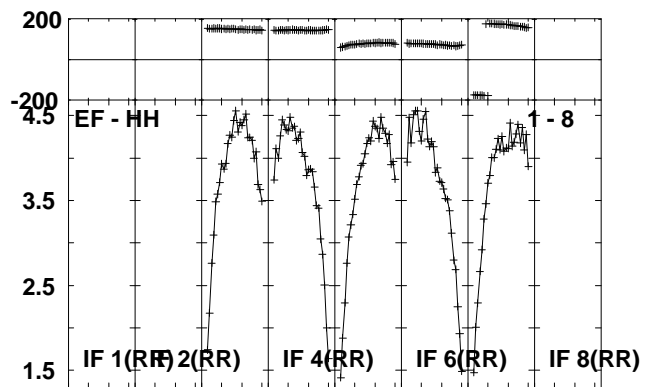
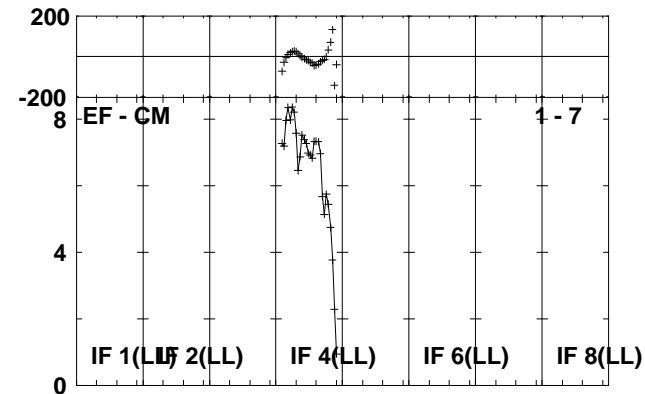
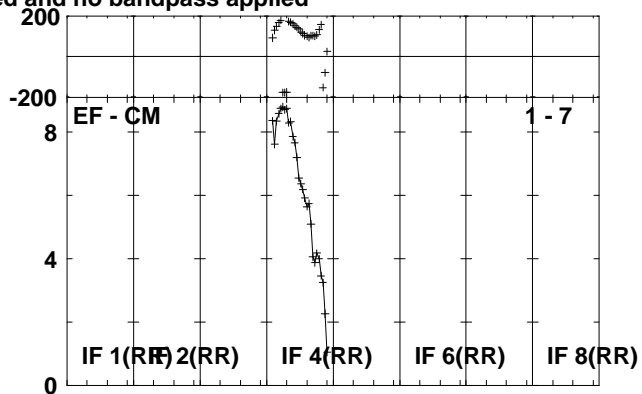
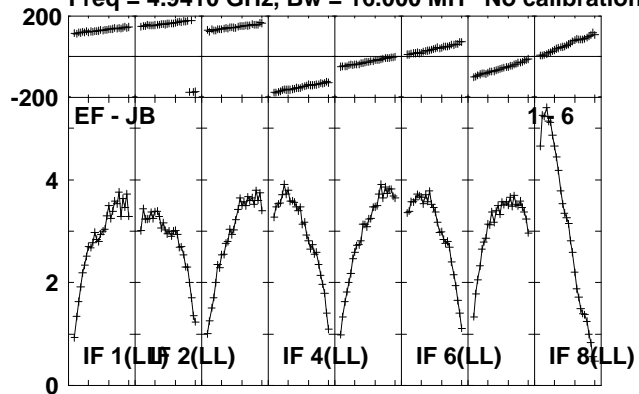

Lower frame: Milli Ampl Jy Top frame: Phas deg
Scalar averaged cross-power spectrum Several baselines displayed
Timerange: 00/13:59:01 to 00/14:03:59

Plot file version 19 created 04-OCT-2010 10:13:58

MAXI J16 RP016A.UVDATA.1

Freq = 4.9410 GHz, Bw = 16.000 MH No calibration applied and no bandpass applied

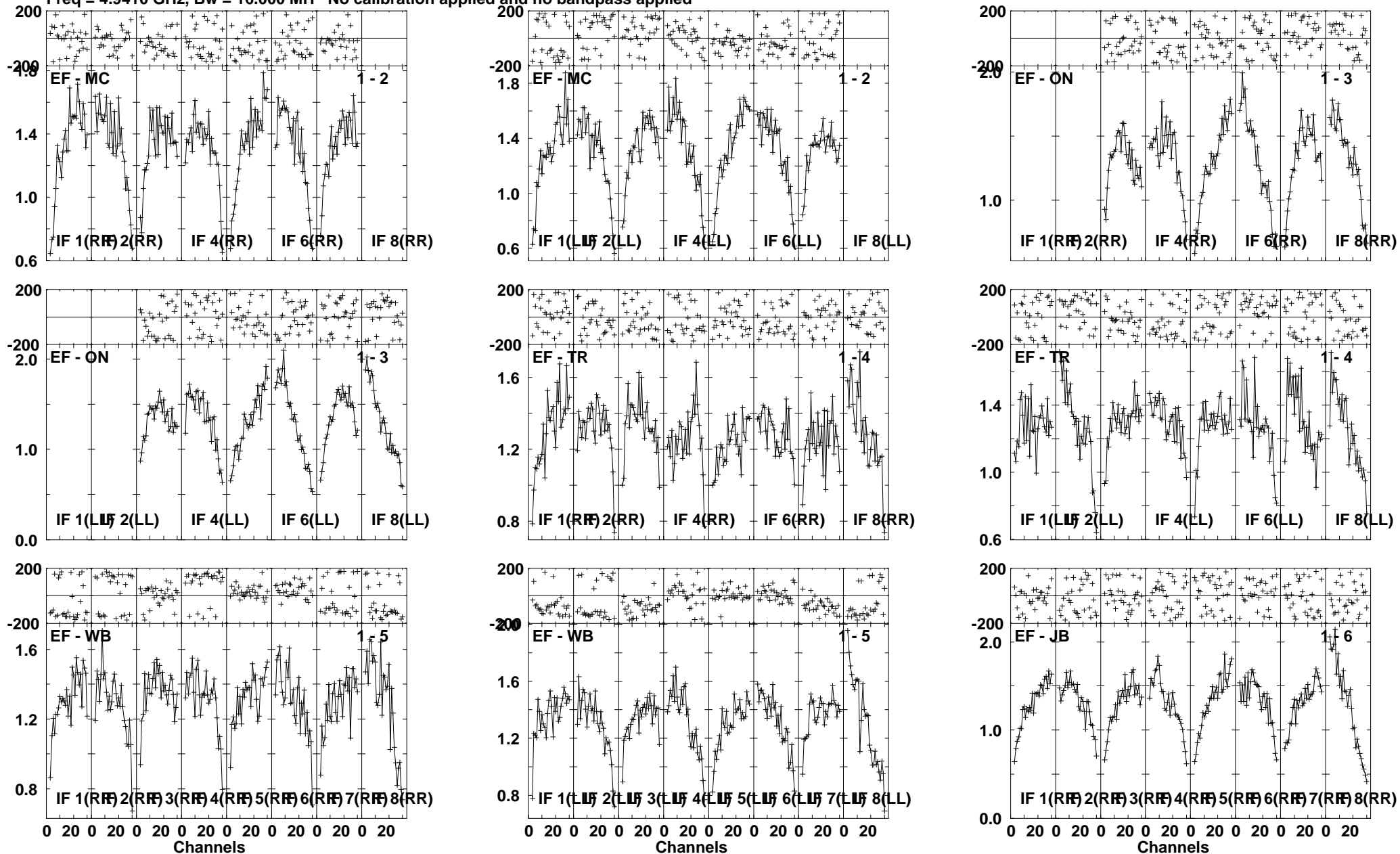

Lower frame: Milli Ampl Jy Top frame: Phas deg
 Scalar averaged cross-power spectrum Several baselines displayed
 Timerange: 00/14:04:01 to 00/14:06:29

Plot file version 20 created 04-OCT-2010 10:14:00

MAXI J16 RP016A.UVDATA.1

Freq = 4.9410 GHz, Bw = 16.000 MH No calibration applied and no bandpass applied

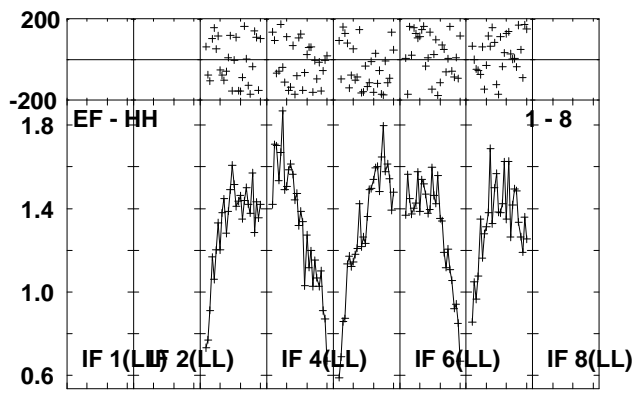
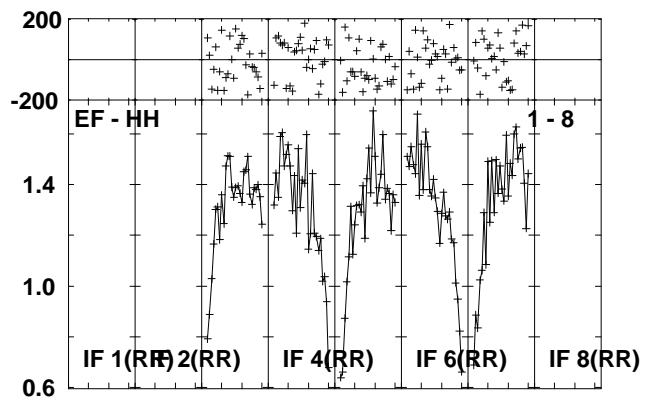
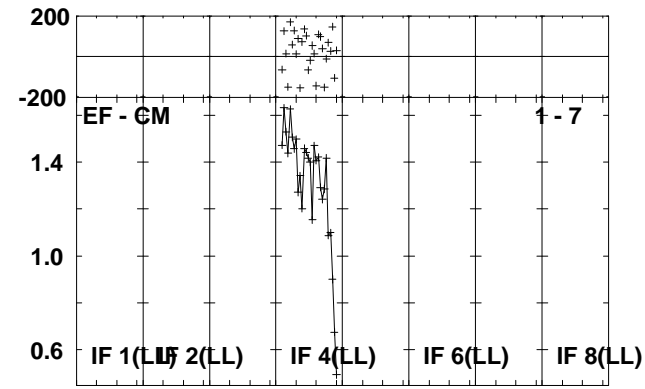
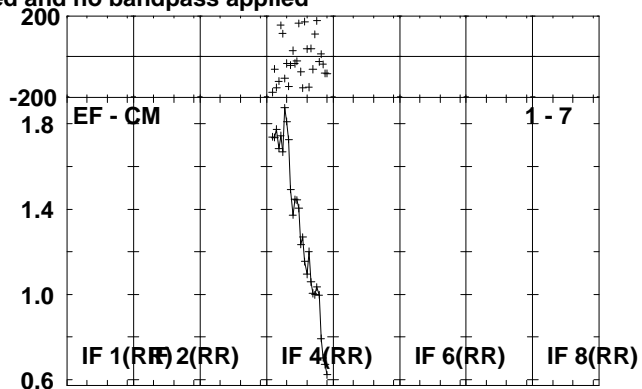
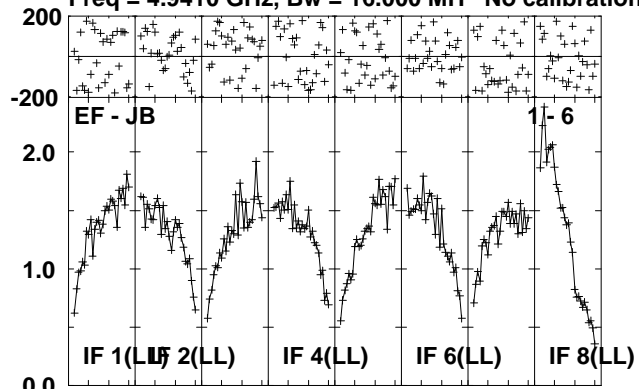

Lower frame: Milli Ampl Jy Top frame: Phas deg
Scalar averaged cross-power spectrum Several baselines displayed
Timerange: 00/14:04:01 to 00/14:06:29

Plot file version 21 created 04-OCT-2010 10:14:01

J1707-14 RP016A.UVDATA.1

Freq = 4.9410 GHz, Bw = 16.000 MH No calibration applied and no bandpass applied

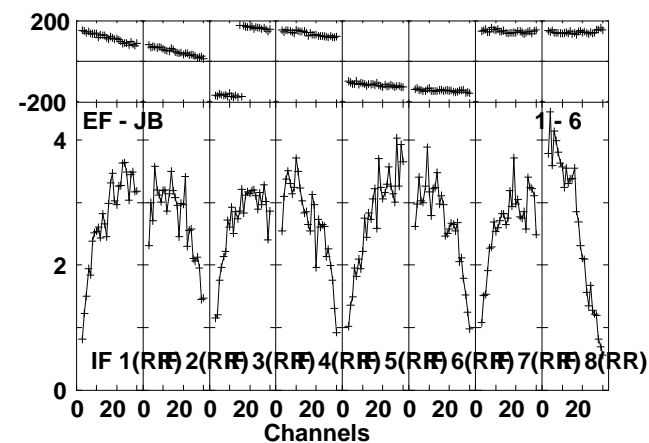
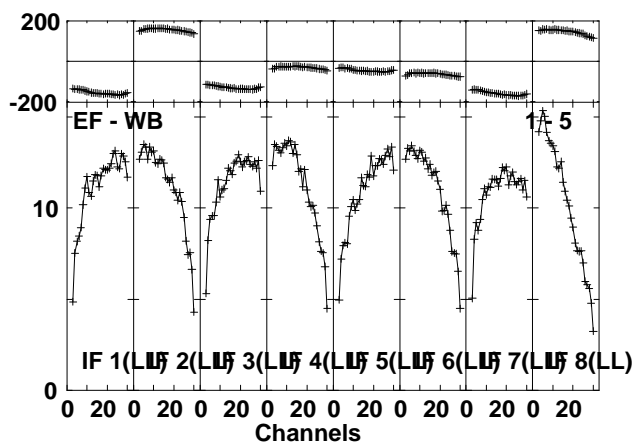
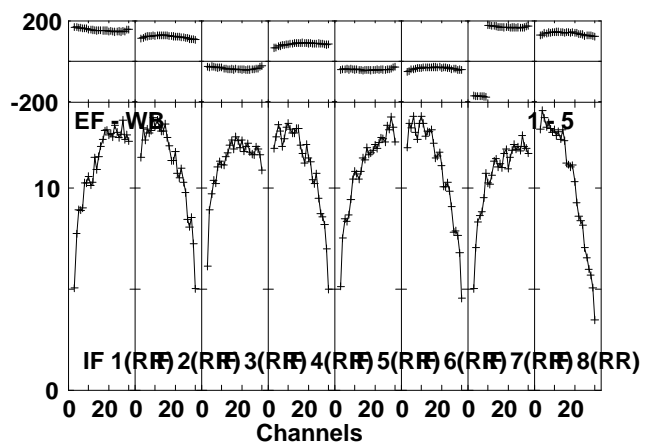
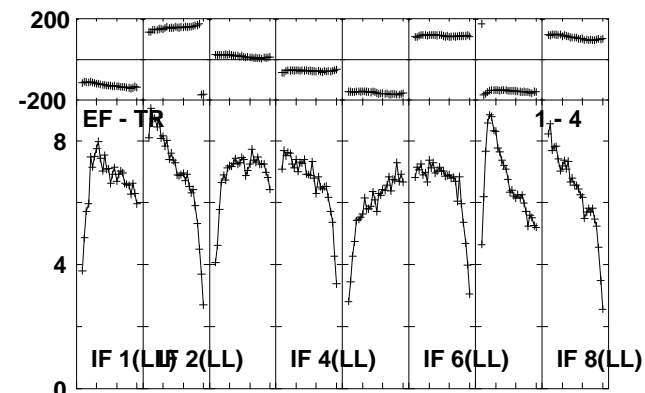
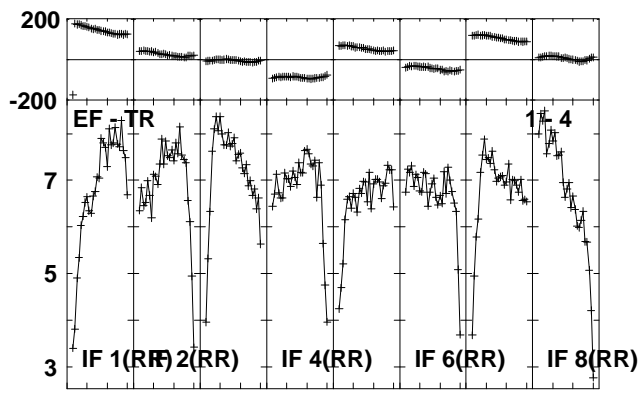
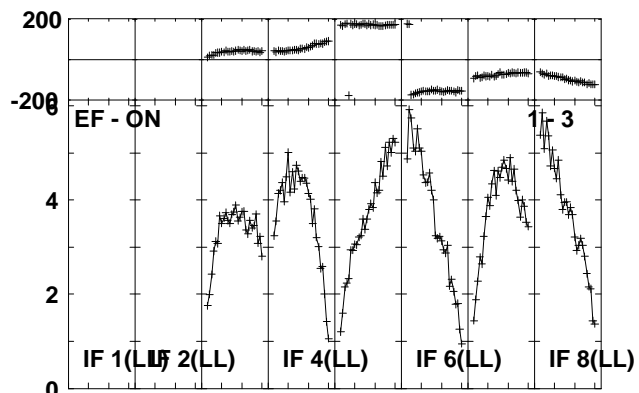
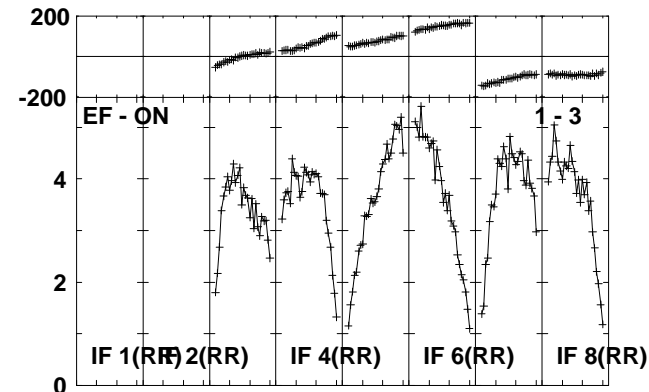
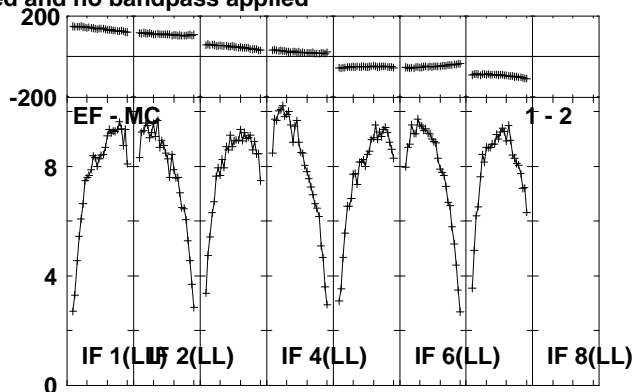
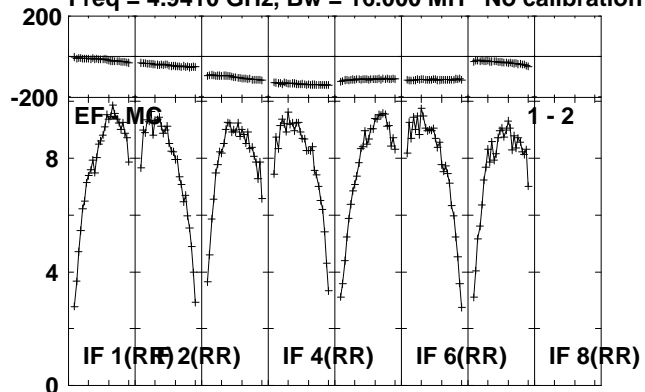

Plot file version 22 created 04-OCT-2010 10:14:02
J1707-14 RP016A.UVDATA.1

Freq = 4.9410 GHz, Bw = 16.000 MH No calibration applied and no bandpass applied

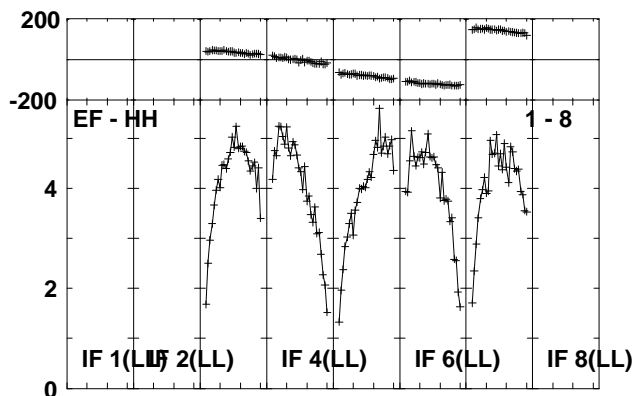
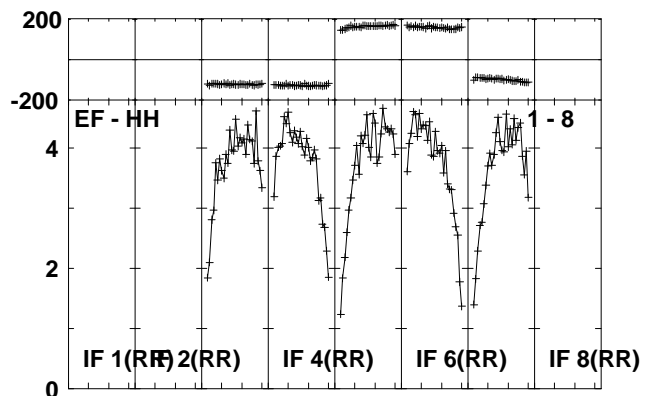
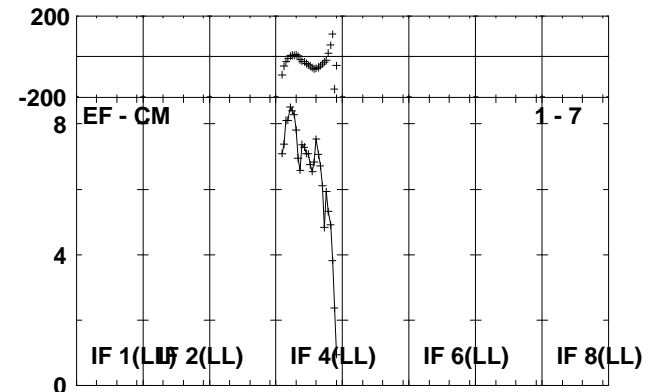
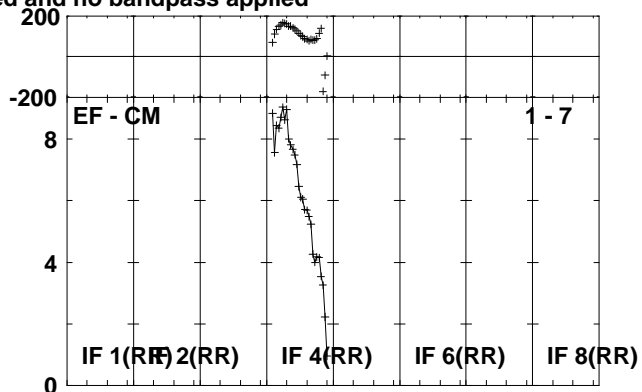
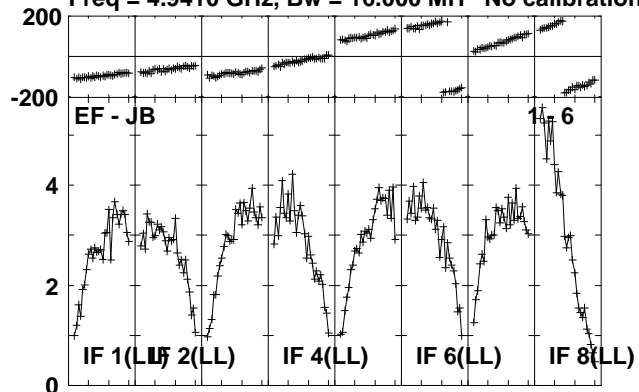

Lower frame: Milli Ampl Jy Top frame: Phas deg
Scalar averaged cross-power spectrum Several baselines displayed
Timerange: 00/14:06:31 to 00/14:07:59

Plot file version 23 created 04-OCT-2010 10:14:03

MAXI J16 RP016A.UVDATA.1

Freq = 4.9410 GHz, Bw = 16.000 MH No calibration applied and no bandpass applied

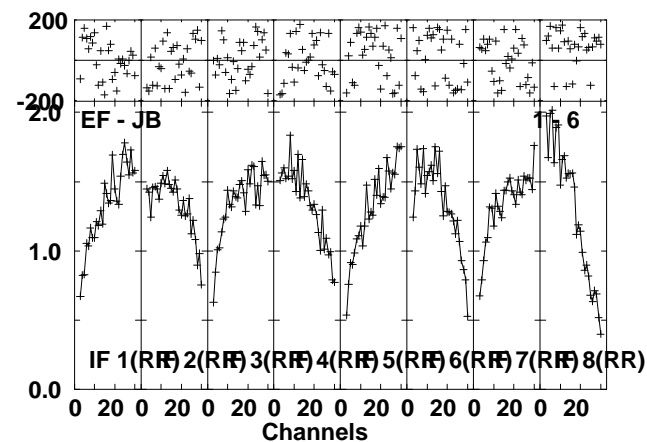
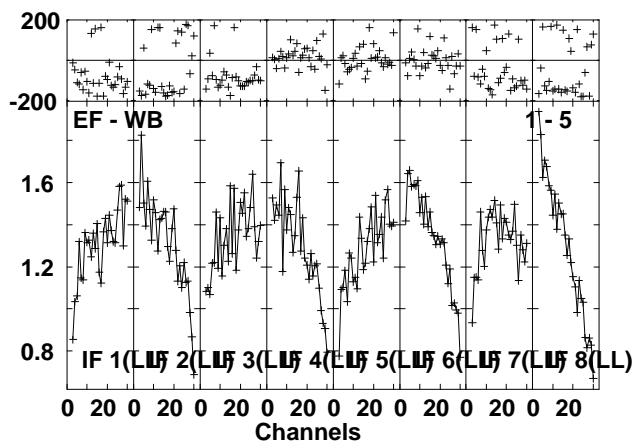
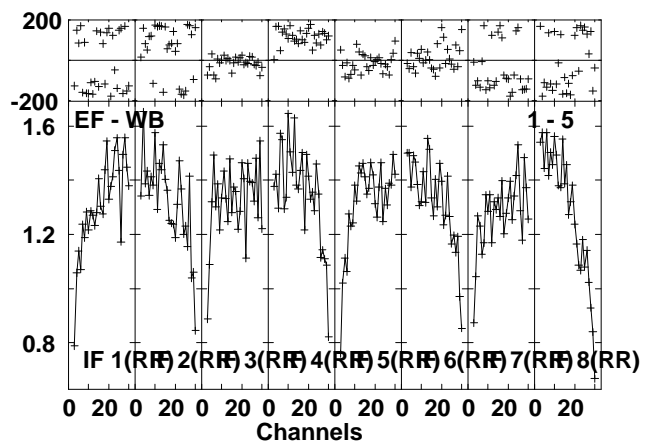
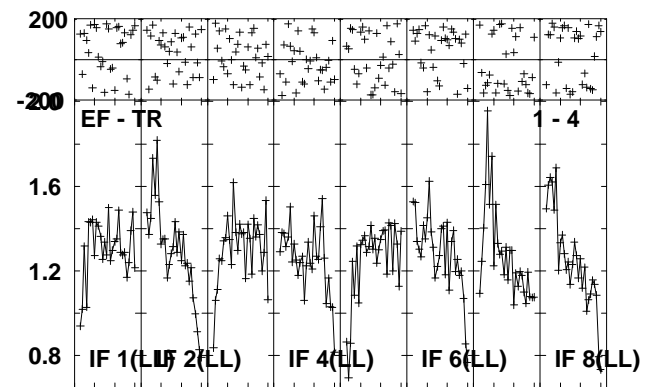
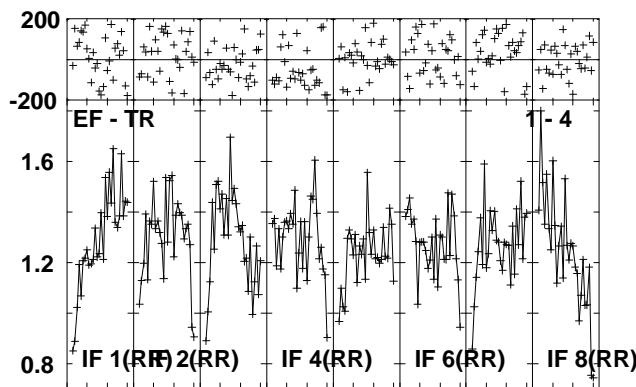
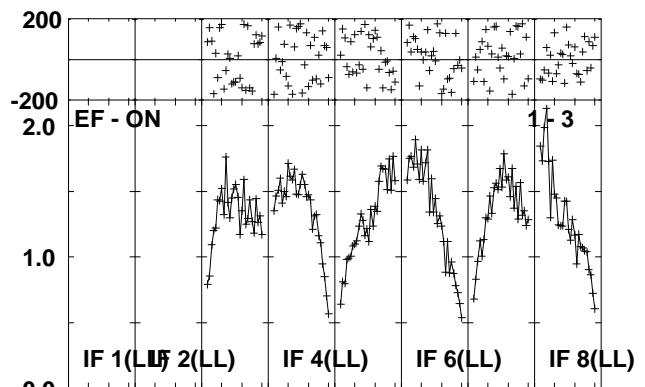
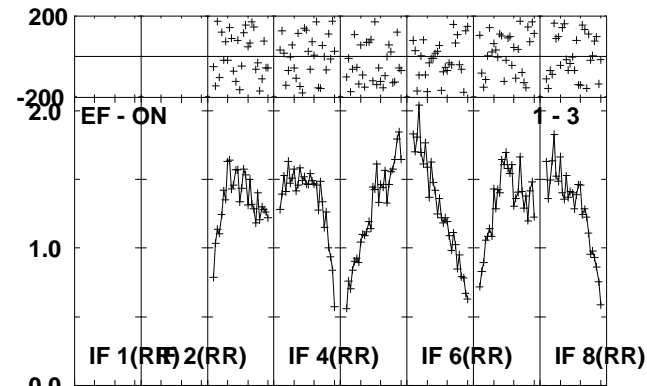
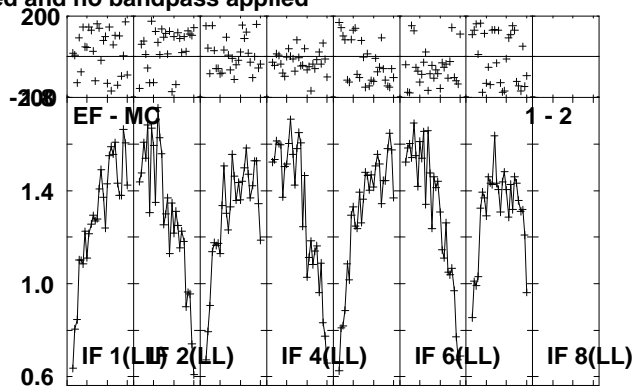
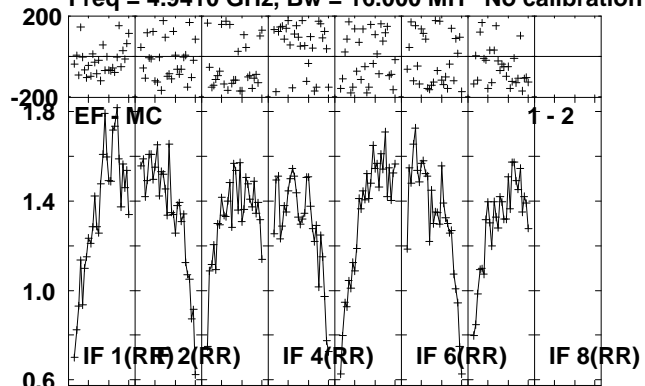

Lower frame: Milli Ampl Jy Top frame: Phas deg
Scalar averaged cross-power spectrum Several baselines displayed
Timerange: 00/14:08:01 to 00/14:10:29

Plot file version 24 created 04-OCT-2010 10:14:05

MAXI J16 RP016A.UVDATA.1

Freq = 4.9410 GHz, Bw = 16.000 MH No calibration applied and no bandpass applied

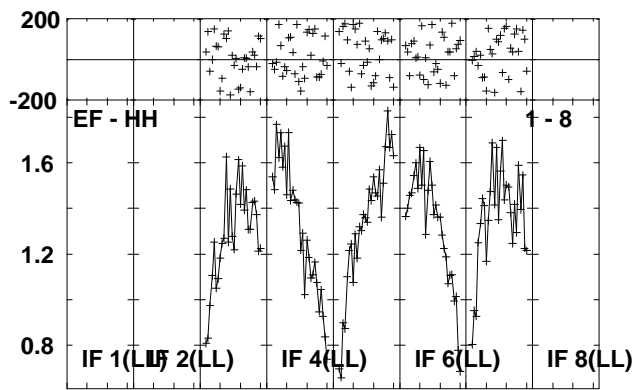
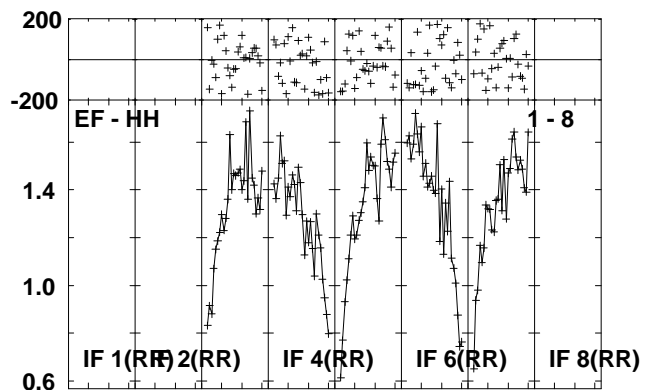
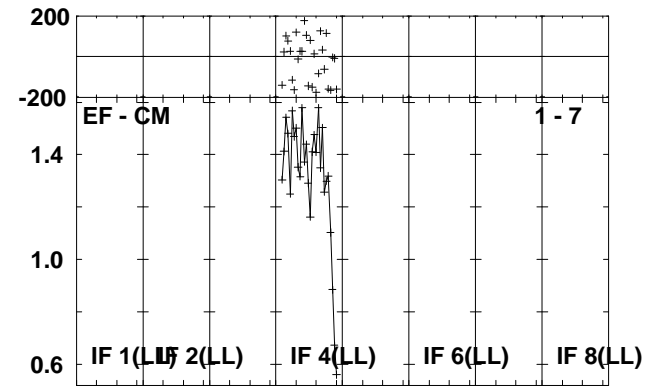
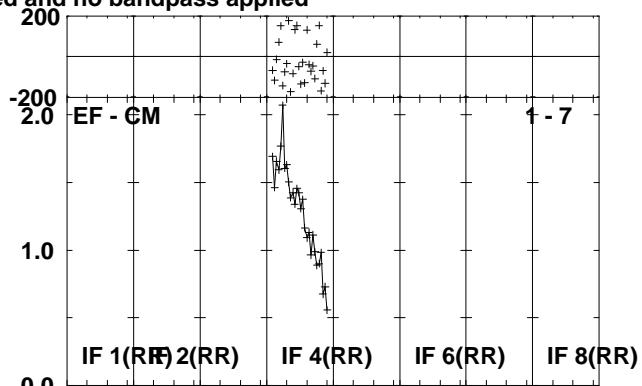
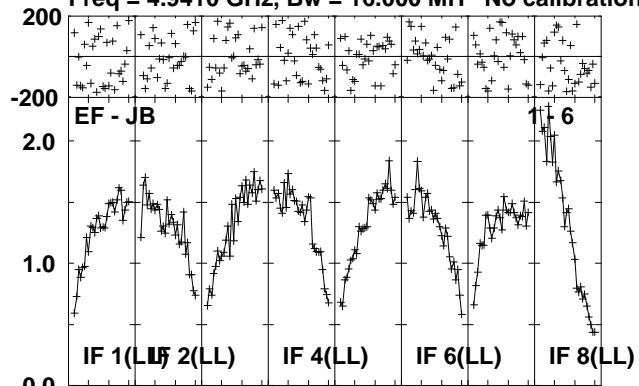

Lower frame: Milli Ampl Jy Top frame: Phas deg
Scalar averaged cross-power spectrum Several baselines displayed
Timerange: 00/14:08:01 to 00/14:10:29

Plot file version 25 created 04-OCT-2010 10:14:06

J1707-14 RP016A.UVDATA.1

Freq = 4.9410 GHz, Bw = 16.000 MH No calibration applied and no bandpass applied

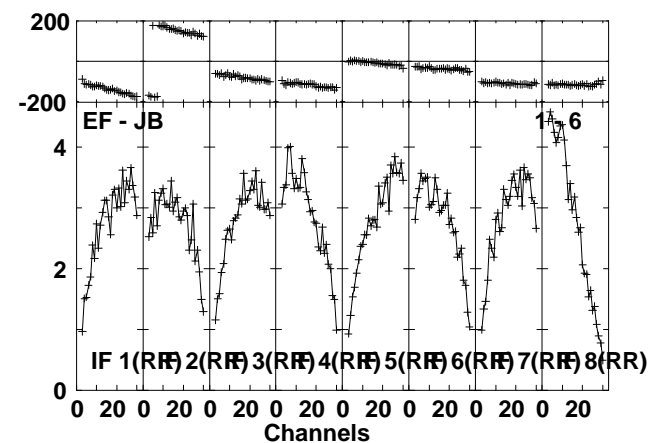
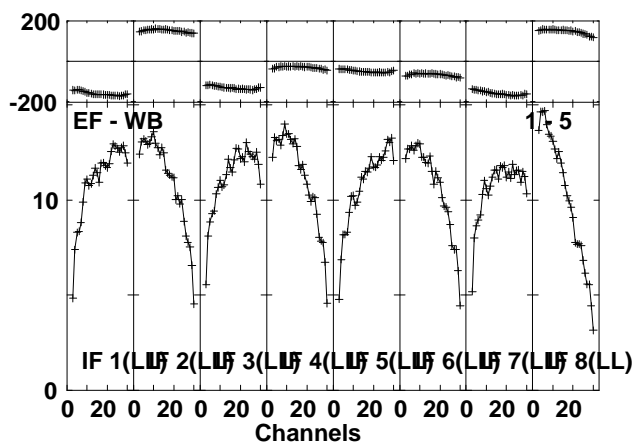
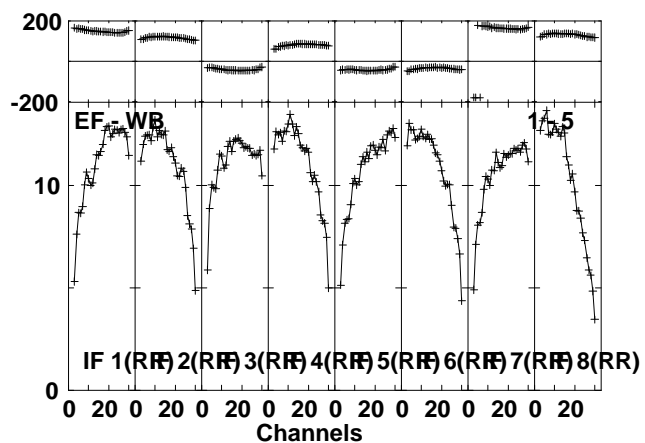
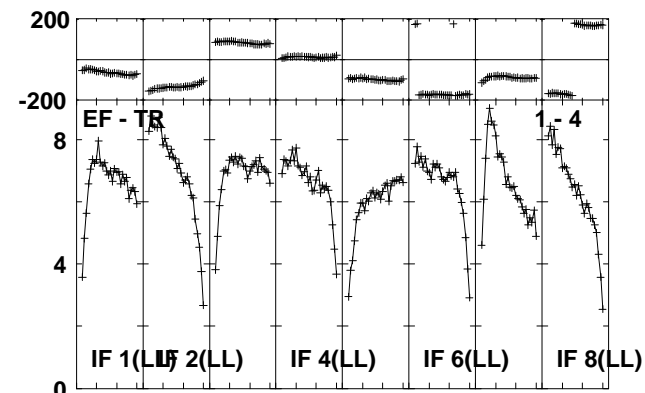
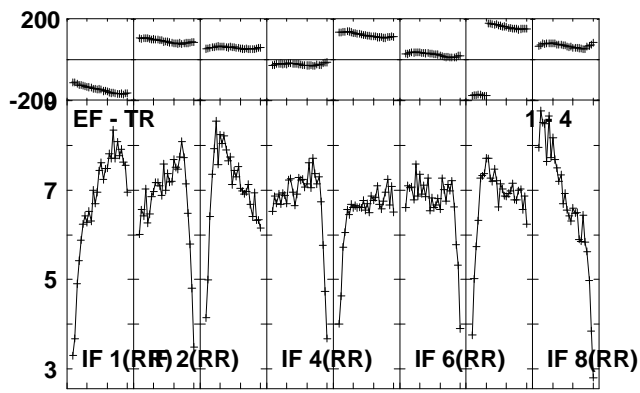
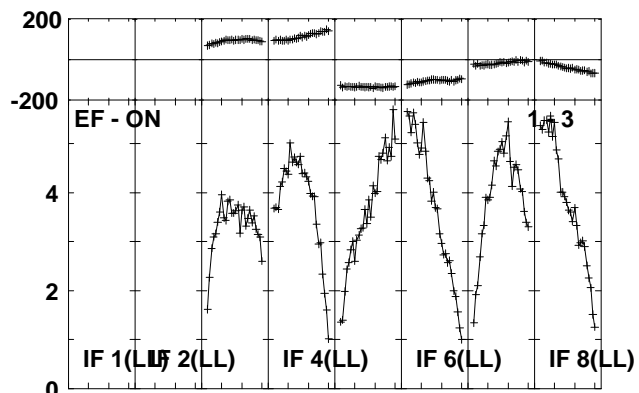
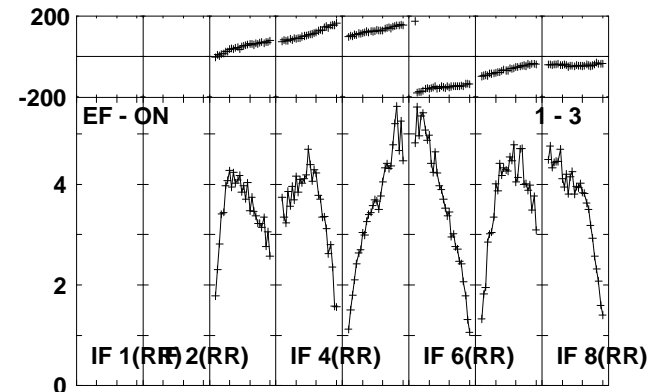
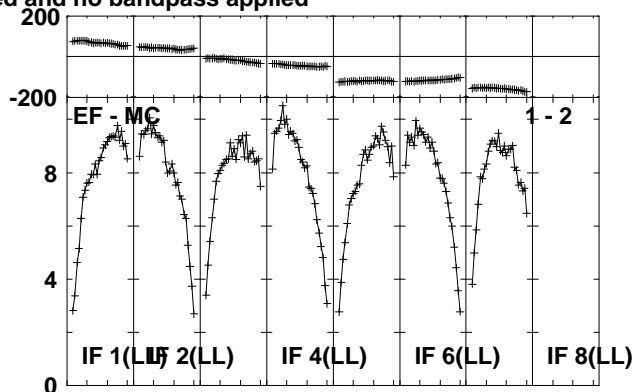
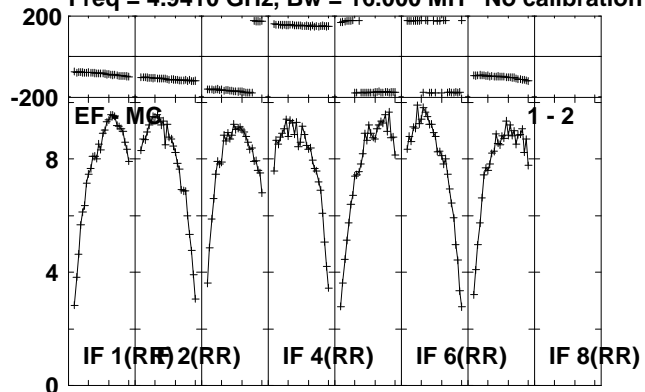

Lower frame: Milli Ampl Jy Top frame: Phas deg
Scalar averaged cross-power spectrum Several baselines displayed
Timerange: 00/14:11:11 to 00/14:12:09

Plot file version 26 created 04-OCT-2010 10:14:07

J1707-14 RP016A.UVDATA.1

Freq = 4.9410 GHz, Bw = 16.000 MH No calibration applied and no bandpass applied

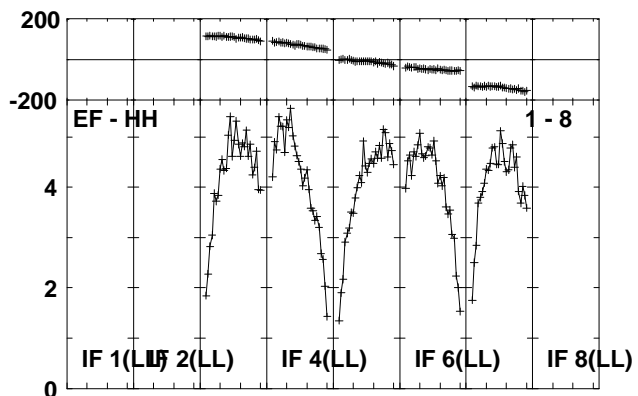
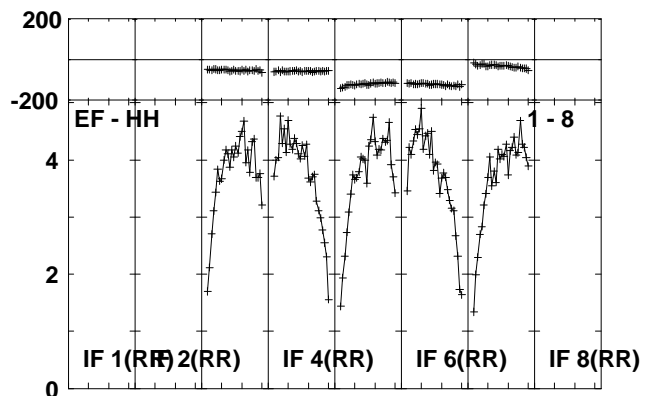
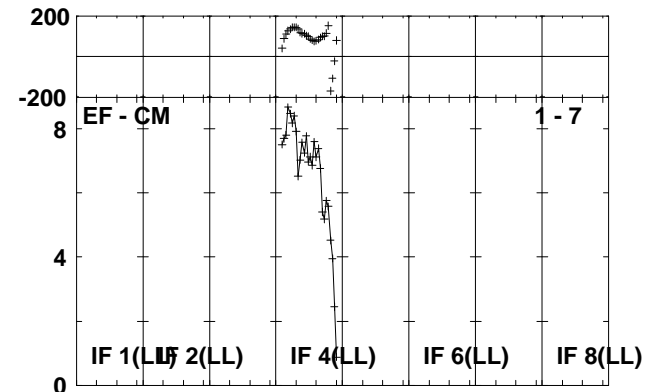
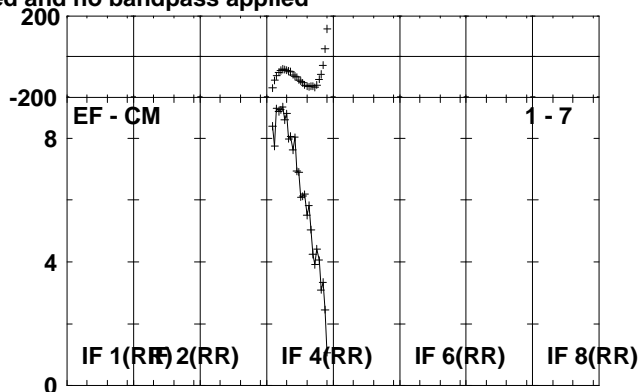
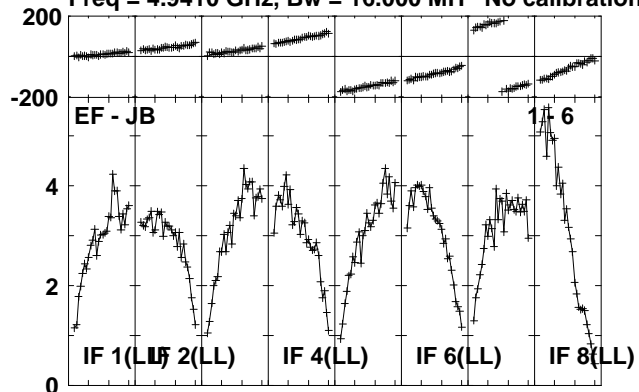

Lower frame: Milli Ampl Jy Top frame: Phas deg
Scalar averaged cross-power spectrum Several baselines displayed
Timerange: 00/14:11:11 to 00/14:12:09

Plot file version 27 created 04-OCT-2010 10:14:07

NVSS3 RP016A.UVDATA.1

Freq = 4.9410 GHz, Bw = 16.000 MH No calibration applied and no bandpass applied

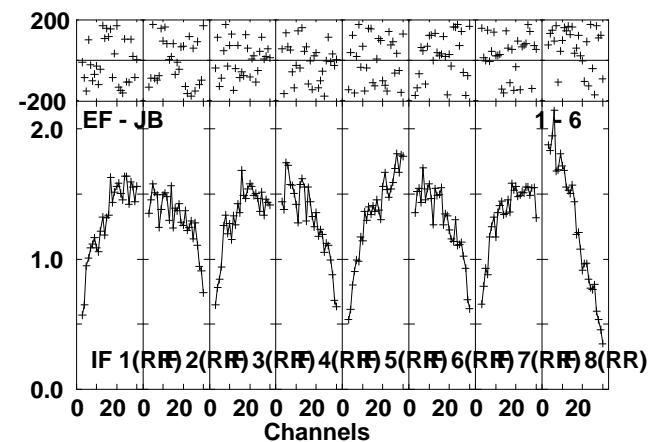
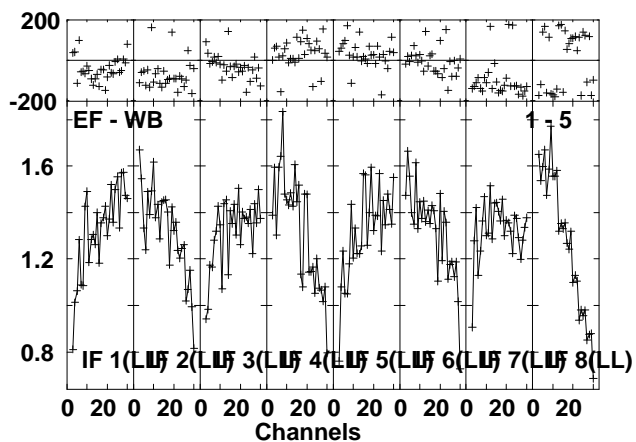
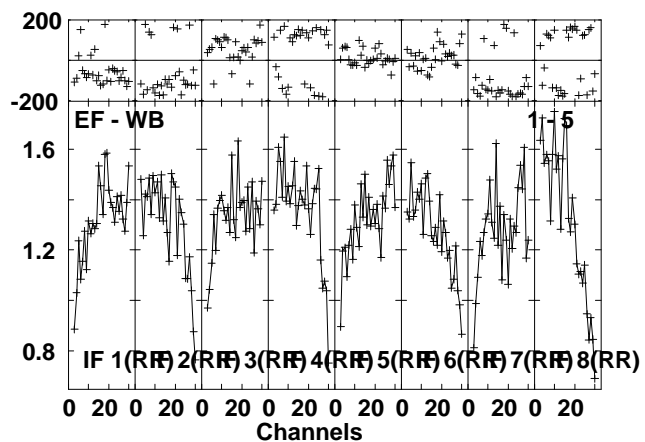
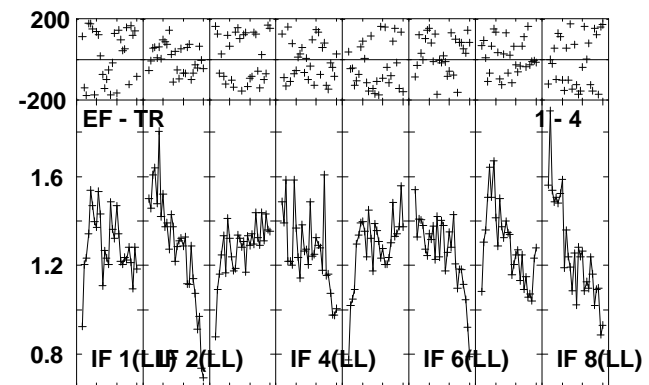
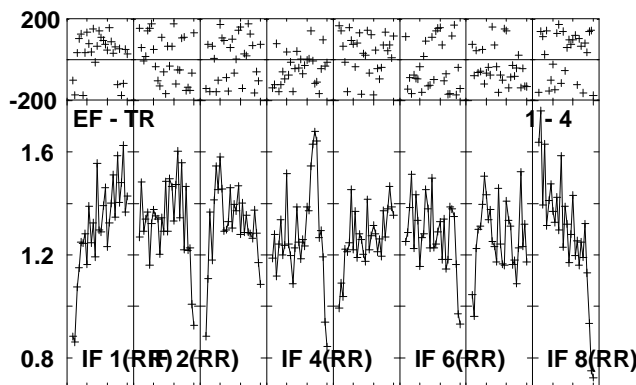
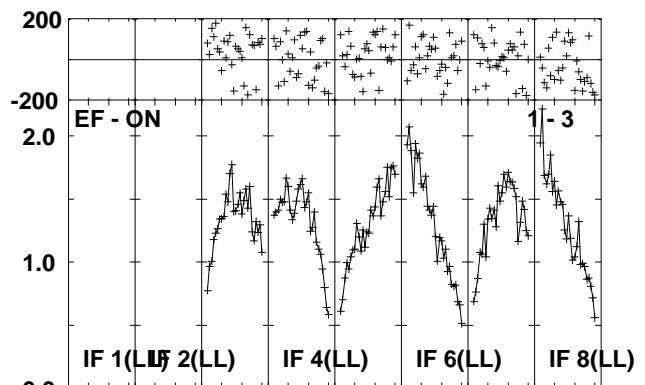
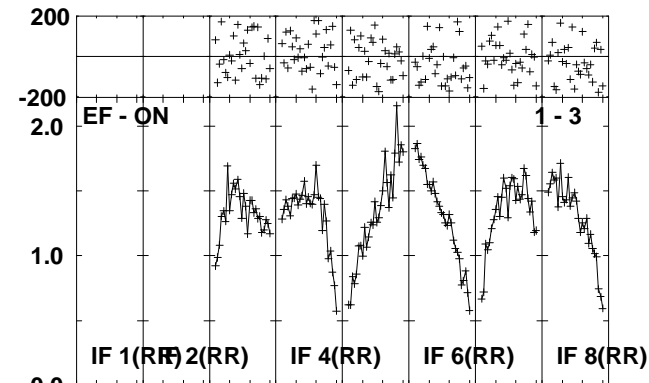
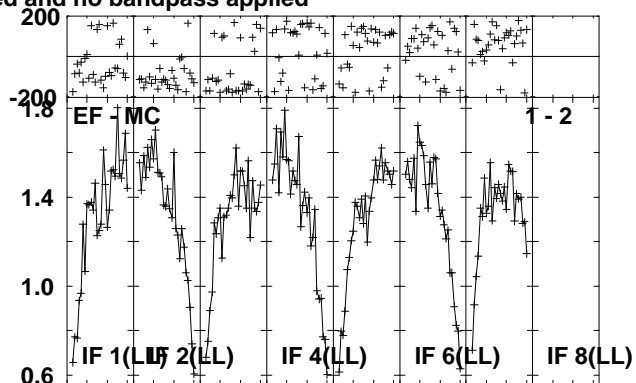
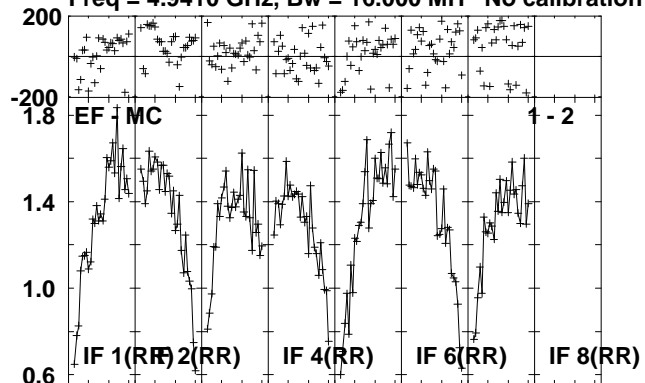

Lower frame: Milli Ampl Jy Top frame: Phas deg
Scalar averaged cross-power spectrum Several baselines displayed
Timerange: 00/14:12:11 to 00/14:14:39

Plot file version 28 created 04-OCT-2010 10:14:09

NVSS3 RP016A.UVDATA.1

Freq = 4.9410 GHz, Bw = 16.000 MH No calibration applied and no bandpass applied

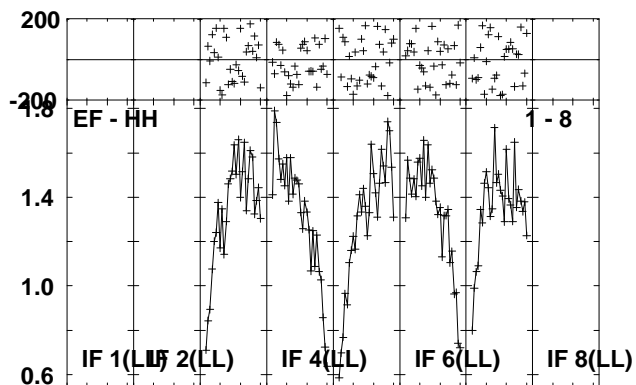
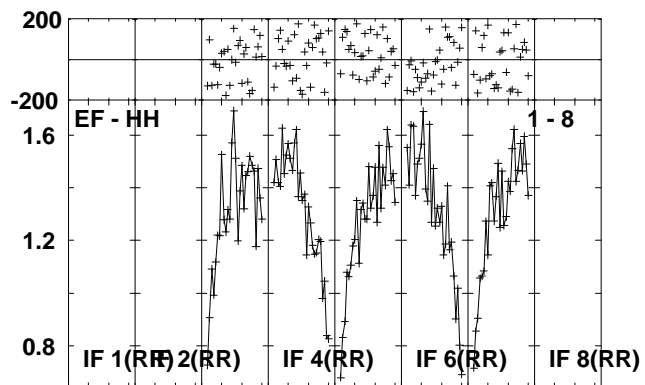
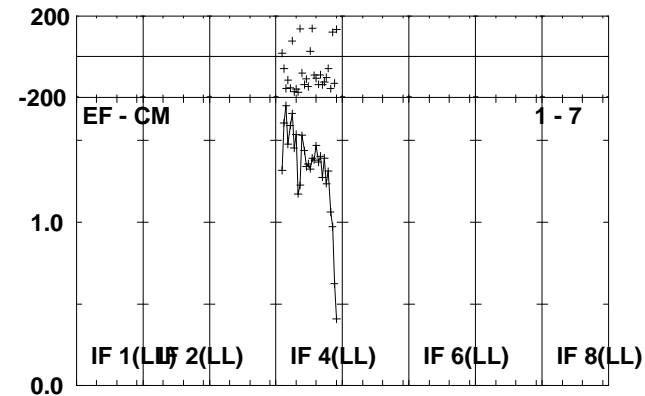
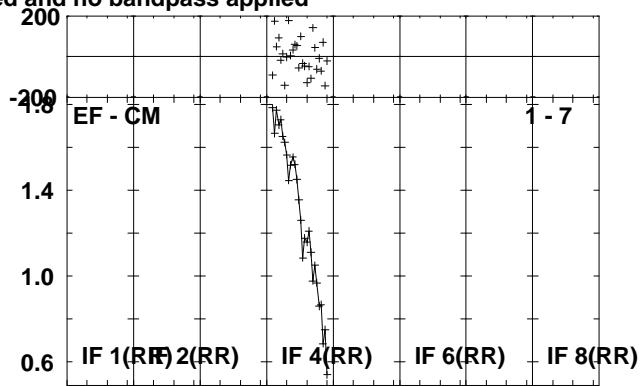
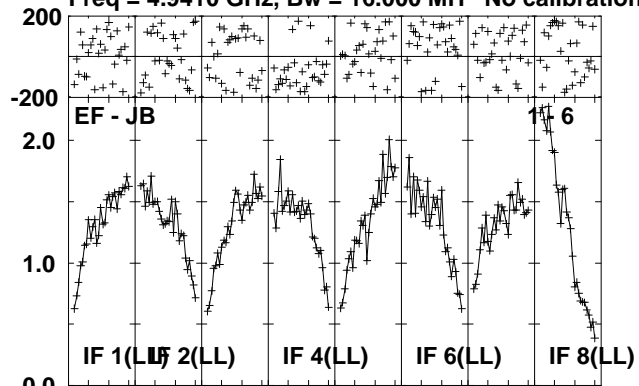

Lower frame: Milli Ampl Jy Top frame: Phas deg
Scalar averaged cross-power spectrum Several baselines displayed
Timerange: 00/14:12:11 to 00/14:14:39

Plot file version 29 created 04-OCT-2010 10:14:10

J1707-14 RP016A.UVDATA.1

Freq = 4.9410 GHz, Bw = 16.000 MH No calibration applied and no bandpass applied

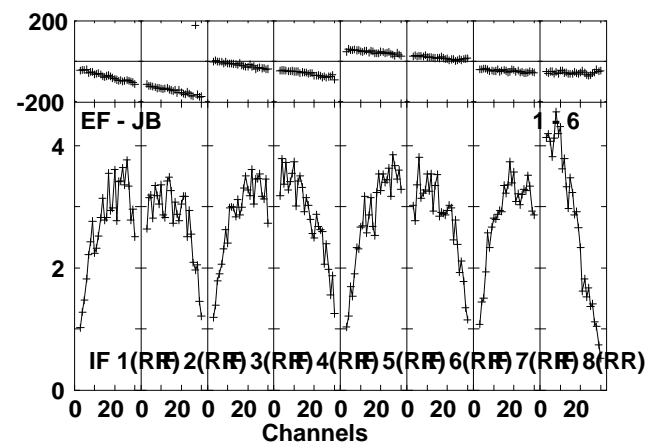
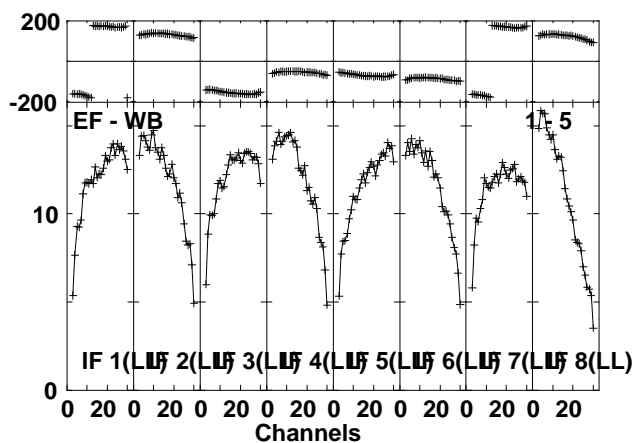
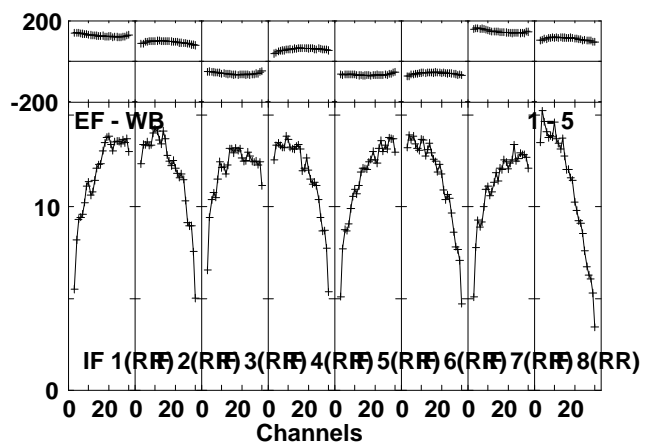
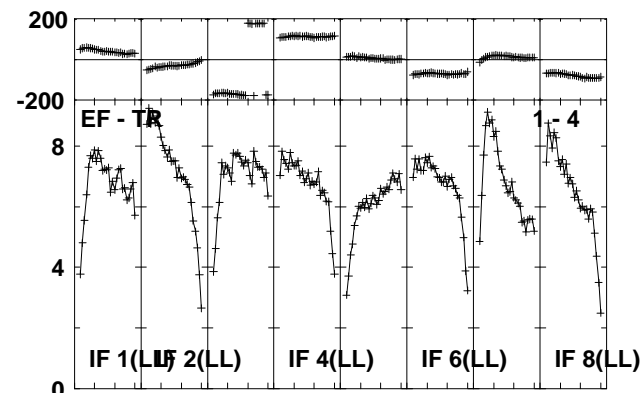
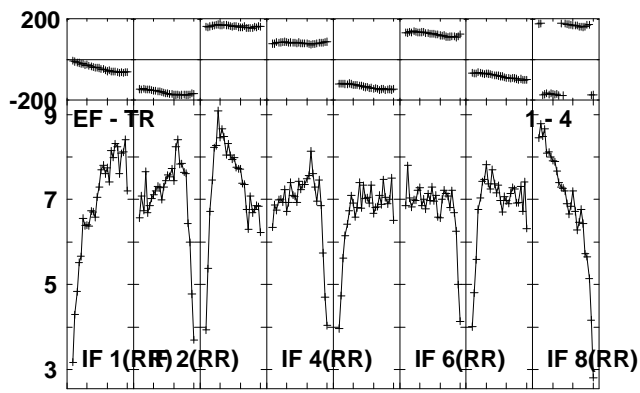
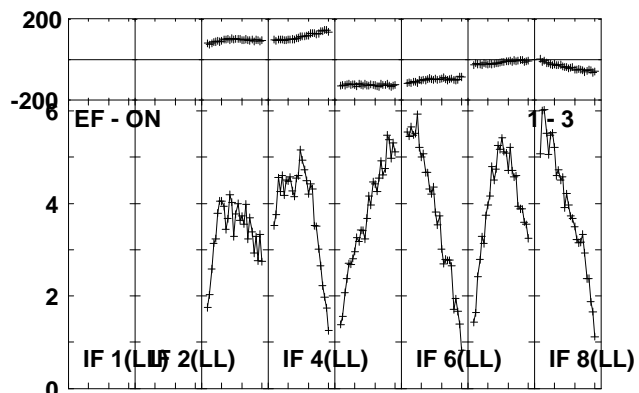
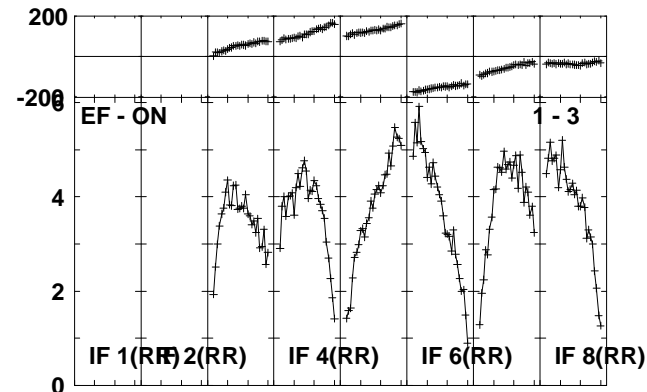
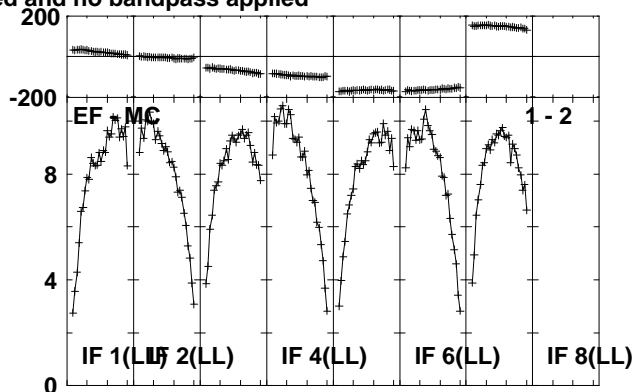
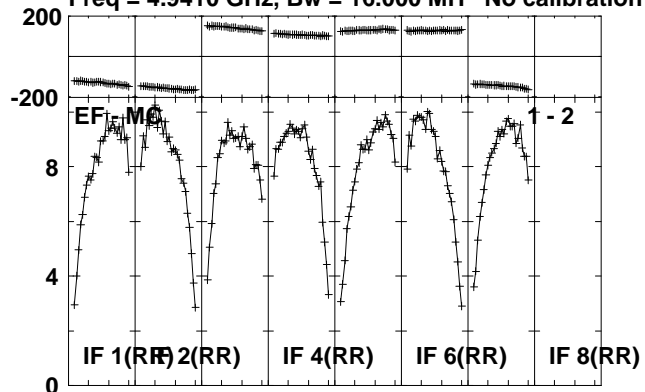

Lower frame: Milli Ampl Jy Top frame: Phas deg
Scalar averaged cross-power spectrum Several baselines displayed
Timerange: 00/14:14:41 to 00/14:16:09

Plot file version 30 created 04-OCT-2010 10:14:11
J1707-14 RP016A.UVDATA.1

Freq = 4.9410 GHz, Bw = 16.000 MH No calibration applied and no bandpass applied

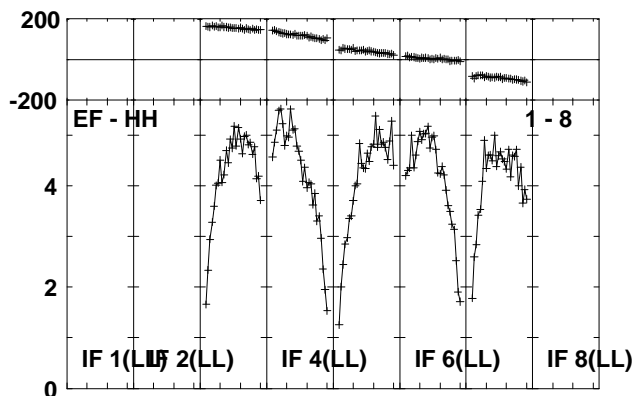
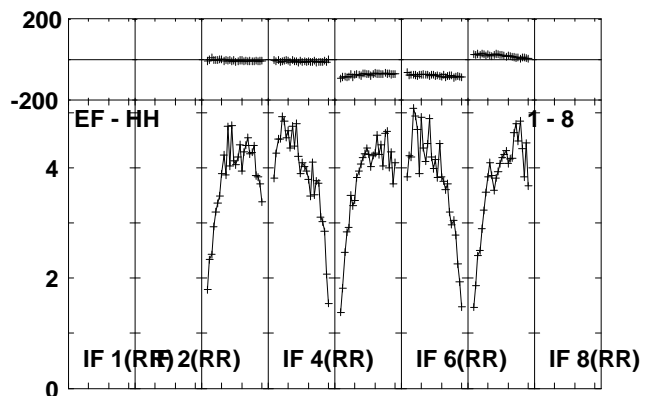
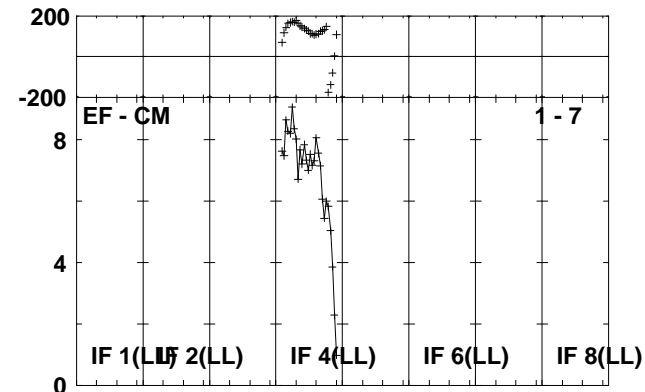
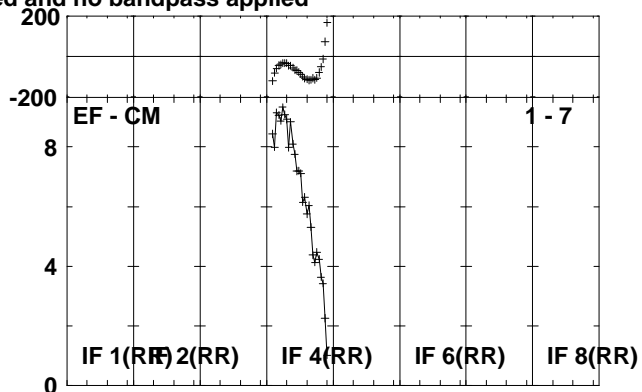
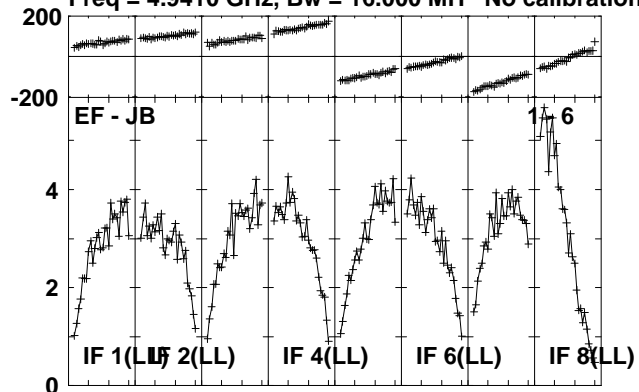

Lower frame: Milli Ampl Jy Top frame: Phas deg
Scalar averaged cross-power spectrum Several baselines displayed
Timerange: 00/14:14:41 to 00/14:16:09

Plot file version 31 created 04-OCT-2010 10:14:12

MAXI J16 RP016A.UVDATA.1

Freq = 4.9410 GHz, Bw = 16.000 MH No calibration applied and no bandpass applied

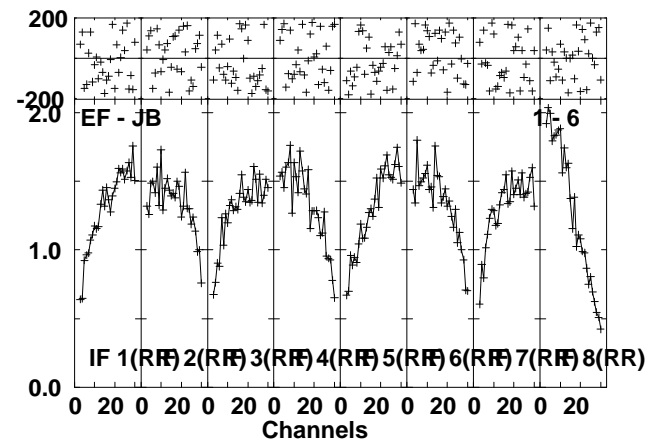
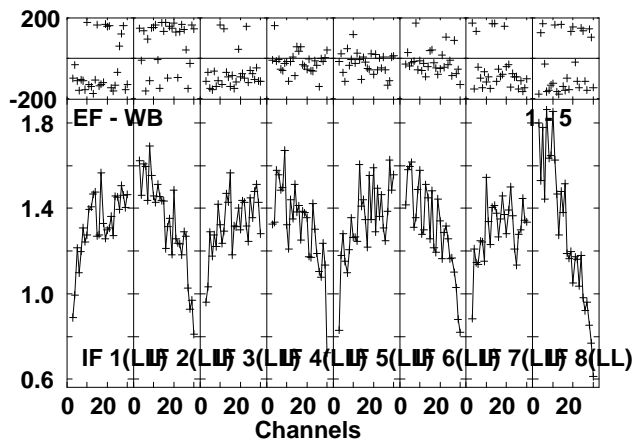
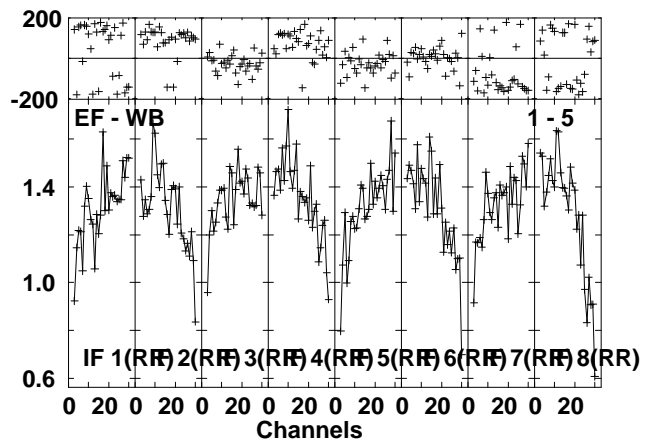
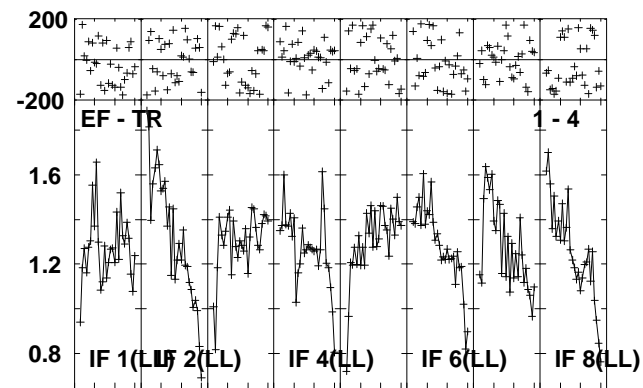
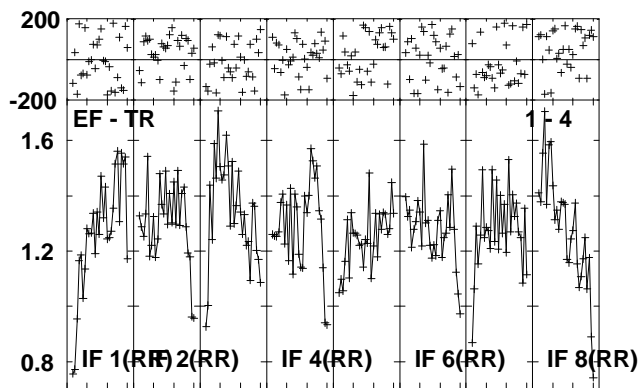
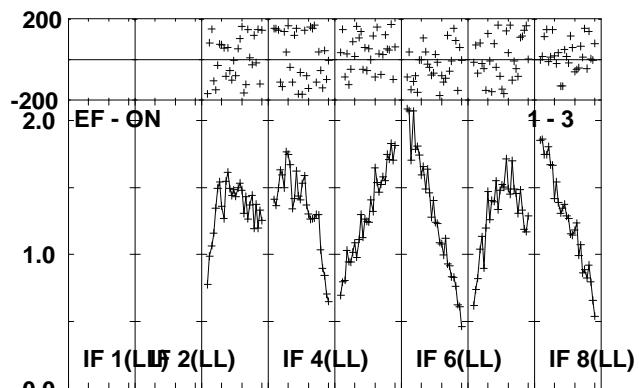
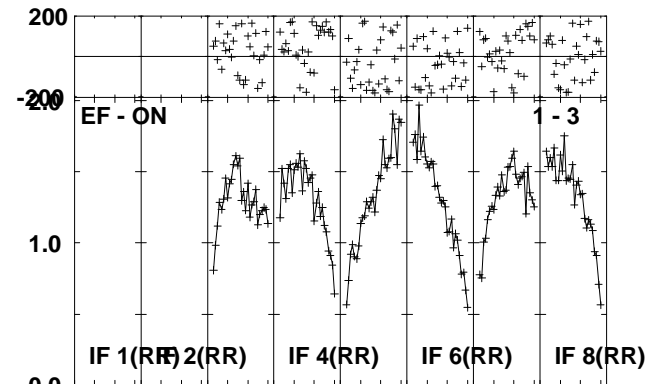
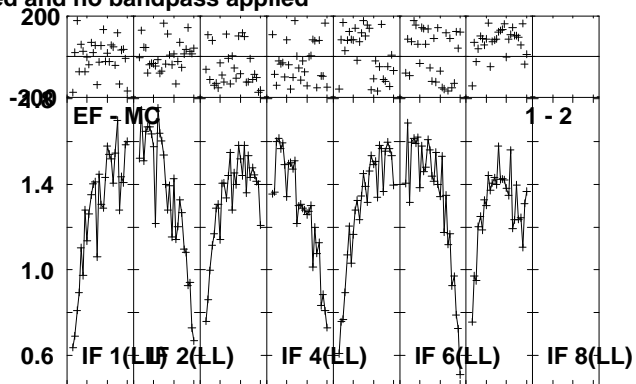
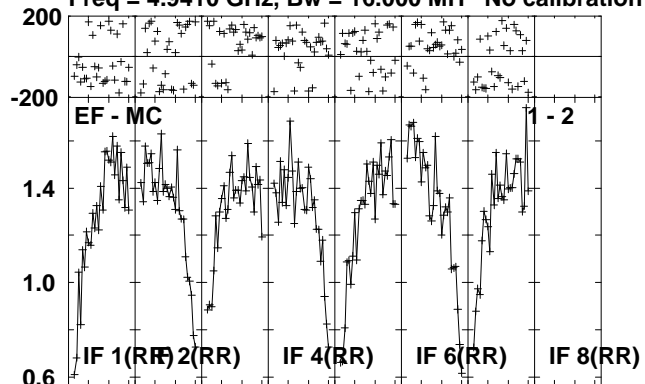

Lower frame: Milli Ampl Jy Top frame: Phas deg
Scalar averaged cross-power spectrum Several baselines displayed
Timerange: 00/14:16:11 to 00/14:18:39

Plot file version 32 created 04-OCT-2010 10:14:14

MAXI J16 RP016A.UVDATA.1

Freq = 4.9410 GHz, Bw = 16.000 MH No calibration applied and no bandpass applied

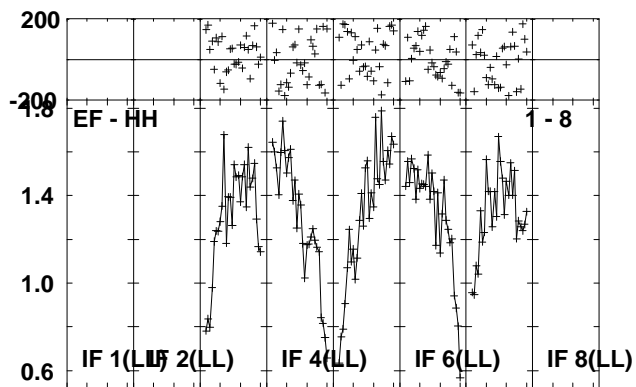
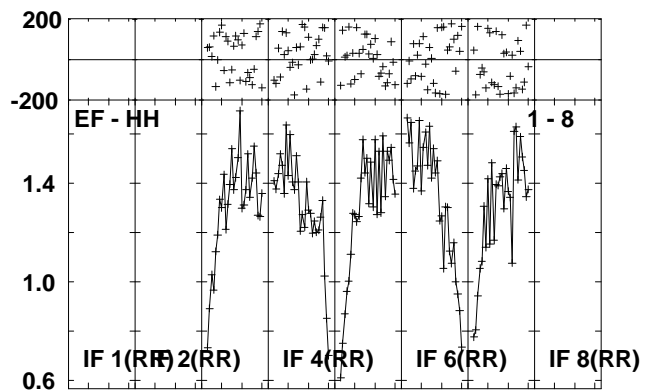
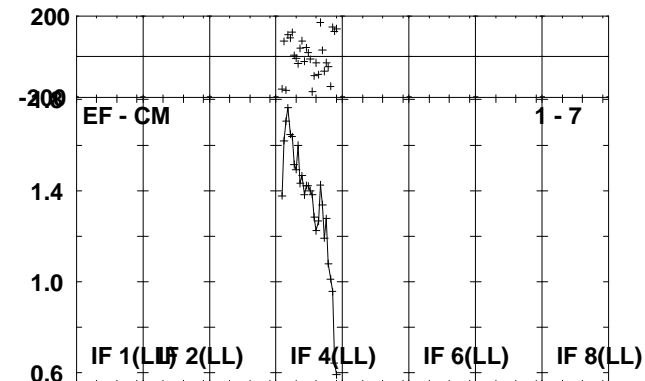
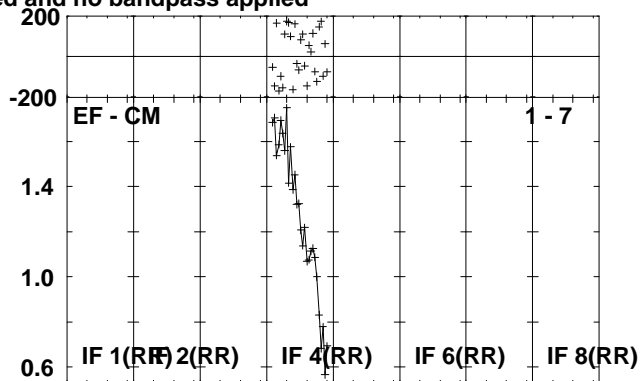
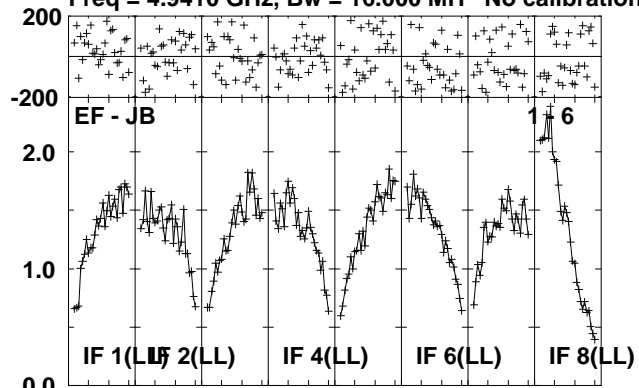

Lower frame: Milli Ampl Jy Top frame: Phas deg
Scalar averaged cross-power spectrum Several baselines displayed
Timerange: 00/14:16:11 to 00/14:18:39

Plot file version 33 created 04-OCT-2010 10:14:15

J1707-14 RP016A.UVDATA.1

Freq = 4.9410 GHz, Bw = 16.000 MH No calibration applied and no bandpass applied

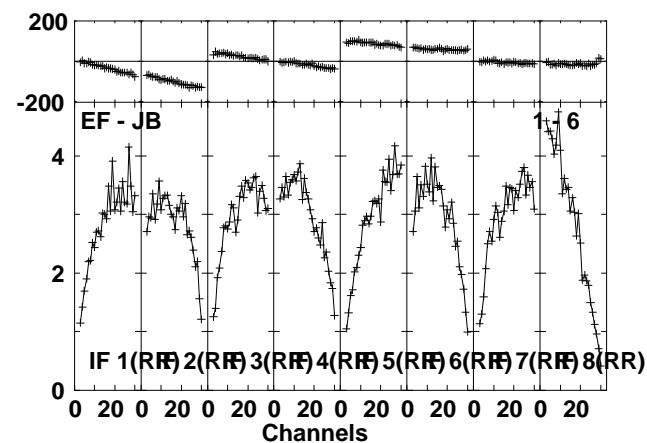
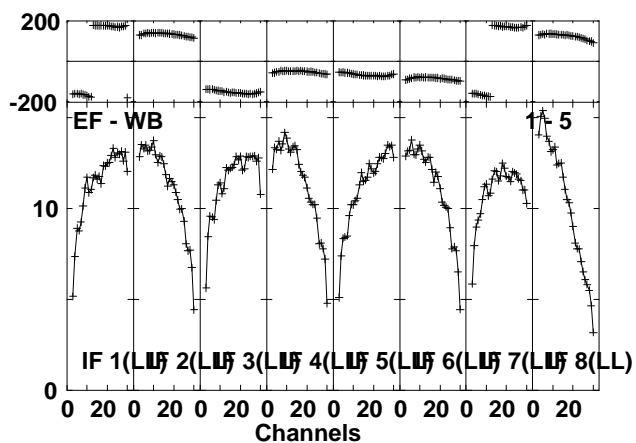
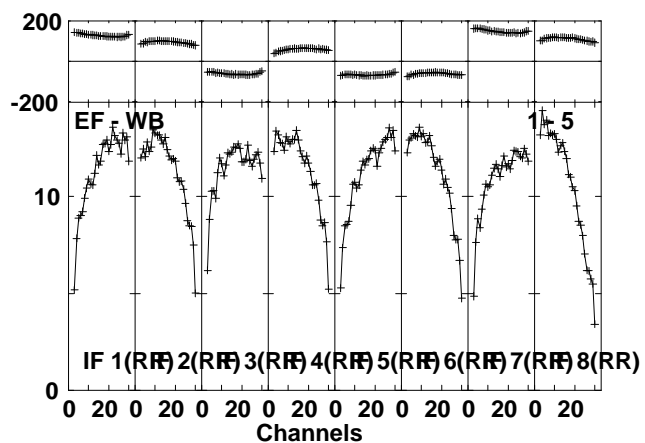
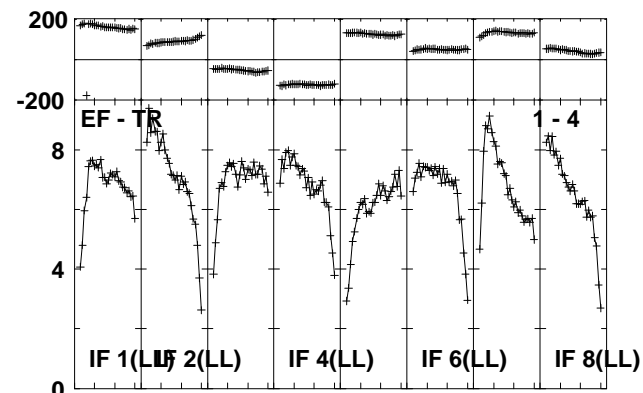
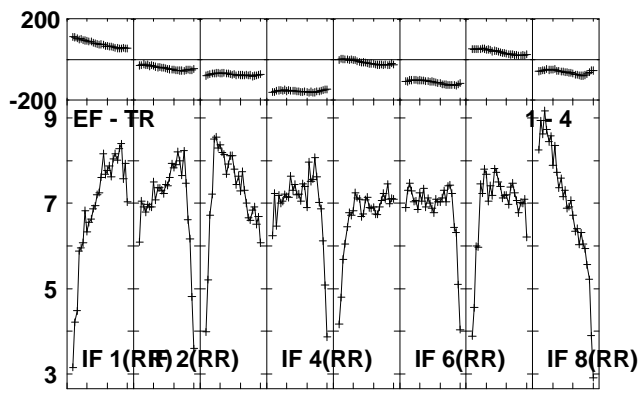
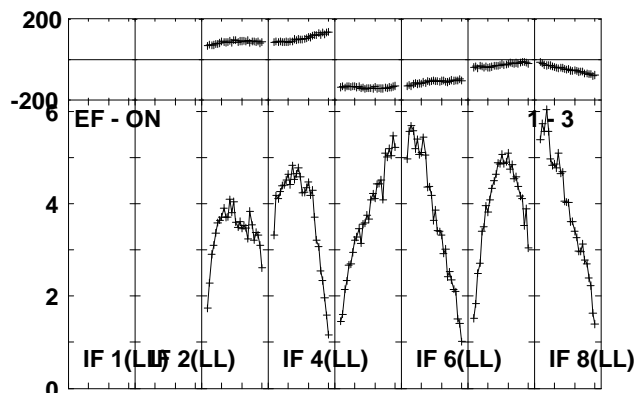
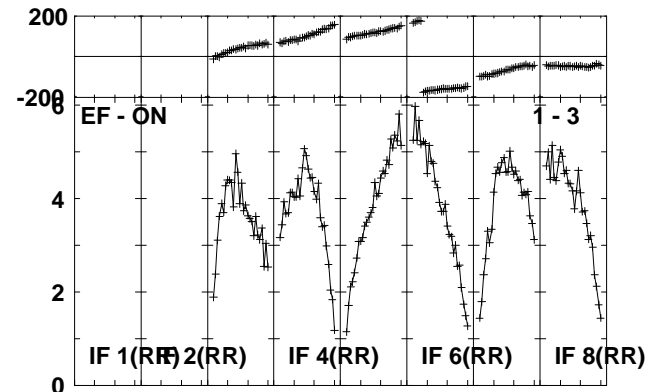
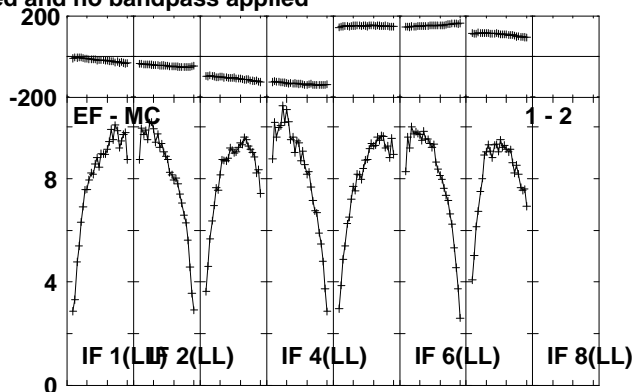
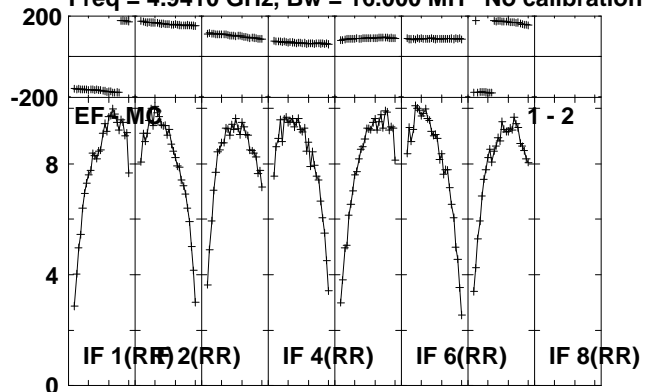

Lower frame: Milli Ampl Jy Top frame: Phas deg
Scalar averaged cross-power spectrum Several baselines displayed
Timerange: 00/14:19:21 to 00/14:20:19

Plot file version 34 created 04-OCT-2010 10:14:16
J1707-14 RP016A.UVDATA.1

Freq = 4.9410 GHz, Bw = 16.000 MH No calibration applied and no bandpass applied

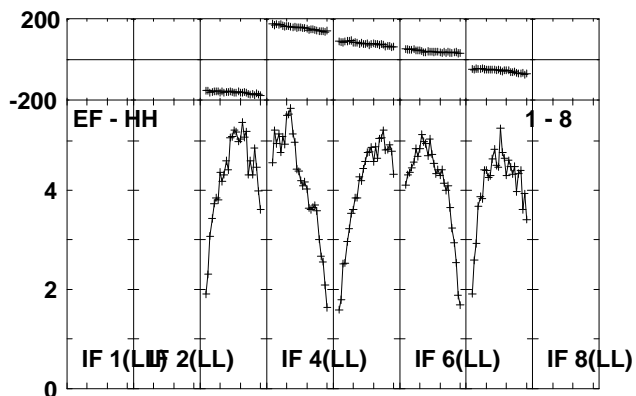
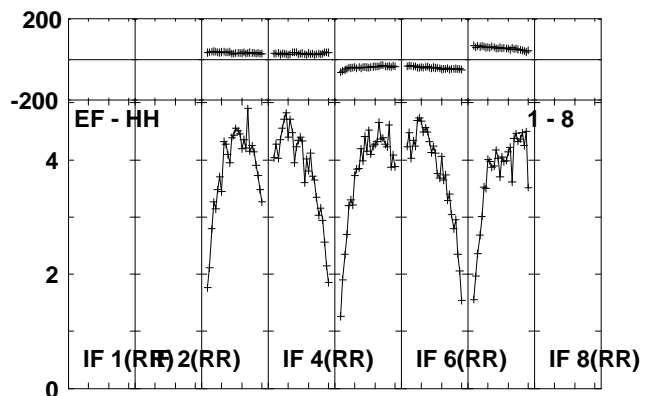
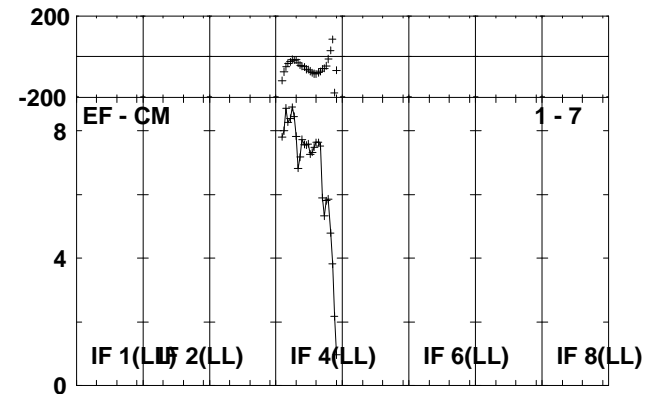
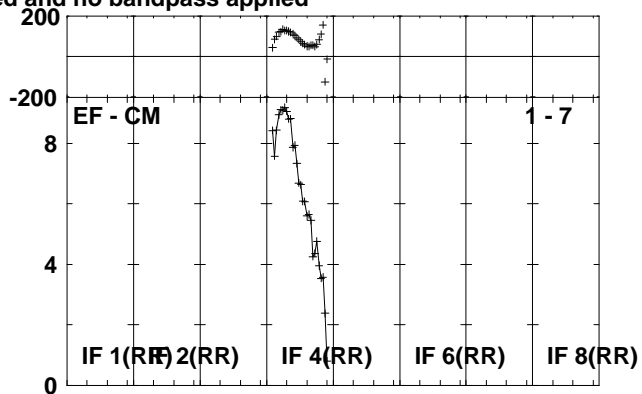
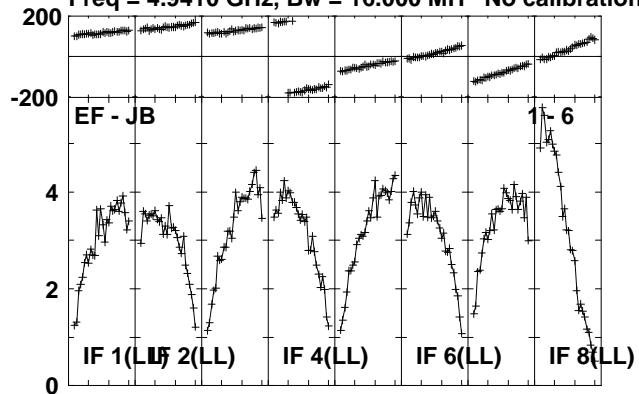

Lower frame: Milli Ampl Jy Top frame: Phas deg
Scalar averaged cross-power spectrum Several baselines displayed
Timerange: 00/14:19:21 to 00/14:20:19

Plot file version 35 created 04-OCT-2010 10:14:17

MAXI J16 RP016A.UVDATA.1

Freq = 4.9410 GHz, Bw = 16.000 MH No calibration applied and no bandpass applied

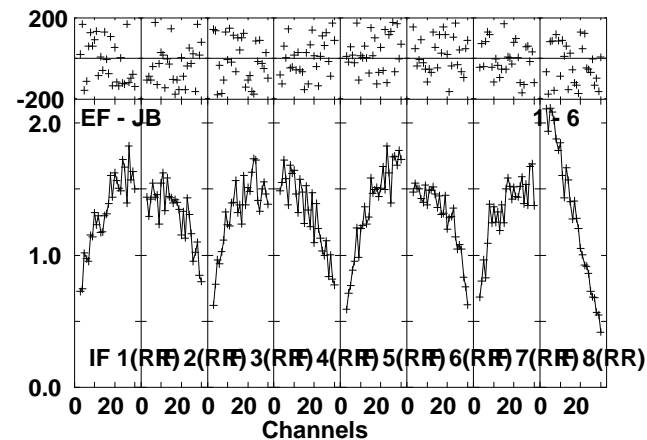
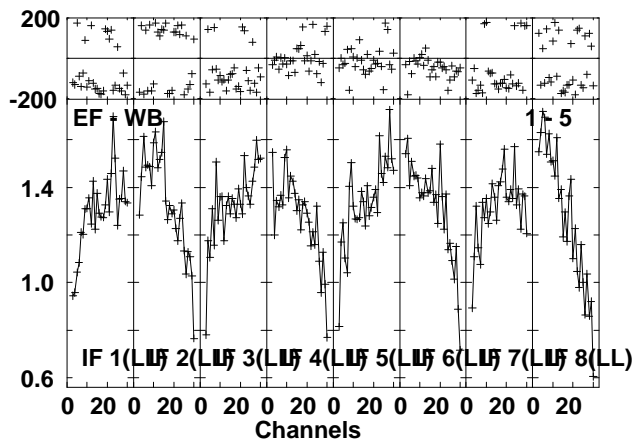
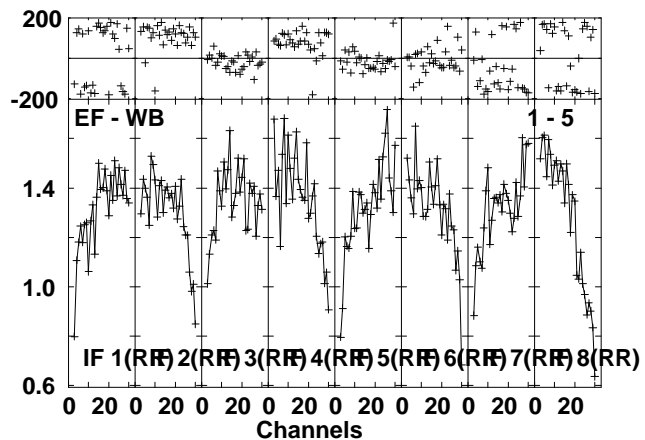
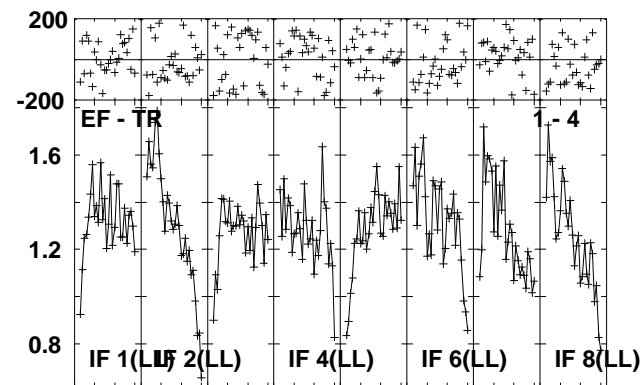
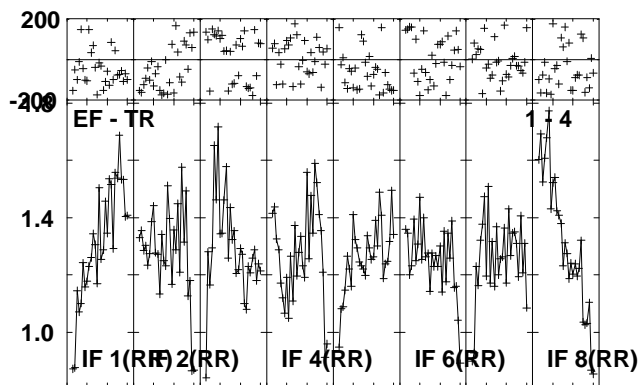
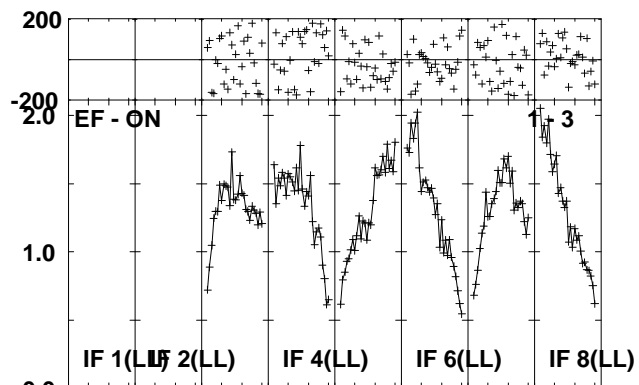
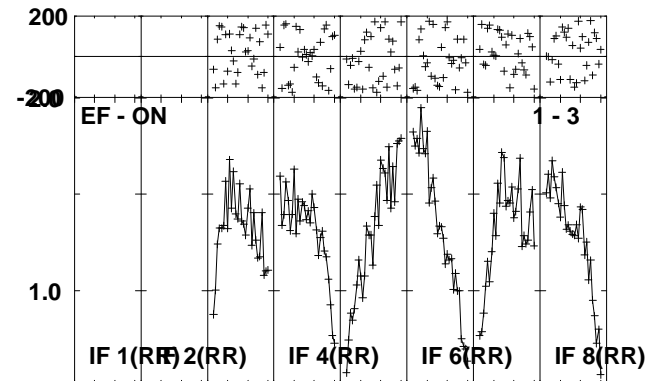
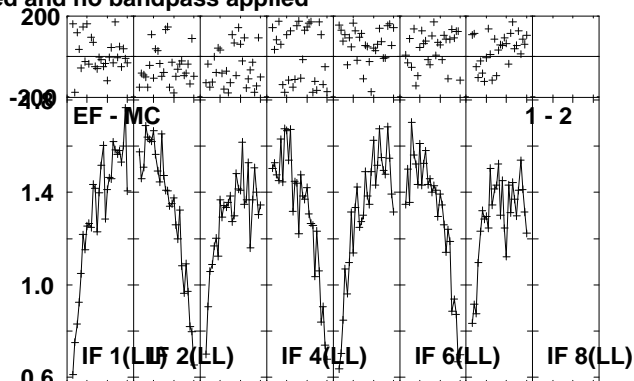
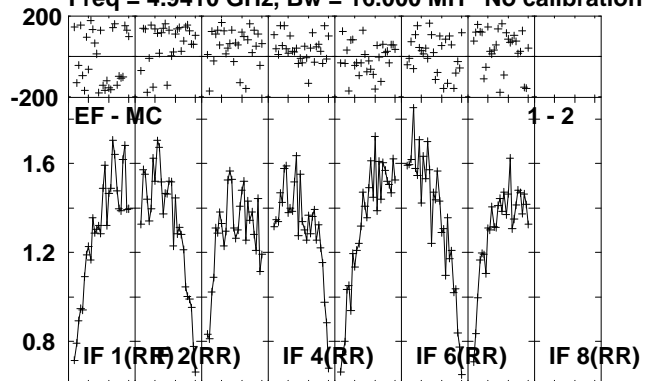

Lower frame: Milli Ampl Jy Top frame: Phas deg
Scalar averaged cross-power spectrum Several baselines displayed
Timerange: 00/14:20:21 to 00/14:22:49

Plot file version 36 created 04-OCT-2010 10:14:18

MAXI J16 RP016A.UVDATA.1

Freq = 4.9410 GHz, Bw = 16.000 MH No calibration applied and no bandpass applied

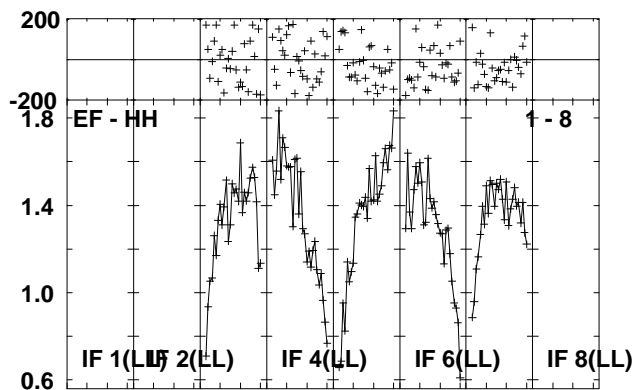
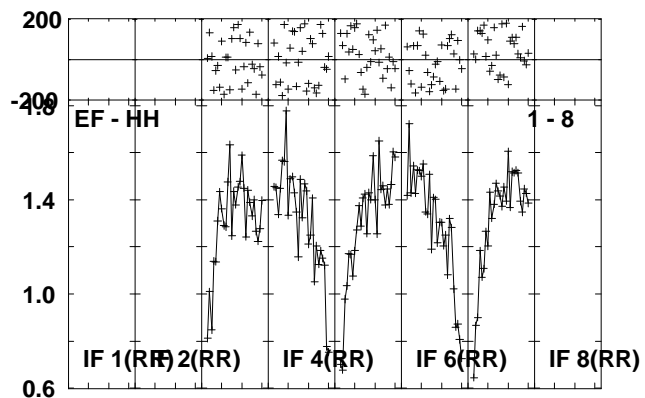
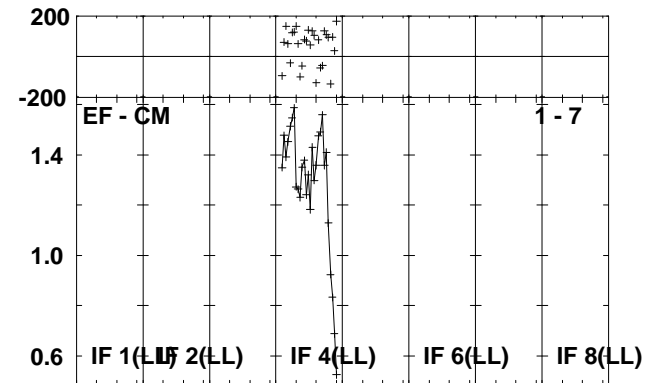
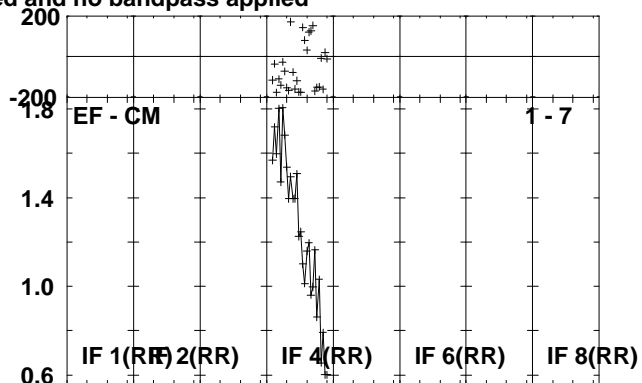
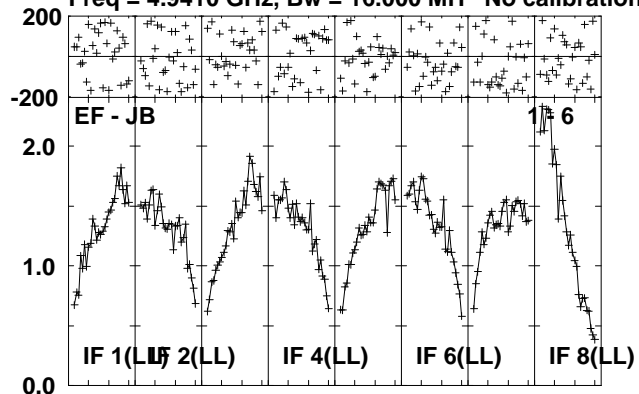

Lower frame: Milli Ampl Jy Top frame: Phas deg
Scalar averaged cross-power spectrum Several baselines displayed
Timerange: 00/14:20:21 to 00/14:22:49

Plot file version 37 created 04-OCT-2010 10:14:19

J1707-14 RP016A.UVDATA.1

Freq = 4.9410 GHz, Bw = 16.000 MH No calibration applied and no bandpass applied

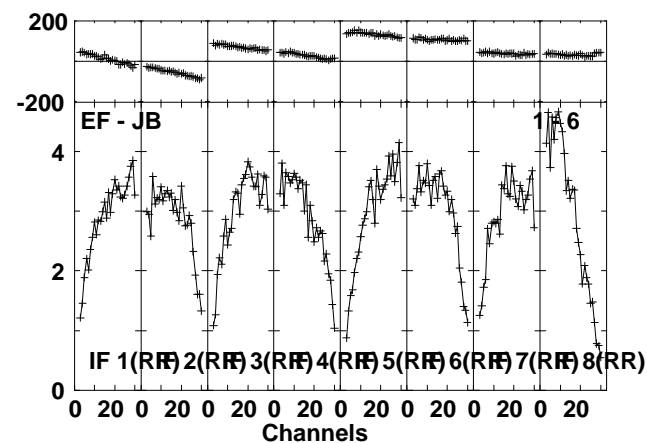
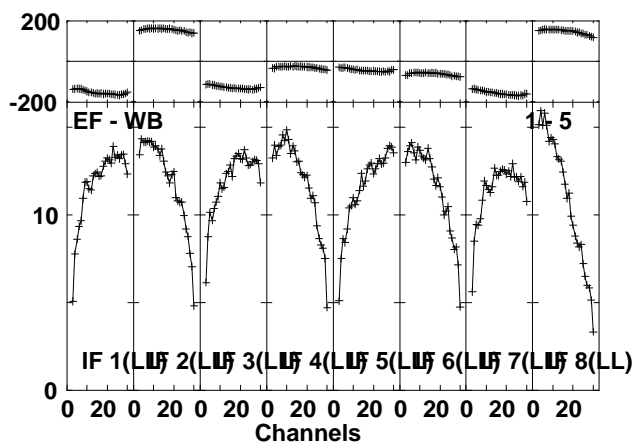
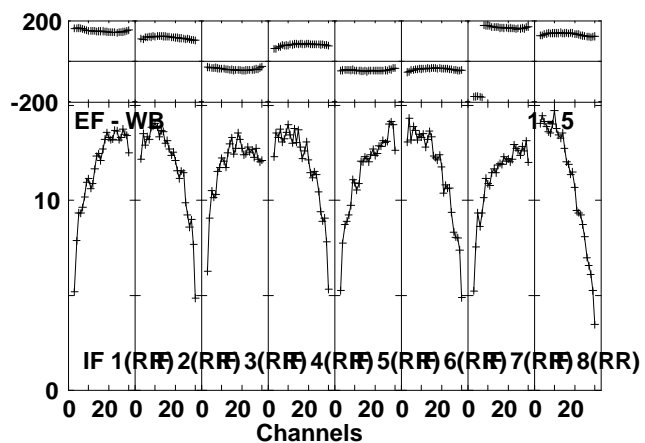
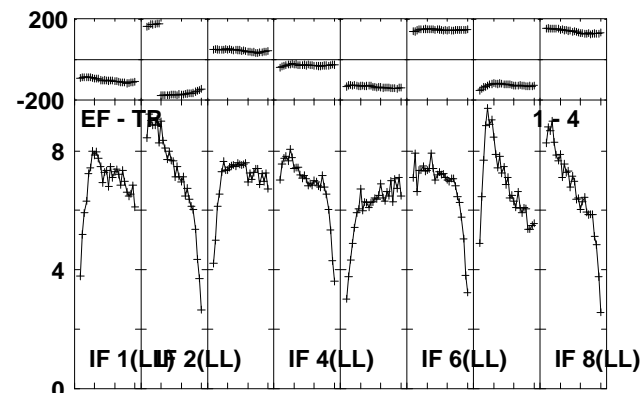
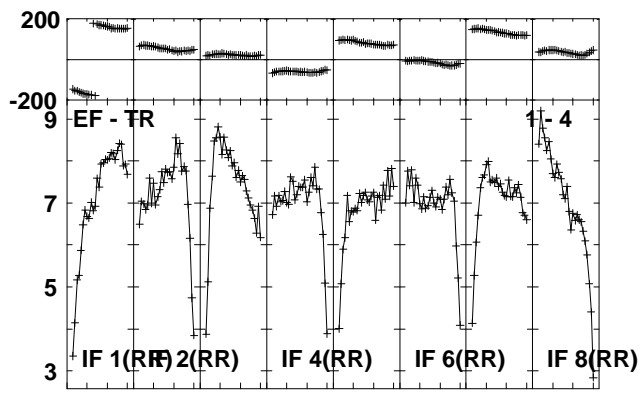
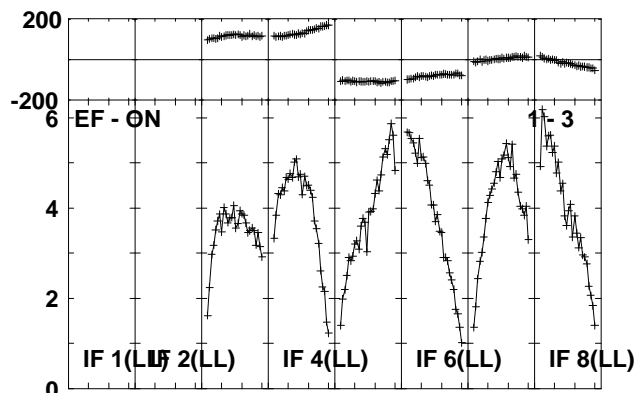
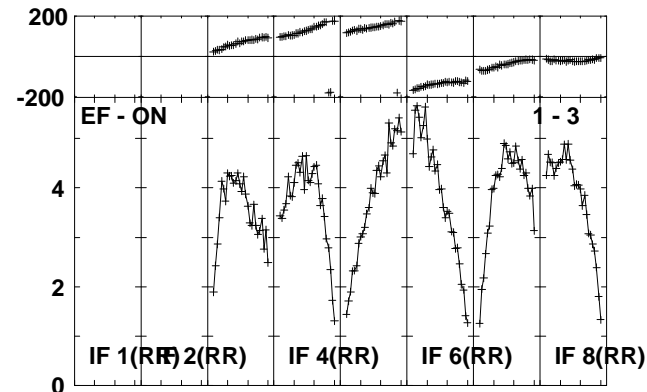
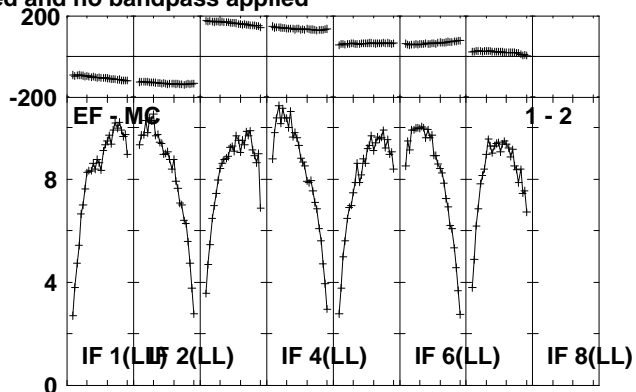
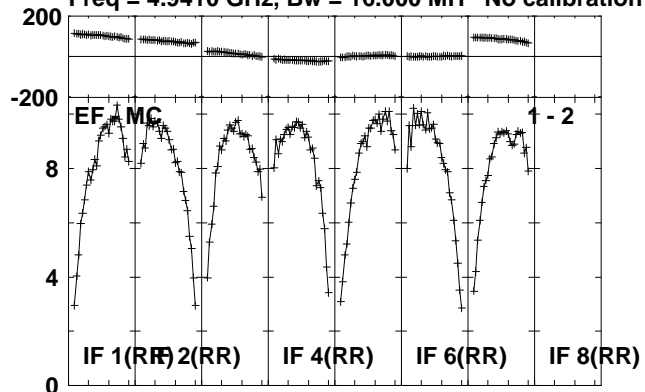

Lower frame: Milli Ampl Jy Top frame: Phas deg
Scalar averaged cross-power spectrum Several baselines displayed
Timerange: 00/14:22:51 to 00/14:24:19

Plot file version 38 created 04-OCT-2010 10:14:21

J1707-14 RP016A.UVDATA.1

Freq = 4.9410 GHz, Bw = 16.000 MH No calibration applied and no bandpass applied

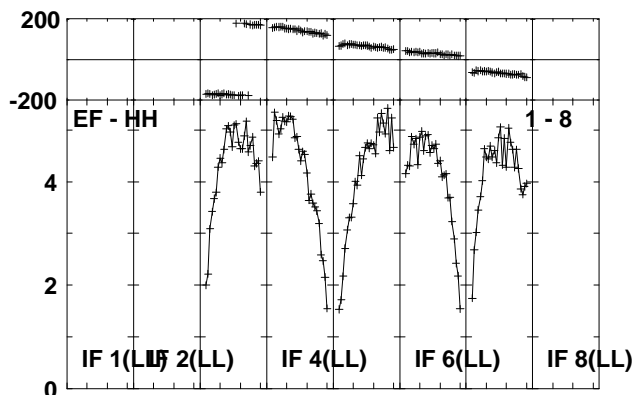
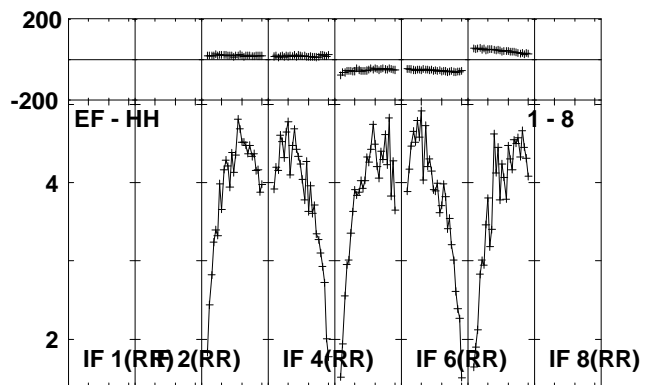
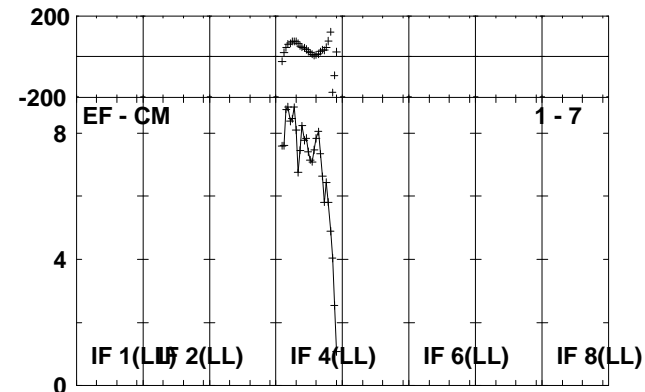
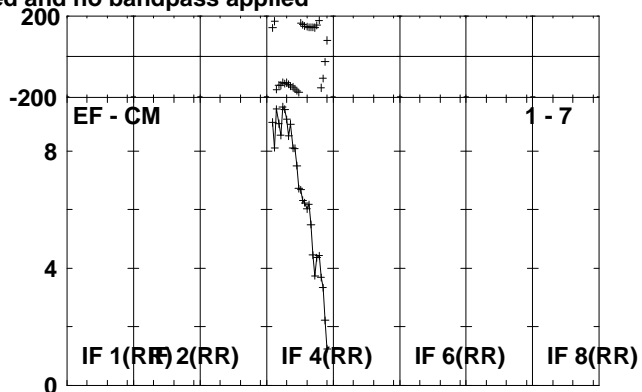
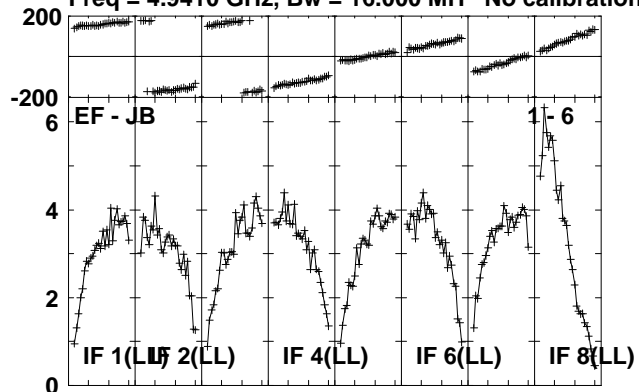

Lower frame: Milli Ampl Jy Top frame: Phas deg
Scalar averaged cross-power spectrum Several baselines displayed
Timerange: 00/14:22:51 to 00/14:24:19

Plot file version 39 created 04-OCT-2010 10:14:22

MAXI J16 RP016A.UVDATA.1

Freq = 4.9410 GHz, Bw = 16.000 MH No calibration applied and no bandpass applied

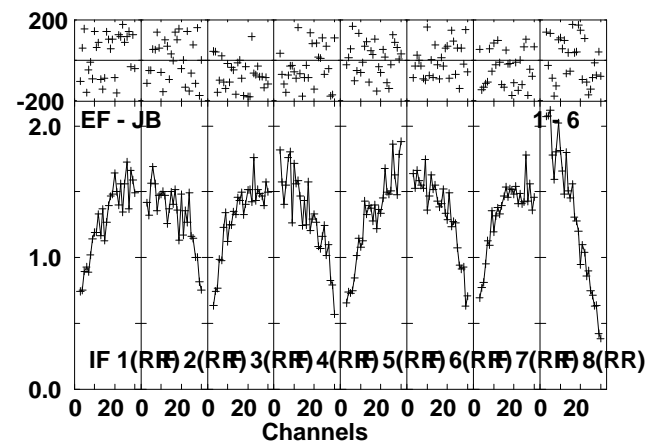
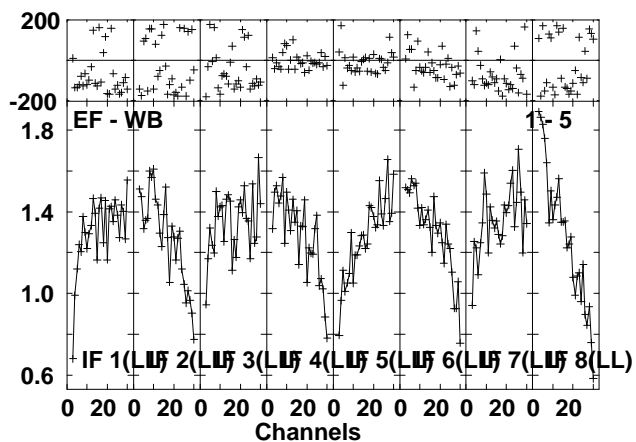
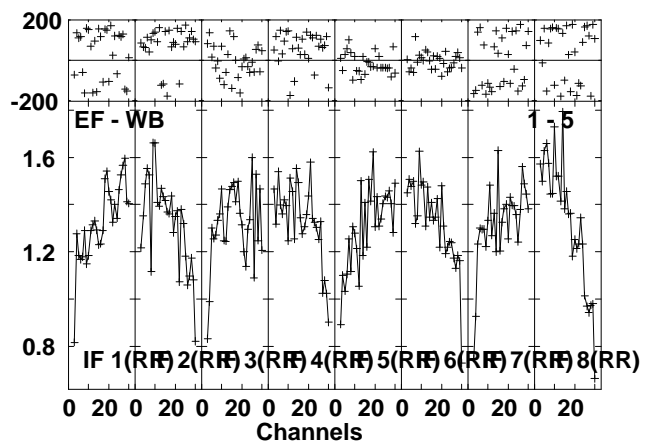
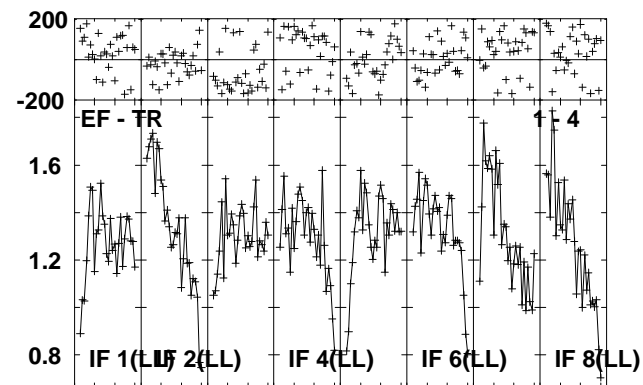
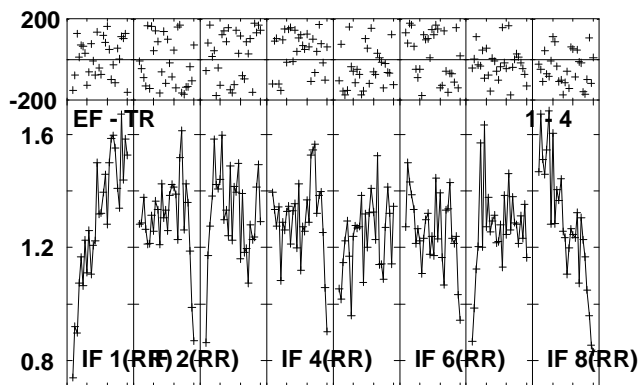
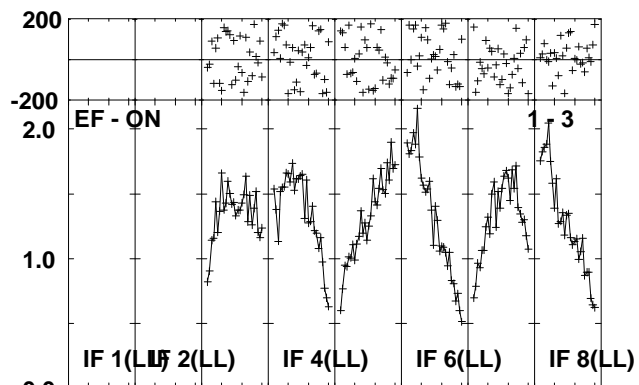
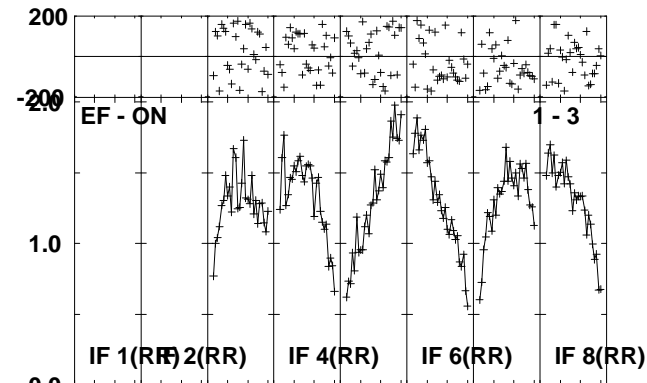
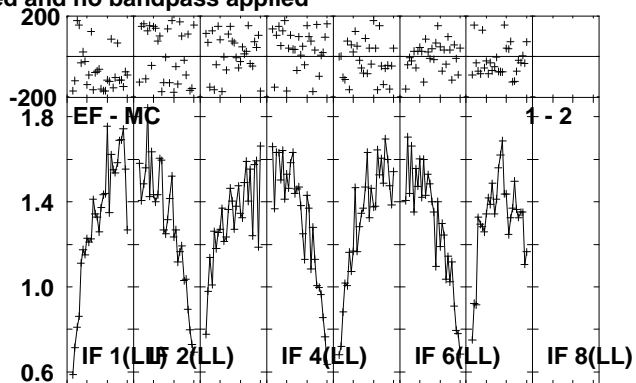
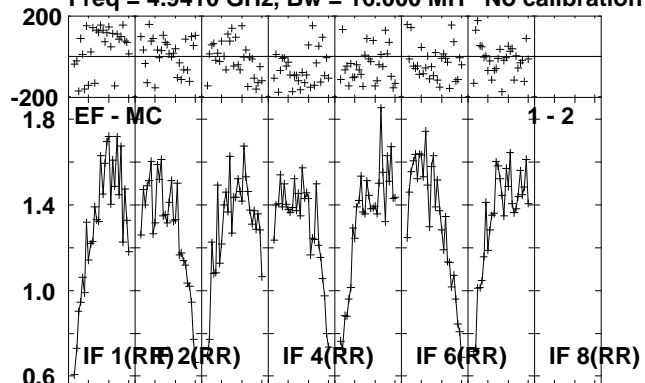

Lower frame: Milli Ampl Jy Top frame: Phas deg
Scalar averaged cross-power spectrum Several baselines displayed
Timerange: 00/14:24:21 to 00/14:26:49

Plot file version 40 created 04-OCT-2010 10:14:23

MAXI J16 RP016A.UVDATA.1

Freq = 4.9410 GHz, Bw = 16.000 MH No calibration applied and no bandpass applied

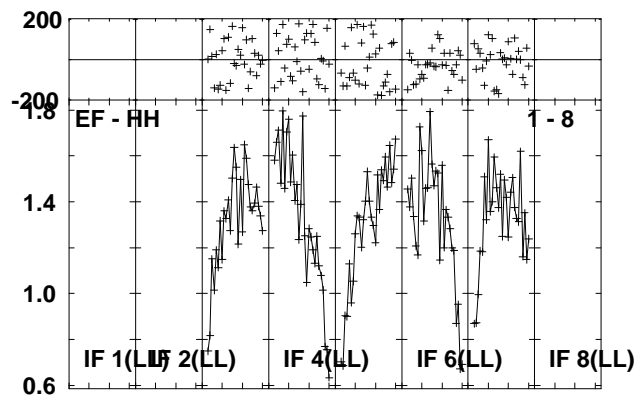
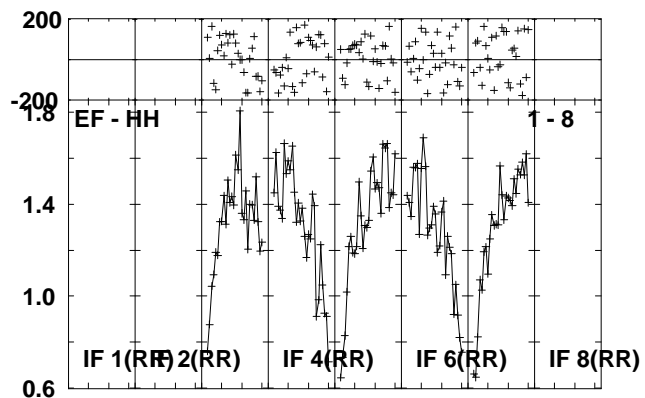
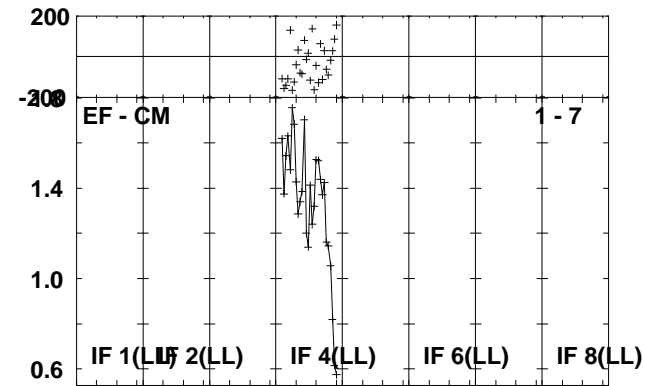
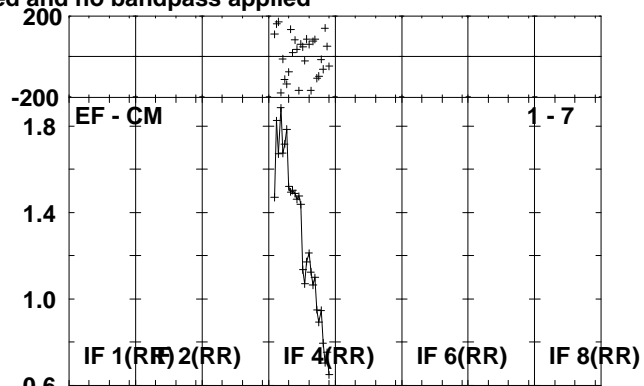
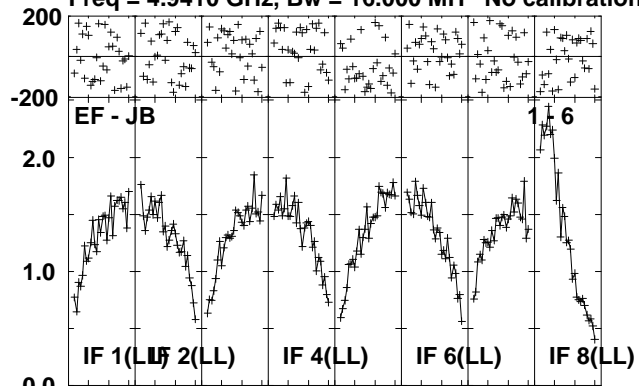

Lower frame: Milli Ampl Jy Top frame: Phas deg
Scalar averaged cross-power spectrum Several baselines displayed
Timerange: 00/14:24:21 to 00/14:26:49

Plot file version 41 created 04-OCT-2010 10:14:24

J1707-14 RP016A.UVDATA.1

Freq = 4.9410 GHz, Bw = 16.000 MH No calibration applied and no bandpass applied

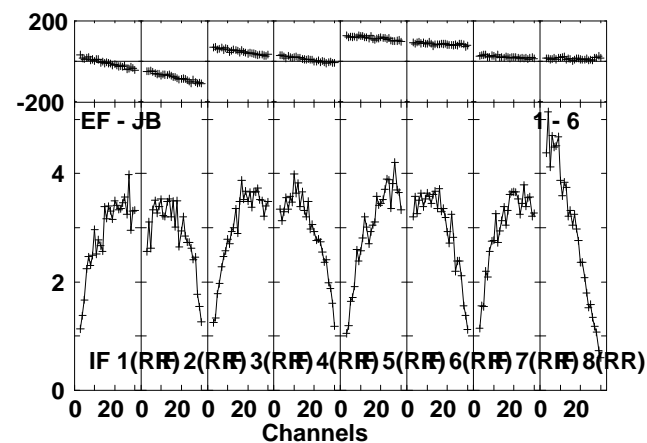
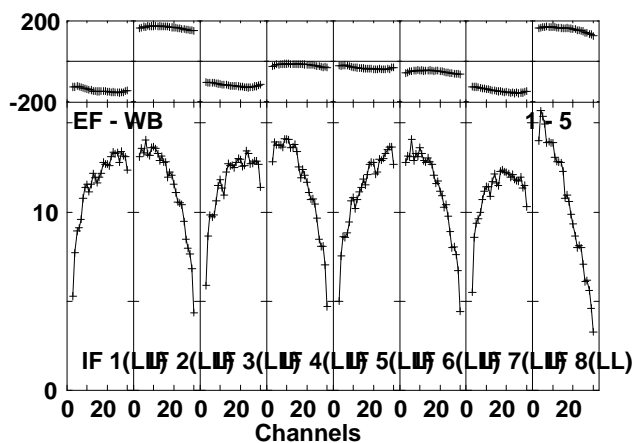
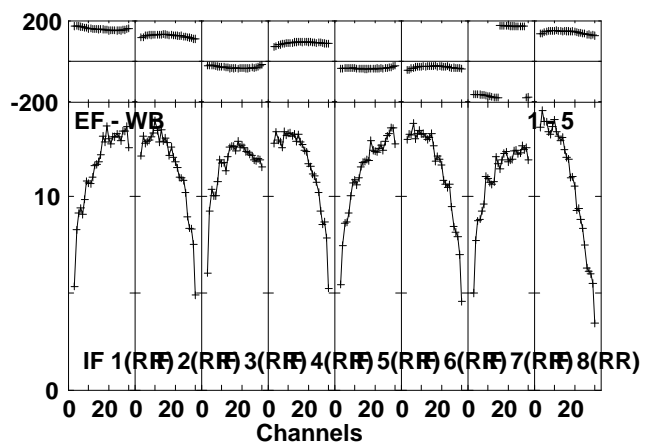
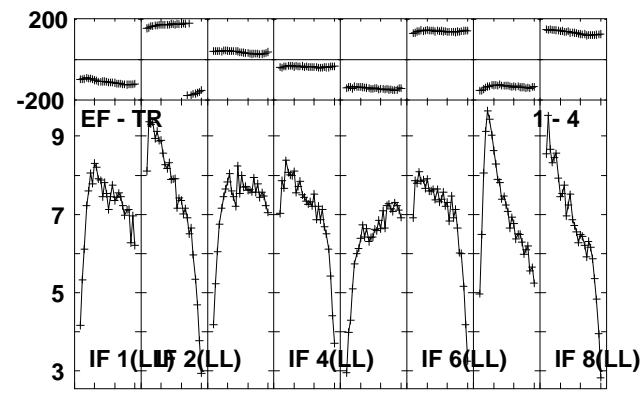
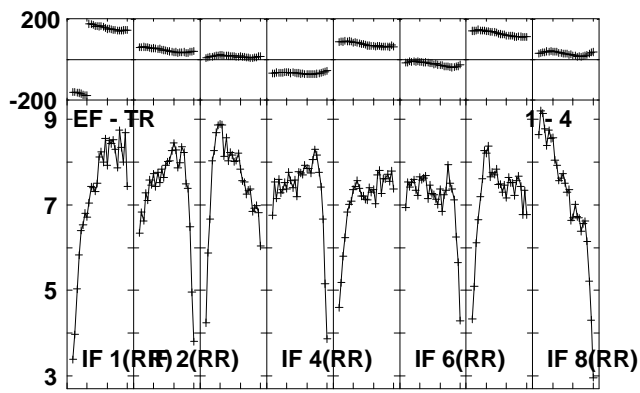
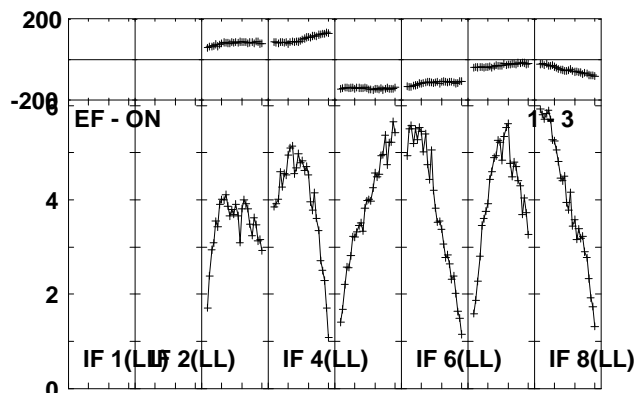
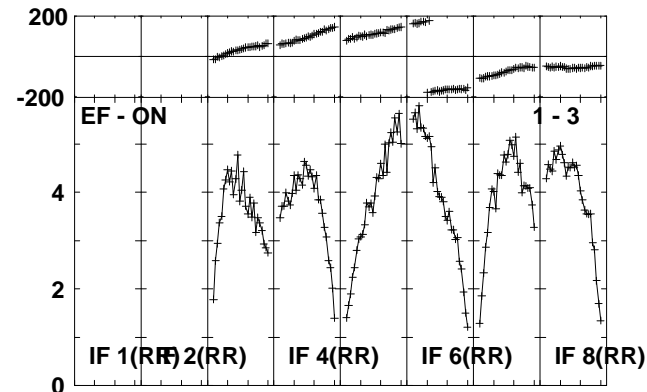
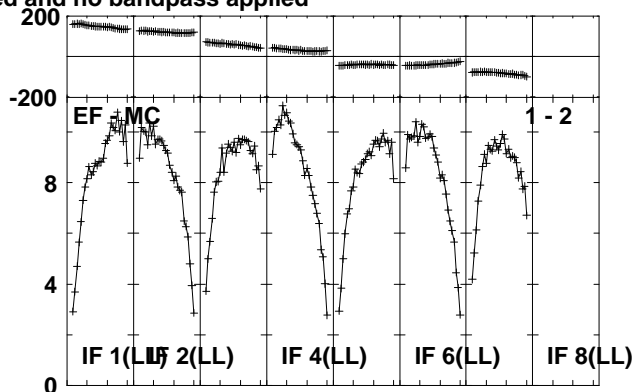
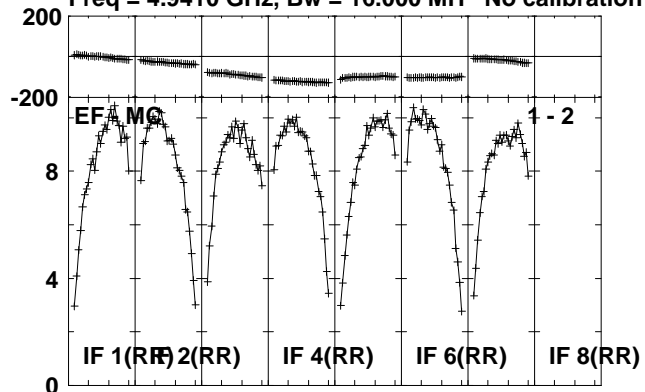

Lower frame: Milli Ampl Jy Top frame: Phas deg
Scalar averaged cross-power spectrum Several baselines displayed
Timerange: 00/14:27:31 to 00/14:28:29

Plot file version 42 created 04-OCT-2010 10:14:25

J1707-14 RP016A.UVDATA.1

Freq = 4.9410 GHz, Bw = 16.000 MH No calibration applied and no bandpass applied

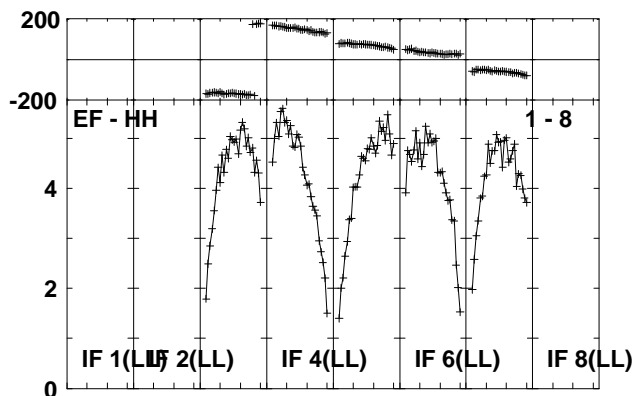
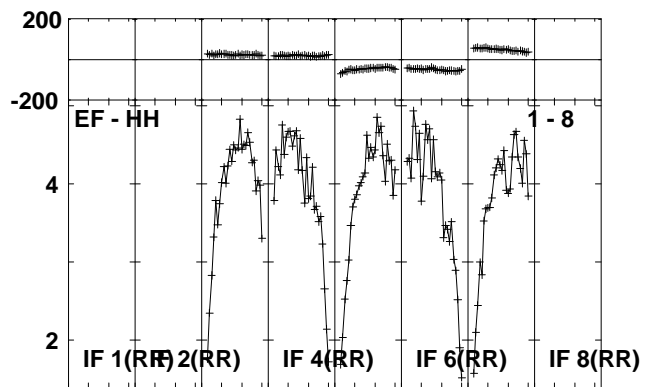
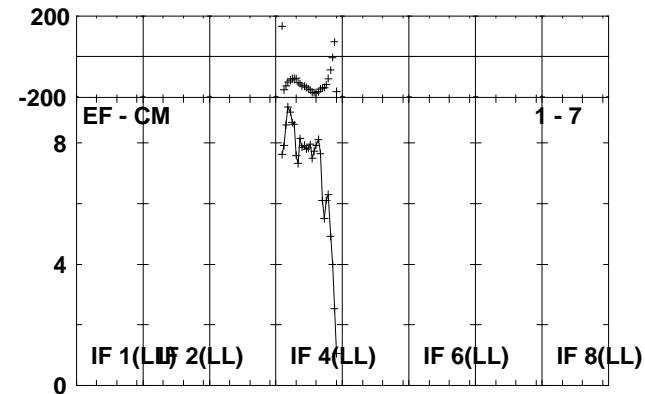
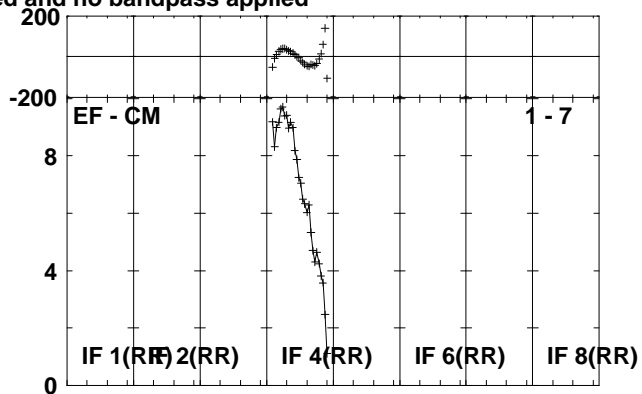
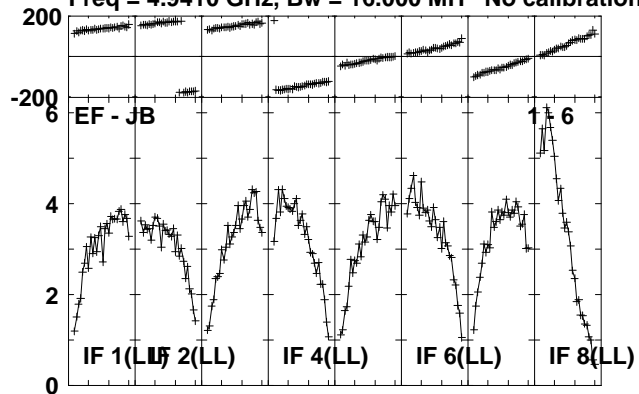

Lower frame: Milli Ampl Jy Top frame: Phas deg
Scalar averaged cross-power spectrum Several baselines displayed
Timerange: 00/14:27:31 to 00/14:28:29

Plot file version 43 created 04-OCT-2010 10:14:26

NVSS3 RP016A.UVDATA.1

Freq = 4.9410 GHz, Bw = 16.000 MH No calibration applied and no bandpass applied

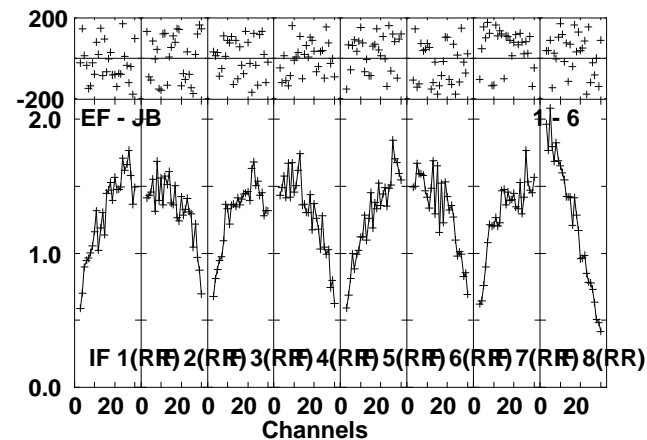
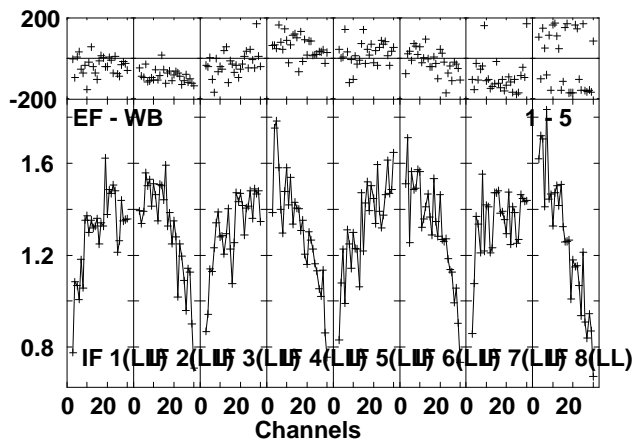
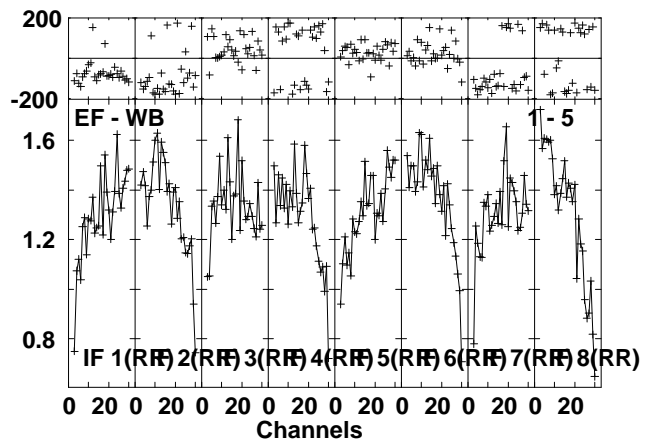
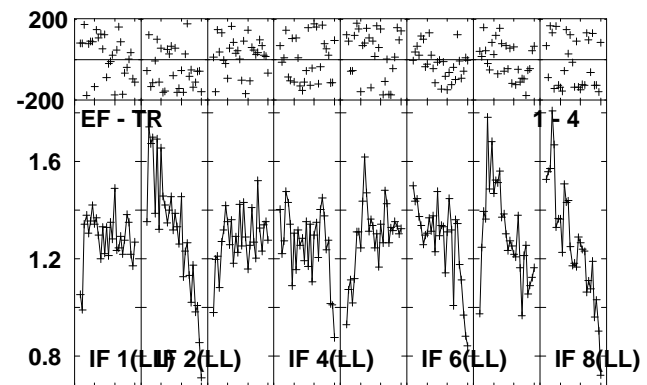
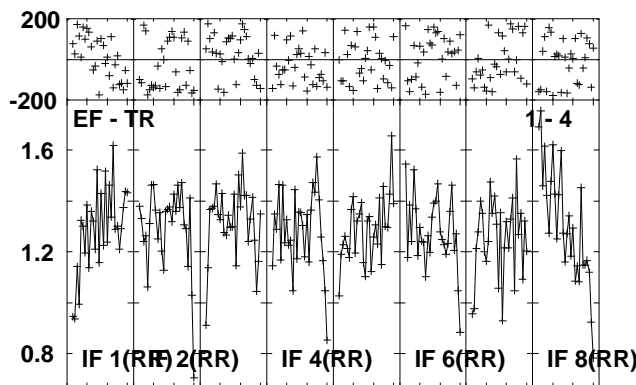
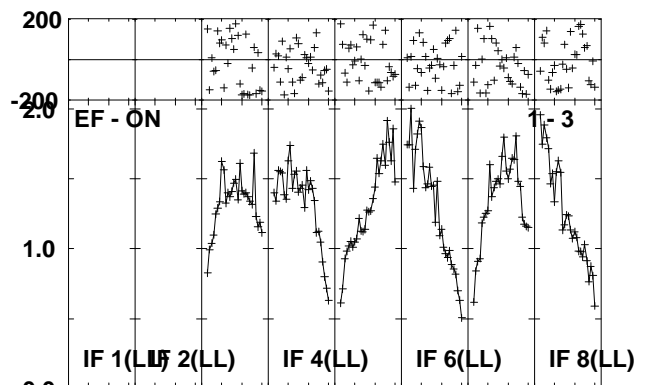
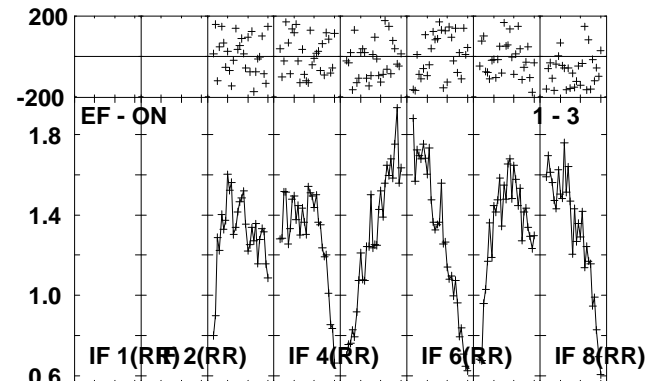
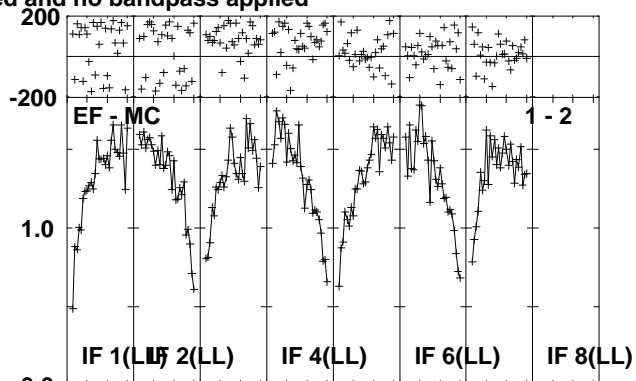
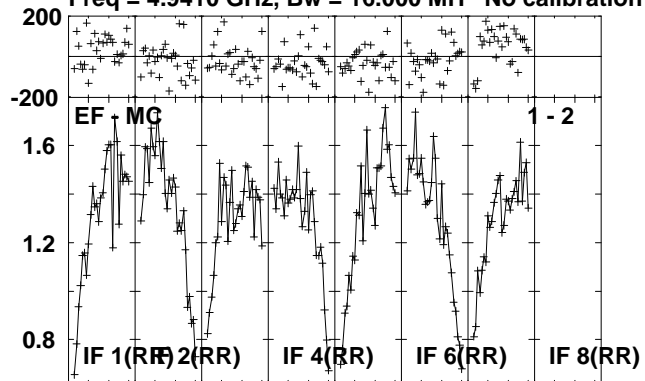

Lower frame: Milli Ampl Jy Top frame: Phas deg
Scalar averaged cross-power spectrum Several baselines displayed
Timerange: 00/14:28:31 to 00/14:30:59

Plot file version 44 created 04-OCT-2010 10:14:28

NVSS3 RP016A.UVDATA.1

Freq = 4.9410 GHz, Bw = 16.000 MH No calibration applied and no bandpass applied

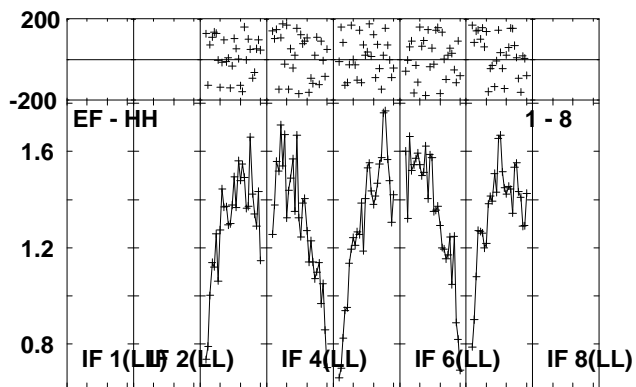
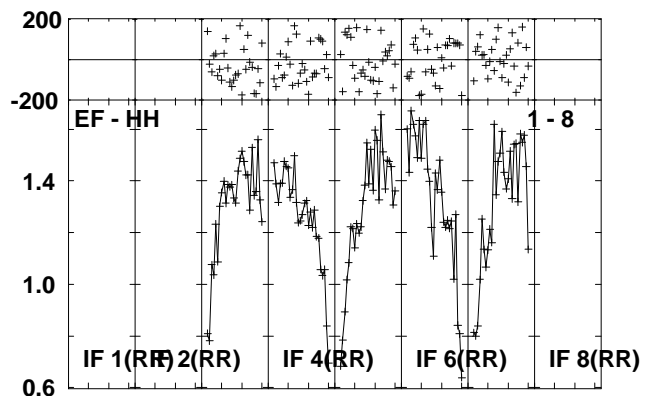
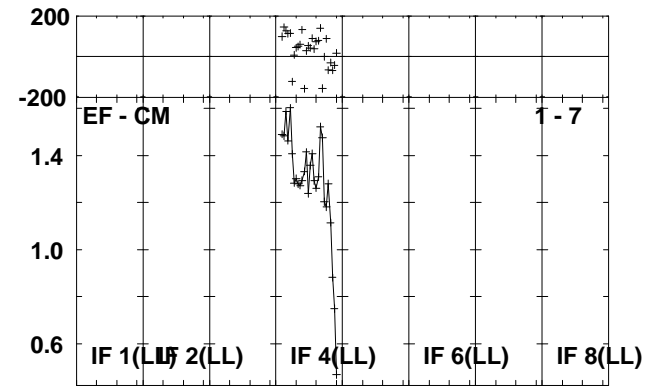
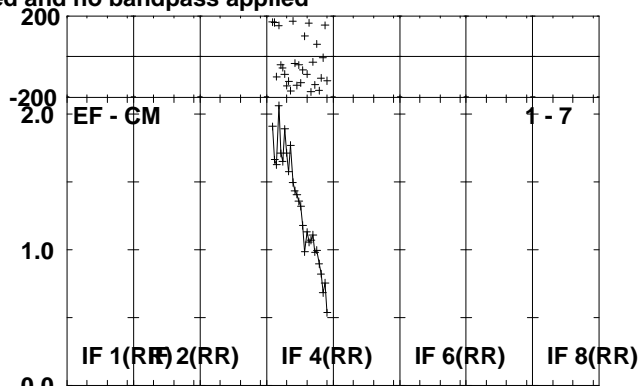
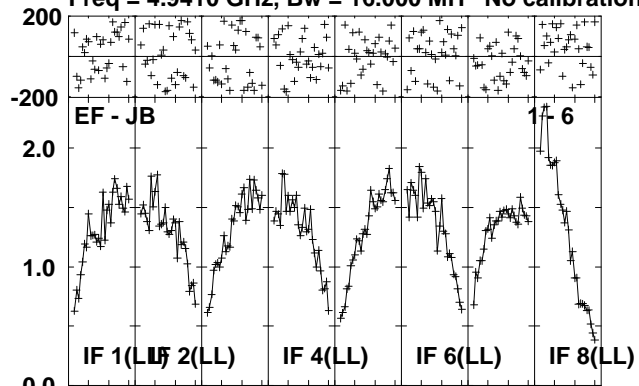

Lower frame: Milli Ampl Jy Top frame: Phas deg
Scalar averaged cross-power spectrum Several baselines displayed
Timerange: 00/14:28:31 to 00/14:30:59

Plot file version 45 created 04-OCT-2010 10:14:29

J1707-14 RP016A.UVDATA.1

Freq = 4.9410 GHz, Bw = 16.000 MH No calibration applied and no bandpass applied

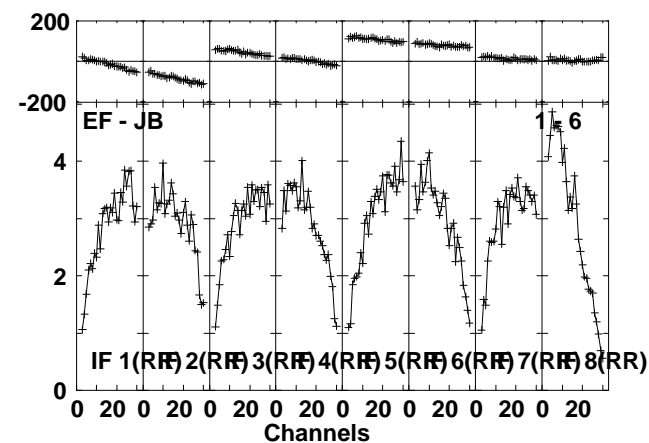
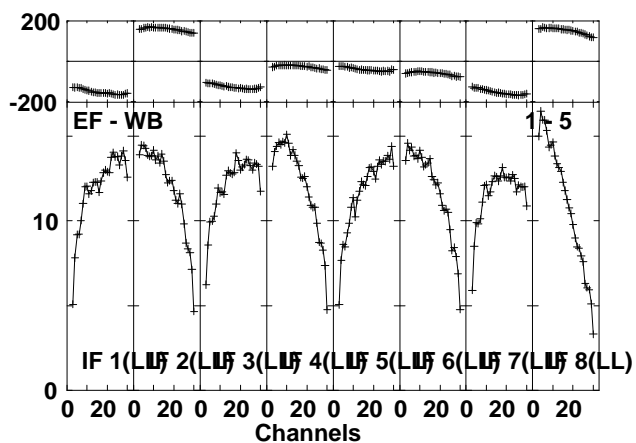
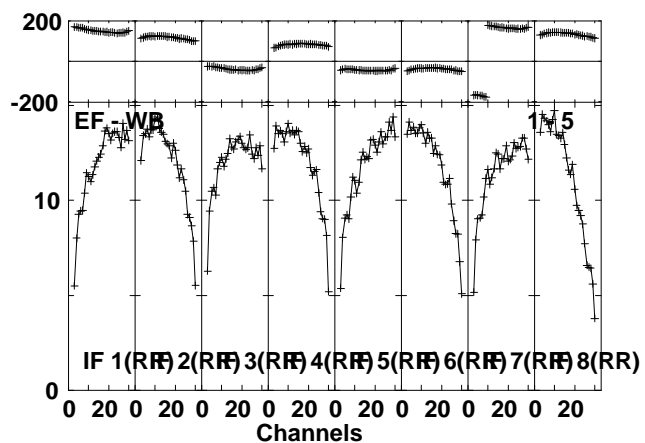
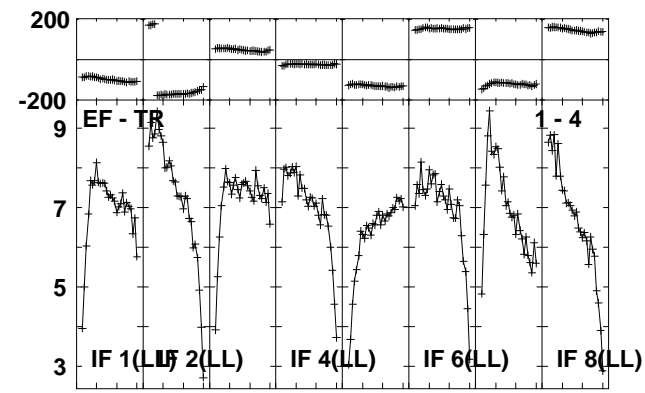
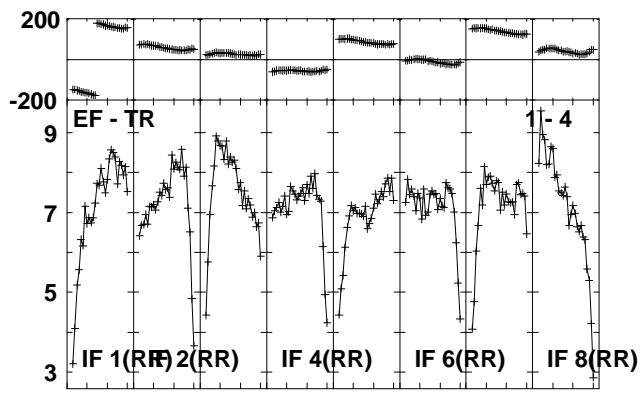
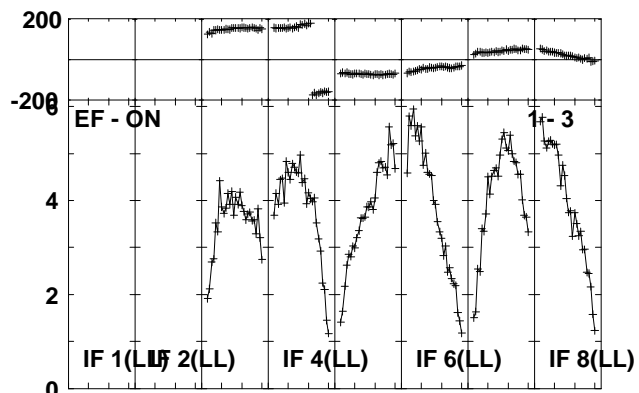
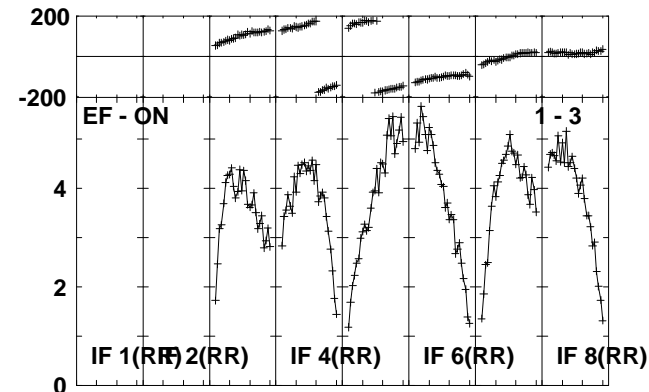
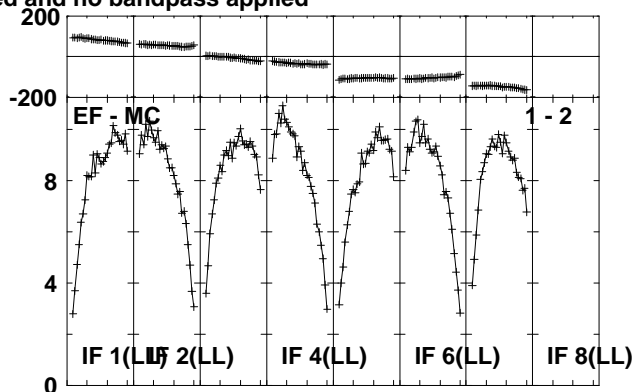
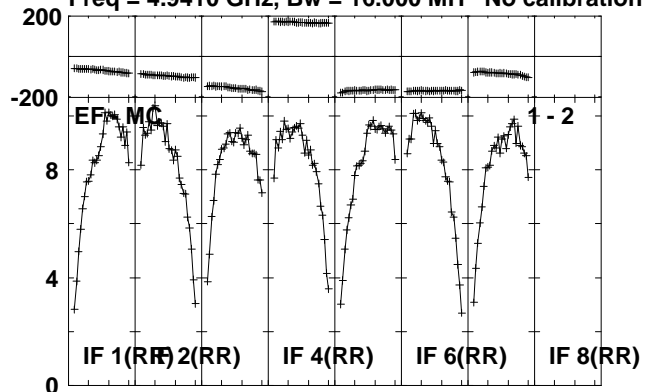

Lower frame: Milli Ampl Jy Top frame: Phas deg
Scalar averaged cross-power spectrum Several baselines displayed
Timerange: 00/14:31:01 to 00/14:32:29

Plot file version 46 created 04-OCT-2010 10:14:30
J1707-14 RP016A.UVDATA.1

Freq = 4.9410 GHz, Bw = 16.000 MH No calibration applied and no bandpass applied

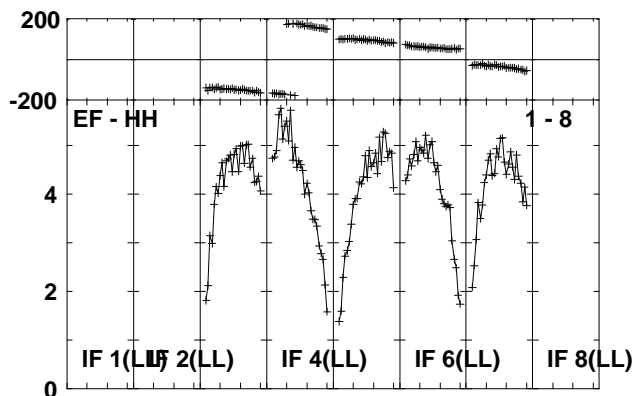
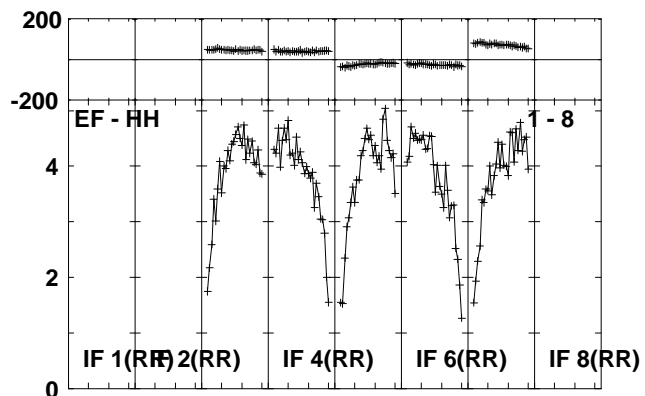
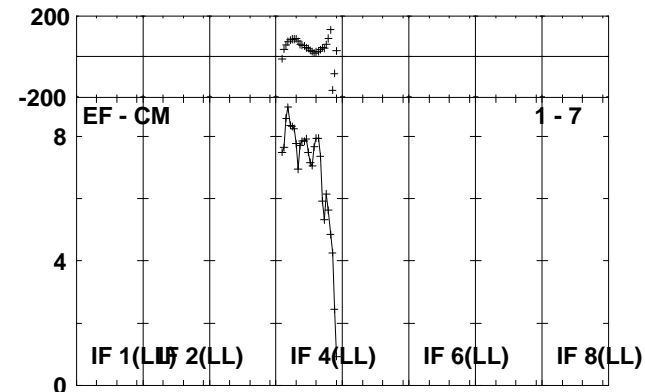
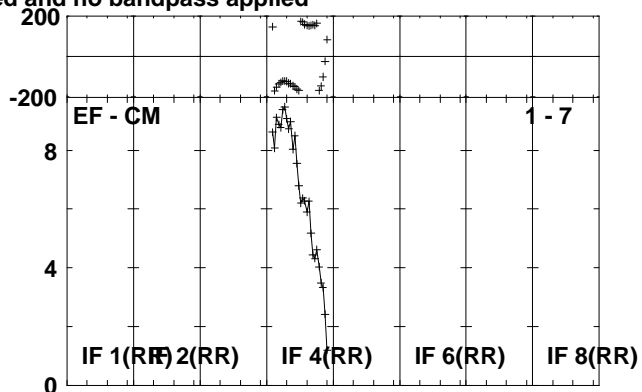
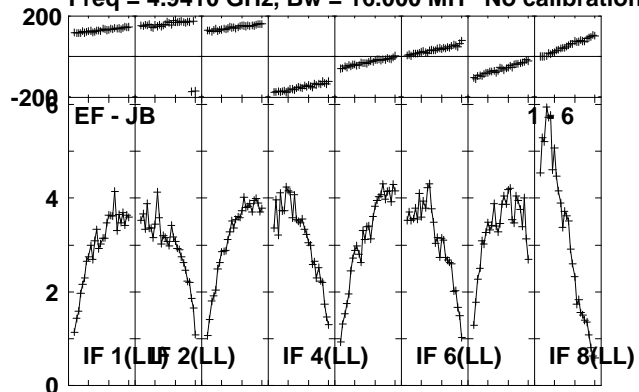

Lower frame: Milli Ampl Jy Top frame: Phas deg
Scalar averaged cross-power spectrum Several baselines displayed
Timerange: 00/14:31:01 to 00/14:32:29

Plot file version 47 created 04-OCT-2010 10:14:31
 MAXI J16 RP016A.UVDATA.1

Freq = 4.9410 GHz, Bw = 16.000 MH No calibration applied and no bandpass applied

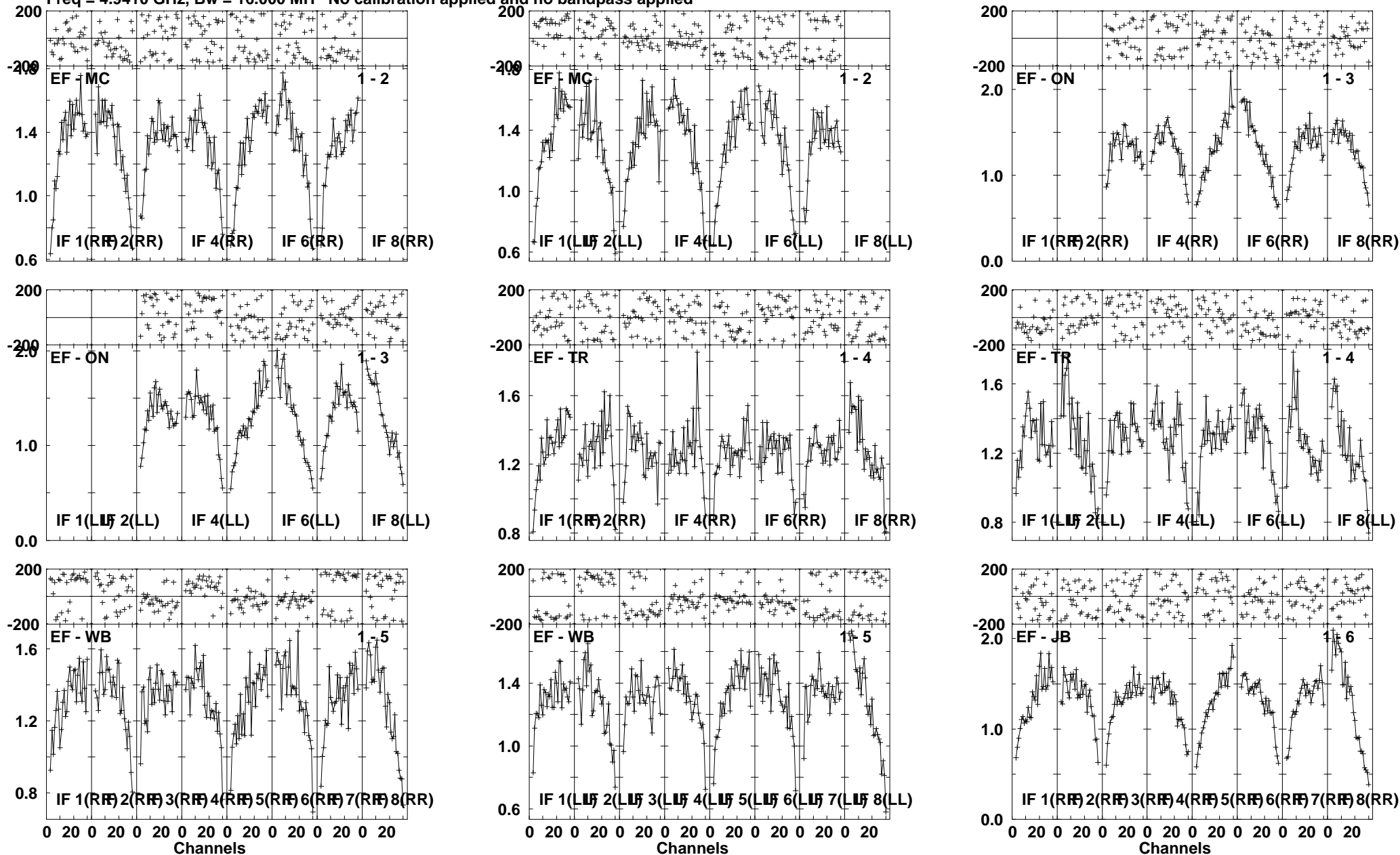

Lower frame: Milli Ampl Jy Top frame: Phas deg
 Scalar averaged cross-power spectrum Several baselines displayed
 Timerange: 00:14:32:31 to 00:14:34:59

Plot file version 48 created 04-OCT-2010 10:14:32

MAXI J16 RP016A.UVDATA.1

Freq = 4.9410 GHz, Bw = 16.000 MH No calibration applied and no bandpass applied

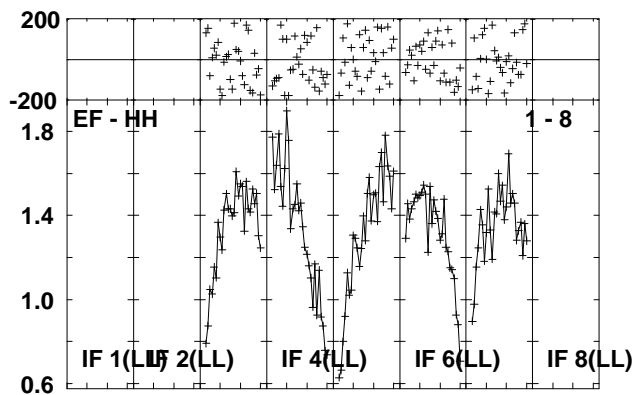
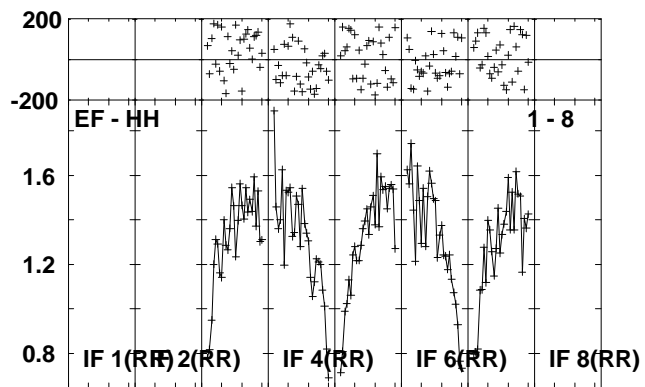
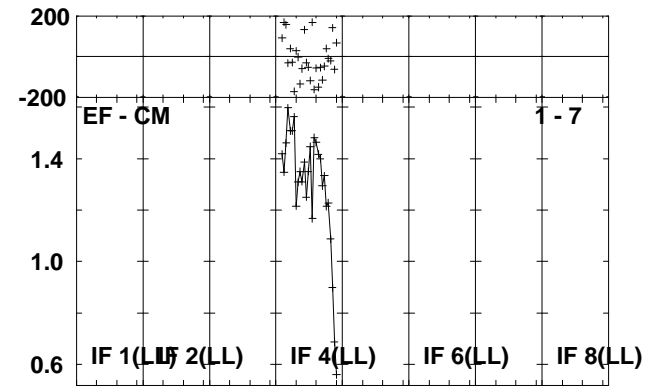
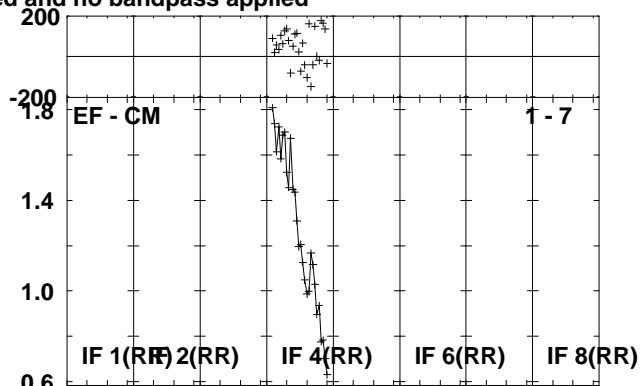
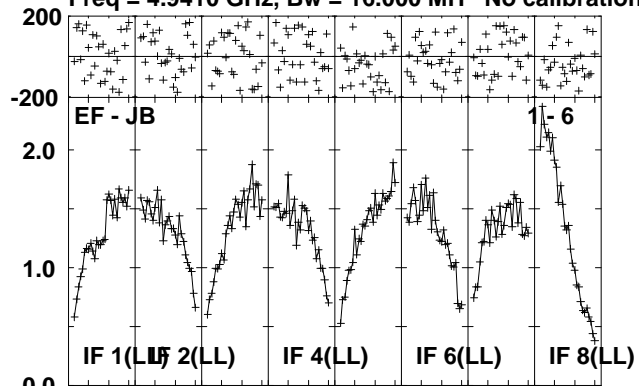

Lower frame: Milli Ampl Jy Top frame: Phas deg
Scalar averaged cross-power spectrum Several baselines displayed
Timerange: 00/14:32:31 to 00/14:34:59

Plot file version 49 created 04-OCT-2010 10:14:34

J1707-14 RP016A.UVDATA.1

Freq = 4.9410 GHz, Bw = 16.000 MH No calibration applied and no bandpass applied

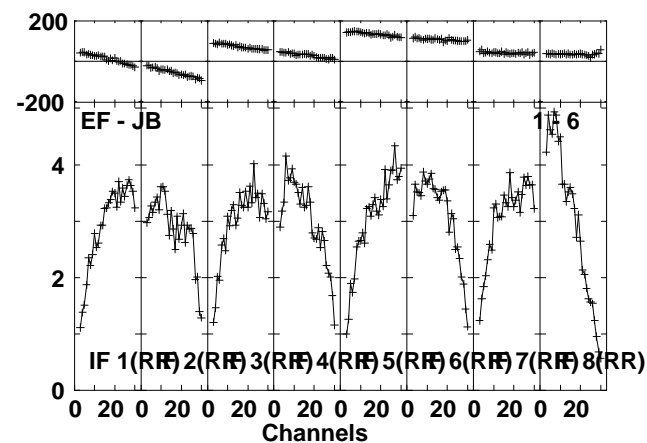
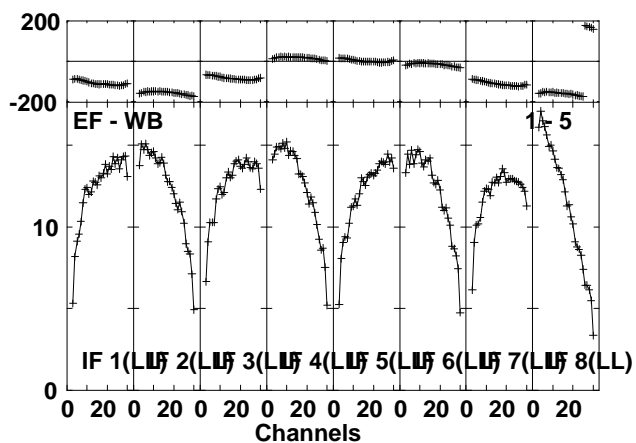
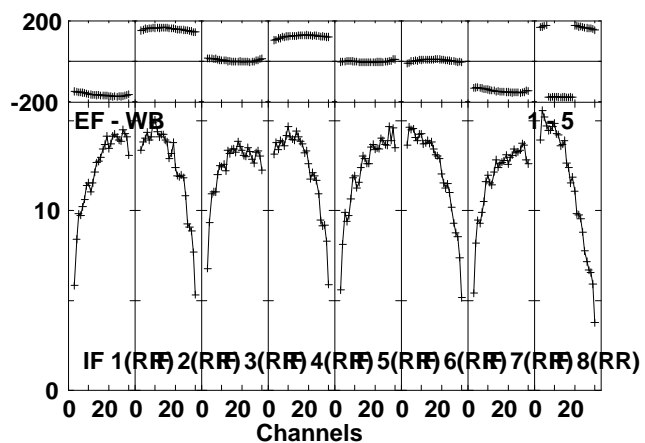
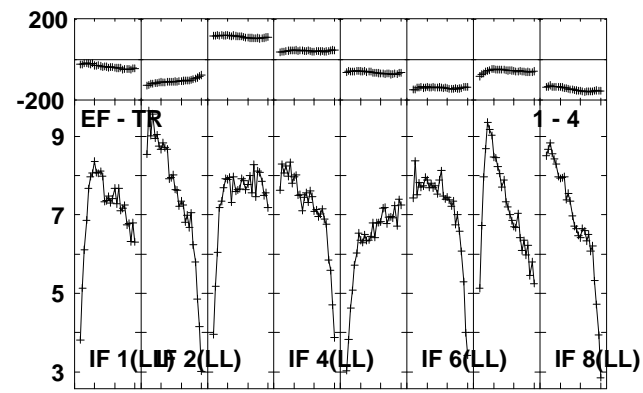
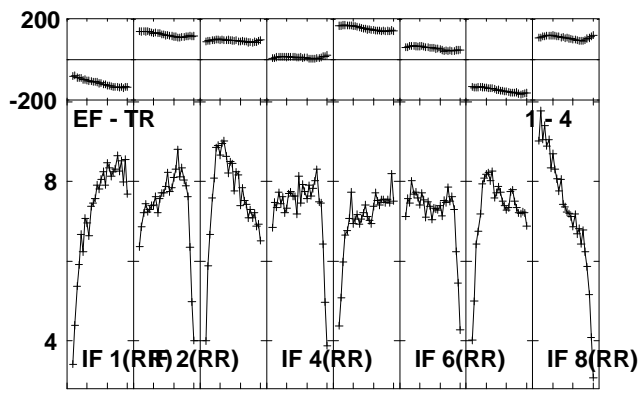
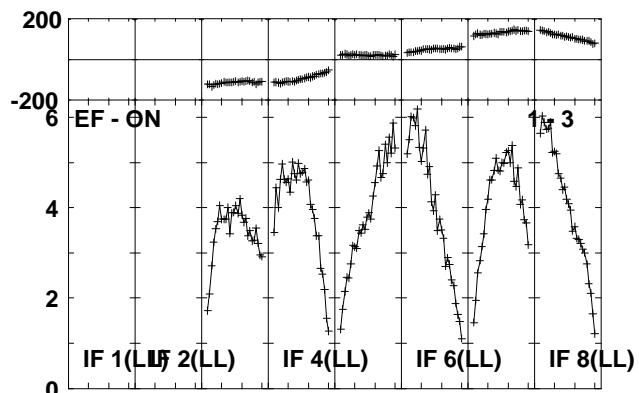
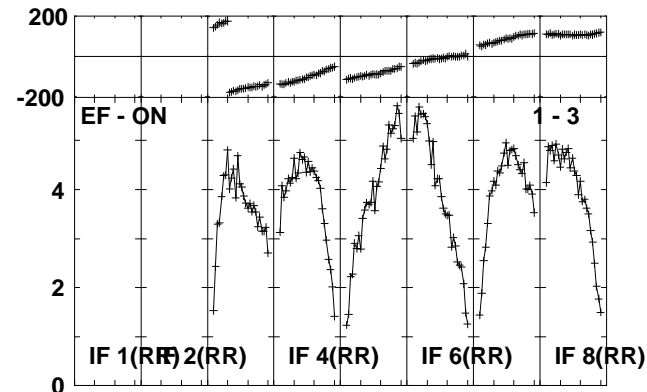
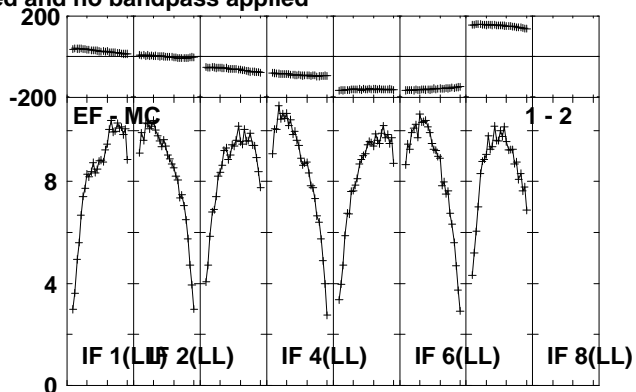
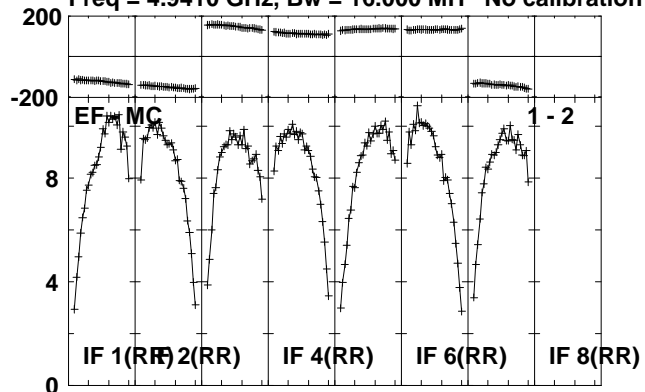

Lower frame: Milli Ampl Jy Top frame: Phas deg
Scalar averaged cross-power spectrum Several baselines displayed
Timerange: 00/14:35:41 to 00/14:36:39

Plot file version 50 created 04-OCT-2010 10:14:34
J1707-14 RP016A.UVDATA.1

Freq = 4.9410 GHz, Bw = 16.000 MH No calibration applied and no bandpass applied

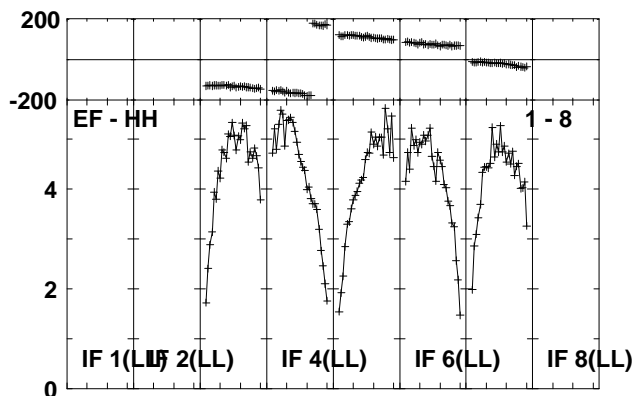
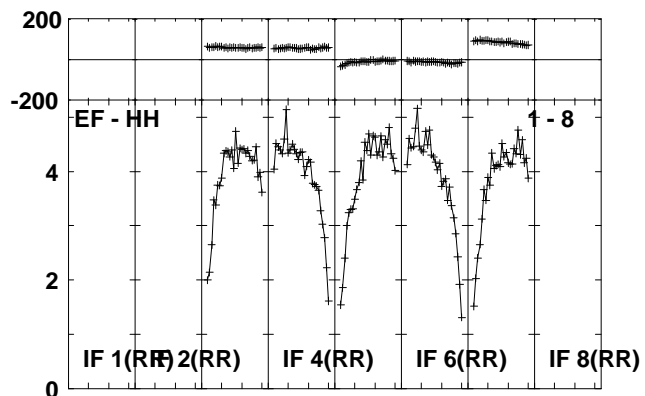
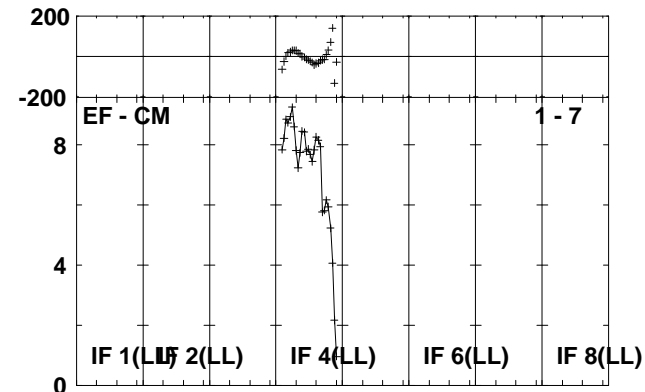
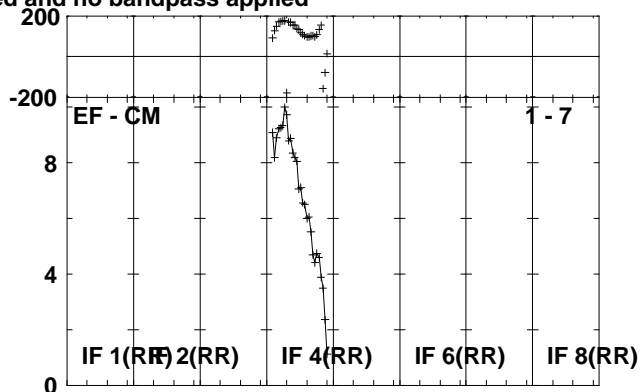
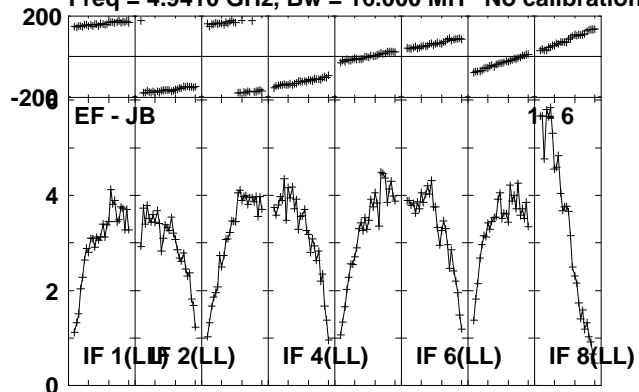

Lower frame: Milli Ampl Jy Top frame: Phas deg
Scalar averaged cross-power spectrum Several baselines displayed
Timerange: 00/14:35:41 to 00/14:36:39

Plot file version 51 created 04-OCT-2010 10:14:35

MAXI J16 RP016A.UVDATA.1

Freq = 4.9410 GHz, Bw = 16.000 MH No calibration applied and no bandpass applied

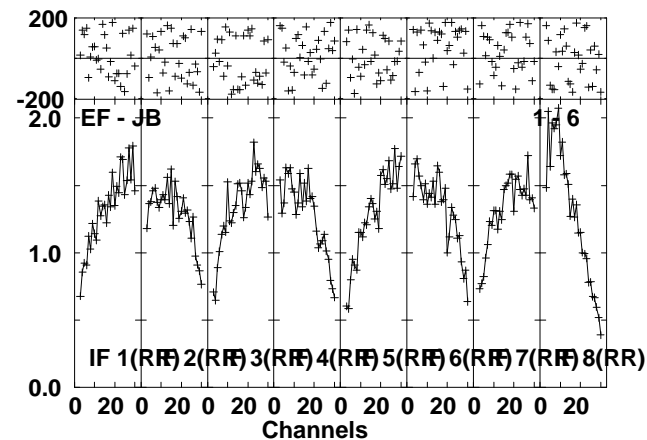
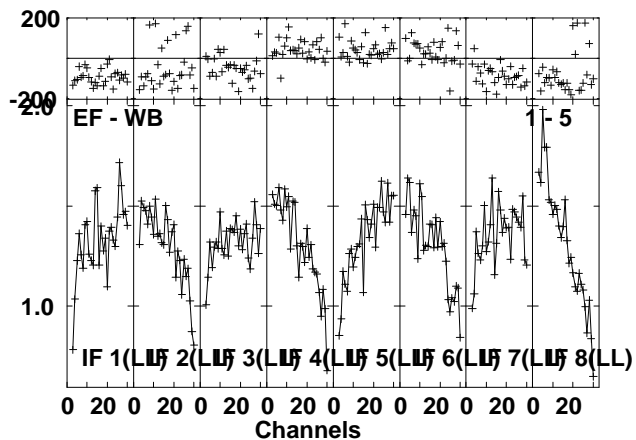
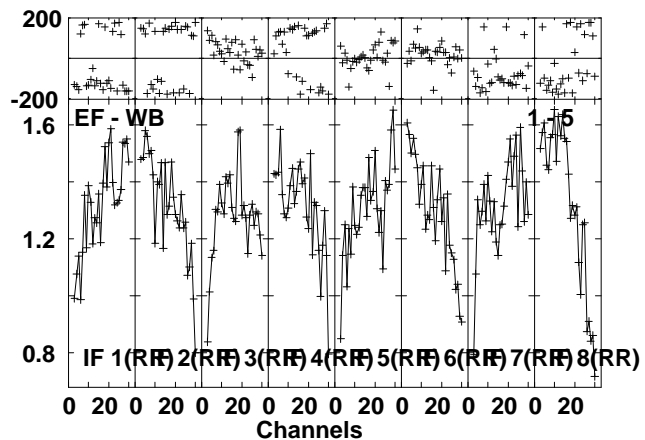
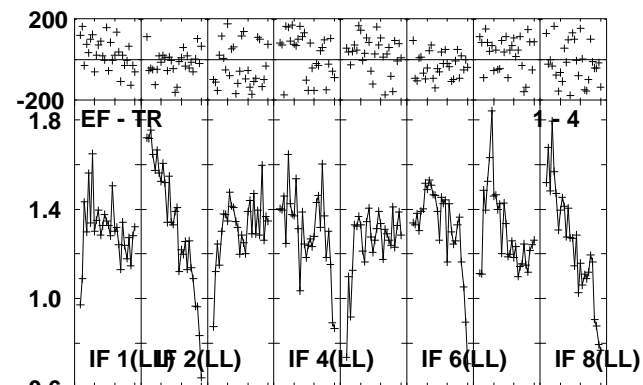
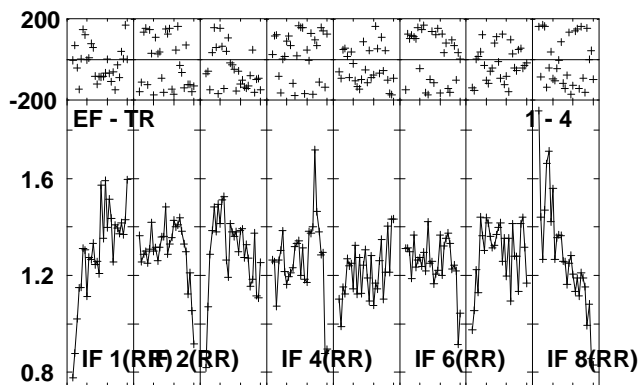
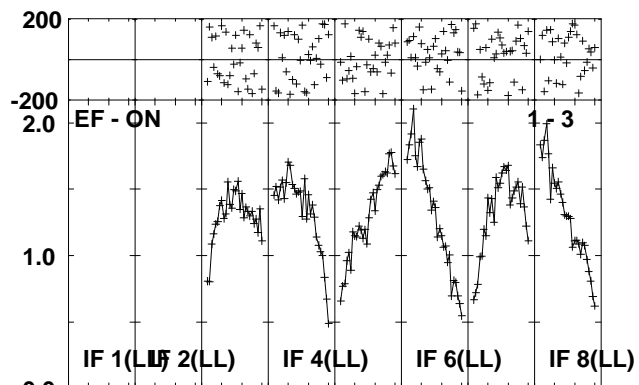
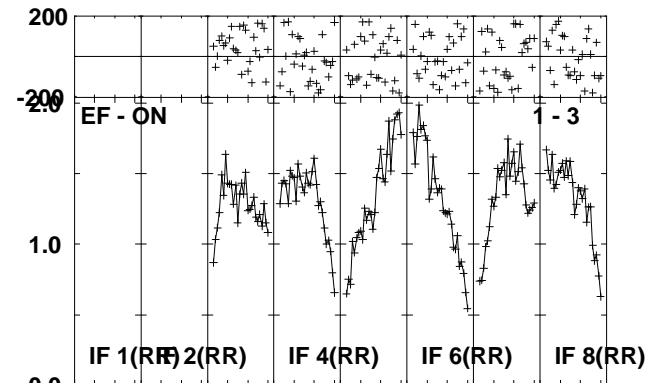
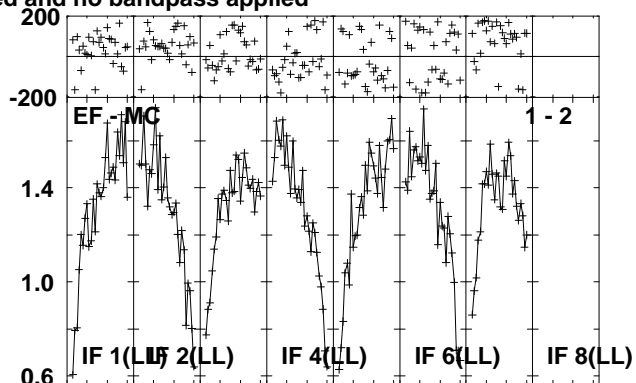
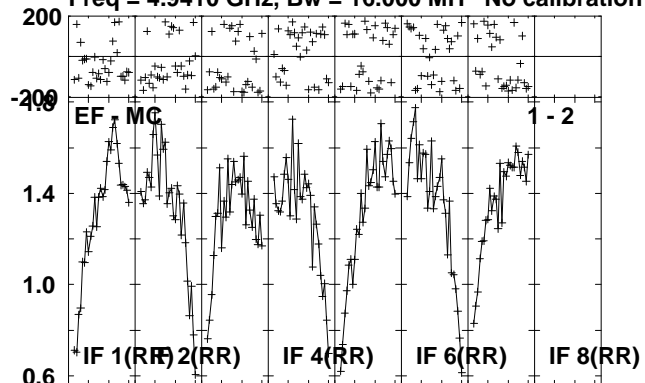

Lower frame: Milli Ampl Jy Top frame: Phas deg
Scalar averaged cross-power spectrum Several baselines displayed
Timerange: 00:14:36:41 to 00:14:39:09

Plot file version 52 created 04-OCT-2010 10:14:37

MAXI J16 RP016A.UVDATA.1

Freq = 4.9410 GHz, Bw = 16.000 MH No calibration applied and no bandpass applied

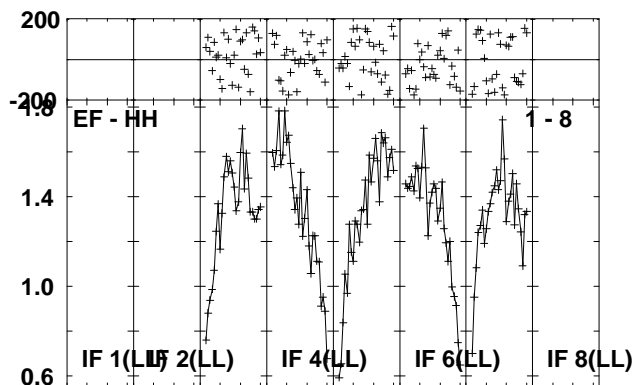
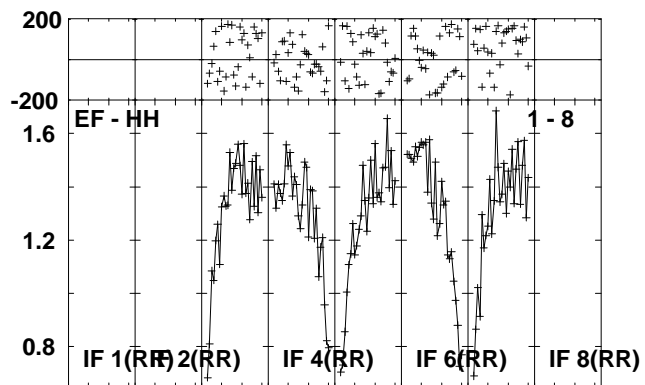
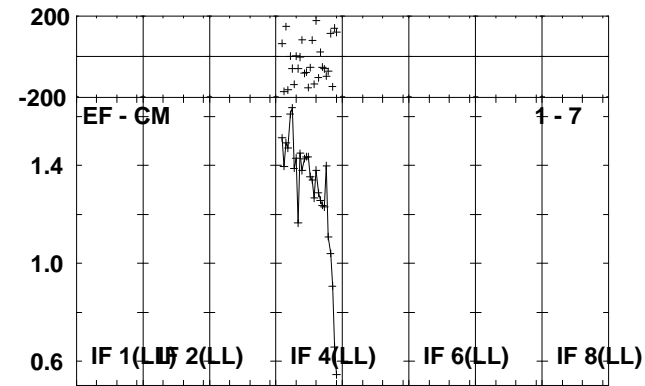
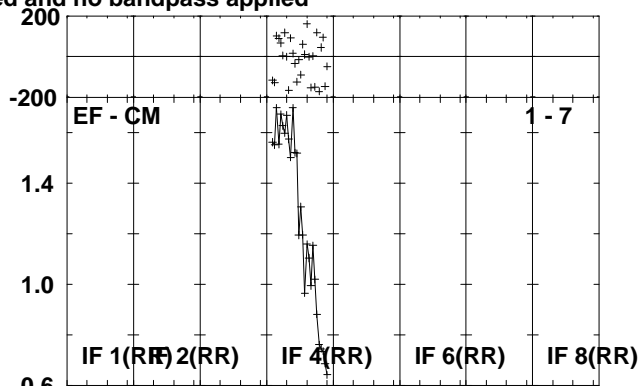
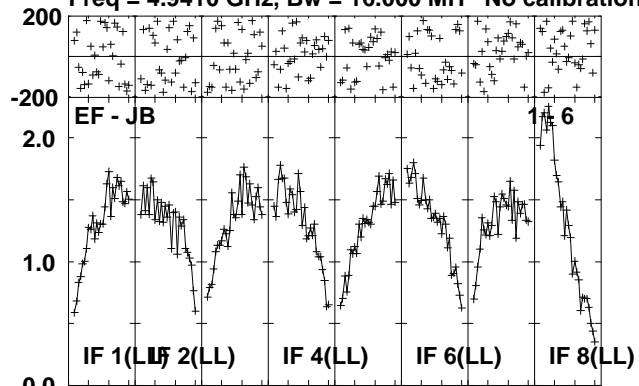

Lower frame: Milli Ampl Jy Top frame: Phas deg
Scalar averaged cross-power spectrum Several baselines displayed
Timerange: 00/14:36:41 to 00/14:39:09

Plot file version 53 created 04-OCT-2010 10:14:38

J1707-14 RP016A.UVDATA.1

Freq = 4.9410 GHz, Bw = 16.000 MH No calibration applied and no bandpass applied

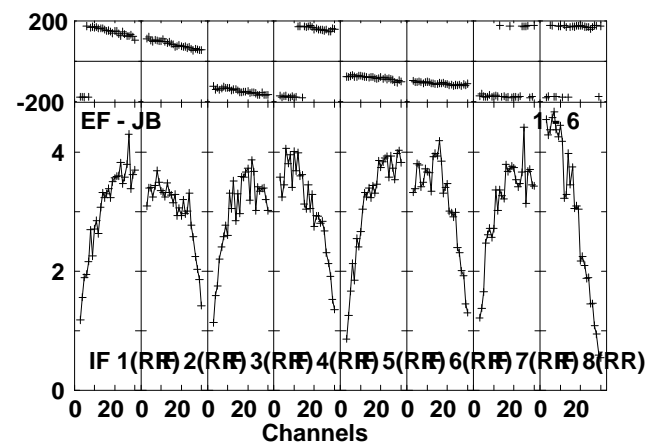
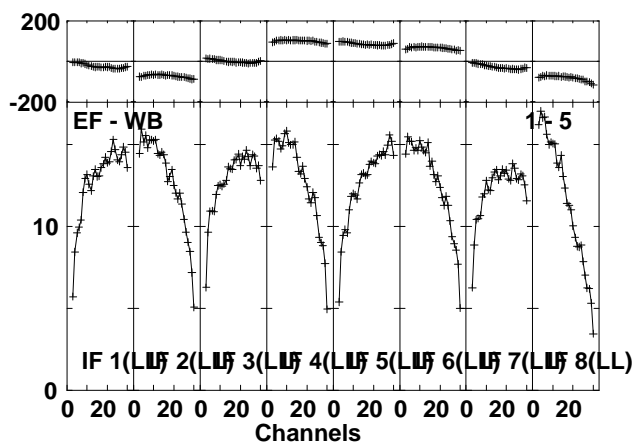
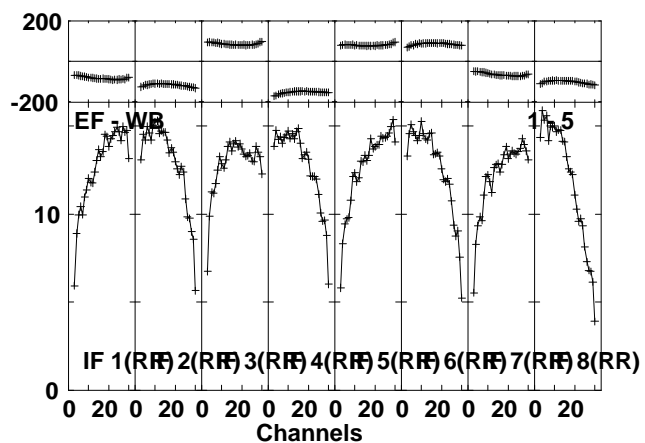
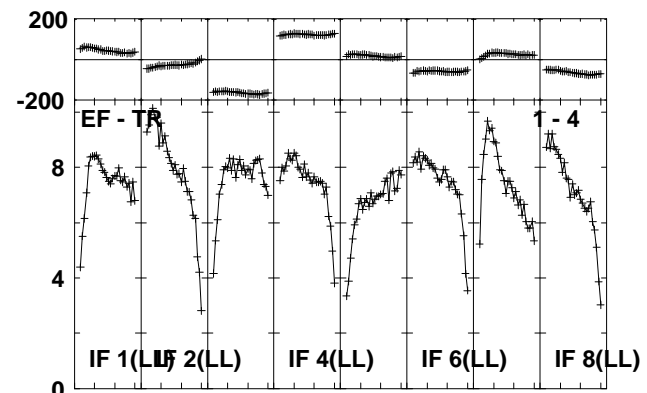
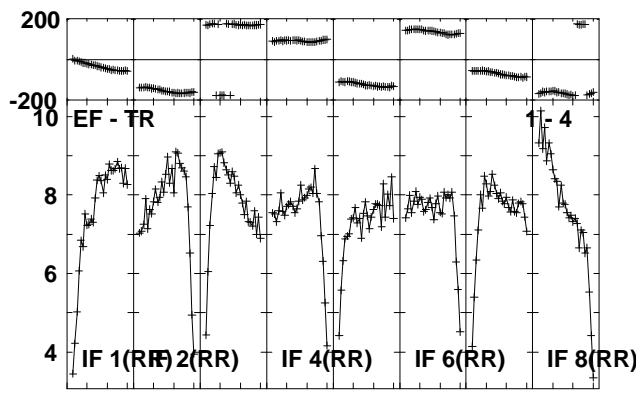
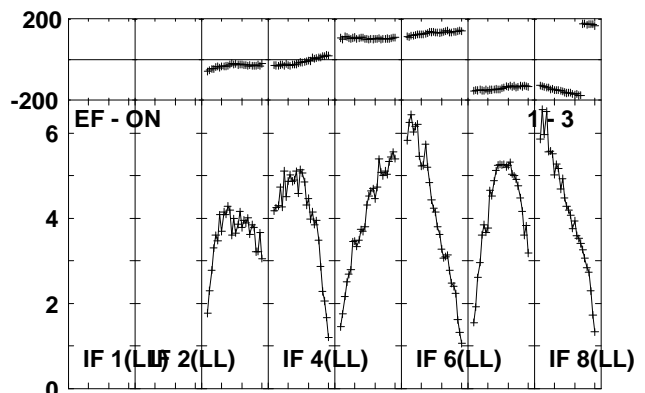
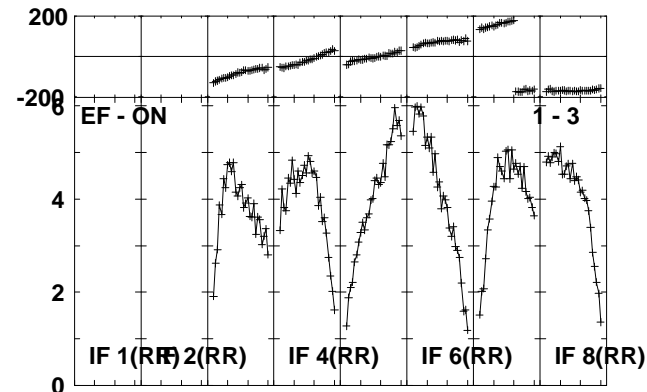
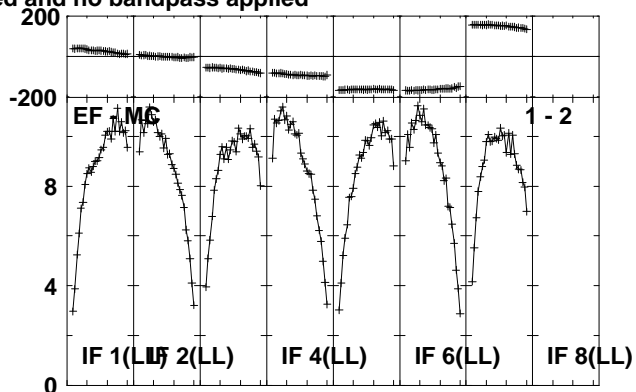
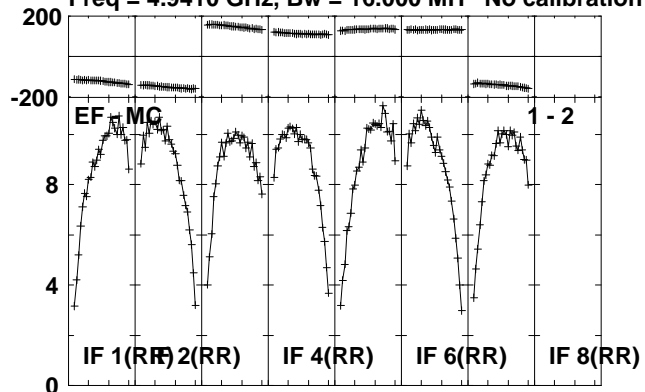

Lower frame: Milli Ampl Jy Top frame: Phas deg
Scalar averaged cross-power spectrum Several baselines displayed
Timerange: 00/14:39:11 to 00/14:40:39

Plot file version 54 created 04-OCT-2010 10:14:39

J1707-14 RP016A.UVDATA.1

Freq = 4.9410 GHz, Bw = 16.000 MH No calibration applied and no bandpass applied

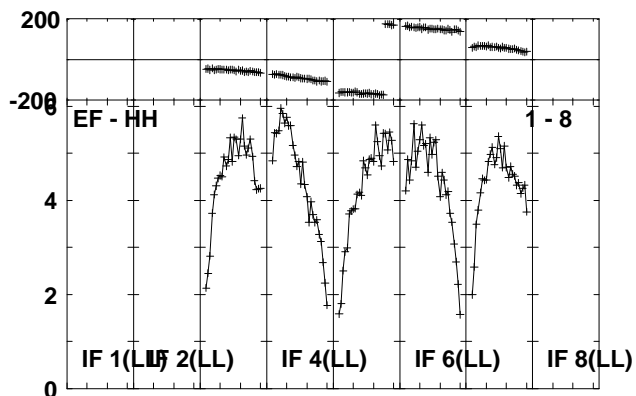
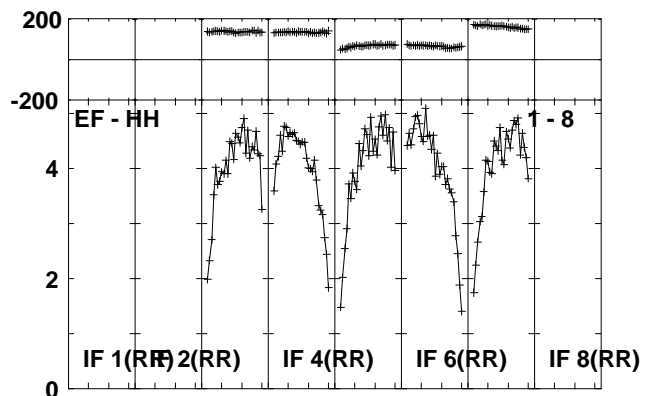
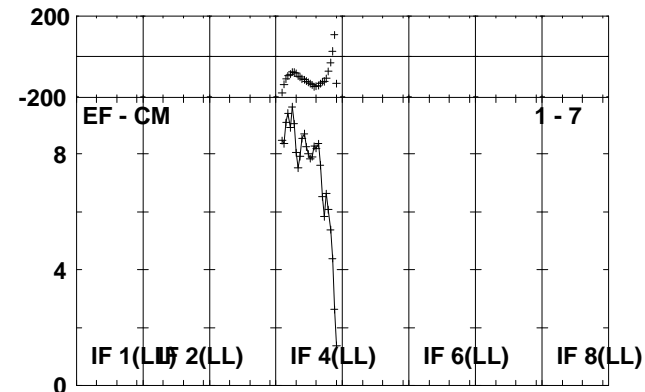
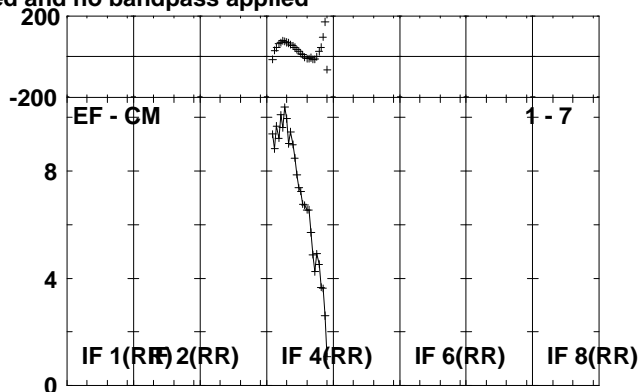
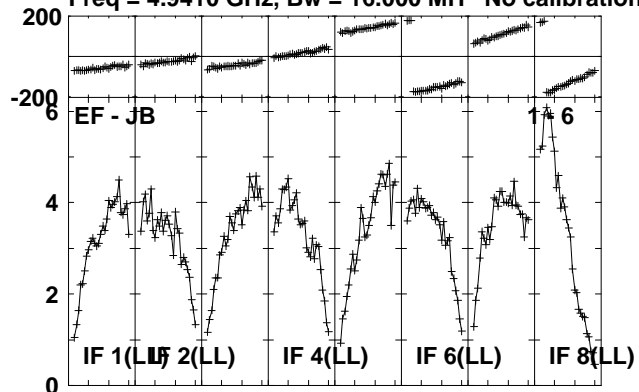

Lower frame: Milli Ampl Jy Top frame: Phas deg
Scalar averaged cross-power spectrum Several baselines displayed
Timerange: 00/14:39:11 to 00/14:40:39

Plot file version 55 created 04-OCT-2010 10:14:40

MAXI J16 RP016A.UVDATA.1

Freq = 4.9410 GHz, Bw = 16.000 MH No calibration applied and no bandpass applied

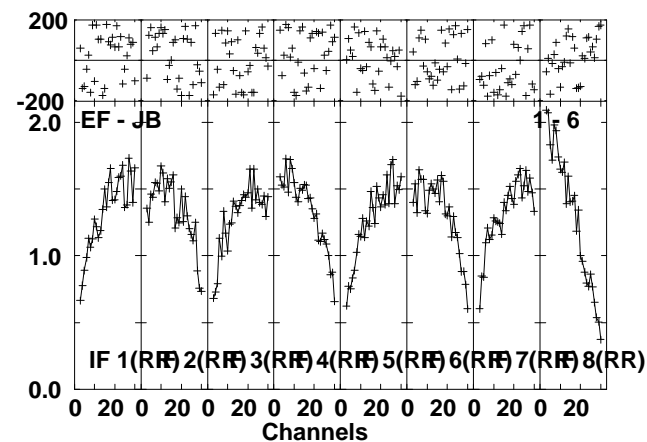
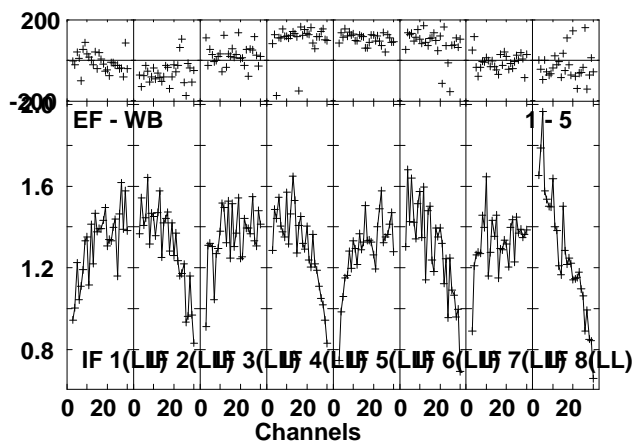
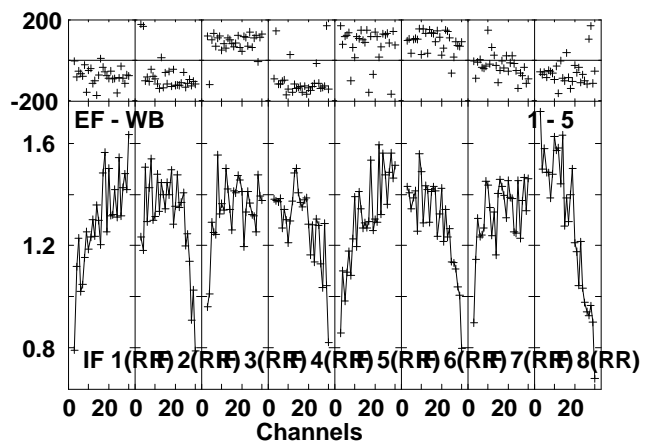
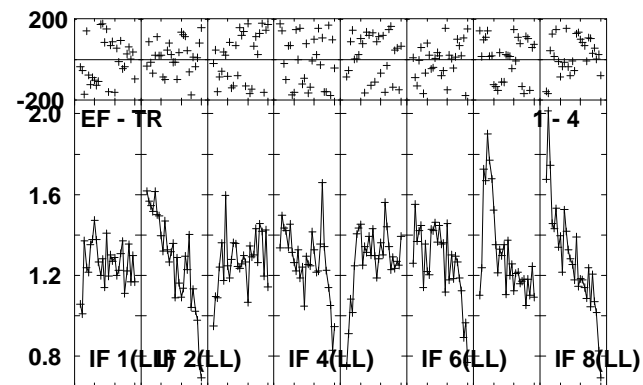
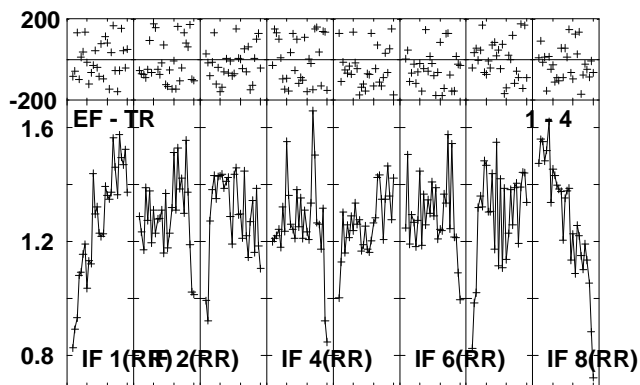
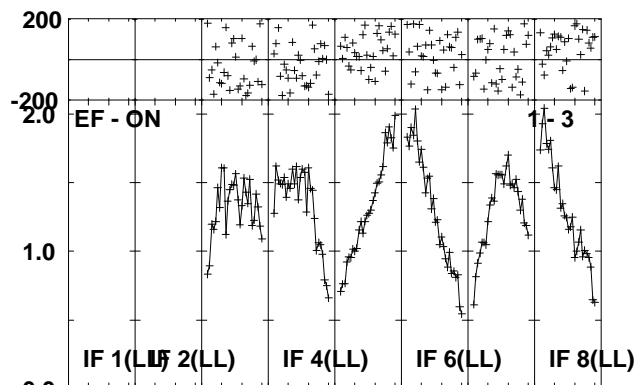
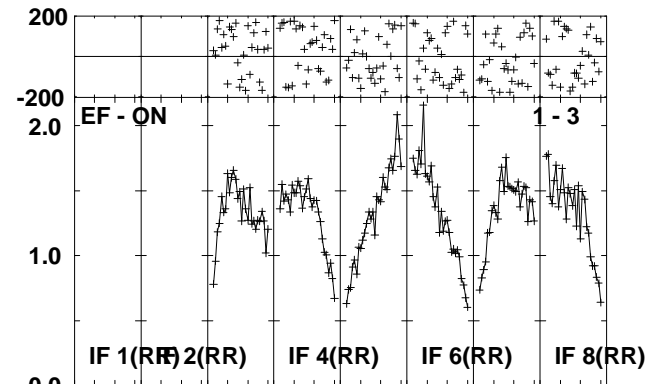
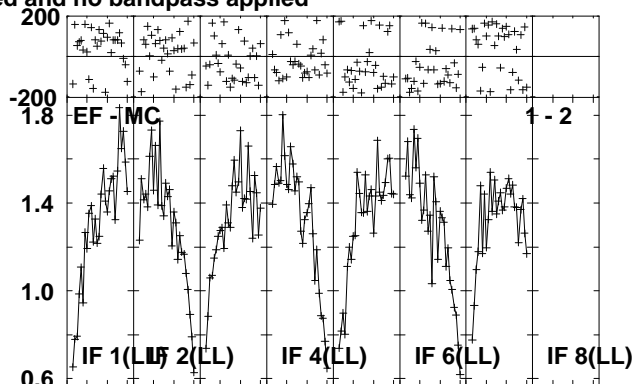
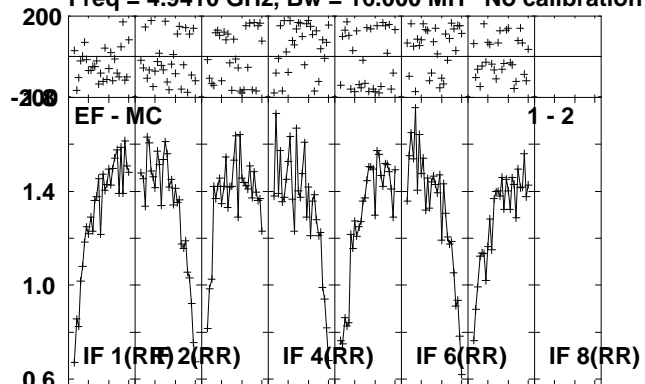

Lower frame: Milli Ampl Jy Top frame: Phas deg
Scalar averaged cross-power spectrum Several baselines displayed
Timerange: 00:14:40:41 to 00:14:43:09

Plot file version 56 created 04-OCT-2010 10:14:42

MAXI J16 RP016A.UVDATA.1

Freq = 4.9410 GHz, Bw = 16.000 MH No calibration applied and no bandpass applied

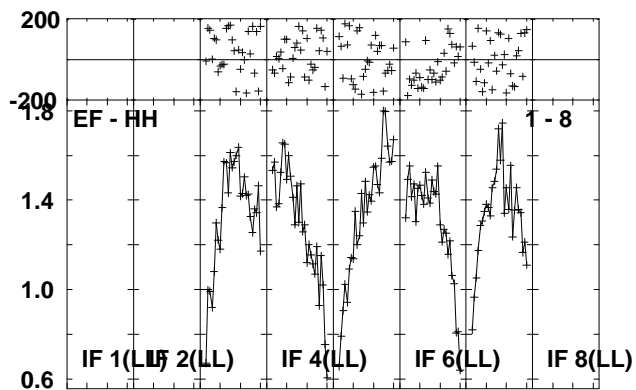
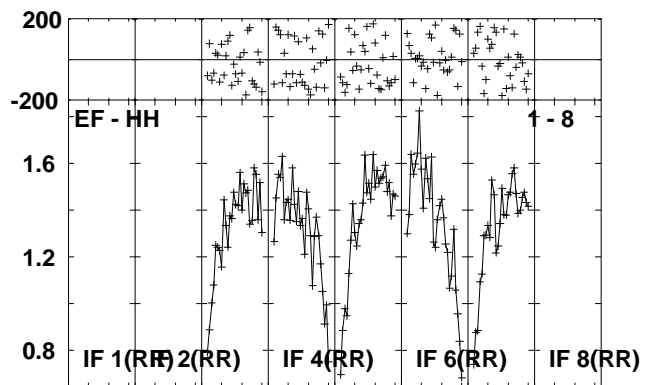
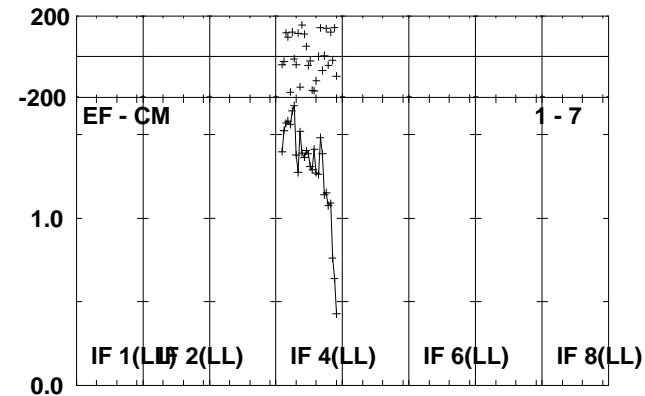
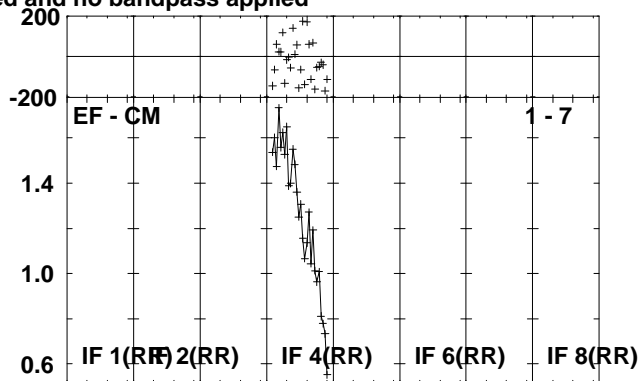
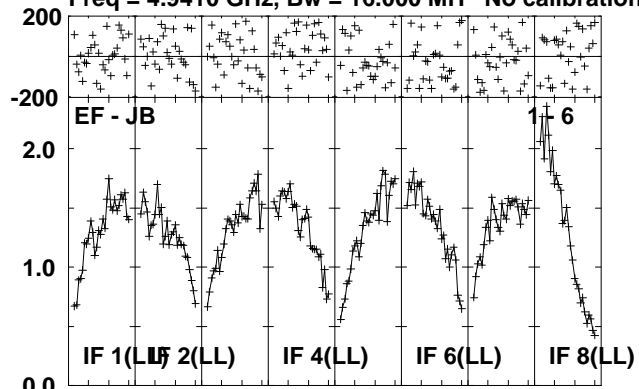

Lower frame: Milli Ampl Jy Top frame: Phas deg
Scalar averaged cross-power spectrum Several baselines displayed
Timerange: 00/14:40:41 to 00/14:43:09

Plot file version 57 created 04-OCT-2010 10:14:43

J1707-14 RP016A.UVDATA.1

Freq = 4.9410 GHz, Bw = 16.000 MH No calibration applied and no bandpass applied

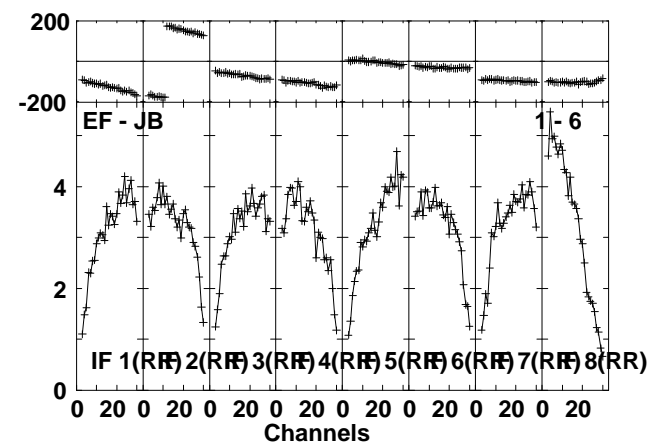
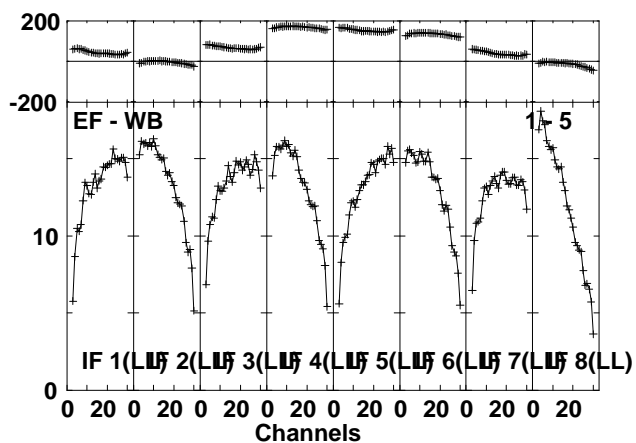
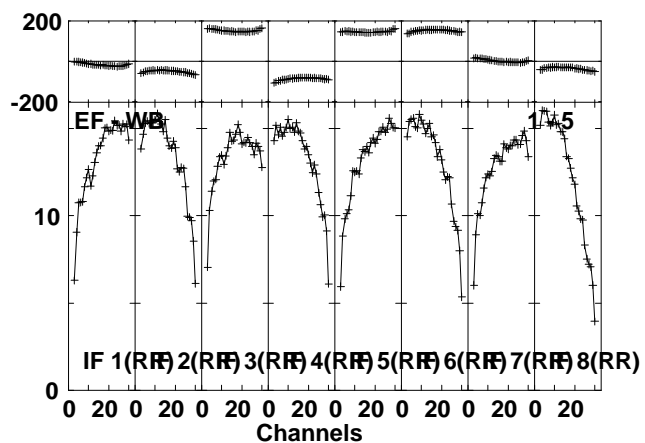
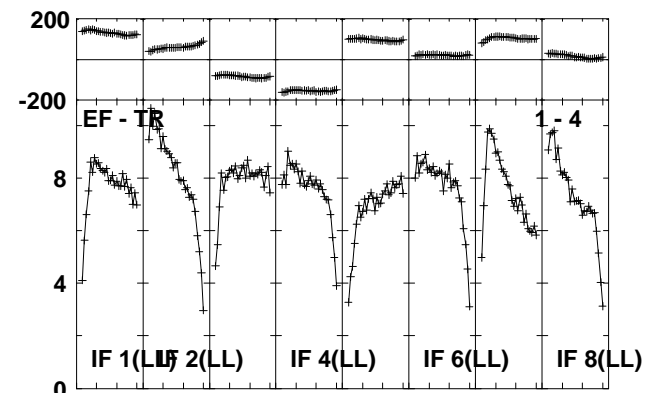
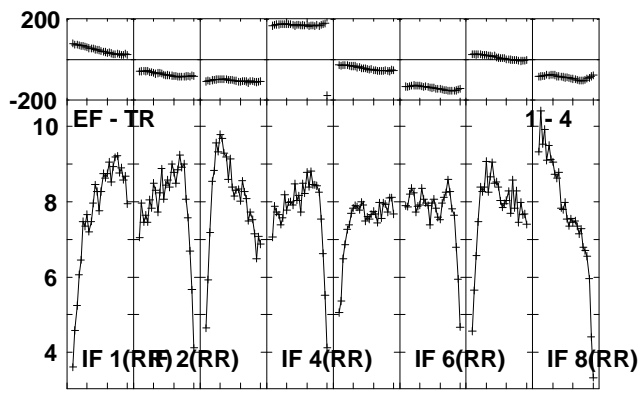
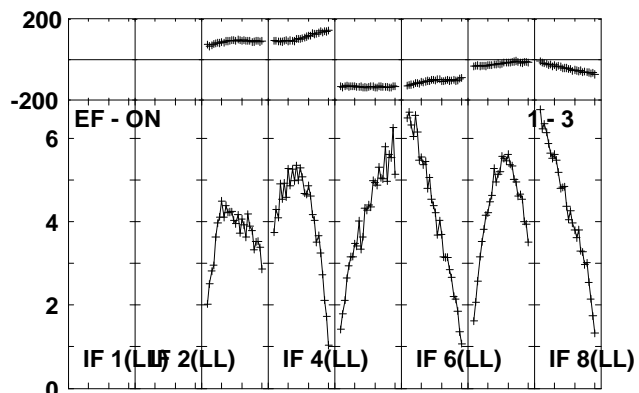
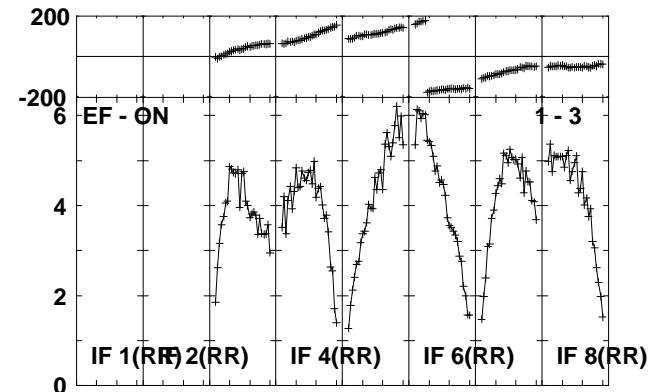
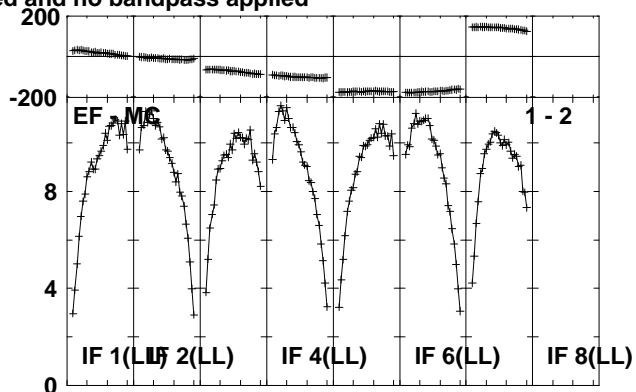
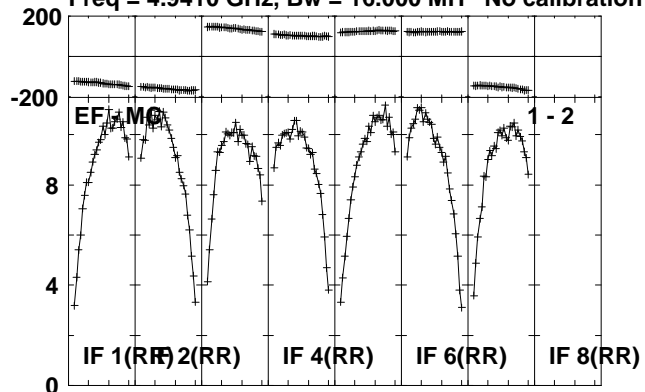

Lower frame: Milli Ampl Jy Top frame: Phas deg
Scalar averaged cross-power spectrum Several baselines displayed
Timerange: 00/14:43:51 to 00/14:44:49

Plot file version 58 created 04-OCT-2010 10:14:43

J1707-14 RP016A.UVDATA.1

Freq = 4.9410 GHz, Bw = 16.000 MH No calibration applied and no bandpass applied

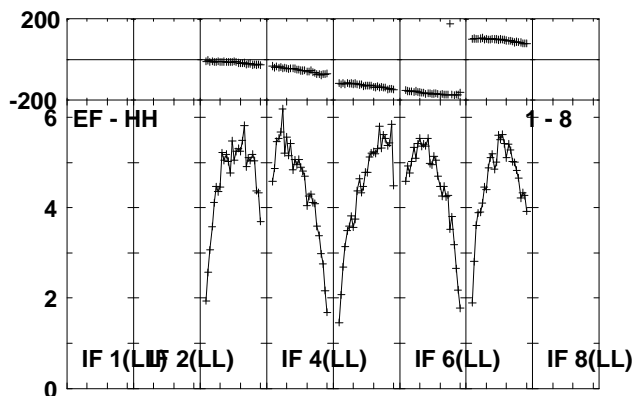
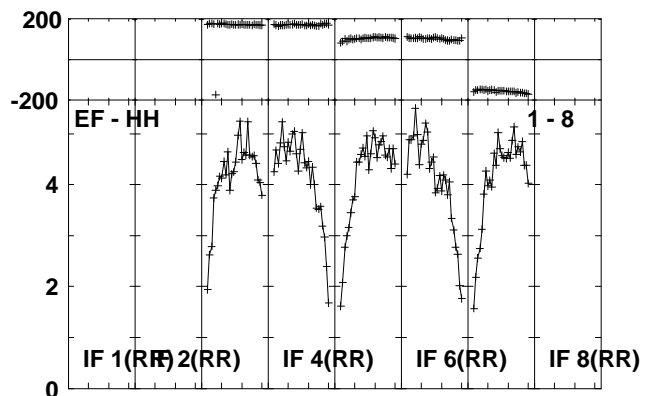
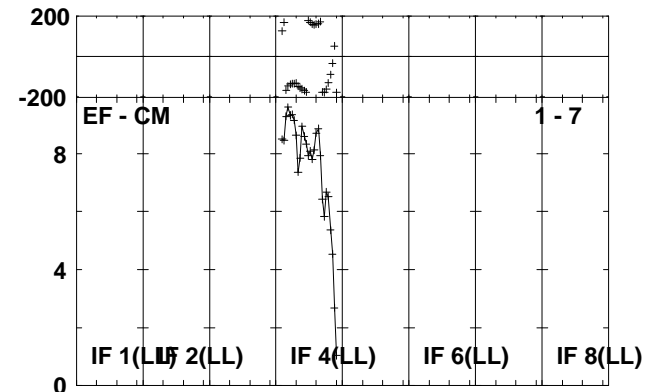
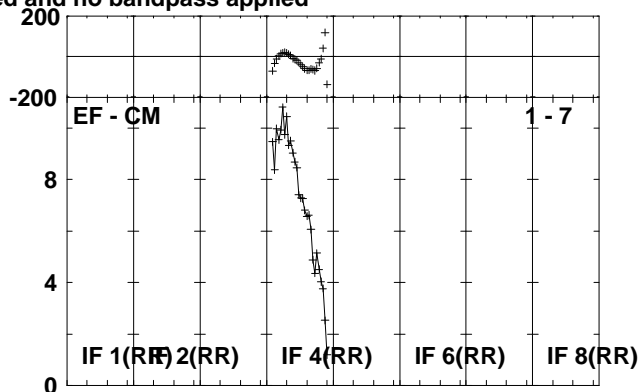
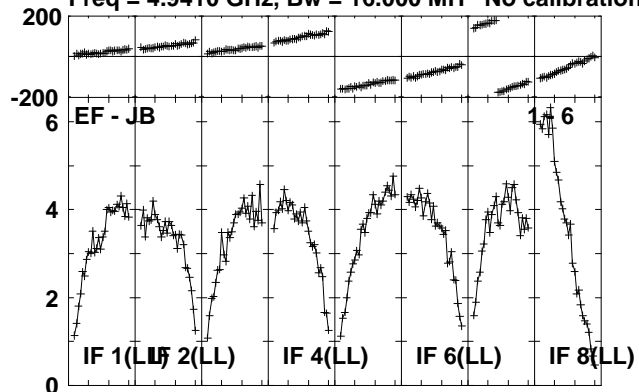

Lower frame: Milli Ampl Jy Top frame: Phas deg
Scalar averaged cross-power spectrum Several baselines displayed
Timerange: 00/14:43:51 to 00/14:44:49

Plot file version 59 created 04-OCT-2010 10:14:44

NVSS3 RP016A.UVDATA.1

Freq = 4.9410 GHz, Bw = 16.000 MH No calibration applied and no bandpass applied

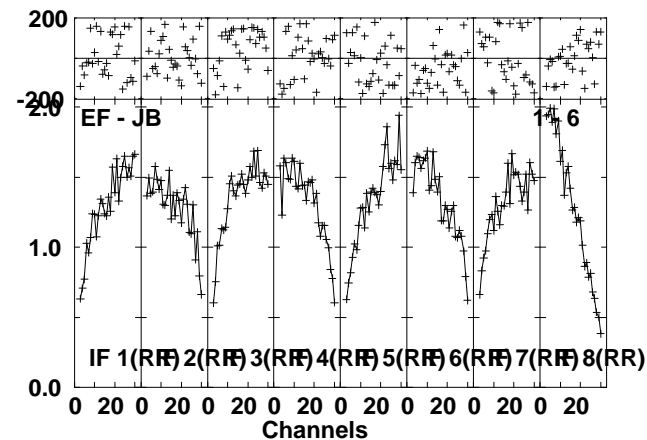
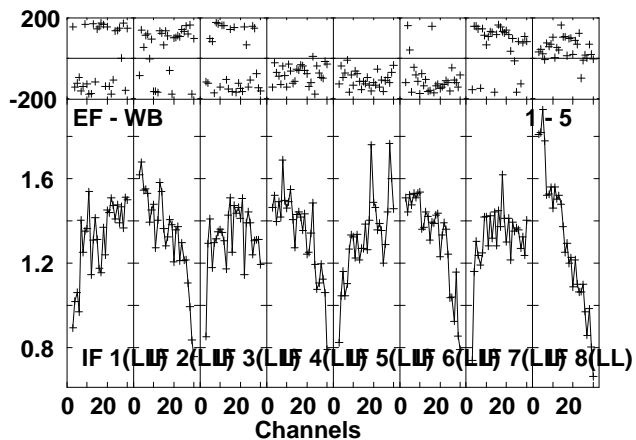
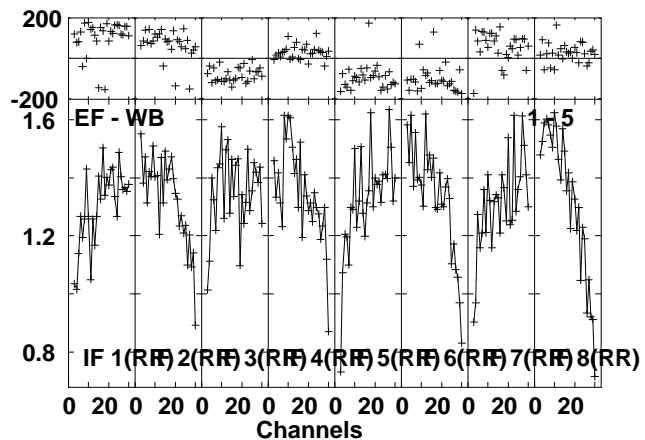
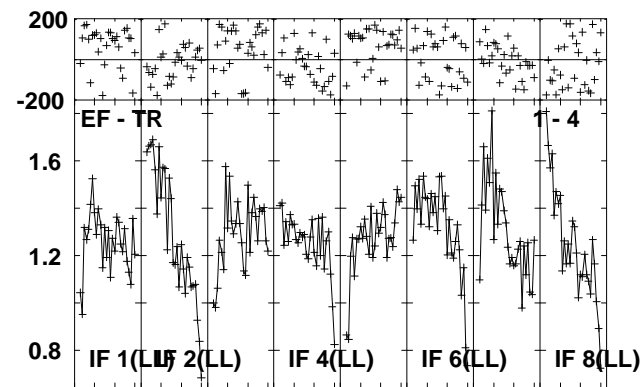
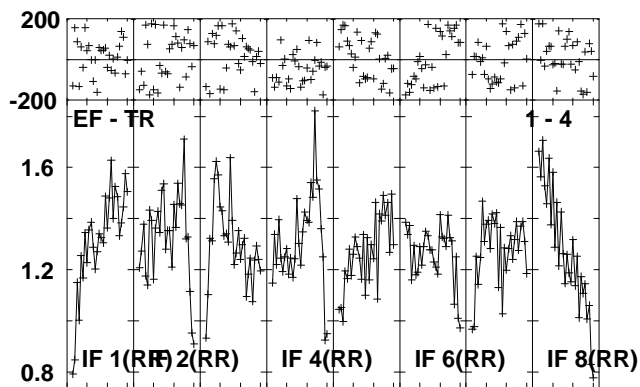
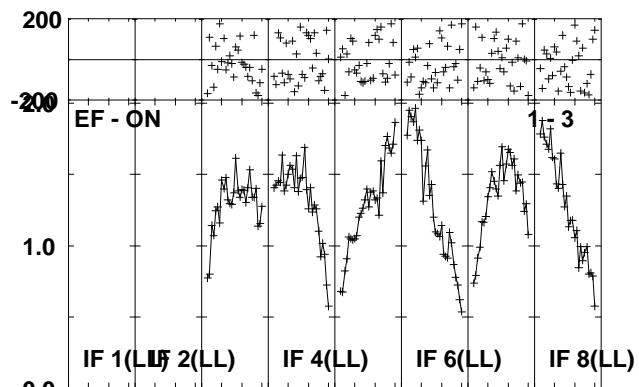
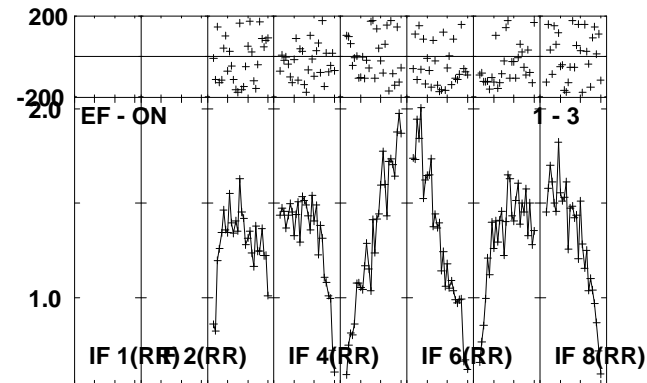
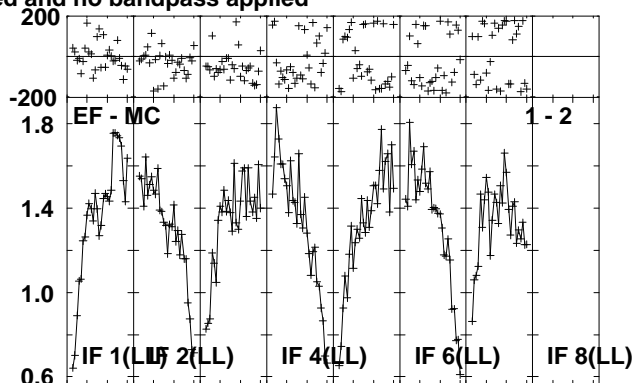
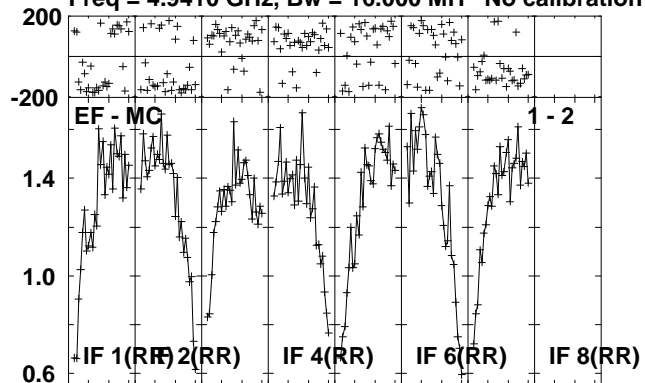

Lower frame: Milli Ampl Jy Top frame: Phas deg
Scalar averaged cross-power spectrum Several baselines displayed
Timerange: 00/14:44:51 to 00/14:47:19

Plot file version 60 created 04-OCT-2010 10:14:46

NVSS3 RP016A.UVDATA.1

Freq = 4.9410 GHz, Bw = 16.000 MH No calibration applied and no bandpass applied

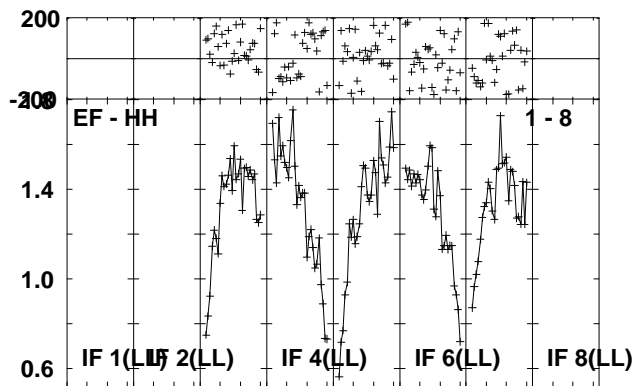
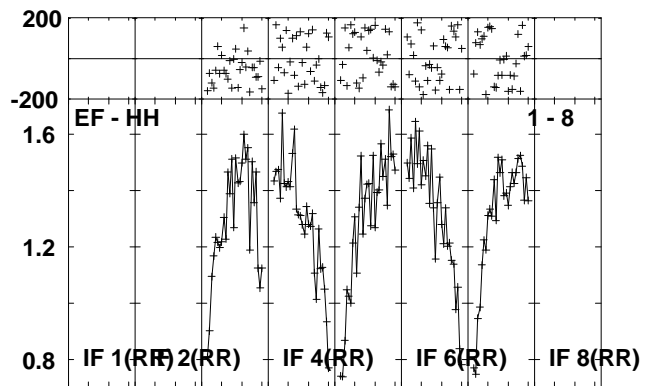
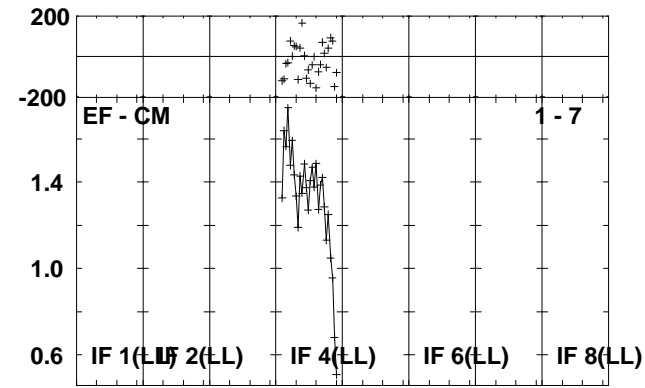
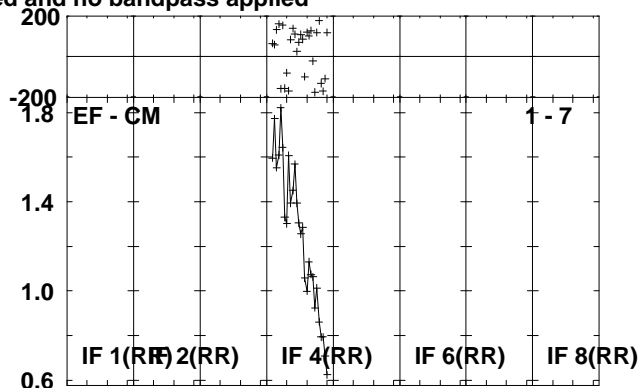
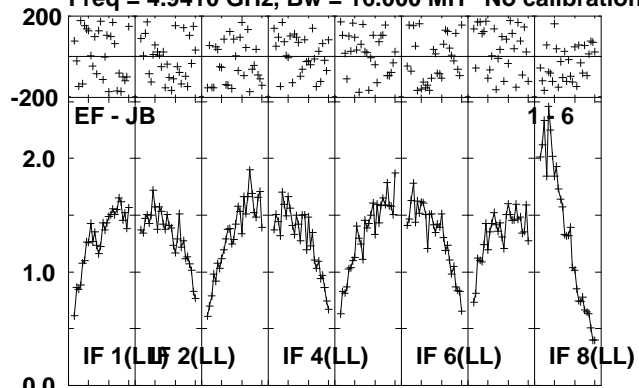

Lower frame: Milli Ampl Jy Top frame: Phas deg
Scalar averaged cross-power spectrum Several baselines displayed
Timerange: 00/14:44:51 to 00/14:47:19

Plot file version 61 created 04-OCT-2010 10:14:47

J1707-14 RP016A.UVDATA.1

Freq = 4.9410 GHz, Bw = 16.000 MH No calibration applied and no bandpass applied

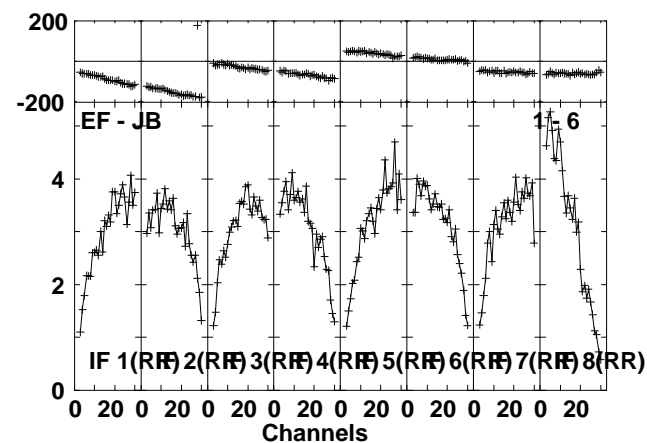
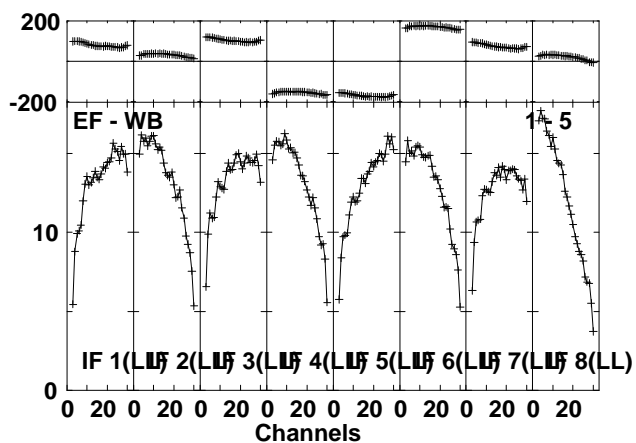
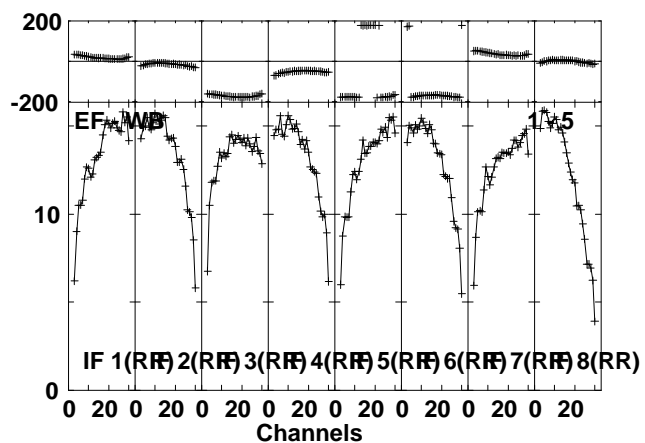
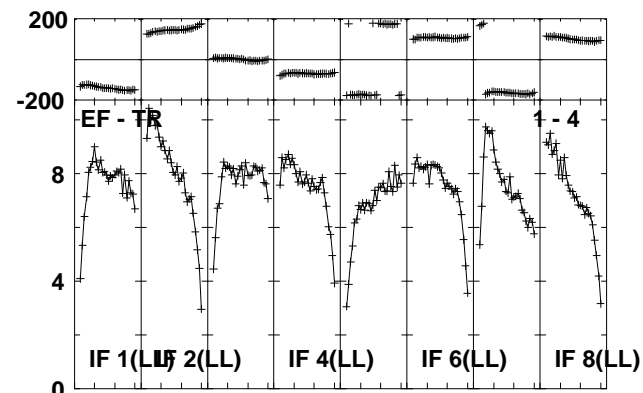
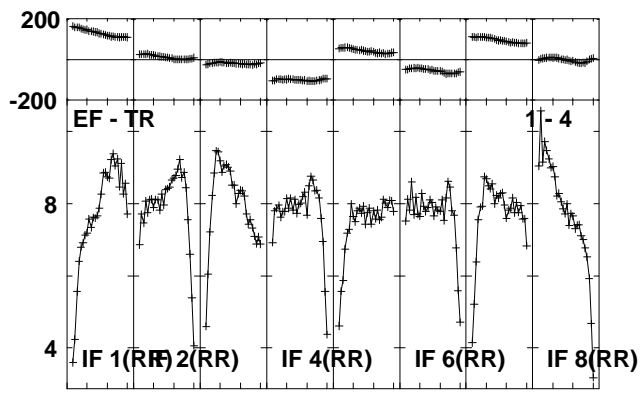
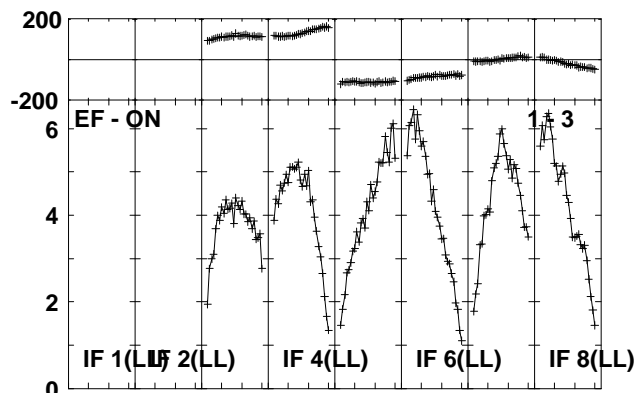
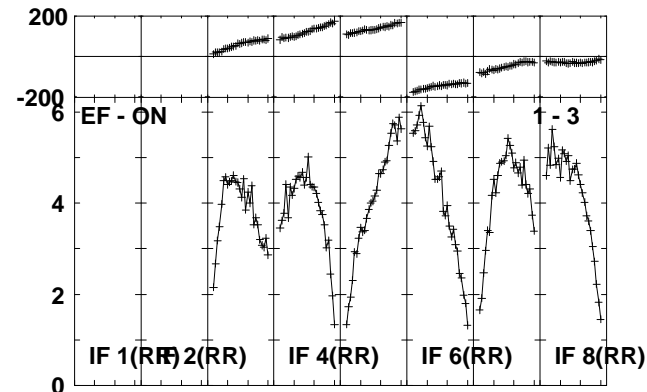
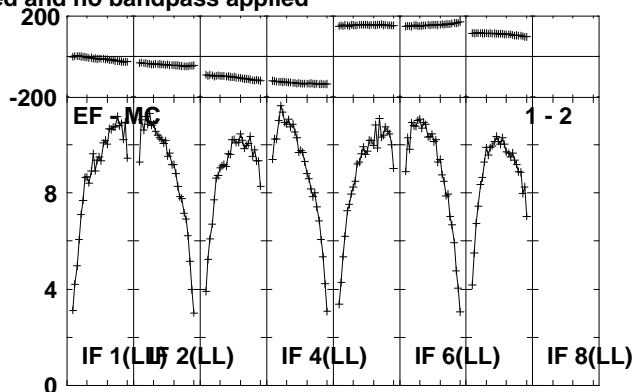
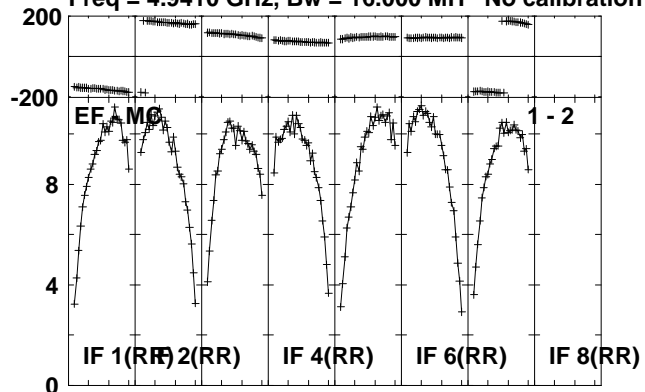

Lower frame: Milli Ampl Jy Top frame: Phas deg
Scalar averaged cross-power spectrum Several baselines displayed
Timerange: 00:14:47:21 to 00:14:48:49

Plot file version 62 created 04-OCT-2010 10:14:48

J1707-14 RP016A.UVDATA.1

Freq = 4.9410 GHz, Bw = 16.000 MH No calibration applied and no bandpass applied

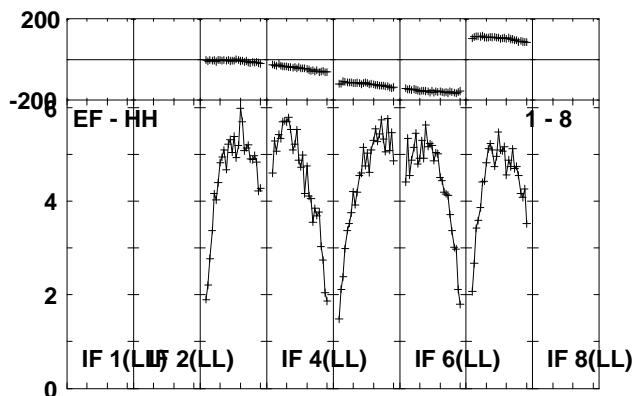
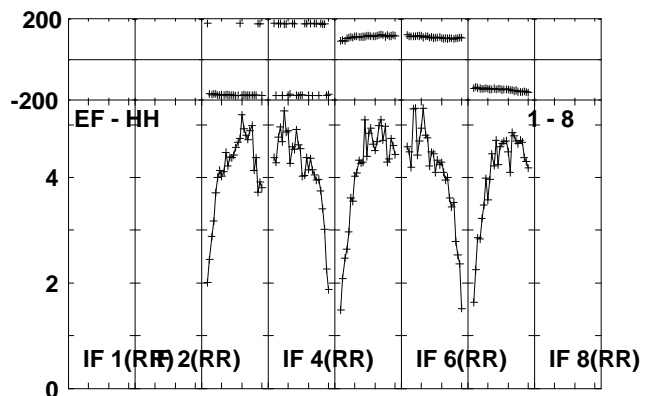
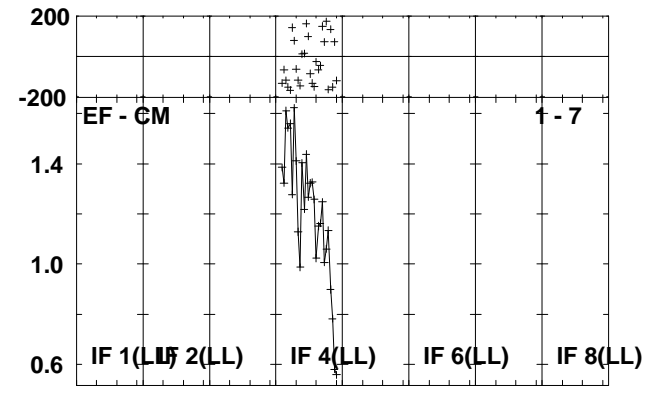
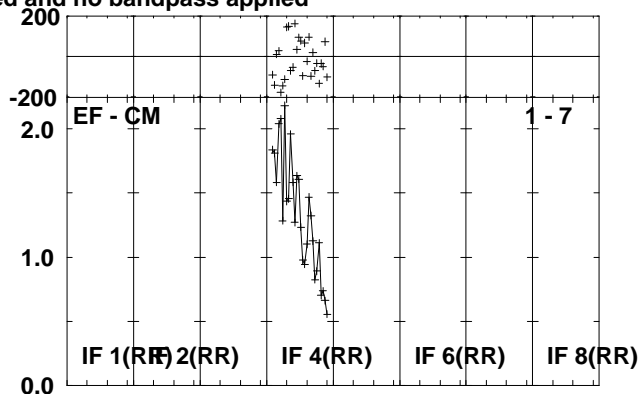
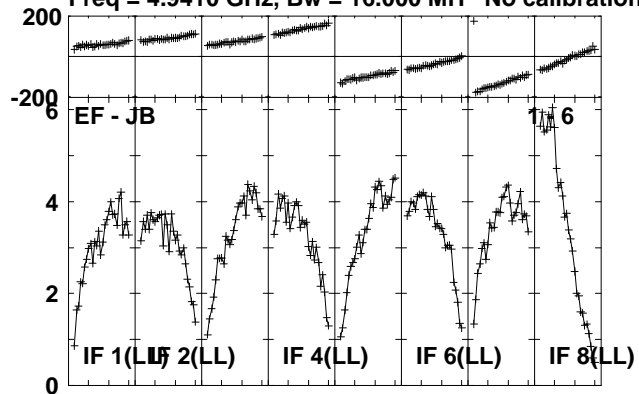

Lower frame: Milli Ampl Jy Top frame: Phas deg
Scalar averaged cross-power spectrum Several baselines displayed
Timerange: 00/14:47:21 to 00/14:48:49

Plot file version 63 created 04-OCT-2010 10:14:49

MAXI J16 RP016A.UVDATA.1

Freq = 4.9410 GHz, Bw = 16.000 MH No calibration applied and no bandpass applied

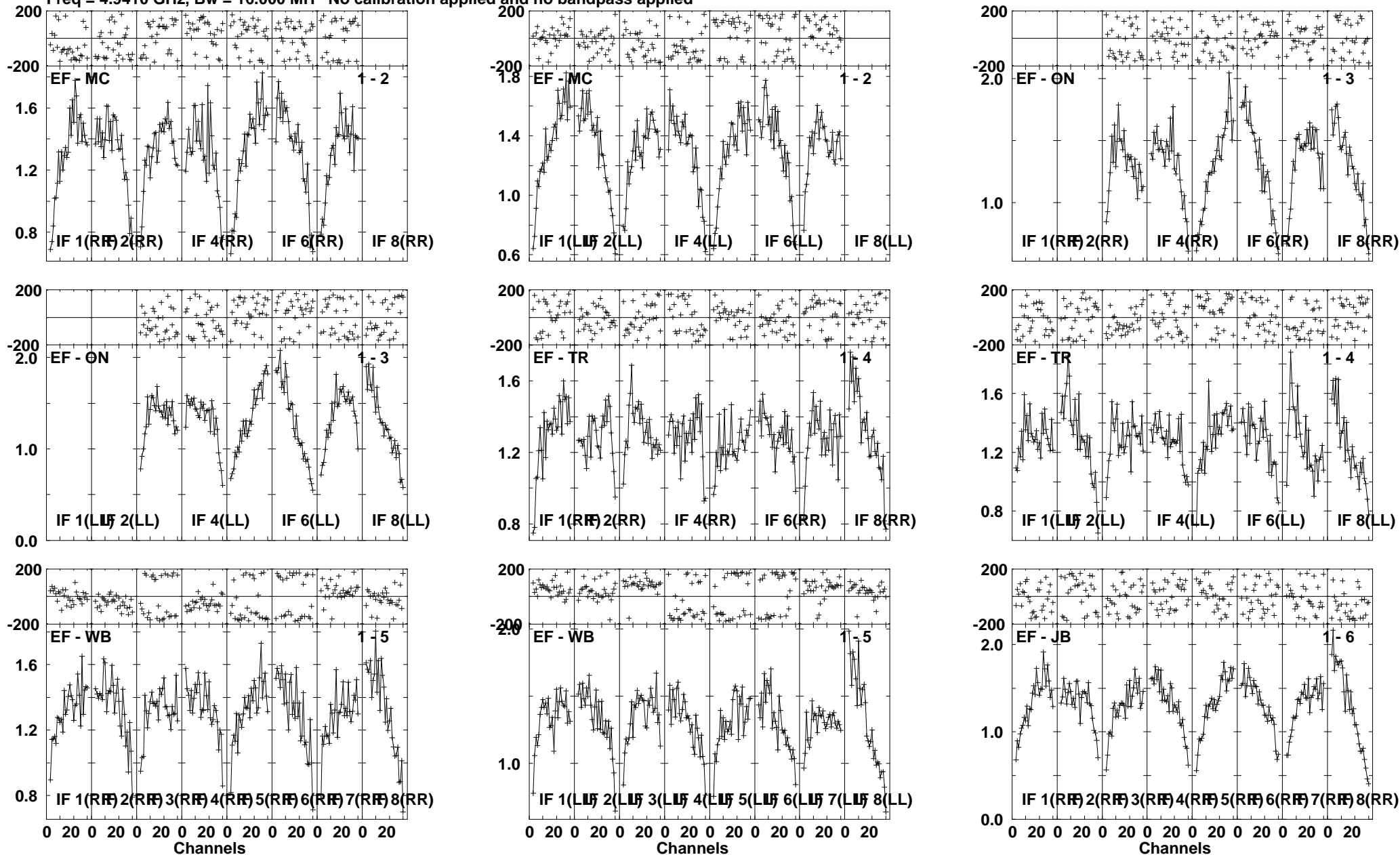

Lower frame: Milli Ampl Jy Top frame: Phas deg
Scalar averaged cross-power spectrum Several baselines displayed
Timerange: 00/14:48:51 to 00/14:51:19

Plot file version 64 created 04-OCT-2010 10:14:50

MAXI J16 RP016A.UVDATA.1

Freq = 4.9410 GHz, Bw = 16.000 MH No calibration applied and no bandpass applied

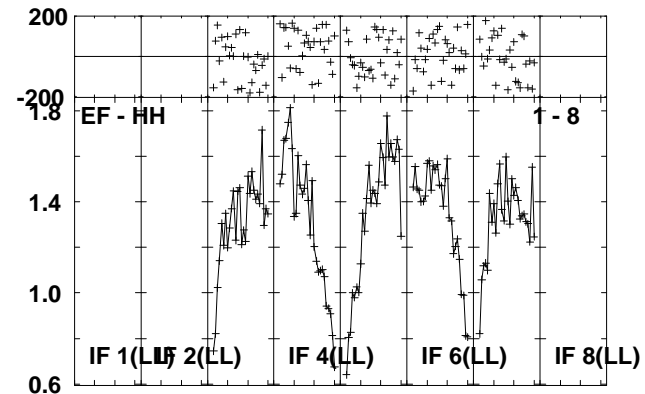
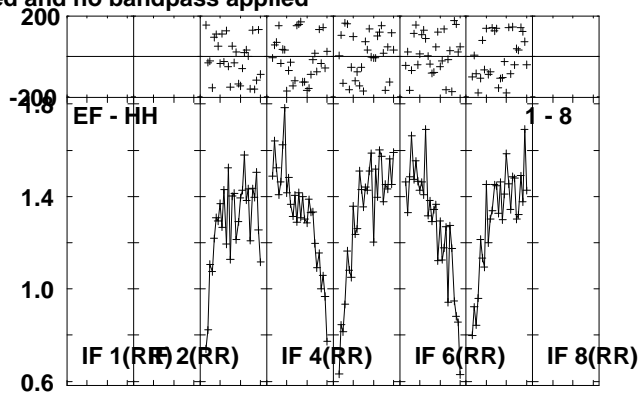
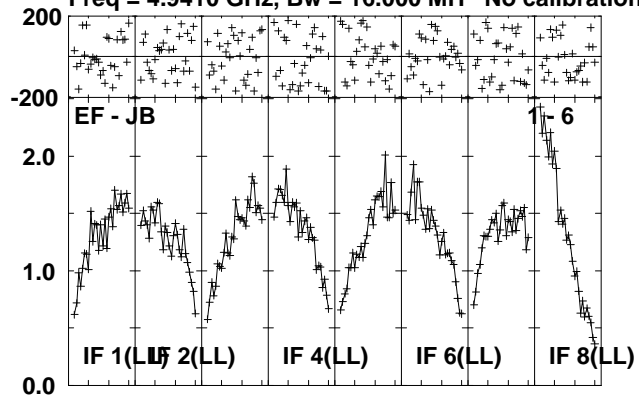

Lower frame: Milli Ampl Jy Top frame: Phas deg
Scalar averaged cross-power spectrum Several baselines displayed
Timerange: 00/14:48:51 to 00/14:51:19

Plot file version 65 created 04-OCT-2010 10:14:51

J1707-14 RP016A.UVDATA.1

Freq = 4.9410 GHz, Bw = 16.000 MH No calibration applied and no bandpass applied

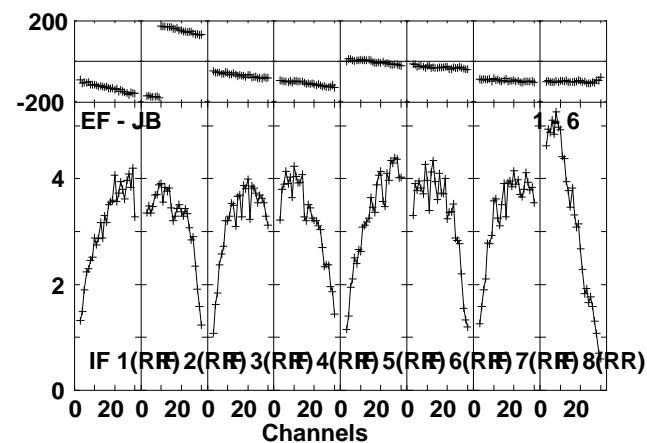
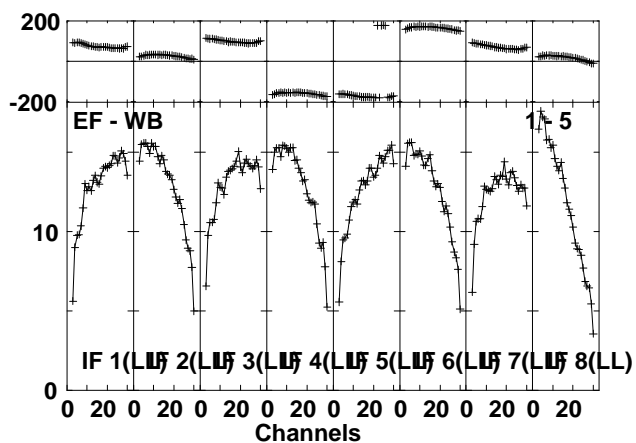
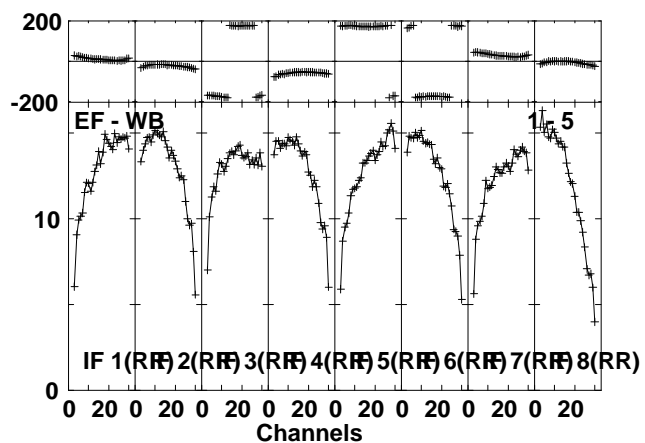
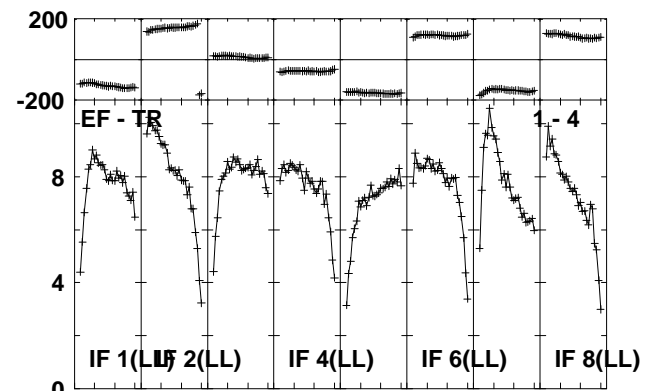
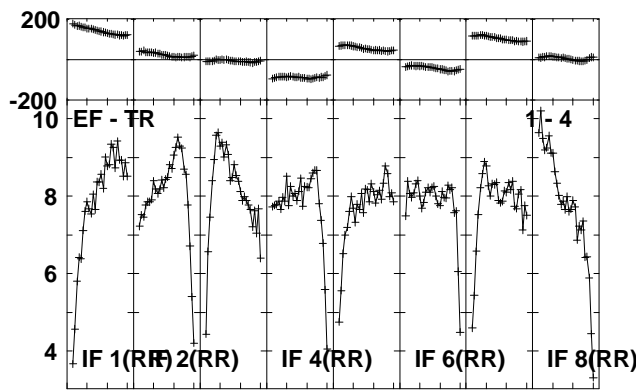
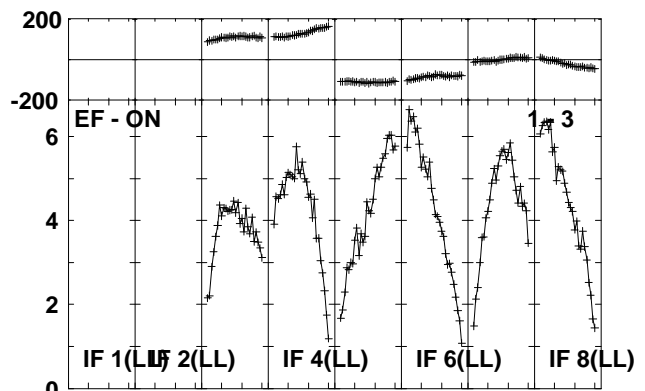
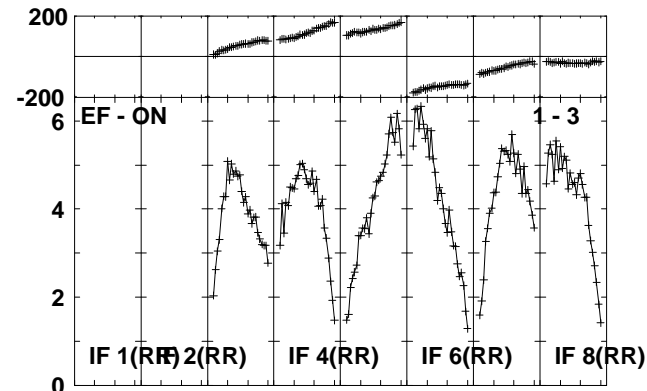
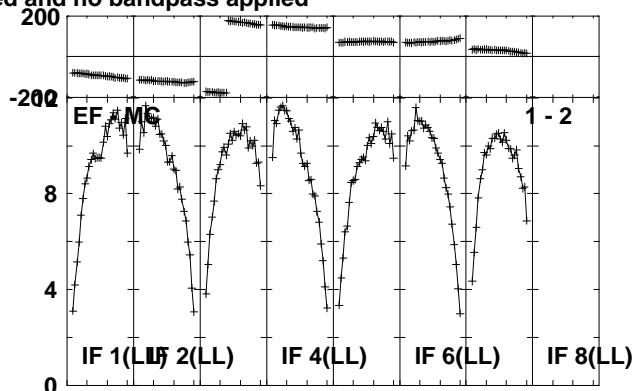
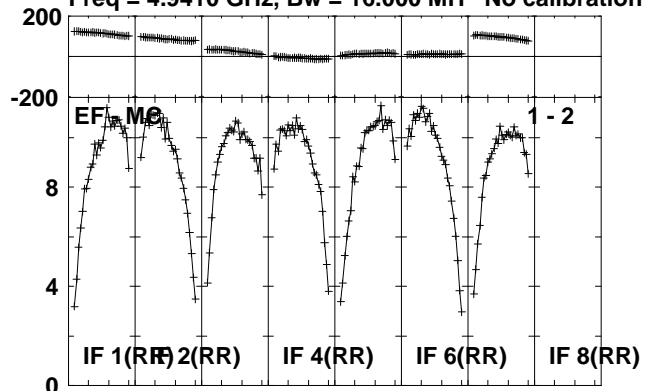

Lower frame: Milli Ampl Jy Top frame: Phas deg
Scalar averaged cross-power spectrum Several baselines displayed
Timerange: 00/14:52:01 to 00/14:52:59

Plot file version 66 created 04-OCT-2010 10:14:52

J1707-14 RP016A.UVDATA.1

Freq = 4.9410 GHz, Bw = 16.000 MH No calibration applied and no bandpass applied

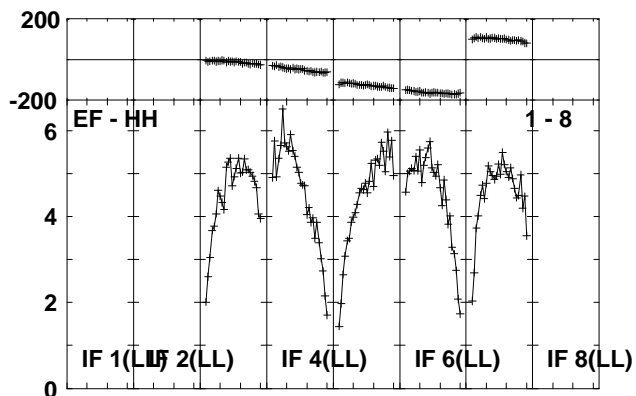
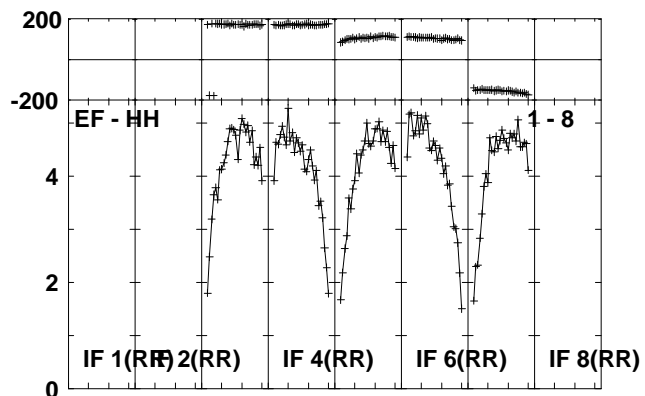
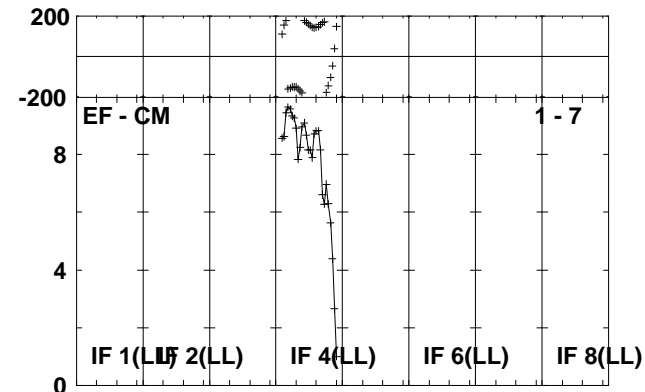
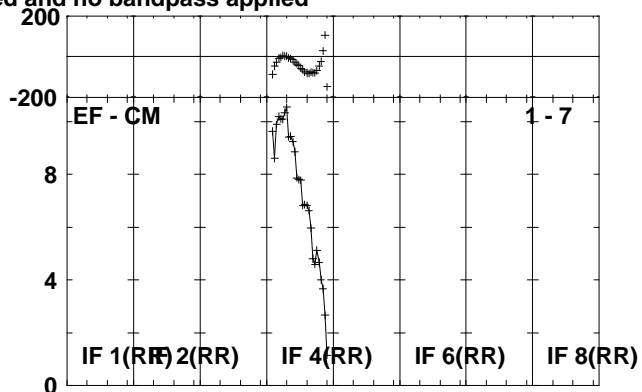
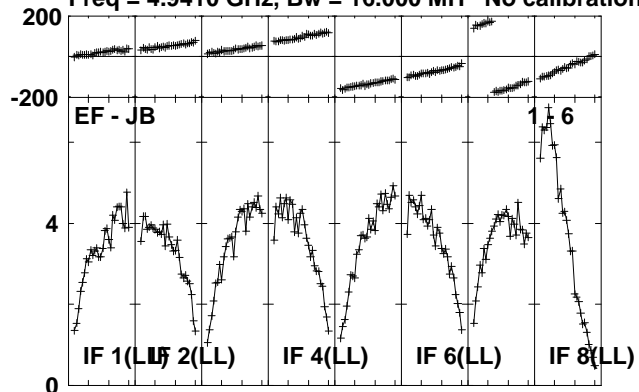

Lower frame: Milli Ampl Jy Top frame: Phas deg
Scalar averaged cross-power spectrum Several baselines displayed
Timerange: 00/14:52:01 to 00/14:52:59

Plot file version 67 created 04-OCT-2010 10:14:52

MAXI J16 RP016A.UVDATA.1

Freq = 4.9410 GHz, Bw = 16.000 MH No calibration applied and no bandpass applied

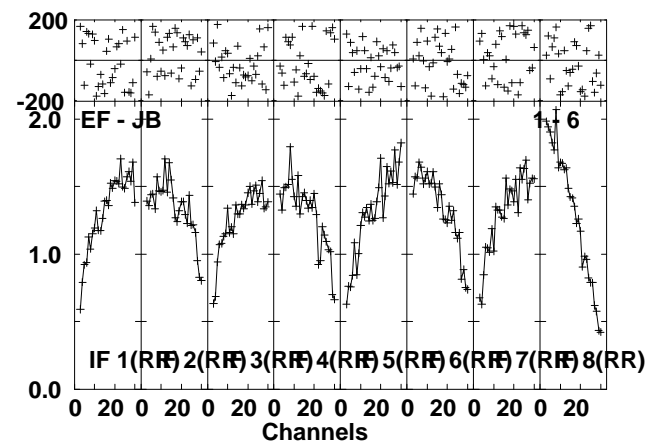
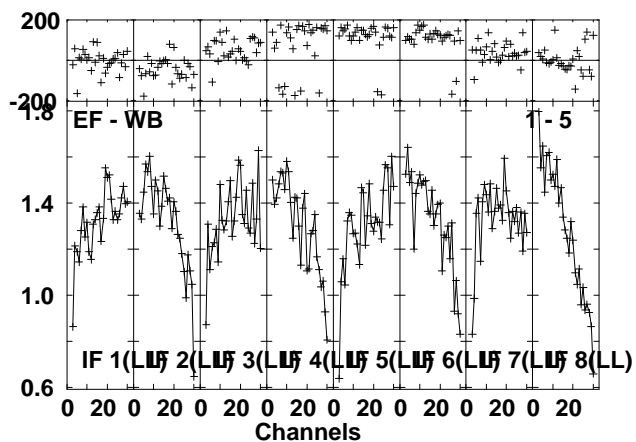
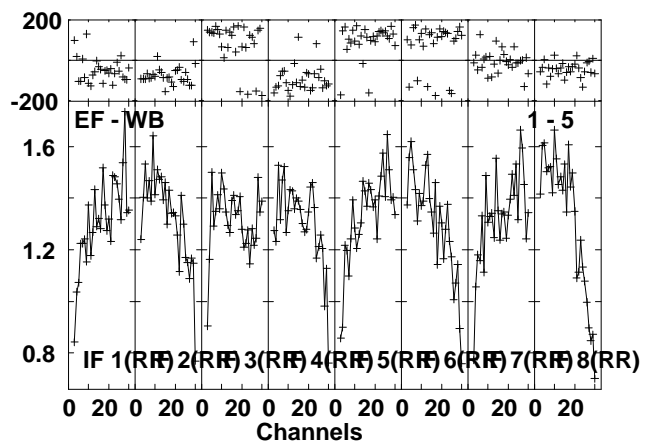
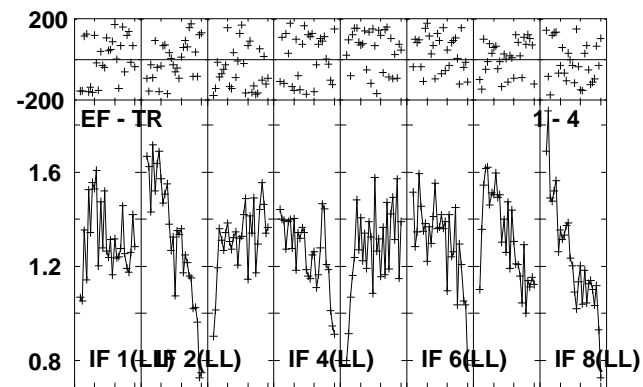
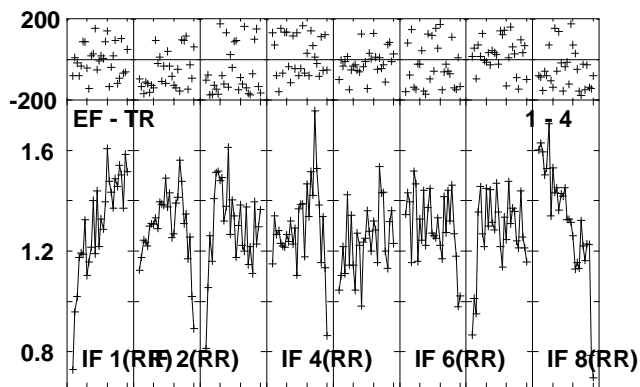
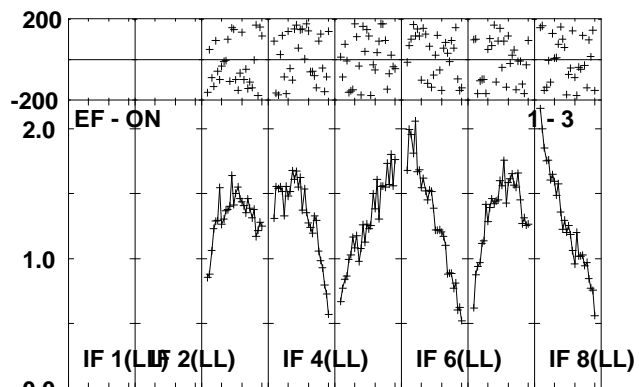
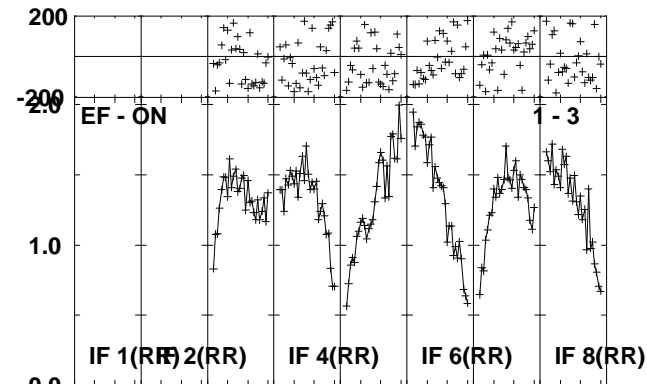
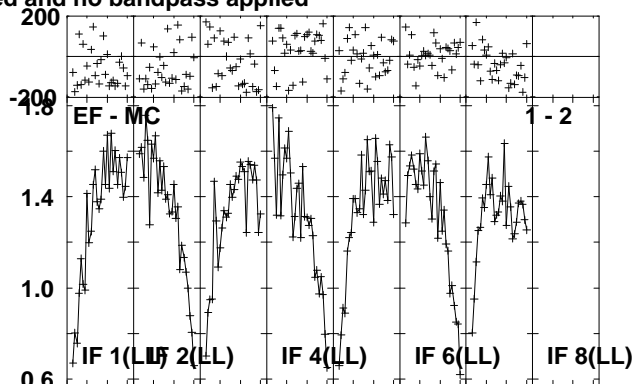
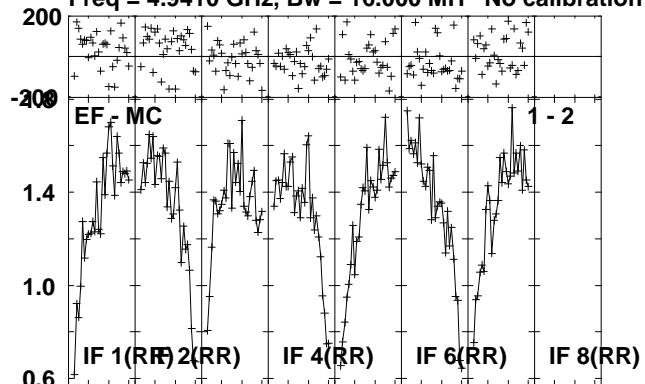

Lower frame: Milli Ampl Jy Top frame: Phas deg
Scalar averaged cross-power spectrum Several baselines displayed
Timerange: 00/14:53:01 to 00/14:55:29

Plot file version 68 created 04-OCT-2010 10:14:54

MAXI J16 RP016A.UVDATA.1

Freq = 4.9410 GHz, Bw = 16.000 MH No calibration applied and no bandpass applied

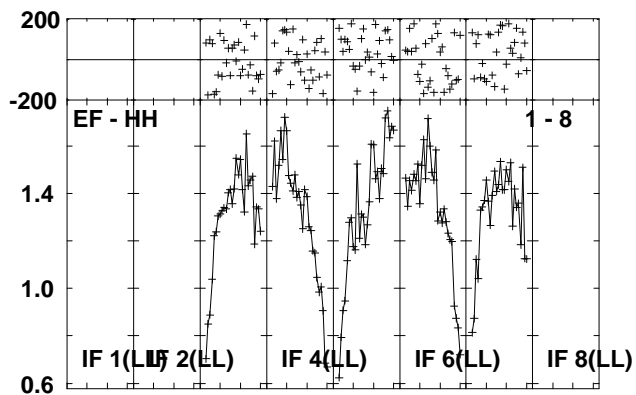
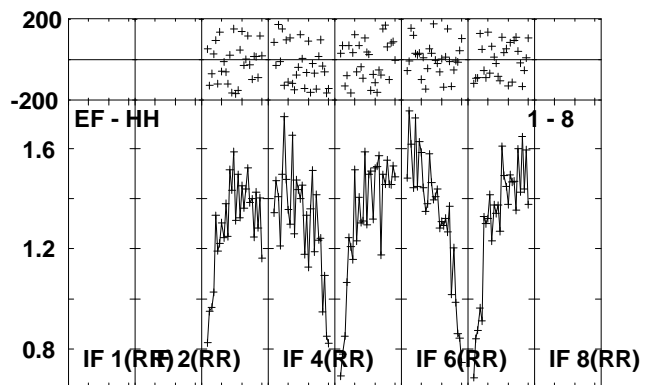
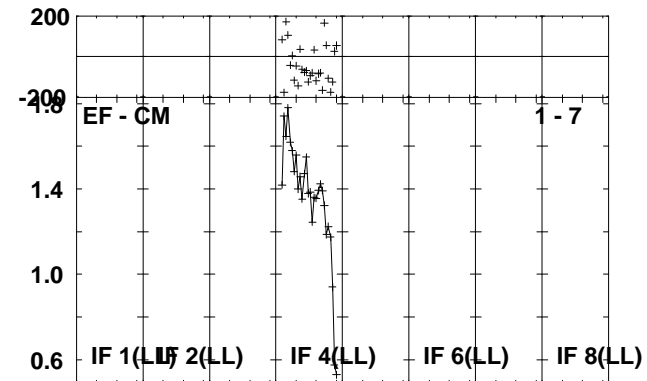
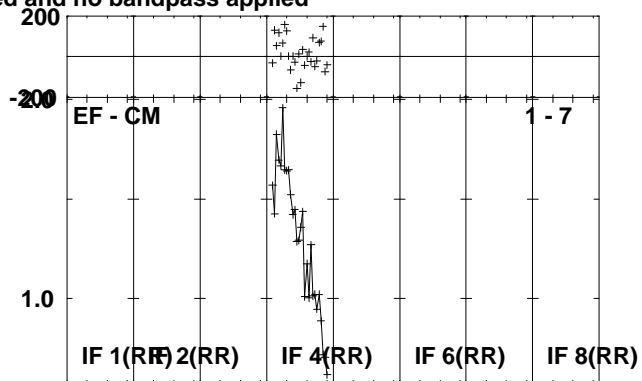
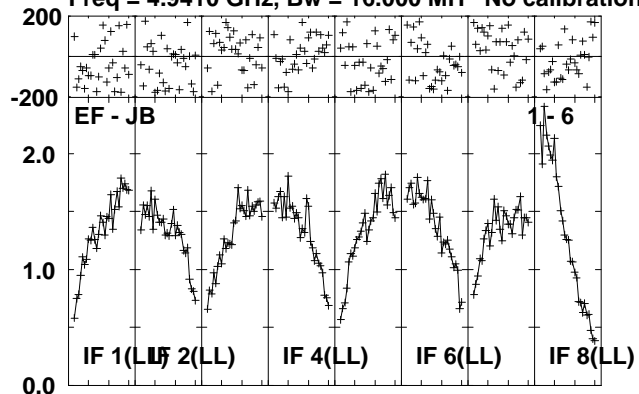

Lower frame: Milli Ampl Jy Top frame: Phas deg
Scalar averaged cross-power spectrum Several baselines displayed
Timerange: 00/14:53:01 to 00/14:55:29

Plot file version 69 created 04-OCT-2010 10:14:55

J1707-14 RP016A.UVDATA.1

Freq = 4.9410 GHz, Bw = 16.000 MH No calibration applied and no bandpass applied

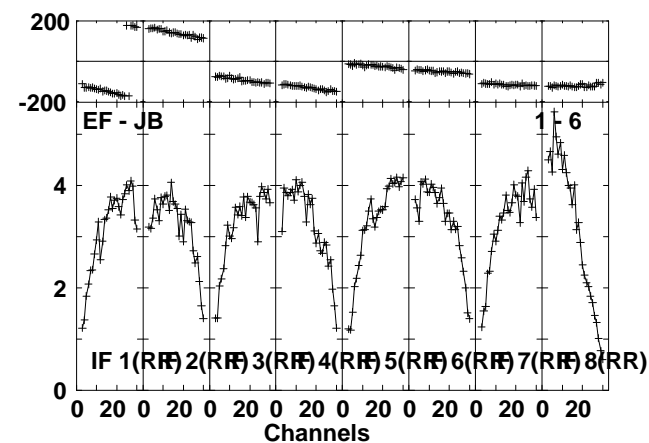
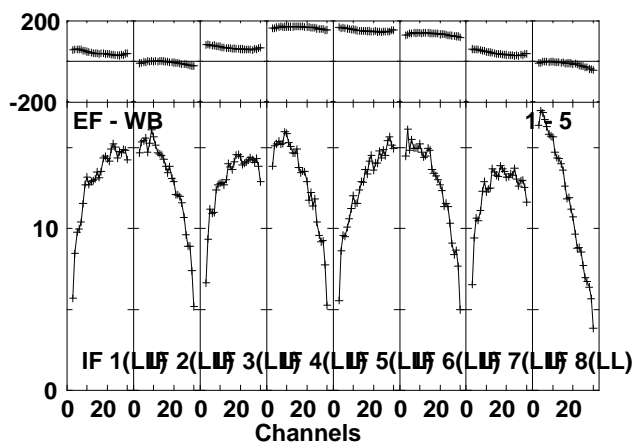
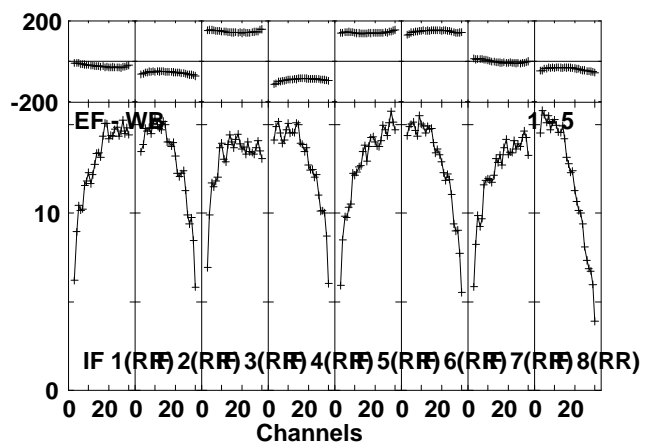
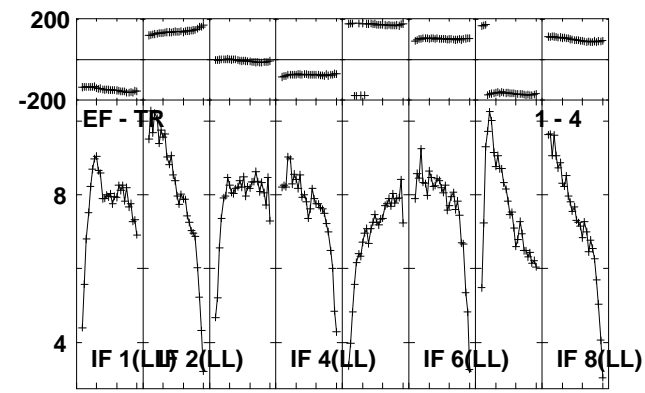
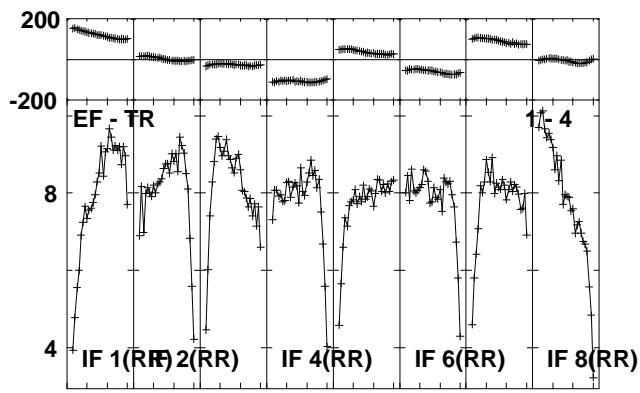
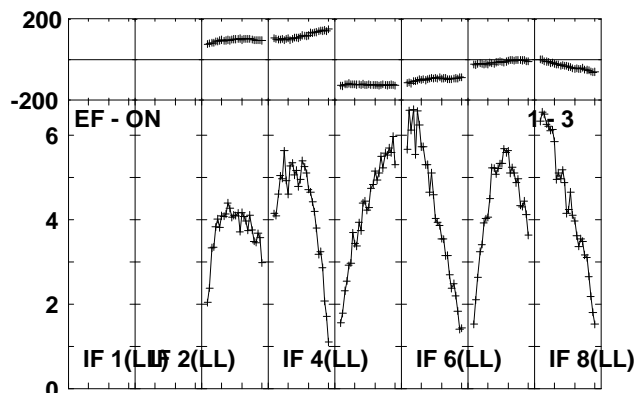
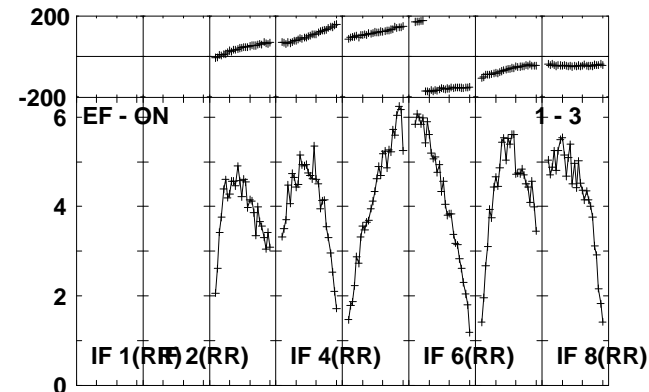
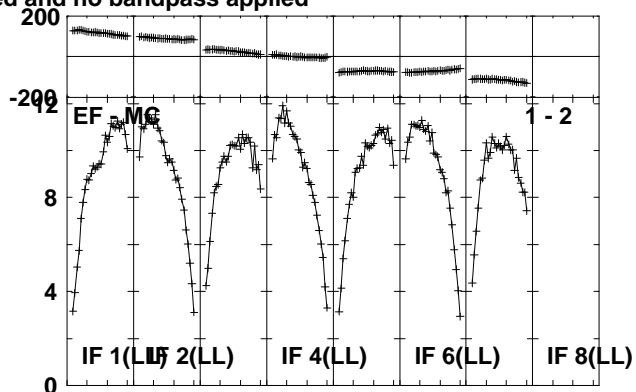
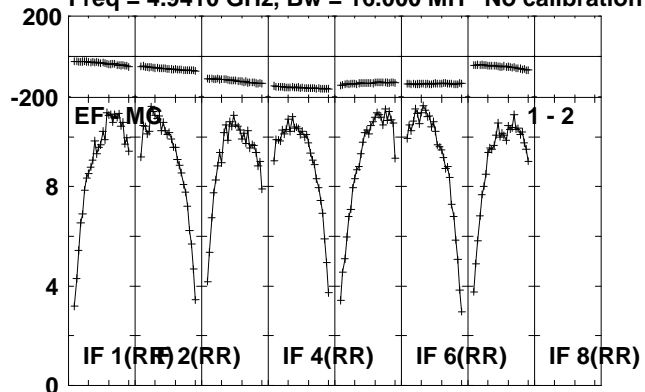

Lower frame: Milli Ampl Jy Top frame: Phas deg
Scalar averaged cross-power spectrum Several baselines displayed
Timerange: 00/14:55:31 to 00/14:56:59

Plot file version 70 created 04-OCT-2010 10:14:56

J1707-14 RP016A.UVDATA.1

Freq = 4.9410 GHz, Bw = 16.000 MH No calibration applied and no bandpass applied

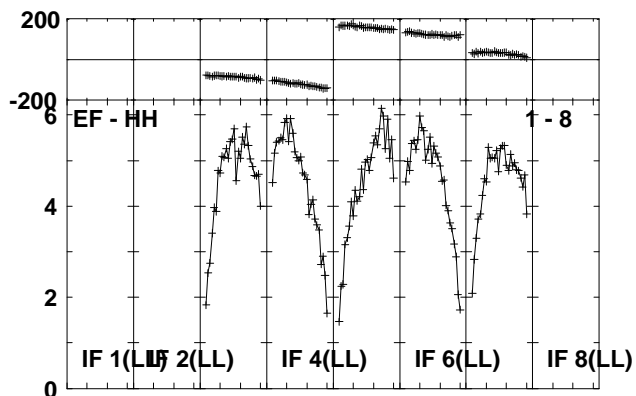
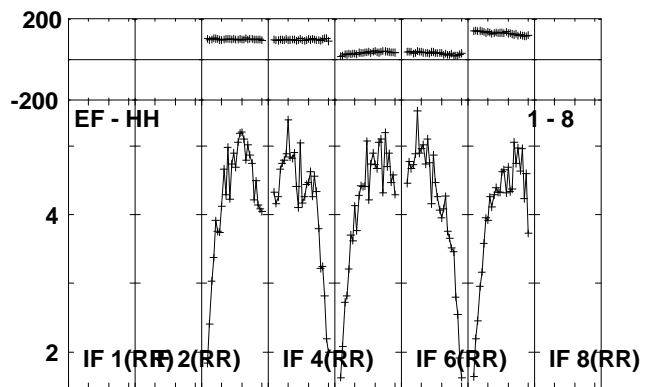
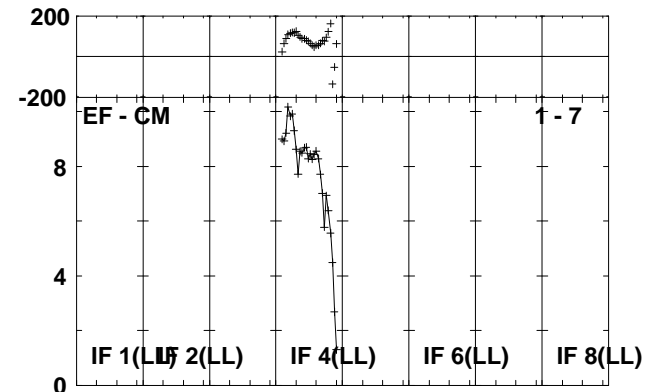
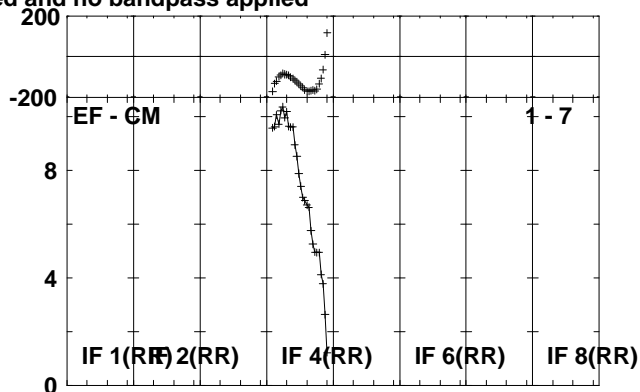
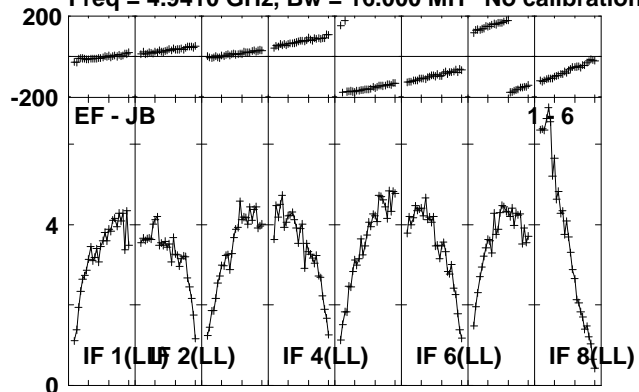

Lower frame: Milli Ampl Jy Top frame: Phas deg
Scalar averaged cross-power spectrum Several baselines displayed
Timerange: 00/14:55:31 to 00/14:56:59

Plot file version 71 created 04-OCT-2010 10:14:57

MAXI J16 RP016A.UVDATA.1

Freq = 4.9410 GHz, Bw = 16.000 MH No calibration applied and no bandpass applied

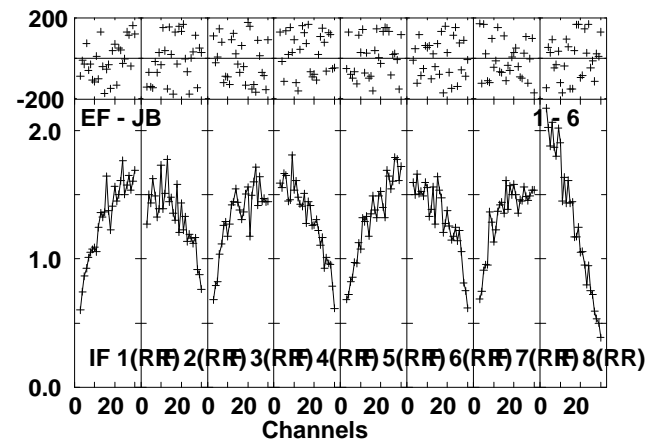
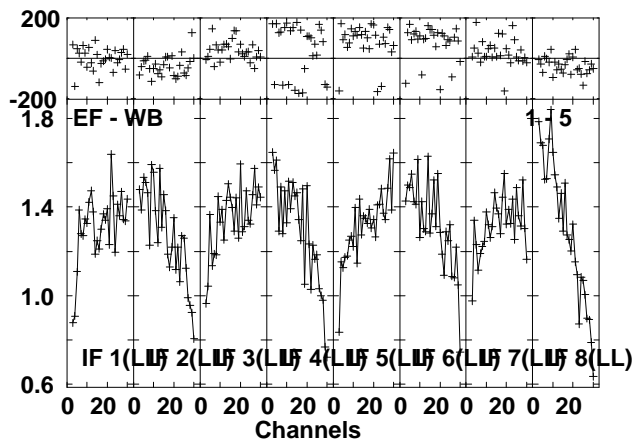
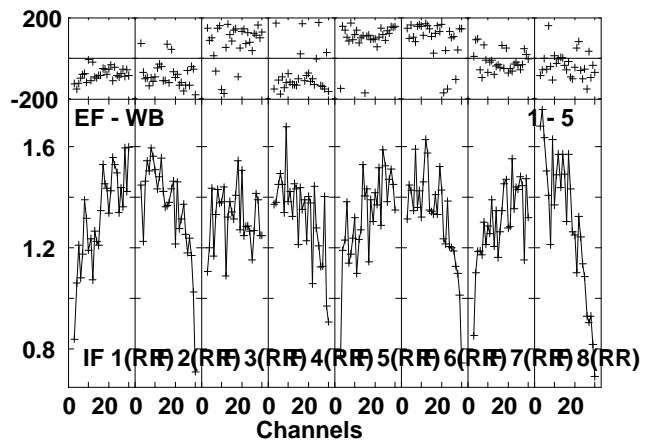
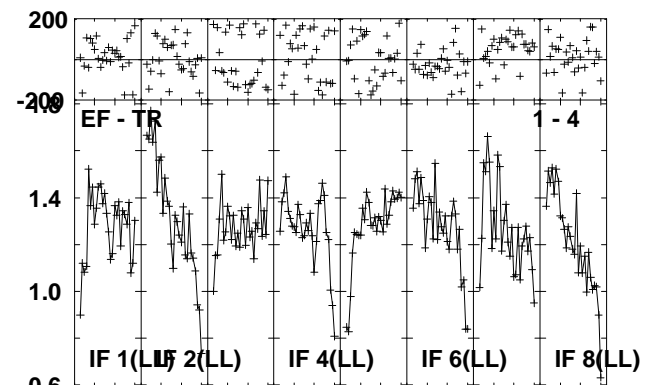
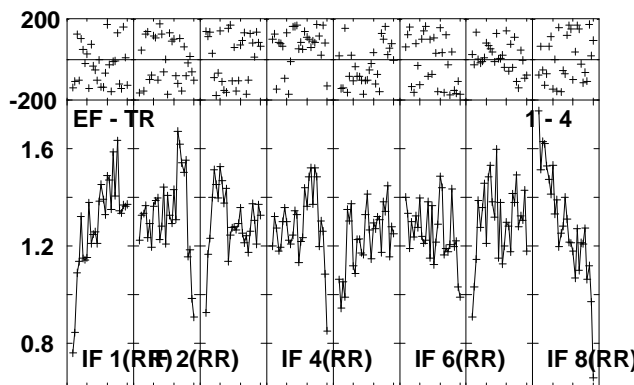
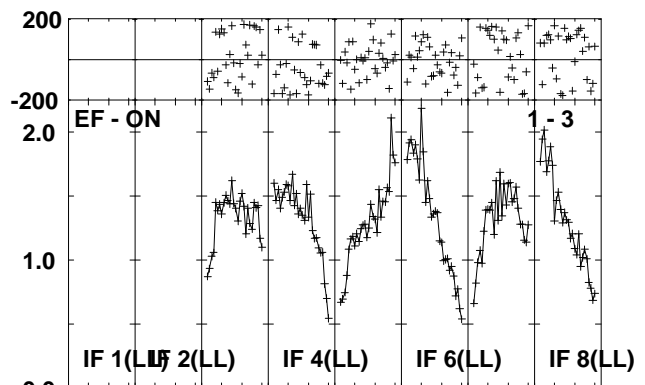
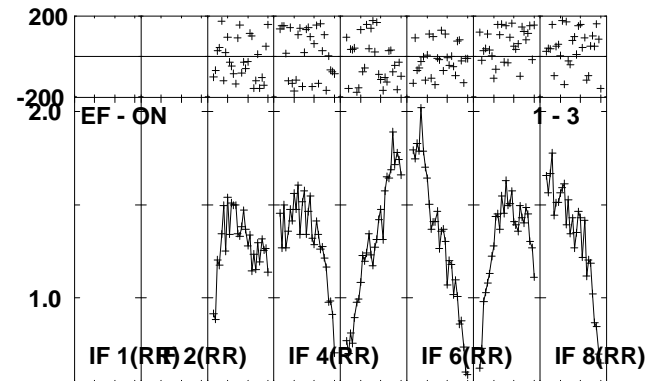
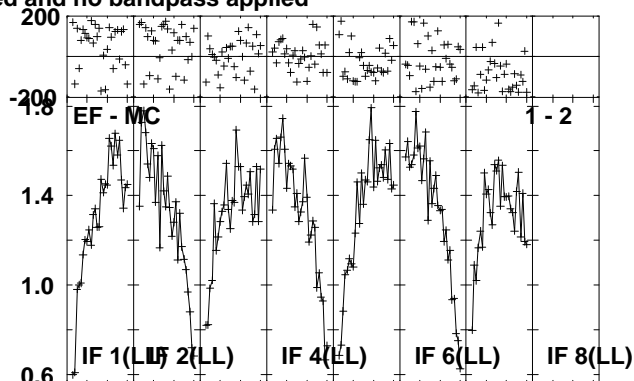
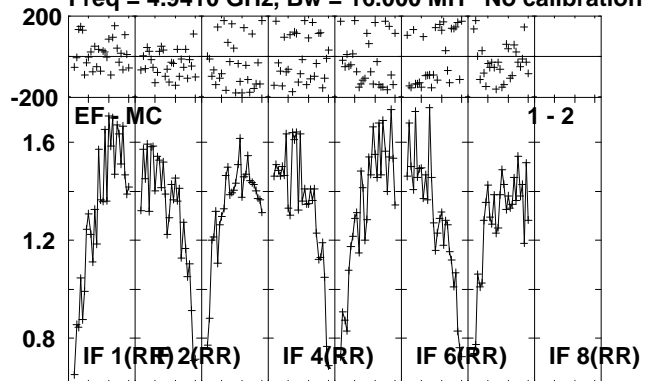

Lower frame: Milli Ampl Jy Top frame: Phas deg
Scalar averaged cross-power spectrum Several baselines displayed
Timerange: 00:14:57:01 to 00:14:59:29

Plot file version 72 created 04-OCT-2010 10:14:59

MAXI J16 RP016A.UVDATA.1

Freq = 4.9410 GHz, Bw = 16.000 MH No calibration applied and no bandpass applied

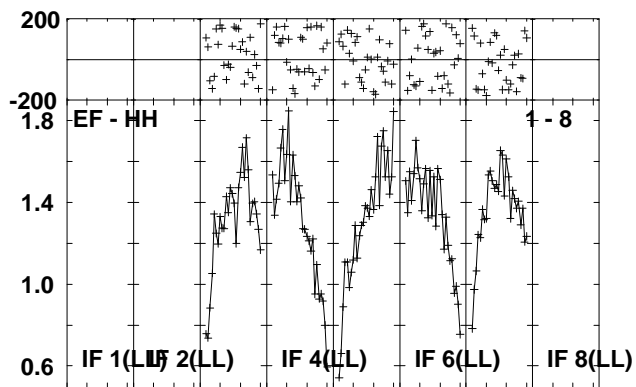
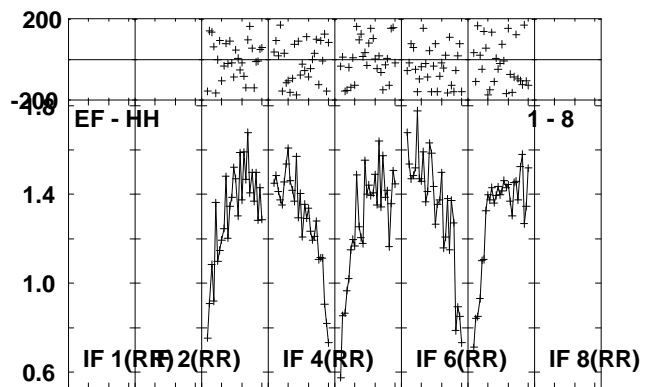
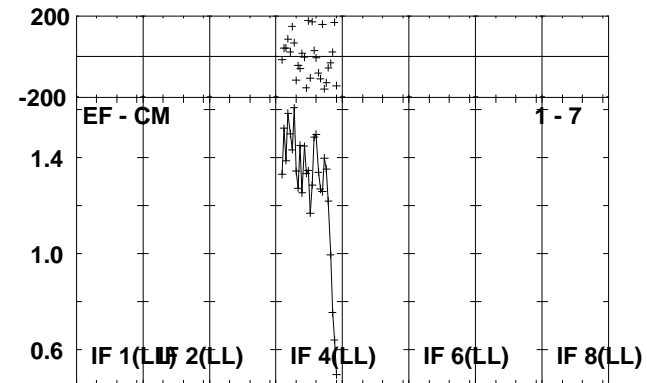
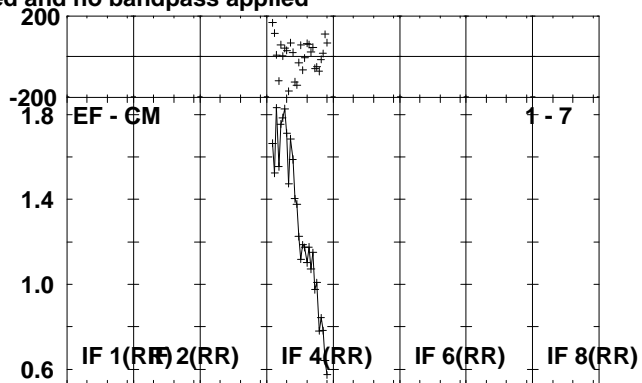
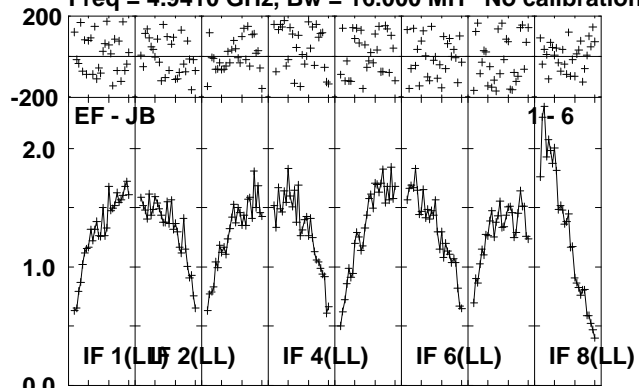

Lower frame: Milli Ampl Jy Top frame: Phas deg
Scalar averaged cross-power spectrum Several baselines displayed
Timerange: 00/14:57:01 to 00/14:59:29

Plot file version 73 created 04-OCT-2010 10:15:00

J1707-14 RP016A.UVDATA.1

Freq = 4.9410 GHz, Bw = 16.000 MH No calibration applied and no bandpass applied

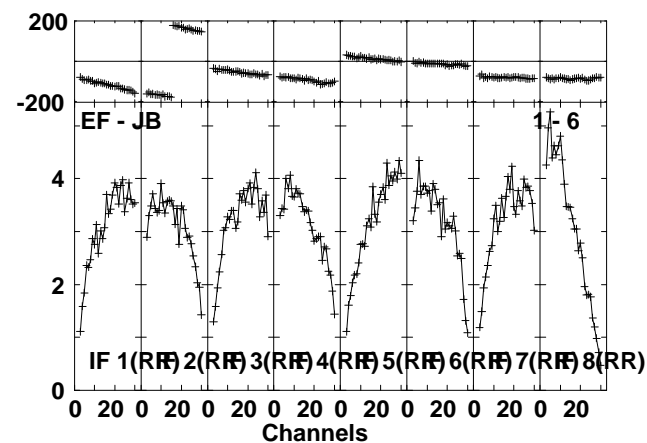
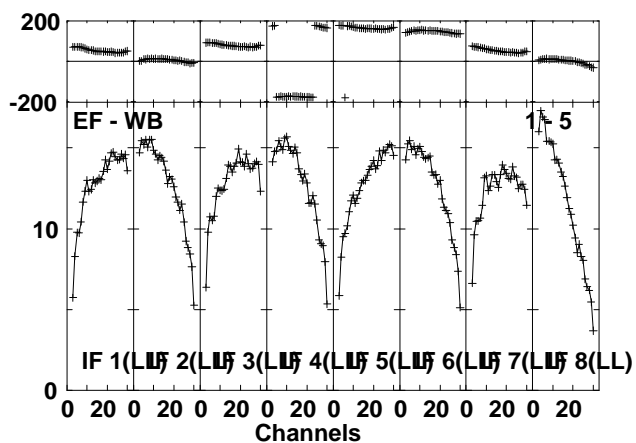
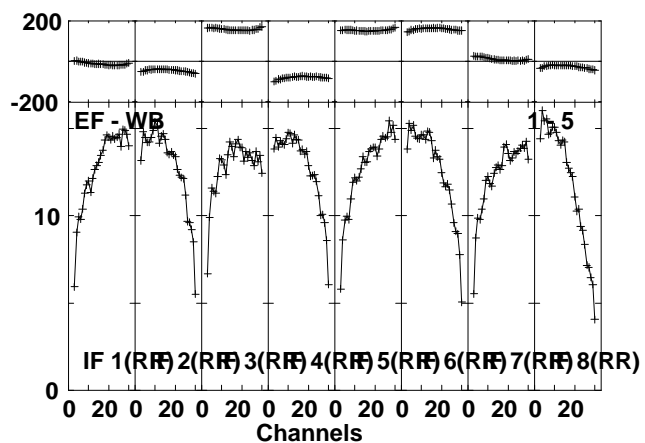
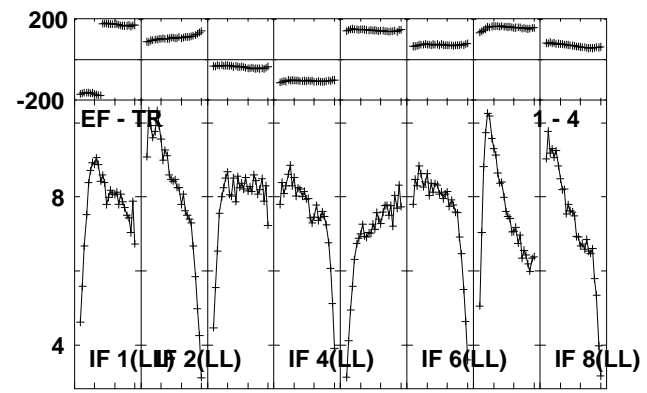
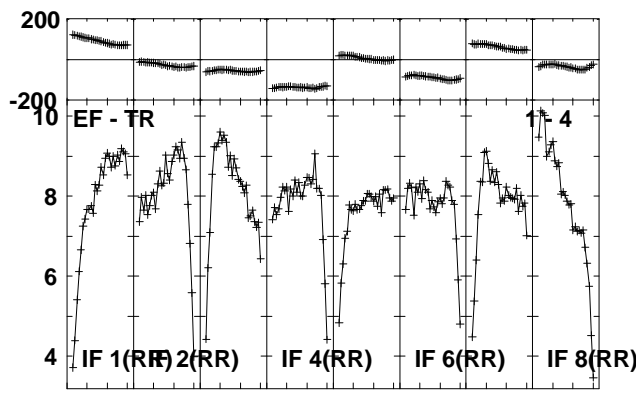
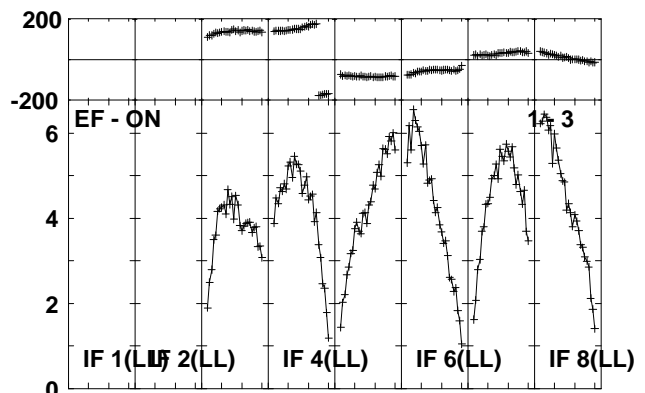
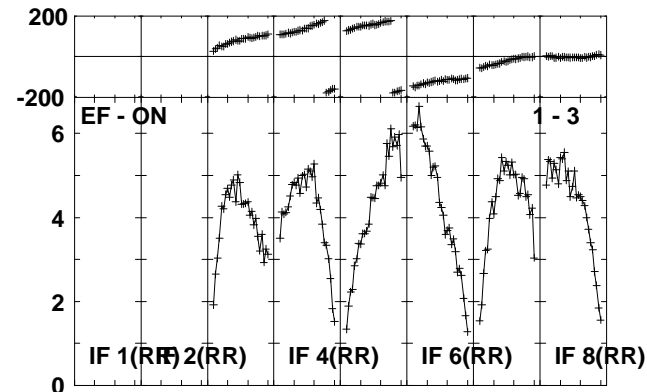
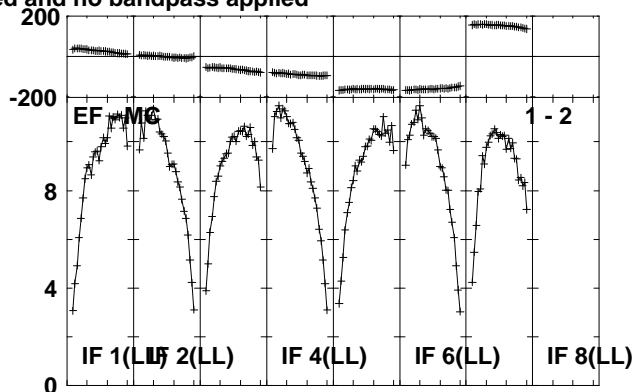
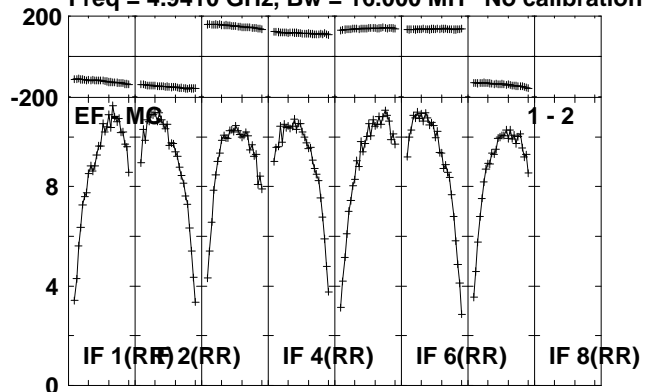

Lower frame: Milli Ampl Jy Top frame: Phas deg
Scalar averaged cross-power spectrum Several baselines displayed
Timerange: 00/15:00:11 to 00/15:01:09

Plot file version 74 created 04-OCT-2010 10:15:01
 J1707-14 RP016A.UVDATA.1

Freq = 4.9410 GHz, Bw = 16.000 MH No calibration applied and no bandpass applied

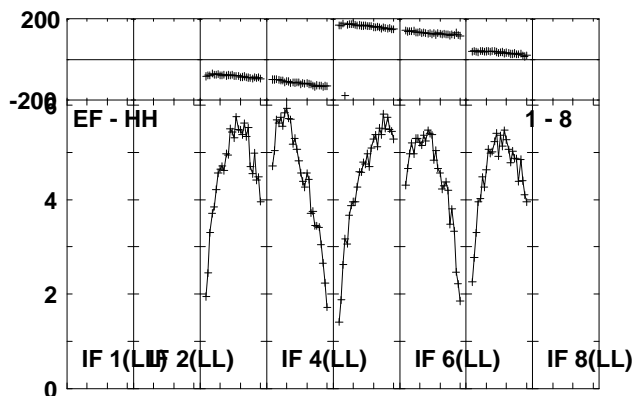
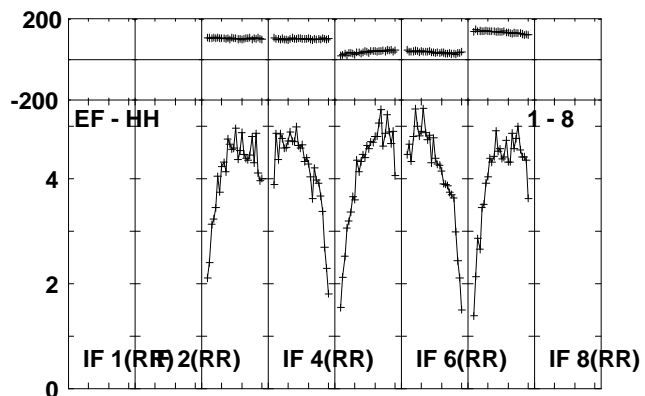
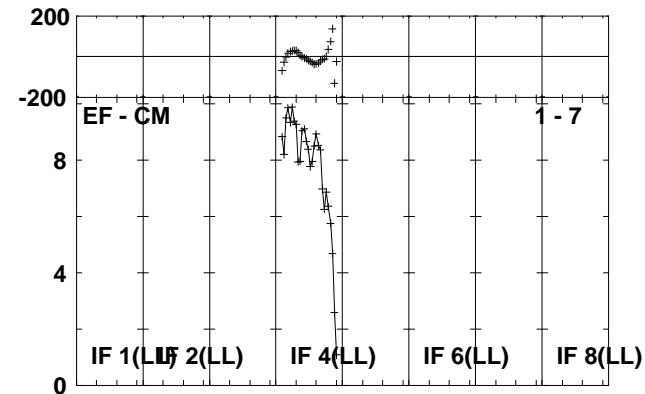
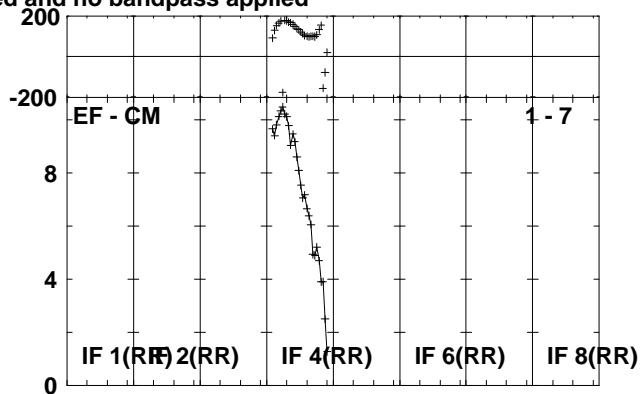
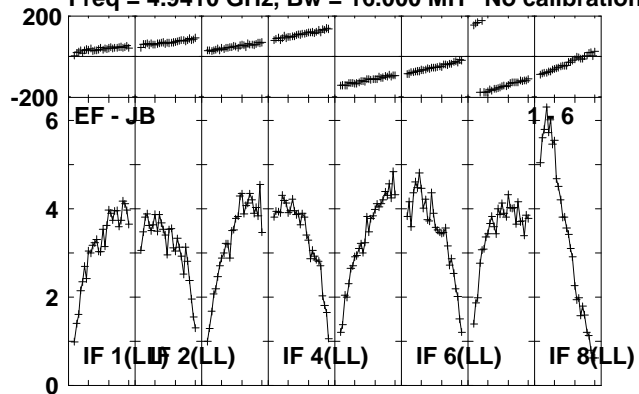

Lower frame: Milli Ampl Jy Top frame: Phas deg
 Scalar averaged cross-power spectrum Several baselines displayed
 Timerange: 00/15:00:11 to 00/15:01:09

Plot file version 75 created 04-OCT-2010 10:15:02

NVSS3 RP016A.UVDATA.1

Freq = 4.9410 GHz, Bw = 16.000 MH No calibration applied and no bandpass applied

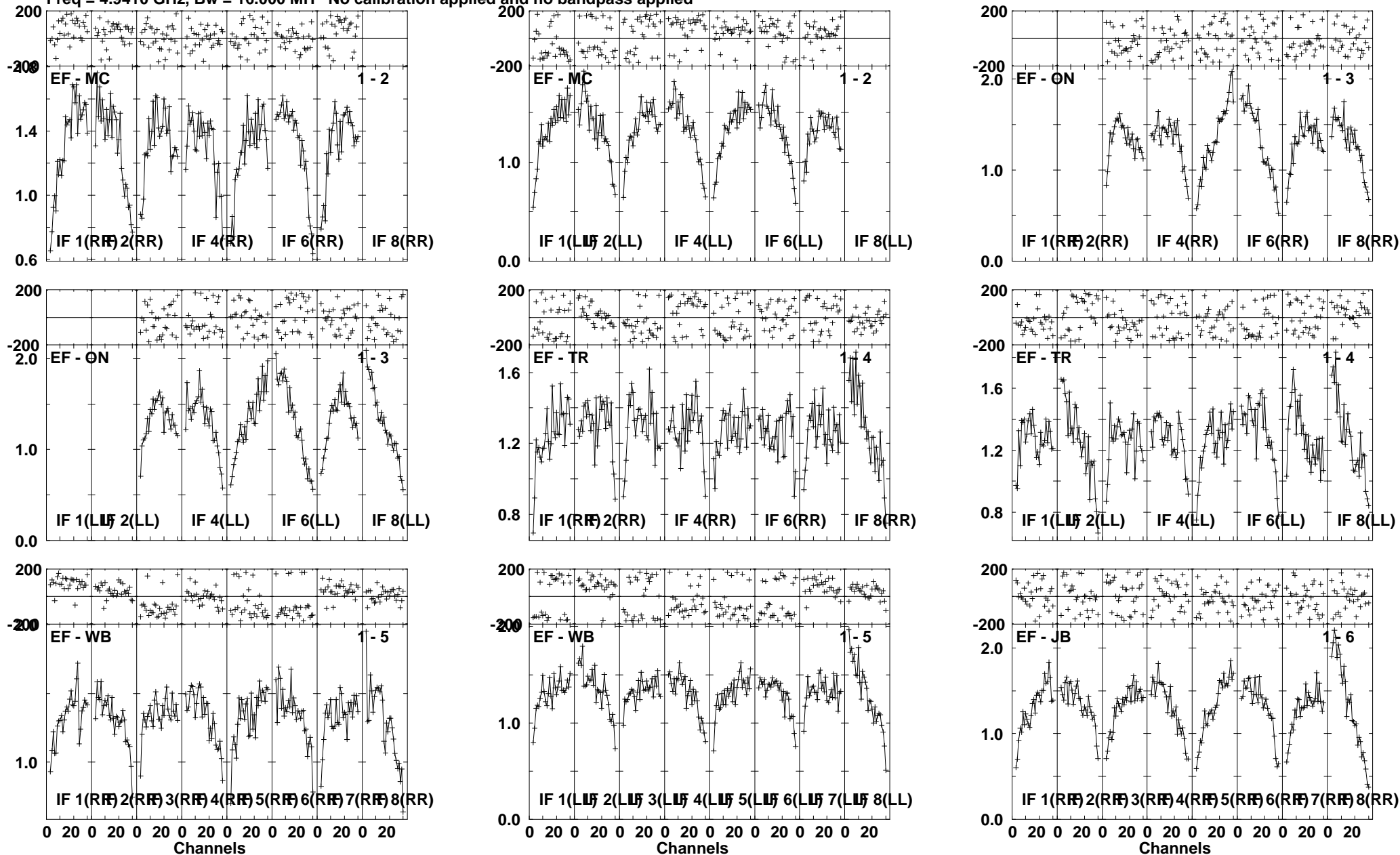

Lower frame: Milli Ampl Jy Top frame: Phas deg
Scalar averaged cross-power spectrum Several baselines displayed
Timerange: 00/15:01:11 to 00/15:03:39

Plot file version 76 created 04-OCT-2010 10:15:03

NVSS3 RP016A.UVDATA.1

Freq = 4.9410 GHz, Bw = 16.000 MH No calibration applied and no bandpass applied

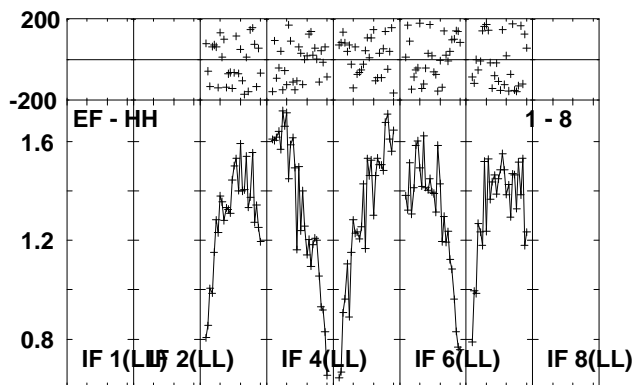
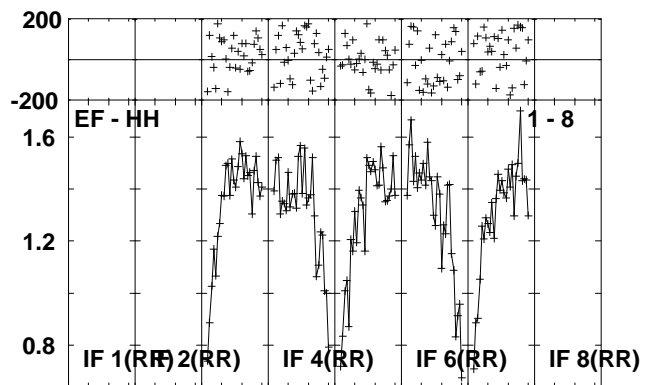
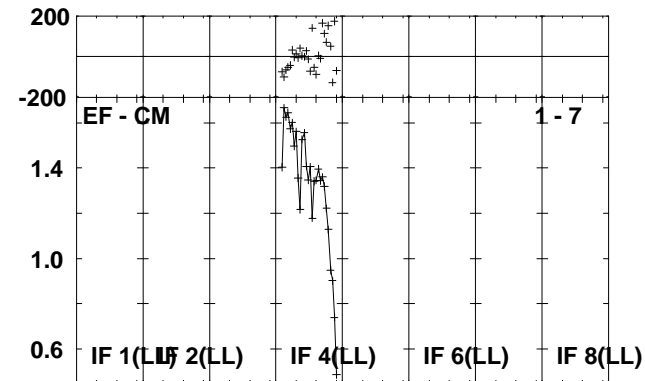
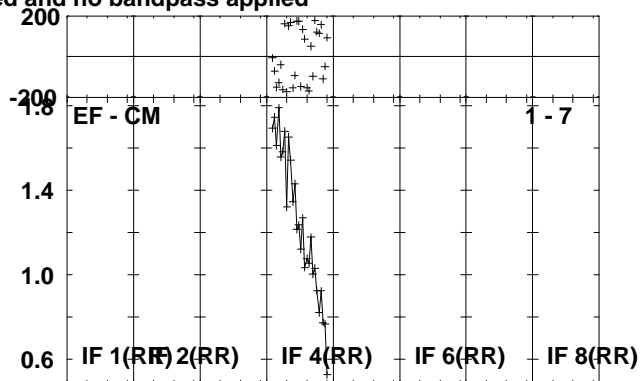
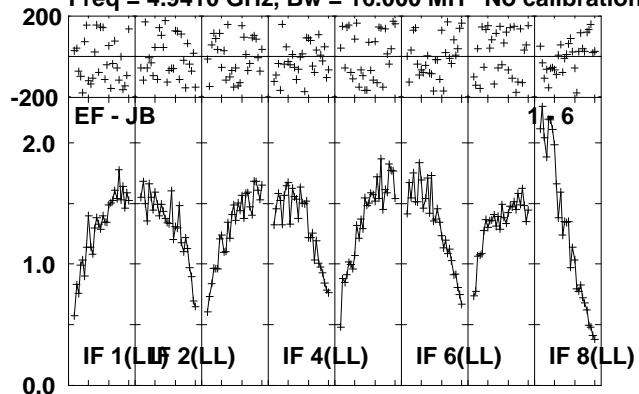

Lower frame: Milli Ampl Jy Top frame: Phas deg
Scalar averaged cross-power spectrum Several baselines displayed
Timerange: 00/15:01:11 to 00/15:03:39

Plot file version 77 created 04-OCT-2010 10:15:04

J1707-14 RP016A.UVDATA.1

Freq = 4.9410 GHz, Bw = 16.000 MH No calibration applied and no bandpass applied

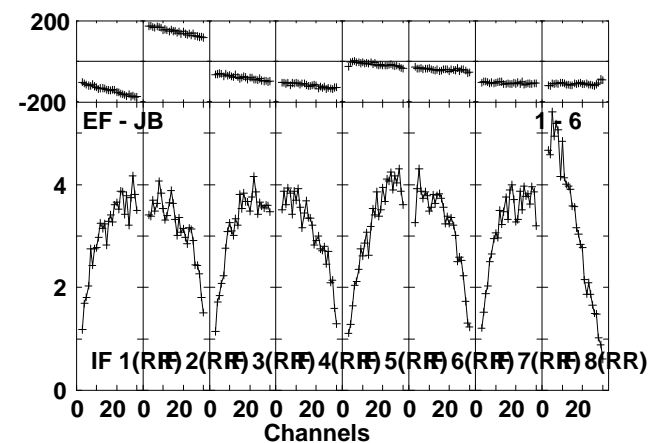
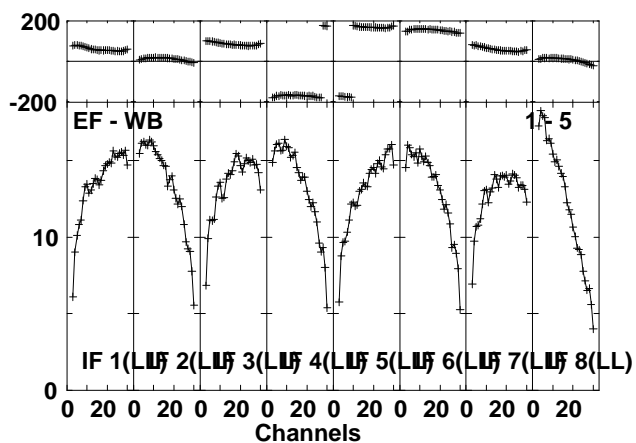
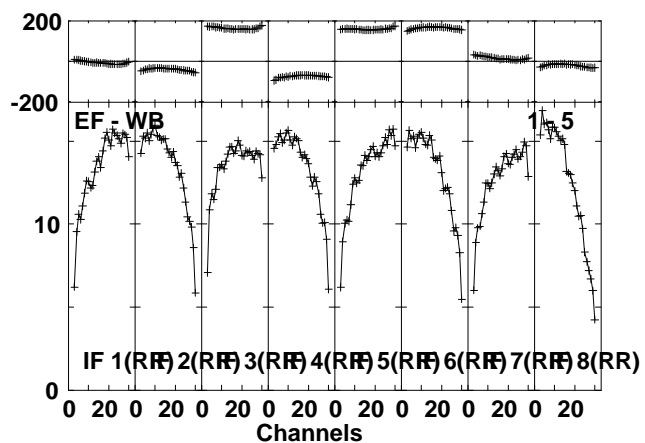
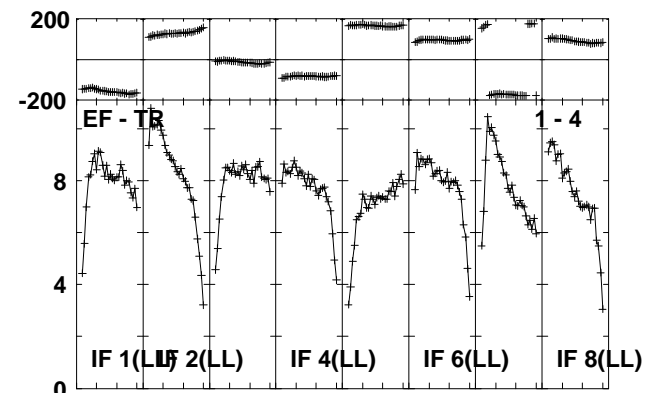
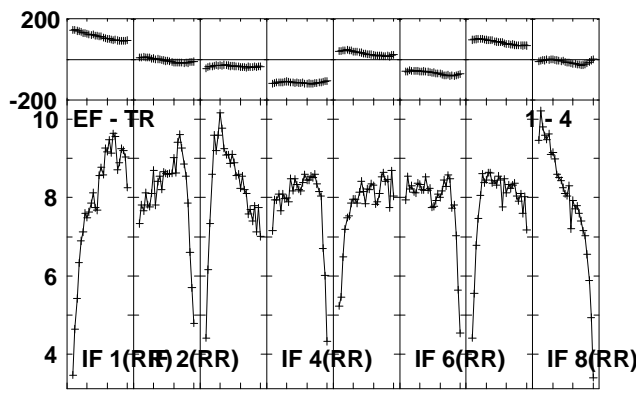
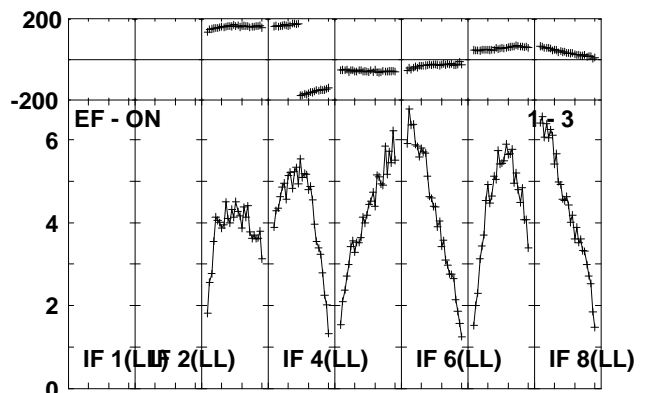
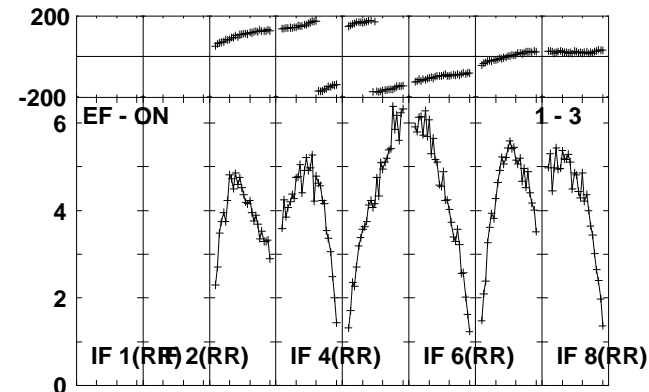
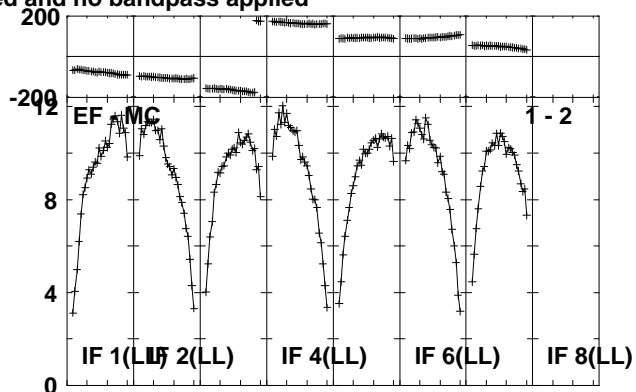
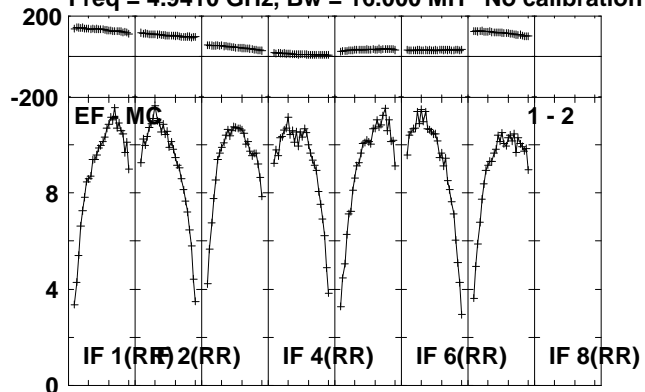

Lower frame: Milli Ampl Jy Top frame: Phas deg
Scalar averaged cross-power spectrum Several baselines displayed
Timerange: 00/15:03:41 to 00/15:05:09

Plot file version 78 created 04-OCT-2010 10:15:05

J1707-14 RP016A.UVDATA.1

Freq = 4.9410 GHz, Bw = 16.000 MH No calibration applied and no bandpass applied

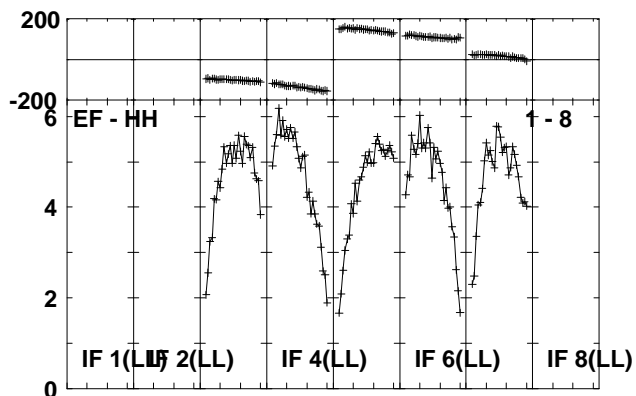
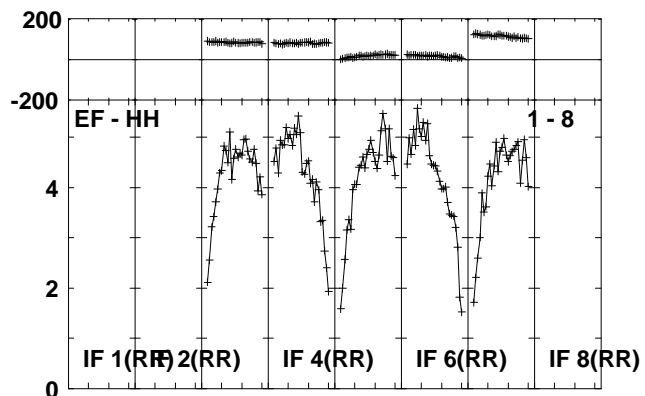
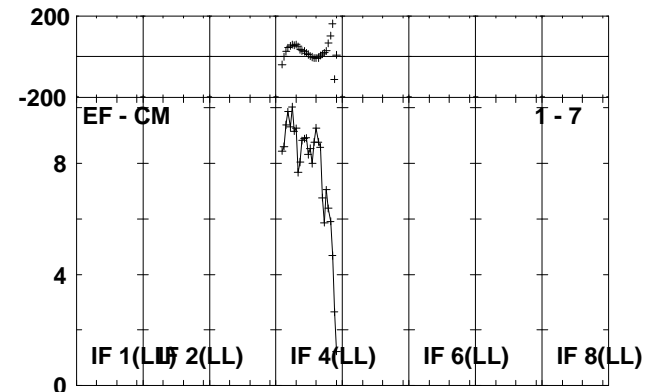
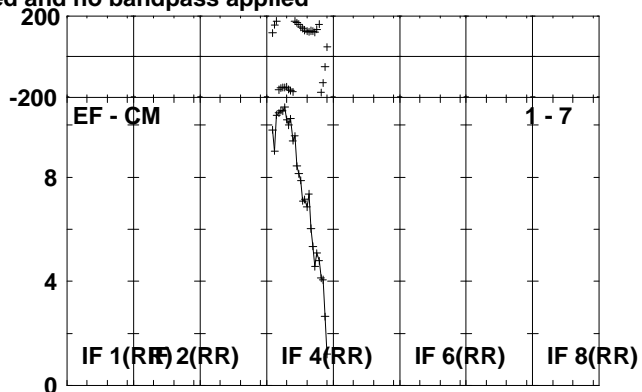
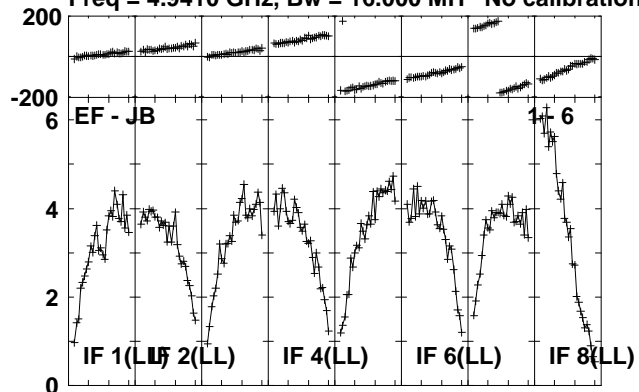

Lower frame: Milli Ampl Jy Top frame: Phas deg
Scalar averaged cross-power spectrum Several baselines displayed
Timerange: 00/15:03:41 to 00/15:05:09

Plot file version 79 created 04-OCT-2010 10:15:06

MAXI J16 RP016A.UVDATA.1

Freq = 4.9410 GHz, Bw = 16.000 MH No calibration applied and no bandpass applied

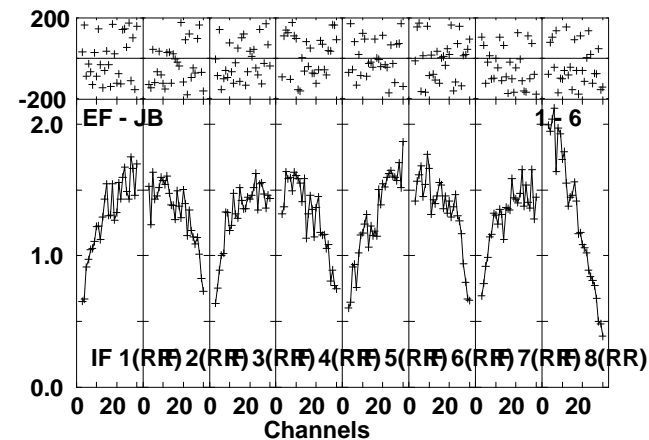
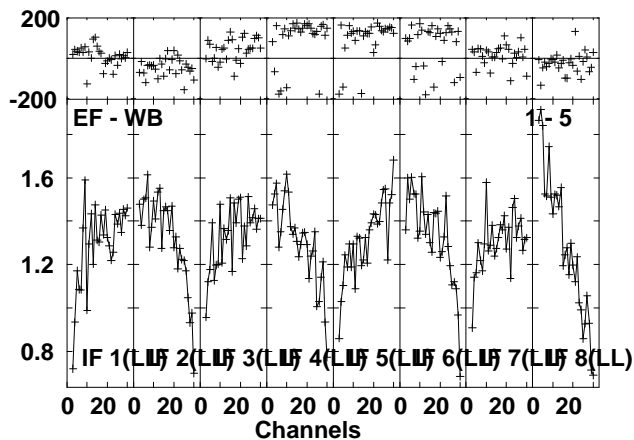
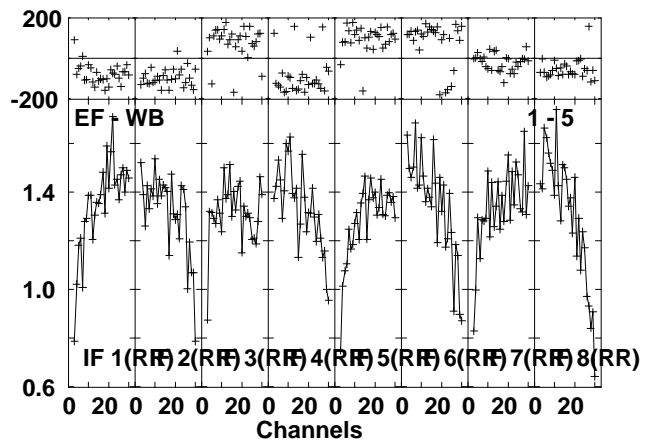
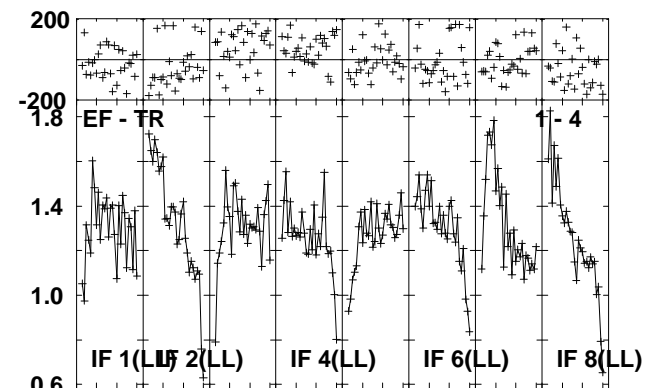
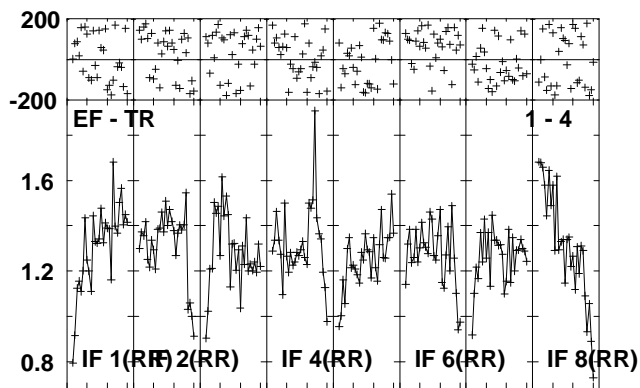
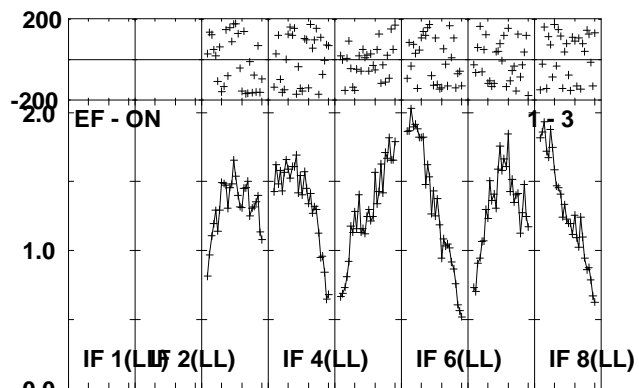
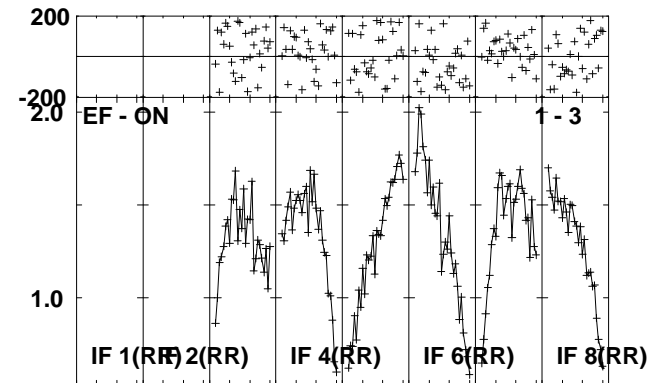
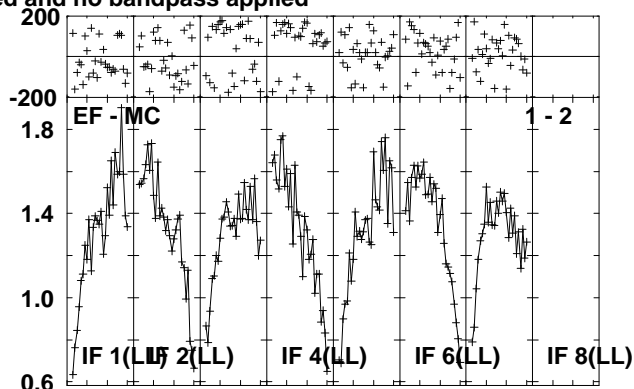
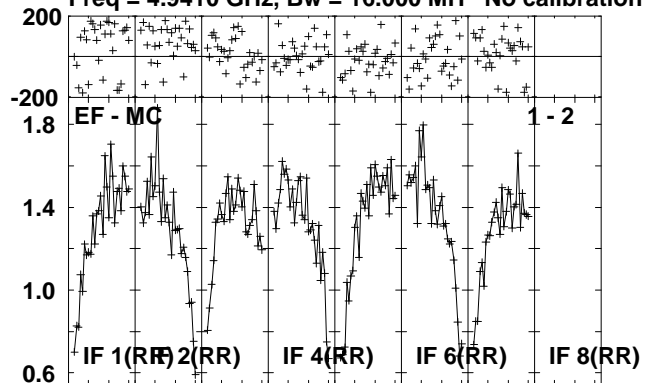

Lower frame: Milli Ampl Jy Top frame: Phas deg
Scalar averaged cross-power spectrum Several baselines displayed
Timerange: 00/15:05:11 to 00/15:07:39

Plot file version 80 created 04-OCT-2010 10:15:08

MAXI J16 RP016A.UVDATA.1

Freq = 4.9410 GHz, Bw = 16.000 MH No calibration applied and no bandpass applied

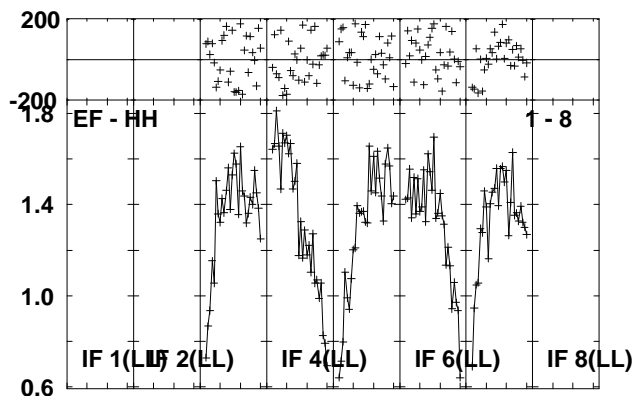
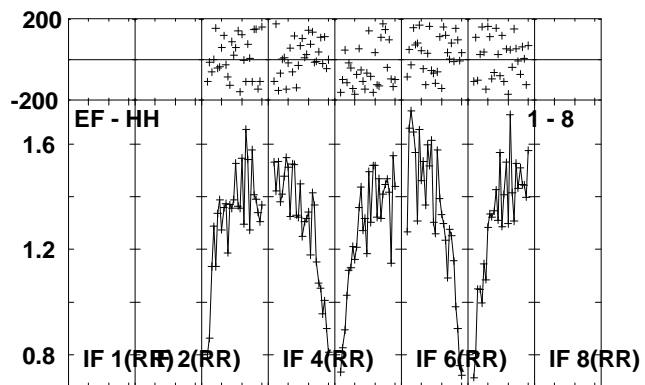
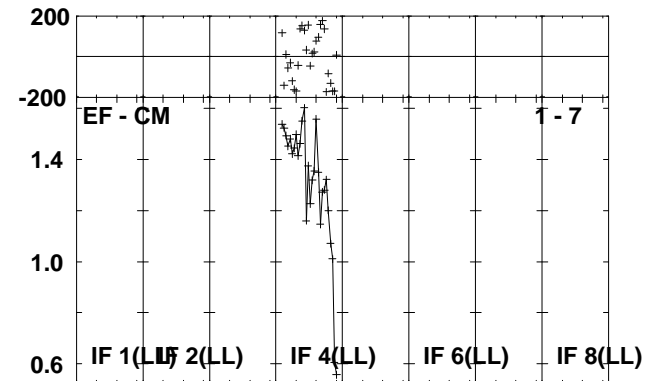
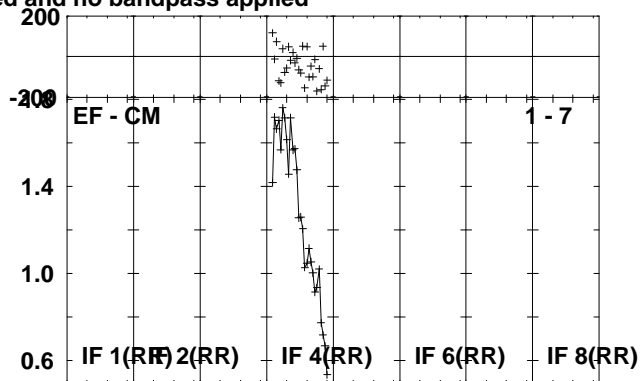
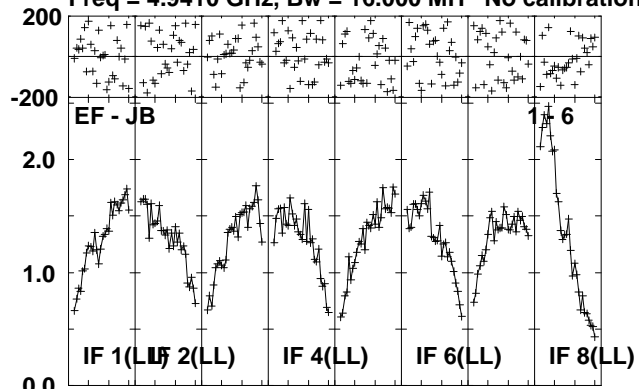

Lower frame: Milli Ampl Jy Top frame: Phas deg
Scalar averaged cross-power spectrum Several baselines displayed
Timerange: 00/15:05:11 to 00/15:07:39

Plot file version 81 created 04-OCT-2010 10:15:09

J1707-14 RP016A.UVDATA.1

Freq = 4.9410 GHz, Bw = 16.000 MH No calibration applied and no bandpass applied

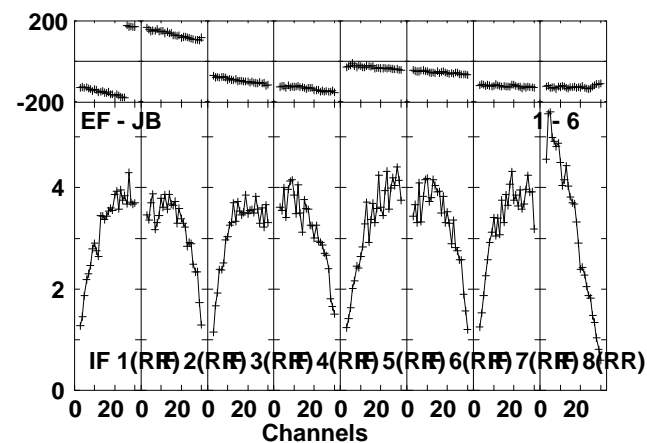
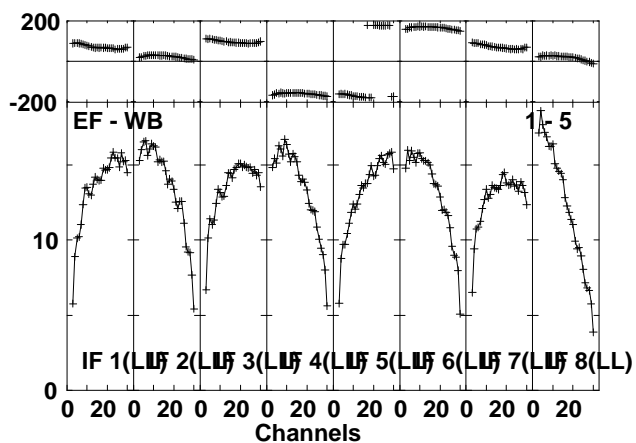
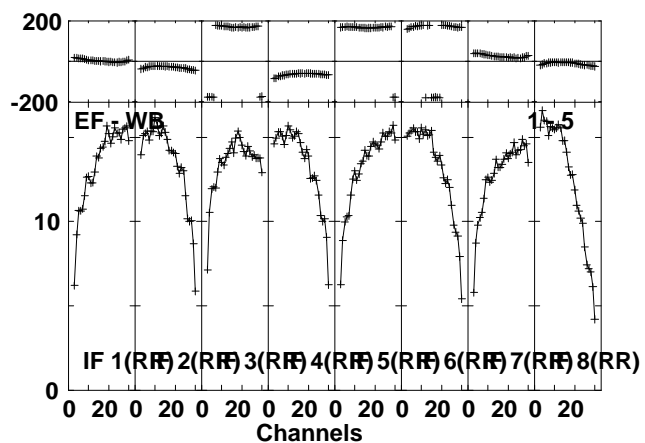
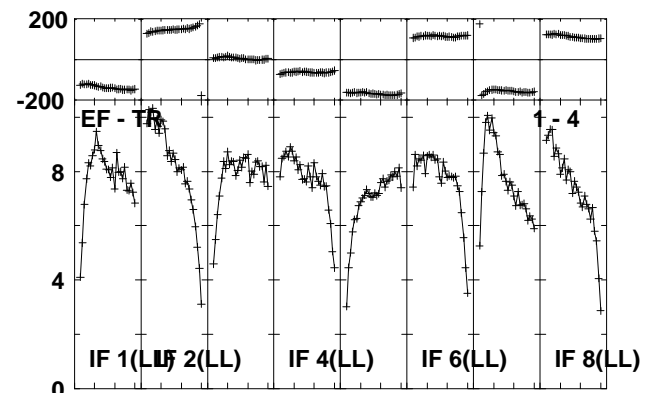
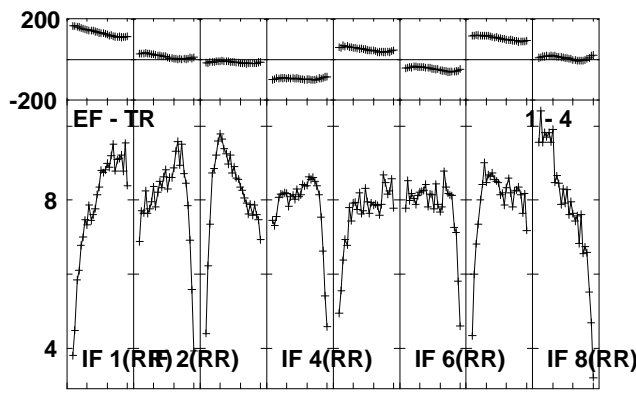
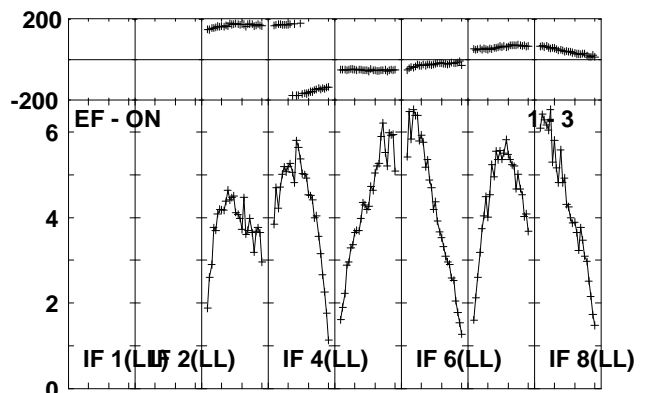
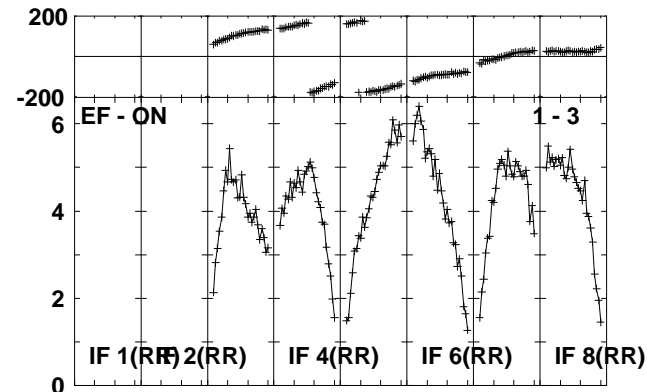
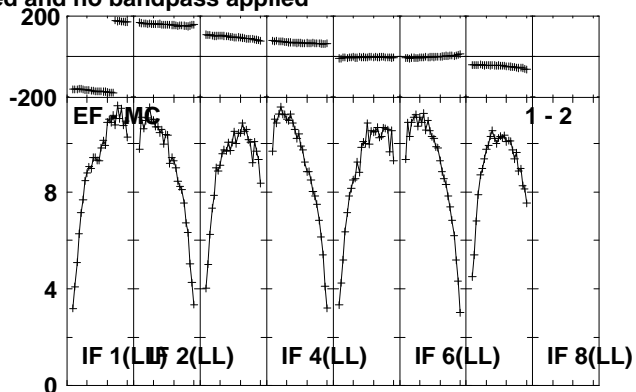
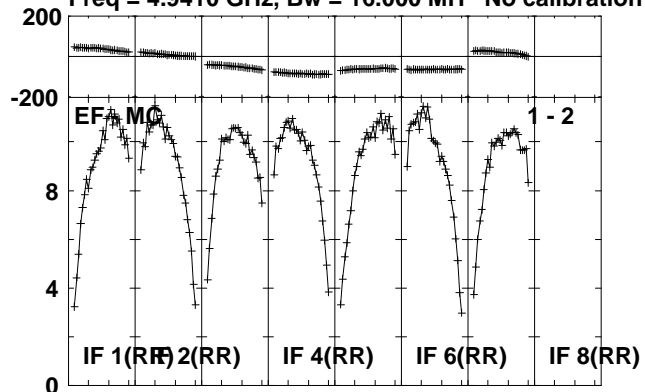

Lower frame: Milli Ampl Jy Top frame: Phas deg
Scalar averaged cross-power spectrum Several baselines displayed
Timerange: 00/15:08:21 to 00/15:09:19

Plot file version 82 created 04-OCT-2010 10:15:10

J1707-14 RP016A.UVDATA.1

Freq = 4.9410 GHz, Bw = 16.000 MH No calibration applied and no bandpass applied

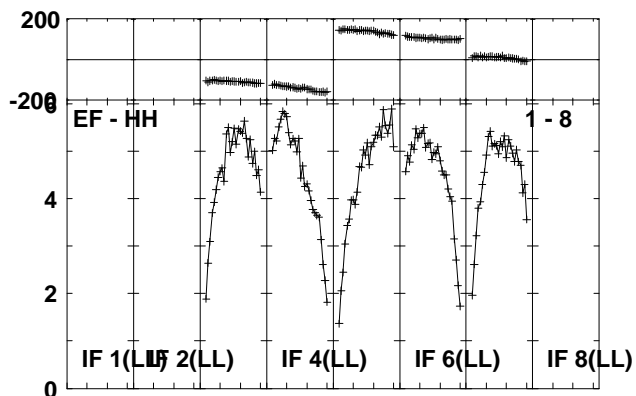
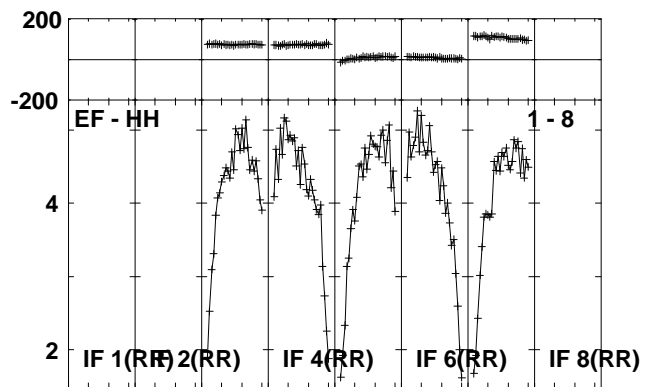
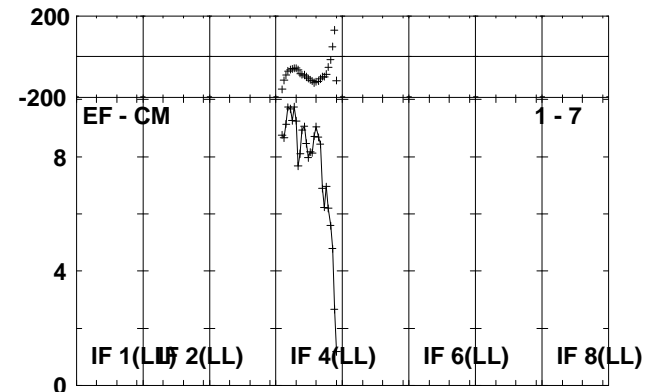
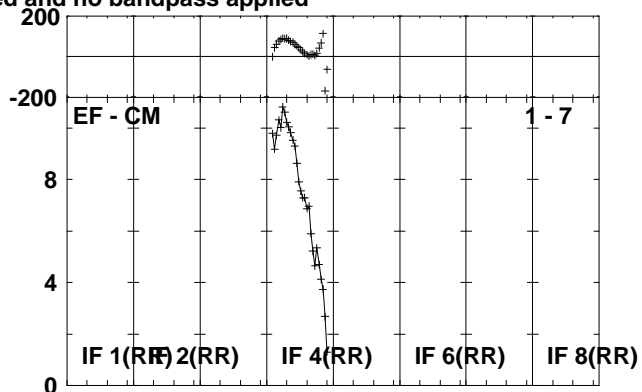
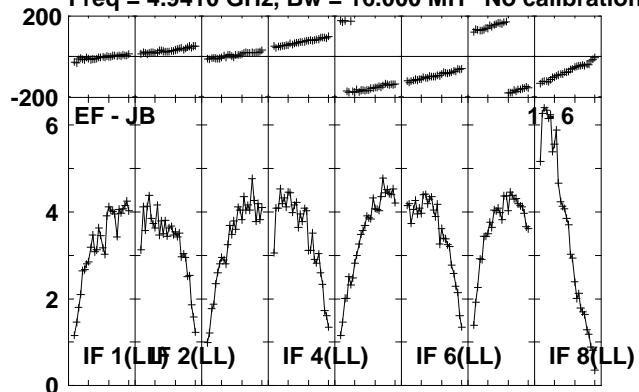

Lower frame: Milli Ampl Jy Top frame: Phas deg
Scalar averaged cross-power spectrum Several baselines displayed
Timerange: 00/15:08:21 to 00/15:09:19

Plot file version 83 created 04-OCT-2010 10:15:13

OQ208 RP016A.UVDATA.1

Freq = 4.9410 GHz, Bw = 16.000 MH No calibration applied and no bandpass applied

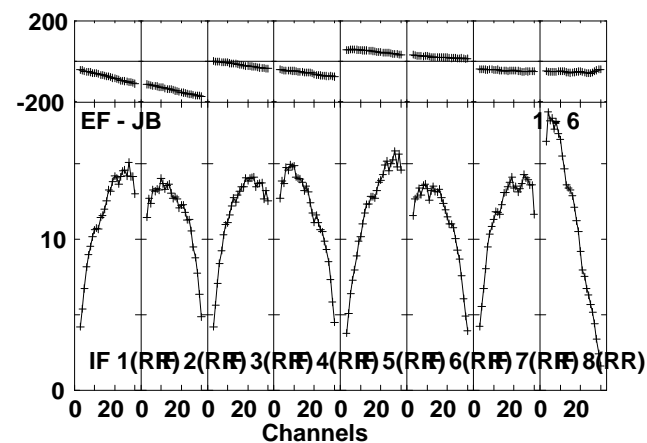
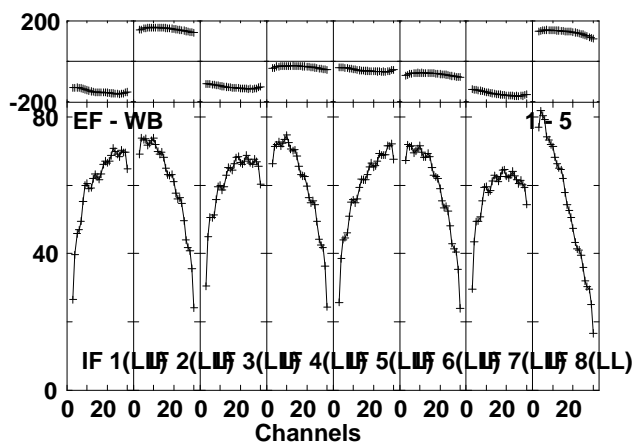
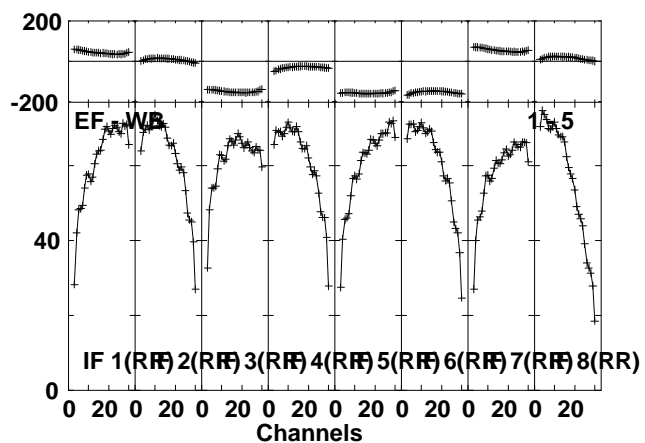
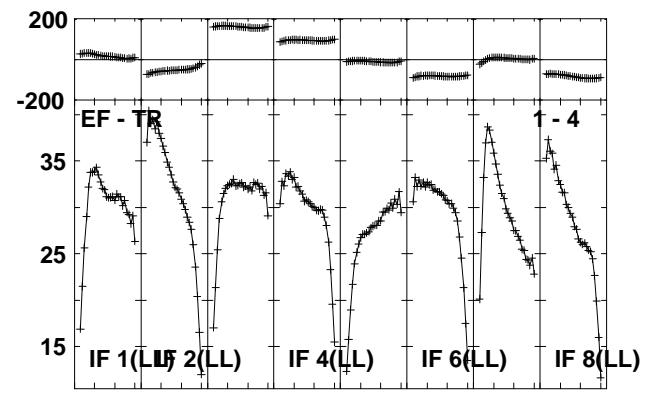
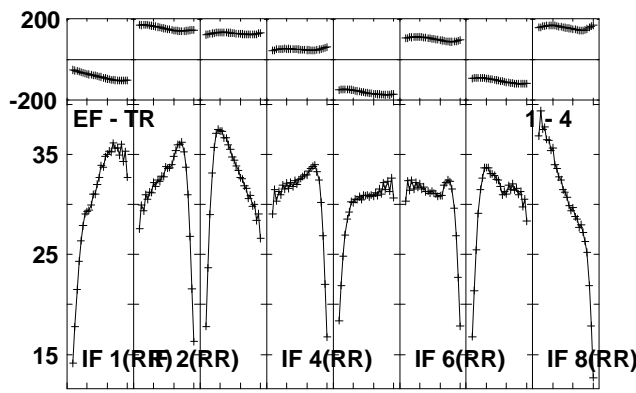
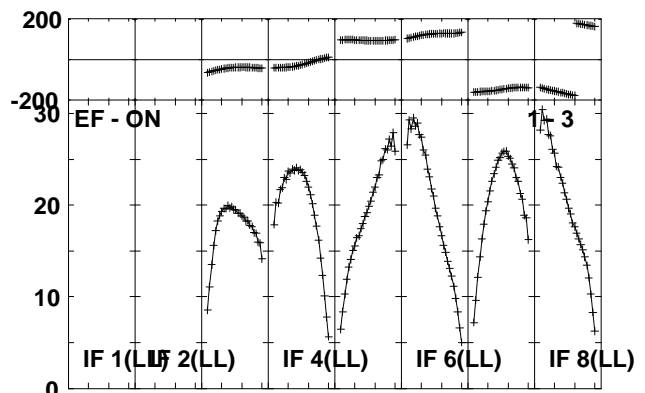
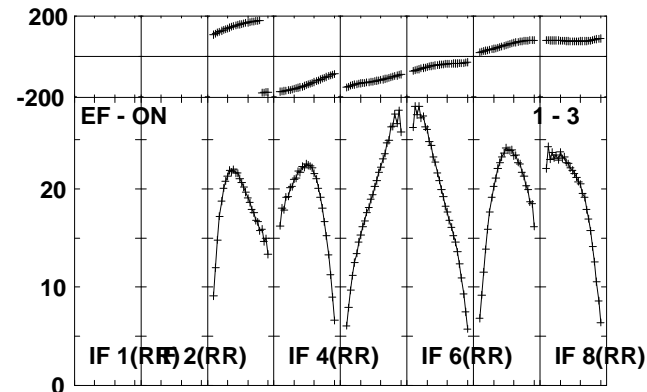
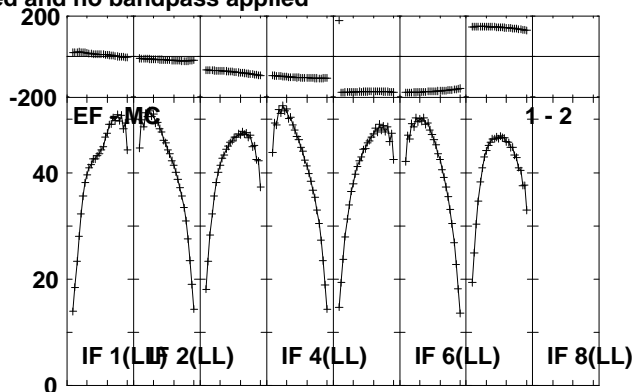
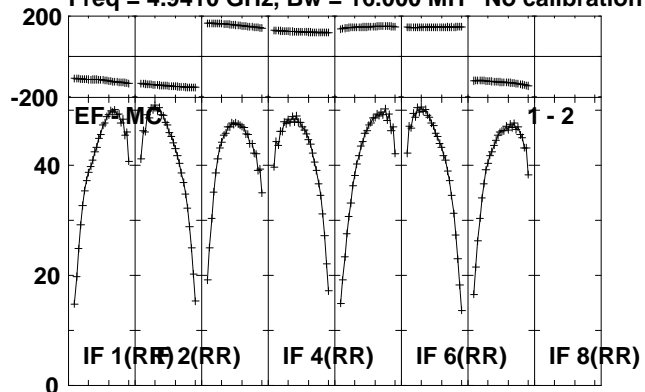

Lower frame: Milli Ampl Jy Top frame: Phas deg
Scalar averaged cross-power spectrum Several baselines displayed
Timerange: 00/15:11:21 to 00/15:24:19

Plot file version 84 created 04-OCT-2010 10:15:21

OQ208 RP016A.UVDATA.1

Freq = 4.9410 GHz, Bw = 16.000 MH No calibration applied and no bandpass applied

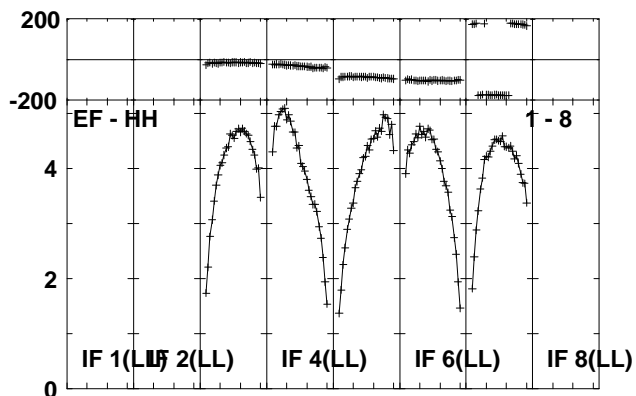
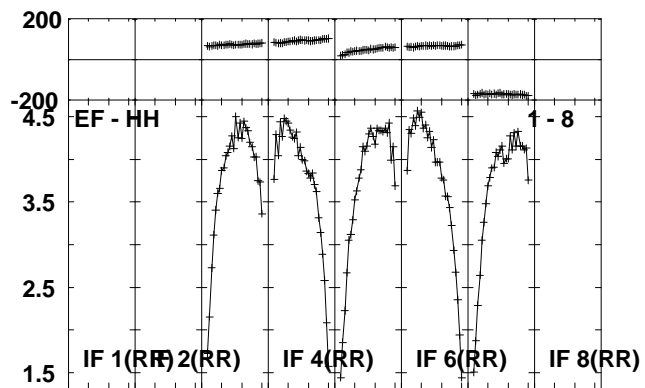
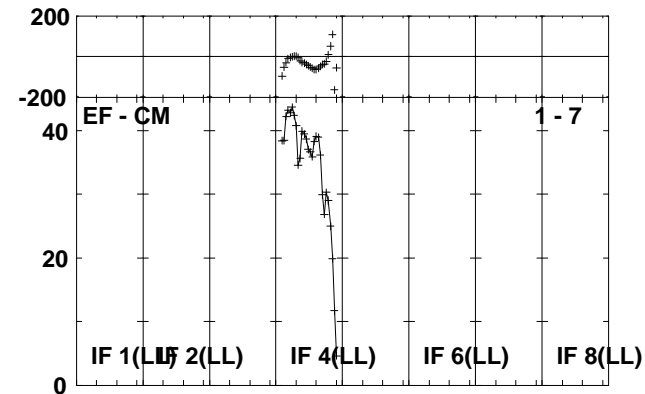
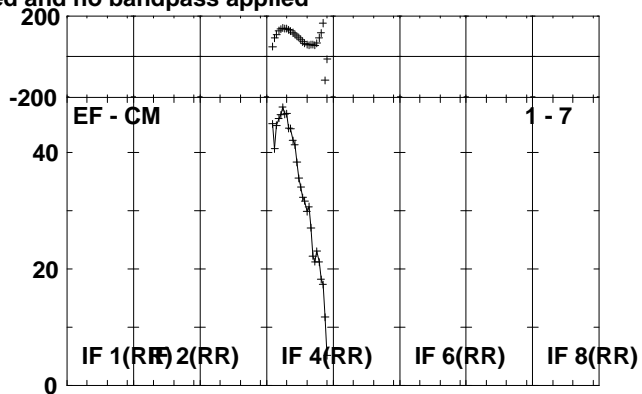
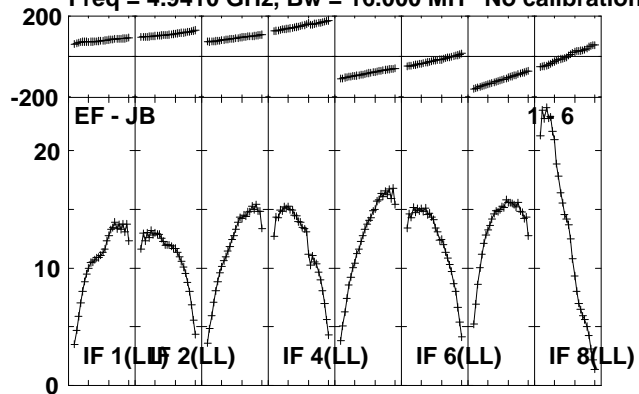

Lower frame: Milli Ampl Jy Top frame: Phas deg
Scalar averaged cross-power spectrum Several baselines displayed
Timerange: 00/15:11:21 to 00/15:24:19

Plot file version 85 created 04-OCT-2010 10:15:26

J1751+09 RP016A.UVDATA.1

Freq = 4.9410 GHz, Bw = 16.000 MH No calibration applied and no bandpass applied

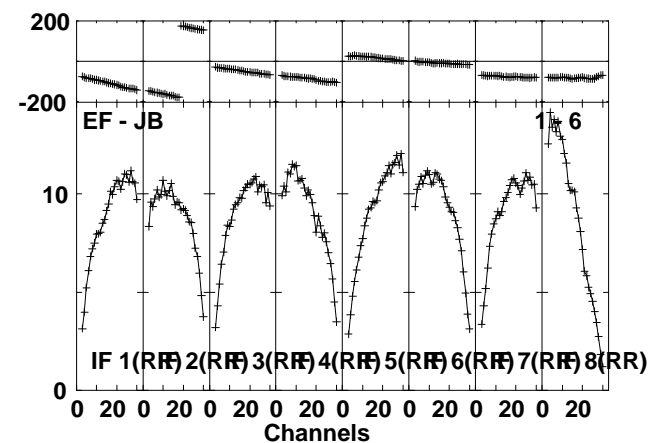
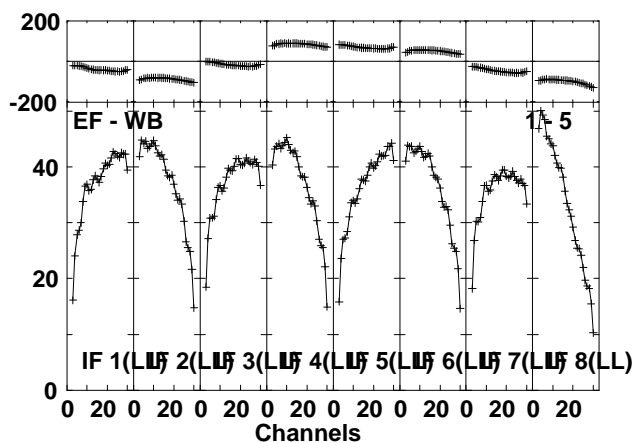
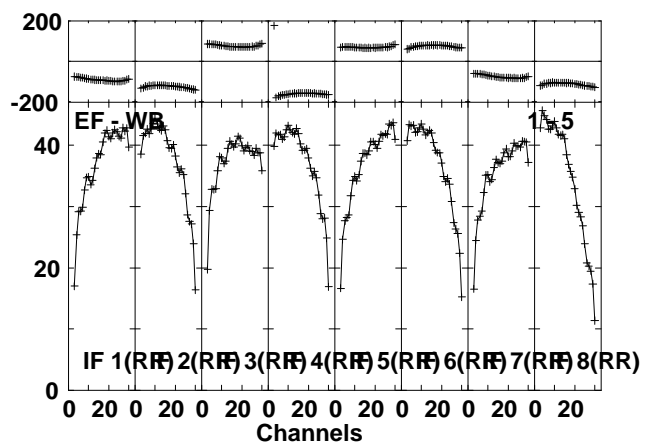
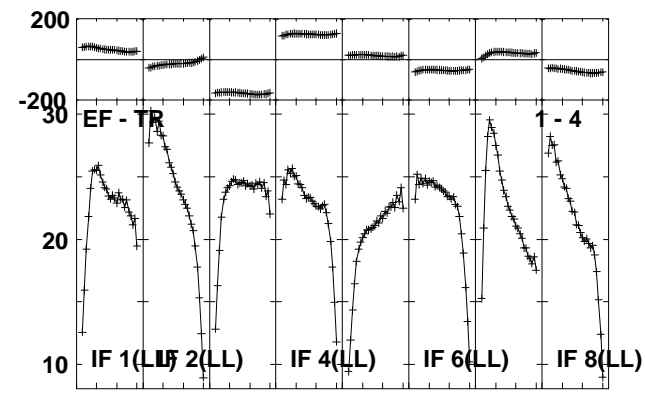
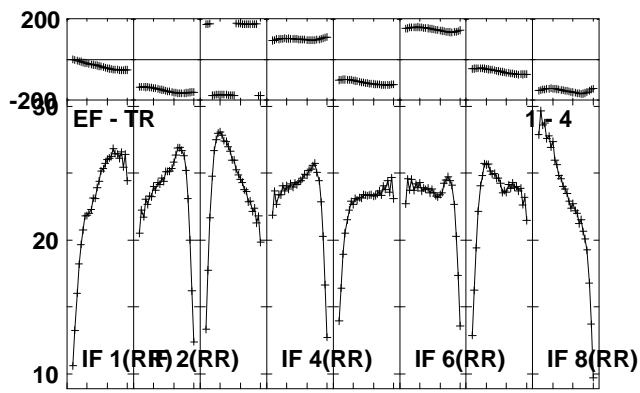
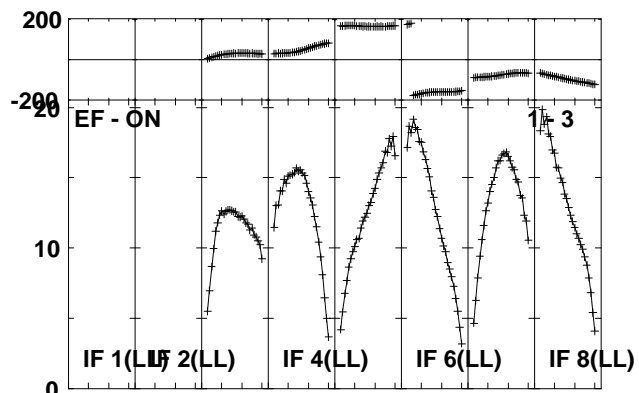
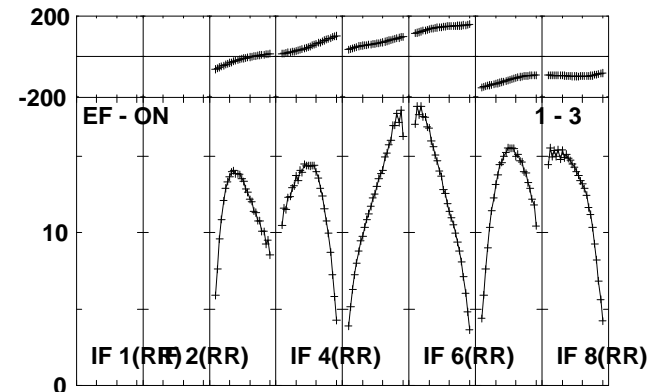
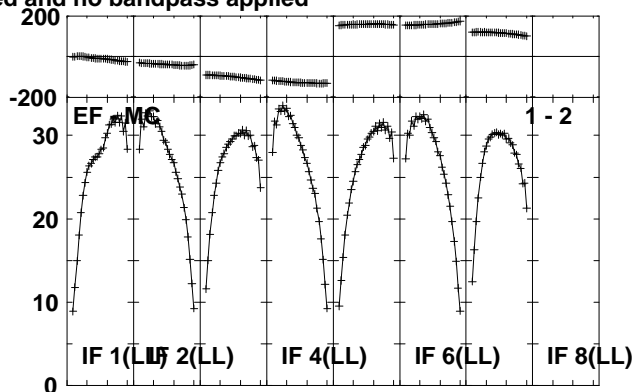
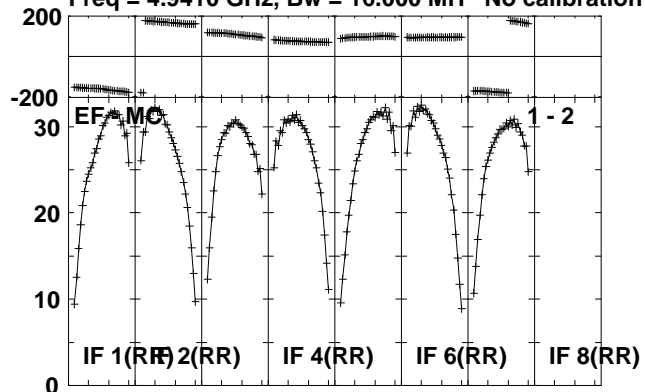

Lower frame: Milli Ampl Jy Top frame: Phas deg
Scalar averaged cross-power spectrum Several baselines displayed
Timerange: 00/15:26:21 to 00/15:32:19

Plot file version 86 created 04-OCT-2010 10:15:30

J1751+09 RP016A.UVDATA.1

Freq = 4.9410 GHz, Bw = 16.000 MH No calibration applied and no bandpass applied

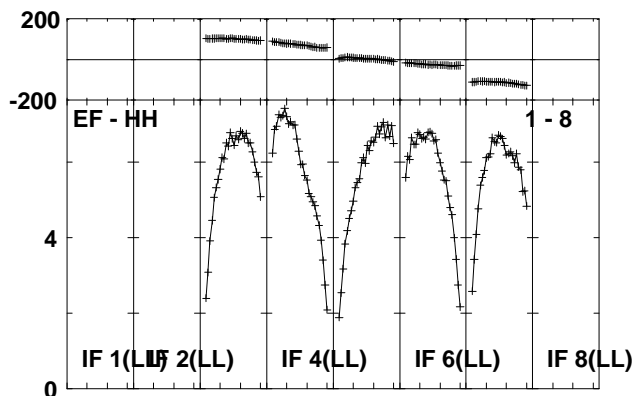
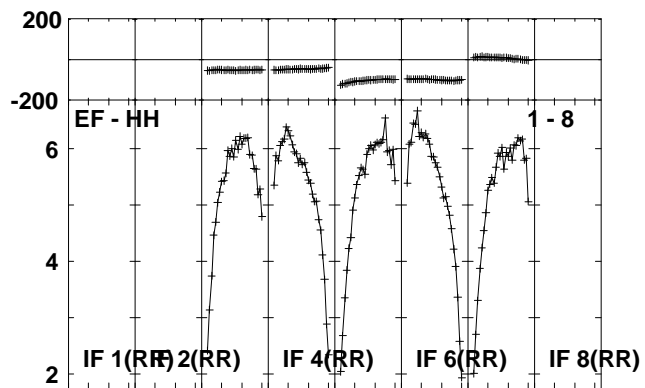
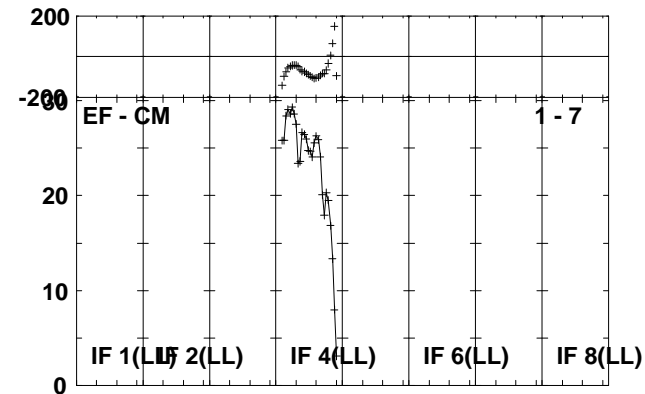
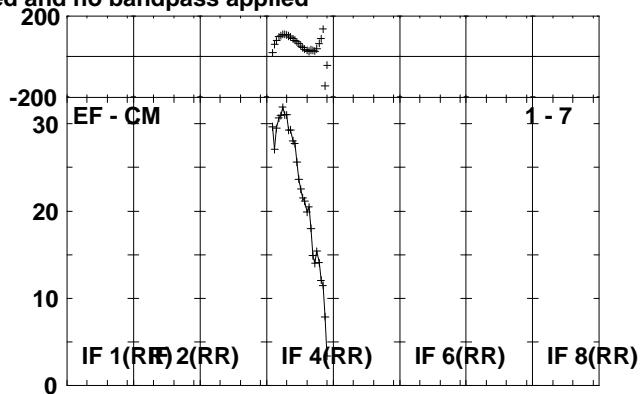
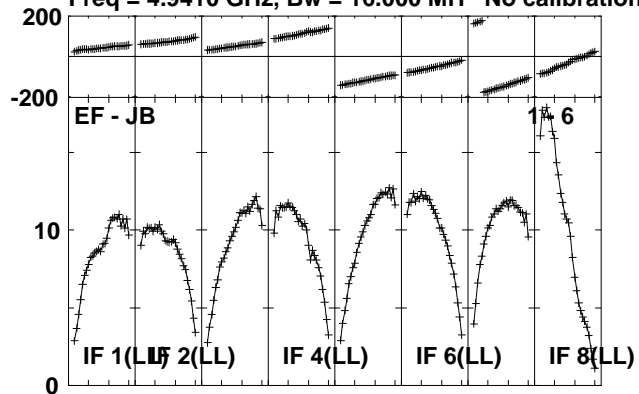

Lower frame: Milli Ampl Jy Top frame: Phas deg
Scalar averaged cross-power spectrum Several baselines displayed
Timerange: 00/15:26:21 to 00/15:32:19

Plot file version 87 created 04-OCT-2010 10:15:33

J1724-14 RP016A.UVDATA.1

Freq = 4.9410 GHz, Bw = 16.000 MH No calibration applied and no bandpass applied

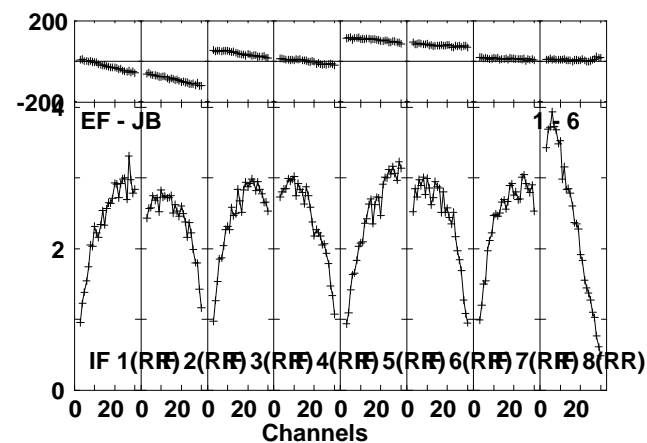
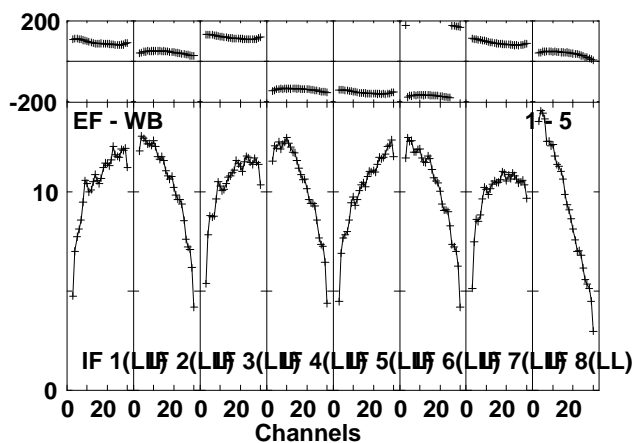
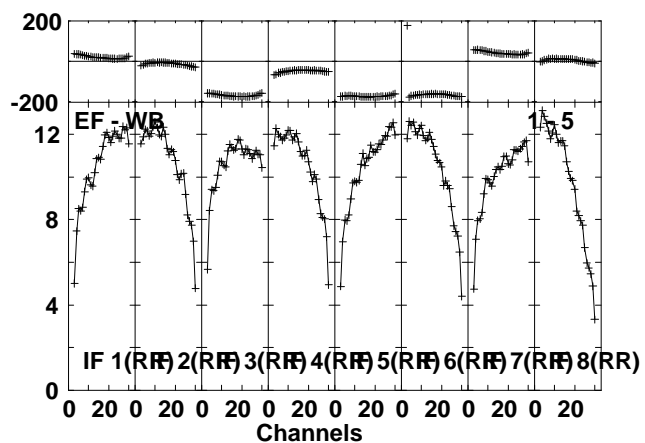
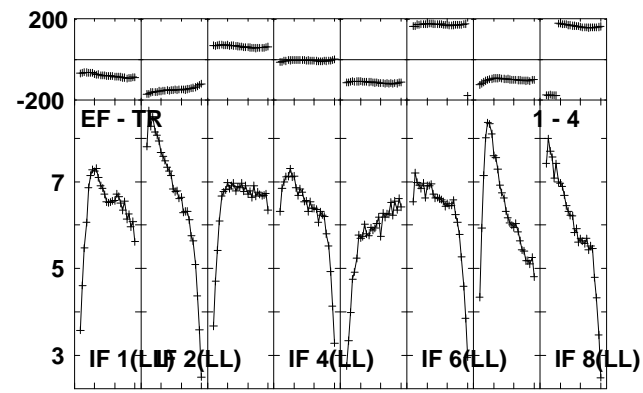
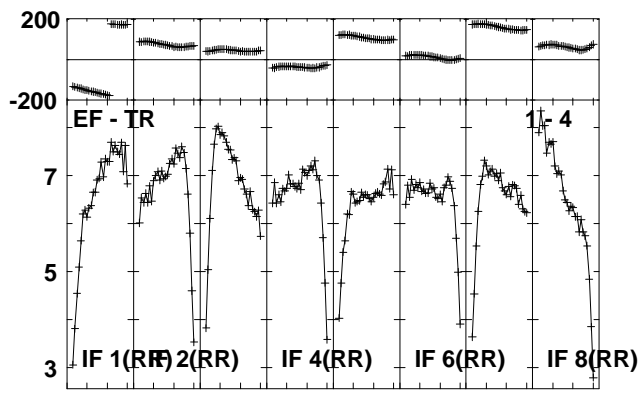
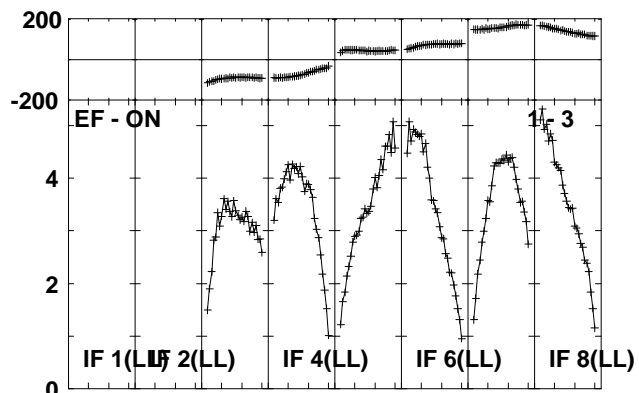
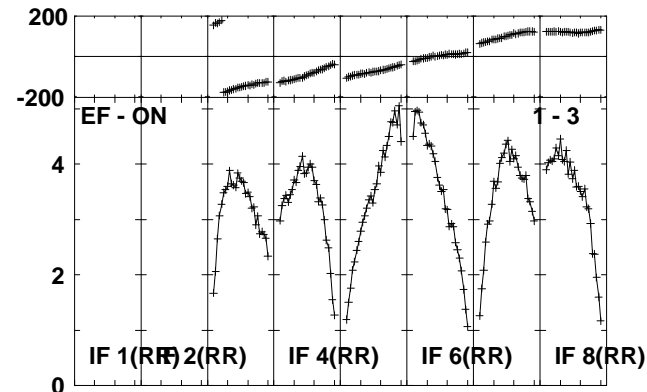
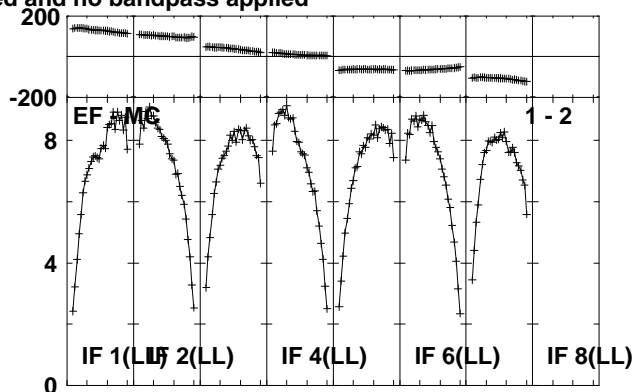
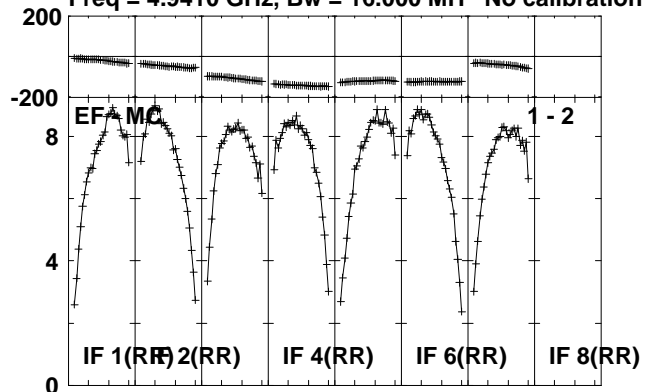

Lower frame: Milli Ampl Jy Top frame: Phas deg
Scalar averaged cross-power spectrum Several baselines displayed
Timerange: 00/15:34:21 to 00/15:38:19

Plot file version 88 created 04-OCT-2010 10:15:35

J1724-14 RP016A.UVDATA.1

Freq = 4.9410 GHz, Bw = 16.000 MH No calibration applied and no bandpass applied

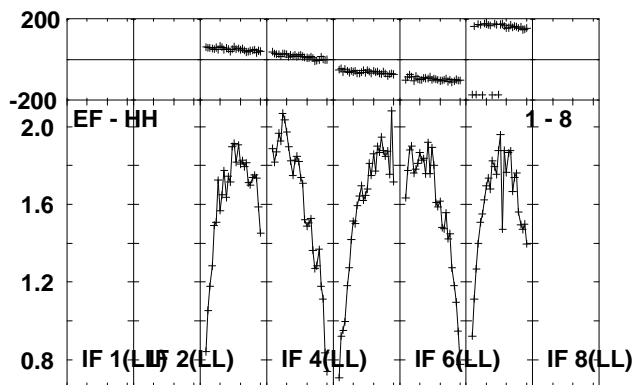
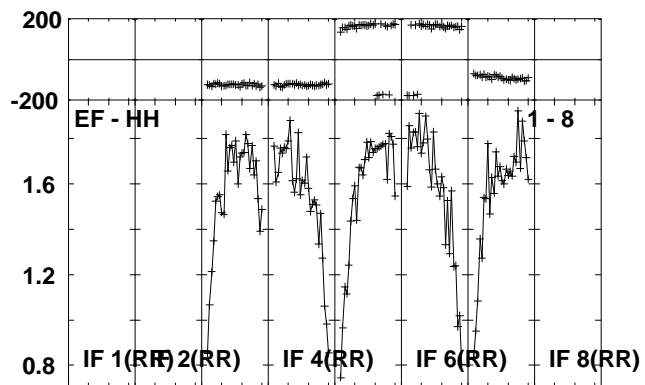
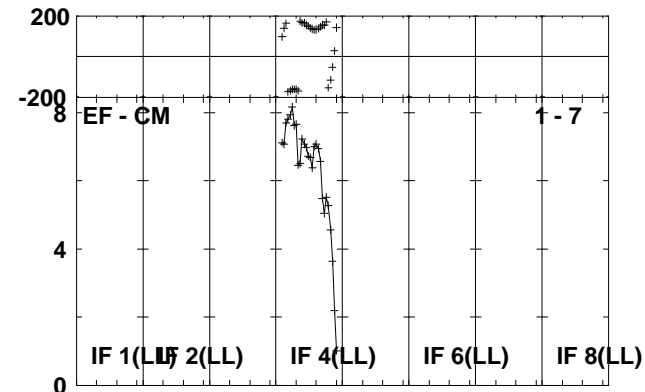
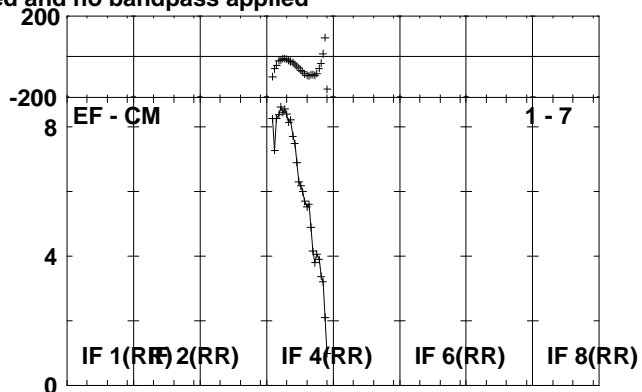
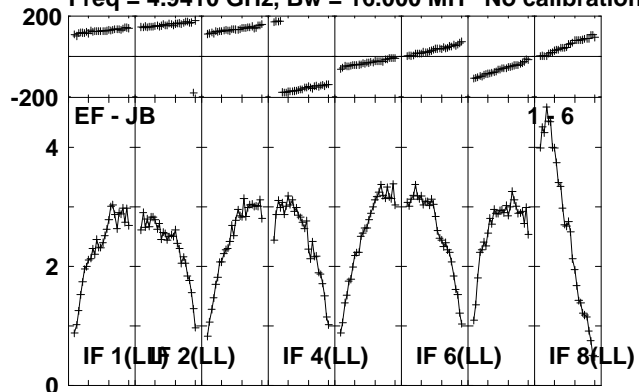

Lower frame: Milli Ampl Jy Top frame: Phas deg
Scalar averaged cross-power spectrum Several baselines displayed
Timerange: 00/15:34:21 to 00/15:38:19

Plot file version 89 created 04-OCT-2010 10:15:37

J1707-14 RP016A.UVDATA.1

Freq = 4.9410 GHz, Bw = 16.000 MH No calibration applied and no bandpass applied

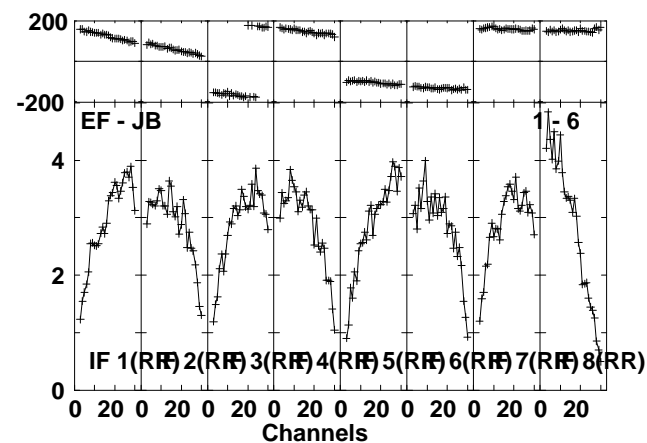
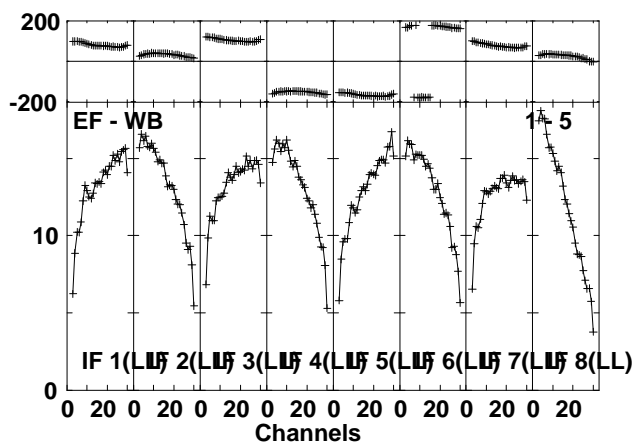
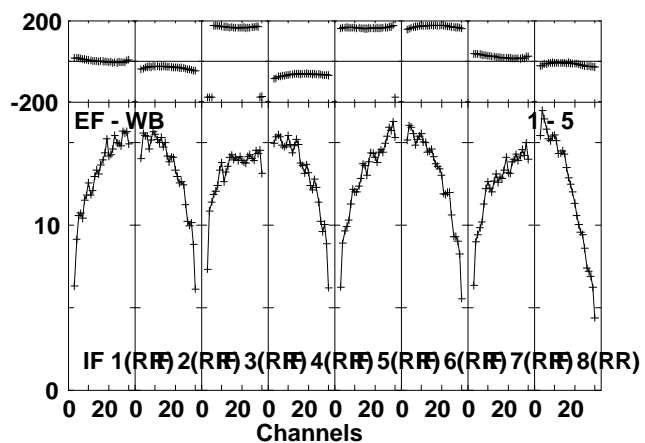
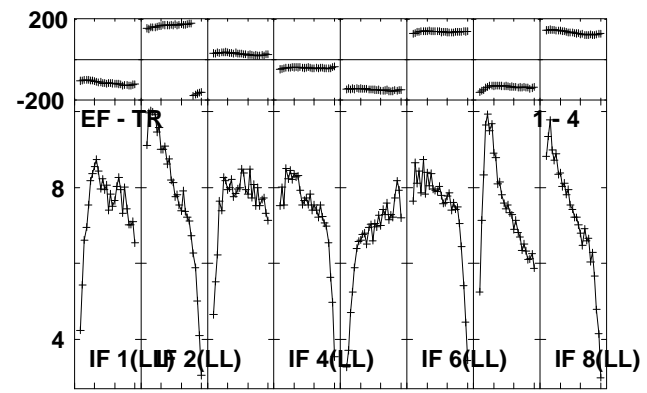
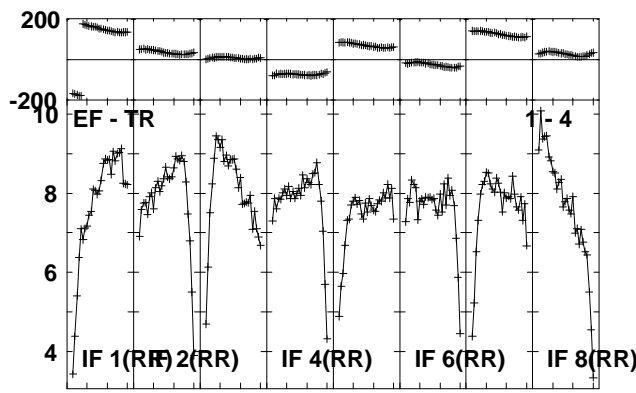
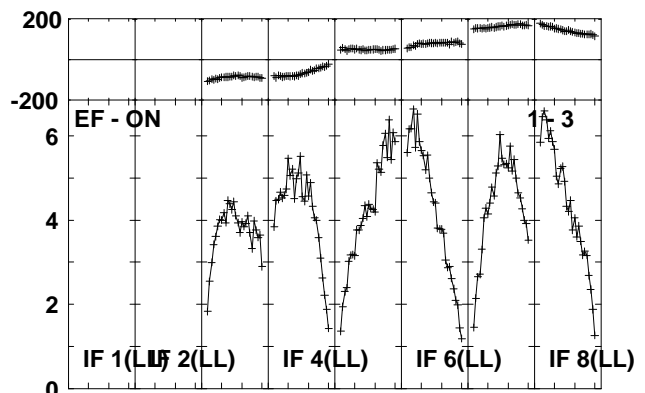
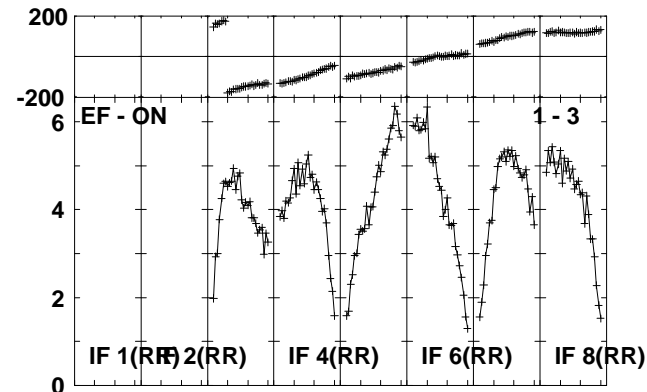
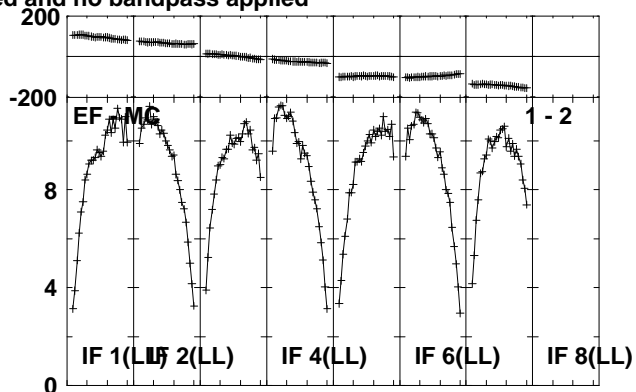
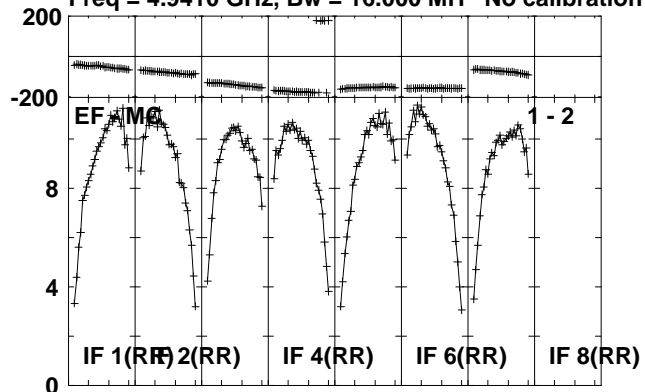

Lower frame: Milli Ampl Jy Top frame: Phas deg
Scalar averaged cross-power spectrum Several baselines displayed
Timerange: 00/15:39:21 to 00/15:40:19

Plot file version 90 created 04-OCT-2010 10:15:38

J1707-14 RP016A.UVDATA.1

Freq = 4.9410 GHz, Bw = 16.000 MH No calibration applied and no bandpass applied

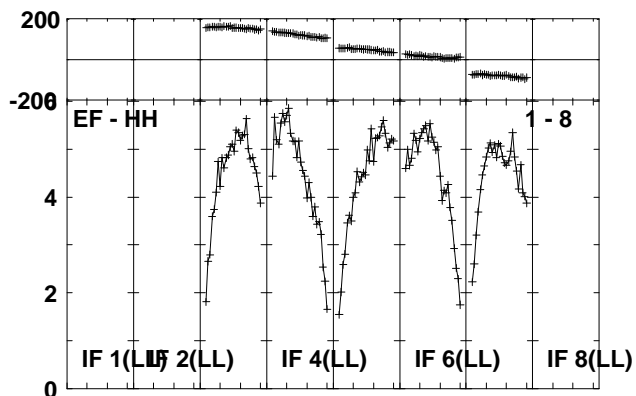
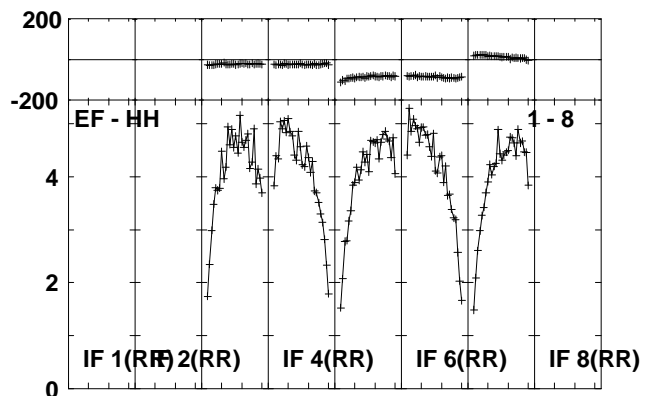
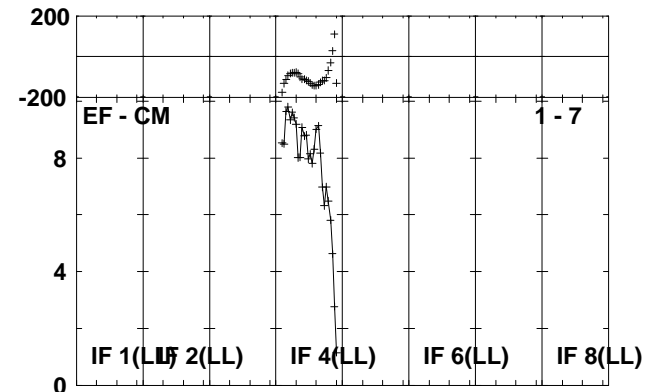
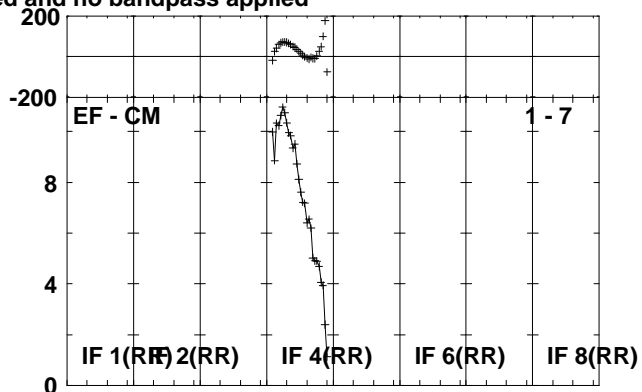
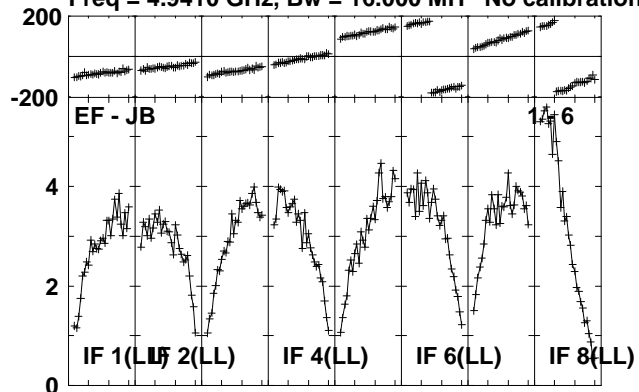

Lower frame: Milli Ampl Jy Top frame: Phas deg
Scalar averaged cross-power spectrum Several baselines displayed
Timerange: 00/15:39:21 to 00/15:40:19

Plot file version 91 created 04-OCT-2010 10:15:38

MAXI J16 RP016A.UVDATA.1

Freq = 4.9410 GHz, Bw = 16.000 MH No calibration applied and no bandpass applied

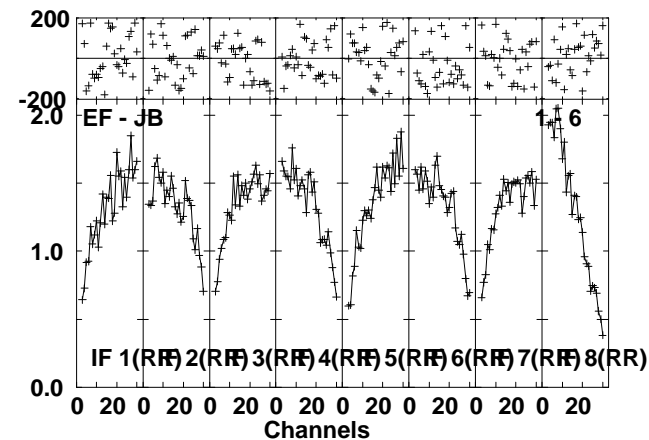
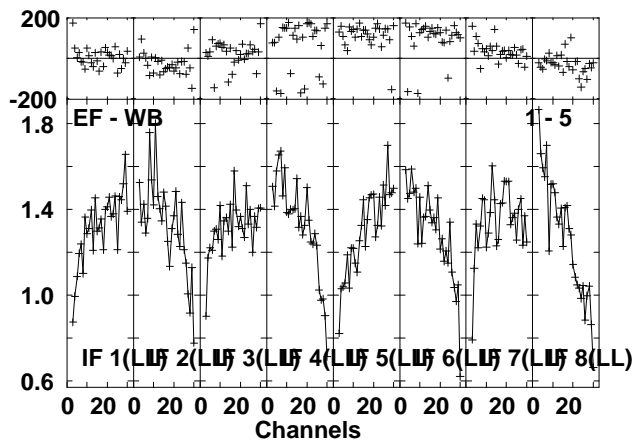
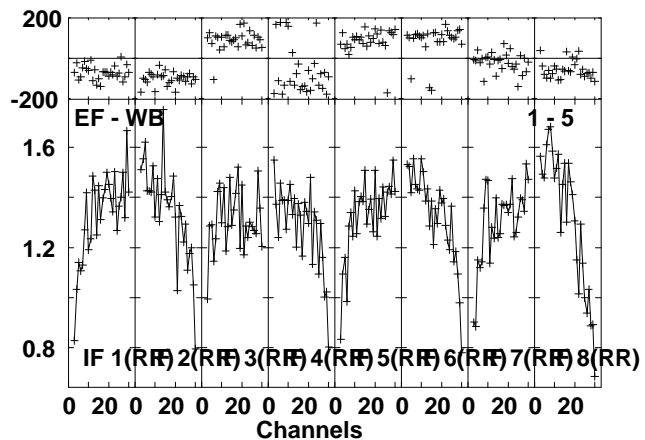
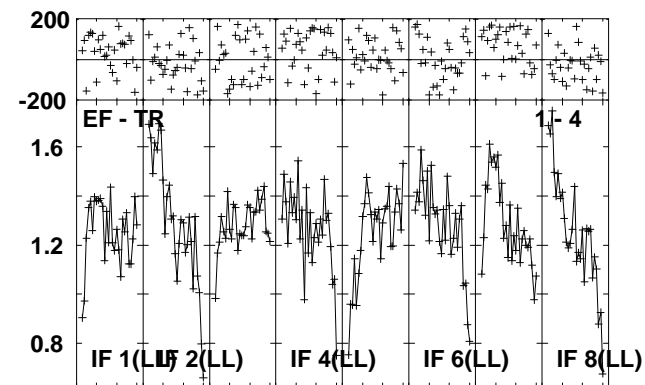
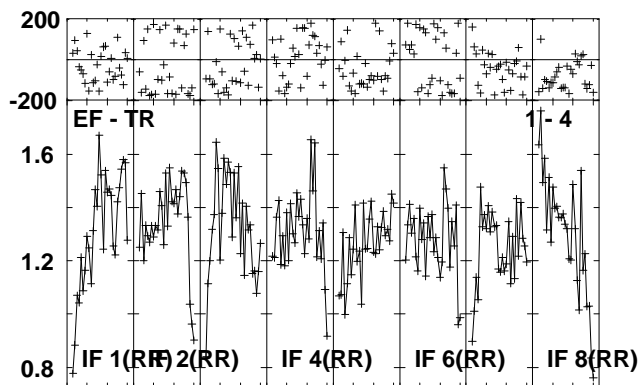
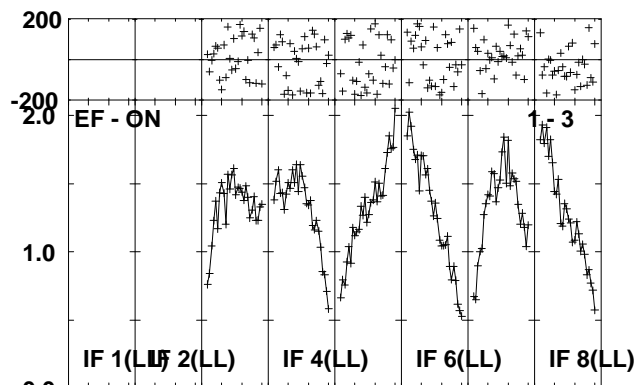
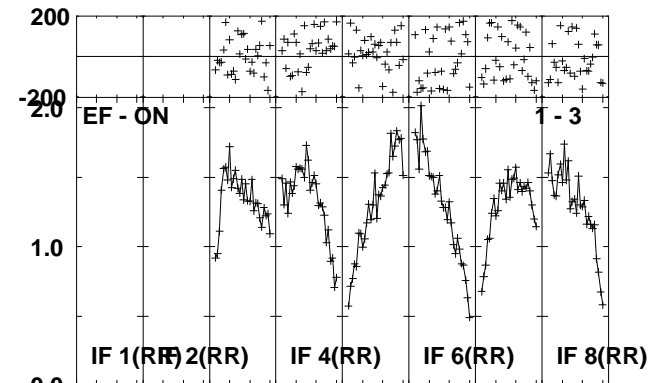
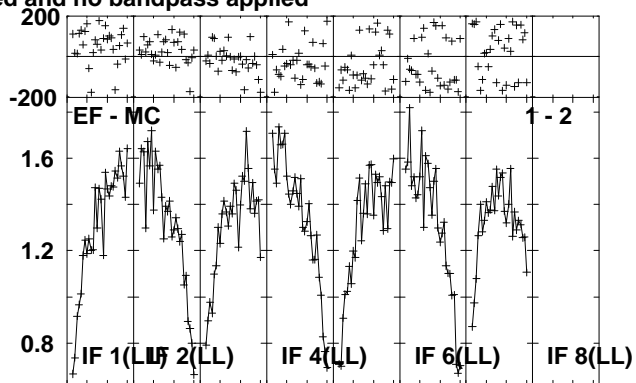
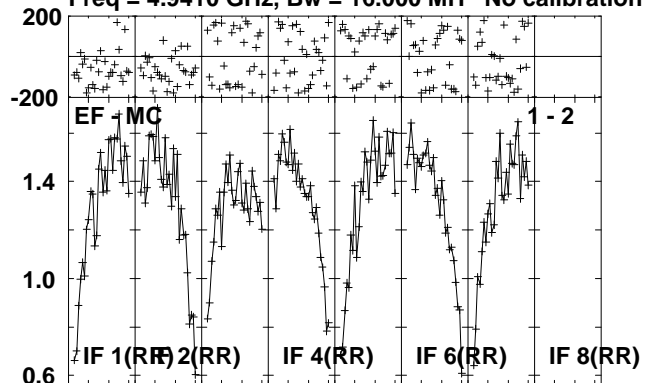

Lower frame: Milli Ampl Jy Top frame: Phas deg
Scalar averaged cross-power spectrum Several baselines displayed
Timerange: 00/15:40:21 to 00/15:42:49

Plot file version 92 created 04-OCT-2010 10:15:40

MAXI J16 RP016A.UVDATA.1

Freq = 4.9410 GHz, Bw = 16.000 MH No calibration applied and no bandpass applied

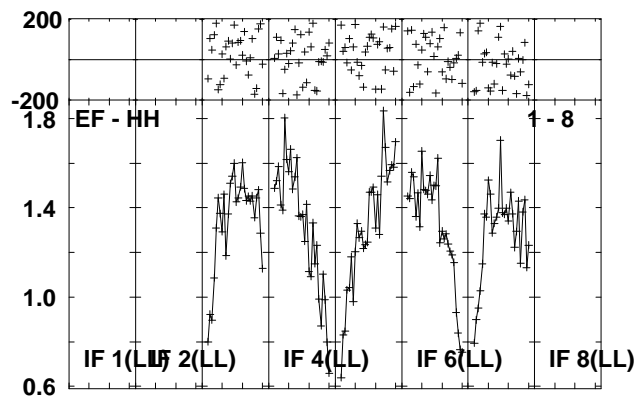
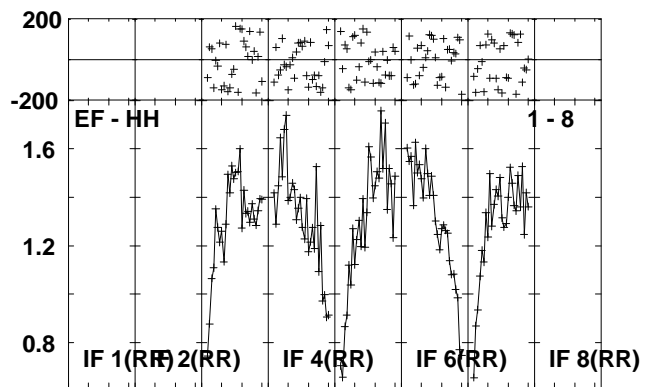
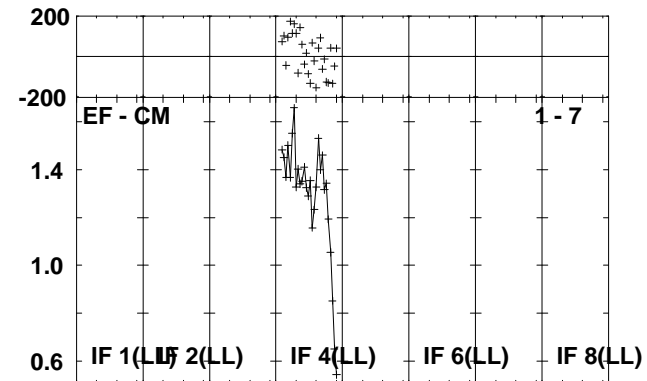
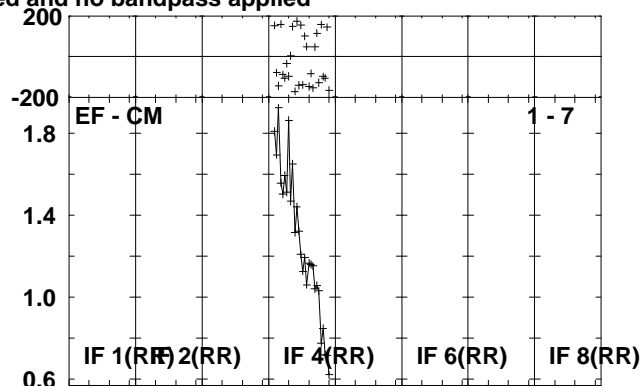
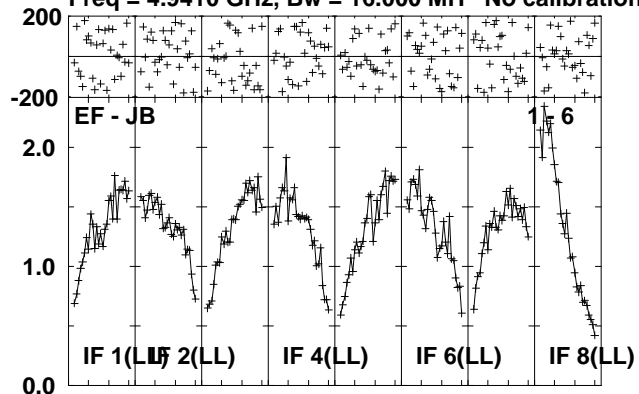

Lower frame: Milli Ampl Jy Top frame: Phas deg
Scalar averaged cross-power spectrum Several baselines displayed
Timerange: 00/15:40:21 to 00/15:42:49

Plot file version 93 created 04-OCT-2010 10:15:41

J1707-14 RP016A.UVDATA.1

Freq = 4.9410 GHz, Bw = 16.000 MH No calibration applied and no bandpass applied

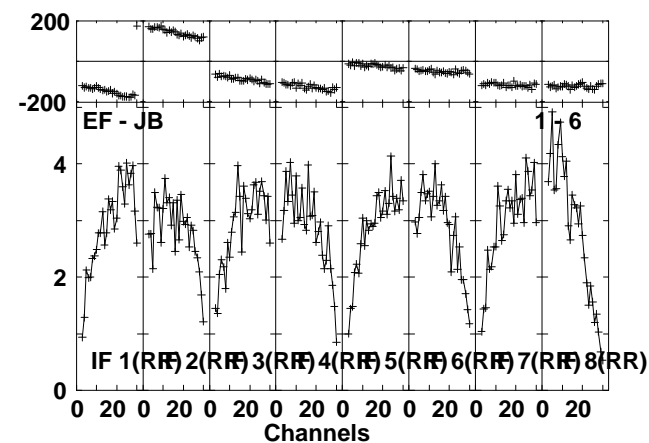
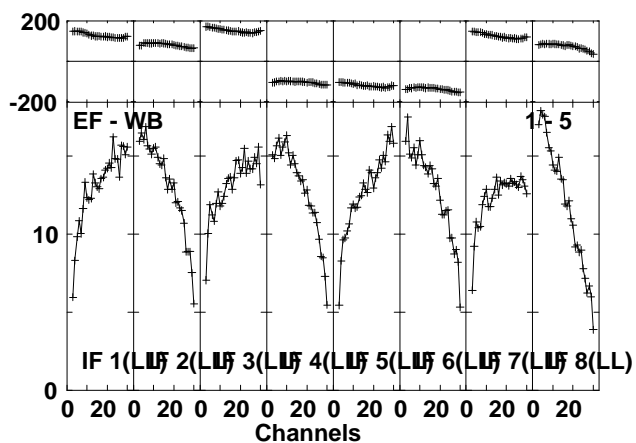
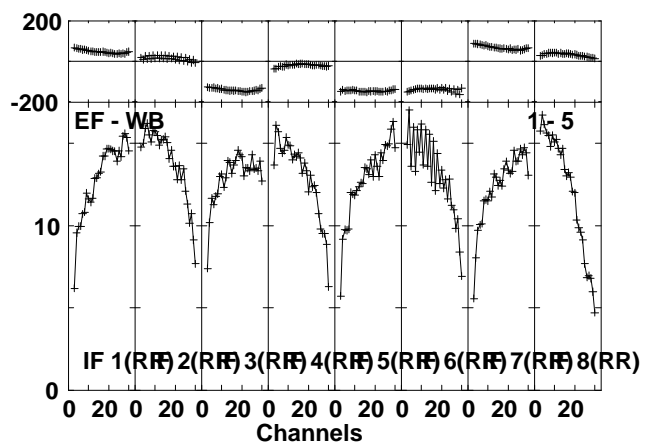
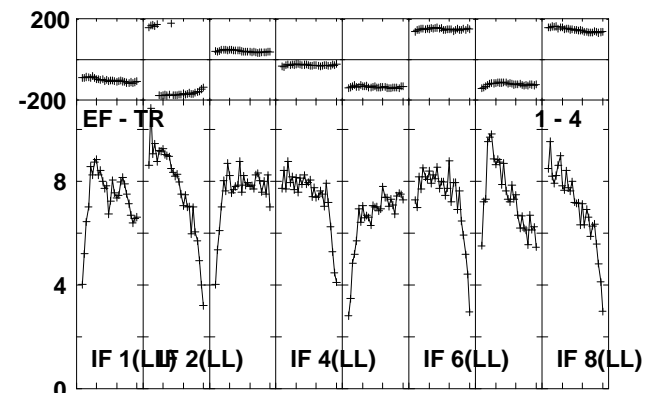
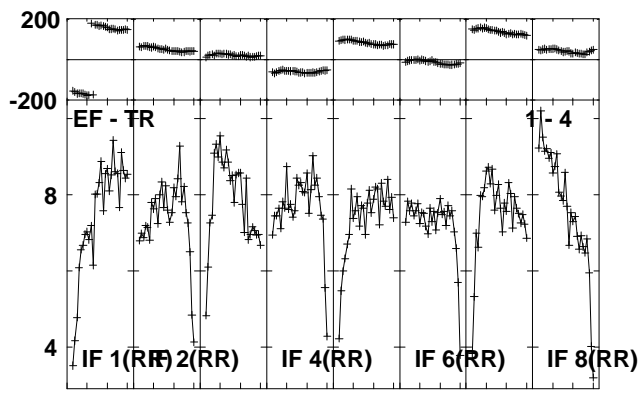
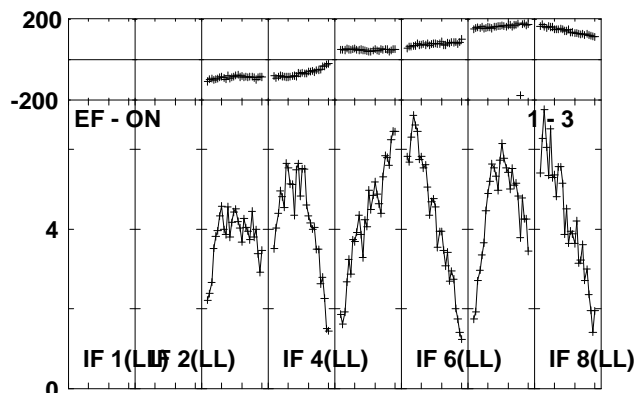
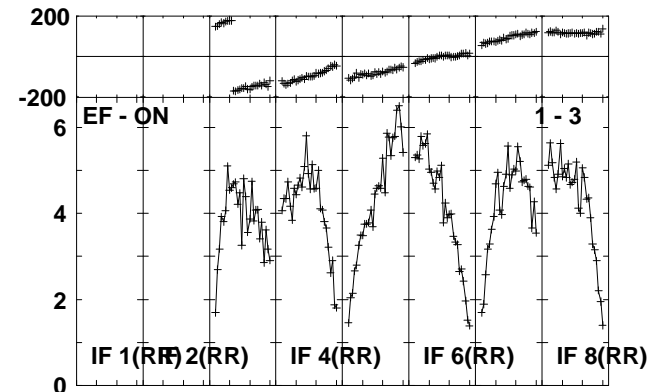
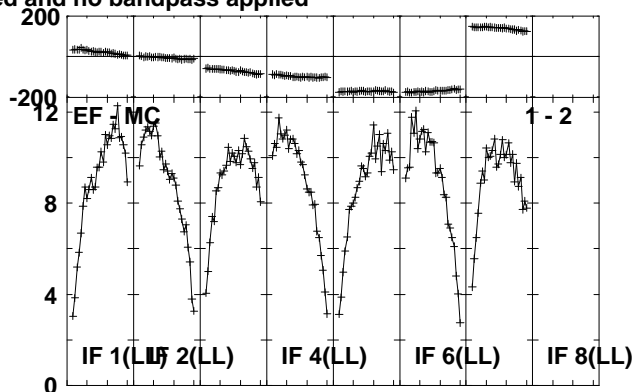
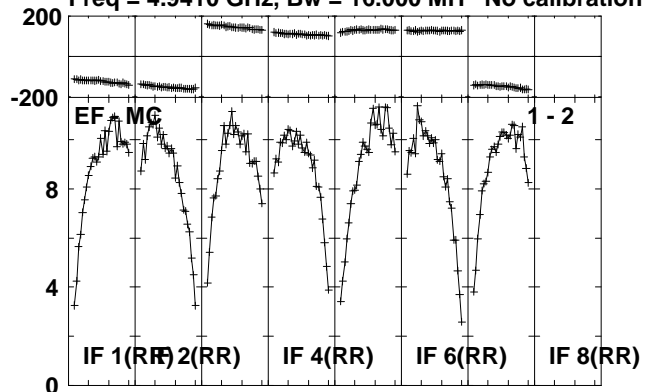

Lower frame: Milli Ampl Jy Top frame: Phas deg
Scalar averaged cross-power spectrum Several baselines displayed
Timerange: 00/15:42:51 to 00/15:44:19

Plot file version 94 created 04-OCT-2010 10:15:42

J1707-14 RP016A.UVDATA.1

Freq = 4.9410 GHz, Bw = 16.000 MH No calibration applied and no bandpass applied

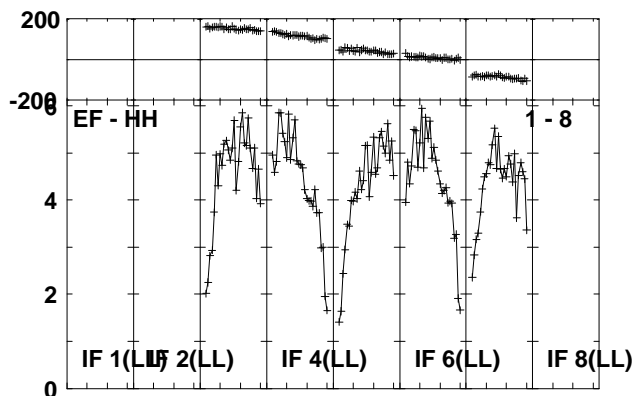
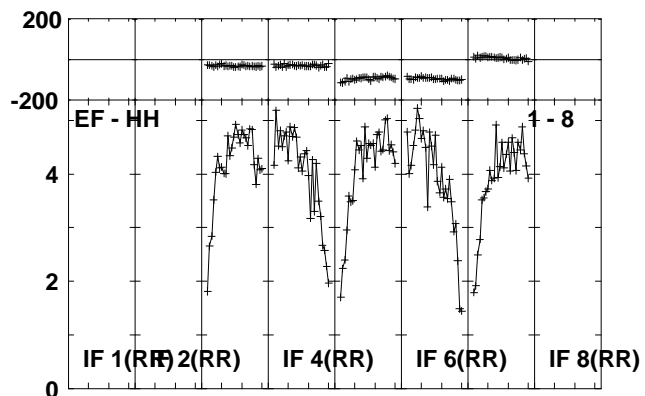
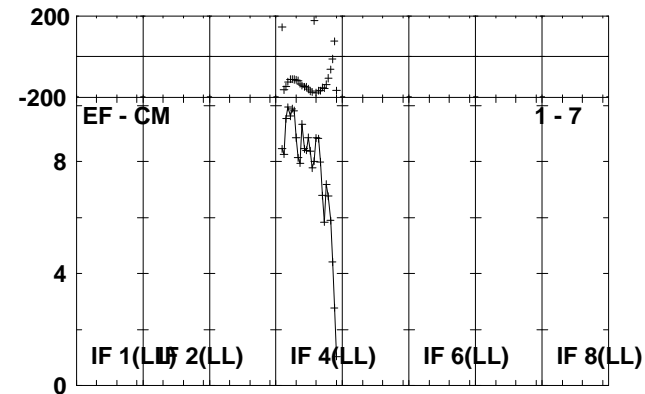
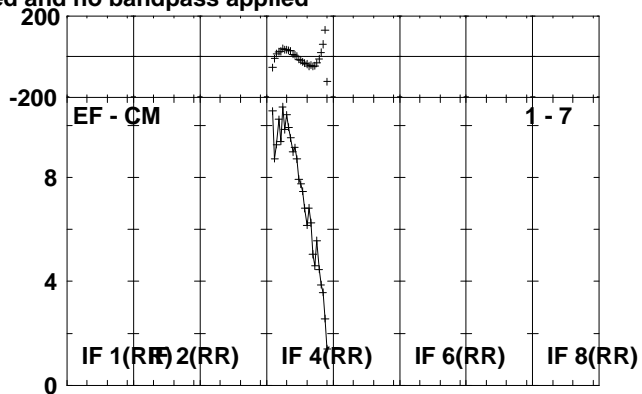
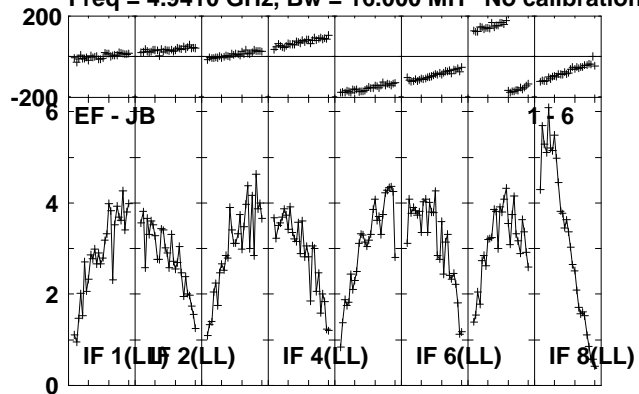

Lower frame: Milli Ampl Jy Top frame: Phas deg
Scalar averaged cross-power spectrum Several baselines displayed
Timerange: 00/15:42:51 to 00/15:44:19

Plot file version 95 created 04-OCT-2010 10:15:43

MAXI J16 RP016A.UVDATA.1

Freq = 4.9410 GHz, Bw = 16.000 MH No calibration applied and no bandpass applied

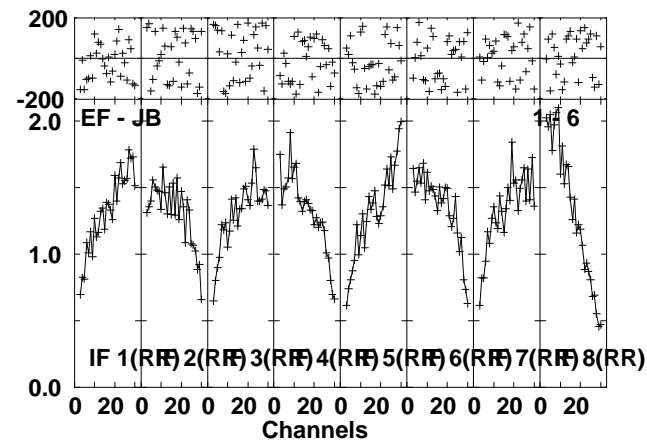
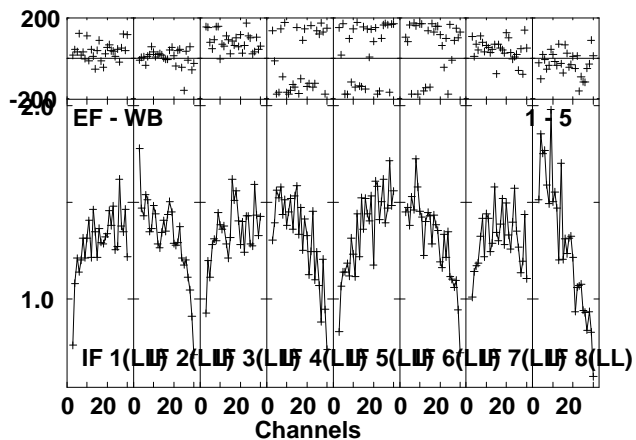
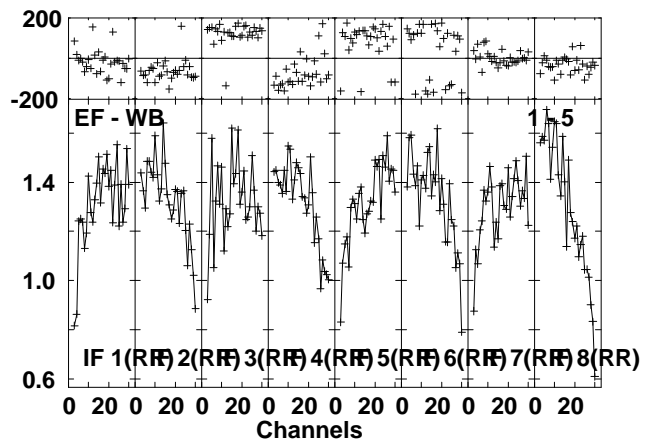
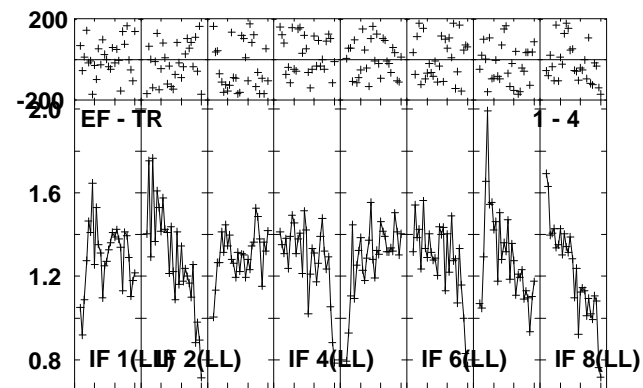
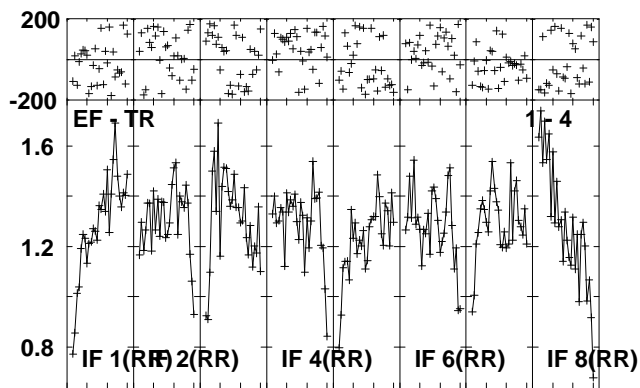
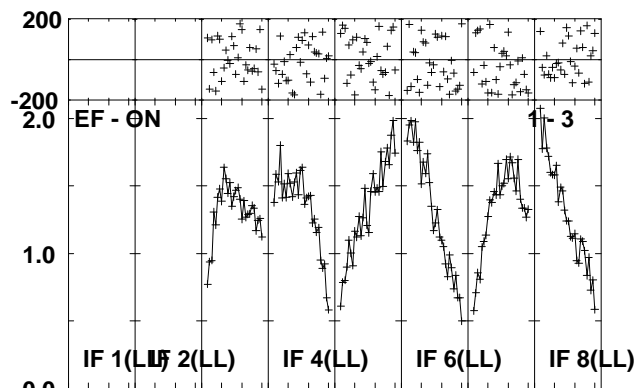
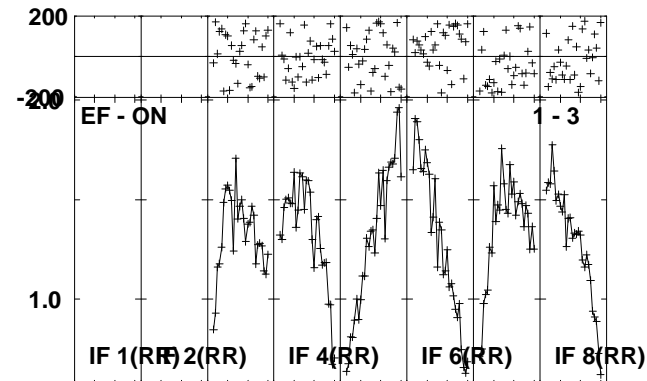
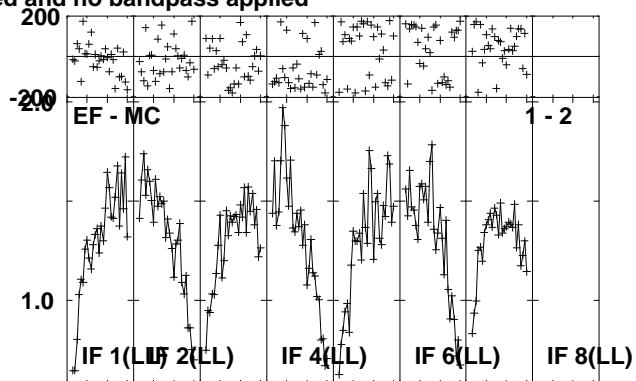
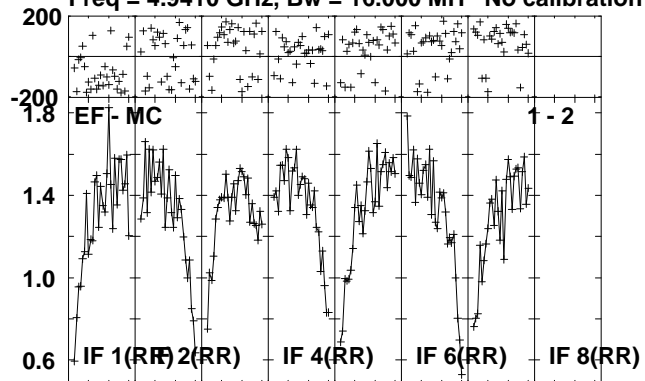

Lower frame: Milli Ampl Jy Top frame: Phas deg
Scalar averaged cross-power spectrum Several baselines displayed
Timerange: 00/15:44:21 to 00/15:46:49

Plot file version 96 created 04-OCT-2010 10:15:45

MAXI J16 RP016A.UVDATA.1

Freq = 4.9410 GHz, Bw = 16.000 MH No calibration applied and no bandpass applied

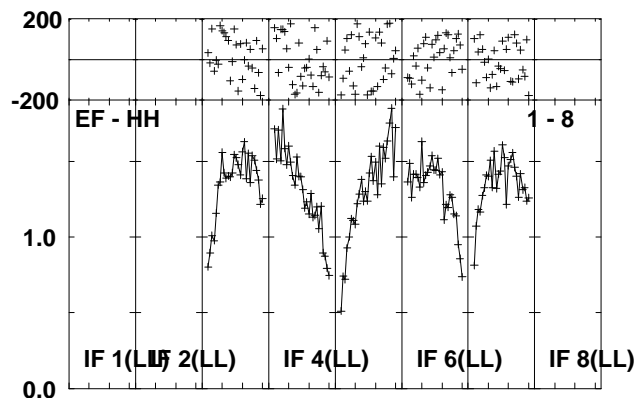
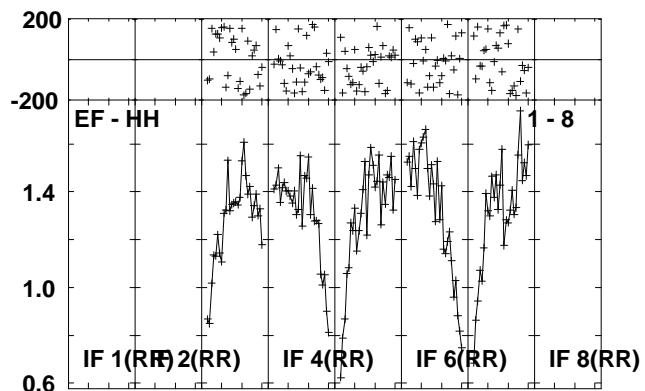
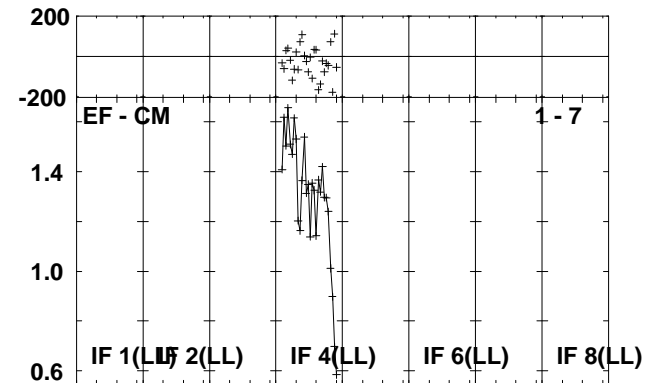
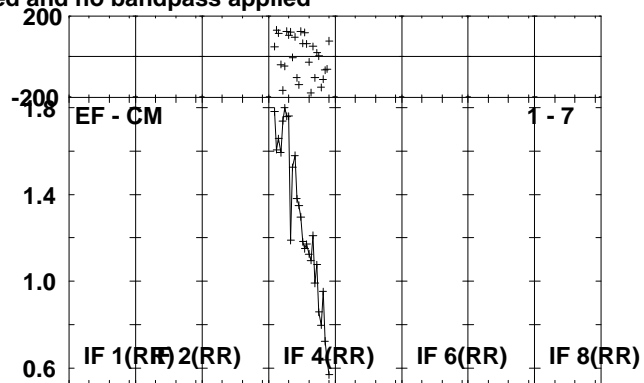
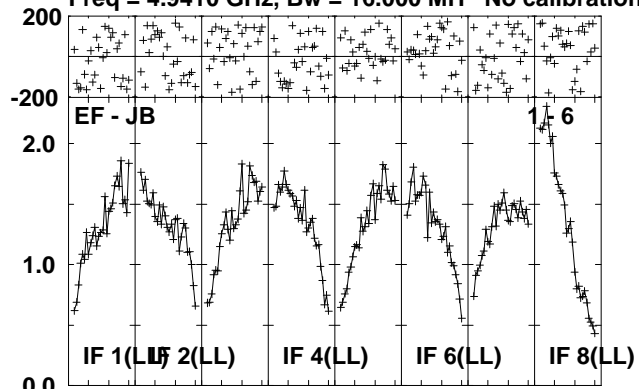

Lower frame: Milli Ampl Jy Top frame: Phas deg
Scalar averaged cross-power spectrum Several baselines displayed
Timerange: 00/15:44:21 to 00/15:46:49

Plot file version 97 created 04-OCT-2010 10:15:46

J1707-14 RP016A.UVDATA.1

Freq = 4.9410 GHz, Bw = 16.000 MH No calibration applied and no bandpass applied

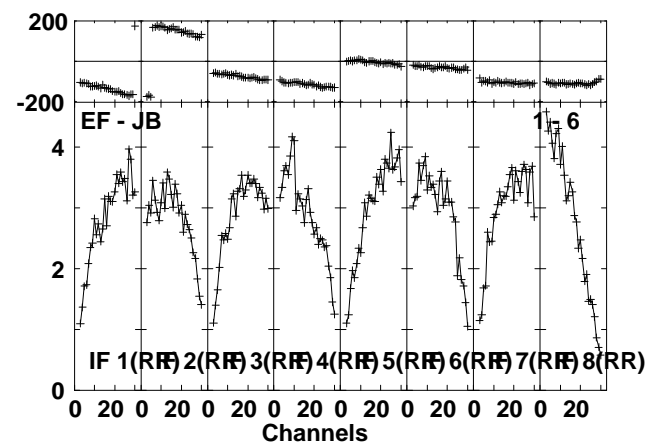
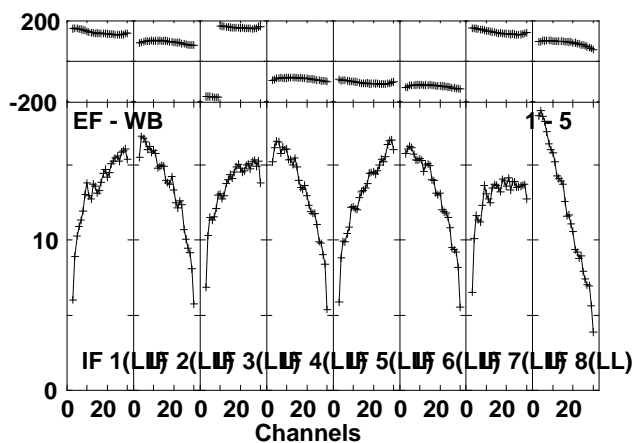
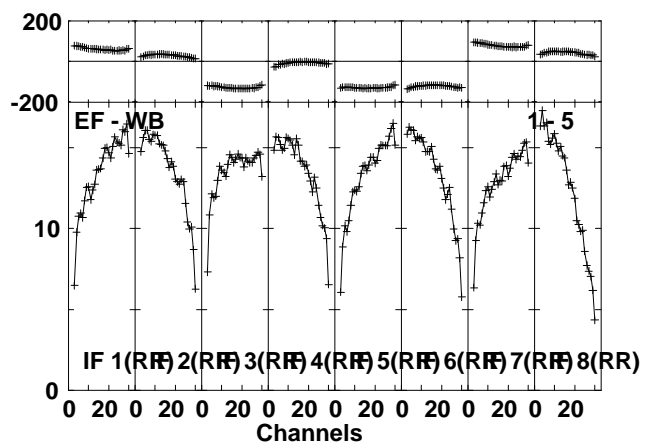
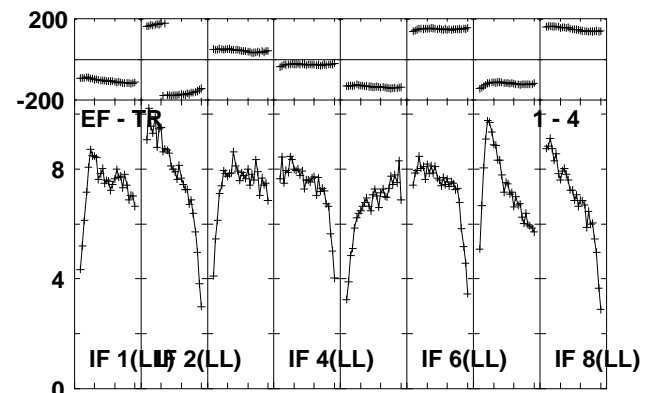
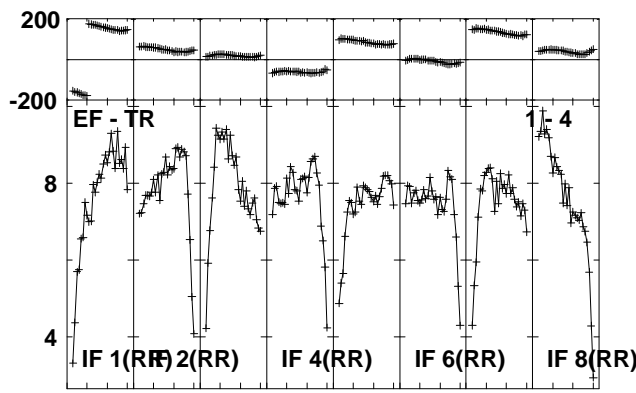
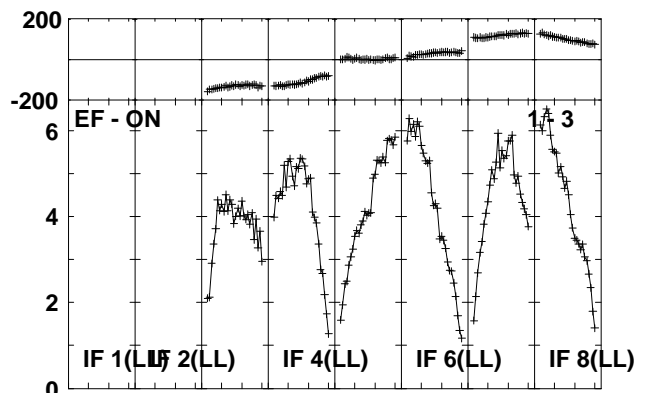
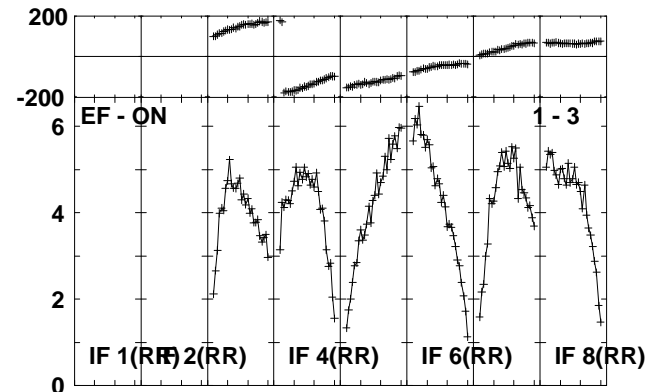
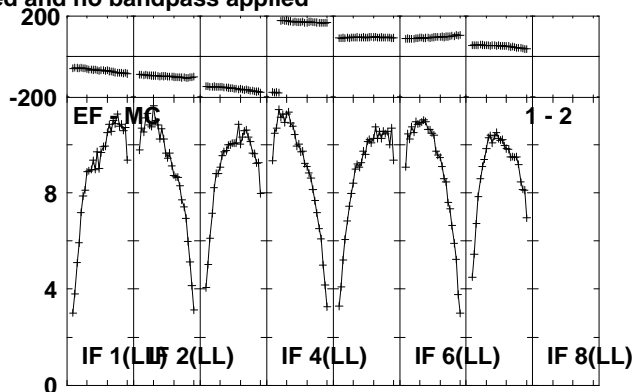
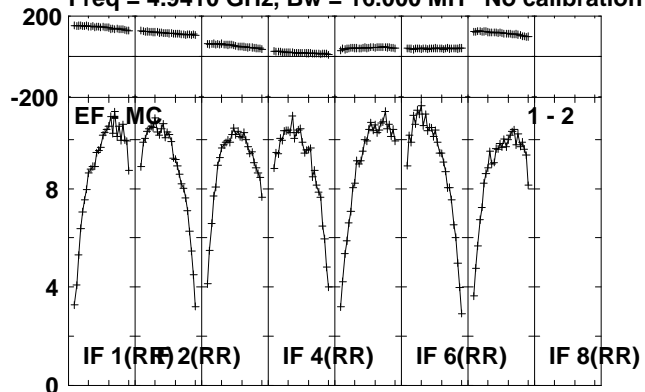

Lower frame: Milli Ampl Jy Top frame: Phas deg
Scalar averaged cross-power spectrum Several baselines displayed
Timerange: 00/15:47:31 to 00/15:48:29

Plot file version 98 created 04-OCT-2010 10:15:47

J1707-14 RP016A.UVDATA.1

Freq = 4.9410 GHz, Bw = 16.000 MH No calibration applied and no bandpass applied

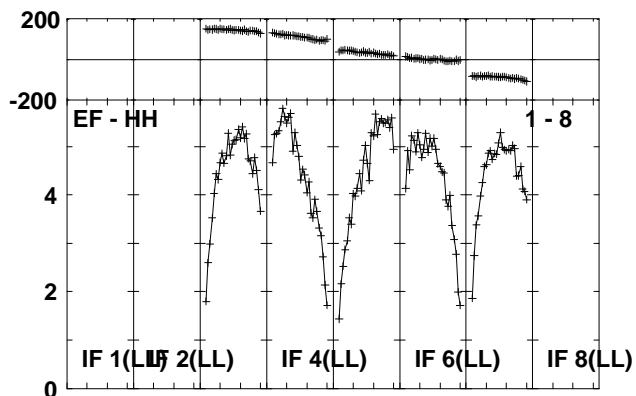
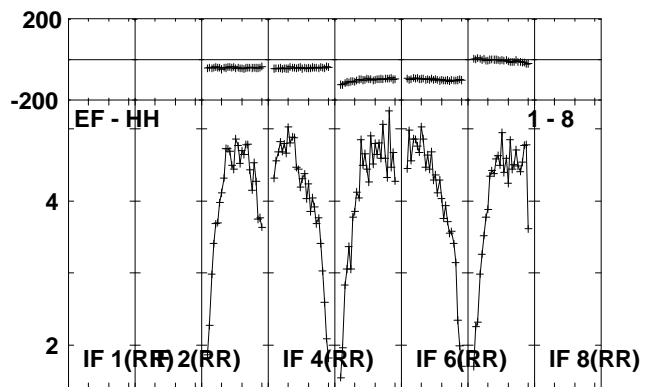
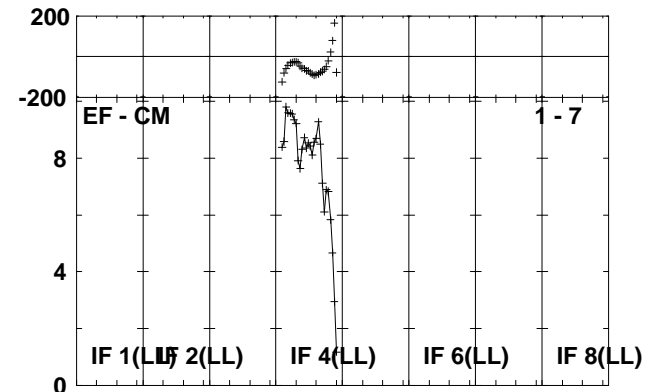
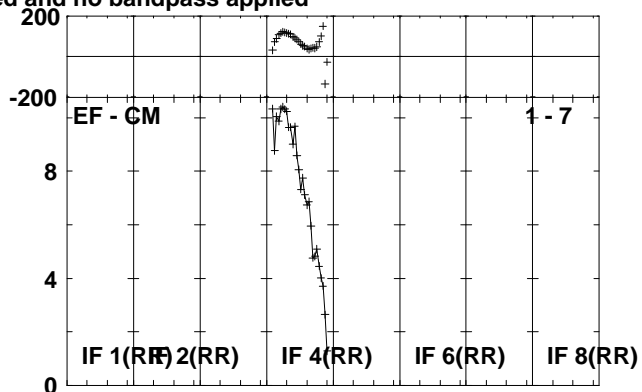
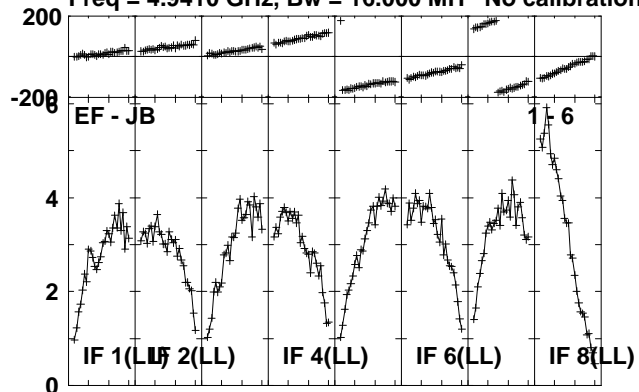

Lower frame: Milli Ampl Jy Top frame: Phas deg
Scalar averaged cross-power spectrum Several baselines displayed
Timerange: 00/15:47:31 to 00/15:48:29

Plot file version 99 created 04-OCT-2010 10:15:47

NVSS3 RP016A.UVDATA.1

Freq = 4.9410 GHz, Bw = 16.000 MH No calibration applied and no bandpass applied

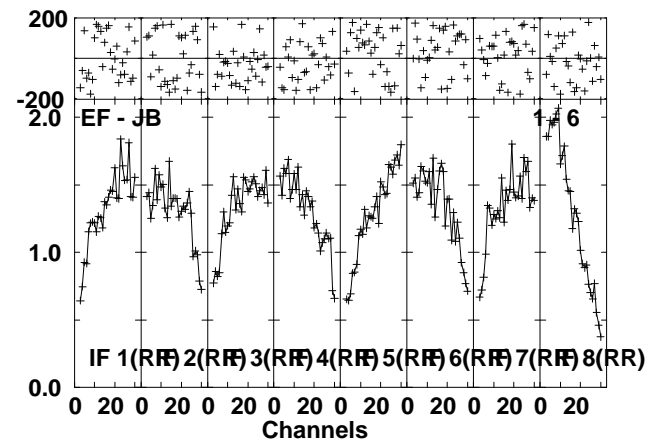
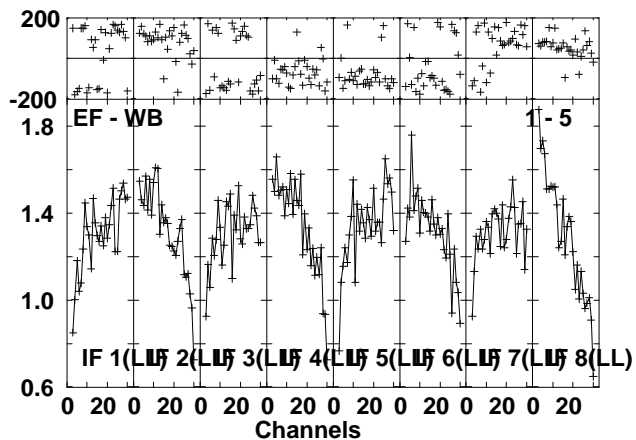
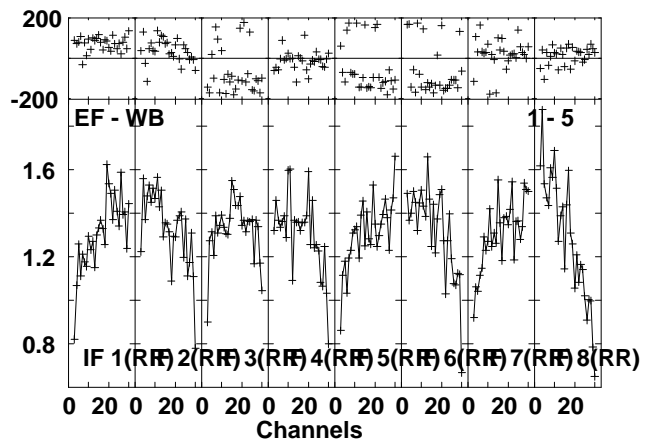
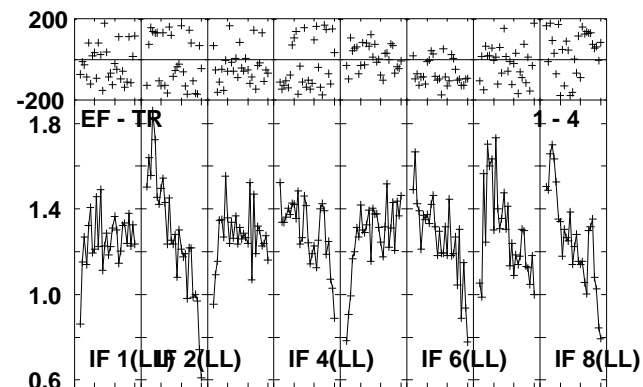
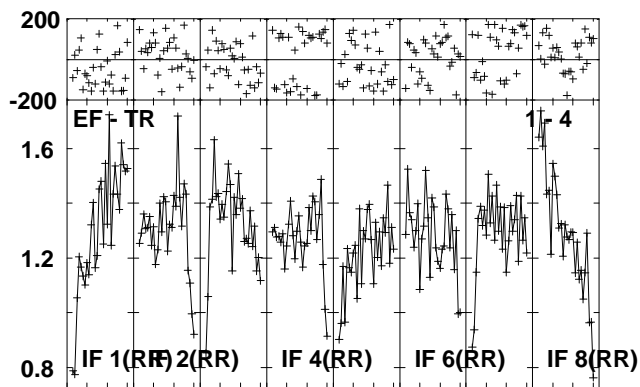
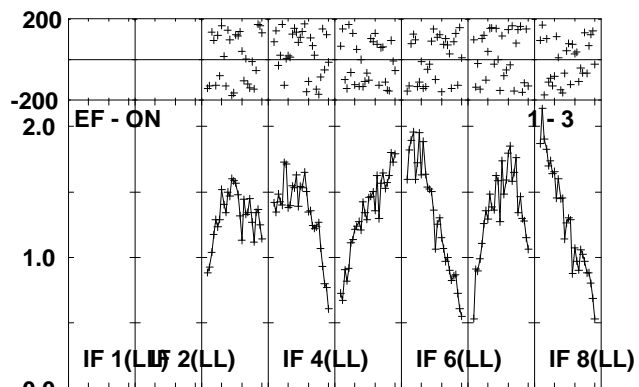
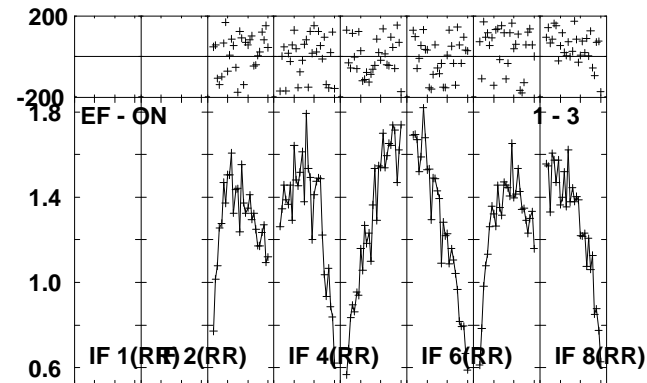
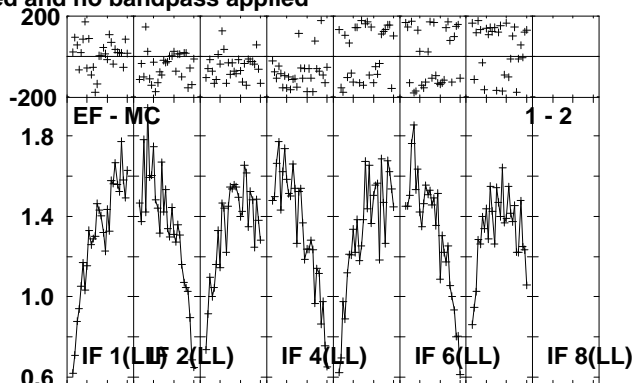
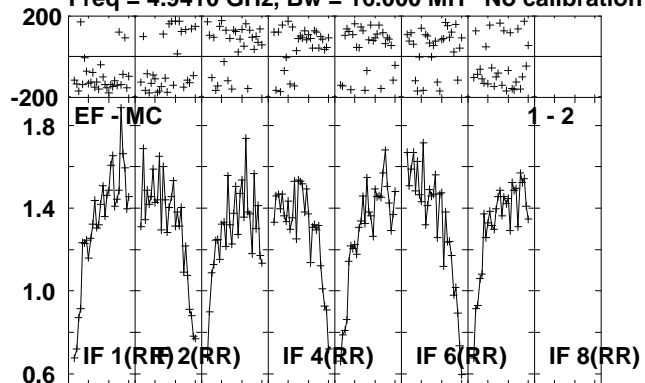

Lower frame: Milli Ampl Jy Top frame: Phas deg
Scalar averaged cross-power spectrum Several baselines displayed
Timerange: 00/15:48:31 to 00/15:50:59

Plot file version 100 created 04-OCT-2010 10:15:49

NVSS3 RP016A.UVDATA.1

Freq = 4.9410 GHz, Bw = 16.000 MH No calibration applied and no bandpass applied

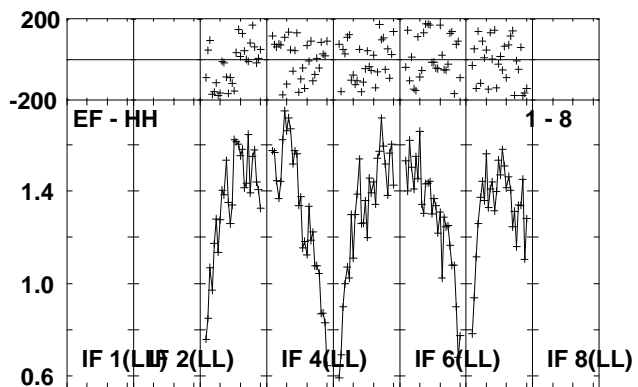
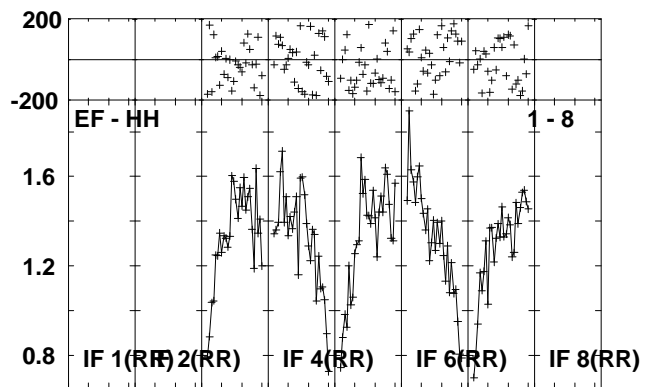
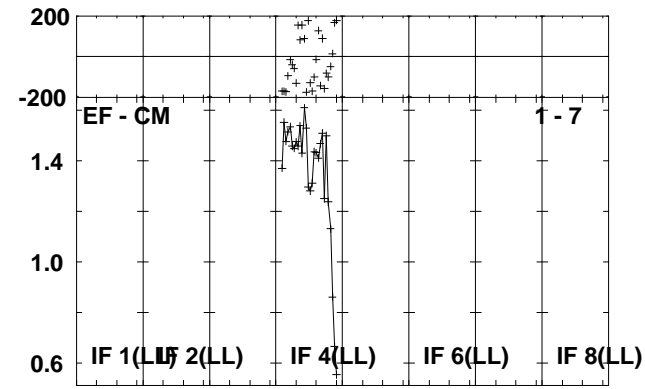
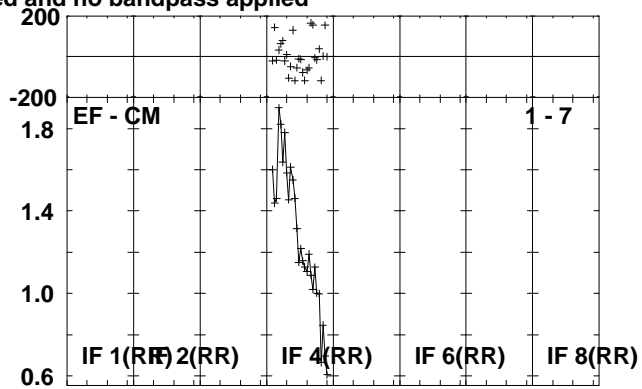
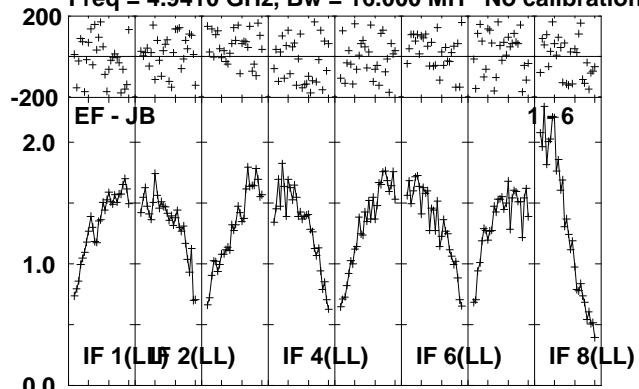

Lower frame: Milli Ampl Jy Top frame: Phas deg
Scalar averaged cross-power spectrum Several baselines displayed
Timerange: 00/15:48:31 to 00/15:50:59

Plot file version 101 created 04-OCT-2010 10:15:50

J1707-14 RP016A.UVDATA.1

Freq = 4.9410 GHz, Bw = 16.000 MH No calibration applied and no bandpass applied

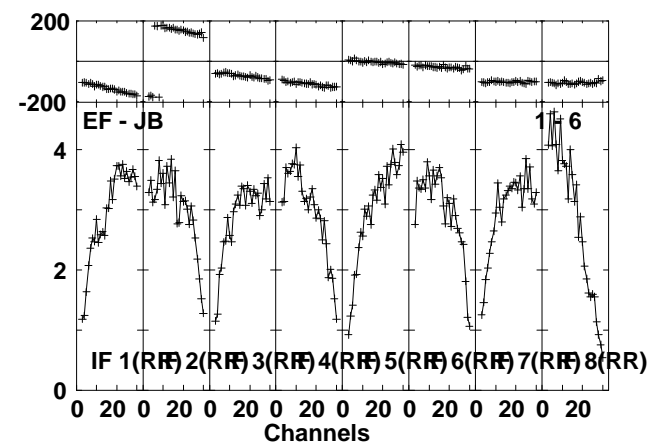
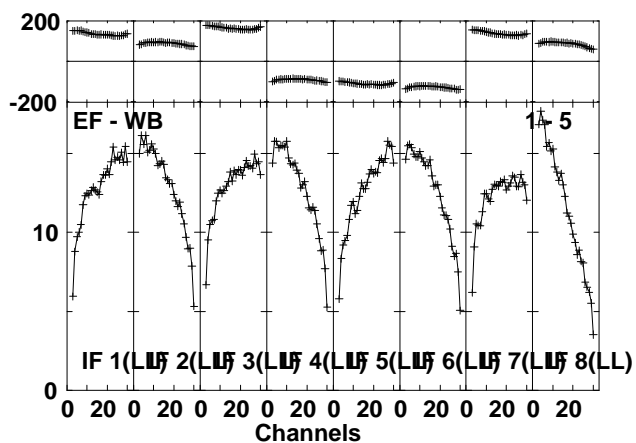
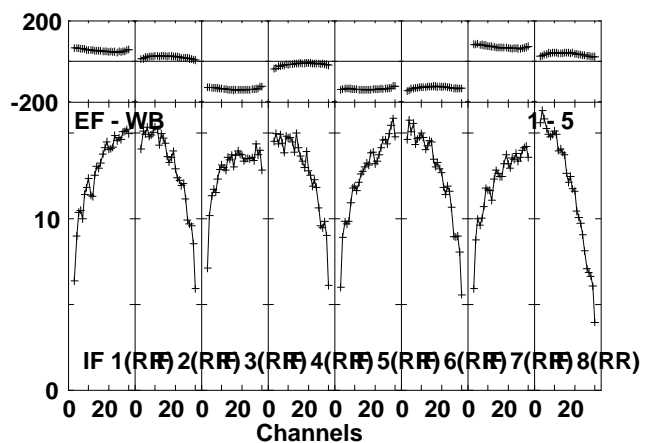
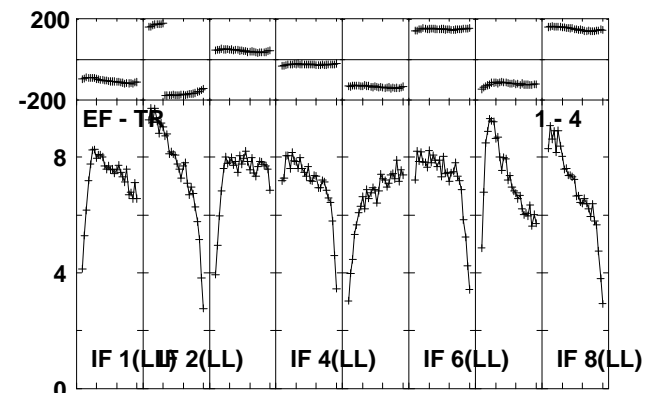
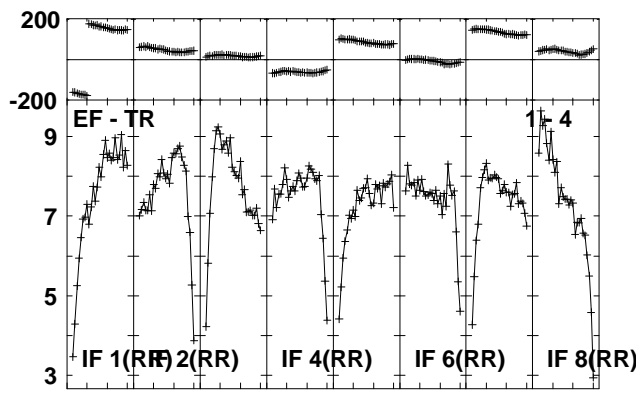
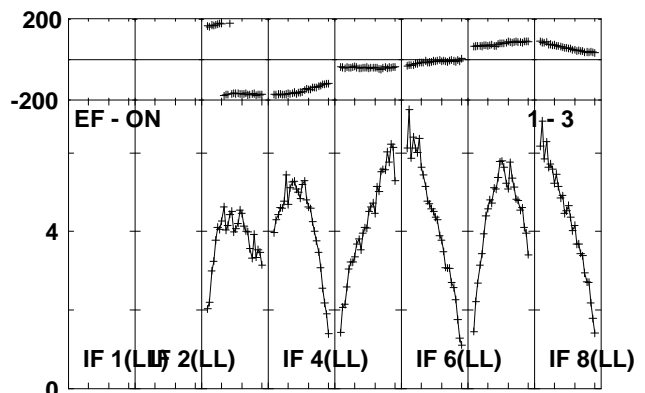
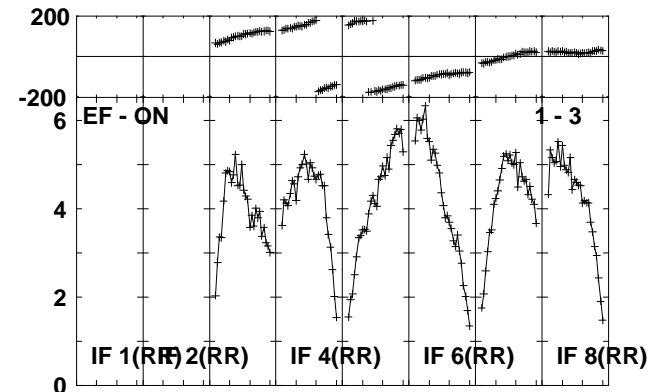
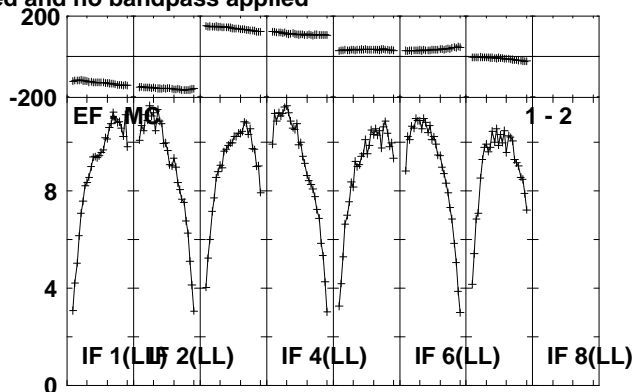
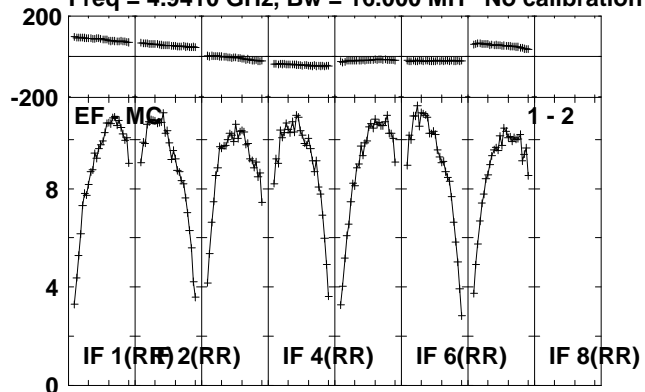

Lower frame: Milli Ampl Jy Top frame: Phas deg
Scalar averaged cross-power spectrum Several baselines displayed
Timerange: 00/15:51:01 to 00/15:52:29

Plot file version 102 created 04-OCT-2010 10:15:51
J1707-14 RP016A.UVDATA.1

Freq = 4.9410 GHz, Bw = 16.000 MH No calibration applied and no bandpass applied

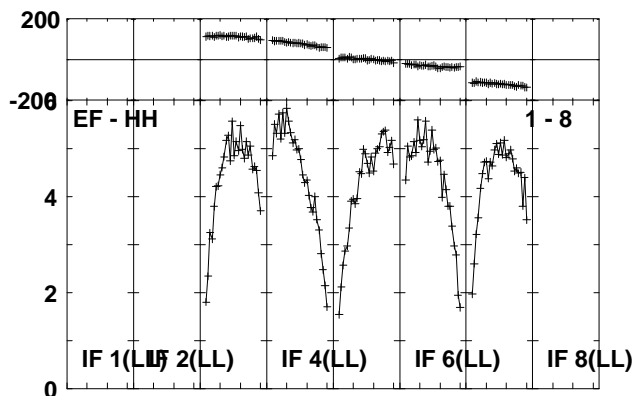
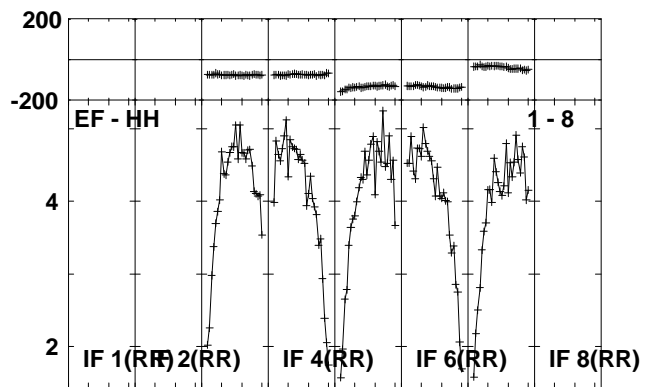
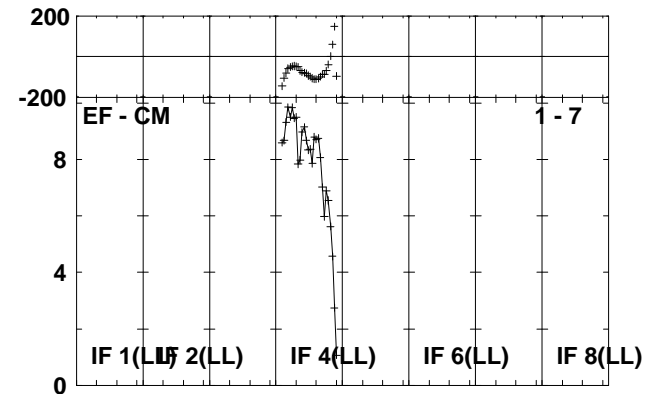
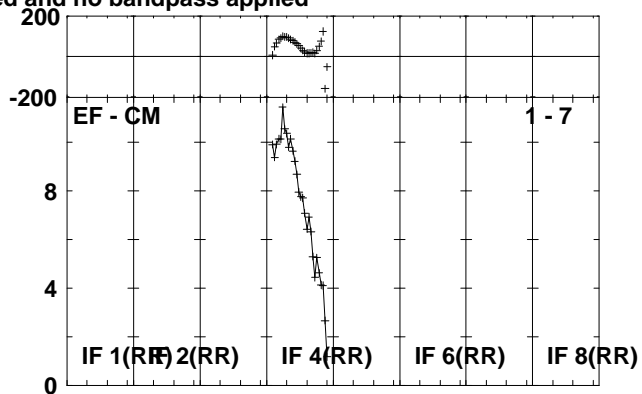
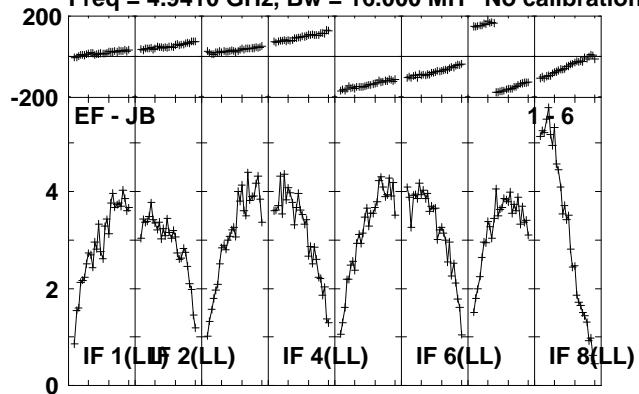

Lower frame: Milli Ampl Jy Top frame: Phas deg
Scalar averaged cross-power spectrum Several baselines displayed
Timerange: 00/15:51:01 to 00/15:52:29

Plot file version 103 created 04-OCT-2010 10:15:52

MAXI J16 RP016A.UVDATA.1

Freq = 4.9410 GHz, Bw = 16.000 MH No calibration applied and no bandpass applied

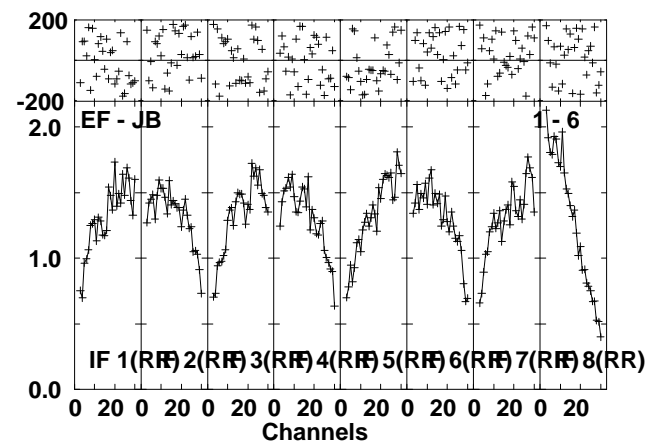
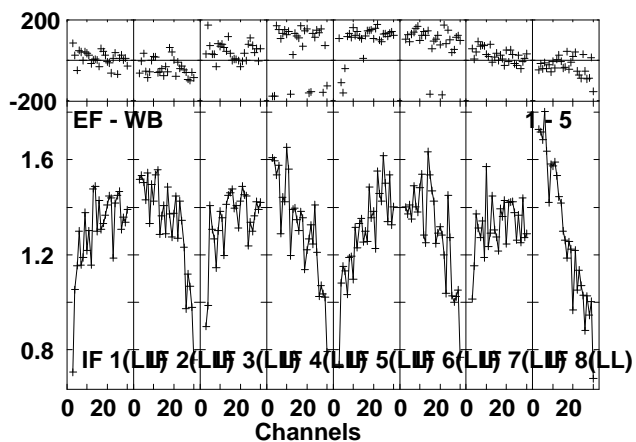
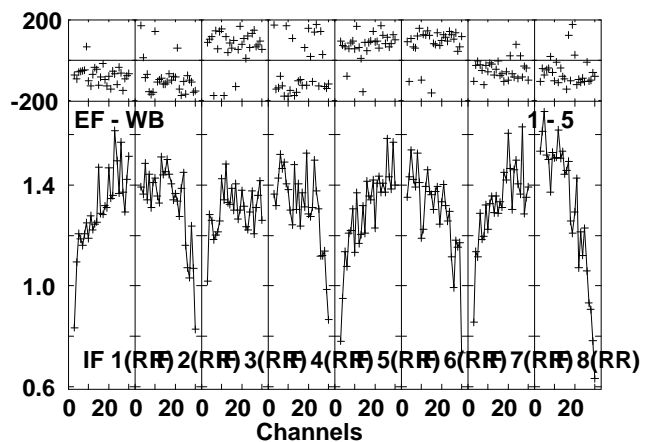
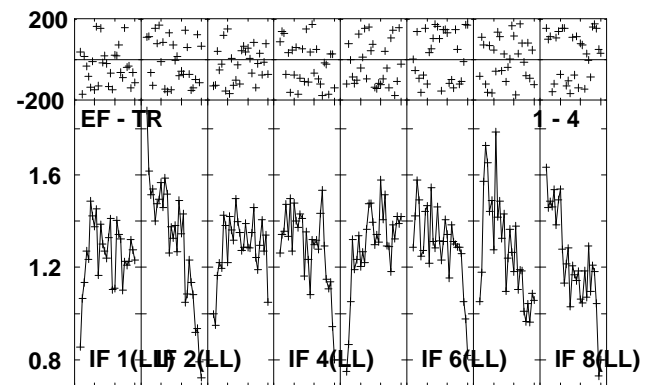
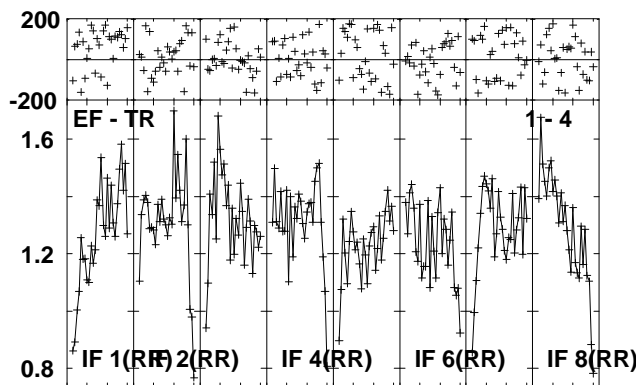
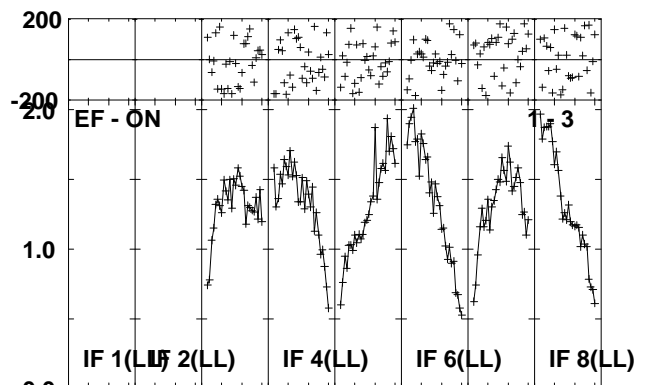
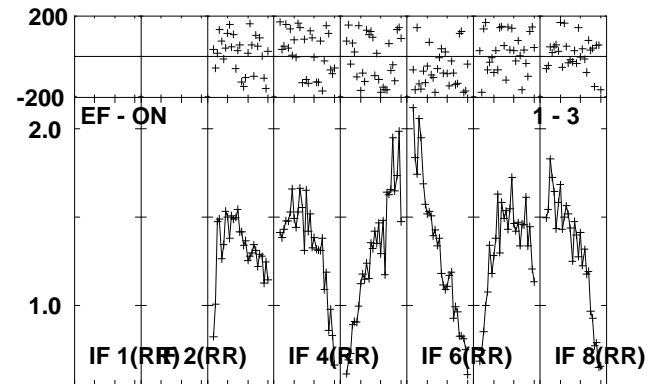
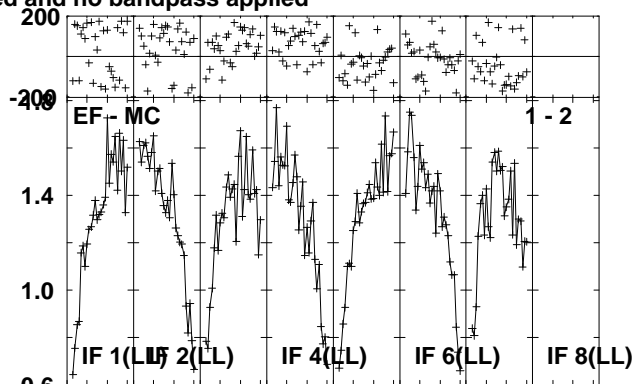
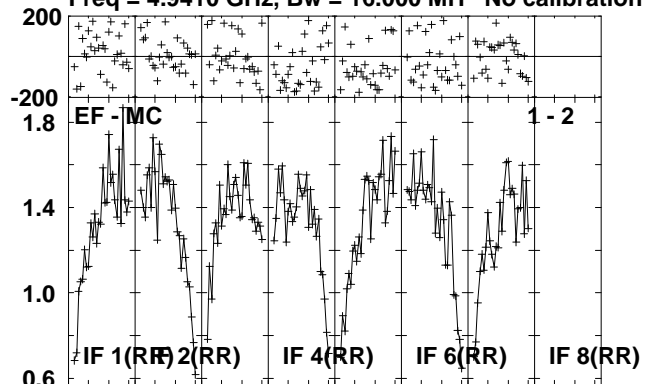

Lower frame: Milli Ampl Jy Top frame: Phas deg
Scalar averaged cross-power spectrum Several baselines displayed
Timerange: 00/15:52:31 to 00/15:54:59

Plot file version 104 created 04-OCT-2010 10:15:54

MAXI J16 RP016A.UVDATA.1

Freq = 4.9410 GHz, Bw = 16.000 MH No calibration applied and no bandpass applied

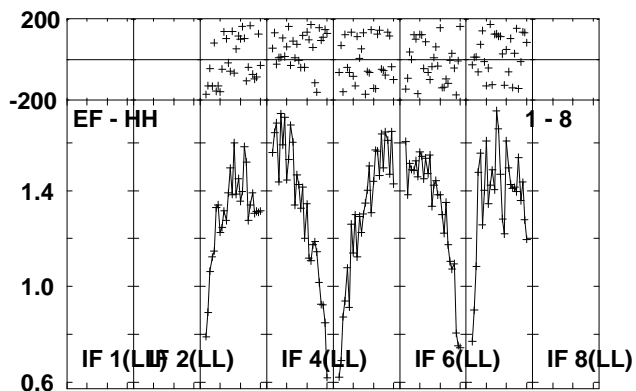
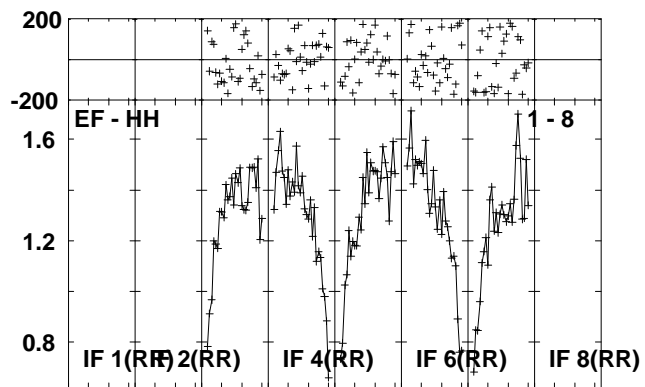
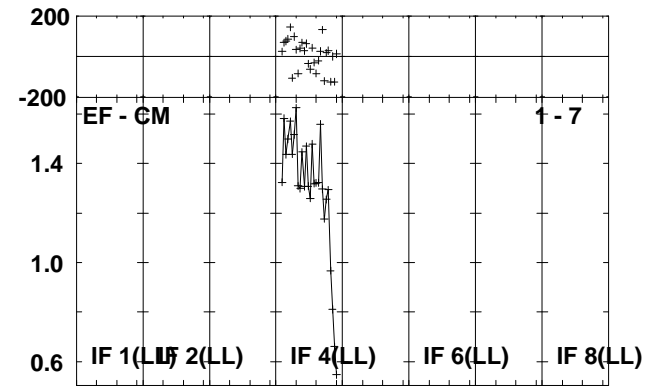
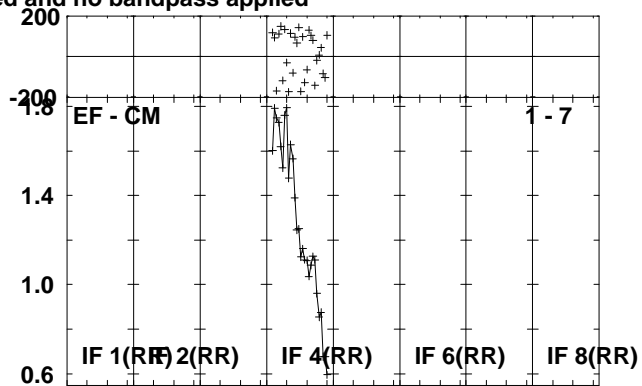
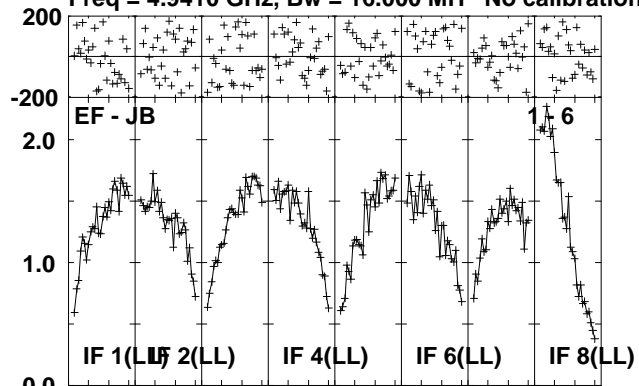

Lower frame: Milli Ampl Jy Top frame: Phas deg
Scalar averaged cross-power spectrum Several baselines displayed
Timerange: 00/15:52:31 to 00/15:54:59

Plot file version 105 created 04-OCT-2010 10:15:55

J1707-14 RP016A.UVDATA.1

Freq = 4.9410 GHz, Bw = 16.000 MH No calibration applied and no bandpass applied

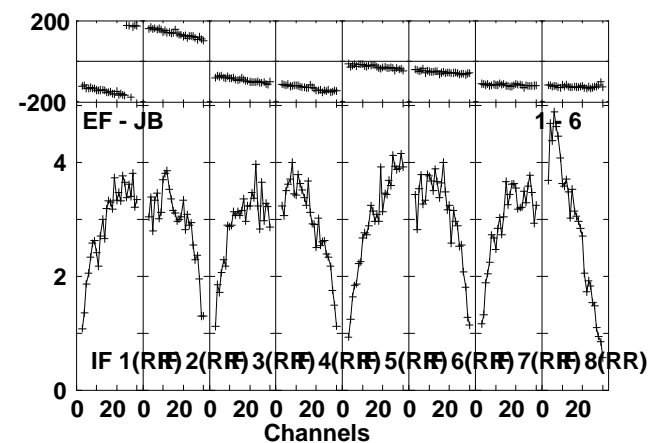
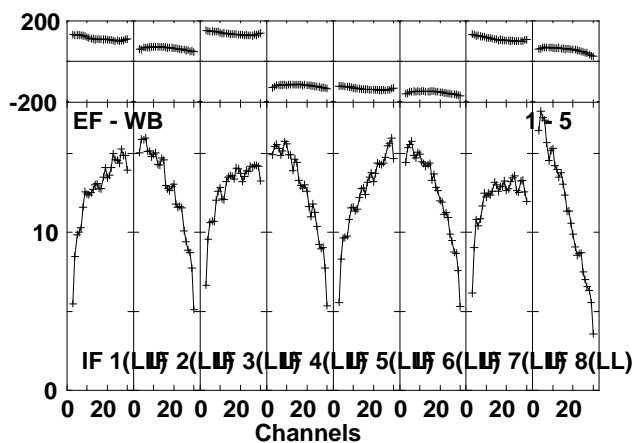
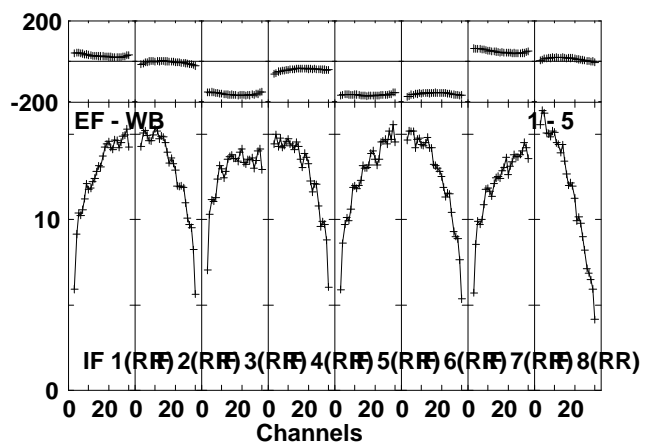
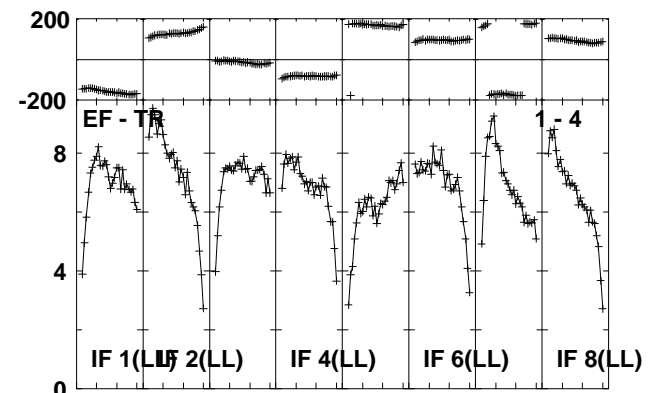
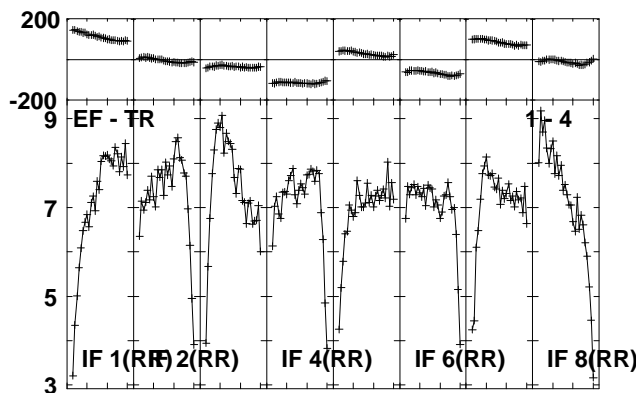
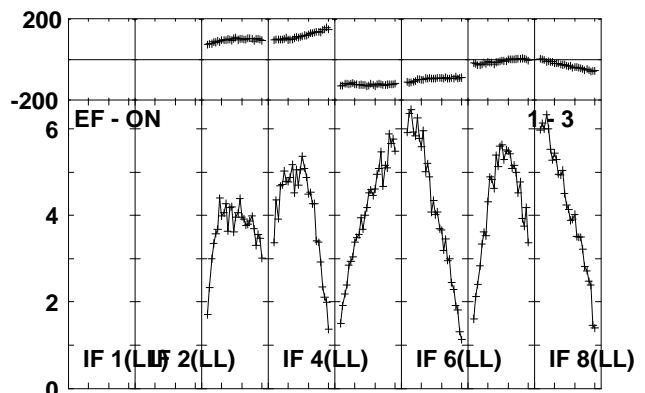
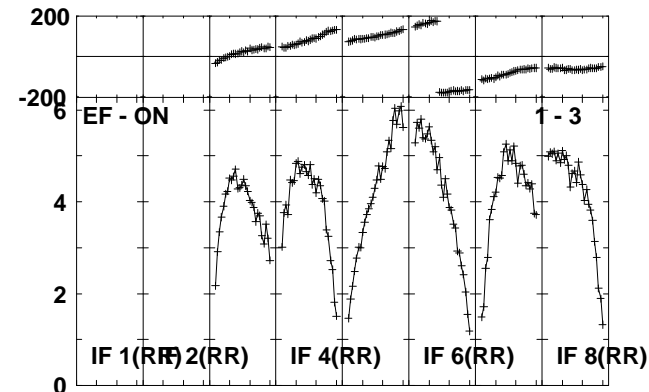
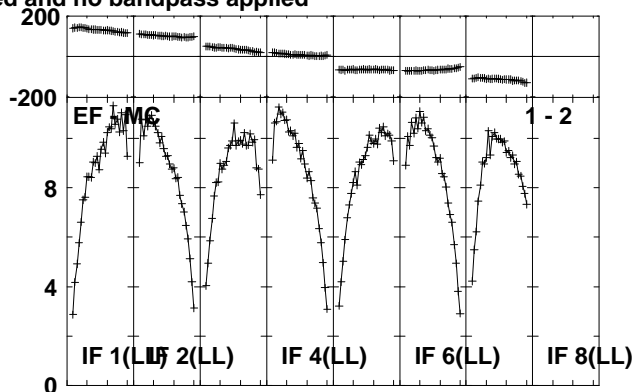
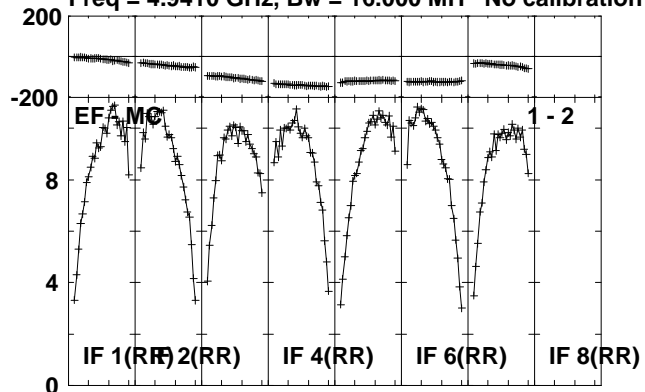

Lower frame: Milli Ampl Jy Top frame: Phas deg
Scalar averaged cross-power spectrum Several baselines displayed
Timerange: 00/15:55:41 to 00/15:56:39

Plot file version 106 created 04-OCT-2010 10:15:56
J1707-14 RP016A.UVDATA.1

Freq = 4.9410 GHz, Bw = 16.000 MH No calibration applied and no bandpass applied

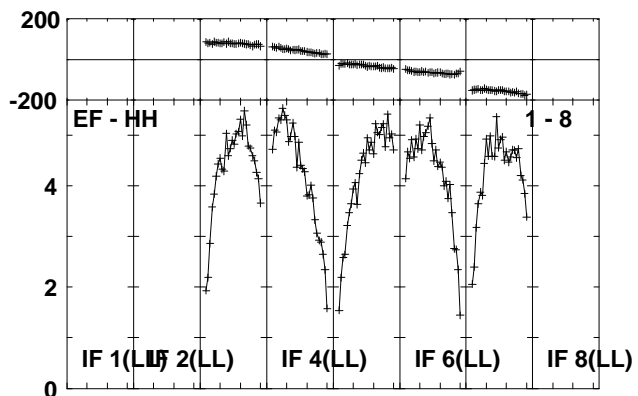
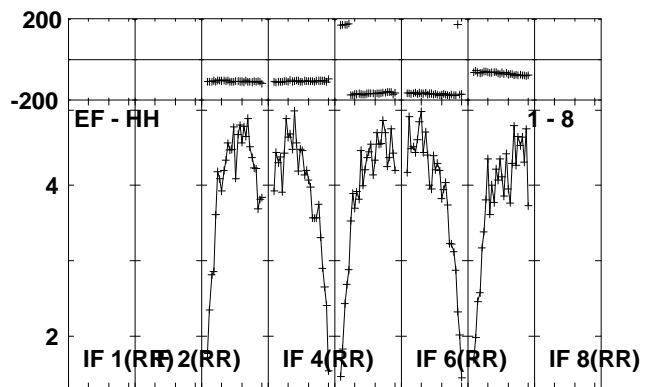
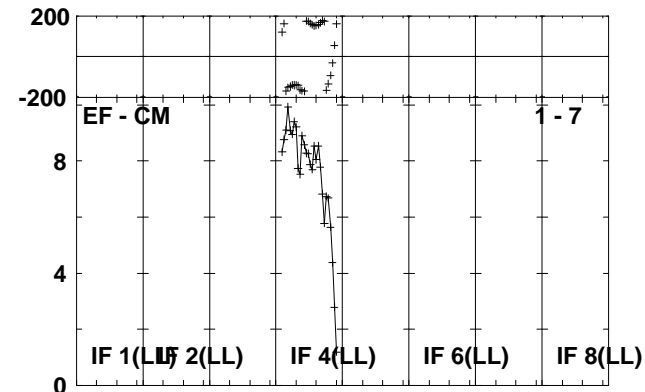
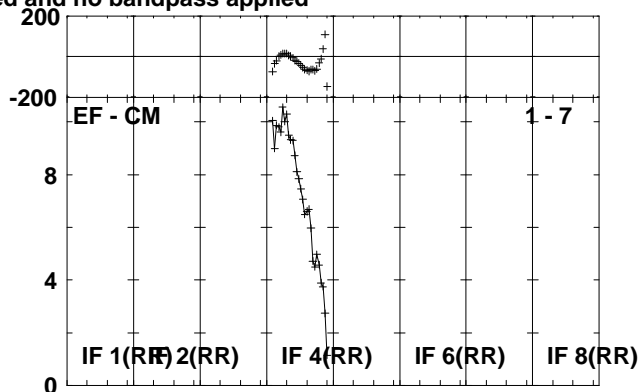
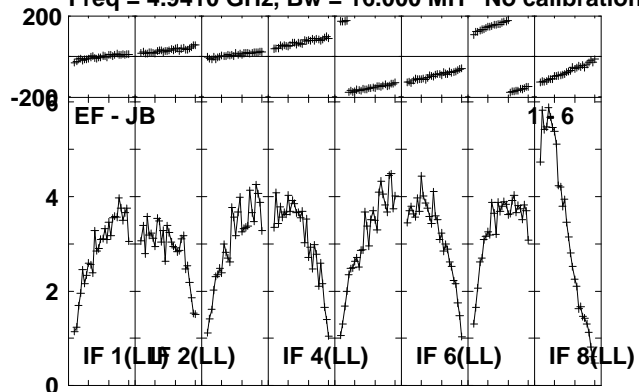

Lower frame: Milli Ampl Jy Top frame: Phas deg
Scalar averaged cross-power spectrum Several baselines displayed
Timerange: 00/15:55:41 to 00/15:56:39

Plot file version 107 created 04-OCT-2010 10:15:56

MAXI J16 RP016A.UVDATA.1

Freq = 4.9410 GHz, Bw = 16.000 MH No calibration applied and no bandpass applied

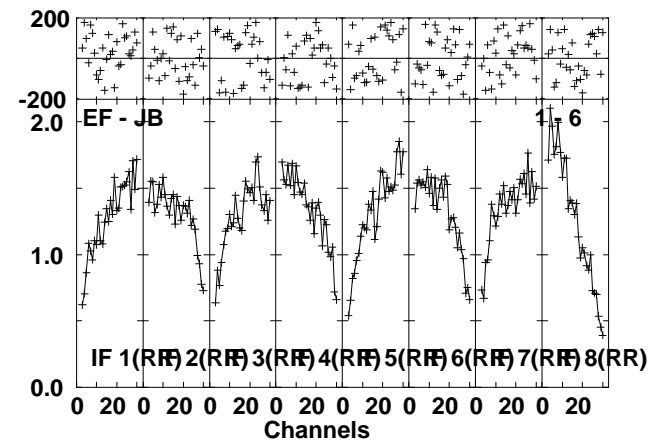
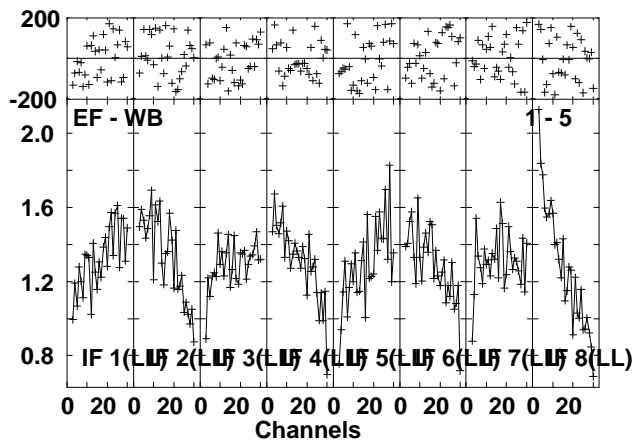
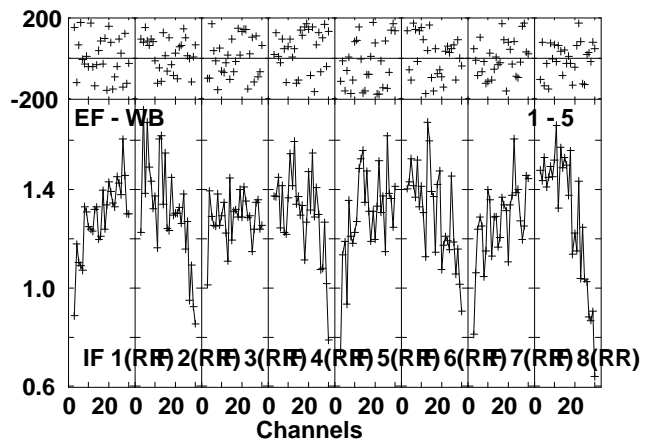
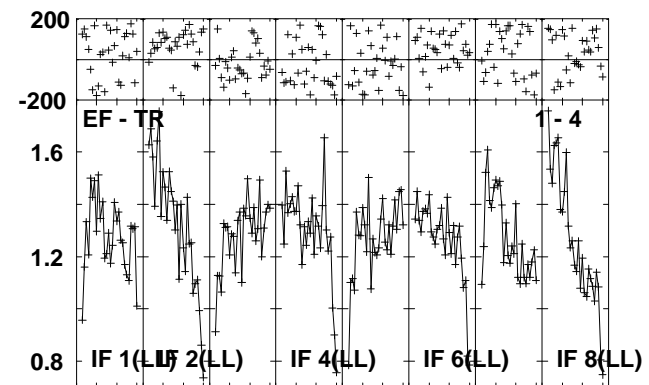
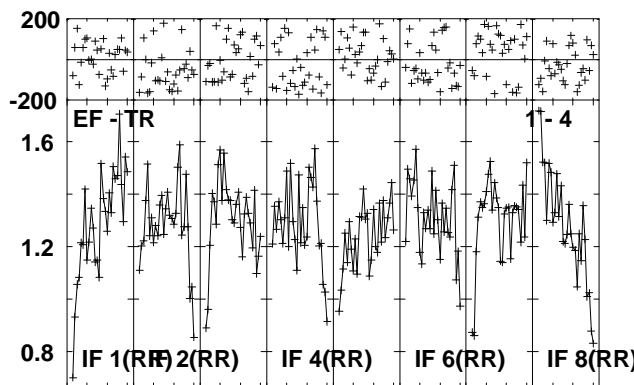
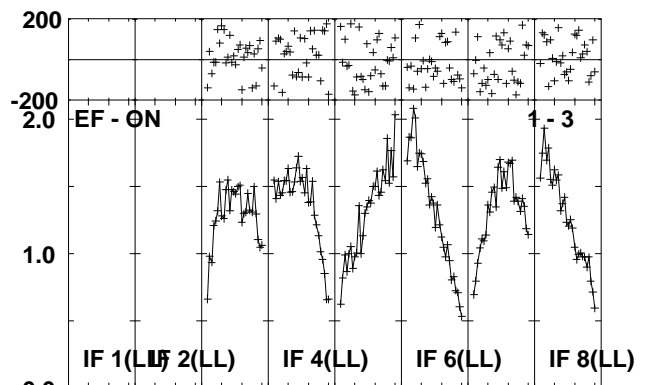
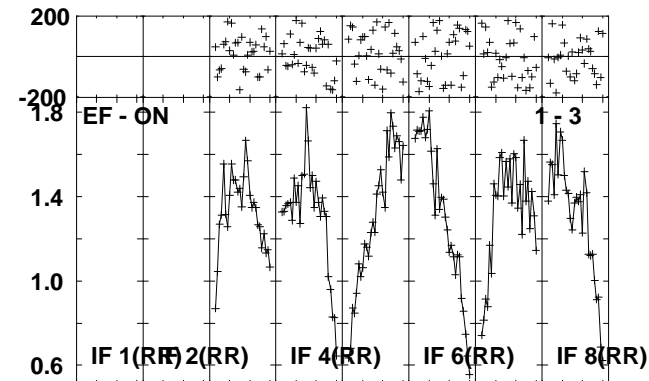
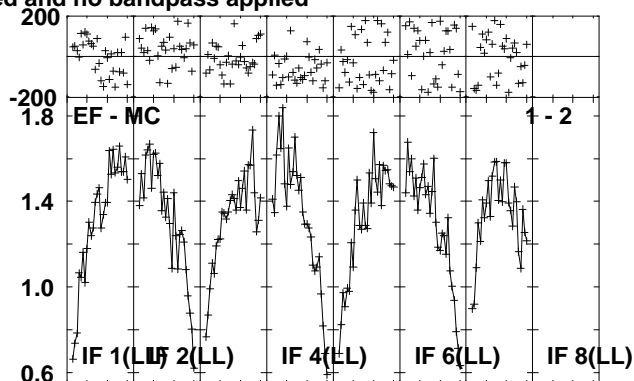
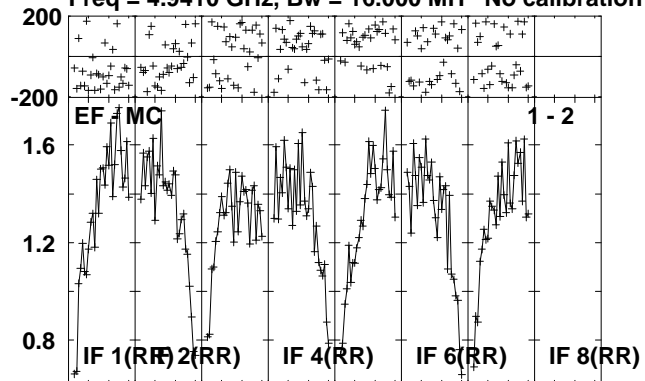

Lower frame: Milli Ampl Jy Top frame: Phas deg
Scalar averaged cross-power spectrum Several baselines displayed
Timerange: 00/15:56:41 to 00/15:59:09

Plot file version 108 created 04-OCT-2010 10:15:58

MAXI J16 RP016A.UVDATA.1

Freq = 4.9410 GHz, Bw = 16.000 MH No calibration applied and no bandpass applied

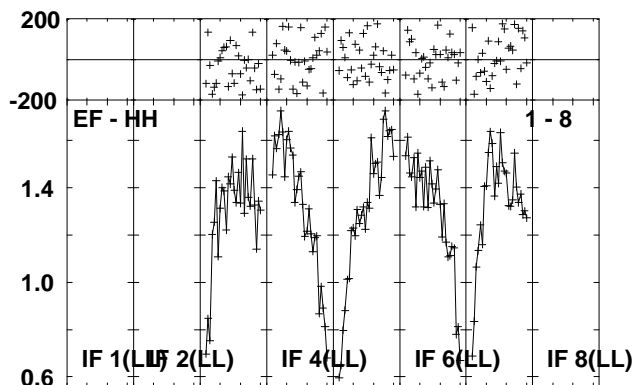
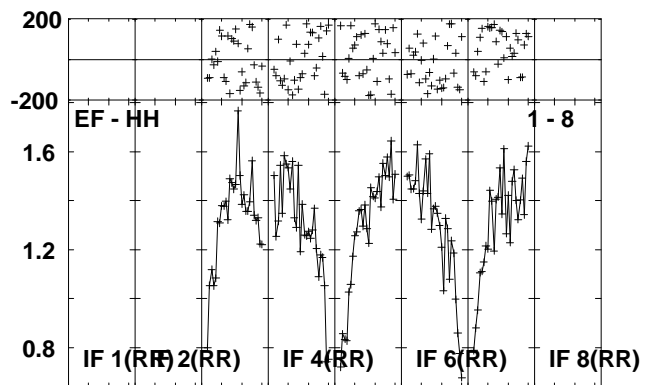
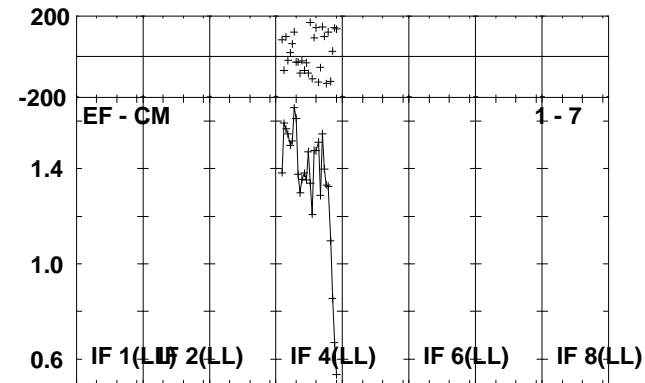
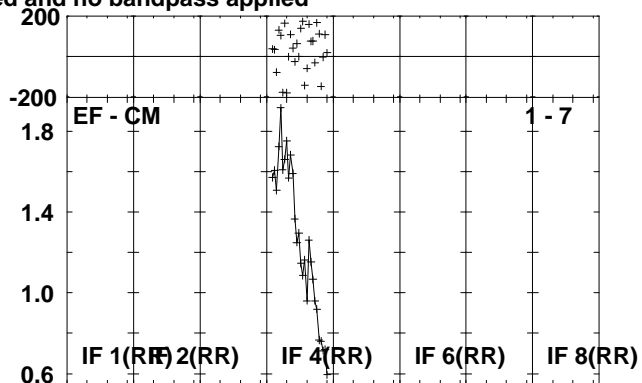
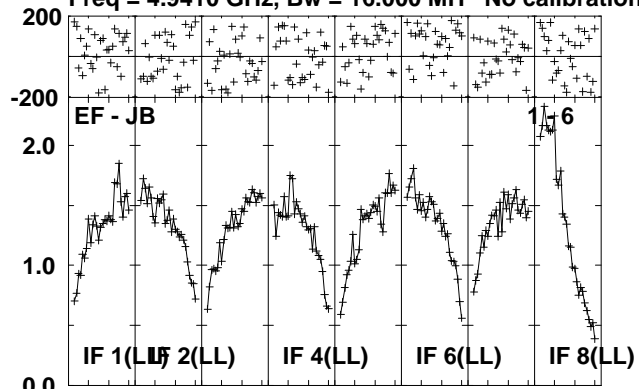

Lower frame: Milli Ampl Jy Top frame: Phas deg
Scalar averaged cross-power spectrum Several baselines displayed
Timerange: 00/15:56:41 to 00/15:59:09

Plot file version 109 created 04-OCT-2010 10:15:59

J1707-14 RP016A.UVDATA.1

Freq = 4.9410 GHz, Bw = 16.000 MH No calibration applied and no bandpass applied

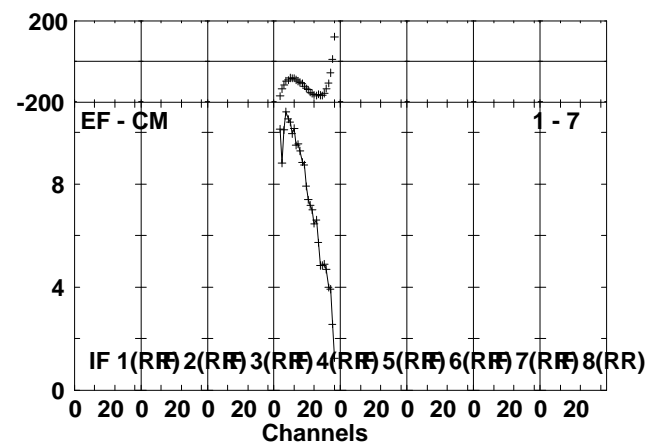
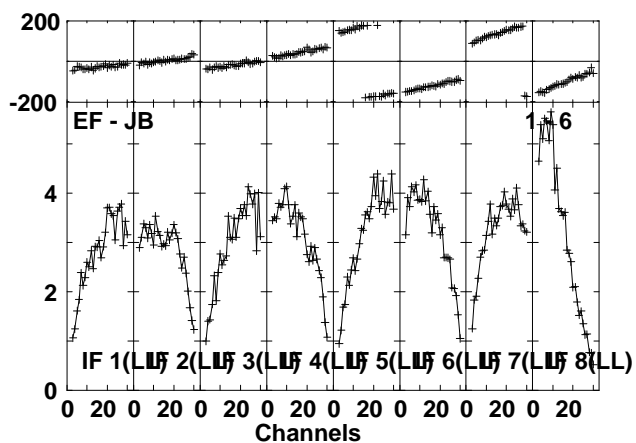
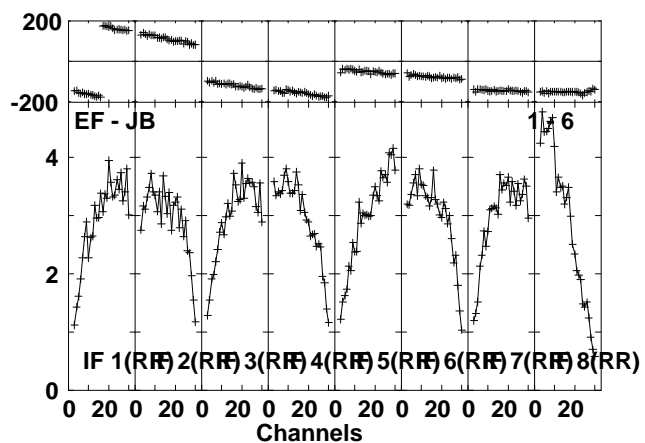
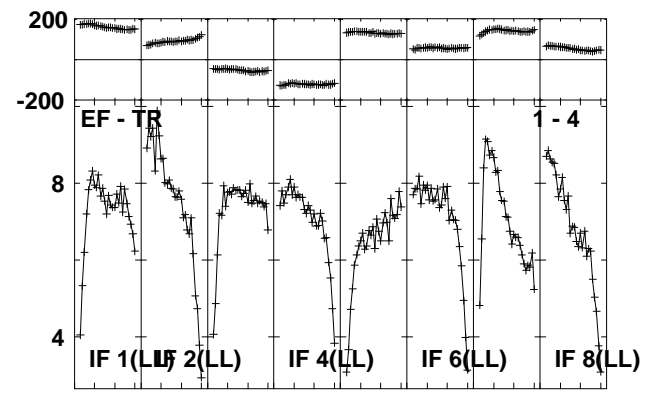
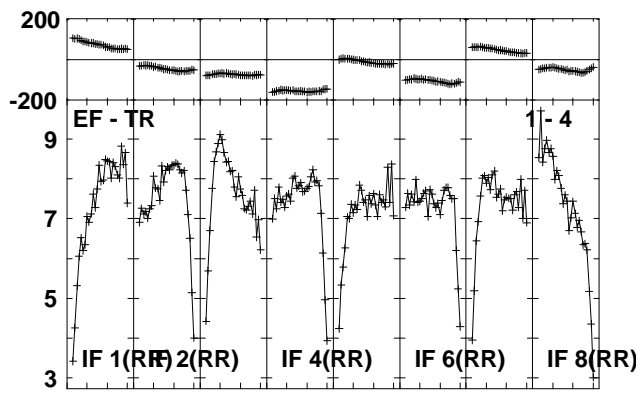
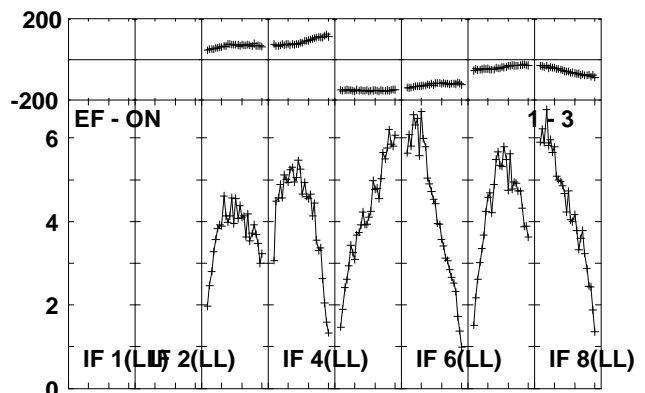
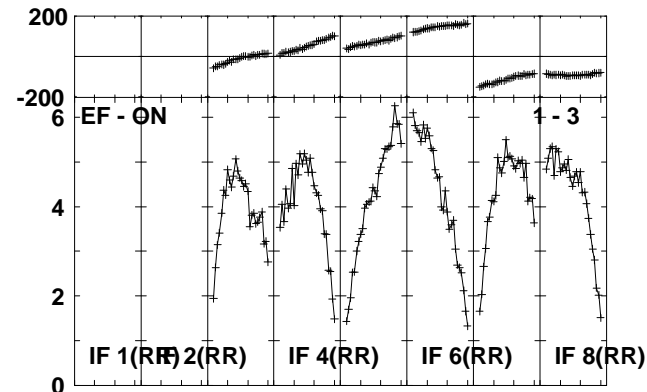
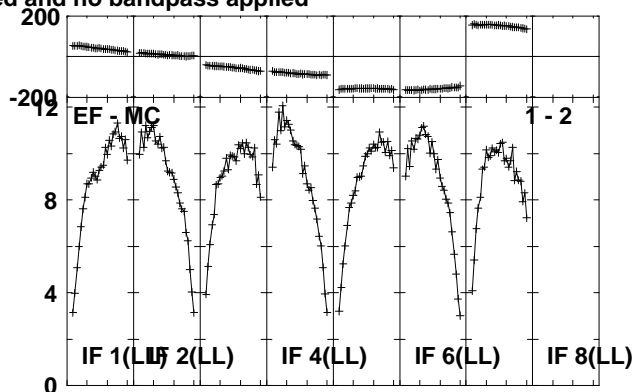
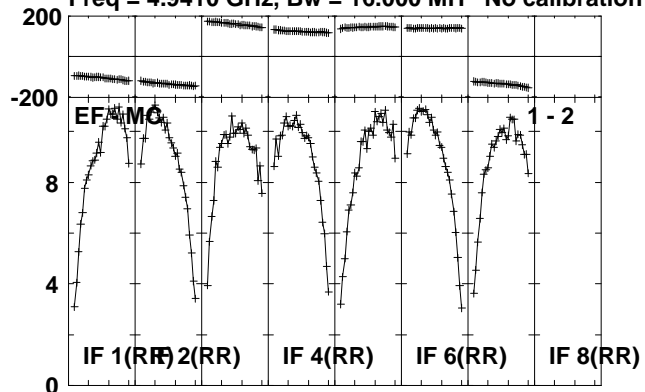

Lower frame: Milli Ampl Jy Top frame: Phas deg
Scalar averaged cross-power spectrum Several baselines displayed
Timerange: 00/15:59:11 to 00/16:00:39

Plot file version 110 created 04-OCT-2010 10:16:00
J1707-14 RP016A.UVDATA.1
Freq = 4.9410 GHz, Bw = 16.000 MH No calibration applied and no bandpass applied

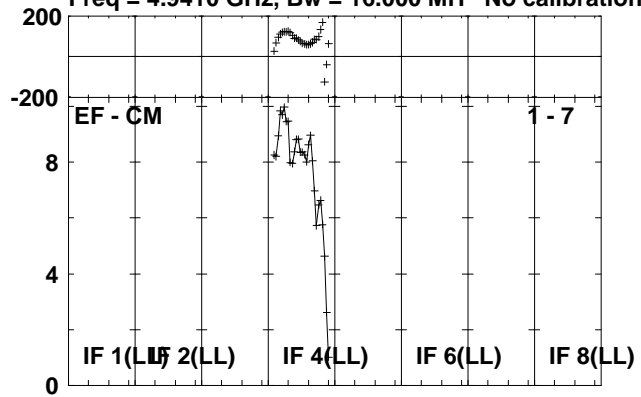

Lower frame: Milli Ampl Jy Top frame: Phas deg
Scalar averaged cross-power spectrum Several baselines displayed
Timerange: 00/15:59:11 to 00/16:00:39

Plot file version 111 created 04-OCT-2010 10:16:00

MAXI J16 RP016A.UVDATA.1

Freq = 4.9410 GHz, Bw = 16.000 MH No calibration applied and no bandpass applied

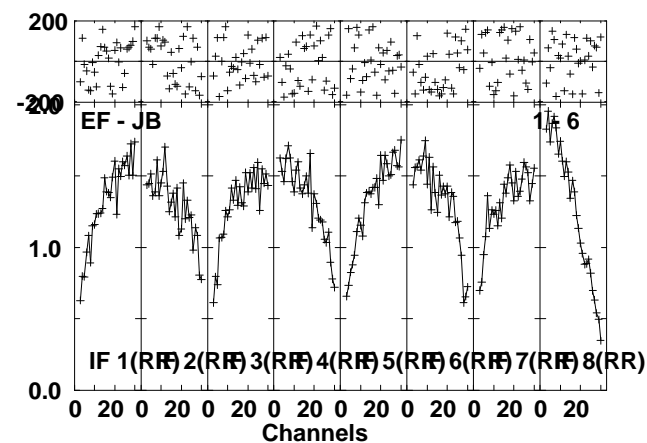
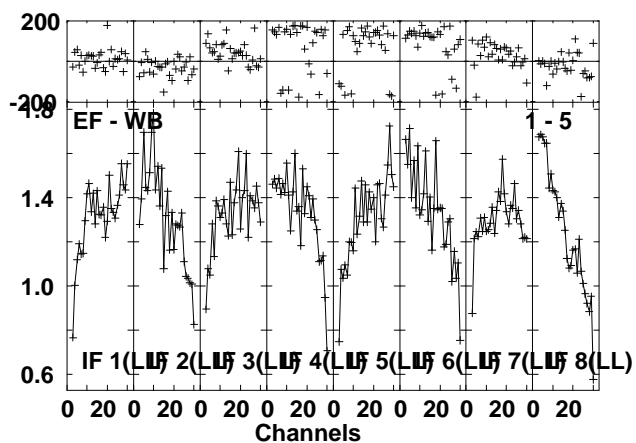
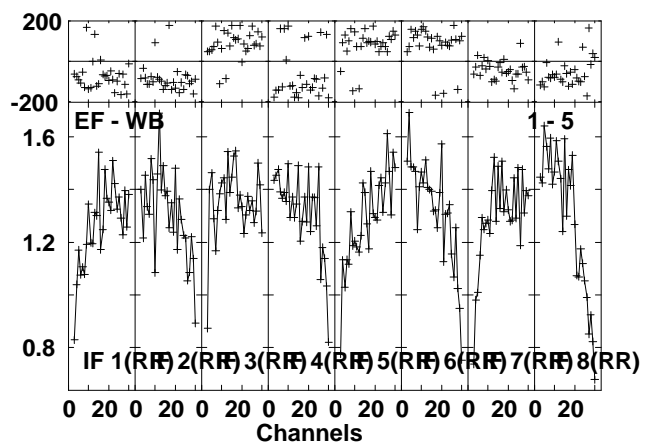
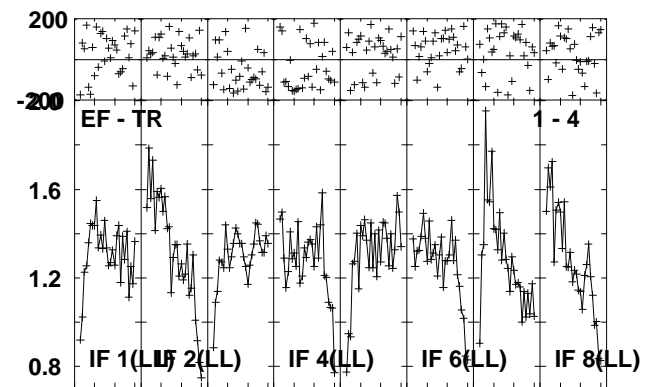
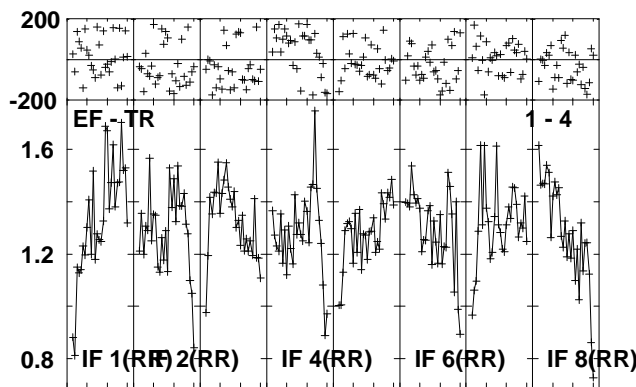
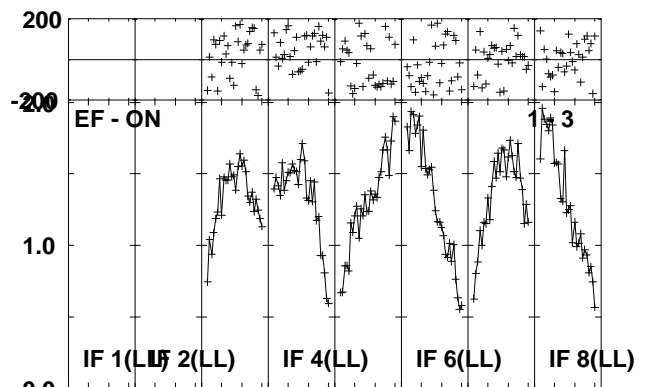
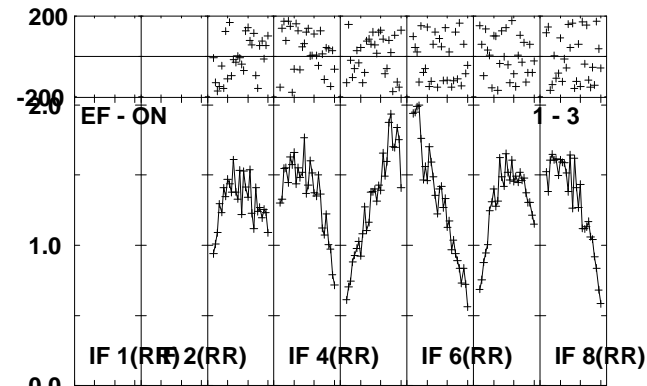
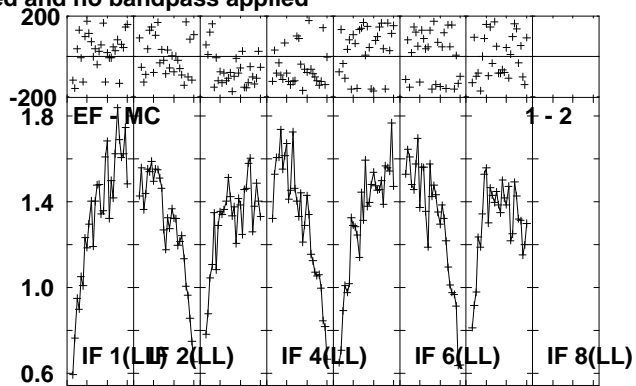
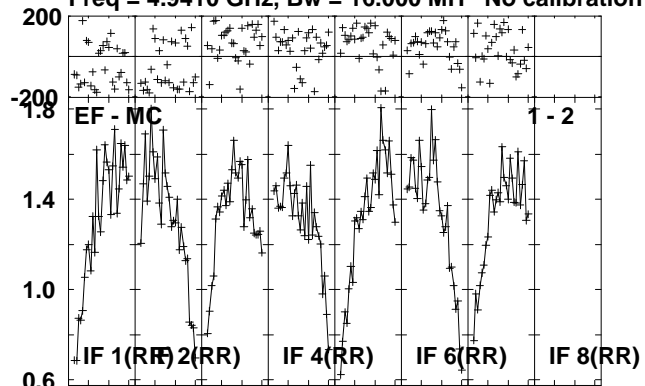

Lower frame: Milli Ampl Jy Top frame: Phas deg
Scalar averaged cross-power spectrum Several baselines displayed
Timerange: 00/16:00:41 to 00/16:03:09

Plot file version 112 created 04-OCT-2010 10:16:01

MAXI J16 RP016A.UVDATA.1

Freq = 4.9410 GHz, Bw = 16.000 MH No calibration applied and no bandpass applied

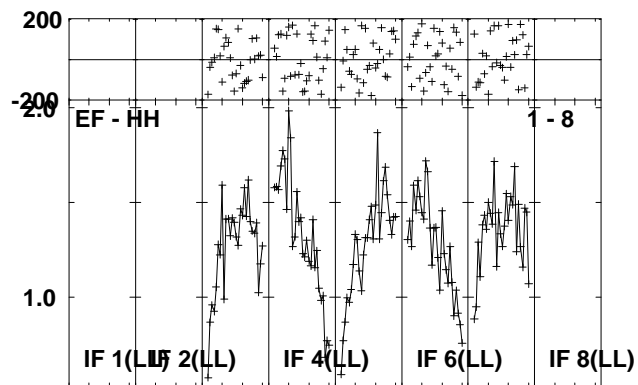
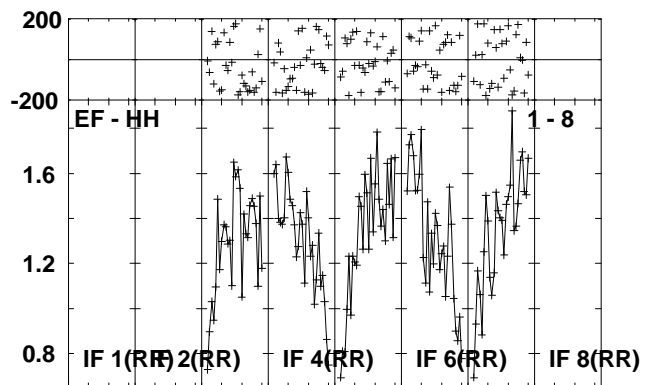
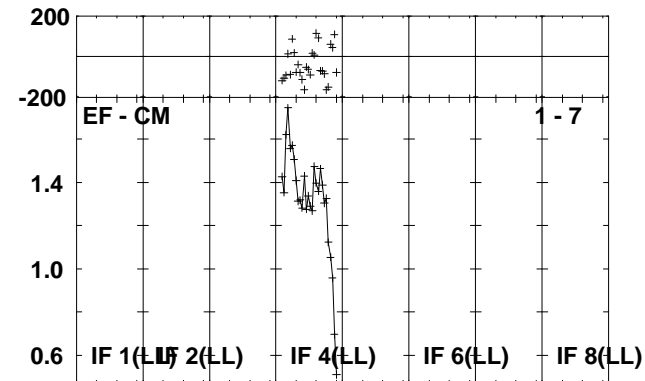
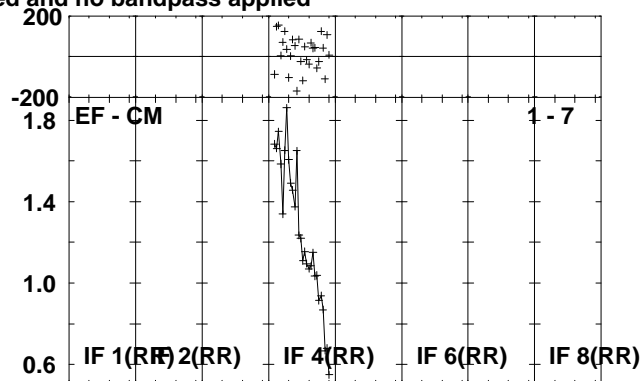
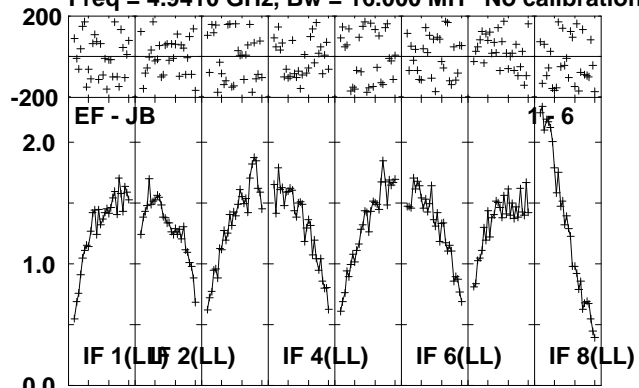

Lower frame: Milli Ampl Jy Top frame: Phas deg
Scalar averaged cross-power spectrum Several baselines displayed
Timerange: 00/16:00:41 to 00/16:03:09

Plot file version 113 created 04-OCT-2010 10:16:02

J1707-14 RP016A.UVDATA.1

Freq = 4.9410 GHz, Bw = 16.000 MH No calibration applied and no bandpass applied

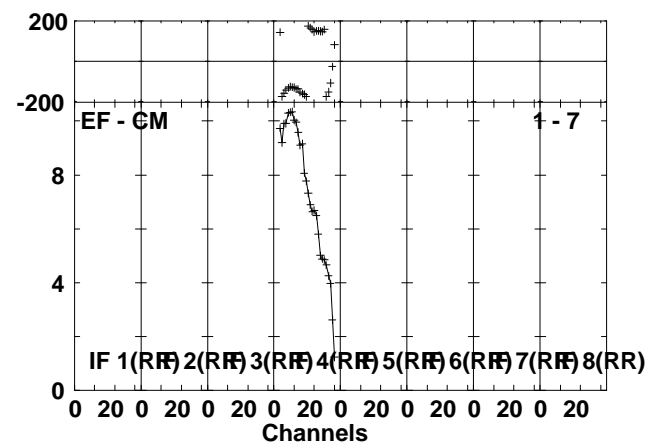
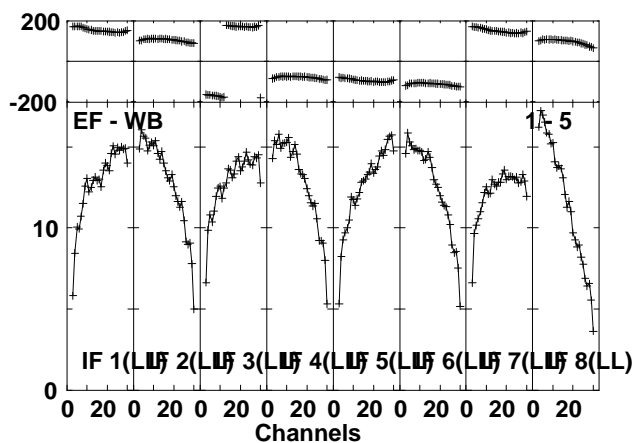
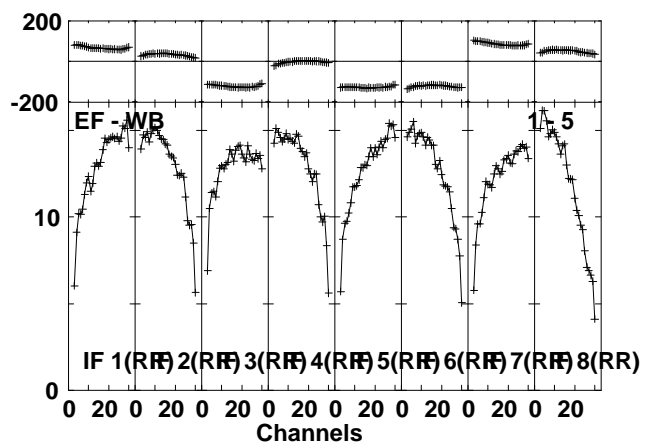
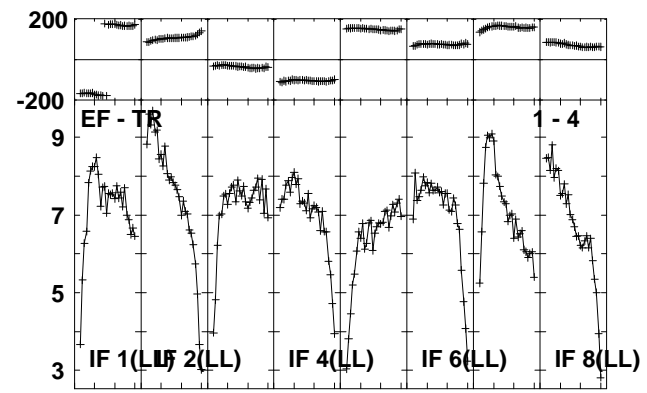
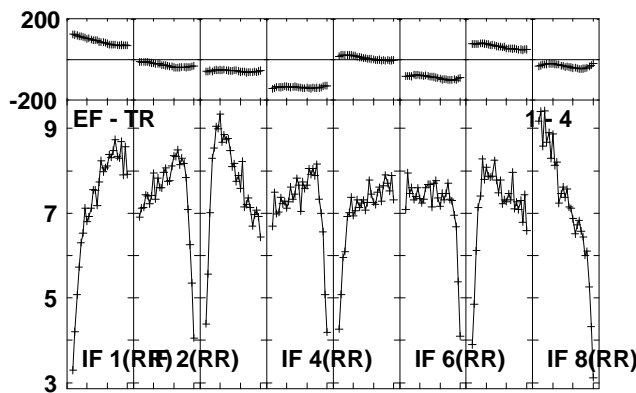
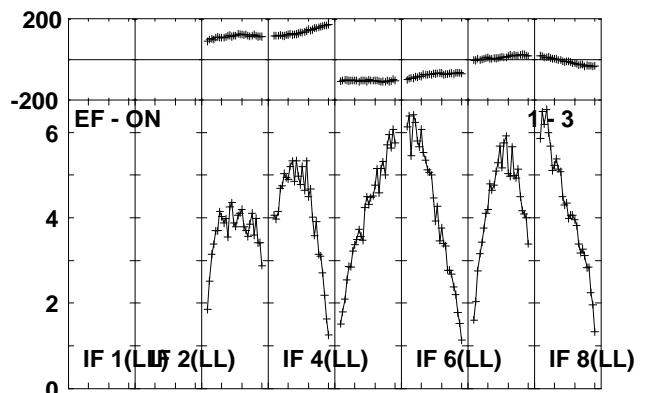
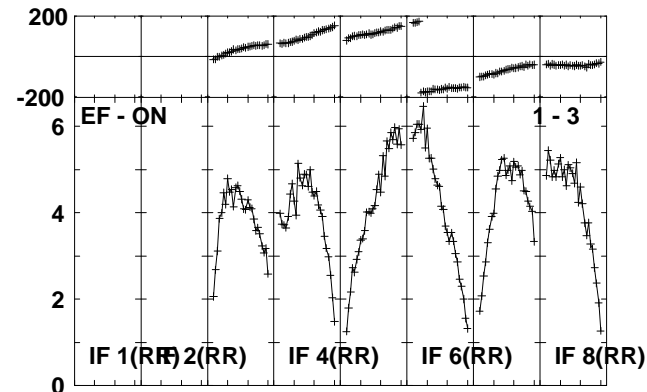
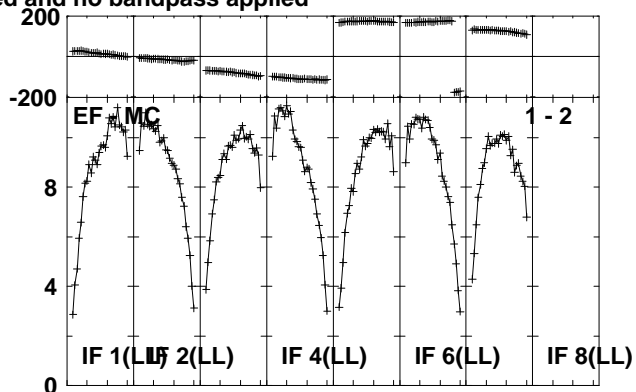
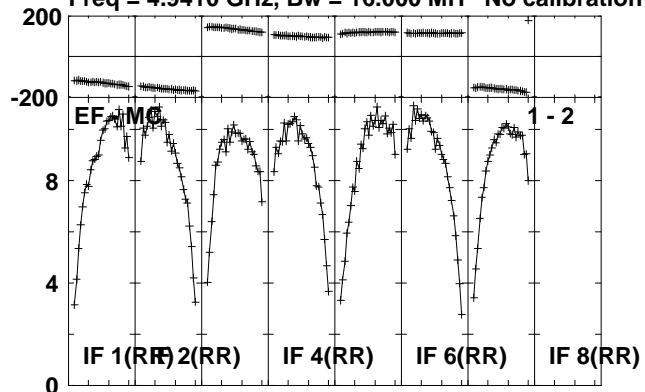

Lower frame: Milli Ampl Jy Top frame: Phas deg
Scalar averaged cross-power spectrum Several baselines displayed
Timerange: 00/16:03:51 to 00/16:04:49

Plot file version 114 created 04-OCT-2010 10:16:03

J1707-14 RP016A.UVDATA.1

Freq = 4.9410 GHz, Bw = 16.000 MH No calibration applied and no bandpass applied

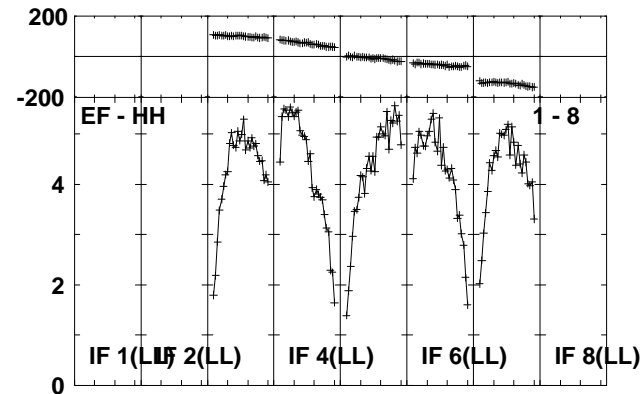
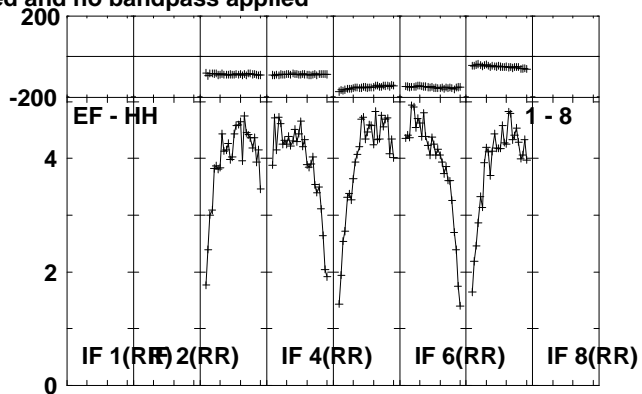
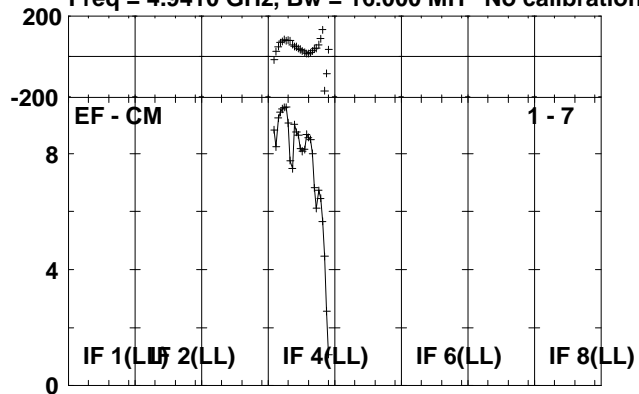

Lower frame: Milli Ampl Jy Top frame: Phas deg
Scalar averaged cross-power spectrum Several baselines displayed
Timerange: 00/16:03:51 to 00/16:04:49

Plot file version 115 created 04-OCT-2010 10:16:03

NVSS3 RP016A.UVDATA.1

Freq = 4.9410 GHz, Bw = 16.000 MH No calibration applied and no bandpass applied

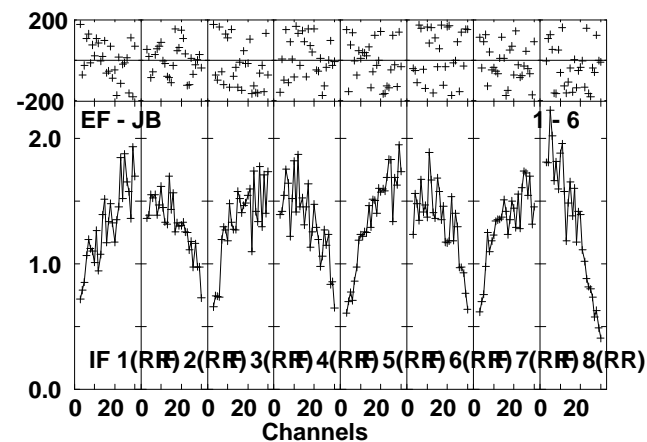
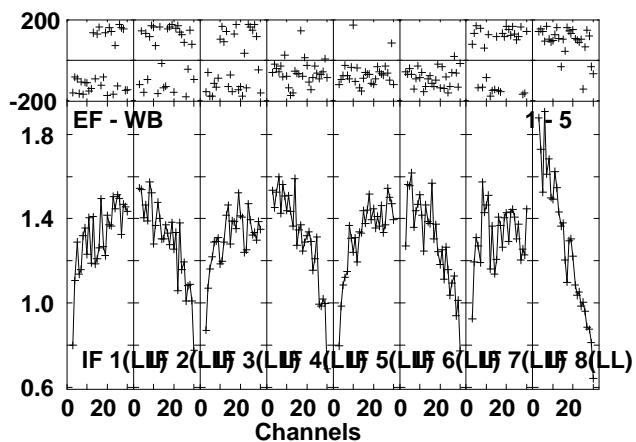
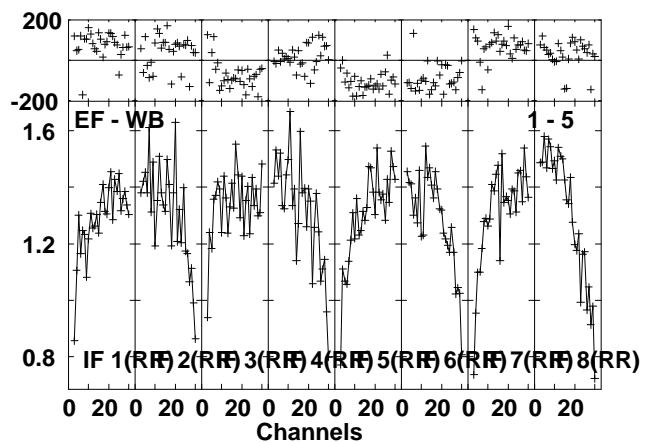
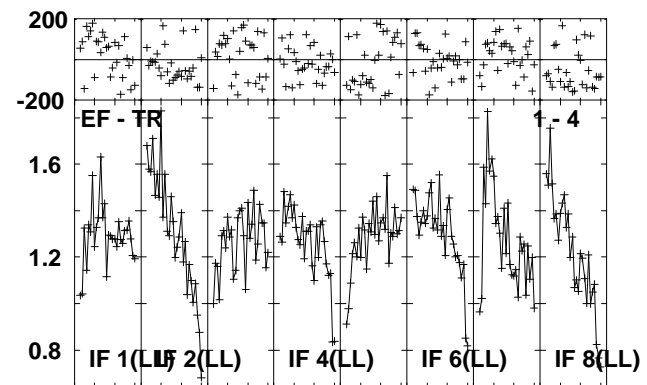
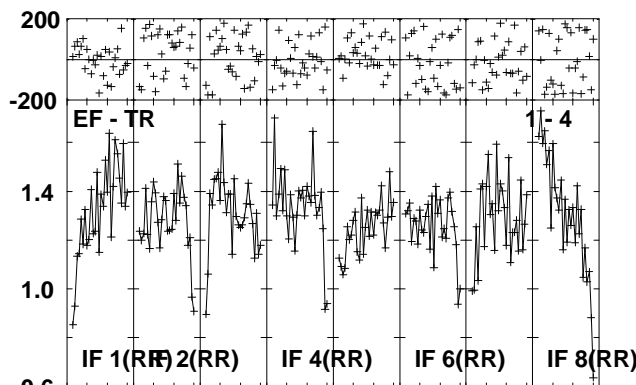
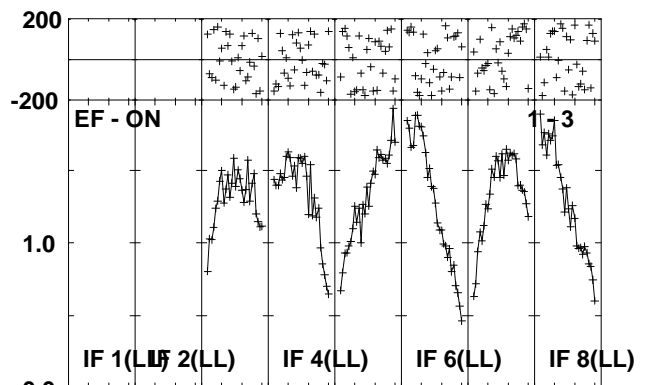
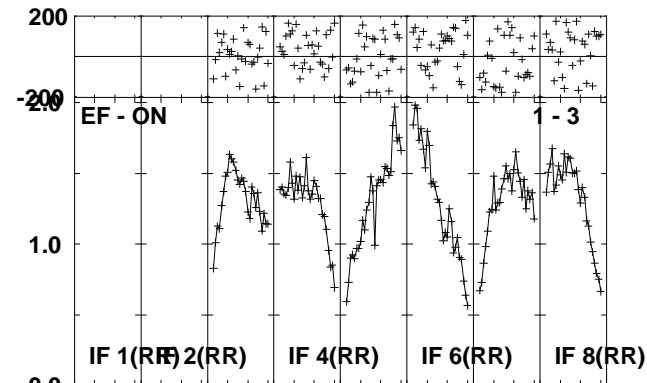
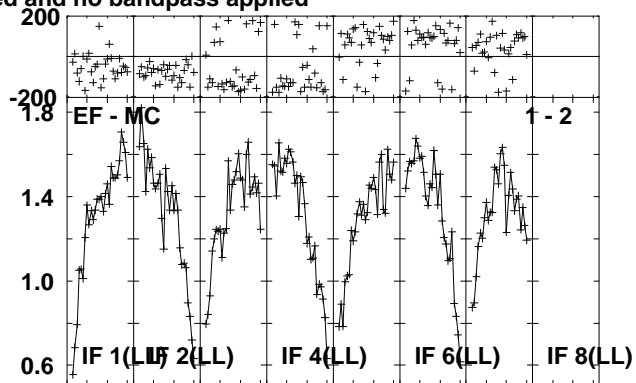
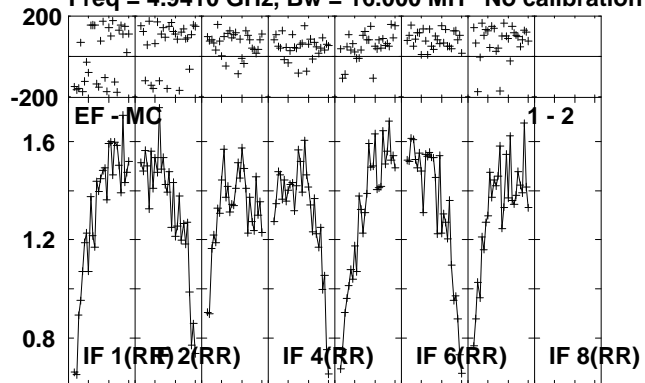

Lower frame: Milli Ampl Jy Top frame: Phas deg
Scalar averaged cross-power spectrum Several baselines displayed
Timerange: 00:16:04:51 to 00:16:07:19

Plot file version 116 created 04-OCT-2010 10:16:05

NVSS3 RP016A.UVDATA.1

Freq = 4.9410 GHz, Bw = 16.000 MH No calibration applied and no bandpass applied

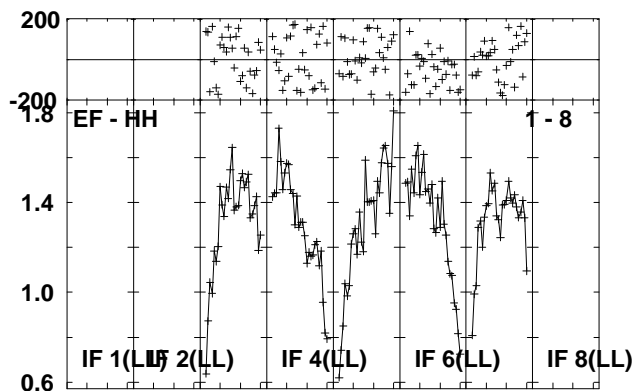
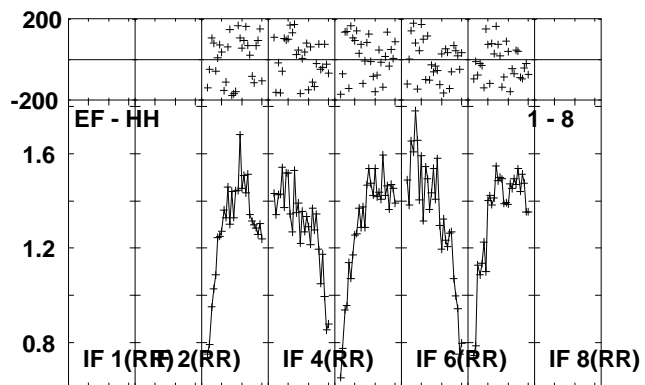
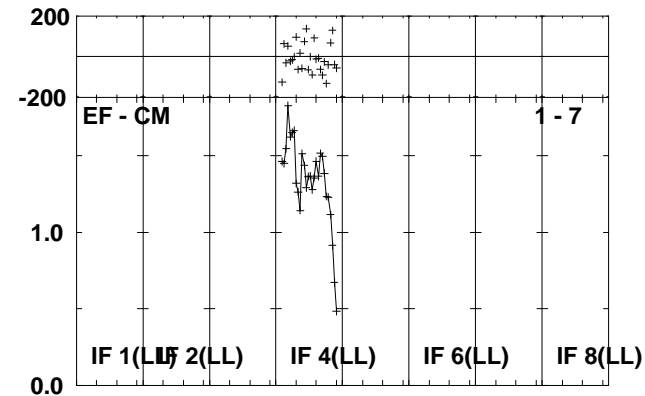
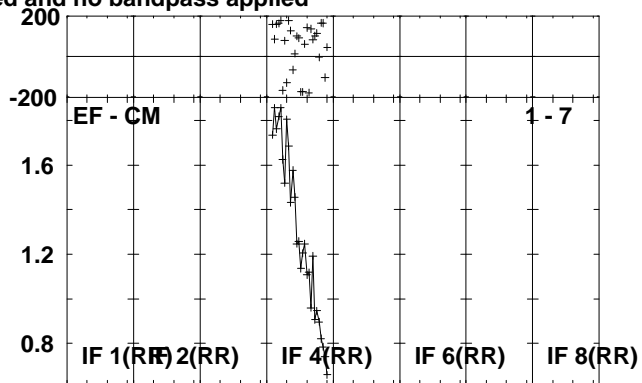
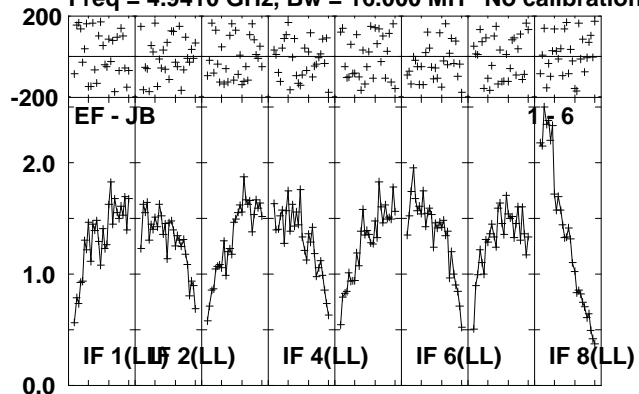

Lower frame: Milli Ampl Jy Top frame: Phas deg
Scalar averaged cross-power spectrum Several baselines displayed
Timerange: 00/16:04:51 to 00/16:07:19

Plot file version 117 created 04-OCT-2010 10:16:06

J1707-14 RP016A.UVDATA.1

Freq = 4.9410 GHz, Bw = 16.000 MH No calibration applied and no bandpass applied

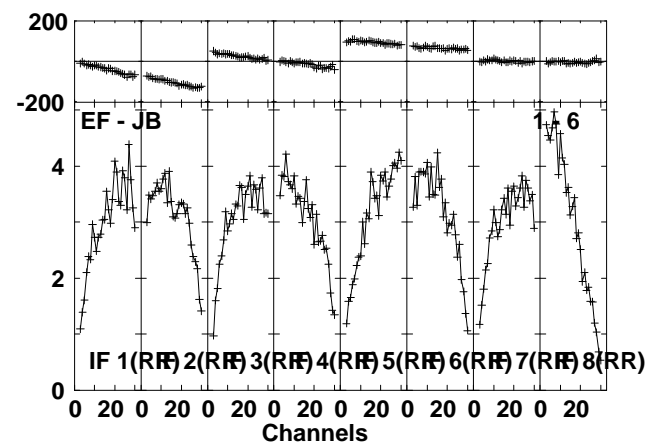
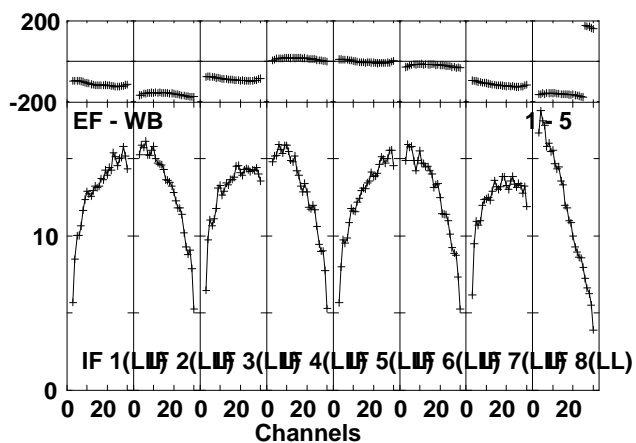
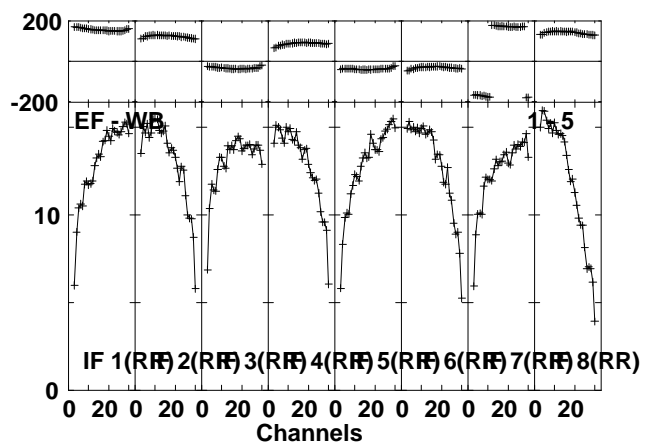
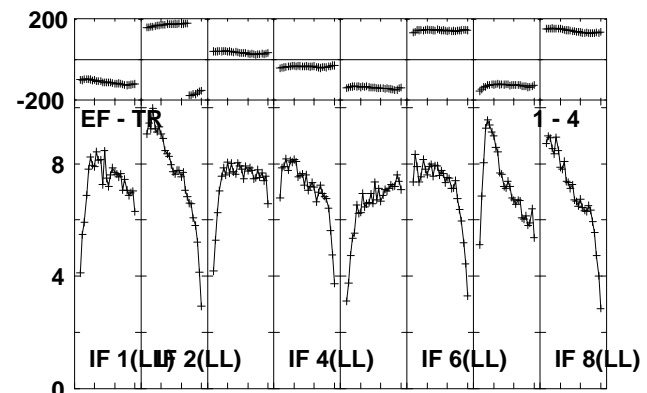
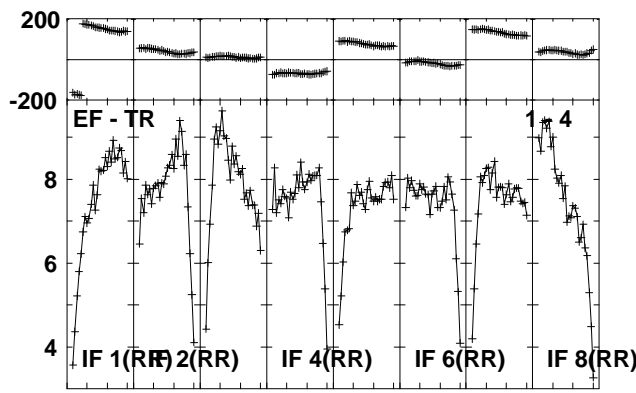
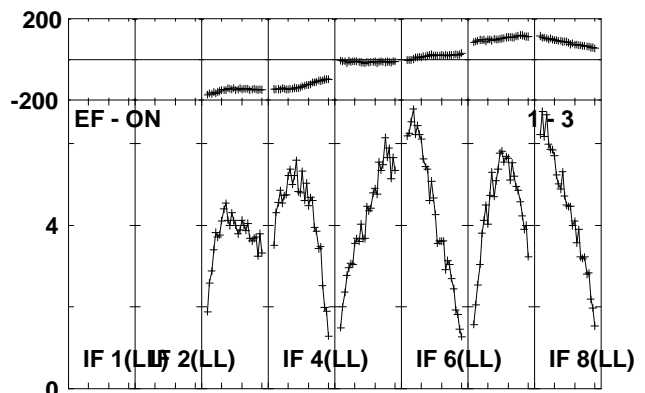
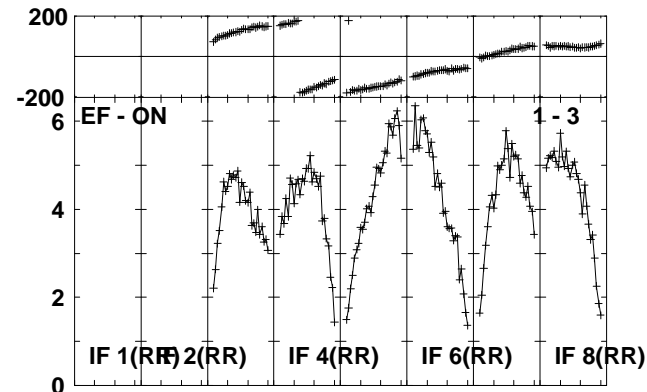
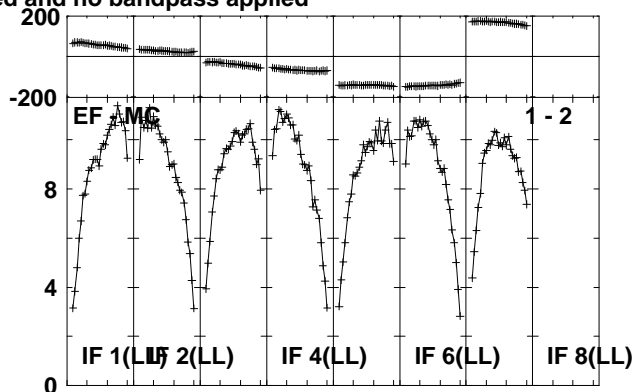
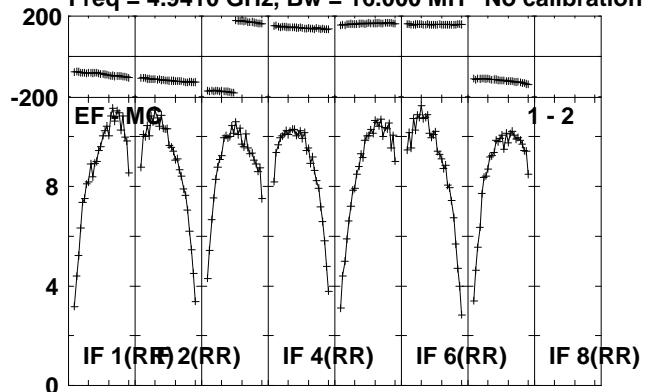

Lower frame: Milli Ampl Jy Top frame: Phas deg
Scalar averaged cross-power spectrum Several baselines displayed
Timerange: 00/16:07:21 to 00/16:08:49

Plot file version 118 created 04-OCT-2010 10:16:07
J1707-14 RP016A.UVDATA.1

Freq = 4.9410 GHz, Bw = 16.000 MH No calibration applied and no bandpass applied

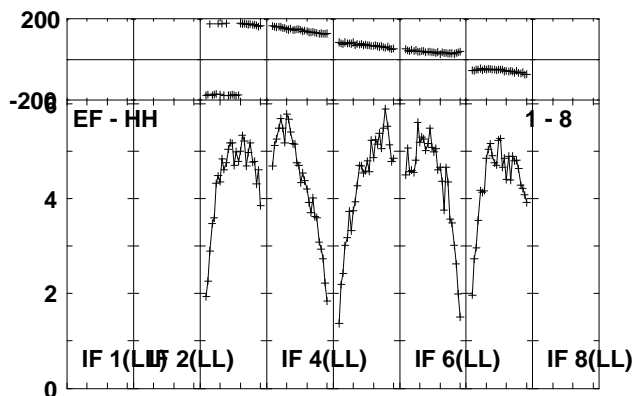
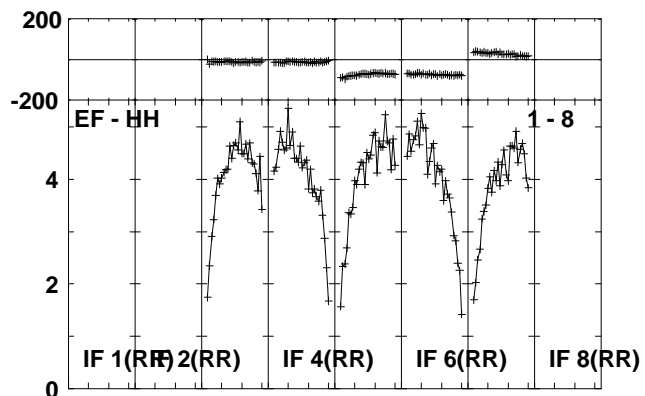
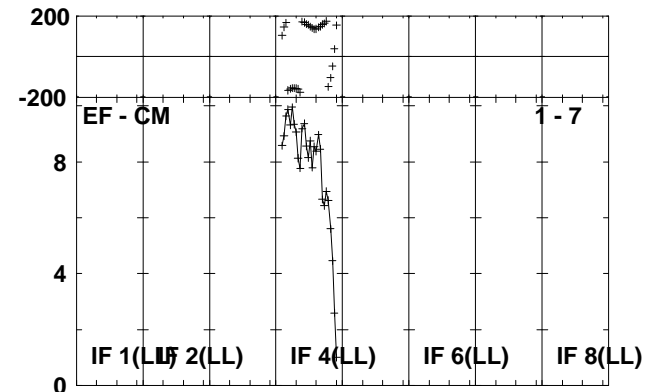
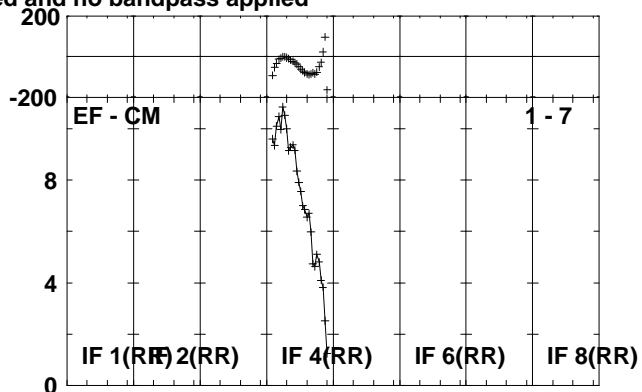
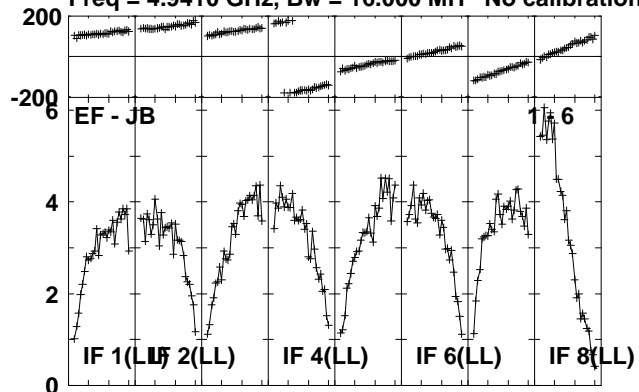

Lower frame: Milli Ampl Jy Top frame: Phas deg
Scalar averaged cross-power spectrum Several baselines displayed
Timerange: 00/16:07:21 to 00/16:08:49

Plot file version 119 created 04-OCT-2010 10:16:08

MAXI J16 RP016A.UVDATA.1

Freq = 4.9410 GHz, Bw = 16.000 MH No calibration applied and no bandpass applied

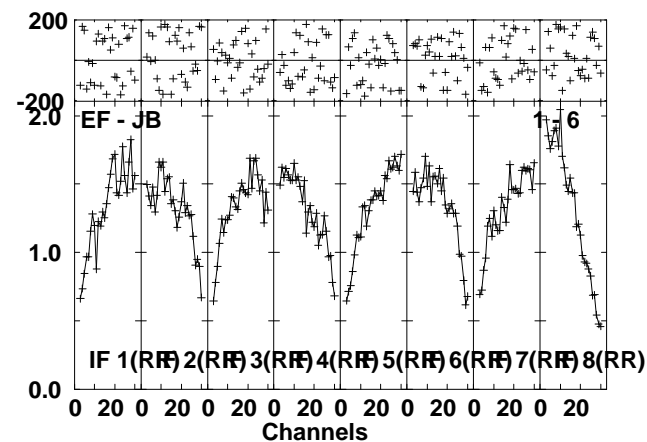
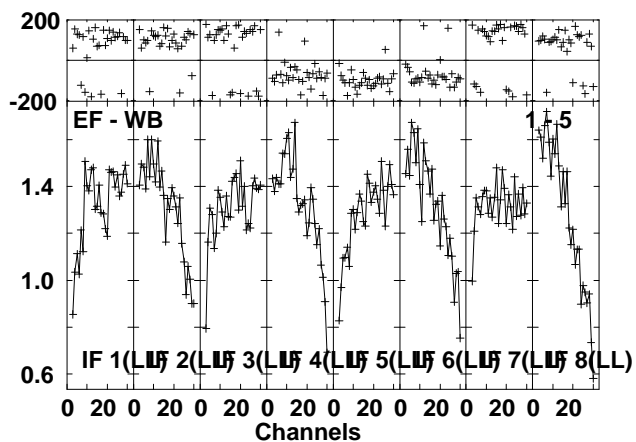
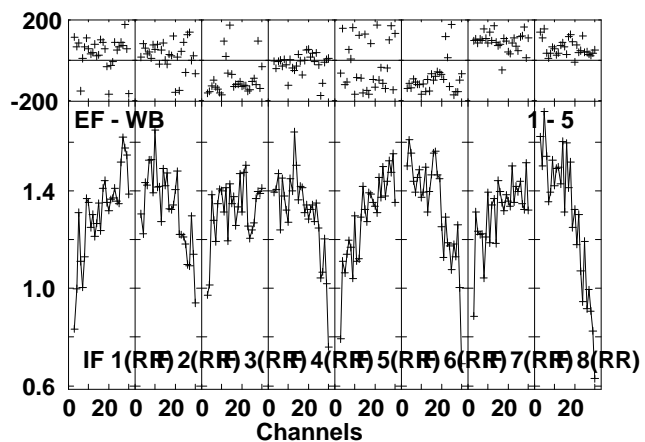
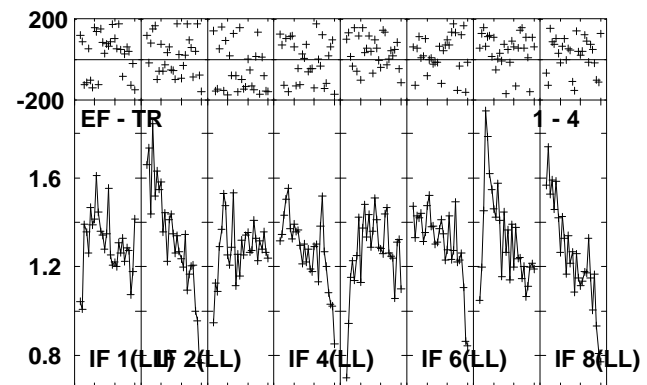
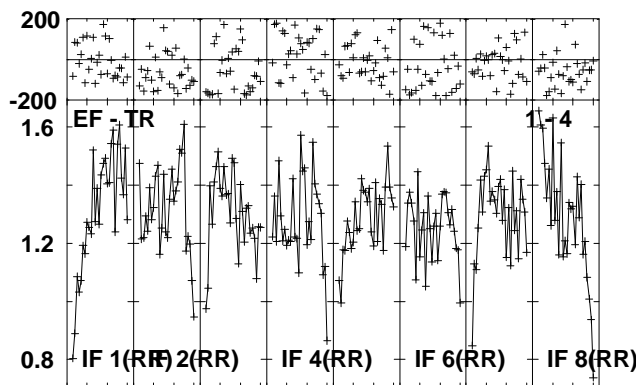
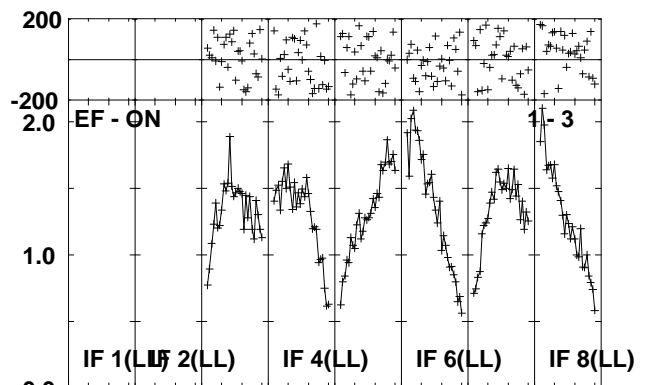
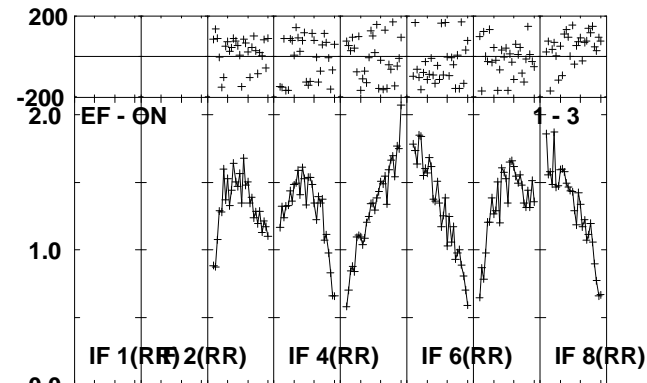
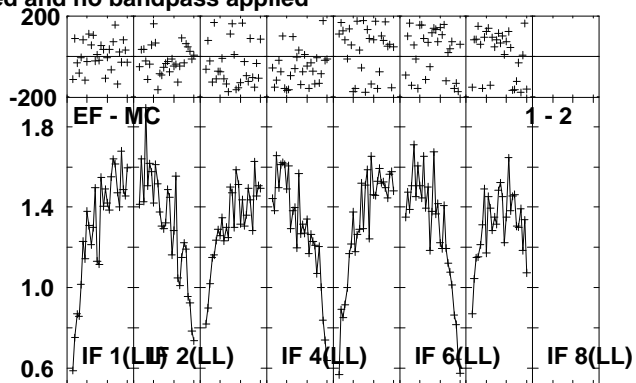
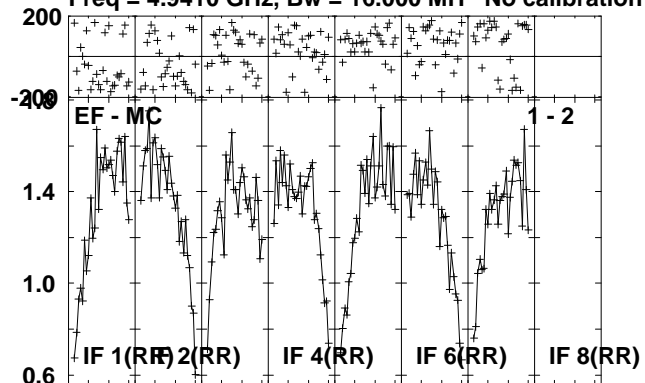

Lower frame: Milli Ampl Jy Top frame: Phas deg
Scalar averaged cross-power spectrum Several baselines displayed
Timerange: 00/16:08:51 to 00/16:11:19

Plot file version 120 created 04-OCT-2010 10:16:09

MAXI J16 RP016A.UVDATA.1

Freq = 4.9410 GHz, Bw = 16.000 MH No calibration applied and no bandpass applied

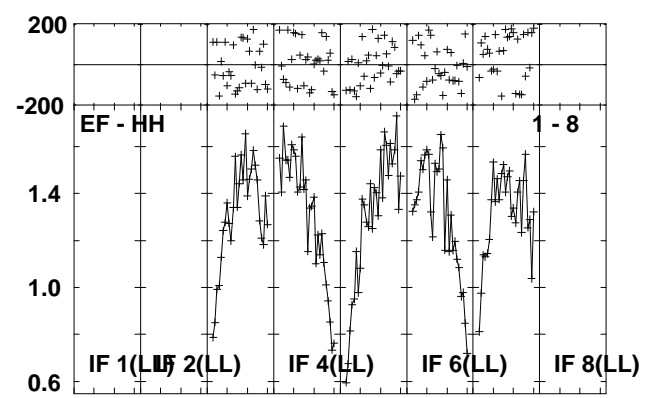
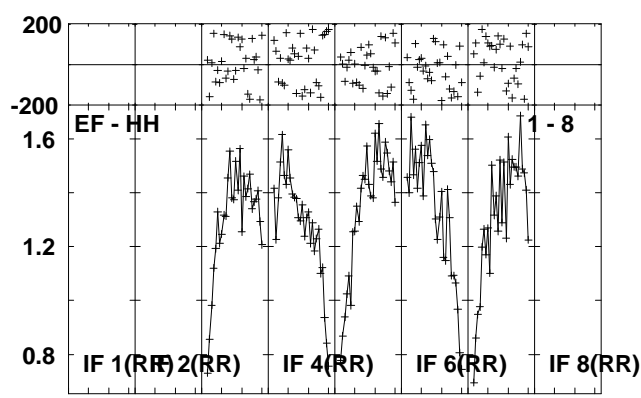
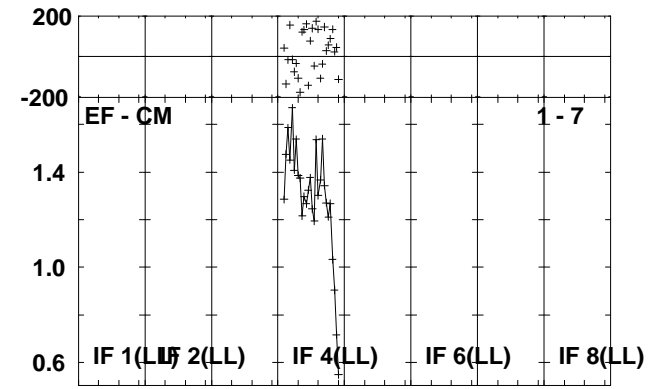
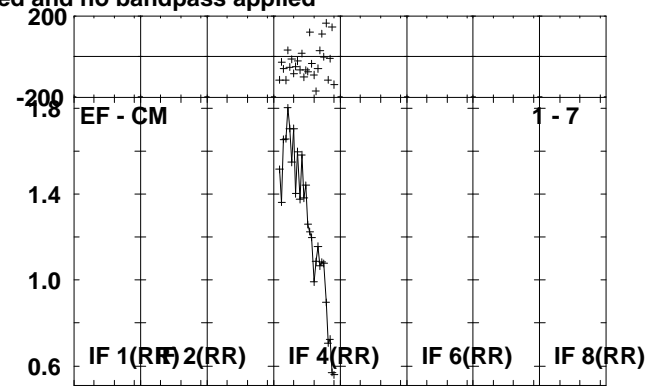
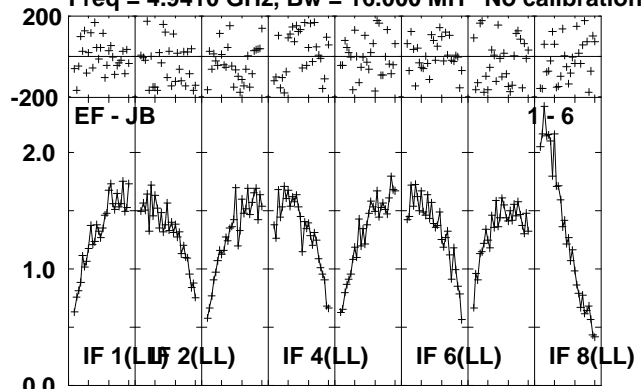

Lower frame: Milli Ampl Jy Top frame: Phas deg
Scalar averaged cross-power spectrum Several baselines displayed
Timerange: 00/16:08:51 to 00/16:11:19

Plot file version 121 created 04-OCT-2010 10:16:10

J1707-14 RP016A.UVDATA.1

Freq = 4.9410 GHz, Bw = 16.000 MH No calibration applied and no bandpass applied

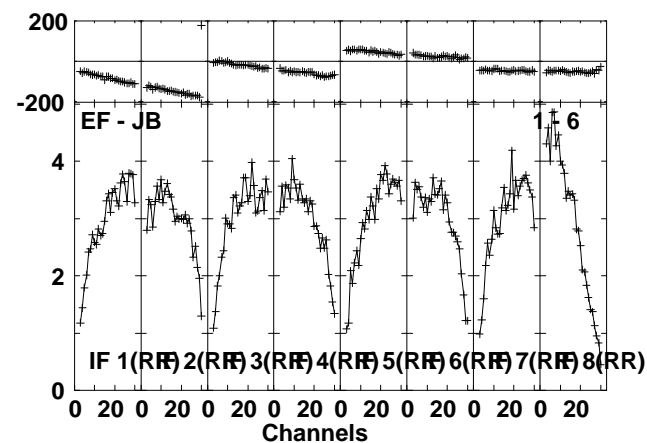
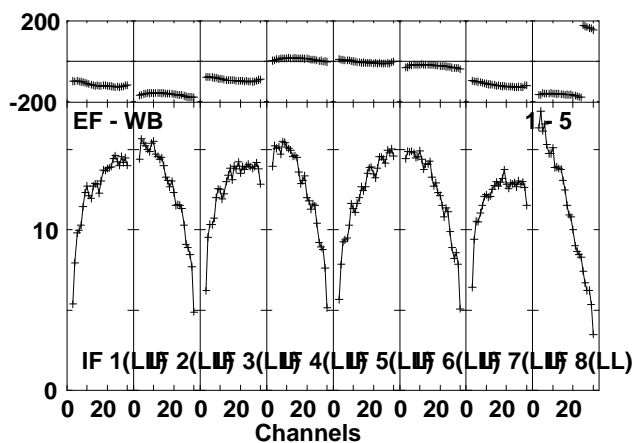
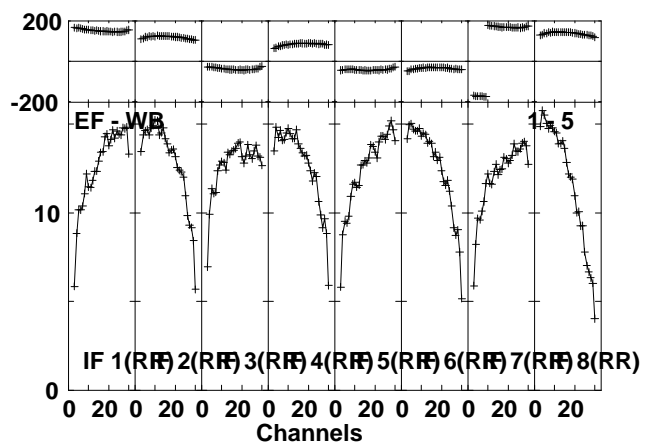
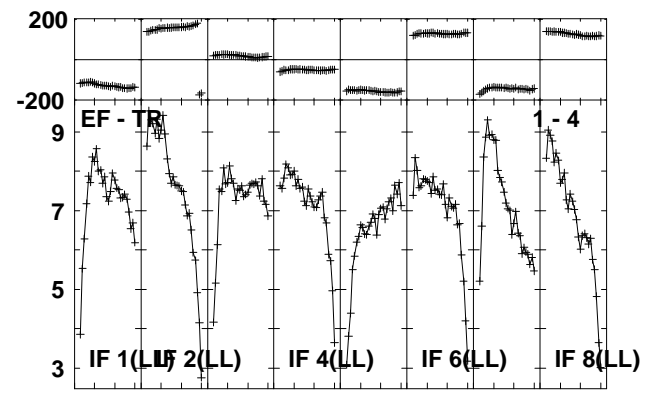
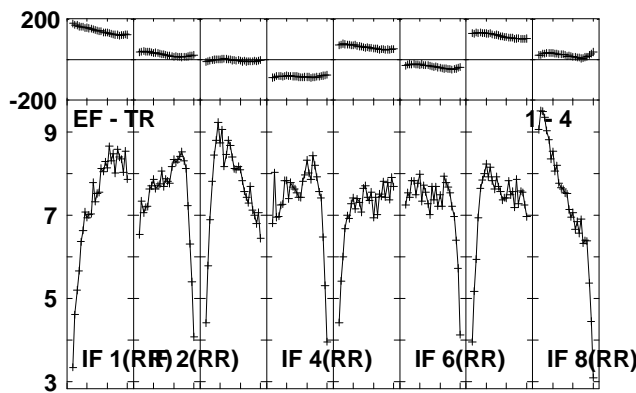
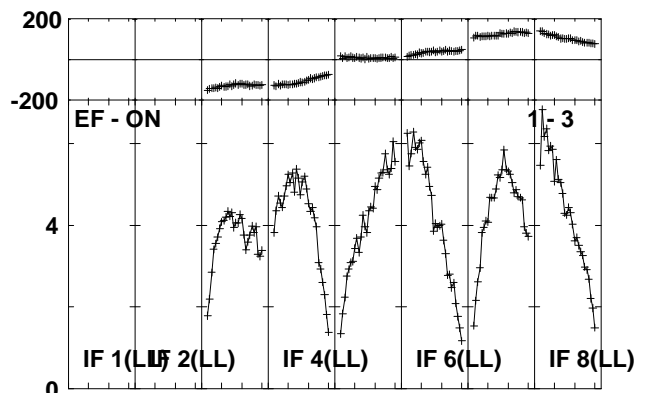
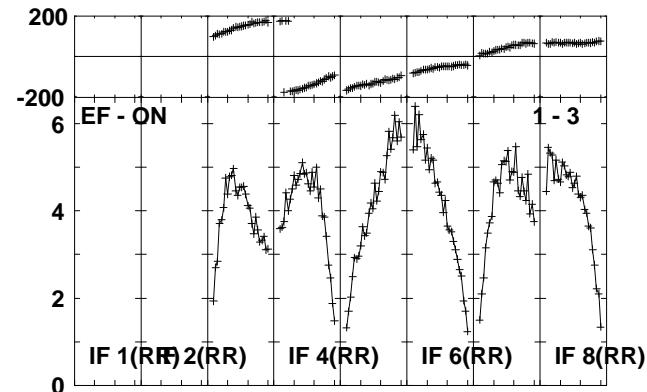
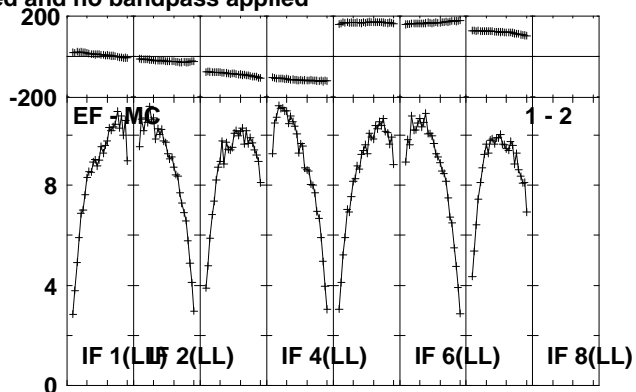
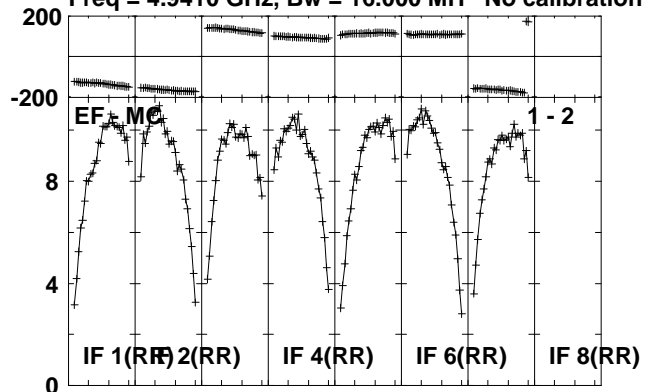

Lower frame: Milli Ampl Jy Top frame: Phas deg
Scalar averaged cross-power spectrum Several baselines displayed
Timerange: 00/16:12:01 to 00/16:12:59

Plot file version 122 created 04-OCT-2010 10:16:11
J1707-14 RP016A.UVDATA.1

Freq = 4.9410 GHz, Bw = 16.000 MH No calibration applied and no bandpass applied

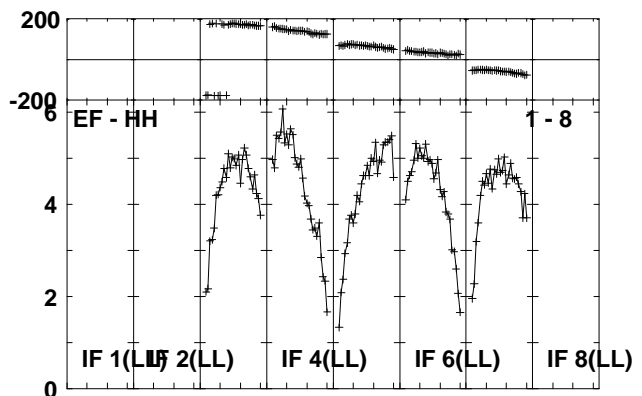
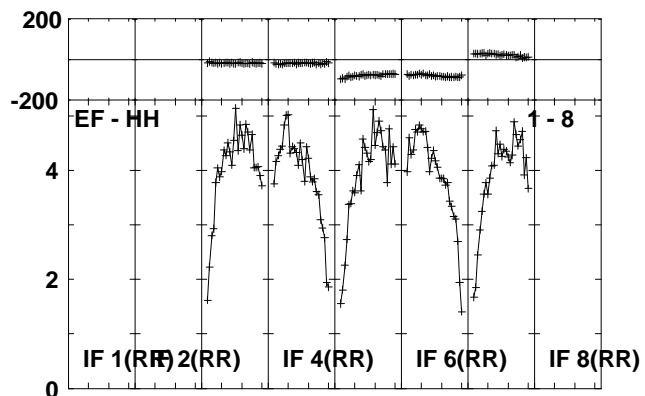
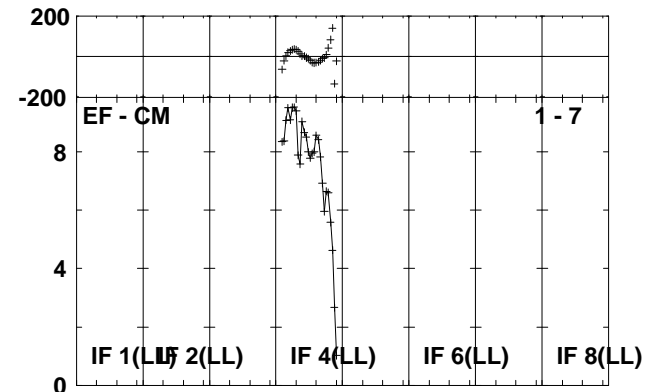
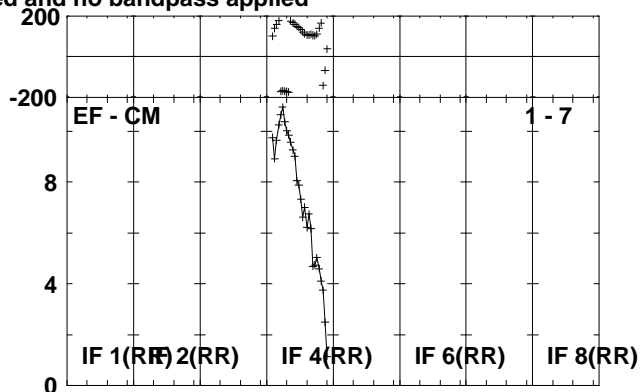
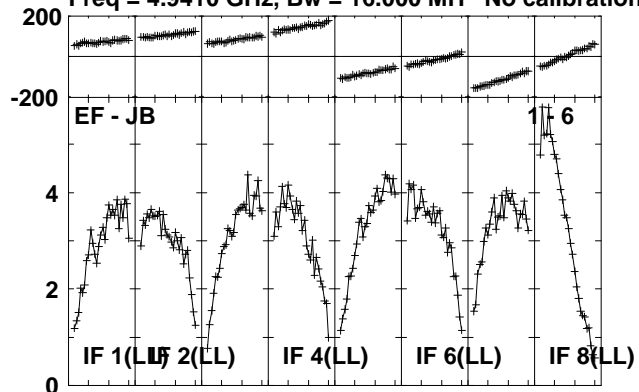

Lower frame: Milli Ampl Jy Top frame: Phas deg
Scalar averaged cross-power spectrum Several baselines displayed
Timerange: 00/16:12:01 to 00/16:12:59

Plot file version 123 created 04-OCT-2010 10:16:12

MAXI J16 RP016A.UVDATA.1

Freq = 4.9410 GHz, Bw = 16.000 MH No calibration applied and no bandpass applied

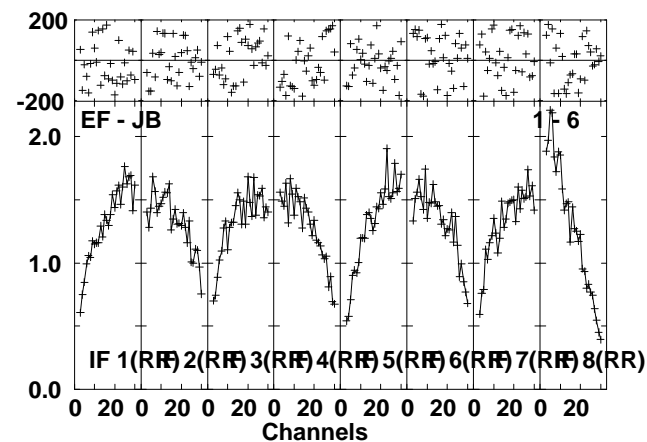
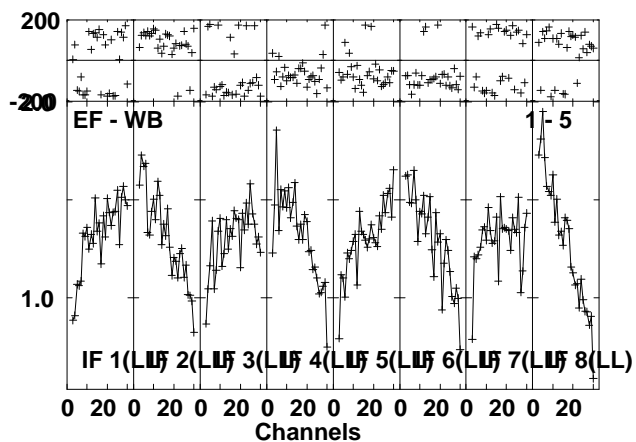
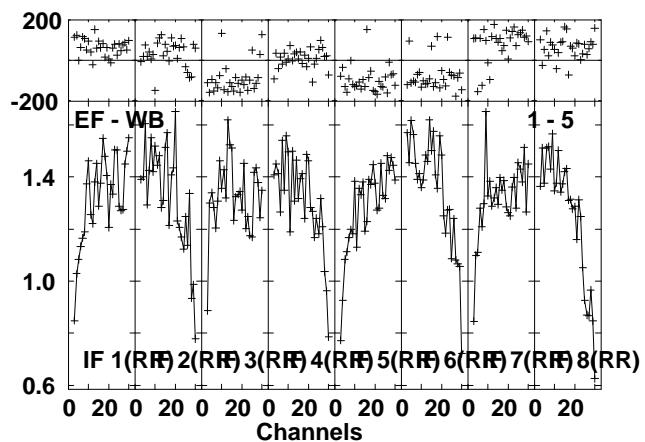
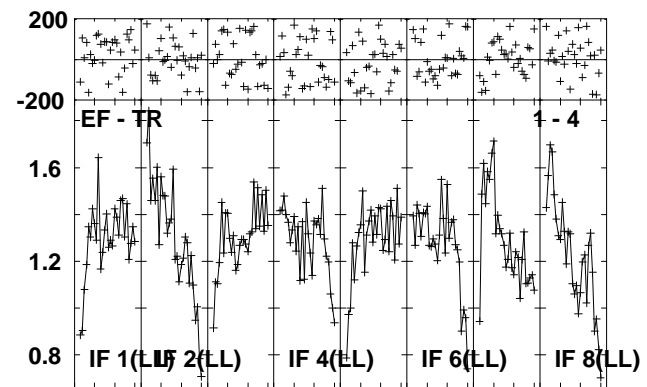
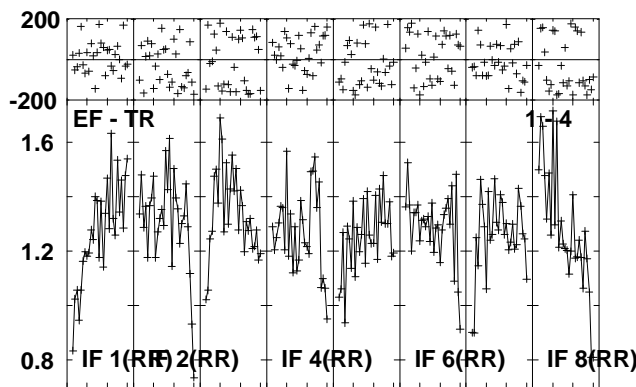
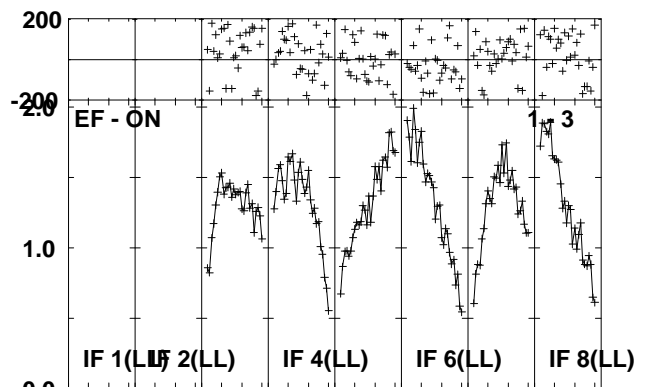
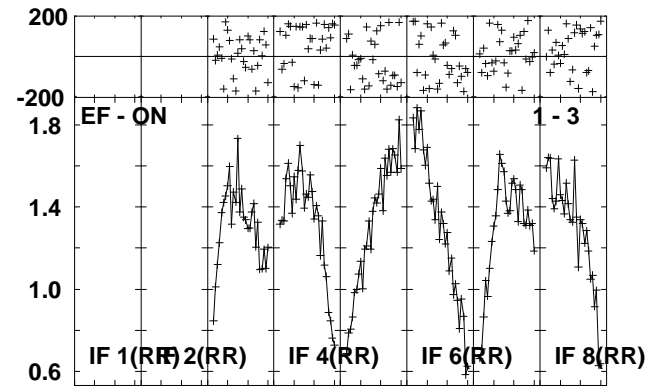
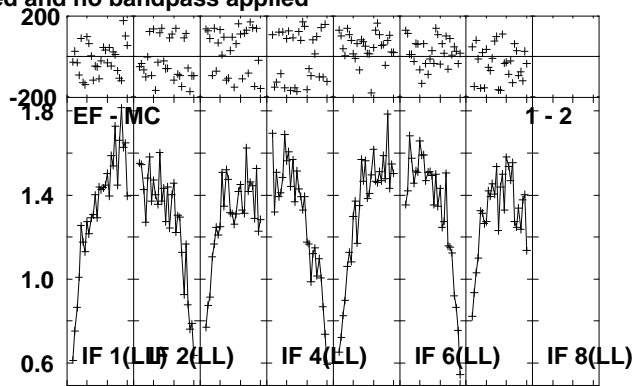
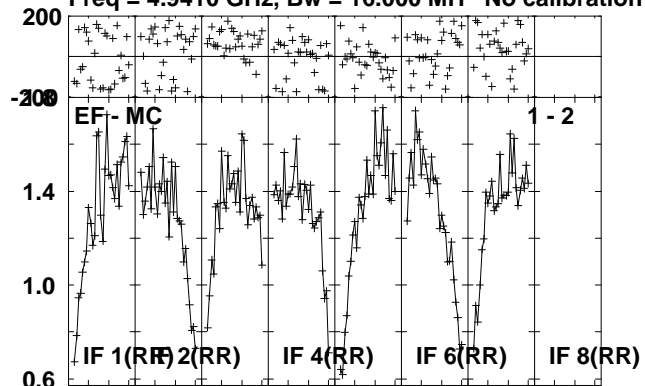

Lower frame: Milli Ampl Jy Top frame: Phas deg
Scalar averaged cross-power spectrum Several baselines displayed
Timerange: 00/16:13:01 to 00/16:15:29

Plot file version 124 created 04-OCT-2010 10:16:14

MAXI J16 RP016A.UVDATA.1

Freq = 4.9410 GHz, Bw = 16.000 MH No calibration applied and no bandpass applied

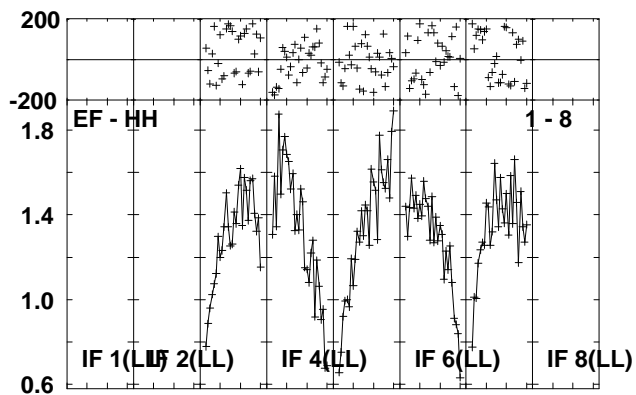
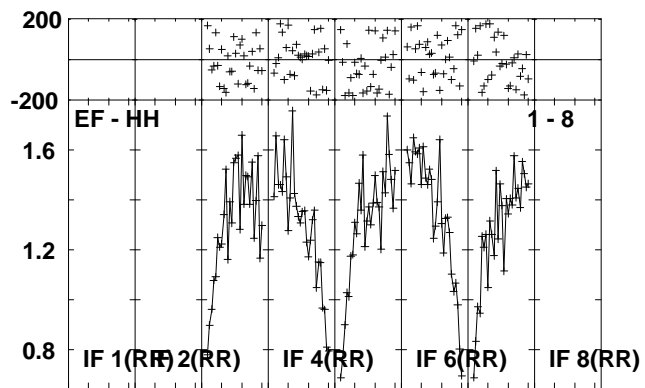
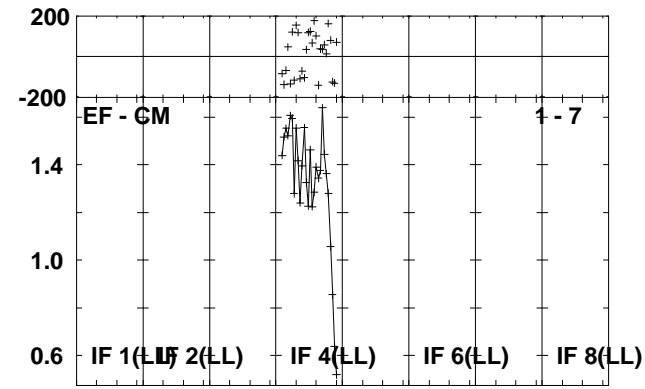
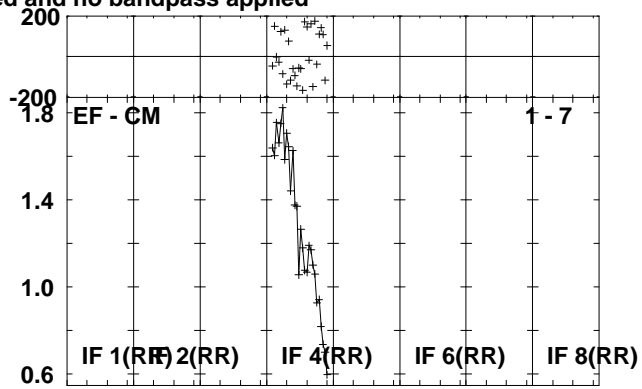
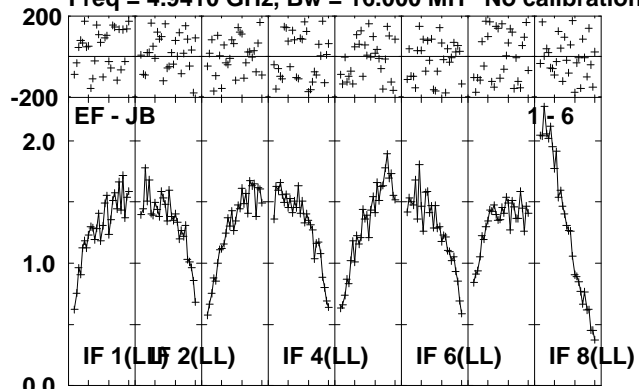

Lower frame: Milli Ampl Jy Top frame: Phas deg
Scalar averaged cross-power spectrum Several baselines displayed
Timerange: 00/16:13:01 to 00/16:15:29

Plot file version 125 created 04-OCT-2010 10:16:15

J1707-14 RP016A.UVDATA.1

Freq = 4.9410 GHz, Bw = 16.000 MH No calibration applied and no bandpass applied

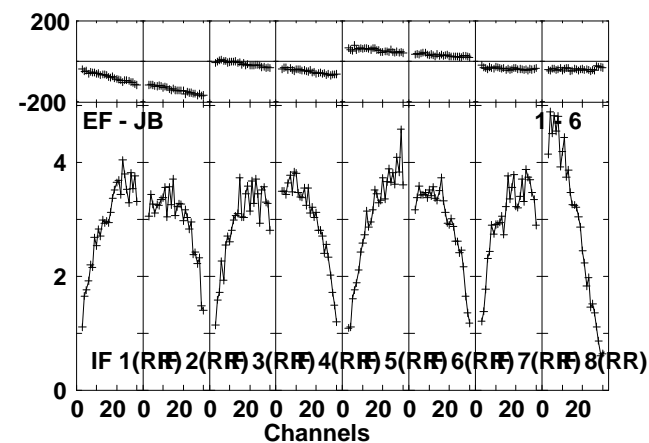
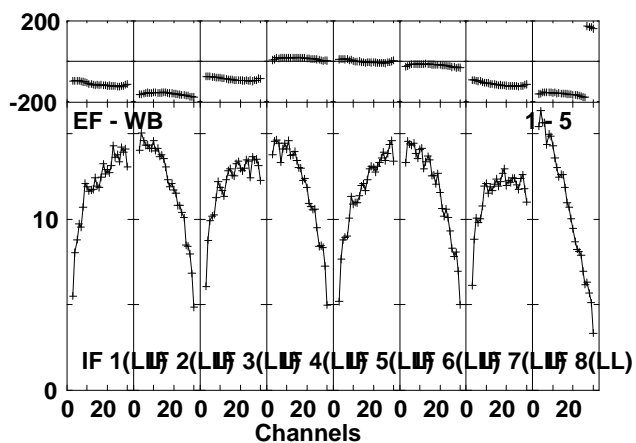
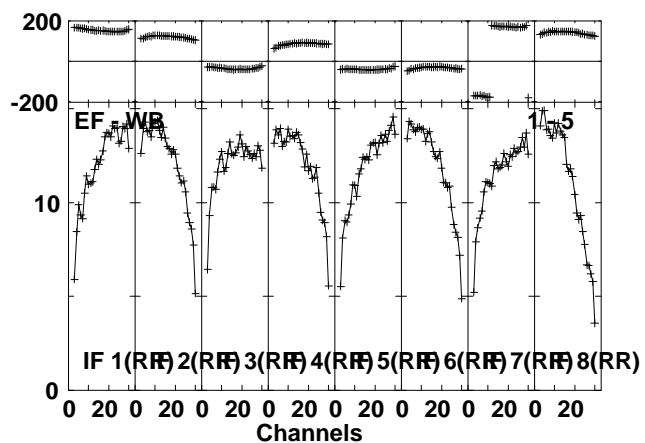
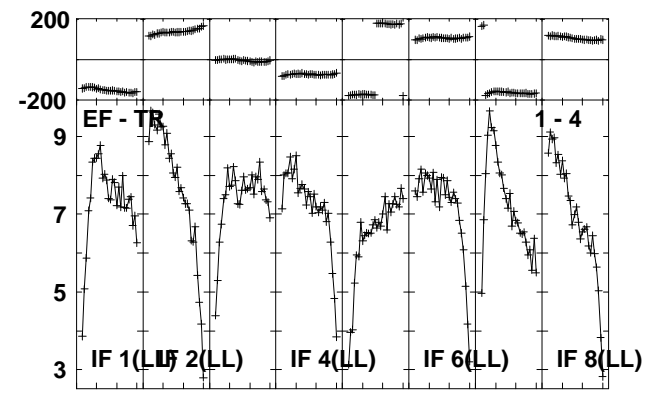
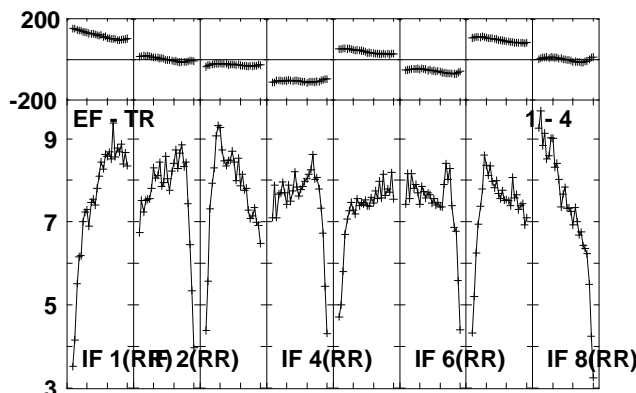
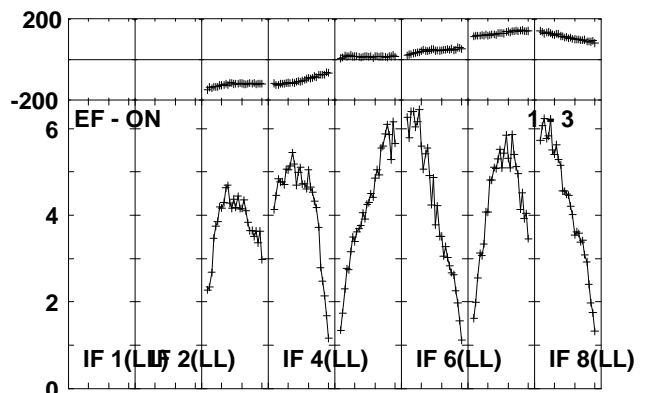
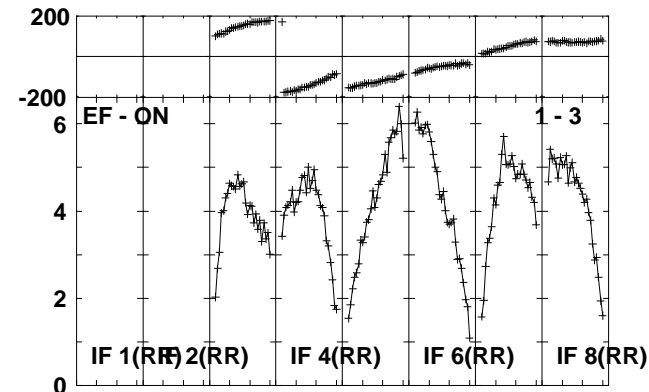
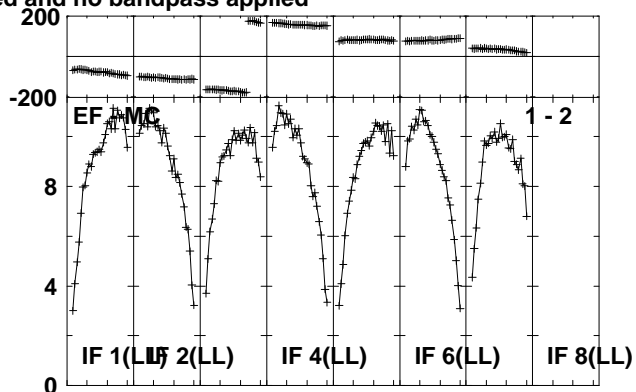
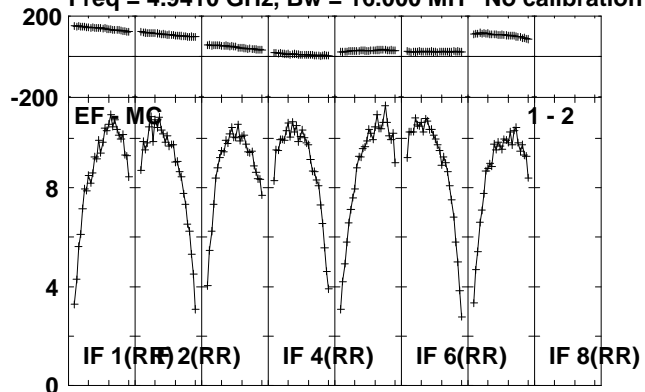

Lower frame: Milli Ampl Jy Top frame: Phas deg
Scalar averaged cross-power spectrum Several baselines displayed
Timerange: 00/16:15:31 to 00/16:16:59

Plot file version 126 created 04-OCT-2010 10:16:16
J1707-14 RP016A.UVDATA.1

Freq = 4.9410 GHz, Bw = 16.000 MH No calibration applied and no bandpass applied

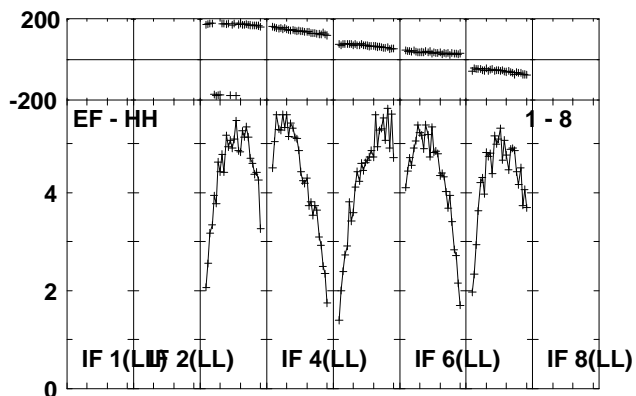
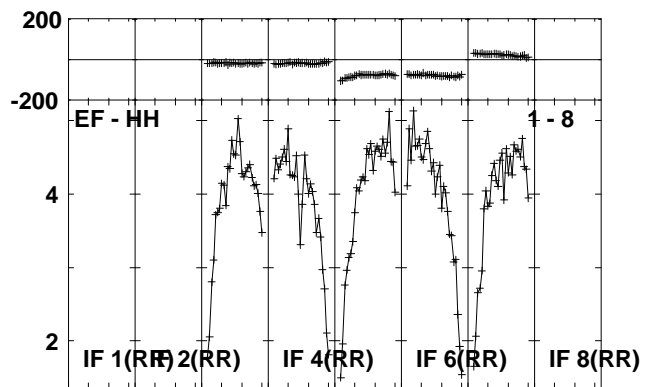
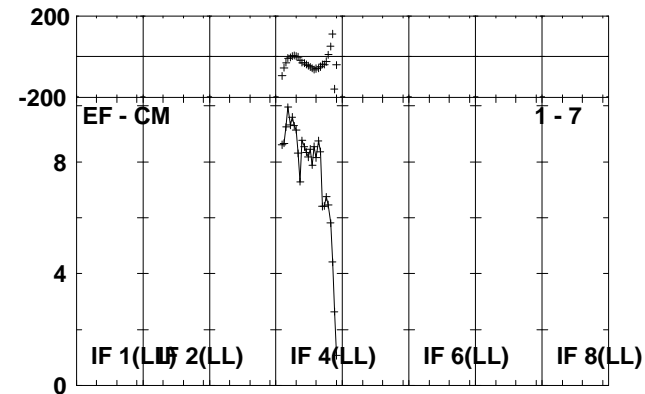
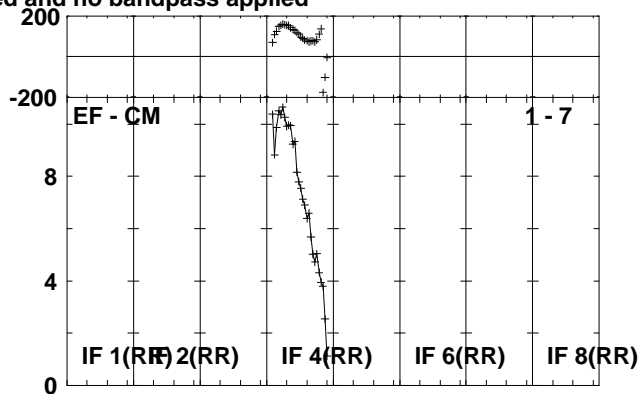
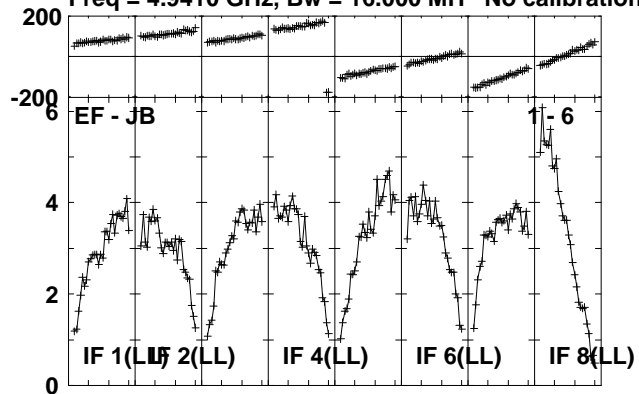

Lower frame: Milli Ampl Jy Top frame: Phas deg
Scalar averaged cross-power spectrum Several baselines displayed
Timerange: 00/16:15:31 to 00/16:16:59

Plot file version 127 created 04-OCT-2010 10:16:17

MAXI J16 RP016A.UVDATA.1

Freq = 4.9410 GHz, Bw = 16.000 MH No calibration applied and no bandpass applied

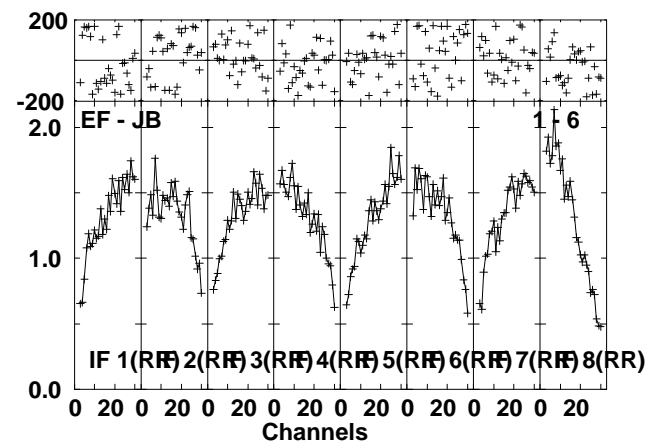
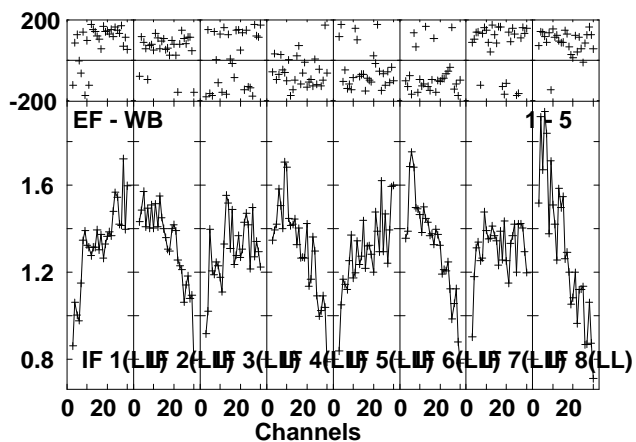
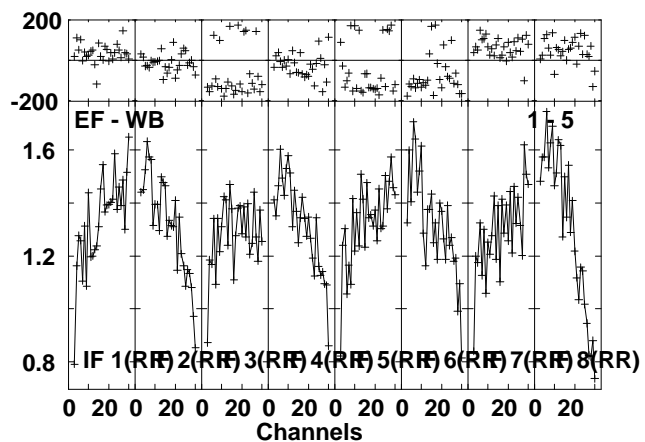
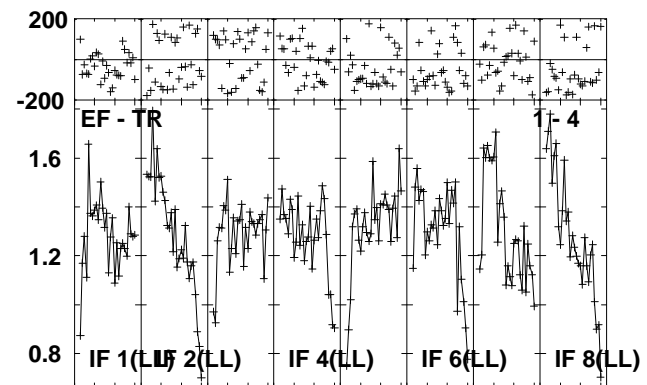
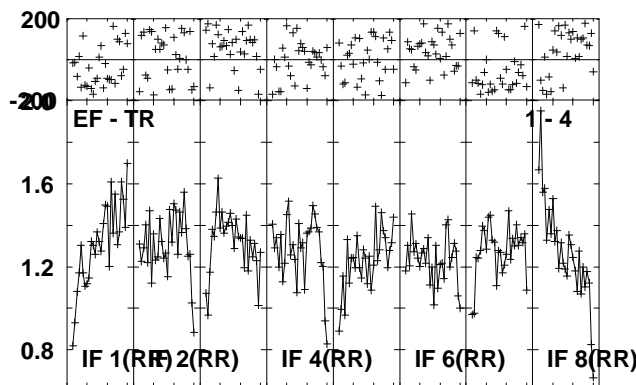
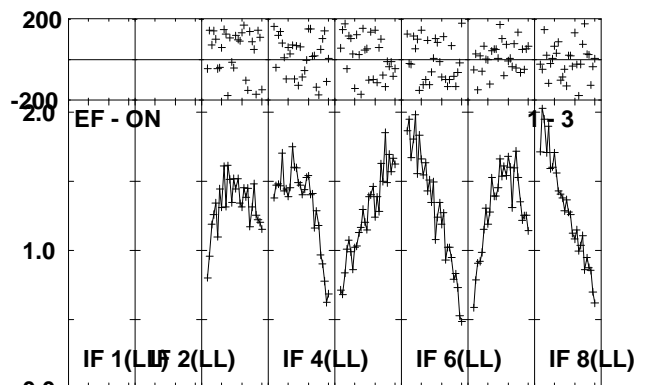
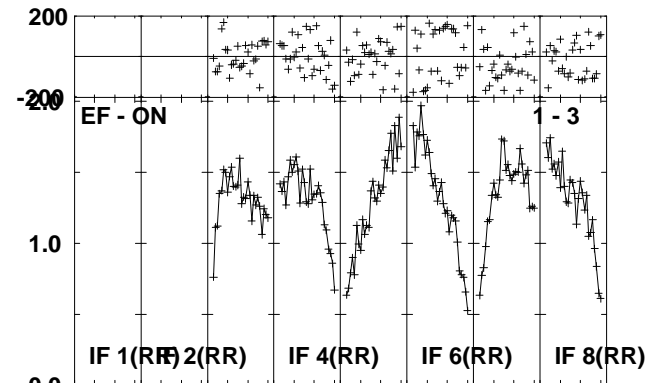
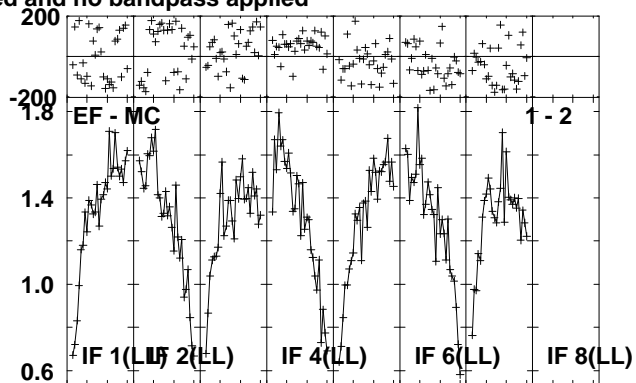
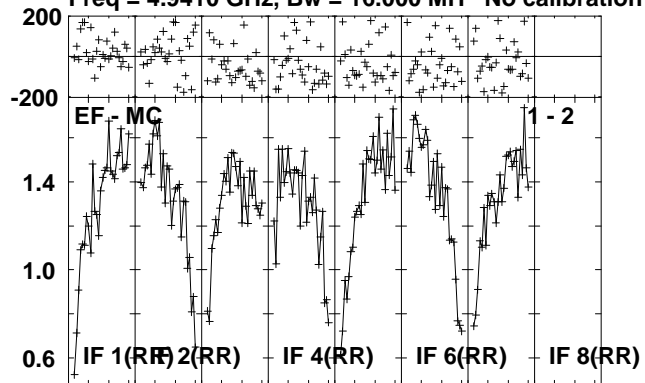

Lower frame: Milli Ampl Jy Top frame: Phas deg
Scalar averaged cross-power spectrum Several baselines displayed
Timerange: 00/16:17:01 to 00/16:19:29

Plot file version 128 created 04-OCT-2010 10:16:18

MAXI J16 RP016A.UVDATA.1

Freq = 4.9410 GHz, Bw = 16.000 MH No calibration applied and no bandpass applied

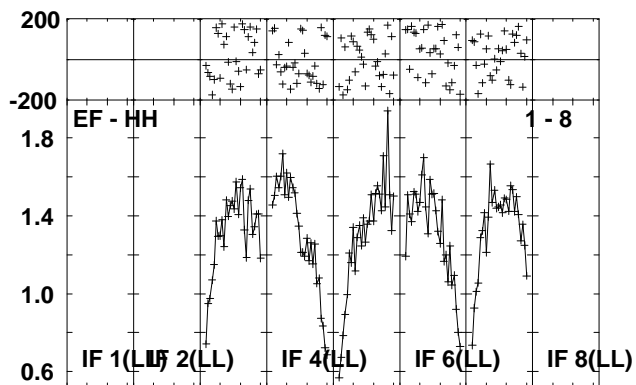
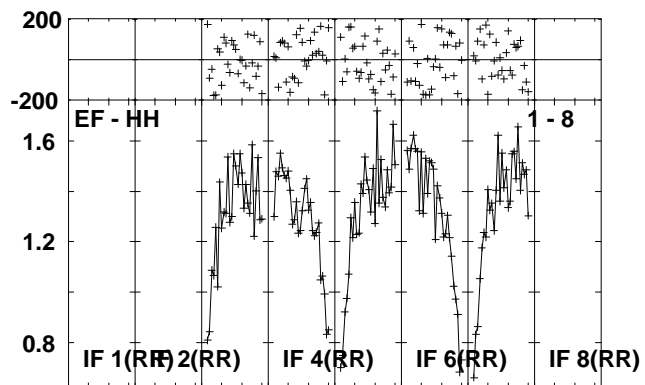
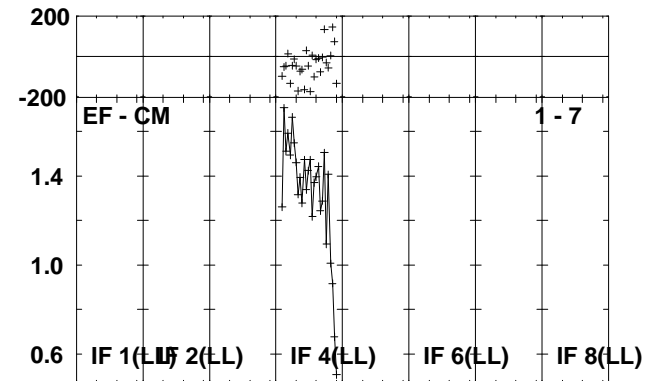
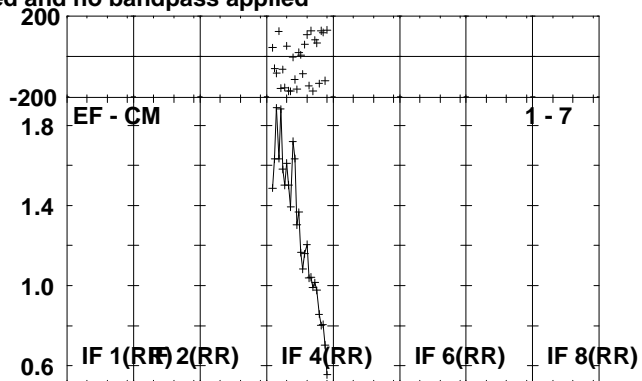
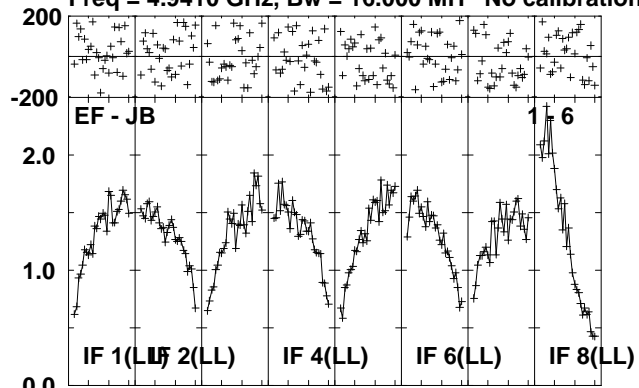

Lower frame: Milli Ampl Jy Top frame: Phas deg
Scalar averaged cross-power spectrum Several baselines displayed
Timerange: 00/16:17:01 to 00/16:19:29

Plot file version 129 created 04-OCT-2010 10:16:19

J1707-14 RP016A.UVDATA.1

Freq = 4.9410 GHz, Bw = 16.000 MH No calibration applied and no bandpass applied

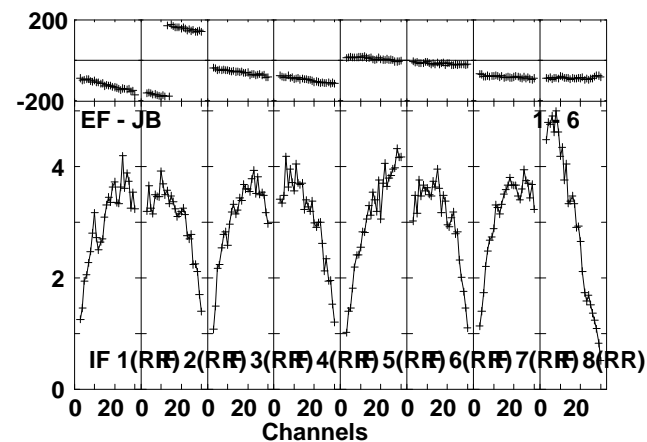
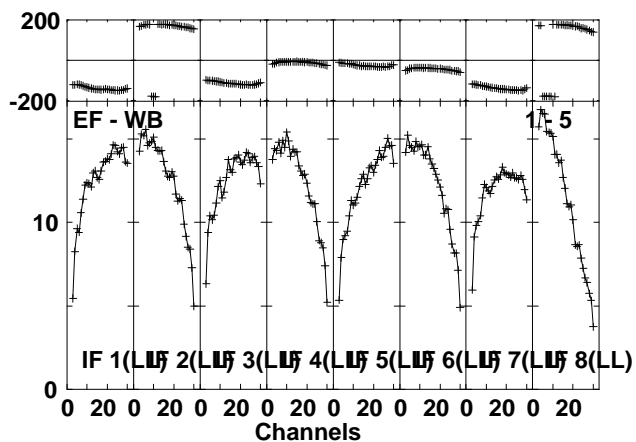
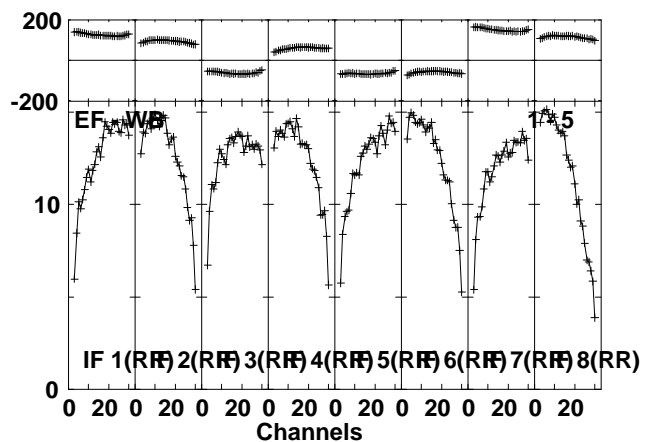
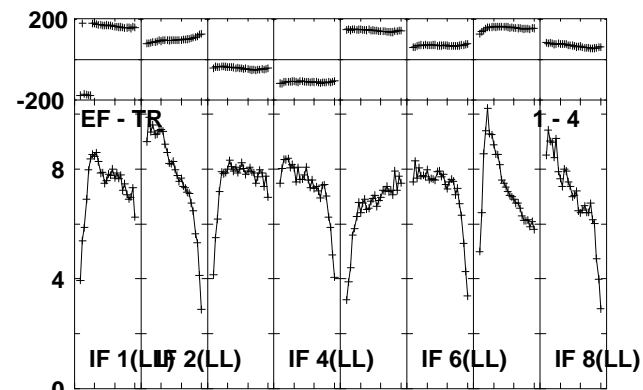
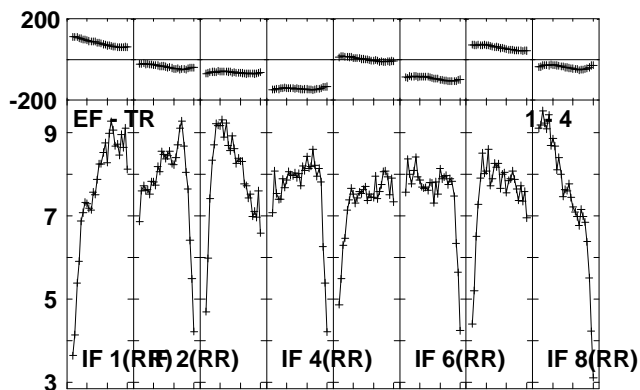
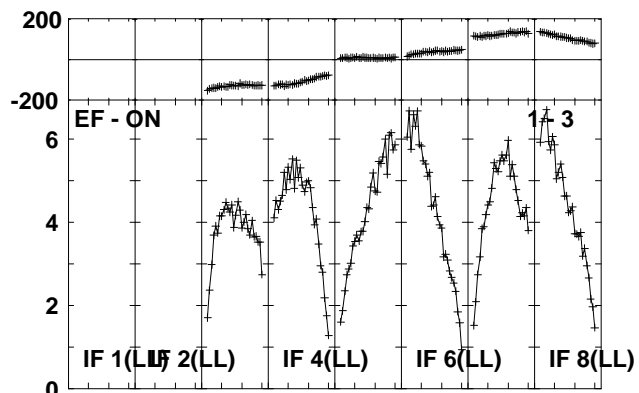
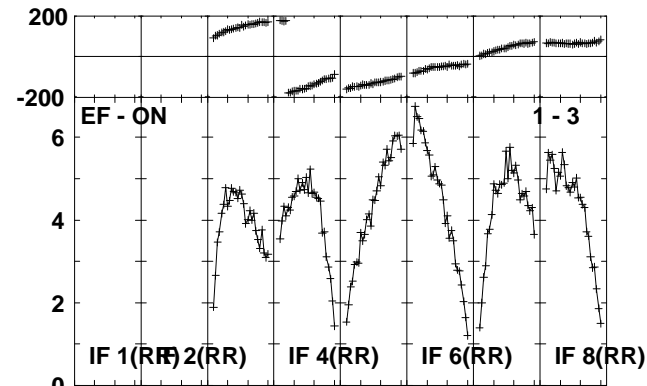
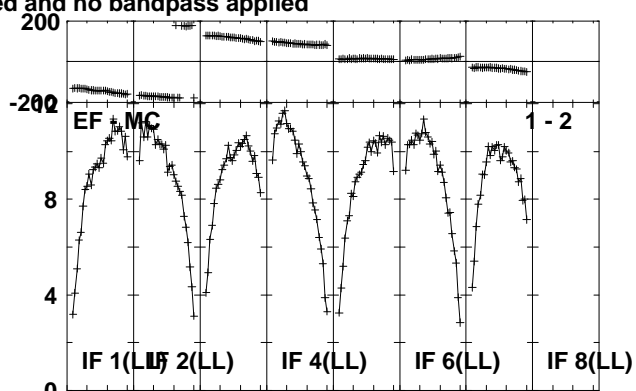
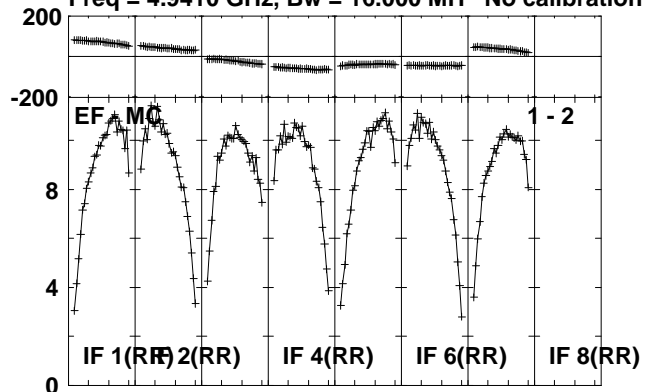

Lower frame: Milli Ampl Jy Top frame: Phas deg
Scalar averaged cross-power spectrum Several baselines displayed
Timerange: 00/16:20:11 to 00/16:21:09

Plot file version 130 created 04-OCT-2010 10:16:20

J1707-14 RP016A.UVDATA.1

Freq = 4.9410 GHz, Bw = 16.000 MH No calibration applied and no bandpass applied

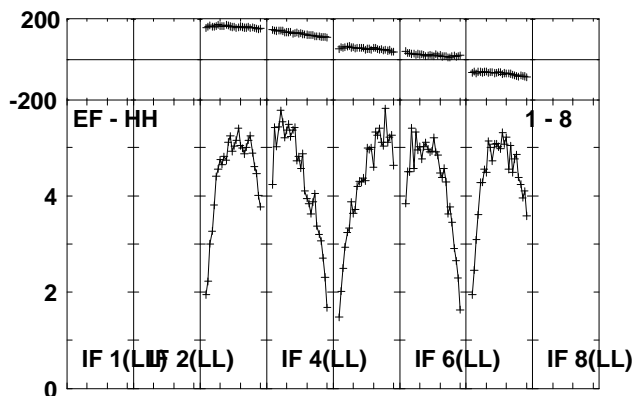
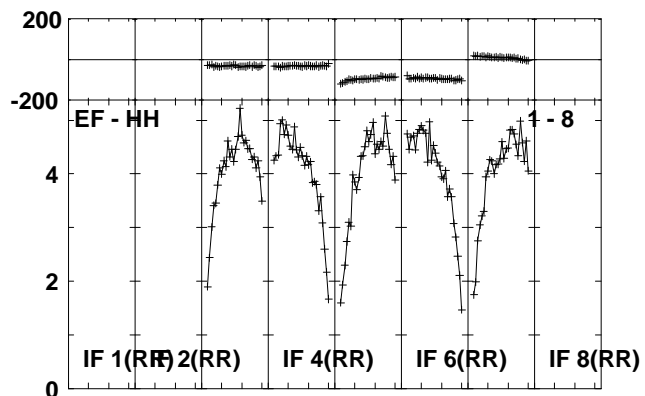
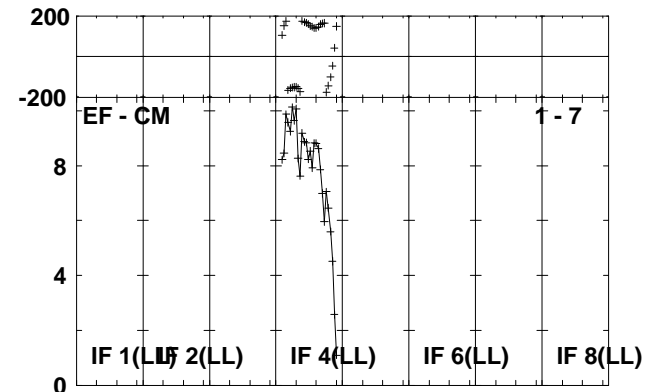
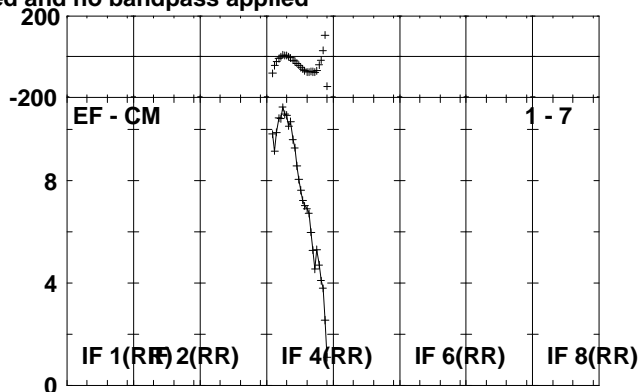
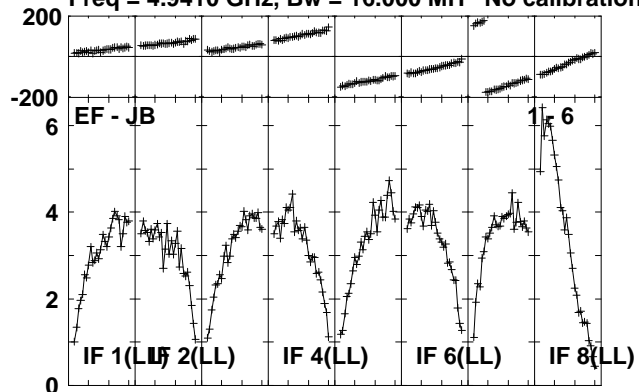

Lower frame: Milli Ampl Jy Top frame: Phas deg
Scalar averaged cross-power spectrum Several baselines displayed
Timerange: 00/16:20:11 to 00/16:21:09

Plot file version 131 created 04-OCT-2010 10:16:21

NVSS3 RP016A.UVDATA.1

Freq = 4.9410 GHz, Bw = 16.000 MH No calibration applied and no bandpass applied

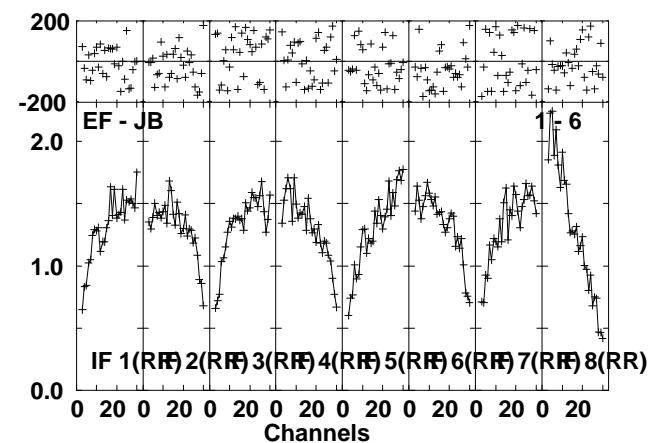
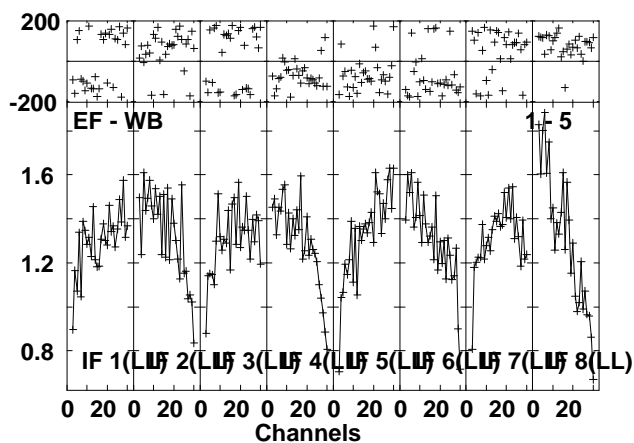
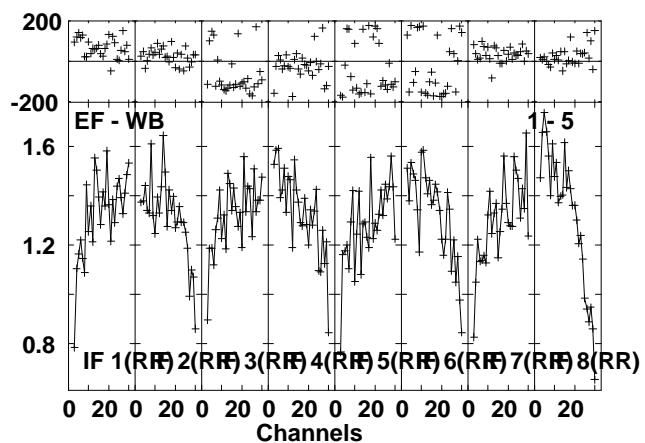
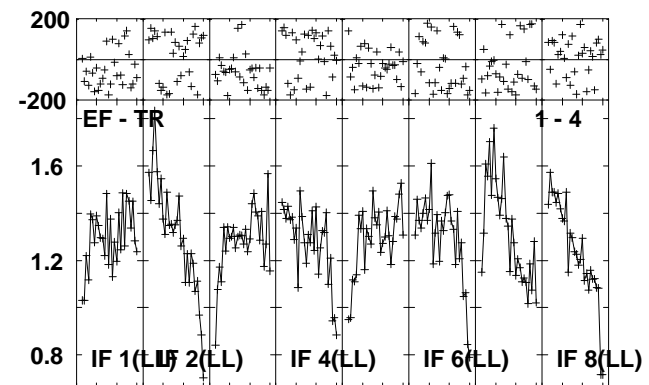
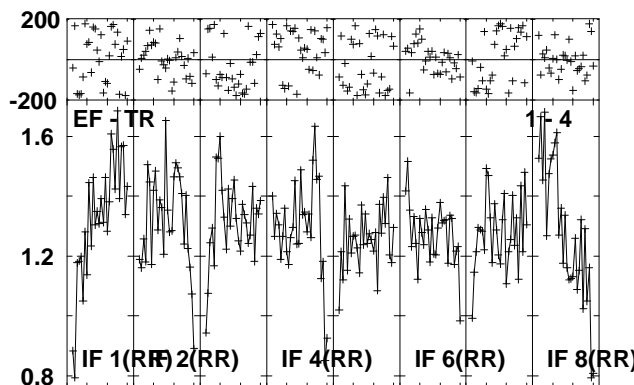
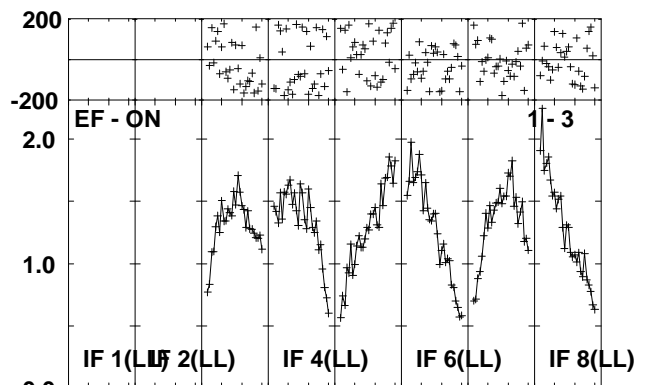
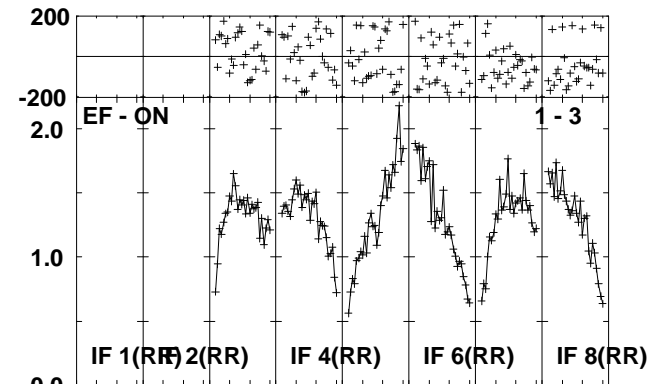
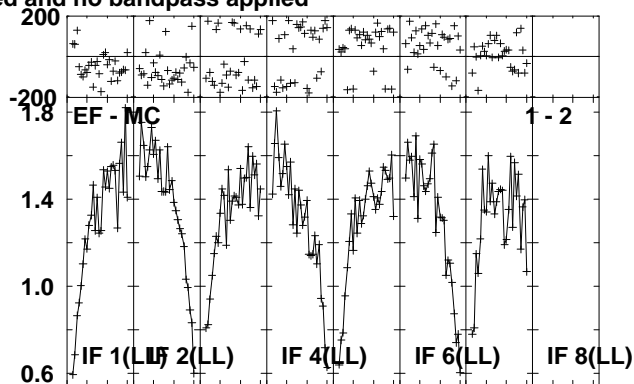
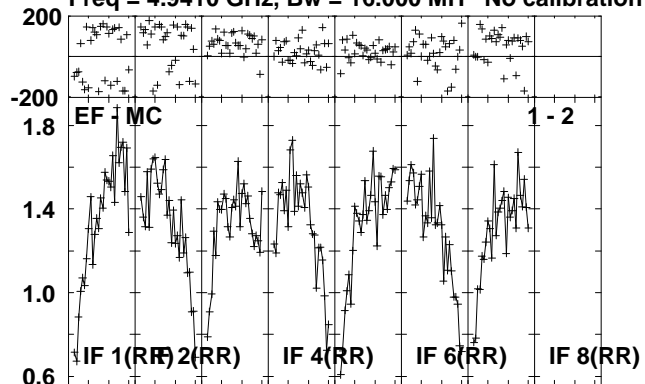

Lower frame: Milli Ampl Jy Top frame: Phas deg
Scalar averaged cross-power spectrum Several baselines displayed
Timerange: 00/16:21:11 to 00/16:23:39

Plot file version 132 created 04-OCT-2010 10:16:23

NVSS3 RP016A.UVDATA.1

Freq = 4.9410 GHz, Bw = 16.000 MH No calibration applied and no bandpass applied

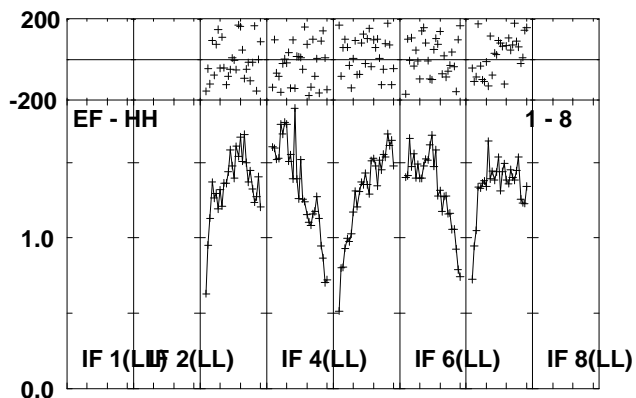
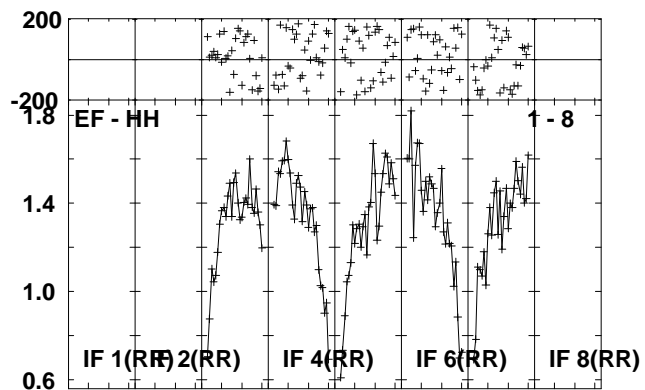
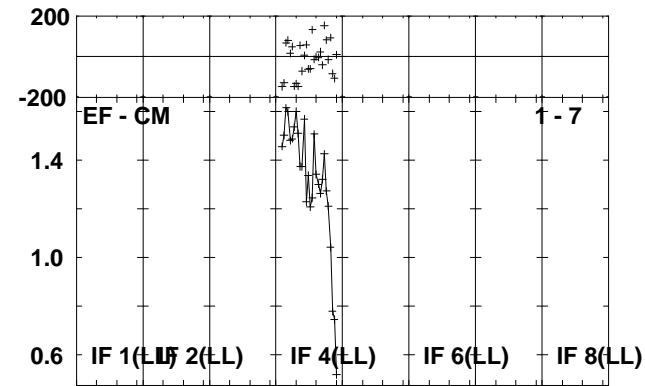
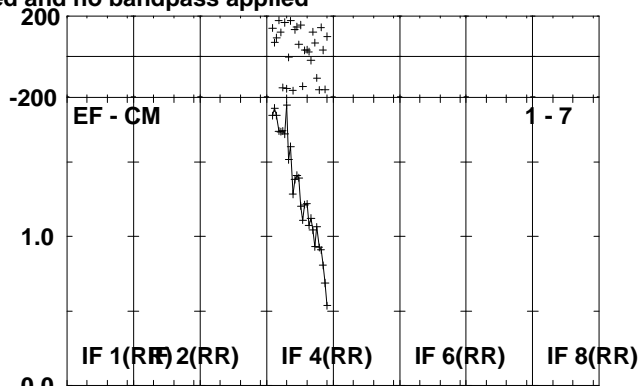
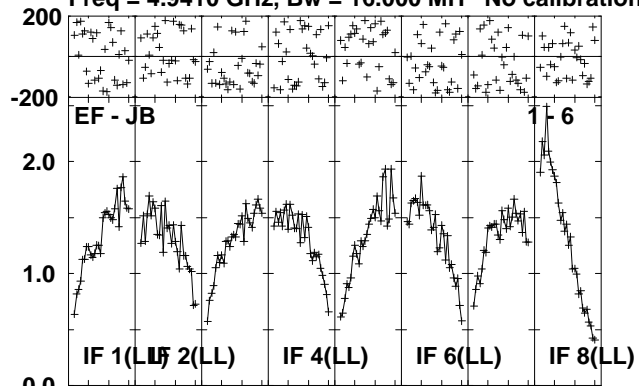

Lower frame: Milli Ampl Jy Top frame: Phas deg
Scalar averaged cross-power spectrum Several baselines displayed
Timerange: 00/16:21:11 to 00/16:23:39

Plot file version 133 created 04-OCT-2010 10:16:24

J1707-14 RP016A.UVDATA.1

Freq = 4.9410 GHz, Bw = 16.000 MH No calibration applied and no bandpass applied

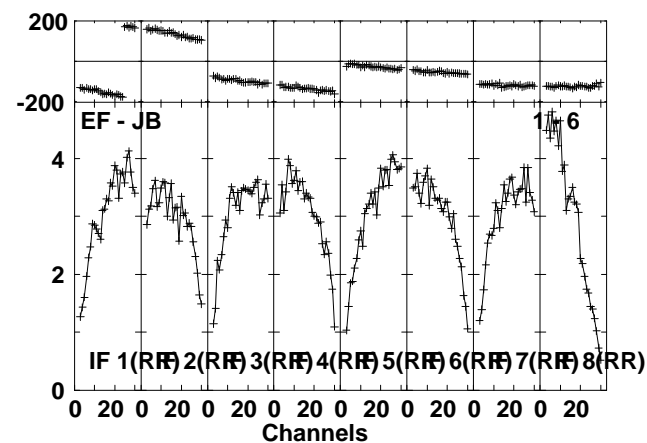
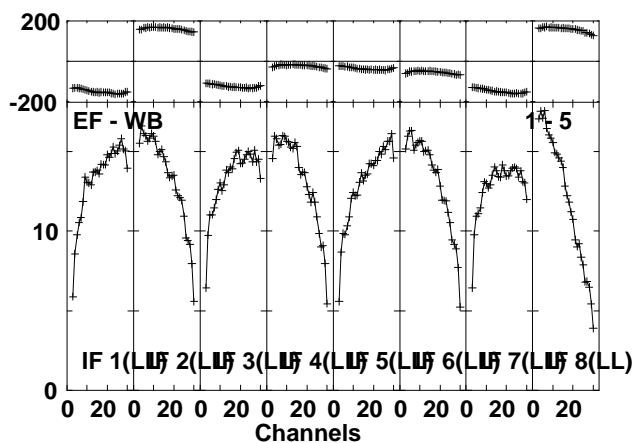
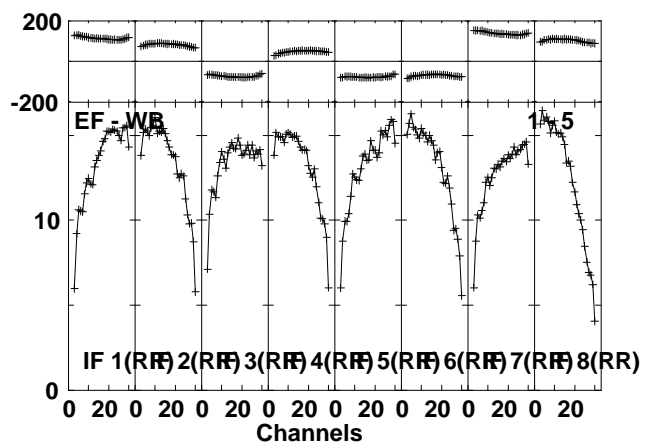
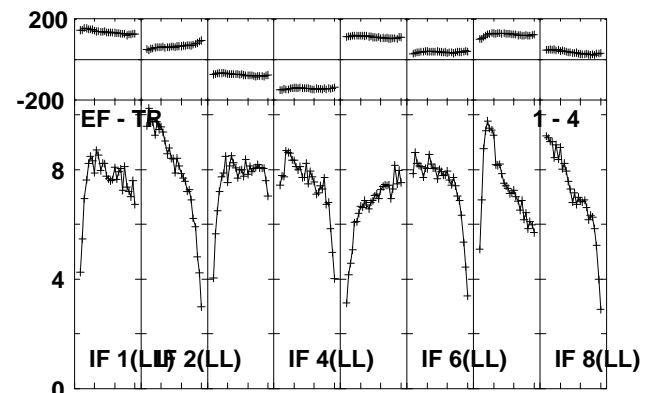
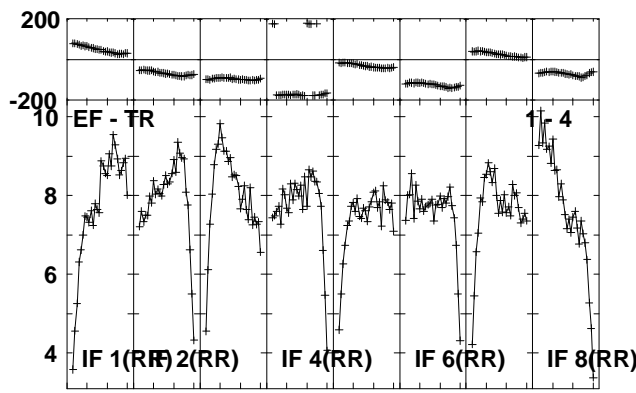
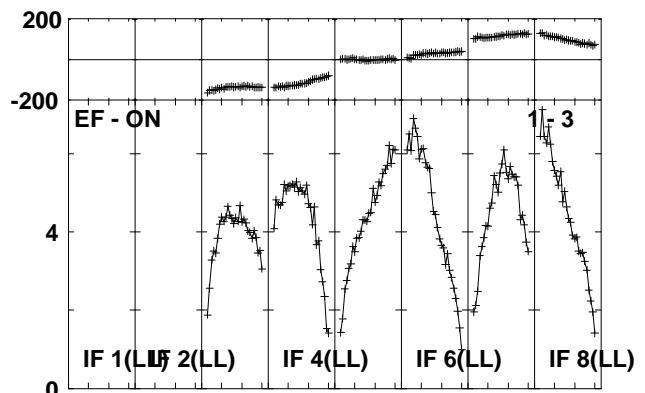
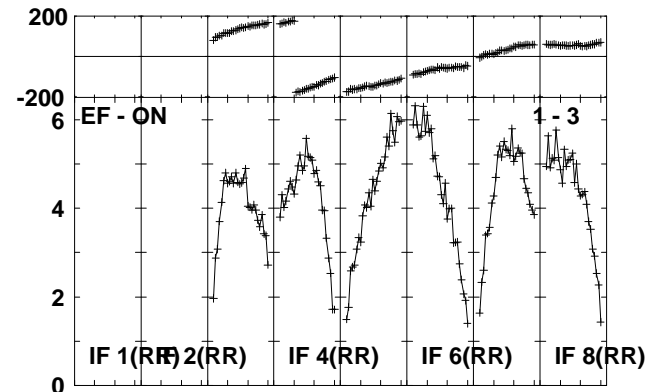
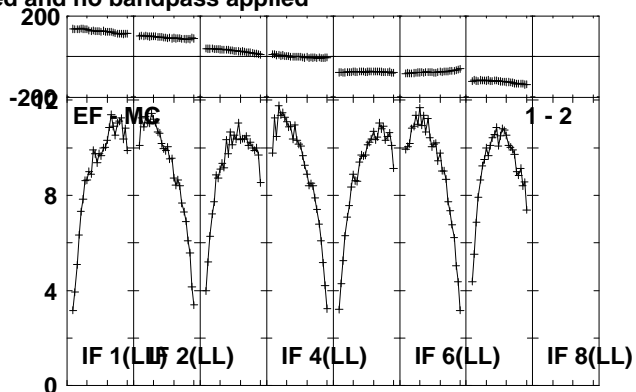
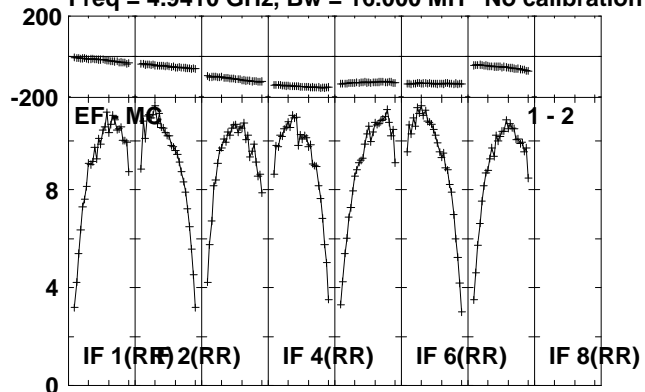

Lower frame: Milli Ampl Jy Top frame: Phas deg
Scalar averaged cross-power spectrum Several baselines displayed
Timerange: 00/16:23:41 to 00/16:25:09

Plot file version 134 created 04-OCT-2010 10:16:25

J1707-14 RP016A.UVDATA.1

Freq = 4.9410 GHz, Bw = 16.000 MH No calibration applied and no bandpass applied

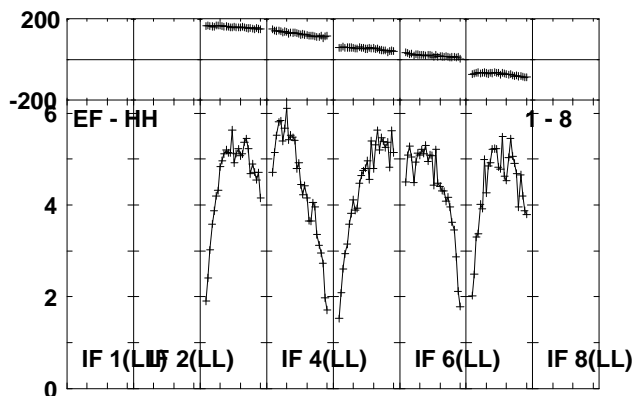
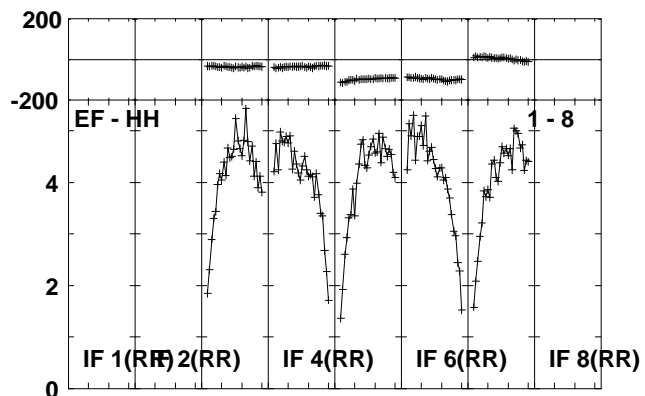
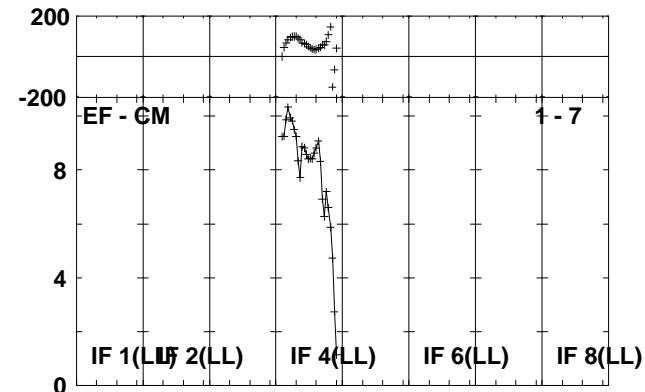
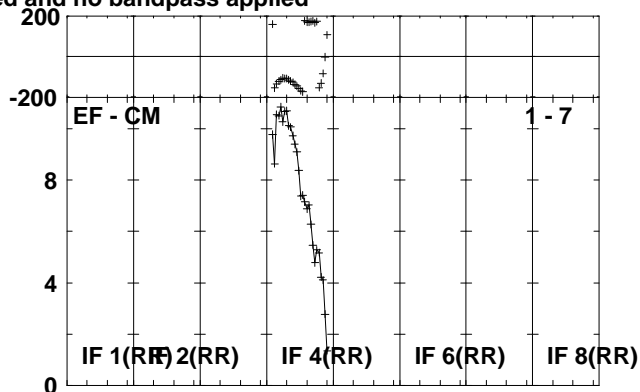
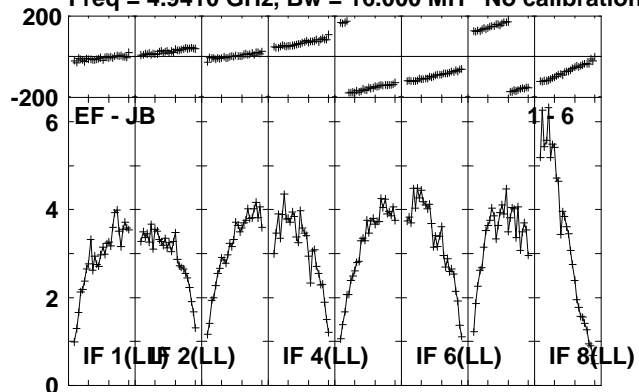

Lower frame: Milli Ampl Jy Top frame: Phas deg
Scalar averaged cross-power spectrum Several baselines displayed
Timerange: 00/16:23:41 to 00/16:25:09

Plot file version 135 created 04-OCT-2010 10:16:26

MAXI J16 RP016A.UVDATA.1

Freq = 4.9410 GHz, Bw = 16.000 MH No calibration applied and no bandpass applied

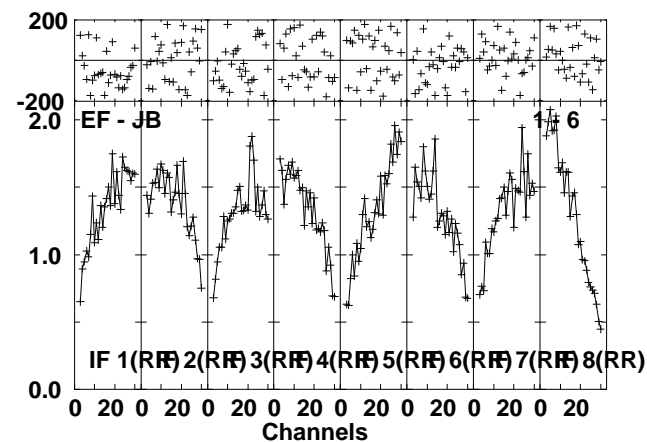
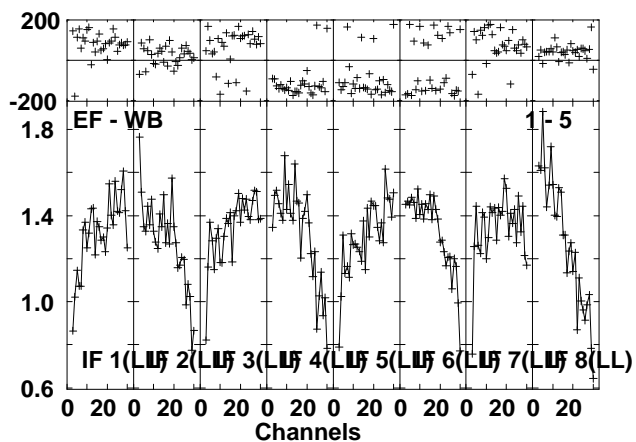
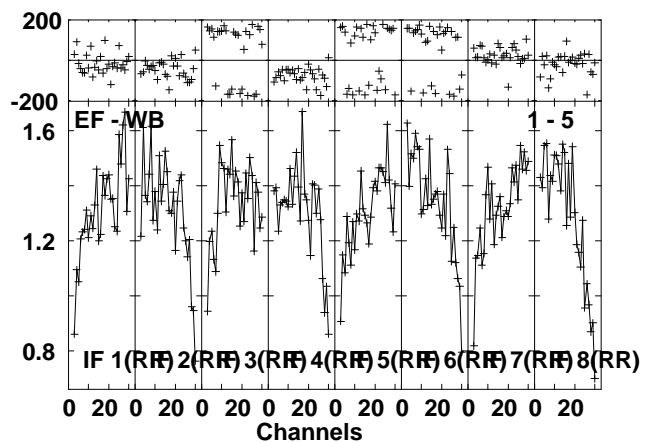
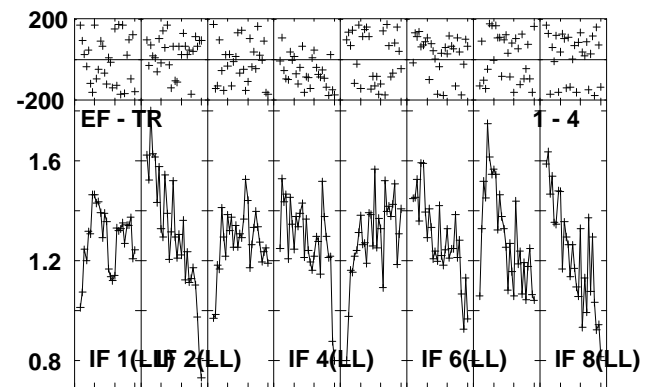
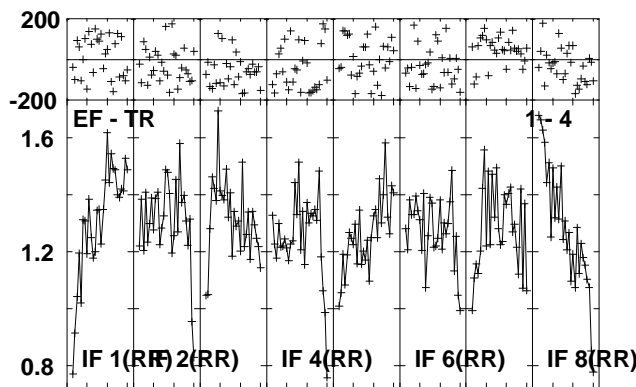
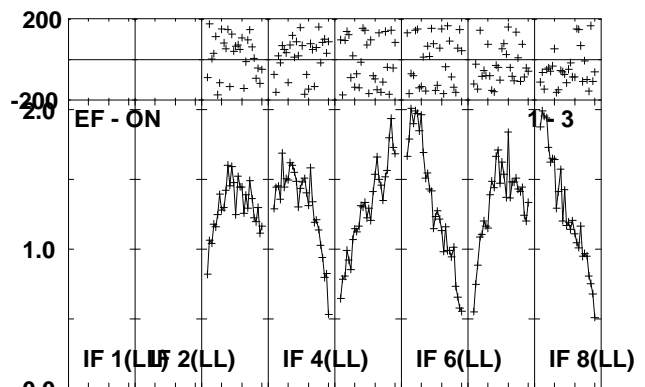
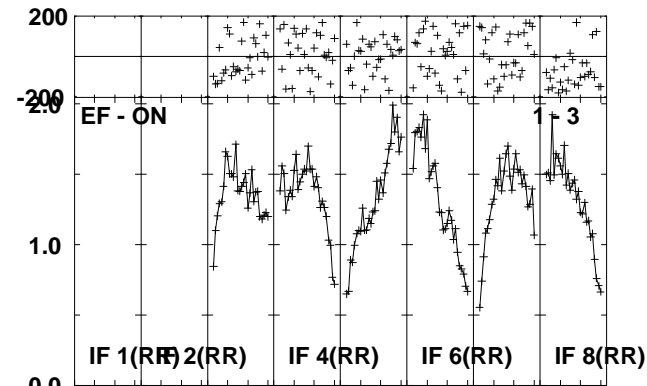
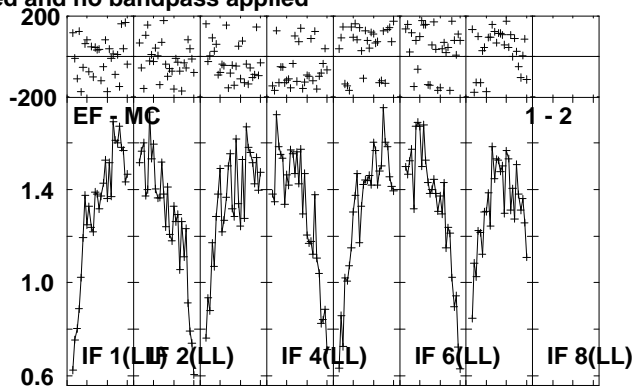
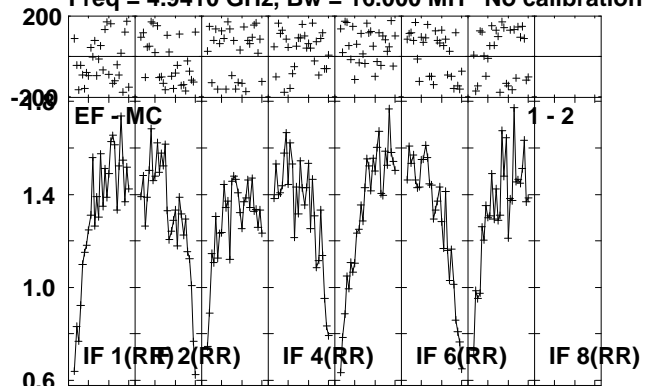

Lower frame: Milli Ampl Jy Top frame: Phas deg
Scalar averaged cross-power spectrum Several baselines displayed
Timerange: 00/16:25:11 to 00/16:27:39

Plot file version 136 created 04-OCT-2010 10:16:27

MAXI J16 RP016A.UVDATA.1

Freq = 4.9410 GHz, Bw = 16.000 MH No calibration applied and no bandpass applied

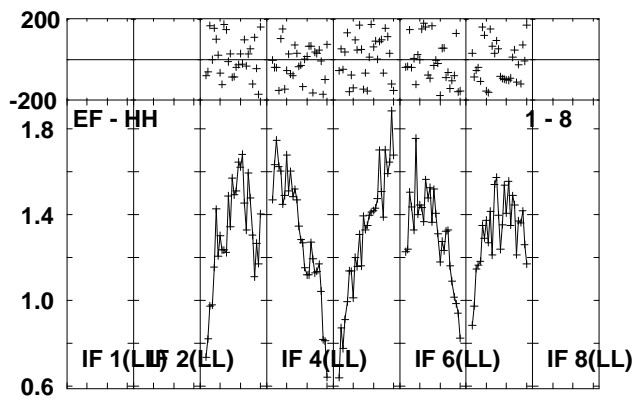
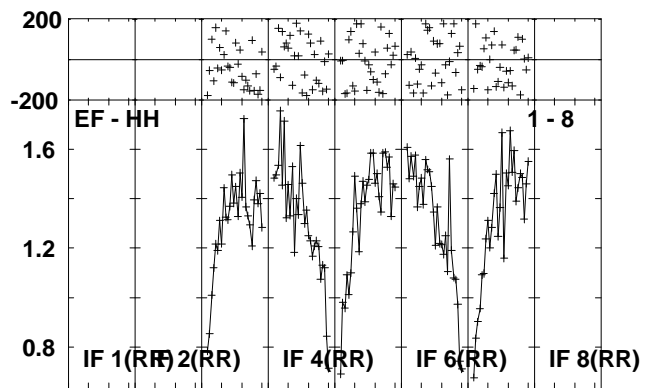
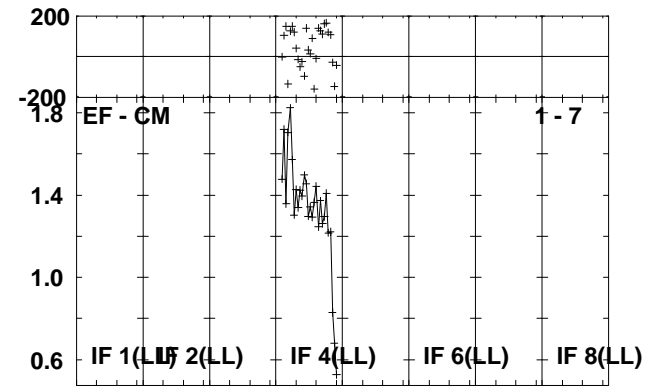
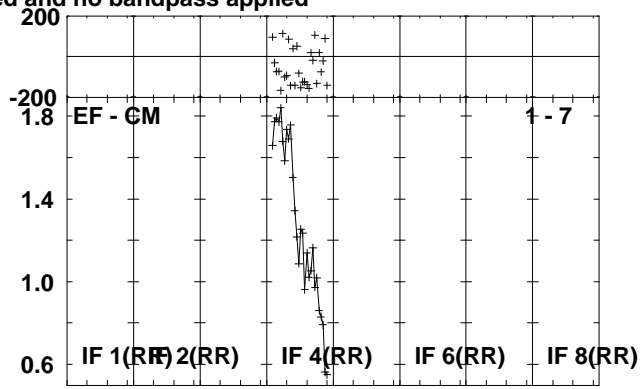
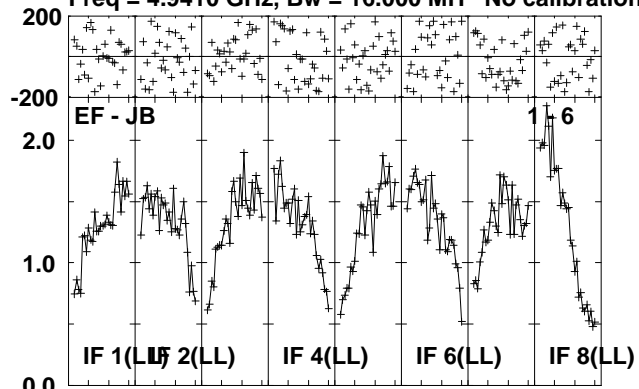

Lower frame: Milli Ampl Jy Top frame: Phas deg
Scalar averaged cross-power spectrum Several baselines displayed
Timerange: 00/16:25:11 to 00/16:27:39

Plot file version 137 created 04-OCT-2010 10:16:28

J1707-14 RP016A.UVDATA.1

Freq = 4.9410 GHz, Bw = 16.000 MH No calibration applied and no bandpass applied

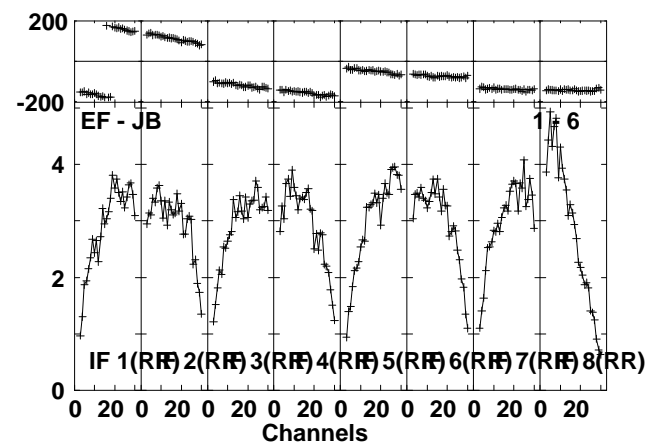
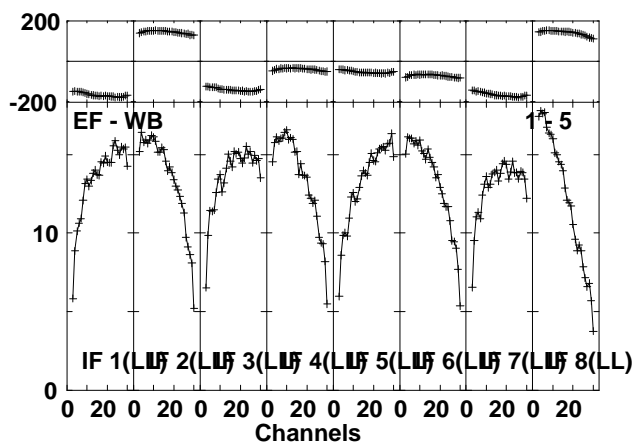
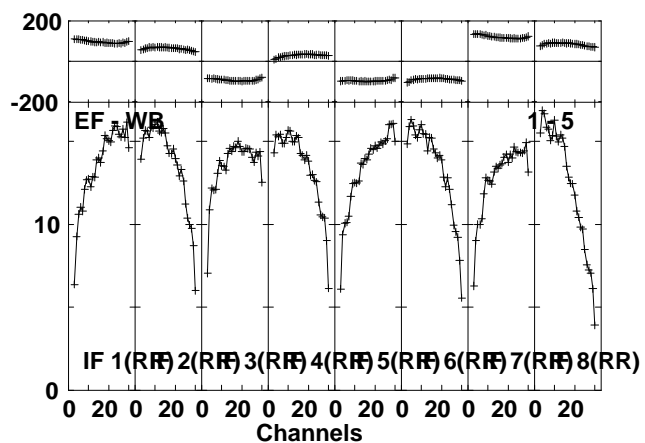
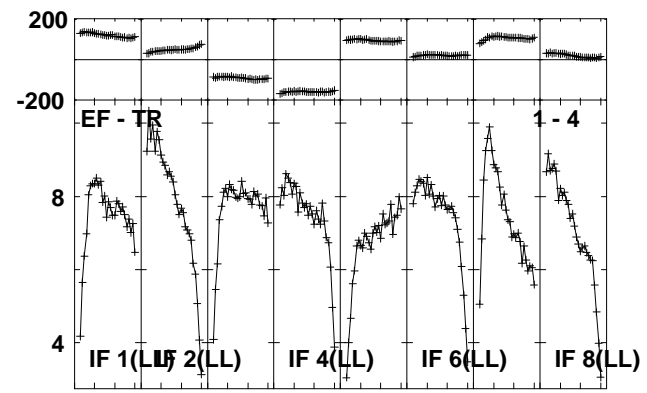
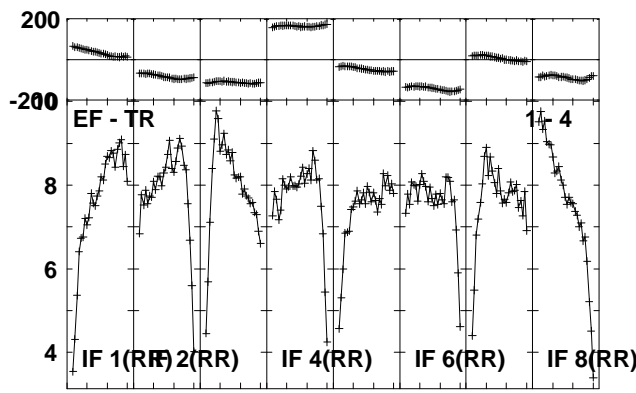
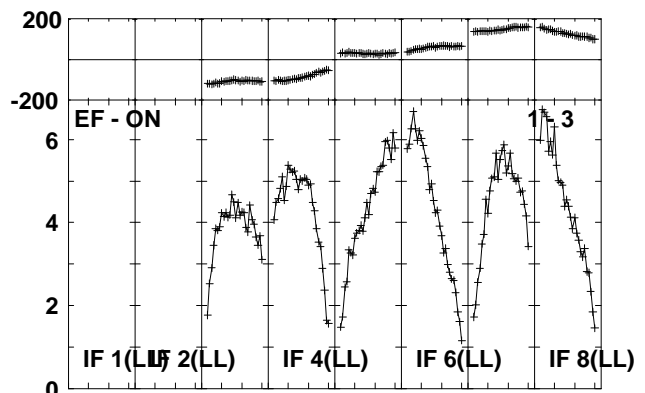
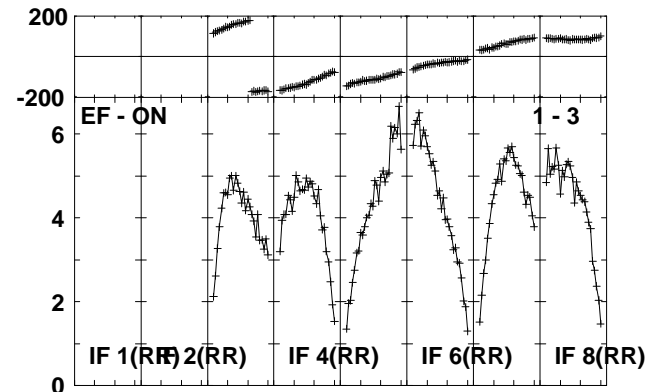
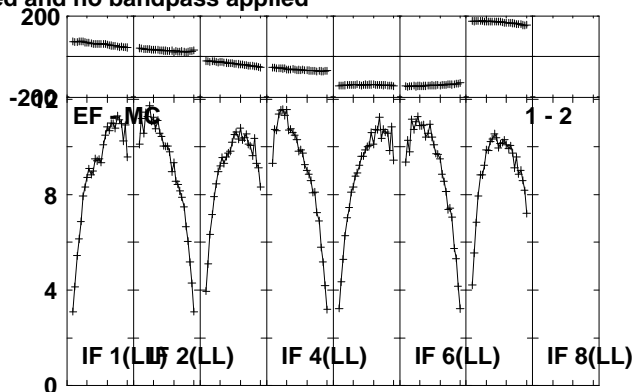
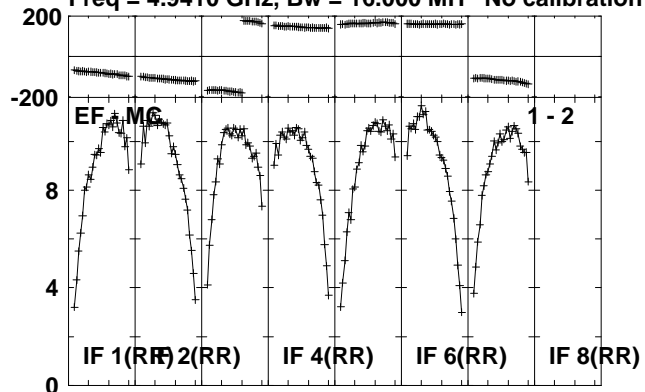

Lower frame: Milli Ampl Jy Top frame: Phas deg
Scalar averaged cross-power spectrum Several baselines displayed
Timerange: 00/16:28:21 to 00/16:29:19

Plot file version 138 created 04-OCT-2010 10:16:29
J1707-14 RP016A.UVDATA.1

Freq = 4.9410 GHz, Bw = 16.000 MH No calibration applied and no bandpass applied

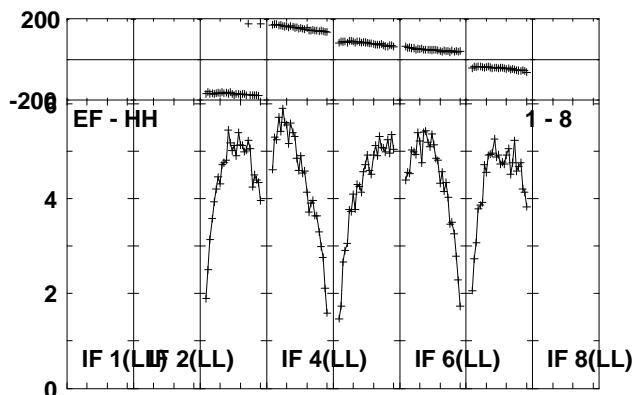
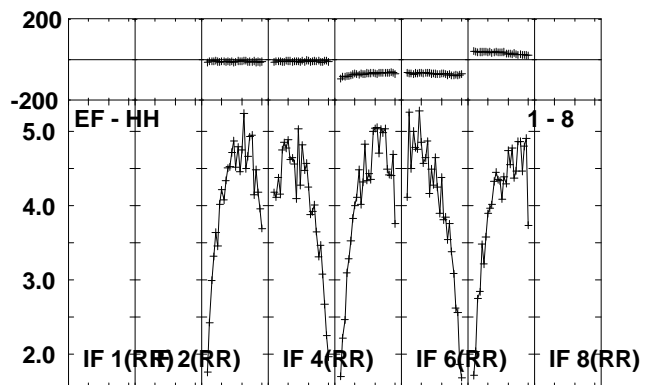
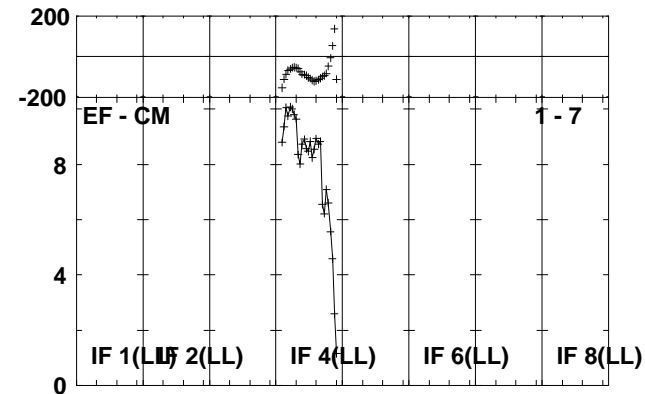
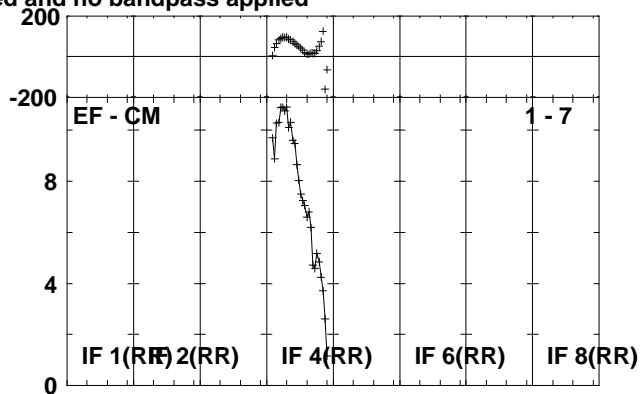
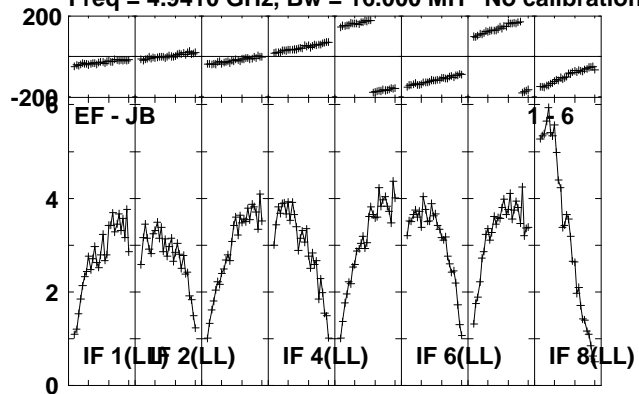

Lower frame: Milli Ampl Jy Top frame: Phas deg
Scalar averaged cross-power spectrum Several baselines displayed
Timerange: 00/16:28:21 to 00/16:29:19

Plot file version 139 created 04-OCT-2010 10:16:30

MAXI J16 RP016A.UVDATA.1

Freq = 4.9410 GHz, Bw = 16.000 MH No calibration applied and no bandpass applied

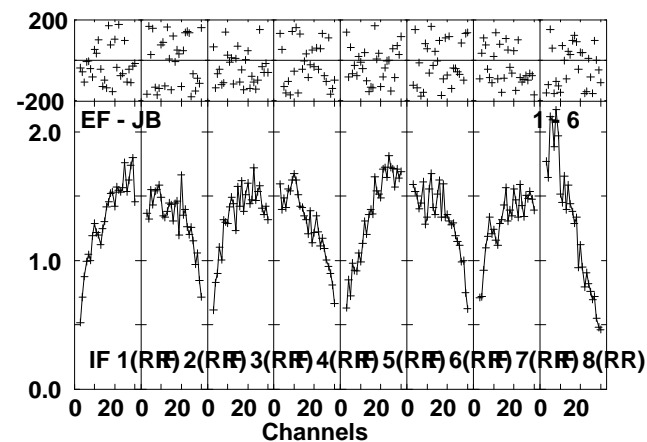
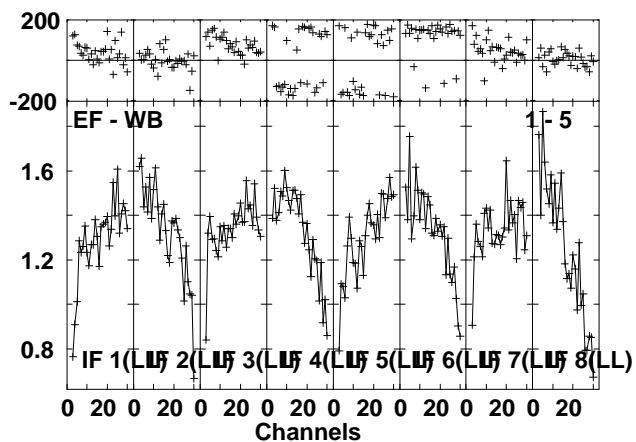
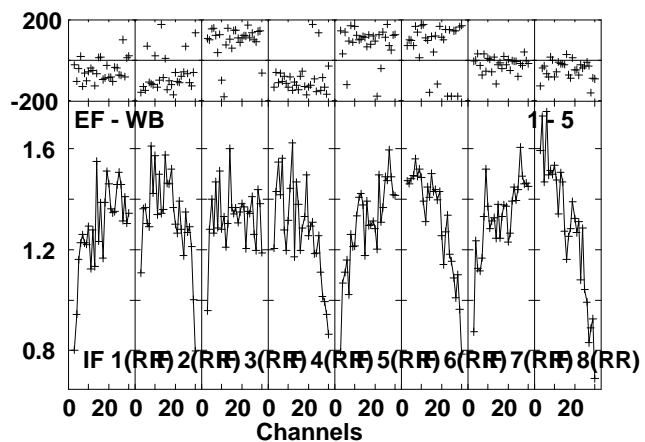
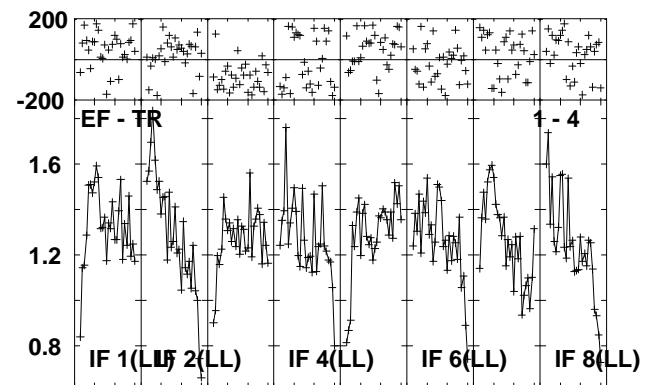
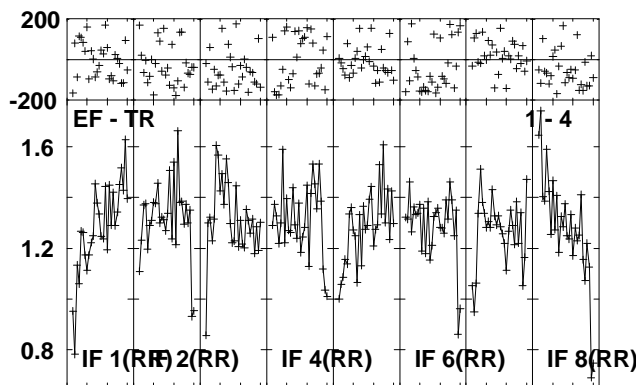
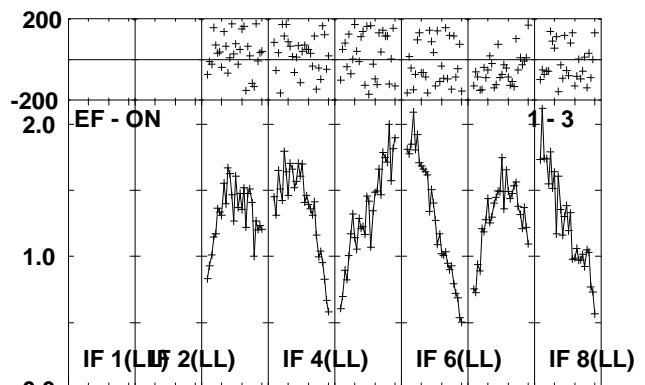
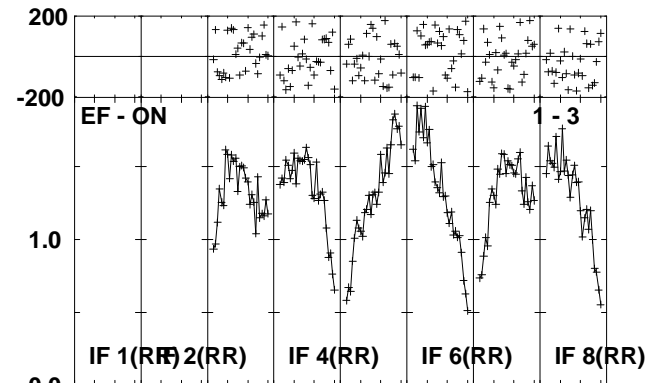
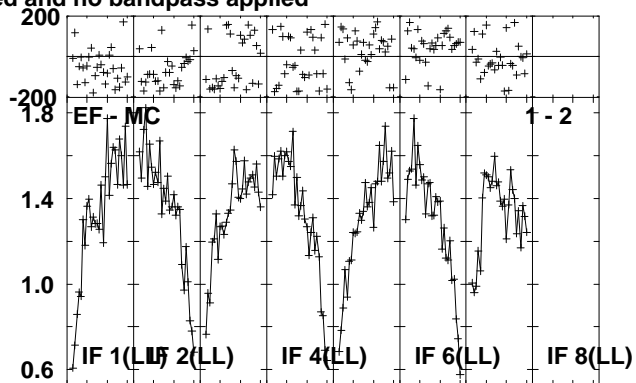
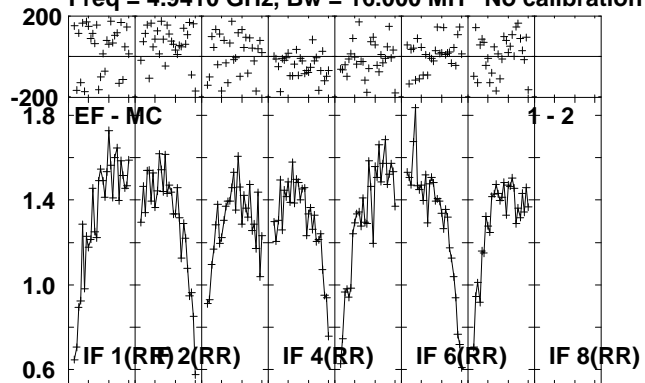

Lower frame: Milli Ampl Jy Top frame: Phas deg
Scalar averaged cross-power spectrum Several baselines displayed
Timerange: 00/16:29:21 to 00/16:31:49

Plot file version 140 created 04-OCT-2010 10:16:31

MAXI J16 RP016A.UVDATA.1

Freq = 4.9410 GHz, Bw = 16.000 MH No calibration applied and no bandpass applied

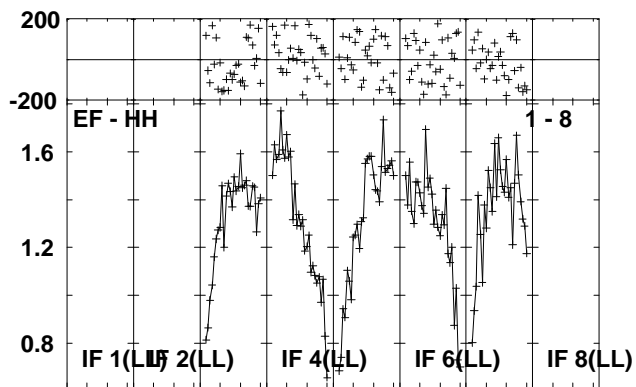
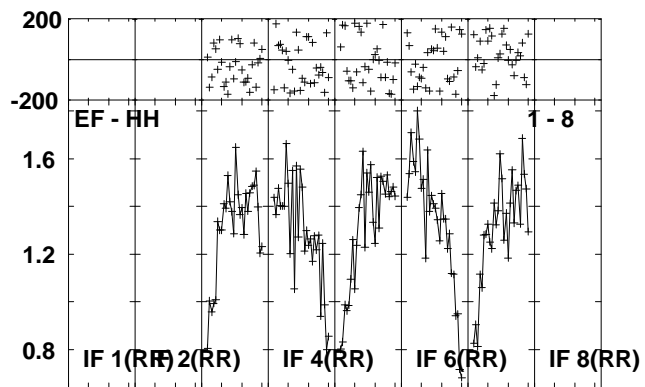
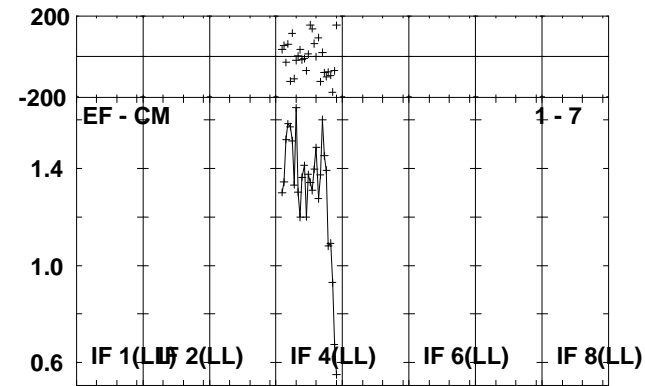
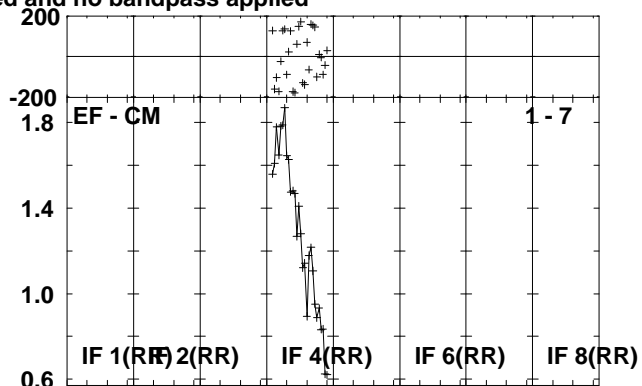
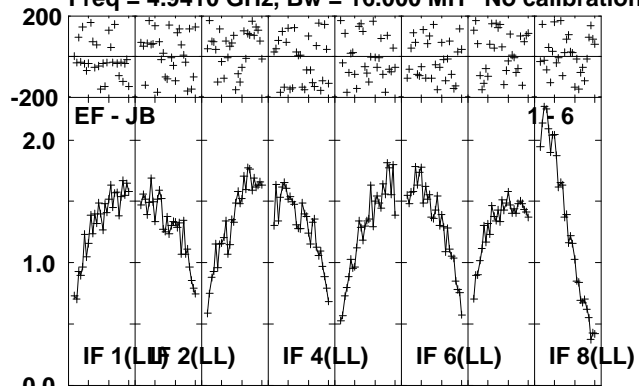

Lower frame: Milli Ampl Jy Top frame: Phas deg
Scalar averaged cross-power spectrum Several baselines displayed
Timerange: 00/16:29:21 to 00/16:31:49

Plot file version 141 created 04-OCT-2010 10:16:32

J1707-14 RP016A.UVDATA.1

Freq = 4.9410 GHz, Bw = 16.000 MH No calibration applied and no bandpass applied

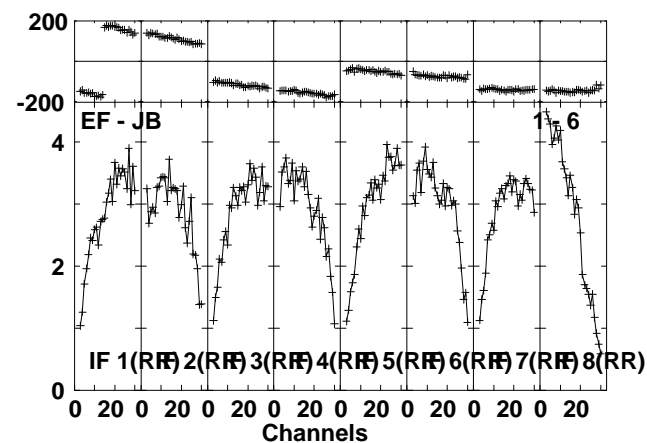
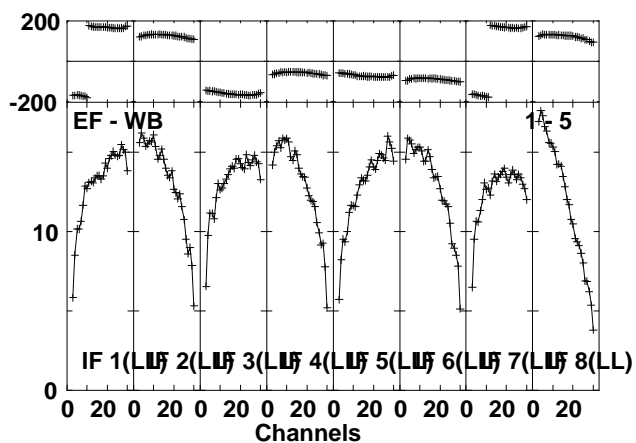
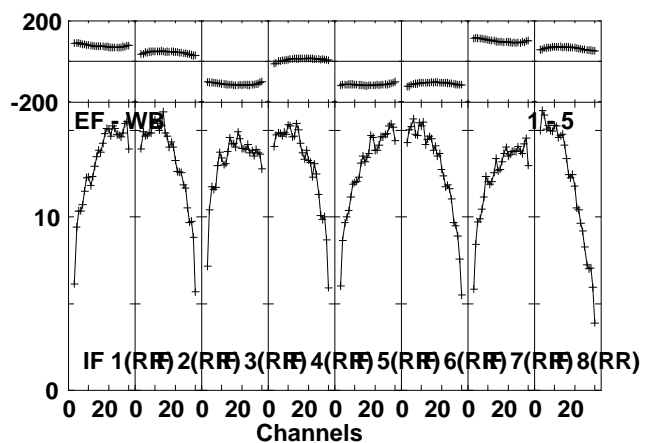
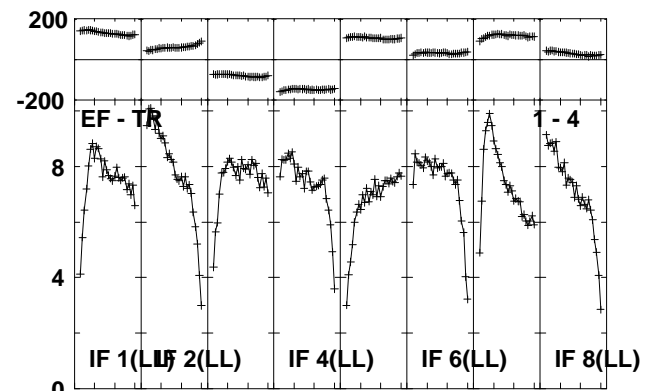
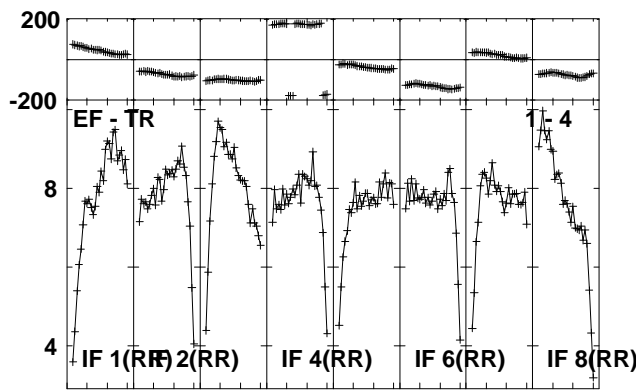
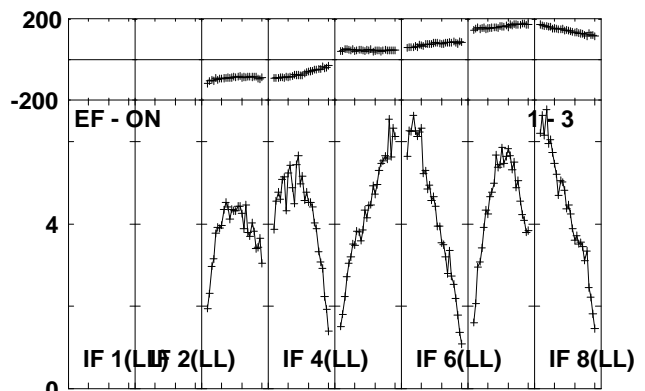
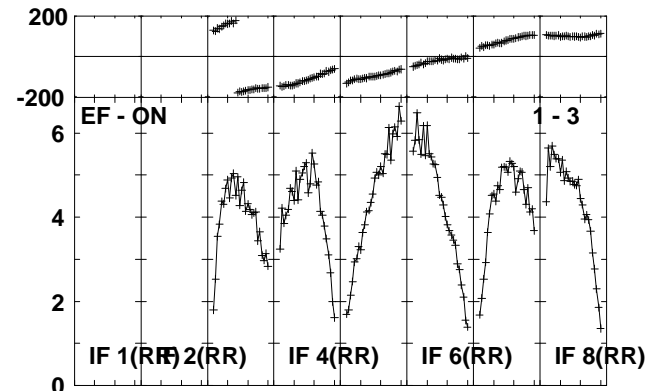
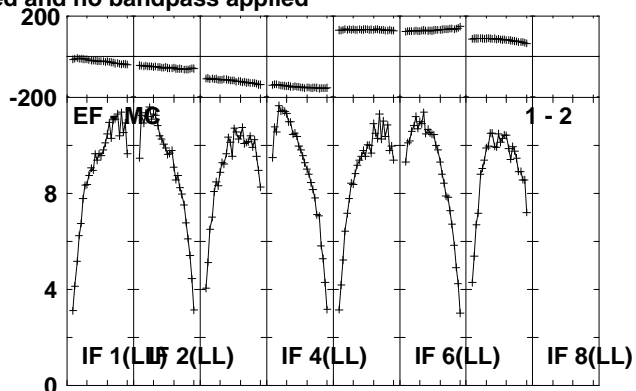
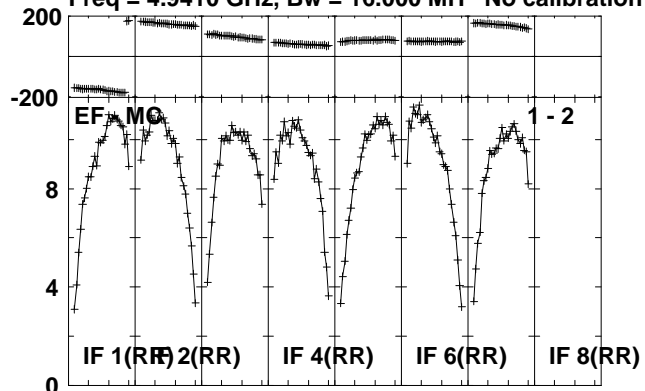

Lower frame: Milli Ampl Jy Top frame: Phas deg
Scalar averaged cross-power spectrum Several baselines displayed
Timerange: 00/16:31:51 to 00/16:33:19

Plot file version 142 created 04-OCT-2010 10:16:34
J1707-14 RP016A.UVDATA.1

Freq = 4.9410 GHz, Bw = 16.000 MH No calibration applied and no bandpass applied

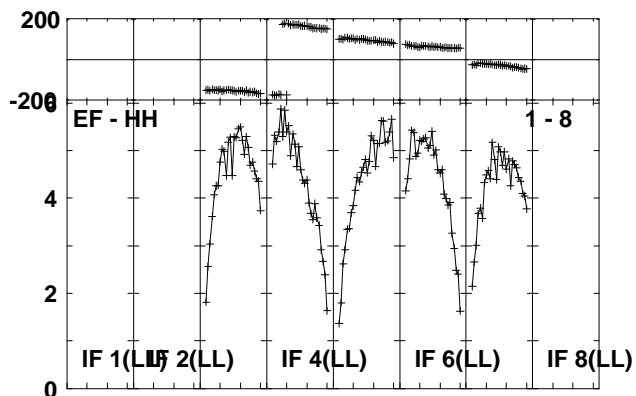
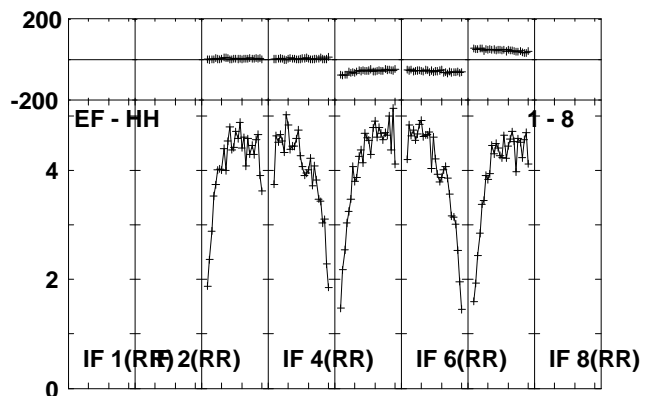
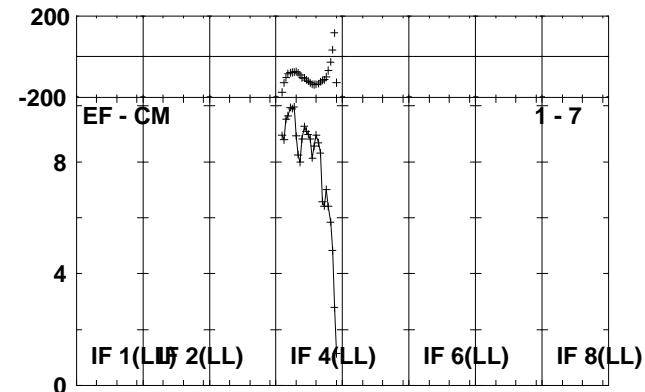
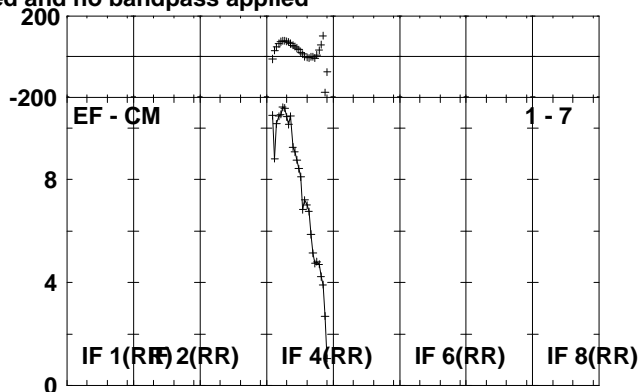
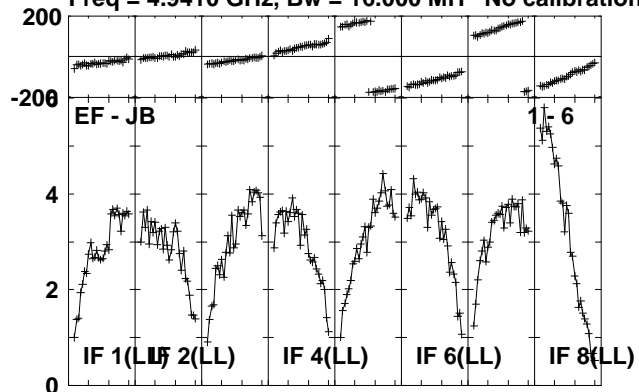

Lower frame: Milli Ampl Jy Top frame: Phas deg
Scalar averaged cross-power spectrum Several baselines displayed
Timerange: 00/16:31:51 to 00/16:33:19

Plot file version 143 created 04-OCT-2010 10:16:34

MAXI J16 RP016A.UVDATA.1

Freq = 4.9410 GHz, Bw = 16.000 MH No calibration applied and no bandpass applied

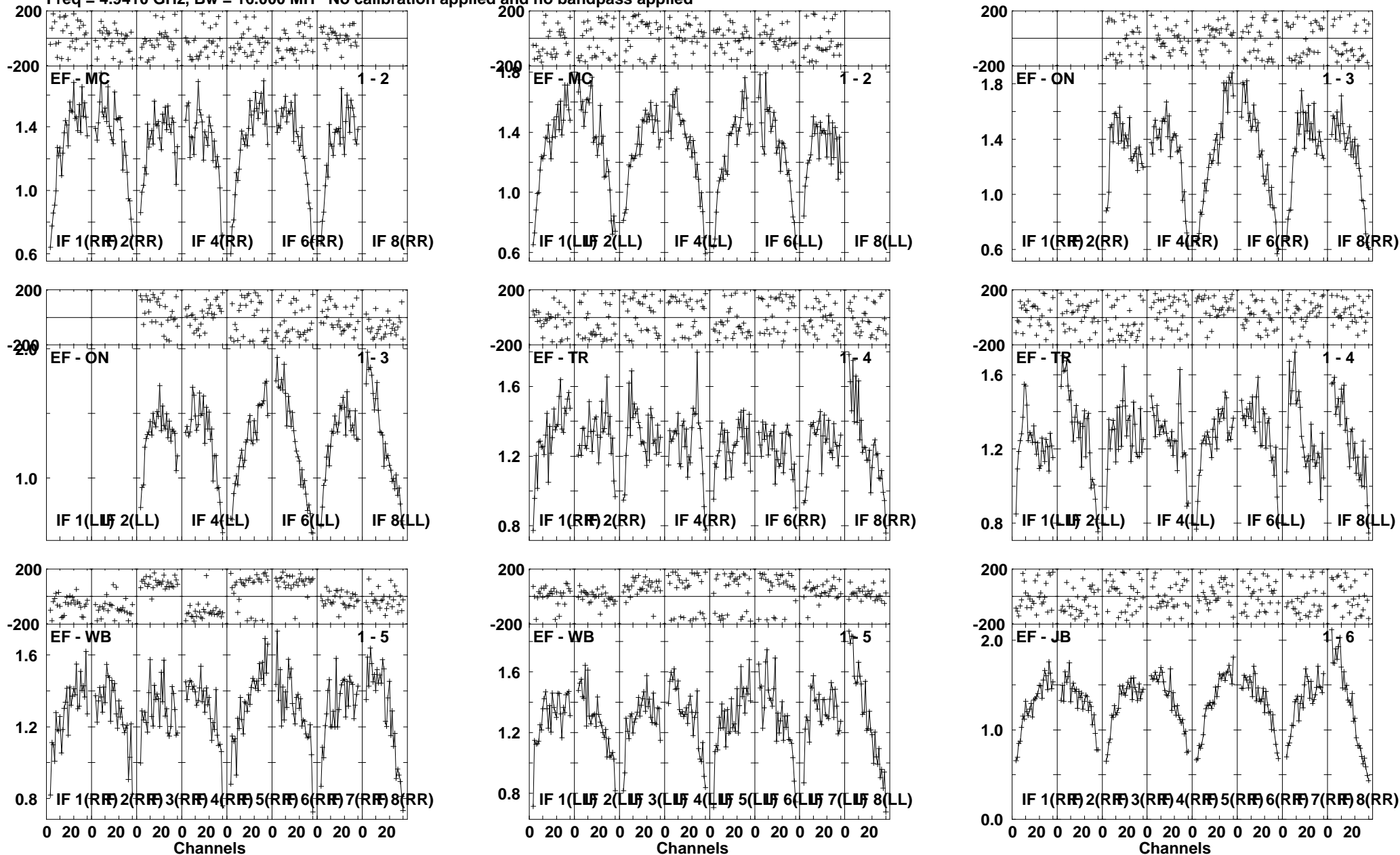

Lower frame: Milli Ampl Jy Top frame: Phas deg
Scalar averaged cross-power spectrum Several baselines displayed
Timerange: 00/16:33:21 to 00/16:35:49

Plot file version 144 created 04-OCT-2010 10:16:36

MAXI J16 RP016A.UVDATA.1

Freq = 4.9410 GHz, Bw = 16.000 MH No calibration applied and no bandpass applied

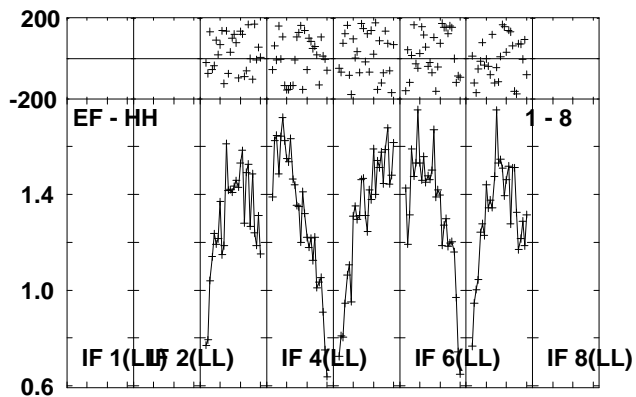
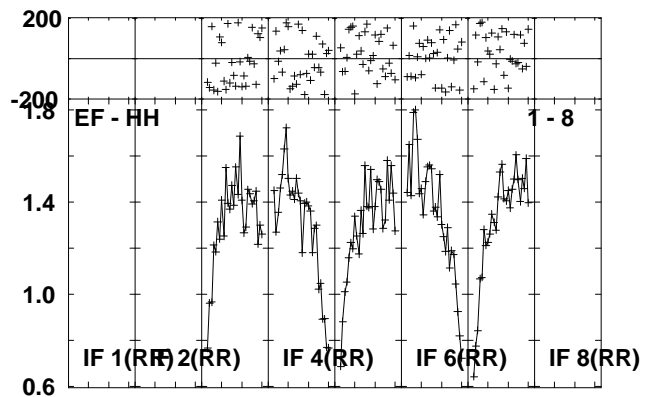
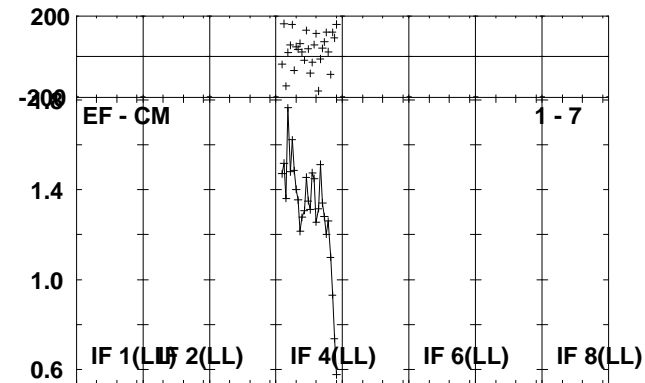
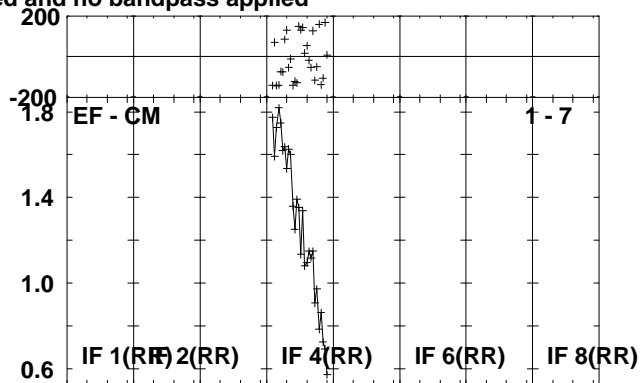
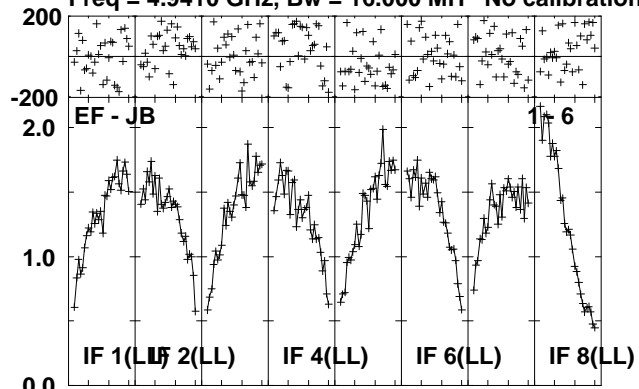

Lower frame: Milli Ampl Jy Top frame: Phas deg
Scalar averaged cross-power spectrum Several baselines displayed
Timerange: 00/16:33:21 to 00/16:35:49

Plot file version 145 created 04-OCT-2010 10:16:37

J1707-14 RP016A.UVDATA.1

Freq = 4.9410 GHz, Bw = 16.000 MH No calibration applied and no bandpass applied

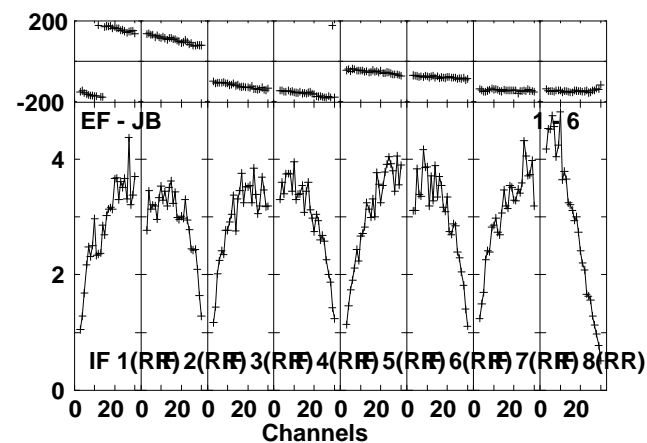
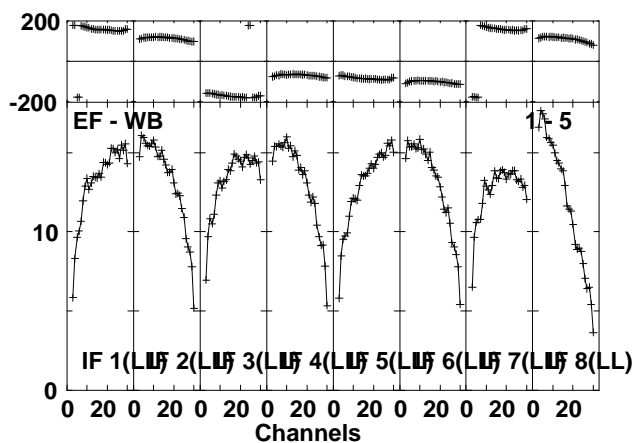
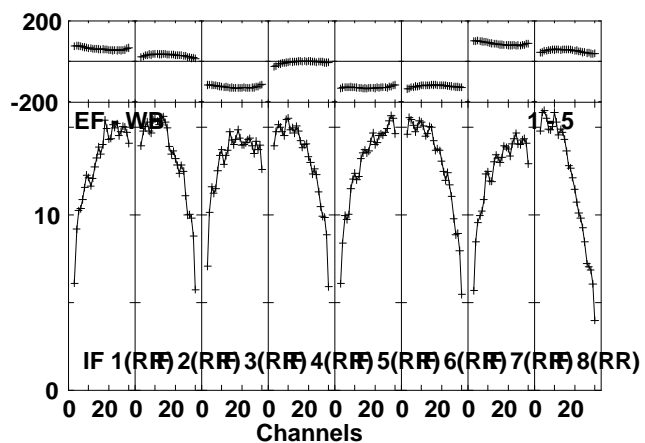
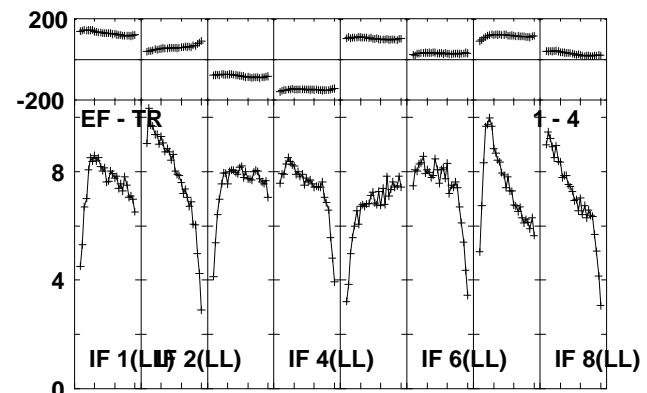
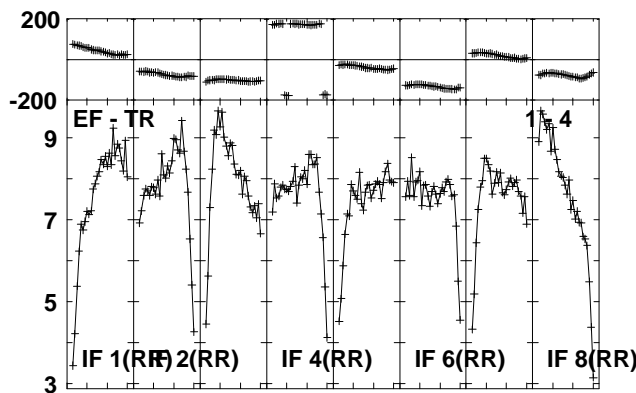
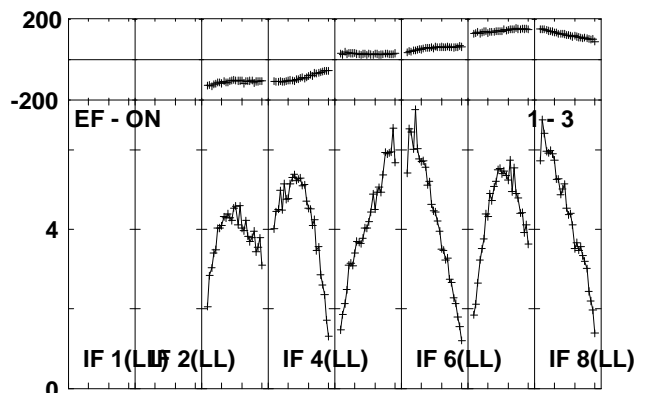
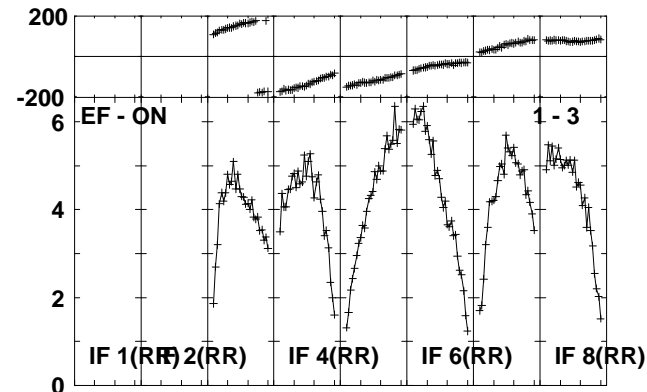
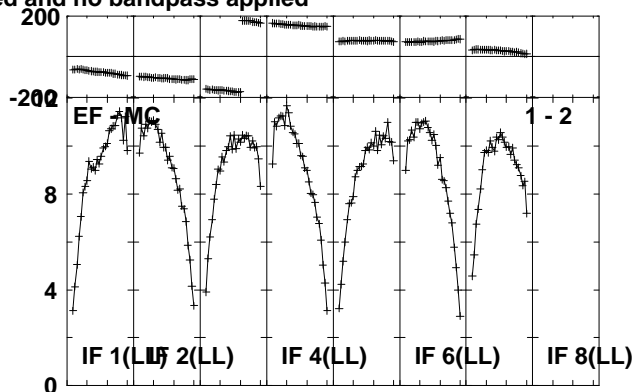
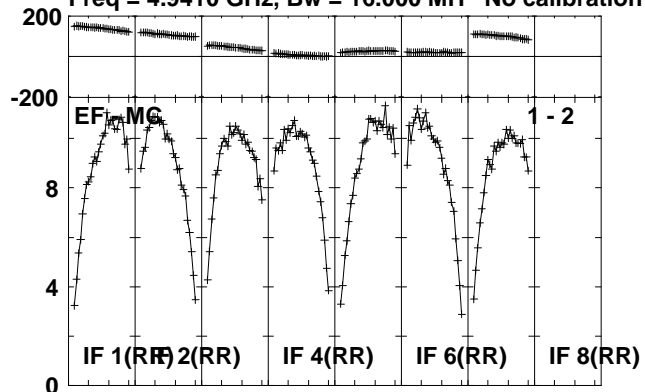

Lower frame: Milli Ampl Jy Top frame: Phas deg
Scalar averaged cross-power spectrum Several baselines displayed
Timerange: 00/16:36:31 to 00/16:37:29

Plot file version 146 created 04-OCT-2010 10:16:38

J1707-14 RP016A.UVDATA.1

Freq = 4.9410 GHz, Bw = 16.000 MH No calibration applied and no bandpass applied

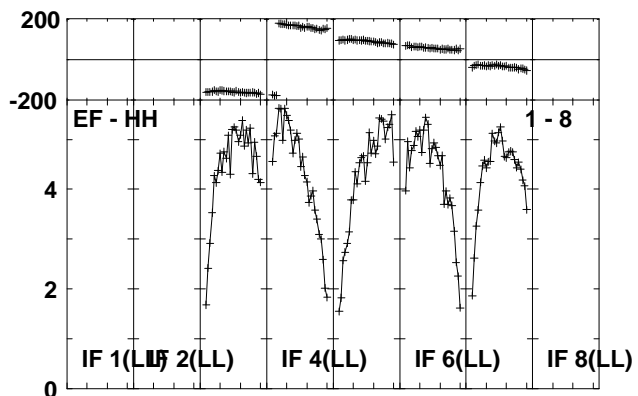
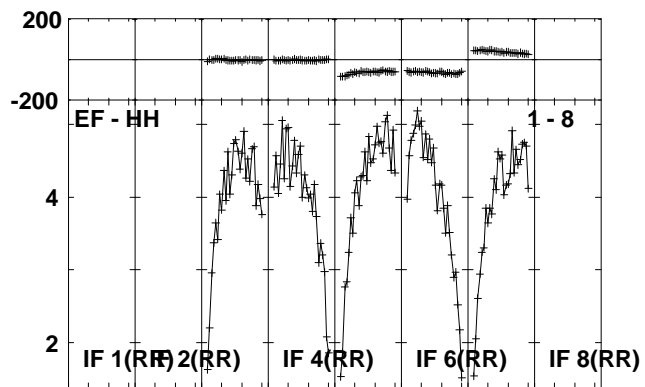
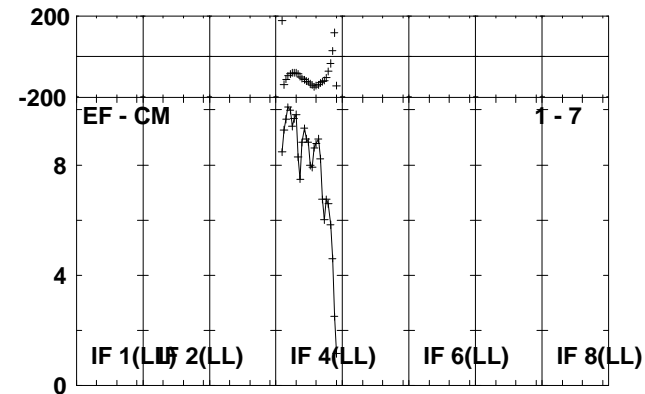
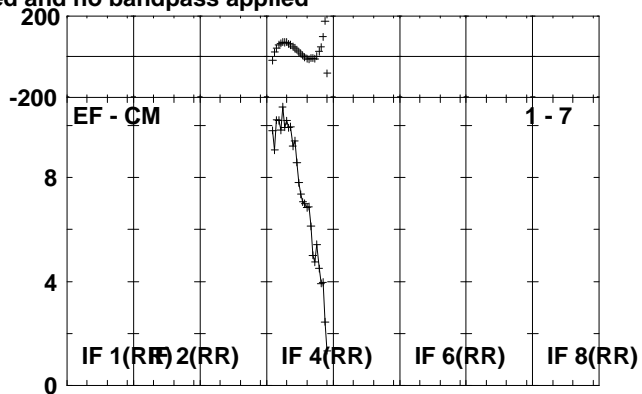
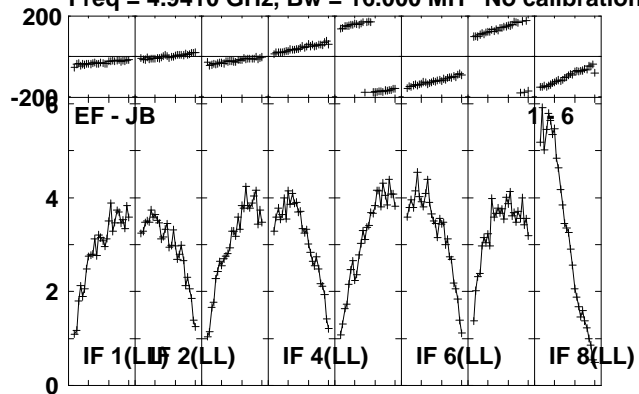

Lower frame: Milli Ampl Jy Top frame: Phas deg
Scalar averaged cross-power spectrum Several baselines displayed
Timerange: 00/16:36:31 to 00/16:37:29

Plot file version 147 created 04-OCT-2010 10:16:39

NVSS3 RP016A.UVDATA.1

Freq = 4.9410 GHz, Bw = 16.000 MH No calibration applied and no bandpass applied

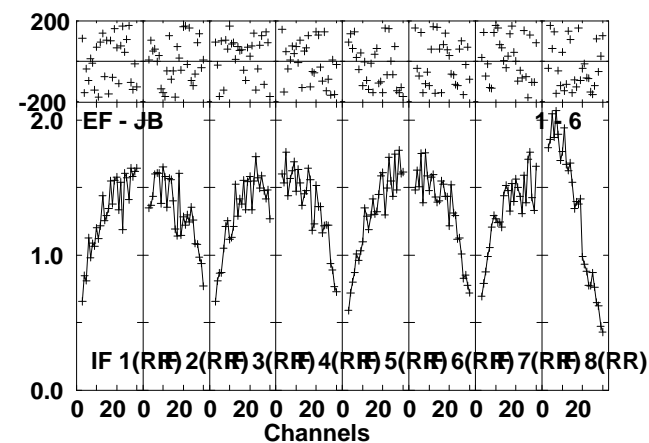
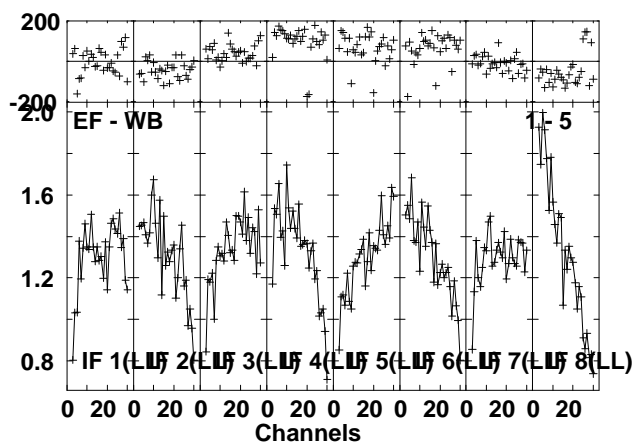
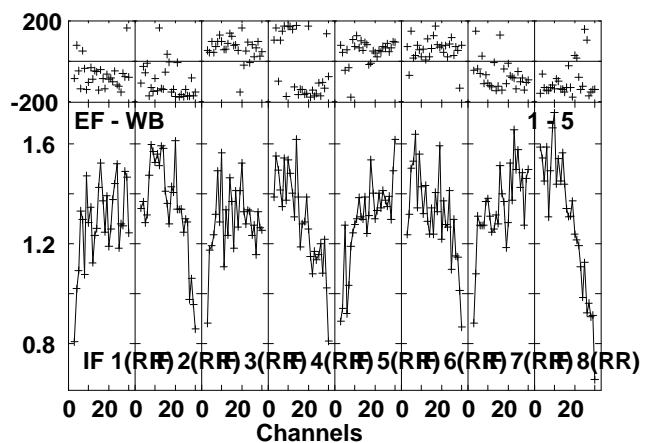
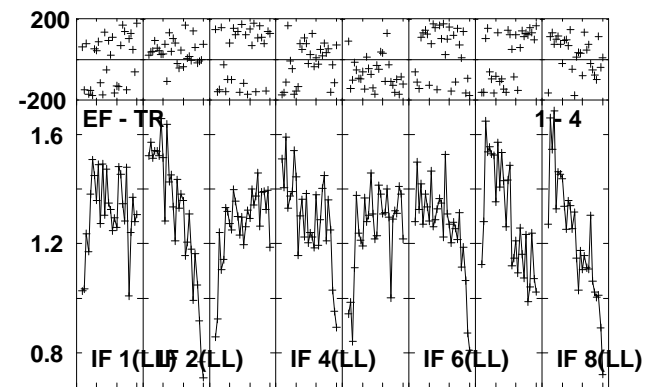
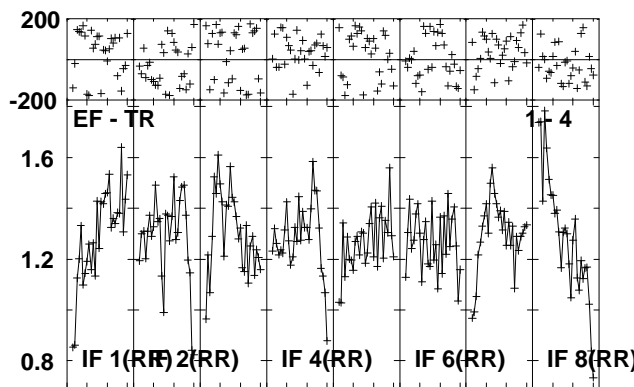
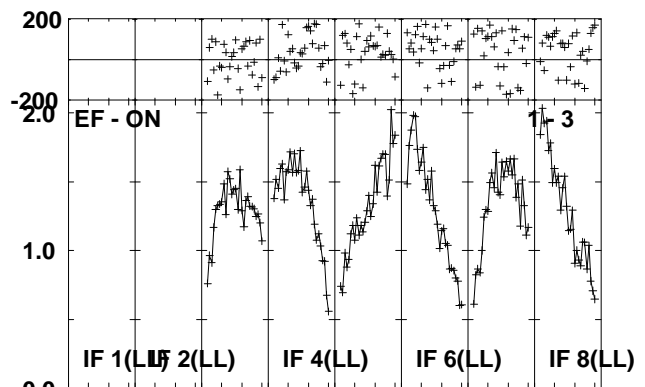
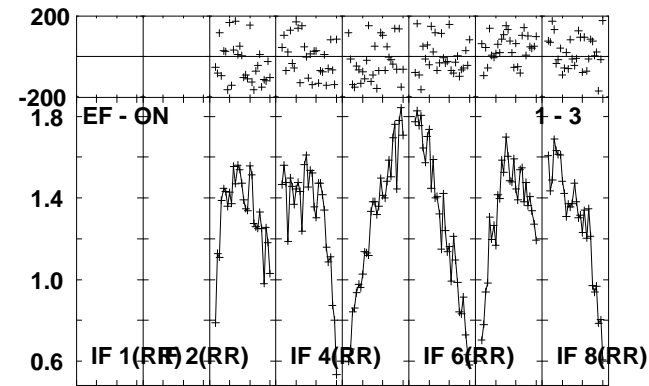
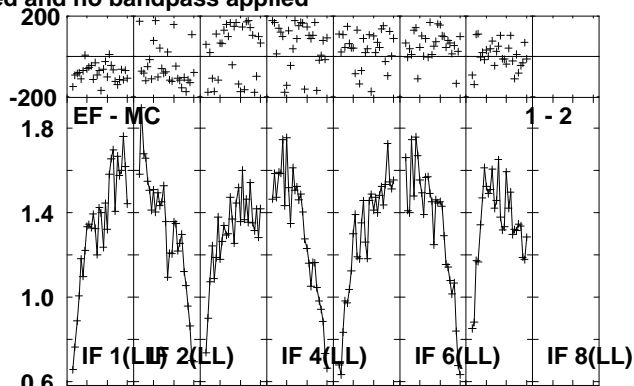
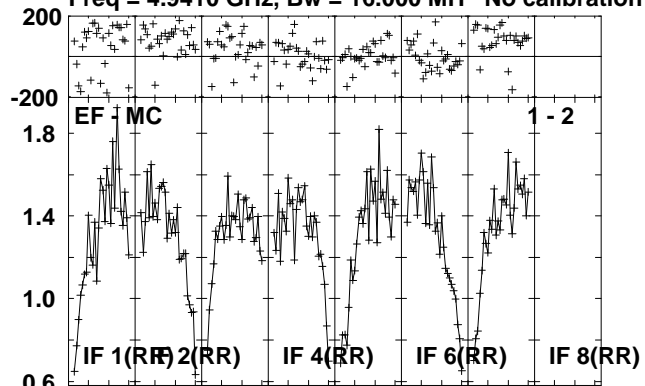

Lower frame: Milli Ampl Jy Top frame: Phas deg
Scalar averaged cross-power spectrum Several baselines displayed
Timerange: 00/16:37:31 to 00/16:39:59

Plot file version 148 created 04-OCT-2010 10:16:40

NVSS3 RP016A.UVDATA.1

Freq = 4.9410 GHz, Bw = 16.000 MH No calibration applied and no bandpass applied

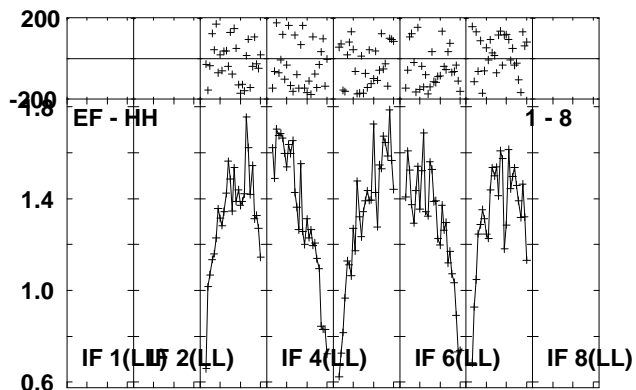
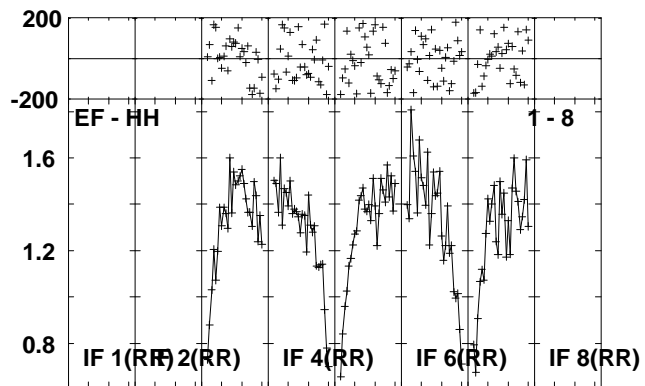
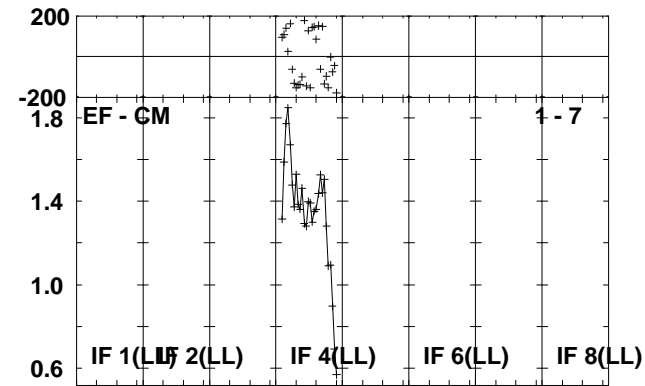
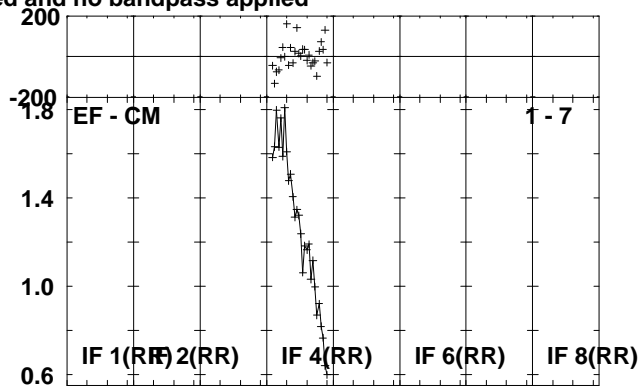
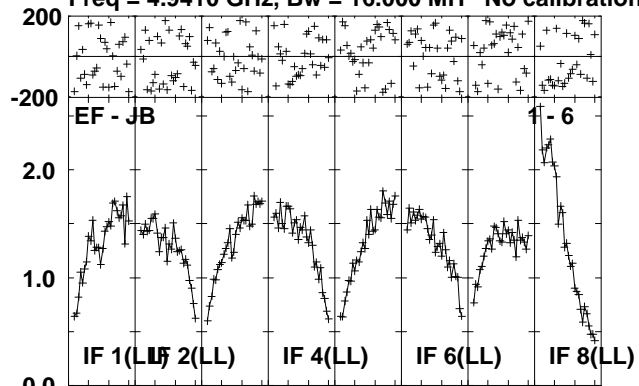

Lower frame: Milli Ampl Jy Top frame: Phas deg
Scalar averaged cross-power spectrum Several baselines displayed
Timerange: 00/16:37:31 to 00/16:39:59

Plot file version 149 created 04-OCT-2010 10:16:42

J1707-14 RP016A.UVDATA.1

Freq = 4.9410 GHz, Bw = 16.000 MH No calibration applied and no bandpass applied

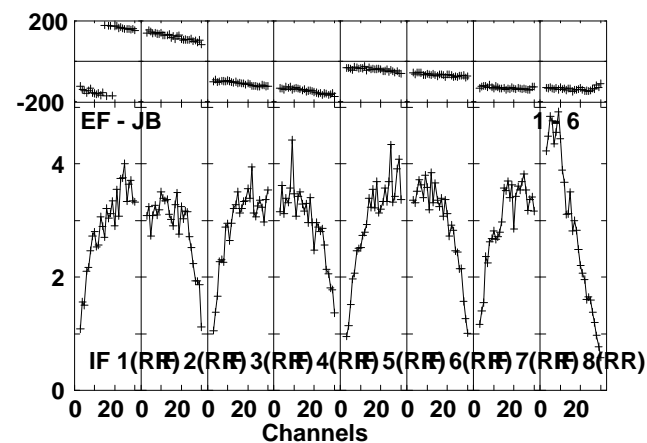
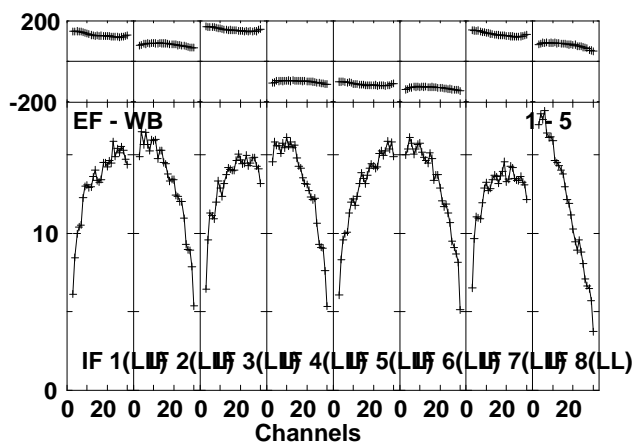
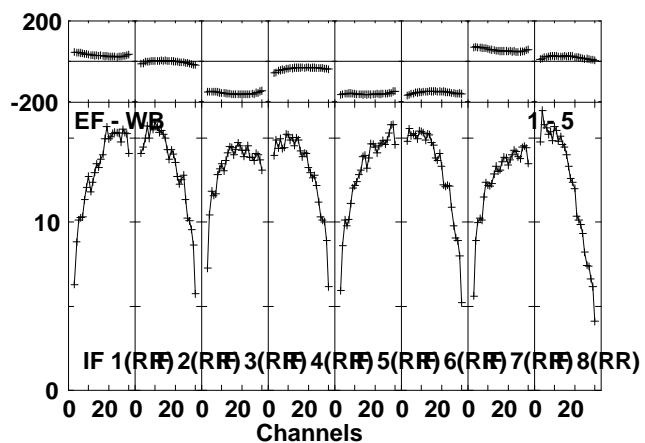
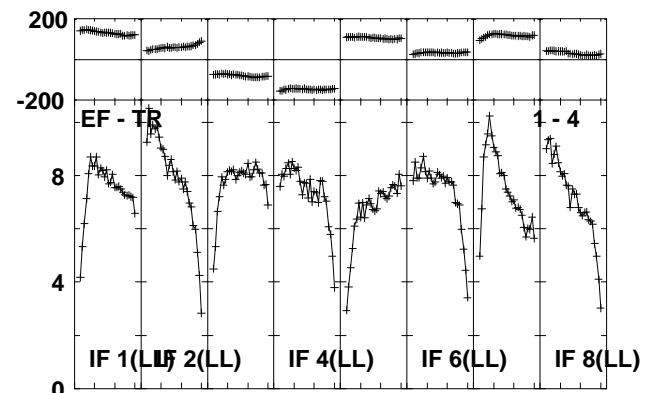
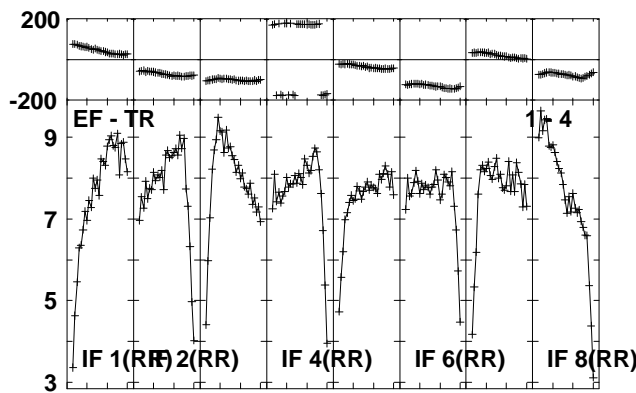
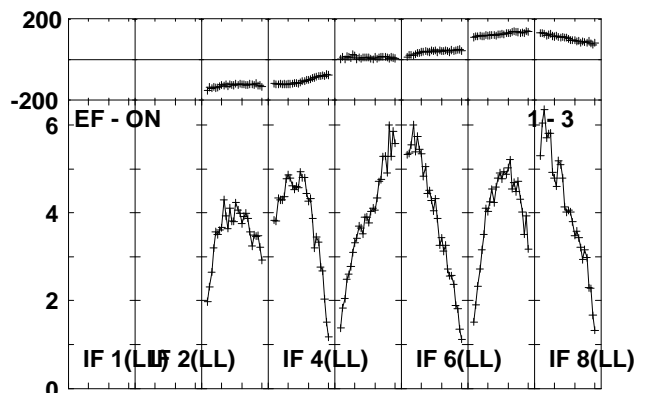
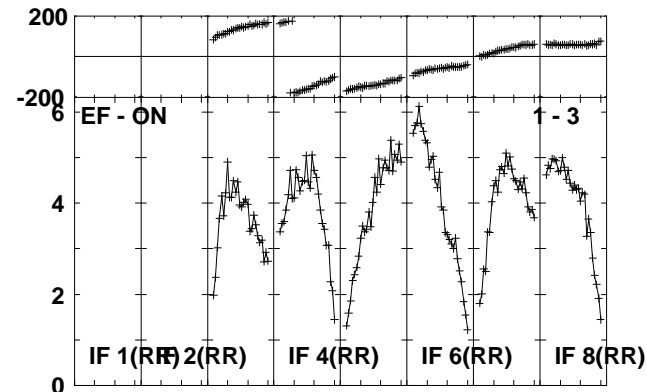
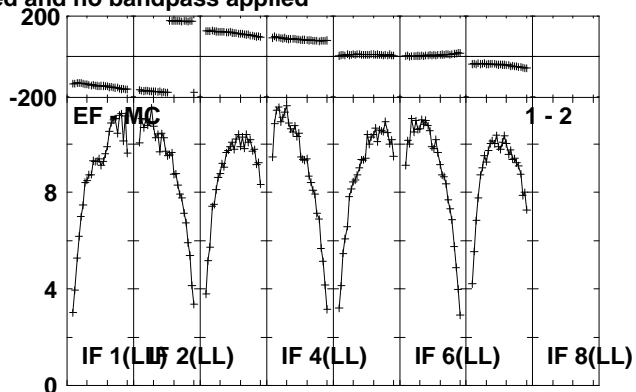
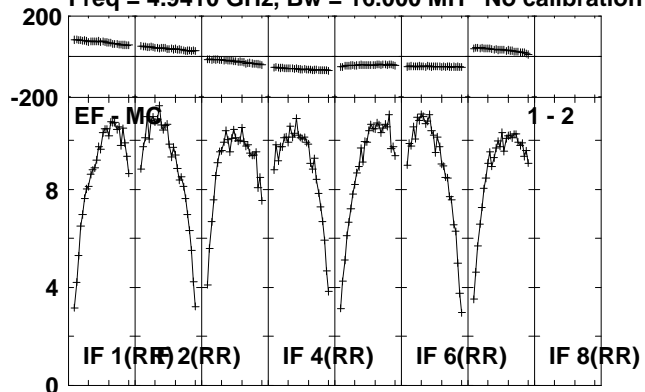

Lower frame: Milli Ampl Jy Top frame: Phas deg
Scalar averaged cross-power spectrum Several baselines displayed
Timerange: 00/16:40:01 to 00/16:41:29

Plot file version 150 created 04-OCT-2010 10:16:43

J1707-14 RP016A.UVDATA.1

Freq = 4.9410 GHz, Bw = 16.000 MH No calibration applied and no bandpass applied

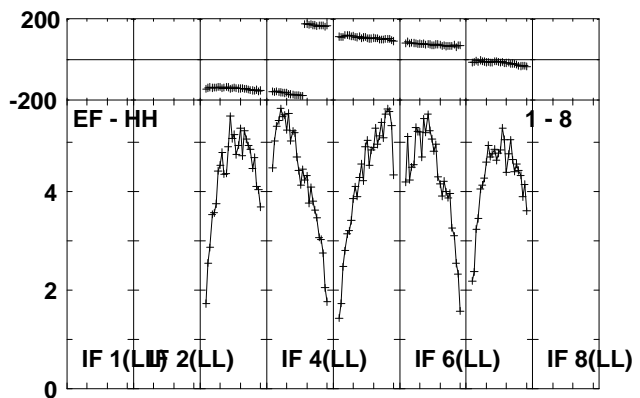
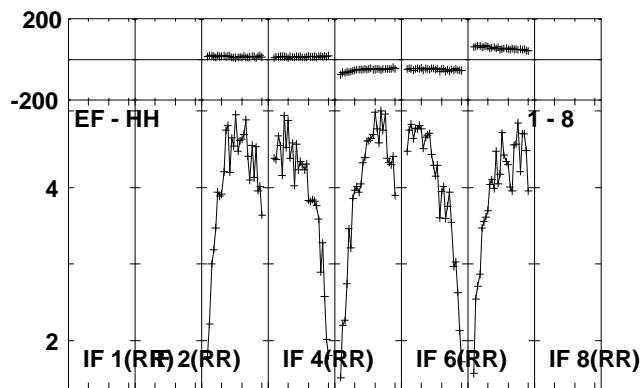
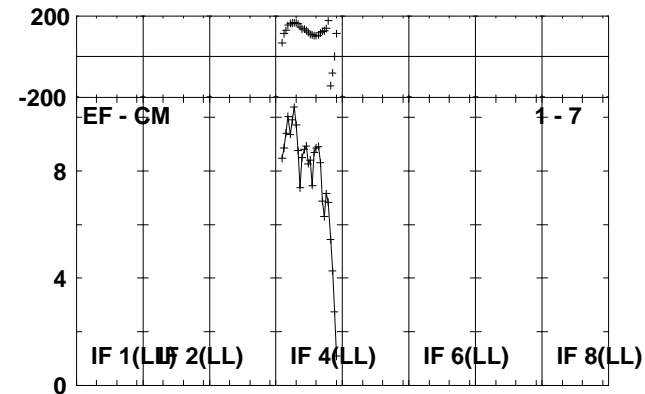
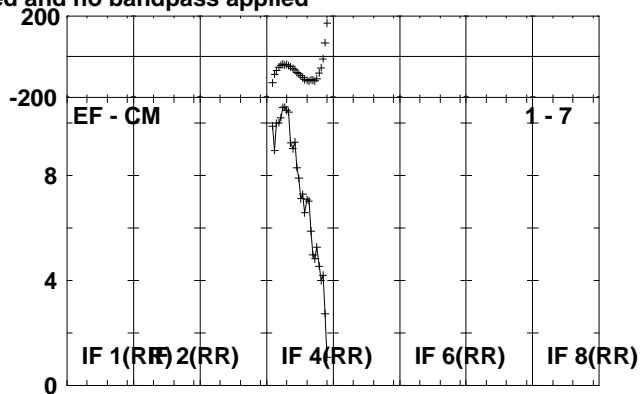
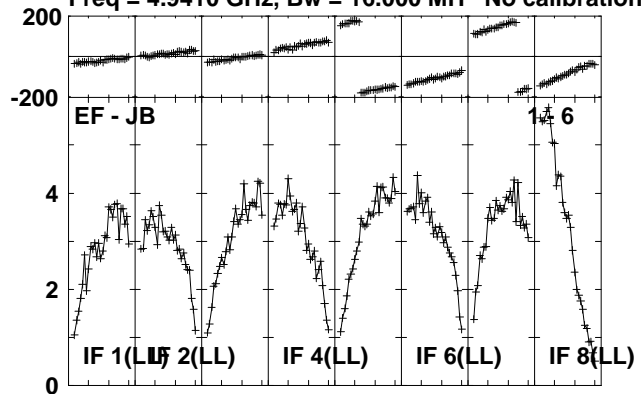

Lower frame: Milli Ampl Jy Top frame: Phas deg
Scalar averaged cross-power spectrum Several baselines displayed
Timerange: 00/16:40:01 to 00/16:41:29

Plot file version 151 created 04-OCT-2010 10:16:44

MAXI J16 RP016A.UVDATA.1

Freq = 4.9410 GHz, Bw = 16.000 MH No calibration applied and no bandpass applied

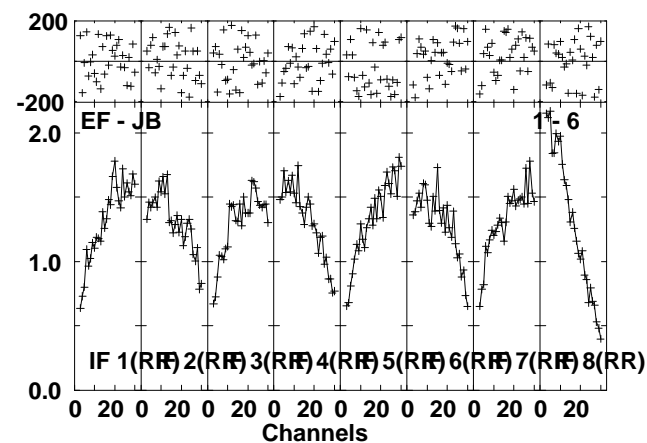
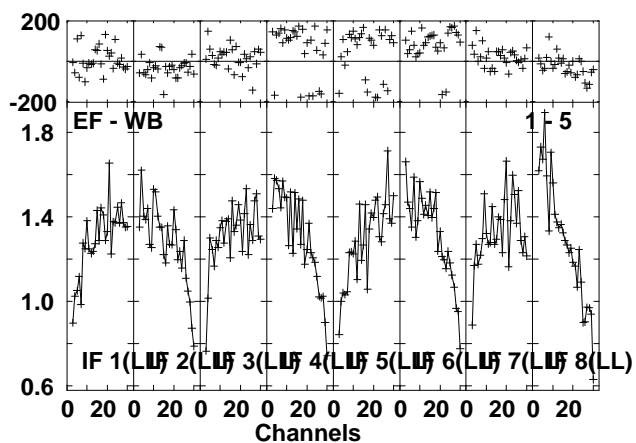
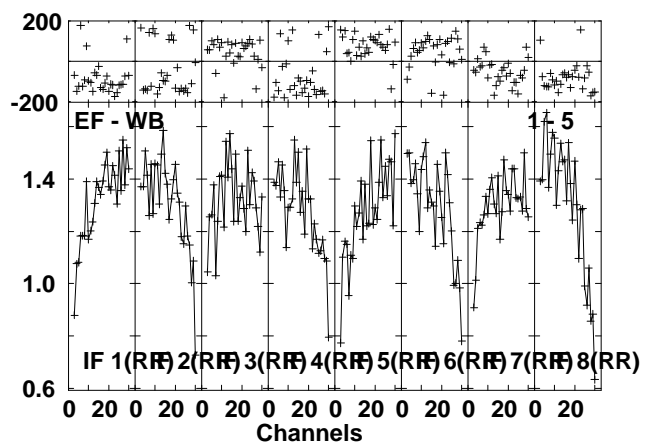
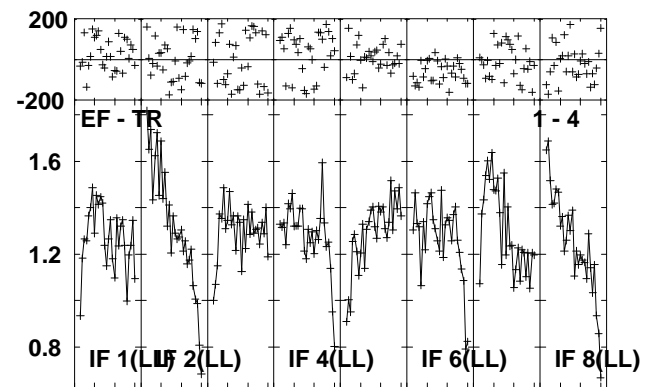
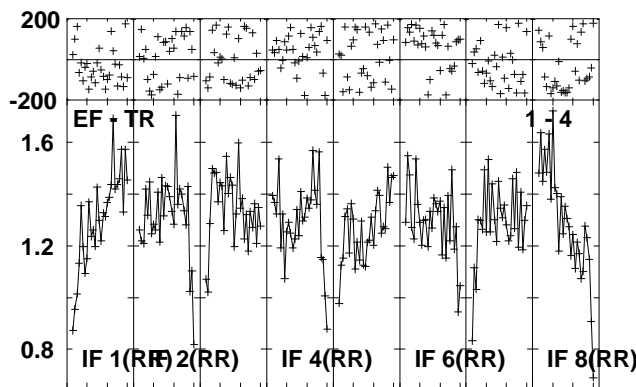
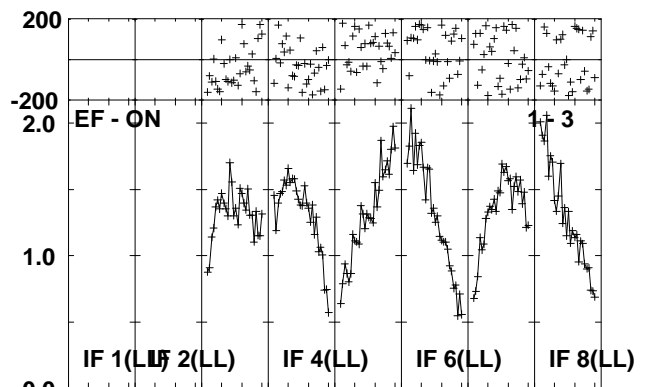
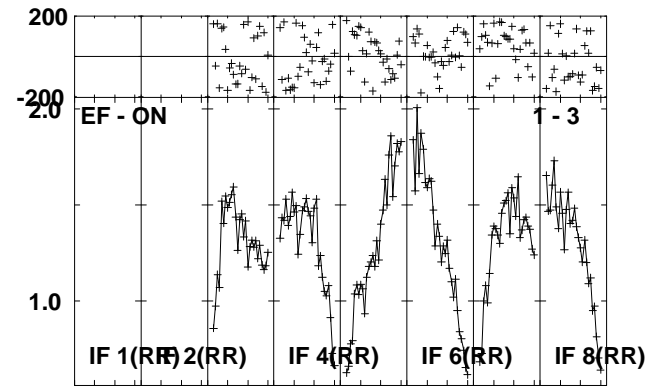
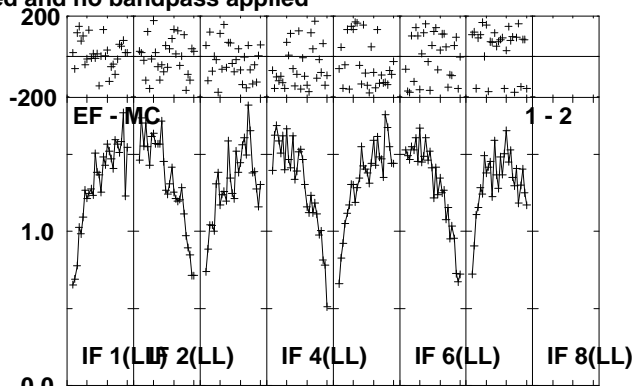
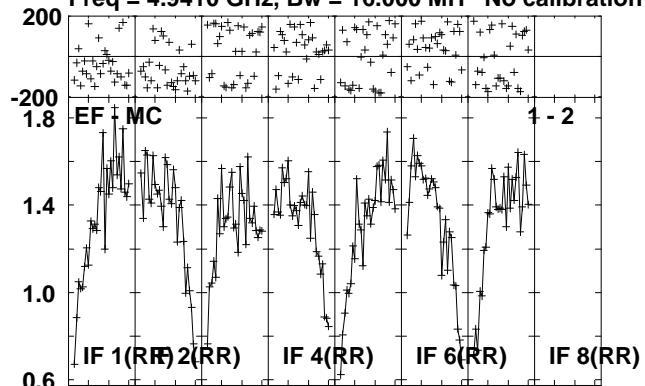

Lower frame: Milli Ampl Jy Top frame: Phas deg
Scalar averaged cross-power spectrum Several baselines displayed
Timerange: 00:16:41:31 to 00:16:43:59

Plot file version 152 created 04-OCT-2010 10:16:45

MAXI J16 RP016A.UVDATA.1

Freq = 4.9410 GHz, Bw = 16.000 MH No calibration applied and no bandpass applied

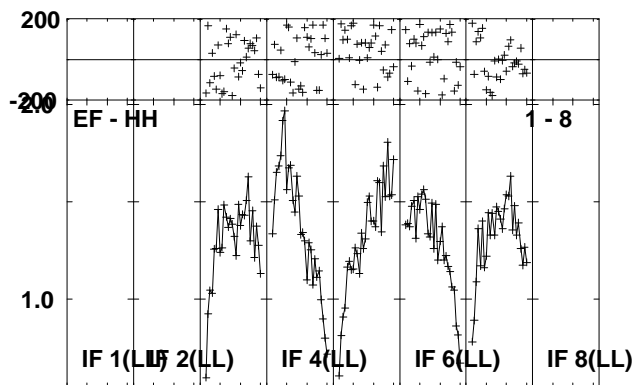
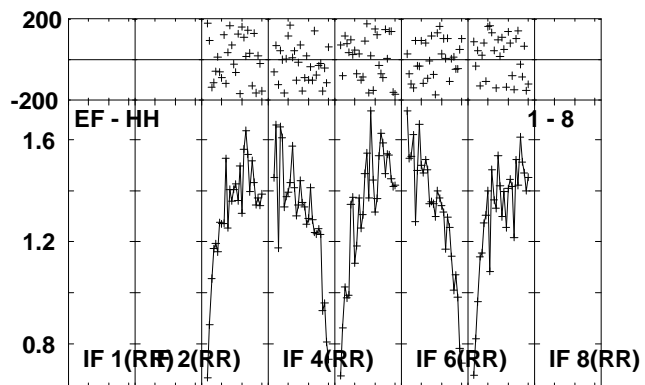
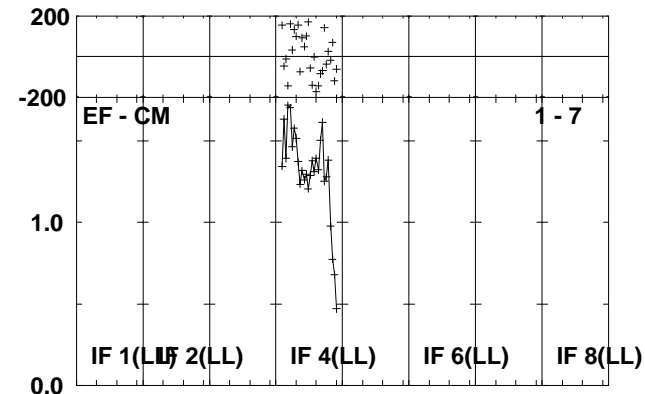
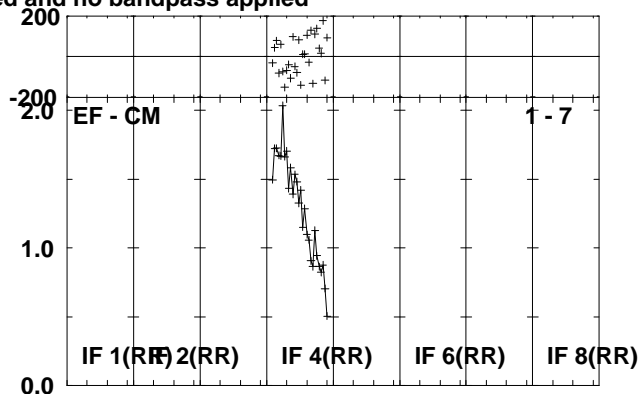
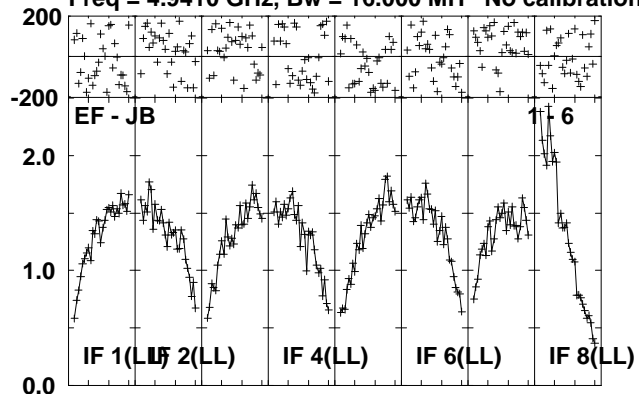

Lower frame: Milli Ampl Jy Top frame: Phas deg
Scalar averaged cross-power spectrum Several baselines displayed
Timerange: 00/16:41:31 to 00/16:43:59

Plot file version 153 created 04-OCT-2010 10:16:46

J1707-14 RP016A.UVDATA.1

Freq = 4.9410 GHz, Bw = 16.000 MH No calibration applied and no bandpass applied

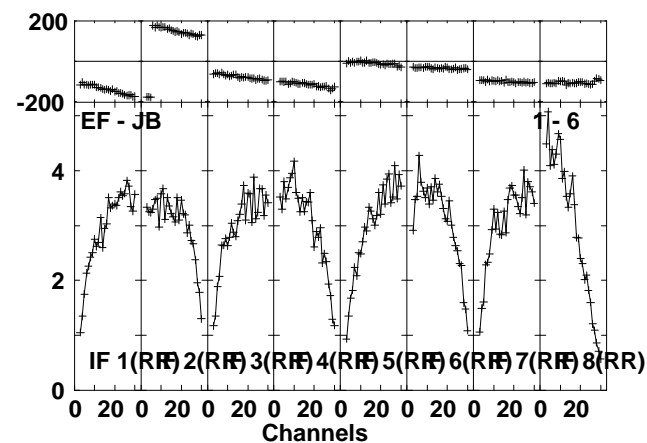
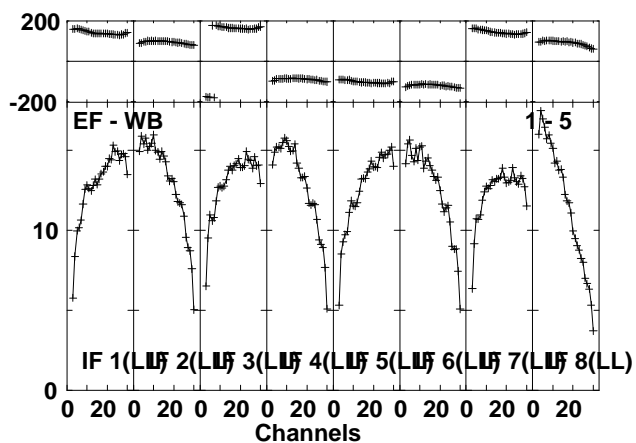
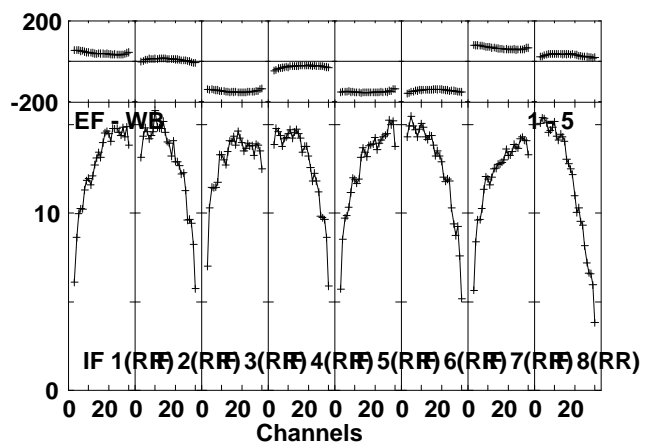
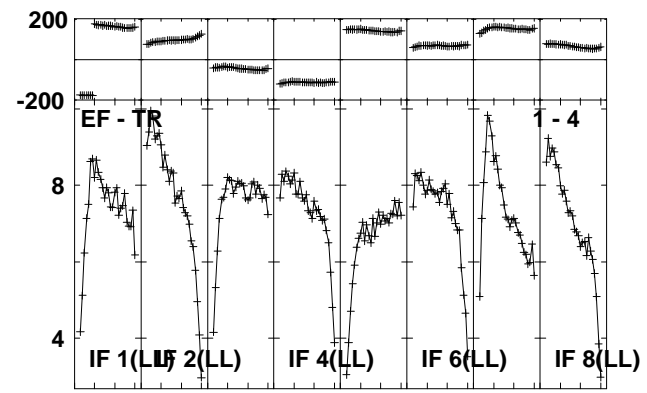
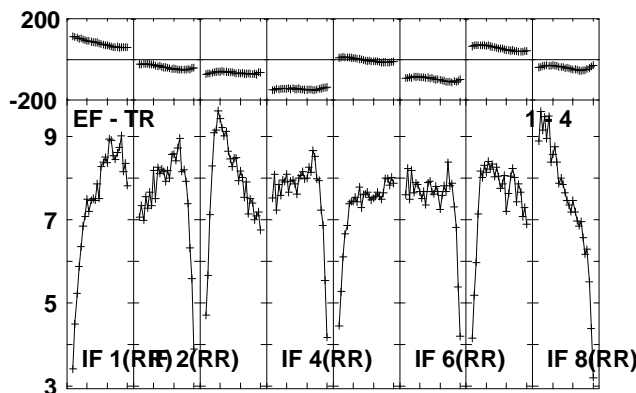
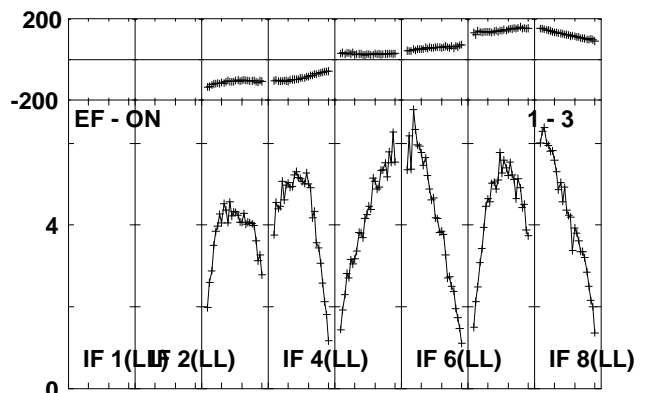
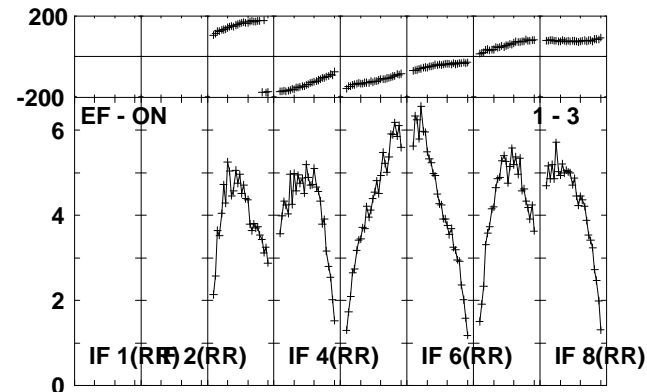
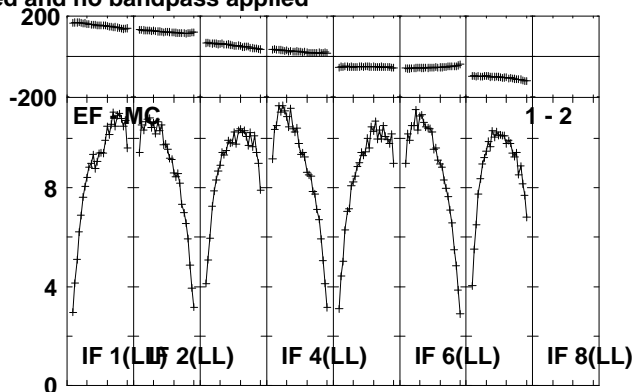
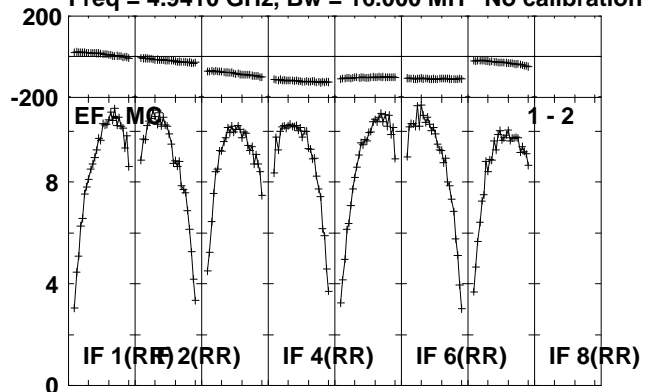

Lower frame: Milli Ampl Jy Top frame: Phas deg
Scalar averaged cross-power spectrum Several baselines displayed
Timerange: 00/16:44:41 to 00/16:45:39

Plot file version 154 created 04-OCT-2010 10:16:47
J1707-14 RP016A.UVDATA.1

Freq = 4.9410 GHz, Bw = 16.000 MH No calibration applied and no bandpass applied

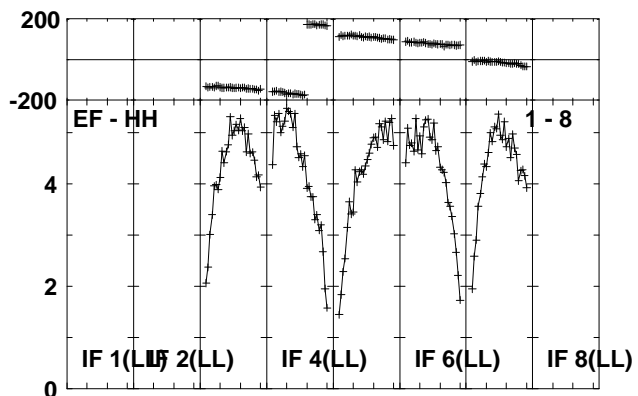
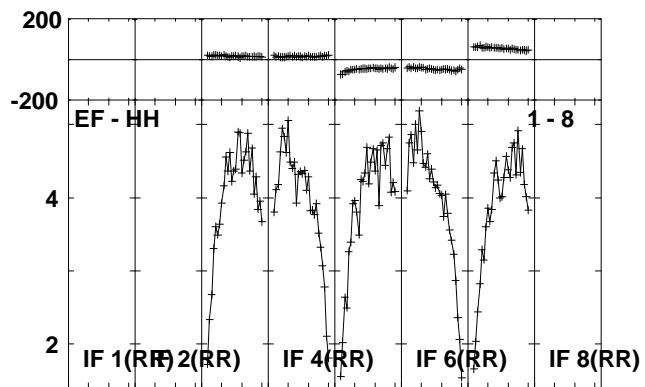
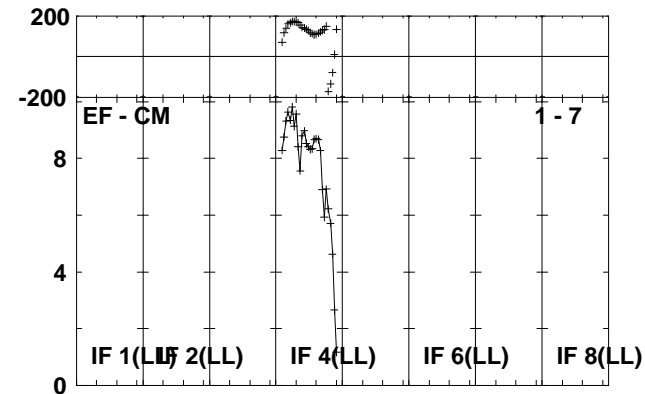
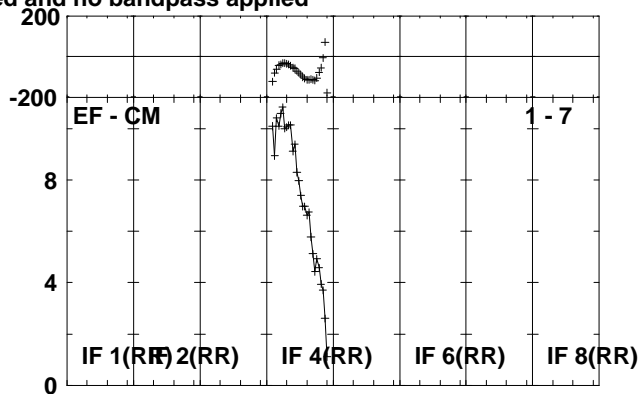
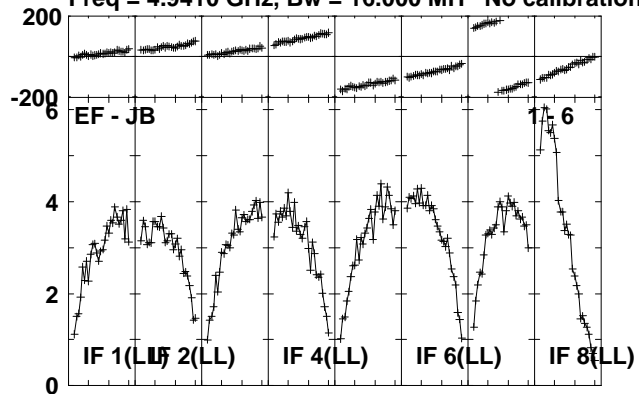

Lower frame: Milli Ampl Jy Top frame: Phas deg
Scalar averaged cross-power spectrum Several baselines displayed
Timerange: 00/16:44:41 to 00/16:45:39

Plot file version 155 created 04-OCT-2010 10:16:48

J1310+32 RP016A.UVDATA.1

Freq = 4.9410 GHz, Bw = 16.000 MH No calibration applied and no bandpass applied

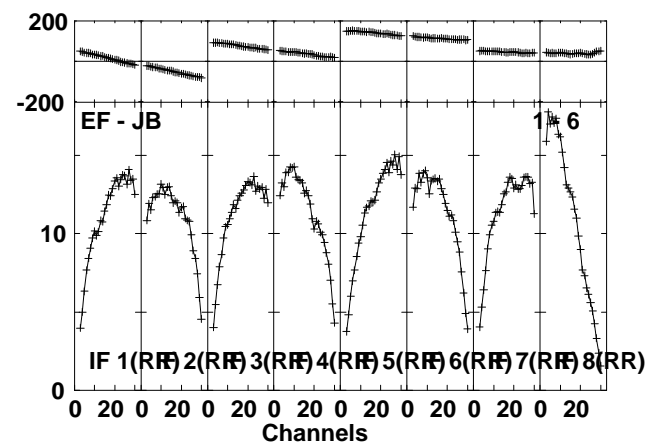
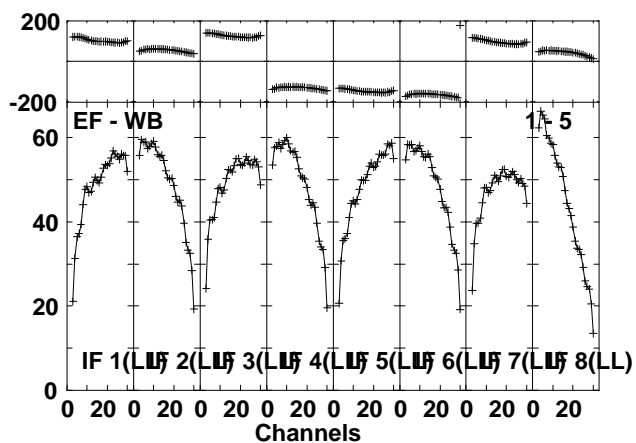
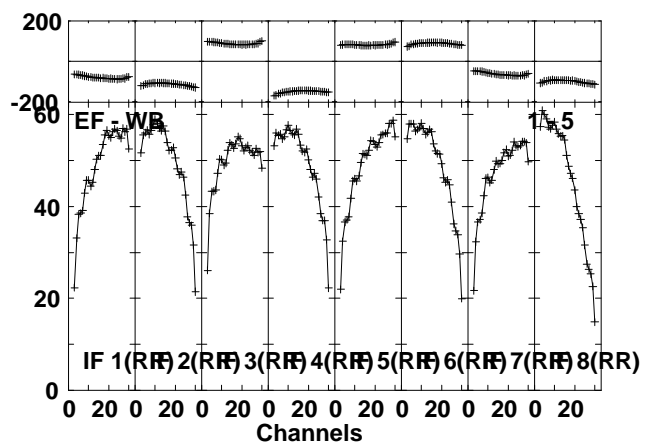
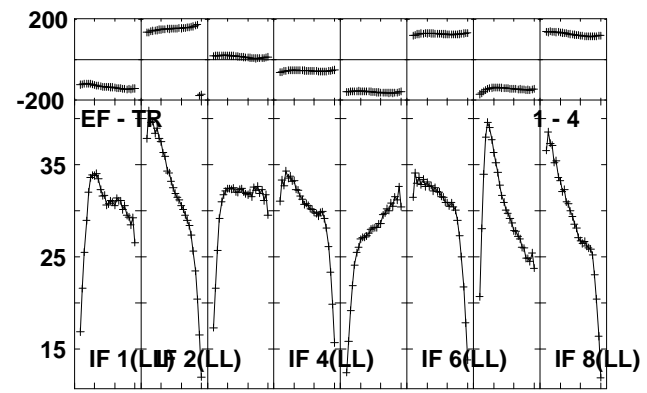
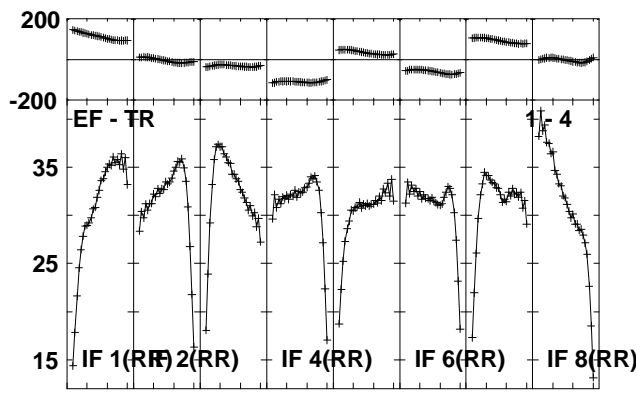
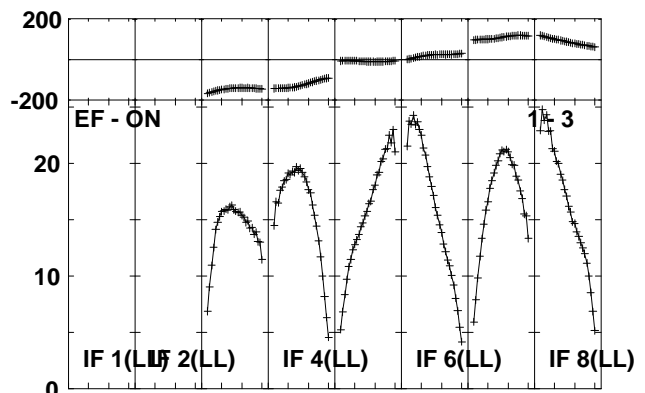
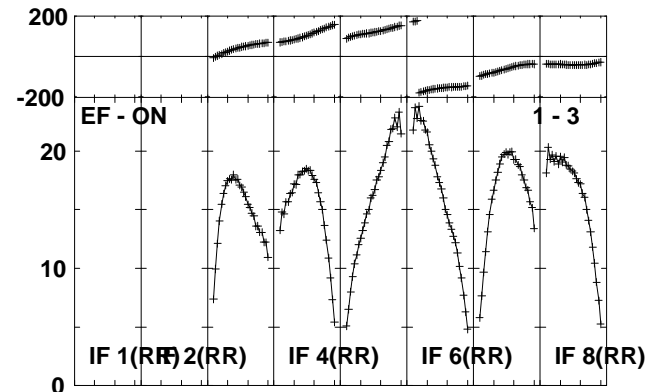
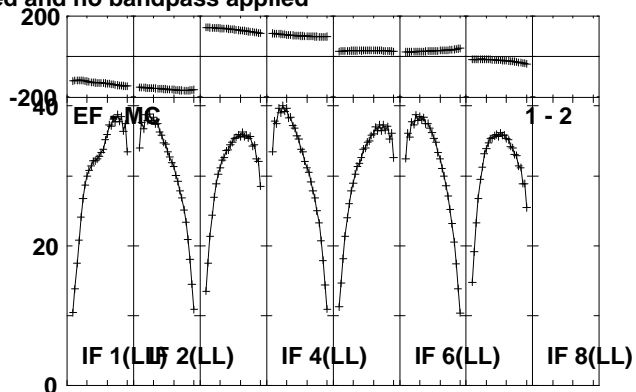
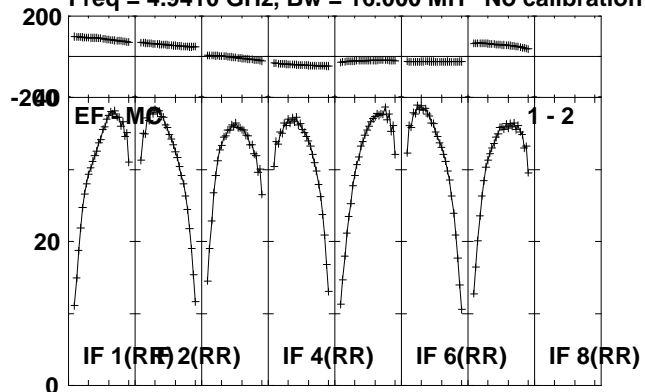

Lower frame: Milli Ampl Jy Top frame: Phas deg
Scalar averaged cross-power spectrum Several baselines displayed
Timerange: 00/16:47:41 to 00/16:53:39

Plot file version 156 created 04-OCT-2010 10:16:52
J1310+32 RP016A.UVDATA.1

Freq = 4.9410 GHz, Bw = 16.000 MH No calibration applied and no bandpass applied

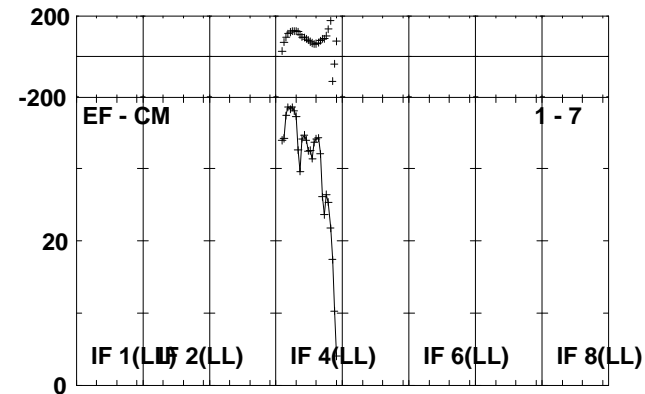
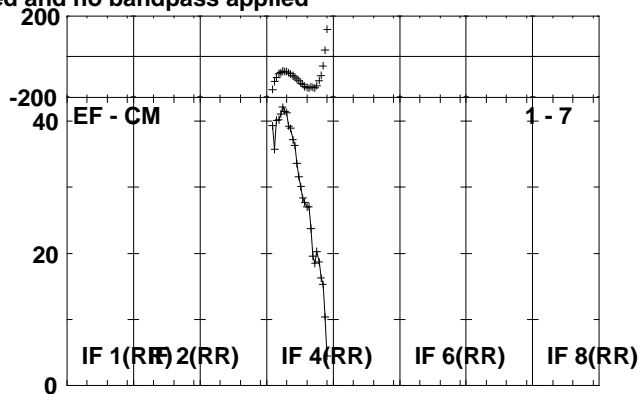
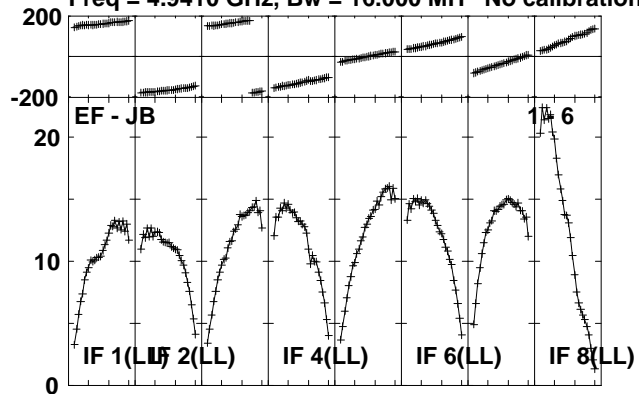

Lower frame: Milli Ampl Jy Top frame: Phas deg
Scalar averaged cross-power spectrum Several baselines displayed
Timerange: 00/16:47:41 to 00/16:53:39

Plot file version 157 created 04-OCT-2010 10:16:55

J1724-14 RP016A.UVDATA.1

Freq = 4.9410 GHz, Bw = 16.000 MH No calibration applied and no bandpass applied

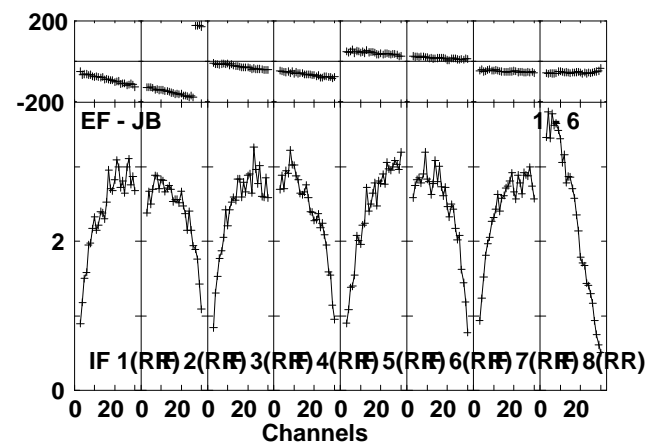
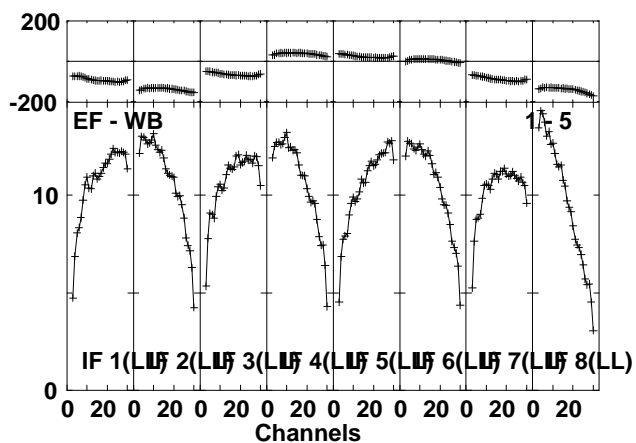
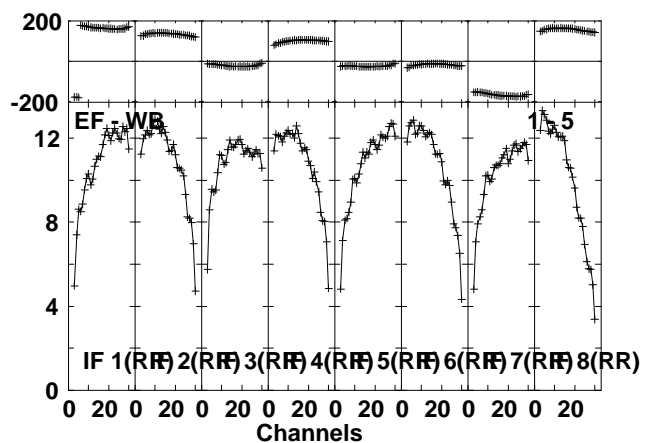
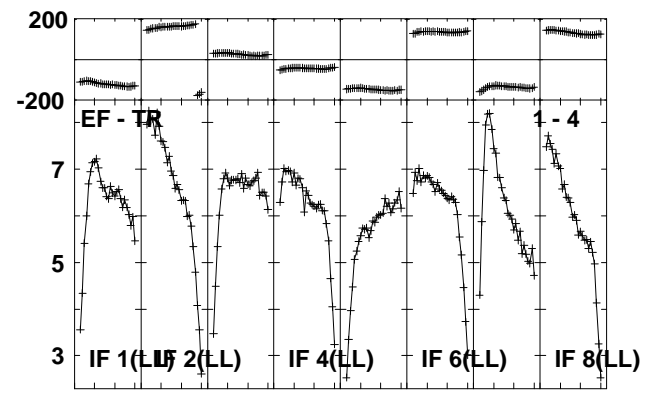
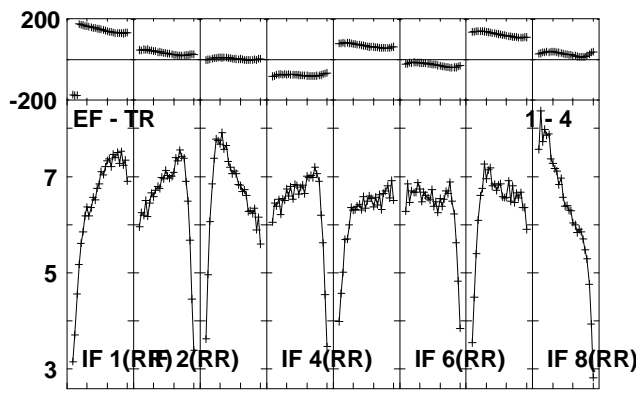
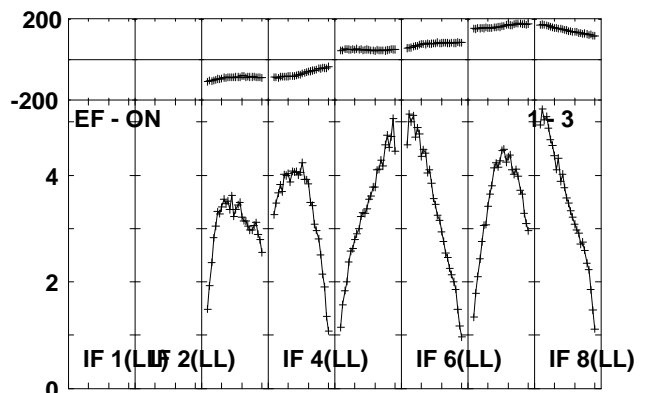
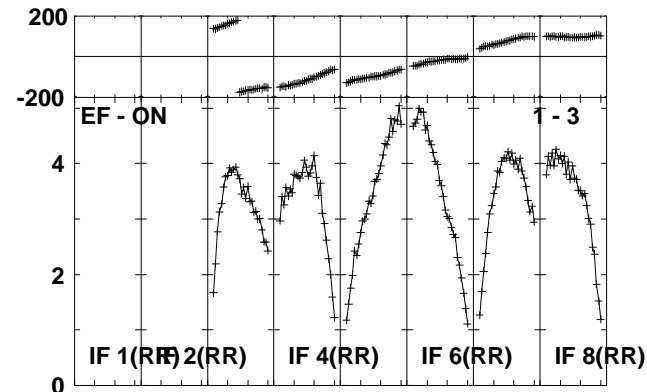
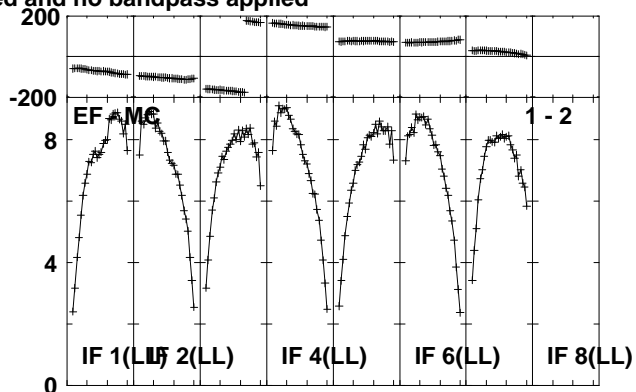
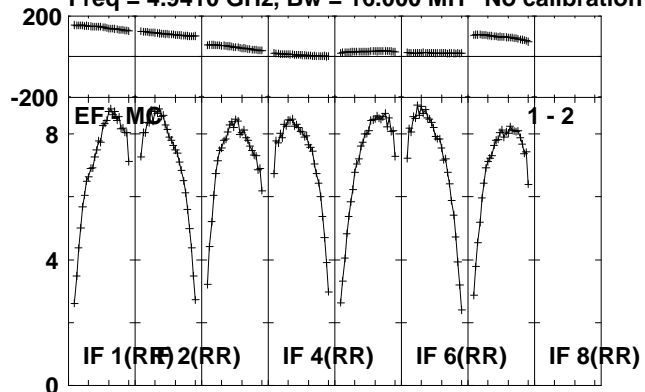

Lower frame: Milli Ampl Jy Top frame: Phas deg
Scalar averaged cross-power spectrum Several baselines displayed
Timerange: 00/16:55:41 to 00/17:01:39

Plot file version 158 created 04-OCT-2010 10:16:59

J1724-14 RP016A.UVDATA.1

Freq = 4.9410 GHz, Bw = 16.000 MH No calibration applied and no bandpass applied

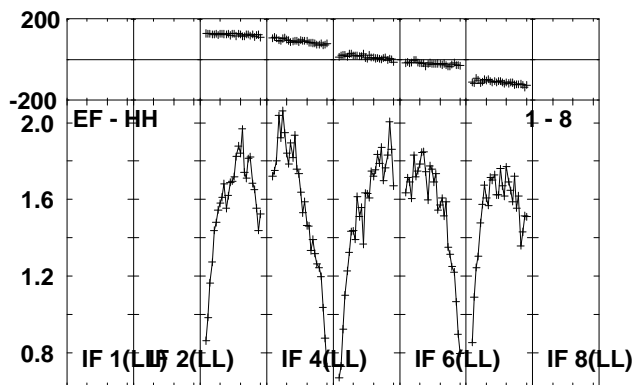
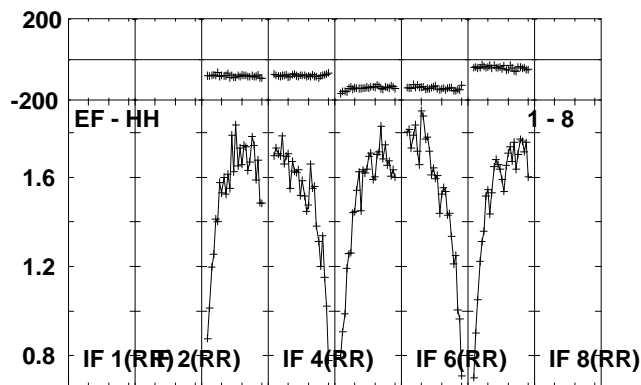
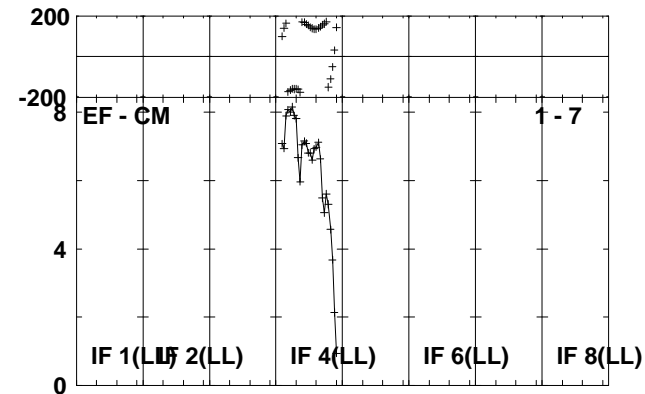
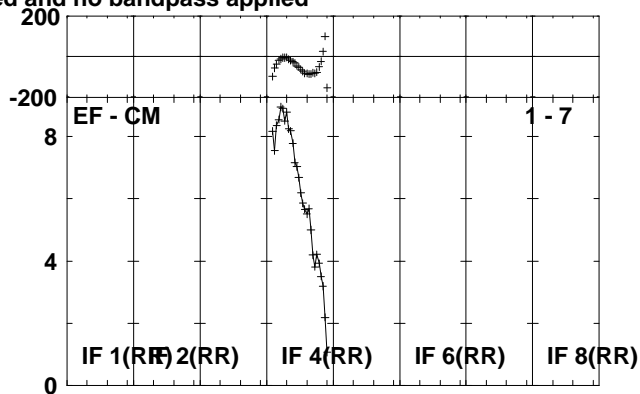
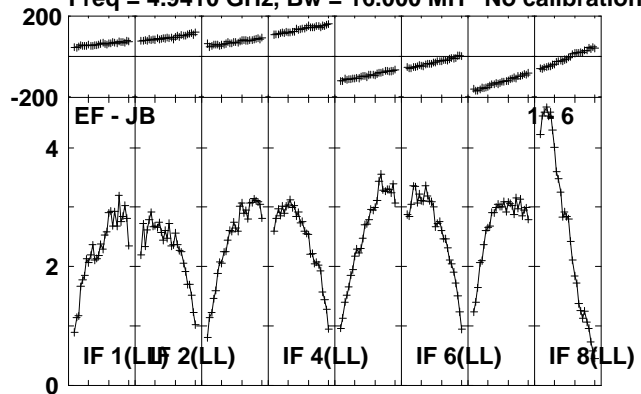

Lower frame: Milli Ampl Jy Top frame: Phas deg
Scalar averaged cross-power spectrum Several baselines displayed
Timerange: 00/16:55:41 to 00/17:01:39

Plot file version 159 created 04-OCT-2010 10:17:02

J1707-14 RP016A.UVDATA.1

Freq = 4.9410 GHz, Bw = 16.000 MH No calibration applied and no bandpass applied

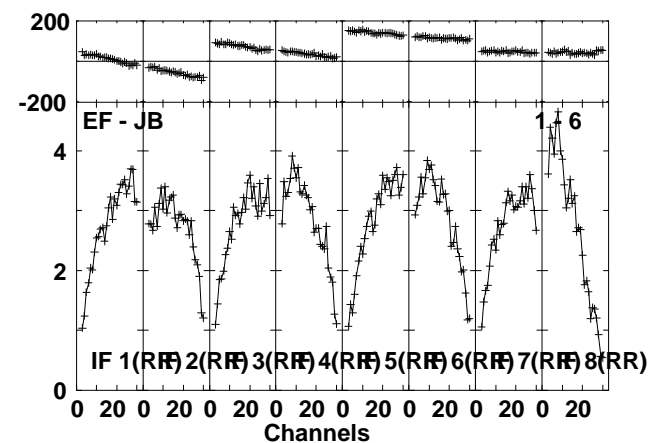
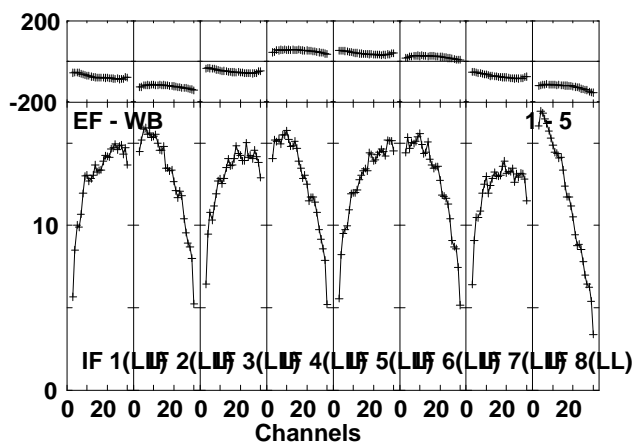
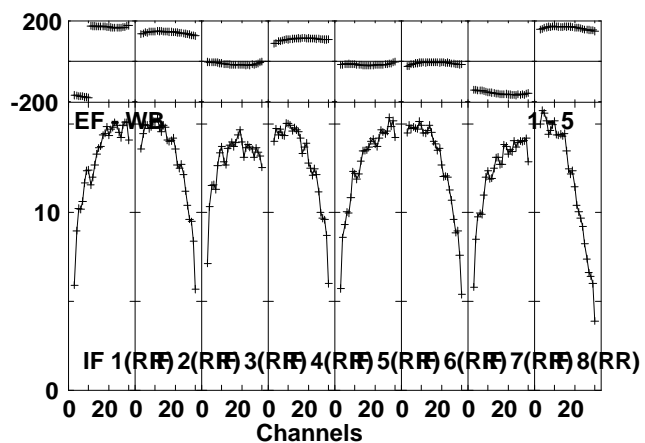
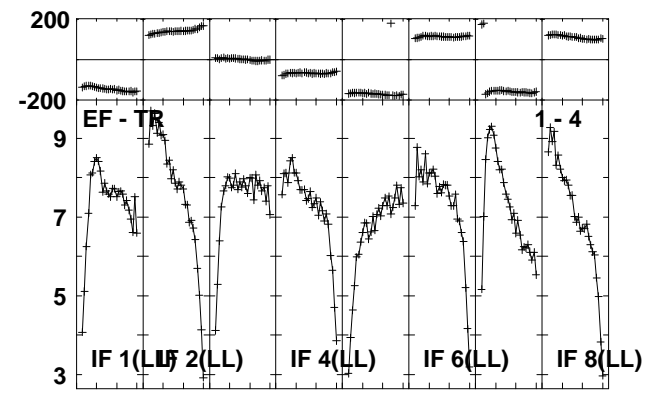
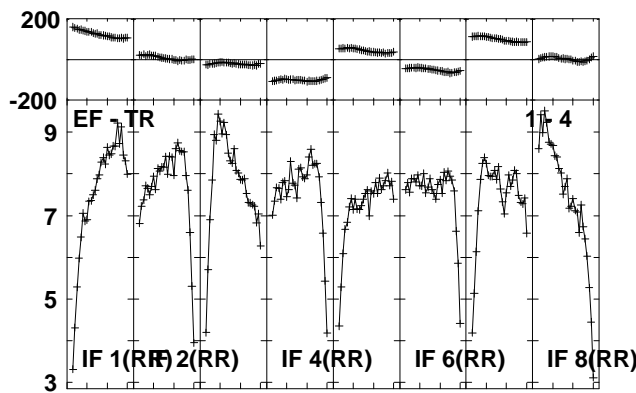
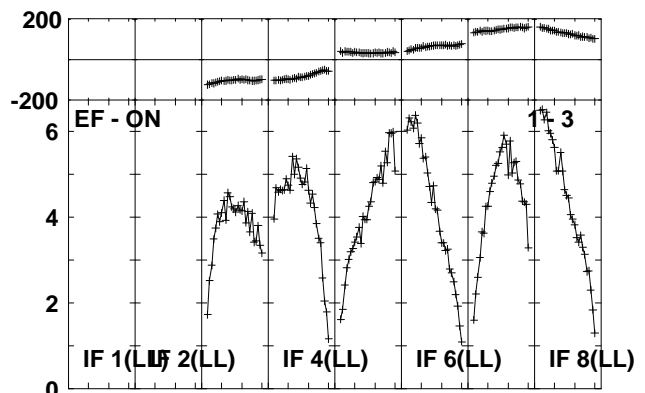
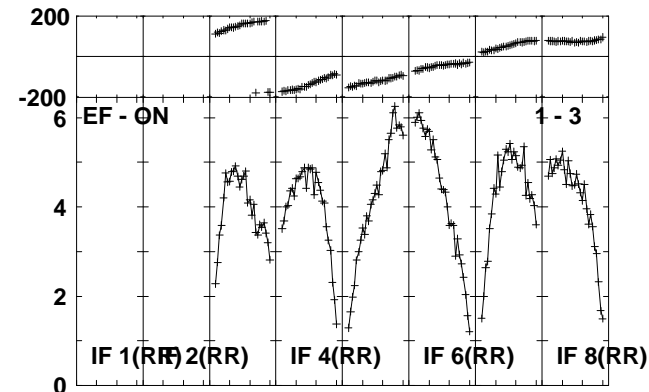
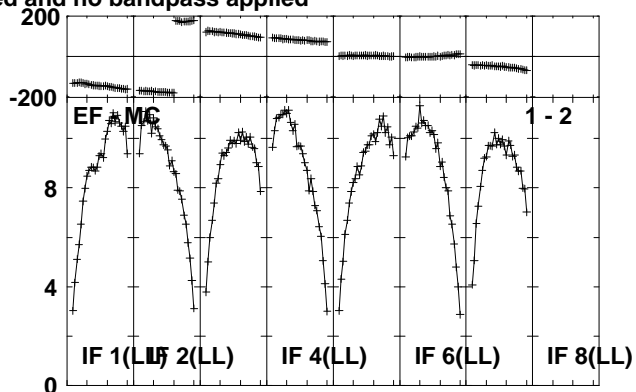
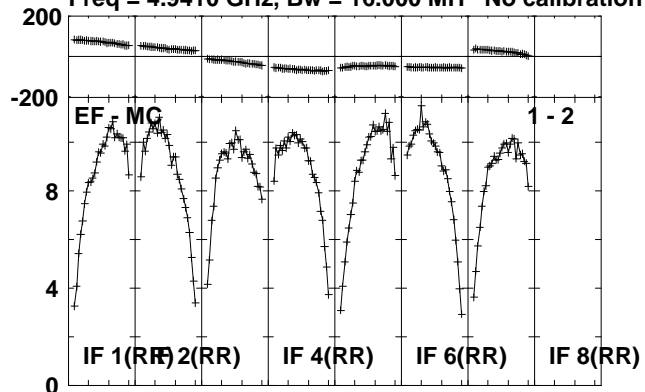

Lower frame: Milli Ampl Jy Top frame: Phas deg
Scalar averaged cross-power spectrum Several baselines displayed
Timerange: 00/17:02:41 to 00/17:03:39

Plot file version 160 created 04-OCT-2010 10:17:02

J1707-14 RP016A.UVDATA.1

Freq = 4.9410 GHz, Bw = 16.000 MH No calibration applied and no bandpass applied

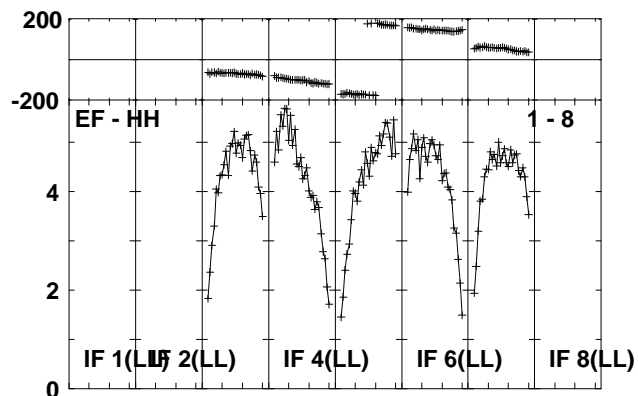
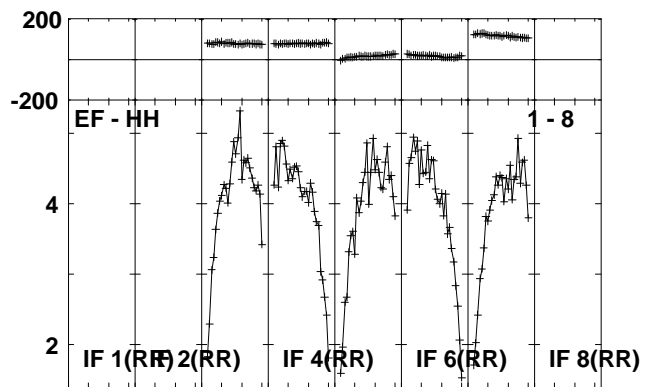
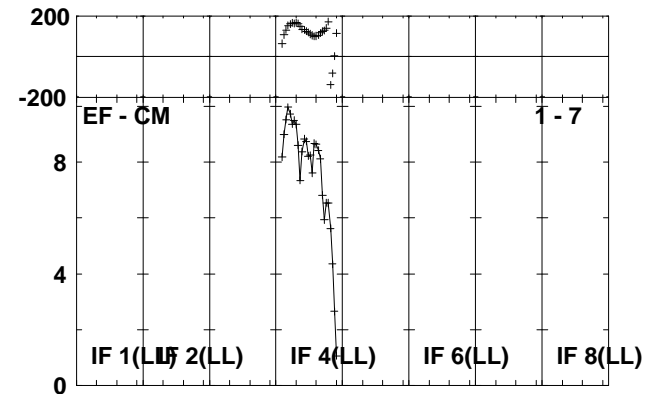
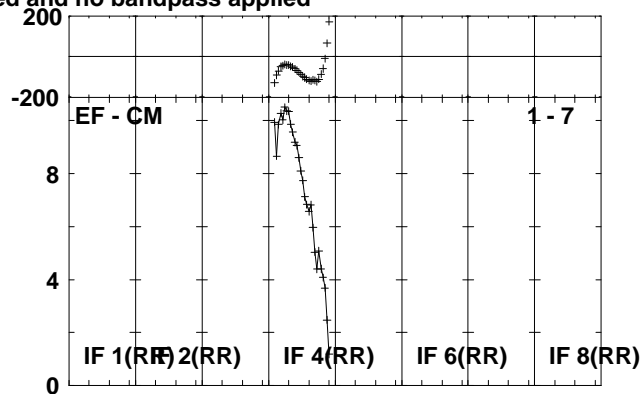
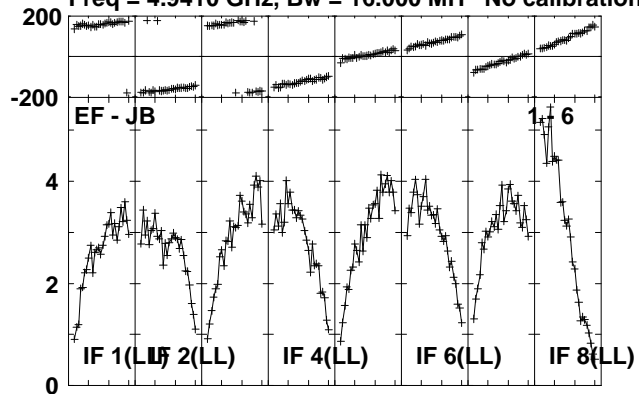

Lower frame: Milli Ampl Jy Top frame: Phas deg
Scalar averaged cross-power spectrum Several baselines displayed
Timerange: 00/17:02:41 to 00/17:03:39

Plot file version 161 created 04-OCT-2010 10:17:03

MAXI J16 RP016A.UVDATA.1

Freq = 4.9410 GHz, Bw = 16.000 MH No calibration applied and no bandpass applied

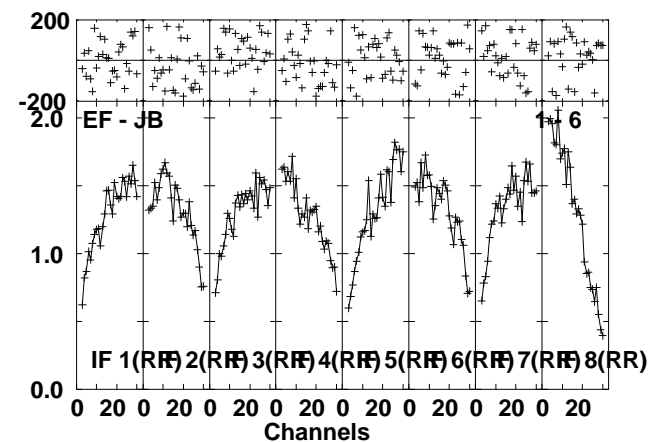
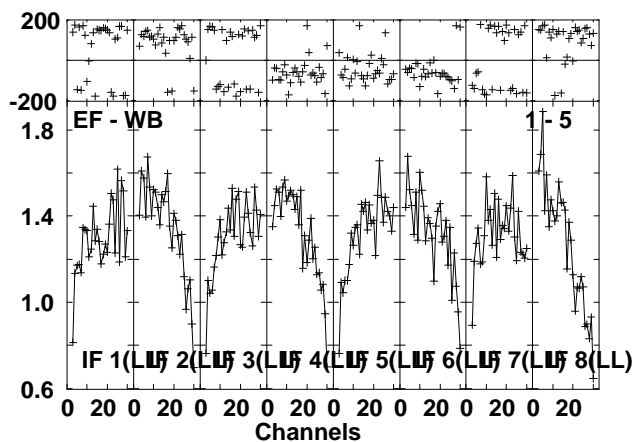
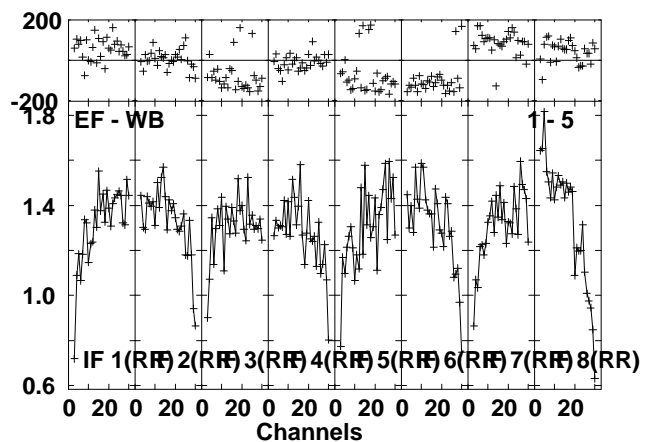
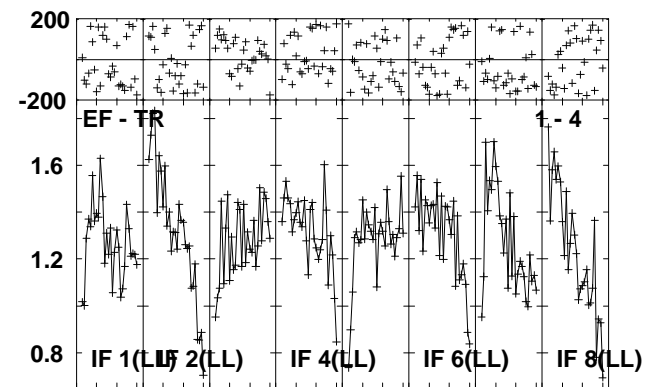
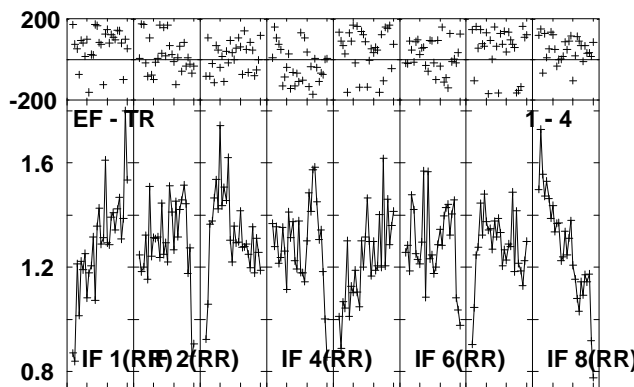
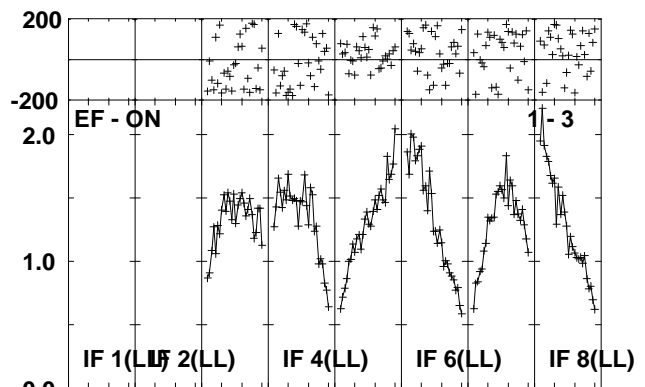
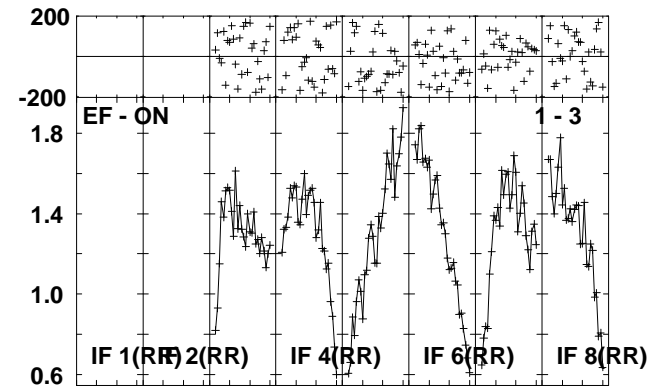
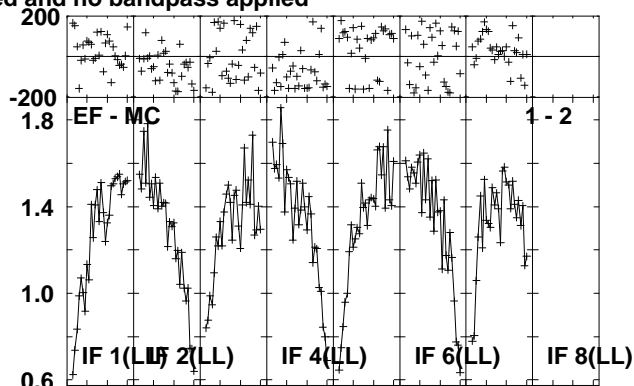
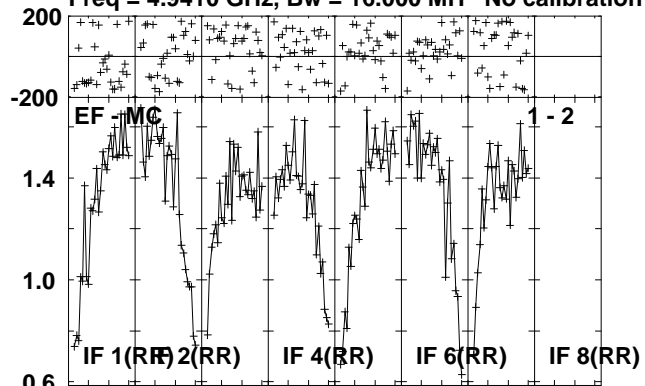

Lower frame: Milli Ampl Jy Top frame: Phas deg
Scalar averaged cross-power spectrum Several baselines displayed
Timerange: 00/17:03:41 to 00/17:06:09

Plot file version 162 created 04-OCT-2010 10:17:05

MAXI J16 RP016A.UVDATA.1

Freq = 4.9410 GHz, Bw = 16.000 MH No calibration applied and no bandpass applied

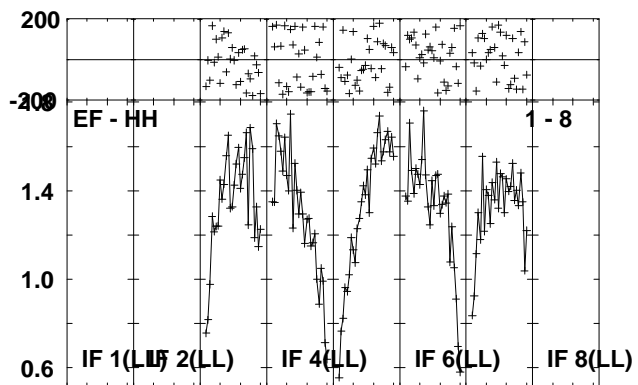
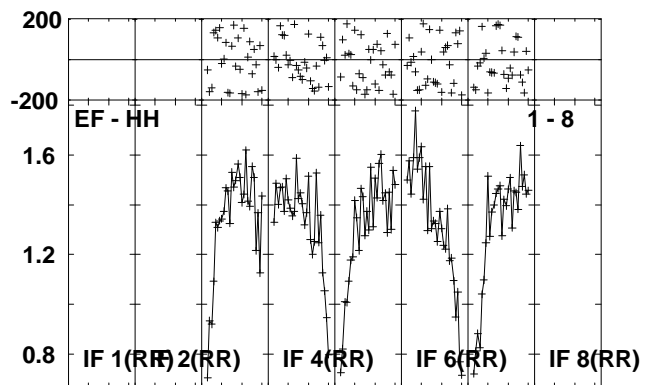
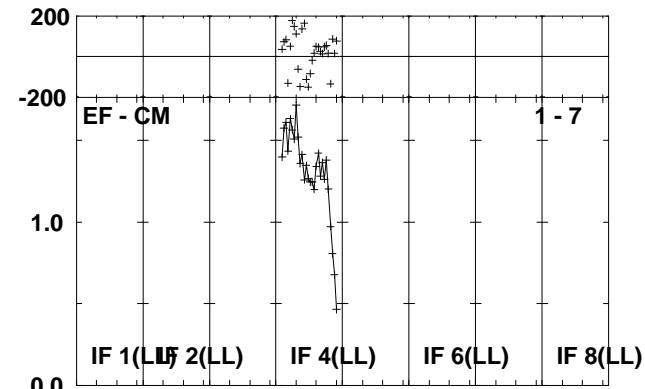
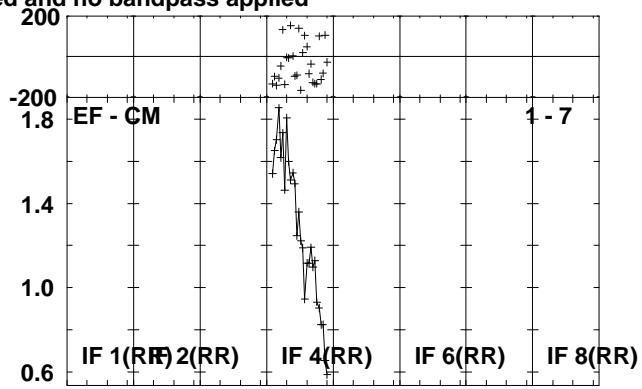
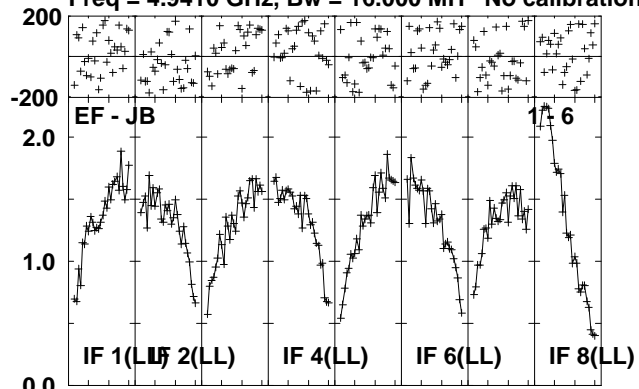

Lower frame: Milli Ampl Jy Top frame: Phas deg
Scalar averaged cross-power spectrum Several baselines displayed
Timerange: 00/17:03:41 to 00/17:06:09

Plot file version 163 created 04-OCT-2010 10:17:06

J1707-14 RP016A.UVDATA.1

Freq = 4.9410 GHz, Bw = 16.000 MH No calibration applied and no bandpass applied

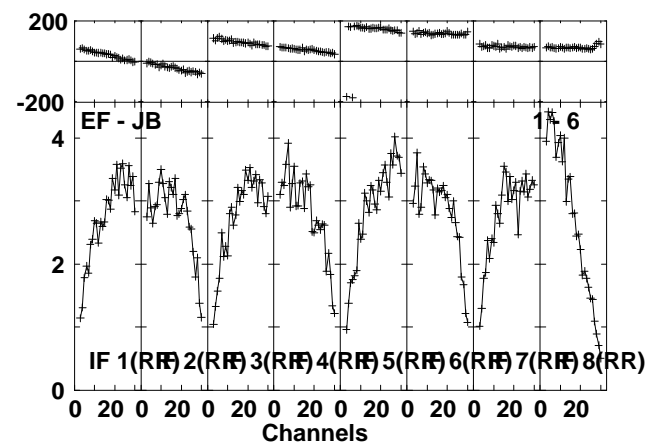
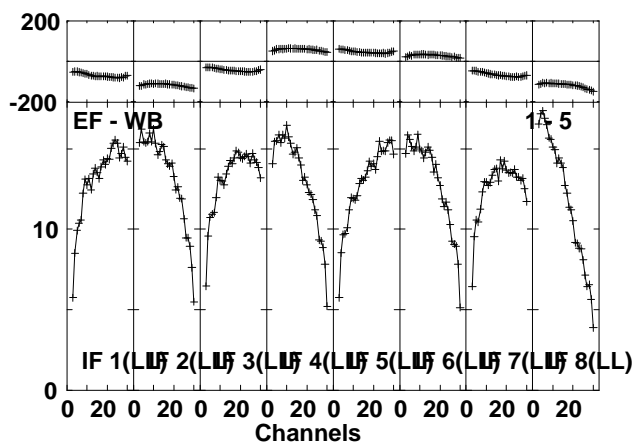
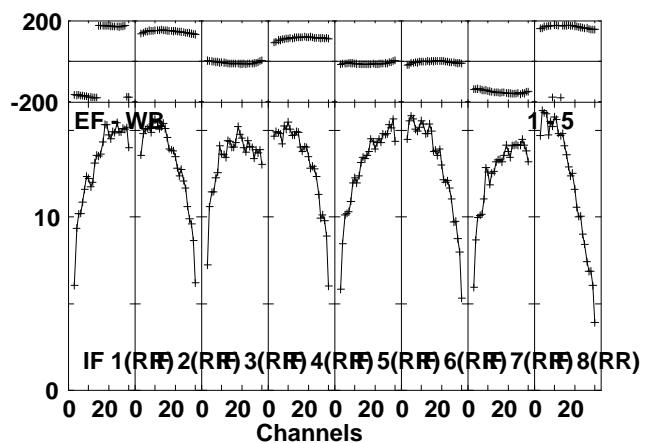
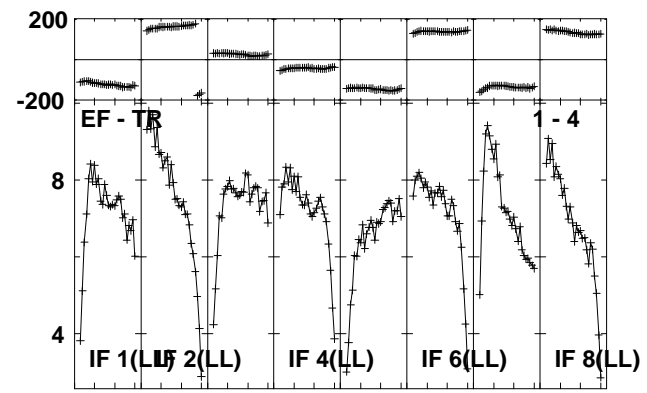
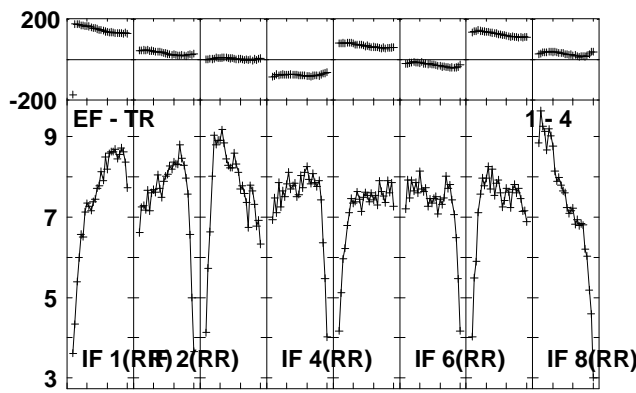
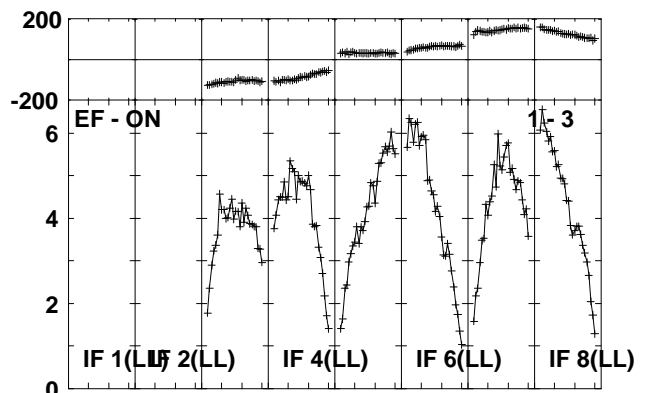
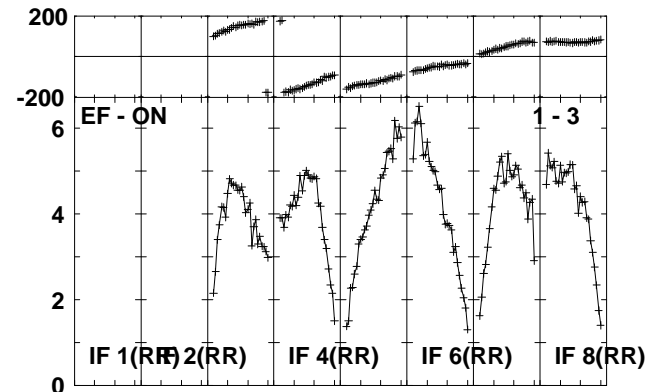
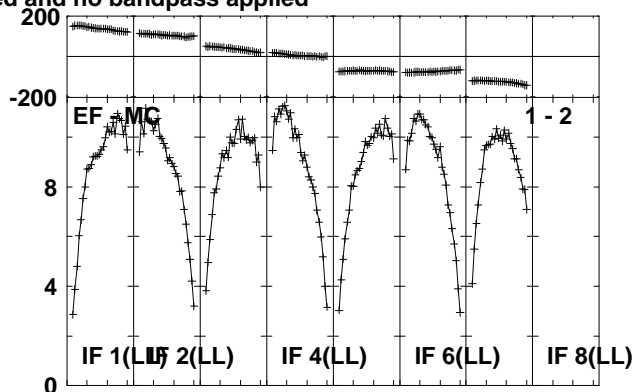
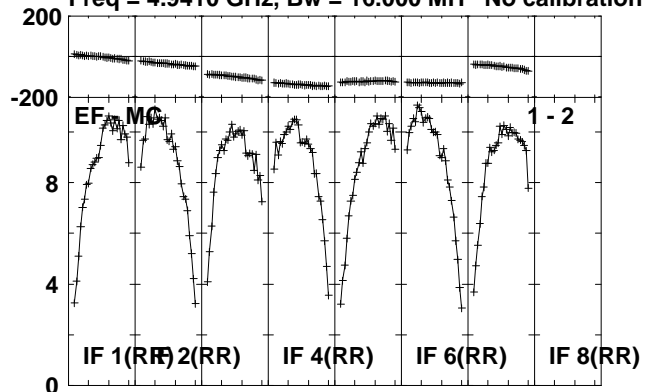

Lower frame: Milli Ampl Jy Top frame: Phas deg
Scalar averaged cross-power spectrum Several baselines displayed
Timerange: 00:17:06:11 to 00:17:07:39

Plot file version 164 created 04-OCT-2010 10:17:07
J1707-14 RP016A.UVDATA.1

Freq = 4.9410 GHz, Bw = 16.000 MH No calibration applied and no bandpass applied

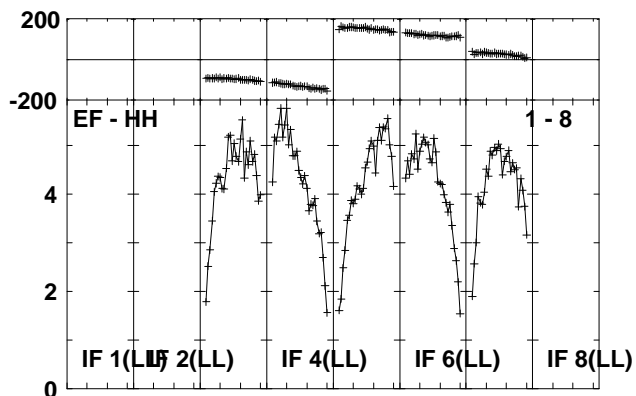
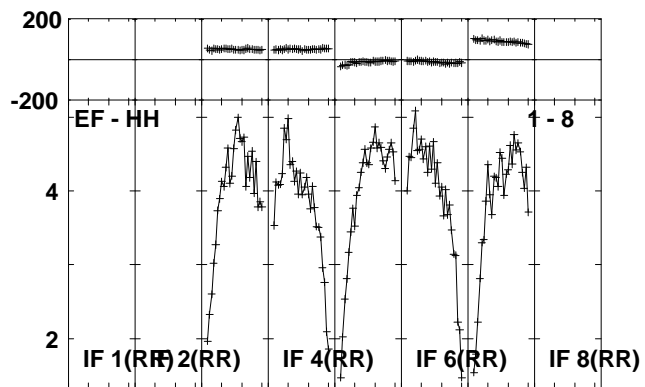
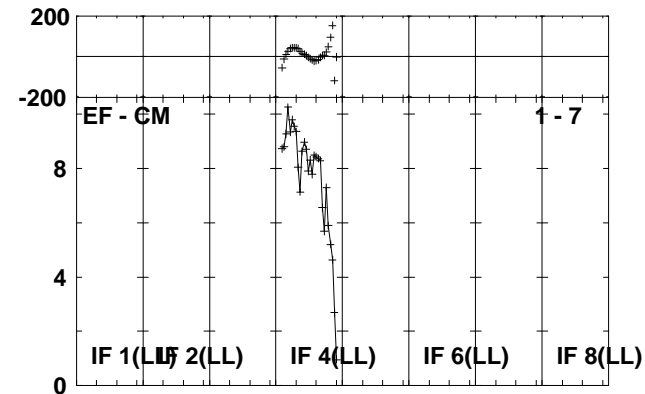
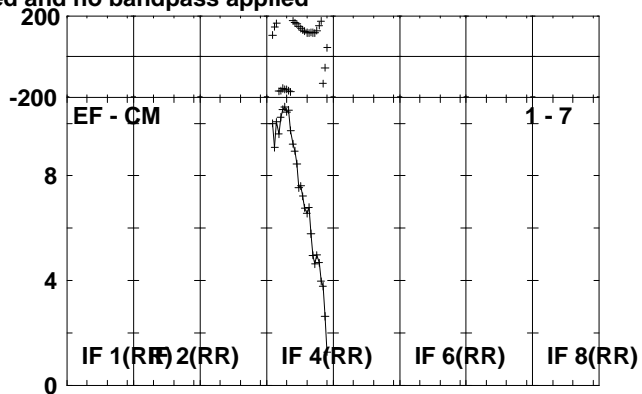
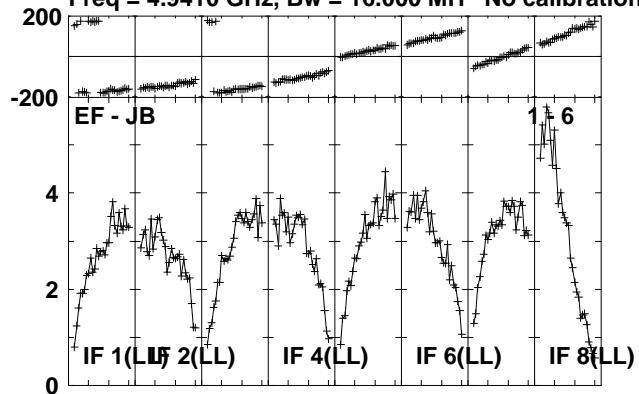

Lower frame: Milli Ampl Jy Top frame: Phas deg
Scalar averaged cross-power spectrum Several baselines displayed
Timerange: 00/17:06:11 to 00/17:07:39

Plot file version 165 created 04-OCT-2010 10:17:08

MAXI J16 RP016A.UVDATA.1

Freq = 4.9410 GHz, Bw = 16.000 MH No calibration applied and no bandpass applied

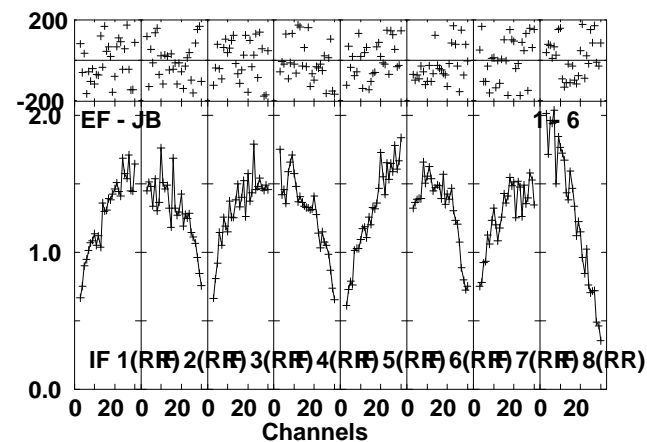
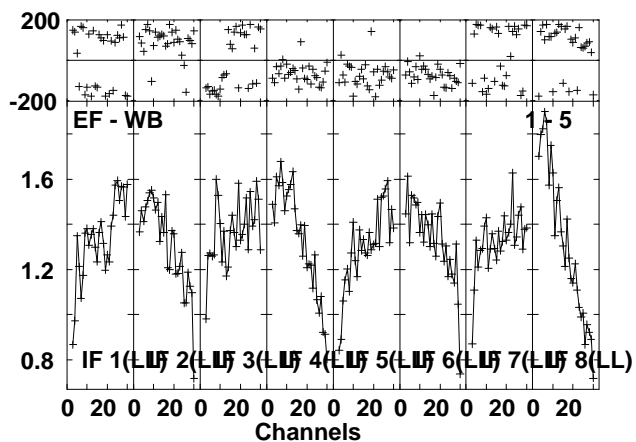
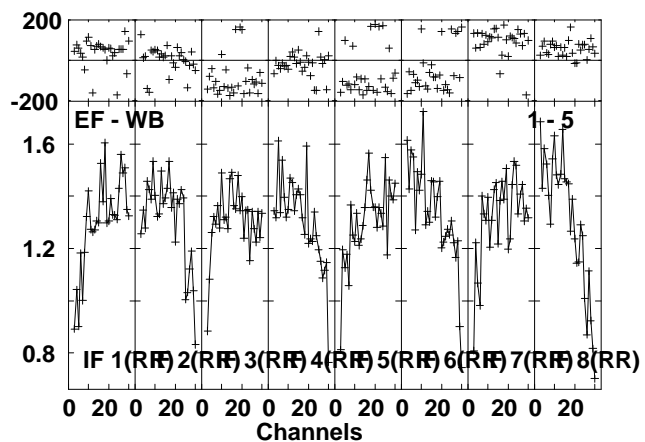
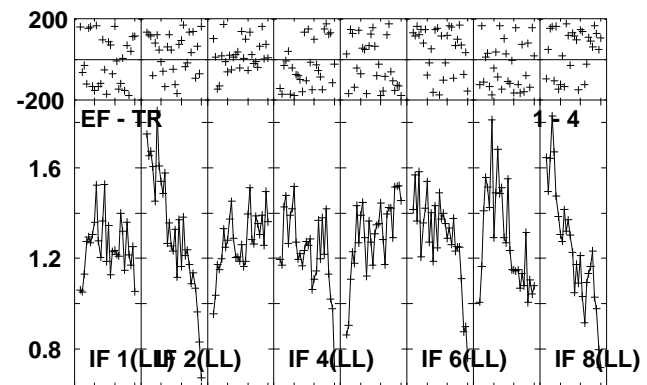
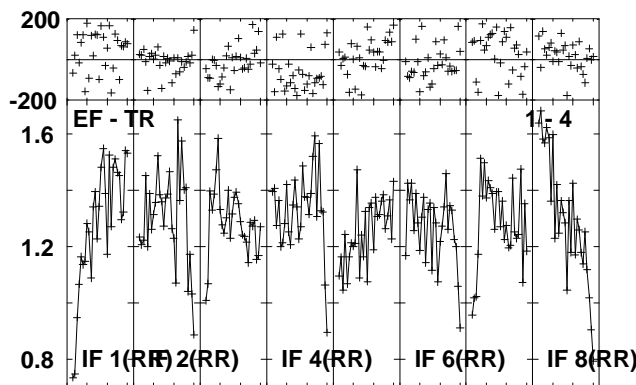
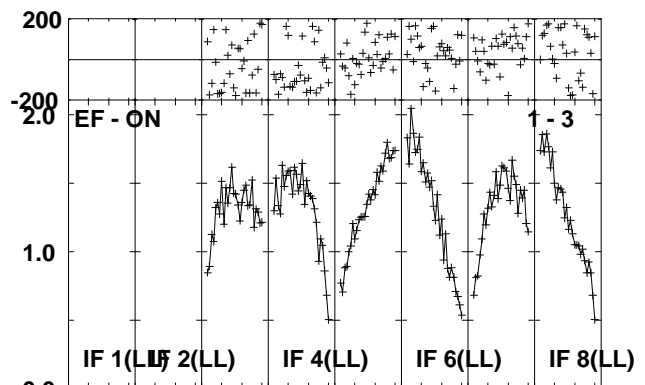
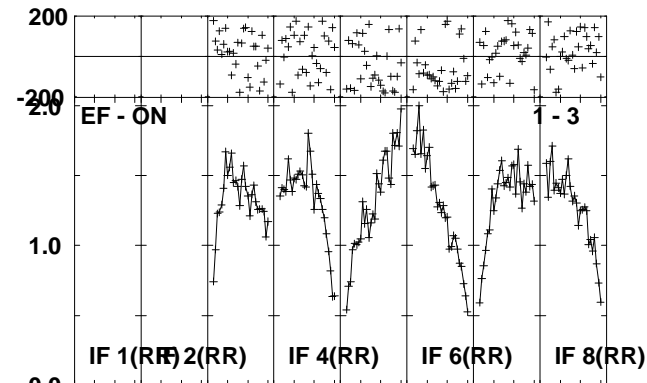
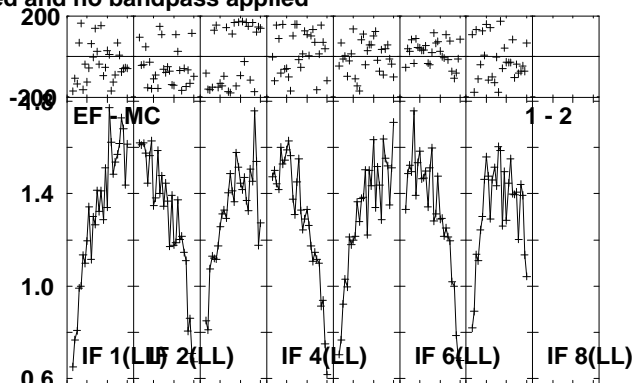
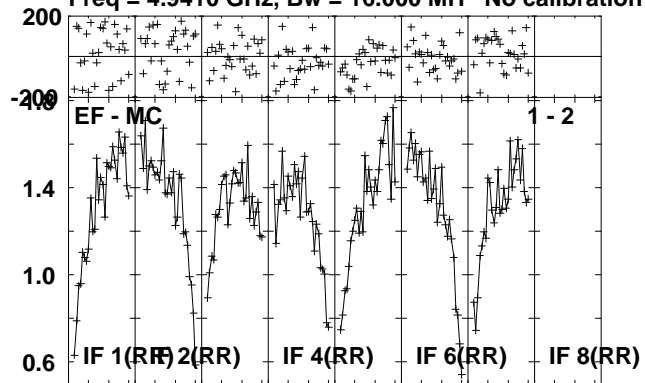

Lower frame: Milli Ampl Jy Top frame: Phas deg
Scalar averaged cross-power spectrum Several baselines displayed
Timerange: 00/17:07:41 to 00/17:10:09

Plot file version 166 created 04-OCT-2010 10:17:09

MAXI J16 RP016A.UVDATA.1

Freq = 4.9410 GHz, Bw = 16.000 MH No calibration applied and no bandpass applied

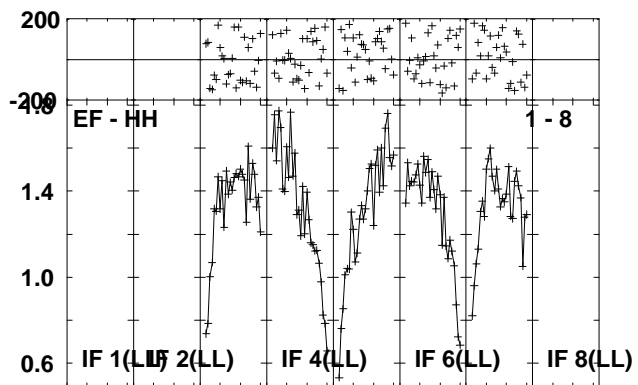
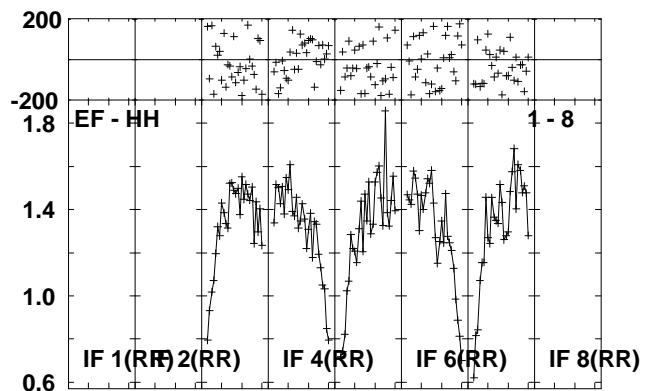
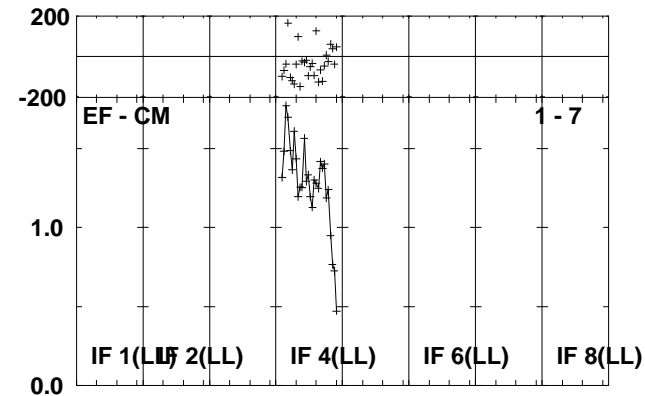
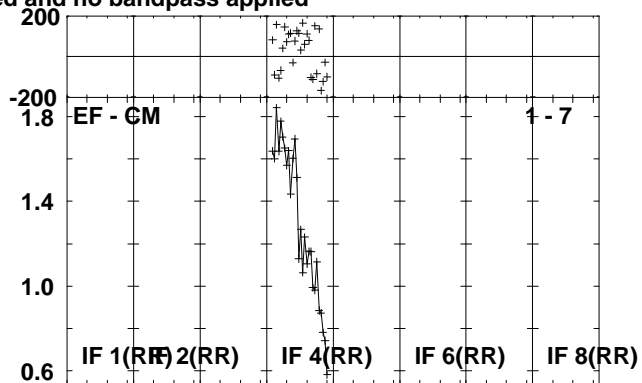
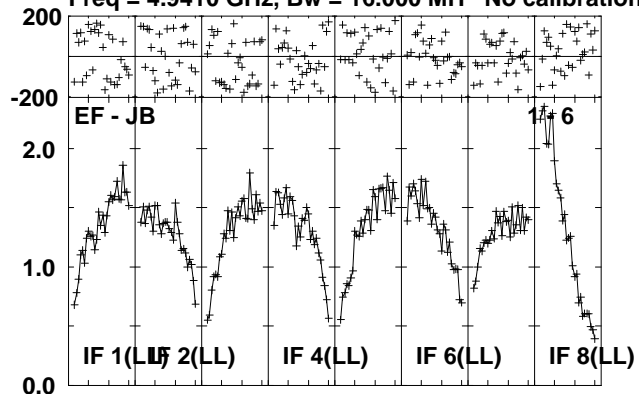

Lower frame: Milli Ampl Jy Top frame: Phas deg
Scalar averaged cross-power spectrum Several baselines displayed
Timerange: 00/17:07:41 to 00/17:10:09

Plot file version 167 created 04-OCT-2010 10:17:10

J1707-14 RP016A.UVDATA.1

Freq = 4.9410 GHz, Bw = 16.000 MH No calibration applied and no bandpass applied

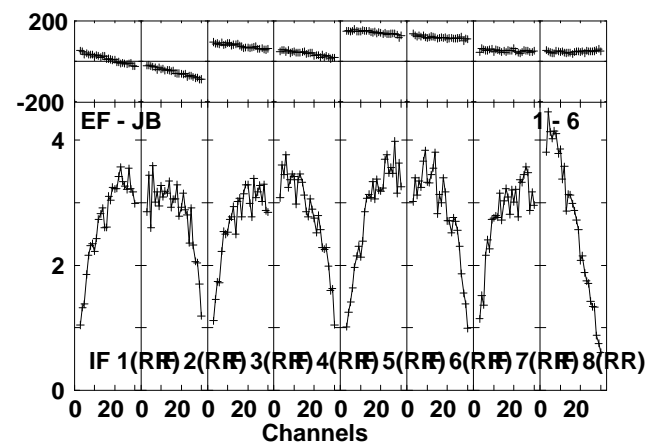
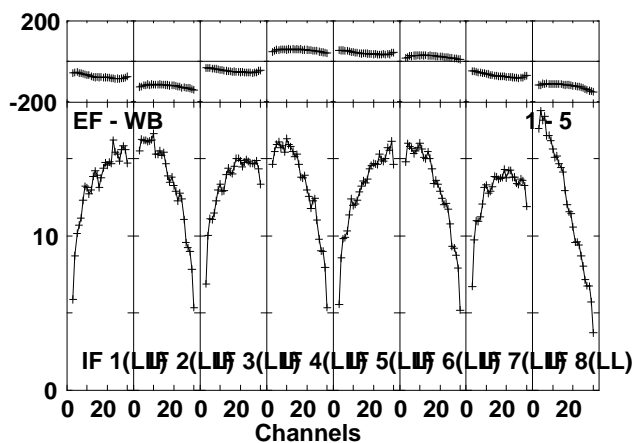
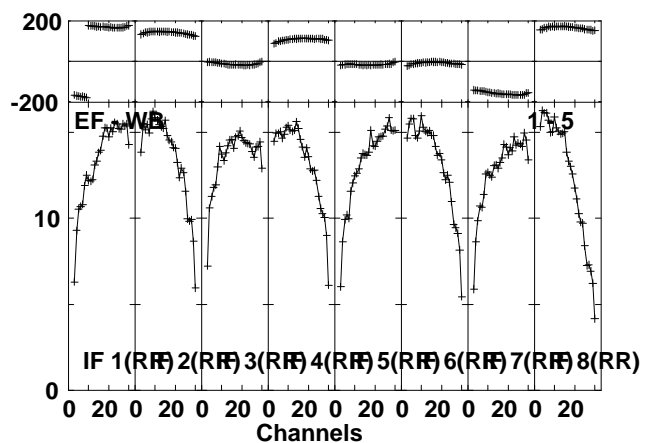
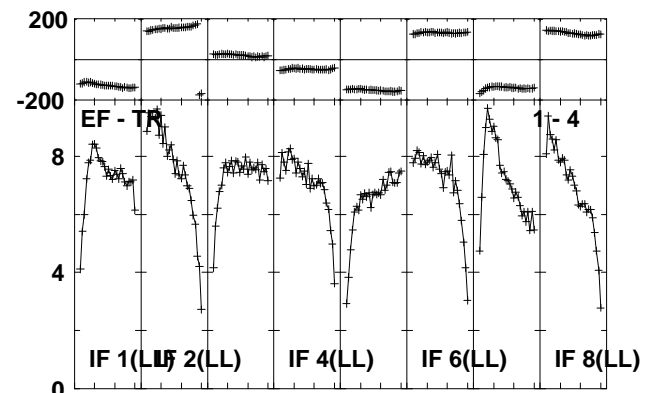
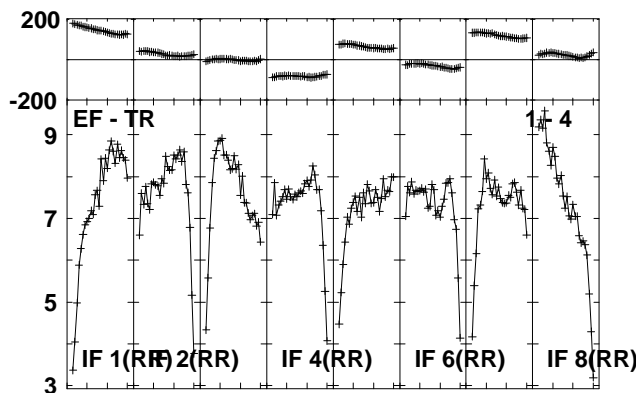
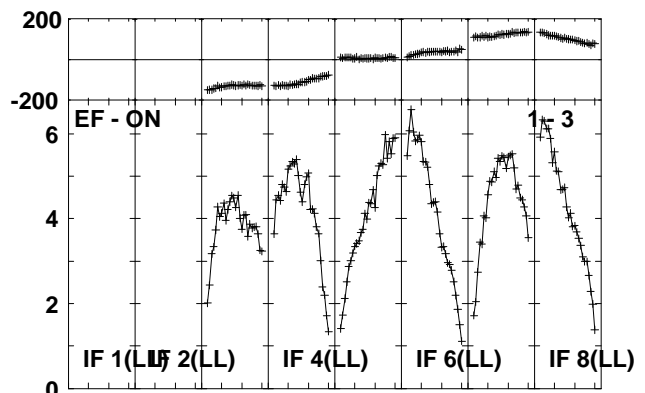
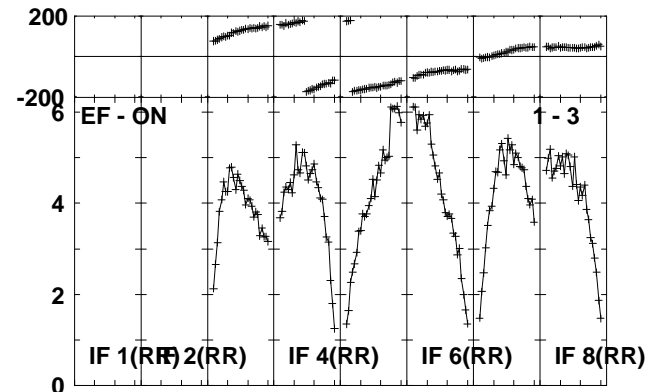
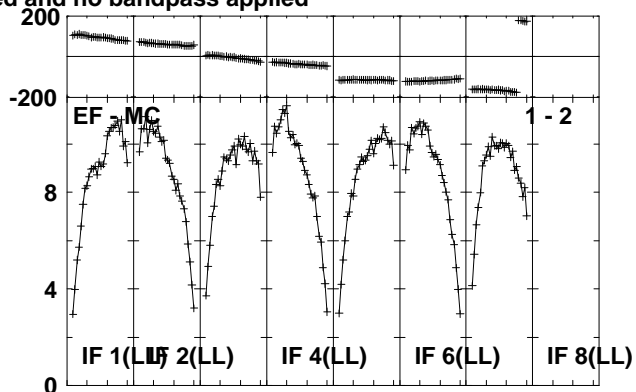
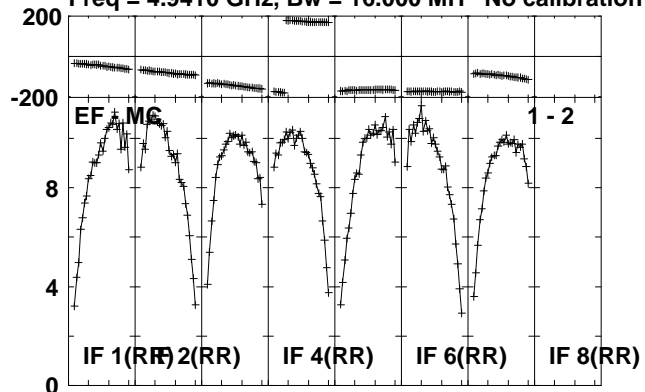

Lower frame: Milli Ampl Jy Top frame: Phas deg
Scalar averaged cross-power spectrum Several baselines displayed
Timerange: 00/17:10:51 to 00/17:11:49

Plot file version 168 created 04-OCT-2010 10:17:11
J1707-14 RP016A.UVDATA.1

Freq = 4.9410 GHz, Bw = 16.000 MH No calibration applied and no bandpass applied

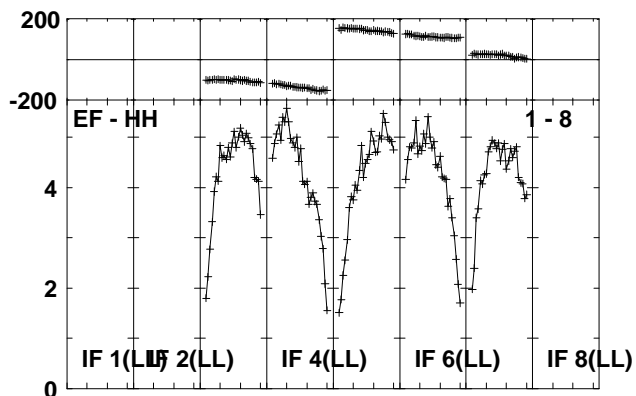
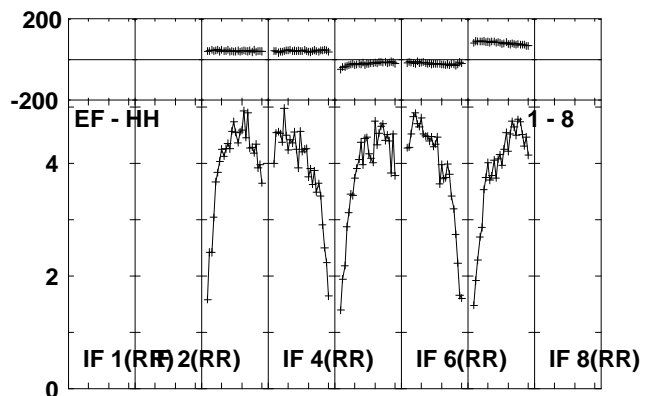
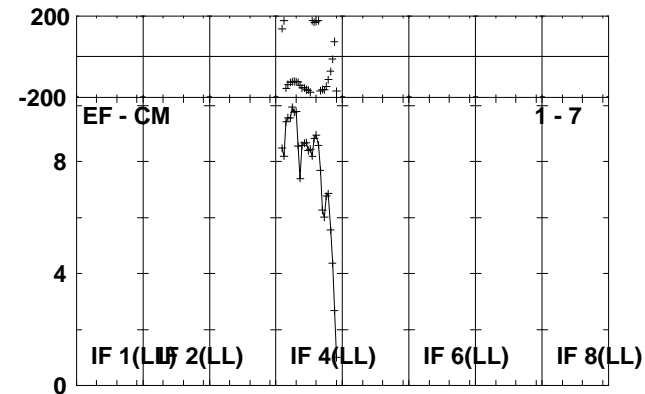
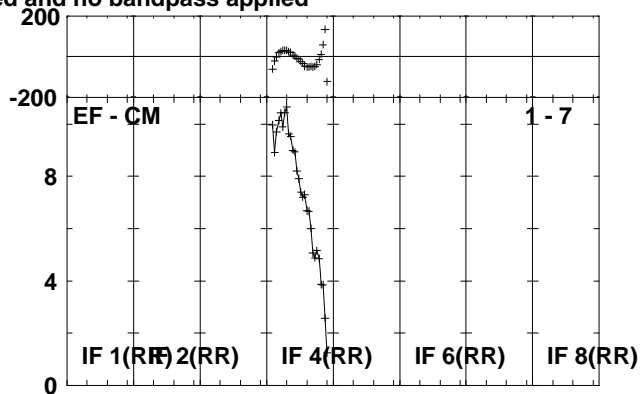
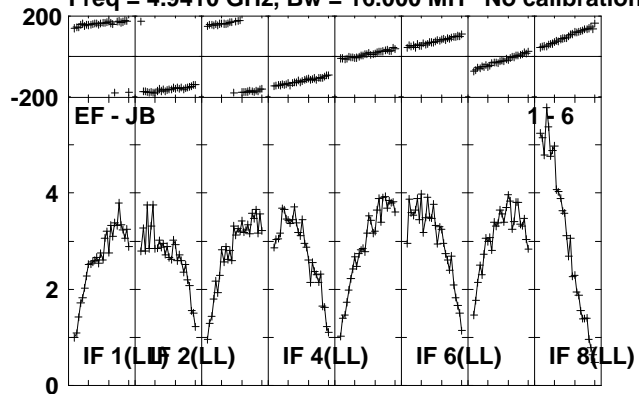

Lower frame: Milli Ampl Jy Top frame: Phas deg
Scalar averaged cross-power spectrum Several baselines displayed
Timerange: 00/17:10:51 to 00/17:11:49

Plot file version 169 created 04-OCT-2010 10:17:12

NVSS3 RP016A.UVDATA.1

Freq = 4.9410 GHz, Bw = 16.000 MH No calibration applied and no bandpass applied

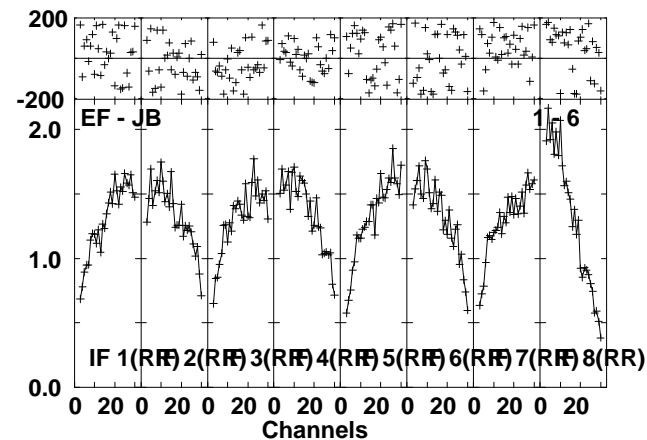
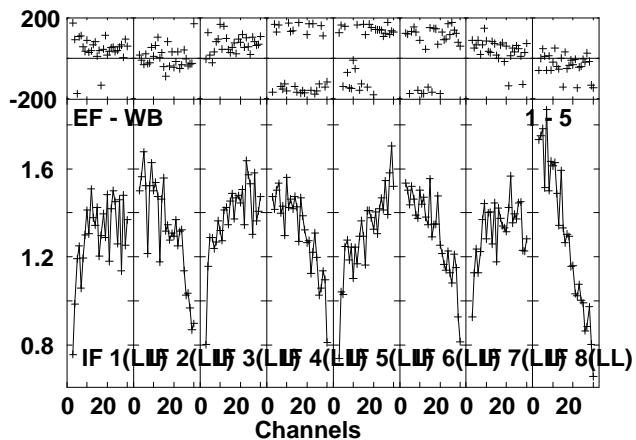
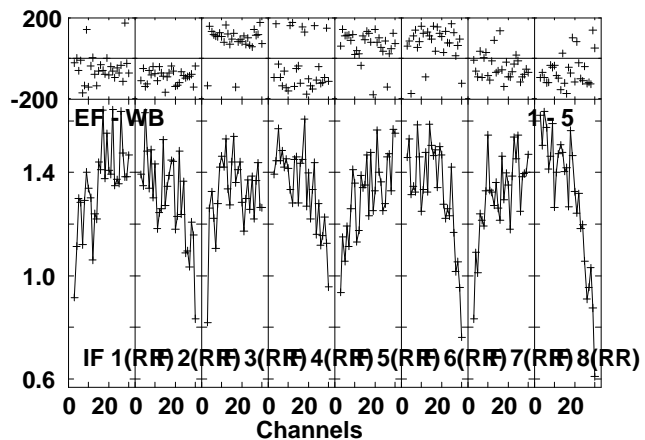
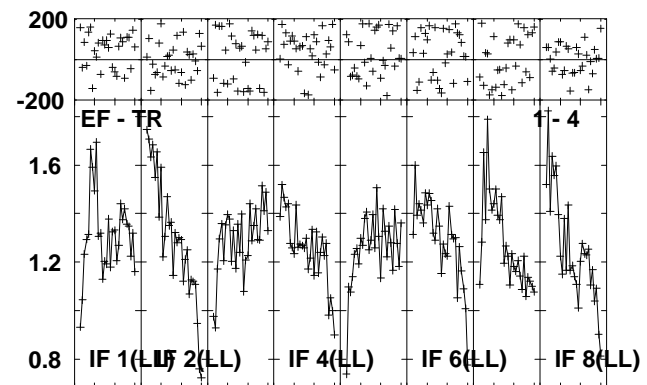
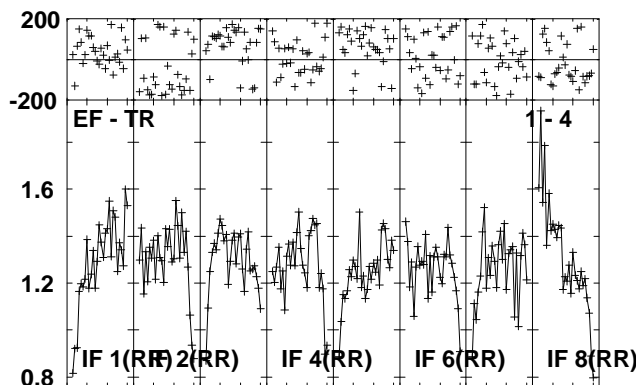
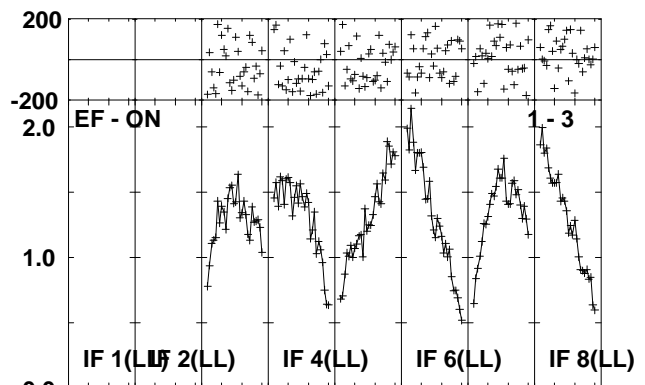
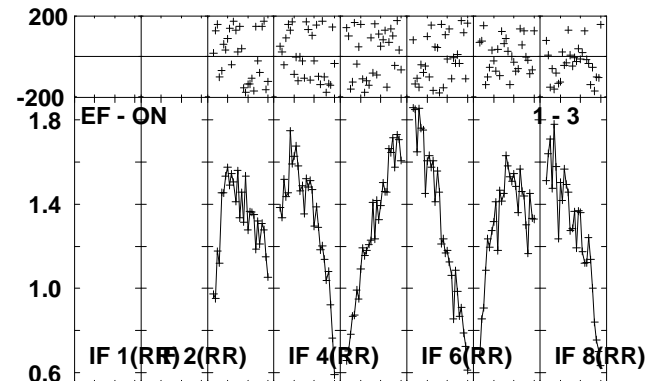
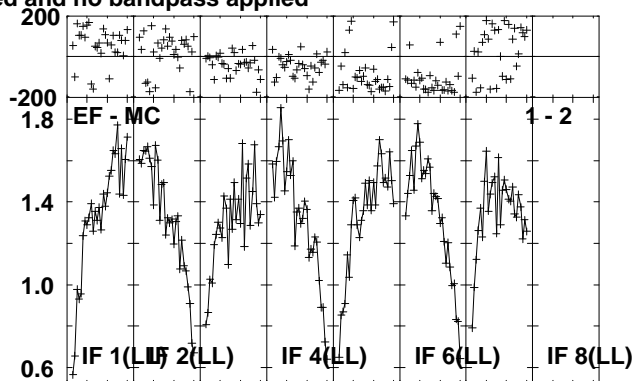
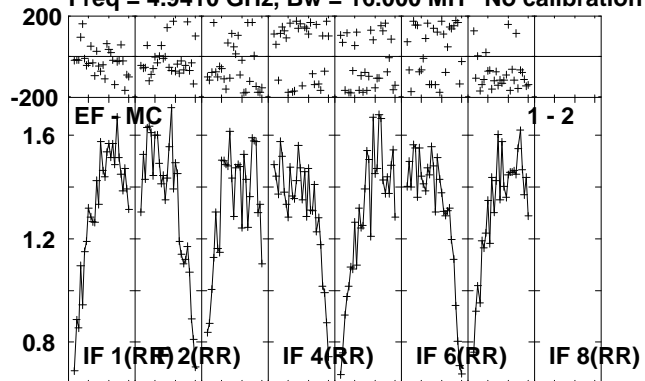

Lower frame: Milli Ampl Jy Top frame: Phas deg
Scalar averaged cross-power spectrum Several baselines displayed
Timerange: 00/17:11:51 to 00/17:14:19

Plot file version 170 created 04-OCT-2010 10:17:14

NVSS3 RP016A.UVDATA.1

Freq = 4.9410 GHz, Bw = 16.000 MH No calibration applied and no bandpass applied

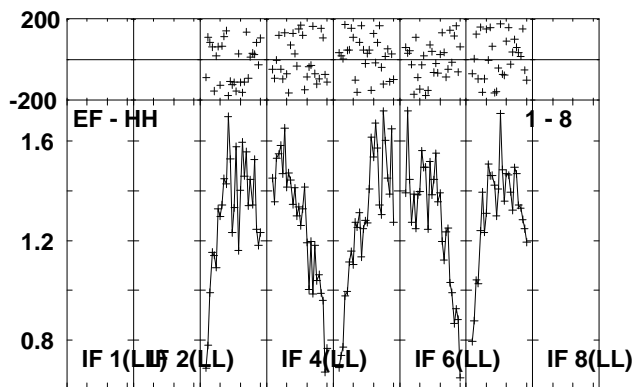
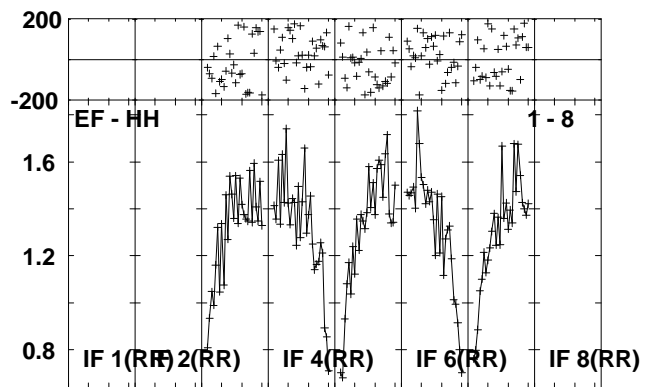
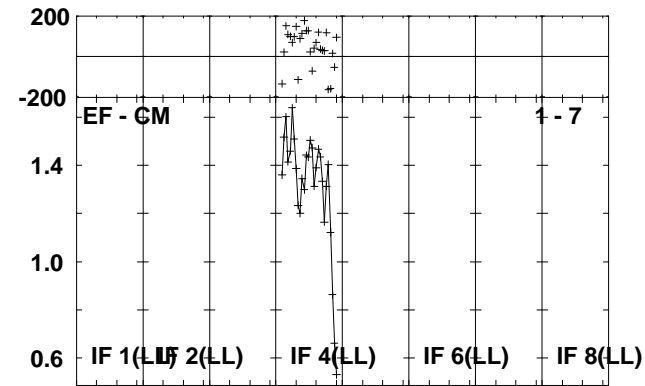
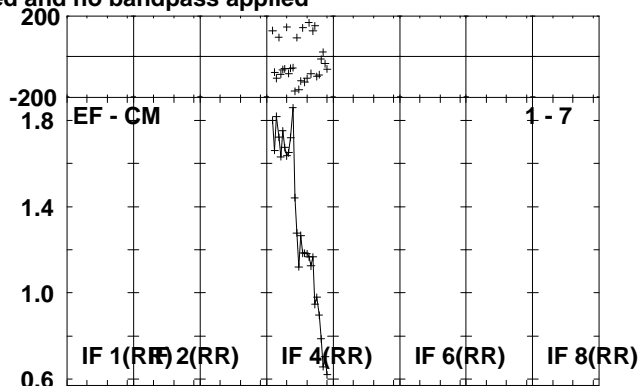
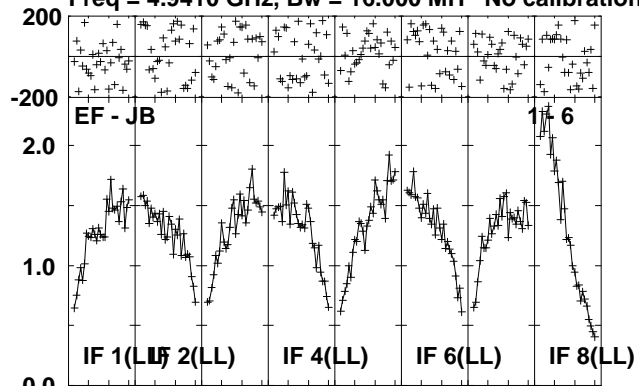

Lower frame: Milli Ampl Jy Top frame: Phas deg
Scalar averaged cross-power spectrum Several baselines displayed
Timerange: 00/17:11:51 to 00/17:14:19

Plot file version 171 created 04-OCT-2010 10:17:15

J1707-14 RP016A.UVDATA.1

Freq = 4.9410 GHz, Bw = 16.000 MH No calibration applied and no bandpass applied

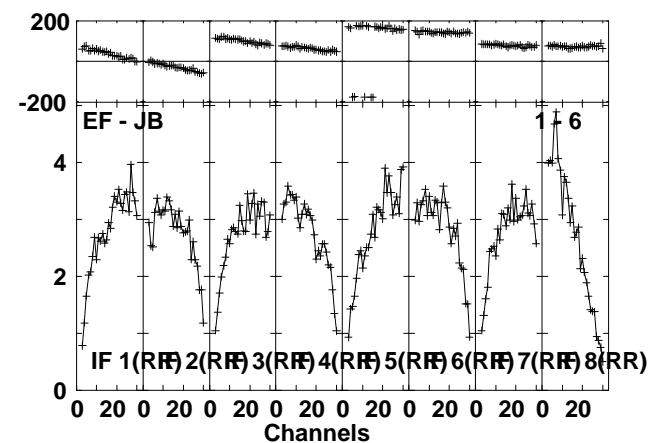
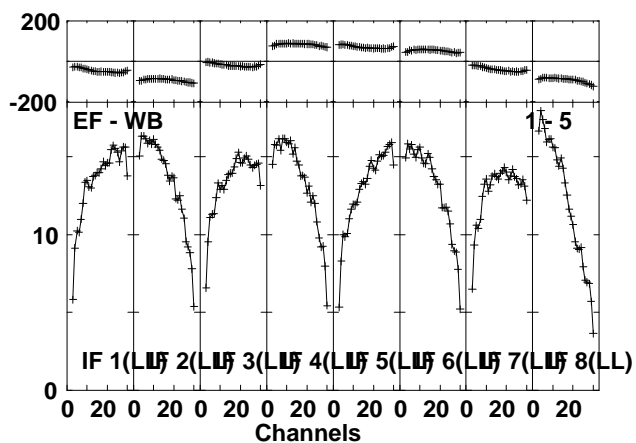
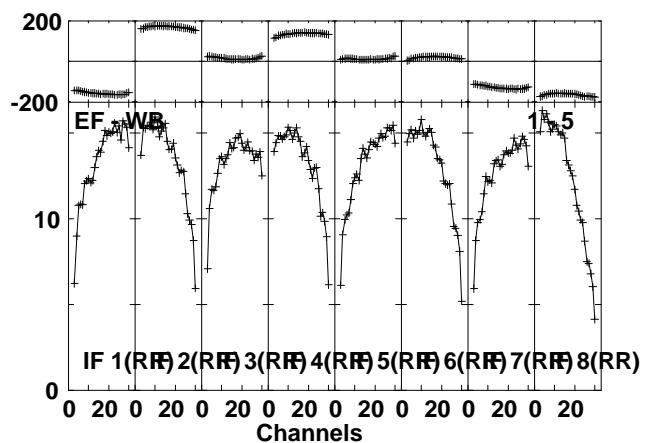
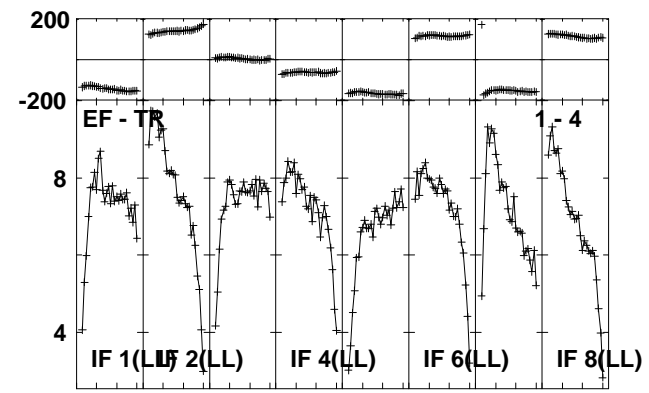
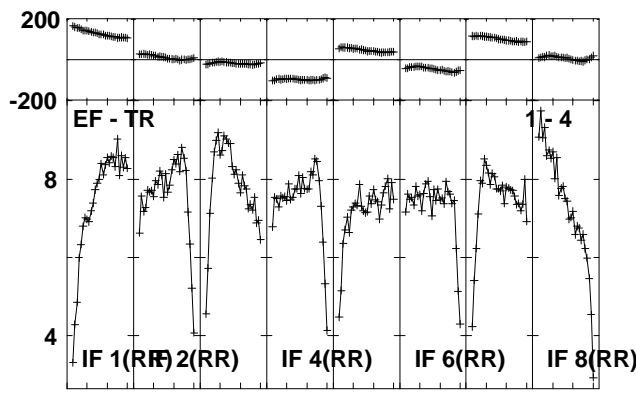
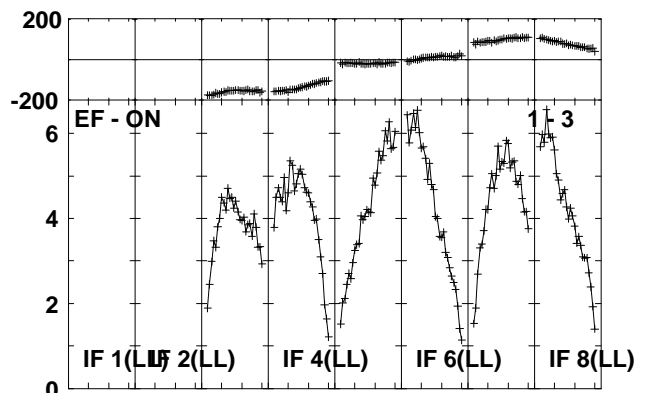
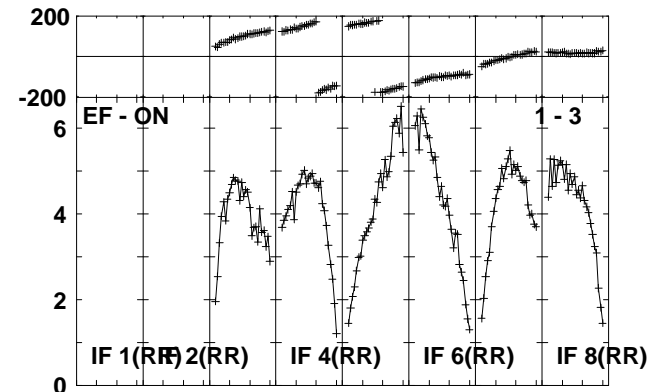
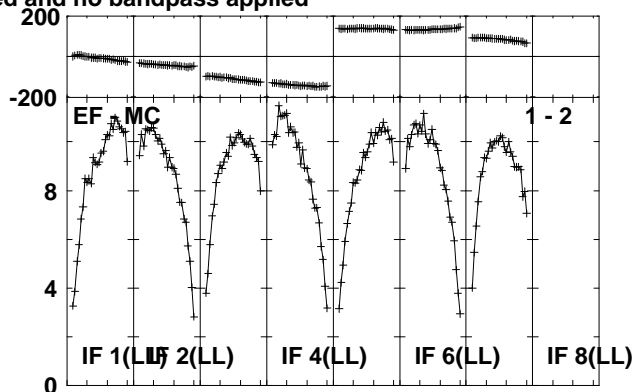
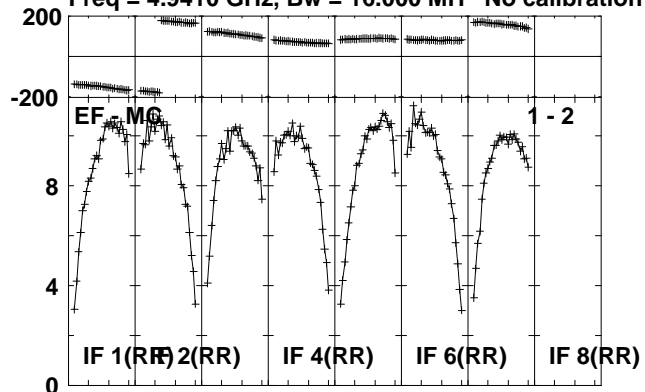

Lower frame: Milli Ampl Jy Top frame: Phas deg
Scalar averaged cross-power spectrum Several baselines displayed
Timerange: 00/17:14:21 to 00/17:15:49

Plot file version 172 created 04-OCT-2010 10:17:16
J1707-14 RP016A.UVDATA.1

Freq = 4.9410 GHz, Bw = 16.000 MH No calibration applied and no bandpass applied

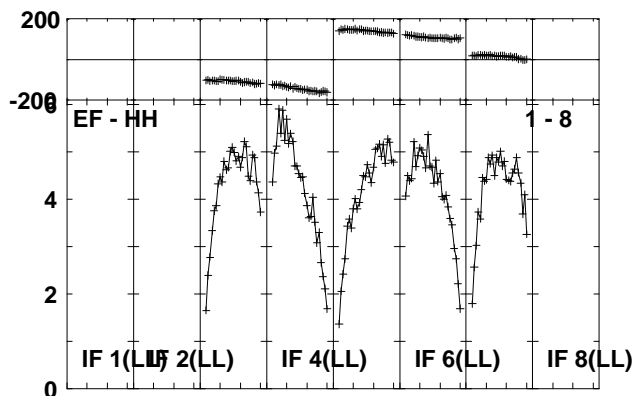
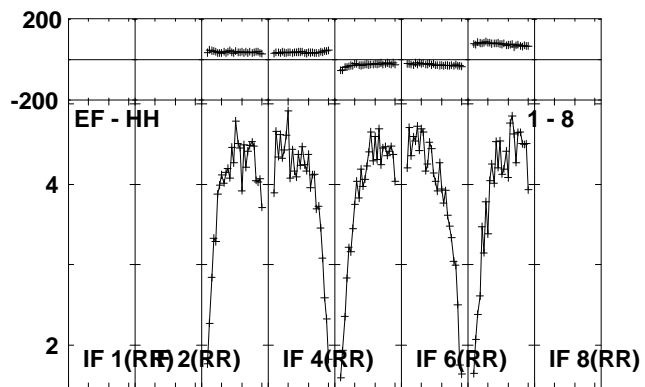
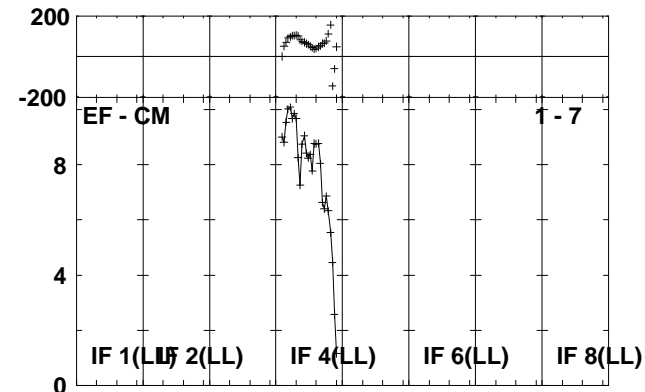
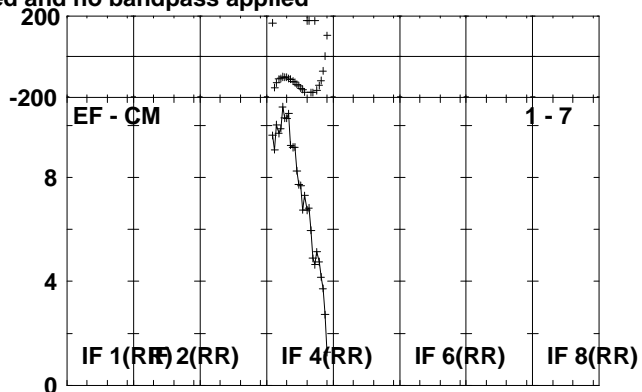
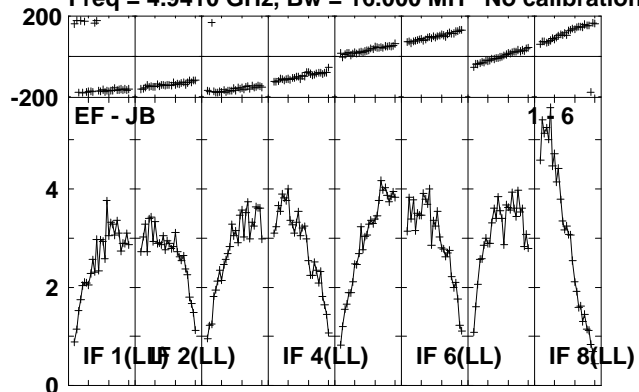

Lower frame: Milli Ampl Jy Top frame: Phas deg
Scalar averaged cross-power spectrum Several baselines displayed
Timerange: 00/17:14:21 to 00/17:15:49

Plot file version 173 created 04-OCT-2010 10:17:17

MAXI J16 RP016A.UVDATA.1

Freq = 4.9410 GHz, Bw = 16.000 MH No calibration applied and no bandpass applied

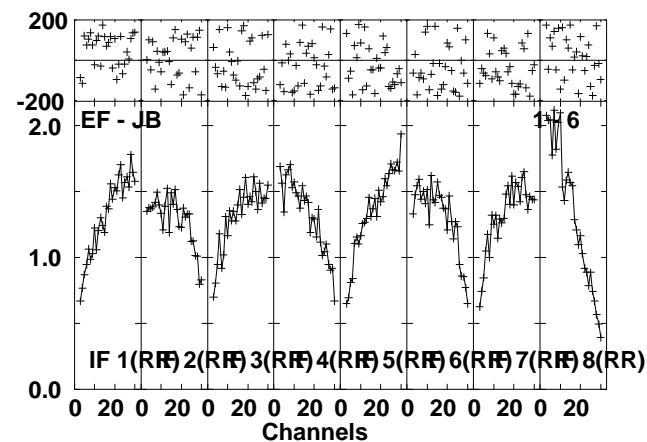
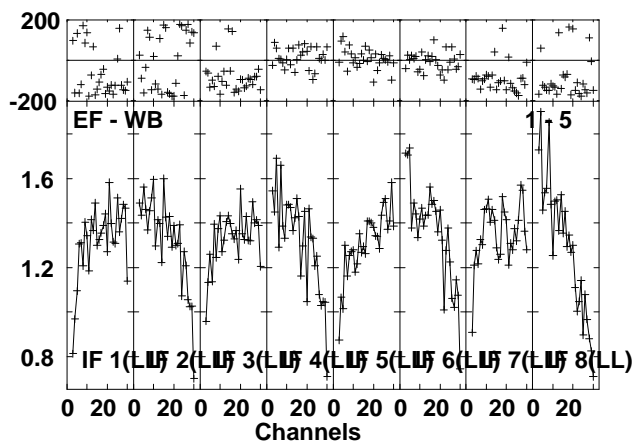
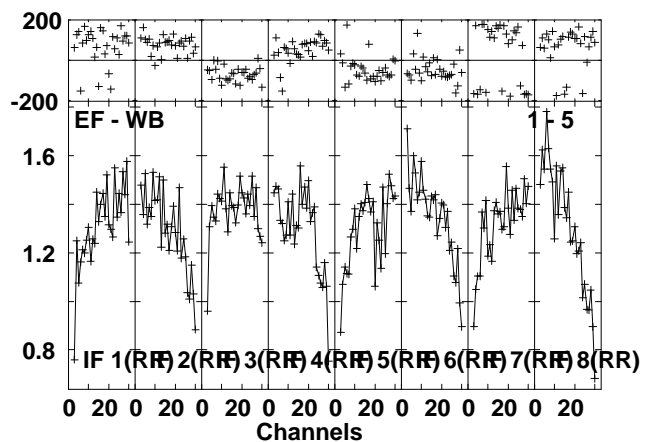
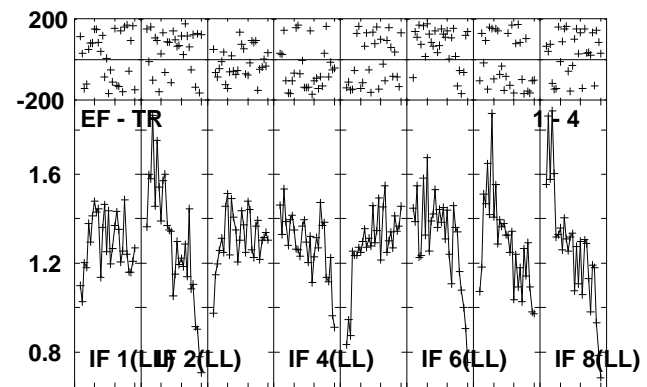
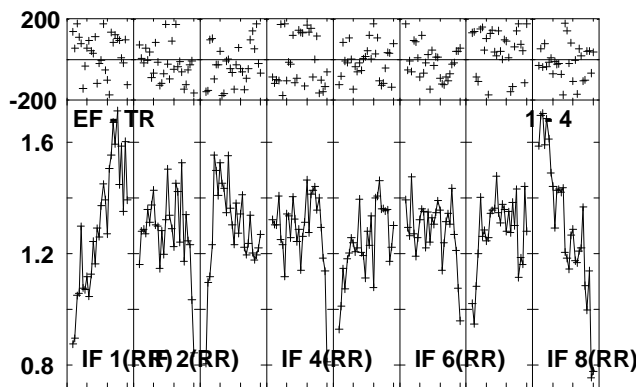
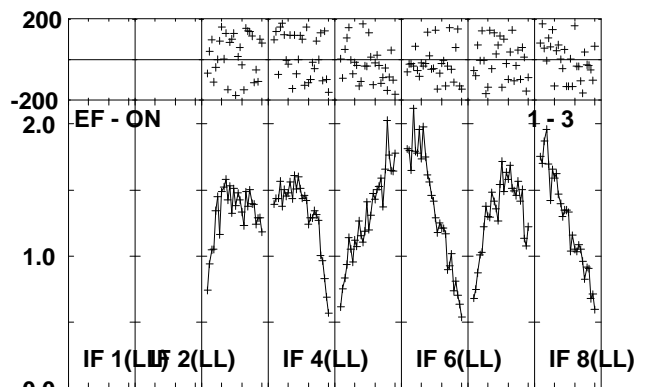
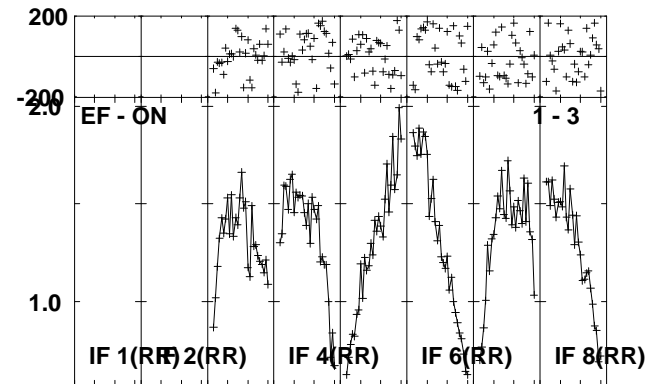
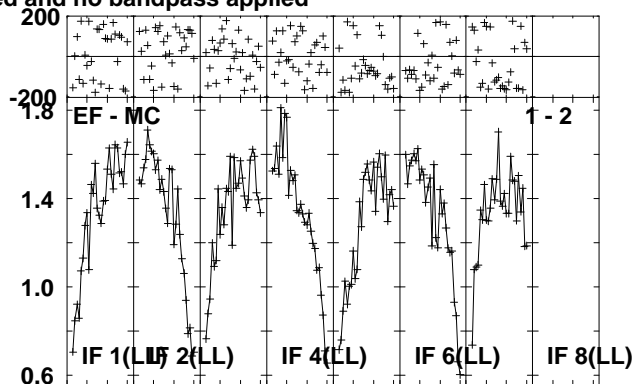
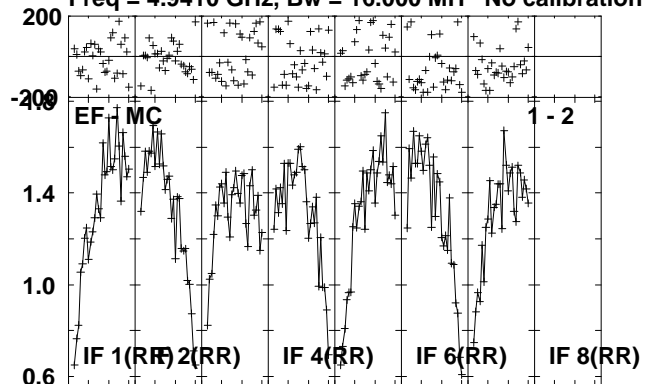

Lower frame: Milli Ampl Jy Top frame: Phas deg
Scalar averaged cross-power spectrum Several baselines displayed
Timerange: 00/17:15:51 to 00/17:18:19

Plot file version 174 created 04-OCT-2010 10:17:19

MAXI J16 RP016A.UVDATA.1

Freq = 4.9410 GHz, Bw = 16.000 MH No calibration applied and no bandpass applied

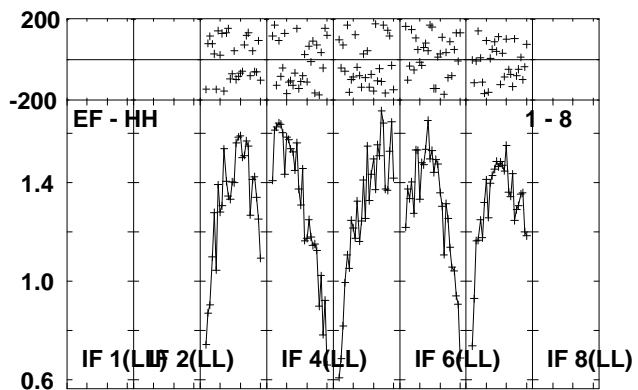
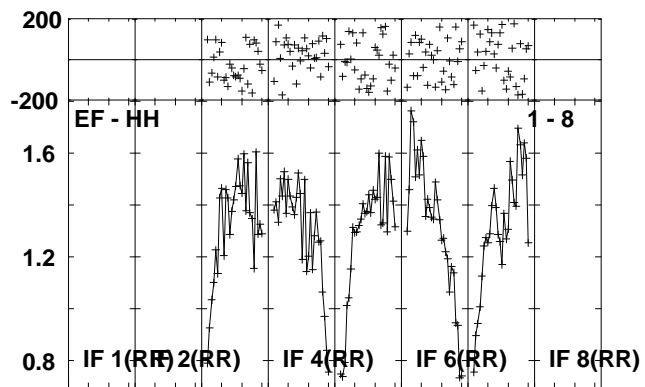
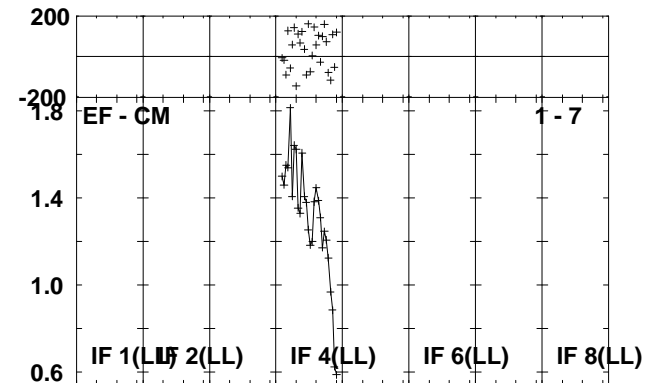
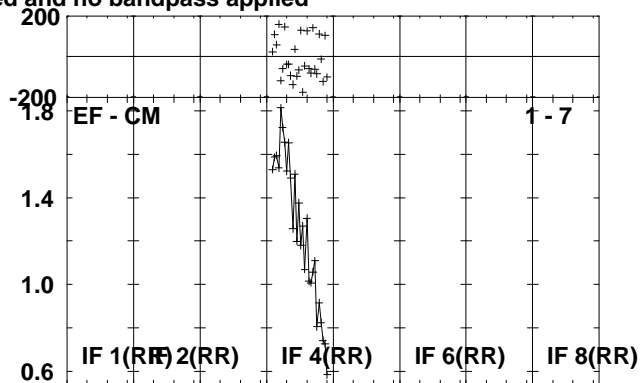
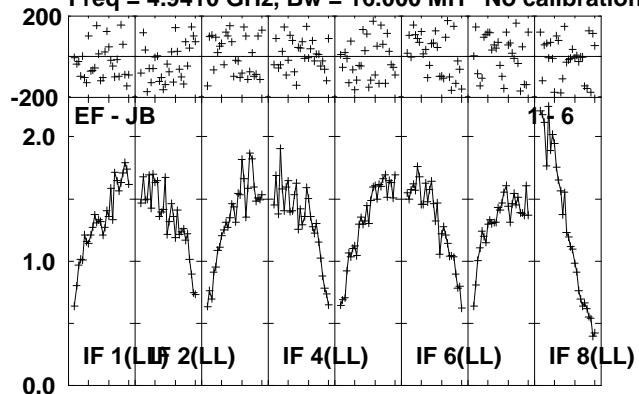

Lower frame: Milli Ampl Jy Top frame: Phas deg
Scalar averaged cross-power spectrum Several baselines displayed
Timerange: 00/17:15:51 to 00/17:18:19

Plot file version 175 created 04-OCT-2010 10:17:20

J1707-14 RP016A.UVDATA.1

Freq = 4.9410 GHz, Bw = 16.000 MH No calibration applied and no bandpass applied

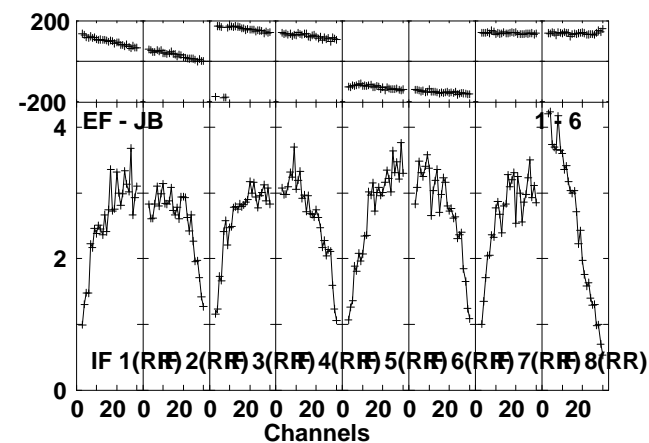
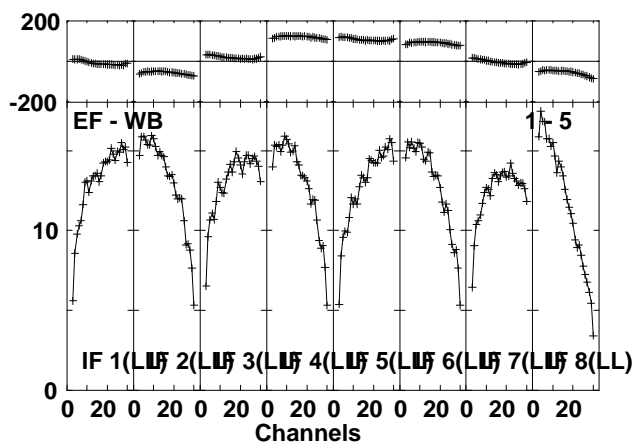
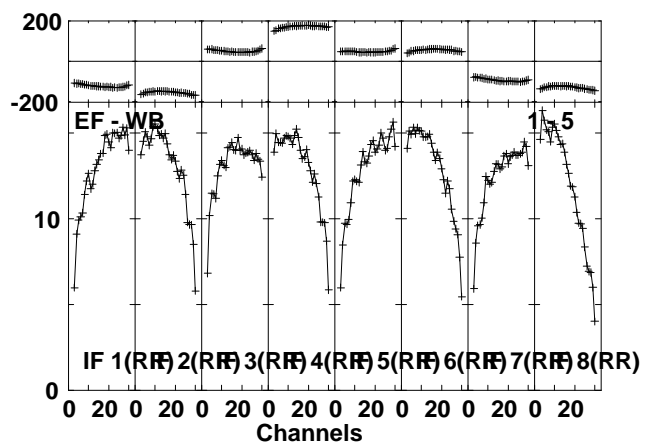
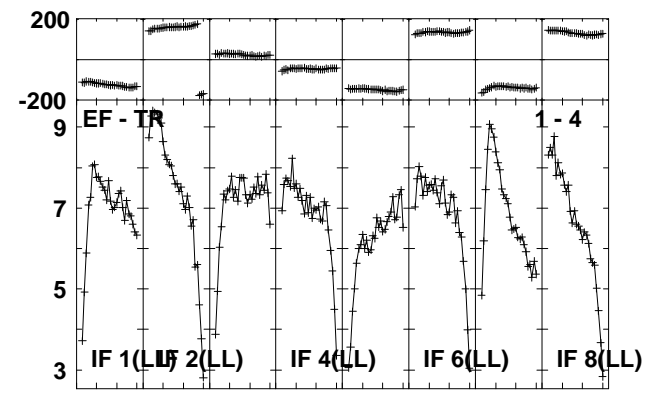
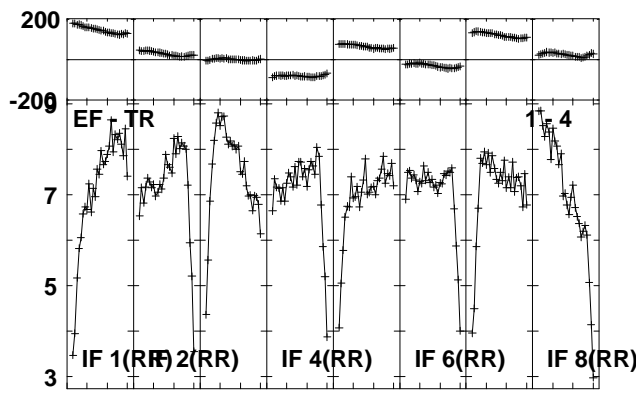
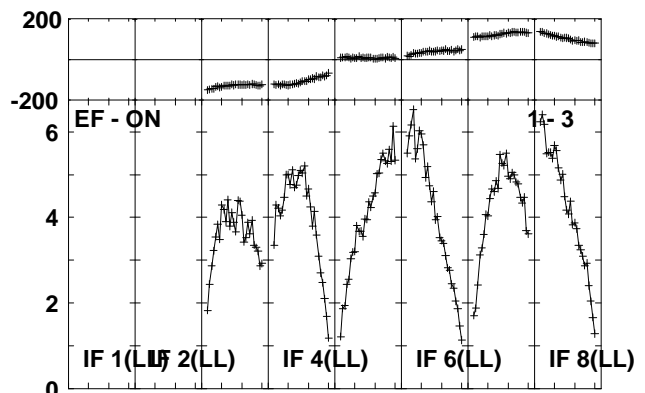
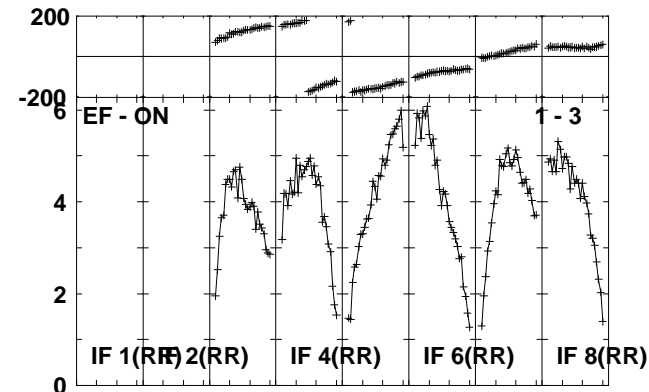
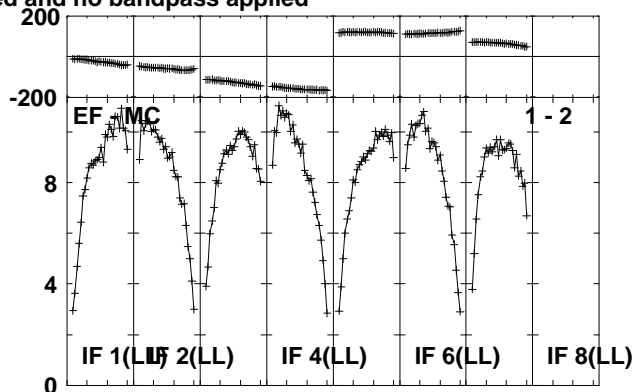
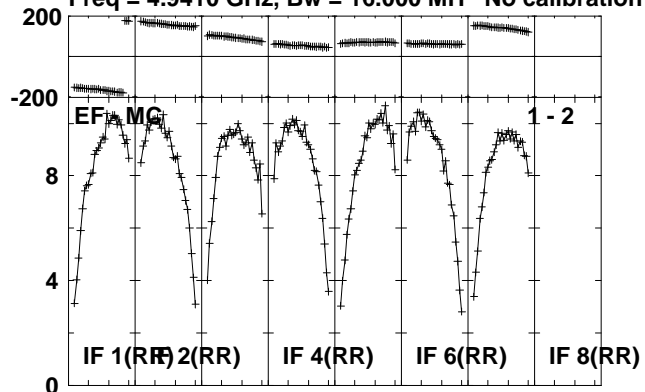

Lower frame: Milli Ampl Jy Top frame: Phas deg
Scalar averaged cross-power spectrum Several baselines displayed
Timerange: 00/17:19:01 to 00/17:19:59

Plot file version 176 created 04-OCT-2010 10:17:20
J1707-14 RP016A.UVDATA.1

Freq = 4.9410 GHz, Bw = 16.000 MH No calibration applied and no bandpass applied

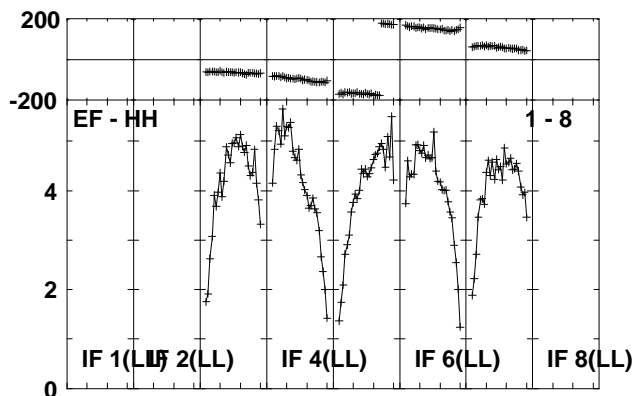
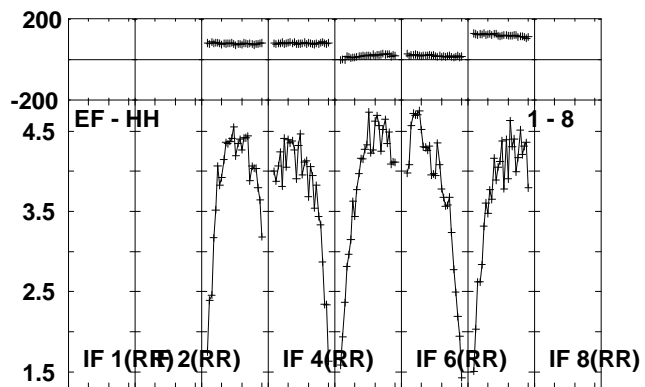
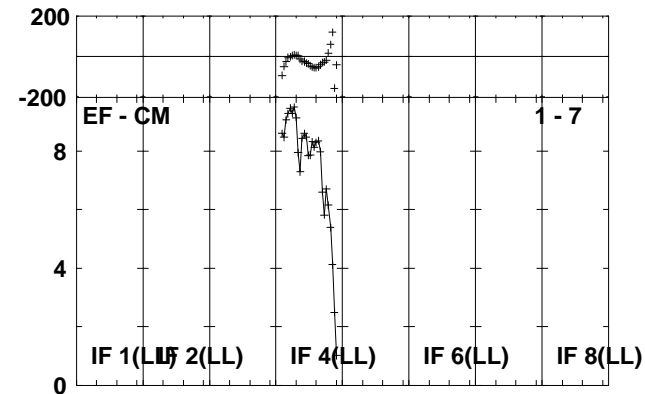
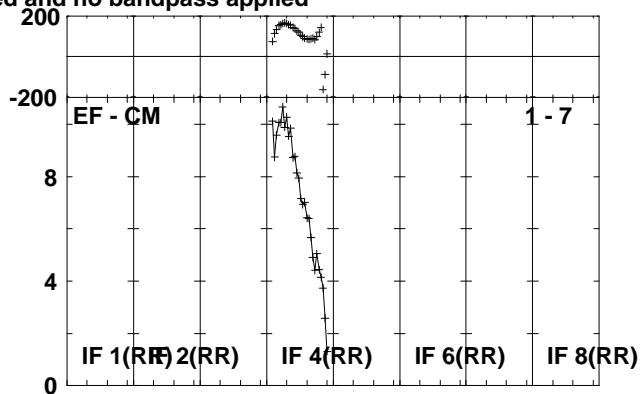
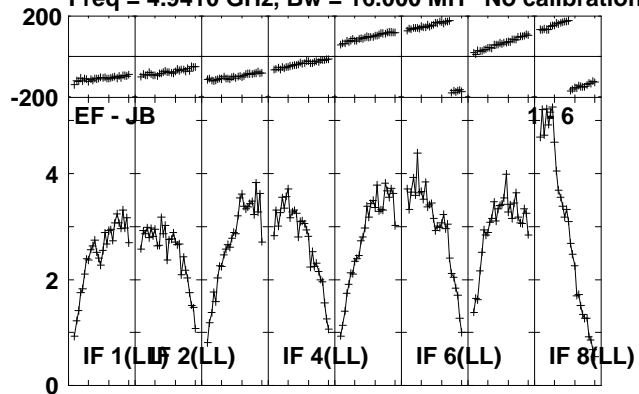

Lower frame: Milli Ampl Jy Top frame: Phas deg
Scalar averaged cross-power spectrum Several baselines displayed
Timerange: 00/17:19:01 to 00/17:19:59

Plot file version 177 created 04-OCT-2010 10:17:21

MAXI J16 RP016A.UVDATA.1

Freq = 4.9410 GHz, Bw = 16.000 MH No calibration applied and no bandpass applied

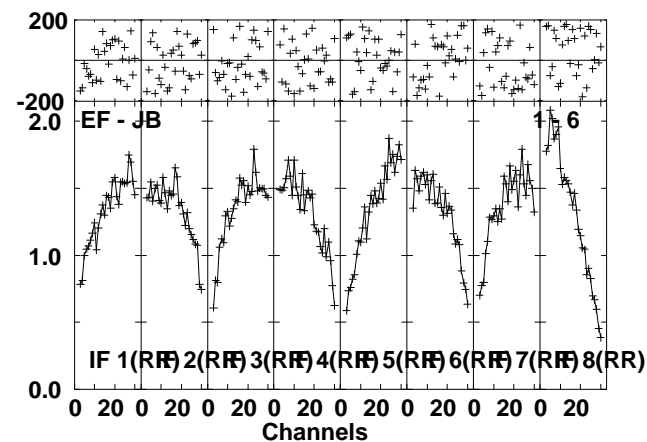
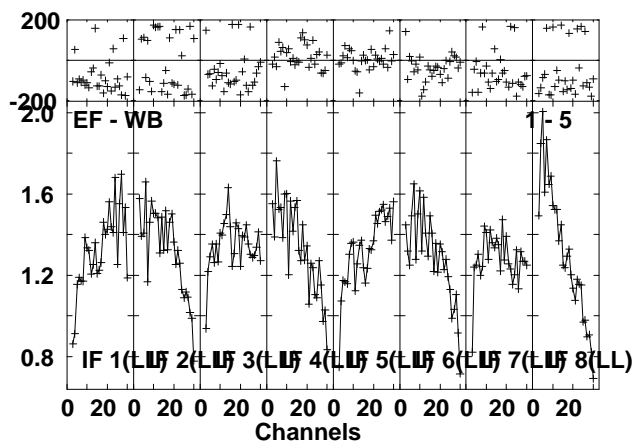
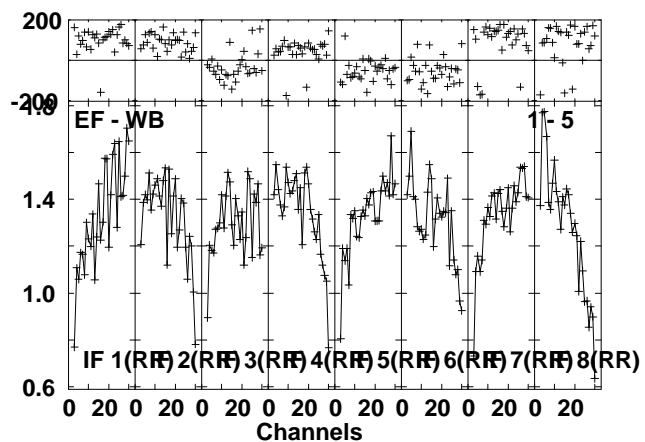
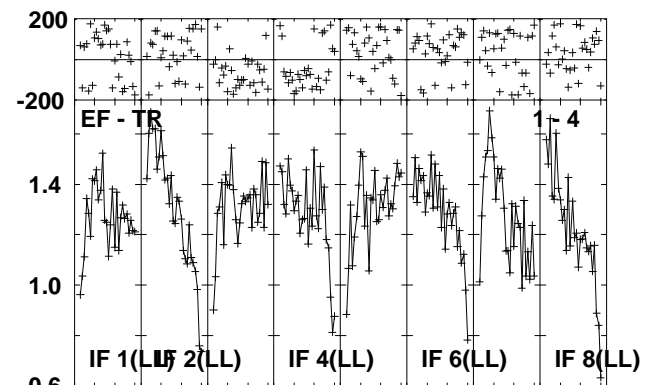
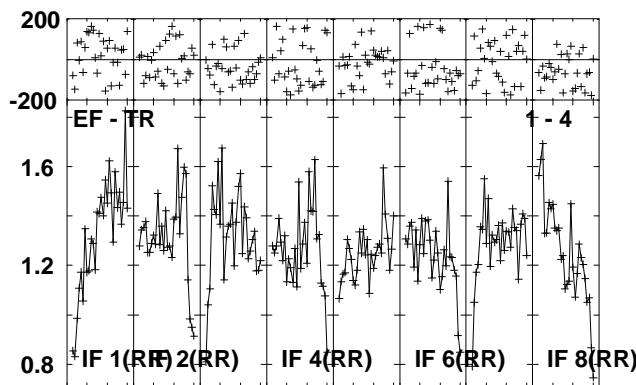
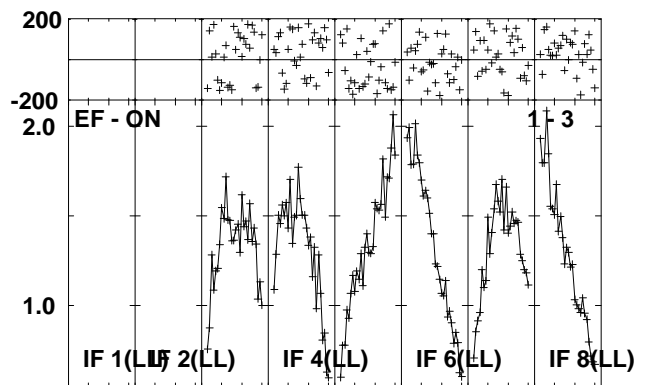
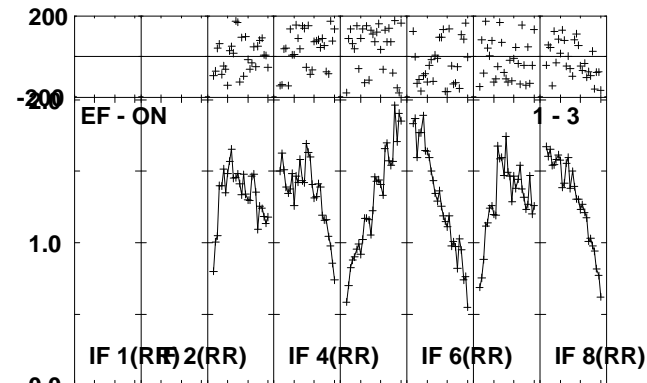
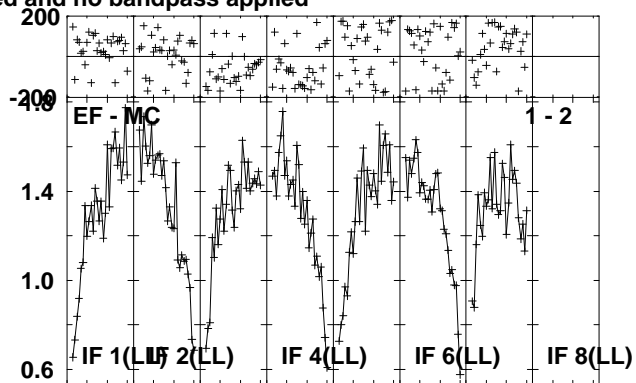
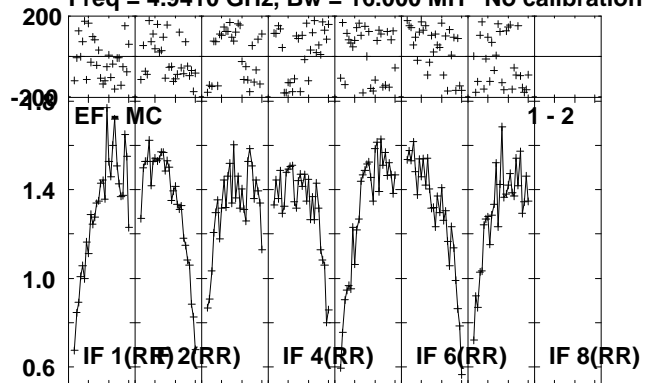

Lower frame: Milli Ampl Jy Top frame: Phas deg
Scalar averaged cross-power spectrum Several baselines displayed
Timerange: 00/17:20:01 to 00/17:22:29

Plot file version 178 created 04-OCT-2010 10:17:23
MAXI J16 RP016A.UVDATA.1

Freq = 4.9410 GHz, Bw = 16.000 MH No calibration applied and no bandpass applied

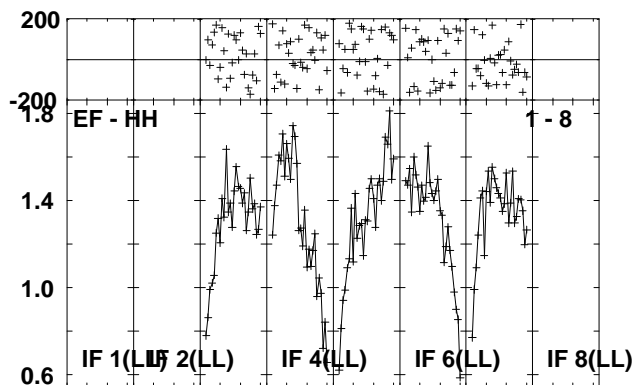
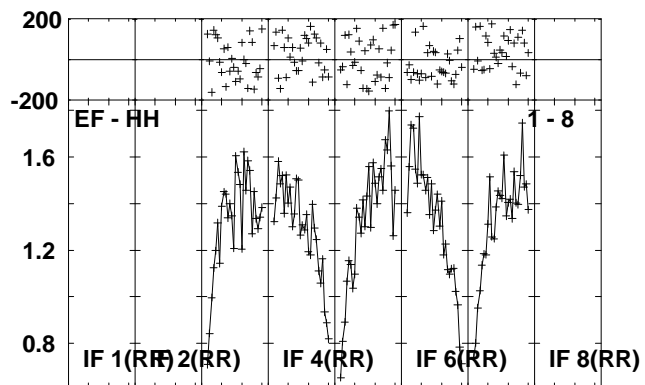
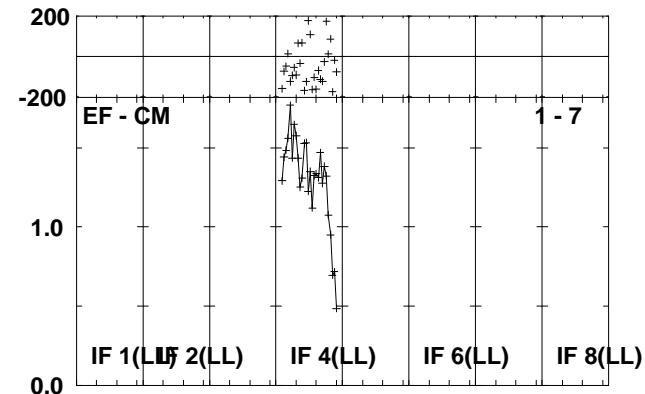
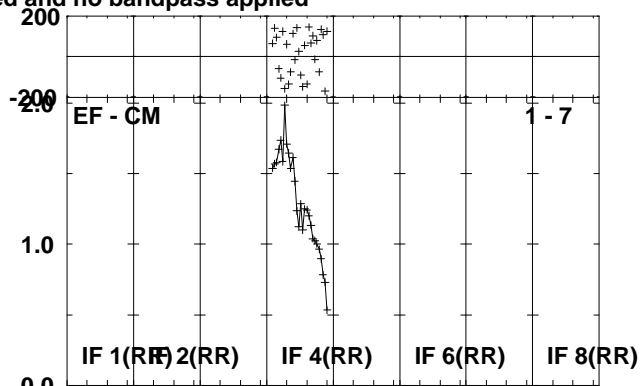
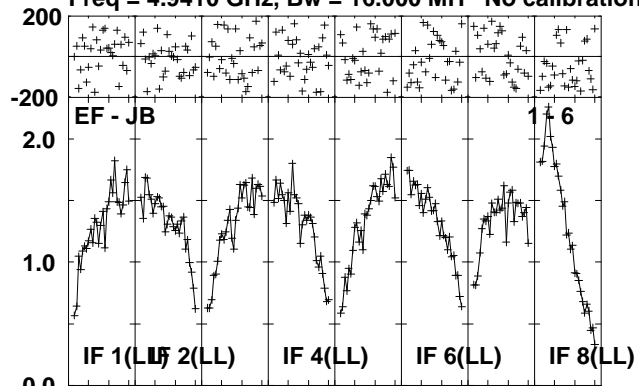

Lower frame: Milli Ampl Jy Top frame: Phas deg
Scalar averaged cross-power spectrum Several baselines displayed
Timerange: 00/17:20:01 to 00/17:22:29

Plot file version 179 created 04-OCT-2010 10:17:24

J1707-14 RP016A.UVDATA.1

Freq = 4.9410 GHz, Bw = 16.000 MH No calibration applied and no bandpass applied

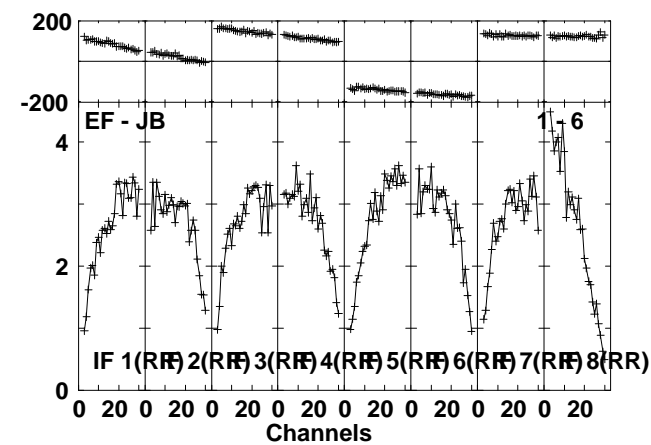
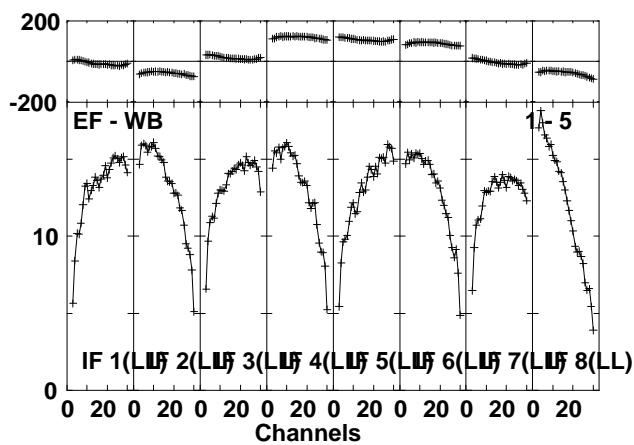
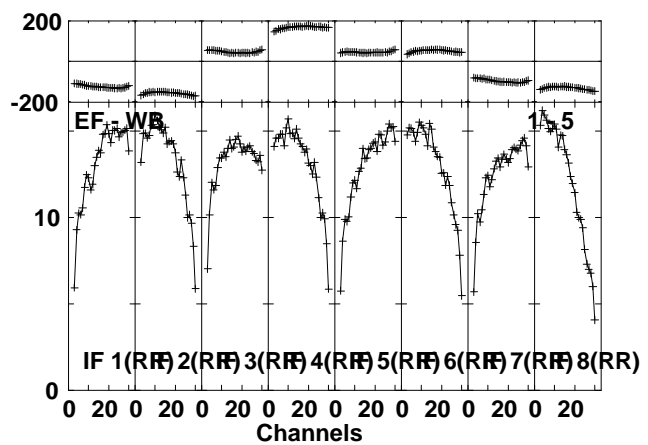
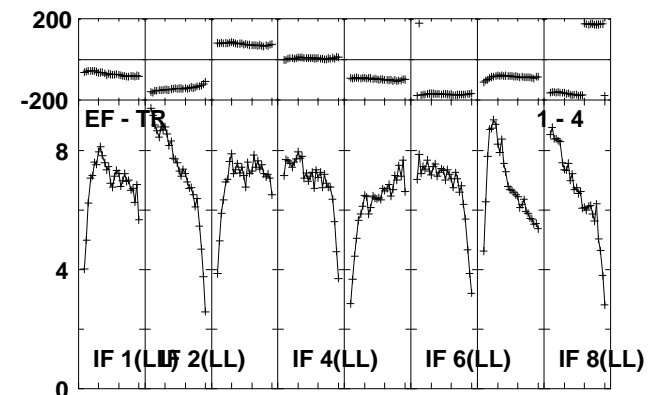
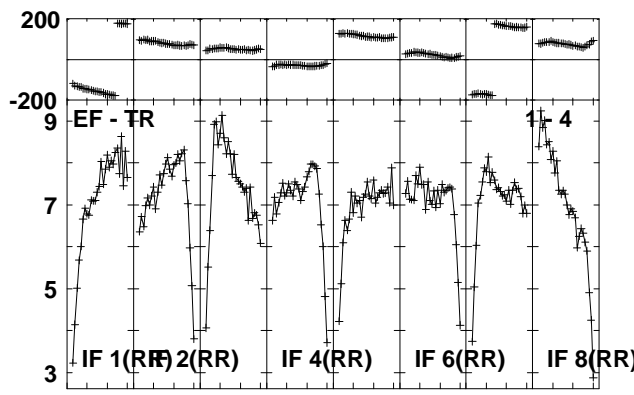
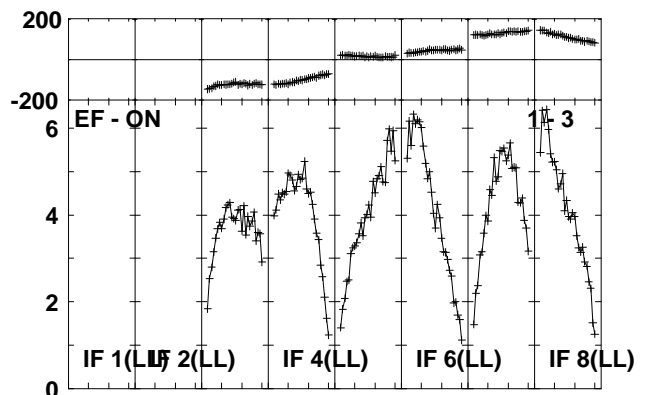
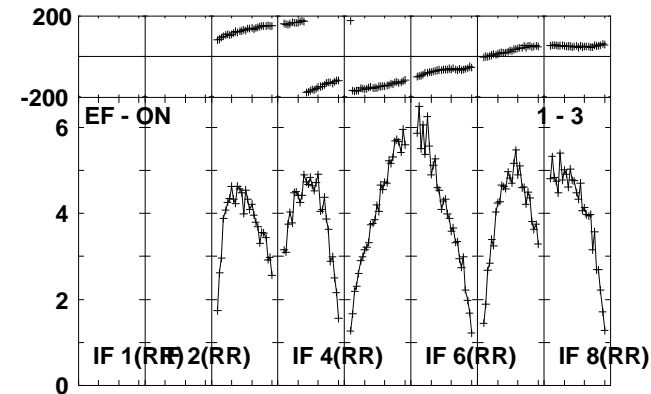
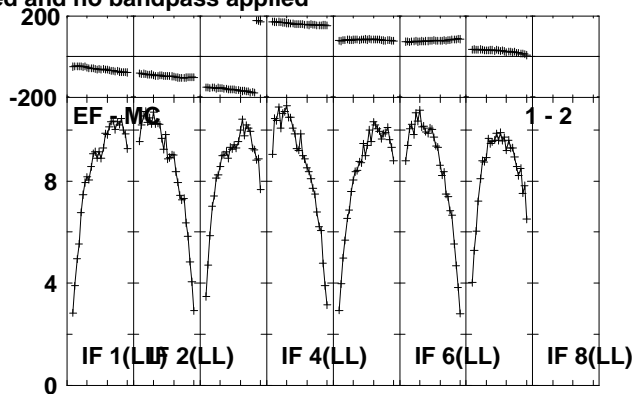
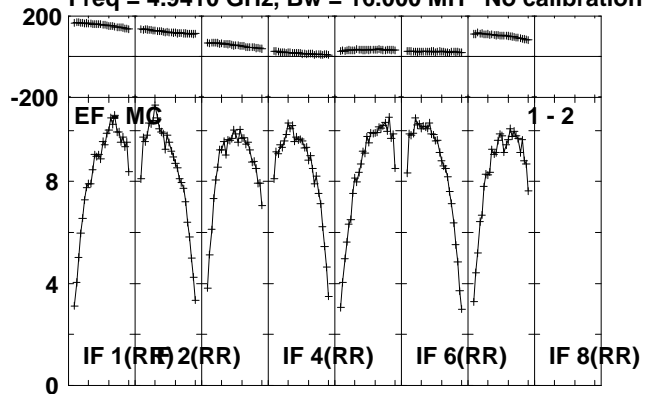

Lower frame: Milli Ampl Jy Top frame: Phas deg
Scalar averaged cross-power spectrum Several baselines displayed
Timerange: 00/17:22:31 to 00/17:23:59

Plot file version 180 created 04-OCT-2010 10:17:25
J1707-14 RP016A.UVDATA.1

Freq = 4.9410 GHz, Bw = 16.000 MH No calibration applied and no bandpass applied

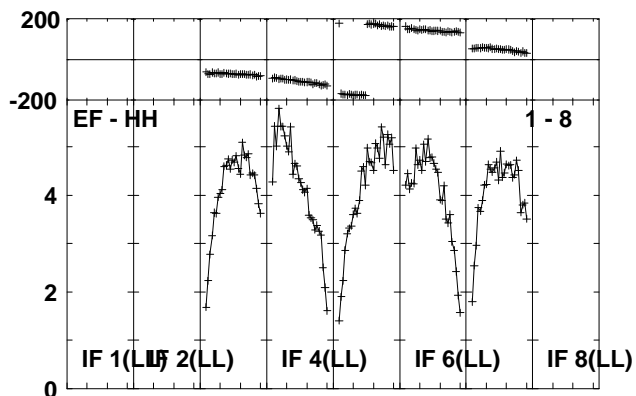
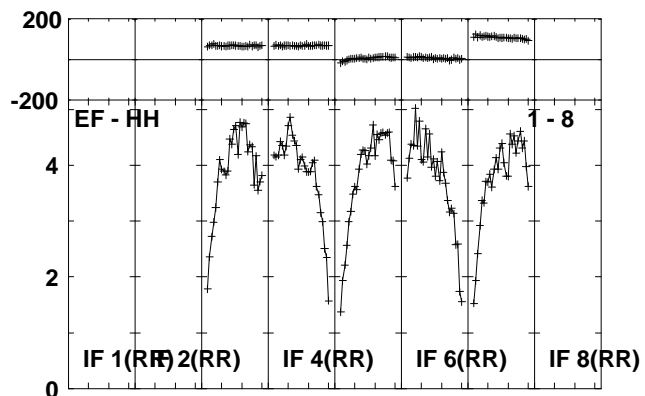
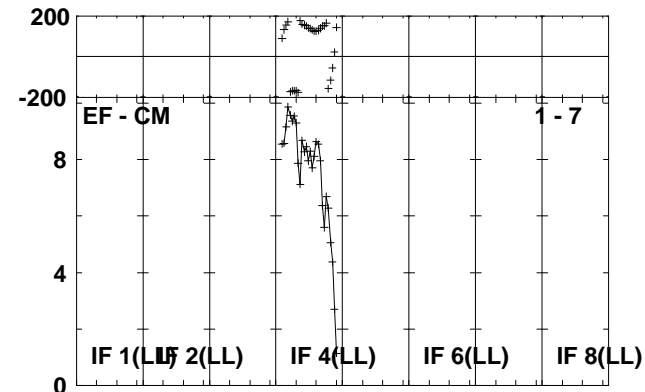
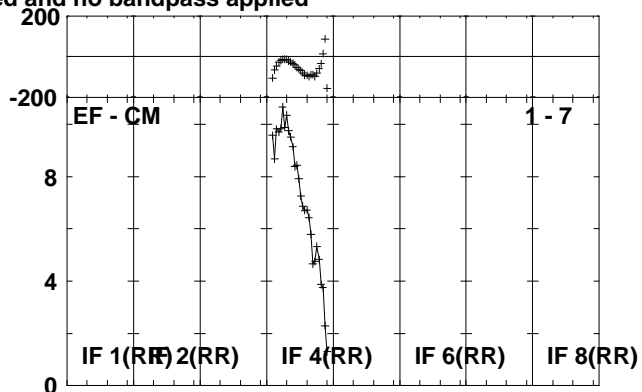
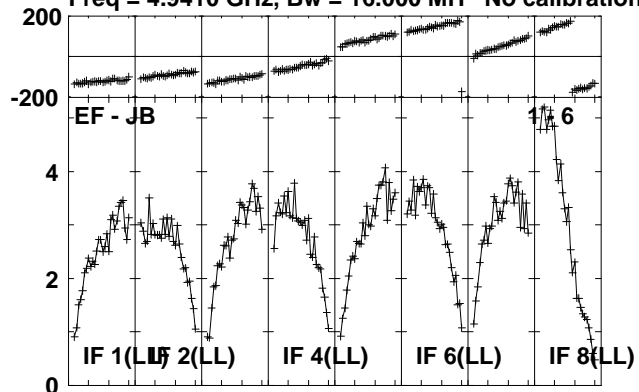

Lower frame: Milli Ampl Jy Top frame: Phas deg
Scalar averaged cross-power spectrum Several baselines displayed
Timerange: 00/17:22:31 to 00/17:23:59

Plot file version 181 created 04-OCT-2010 10:17:26

MAXI J16 RP016A.UVDATA.1

Freq = 4.9410 GHz, Bw = 16.000 MH No calibration applied and no bandpass applied

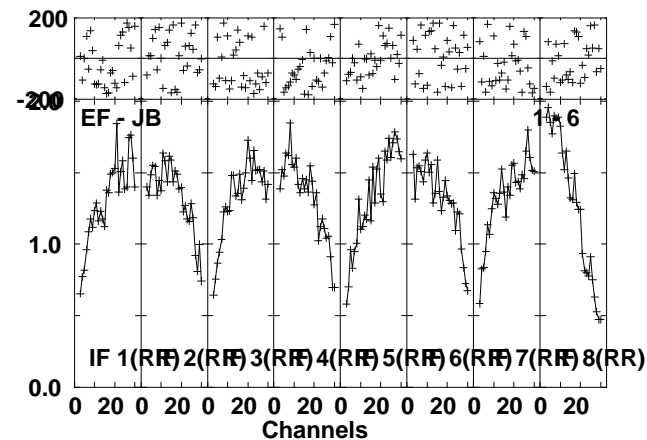
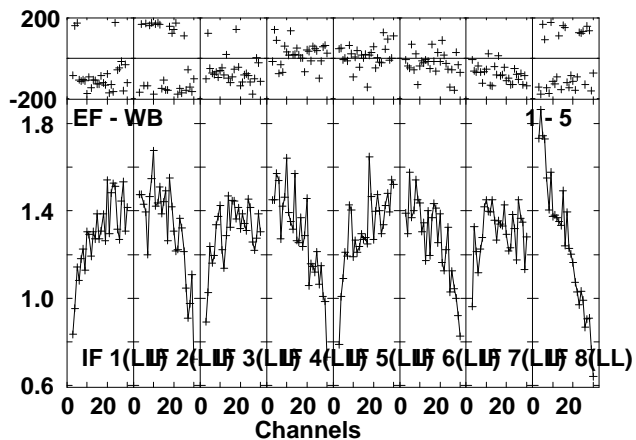
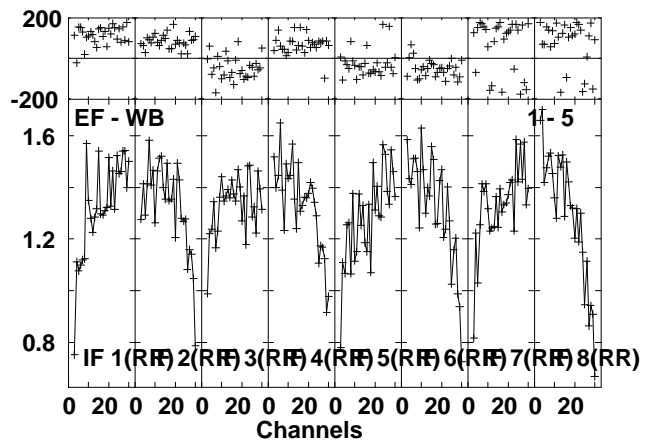
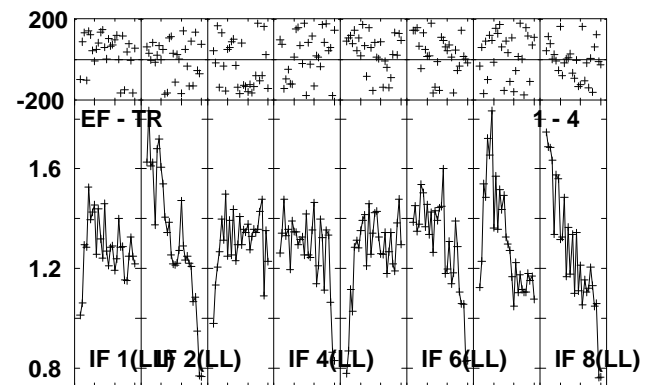
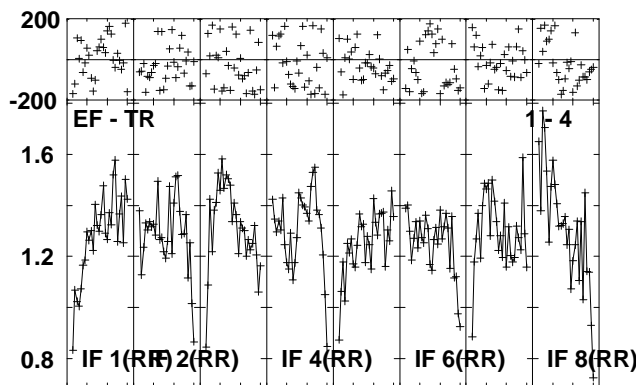
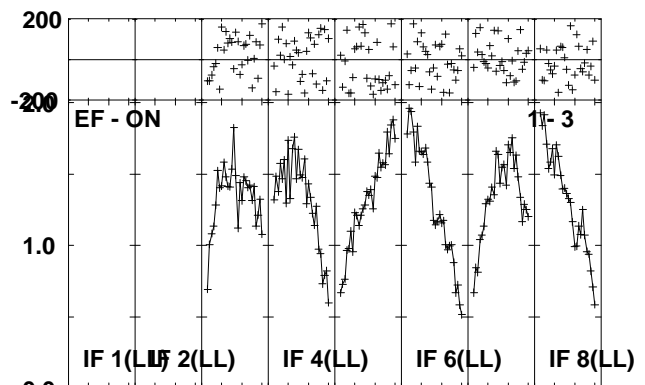
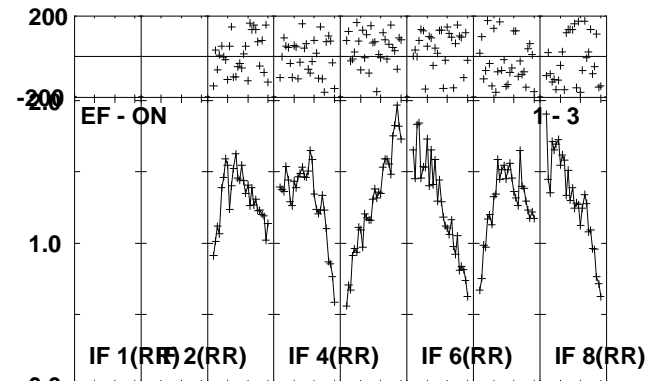
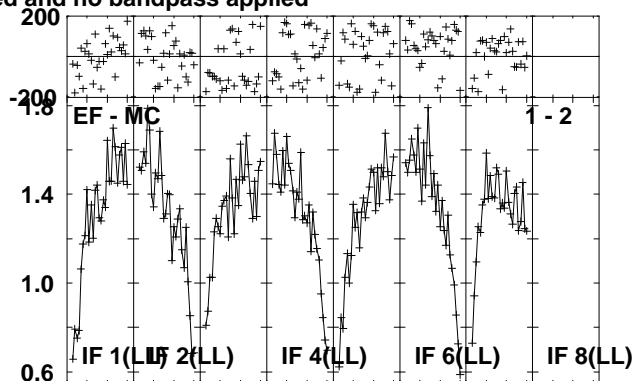
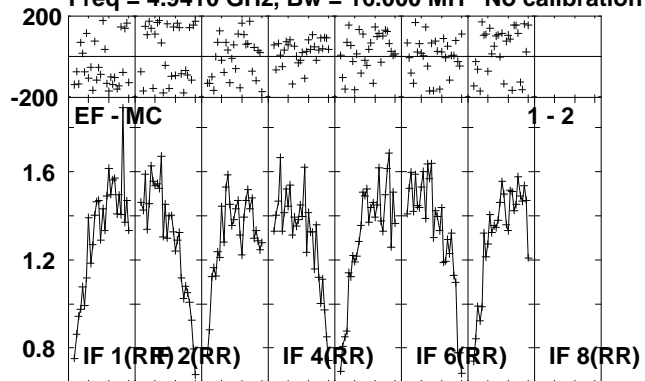

Lower frame: Milli Ampl Jy Top frame: Phas deg
Scalar averaged cross-power spectrum Several baselines displayed
Timerange: 00/17:24:01 to 00/17:26:29

Plot file version 182 created 04-OCT-2010 10:17:28

MAXI J16 RP016A.UVDATA.1

Freq = 4.9410 GHz, Bw = 16.000 MH No calibration applied and no bandpass applied

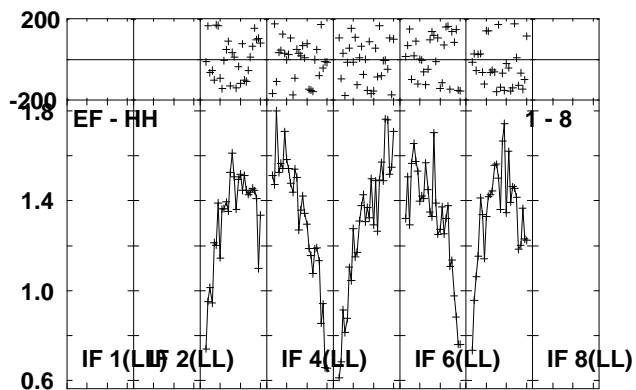
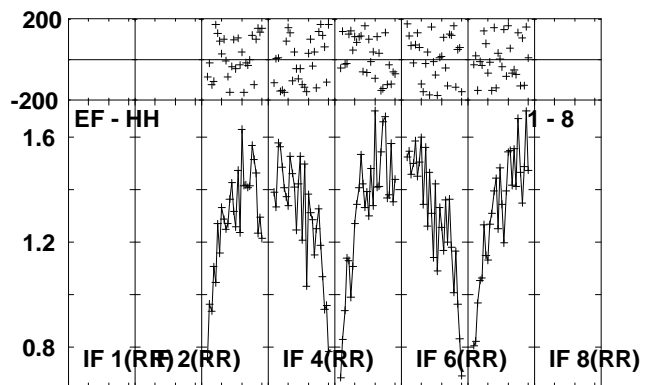
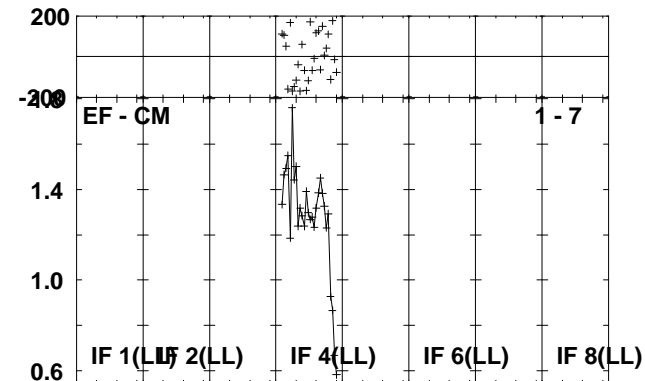
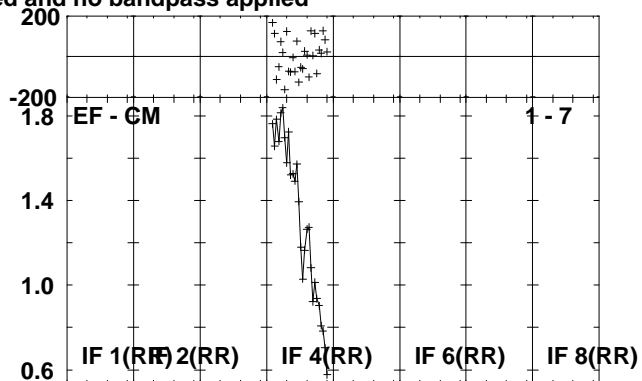
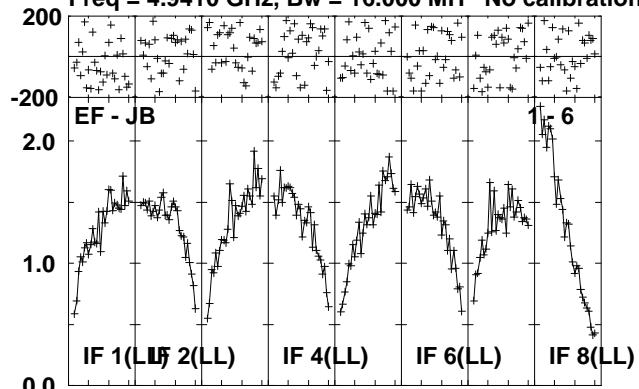

Lower frame: Milli Ampl Jy Top frame: Phas deg
Scalar averaged cross-power spectrum Several baselines displayed
Timerange: 00/17:24:01 to 00/17:26:29

Plot file version 183 created 04-OCT-2010 10:17:29

J1707-14 RP016A.UVDATA.1

Freq = 4.9410 GHz, Bw = 16.000 MH No calibration applied and no bandpass applied

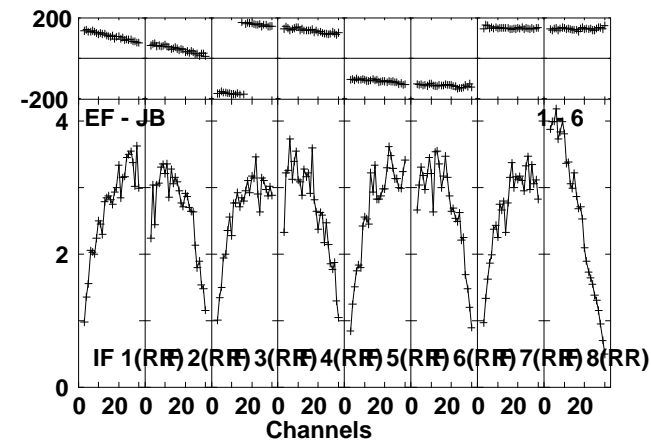
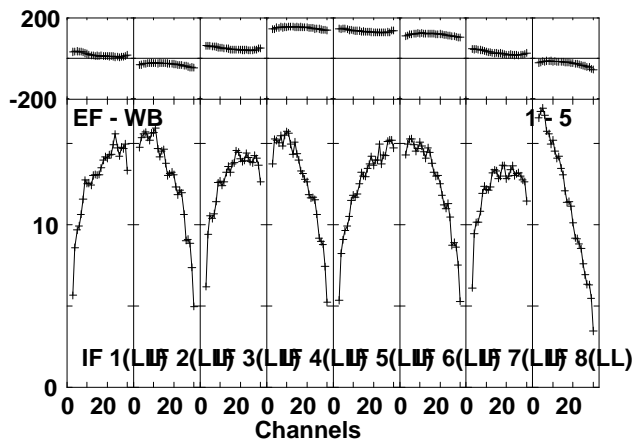
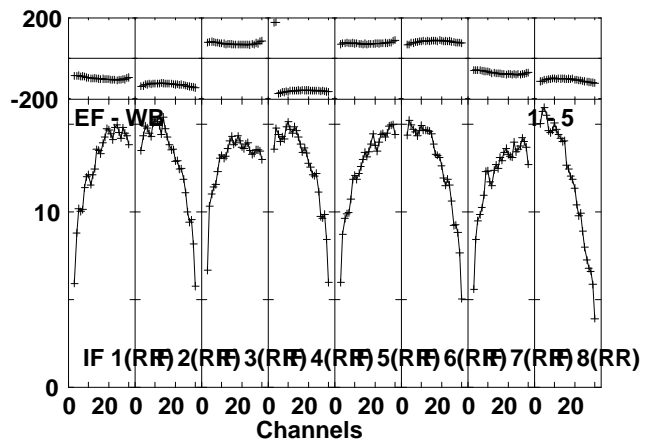
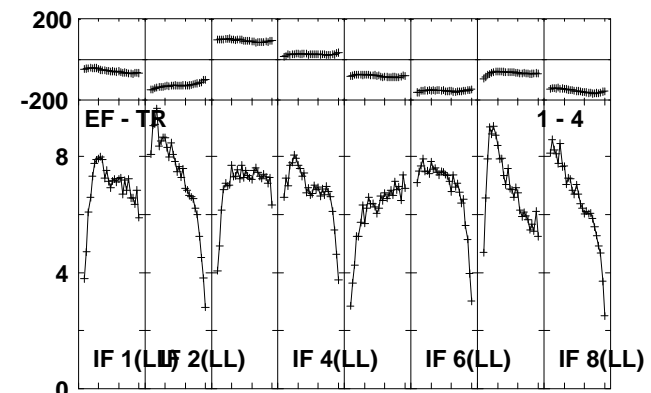
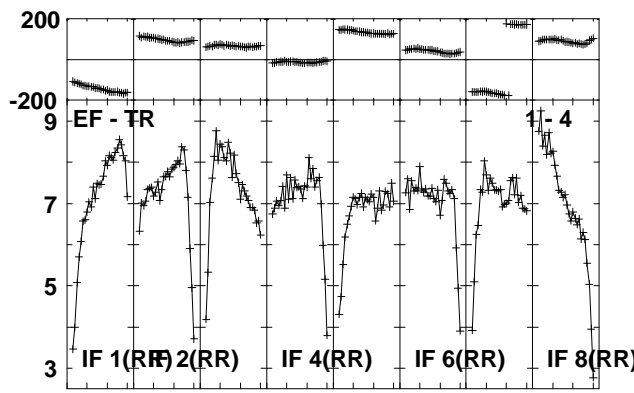
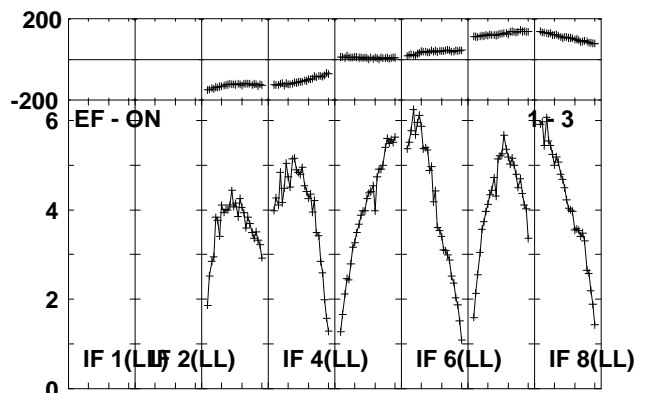
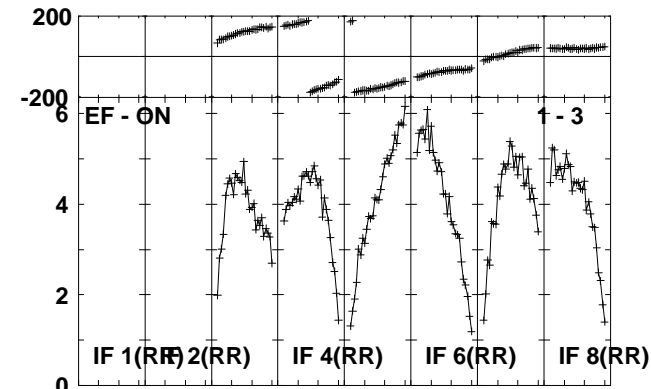
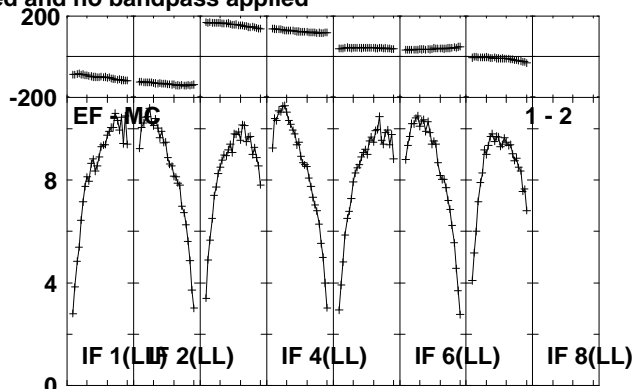
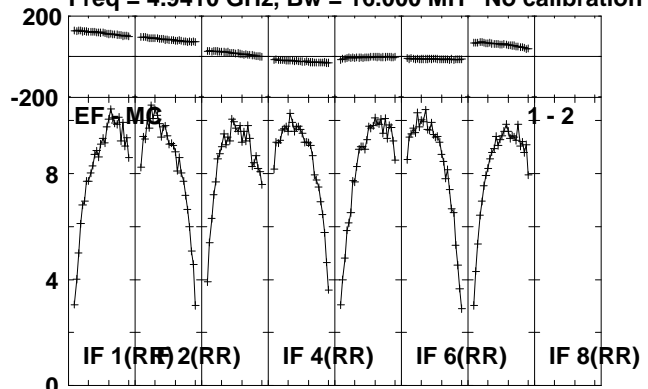

Lower frame: Milli Ampl Jy Top frame: Phas deg
Scalar averaged cross-power spectrum Several baselines displayed
Timerange: 00/17:27:11 to 00/17:28:09

Plot file version 184 created 04-OCT-2010 10:17:29
J1707-14 RP016A.UVDATA.1

Freq = 4.9410 GHz, Bw = 16.000 MH No calibration applied and no bandpass applied

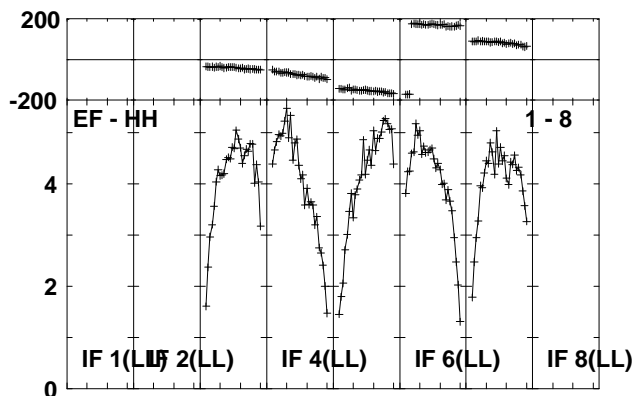
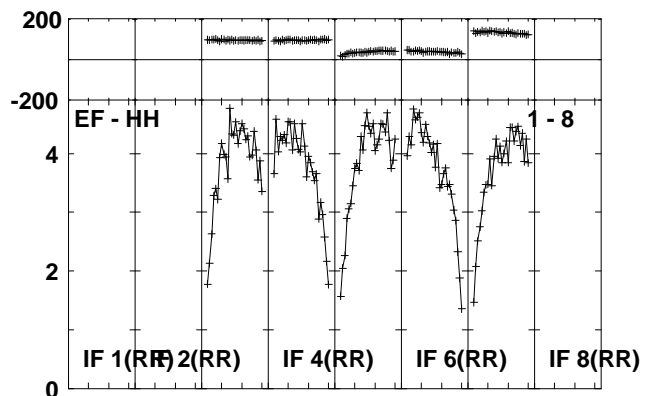
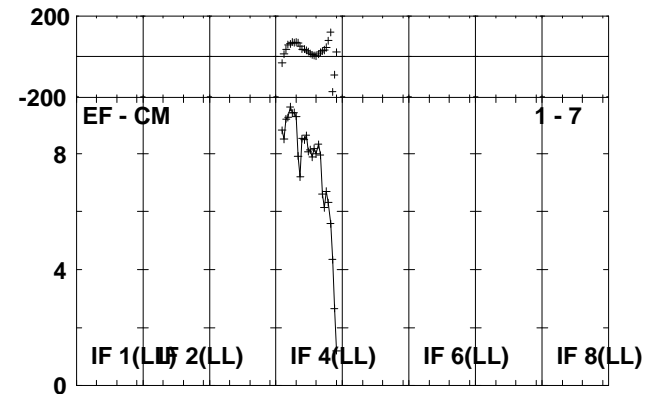
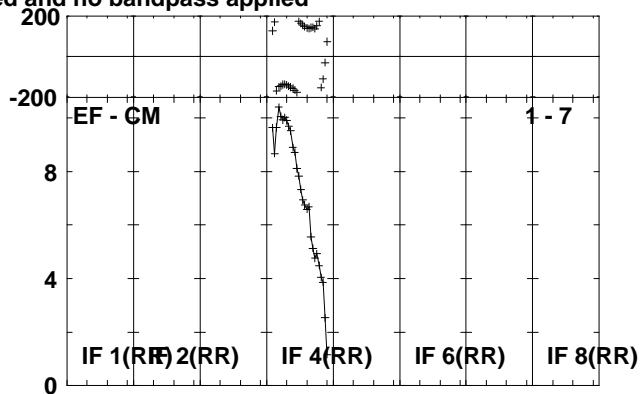
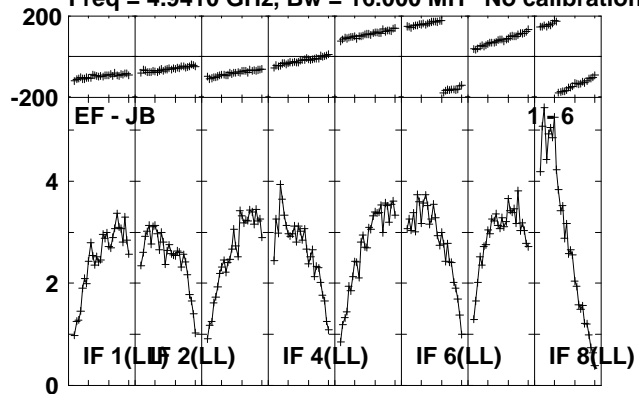

Lower frame: Milli Ampl Jy Top frame: Phas deg
Scalar averaged cross-power spectrum Several baselines displayed
Timerange: 00/17:27:11 to 00/17:28:09

Plot file version 185 created 04-OCT-2010 10:17:30

NVSS3 RP016A.UVDATA.1

Freq = 4.9410 GHz, Bw = 16.000 MH No calibration applied and no bandpass applied

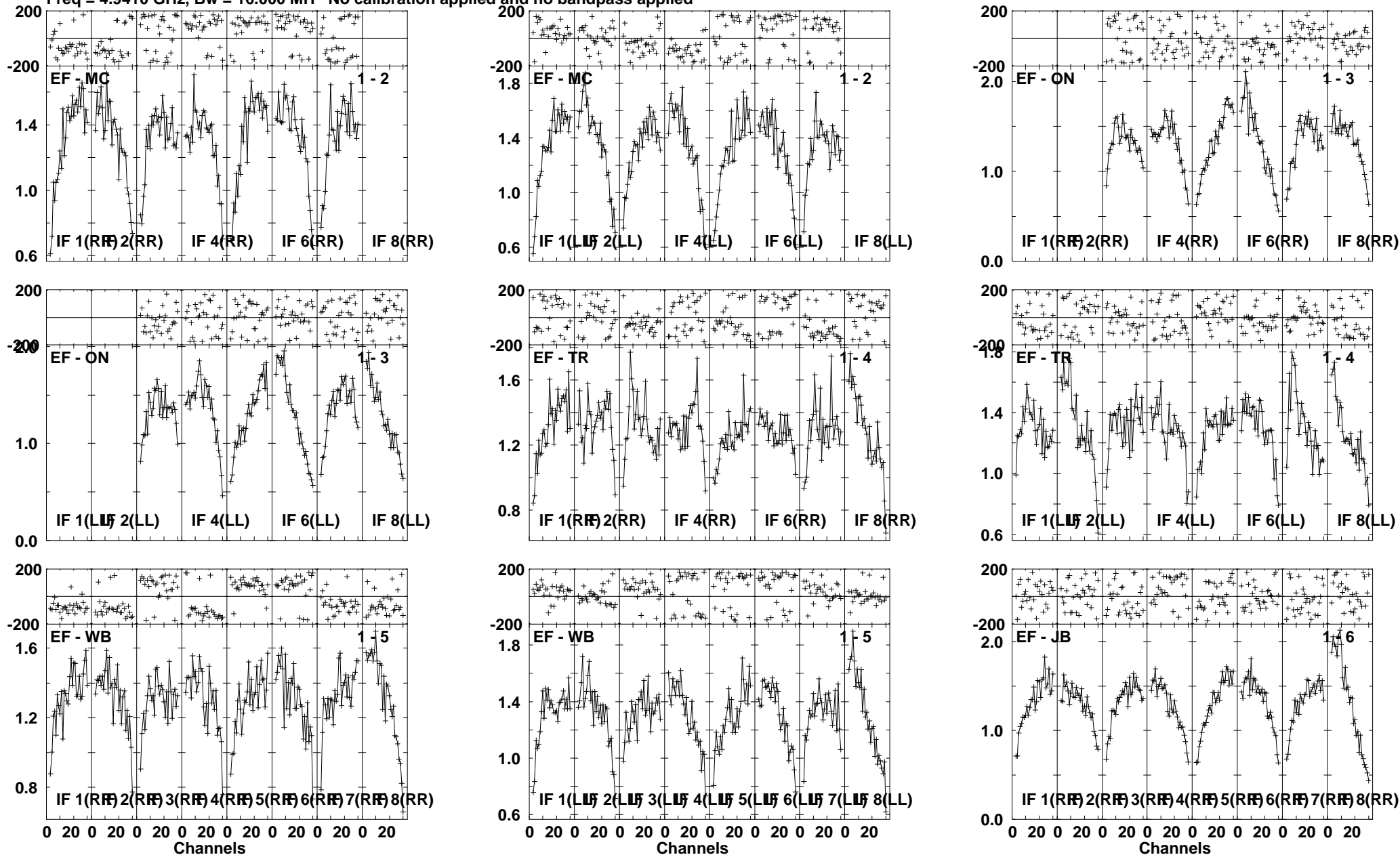

Lower frame: Milli Ampl Jy Top frame: Phas deg
Scalar averaged cross-power spectrum Several baselines displayed
Timerange: 00/17:28:11 to 00/17:30:39

Plot file version 186 created 04-OCT-2010 10:17:32

NVSS3 RP016A.UVDATA.1

Freq = 4.9410 GHz, Bw = 16.000 MH No calibration applied and no bandpass applied

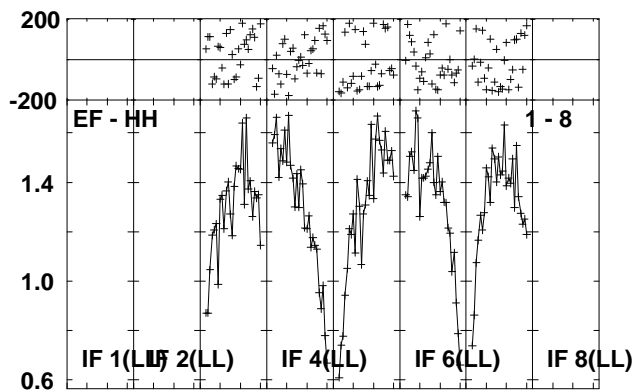
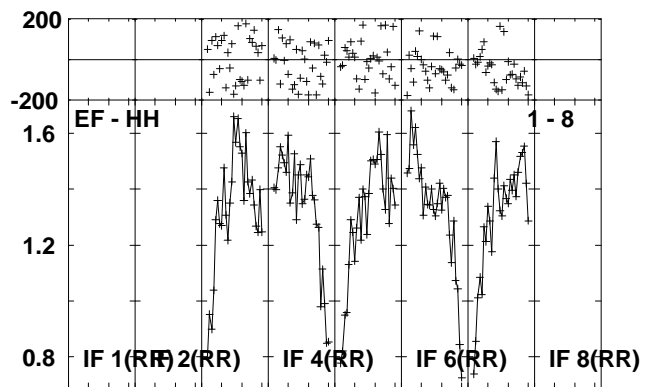
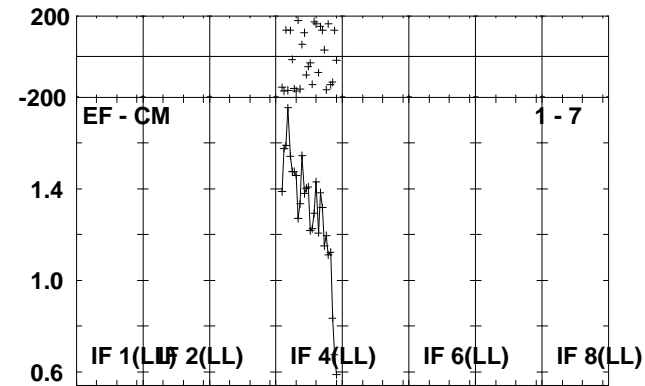
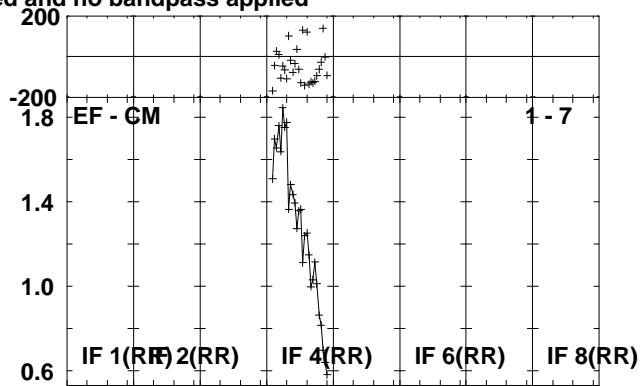
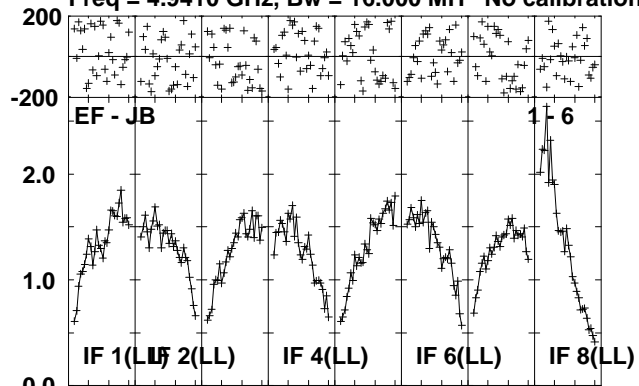

Lower frame: Milli Ampl Jy Top frame: Phas deg
Scalar averaged cross-power spectrum Several baselines displayed
Timerange: 00/17:28:11 to 00/17:30:39

Plot file version 187 created 04-OCT-2010 10:17:33

J1707-14 RP016A.UVDATA.1

Freq = 4.9410 GHz, Bw = 16.000 MH No calibration applied and no bandpass applied

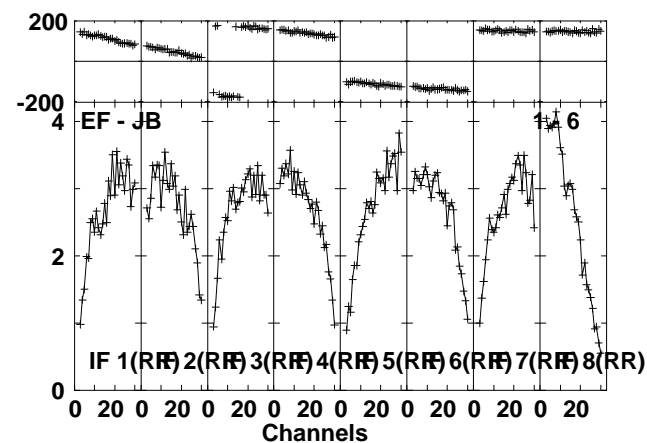
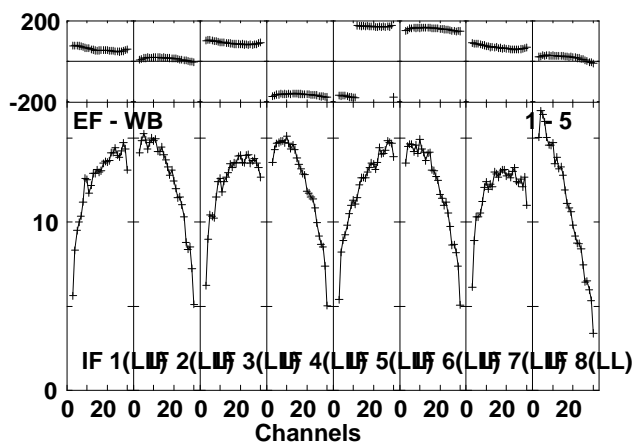
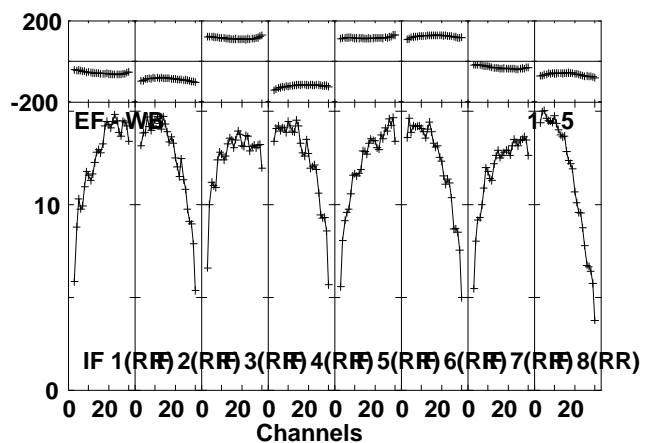
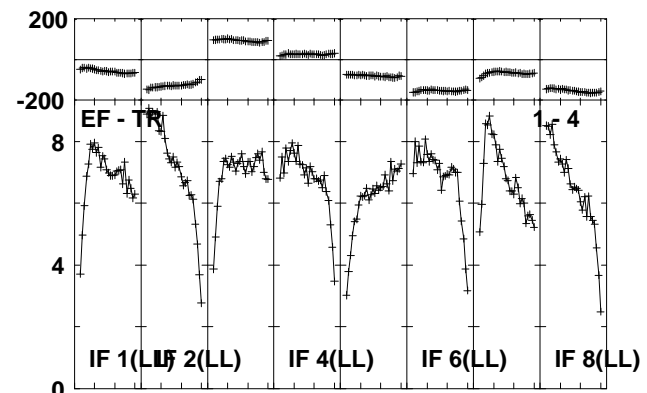
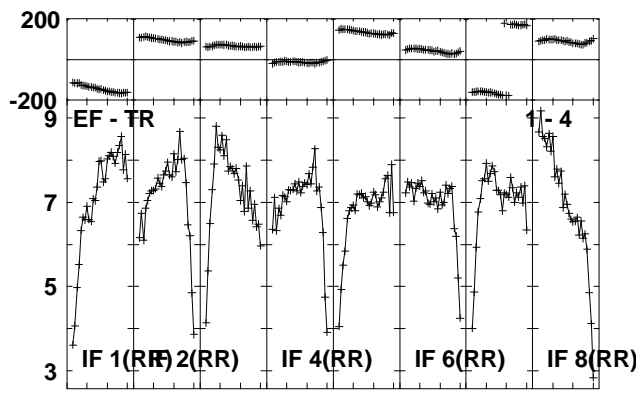
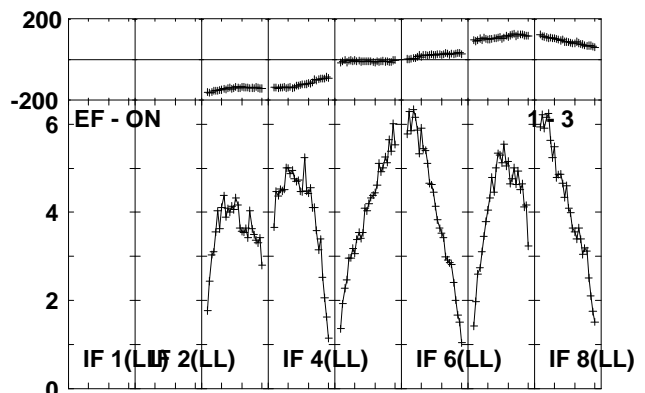
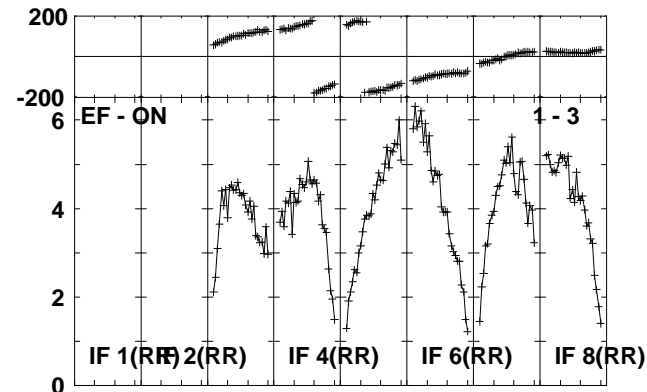
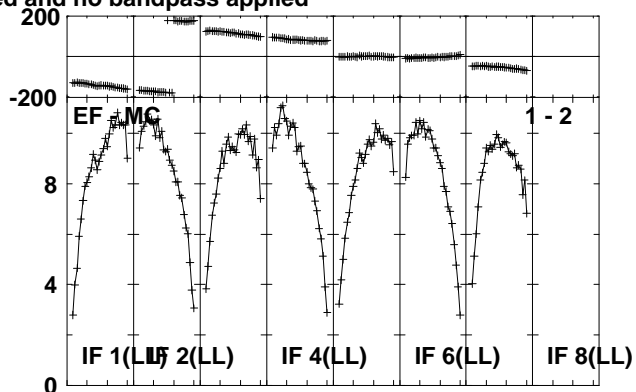
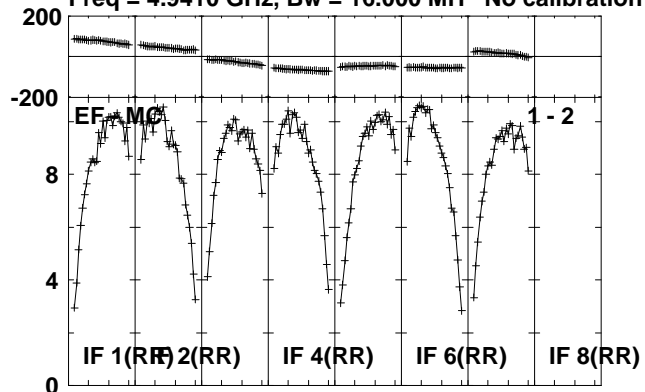

Lower frame: Milli Ampl Jy Top frame: Phas deg
Scalar averaged cross-power spectrum Several baselines displayed
Timerange: 00/17:30:41 to 00/17:32:09

Plot file version 188 created 04-OCT-2010 10:17:34

J1707-14 RP016A.UVDATA.1

Freq = 4.9410 GHz, Bw = 16.000 MH No calibration applied and no bandpass applied

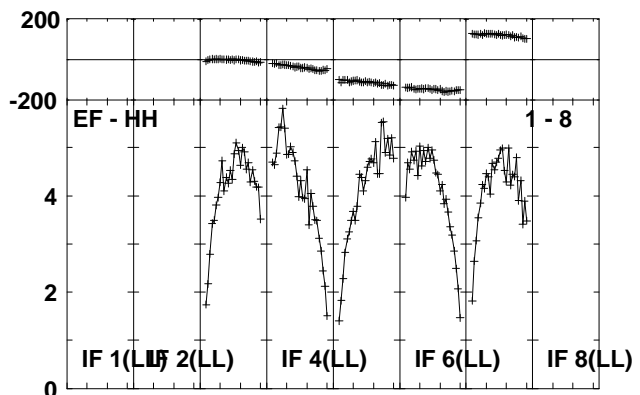
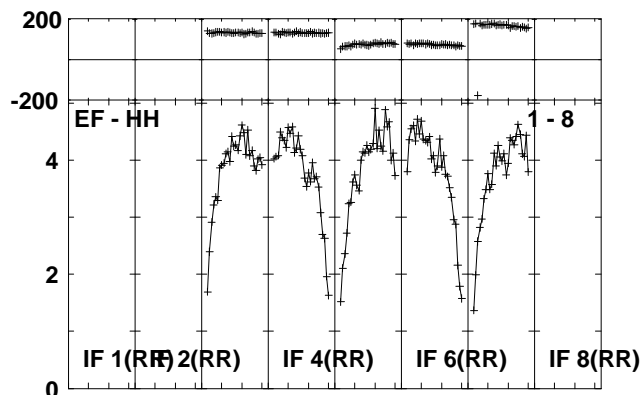
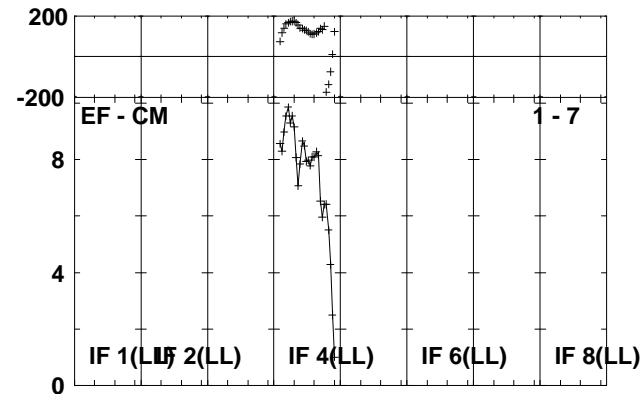
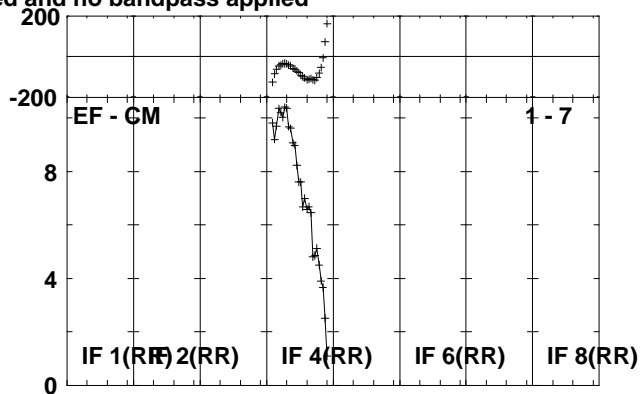
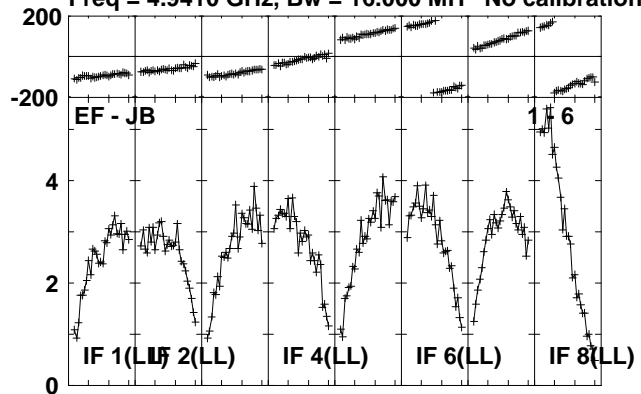

Lower frame: Milli Ampl Jy Top frame: Phas deg
Scalar averaged cross-power spectrum Several baselines displayed
Timerange: 00:17:30:41 to 00:17:32:09

Plot file version 189 created 04-OCT-2010 10:17:35

MAXI J16 RP016A.UVDATA.1

Freq = 4.9410 GHz, Bw = 16.000 MH No calibration applied and no bandpass applied

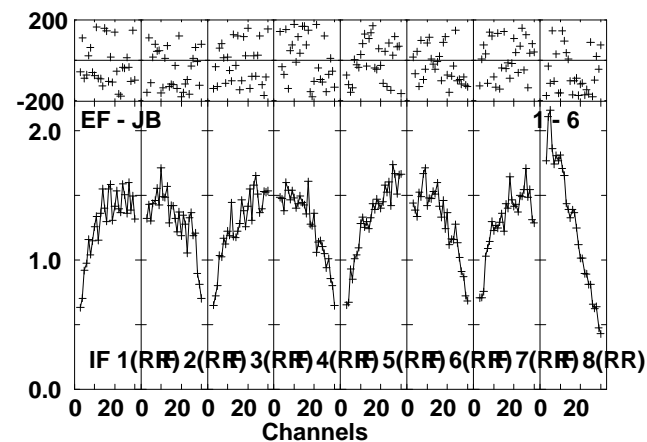
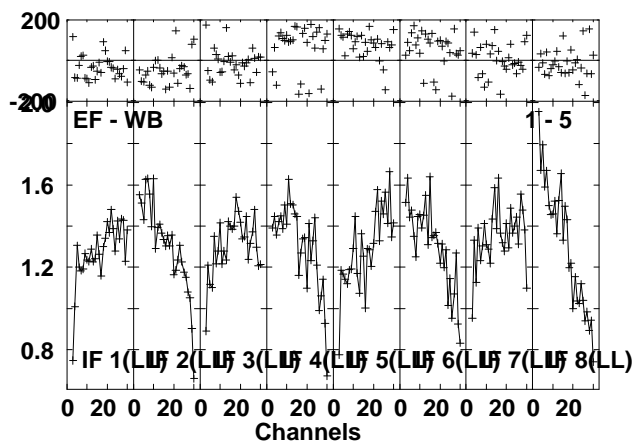
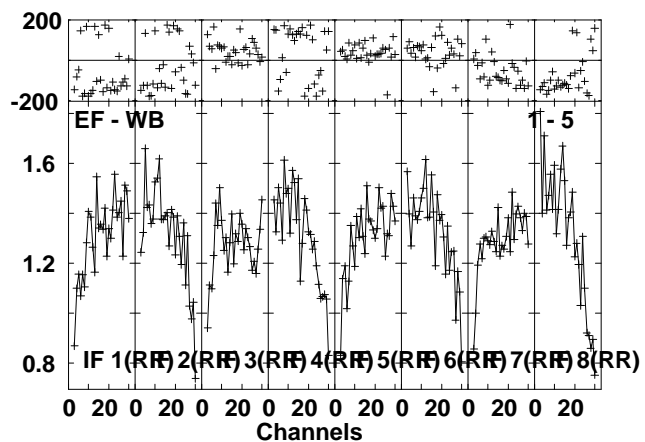
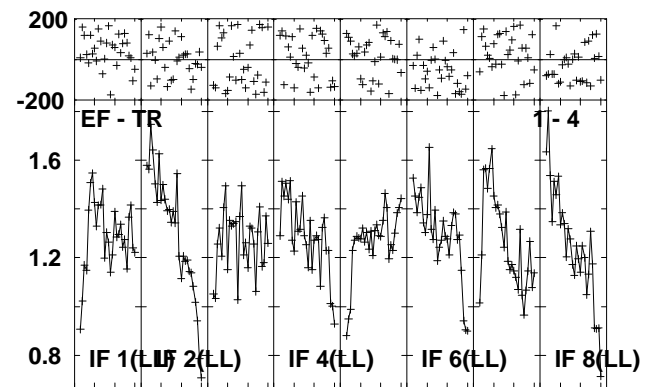
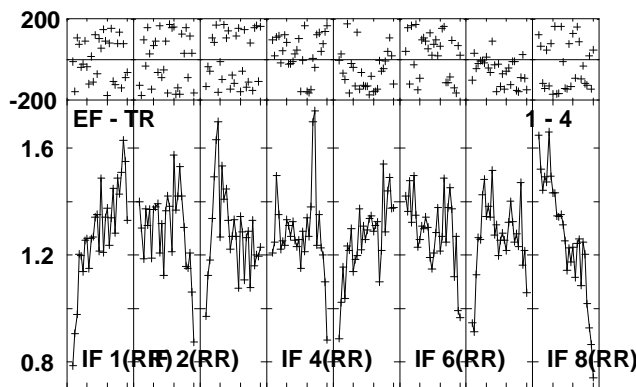
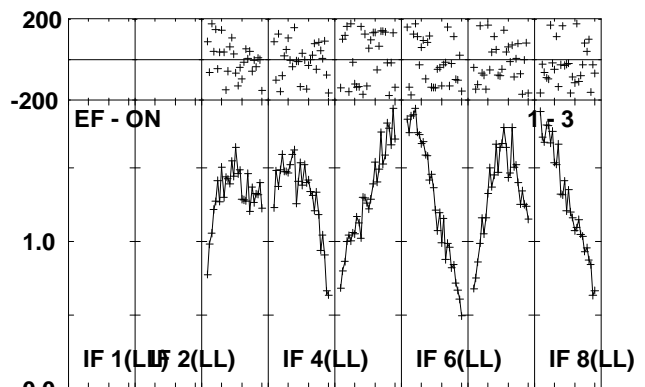
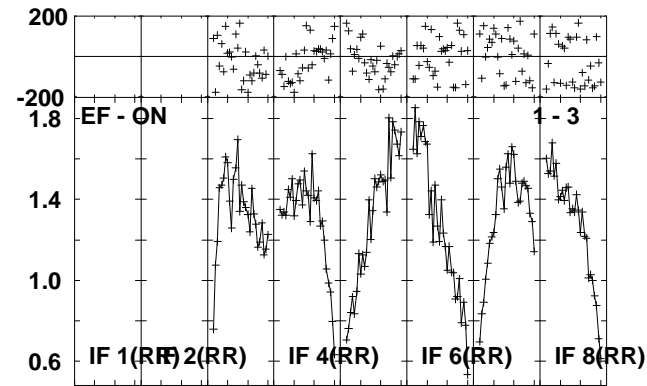
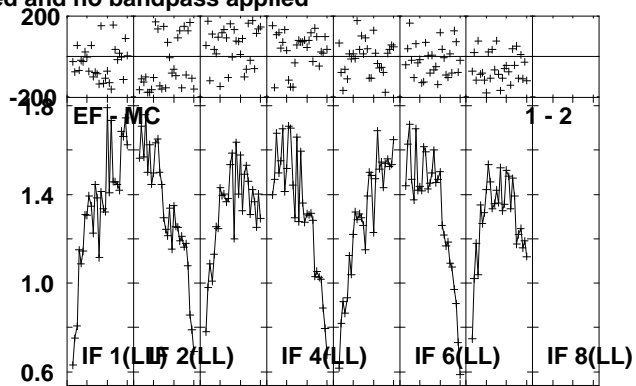
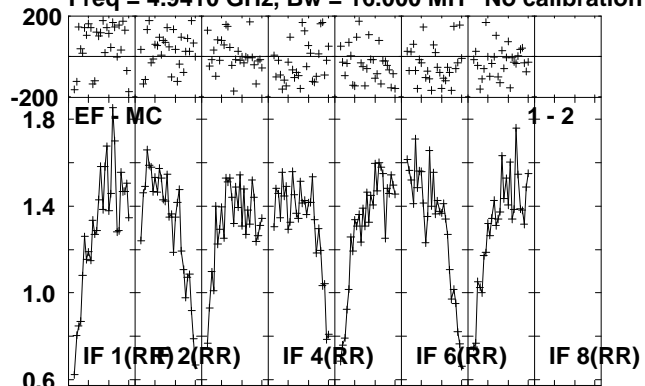

Lower frame: Milli Ampl Jy Top frame: Phas deg
Scalar averaged cross-power spectrum Several baselines displayed
Timerange: 00:17:32:11 to 00:17:34:39

Plot file version 190 created 04-OCT-2010 10:17:37

MAXI J16 RP016A.UVDATA.1

Freq = 4.9410 GHz, Bw = 16.000 MH No calibration applied and no bandpass applied

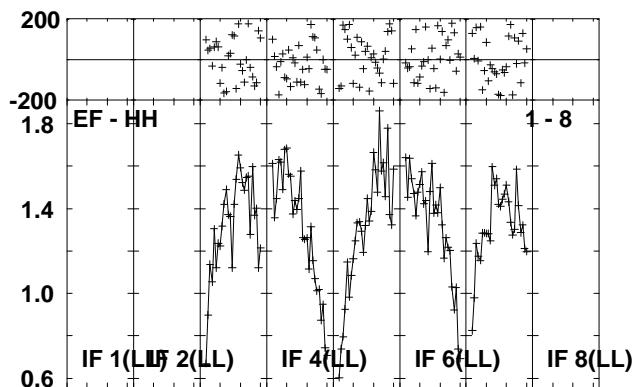
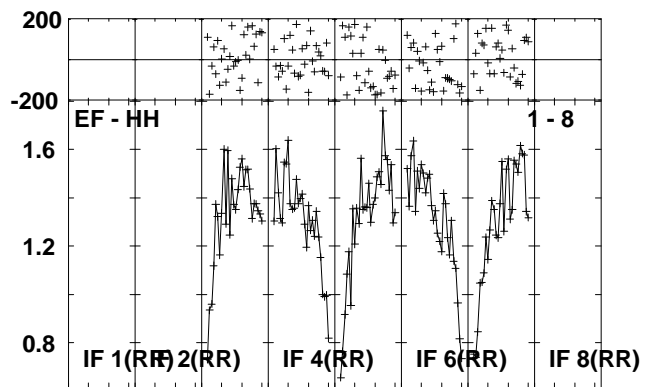
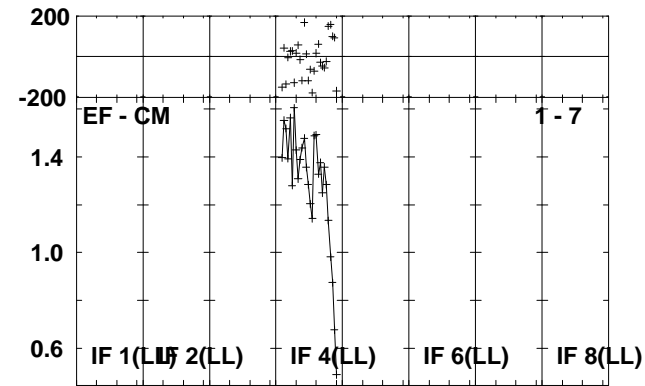
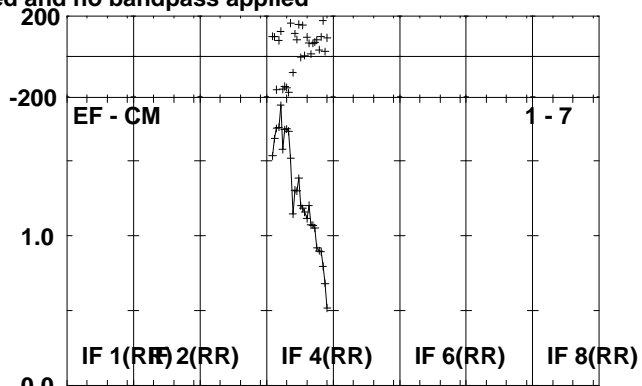
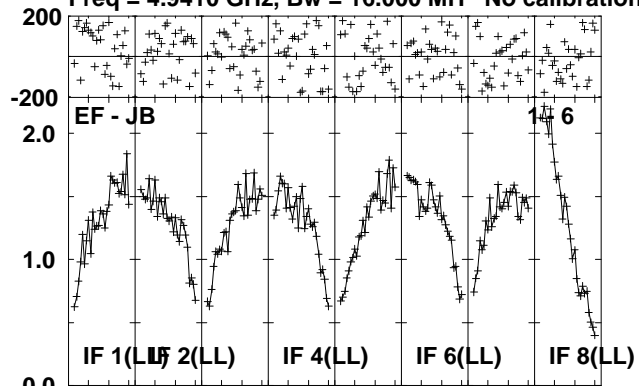

Lower frame: Milli Ampl Jy Top frame: Phas deg
Scalar averaged cross-power spectrum Several baselines displayed
Timerange: 00/17:32:11 to 00/17:34:39

Plot file version 191 created 04-OCT-2010 10:17:38

J1707-14 RP016A.UVDATA.1

Freq = 4.9410 GHz, Bw = 16.000 MH No calibration applied and no bandpass applied

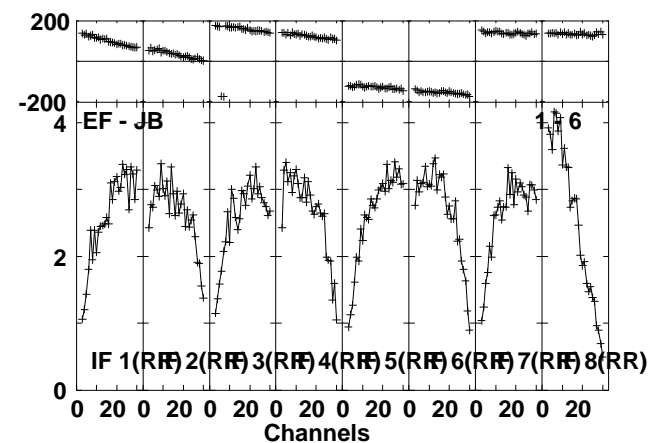
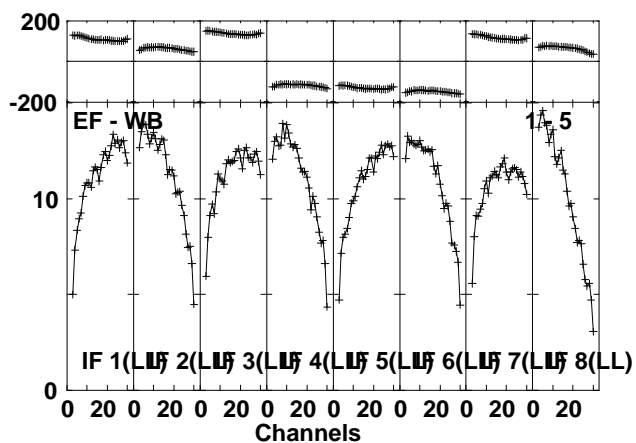
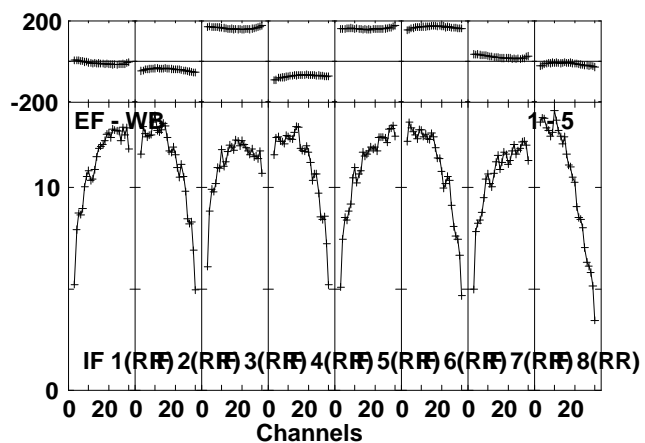
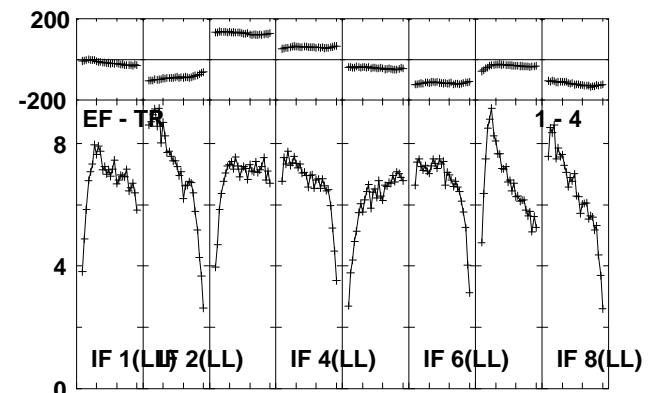
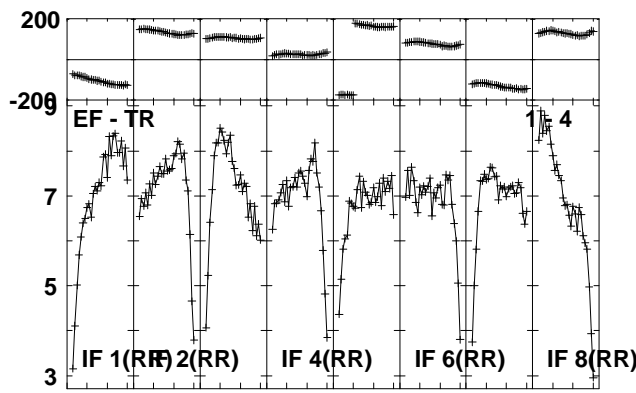
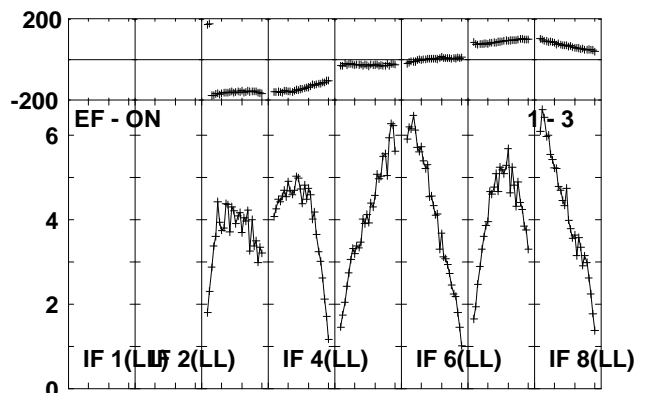
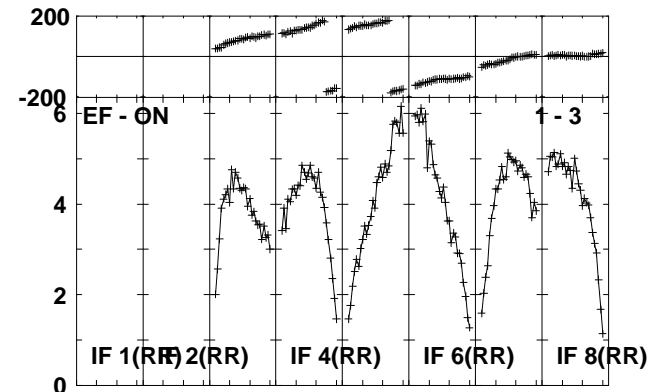
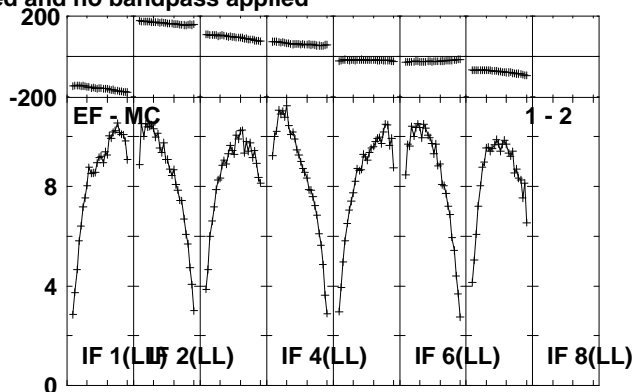
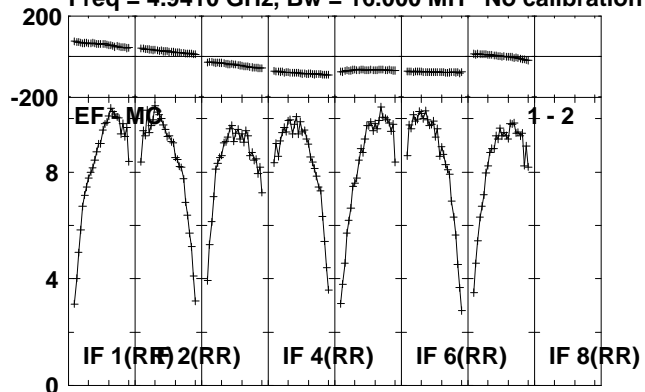

Lower frame: Milli Ampl Jy Top frame: Phas deg
Scalar averaged cross-power spectrum Several baselines displayed
Timerange: 00/17:35:21 to 00/17:36:19

Plot file version 192 created 04-OCT-2010 10:17:38
J1707-14 RP016A.UVDATA.1

Freq = 4.9410 GHz, Bw = 16.000 MH No calibration applied and no bandpass applied

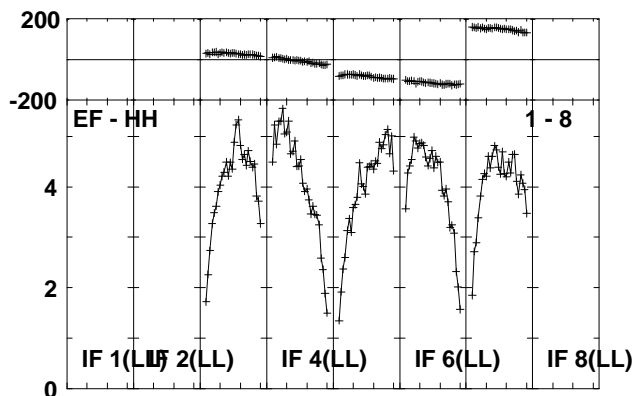
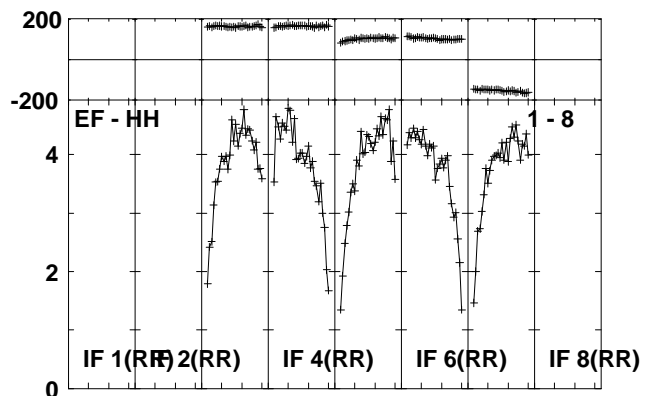
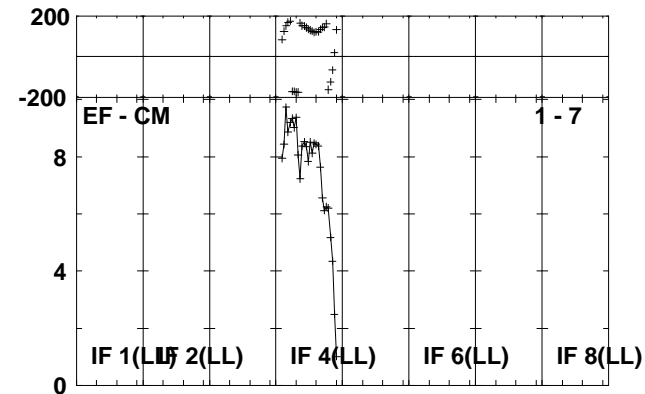
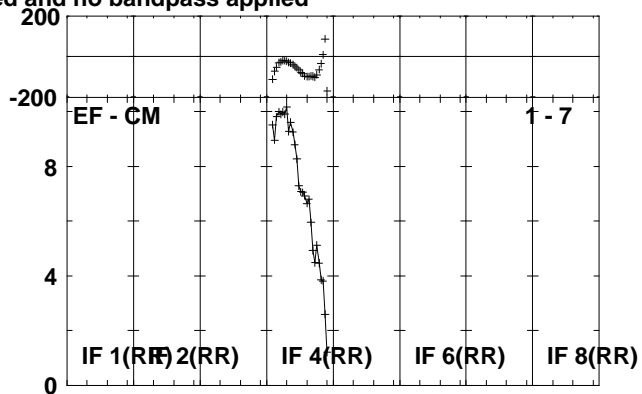
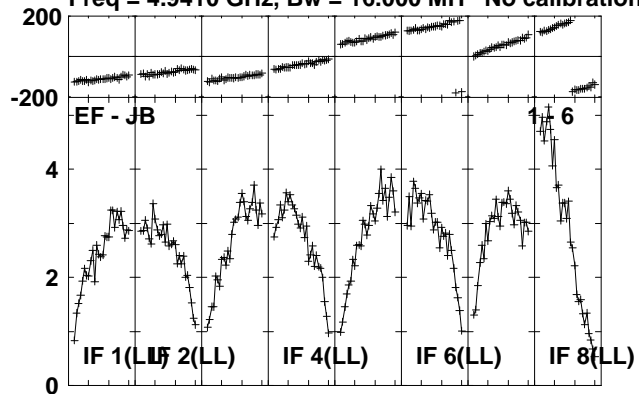

Lower frame: Milli Ampl Jy Top frame: Phas deg
Scalar averaged cross-power spectrum Several baselines displayed
Timerange: 00/17:35:21 to 00/17:36:19

Plot file version 193 created 04-OCT-2010 10:17:39

MAXI J16 RP016A.UVDATA.1

Freq = 4.9410 GHz, Bw = 16.000 MH No calibration applied and no bandpass applied

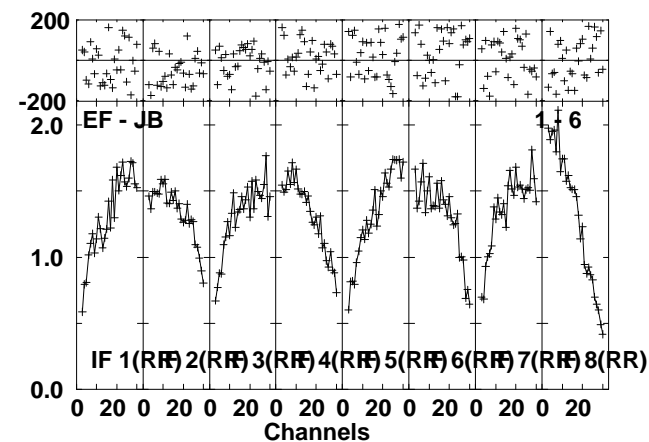
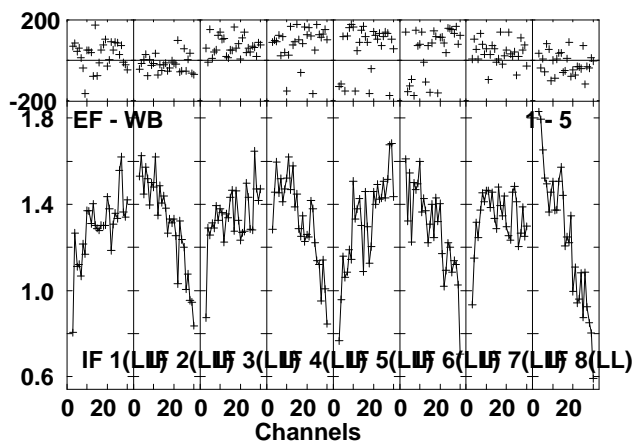
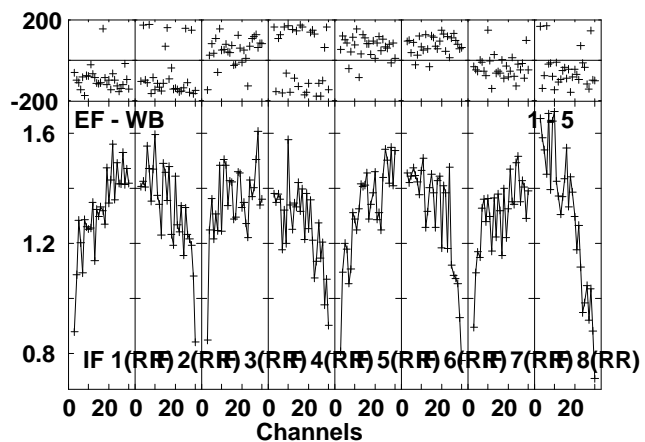
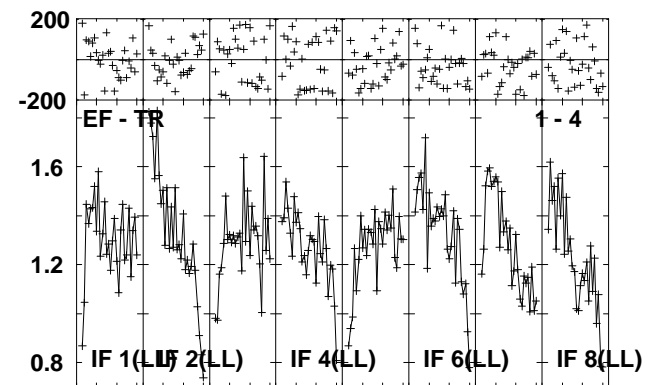
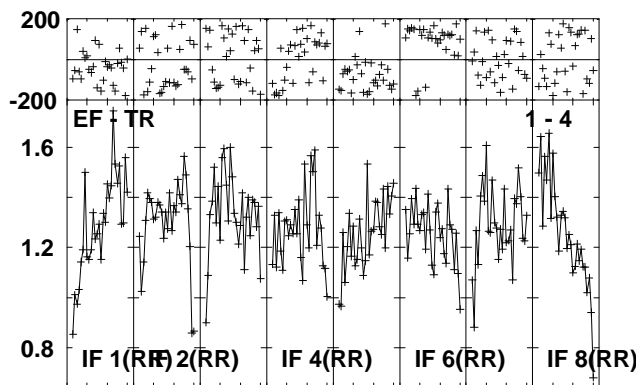
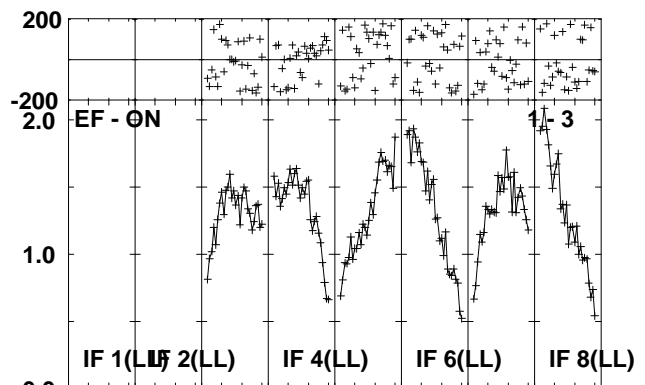
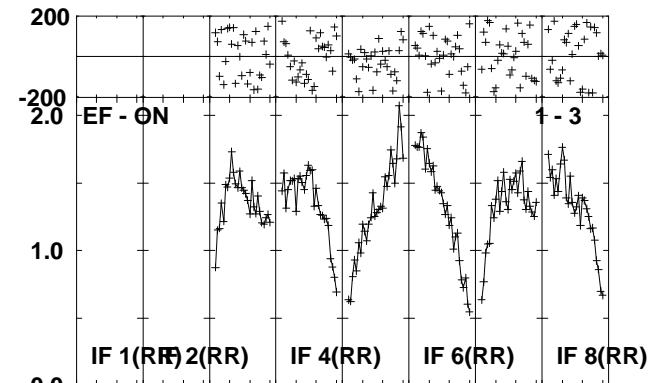
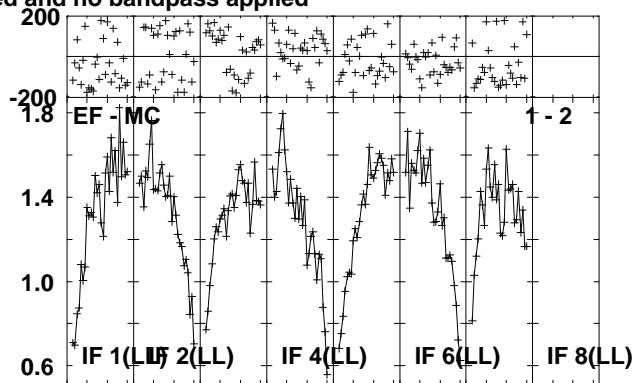
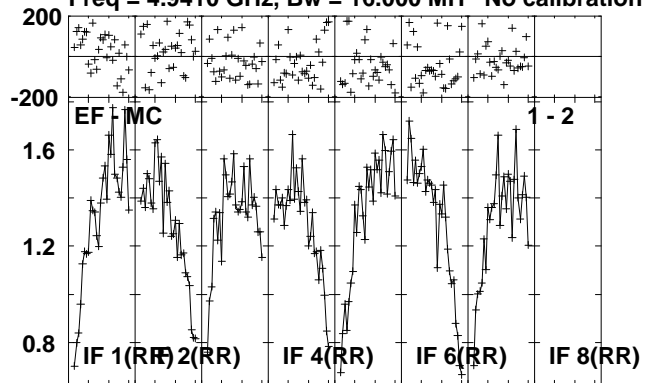

Lower frame: Milli Ampl Jy Top frame: Phas deg
Scalar averaged cross-power spectrum Several baselines displayed
Timerange: 00/17:36:21 to 00/17:38:49

Plot file version 194 created 04-OCT-2010 10:17:41

MAXI J16 RP016A.UVDATA.1

Freq = 4.9410 GHz, Bw = 16.000 MH No calibration applied and no bandpass applied

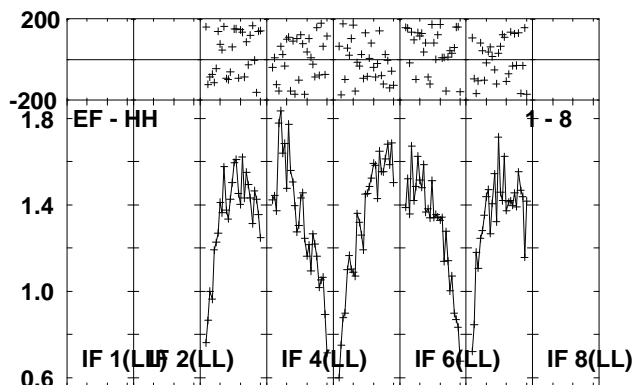
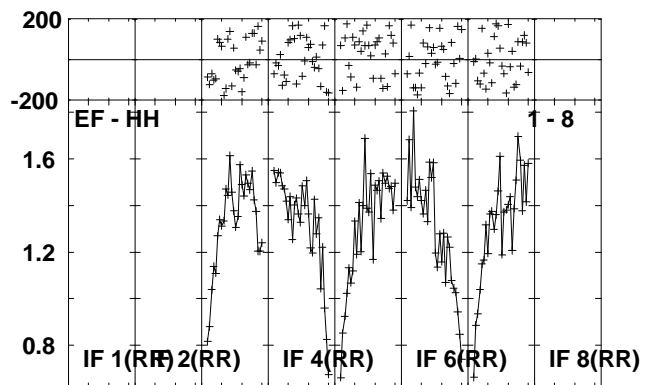
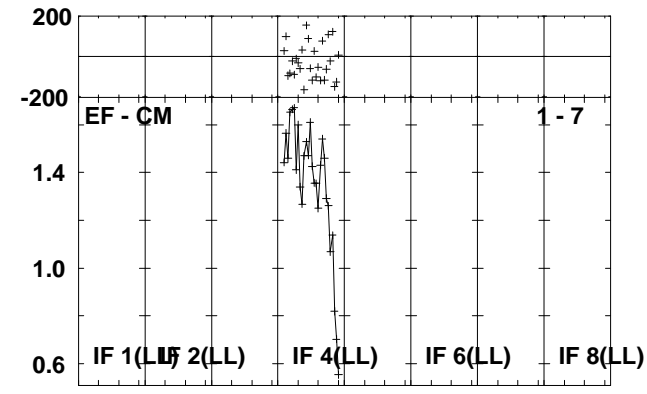
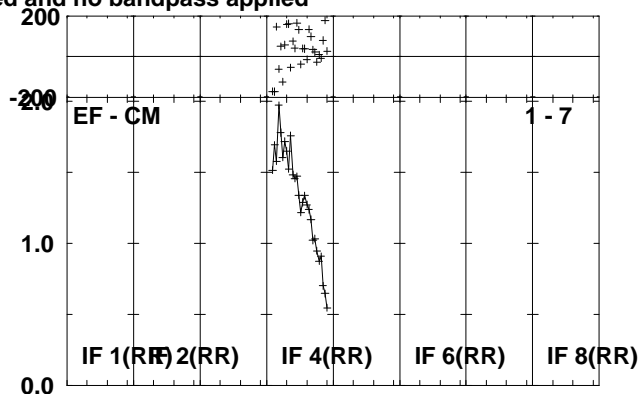
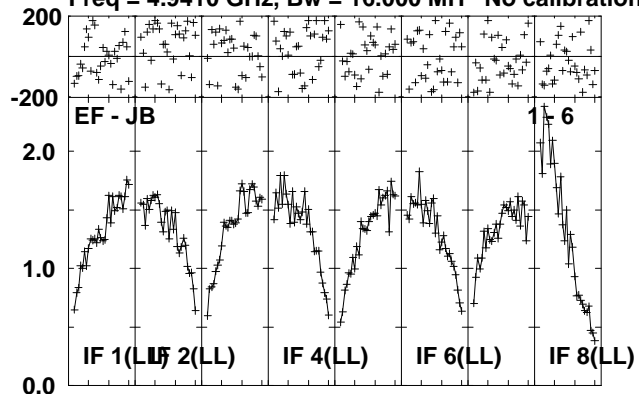

Lower frame: Milli Ampl Jy Top frame: Phas deg
Scalar averaged cross-power spectrum Several baselines displayed
Timerange: 00/17:36:21 to 00/17:38:49

Plot file version 195 created 04-OCT-2010 10:17:42

J1707-14 RP016A.UVDATA.1

Freq = 4.9410 GHz, Bw = 16.000 MH No calibration applied and no bandpass applied

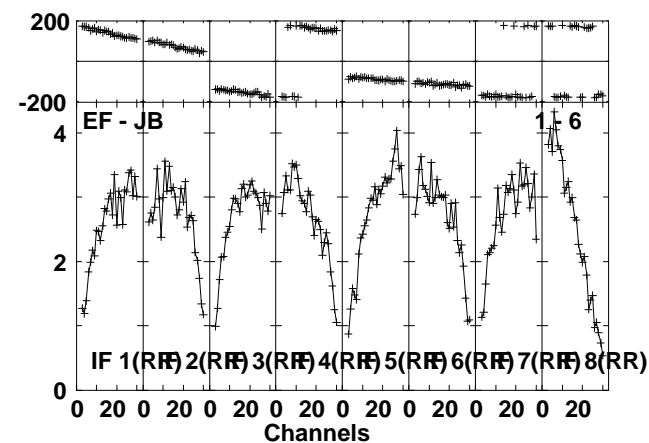
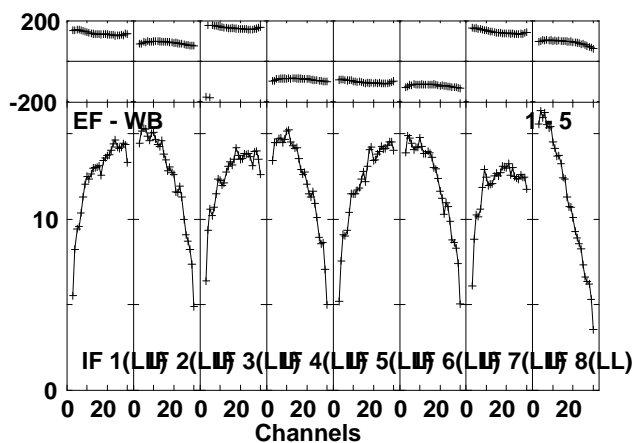
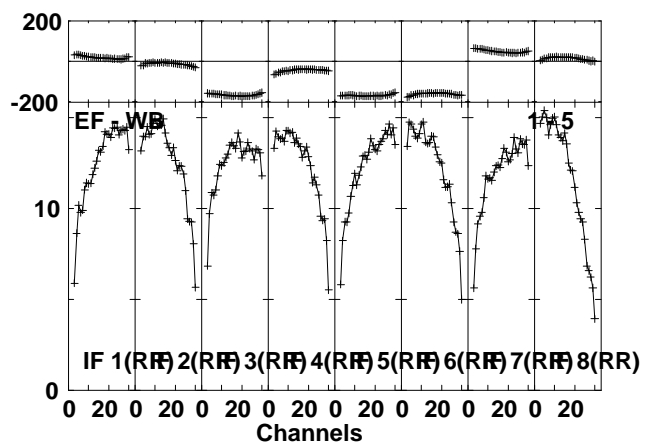
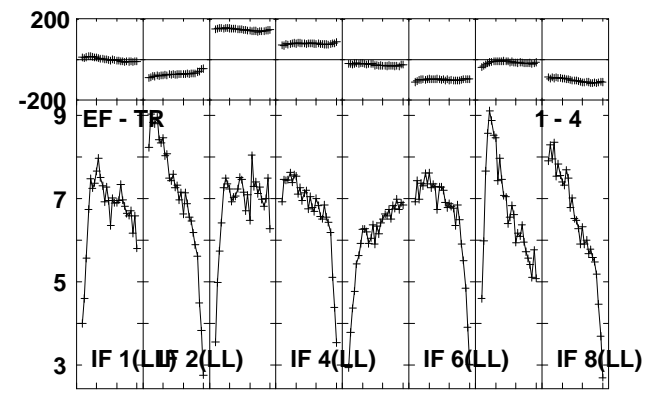
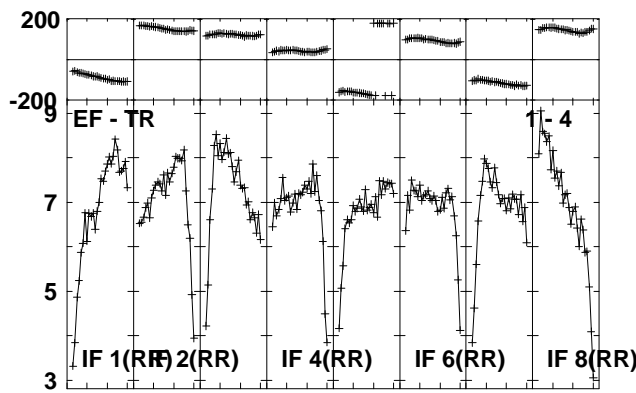
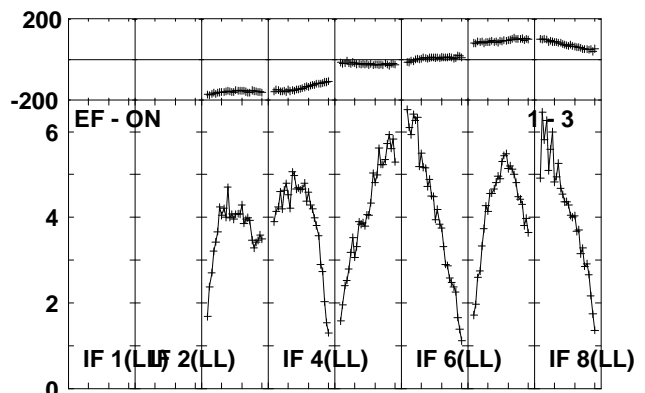
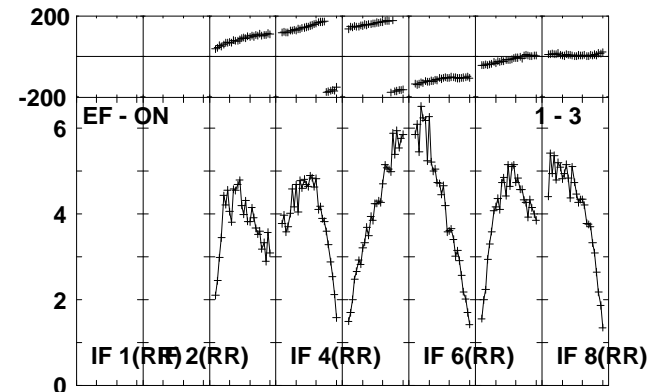
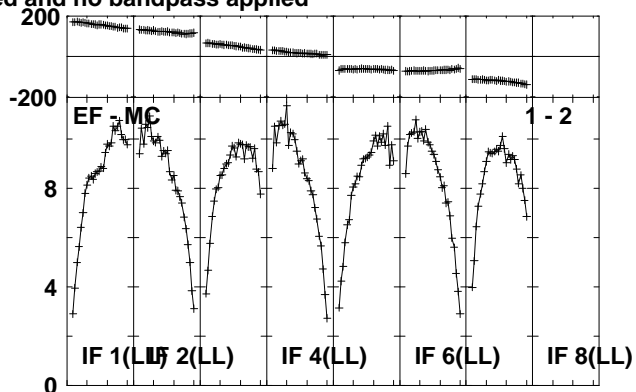
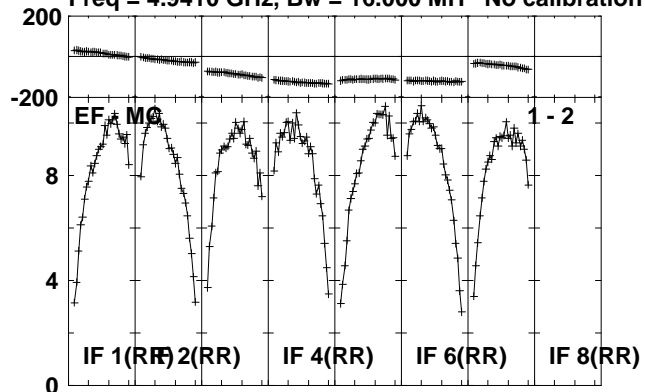

Lower frame: Milli Ampl Jy Top frame: Phas deg
Scalar averaged cross-power spectrum Several baselines displayed
Timerange: 00/17:38:51 to 00/17:40:19

Plot file version 196 created 04-OCT-2010 10:17:43
J1707-14 RP016A.UVDATA.1

Freq = 4.9410 GHz, Bw = 16.000 MH No calibration applied and no bandpass applied

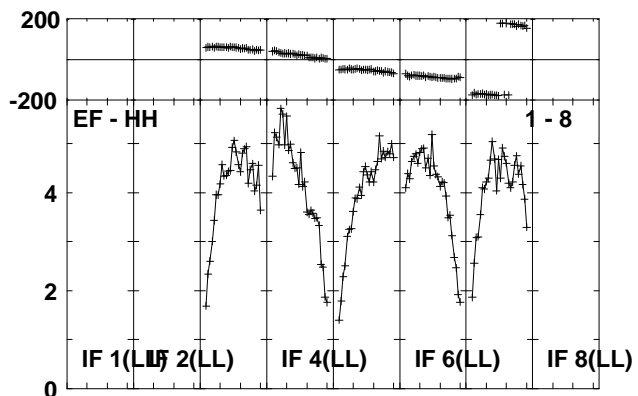
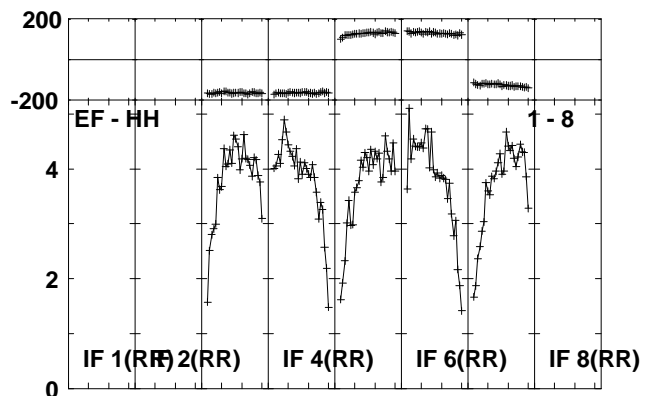
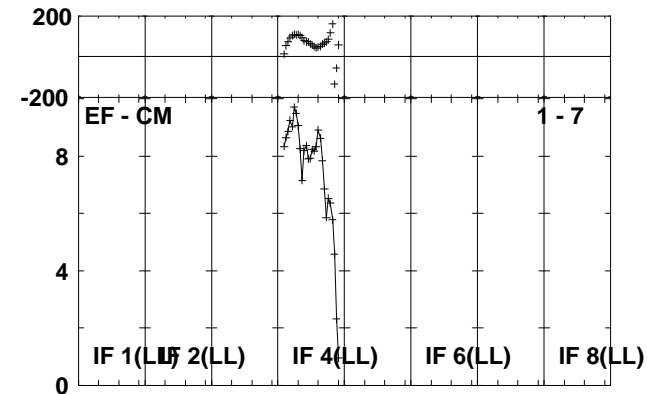
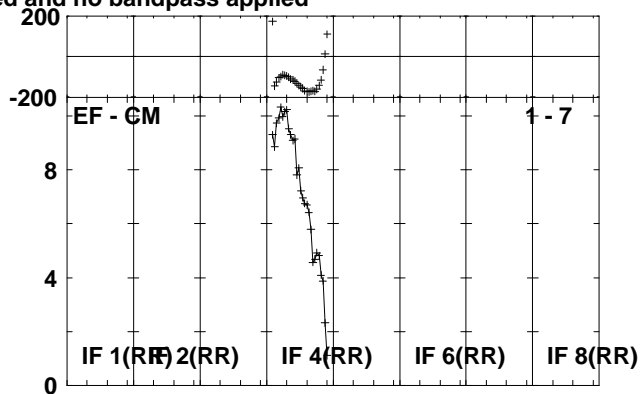
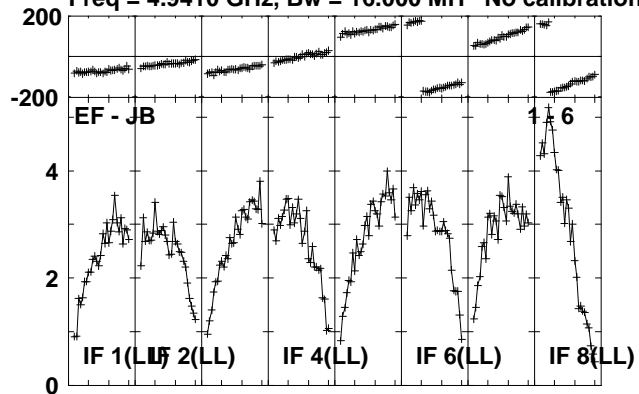

Lower frame: Milli Ampl Jy Top frame: Phas deg
Scalar averaged cross-power spectrum Several baselines displayed
Timerange: 00/17:38:51 to 00/17:40:19

Plot file version 197 created 04-OCT-2010 10:17:44

MAXI J16 RP016A.UVDATA.1

Freq = 4.9410 GHz, Bw = 16.000 MH No calibration applied and no bandpass applied

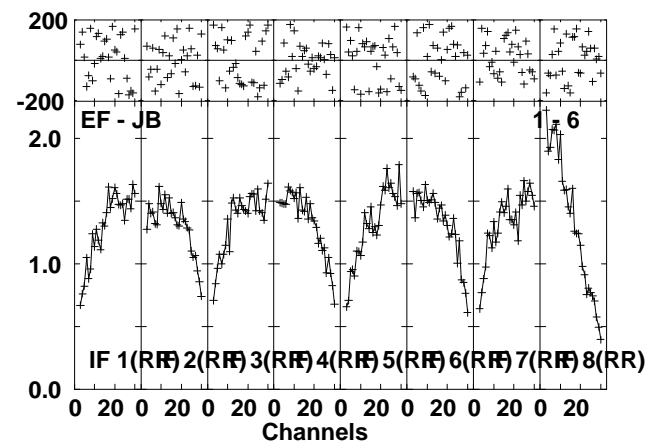
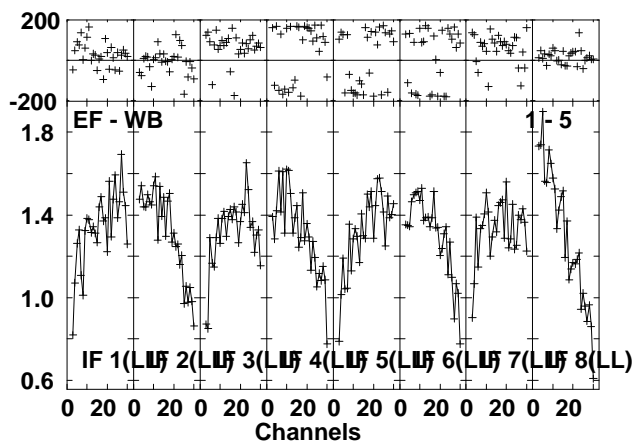
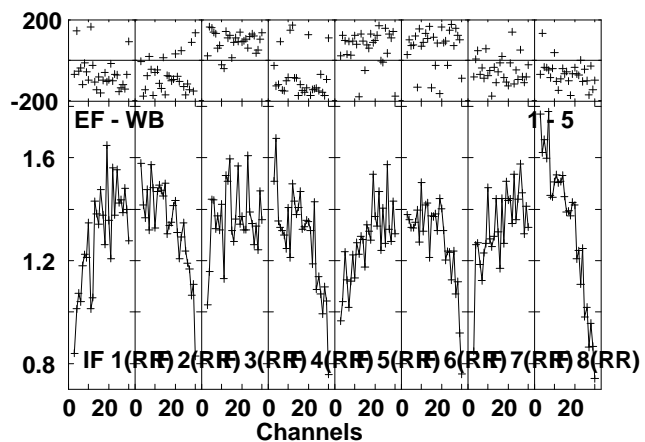
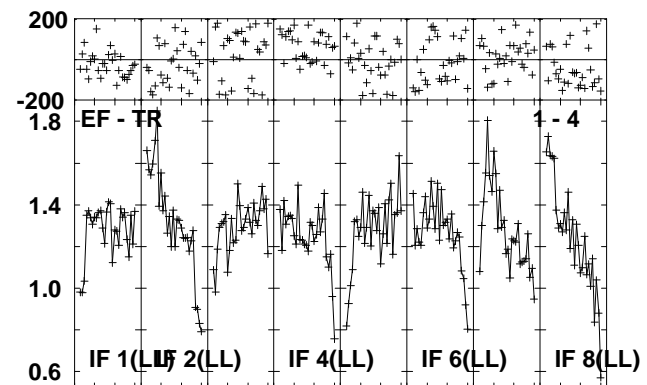
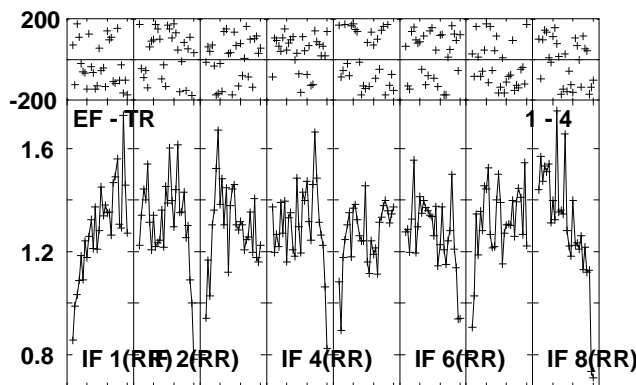
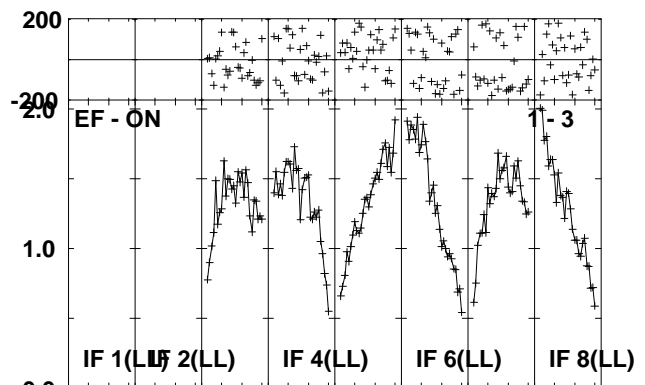
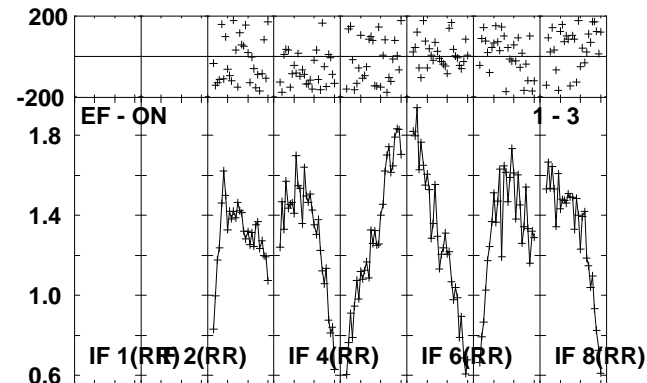
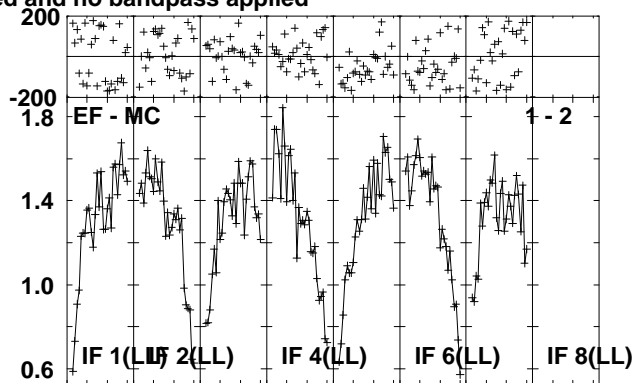
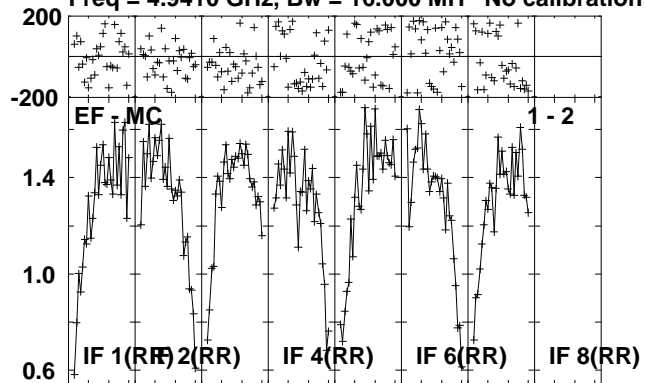

Lower frame: Milli Ampl Jy Top frame: Phas deg
Scalar averaged cross-power spectrum Several baselines displayed
Timerange: 00:17:40:21 to 00:17:42:49

Plot file version 198 created 04-OCT-2010 10:17:46

MAXI J16 RP016A.UVDATA.1

Freq = 4.9410 GHz, Bw = 16.000 MH No calibration applied and no bandpass applied

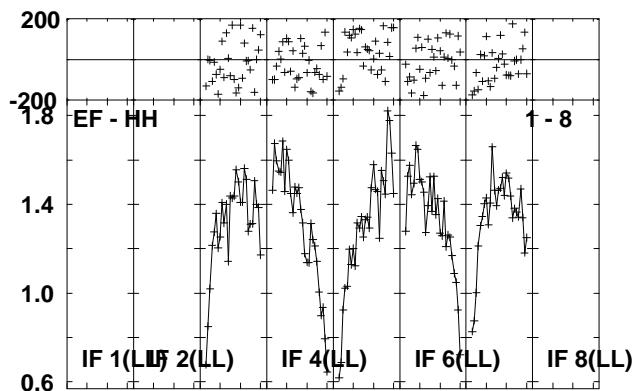
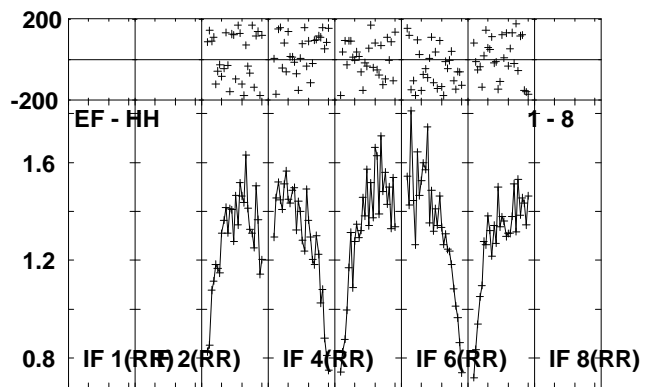
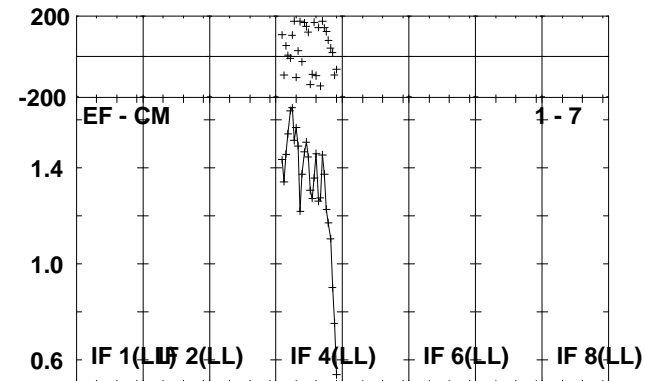
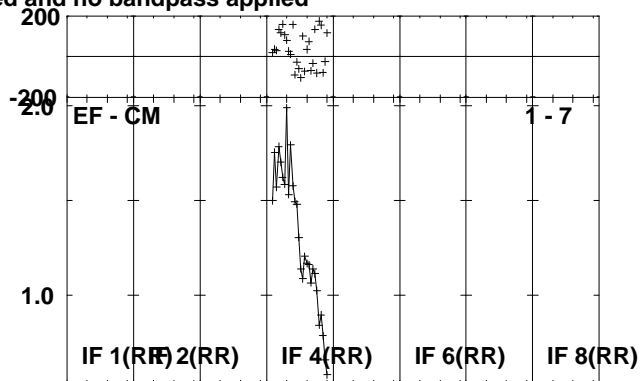
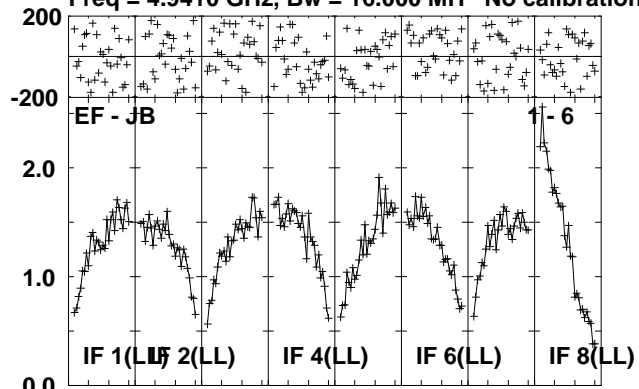

Lower frame: Milli Ampl Jy Top frame: Phas deg
Scalar averaged cross-power spectrum Several baselines displayed
Timerange: 00:17:40:21 to 00:17:42:49

Plot file version 199 created 04-OCT-2010 10:17:47

J1707-14 RP016A.UVDATA.1

Freq = 4.9410 GHz, Bw = 16.000 MH No calibration applied and no bandpass applied

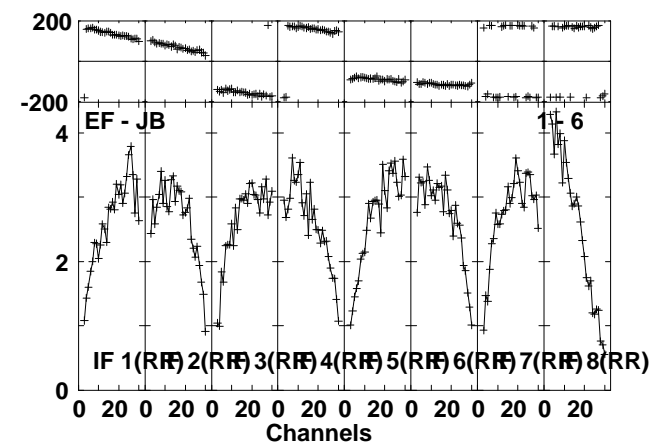
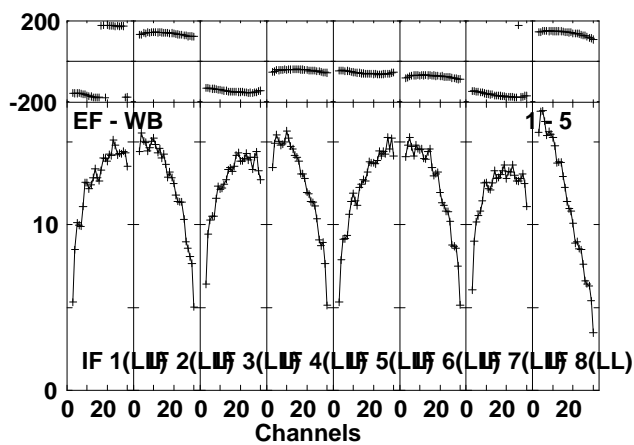
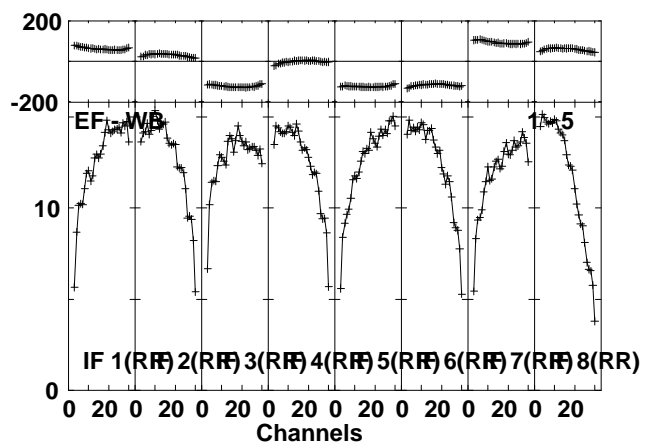
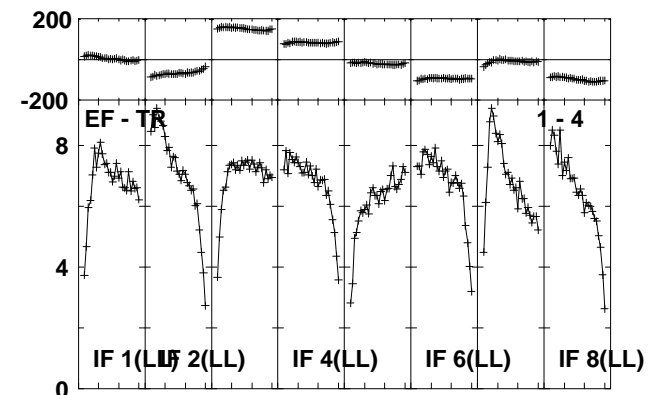
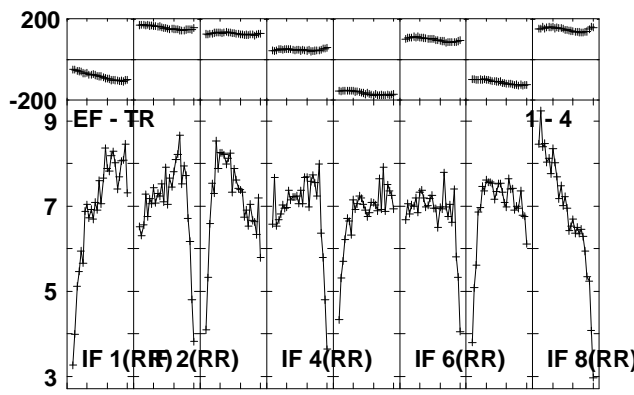
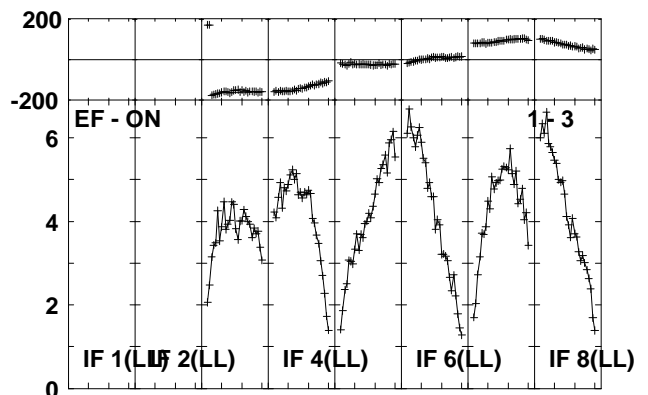
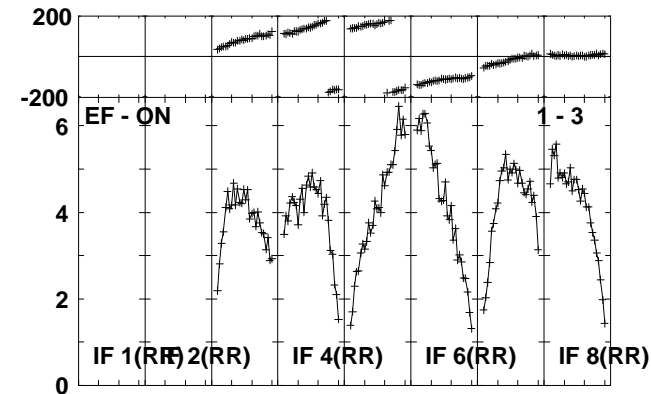
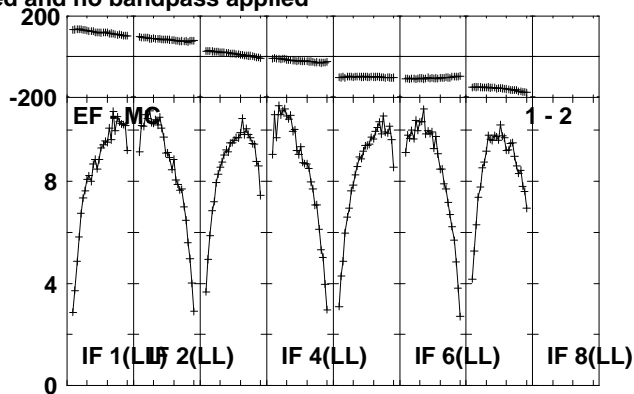
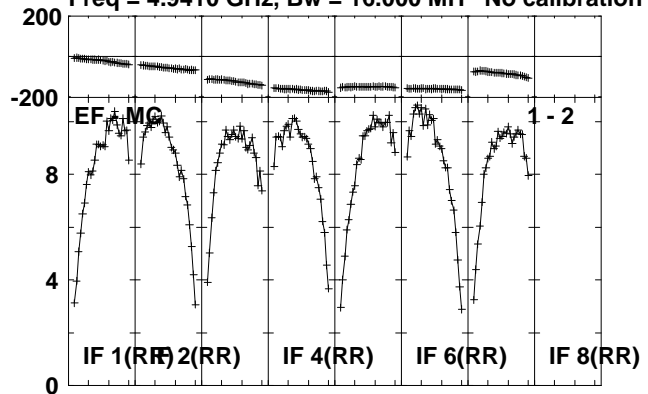

Lower frame: Milli Ampl Jy Top frame: Phas deg
Scalar averaged cross-power spectrum Several baselines displayed
Timerange: 00/17:43:31 to 00/17:44:29

Plot file version 200 created 04-OCT-2010 10:17:47
J1707-14 RP016A.UVDATA.1

Freq = 4.9410 GHz, Bw = 16.000 MH No calibration applied and no bandpass applied

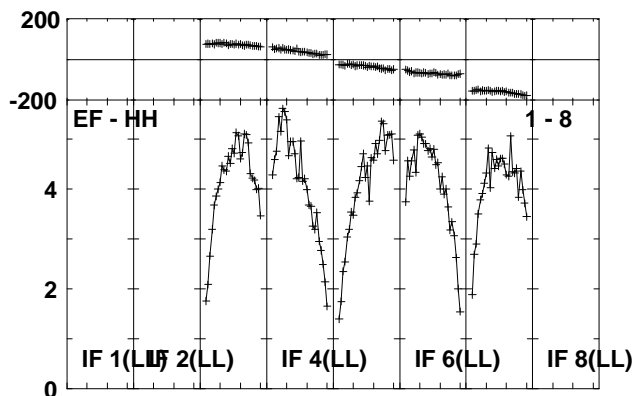
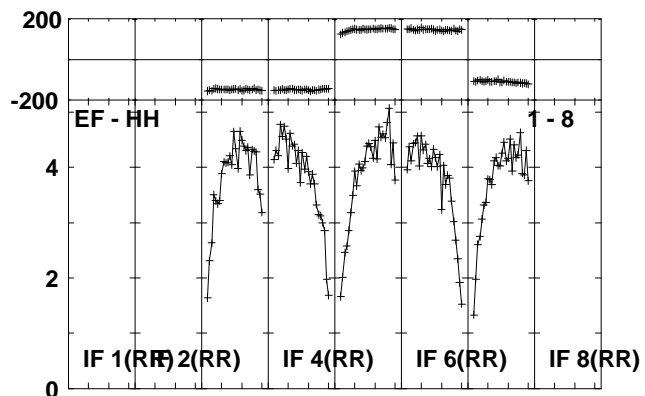
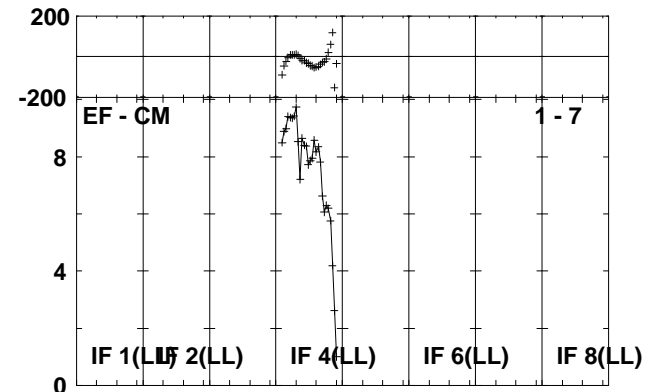
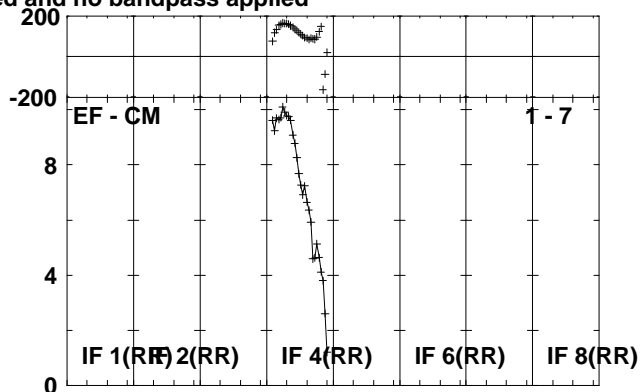
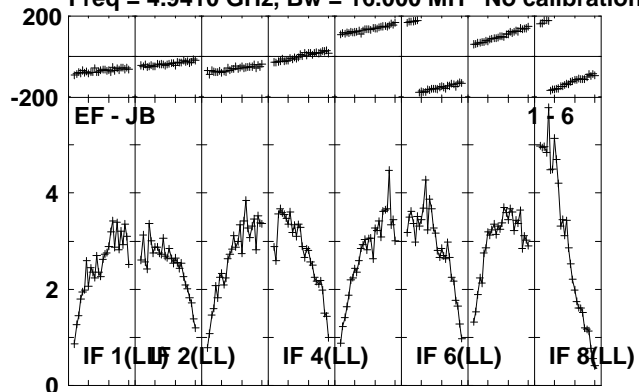

Lower frame: Milli Ampl Jy Top frame: Phas deg
Scalar averaged cross-power spectrum Several baselines displayed
Timerange: 00/17:43:31 to 00/17:44:29

Plot file version 201 created 04-OCT-2010 10:17:48

NVSS3 RP016A.UVDATA.1

Freq = 4.9410 GHz, Bw = 16.000 MH No calibration applied and no bandpass applied

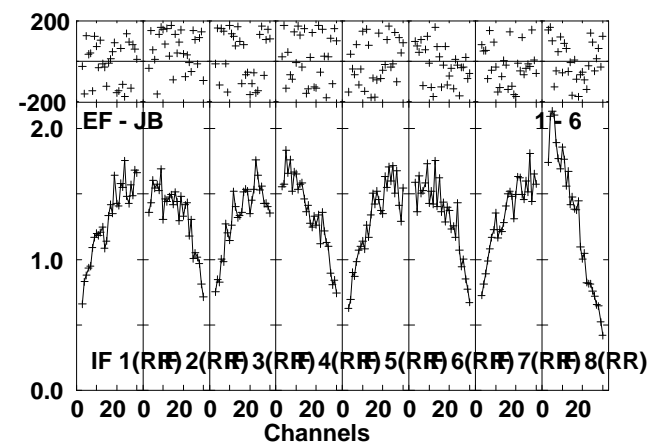
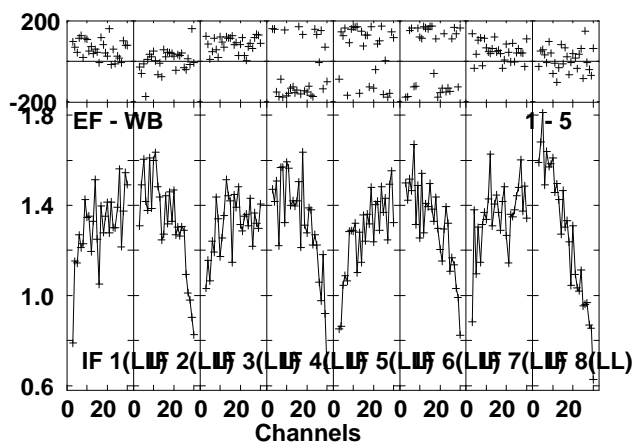
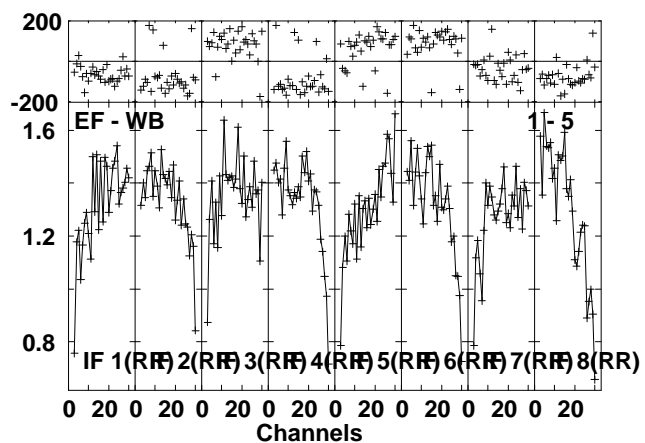
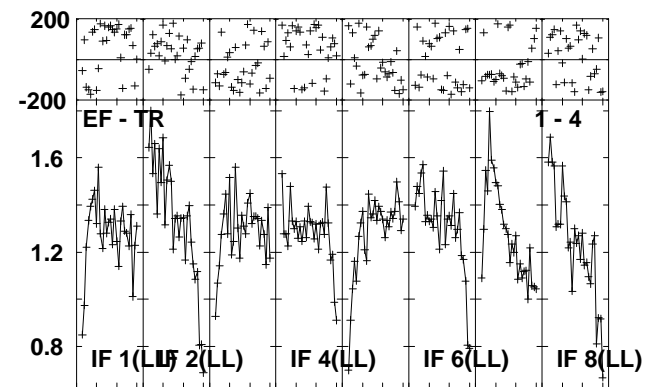
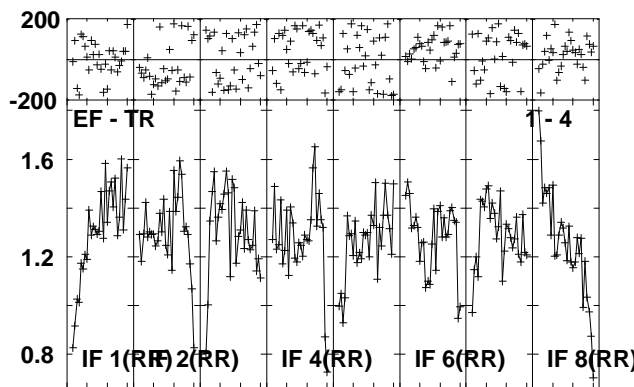
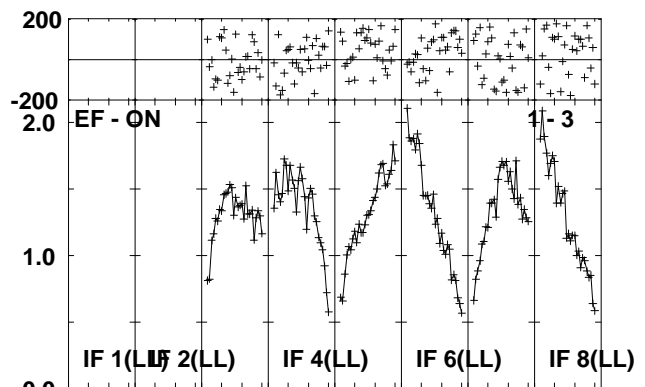
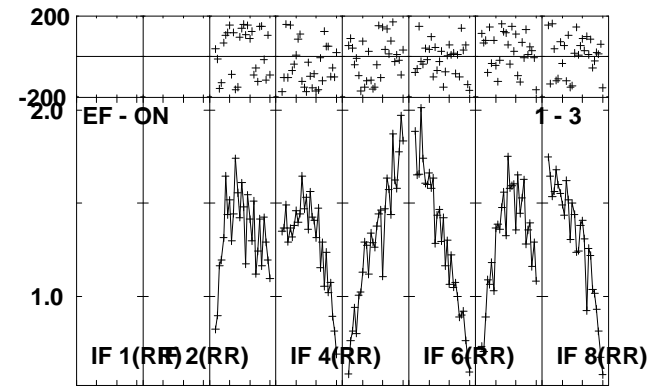
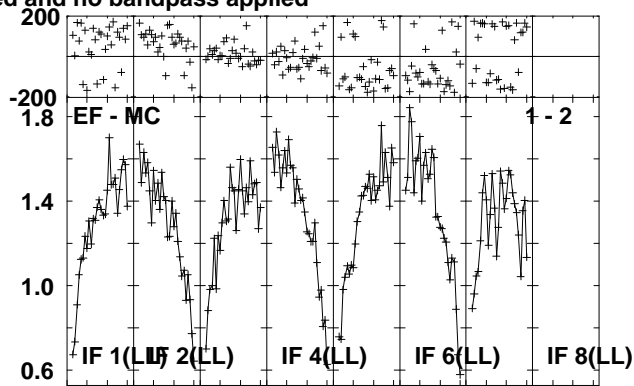
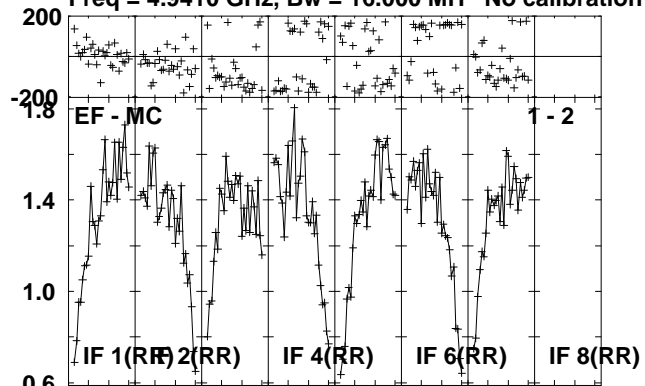

Lower frame: Milli Ampl Jy Top frame: Phas deg
Scalar averaged cross-power spectrum Several baselines displayed
Timerange: 00/17:44:31 to 00/17:46:59

Plot file version 202 created 04-OCT-2010 10:17:50

NVSS3 RP016A.UVDATA.1

Freq = 4.9410 GHz, Bw = 16.000 MH No calibration applied and no bandpass applied

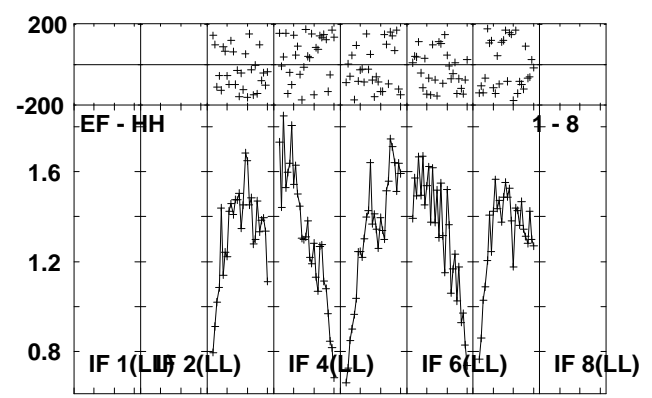
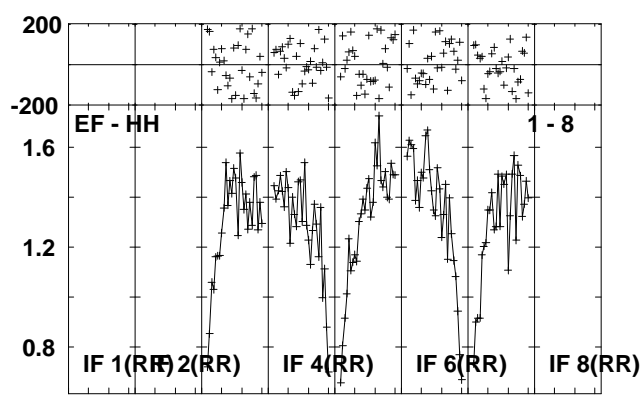
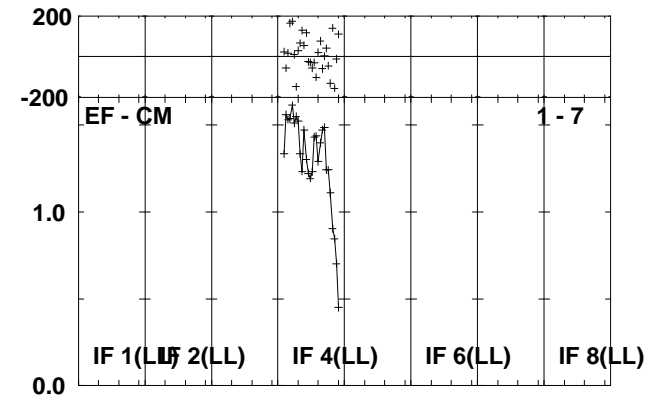
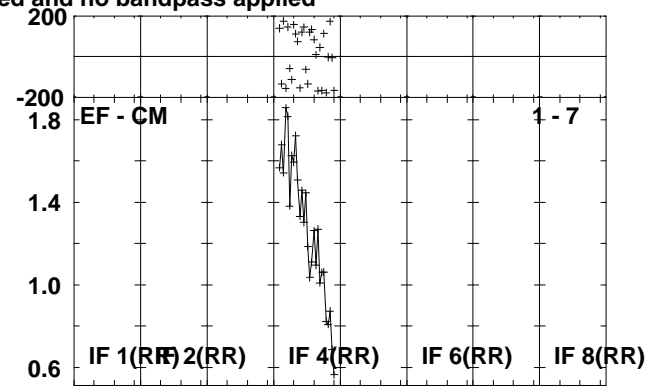
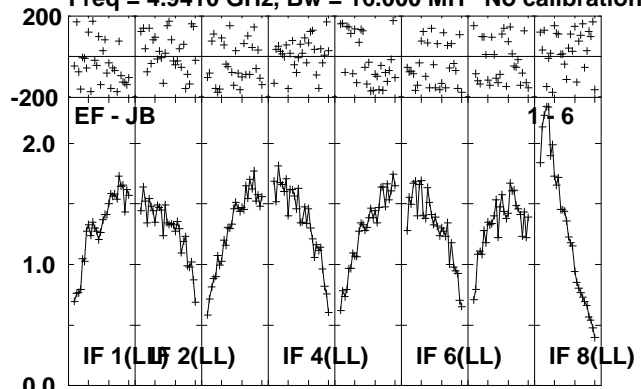

Lower frame: Milli Ampl Jy Top frame: Phas deg
Scalar averaged cross-power spectrum Several baselines displayed
Timerange: 00/17:44:31 to 00/17:46:59

Plot file version 203 created 04-OCT-2010 10:17:51

J1707-14 RP016A.UVDATA.1

Freq = 4.9410 GHz, Bw = 16.000 MH No calibration applied and no bandpass applied

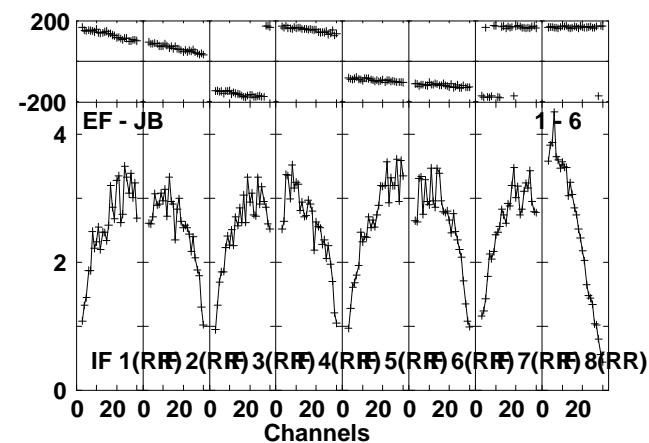
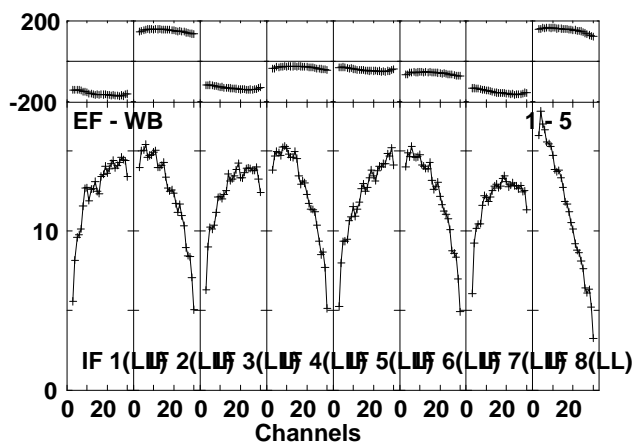
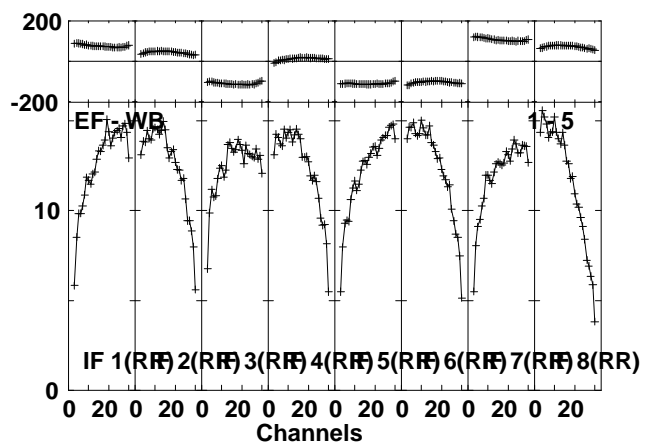
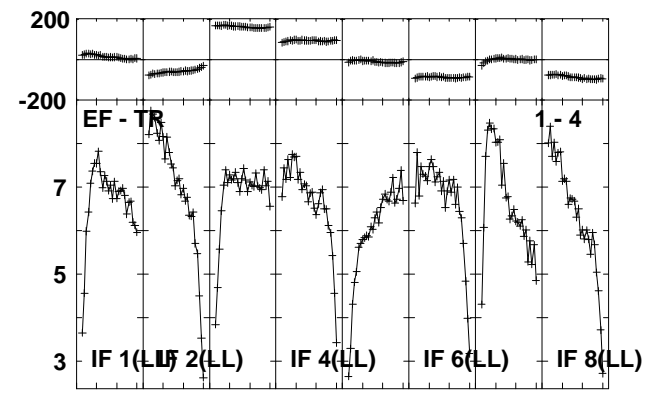
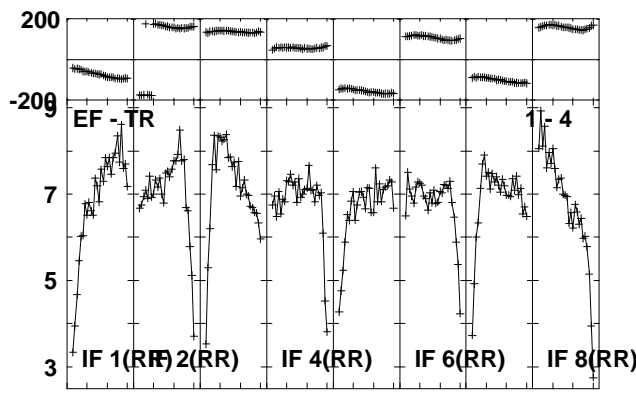
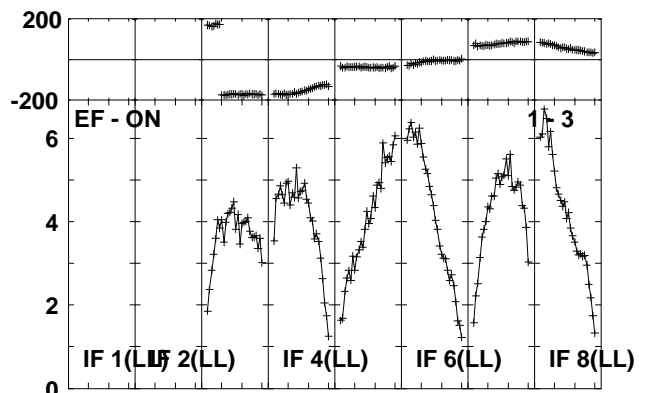
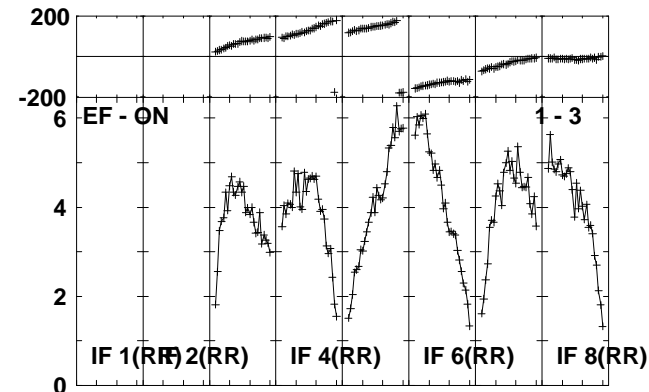
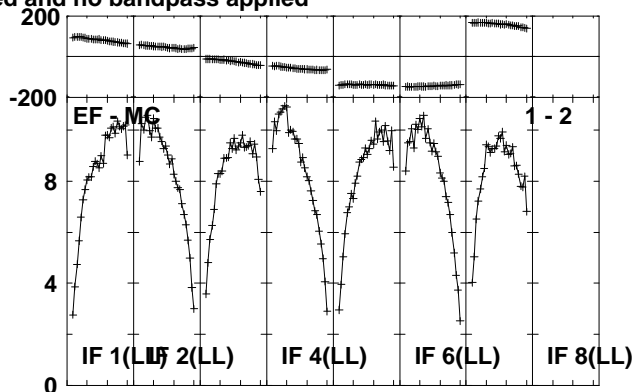
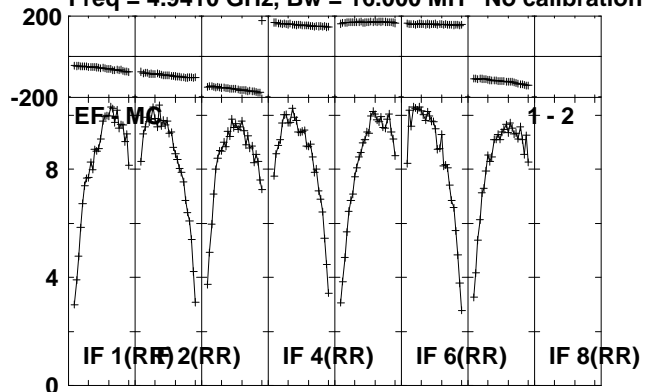

Lower frame: Milli Ampl Jy Top frame: Phas deg
Scalar averaged cross-power spectrum Several baselines displayed
Timerange: 00/17:47:01 to 00/17:48:29

Plot file version 204 created 04-OCT-2010 10:17:52
J1707-14 RP016A.UVDATA.1

Freq = 4.9410 GHz, Bw = 16.000 MH No calibration applied and no bandpass applied

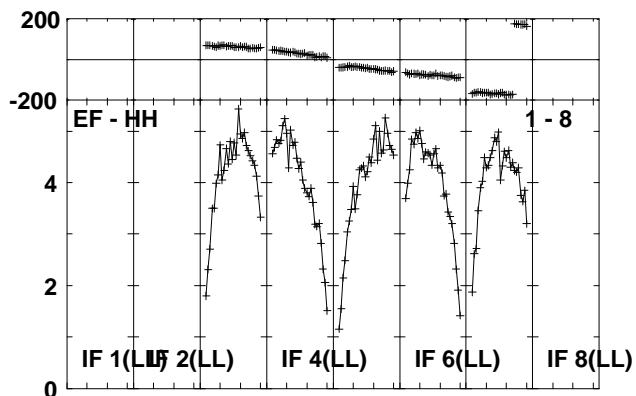
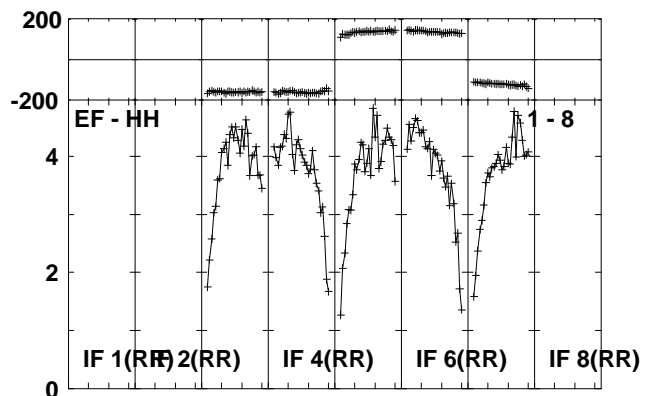
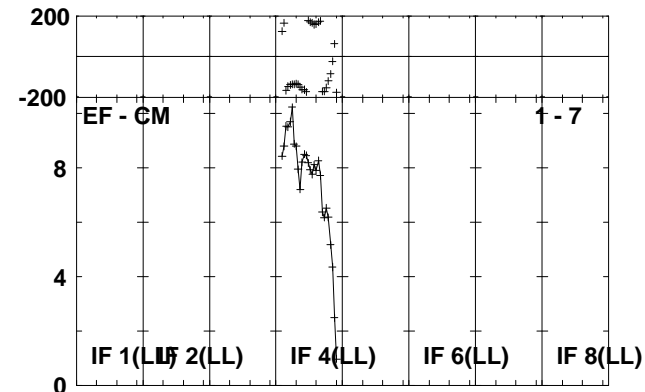
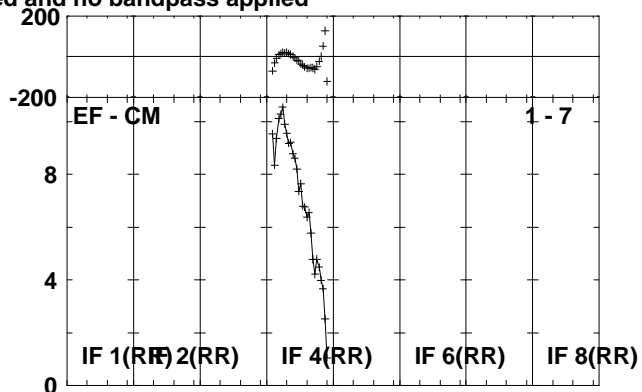
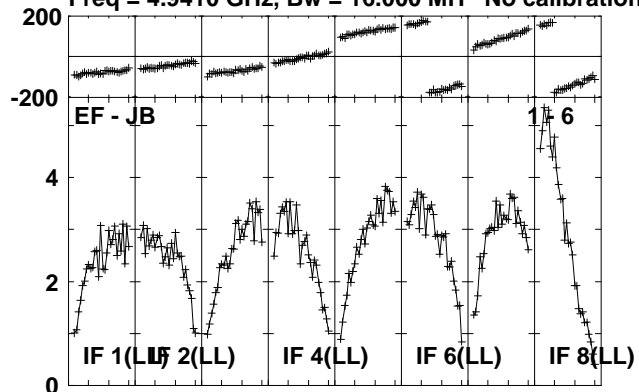

Lower frame: Milli Ampl Jy Top frame: Phas deg
Scalar averaged cross-power spectrum Several baselines displayed
Timerange: 00/17:47:01 to 00/17:48:29

Plot file version 205 created 04-OCT-2010 10:17:53

MAXI J16 RP016A.UVDATA.1

Freq = 4.9410 GHz, Bw = 16.000 MH No calibration applied and no bandpass applied

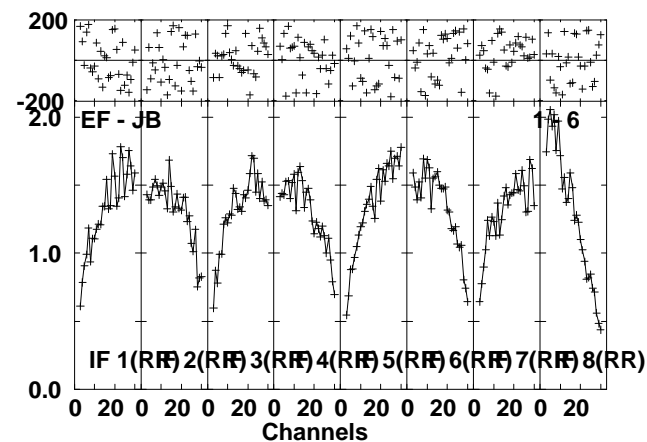
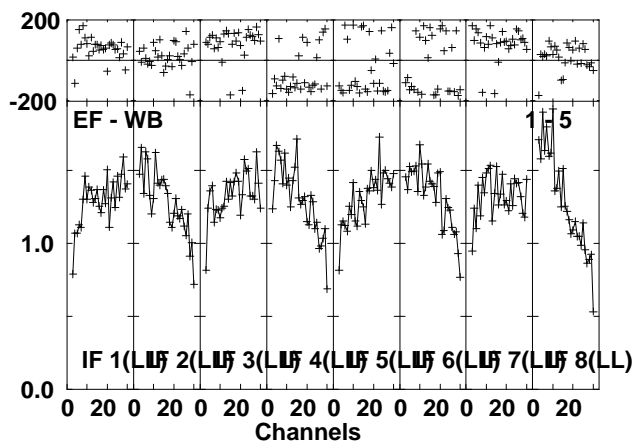
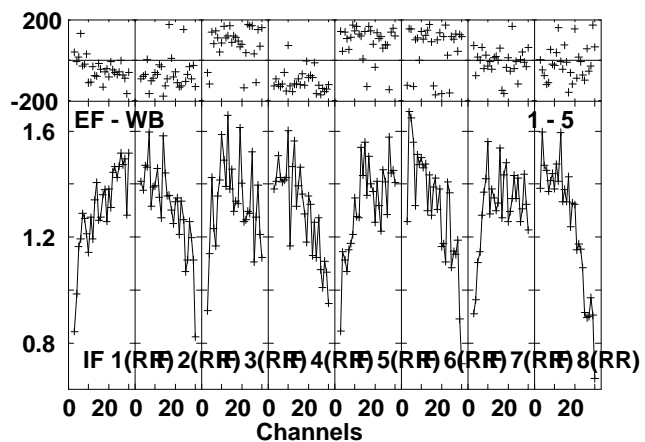
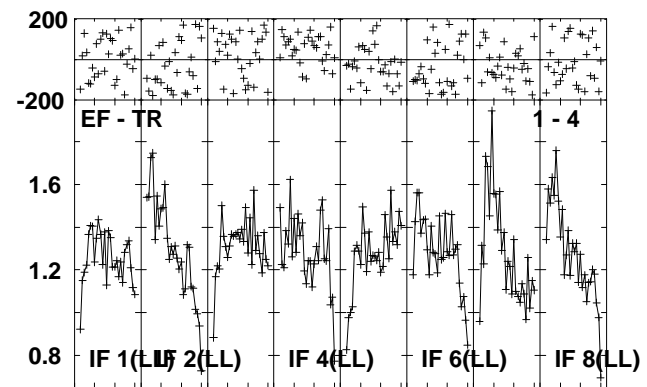
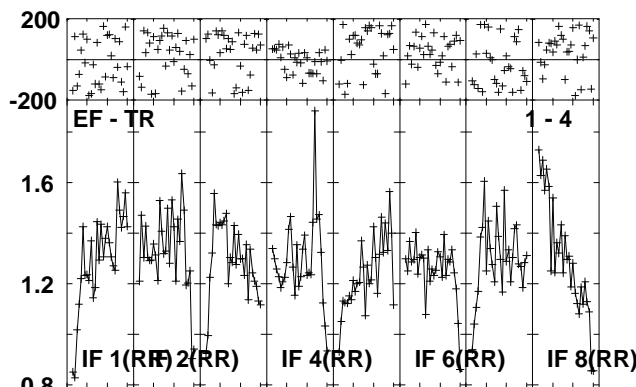
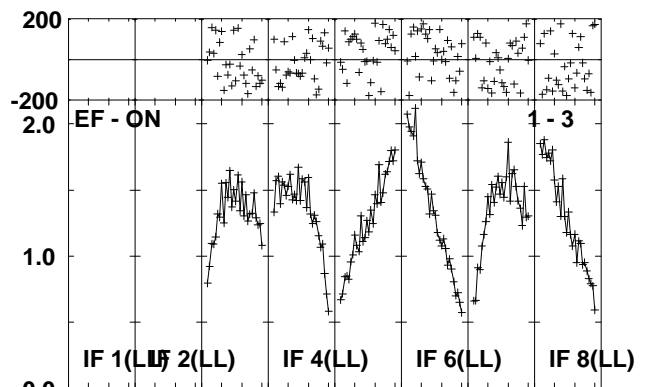
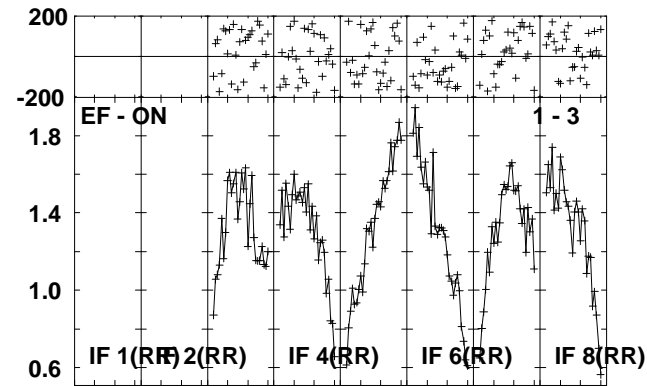
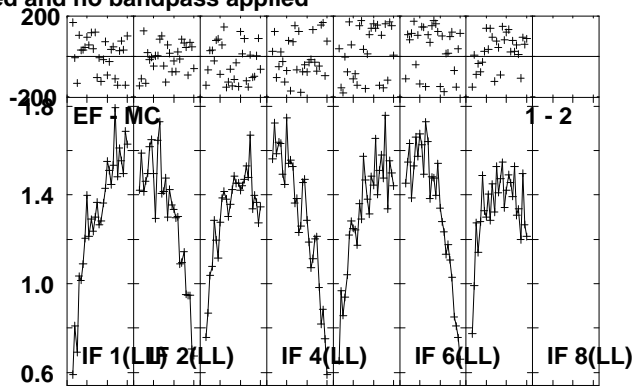
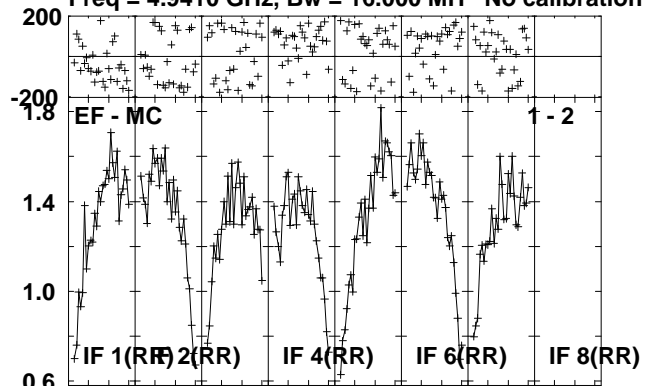

Lower frame: Milli Ampl Jy Top frame: Phas deg
Scalar averaged cross-power spectrum Several baselines displayed
Timerange: 00/17:48:31 to 00/17:50:59

Plot file version 206 created 04-OCT-2010 10:17:55

MAXI J16 RP016A.UVDATA.1

Freq = 4.9410 GHz, Bw = 16.000 MH No calibration applied and no bandpass applied

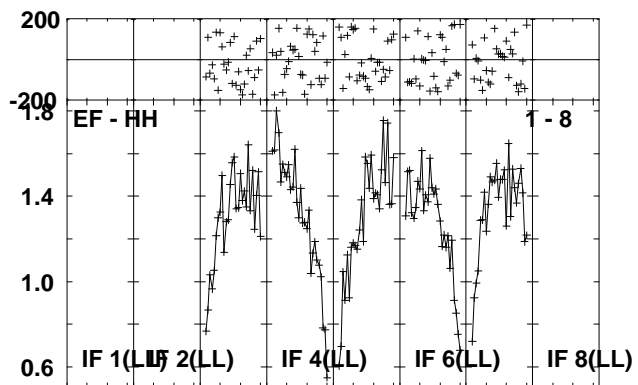
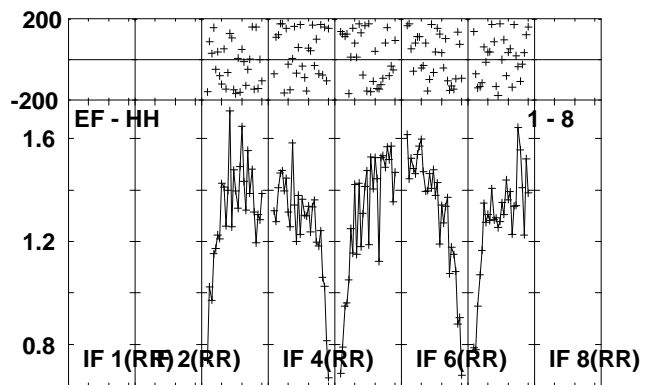
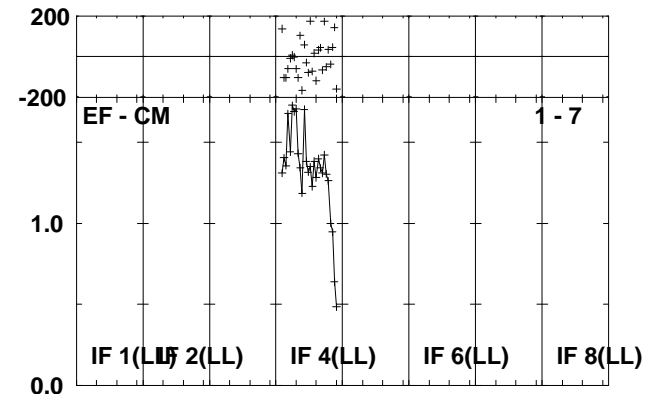
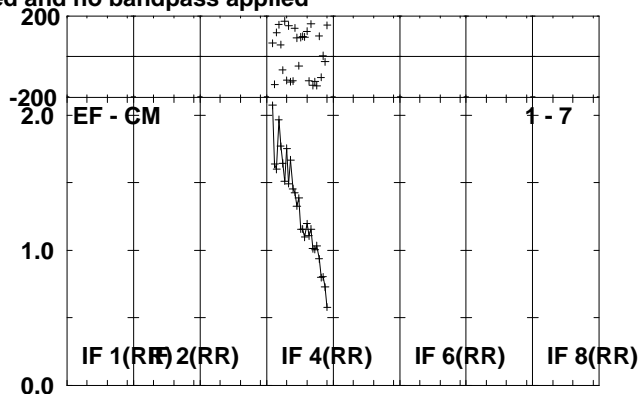
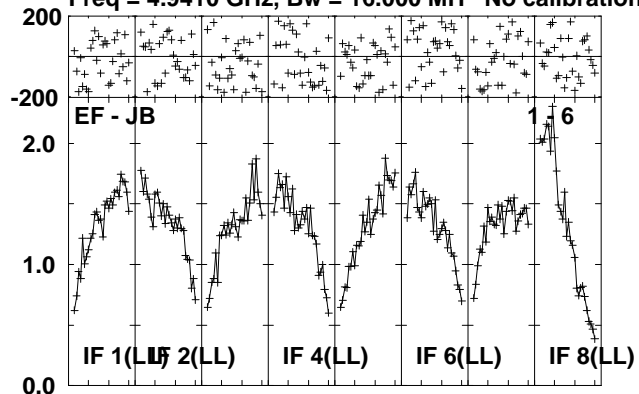

Lower frame: Milli Ampl Jy Top frame: Phas deg
Scalar averaged cross-power spectrum Several baselines displayed
Timerange: 00/17:48:31 to 00/17:50:59

Plot file version 207 created 04-OCT-2010 10:17:56

J1707-14 RP016A.UVDATA.1

Freq = 4.9410 GHz, Bw = 16.000 MH No calibration applied and no bandpass applied

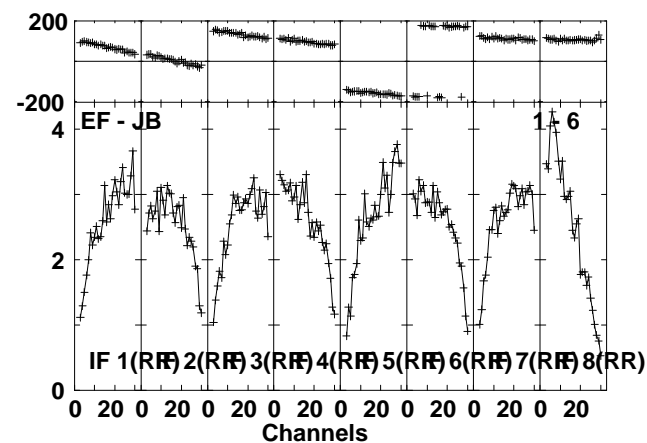
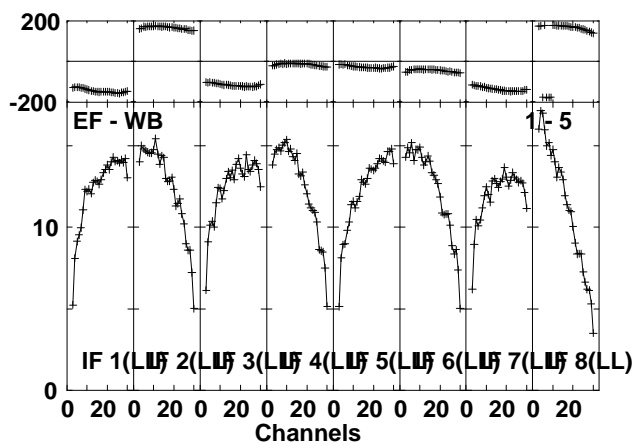
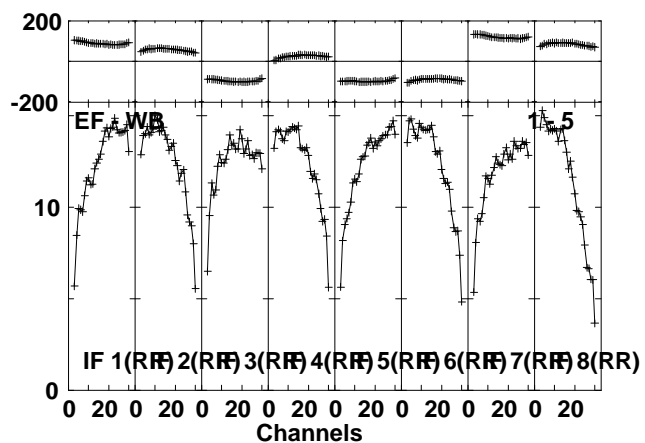
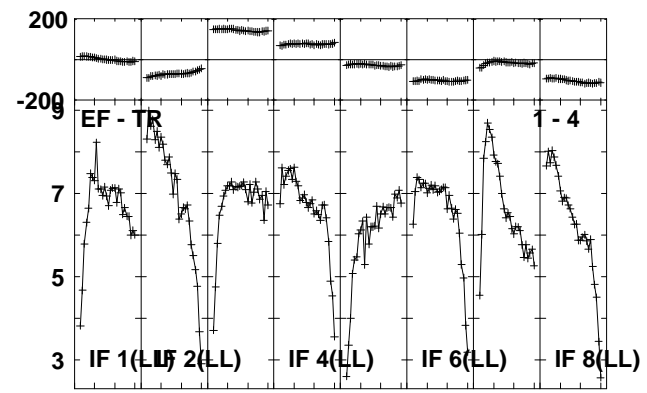
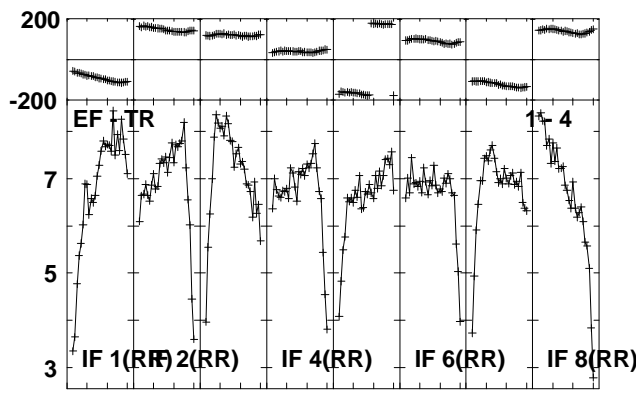
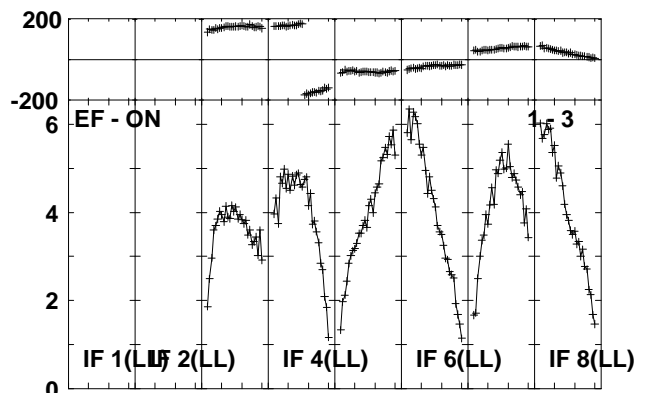
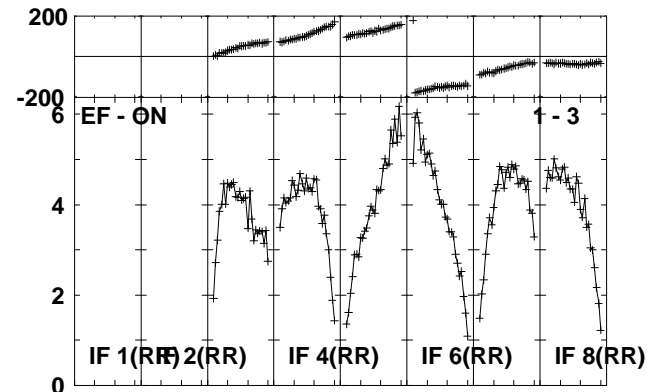
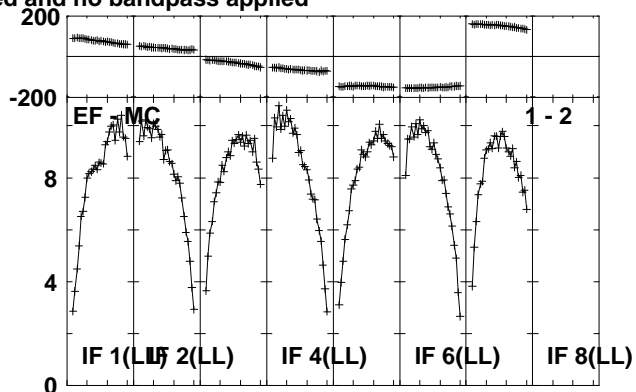
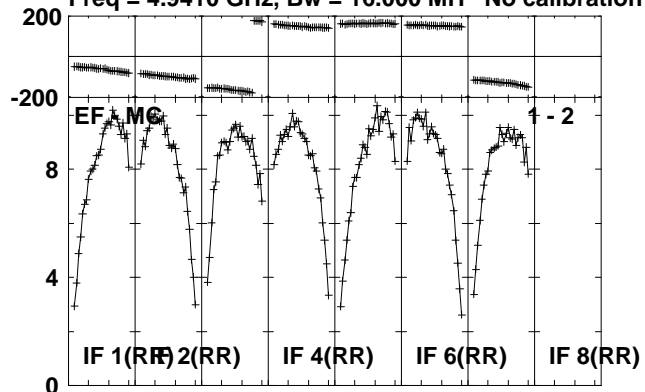

Lower frame: Milli Ampl Jy Top frame: Phas deg
Scalar averaged cross-power spectrum Several baselines displayed
Timerange: 00/17:51:41 to 00/17:52:39

Plot file version 208 created 04-OCT-2010 10:17:57
J1707-14 RP016A.UVDATA.1

Freq = 4.9410 GHz, Bw = 16.000 MH No calibration applied and no bandpass applied

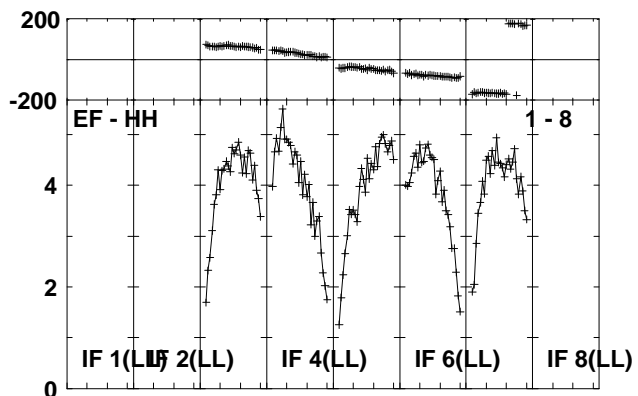
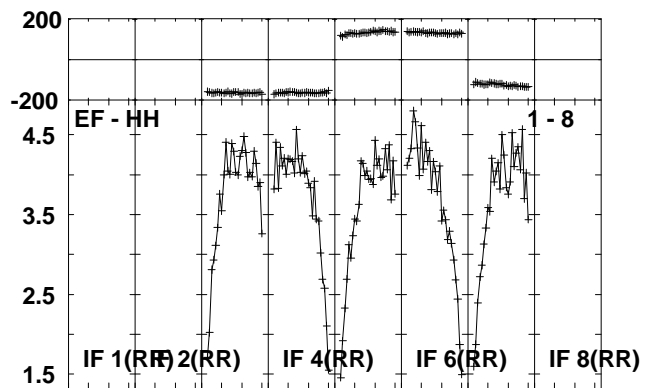
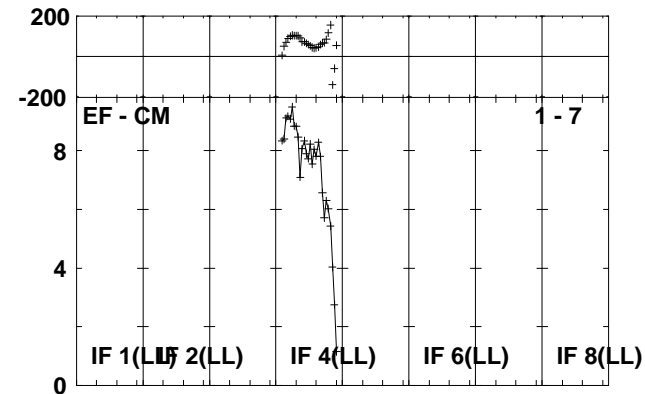
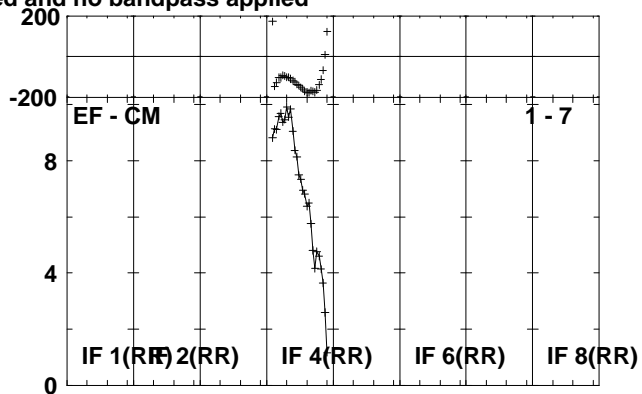
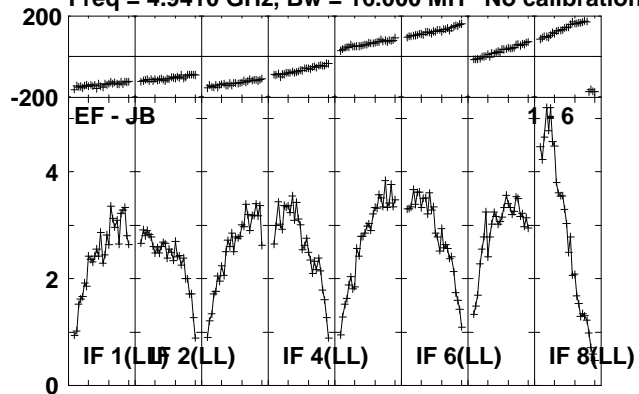

Lower frame: Milli Ampl Jy Top frame: Phas deg
Scalar averaged cross-power spectrum Several baselines displayed
Timerange: 00/17:51:41 to 00/17:52:39

Plot file version 209 created 04-OCT-2010 10:17:57

MAXI J16 RP016A.UVDATA.1

Freq = 4.9410 GHz, Bw = 16.000 MH No calibration applied and no bandpass applied

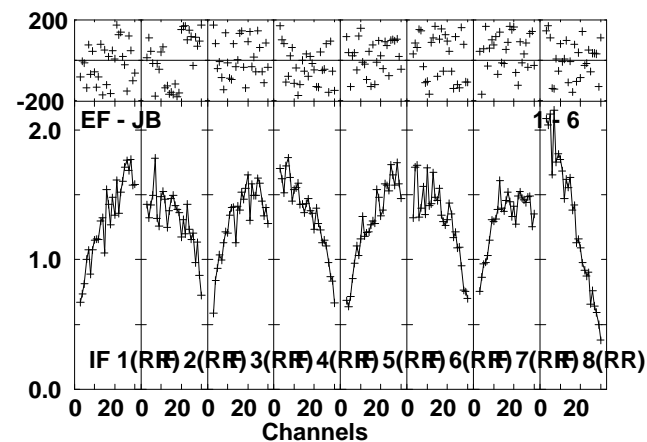
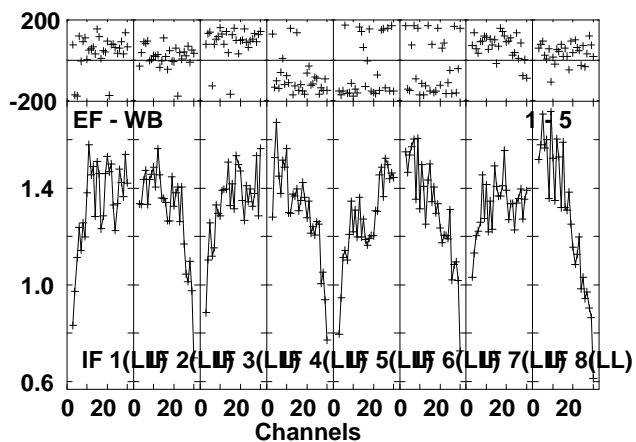
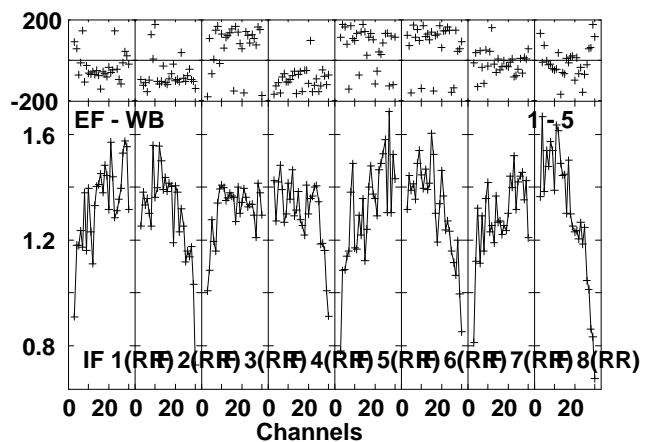
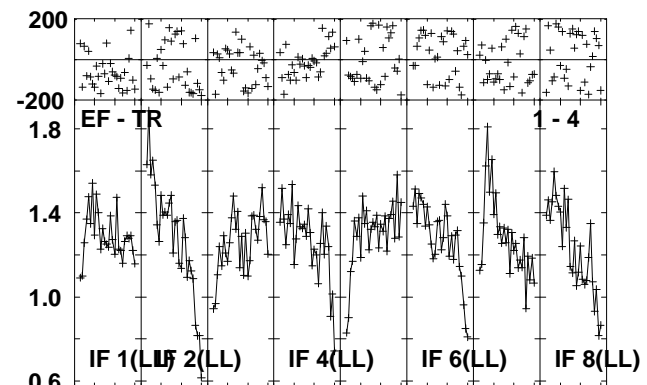
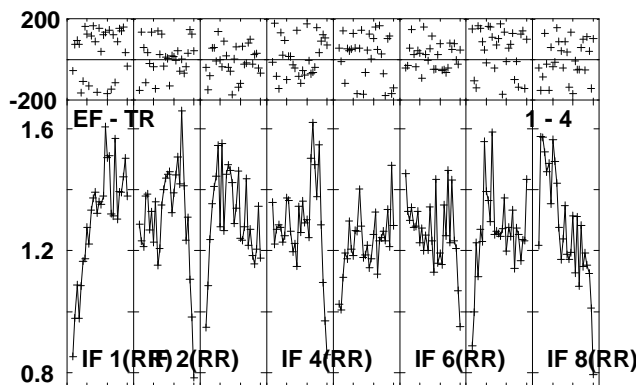
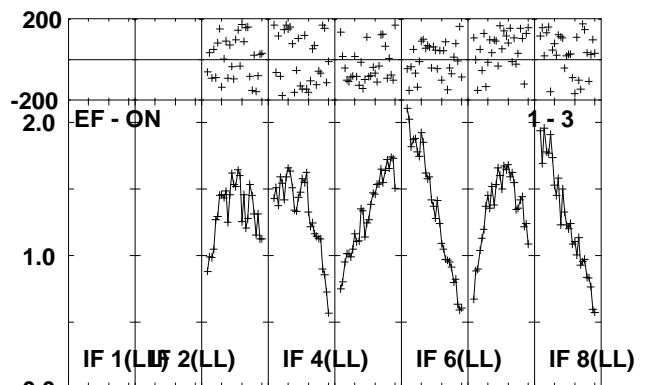
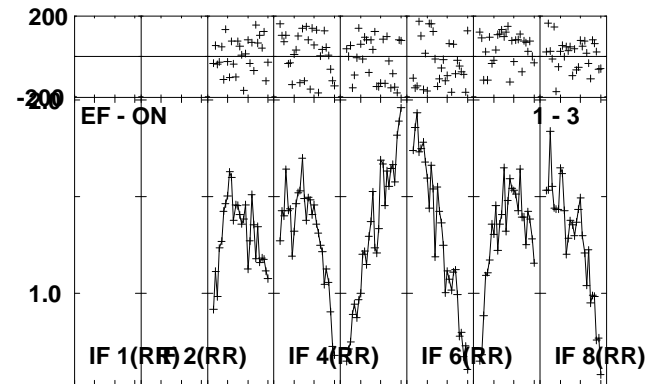
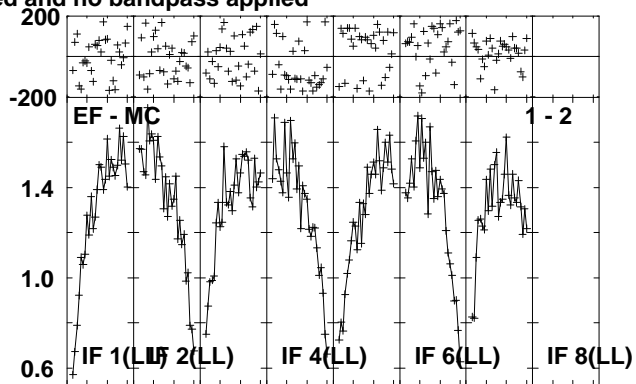
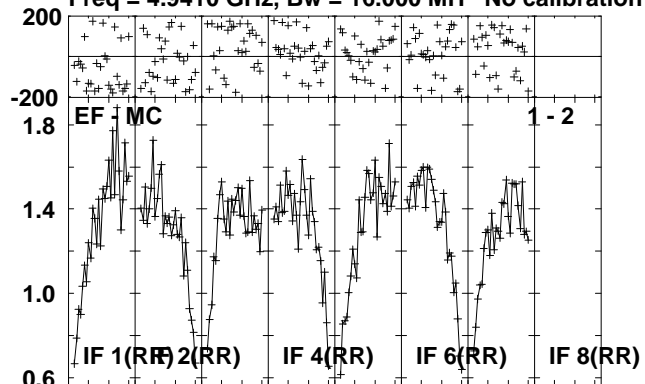

Lower frame: Milli Ampl Jy Top frame: Phas deg
Scalar averaged cross-power spectrum Several baselines displayed
Timerange: 00/17:52:41 to 00/17:55:09

Plot file version 210 created 04-OCT-2010 10:17:59

MAXI J16 RP016A.UVDATA.1

Freq = 4.9410 GHz, Bw = 16.000 MH No calibration applied and no bandpass applied

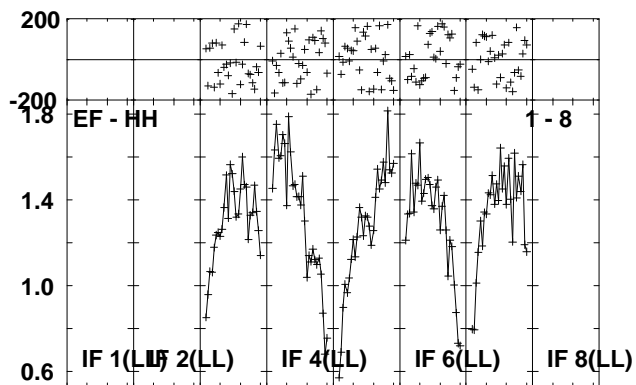
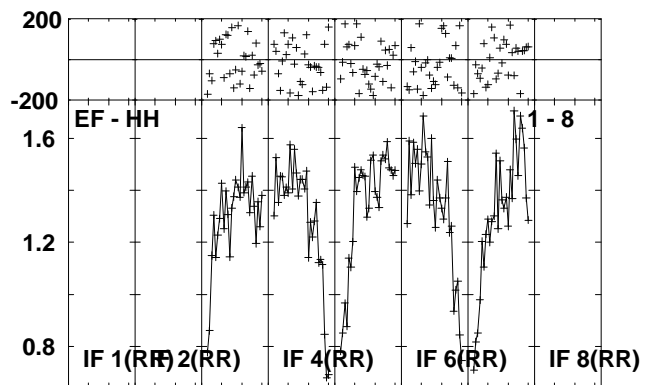
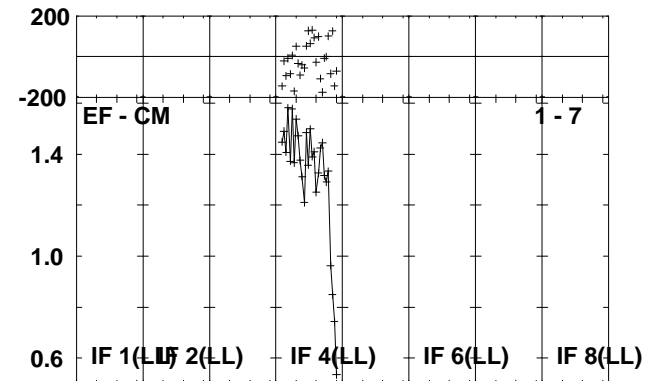
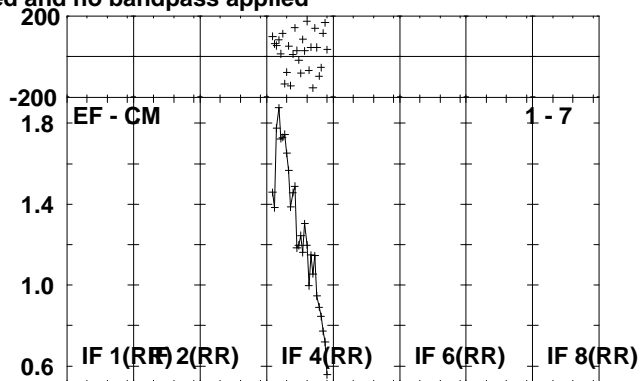
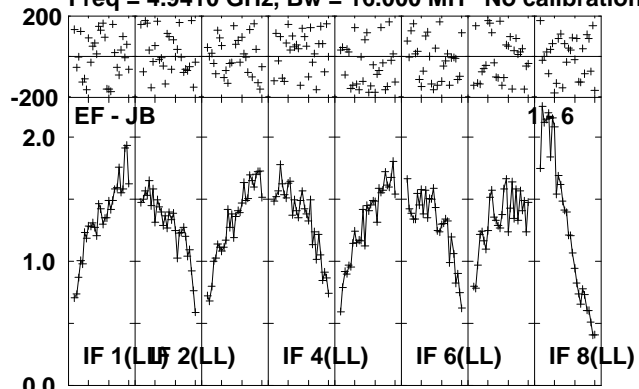

Lower frame: Milli Ampl Jy Top frame: Phas deg
Scalar averaged cross-power spectrum Several baselines displayed
Timerange: 00/17:52:41 to 00/17:55:09

Plot file version 211 created 04-OCT-2010 10:18:00

J1707-14 RP016A.UVDATA.1

Freq = 4.9410 GHz, Bw = 16.000 MH No calibration applied and no bandpass applied

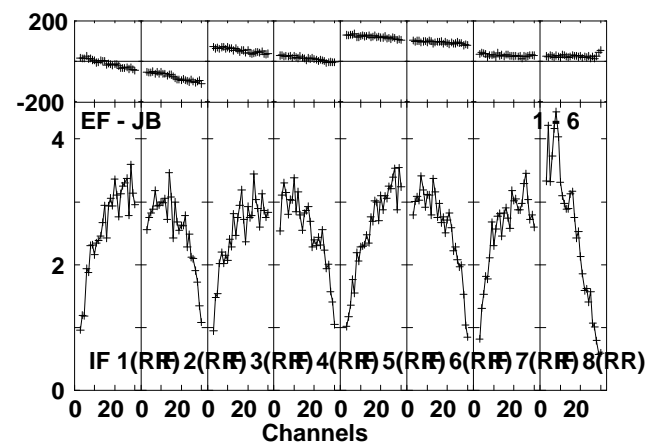
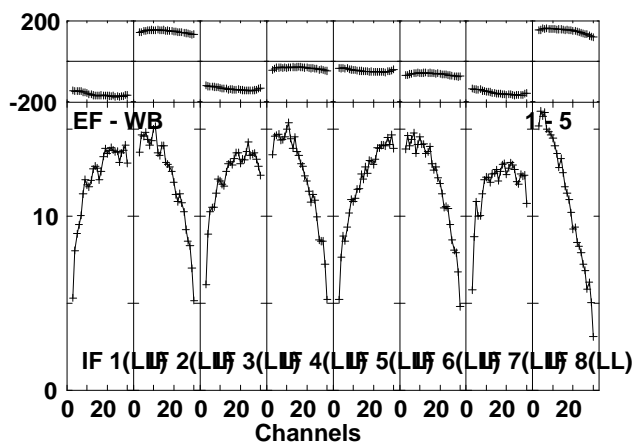
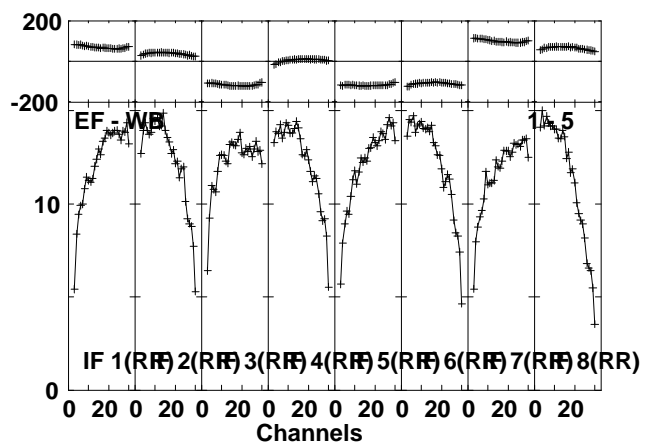
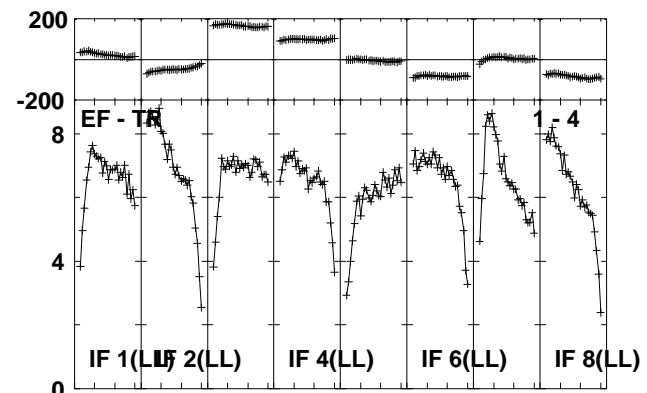
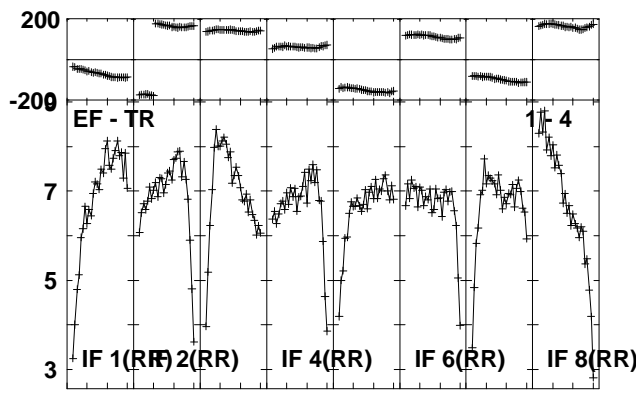
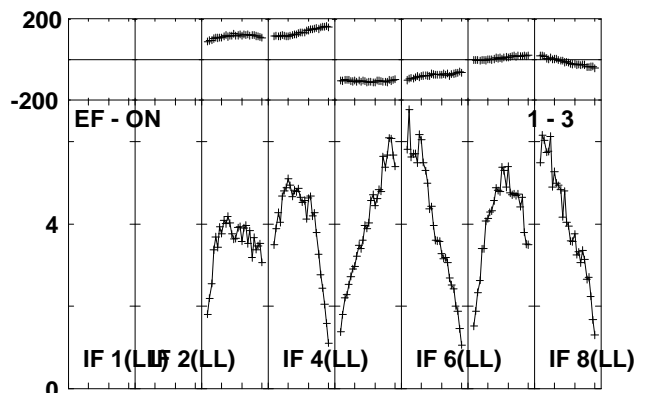
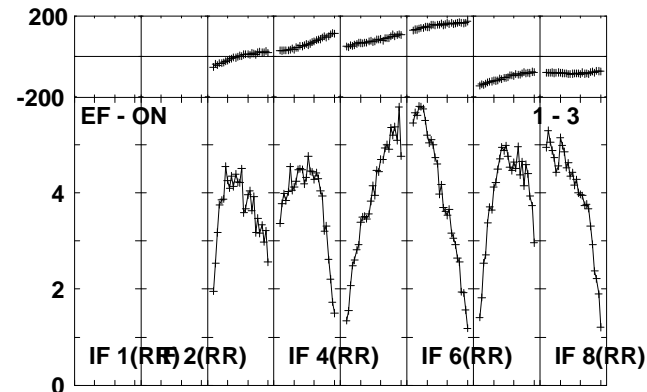
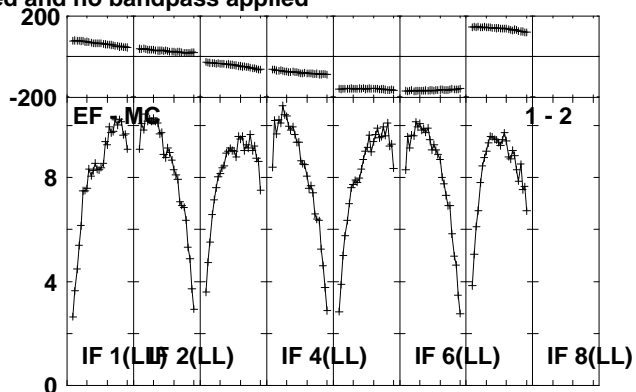
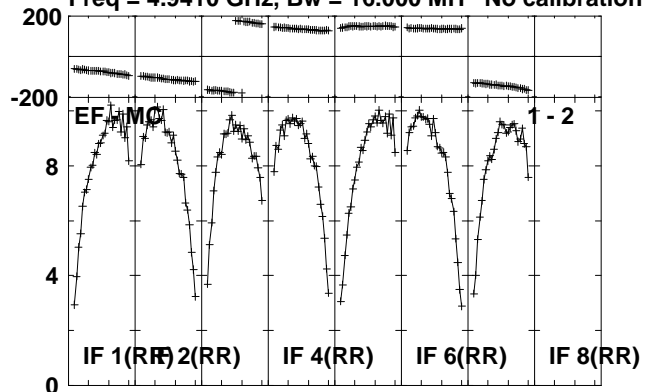

Lower frame: Milli Ampl Jy Top frame: Phas deg
Scalar averaged cross-power spectrum Several baselines displayed
Timerange: 00/17:55:11 to 00/17:56:39

Plot file version 212 created 04-OCT-2010 10:18:01
J1707-14 RP016A.UVDATA.1

Freq = 4.9410 GHz, Bw = 16.000 MH No calibration applied and no bandpass applied

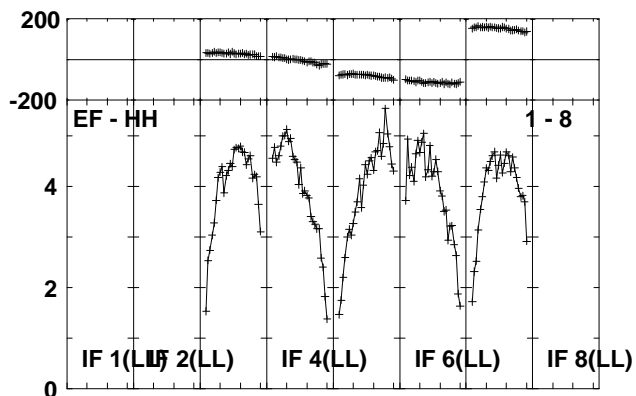
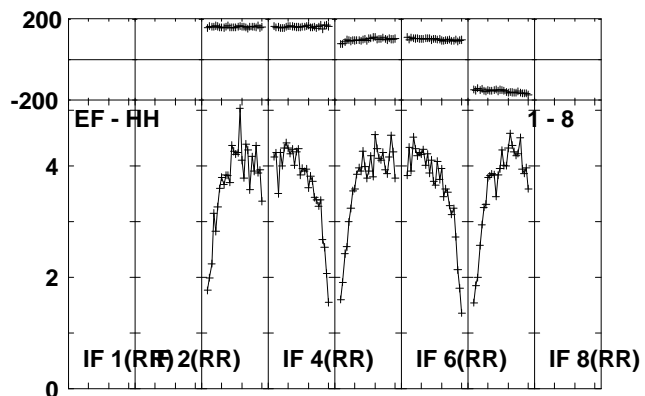
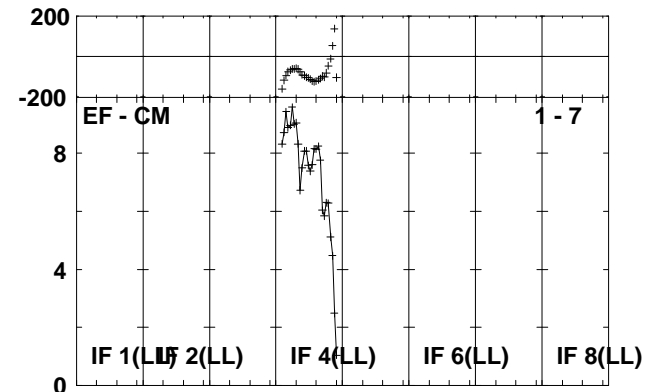
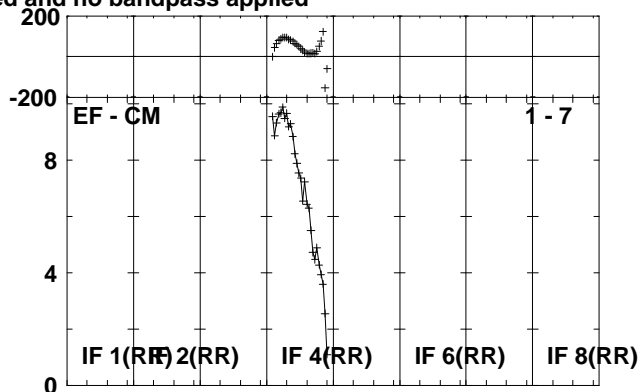
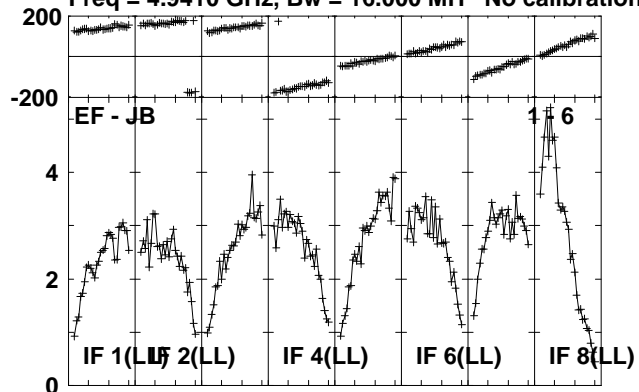

Lower frame: Milli Ampl Jy Top frame: Phas deg
Scalar averaged cross-power spectrum Several baselines displayed
Timerange: 00/17:55:11 to 00/17:56:39

Plot file version 213 created 04-OCT-2010 10:18:02

MAXI J16 RP016A.UVDATA.1

Freq = 4.9410 GHz, Bw = 16.000 MH No calibration applied and no bandpass applied

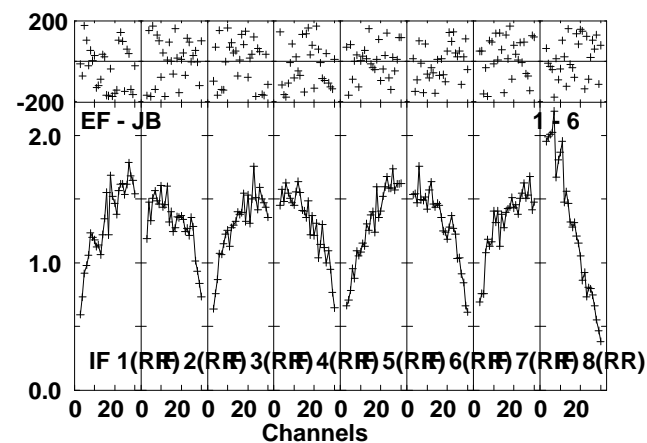
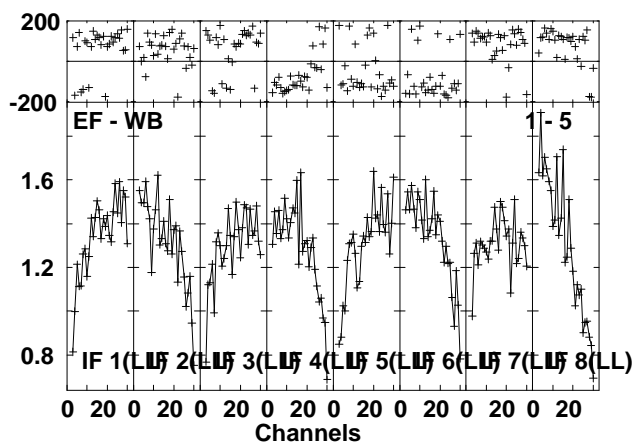
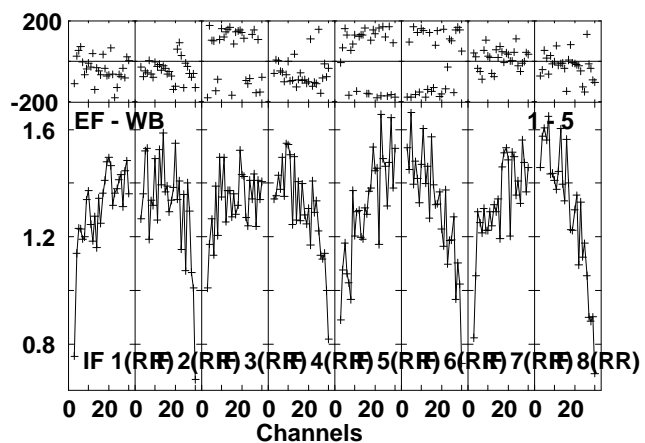
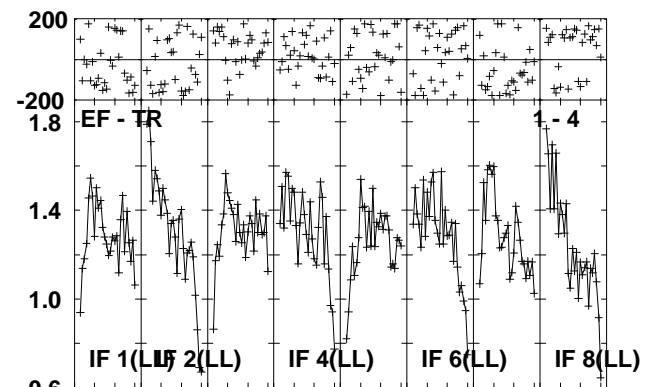
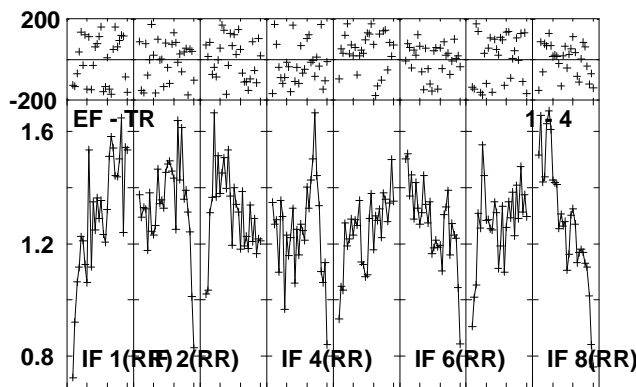
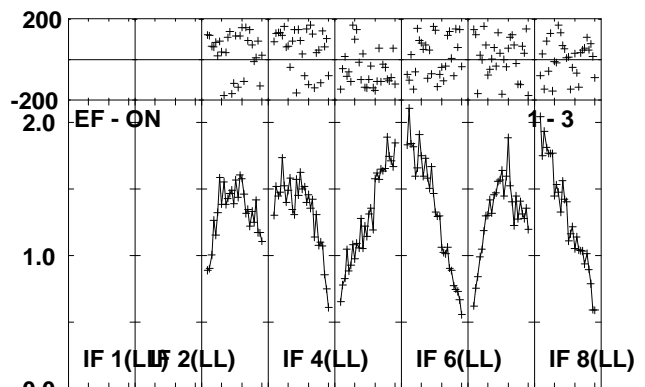
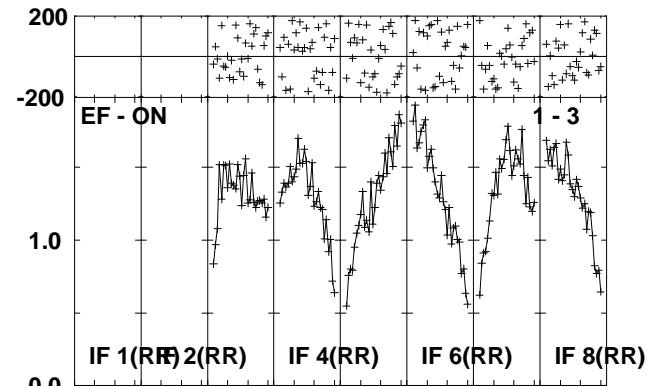
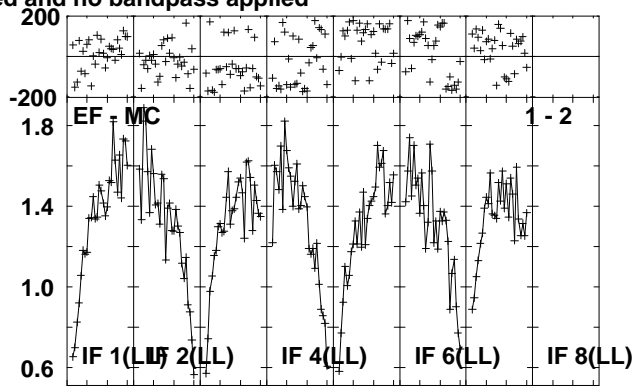
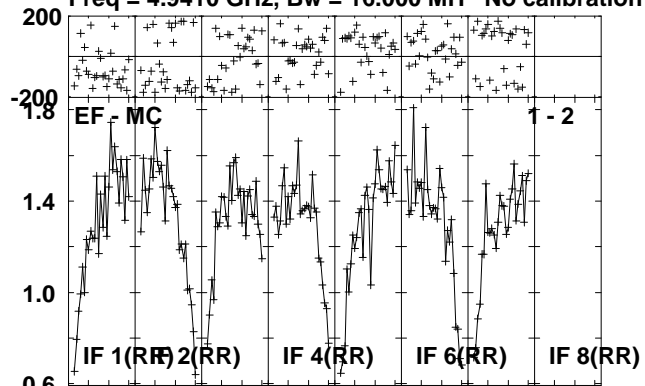

Lower frame: Milli Ampl Jy Top frame: Phas deg
Scalar averaged cross-power spectrum Several baselines displayed
Timerange: 00/17:56:41 to 00/17:59:09

Plot file version 214 created 04-OCT-2010 10:18:04

MAXI J16 RP016A.UVDATA.1

Freq = 4.9410 GHz, Bw = 16.000 MH No calibration applied and no bandpass applied

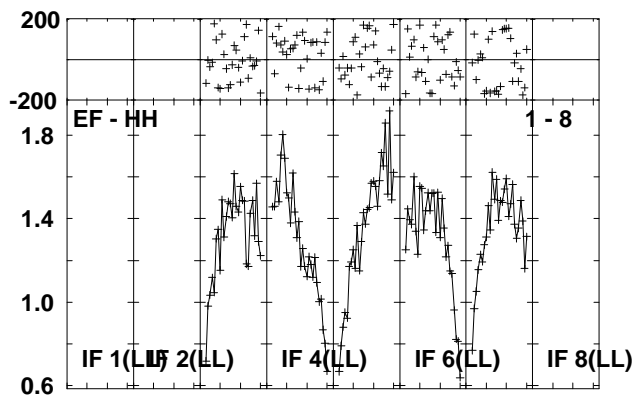
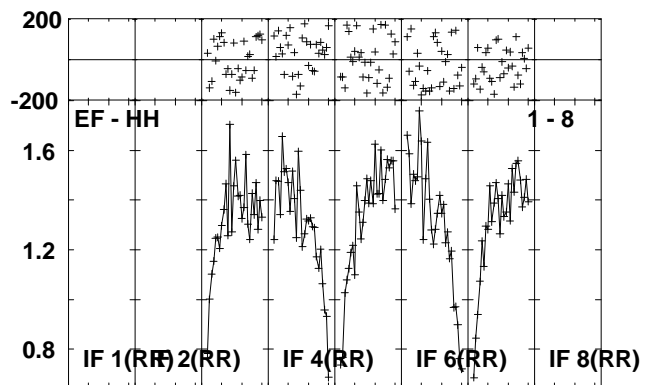
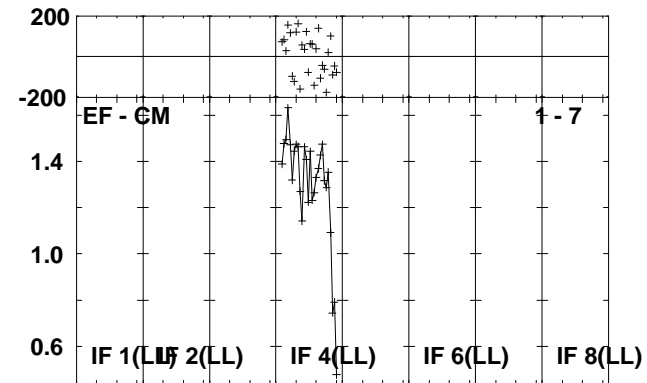
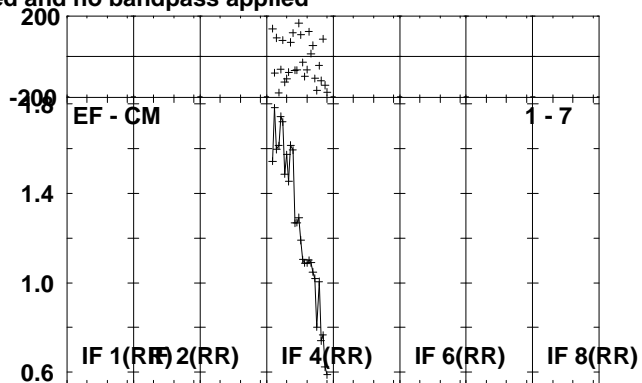
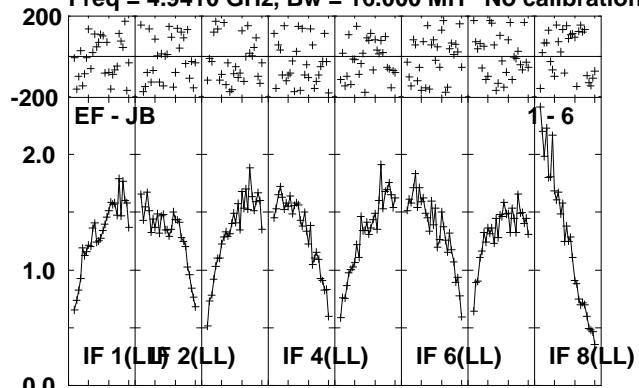

Lower frame: Milli Ampl Jy Top frame: Phas deg
Scalar averaged cross-power spectrum Several baselines displayed
Timerange: 00/17:56:41 to 00/17:59:09

Plot file version 215 created 04-OCT-2010 10:18:05

J1707-14 RP016A.UVDATA.1

Freq = 4.9410 GHz, Bw = 16.000 MH No calibration applied and no bandpass applied

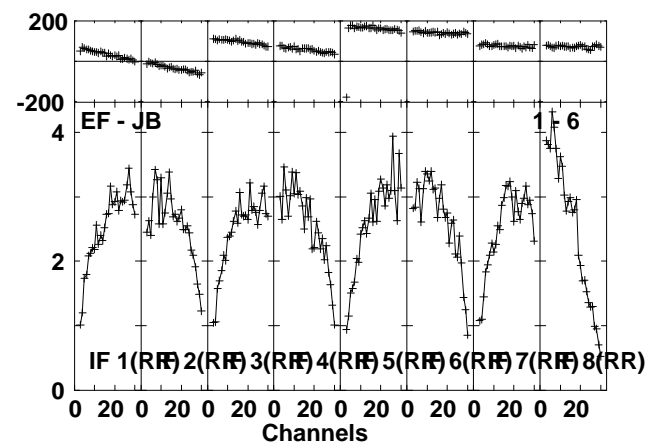
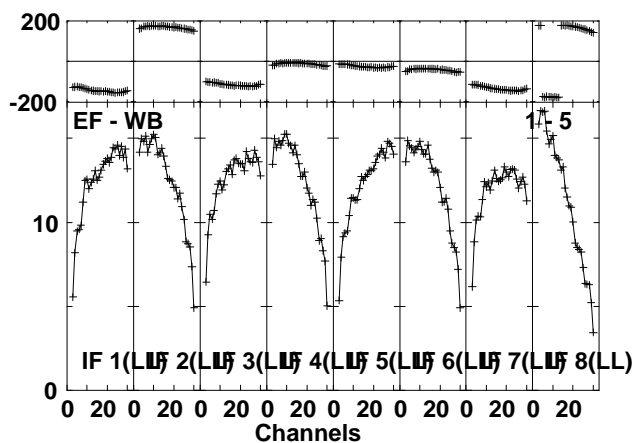
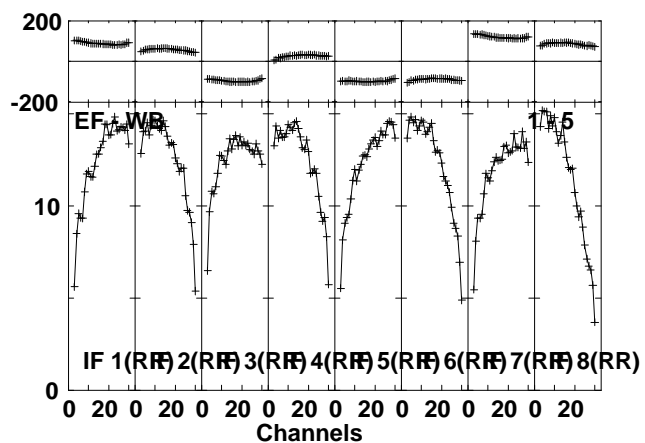
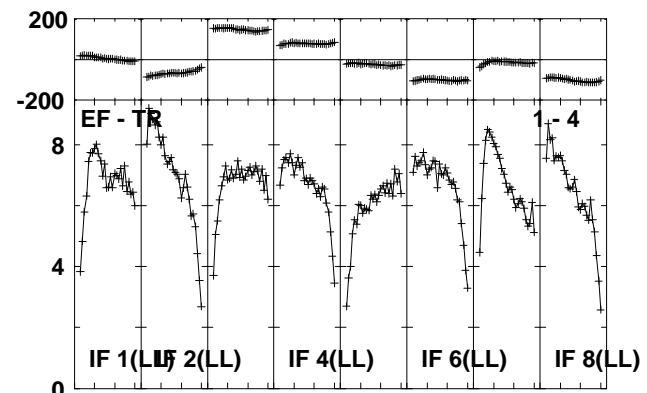
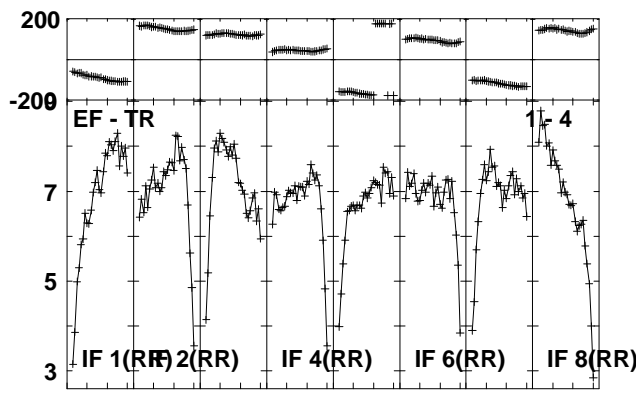
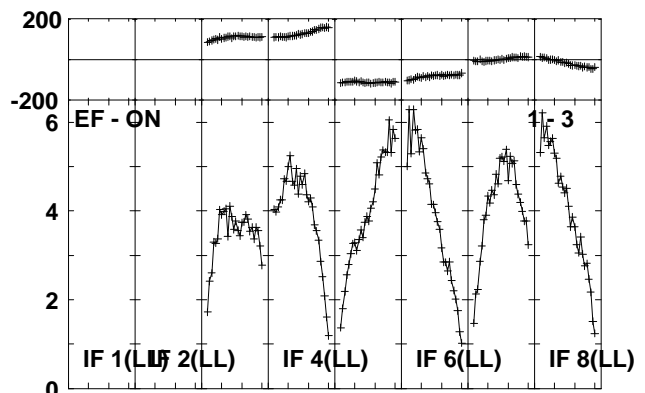
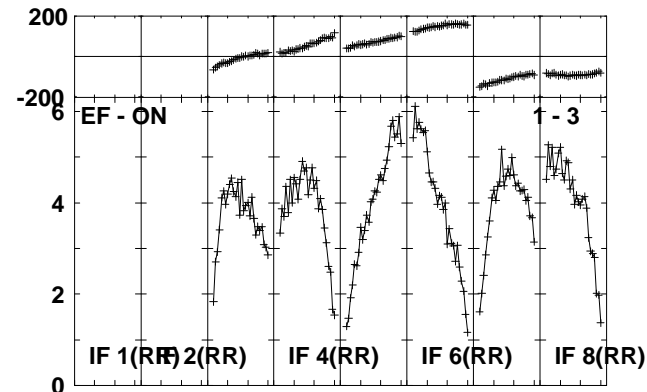
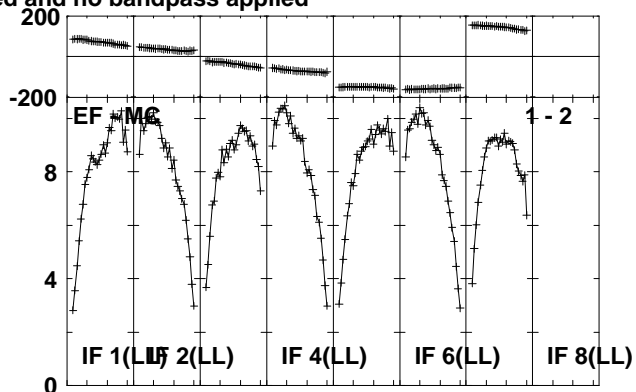
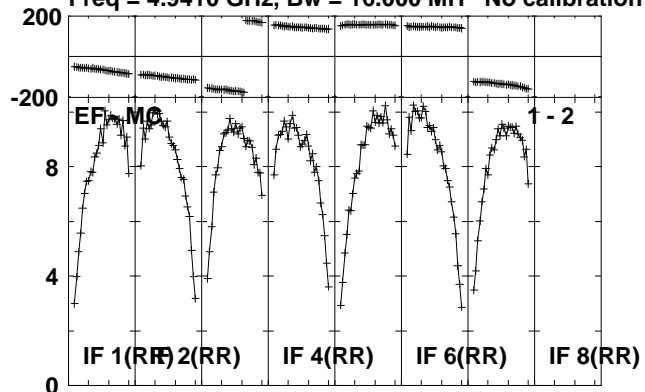

Lower frame: Milli Ampl Jy Top frame: Phas deg
Scalar averaged cross-power spectrum Several baselines displayed
Timerange: 00/17:59:51 to 00/18:00:49

Plot file version 216 created 04-OCT-2010 10:18:06

J1707-14 RP016A.UVDATA.1

Freq = 4.9410 GHz, Bw = 16.000 MH No calibration applied and no bandpass applied

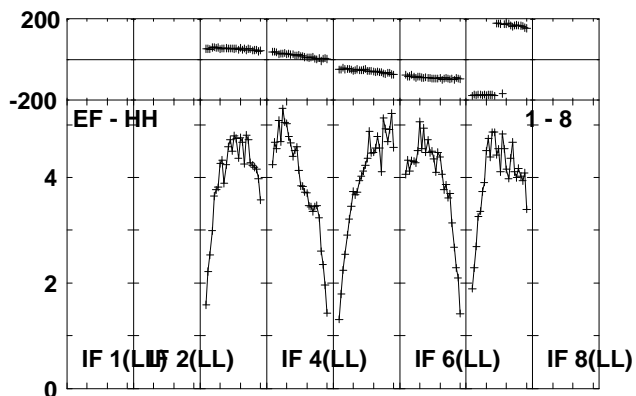
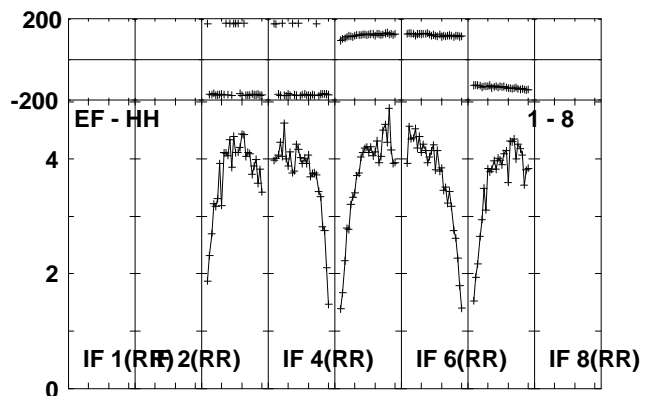
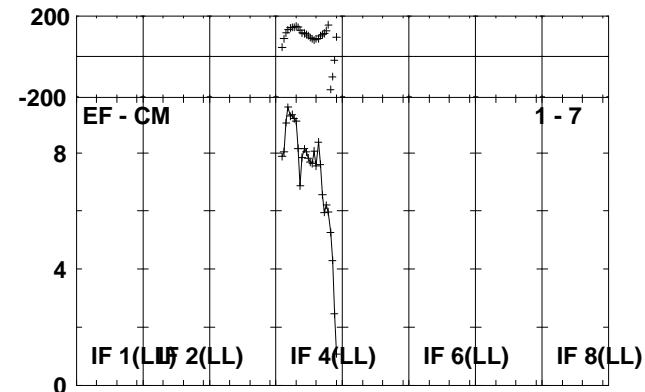
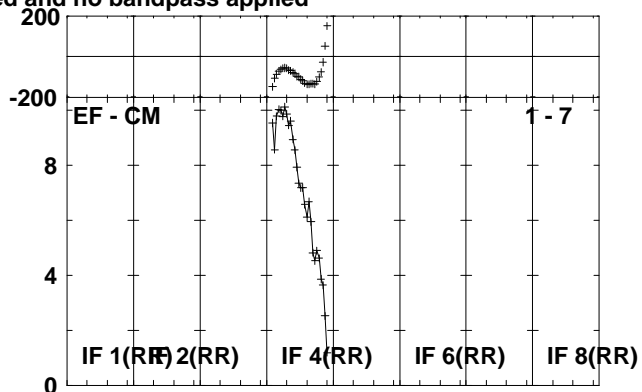
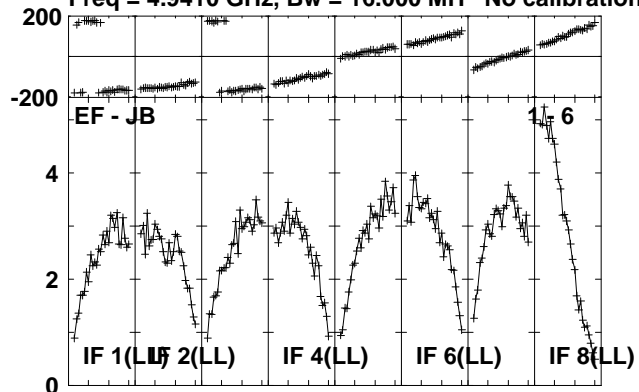

Lower frame: Milli Ampl Jy Top frame: Phas deg
Scalar averaged cross-power spectrum Several baselines displayed
Timerange: 00/17:59:51 to 00/18:00:49

Plot file version 217 created 04-OCT-2010 10:18:07

NVSS3 RP016A.UVDATA.1

Freq = 4.9410 GHz, Bw = 16.000 MH No calibration applied and no bandpass applied

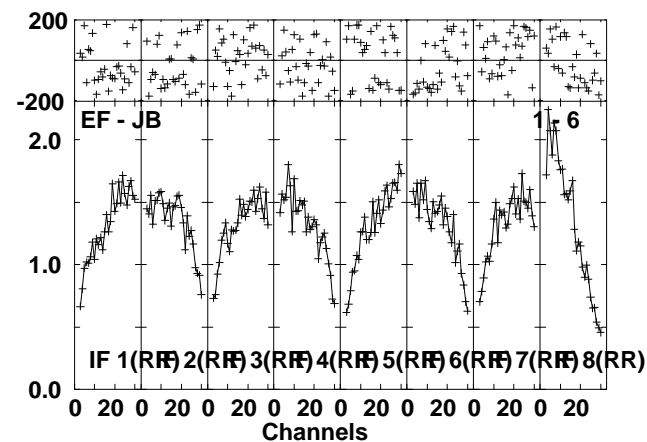
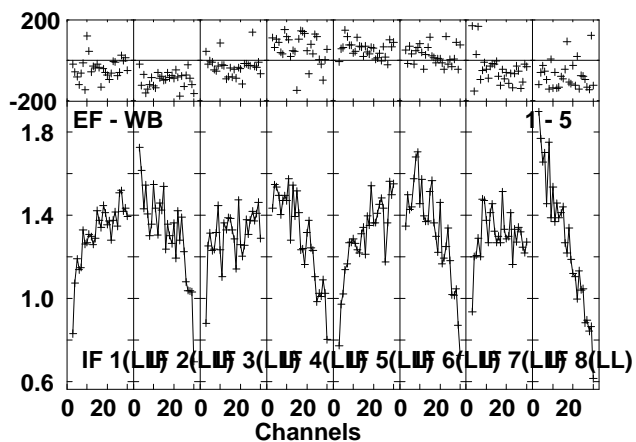
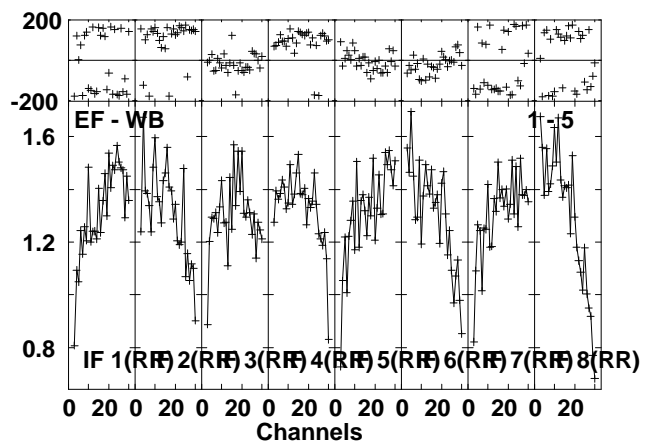
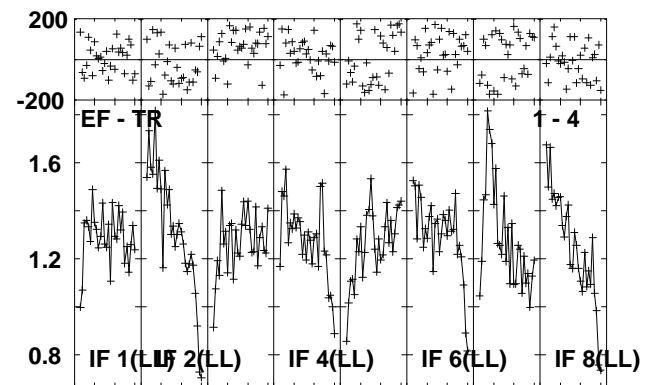
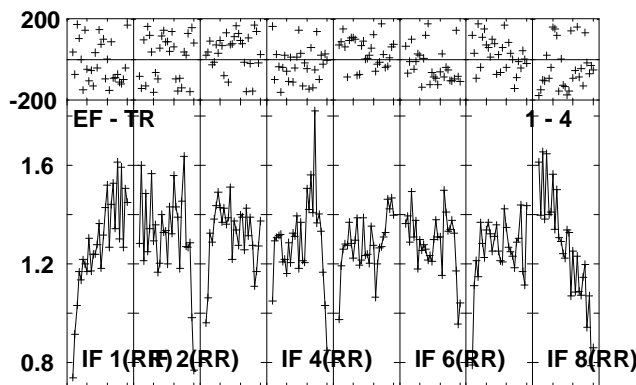
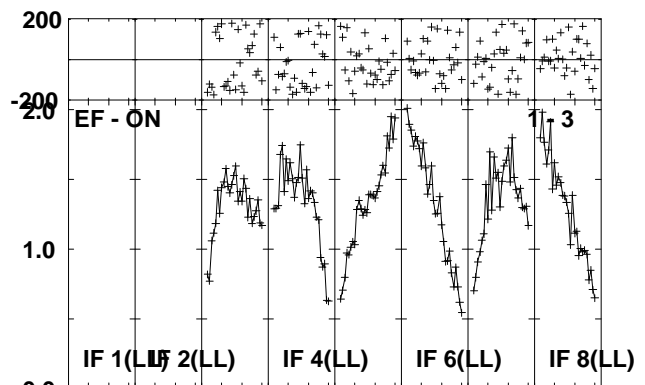
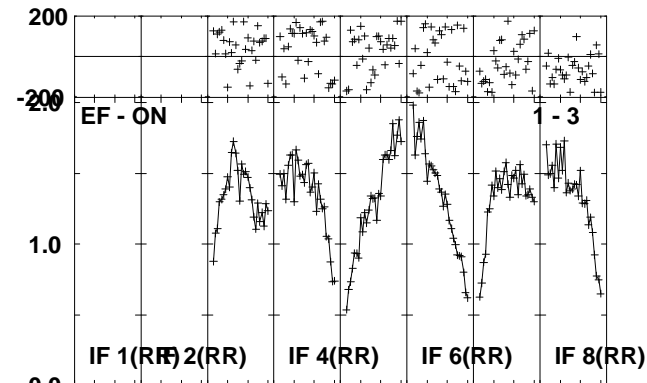
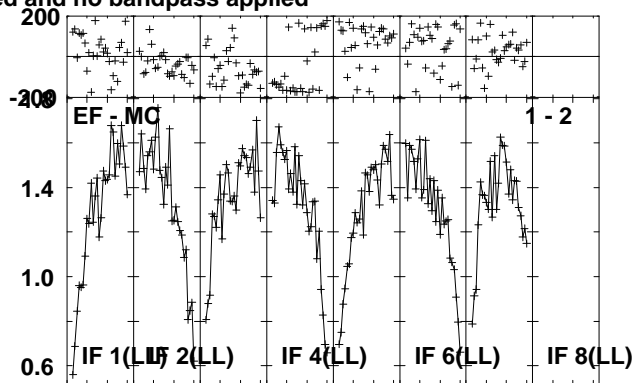
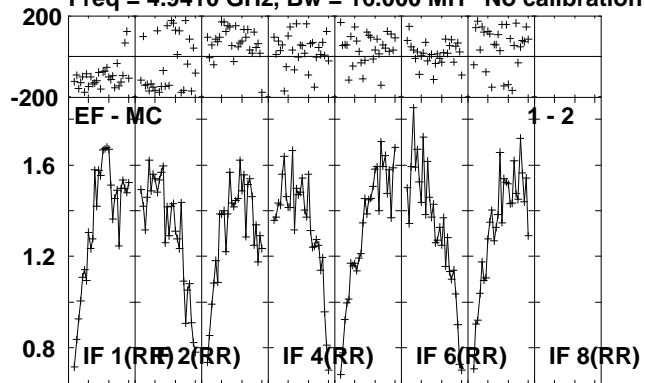

Lower frame: Milli Ampl Jy Top frame: Phas deg
Scalar averaged cross-power spectrum Several baselines displayed
Timerange: 00:18:00:51 to 00:18:03:19

Plot file version 218 created 04-OCT-2010 10:18:08

NVSS3 RP016A.UVDATA.1

Freq = 4.9410 GHz, Bw = 16.000 MH No calibration applied and no bandpass applied

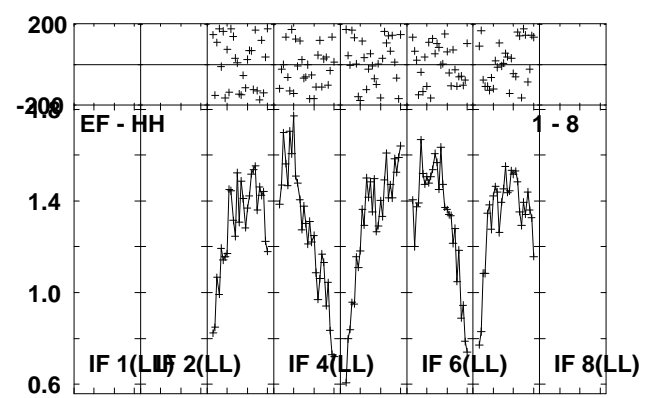
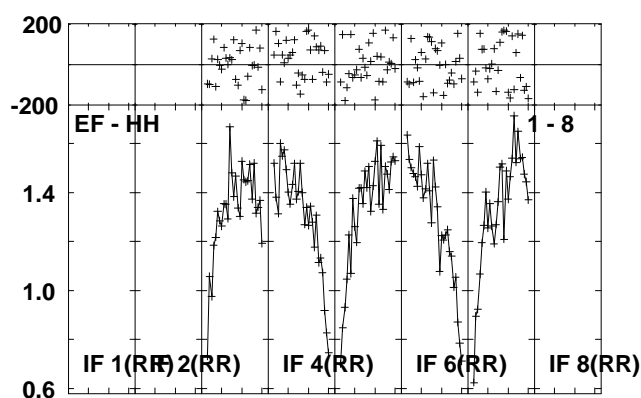
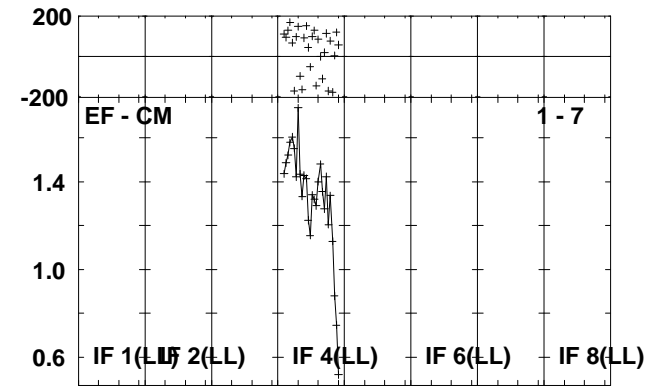
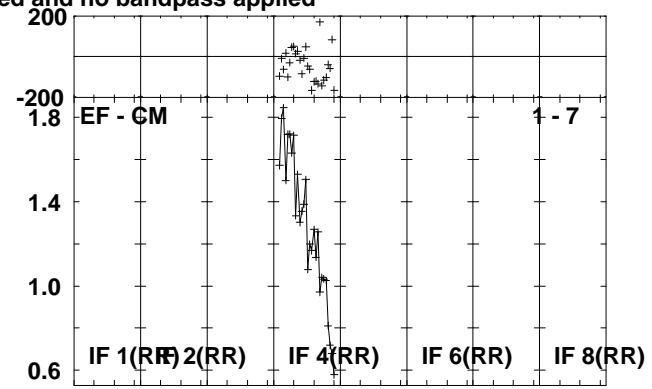
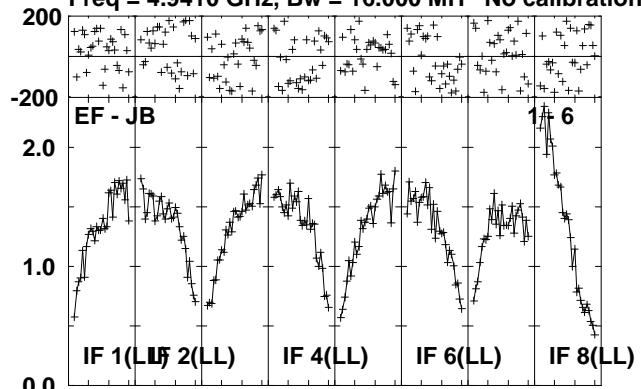

Lower frame: Milli Ampl Jy Top frame: Phas deg
Scalar averaged cross-power spectrum Several baselines displayed
Timerange: 00:18:00:51 to 00:18:03:19

Plot file version 219 created 04-OCT-2010 10:18:09

J1707-14 RP016A.UVDATA.1

Freq = 4.9410 GHz, Bw = 16.000 MH No calibration applied and no bandpass applied

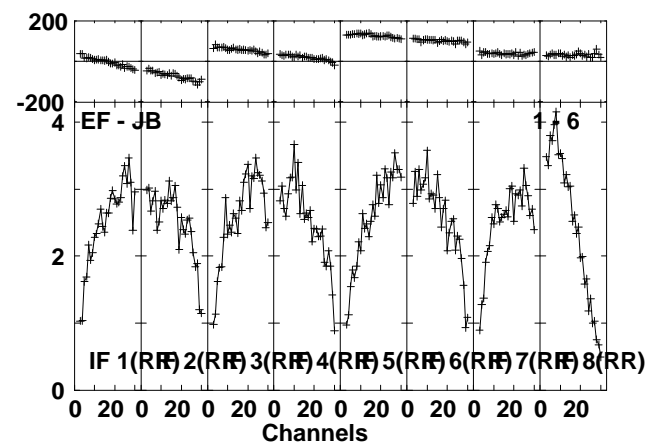
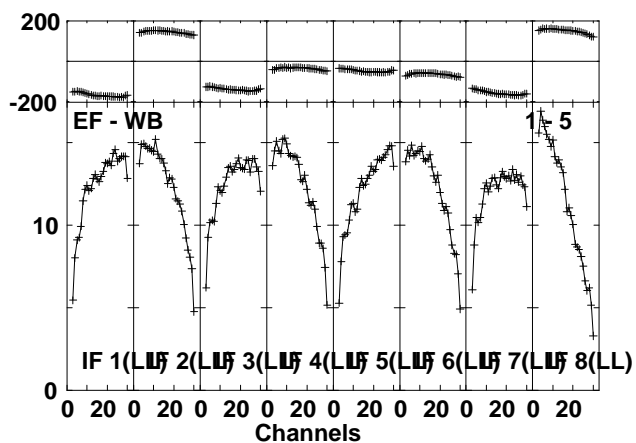
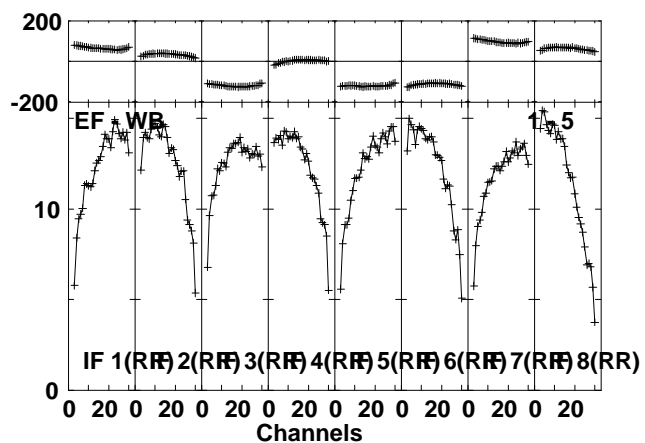
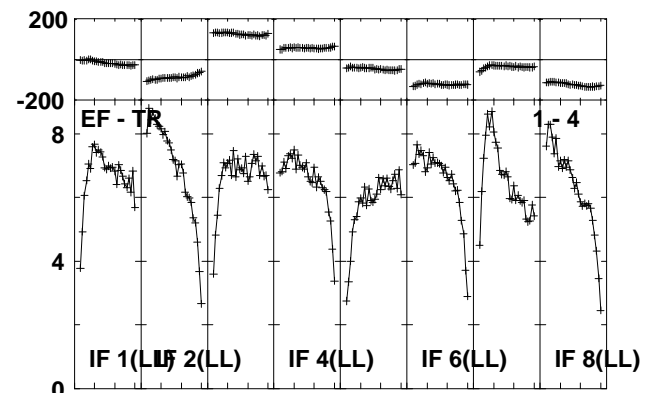
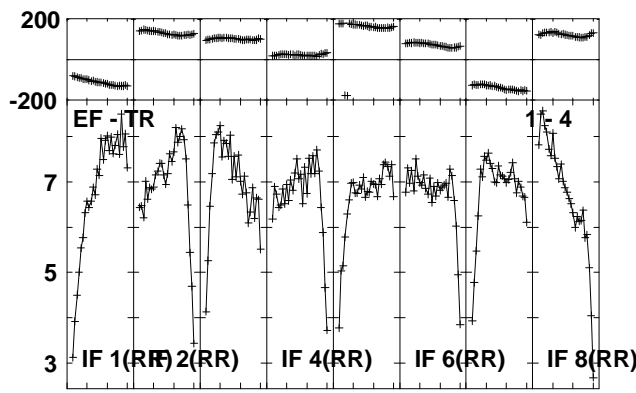
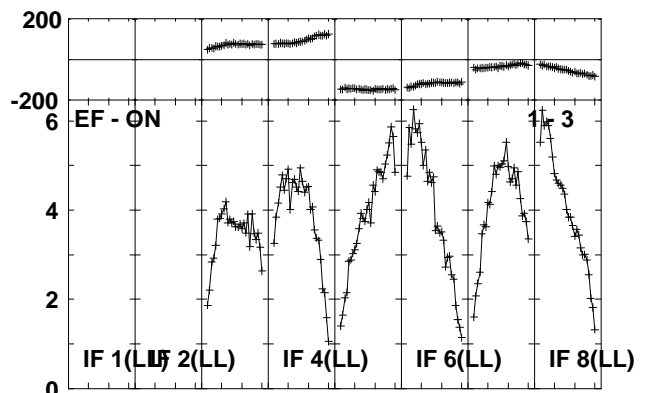
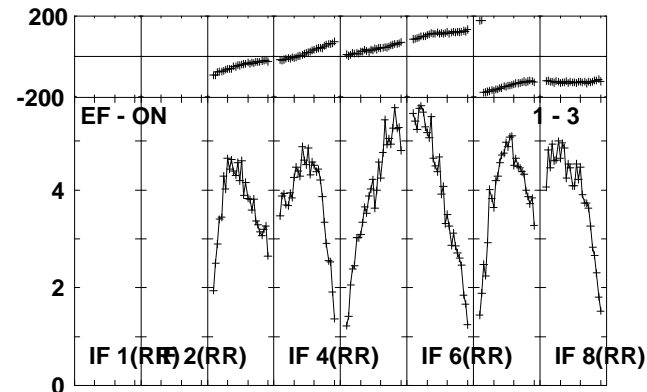
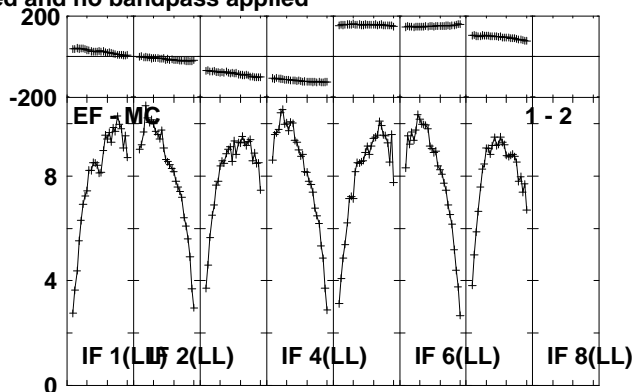
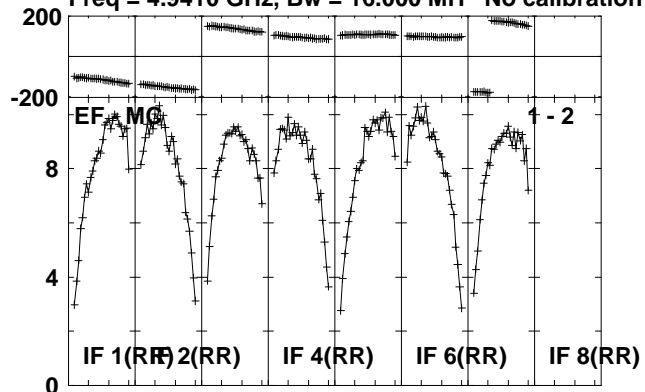

Lower frame: Milli Ampl Jy Top frame: Phas deg
Scalar averaged cross-power spectrum Several baselines displayed
Timerange: 00/18:03:21 to 00/18:04:49

Plot file version 220 created 04-OCT-2010 10:18:10

J1707-14 RP016A.UVDATA.1

Freq = 4.9410 GHz, Bw = 16.000 MH No calibration applied and no bandpass applied

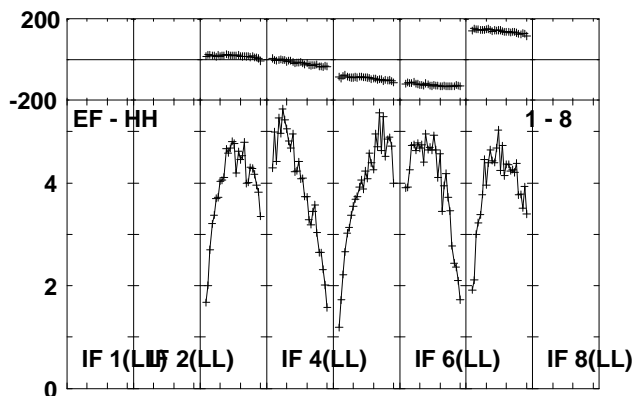
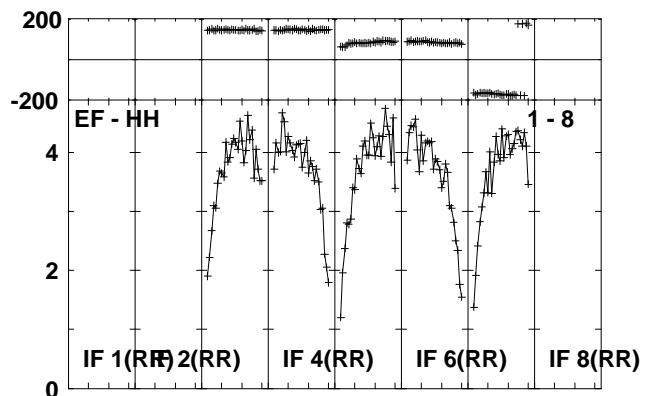
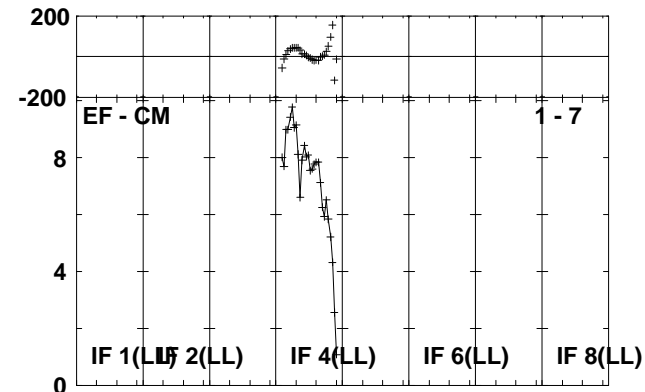
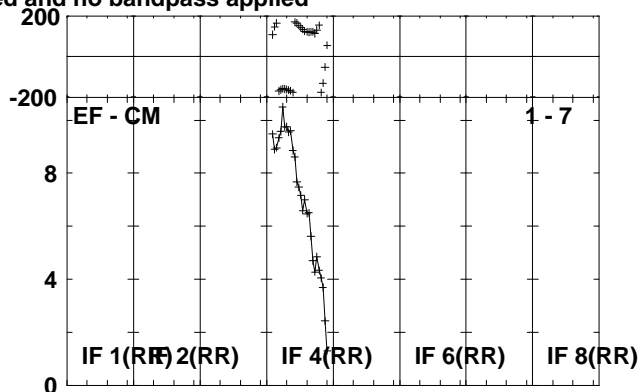
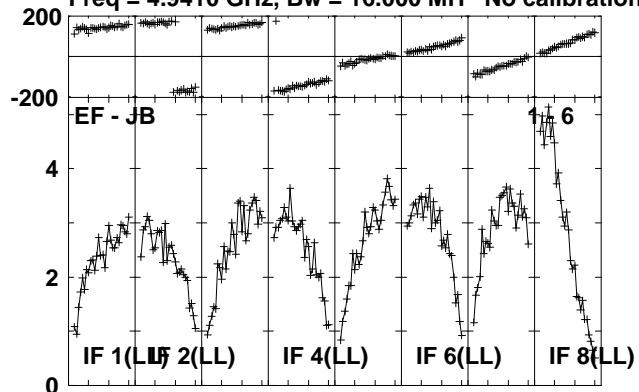

Lower frame: Milli Ampl Jy Top frame: Phas deg
Scalar averaged cross-power spectrum Several baselines displayed
Timerange: 00/18:03:21 to 00/18:04:49

Plot file version 221 created 04-OCT-2010 10:18:11

MAXI J16 RP016A.UVDATA.1

Freq = 4.9410 GHz, Bw = 16.000 MH No calibration applied and no bandpass applied

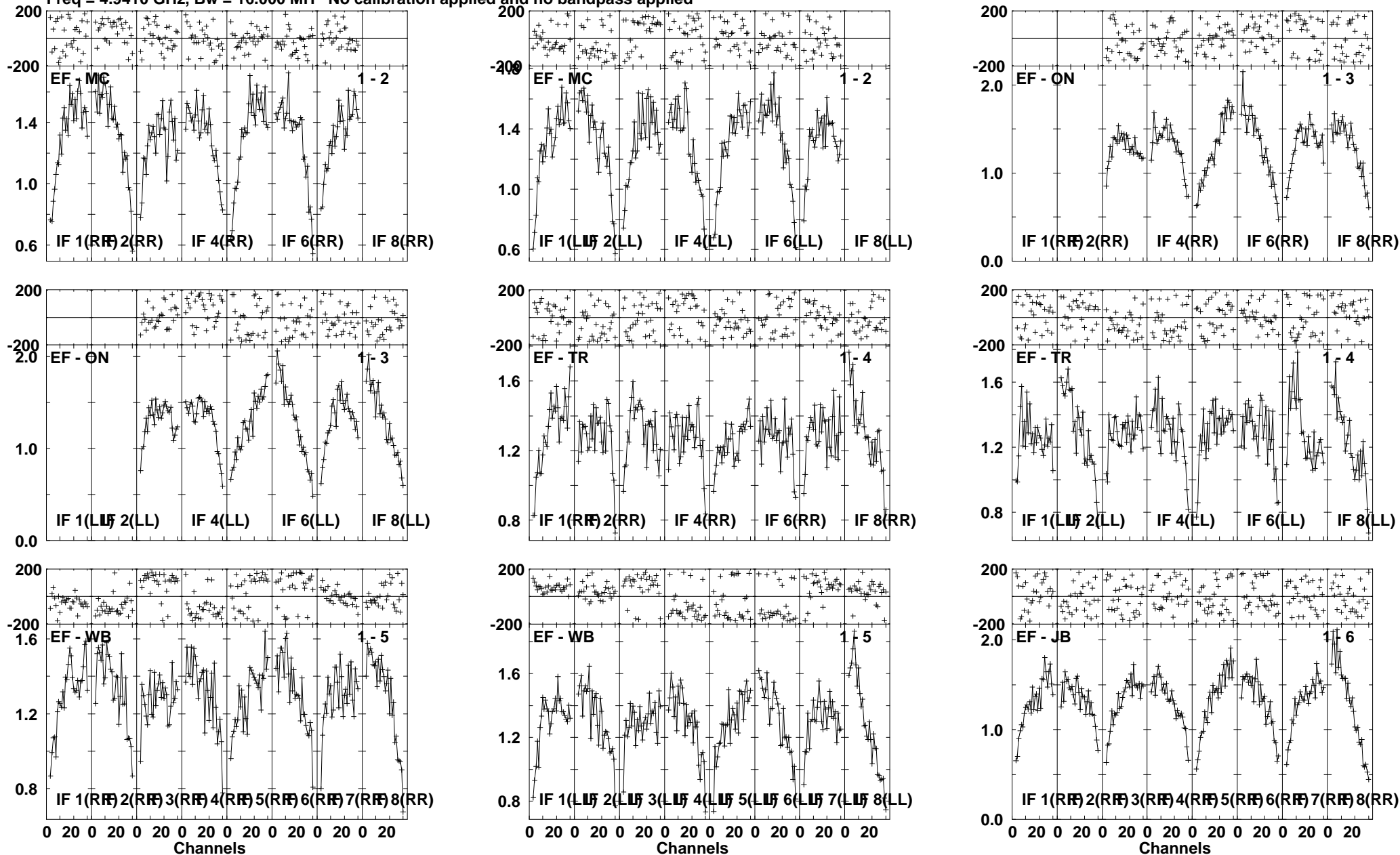

Lower frame: Milli Ampl Jy Top frame: Phas deg
Scalar averaged cross-power spectrum Several baselines displayed
Timerange: 00:18:04:51 to 00:18:07:19

Plot file version 222 created 04-OCT-2010 10:18:13

MAXI J16 RP016A.UVDATA.1

Freq = 4.9410 GHz, Bw = 16.000 MH No calibration applied and no bandpass applied

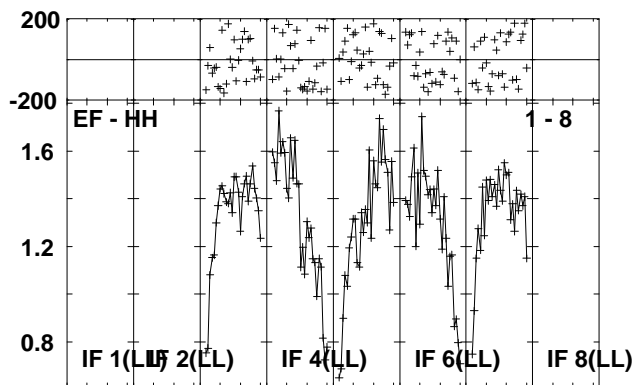
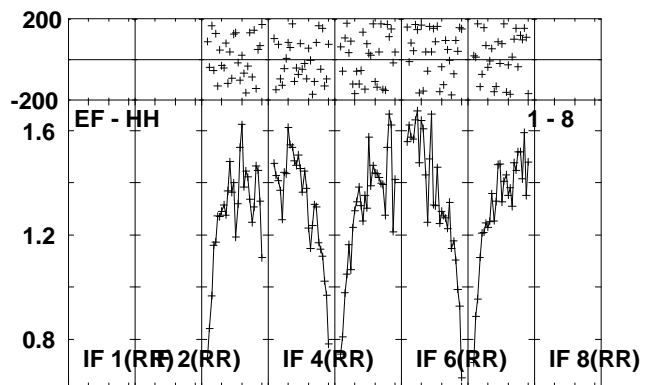
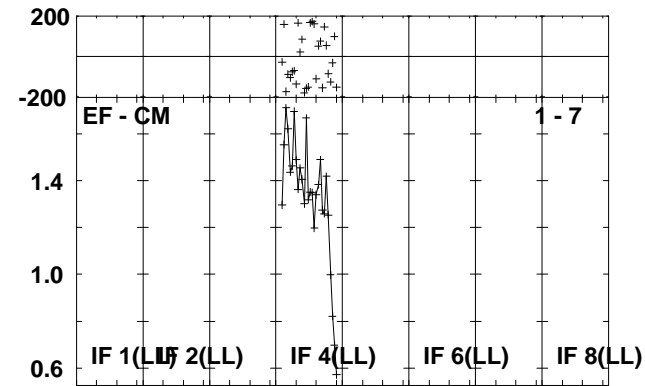
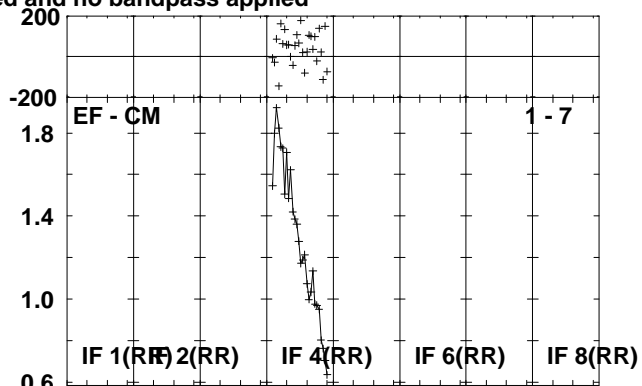
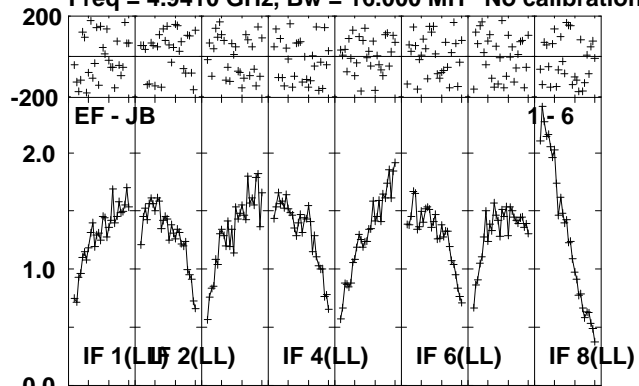

Lower frame: Milli Ampl Jy Top frame: Phas deg
Scalar averaged cross-power spectrum Several baselines displayed
Timerange: 00/18:04:51 to 00/18:07:19

Plot file version 223 created 04-OCT-2010 10:18:14

J1707-14 RP016A.UVDATA.1

Freq = 4.9410 GHz, Bw = 16.000 MH No calibration applied and no bandpass applied

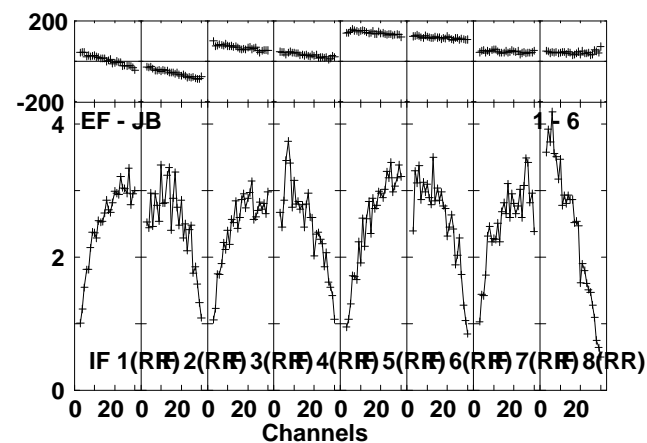
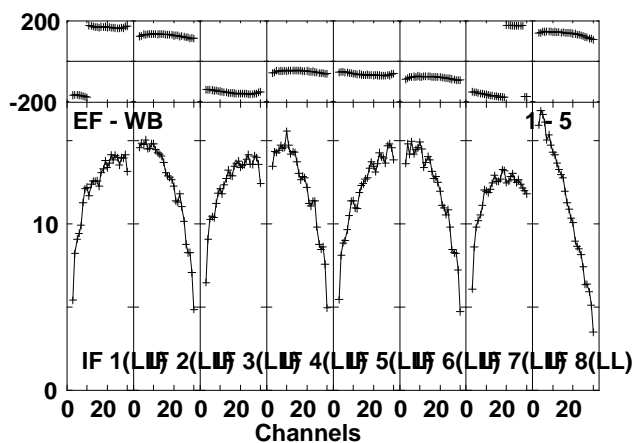
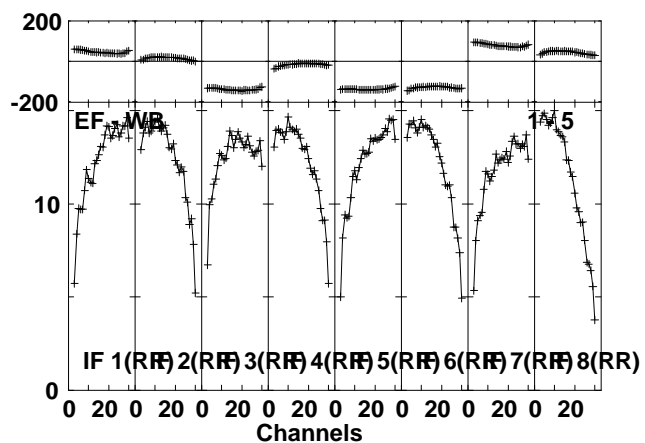
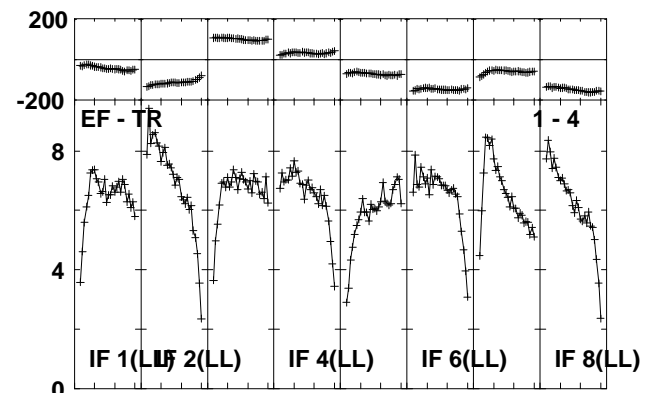
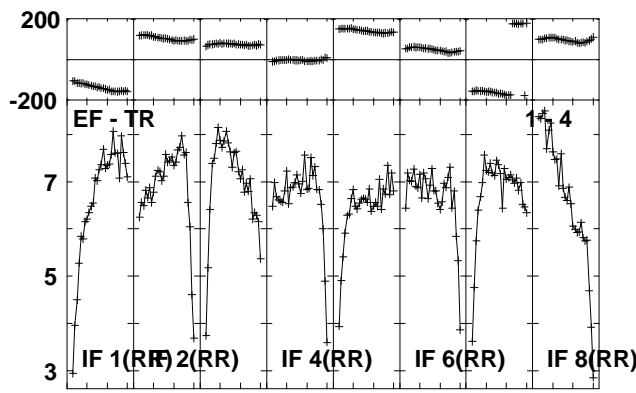
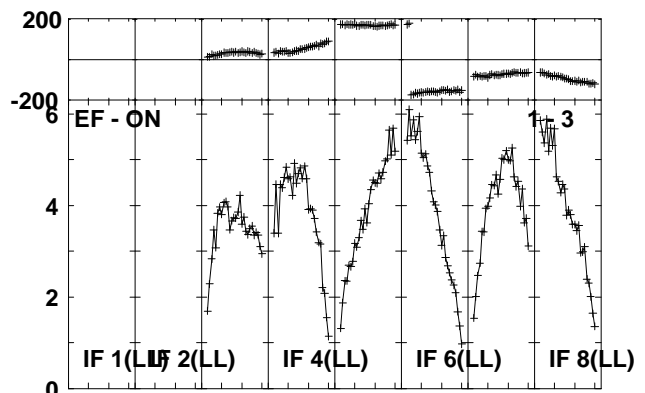
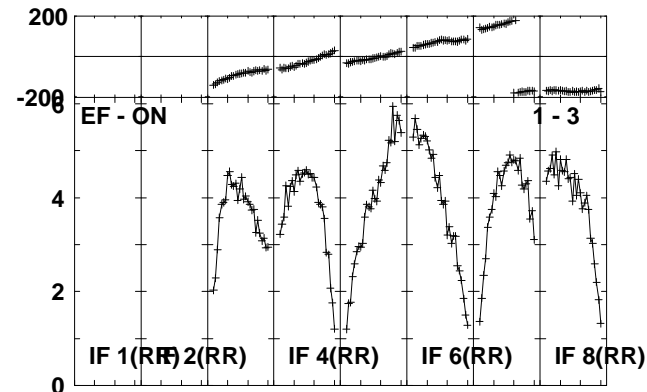
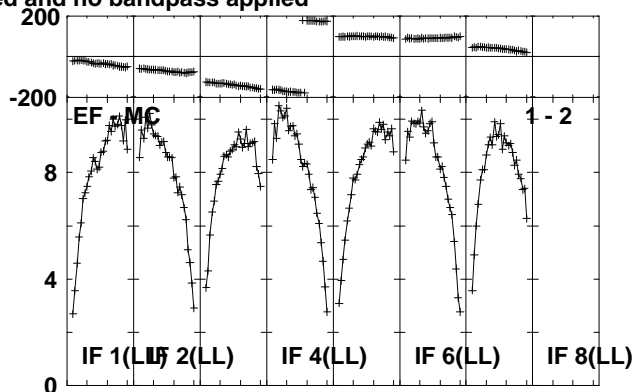
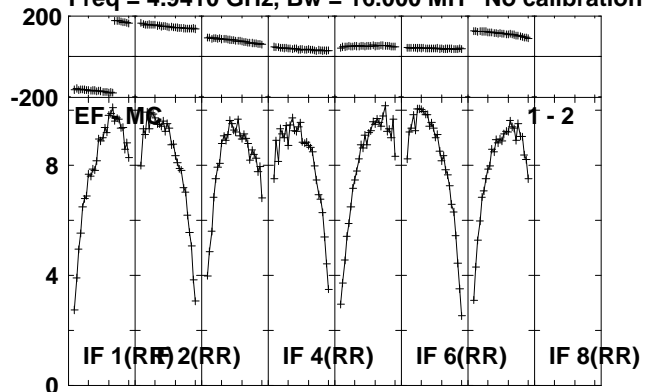

Lower frame: Milli Ampl Jy Top frame: Phas deg
Scalar averaged cross-power spectrum Several baselines displayed
Timerange: 00/18:08:01 to 00/18:08:59

Plot file version 224 created 04-OCT-2010 10:18:15

J1707-14 RP016A.UVDATA.1

Freq = 4.9410 GHz, Bw = 16.000 MH No calibration applied and no bandpass applied

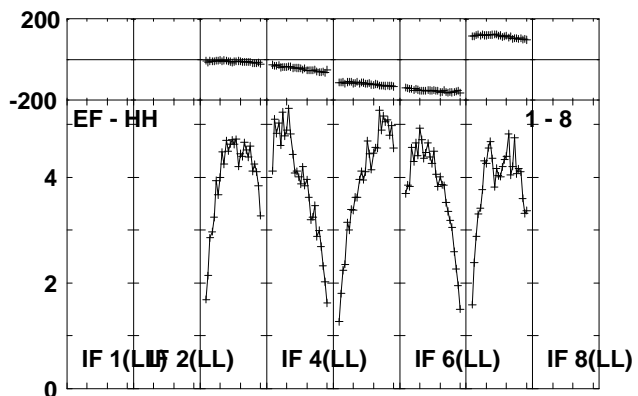
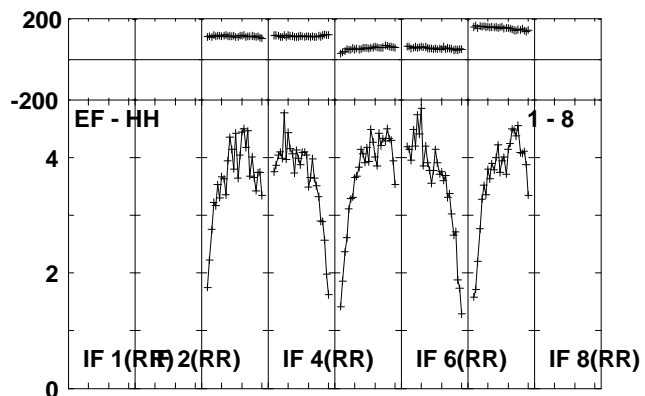
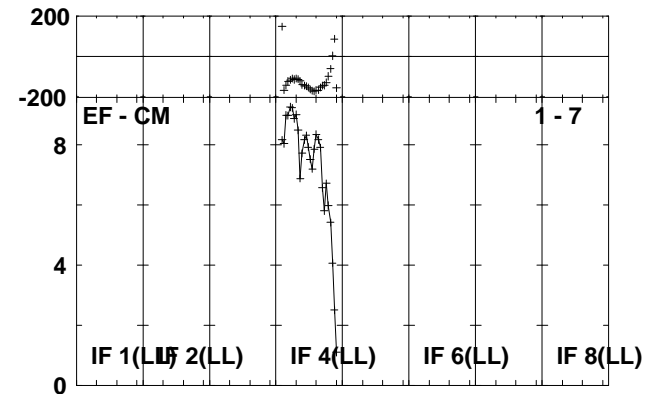
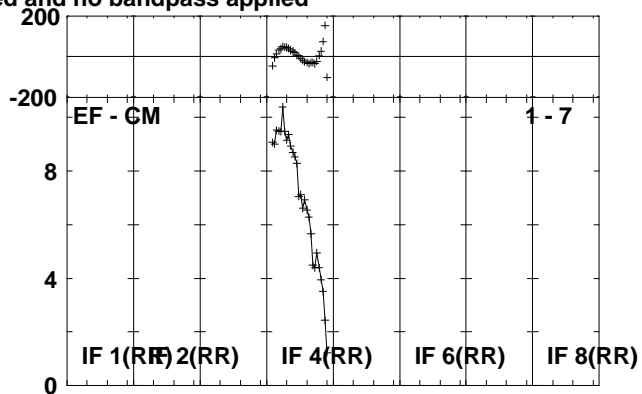
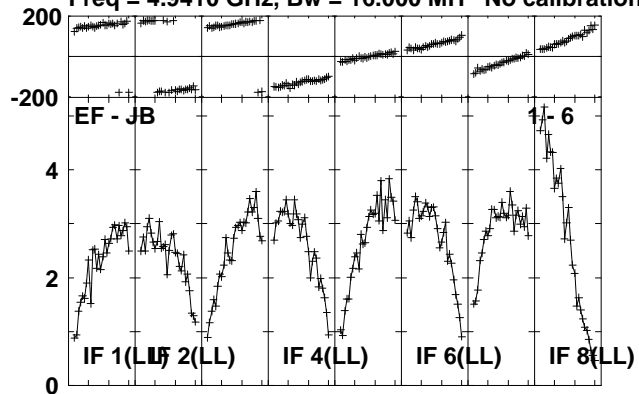

Lower frame: Milli Ampl Jy Top frame: Phas deg
Scalar averaged cross-power spectrum Several baselines displayed
Timerange: 00/18:08:01 to 00/18:08:59

Plot file version 225 created 04-OCT-2010 10:18:19
 3C286 RP016A.UVDATA.1
 Freq = 4.9410 GHz, Bw = 16.000 MH No calibration applied and no bandpass applied

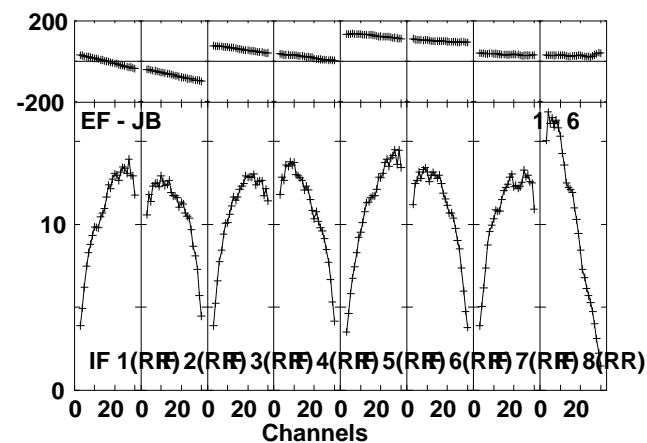
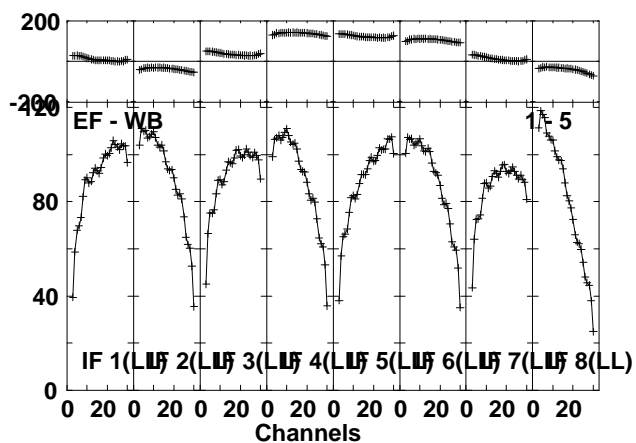
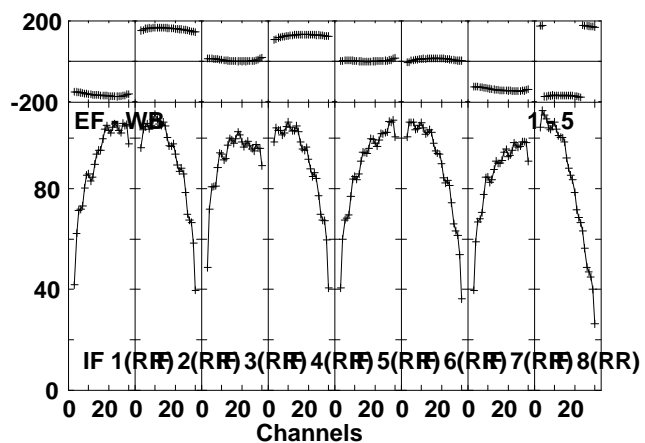
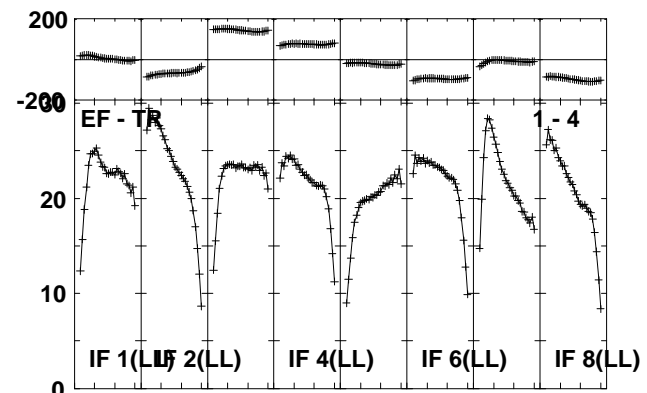
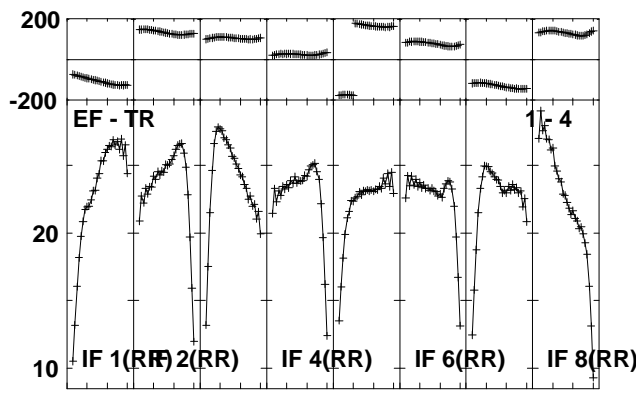
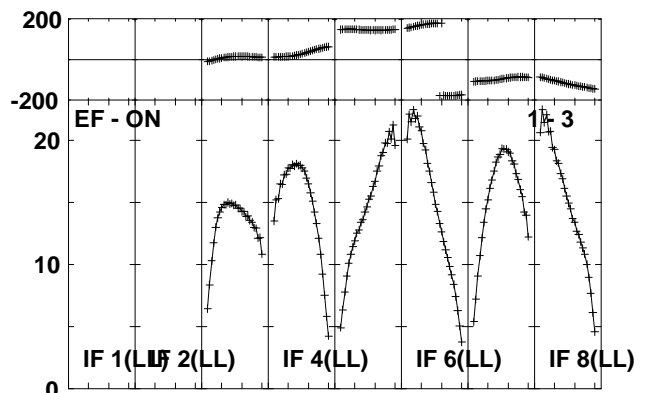
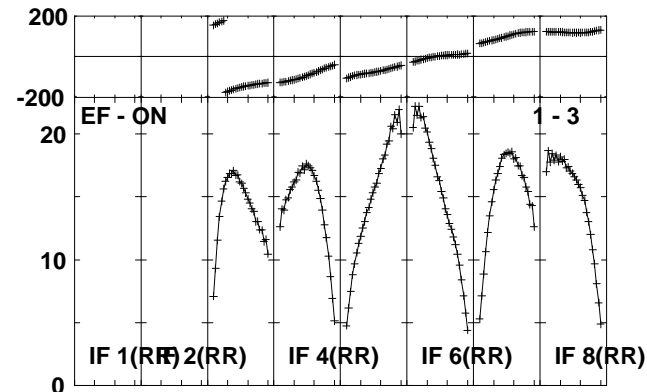
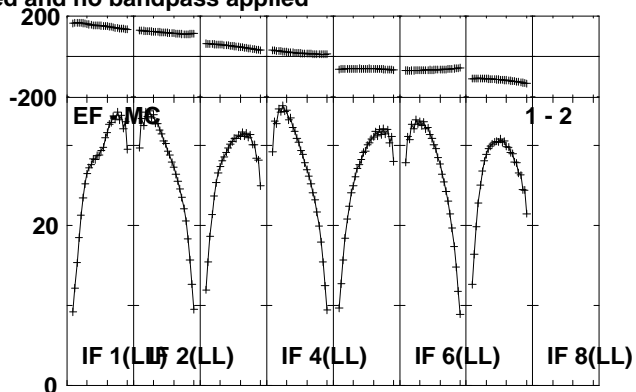
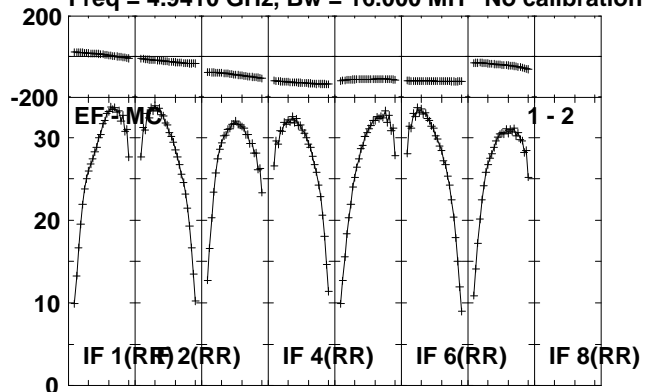

Lower frame: Milli Ampl Jy Top frame: Phas deg
 Scalar averaged cross-power spectrum Several baselines displayed
 Timerange: 00/18:11:01 to 00/18:29:59

Plot file version 226 created 04-OCT-2010 10:18:31

3C286 RP016A.UVDATA.1

Freq = 4.9410 GHz, Bw = 16.000 MH No calibration applied and no bandpass applied

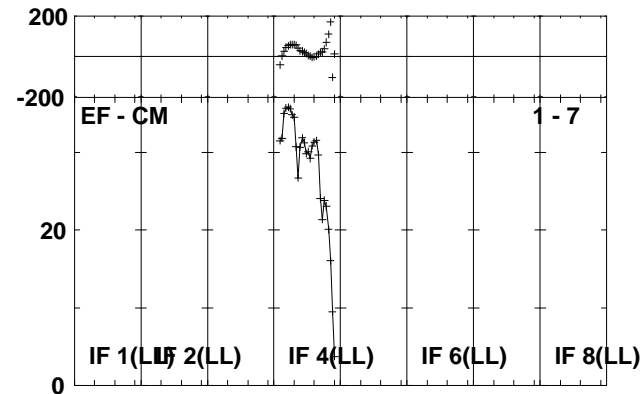
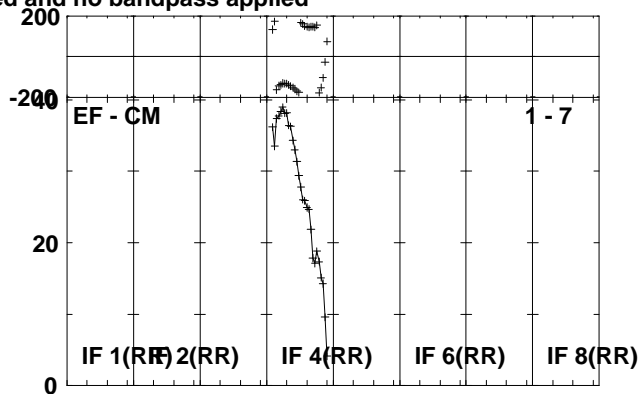
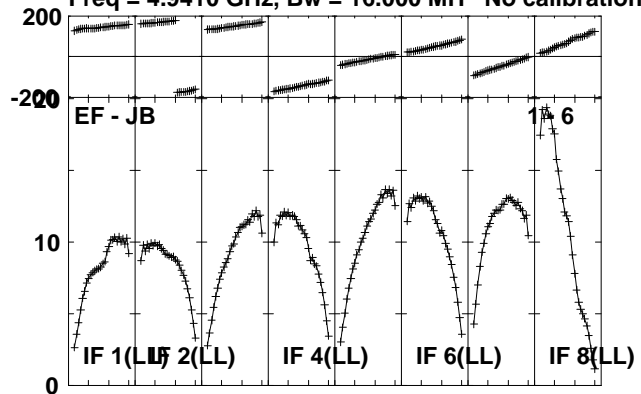

Lower frame: Milli Ampl Jy Top frame: Phas deg
Scalar averaged cross-power spectrum Several baselines displayed
Timerange: 00/18:11:01 to 00/18:29:59