

Plot file version 1 created 19-FEB-2019 18:12:47

J2253+1608 RP028B.UVDATA.1

Freq = 4.7990 GHz, Bw = 32.000 MH No calibration applied and no bandpass applied

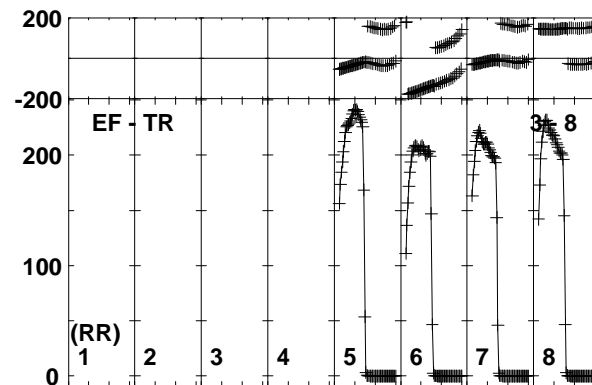
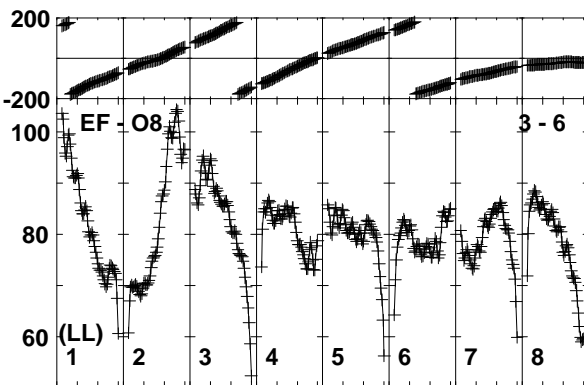
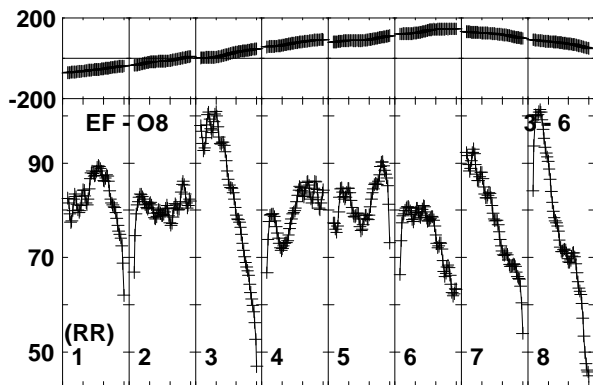
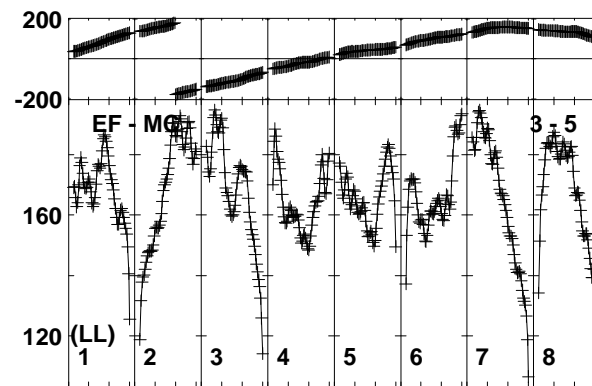
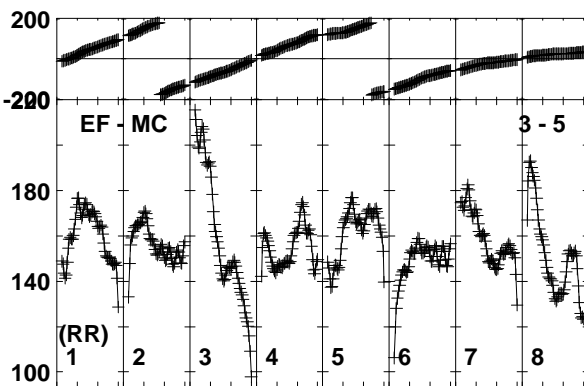
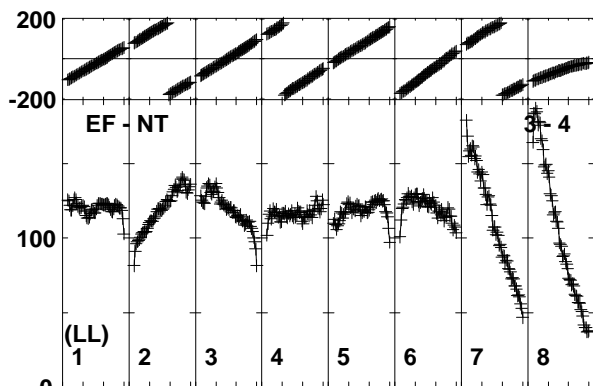
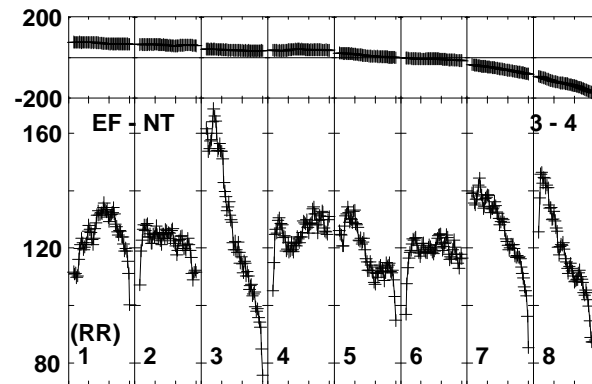
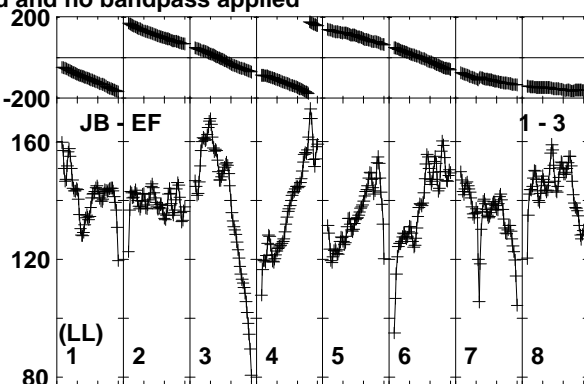
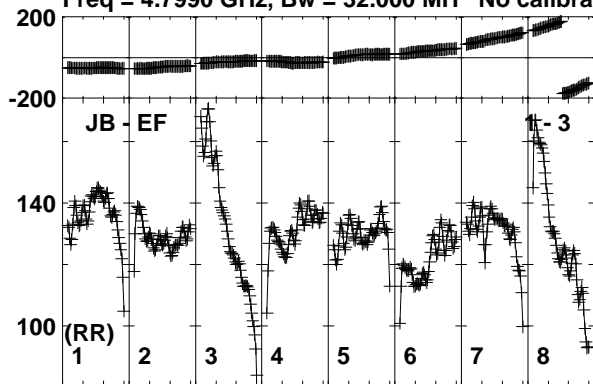

Lower frame: Milli Ampl Jy Top frame: Phas deg
Vector averaged cross-power spectrum Baseline: JB (01) - EF (03)
Timerange: 00/08:20:19 to 00/08:24:59

Plot file version 2 created 19-FEB-2019 18:12:47

J2253+1608 RP028B.UVDATA.1

Freq = 4.7990 GHz, Bw = 32.000 MH No calibration applied and no bandpass applied

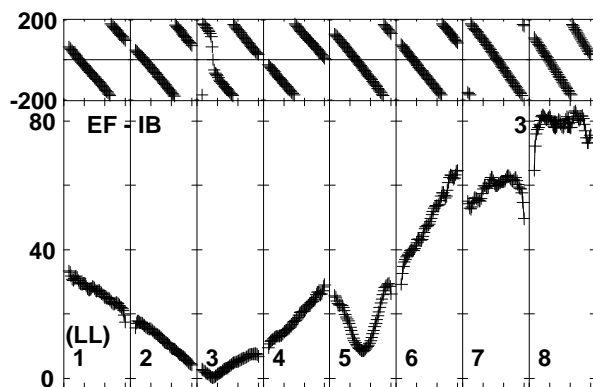
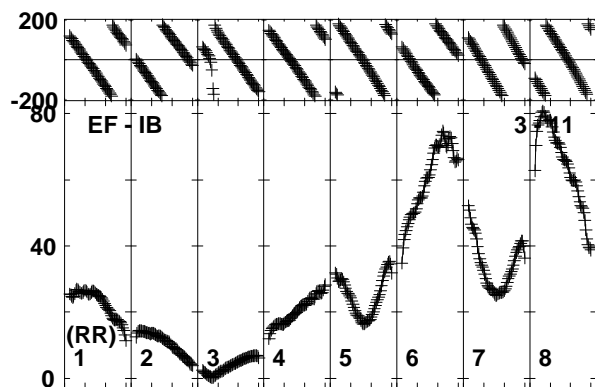
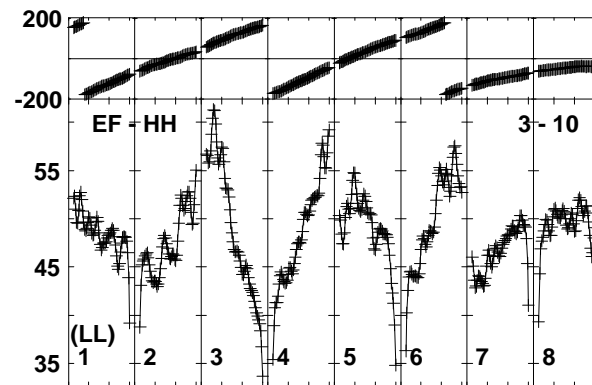
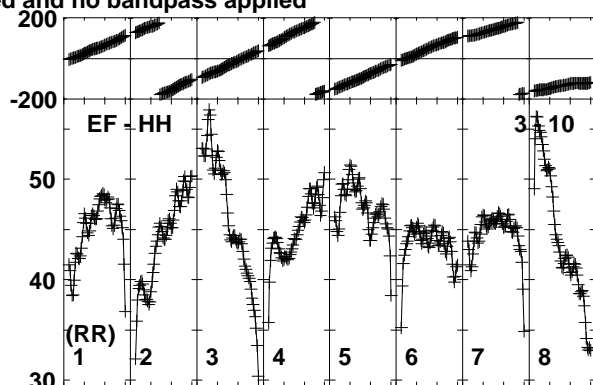
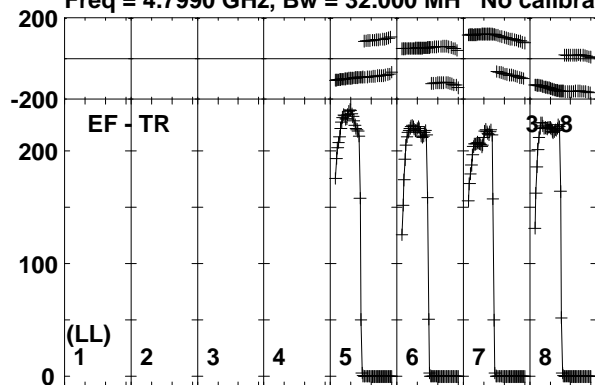

Lower frame: Milli Ampl Jy Top frame: Phas deg
Vector averaged cross-power spectrum Baseline: EF (03) - TR (08)
Timerange: 00/08:20:19 to 00/08:24:59

Plot file version 3 created 19-FEB-2019 18:12:48
 J2353+5518 RP028B.UVDATA.1
 Freq = 4.7990 GHz, Bw = 32.000 MH No calibration applied and no bandpass applied

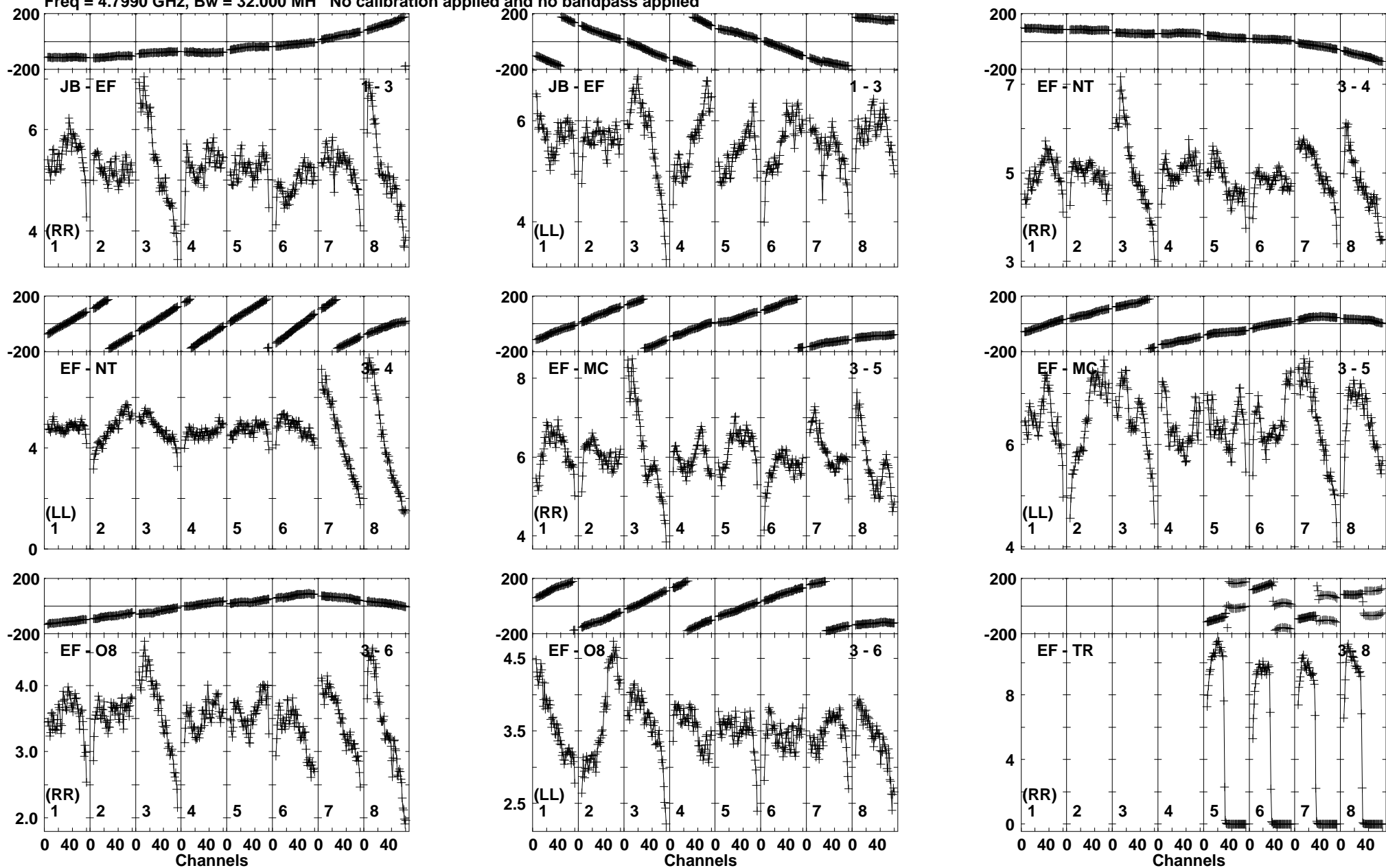

Lower frame: Milli Ampl Jy Top frame: Phas deg
 Vector averaged cross-power spectrum Baseline: JB (01) - EF (03)
 Timerange: 00:08:35:04 to 00:08:36:00

Plot file version 4 created 19-FEB-2019 18:12:48

J2353+5518 RP028B.UVDATA.1

Freq = 4.7990 GHz, Bw = 32.000 MH No calibration applied and no bandpass applied

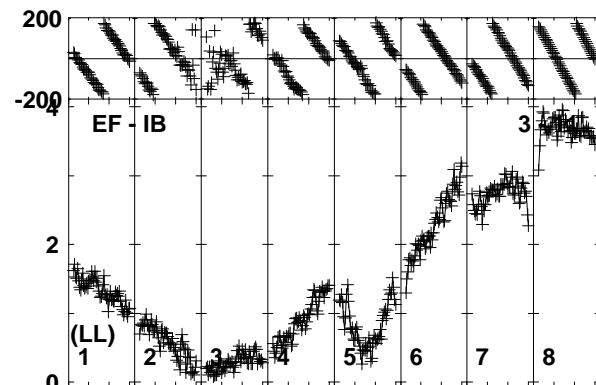
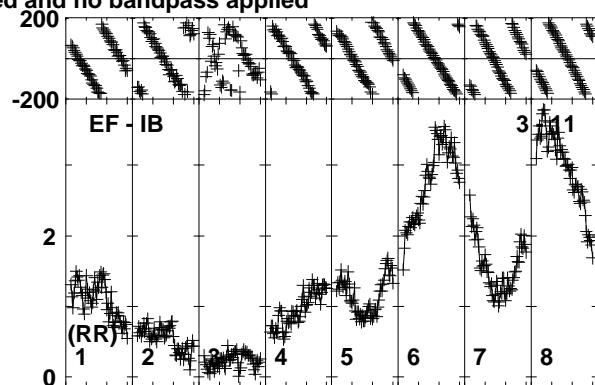
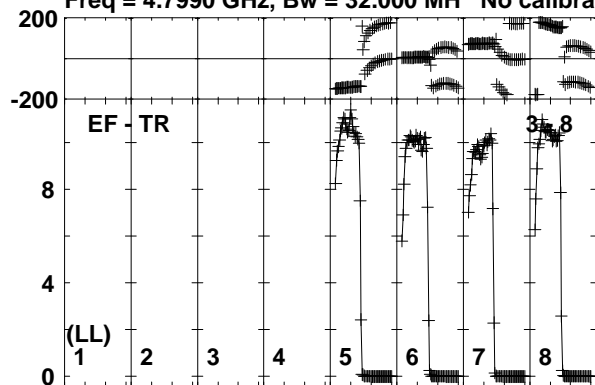

Lower frame: Milli Ampl Jy Top frame: Phas deg
Vector averaged cross-power spectrum Baseline: EF (03) - TR (08)
Timerange: 00/08:35:04 to 00/08:36:00

Plot file version 5 created 19-FEB-2019 18:12:48

IRAS23436 RP028B.UVDATA.1

Freq = 4.7990 GHz, Bw = 32.000 MH No calibration applied and no bandpass applied

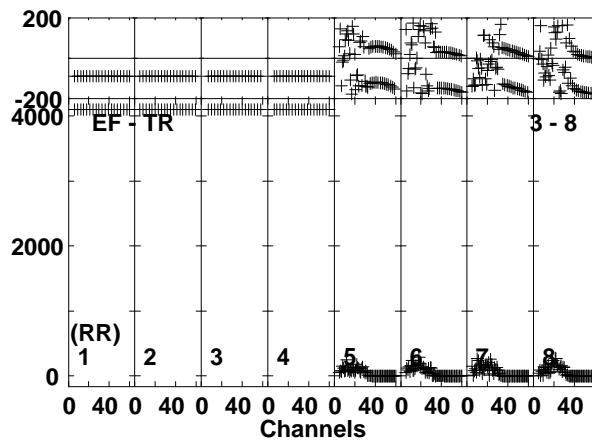
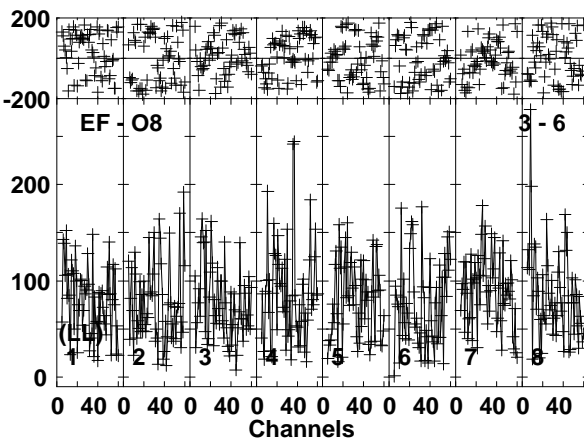
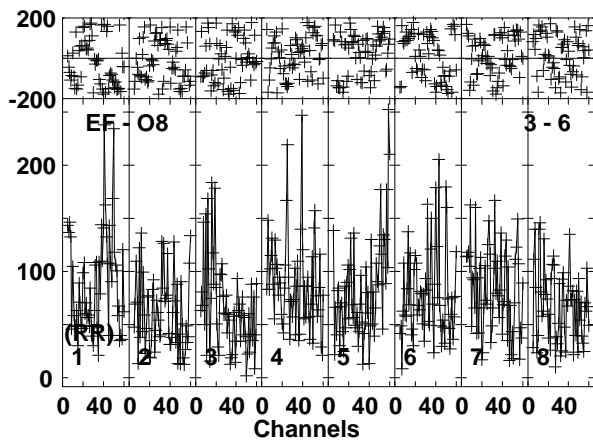
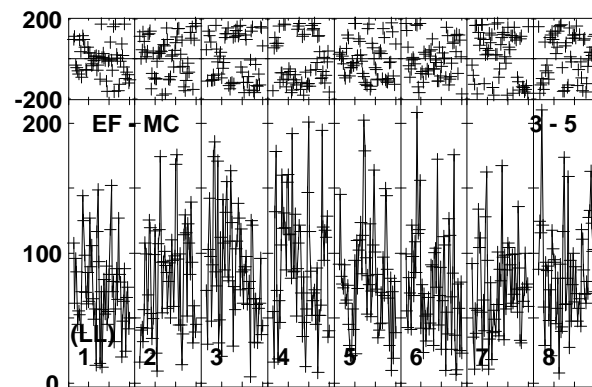
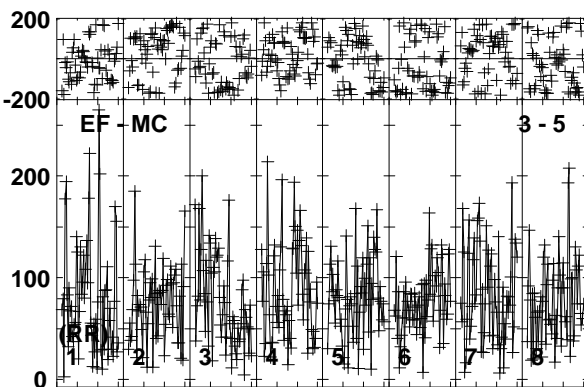
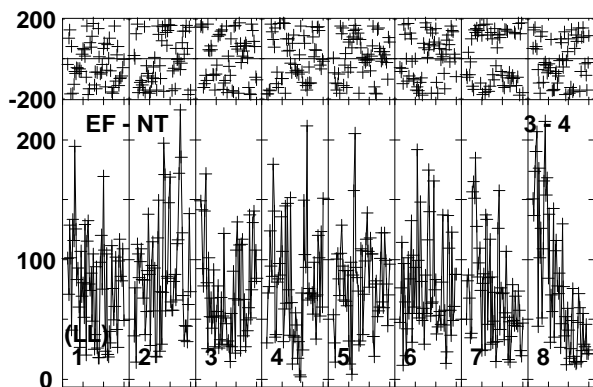
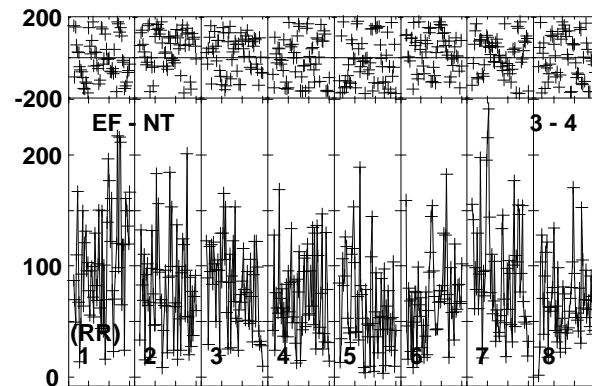
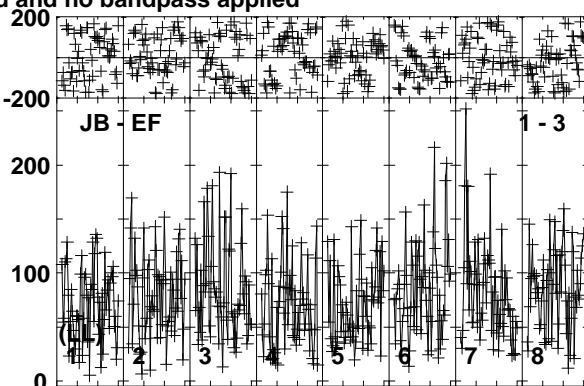
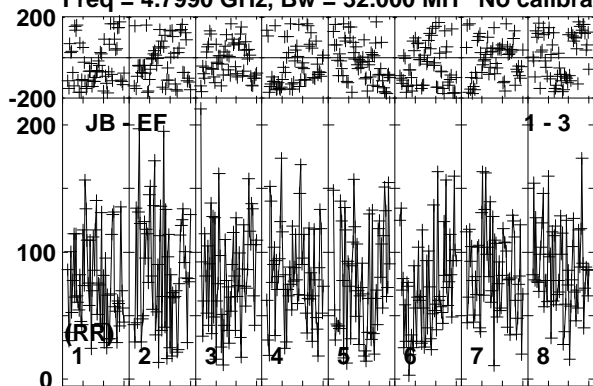

Lower frame: Micro Ampl Jy Top frame: Phas deg
Vector averaged cross-power spectrum Baseline: JB (01) - EF (03)
Timerange: 00/08:36:01 to 00/08:39:43

Plot file version 6 created 19-FEB-2019 18:12:48

IRAS23436 RP028B.UVDATA.1

Freq = 4.7990 GHz, Bw = 32.000 MH No calibration applied and no bandpass applied

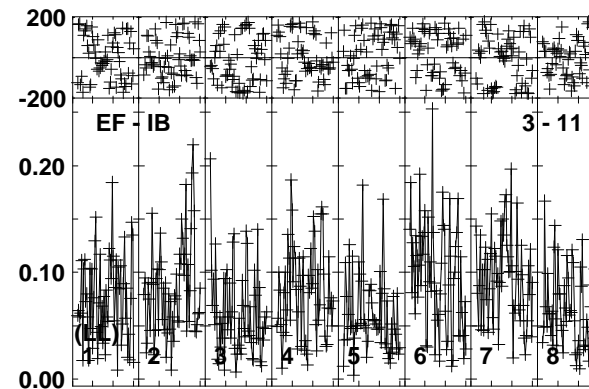
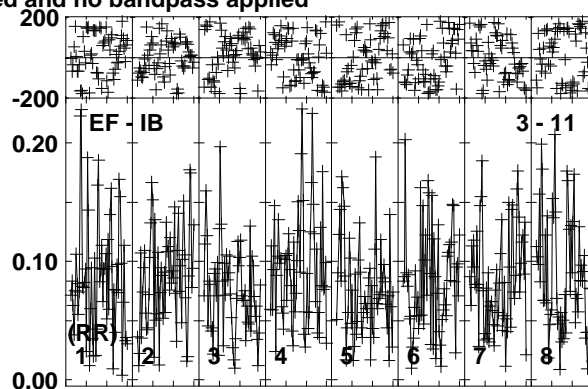
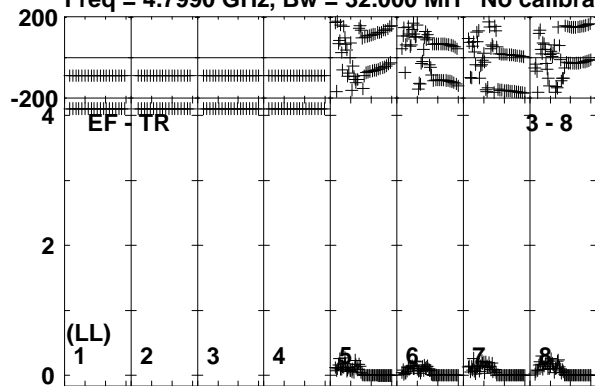

Lower frame: Milli Ampl Jy Top frame: Phas deg
Vector averaged cross-power spectrum Baseline: EF (03) - TR (08)
Timerange: 00/08:36:01 to 00/08:39:43

Plot file version 7 created 19-FEB-2019 18:12:48

J2353+5518 RP028B.UVDATA.1

Freq = 4.7990 GHz, Bw = 32.000 MH No calibration applied and no bandpass applied

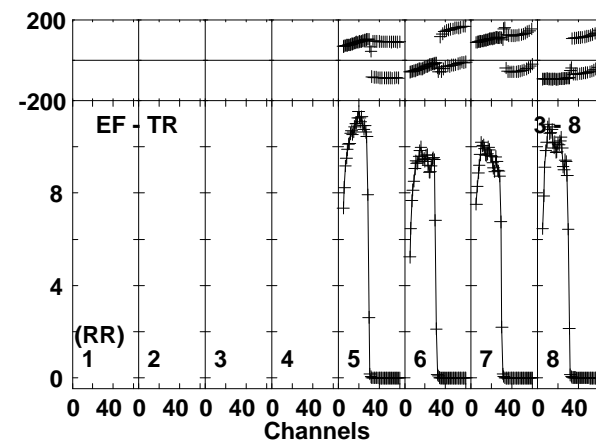
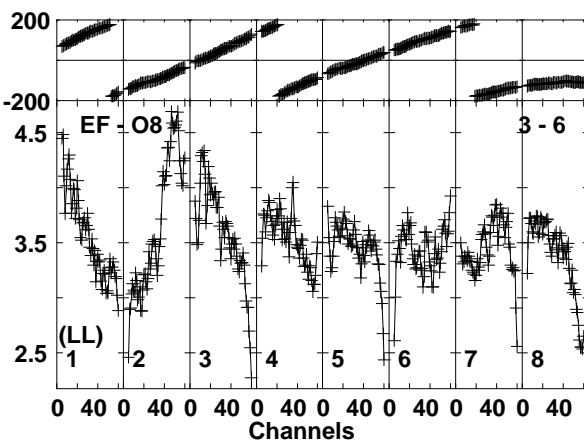
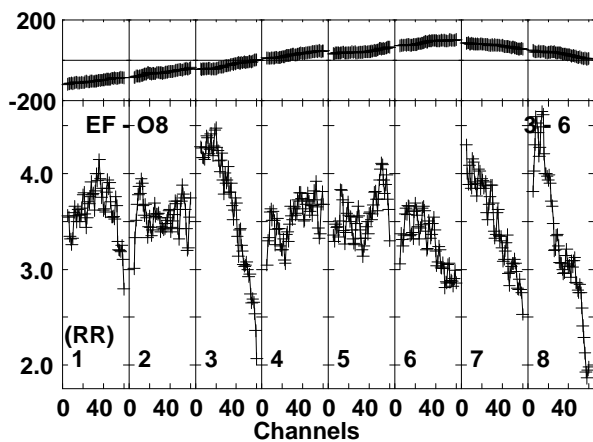
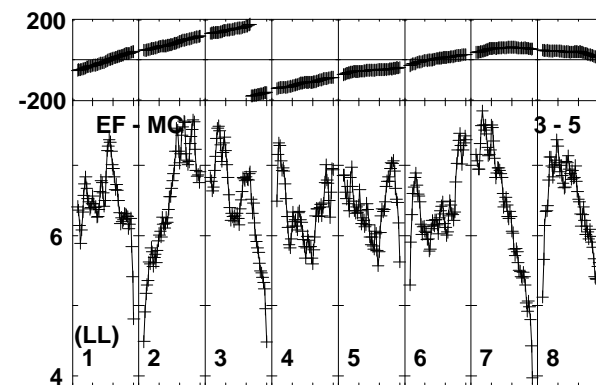
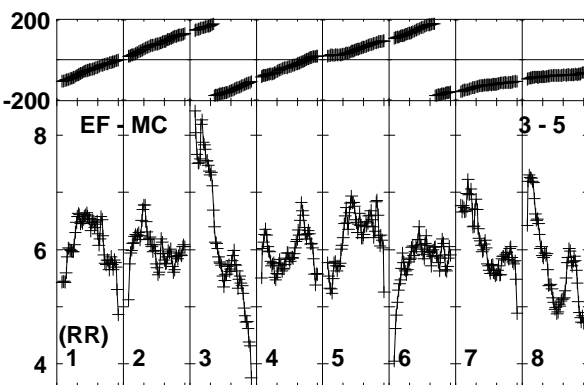
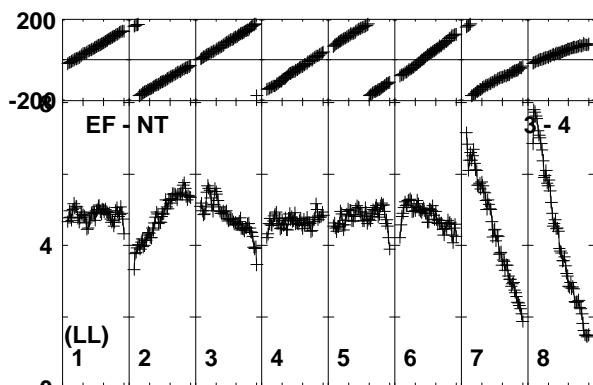
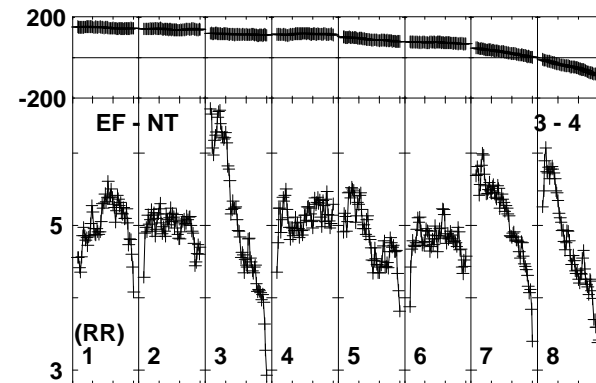
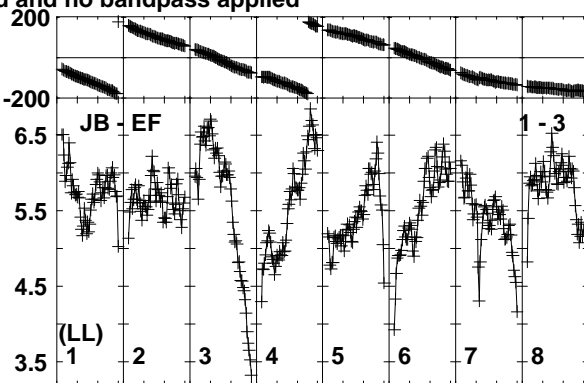
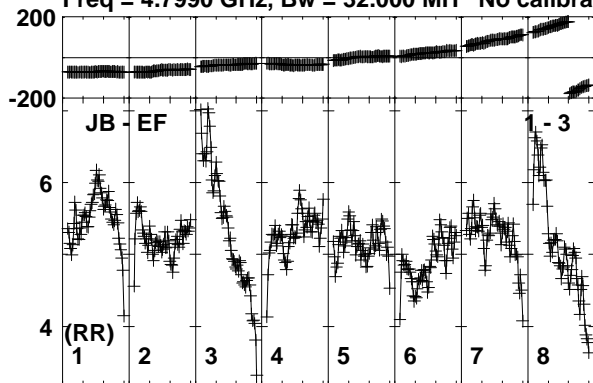

Lower frame: Milli Ampl Jy Top frame: Phas deg
Vector averaged cross-power spectrum Baseline: JB (01) - EF (03)
Timerange: 00/08:40:25 to 00/08:41:24

Plot file version 8 created 19-FEB-2019 18:12:49

J2353+5518 RP028B.UVDATA.1

Freq = 4.7990 GHz, Bw = 32.000 MH No calibration applied and no bandpass applied

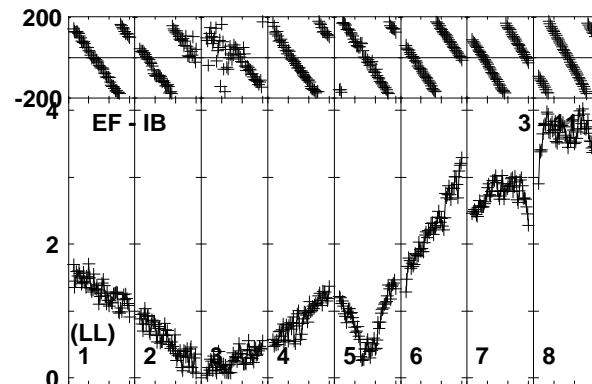
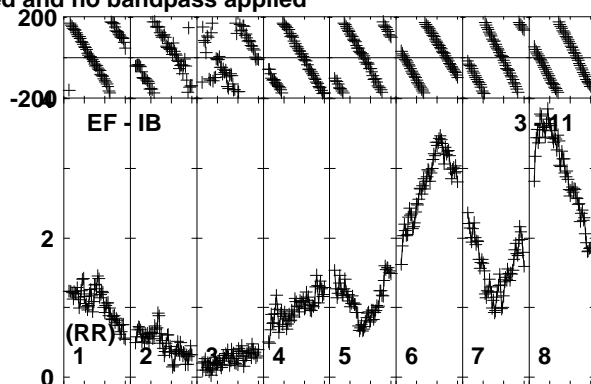
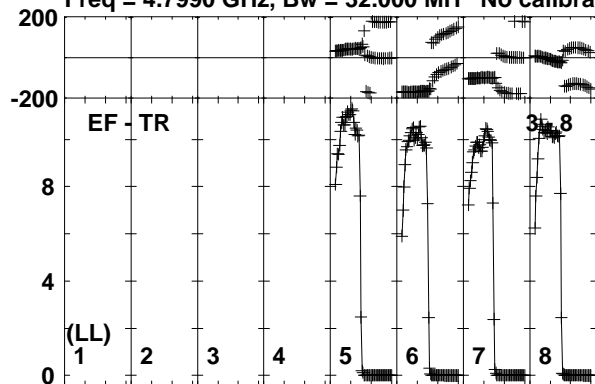

Lower frame: Milli Ampl Jy Top frame: Phas deg
Vector averaged cross-power spectrum Baseline: EF (03) - TR (08)
Timerange: 00/08:40:25 to 00/08:41:24

Plot file version 9 created 19-FEB-2019 18:12:49

IRAS23436 RP028B.UVDATA.1

Freq = 4.7990 GHz, Bw = 32.000 MH No calibration applied and no bandpass applied

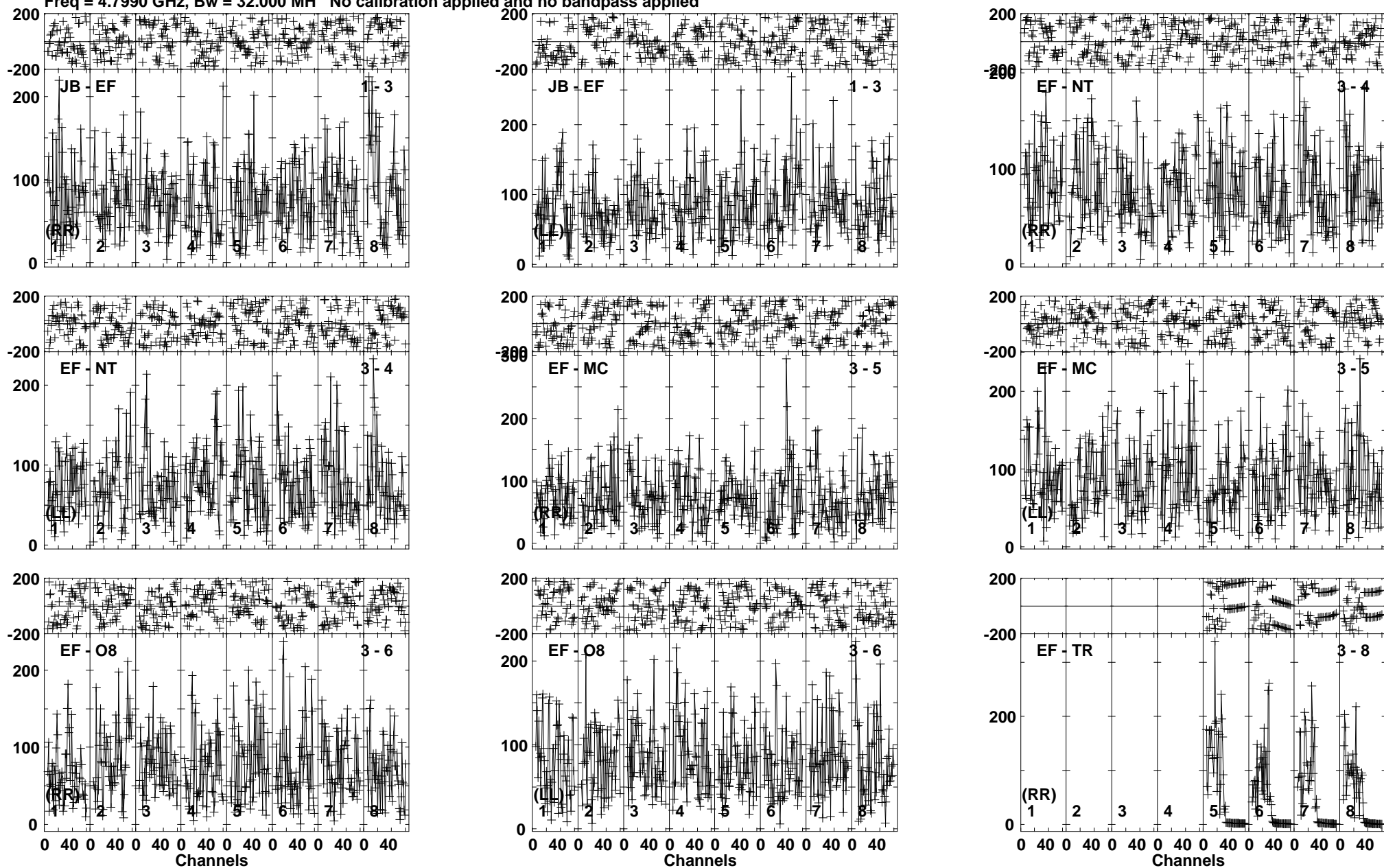

Lower frame: Micro Ampl Jy Top frame: Phas deg
Vector averaged cross-power spectrum Baseline: JB (01) - EF (03)
Timerange: 00/08:41:24 to 00/08:45:04

Plot file version 10 created 19-FEB-2019 18:12:49

IRAS23436 RP028B.UVDATA.1

Freq = 4.7990 GHz, Bw = 32.000 MH No calibration applied and no bandpass applied

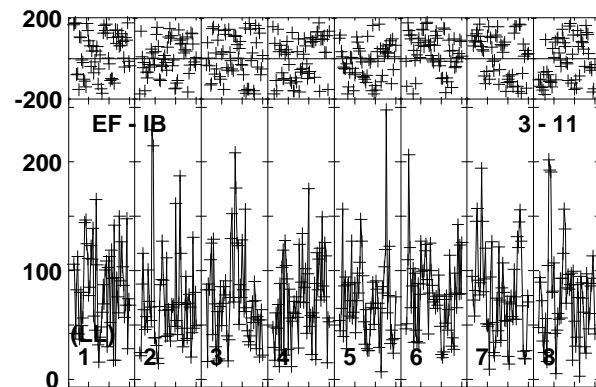
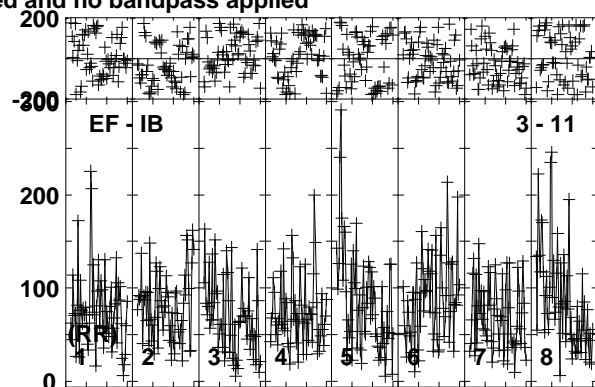
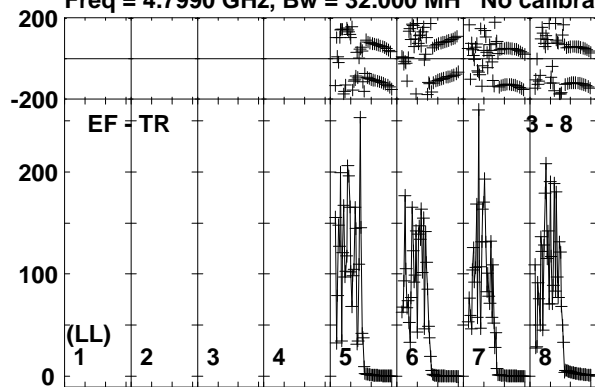

Lower frame: Micro Ampl Jy Top frame: Phas deg
Vector averaged cross-power spectrum Baseline: EF (03) - TR (08)
Timerange: 00/08:41:24 to 00/08:45:04

Plot file version 11 created 19-FEB-2019 18:12:49

J2353+5518 RP028B.UVDATA.1

Freq = 4.7990 GHz, Bw = 32.000 MH No calibration applied and no bandpass applied

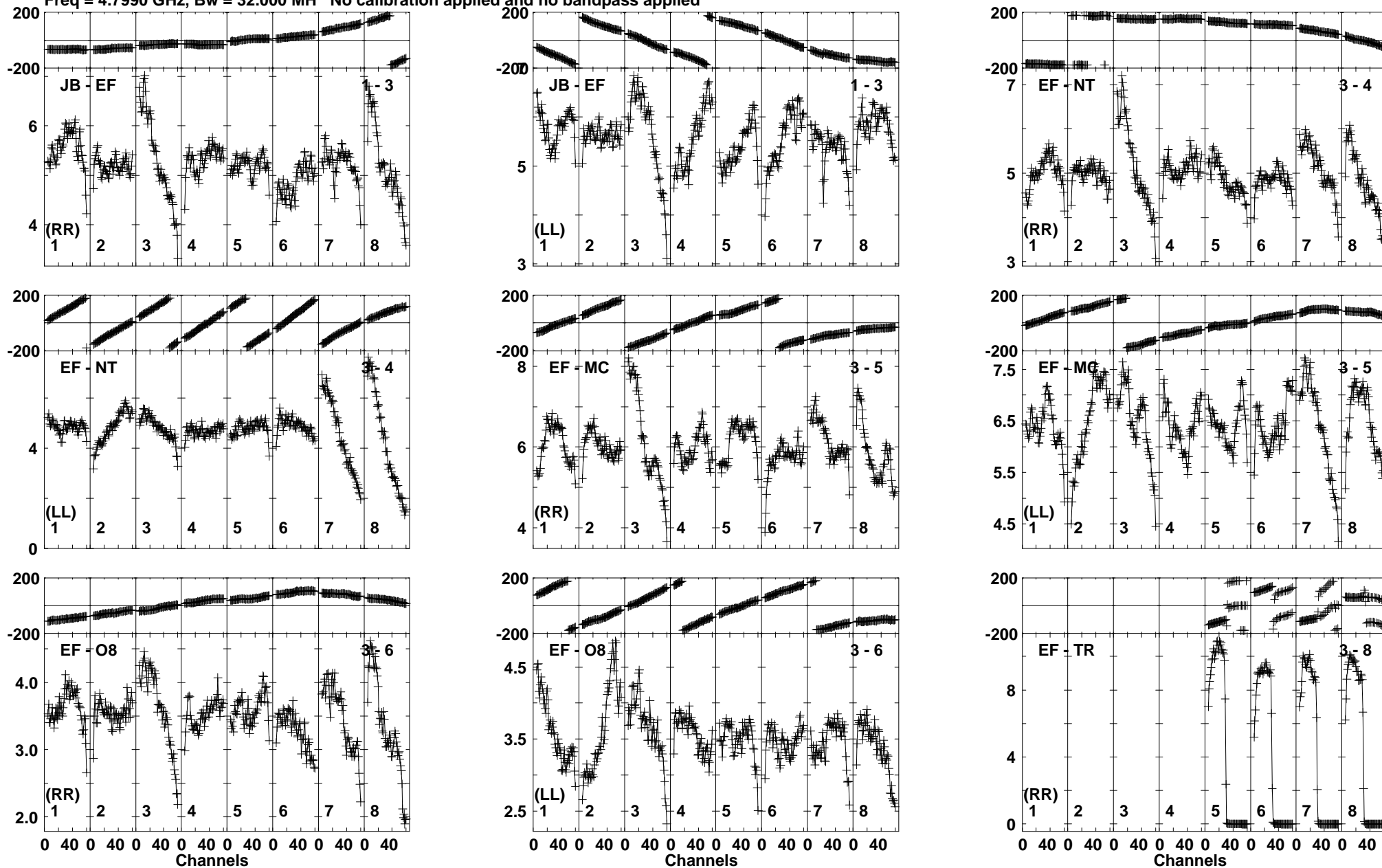

Lower frame: Milli Ampl Jy Top frame: Phas deg
Vector averaged cross-power spectrum Baseline: JB (01) - EF (03)
Timerange: 00/08:45:04 to 00/08:46:34

Plot file version 12 created 19-FEB-2019 18:12:50

J2353+5518 RP028B.UVDATA.1

Freq = 4.7990 GHz, Bw = 32.000 MH No calibration applied and no bandpass applied

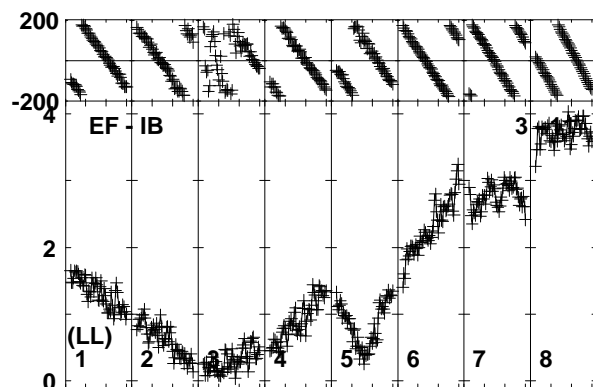
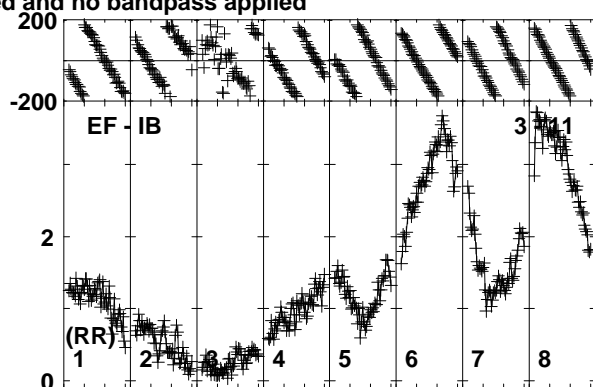
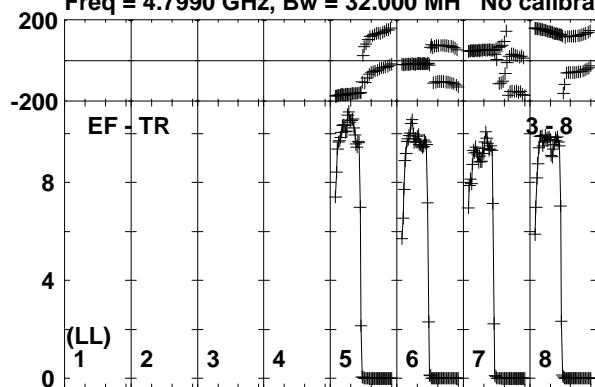

Lower frame: Milli Ampl Jy Top frame: Phas deg
Vector averaged cross-power spectrum Baseline: EF (03) - TR (08)
Timerange: 00/08:45:04 to 00/08:46:34

Plot file version 13 created 19-FEB-2019 18:12:50

IRAS23436 RP028B.UVDATA.1

Freq = 4.7990 GHz, Bw = 32.000 MH No calibration applied and no bandpass applied

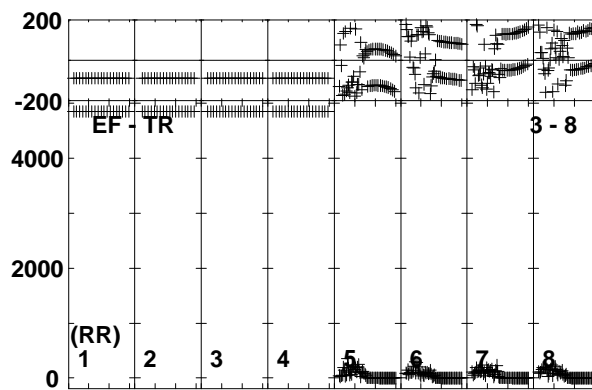
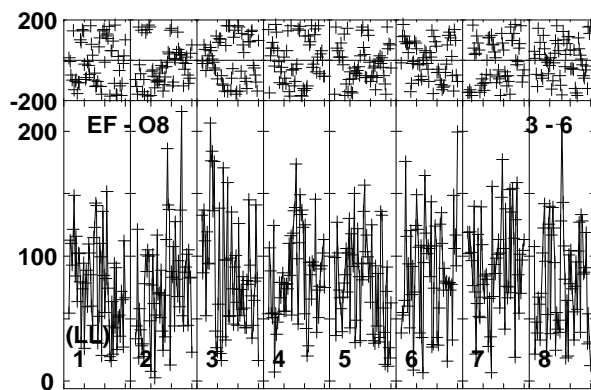
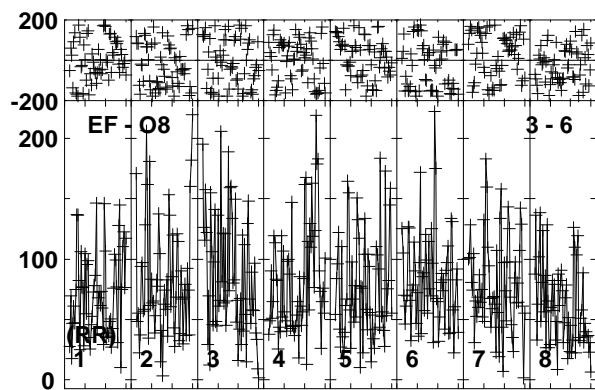
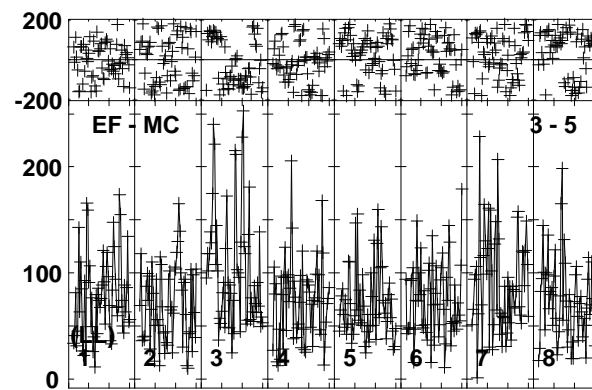
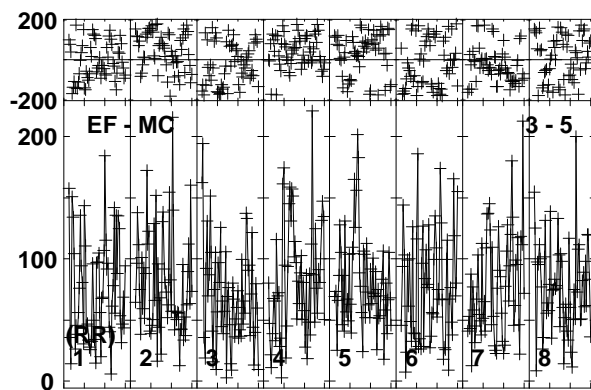
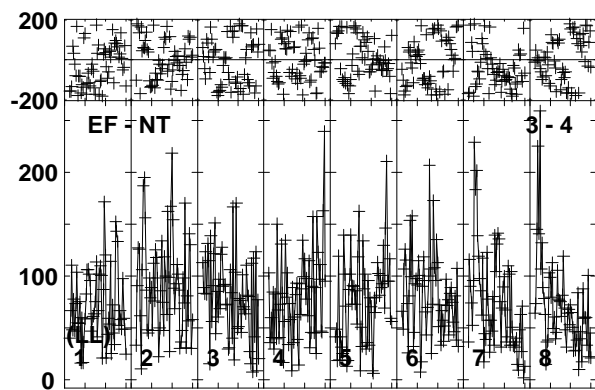
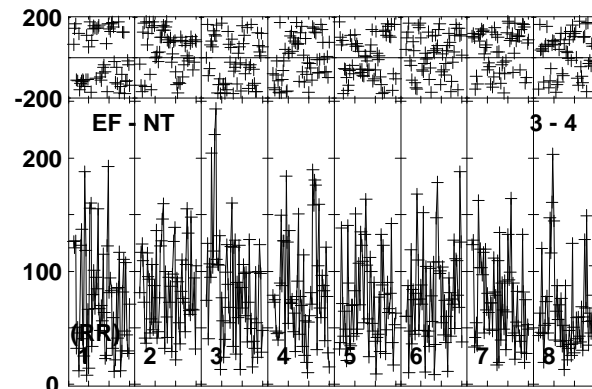
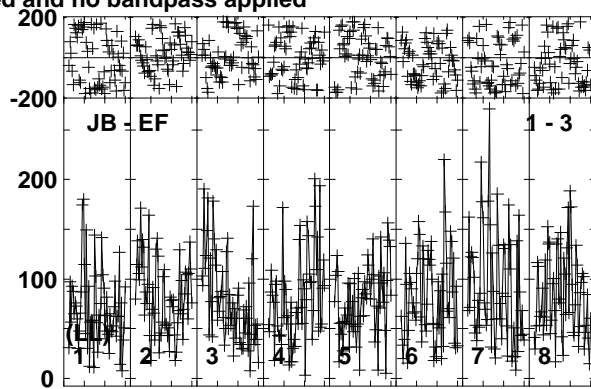
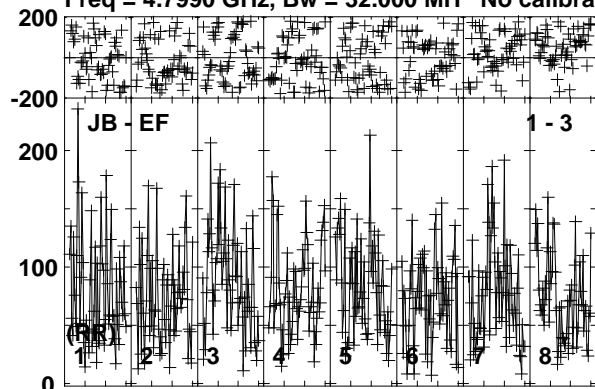

Lower frame: Micro Ampl Jy Top frame: Phas deg
Vector averaged cross-power spectrum Baseline: JB (01) - EF (03)
Timerange: 00/08:46:34 to 00/08:50:17

Plot file version 14 created 19-FEB-2019 18:12:50

IRAS23436 RP028B.UVDATA.1

Freq = 4.7990 GHz, Bw = 32.000 MH No calibration applied and no bandpass applied

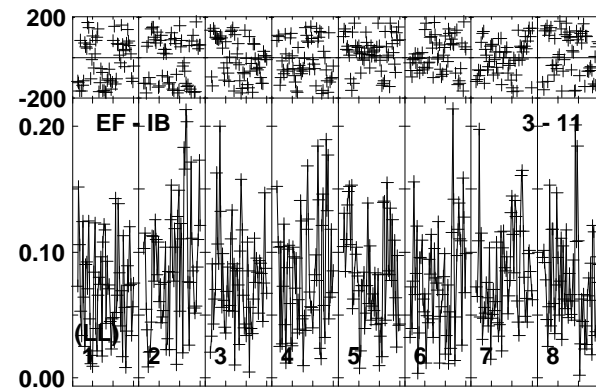
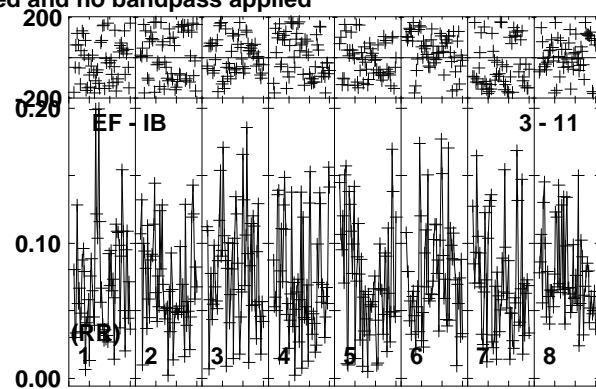
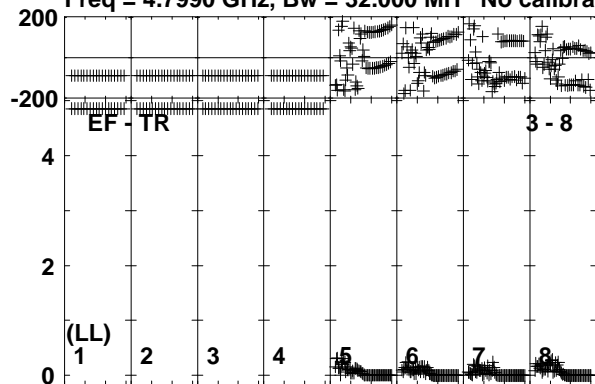

Lower frame: Milli Ampl Jy Top frame: Phas deg
Vector averaged cross-power spectrum Baseline: EF (03) - TR (08)
Timerange: 00/08:46:34 to 00/08:50:17

Plot file version 15 created 19-FEB-2019 18:12:50

J2353+5518 RP028B.UVDATA.1

Freq = 4.7990 GHz, Bw = 32.000 MH No calibration applied and no bandpass applied

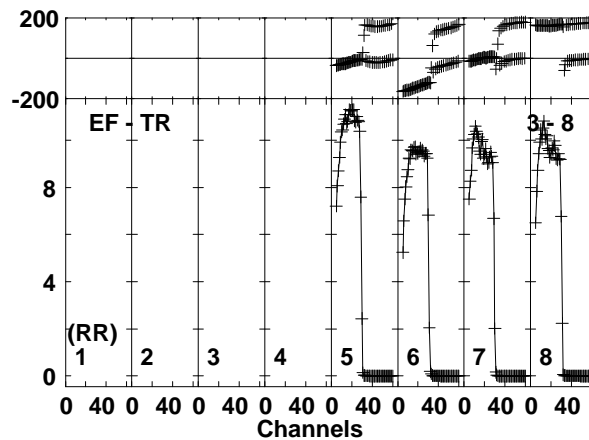
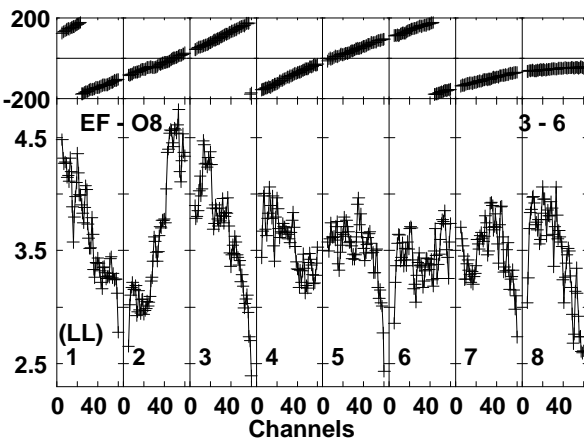
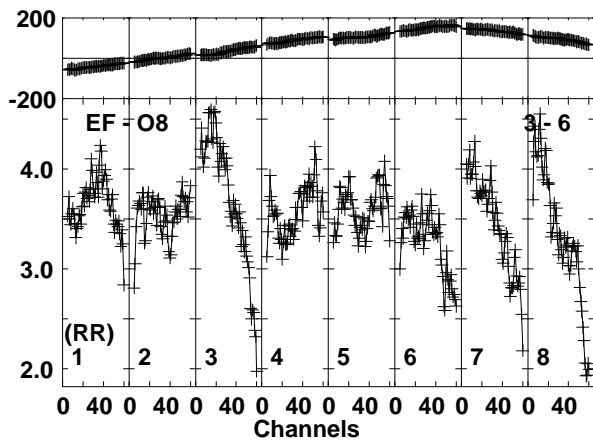
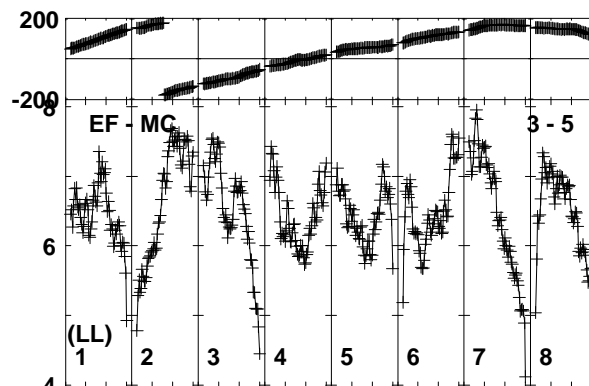
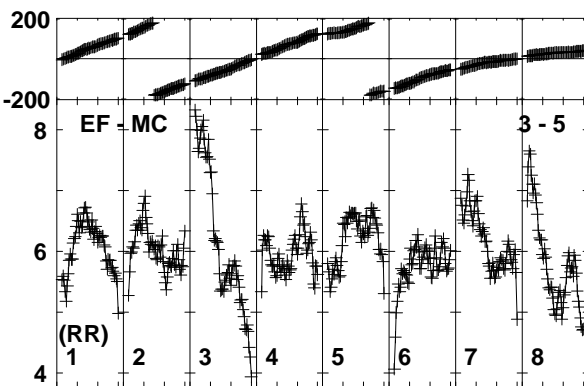
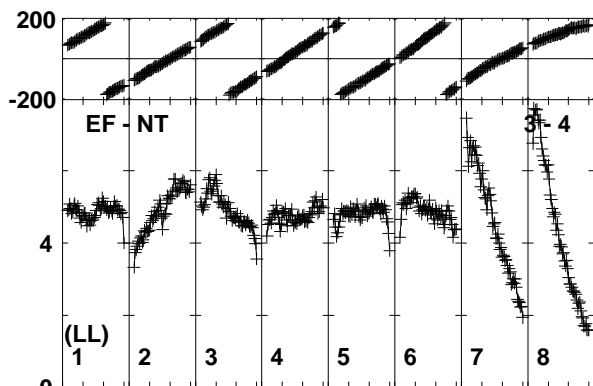
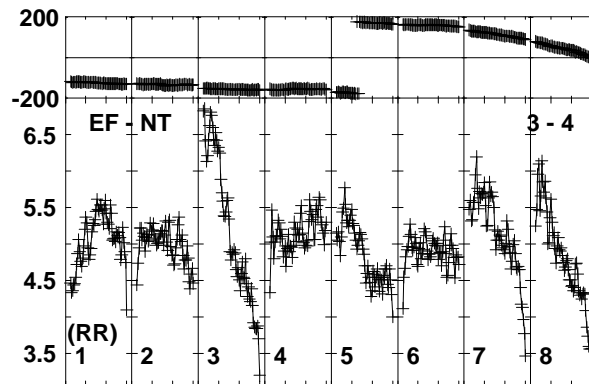
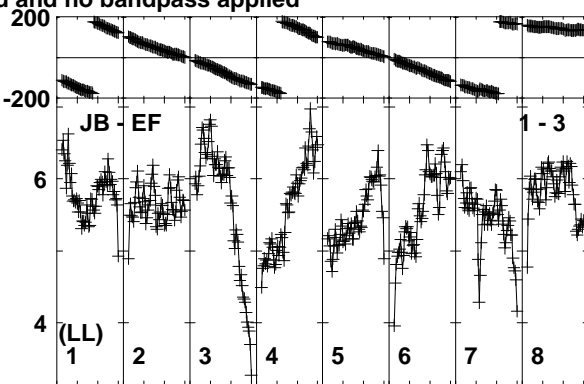
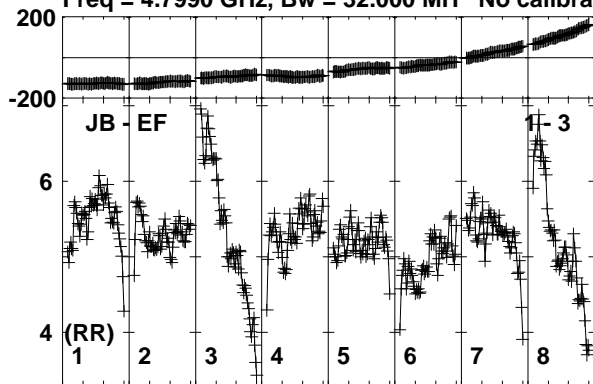

Lower frame: Milli Ampl Jy Top frame: Phas deg
Vector averaged cross-power spectrum Baseline: JB (01) - EF (03)
Timerange: 00/08:50:58 to 00/08:51:48

Plot file version 16 created 19-FEB-2019 18:12:50

J2353+5518 RP028B.UVDATA.1

Freq = 4.7990 GHz, Bw = 32.000 MH No calibration applied and no bandpass applied

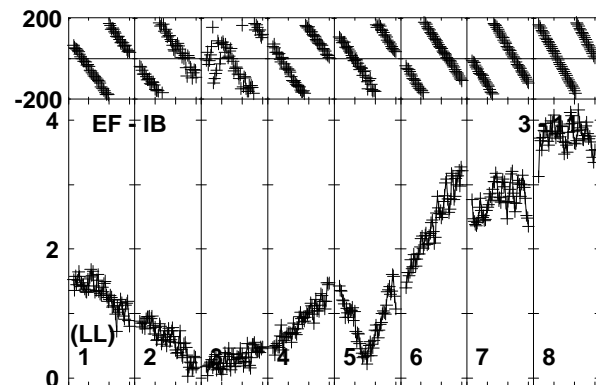
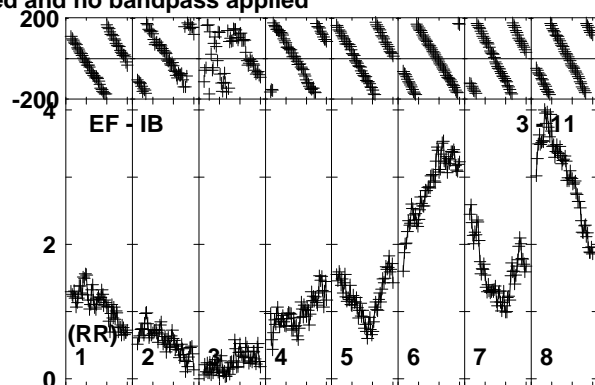
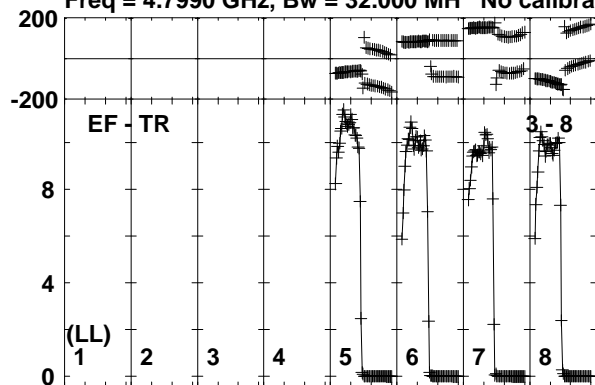

Lower frame: Milli Ampl Jy Top frame: Phas deg
Vector averaged cross-power spectrum Baseline: EF (03) - TR (08)
Timerange: 00/08:50:58 to 00/08:51:48

Plot file version 17 created 19-FEB-2019 18:12:50

IRAS23436 RP028B.UVDATA.1

Freq = 4.7990 GHz, Bw = 32.000 MH No calibration applied and no bandpass applied

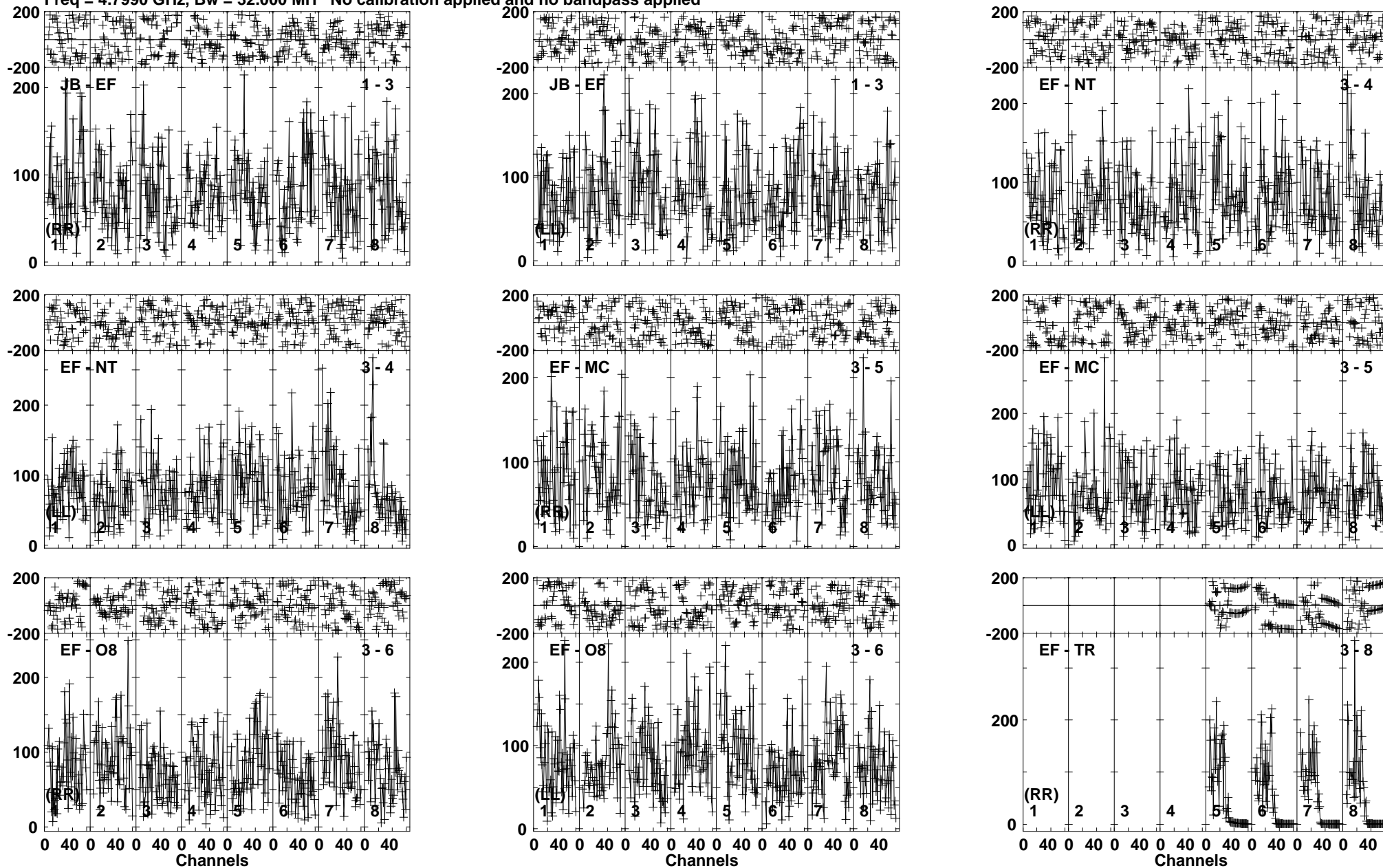

Lower frame: Micro Ampl Jy Top frame: Phas deg
Vector averaged cross-power spectrum Baseline: JB (01) - EF (03)
Timerange: 00/08:51:48 to 00/08:55:31

Plot file version 18 created 19-FEB-2019 18:12:51

IRAS23436 RP028B.UVDATA.1

Freq = 4.7990 GHz, Bw = 32.000 MH No calibration applied and no bandpass applied

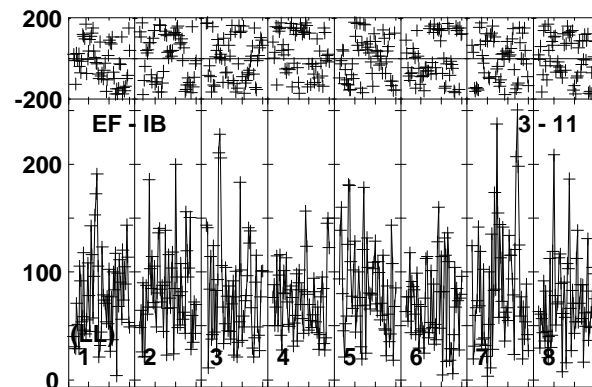
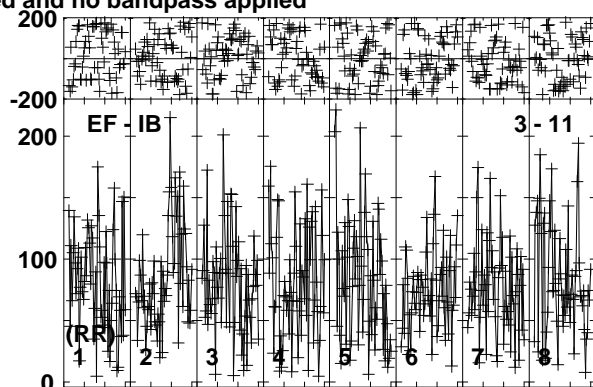
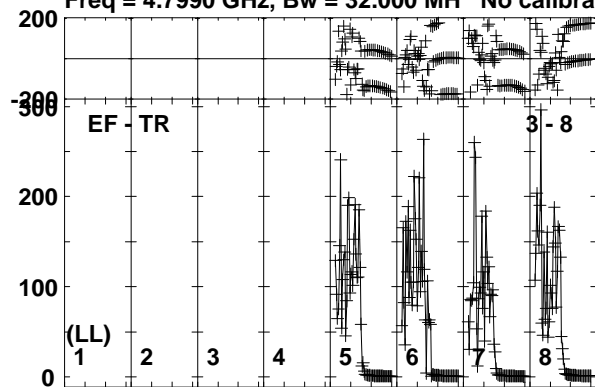

Lower frame: Micro Ampl Jy Top frame: Phas deg
Vector averaged cross-power spectrum Baseline: EF (03) - TR (08)
Timerange: 00/08:51:48 to 00/08:55:31

Plot file version 19 created 19-FEB-2019 18:12:51

J2353+5518 RP028B.UVDATA.1

Freq = 4.7990 GHz, Bw = 32.000 MH No calibration applied and no bandpass applied

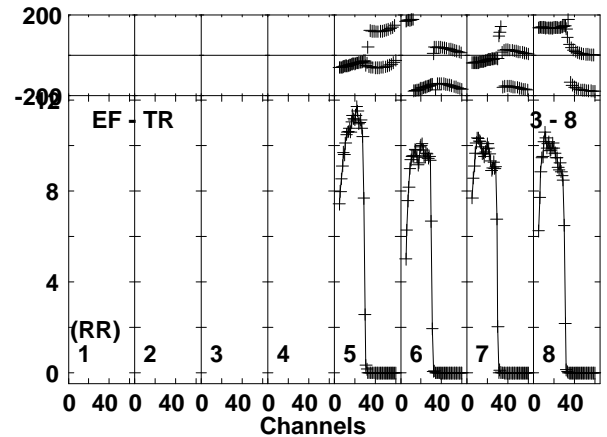
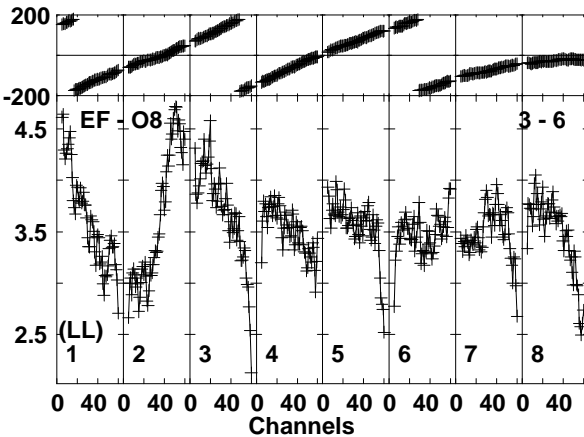
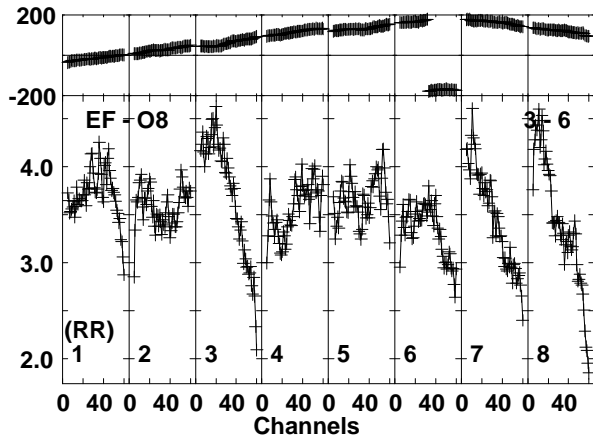
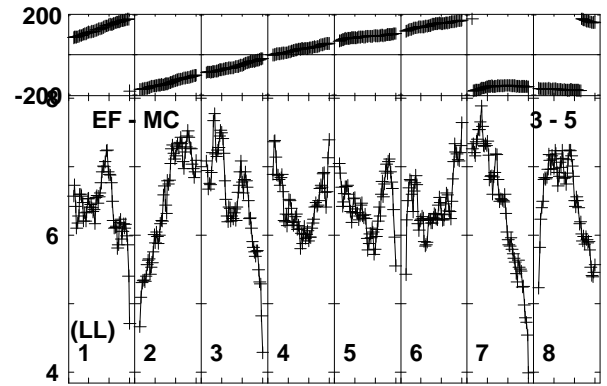
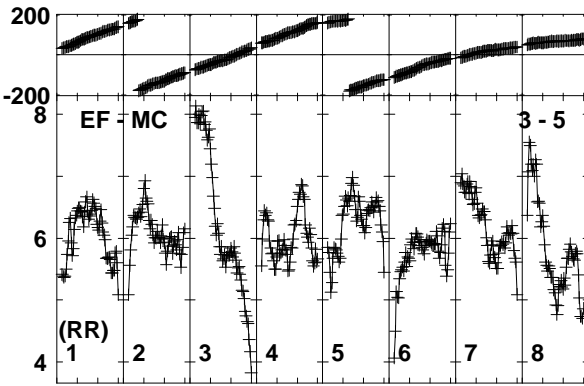
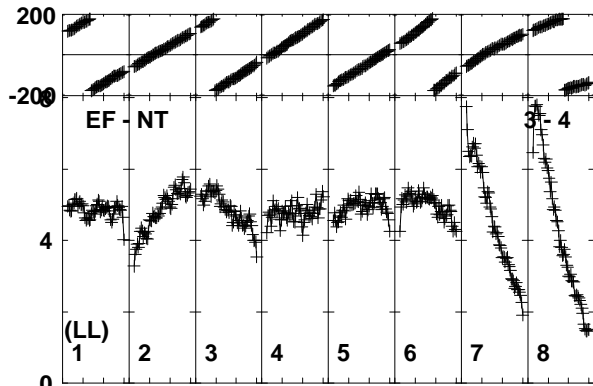
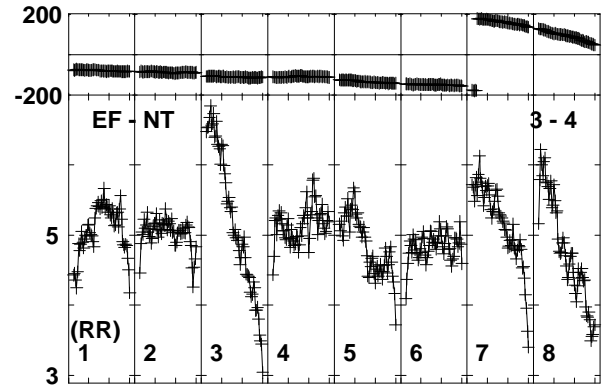
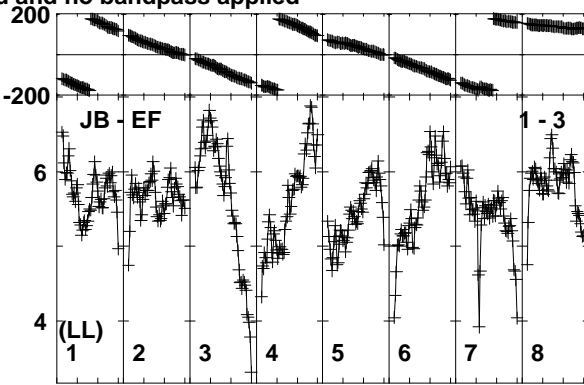
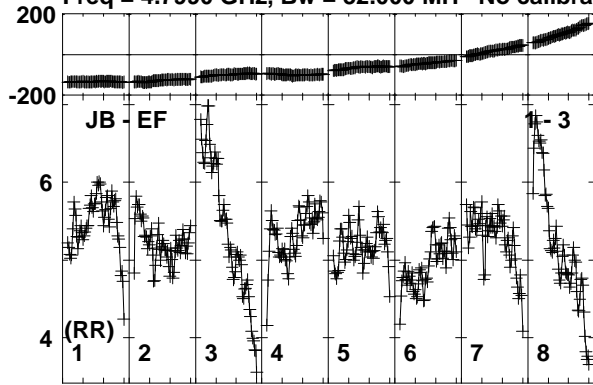

Lower frame: Milli Ampl Jy Top frame: Phas deg
Vector averaged cross-power spectrum Baseline: JB (01) - EF (03)
Timerange: 00/08:55:33 to 00/08:57:01

Plot file version 20 created 19-FEB-2019 18:12:51

J2353+5518 RP028B.UVDATA.1

Freq = 4.7990 GHz, Bw = 32.000 MH No calibration applied and no bandpass applied

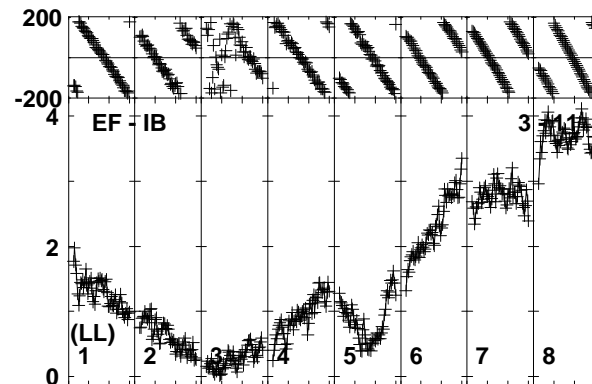
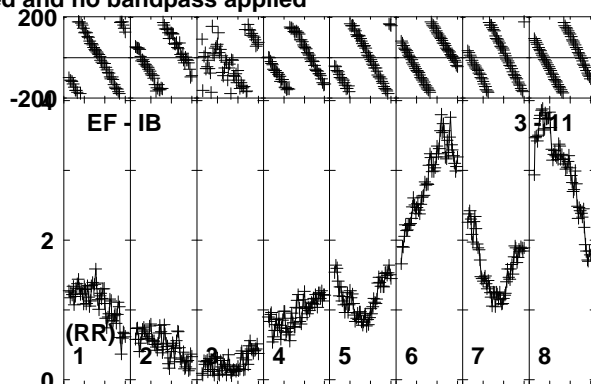
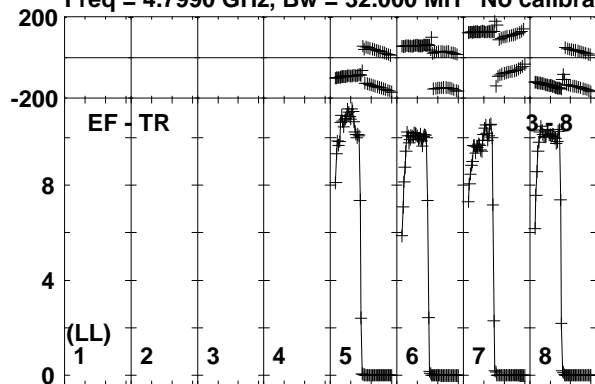

Lower frame: Milli Ampl Jy Top frame: Phas deg
Vector averaged cross-power spectrum Baseline: EF (03) - TR (08)
Timerange: 00/08:55:33 to 00/08:57:01

Plot file version 22 created 19-FEB-2019 18:12:52

IRAS23436 RP028B.UVDATA.1

Freq = 4.7990 GHz, Bw = 32.000 MH No calibration applied and no bandpass applied

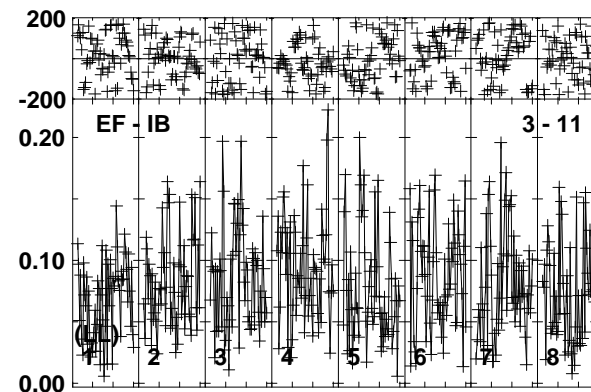
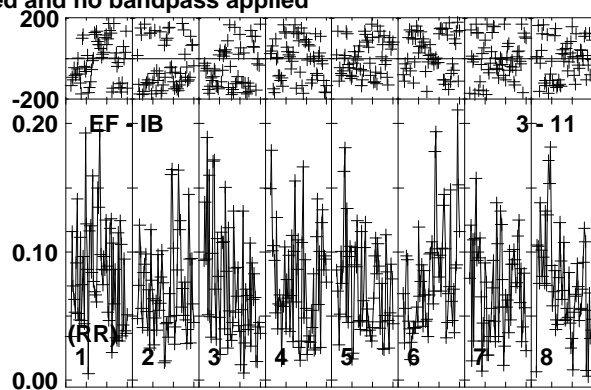
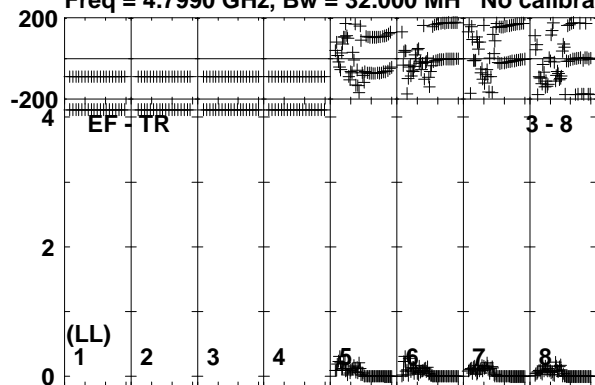

Lower frame: Milli Ampl Jy Top frame: Phas deg
Vector averaged cross-power spectrum Baseline: EF (03) - TR (08)
Timerange: 00/08:57:03 to 00/09:00:45

Plot file version 23 created 19-FEB-2019 18:12:52

J2353+5518 RP028B.UVDATA.1

Freq = 4.7990 GHz, Bw = 32.000 MH No calibration applied and no bandpass applied

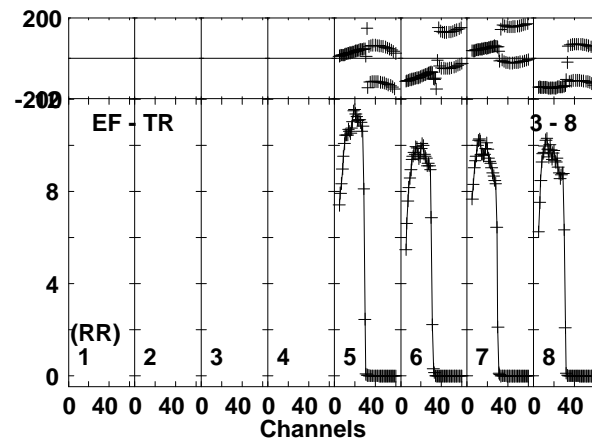
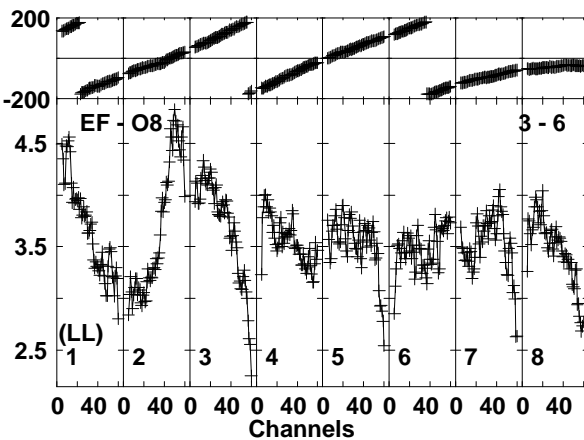
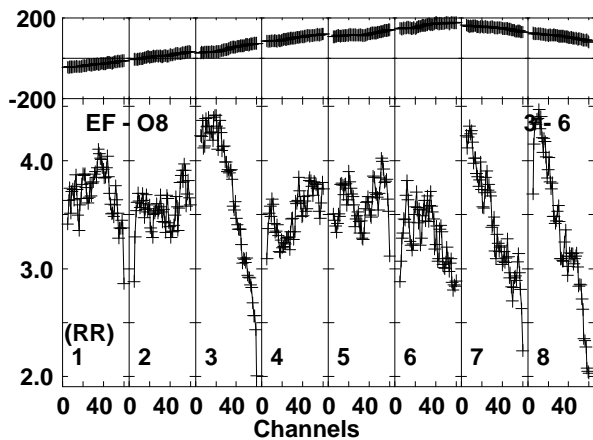
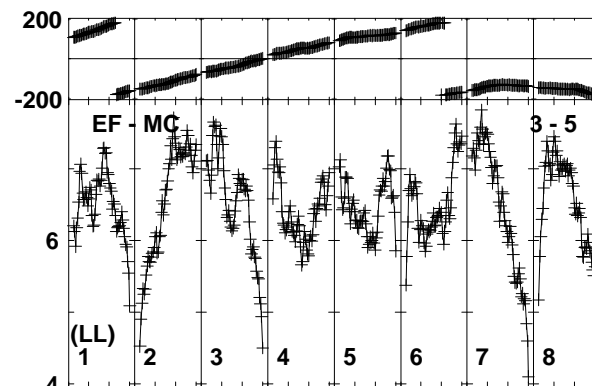
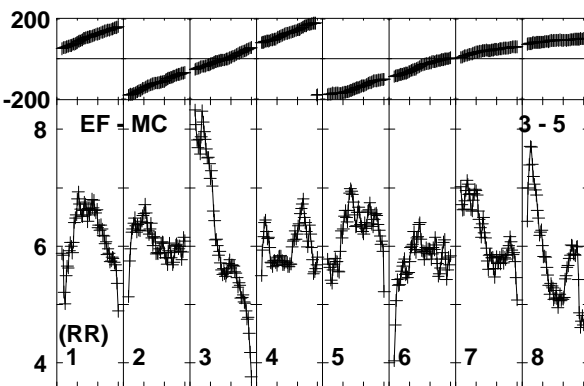
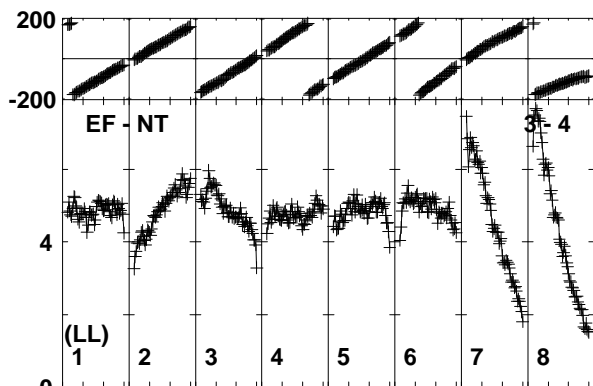
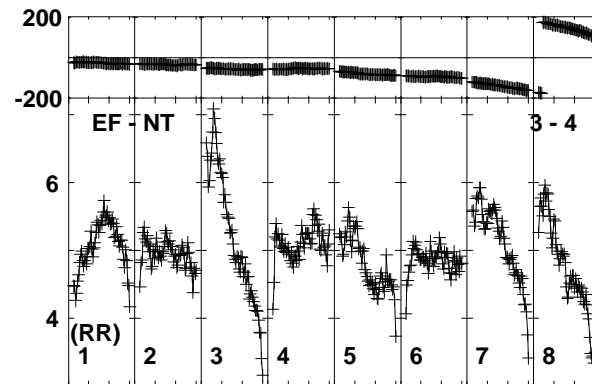
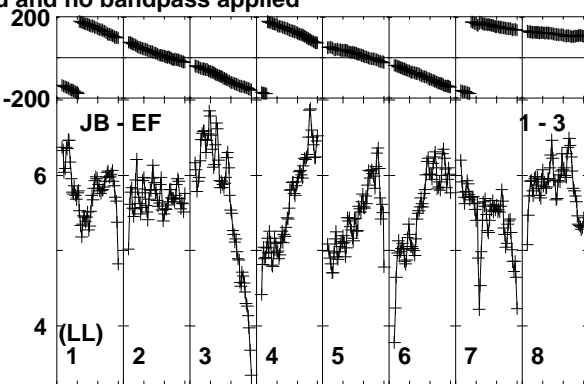
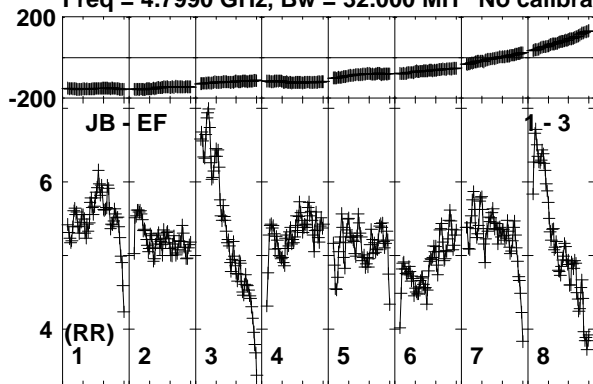

Lower frame: Milli Ampl Jy Top frame: Phas deg
Vector averaged cross-power spectrum Baseline: JB (01) - EF (03)
Timerange: 00/09:01:27 to 00/09:02:26

Plot file version 24 created 19-FEB-2019 18:12:52

J2353+5518 RP028B.UVDATA.1

Freq = 4.7990 GHz, Bw = 32.000 MH No calibration applied and no bandpass applied

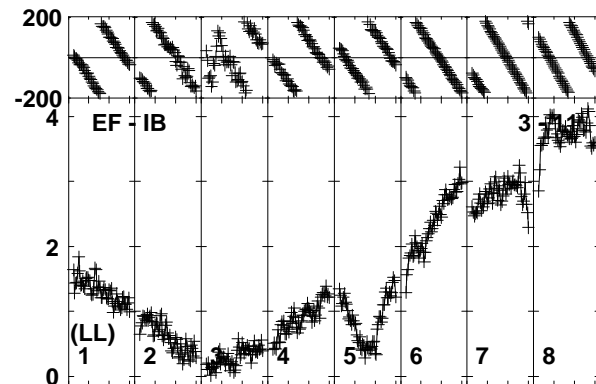
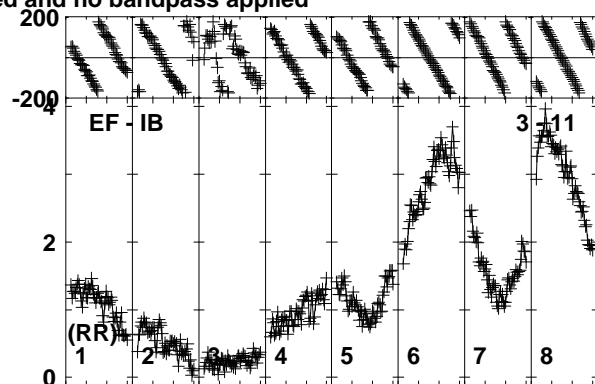
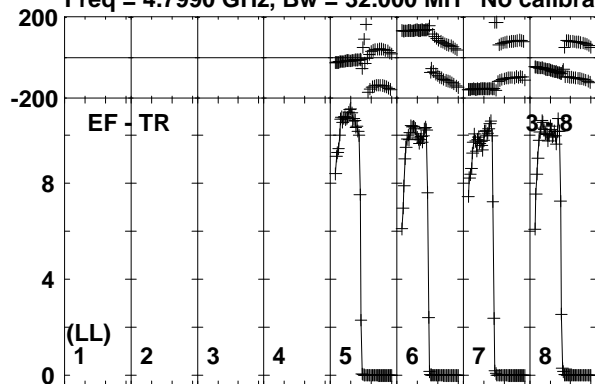

Lower frame: Milli Ampl Jy Top frame: Phas deg
Vector averaged cross-power spectrum Baseline: EF (03) - TR (08)
Timerange: 00/09:01:27 to 00/09:02:26

Plot file version 25 created 19-FEB-2019 18:12:52

IRAS23436 RP028B.UVDATA.1

Freq = 4.7990 GHz, Bw = 32.000 MH No calibration applied and no bandpass applied

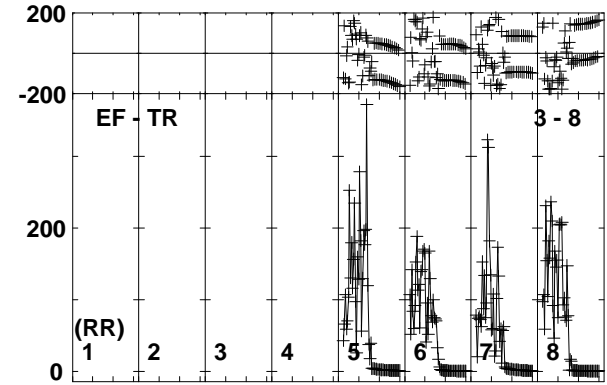
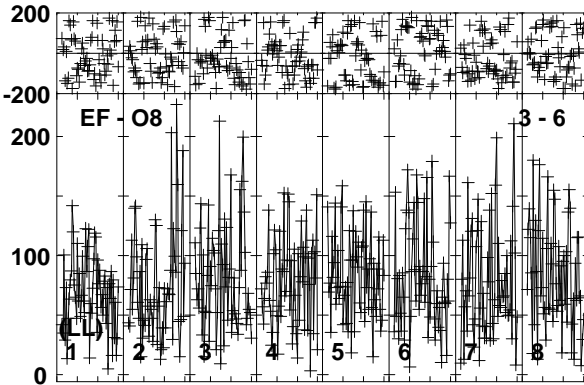
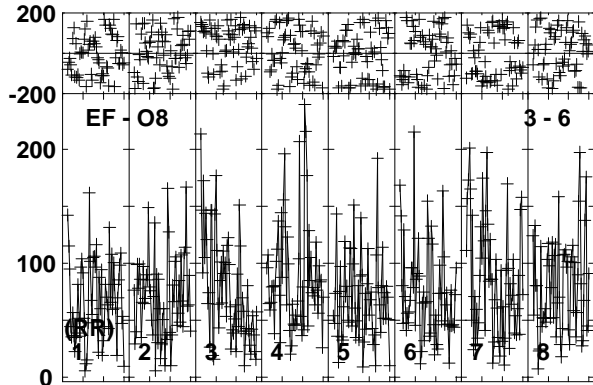
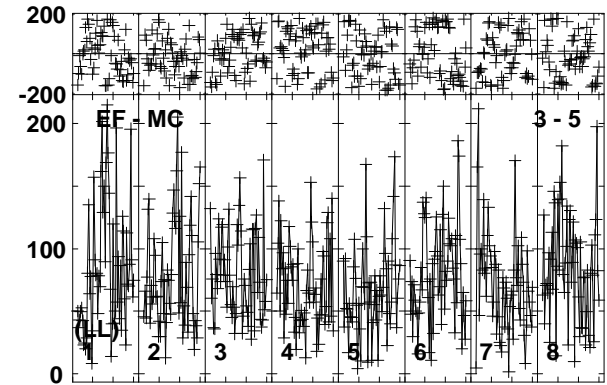
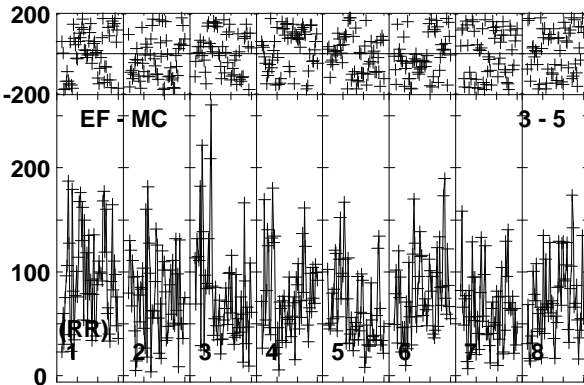
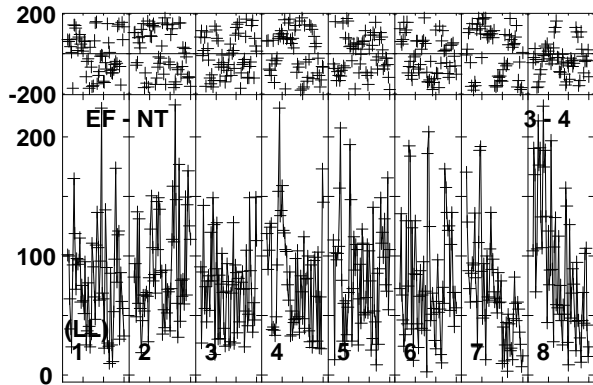
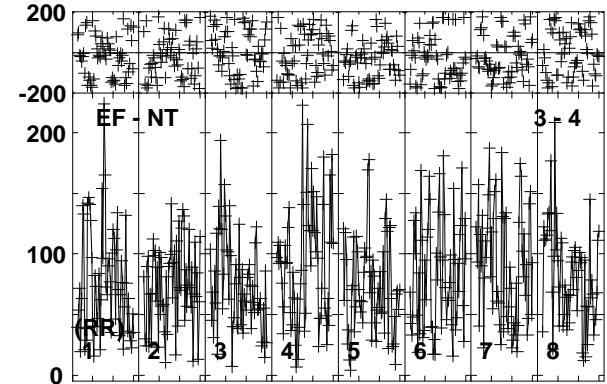
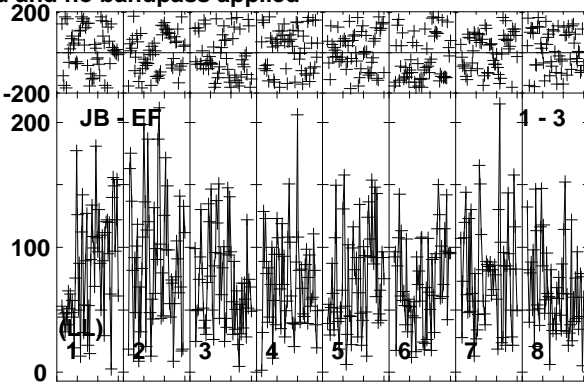
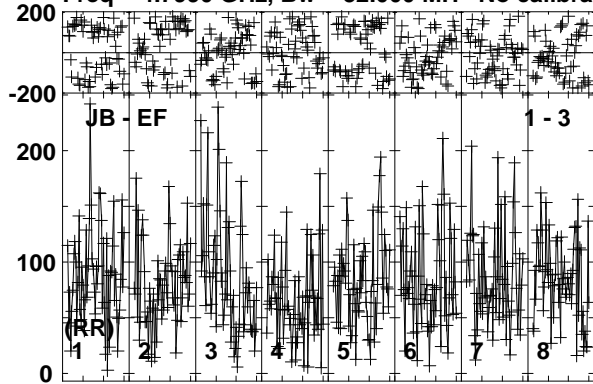

Lower frame: Micro Ampl Jy Top frame: Phas deg
Vector averaged cross-power spectrum Baseline: JB (01) - EF (03)
Timerange: 00/09:02:26 to 00/09:06:06

Plot file version 26 created 19-FEB-2019 18:12:52

IRAS23436 RP028B.UVDATA.1

Freq = 4.7990 GHz, Bw = 32.000 MH No calibration applied and no bandpass applied

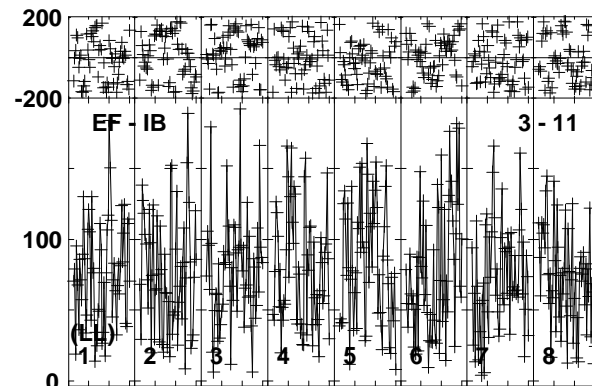
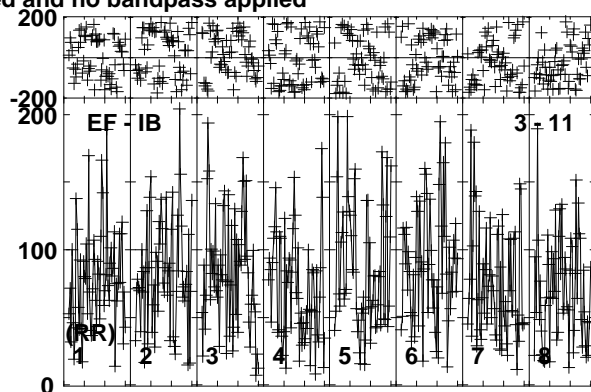
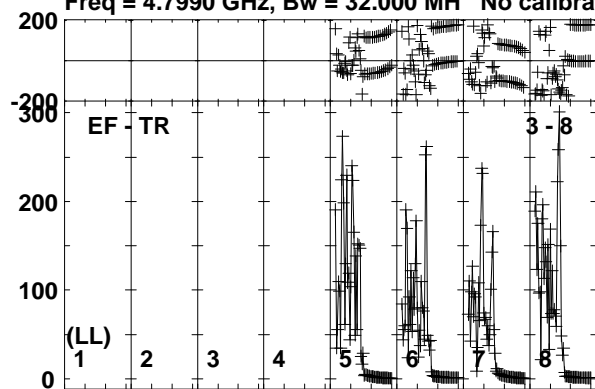

Lower frame: Micro Ampl Jy Top frame: Phas deg
Vector averaged cross-power spectrum Baseline: EF (03) - TR (08)
Timerange: 00/09:02:26 to 00/09:06:06

Plot file version 27 created 19-FEB-2019 18:12:53

J2353+5518 RP028B.UVDATA.1

Freq = 4.7990 GHz, Bw = 32.000 MH No calibration applied and no bandpass applied

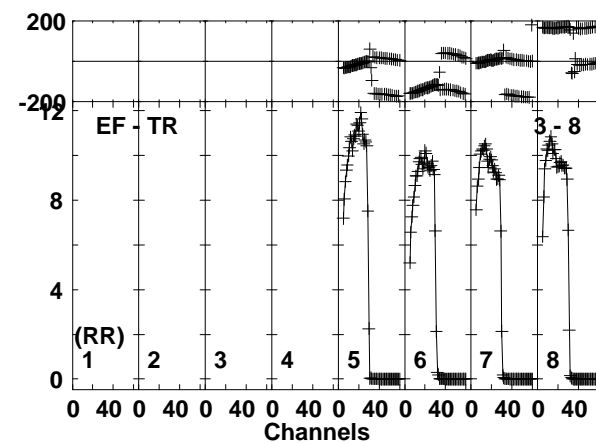
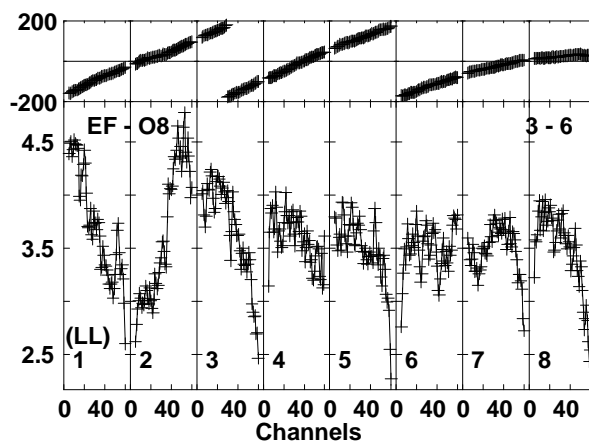
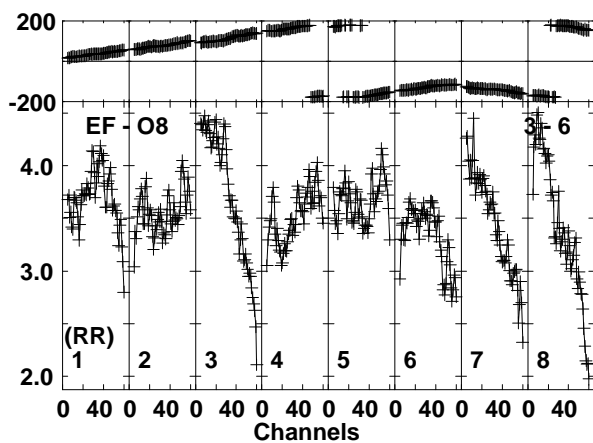
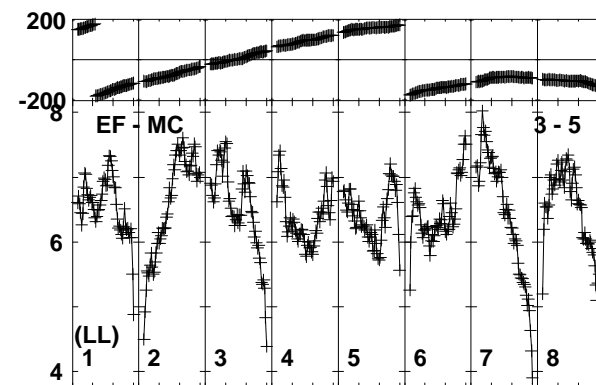
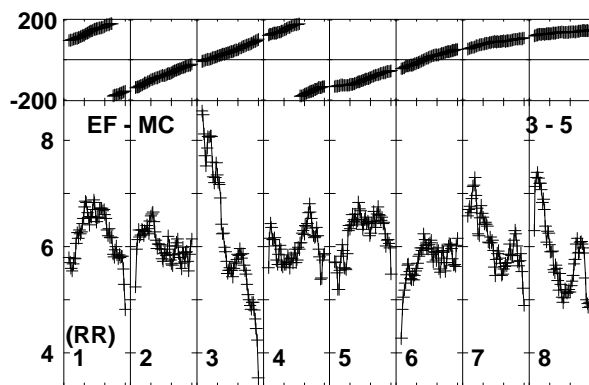
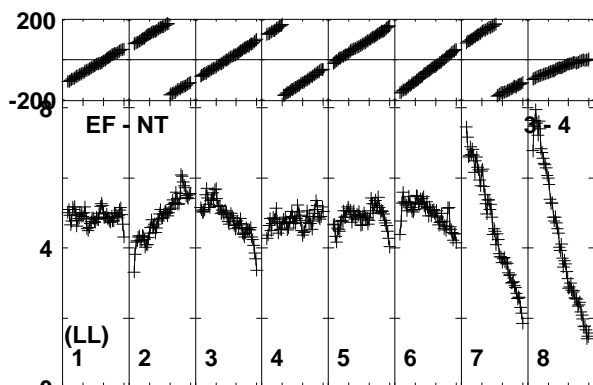
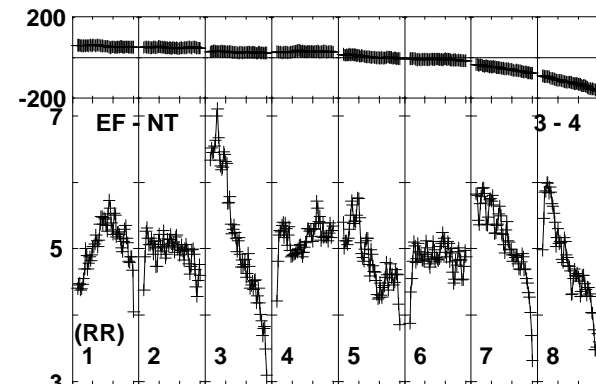
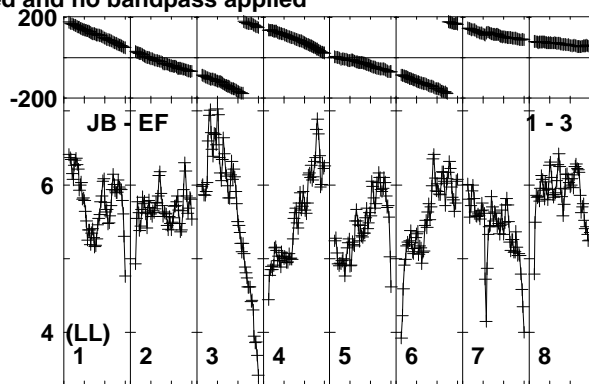
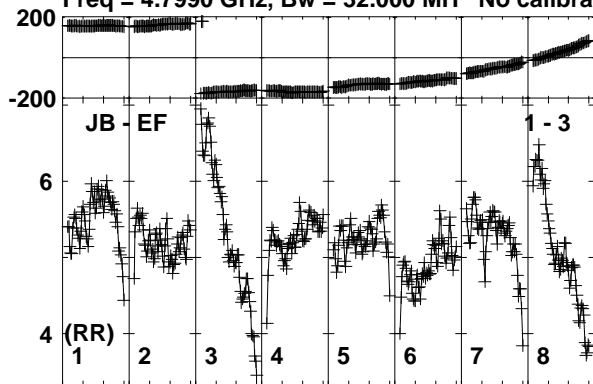

Lower frame: Milli Ampl Jy Top frame: Phas deg
Vector averaged cross-power spectrum Baseline: JB (01) - EF (03)
Timerange: 00/09:06:06 to 00/09:07:36

Plot file version 28 created 19-FEB-2019 18:12:53

J2353+5518 RP028B.UVDATA.1

Freq = 4.7990 GHz, Bw = 32.000 MH No calibration applied and no bandpass applied

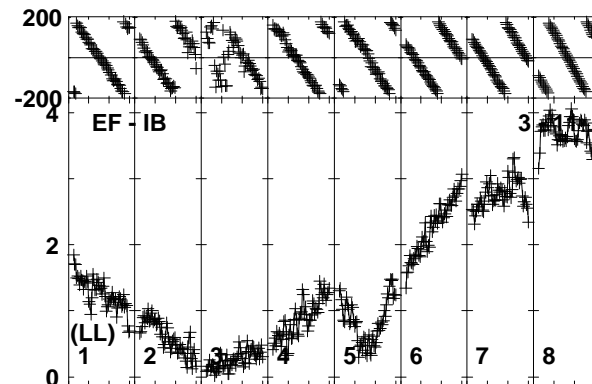
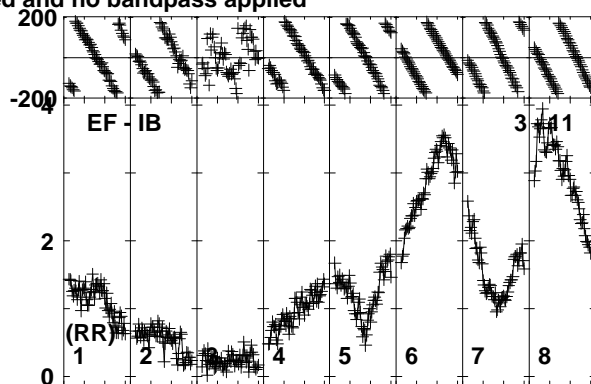
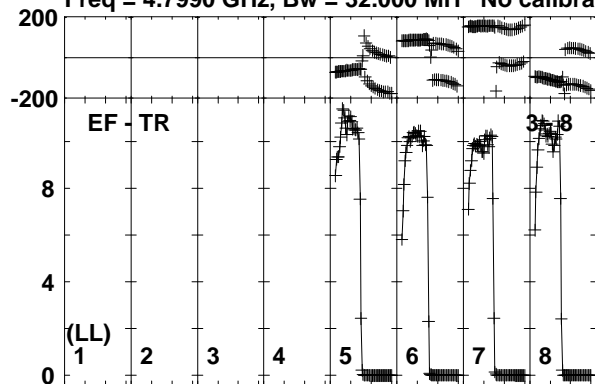

Lower frame: Milli Ampl Jy Top frame: Phas deg
Vector averaged cross-power spectrum Baseline: EF (03) - TR (08)
Timerange: 00/09:06:06 to 00/09:07:36

Plot file version 29 created 19-FEB-2019 18:12:53

IRAS23436 RP028B.UVDATA.1

Freq = 4.7990 GHz, Bw = 32.000 MH No calibration applied and no bandpass applied

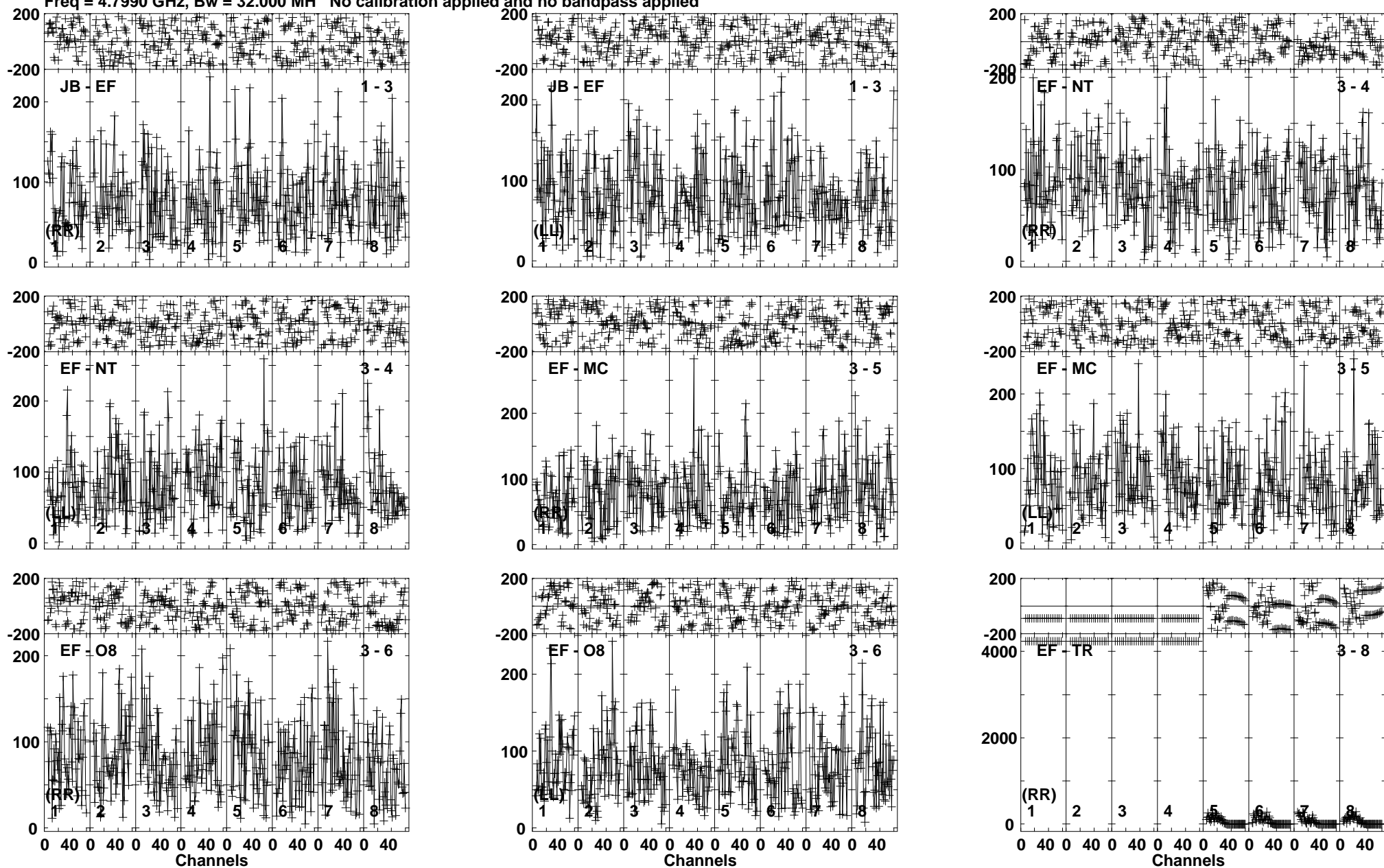

Lower frame: Micro Ampl Jy Top frame: Phas deg
Vector averaged cross-power spectrum Baseline: JB (01) - EF (03)
Timerange: 00/09:07:37 to 00/09:11:20

Plot file version 30 created 19-FEB-2019 18:12:53

IRAS23436 RP028B.UVDATA.1

Freq = 4.7990 GHz, Bw = 32.000 MH No calibration applied and no bandpass applied

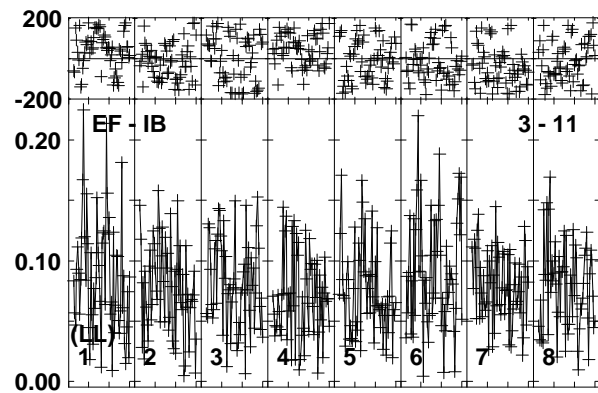
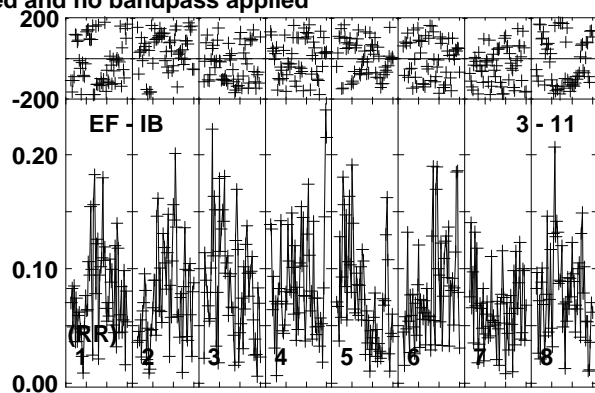
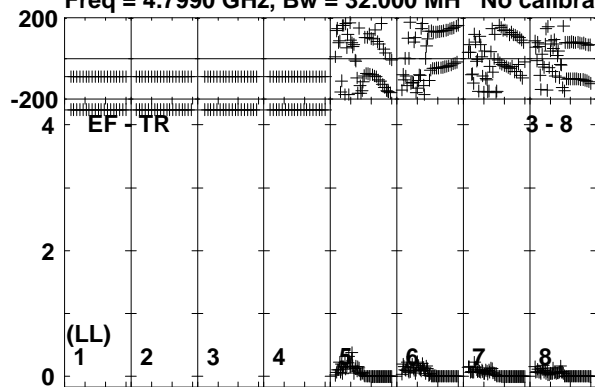

Lower frame: Milli Ampl Jy Top frame: Phas deg
Vector averaged cross-power spectrum Baseline: EF (03) - TR (08)
Timerange: 00/09:07:37 to 00/09:11:20

Plot file version 31 created 19-FEB-2019 18:12:53

J2353+5518 RP028B.UVDATA.1

Freq = 4.7990 GHz, Bw = 32.000 MH No calibration applied and no bandpass applied

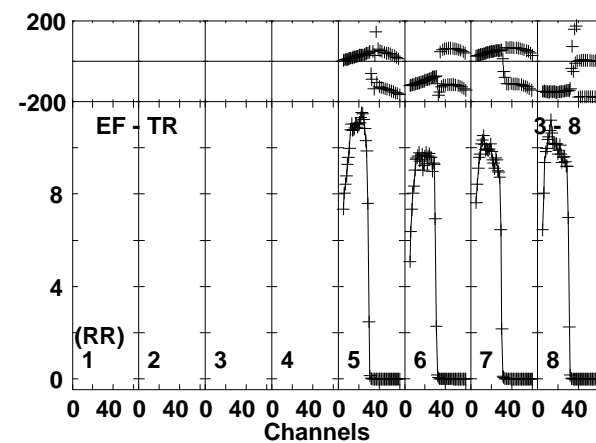
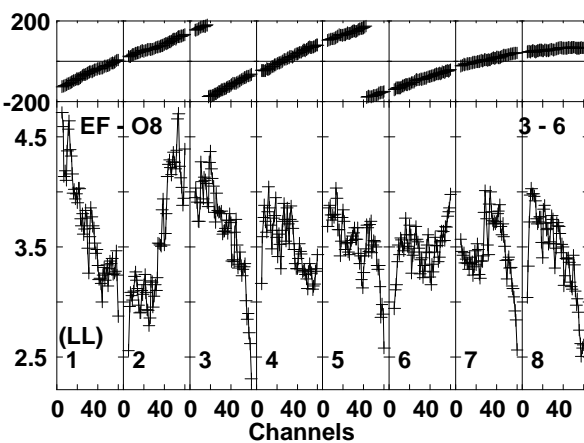
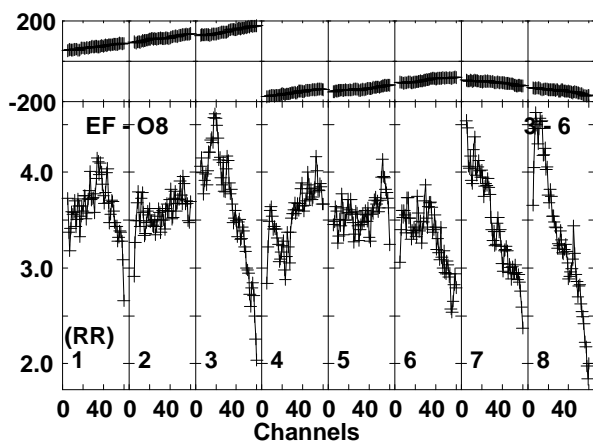
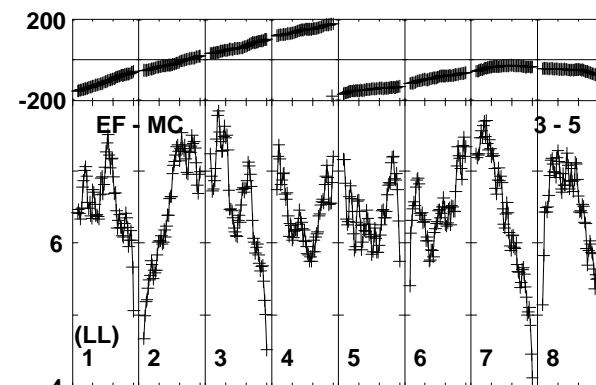
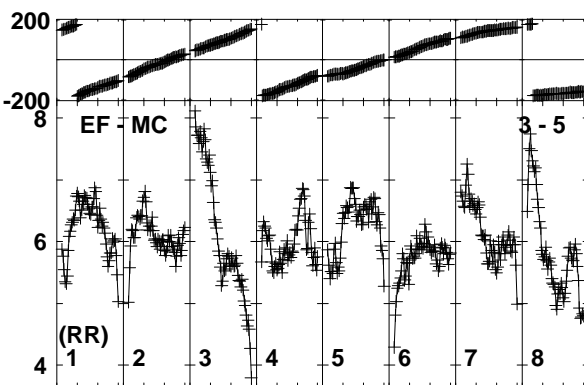
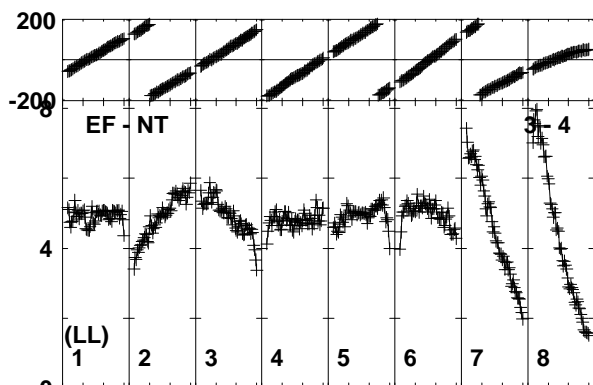
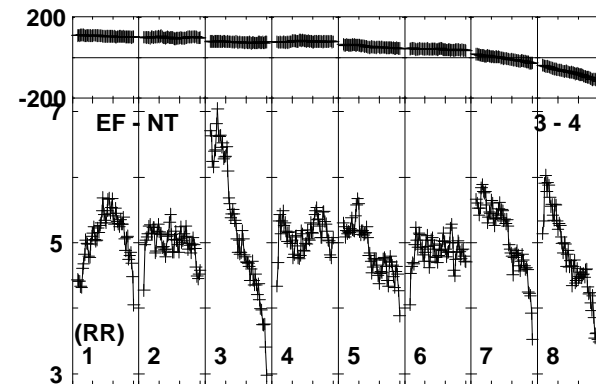
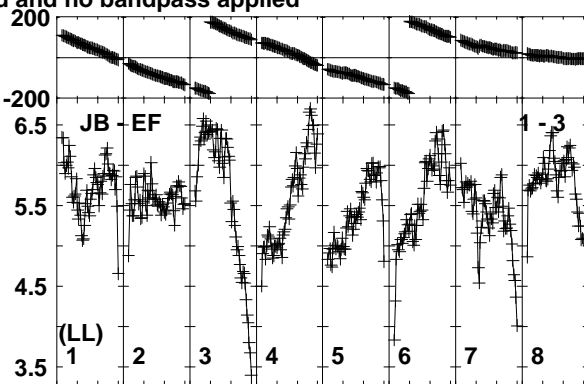
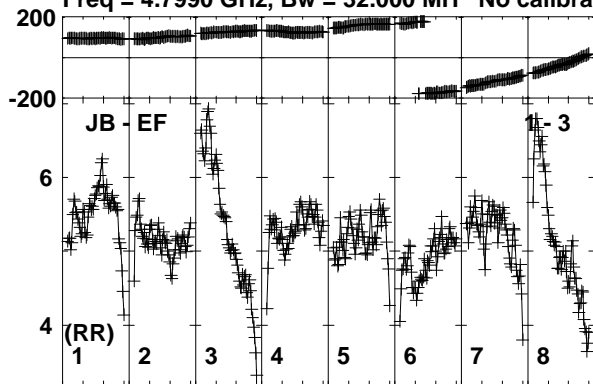

Lower frame: Milli Ampl Jy Top frame: Phas deg
Vector averaged cross-power spectrum Baseline: JB (01) - EF (03)
Timerange: 00/09:12:00 to 00/09:12:49

Plot file version 32 created 19-FEB-2019 18:12:54

J2353+5518 RP028B.UVDATA.1

Freq = 4.7990 GHz, Bw = 32.000 MH No calibration applied and no bandpass applied

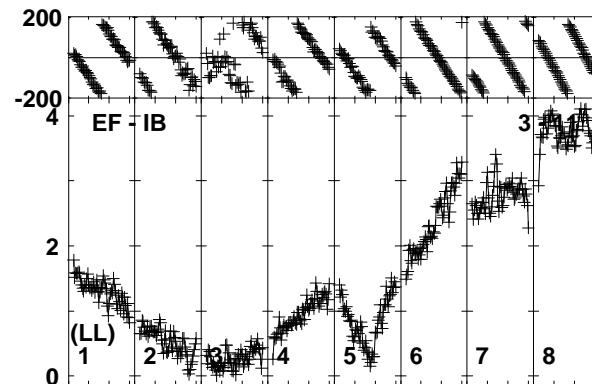
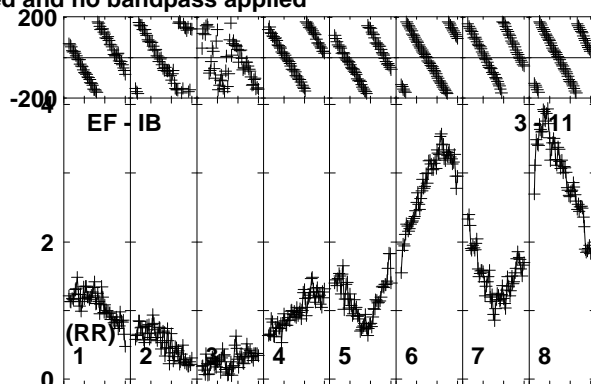
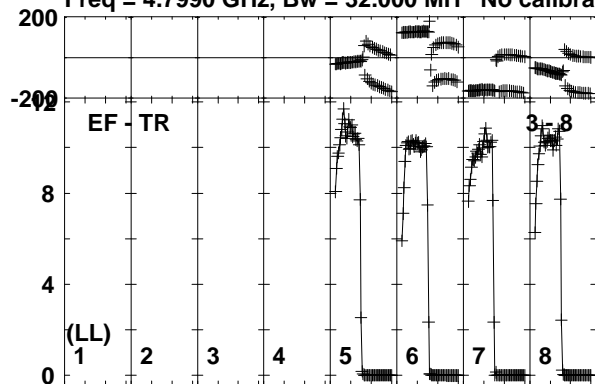

Lower frame: Milli Ampl Jy Top frame: Phas deg
Vector averaged cross-power spectrum Baseline: EF (03) - TR (08)
Timerange: 00/09:12:00 to 00/09:12:49

Plot file version 33 created 19-FEB-2019 18:12:54

IRAS23436 RP028B.UVDATA.1

Freq = 4.7990 GHz, Bw = 32.000 MH No calibration applied and no bandpass applied

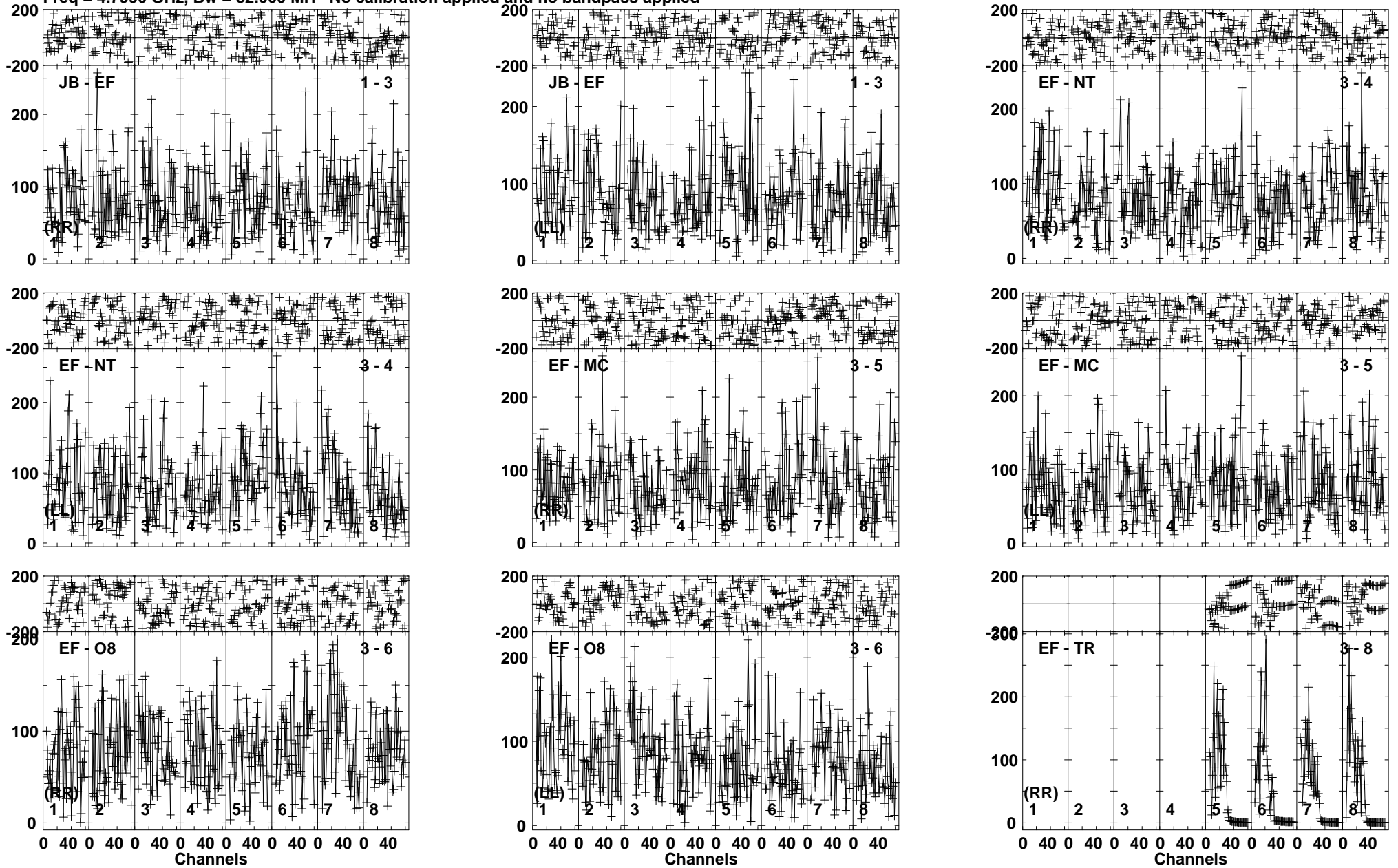

Lower frame: Micro Ampl Jy Top frame: Phas deg
Vector averaged cross-power spectrum Baseline: JB (01) - EF (03)
Timerange: 00/09:12:51 to 00/09:16:34

Plot file version 34 created 19-FEB-2019 18:12:54

IRAS23436 RP028B.UVDATA.1

Freq = 4.7990 GHz, Bw = 32.000 MH No calibration applied and no bandpass applied

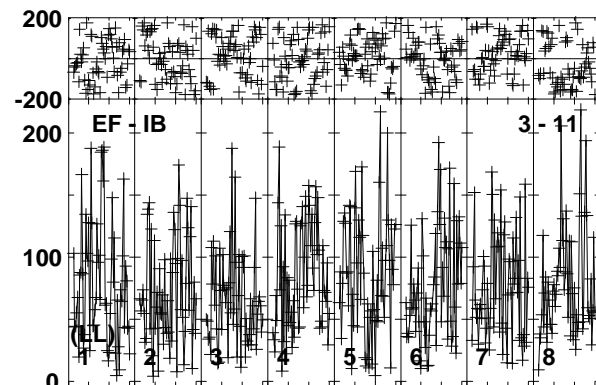
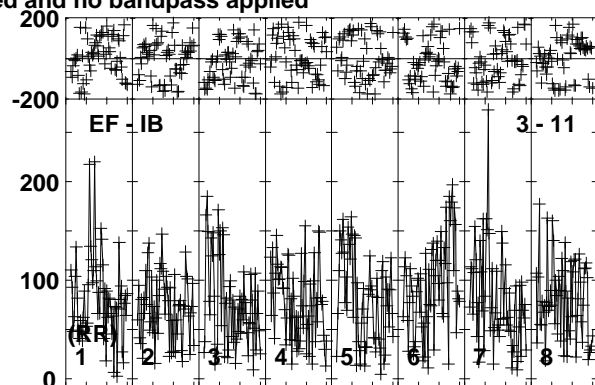
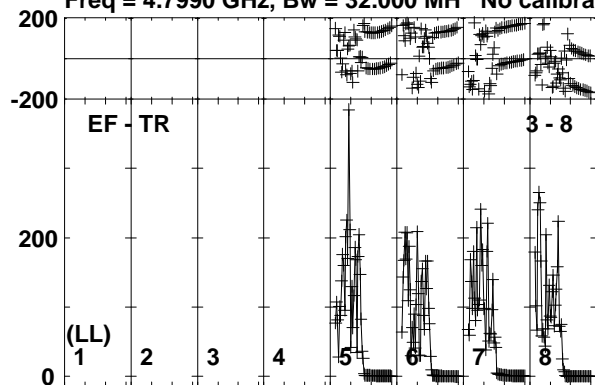

Lower frame: Micro Ampl Jy Top frame: Phas deg
Vector averaged cross-power spectrum Baseline: EF (03) - TR (08)
Timerange: 00/09:12:51 to 00/09:16:34

Plot file version 35 created 19-FEB-2019 18:12:54

J2353+5518 RP028B.UVDATA.1

Freq = 4.7990 GHz, Bw = 32.000 MH No calibration applied and no bandpass applied

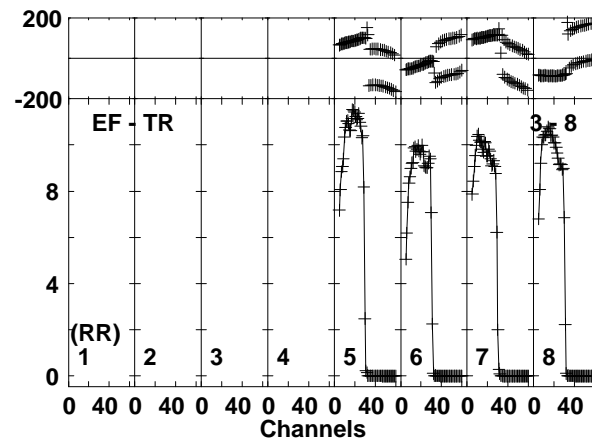
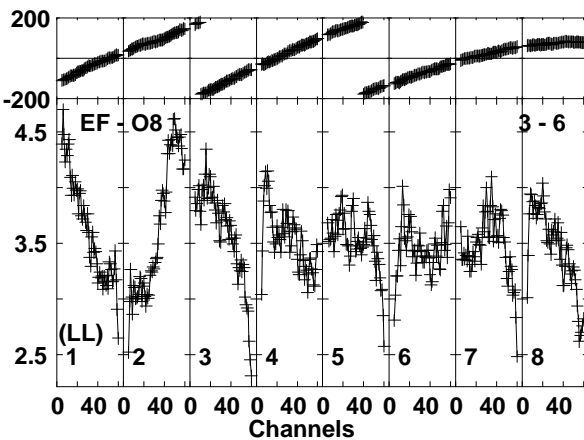
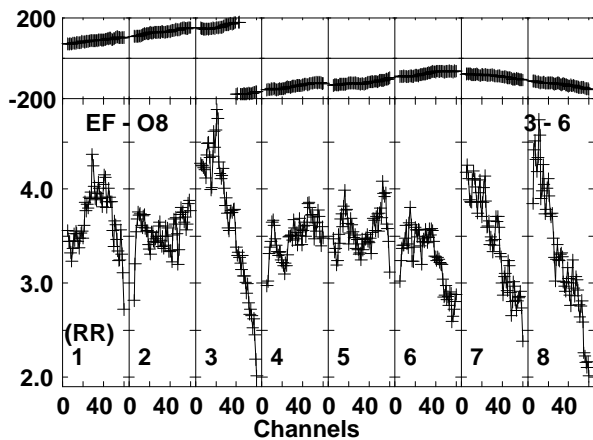
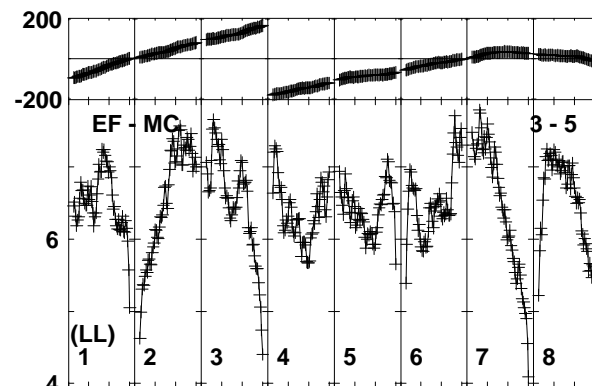
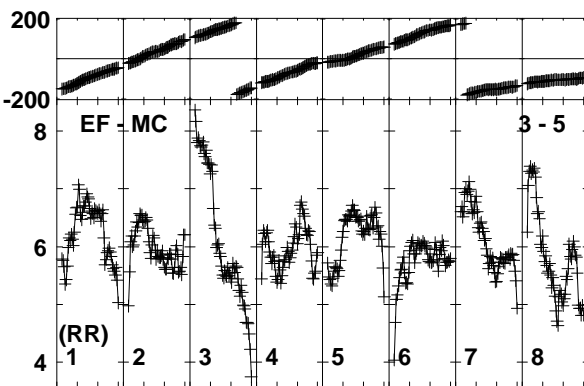
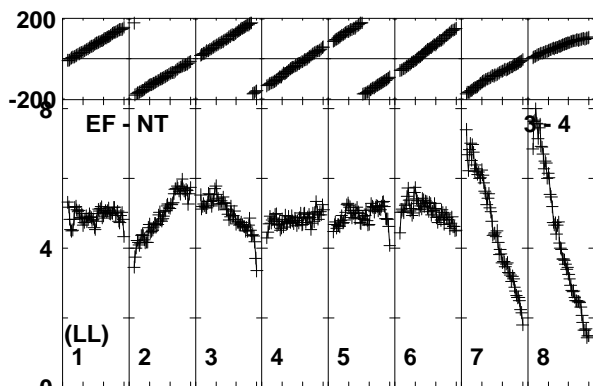
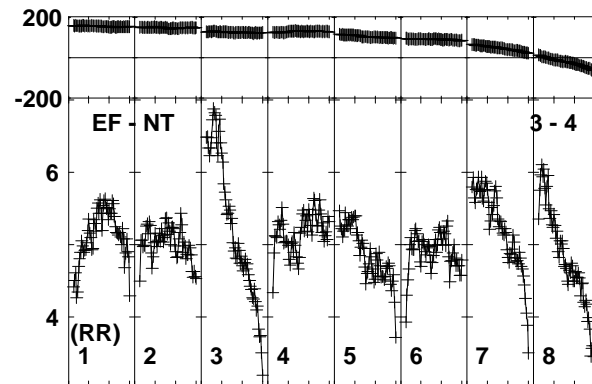
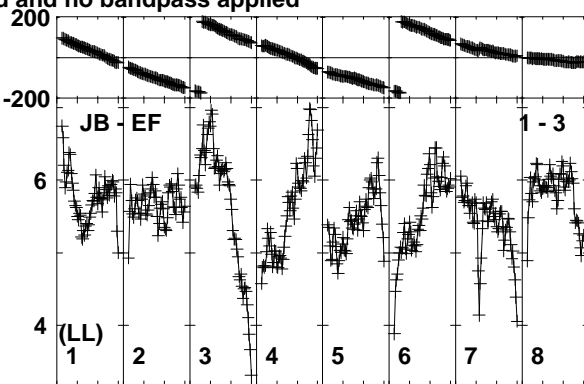
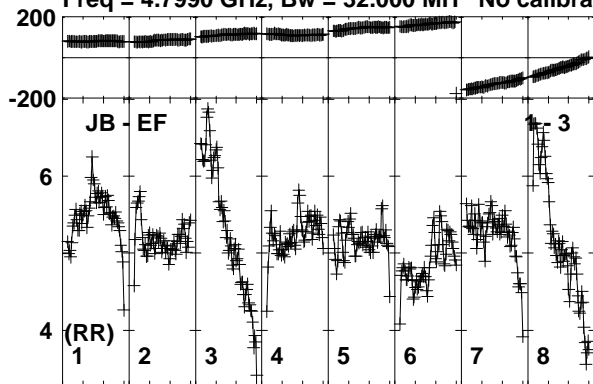

Lower frame: Milli Ampl Jy Top frame: Phas deg
Vector averaged cross-power spectrum Baseline: JB (01) - EF (03)
Timerange: 00/09:16:35 to 00/09:18:03

Plot file version 36 created 19-FEB-2019 18:12:54

J2353+5518 RP028B.UVDATA.1

Freq = 4.7990 GHz, Bw = 32.000 MH No calibration applied and no bandpass applied

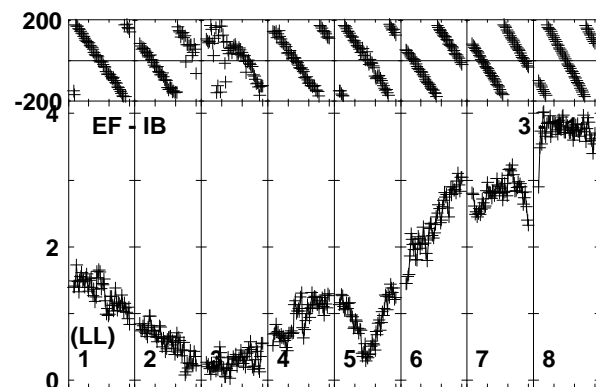
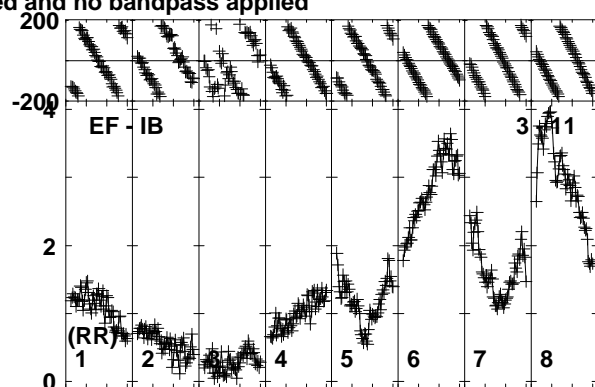
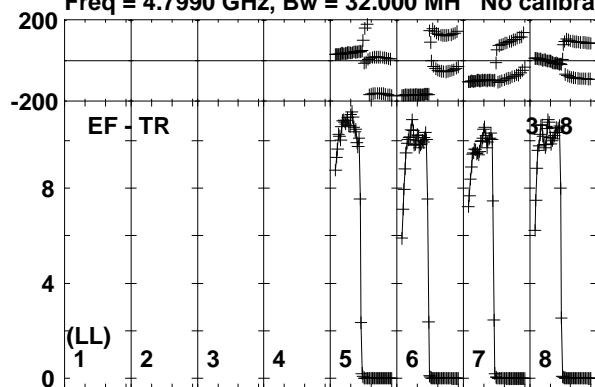

Lower frame: Milli Ampl Jy Top frame: Phas deg
Vector averaged cross-power spectrum Baseline: EF (03) - TR (08)
Timerange: 00/09:16:35 to 00/09:18:03

Plot file version 37 created 19-FEB-2019 18:12:55

IRAS23436 RP028B.UVDATA.1

Freq = 4.7990 GHz, Bw = 32.000 MH No calibration applied and no bandpass applied

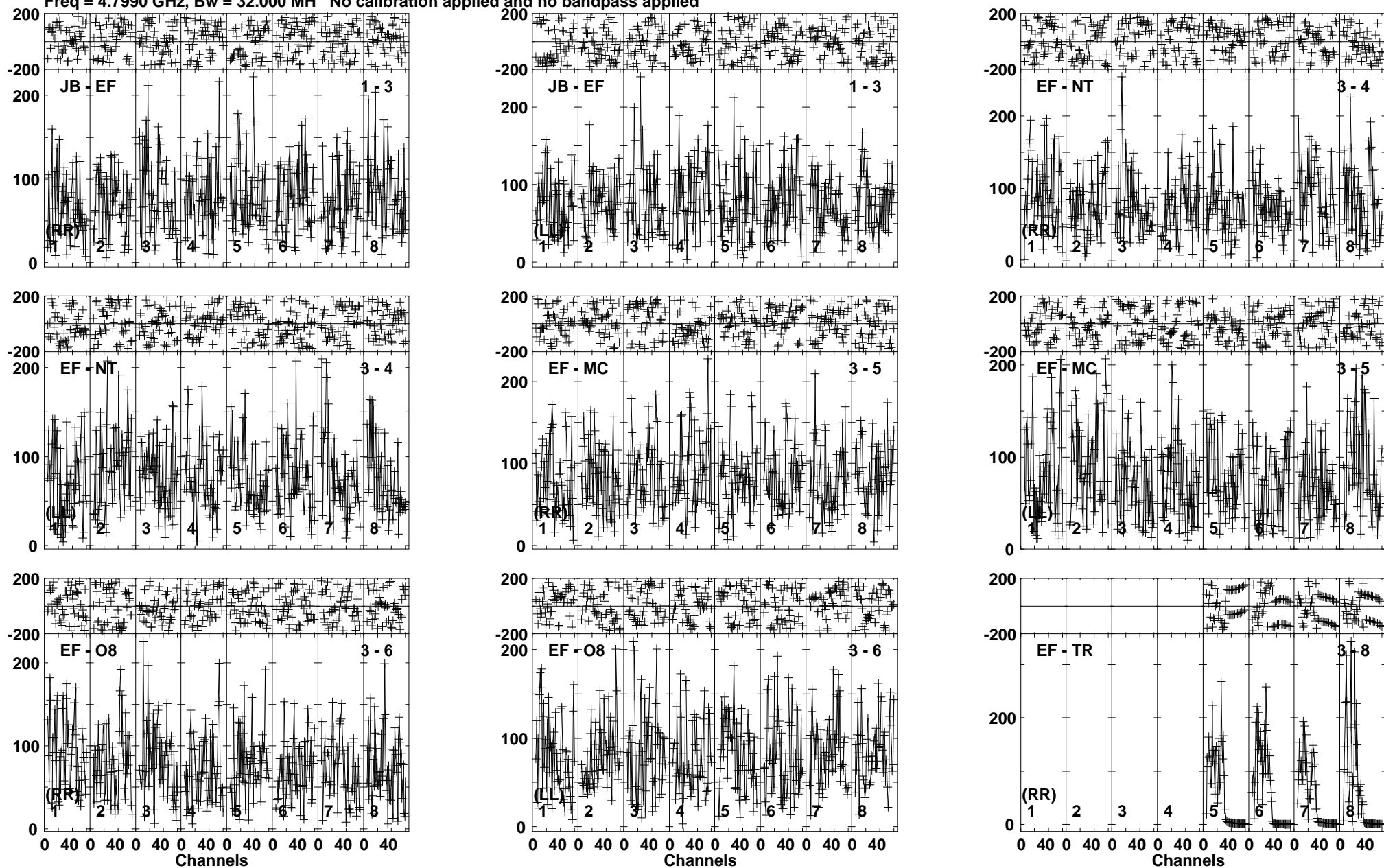

Lower frame: Micro Ampl Jy Top frame: Phas deg
Vector averaged cross-power spectrum Baseline: JB (01) - EF (03)
Timerange: 00/09:18:05 to 00/09:21:47

Plot file version 38 created 19-FEB-2019 18:12:55

IRAS23436 RP028B.UVDATA.1

Freq = 4.7990 GHz, Bw = 32.000 MH No calibration applied and no bandpass applied

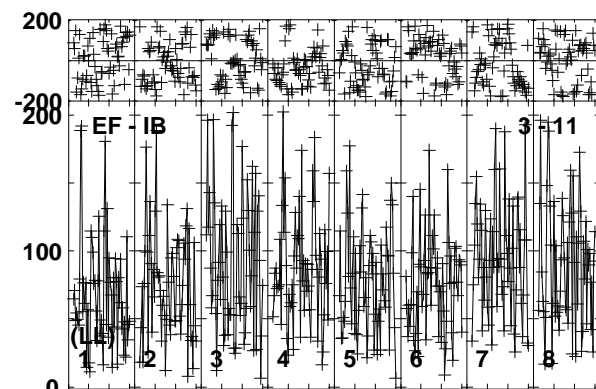
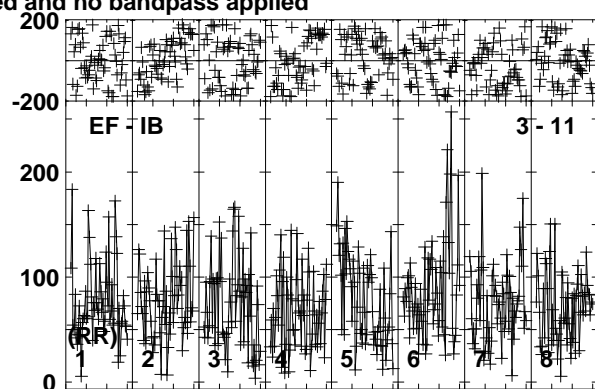
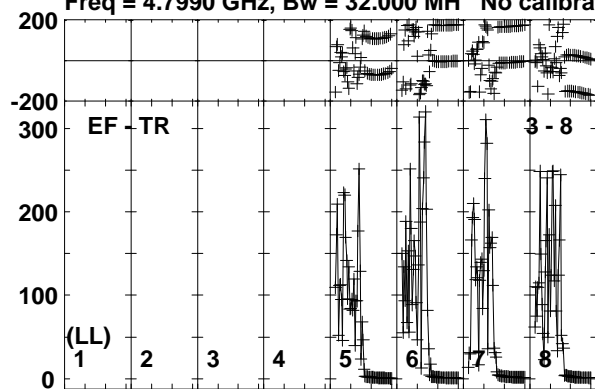

Lower frame: Micro Ampl Jy Top frame: Phas deg
Vector averaged cross-power spectrum Baseline: EF (03) - TR (08)
Timerange: 00/09:18:05 to 00/09:21:47

Plot file version 39 created 19-FEB-2019 18:12:55

J2353+5518 RP028B.UVDATA.1

Freq = 4.7990 GHz, Bw = 32.000 MH No calibration applied and no bandpass applied

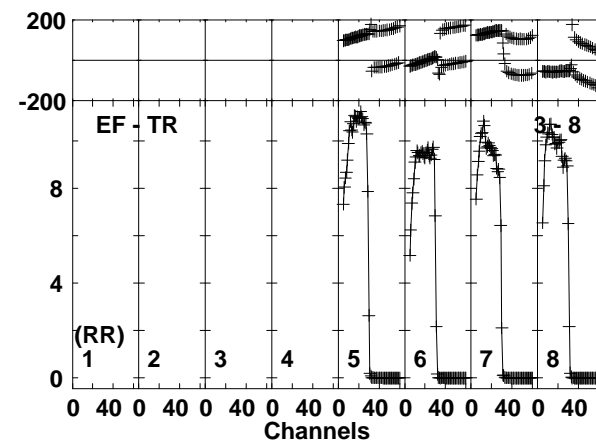
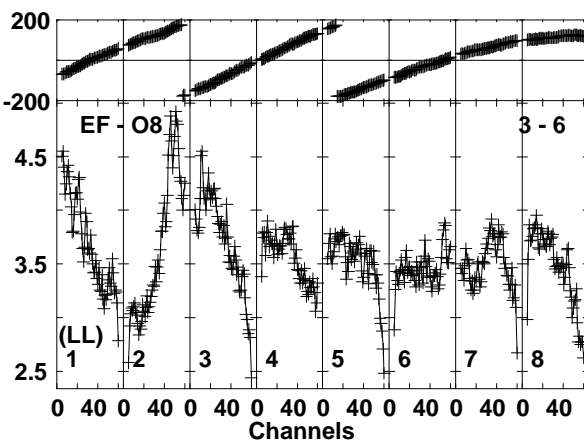
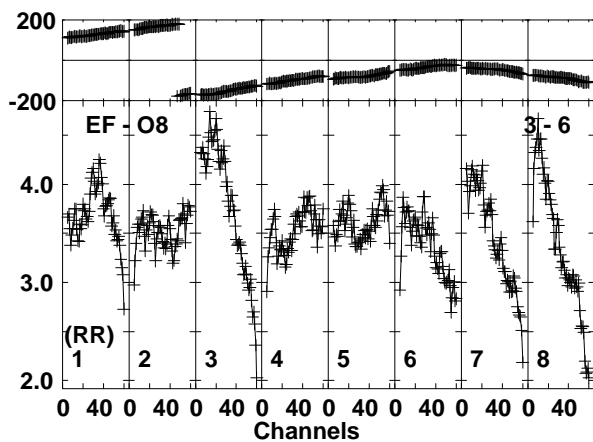
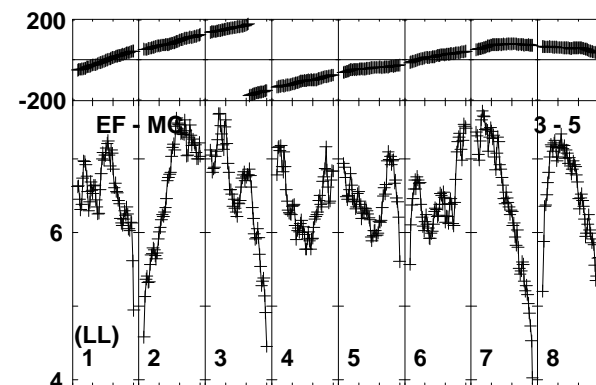
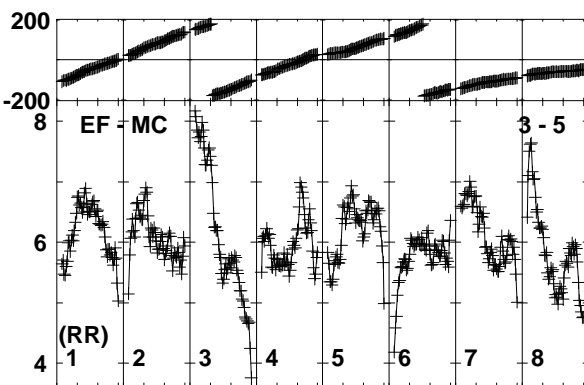
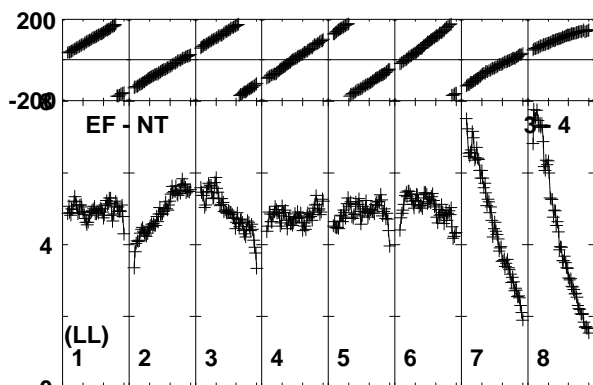
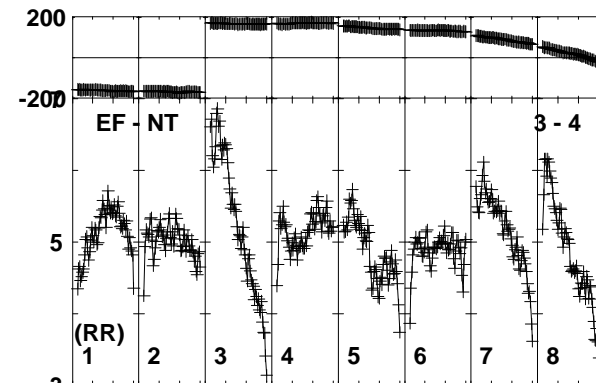
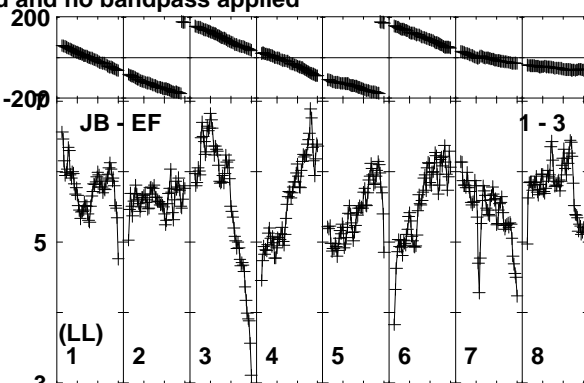
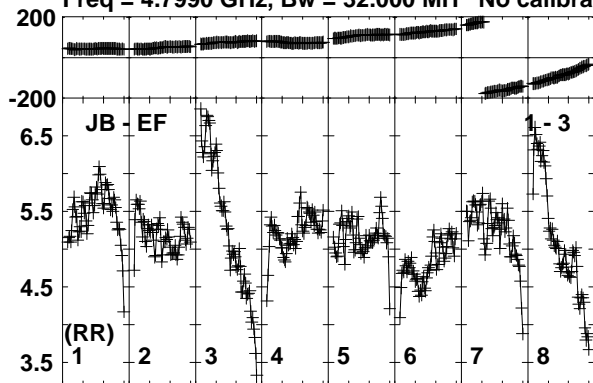

Lower frame: Milli Ampl Jy Top frame: Phas deg
Vector averaged cross-power spectrum Baseline: JB (01) - EF (03)
Timerange: 00/09:22:28 to 00/09:23:27

Plot file version 40 created 19-FEB-2019 18:12:55

J2353+5518 RP028B.UVDATA.1

Freq = 4.7990 GHz, Bw = 32.000 MH No calibration applied and no bandpass applied

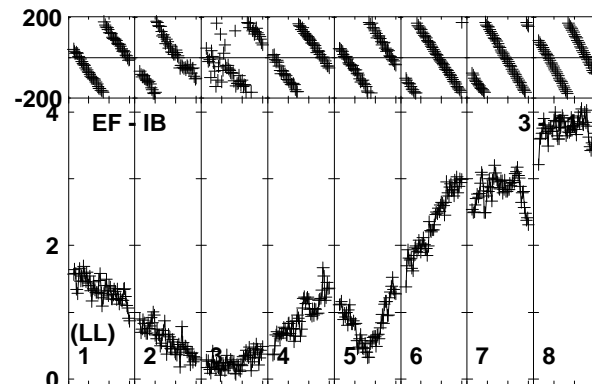
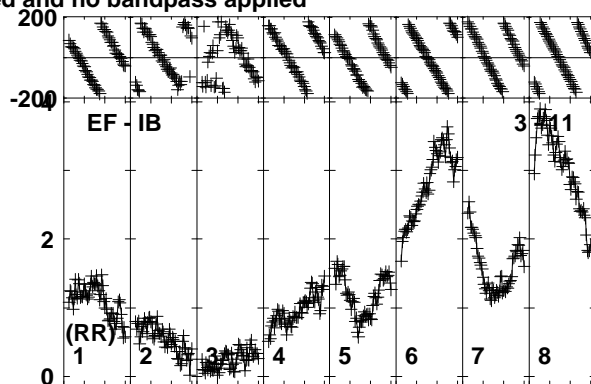
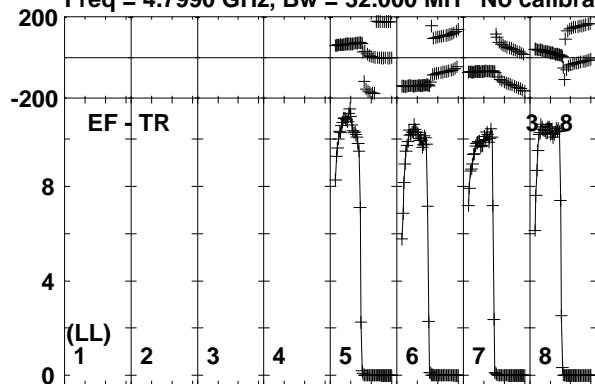

Lower frame: Milli Ampl Jy Top frame: Phas deg
Vector averaged cross-power spectrum Baseline: EF (03) - TR (08)
Timerange: 00/09:22:28 to 00/09:23:27

Plot file version 41 created 19-FEB-2019 18:12:55

IRAS23436 RP028B.UVDATA.1

Freq = 4.7990 GHz, Bw = 32.000 MH No calibration applied and no bandpass applied

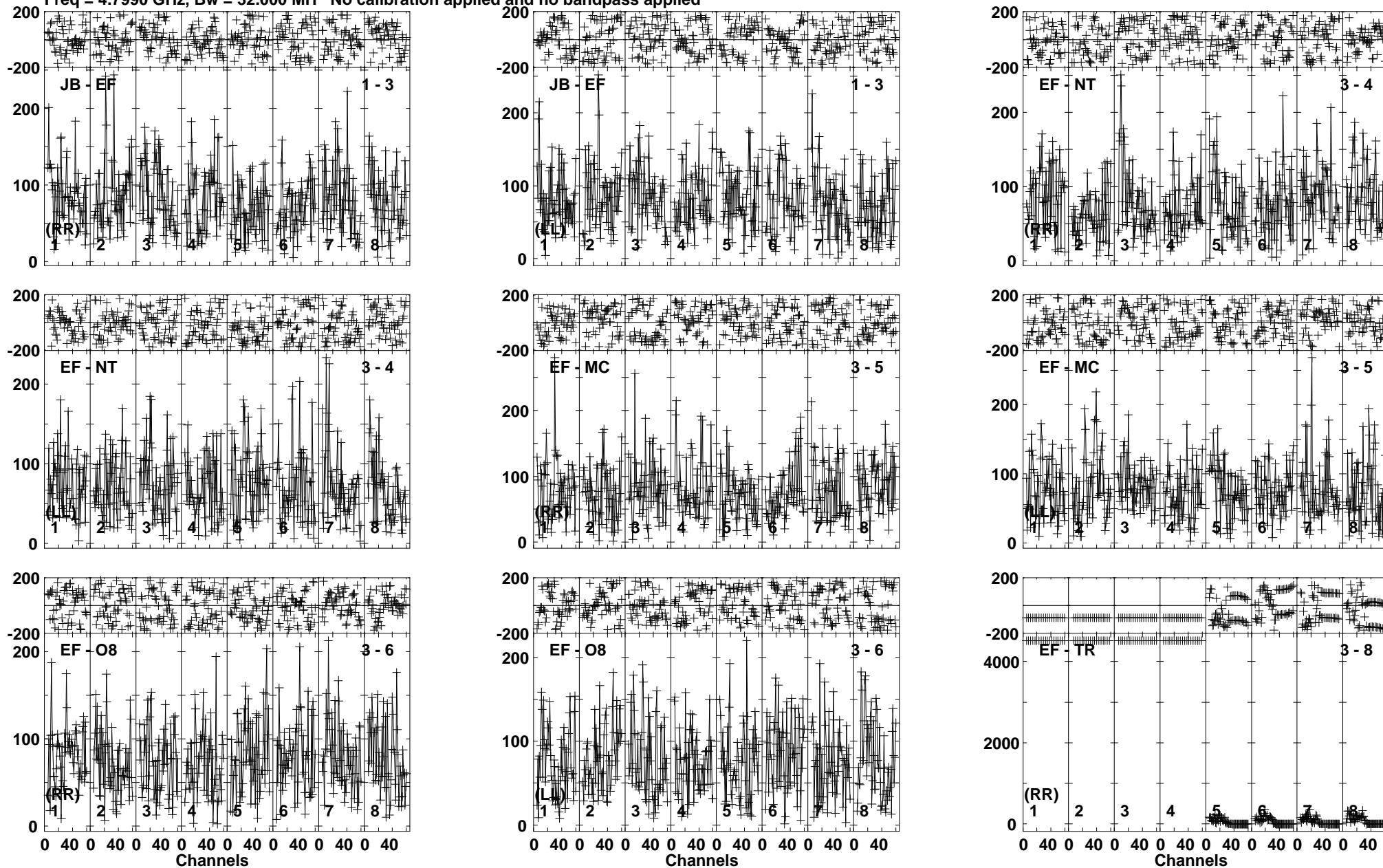

Lower frame: Micro Ampl Jy Top frame: Phas deg
Vector averaged cross-power spectrum Baseline: JB (01) - EF (03)
Timerange: 00/09:23:28 to 00/09:27:08

Plot file version 42 created 19-FEB-2019 18:12:56

IRAS23436 RP028B.UVDATA.1

Freq = 4.7990 GHz, Bw = 32.000 MH No calibration applied and no bandpass applied

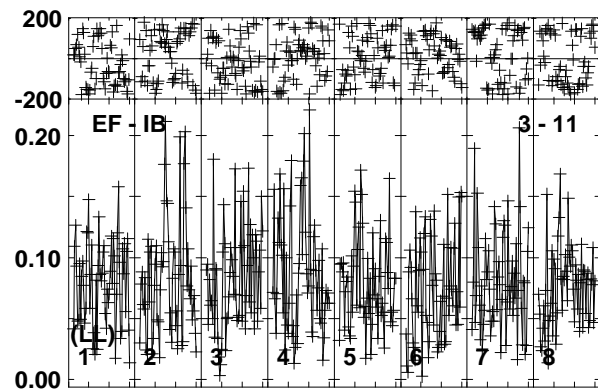
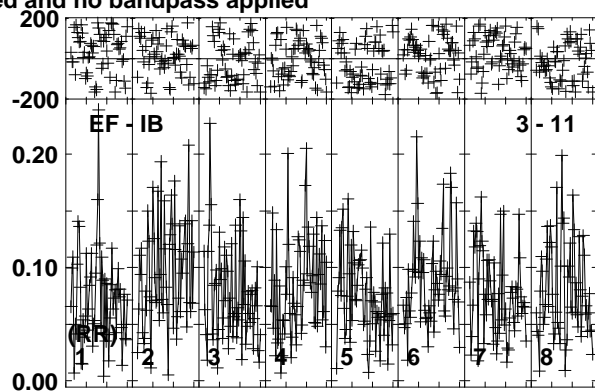
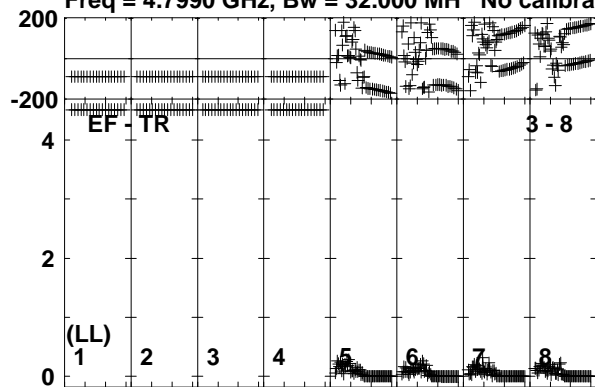

Lower frame: Milli Ampl Jy Top frame: Phas deg
Vector averaged cross-power spectrum Baseline: EF (03) - TR (08)
Timerange: 00/09:23:28 to 00/09:27:08

Plot file version 43 created 19-FEB-2019 18:12:56

J2353+5518 RP028B.UVDATA.1

Freq = 4.7990 GHz, Bw = 32.000 MH No calibration applied and no bandpass applied

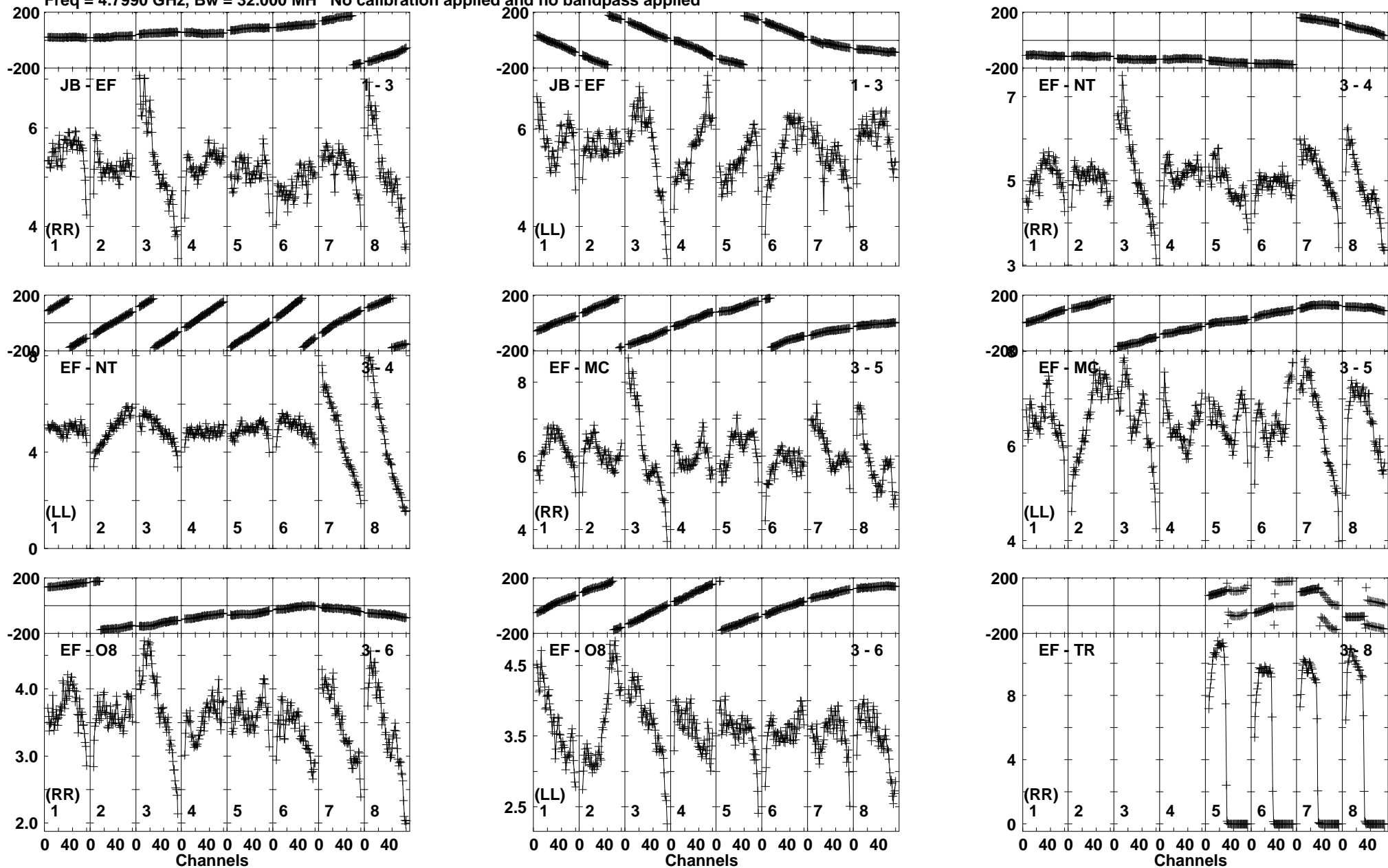

Lower frame: Milli Ampl Jy Top frame: Phas deg
Vector averaged cross-power spectrum Baseline: JB (01) - EF (03)
Timerange: 00/09:27:08 to 00/09:28:37

Plot file version 44 created 19-FEB-2019 18:12:56

J2353+5518 RP028B.UVDATA.1

Freq = 4.7990 GHz, Bw = 32.000 MH No calibration applied and no bandpass applied

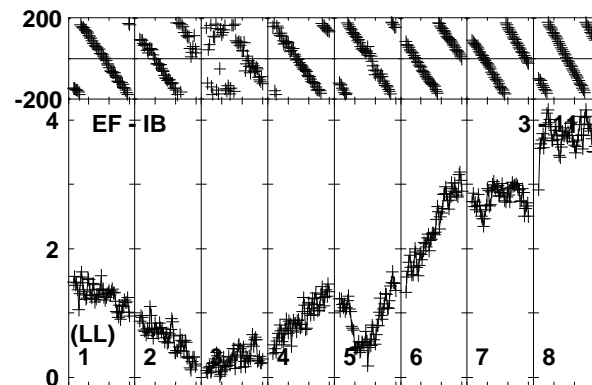
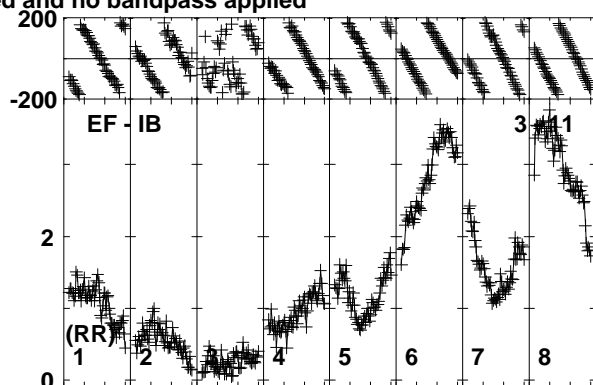
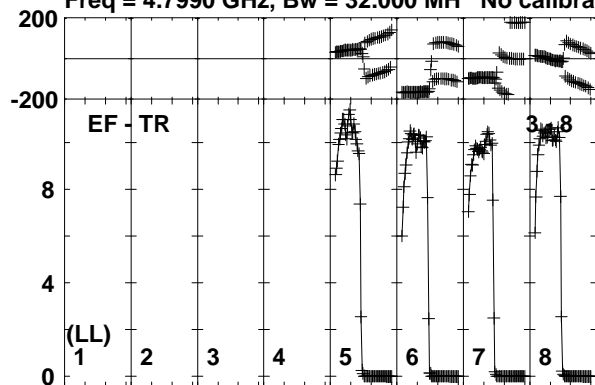

Lower frame: Milli Ampl Jy Top frame: Phas deg
Vector averaged cross-power spectrum Baseline: EF (03) - TR (08)
Timerange: 00/09:27:08 to 00/09:28:37

Plot file version 45 created 19-FEB-2019 18:12:56

IRAS23436 RP028B.UVDATA.1

Freq = 4.7990 GHz, Bw = 32.000 MH No calibration applied and no bandpass applied

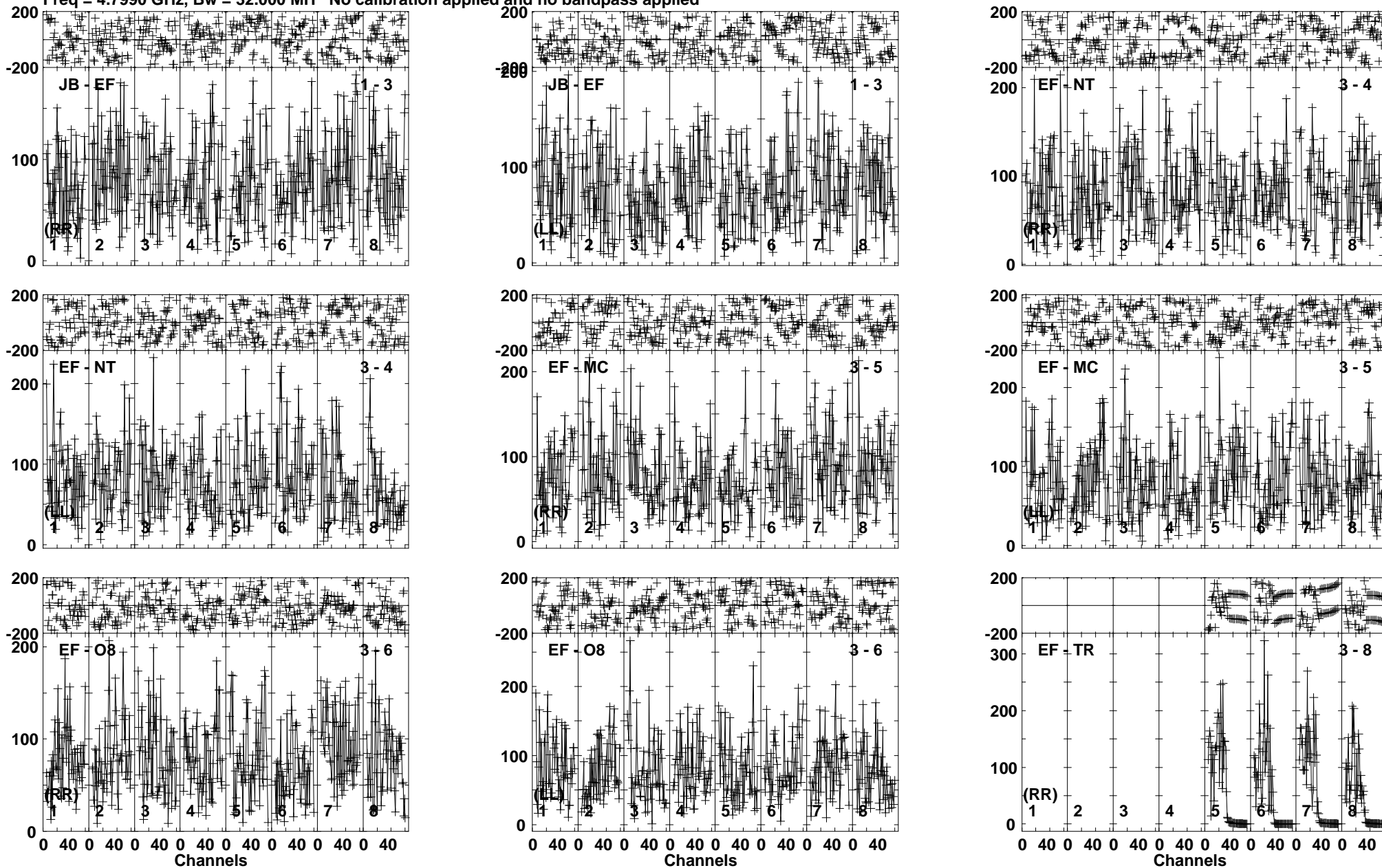

Lower frame: Micro Ampl Jy Top frame: Phas deg
Vector averaged cross-power spectrum Baseline: JB (01) - EF (03)
Timerange: 00/09:28:39 to 00/09:32:22

Plot file version 46 created 19-FEB-2019 18:12:57

IRAS23436 RP028B.UVDATA.1

Freq = 4.7990 GHz, Bw = 32.000 MH No calibration applied and no bandpass applied

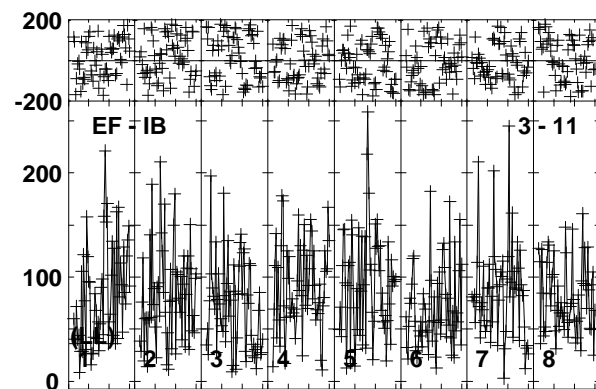
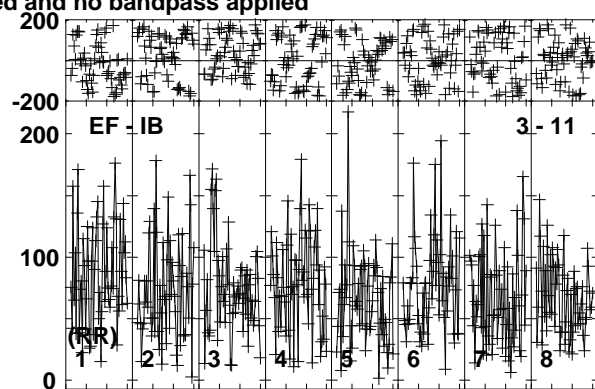
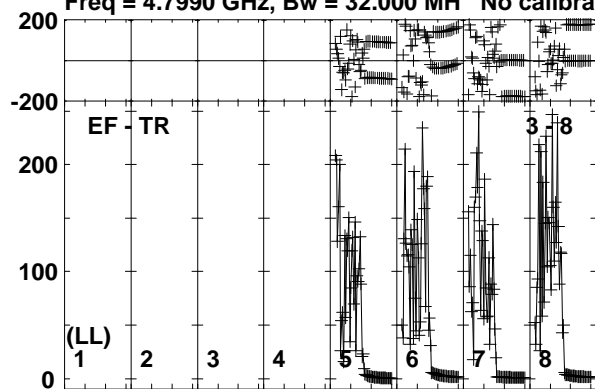

Lower frame: Micro Ampl Jy Top frame: Phas deg
Vector averaged cross-power spectrum Baseline: EF (03) - TR (08)
Timerange: 00/09:28:39 to 00/09:32:22

Plot file version 47 created 19-FEB-2019 18:12:57

J2353+5518 RP028B.UVDATA.1

Freq = 4.7990 GHz, Bw = 32.000 MH No calibration applied and no bandpass applied

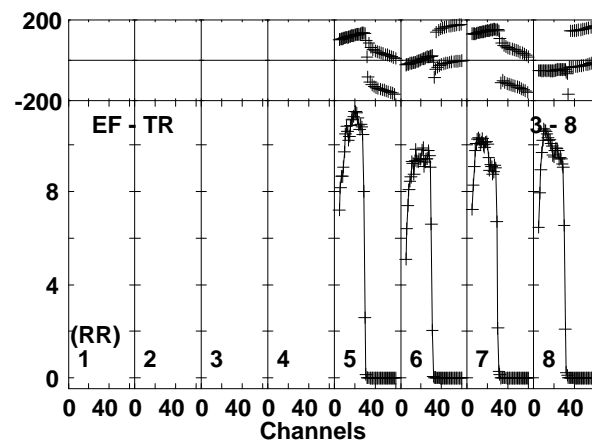
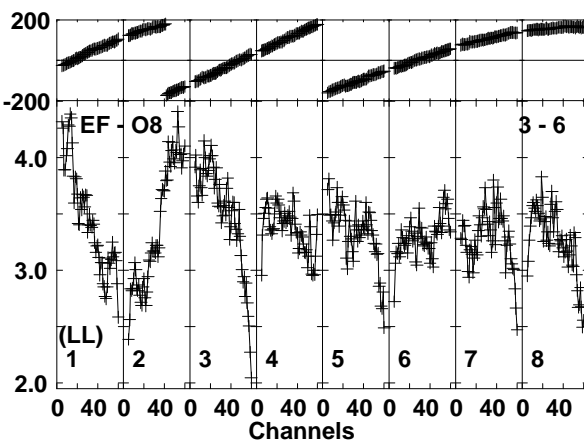
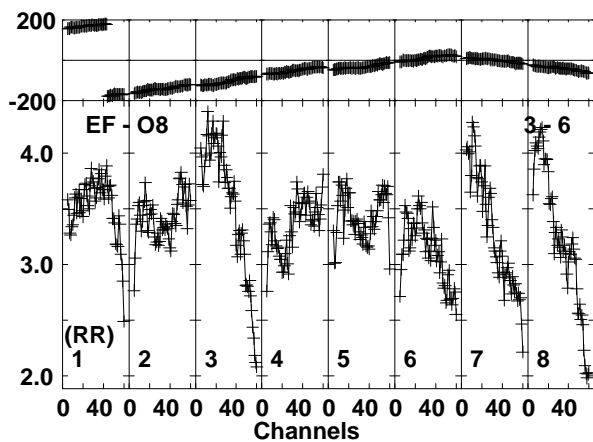
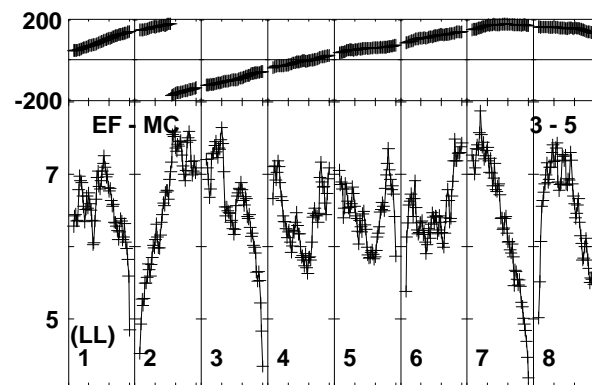
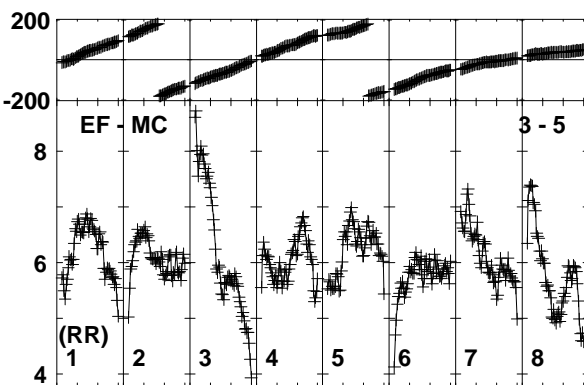
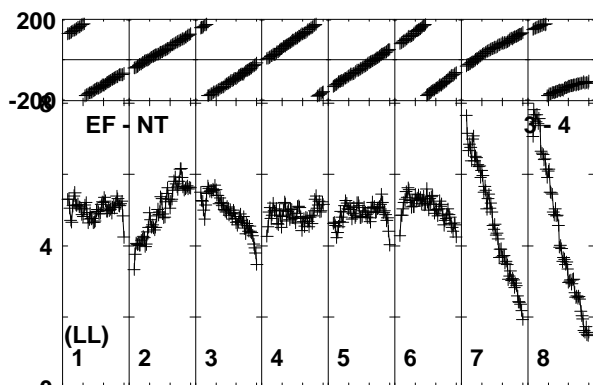
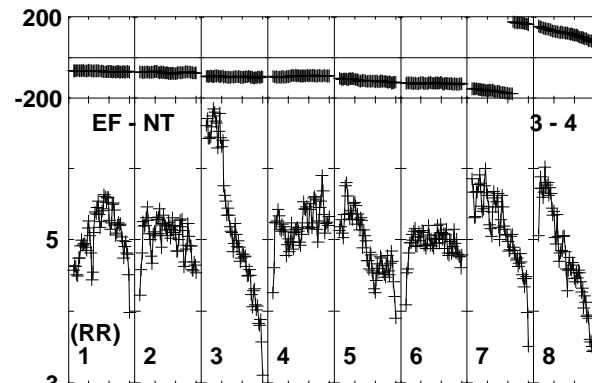
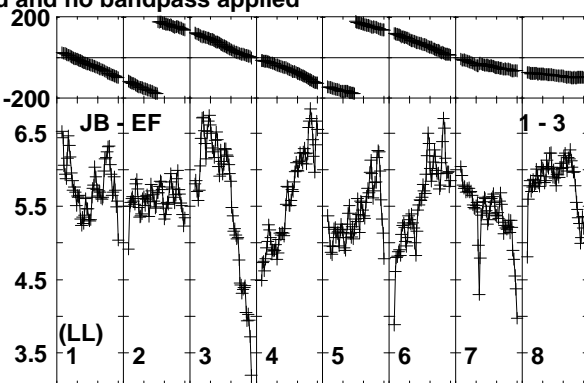
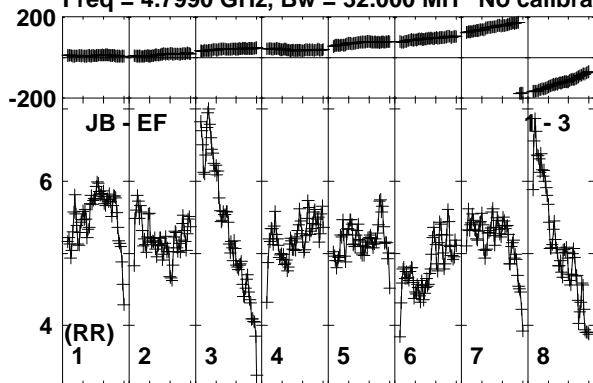

Lower frame: Milli Ampl Jy Top frame: Phas deg
Vector averaged cross-power spectrum Baseline: JB (01) - EF (03)
Timerange: 00/09:33:03 to 00/09:33:51

Plot file version 48 created 19-FEB-2019 18:12:57

J2353+5518 RP028B.UVDATA.1

Freq = 4.7990 GHz, Bw = 32.000 MH No calibration applied and no bandpass applied

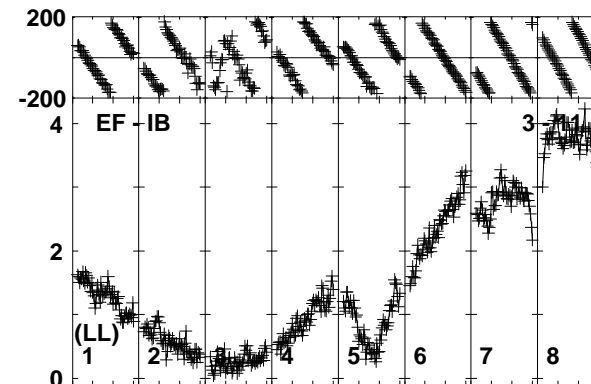
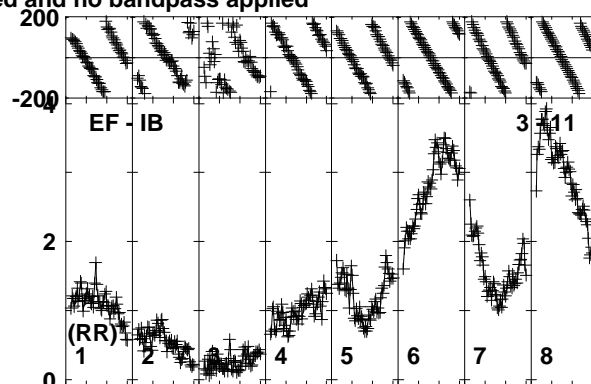
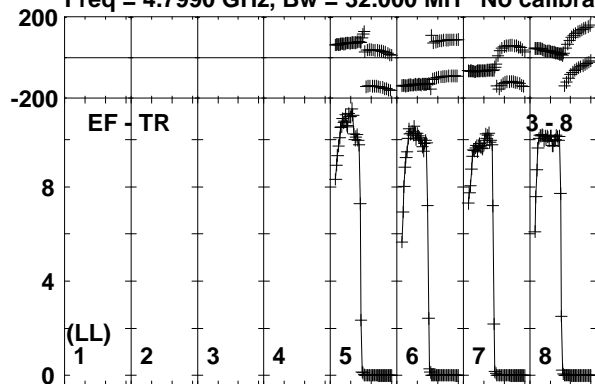

Lower frame: Milli Ampl Jy Top frame: Phas deg
Vector averaged cross-power spectrum Baseline: EF (03) - TR (08)
Timerange: 00/09:33:03 to 00/09:33:51

Plot file version 49 created 19-FEB-2019 18:12:57

IRAS23436 RP028B.UVDATA.1

Freq = 4.7990 GHz, Bw = 32.000 MH No calibration applied and no bandpass applied

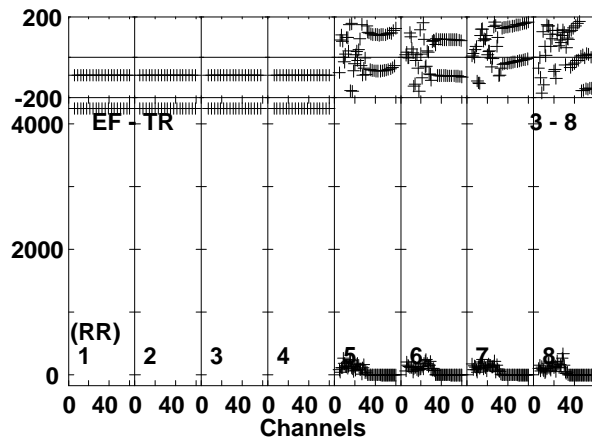
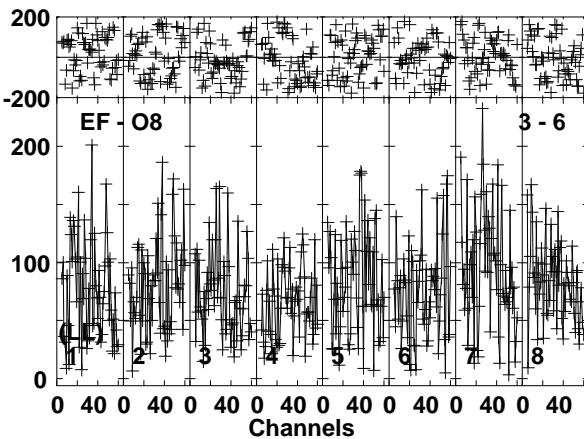
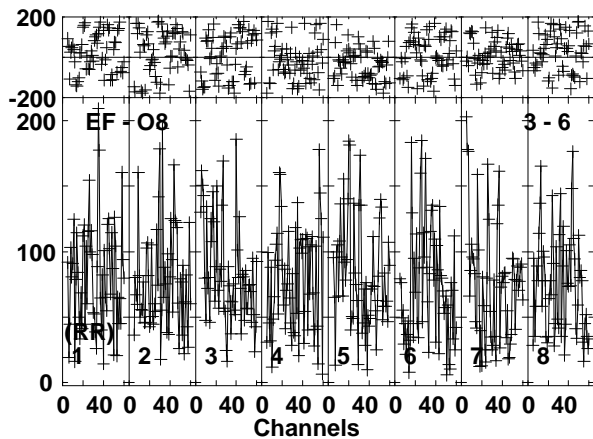
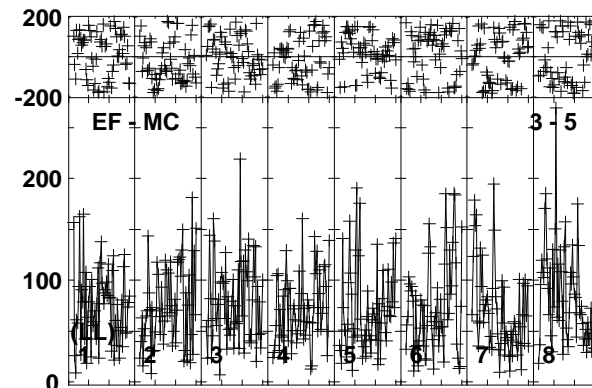
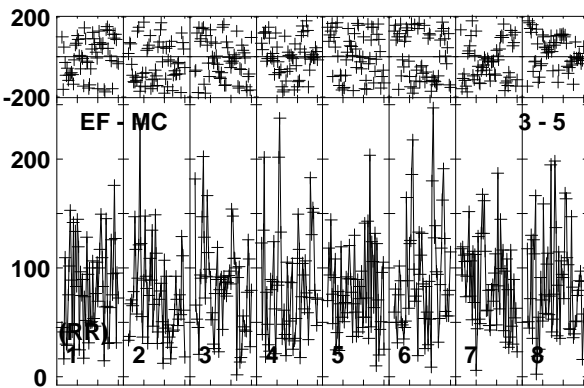
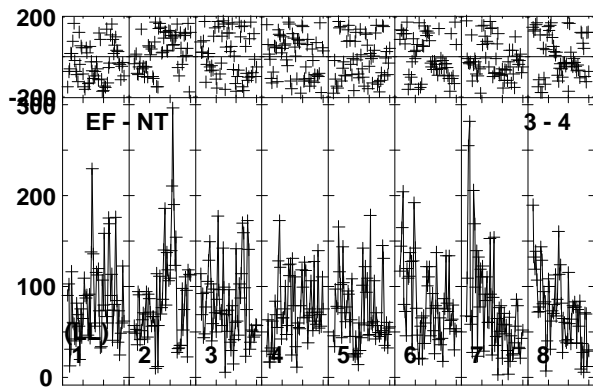
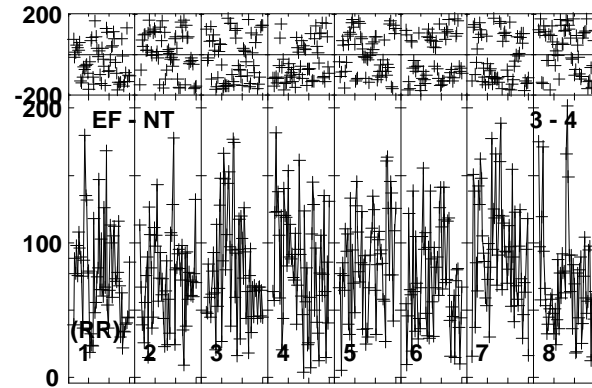
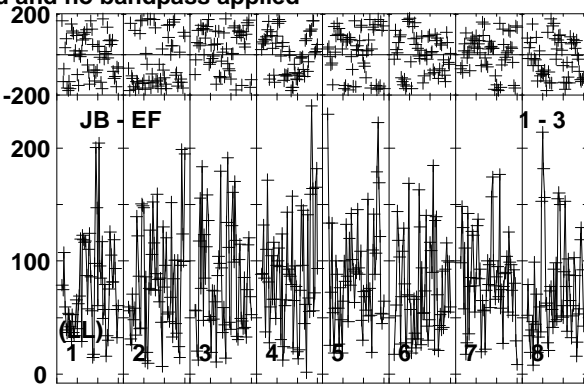
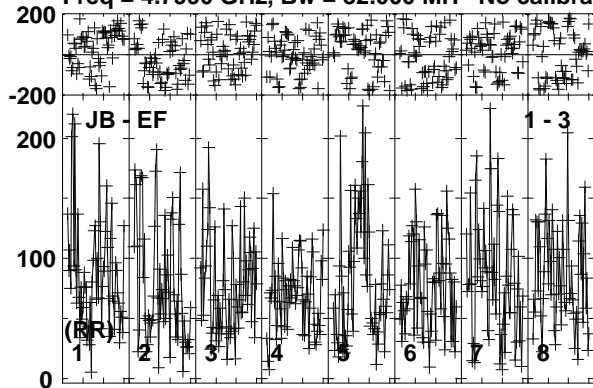

Lower frame: Micro Ampl Jy Top frame: Phas deg
Vector averaged cross-power spectrum Baseline: JB (01) - EF (03)
Timerange: 00/09:33:53 to 00/09:37:36

Plot file version 50 created 19-FEB-2019 18:12:57

IRAS23436 RP028B.UVDATA.1

Freq = 4.7990 GHz, Bw = 32.000 MH No calibration applied and no bandpass applied

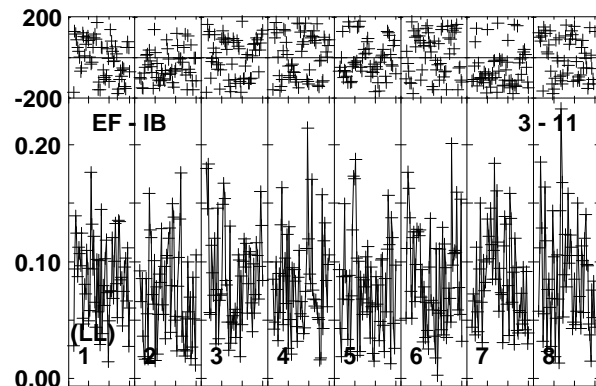
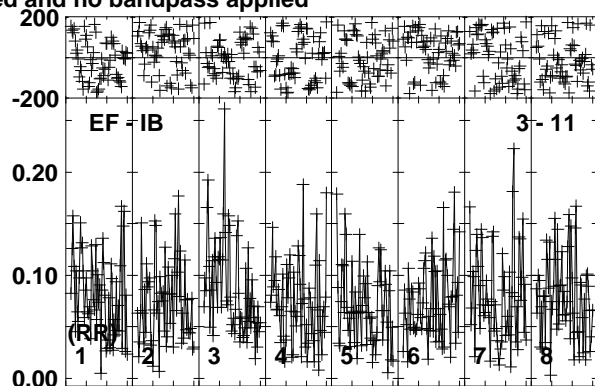
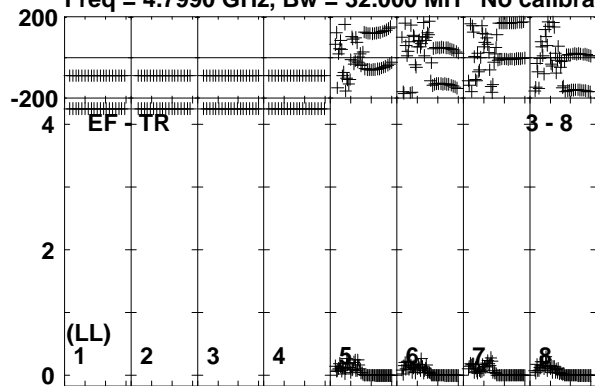

Lower frame: Milli Ampl Jy Top frame: Phas deg
Vector averaged cross-power spectrum Baseline: EF (03) - TR (08)
Timerange: 00/09:33:53 to 00/09:37:36

Plot file version 51 created 19-FEB-2019 18:12:57

J2353+5518 RP028B.UVDATA.1

Freq = 4.7990 GHz, Bw = 32.000 MH No calibration applied and no bandpass applied

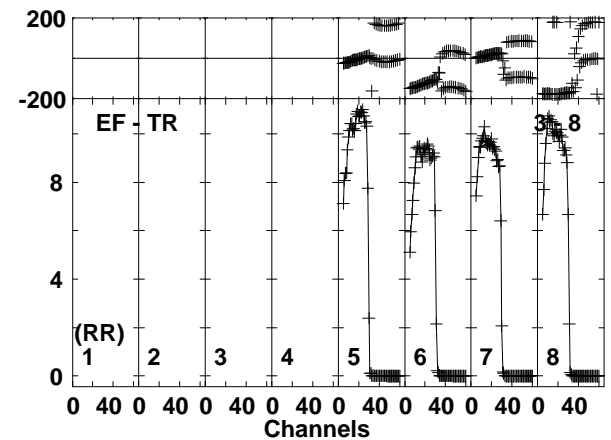
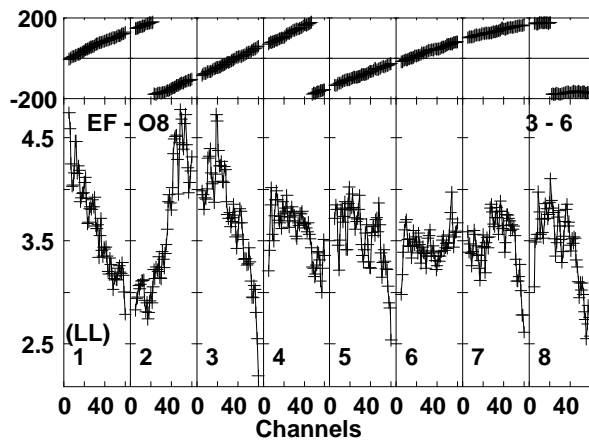
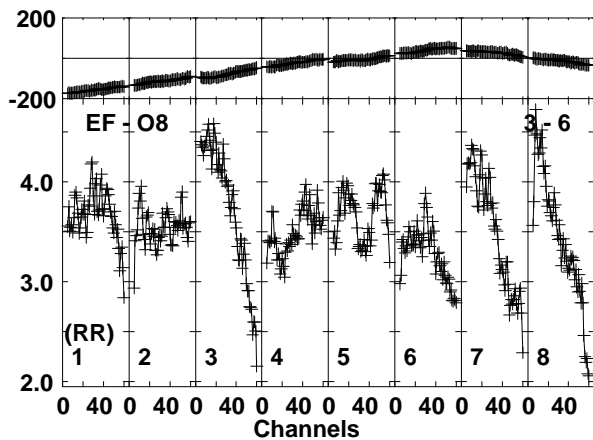
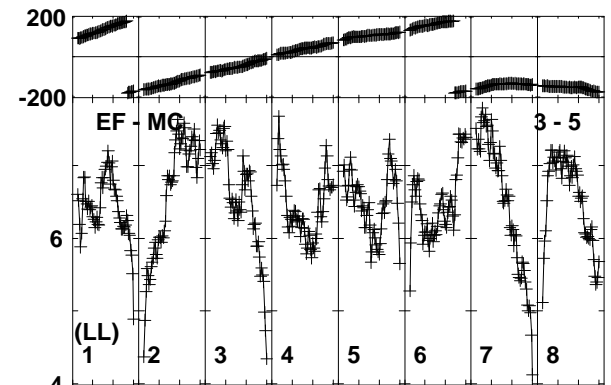
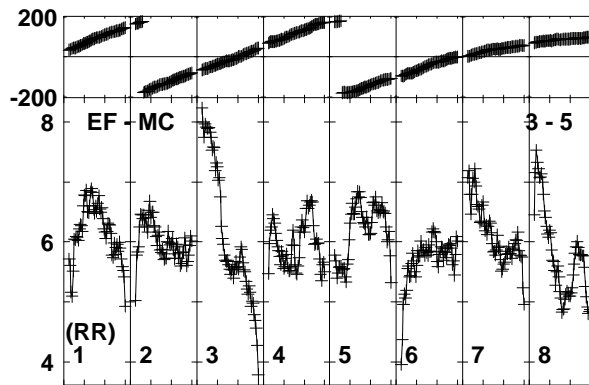
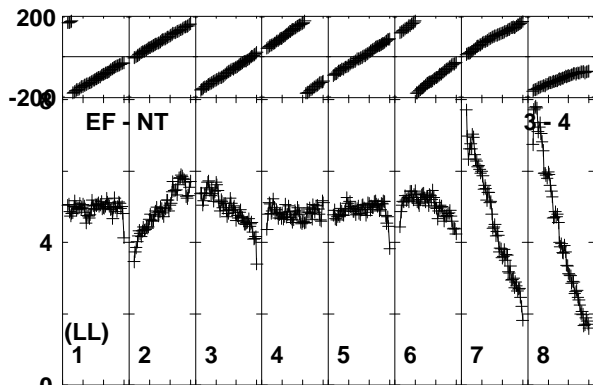
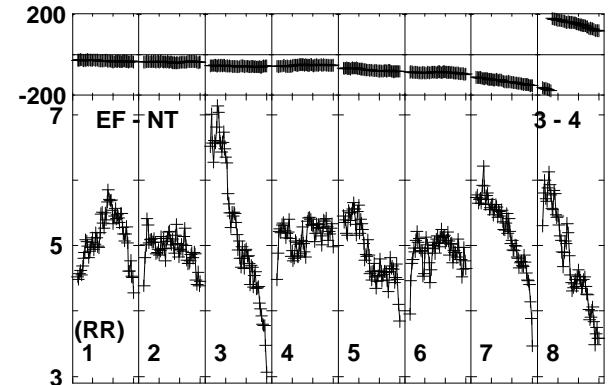
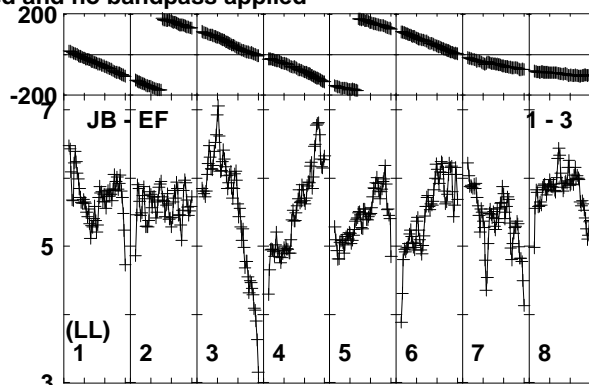
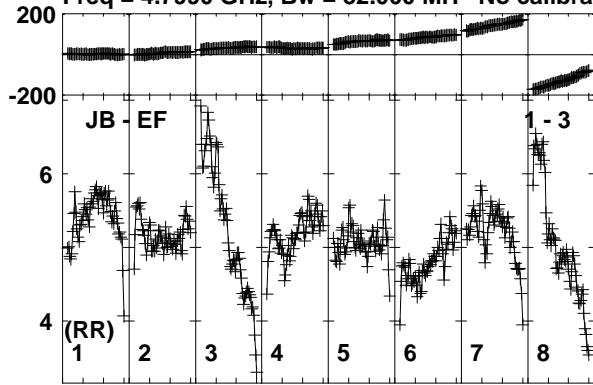

Lower frame: Milli Ampl Jy Top frame: Phas deg
Vector averaged cross-power spectrum Baseline: JB (01) - EF (03)
Timerange: 00/09:37:37 to 00/09:39:05

Plot file version 52 created 19-FEB-2019 18:12:58

J2353+5518 RP028B.UVDATA.1

Freq = 4.7990 GHz, Bw = 32.000 MH No calibration applied and no bandpass applied

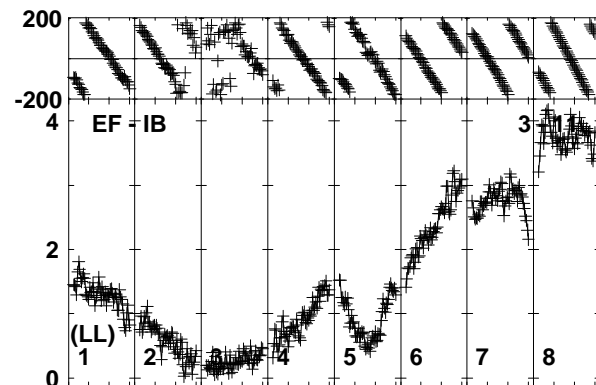
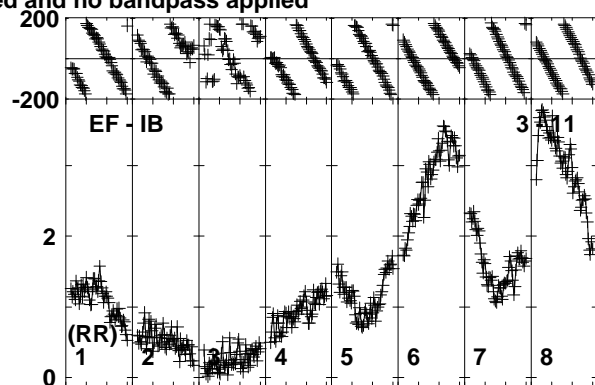
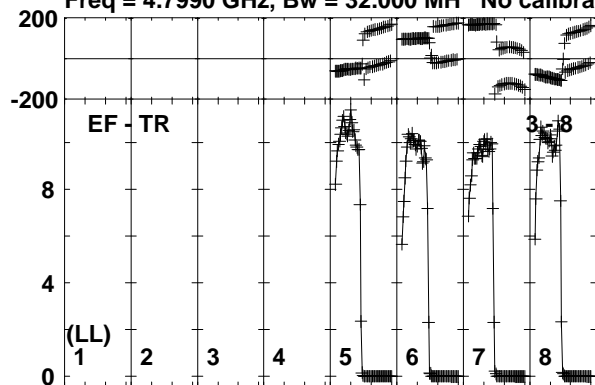

Lower frame: Milli Ampl Jy Top frame: Phas deg
Vector averaged cross-power spectrum Baseline: EF (03) - TR (08)
Timerange: 00/09:37:37 to 00/09:39:05

Plot file version 53 created 19-FEB-2019 18:12:58

IRAS23436 RP028B.UVDATA.1

Freq = 4.7990 GHz, Bw = 32.000 MH No calibration applied and no bandpass applied

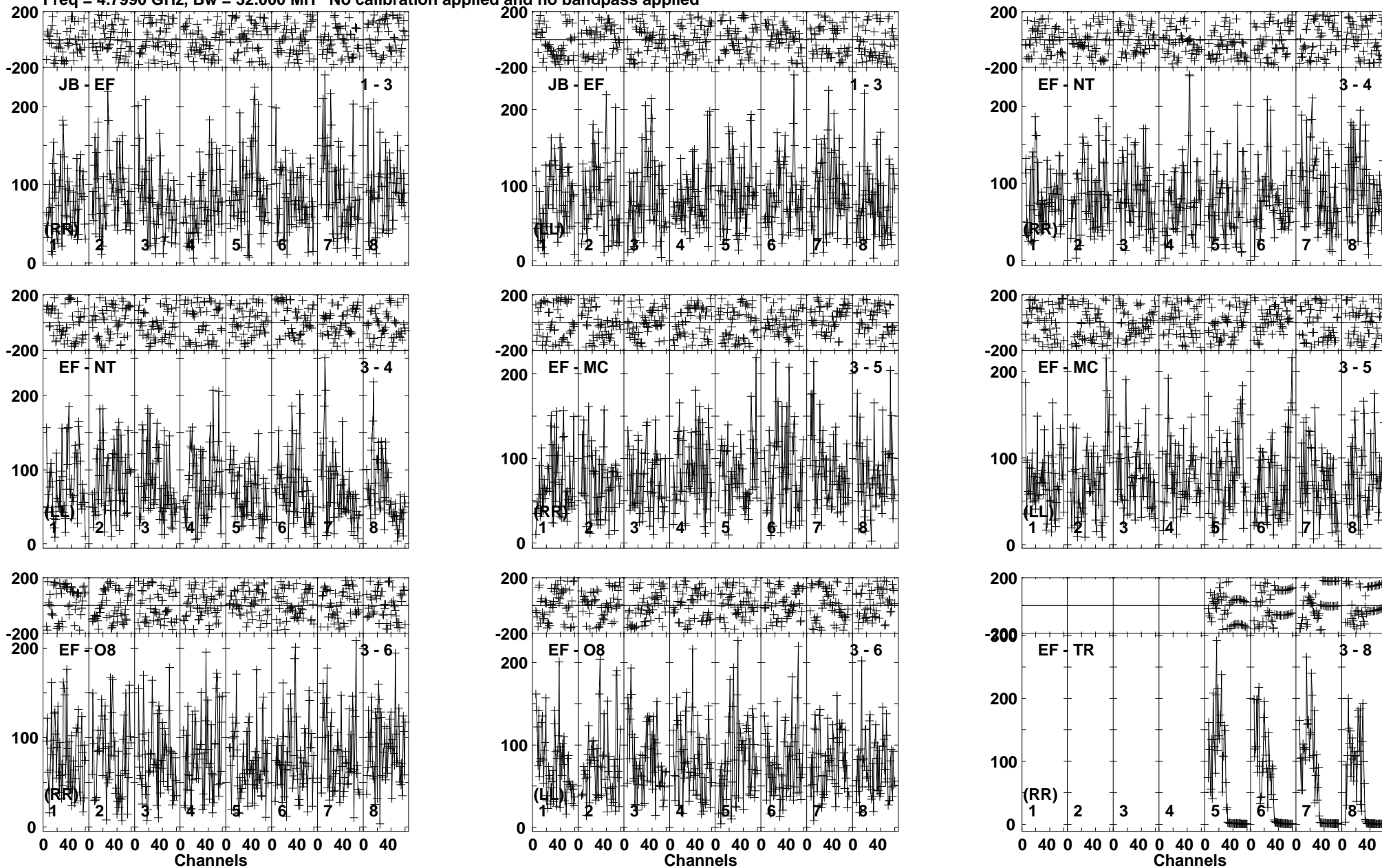

Lower frame: Micro Ampl Jy Top frame: Phas deg
Vector averaged cross-power spectrum Baseline: JB (01) - EF (03)
Timerange: 00/09:39:07 to 00/09:42:49

Plot file version 54 created 19-FEB-2019 18:12:58

IRAS23436 RP028B.UVDATA.1

Freq = 4.7990 GHz, Bw = 32.000 MH No calibration applied and no bandpass applied

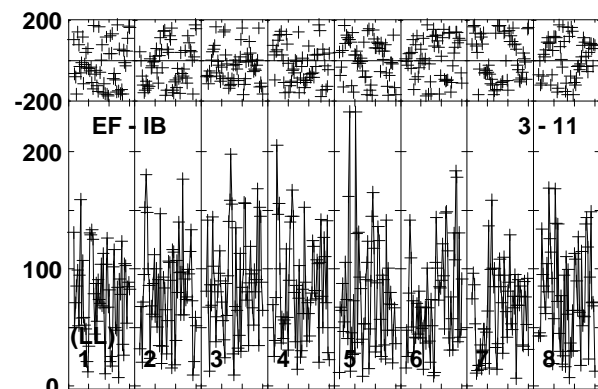
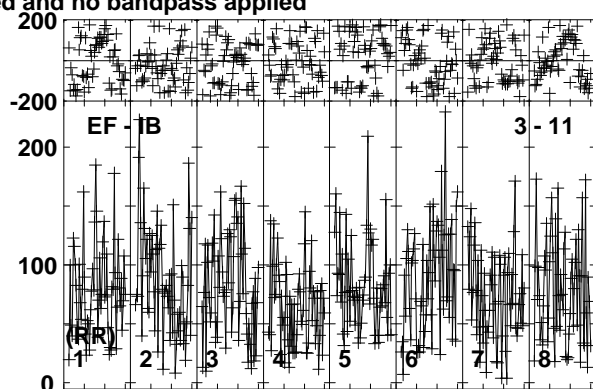
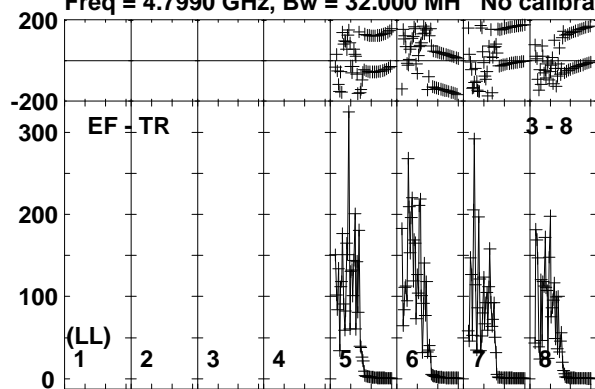

Lower frame: Micro Ampl Jy Top frame: Phas deg
Vector averaged cross-power spectrum Baseline: EF (03) - TR (08)
Timerange: 00/09:39:07 to 00/09:42:49

Plot file version 55 created 19-FEB-2019 18:12:58

J2353+5518 RP028B.UVDATA.1

Freq = 4.7990 GHz, Bw = 32.000 MH No calibration applied and no bandpass applied

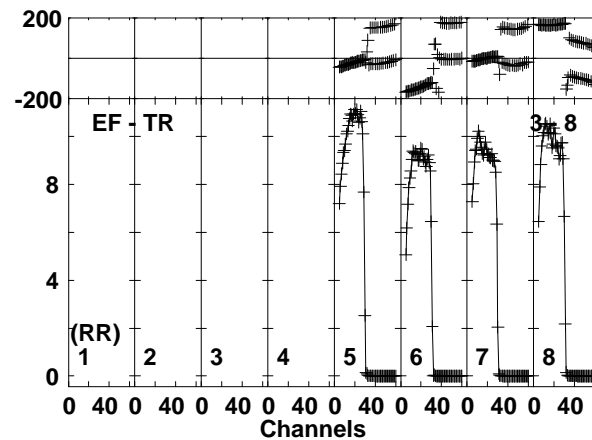
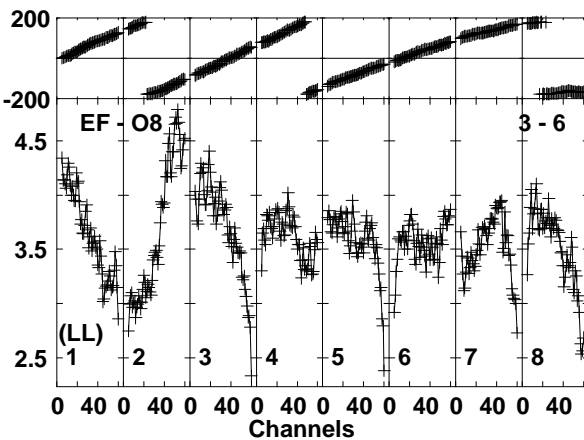
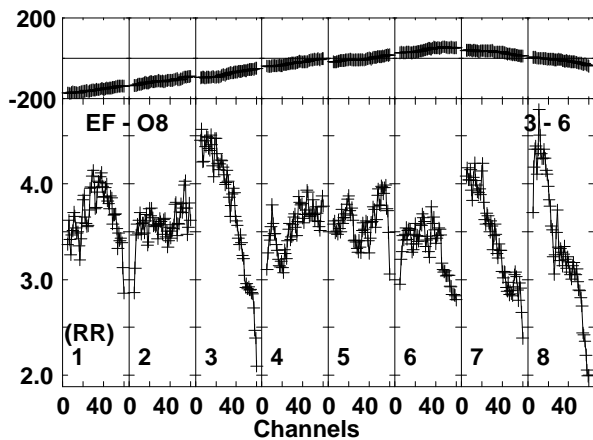
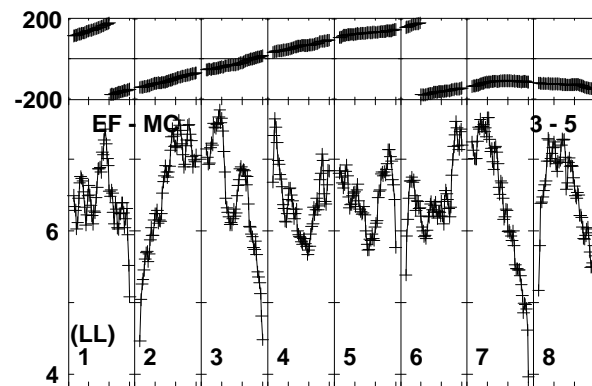
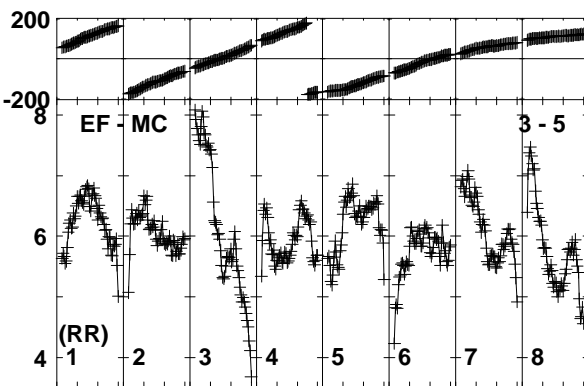
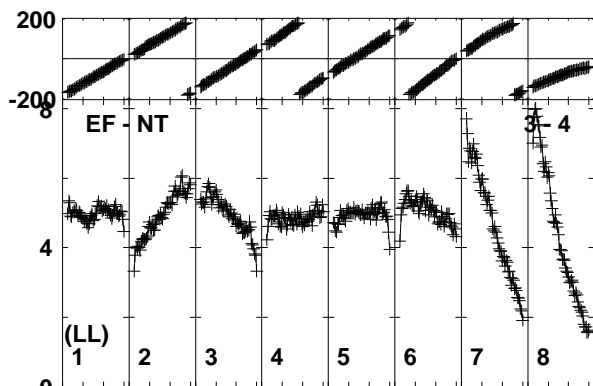
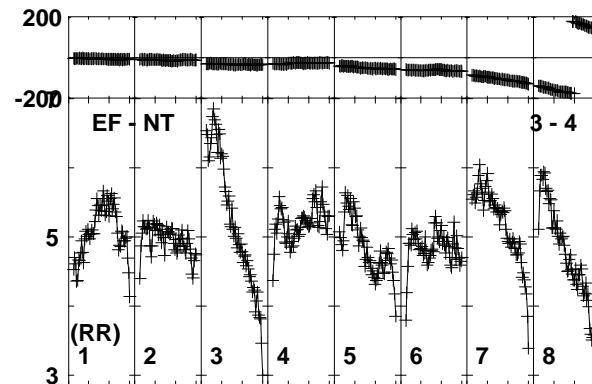
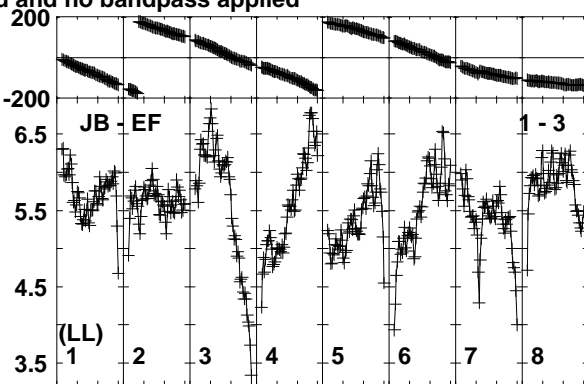
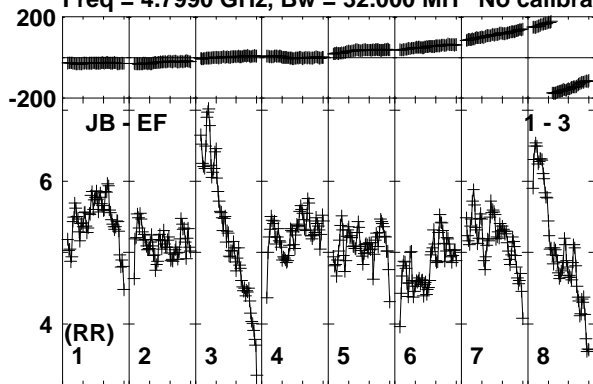

Lower frame: Milli Ampl Jy Top frame: Phas deg
Vector averaged cross-power spectrum Baseline: JB (01) - EF (03)
Timerange: 00/09:43:31 to 00/09:44:29

Plot file version 56 created 19-FEB-2019 18:12:58

J2353+5518 RP028B.UVDATA.1

Freq = 4.7990 GHz, Bw = 32.000 MH No calibration applied and no bandpass applied

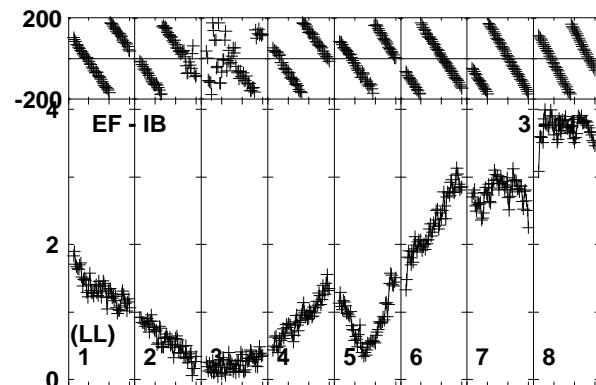
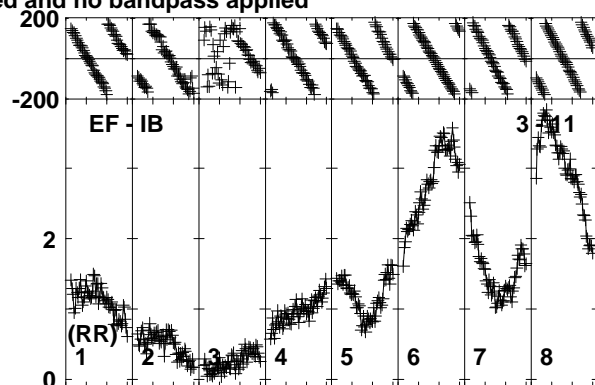
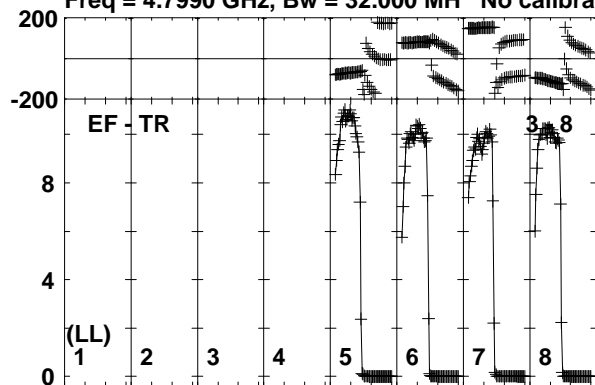

Lower frame: Milli Ampl Jy Top frame: Phas deg
Vector averaged cross-power spectrum Baseline: EF (03) - TR (08)
Timerange: 00/09:43:31 to 00/09:44:29

Plot file version 57 created 19-FEB-2019 18:12:59

IRAS23436 RP028B.UVDATA.1

Freq = 4.7990 GHz, Bw = 32.000 MH No calibration applied and no bandpass applied

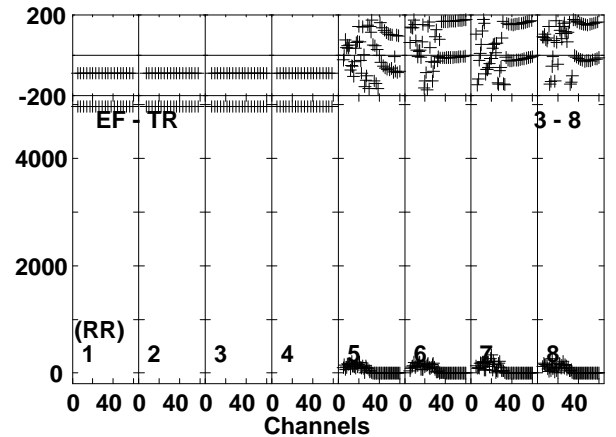
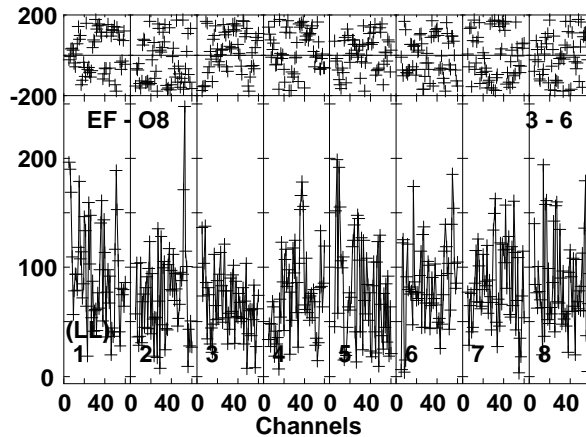
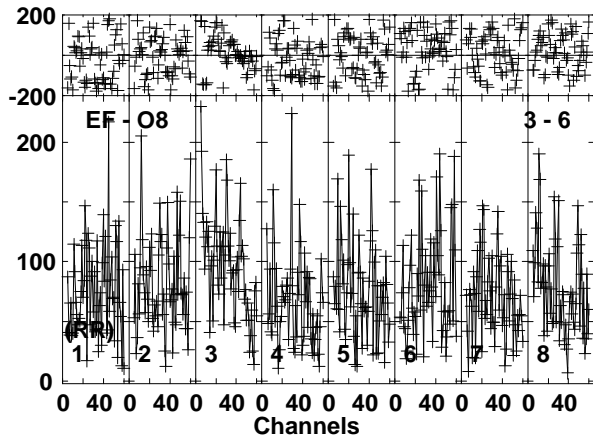
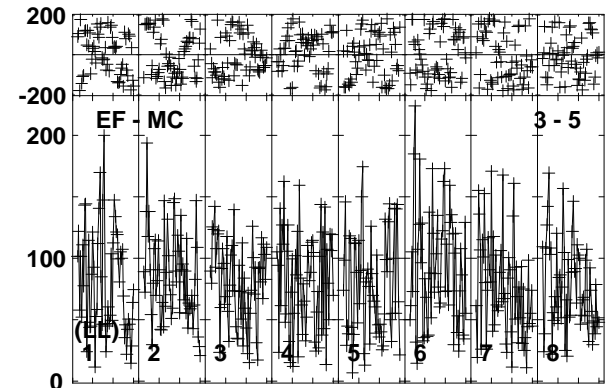
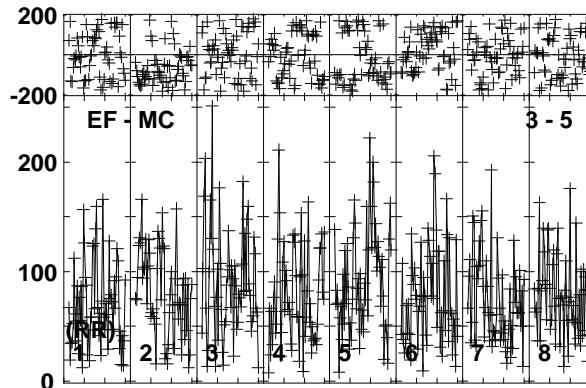
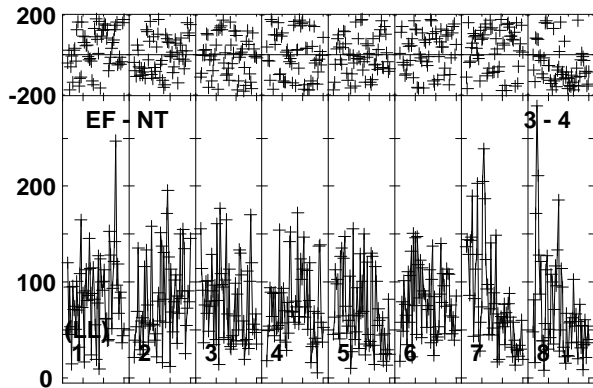
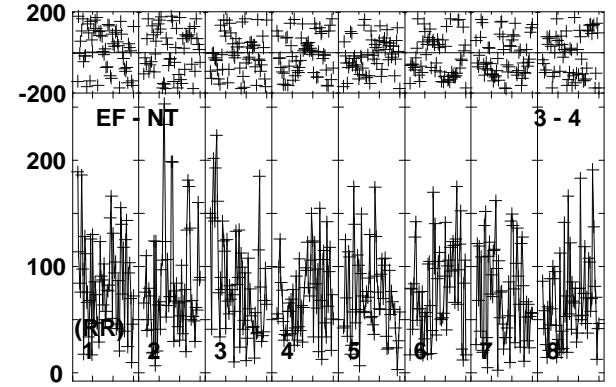
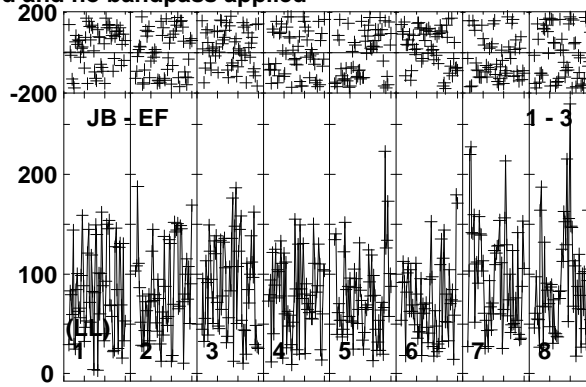
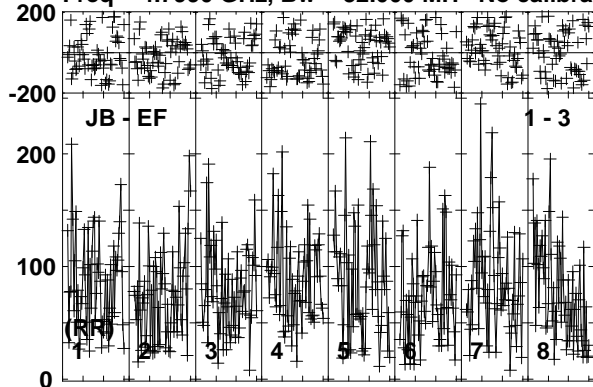

Lower frame: Micro Ampl Jy Top frame: Phas deg
Vector averaged cross-power spectrum Baseline: JB (01) - EF (03)
Timerange: 00/09:44:30 to 00/09:48:10

Plot file version 58 created 19-FEB-2019 18:12:59

IRAS23436 RP028B.UVDATA.1

Freq = 4.7990 GHz, Bw = 32.000 MH No calibration applied and no bandpass applied

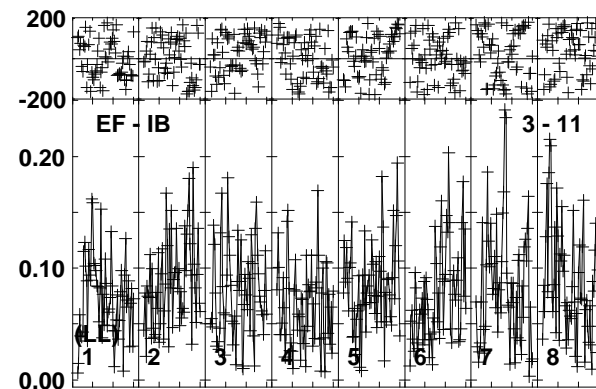
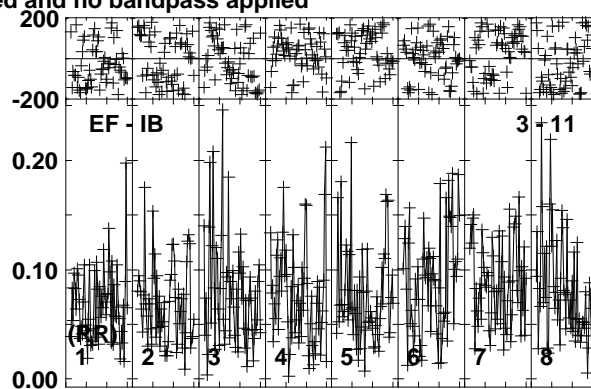
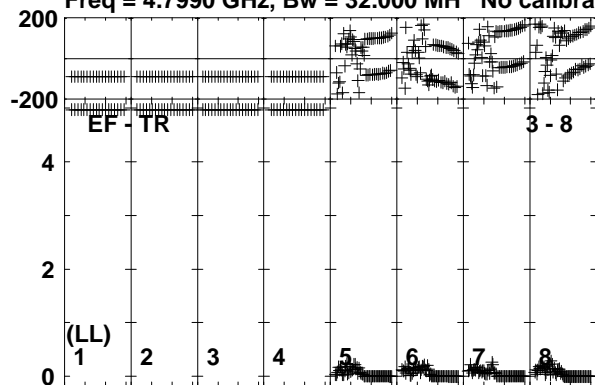

Lower frame: Milli Ampl Jy Top frame: Phas deg
Vector averaged cross-power spectrum Baseline: EF (03) - TR (08)
Timerange: 00/09:44:30 to 00/09:48:10

Plot file version 59 created 19-FEB-2019 18:12:59

J2353+5518 RP028B.UVDATA.1

Freq = 4.7990 GHz, Bw = 32.000 MH No calibration applied and no bandpass applied

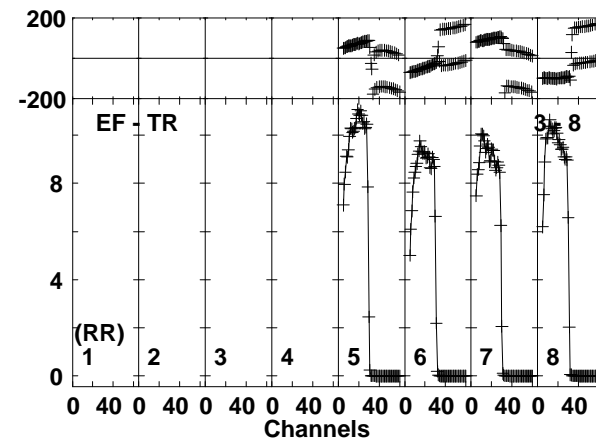
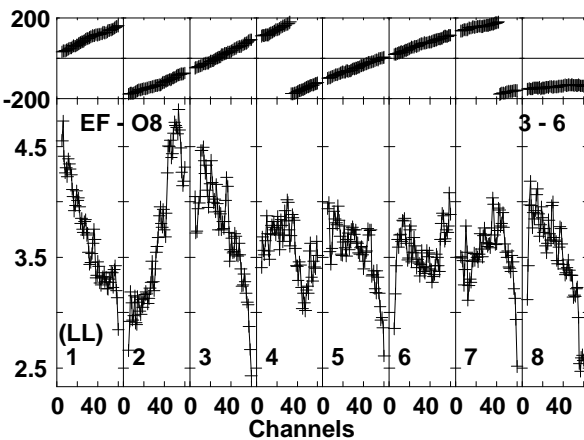
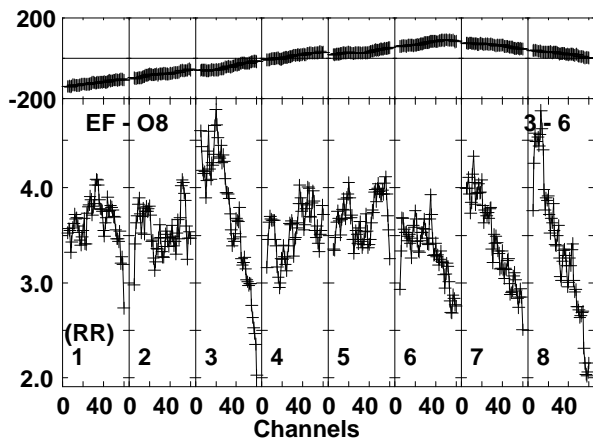
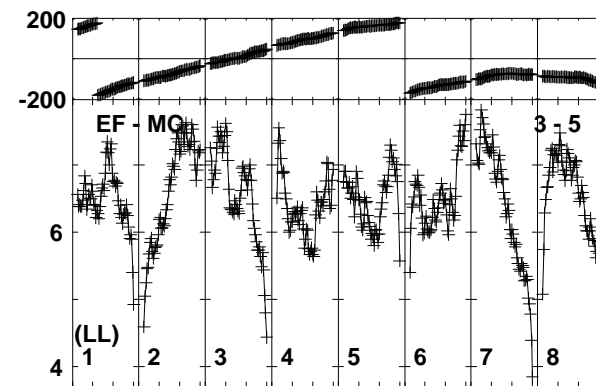
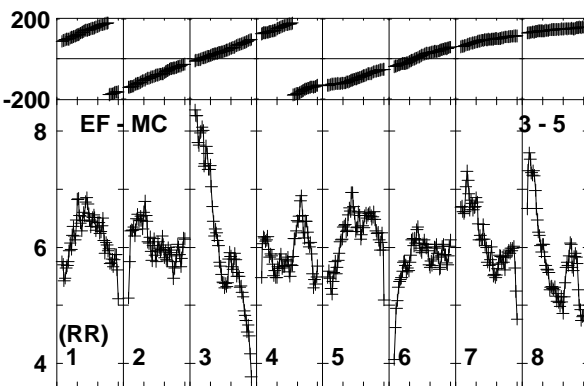
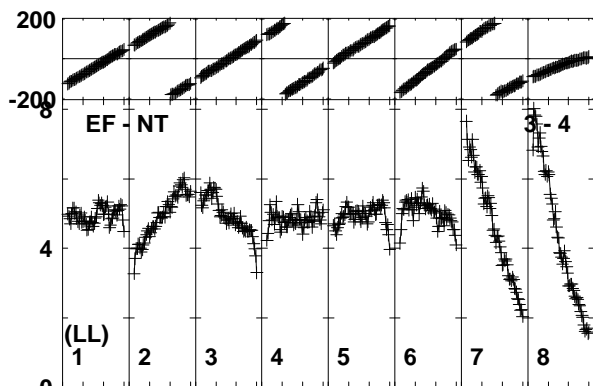
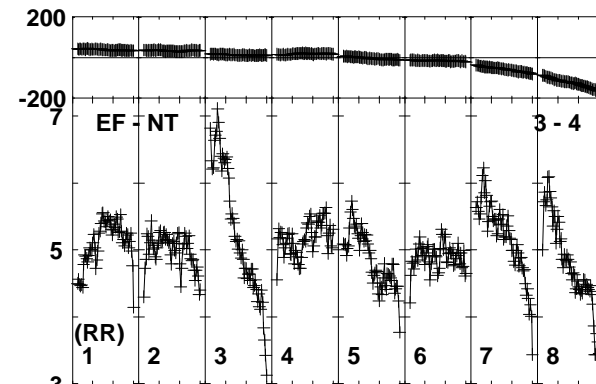
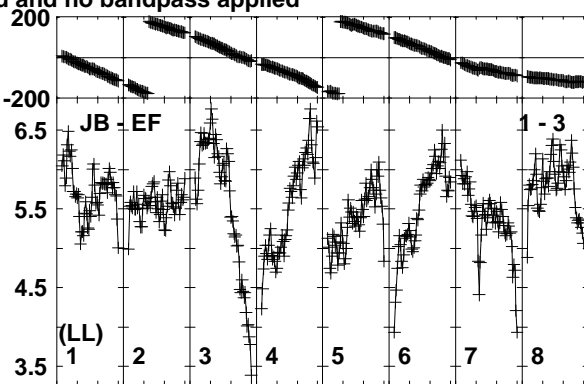
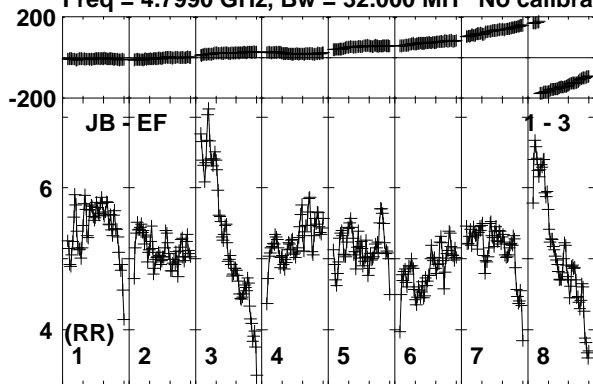

Lower frame: Milli Ampl Jy Top frame: Phas deg
Vector averaged cross-power spectrum Baseline: JB (01) - EF (03)
Timerange: 00/09:48:10 to 00/09:49:39

Plot file version 60 created 19-FEB-2019 18:12:59

J2353+5518 RP028B.UVDATA.1

Freq = 4.7990 GHz, Bw = 32.000 MH No calibration applied and no bandpass applied

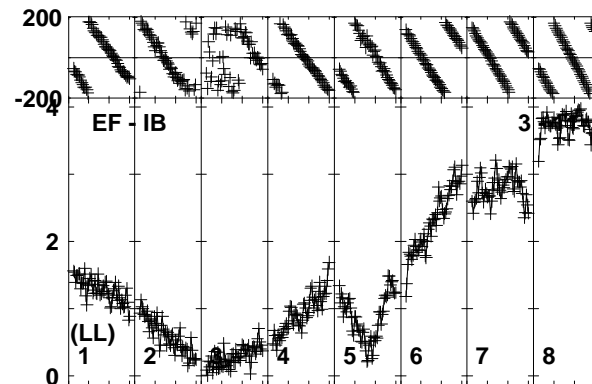
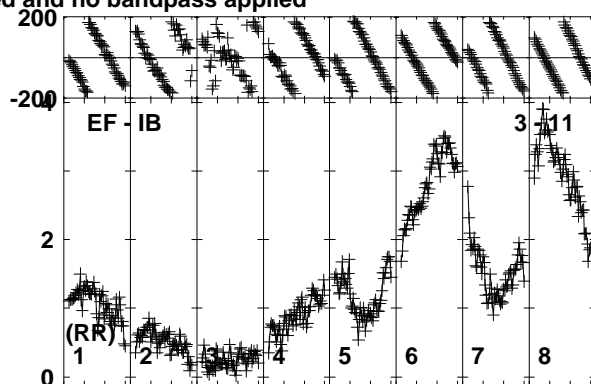
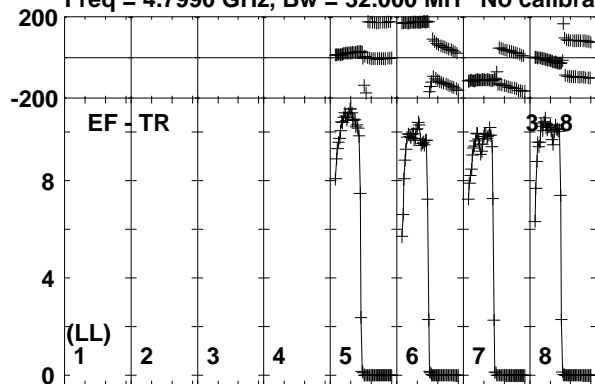

Lower frame: Milli Ampl Jy Top frame: Phas deg
Vector averaged cross-power spectrum Baseline: EF (03) - TR (08)
Timerange: 00/09:48:10 to 00/09:49:39

Plot file version 61 created 19-FEB-2019 18:12:59

IRAS23436 RP028B.UVDATA.1

Freq = 4.7990 GHz, Bw = 32.000 MH No calibration applied and no bandpass applied

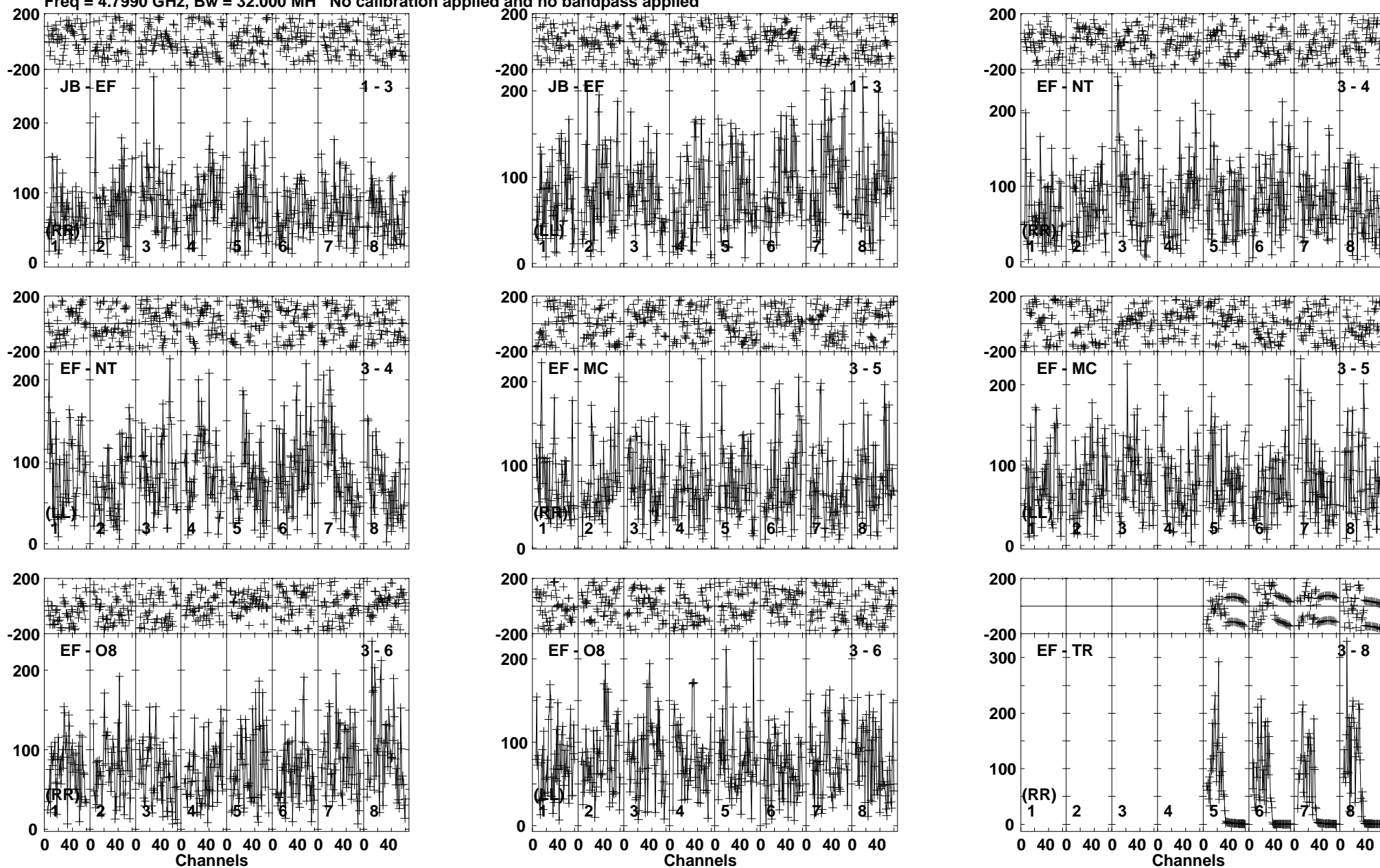

Lower frame: Micro Ampl Jy Top frame: Phas deg
Vector averaged cross-power spectrum Baseline: JB (01) - EF (03)
Timerange: 00/09:49:41 to 00/09:53:23

Plot file version 62 created 19-FEB-2019 18:13:00

IRAS23436 RP028B.UVDATA.1

Freq = 4.7990 GHz, Bw = 32.000 MH No calibration applied and no bandpass applied

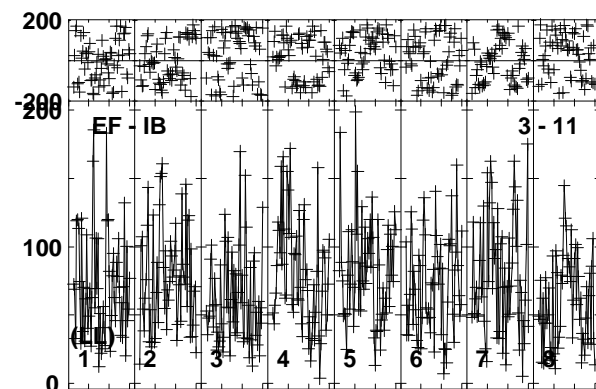
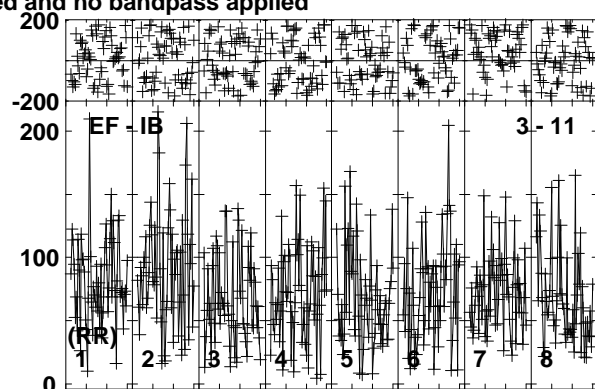
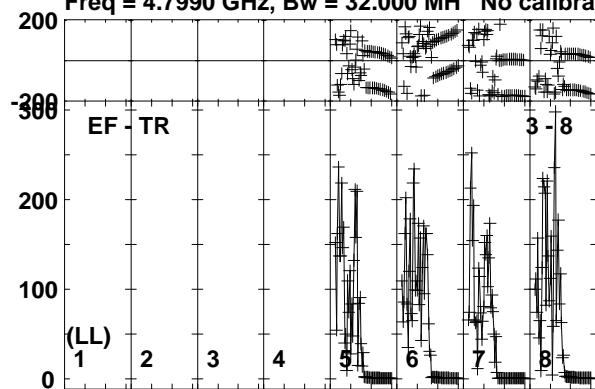

Lower frame: Micro Ampl Jy Top frame: Phas deg
Vector averaged cross-power spectrum Baseline: EF (03) - TR (08)
Timerange: 00/09:49:41 to 00/09:53:23

Plot file version 63 created 19-FEB-2019 18:13:00

J2353+5518 RP028B.UVDATA.1

Freq = 4.7990 GHz, Bw = 32.000 MH No calibration applied and no bandpass applied

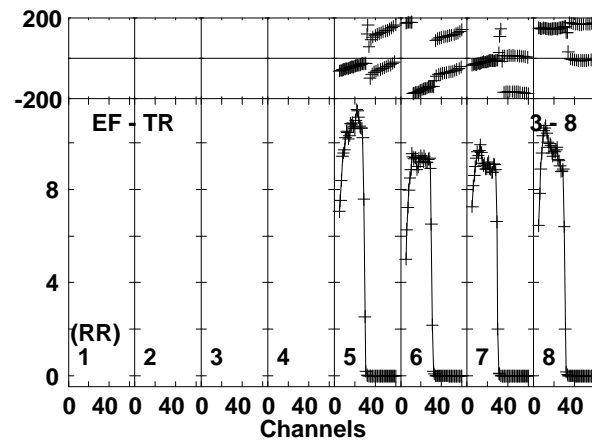
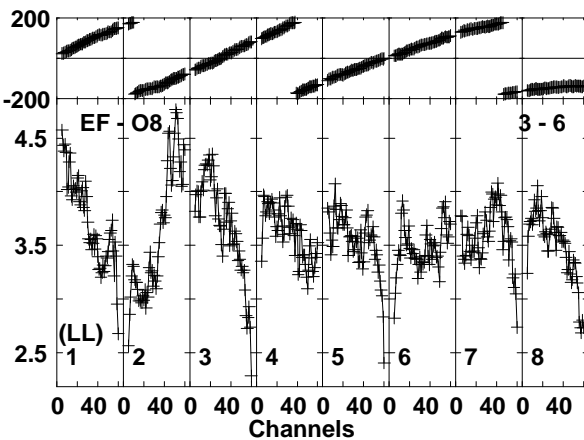
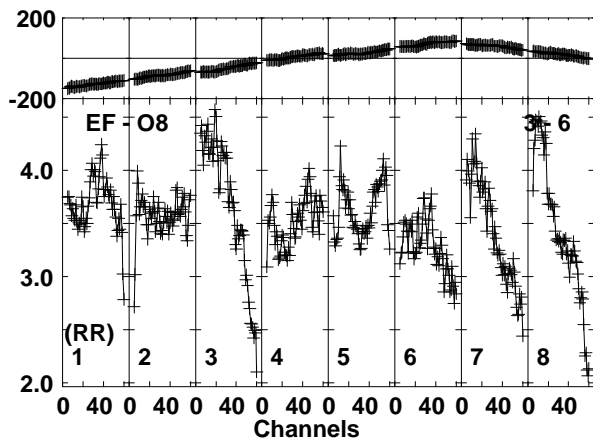
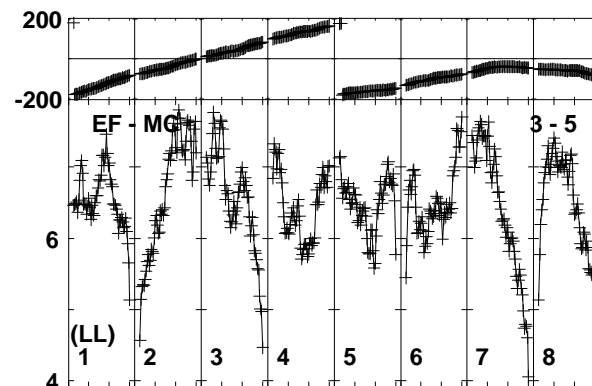
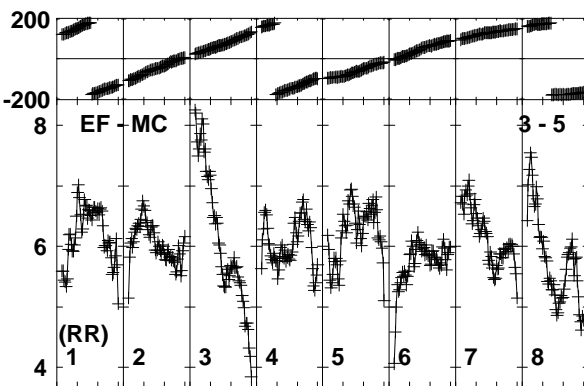
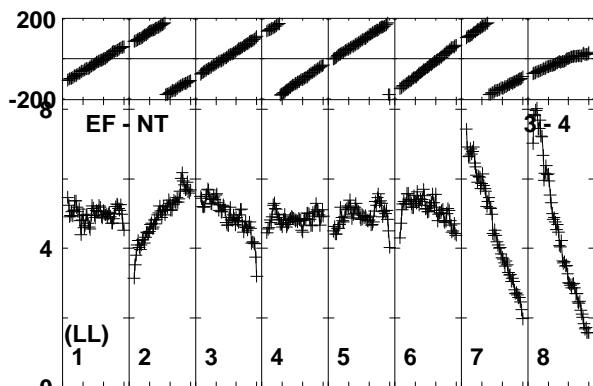
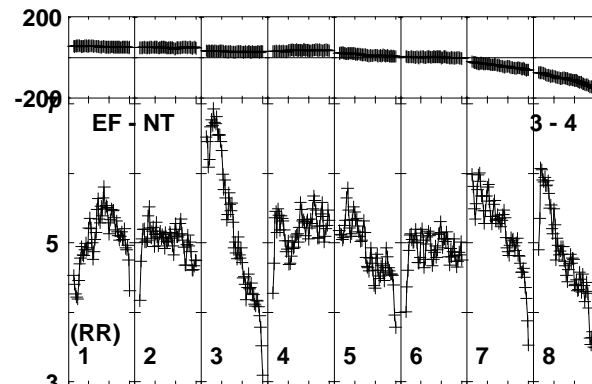
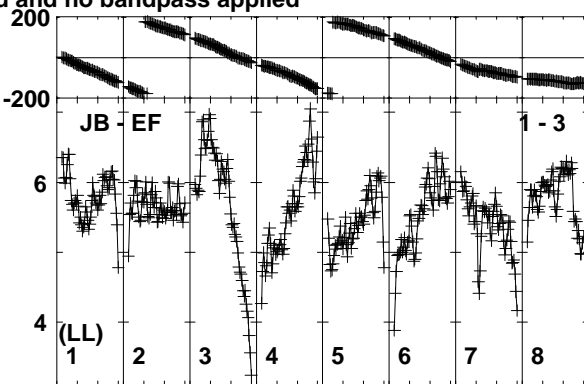
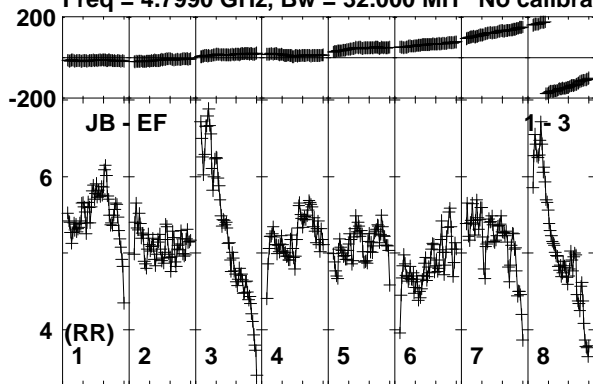

Lower frame: Milli Ampl Jy Top frame: Phas deg
Vector averaged cross-power spectrum Baseline: JB (01) - EF (03)
Timerange: 00/09:54:04 to 00/09:54:54

Plot file version 64 created 19-FEB-2019 18:13:00

J2353+5518 RP028B.UVDATA.1

Freq = 4.7990 GHz, Bw = 32.000 MH No calibration applied and no bandpass applied

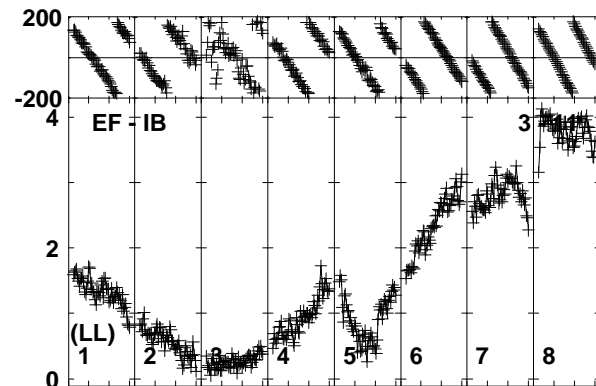
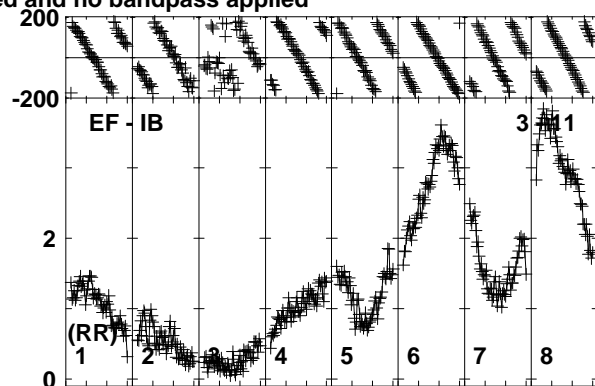
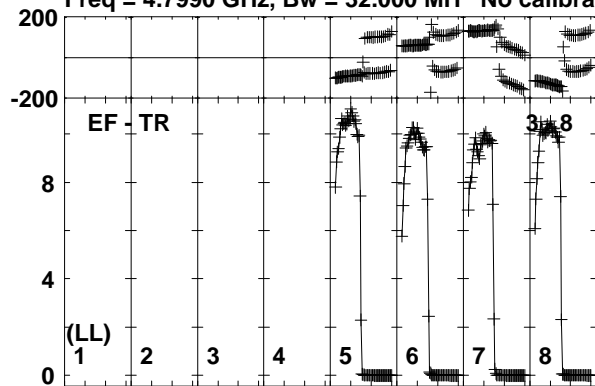

Lower frame: Milli Ampl Jy Top frame: Phas deg
Vector averaged cross-power spectrum Baseline: EF (03) - TR (08)
Timerange: 00/09:54:04 to 00/09:54:54

Plot file version 65 created 19-FEB-2019 18:13:00

IRAS23436 RP028B.UVDATA.1

Freq = 4.7990 GHz, Bw = 32.000 MH No calibration applied and no bandpass applied

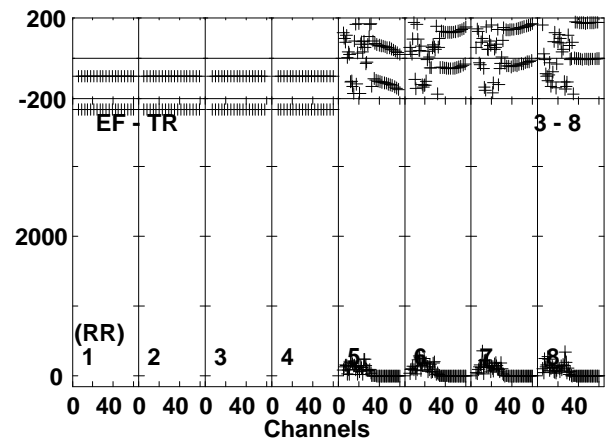
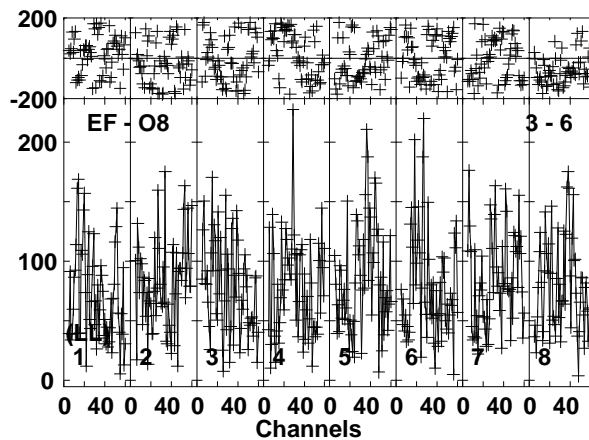
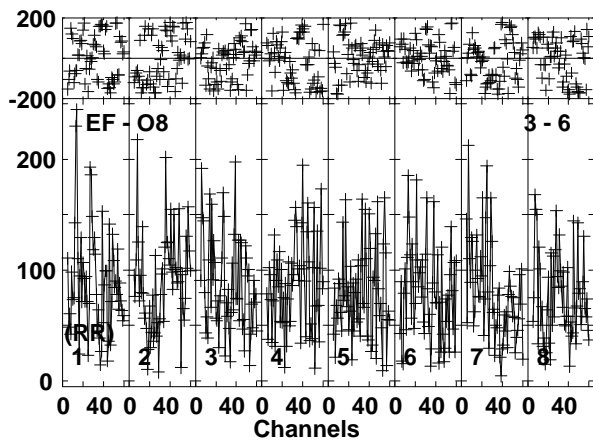
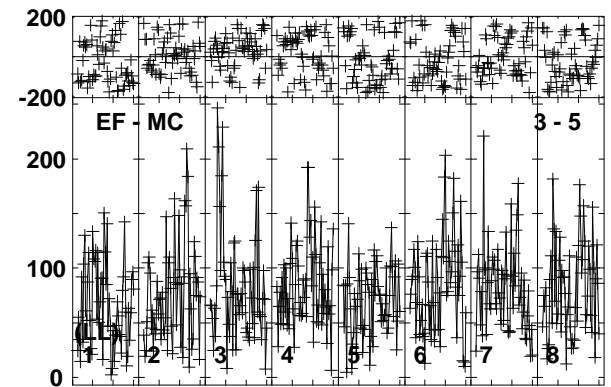
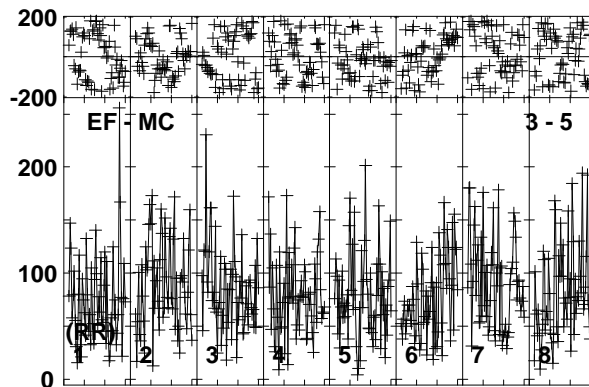
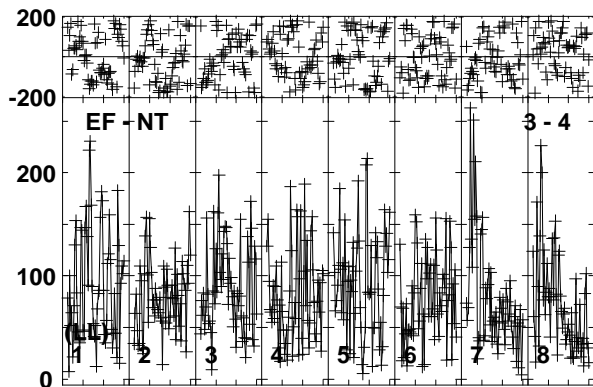
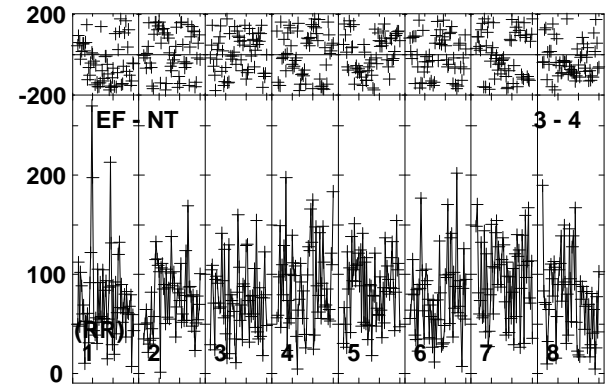
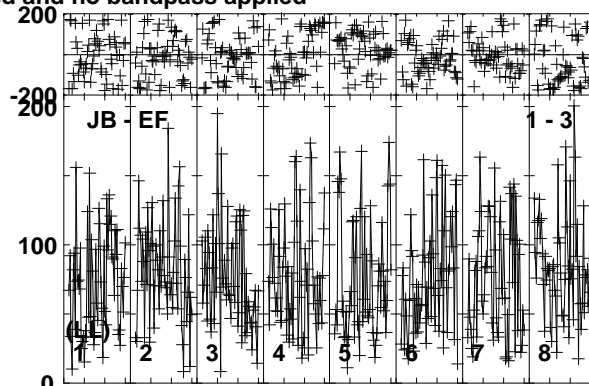
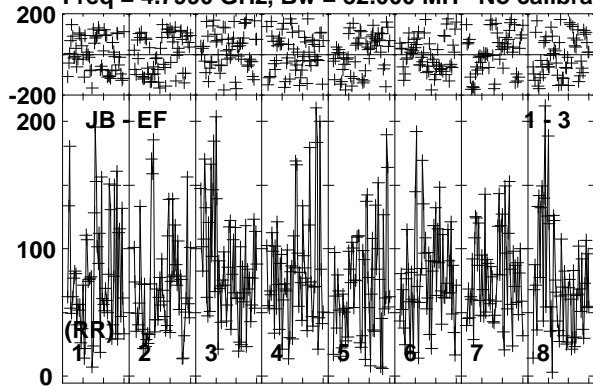

Lower frame: Micro Ampl Jy Top frame: Phas deg
Vector averaged cross-power spectrum Baseline: JB (01) - EF (03)
Timerange: 00/09:54:55 to 00/09:58:37

Plot file version 66 created 19-FEB-2019 18:13:01

IRAS23436 RP028B.UVDATA.1

Freq = 4.7990 GHz, Bw = 32.000 MH No calibration applied and no bandpass applied

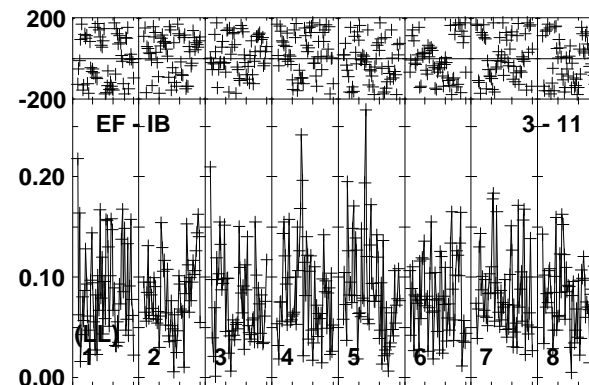
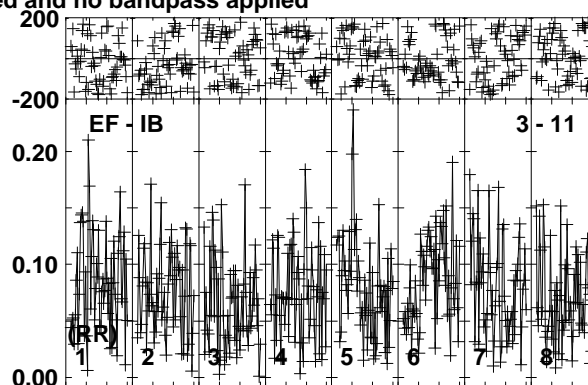
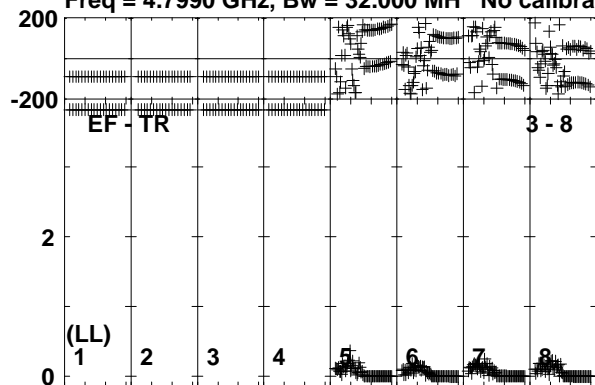

Lower frame: Milli Ampl Jy Top frame: Phas deg
Vector averaged cross-power spectrum Baseline: EF (03) - TR (08)
Timerange: 00/09:54:55 to 00/09:58:37

Plot file version 67 created 19-FEB-2019 18:13:01

J2353+5518 RP028B.UVDATA.1

Freq = 4.7990 GHz, Bw = 32.000 MH No calibration applied and no bandpass applied

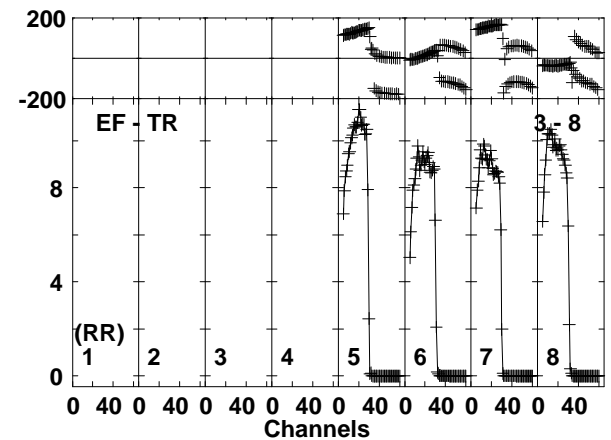
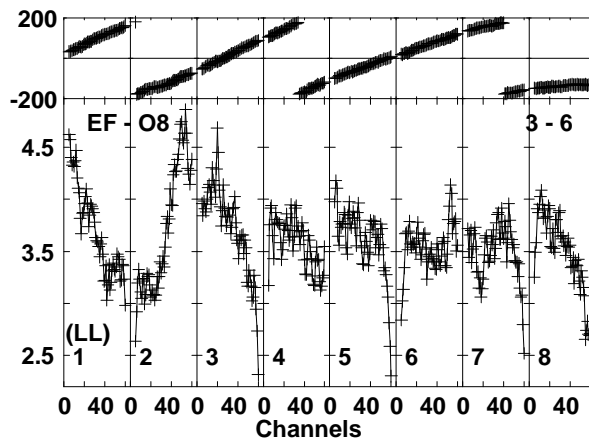
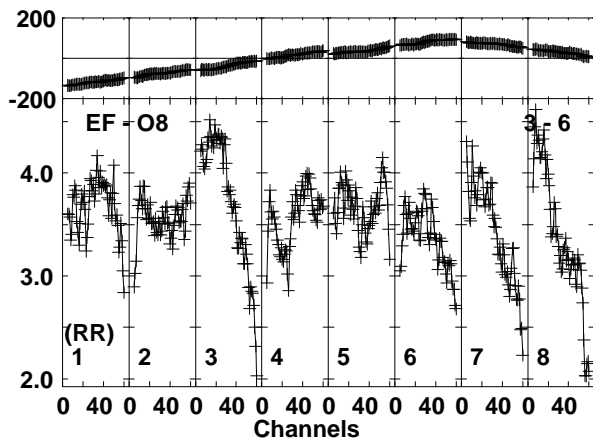
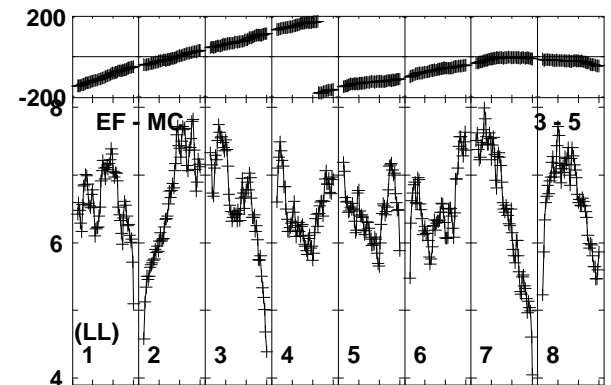
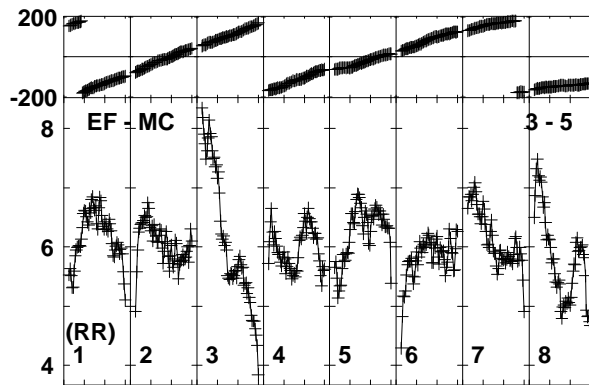
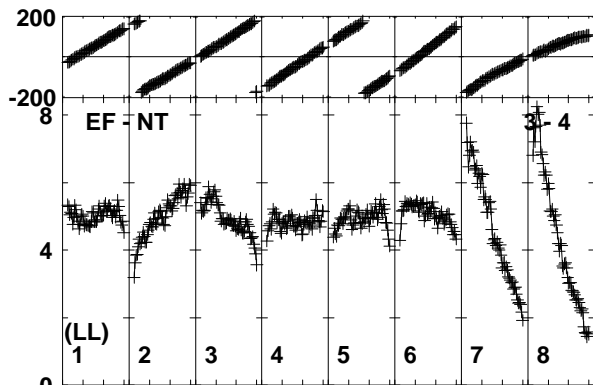
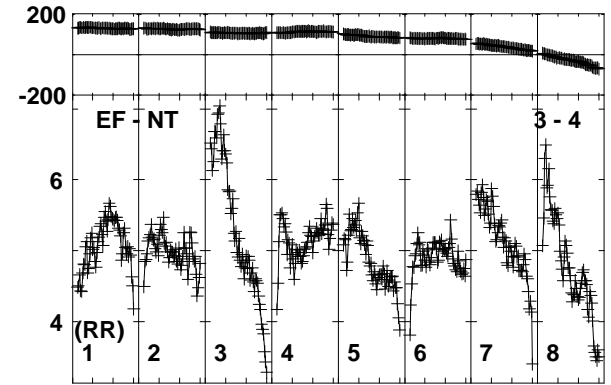
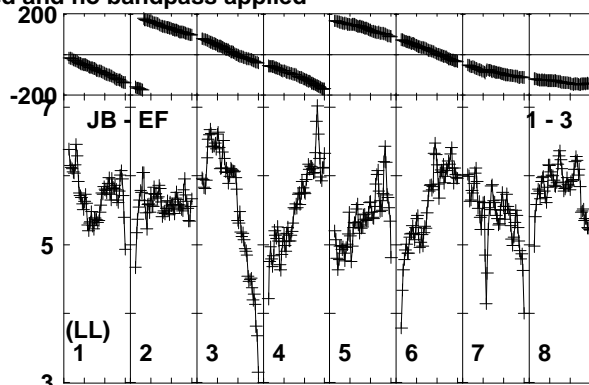
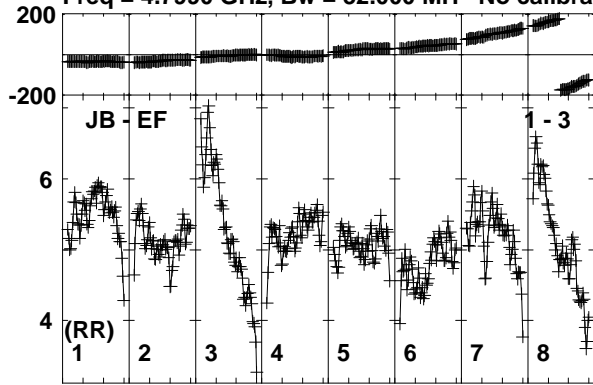

Lower frame: Milli Ampl Jy Top frame: Phas deg
Vector averaged cross-power spectrum Baseline: JB (01) - EF (03)
Timerange: 00/09:58:39 to 00/10:00:07

Plot file version 68 created 19-FEB-2019 18:13:01

J2353+5518 RP028B.UVDATA.1

Freq = 4.7990 GHz, Bw = 32.000 MH No calibration applied and no bandpass applied

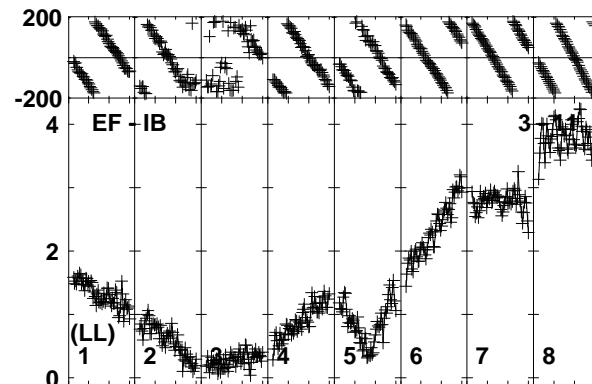
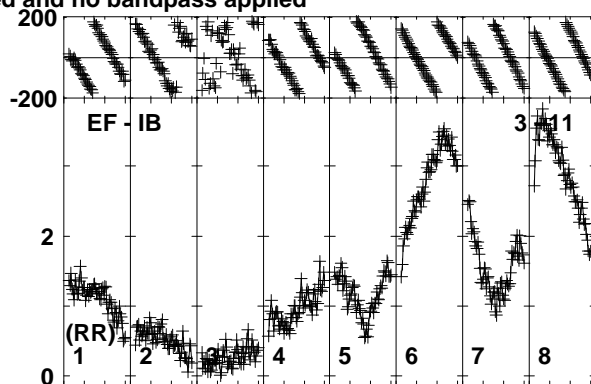
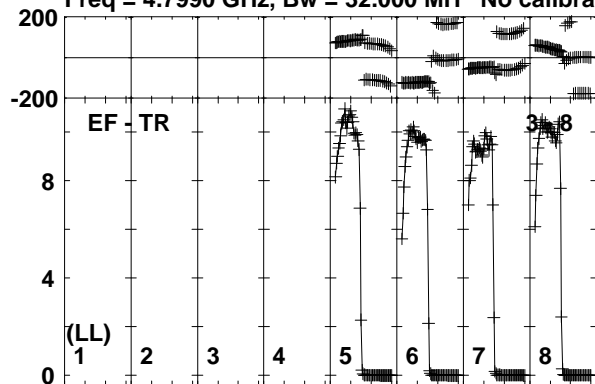

Lower frame: Milli Ampl Jy Top frame: Phas deg
Vector averaged cross-power spectrum Baseline: EF (03) - TR (08)
Timerange: 00/09:58:39 to 00/10:00:07

Plot file version 69 created 19-FEB-2019 18:13:01

IRAS23436 RP028B.UVDATA.1

Freq = 4.7990 GHz, Bw = 32.000 MH No calibration applied and no bandpass applied

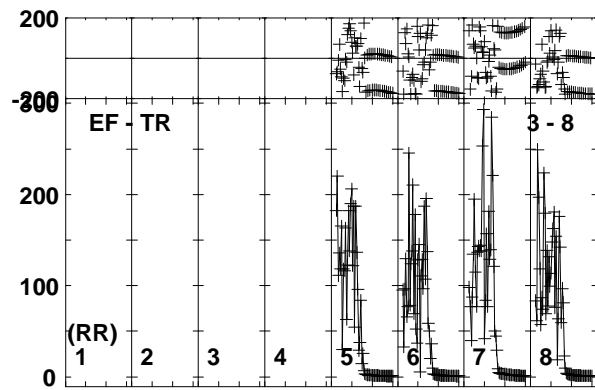
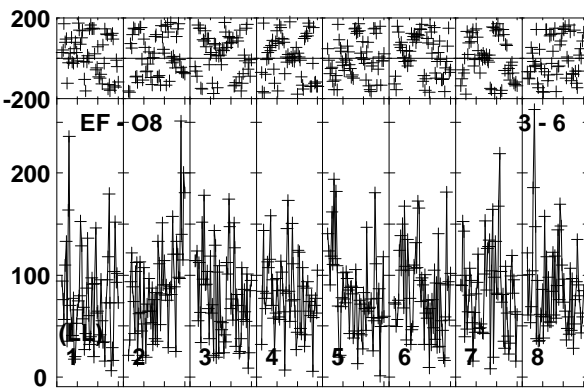
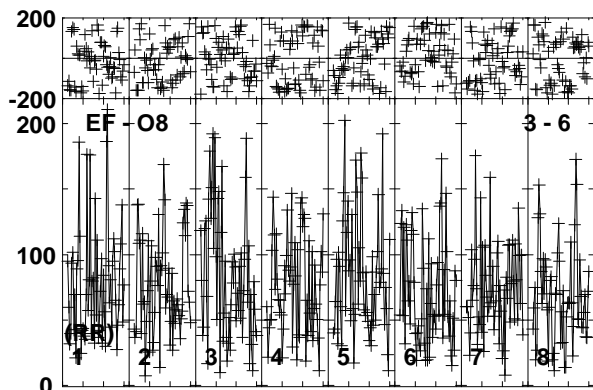
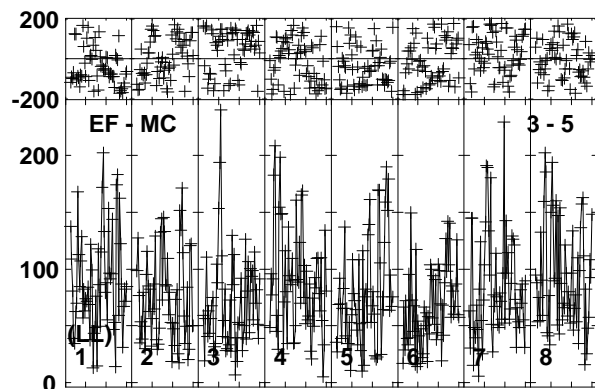
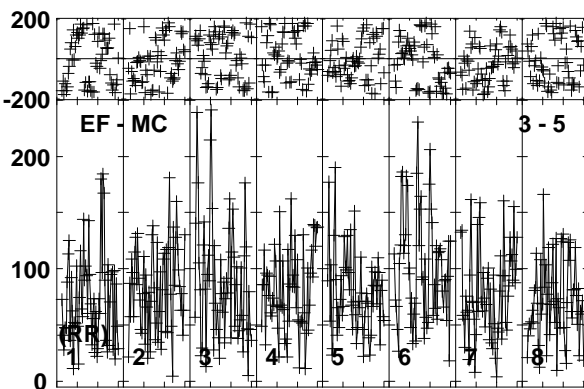
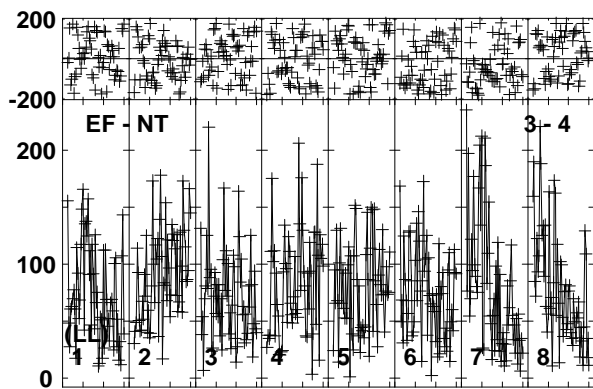
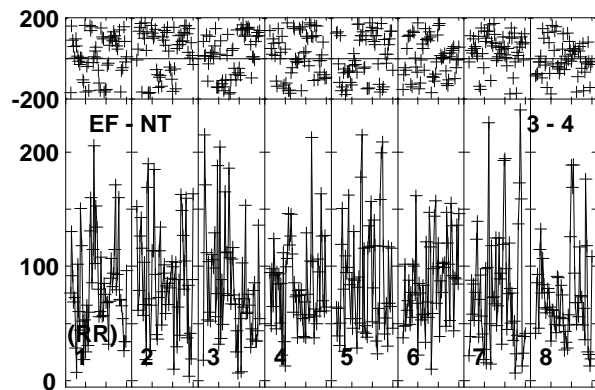
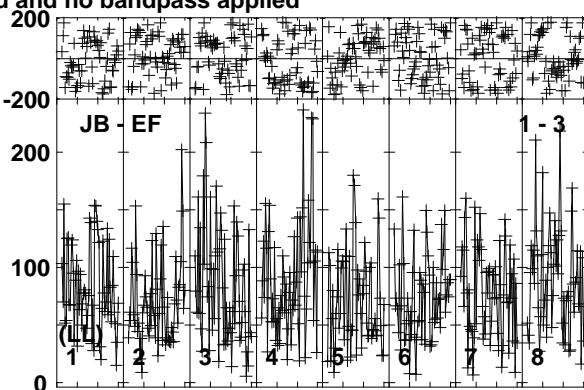
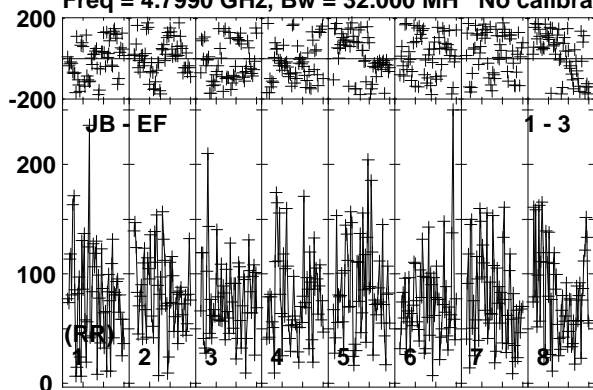

Lower frame: Micro Ampl Jy Top frame: Phas deg
Vector averaged cross-power spectrum Baseline: JB (01) - EF (03)
Timerange: 00/10:00:09 to 00/10:03:51

Plot file version 70 created 19-FEB-2019 18:13:02

IRAS23436 RP028B.UVDATA.1

Freq = 4.7990 GHz, Bw = 32.000 MH No calibration applied and no bandpass applied

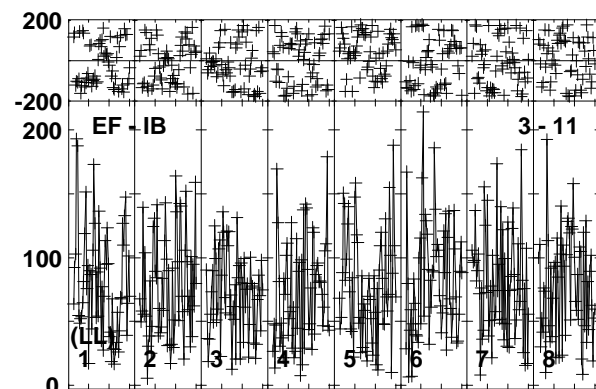
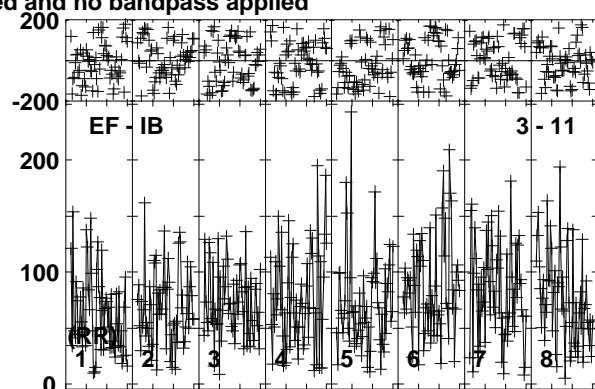
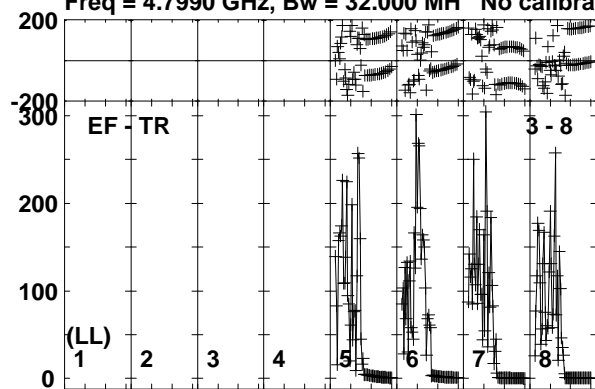

Lower frame: Micro Ampl Jy Top frame: Phas deg
Vector averaged cross-power spectrum Baseline: EF (03) - TR (08)
Timerange: 00/10:00:09 to 00/10:03:51

Plot file version 71 created 19-FEB-2019 18:13:02

J2353+5518 RP028B.UVDATA.1

Freq = 4.7990 GHz, Bw = 32.000 MH No calibration applied and no bandpass applied

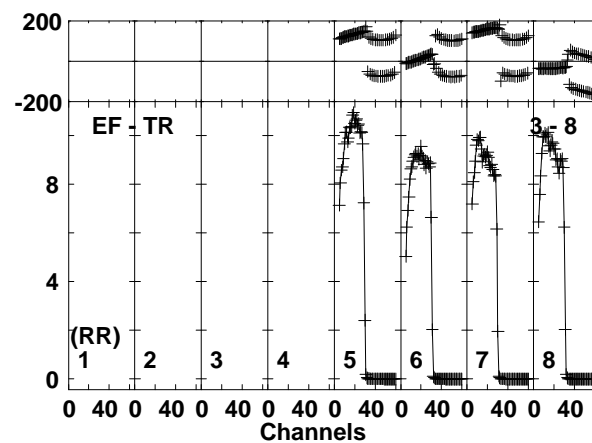
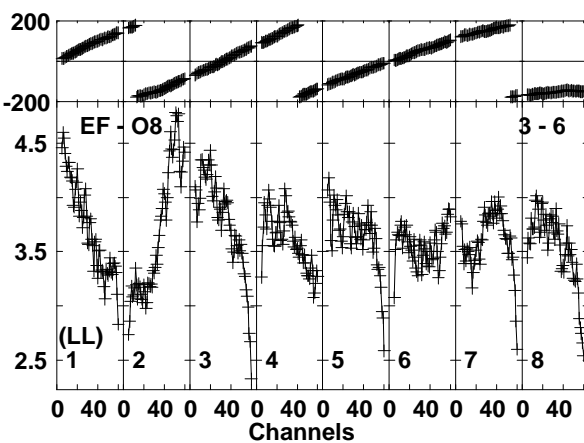
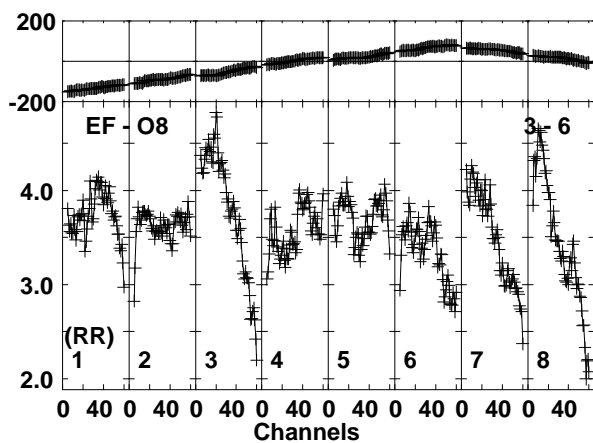
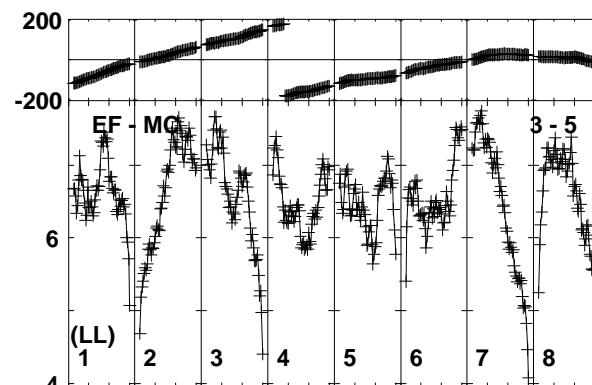
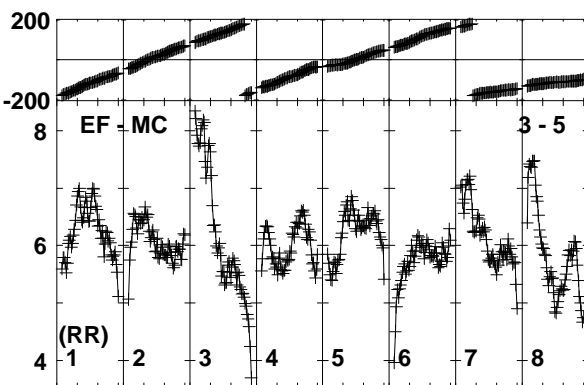
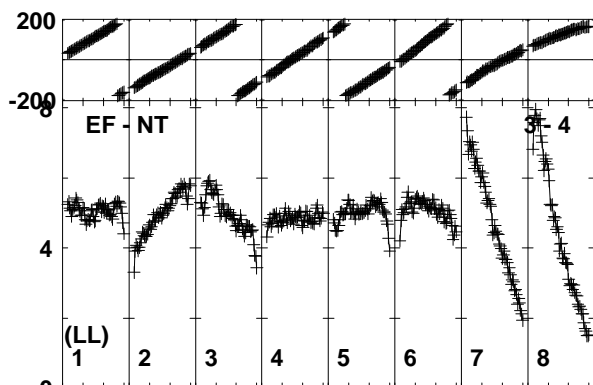
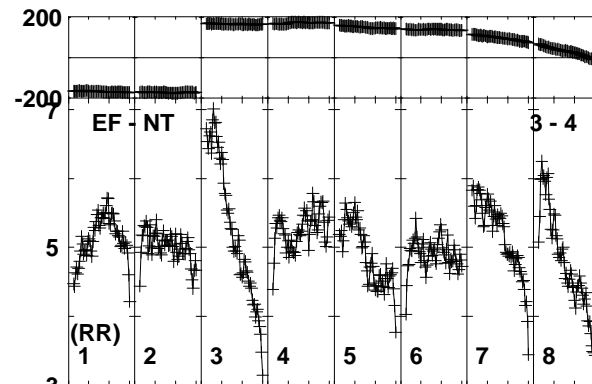
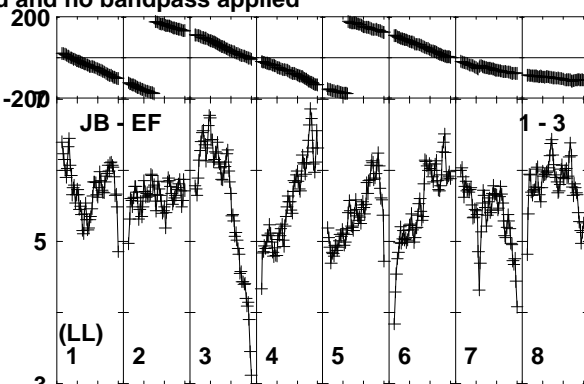
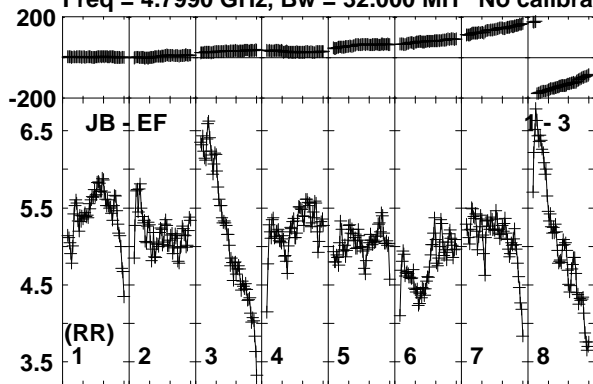

Lower frame: Milli Ampl Jy Top frame: Phas deg
Vector averaged cross-power spectrum Baseline: JB (01) - EF (03)
Timerange: 00/10/04:33 to 00/10/05:31

Plot file version 72 created 19-FEB-2019 18:13:02

J2353+5518 RP028B.UVDATA.1

Freq = 4.7990 GHz, Bw = 32.000 MH No calibration applied and no bandpass applied

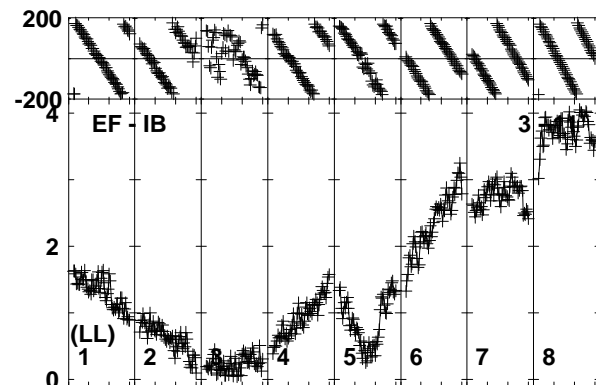
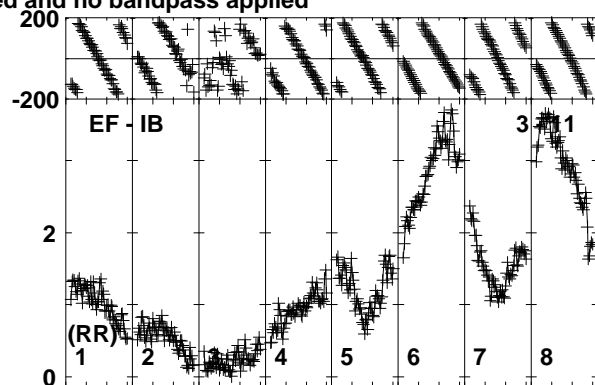
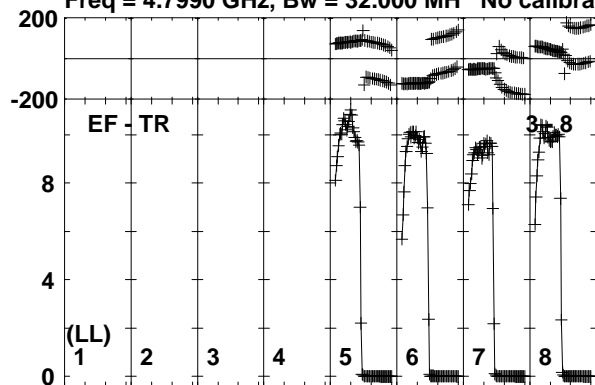

Lower frame: Milli Ampl Jy Top frame: Phas deg
Vector averaged cross-power spectrum Baseline: EF (03) - TR (08)
Timerange: 00/10:04:33 to 00/10:05:31

Plot file version 73 created 19-FEB-2019 18:13:02

IRAS23436 RP028B.UVDATA.1

Freq = 4.7990 GHz, Bw = 32.000 MH No calibration applied and no bandpass applied

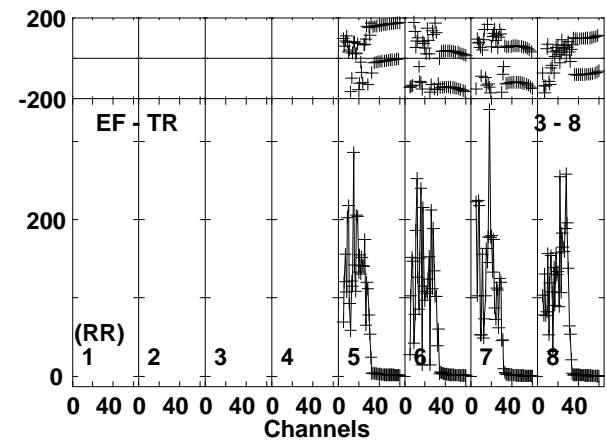
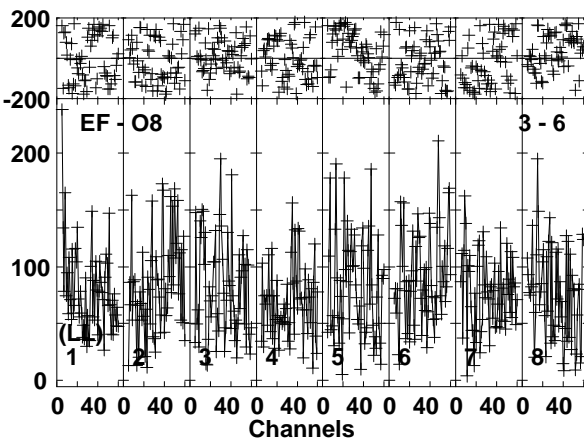
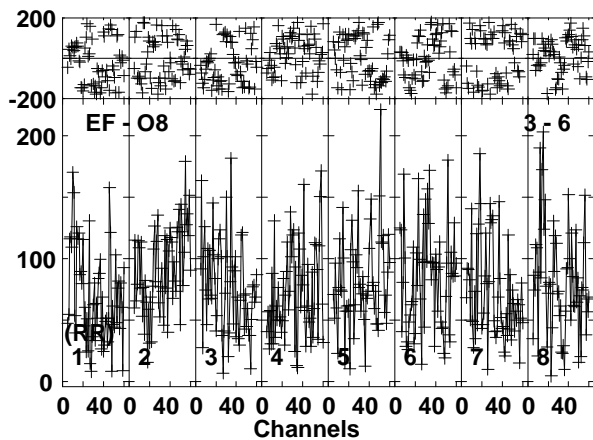
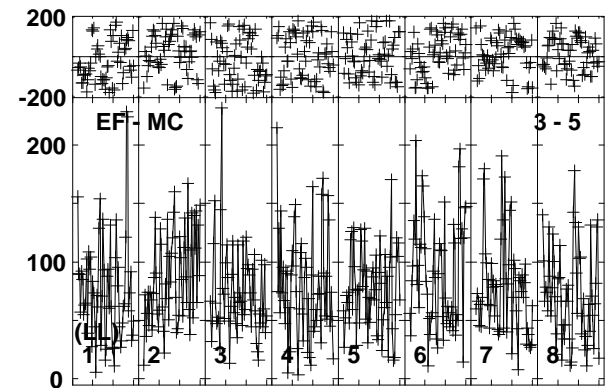
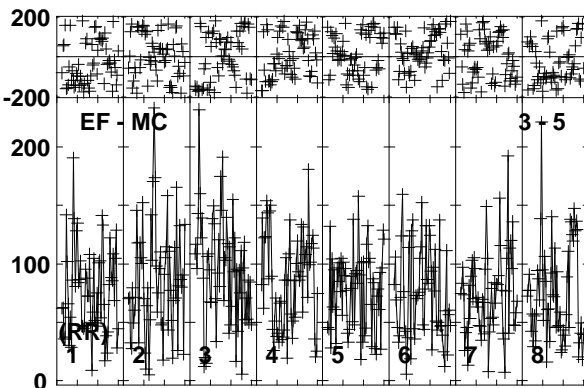
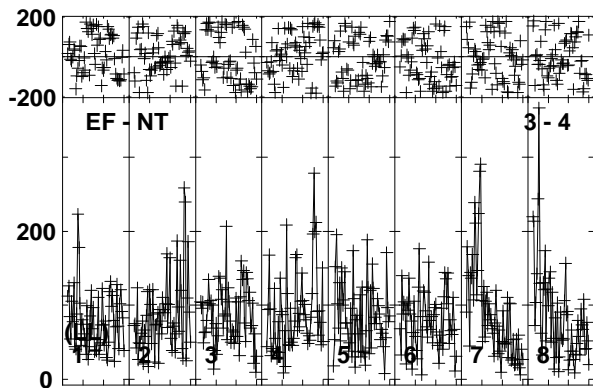
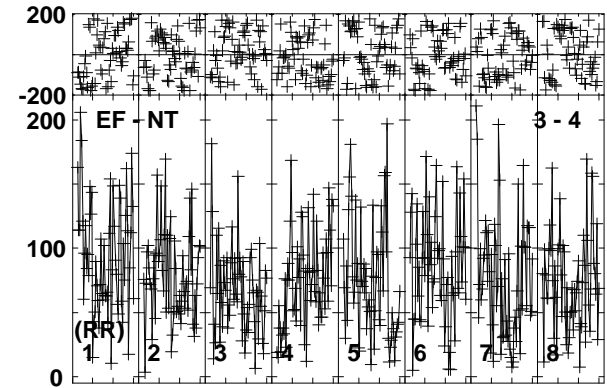
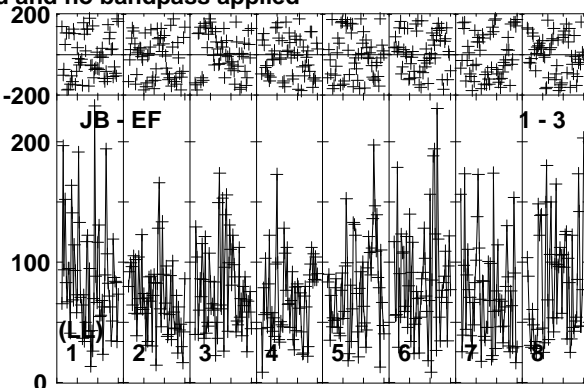
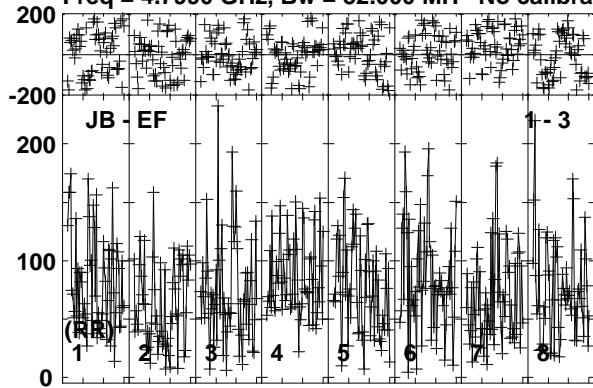

Lower frame: Micro Ampl Jy Top frame: Phas deg
 Vector averaged cross-power spectrum Baseline: JB (01) - EF (03)
 Timerange: 00/10:05:33 to 00/10:09:12

Plot file version 74 created 19-FEB-2019 18:13:03

IRAS23436 RP028B.UVDATA.1

Freq = 4.7990 GHz, Bw = 32.000 MH No calibration applied and no bandpass applied

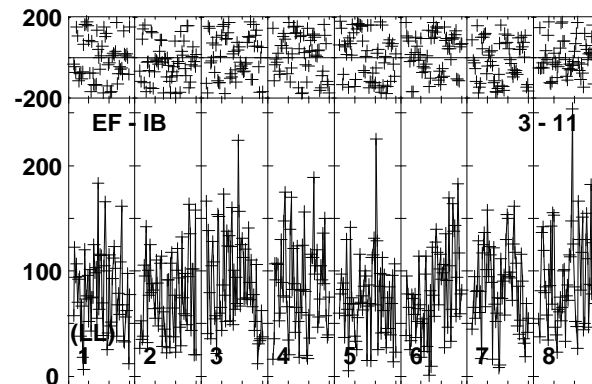
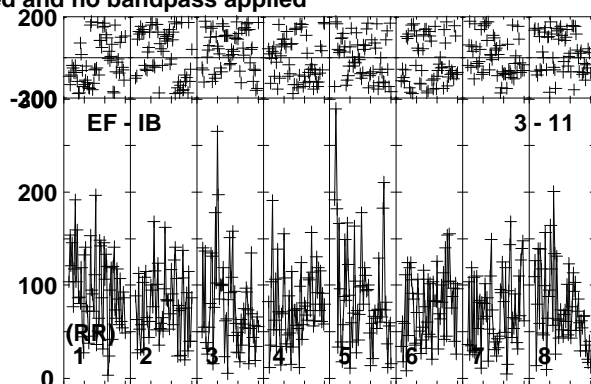
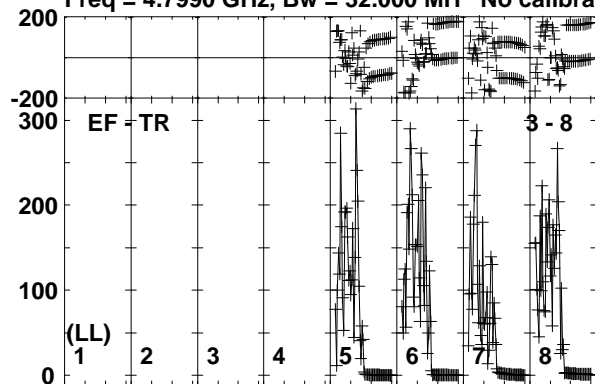

Lower frame: Micro Ampl Jy Top frame: Phas deg
Vector averaged cross-power spectrum Baseline: EF (03) - TR (08)
Timerange: 00/10:05:33 to 00/10:09:12

Plot file version 75 created 19-FEB-2019 18:13:03

J2353+5518 RP028B.UVDATA.1

Freq = 4.7990 GHz, Bw = 32.000 MH No calibration applied and no bandpass applied

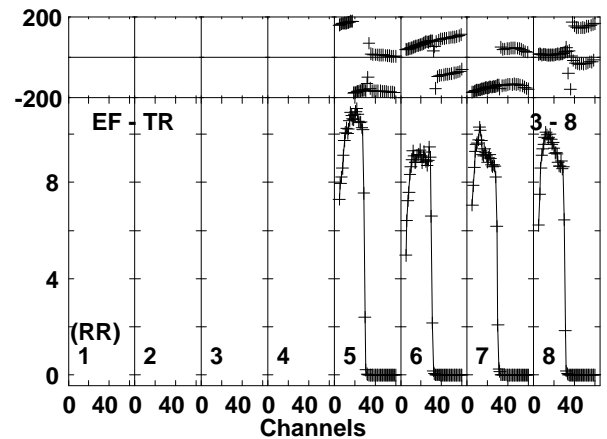
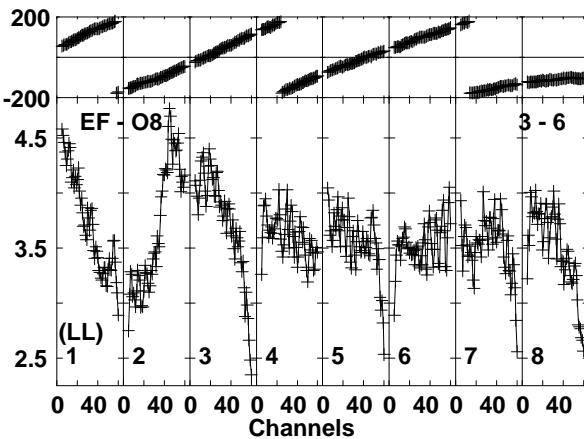
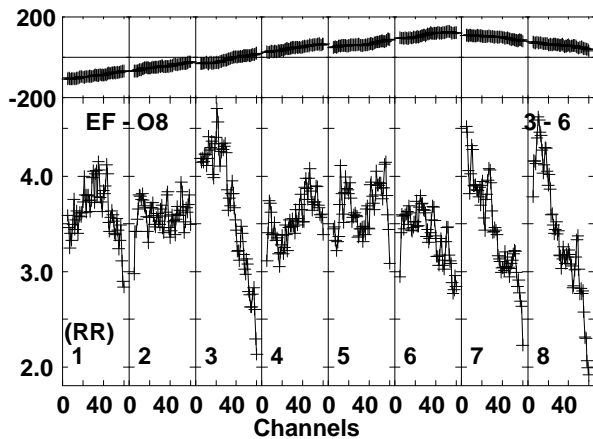
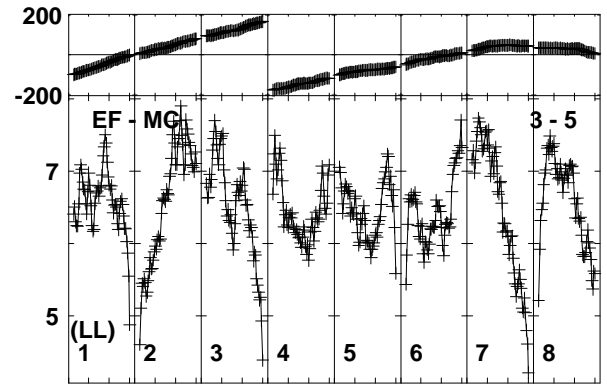
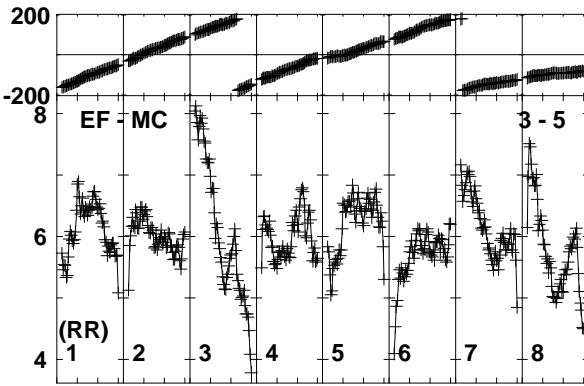
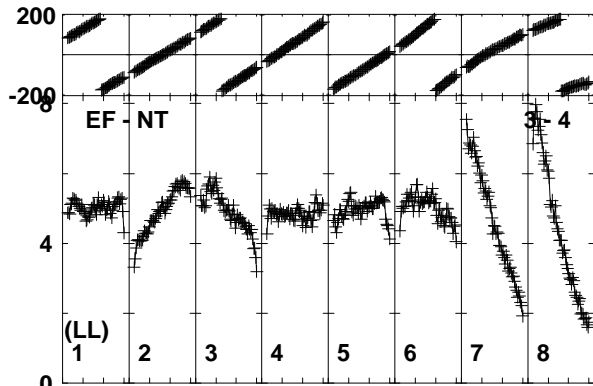
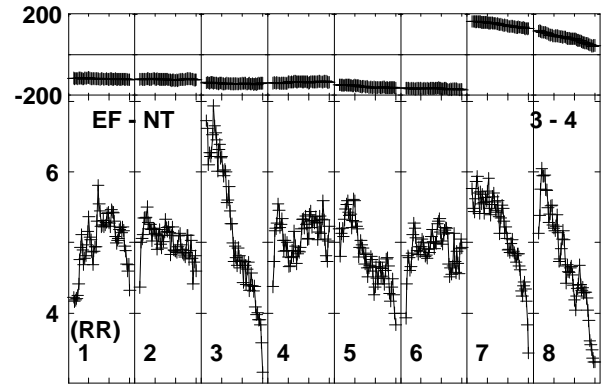
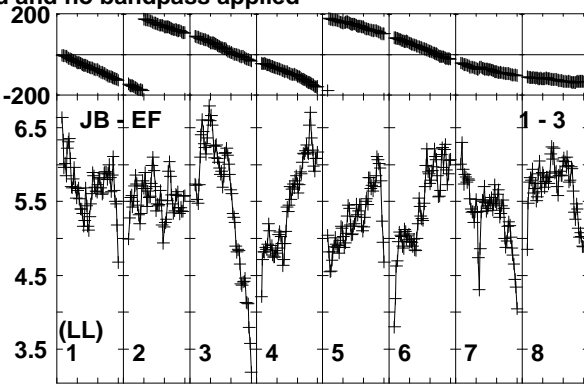
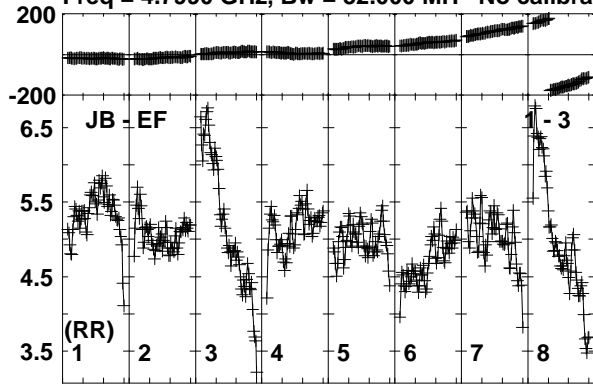

Lower frame: Milli Ampl Jy Top frame: Phas deg
Vector averaged cross-power spectrum Baseline: JB (01) - EF (03)
Timerange: 00/10/09:12 to 00/10/10:41

Plot file version 76 created 19-FEB-2019 18:13:03

J2353+5518 RP028B.UVDATA.1

Freq = 4.7990 GHz, Bw = 32.000 MH No calibration applied and no bandpass applied

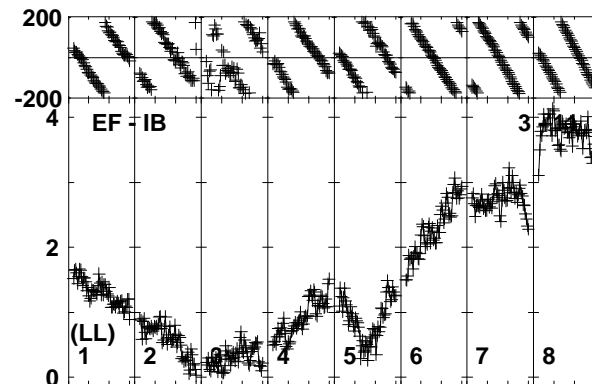
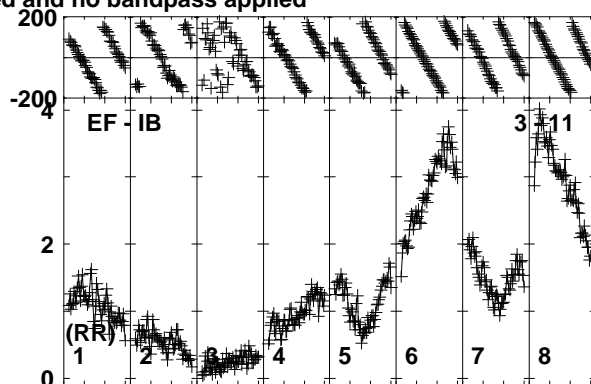
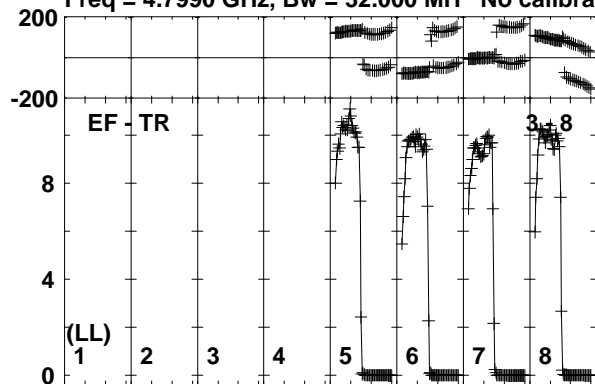

Lower frame: Milli Ampl Jy Top frame: Phas deg
Vector averaged cross-power spectrum Baseline: EF (03) - TR (08)
Timerange: 00/10:09:12 to 00/10:10:41

Plot file version 77 created 19-FEB-2019 18:13:03

IRAS23436 RP028B.UVDATA.1

Freq = 4.7990 GHz, Bw = 32.000 MH No calibration applied and no bandpass applied

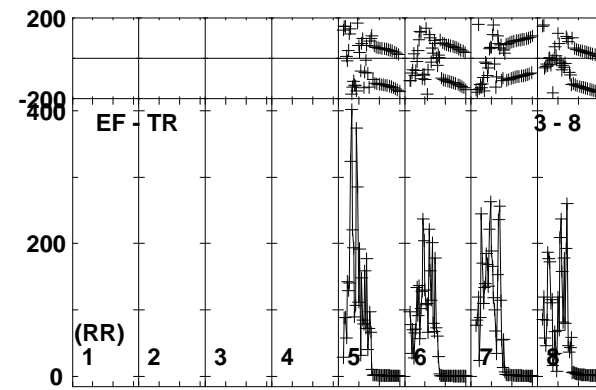
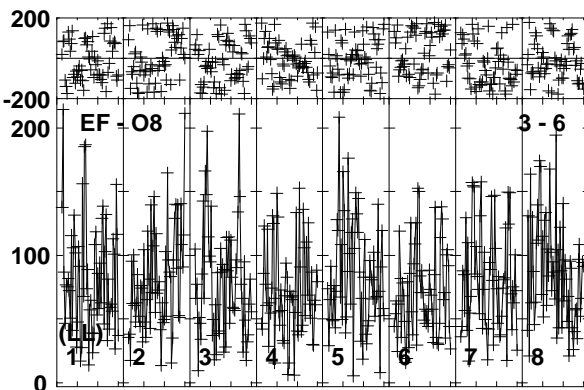
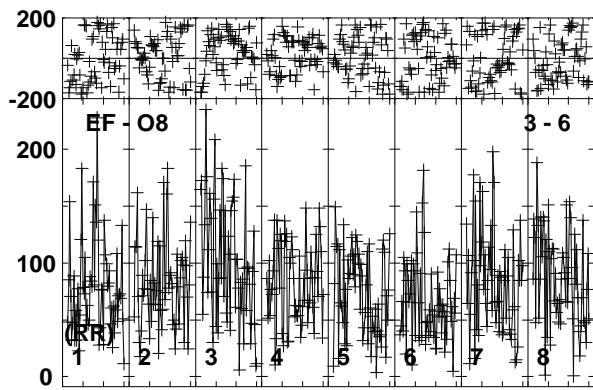
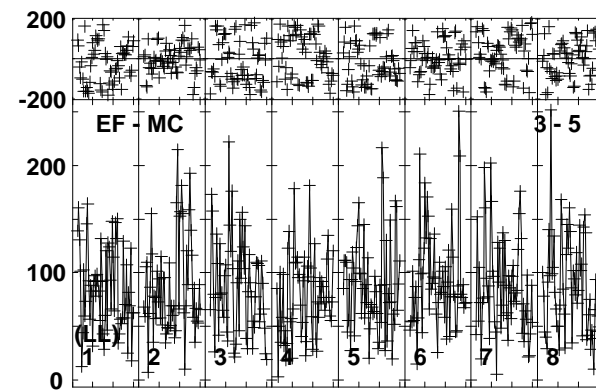
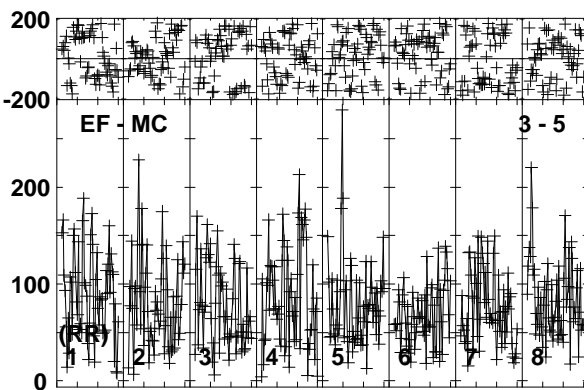
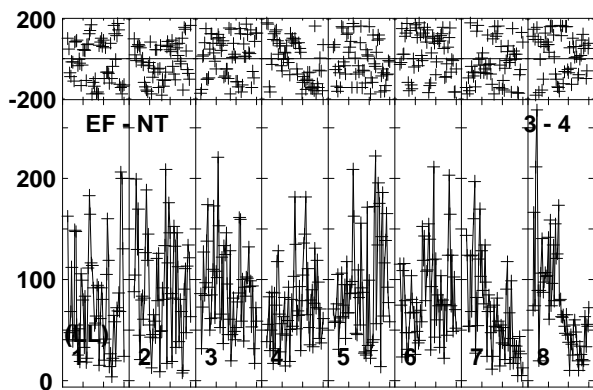
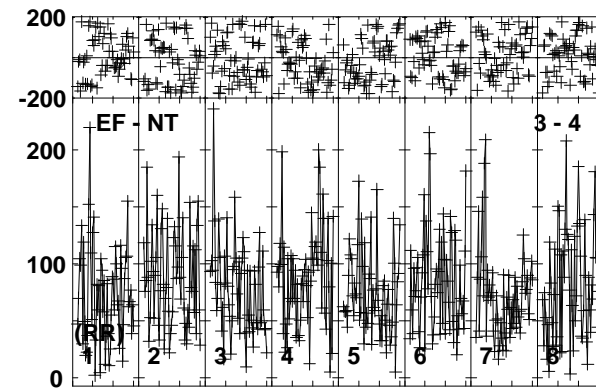
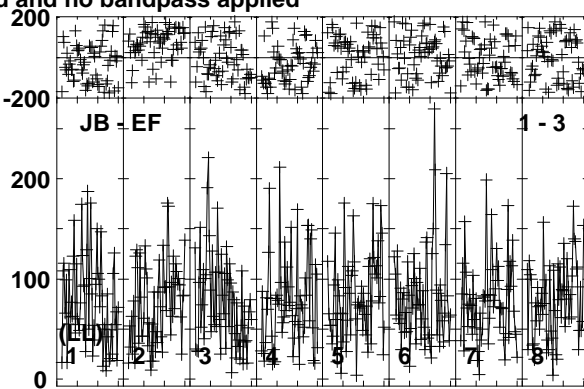
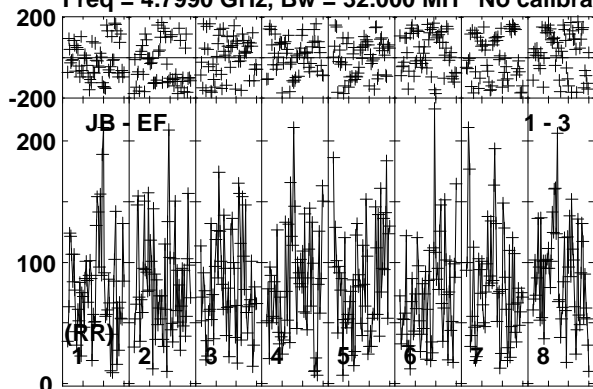

Lower frame: Micro Ampl Jy Top frame: Phas deg
Vector averaged cross-power spectrum Baseline: JB (01) - EF (03)
Timerange: 00/10:10:43 to 00/10:14:25

Plot file version 78 created 19-FEB-2019 18:13:04

IRAS23436 RP028B.UVDATA.1

Freq = 4.7990 GHz, Bw = 32.000 MH No calibration applied and no bandpass applied

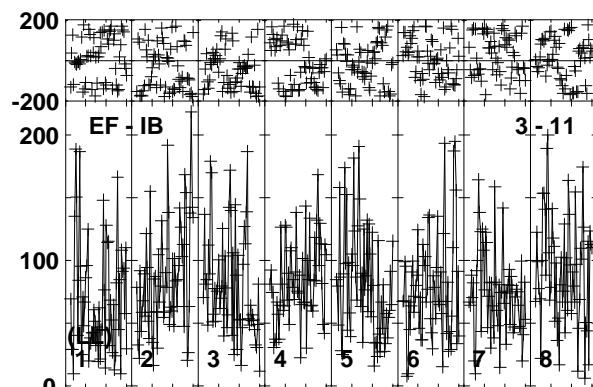
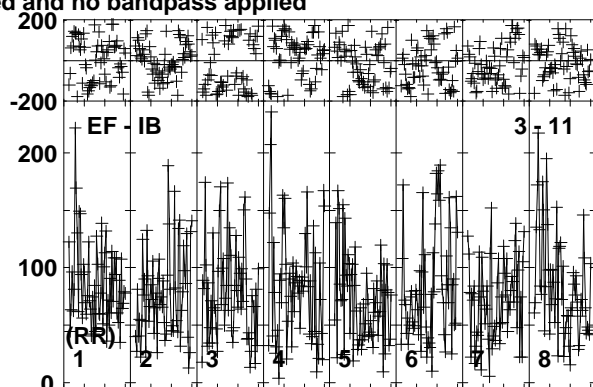
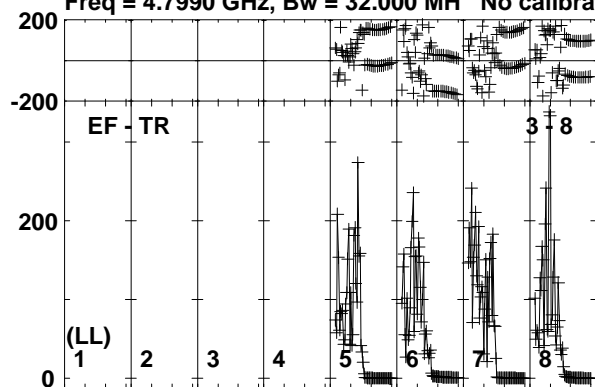

Lower frame: Micro Ampl Jy Top frame: Phas deg
Vector averaged cross-power spectrum Baseline: EF (03) - TR (08)
Timerange: 00/10:10:43 to 00/10:14:25

Plot file version 79 created 19-FEB-2019 18:13:04

J2353+5518 RP028B.UVDATA.1

Freq = 4.7990 GHz, Bw = 32.000 MH No calibration applied and no bandpass applied

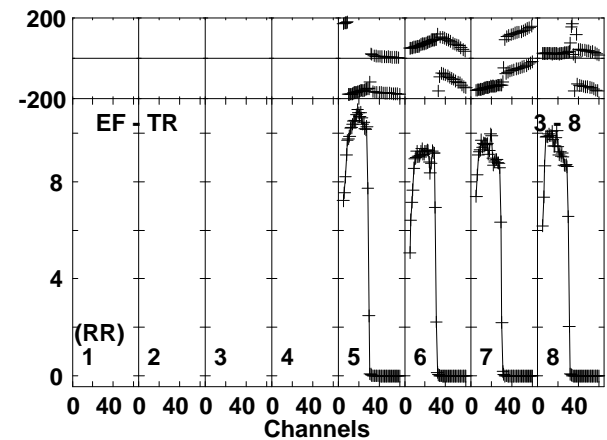
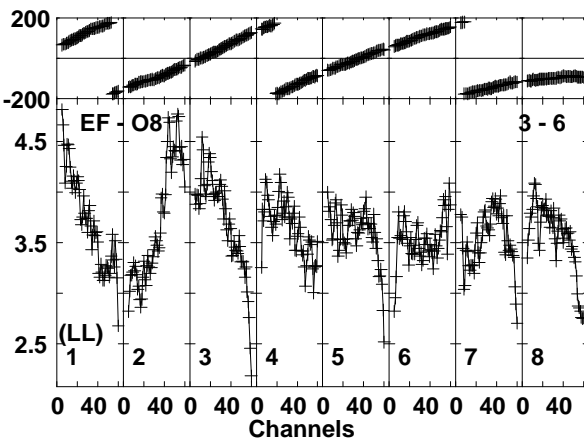
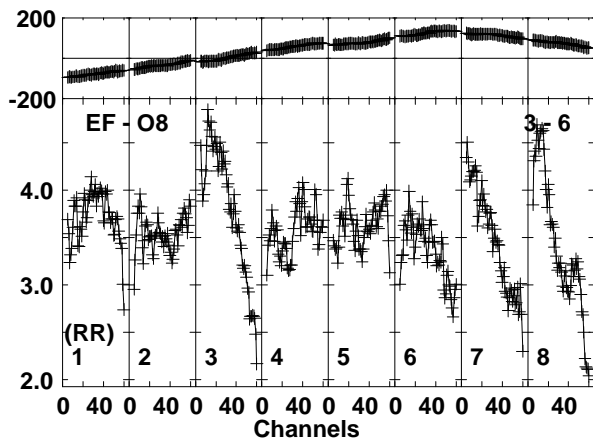
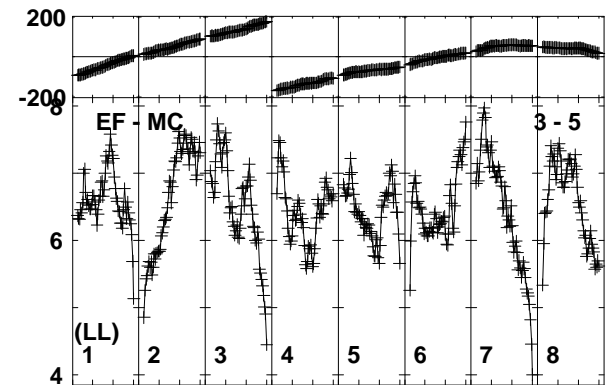
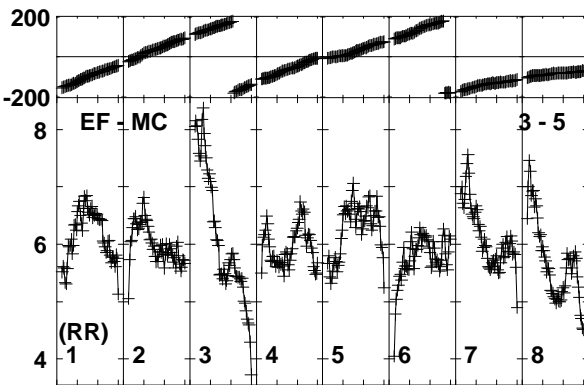
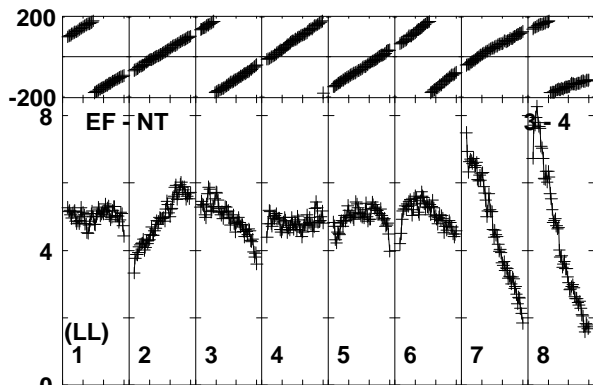
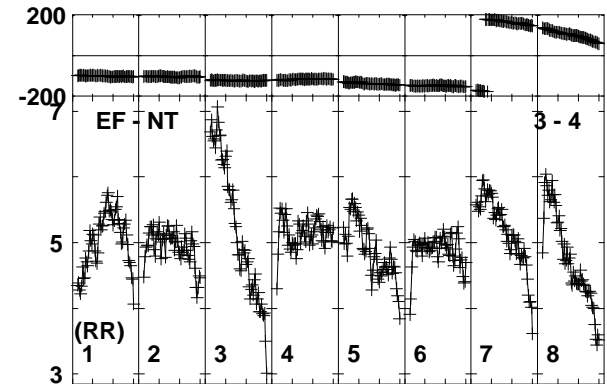
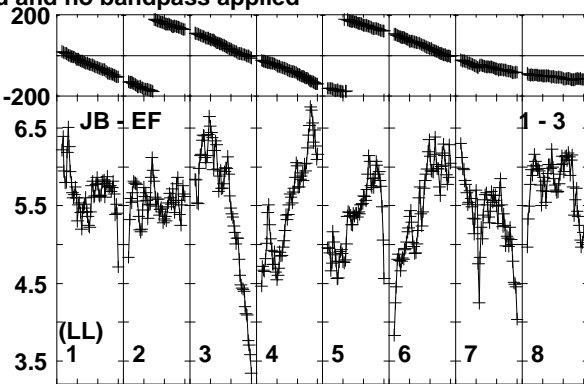
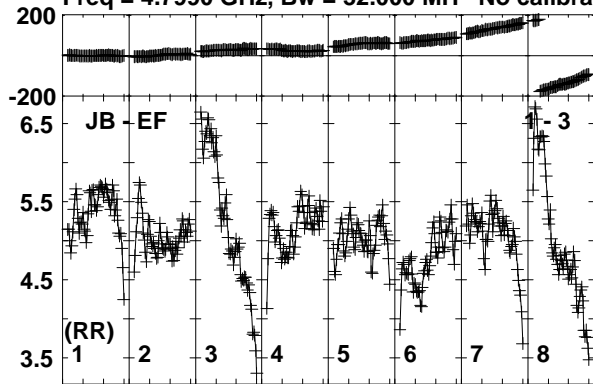

Lower frame: Milli Ampl Jy Top frame: Phas deg
Vector averaged cross-power spectrum Baseline: JB (01) - EF (03)
Timerange: 00/10:15:06 to 00/10:15:56

Plot file version 80 created 19-FEB-2019 18:13:04

J2353+5518 RP028B.UVDATA.1

Freq = 4.7990 GHz, Bw = 32.000 MH No calibration applied and no bandpass applied

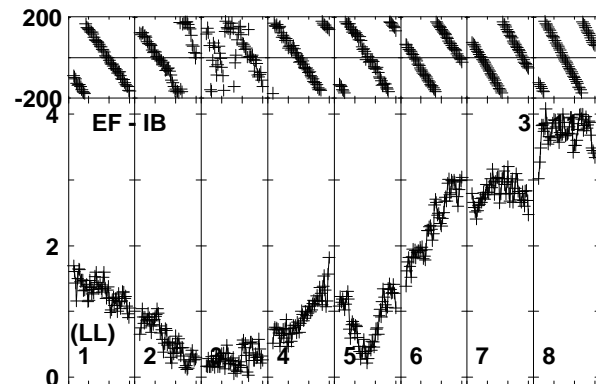
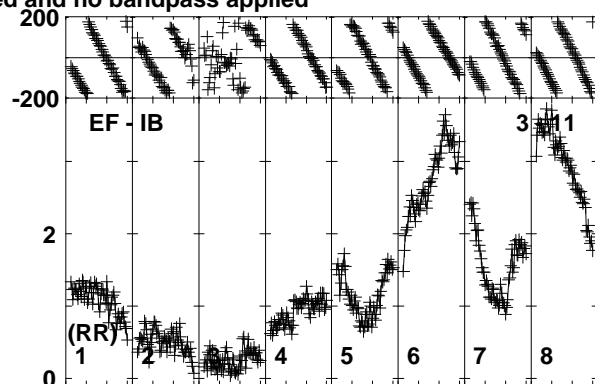
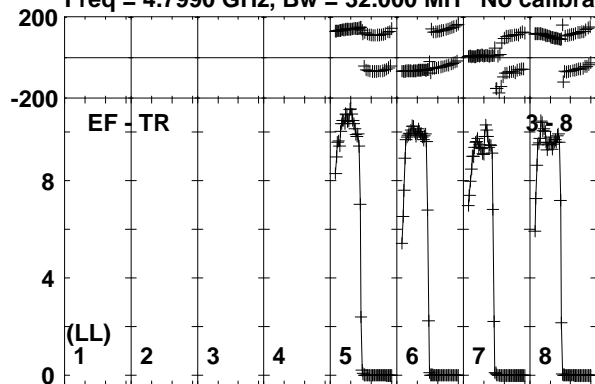

Lower frame: Milli Ampl Jy Top frame: Phas deg
Vector averaged cross-power spectrum Baseline: EF (03) - TR (08)
Timerange: 00/10:15:06 to 00/10:15:56

Plot file version 81 created 19-FEB-2019 18:13:04

IRAS23436 RP028B.UVDATA.1

Freq = 4.7990 GHz, Bw = 32.000 MH No calibration applied and no bandpass applied

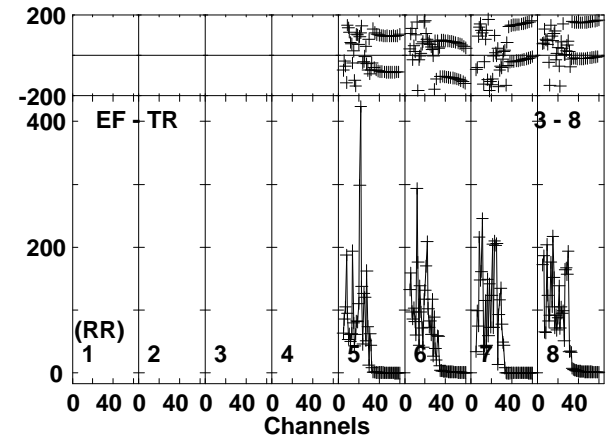
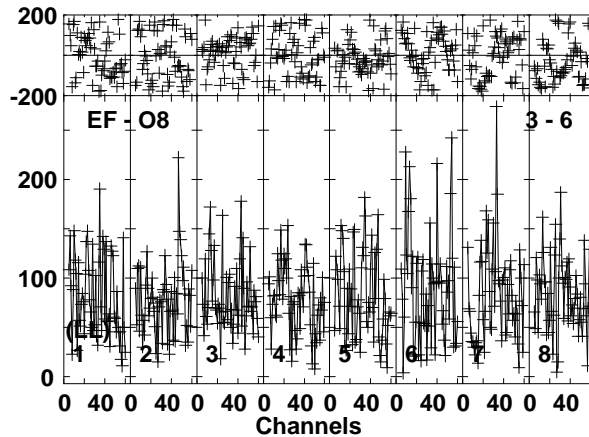
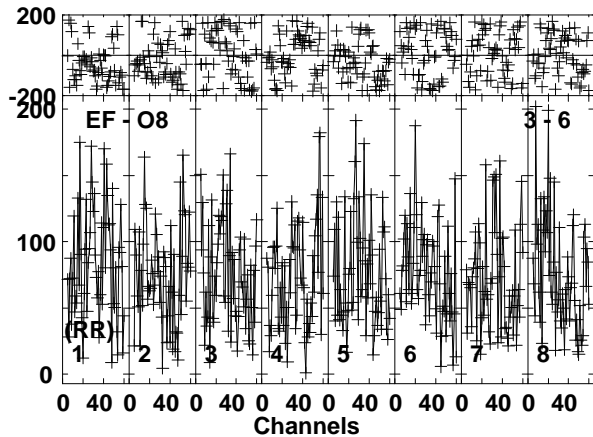
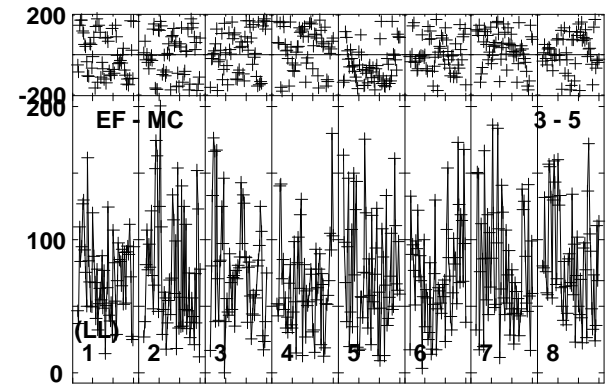
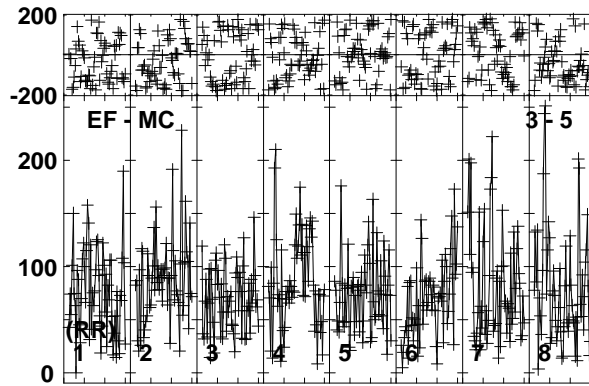
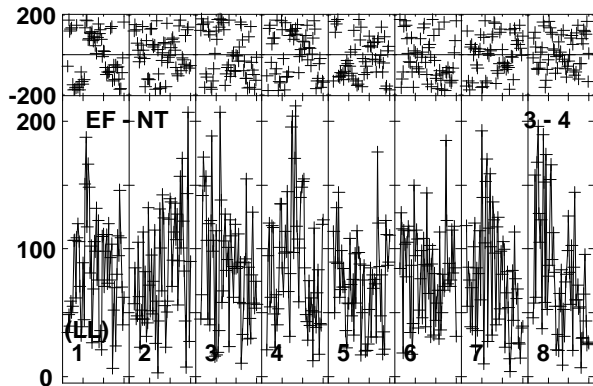
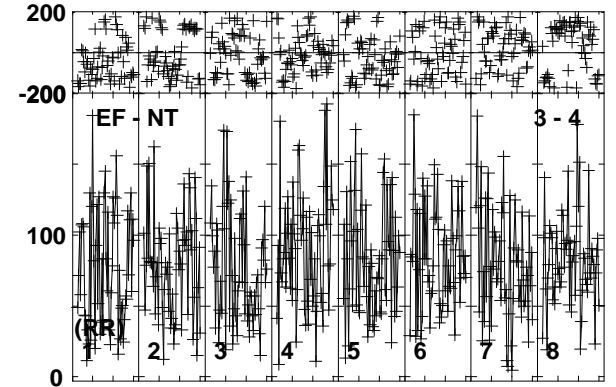
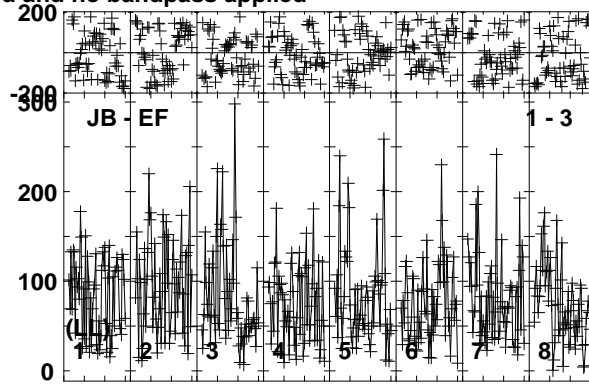
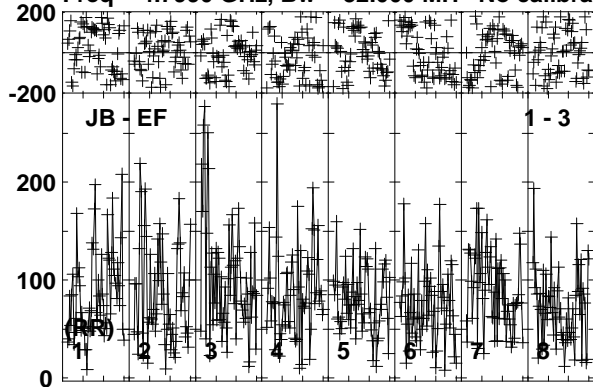

Lower frame: Micro Ampl Jy Top frame: Phas deg
Vector averaged cross-power spectrum Baseline: JB (01) - EF (03)
Timerange: 00/10:15:57 to 00/10:19:39

Plot file version 82 created 19-FEB-2019 18:13:05

IRAS23436 RP028B.UVDATA.1

Freq = 4.7990 GHz, Bw = 32.000 MH No calibration applied and no bandpass applied

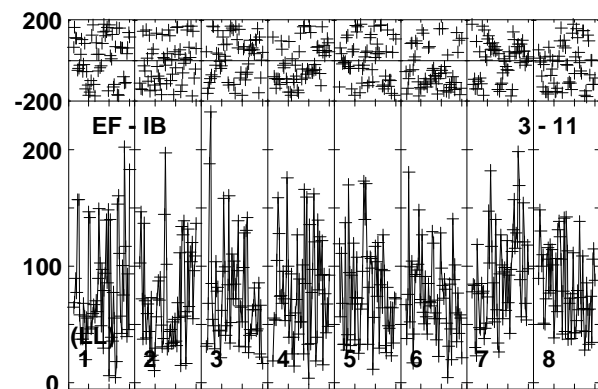
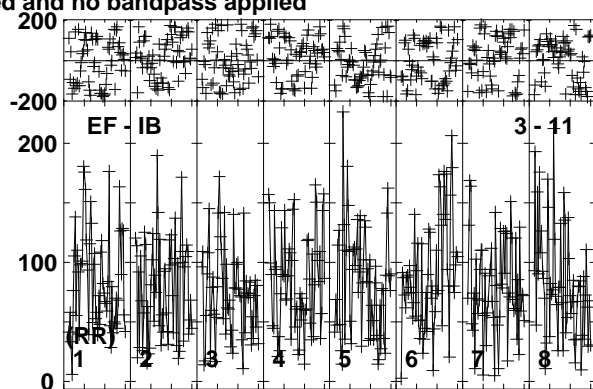
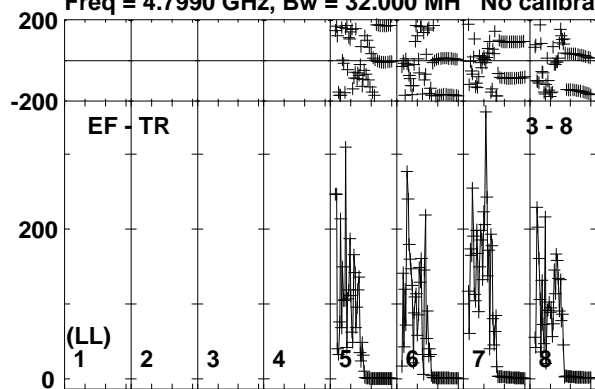

Lower frame: Micro Ampl Jy Top frame: Phas deg
Vector averaged cross-power spectrum Baseline: EF (03) - TR (08)
Timerange: 00/10:15:57 to 00/10:19:39

Plot file version 83 created 19-FEB-2019 18:13:05

J2353+5518 RP028B.UVDATA.1

Freq = 4.7990 GHz, Bw = 32.000 MH No calibration applied and no bandpass applied

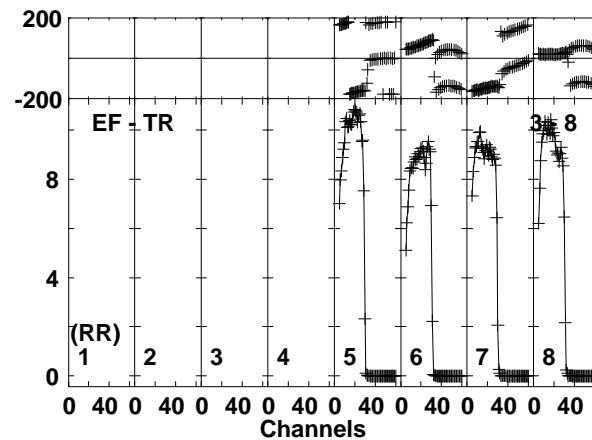
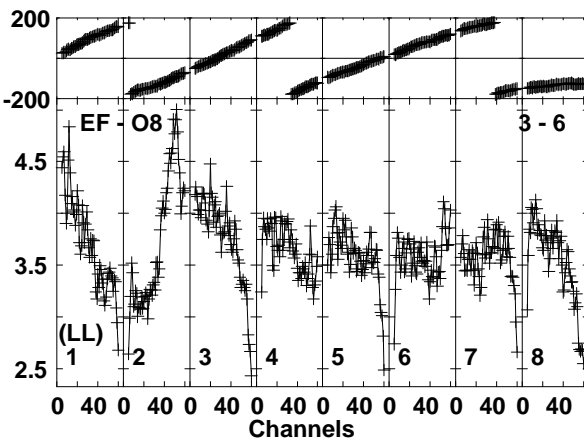
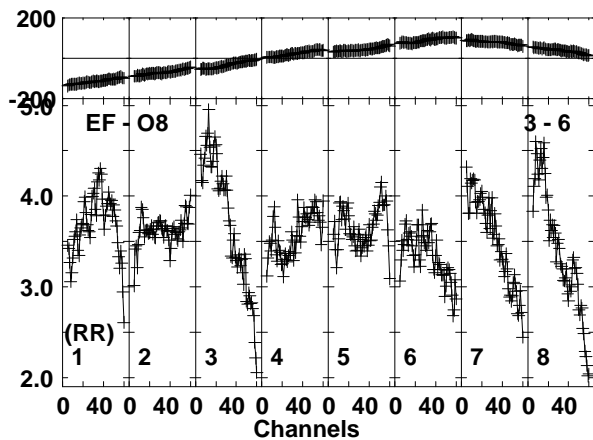
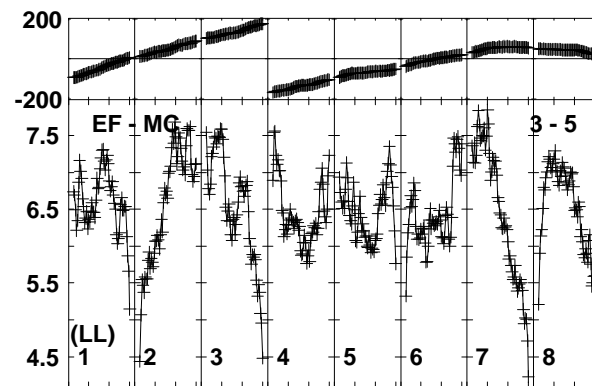
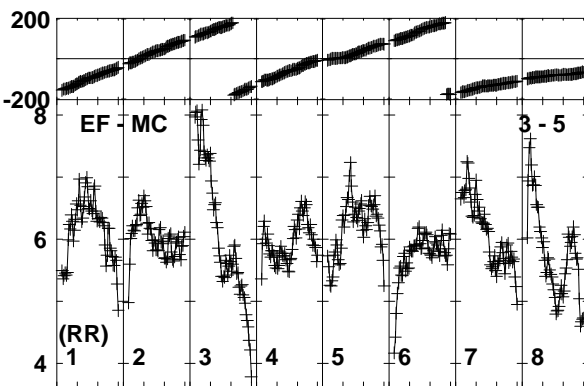
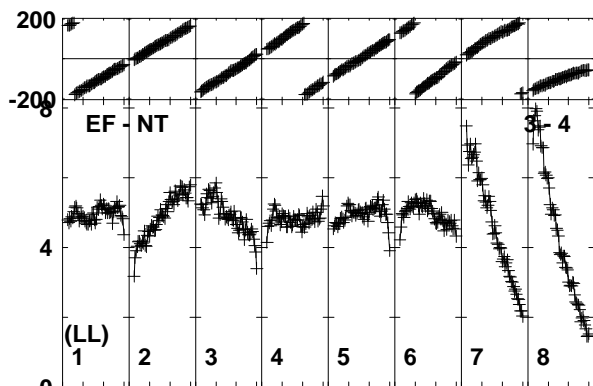
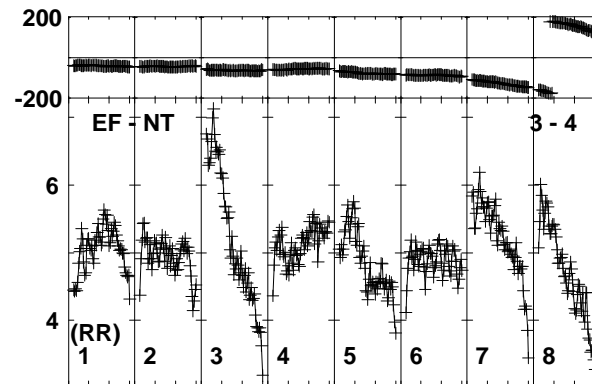
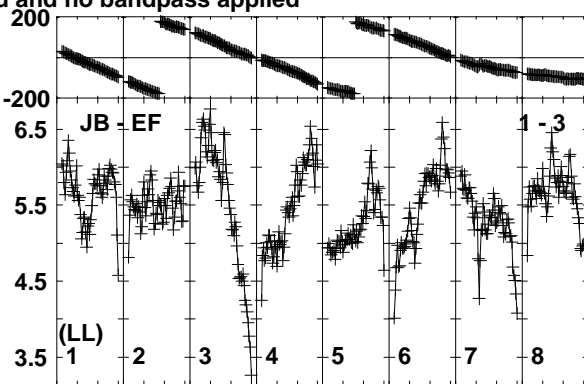
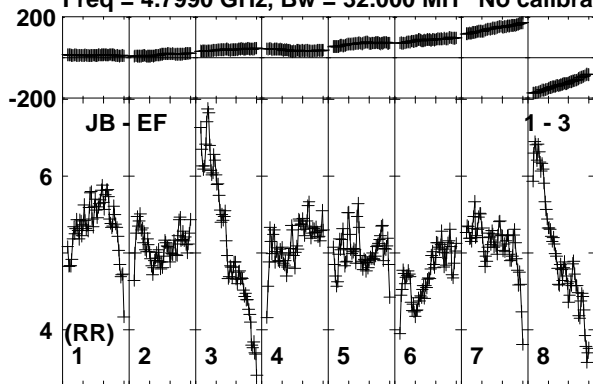

Lower frame: Milli Ampl Jy Top frame: Phas deg
Vector averaged cross-power spectrum Baseline: JB (01) - EF (03)
Timerange: 00/10:19:41 to 00/10:21:09

Plot file version 84 created 19-FEB-2019 18:13:05

J2353+5518 RP028B.UVDATA.1

Freq = 4.7990 GHz, Bw = 32.000 MH No calibration applied and no bandpass applied

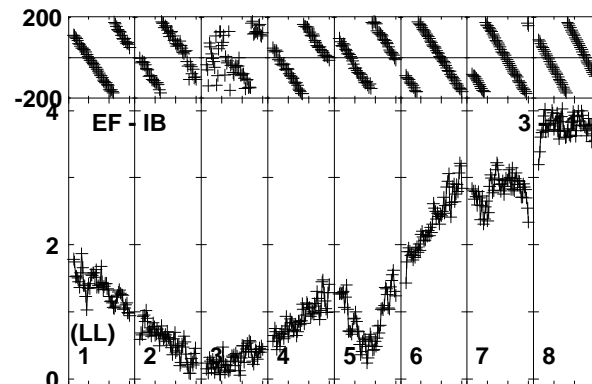
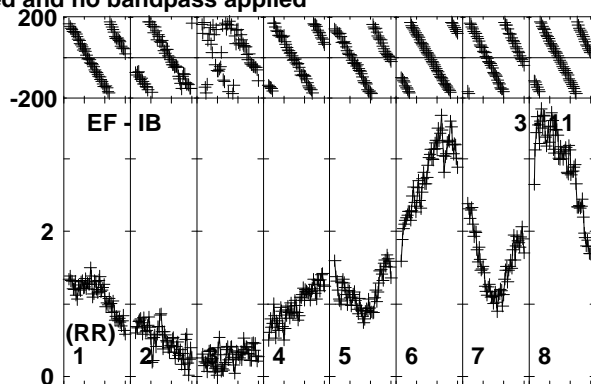
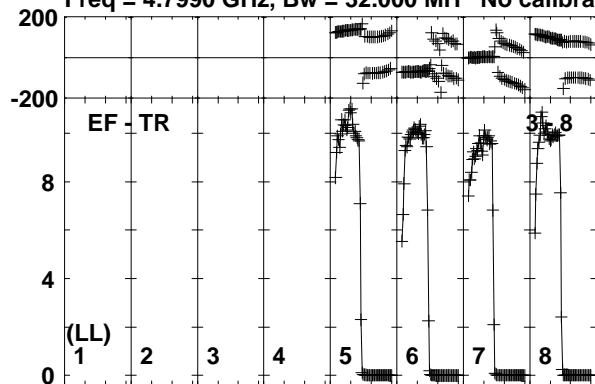

Lower frame: Milli Ampl Jy Top frame: Phas deg
Vector averaged cross-power spectrum Baseline: EF (03) - TR (08)
Timerange: 00/10:19:41 to 00/10:21:09

Plot file version 85 created 19-FEB-2019 18:13:06

IRAS23436 RP028B.UVDATA.1

Freq = 4.7990 GHz, Bw = 32.000 MH No calibration applied and no bandpass applied

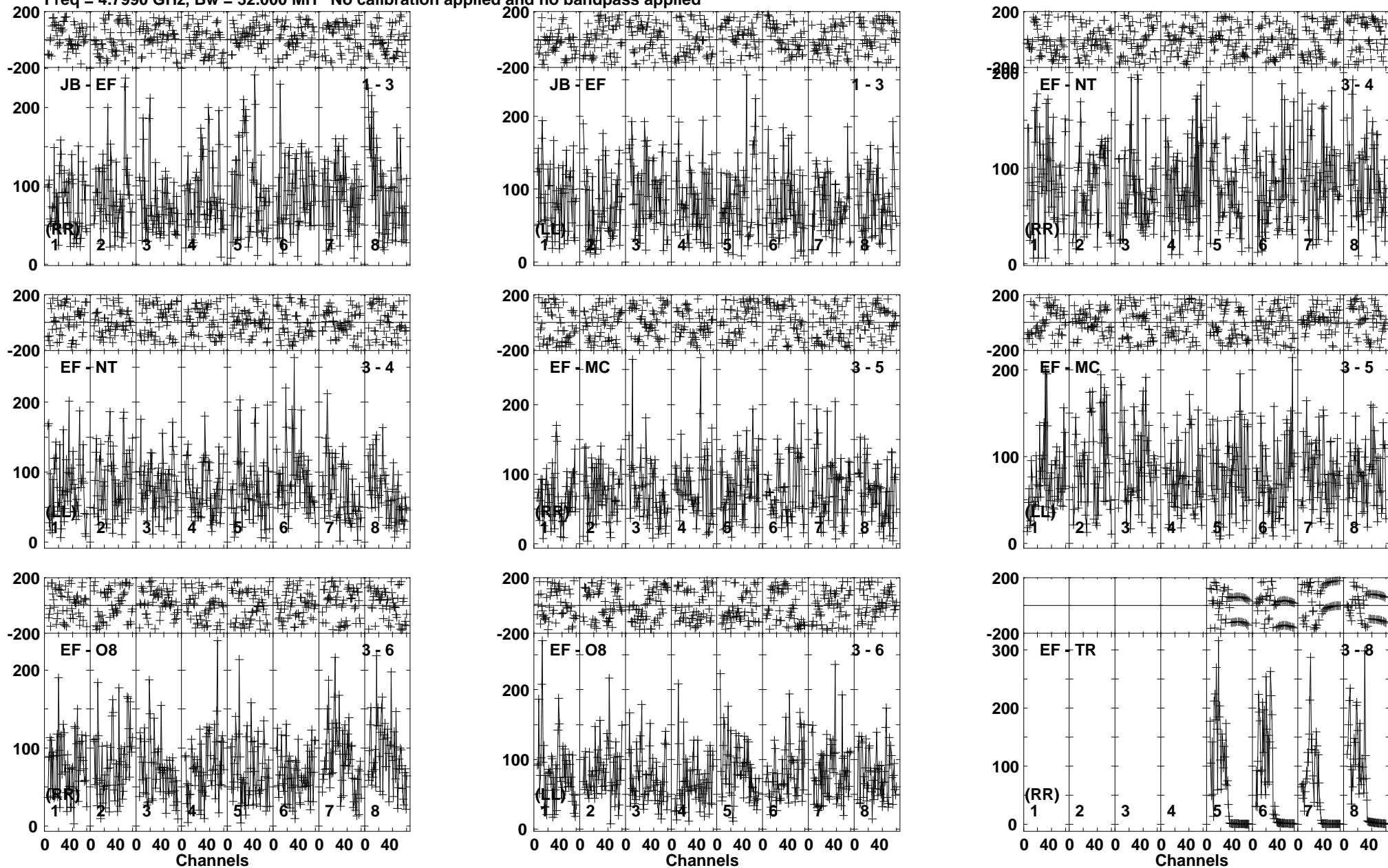

Lower frame: Micro Ampl Jy Top frame: Phas deg
Vector averaged cross-power spectrum Baseline: JB (01) - EF (03)
Timerange: 00/10:21:11 to 00/10:24:53

Plot file version 86 created 19-FEB-2019 18:13:06

IRAS23436 RP028B.UVDATA.1

Freq = 4.7990 GHz, Bw = 32.000 MH No calibration applied and no bandpass applied

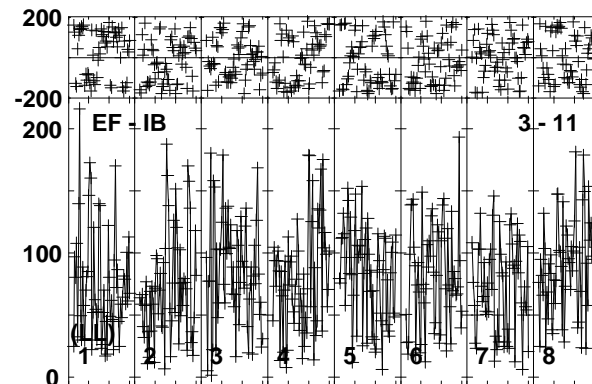
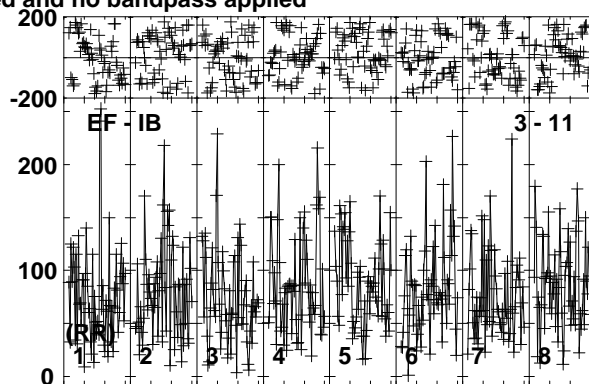
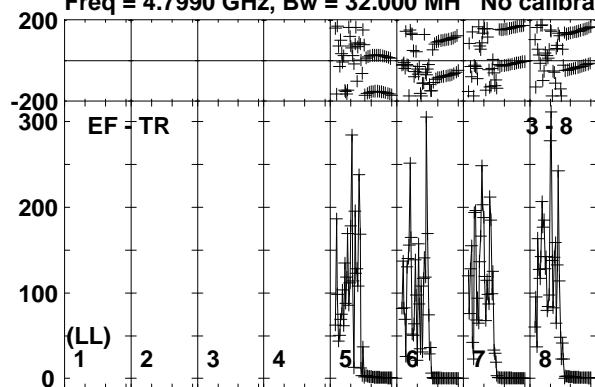

Lower frame: Micro Ampl Jy Top frame: Phas deg
Vector averaged cross-power spectrum Baseline: EF (03) - TR (08)
Timerange: 00/10:21:11 to 00/10:24:53

Plot file version 87 created 19-FEB-2019 18:13:06

J2353+5518 RP028B.UVDATA.1

Freq = 4.7990 GHz, Bw = 32.000 MH No calibration applied and no bandpass applied

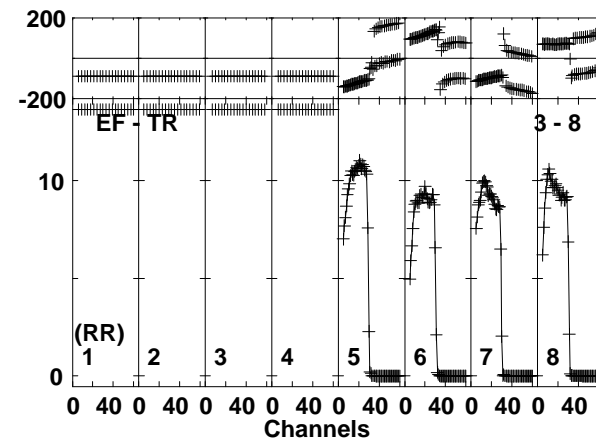
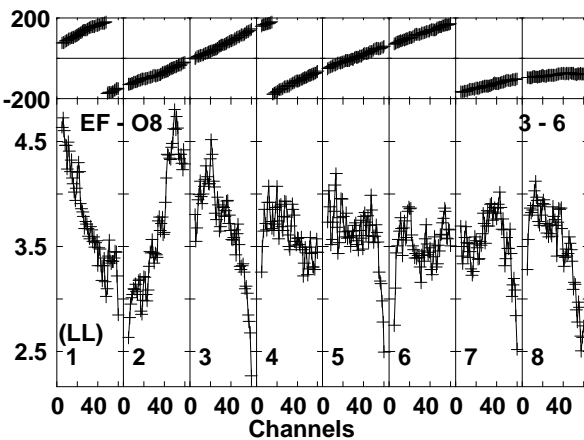
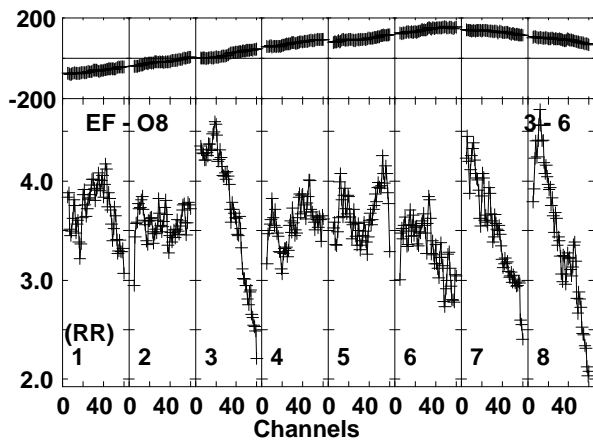
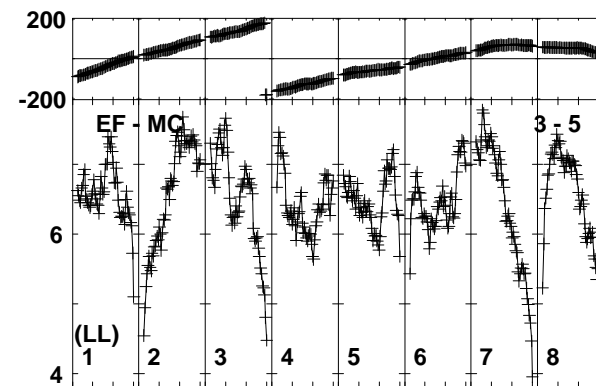
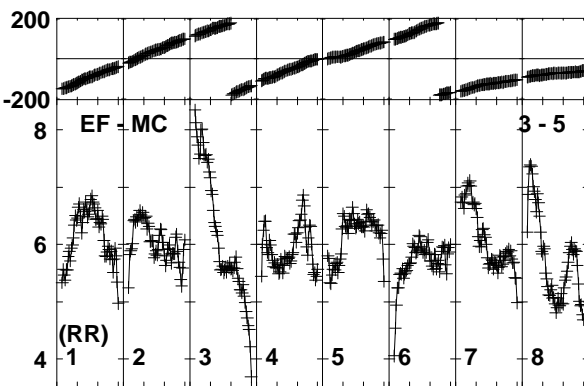
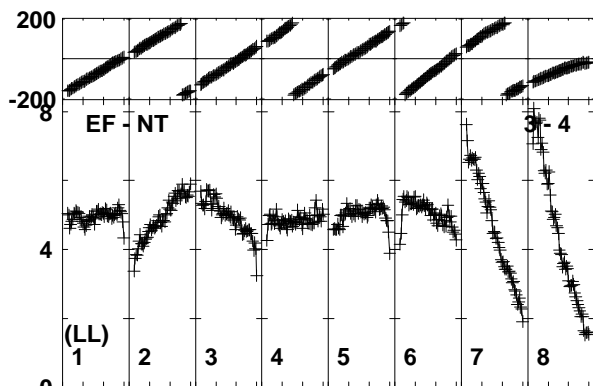
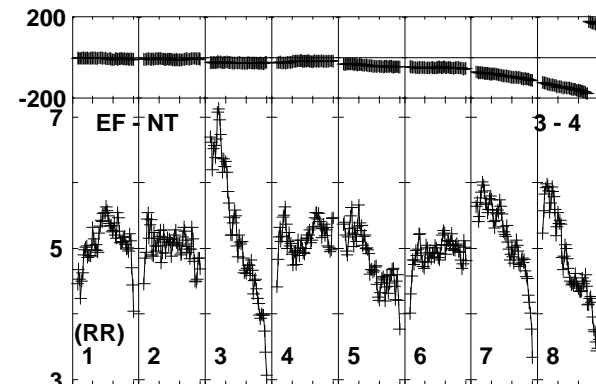
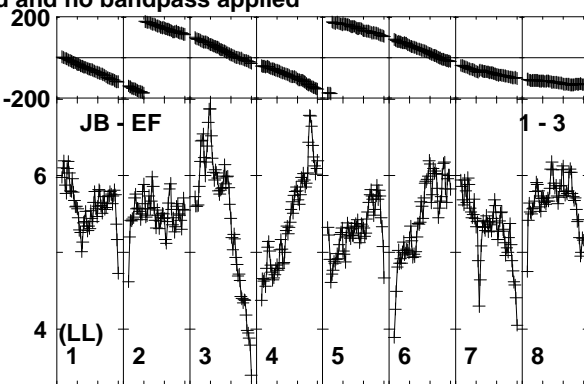
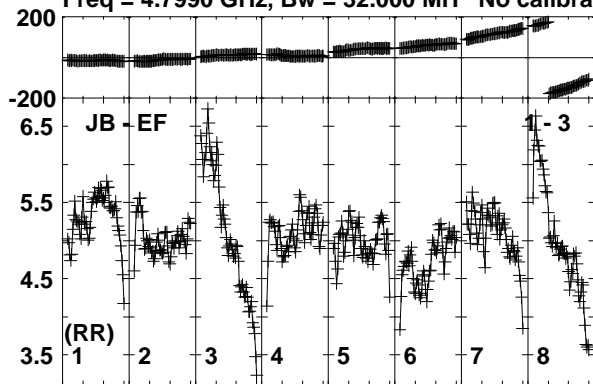

Lower frame: Milli Ampl Jy Top frame: Phas deg
Vector averaged cross-power spectrum Baseline: JB (01) - EF (03)
Timerange: 00/10:25:35 to 00/10:26:33

Plot file version 88 created 19-FEB-2019 18:13:06

J2353+5518 RP028B.UVDATA.1

Freq = 4.7990 GHz, Bw = 32.000 MH No calibration applied and no bandpass applied

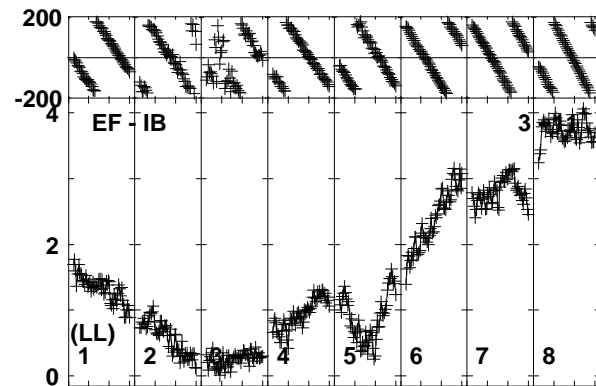
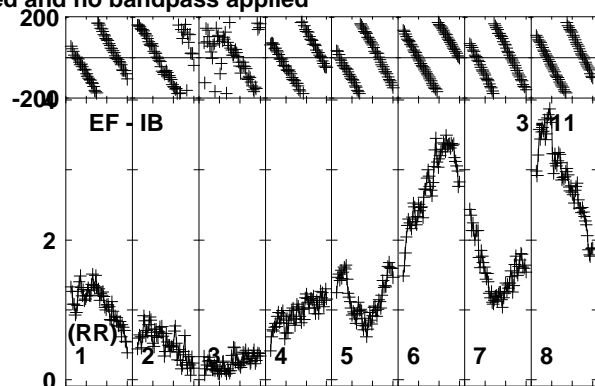
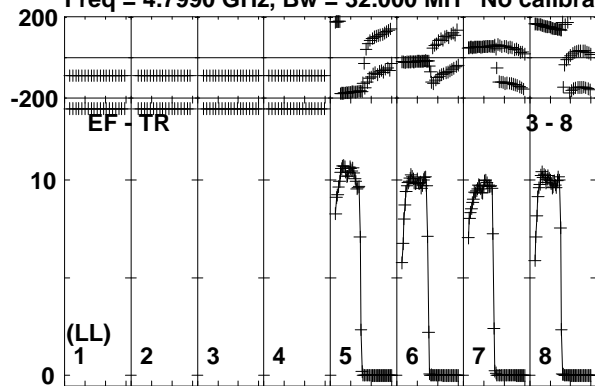

Lower frame: Milli Ampl Jy Top frame: Phas deg
Vector averaged cross-power spectrum Baseline: EF (03) - TR (08)
Timerange: 00/10:25:35 to 00/10:26:33

Plot file version 89 created 19-FEB-2019 18:13:06

IRAS23436 RP028B.UVDATA.1

Freq = 4.7990 GHz, Bw = 32.000 MH No calibration applied and no bandpass applied

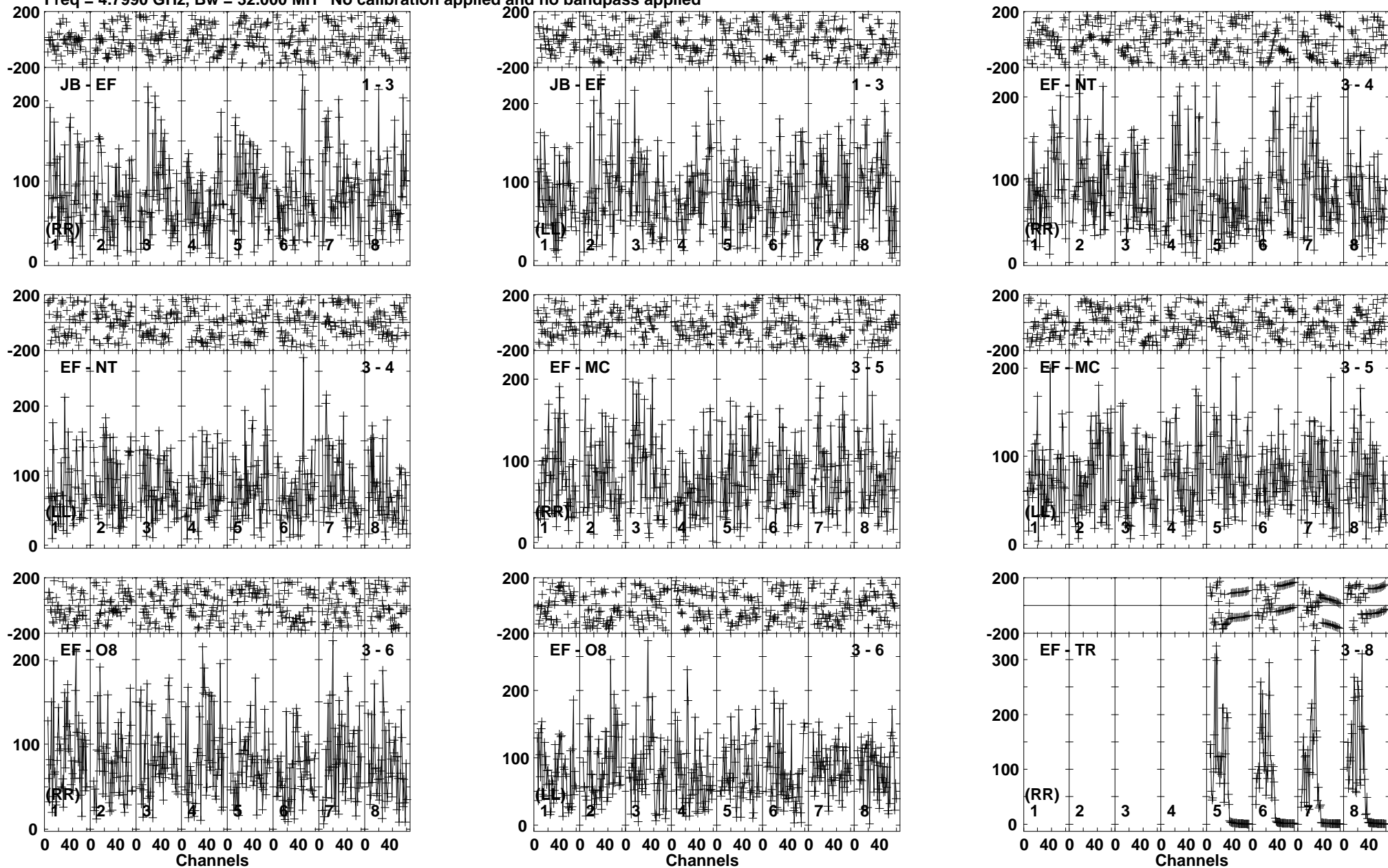

Lower frame: Micro Ampl Jy Top frame: Phas deg
Vector averaged cross-power spectrum Baseline: JB (01) - EF (03)
Timerange: 00/10:26:35 to 00/10:30:14

Plot file version 90 created 19-FEB-2019 18:13:07

IRAS23436 RP028B.UVDATA.1

Freq = 4.7990 GHz, Bw = 32.000 MH No calibration applied and no bandpass applied

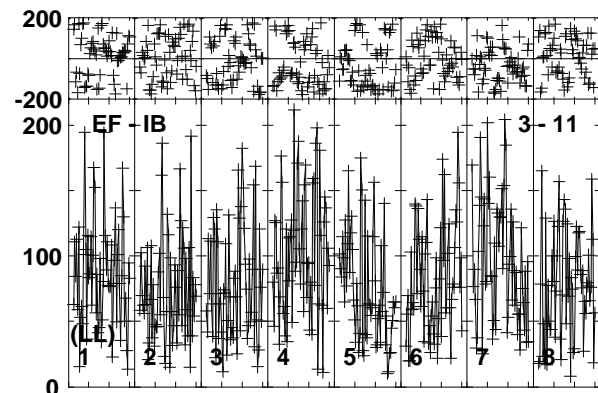
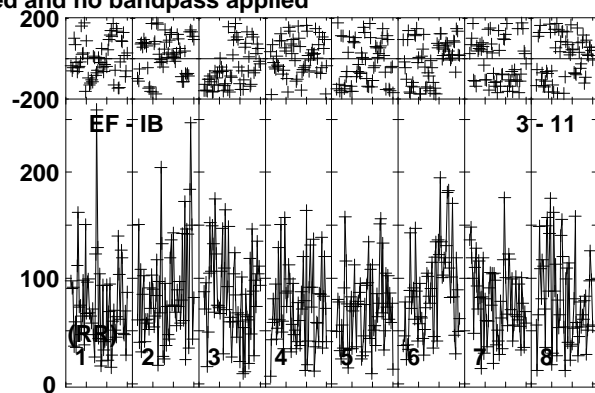
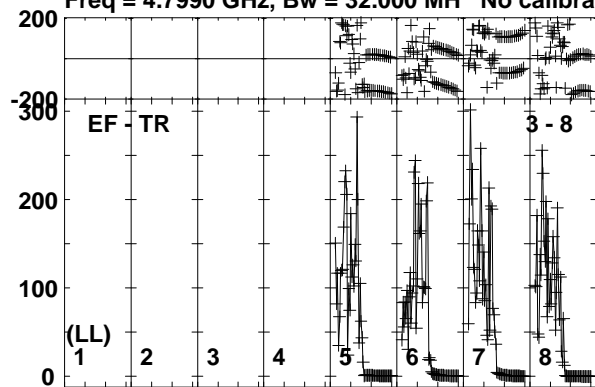

Lower frame: Micro Ampl Jy Top frame: Phas deg
Vector averaged cross-power spectrum Baseline: EF (03) - TR (08)
Timerange: 00/10:26:35 to 00/10:30:14

Plot file version 91 created 19-FEB-2019 18:13:07

J2353+5518 RP028B.UVDATA.1

Freq = 4.7990 GHz, Bw = 32.000 MH No calibration applied and no bandpass applied

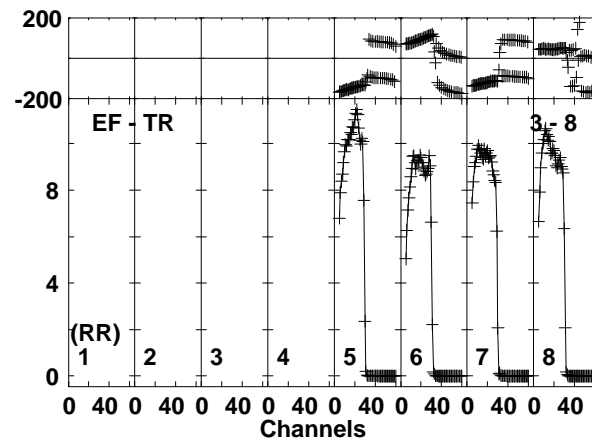
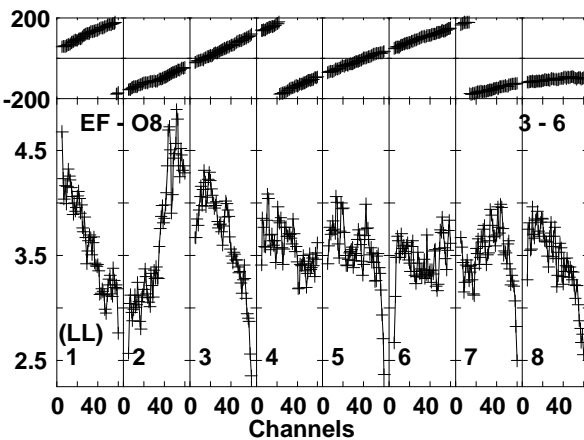
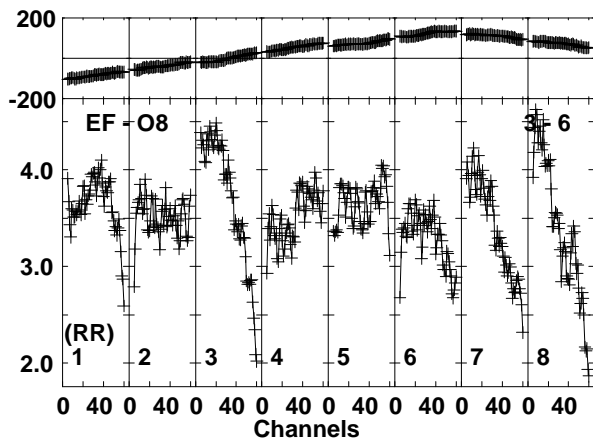
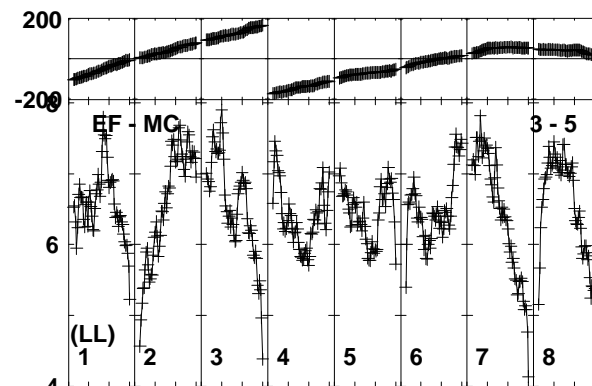
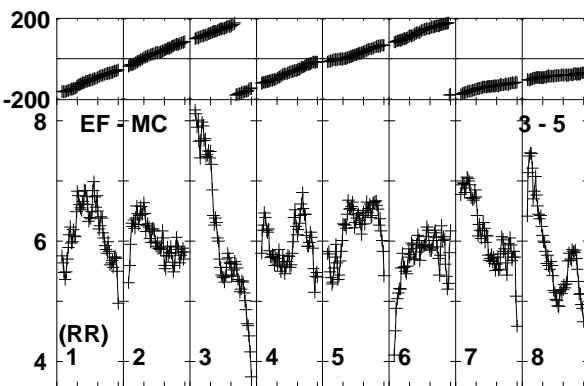
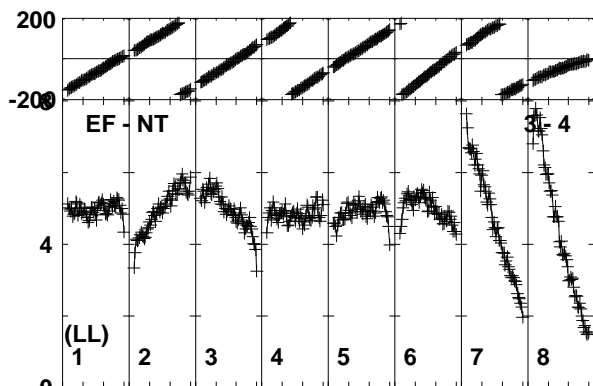
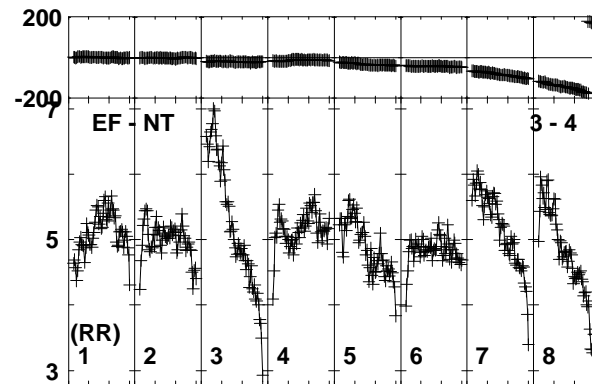
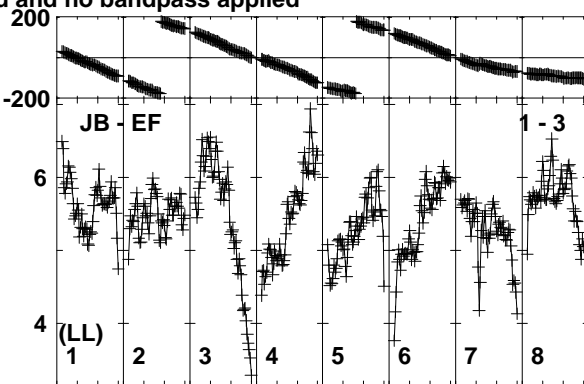
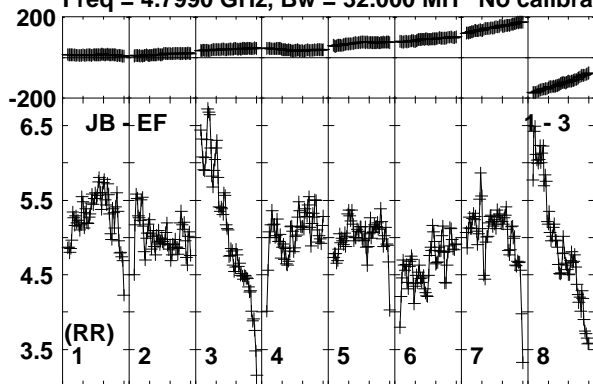

Lower frame: Milli Ampl Jy Top frame: Phas deg
Vector averaged cross-power spectrum Baseline: JB (01) - EF (03)
Timerange: 00/10:30:14 to 00/10:31:43

Plot file version 92 created 19-FEB-2019 18:13:07

J2353+5518 RP028B.UVDATA.1

Freq = 4.7990 GHz, Bw = 32.000 MH No calibration applied and no bandpass applied

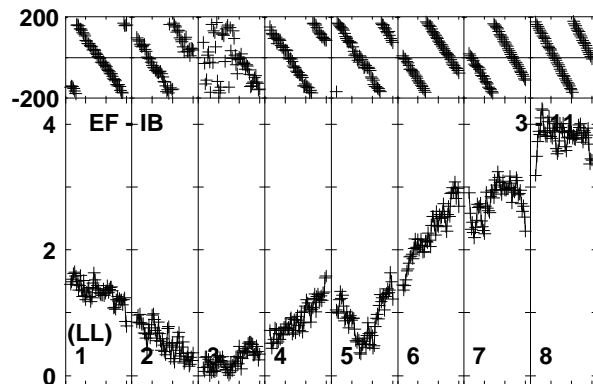
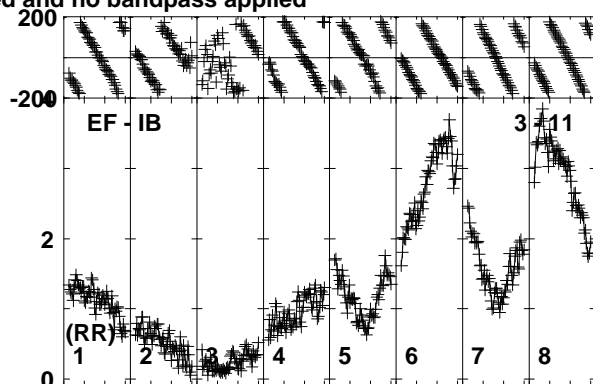
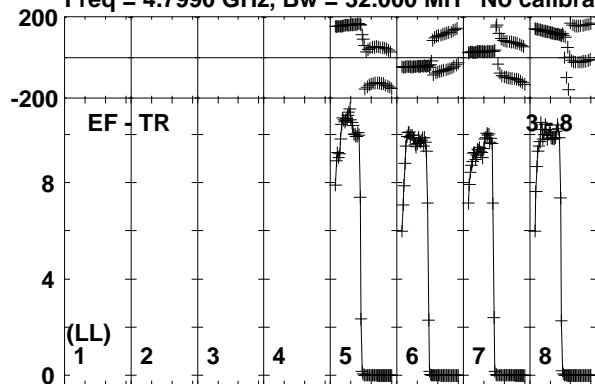

Lower frame: Milli Ampl Jy Top frame: Phas deg
Vector averaged cross-power spectrum Baseline: EF (03) - TR (08)
Timerange: 00/10:30:14 to 00/10:31:43

Plot file version 93 created 19-FEB-2019 18:13:07

IRAS23436 RP028B.UVDATA.1

Freq = 4.7990 GHz, Bw = 32.000 MH No calibration applied and no bandpass applied

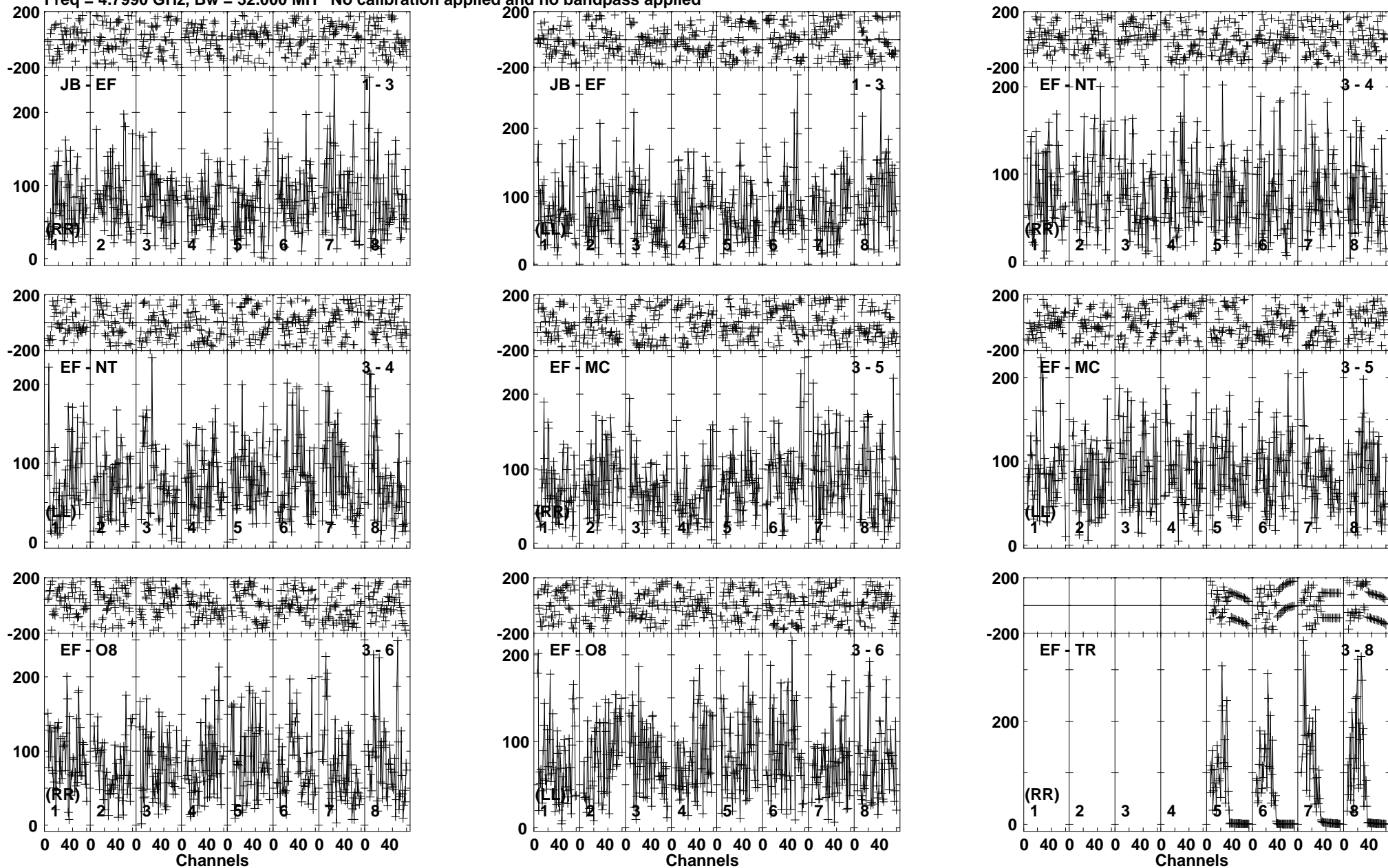

Plot file version 94 created 19-FEB-2019 18:13:07

IRAS23436 RP028B.UVDATA.1

Freq = 4.7990 GHz, Bw = 32.000 MH No calibration applied and no bandpass applied

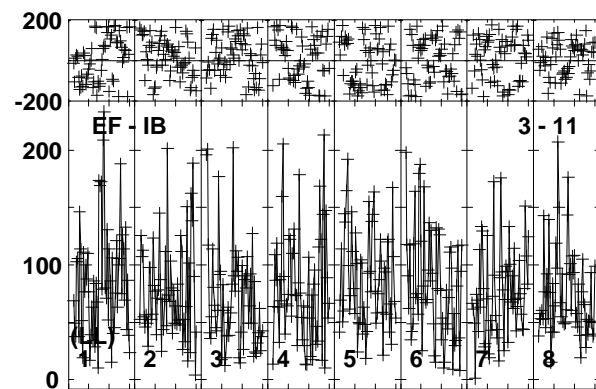
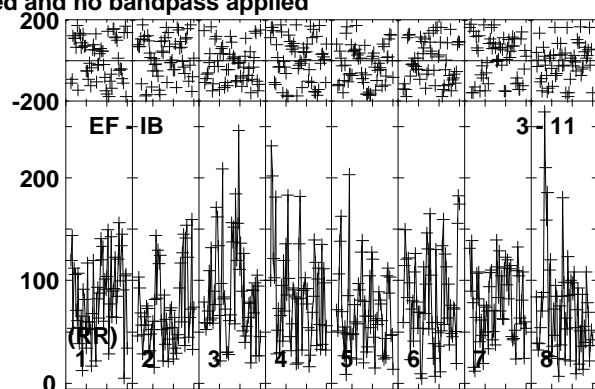
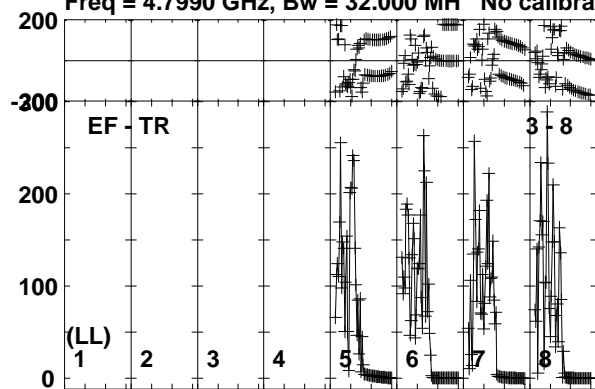

Lower frame: Micro Ampl Jy Top frame: Phas deg
Vector averaged cross-power spectrum Baseline: EF (03) - TR (08)
Timerange: 00/10:31:45 to 00/10:35:27

Plot file version 95 created 19-FEB-2019 18:13:08

J2353+5518 RP028B.UVDATA.1

Freq = 4.7990 GHz, Bw = 32.000 MH No calibration applied and no bandpass applied

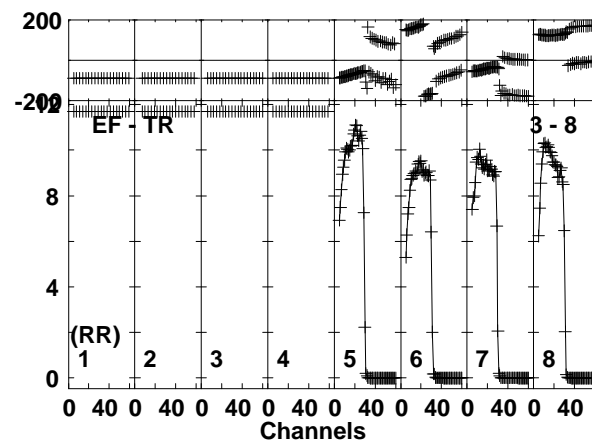
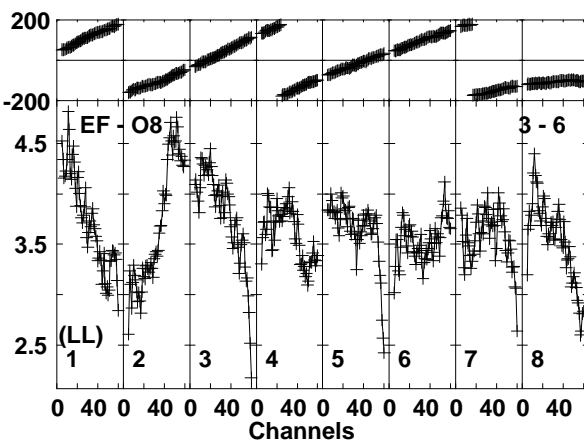
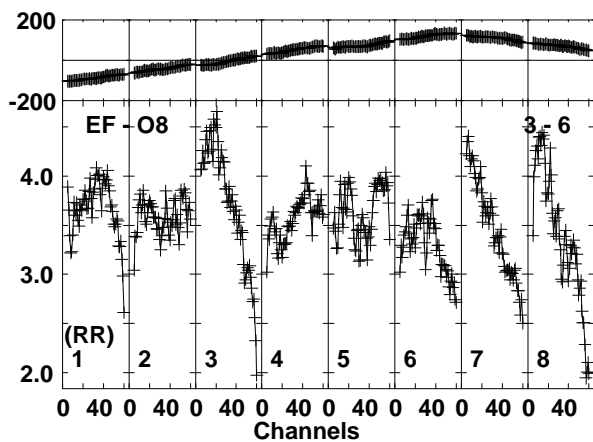
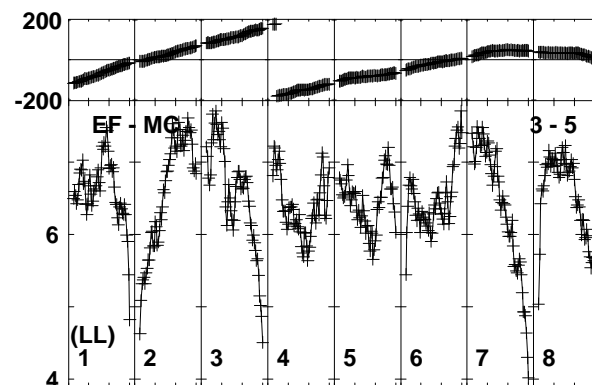
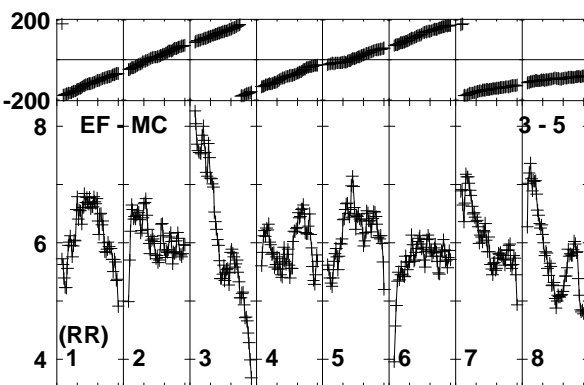
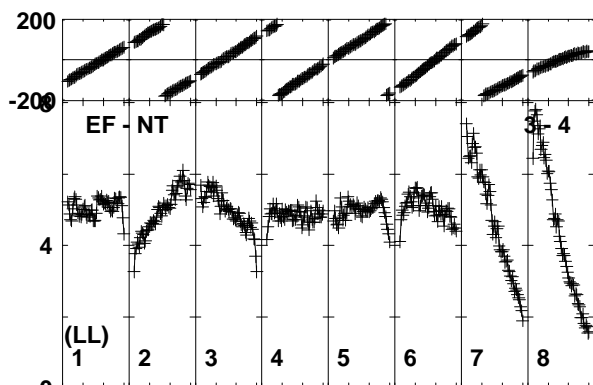
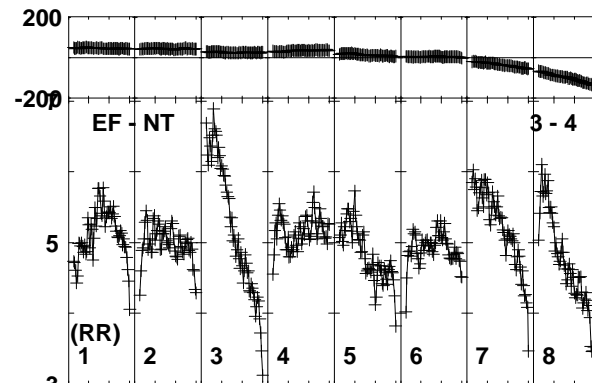
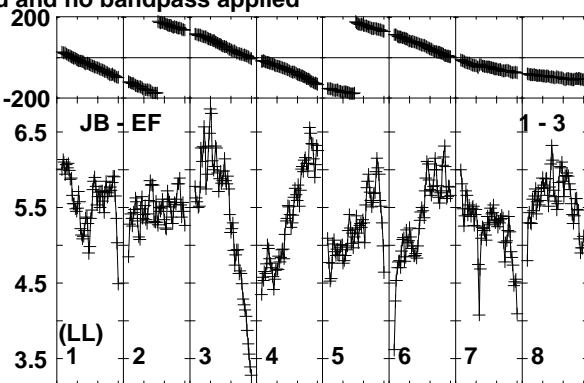
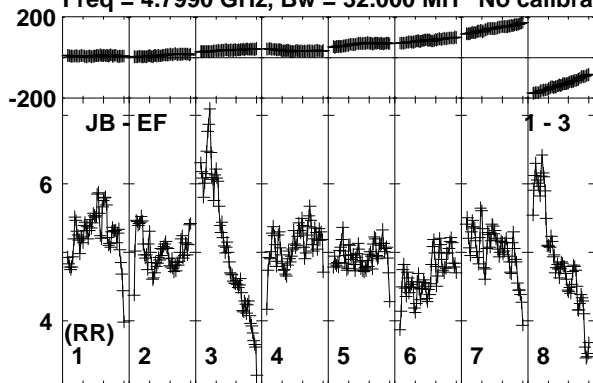

Lower frame: Milli Ampl Jy Top frame: Phas deg
Vector averaged cross-power spectrum Baseline: JB (01) - EF (03)
Timerange: 00/10:36:08 to 00/10:36:58

Plot file version 96 created 19-FEB-2019 18:13:08

J2353+5518 RP028B.UVDATA.1

Freq = 4.7990 GHz, Bw = 32.000 MH No calibration applied and no bandpass applied

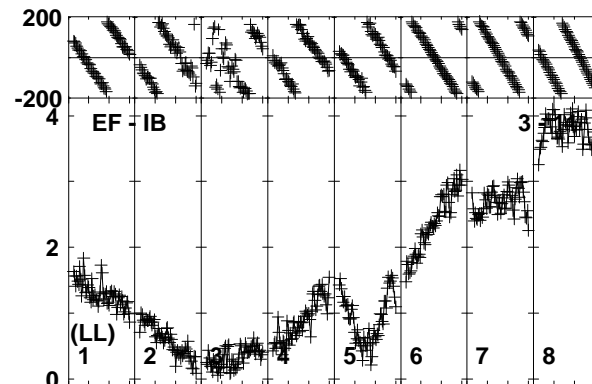
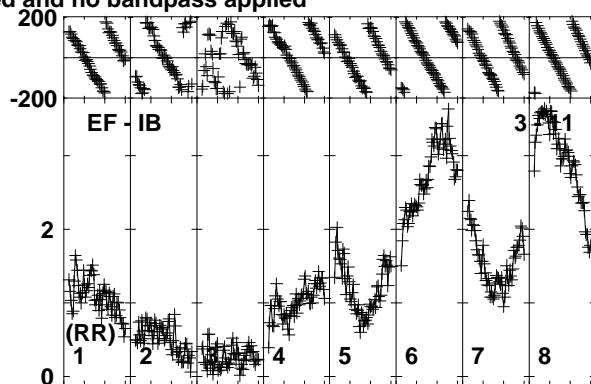
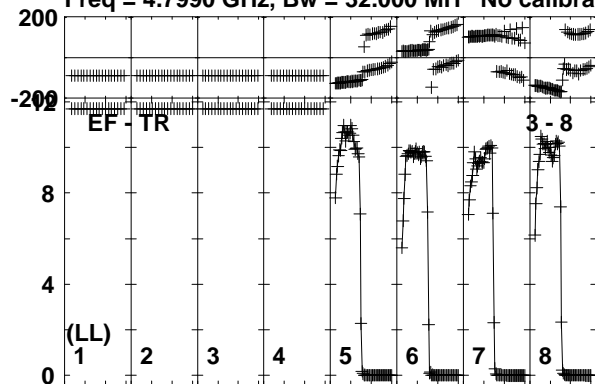

Lower frame: Milli Ampl Jy Top frame: Phas deg
Vector averaged cross-power spectrum Baseline: EF (03) - TR (08)
Timerange: 00/10:36:08 to 00/10:36:58

Plot file version 97 created 19-FEB-2019 18:13:08

IRAS23436 RP028B.UVDATA.1

Freq = 4.7990 GHz, Bw = 32.000 MH No calibration applied and no bandpass applied

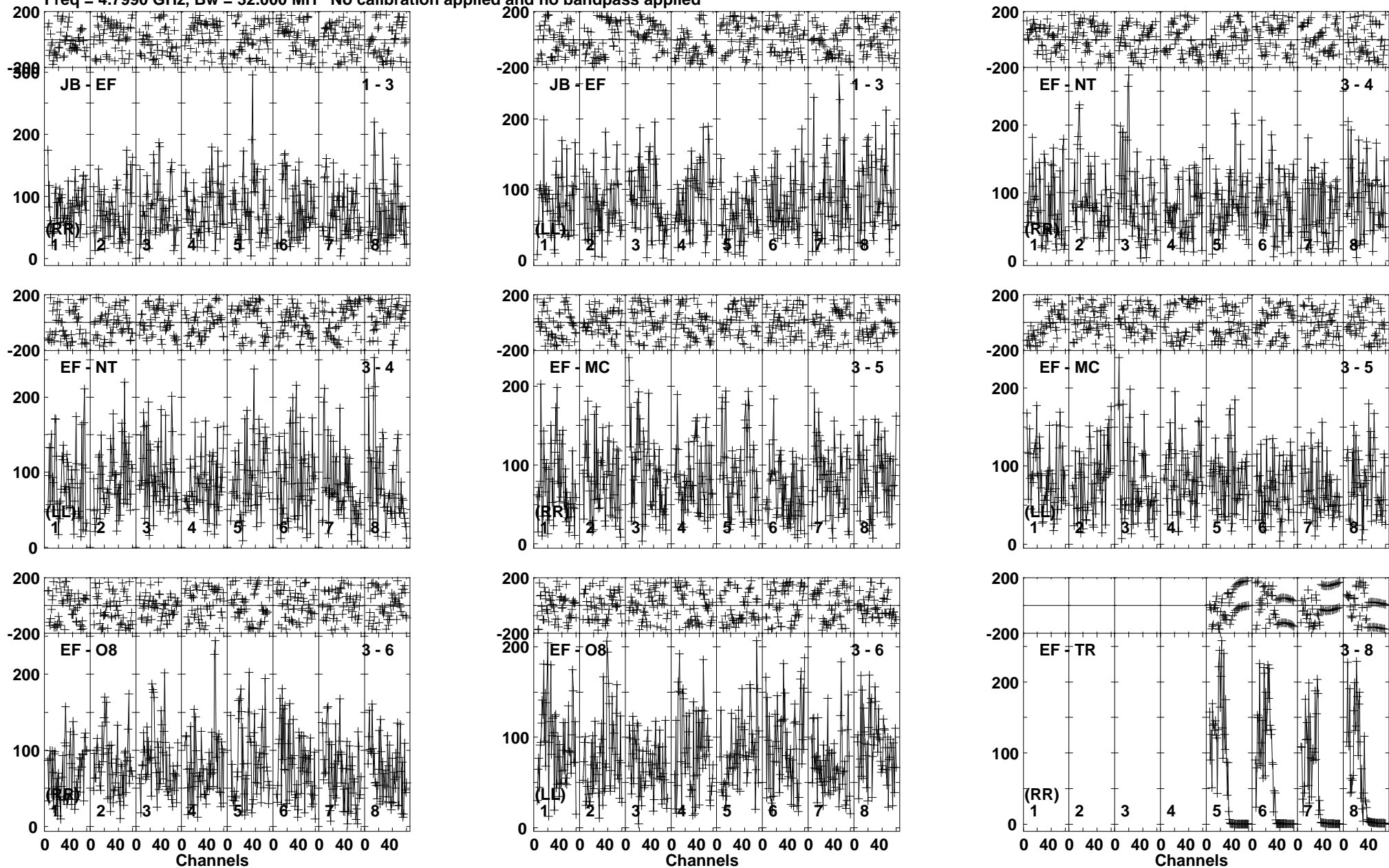

Lower frame: Micro Ampl Jy Top frame: Phas deg
Vector averaged cross-power spectrum Baseline: JB (01) - EF (03)
Timerange: 00/10:36:59 to 00/10:40:41

Plot file version 98 created 19-FEB-2019 18:13:08

IRAS23436 RP028B.UVDATA.1

Freq = 4.7990 GHz, Bw = 32.000 MH No calibration applied and no bandpass applied

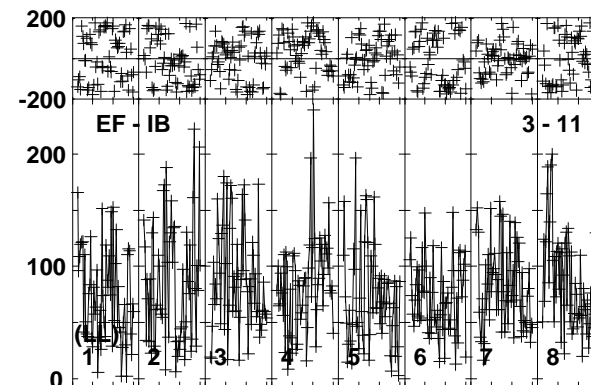
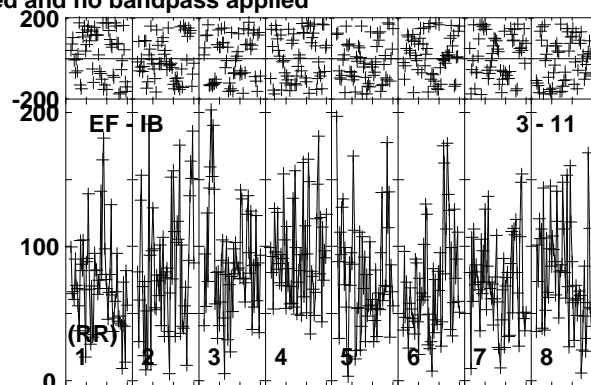
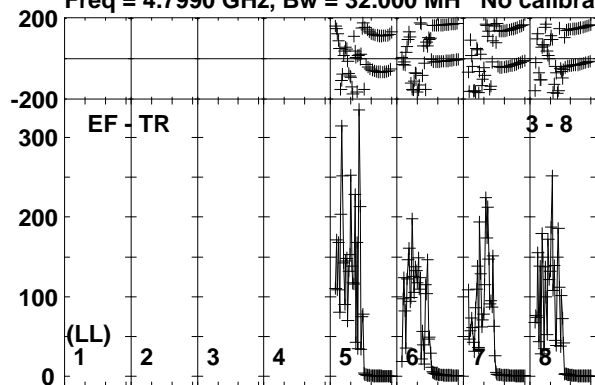

Lower frame: Micro Ampl Jy Top frame: Phas deg
Vector averaged cross-power spectrum Baseline: EF (03) - TR (08)
Timerange: 00/10:36:59 to 00/10:40:41

Plot file version 99 created 19-FEB-2019 18:13:08

J2353+5518 RP028B.UVDATA.1

Freq = 4.7990 GHz, Bw = 32.000 MH No calibration applied and no bandpass applied

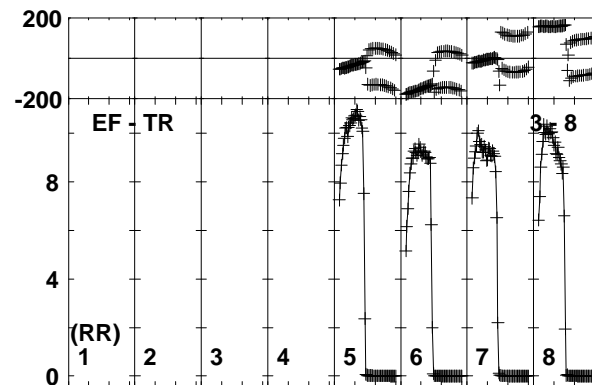
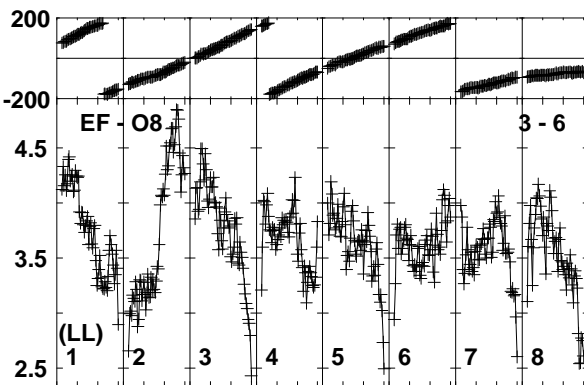
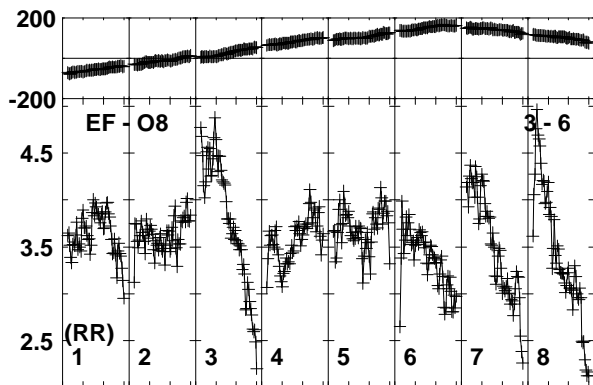
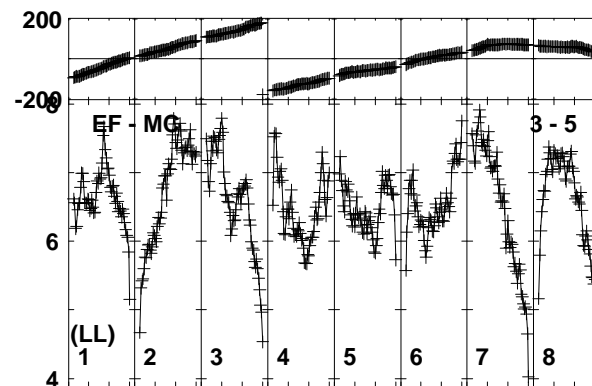
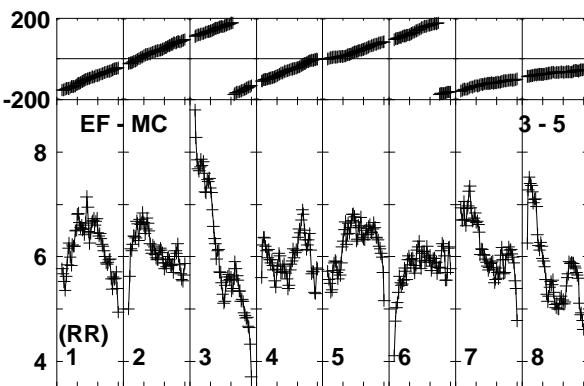
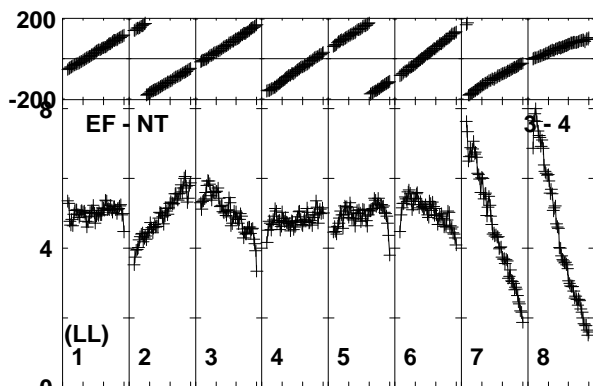
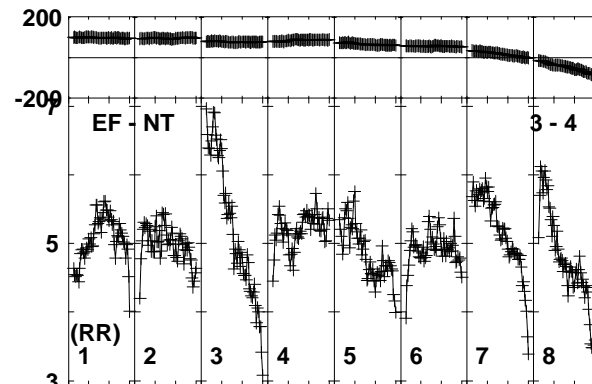
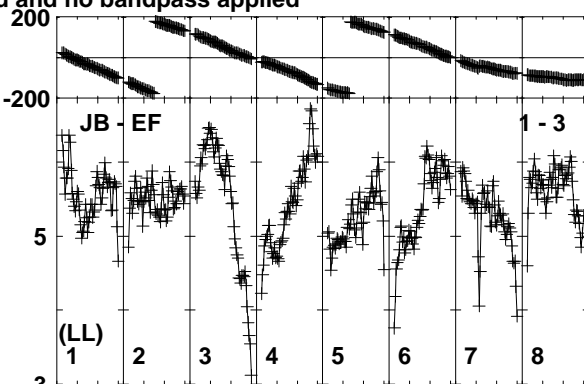
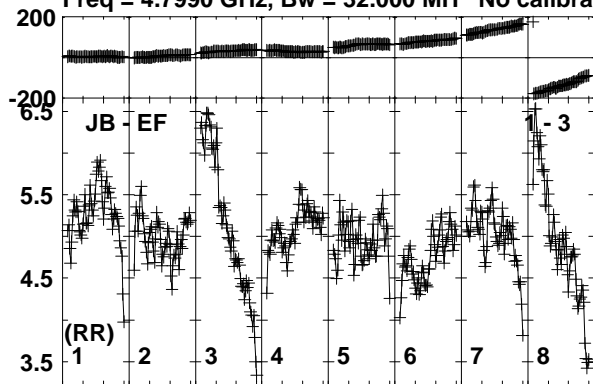

Lower frame: Milli Ampl Jy Top frame: Phas deg
Vector averaged cross-power spectrum Baseline: JB (01) - EF (03)
Timerange: 00/10:40:43 to 00/10:42:11

Plot file version 100 created 19-FEB-2019 18:13:09

J2353+5518 RP028B.UVDATA.1

Freq = 4.7990 GHz, Bw = 32.000 MH No calibration applied and no bandpass applied

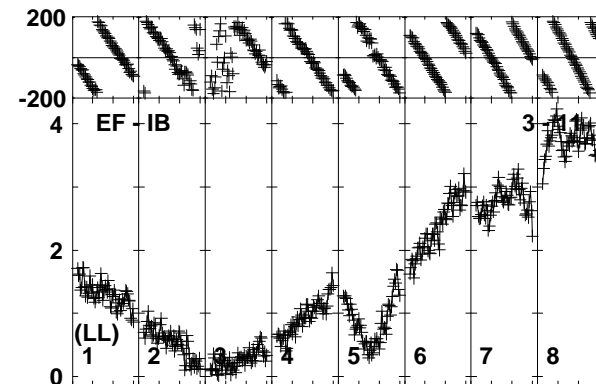
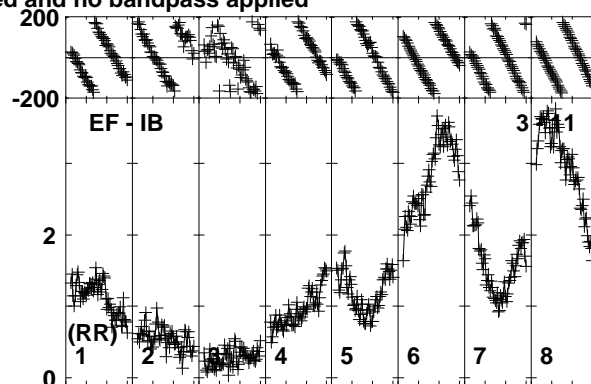
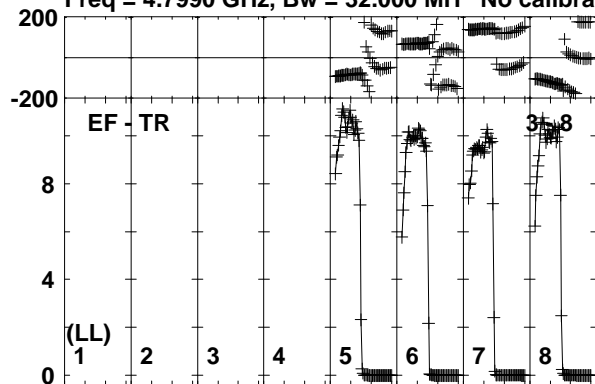

Lower frame: Milli Ampl Jy Top frame: Phas deg
Vector averaged cross-power spectrum Baseline: EF (03) - TR (08)
Timerange: 00/10:40:43 to 00/10:42:11

Plot file version 101 created 19-FEB-2019 18:13:09

IRAS23436 RP028B.UVDATA.1

Freq = 4.7990 GHz, Bw = 32.000 MH No calibration applied and no bandpass applied

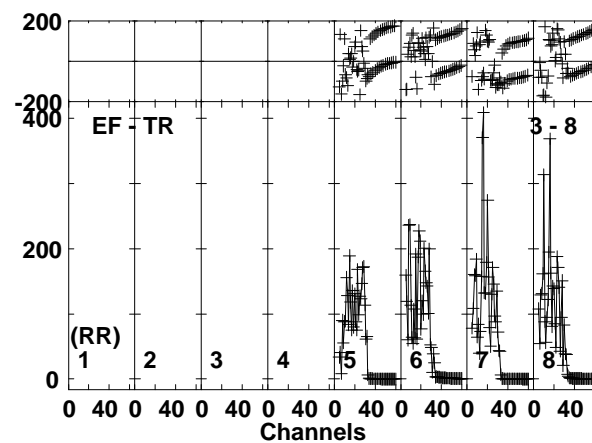
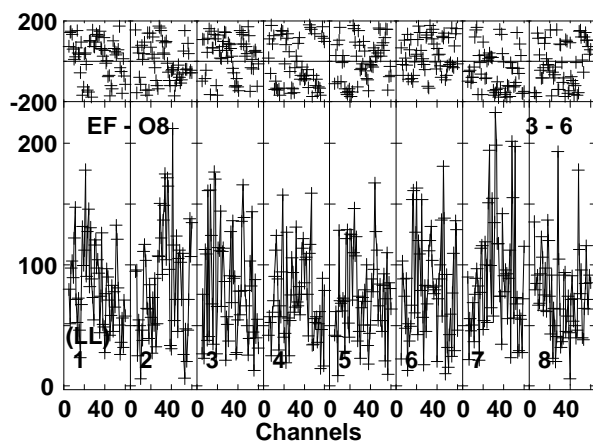
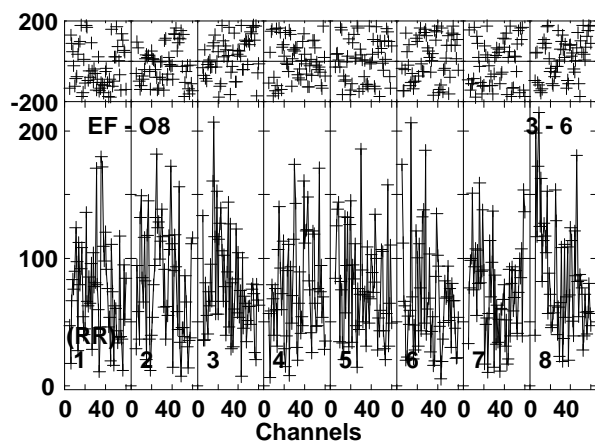
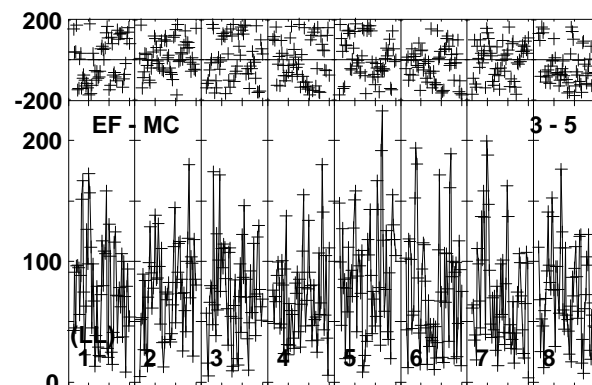
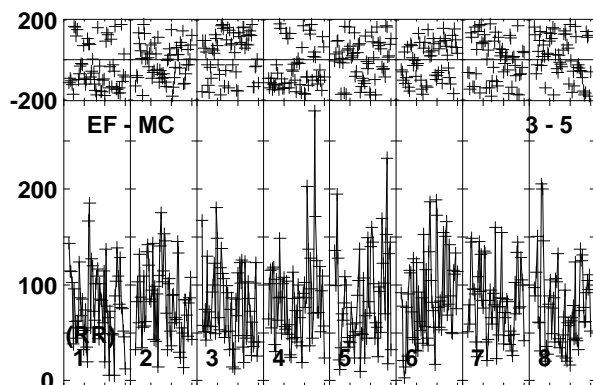
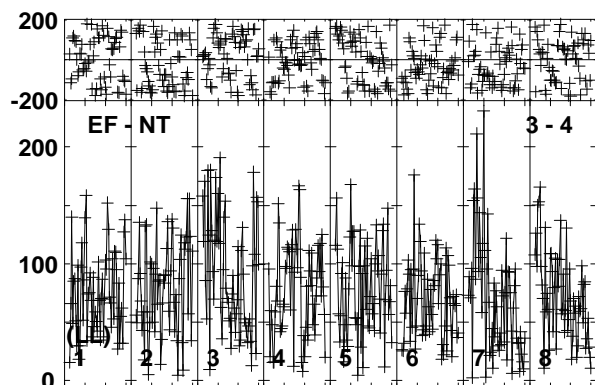
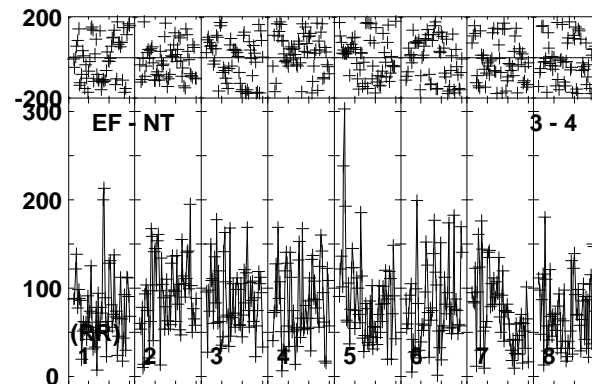
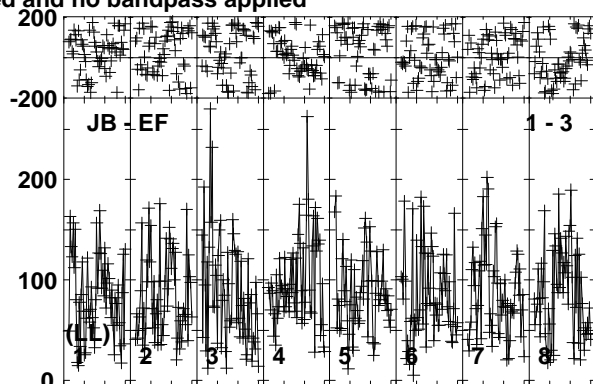
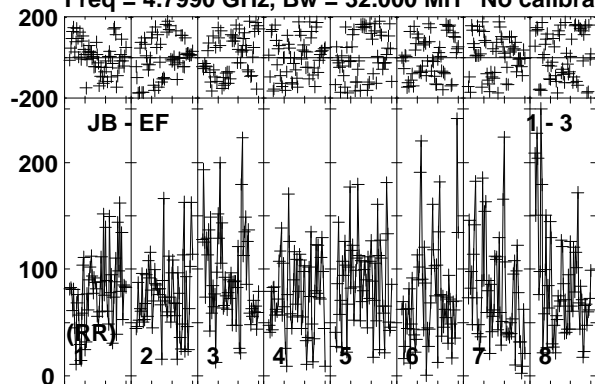

Lower frame: Micro Ampl Jy Top frame: Phas deg
Vector averaged cross-power spectrum Baseline: JB (01) - EF (03)
Timerange: 00/10:42:12 to 00/10:45:55

Plot file version 102 created 19-FEB-2019 18:13:09

IRAS23436 RP028B.UVDATA.1

Freq = 4.7990 GHz, Bw = 32.000 MH No calibration applied and no bandpass applied

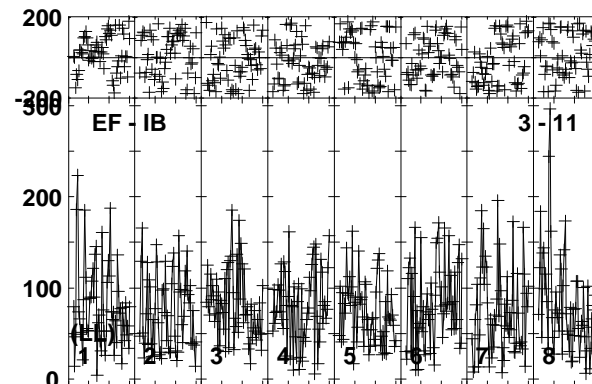
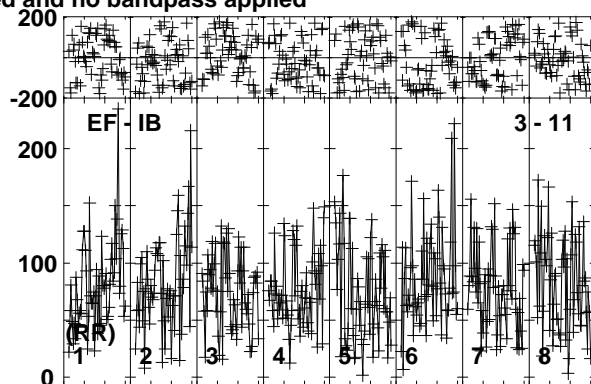
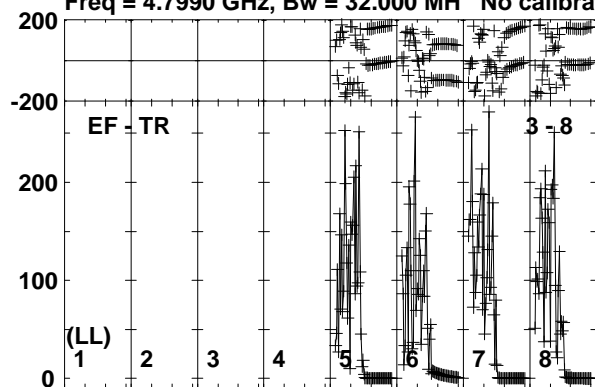

Lower frame: Micro Ampl Jy Top frame: Phas deg
Vector averaged cross-power spectrum Baseline: EF (03) - TR (08)
Timerange: 00/10:42:12 to 00/10:45:55

Plot file version 103 created 19-FEB-2019 18:13:09

J2353+5518 RP028B.UVDATA.1

Freq = 4.7990 GHz, Bw = 32.000 MH No calibration applied and no bandpass applied

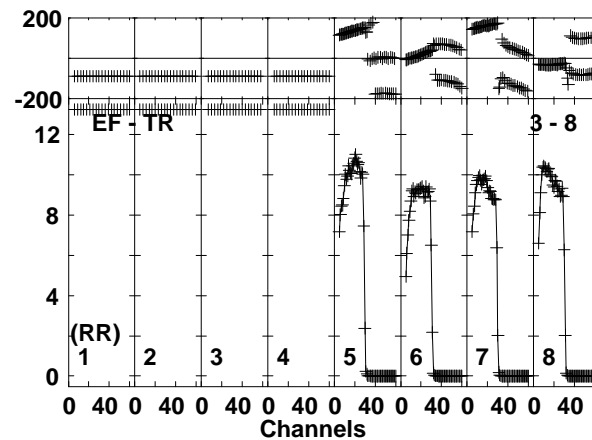
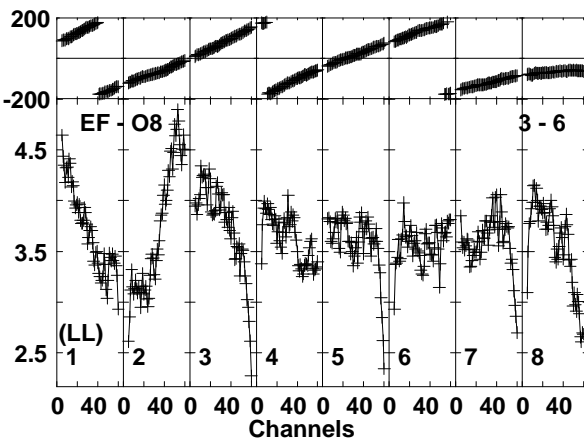
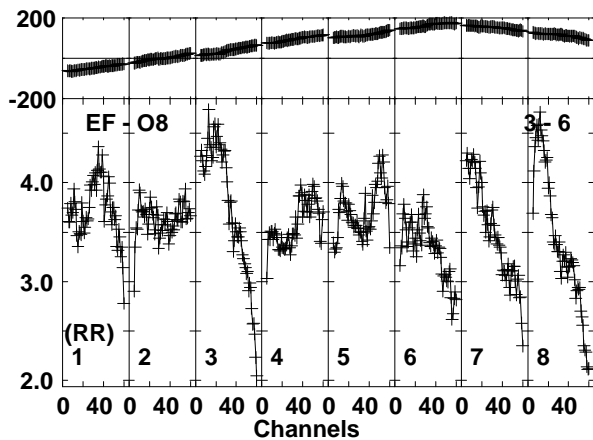
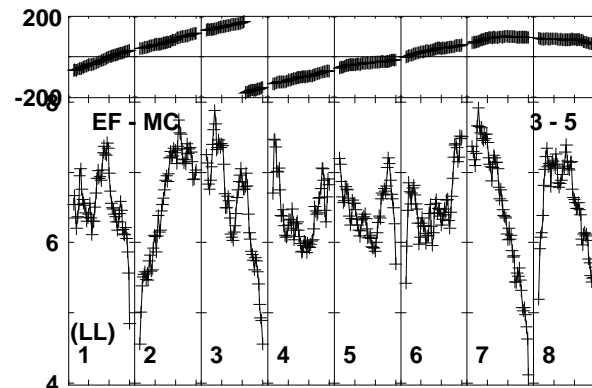
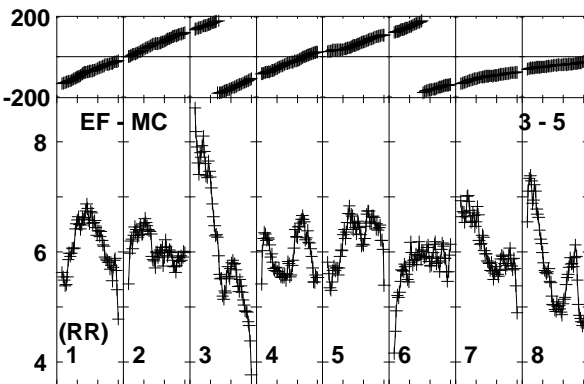
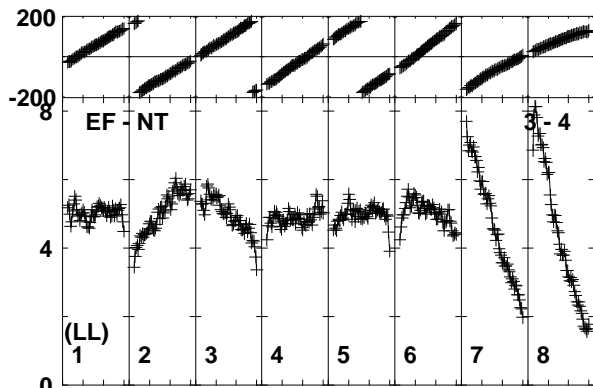
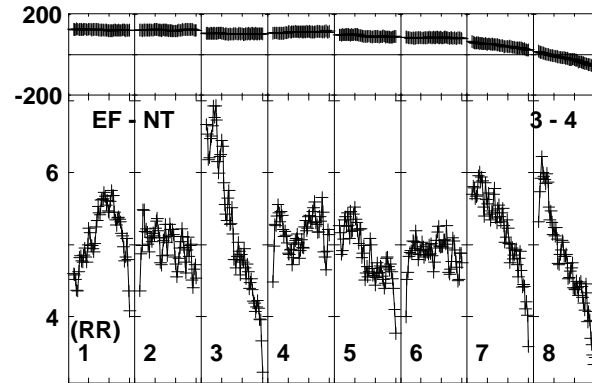
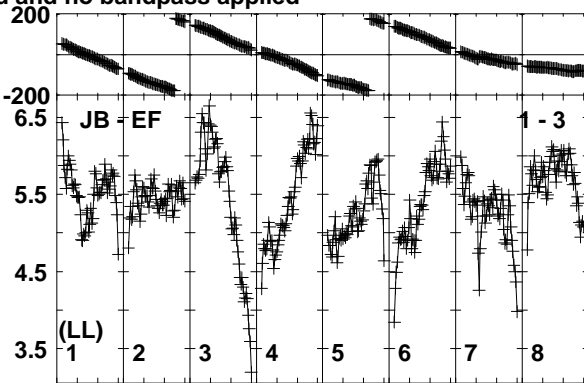
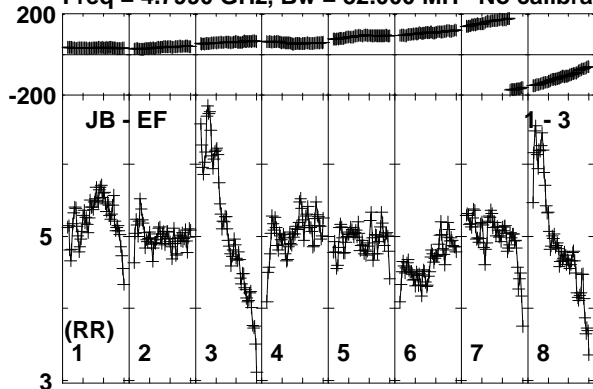

Lower frame: Milli Ampl Jy Top frame: Phas deg
Vector averaged cross-power spectrum Baseline: JB (01) - EF (03)
Timerange: 00/10:46:37 to 00/10:47:36

Plot file version 104 created 19-FEB-2019 18:13:09

J2353+5518 RP028B.UVDATA.1

Freq = 4.7990 GHz, Bw = 32.000 MH No calibration applied and no bandpass applied

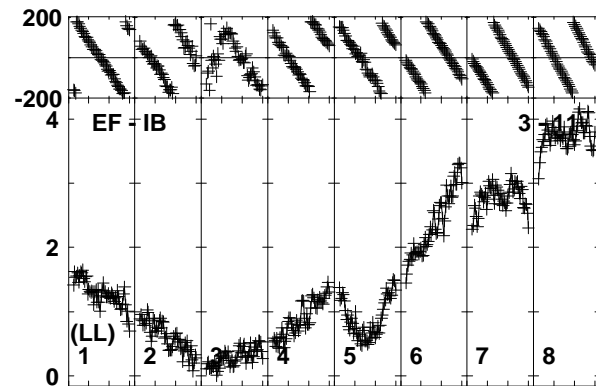
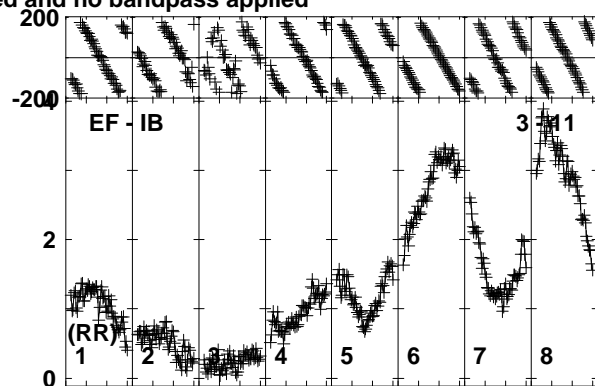
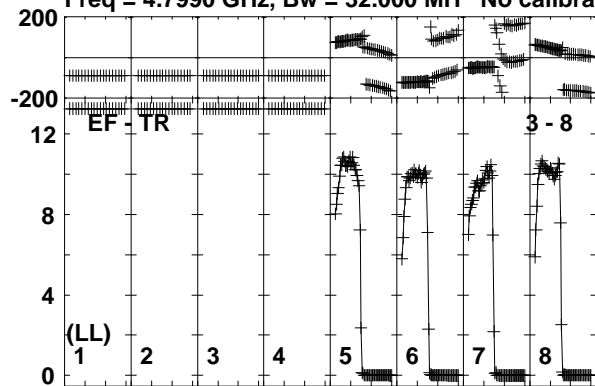

Lower frame: Milli Ampl Jy Top frame: Phas deg
Vector averaged cross-power spectrum Baseline: EF (03) - TR (08)
Timerange: 00/10:46:37 to 00/10:47:36

Plot file version 106 created 19-FEB-2019 18:13:10

IRAS23436 RP028B.UVDATA.1

Freq = 4.7990 GHz, Bw = 32.000 MH No calibration applied and no bandpass applied

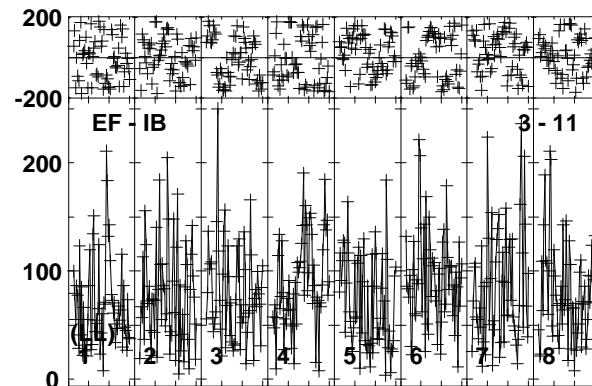
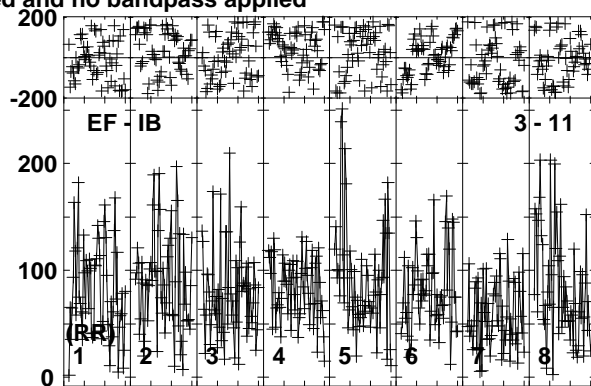
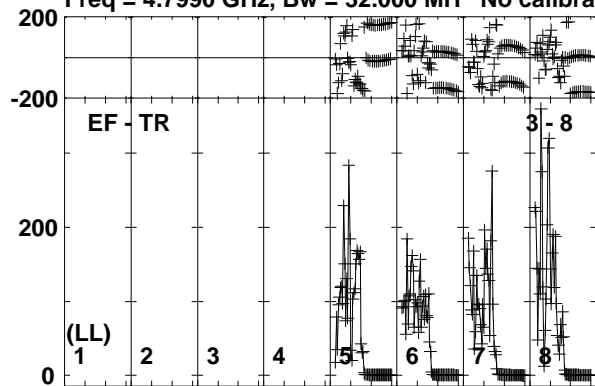

Lower frame: Micro Ampl Jy Top frame: Phas deg
Vector averaged cross-power spectrum Baseline: EF (03) - TR (08)
Timerange: 00/10:47:37 to 00/10:51:16

Plot file version 107 created 19-FEB-2019 18:13:10

J2353+5518 RP028B.UVDATA.1

Freq = 4.7990 GHz, Bw = 32.000 MH No calibration applied and no bandpass applied

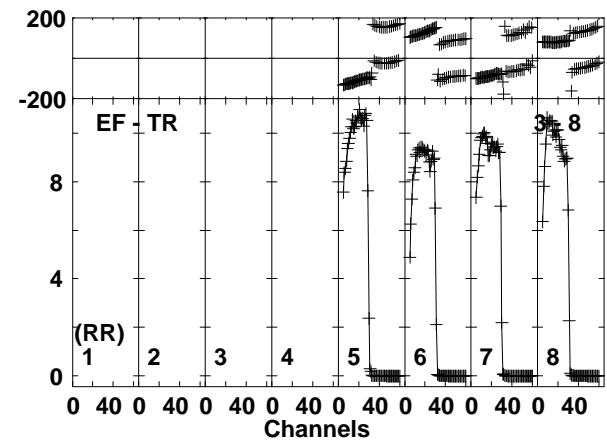
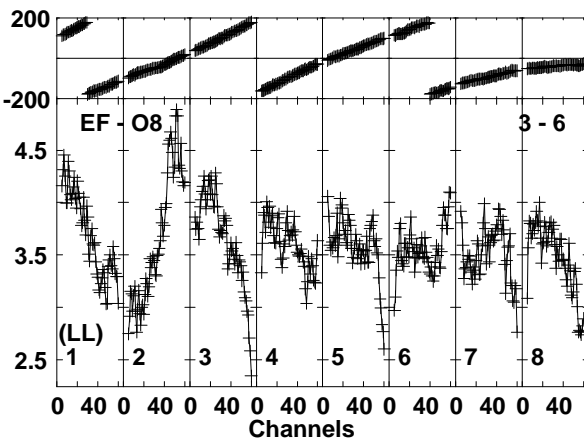
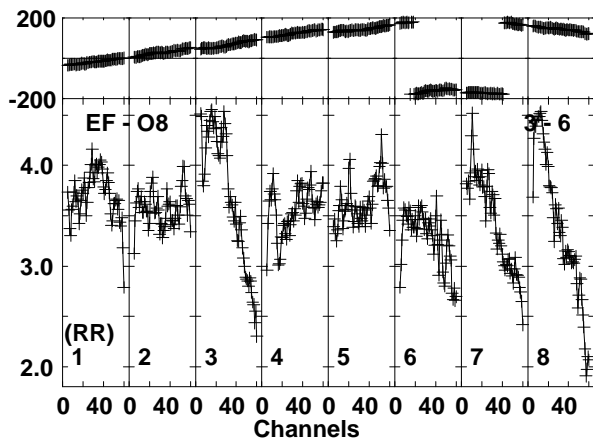
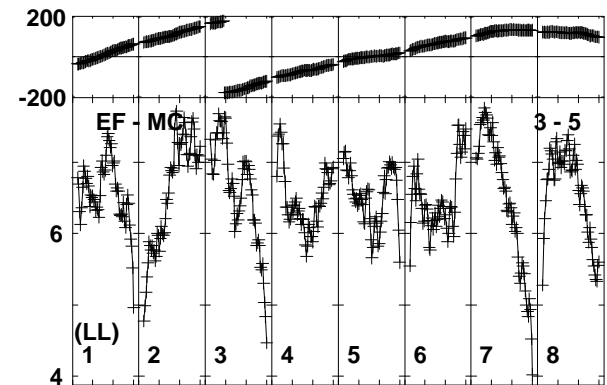
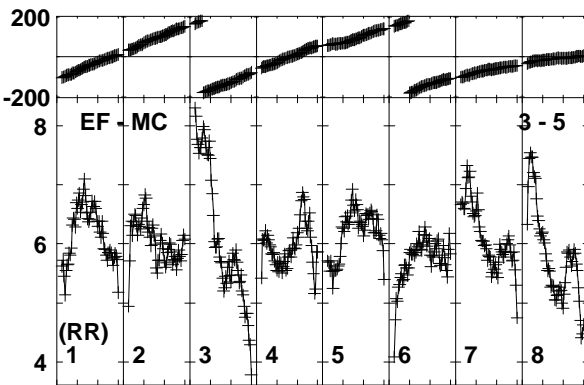
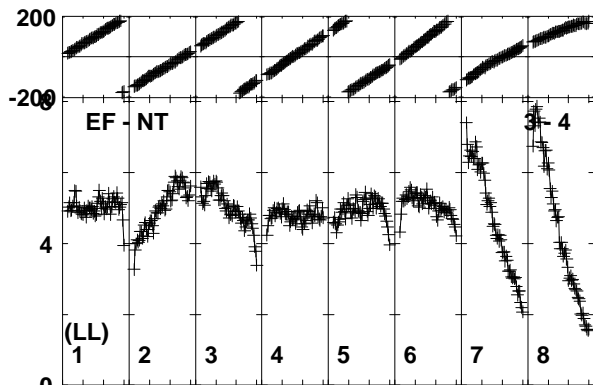
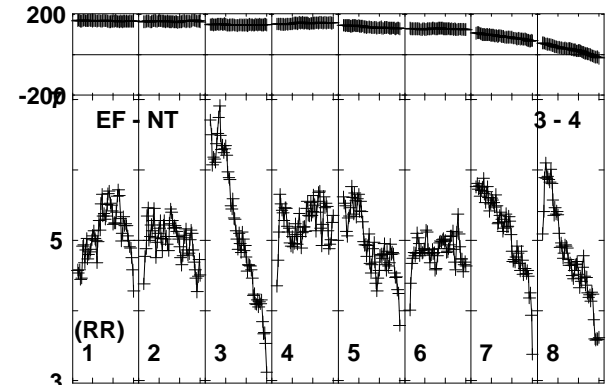
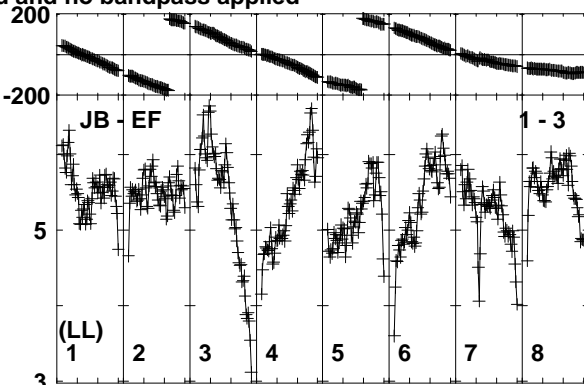
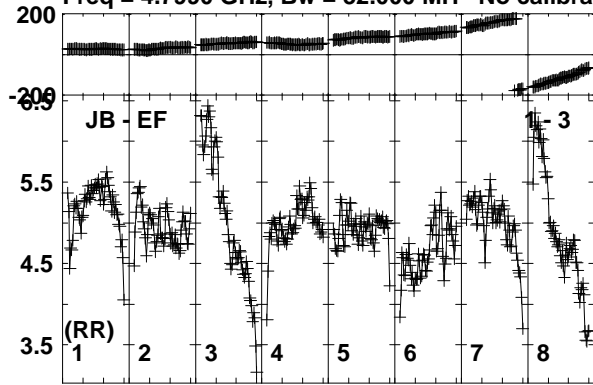

Lower frame: Milli Ampl Jy Top frame: Phas deg
Vector averaged cross-power spectrum Baseline: JB (01) - EF (03)
Timerange: 00/10:51:17 to 00/10:52:46

Plot file version 108 created 19-FEB-2019 18:13:10

J2353+5518 RP028B.UVDATA.1

Freq = 4.7990 GHz, Bw = 32.000 MH No calibration applied and no bandpass applied

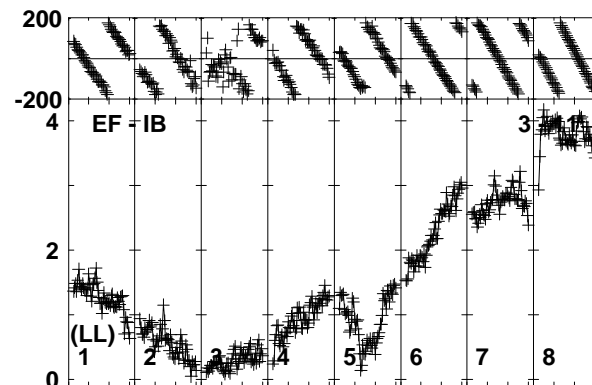
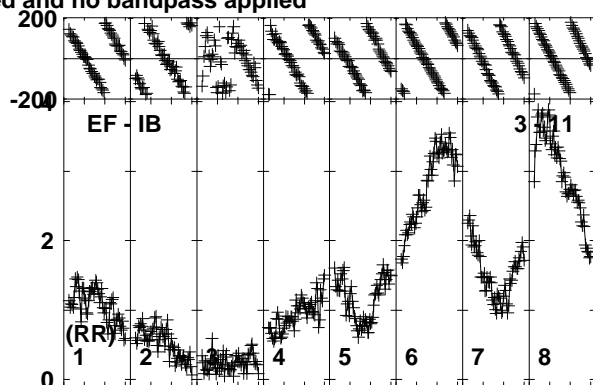
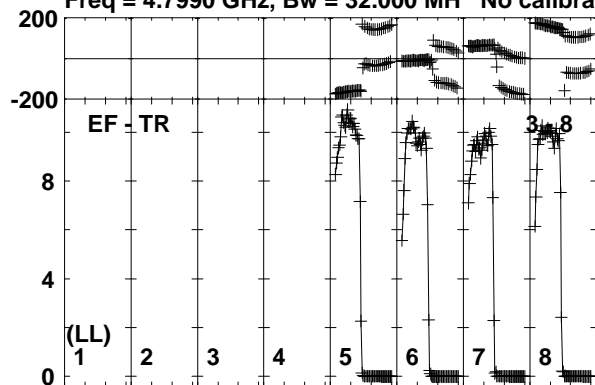

Lower frame: Milli Ampl Jy Top frame: Phas deg
Vector averaged cross-power spectrum Baseline: EF (03) - TR (08)
Timerange: 00/10:51:17 to 00/10:52:46

Plot file version 109 created 19-FEB-2019 18:13:10

IRAS23436 RP028B.UVDATA.1

Freq = 4.7990 GHz, Bw = 32.000 MH No calibration applied and no bandpass applied

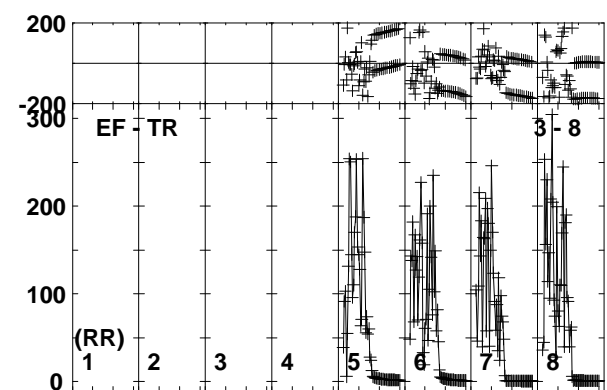
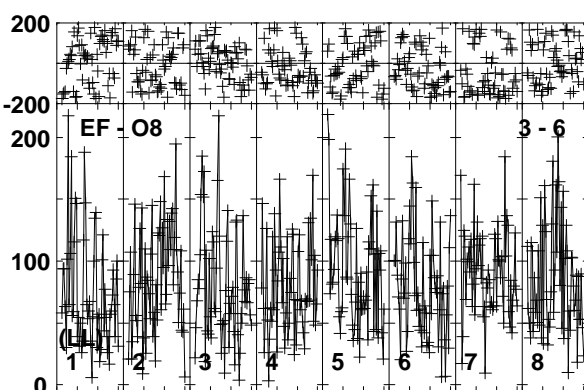
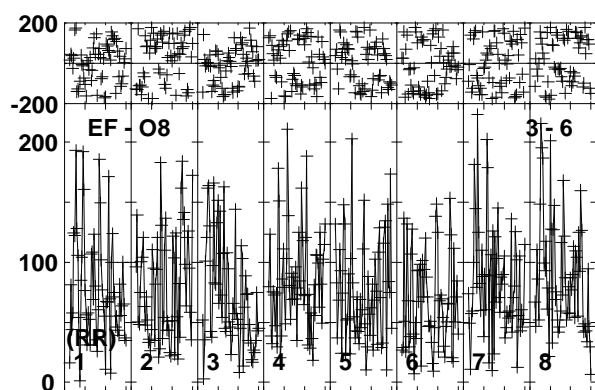
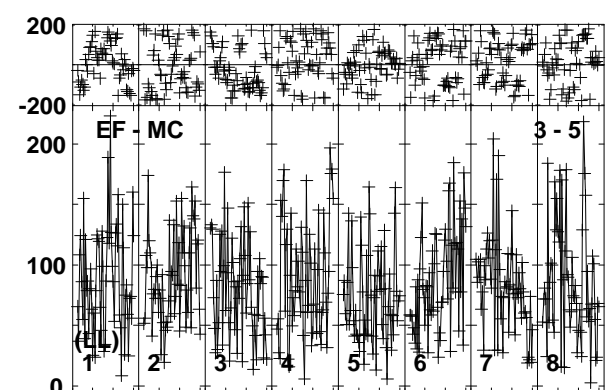
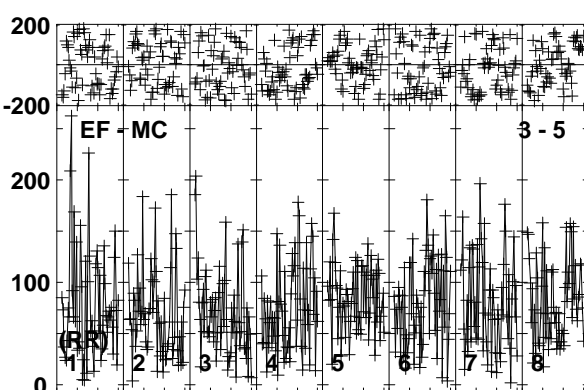
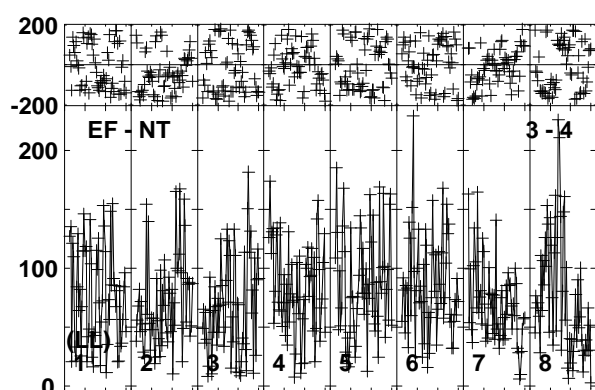
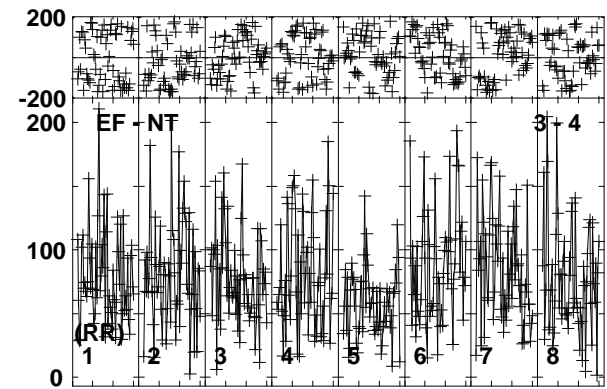
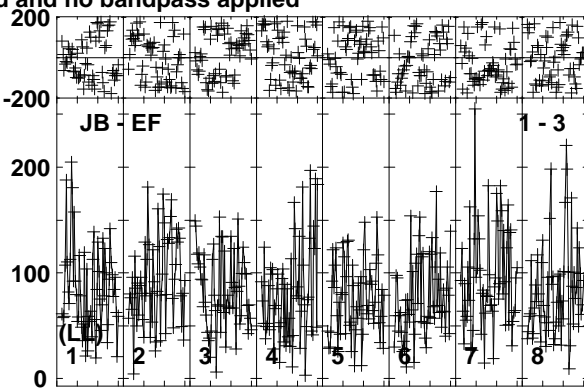
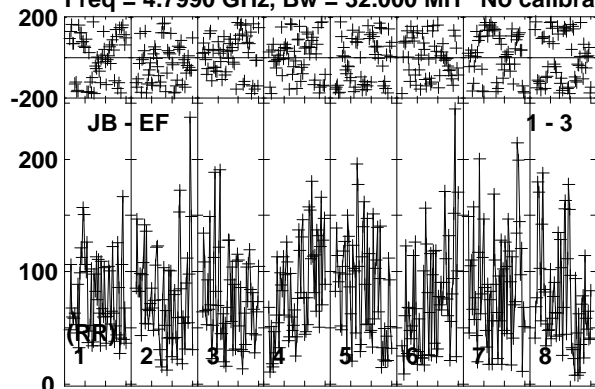

Lower frame: Micro Ampl Jy Top frame: Phas deg
Vector averaged cross-power spectrum Baseline: JB (01) - EF (03)
Timerange: 00/10:52:47 to 00/10:56:29

Plot file version 110 created 19-FEB-2019 18:13:10

IRAS23436 RP028B.UVDATA.1

Freq = 4.7990 GHz, Bw = 32.000 MH No calibration applied and no bandpass applied

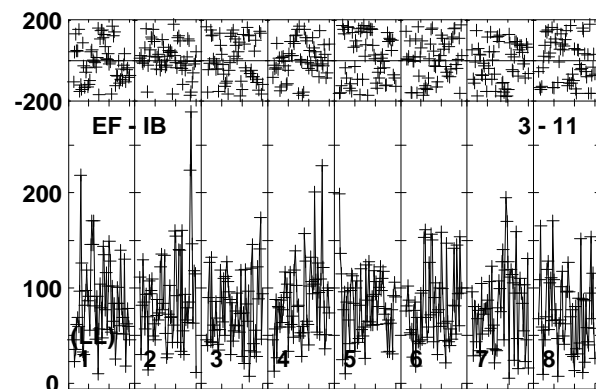
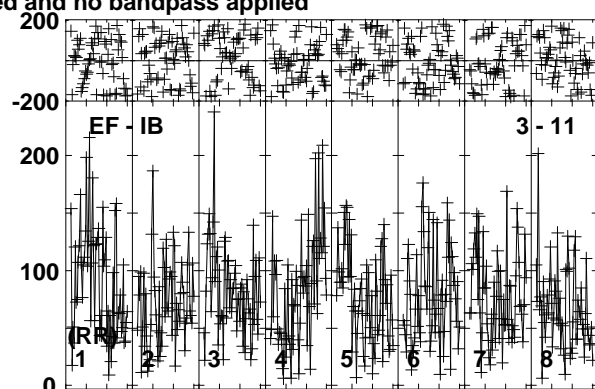
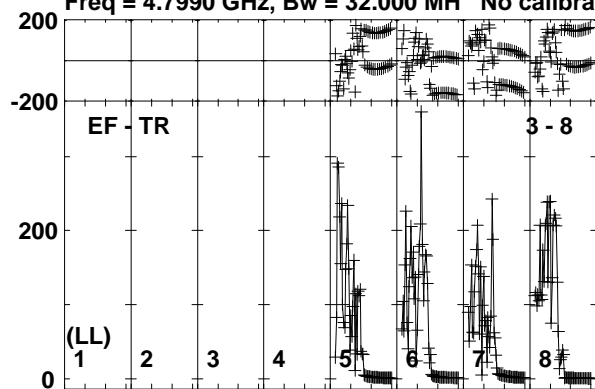

Lower frame: Micro Ampl Jy Top frame: Phas deg
Vector averaged cross-power spectrum Baseline: EF (03) - TR (08)
Timerange: 00/10:52:47 to 00/10:56:29

Plot file version 111 created 19-FEB-2019 18:13:11
 J2353+5518 RP028B.UVDATA.1
 Freq = 4.7990 GHz, Bw = 32.000 MH No calibration applied and no bandpass applied

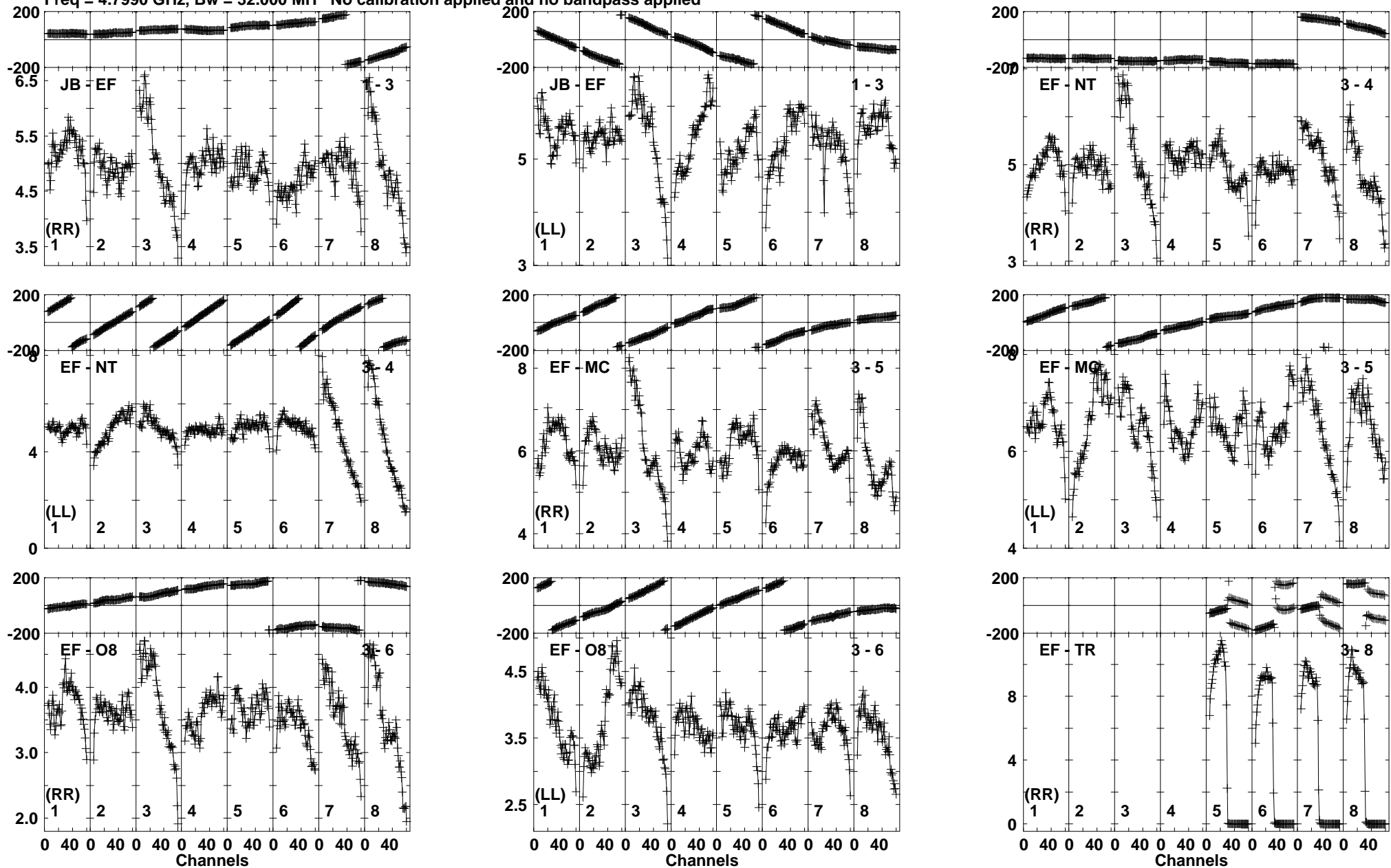

Lower frame: Milli Ampl Jy Top frame: Phas deg
 Vector averaged cross-power spectrum Baseline: JB (01) - EF (03)
 Timerange: 00/10:57:10 to 00/10:58:00

Plot file version 112 created 19-FEB-2019 18:13:11

J2353+5518 RP028B.UVDATA.1

Freq = 4.7990 GHz, Bw = 32.000 MH No calibration applied and no bandpass applied

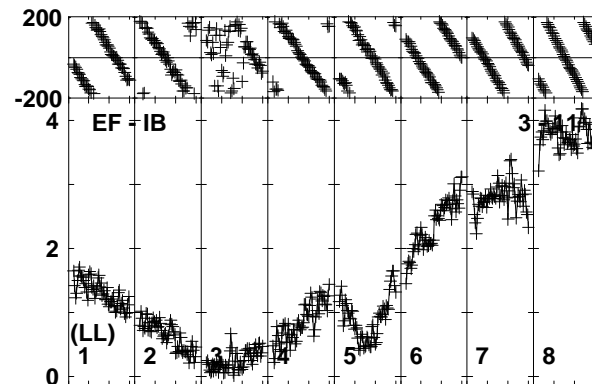
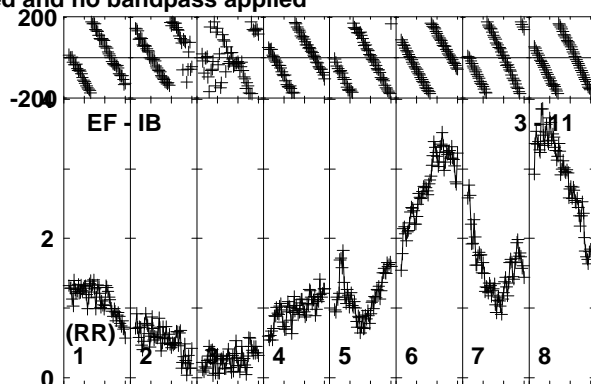
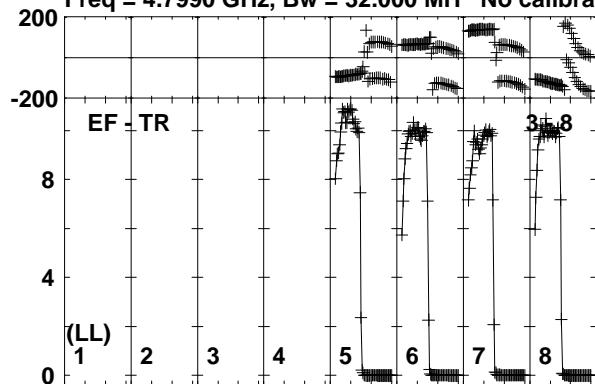

Lower frame: Milli Ampl Jy Top frame: Phas deg
Vector averaged cross-power spectrum Baseline: EF (03) - TR (08)
Timerange: 00/10:57:10 to 00/10:58:00

Plot file version 113 created 19-FEB-2019 18:13:11

IRAS23436 RP028B.UVDATA.1

Freq = 4.7990 GHz, Bw = 32.000 MH No calibration applied and no bandpass applied

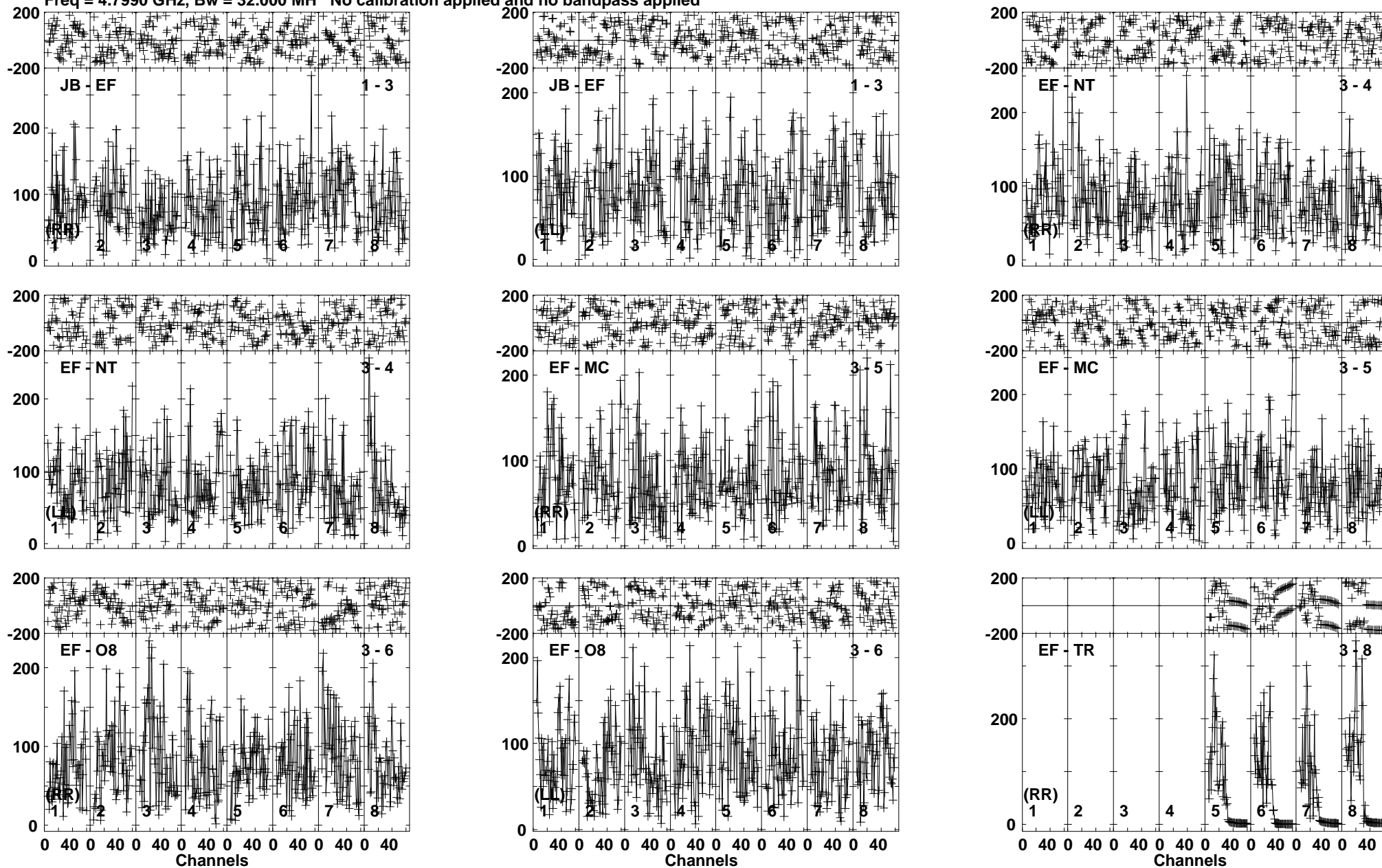

Lower frame: Micro Ampl Jy Top frame: Phas deg
Vector averaged cross-power spectrum Baseline: JB (01) - EF (03)
Timerange: 00/10:58:01 to 00/11:01:43

Plot file version 114 created 19-FEB-2019 18:13:11

IRAS23436 RP028B.UVDATA.1

Freq = 4.7990 GHz, Bw = 32.000 MH No calibration applied and no bandpass applied

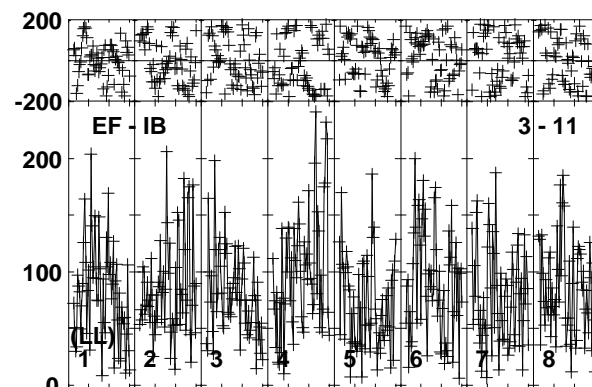
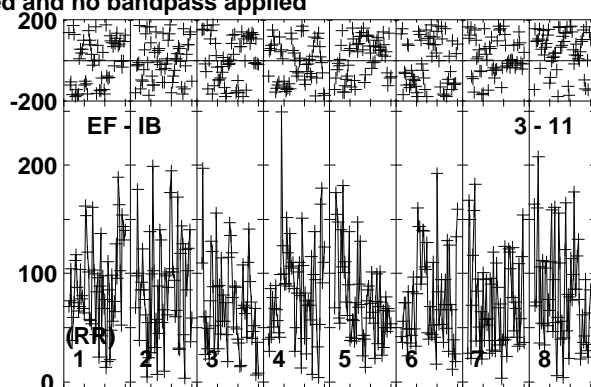
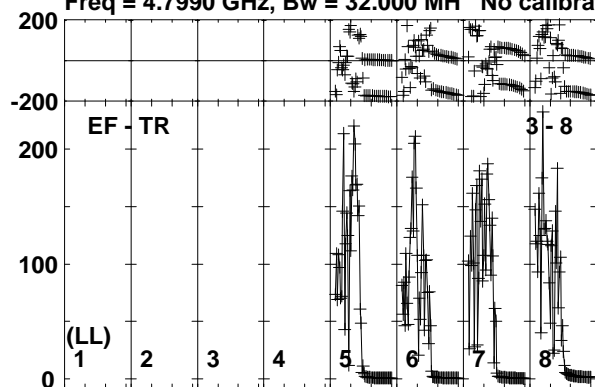

Lower frame: Micro Ampl Jy Top frame: Phas deg
Vector averaged cross-power spectrum Baseline: EF (03) - TR (08)
Timerange: 00/10:58:01 to 00/11:01:43

Plot file version 115 created 19-FEB-2019 18:13:11

J2353+5518 RP028B.UVDATA.1

Freq = 4.7990 GHz, Bw = 32.000 MH No calibration applied and no bandpass applied

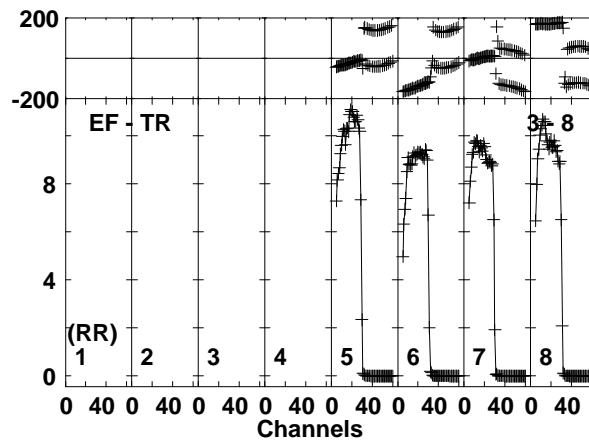
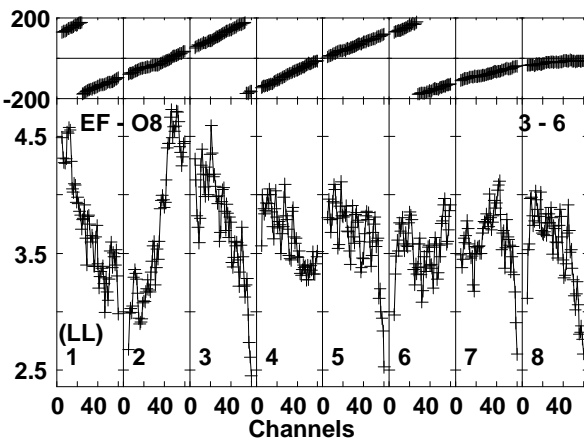
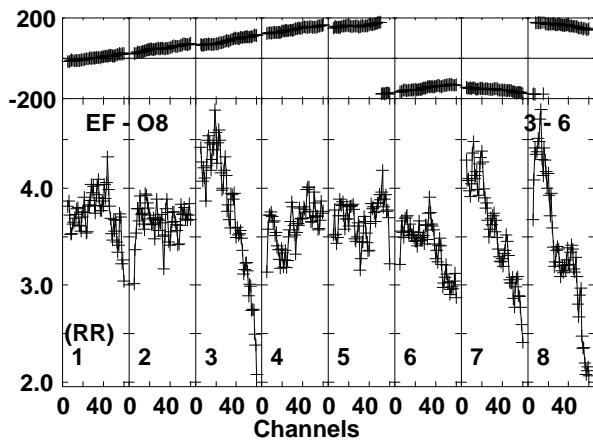
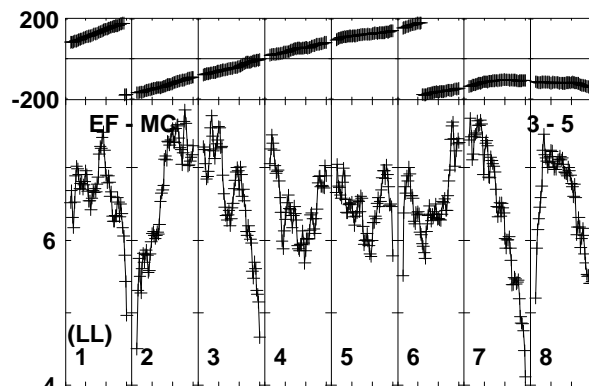
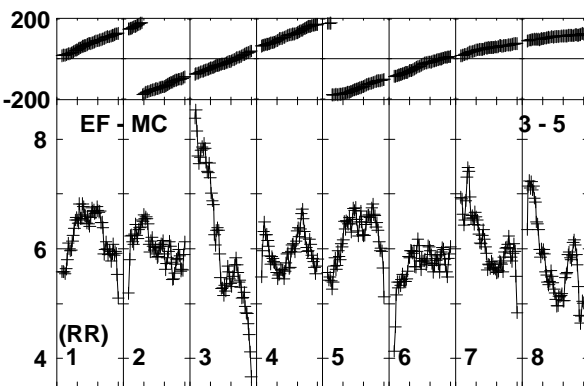
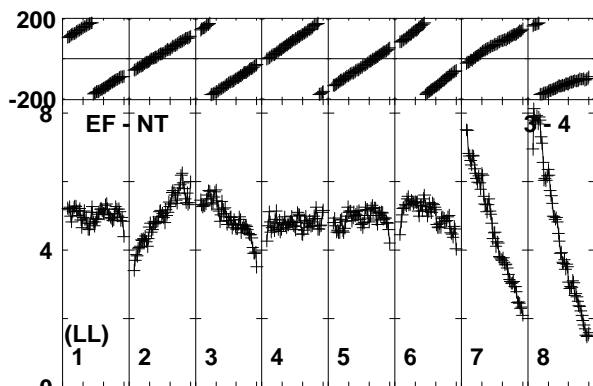
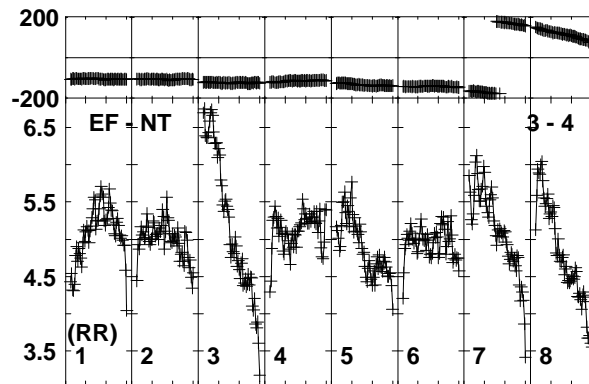
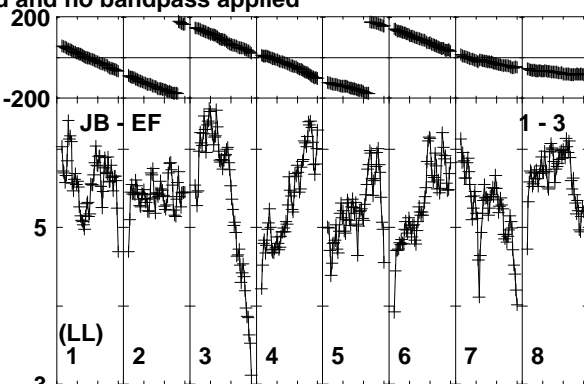
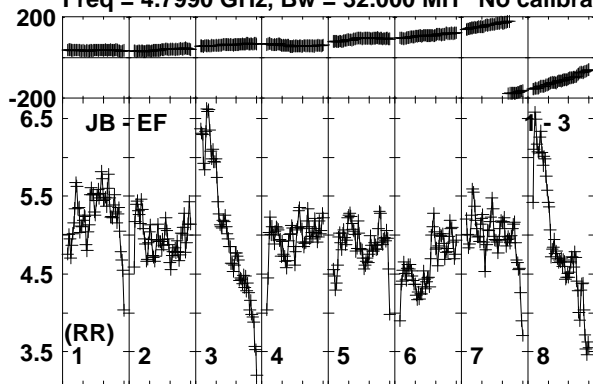

Lower frame: Milli Ampl Jy Top frame: Phas deg
Vector averaged cross-power spectrum Baseline: JB (01) - EF (03)
Timerange: 00/11:01:45 to 00/11:03:13

Plot file version 116 created 19-FEB-2019 18:13:12

J2353+5518 RP028B.UVDATA.1

Freq = 4.7990 GHz, Bw = 32.000 MH No calibration applied and no bandpass applied

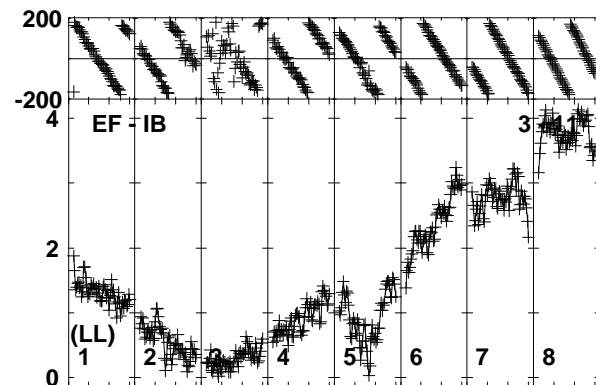
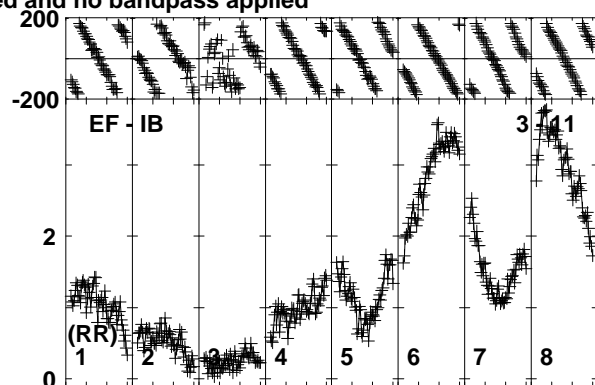
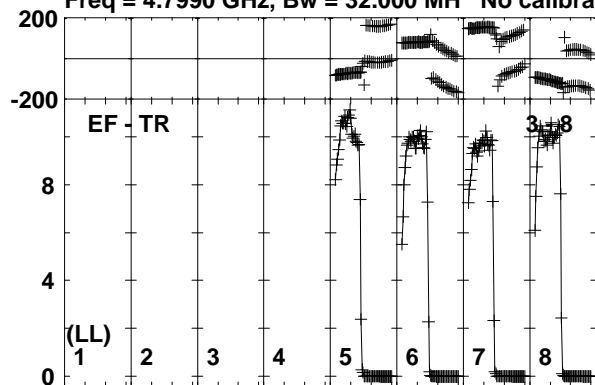

Lower frame: Milli Ampl Jy Top frame: Phas deg
Vector averaged cross-power spectrum Baseline: EF (03) - TR (08)
Timerange: 00/11:01:45 to 00/11:03:13

Plot file version 117 created 19-FEB-2019 18:13:12

IRAS23436 RP028B.UVDATA.1

Freq = 4.7990 GHz, Bw = 32.000 MH No calibration applied and no bandpass applied

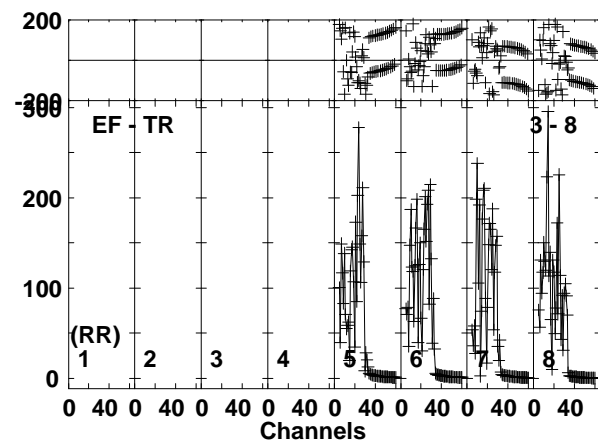
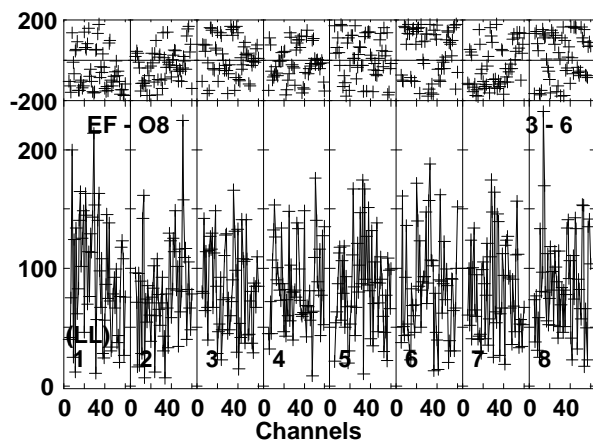
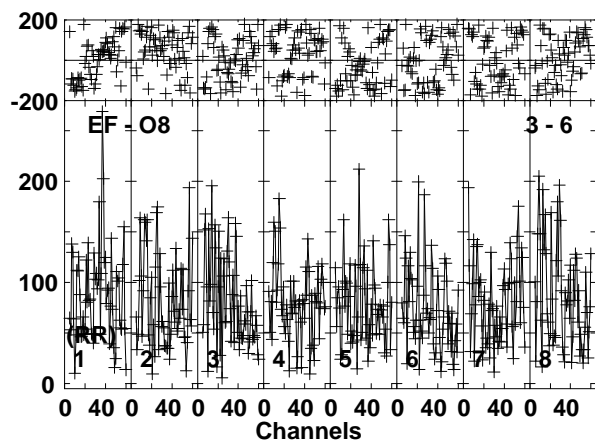
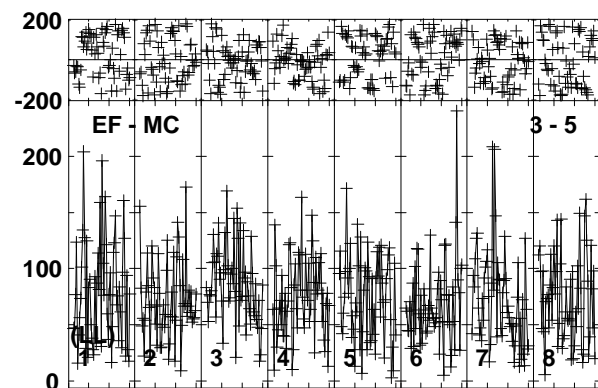
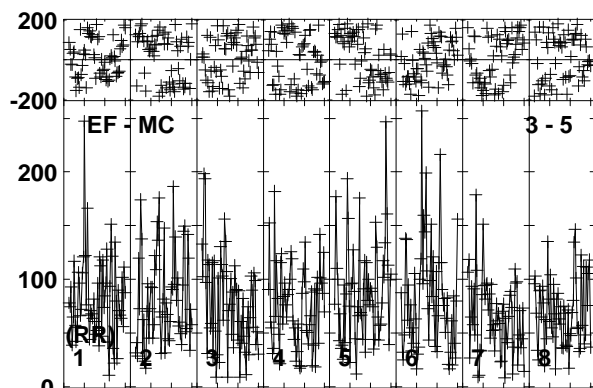
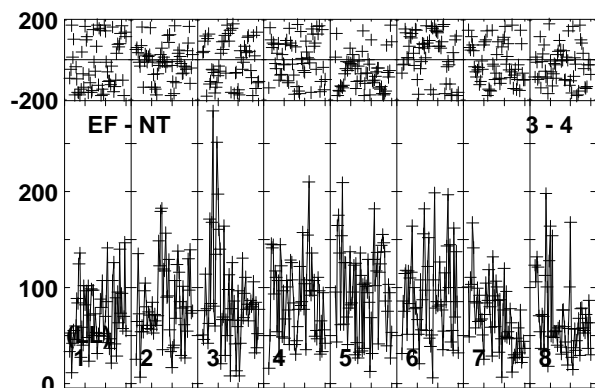
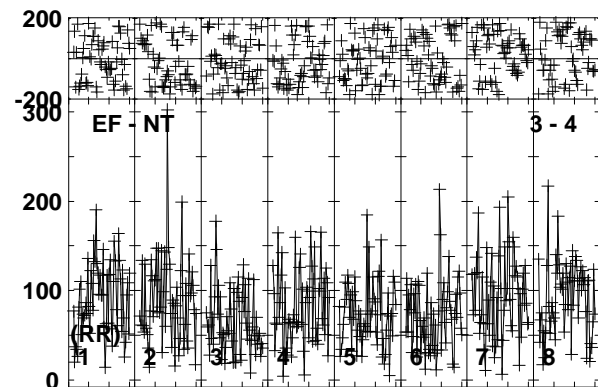
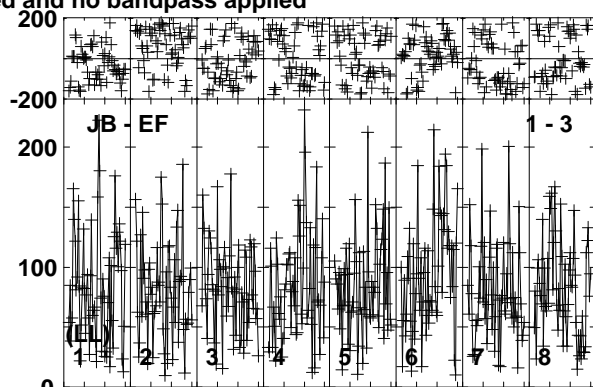
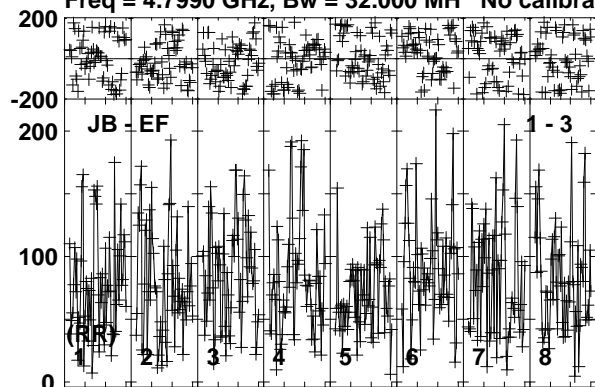

Lower frame: Micro Ampl Jy Top frame: Phas deg
Vector averaged cross-power spectrum Baseline: JB (01) - EF (03)
Timerange: 00/11:03:15 to 00/11:06:58

Plot file version 118 created 19-FEB-2019 18:13:12

IRAS23436 RP028B.UVDATA.1

Freq = 4.7990 GHz, Bw = 32.000 MH No calibration applied and no bandpass applied

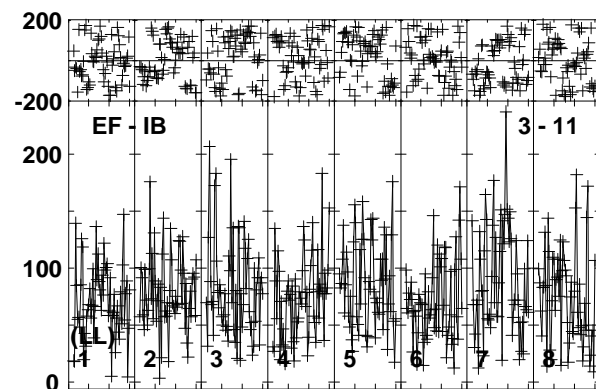
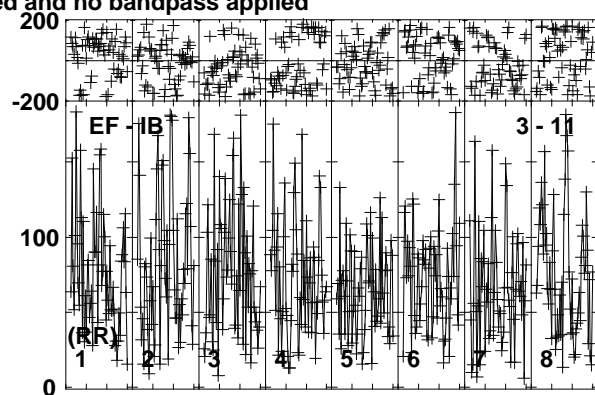
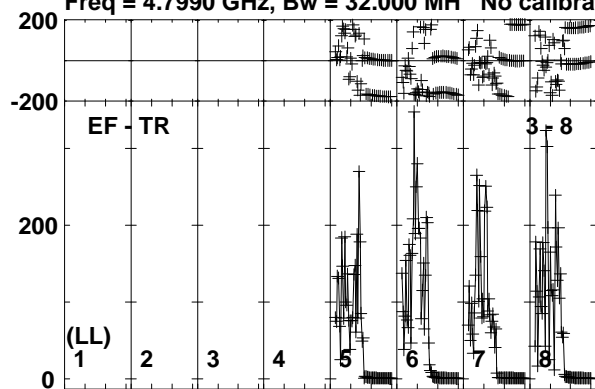

Lower frame: Micro Ampl Jy Top frame: Phas deg
Vector averaged cross-power spectrum Baseline: EF (03) - TR (08)
Timerange: 00/11:03:15 to 00/11:06:58

Plot file version 119 created 19-FEB-2019 18:13:12

J2353+5518 RP028B.UVDATA.1

Freq = 4.7990 GHz, Bw = 32.000 MH No calibration applied and no bandpass applied

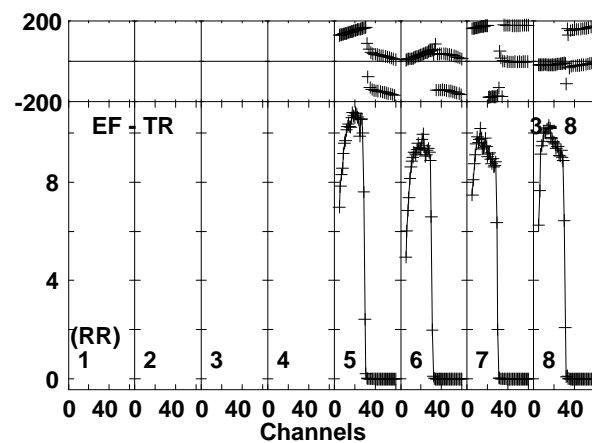
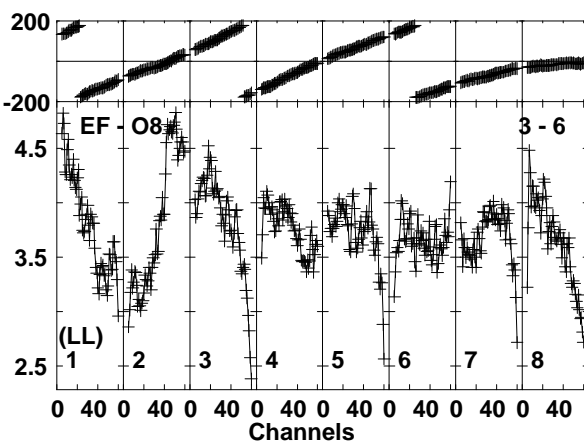
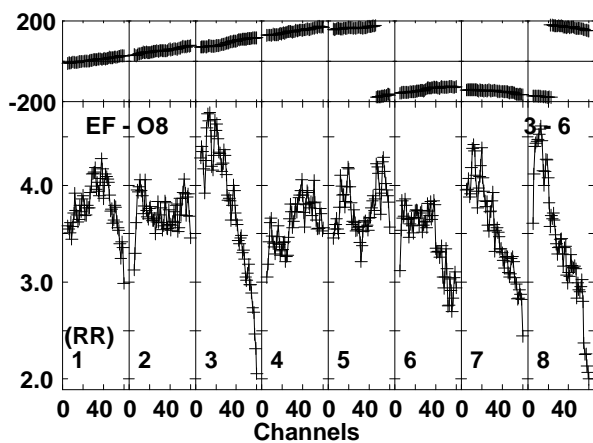
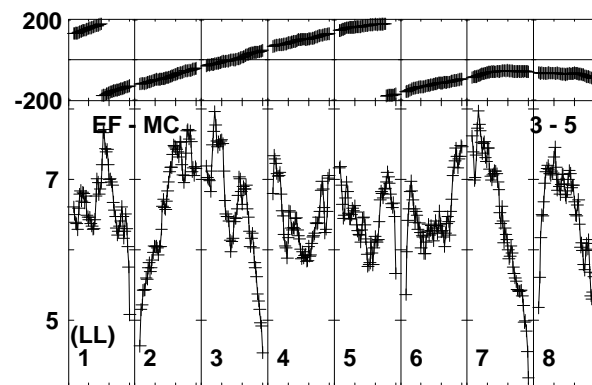
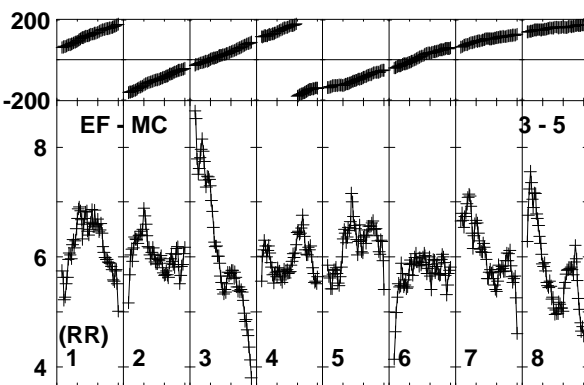
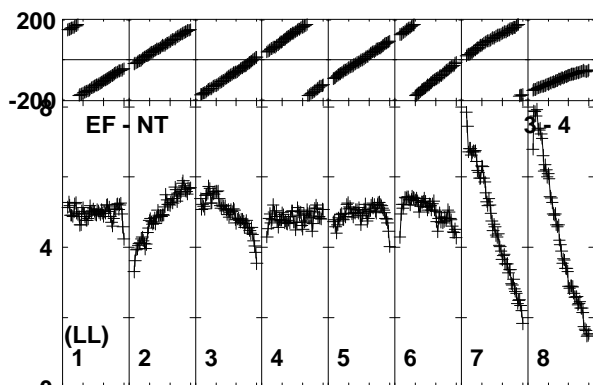
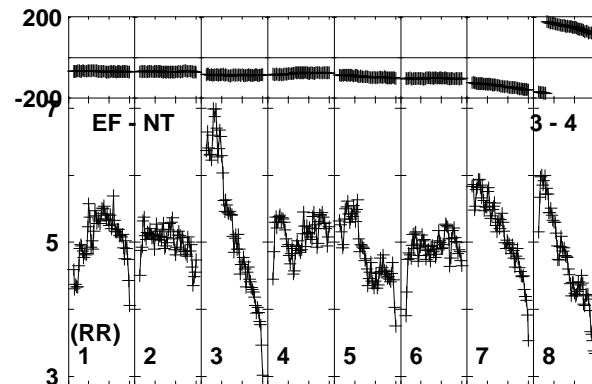
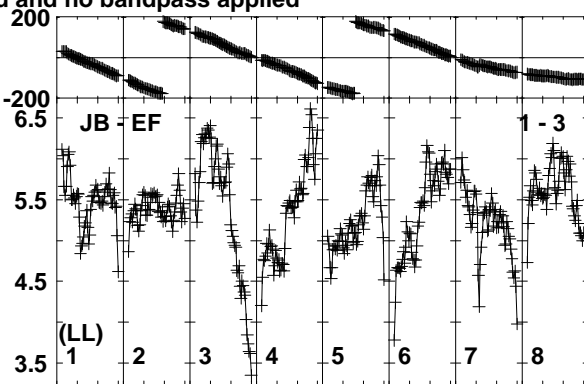
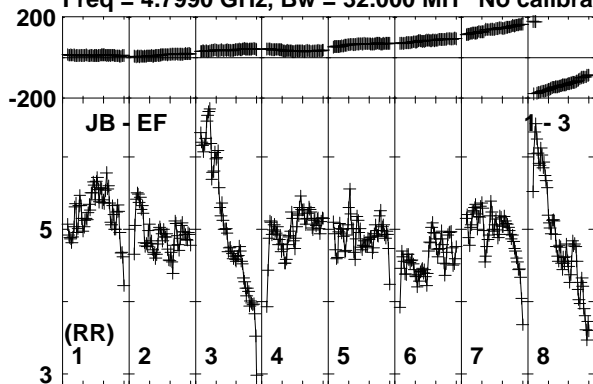

Lower frame: Milli Ampl Jy Top frame: Phas deg
Vector averaged cross-power spectrum Baseline: JB (01) - EF (03)
Timerange: 00/11:07:39 to 00/11:08:38

Plot file version 120 created 19-FEB-2019 18:13:12

J2353+5518 RP028B.UVDATA.1

Freq = 4.7990 GHz, Bw = 32.000 MH No calibration applied and no bandpass applied

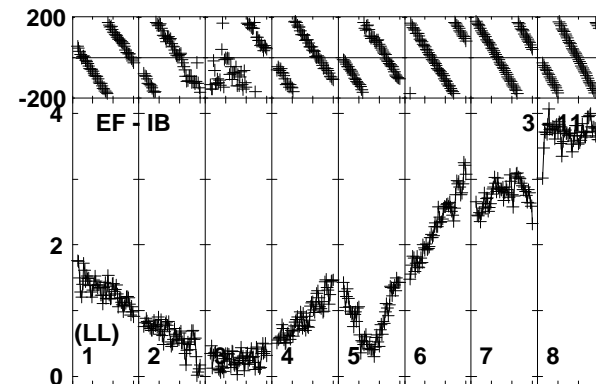
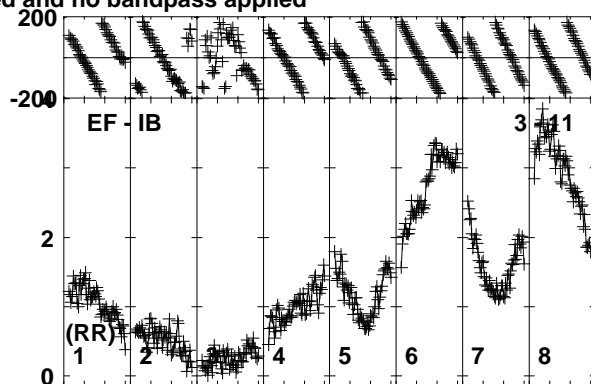
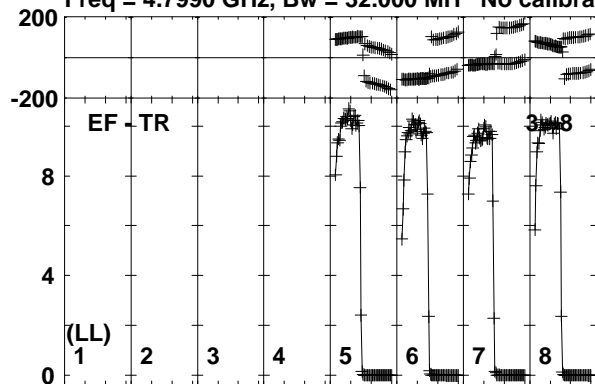

Lower frame: Milli Ampl Jy Top frame: Phas deg
Vector averaged cross-power spectrum Baseline: EF (03) - TR (08)
Timerange: 00/11:07:39 to 00/11:08:38

Plot file version 121 created 19-FEB-2019 18:13:12

IRAS23436 RP028B.UVDATA.1

Freq = 4.7990 GHz, Bw = 32.000 MH No calibration applied and no bandpass applied

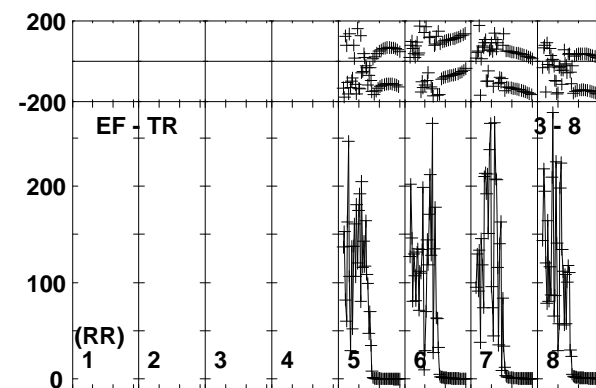
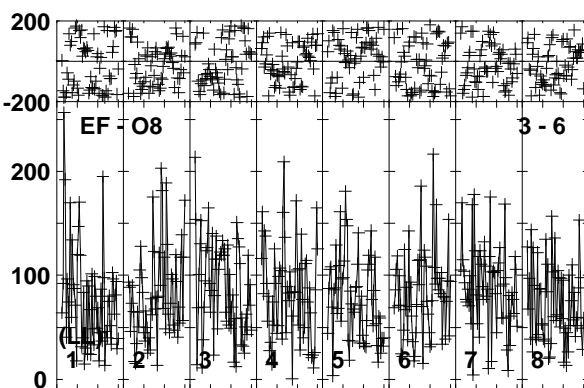
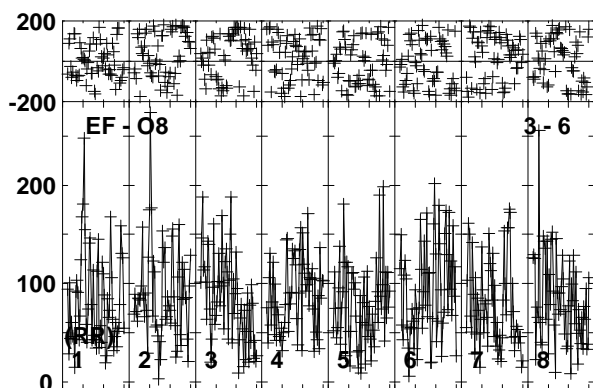
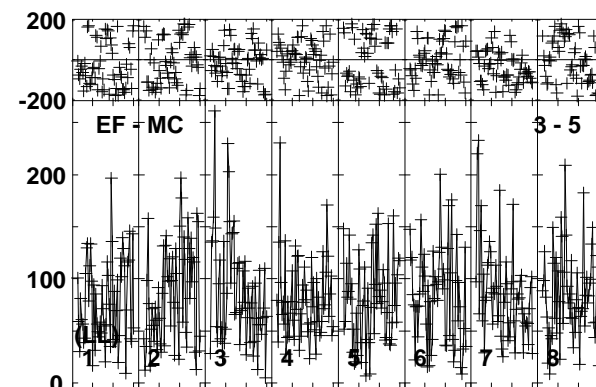
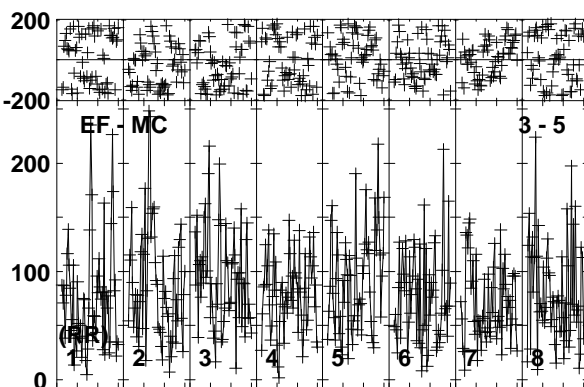
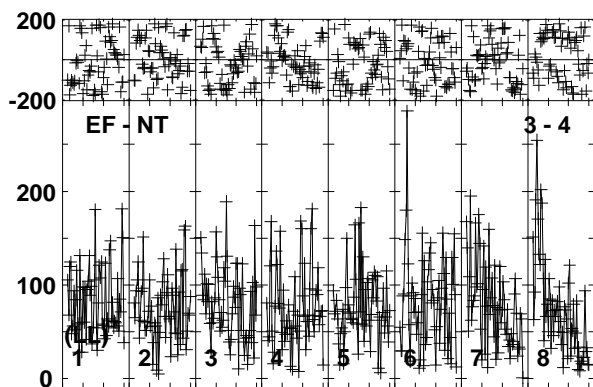
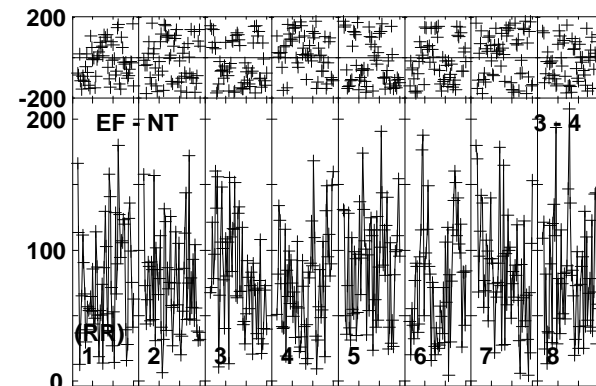
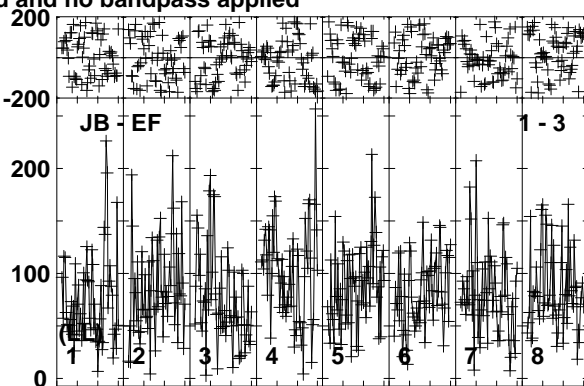
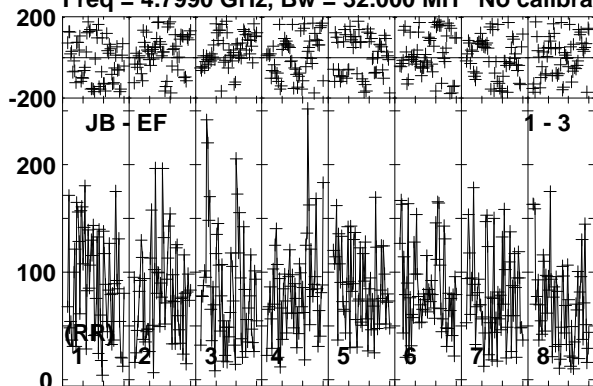

Lower frame: Micro Ampl Jy Top frame: Phas deg
Vector averaged cross-power spectrum Baseline: JB (01) - EF (03)
Timerange: 00/11:08:38 to 00/11:12:18

Plot file version 122 created 19-FEB-2019 18:13:13

IRAS23436 RP028B.UVDATA.1

Freq = 4.7990 GHz, Bw = 32.000 MH No calibration applied and no bandpass applied

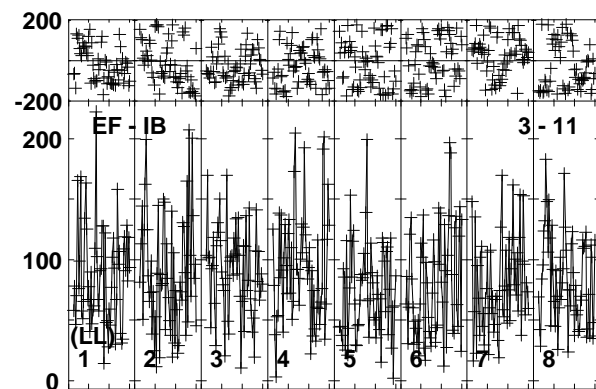
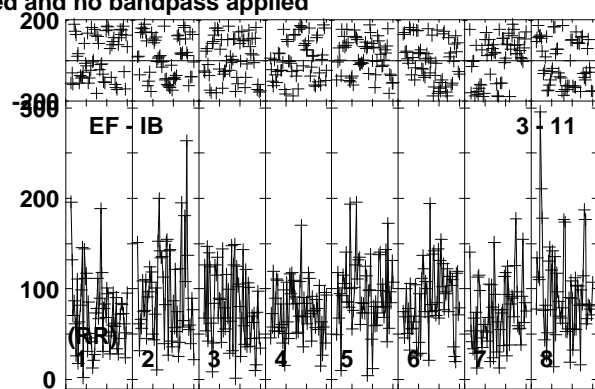
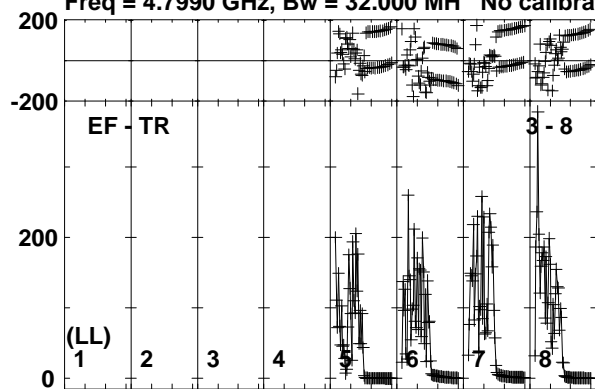

Lower frame: Micro Ampl Jy Top frame: Phas deg
Vector averaged cross-power spectrum Baseline: EF (03) - TR (08)
Timerange: 00/11:08:38 to 00/11:12:18

Plot file version 123 created 19-FEB-2019 18:13:13

J2353+5518 RP028B.UVDATA.1

Freq = 4.7990 GHz, Bw = 32.000 MH No calibration applied and no bandpass applied

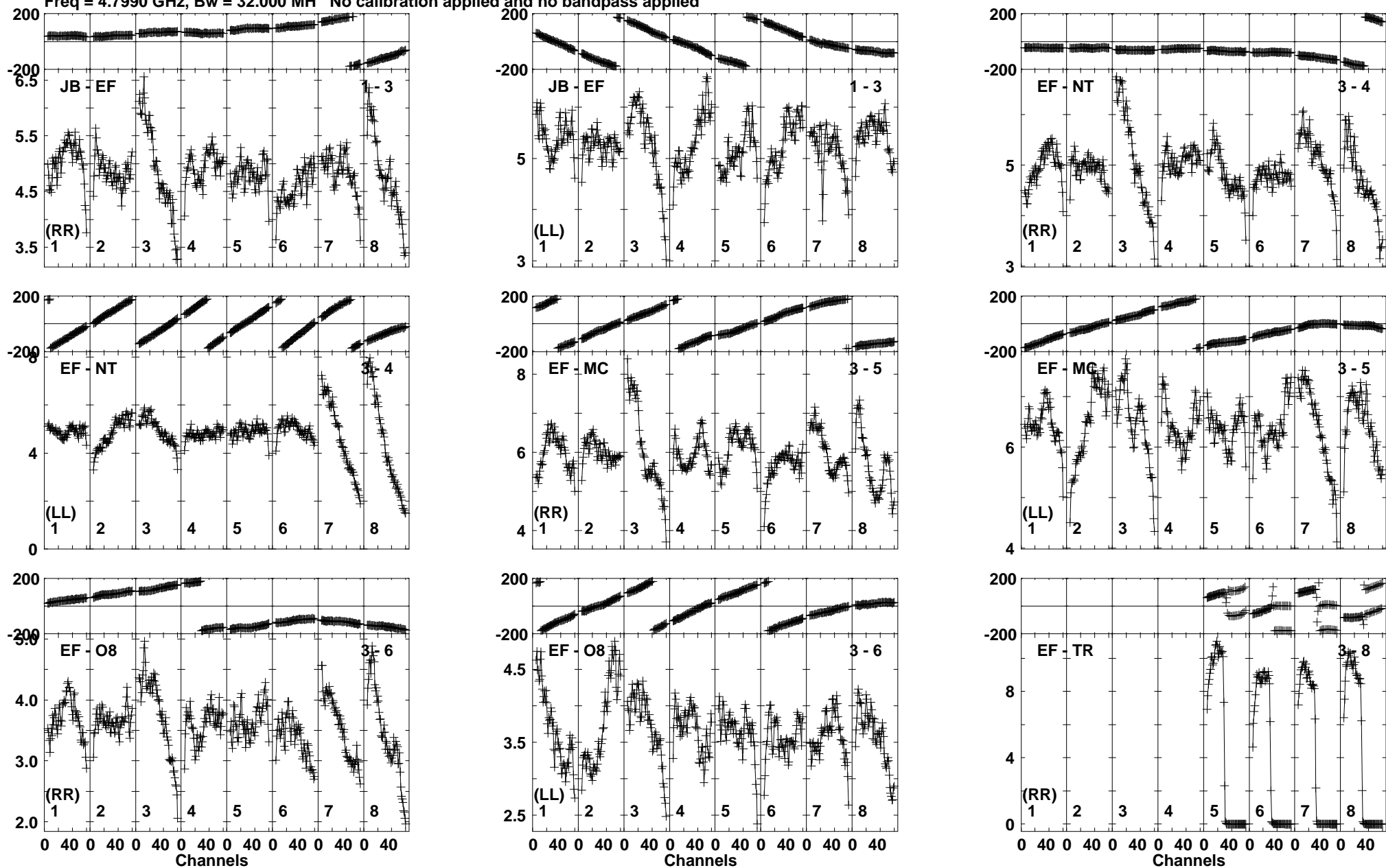

Lower frame: Milli Ampl Jy Top frame: Phas deg
Vector averaged cross-power spectrum Baseline: JB (01) - EF (03)
Timerange: 00/11:12:19 to 00/11:13:48

Plot file version 124 created 19-FEB-2019 18:13:13

J2353+5518 RP028B.UVDATA.1

Freq = 4.7990 GHz, Bw = 32.000 MH No calibration applied and no bandpass applied

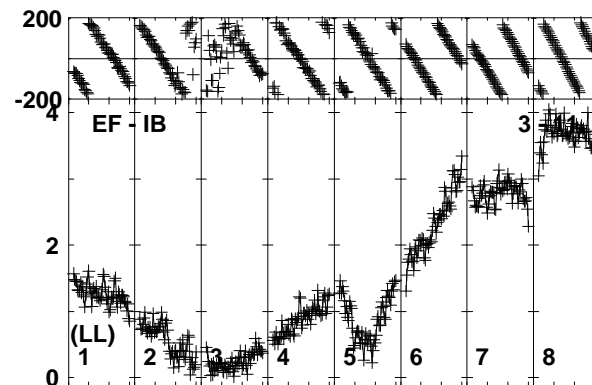
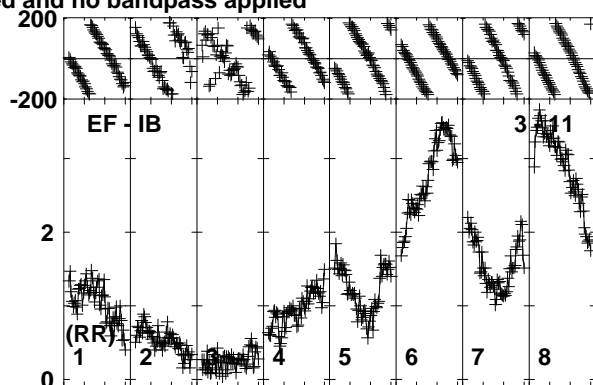
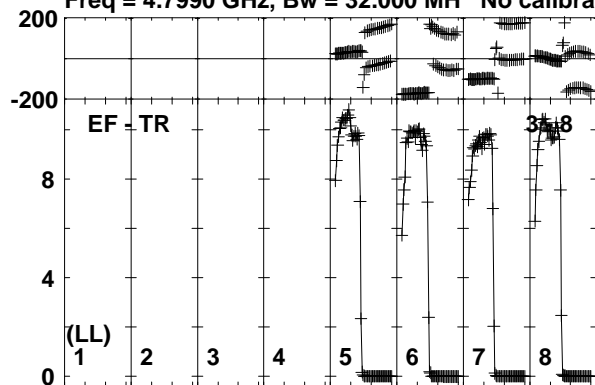

Lower frame: Milli Ampl Jy Top frame: Phas deg
Vector averaged cross-power spectrum Baseline: EF (03) - TR (08)
Timerange: 00/11:12:19 to 00/11:13:48

Plot file version 125 created 19-FEB-2019 18:13:13

IRAS23436 RP028B.UVDATA.1

Freq = 4.7990 GHz, Bw = 32.000 MH No calibration applied and no bandpass applied

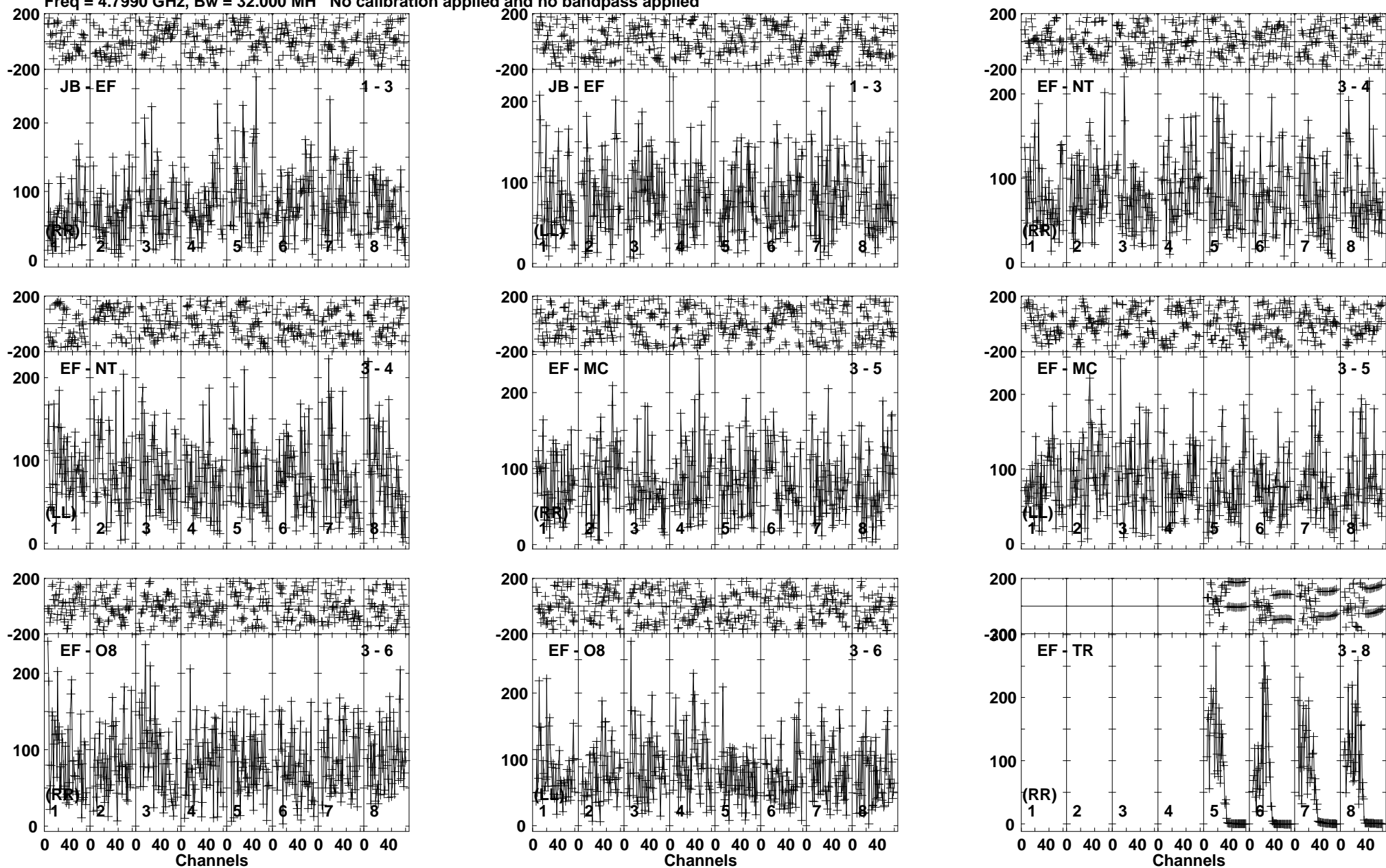

Lower frame: Micro Ampl Jy Top frame: Phas deg
Vector averaged cross-power spectrum Baseline: JB (01) - EF (03)
Timerange: 00/11:13:48 to 00/11:17:31

Plot file version 126 created 19-FEB-2019 18:13:13

IRAS23436 RP028B.UVDATA.1

Freq = 4.7990 GHz, Bw = 32.000 MH No calibration applied and no bandpass applied

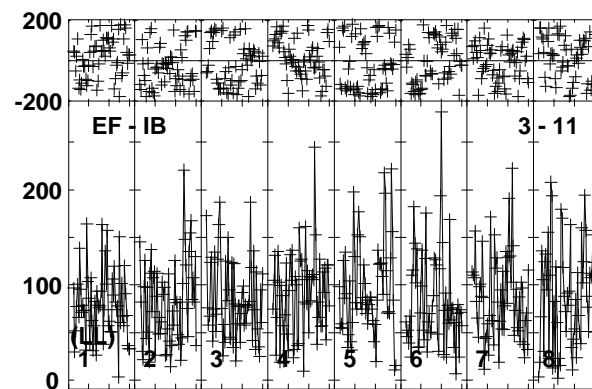
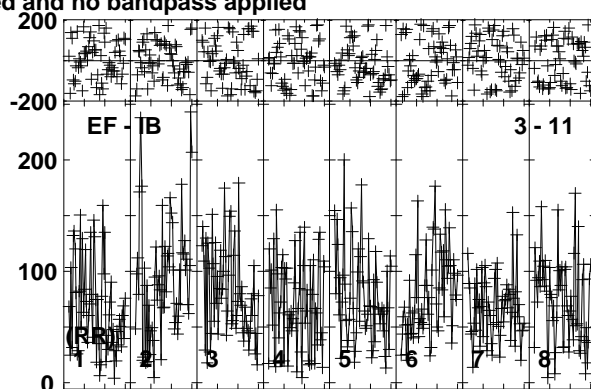
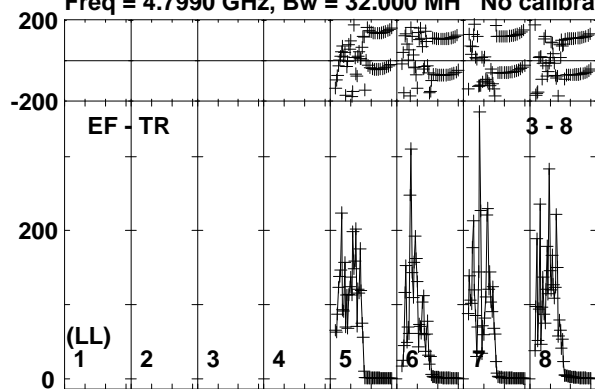

Lower frame: Micro Ampl Jy Top frame: Phas deg
Vector averaged cross-power spectrum Baseline: EF (03) - TR (08)
Timerange: 00/11:13:48 to 00/11:17:31

Plot file version 127 created 19-FEB-2019 18:13:14

J2353+5518 RP028B.UVDATA.1

Freq = 4.7990 GHz, Bw = 32.000 MH No calibration applied and no bandpass applied

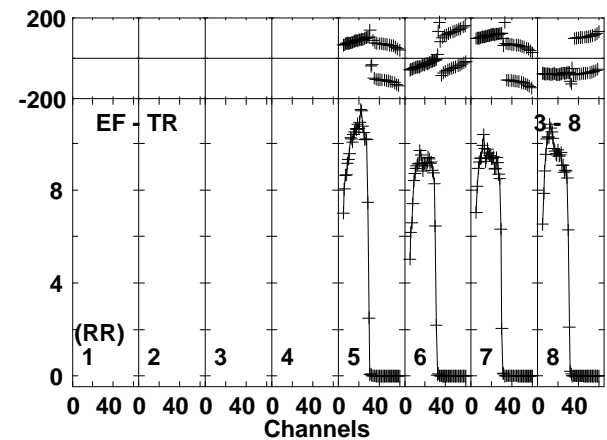
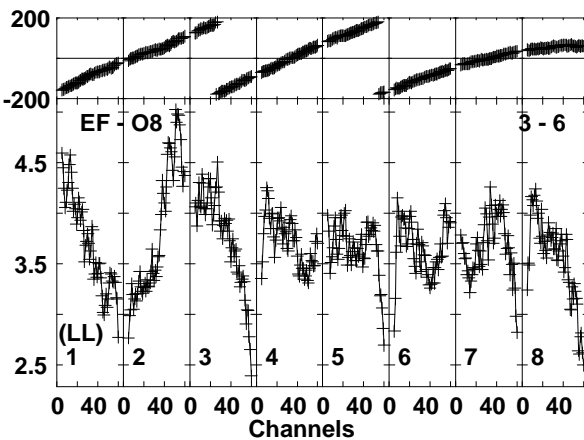
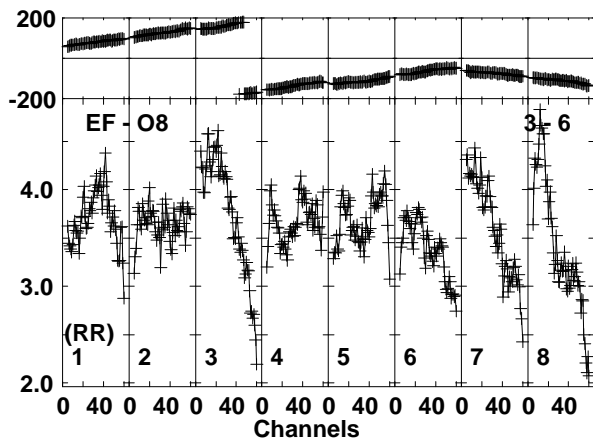
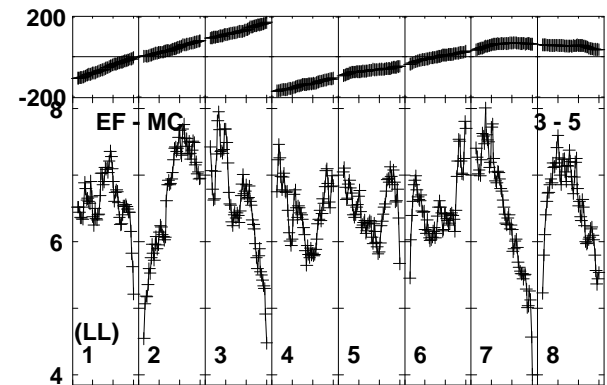
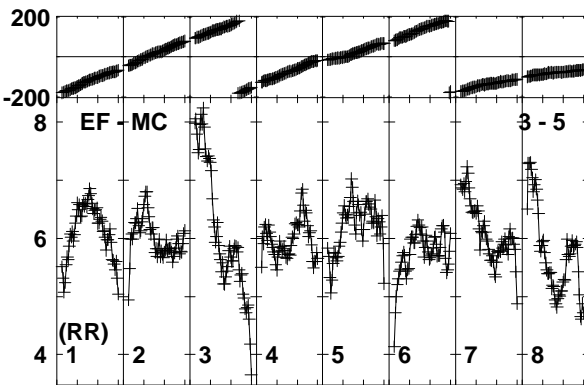
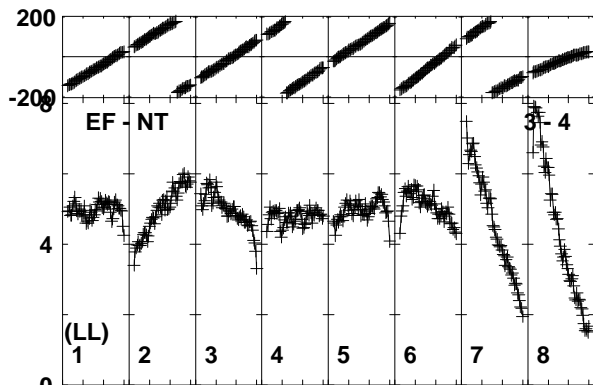
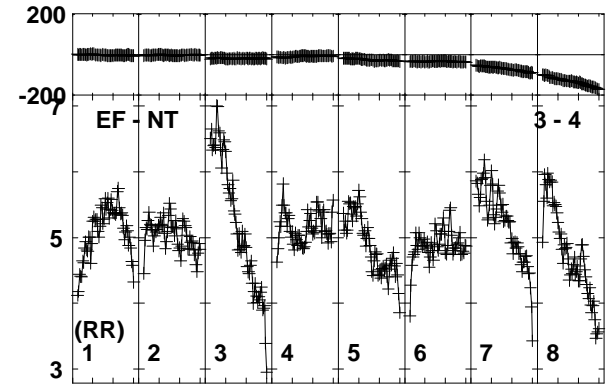
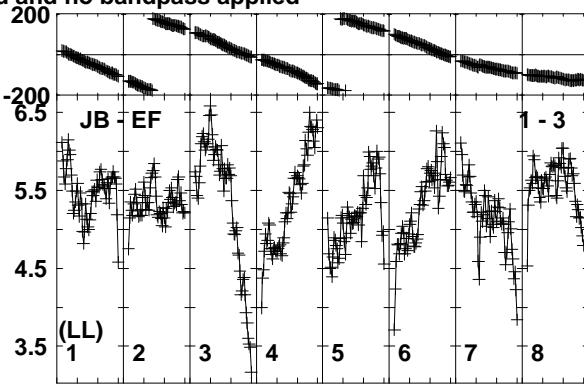
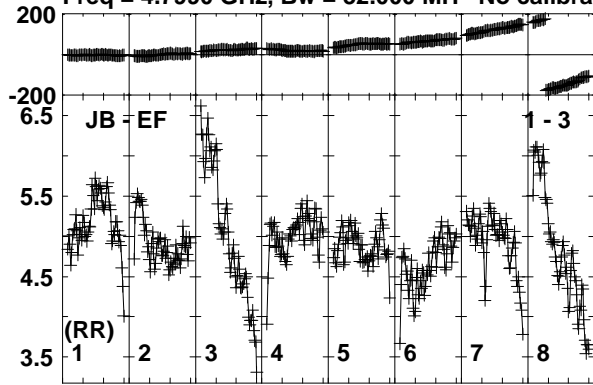

Lower frame: Milli Ampl Jy Top frame: Phas deg
Vector averaged cross-power spectrum Baseline: JB (01) - EF (03)
Timerange: 00/11:18:13 to 00/11:19:01

Plot file version 128 created 19-FEB-2019 18:13:14

J2353+5518 RP028B.UVDATA.1

Freq = 4.7990 GHz, Bw = 32.000 MH No calibration applied and no bandpass applied

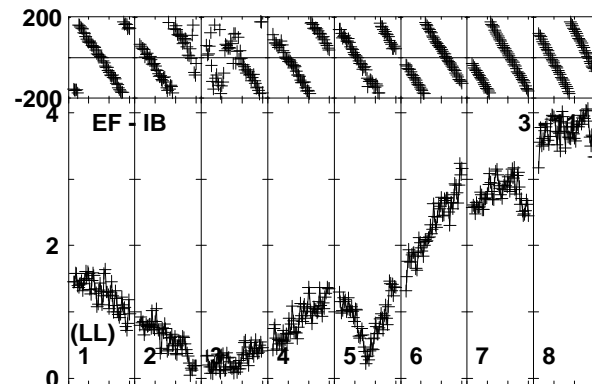
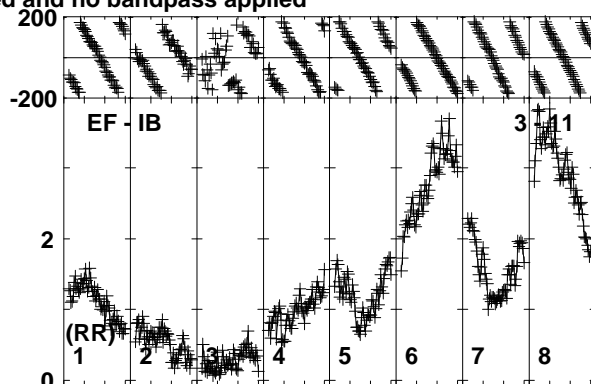
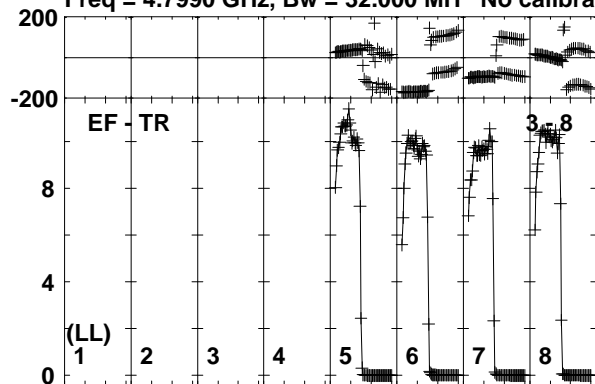

Lower frame: Milli Ampl Jy Top frame: Phas deg
Vector averaged cross-power spectrum Baseline: EF (03) - TR (08)
Timerange: 00/11:18:13 to 00/11:19:01

Plot file version 129 created 19-FEB-2019 18:13:14

IRAS23436 RP028B.UVDATA.1

Freq = 4.7990 GHz, Bw = 32.000 MH No calibration applied and no bandpass applied

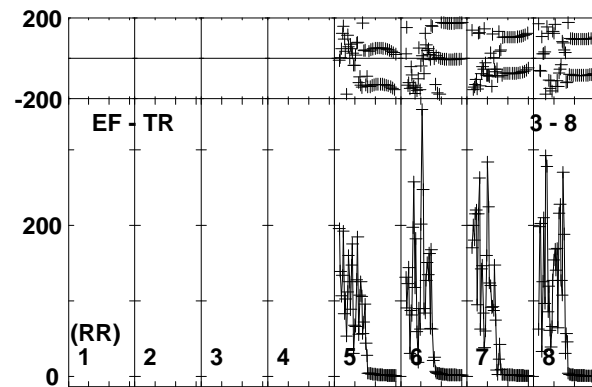
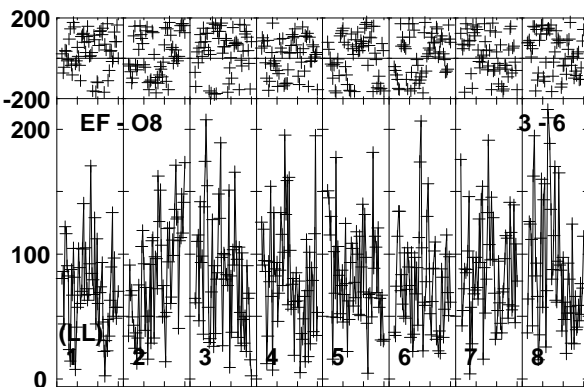
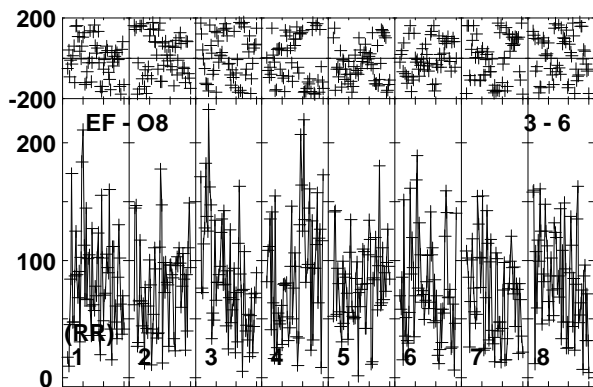
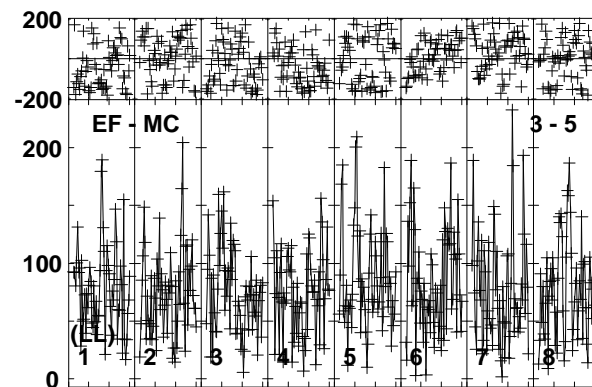
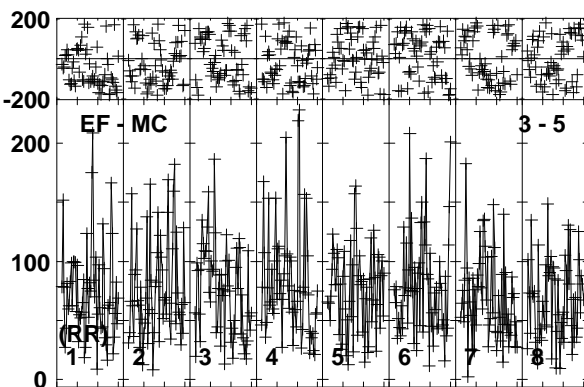
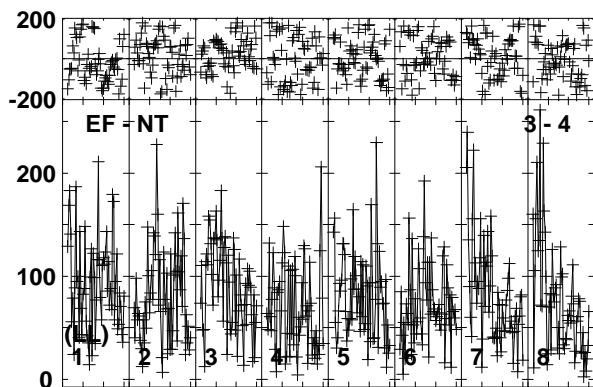
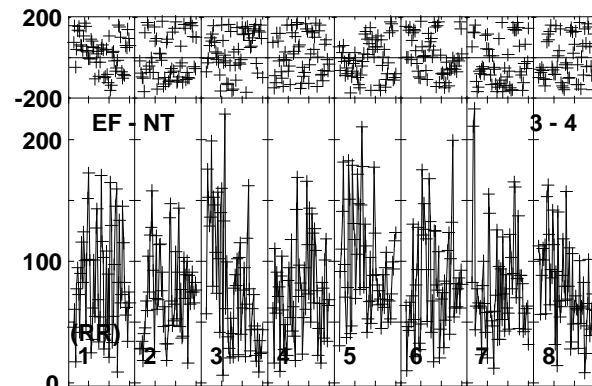
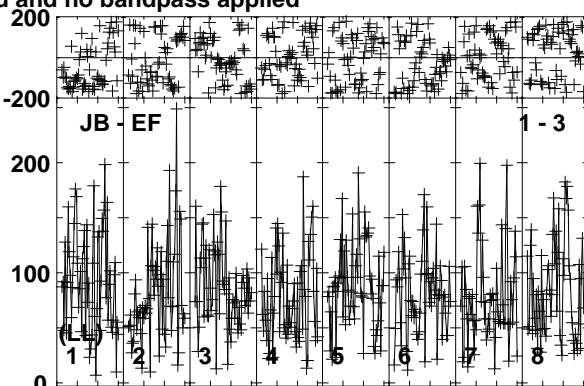
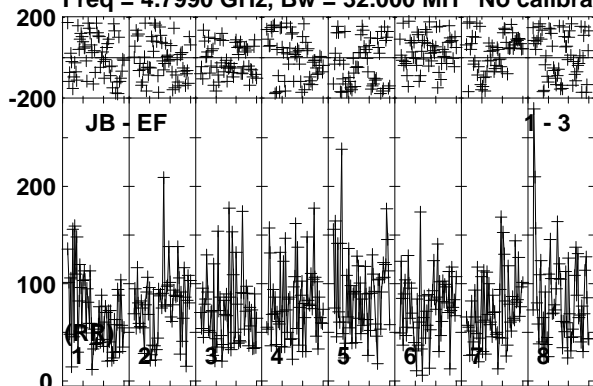

Lower frame: Micro Ampl Jy Top frame: Phas deg
Vector averaged cross-power spectrum Baseline: JB (01) - EF (03)
Timerange: 00/11:19:03 to 00/11:22:45

Plot file version 130 created 19-FEB-2019 18:13:14

IRAS23436 RP028B.UVDATA.1

Freq = 4.7990 GHz, Bw = 32.000 MH No calibration applied and no bandpass applied

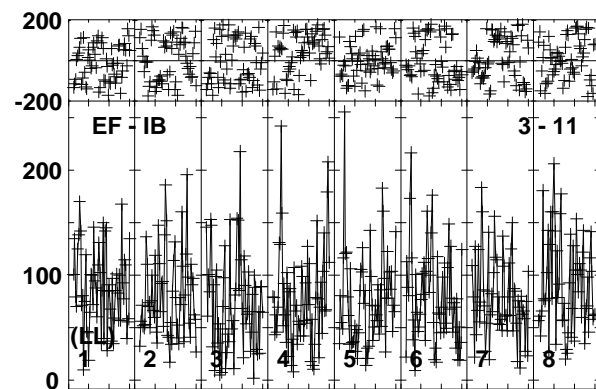
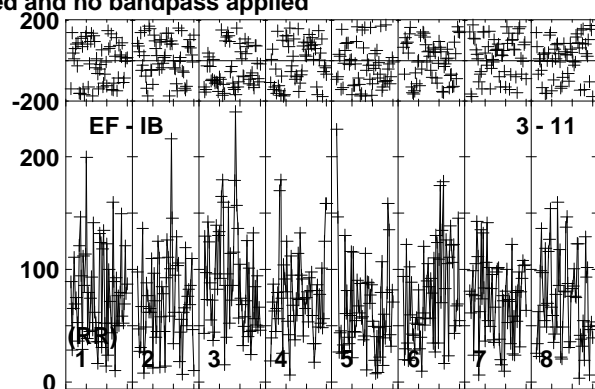
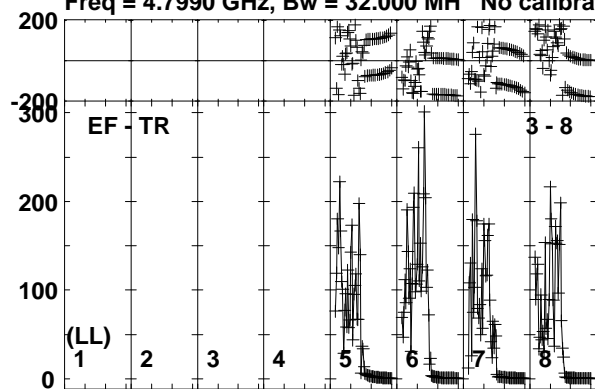

Lower frame: Micro Ampl Jy Top frame: Phas deg
Vector averaged cross-power spectrum Baseline: EF (03) - TR (08)
Timerange: 00/11:19:03 to 00/11:22:45

Plot file version 131 created 19-FEB-2019 18:13:14

J2353+5518 RP028B.UVDATA.1

Freq = 4.7990 GHz, Bw = 32.000 MH No calibration applied and no bandpass applied

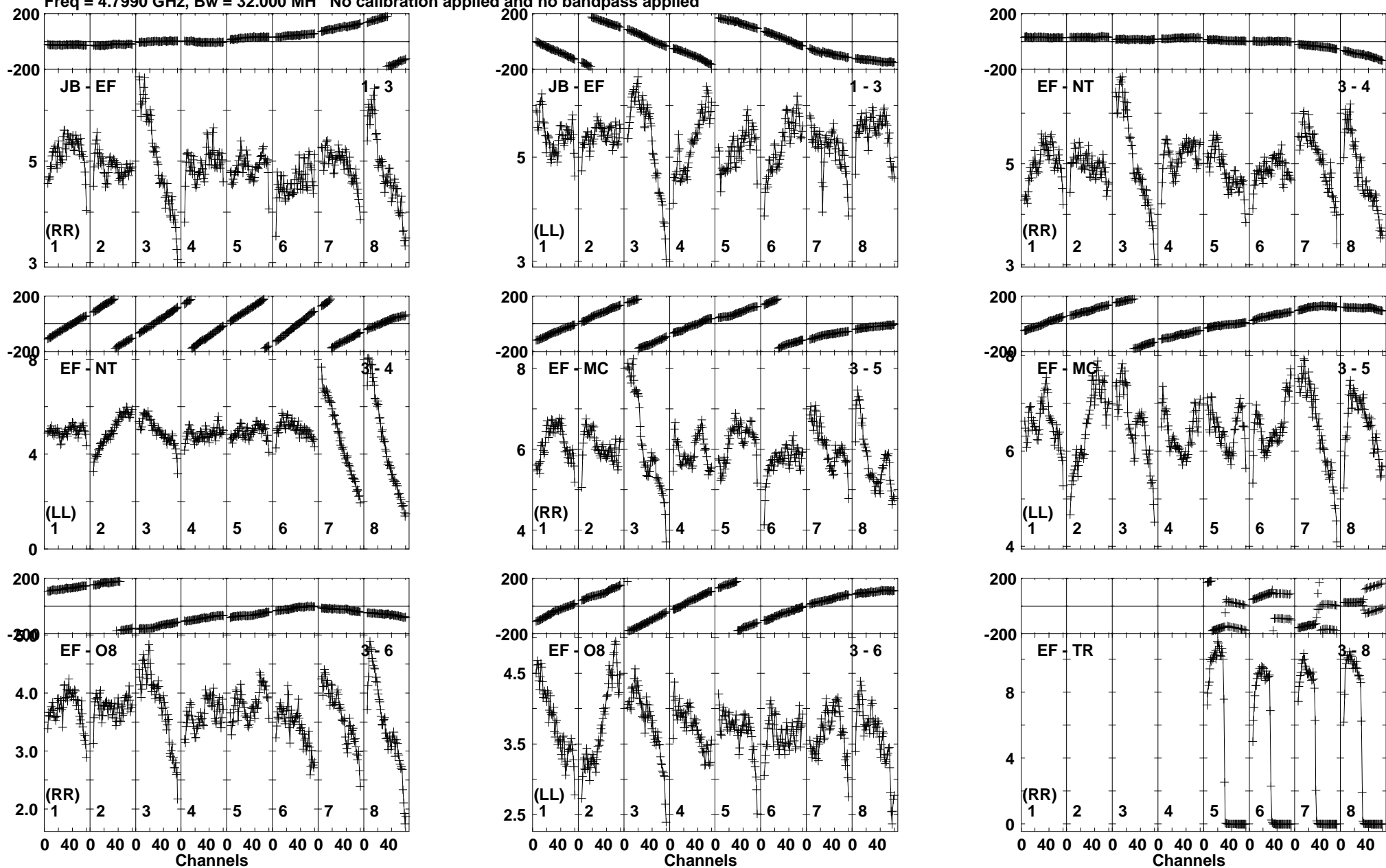

Lower frame: Milli Ampl Jy Top frame: Phas deg
Vector averaged cross-power spectrum Baseline: JB (01) - EF (03)
Timerange: 00/11:22:47 to 00/11:24:15

Plot file version 132 created 19-FEB-2019 18:13:14

J2353+5518 RP028B.UVDATA.1

Freq = 4.7990 GHz, Bw = 32.000 MH No calibration applied and no bandpass applied

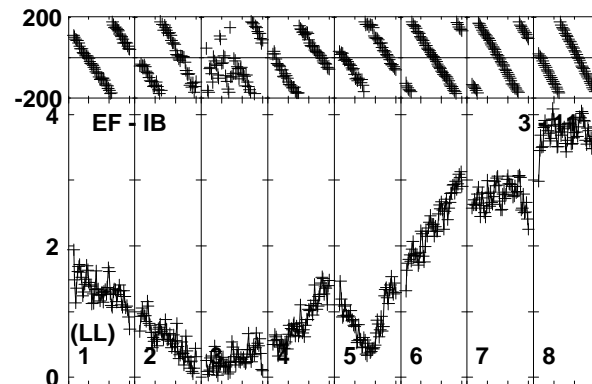
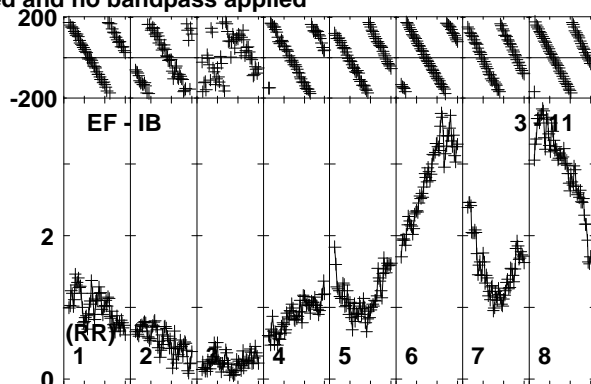
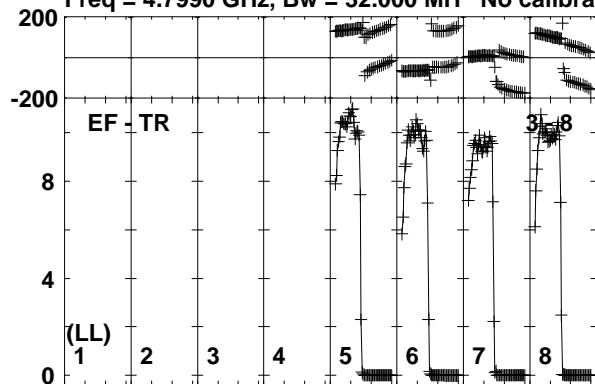

Lower frame: Milli Ampl Jy Top frame: Phas deg
Vector averaged cross-power spectrum Baseline: EF (03) - TR (08)
Timerange: 00/11:22:47 to 00/11:24:15

Plot file version 133 created 19-FEB-2019 18:13:15

IRAS23436 RP028B.UVDATA.1

Freq = 4.7990 GHz, Bw = 32.000 MH No calibration applied and no bandpass applied

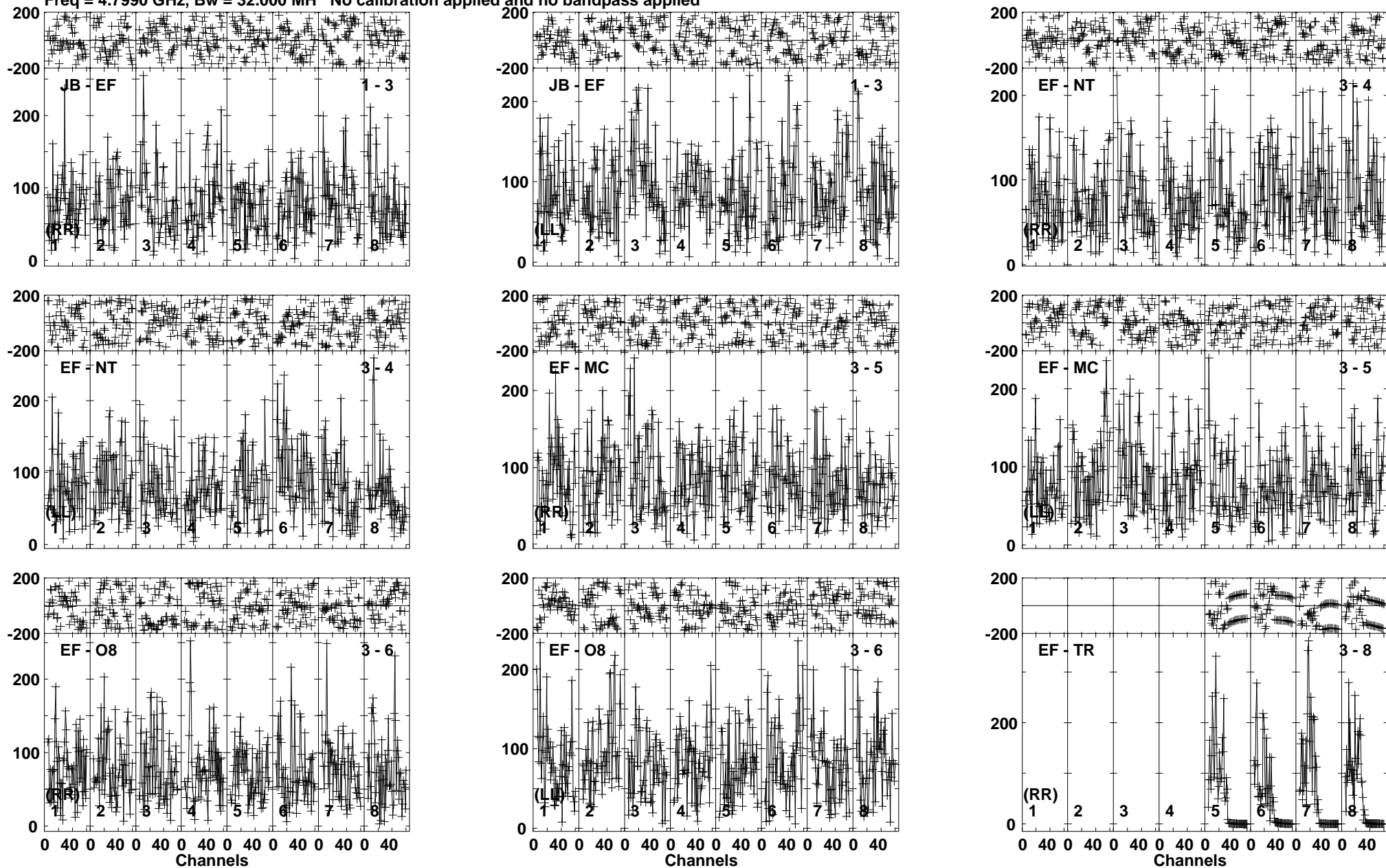

Lower frame: Micro Ampl Jy Top frame: Phas deg
Vector averaged cross-power spectrum Baseline: JB (01) - EF (03)
Timerange: 00/11:24:17 to 00/11:28:00

Plot file version 134 created 19-FEB-2019 18:13:15

IRAS23436 RP028B.UVDATA.1

Freq = 4.7990 GHz, Bw = 32.000 MH No calibration applied and no bandpass applied

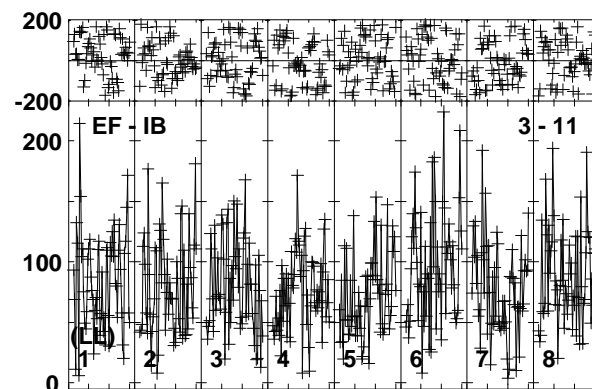
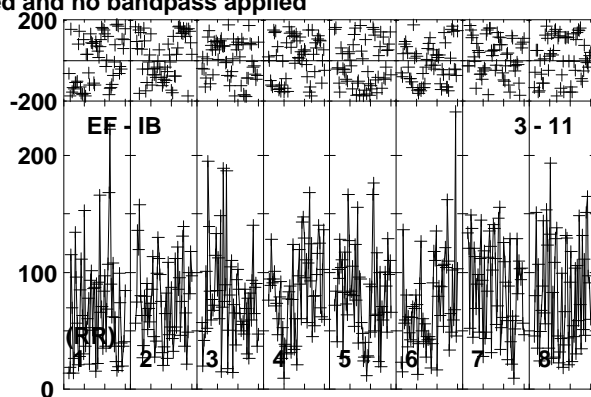
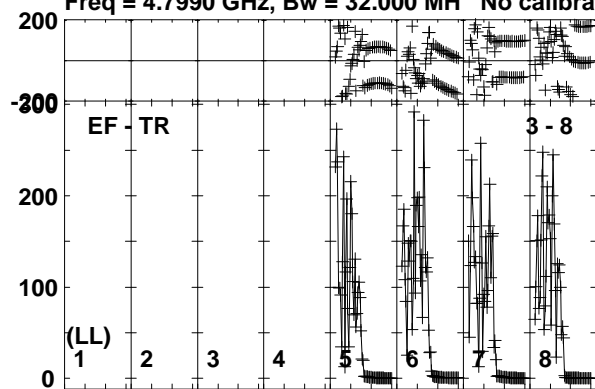

Lower frame: Micro Ampl Jy Top frame: Phas deg
Vector averaged cross-power spectrum Baseline: EF (03) - TR (08)
Timerange: 00/11:24:17 to 00/11:28:00

Plot file version 135 created 19-FEB-2019 18:13:15

J2353+5518 RP028B.UVDATA.1

Freq = 4.7990 GHz, Bw = 32.000 MH No calibration applied and no bandpass applied

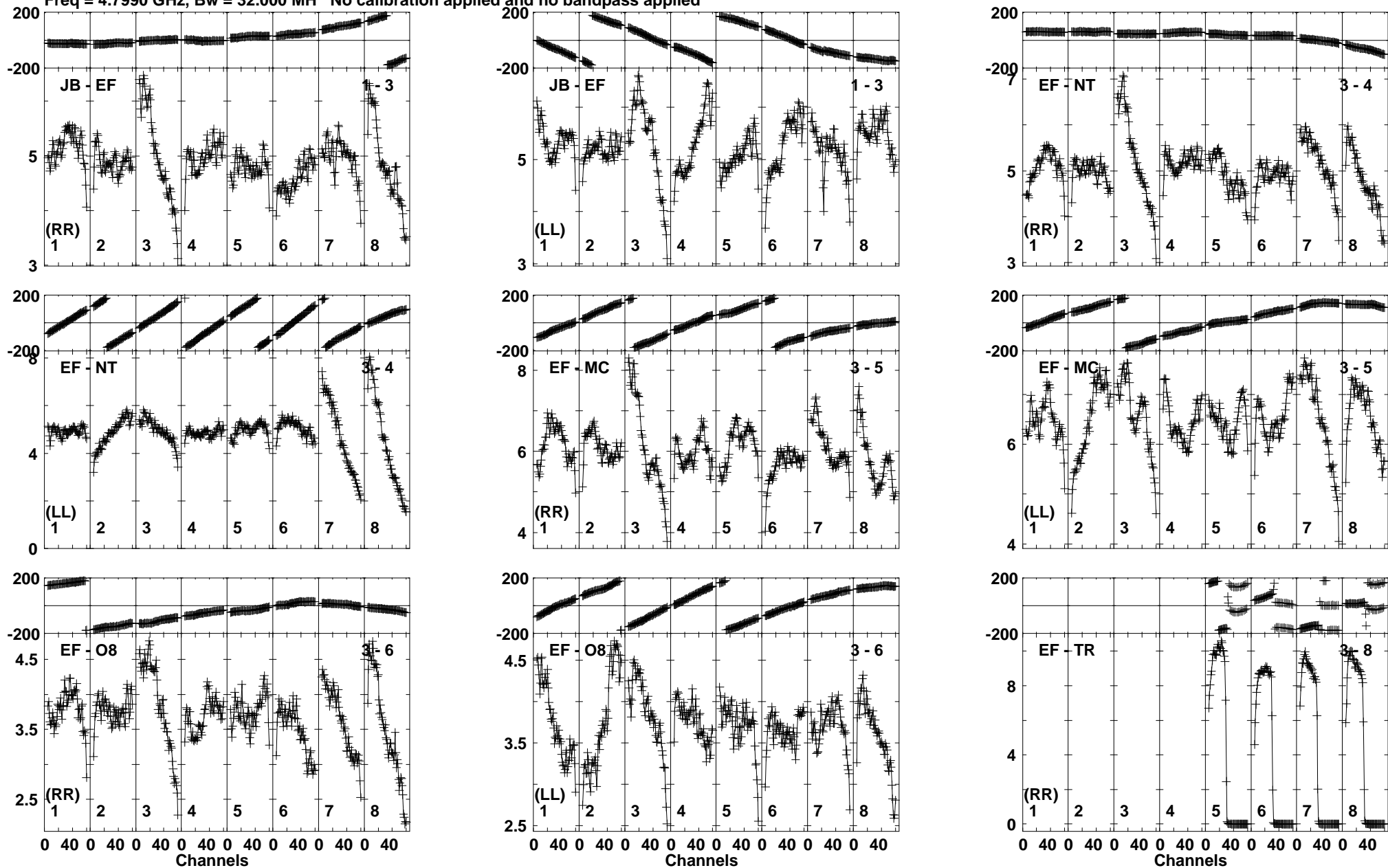

Lower frame: Milli Ampl Jy Top frame: Phas deg
Vector averaged cross-power spectrum Baseline: JB (01) - EF (03)
Timerange: 00/11:28:50 to 00/11:30:09

Plot file version 136 created 19-FEB-2019 18:13:15

J2353+5518 RP028B.UVDATA.1

Freq = 4.7990 GHz, Bw = 32.000 MH No calibration applied and no bandpass applied

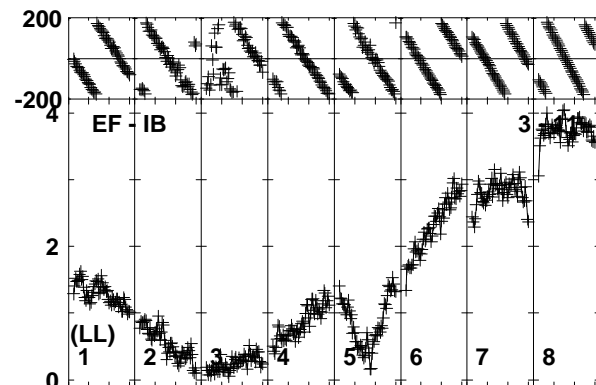
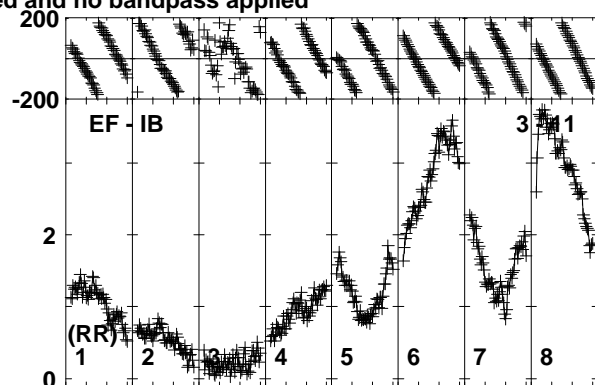
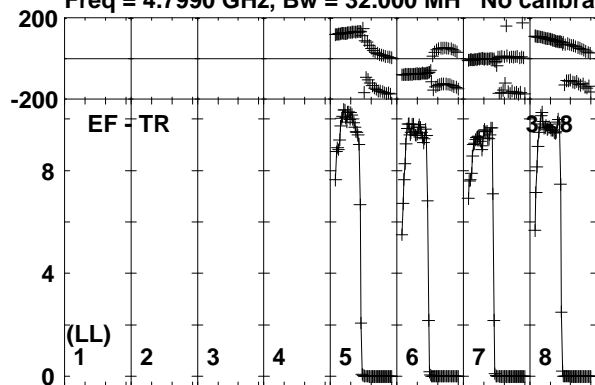

Lower frame: Milli Ampl Jy Top frame: Phas deg
Vector averaged cross-power spectrum Baseline: EF (03) - TR (08)
Timerange: 00/11:28:50 to 00/11:30:09

Plot file version 137 created 19-FEB-2019 18:13:15

IRAS23436 RP028B.UVDATA.1

Freq = 4.7990 GHz, Bw = 32.000 MH No calibration applied and no bandpass applied

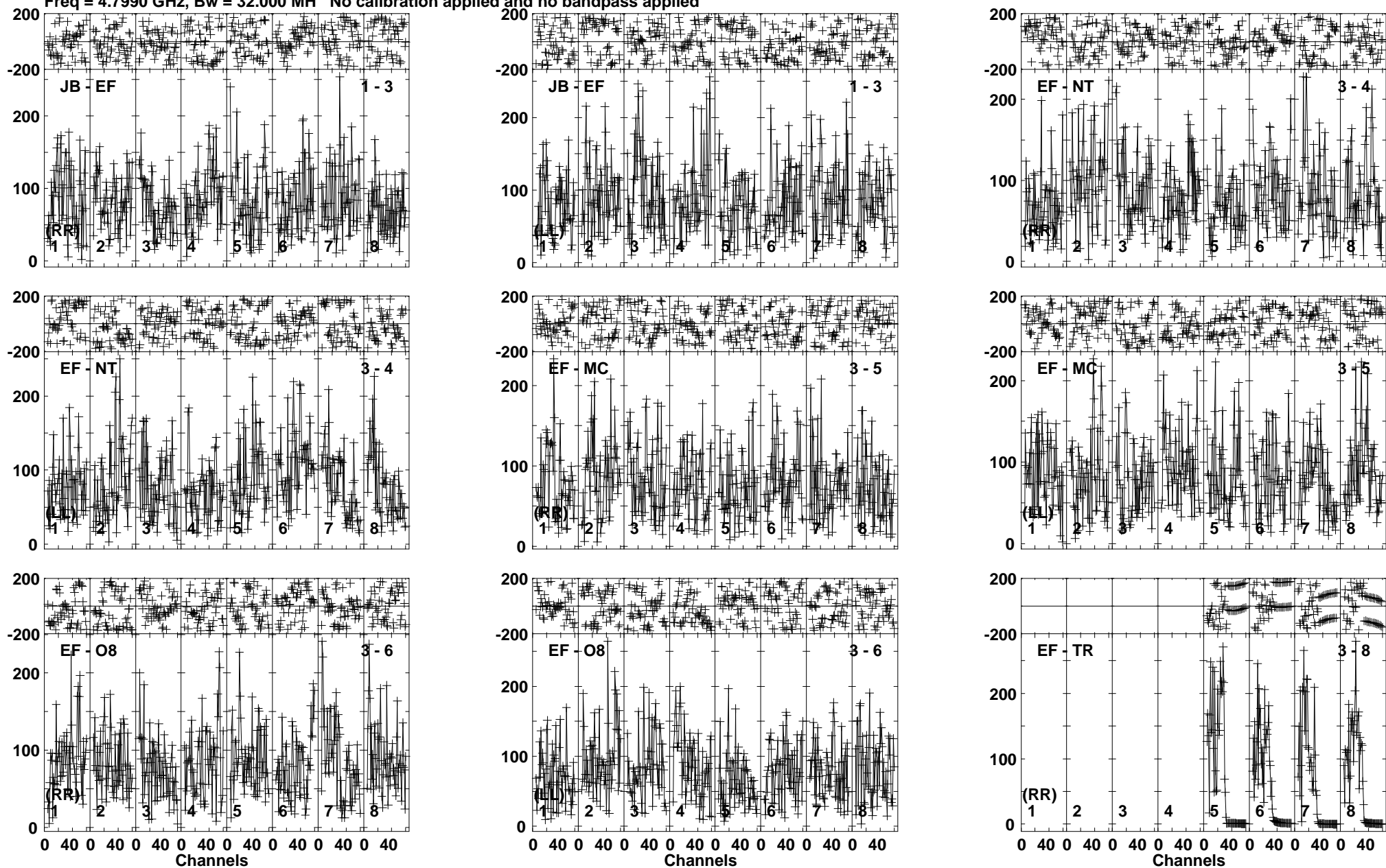

Lower frame: Micro Ampl Jy Top frame: Phas deg
Vector averaged cross-power spectrum Baseline: JB (01) - EF (03)
Timerange: 00/11:30:11 to 00/11:33:54

Plot file version 138 created 19-FEB-2019 18:13:16

IRAS23436 RP028B.UVDATA.1

Freq = 4.7990 GHz, Bw = 32.000 MH No calibration applied and no bandpass applied

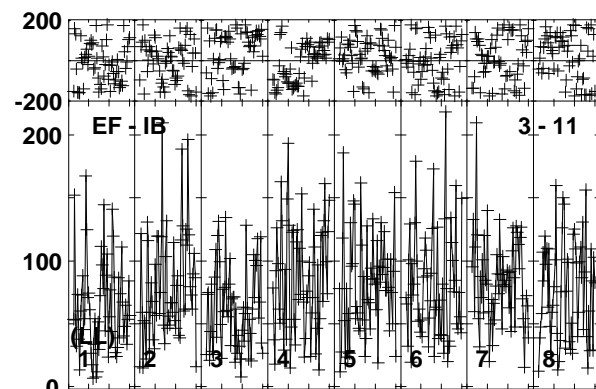
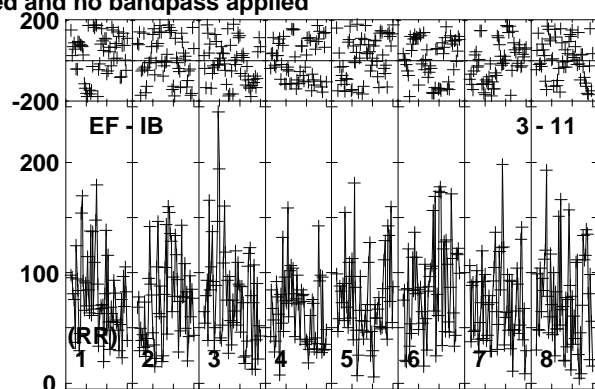
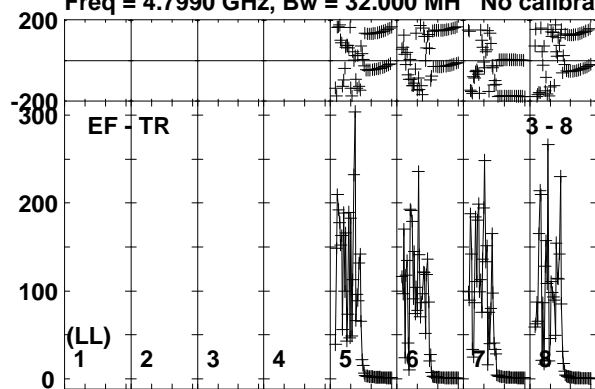

Lower frame: Micro Ampl Jy Top frame: Phas deg
Vector averaged cross-power spectrum Baseline: EF (03) - TR (08)
Timerange: 00/11:30:11 to 00/11:33:54

Plot file version 139 created 19-FEB-2019 18:13:16

J2353+5518 RP028B.UVDATA.1

Freq = 4.7990 GHz, Bw = 32.000 MH No calibration applied and no bandpass applied

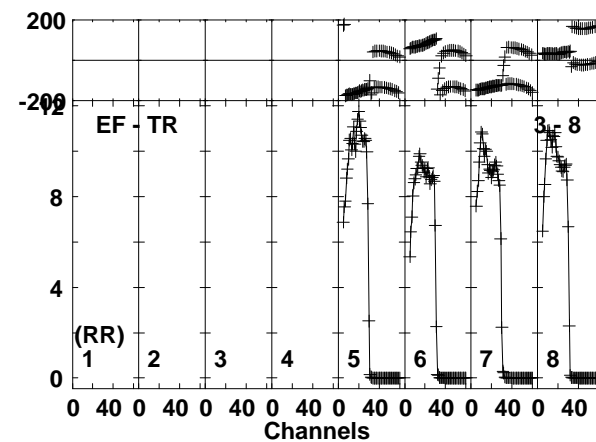
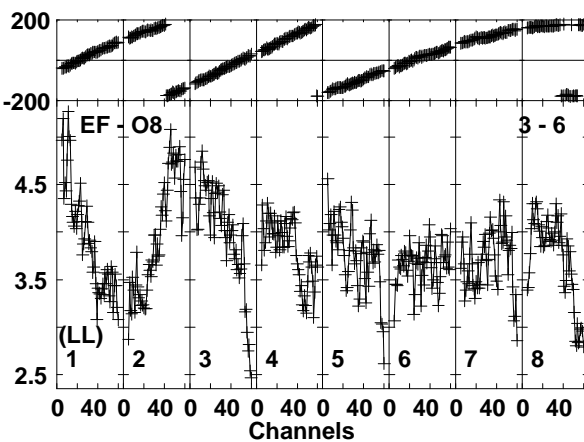
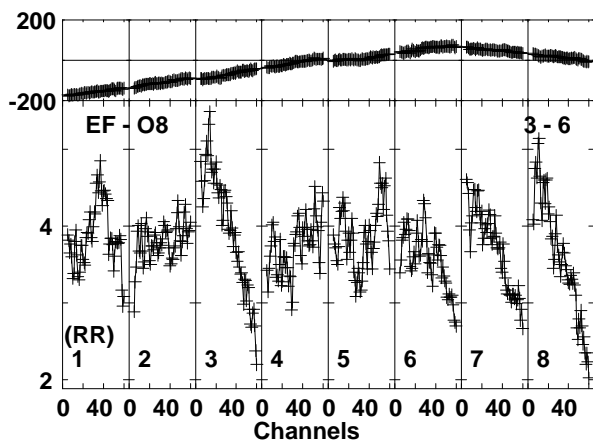
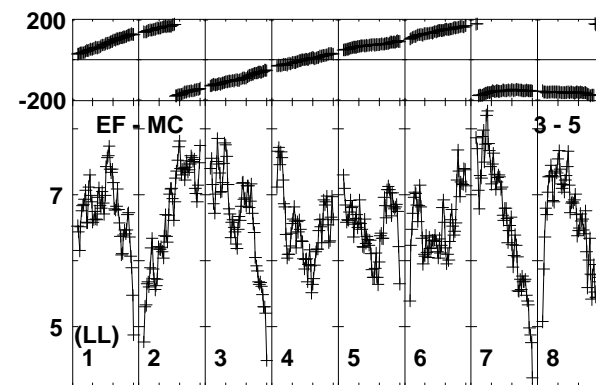
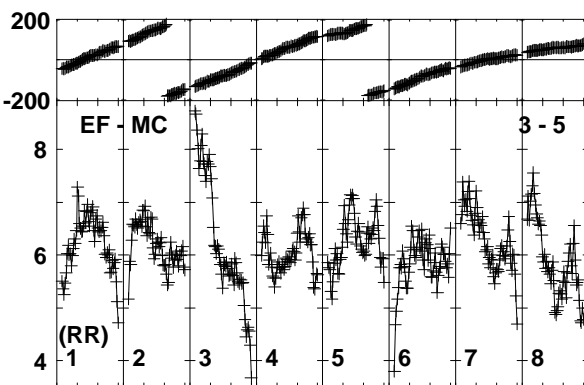
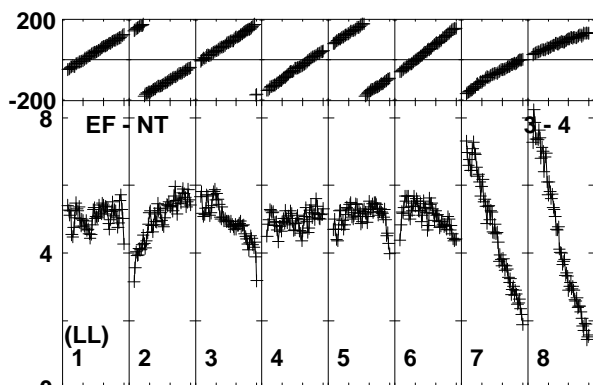
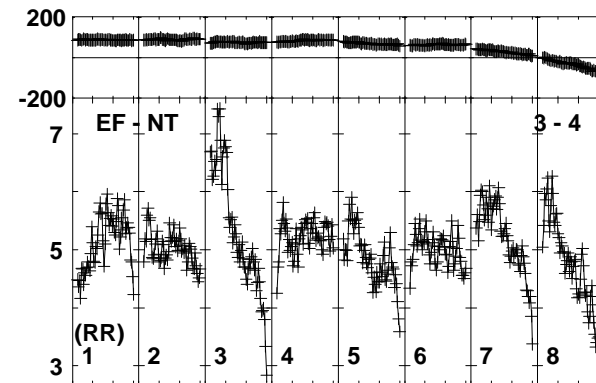
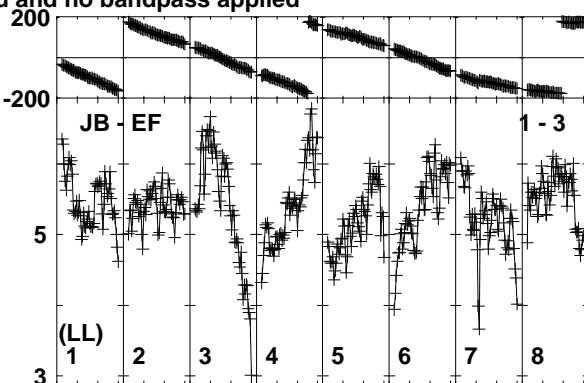
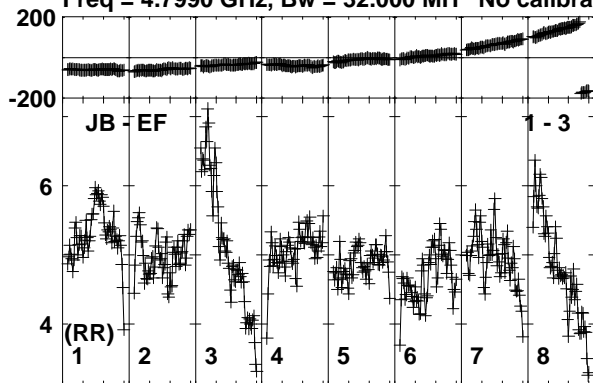

Lower frame: Milli Ampl Jy Top frame: Phas deg
Vector averaged cross-power spectrum Baseline: JB (01) - EF (03)
Timerange: 00/11:33:54 to 00/11:35:23

Plot file version 140 created 19-FEB-2019 18:13:16

J2353+5518 RP028B.UVDATA.1

Freq = 4.7990 GHz, Bw = 32.000 MH No calibration applied and no bandpass applied

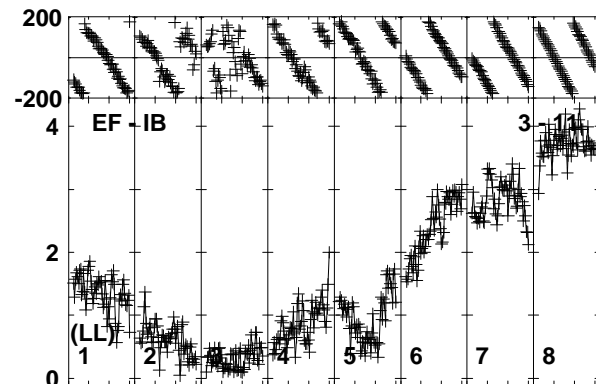
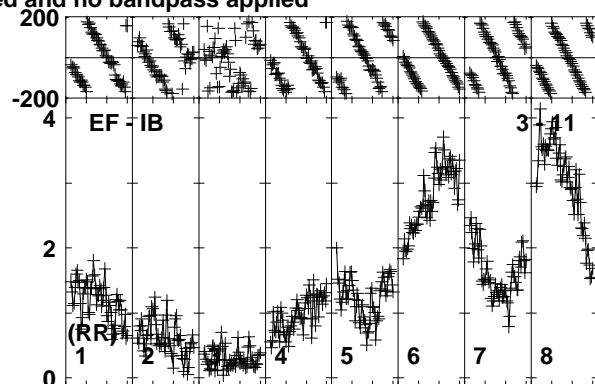
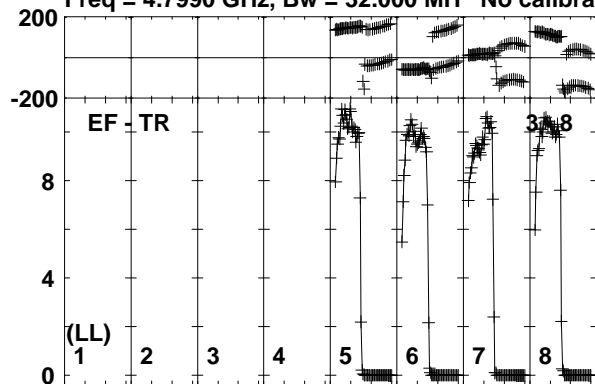

Lower frame: Milli Ampl Jy Top frame: Phas deg
Vector averaged cross-power spectrum Baseline: EF (03) - TR (08)
Timerange: 00/11:33:54 to 00/11:35:23

Plot file version 141 created 19-FEB-2019 18:13:16
IRAS23436 RP028B.UVDATA.1

Freq = 4.7990 GHz, Bw = 32.000 MH No calibration applied and no bandpass applied

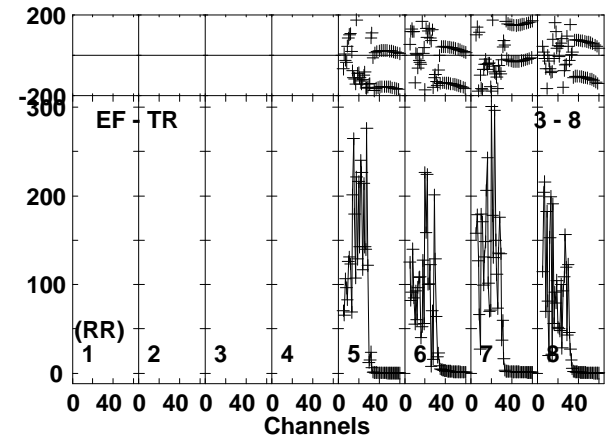
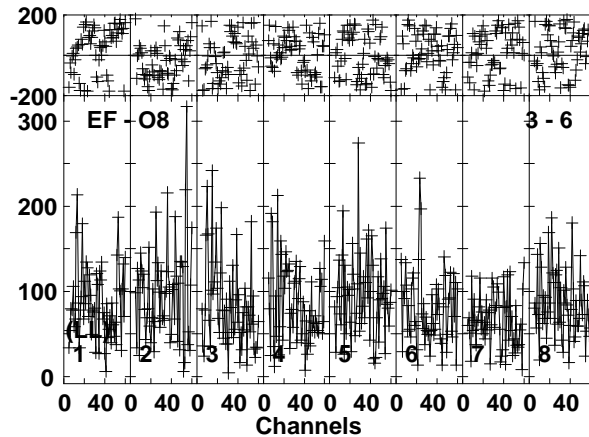
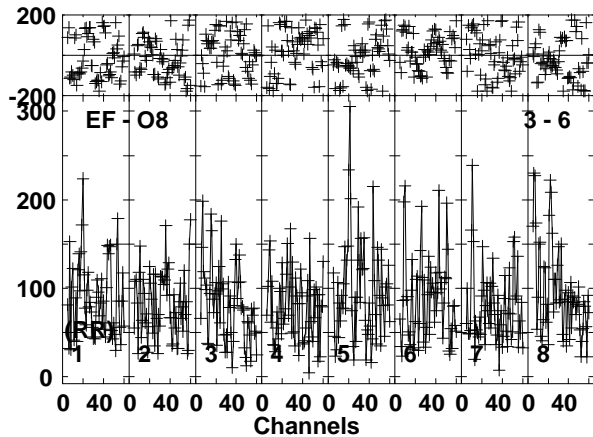
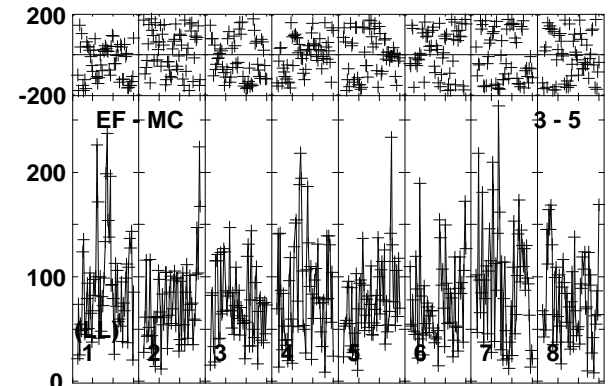
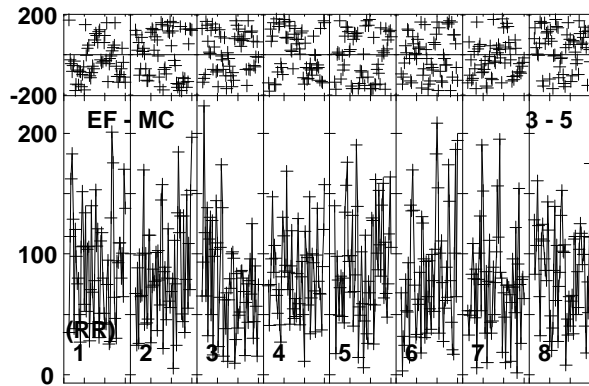
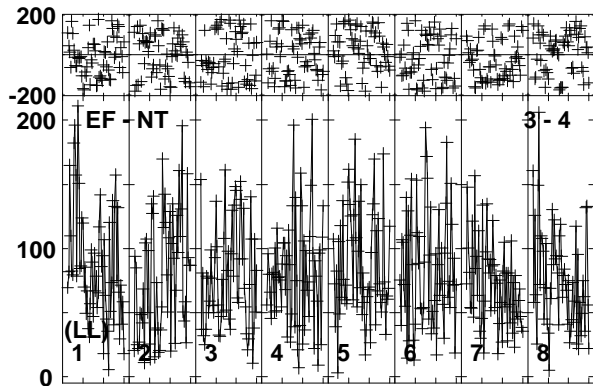
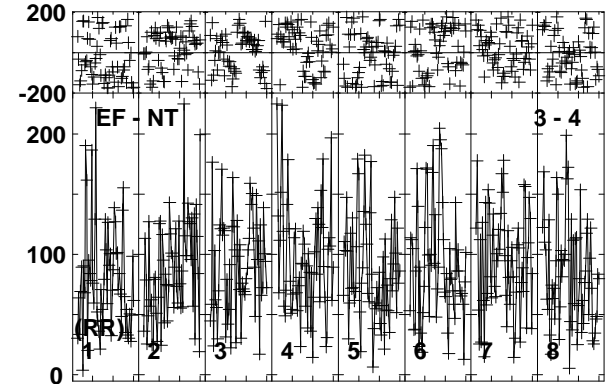
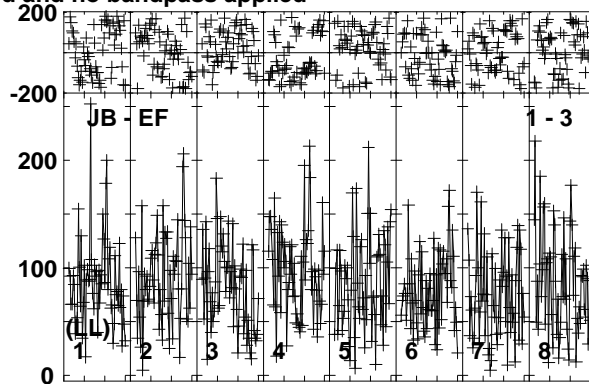
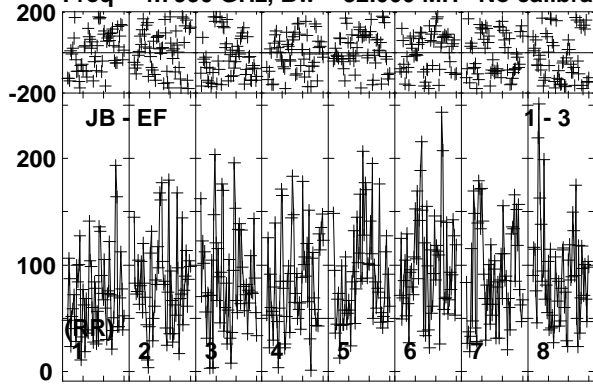

Lower frame: Micro Ampl Jy Top frame: Phas deg
Vector averaged cross-power spectrum Baseline: JB (01) - EF (03)
Timerange: 00/11:35:24 to 00/11:39:04

Plot file version 142 created 19-FEB-2019 18:13:16

IRAS23436 RP028B.UVDATA.1

Freq = 4.7990 GHz, Bw = 32.000 MH No calibration applied and no bandpass applied

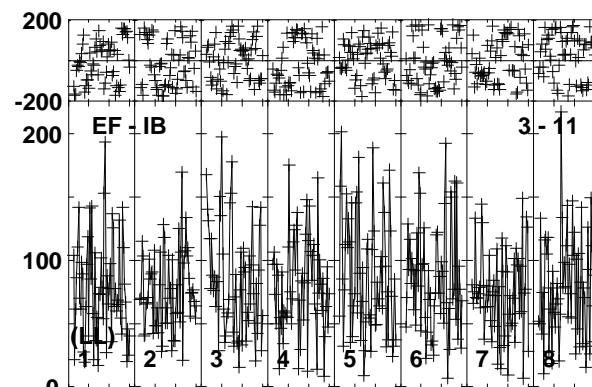
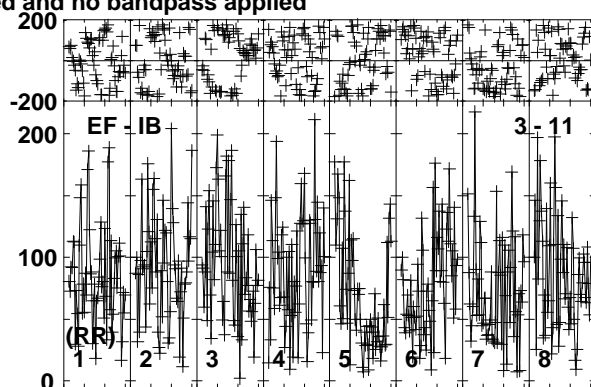
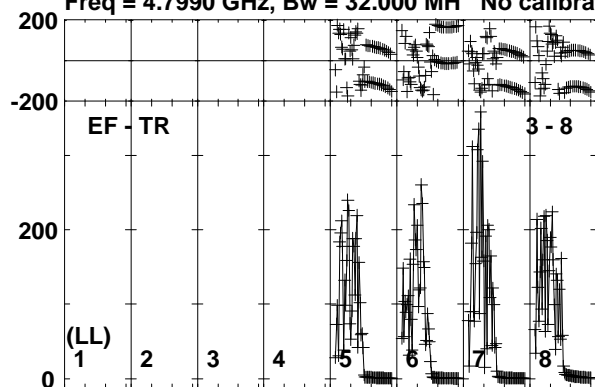

Lower frame: Micro Ampl Jy Top frame: Phas deg
Vector averaged cross-power spectrum Baseline: EF (03) - TR (08)
Timerange: 00/11:35:24 to 00/11:39:04

Plot file version 143 created 19-FEB-2019 18:13:17

J2353+5518 RP028B.UVDATA.1

Freq = 4.7990 GHz, Bw = 32.000 MH No calibration applied and no bandpass applied

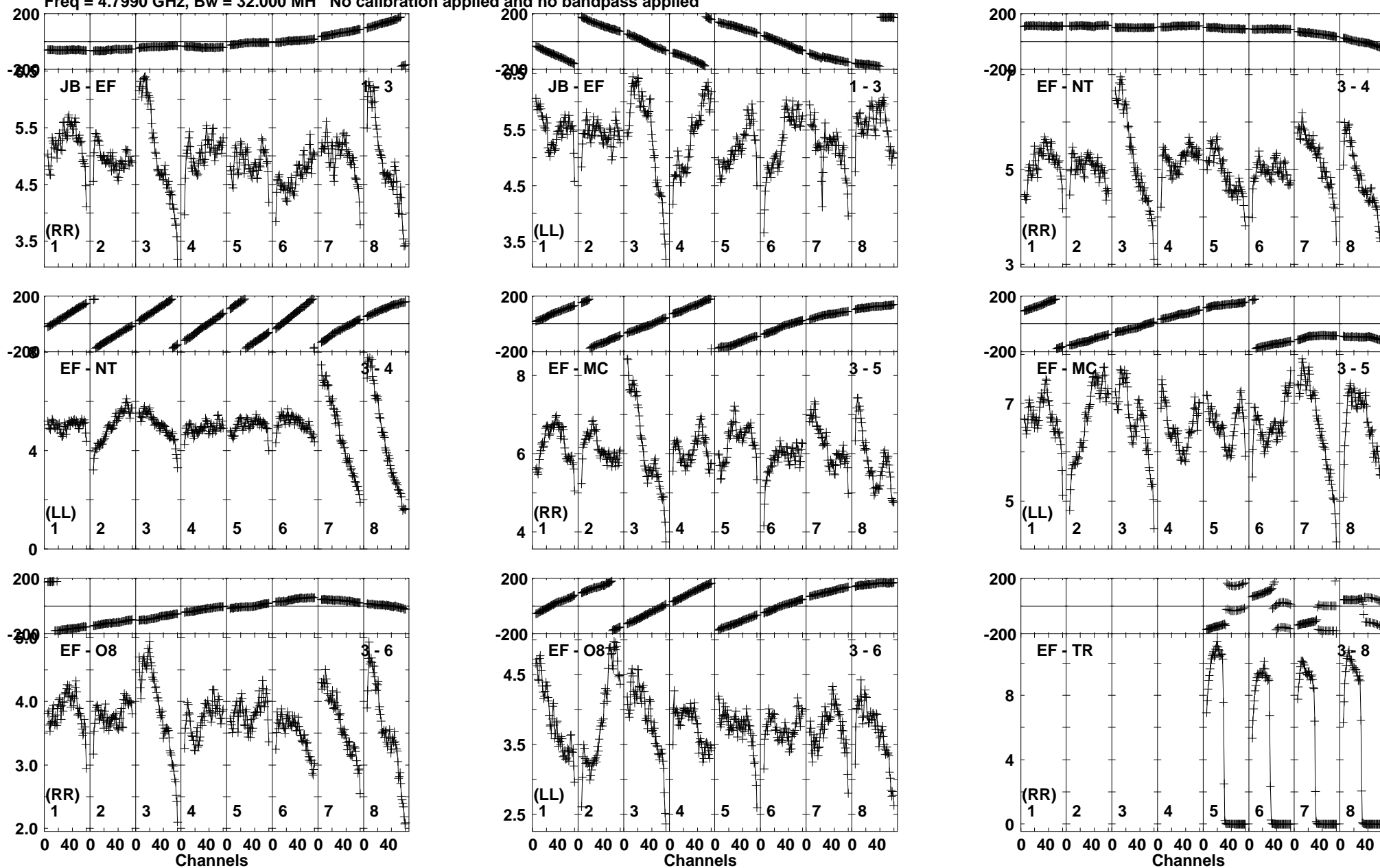

Lower frame: Milli Ampl Jy Top frame: Phas deg
Vector averaged cross-power spectrum Baseline: JB (01) - EF (03)
Timerange: 00/11:39:54 to 00/11:41:13

Plot file version 144 created 19-FEB-2019 18:13:17

J2353+5518 RP028B.UVDATA.1

Freq = 4.7990 GHz, Bw = 32.000 MH No calibration applied and no bandpass applied

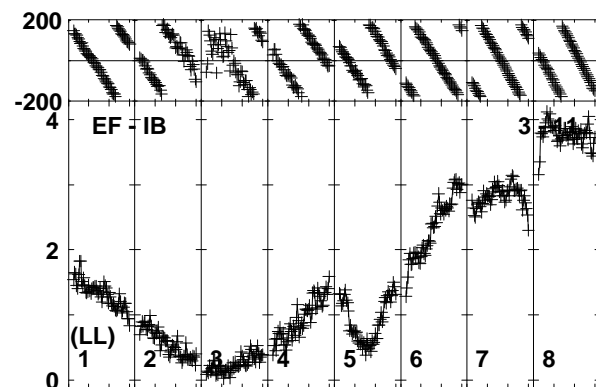
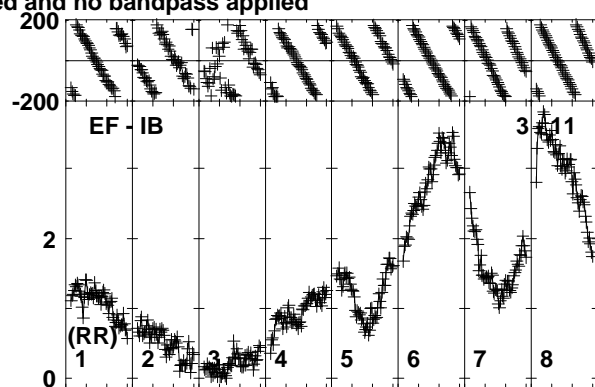
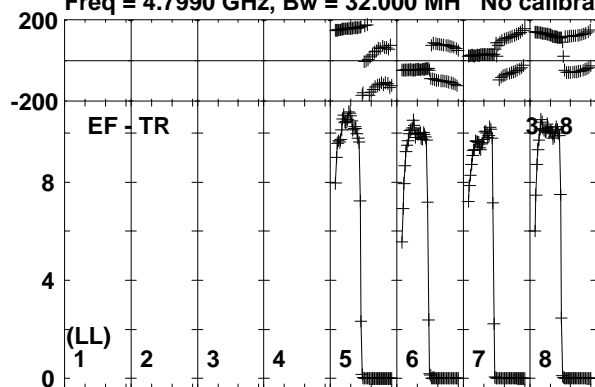

Lower frame: Milli Ampl Jy Top frame: Phas deg
Vector averaged cross-power spectrum Baseline: EF (03) - TR (08)
Timerange: 00/11:39:54 to 00/11:41:13

Plot file version 145 created 19-FEB-2019 18:13:17

IRAS23436 RP028B.UVDATA.1

Freq = 4.7990 GHz, Bw = 32.000 MH No calibration applied and no bandpass applied

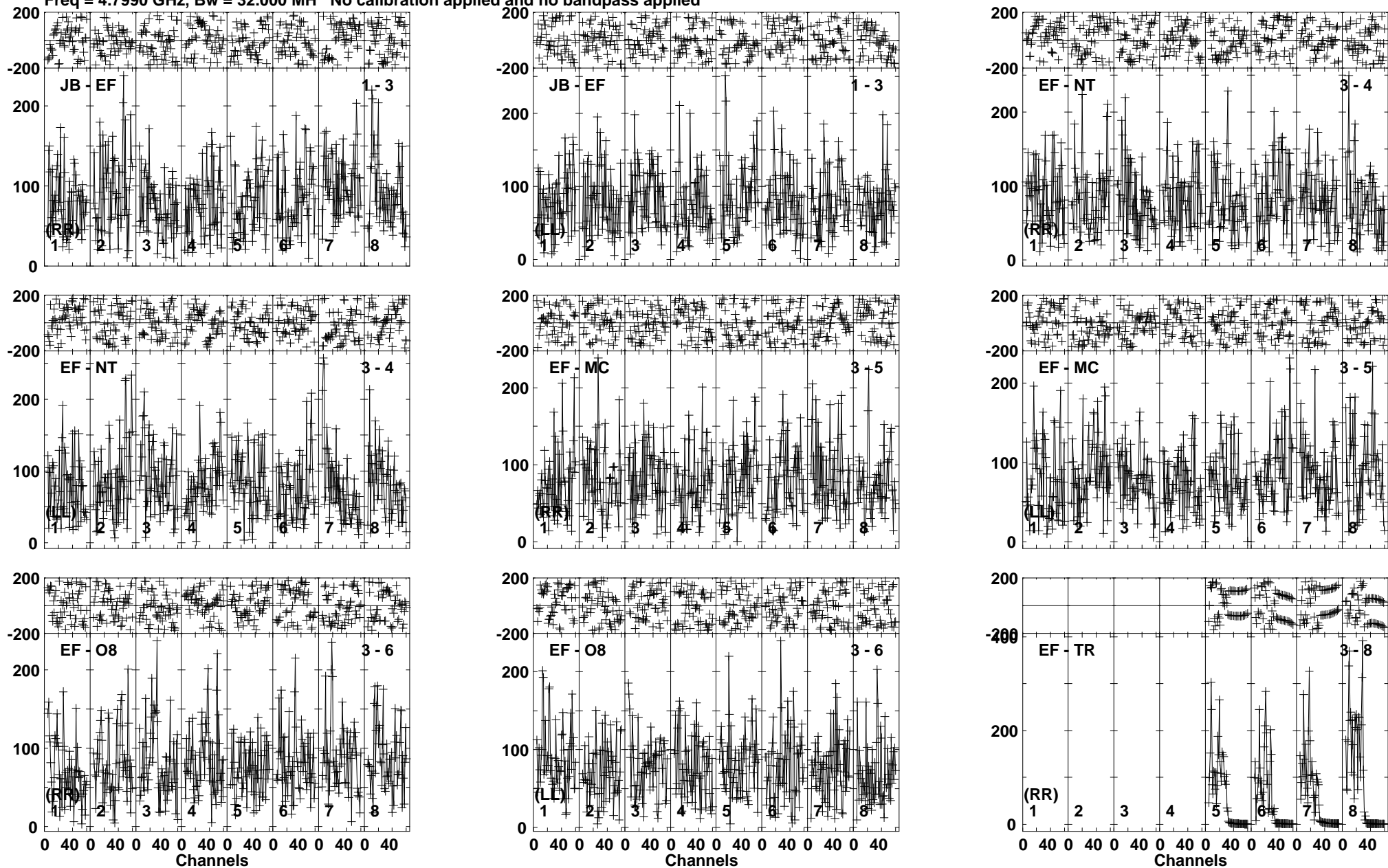

Lower frame: Micro Ampl Jy Top frame: Phas deg
Vector averaged cross-power spectrum Baseline: JB (01) - EF (03)
Timerange: 00/11:41:15 to 00/11:44:58

Plot file version 146 created 19-FEB-2019 18:13:17

IRAS23436 RP028B.UVDATA.1

Freq = 4.7990 GHz, Bw = 32.000 MH No calibration applied and no bandpass applied

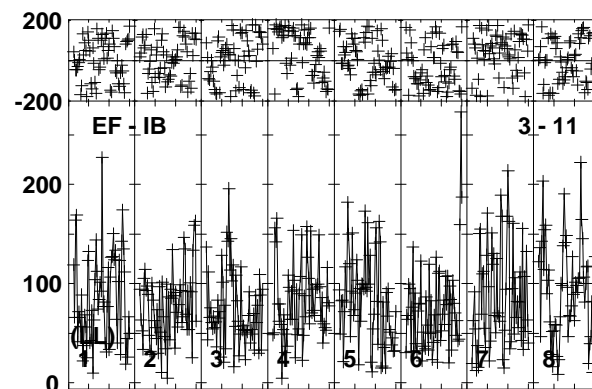
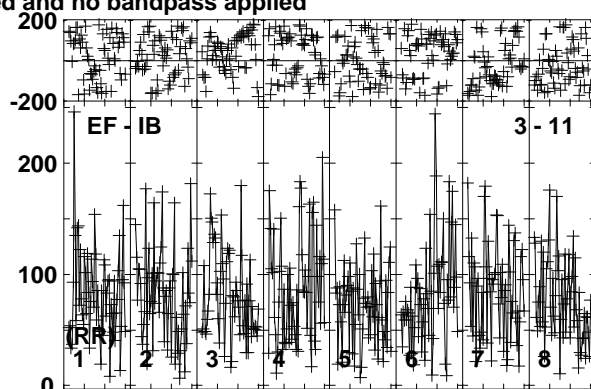
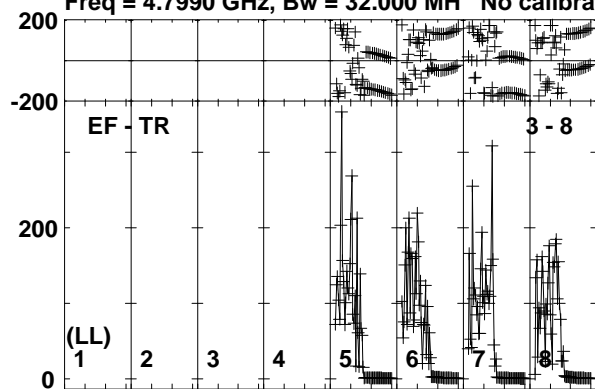

Lower frame: Micro Ampl Jy Top frame: Phas deg
Vector averaged cross-power spectrum Baseline: EF (03) - TR (08)
Timerange: 00/11:41:15 to 00/11:44:58

Plot file version 147 created 19-FEB-2019 18:13:17

J2353+5518 RP028B.UVDATA.1

Freq = 4.7990 GHz, Bw = 32.000 MH No calibration applied and no bandpass applied

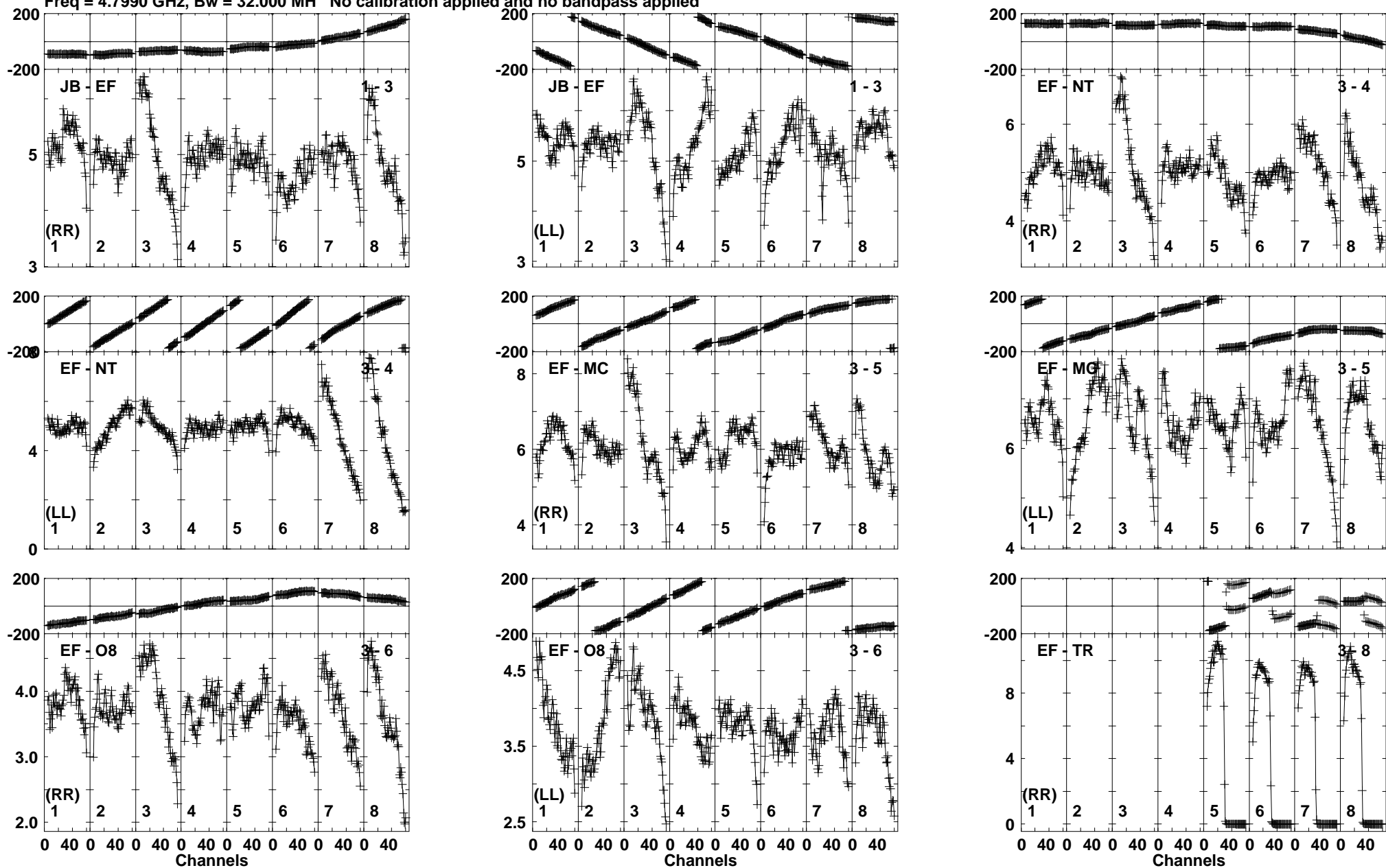

Lower frame: Milli Ampl Jy Top frame: Phas deg
Vector averaged cross-power spectrum Baseline: JB (01) - EF (03)
Timerange: 00/11:44:58 to 00/11:46:27

Plot file version 148 created 19-FEB-2019 18:13:17

J2353+5518 RP028B.UVDATA.1

Freq = 4.7990 GHz, Bw = 32.000 MH No calibration applied and no bandpass applied

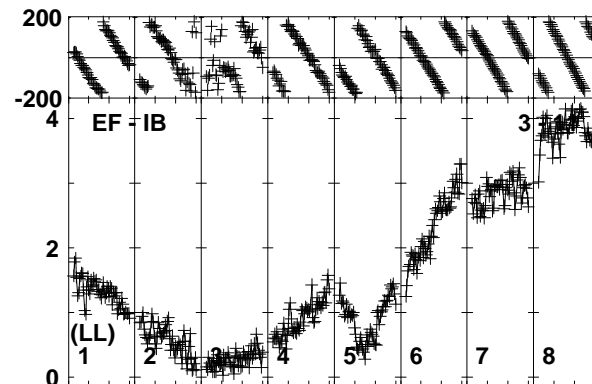
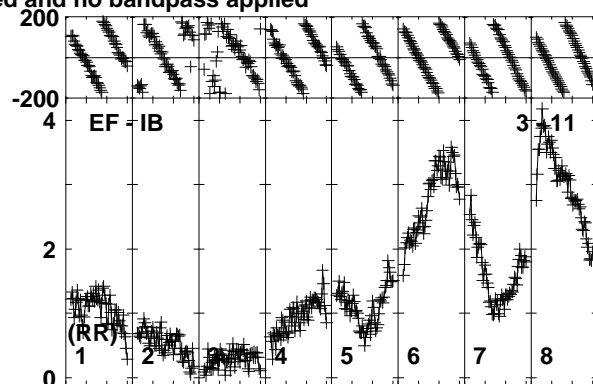
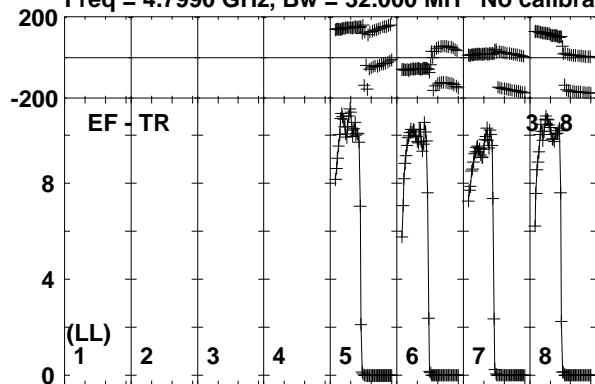

Lower frame: Milli Ampl Jy Top frame: Phas deg
Vector averaged cross-power spectrum Baseline: EF (03) - TR (08)
Timerange: 00/11:44:58 to 00/11:46:27

Plot file version 149 created 19-FEB-2019 18:13:18

IRAS23436 RP028B.UVDATA.1

Freq = 4.7990 GHz, Bw = 32.000 MH No calibration applied and no bandpass applied

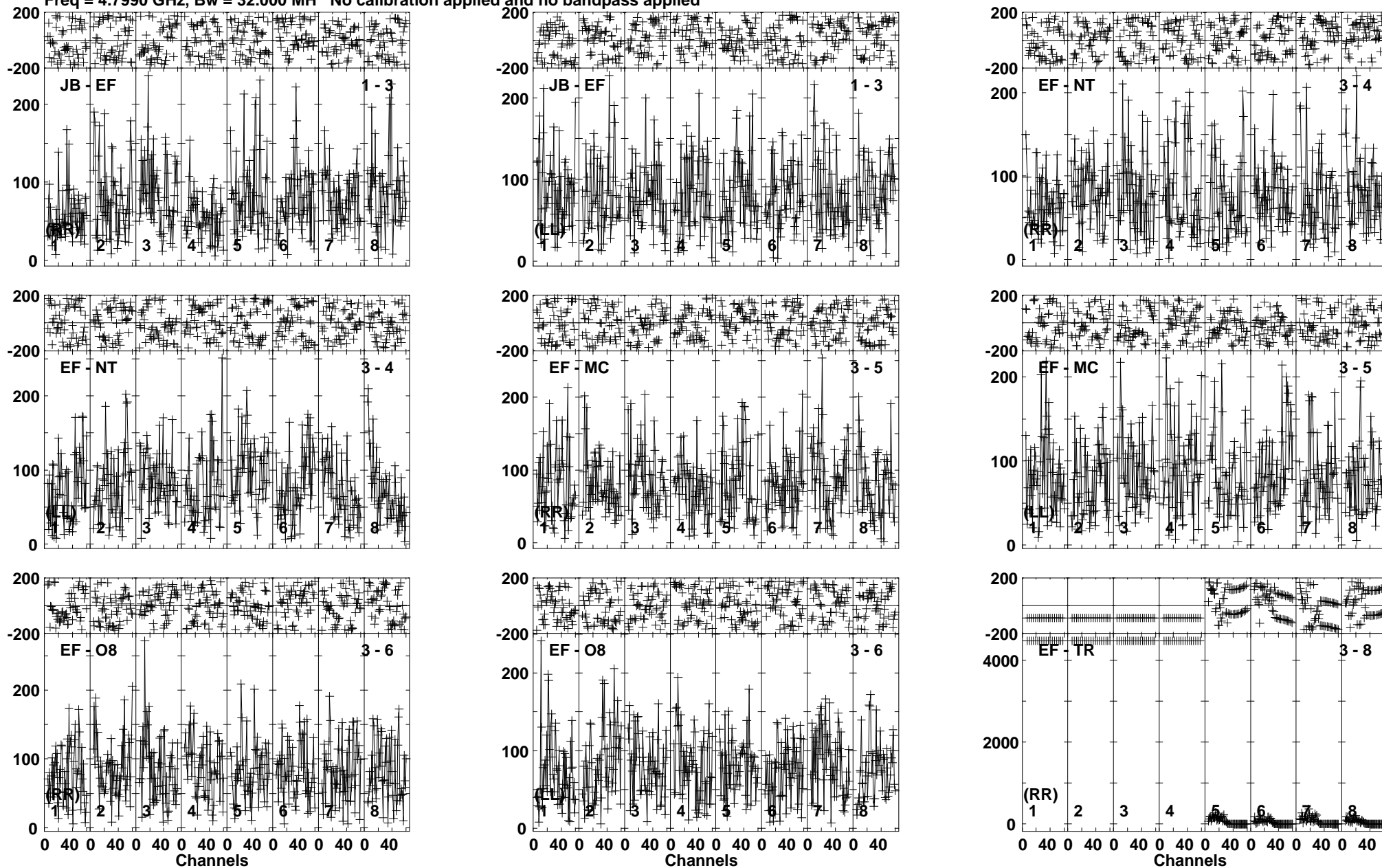

Lower frame: Micro Ampl Jy Top frame: Phas deg
Vector averaged cross-power spectrum Baseline: JB (01) - EF (03)
Timerange: 00/11:46:29 to 00/11:50:12

Plot file version 150 created 19-FEB-2019 18:13:18

IRAS23436 RP028B.UVDATA.1

Freq = 4.7990 GHz, Bw = 32.000 MH No calibration applied and no bandpass applied

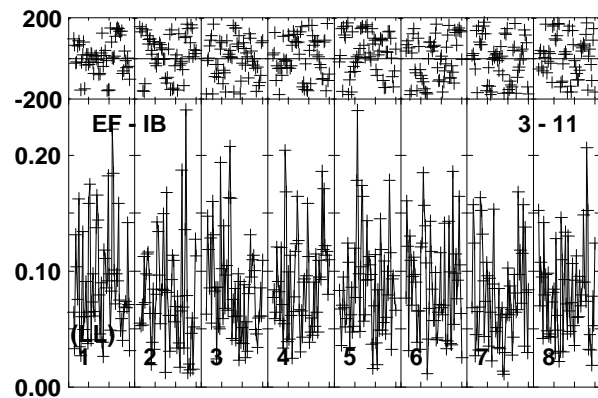
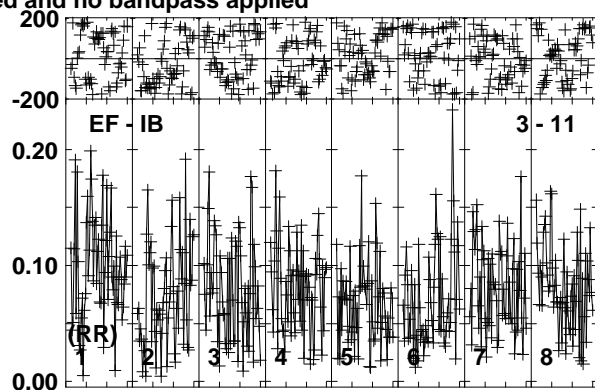
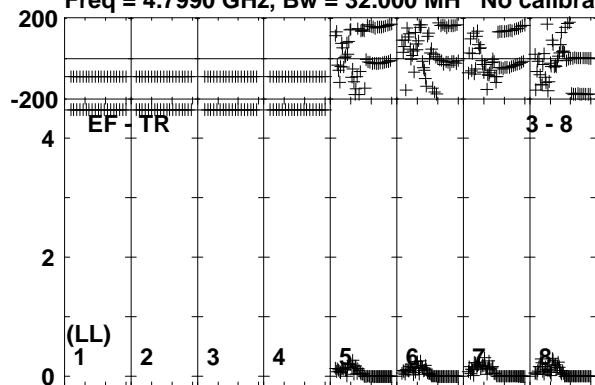

Lower frame: Milli Ampl Jy Top frame: Phas deg
Vector averaged cross-power spectrum Baseline: EF (03) - TR (08)
Timerange: 00/11:46:29 to 00/11:50:12

Plot file version 151 created 19-FEB-2019 18:13:18

J2353+5518 RP028B.UVDATA.1

Freq = 4.7990 GHz, Bw = 32.000 MH No calibration applied and no bandpass applied

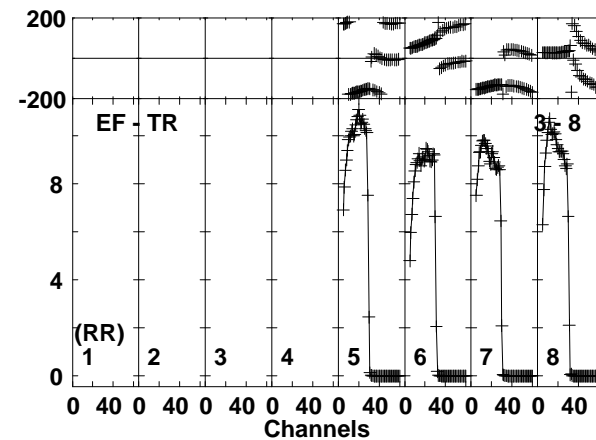
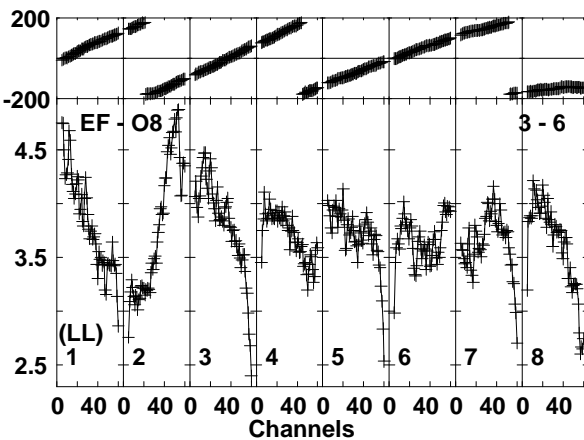
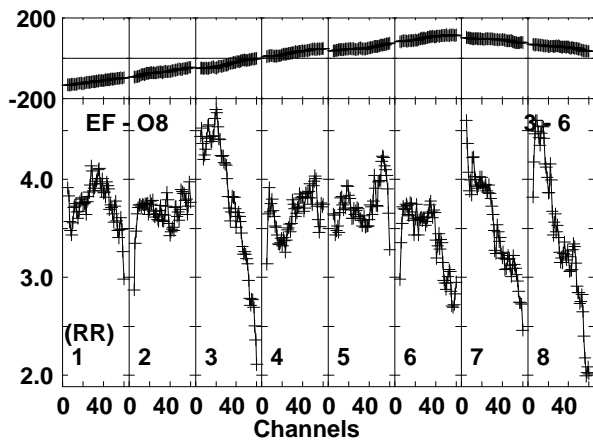
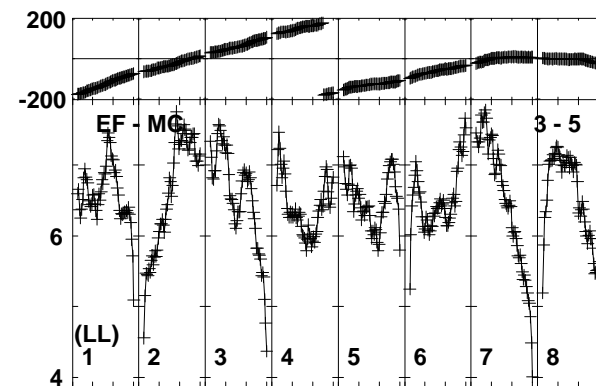
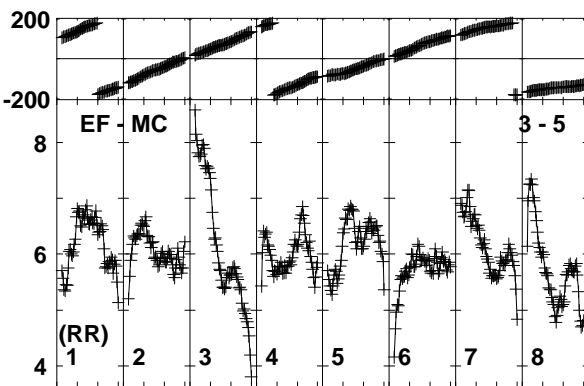
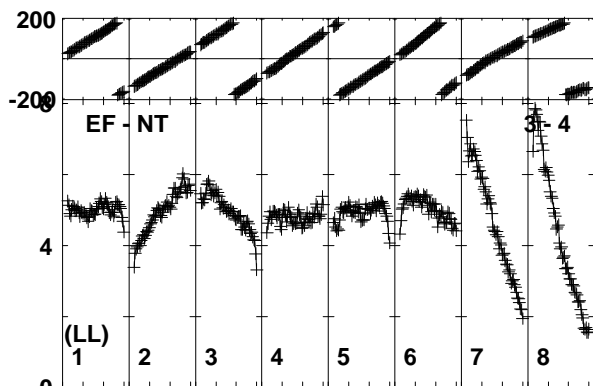
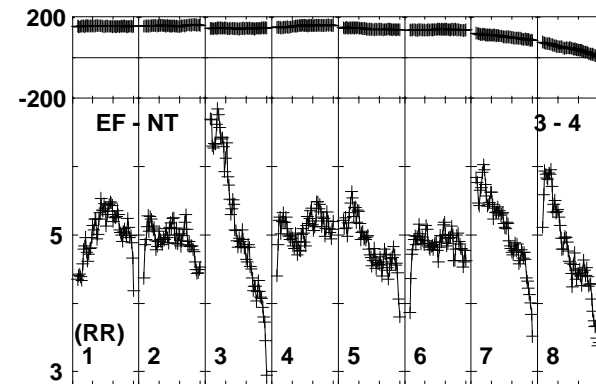
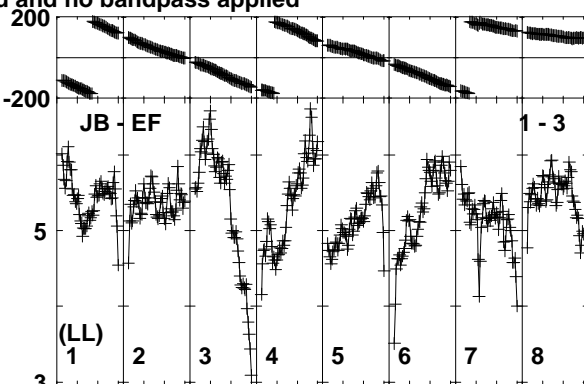
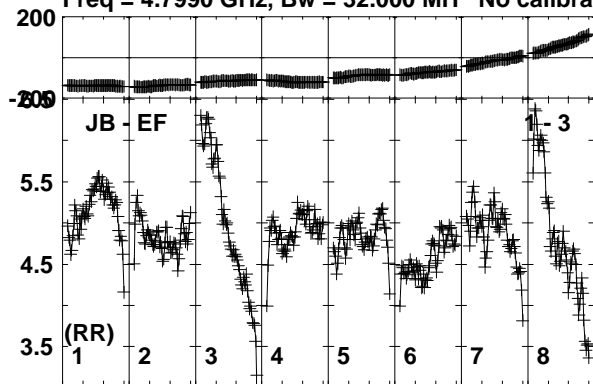

Lower frame: Milli Ampl Jy Top frame: Phas deg
Vector averaged cross-power spectrum Baseline: JB (01) - EF (03)
Timerange: 00/11:51:03 to 00/11:52:21

Plot file version 152 created 19-FEB-2019 18:13:18

J2353+5518 RP028B.UVDATA.1

Freq = 4.7990 GHz, Bw = 32.000 MH No calibration applied and no bandpass applied

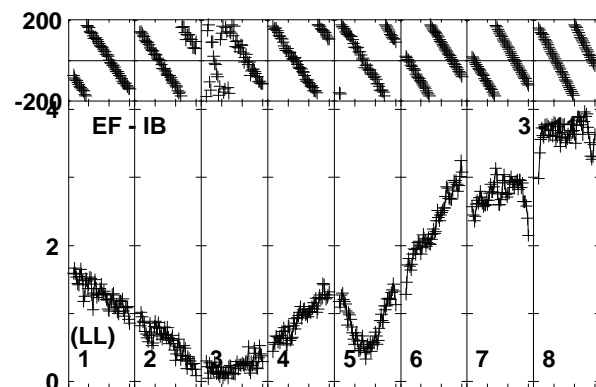
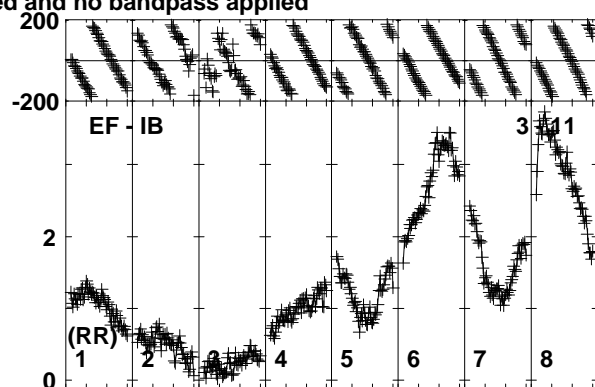
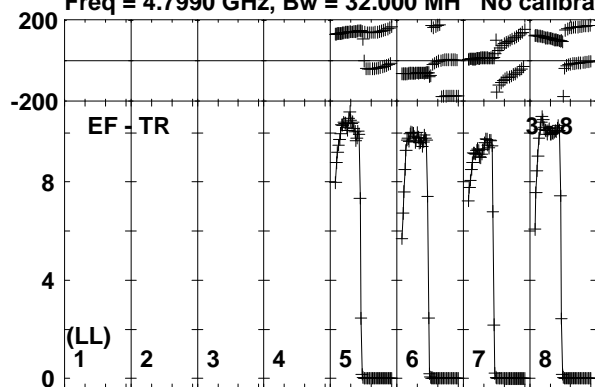

Lower frame: Milli Ampl Jy Top frame: Phas deg
Vector averaged cross-power spectrum Baseline: EF (03) - TR (08)
Timerange: 00/11:51:03 to 00/11:52:21

Plot file version 153 created 19-FEB-2019 18:13:18

IRAS23436 RP028B.UVDATA.1

Freq = 4.7990 GHz, Bw = 32.000 MH No calibration applied and no bandpass applied

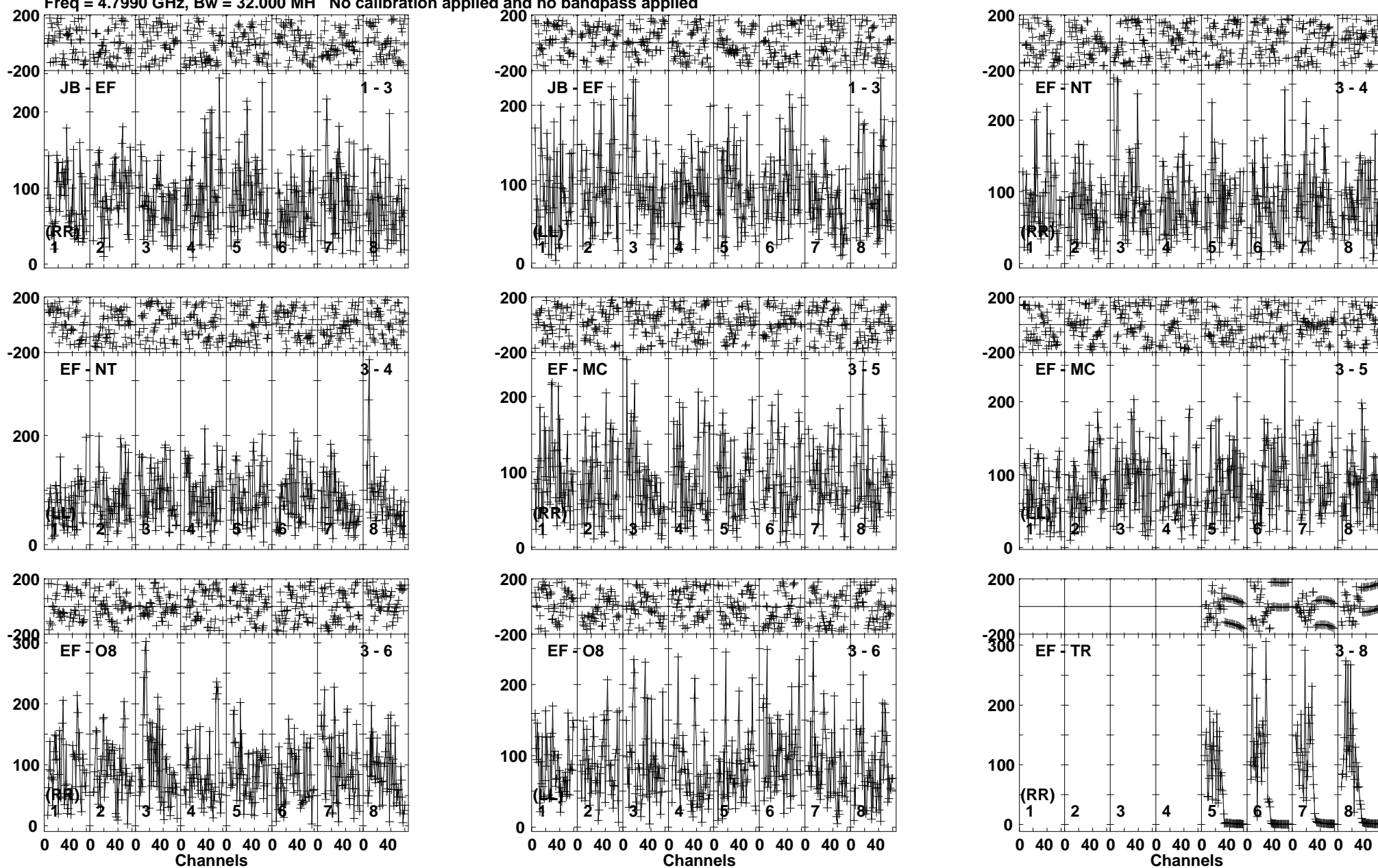

Plot file version 154 created 19-FEB-2019 18:13:19

IRAS23436 RP028B.UVDATA.1

Freq = 4.7990 GHz, Bw = 32.000 MH No calibration applied and no bandpass applied

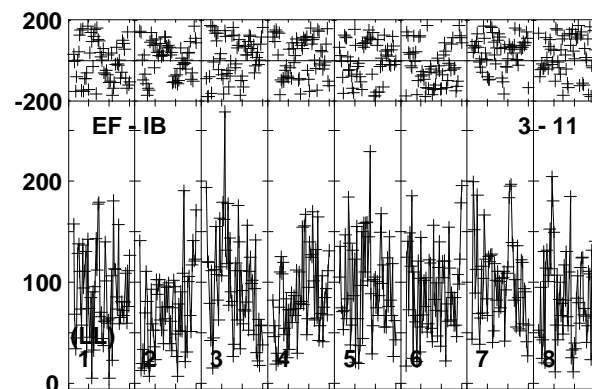
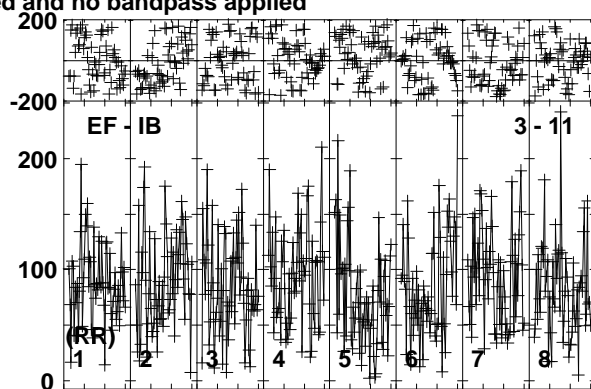
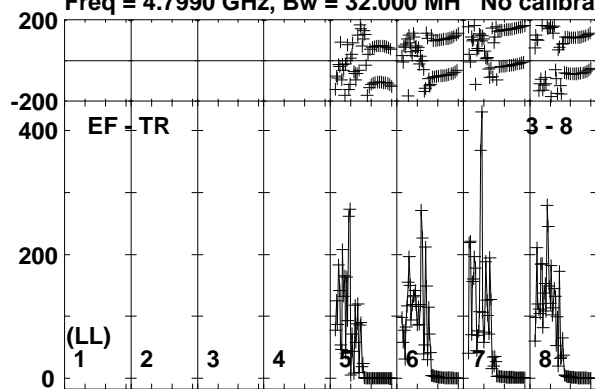

Lower frame: Micro Ampl Jy Top frame: Phas deg
Vector averaged cross-power spectrum Baseline: EF (03) - TR (08)
Timerange: 00/11:52:23 to 00/11:56:06

Plot file version 155 created 19-FEB-2019 18:13:19

J2353+5518 RP028B.UVDATA.1

Freq = 4.7990 GHz, Bw = 32.000 MH No calibration applied and no bandpass applied

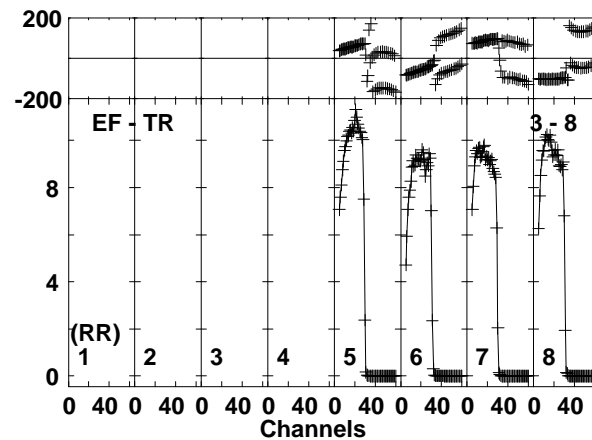
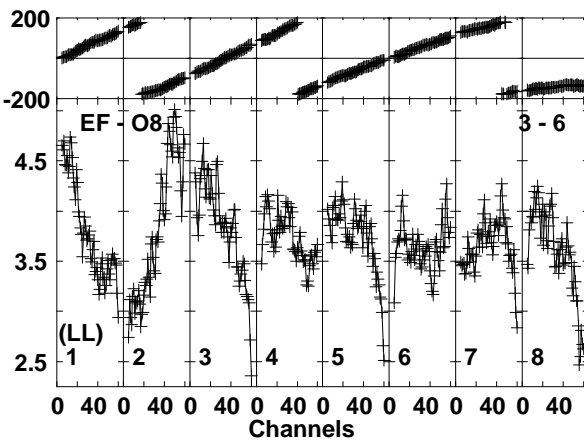
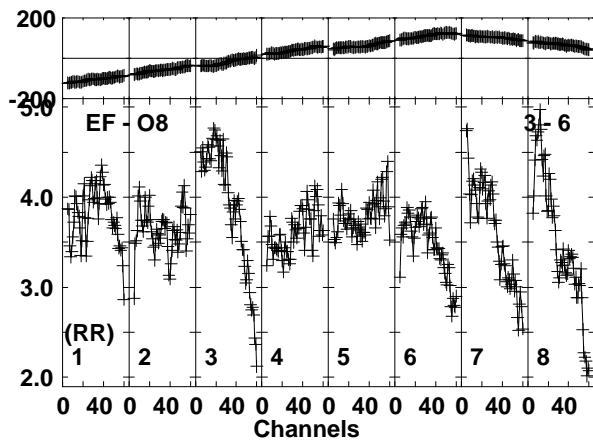
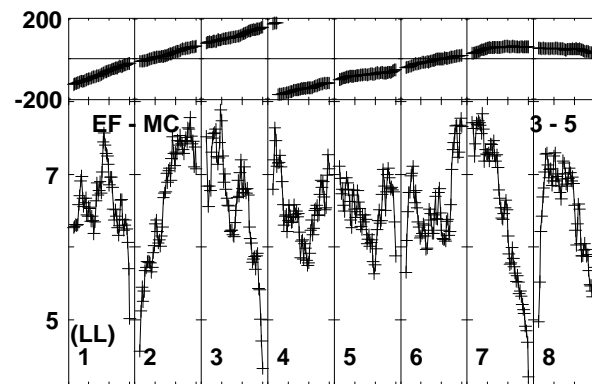
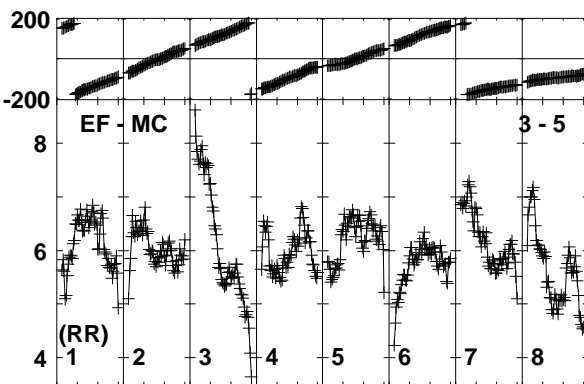
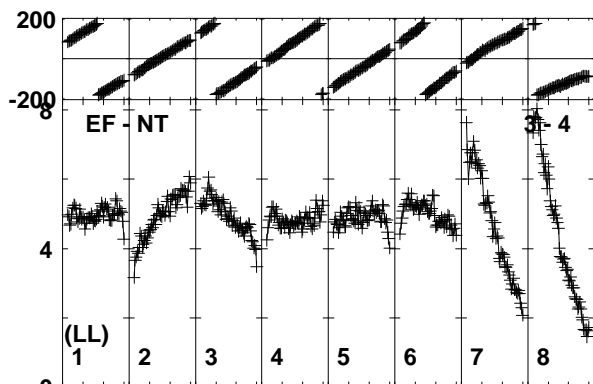
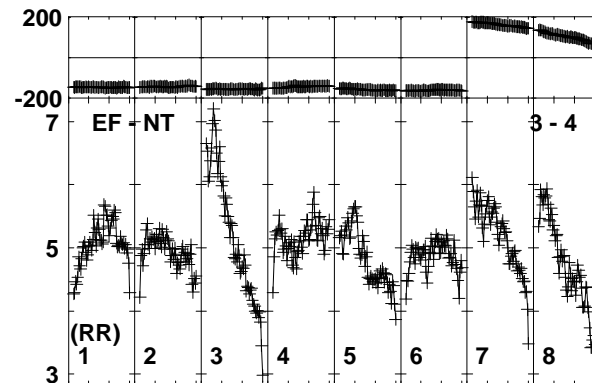
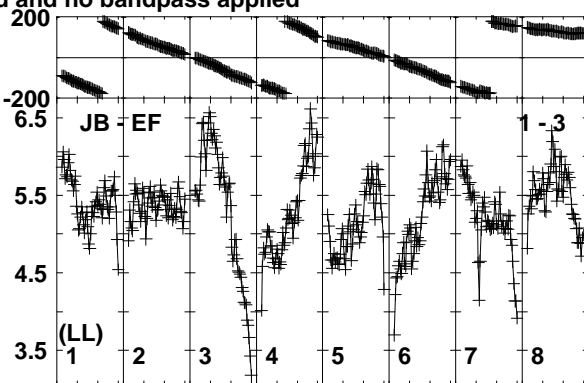
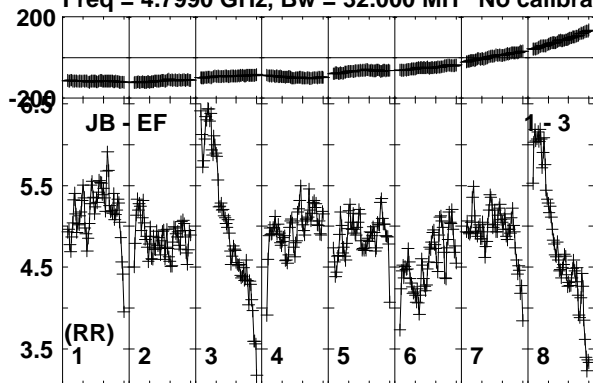

Lower frame: Milli Ampl Jy Top frame: Phas deg
Vector averaged cross-power spectrum Baseline: JB (01) - EF (03)
Timerange: 00/11:56:06 to 00/11:57:36

Plot file version 156 created 19-FEB-2019 18:13:19

J2353+5518 RP028B.UVDATA.1

Freq = 4.7990 GHz, Bw = 32.000 MH No calibration applied and no bandpass applied

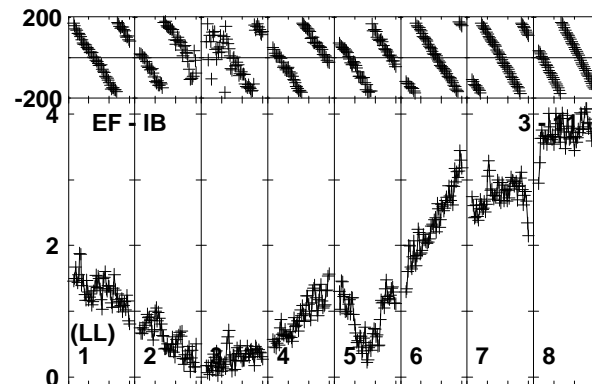
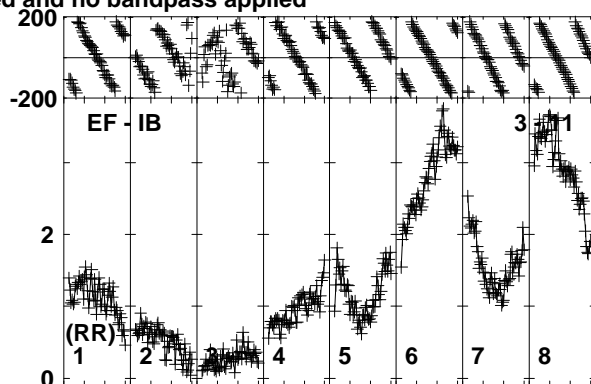
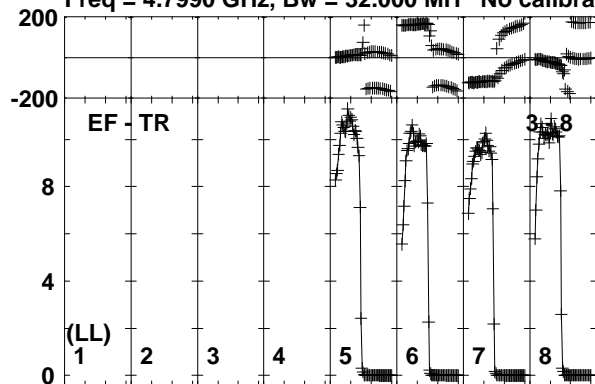

Lower frame: Milli Ampl Jy Top frame: Phas deg
Vector averaged cross-power spectrum Baseline: EF (03) - TR (08)
Timerange: 00/11:56:06 to 00/11:57:36

Plot file version 157 created 19-FEB-2019 18:13:19

IRAS23436 RP028B.UVDATA.1

Freq = 4.7990 GHz, Bw = 32.000 MH No calibration applied and no bandpass applied

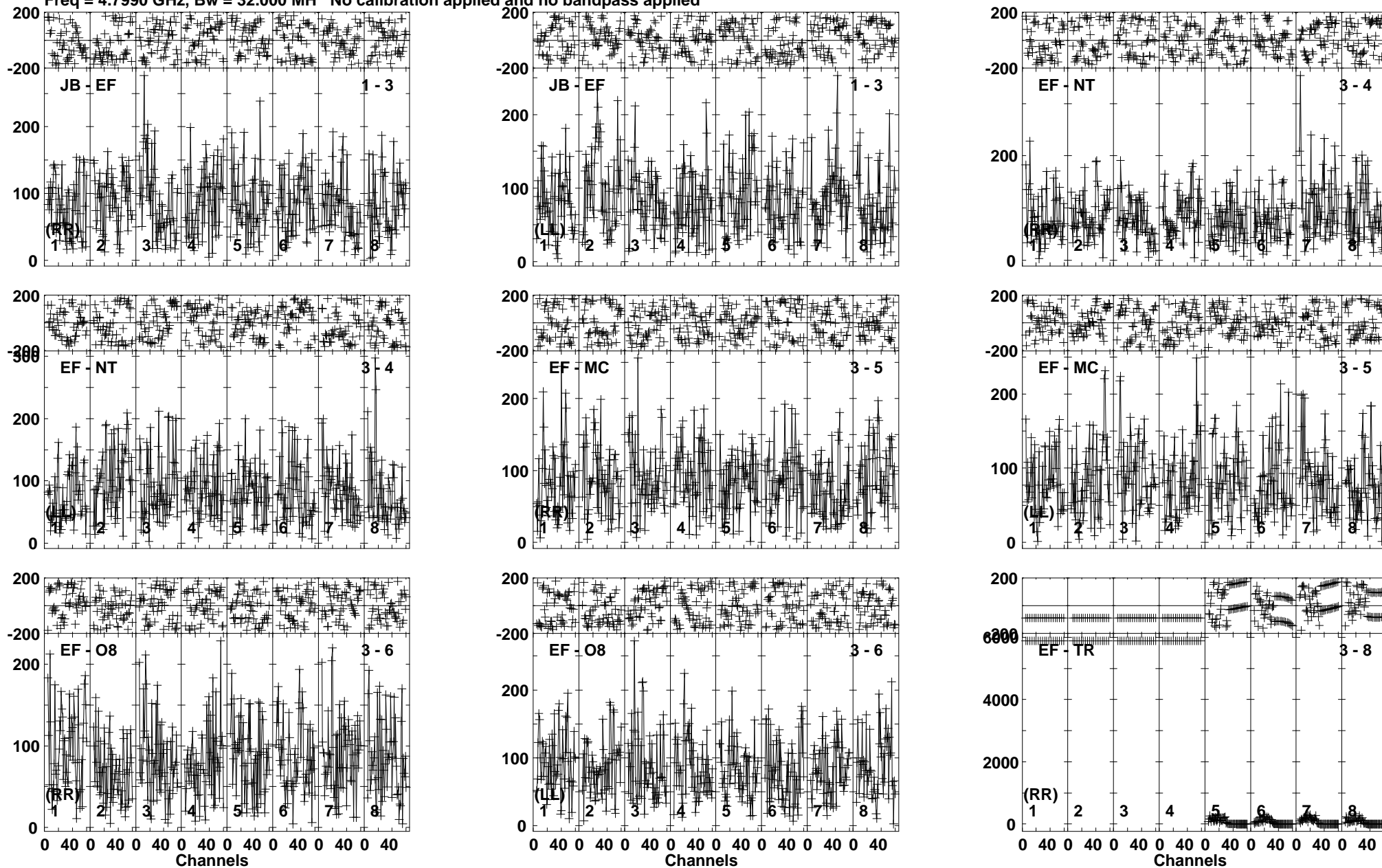

Lower frame: Micro Ampl Jy Top frame: Phas deg
Vector averaged cross-power spectrum Baseline: JB (01) - EF (03)
Timerange: 00/11:57:36 to 00/12:01:19

Plot file version 158 created 19-FEB-2019 18:13:20

IRAS23436 RP028B.UVDATA.1

Freq = 4.7990 GHz, Bw = 32.000 MH No calibration applied and no bandpass applied

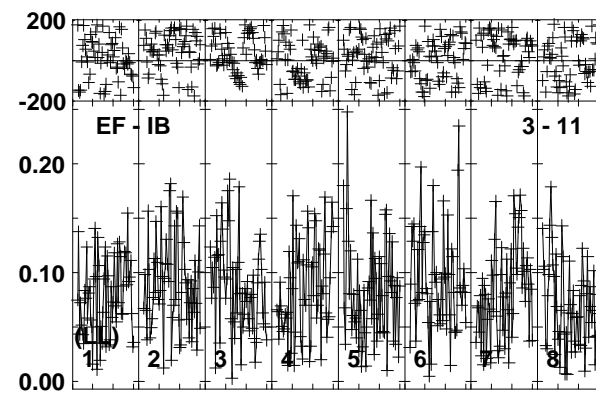
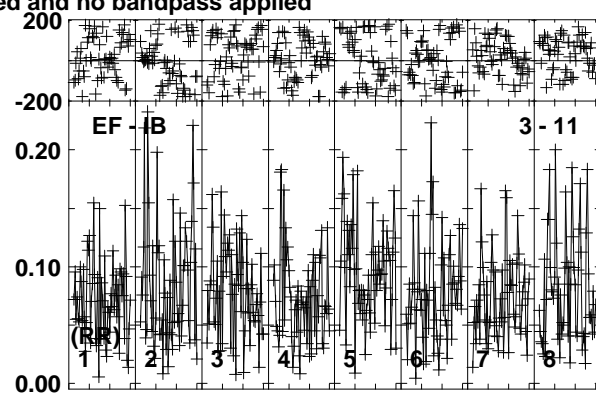
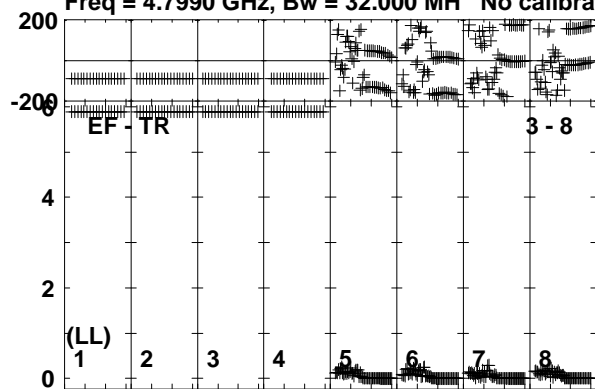

Lower frame: Milli Ampl Jy Top frame: Phas deg
Vector averaged cross-power spectrum Baseline: EF (03) - TR (08)
Timerange: 00/11:57:36 to 00/12:01:19

Plot file version 159 created 19-FEB-2019 18:13:20

J2353+5518 RP028B.UVDATA.1

Freq = 4.7990 GHz, Bw = 32.000 MH No calibration applied and no bandpass applied

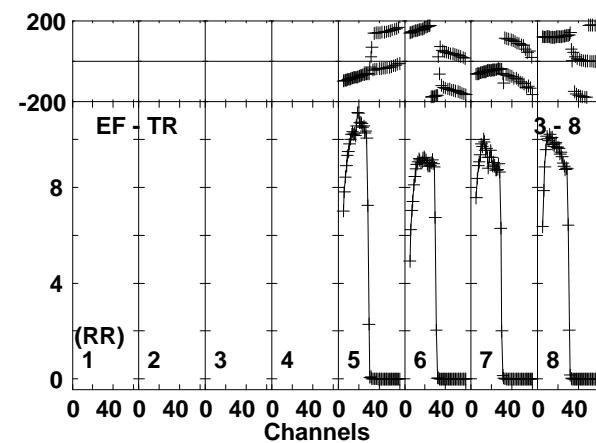
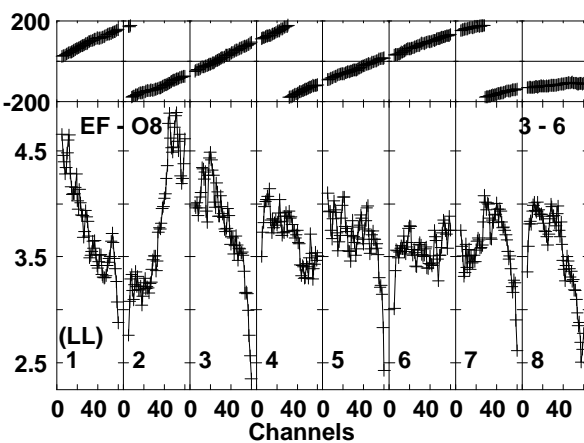
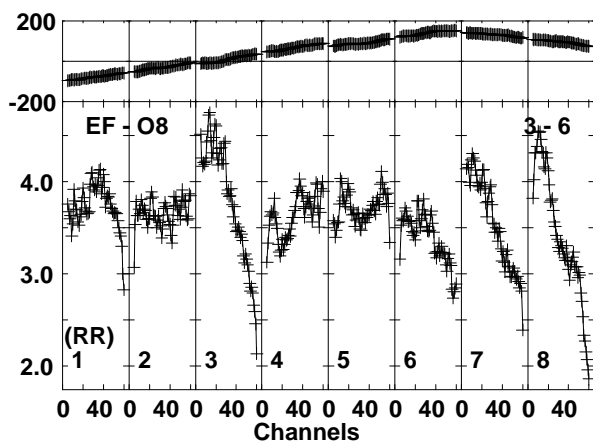
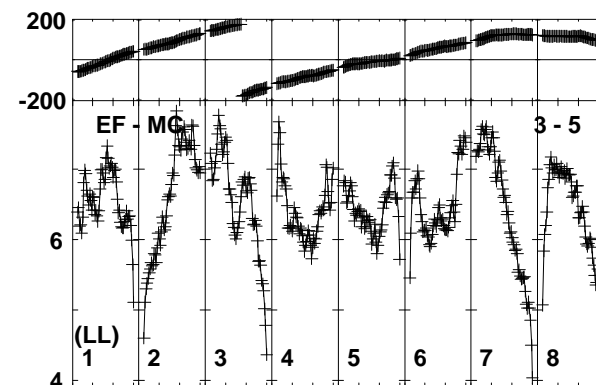
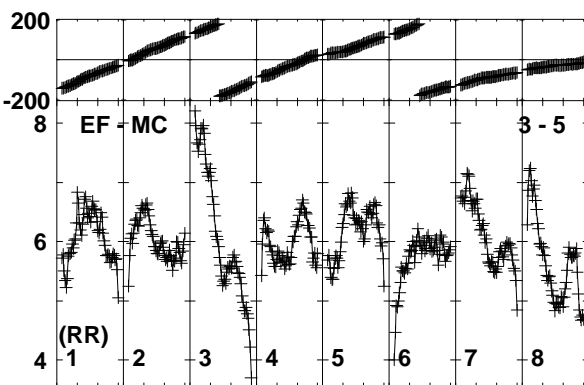
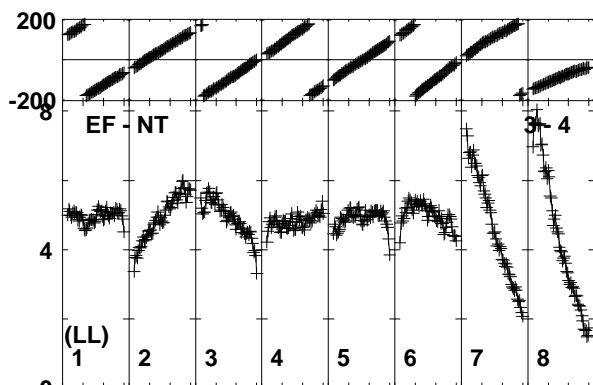
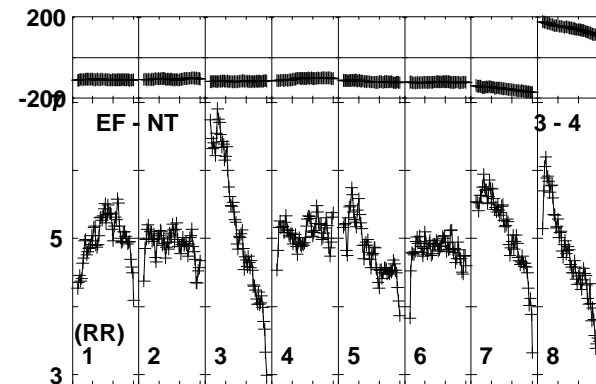
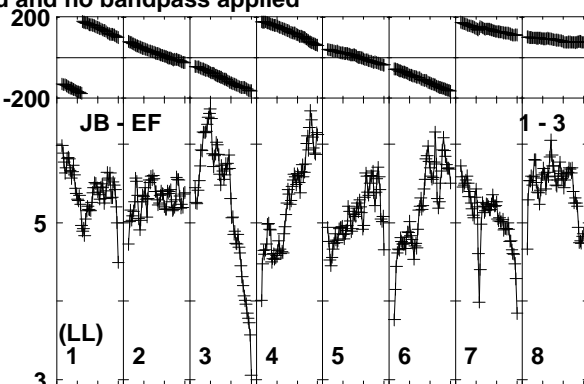
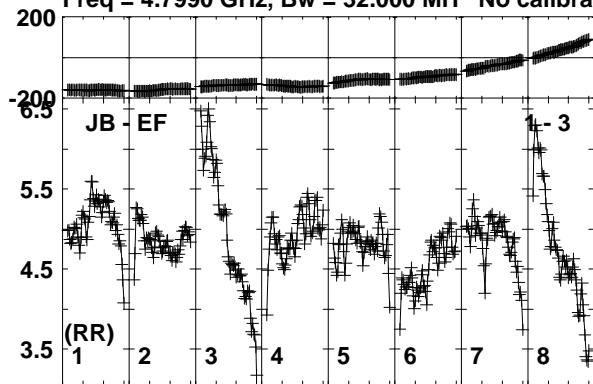

Lower frame: Milli Ampl Jy Top frame: Phas deg
Vector averaged cross-power spectrum Baseline: JB (01) - EF (03)
Timerange: 00:12:02:11 to 00:12:03:30

Plot file version 160 created 19-FEB-2019 18:13:20

J2353+5518 RP028B.UVDATA.1

Freq = 4.7990 GHz, Bw = 32.000 MH No calibration applied and no bandpass applied

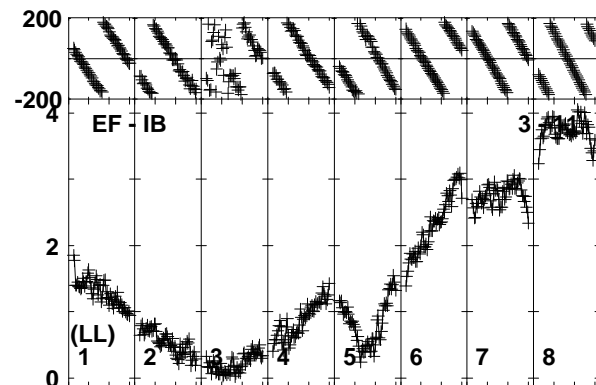
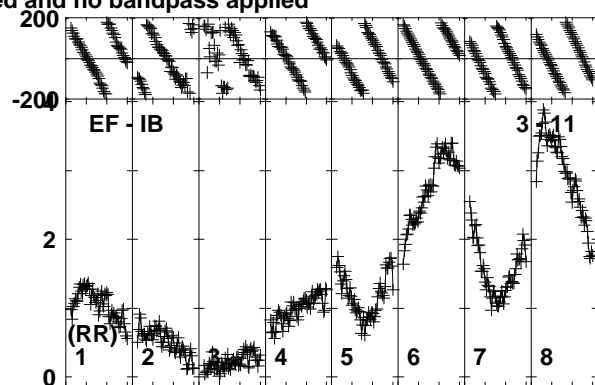
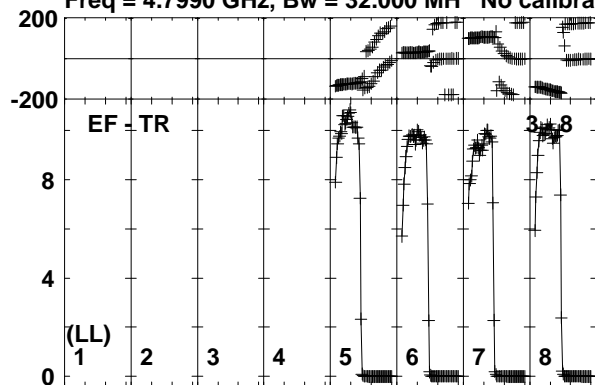

Lower frame: Milli Ampl Jy Top frame: Phas deg
Vector averaged cross-power spectrum Baseline: EF (03) - TR (08)
Timerange: 00/12:02:11 to 00/12:03:30

Plot file version 161 created 19-FEB-2019 18:13:20

IRAS23436 RP028B.UVDATA.1

Freq = 4.7990 GHz, Bw = 32.000 MH No calibration applied and no bandpass applied

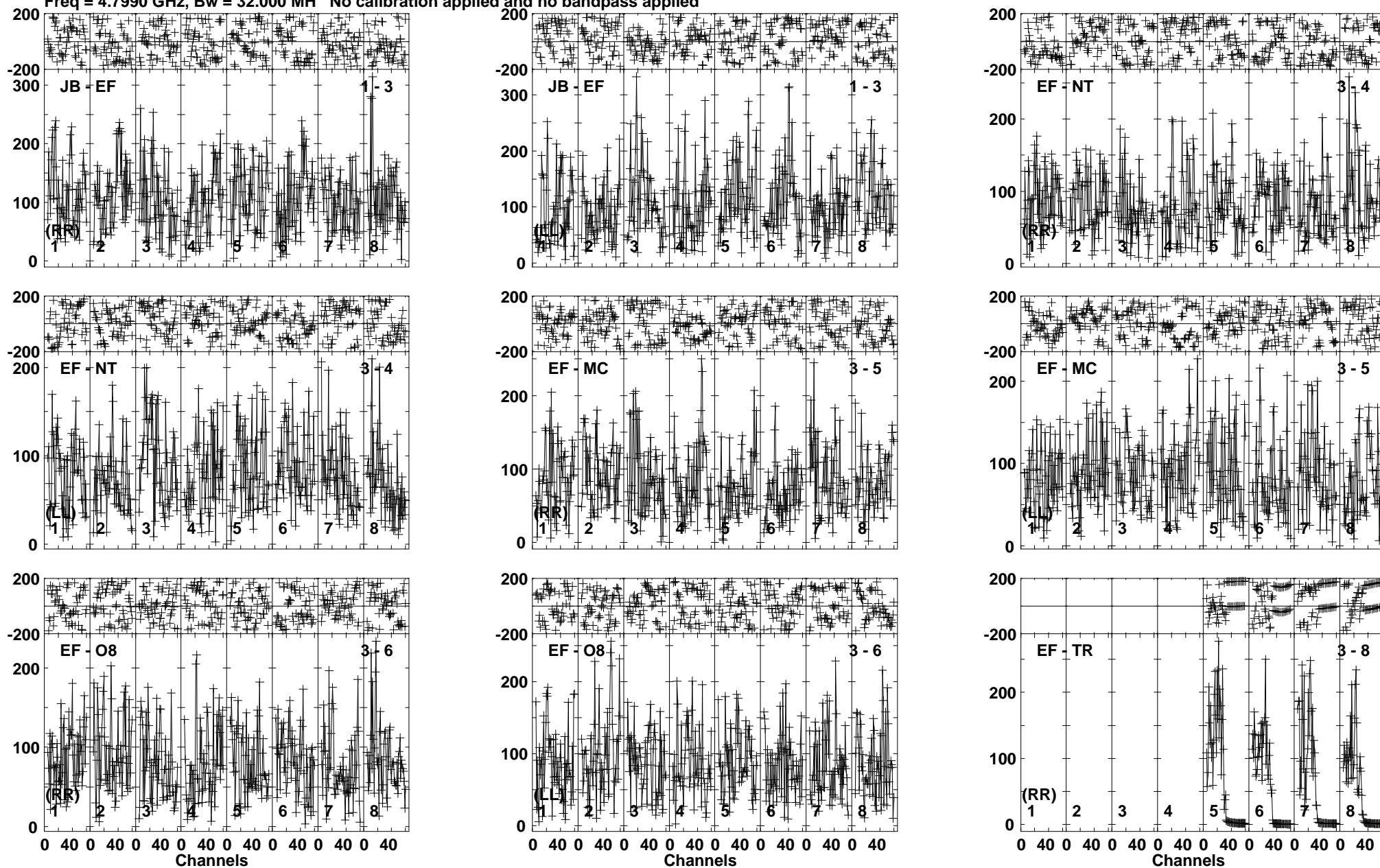

Lower frame: Micro Ampl Jy Top frame: Phas deg
Vector averaged cross-power spectrum Baseline: JB (01) - EF (03)
Timerange: 00/12:03:30 to 00/12:07:10

Plot file version 162 created 19-FEB-2019 18:13:20

IRAS23436 RP028B.UVDATA.1

Freq = 4.7990 GHz, Bw = 32.000 MH No calibration applied and no bandpass applied

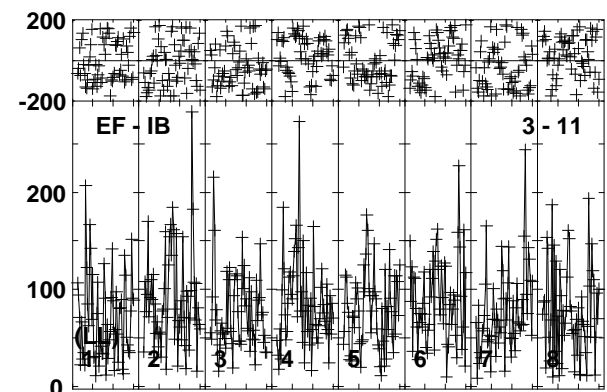
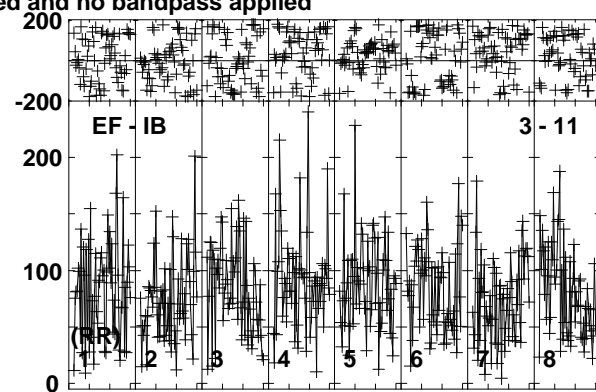
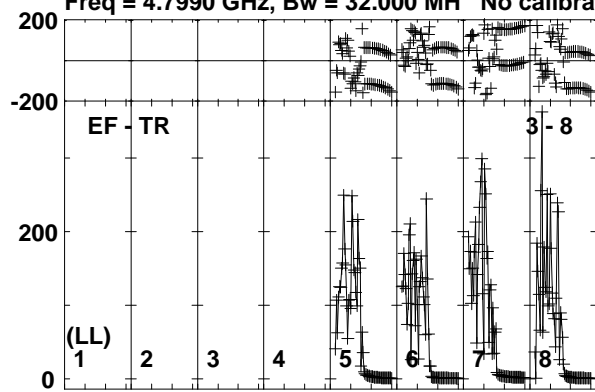

Lower frame: Micro Ampl Jy Top frame: Phas deg
Vector averaged cross-power spectrum Baseline: EF (03) - TR (08)
Timerange: 00/12:03:30 to 00/12:07:10

Plot file version 163 created 19-FEB-2019 18:13:20

J2353+5518 RP028B.UVDATA.1

Freq = 4.7990 GHz, Bw = 32.000 MH No calibration applied and no bandpass applied

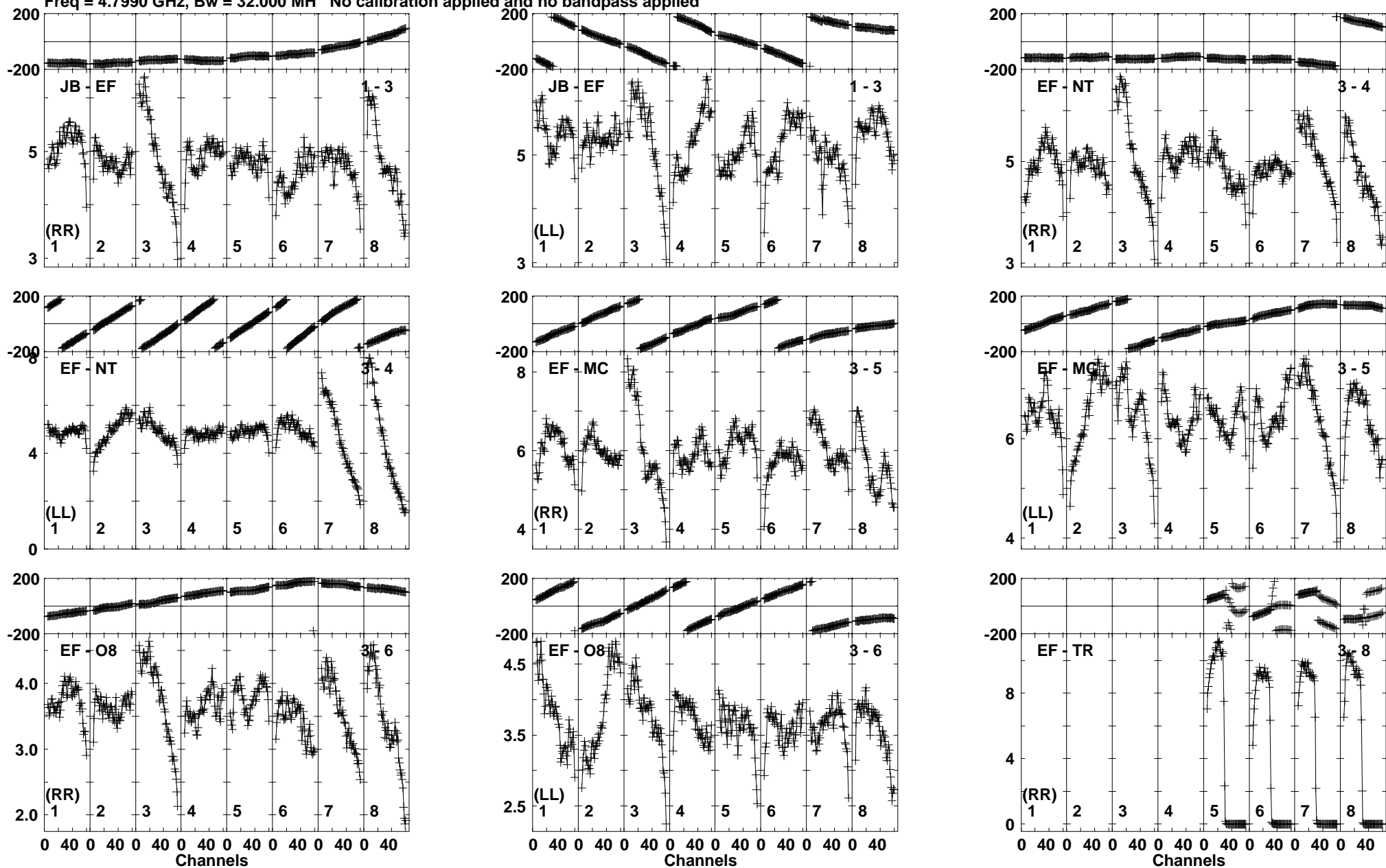

Lower frame: Milli Ampl Jy Top frame: Phas deg
Vector averaged cross-power spectrum Baseline: JB (01) - EF (03)
Timerange: 00:12:07:10 to 00:12:09:06

Plot file version 164 created 19-FEB-2019 18:13:21

J2353+5518 RP028B.UVDATA.1

Freq = 4.7990 GHz, Bw = 32.000 MH No calibration applied and no bandpass applied

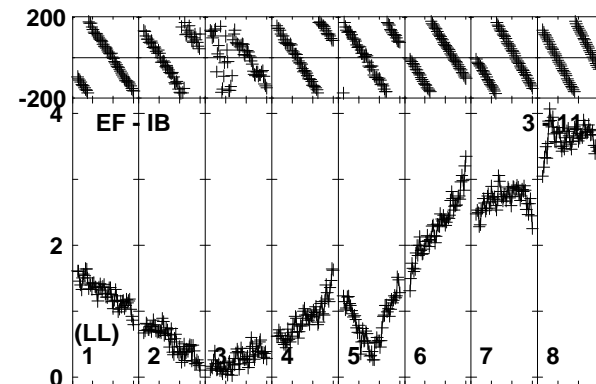
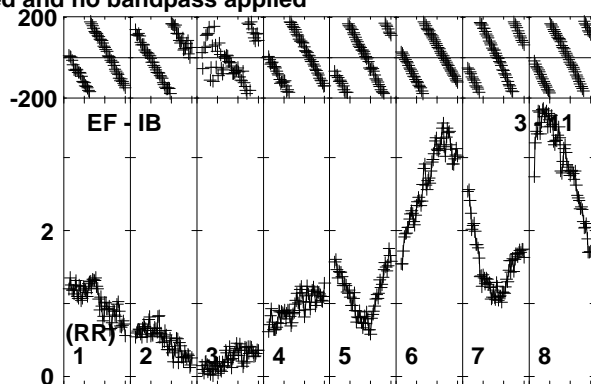
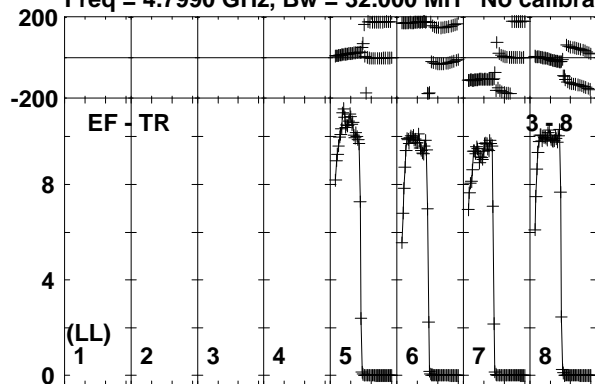

Lower frame: Milli Ampl Jy Top frame: Phas deg
Vector averaged cross-power spectrum Baseline: EF (03) - TR (08)
Timerange: 00/12:07:10 to 00/12:09:06

Plot file version 165 created 19-FEB-2019 18:13:21

J0121+1149 RP028B.UVDATA.1

Freq = 4.7990 GHz, Bw = 32.000 MH No calibration applied and no bandpass applied

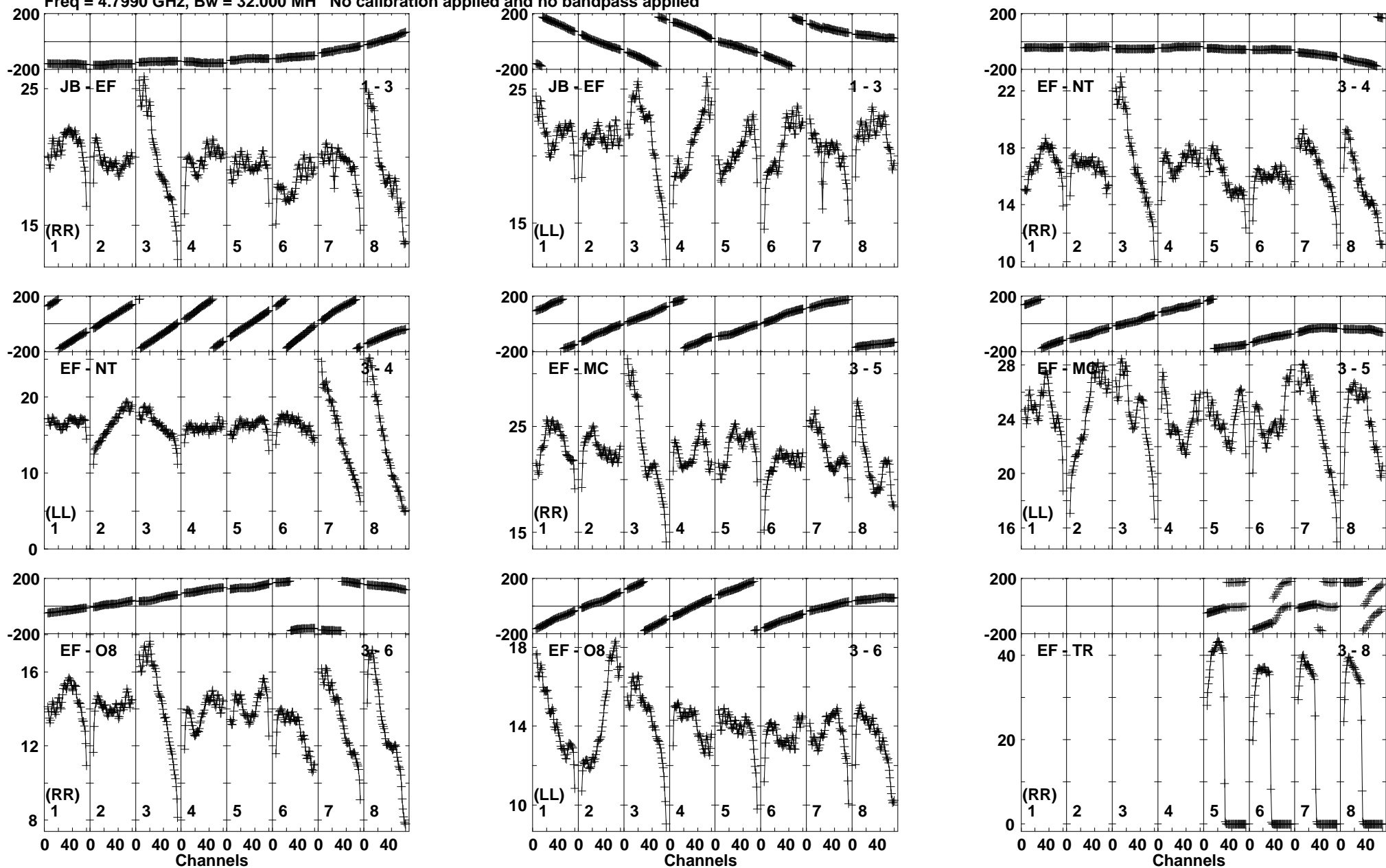

Lower frame: Milli Ampl Jy Top frame: Phas deg
Vector averaged cross-power spectrum Baseline: JB (01) - EF (03)
Timerange: 00:12:12:06 to 00:12:15:35

Plot file version 166 created 19-FEB-2019 18:13:21

J0121+1149 RP028B.UVDATA.1

Freq = 4.7990 GHz, Bw = 32.000 MH No calibration applied and no bandpass applied

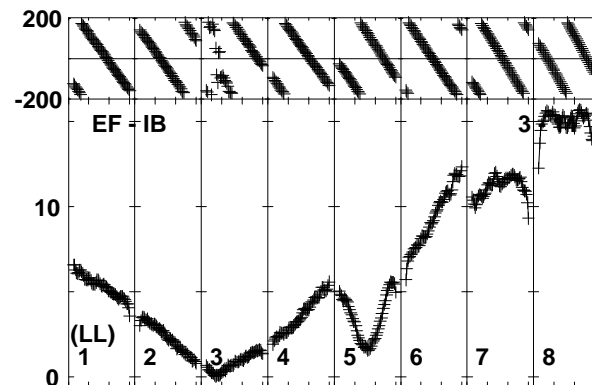
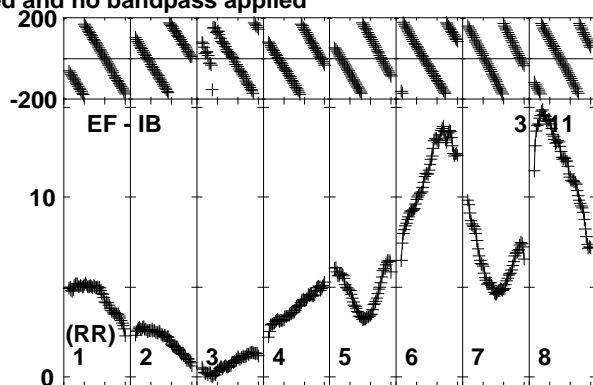
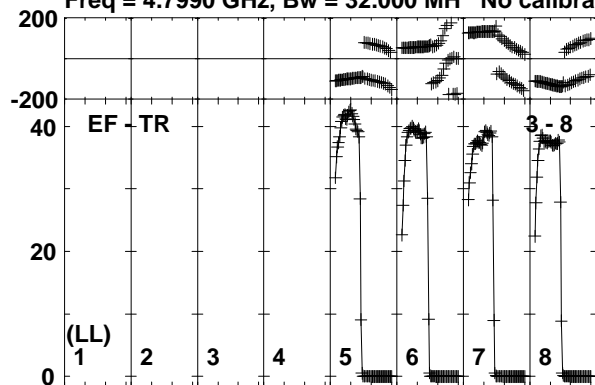

Lower frame: Milli Ampl Jy Top frame: Phas deg
Vector averaged cross-power spectrum Baseline: EF (03) - TR (08)
Timerange: 00/12:12:06 to 00/12:15:35

Plot file version 167 created 19-FEB-2019 18:13:22

J2353+5518 RP028B.UVDATA.1

Freq = 4.7990 GHz, Bw = 32.000 MH No calibration applied and no bandpass applied

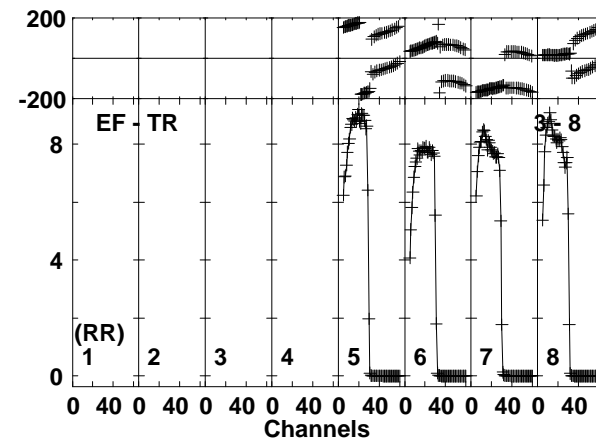
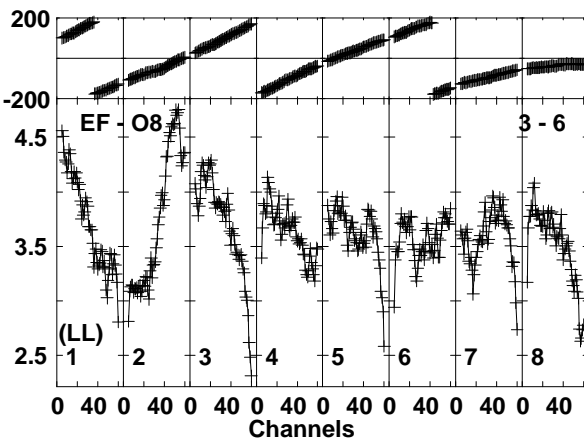
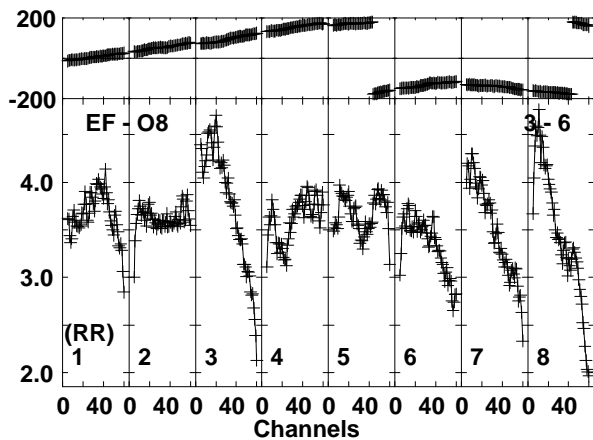
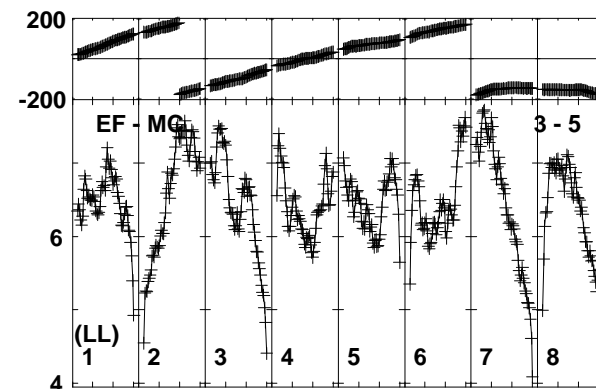
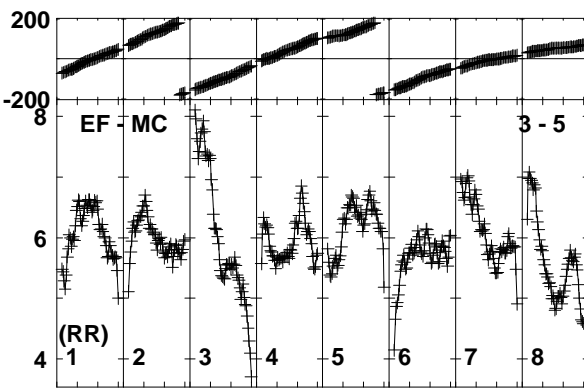
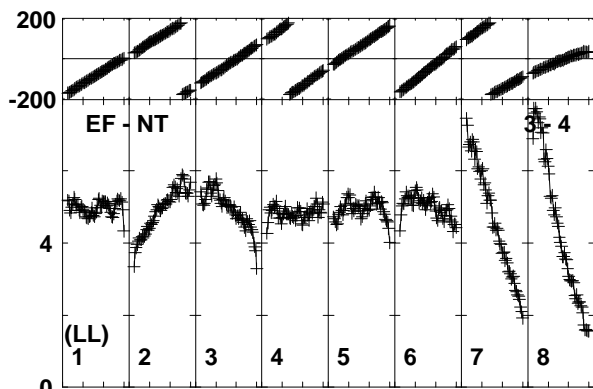
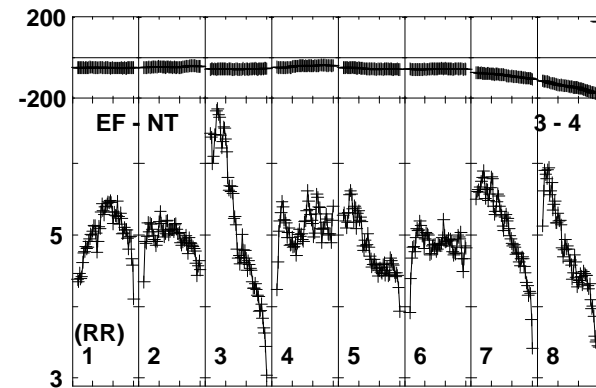
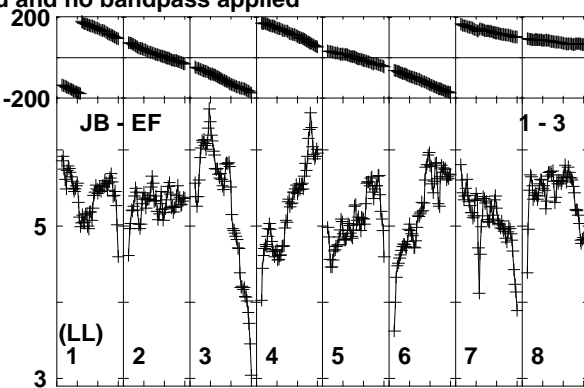
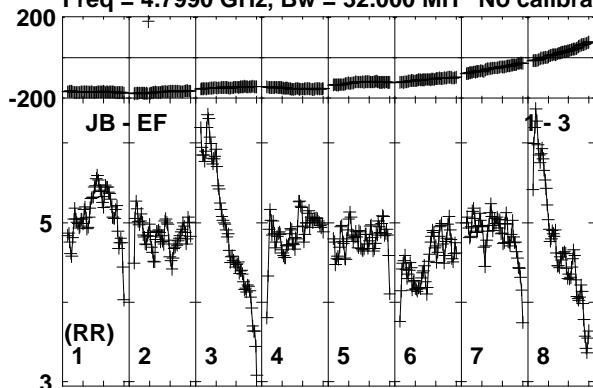

Lower frame: Milli Ampl Jy Top frame: Phas deg
Vector averaged cross-power spectrum Baseline: JB (01) - EF (03)
Timerange: 00:12:19:56 to 00:12:21:29

Plot file version 168 created 19-FEB-2019 18:13:22

J2353+5518 RP028B.UVDATA.1

Freq = 4.7990 GHz, Bw = 32.000 MH No calibration applied and no bandpass applied

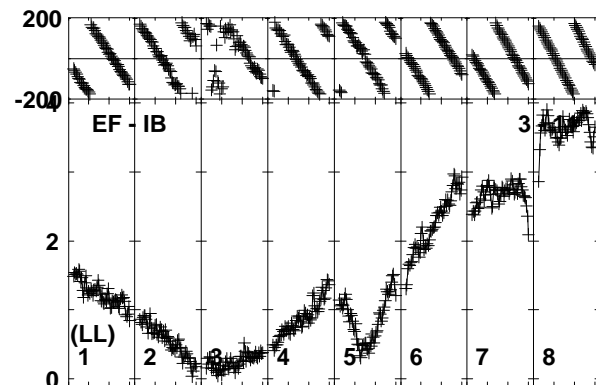
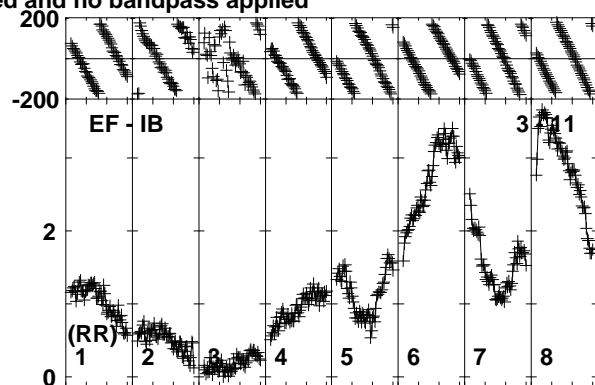
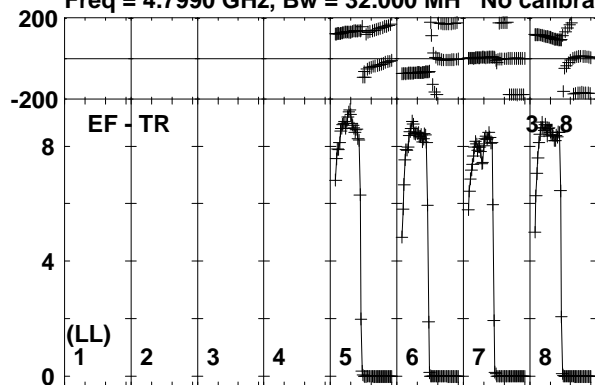

Lower frame: Milli Ampl Jy Top frame: Phas deg
Vector averaged cross-power spectrum Baseline: EF (03) - TR (08)
Timerange: 00/12:19:56 to 00/12:21:29

Plot file version 169 created 19-FEB-2019 18:13:22

IRAS23436 RP028B.UVDATA.1

Freq = 4.7990 GHz, Bw = 32.000 MH No calibration applied and no bandpass applied

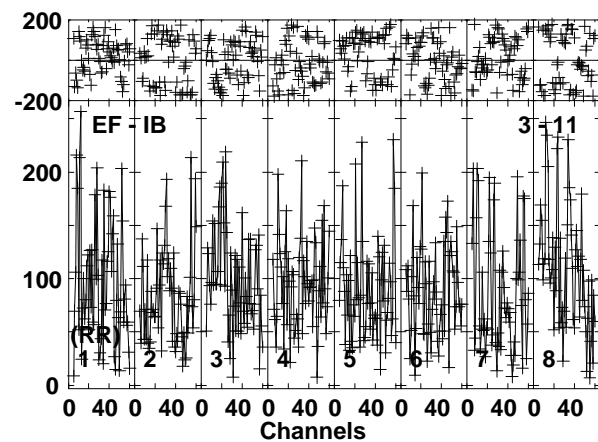
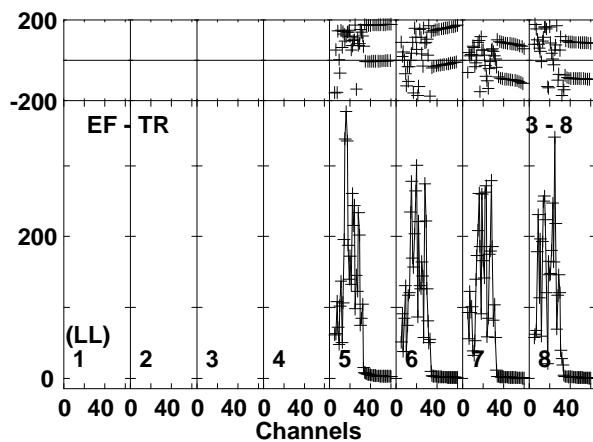
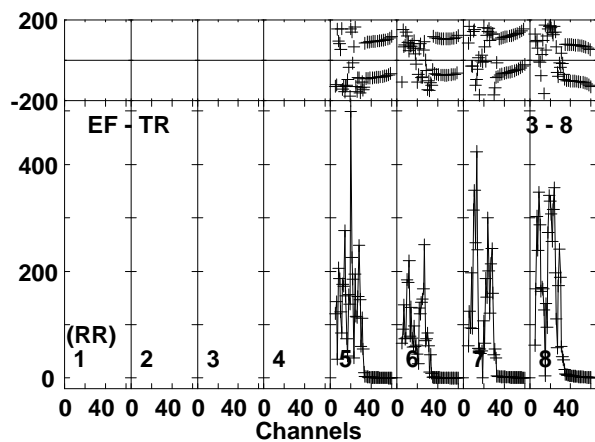
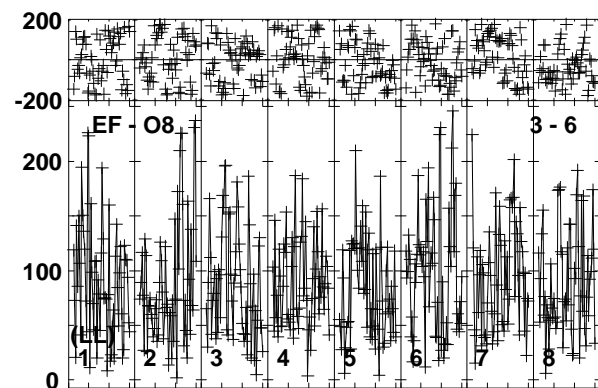
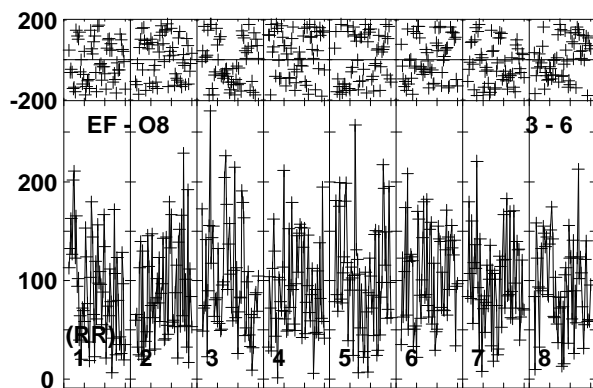
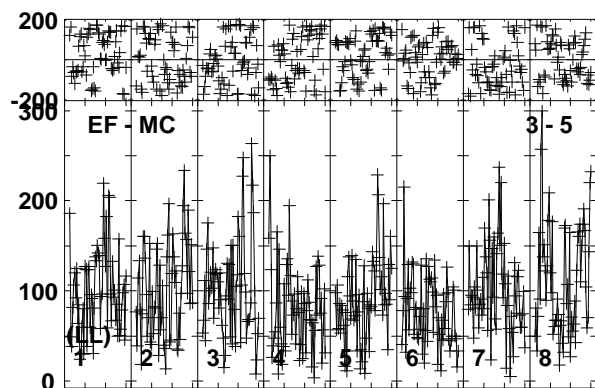
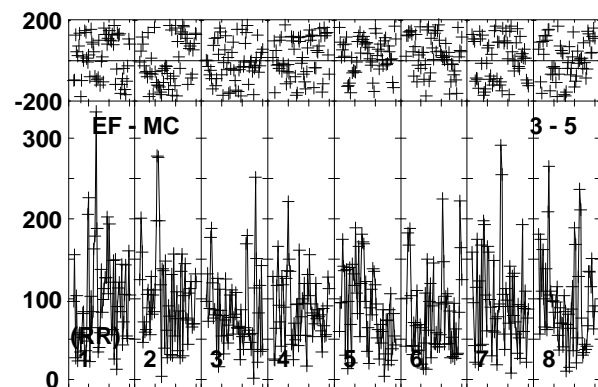
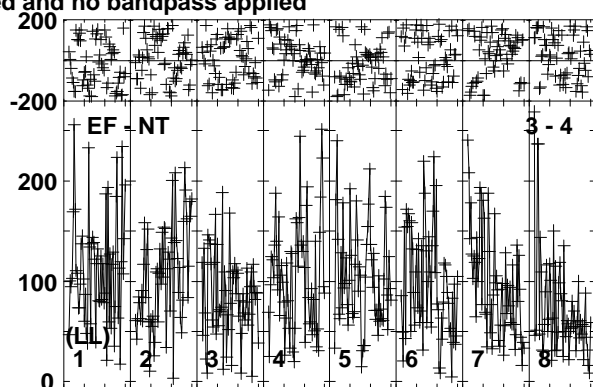
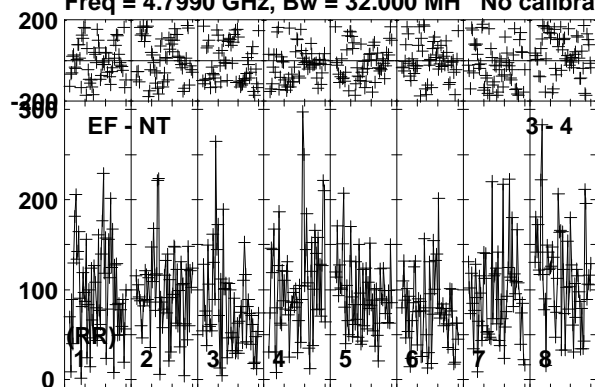

Lower frame: Micro Ampl Jy Top frame: Phas deg
Vector averaged cross-power spectrum Baseline: EF (03) - NT (04)
Timerange: 00/12:21:30 to 00/12:24:39

Plot file version 170 created 19-FEB-2019 18:13:22
IRAS23436 RP028B.UVDATA.1
Freq = 4.7990 GHz, Bw = 32.000 MH No calibration applied and no bandpass applied

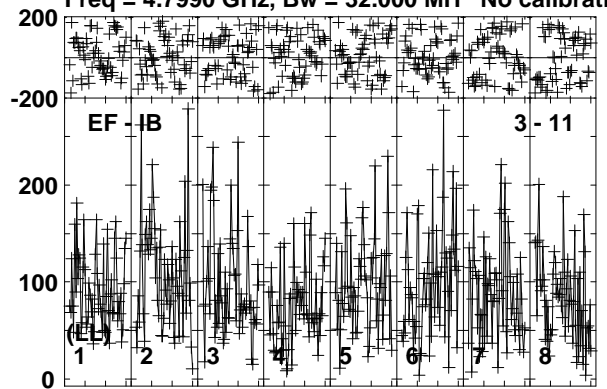

Lower frame: Micro Ampl Jy Top frame: Phas deg
Vector averaged cross-power spectrum Baseline: EF (03) - IB (11)
Timerange: 00/12:21:30 to 00/12:24:39

Plot file version 171 created 19-FEB-2019 18:13:22

J2353+5518 RP028B.UVDATA.1

Freq = 4.7990 GHz, Bw = 32.000 MH No calibration applied and no bandpass applied

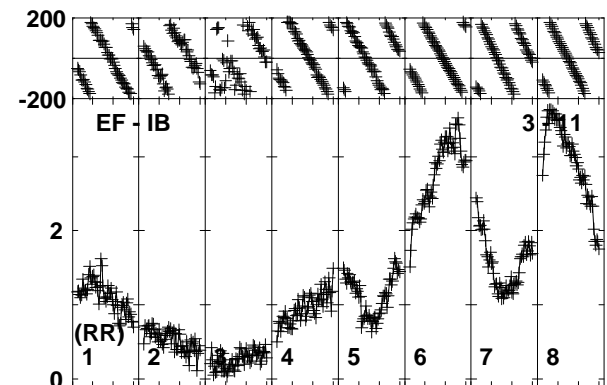
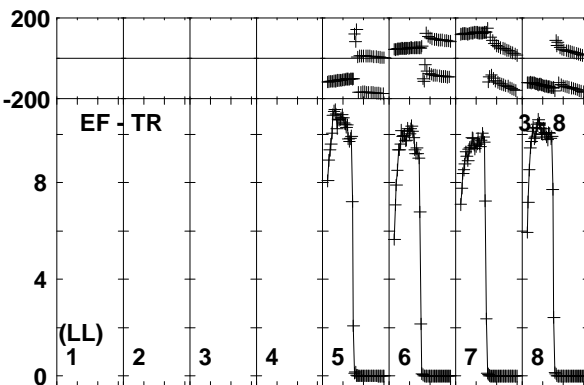
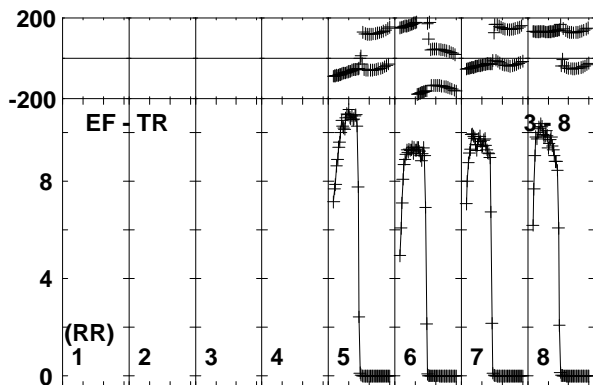
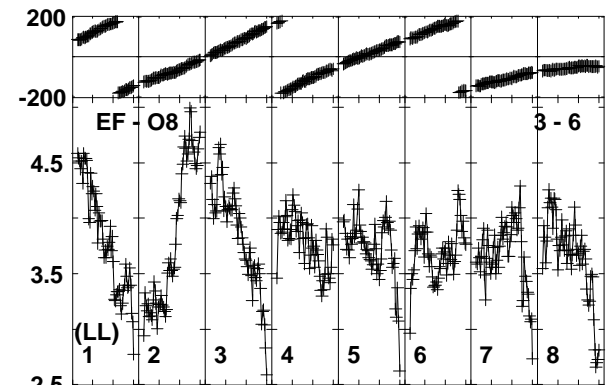
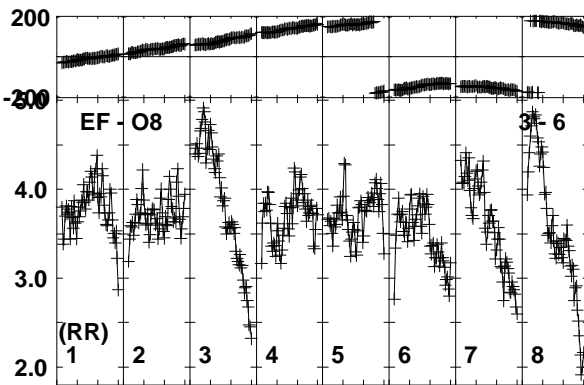
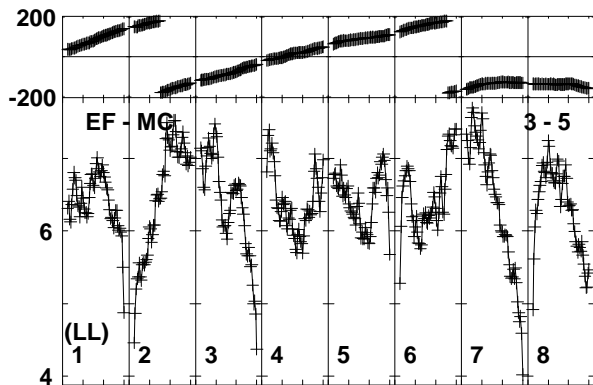
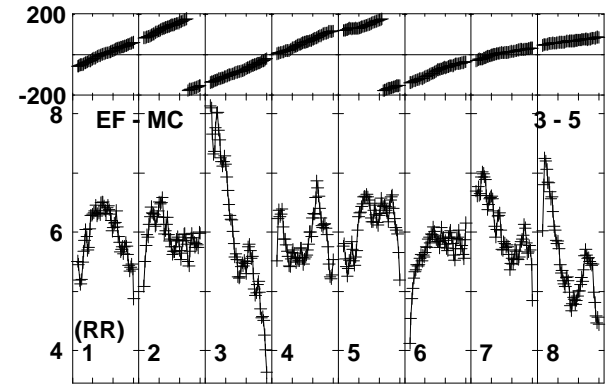
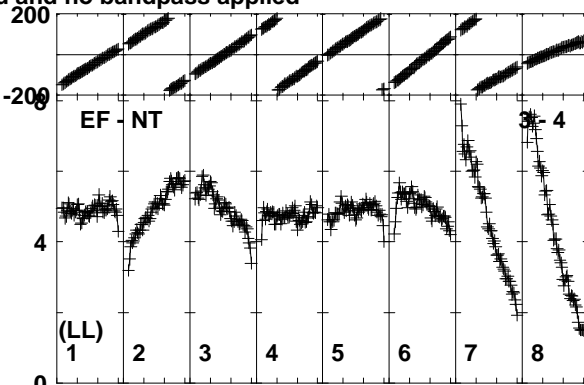
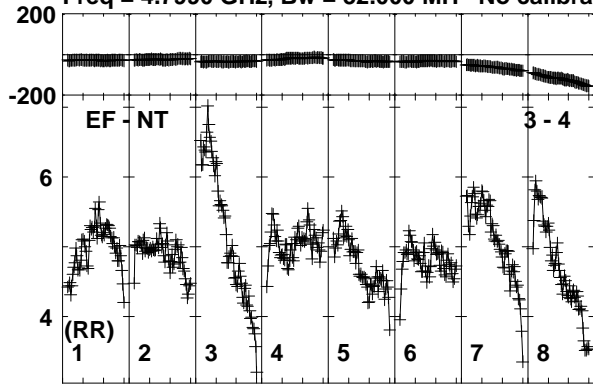

Lower frame: Milli Ampl Jy Top frame: Phas deg
Vector averaged cross-power spectrum Baseline: EF (03) - NT (04)
Timerange: 00:12:24:40 to 00:12:26:39

Plot file version 172 created 19-FEB-2019 18:13:22
J2353+5518 RP028B.UVDATA.1
Freq = 4.7990 GHz, Bw = 32.000 MH No calibration applied and no bandpass applied

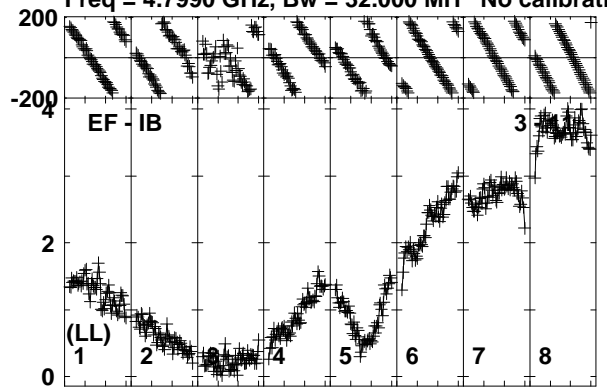

Lower frame: Milli Ampl Jy Top frame: Phas deg
Vector averaged cross-power spectrum Baseline: EF (03) - IB (11)
Timerange: 00/12:24:40 to 00/12:26:39

Plot file version 173 created 19-FEB-2019 18:13:22

IRAS23436 RP028B.UVDATA.1

Freq = 4.7990 GHz, Bw = 32.000 MH No calibration applied and no bandpass applied

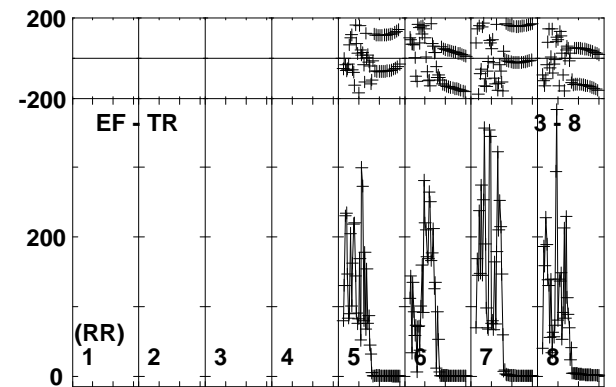
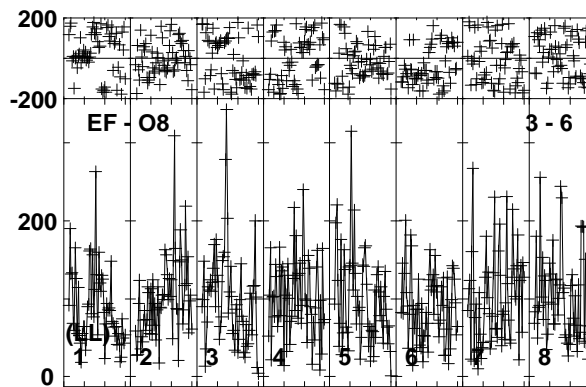
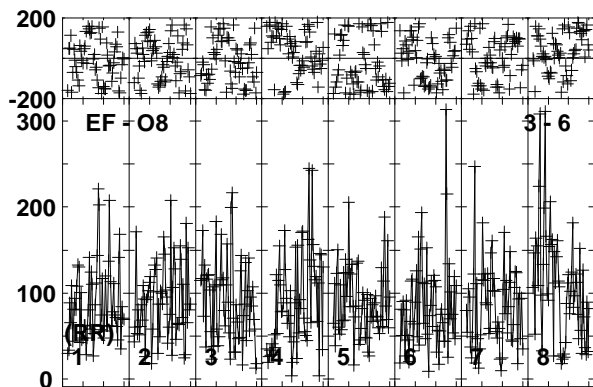
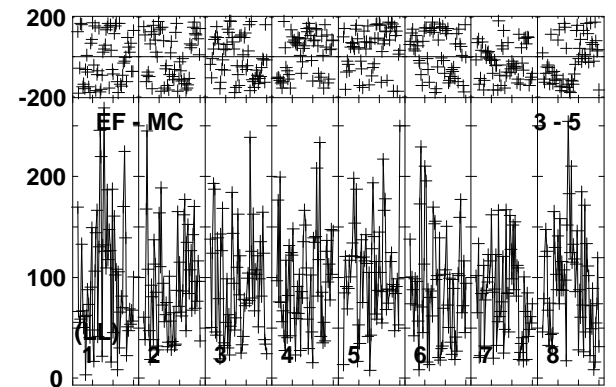
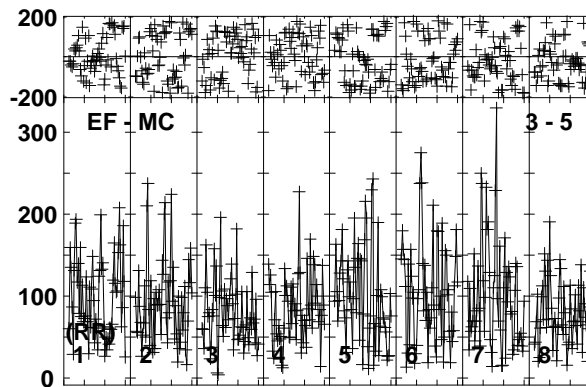
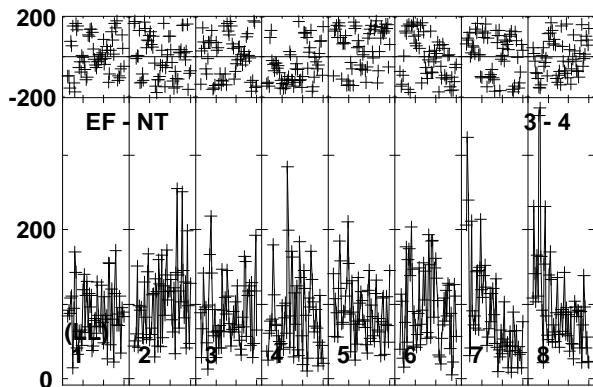
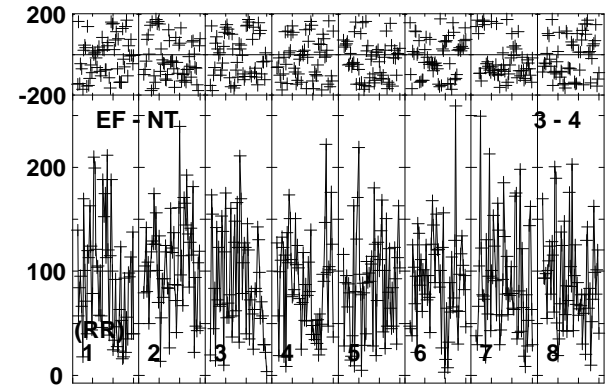
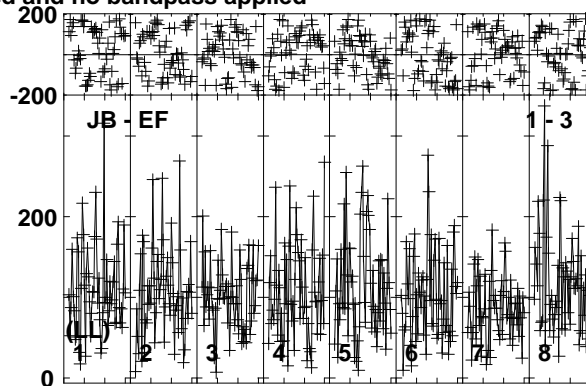
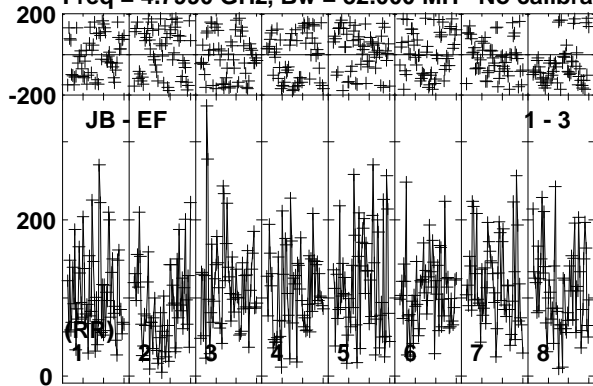

Lower frame: Micro Ampl Jy Top frame: Phas deg
Vector averaged cross-power spectrum Baseline: JB (01) - EF (03)
Timerange: 00/12:26:40 to 00/12:29:53

Plot file version 174 created 19-FEB-2019 18:13:23

IRAS23436 RP028B.UVDATA.1

Freq = 4.7990 GHz, Bw = 32.000 MH No calibration applied and no bandpass applied

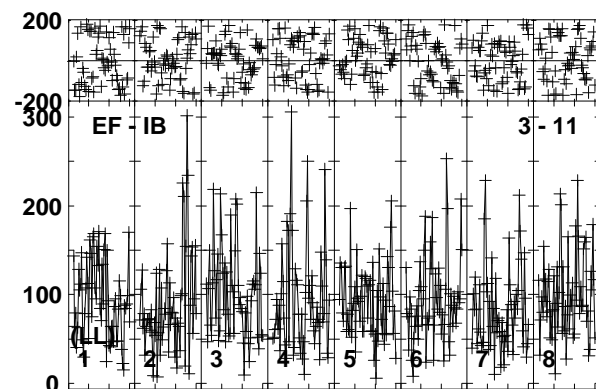
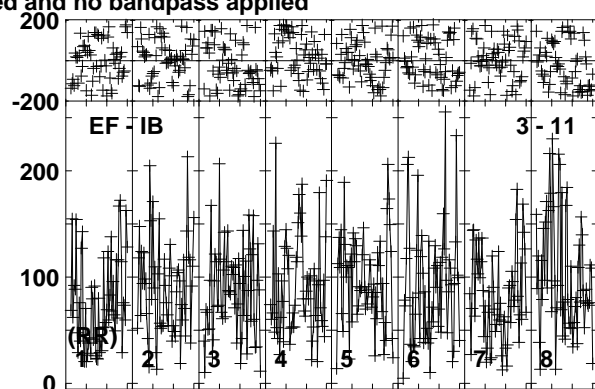
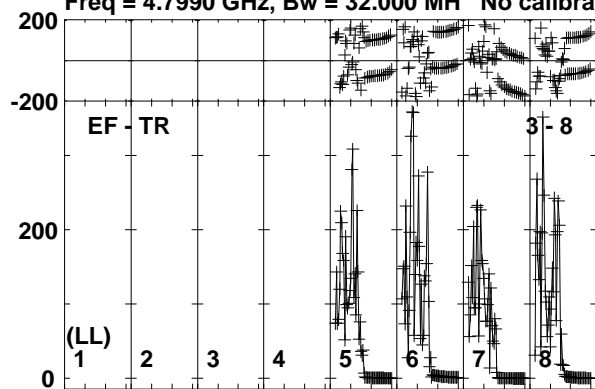

Lower frame: Micro Ampl Jy Top frame: Phas deg
Vector averaged cross-power spectrum Baseline: EF (03) - TR (08)
Timerange: 00/12:26:40 to 00/12:29:53

Plot file version 175 created 19-FEB-2019 18:13:23

J2353+5518 RP028B.UVDATA.1

Freq = 4.7990 GHz, Bw = 32.000 MH No calibration applied and no bandpass applied

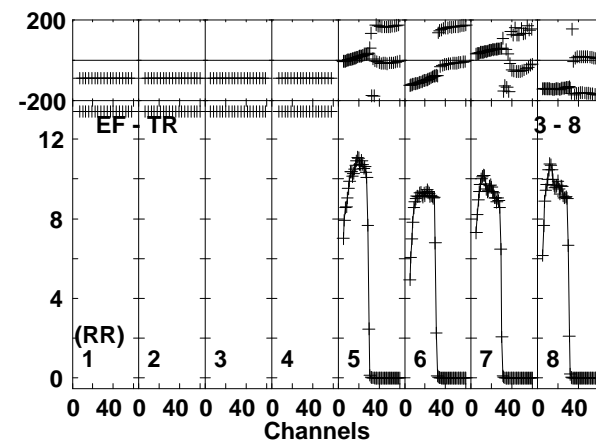
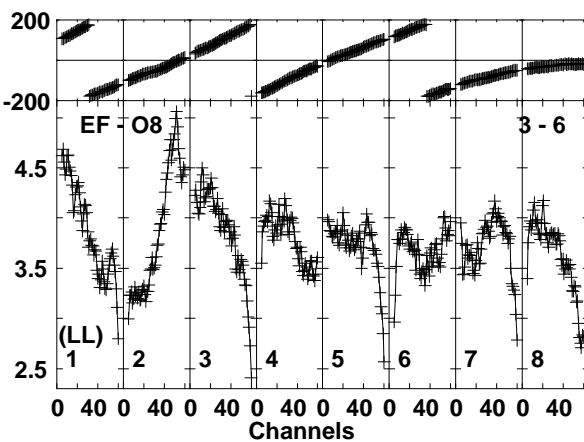
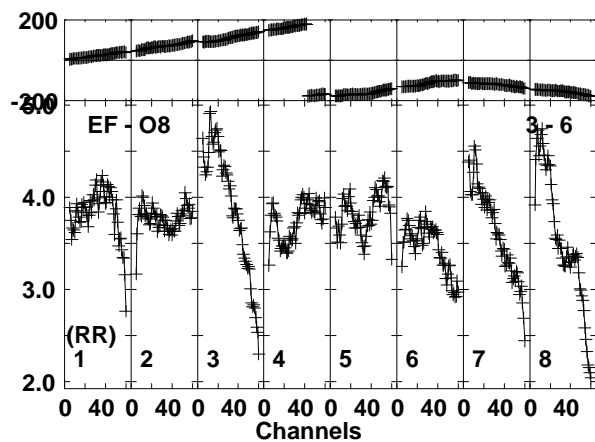
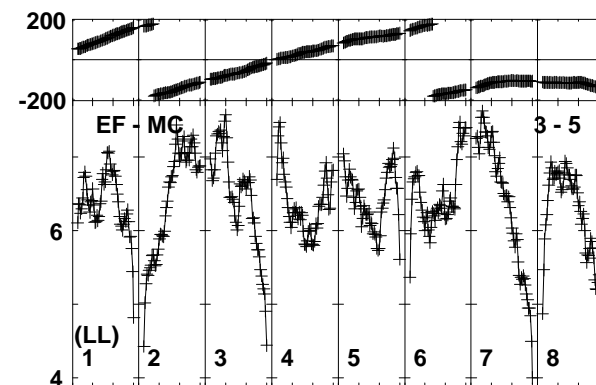
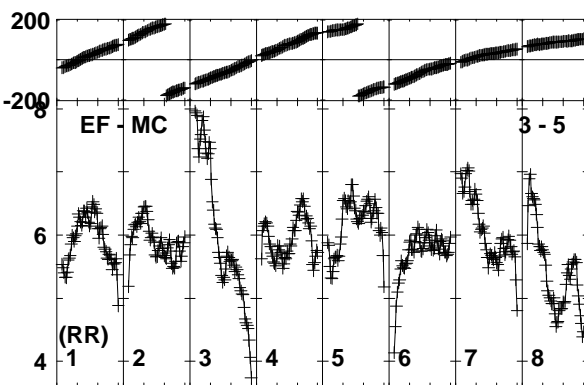
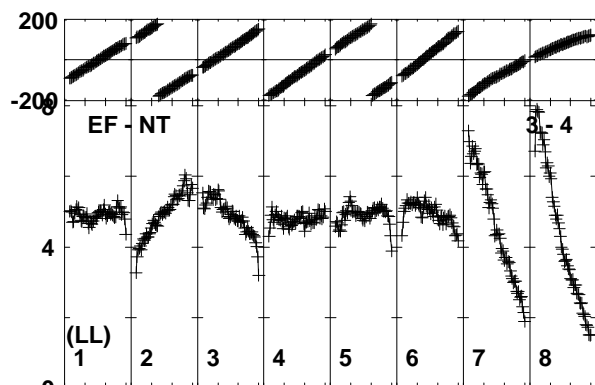
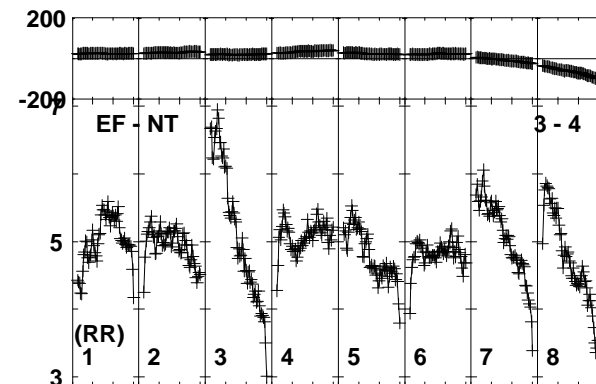
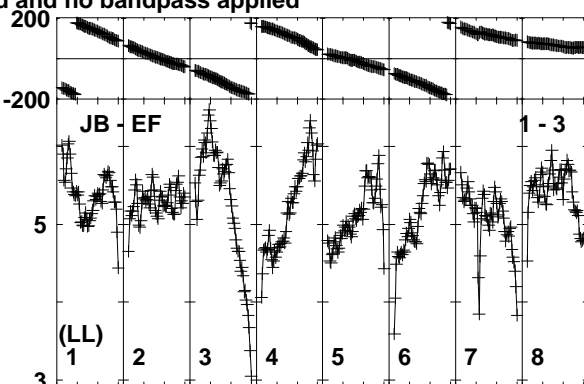
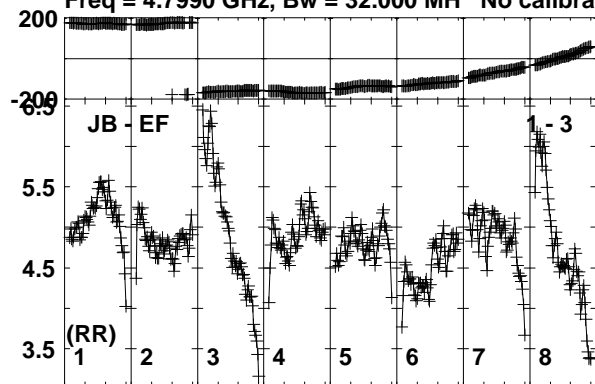

Lower frame: Milli Ampl Jy Top frame: Phas deg
Vector averaged cross-power spectrum Baseline: JB (01) - EF (03)
Timerange: 00:12:30:44 to 00:12:32:33

Plot file version 176 created 19-FEB-2019 18:13:23

J2353+5518 RP028B.UVDATA.1

Freq = 4.7990 GHz, Bw = 32.000 MH No calibration applied and no bandpass applied

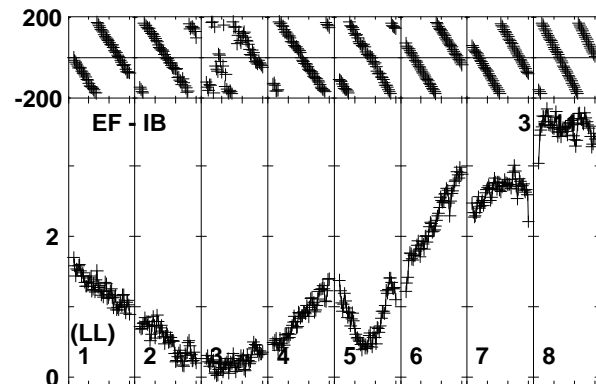
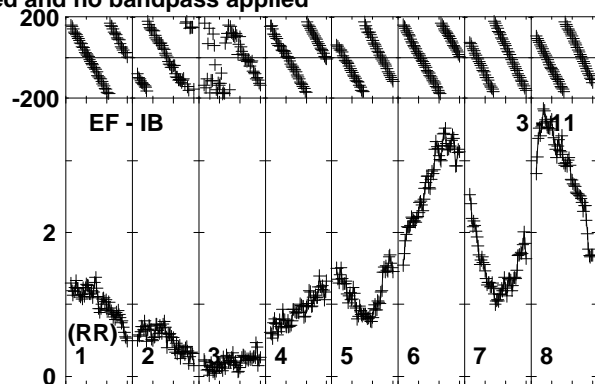
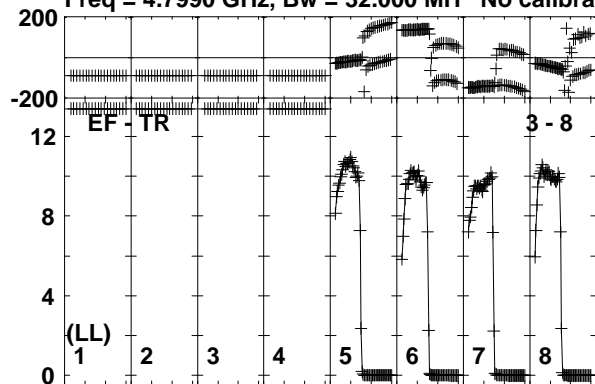

Lower frame: Milli Ampl Jy Top frame: Phas deg
Vector averaged cross-power spectrum Baseline: EF (03) - TR (08)
Timerange: 00/12:30:44 to 00/12:32:33

Plot file version 177 created 19-FEB-2019 18:13:23

IRAS23436 RP028B.UVDATA.1

Freq = 4.7990 GHz, Bw = 32.000 MH No calibration applied and no bandpass applied

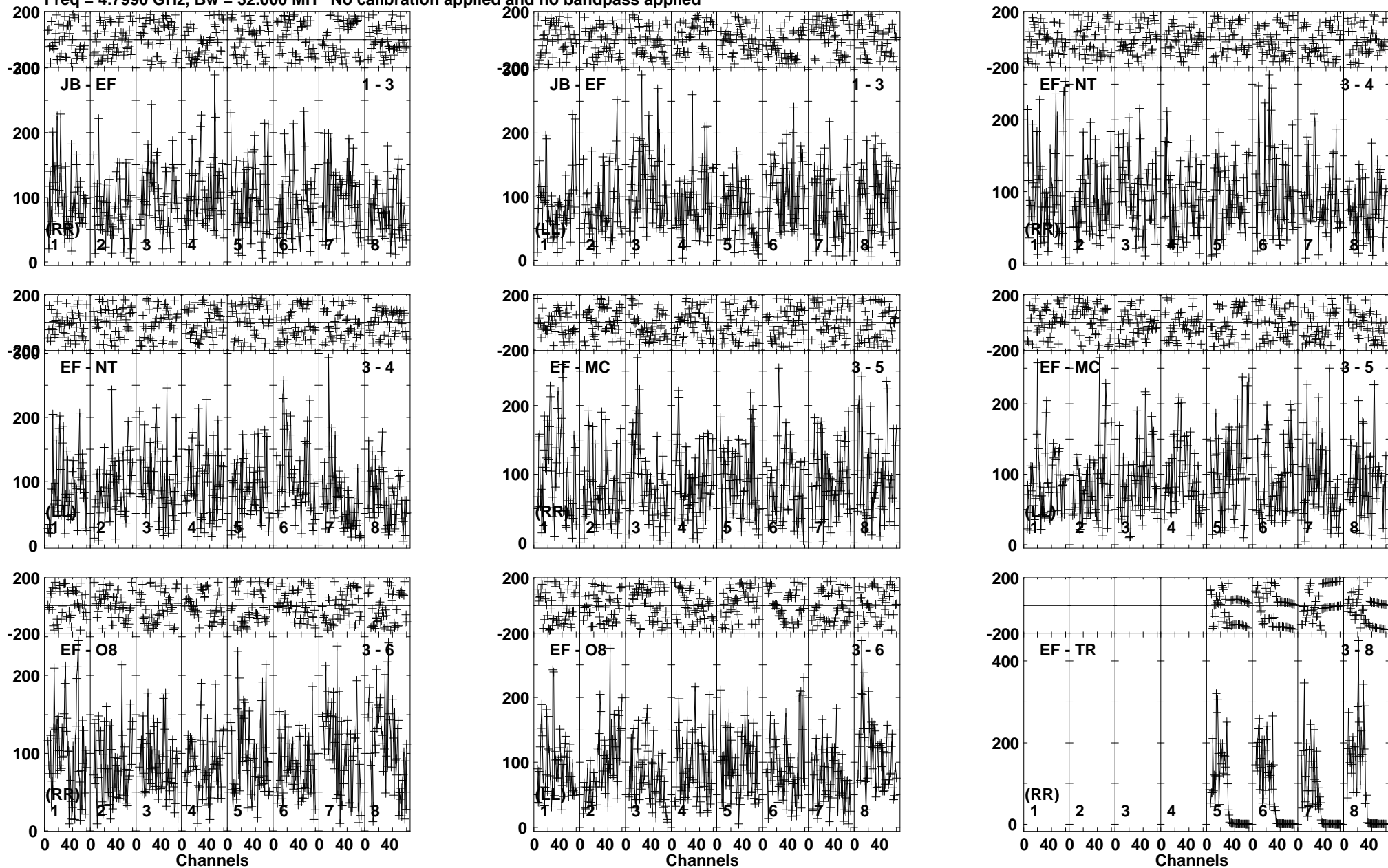

Lower frame: Micro Ampl Jy Top frame: Phas deg
Vector averaged cross-power spectrum Baseline: JB (01) - EF (03)
Timerange: 00:12:32:34 to 00:12:35:47

Plot file version 178 created 19-FEB-2019 18:13:24

IRAS23436 RP028B.UVDATA.1

Freq = 4.7990 GHz, Bw = 32.000 MH No calibration applied and no bandpass applied

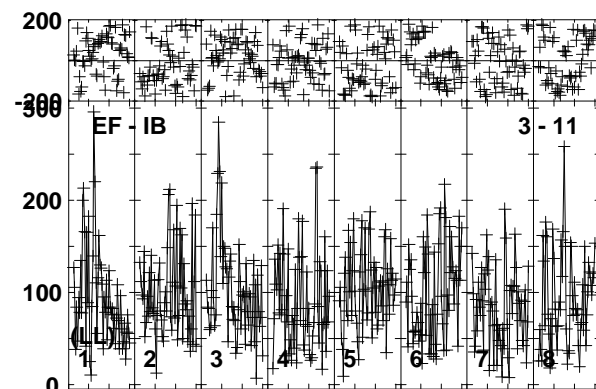
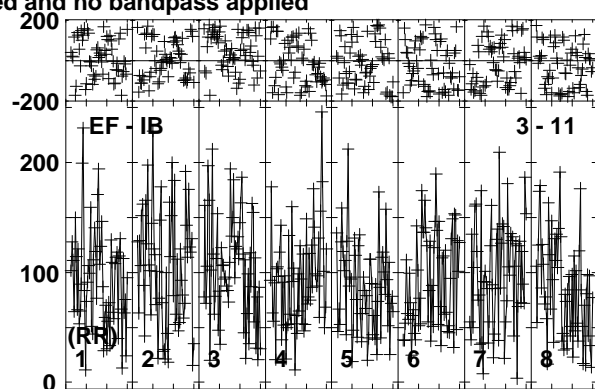
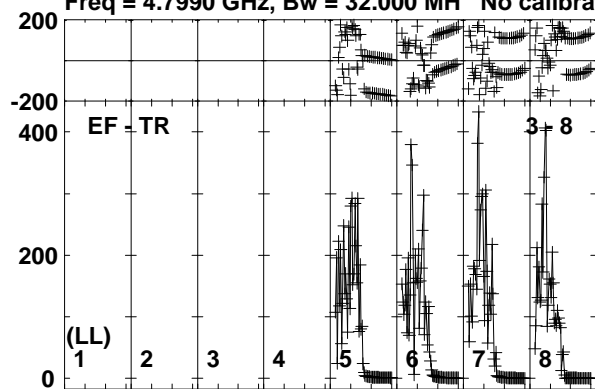

Lower frame: Micro Ampl Jy Top frame: Phas deg
Vector averaged cross-power spectrum Baseline: EF (03) - TR (08)
Timerange: 00/12:32:34 to 00/12:35:47

Plot file version 179 created 19-FEB-2019 18:13:24

J2353+5518 RP028B.UVDATA.1

Freq = 4.7990 GHz, Bw = 32.000 MH No calibration applied and no bandpass applied

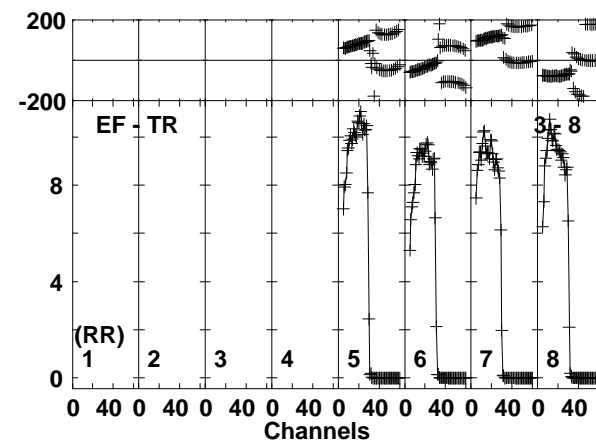
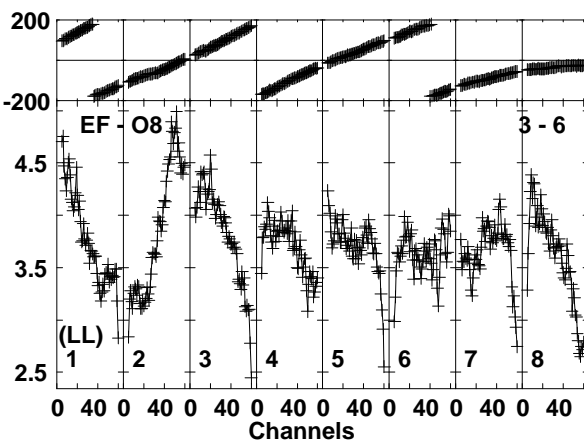
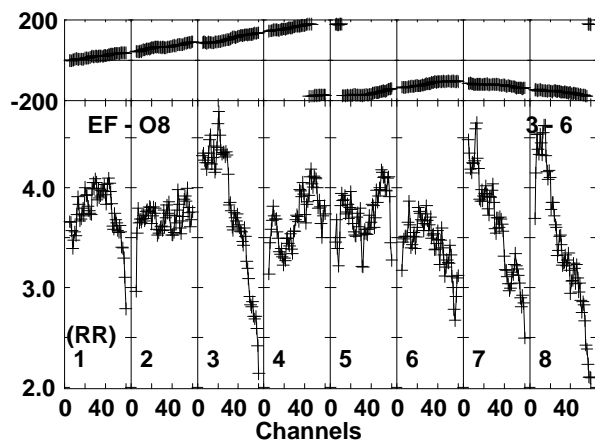
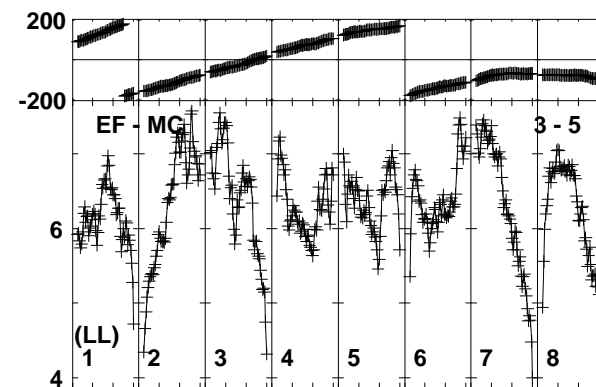
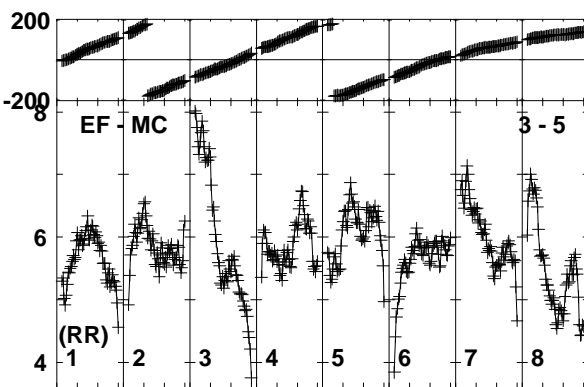
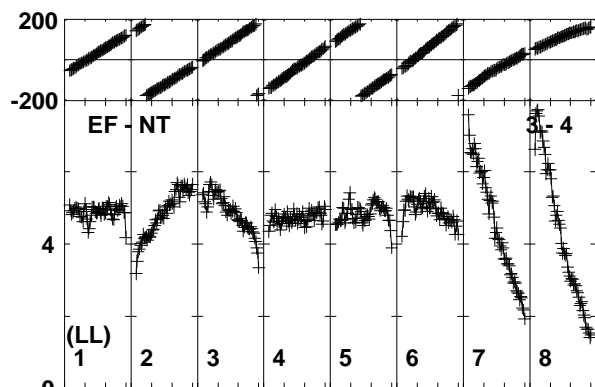
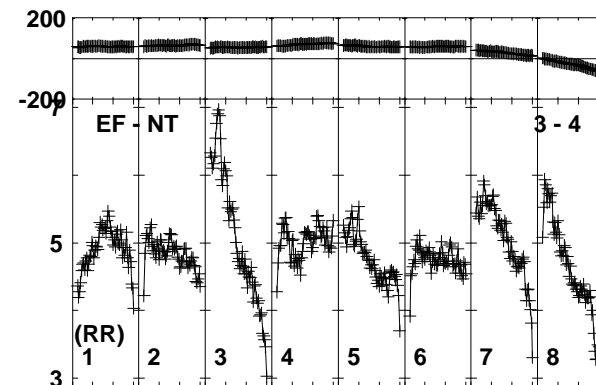
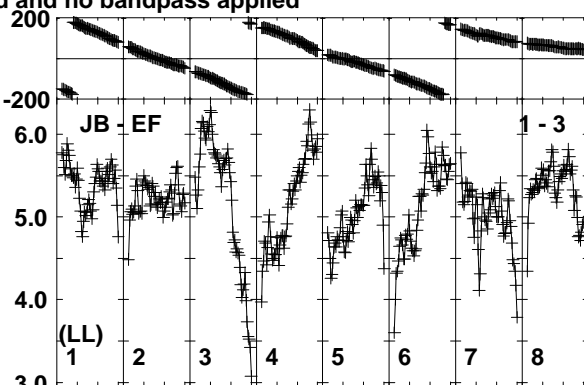
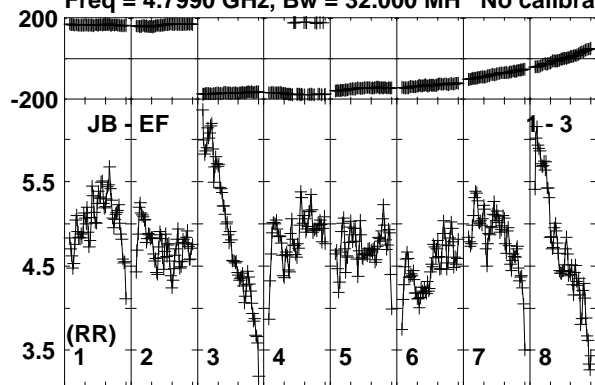

Lower frame: Milli Ampl Jy Top frame: Phas deg
Vector averaged cross-power spectrum Baseline: JB (01) - EF (03)
Timerange: 00:12:35:49 to 00:12:37:48

Plot file version 180 created 19-FEB-2019 18:13:24

J2353+5518 RP028B.UVDATA.1

Freq = 4.7990 GHz, Bw = 32.000 MH No calibration applied and no bandpass applied

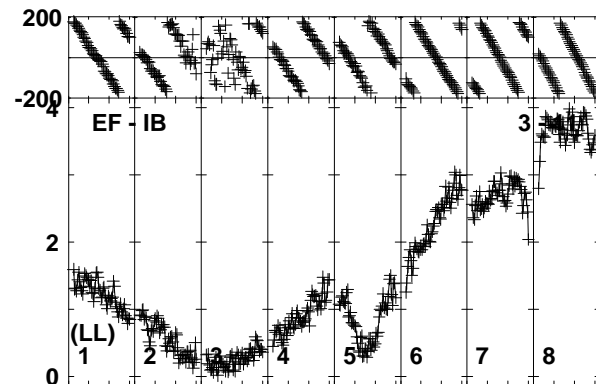
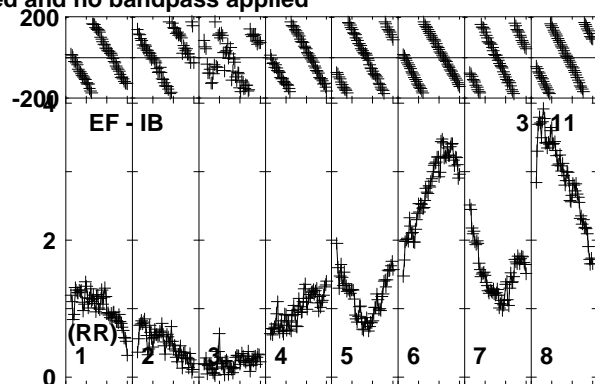
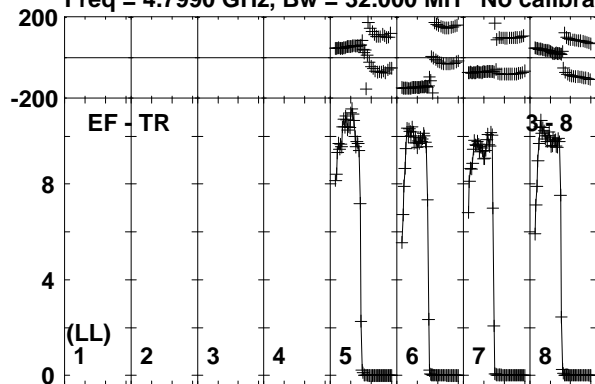

Lower frame: Milli Ampl Jy Top frame: Phas deg
Vector averaged cross-power spectrum Baseline: EF (03) - TR (08)
Timerange: 00/12:35:49 to 00/12:37:48

Plot file version 181 created 19-FEB-2019 18:13:24

IRAS23436 RP028B.UVDATA.1

Freq = 4.7990 GHz, Bw = 32.000 MH No calibration applied and no bandpass applied

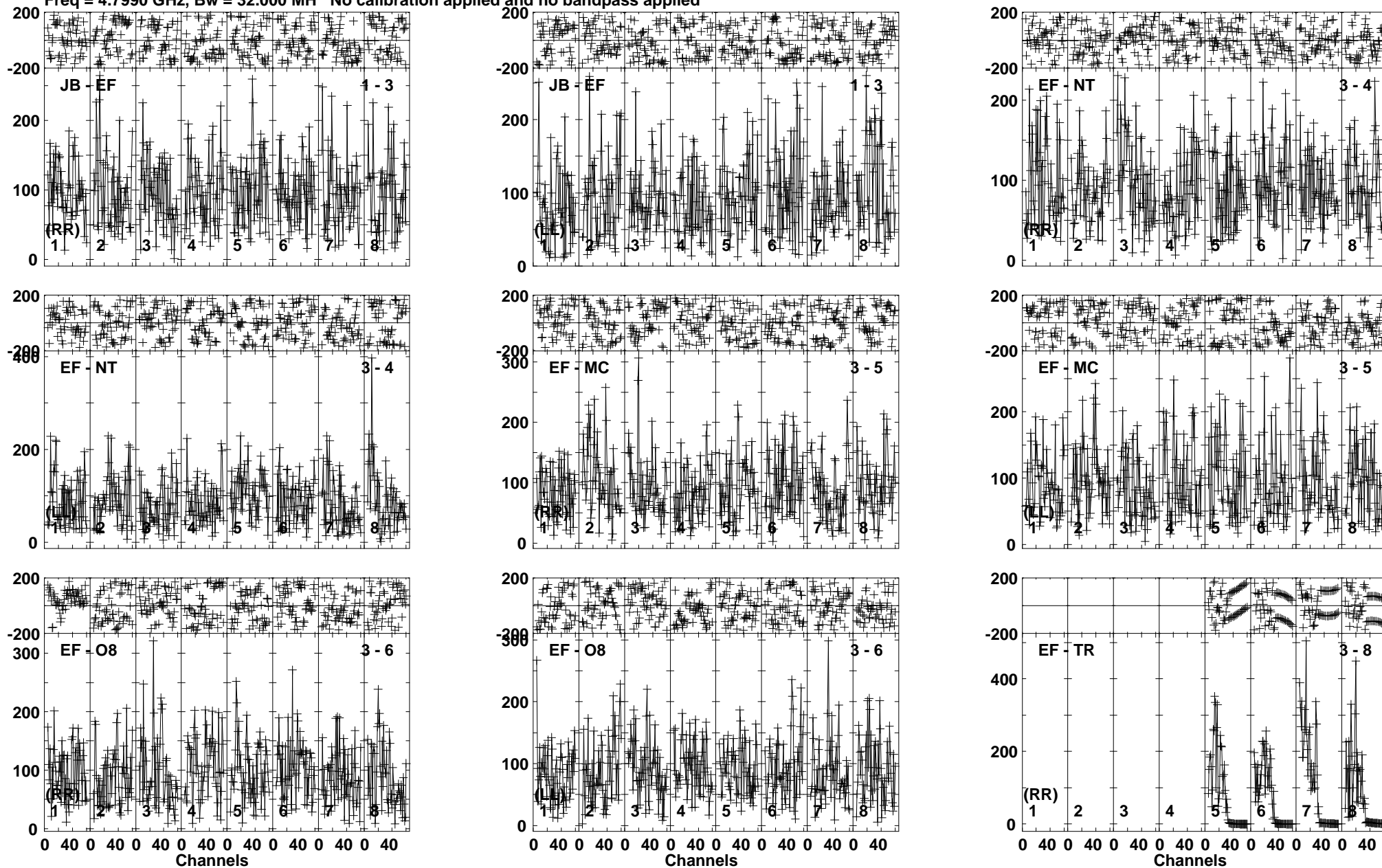

Lower frame: Micro Ampl Jy Top frame: Phas deg
Vector averaged cross-power spectrum Baseline: JB (01) - EF (03)
Timerange: 00:12:37:49 to 00:12:41:02

Plot file version 182 created 19-FEB-2019 18:13:24

IRAS23436 RP028B.UVDATA.1

Freq = 4.7990 GHz, Bw = 32.000 MH No calibration applied and no bandpass applied

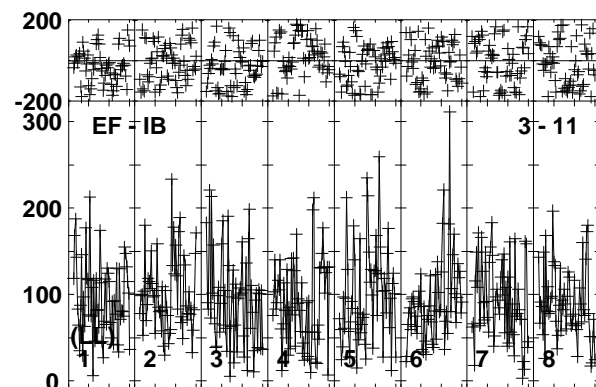
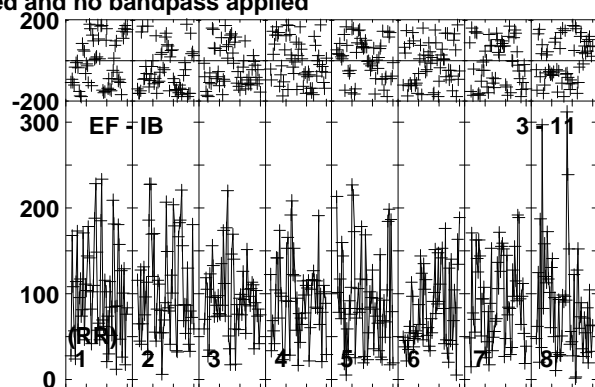
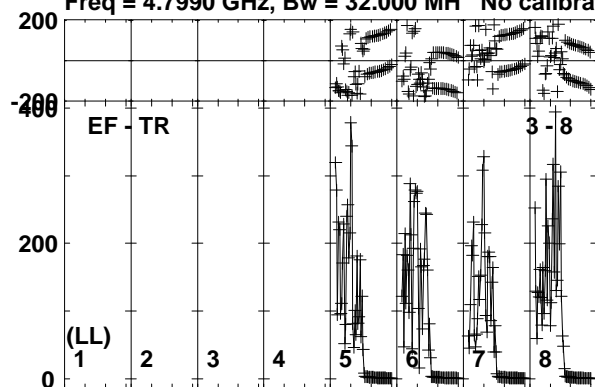

Lower frame: Micro Ampl Jy Top frame: Phas deg
Vector averaged cross-power spectrum Baseline: EF (03) - TR (08)
Timerange: 00/12:37:49 to 00/12:41:02

Plot file version 183 created 19-FEB-2019 18:13:24

J2353+5518 RP028B.UVDATA.1

Freq = 4.7990 GHz, Bw = 32.000 MH No calibration applied and no bandpass applied

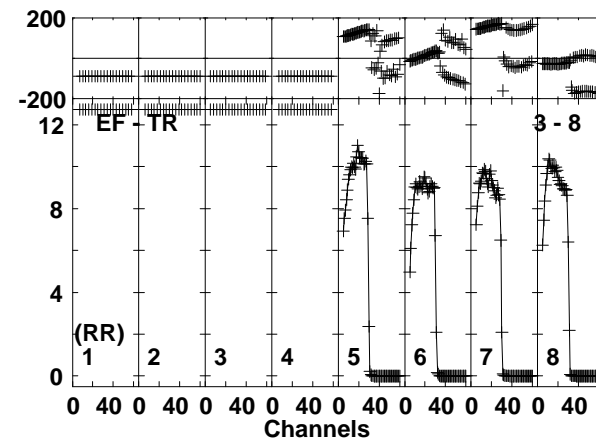
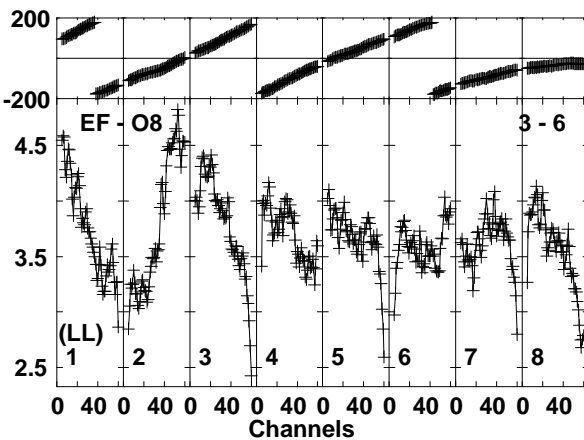
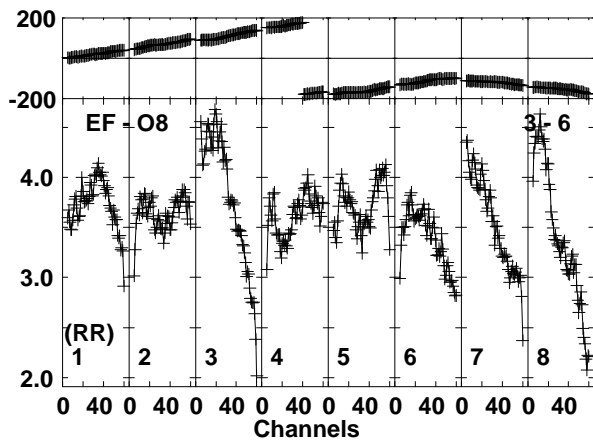
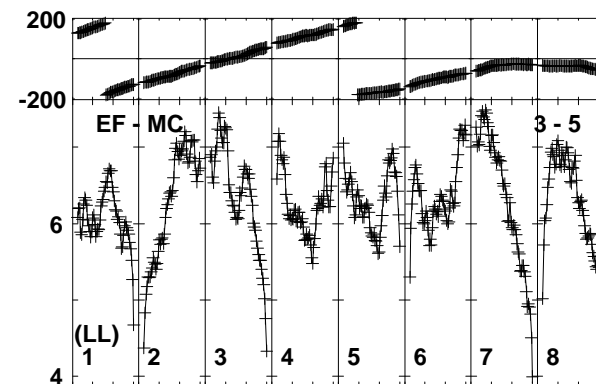
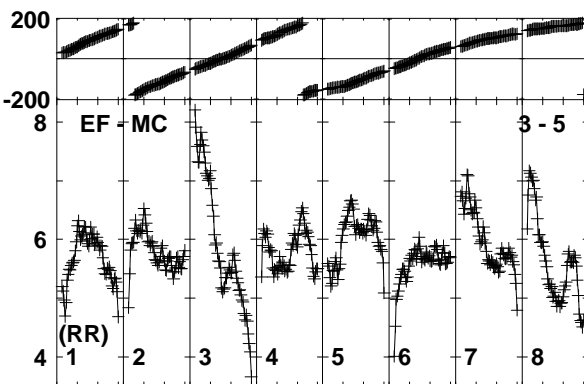
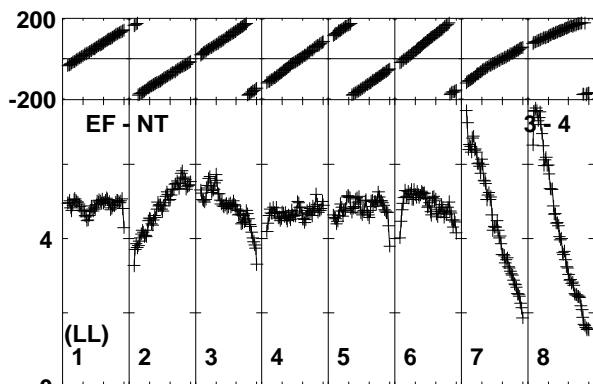
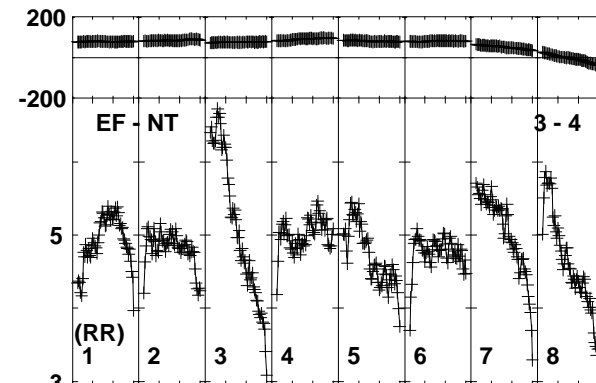
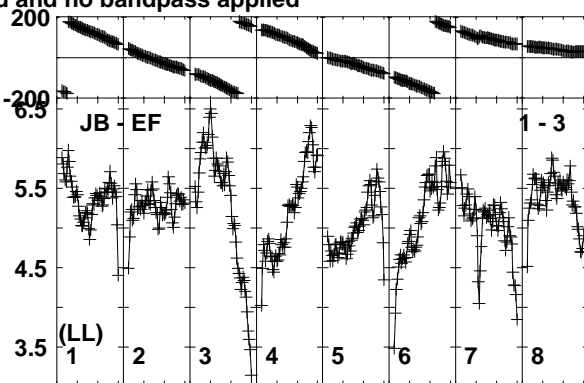
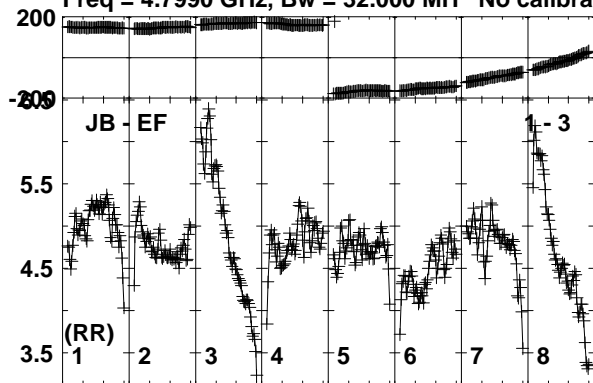

Lower frame: Milli Ampl Jy Top frame: Phas deg
Vector averaged cross-power spectrum Baseline: JB (01) - EF (03)
Timerange: 00:12:42:08 to 00:12:43:41

Plot file version 184 created 19-FEB-2019 18:13:25

J2353+5518 RP028B.UVDATA.1

Freq = 4.7990 GHz, Bw = 32.000 MH No calibration applied and no bandpass applied

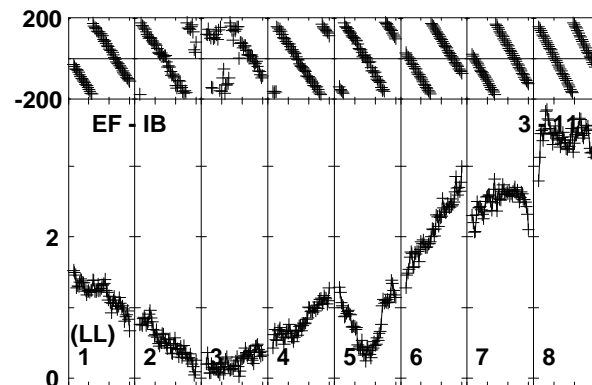
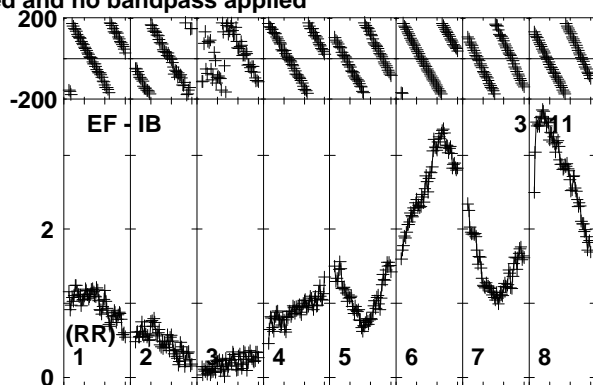
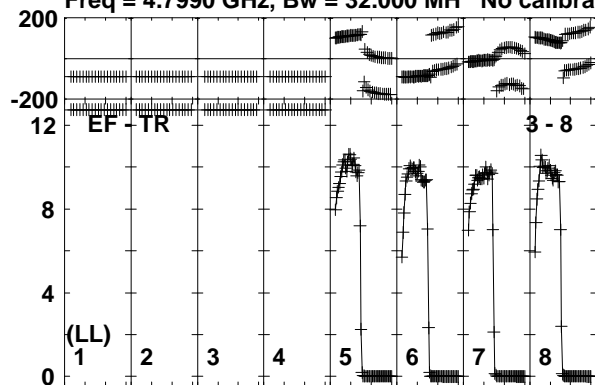

Lower frame: Milli Ampl Jy Top frame: Phas deg
Vector averaged cross-power spectrum Baseline: EF (03) - TR (08)
Timerange: 00/12:42:08 to 00/12:43:41

Plot file version 185 created 19-FEB-2019 18:13:25

IRAS23436 RP028B.UVDATA.1

Freq = 4.7990 GHz, Bw = 32.000 MH No calibration applied and no bandpass applied

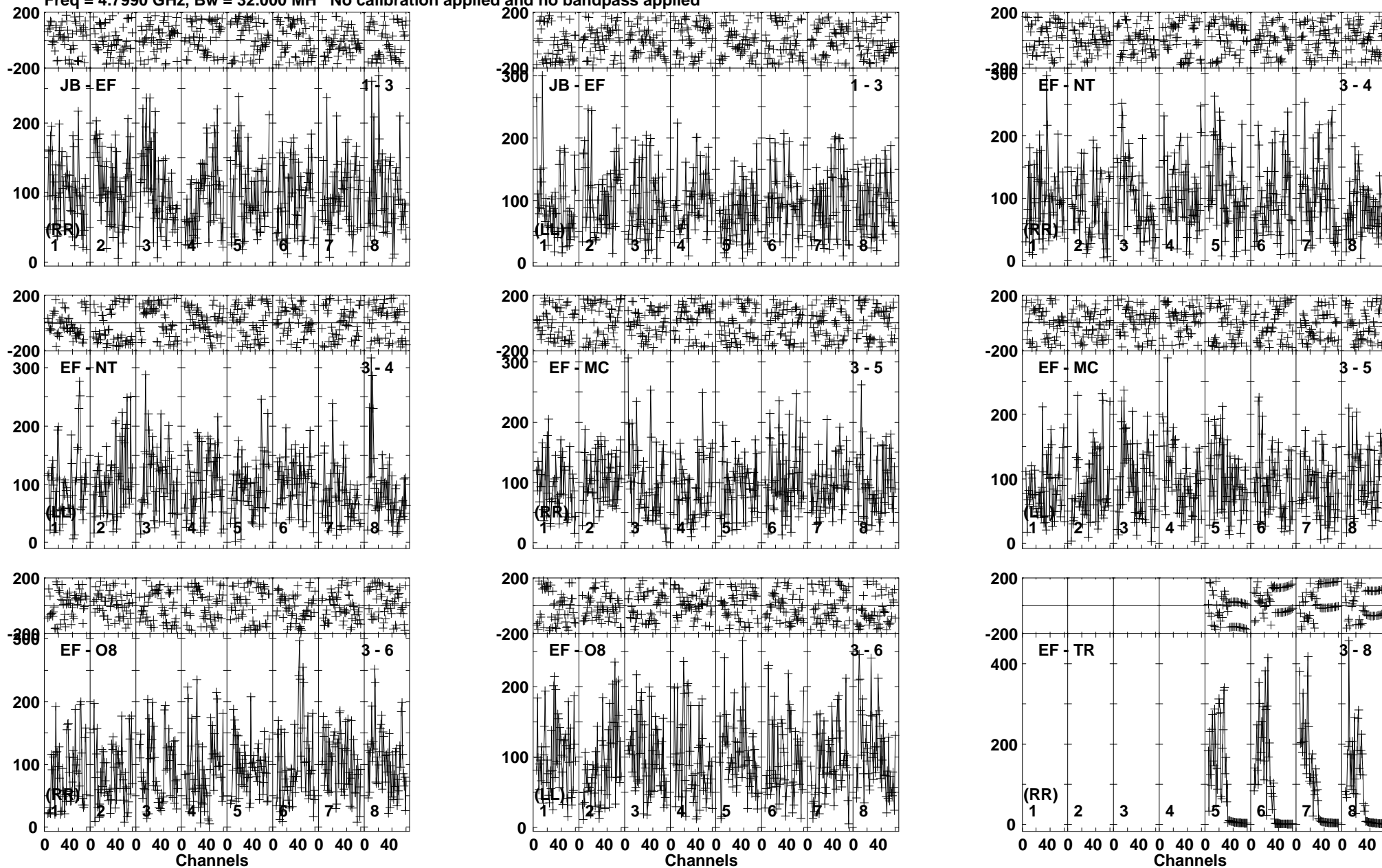

Lower frame: Micro Ampl Jy Top frame: Phas deg
Vector averaged cross-power spectrum Baseline: JB (01) - EF (03)
Timerange: 00:12:43:42 to 00:12:46:51

Plot file version 186 created 19-FEB-2019 18:13:25

IRAS23436 RP028B.UVDATA.1

Freq = 4.7990 GHz, Bw = 32.000 MH No calibration applied and no bandpass applied

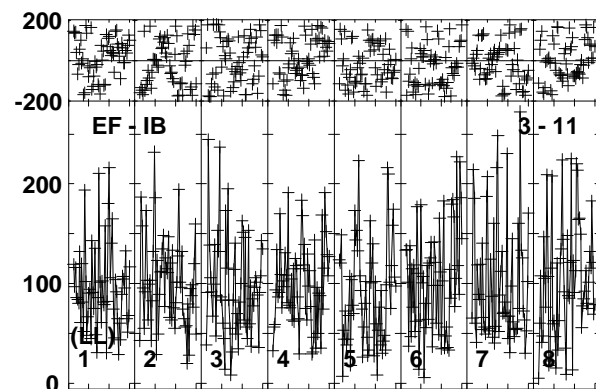
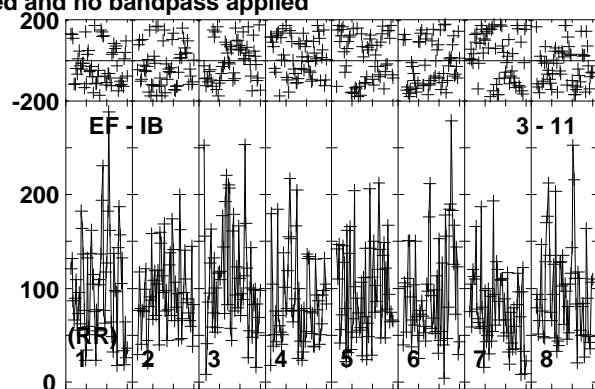
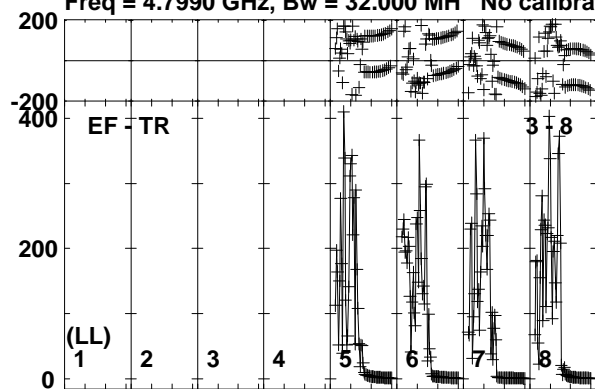

Lower frame: Micro Ampl Jy Top frame: Phas deg
Vector averaged cross-power spectrum Baseline: EF (03) - TR (08)
Timerange: 00/12:43:42 to 00/12:46:51

Plot file version 187 created 19-FEB-2019 18:13:25

J2353+5518 RP028B.UVDATA.1

Freq = 4.7990 GHz, Bw = 32.000 MH No calibration applied and no bandpass applied

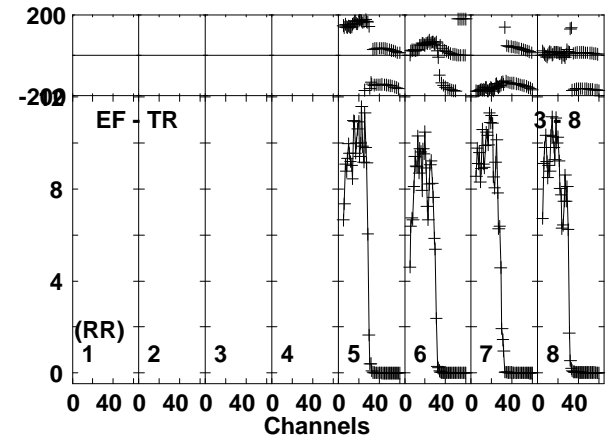
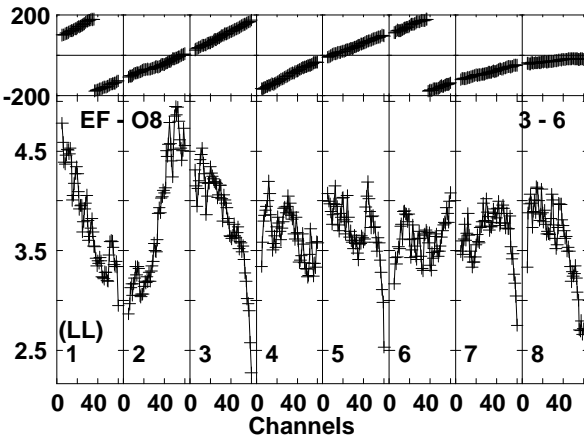
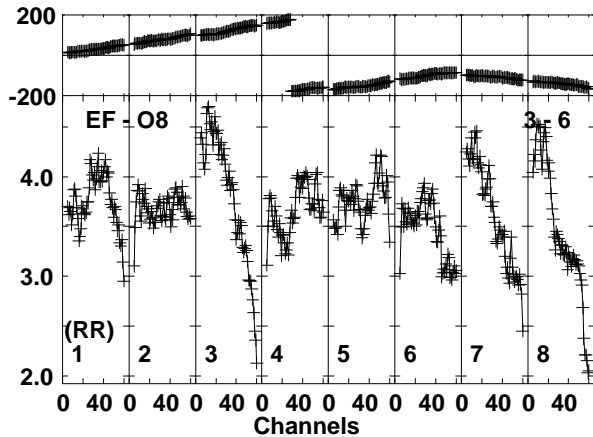
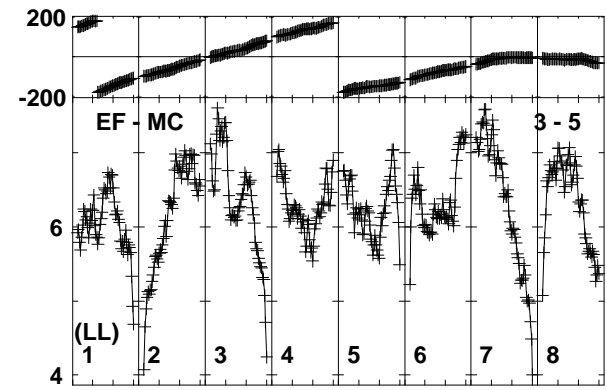
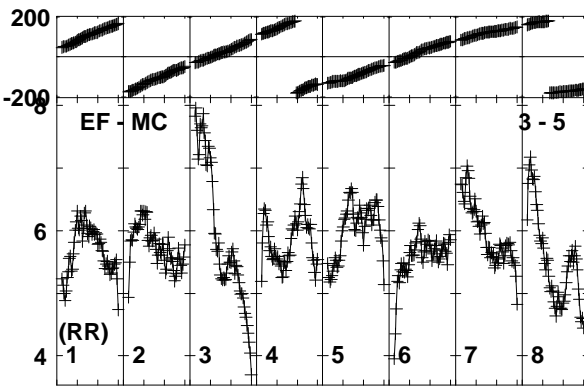
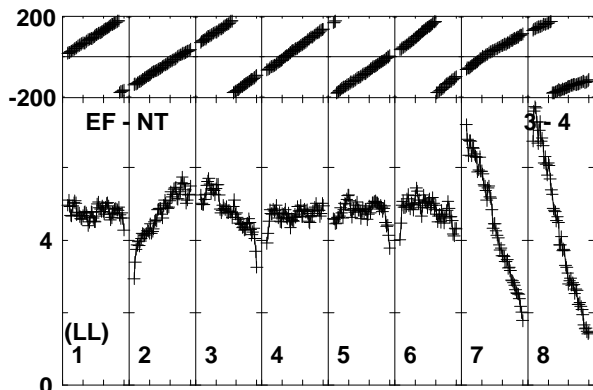
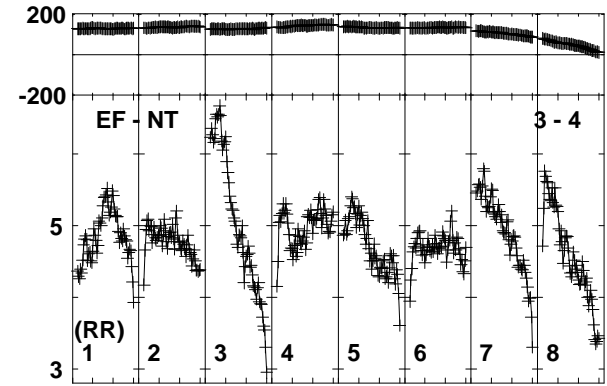
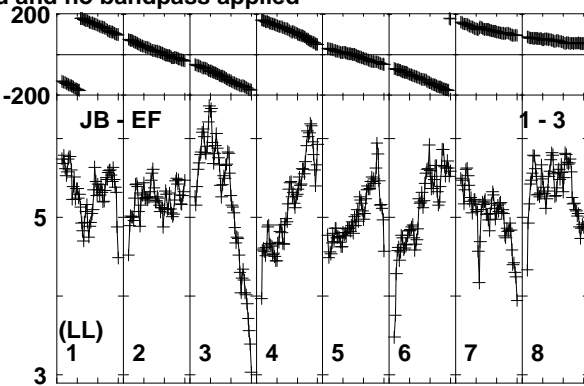
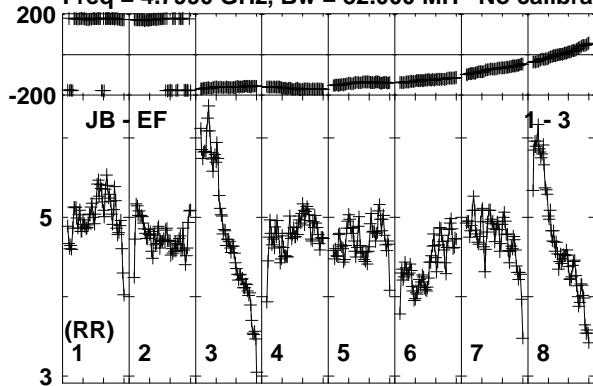

Lower frame: Milli Ampl Jy Top frame: Phas deg
Vector averaged cross-power spectrum Baseline: JB (01) - EF (03)
Timerange: 00:12:46:53 to 00:12:48:52

Plot file version 188 created 19-FEB-2019 18:13:25

J2353+5518 RP028B.UVDATA.1

Freq = 4.7990 GHz, Bw = 32.000 MH No calibration applied and no bandpass applied

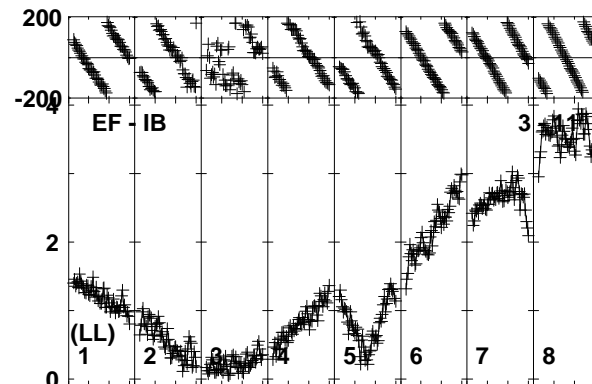
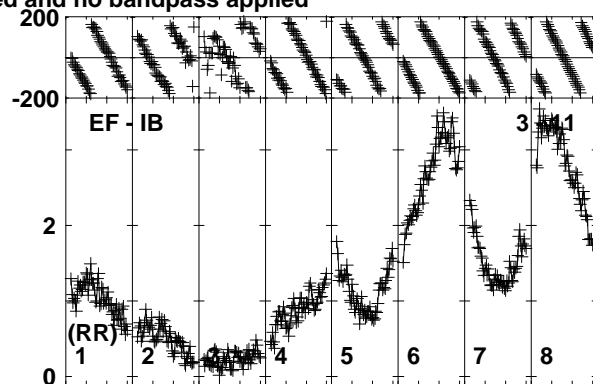
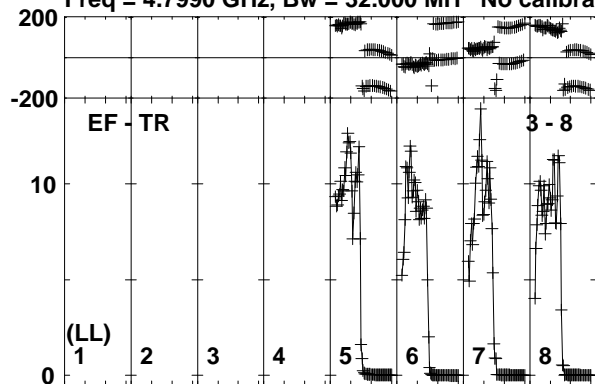

Lower frame: Milli Ampl Jy Top frame: Phas deg
Vector averaged cross-power spectrum Baseline: EF (03) - TR (08)
Timerange: 00/12:46:53 to 00/12:48:52

Plot file version 189 created 19-FEB-2019 18:13:25
 IRAS23436 RP028B.UVDATA.1
 Freq = 4.7990 GHz, Bw = 32.000 MH No calibration applied and no bandpass applied

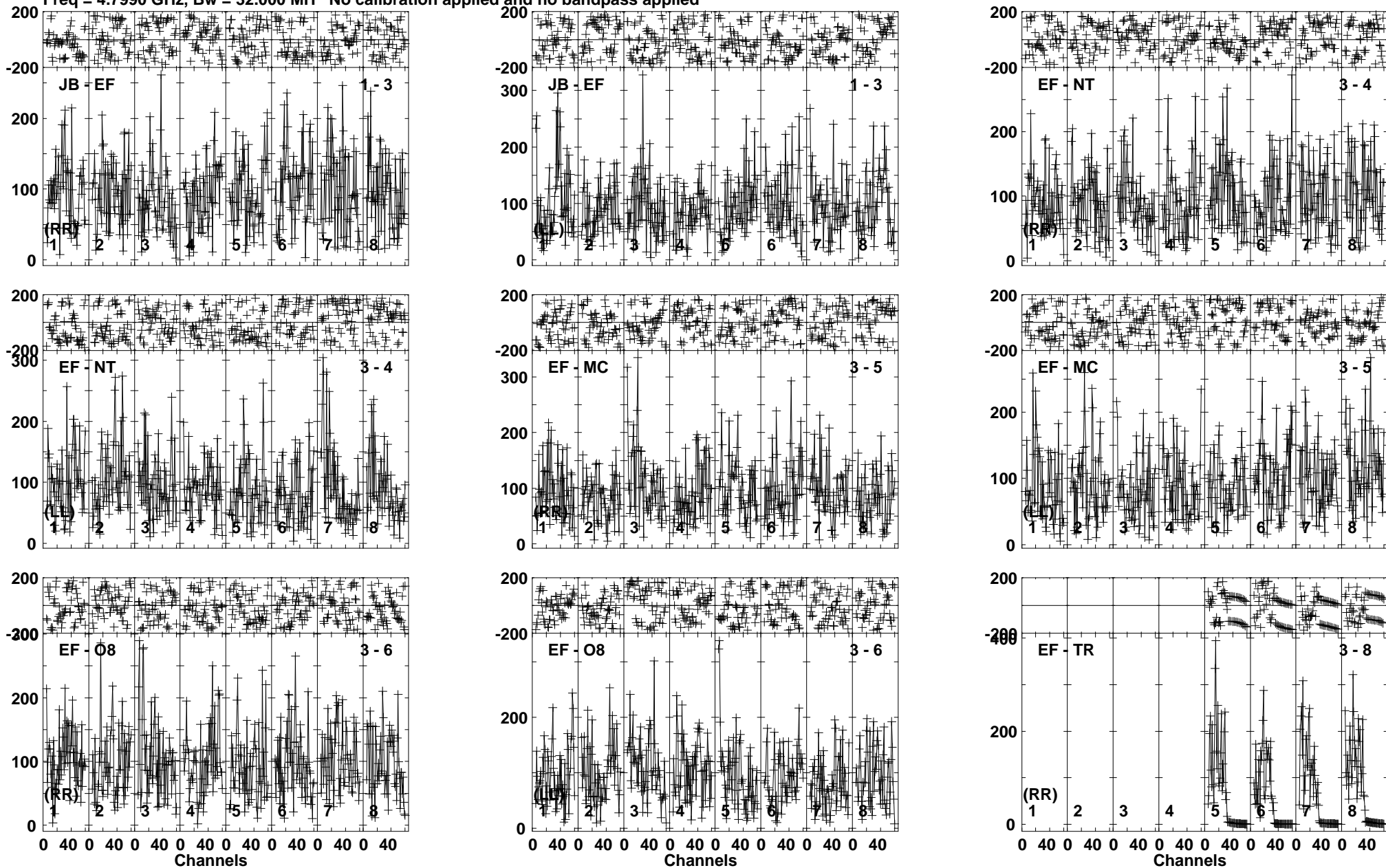

Lower frame: Micro Ampl Jy Top frame: Phas deg
 Vector averaged cross-power spectrum Baseline: JB (01) - EF (03)
 Timerange: 00:12:48:53 to 00:12:52:06

Plot file version 190 created 19-FEB-2019 18:13:26

IRAS23436 RP028B.UVDATA.1

Freq = 4.7990 GHz, Bw = 32.000 MH No calibration applied and no bandpass applied

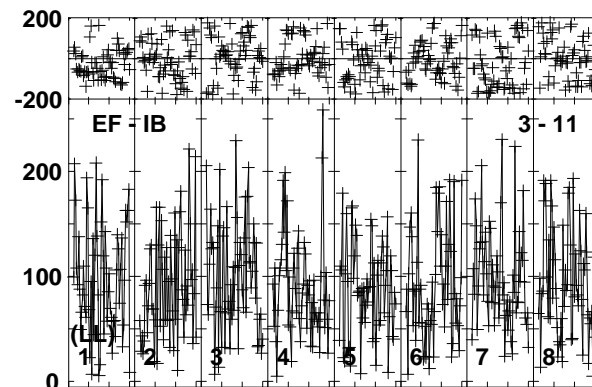
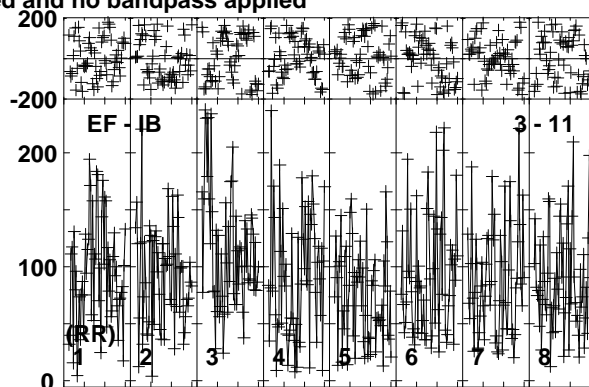
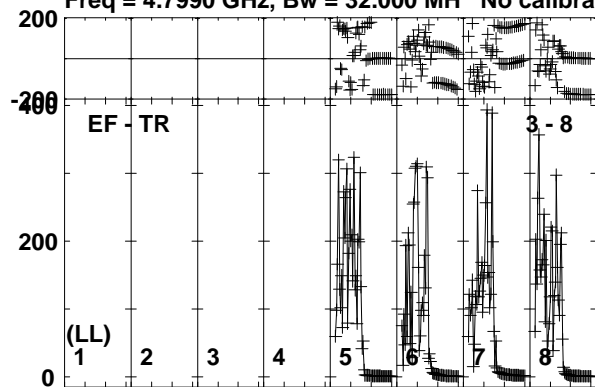

Lower frame: Micro Ampl Jy Top frame: Phas deg
Vector averaged cross-power spectrum Baseline: EF (03) - TR (08)
Timerange: 00/12:48:53 to 00/12:52:06

Plot file version 191 created 19-FEB-2019 18:13:26

J2353+5518 RP028B.UVDATA.1

Freq = 4.7990 GHz, Bw = 32.000 MH No calibration applied and no bandpass applied

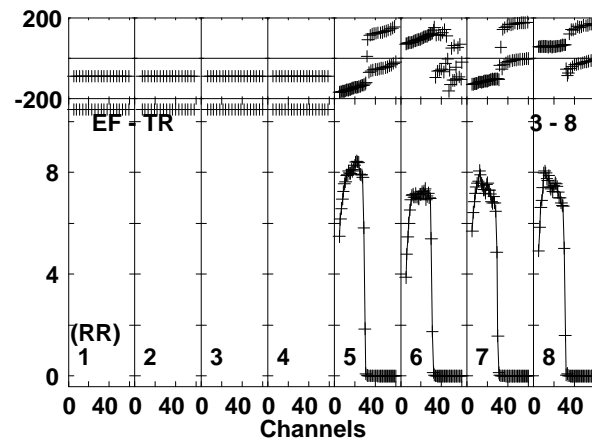
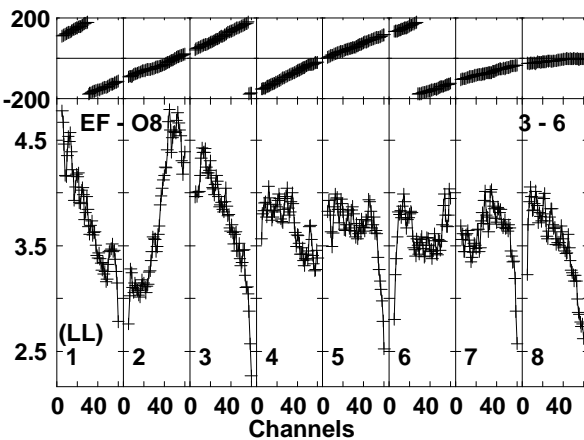
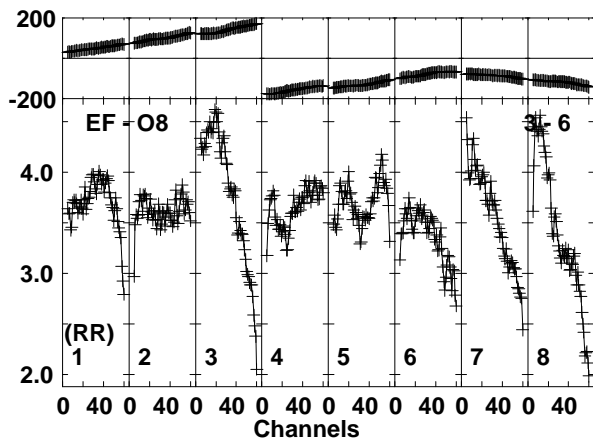
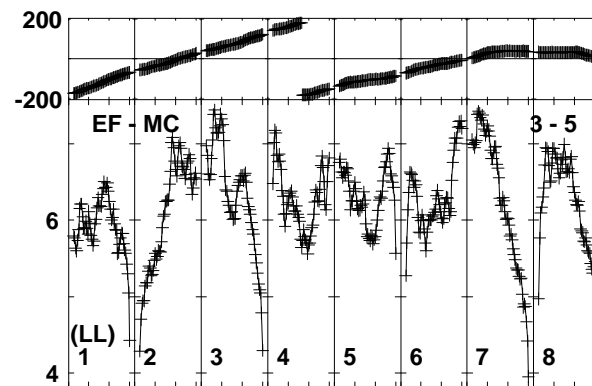
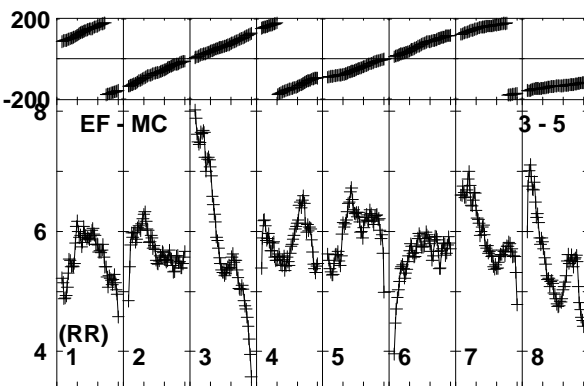
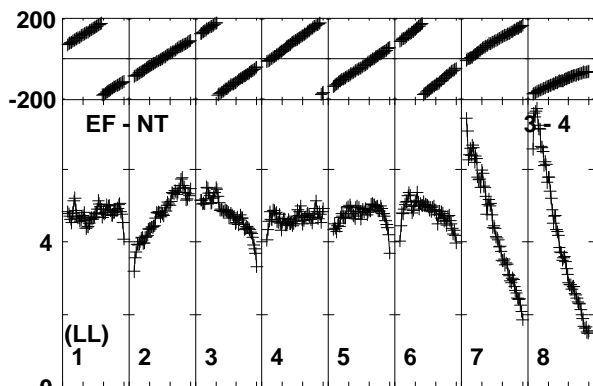
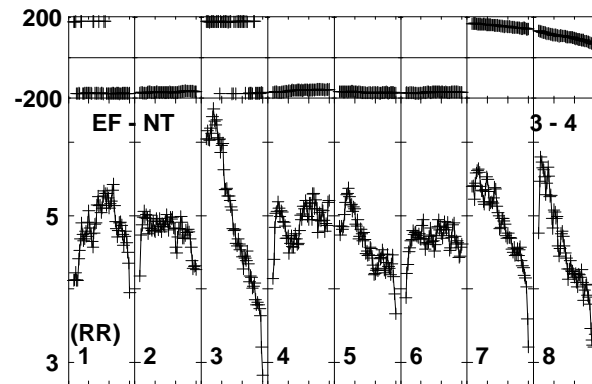
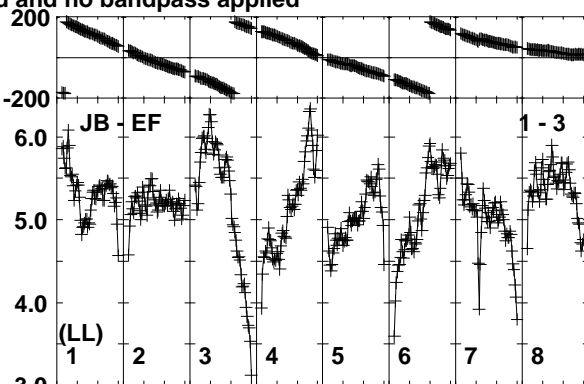
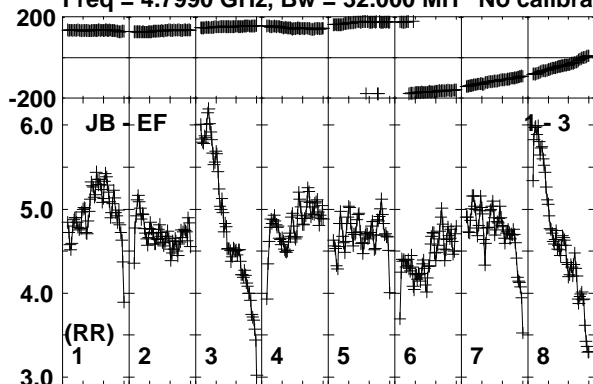

Lower frame: Milli Ampl Jy Top frame: Phas deg
Vector averaged cross-power spectrum Baseline: JB (01) - EF (03)
Timerange: 00:12:52:56 to 00:12:54:46

Plot file version 192 created 19-FEB-2019 18:13:26

J2353+5518 RP028B.UVDATA.1

Freq = 4.7990 GHz, Bw = 32.000 MH No calibration applied and no bandpass applied

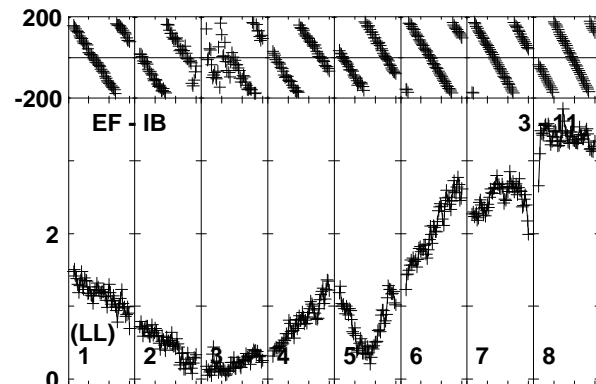
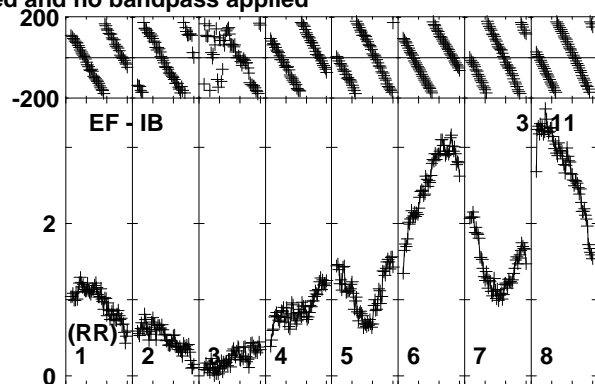
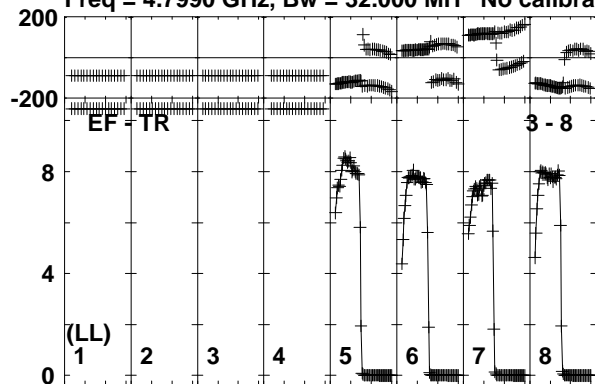

Lower frame: Milli Ampl Jy Top frame: Phas deg
Vector averaged cross-power spectrum Baseline: EF (03) - TR (08)
Timerange: 00/12:52:56 to 00/12:54:46

Plot file version 193 created 19-FEB-2019 18:13:26

IRAS23436 RP028B.UVDATA.1

Freq = 4.7990 GHz, Bw = 32.000 MH No calibration applied and no bandpass applied

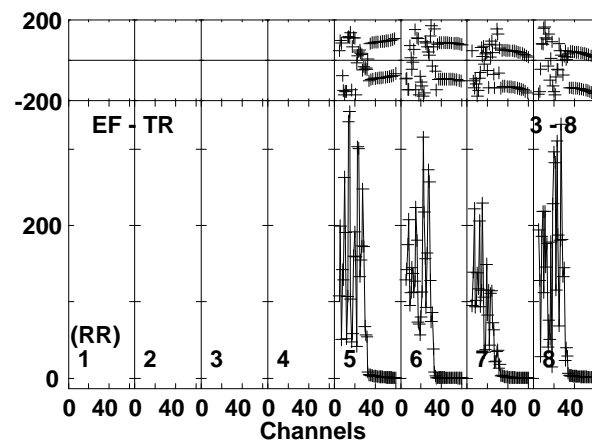
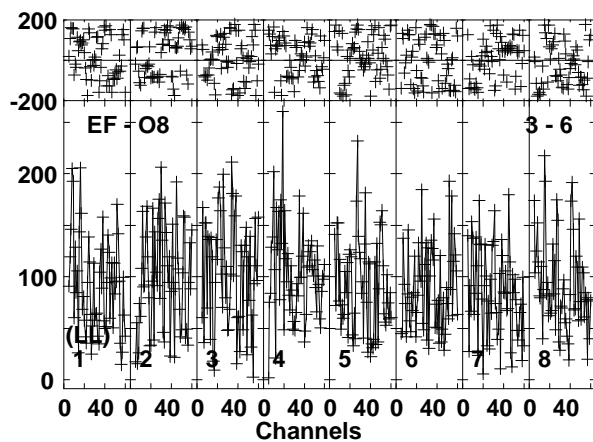
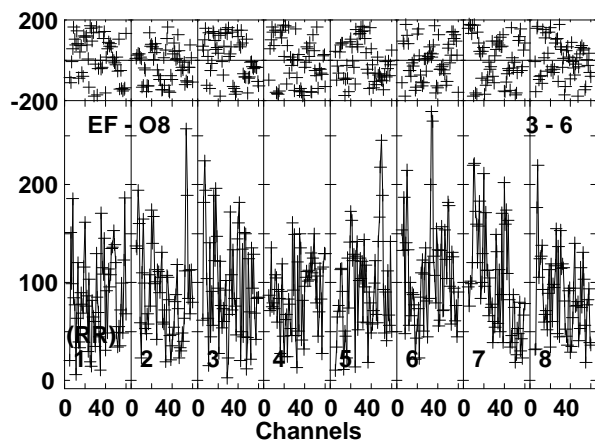
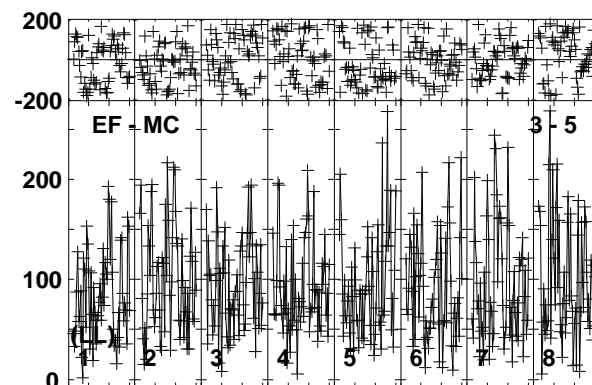
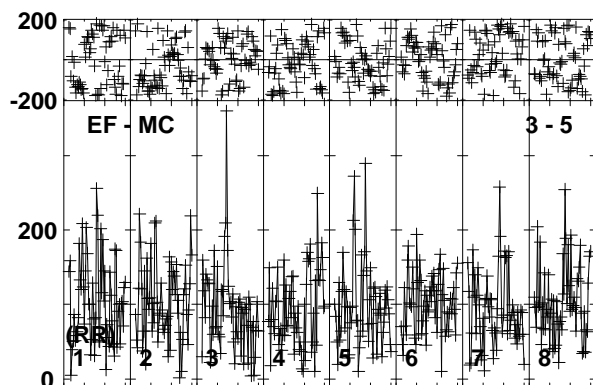
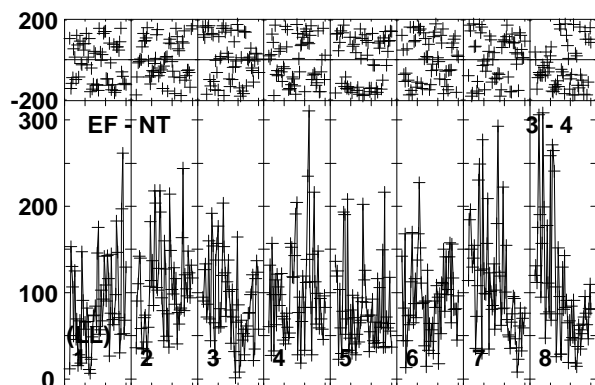
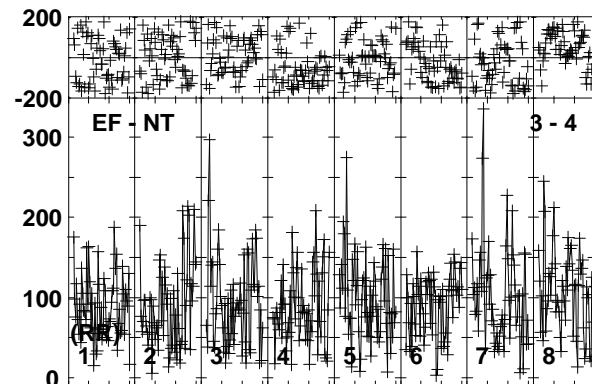
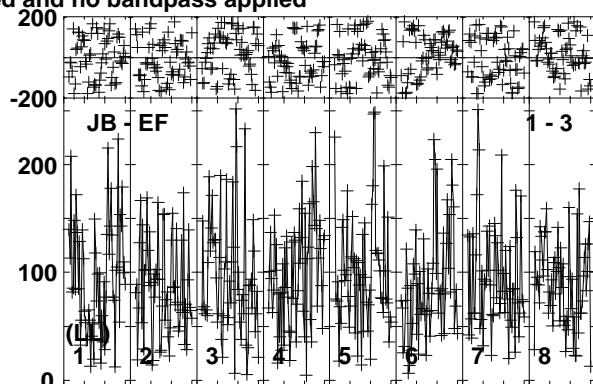
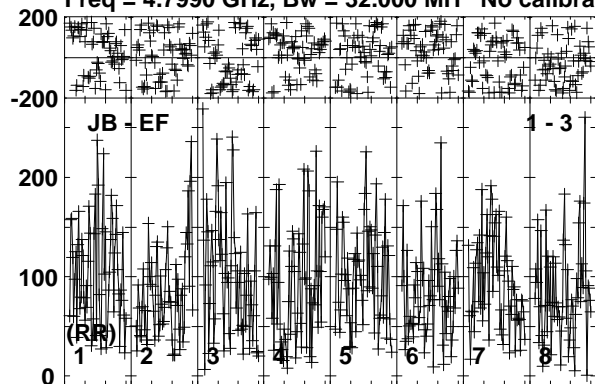

Lower frame: Micro Ampl Jy Top frame: Phas deg
Vector averaged cross-power spectrum Baseline: JB (01) - EF (03)
Timerange: 00:12:54:47 to 00:12:58:00

Plot file version 194 created 19-FEB-2019 18:13:26

IRAS23436 RP028B.UVDATA.1

Freq = 4.7990 GHz, Bw = 32.000 MH No calibration applied and no bandpass applied

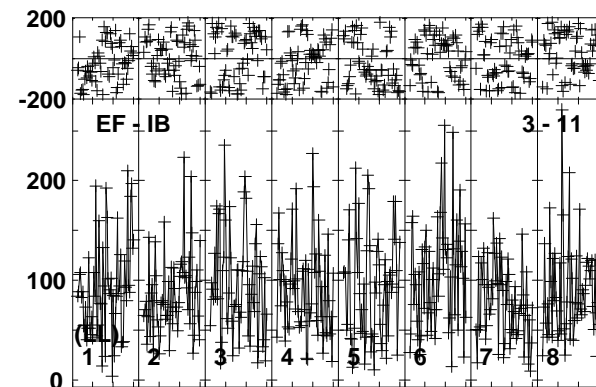
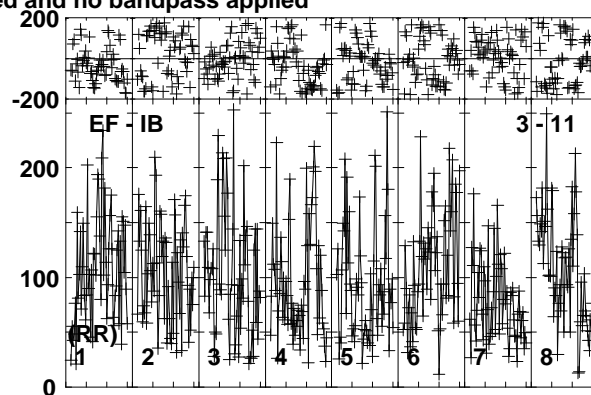
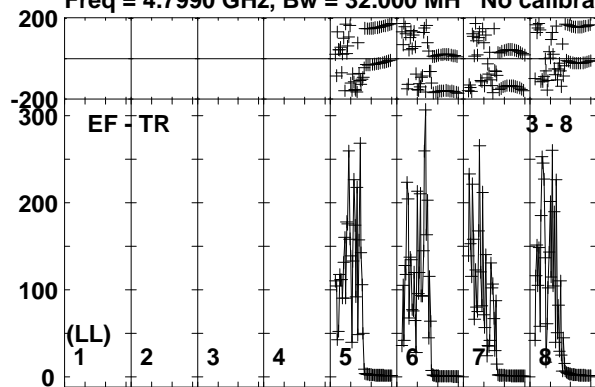

Lower frame: Micro Ampl Jy Top frame: Phas deg
Vector averaged cross-power spectrum Baseline: EF (03) - TR (08)
Timerange: 00/12:54:47 to 00/12:58:00

Plot file version 195 created 19-FEB-2019 18:13:27

J2353+5518 RP028B.UVDATA.1

Freq = 4.7990 GHz, Bw = 32.000 MH No calibration applied and no bandpass applied

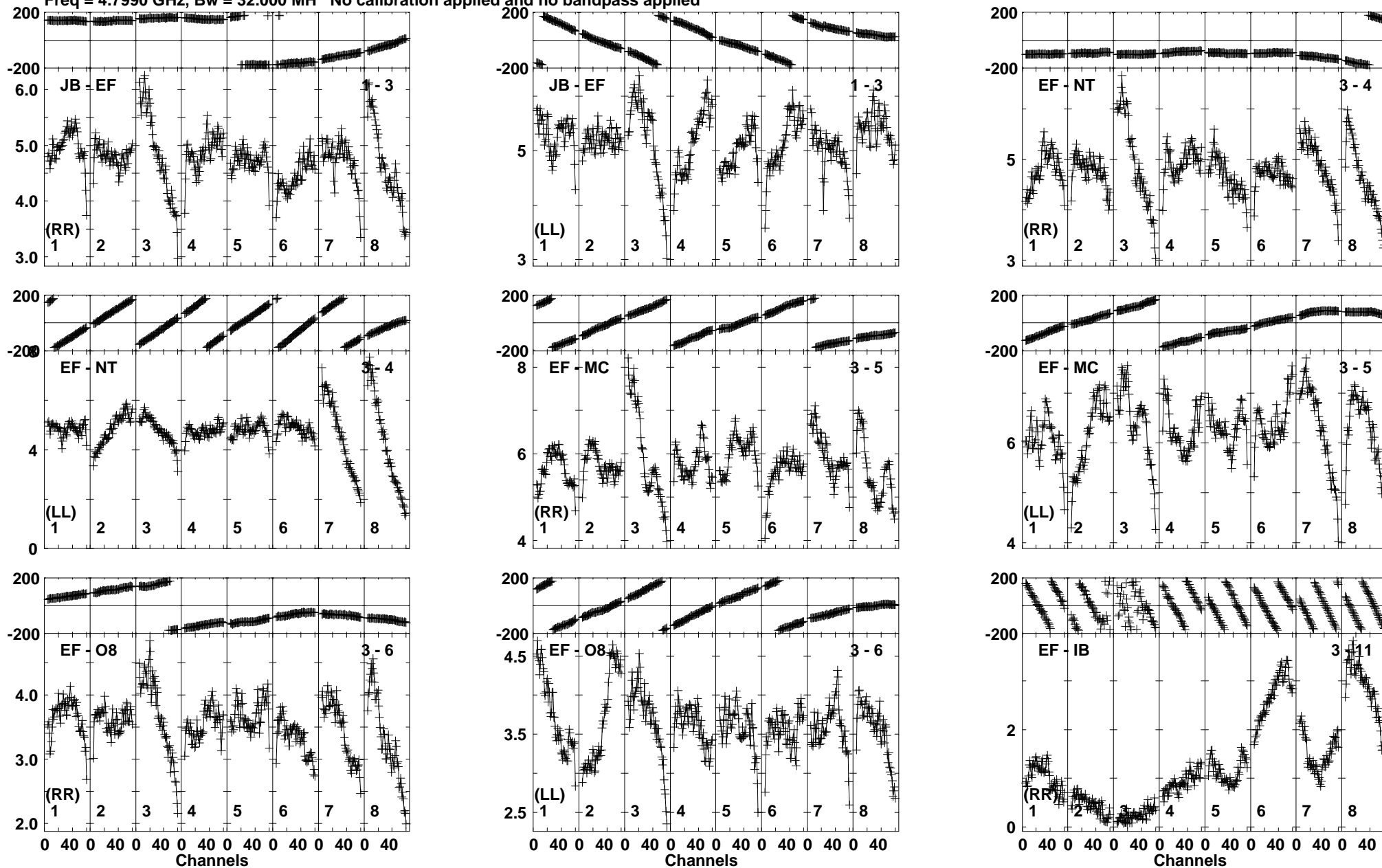

Lower frame: Milli Ampl Jy Top frame: Phas deg
Vector averaged cross-power spectrum Baseline: JB (01) - EF (03)
Timerange: 00/12:58:00 to 00/13:00:00

Plot file version 196 created 19-FEB-2019 18:13:27
J2353+5518 RP028B.UVDATA.1
Freq = 4.7990 GHz, Bw = 32.000 MH No calibration applied and no bandpass applied

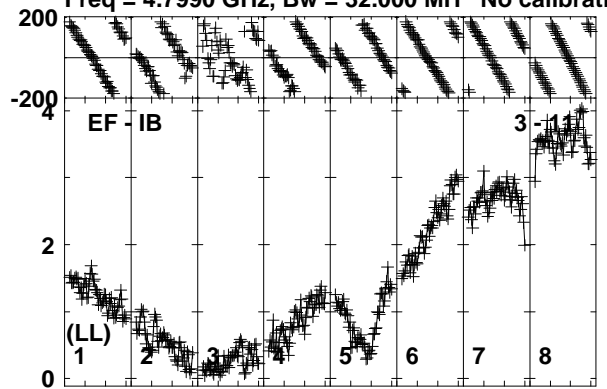

Lower frame: Milli Ampl Jy Top frame: Phas deg
Vector averaged cross-power spectrum Baseline: EF (03) - IB (11)
Timerange: 00/12:58:00 to 00/13:00:00