

Plot file version 1 created 03-OCT-2017 13:09:31

J0013+4051 RP028.UVDATA.1

Freq = 4.7990 GHz, Bw = 32.000 MH No calibration applied and no bandpass applied

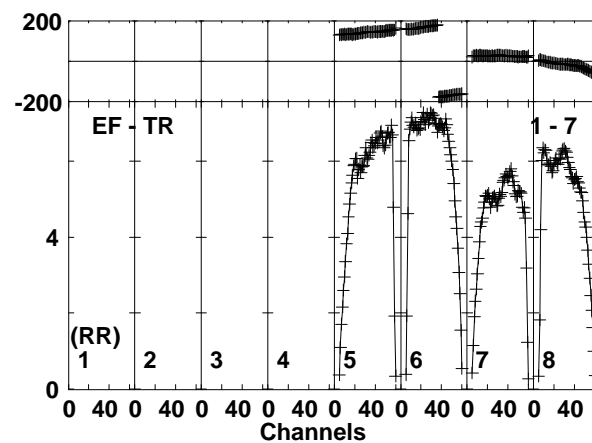
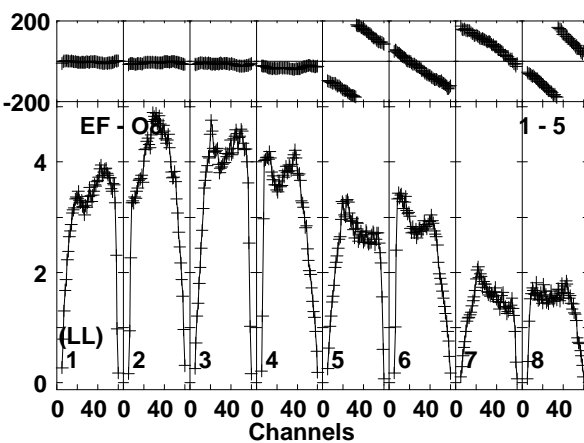
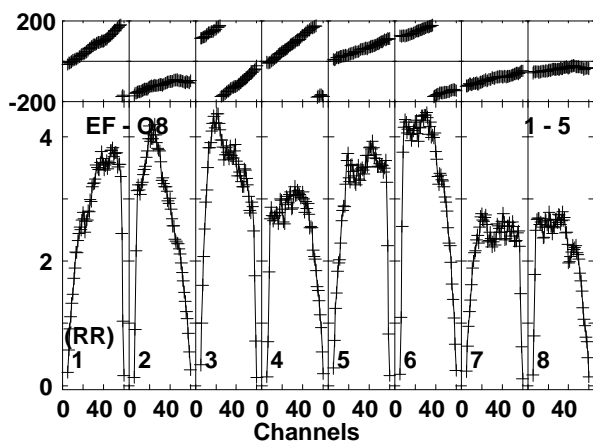
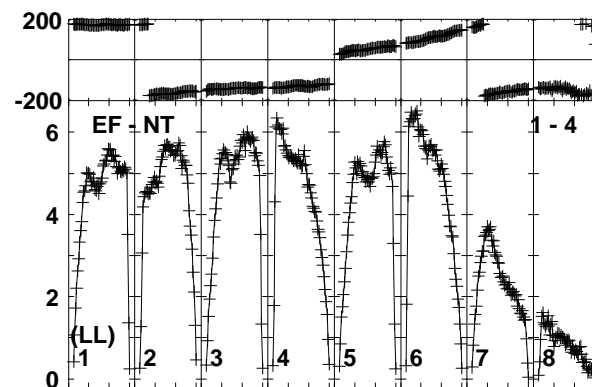
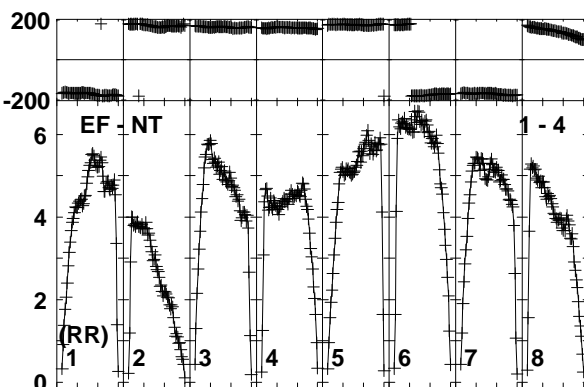
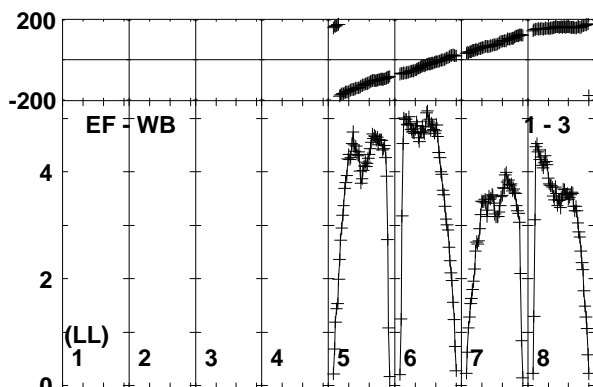
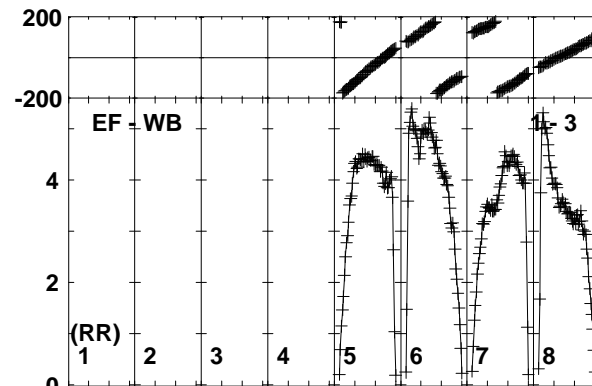
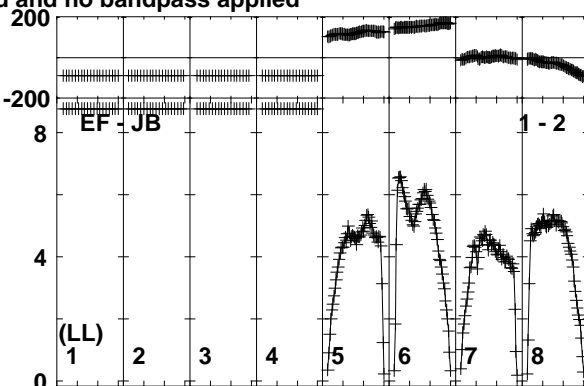
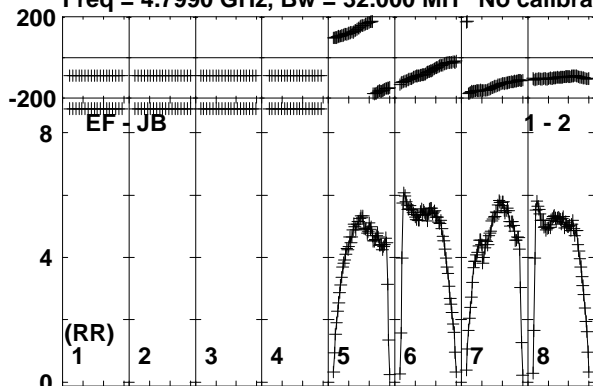

Lower frame: Milli Ampl Jy Top frame: Phas deg
Vector averaged cross-power spectrum Baseline: EF (01) - JB (02)
Timerange: 00:17:58:15 to 00:17:59:39

Plot file version 2 created 03-OCT-2017 13:09:31

J0013+4051 RP028.UVDATA.1

Freq = 4.7990 GHz, Bw = 32.000 MH No calibration applied and no bandpass applied

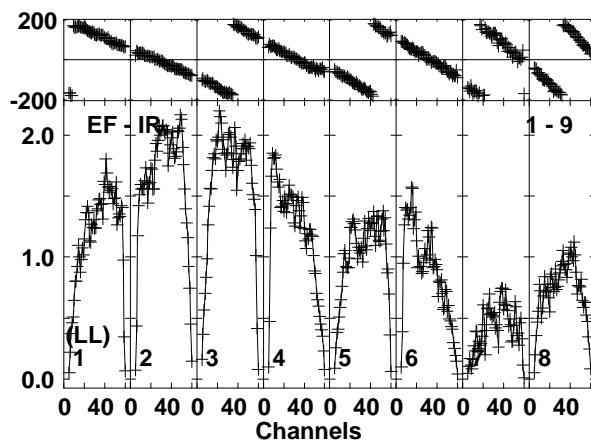
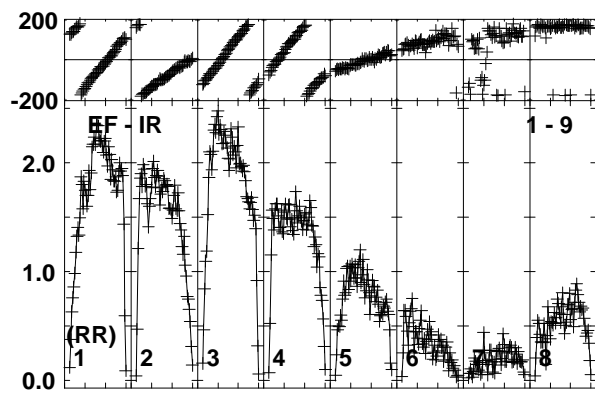
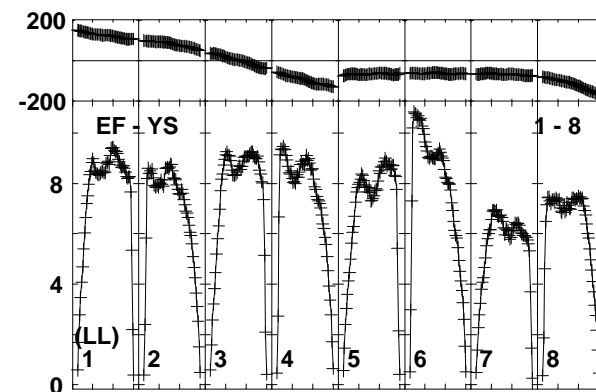
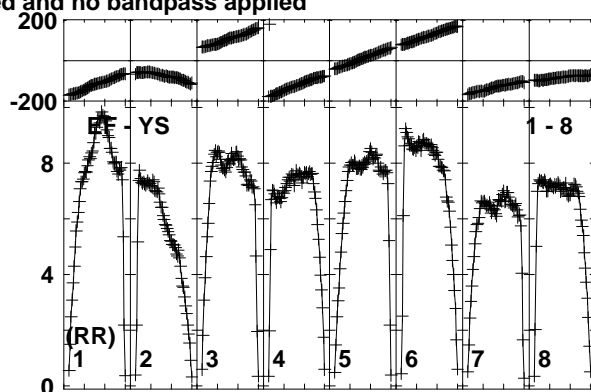
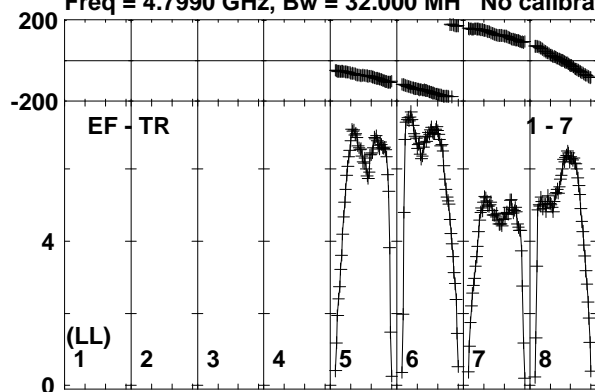

Lower frame: Milli Ampl Jy Top frame: Phas deg
Vector averaged cross-power spectrum Baseline: EF (01) - TR (07)
Timerange: 00/17:58:15 to 00/17:59:39

Plot file version 3 created 03-OCT-2017 13:09:31

J0013+4051 RP028.UVDATA.1

Freq = 4.7990 GHz, Bw = 32.000 MH No calibration applied and no bandpass applied

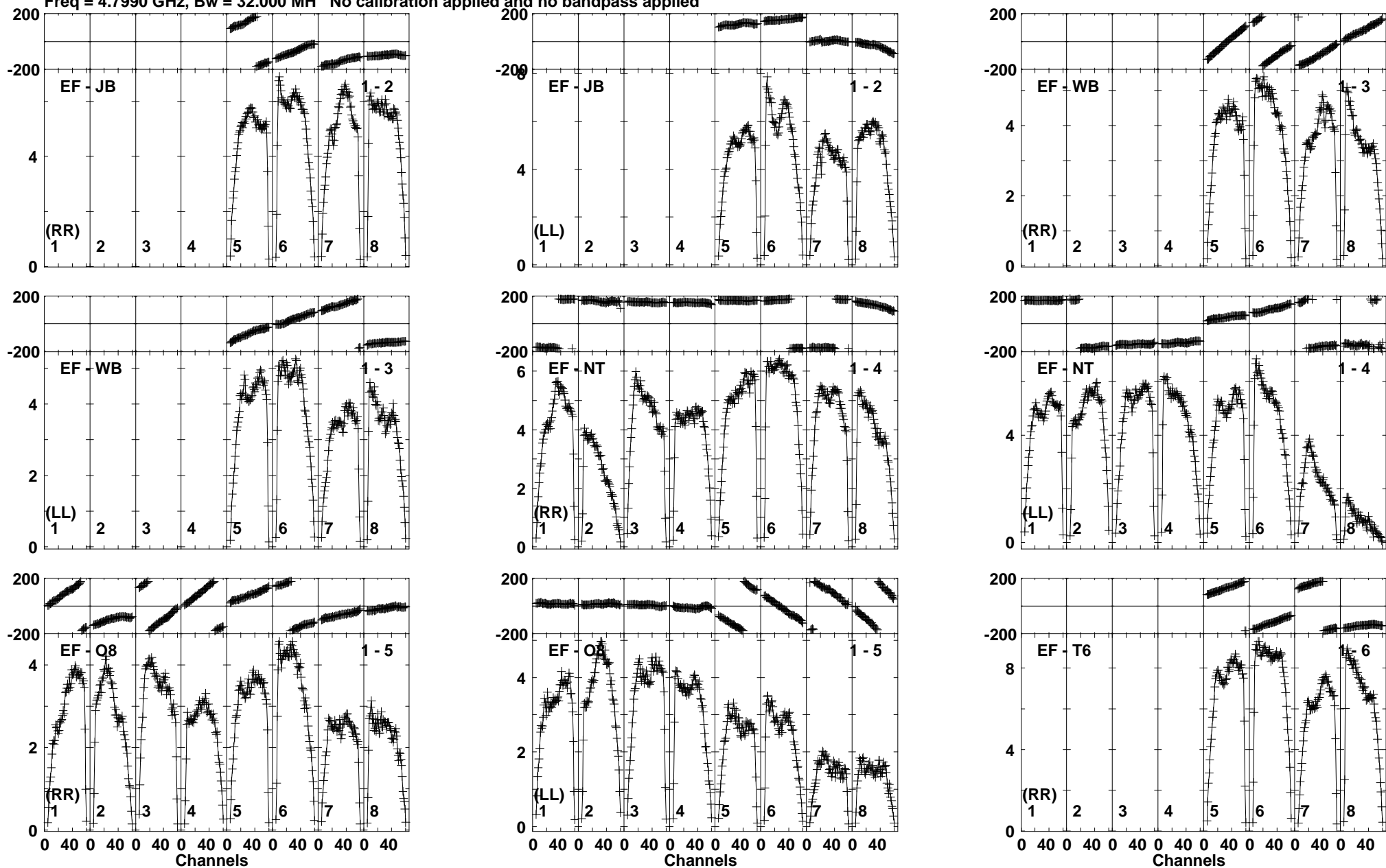

Plot file version 4 created 03-OCT-2017 13:09:31

J0013+4051 RP028.UVDATA.1

Freq = 4.7990 GHz, Bw = 32.000 MH No calibration applied and no bandpass applied

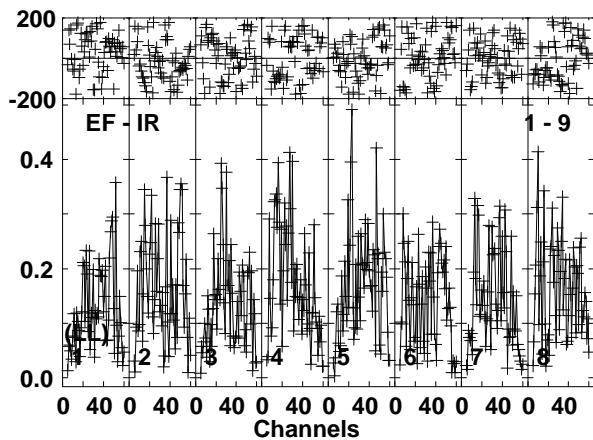
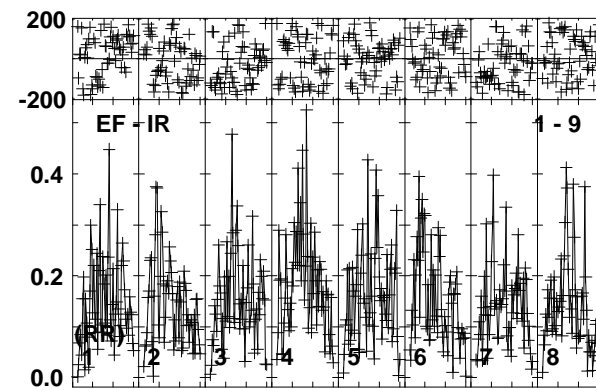
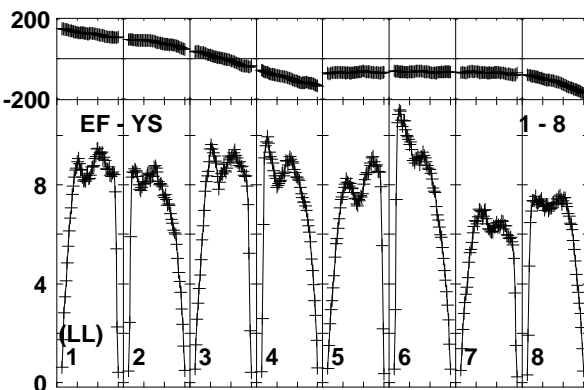
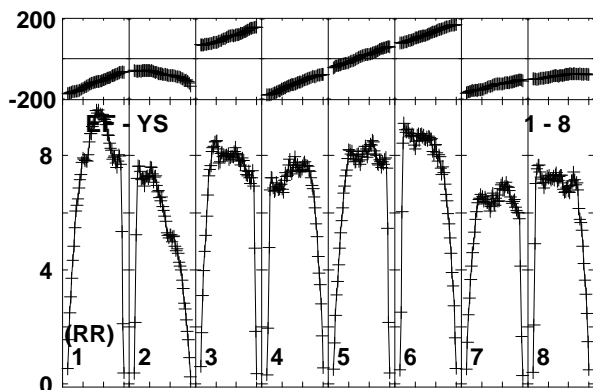
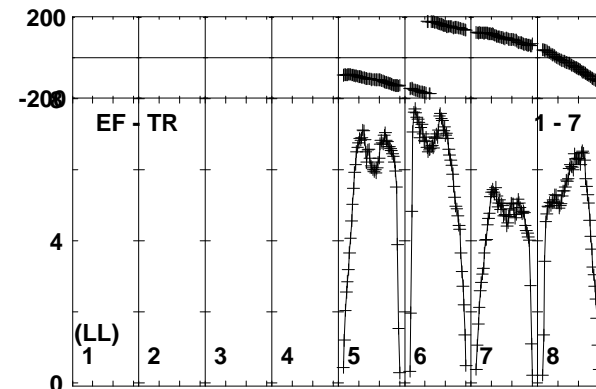
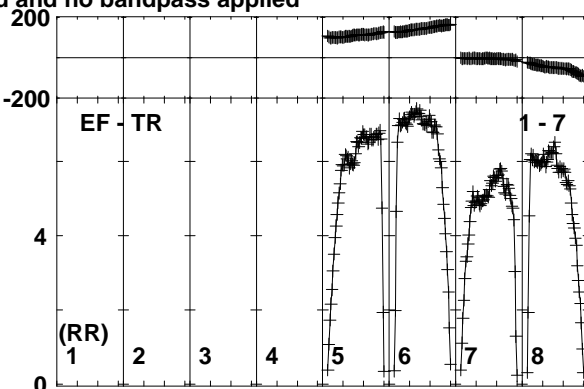
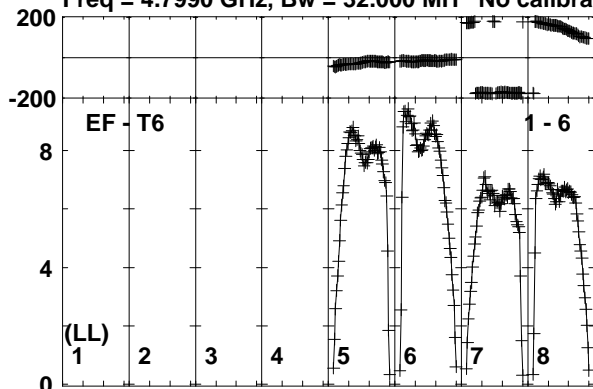

Lower frame: Milli Ampl Jy Top frame: Phas deg
Vector averaged cross-power spectrum Baseline: EF (01) - T6 (06)
Timerange: 00/18:00:01 to 00/18:01:00

Plot file version 5 created 03-OCT-2017 13:09:33

IRAS23436 RP028.UVDATA.1

Freq = 4.7990 GHz, Bw = 32.000 MH No calibration applied and no bandpass applied

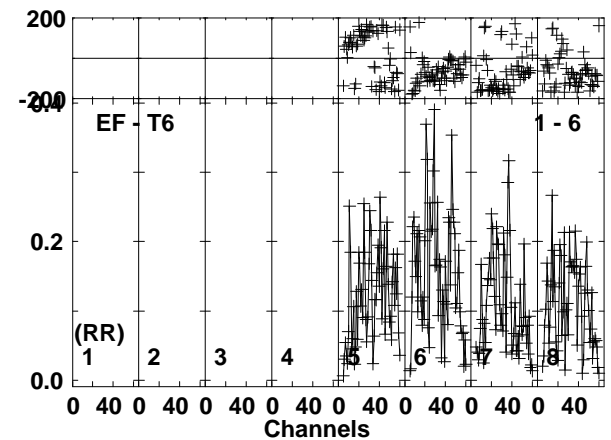
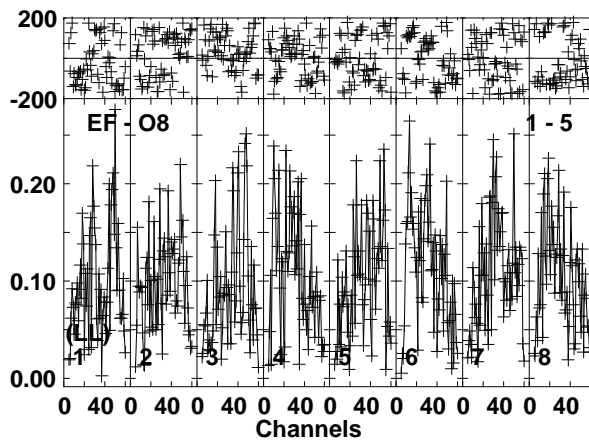
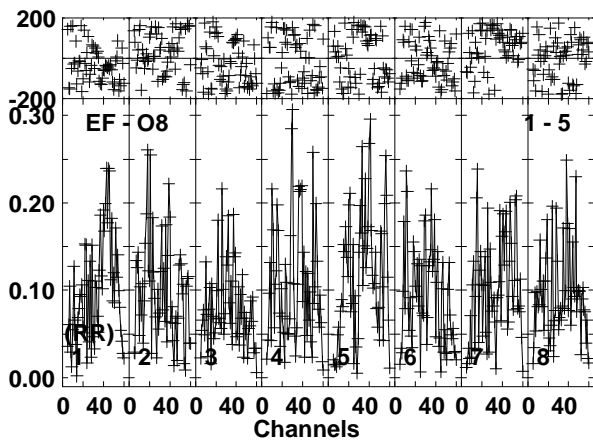
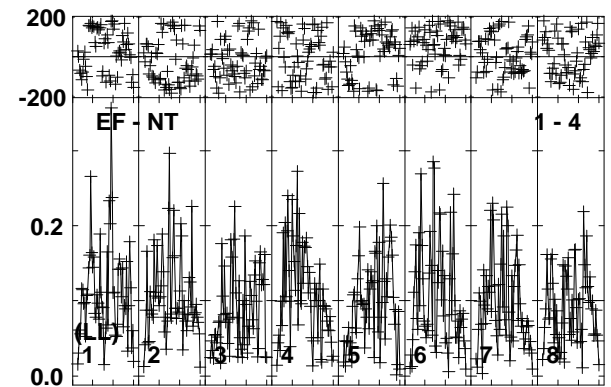
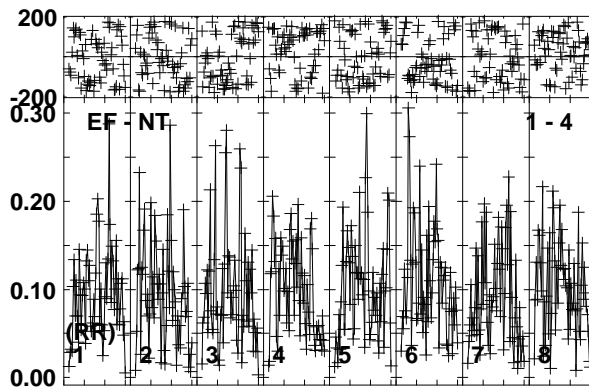
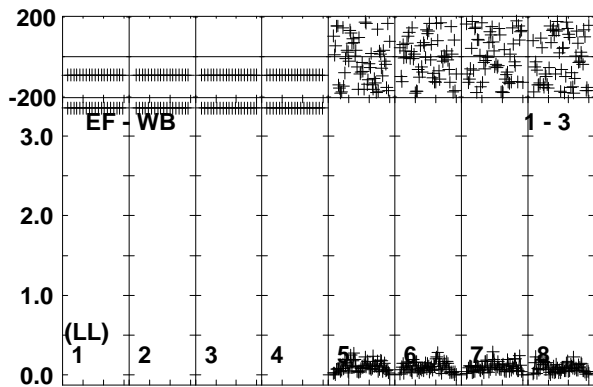
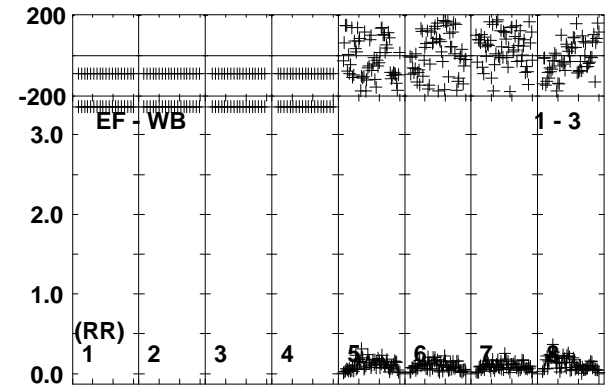
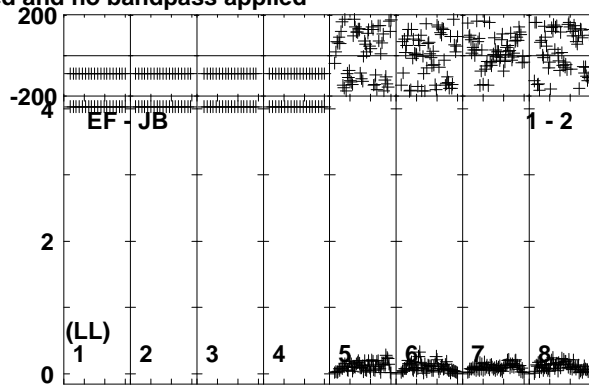
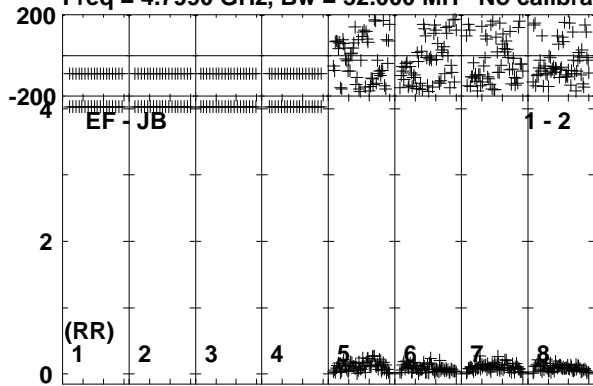

Lower frame: Milli Ampl Jy Top frame: Phas deg
Vector averaged cross-power spectrum Baseline: EF (01) - JB (02)
Timerange: 00/18:13:34 to 00/18:17:18

Plot file version 6 created 03-OCT-2017 13:09:34

IRAS23436 RP028.UVDATA.1

Freq = 4.7990 GHz, Bw = 32.000 MH No calibration applied and no bandpass applied

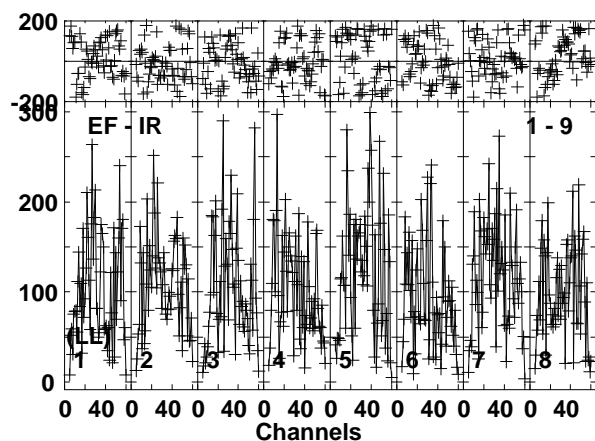
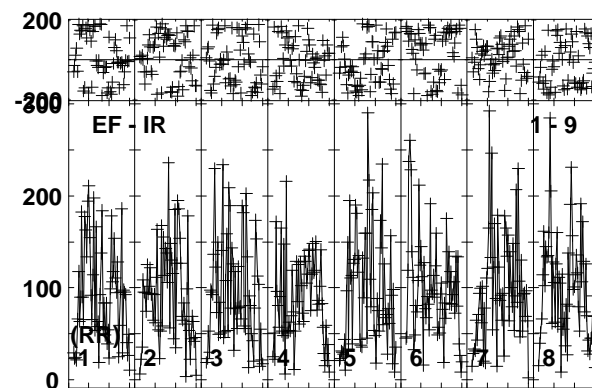
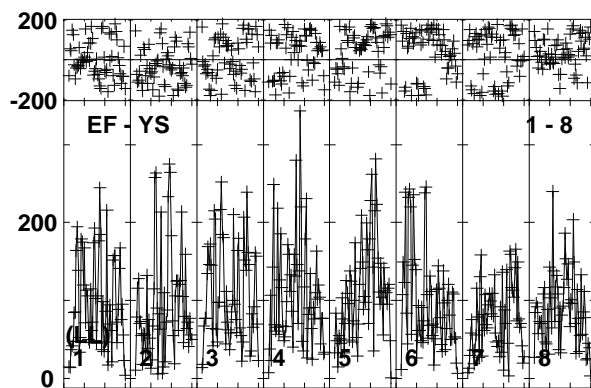
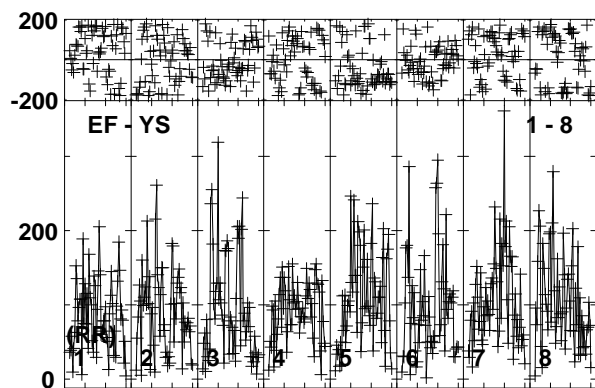
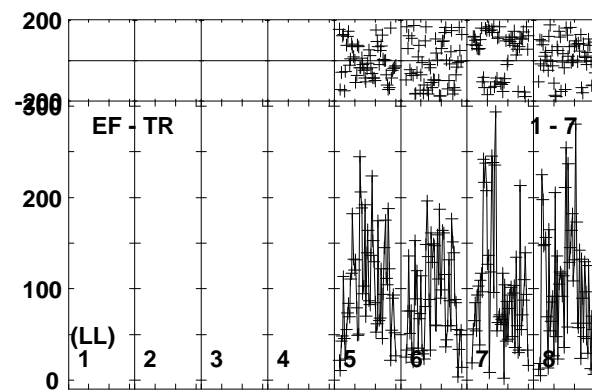
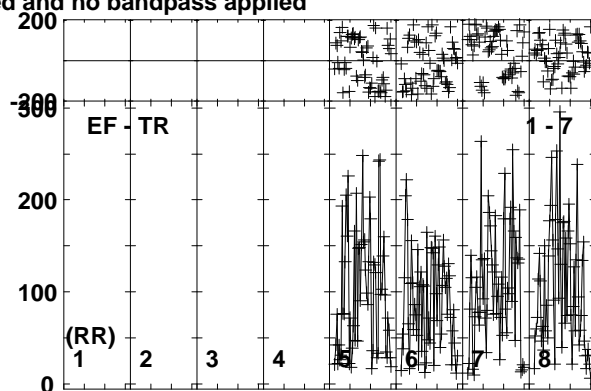
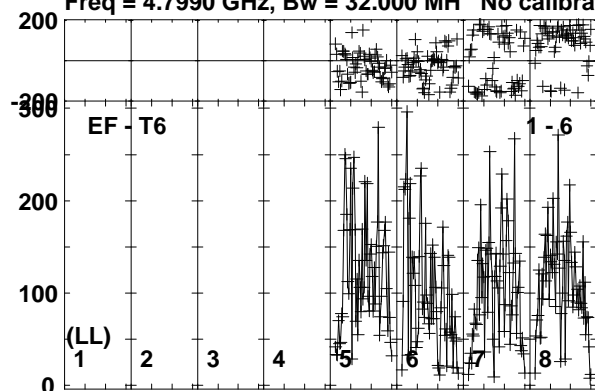

Lower frame: Micro Ampl Jy Top frame: Phas deg
Vector averaged cross-power spectrum Baseline: EF (01) - T6 (06)
Timerange: 00/18:13:34 to 00/18:17:18

Plot file version 7 created 03-OCT-2017 13:09:34

J2353+5518 RP028.UVDATA.1

Freq = 4.7990 GHz, Bw = 32.000 MH No calibration applied and no bandpass applied

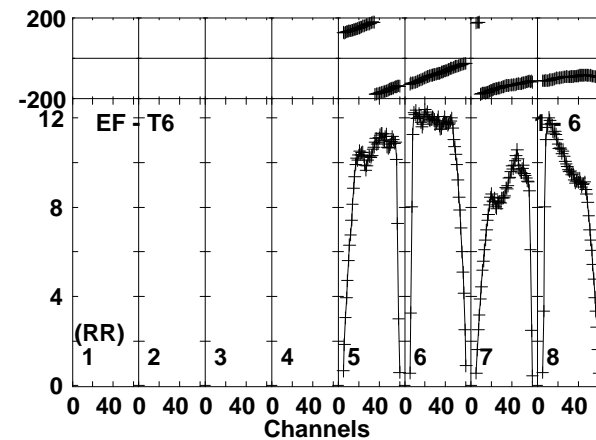
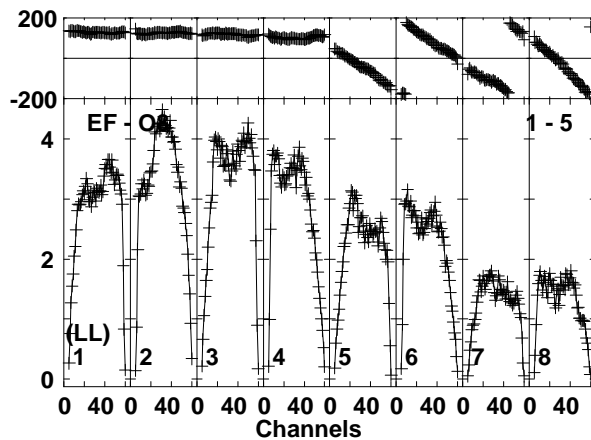
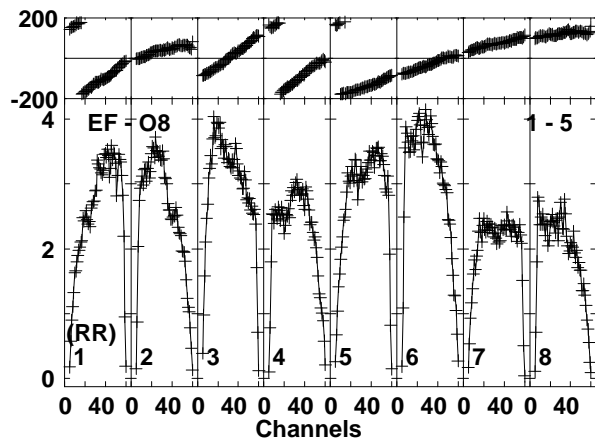
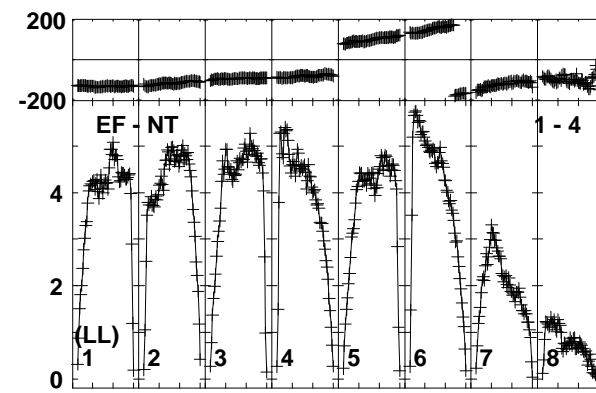
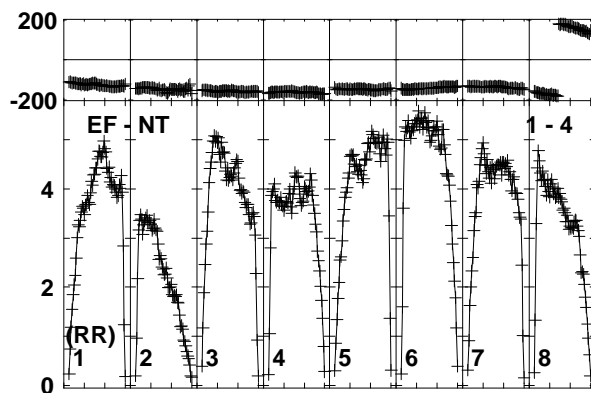
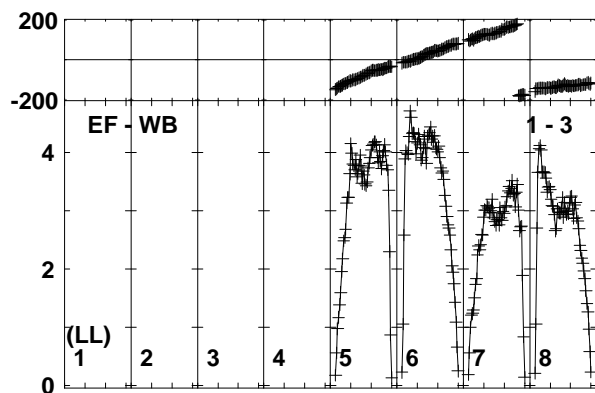
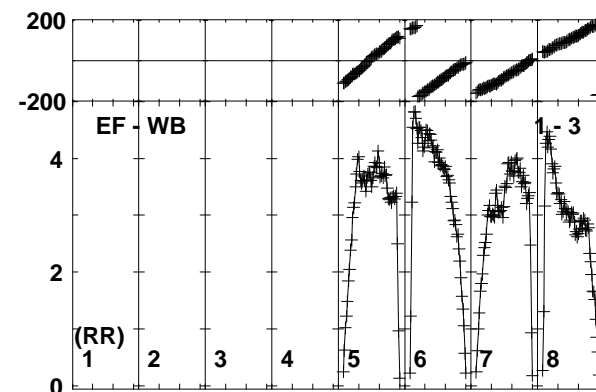
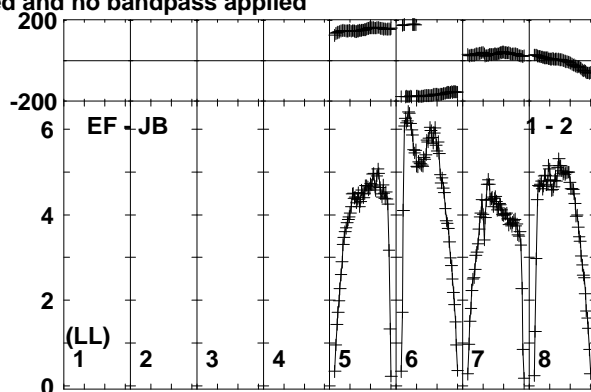
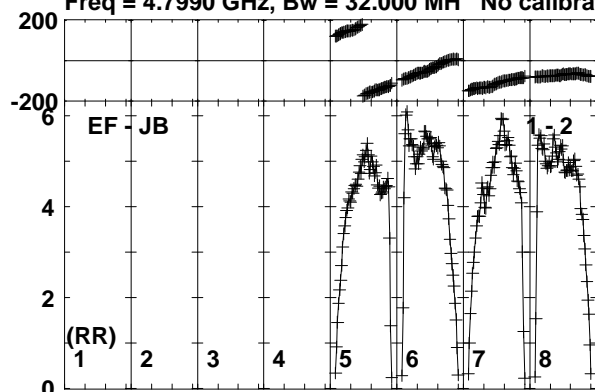

Lower frame: Milli Ampl Jy Top frame: Phas deg
Vector averaged cross-power spectrum Baseline: EF (01) - JB (02)
Timerange: 00:18:17:59 to 00:18:18:48

Plot file version 8 created 03-OCT-2017 13:09:34

J2353+5518 RP028.UVDATA.1

Freq = 4.7990 GHz, Bw = 32.000 MH No calibration applied and no bandpass applied

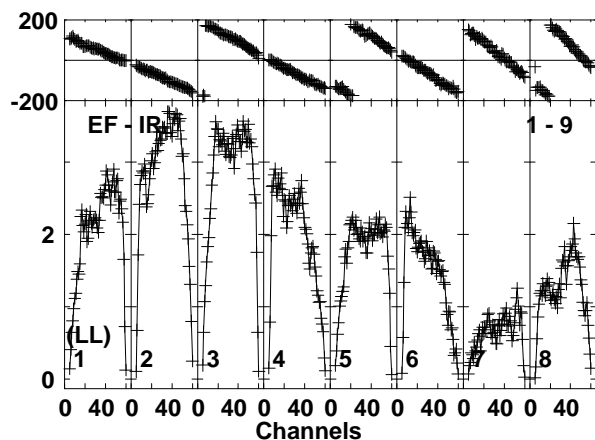
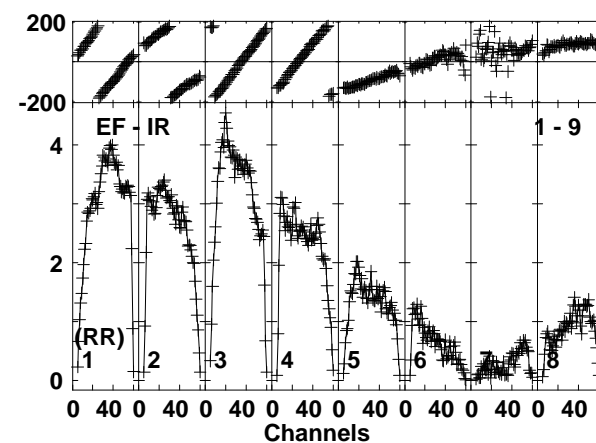
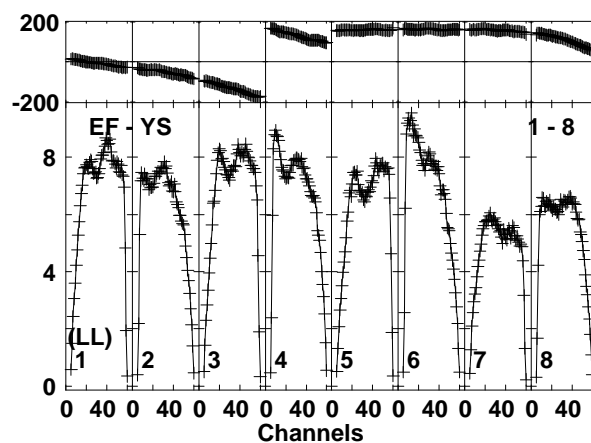
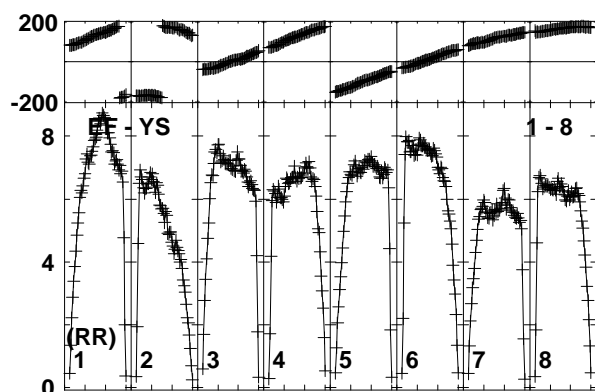
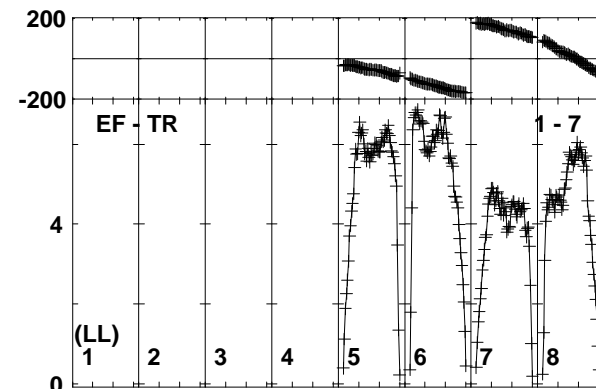
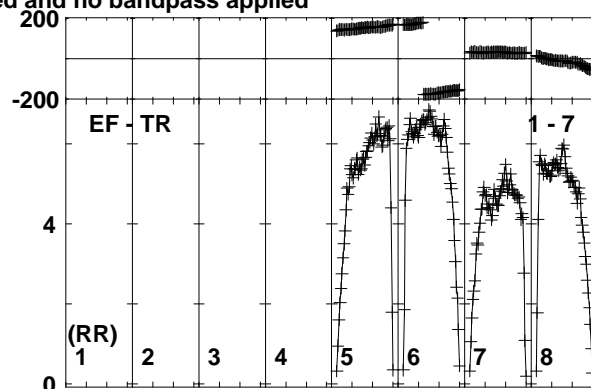
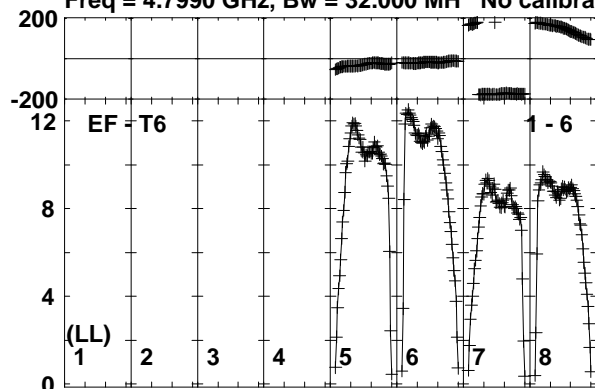

Lower frame: Milli Ampl Jy Top frame: Phas deg
Vector averaged cross-power spectrum Baseline: EF (01) - T6 (06)
Timerange: 00/18:17:59 to 00/18:18:48

Plot file version 9 created 03-OCT-2017 13:09:34

IRAS23436 RP028.UVDATA.1

Freq = 4.7990 GHz, Bw = 32.000 MH No calibration applied and no bandpass applied

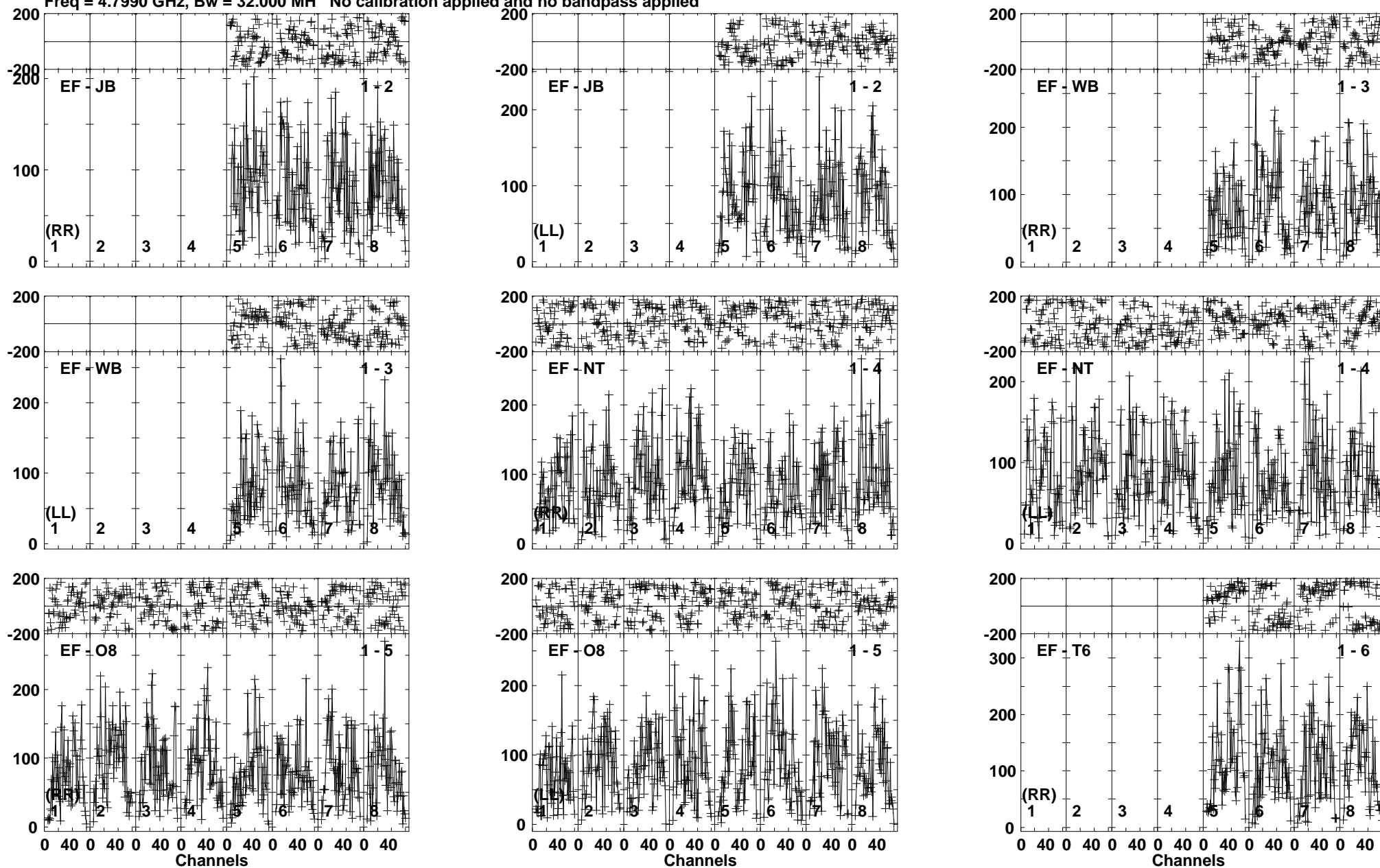

Lower frame: Micro Ampl Jy Top frame: Phas deg
Vector averaged cross-power spectrum Baseline: EF (01) - JB (02)
Timerange: 00/18:18:49 to 00/18:22:31

Plot file version 10 created 03-OCT-2017 13:09:35

IRAS23436 RP028.UVDATA.1

Freq = 4.7990 GHz, Bw = 32.000 MH No calibration applied and no bandpass applied

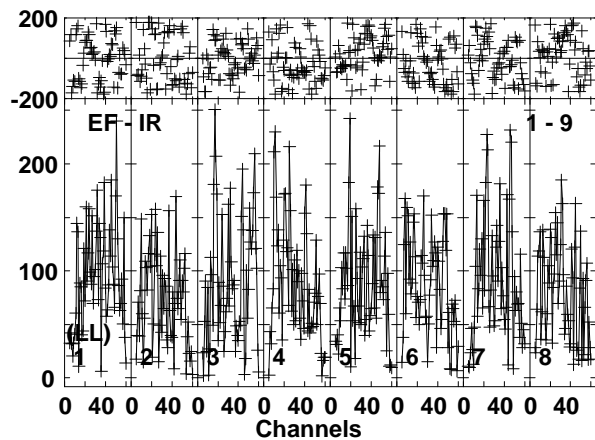
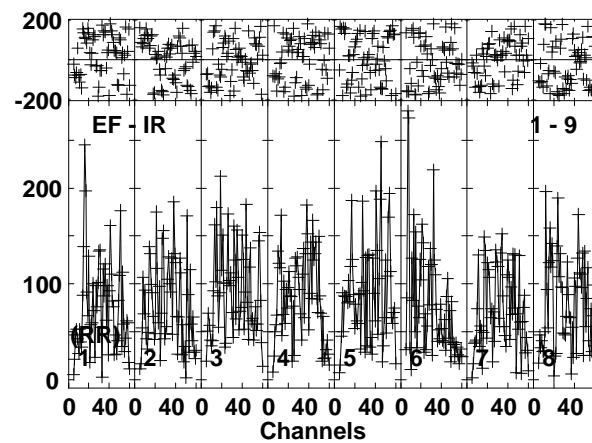
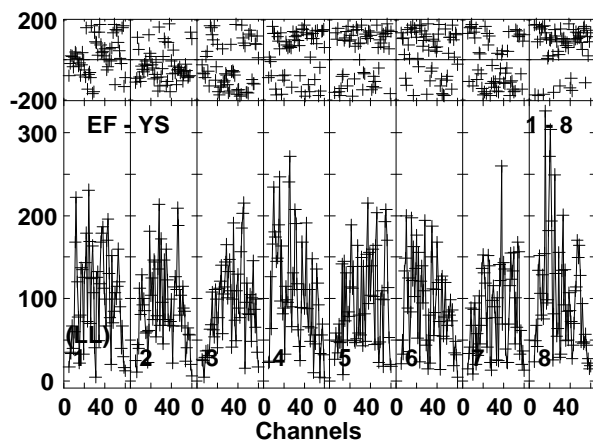
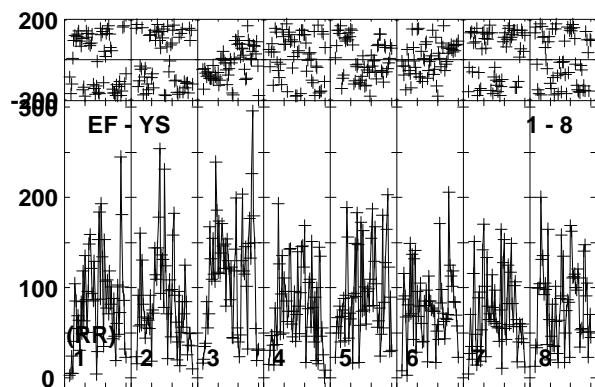
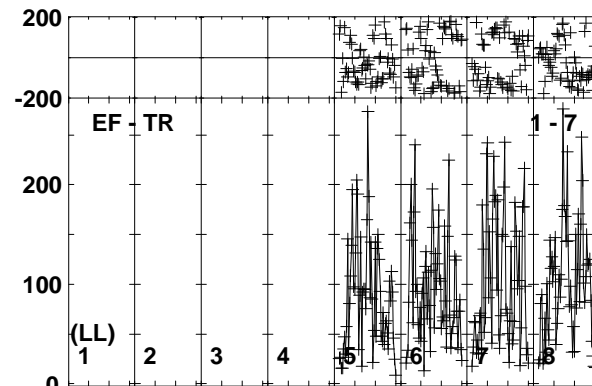
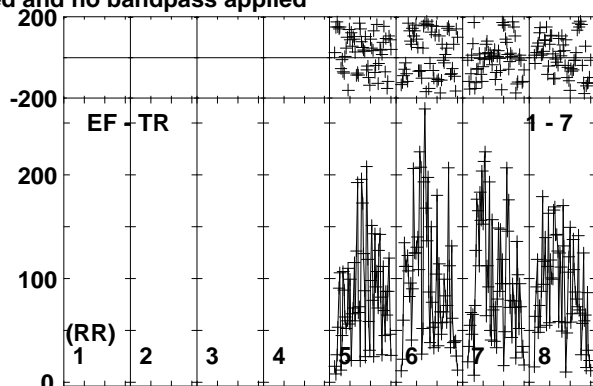
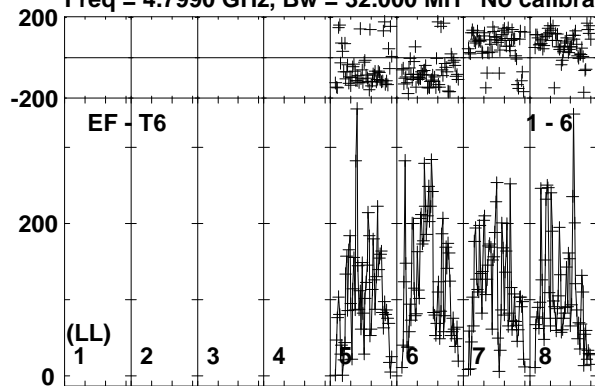

Lower frame: Micro Ampl Jy Top frame: Phas deg
 Vector averaged cross-power spectrum Baseline: EF (01) - T6 (06)
 Timerange: 00/18:18:49 to 00/18:22:31

Plot file version 11 created 03-OCT-2017 13:09:35

J2353+5518 RP028.UVDATA.1

Freq = 4.7990 GHz, Bw = 32.000 MH No calibration applied and no bandpass applied

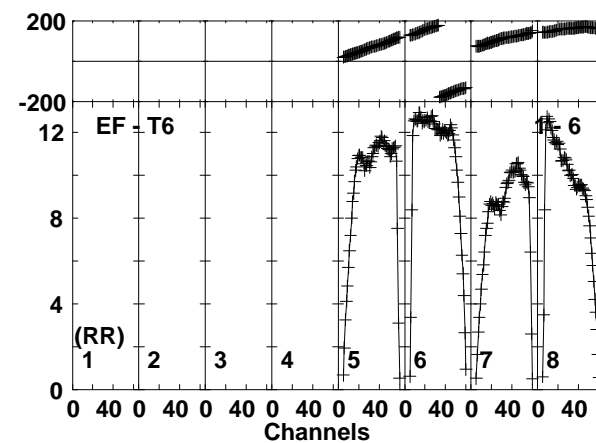
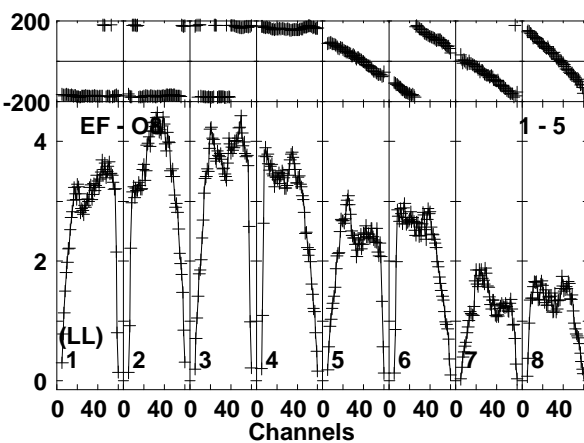
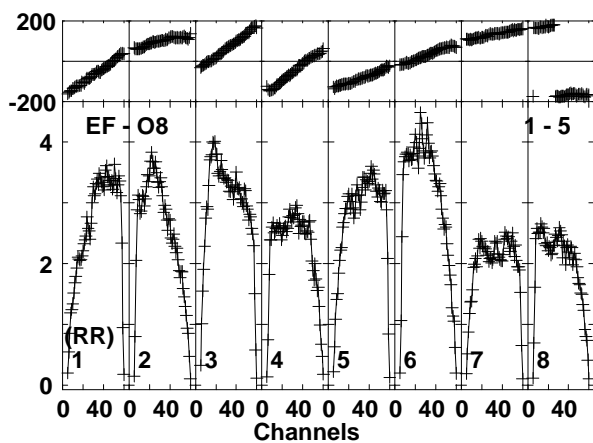
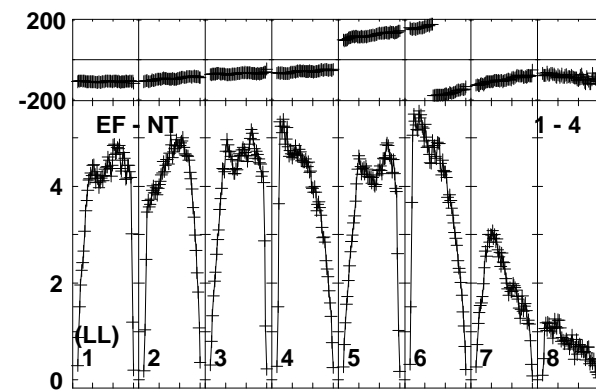
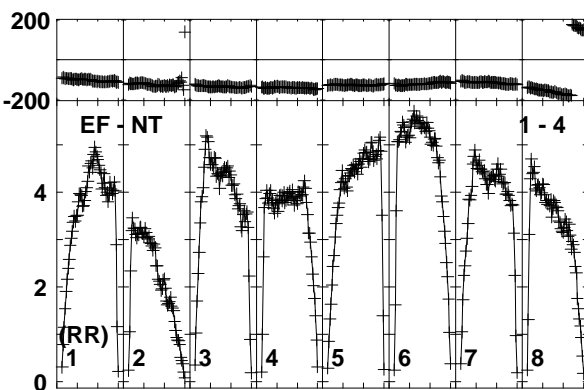
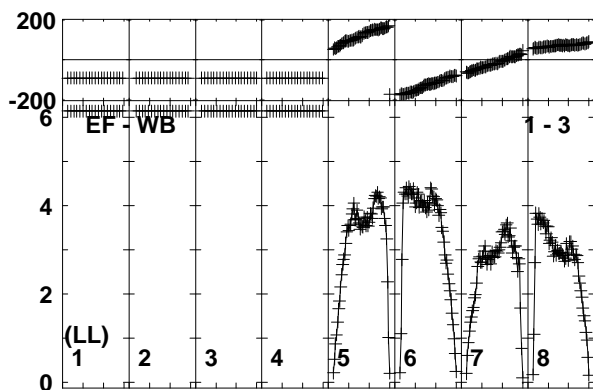
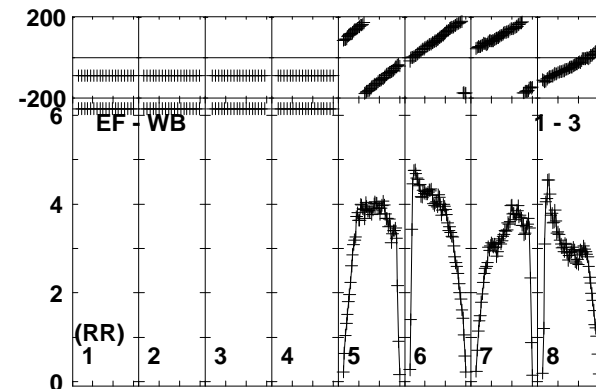
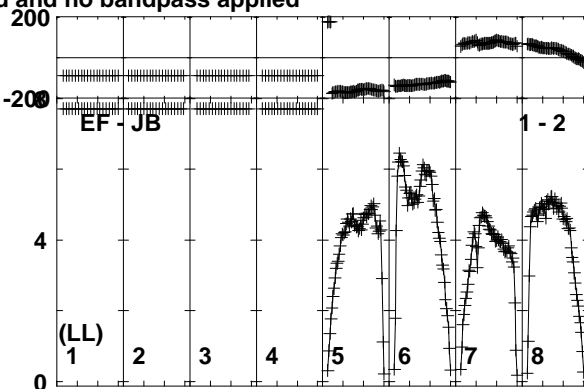
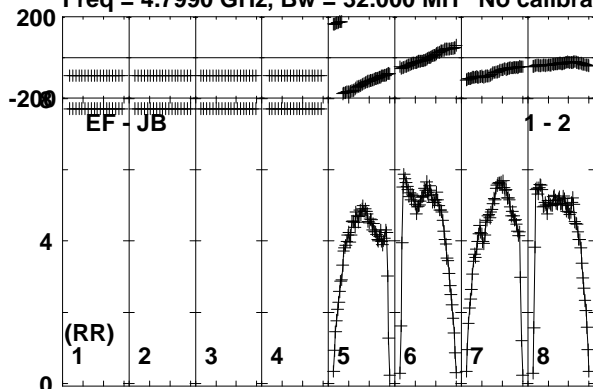

Lower frame: Milli Ampl Jy Top frame: Phas deg
Vector averaged cross-power spectrum Baseline: EF (01) - JB (02)
Timerange: 00/18:22:32 to 00/18:24:02

Plot file version 12 created 03-OCT-2017 13:09:35

J2353+5518 RP028.UVDATA.1

Freq = 4.7990 GHz, Bw = 32.000 MH No calibration applied and no bandpass applied

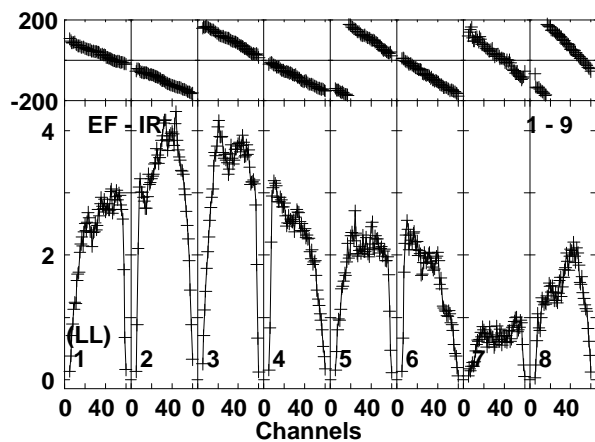
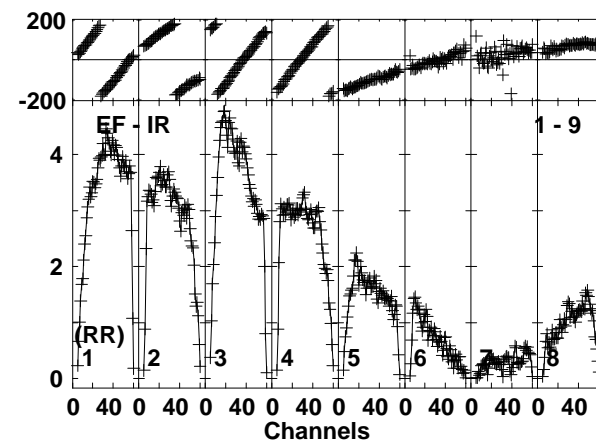
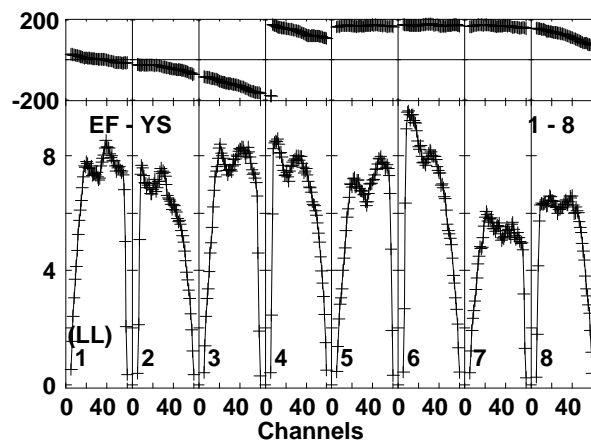
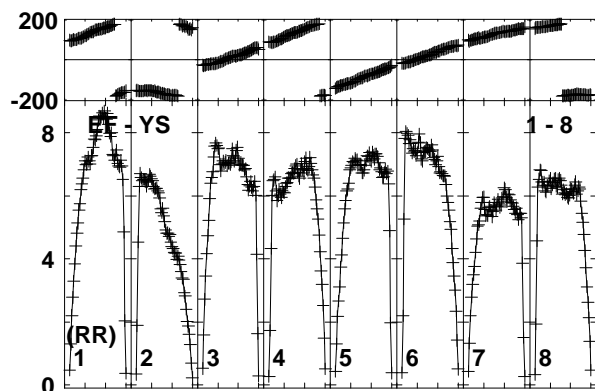
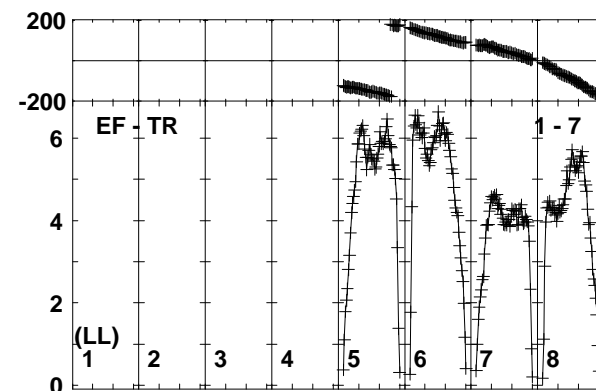
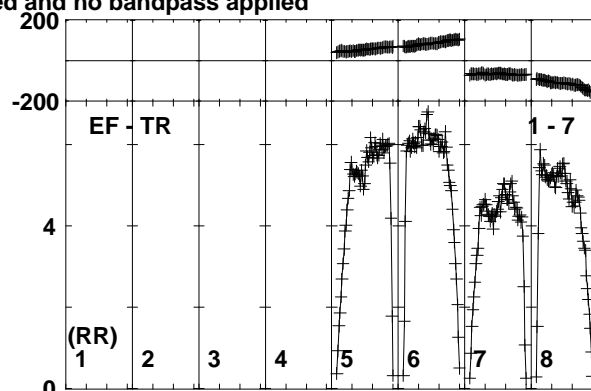
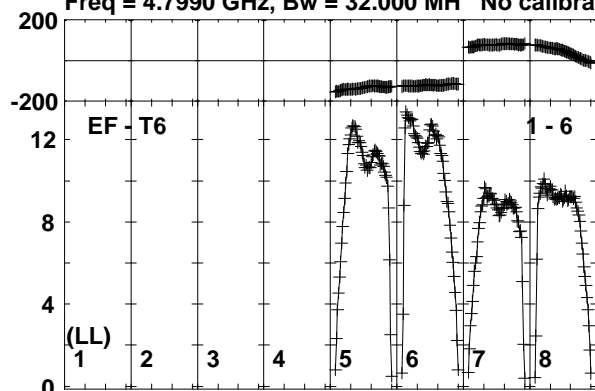

Lower frame: Milli Ampl Jy Top frame: Phas deg
Vector averaged cross-power spectrum Baseline: EF (01) - T6 (06)
Timerange: 00/18:22:32 to 00/18:24:02

Plot file version 13 created 03-OCT-2017 13:09:35

IRAS23436 RP028.UVDATA.1

Freq = 4.7990 GHz, Bw = 32.000 MH No calibration applied and no bandpass applied

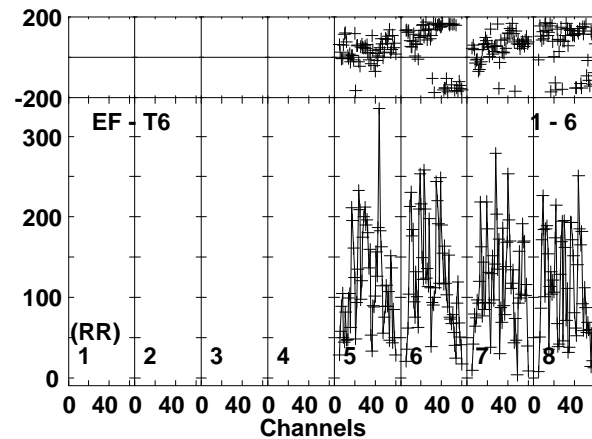
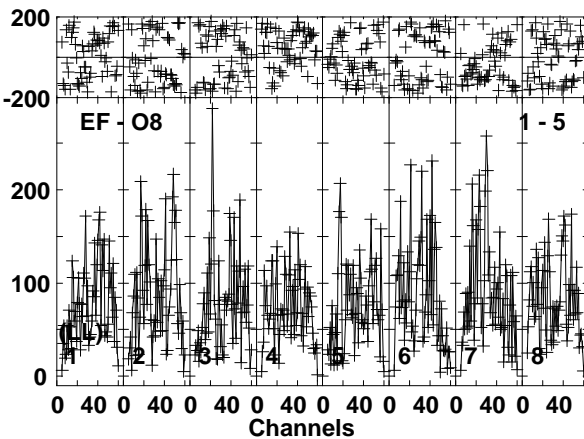
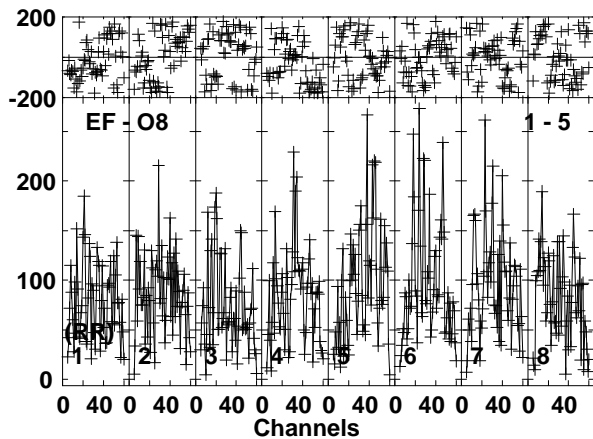
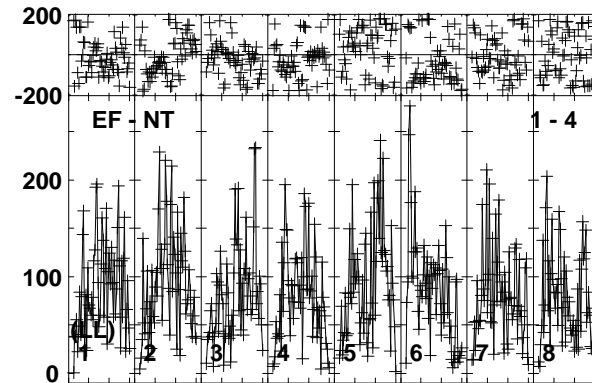
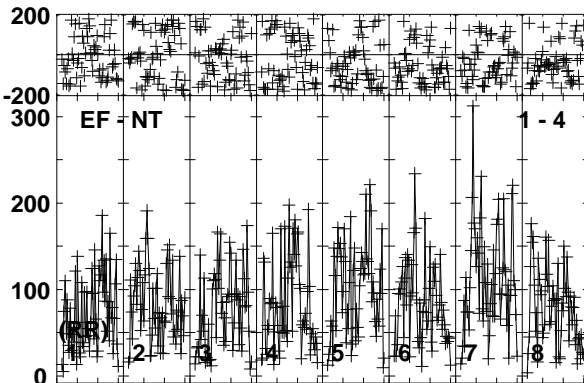
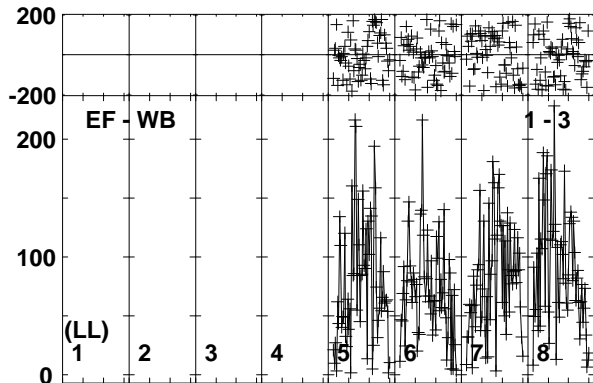
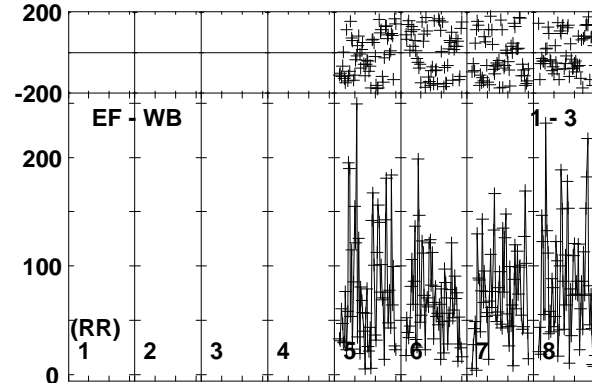
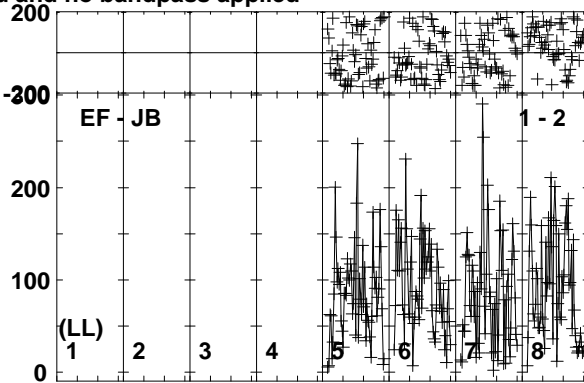
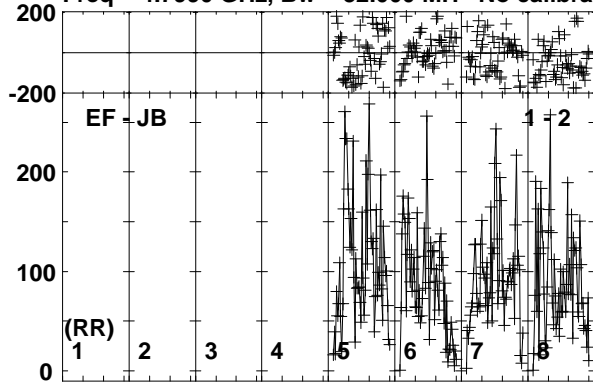

Lower frame: Micro Ampl Jy Top frame: Phas deg
Vector averaged cross-power spectrum Baseline: EF (01) - JB (02)
Timerange: 00/18:24:03 to 00/18:27:45

Plot file version 14 created 03-OCT-2017 13:09:36

IRAS23436 RP028.UVDATA.1

Freq = 4.7990 GHz, Bw = 32.000 MH No calibration applied and no bandpass applied

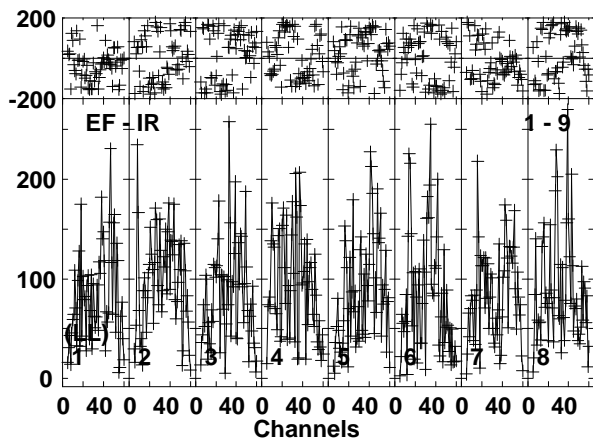
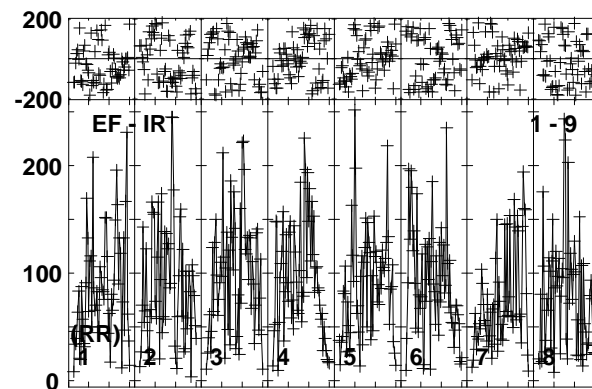
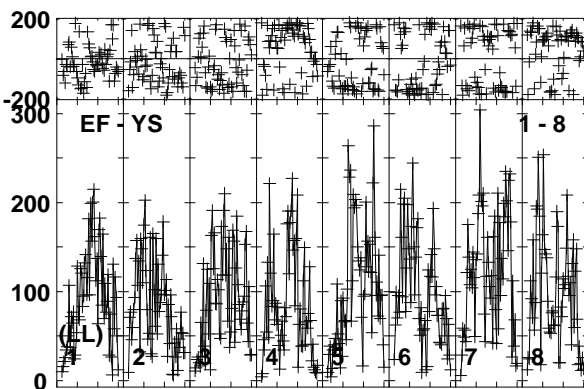
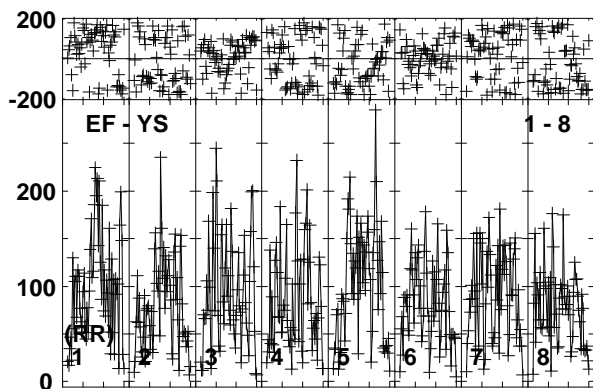
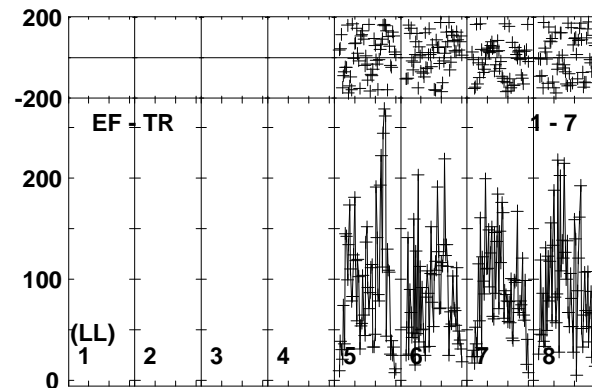
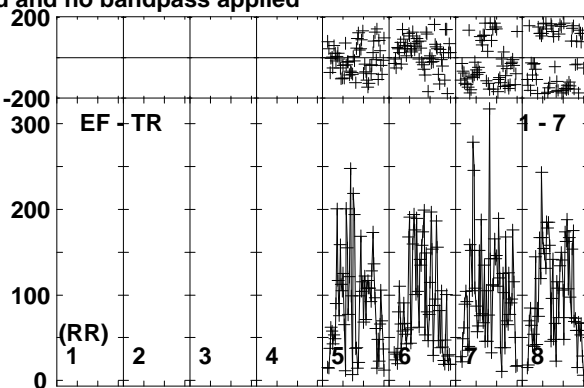
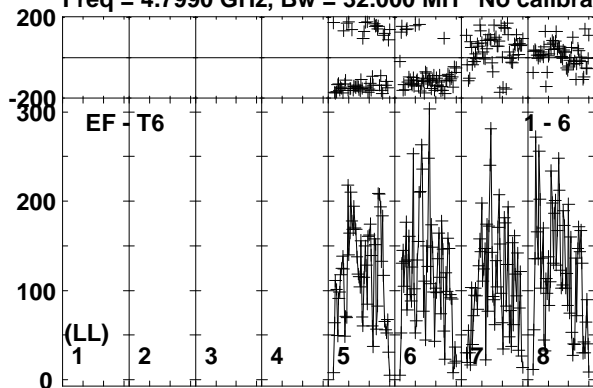

Lower frame: Micro Ampl Jy Top frame: Phas deg
Vector averaged cross-power spectrum Baseline: EF (01) - T6 (06)
Timerange: 00/18:24:03 to 00/18:27:45

Plot file version 15 created 03-OCT-2017 13:09:36

J2353+5518 RP028.UVDATA.1

Freq = 4.7990 GHz, Bw = 32.000 MH No calibration applied and no bandpass applied

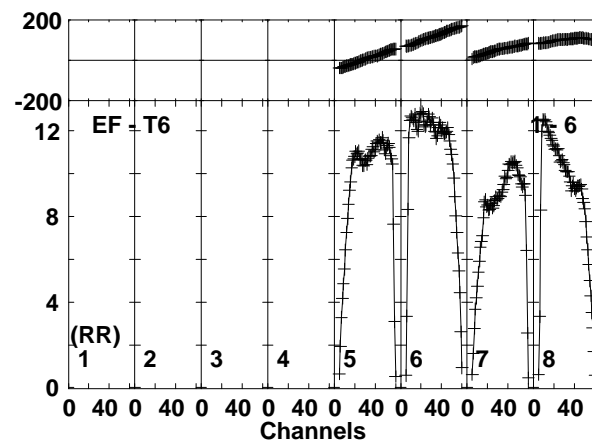
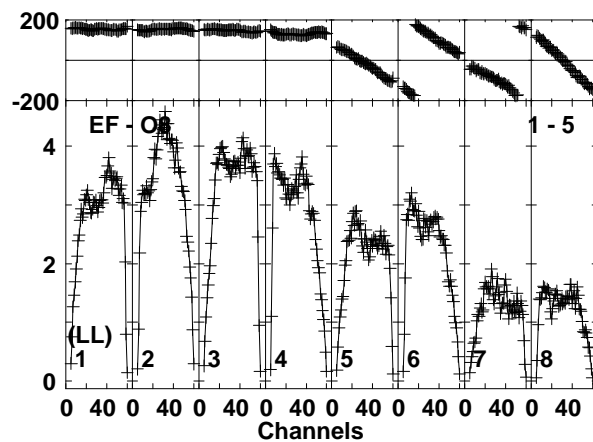
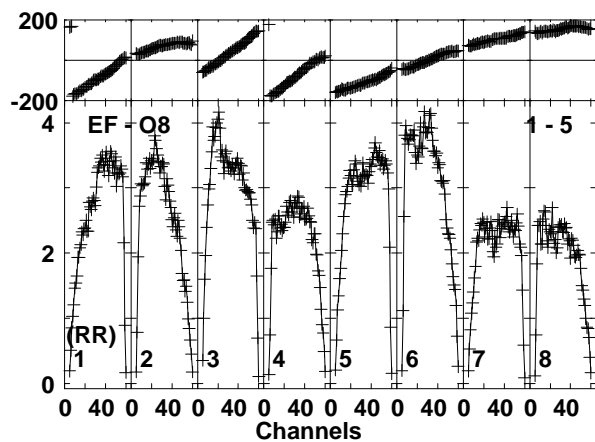
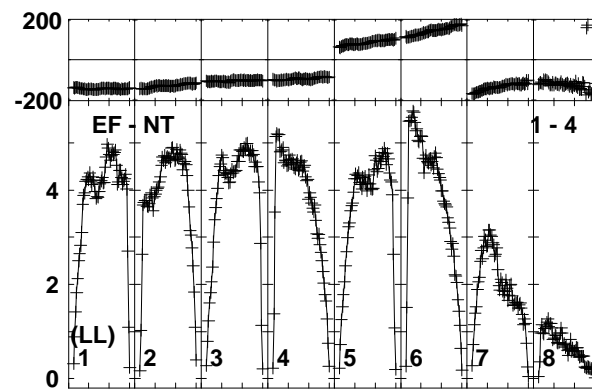
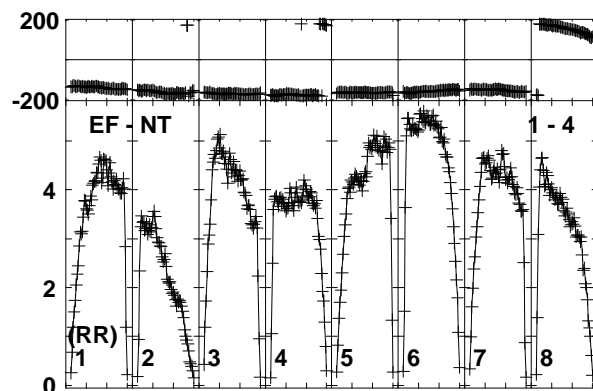
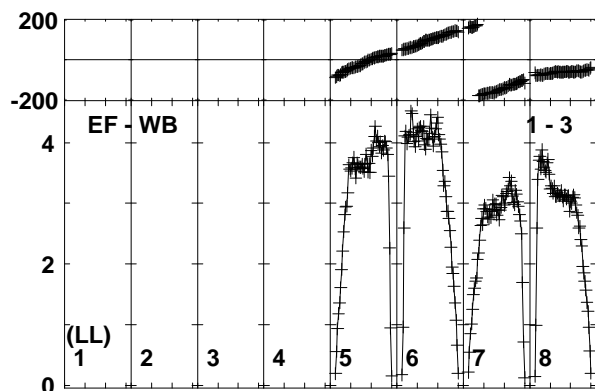
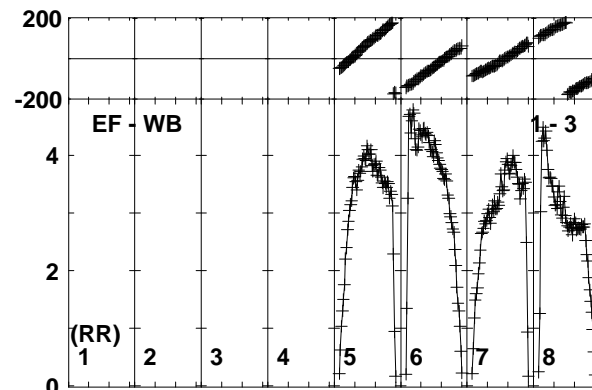
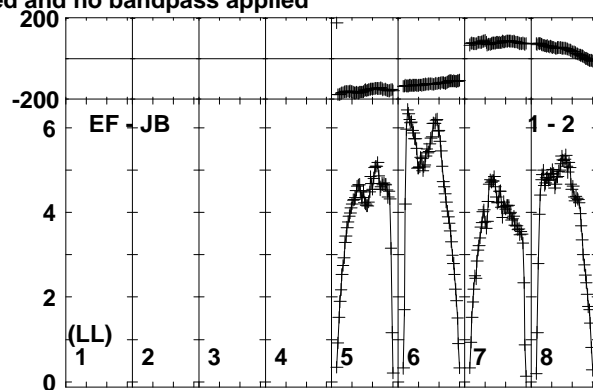
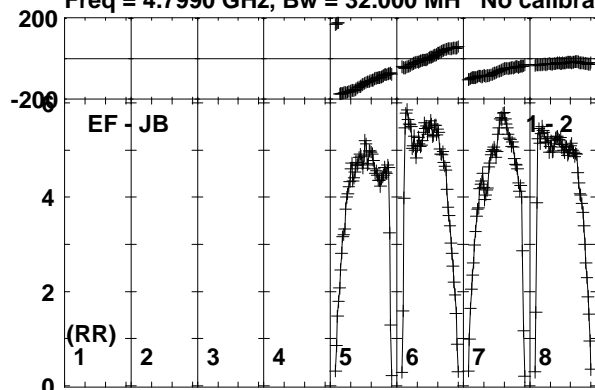

Lower frame: Milli Ampl Jy Top frame: Phas deg
Vector averaged cross-power spectrum Baseline: EF (01) - JB (02)
Timerange: 00/18:28:27 to 00/18:29:26

Plot file version 16 created 03-OCT-2017 13:09:36

J2353+5518 RP028.UVDATA.1

Freq = 4.7990 GHz, Bw = 32.000 MH No calibration applied and no bandpass applied

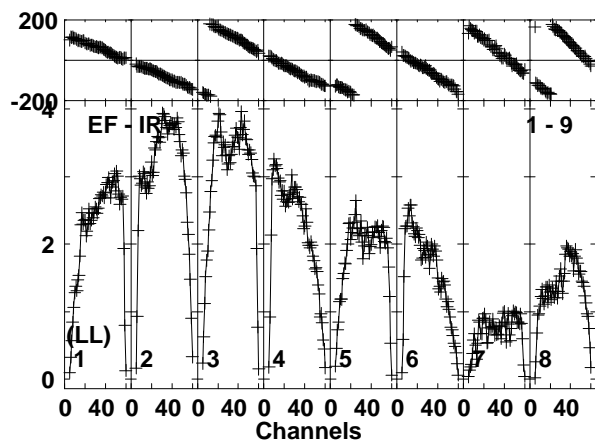
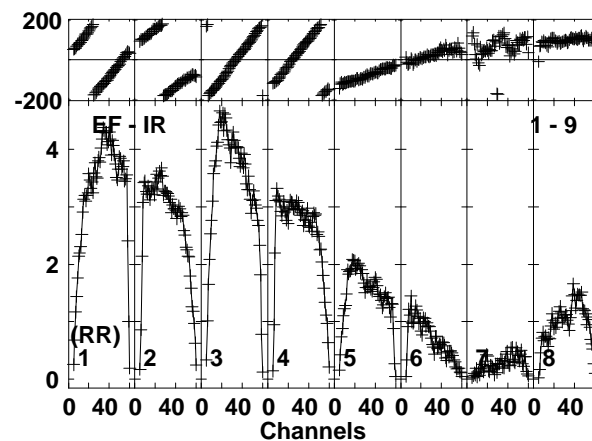
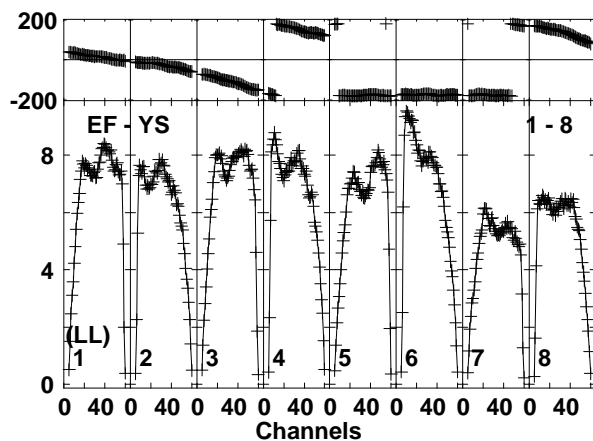
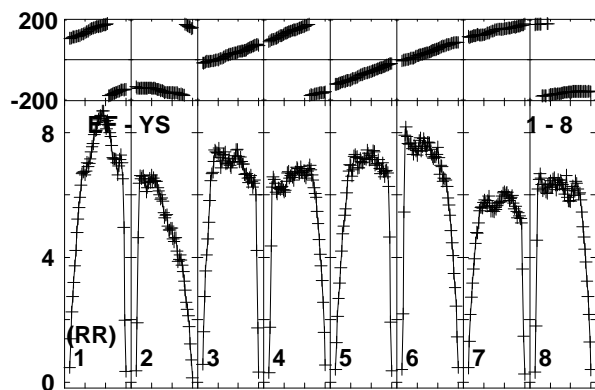
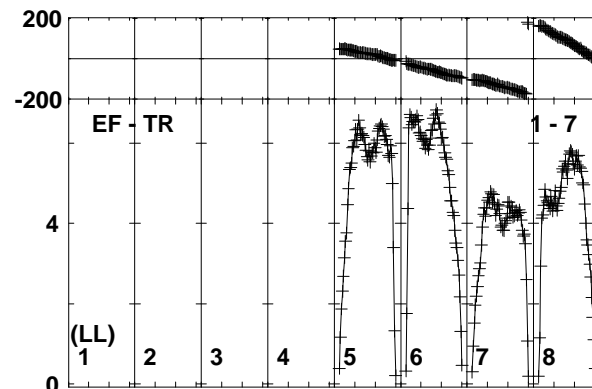
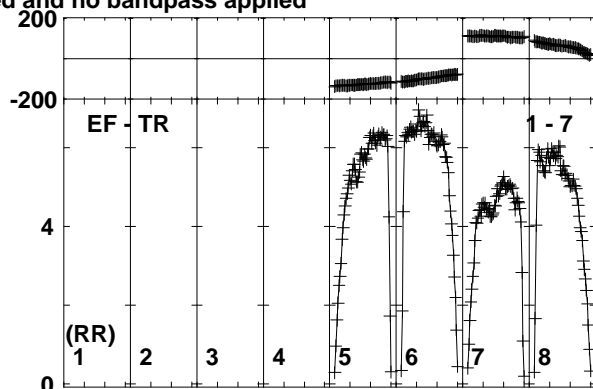
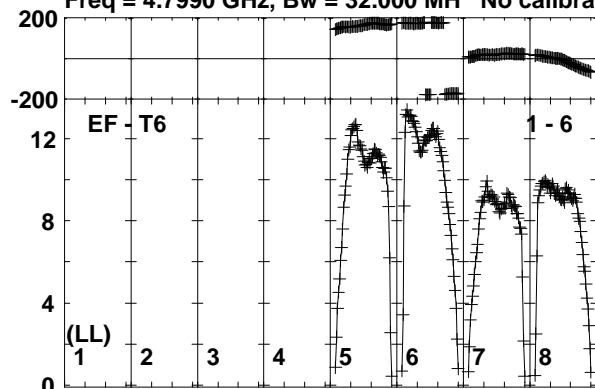

Lower frame: Milli Ampl Jy Top frame: Phas deg
Vector averaged cross-power spectrum Baseline: EF (01) - T6 (06)
Timerange: 00/18:28:27 to 00/18:29:26

Plot file version 17 created 03-OCT-2017 13:09:36

IRAS23436 RP028.UVDATA.1

Freq = 4.7990 GHz, Bw = 32.000 MH No calibration applied and no bandpass applied

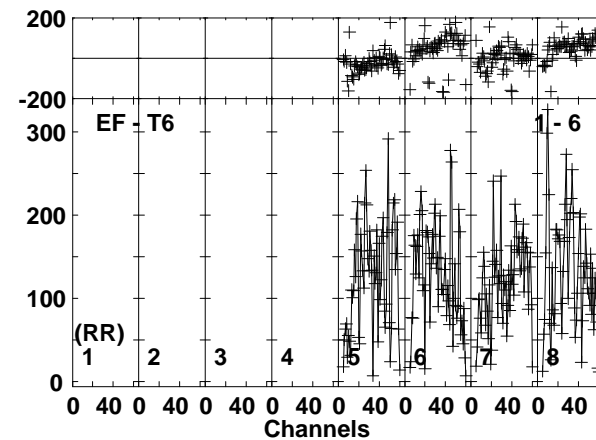
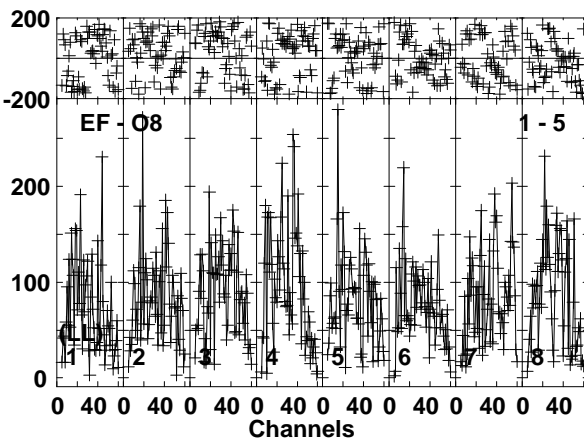
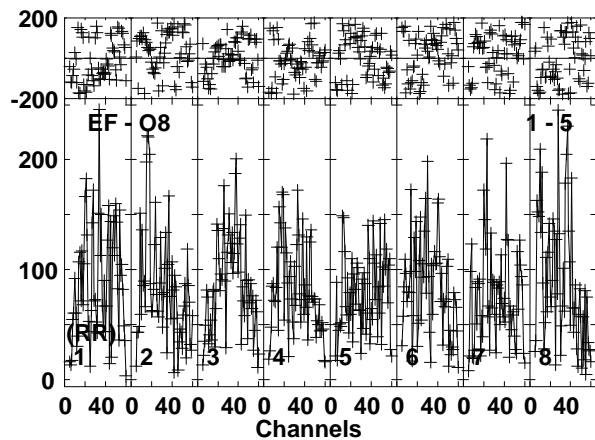
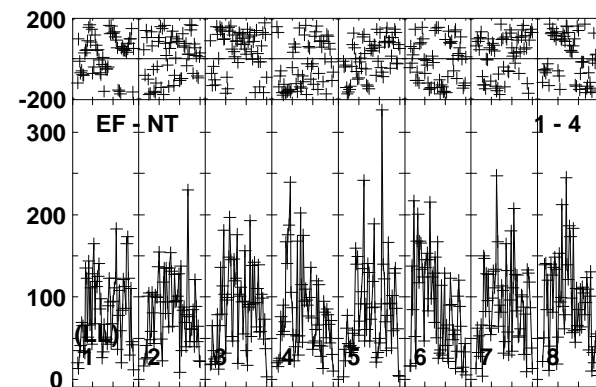
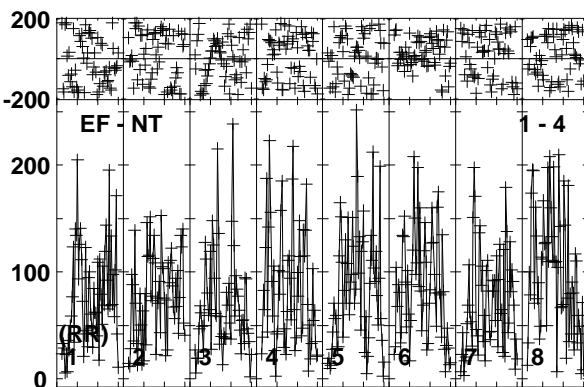
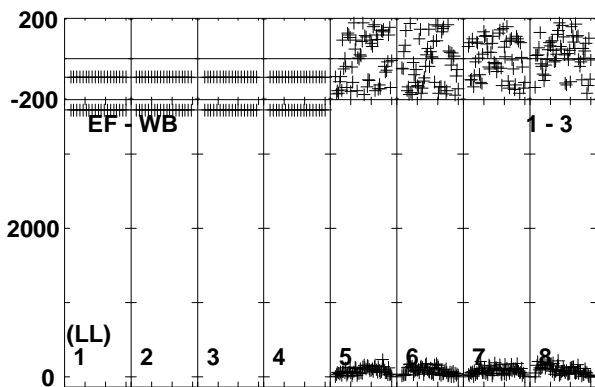
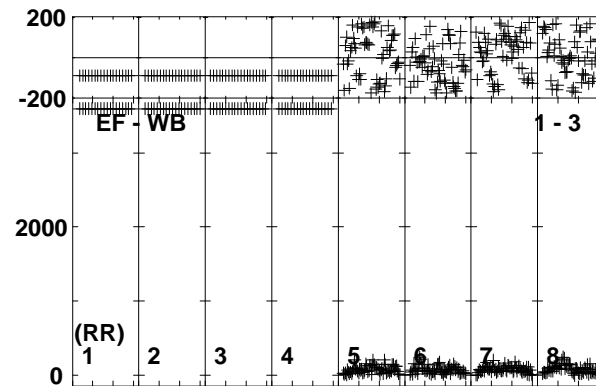
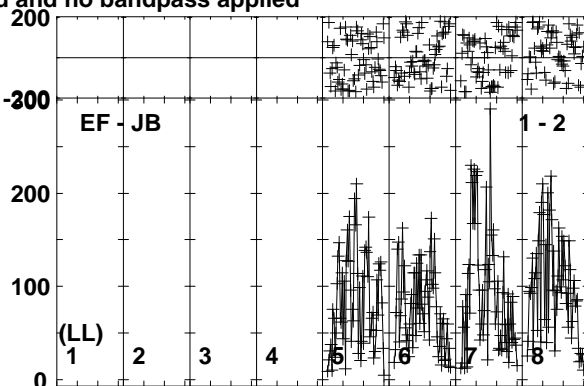
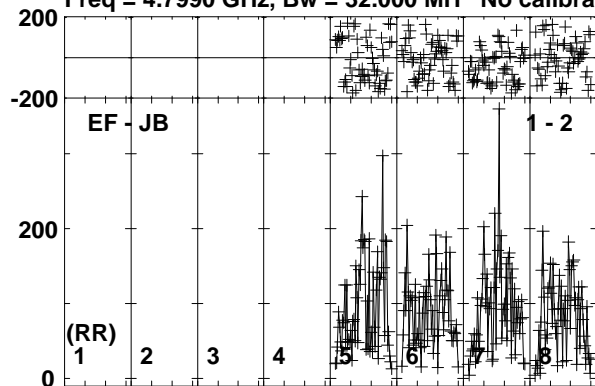

Lower frame: Micro Ampl Jy Top frame: Phas deg
Vector averaged cross-power spectrum Baseline: EF (01) - JB (02)
Timerange: 00/18:29:26 to 00/18:33:06

Plot file version 18 created 03-OCT-2017 13:09:36

IRAS23436 RP028.UVDATA.1

Freq = 4.7990 GHz, Bw = 32.000 MH No calibration applied and no bandpass applied

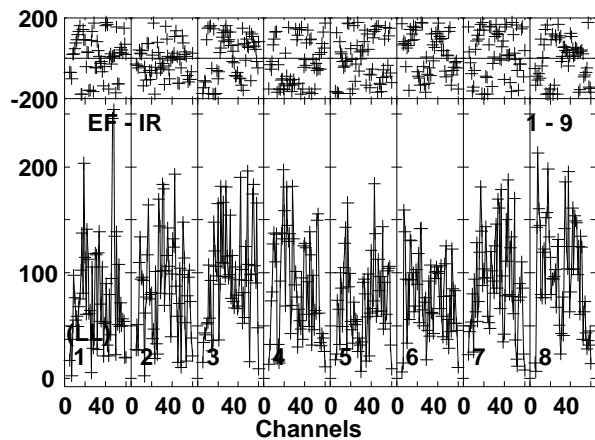
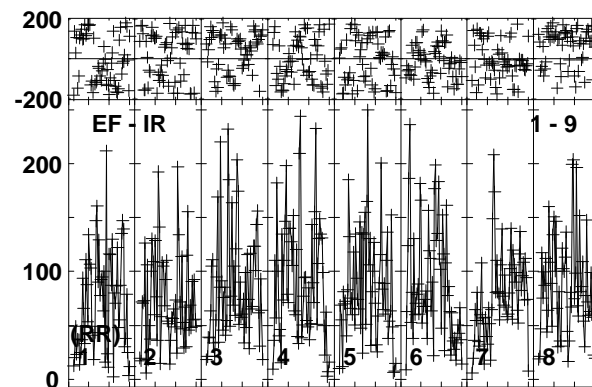
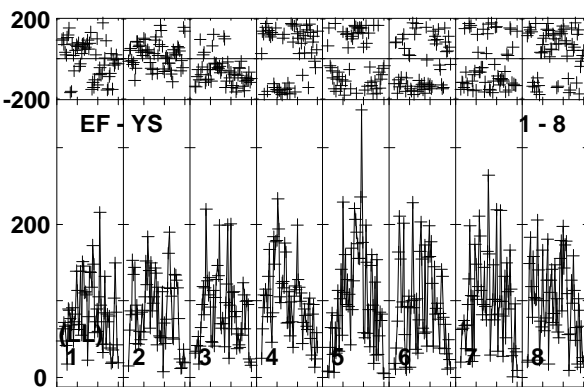
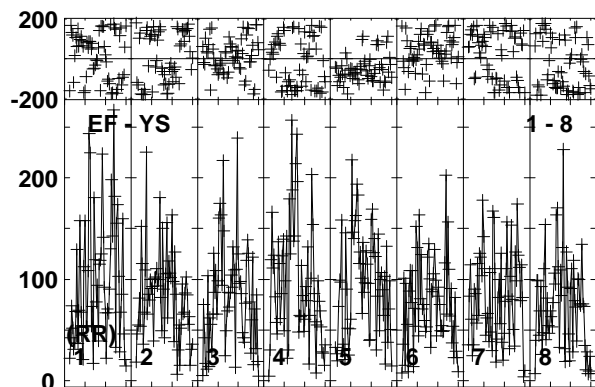
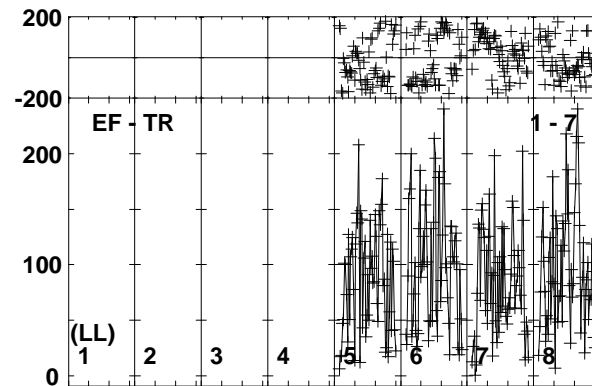
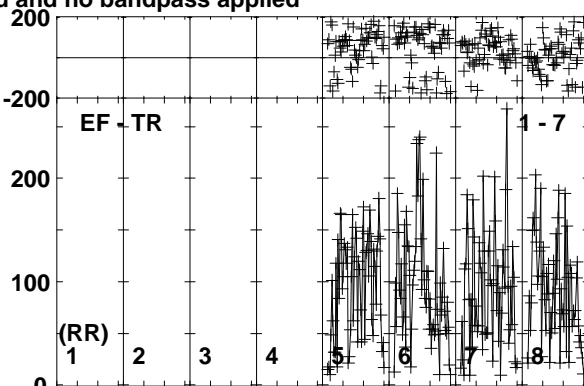
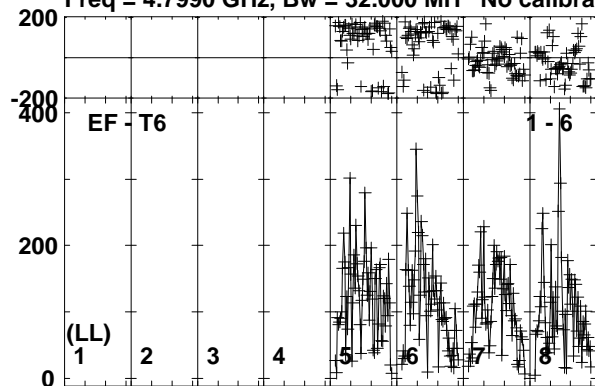

Lower frame: Micro Ampl Jy Top frame: Phas deg
Vector averaged cross-power spectrum Baseline: EF (01) - T6 (06)
Timerange: 00/18:29:26 to 00/18:33:06

Plot file version 19 created 03-OCT-2017 13:09:37

J2353+5518 RP028.UVDATA.1

Freq = 4.7990 GHz, Bw = 32.000 MH No calibration applied and no bandpass applied

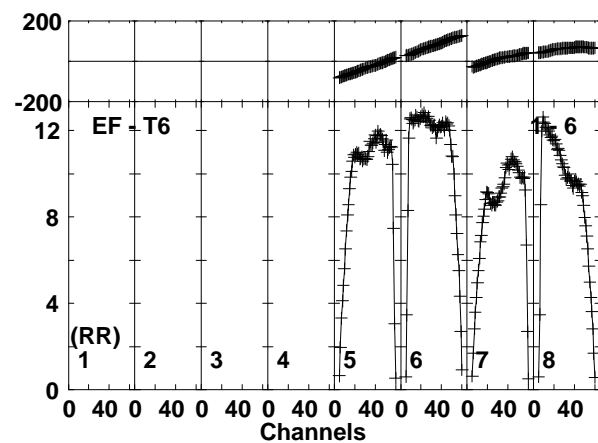
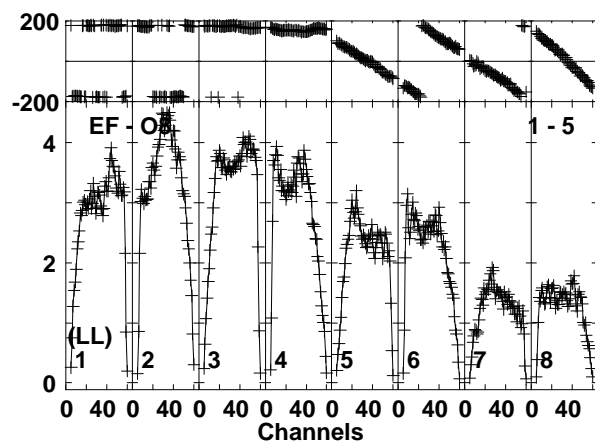
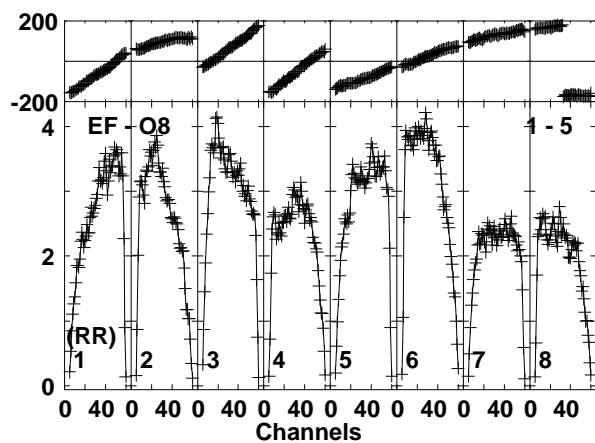
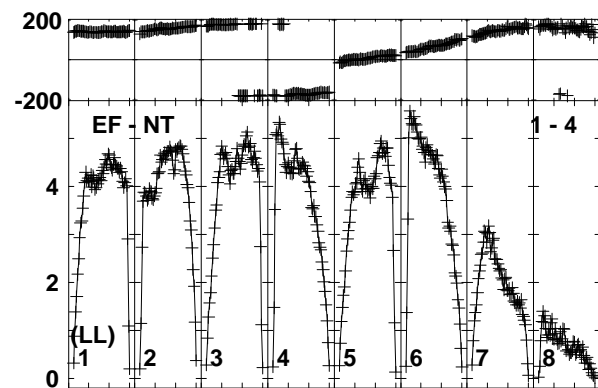
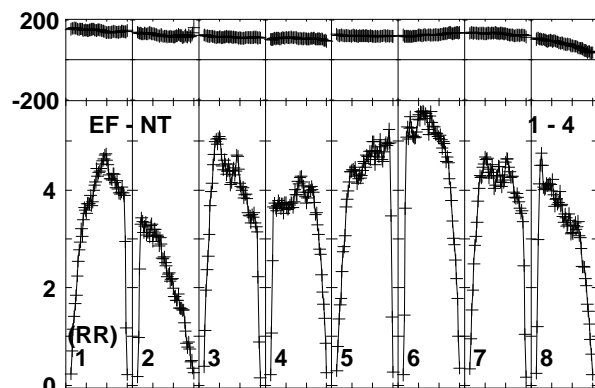
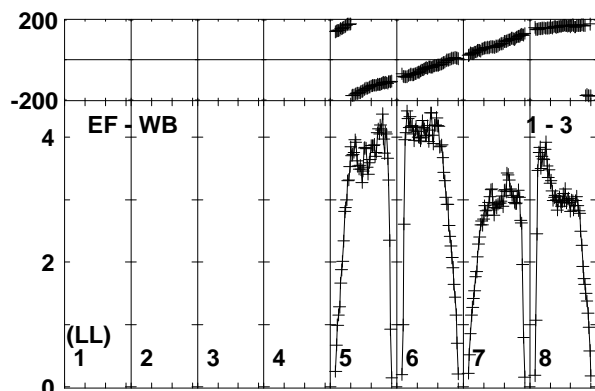
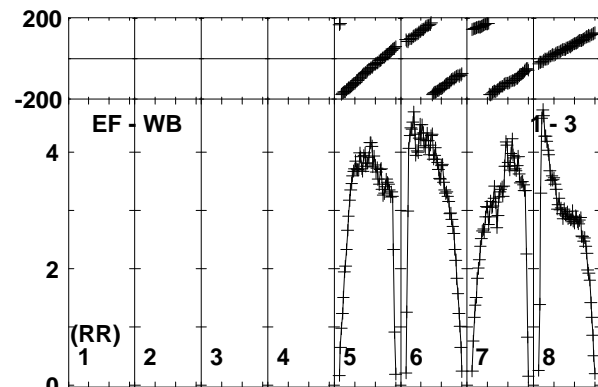
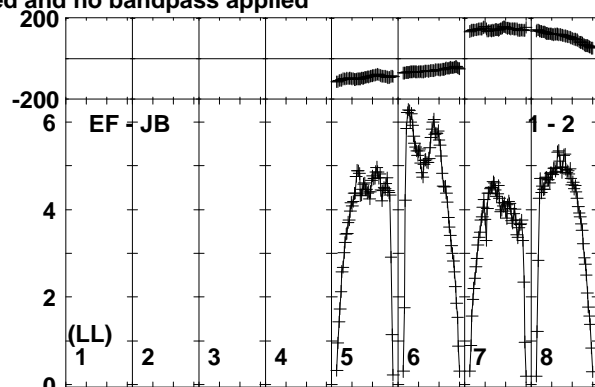
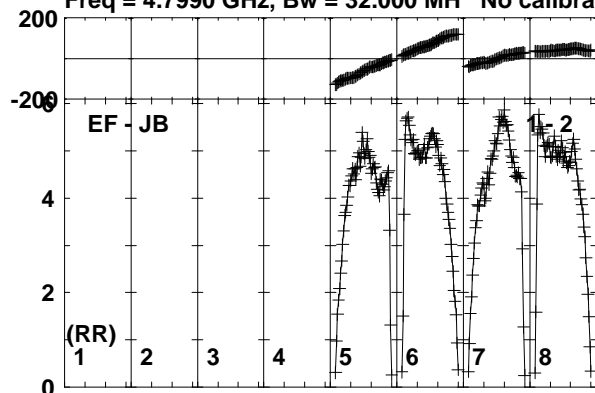

Lower frame: Milli Ampl Jy Top frame: Phas deg
Vector averaged cross-power spectrum Baseline: EF (01) - JB (02)
Timerange: 00:18:33:06 to 00:18:34:35

Plot file version 20 created 03-OCT-2017 13:09:37

J2353+5518 RP028.UVDATA.1

Freq = 4.7990 GHz, Bw = 32.000 MH No calibration applied and no bandpass applied

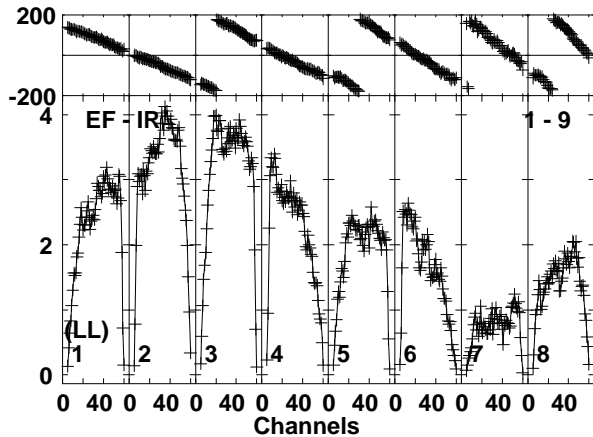
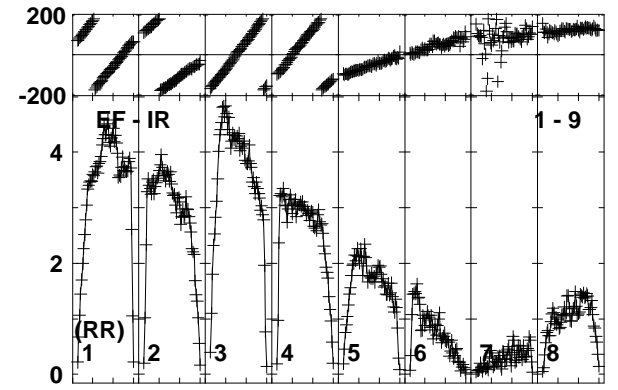
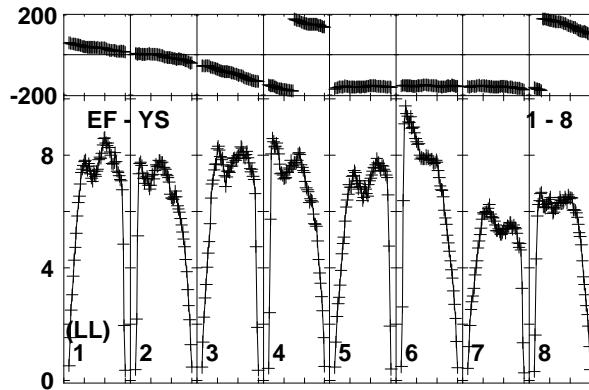
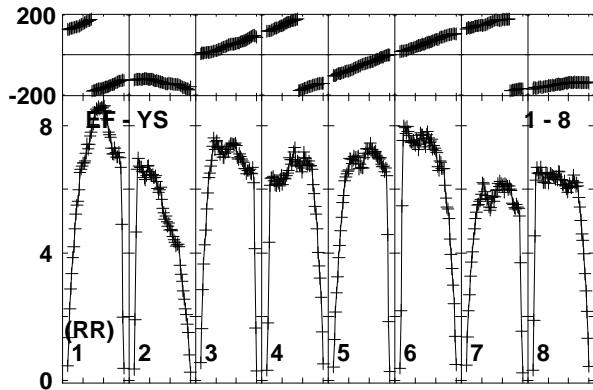
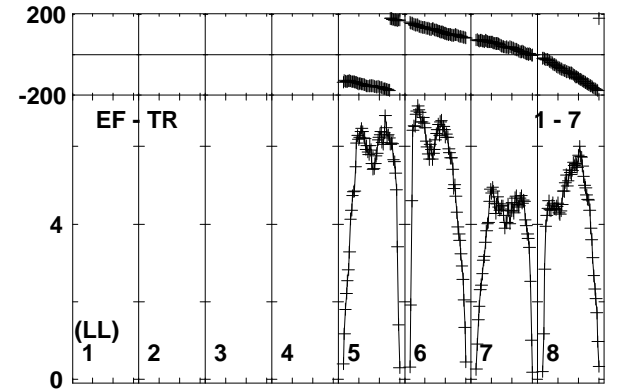
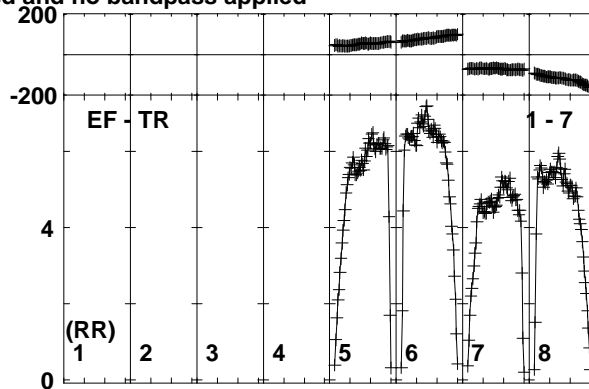
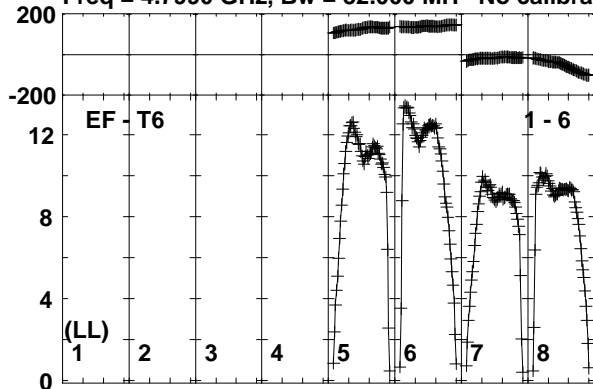

Lower frame: Milli Ampl Jy Top frame: Phas deg
Vector averaged cross-power spectrum Baseline: EF (01) - T6 (06)
Timerange: 00/18:33:06 to 00/18:34:35

Plot file version 21 created 03-OCT-2017 13:09:37

IRAS23436 RP028.UVDATA.1

Freq = 4.7990 GHz, Bw = 32.000 MH No calibration applied and no bandpass applied

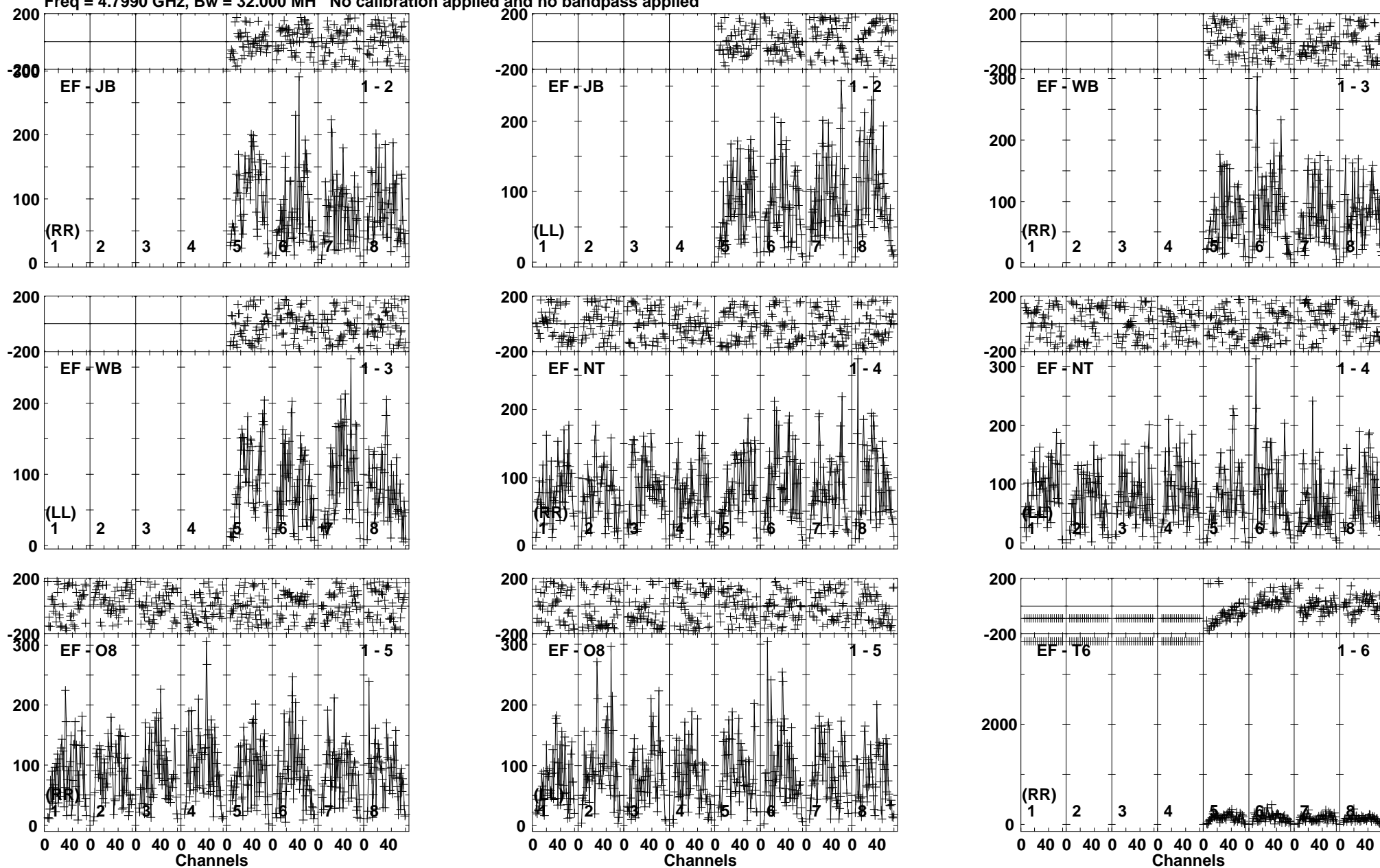

Lower frame: Micro Ampl Jy Top frame: Phas deg
Vector averaged cross-power spectrum Baseline: EF (01) - JB (02)
Timerange: 00/18:34:36 to 00/18:38:20

Plot file version 22 created 03-OCT-2017 13:09:37

IRAS23436 RP028.UVDATA.1

Freq = 4.7990 GHz, Bw = 32.000 MH No calibration applied and no bandpass applied

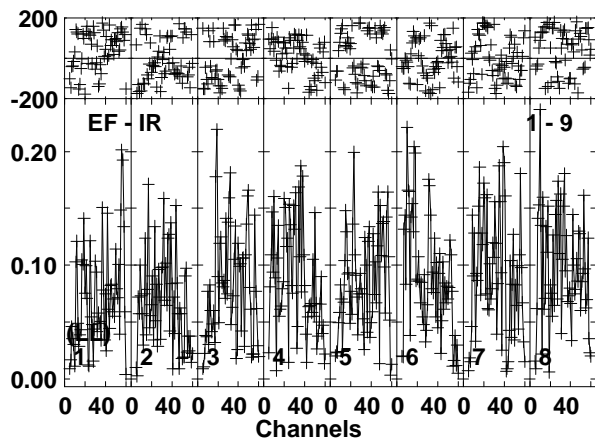
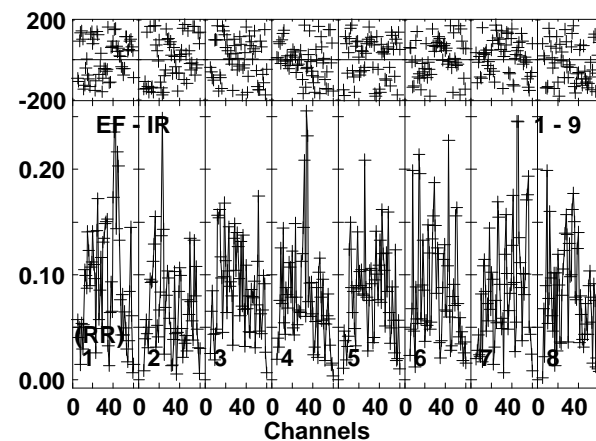
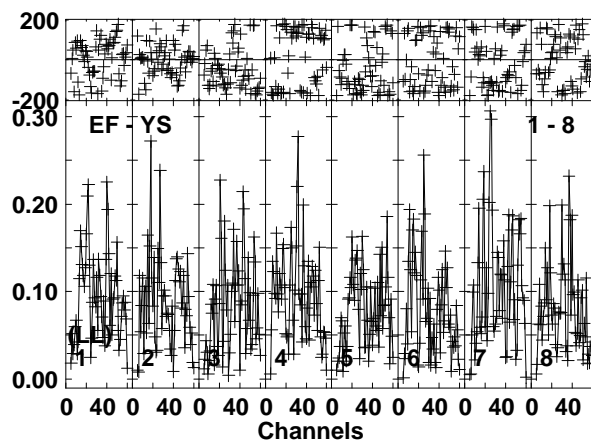
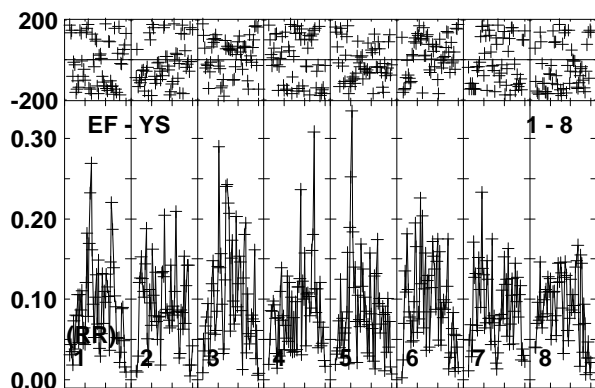
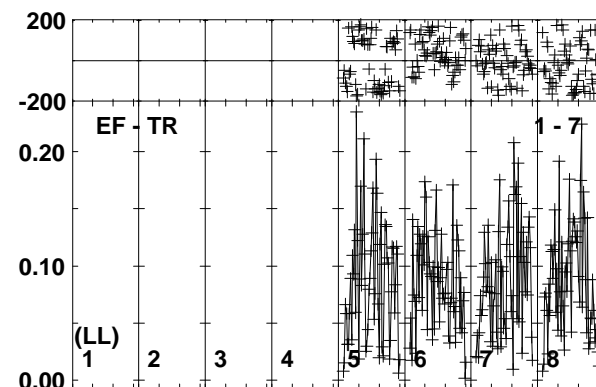
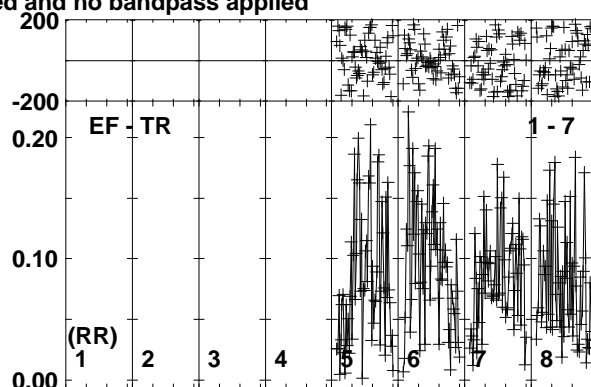
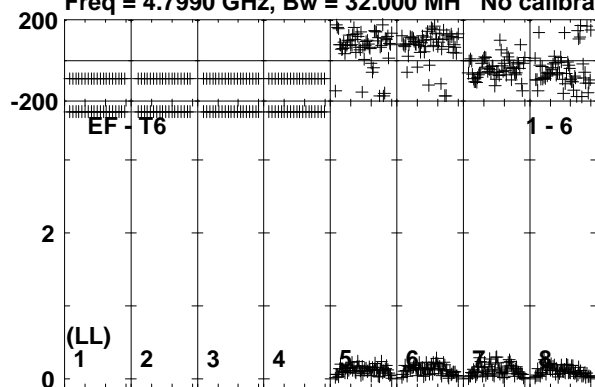

Lower frame: Milli Ampl Jy Top frame: Phas deg
Vector averaged cross-power spectrum Baseline: EF (01) - T6 (06)
Timerange: 00/18:34:36 to 00/18:38:20

Plot file version 23 created 03-OCT-2017 13:09:37

J2353+5518 RP028.UVDATA.1

Freq = 4.7990 GHz, Bw = 32.000 MH No calibration applied and no bandpass applied

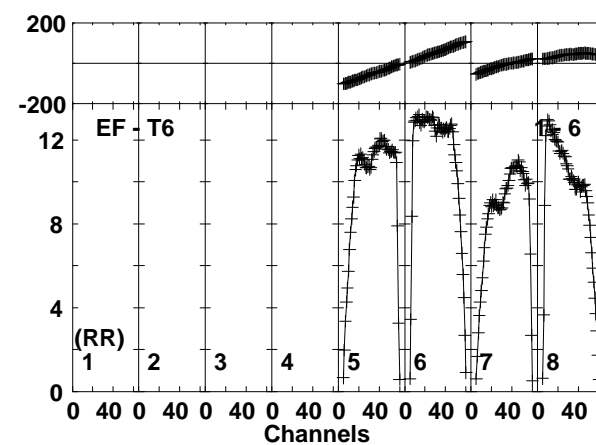
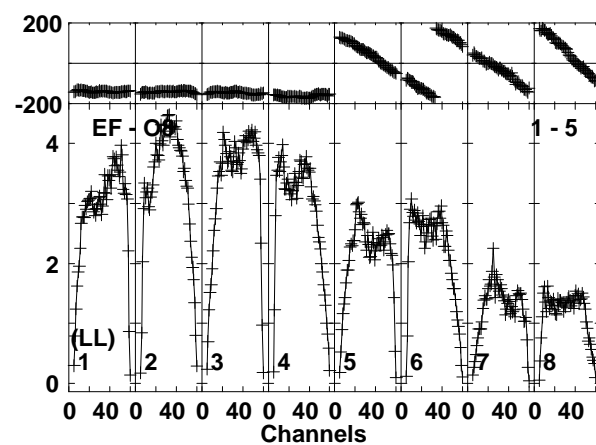
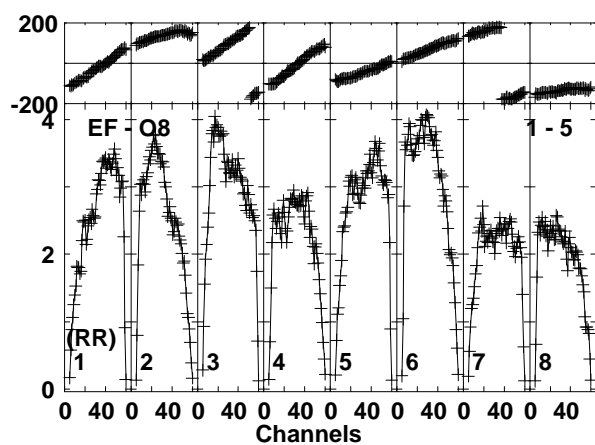
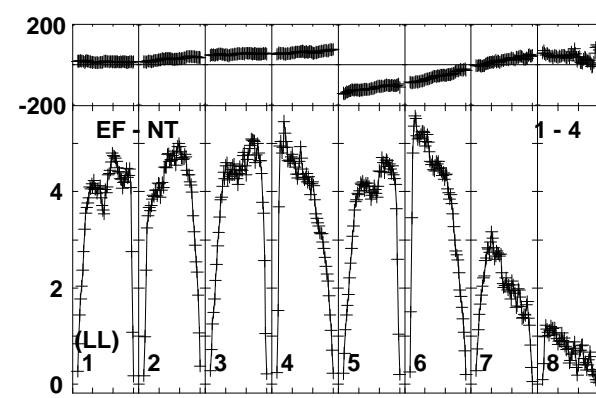
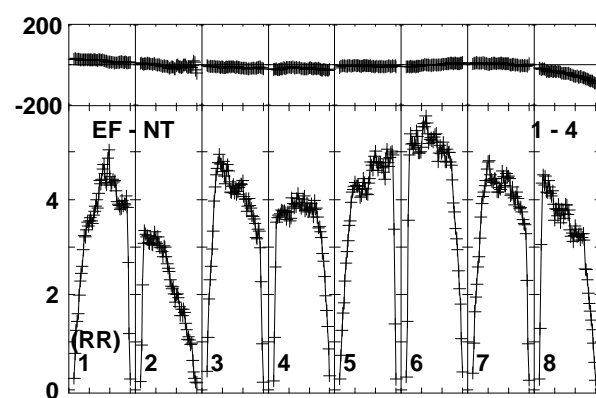
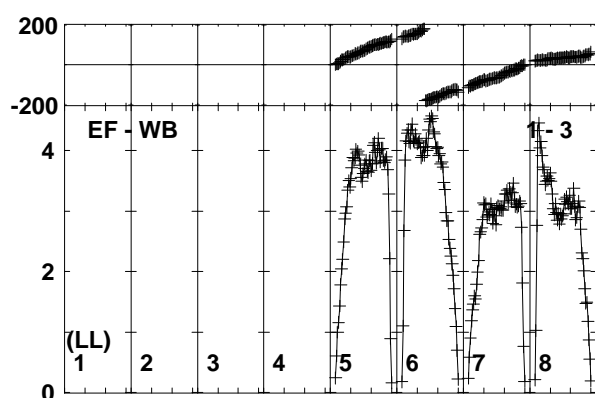
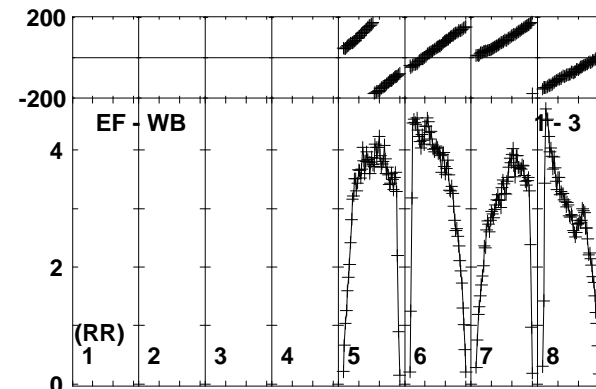
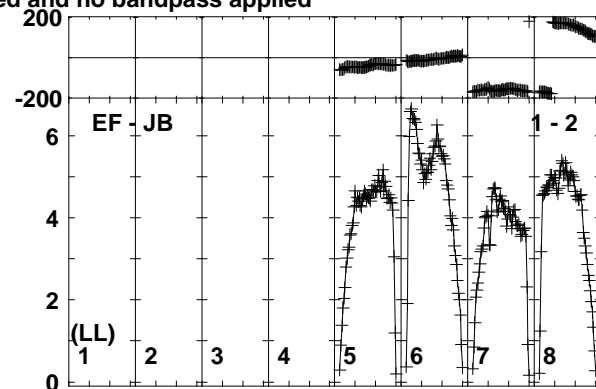
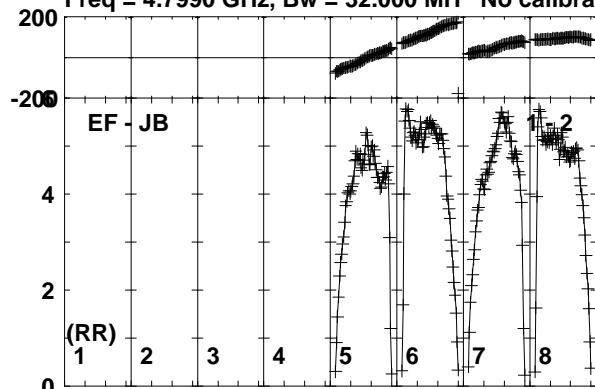

Lower frame: Milli Ampl Jy Top frame: Phas deg
Vector averaged cross-power spectrum Baseline: EF (01) - JB (02)
Timerange: 00:18:39:00 to 00:18:39:50

Plot file version 24 created 03-OCT-2017 13:09:38

J2353+5518 RP028.UVDATA.1

Freq = 4.7990 GHz, Bw = 32.000 MH No calibration applied and no bandpass applied

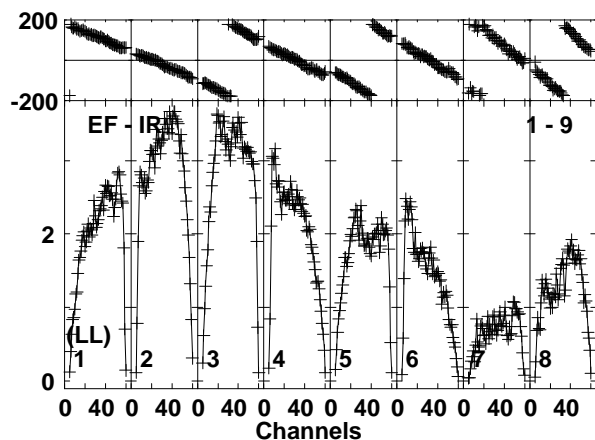
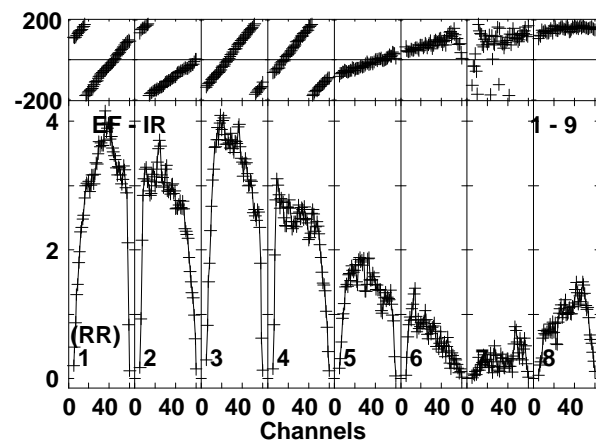
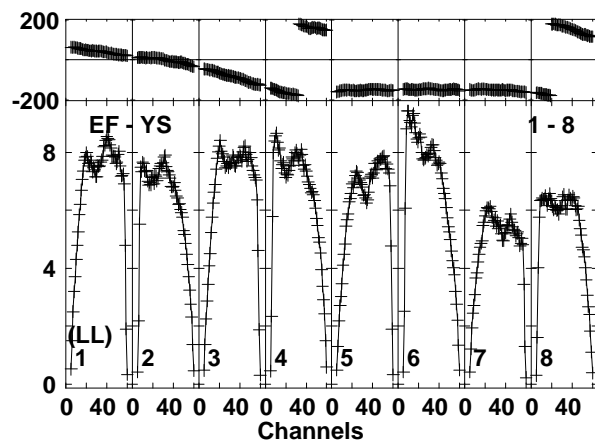
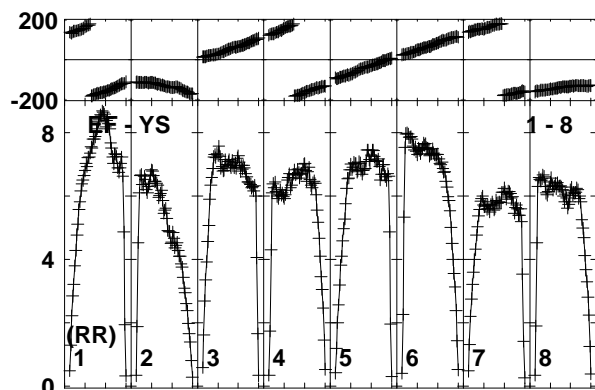
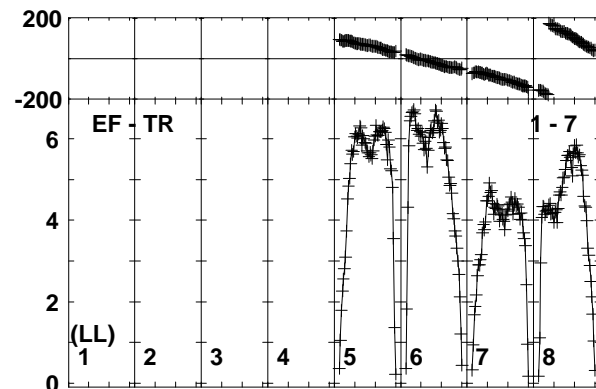
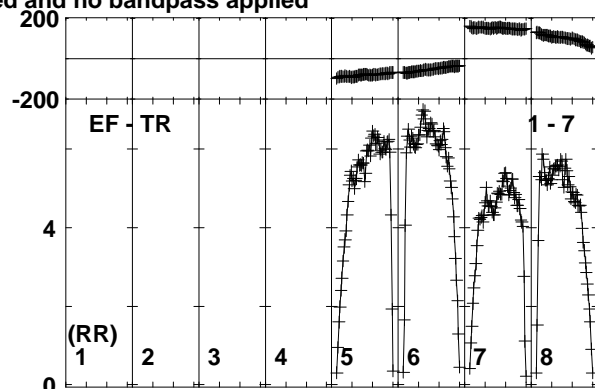
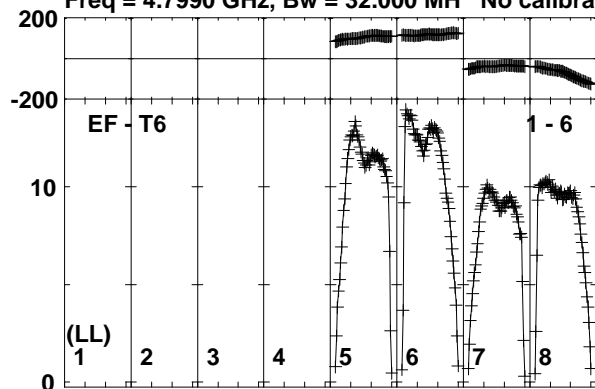

Lower frame: Milli Ampl Jy Top frame: Phas deg
Vector averaged cross-power spectrum Baseline: EF (01) - T6 (06)
Timerange: 00/18:39:00 to 00/18:39:50

Plot file version 25 created 03-OCT-2017 13:09:38

IRAS23436 RP028.UVDATA.1

Freq = 4.7990 GHz, Bw = 32.000 MH No calibration applied and no bandpass applied

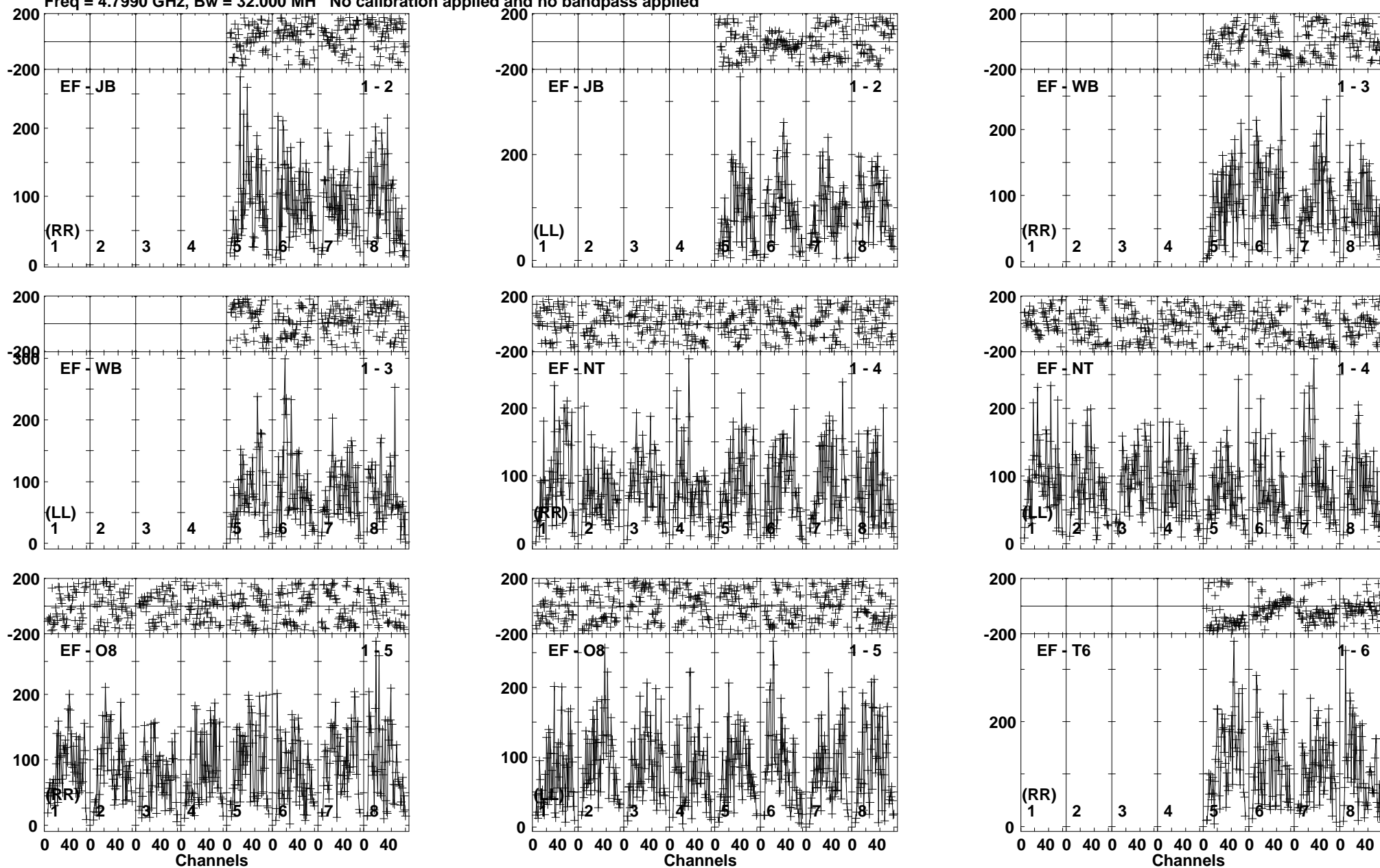

Lower frame: Micro Ampl Jy Top frame: Phas deg
Vector averaged cross-power spectrum Baseline: EF (01) - JB (02)
Timerange: 00/18:39:51 to 00/18:43:33

Plot file version 26 created 03-OCT-2017 13:09:38

IRAS23436 RP028.UVDATA.1

Freq = 4.7990 GHz, Bw = 32.000 MH No calibration applied and no bandpass applied

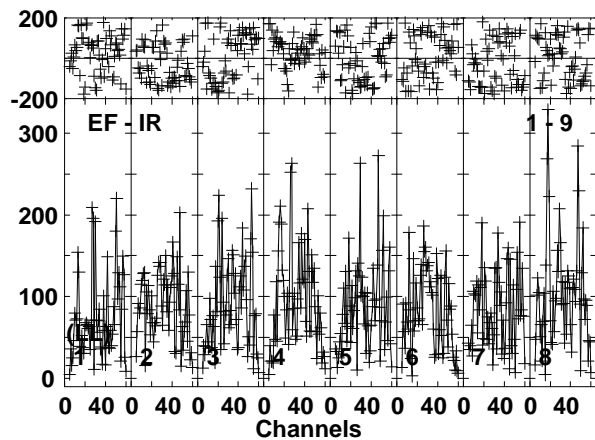
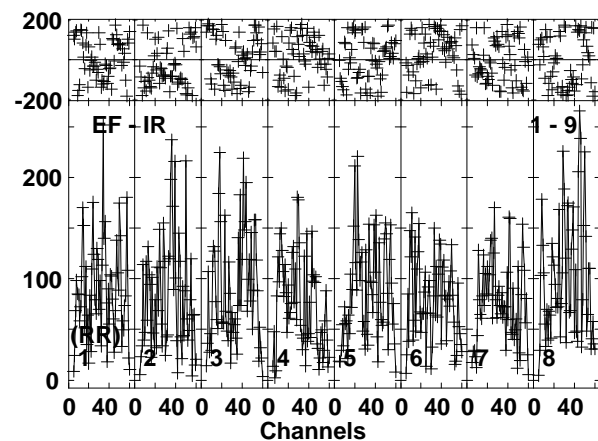
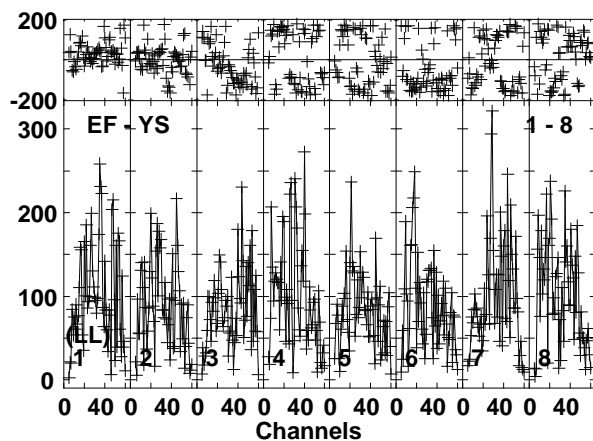
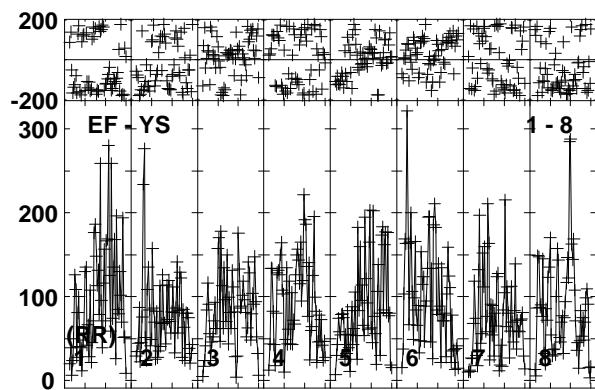
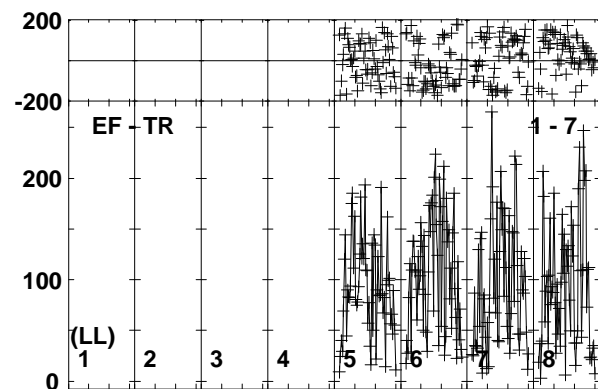
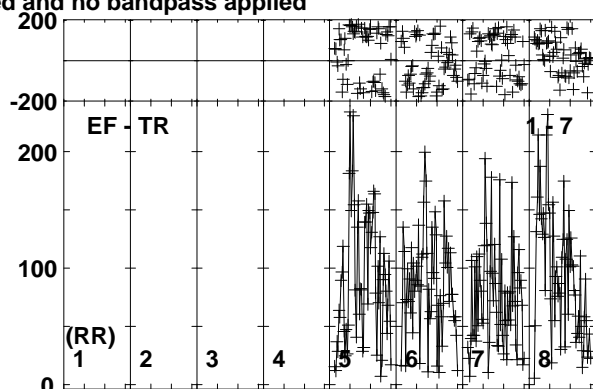
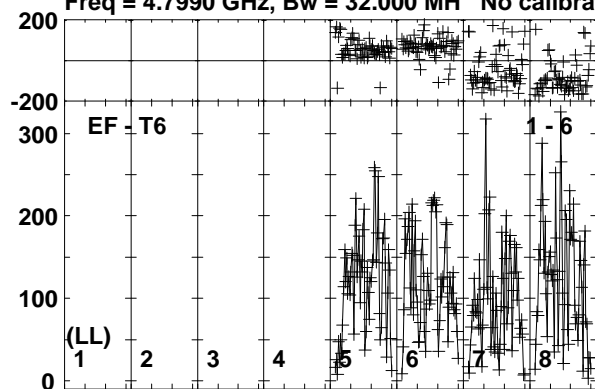

Lower frame: Micro Ampl Jy Top frame: Phas deg
Vector averaged cross-power spectrum Baseline: EF (01) - T6 (06)
Timerange: 00/18:39:51 to 00/18:43:33

Plot file version 27 created 03-OCT-2017 13:09:38

J2353+5518 RP028.UVDATA.1

Freq = 4.7990 GHz, Bw = 32.000 MH No calibration applied and no bandpass applied

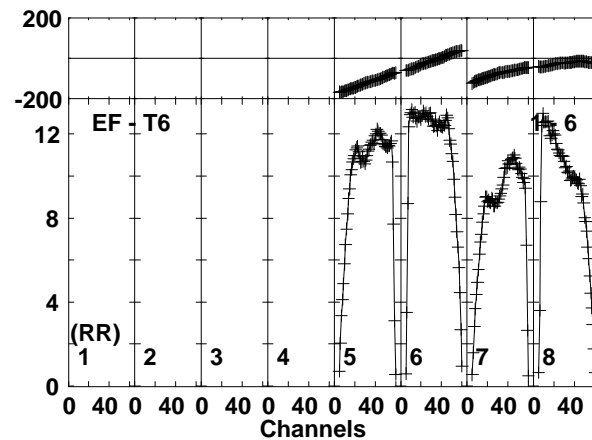
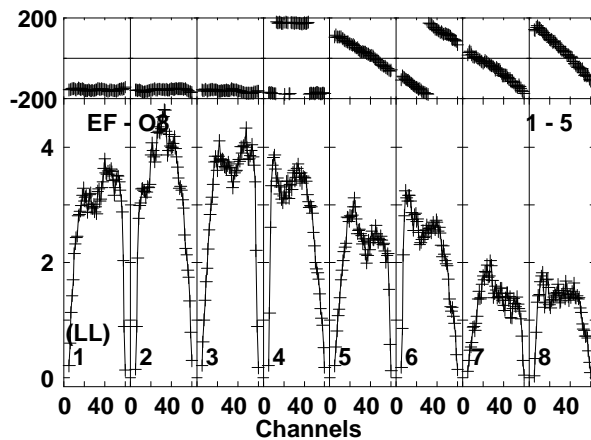
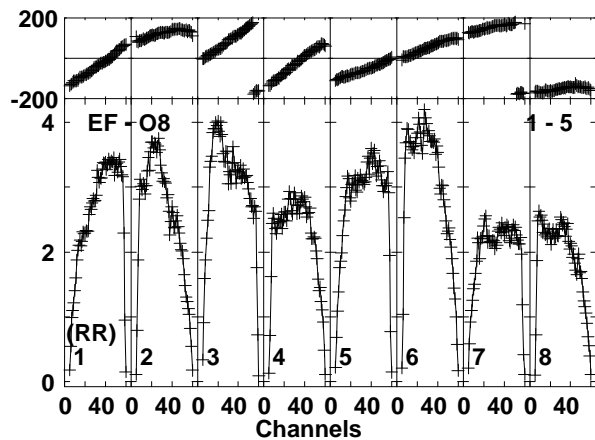
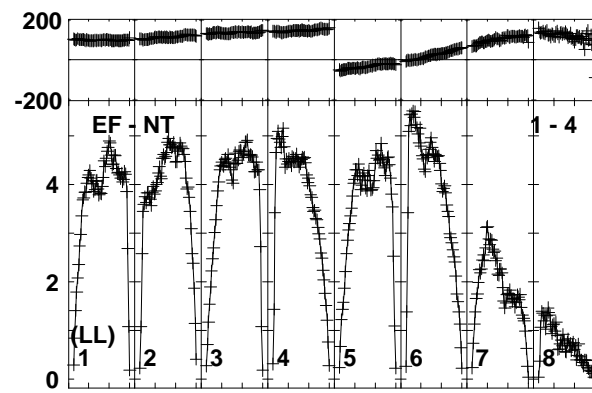
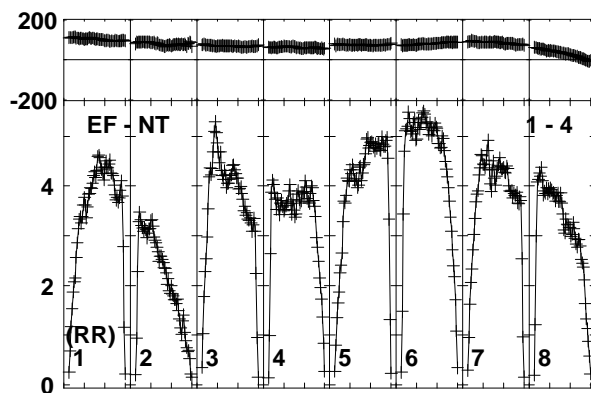
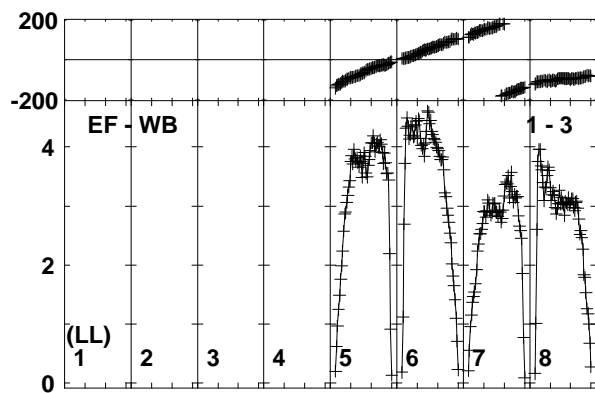
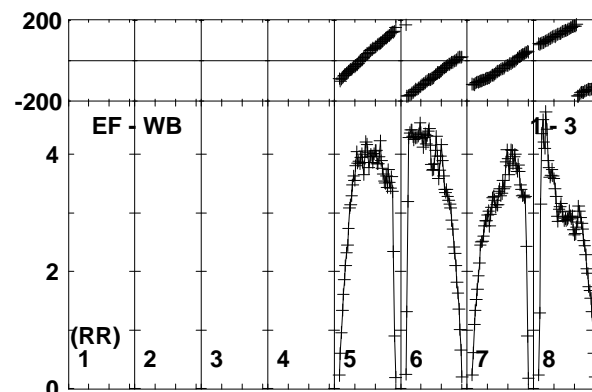
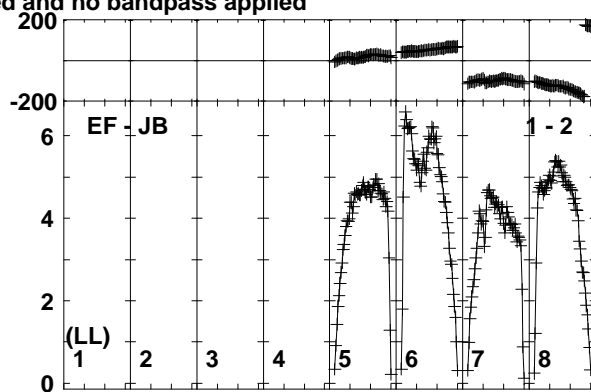
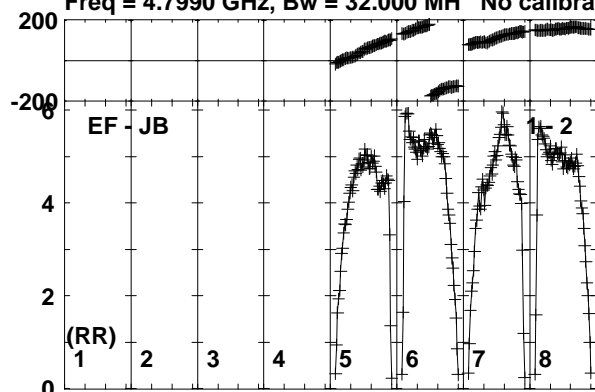

Lower frame: Milli Ampl Jy Top frame: Phas deg
Vector averaged cross-power spectrum Baseline: EF (01) - JB (02)
Timerange: 00/18:43:34 to 00/18:45:04

Plot file version 28 created 03-OCT-2017 13:09:38

J2353+5518 RP028.UVDATA.1

Freq = 4.7990 GHz, Bw = 32.000 MH No calibration applied and no bandpass applied

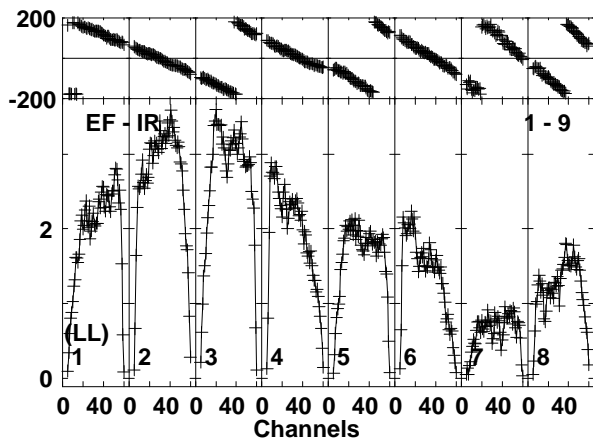
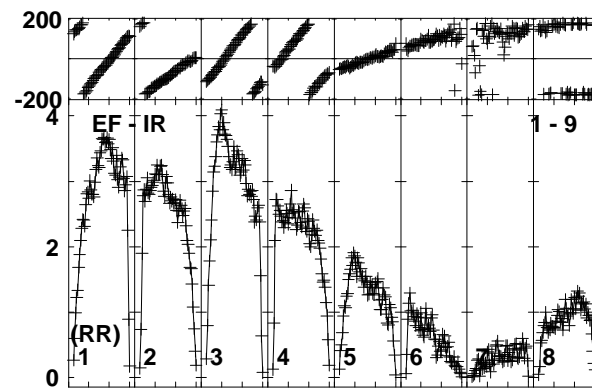
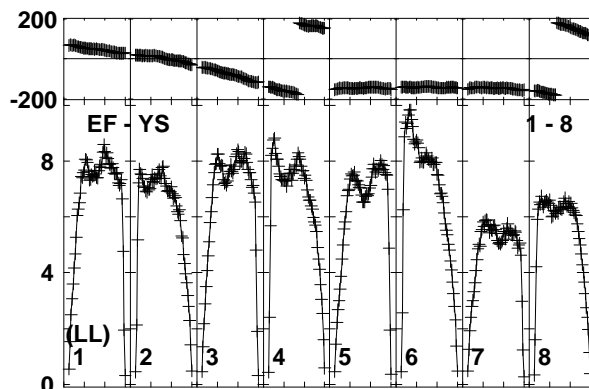
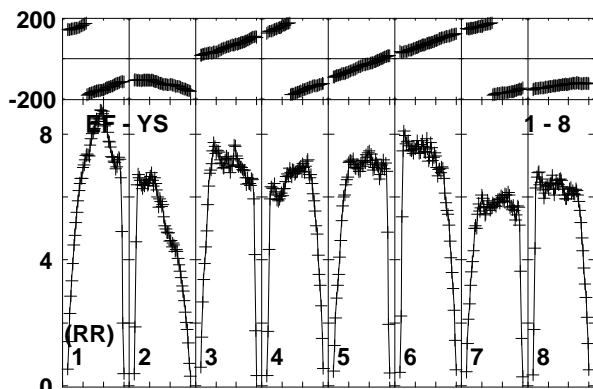
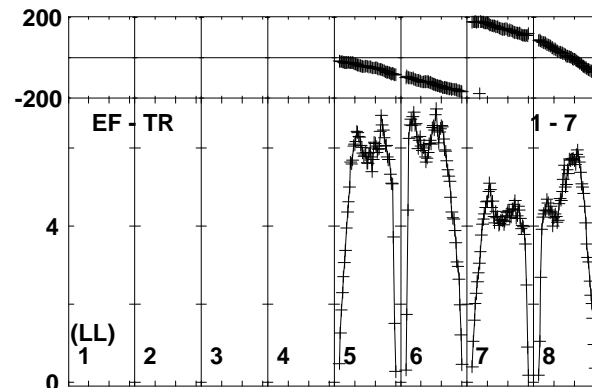
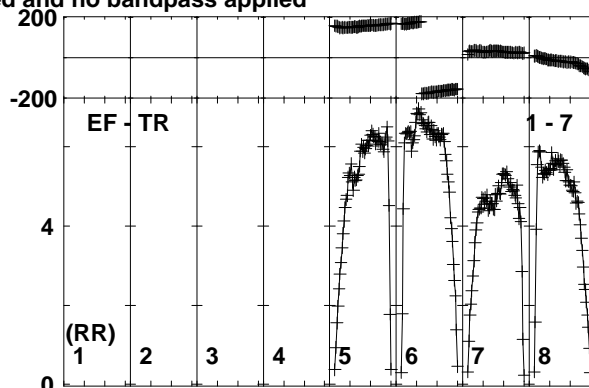
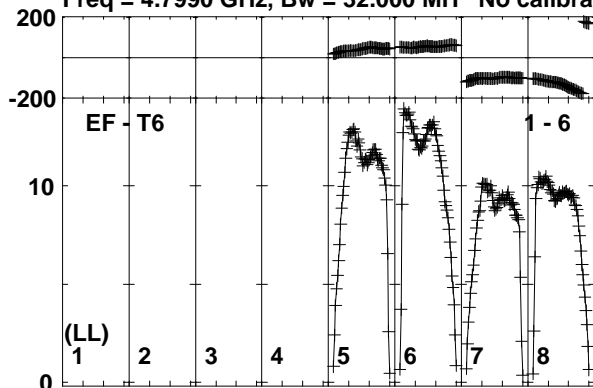

Lower frame: Milli Ampl Jy Top frame: Phas deg
Vector averaged cross-power spectrum Baseline: EF (01) - T6 (06)
Timerange: 00/18:43:34 to 00/18:45:04

Plot file version 29 created 03-OCT-2017 13:09:39
 IRAS23436 RP028.UVDATA.1
 Freq = 4.7990 GHz, Bw = 32.000 MH No calibration applied and no bandpass applied

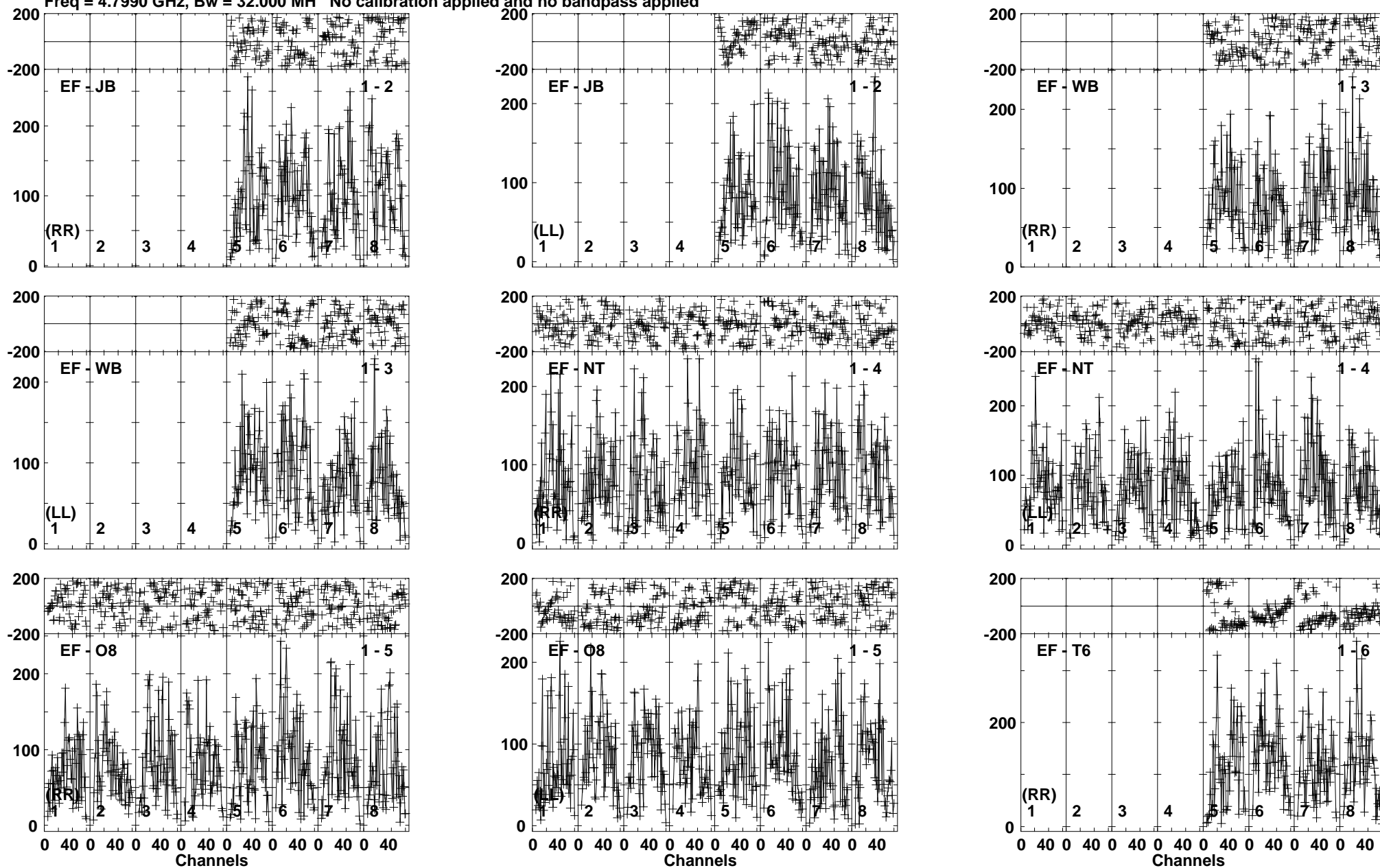

Lower frame: Micro Ampl Jy Top frame: Phas deg
 Vector averaged cross-power spectrum Baseline: EF (01) - JB (02)
 Timerange: 00/18:45:05 to 00/18:48:47

Plot file version 30 created 03-OCT-2017 13:09:39

IRAS23436 RP028.UVDATA.1

Freq = 4.7990 GHz, Bw = 32.000 MH No calibration applied and no bandpass applied

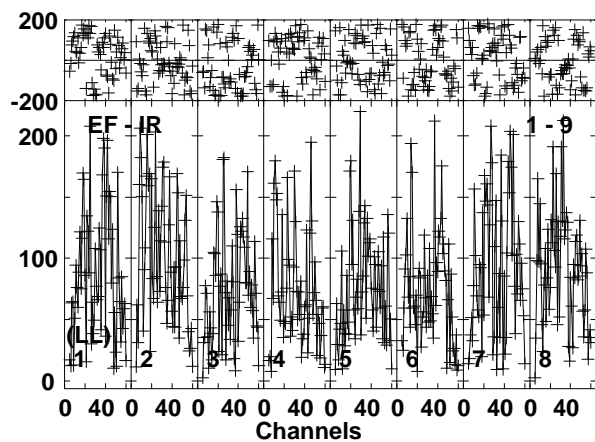
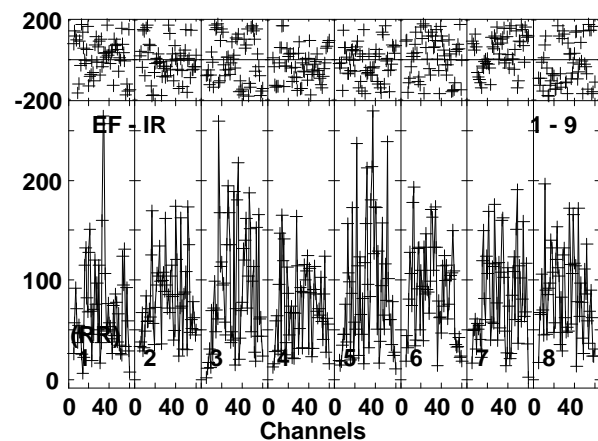
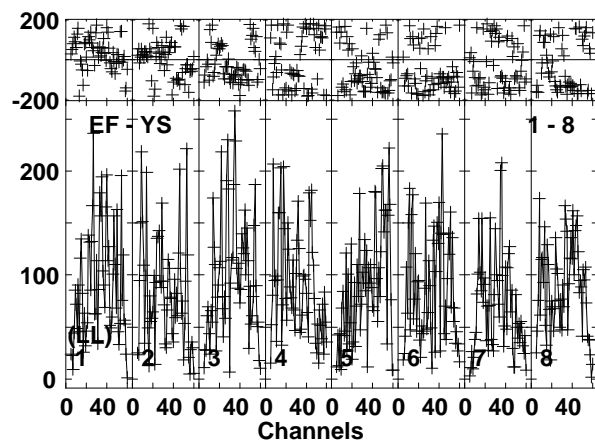
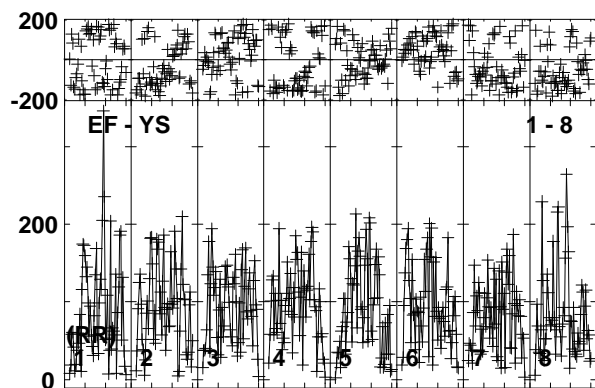
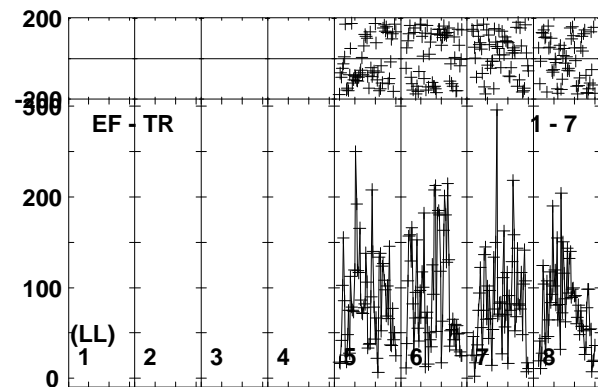
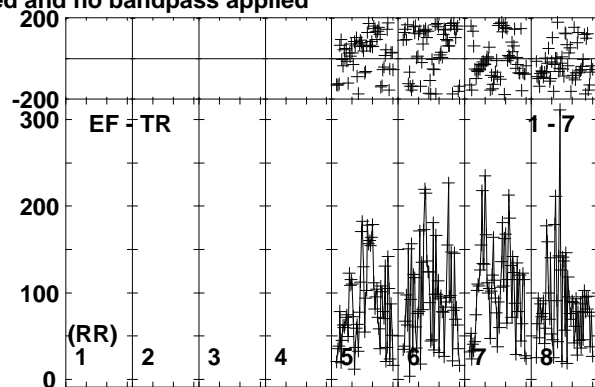
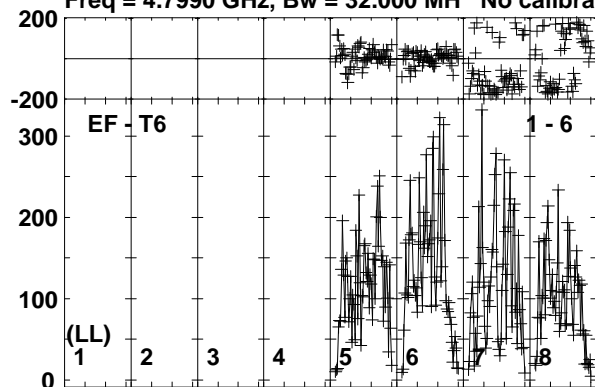

Lower frame: Micro Ampl Jy Top frame: Phas deg
Vector averaged cross-power spectrum Baseline: EF (01) - T6 (06)
Timerange: 00/18:45:05 to 00/18:48:47

Plot file version 31 created 03-OCT-2017 13:09:39

J2353+5518 RP028.UVDATA.1

Freq = 4.7990 GHz, Bw = 32.000 MH No calibration applied and no bandpass applied

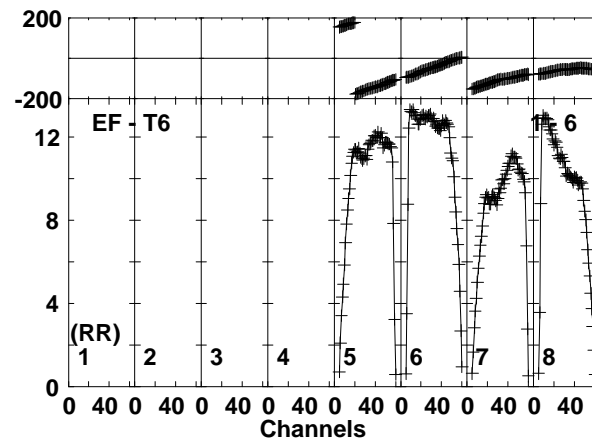
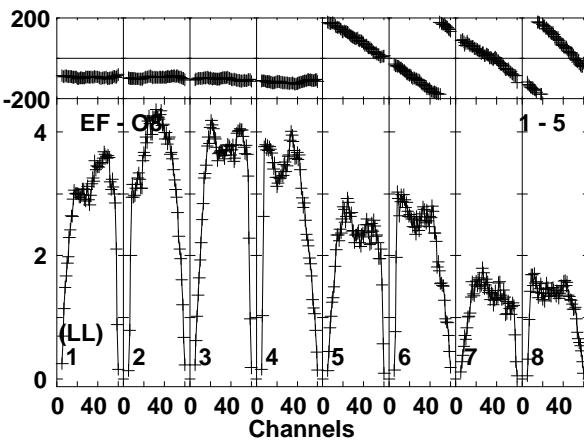
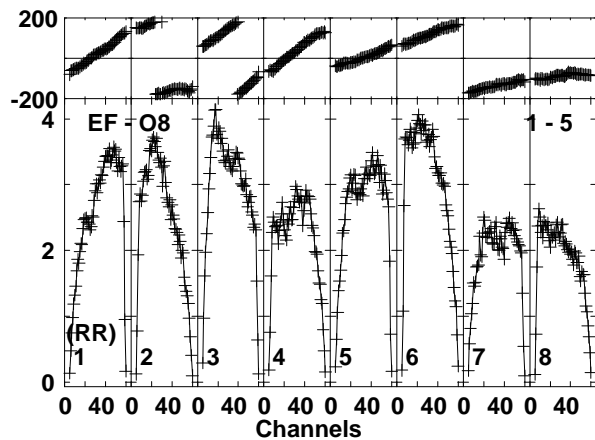
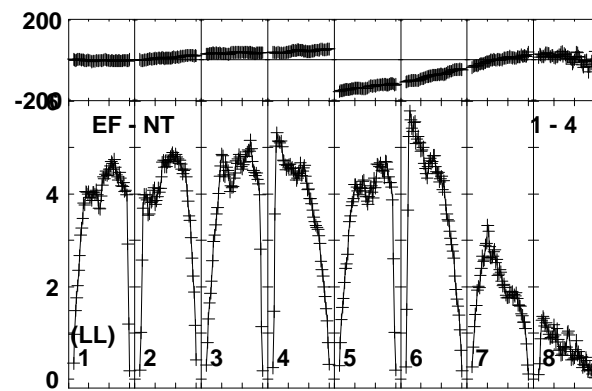
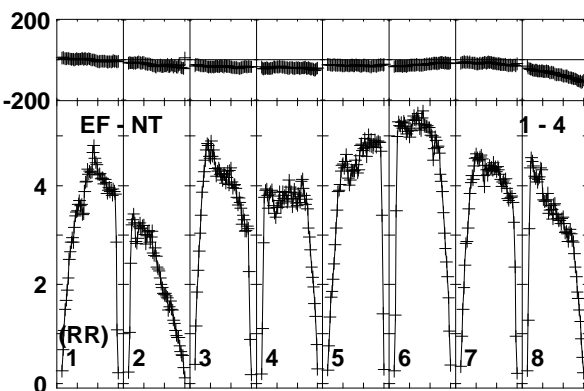
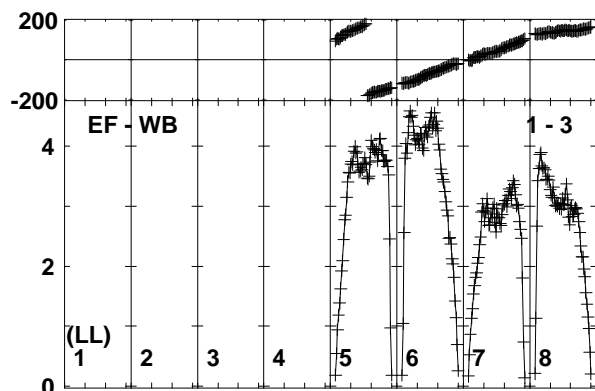
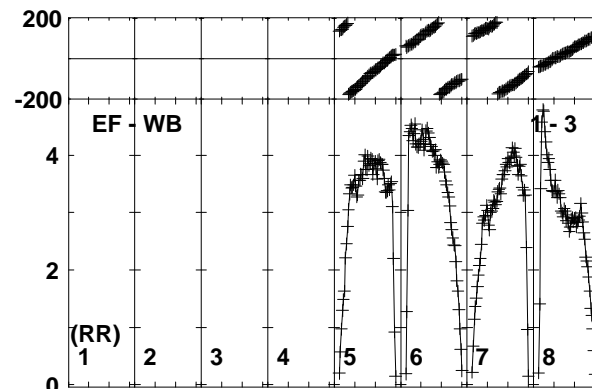
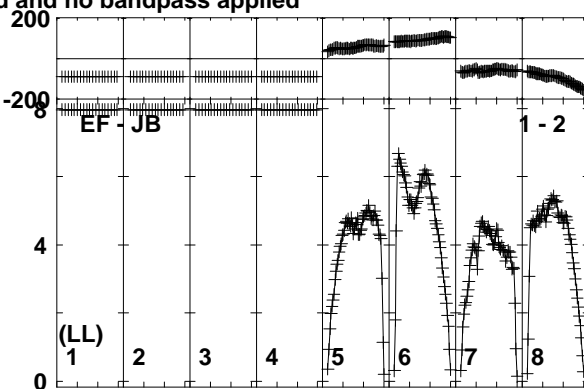
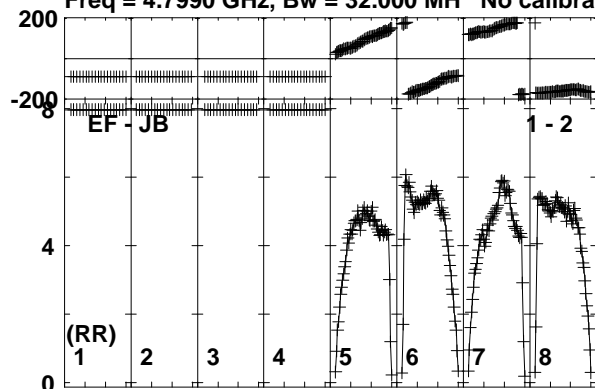

Lower frame: Milli Ampl Jy Top frame: Phas deg
Vector averaged cross-power spectrum Baseline: EF (01) - JB (02)
Timerange: 00/18:49:29 to 00/18:50:28

Plot file version 32 created 03-OCT-2017 13:09:39

J2353+5518 RP028.UVDATA.1

Freq = 4.7990 GHz, Bw = 32.000 MH No calibration applied and no bandpass applied

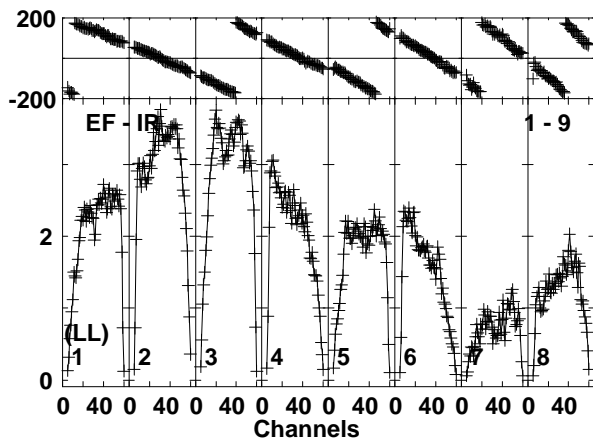
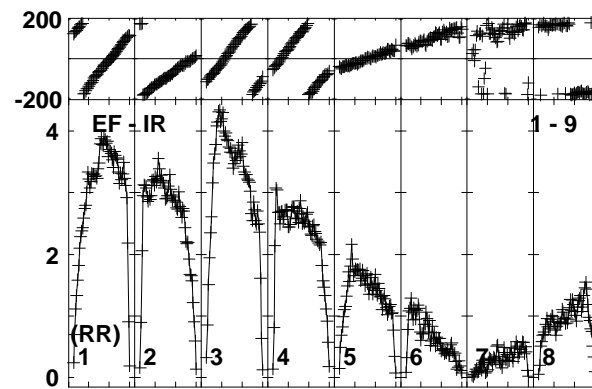
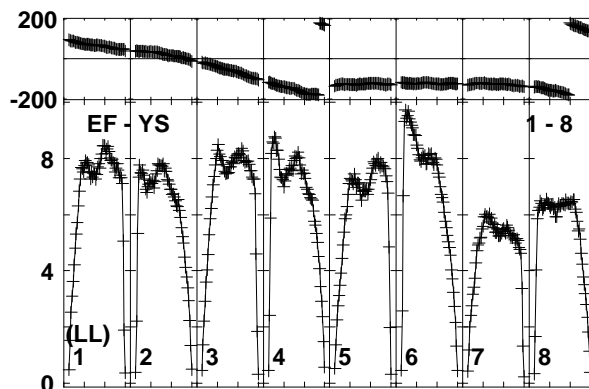
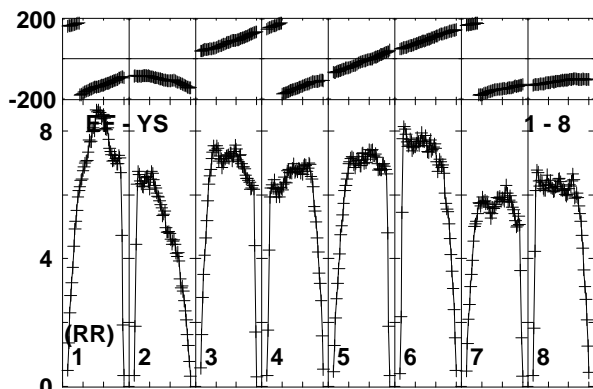
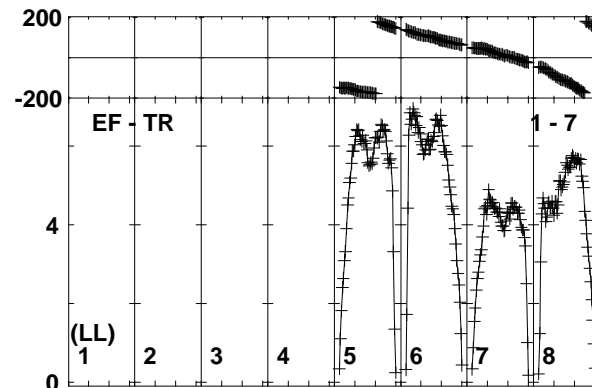
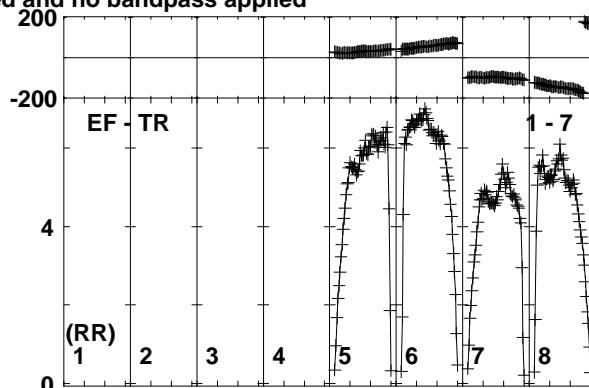
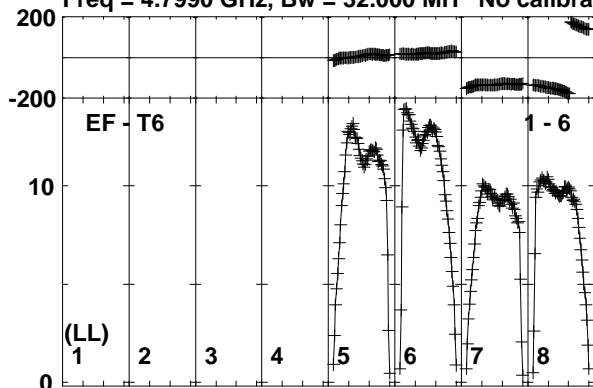

Lower frame: Milli Ampl Jy Top frame: Phas deg
Vector averaged cross-power spectrum Baseline: EF (01) - T6 (06)
Timerange: 00/18:49:29 to 00/18:50:28

Plot file version 33 created 03-OCT-2017 13:09:40

IRAS23436 RP028.UVDATA.1

Freq = 4.7990 GHz, Bw = 32.000 MH No calibration applied and no bandpass applied

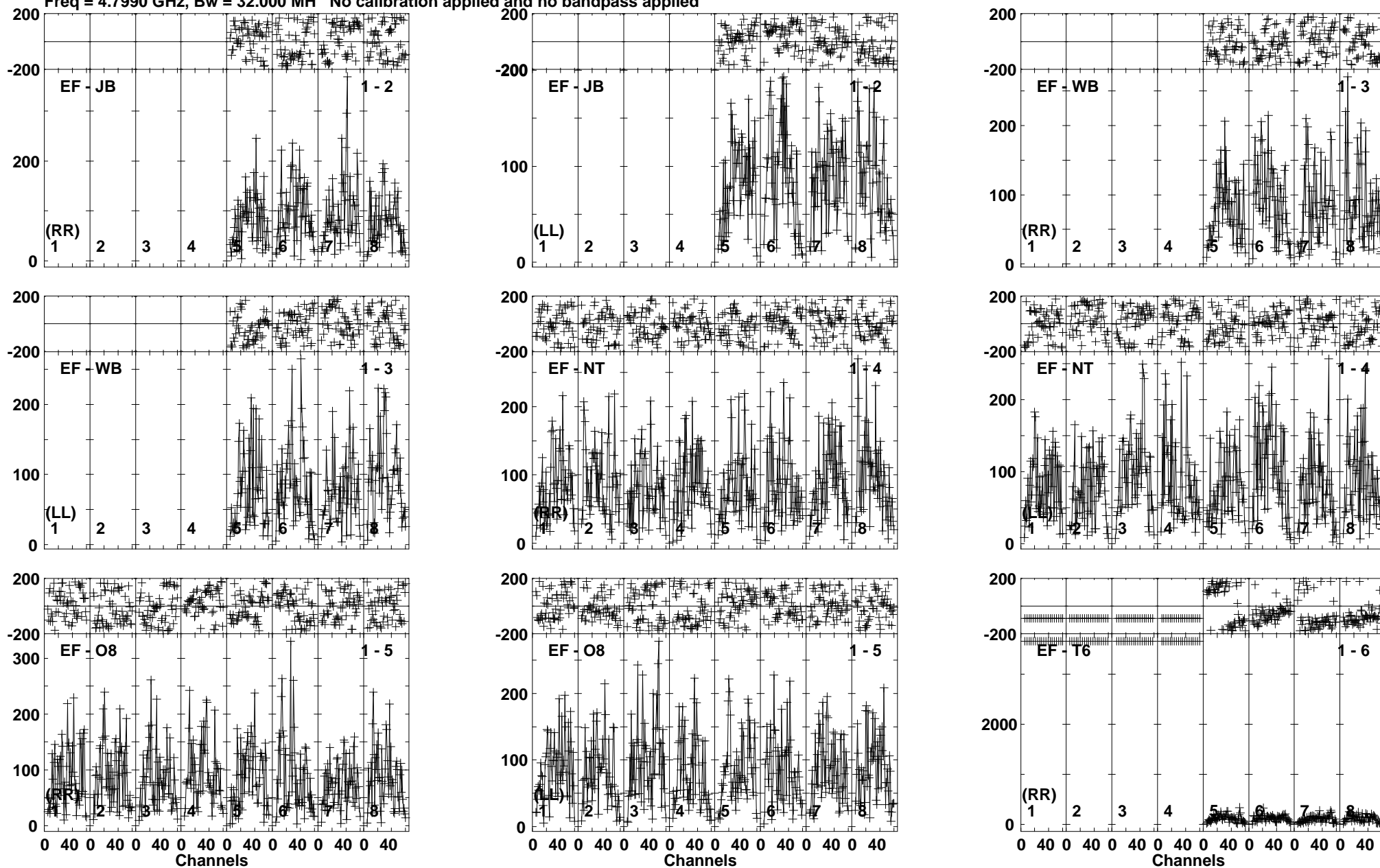

Lower frame: Micro Ampl Jy Top frame: Phas deg
Vector averaged cross-power spectrum Baseline: EF (01) - JB (02)
Timerange: 00:18:50:28 to 00:18:54:08

Plot file version 34 created 03-OCT-2017 13:09:40

IRAS23436 RP028.UVDATA.1

Freq = 4.7990 GHz, Bw = 32.000 MH No calibration applied and no bandpass applied

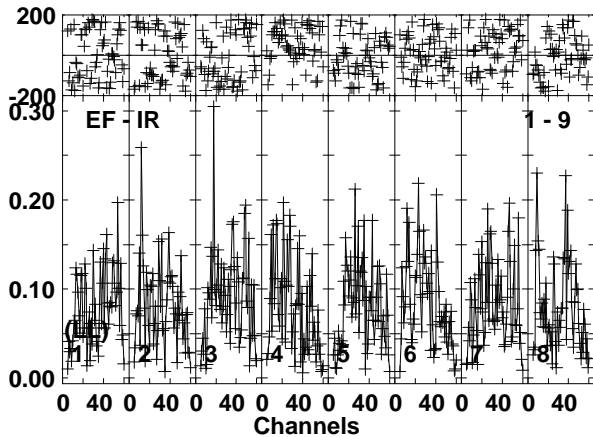
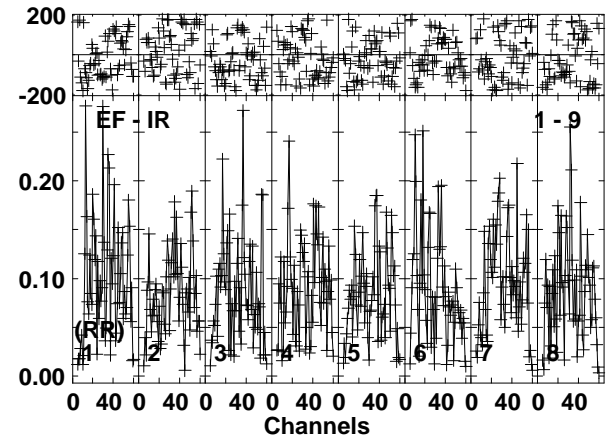
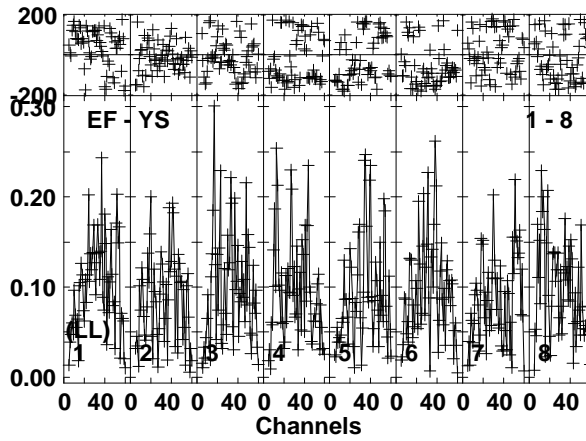
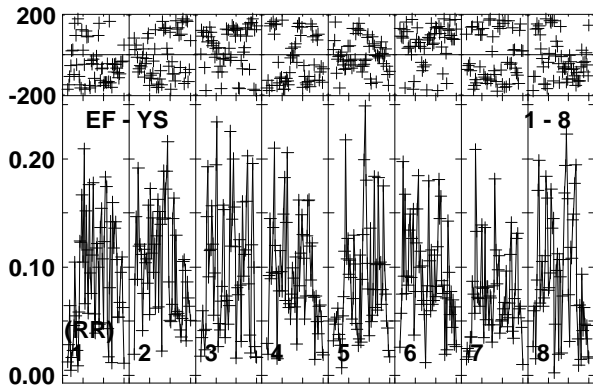
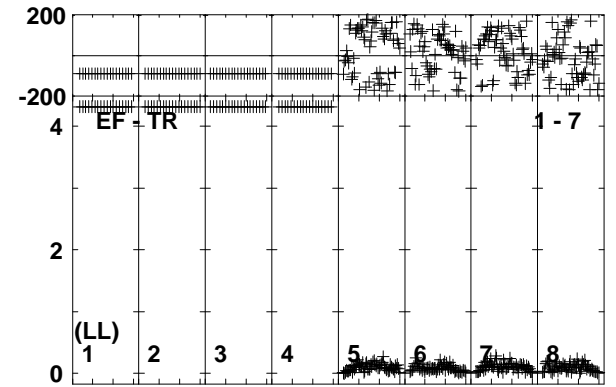
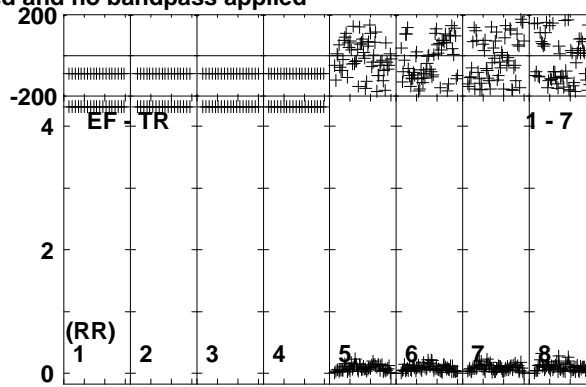
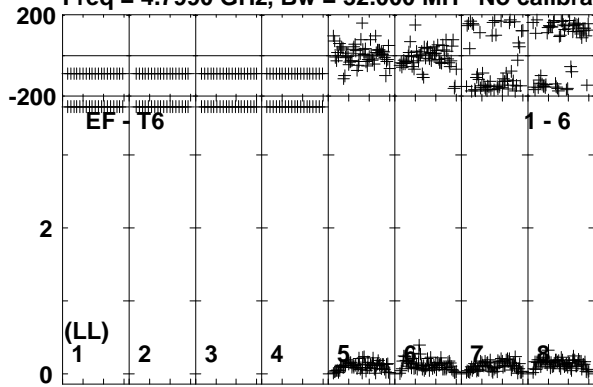

Lower frame: Milli Ampl Jy Top frame: Phas deg
Vector averaged cross-power spectrum Baseline: EF (01) - T6 (06)
Timerange: 00/18:50:28 to 00/18:54:08

Plot file version 35 created 03-OCT-2017 13:09:40

J2353+5518 RP028.UVDATA.1

Freq = 4.7990 GHz, Bw = 32.000 MH No calibration applied and no bandpass applied

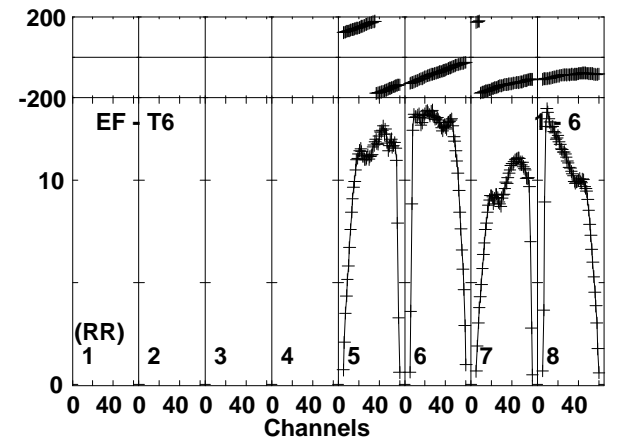
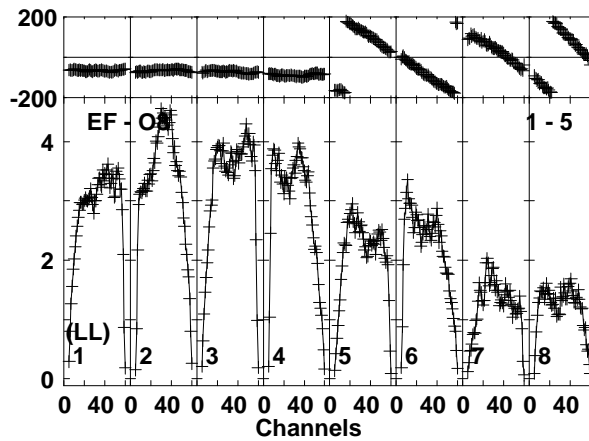
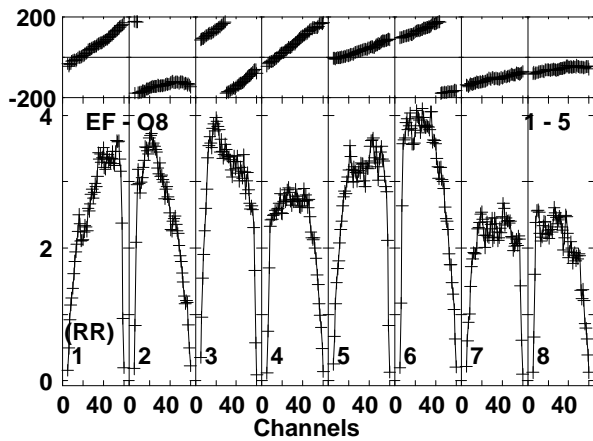
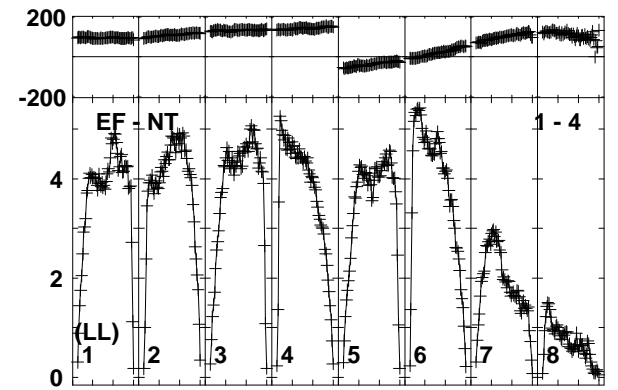
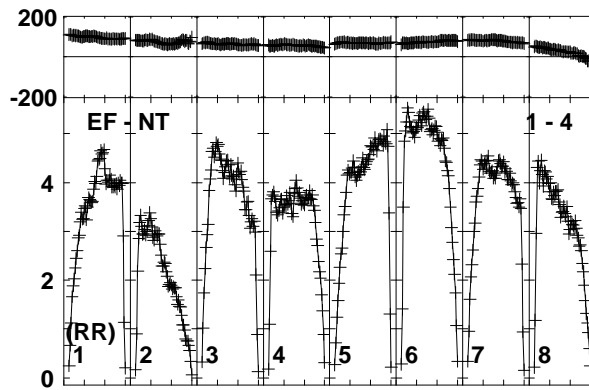
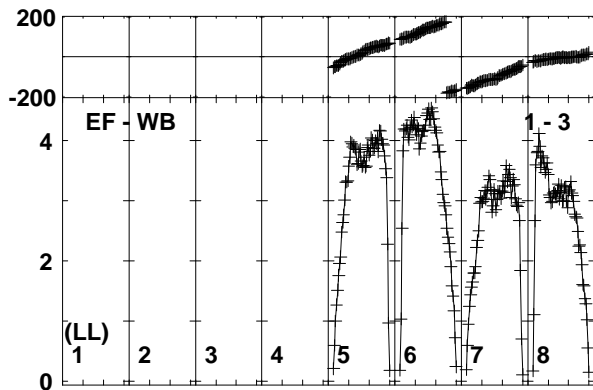
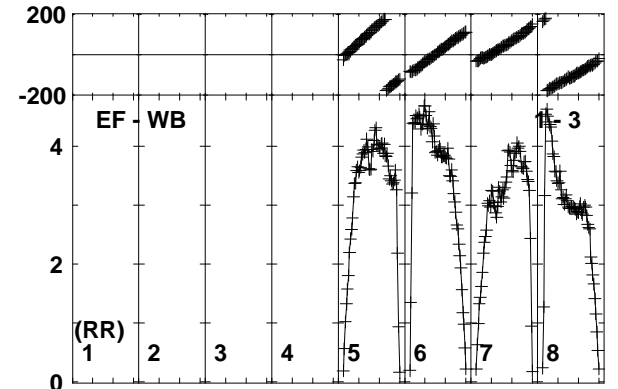
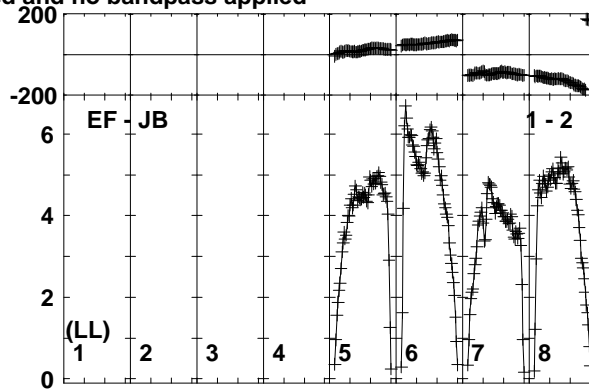
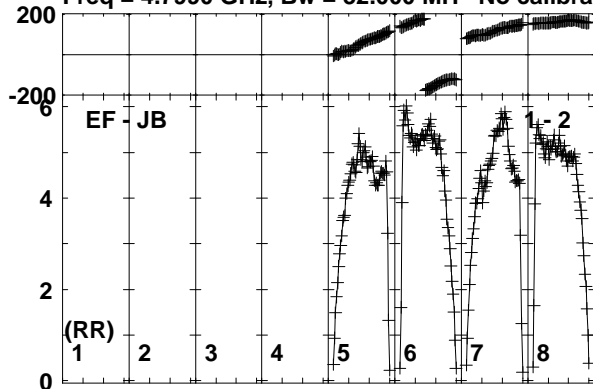

Lower frame: Milli Ampl Jy Top frame: Phas deg
Vector averaged cross-power spectrum Baseline: EF (01) - JB (02)
Timerange: 00/18:54:08 to 00/18:55:37

Plot file version 36 created 03-OCT-2017 13:09:40

J2353+5518 RP028.UVDATA.1

Freq = 4.7990 GHz, Bw = 32.000 MH No calibration applied and no bandpass applied

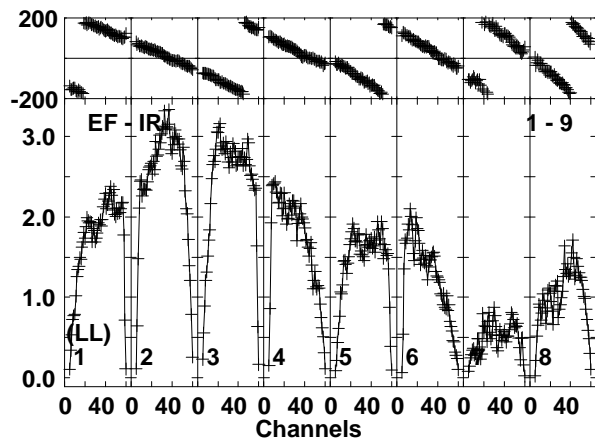
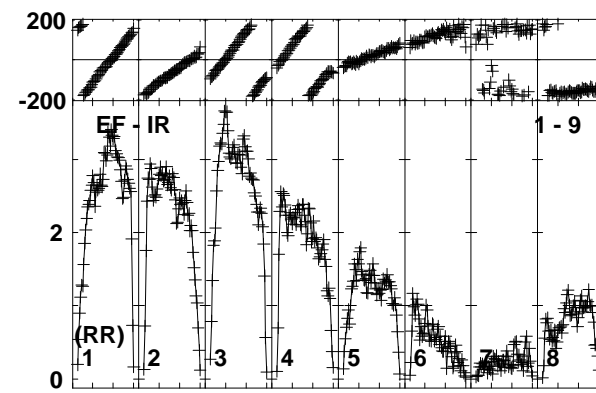
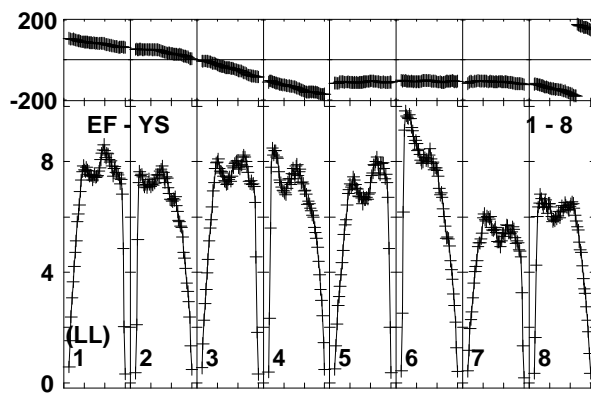
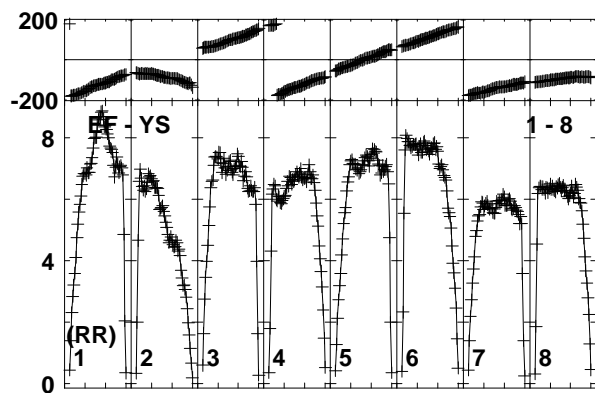
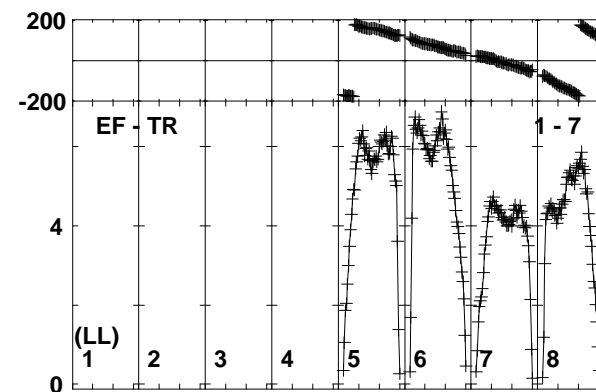
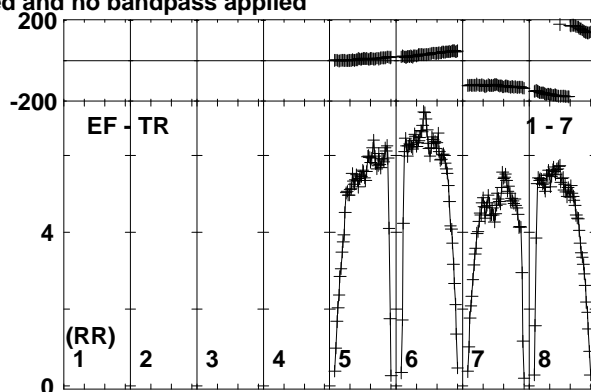
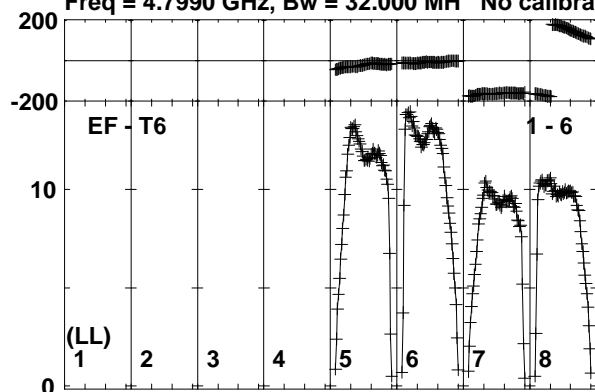

Lower frame: Milli Ampl Jy Top frame: Phas deg
Vector averaged cross-power spectrum Baseline: EF (01) - T6 (06)
Timerange: 00/18:54:08 to 00/18:55:37

Plot file version 37 created 03-OCT-2017 13:09:40

IRAS23436 RP028.UVDATA.1

Freq = 4.7990 GHz, Bw = 32.000 MH No calibration applied and no bandpass applied

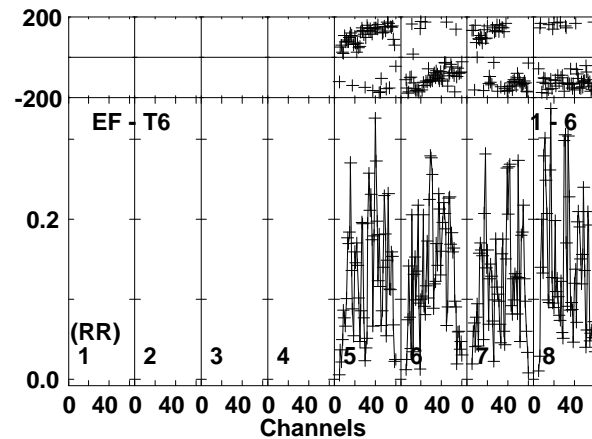
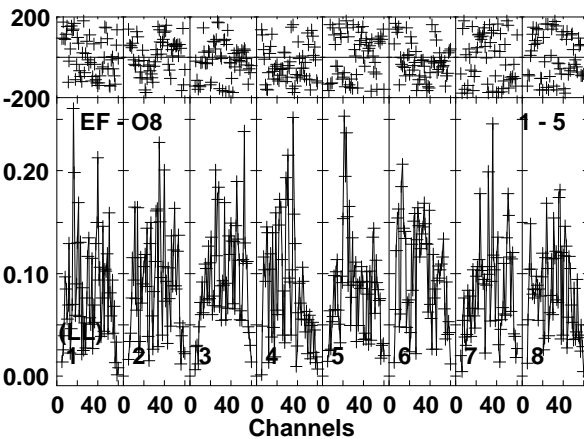
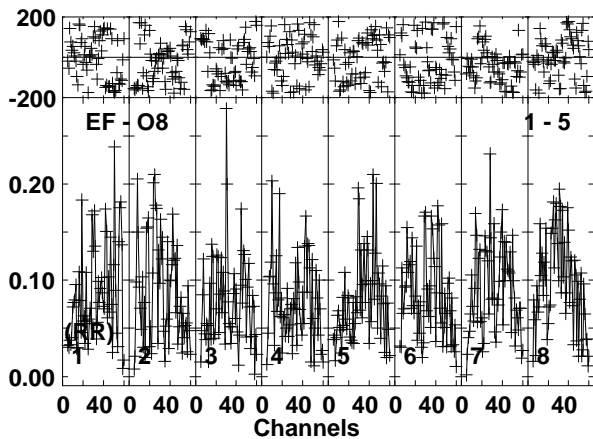
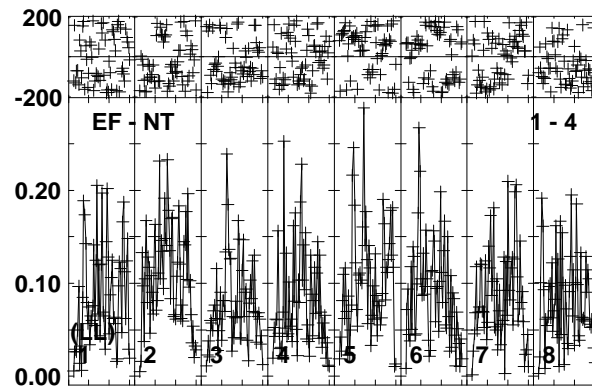
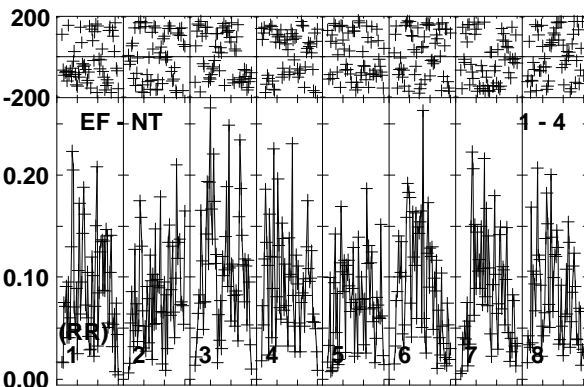
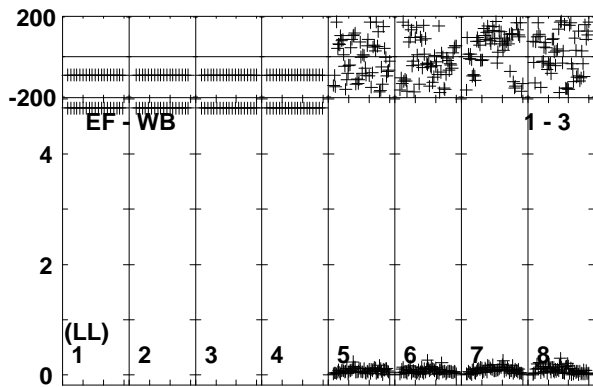
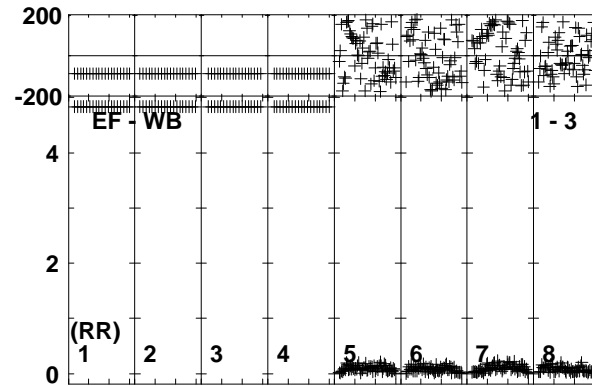
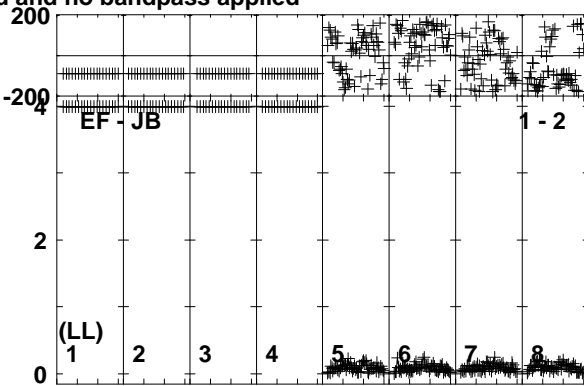
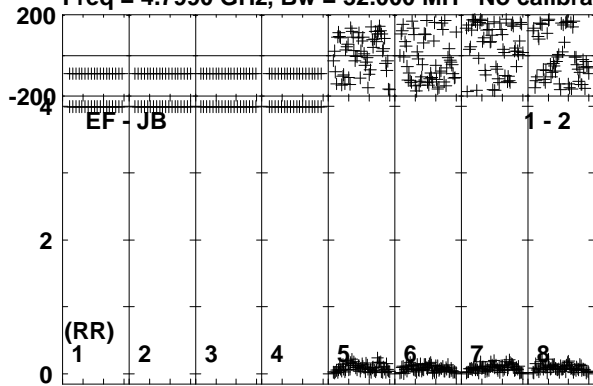

Lower frame: Milli Ampl Jy Top frame: Phas deg
Vector averaged cross-power spectrum Baseline: EF (01) - JB (02)
Timerange: 00/18:55:38 to 00/18:59:22

Plot file version 38 created 03-OCT-2017 13:09:41

IRAS23436 RP028.UVDATA.1

Freq = 4.7990 GHz, Bw = 32.000 MH No calibration applied and no bandpass applied

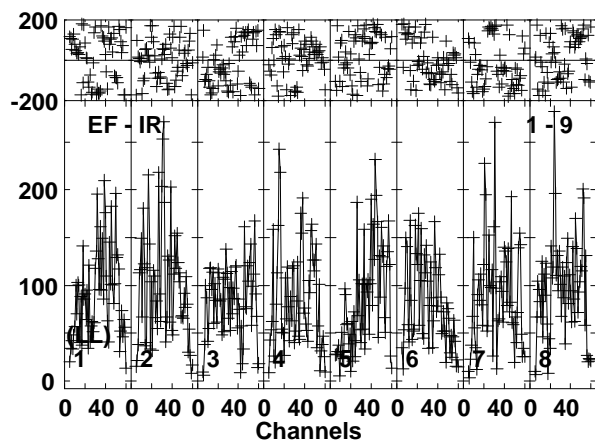
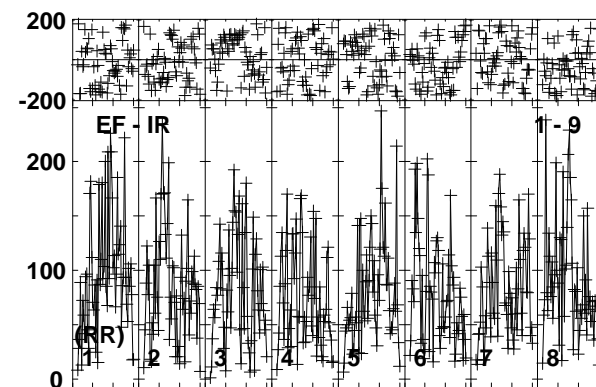
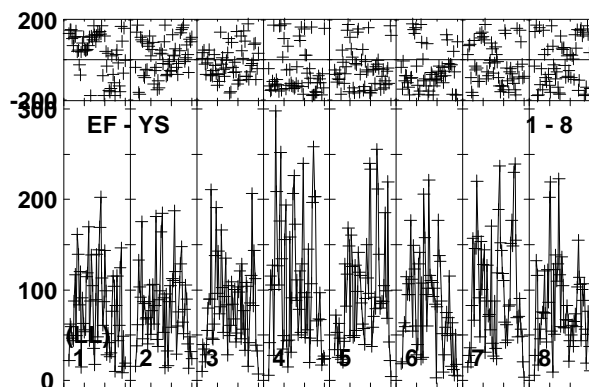
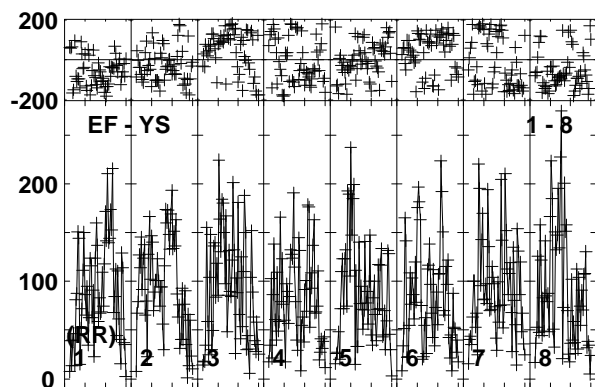
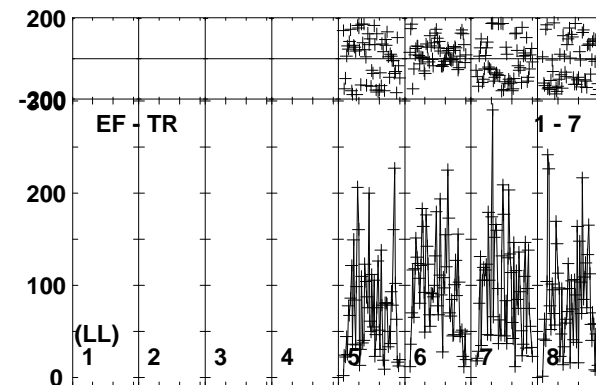
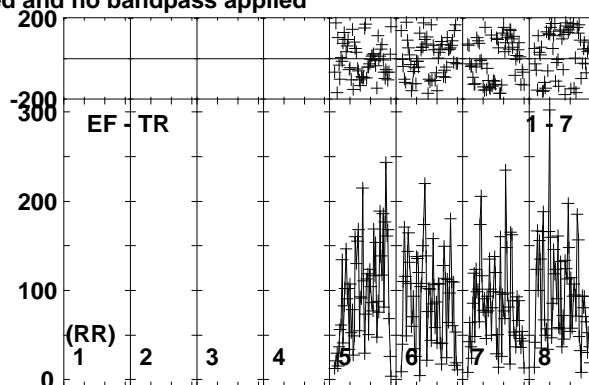
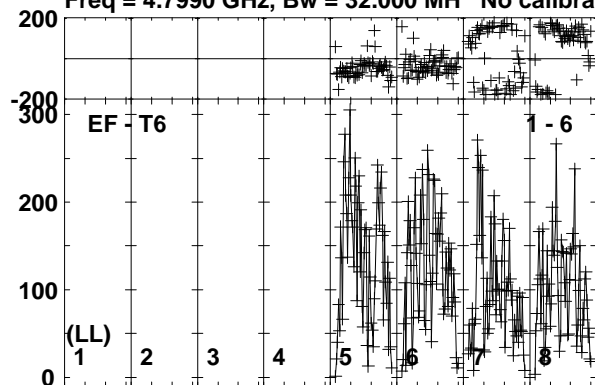

Lower frame: Micro Ampl Jy Top frame: Phas deg
Vector averaged cross-power spectrum Baseline: EF (01) - T6 (06)
Timerange: 00/18:55:38 to 00/18:59:22

Plot file version 39 created 03-OCT-2017 13:09:41

J2353+5518 RP028.UVDATA.1

Freq = 4.7990 GHz, Bw = 32.000 MH No calibration applied and no bandpass applied

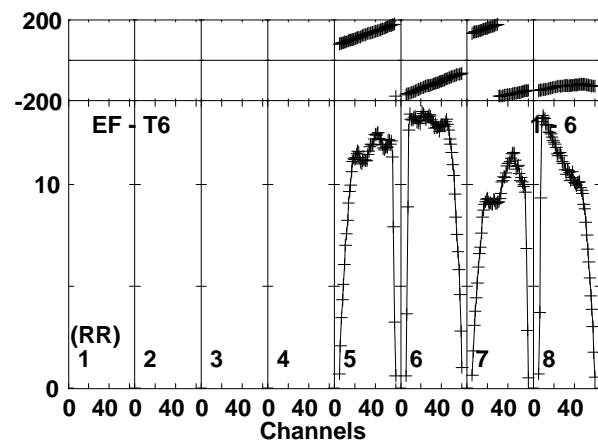
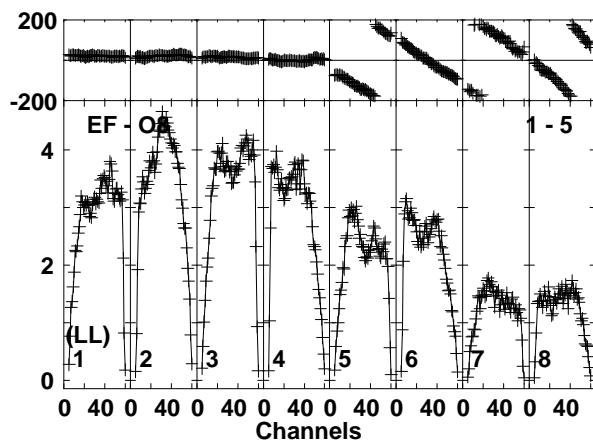
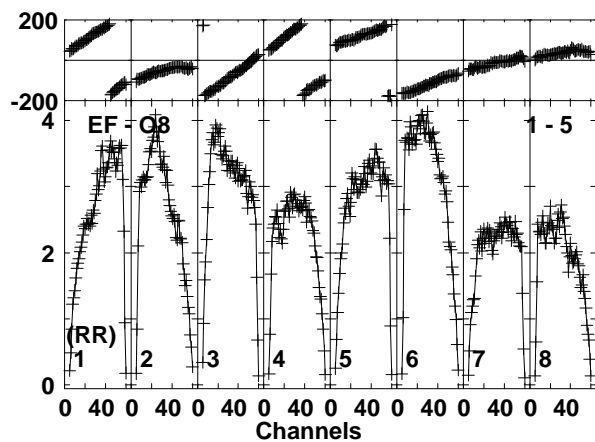
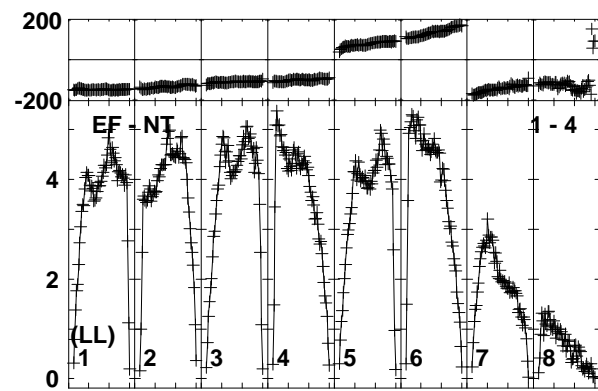
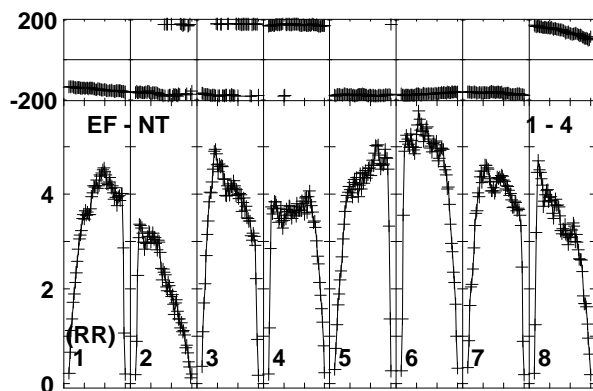
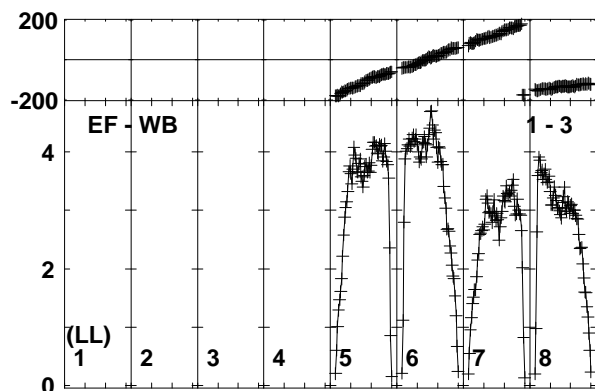
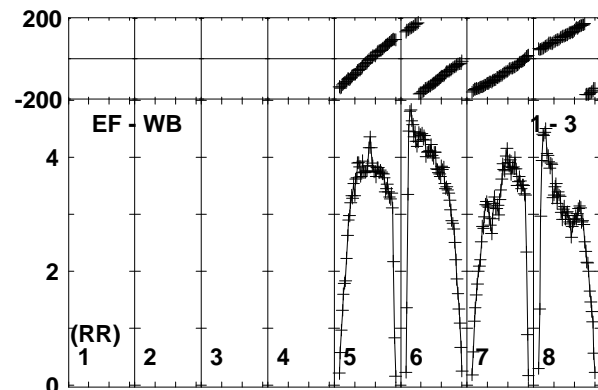
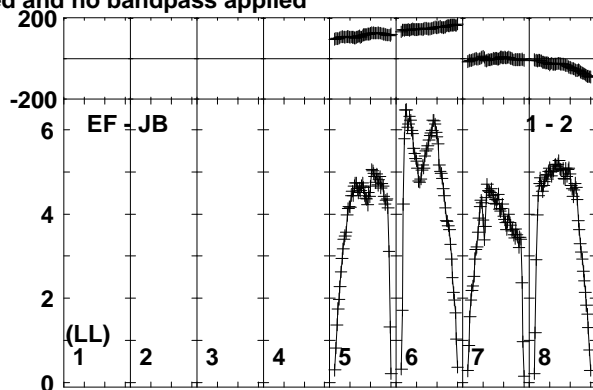
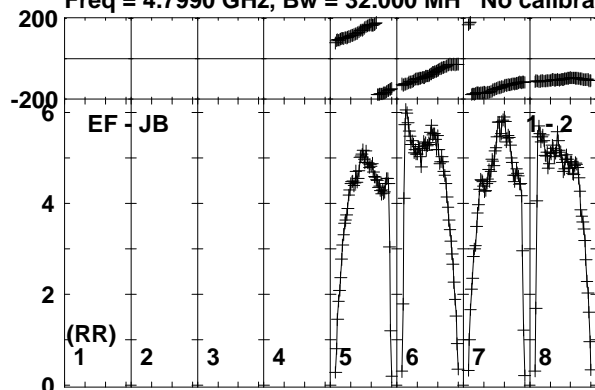

Lower frame: Milli Ampl Jy Top frame: Phas deg
Vector averaged cross-power spectrum Baseline: EF (01) - JB (02)
Timerange: 00:19:00:02 to 00:19:00:52

Plot file version 40 created 03-OCT-2017 13:09:41

J2353+5518 RP028.UVDATA.1

Freq = 4.7990 GHz, Bw = 32.000 MH No calibration applied and no bandpass applied

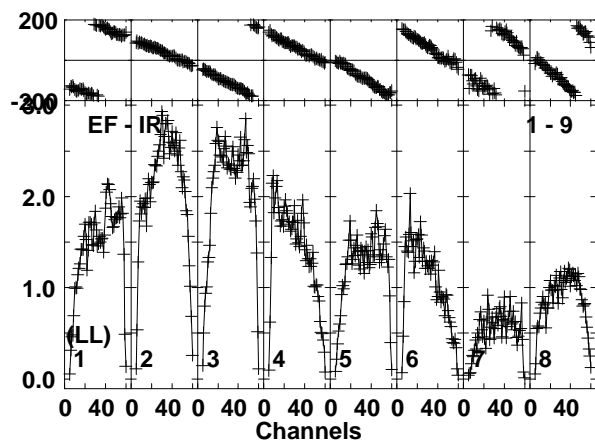
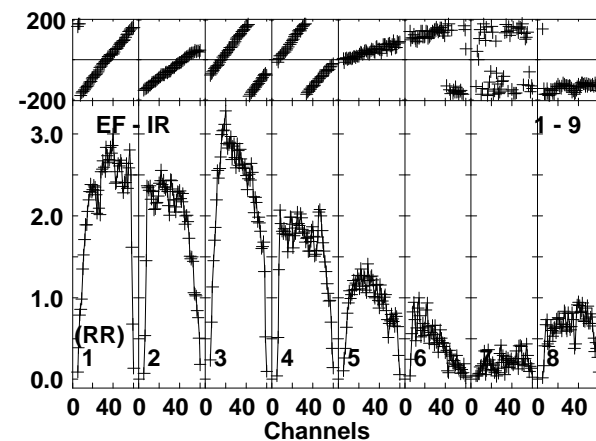
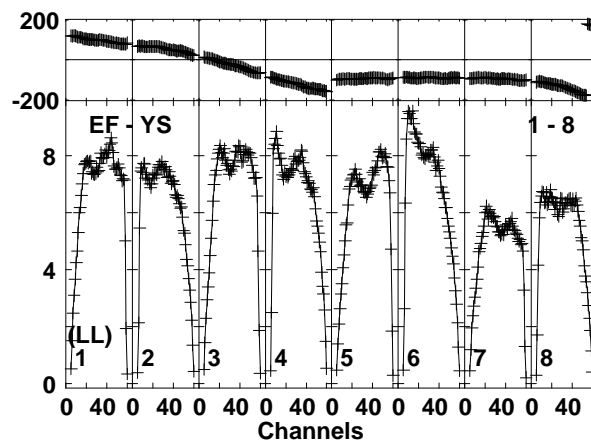
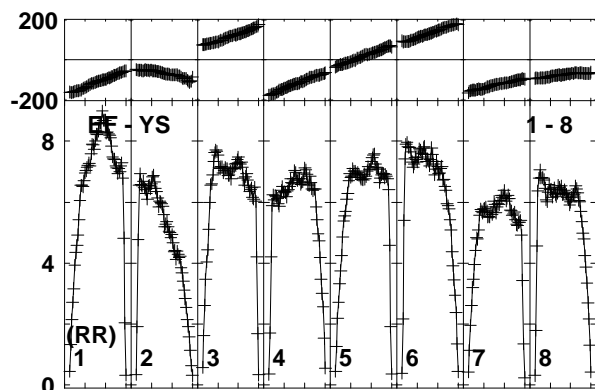
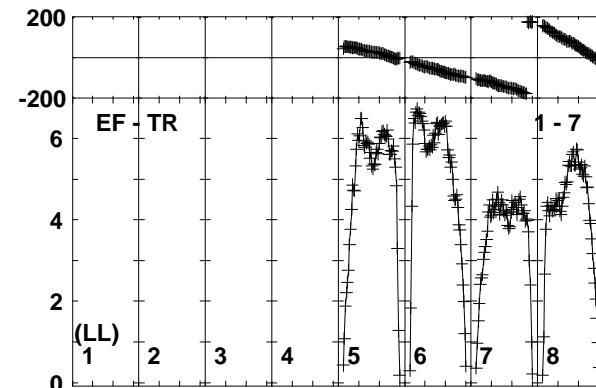
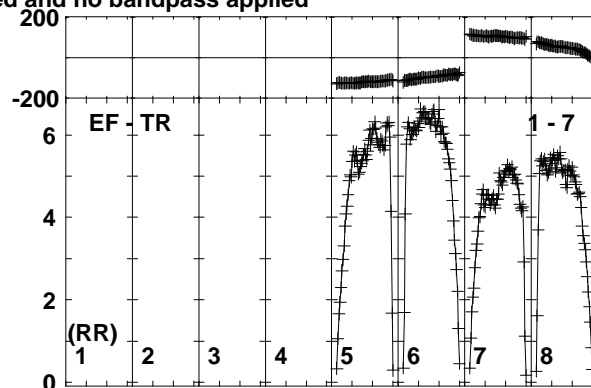
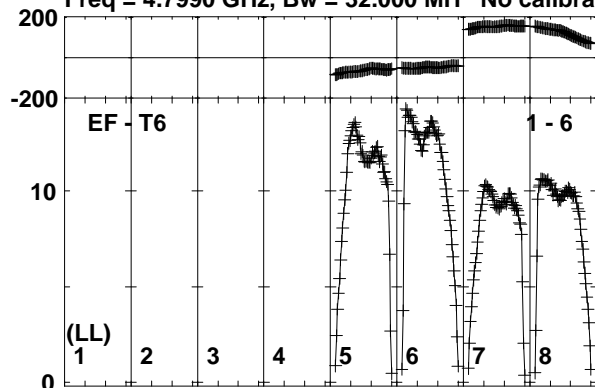

Lower frame: Milli Ampl Jy Top frame: Phas deg
Vector averaged cross-power spectrum Baseline: EF (01) - T6 (06)
Timerange: 00/19:00:02 to 00/19:00:52

Plot file version 41 created 03-OCT-2017 13:09:41

IRAS23436 RP028.UVDATA.1

Freq = 4.7990 GHz, Bw = 32.000 MH No calibration applied and no bandpass applied

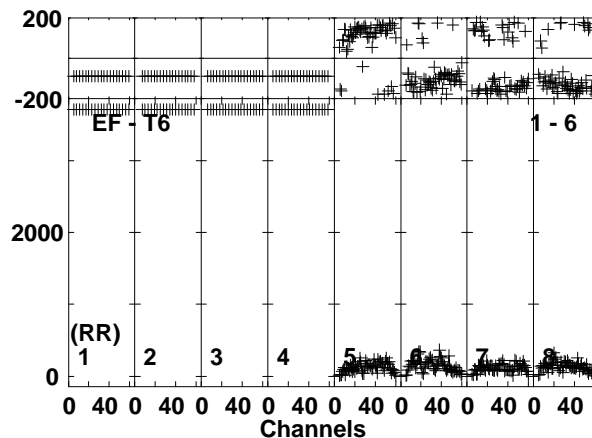
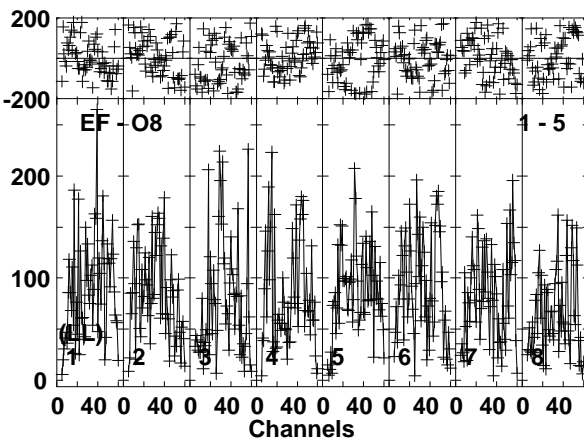
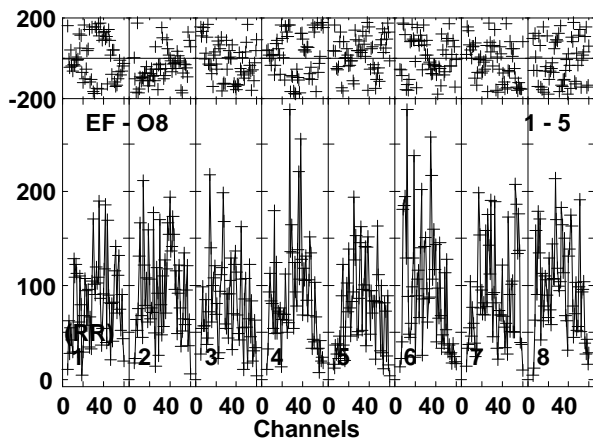
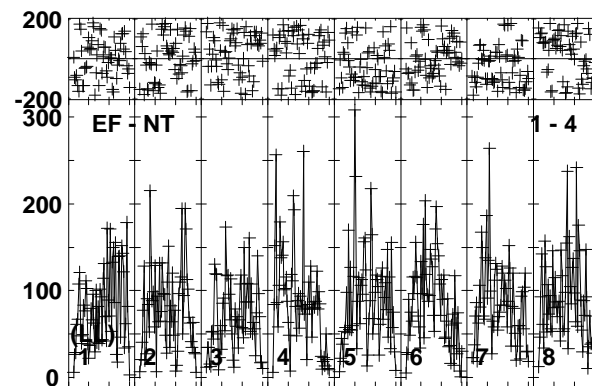
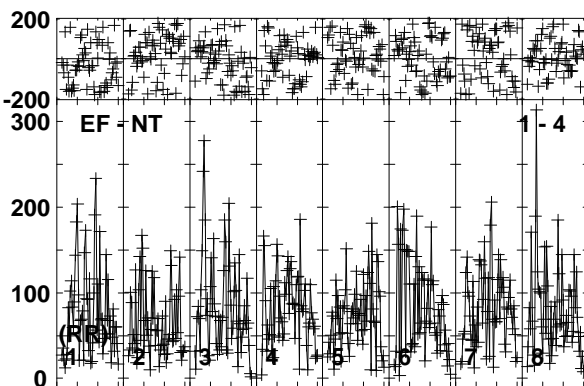
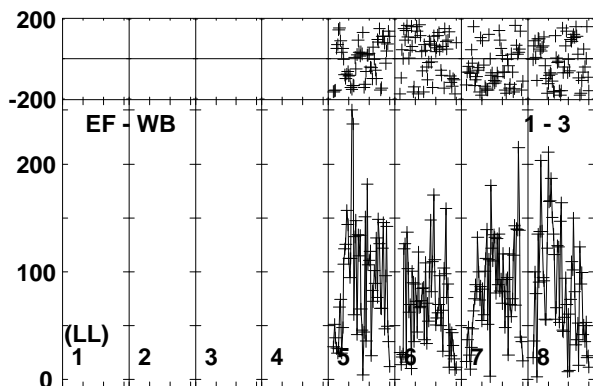
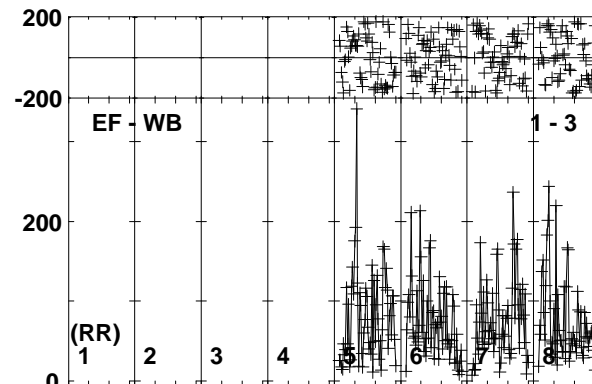
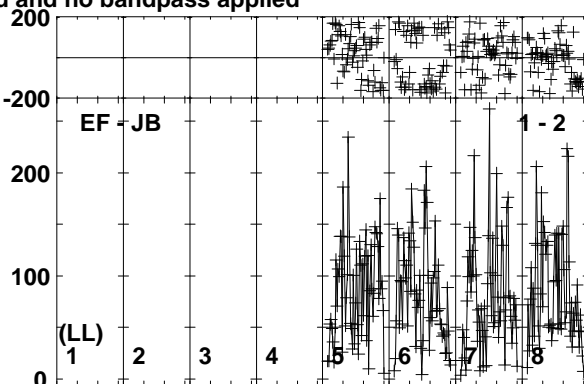
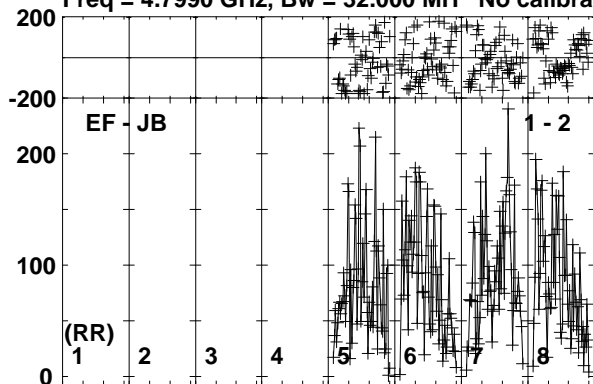

Lower frame: Micro Ampl Jy Top frame: Phas deg
Vector averaged cross-power spectrum Baseline: EF (01) - JB (02)
Timerange: 00/19:00:53 to 00/19:04:35

Plot file version 42 created 03-OCT-2017 13:09:41

IRAS23436 RP028.UVDATA.1

Freq = 4.7990 GHz, Bw = 32.000 MH No calibration applied and no bandpass applied

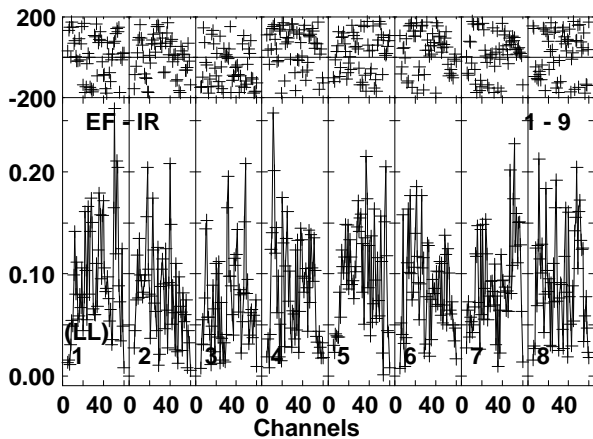
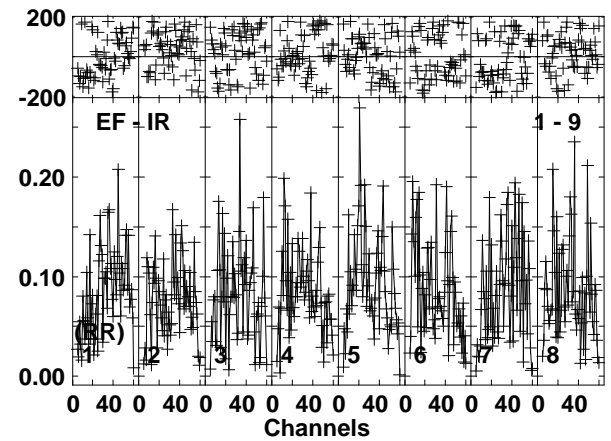
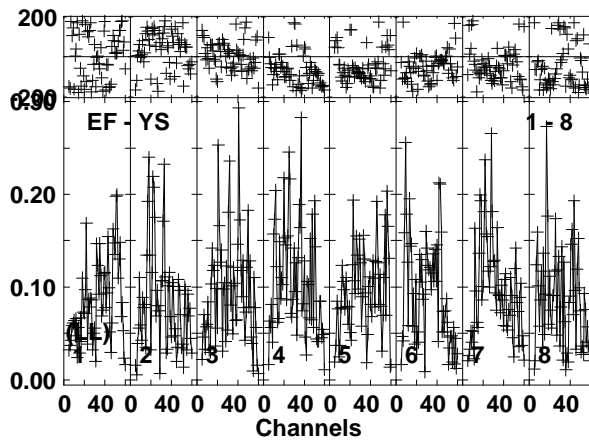
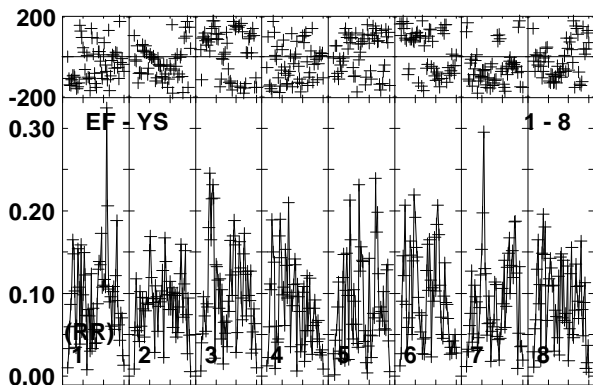
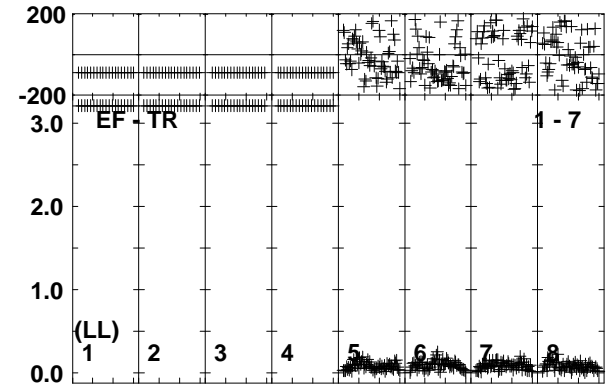
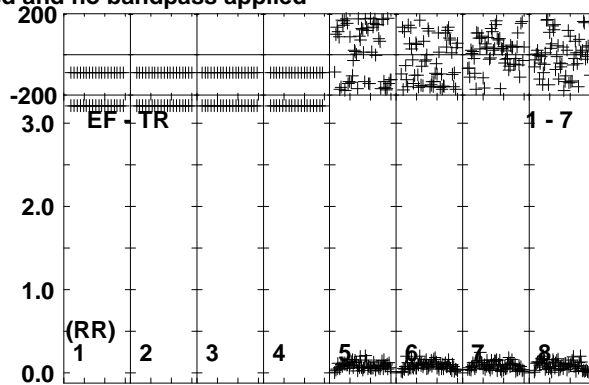
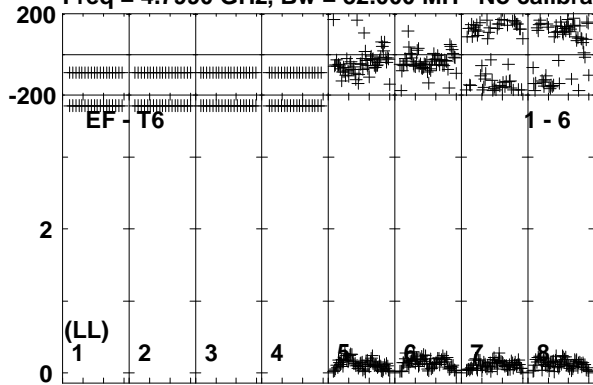

Lower frame: Milli Ampl Jy Top frame: Phas deg
Vector averaged cross-power spectrum Baseline: EF (01) - T6 (06)
Timerange: 00:19:00:53 to 00:19:04:35

Plot file version 43 created 03-OCT-2017 13:09:42
 J2353+5518 RP028.UVDATA.1
 Freq = 4.7990 GHz, Bw = 32.000 MH No calibration applied and no bandpass applied

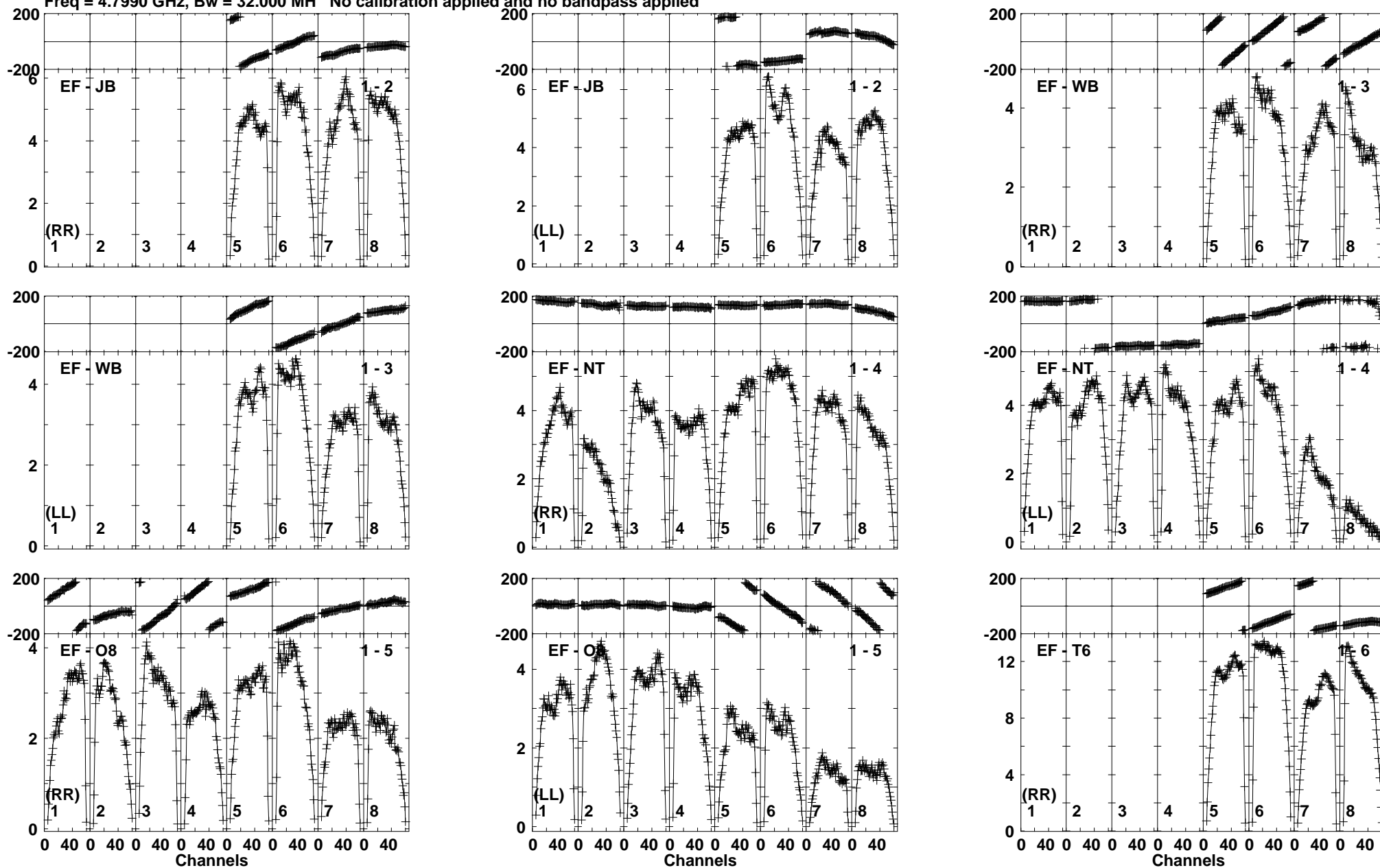

Lower frame: Milli Ampl Jy Top frame: Phas deg
 Vector averaged cross-power spectrum Baseline: EF (01) - JB (02)
 Timerange: 00/19:04:36 to 00/19:06:06

Plot file version 44 created 03-OCT-2017 13:09:42

J2353+5518 RP028.UVDATA.1

Freq = 4.7990 GHz, Bw = 32.000 MH No calibration applied and no bandpass applied

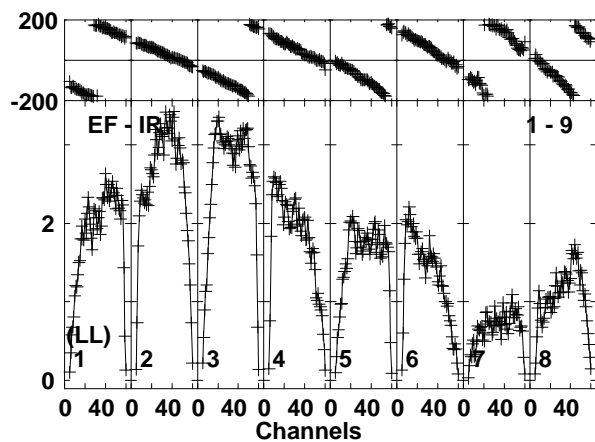
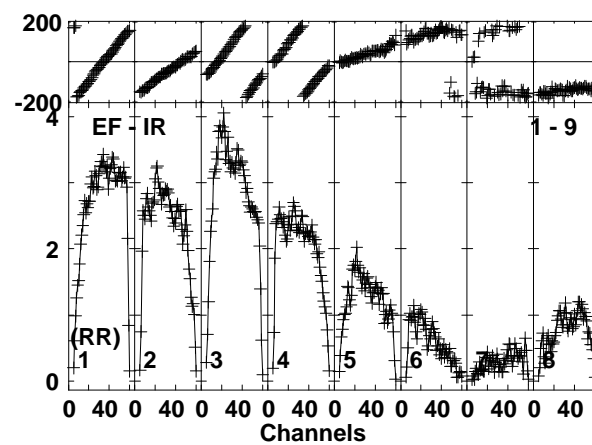
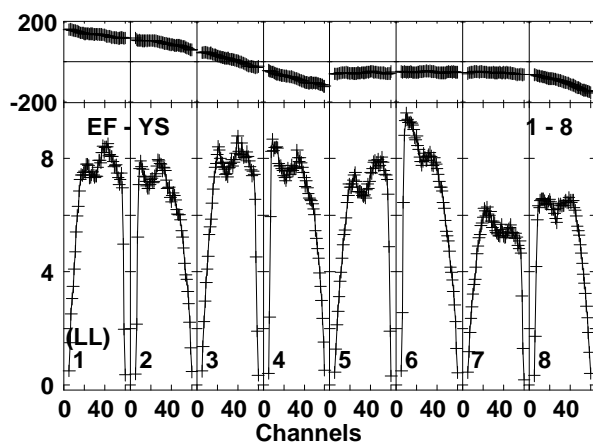
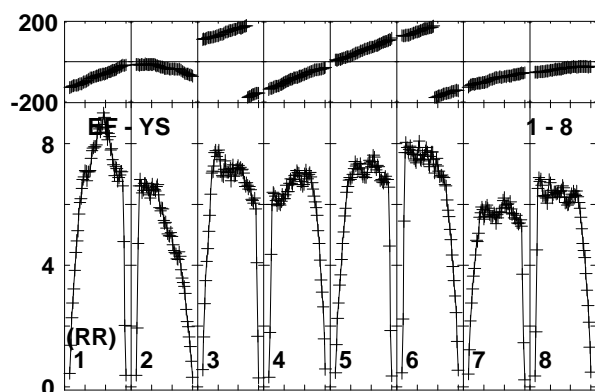
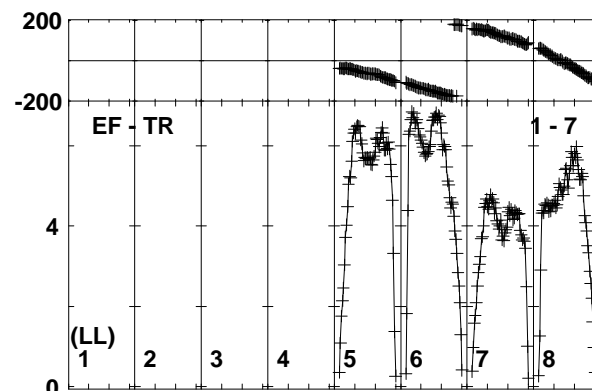
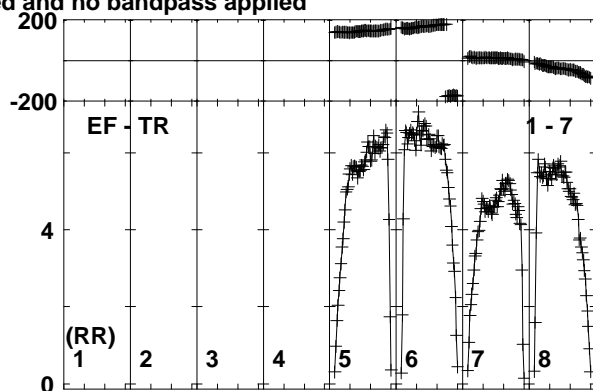
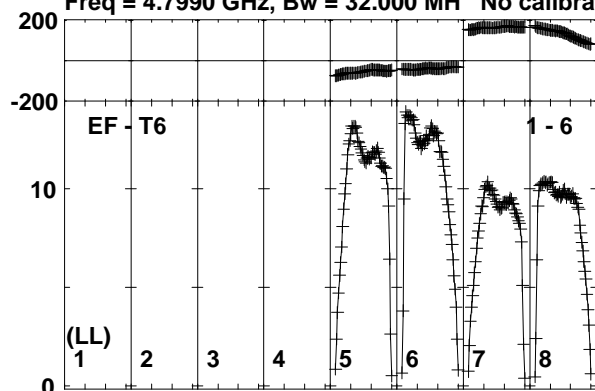

Lower frame: Milli Ampl Jy Top frame: Phas deg
Vector averaged cross-power spectrum Baseline: EF (01) - T6 (06)
Timerange: 00/19:04:36 to 00/19:06:06

Plot file version 45 created 03-OCT-2017 13:09:42

IRAS23436 RP028.UVDATA.1

Freq = 4.7990 GHz, Bw = 32.000 MH No calibration applied and no bandpass applied

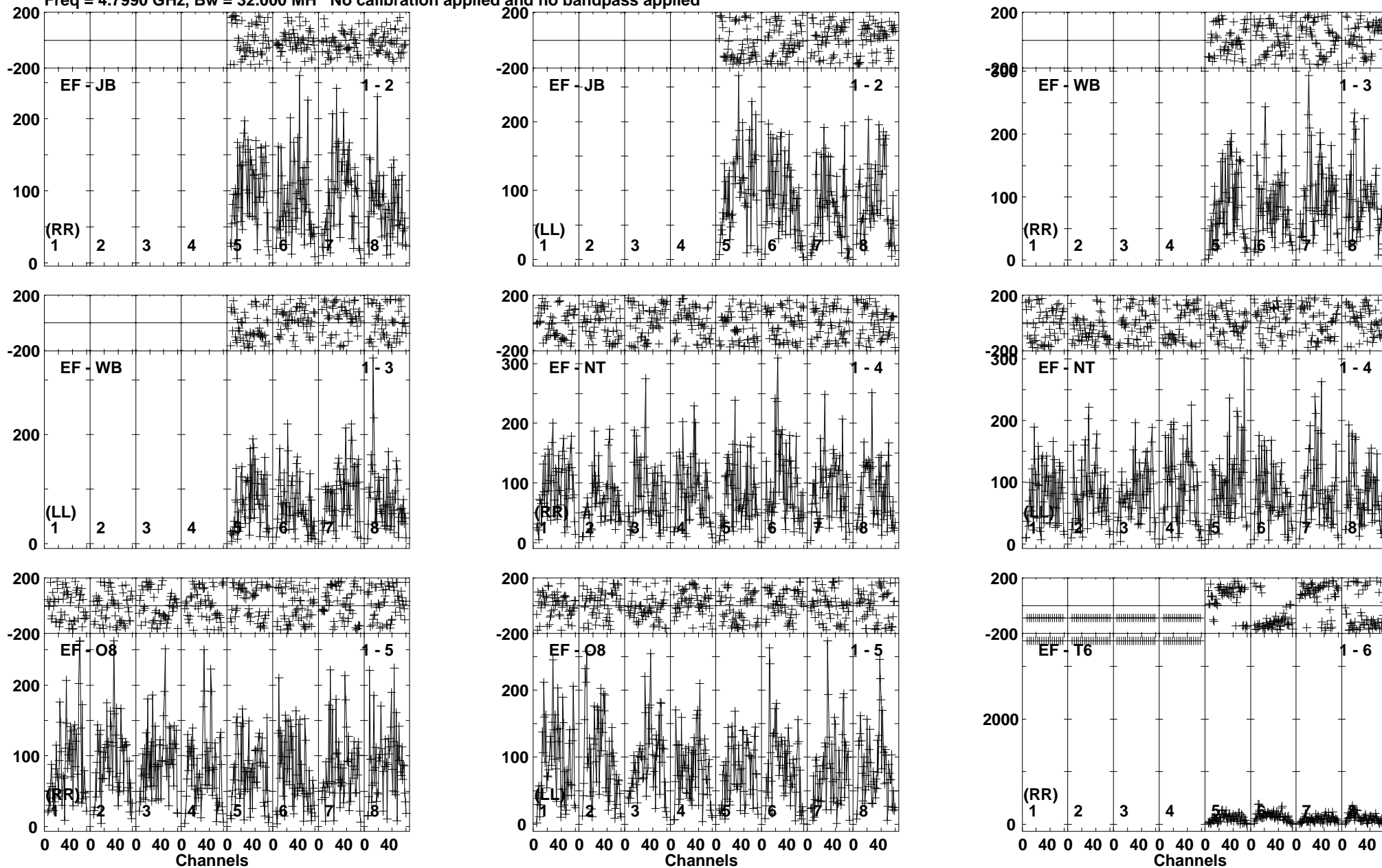

Lower frame: Micro Ampl Jy Top frame: Phas deg
Vector averaged cross-power spectrum Baseline: EF (01) - JB (02)
Timerange: 00/19:06:07 to 00/19:09:49

Plot file version 46 created 03-OCT-2017 13:09:42

IRAS23436 RP028.UVDATA.1

Freq = 4.7990 GHz, Bw = 32.000 MH No calibration applied and no bandpass applied

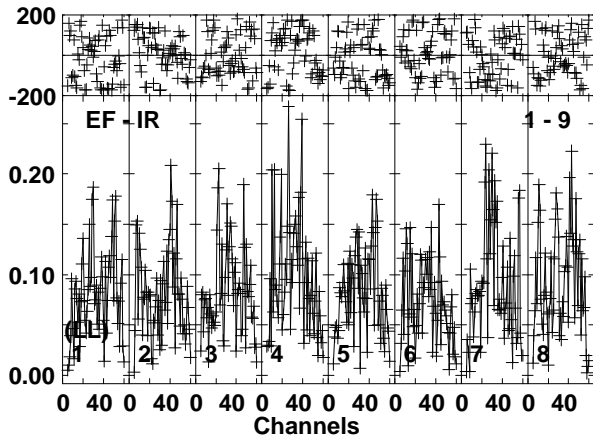
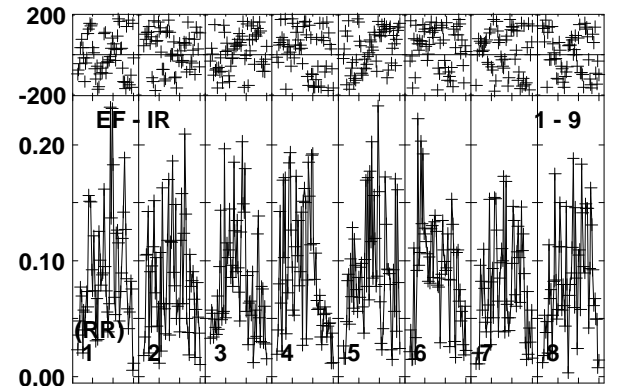
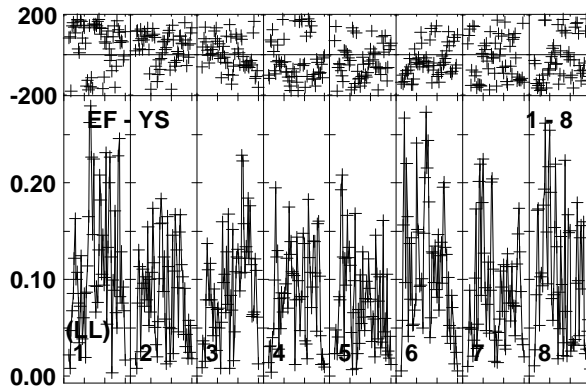
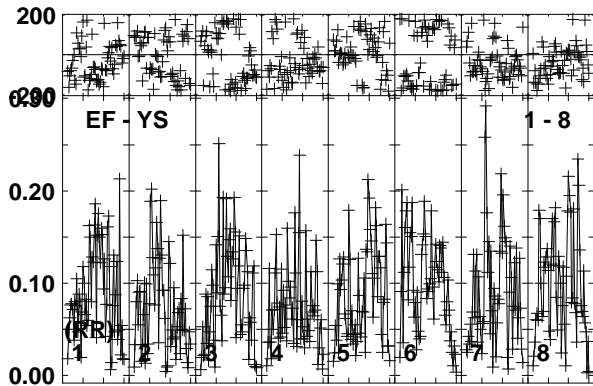
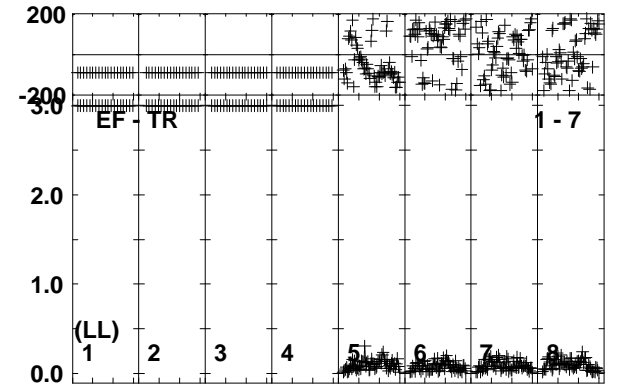
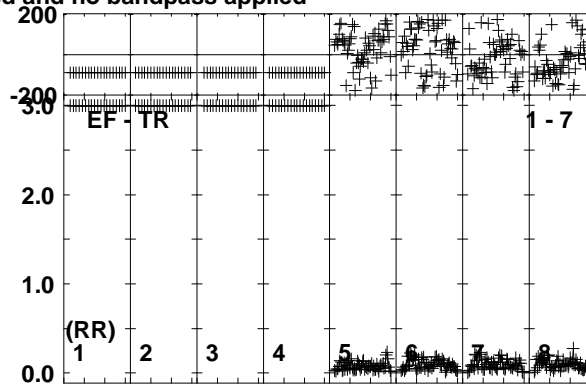
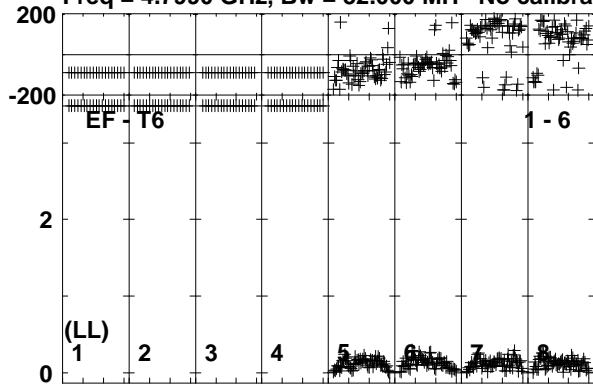

Lower frame: Milli Ampl Jy Top frame: Phas deg
Vector averaged cross-power spectrum Baseline: EF (01) - T6 (06)
Timerange: 00/19:06:07 to 00/19:09:49

Plot file version 47 created 03-OCT-2017 13:09:43

J2353+5518 RP028.UVDATA.1

Freq = 4.7990 GHz, Bw = 32.000 MH No calibration applied and no bandpass applied

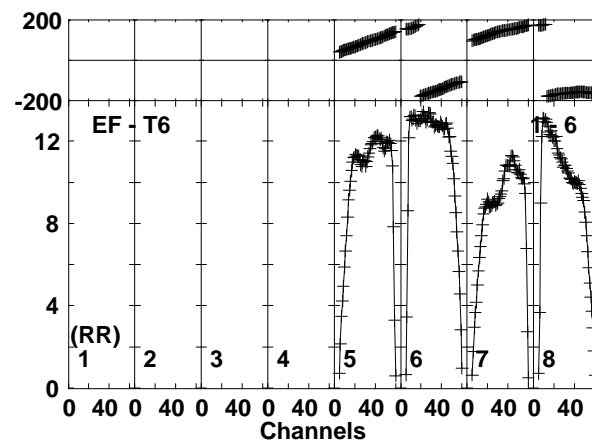
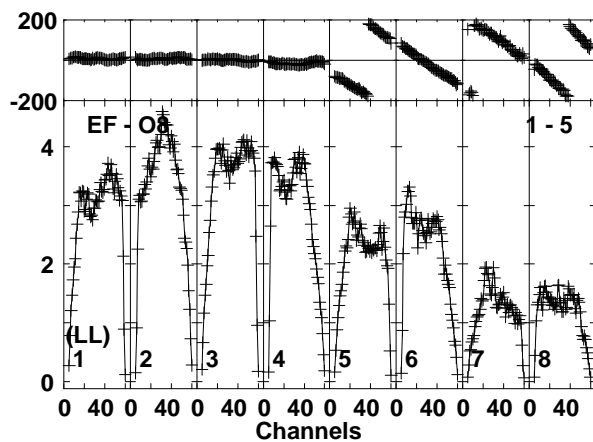
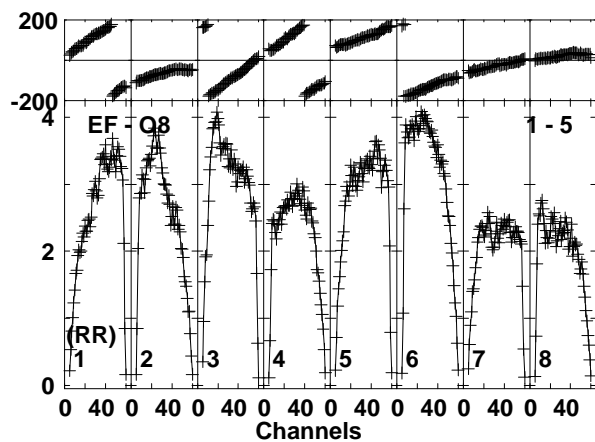
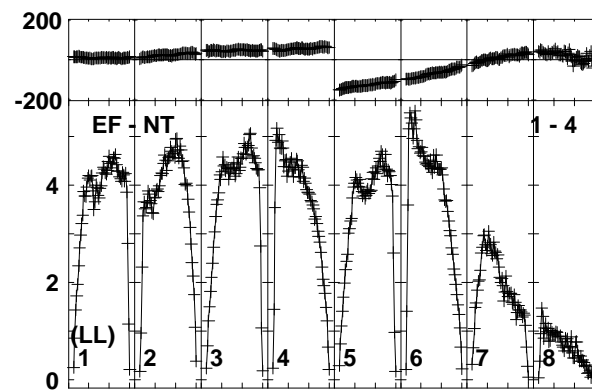
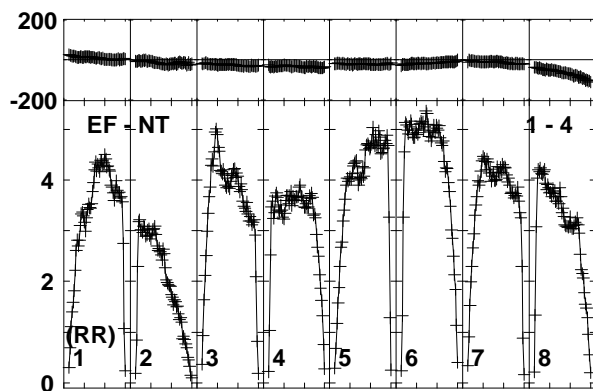
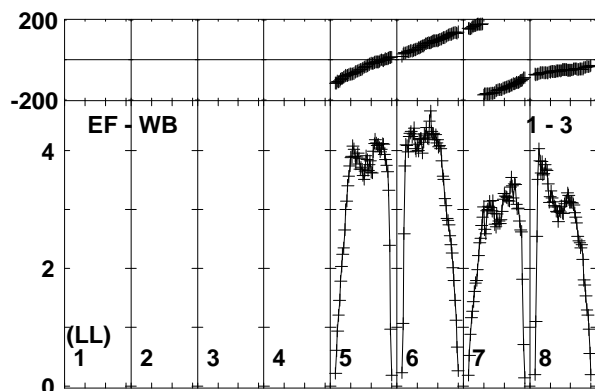
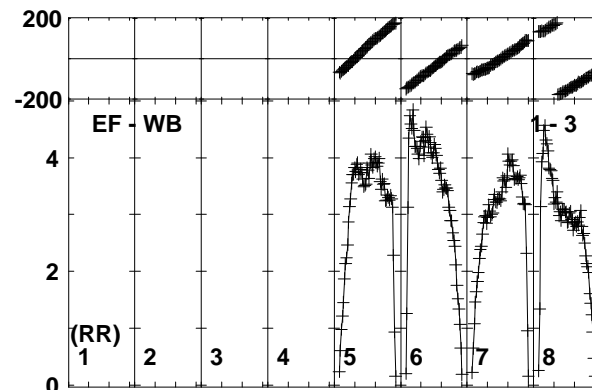
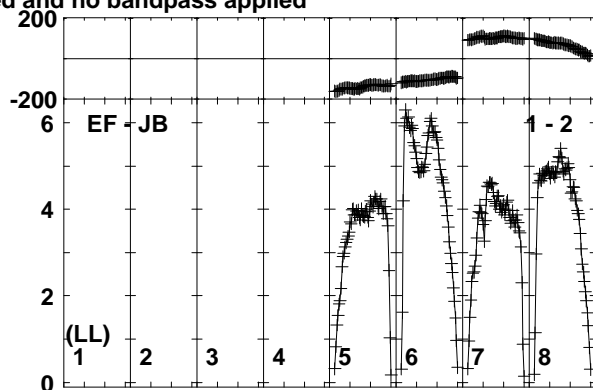
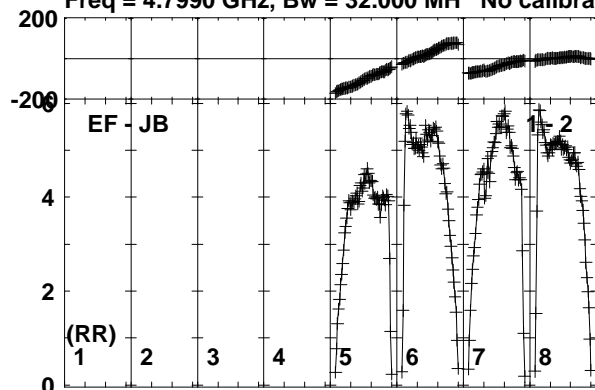

Lower frame: Milli Ampl Jy Top frame: Phas deg
Vector averaged cross-power spectrum Baseline: EF (01) - JB (02)
Timerange: 00/19:10:31 to 00/19:11:30

Plot file version 48 created 03-OCT-2017 13:09:43

J2353+5518 RP028.UVDATA.1

Freq = 4.7990 GHz, Bw = 32.000 MH No calibration applied and no bandpass applied

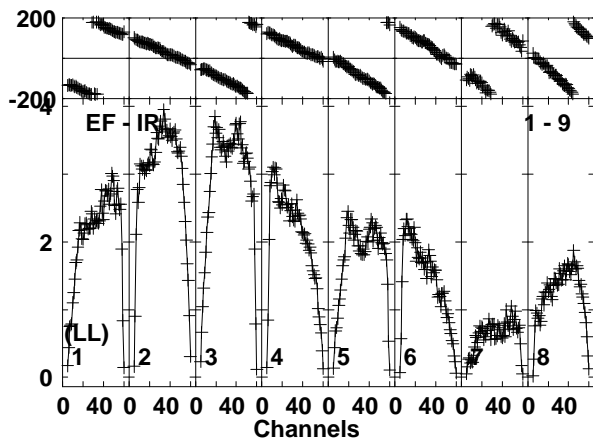
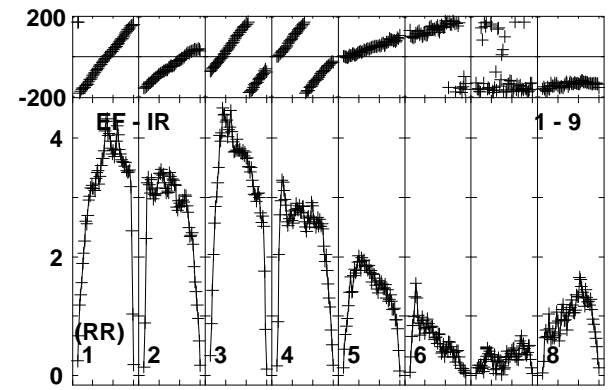
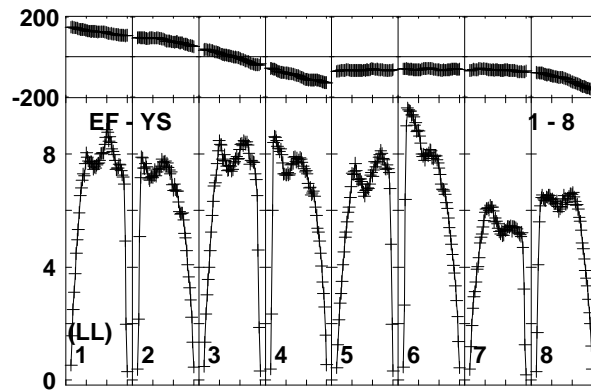
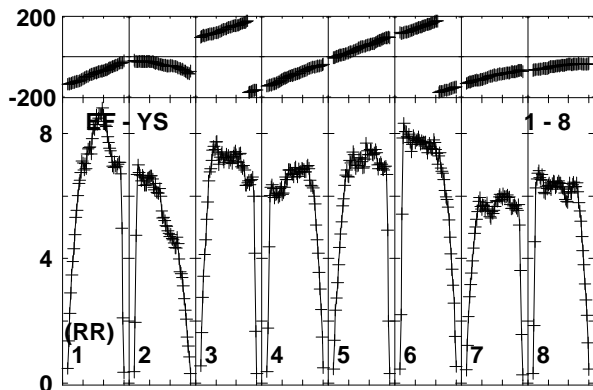
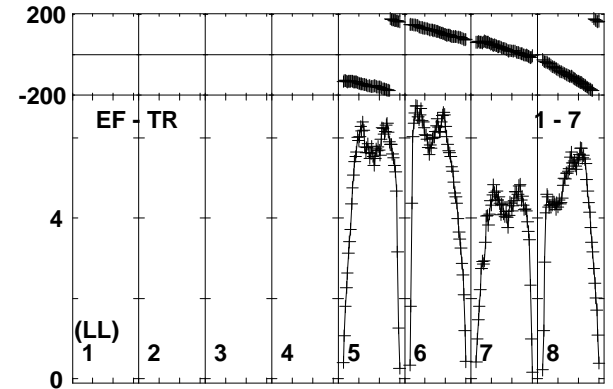
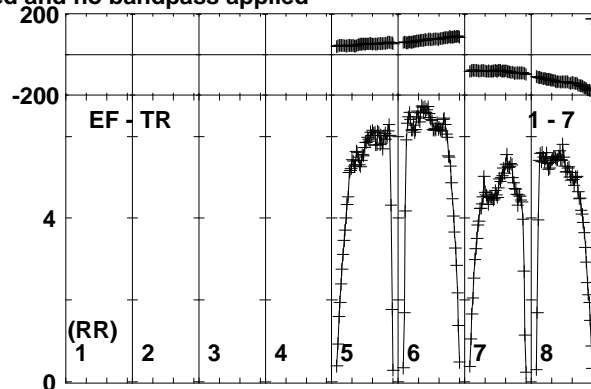
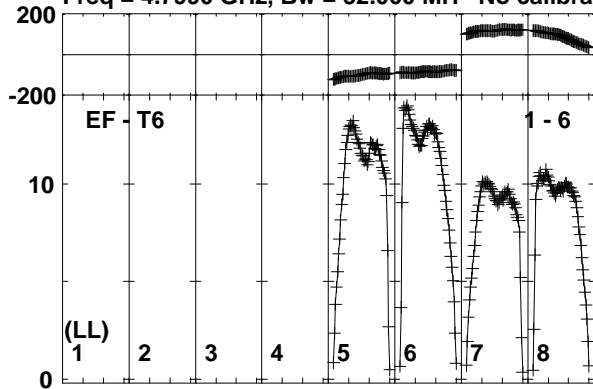

Lower frame: Milli Ampl Jy Top frame: Phas deg

Vector averaged cross-power spectrum Baseline: EF (01) - T6 (06)

Timerange: 00/19:10:31 to 00/19:11:30

Plot file version 49 created 03-OCT-2017 13:09:43

IRAS23436 RP028.UVDATA.1

Freq = 4.7990 GHz, Bw = 32.000 MH No calibration applied and no bandpass applied

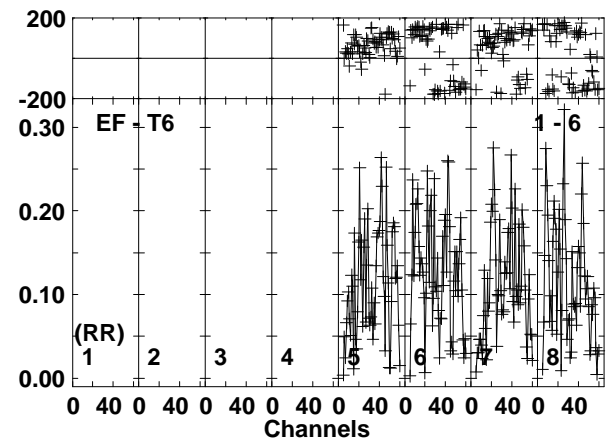
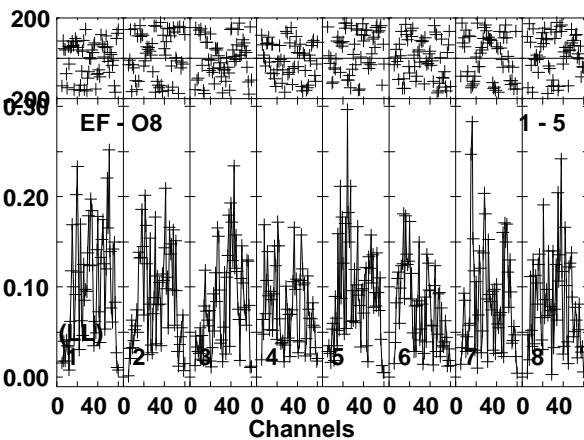
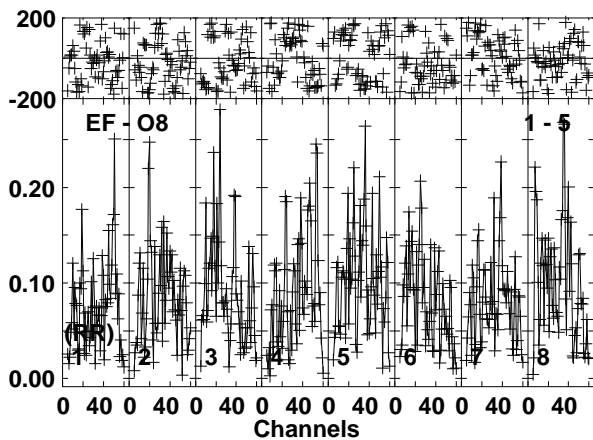
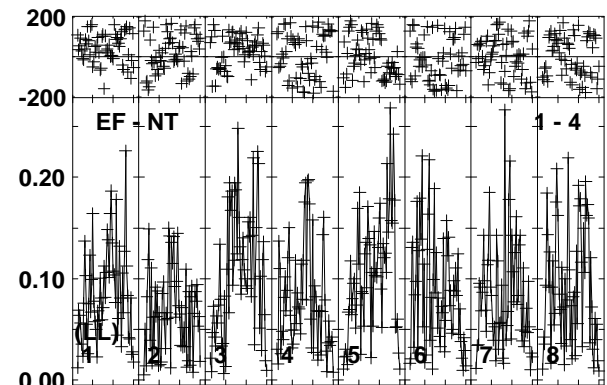
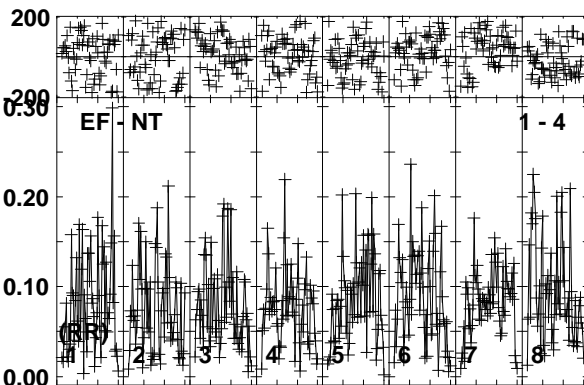
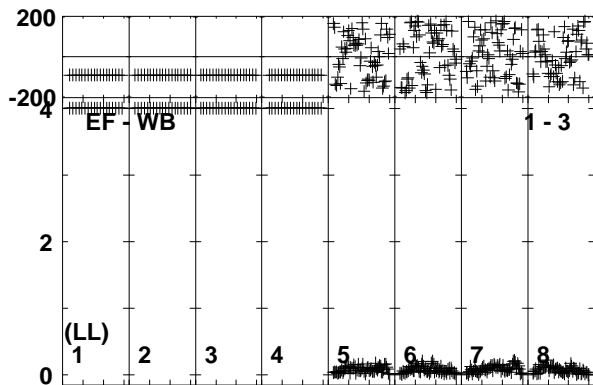
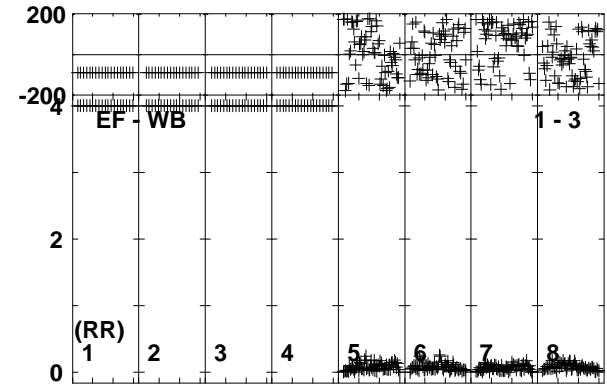
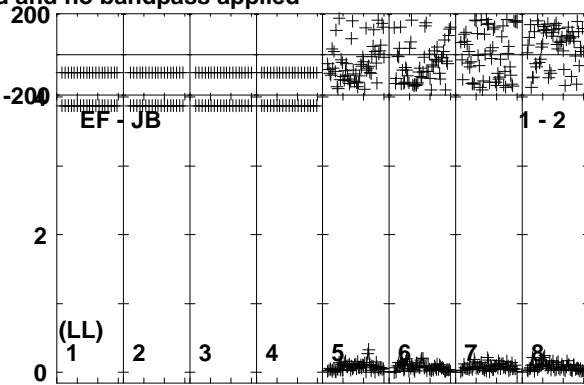
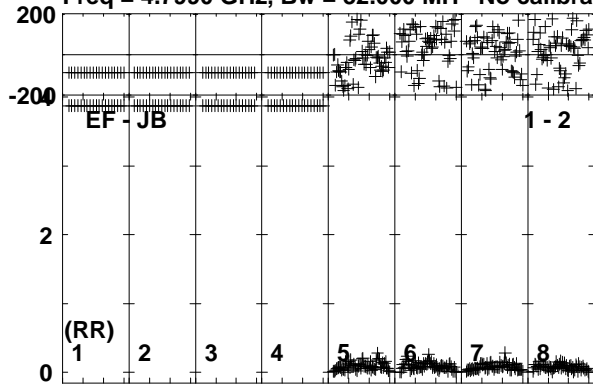

Lower frame: Milli Ampl Jy Top frame: Phas deg
Vector averaged cross-power spectrum Baseline: EF (01) - JB (02)
Timerange: 00/19:11:30 to 00/19:15:10

Plot file version 50 created 03-OCT-2017 13:09:43

IRAS23436 RP028.UVDATA.1

Freq = 4.7990 GHz, Bw = 32.000 MH No calibration applied and no bandpass applied

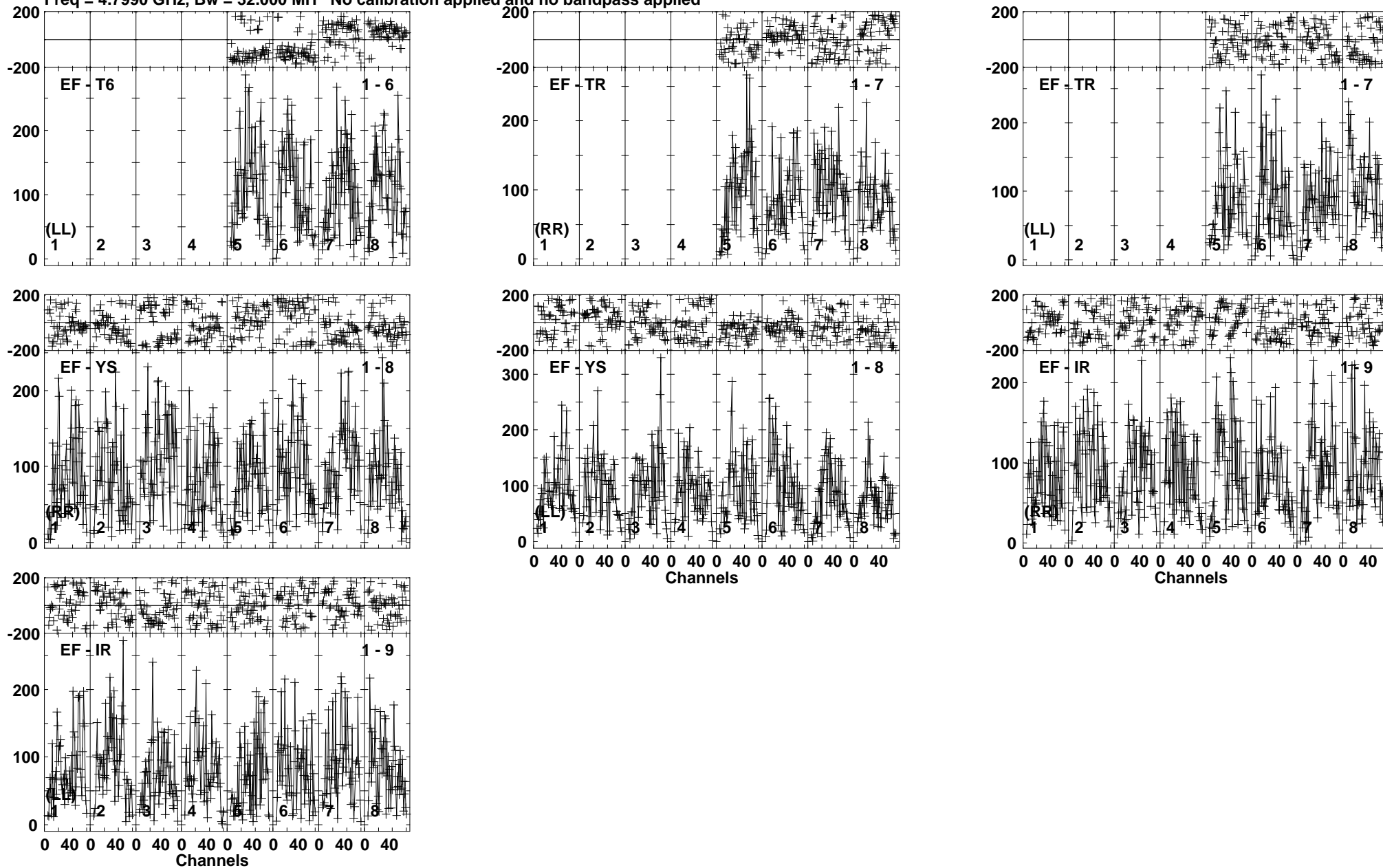

Lower frame: Micro Ampl Jy Top frame: Phas deg
Vector averaged cross-power spectrum Baseline: EF (01) - T6 (06)
Timerange: 00/19:11:30 to 00/19:15:10

Plot file version 51 created 03-OCT-2017 13:09:43

J2353+5518 RP028.UVDATA.1

Freq = 4.7990 GHz, Bw = 32.000 MH No calibration applied and no bandpass applied

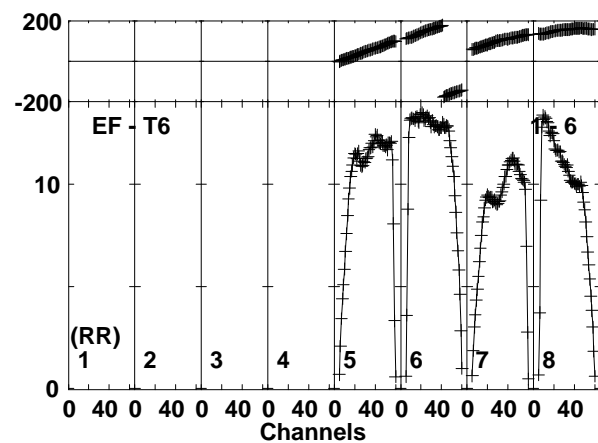
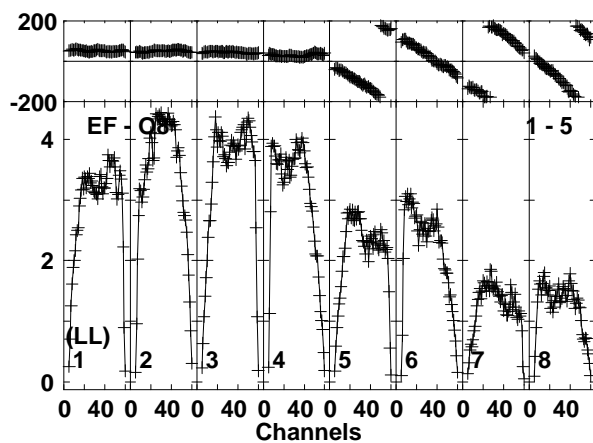
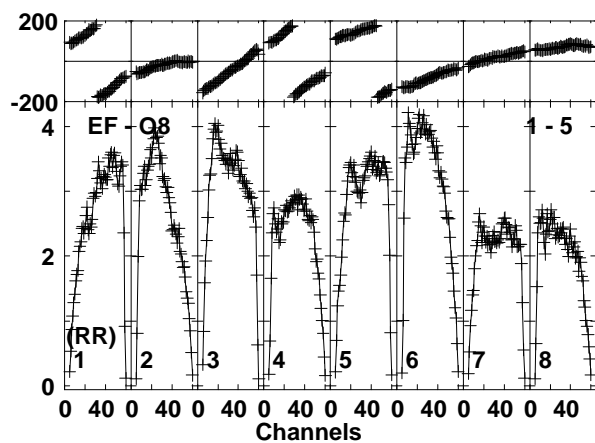
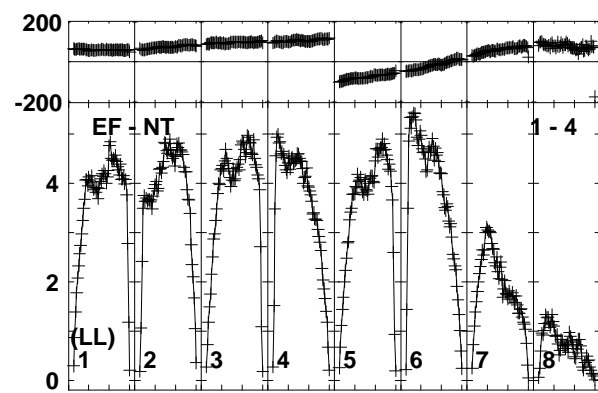
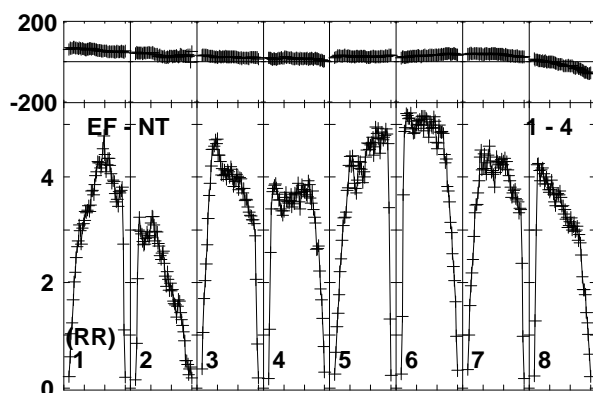
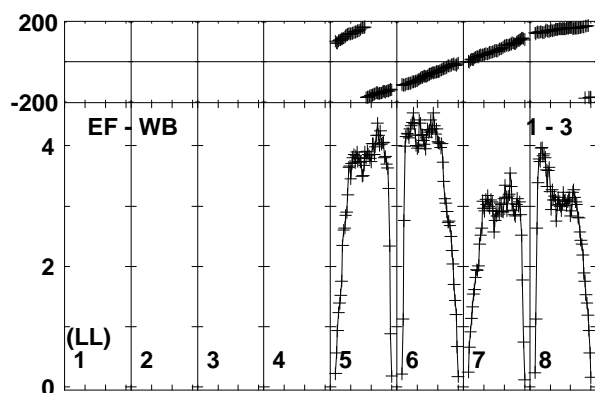
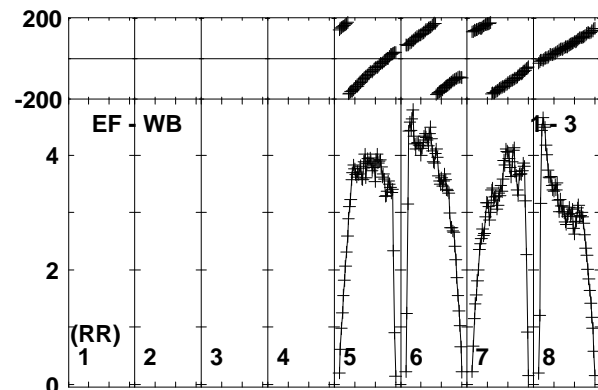
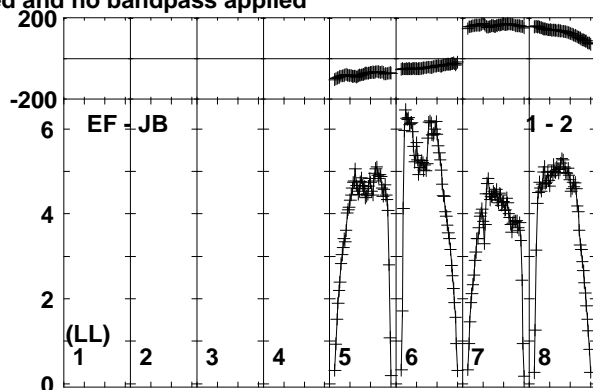
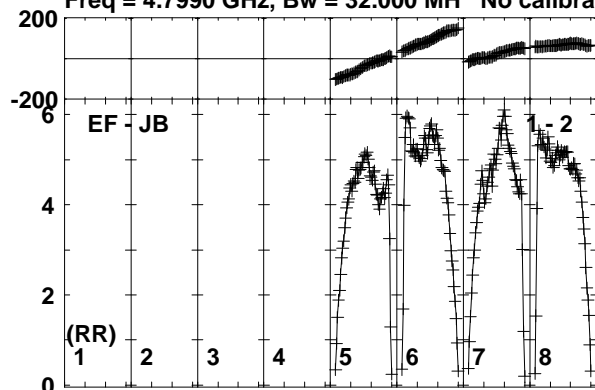

Lower frame: Milli Ampl Jy Top frame: Phas deg
Vector averaged cross-power spectrum Baseline: EF (01) - JB (02)
Timerange: 00/19:15:10 to 00/19:16:39

Plot file version 52 created 03-OCT-2017 13:09:44

J2353+5518 RP028.UVDATA.1

Freq = 4.7990 GHz, Bw = 32.000 MH No calibration applied and no bandpass applied

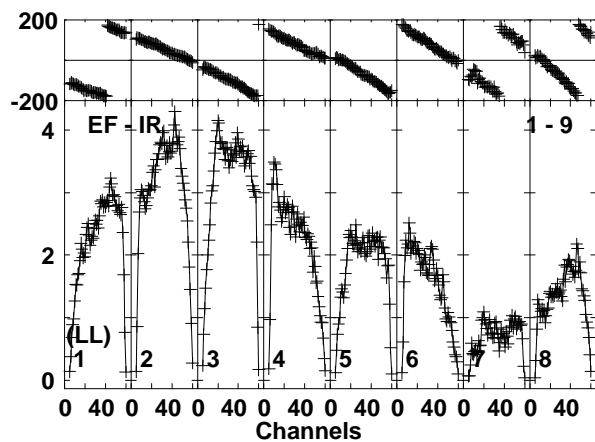
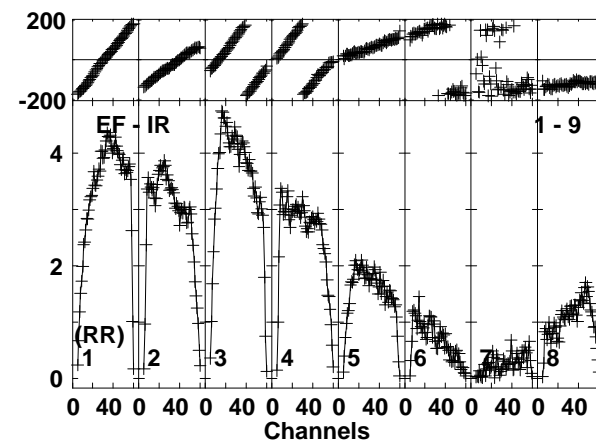
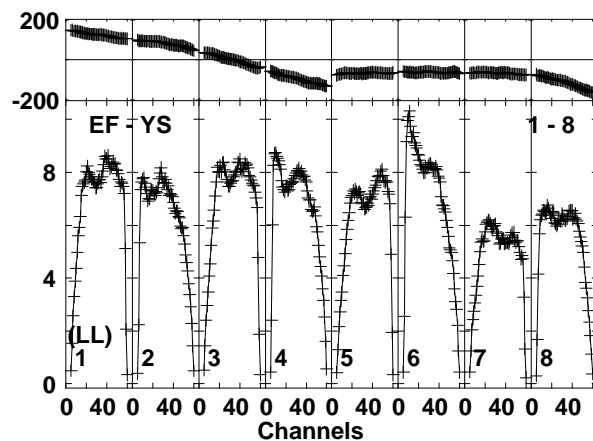
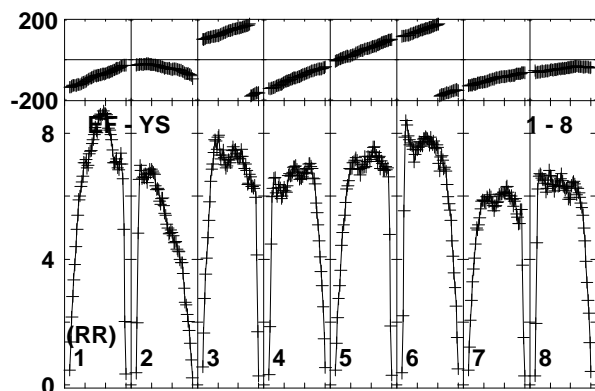
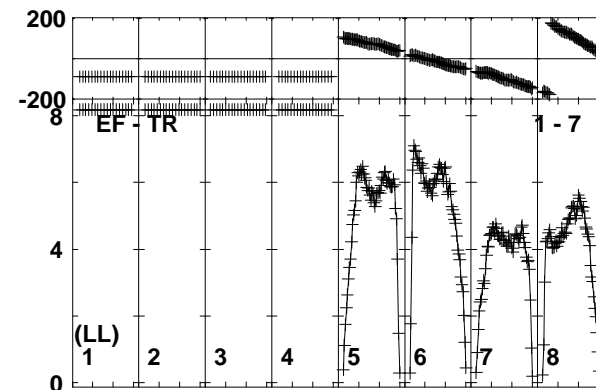
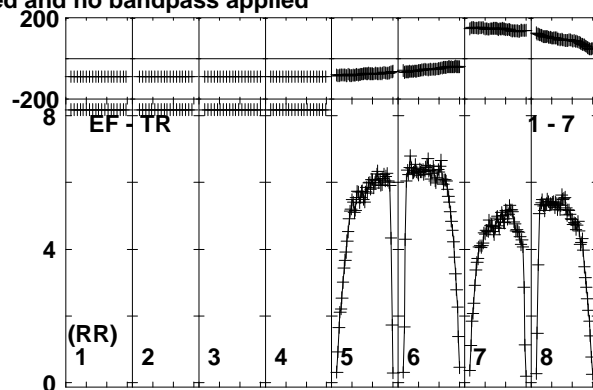
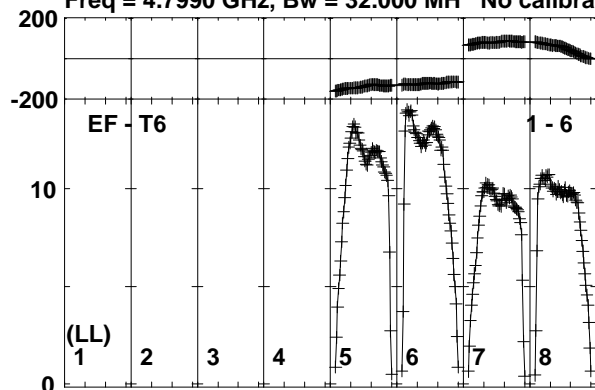

Lower frame: Milli Ampl Jy Top frame: Phas deg
Vector averaged cross-power spectrum Baseline: EF (01) - T6 (06)
Timerange: 00/19:15:10 to 00/19:16:39

Plot file version 53 created 03-OCT-2017 13:09:44

IRAS23436 RP028.UVDATA.1

Freq = 4.7990 GHz, Bw = 32.000 MH No calibration applied and no bandpass applied

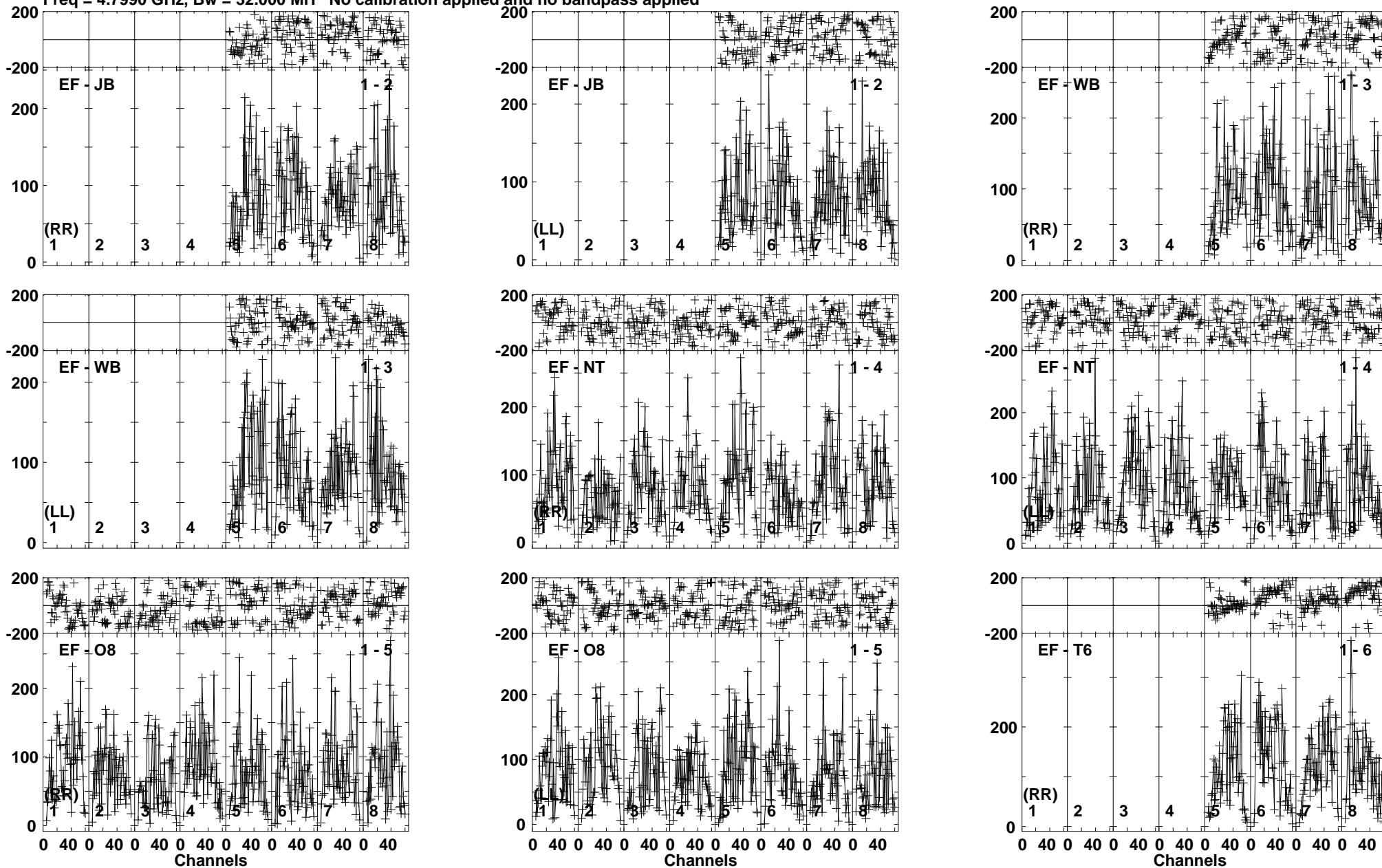

Lower frame: Micro Ampl Jy Top frame: Phas deg
 Vector averaged cross-power spectrum Baseline: EF (01) - JB (02)
 Timerange: 00/19:16:40 to 00/19:20:24

Plot file version 54 created 03-OCT-2017 13:09:44

IRAS23436 RP028.UVDATA.1

Freq = 4.7990 GHz, Bw = 32.000 MH No calibration applied and no bandpass applied

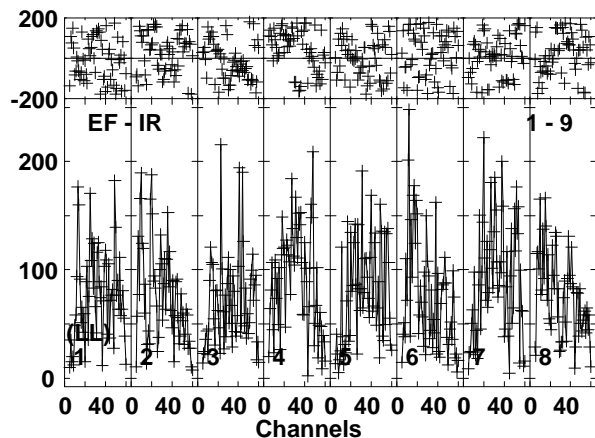
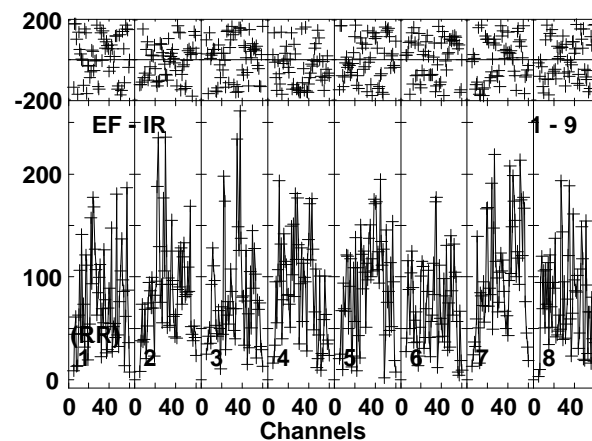
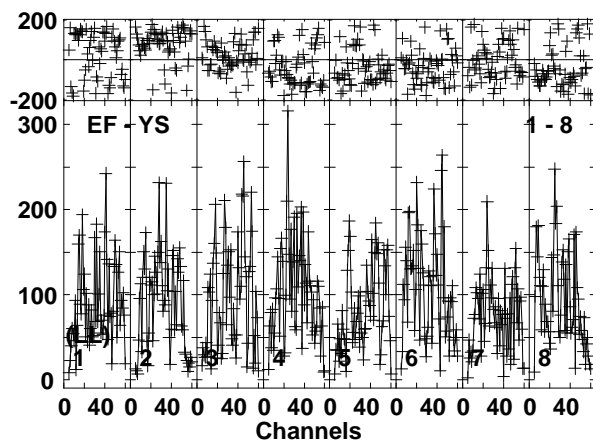
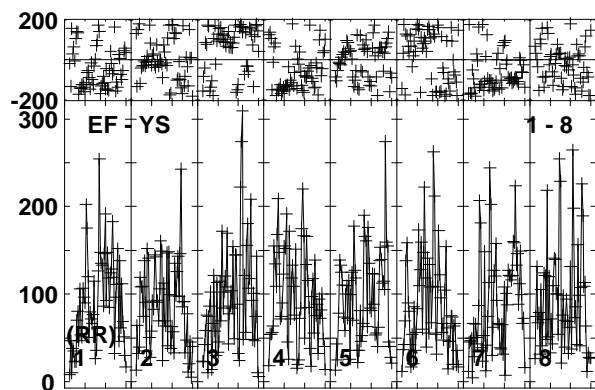
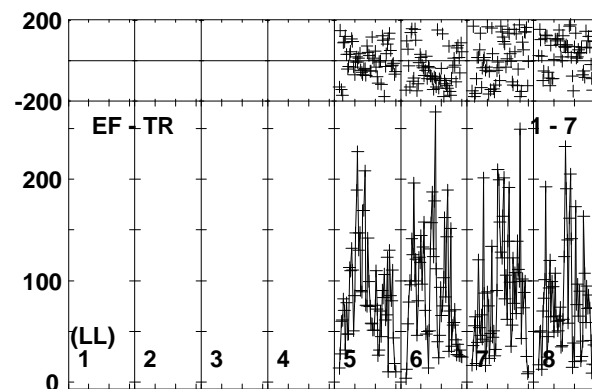
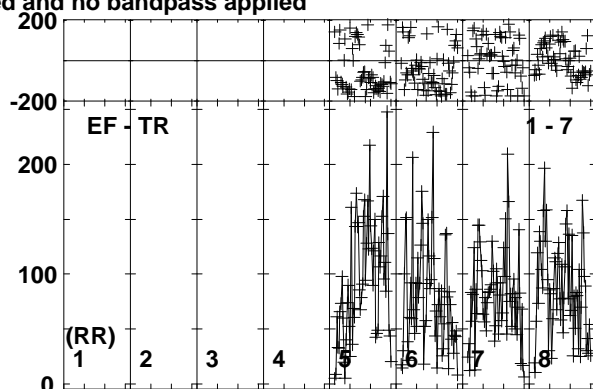
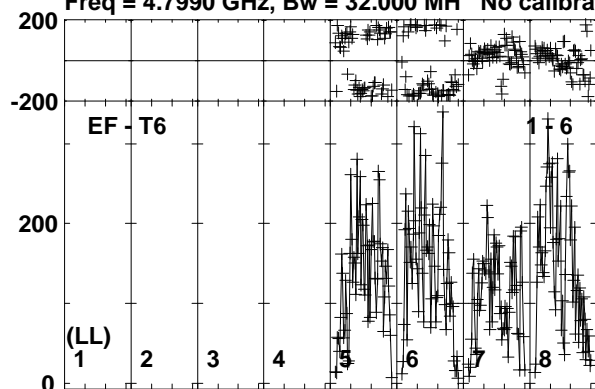

Lower frame: Micro Ampl Jy Top frame: Phas deg
Vector averaged cross-power spectrum Baseline: EF (01) - T6 (06)
Timerange: 00/19:16:40 to 00/19:20:24

Plot file version 55 created 03-OCT-2017 13:09:44

J2353+5518 RP028.UVDATA.1

Freq = 4.7990 GHz, Bw = 32.000 MH No calibration applied and no bandpass applied

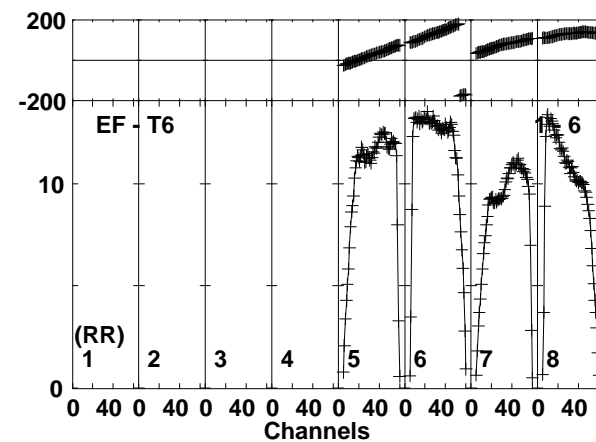
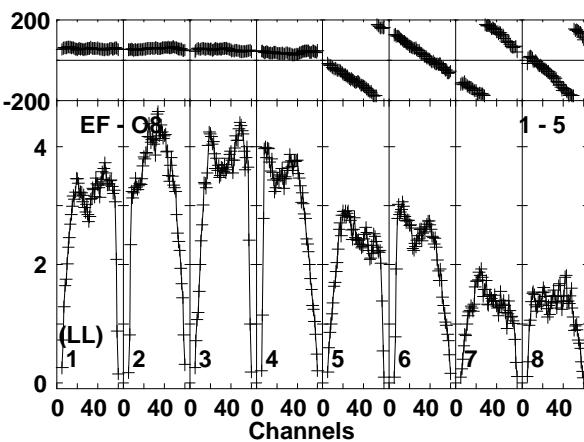
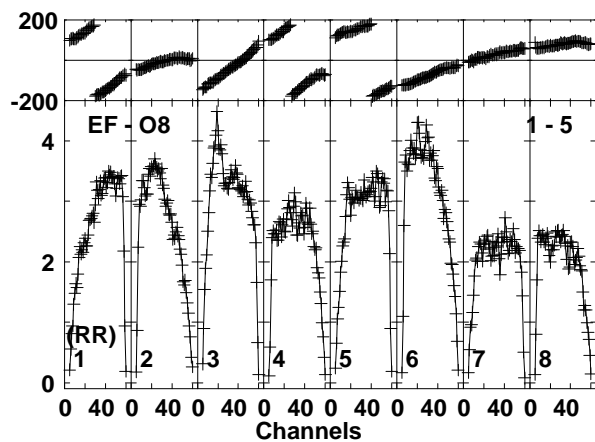
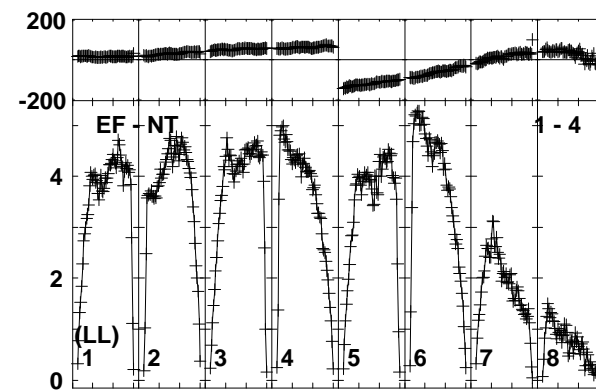
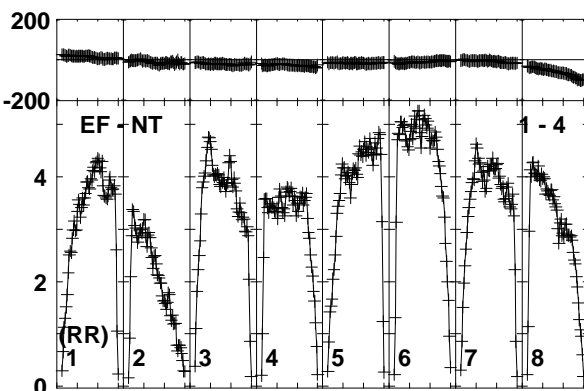
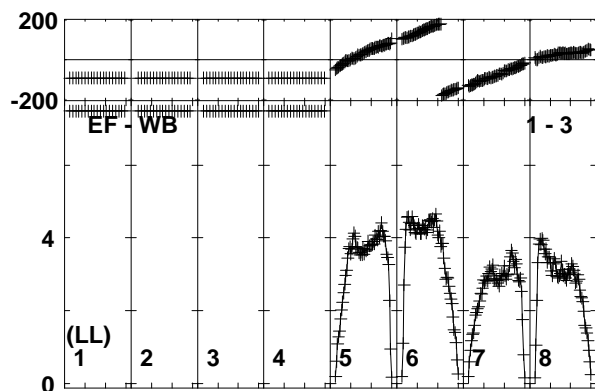
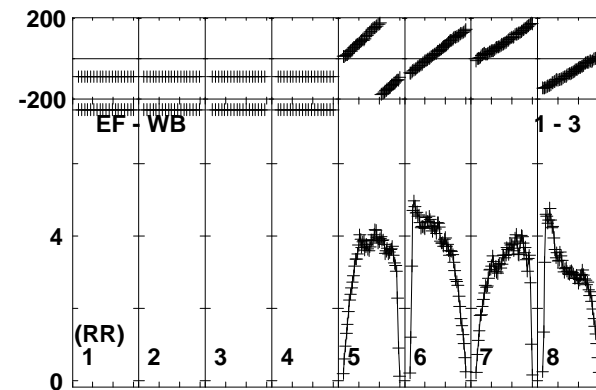
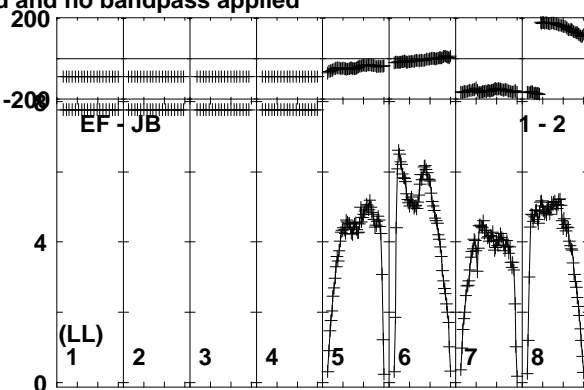
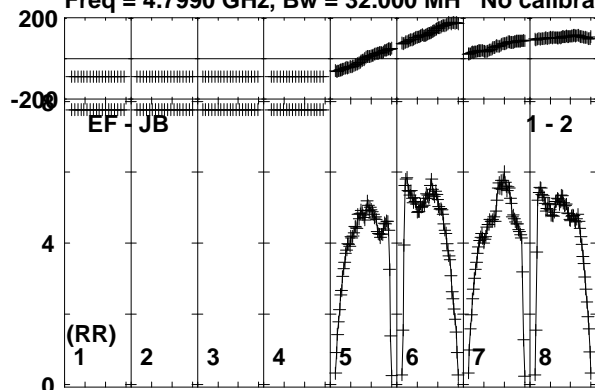

Lower frame: Milli Ampl Jy Top frame: Phas deg
Vector averaged cross-power spectrum Baseline: EF (01) - JB (02)
Timerange: 00/19:21:04 to 00/19:21:54

Plot file version 56 created 03-OCT-2017 13:09:44

J2353+5518 RP028.UVDATA.1

Freq = 4.7990 GHz, Bw = 32.000 MH No calibration applied and no bandpass applied

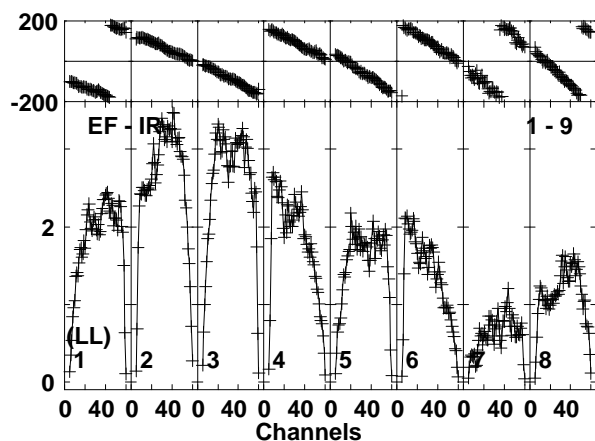
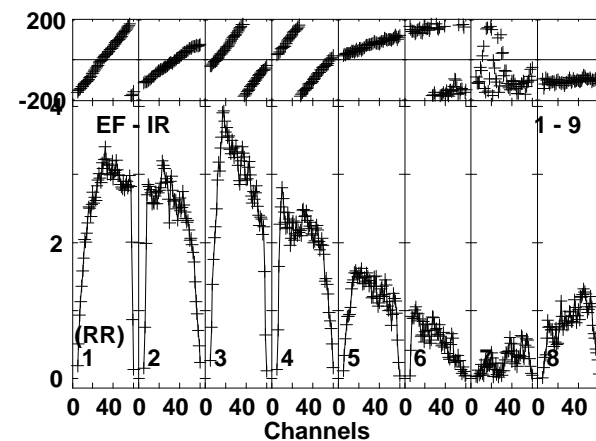
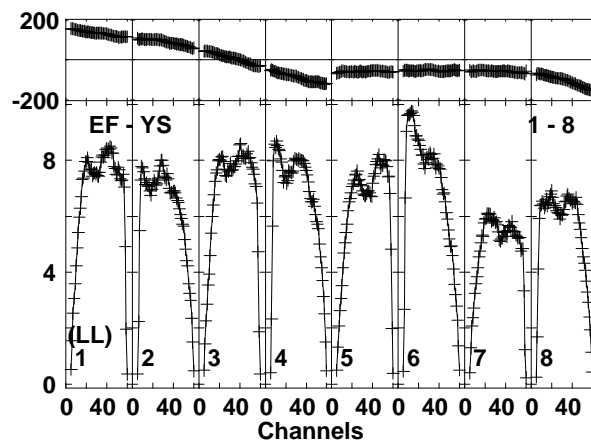
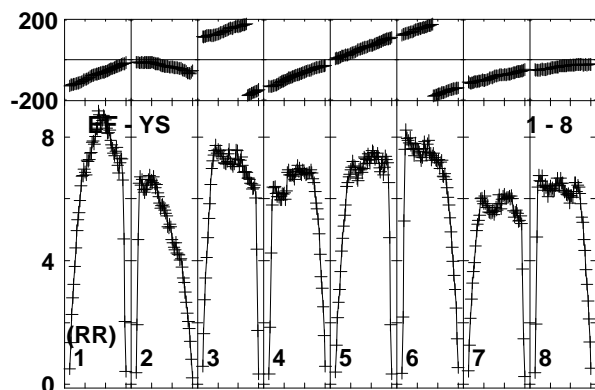
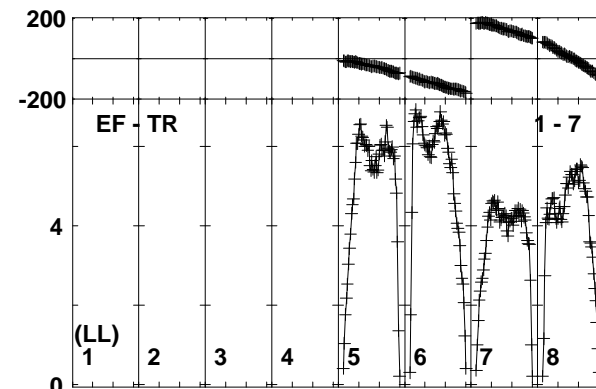
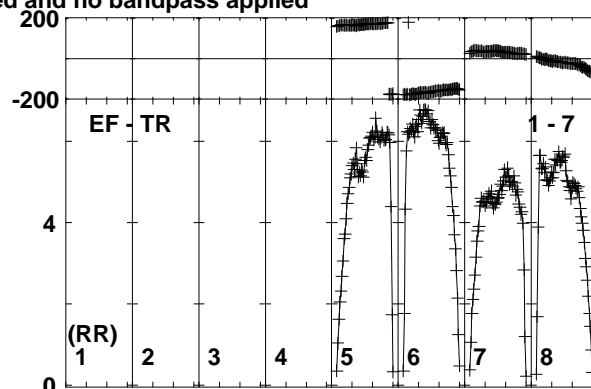
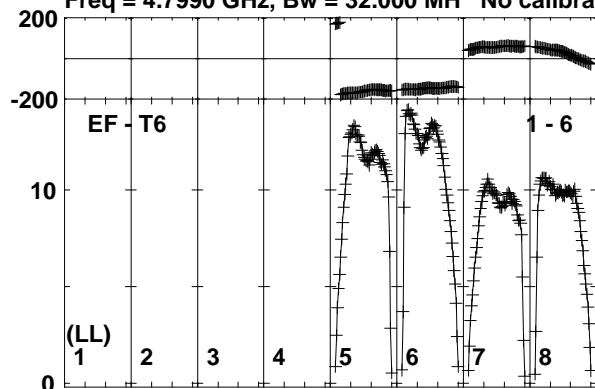

Lower frame: Milli Ampl Jy Top frame: Phas deg

Vector averaged cross-power spectrum Baseline: EF (01) - T6 (06)

Timerange: 00/19:21:04 to 00/19:21:54

Plot file version 57 created 03-OCT-2017 13:09:45

IRAS23436 RP028.UVDATA.1

Freq = 4.7990 GHz, Bw = 32.000 MH No calibration applied and no bandpass applied

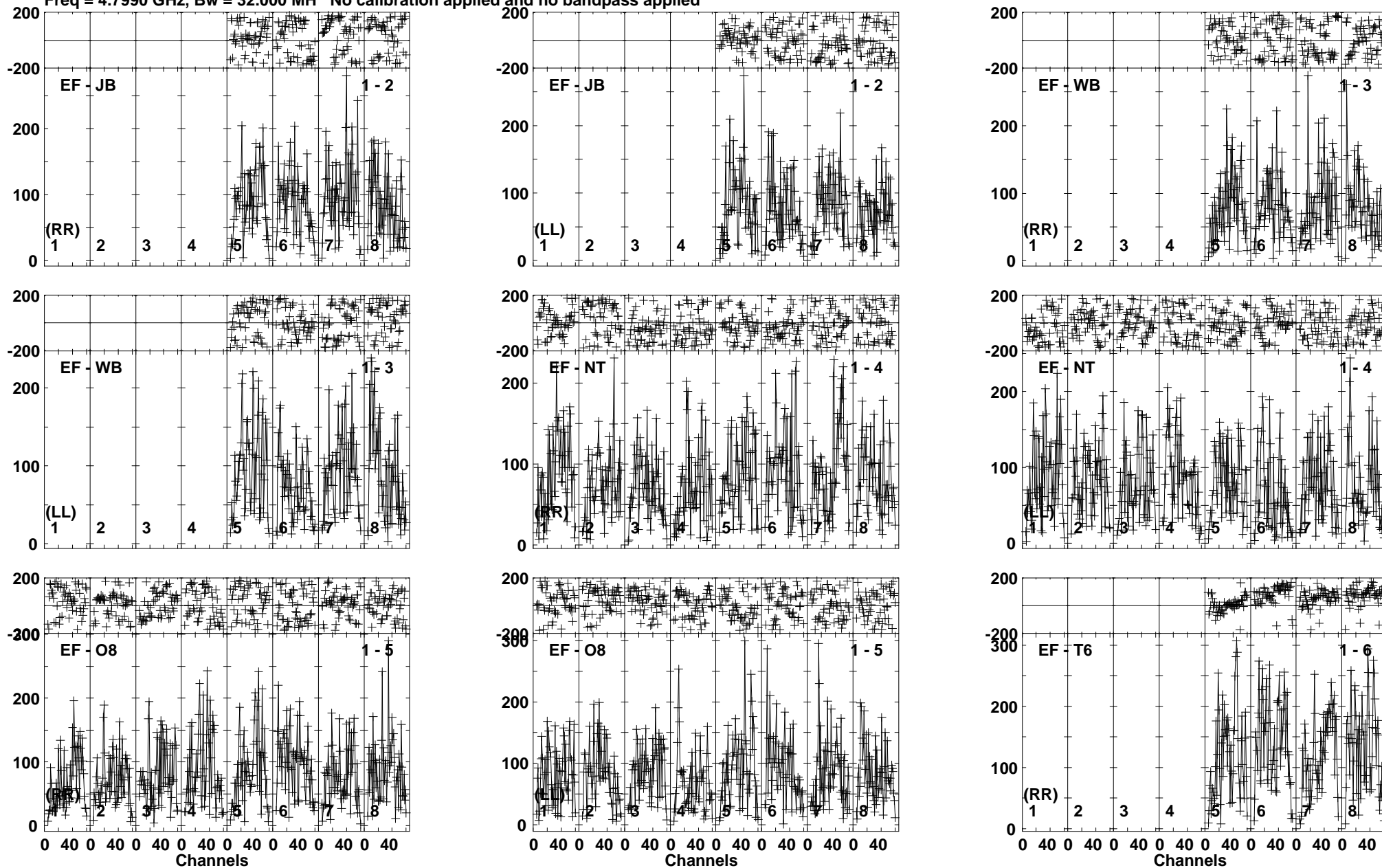

Lower frame: Micro Ampl Jy Top frame: Phas deg
Vector averaged cross-power spectrum Baseline: EF (01) - JB (02)
Timerange: 00/19:21:54 to 00/19:25:38

Plot file version 58 created 03-OCT-2017 13:09:45

IRAS23436 RP028.UVDATA.1

Freq = 4.7990 GHz, Bw = 32.000 MH No calibration applied and no bandpass applied

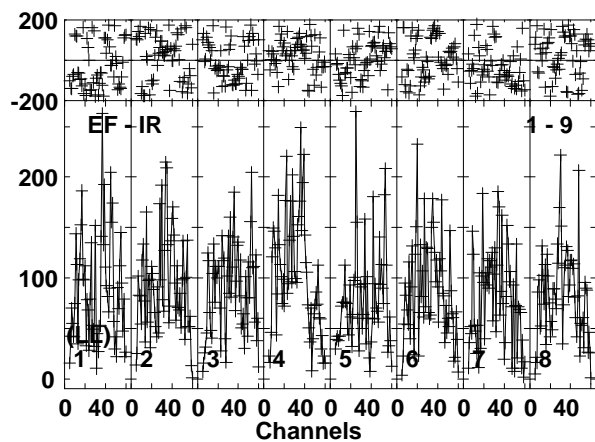
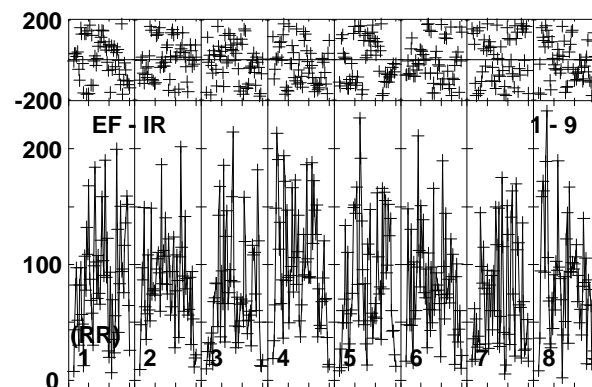
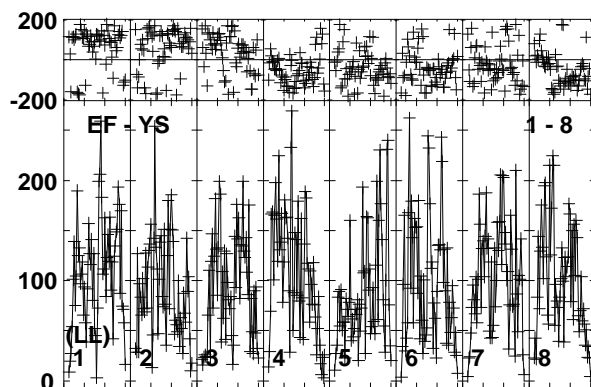
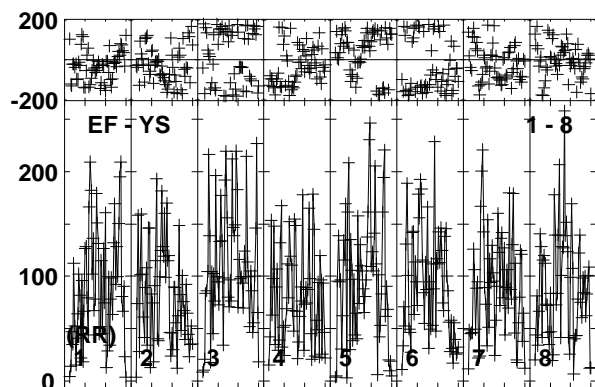
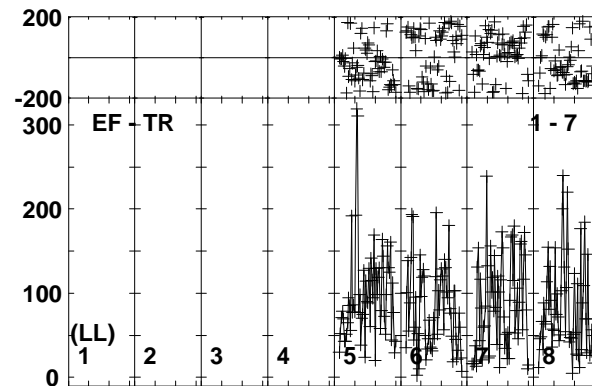
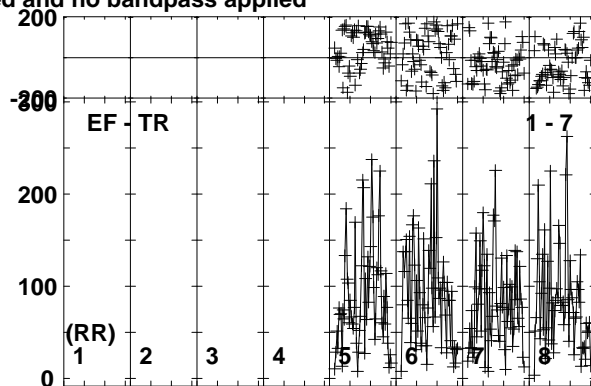
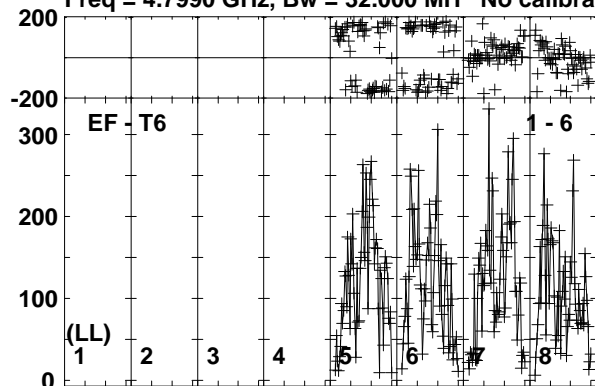

Lower frame: Micro Ampl Jy Top frame: Phas deg
Vector averaged cross-power spectrum Baseline: EF (01) - T6 (06)
Timerange: 00/19:21:54 to 00/19:25:38

Plot file version 59 created 03-OCT-2017 13:09:45

J2353+5518 RP028.UVDATA.1

Freq = 4.7990 GHz, Bw = 32.000 MH No calibration applied and no bandpass applied

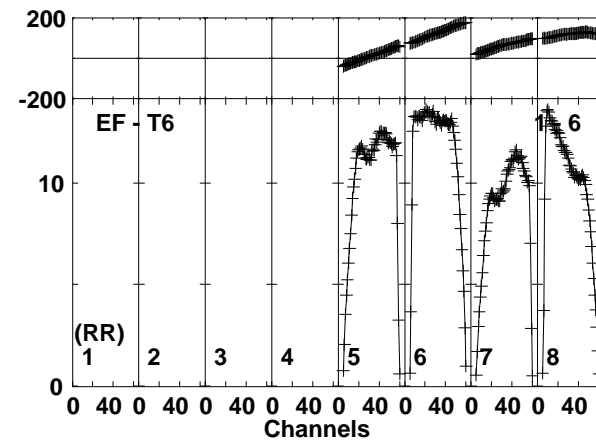
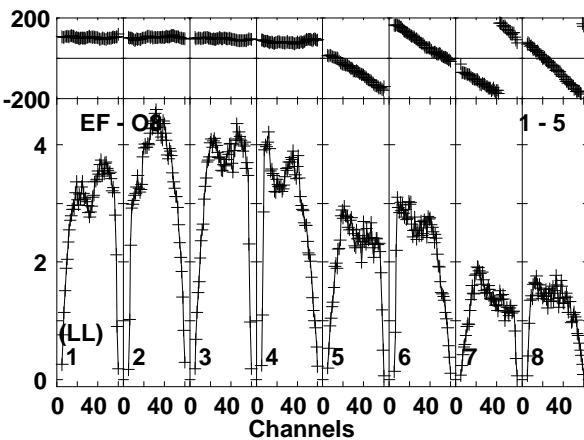
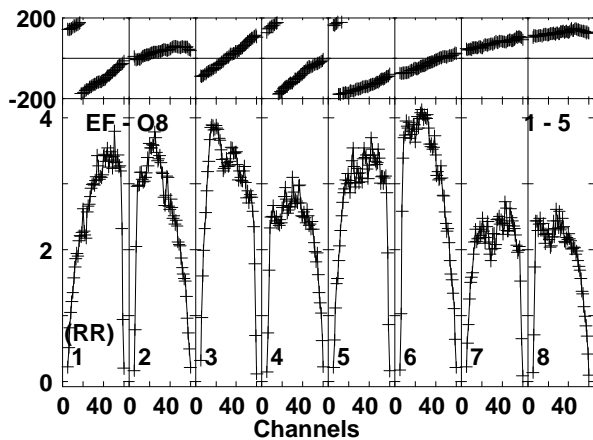
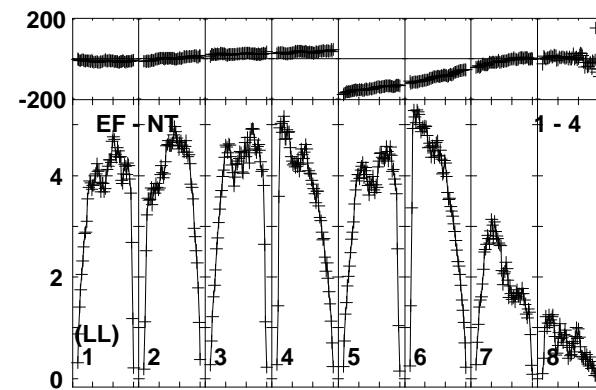
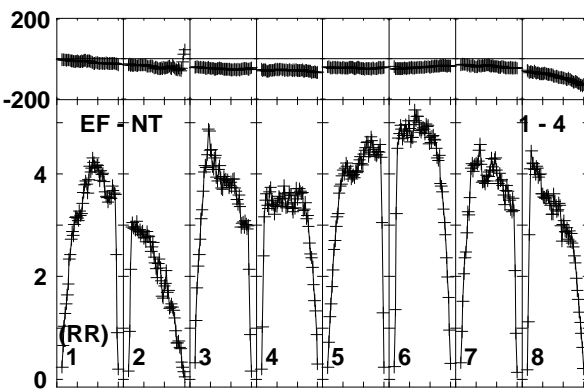
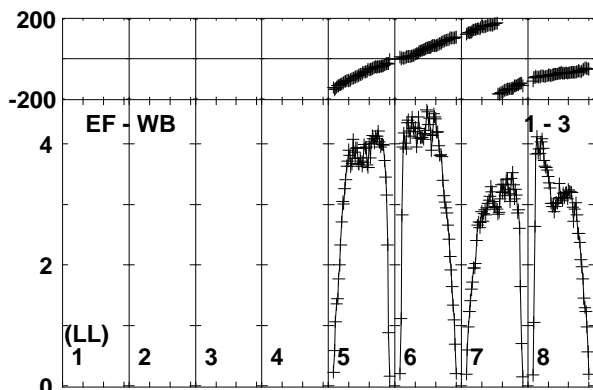
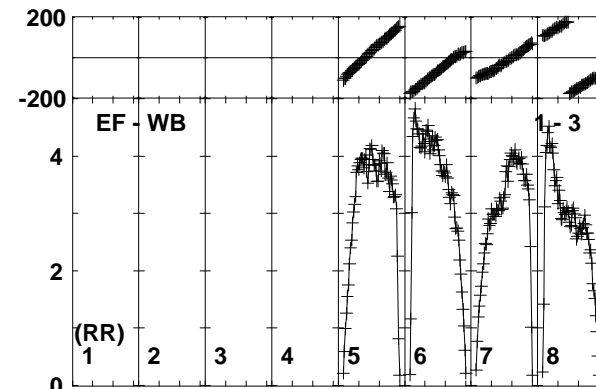
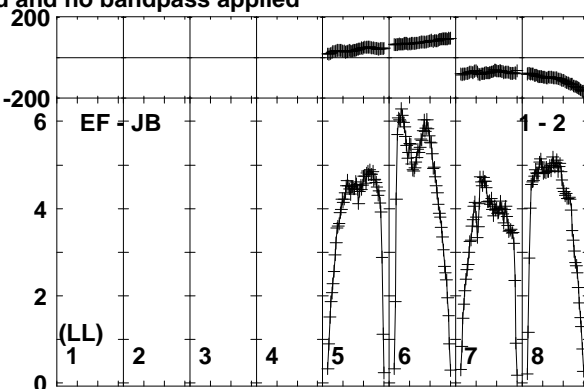
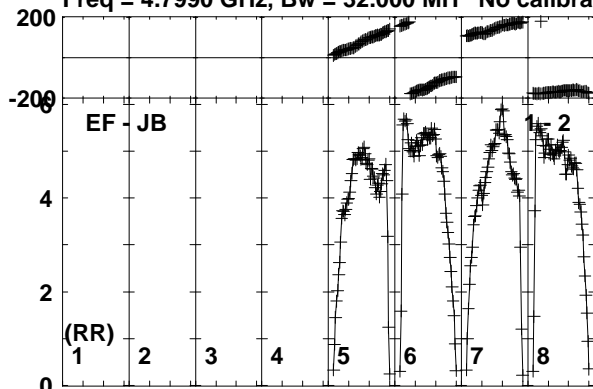

Lower frame: Milli Ampl Jy Top frame: Phas deg
Vector averaged cross-power spectrum Baseline: EF (01) - JB (02)
Timerange: 00/19:25:38 to 00/19:27:08

Plot file version 60 created 03-OCT-2017 13:09:45

J2353+5518 RP028.UVDATA.1

Freq = 4.7990 GHz, Bw = 32.000 MH No calibration applied and no bandpass applied

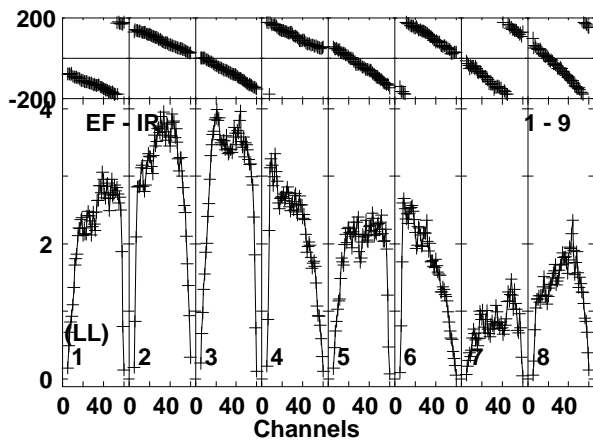
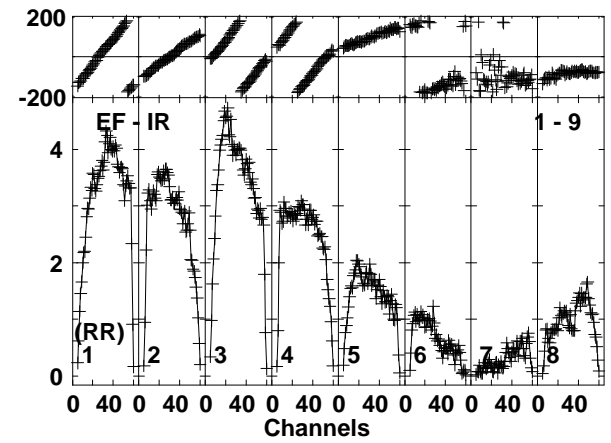
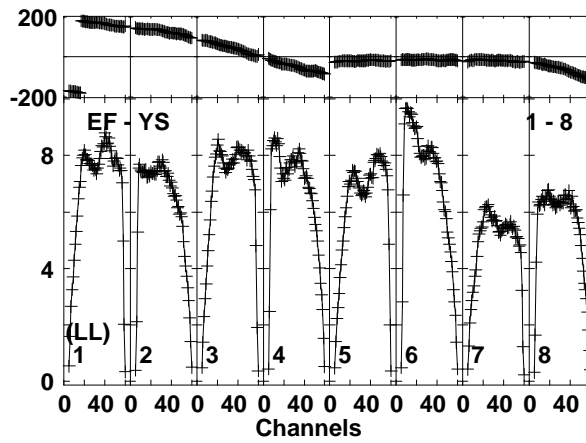
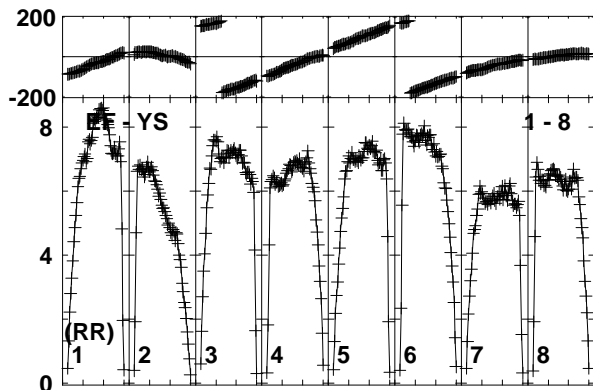
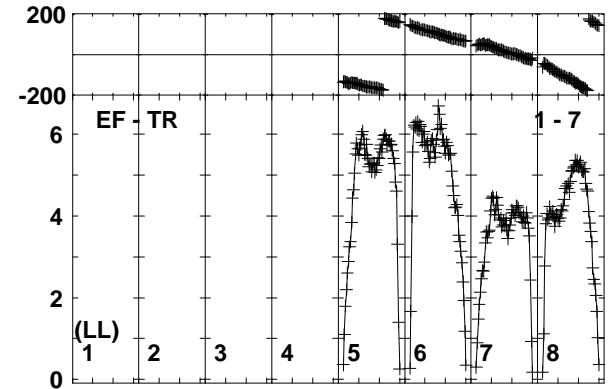
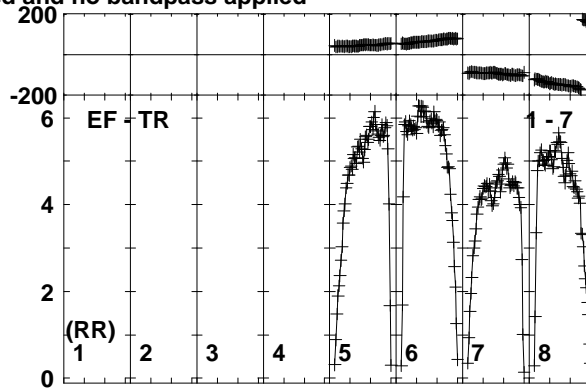
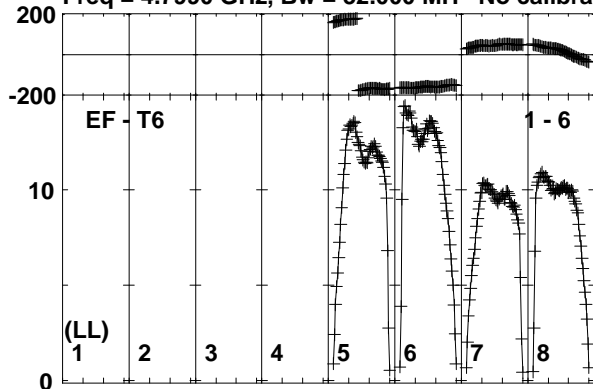

Lower frame: Milli Ampl Jy Top frame: Phas deg
Vector averaged cross-power spectrum Baseline: EF (01) - T6 (06)
Timerange: 00/19:25:38 to 00/19:27:08

Plot file version 61 created 03-OCT-2017 13:09:46

IRAS23436 RP028.UVDATA.1

Freq = 4.7990 GHz, Bw = 32.000 MH No calibration applied and no bandpass applied

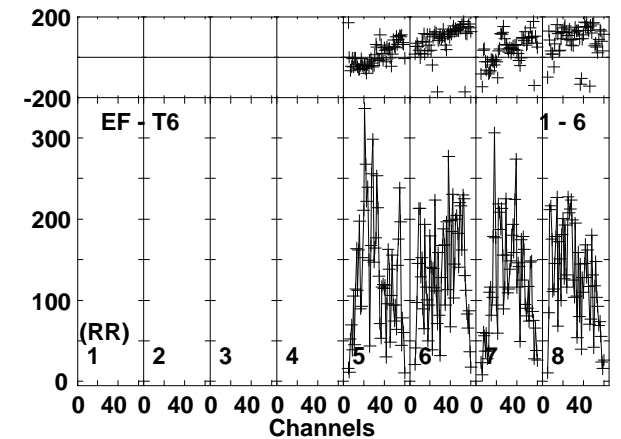
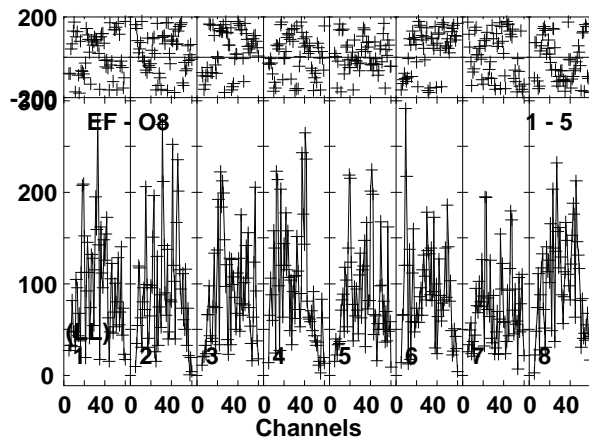
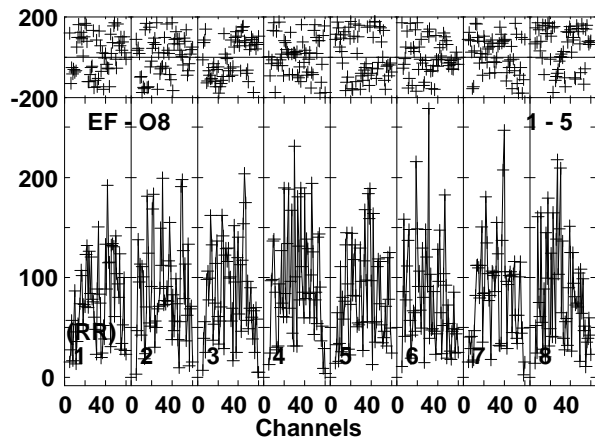
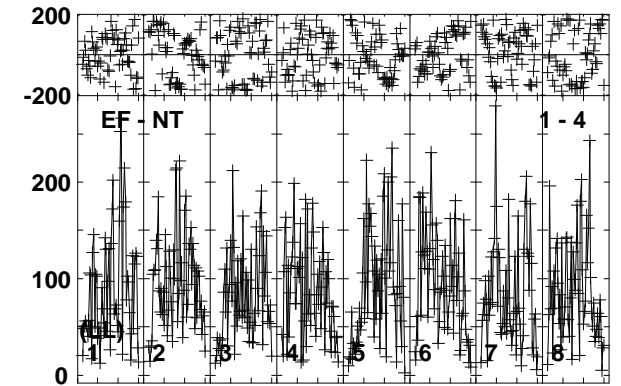
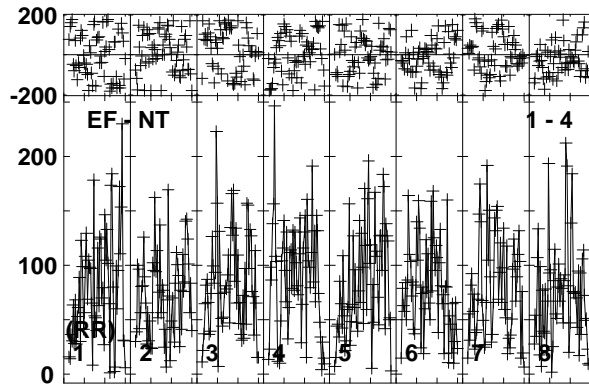
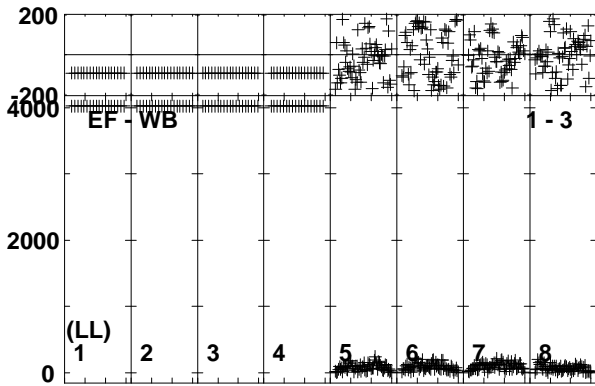
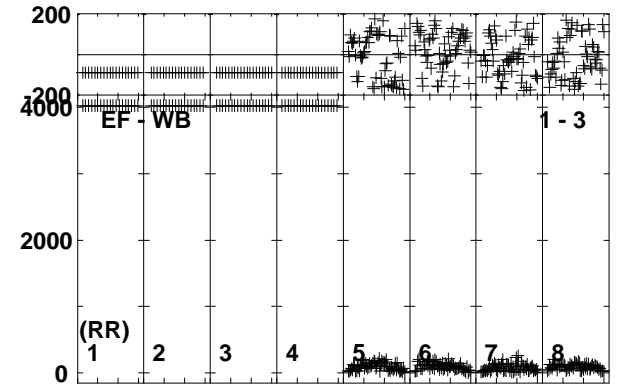
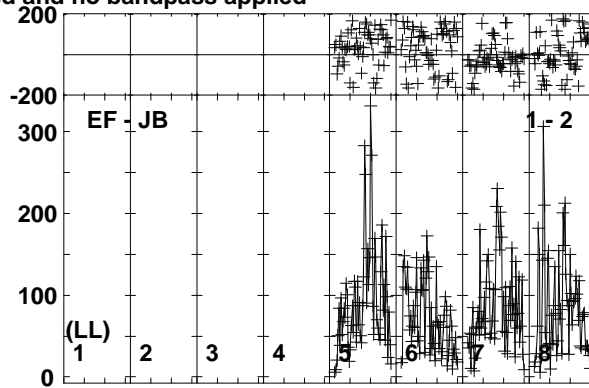
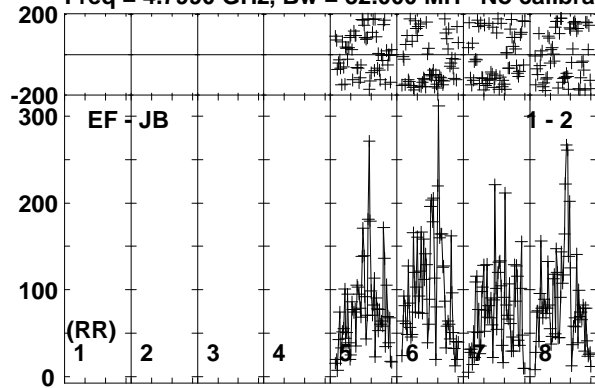

Lower frame: Micro Ampl Jy Top frame: Phas deg
Vector averaged cross-power spectrum Baseline: EF (01) - JB (02)
Timerange: 00/19:27:09 to 00/19:30:51

Plot file version 62 created 03-OCT-2017 13:09:46

IRAS23436 RP028.UVDATA.1

Freq = 4.7990 GHz, Bw = 32.000 MH No calibration applied and no bandpass applied

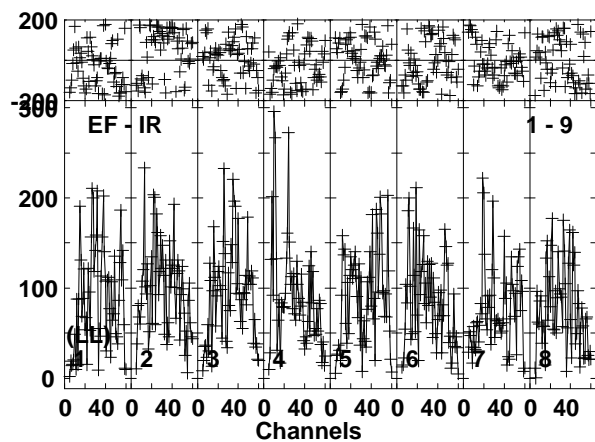
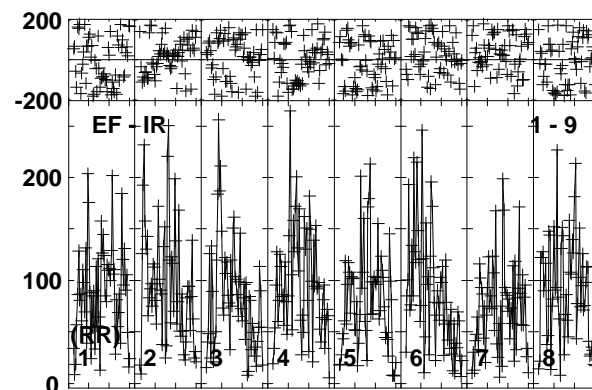
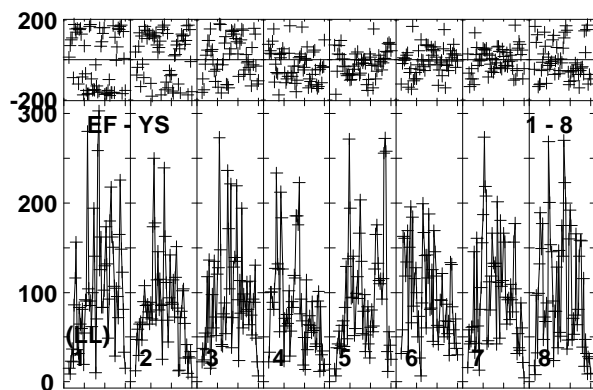
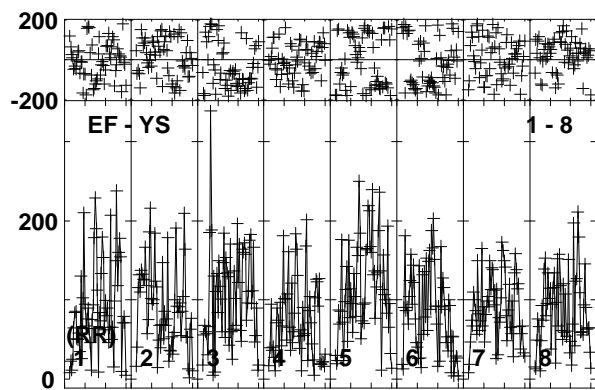
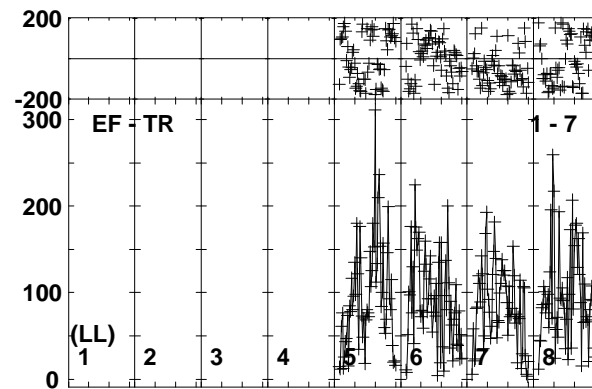
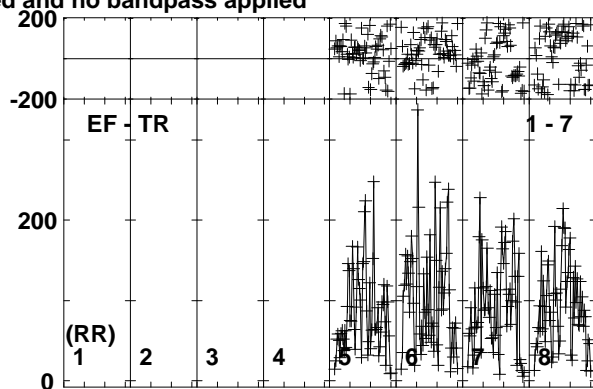
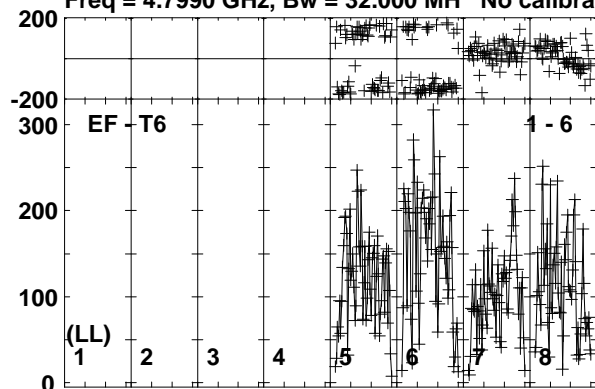

Lower frame: Micro Ampl Jy Top frame: Phas deg
Vector averaged cross-power spectrum Baseline: EF (01) - T6 (06)
Timerange: 00/19:27:09 to 00/19:30:51

Plot file version 63 created 03-OCT-2017 13:09:46

J2353+5518 RP028.UVDATA.1

Freq = 4.7990 GHz, Bw = 32.000 MH No calibration applied and no bandpass applied

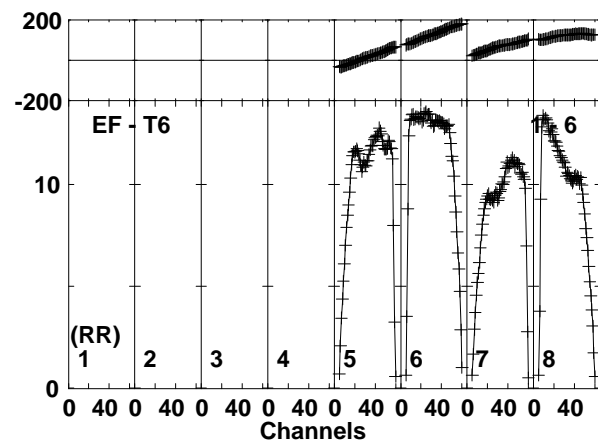
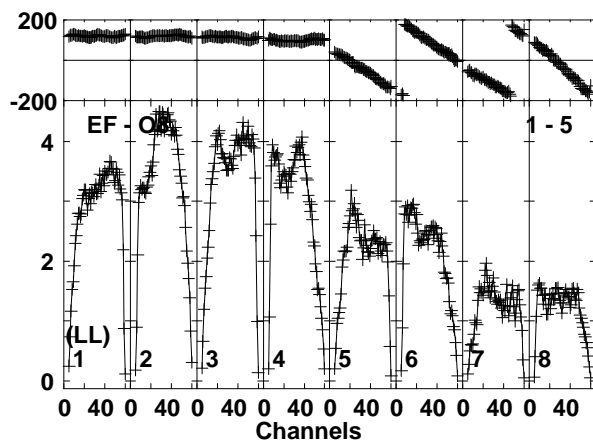
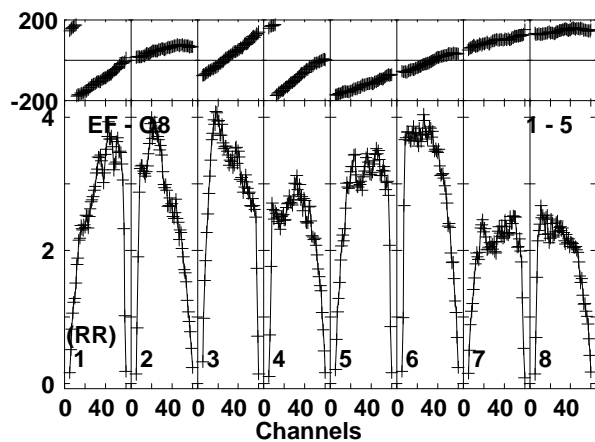
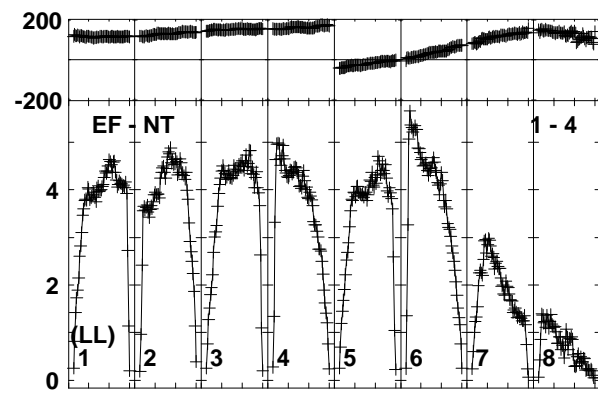
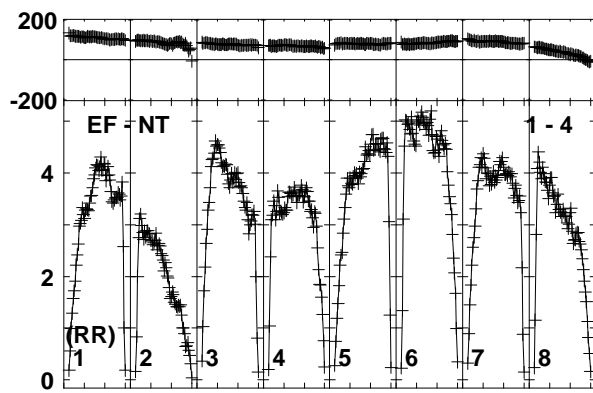
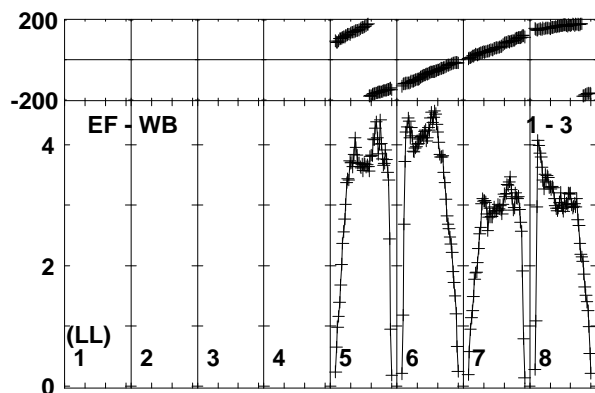
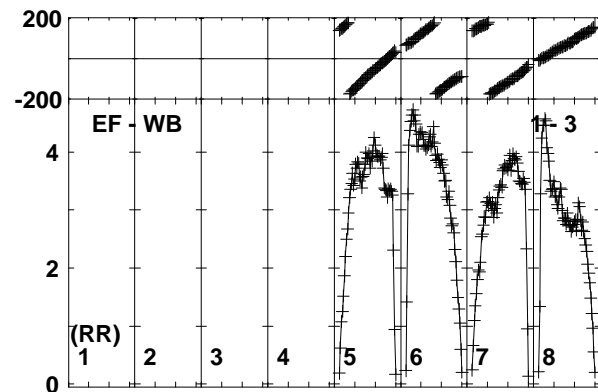
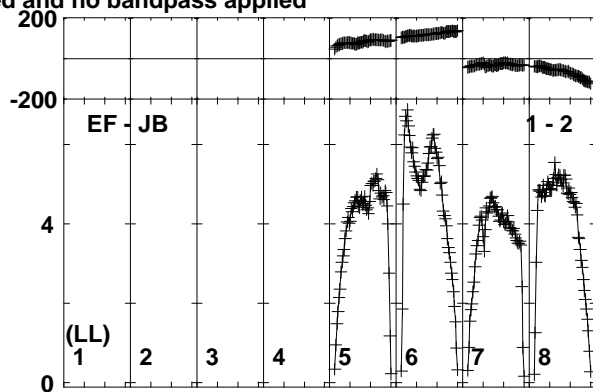
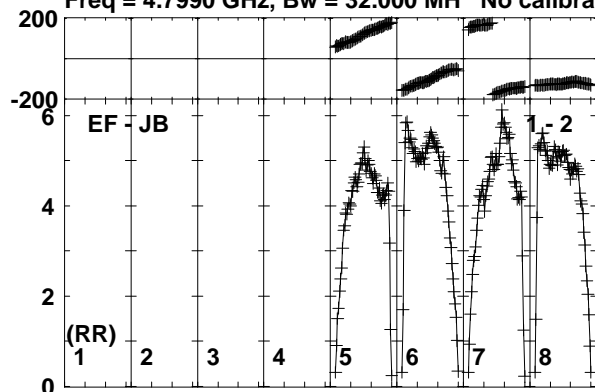

Lower frame: Milli Ampl Jy Top frame: Phas deg
Vector averaged cross-power spectrum Baseline: EF (01) - JB (02)
Timerange: 00:19:31:33 to 00:19:32:32

Plot file version 64 created 03-OCT-2017 13:09:46

J2353+5518 RP028.UVDATA.1

Freq = 4.7990 GHz, Bw = 32.000 MH No calibration applied and no bandpass applied

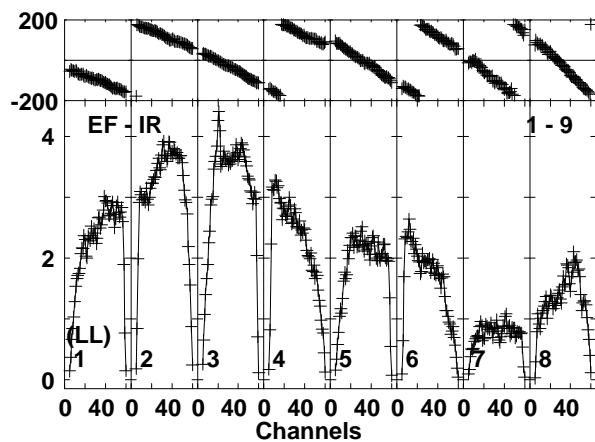
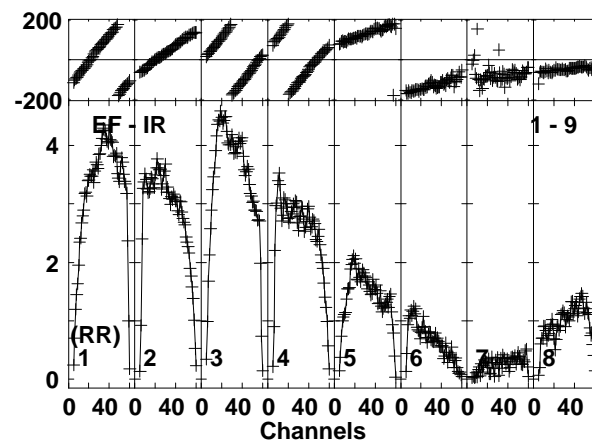
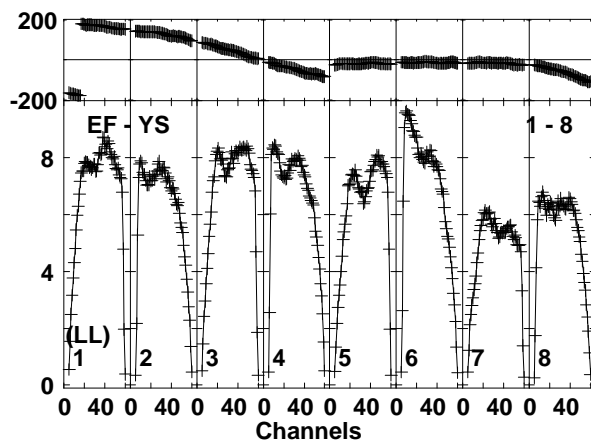
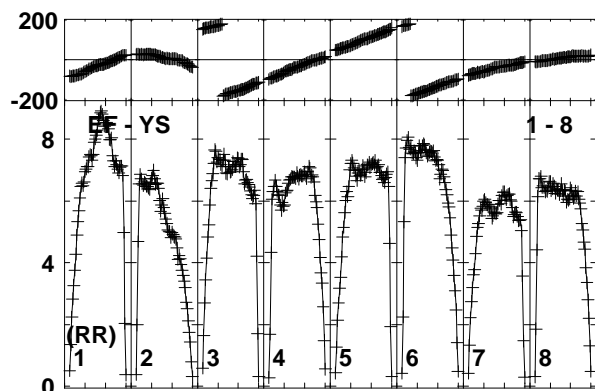
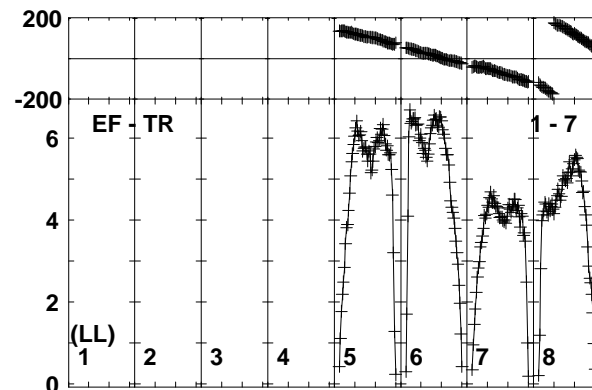
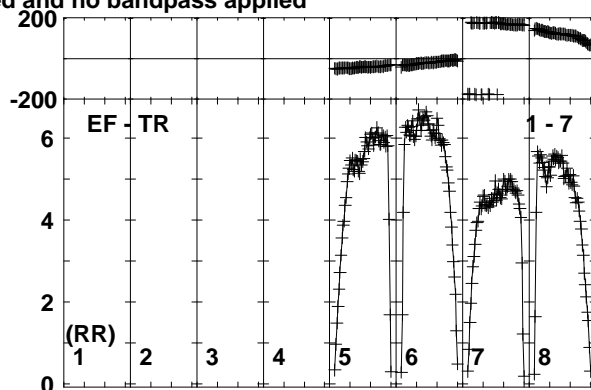
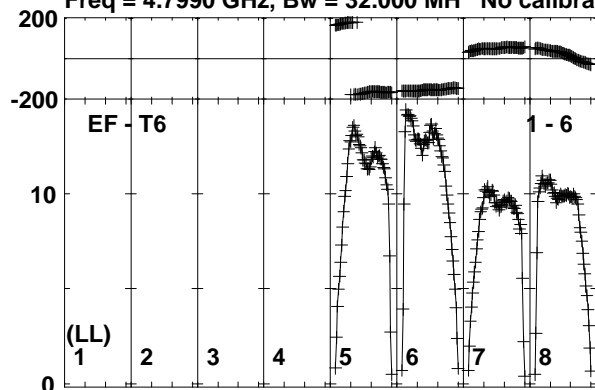

Lower frame: Milli Ampl Jy Top frame: Phas deg
Vector averaged cross-power spectrum Baseline: EF (01) - T6 (06)
Timerange: 00/19:31:33 to 00/19:32:32

Plot file version 65 created 03-OCT-2017 13:09:46

IRAS23436 RP028.UVDATA.1

Freq = 4.7990 GHz, Bw = 32.000 MH No calibration applied and no bandpass applied

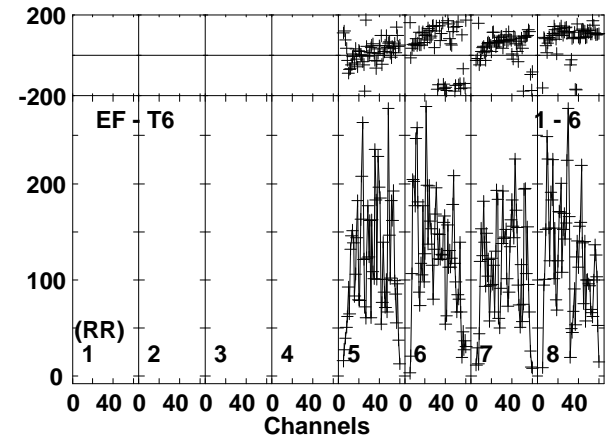
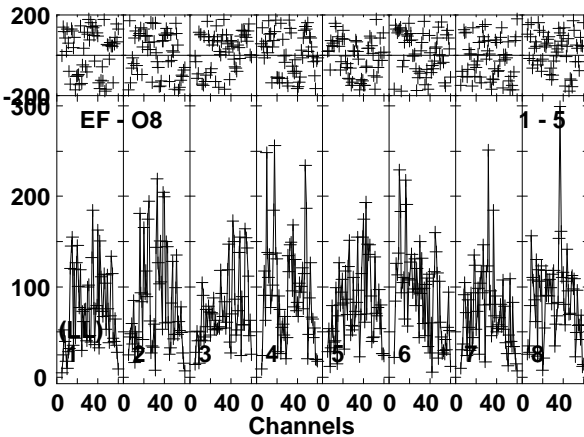
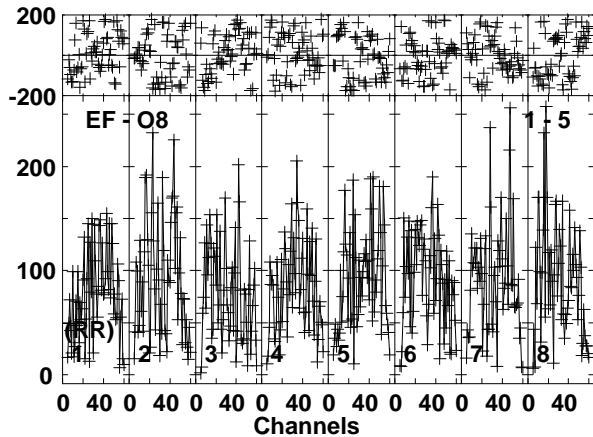
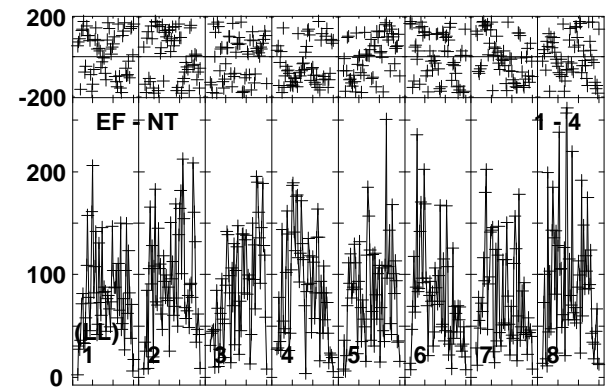
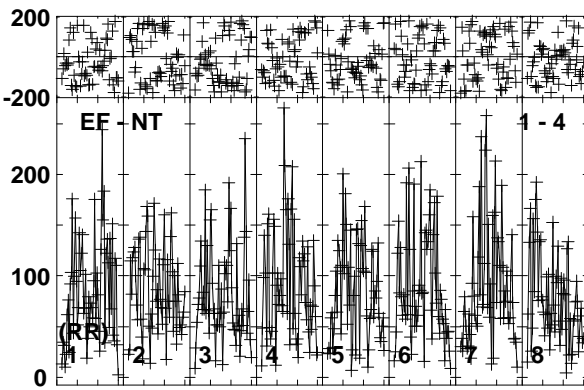
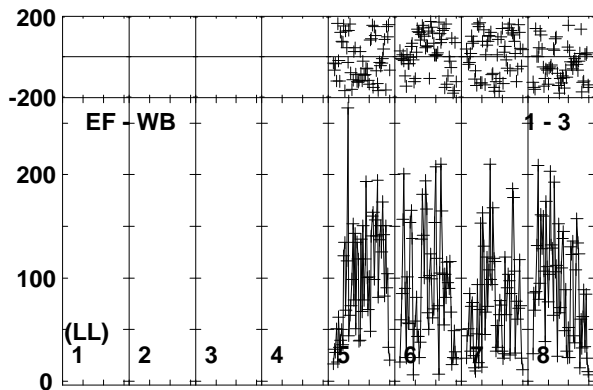
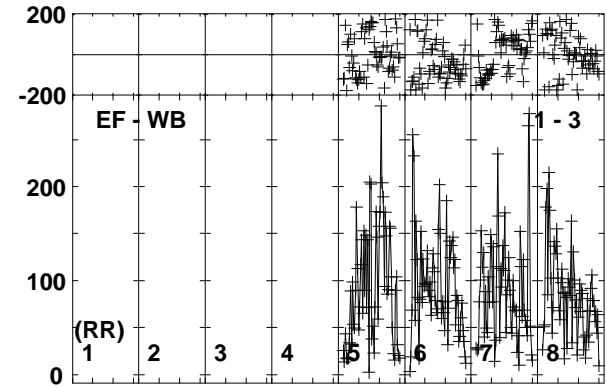
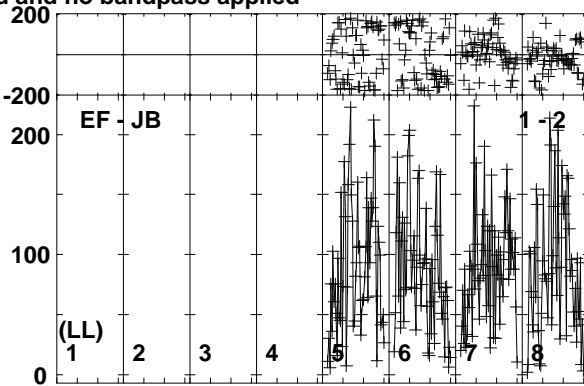
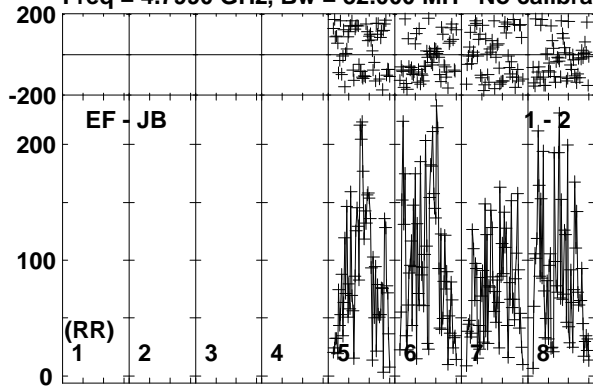

Lower frame: Micro Ampl Jy Top frame: Phas deg
Vector averaged cross-power spectrum Baseline: EF (01) - JB (02)
Timerange: 00/19:32:33 to 00/19:36:12

Plot file version 66 created 03-OCT-2017 13:09:47

IRAS23436 RP028.UVDATA.1

Freq = 4.7990 GHz, Bw = 32.000 MH No calibration applied and no bandpass applied

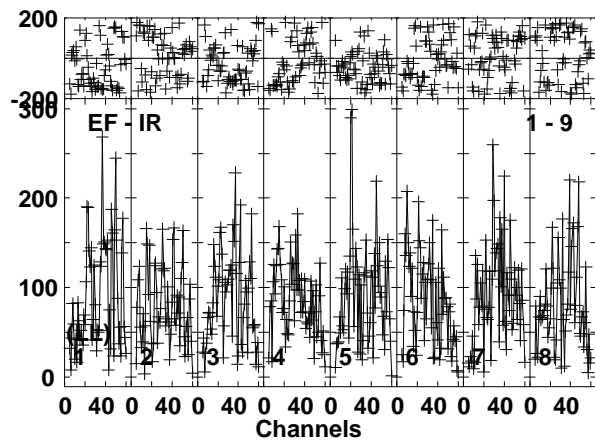
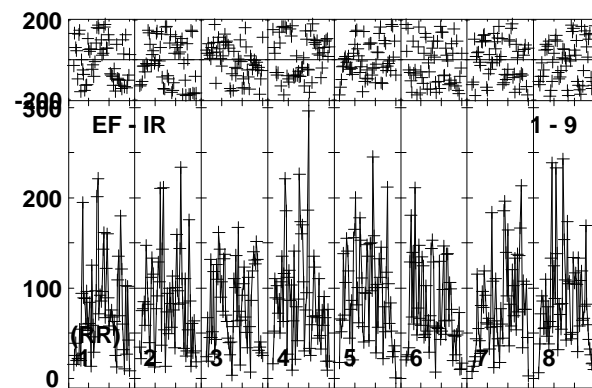
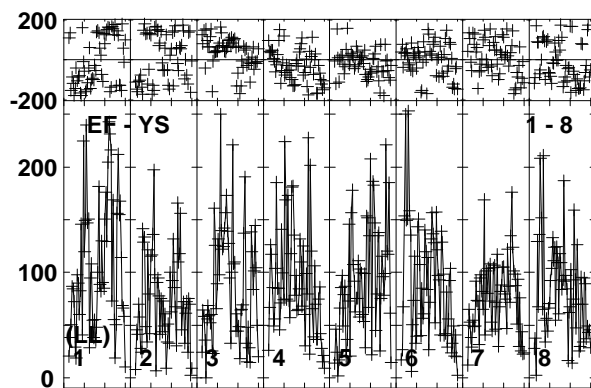
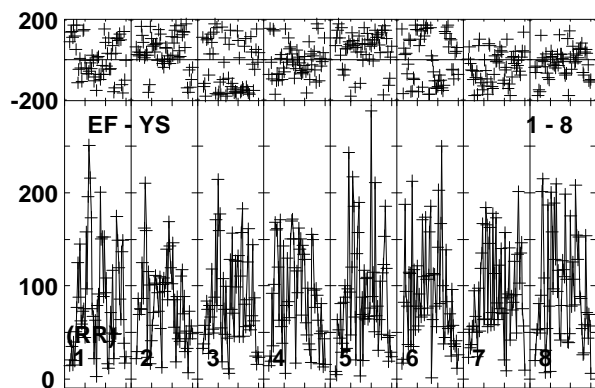
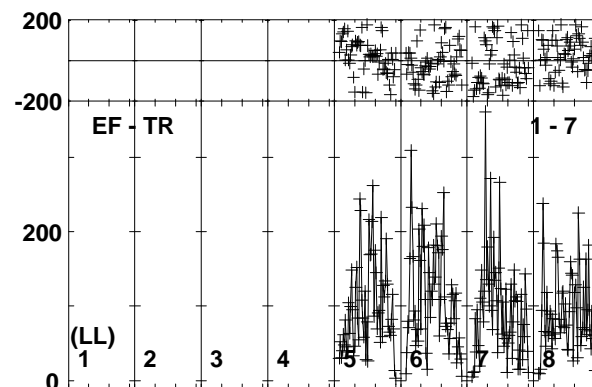
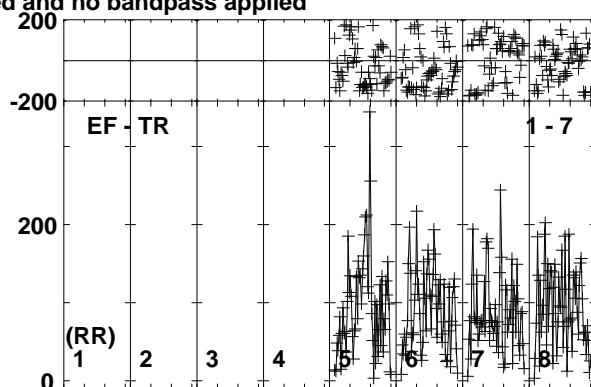
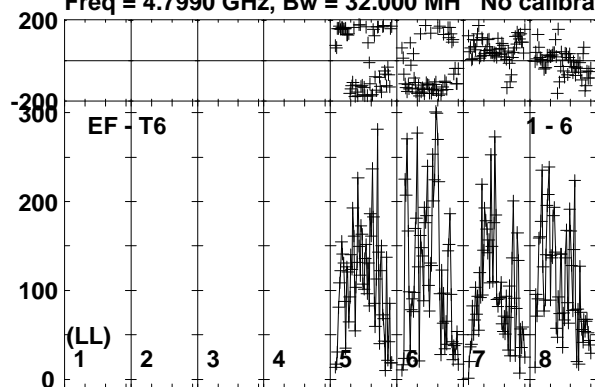

Lower frame: Micro Ampl Jy Top frame: Phas deg
Vector averaged cross-power spectrum Baseline: EF (01) - T6 (06)
Timerange: 00/19:32:33 to 00/19:36:12

Plot file version 67 created 03-OCT-2017 13:09:47

J2353+5518 RP028.UVDATA.1

Freq = 4.7990 GHz, Bw = 32.000 MH No calibration applied and no bandpass applied

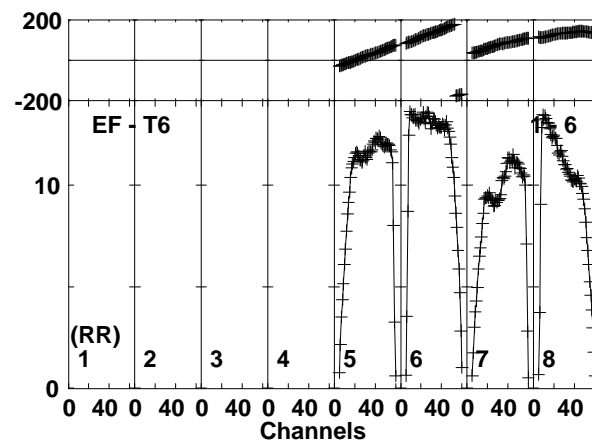
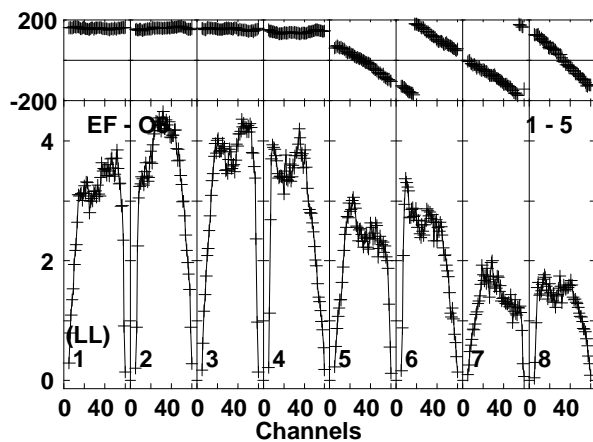
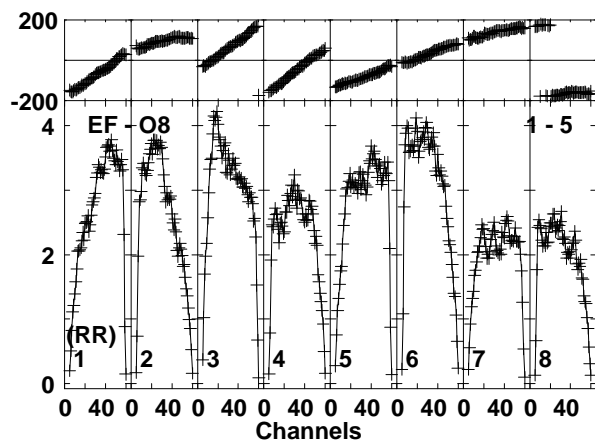
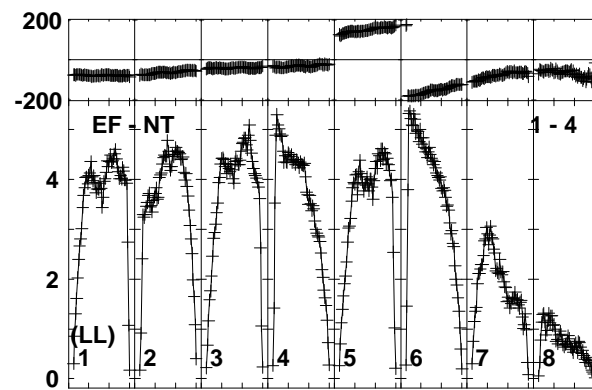
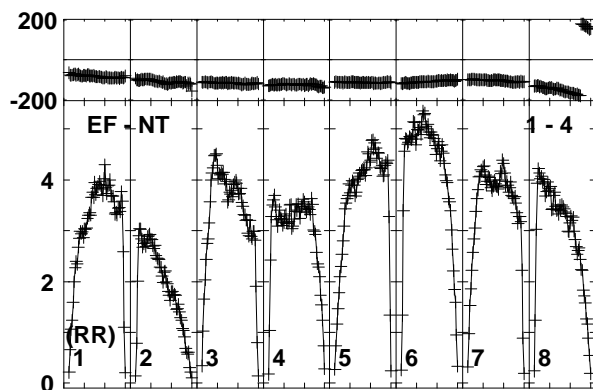
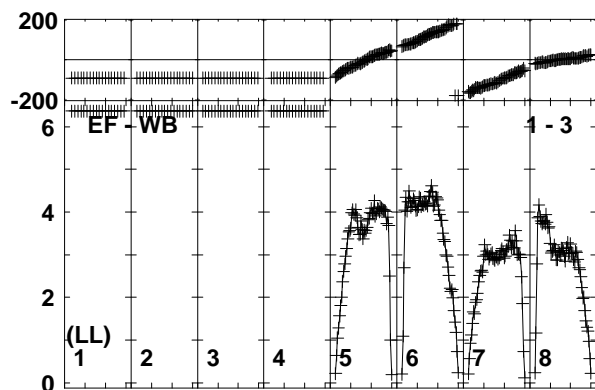
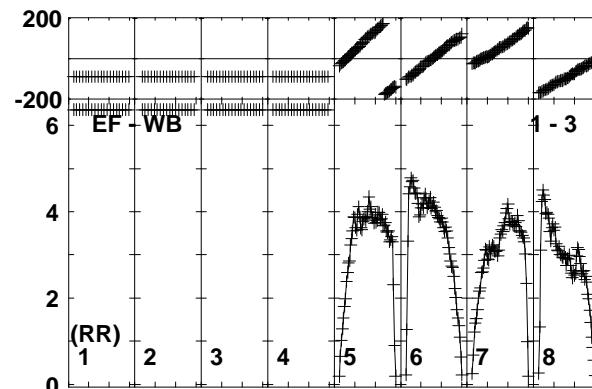
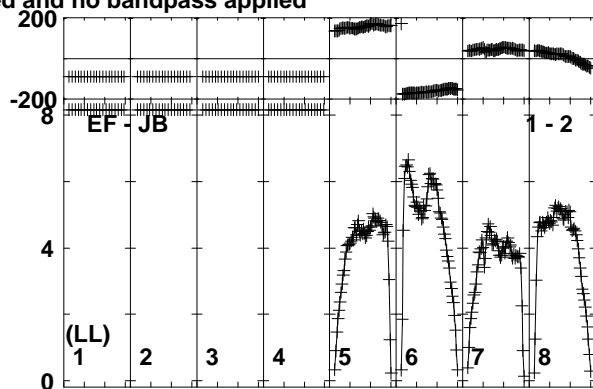
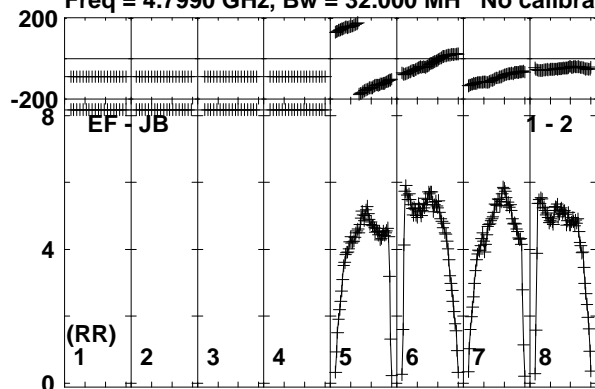

Lower frame: Milli Ampl Jy Top frame: Phas deg
Vector averaged cross-power spectrum Baseline: EF (01) - JB (02)
Timerange: 00/19:36:12 to 00/19:37:41

Plot file version 68 created 03-OCT-2017 13:09:47

J2353+5518 RP028.UVDATA.1

Freq = 4.7990 GHz, Bw = 32.000 MH No calibration applied and no bandpass applied

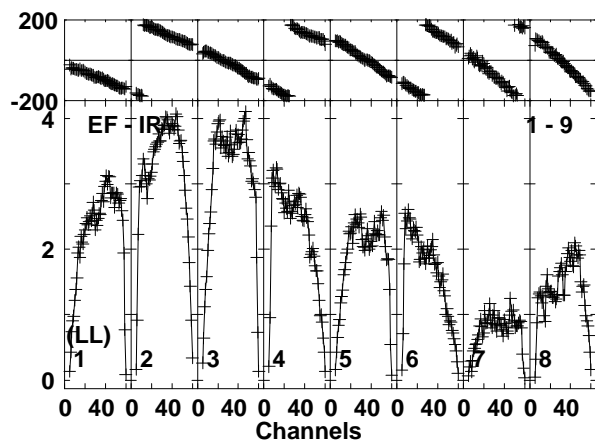
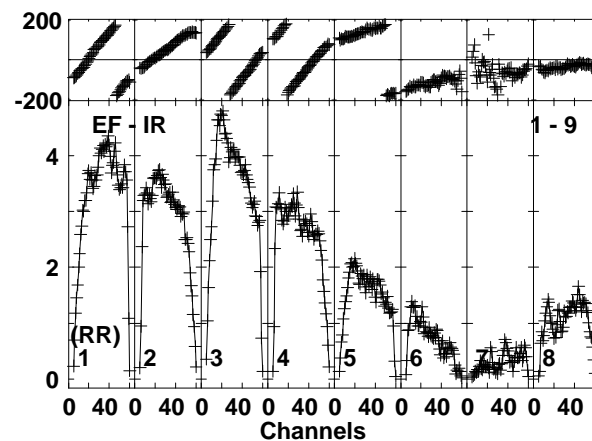
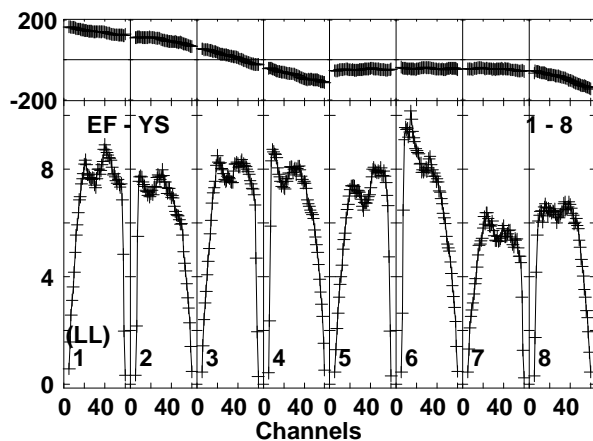
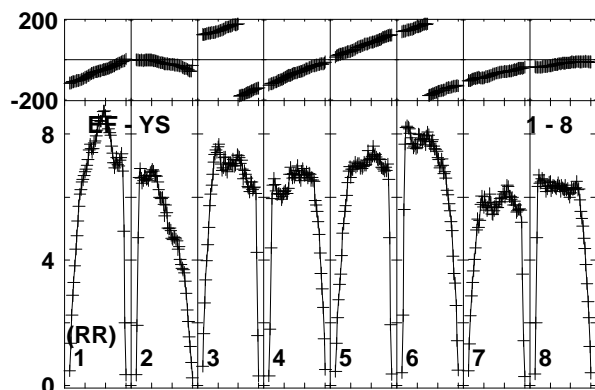
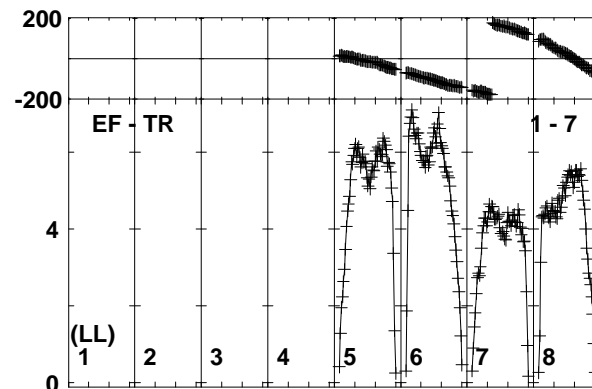
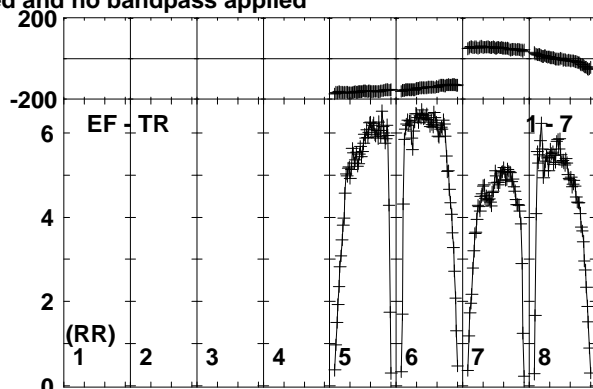
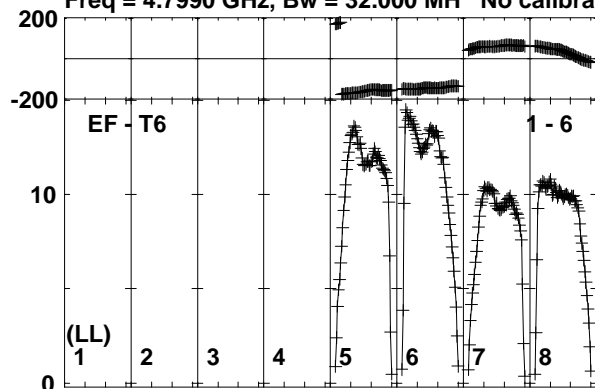

Lower frame: Milli Ampl Jy Top frame: Phas deg
Vector averaged cross-power spectrum Baseline: EF (01) - T6 (06)
Timerange: 00:19:36:12 to 00:19:37:41

Plot file version 69 created 03-OCT-2017 13:09:47

IRAS23436 RP028.UVDATA.1

Freq = 4.7990 GHz, Bw = 32.000 MH No calibration applied and no bandpass applied

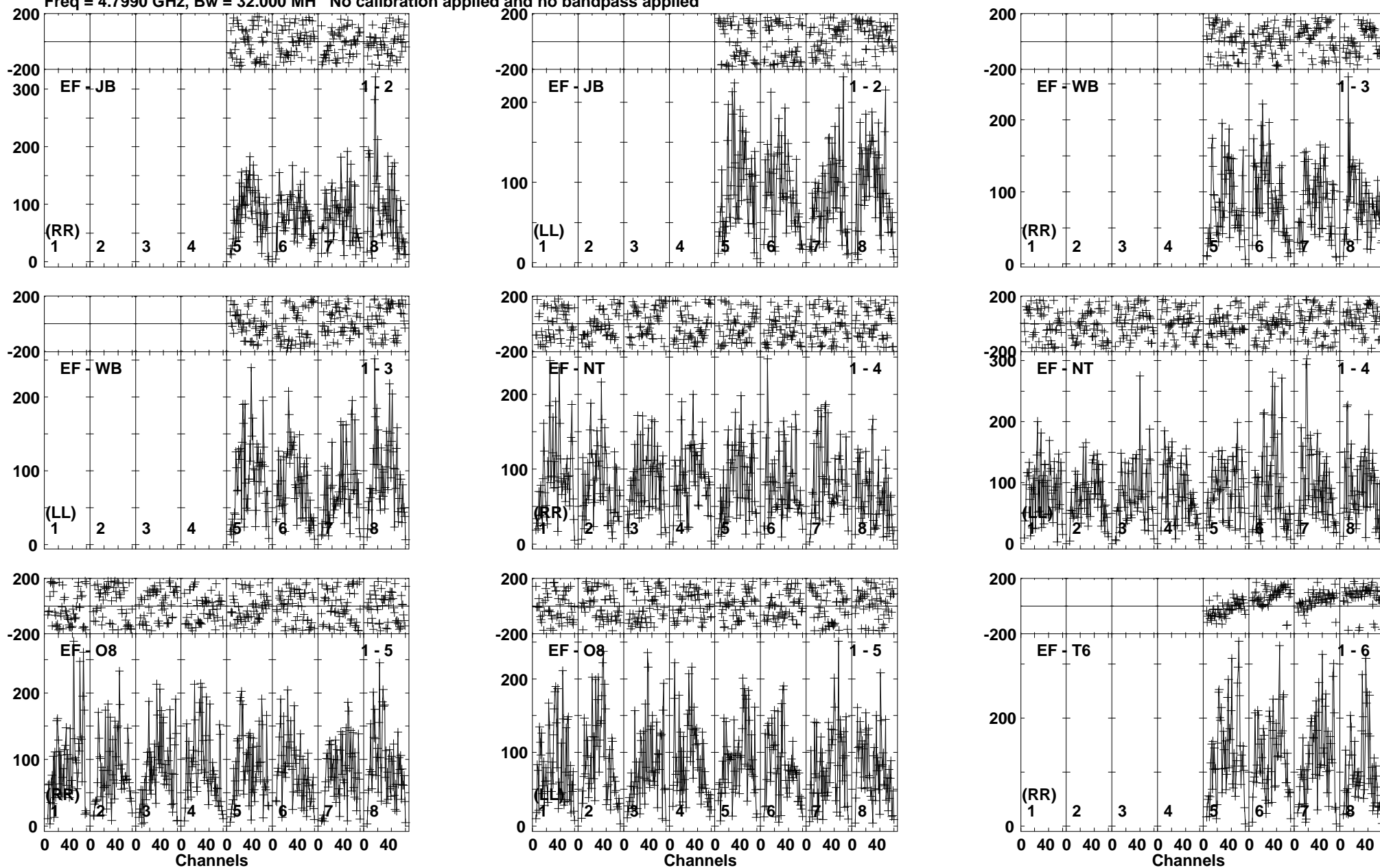

Lower frame: Micro Ampl Jy Top frame: Phas deg
Vector averaged cross-power spectrum Baseline: EF (01) - JB (02)
Timerange: 00:19:37:43 to 00:19:41:25

Plot file version 70 created 03-OCT-2017 13:09:48

IRAS23436 RP028.UVDATA.1

Freq = 4.7990 GHz, Bw = 32.000 MH No calibration applied and no bandpass applied

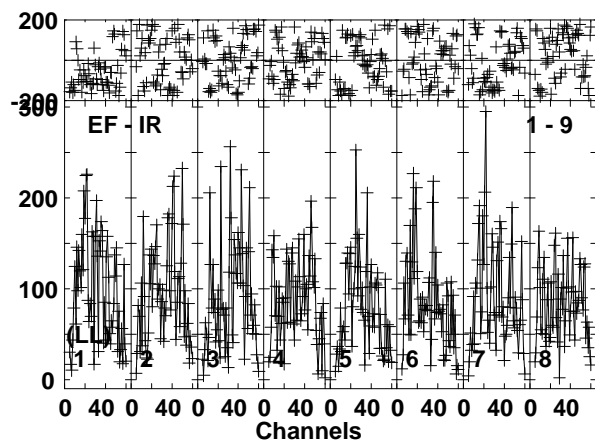
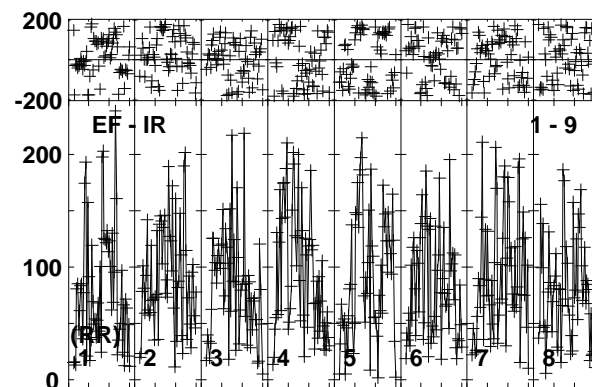
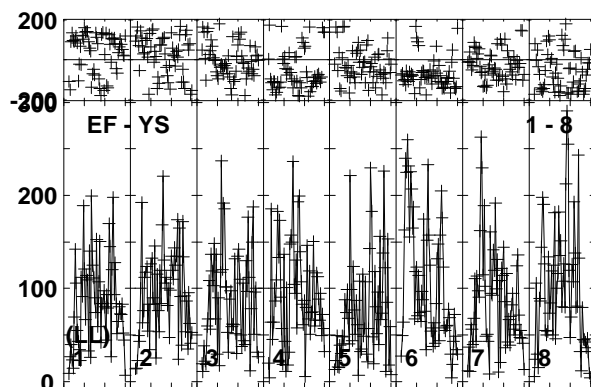
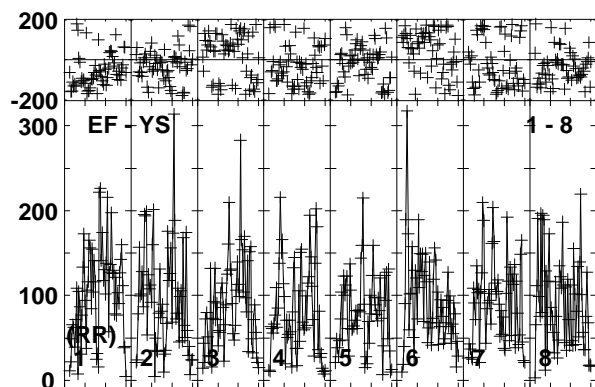
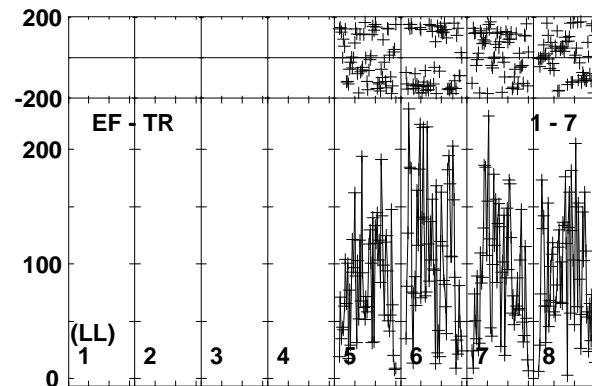
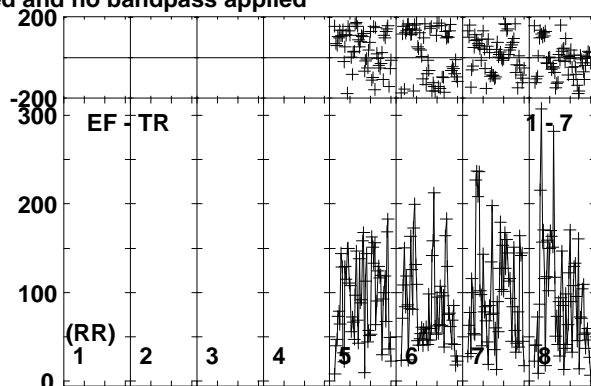
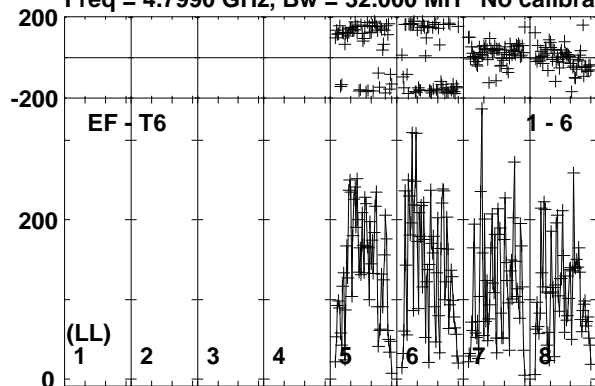

Lower frame: Micro Ampl Jy Top frame: Phas deg
Vector averaged cross-power spectrum Baseline: EF (01) - T6 (06)
Timerange: 00/19:37:43 to 00/19:41:25

Plot file version 71 created 03-OCT-2017 13:09:48

J2353+5518 RP028.UVDATA.1

Freq = 4.7990 GHz, Bw = 32.000 MH No calibration applied and no bandpass applied

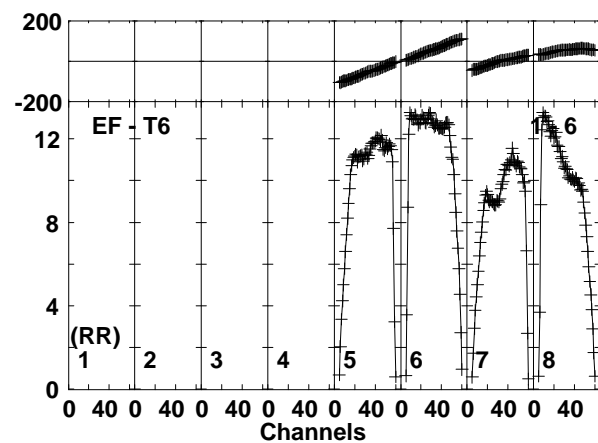
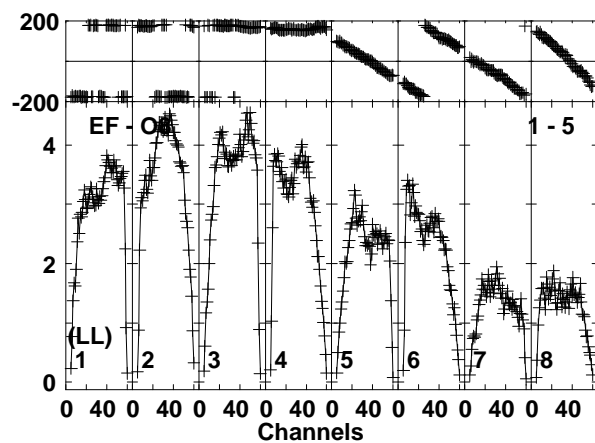
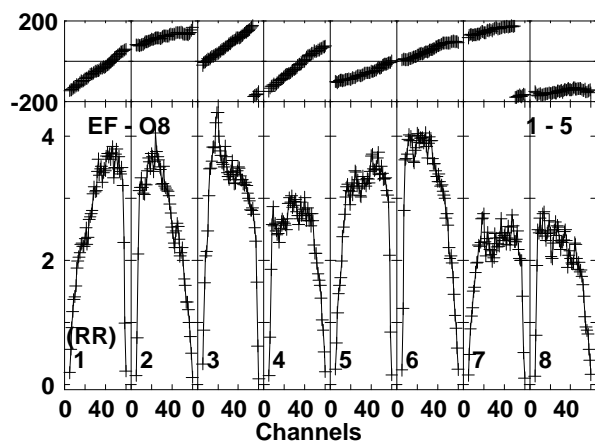
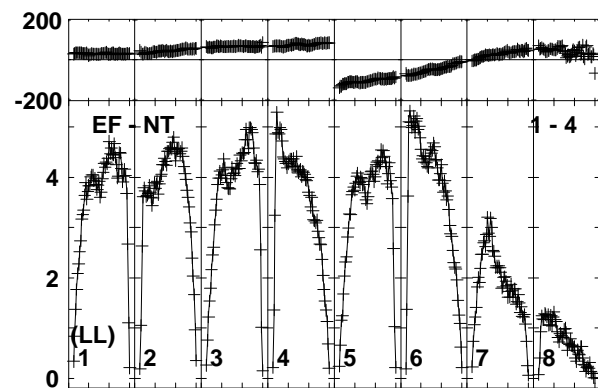
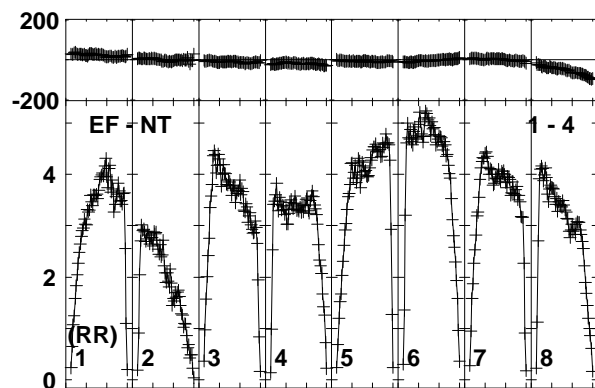
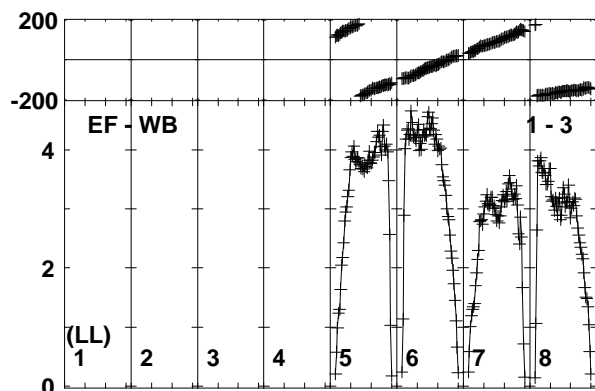
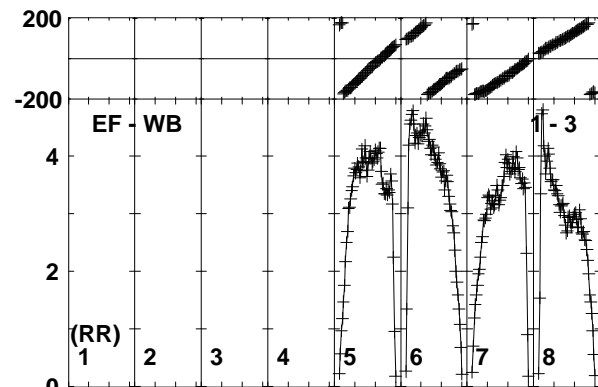
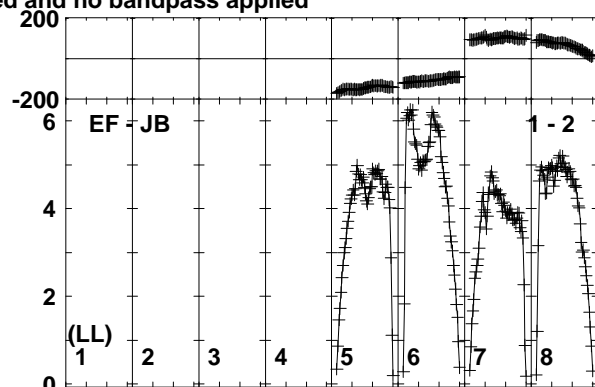
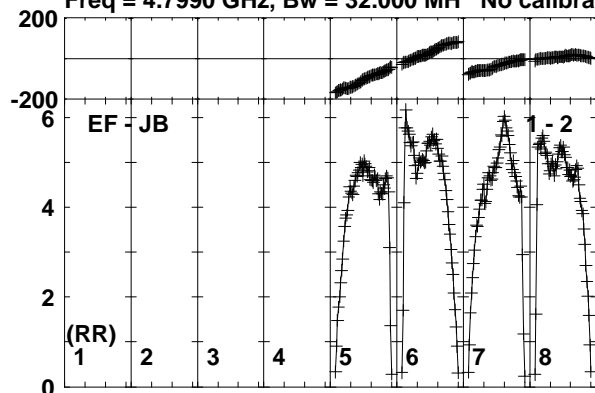

Lower frame: Milli Ampl Jy Top frame: Phas deg
Vector averaged cross-power spectrum Baseline: EF (01) - JB (02)
Timerange: 00:19:42:06 to 00:19:42:56

Plot file version 72 created 03-OCT-2017 13:09:48

J2353+5518 RP028.UVDATA.1

Freq = 4.7990 GHz, Bw = 32.000 MH No calibration applied and no bandpass applied

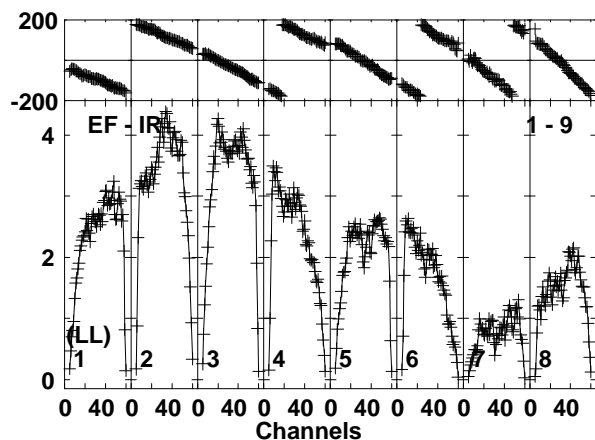
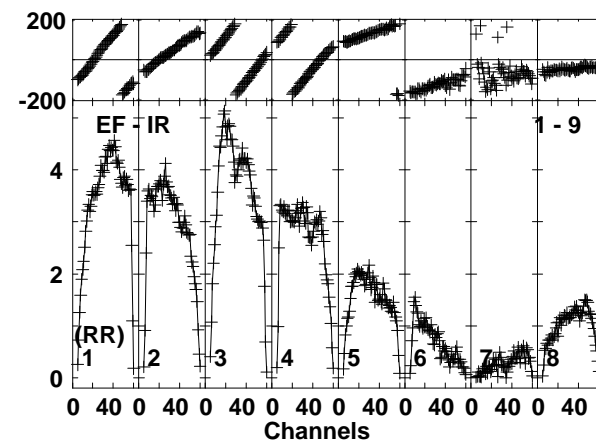
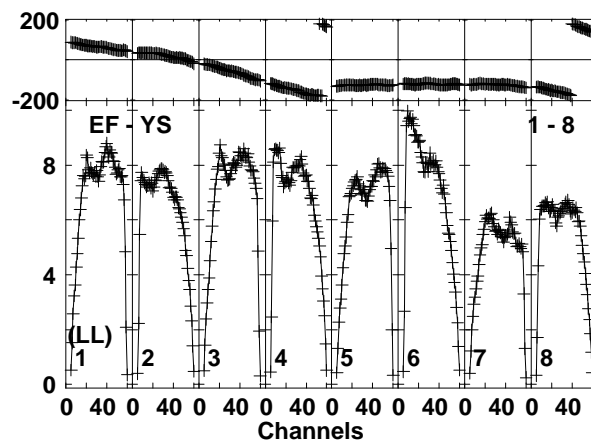
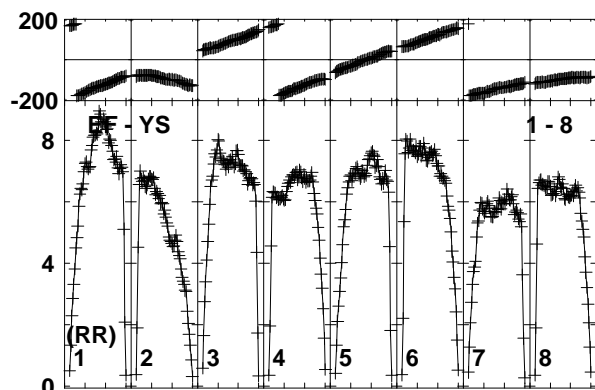
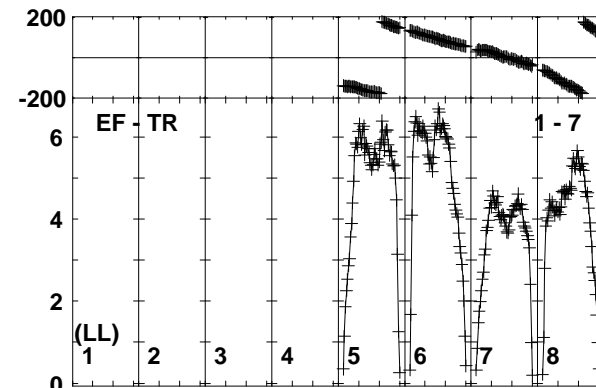
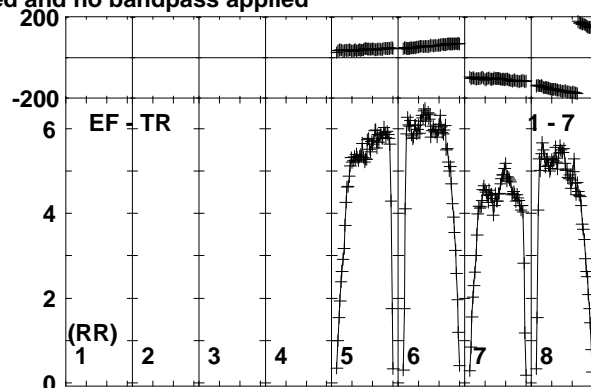
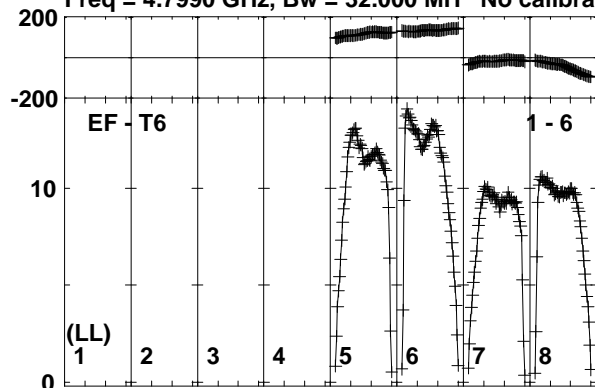

Lower frame: Milli Ampl Jy Top frame: Phas deg
Vector averaged cross-power spectrum Baseline: EF (01) - T6 (06)
Timerange: 00:19:42:06 to 00:19:42:56

Plot file version 73 created 03-OCT-2017 13:09:48

IRAS23436 RP028.UVDATA.1

Freq = 4.7990 GHz, Bw = 32.000 MH No calibration applied and no bandpass applied

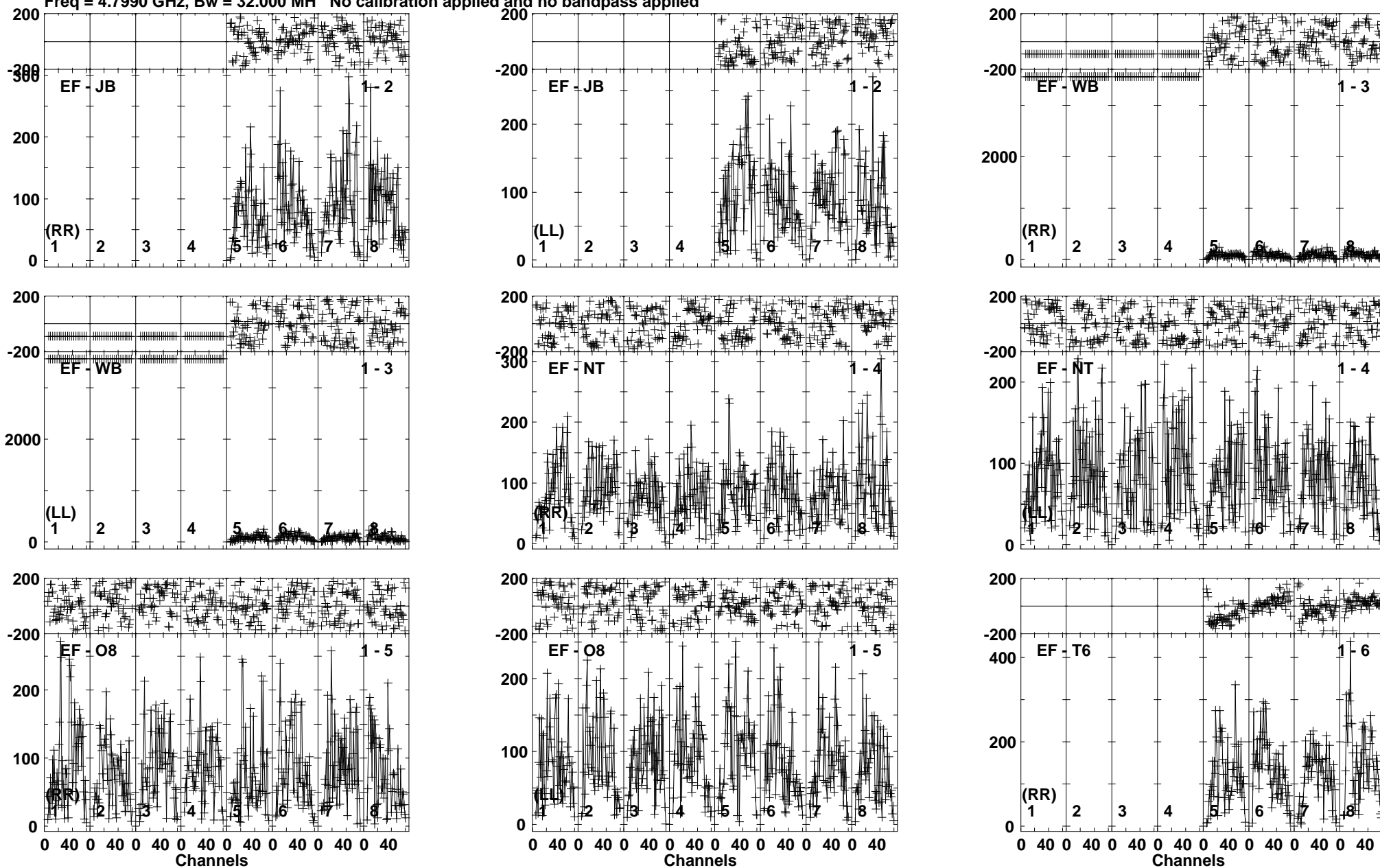

Lower frame: Micro Ampl Jy Top frame: Phas deg
Vector averaged cross-power spectrum Baseline: EF (01) - JB (02)
Timerange: 00:19:42:56 to 00:19:46:40

Plot file version 74 created 03-OCT-2017 13:09:48

IRAS23436 RP028.UVDATA.1

Freq = 4.7990 GHz, Bw = 32.000 MH No calibration applied and no bandpass applied

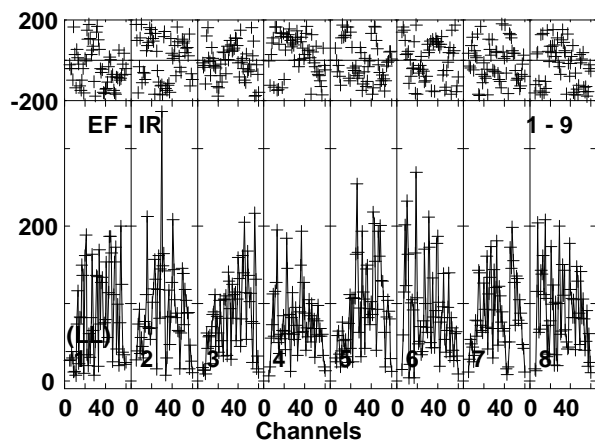
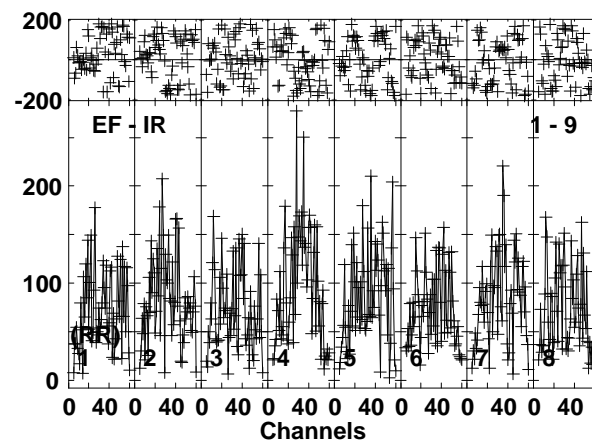
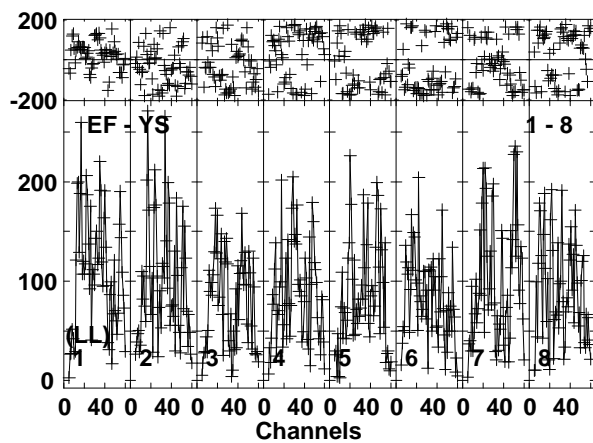
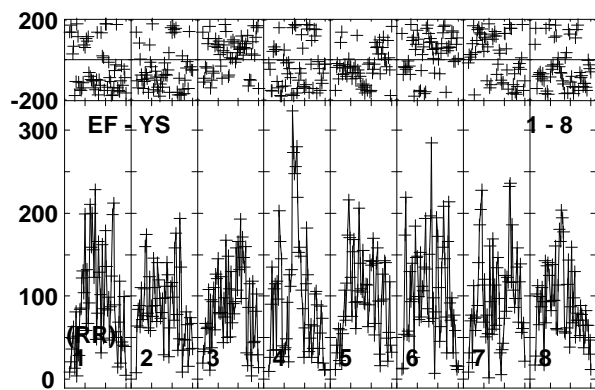
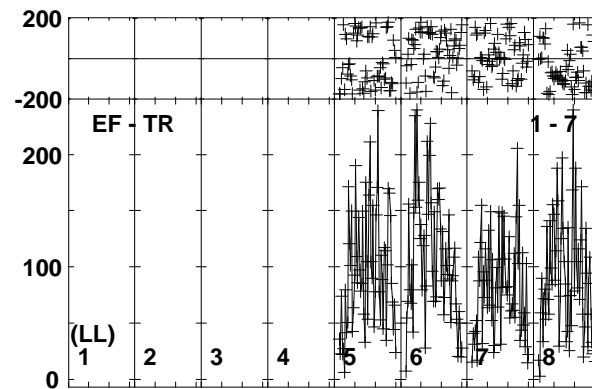
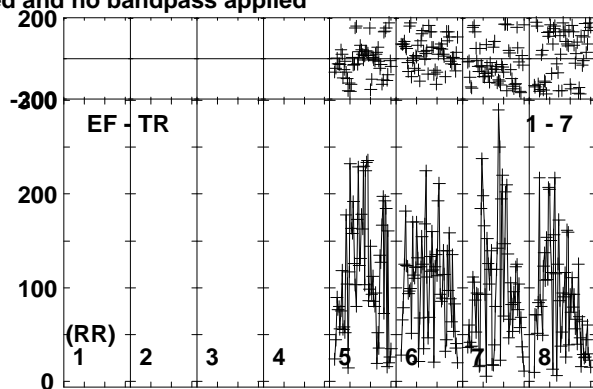
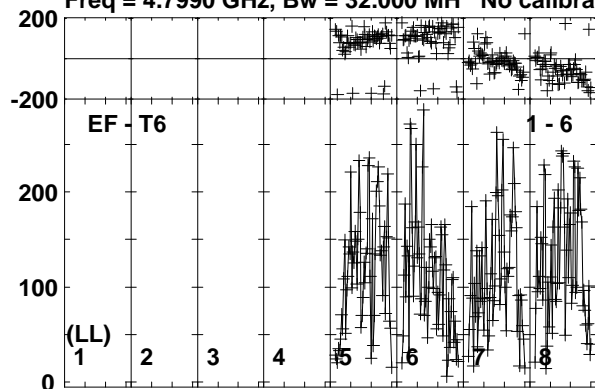

Lower frame: Micro Ampl Jy Top frame: Phas deg
Vector averaged cross-power spectrum Baseline: EF (01) - T6 (06)
Timerange: 00/19:42:56 to 00/19:46:40

Plot file version 75 created 03-OCT-2017 13:09:49

J2353+5518 RP028.UVDATA.1

Freq = 4.7990 GHz, Bw = 32.000 MH No calibration applied and no bandpass applied

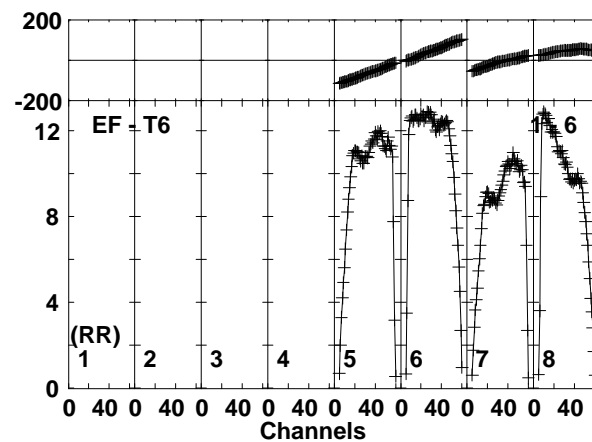
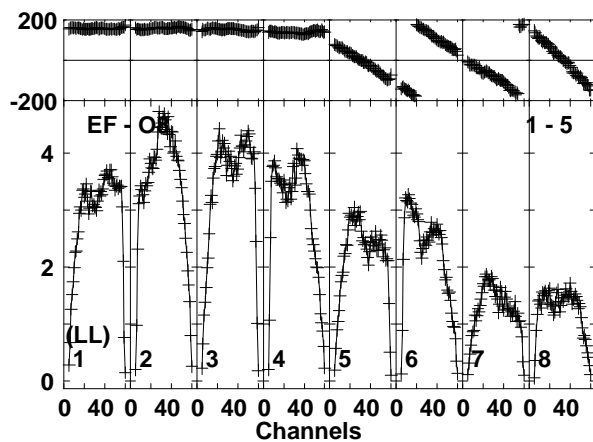
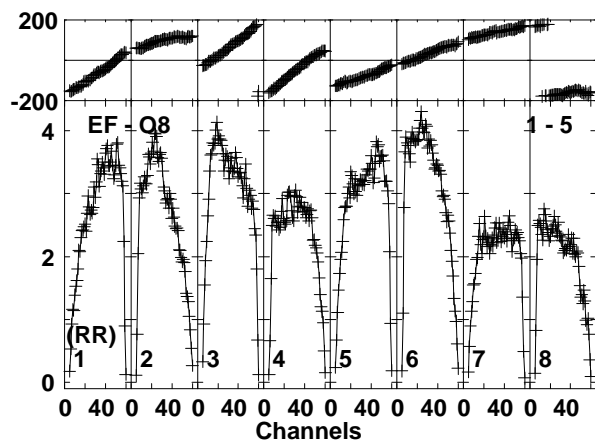
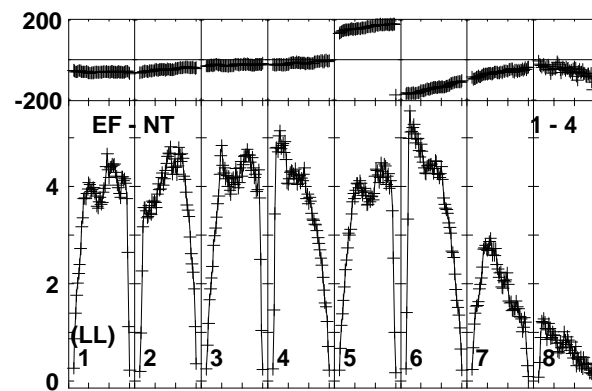
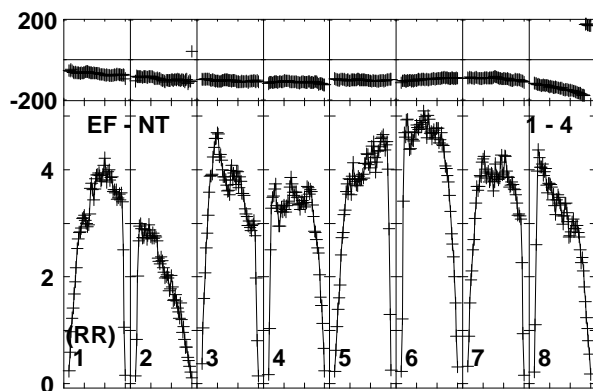
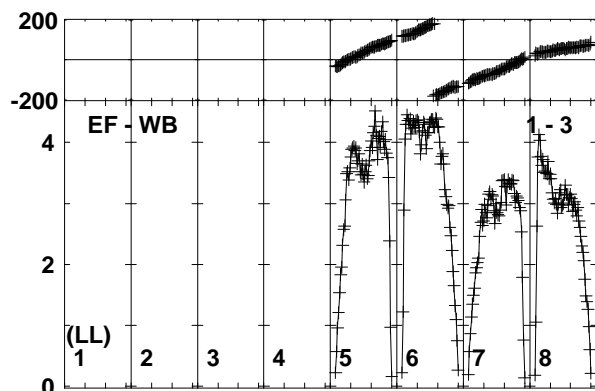
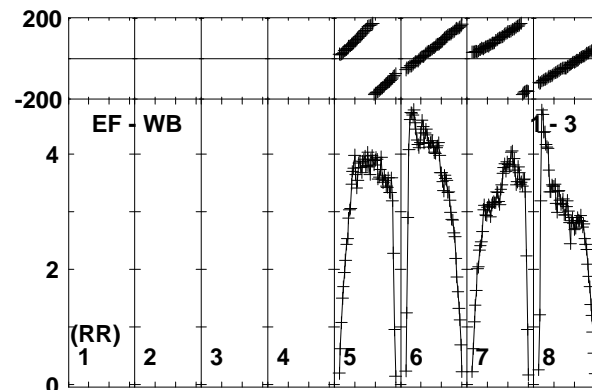
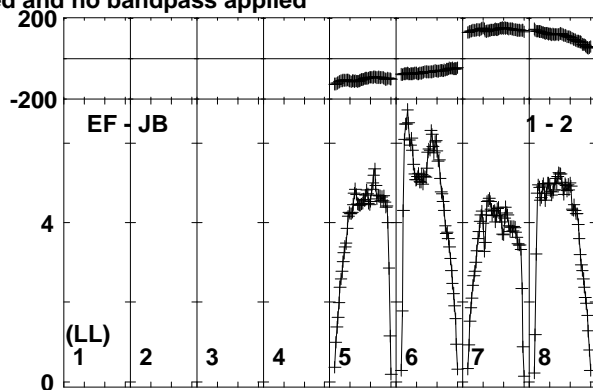
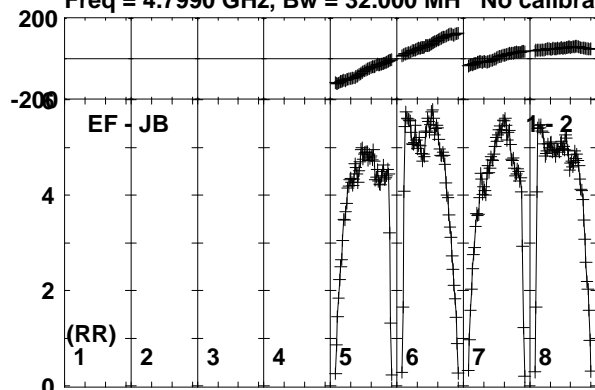

Lower frame: Milli Ampl Jy Top frame: Phas deg
Vector averaged cross-power spectrum Baseline: EF (01) - JB (02)
Timerange: 00:19:46:40 to 00:19:48:10

Plot file version 76 created 03-OCT-2017 13:09:49

J2353+5518 RP028.UVDATA.1

Freq = 4.7990 GHz, Bw = 32.000 MH No calibration applied and no bandpass applied

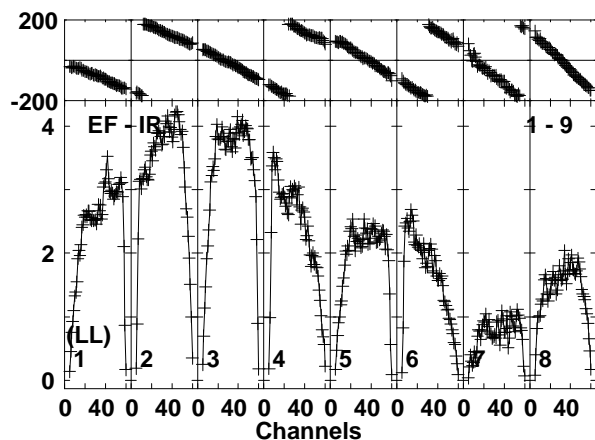
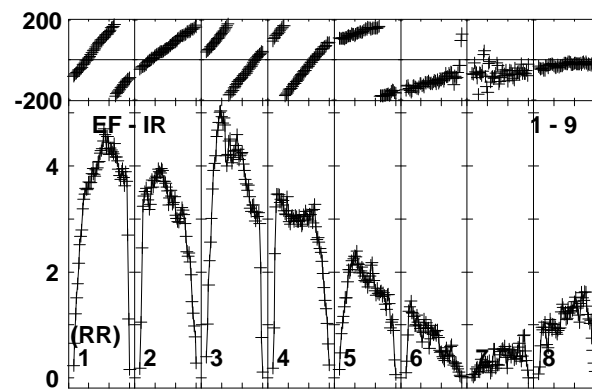
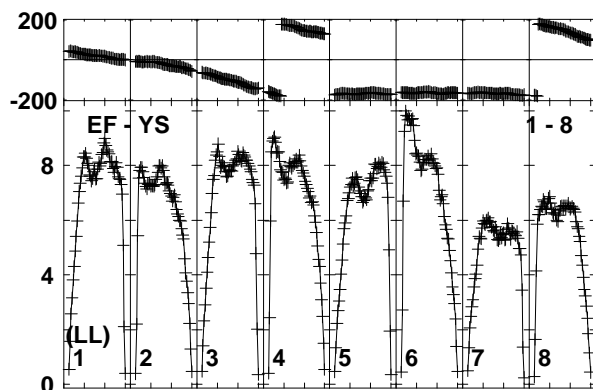
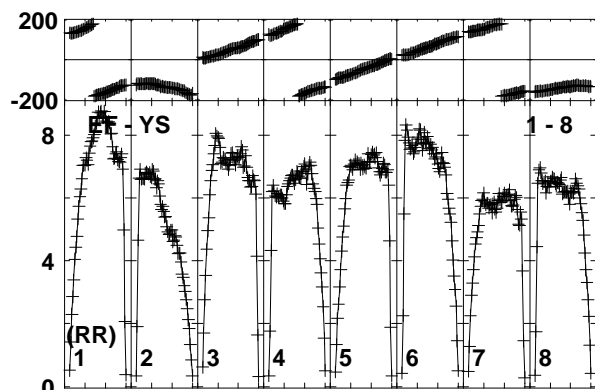
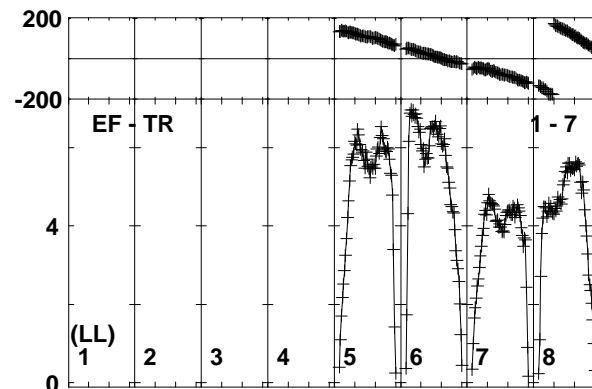
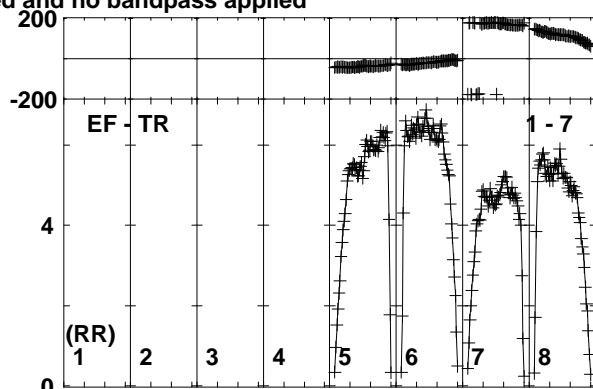
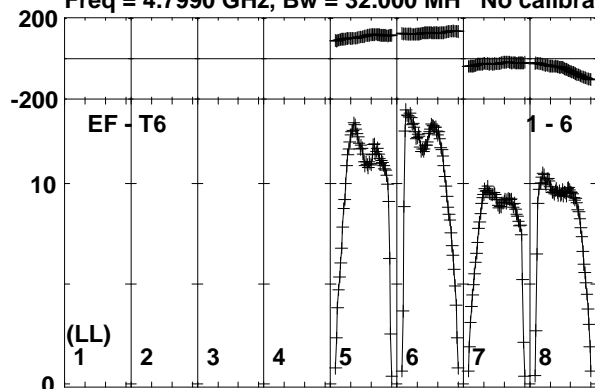

Lower frame: Milli Ampl Jy Top frame: Phas deg
Vector averaged cross-power spectrum Baseline: EF (01) - T6 (06)
Timerange: 00:19:46:40 to 00:19:48:10

Plot file version 77 created 03-OCT-2017 13:09:49

IRAS23436 RP028.UVDATA.1

Freq = 4.7990 GHz, Bw = 32.000 MH No calibration applied and no bandpass applied

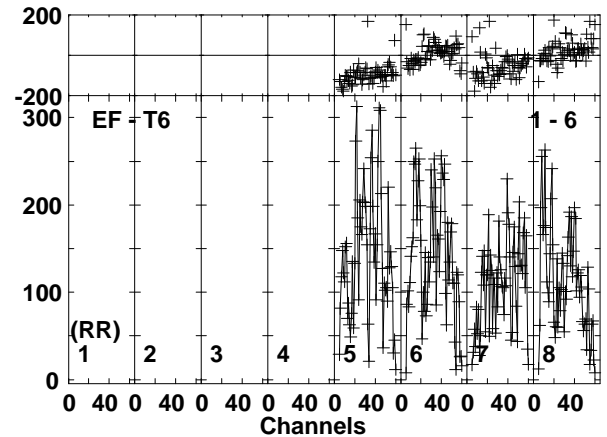
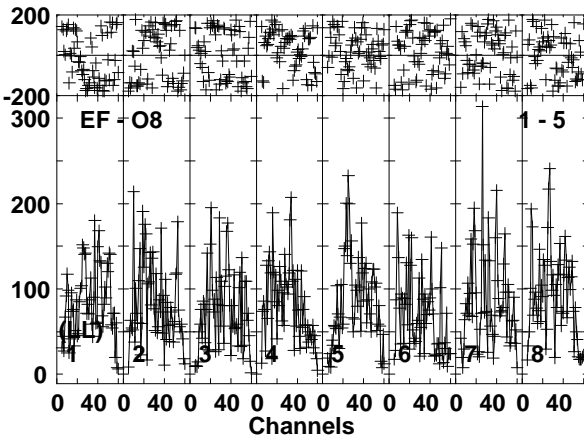
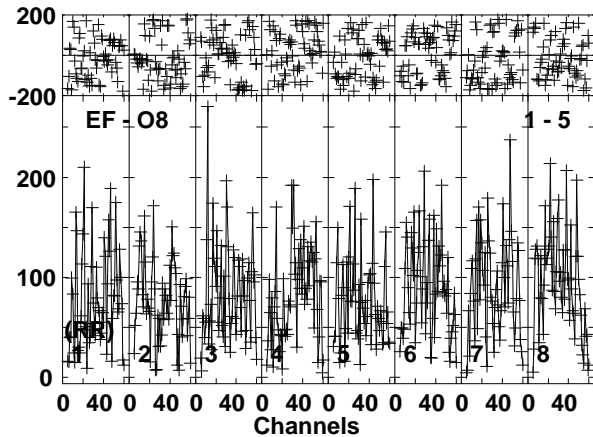
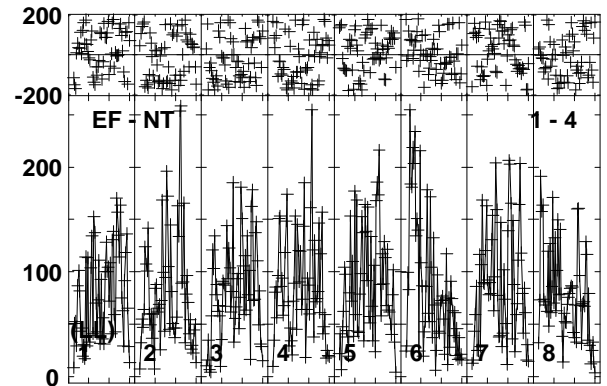
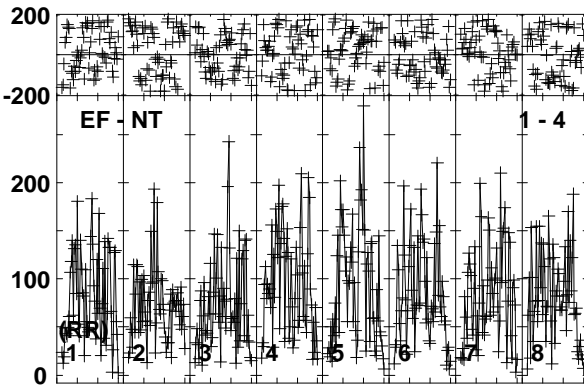
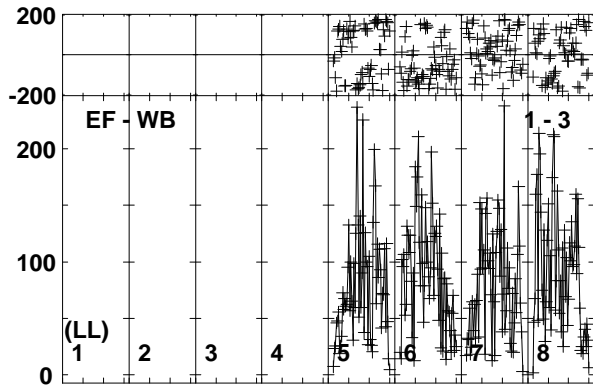
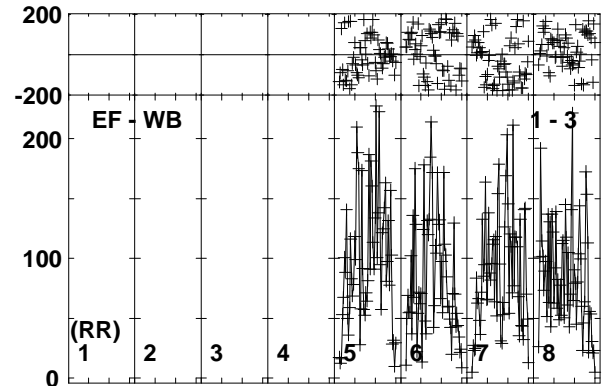
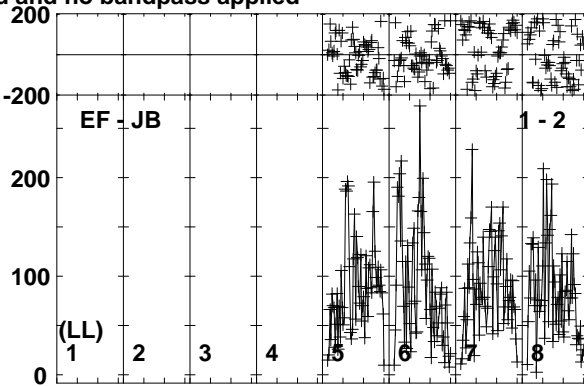
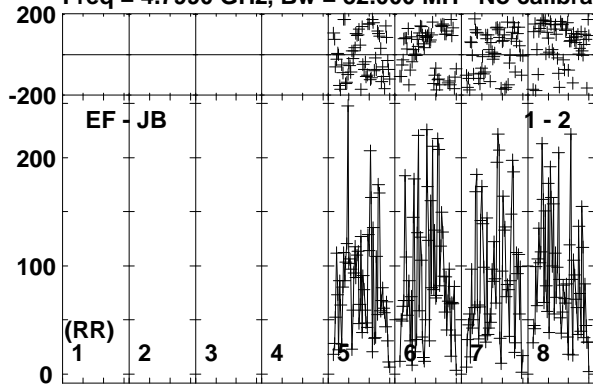

Lower frame: Micro Ampl Jy Top frame: Phas deg
Vector averaged cross-power spectrum Baseline: EF (01) - JB (02)
Timerange: 00:19:48:11 to 00:19:51:53

Plot file version 78 created 03-OCT-2017 13:09:49

IRAS23436 RP028.UVDATA.1

Freq = 4.7990 GHz, Bw = 32.000 MH No calibration applied and no bandpass applied

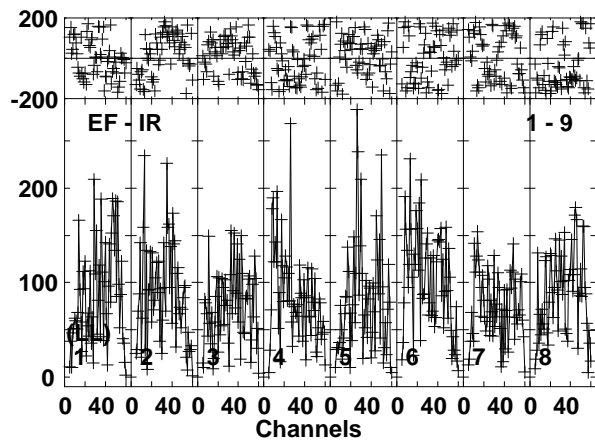
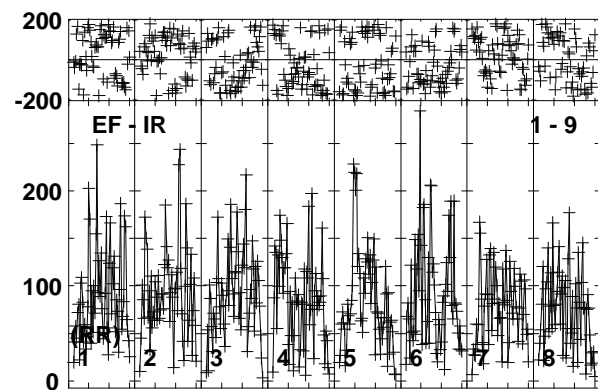
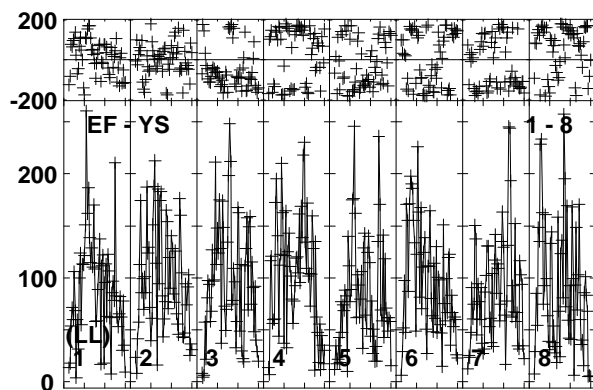
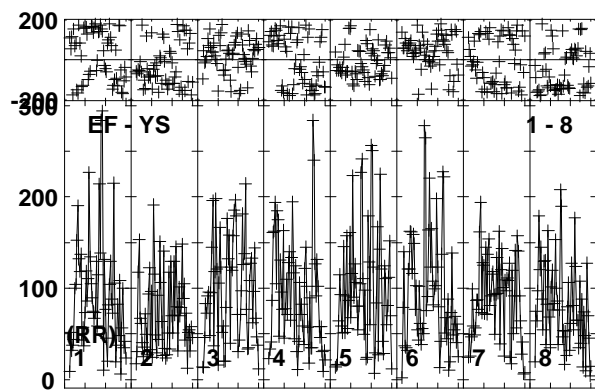
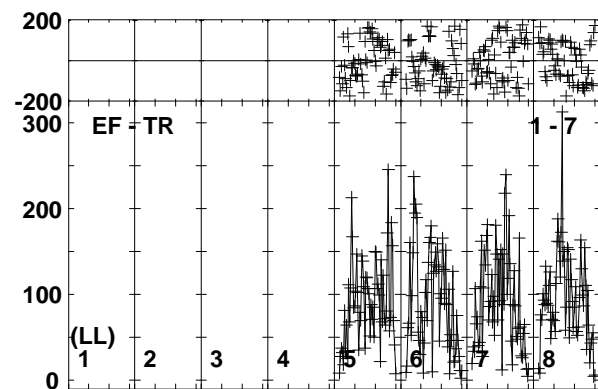
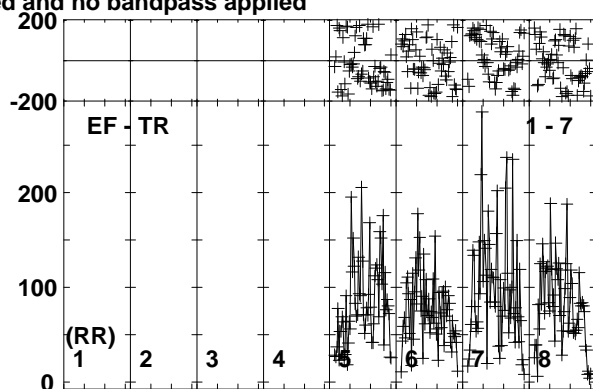
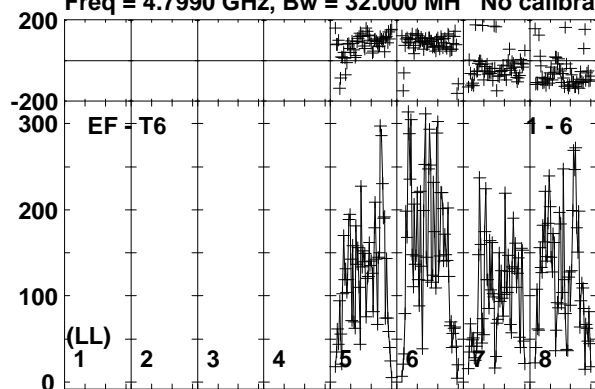

Lower frame: Micro Ampl Jy Top frame: Phas deg
Vector averaged cross-power spectrum Baseline: EF (01) - T6 (06)
Timerange: 00/19:48:11 to 00/19:51:53

Plot file version 79 created 03-OCT-2017 13:09:50

J2353+5518 RP028.UVDATA.1

Freq = 4.7990 GHz, Bw = 32.000 MH No calibration applied and no bandpass applied

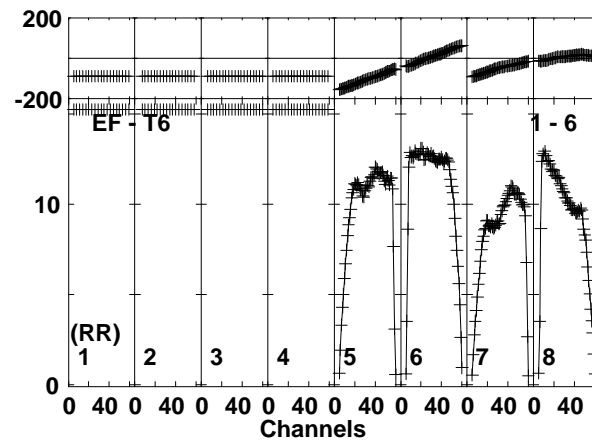
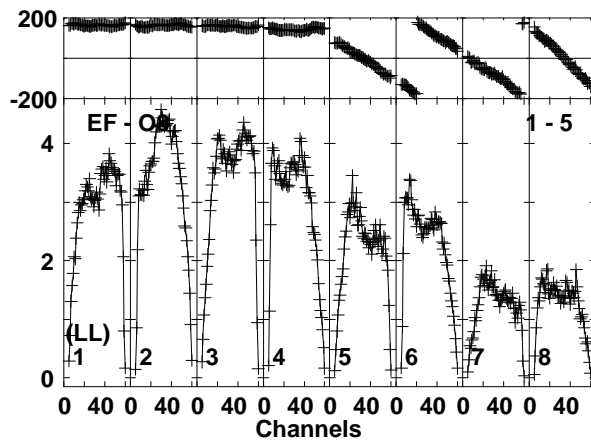
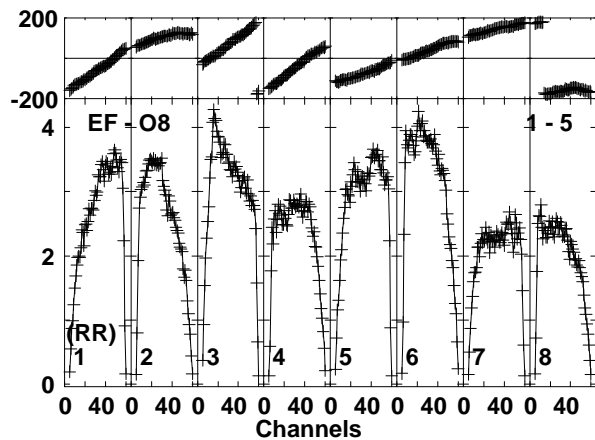
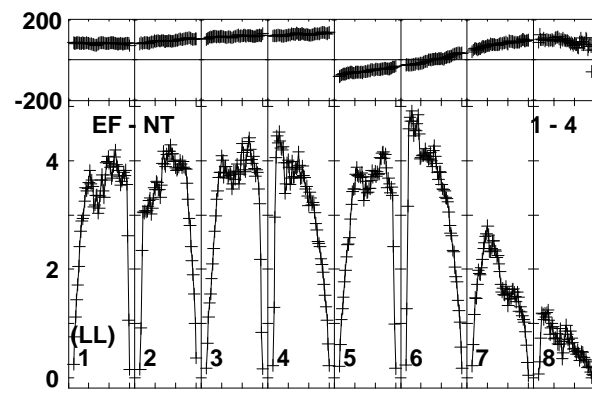
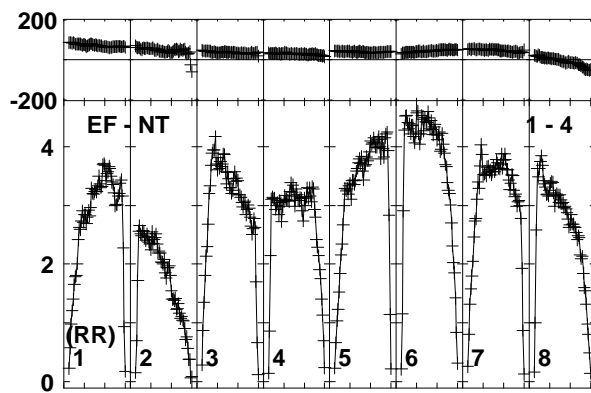
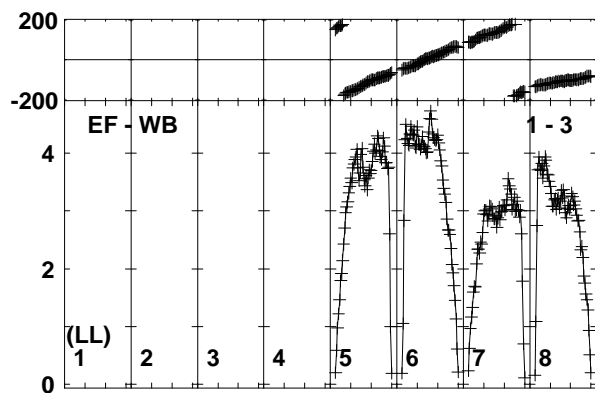
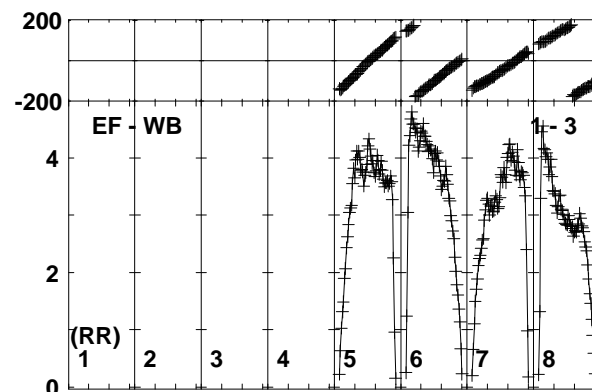
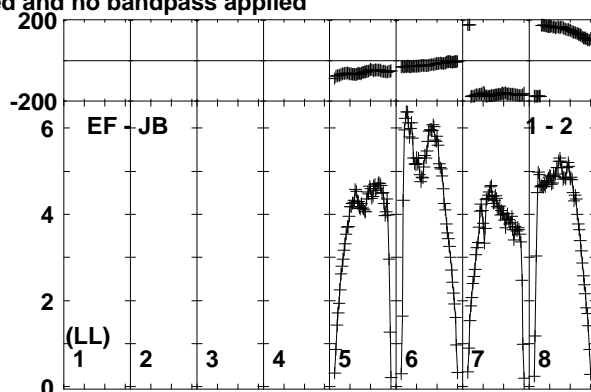
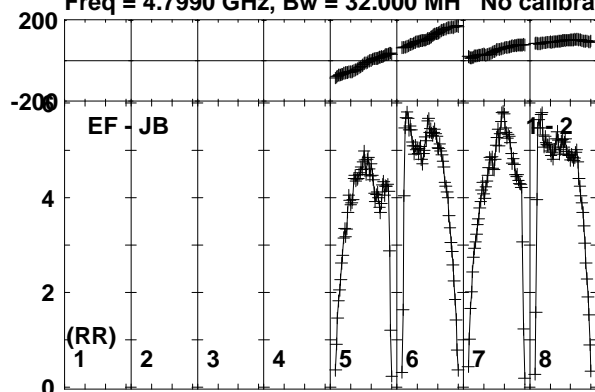

Lower frame: Milli Ampl Jy Top frame: Phas deg
Vector averaged cross-power spectrum Baseline: EF (01) - JB (02)
Timerange: 00:19:52:35 to 00:19:53:34

Plot file version 80 created 03-OCT-2017 13:09:50

J2353+5518 RP028.UVDATA.1

Freq = 4.7990 GHz, Bw = 32.000 MH No calibration applied and no bandpass applied

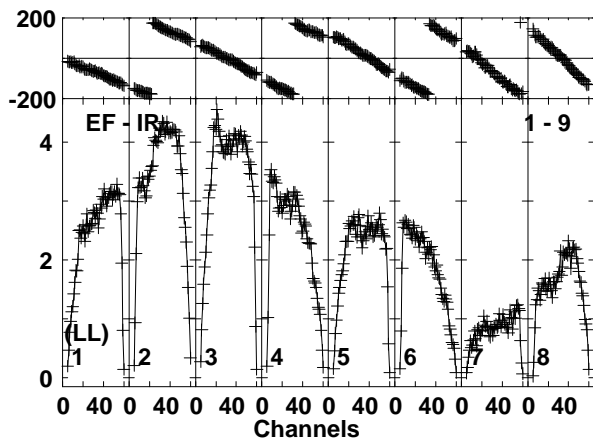
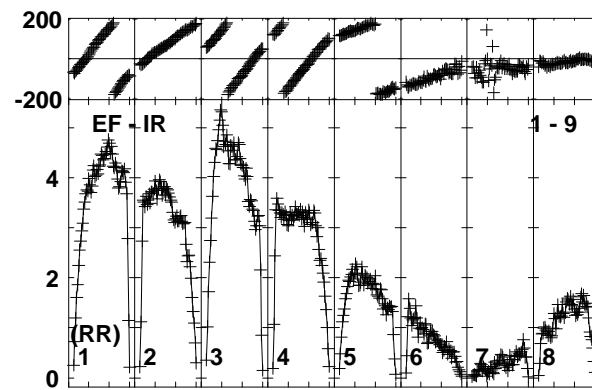
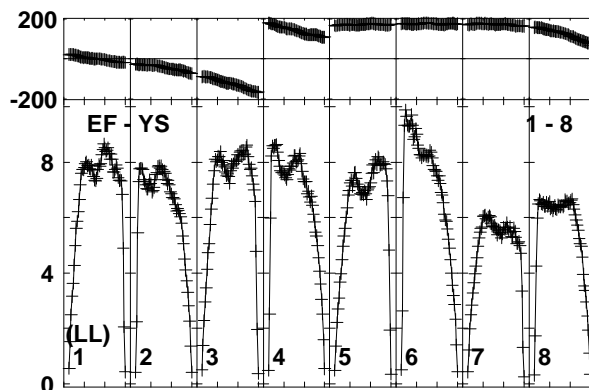
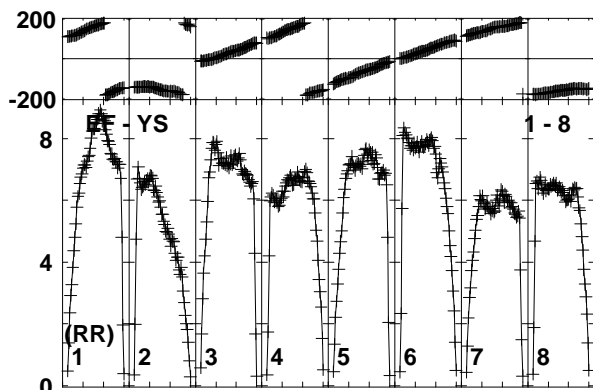
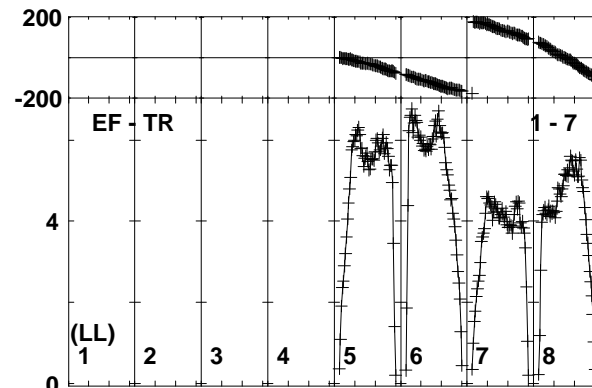
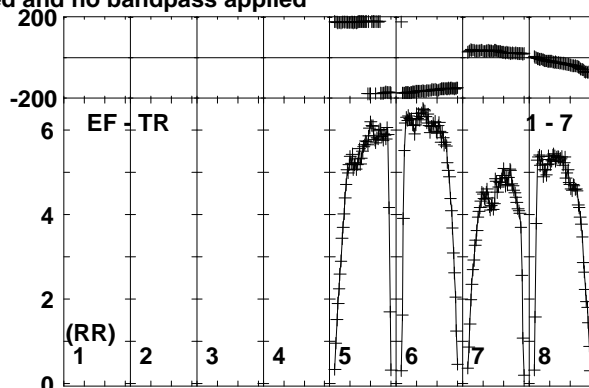
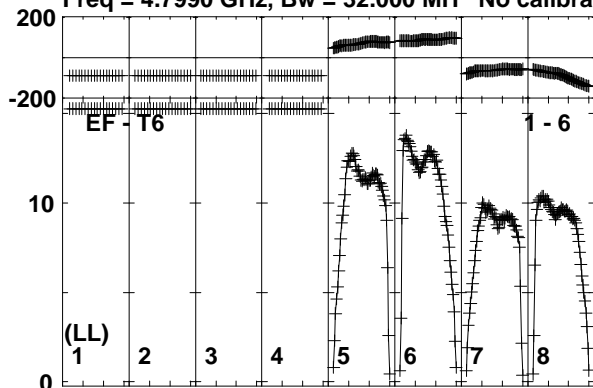

Lower frame: Milli Ampl Jy Top frame: Phas deg
Vector averaged cross-power spectrum Baseline: EF (01) - T6 (06)
Timerange: 00/19:52:35 to 00/19:53:34

Plot file version 81 created 03-OCT-2017 13:09:50

IRAS23436 RP028.UVDATA.1

Freq = 4.7990 GHz, Bw = 32.000 MH No calibration applied and no bandpass applied

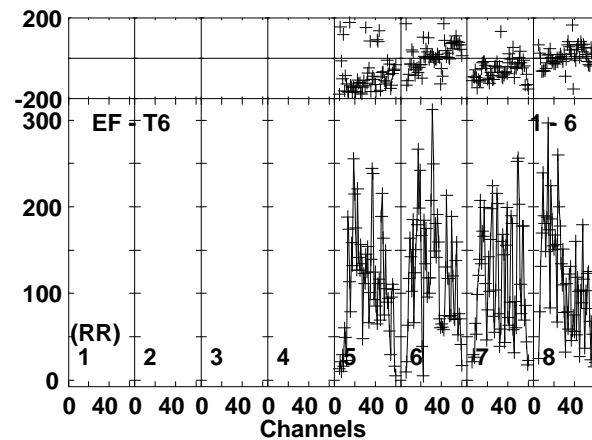
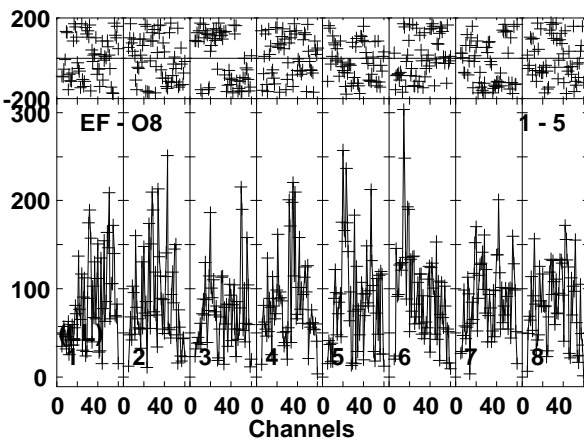
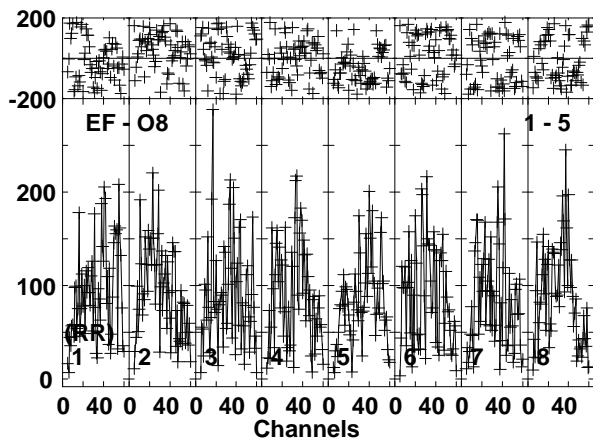
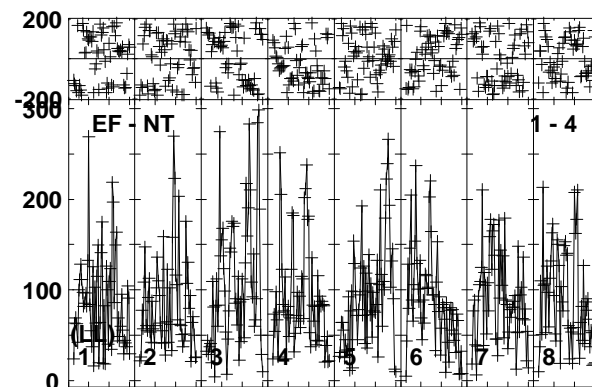
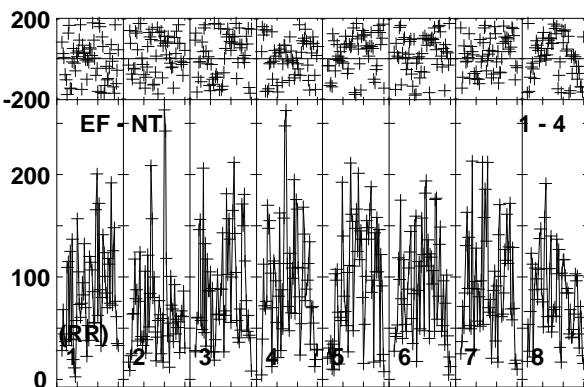
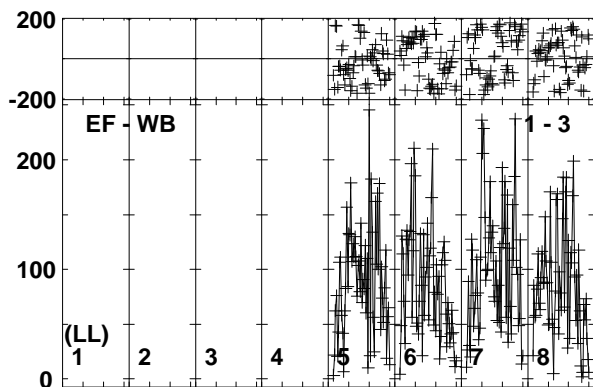
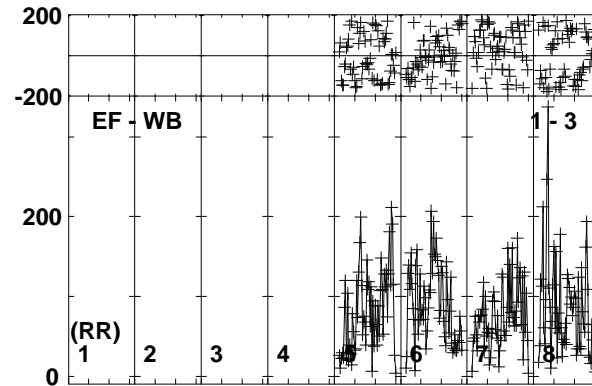
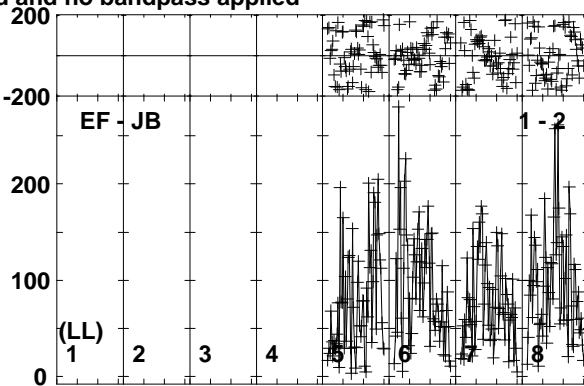
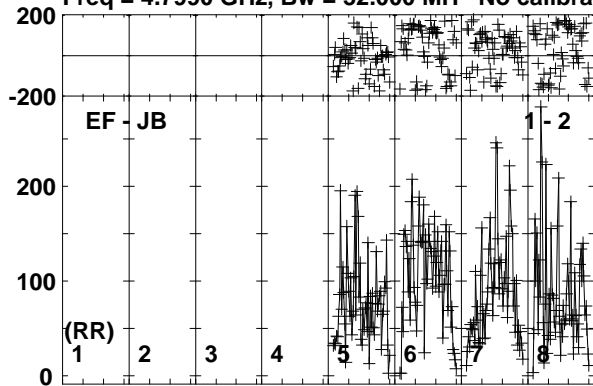

Lower frame: Micro Ampl Jy Top frame: Phas deg
Vector averaged cross-power spectrum Baseline: EF (01) - JB (02)
Timerange: 00/19:53:35 to 00/19:57:14

Plot file version 82 created 03-OCT-2017 13:09:50

IRAS23436 RP028.UVDATA.1

Freq = 4.7990 GHz, Bw = 32.000 MH No calibration applied and no bandpass applied

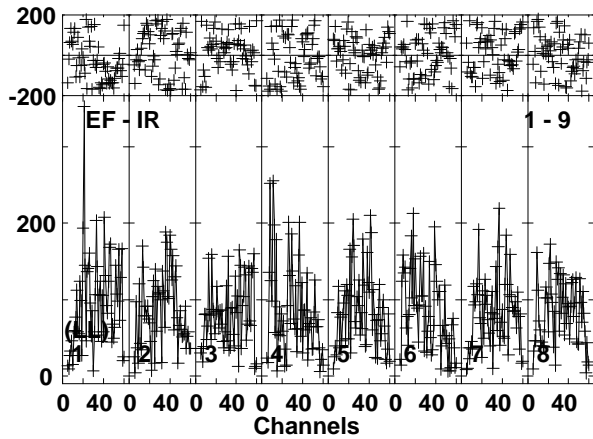
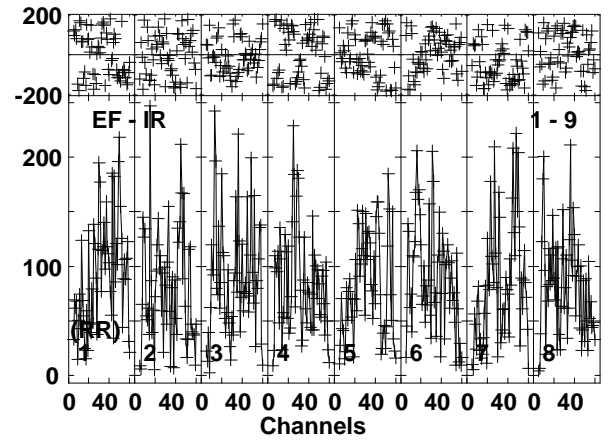
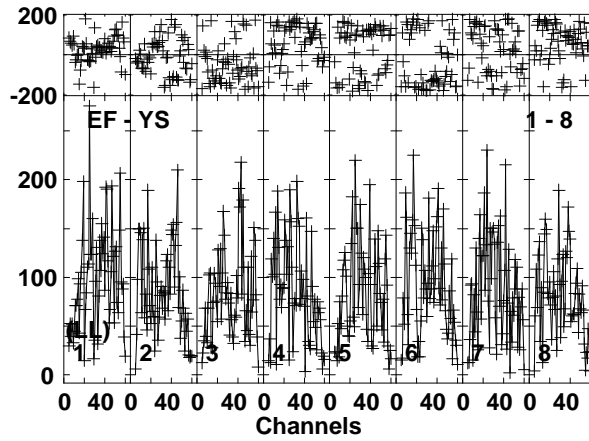
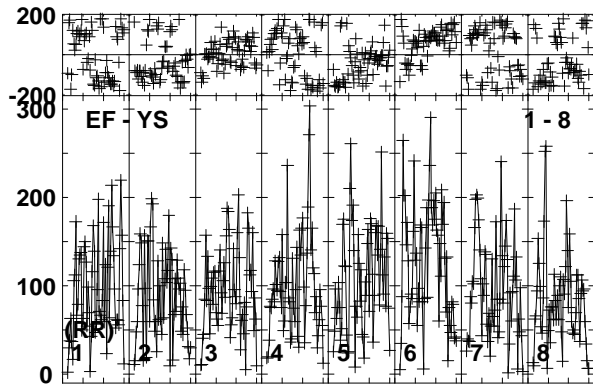
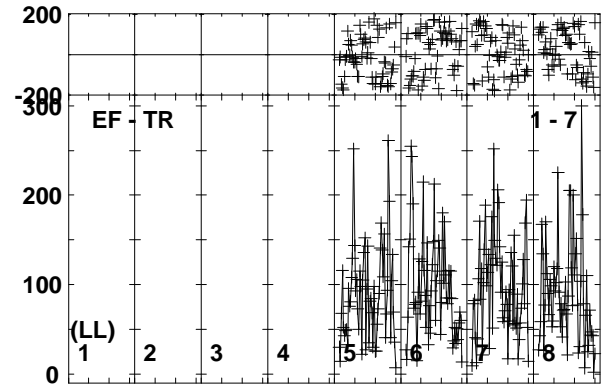
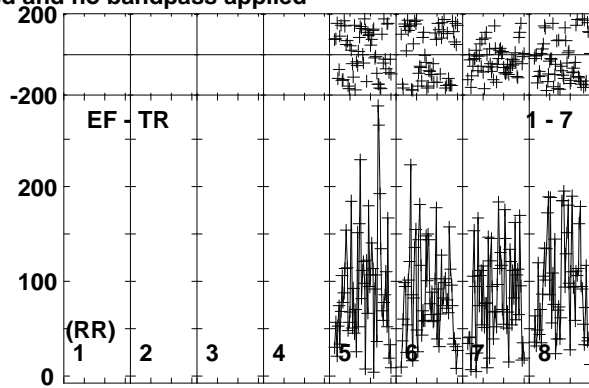
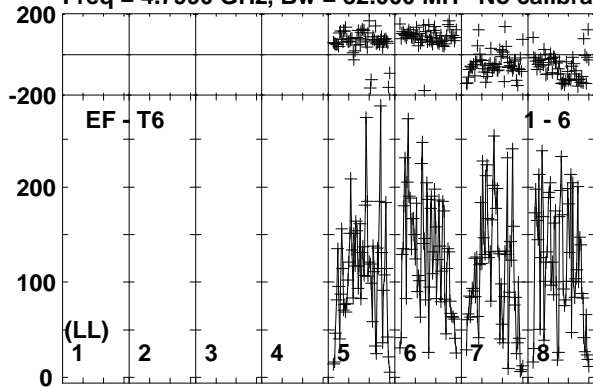

Lower frame: Micro Ampl Jy Top frame: Phas deg
Vector averaged cross-power spectrum Baseline: EF (01) - T6 (06)
Timerange: 00/19:53:35 to 00/19:57:14

Plot file version 83 created 03-OCT-2017 13:09:50

J2353+5518 RP028.UVDATA.1

Freq = 4.7990 GHz, Bw = 32.000 MH No calibration applied and no bandpass applied

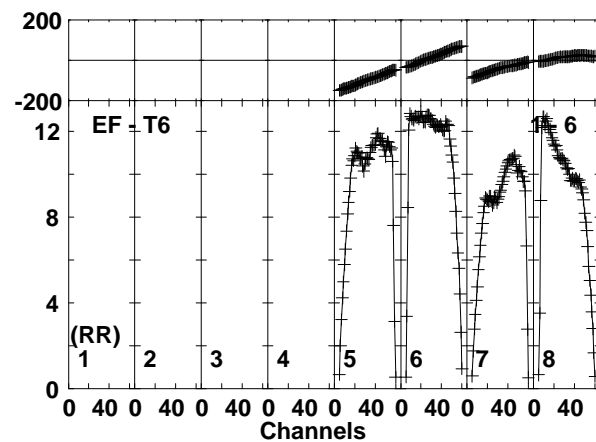
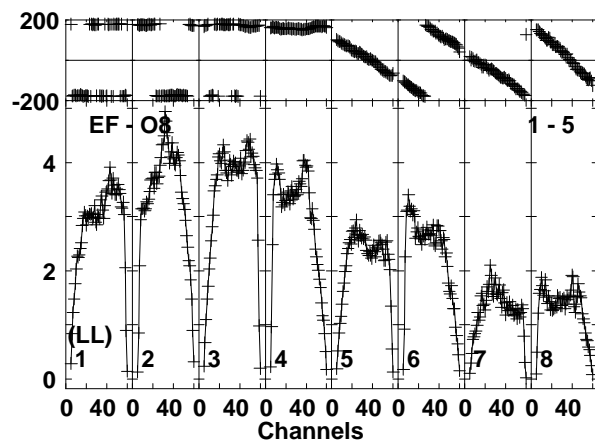
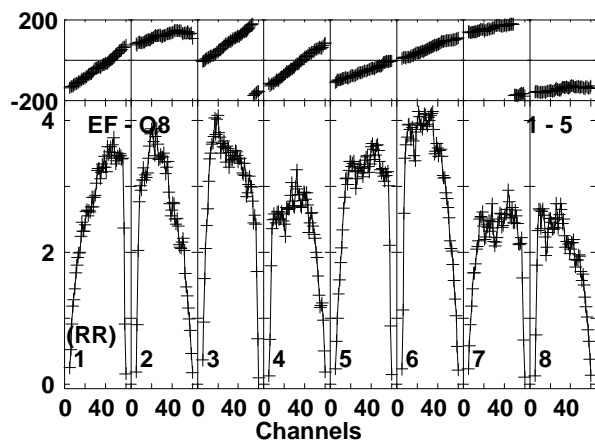
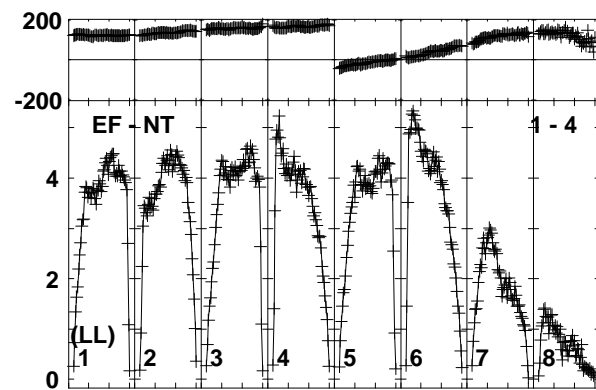
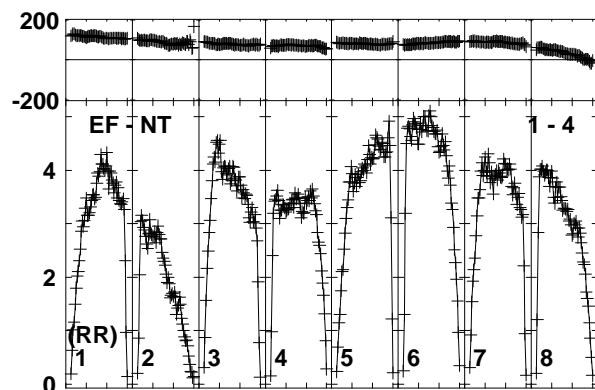
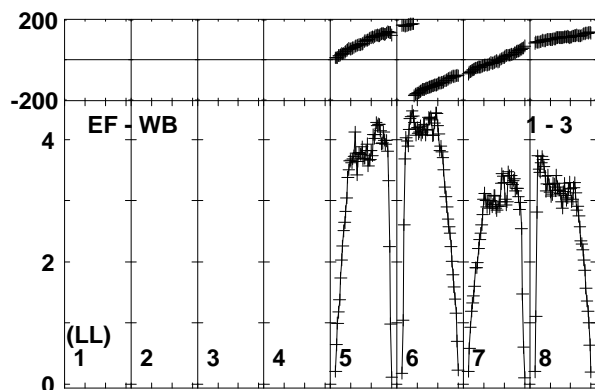
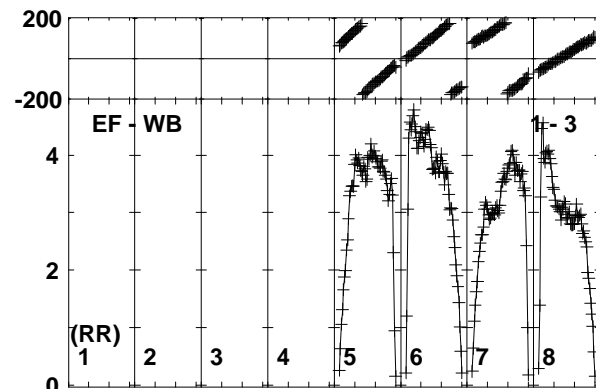
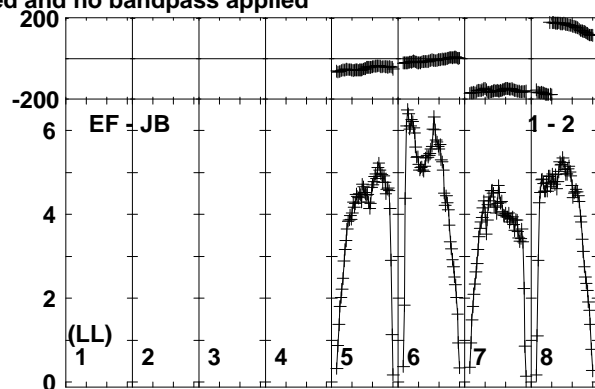
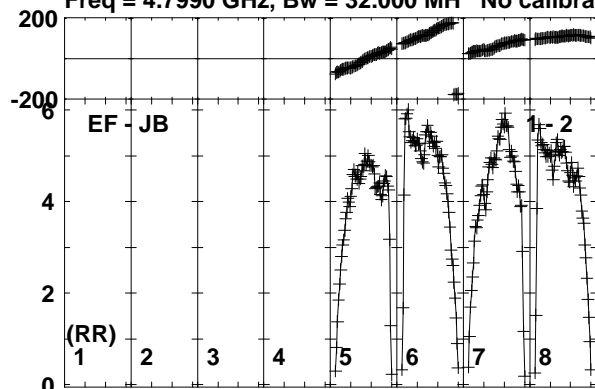

Lower frame: Milli Ampl Jy Top frame: Phas deg
Vector averaged cross-power spectrum Baseline: EF (01) - JB (02)
Timerange: 00:19:57:14 to 00:19:58:44

Plot file version 84 created 03-OCT-2017 13:09:51

J2353+5518 RP028.UVDATA.1

Freq = 4.7990 GHz, Bw = 32.000 MH No calibration applied and no bandpass applied

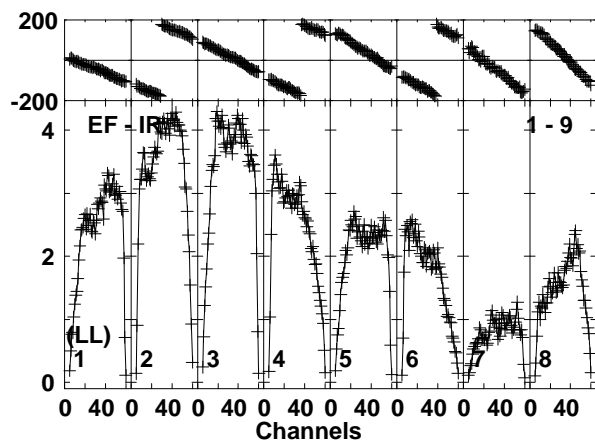
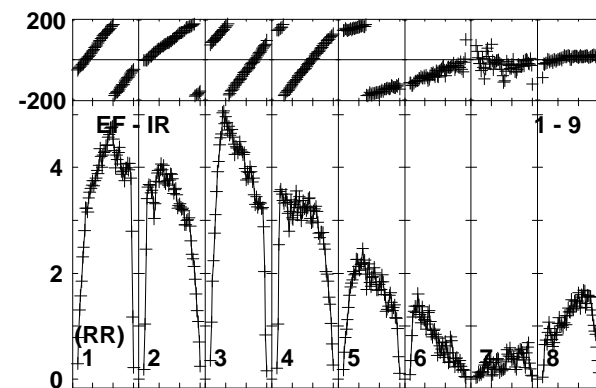
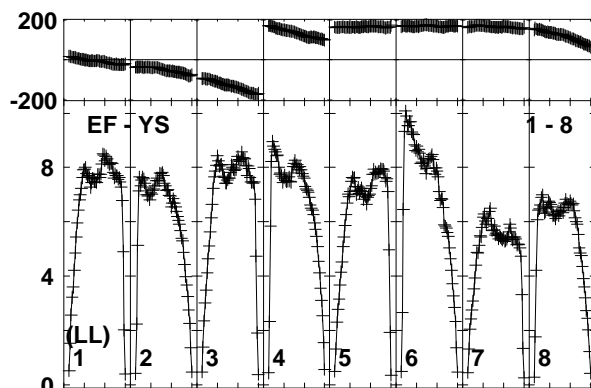
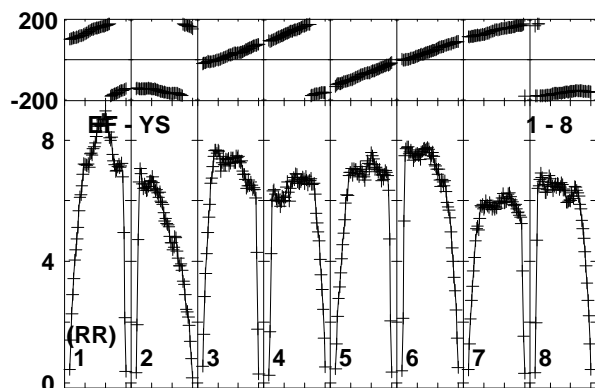
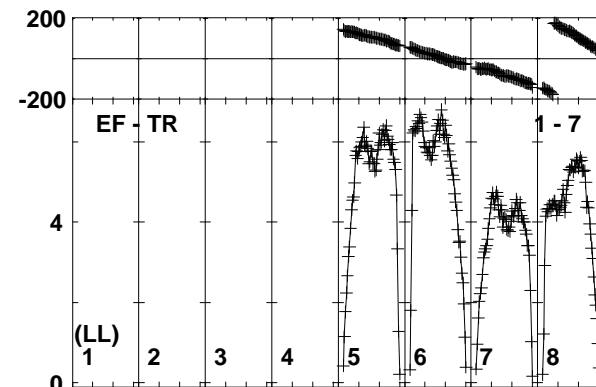
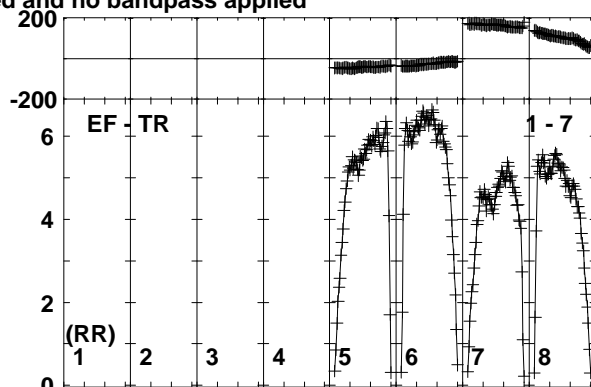
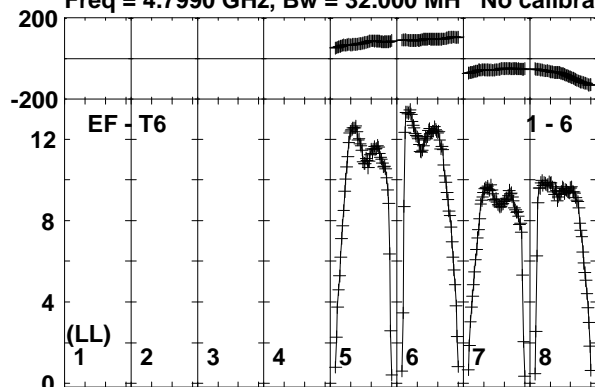

Lower frame: Milli Ampl Jy Top frame: Phas deg
Vector averaged cross-power spectrum Baseline: EF (01) - T6 (06)
Timerange: 00/19:57:14 to 00/19:58:44

Plot file version 85 created 03-OCT-2017 13:09:51

IRAS23436 RP028.UVDATA.1

Freq = 4.7990 GHz, Bw = 32.000 MH No calibration applied and no bandpass applied

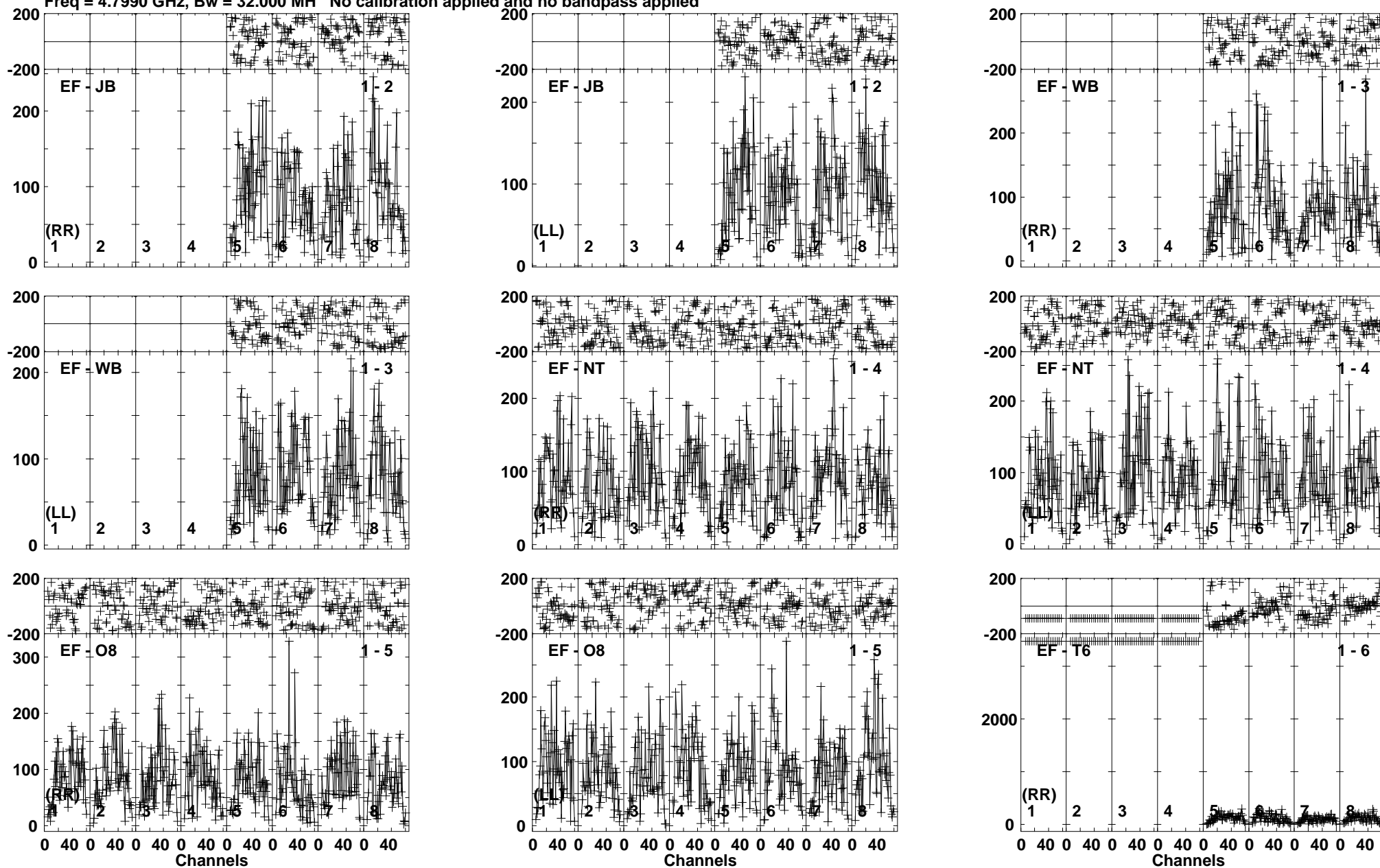

Lower frame: Micro Ampl Jy Top frame: Phas deg
Vector averaged cross-power spectrum Baseline: EF (01) - JB (02)
Timerange: 00/19:58:45 to 00/20:02:27

Plot file version 86 created 03-OCT-2017 13:09:51

IRAS23436 RP028.UVDATA.1

Freq = 4.7990 GHz, Bw = 32.000 MH No calibration applied and no bandpass applied

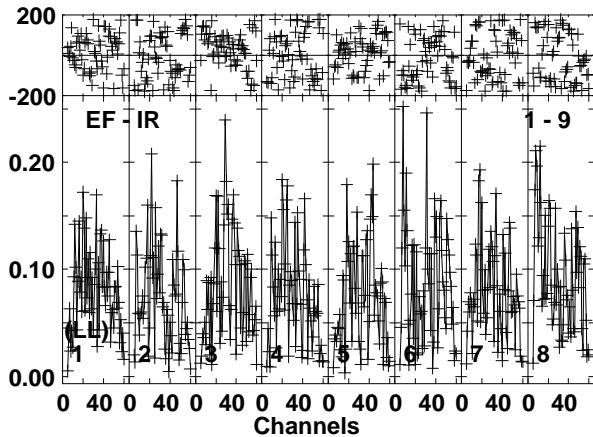
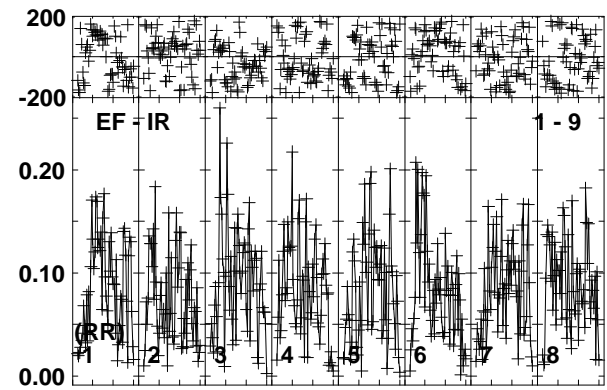
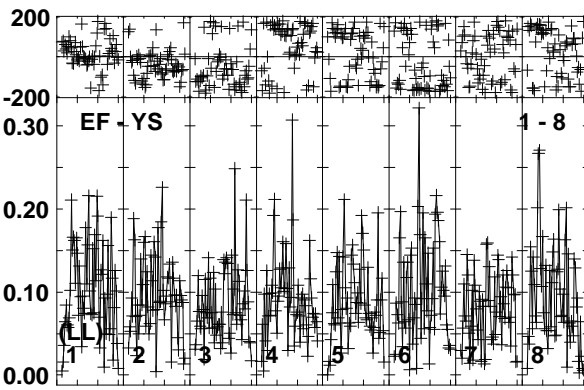
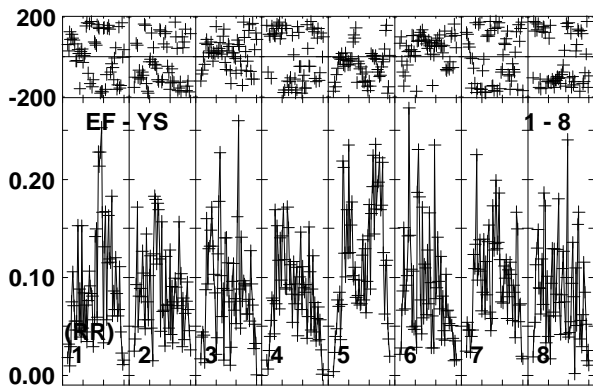
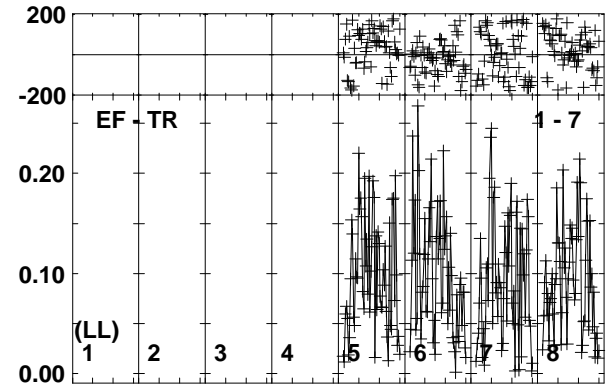
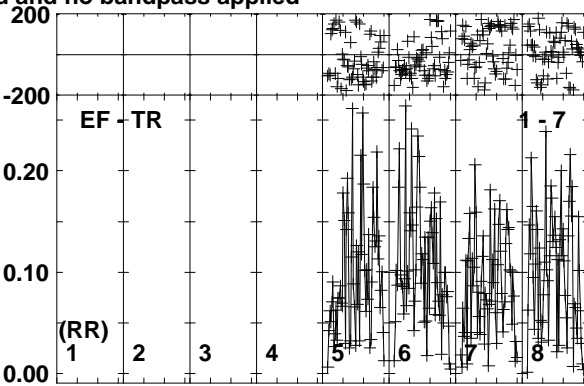
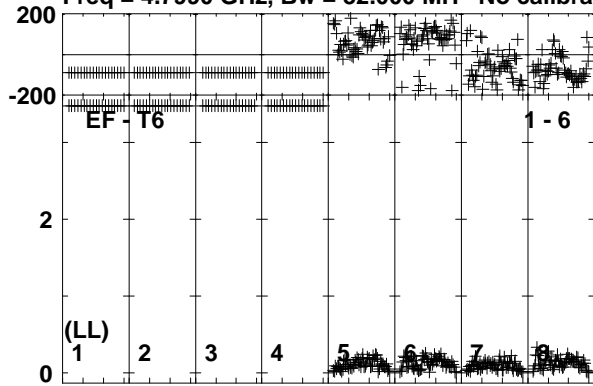

Lower frame: Milli Ampl Jy Top frame: Phas deg
Vector averaged cross-power spectrum Baseline: EF (01) - T6 (06)
Timerange: 00/19:58:45 to 00/20:02:27

Plot file version 87 created 03-OCT-2017 13:09:51

J2353+5518 RP028.UVDATA.1

Freq = 4.7990 GHz, Bw = 32.000 MH No calibration applied and no bandpass applied

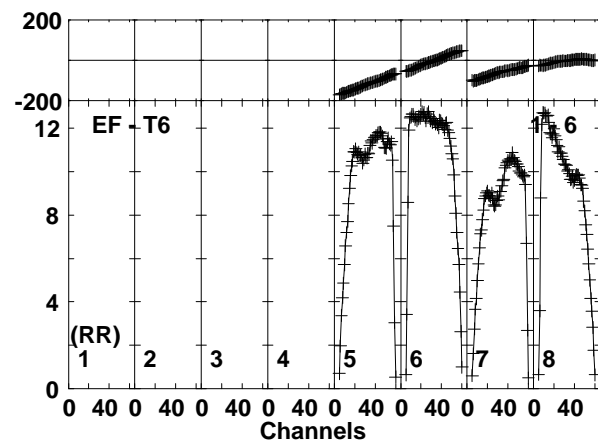
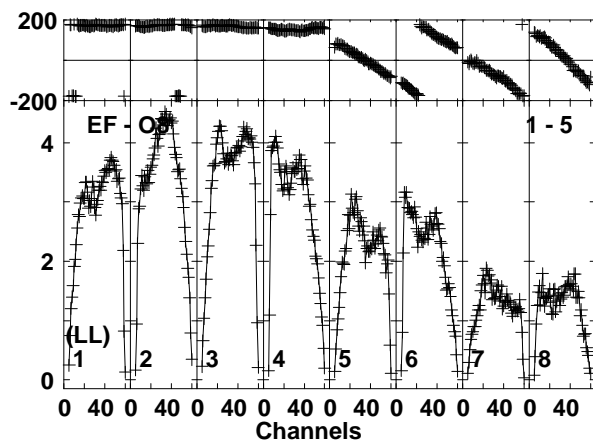
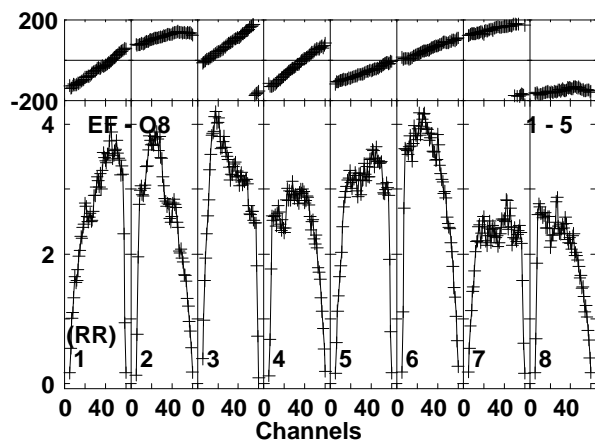
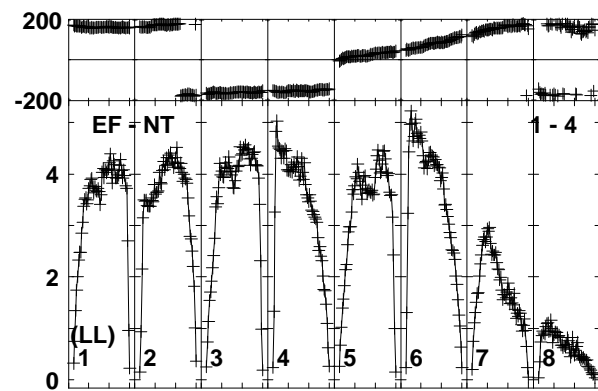
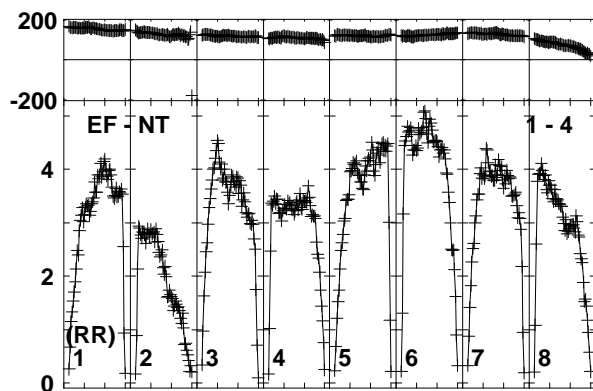
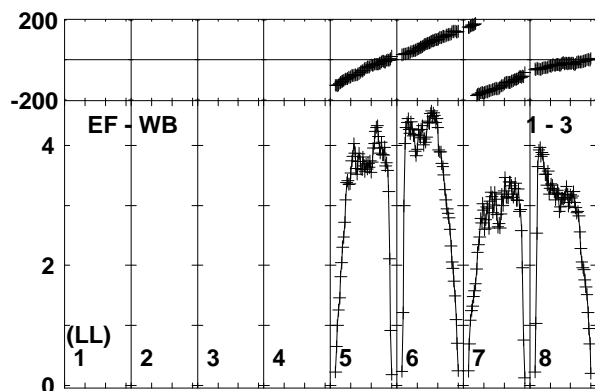
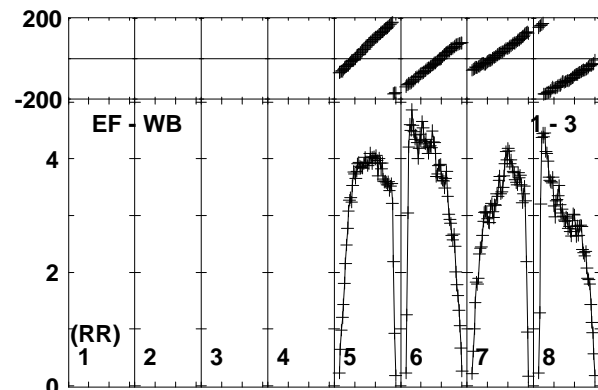
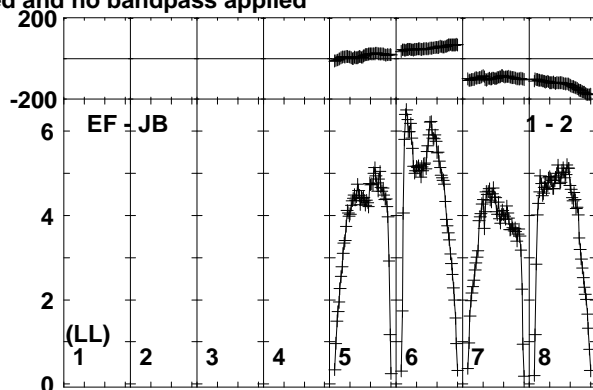
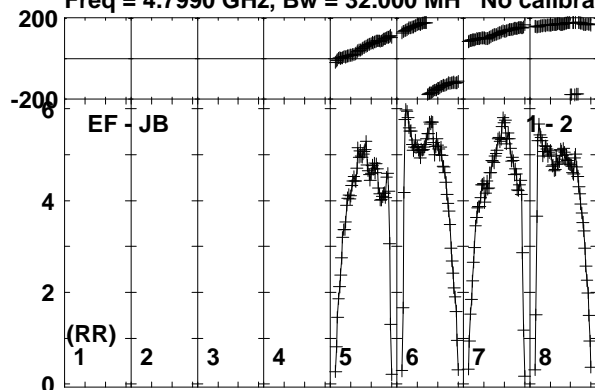

Lower frame: Milli Ampl Jy Top frame: Phas deg
Vector averaged cross-power spectrum Baseline: EF (01) - JB (02)
Timerange: 00/20:03:08 to 00/20:03:58

Plot file version 88 created 03-OCT-2017 13:09:51

J2353+5518 RP028.UVDATA.1

Freq = 4.7990 GHz, Bw = 32.000 MH No calibration applied and no bandpass applied

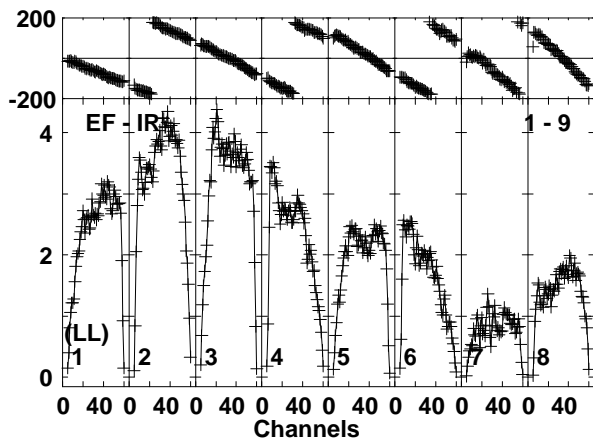
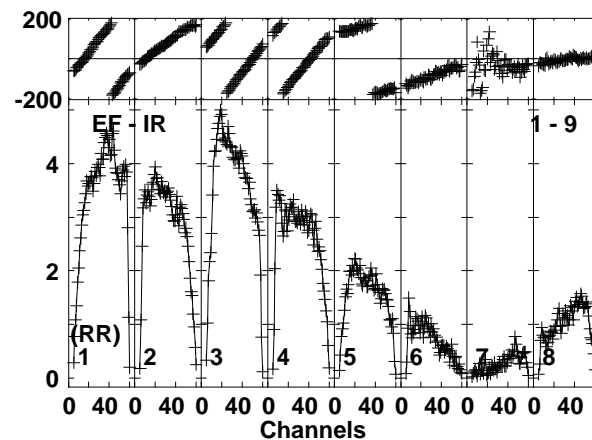
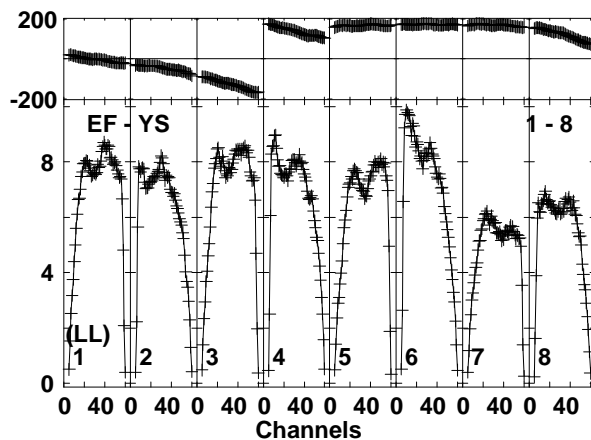
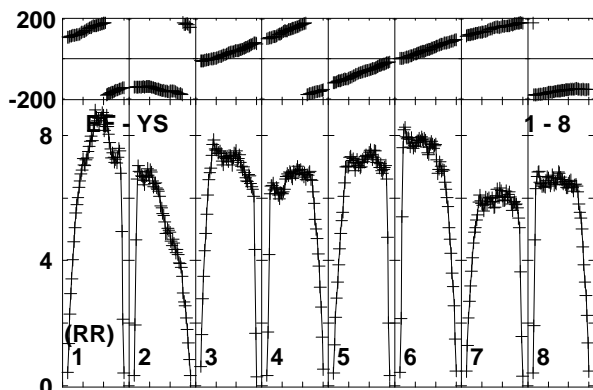
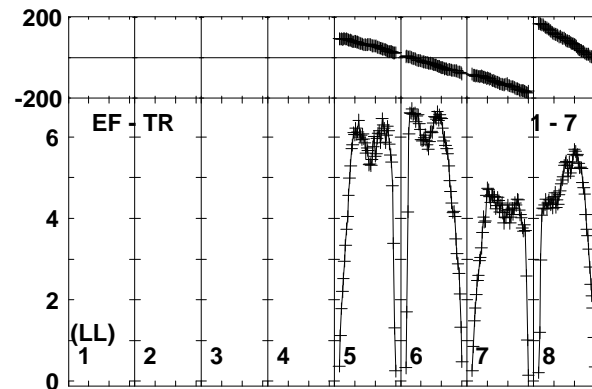
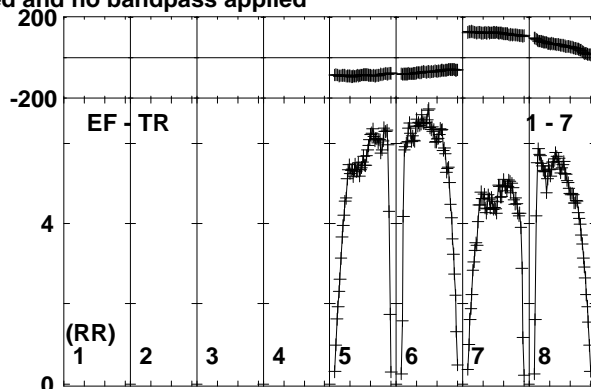
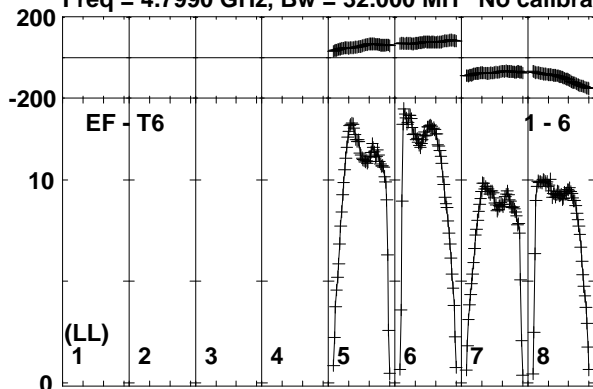

Lower frame: Milli Ampl Jy Top frame: Phas deg
Vector averaged cross-power spectrum Baseline: EF (01) - T6 (06)
Timerange: 00/20:03:08 to 00/20:03:58

Plot file version 89 created 03-OCT-2017 13:09:52

IRAS23436 RP028.UVDATA.1

Freq = 4.7990 GHz, Bw = 32.000 MH No calibration applied and no bandpass applied

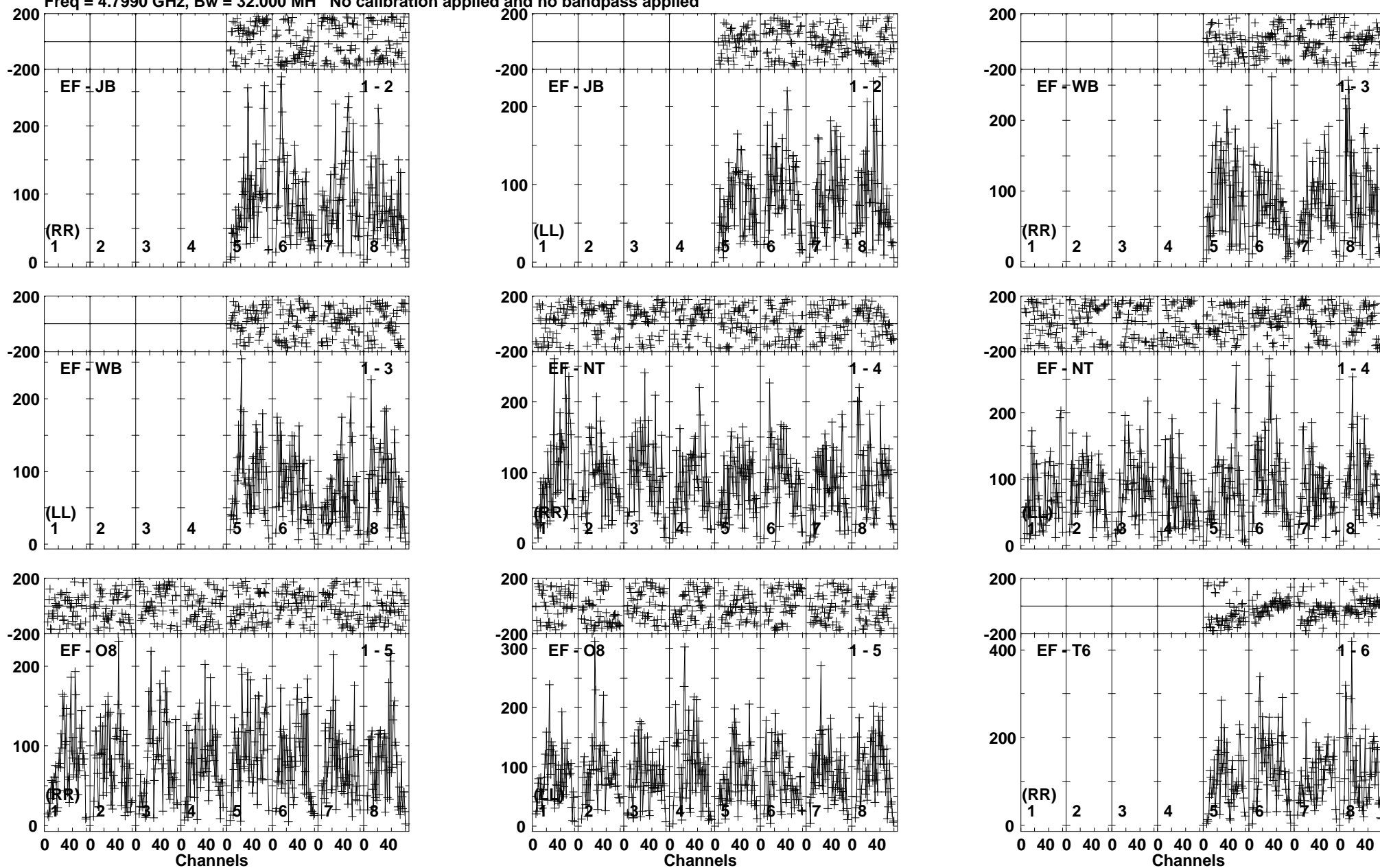

Lower frame: Micro Ampl Jy Top frame: Phas deg
Vector averaged cross-power spectrum Baseline: EF (01) - JB (02)
Timerange: 00/20:03:58 to 00/20:07:42

Plot file version 90 created 03-OCT-2017 13:09:52

IRAS23436 RP028.UVDATA.1

Freq = 4.7990 GHz, Bw = 32.000 MH No calibration applied and no bandpass applied

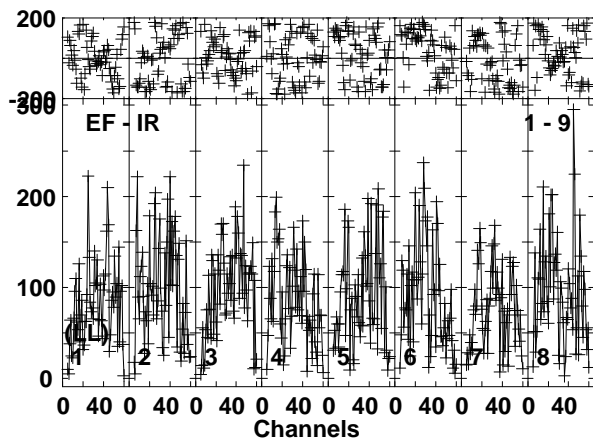
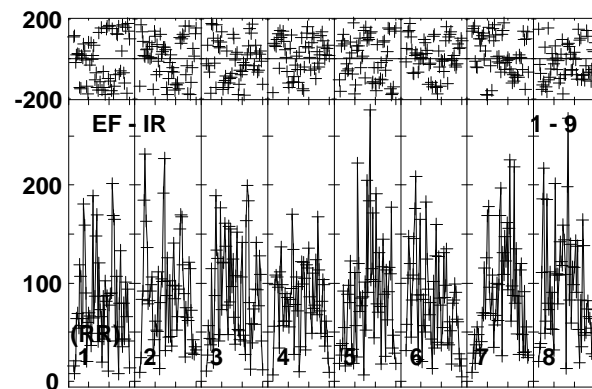
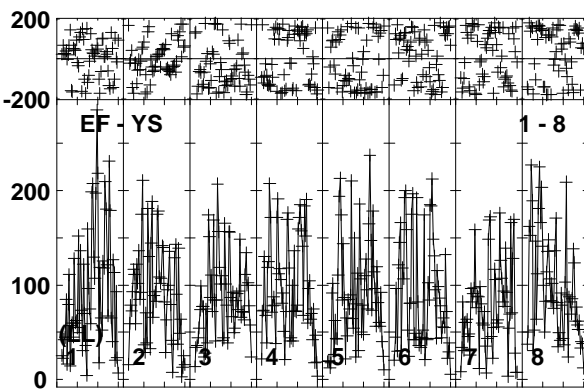
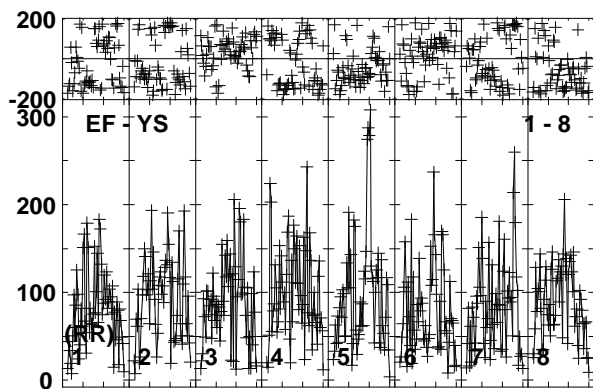
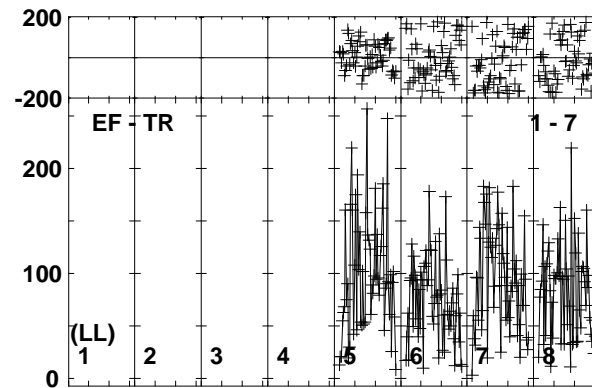
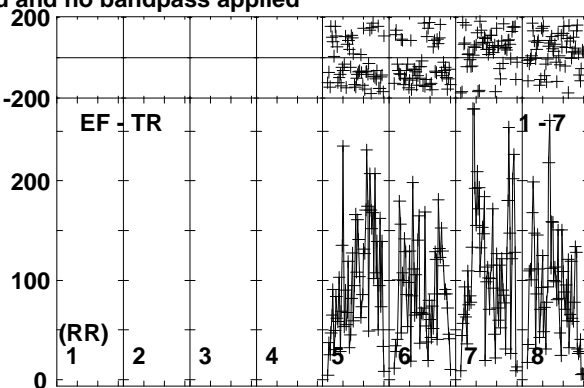
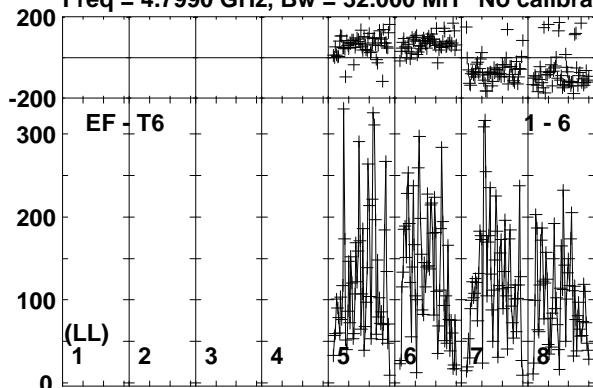

Lower frame: Micro Ampl Jy Top frame: Phas deg
Vector averaged cross-power spectrum Baseline: EF (01) - T6 (06)
Timerange: 00/20:03:58 to 00/20:07:42

Plot file version 91 created 03-OCT-2017 13:09:52

J2353+5518 RP028.UVDATA.1

Freq = 4.7990 GHz, Bw = 32.000 MH No calibration applied and no bandpass applied

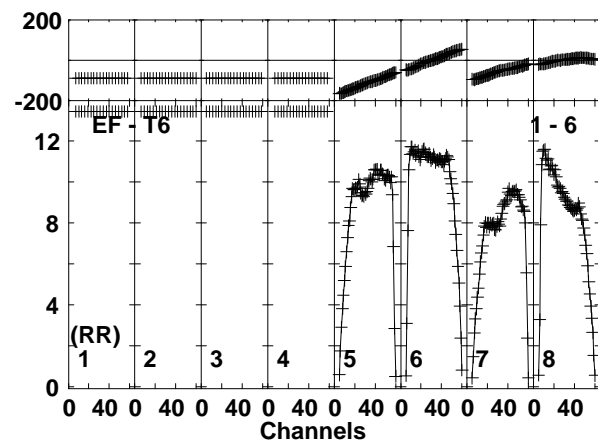
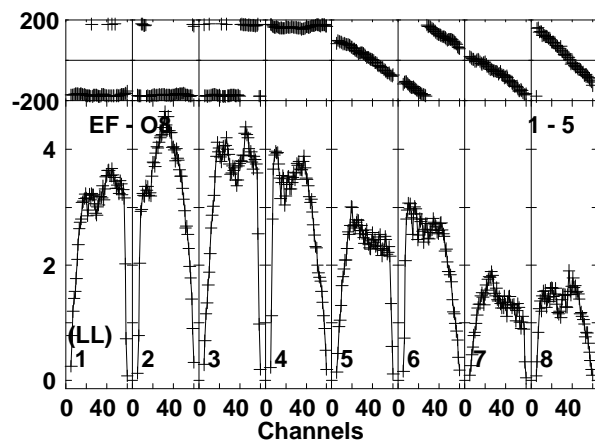
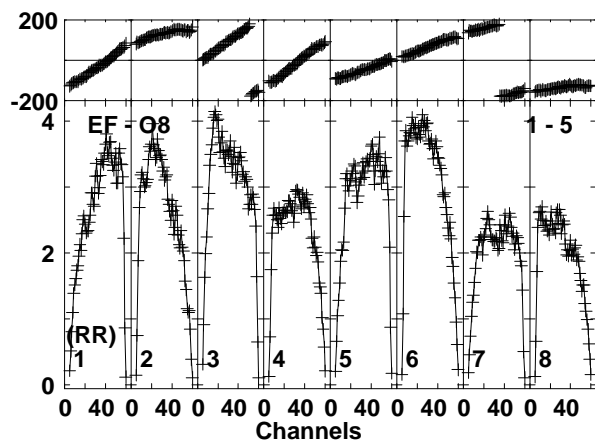
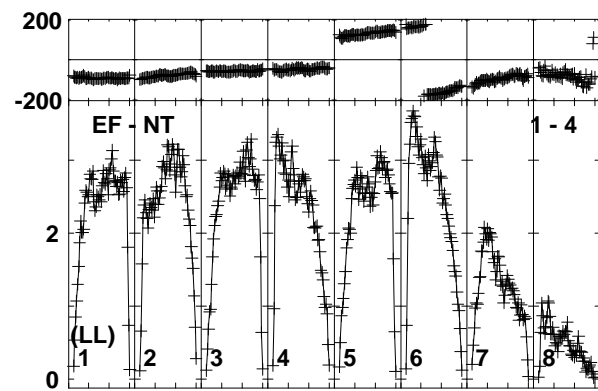
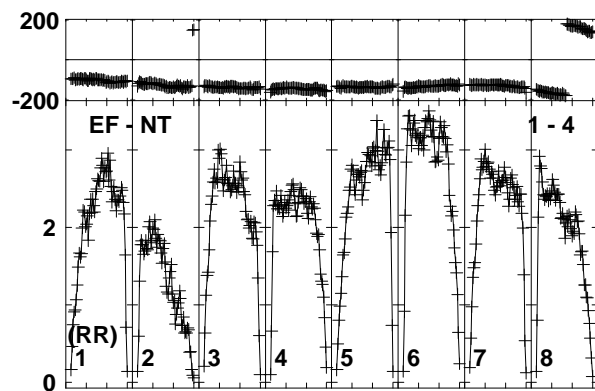
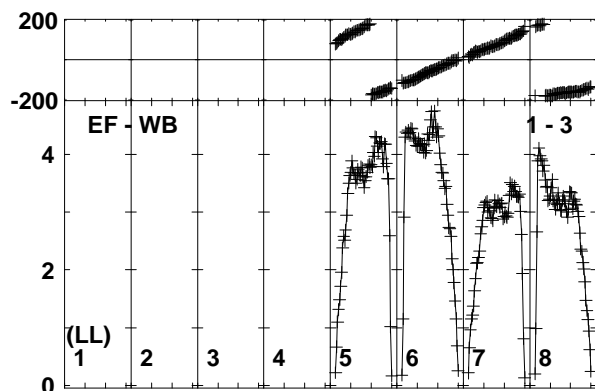
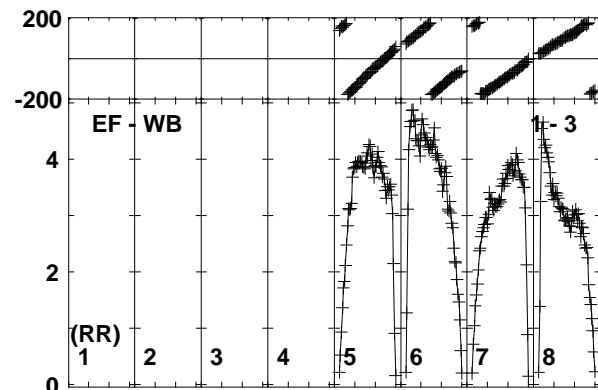
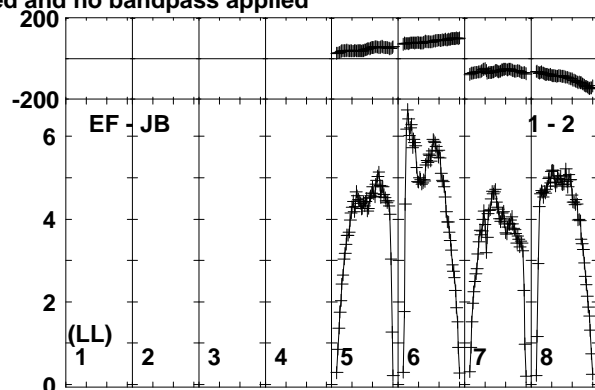
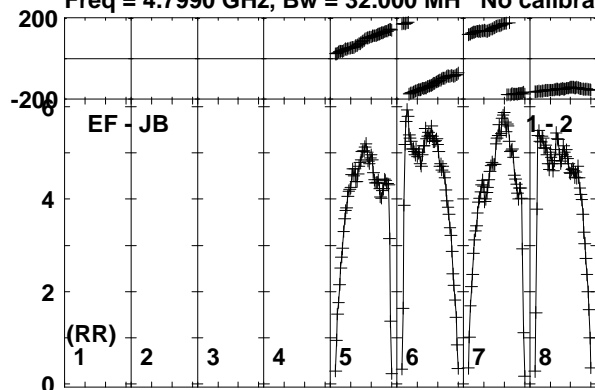

Lower frame: Milli Ampl Jy Top frame: Phas deg
Vector averaged cross-power spectrum Baseline: EF (01) - JB (02)
Timerange: 00/20:07:42 to 00/20:09:11

Plot file version 92 created 03-OCT-2017 13:09:52

J2353+5518 RP028.UVDATA.1

Freq = 4.7990 GHz, Bw = 32.000 MH No calibration applied and no bandpass applied

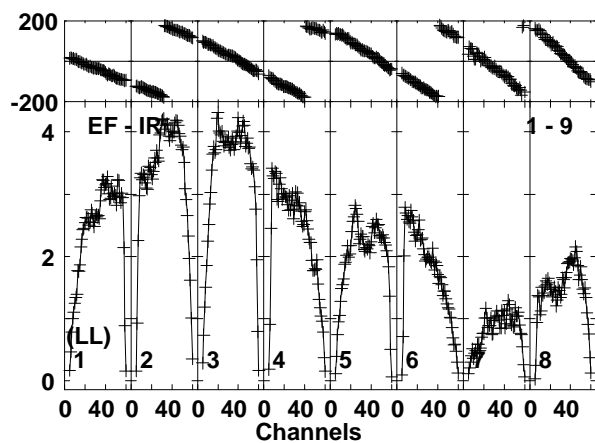
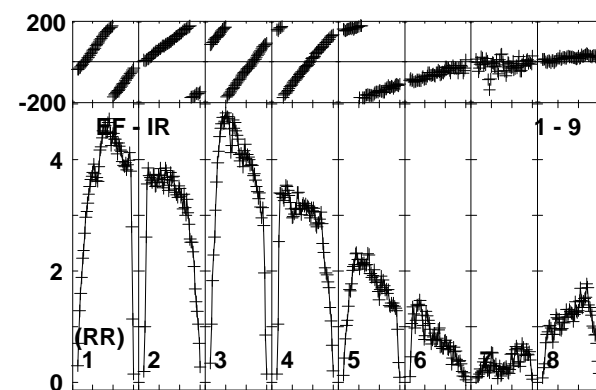
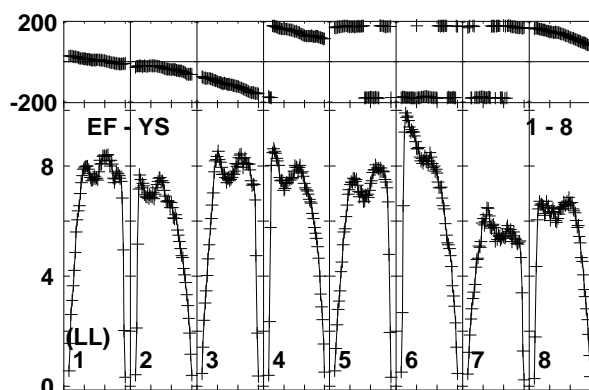
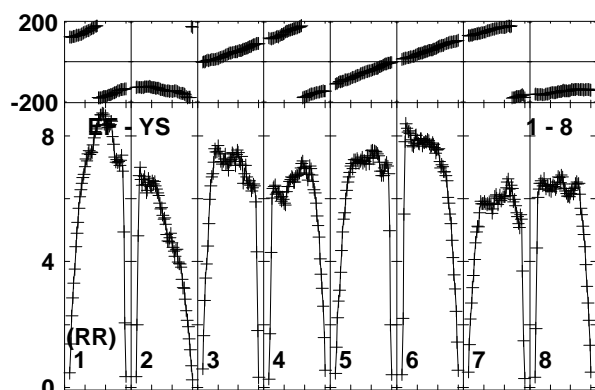
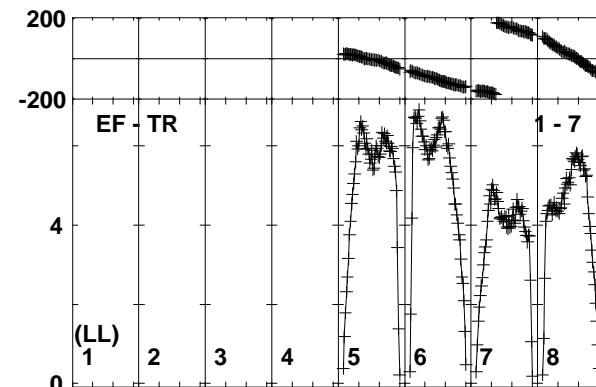
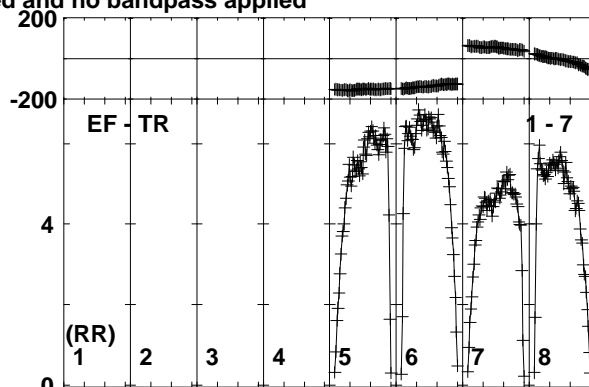
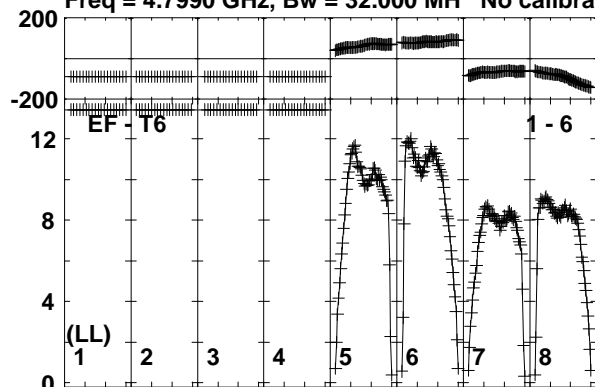

Lower frame: Milli Ampl Jy Top frame: Phas deg
Vector averaged cross-power spectrum Baseline: EF (01) - T6 (06)
Timerange: 00/20:07:42 to 00/20:09:11

Plot file version 93 created 03-OCT-2017 13:09:52

IRAS23436 RP028.UVDATA.1

Freq = 4.7990 GHz, Bw = 32.000 MH No calibration applied and no bandpass applied

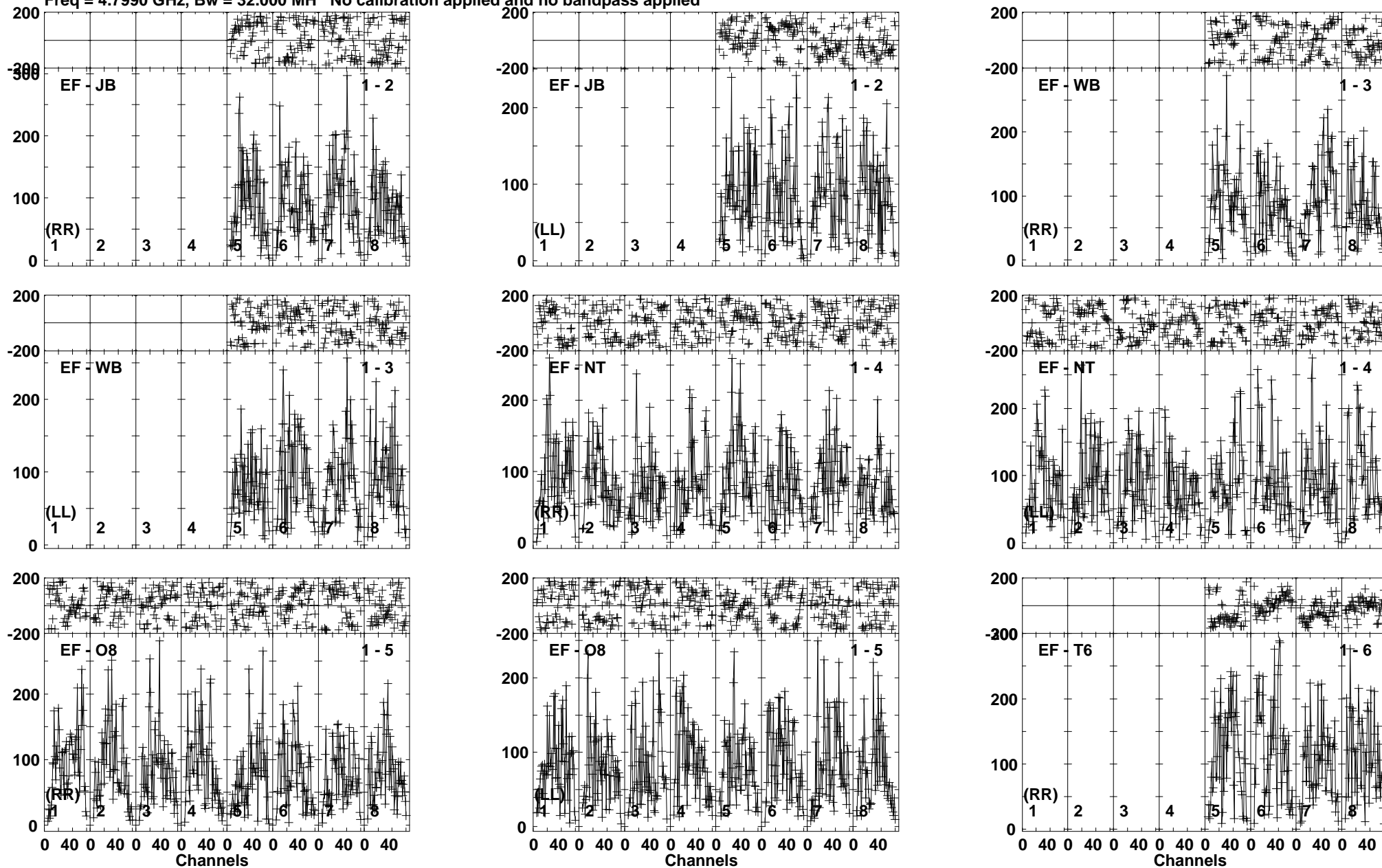

Lower frame: Micro Ampl Jy Top frame: Phas deg
Vector averaged cross-power spectrum Baseline: EF (01) - JB (02)
Timerange: 00/20:09:13 to 00/20:12:55

Plot file version 94 created 03-OCT-2017 13:09:53

IRAS23436 RP028.UVDATA.1

Freq = 4.7990 GHz, Bw = 32.000 MH No calibration applied and no bandpass applied

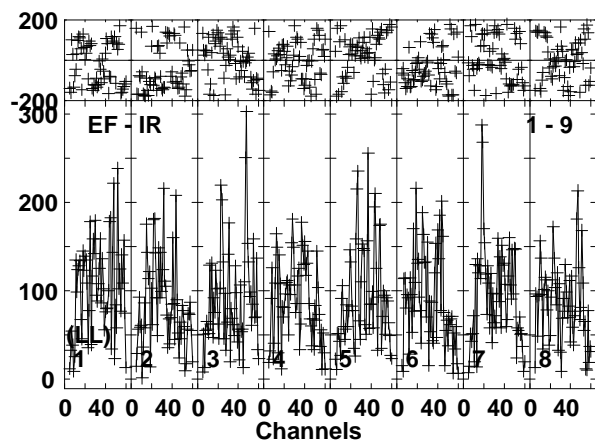
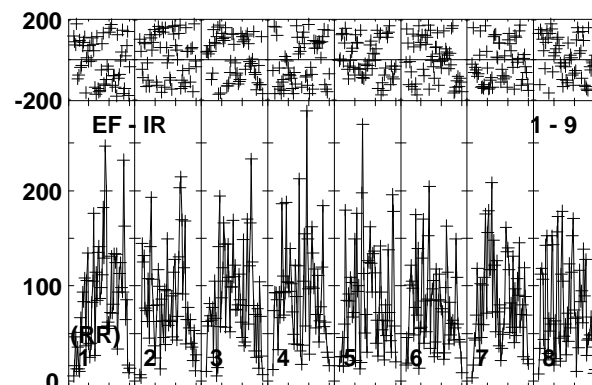
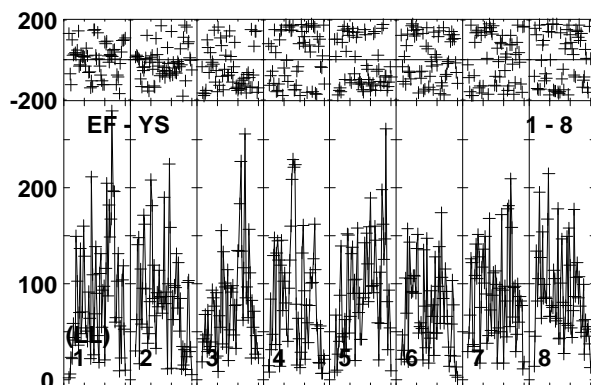
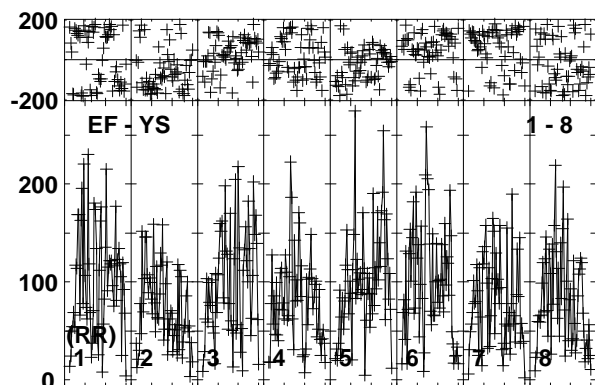
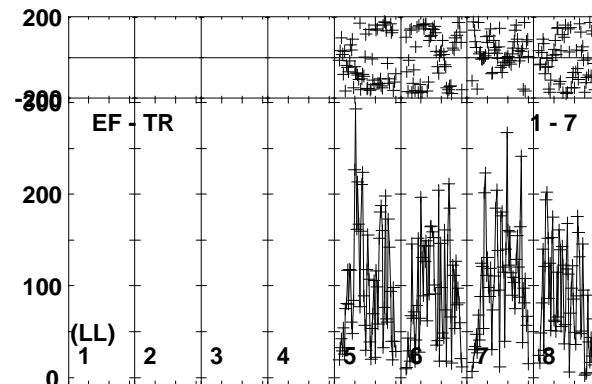
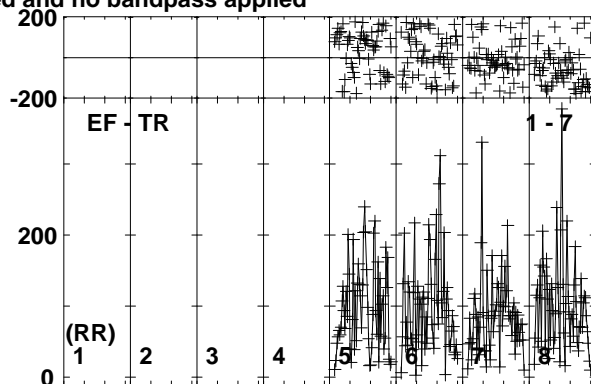
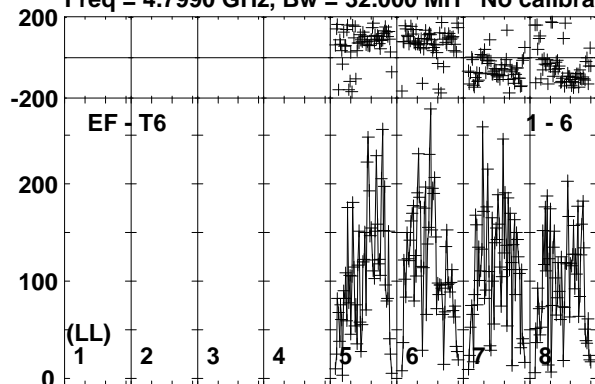

Lower frame: Micro Ampl Jy Top frame: Phas deg
Vector averaged cross-power spectrum Baseline: EF (01) - T6 (06)
Timerange: 00/20:09:13 to 00/20:12:55

Plot file version 95 created 03-OCT-2017 13:09:53

J2353+5518 RP028.UVDATA.1

Freq = 4.7990 GHz, Bw = 32.000 MH No calibration applied and no bandpass applied

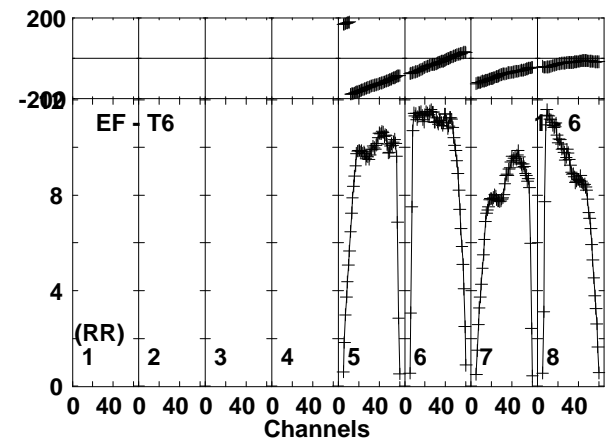
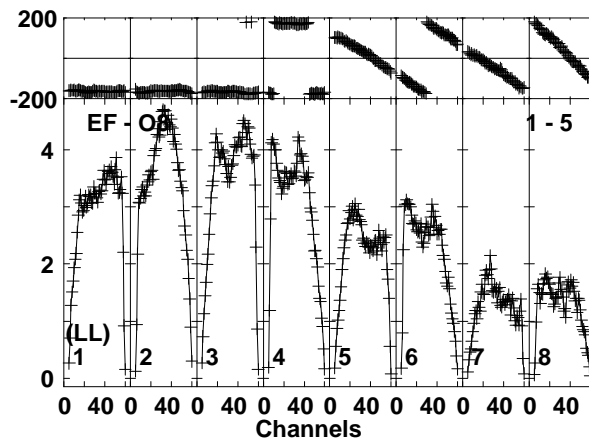
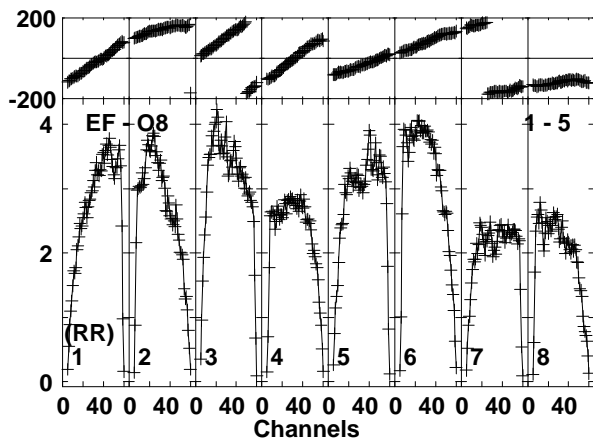
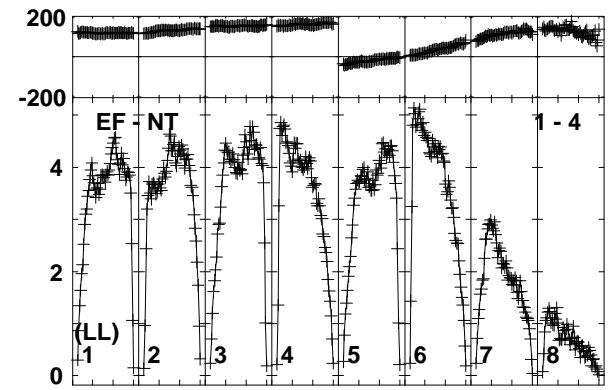
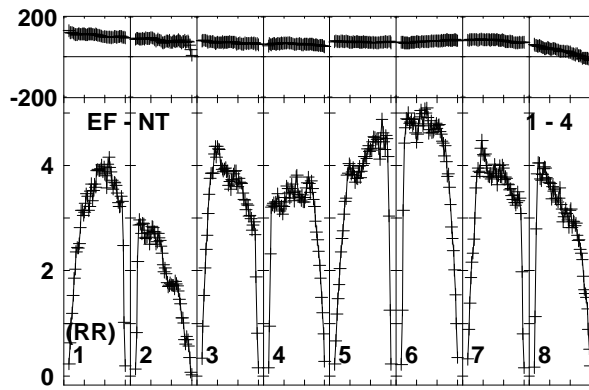
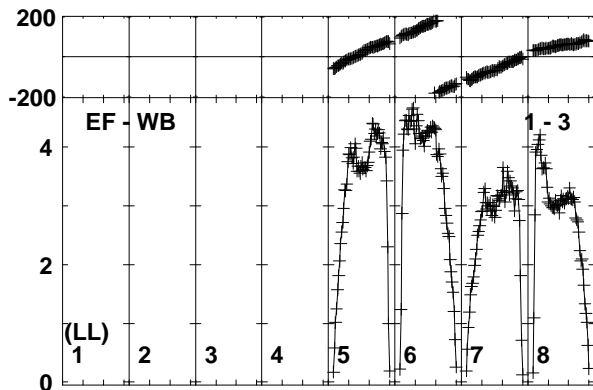
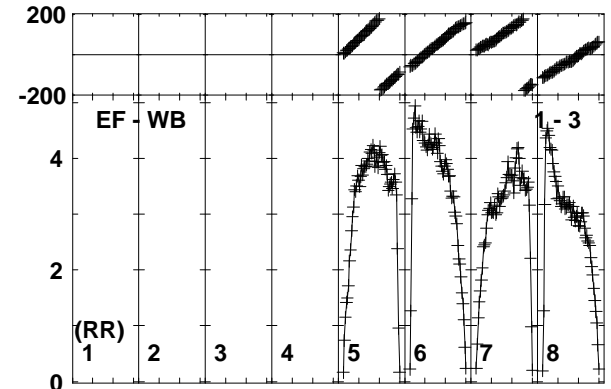
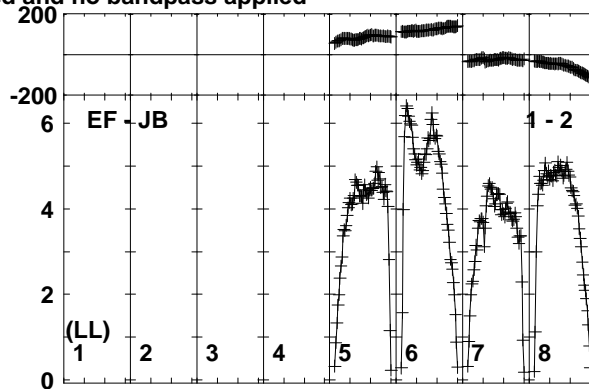
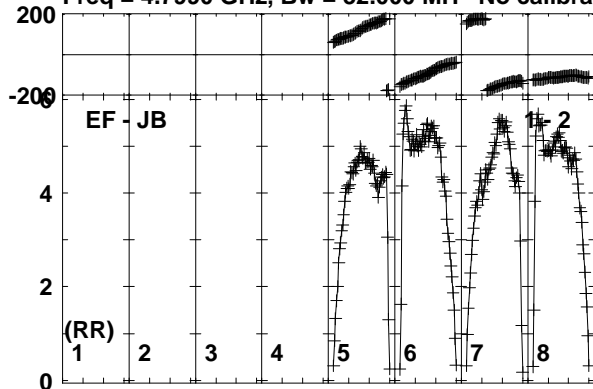

Lower frame: Milli Ampl Jy Top frame: Phas deg
Vector averaged cross-power spectrum Baseline: EF (01) - JB (02)
Timerange: 00/20:13:37 to 00/20:14:36

Plot file version 96 created 03-OCT-2017 13:09:53

J2353+5518 RP028.UVDATA.1

Freq = 4.7990 GHz, Bw = 32.000 MH No calibration applied and no bandpass applied

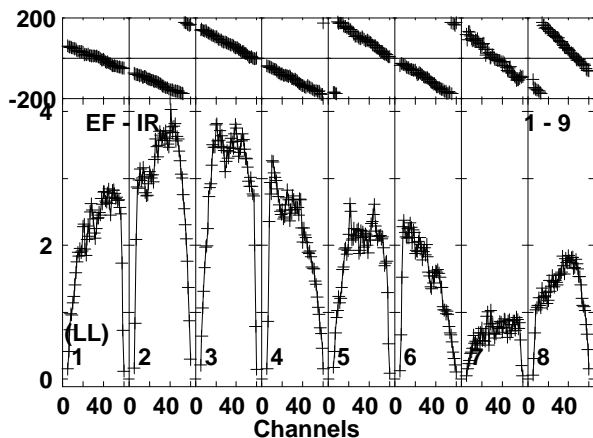
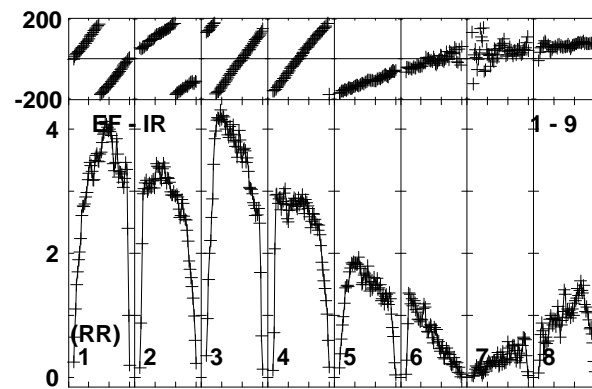
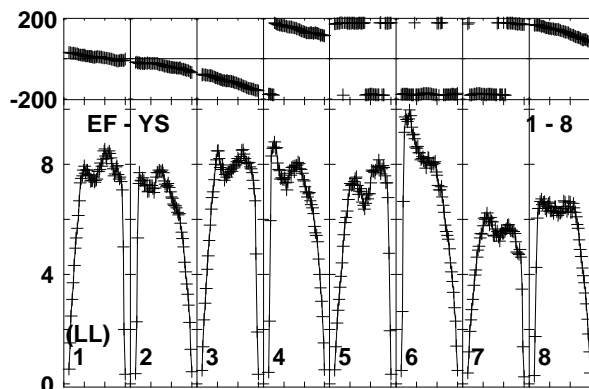
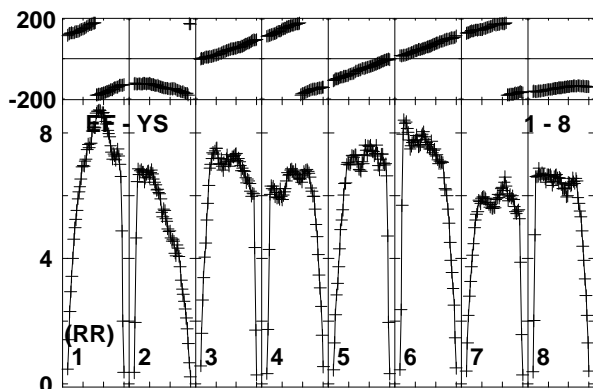
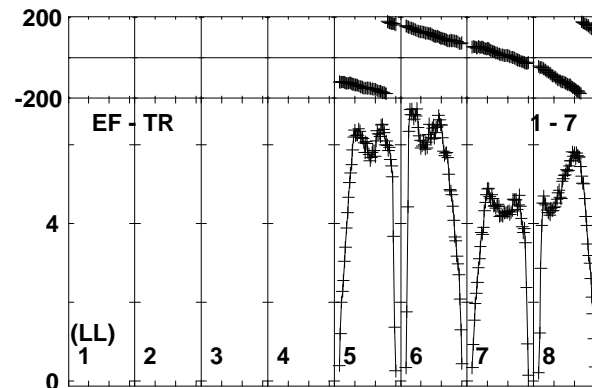
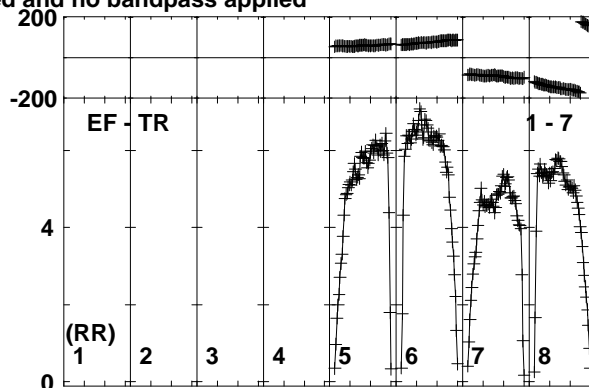
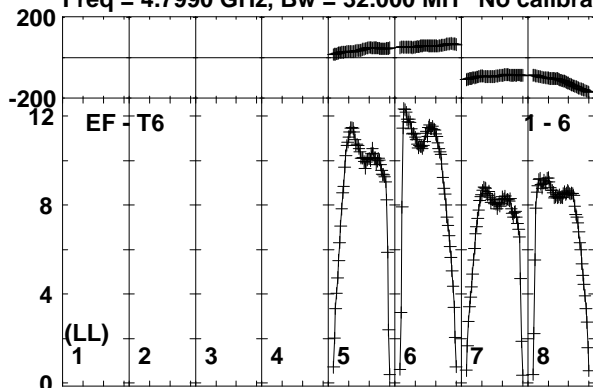

Lower frame: Milli Ampl Jy Top frame: Phas deg
Vector averaged cross-power spectrum Baseline: EF (01) - T6 (06)
Timerange: 00/20:13:37 to 00/20:14:36

Plot file version 97 created 03-OCT-2017 13:09:53

IRAS23436 RP028.UVDATA.1

Freq = 4.7990 GHz, Bw = 32.000 MH No calibration applied and no bandpass applied

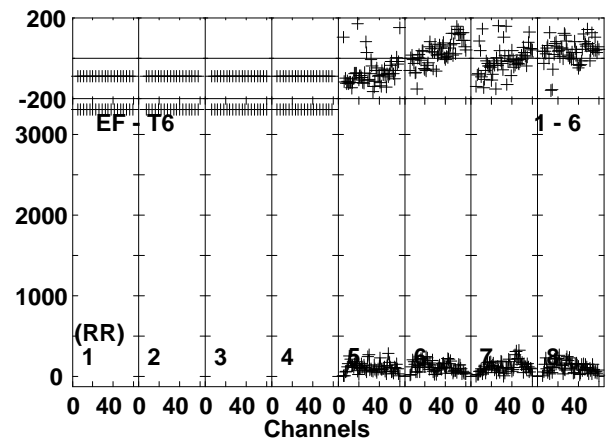
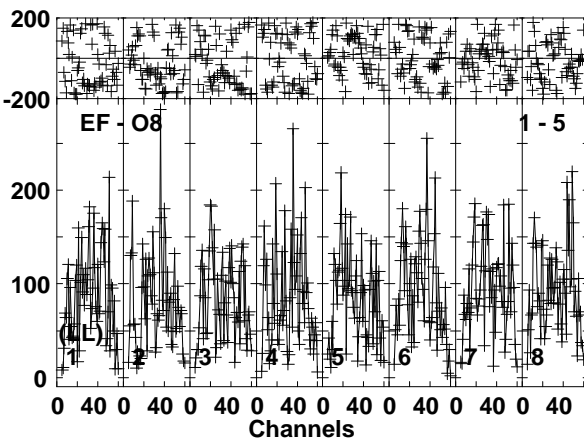
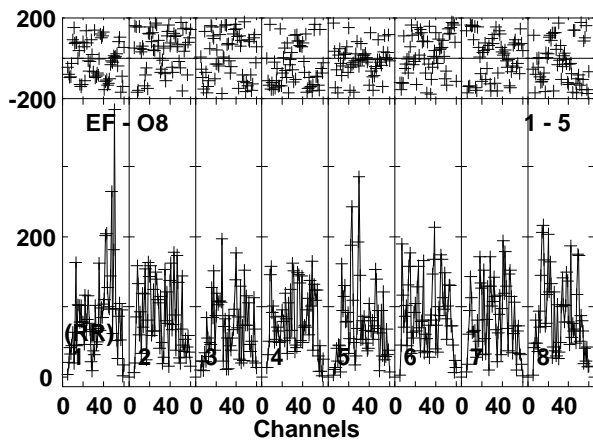
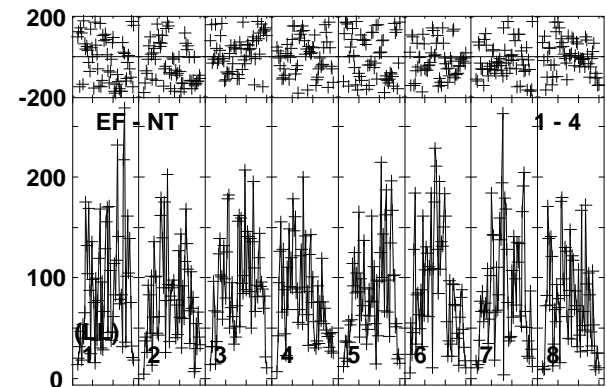
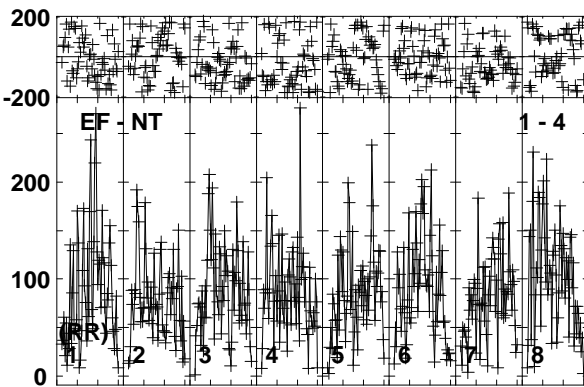
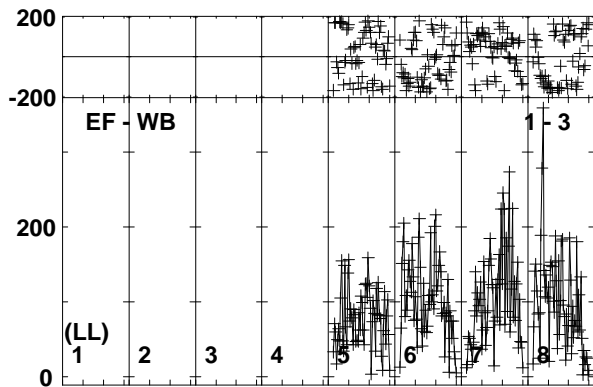
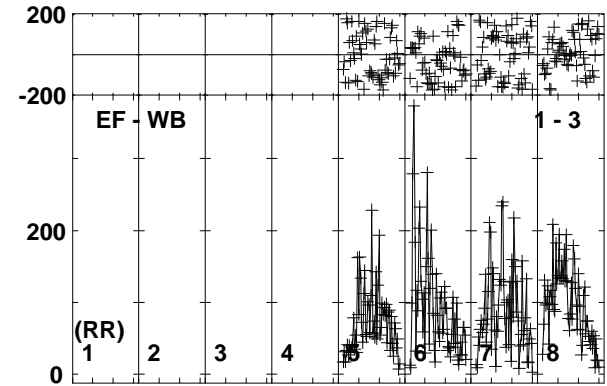
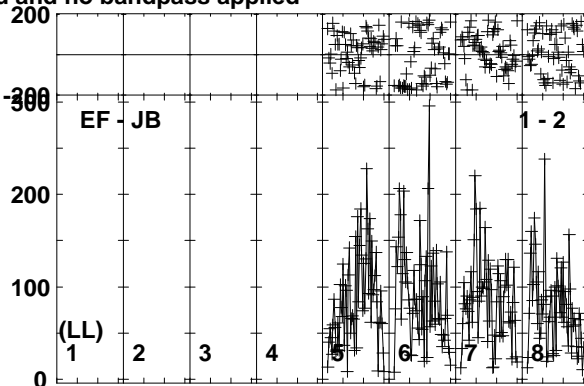
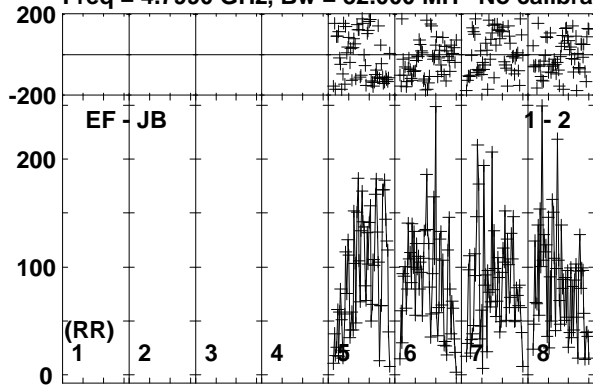

Lower frame: Micro Ampl Jy Top frame: Phas deg
Vector averaged cross-power spectrum Baseline: EF (01) - JB (02)
Timerange: 00/20:14:37 to 00/20:18:16

Plot file version 98 created 03-OCT-2017 13:09:53

IRAS23436 RP028.UVDATA.1

Freq = 4.7990 GHz, Bw = 32.000 MH No calibration applied and no bandpass applied

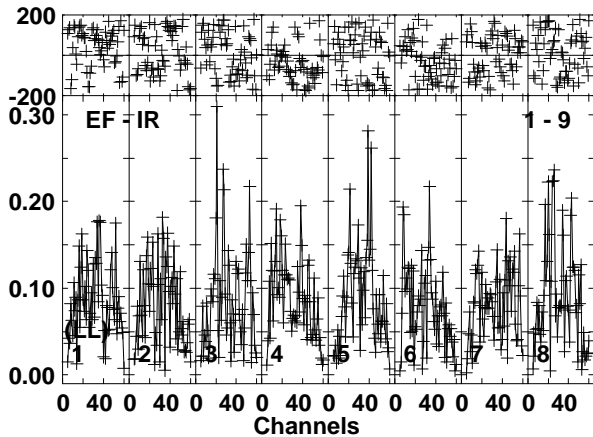
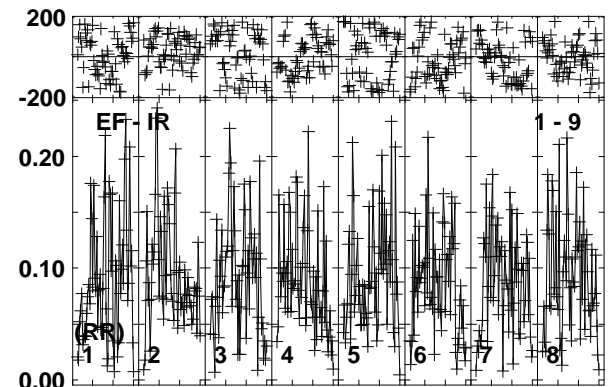
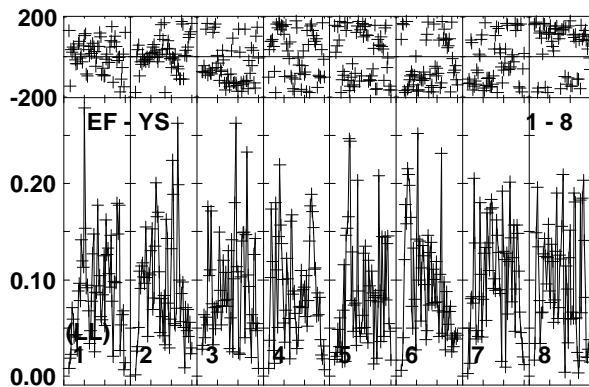
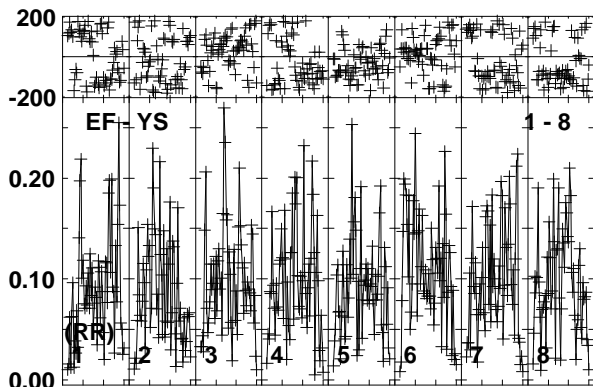
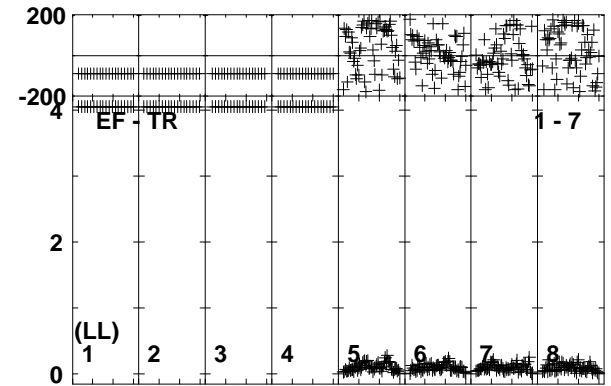
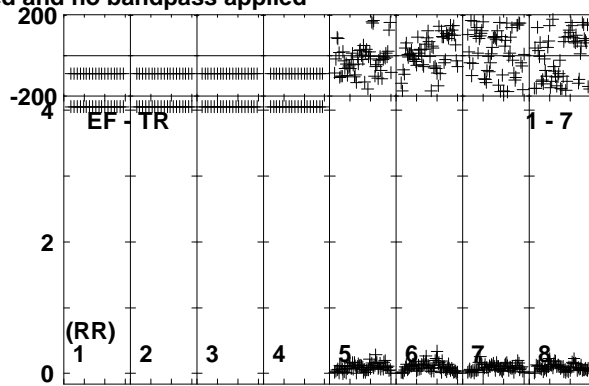
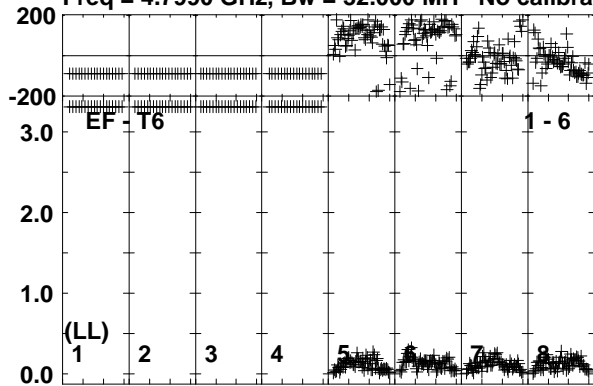

Lower frame: Milli Ampl Jy Top frame: Phas deg
Vector averaged cross-power spectrum Baseline: EF (01) - T6 (06)
Timerange: 00/20:14:37 to 00/20:18:16

Plot file version 99 created 03-OCT-2017 13:09:54

J2353+5518 RP028.UVDATA.1

Freq = 4.7990 GHz, Bw = 32.000 MH No calibration applied and no bandpass applied

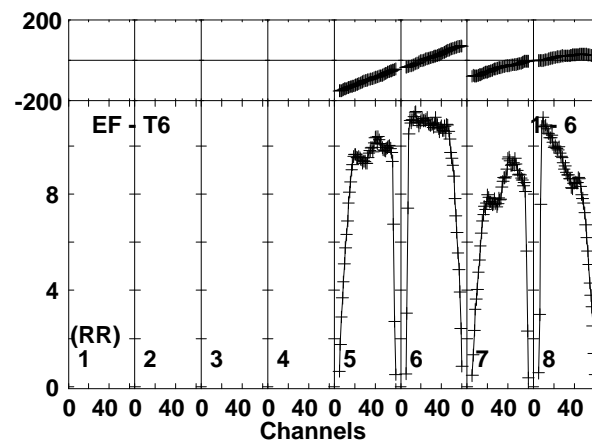
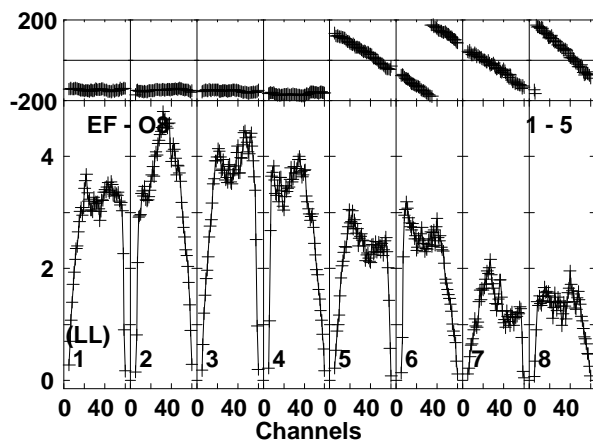
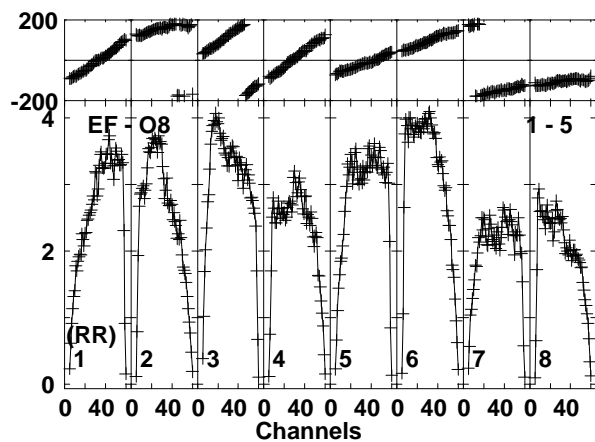
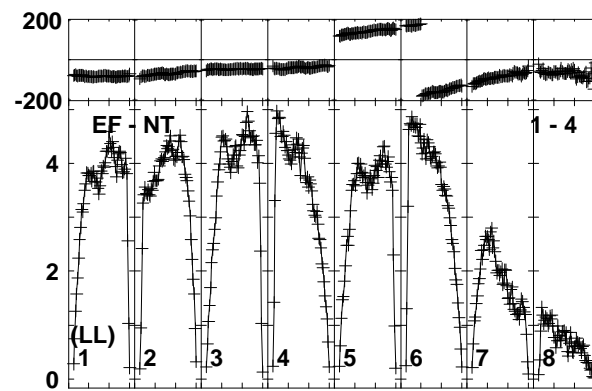
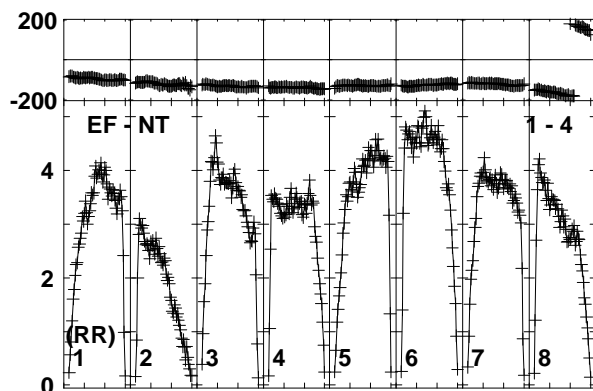
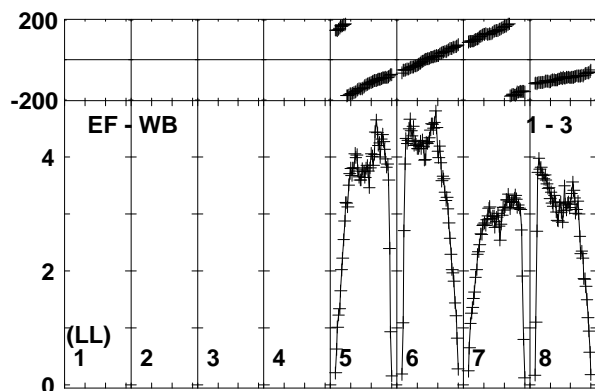
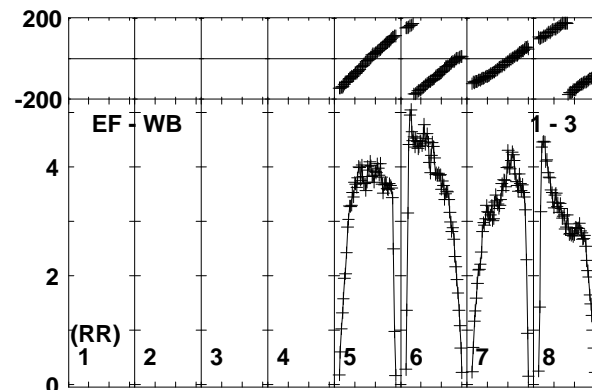
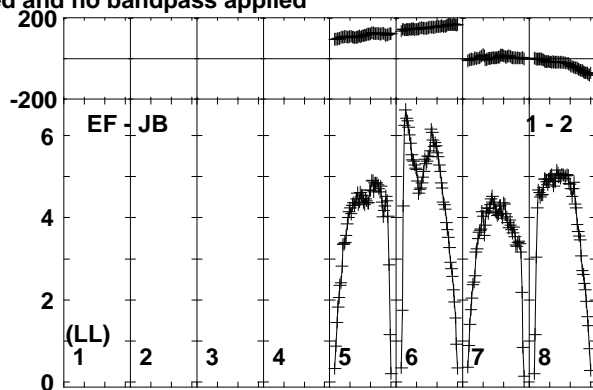
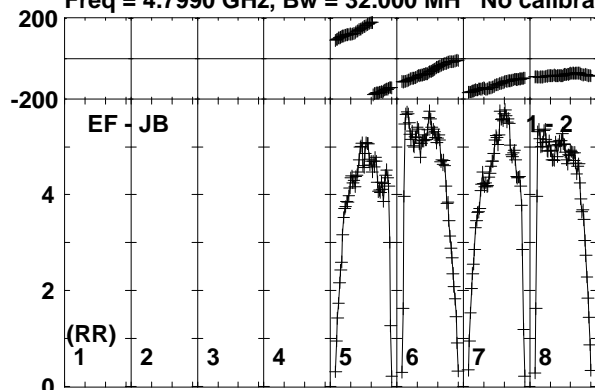

Lower frame: Milli Ampl Jy Top frame: Phas deg
Vector averaged cross-power spectrum Baseline: EF (01) - JB (02)
Timerange: 00/20:18:17 to 00/20:19:46

Plot file version 100 created 03-OCT-2017 13:09:54

J2353+5518 RP028.UVDATA.1

Freq = 4.7990 GHz, Bw = 32.000 MH No calibration applied and no bandpass applied

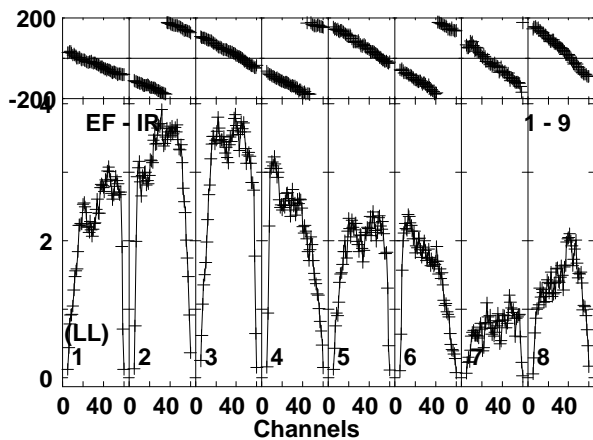
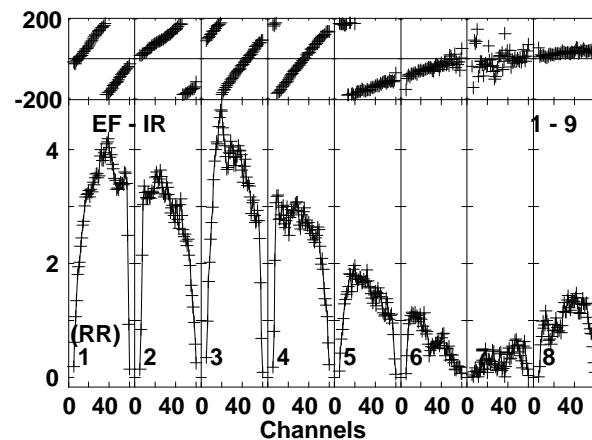
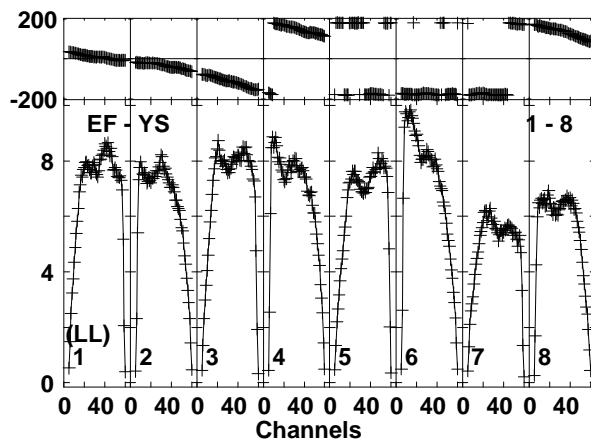
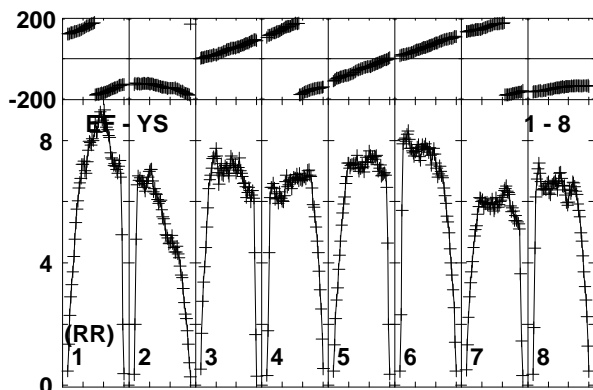
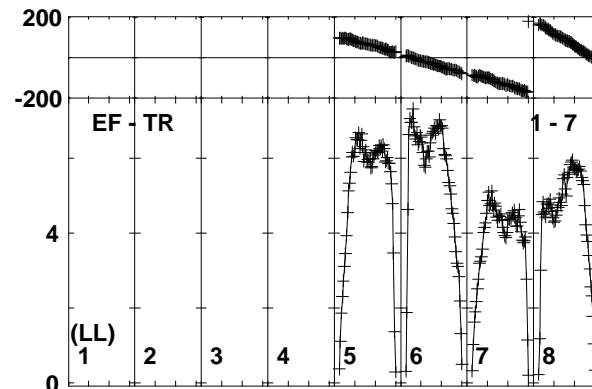
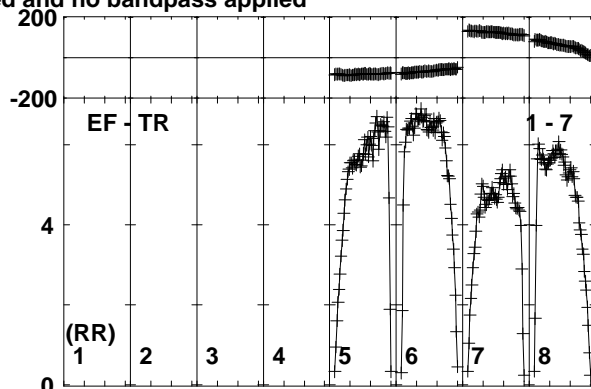
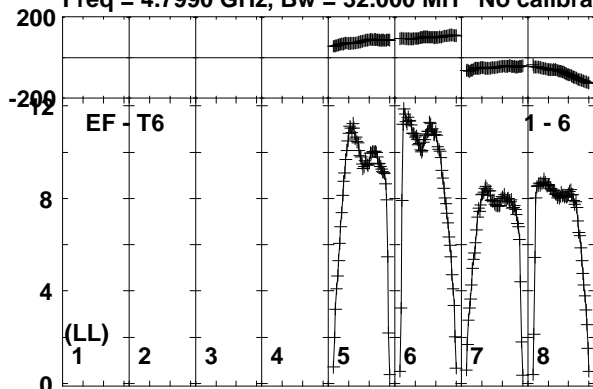

Lower frame: Milli Ampl Jy Top frame: Phas deg
Vector averaged cross-power spectrum Baseline: EF (01) - T6 (06)
Timerange: 00/20:18:17 to 00/20:19:46

Plot file version 101 created 03-OCT-2017 13:09:54

IRAS23436 RP028.UVDATA.1

Freq = 4.7990 GHz, Bw = 32.000 MH No calibration applied and no bandpass applied

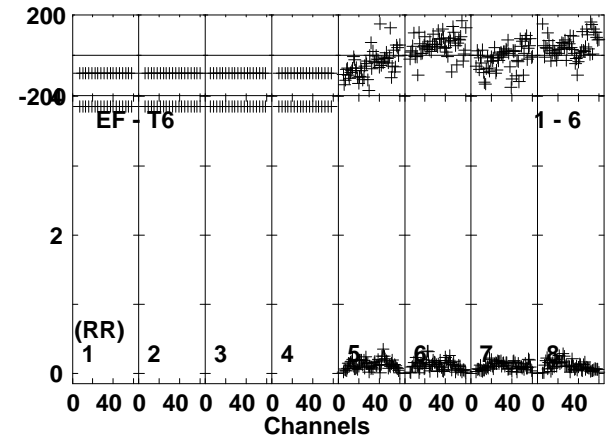
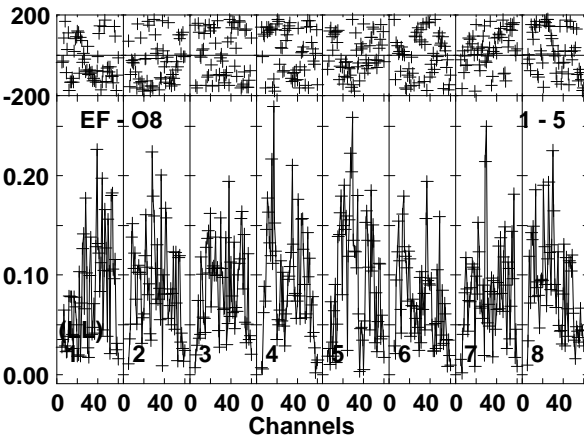
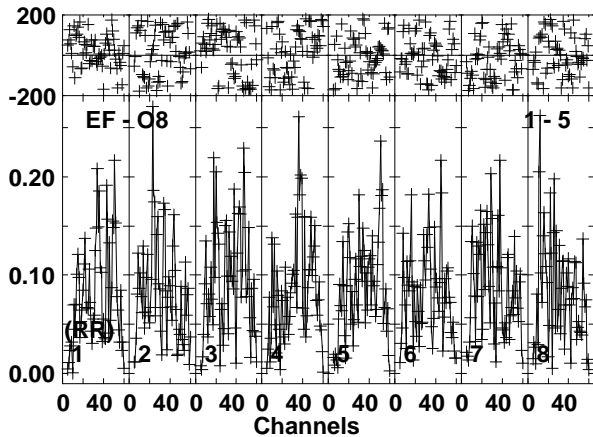
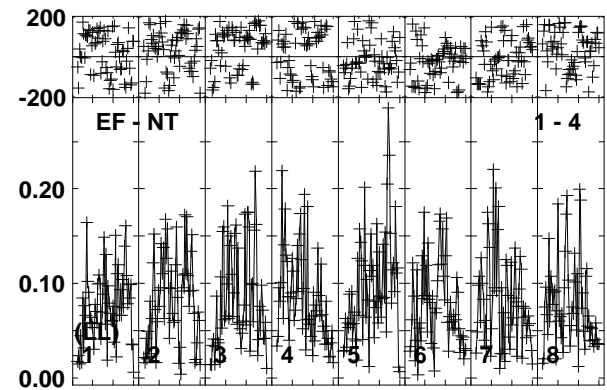
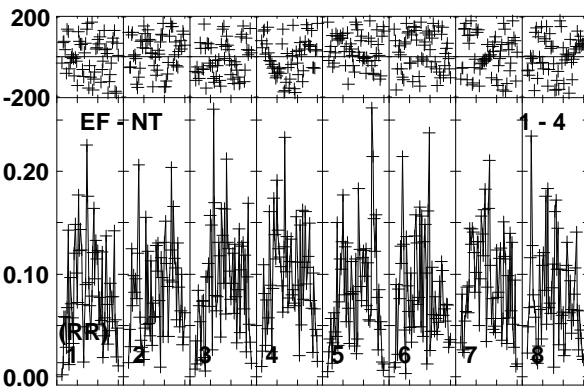
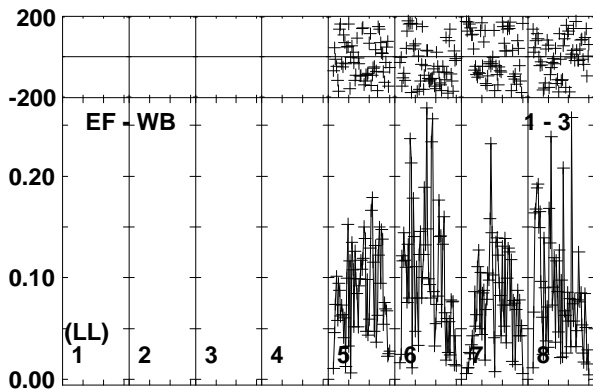
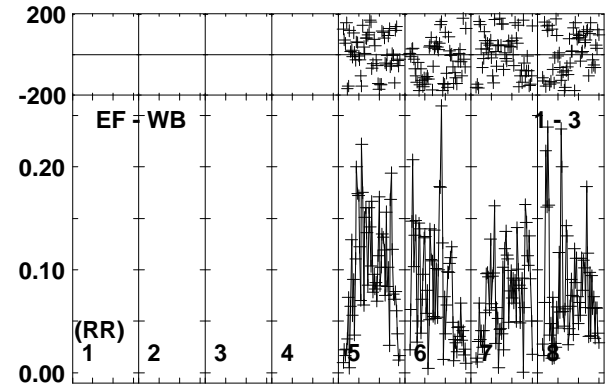
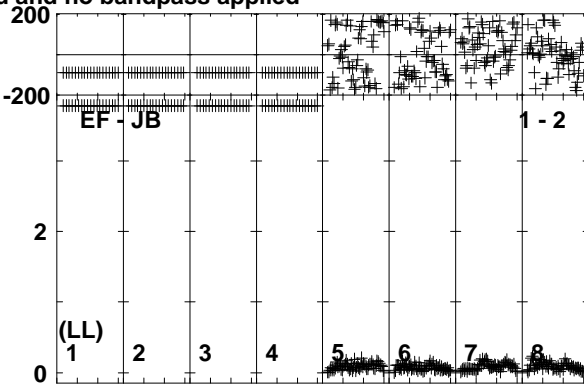
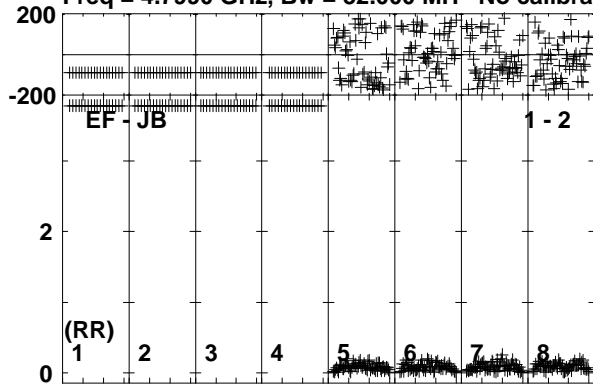

Lower frame: Milli Ampl Jy Top frame: Phas deg
Vector averaged cross-power spectrum Baseline: EF (01) - JB (02)
Timerange: 00/20:19:47 to 00/20:23:29

Plot file version 102 created 03-OCT-2017 13:09:54

IRAS23436 RP028.UVDATA.1

Freq = 4.7990 GHz, Bw = 32.000 MH No calibration applied and no bandpass applied

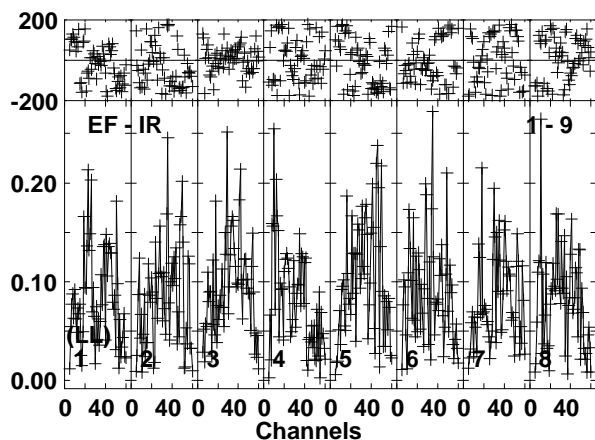
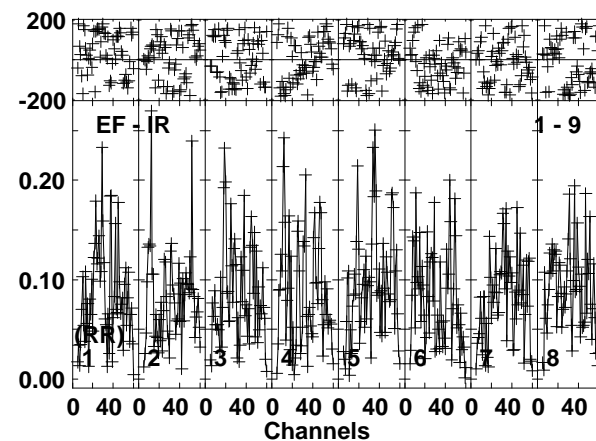
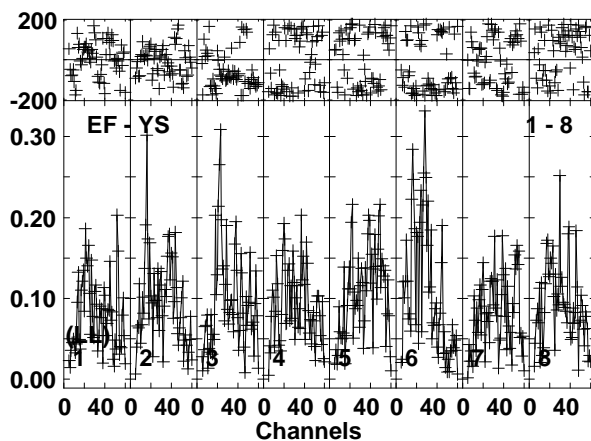
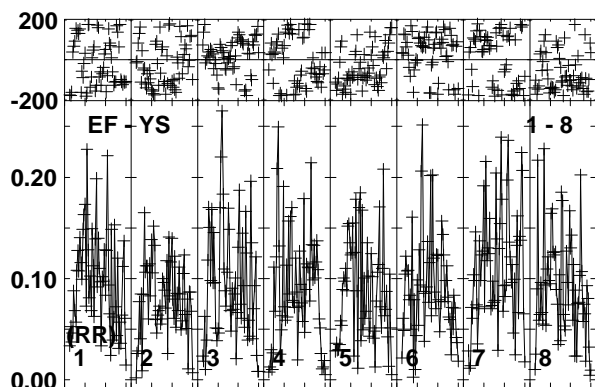
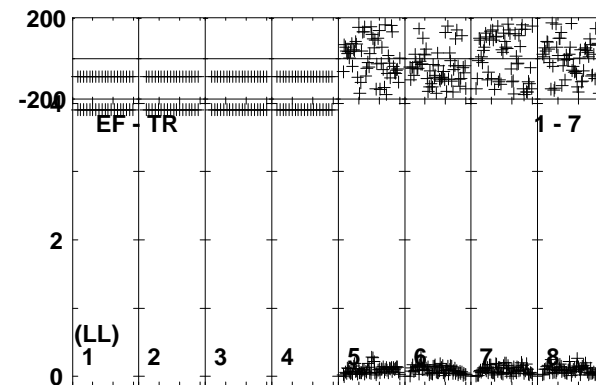
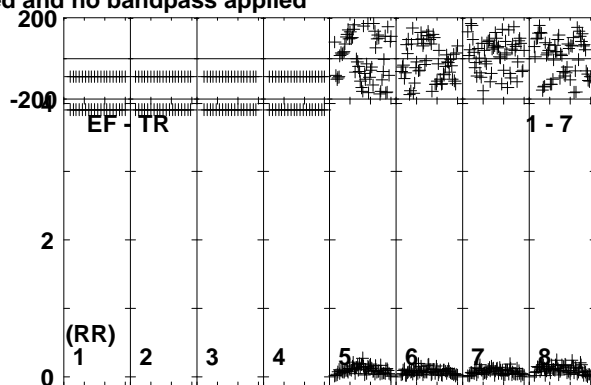
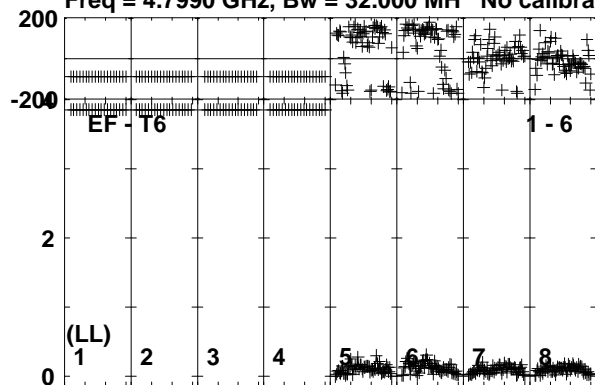

Lower frame: Milli Ampl Jy Top frame: Phas deg
Vector averaged cross-power spectrum Baseline: EF (01) - T6 (06)
Timerange: 00/20:19:47 to 00/20:23:29

Plot file version 103 created 03-OCT-2017 13:09:55

J2353+5518 RP028.UVDATA.1

Freq = 4.7990 GHz, Bw = 32.000 MH No calibration applied and no bandpass applied

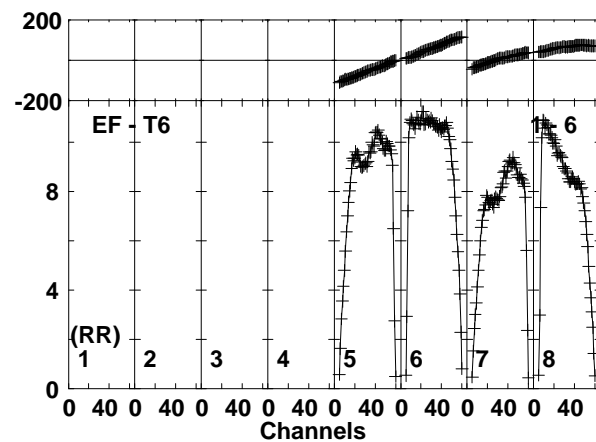
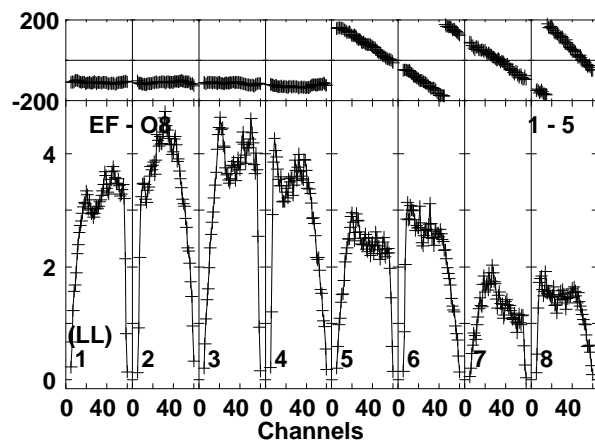
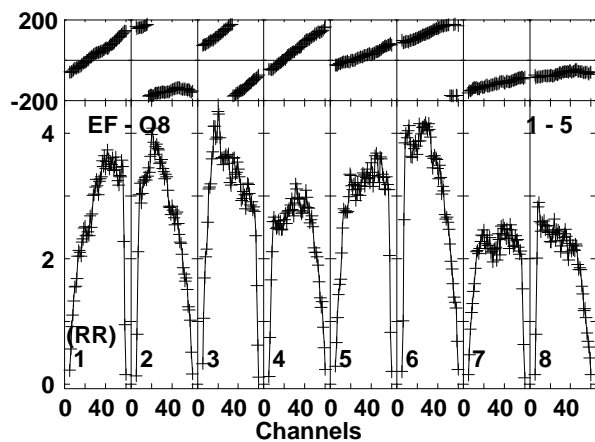
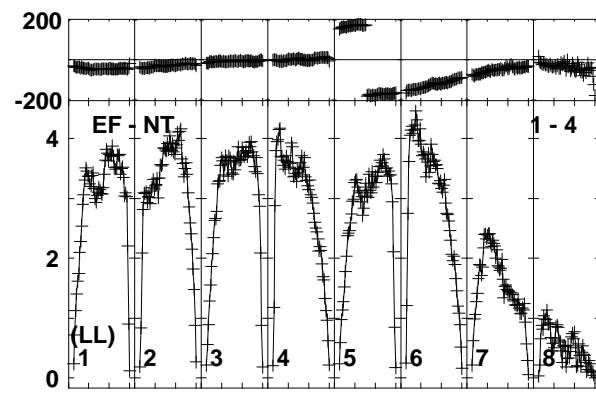
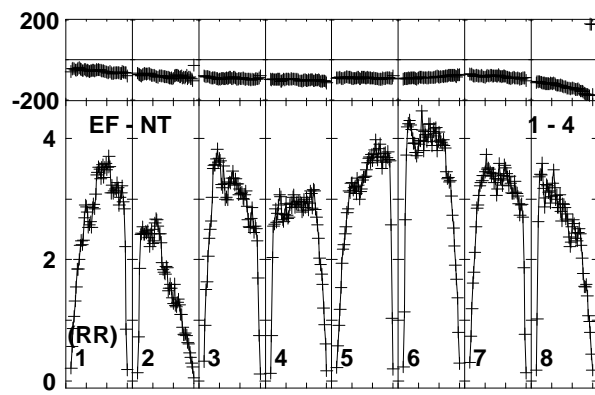
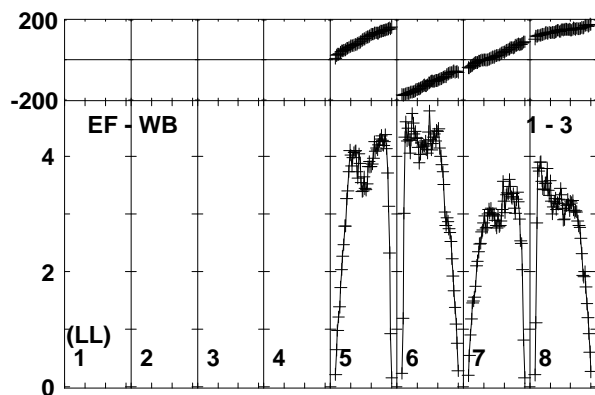
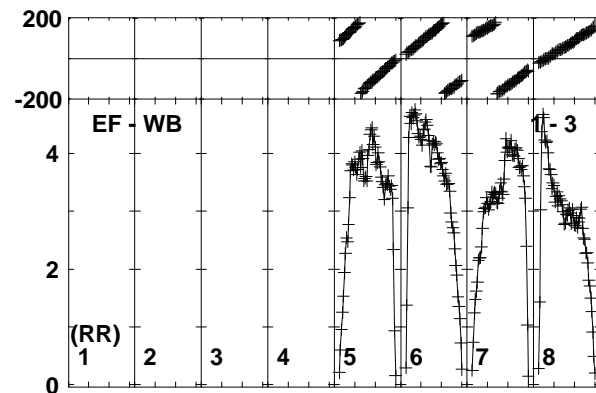
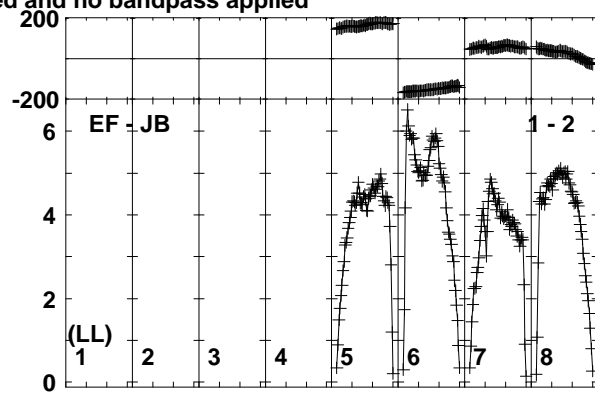
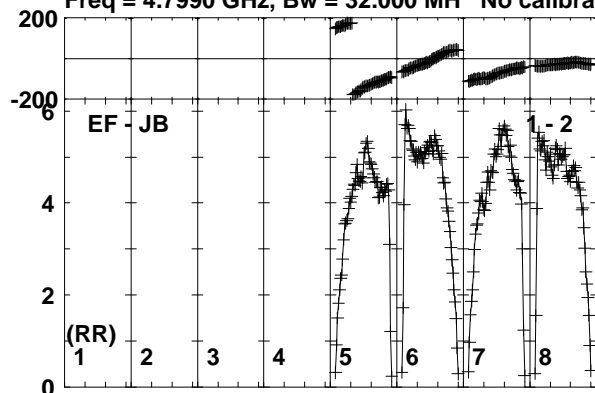

Lower frame: Milli Ampl Jy Top frame: Phas deg
Vector averaged cross-power spectrum Baseline: EF (01) - JB (02)
Timerange: 00/20:24:10 to 00/20:25:00

Plot file version 104 created 03-OCT-2017 13:09:55

J2353+5518 RP028.UVDATA.1

Freq = 4.7990 GHz, Bw = 32.000 MH No calibration applied and no bandpass applied

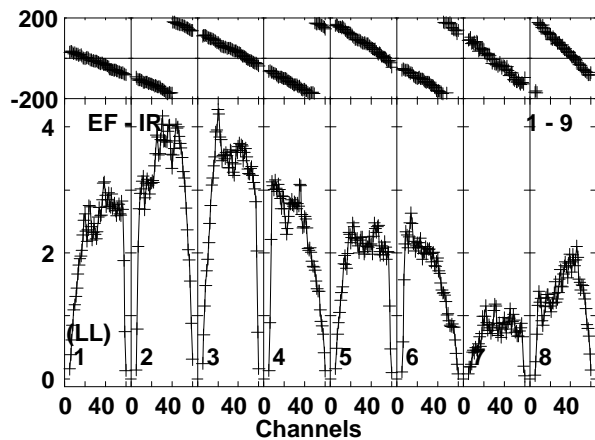
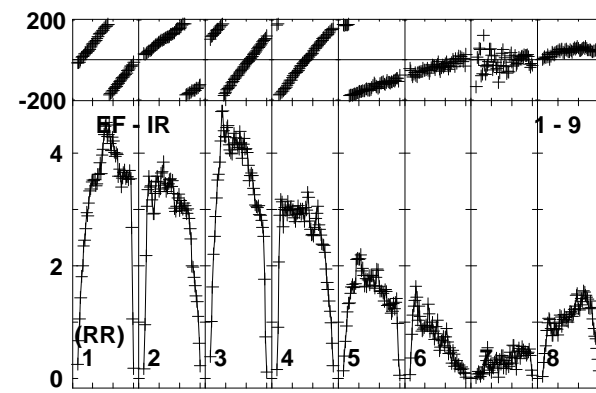
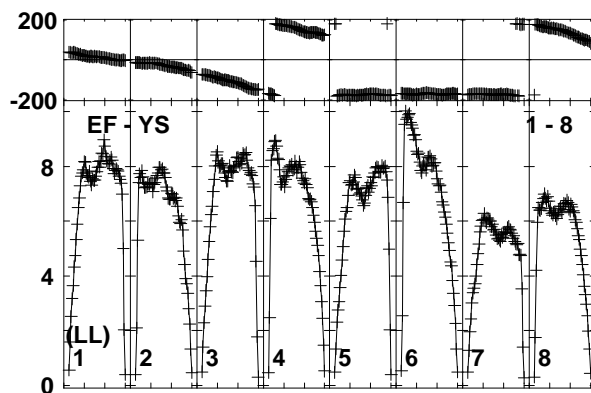
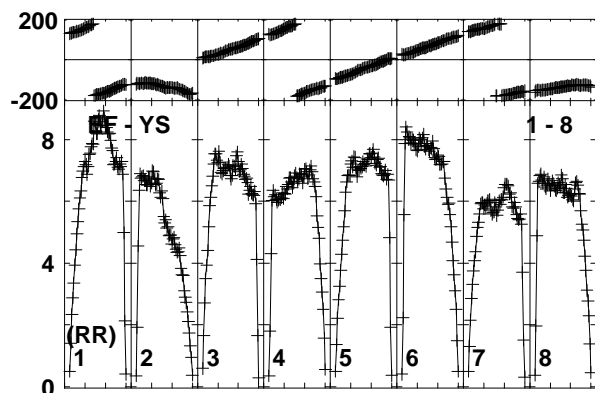
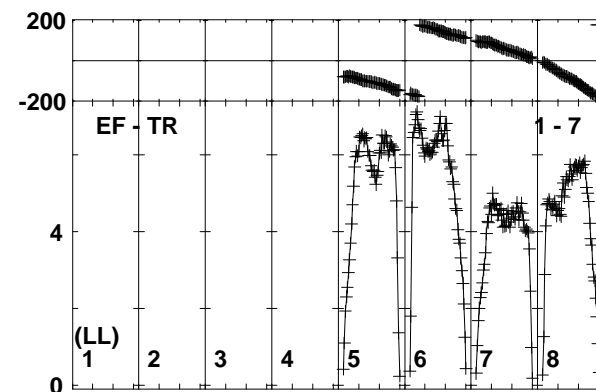
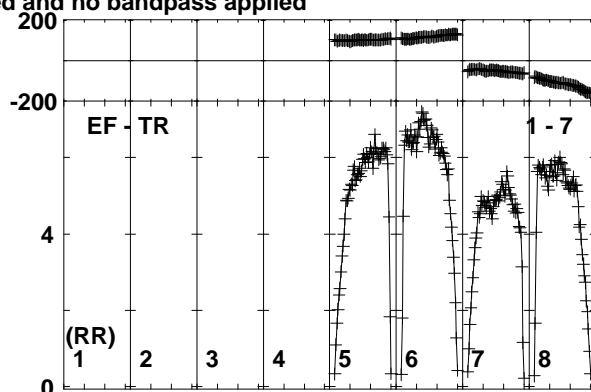
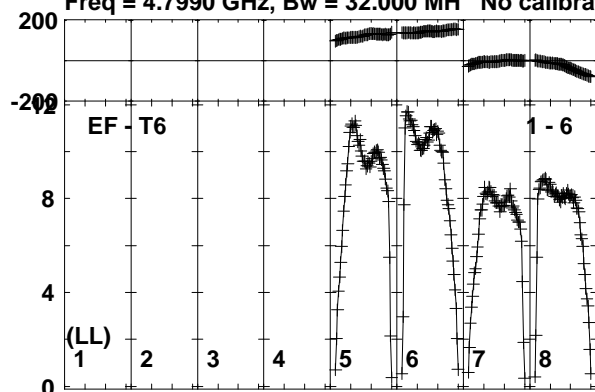

Lower frame: Milli Ampl Jy Top frame: Phas deg
Vector averaged cross-power spectrum Baseline: EF (01) - T6 (06)
Timerange: 00/20:24:10 to 00/20:25:00

Plot file version 105 created 03-OCT-2017 13:09:55

IRAS23436 RP028.UVDATA.1

Freq = 4.7990 GHz, Bw = 32.000 MH No calibration applied and no bandpass applied

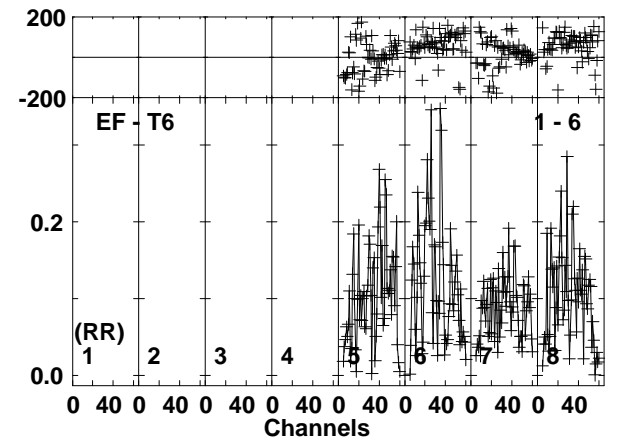
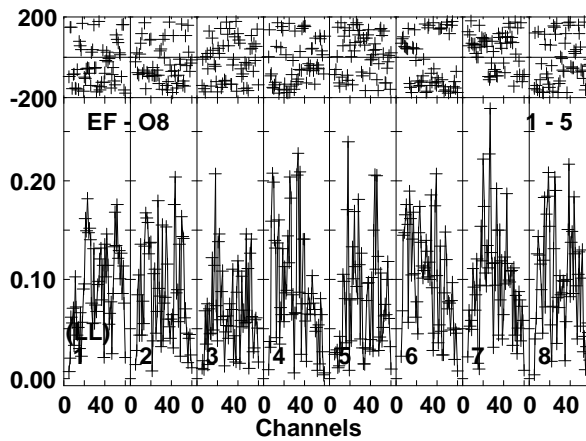
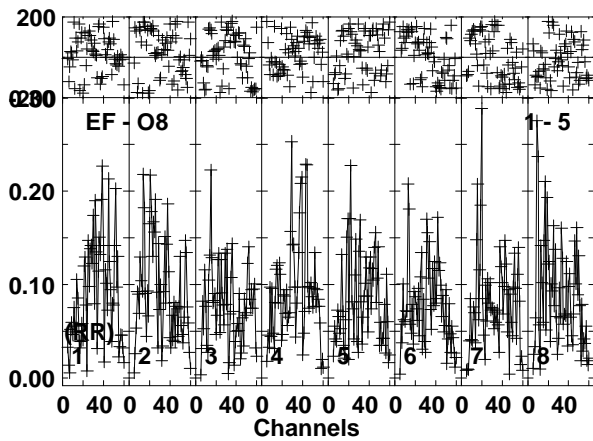
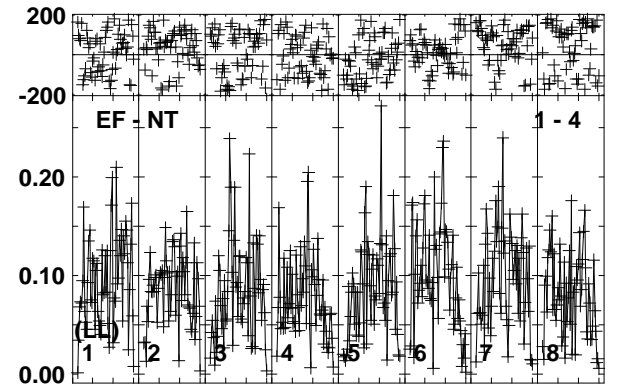
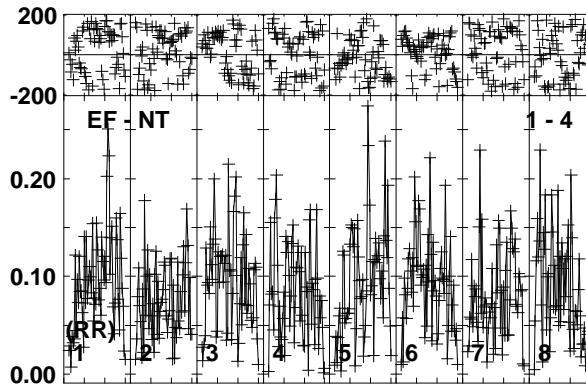
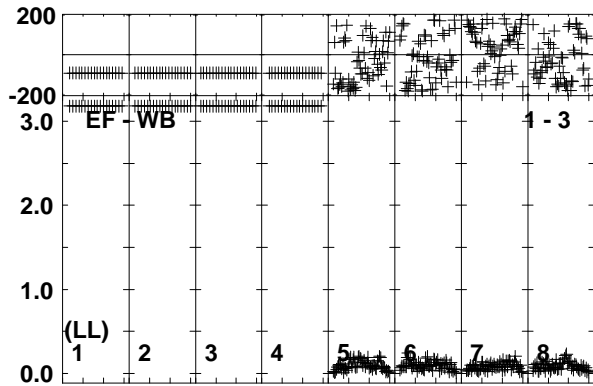
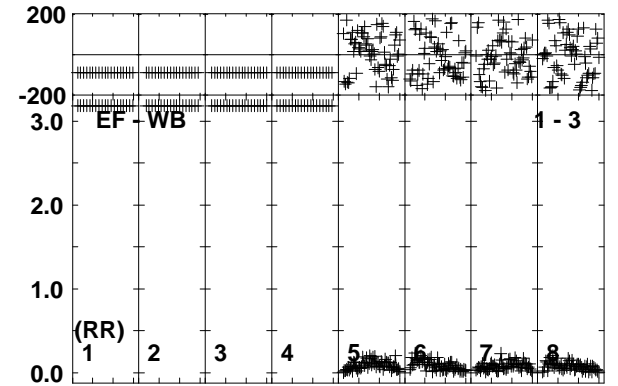
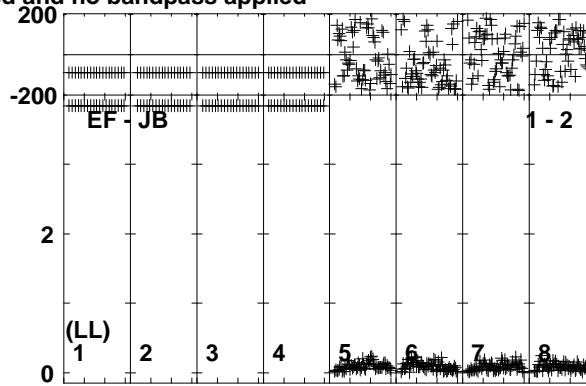
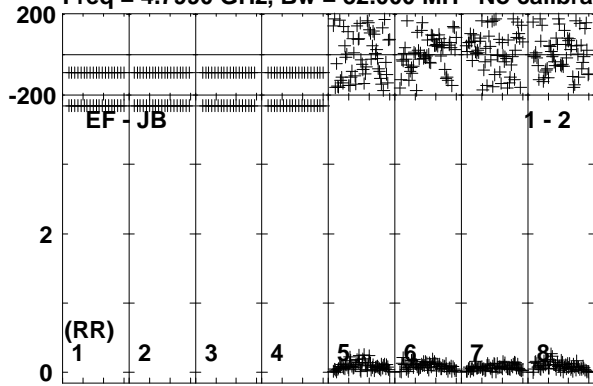

Lower frame: Milli Ampl Jy Top frame: Phas deg
Vector averaged cross-power spectrum Baseline: EF (01) - JB (02)
Timerange: 00/20:25:00 to 00/20:28:44

Plot file version 106 created 03-OCT-2017 13:09:55

IRAS23436 RP028.UVDATA.1

Freq = 4.7990 GHz, Bw = 32.000 MH No calibration applied and no bandpass applied

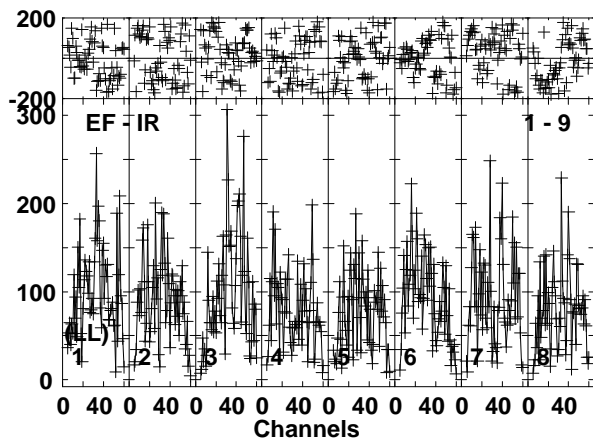
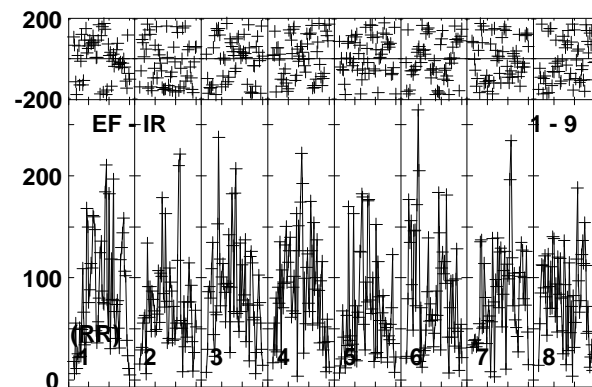
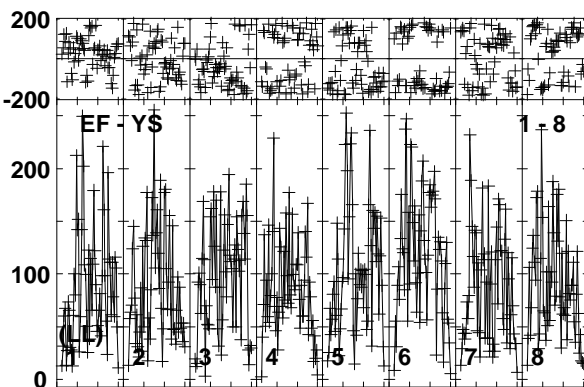
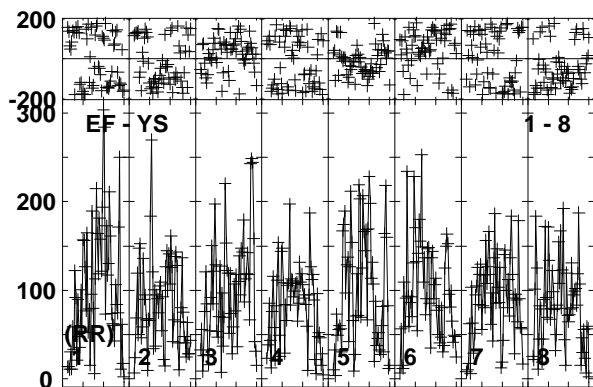
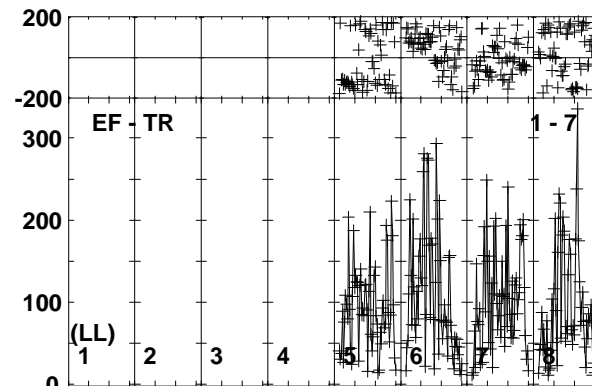
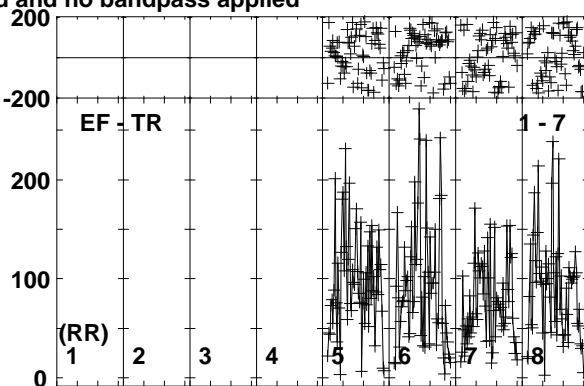
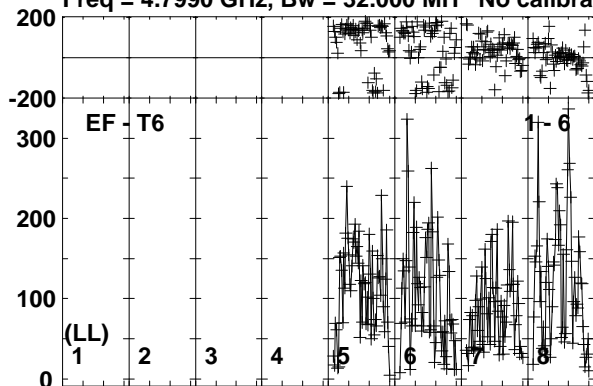

Lower frame: Micro Ampl Jy Top frame: Phas deg
Vector averaged cross-power spectrum Baseline: EF (01) - T6 (06)
Timerange: 00/20:25:00 to 00/20:28:44

Plot file version 107 created 03-OCT-2017 13:09:55

J2353+5518 RP028.UVDATA.1

Freq = 4.7990 GHz, Bw = 32.000 MH No calibration applied and no bandpass applied

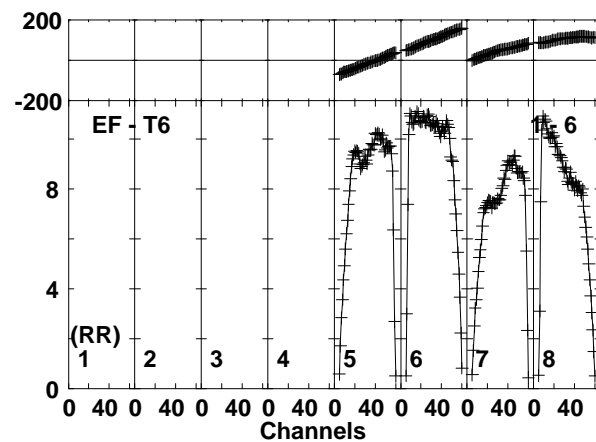
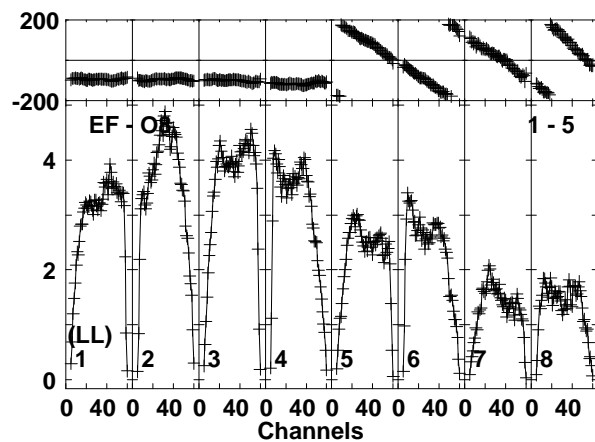
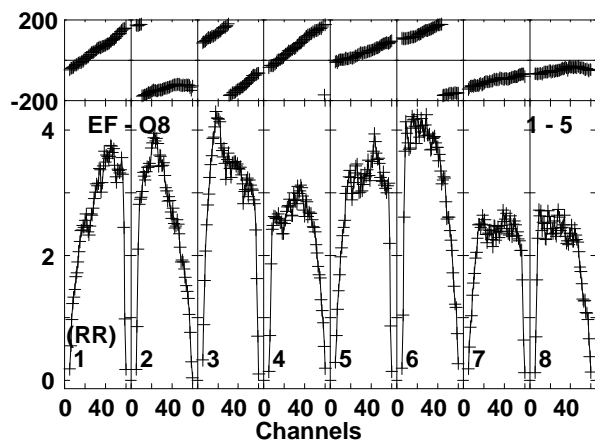
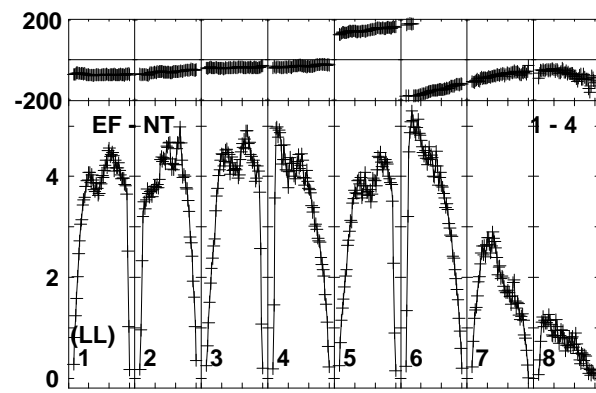
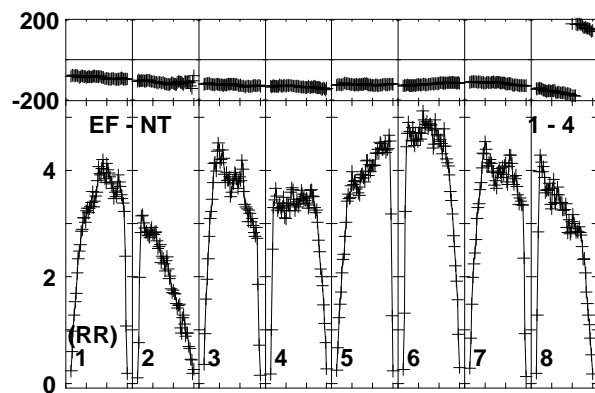
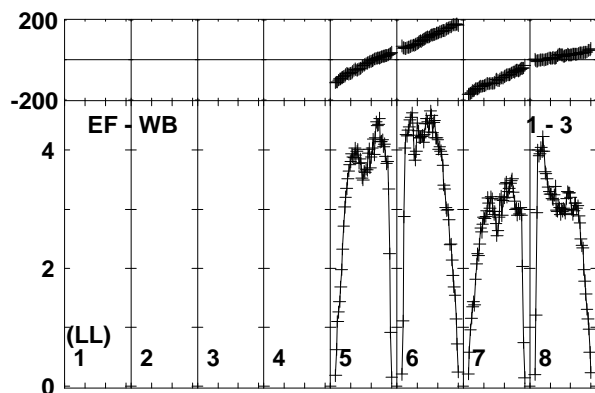
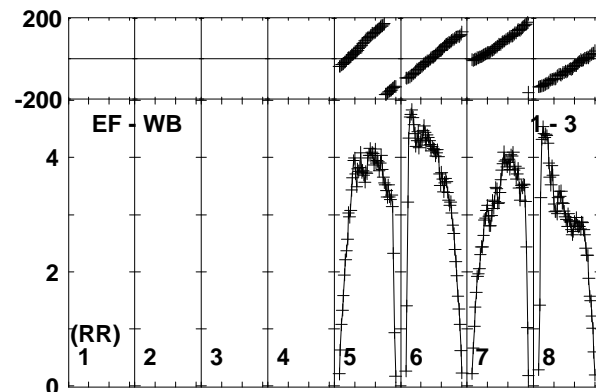
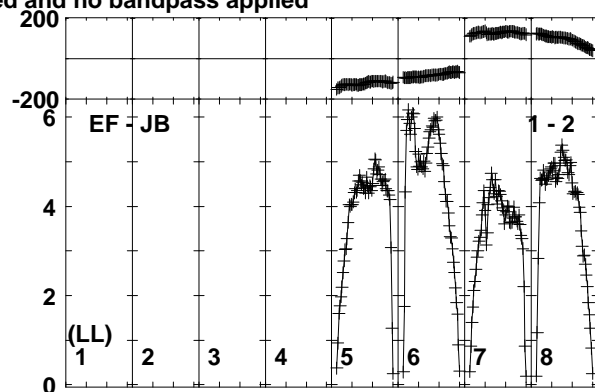
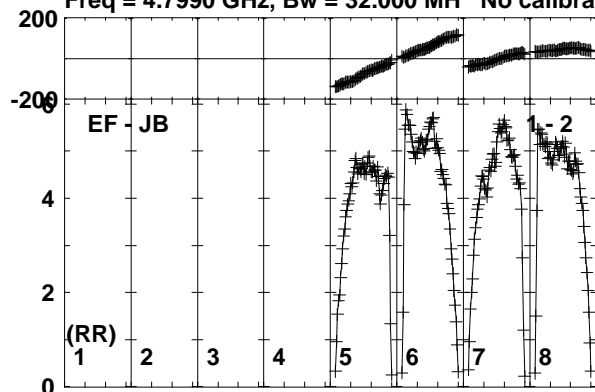

Lower frame: Milli Ampl Jy Top frame: Phas deg
Vector averaged cross-power spectrum Baseline: EF (01) - JB (02)
Timerange: 00/20:28:44 to 00/20:30:13

Plot file version 108 created 03-OCT-2017 13:09:56

J2353+5518 RP028.UVDATA.1

Freq = 4.7990 GHz, Bw = 32.000 MH No calibration applied and no bandpass applied

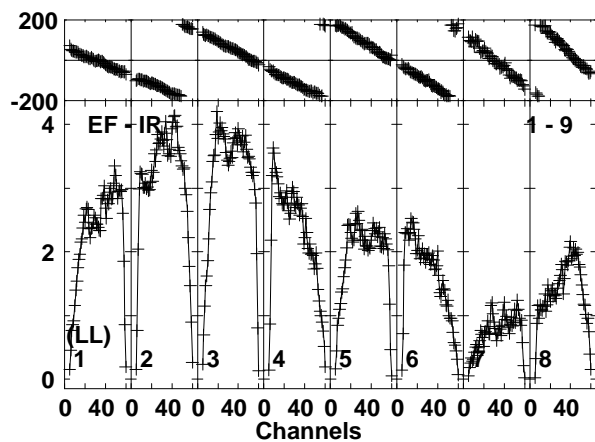
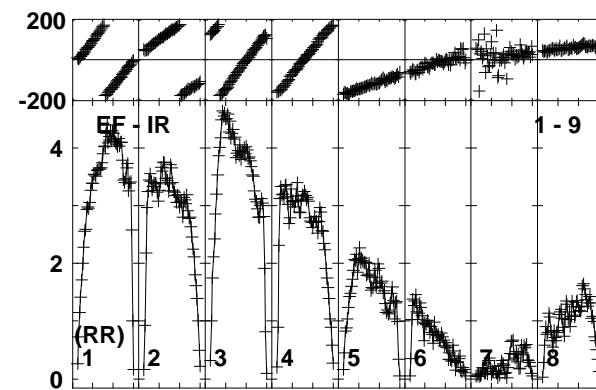
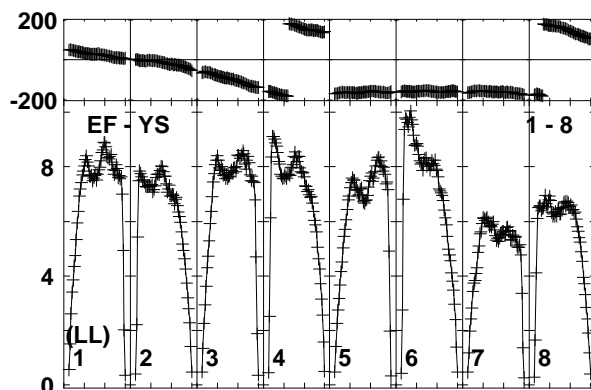
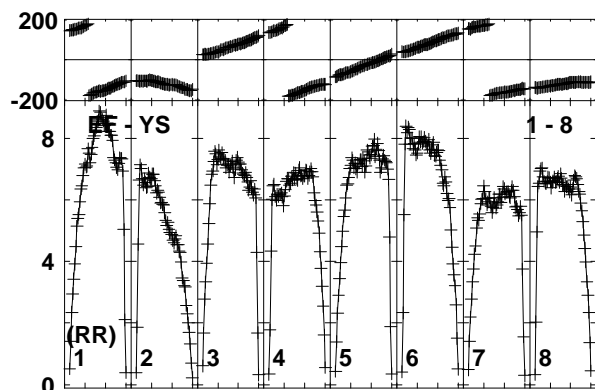
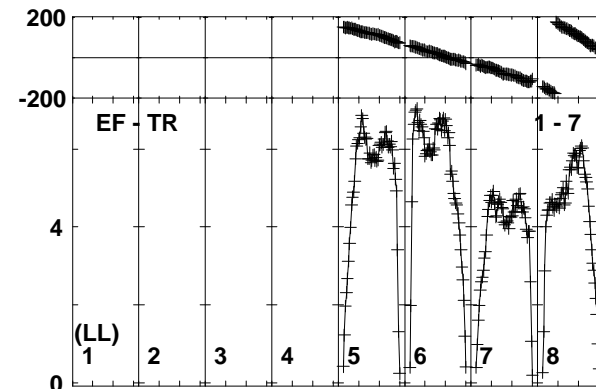
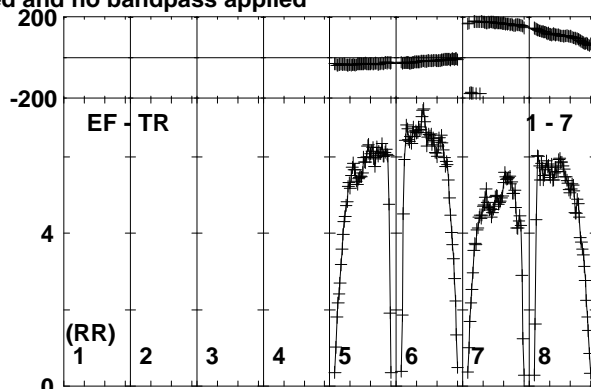
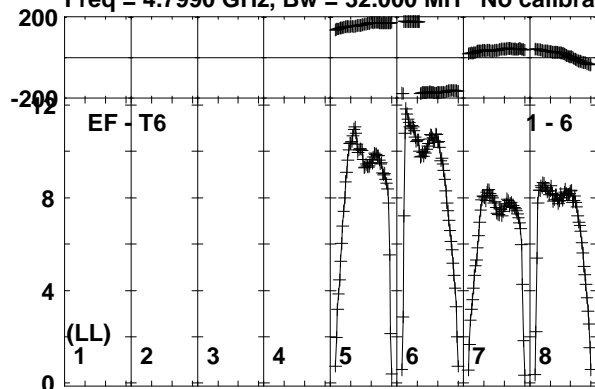

Lower frame: Milli Ampl Jy Top frame: Phas deg
Vector averaged cross-power spectrum Baseline: EF (01) - T6 (06)
Timerange: 00/20:28:44 to 00/20:30:13

Plot file version 109 created 03-OCT-2017 13:09:56

IRAS23436 RP028.UVDATA.1

Freq = 4.7990 GHz, Bw = 32.000 MH No calibration applied and no bandpass applied

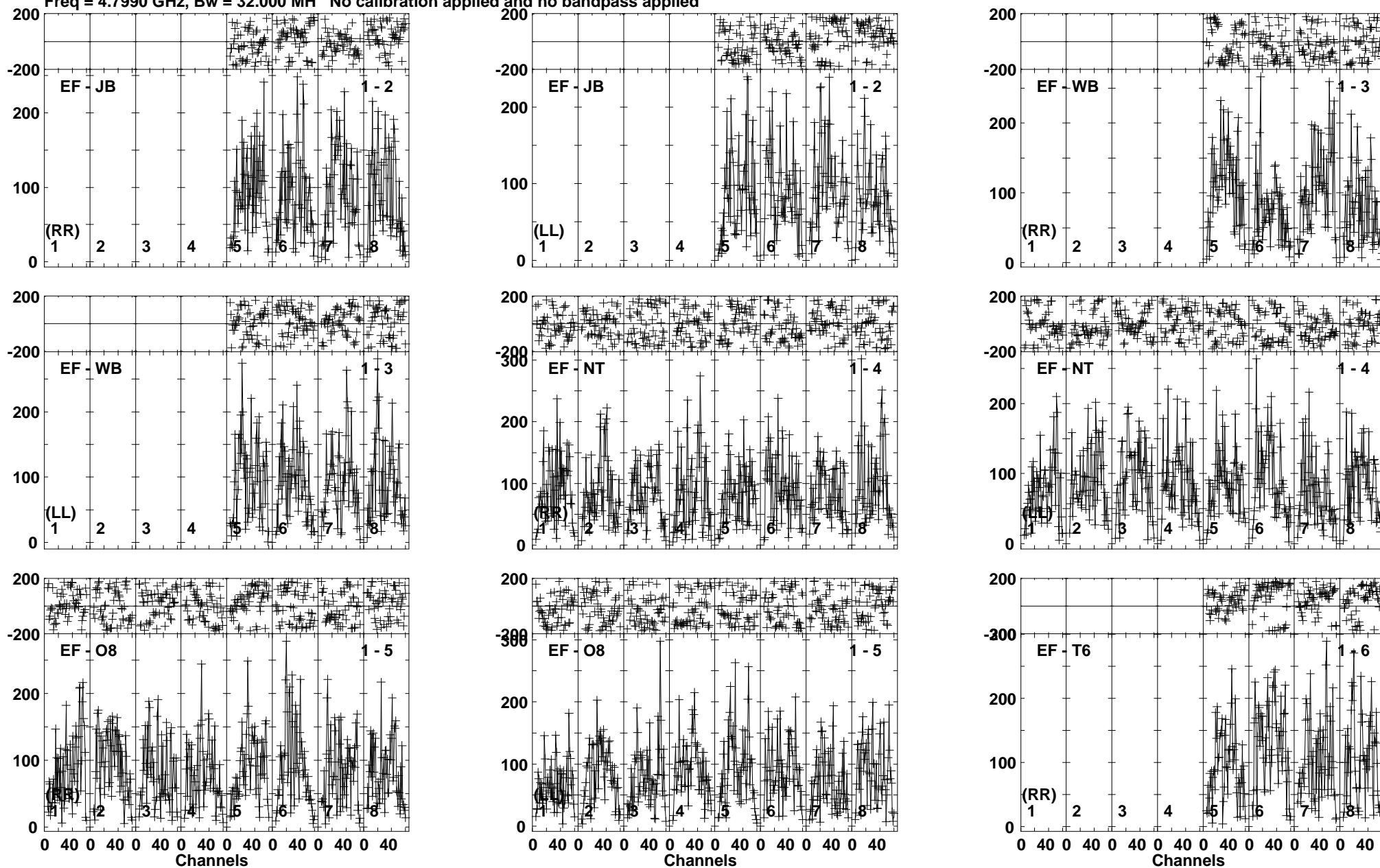

Lower frame: Micro Ampl Jy Top frame: Phas deg
Vector averaged cross-power spectrum Baseline: EF (01) - JB (02)
Timerange: 00/20:30:15 to 00/20:33:58

Plot file version 110 created 03-OCT-2017 13:09:56

IRAS23436 RP028.UVDATA.1

Freq = 4.7990 GHz, Bw = 32.000 MH No calibration applied and no bandpass applied

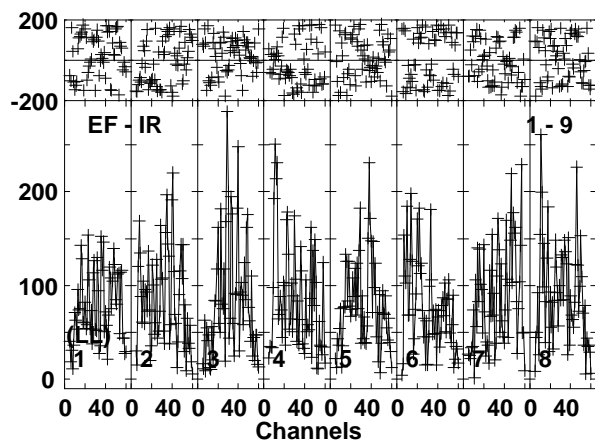
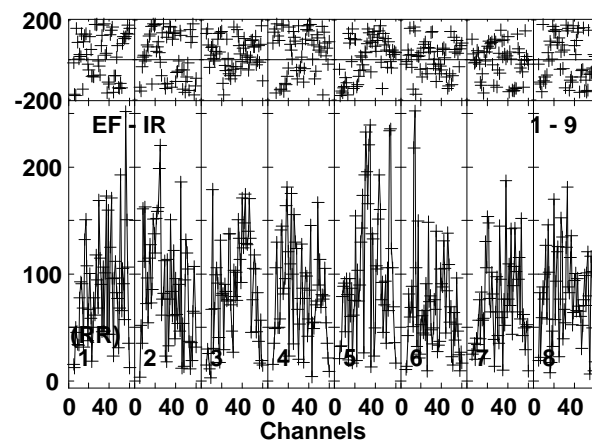
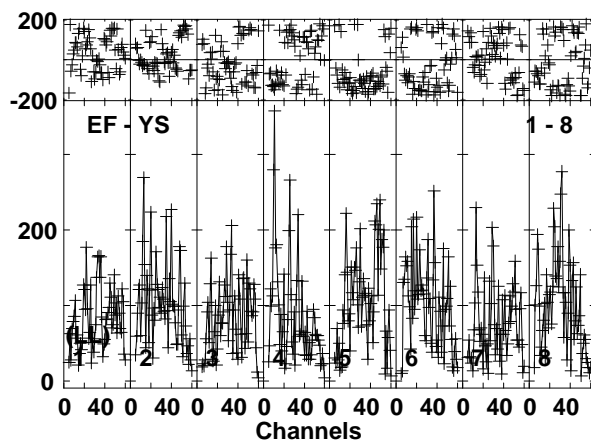
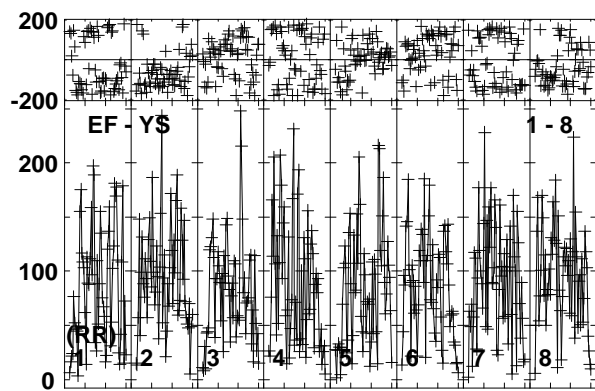
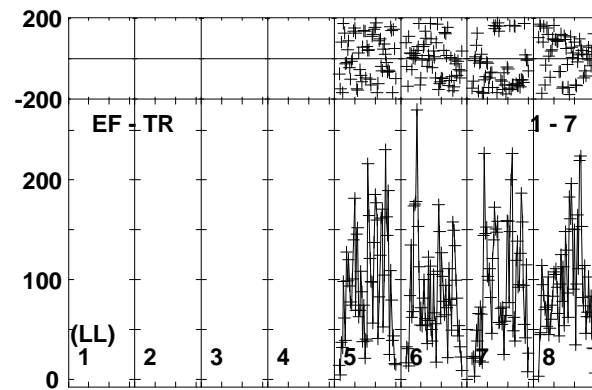
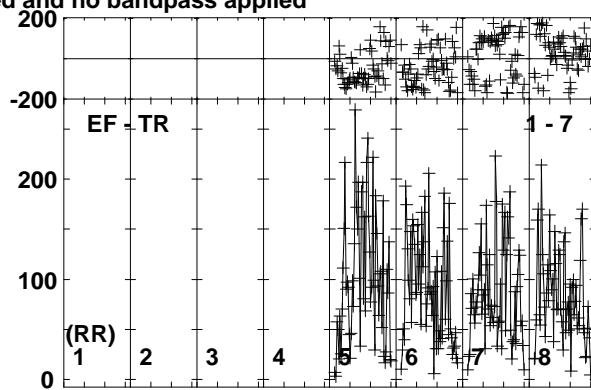
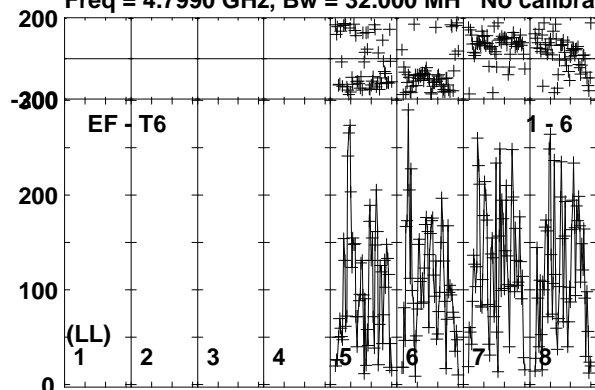

Lower frame: Micro Ampl Jy Top frame: Phas deg
Vector averaged cross-power spectrum Baseline: EF (01) - T6 (06)
Timerange: 00/20:30:15 to 00/20:33:58

Plot file version 111 created 03-OCT-2017 13:09:56

J2353+5518 RP028.UVDATA.1

Freq = 4.7990 GHz, Bw = 32.000 MH No calibration applied and no bandpass applied

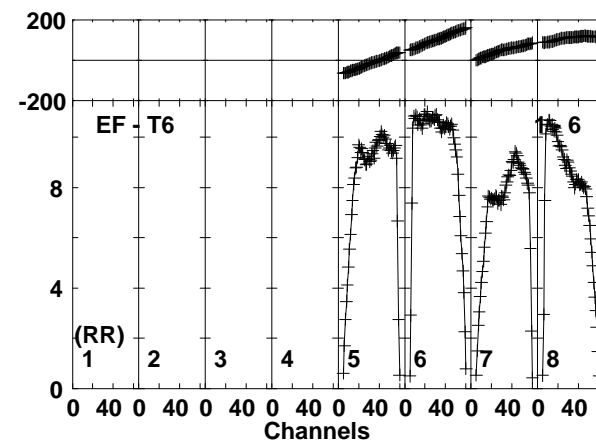
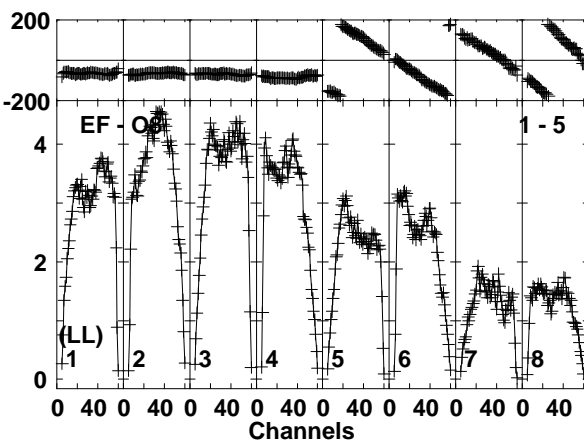
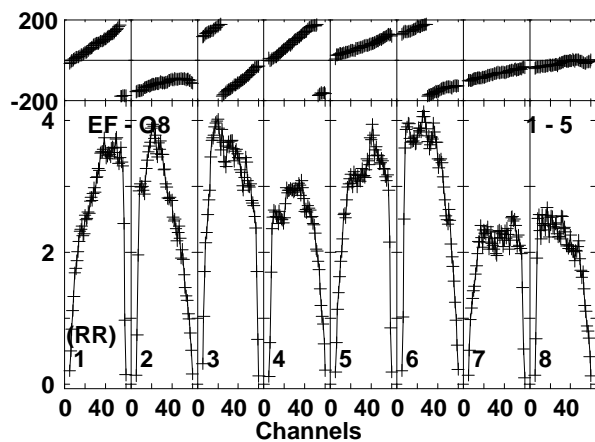
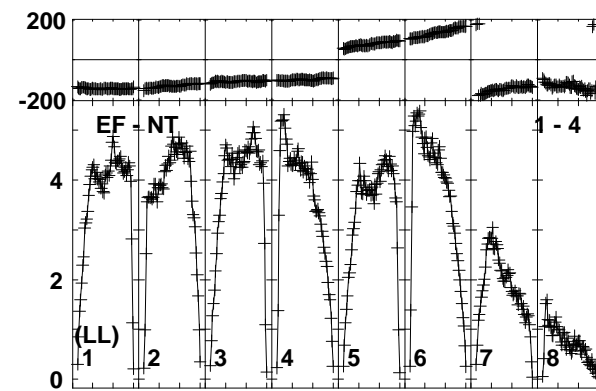
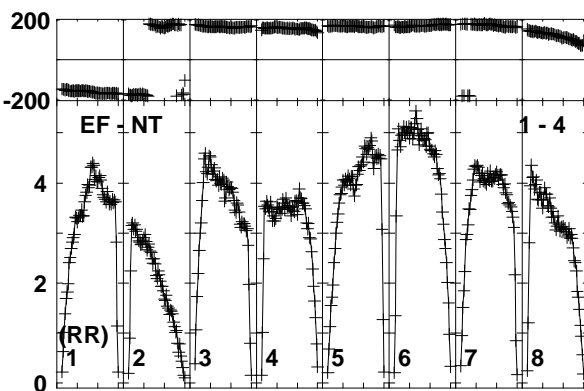
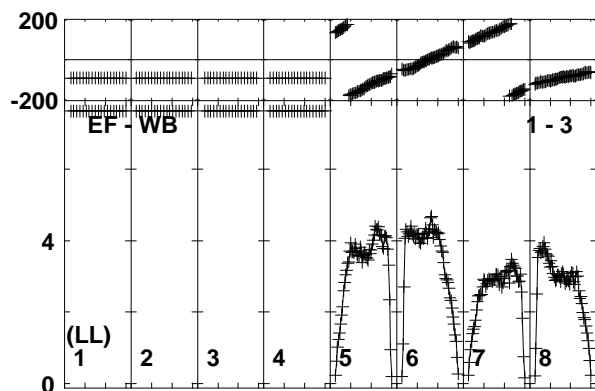
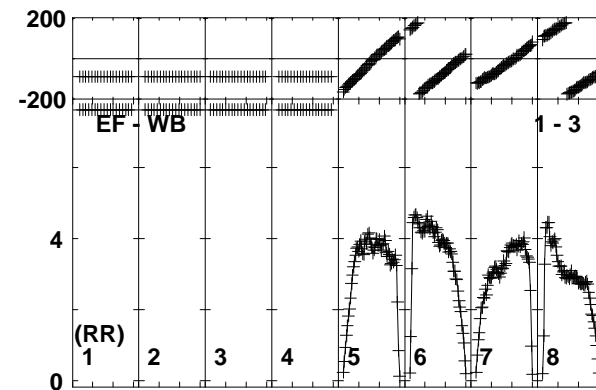
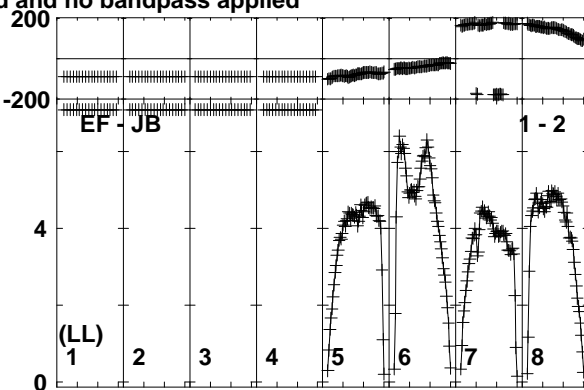
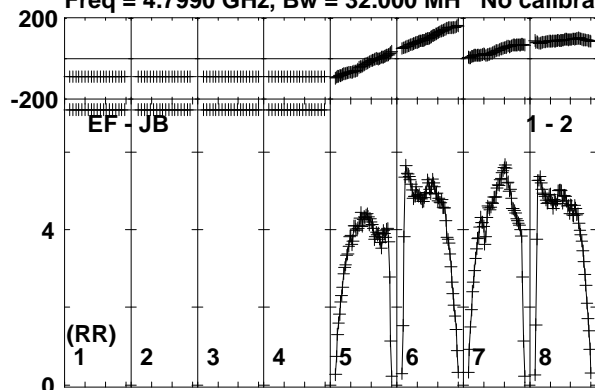

Lower frame: Milli Ampl Jy Top frame: Phas deg
Vector averaged cross-power spectrum Baseline: EF (01) - JB (02)
Timerange: 00/20:34:39 to 00/20:35:38

Plot file version 112 created 03-OCT-2017 13:09:56

J2353+5518 RP028.UVDATA.1

Freq = 4.7990 GHz, Bw = 32.000 MH No calibration applied and no bandpass applied

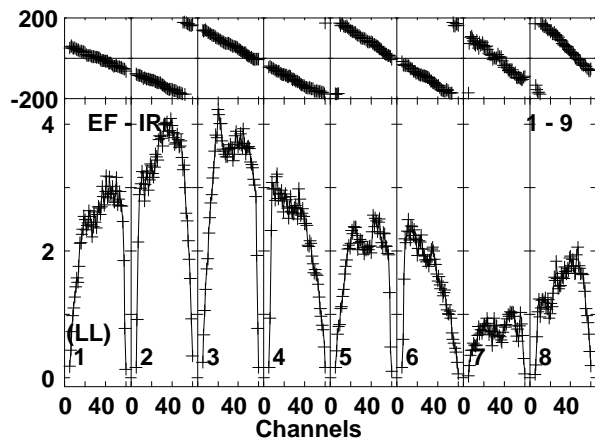
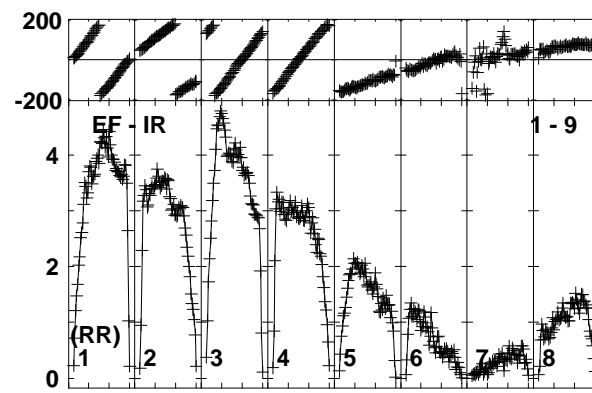
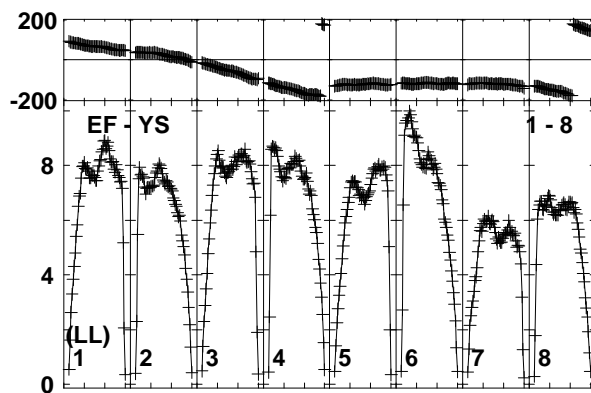
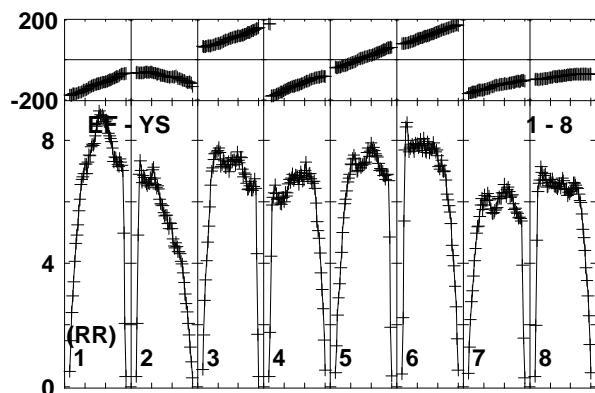
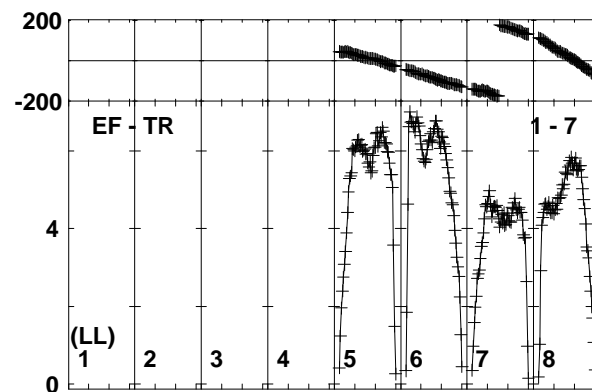
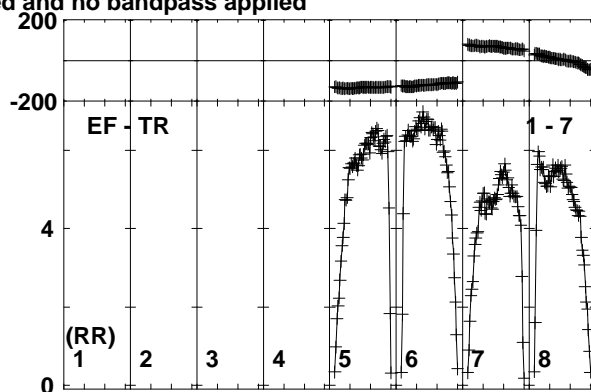
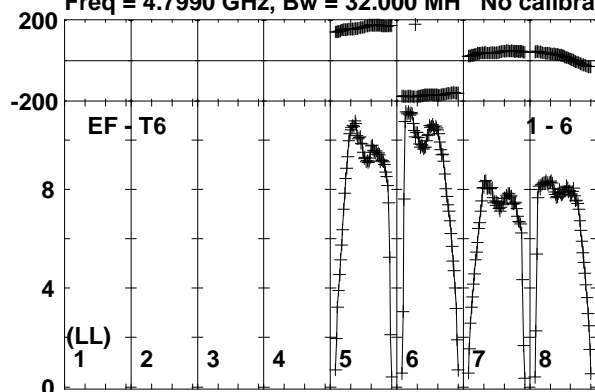

Lower frame: Milli Ampl Jy Top frame: Phas deg
Vector averaged cross-power spectrum Baseline: EF (01) - T6 (06)
Timerange: 00/20:34:39 to 00/20:35:38

Plot file version 113 created 03-OCT-2017 13:09:57

IRAS23436 RP028.UVDATA.1

Freq = 4.7990 GHz, Bw = 32.000 MH No calibration applied and no bandpass applied

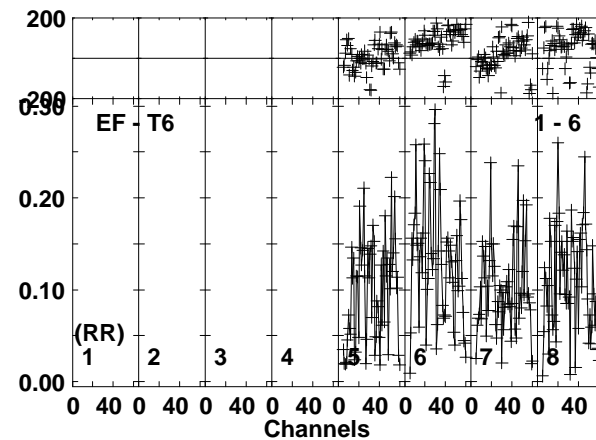
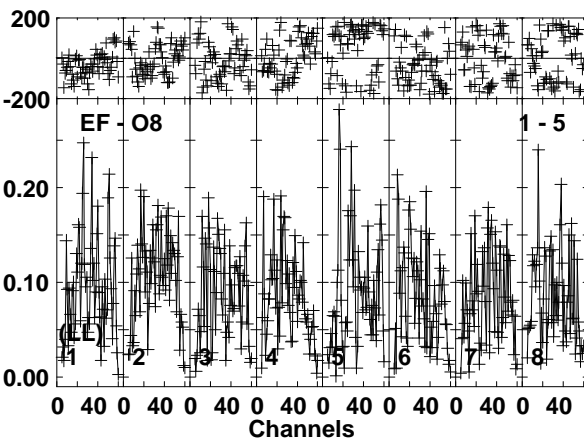
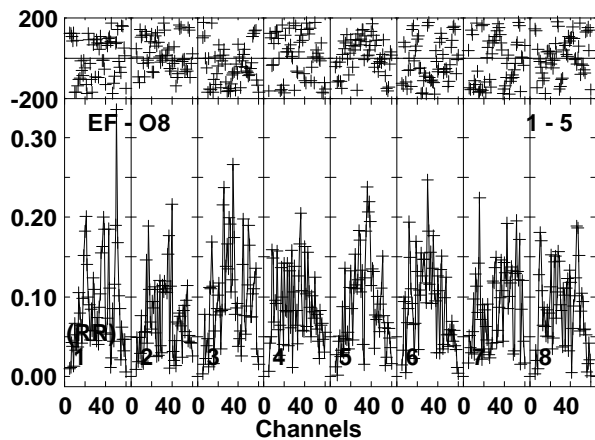
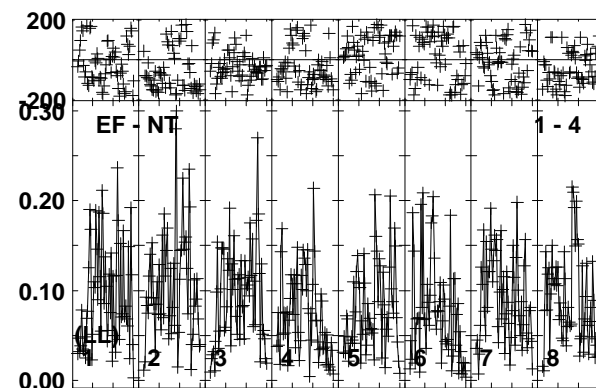
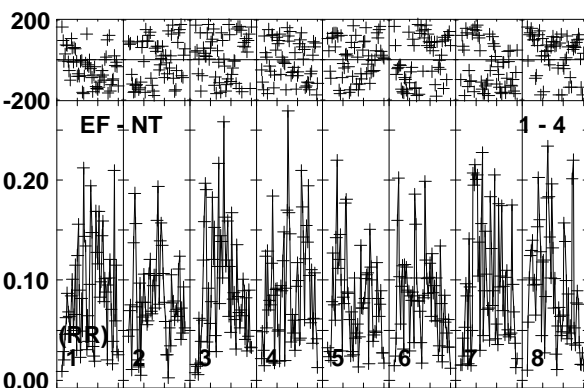
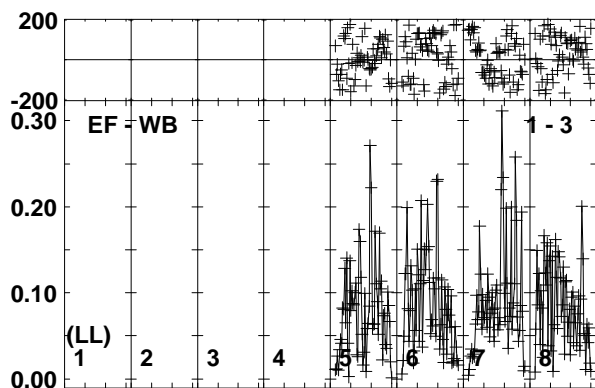
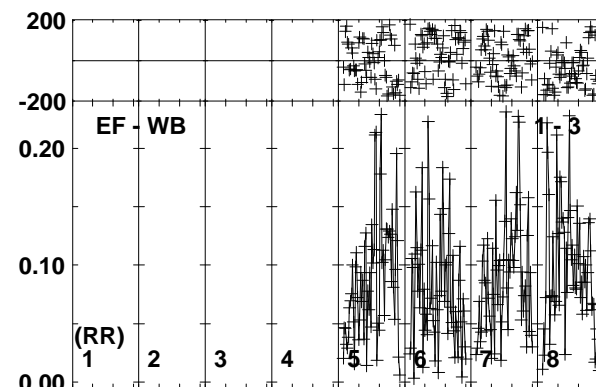
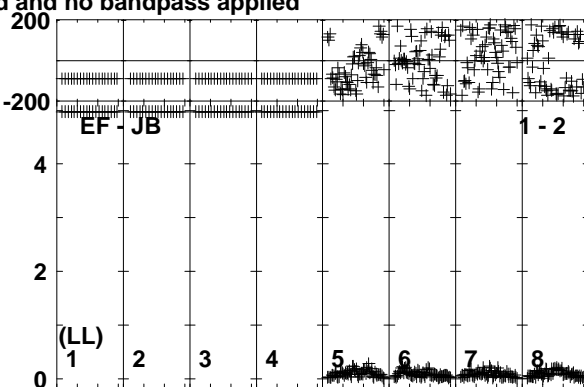
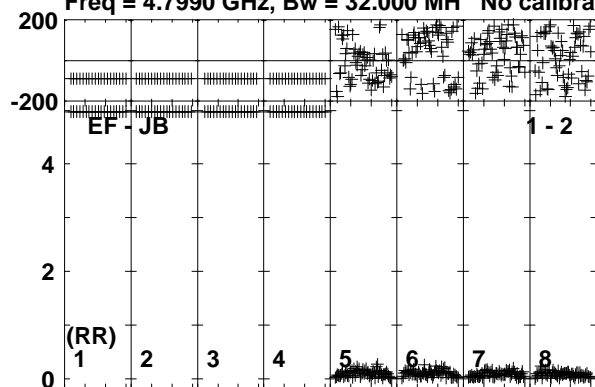

Lower frame: Milli Ampl Jy Top frame: Phas deg
Vector averaged cross-power spectrum Baseline: EF (01) - JB (02)
Timerange: 00/20:35:39 to 00/20:39:18

Plot file version 114 created 03-OCT-2017 13:09:57

IRAS23436 RP028.UVDATA.1

Freq = 4.7990 GHz, Bw = 32.000 MH No calibration applied and no bandpass applied

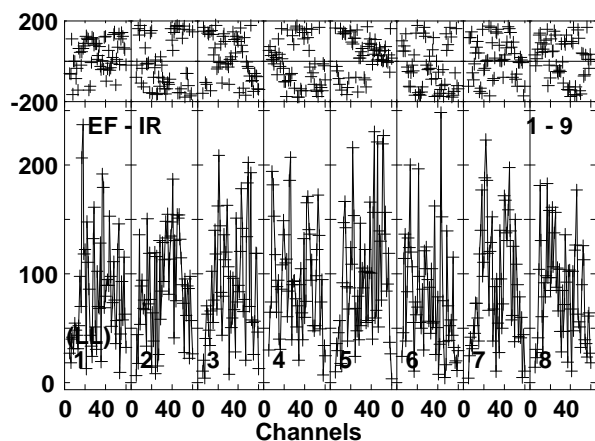
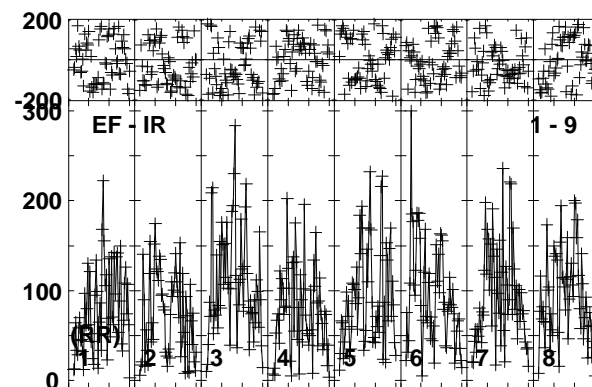
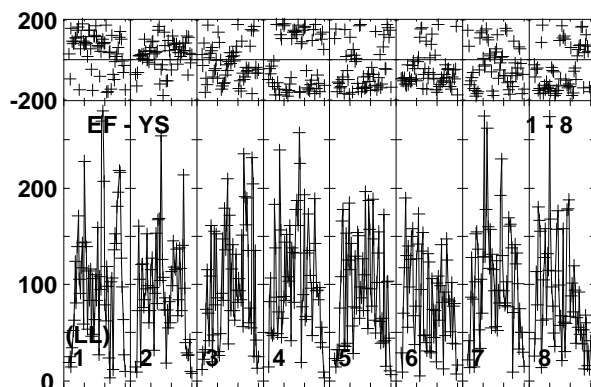
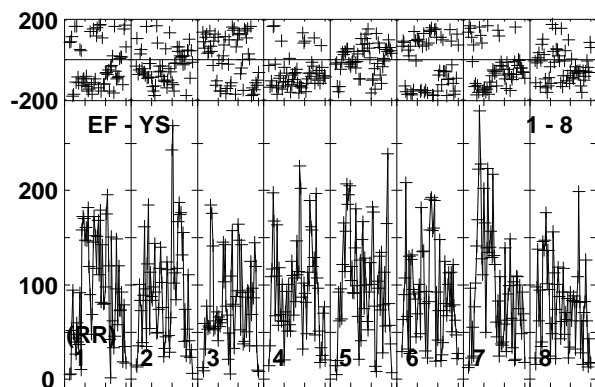
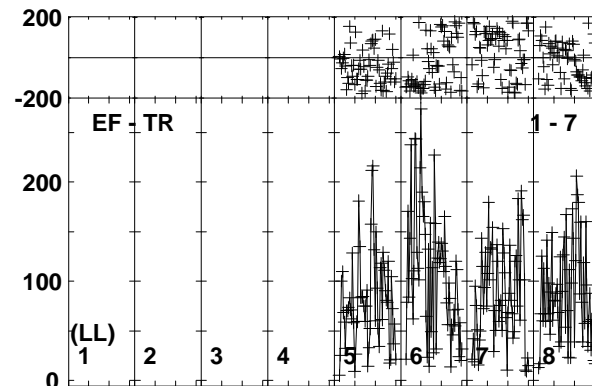
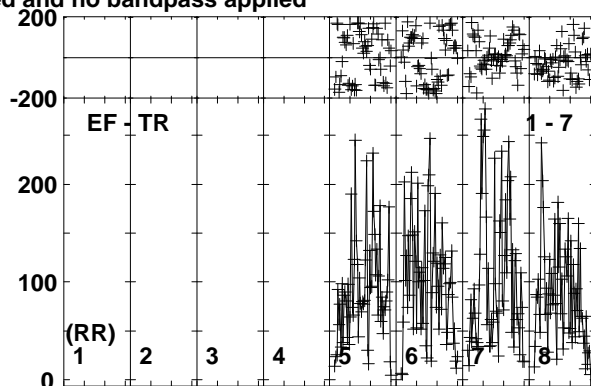
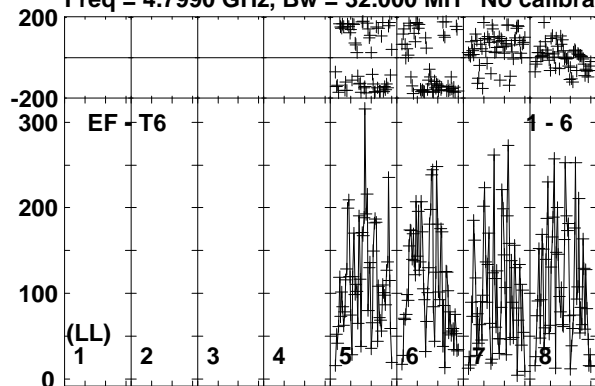

Lower frame: Micro Ampl Jy Top frame: Phas deg
Vector averaged cross-power spectrum Baseline: EF (01) - T6 (06)
Timerange: 00/20:35:39 to 00/20:39:18

Plot file version 115 created 03-OCT-2017 13:09:57

J2353+5518 RP028.UVDATA.1

Freq = 4.7990 GHz, Bw = 32.000 MH No calibration applied and no bandpass applied

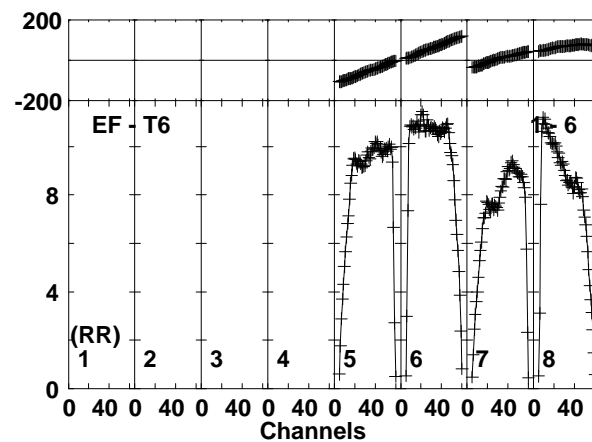
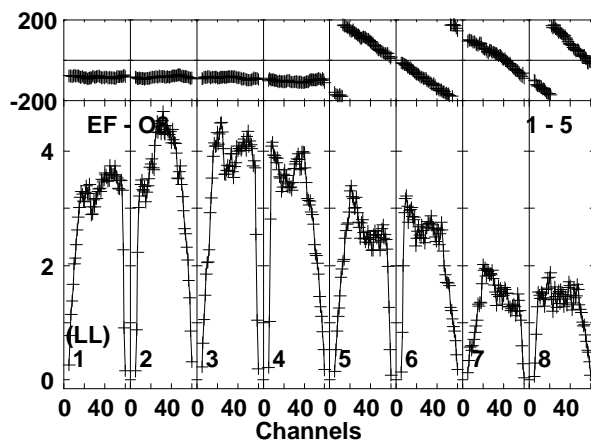
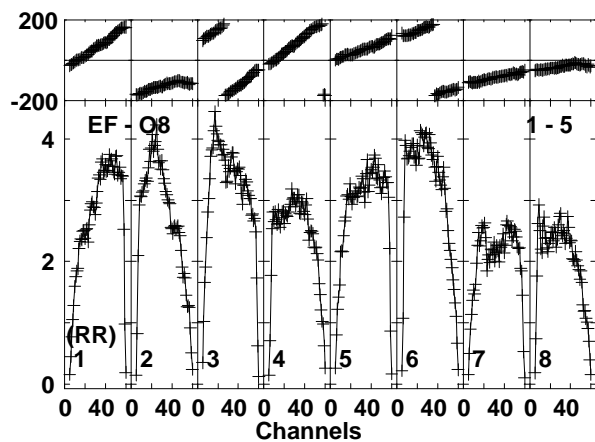
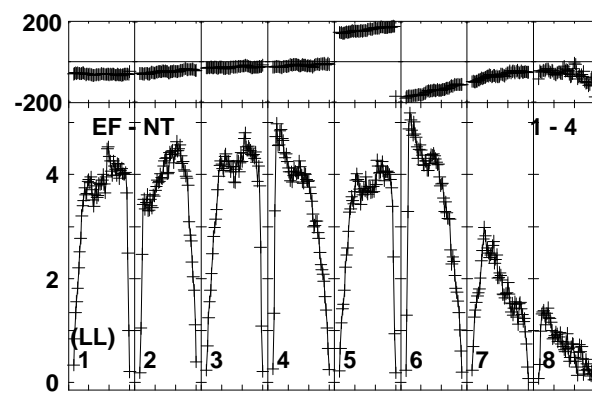
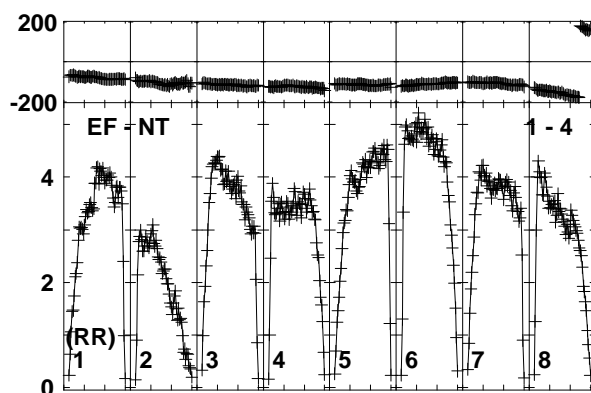
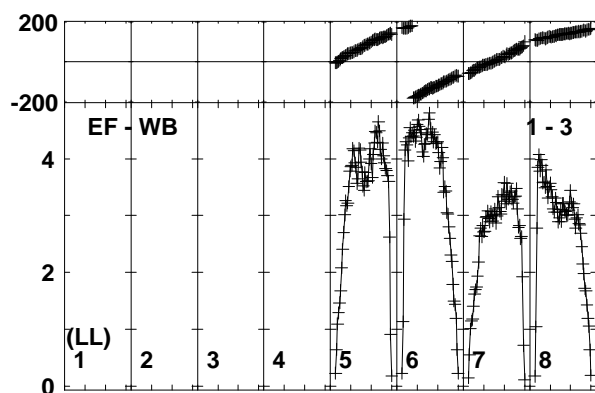
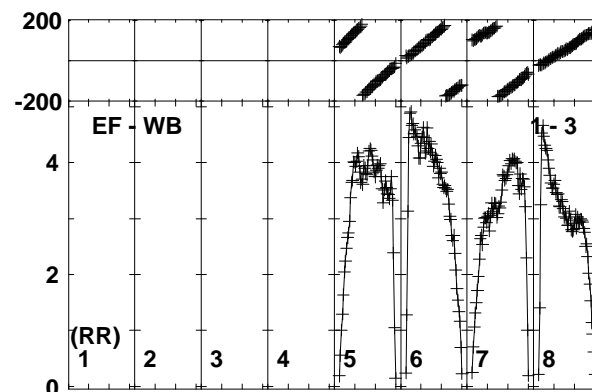
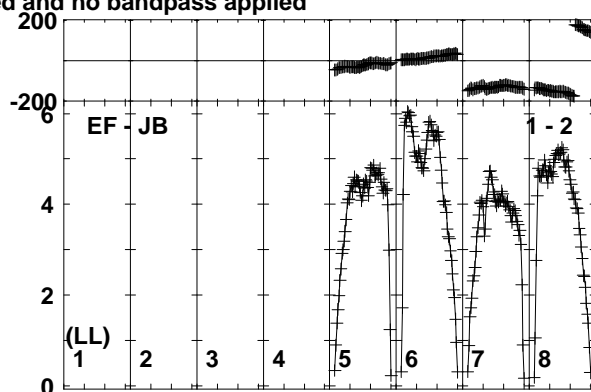
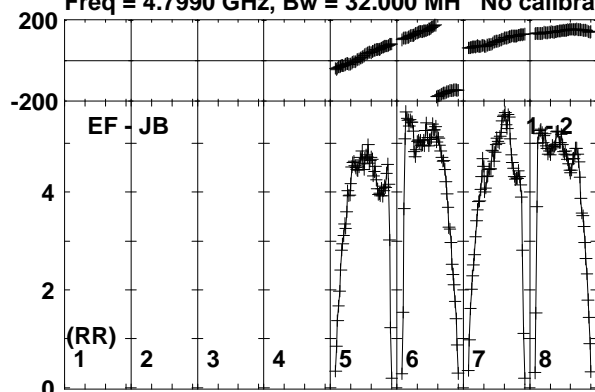

Lower frame: Milli Ampl Jy Top frame: Phas deg
Vector averaged cross-power spectrum Baseline: EF (01) - JB (02)
Timerange: 00/20:39:19 to 00/20:40:47

Plot file version 116 created 03-OCT-2017 13:09:57

J2353+5518 RP028.UVDATA.1

Freq = 4.7990 GHz, Bw = 32.000 MH No calibration applied and no bandpass applied

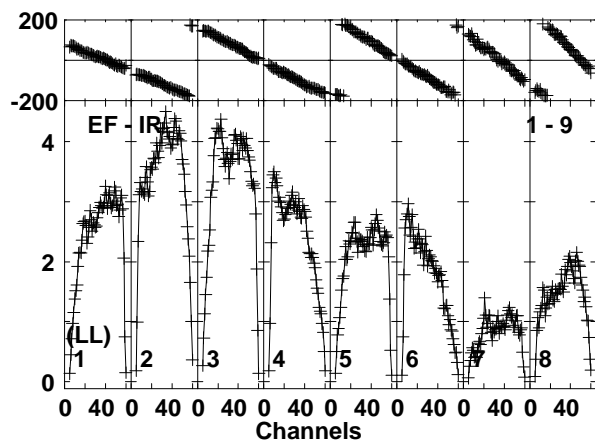
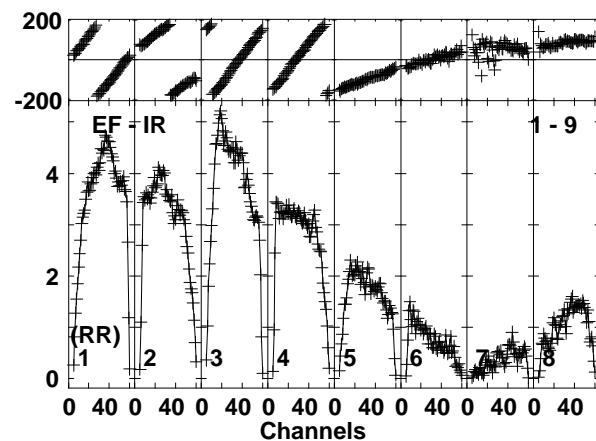
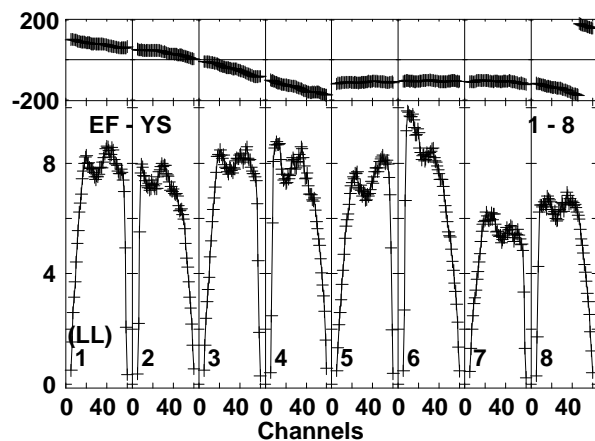
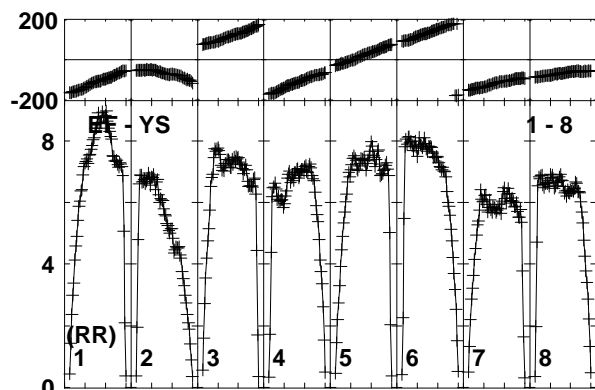
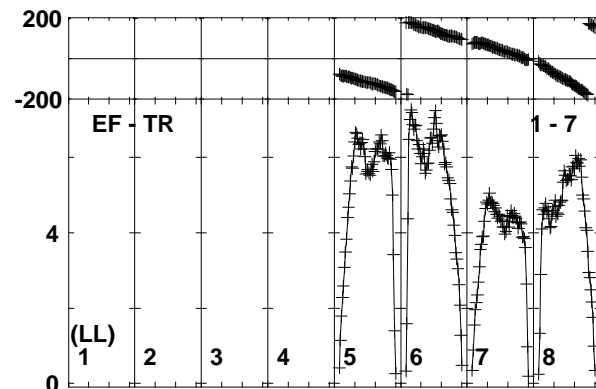
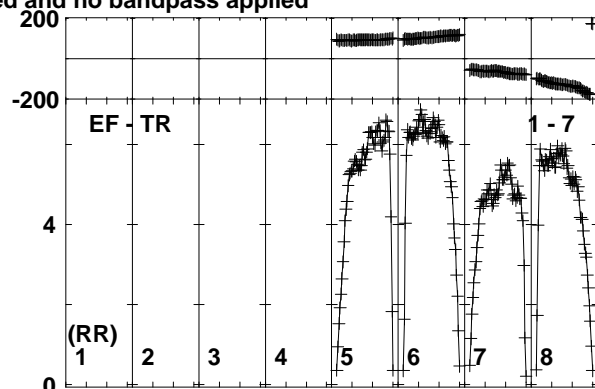
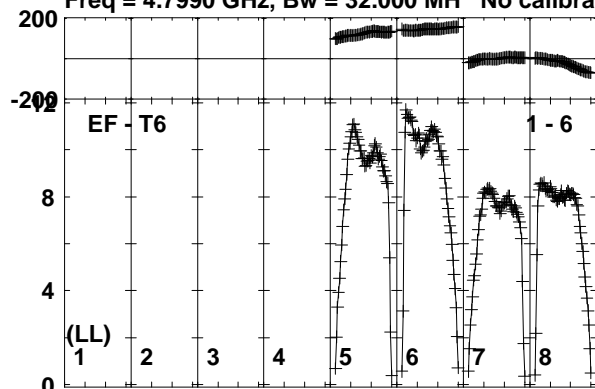

Lower frame: Milli Ampl Jy Top frame: Phas deg
Vector averaged cross-power spectrum Baseline: EF (01) - T6 (06)
Timerange: 00/20:39:19 to 00/20:40:47

Plot file version 117 created 03-OCT-2017 13:09:57

IRAS23436 RP028.UVDATA.1

Freq = 4.7990 GHz, Bw = 32.000 MH No calibration applied and no bandpass applied

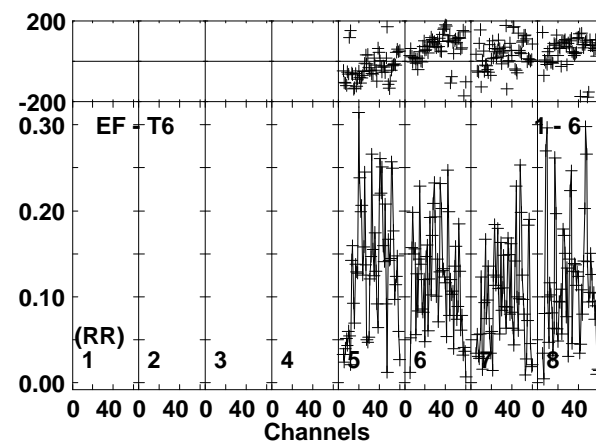
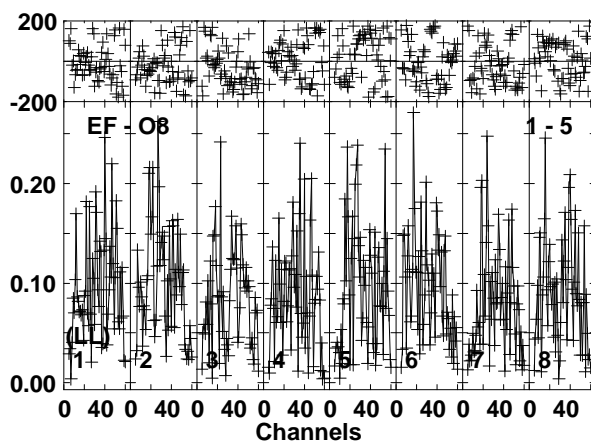
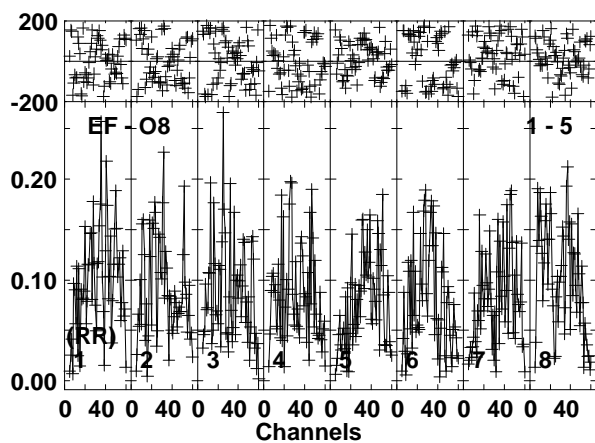
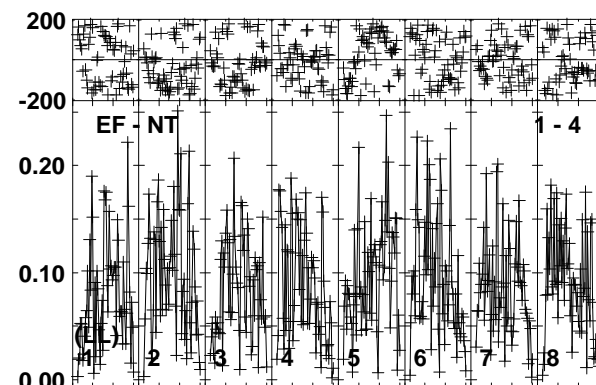
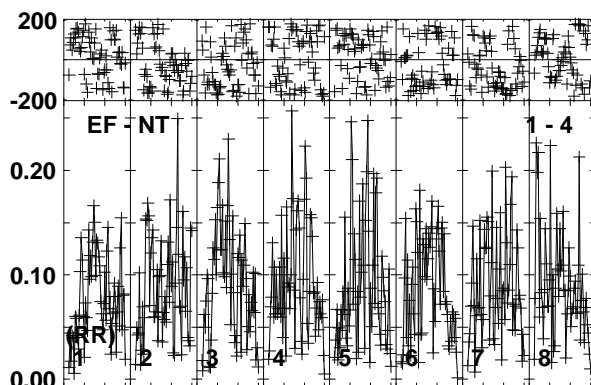
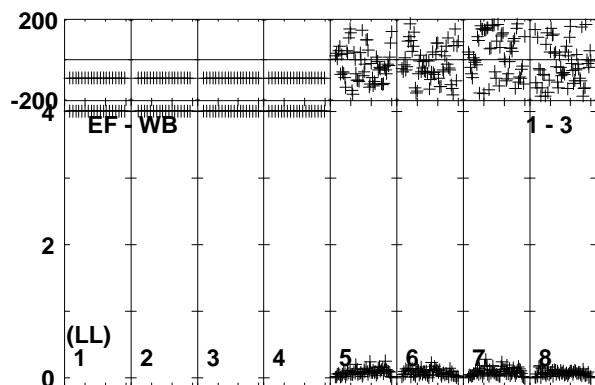
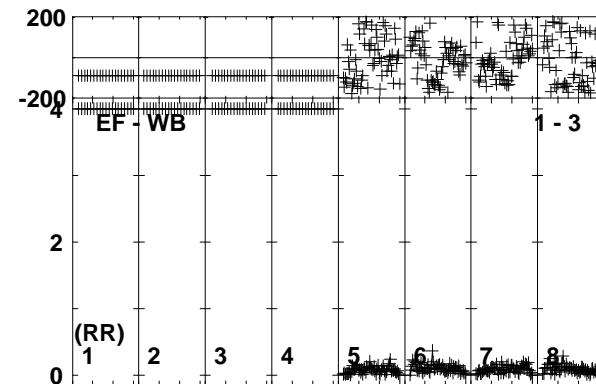
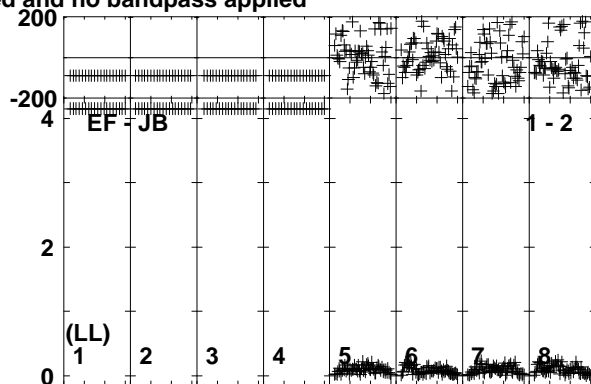
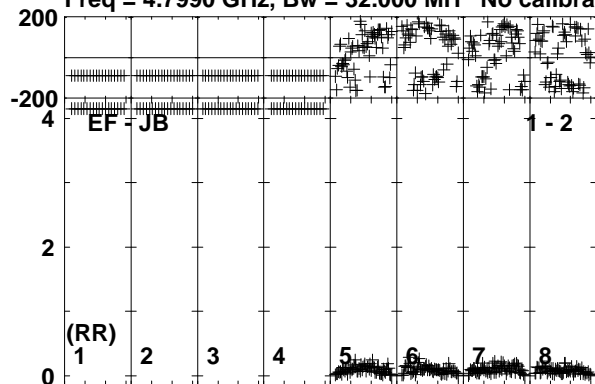

Lower frame: Milli Ampl Jy Top frame: Phas deg
Vector averaged cross-power spectrum Baseline: EF (01) - JB (02)
Timerange: 00/20:40:49 to 00/20:44:31

Plot file version 118 created 03-OCT-2017 13:09:58

IRAS23436 RP028.UVDATA.1

Freq = 4.7990 GHz, Bw = 32.000 MH No calibration applied and no bandpass applied

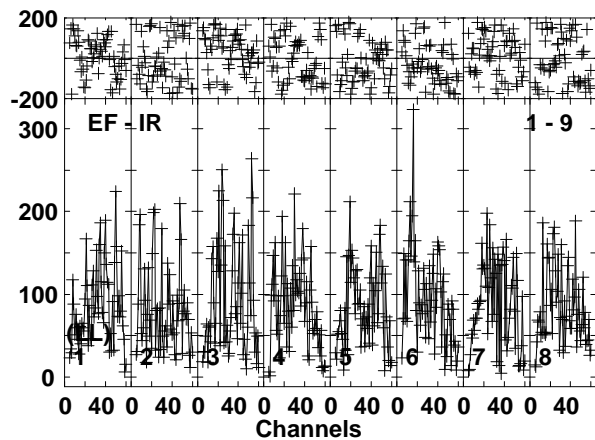
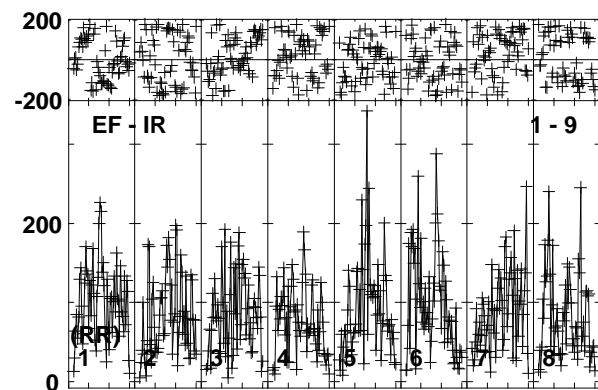
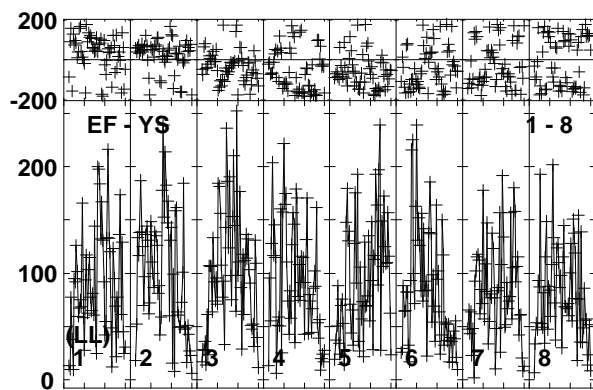
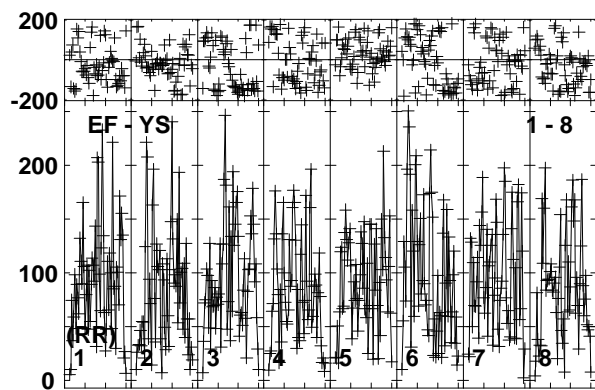
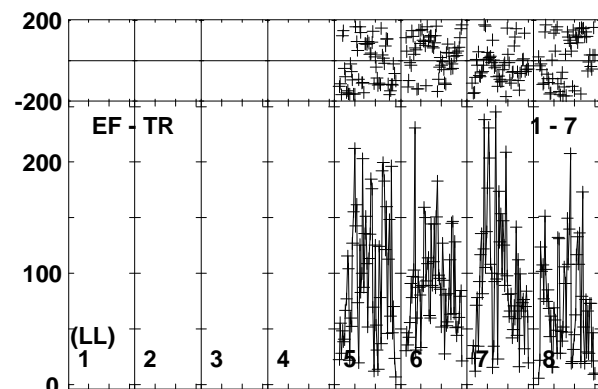
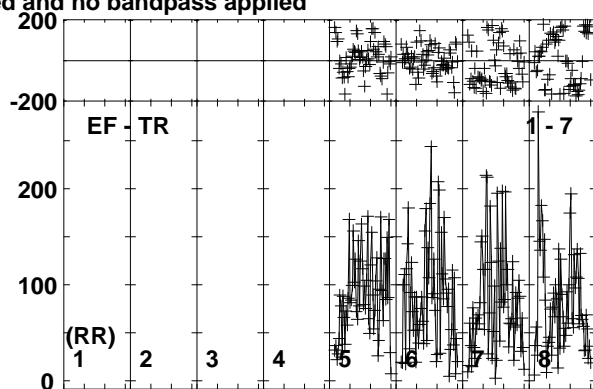
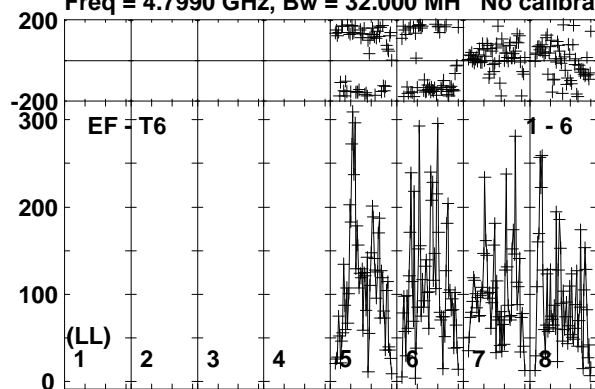

Lower frame: Micro Ampl Jy Top frame: Phas deg
Vector averaged cross-power spectrum Baseline: EF (01) - T6 (06)
Timerange: 00/20:40:49 to 00/20:44:31

Plot file version 119 created 03-OCT-2017 13:09:58

J2353+5518 RP028.UVDATA.1

Freq = 4.7990 GHz, Bw = 32.000 MH No calibration applied and no bandpass applied

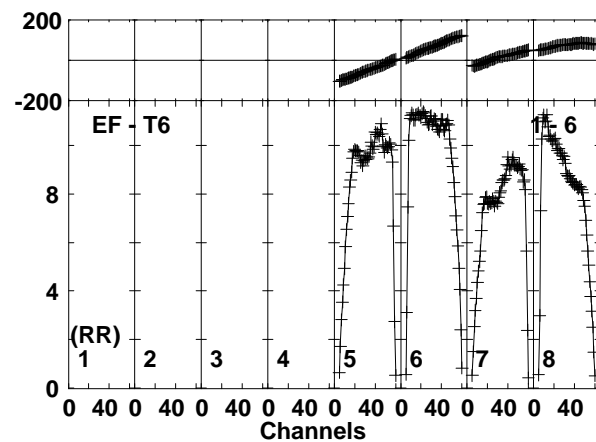
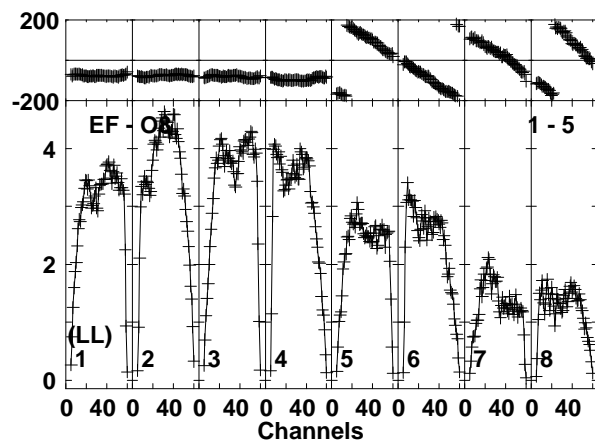
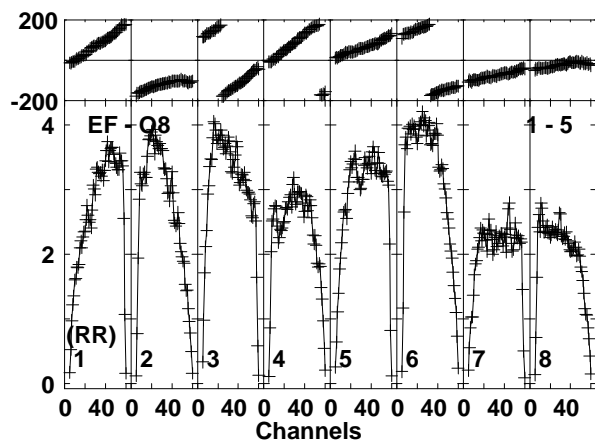
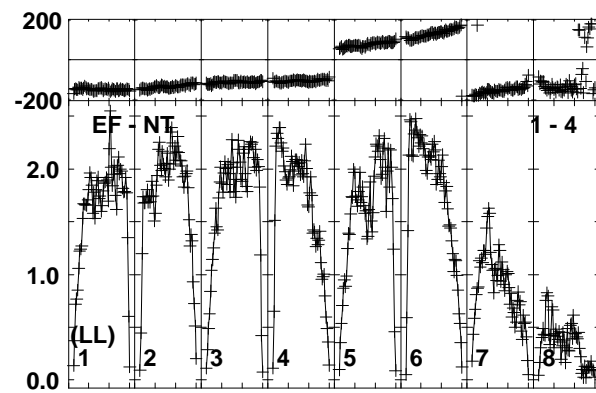
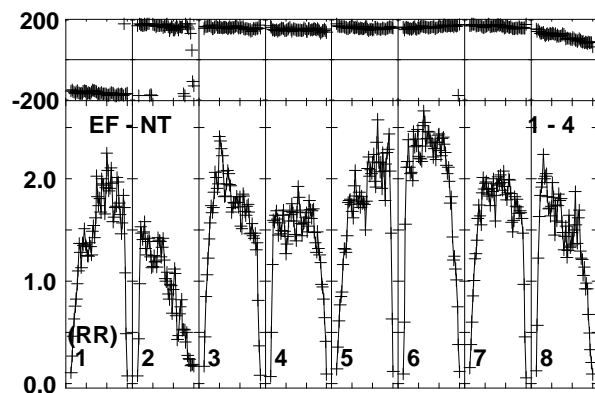
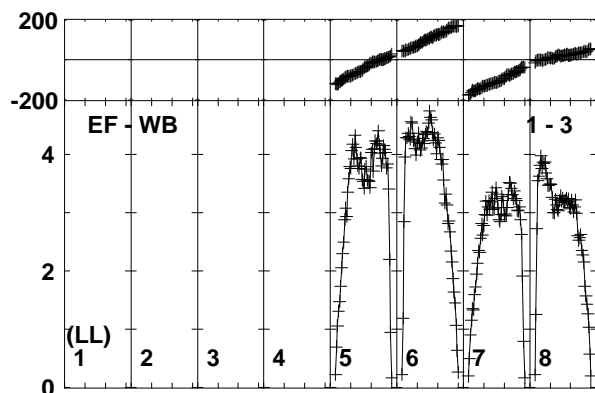
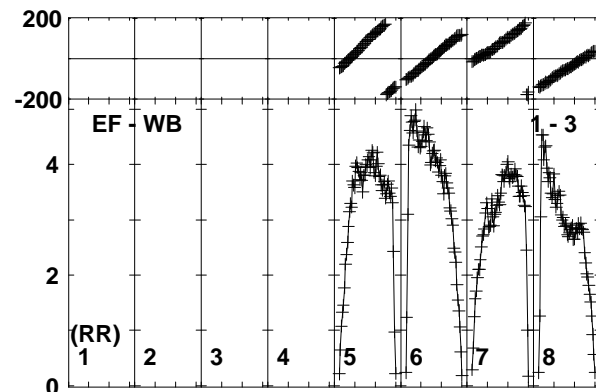
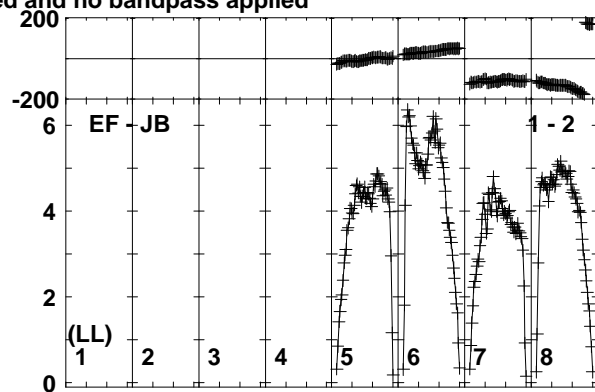
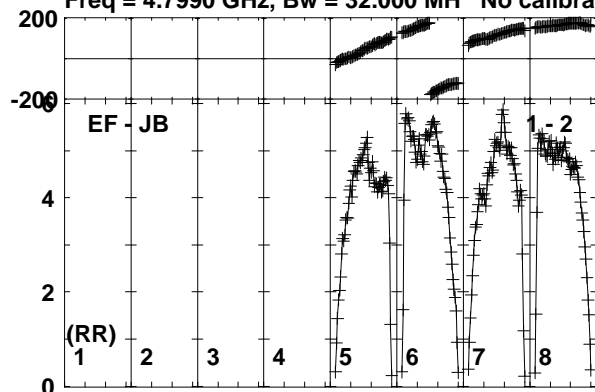

Lower frame: Milli Ampl Jy Top frame: Phas deg
Vector averaged cross-power spectrum Baseline: EF (01) - JB (02)
Timerange: 00/20:45:13 to 00/20:46:01

Plot file version 120 created 03-OCT-2017 13:09:58

J2353+5518 RP028.UVDATA.1

Freq = 4.7990 GHz, Bw = 32.000 MH No calibration applied and no bandpass applied

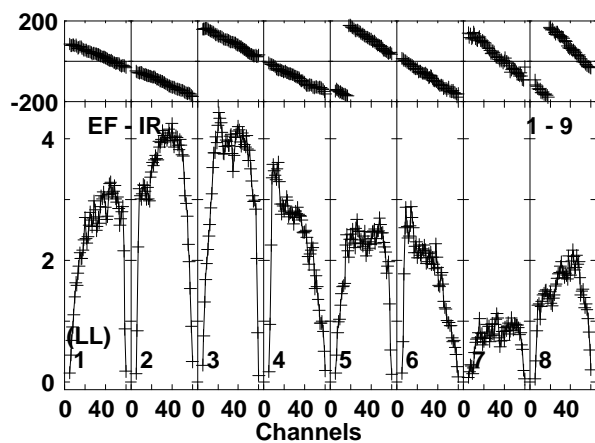
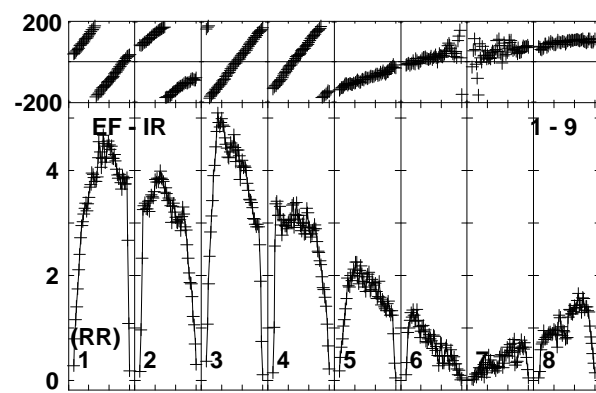
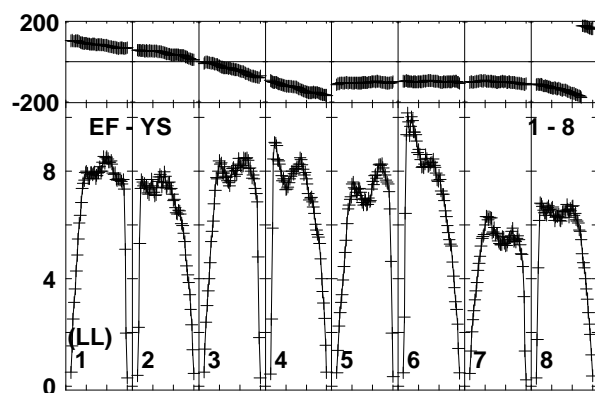
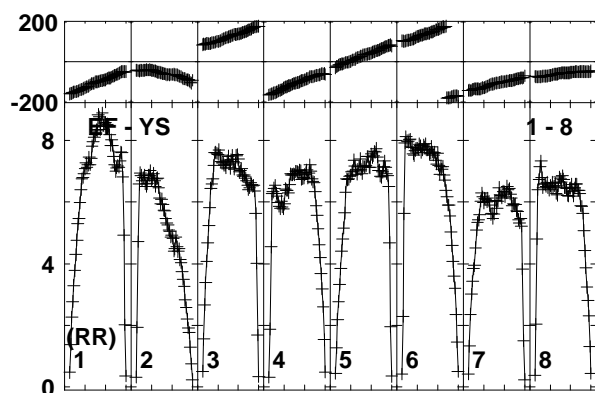
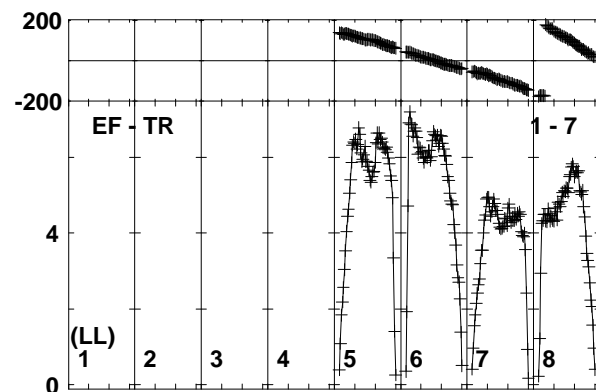
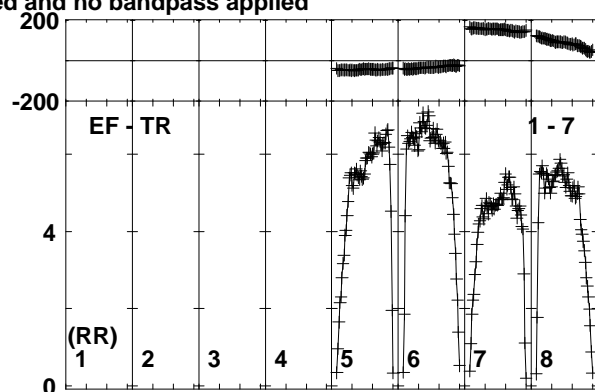
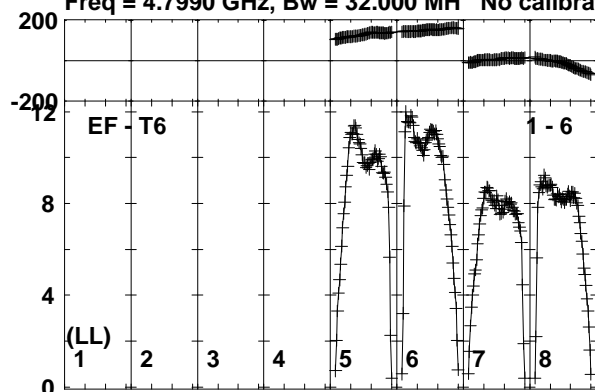

Lower frame: Milli Ampl Jy Top frame: Phas deg

Vector averaged cross-power spectrum Baseline: EF (01) - T6 (06)

Timerange: 00/20:45:13 to 00/20:46:01

Plot file version 121 created 03-OCT-2017 13:09:58

IRAS23436 RP028.UVDATA.1

Freq = 4.7990 GHz, Bw = 32.000 MH No calibration applied and no bandpass applied

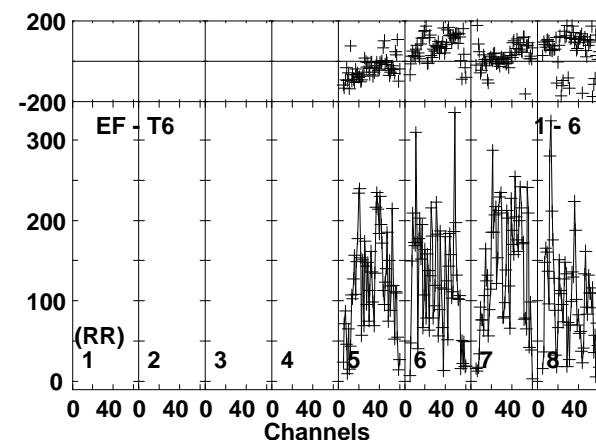
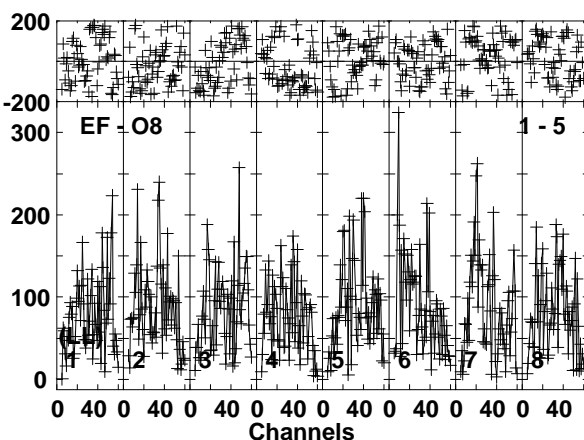
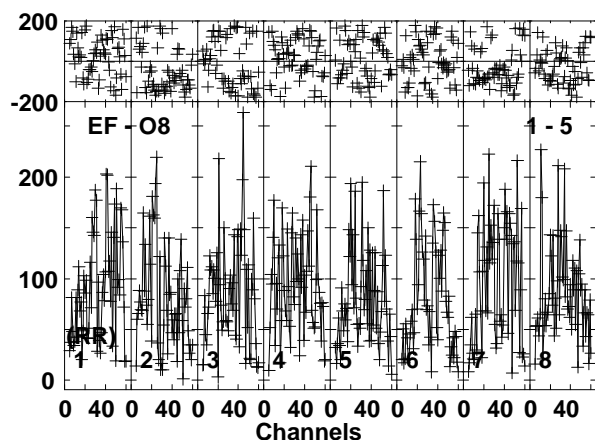
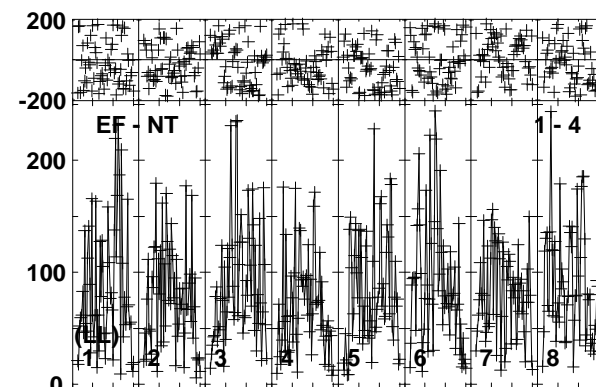
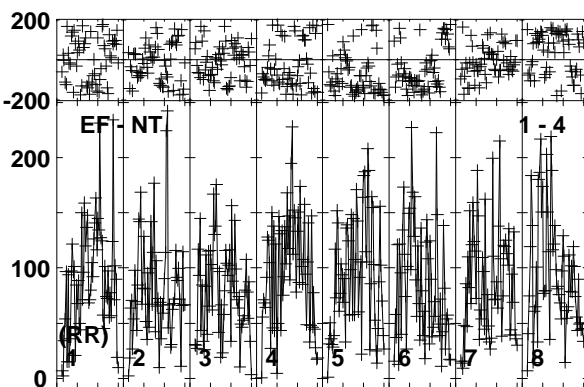
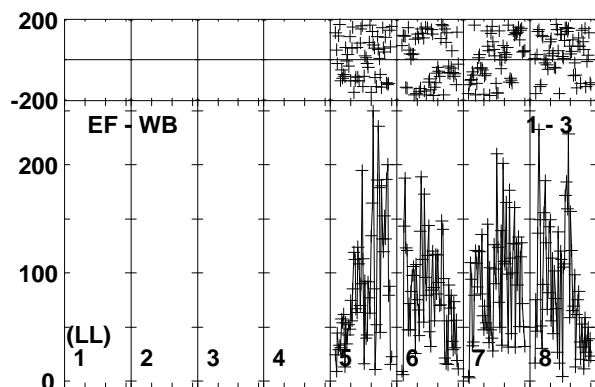
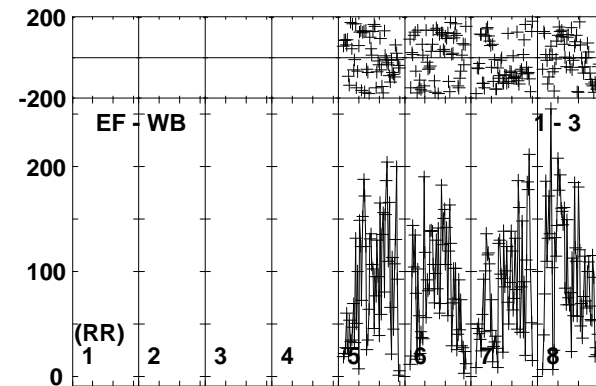
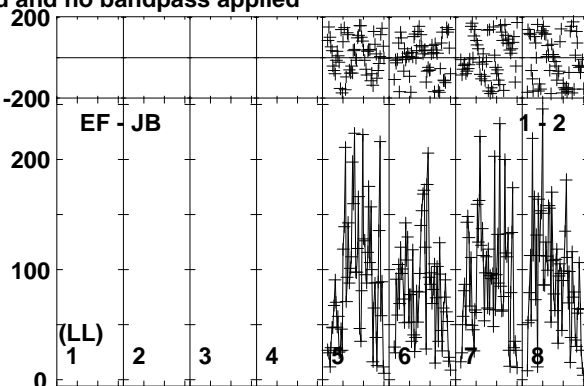
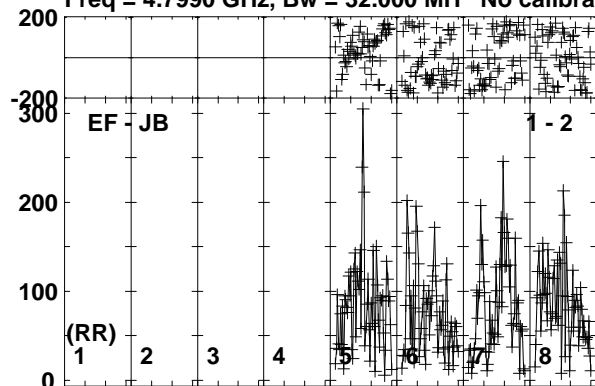

Lower frame: Micro Ampl Jy Top frame: Phas deg
Vector averaged cross-power spectrum Baseline: EF (01) - JB (02)
Timerange: 00/20:46:02 to 00/20:49:46

Plot file version 122 created 03-OCT-2017 13:09:58

IRAS23436 RP028.UVDATA.1

Freq = 4.7990 GHz, Bw = 32.000 MH No calibration applied and no bandpass applied

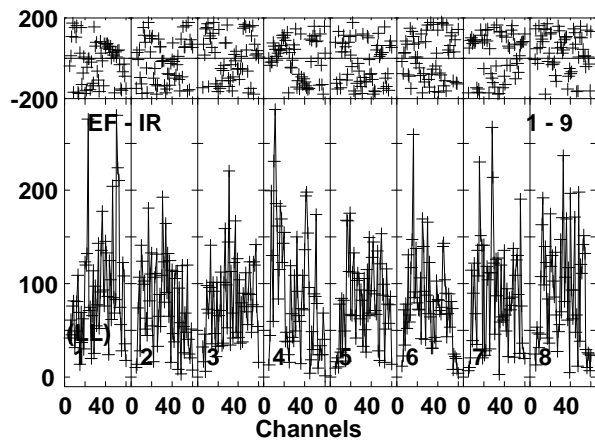
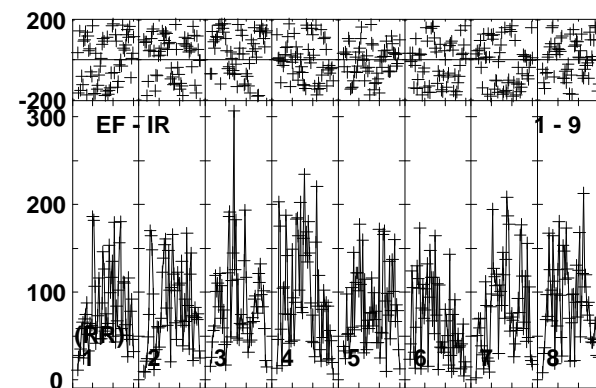
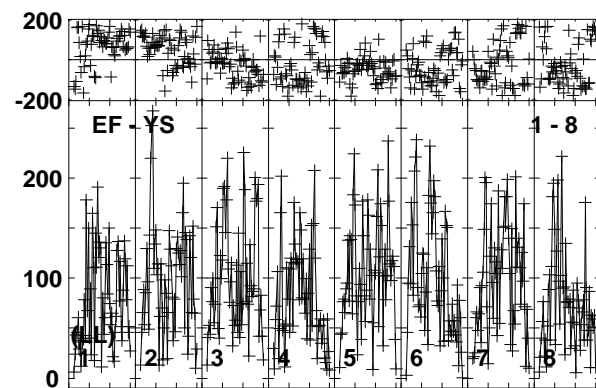
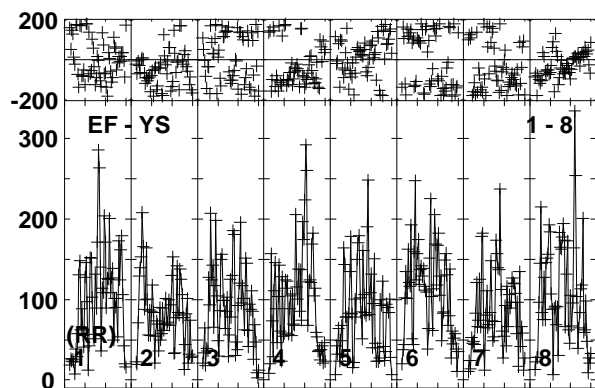
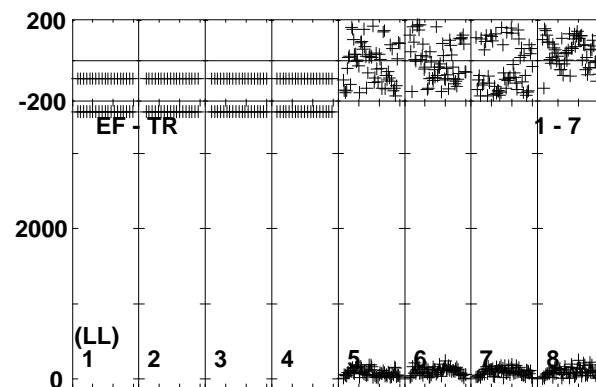
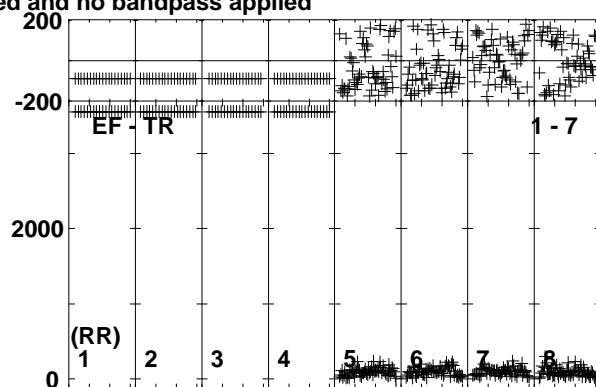
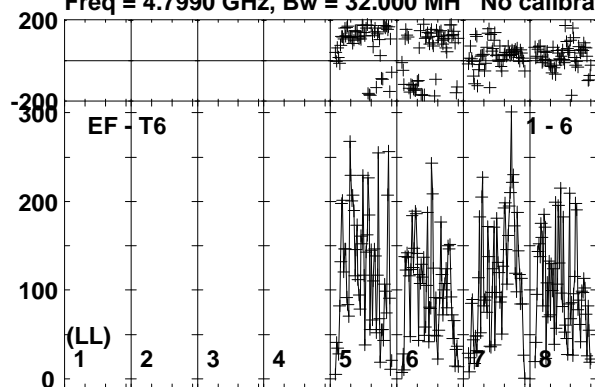

Lower frame: Micro Ampl Jy Top frame: Phas deg
Vector averaged cross-power spectrum Baseline: EF (01) - T6 (06)
Timerange: 00/20:46:02 to 00/20:49:46

Plot file version 123 created 03-OCT-2017 13:09:59

J2353+5518 RP028.UVDATA.1

Freq = 4.7990 GHz, Bw = 32.000 MH No calibration applied and no bandpass applied

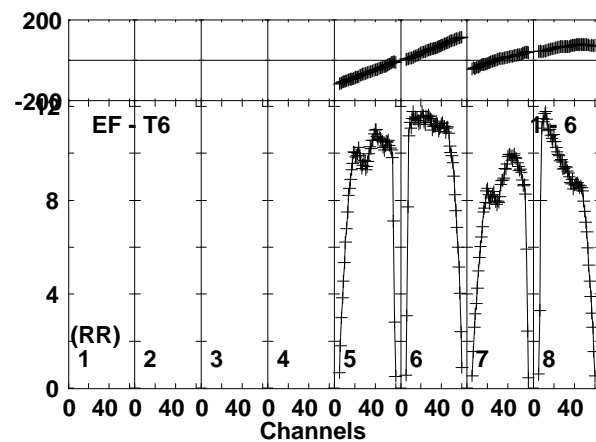
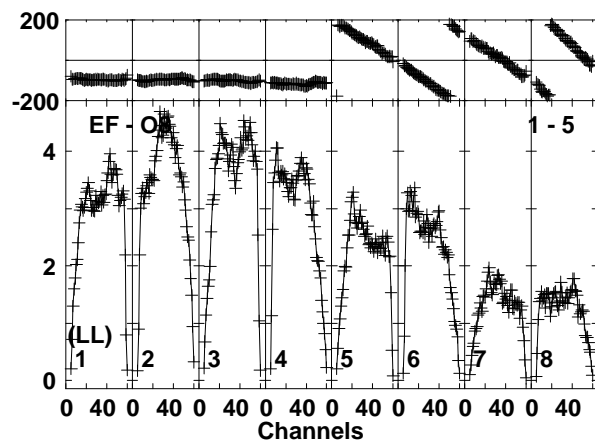
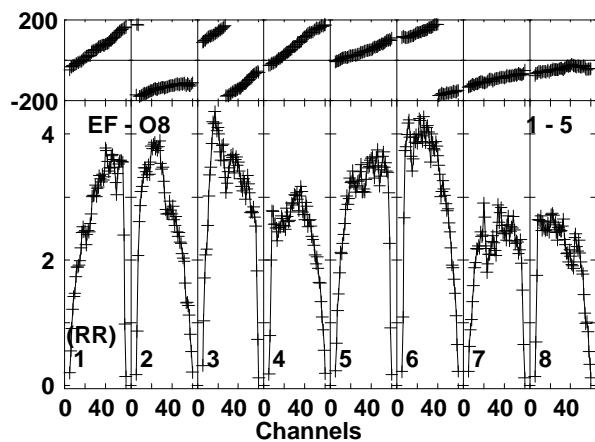
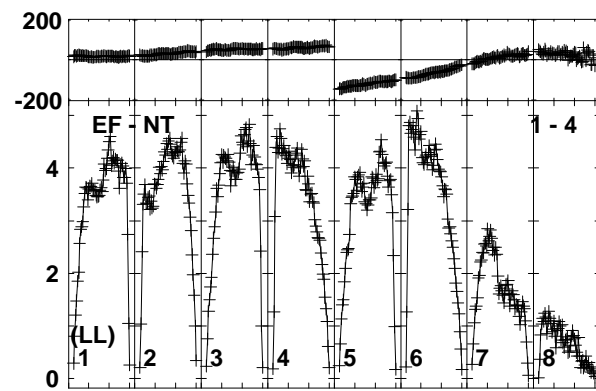
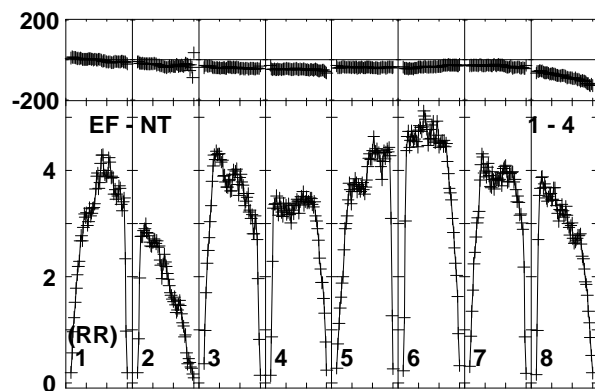
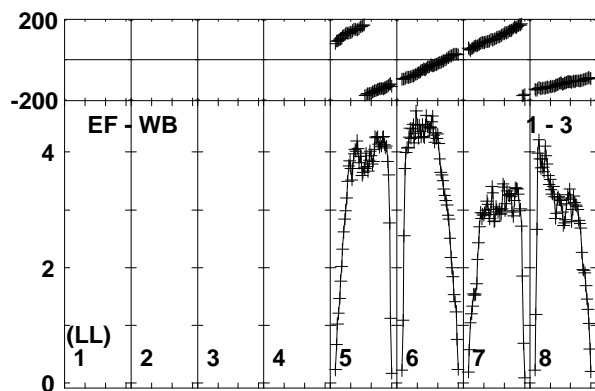
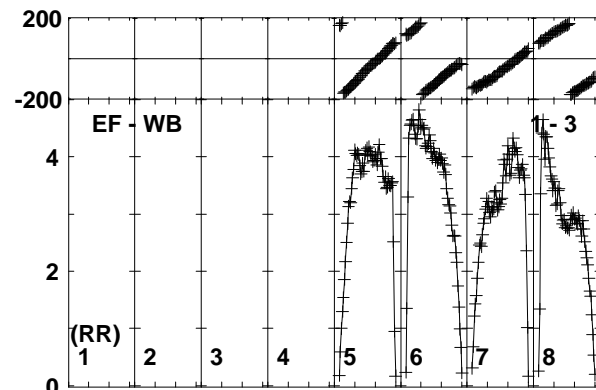
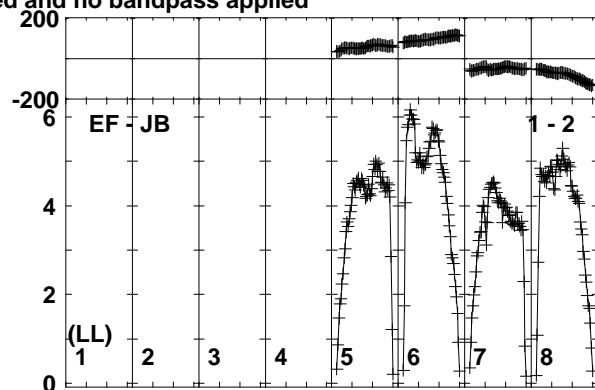
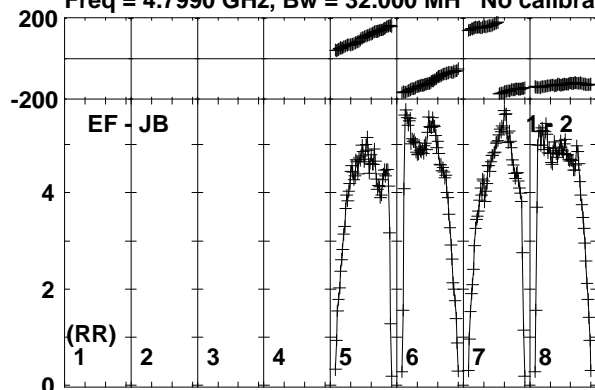

Lower frame: Milli Ampl Jy Top frame: Phas deg
Vector averaged cross-power spectrum Baseline: EF (01) - JB (02)
Timerange: 00/20:49:46 to 00/20:51:15

Plot file version 124 created 03-OCT-2017 13:09:59

J2353+5518 RP028.UVDATA.1

Freq = 4.7990 GHz, Bw = 32.000 MH No calibration applied and no bandpass applied

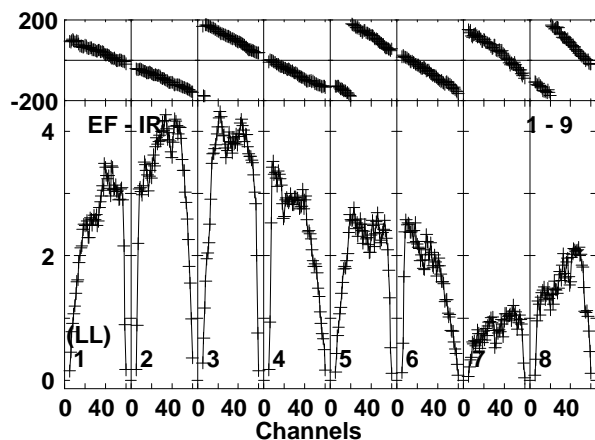
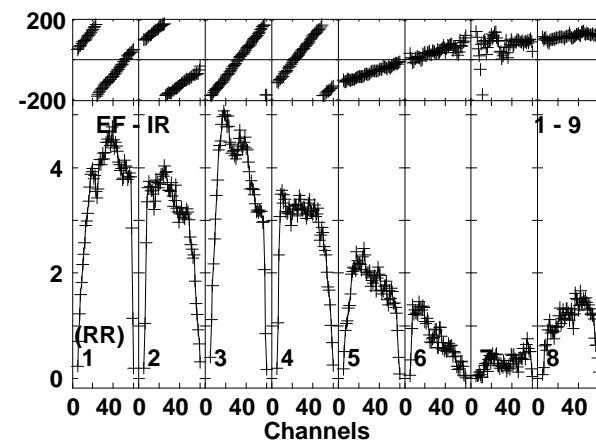
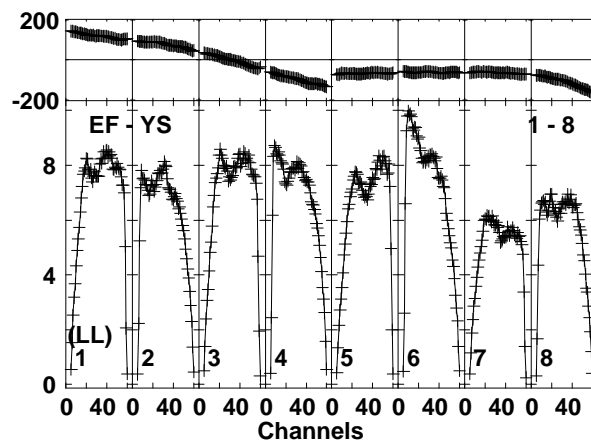
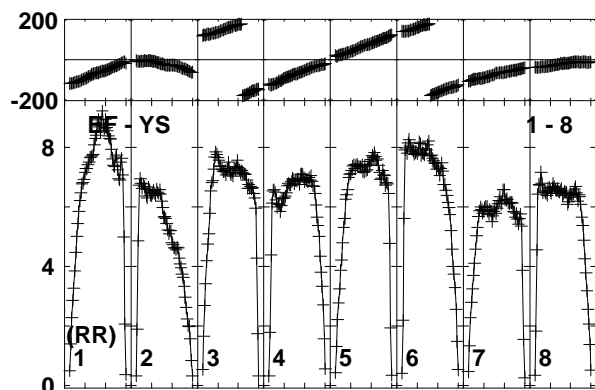
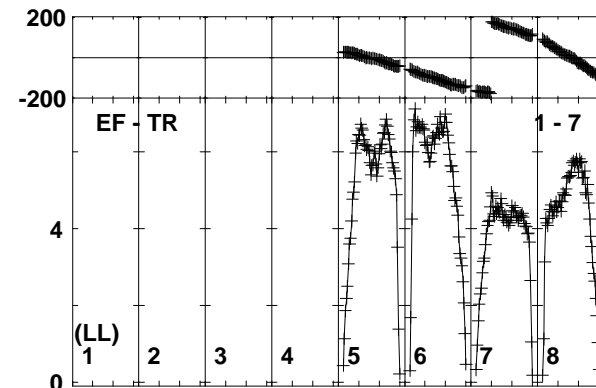
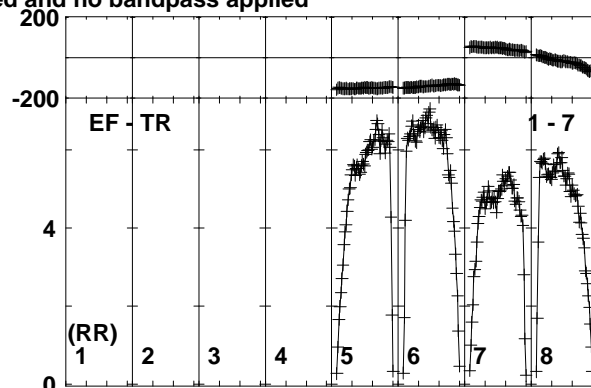
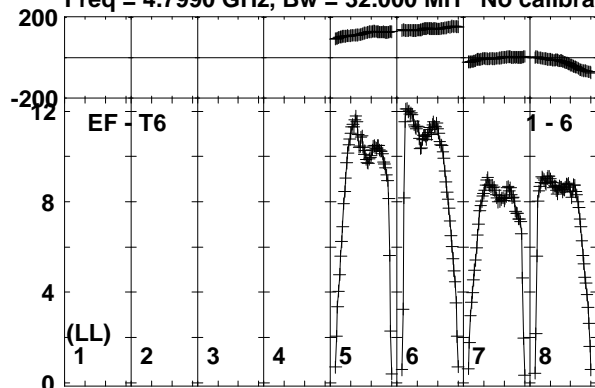

Lower frame: Milli Ampl Jy Top frame: Phas deg
Vector averaged cross-power spectrum Baseline: EF (01) - T6 (06)
Timerange: 00/20:49:46 to 00/20:51:15

Plot file version 125 created 03-OCT-2017 13:09:59

IRAS23436 RP028.UVDATA.1

Freq = 4.7990 GHz, Bw = 32.000 MH No calibration applied and no bandpass applied

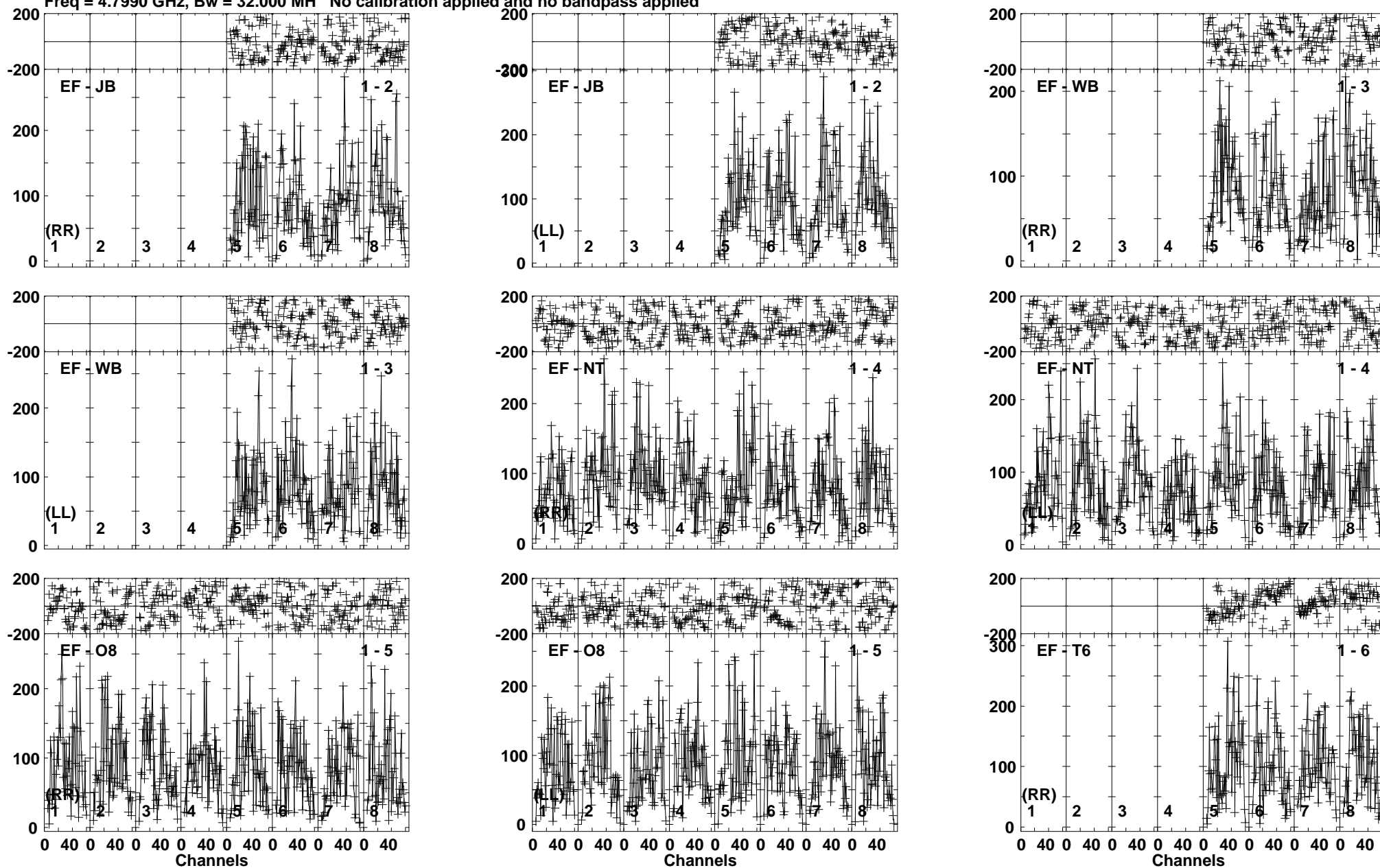

Lower frame: Micro Ampl Jy Top frame: Phas deg
Vector averaged cross-power spectrum Baseline: EF (01) - JB (02)
Timerange: 00/20:51:17 to 00/20:55:00

Plot file version 126 created 03-OCT-2017 13:09:59

IRAS23436 RP028.UVDATA.1

Freq = 4.7990 GHz, Bw = 32.000 MH No calibration applied and no bandpass applied

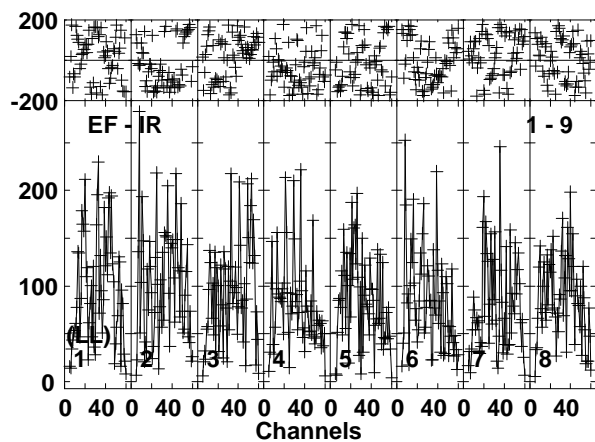
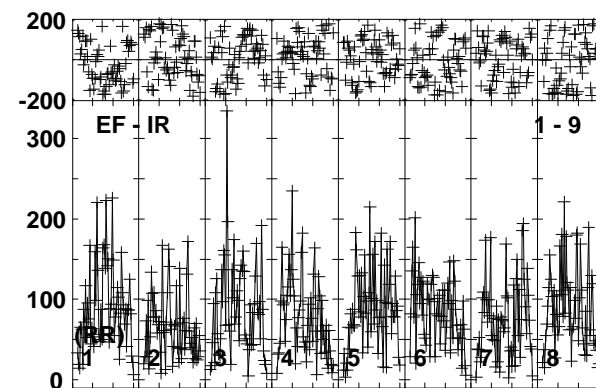
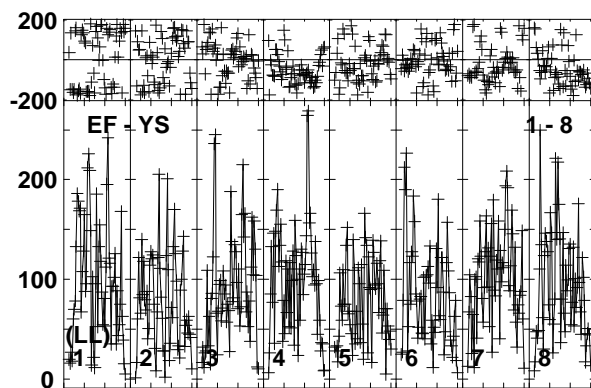
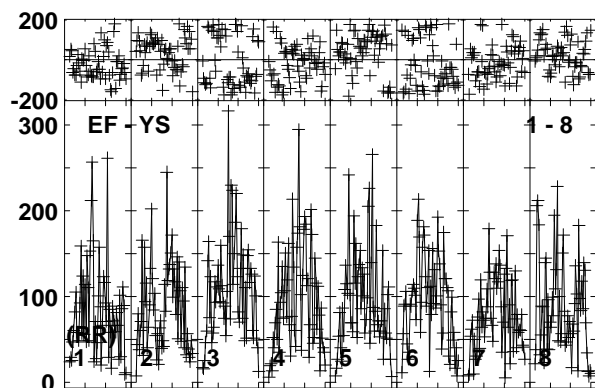
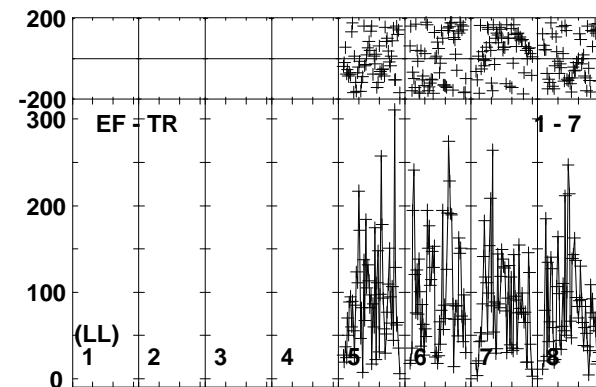
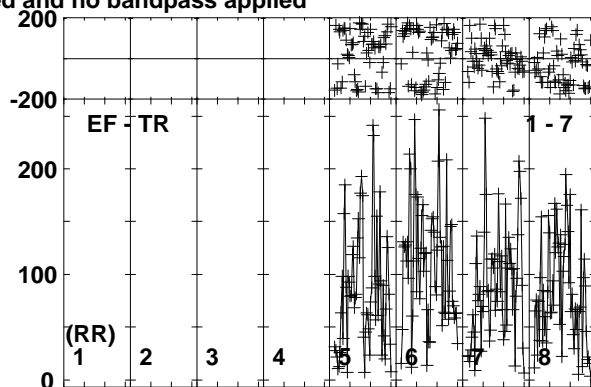
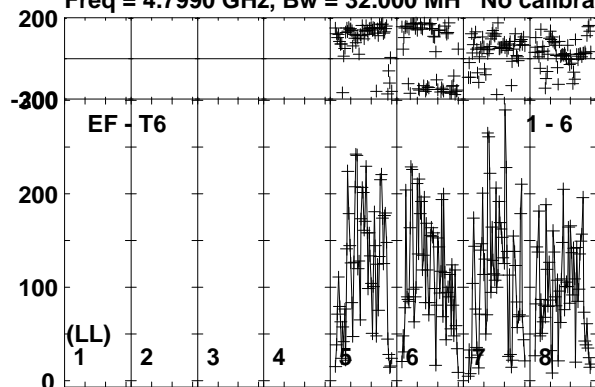

Lower frame: Micro Ampl Jy Top frame: Phas deg
Vector averaged cross-power spectrum Baseline: EF (01) - T6 (06)
Timerange: 00/20:51:17 to 00/20:55:00

Plot file version 127 created 03-OCT-2017 13:10:00
 J2353+5518 RP028.UVDATA.1
 Freq = 4.7990 GHz, Bw = 32.000 MH No calibration applied and no bandpass applied

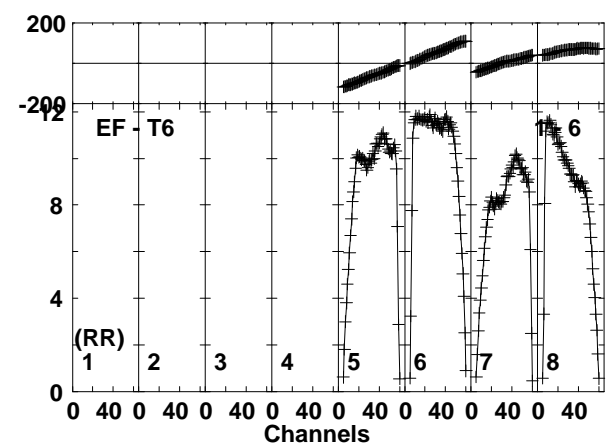
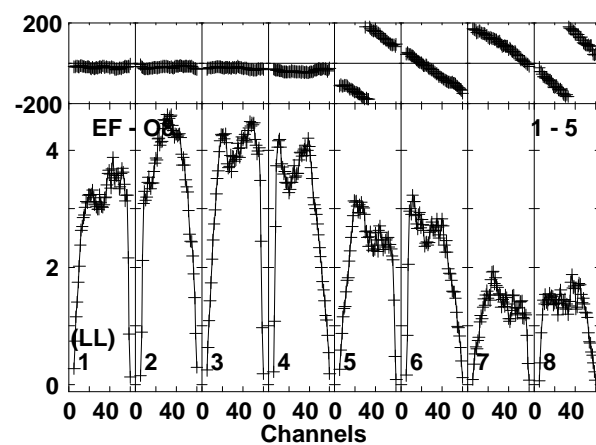
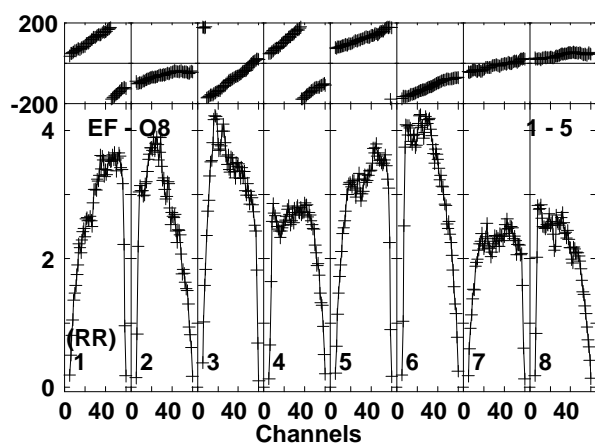
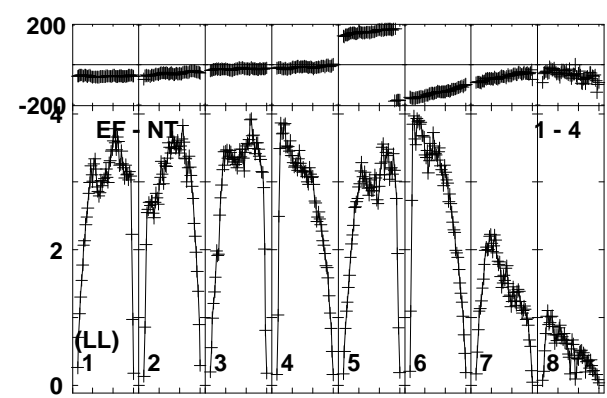
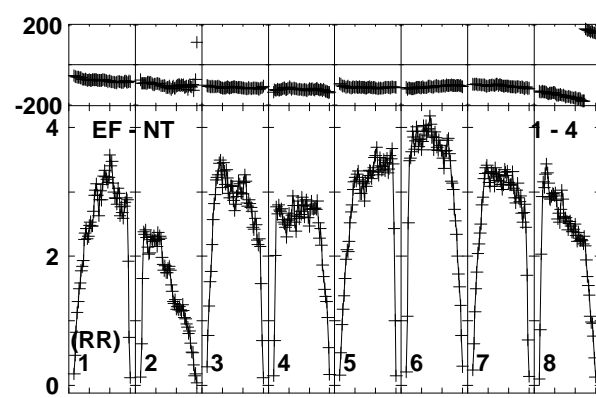
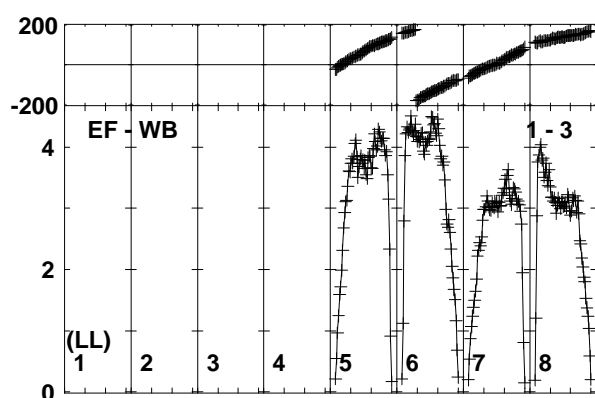
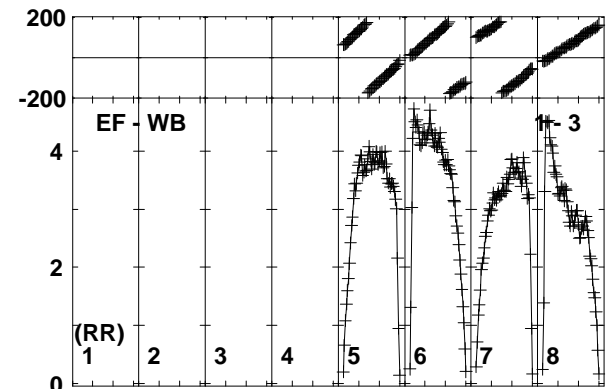
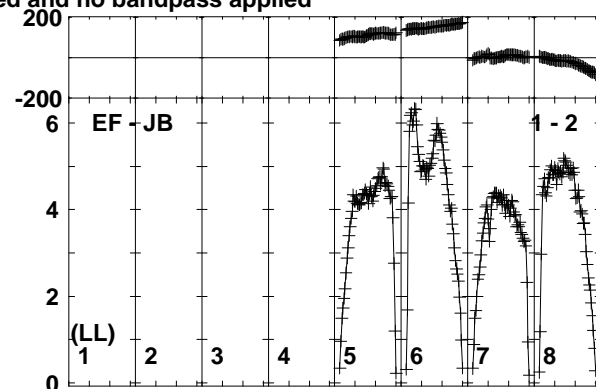
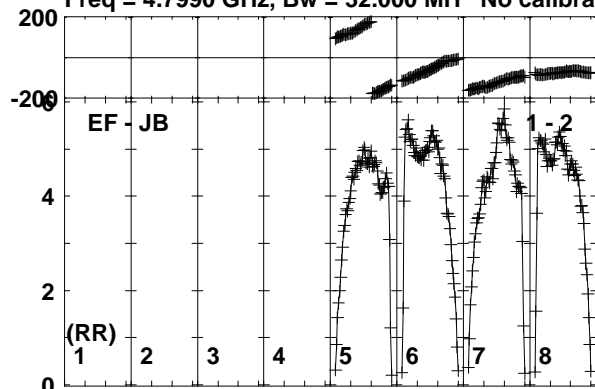

Lower frame: Milli Ampl Jy Top frame: Phas deg
 Vector averaged cross-power spectrum Baseline: EF (01) - JB (02)
 Timerange: 00/20:55:41 to 00/20:56:39

Plot file version 128 created 03-OCT-2017 13:10:00

J2353+5518 RP028.UVDATA.1

Freq = 4.7990 GHz, Bw = 32.000 MH No calibration applied and no bandpass applied

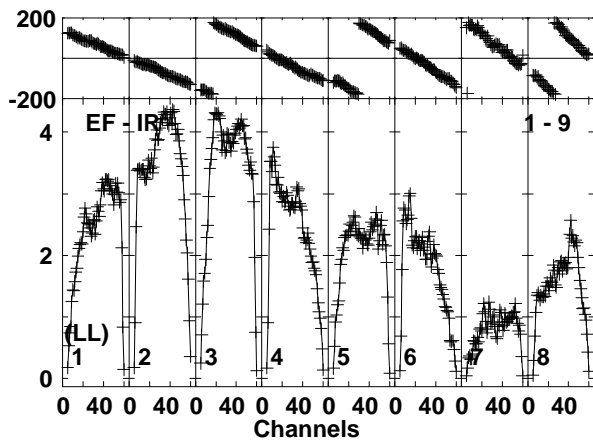
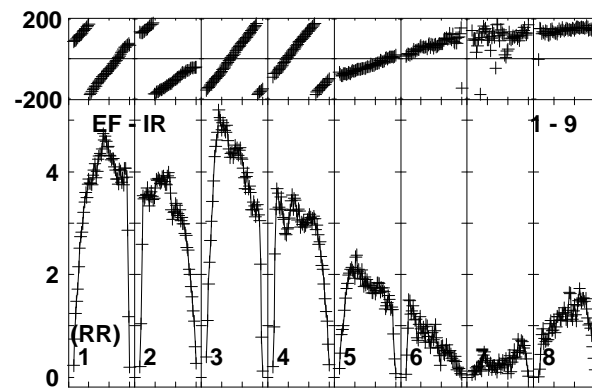
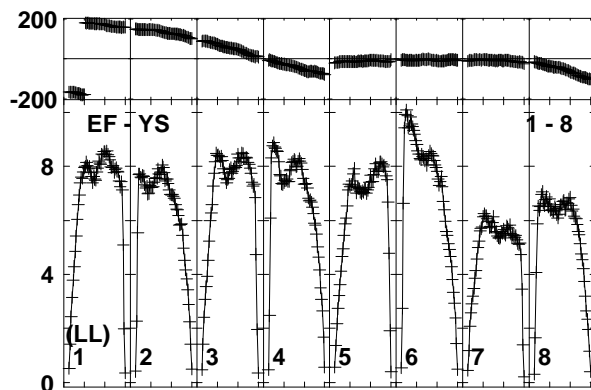
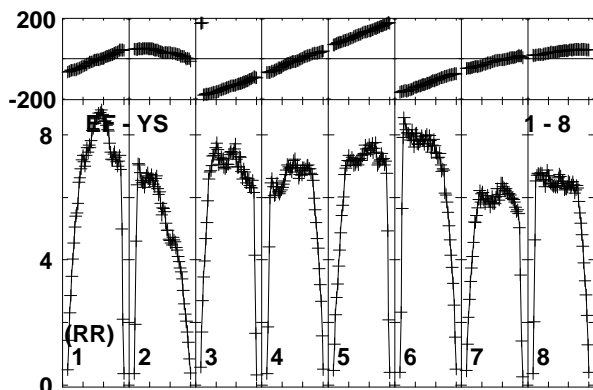
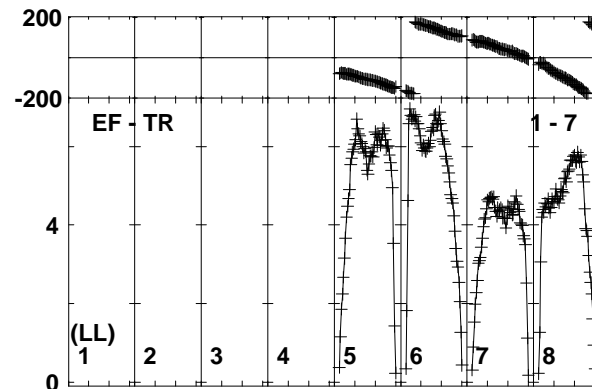
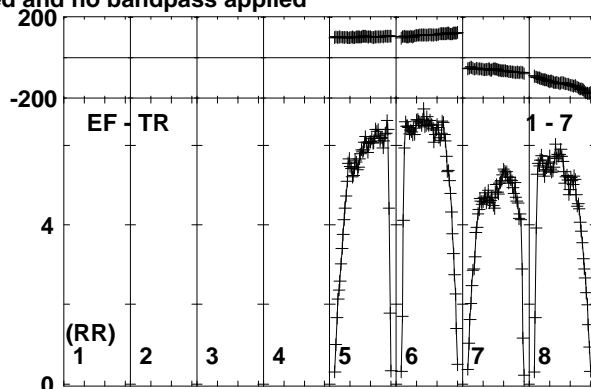
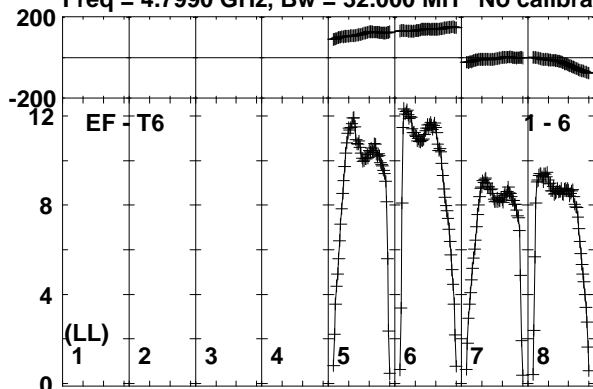

Lower frame: Milli Ampl Jy Top frame: Phas deg

Vector averaged cross-power spectrum Baseline: EF (01) - T6 (06)

Timerange: 00/20:55:41 to 00/20:56:39

Plot file version 129 created 03-OCT-2017 13:10:00

IRAS23436 RP028.UVDATA.1

Freq = 4.7990 GHz, Bw = 32.000 MH No calibration applied and no bandpass applied

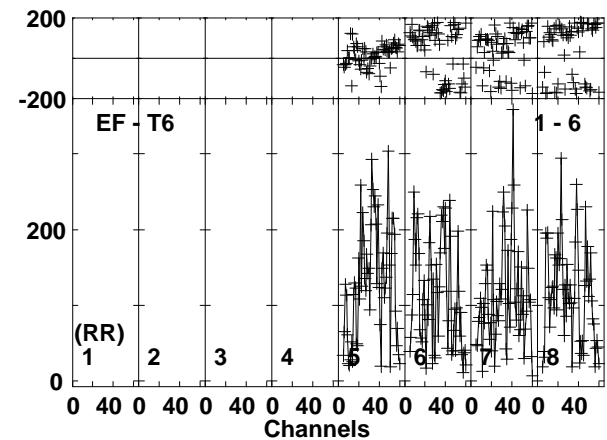
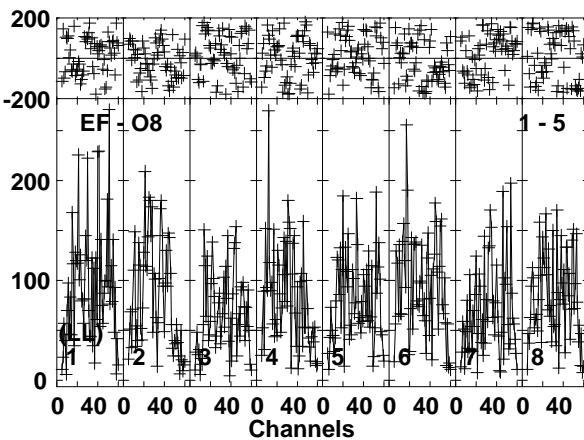
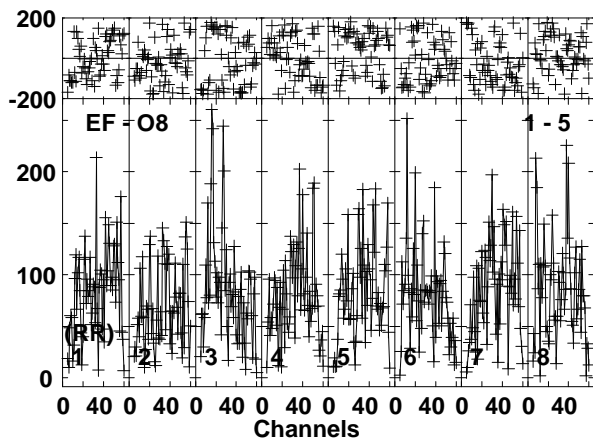
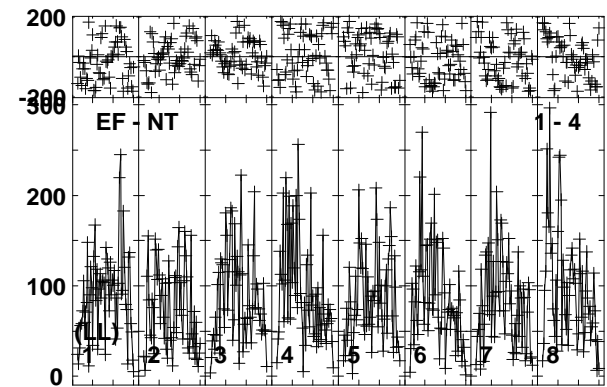
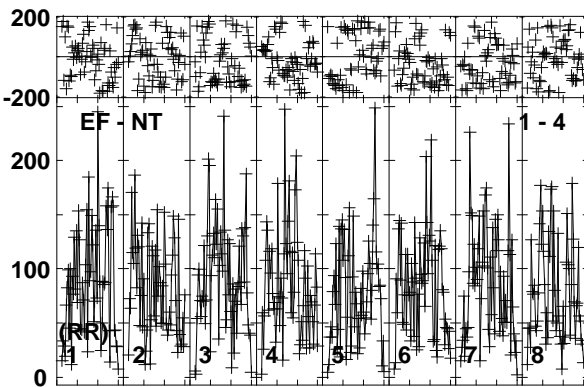
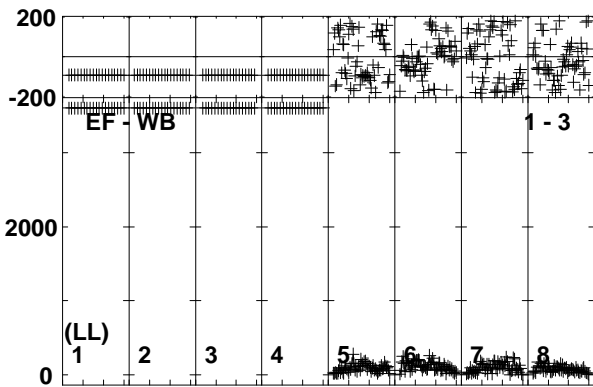
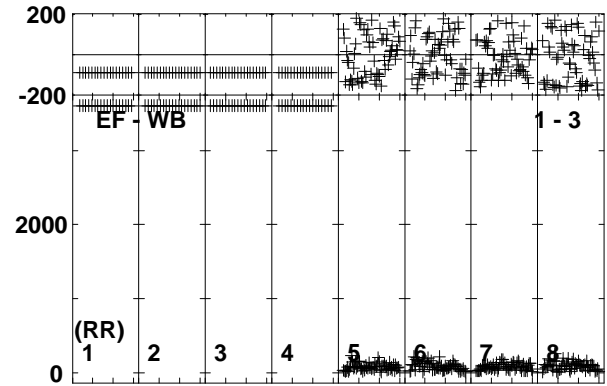
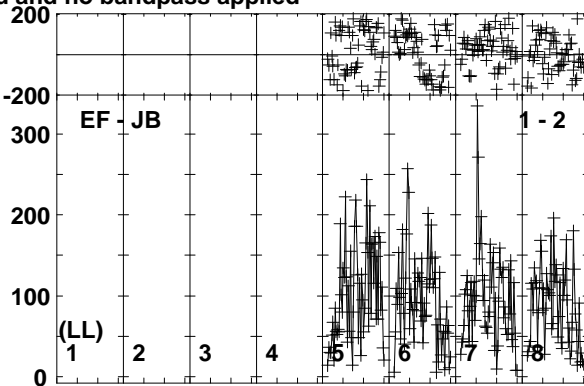
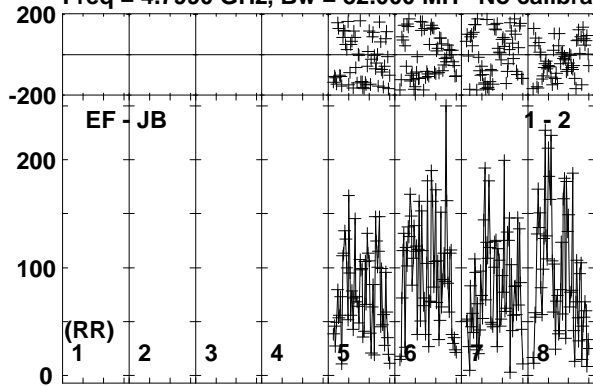

Lower frame: Micro Ampl Jy Top frame: Phas deg
Vector averaged cross-power spectrum Baseline: EF (01) - JB (02)
Timerange: 00/20:56:41 to 00/21:00:20

Plot file version 130 created 03-OCT-2017 13:10:00

IRAS23436 RP028.UVDATA.1

Freq = 4.7990 GHz, Bw = 32.000 MH No calibration applied and no bandpass applied

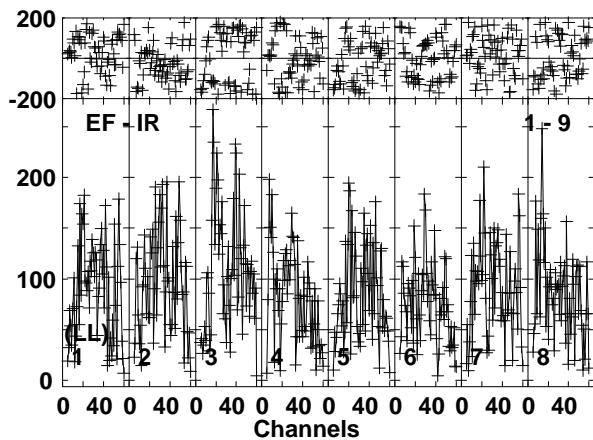
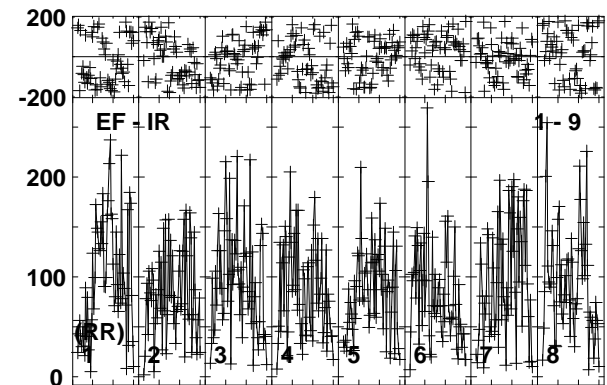
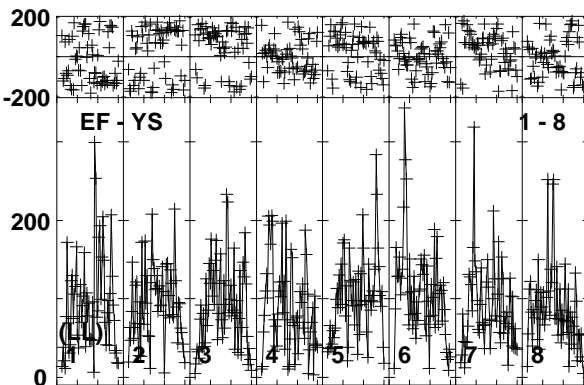
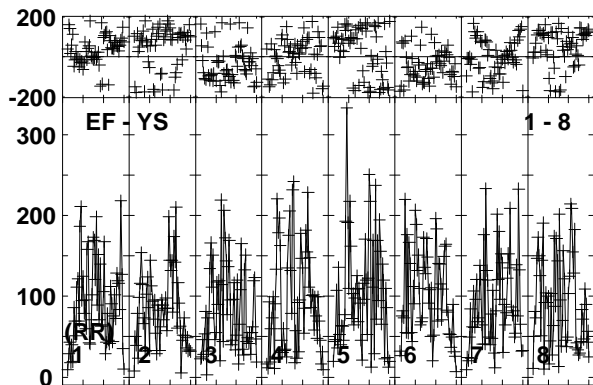
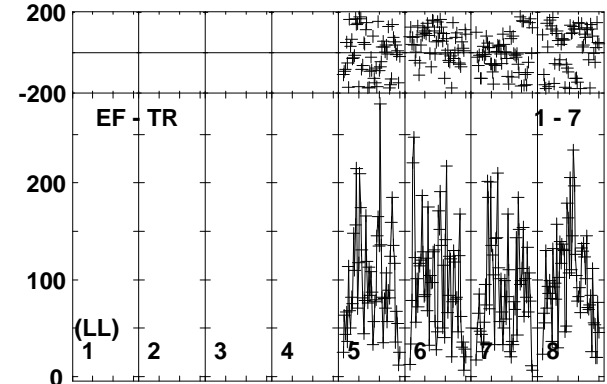
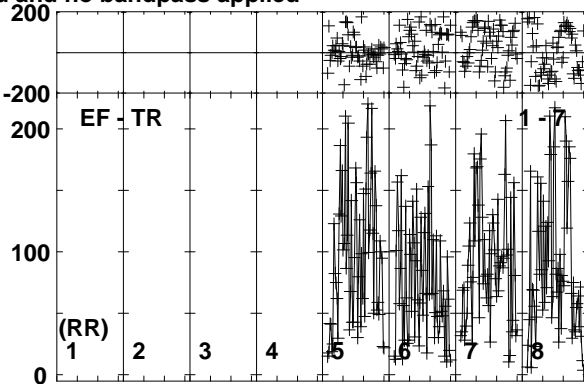
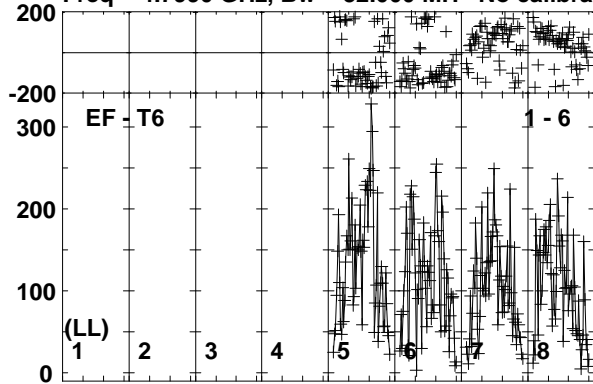

Lower frame: Micro Ampl Jy Top frame: Phas deg
Vector averaged cross-power spectrum Baseline: EF (01) - T6 (06)
Timerange: 00/20:56:41 to 00/21:00:20

Plot file version 131 created 03-OCT-2017 13:10:00

J2353+5518 RP028.UVDATA.1

Freq = 4.7990 GHz, Bw = 32.000 MH No calibration applied and no bandpass applied

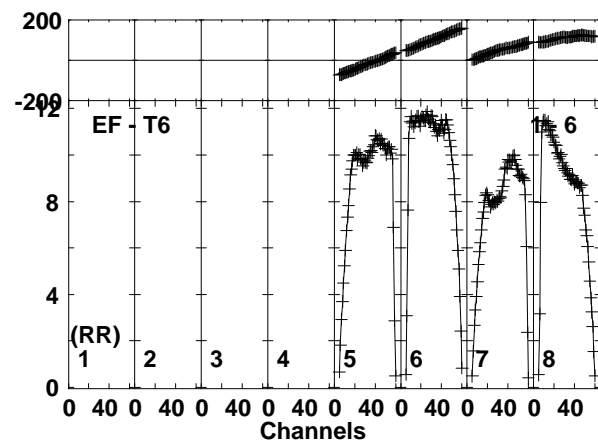
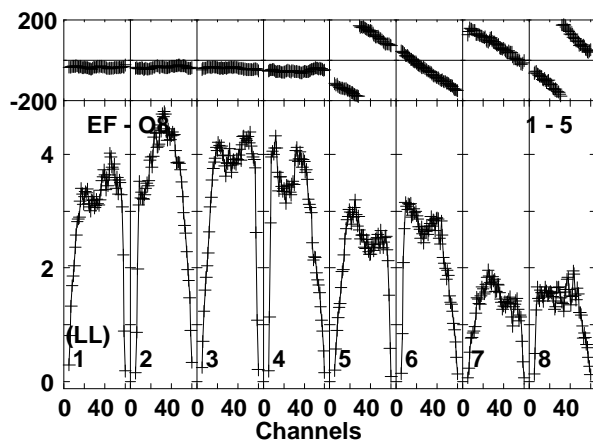
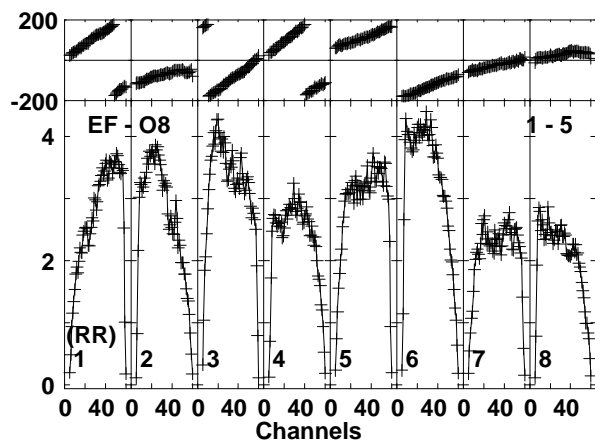
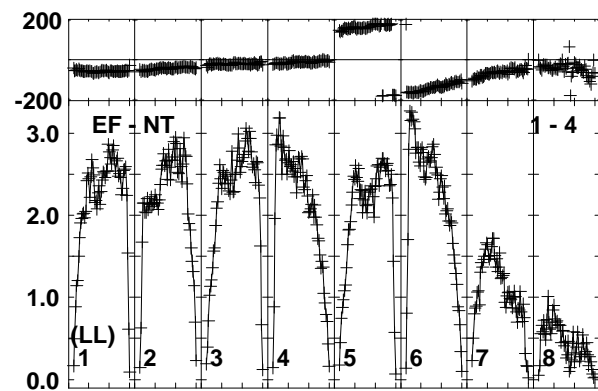
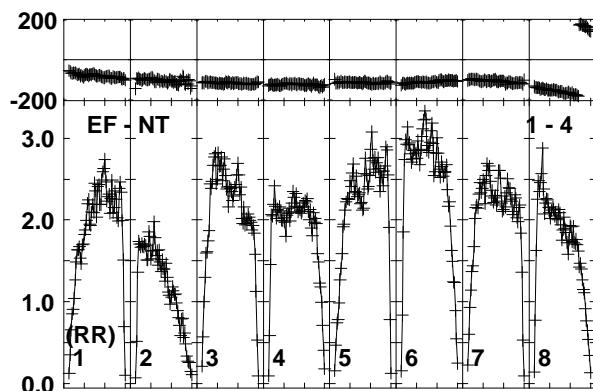
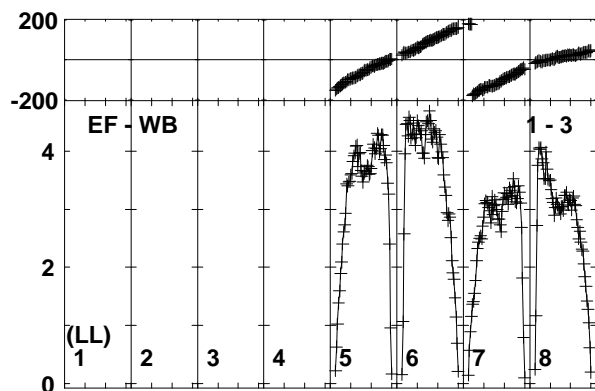
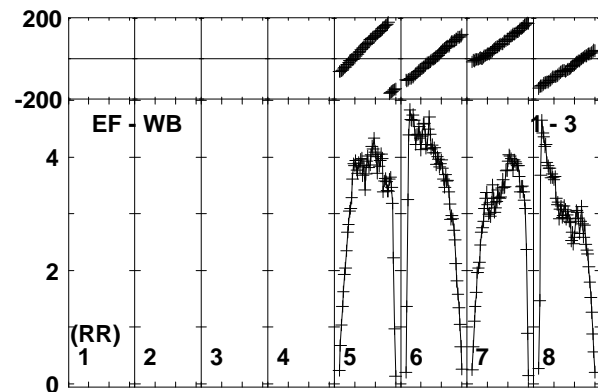
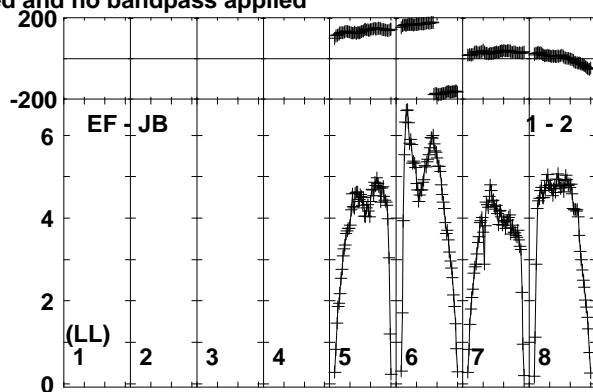
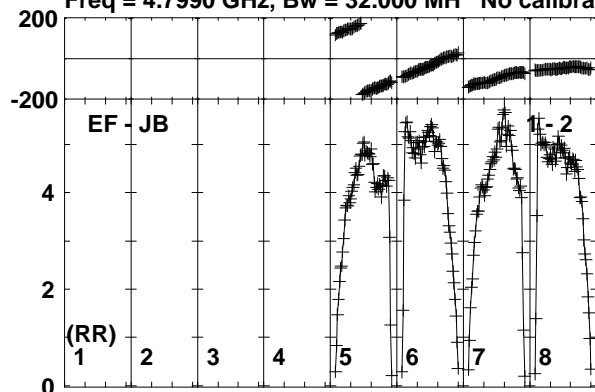

Lower frame: Milli Ampl Jy Top frame: Phas deg
Vector averaged cross-power spectrum Baseline: EF (01) - JB (02)
Timerange: 00/21:00:21 to 00/21:01:49

Plot file version 132 created 03-OCT-2017 13:10:01

J2353+5518 RP028.UVDATA.1

Freq = 4.7990 GHz, Bw = 32.000 MH No calibration applied and no bandpass applied

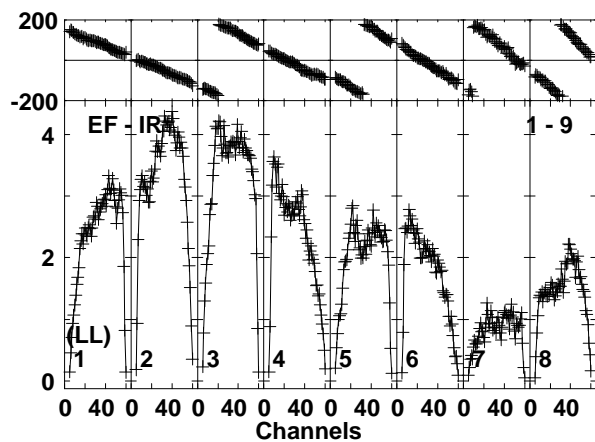
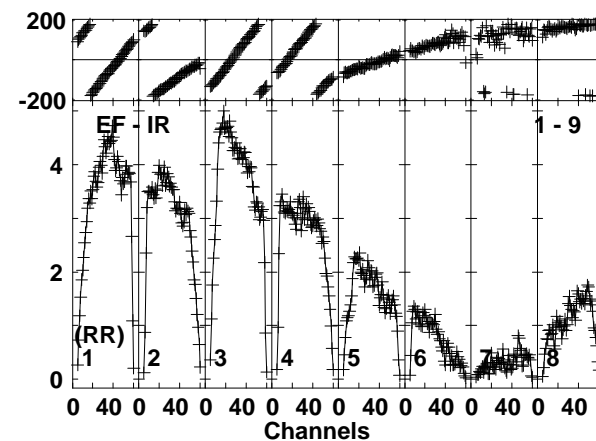
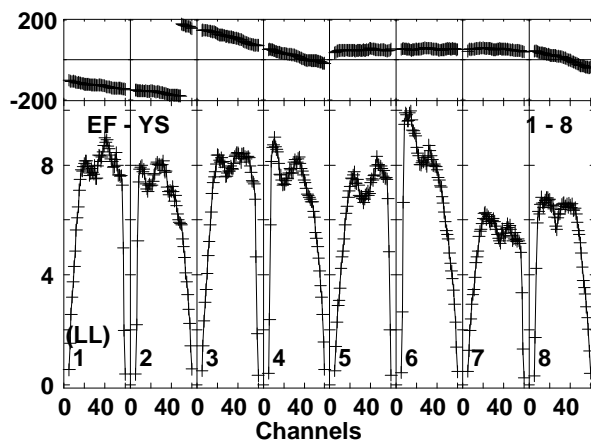
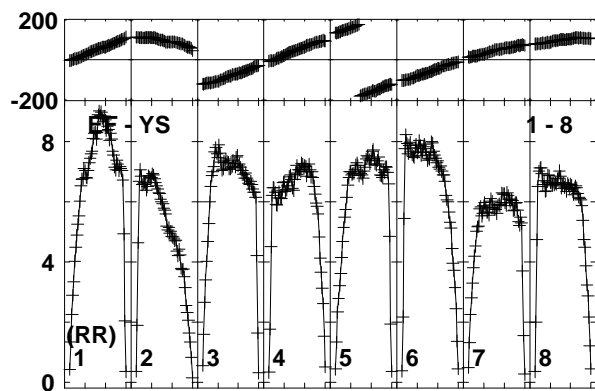
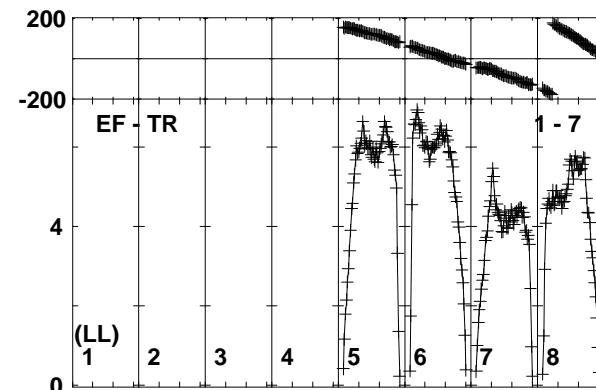
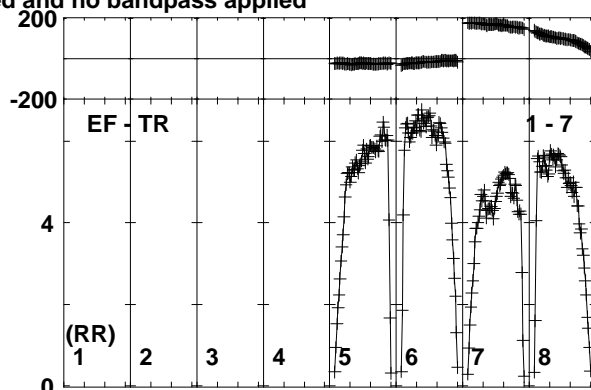
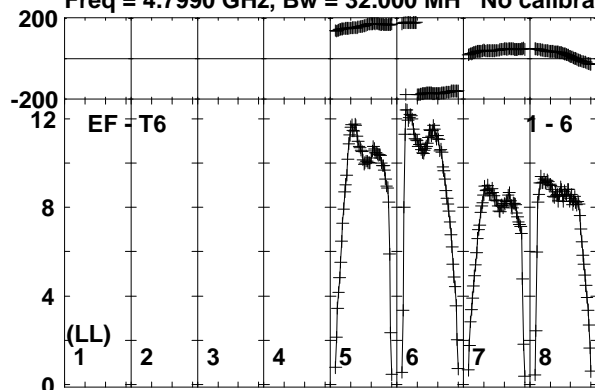

Lower frame: Milli Ampl Jy Top frame: Phas deg
Vector averaged cross-power spectrum Baseline: EF (01) - T6 (06)
Timerange: 00/21:00:21 to 00/21:01:49

Plot file version 133 created 03-OCT-2017 13:10:01

IRAS23436 RP028.UVDATA.1

Freq = 4.7990 GHz, Bw = 32.000 MH No calibration applied and no bandpass applied

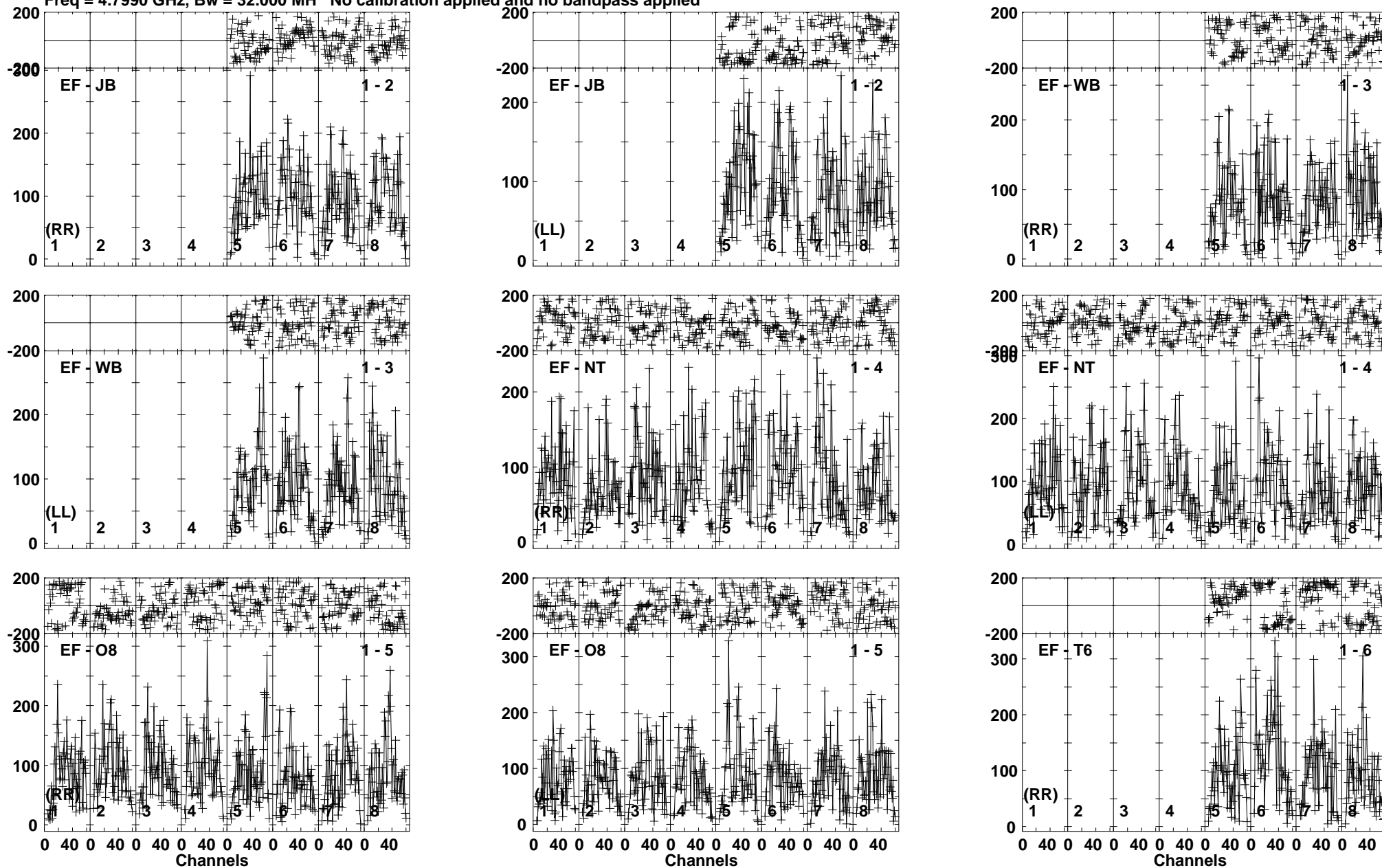

Lower frame: Micro Ampl Jy Top frame: Phas deg
Vector averaged cross-power spectrum Baseline: EF (01) - JB (02)
Timerange: 00/21:01:51 to 00/21:05:33

Plot file version 134 created 03-OCT-2017 13:10:01

IRAS23436 RP028.UVDATA.1

Freq = 4.7990 GHz, Bw = 32.000 MH No calibration applied and no bandpass applied

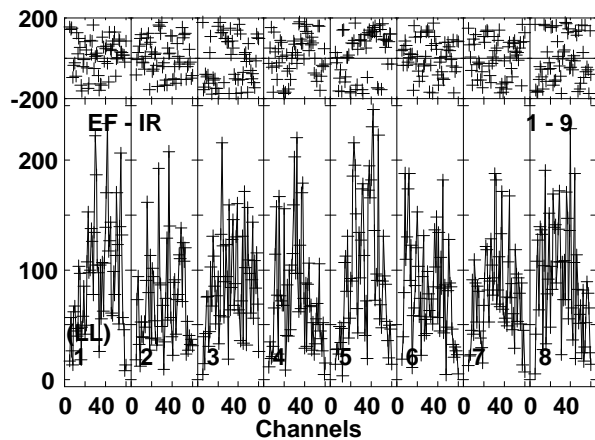
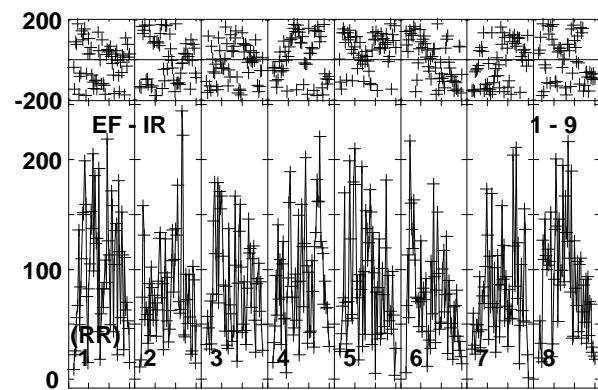
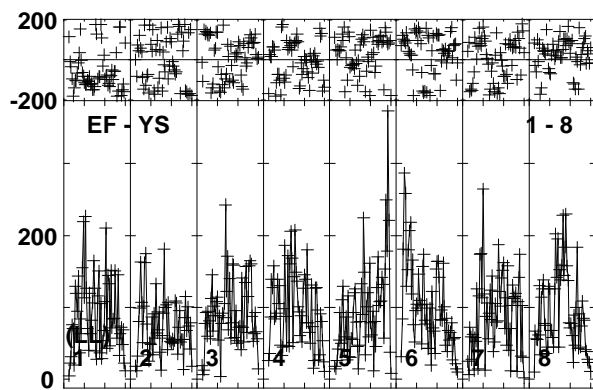
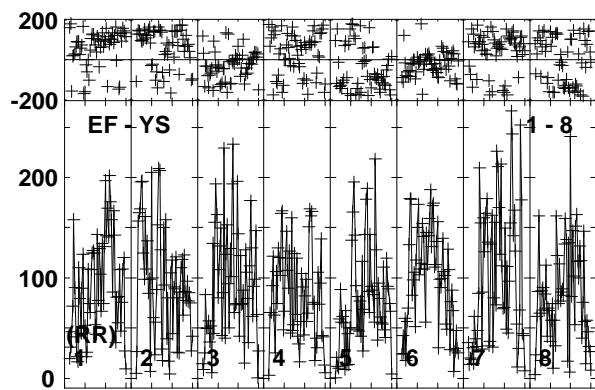
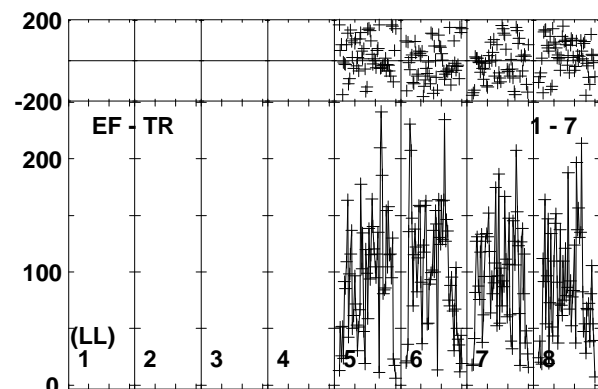
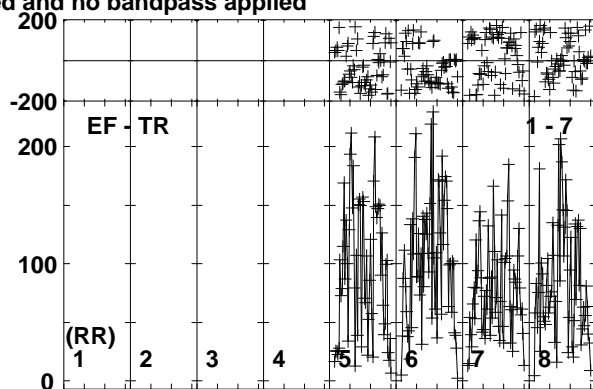
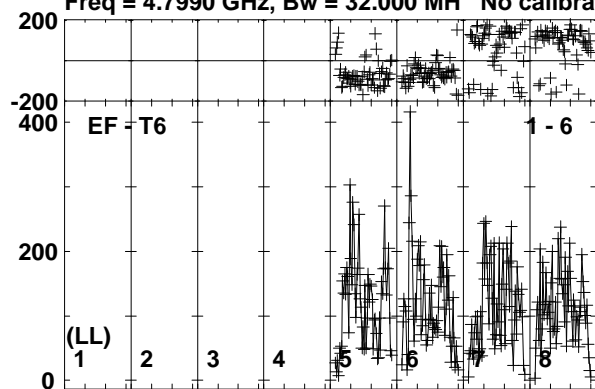

Lower frame: Micro Ampl Jy Top frame: Phas deg
Vector averaged cross-power spectrum Baseline: EF (01) - T6 (06)
Timerange: 00/21:01:51 to 00/21:05:33

Plot file version 135 created 03-OCT-2017 13:10:01

J2353+5518 RP028.UVDATA.1

Freq = 4.7990 GHz, Bw = 32.000 MH No calibration applied and no bandpass applied

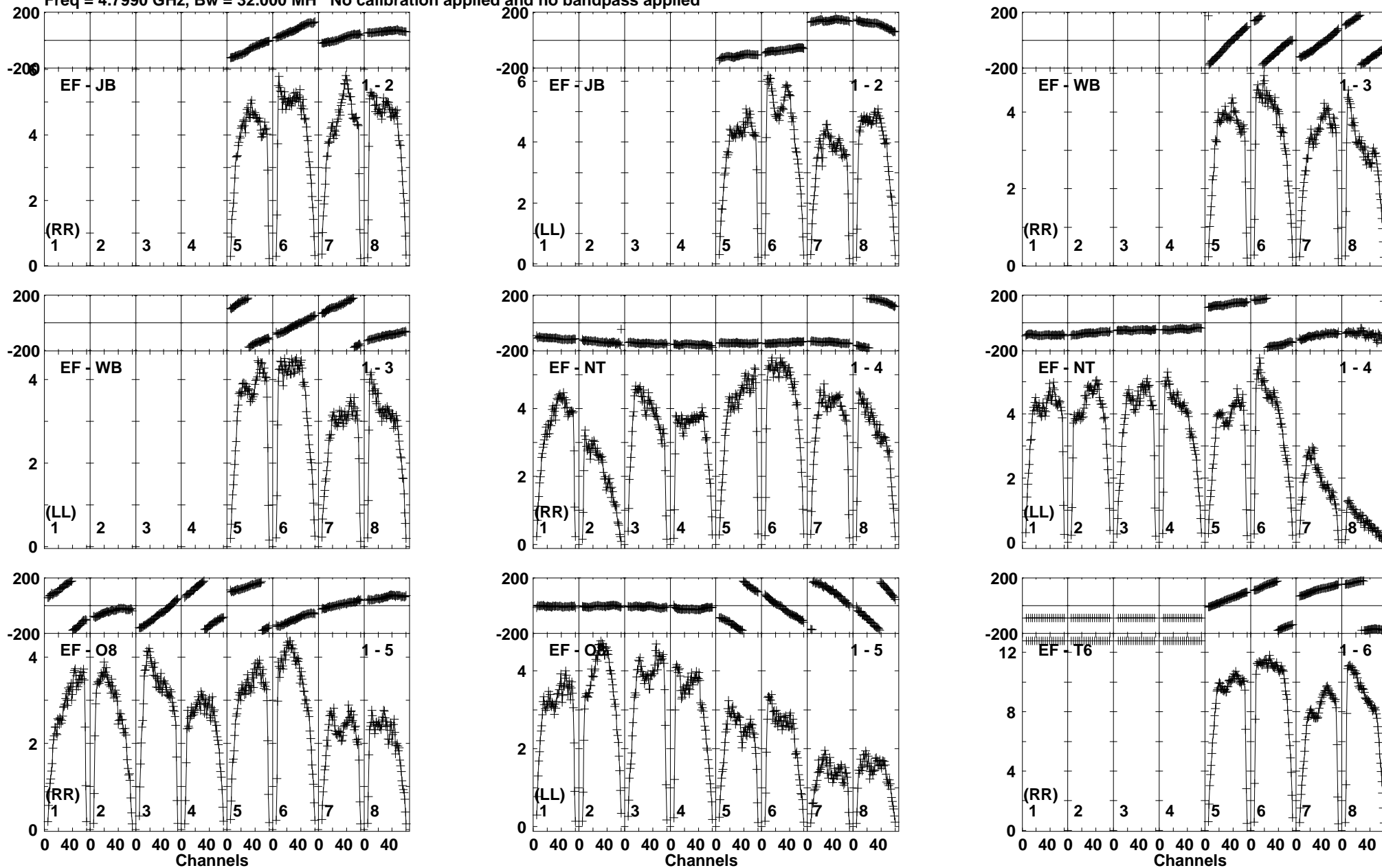

Lower frame: Milli Ampl Jy Top frame: Phas deg
Vector averaged cross-power spectrum Baseline: EF (01) - JB (02)
Timerange: 00/21:06:14 to 00/21:07:04

Plot file version 136 created 03-OCT-2017 13:10:02

J2353+5518 RP028.UVDATA.1

Freq = 4.7990 GHz, Bw = 32.000 MH No calibration applied and no bandpass applied

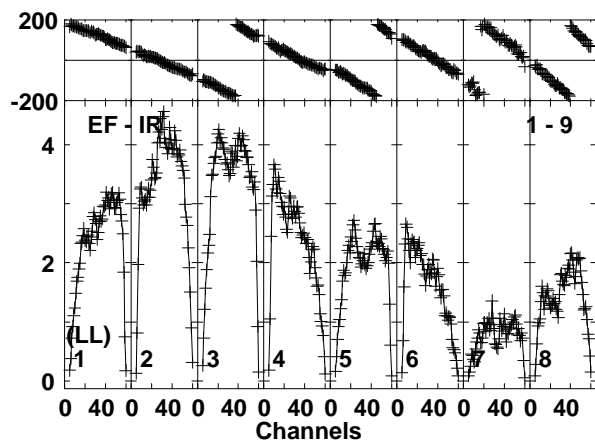
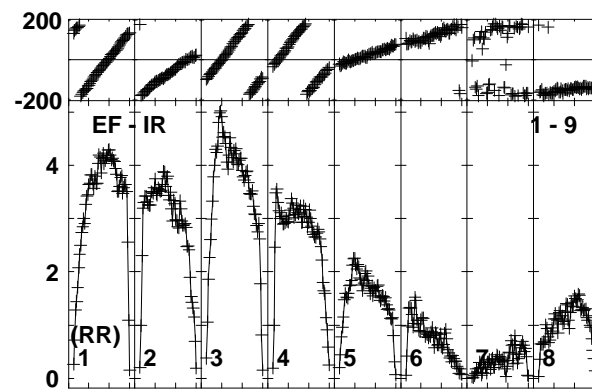
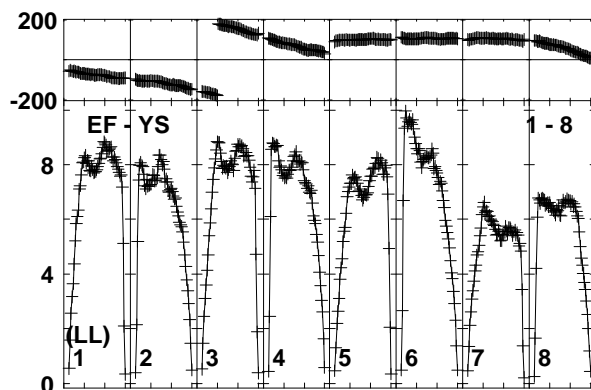
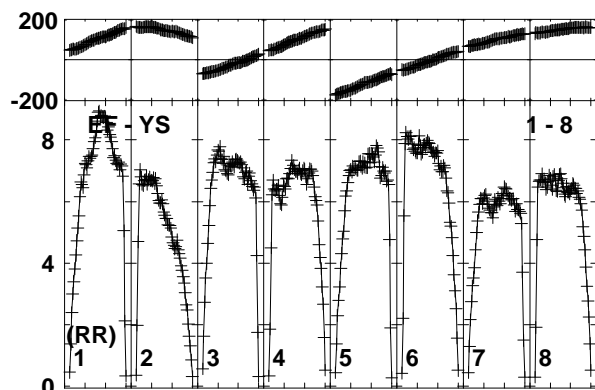
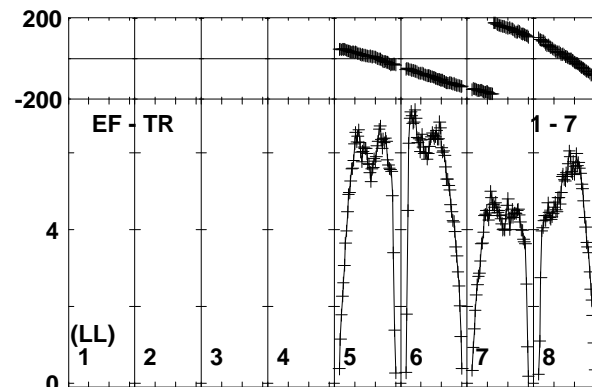
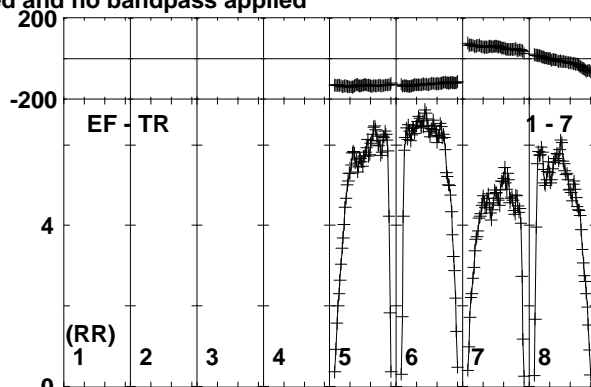
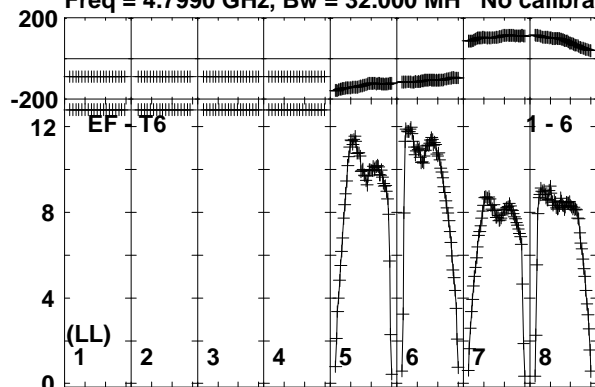

Lower frame: Milli Ampl Jy Top frame: Phas deg
Vector averaged cross-power spectrum Baseline: EF (01) - T6 (06)
Timerange: 00/21:06:14 to 00/21:07:04

Plot file version 137 created 03-OCT-2017 13:10:02

IRAS23436 RP028.UVDATA.1

Freq = 4.7990 GHz, Bw = 32.000 MH No calibration applied and no bandpass applied

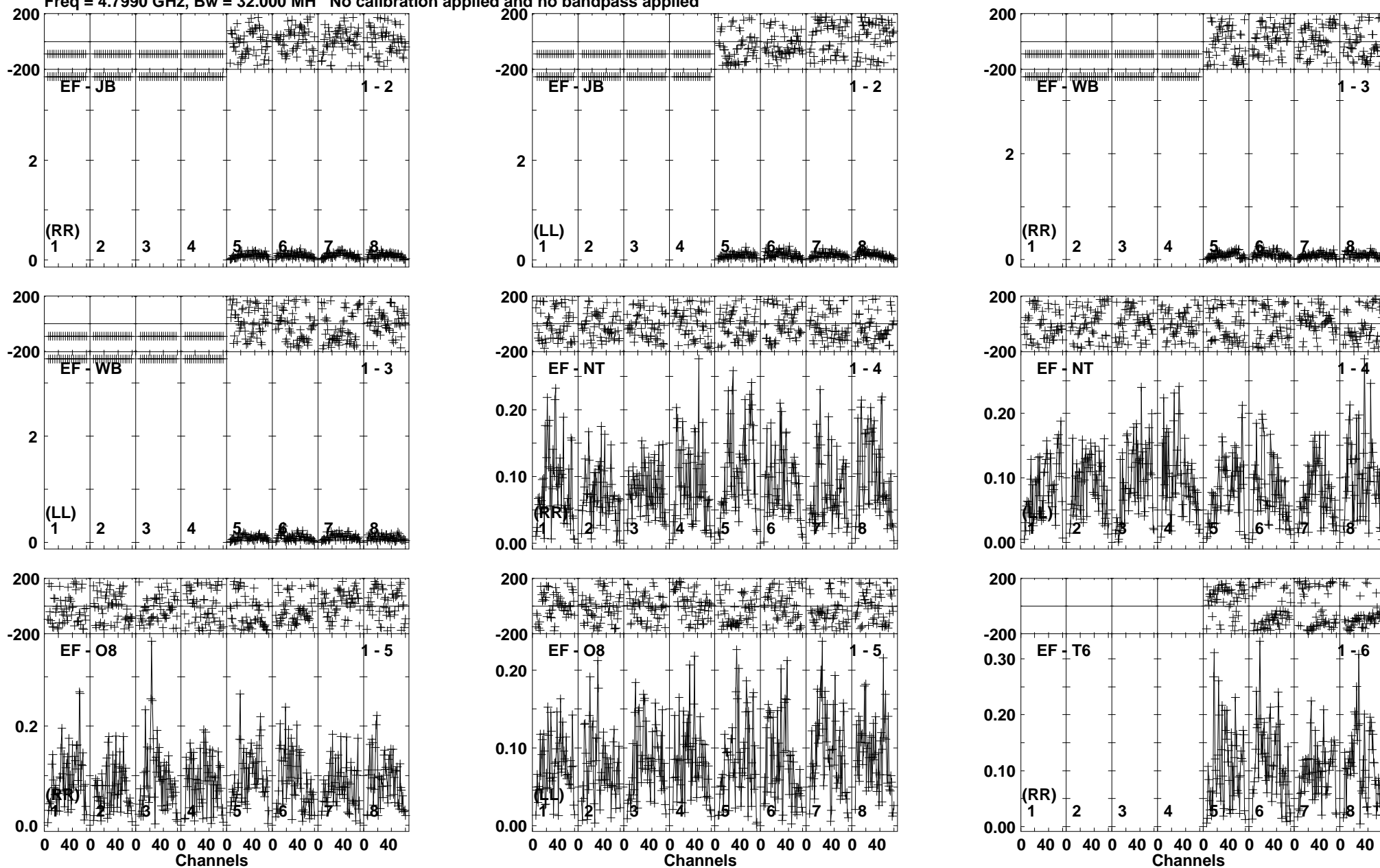

Lower frame: Milli Ampl Jy Top frame: Phas deg
Vector averaged cross-power spectrum Baseline: EF (01) - JB (02)
Timerange: 00/21:07:04 to 00/21:10:47

Plot file version 138 created 03-OCT-2017 13:10:02

IRAS23436 RP028.UVDATA.1

Freq = 4.7990 GHz, Bw = 32.000 MH No calibration applied and no bandpass applied

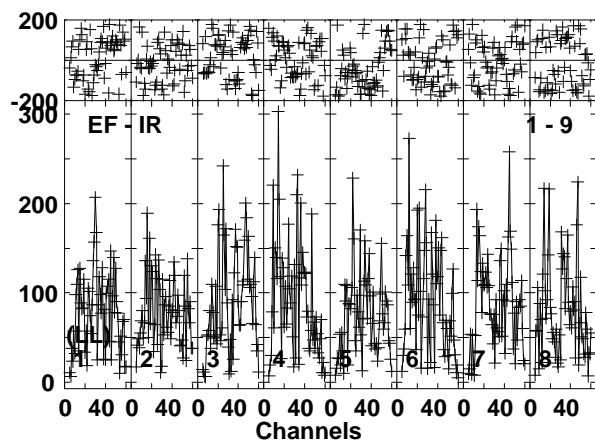
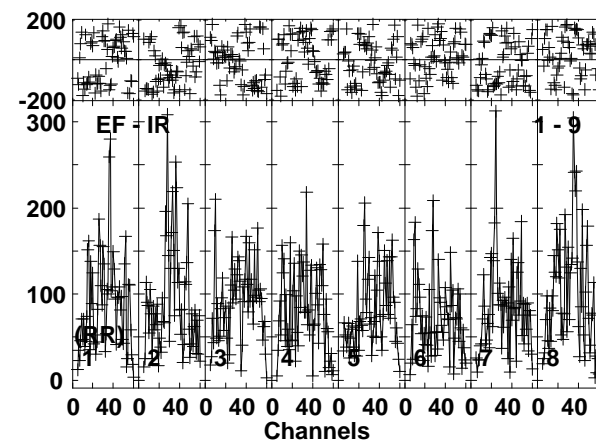
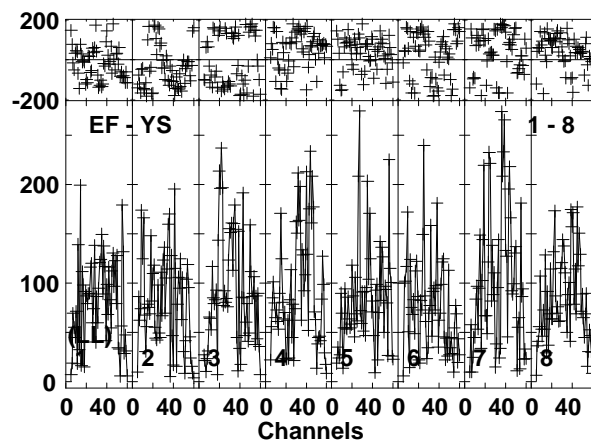
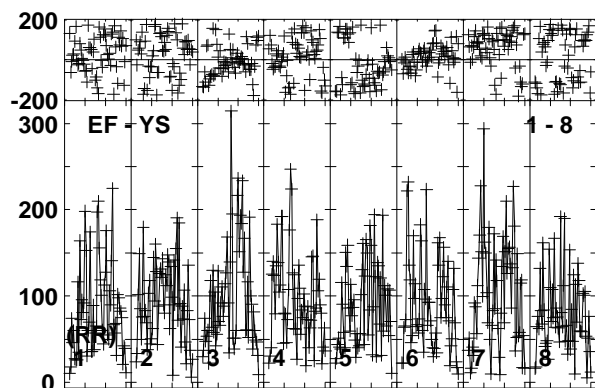
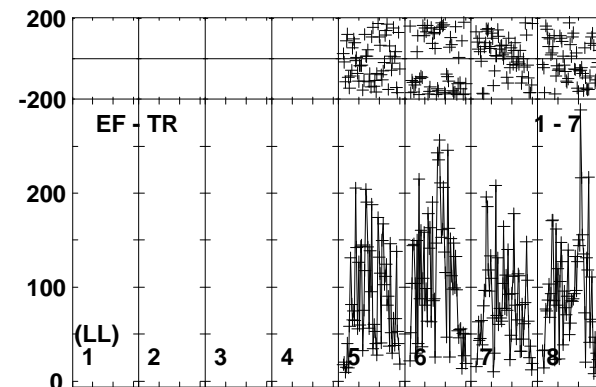
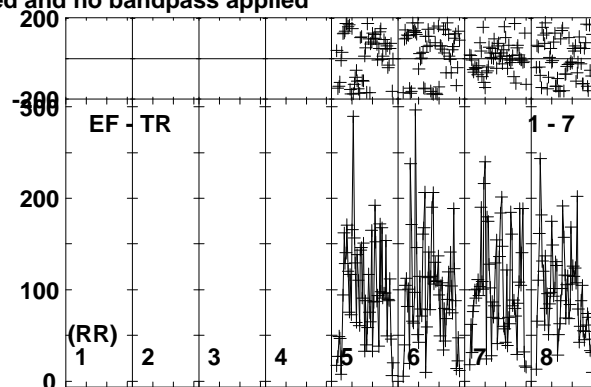
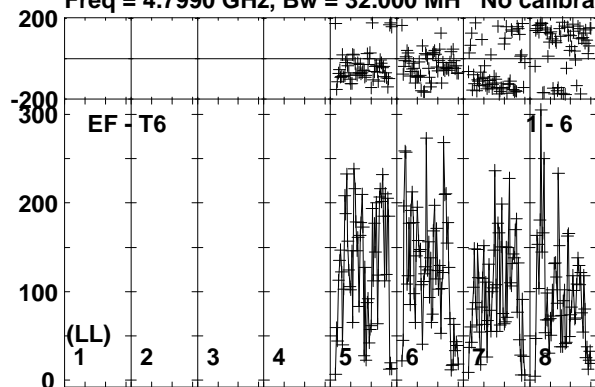

Lower frame: Micro Ampl Jy Top frame: Phas deg
Vector averaged cross-power spectrum Baseline: EF (01) - T6 (06)
Timerange: 00/21:07:04 to 00/21:10:47

Plot file version 139 created 03-OCT-2017 13:10:02

J2353+5518 RP028.UVDATA.1

Freq = 4.7990 GHz, Bw = 32.000 MH No calibration applied and no bandpass applied

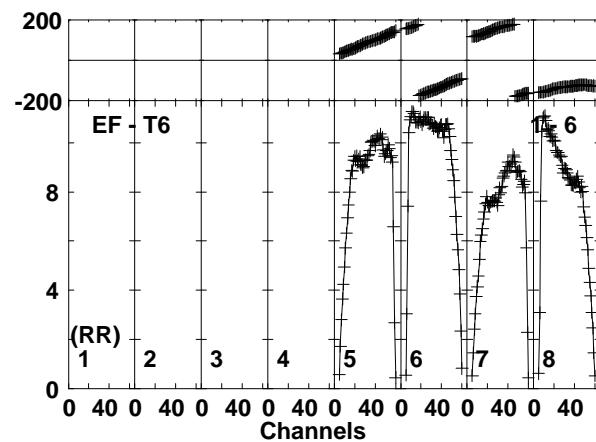
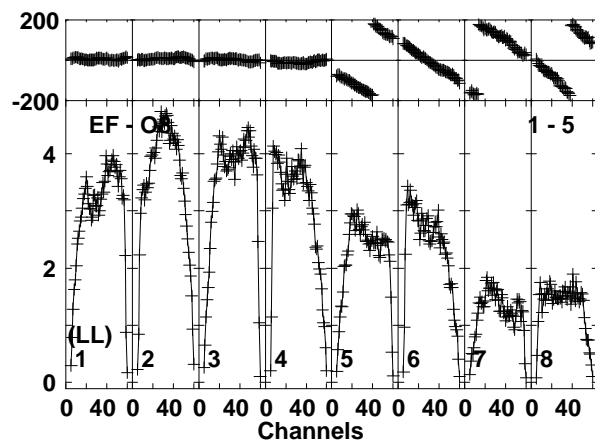
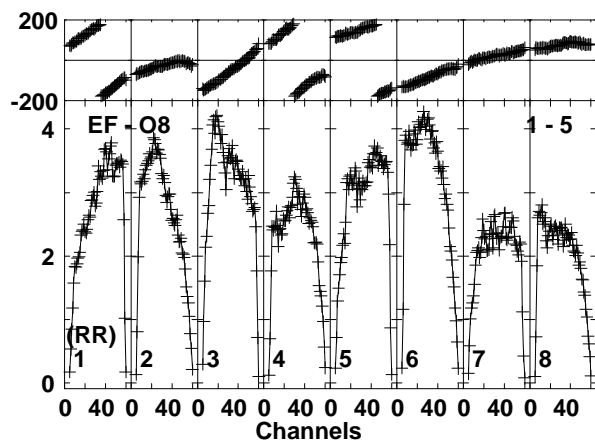
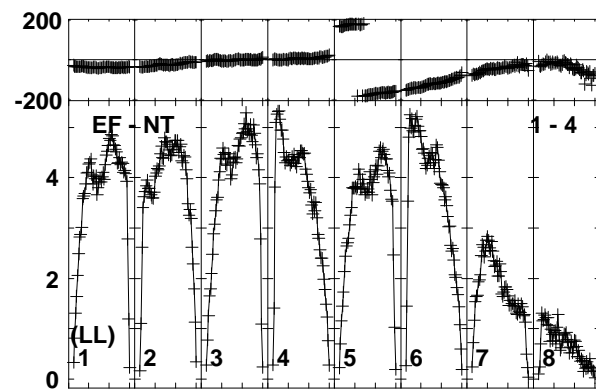
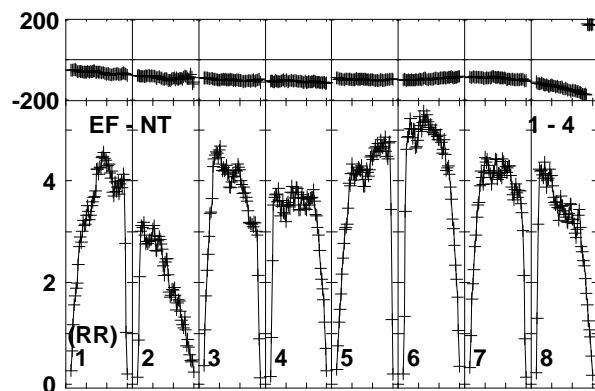
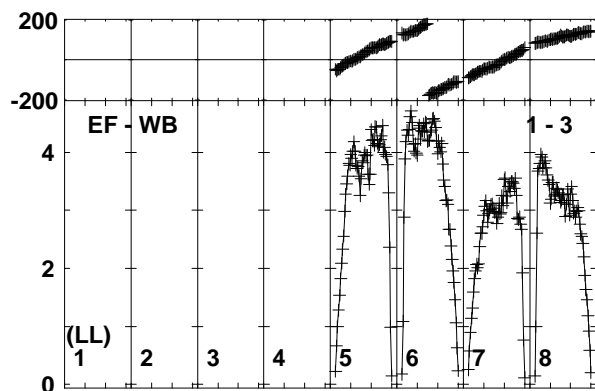
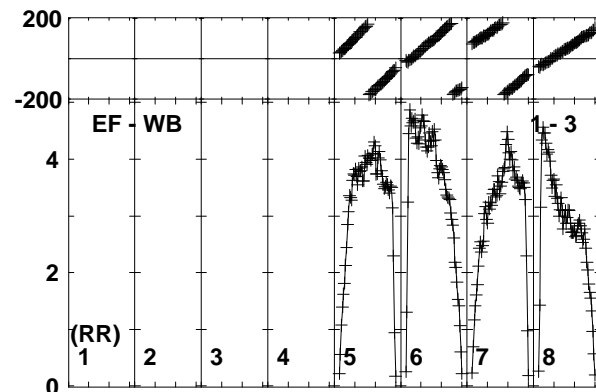
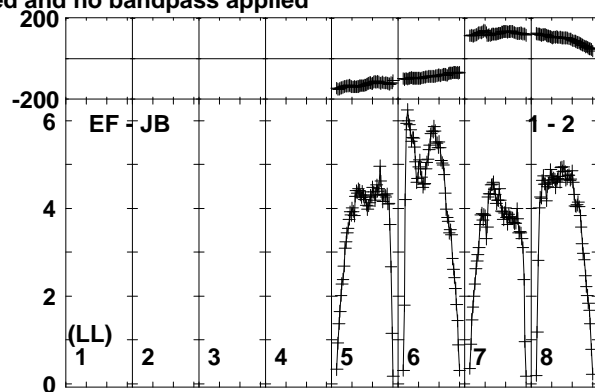
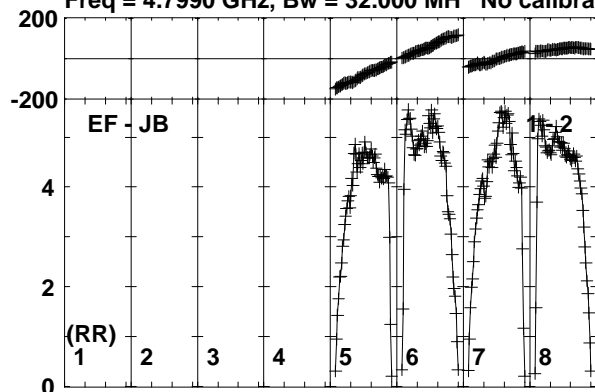

Lower frame: Milli Ampl Jy Top frame: Phas deg
Vector averaged cross-power spectrum Baseline: EF (01) - JB (02)
Timerange: 00/21:10:48 to 00/21:12:17

Plot file version 140 created 03-OCT-2017 13:10:02

J2353+5518 RP028.UVDATA.1

Freq = 4.7990 GHz, Bw = 32.000 MH No calibration applied and no bandpass applied

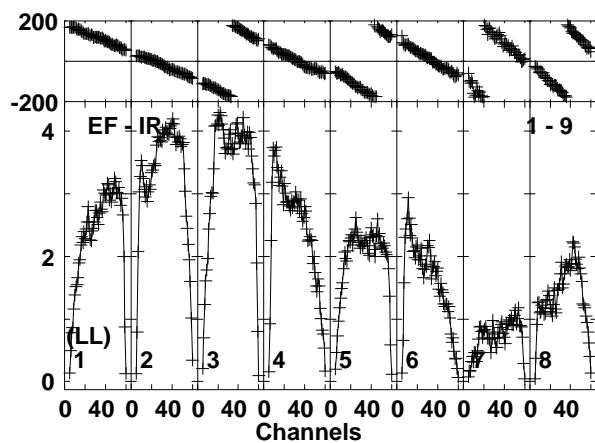
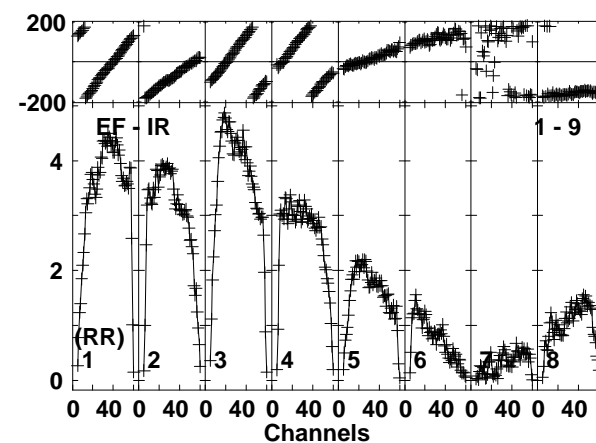
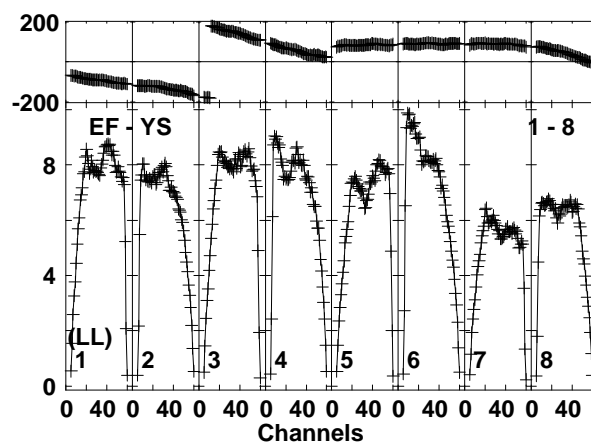
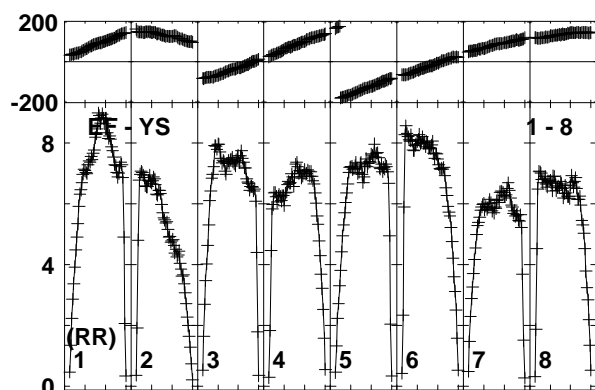
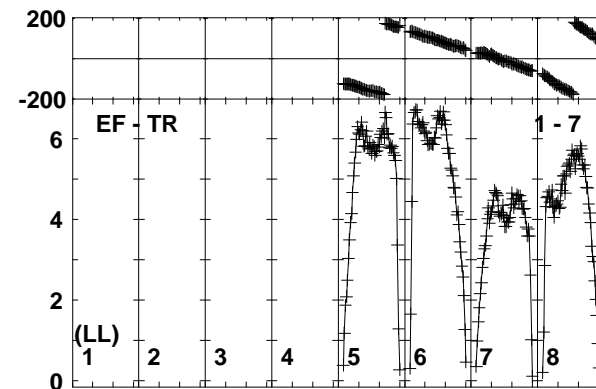
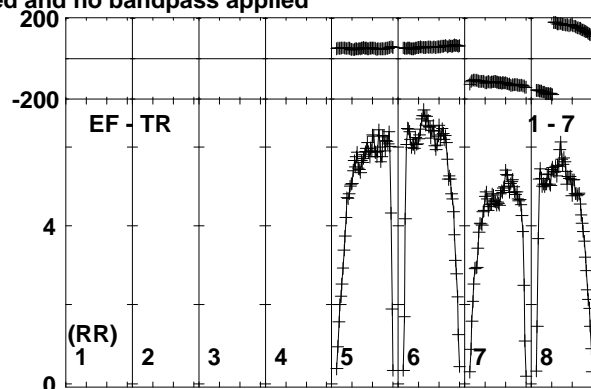
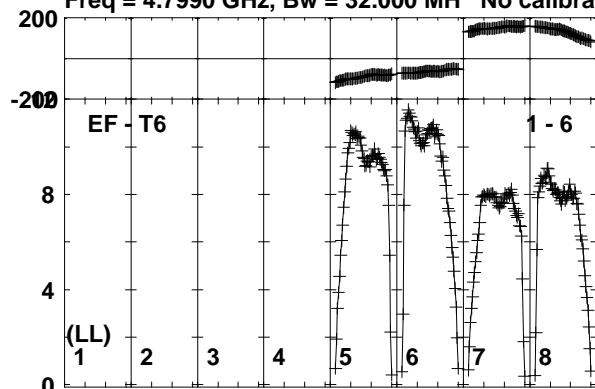

Lower frame: Milli Ampl Jy Top frame: Phas deg
Vector averaged cross-power spectrum Baseline: EF (01) - T6 (06)
Timerange: 00/21:10:48 to 00/21:12:17

Plot file version 141 created 03-OCT-2017 13:10:03

IRAS23436 RP028.UVDATA.1

Freq = 4.7990 GHz, Bw = 32.000 MH No calibration applied and no bandpass applied

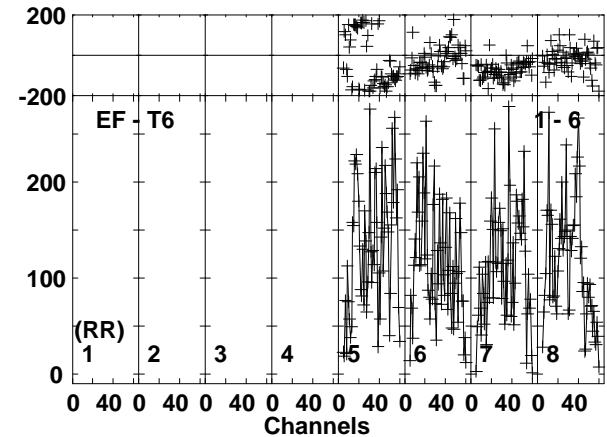
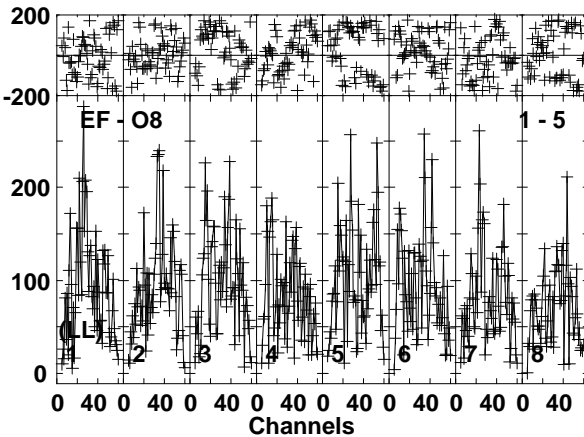
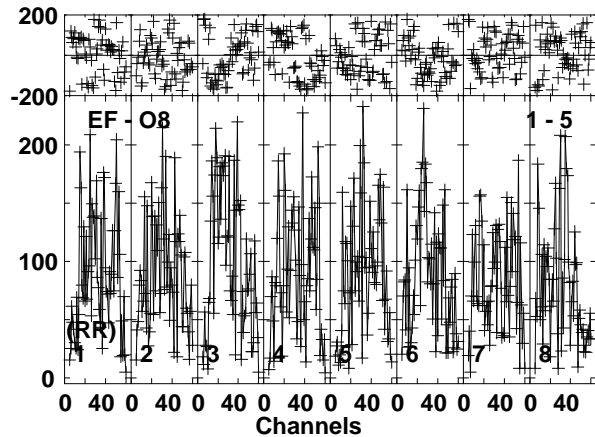
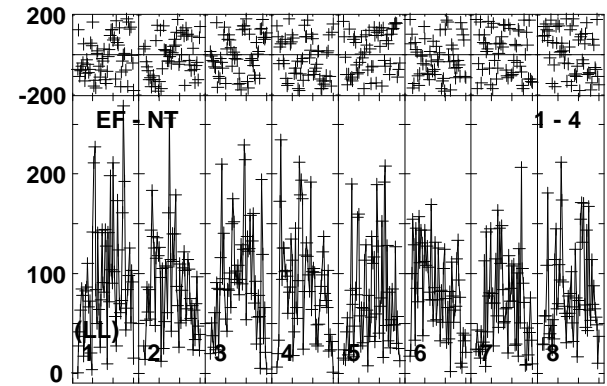
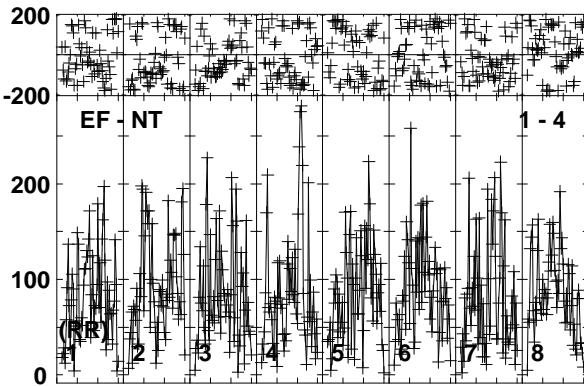
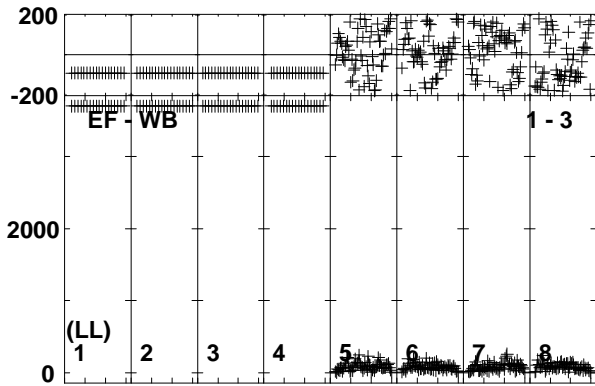
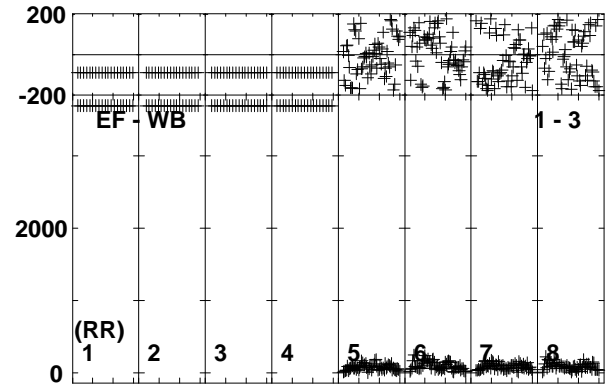
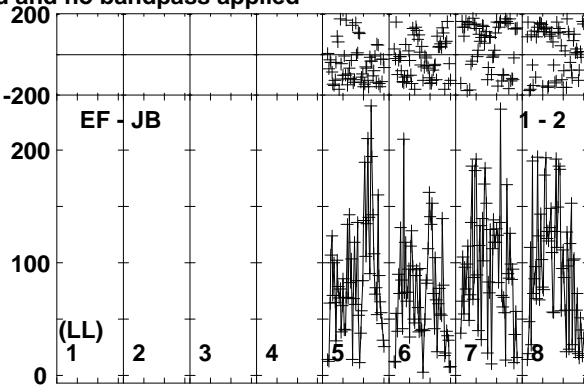
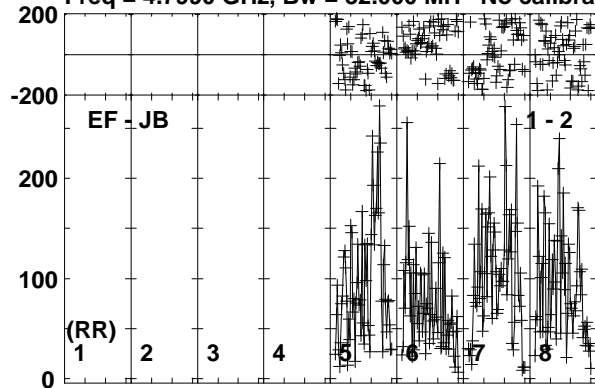

Lower frame: Micro Ampl Jy Top frame: Phas deg
Vector averaged cross-power spectrum Baseline: EF (01) - JB (02)
Timerange: 00/21:12:19 to 00/21:16:02

Plot file version 142 created 03-OCT-2017 13:10:03

IRAS23436 RP028.UVDATA.1

Freq = 4.7990 GHz, Bw = 32.000 MH No calibration applied and no bandpass applied

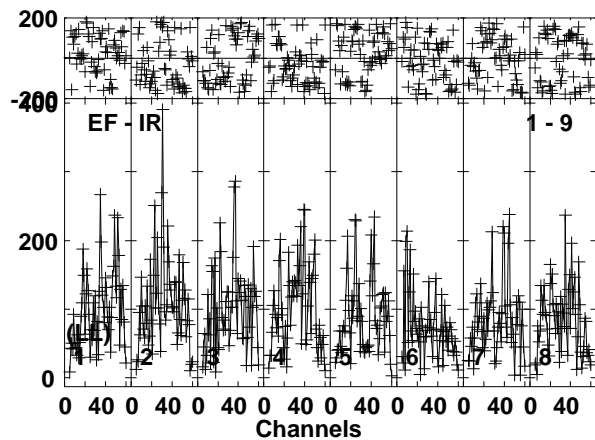
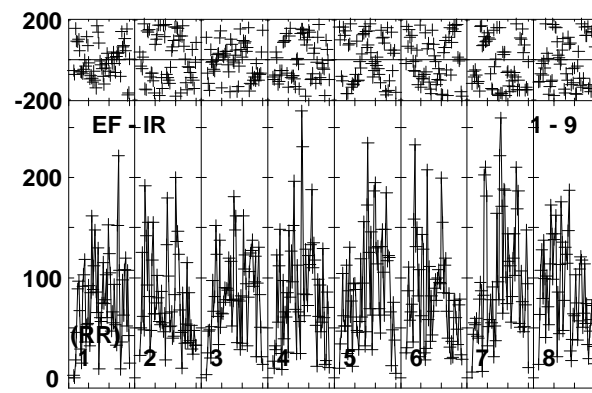
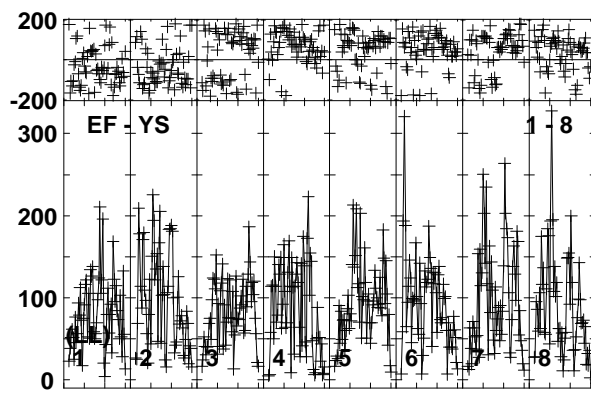
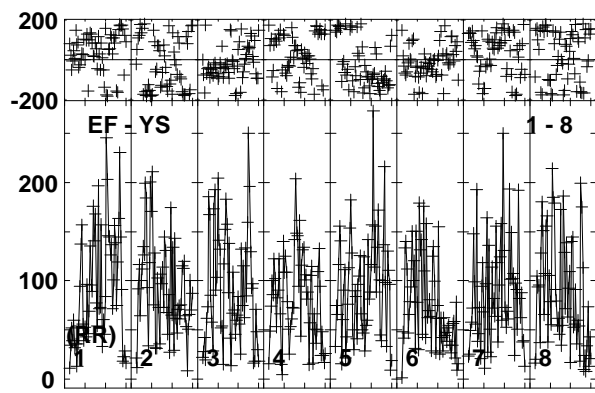
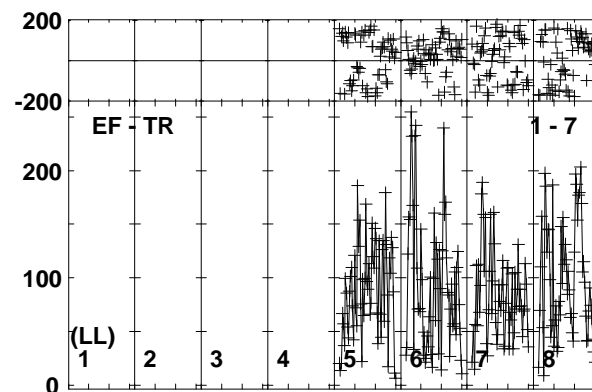
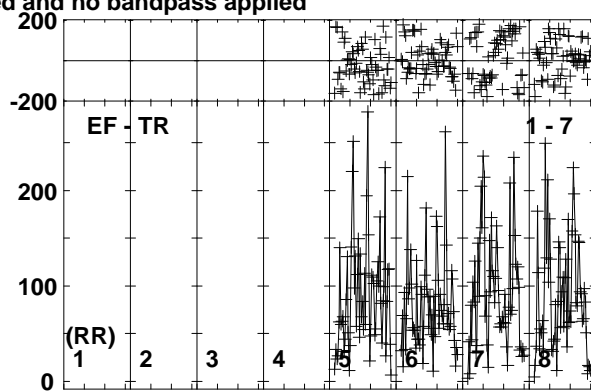
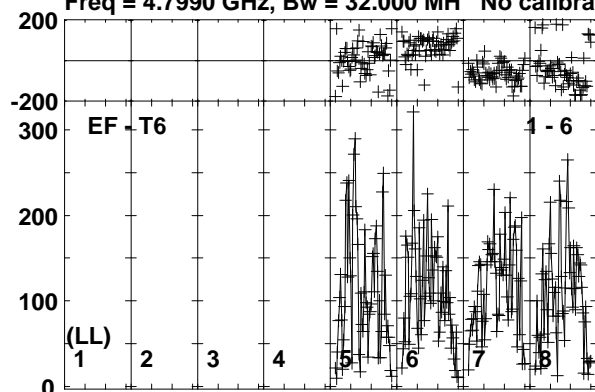

Lower frame: Micro Ampl Jy Top frame: Phas deg
Vector averaged cross-power spectrum Baseline: EF (01) - T6 (06)
Timerange: 00/21:12:19 to 00/21:16:02

Plot file version 143 created 03-OCT-2017 13:10:03

J2353+5518 RP028.UVDATA.1

Freq = 4.7990 GHz, Bw = 32.000 MH No calibration applied and no bandpass applied

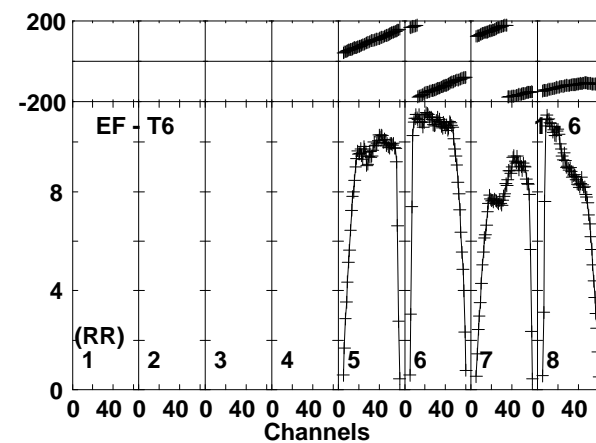
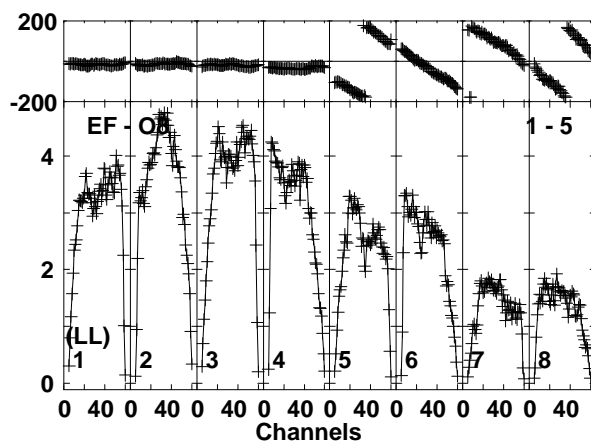
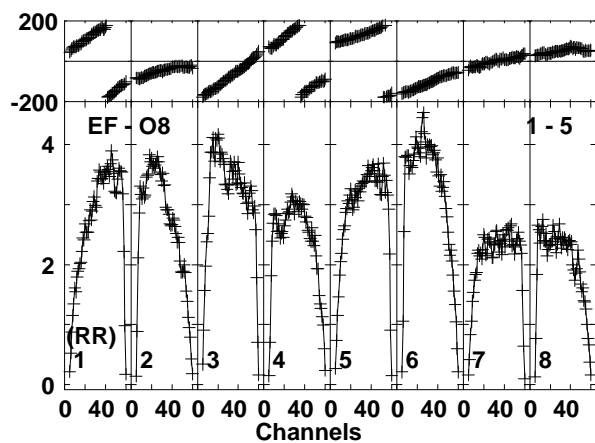
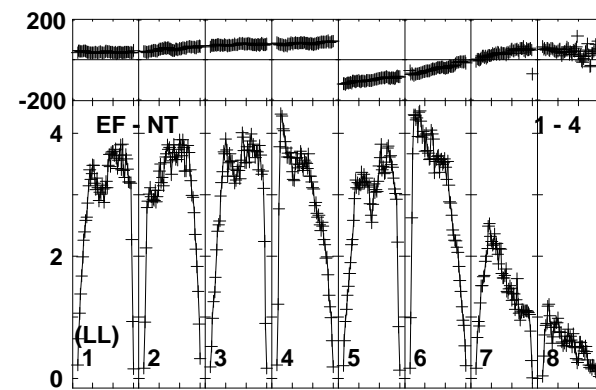
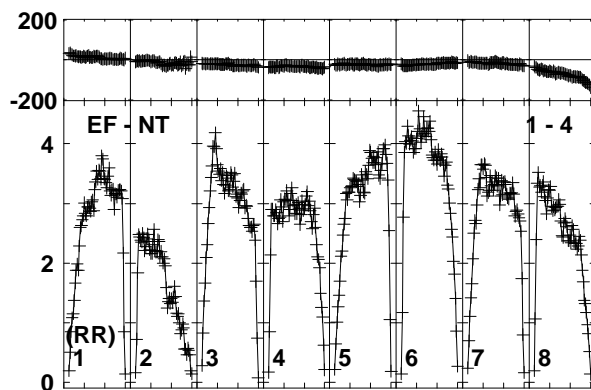
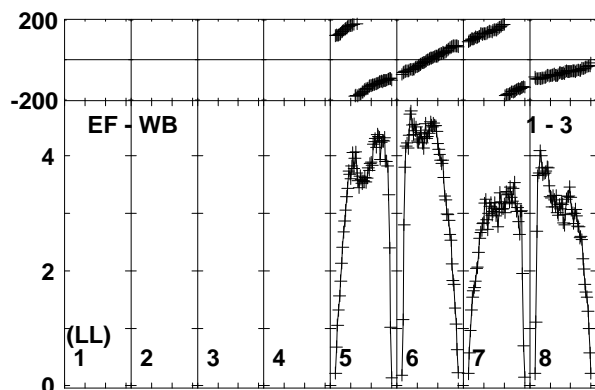
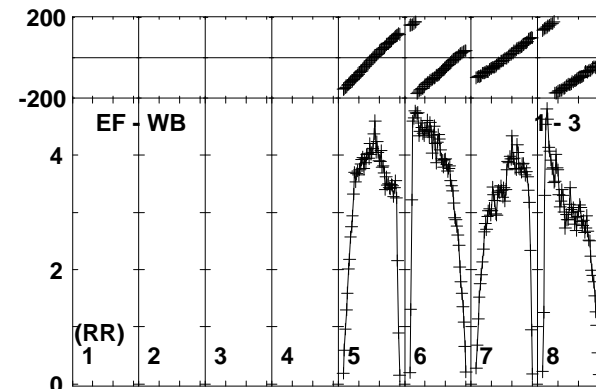
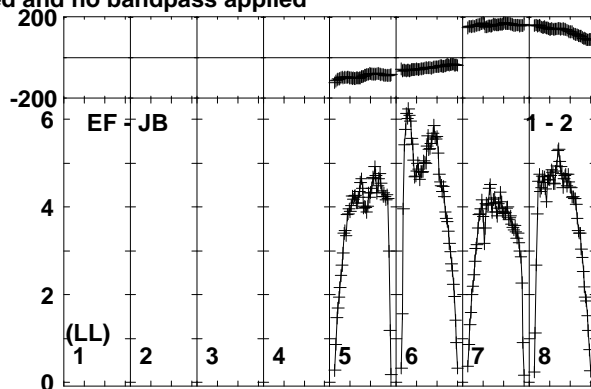
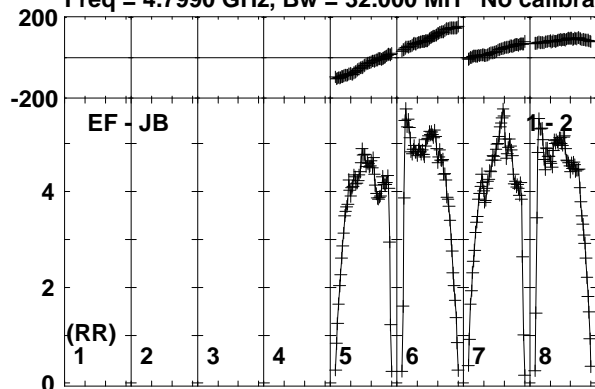

Lower frame: Milli Ampl Jy Top frame: Phas deg
Vector averaged cross-power spectrum Baseline: EF (01) - JB (02)
Timerange: 00/21:16:02 to 00/21:17:32

Plot file version 144 created 03-OCT-2017 13:10:03

J2353+5518 RP028.UVDATA.1

Freq = 4.7990 GHz, Bw = 32.000 MH No calibration applied and no bandpass applied

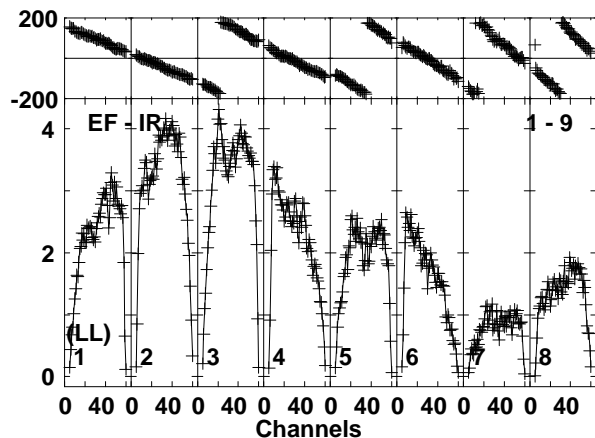
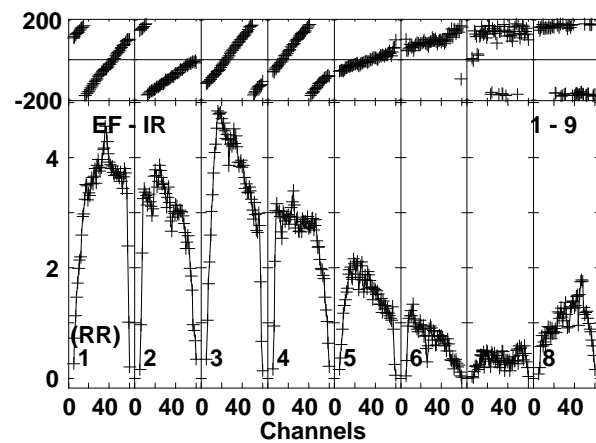
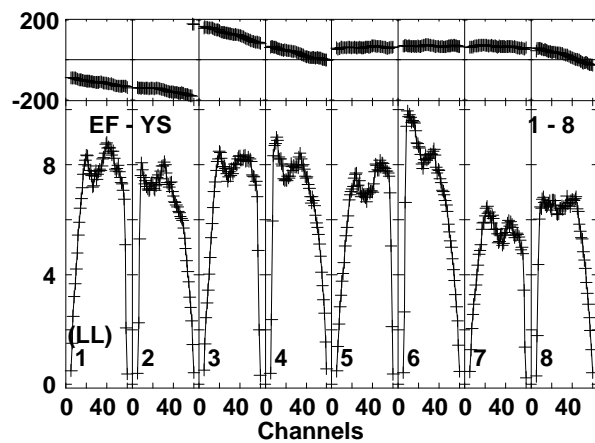
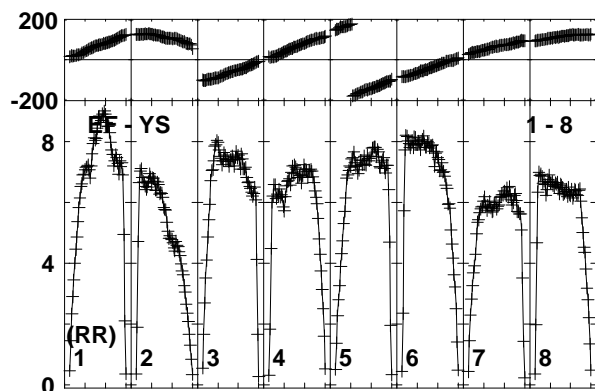
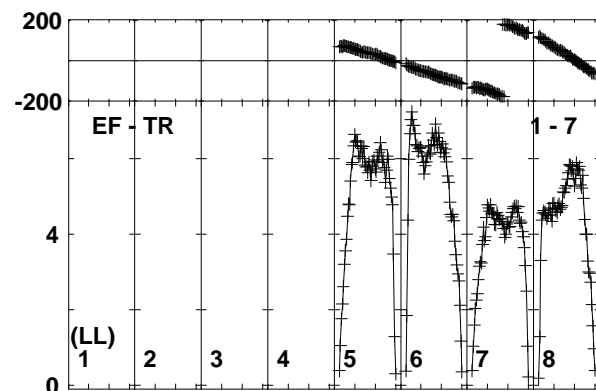
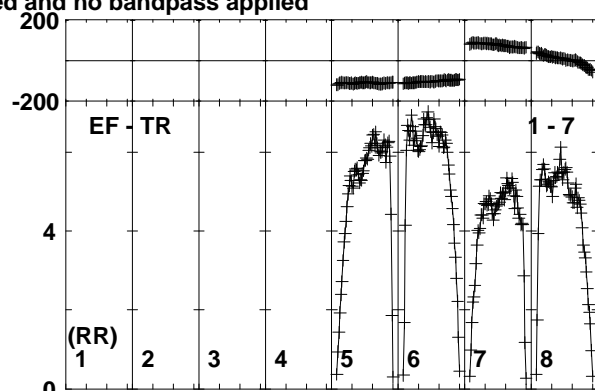
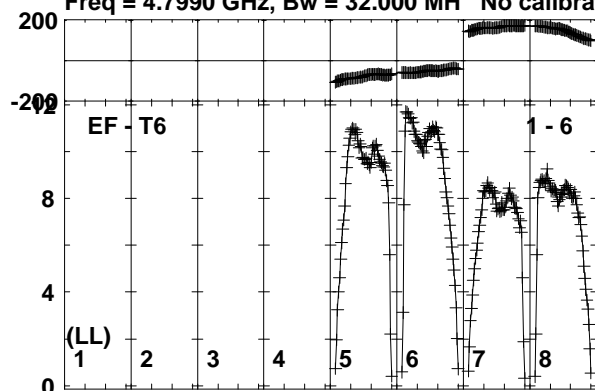

Lower frame: Milli Ampl Jy Top frame: Phas deg
Vector averaged cross-power spectrum Baseline: EF (01) - T6 (06)
Timerange: 00/21:16:02 to 00/21:17:32

Plot file version 145 created 03-OCT-2017 13:10:04

IRAS23436 RP028.UVDATA.1

Freq = 4.7990 GHz, Bw = 32.000 MH No calibration applied and no bandpass applied

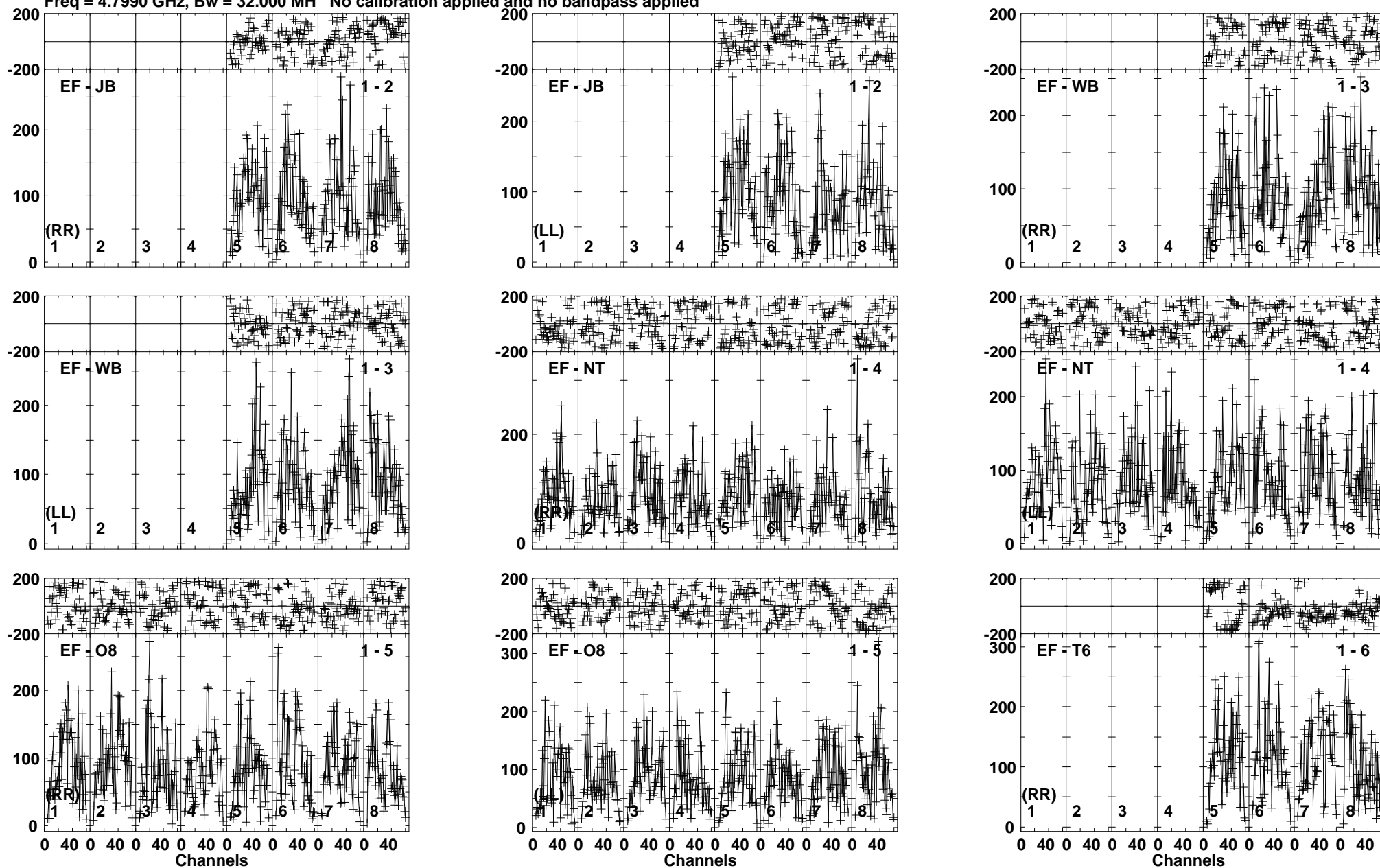

Lower frame: Micro Ampl Jy Top frame: Phas deg
Vector averaged cross-power spectrum Baseline: EF (01) - JB (02)
Timerange: 00/21:17:32 to 00/21:21:15

Plot file version 146 created 03-OCT-2017 13:10:04

IRAS23436 RP028.UVDATA.1

Freq = 4.7990 GHz, Bw = 32.000 MH No calibration applied and no bandpass applied

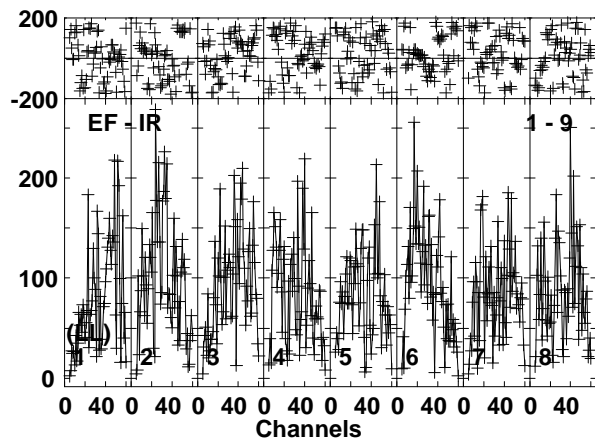
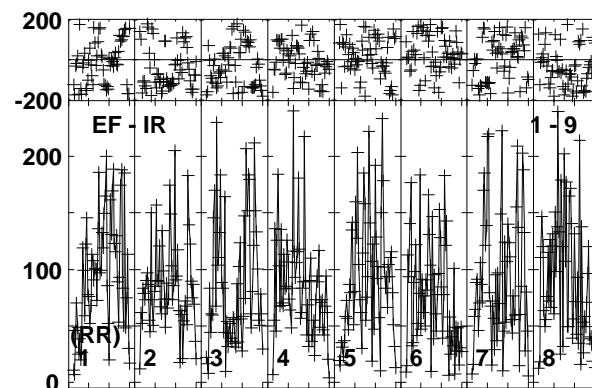
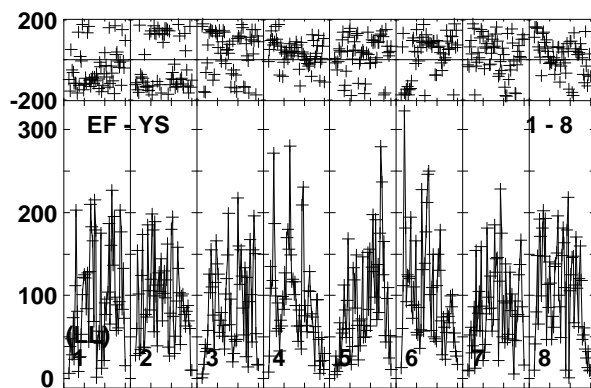
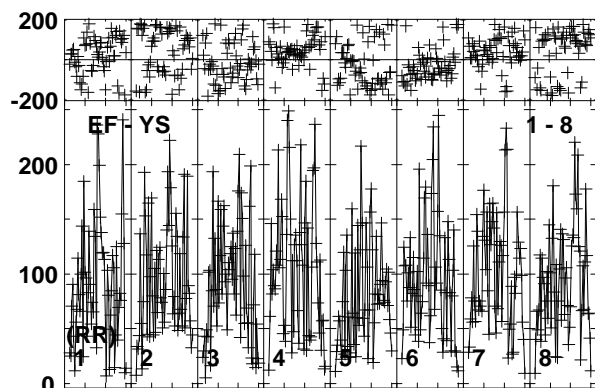
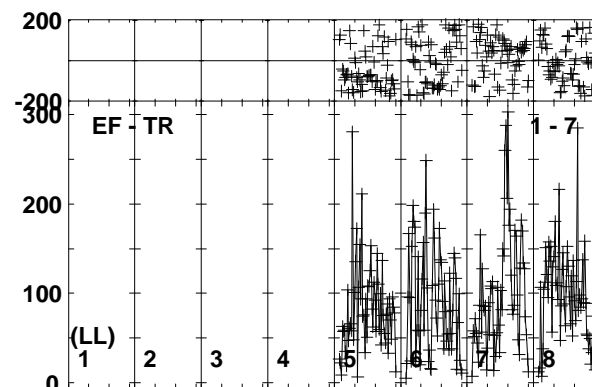
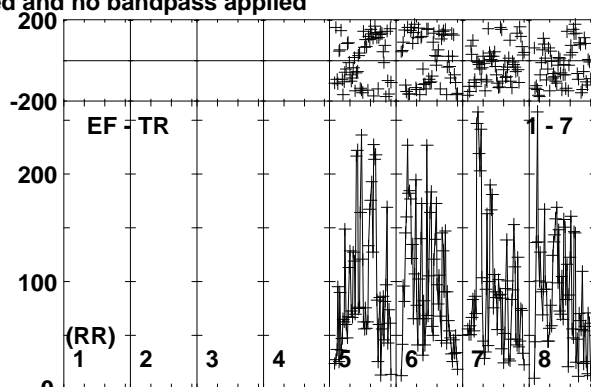
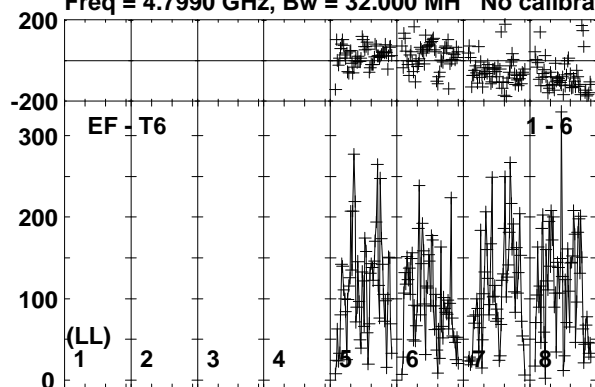

Lower frame: Micro Ampl Jy Top frame: Phas deg
Vector averaged cross-power spectrum Baseline: EF (01) - T6 (06)
Timerange: 00/21:17:32 to 00/21:21:15

Plot file version 147 created 03-OCT-2017 13:10:04

J2353+5518 RP028.UVDATA.1

Freq = 4.7990 GHz, Bw = 32.000 MH No calibration applied and no bandpass applied

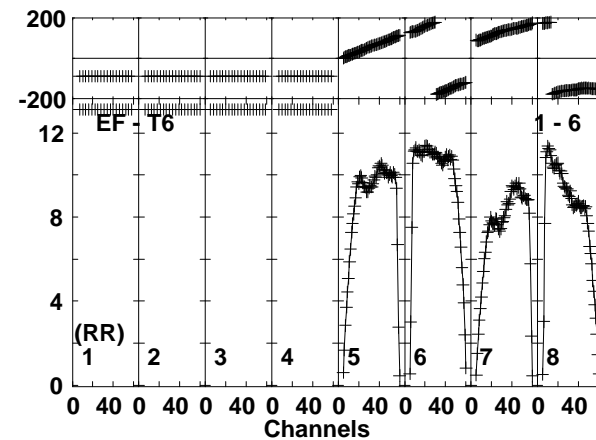
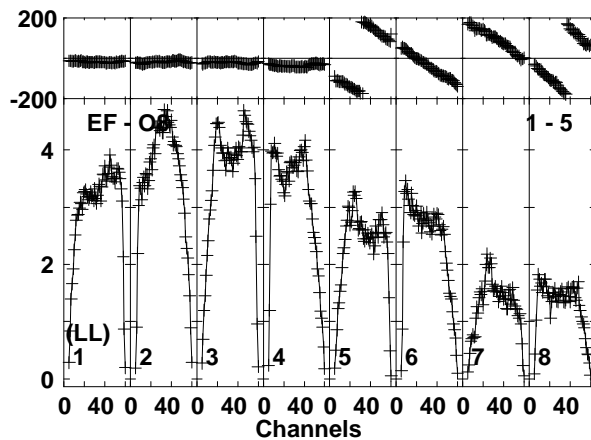
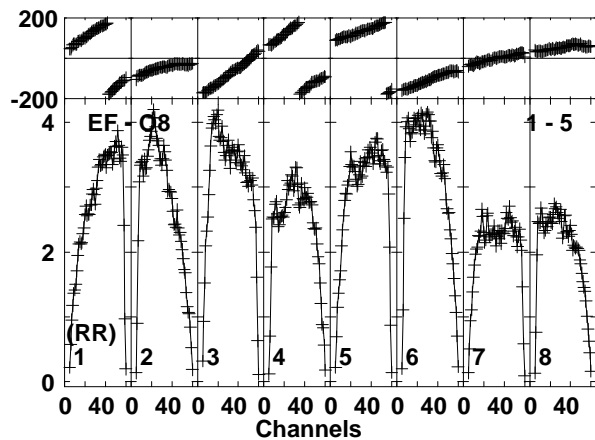
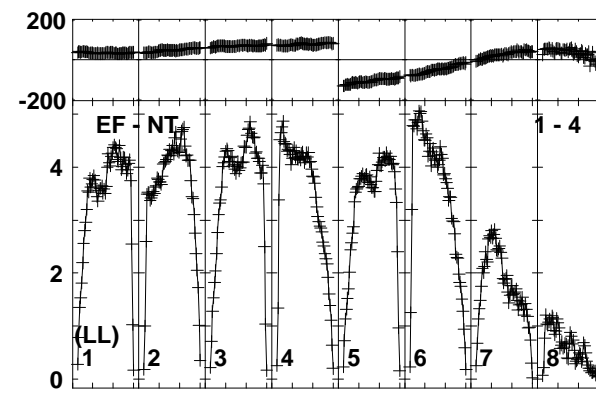
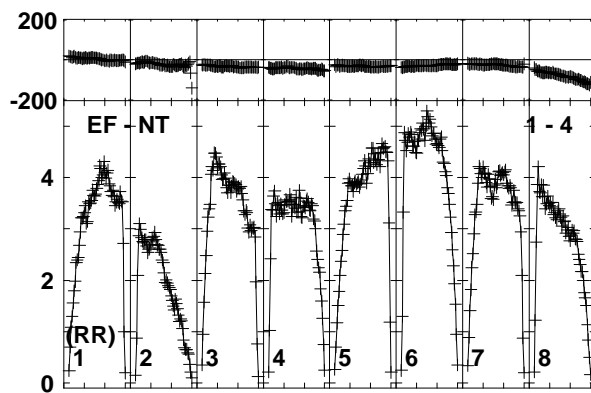
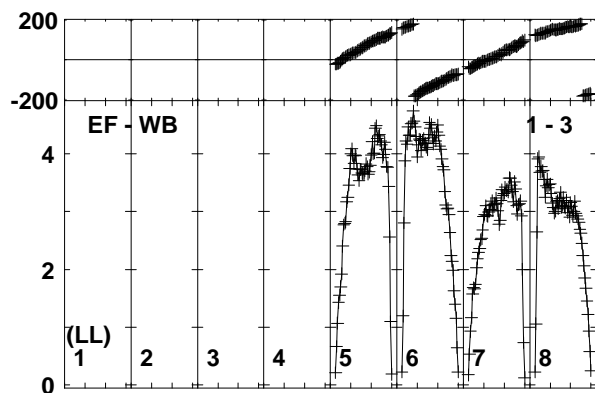
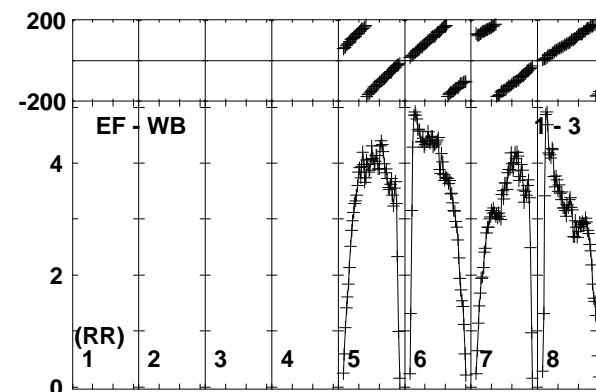
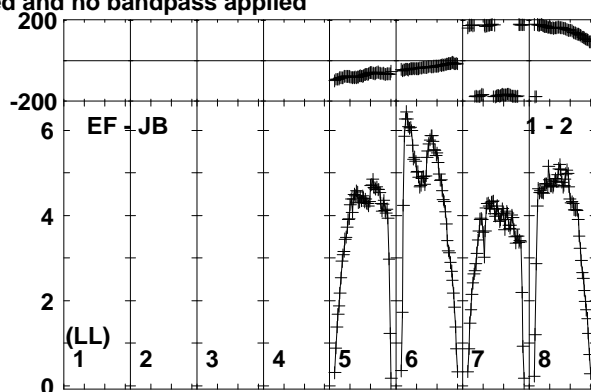
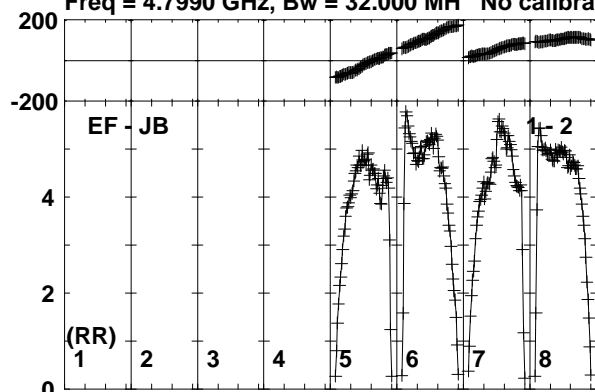

Lower frame: Milli Ampl Jy Top frame: Phas deg
Vector averaged cross-power spectrum Baseline: EF (01) - JB (02)
Timerange: 00/21:22:07 to 00/21:23:05

Plot file version 148 created 03-OCT-2017 13:10:04

J2353+5518 RP028.UVDATA.1

Freq = 4.7990 GHz, Bw = 32.000 MH No calibration applied and no bandpass applied

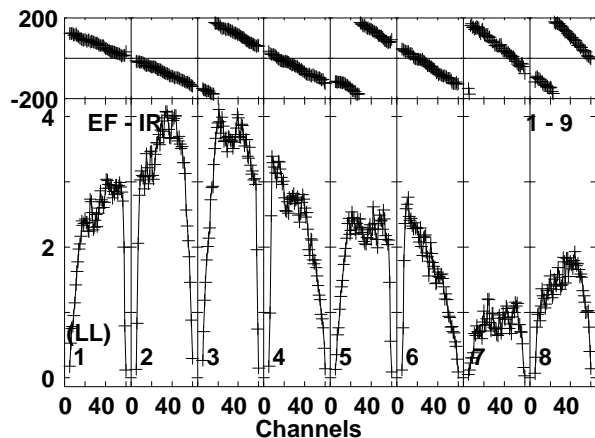
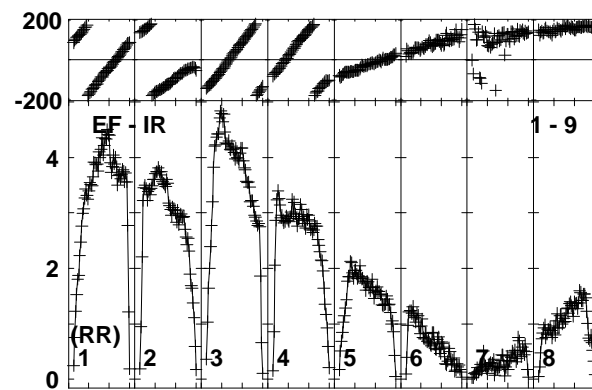
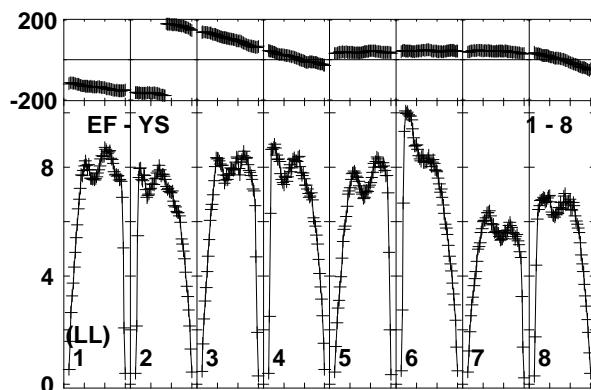
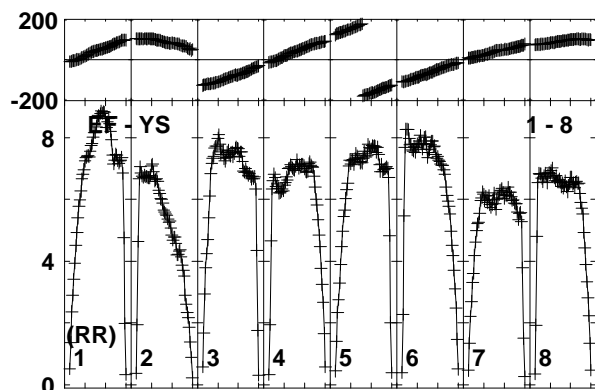
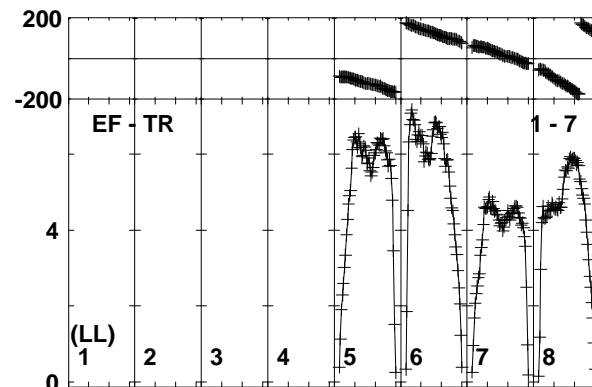
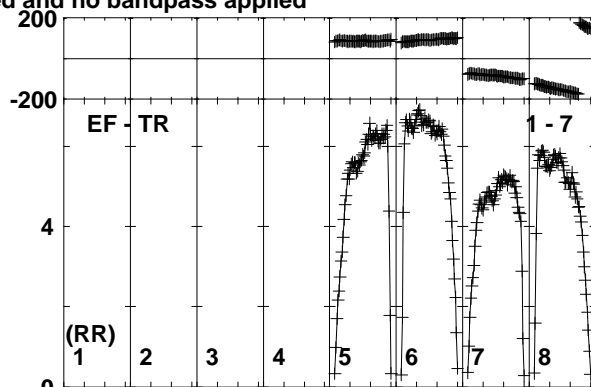
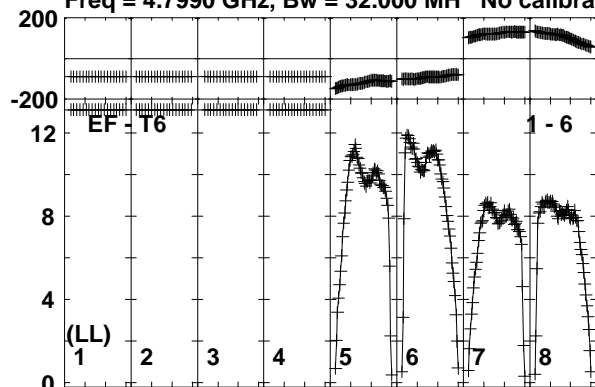

Lower frame: Milli Ampl Jy Top frame: Phas deg
Vector averaged cross-power spectrum Baseline: EF (01) - T6 (06)
Timerange: 00/21:22:07 to 00/21:23:05

Plot file version 149 created 03-OCT-2017 13:10:04

IRAS23436 RP028.UVDATA.1

Freq = 4.7990 GHz, Bw = 32.000 MH No calibration applied and no bandpass applied

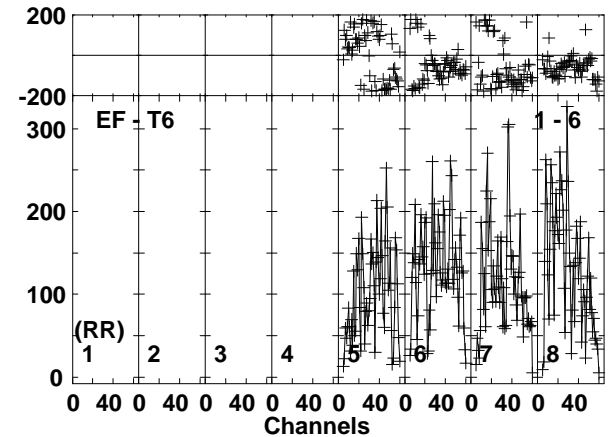
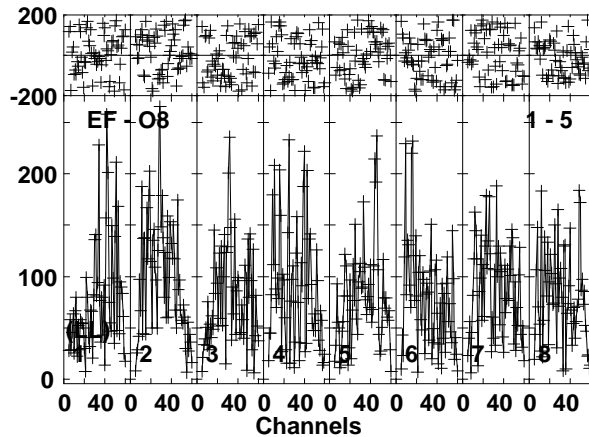
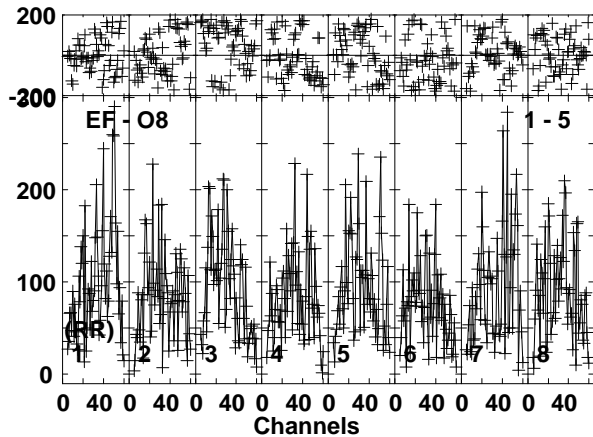
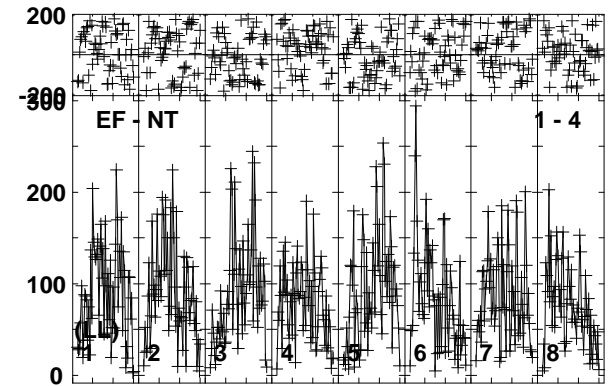
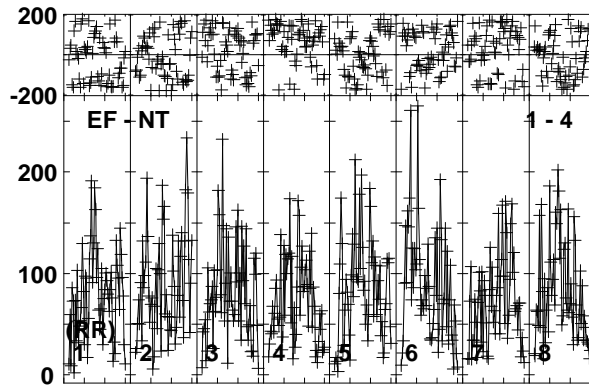
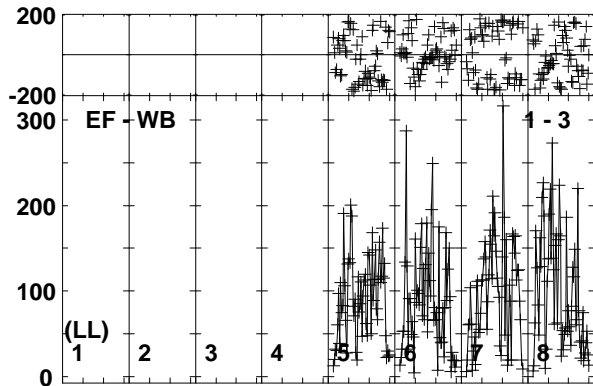
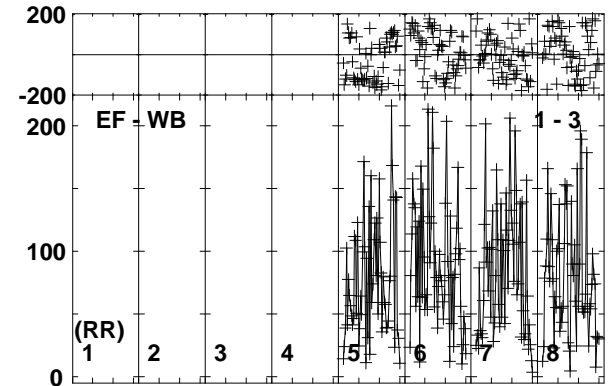
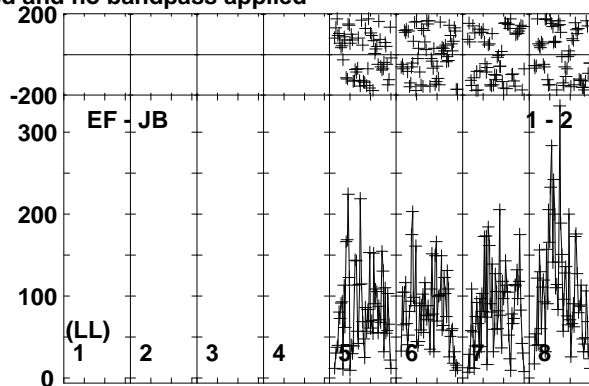
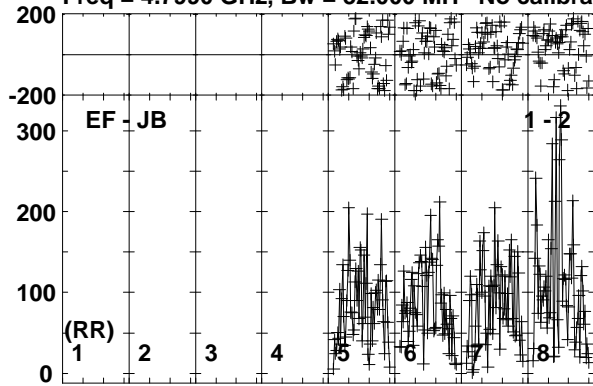

Lower frame: Micro Ampl Jy Top frame: Phas deg
Vector averaged cross-power spectrum Baseline: EF (01) - JB (02)
Timerange: 00:21:23:07 to 00:21:26:45

Plot file version 150 created 03-OCT-2017 13:10:05

IRAS23436 RP028.UVDATA.1

Freq = 4.7990 GHz, Bw = 32.000 MH No calibration applied and no bandpass applied

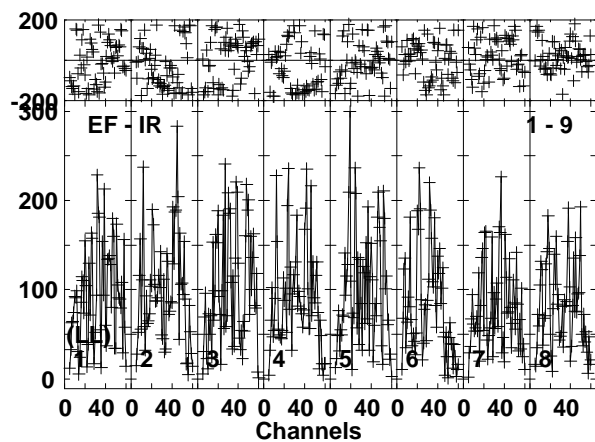
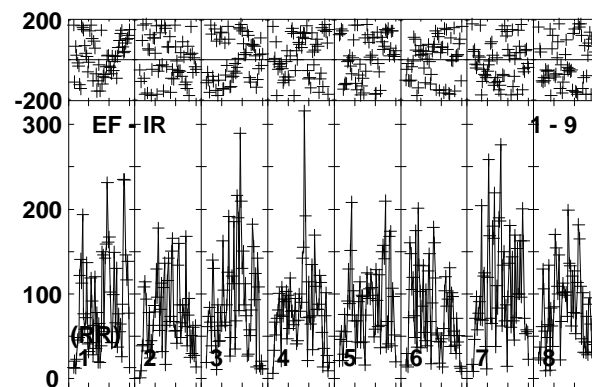
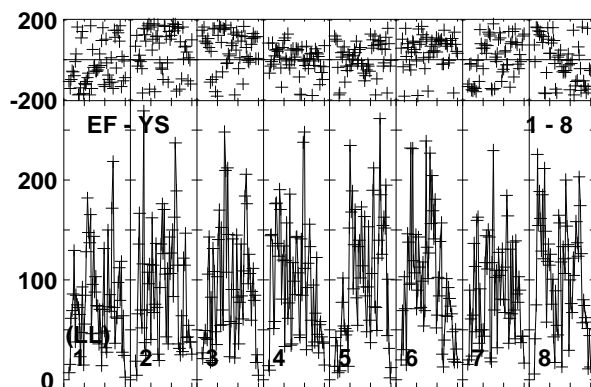
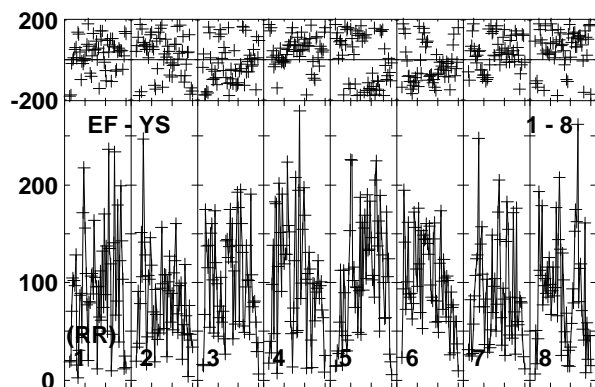
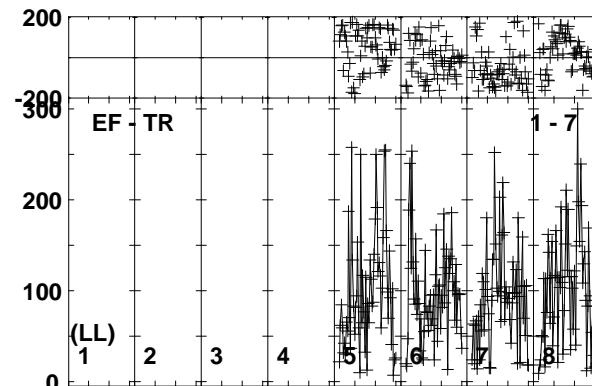
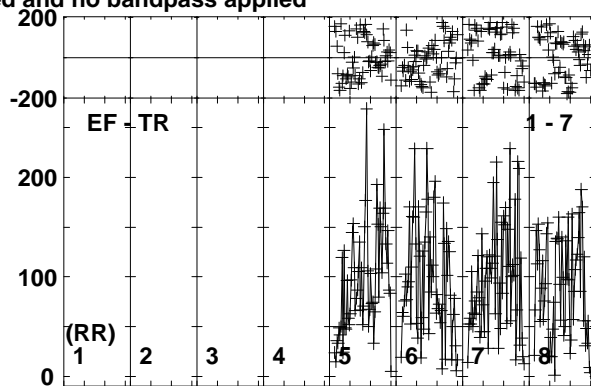
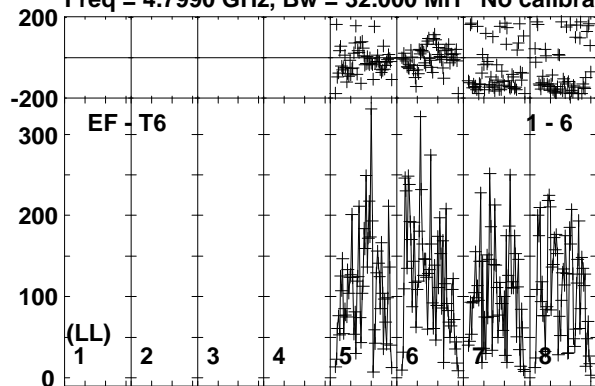

Lower frame: Micro Ampl Jy Top frame: Phas deg
Vector averaged cross-power spectrum Baseline: EF (01) - T6 (06)
Timerange: 00/21:23:07 to 00/21:26:45

Plot file version 151 created 03-OCT-2017 13:10:05

J2353+5518 RP028.UVDATA.1

Freq = 4.7990 GHz, Bw = 32.000 MH No calibration applied and no bandpass applied

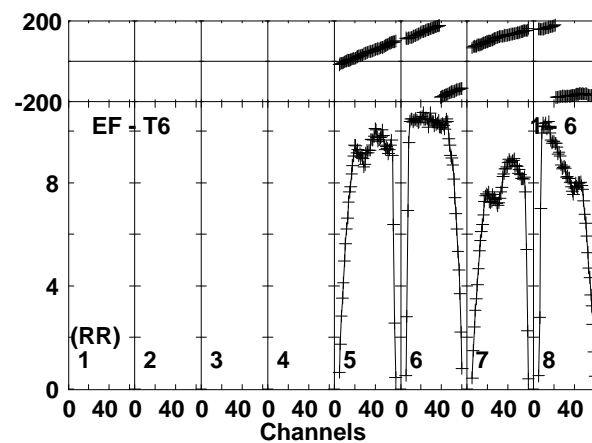
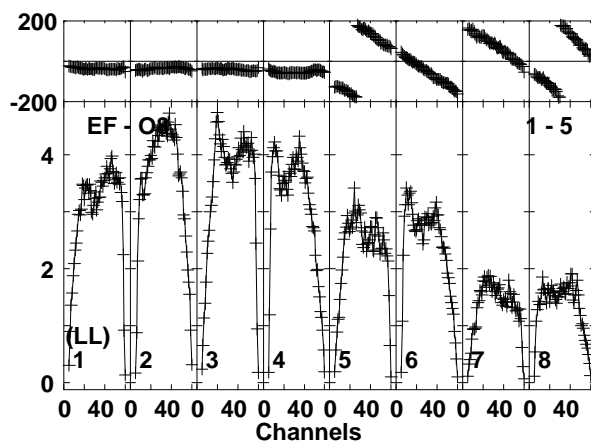
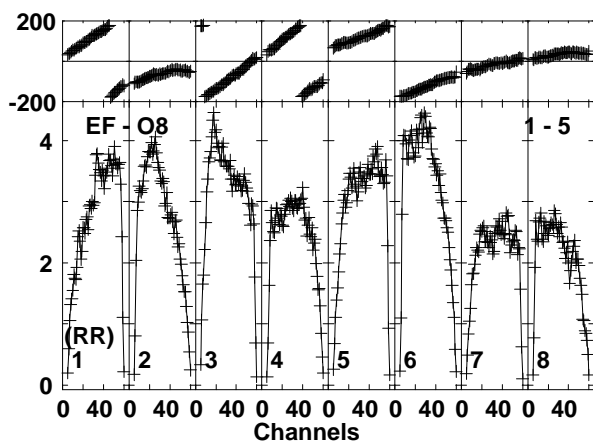
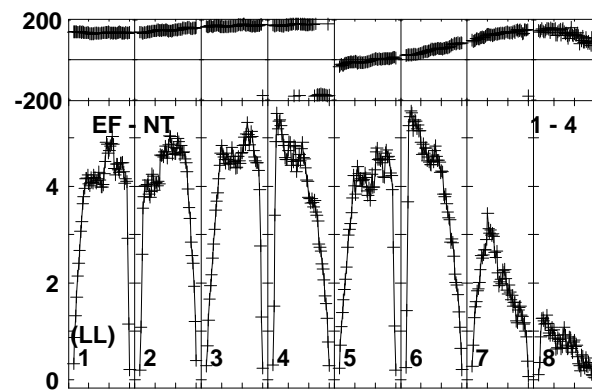
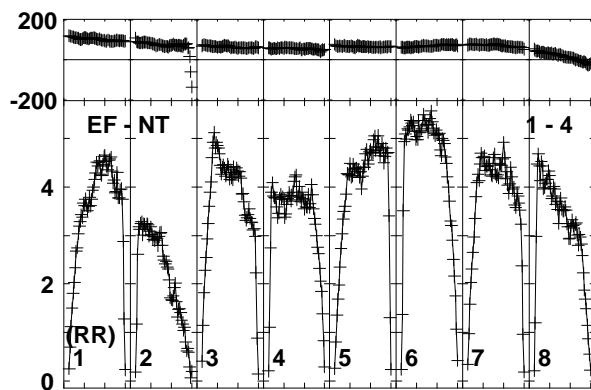
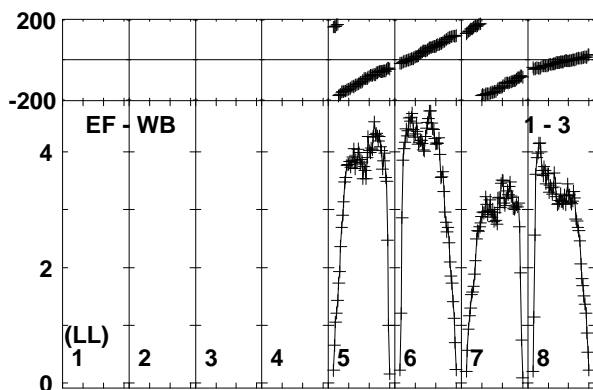
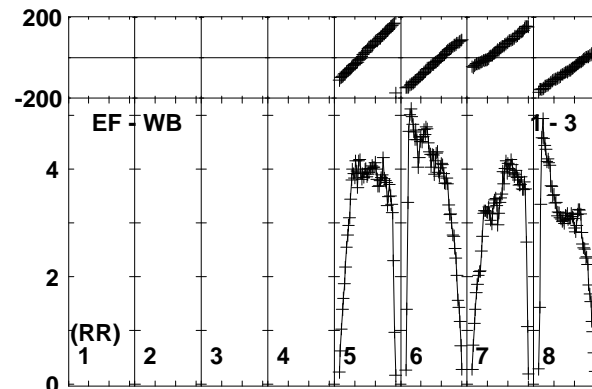
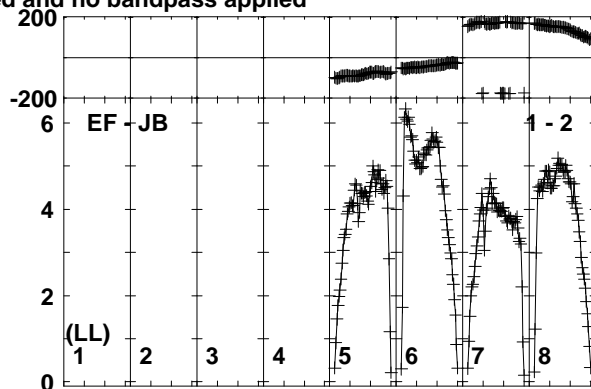
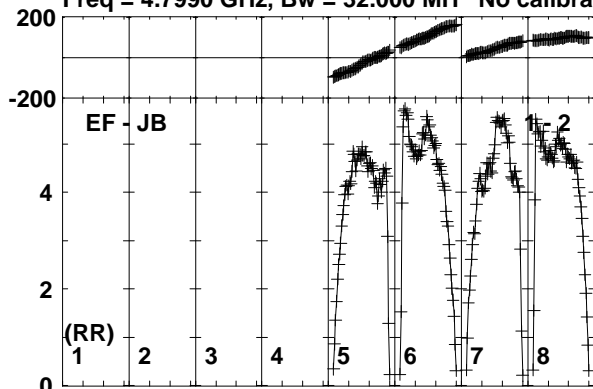

Lower frame: Milli Ampl Jy Top frame: Phas deg
Vector averaged cross-power spectrum Baseline: EF (01) - JB (02)
Timerange: 00/21:26:46 to 00/21:28:15

Plot file version 152 created 03-OCT-2017 13:10:05

J2353+5518 RP028.UVDATA.1

Freq = 4.7990 GHz, Bw = 32.000 MH No calibration applied and no bandpass applied

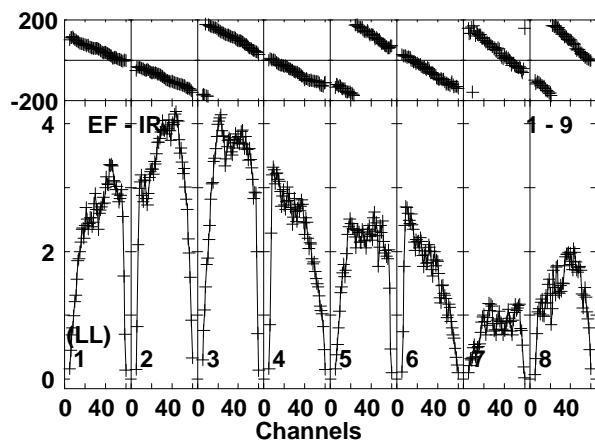
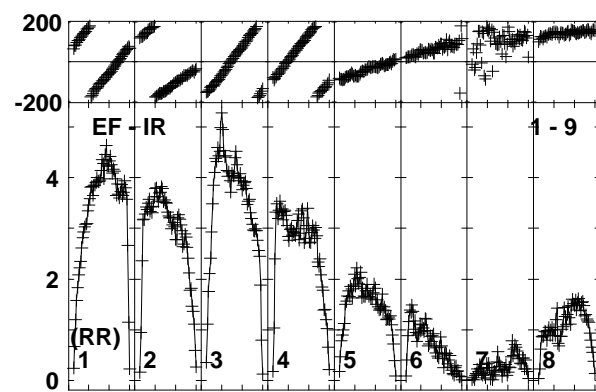
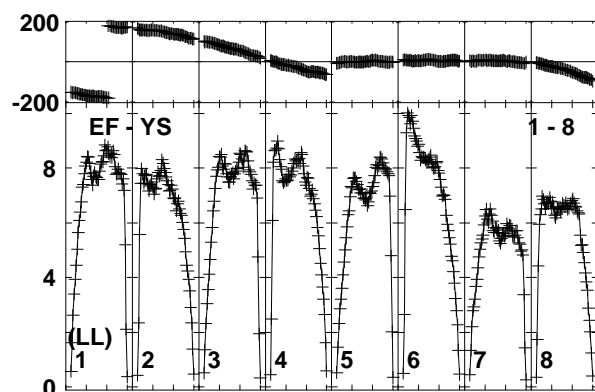
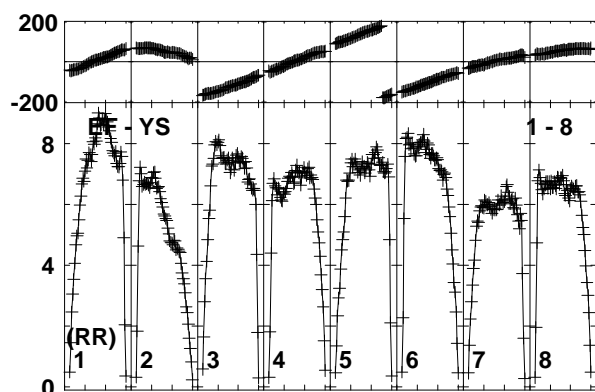
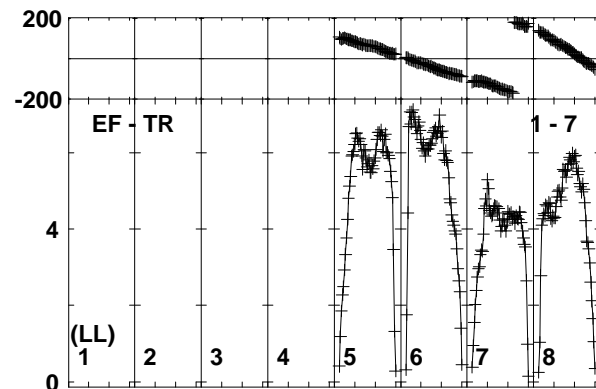
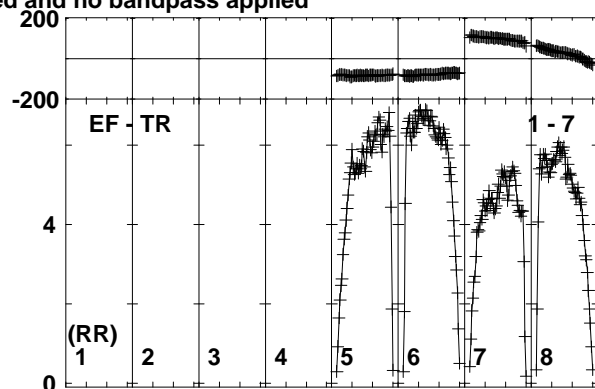
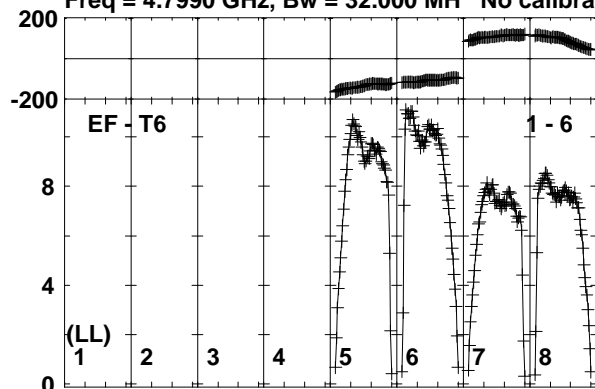

Lower frame: Milli Ampl Jy Top frame: Phas deg
Vector averaged cross-power spectrum Baseline: EF (01) - T6 (06)
Timerange: 00/21:26:46 to 00/21:28:15

Plot file version 153 created 03-OCT-2017 13:10:05

IRAS23436 RP028.UVDATA.1

Freq = 4.7990 GHz, Bw = 32.000 MH No calibration applied and no bandpass applied

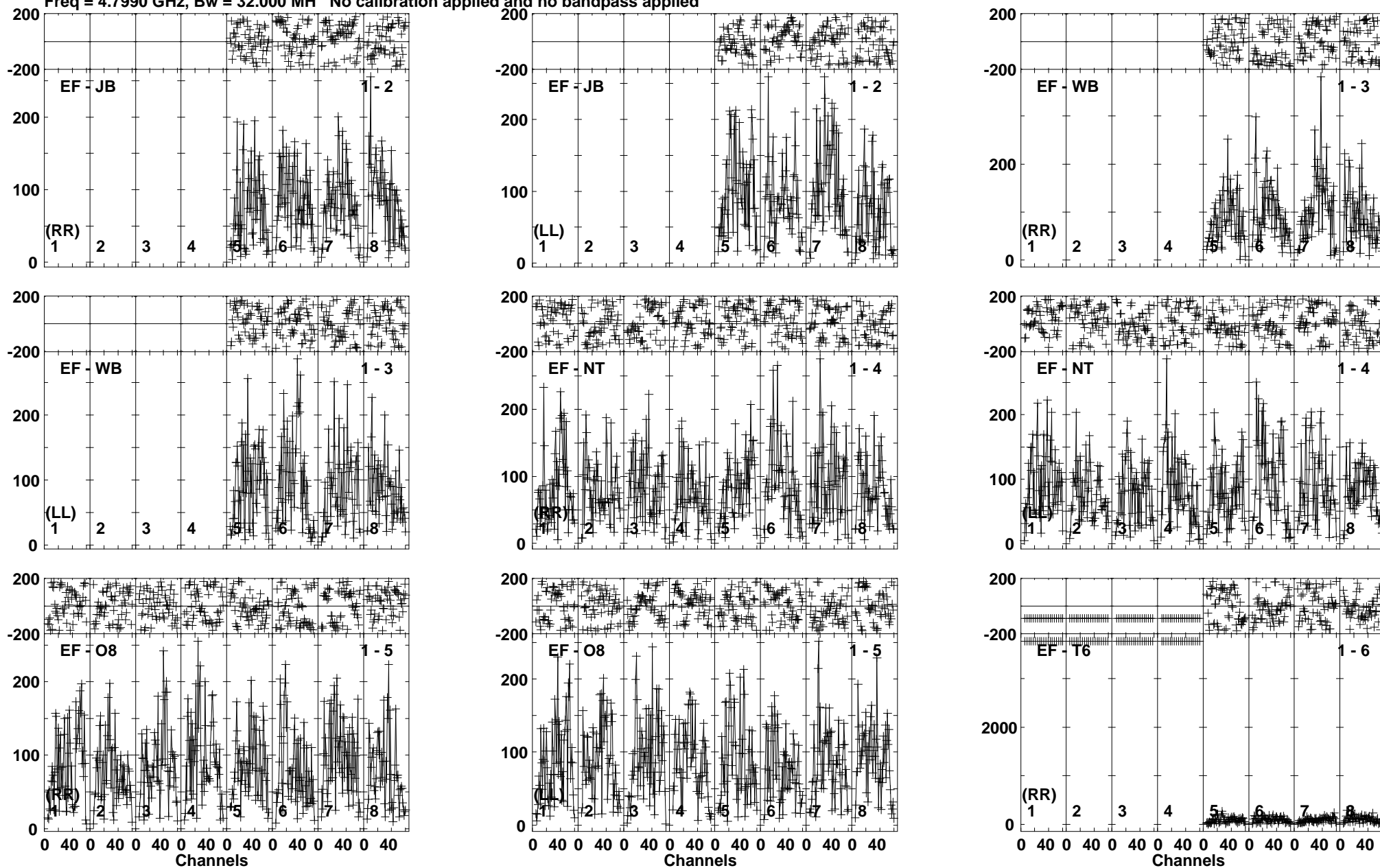

Lower frame: Micro Ampl Jy Top frame: Phas deg
Vector averaged cross-power spectrum Baseline: EF (01) - JB (02)
Timerange: 00/21:28:17 to 00/21:32:00

Plot file version 154 created 03-OCT-2017 13:10:05

IRAS23436 RP028.UVDATA.1

Freq = 4.7990 GHz, Bw = 32.000 MH No calibration applied and no bandpass applied

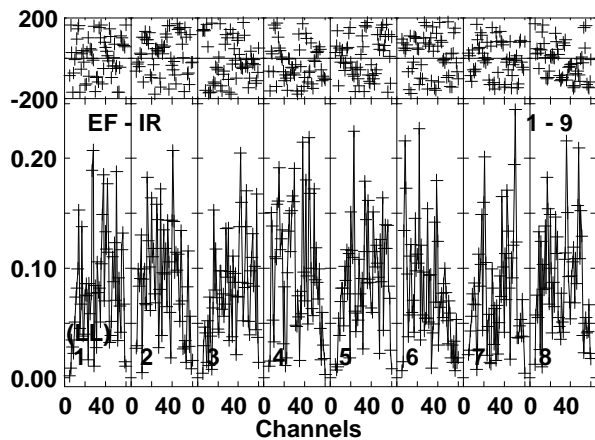
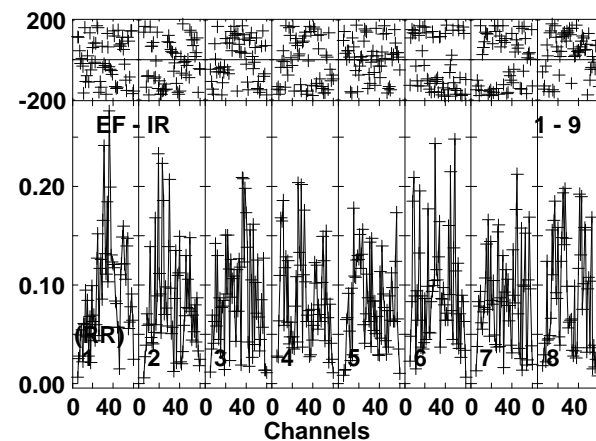
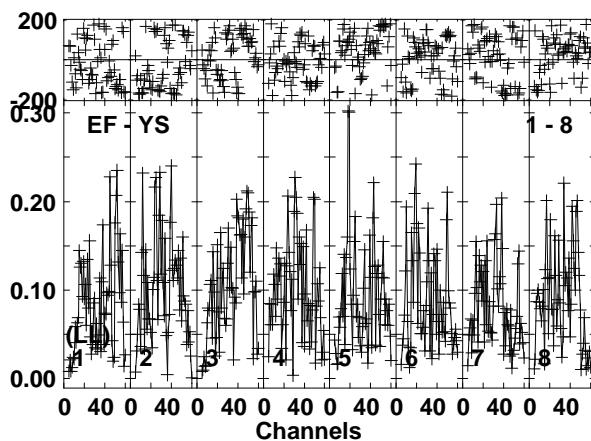
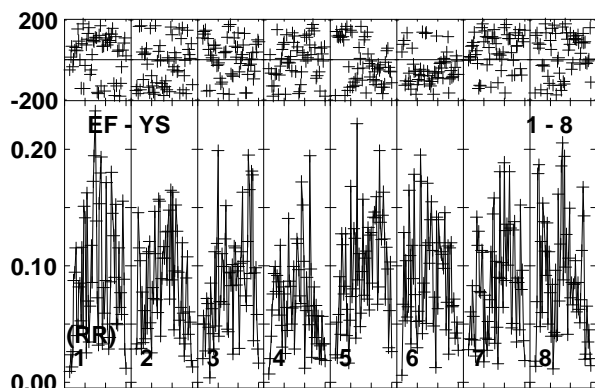
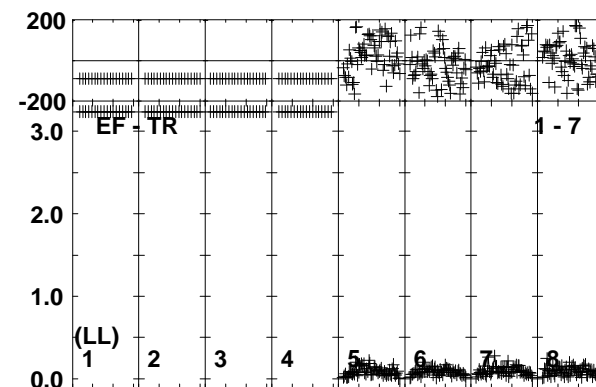
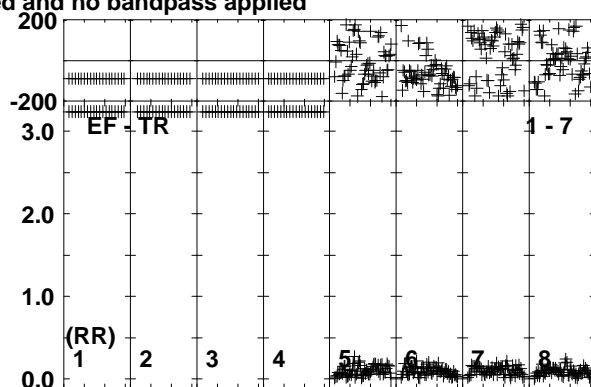
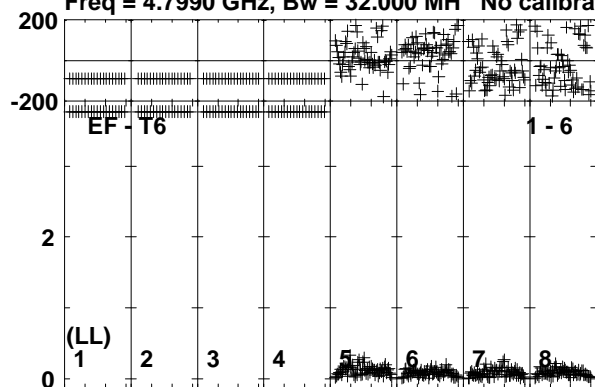

Lower frame: Milli Ampl Jy Top frame: Phas deg
Vector averaged cross-power spectrum Baseline: EF (01) - T6 (06)
Timerange: 00/21:28:17 to 00/21:32:00

Plot file version 155 created 03-OCT-2017 13:10:06

J2353+5518 RP028.UVDATA.1

Freq = 4.7990 GHz, Bw = 32.000 MH No calibration applied and no bandpass applied

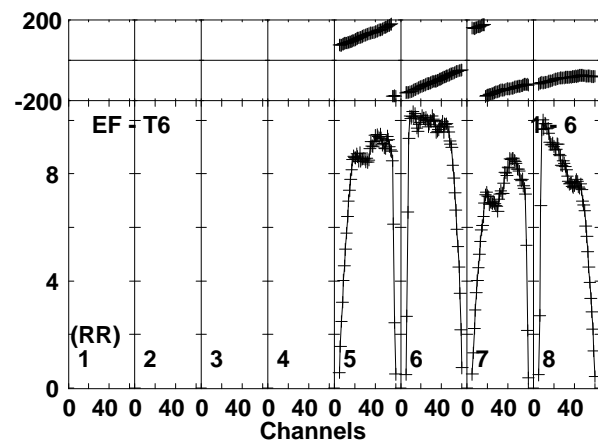
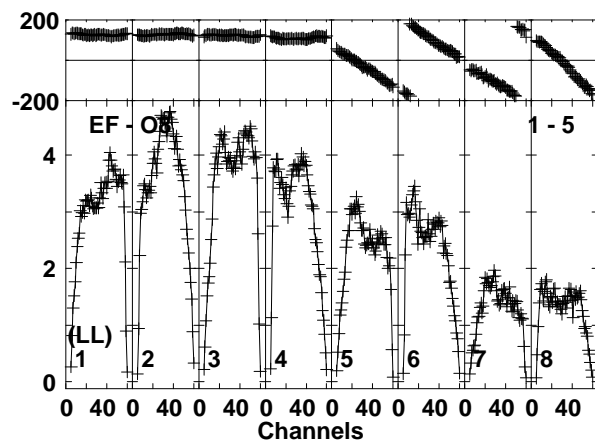
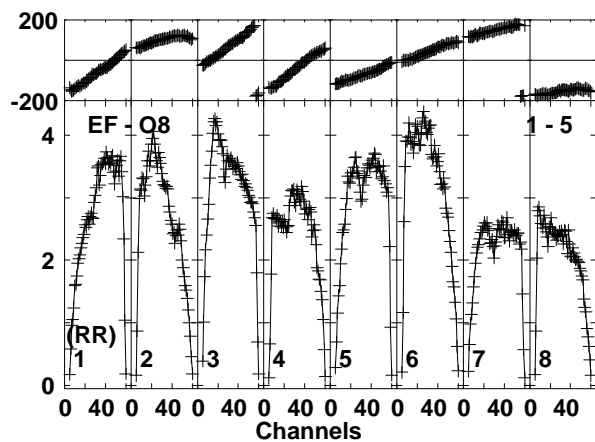
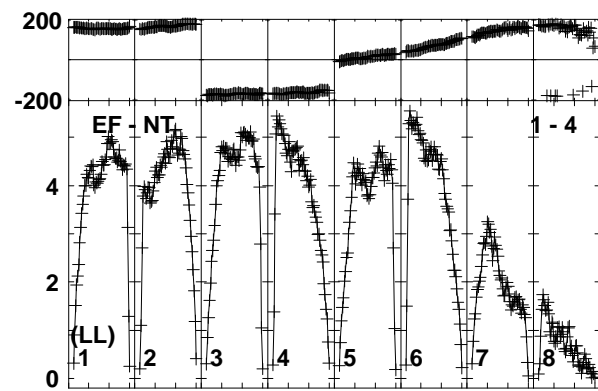
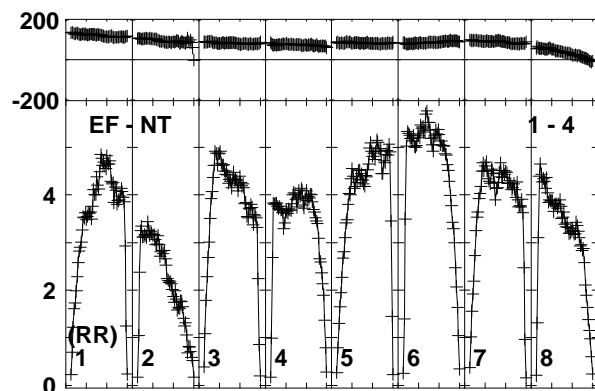
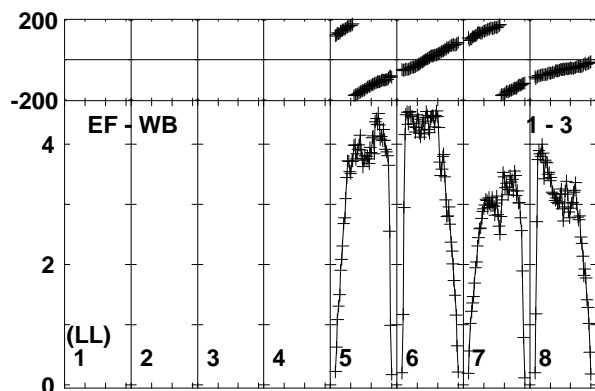
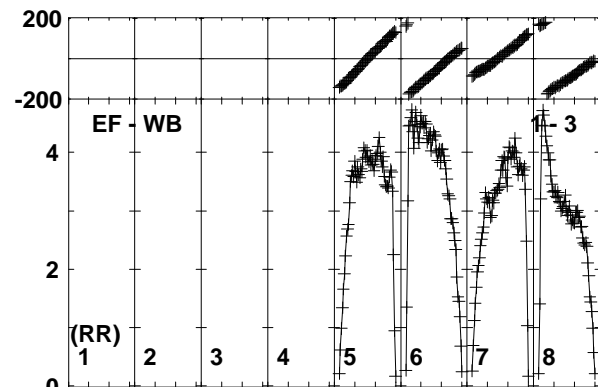
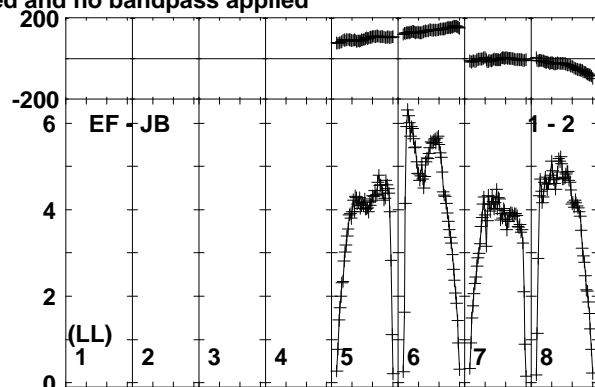
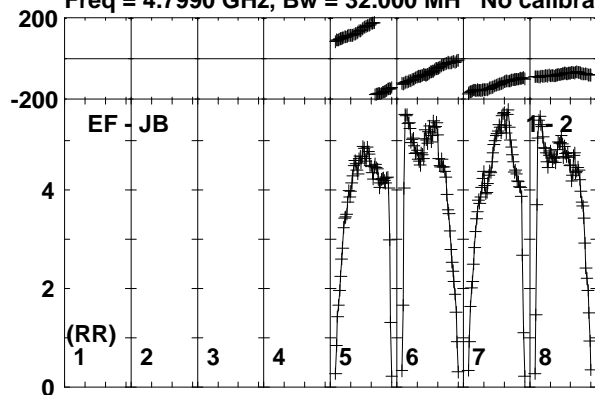

Lower frame: Milli Ampl Jy Top frame: Phas deg
Vector averaged cross-power spectrum Baseline: EF (01) - JB (02)
Timerange: 00/21:32:50 to 00/21:33:39

Plot file version 156 created 03-OCT-2017 13:10:06

J2353+5518 RP028.UVDATA.1

Freq = 4.7990 GHz, Bw = 32.000 MH No calibration applied and no bandpass applied

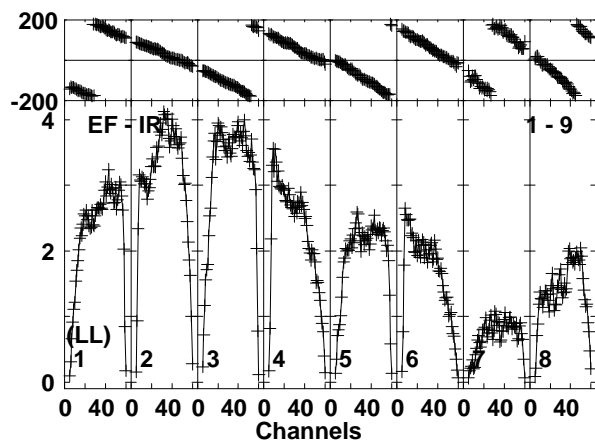
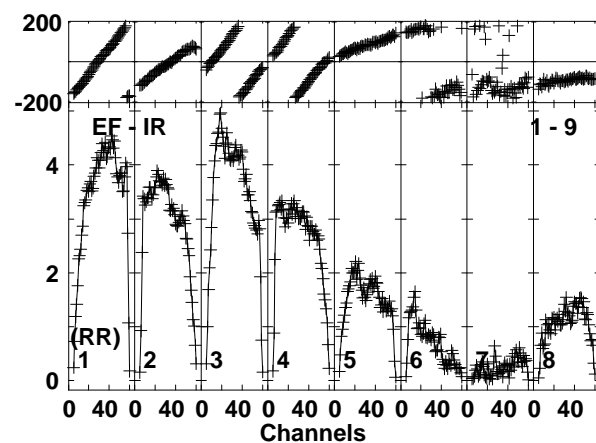
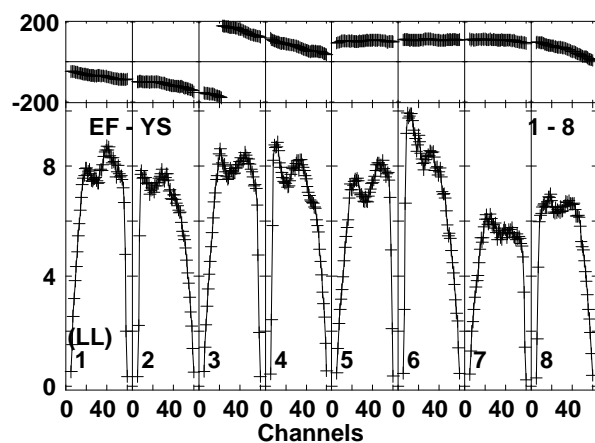
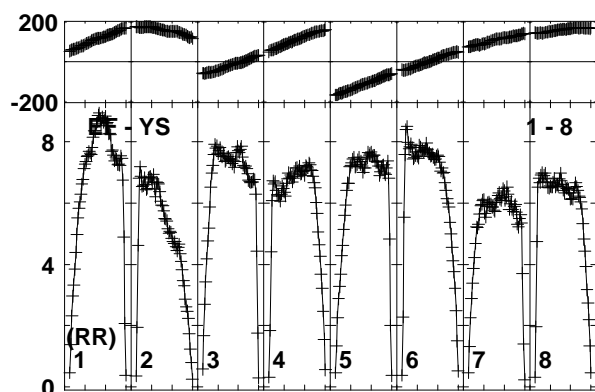
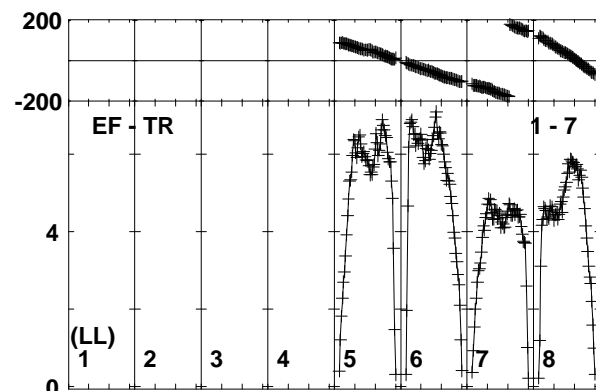
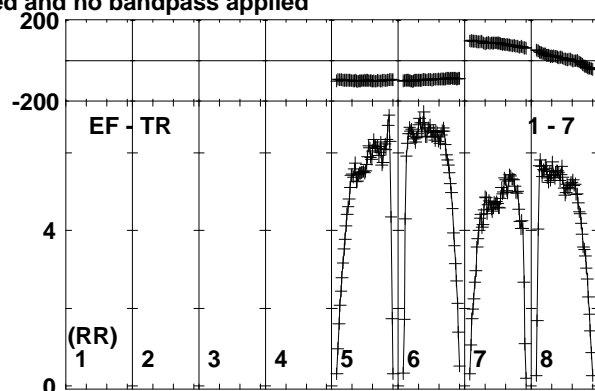
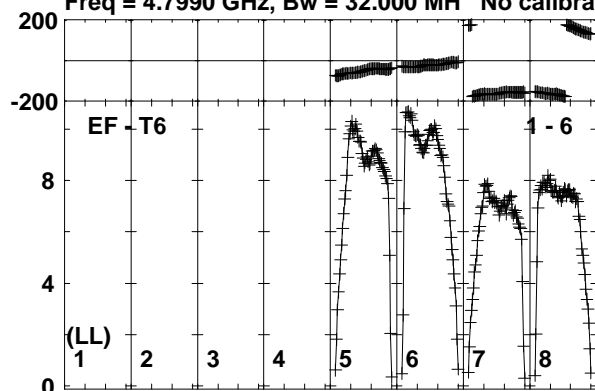

Lower frame: Milli Ampl Jy Top frame: Phas deg
Vector averaged cross-power spectrum Baseline: EF (01) - T6 (06)
Timerange: 00/21:32:50 to 00/21:33:39

Plot file version 157 created 03-OCT-2017 13:10:06

IRAS23436 RP028.UVDATA.1

Freq = 4.7990 GHz, Bw = 32.000 MH No calibration applied and no bandpass applied

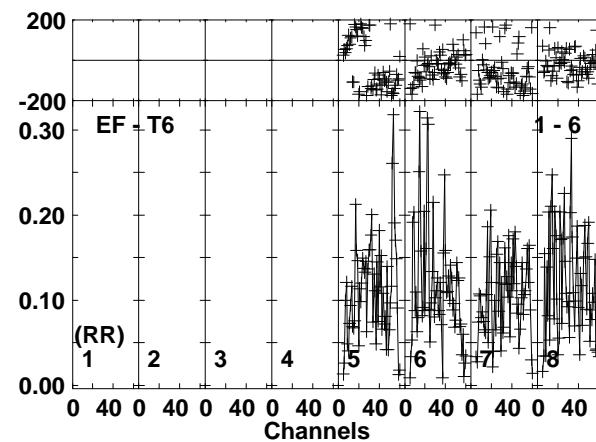
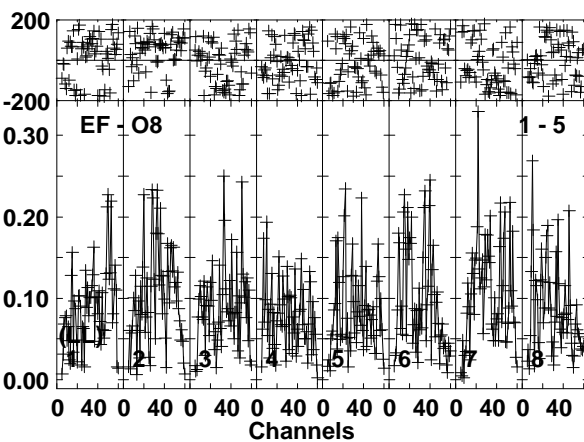
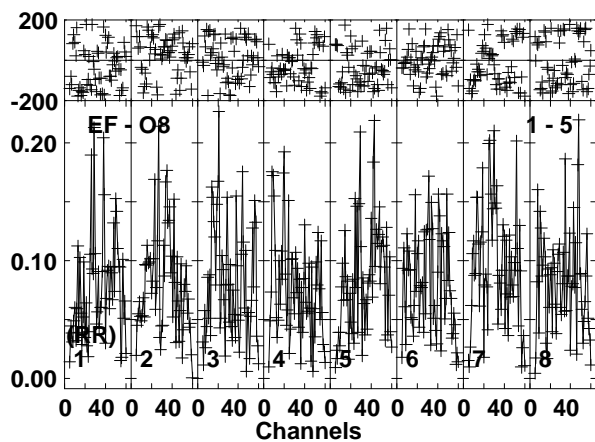
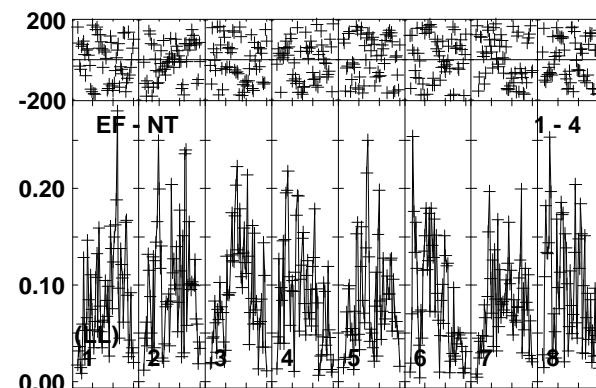
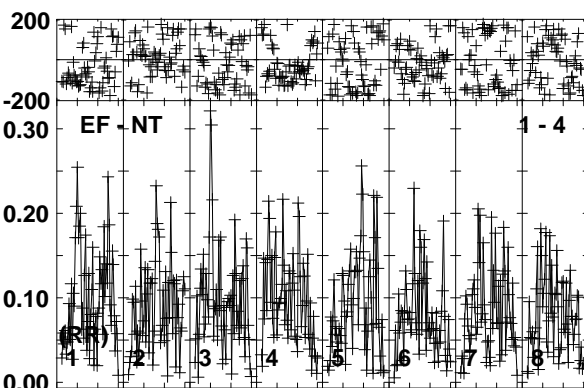
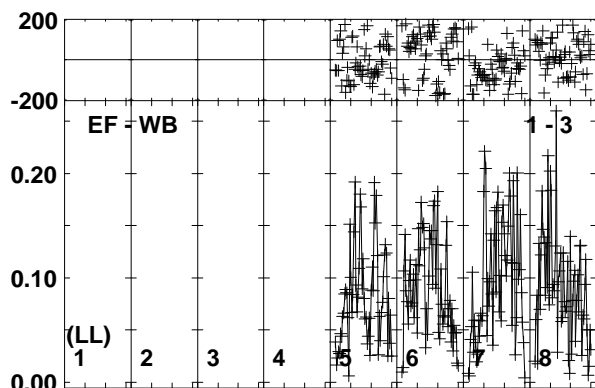
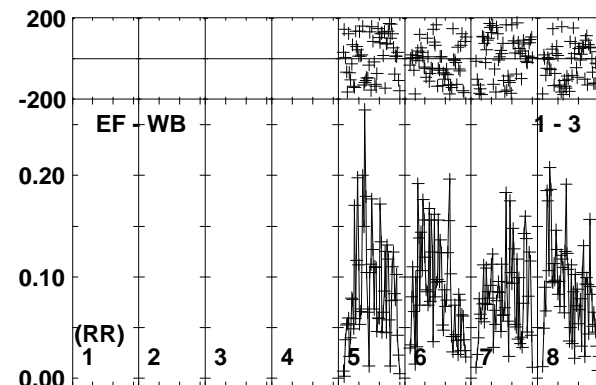
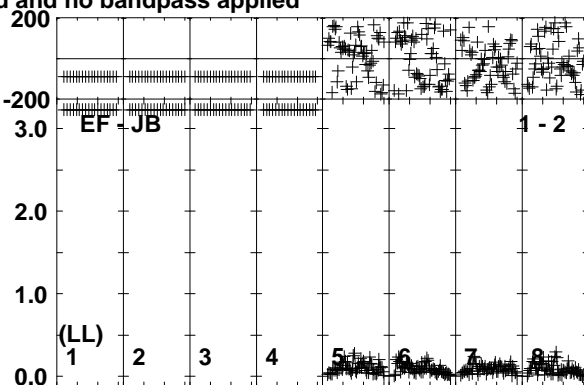
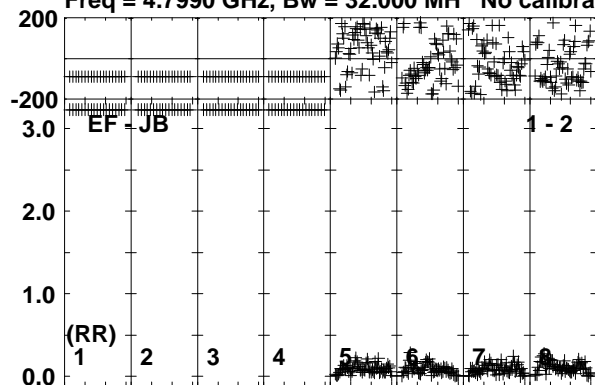

Lower frame: Milli Ampl Jy Top frame: Phas deg
Vector averaged cross-power spectrum Baseline: EF (01) - JB (02)
Timerange: 00/21:33:40 to 00/21:37:23

Plot file version 158 created 03-OCT-2017 13:10:06

IRAS23436 RP028.UVDATA.1

Freq = 4.7990 GHz, Bw = 32.000 MH No calibration applied and no bandpass applied

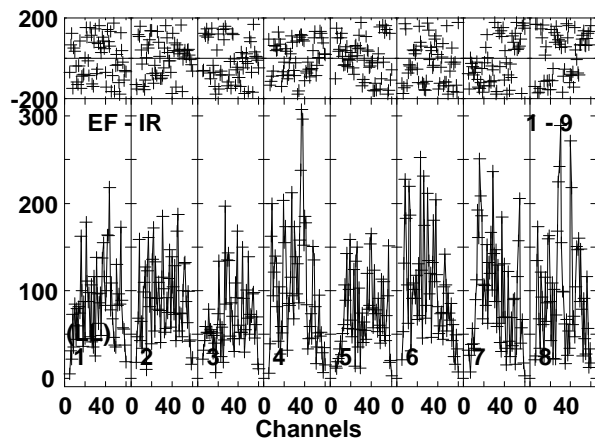
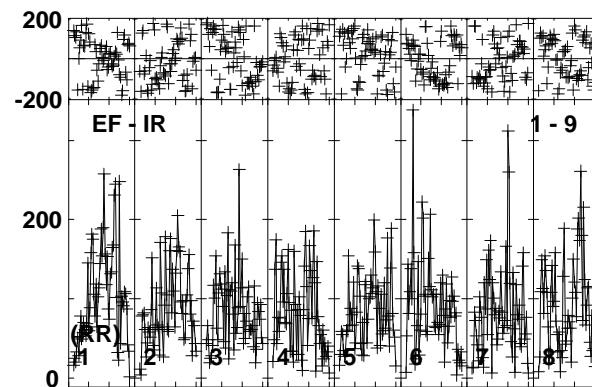
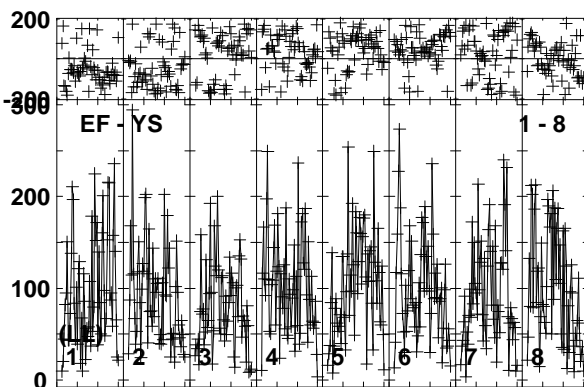
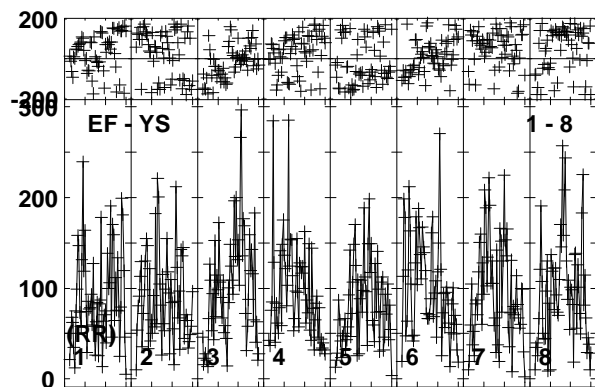
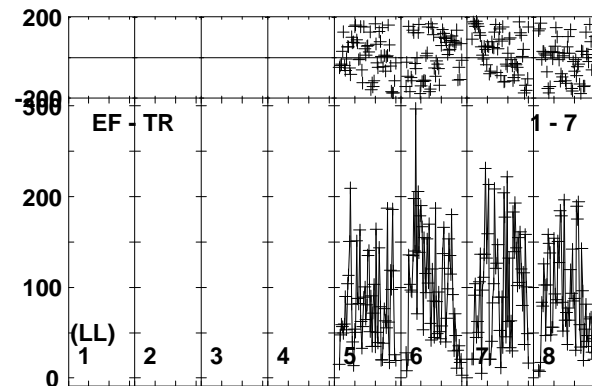
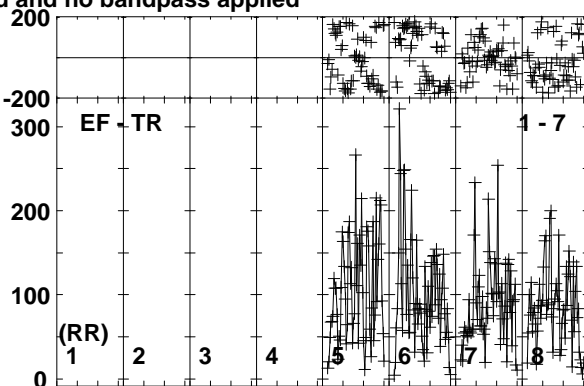
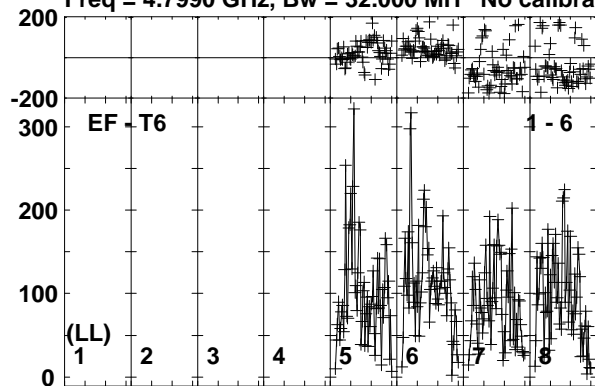

Lower frame: Micro Ampl Jy Top frame: Phas deg
Vector averaged cross-power spectrum Baseline: EF (01) - T6 (06)
Timerange: 00/21:33:40 to 00/21:37:23

Plot file version 159 created 03-OCT-2017 13:10:07

J2353+5518 RP028.UVDATA.1

Freq = 4.7990 GHz, Bw = 32.000 MH No calibration applied and no bandpass applied

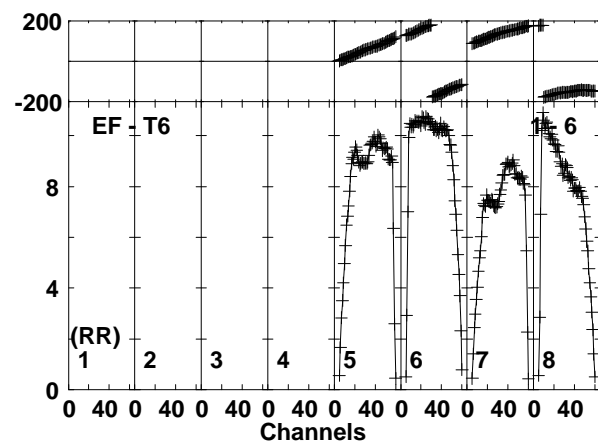
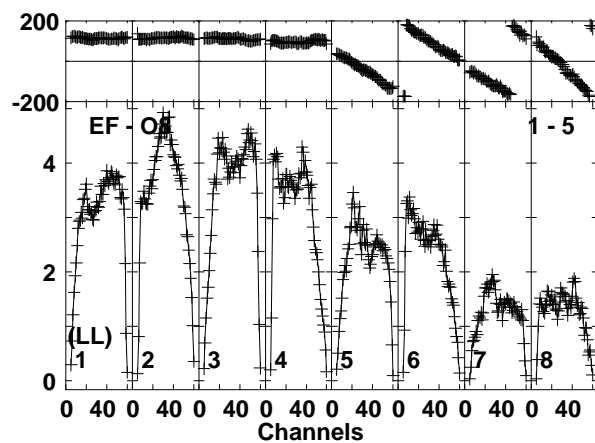
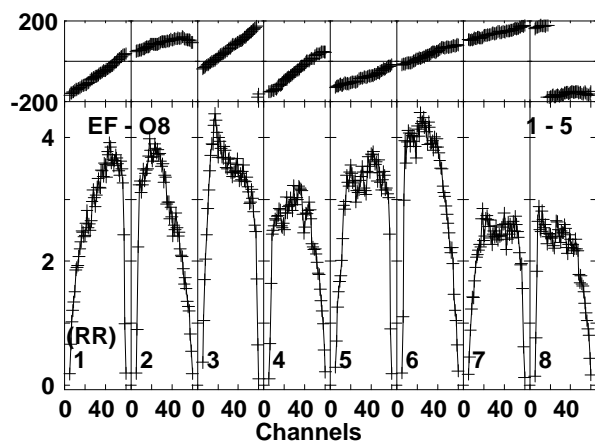
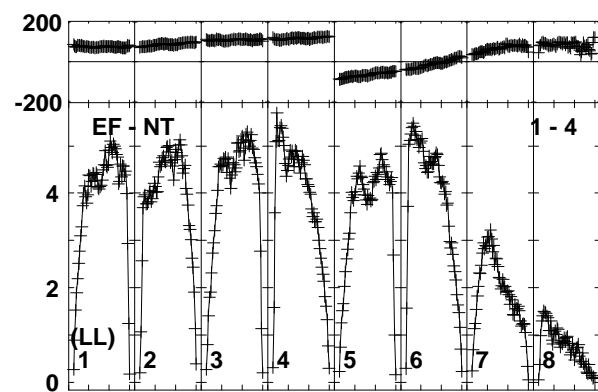
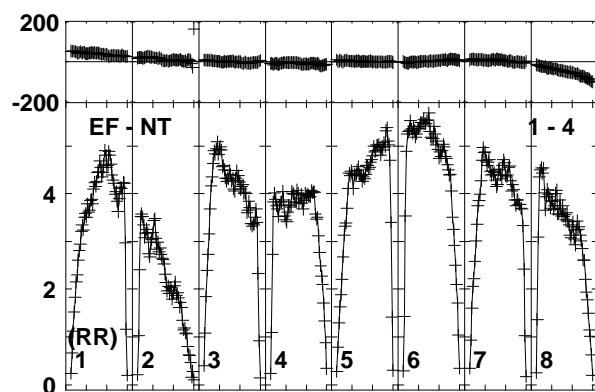
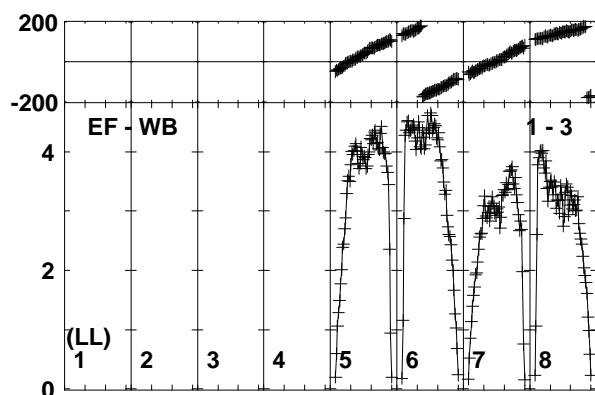
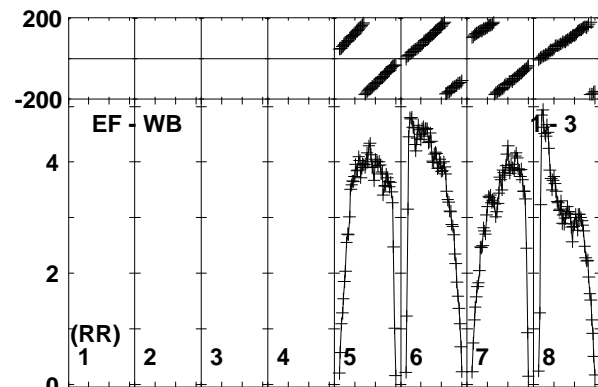
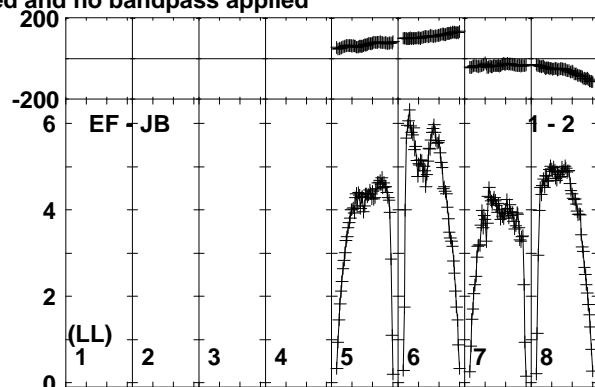
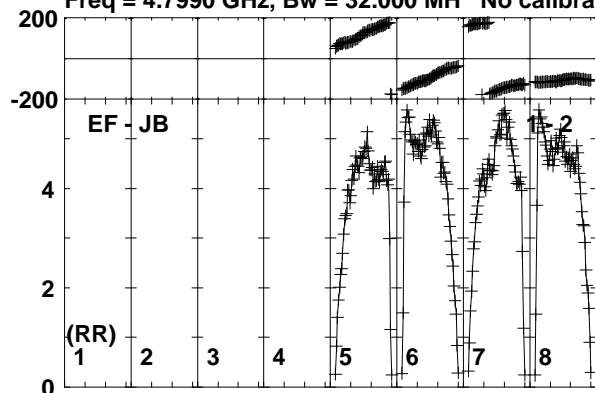

Lower frame: Milli Ampl Jy Top frame: Phas deg
Vector averaged cross-power spectrum Baseline: EF (01) - JB (02)
Timerange: 00/21:37:24 to 00/21:38:54

Plot file version 160 created 03-OCT-2017 13:10:07

J2353+5518 RP028.UVDATA.1

Freq = 4.7990 GHz, Bw = 32.000 MH No calibration applied and no bandpass applied

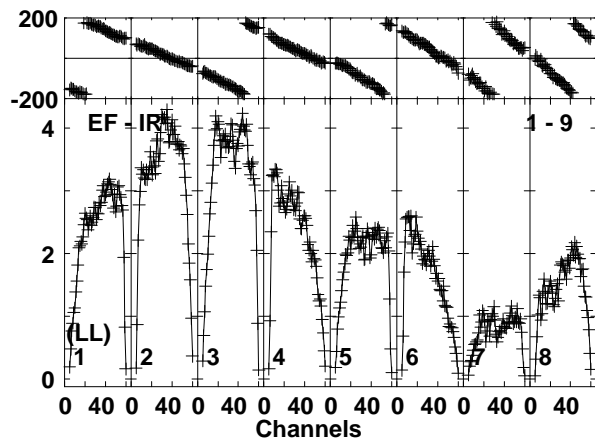
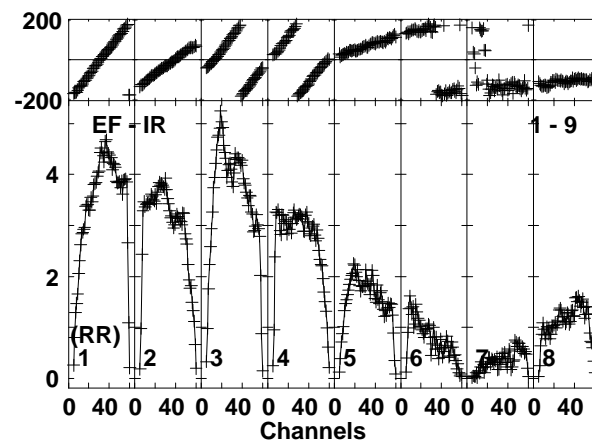
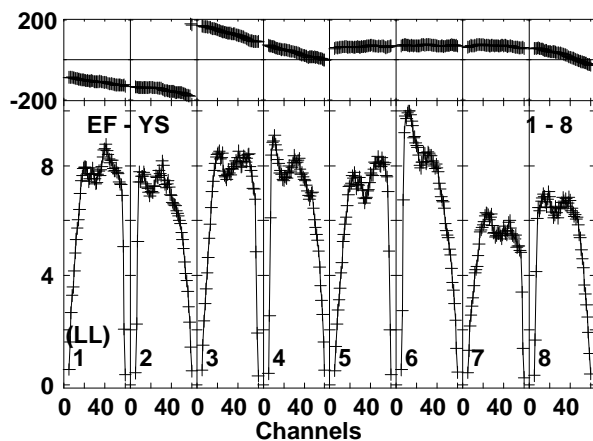
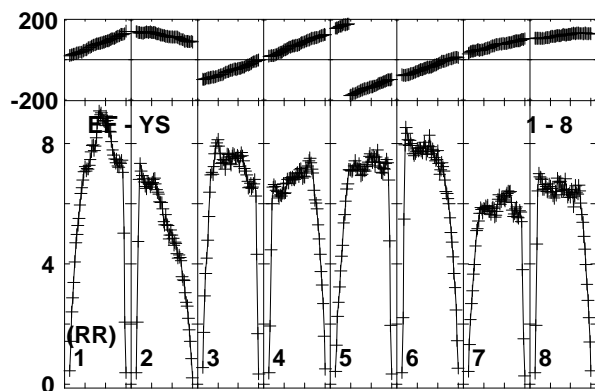
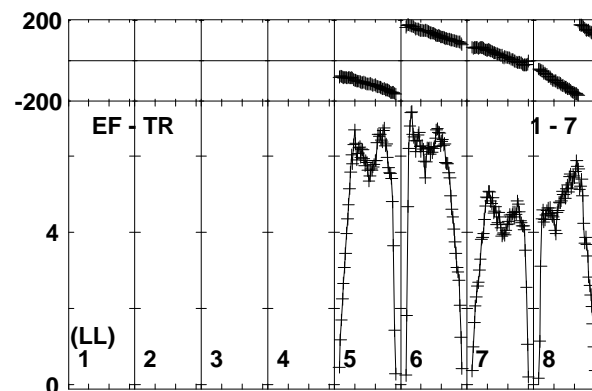
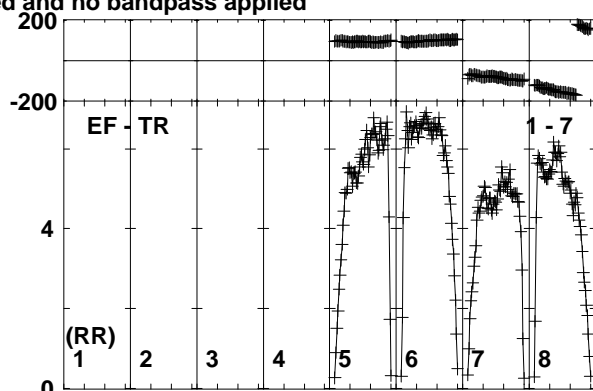
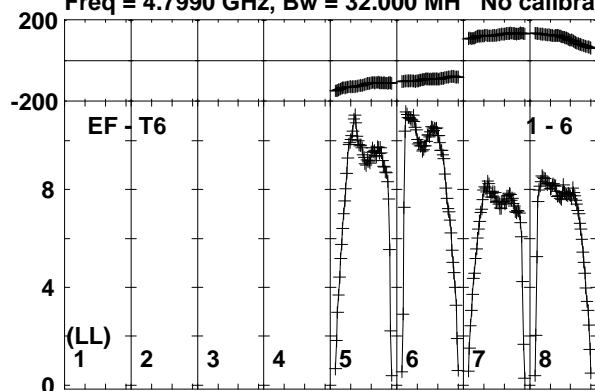

Lower frame: Milli Ampl Jy Top frame: Phas deg
Vector averaged cross-power spectrum Baseline: EF (01) - T6 (06)
Timerange: 00/21:37:24 to 00/21:38:54

Plot file version 161 created 03-OCT-2017 13:10:07

IRAS23436 RP028.UVDATA.1

Freq = 4.7990 GHz, Bw = 32.000 MH No calibration applied and no bandpass applied

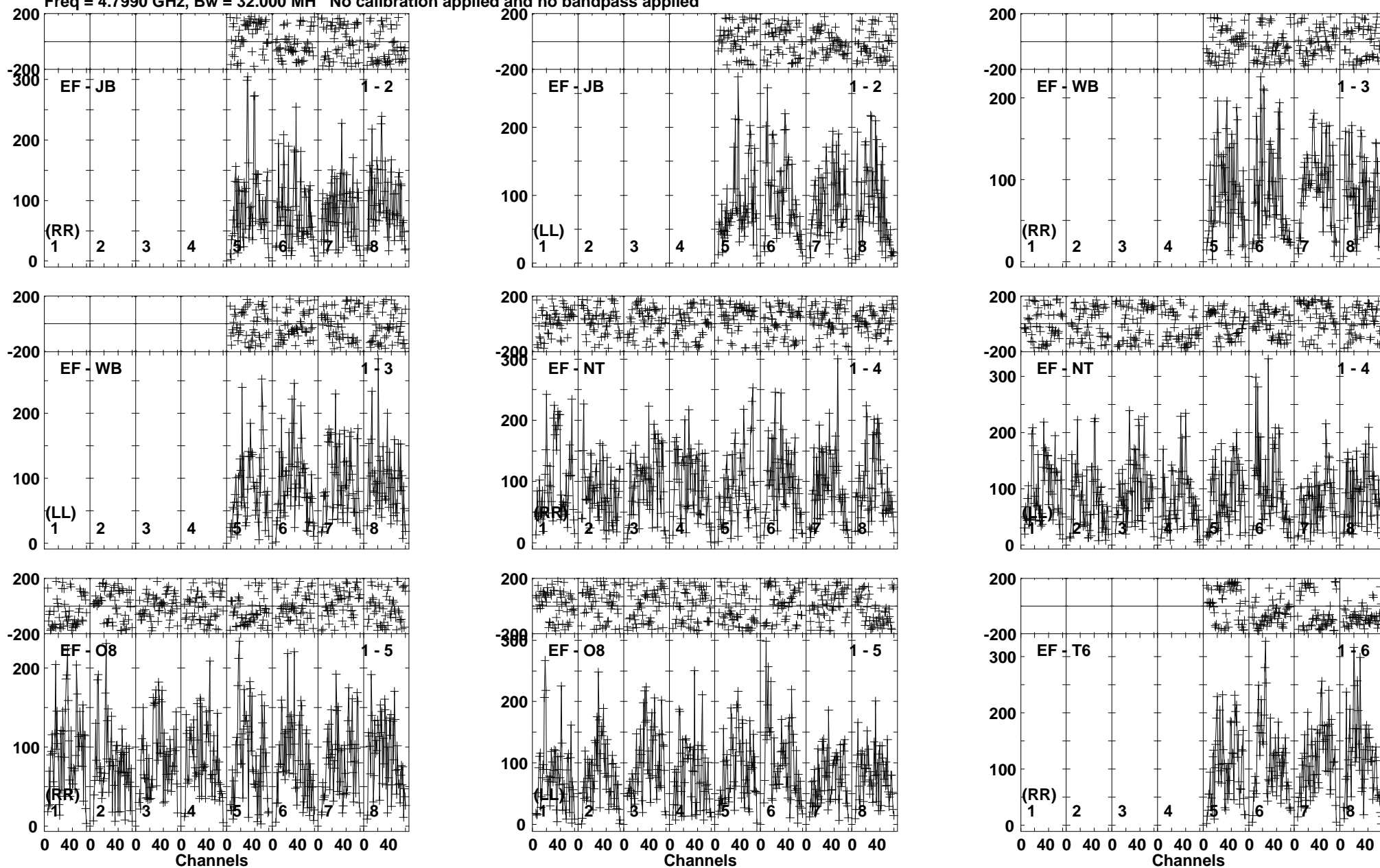

Lower frame: Micro Ampl Jy Top frame: Phas deg
Vector averaged cross-power spectrum Baseline: EF (01) - JB (02)
Timerange: 00/21:38:54 to 00/21:42:38

Plot file version 162 created 03-OCT-2017 13:10:07

IRAS23436 RP028.UVDATA.1

Freq = 4.7990 GHz, Bw = 32.000 MH No calibration applied and no bandpass applied

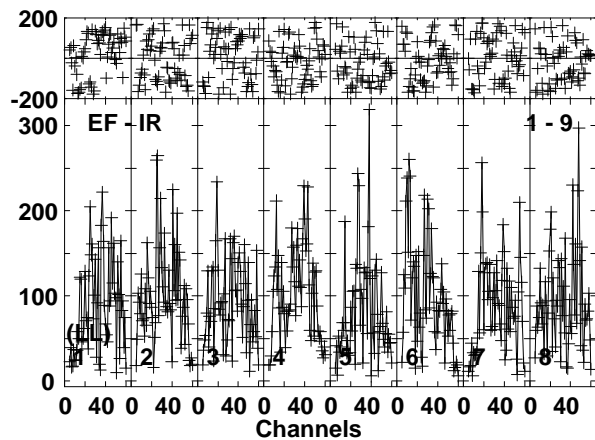
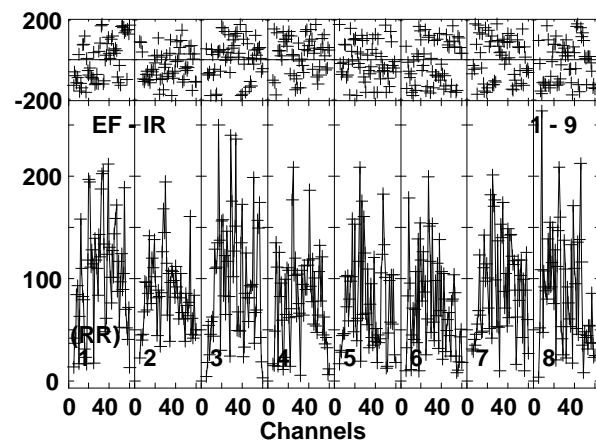
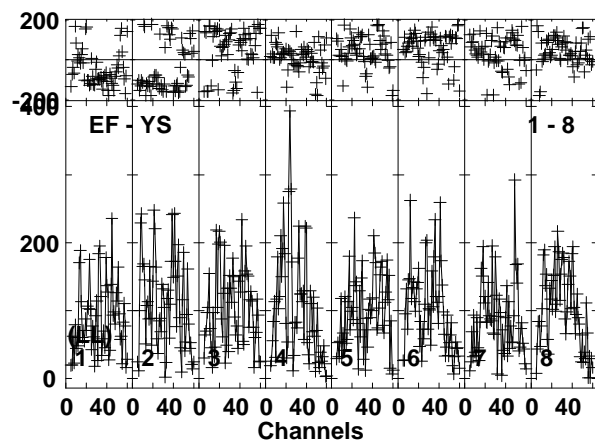
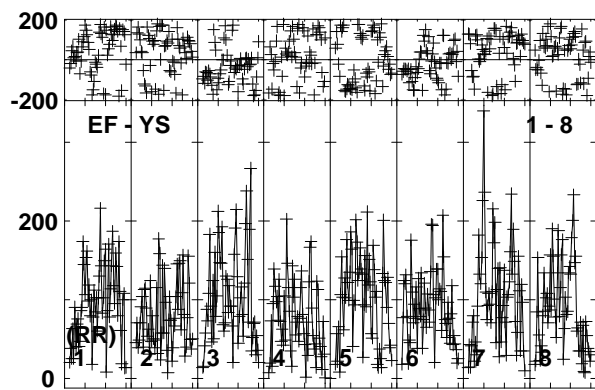
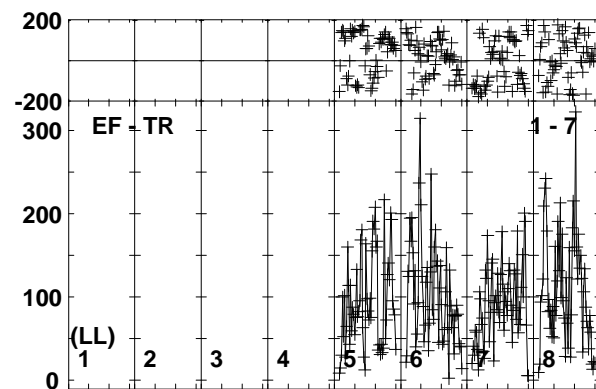
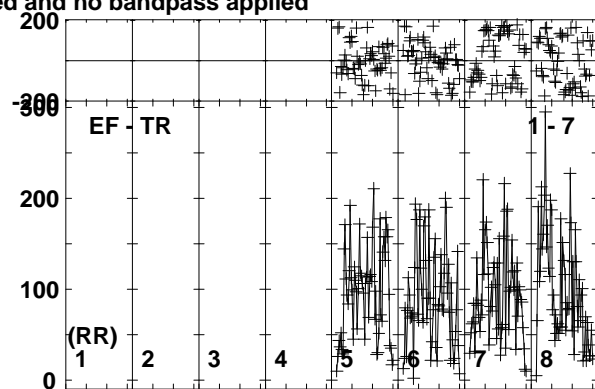
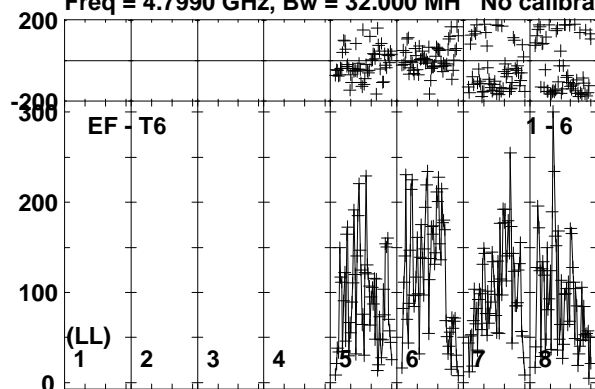

Lower frame: Micro Ampl Jy Top frame: Phas deg
Vector averaged cross-power spectrum Baseline: EF (01) - T6 (06)
Timerange: 00/21:38:54 to 00/21:42:38

Plot file version 163 created 03-OCT-2017 13:10:08

J2353+5518 RP028.UVDATA.1

Freq = 4.7990 GHz, Bw = 32.000 MH No calibration applied and no bandpass applied

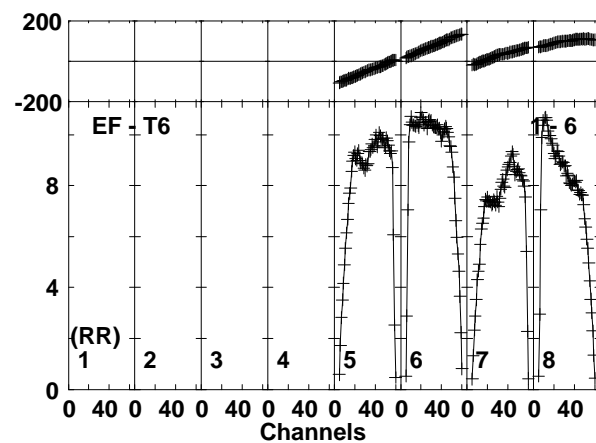
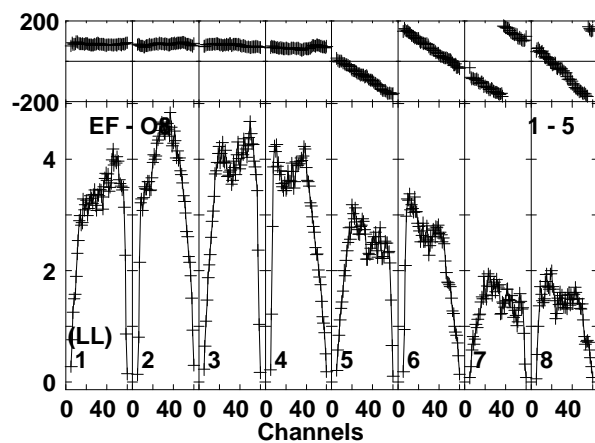
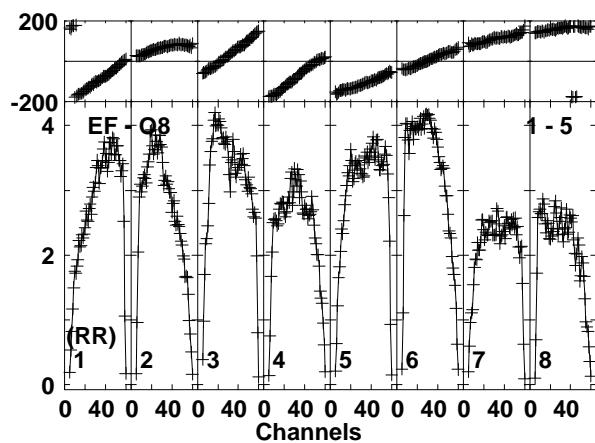
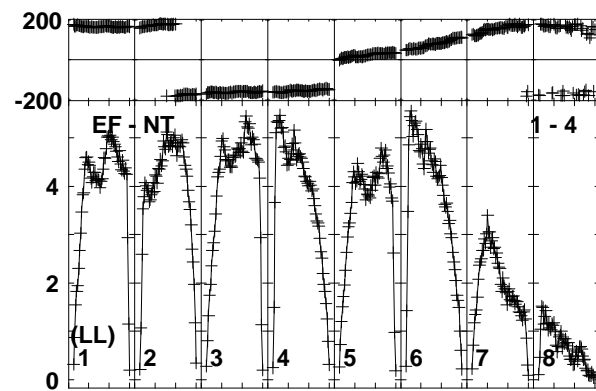
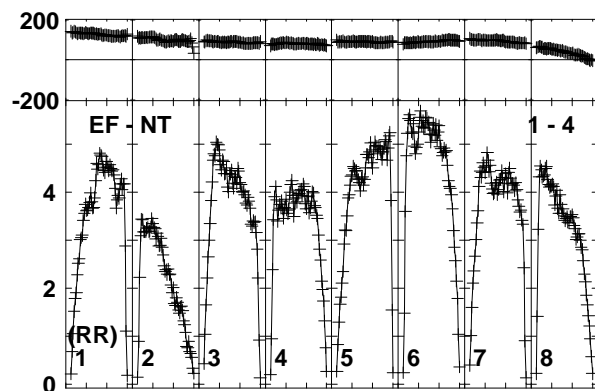
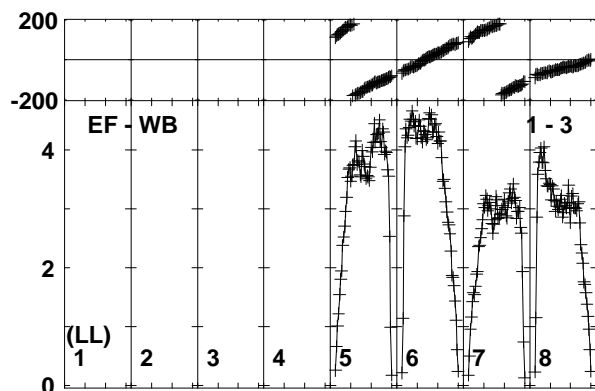
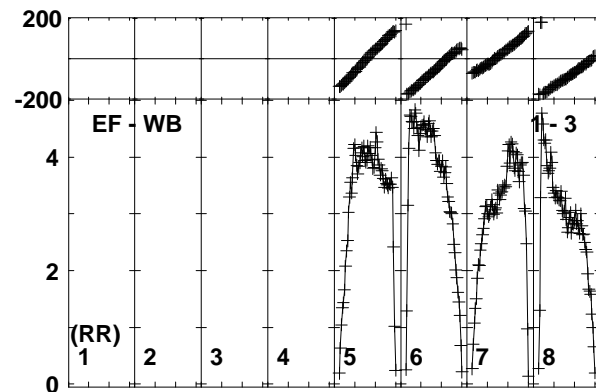
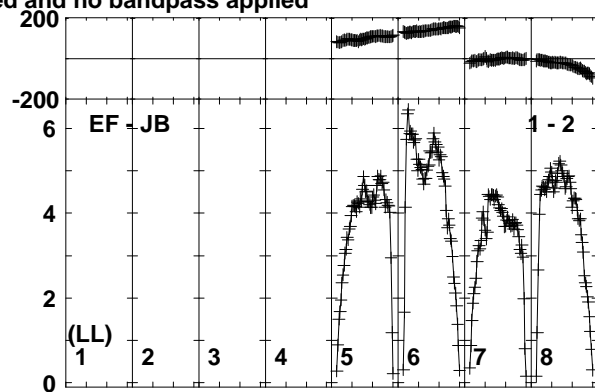
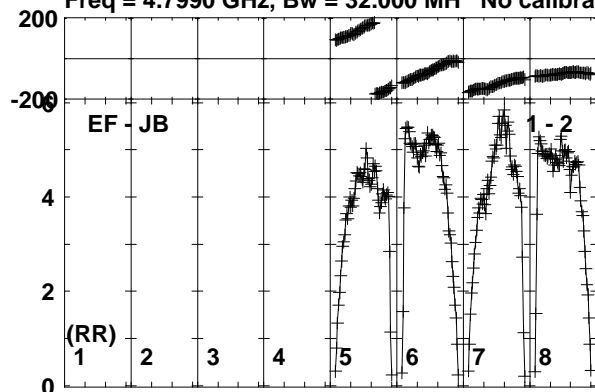

Lower frame: Milli Ampl Jy Top frame: Phas deg
Vector averaged cross-power spectrum Baseline: EF (01) - JB (02)
Timerange: 00/21:42:38 to 00/21:44:07

Plot file version 164 created 03-OCT-2017 13:10:08

J2353+5518 RP028.UVDATA.1

Freq = 4.7990 GHz, Bw = 32.000 MH No calibration applied and no bandpass applied

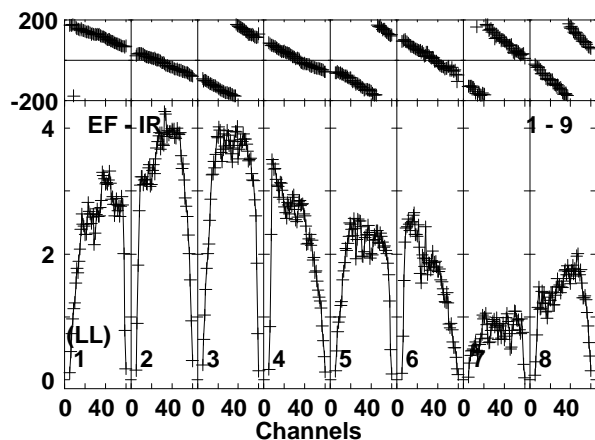
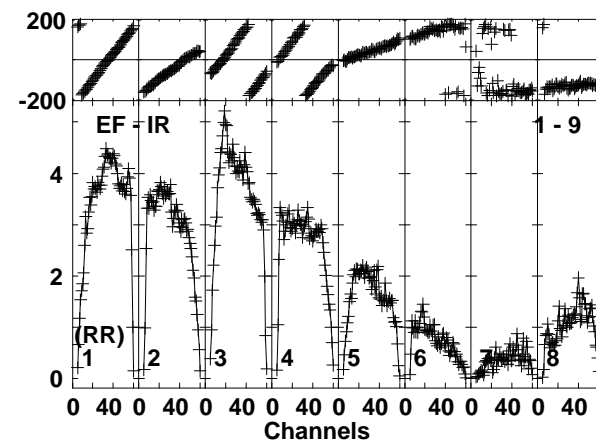
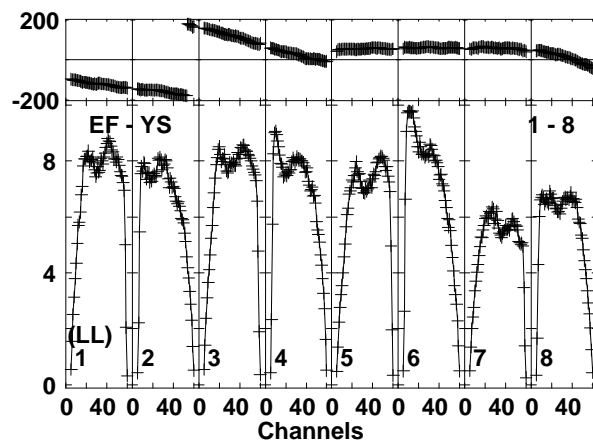
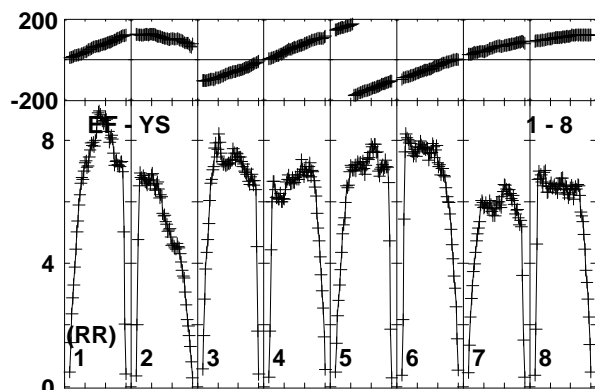
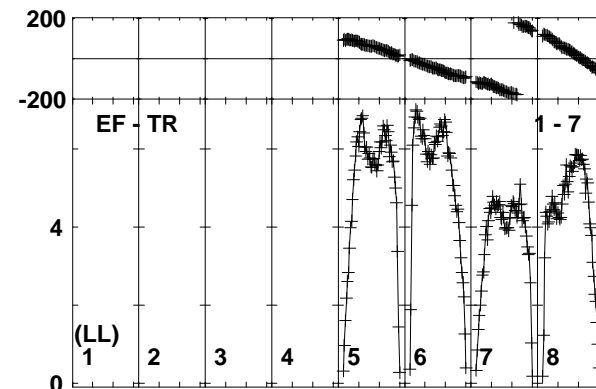
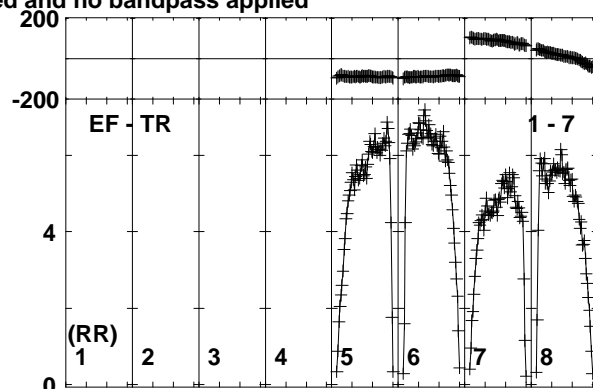
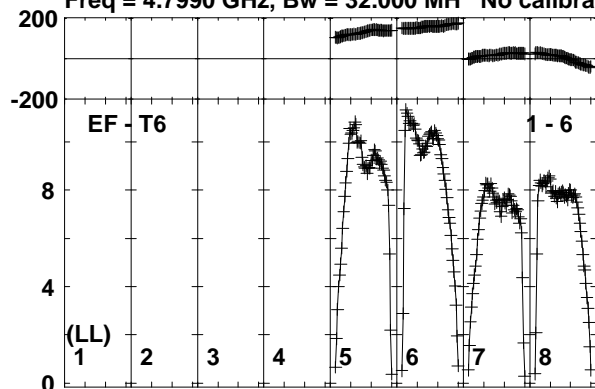

Lower frame: Milli Ampl Jy Top frame: Phas deg
Vector averaged cross-power spectrum Baseline: EF (01) - T6 (06)
Timerange: 00/21:42:38 to 00/21:44:07

Plot file version 165 created 03-OCT-2017 13:10:08

IRAS23436 RP028.UVDATA.1

Freq = 4.7990 GHz, Bw = 32.000 MH No calibration applied and no bandpass applied

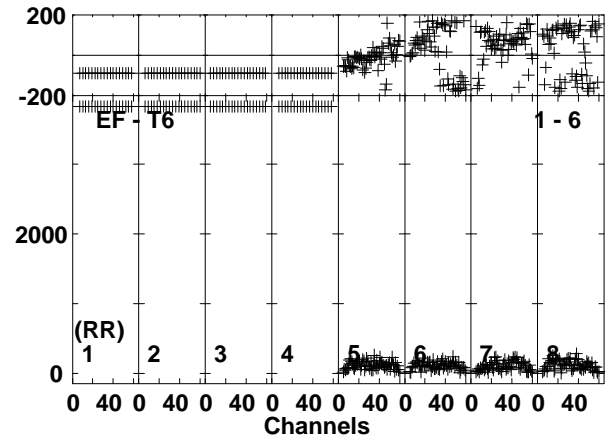
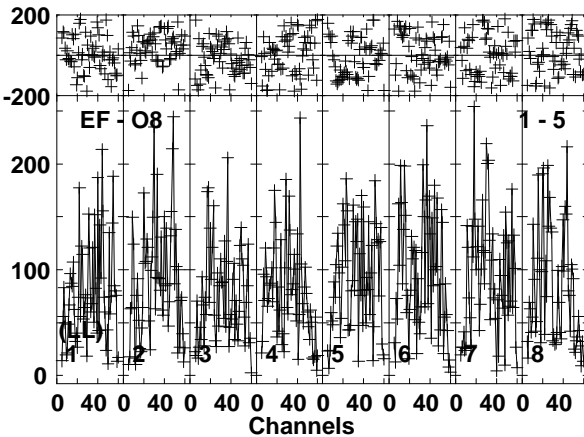
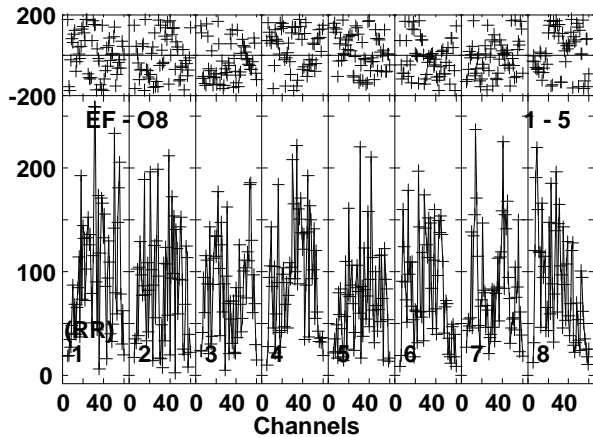
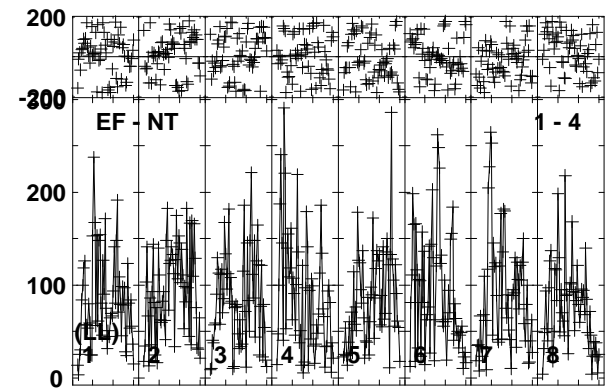
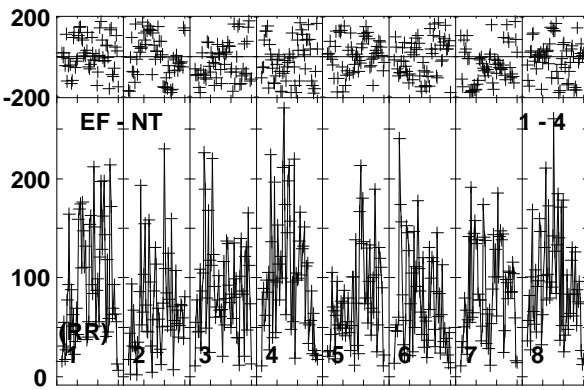
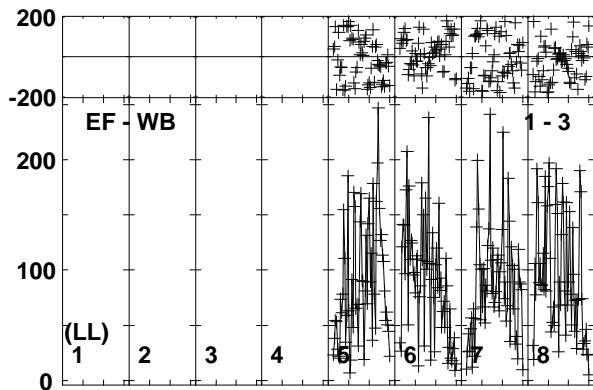
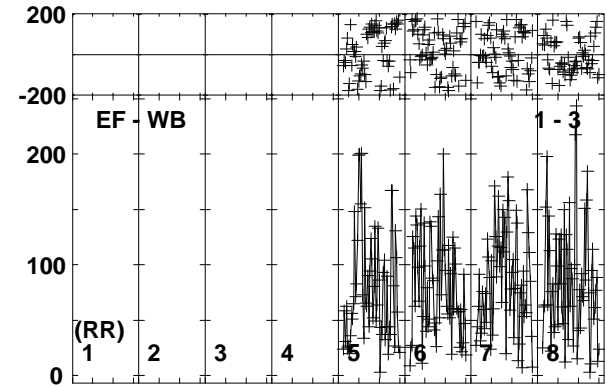
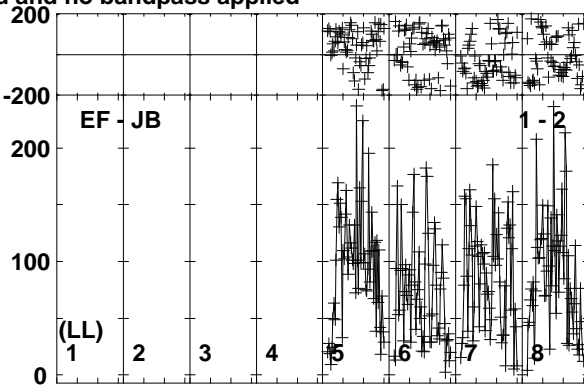
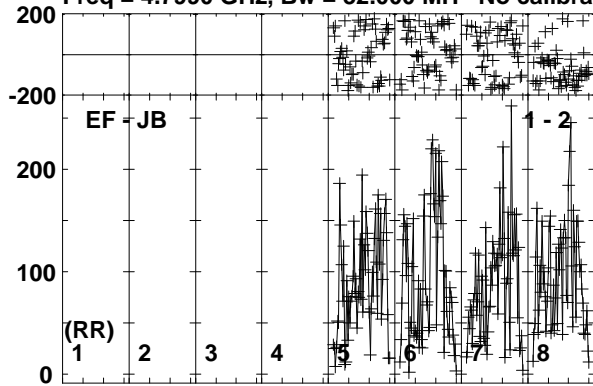

Lower frame: Micro Ampl Jy Top frame: Phas deg
Vector averaged cross-power spectrum Baseline: EF (01) - JB (02)
Timerange: 00/21:44:09 to 00/21:47:51

Plot file version 166 created 03-OCT-2017 13:10:08

IRAS23436 RP028.UVDATA.1

Freq = 4.7990 GHz, Bw = 32.000 MH No calibration applied and no bandpass applied

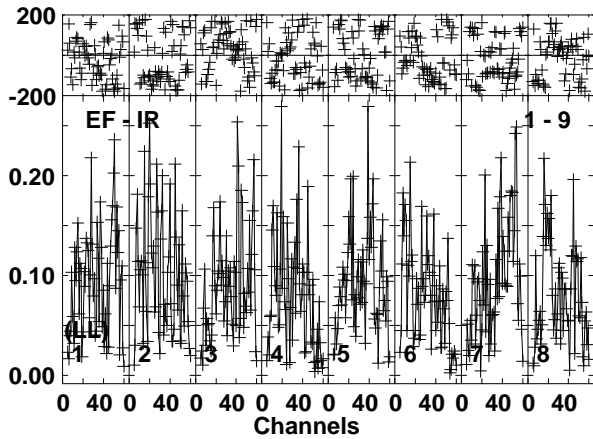
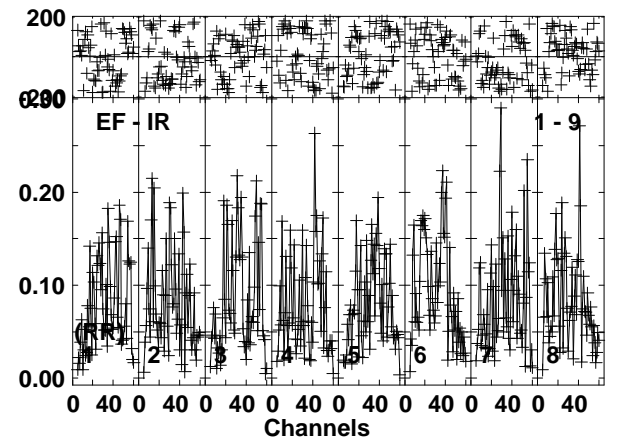
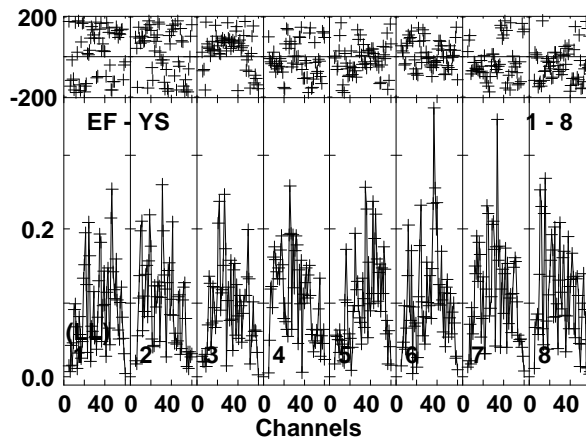
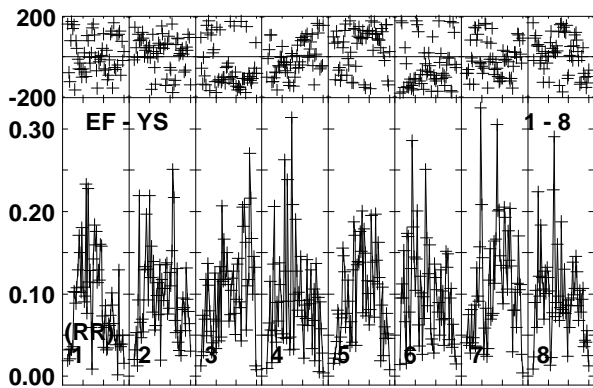
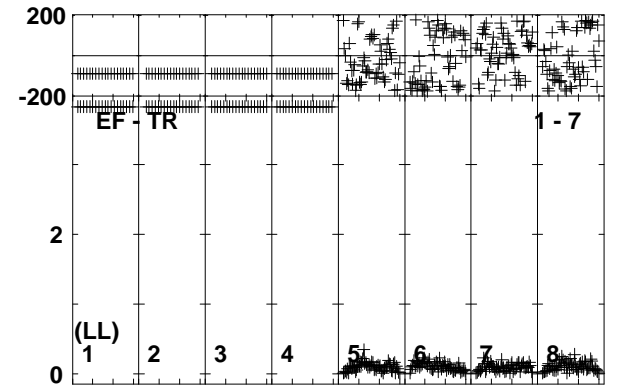
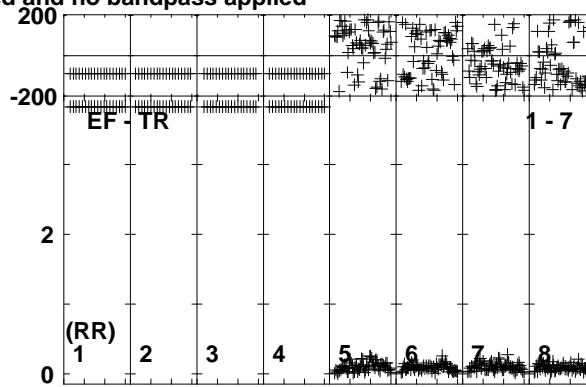
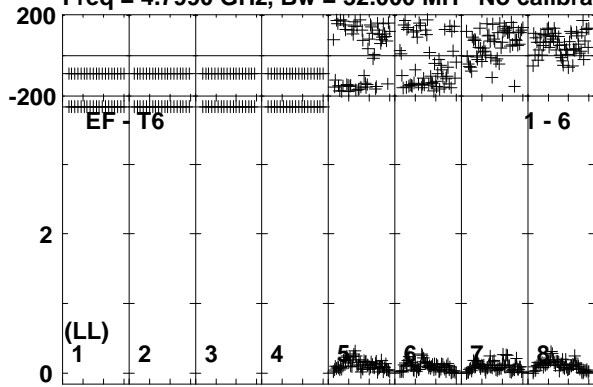

Lower frame: Milli Ampl Jy Top frame: Phas deg
Vector averaged cross-power spectrum Baseline: EF (01) - T6 (06)
Timerange: 00/21:44:09 to 00/21:47:51

Plot file version 167 created 03-OCT-2017 13:10:08

J2353+5518 RP028.UVDATA.1

Freq = 4.7990 GHz, Bw = 32.000 MH No calibration applied and no bandpass applied

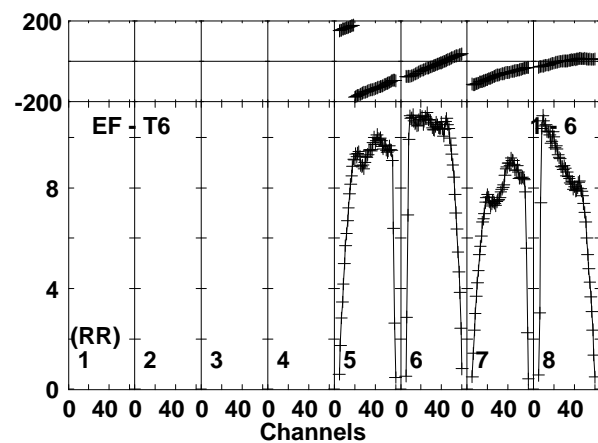
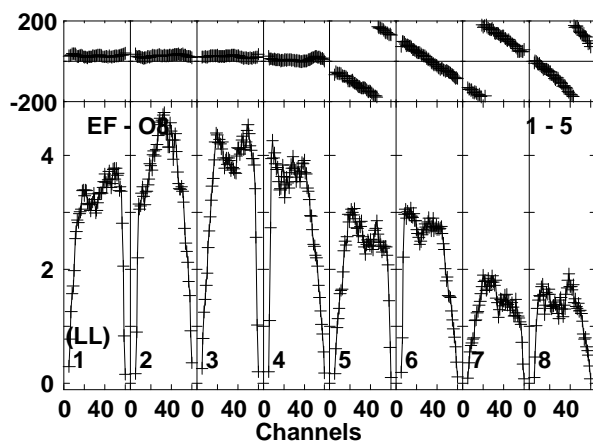
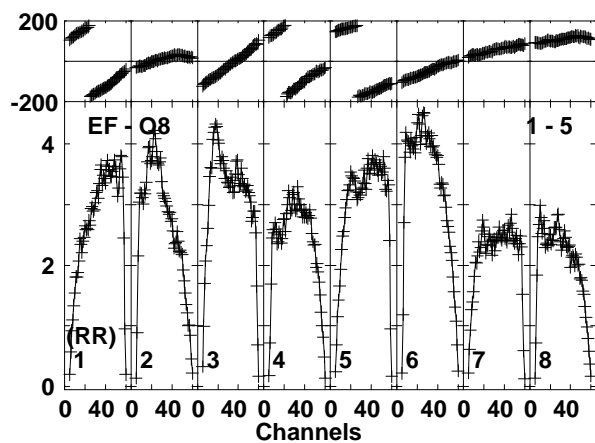
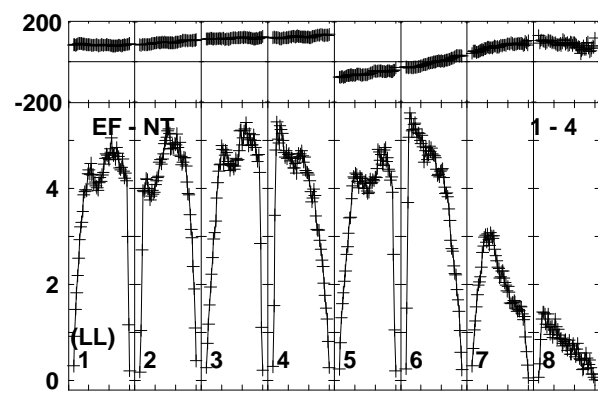
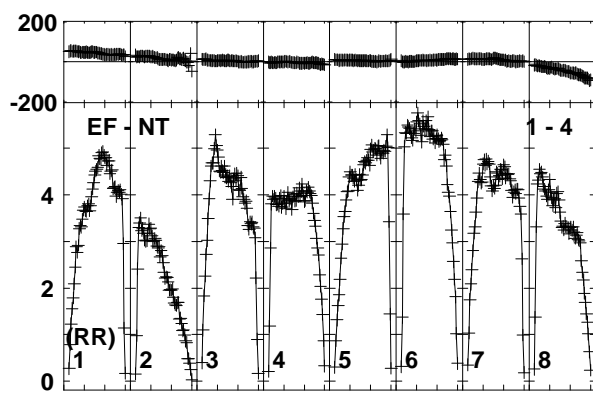
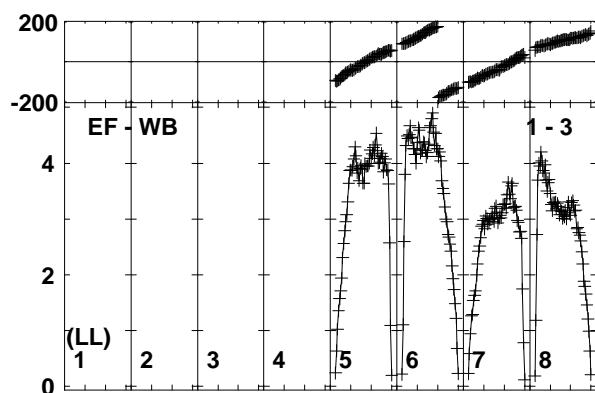
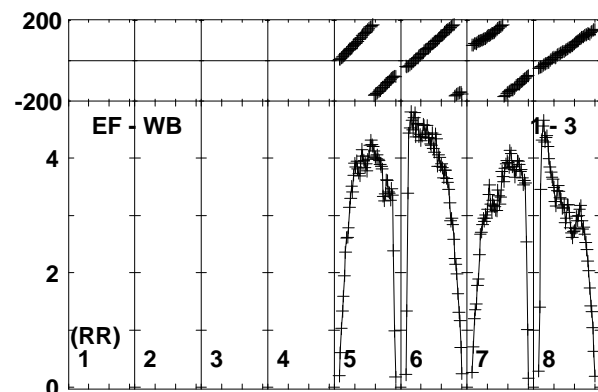
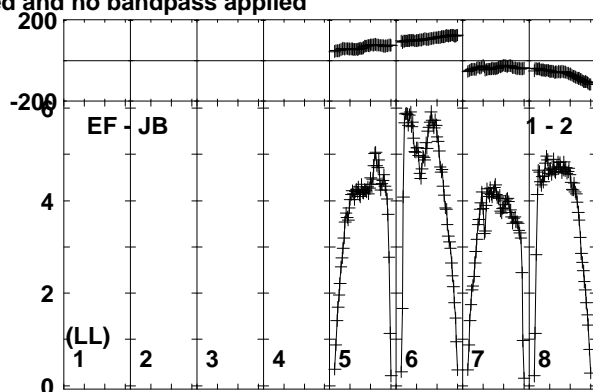
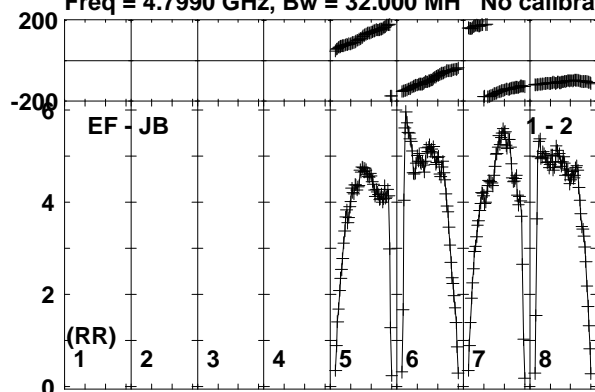

Lower frame: Milli Ampl Jy Top frame: Phas deg
Vector averaged cross-power spectrum Baseline: EF (01) - JB (02)
Timerange: 00/21:48:43 to 00/21:49:41

Plot file version 168 created 03-OCT-2017 13:10:09

J2353+5518 RP028.UVDATA.1

Freq = 4.7990 GHz, Bw = 32.000 MH No calibration applied and no bandpass applied

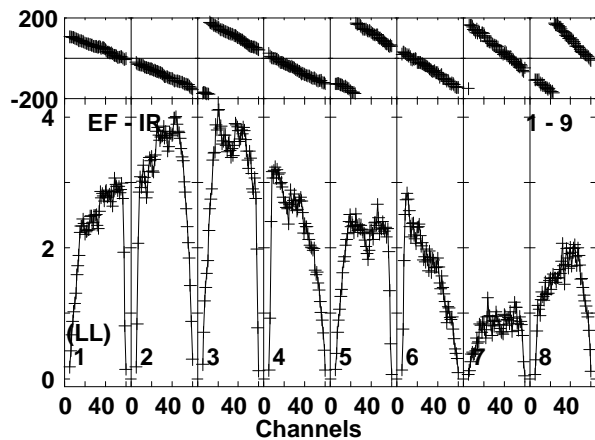
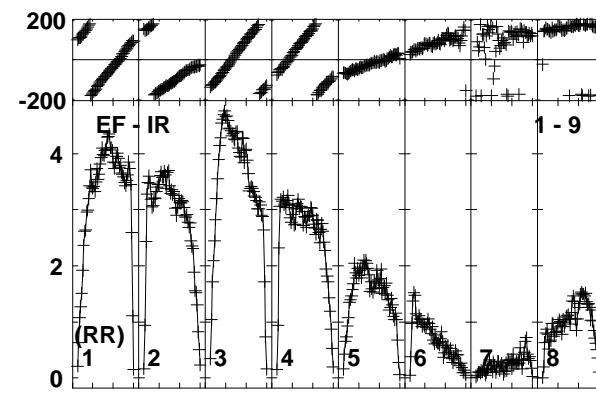
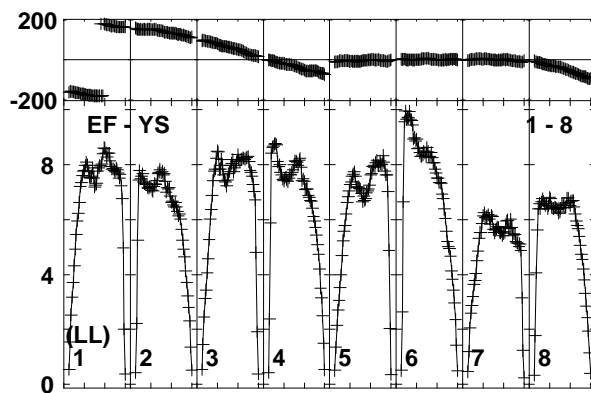
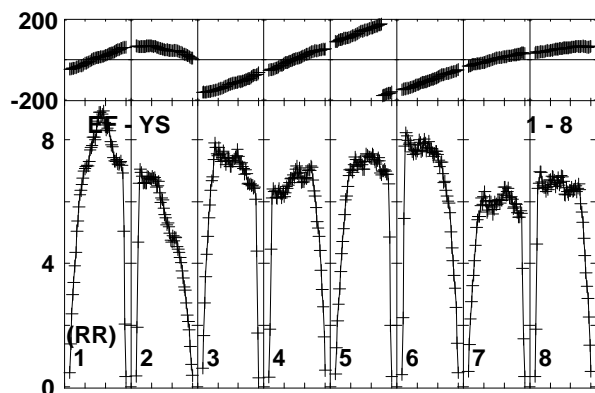
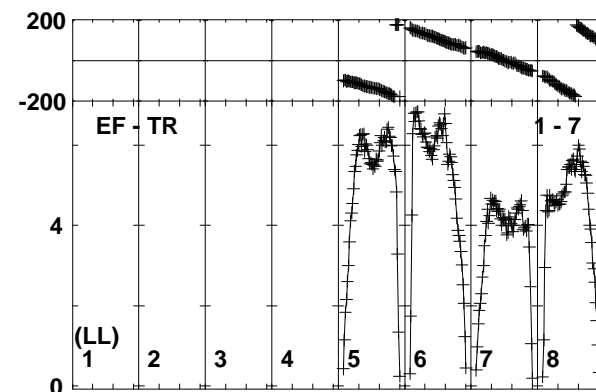
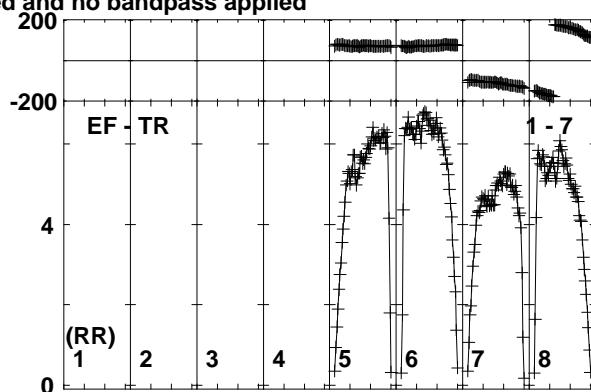
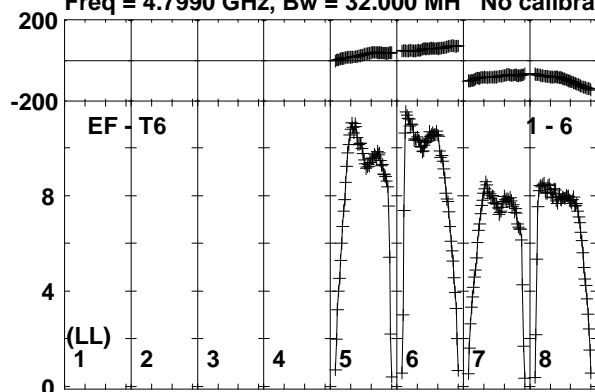

Lower frame: Milli Ampl Jy Top frame: Phas deg
Vector averaged cross-power spectrum Baseline: EF (01) - T6 (06)
Timerange: 00/21:48:43 to 00/21:49:41

Plot file version 169 created 03-OCT-2017 13:10:09

IRAS23436 RP028.UVDATA.1

Freq = 4.7990 GHz, Bw = 32.000 MH No calibration applied and no bandpass applied

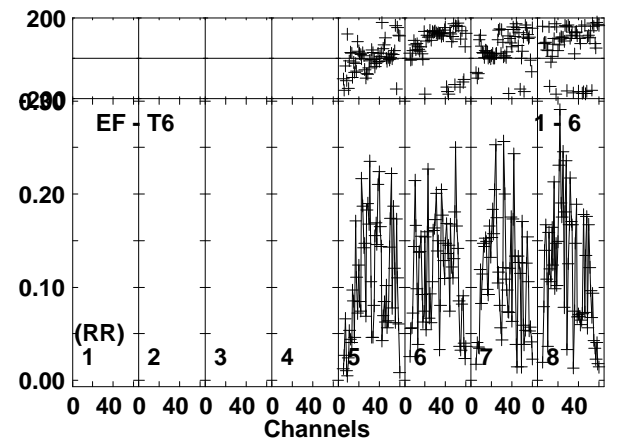
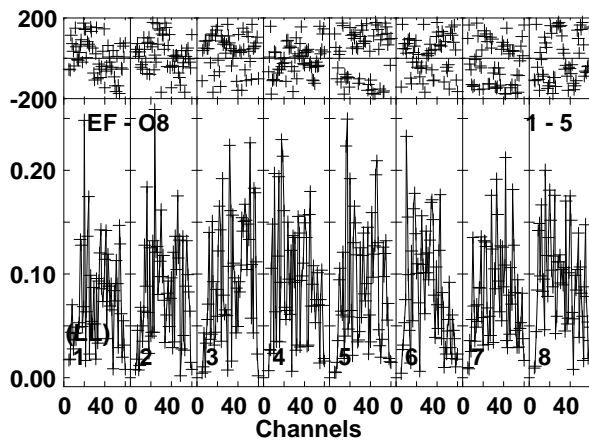
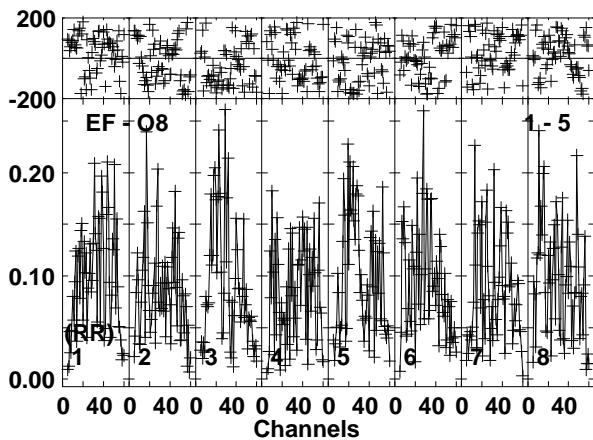
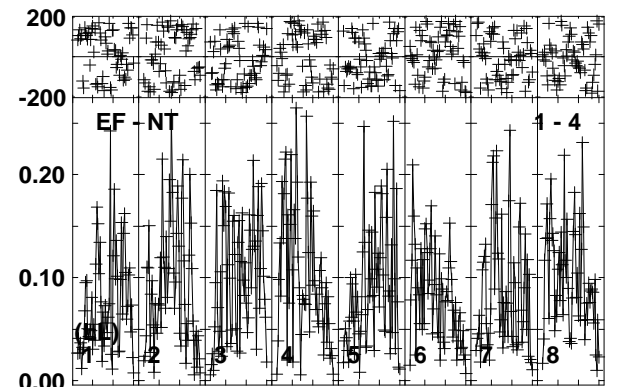
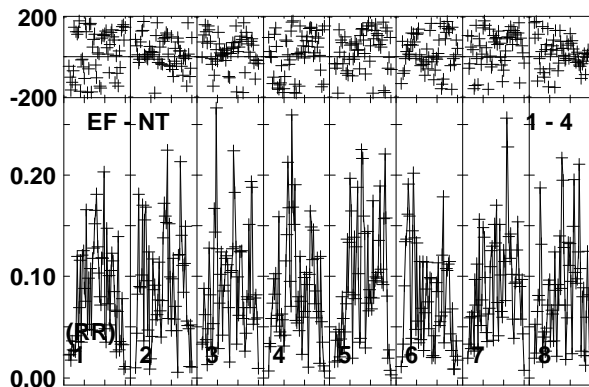
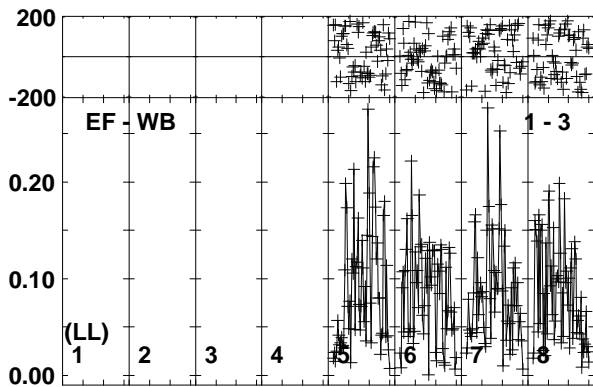
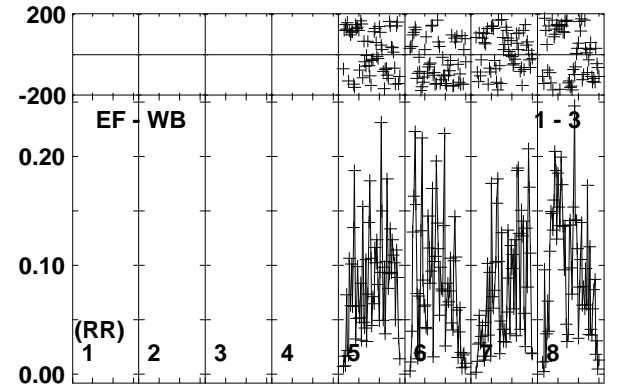
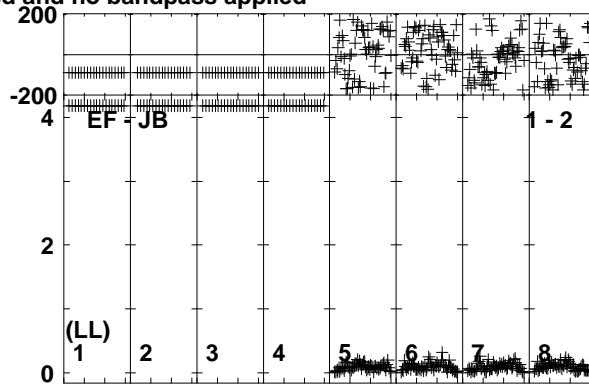
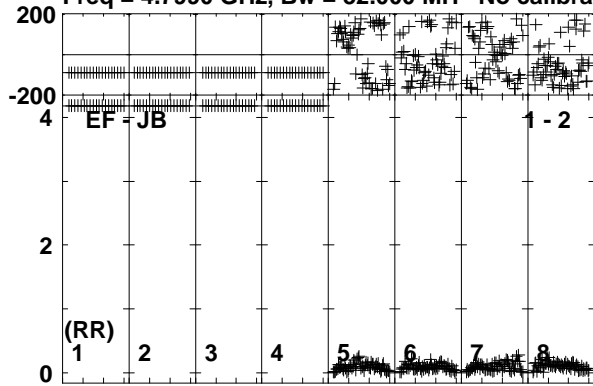

Lower frame: Milli Ampl Jy Top frame: Phas deg
Vector averaged cross-power spectrum Baseline: EF (01) - JB (02)
Timerange: 00/21:49:42 to 00/21:53:21

Plot file version 170 created 03-OCT-2017 13:10:09

IRAS23436 RP028.UVDATA.1

Freq = 4.7990 GHz, Bw = 32.000 MH No calibration applied and no bandpass applied

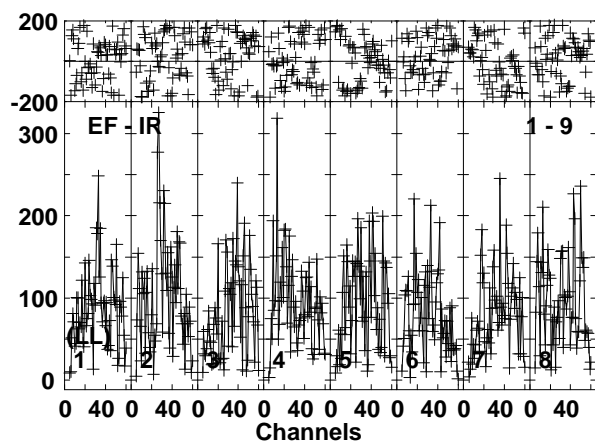
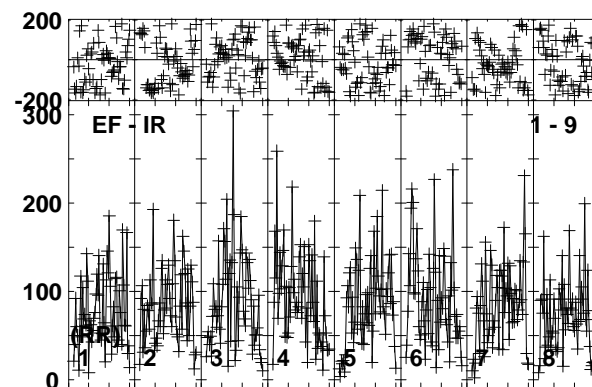
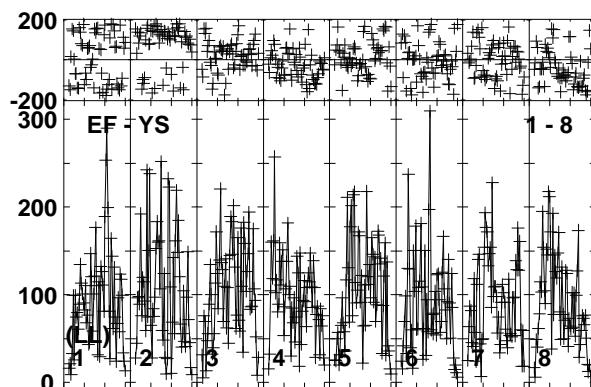
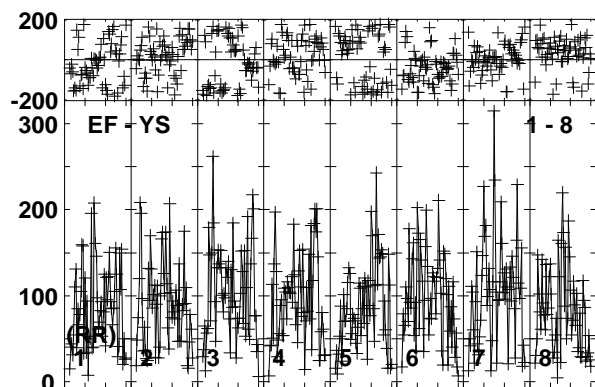
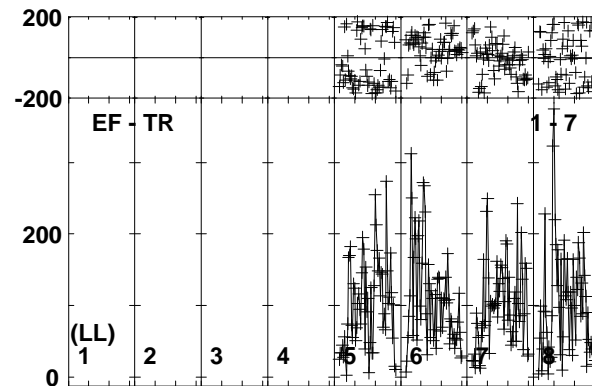
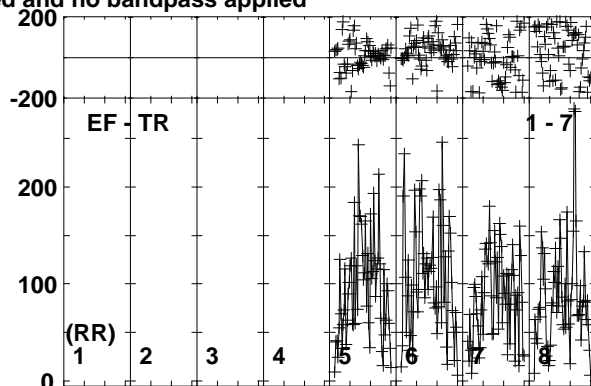
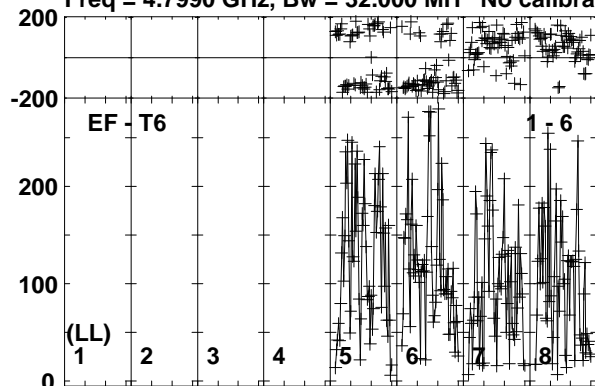

Lower frame: Micro Ampl Jy Top frame: Phas deg
Vector averaged cross-power spectrum Baseline: EF (01) - T6 (06)
Timerange: 00/21:49:42 to 00/21:53:21

Plot file version 171 created 03-OCT-2017 13:10:09

J2353+5518 RP028.UVDATA.1

Freq = 4.7990 GHz, Bw = 32.000 MH No calibration applied and no bandpass applied

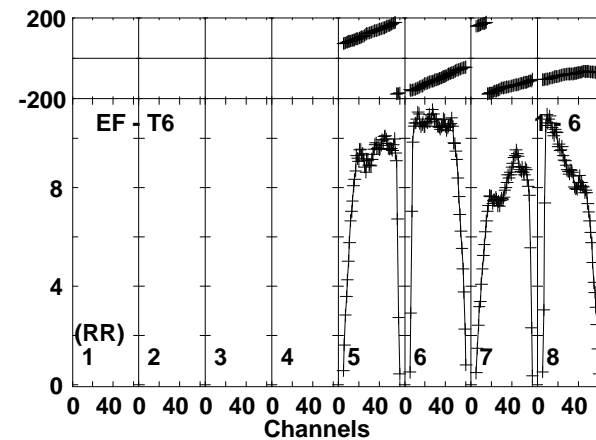
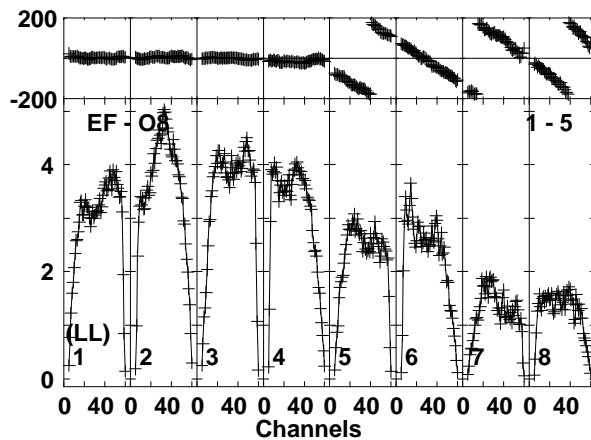
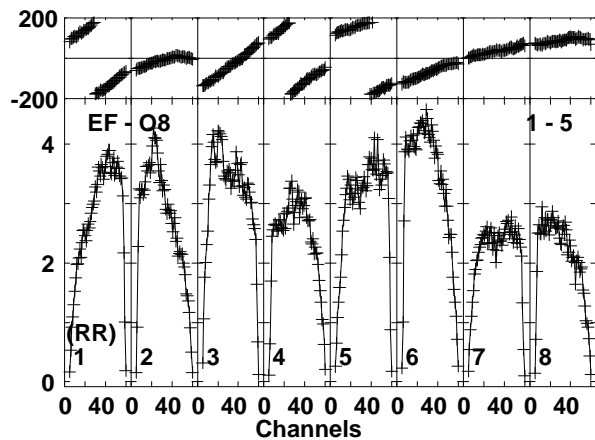
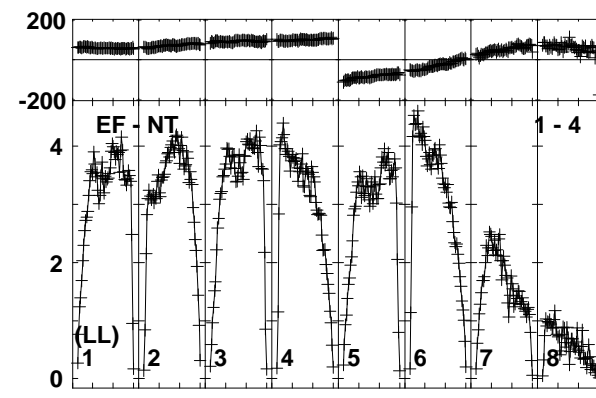
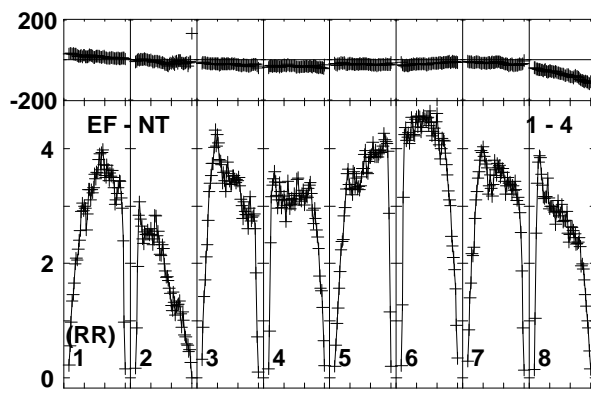
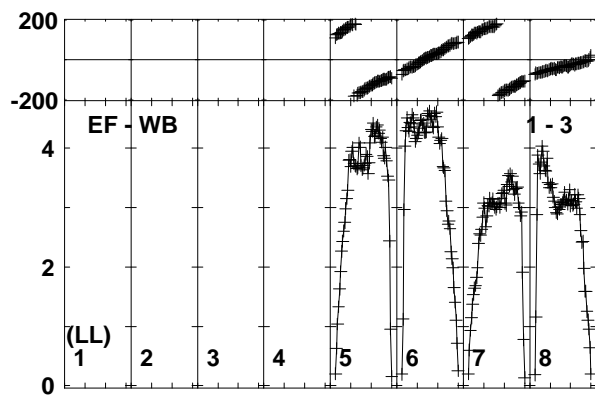
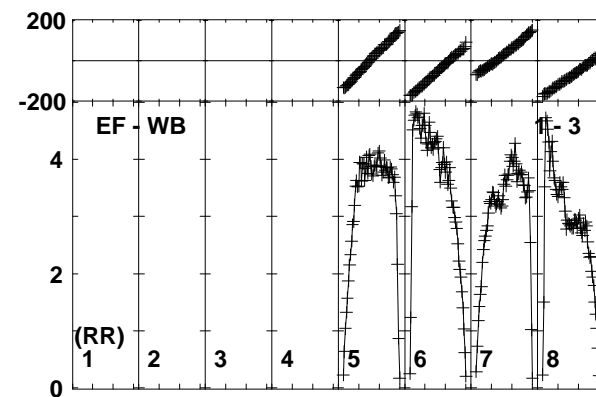
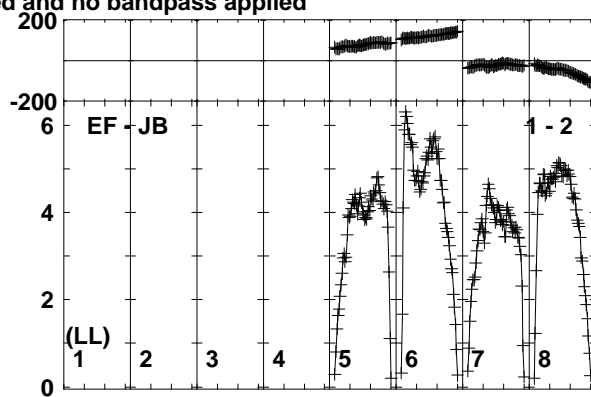
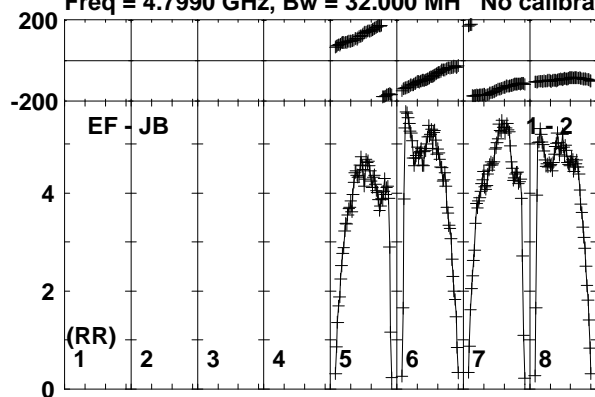

Lower frame: Milli Ampl Jy Top frame: Phas deg
Vector averaged cross-power spectrum Baseline: EF (01) - JB (02)
Timerange: 00/21:53:23 to 00/21:54:52

Plot file version 172 created 03-OCT-2017 13:10:10

J2353+5518 RP028.UVDATA.1

Freq = 4.7990 GHz, Bw = 32.000 MH No calibration applied and no bandpass applied

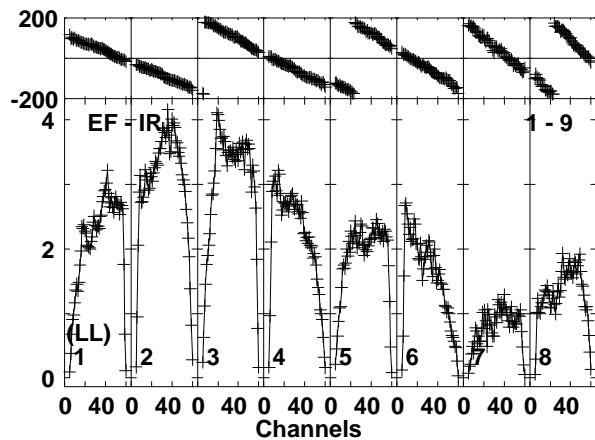
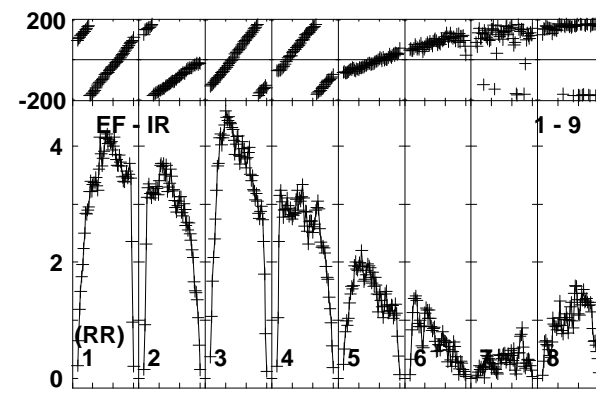
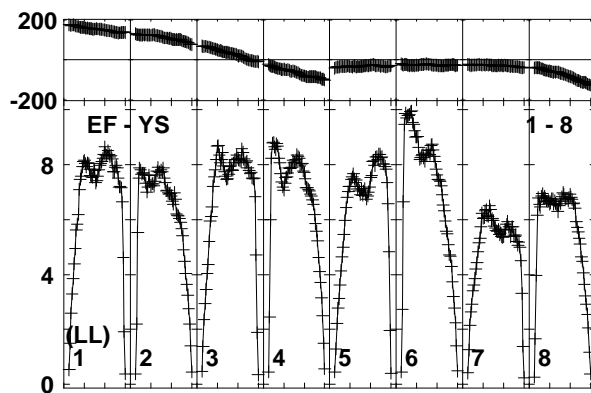
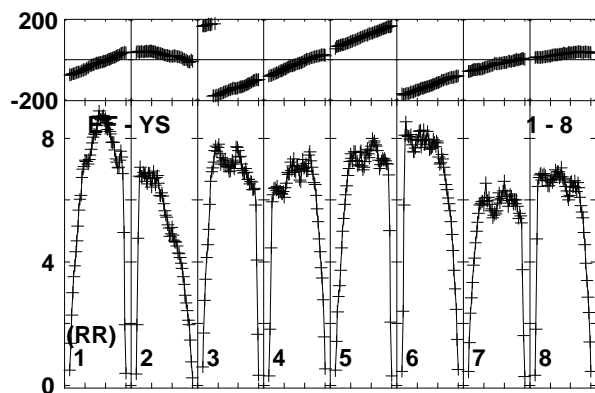
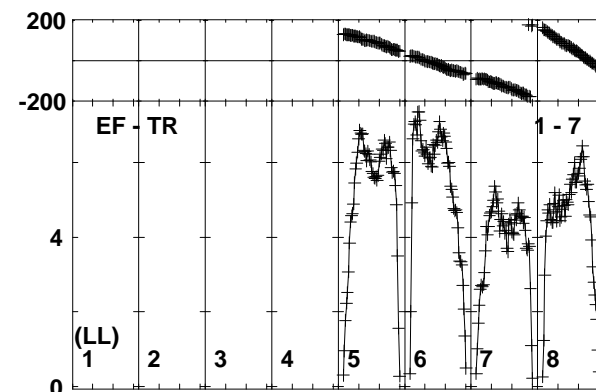
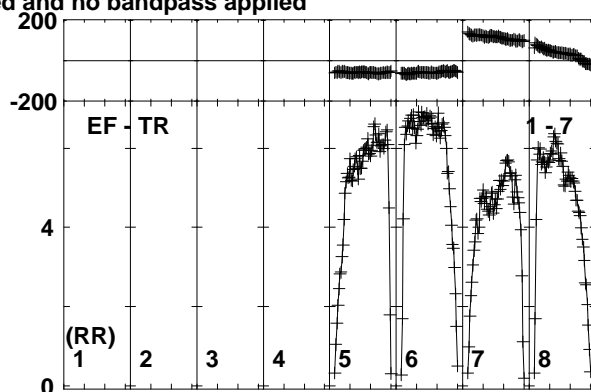
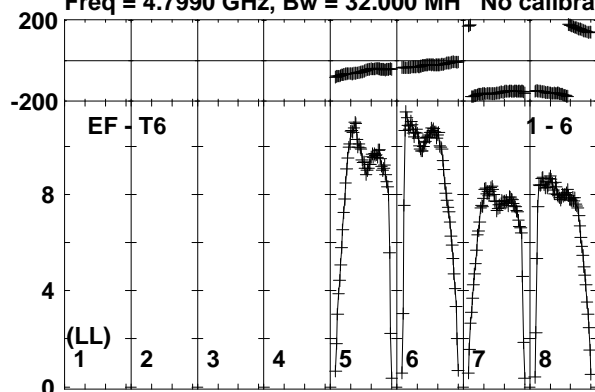

Lower frame: Milli Ampl Jy Top frame: Phas deg
Vector averaged cross-power spectrum Baseline: EF (01) - T6 (06)
Timerange: 00/21:53:23 to 00/21:54:52

Plot file version 173 created 03-OCT-2017 13:10:10

IRAS23436 RP028.UVDATA.1

Freq = 4.7990 GHz, Bw = 32.000 MH No calibration applied and no bandpass applied

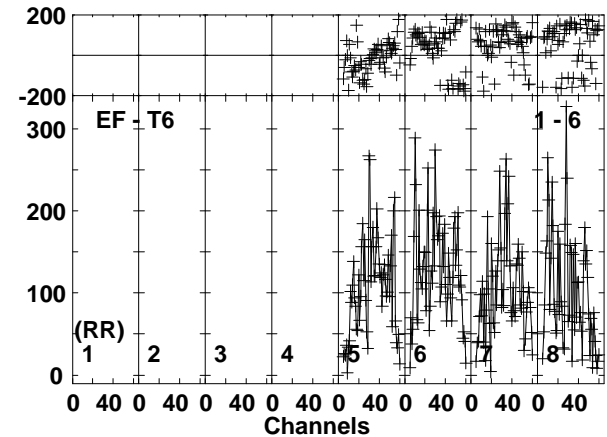
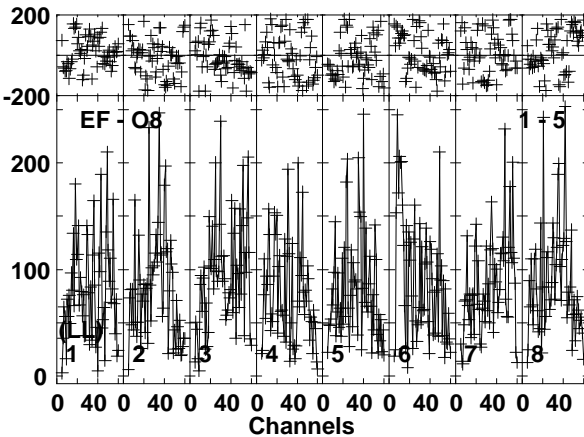
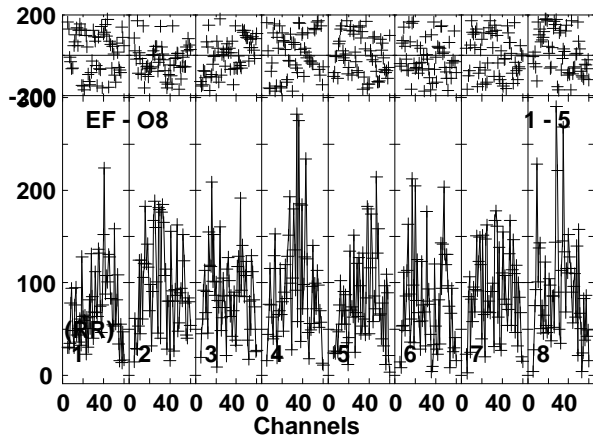
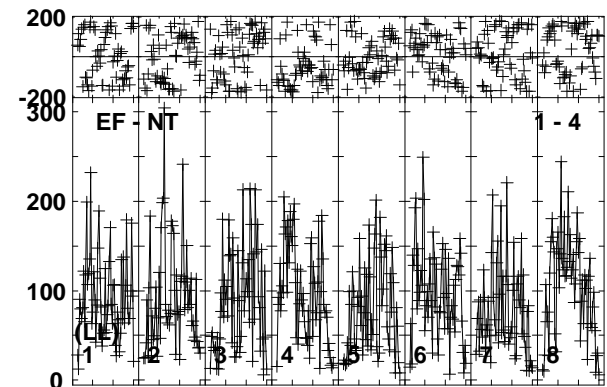
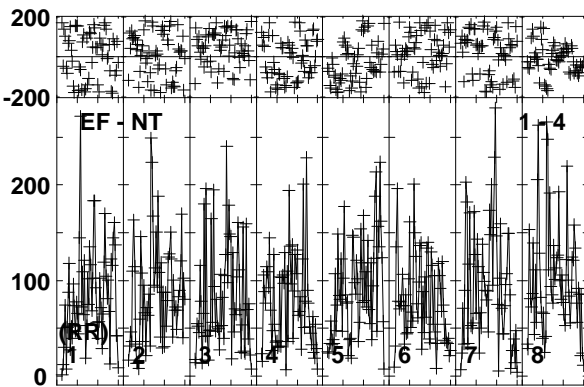
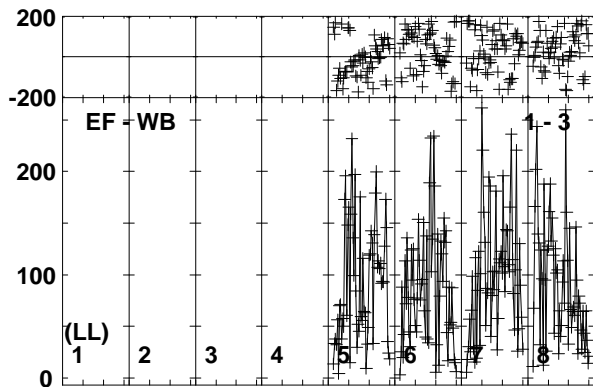
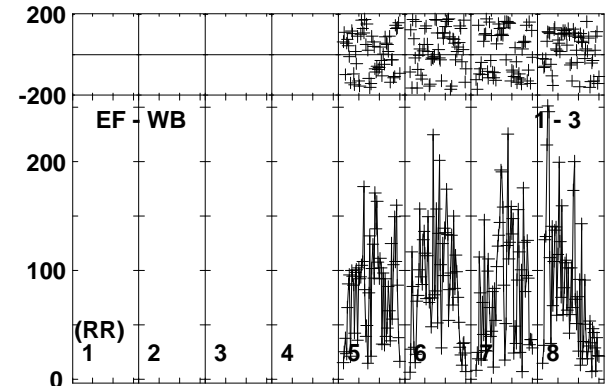
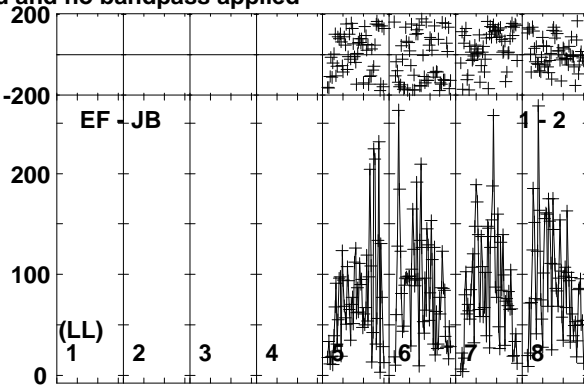
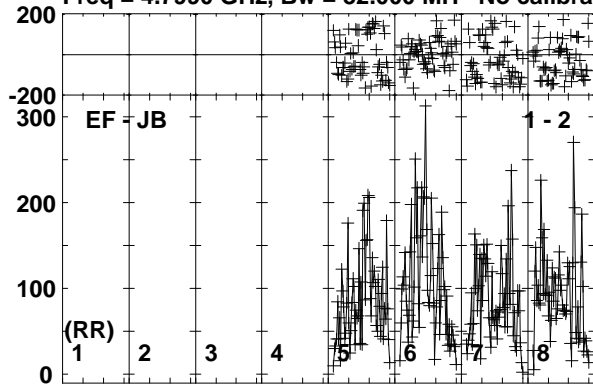

Lower frame: Micro Ampl Jy Top frame: Phas deg
Vector averaged cross-power spectrum Baseline: EF (01) - JB (02)
Timerange: 00/21:54:52 to 00/21:58:36

Plot file version 174 created 03-OCT-2017 13:10:10

IRAS23436 RP028.UVDATA.1

Freq = 4.7990 GHz, Bw = 32.000 MH No calibration applied and no bandpass applied

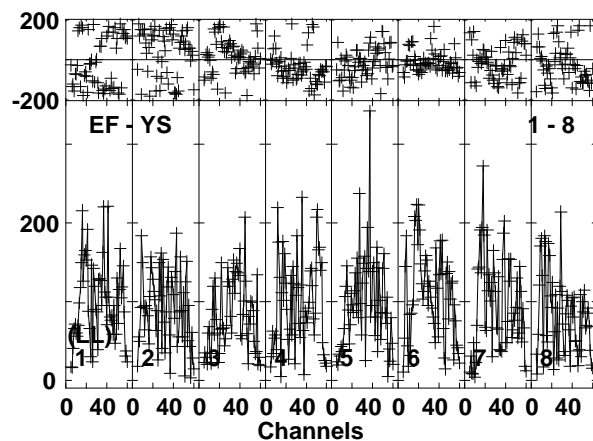
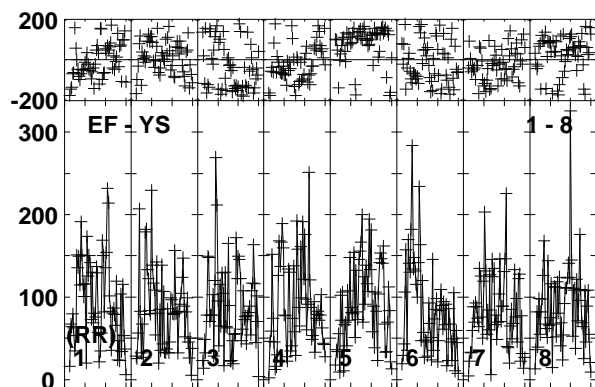
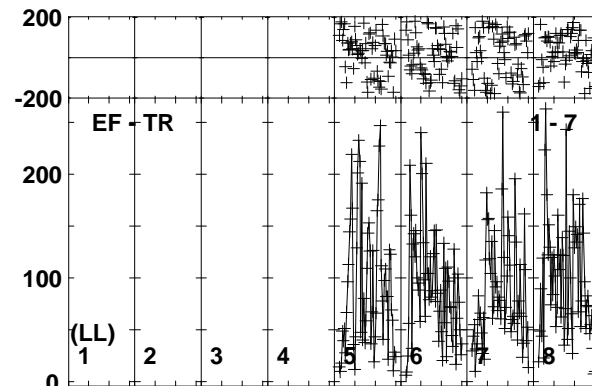
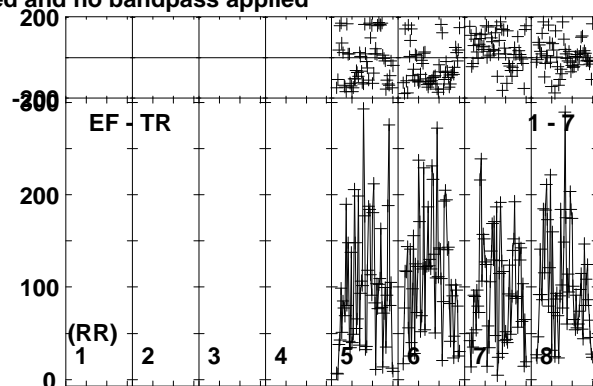
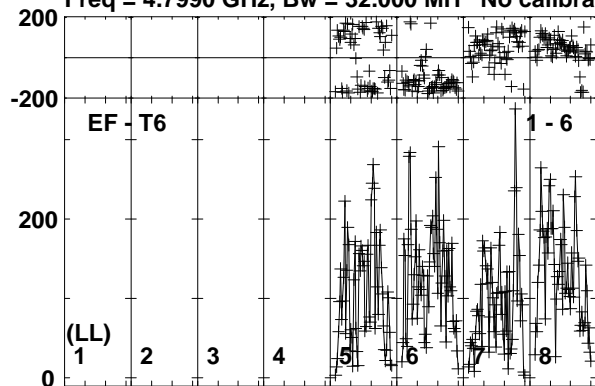

Lower frame: Micro Ampl Jy Top frame: Phas deg
Vector averaged cross-power spectrum Baseline: EF (01) - T6 (06)
Timerange: 00/21:54:52 to 00/21:58:36

Plot file version 175 created 03-OCT-2017 13:10:10

J2353+5518 RP028.UVDATA.1

Freq = 4.7990 GHz, Bw = 32.000 MH No calibration applied and no bandpass applied

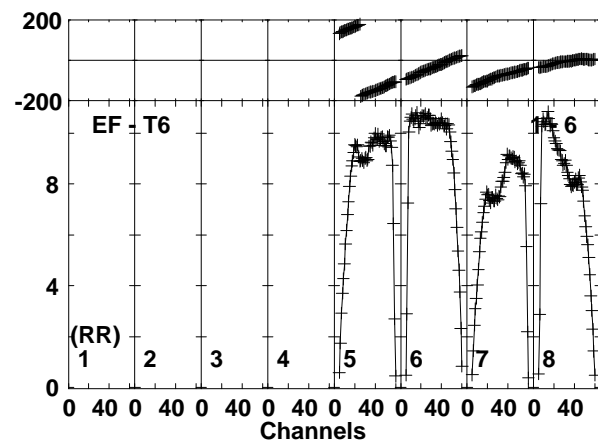
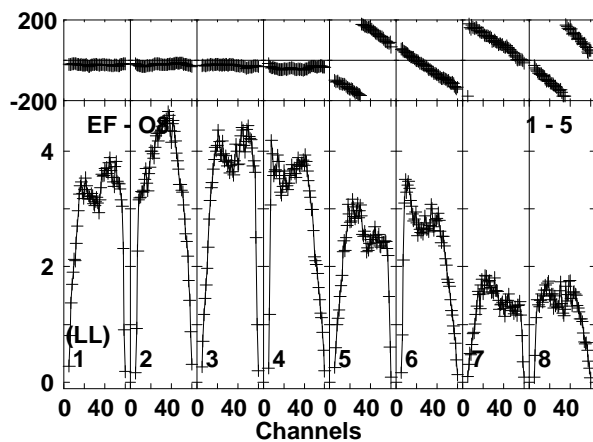
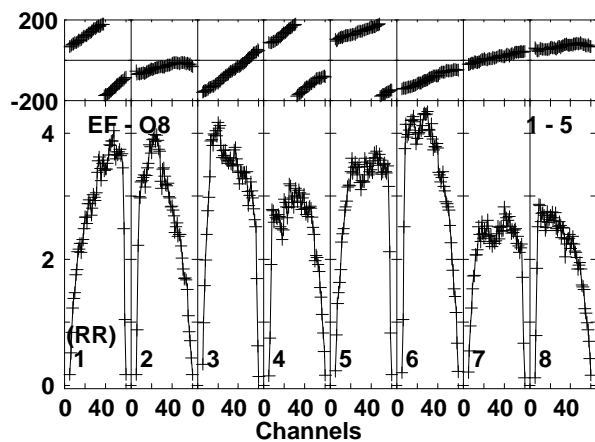
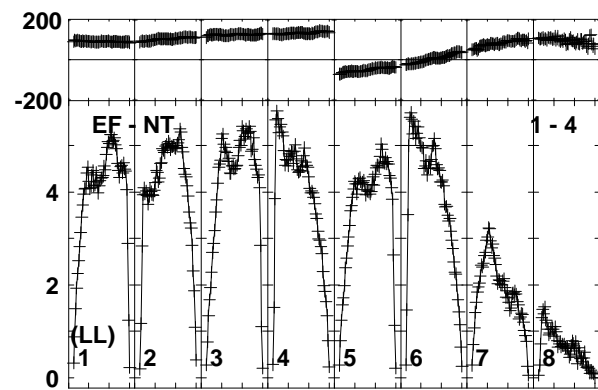
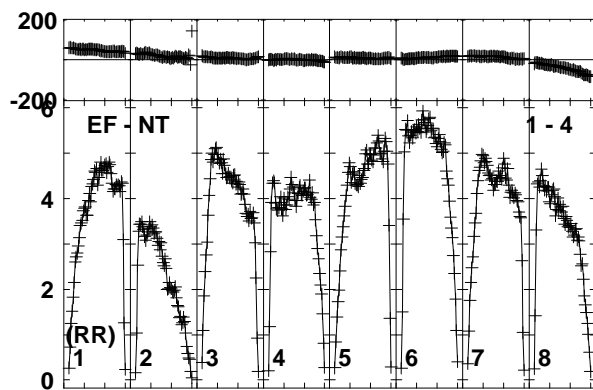
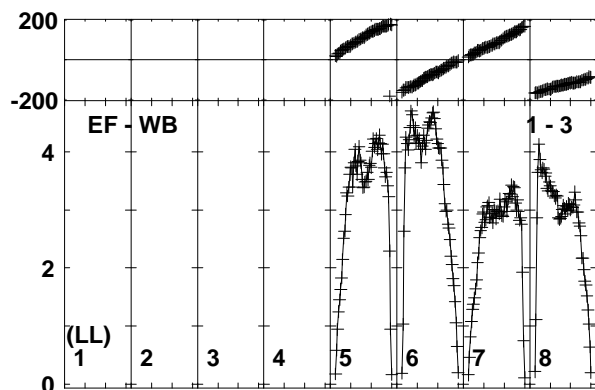
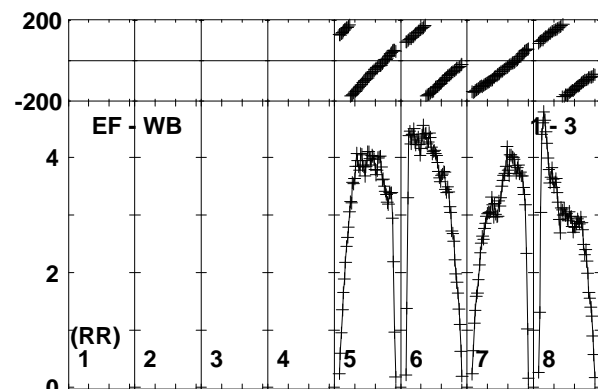
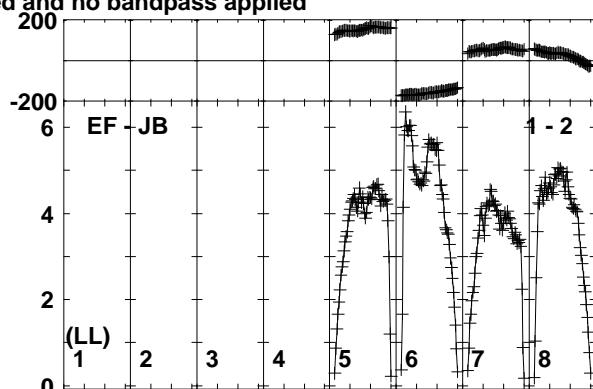
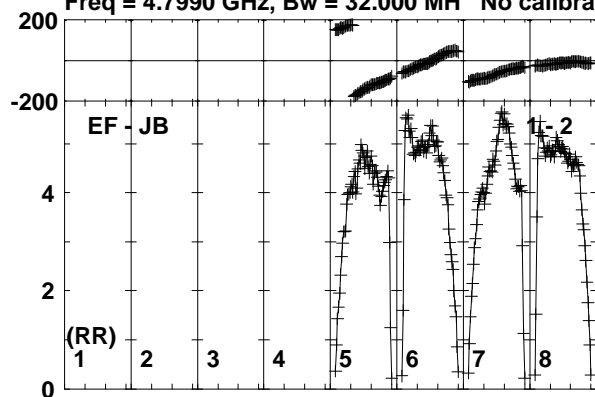

Lower frame: Milli Ampl Jy Top frame: Phas deg
Vector averaged cross-power spectrum Baseline: EF (01) - JB (02)
Timerange: 00:21:59:37 to 00:22:00:35

Plot file version 176 created 03-OCT-2017 13:10:10

J2353+5518 RP028.UVDATA.1

Freq = 4.7990 GHz, Bw = 32.000 MH No calibration applied and no bandpass applied

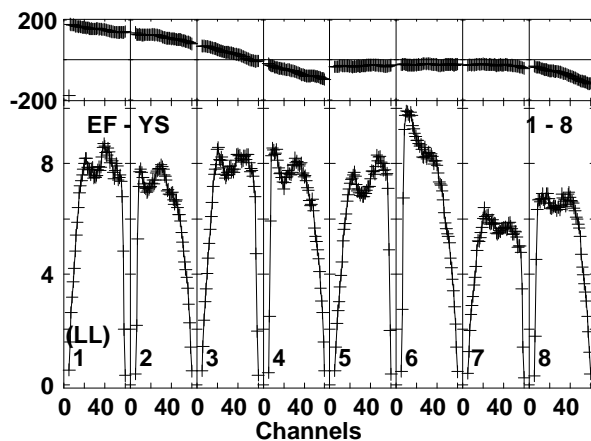
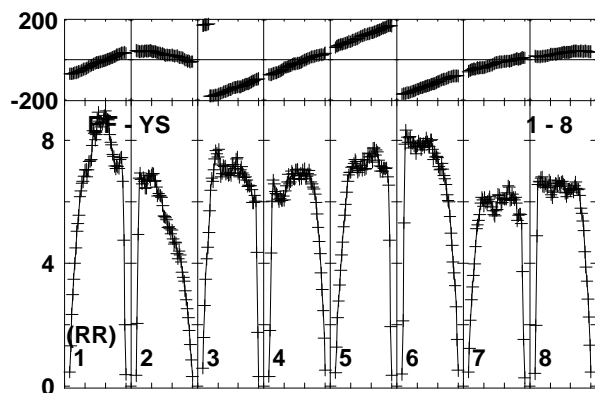
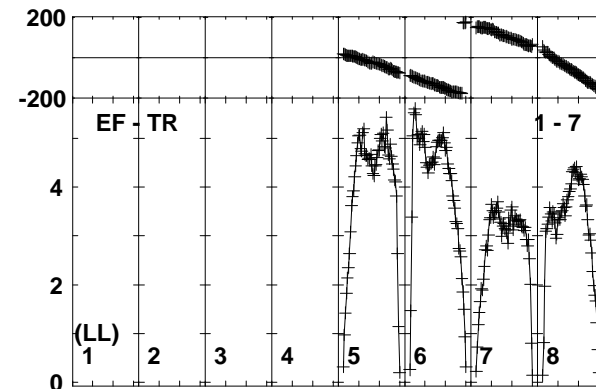
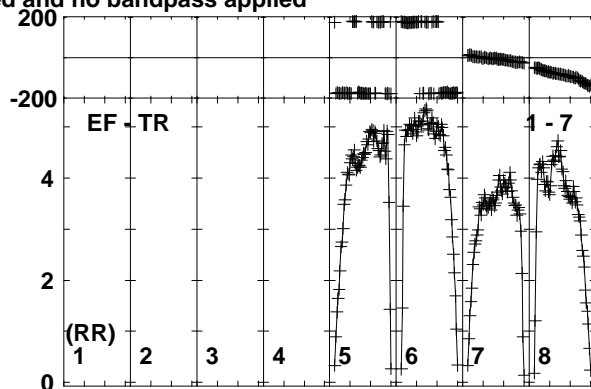
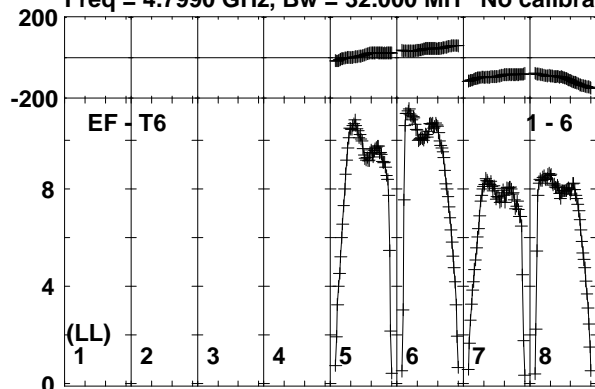

Lower frame: Milli Ampl Jy Top frame: Phas deg
Vector averaged cross-power spectrum Baseline: EF (01) - T6 (06)
Timerange: 00/21:59:37 to 00/22:00:35

Plot file version 177 created 03-OCT-2017 13:10:11

IRAS23436 RP028.UVDATA.1

Freq = 4.7990 GHz, Bw = 32.000 MH No calibration applied and no bandpass applied

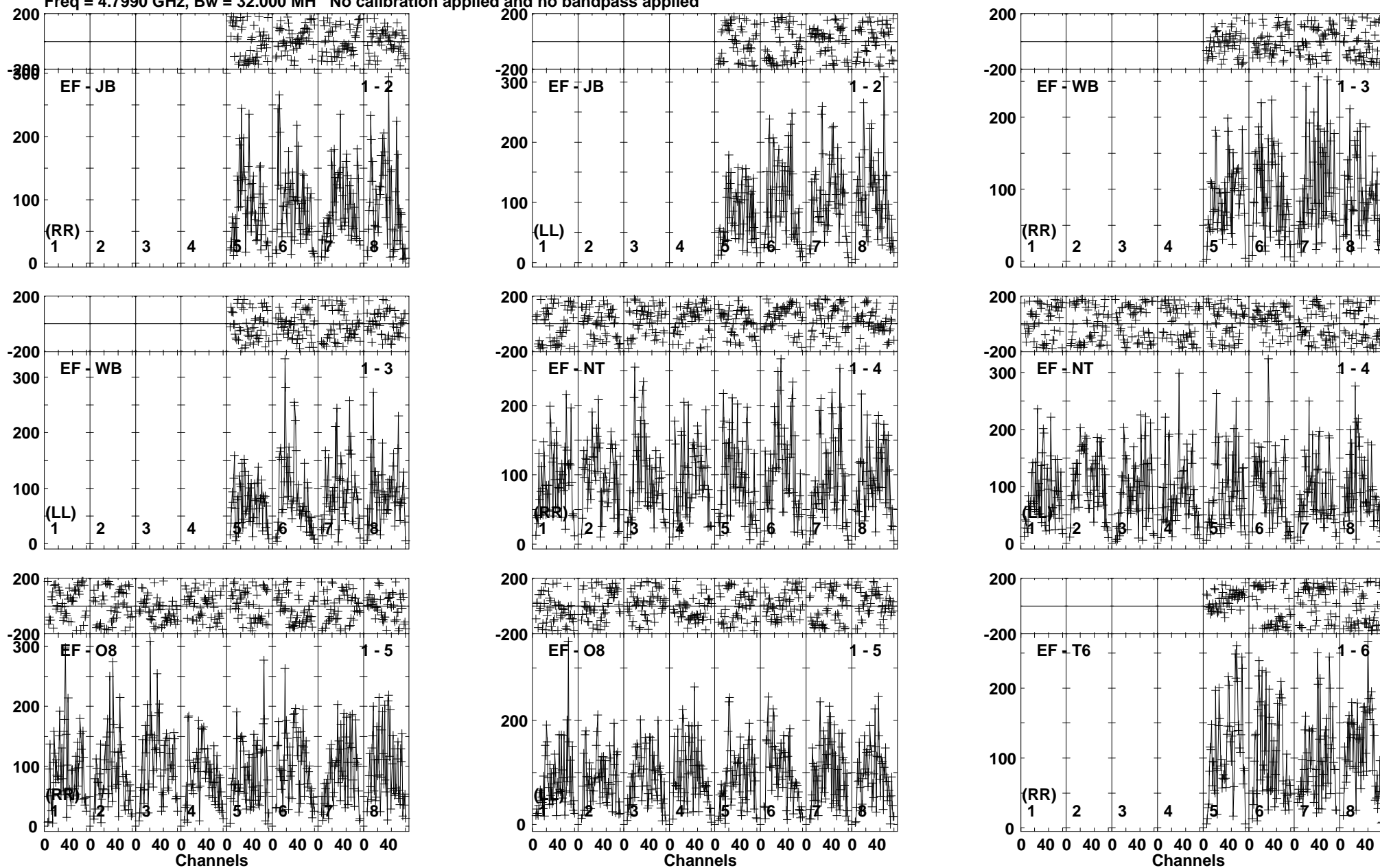

Lower frame: Micro Ampl Jy Top frame: Phas deg
Vector averaged cross-power spectrum Baseline: EF (01) - JB (02)
Timerange: 00/22:00:37 to 00/22:04:16

Plot file version 178 created 03-OCT-2017 13:10:11

IRAS23436 RP028.UVDATA.1

Freq = 4.7990 GHz, Bw = 32.000 MH No calibration applied and no bandpass applied

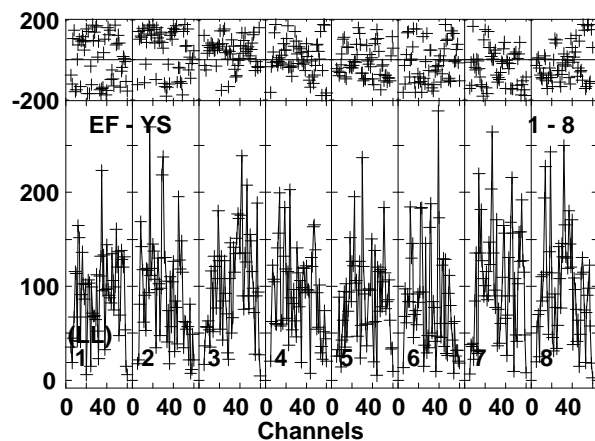
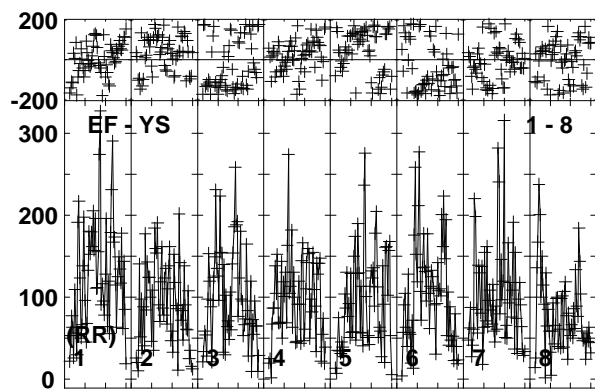
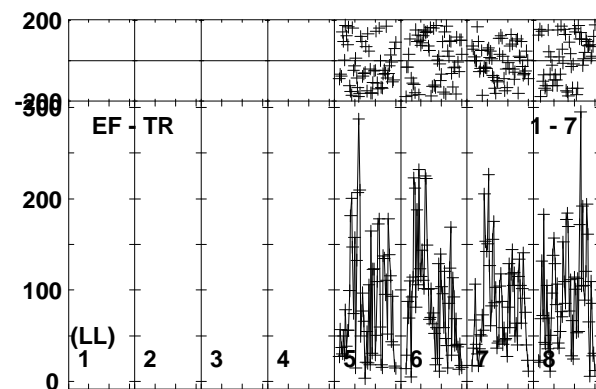
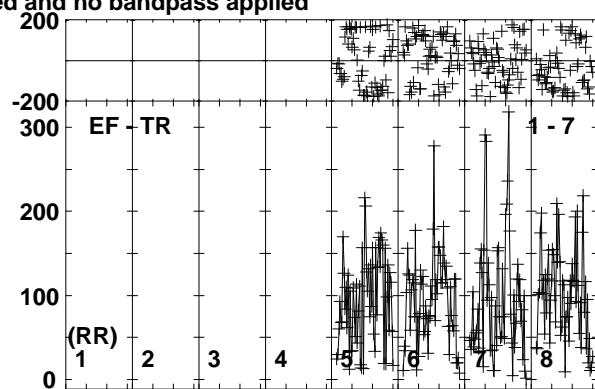
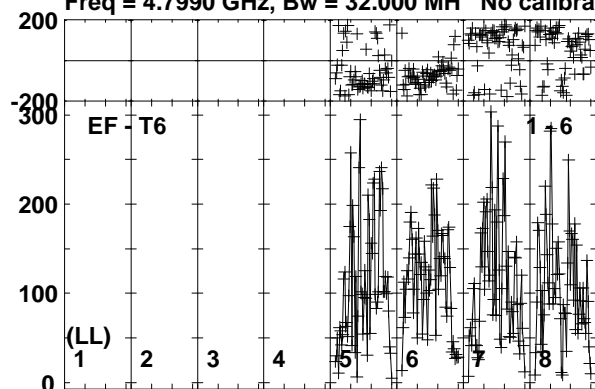

Lower frame: Micro Ampl Jy Top frame: Phas deg
Vector averaged cross-power spectrum Baseline: EF (01) - T6 (06)
Timerange: 00/22:00:37 to 00/22:04:16

Plot file version 179 created 03-OCT-2017 13:10:11

J2353+5518 RP028.UVDATA.1

Freq = 4.7990 GHz, Bw = 32.000 MH No calibration applied and no bandpass applied

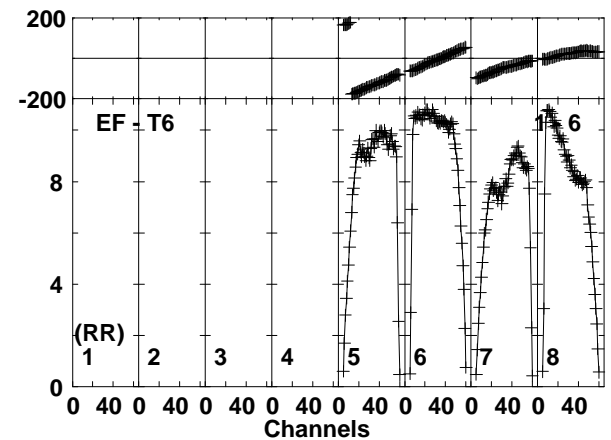
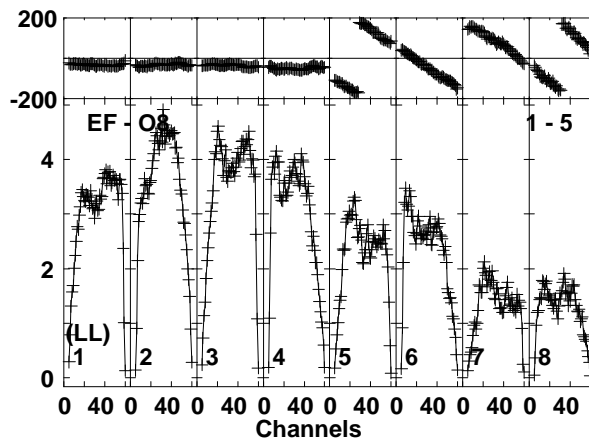
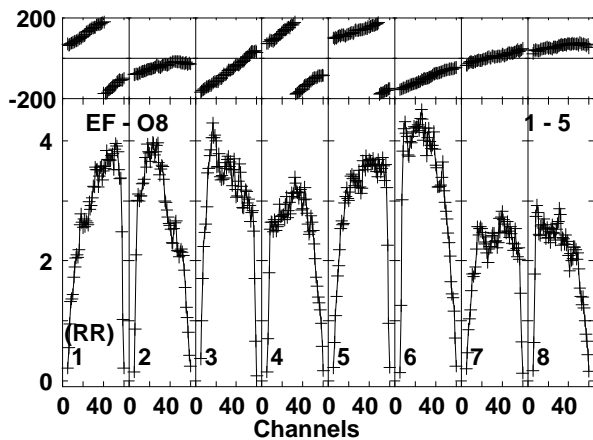
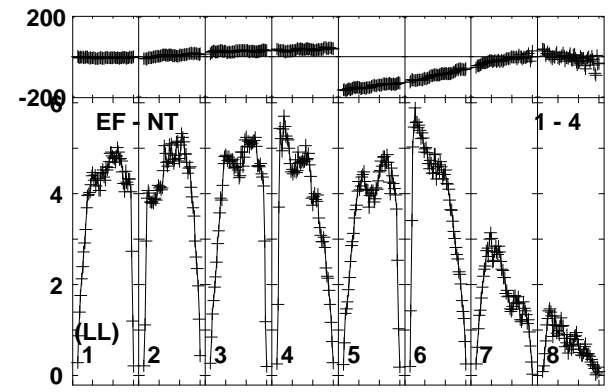
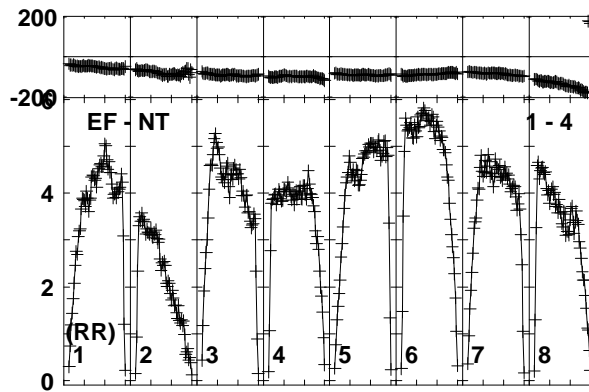
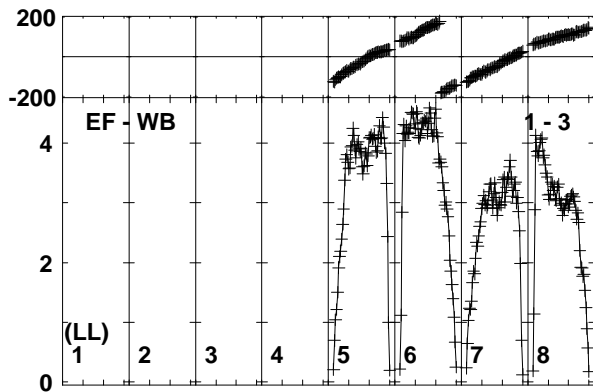
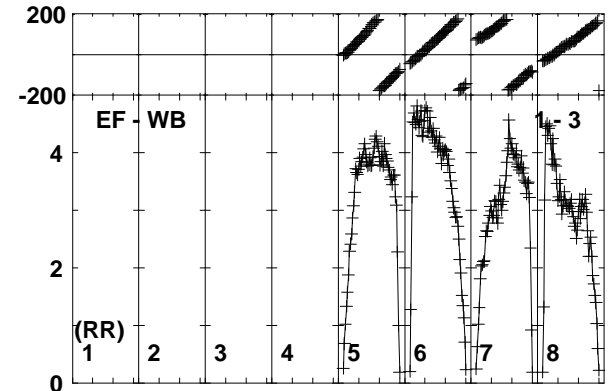
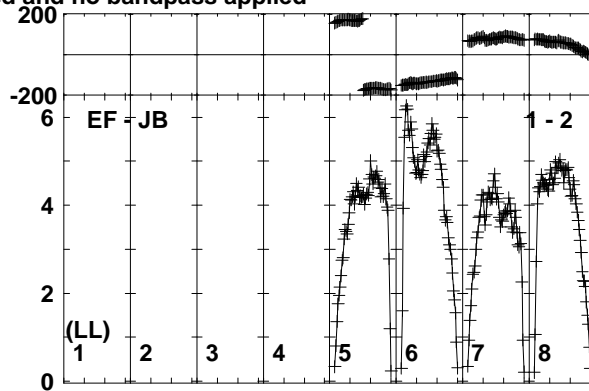
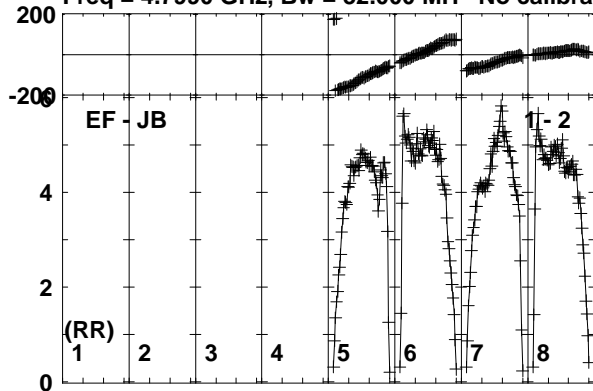

Lower frame: Milli Ampl Jy Top frame: Phas deg
Vector averaged cross-power spectrum Baseline: EF (01) - JB (02)
Timerange: 00/22:04:17 to 00/22:05:45

Plot file version 180 created 03-OCT-2017 13:10:11

J2353+5518 RP028.UVDATA.1

Freq = 4.7990 GHz, Bw = 32.000 MH No calibration applied and no bandpass applied

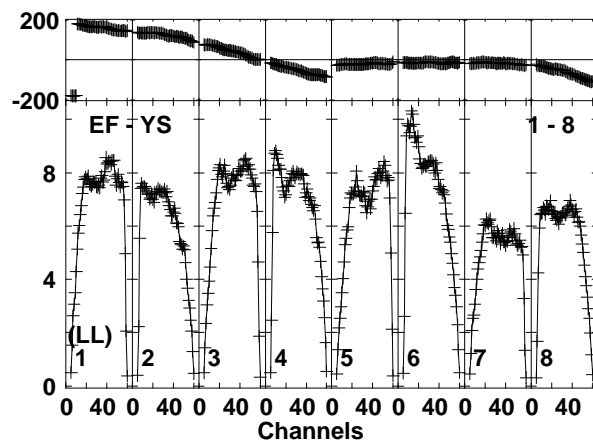
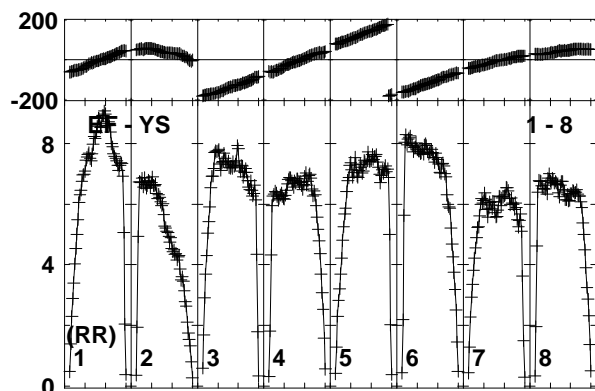
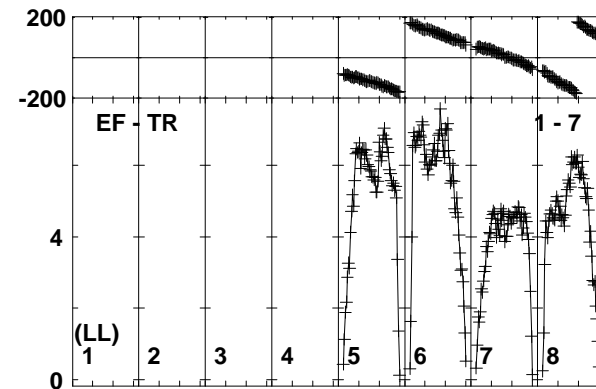
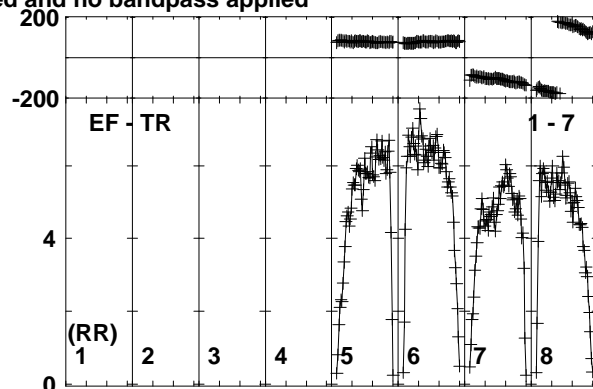
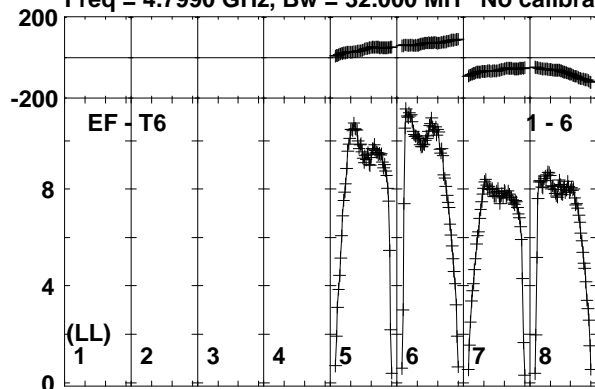

Lower frame: Milli Ampl Jy Top frame: Phas deg
Vector averaged cross-power spectrum Baseline: EF (01) - T6 (06)
Timerange: 00/22:04:17 to 00/22:05:45

Plot file version 181 created 03-OCT-2017 13:10:11

IRAS23436 RP028.UVDATA.1

Freq = 4.7990 GHz, Bw = 32.000 MH No calibration applied and no bandpass applied

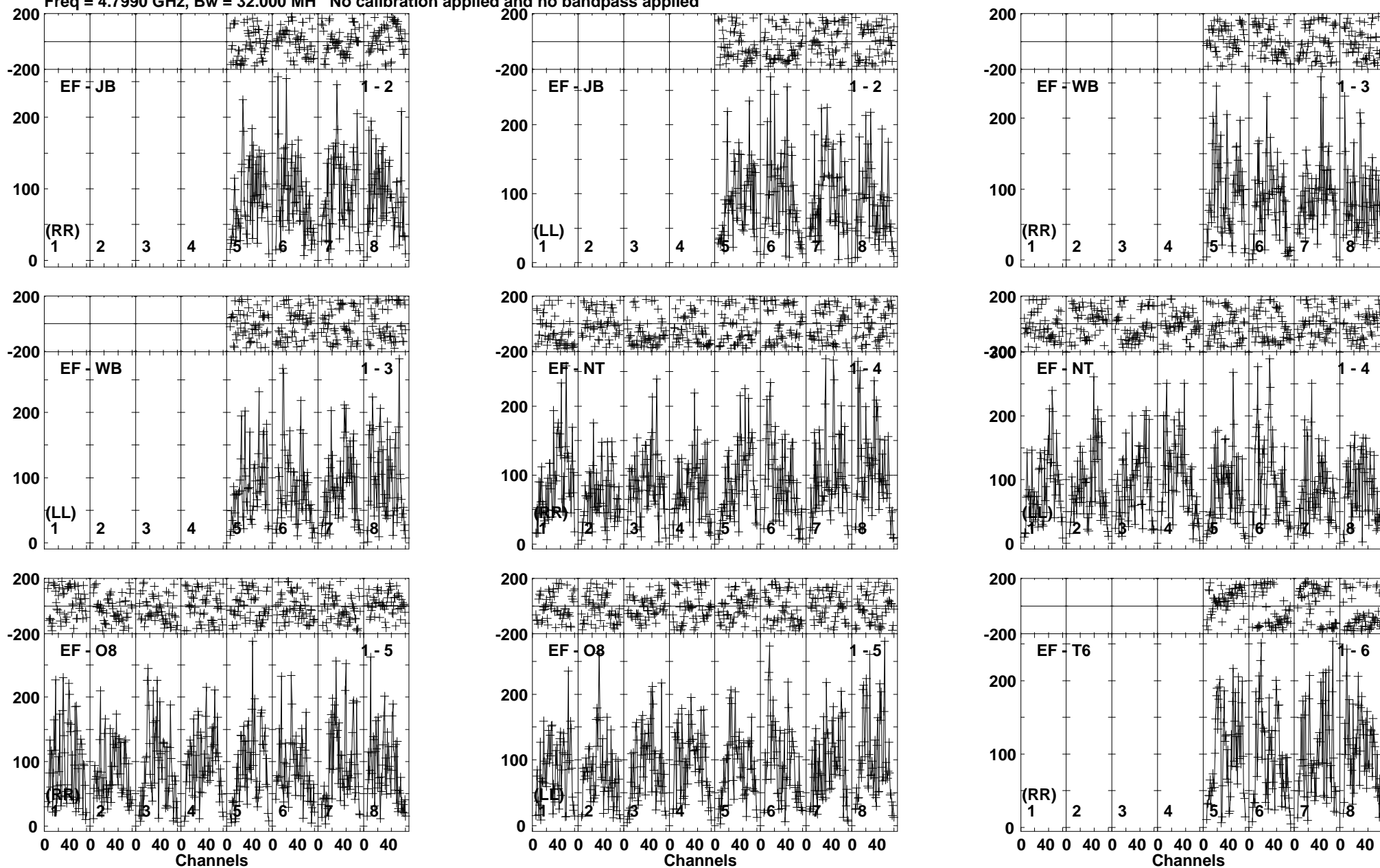

Lower frame: Micro Ampl Jy Top frame: Phas deg
Vector averaged cross-power spectrum Baseline: EF (01) - JB (02)
Timerange: 00/22:05:46 to 00/22:09:30

Plot file version 182 created 03-OCT-2017 13:10:12

IRAS23436 RP028.UVDATA.1

Freq = 4.7990 GHz, Bw = 32.000 MH No calibration applied and no bandpass applied

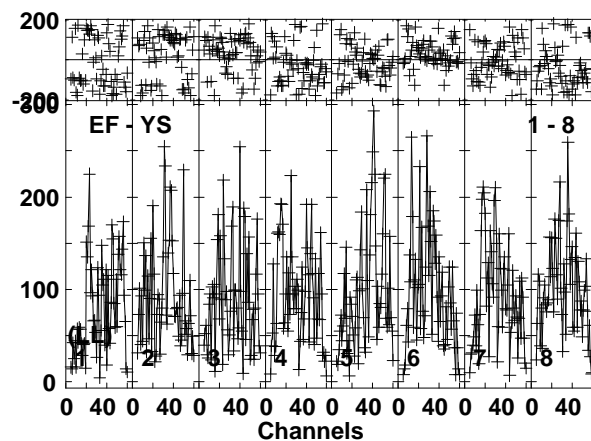
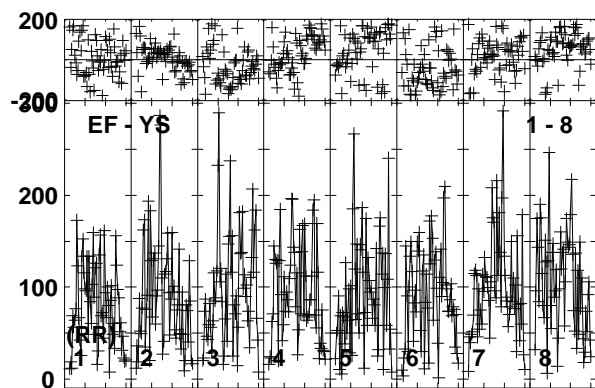
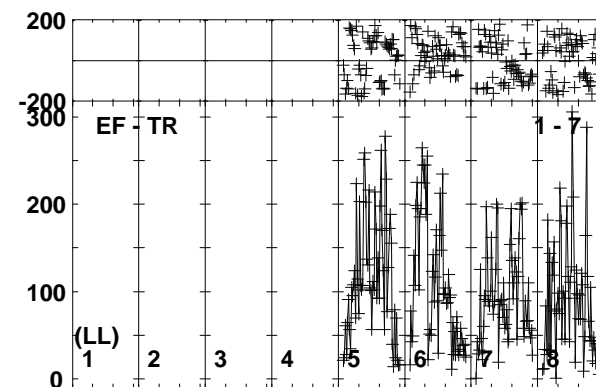
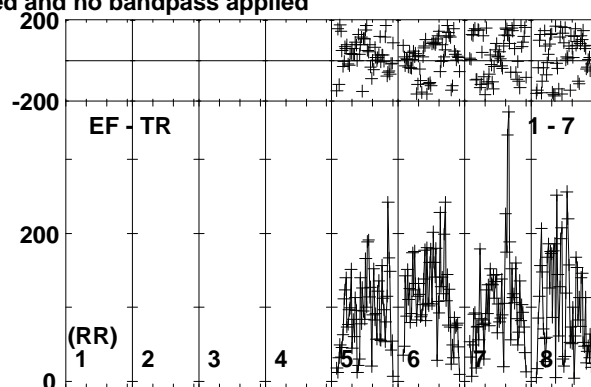
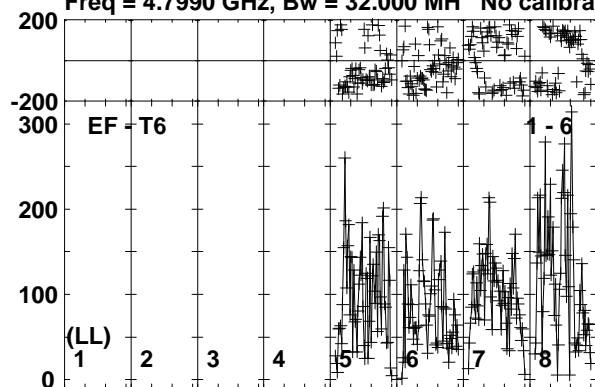

Lower frame: Micro Ampl Jy Top frame: Phas deg
Vector averaged cross-power spectrum Baseline: EF (01) - T6 (06)
Timerange: 00/22:05:46 to 00/22:09:30

Plot file version 183 created 03-OCT-2017 13:10:12

J2353+5518 RP028.UVDATA.1

Freq = 4.7990 GHz, Bw = 32.000 MH No calibration applied and no bandpass applied

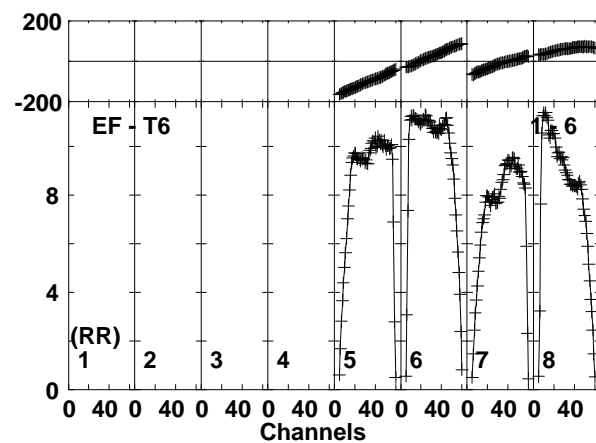
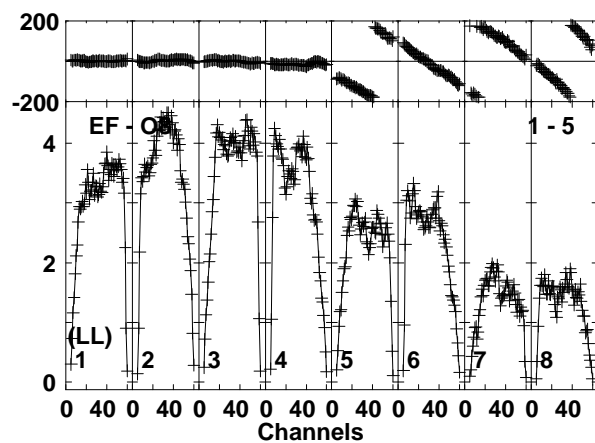
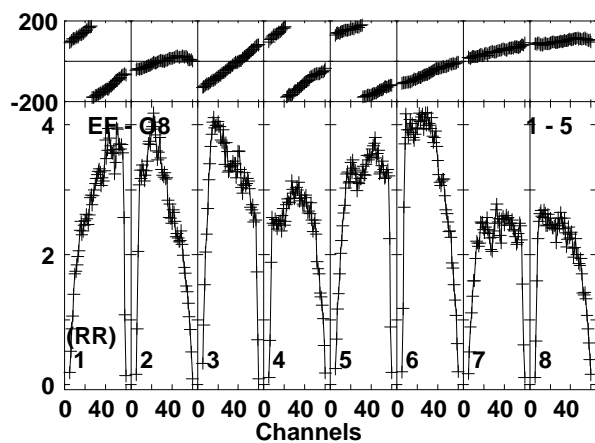
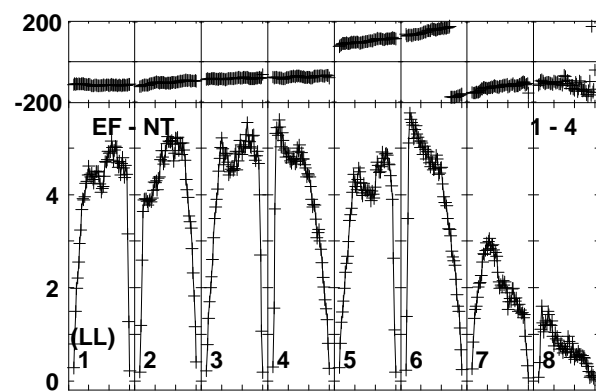
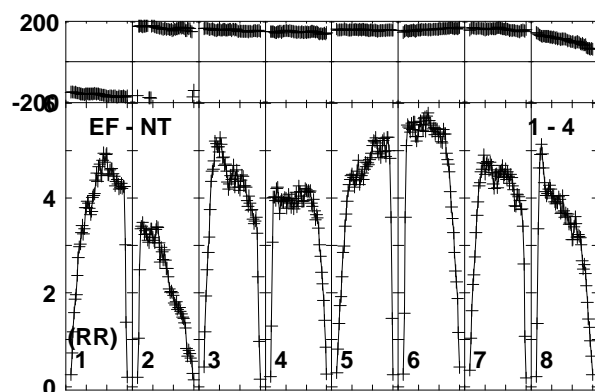
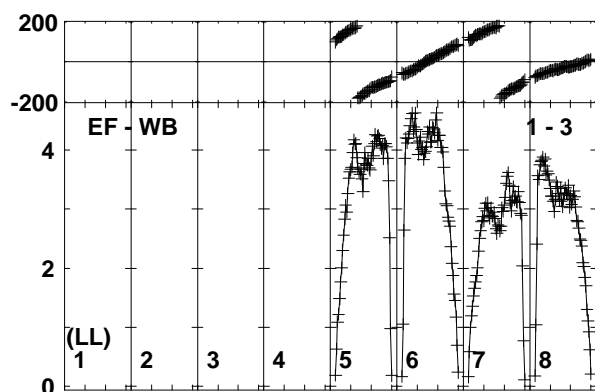
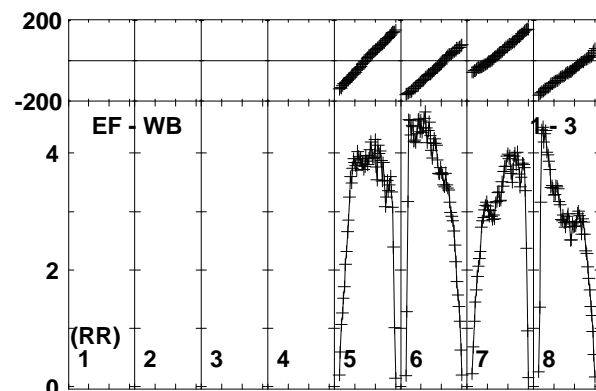
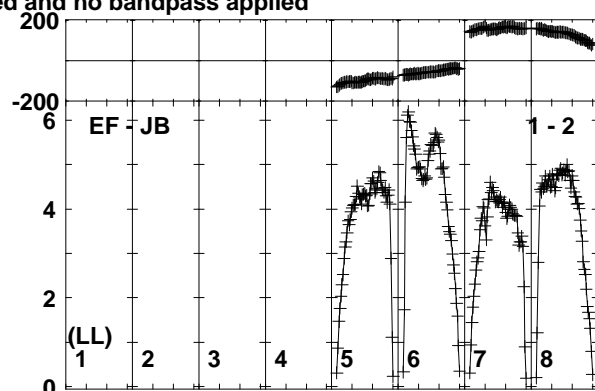
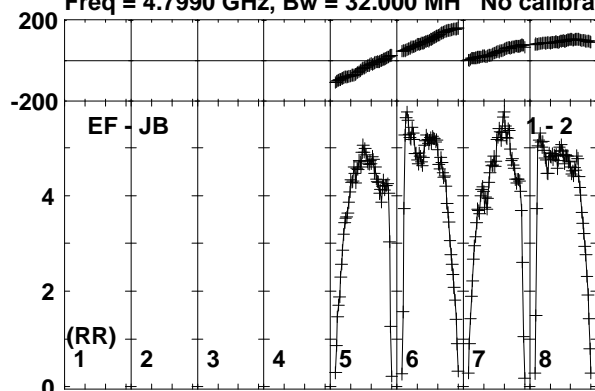

Lower frame: Milli Ampl Jy Top frame: Phas deg
Vector averaged cross-power spectrum Baseline: EF (01) - JB (02)
Timerange: 00/22:10:31 to 00/22:11:19

Plot file version 184 created 03-OCT-2017 13:10:12

J2353+5518 RP028.UVDATA.1

Freq = 4.7990 GHz, Bw = 32.000 MH No calibration applied and no bandpass applied

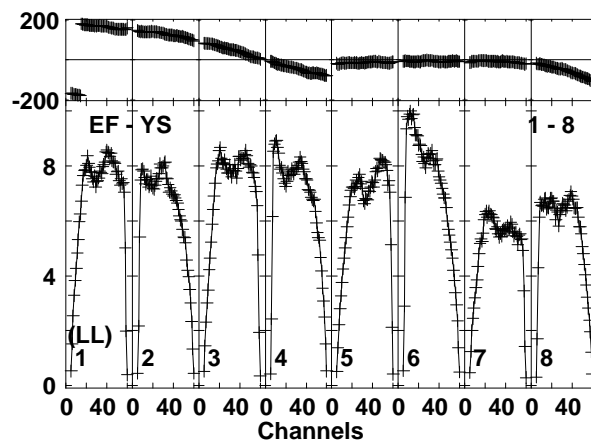
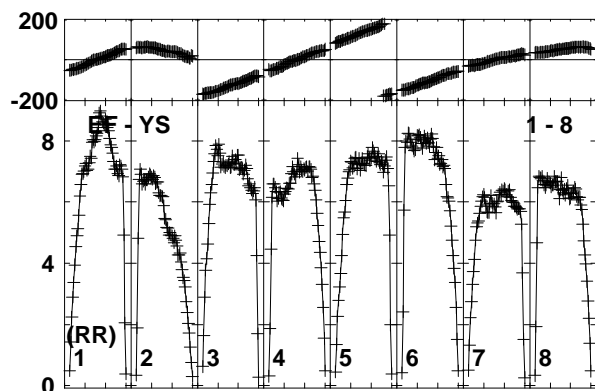
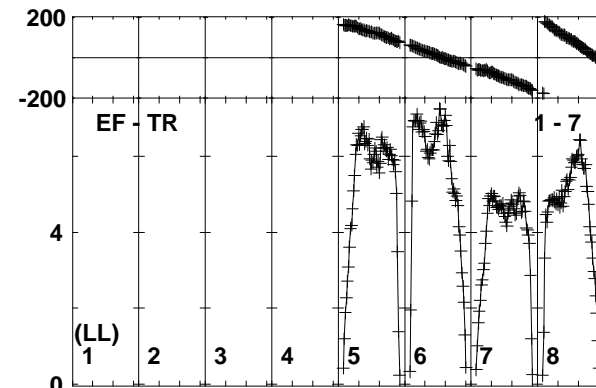
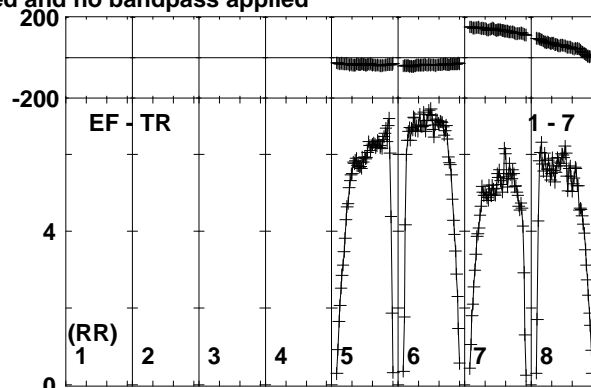
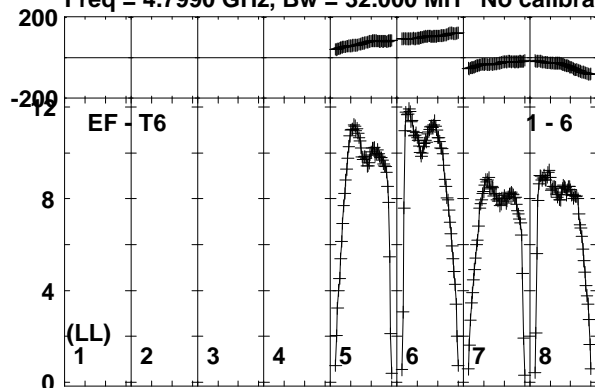

Lower frame: Milli Ampl Jy Top frame: Phas deg
Vector averaged cross-power spectrum Baseline: EF (01) - T6 (06)
Timerange: 00/22:10:31 to 00/22:11:19

Plot file version 185 created 03-OCT-2017 13:10:12

IRAS23436 RP028.UVDATA.1

Freq = 4.7990 GHz, Bw = 32.000 MH No calibration applied and no bandpass applied

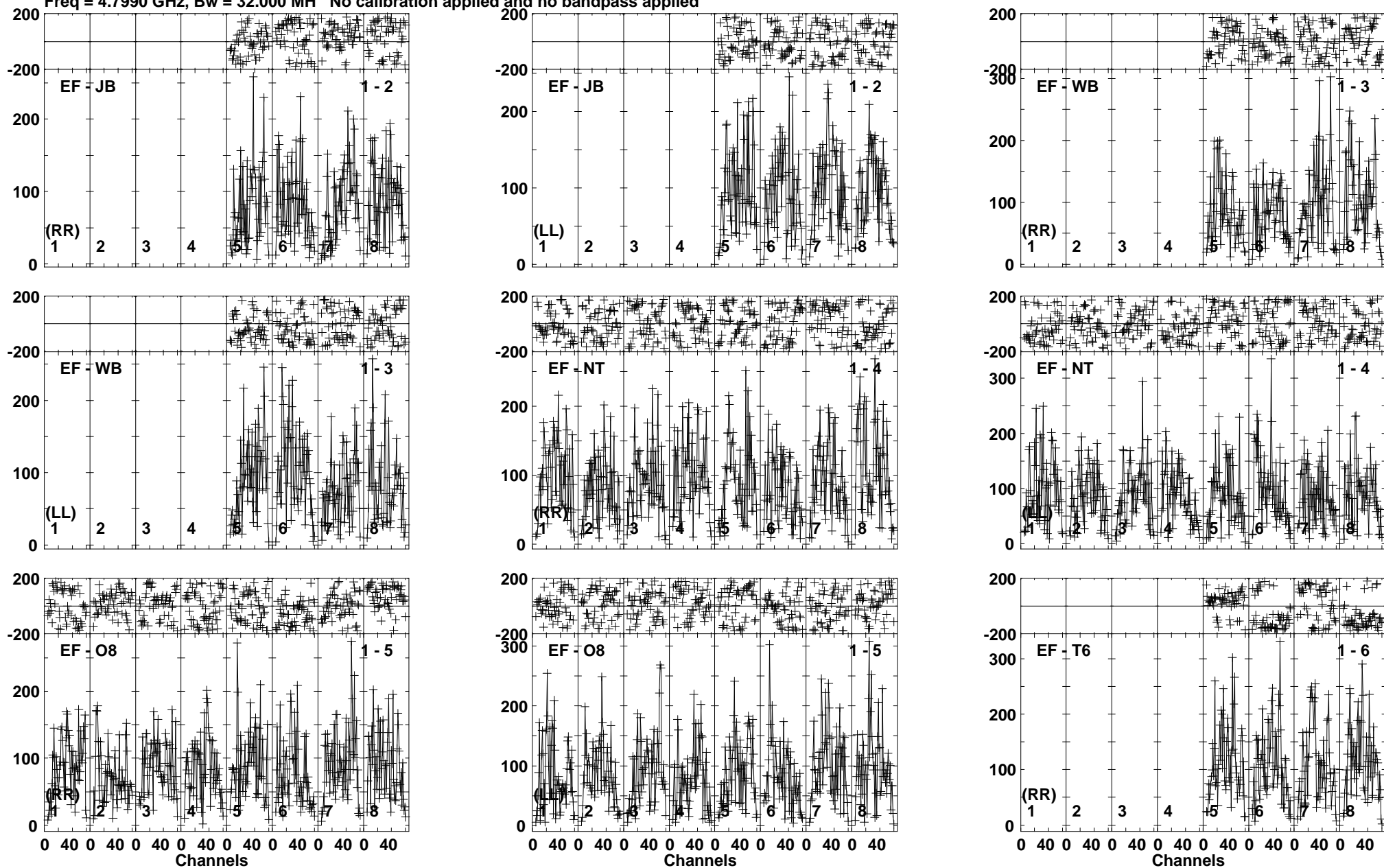

Lower frame: Micro Ampl Jy Top frame: Phas deg
Vector averaged cross-power spectrum Baseline: EF (01) - JB (02)
Timerange: 00:22:11:21 to 00:22:15:04

Plot file version 186 created 03-OCT-2017 13:10:13

IRAS23436 RP028.UVDATA.1

Freq = 4.7990 GHz, Bw = 32.000 MH No calibration applied and no bandpass applied

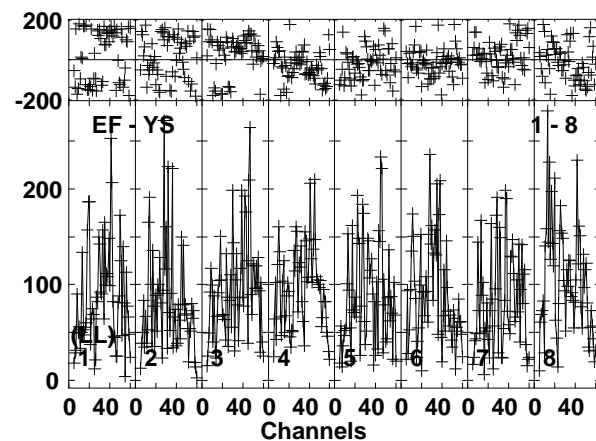
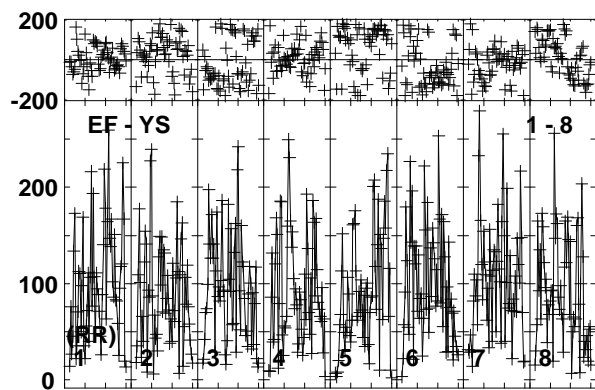
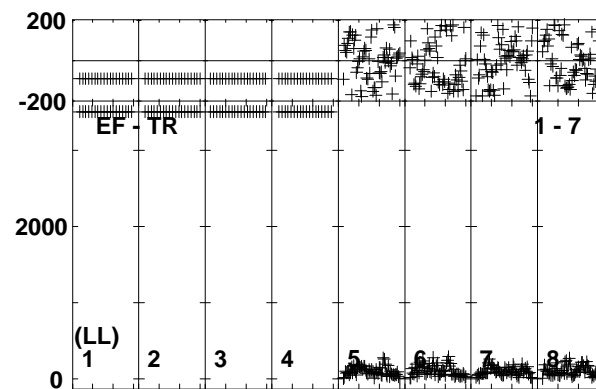
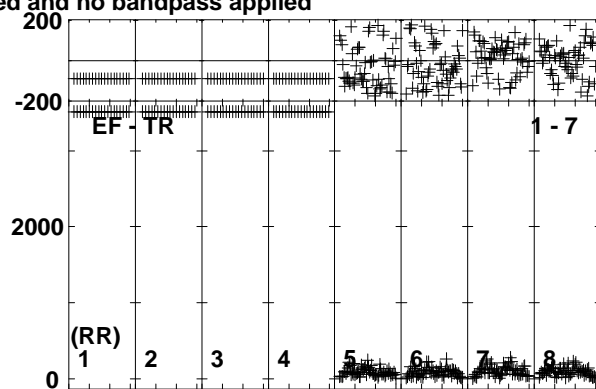
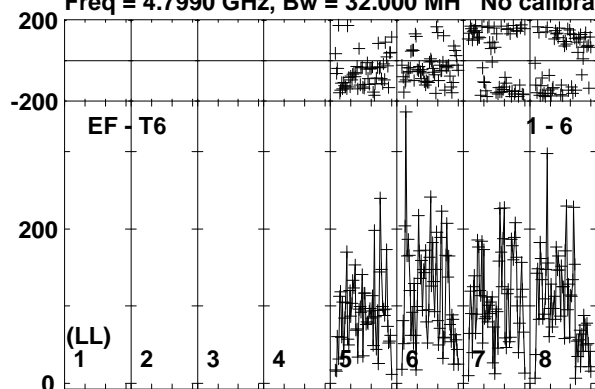

Lower frame: Micro Ampl Jy Top frame: Phas deg
Vector averaged cross-power spectrum Baseline: EF (01) - T6 (06)
Timerange: 00/22:11:21 to 00/22:15:04

Plot file version 187 created 03-OCT-2017 13:10:13

J2353+5518 RP028.UVDATA.1

Freq = 4.7990 GHz, Bw = 32.000 MH No calibration applied and no bandpass applied

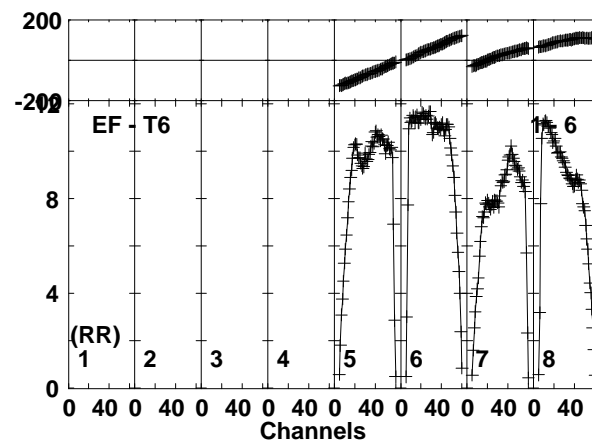
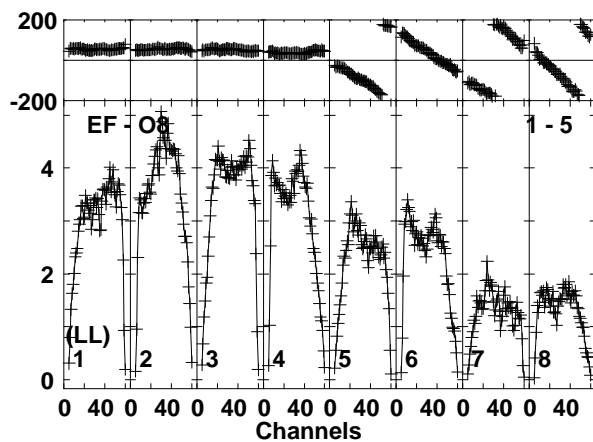
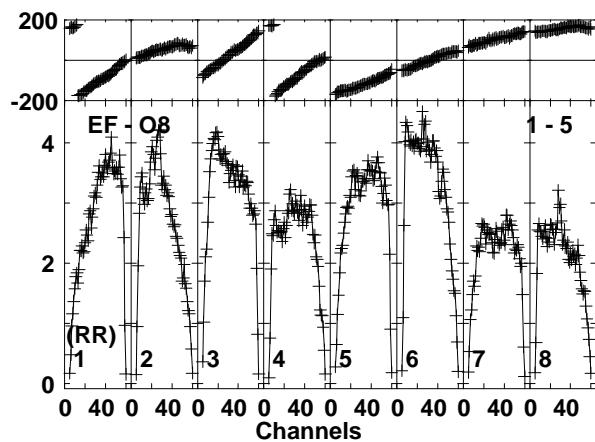
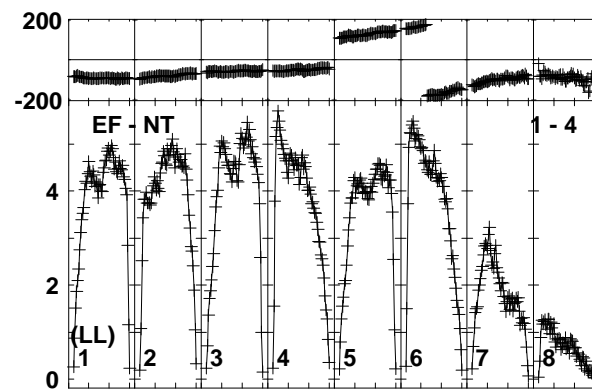
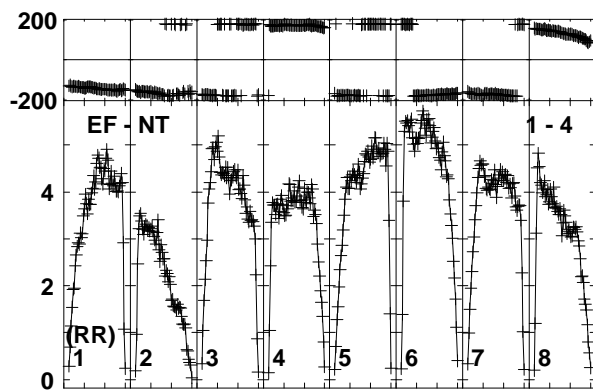
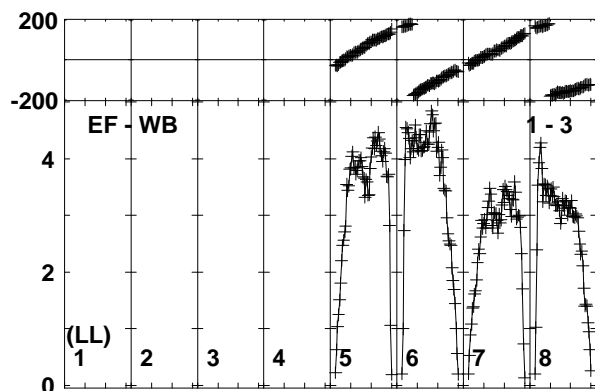
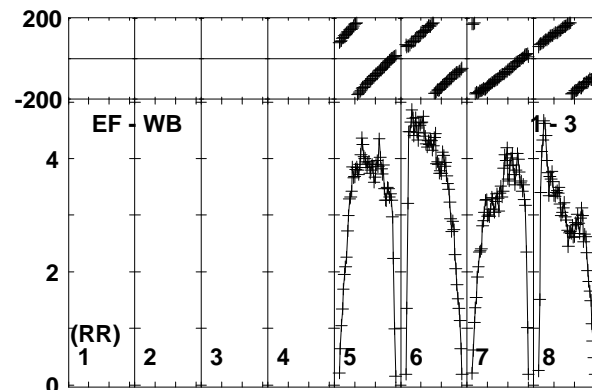
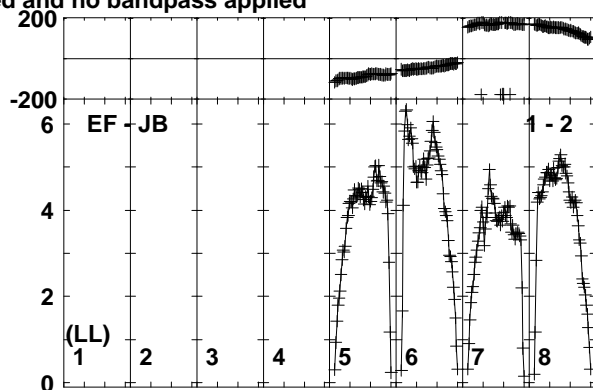
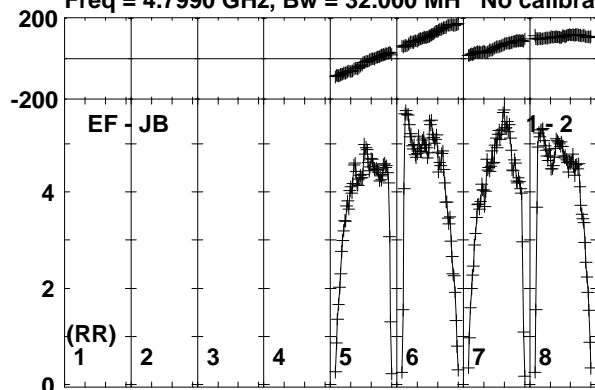

Lower frame: Milli Ampl Jy Top frame: Phas deg
Vector averaged cross-power spectrum Baseline: EF (01) - JB (02)
Timerange: 00:22:15:04 to 00:22:16:34

Plot file version 188 created 03-OCT-2017 13:10:13

J2353+5518 RP028.UVDATA.1

Freq = 4.7990 GHz, Bw = 32.000 MH No calibration applied and no bandpass applied

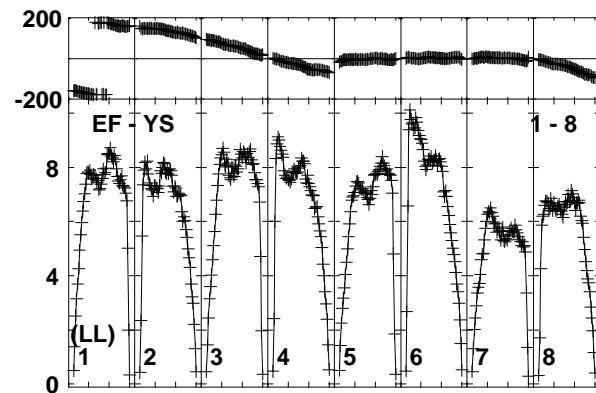
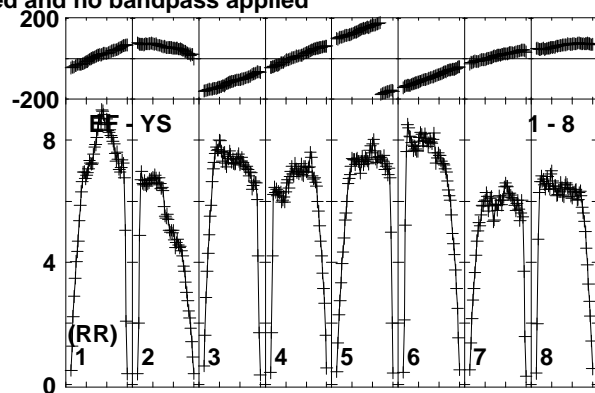
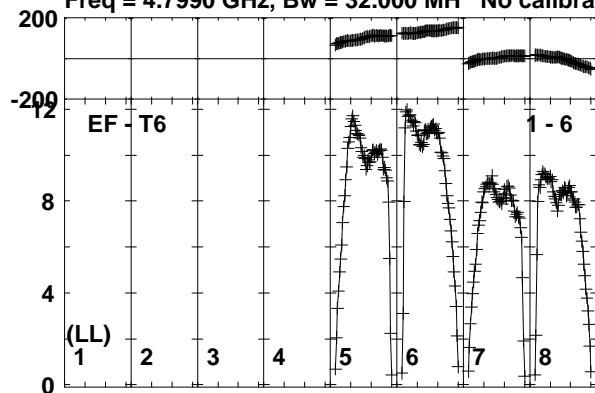

Lower frame: Milli Ampl Jy Top frame: Phas deg
Vector averaged cross-power spectrum Baseline: EF (01) - T6 (06)
Timerange: 00/22:15:04 to 00/22:16:34

Plot file version 189 created 03-OCT-2017 13:10:13

IRAS23436 RP028.UVDATA.1

Freq = 4.7990 GHz, Bw = 32.000 MH No calibration applied and no bandpass applied

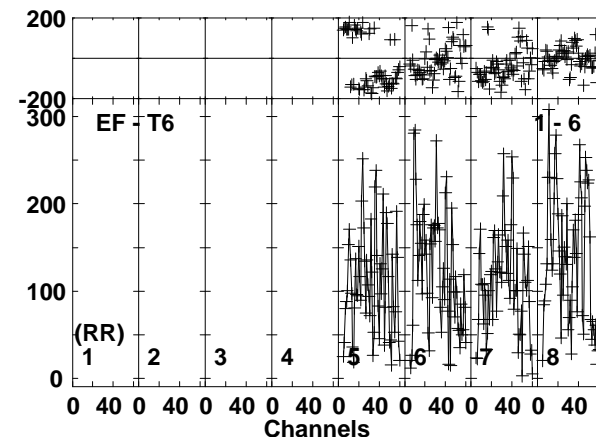
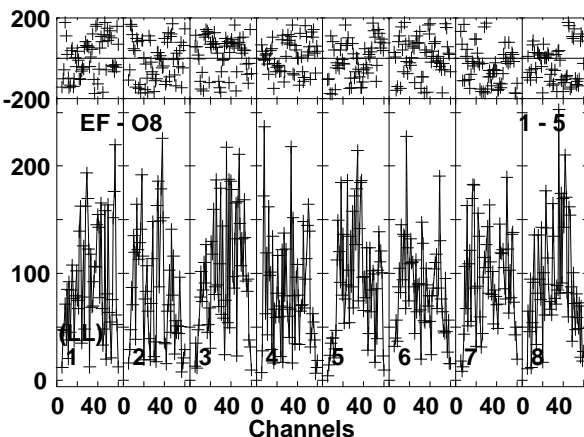
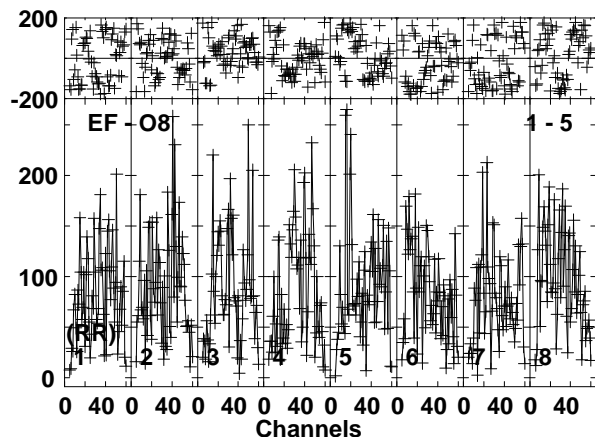
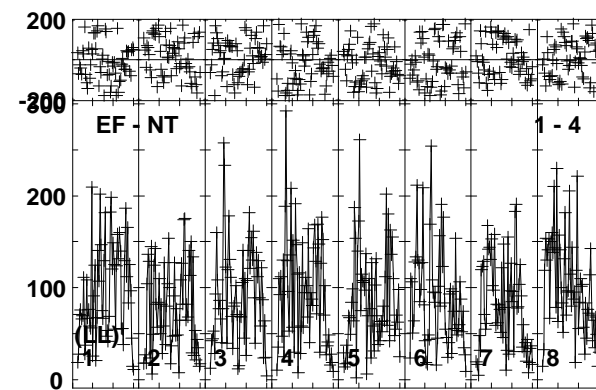
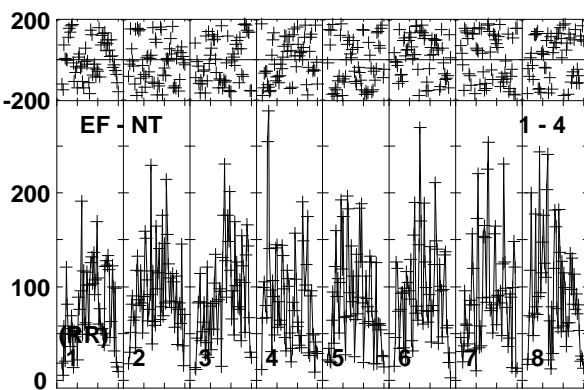
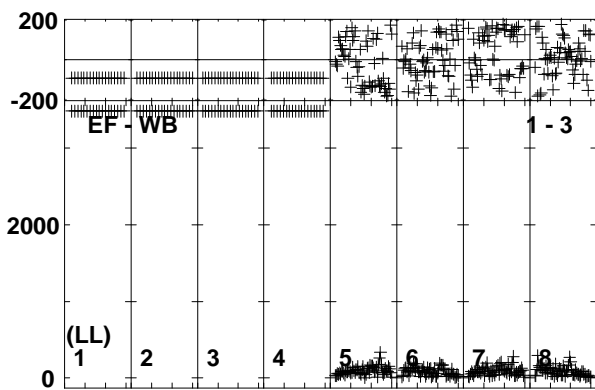
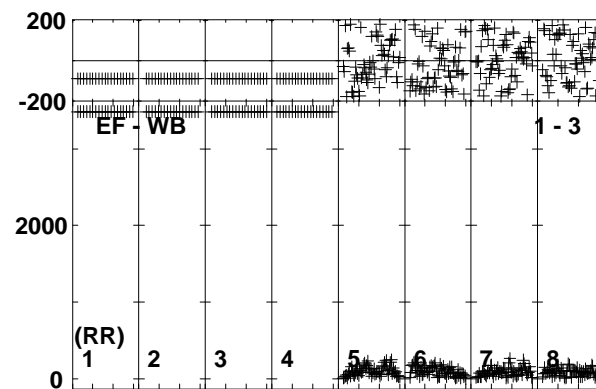
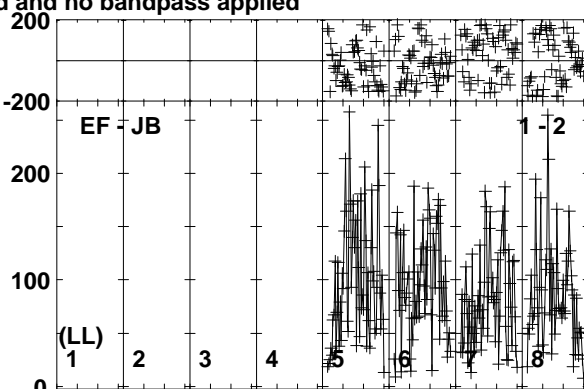
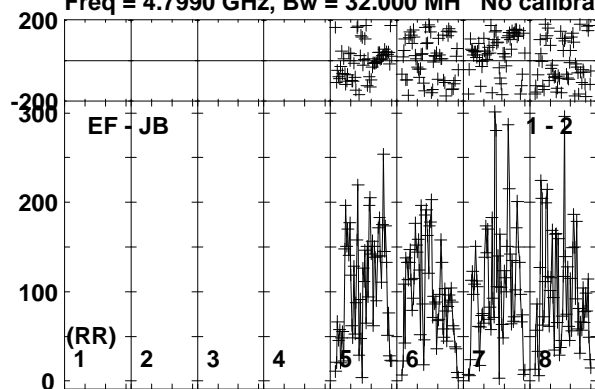

Lower frame: Micro Ampl Jy Top frame: Phas deg
Vector averaged cross-power spectrum Baseline: EF (01) - JB (02)
Timerange: 00/22:16:34 to 00/22:20:18

Plot file version 190 created 03-OCT-2017 13:10:13

IRAS23436 RP028.UVDATA.1

Freq = 4.7990 GHz, Bw = 32.000 MH No calibration applied and no bandpass applied

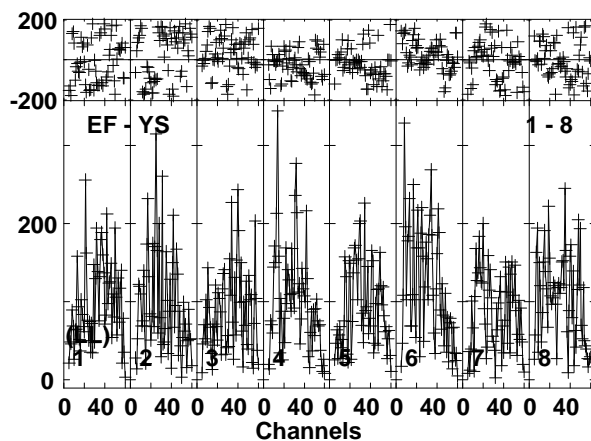
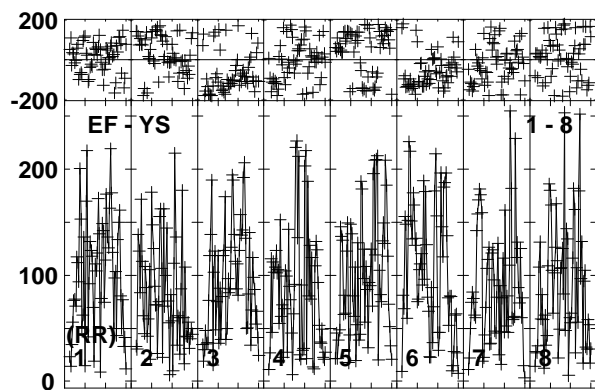
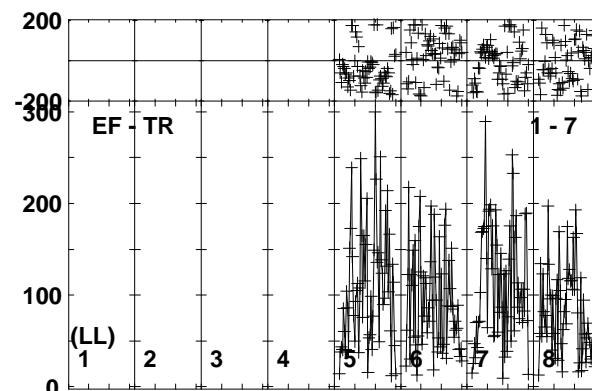
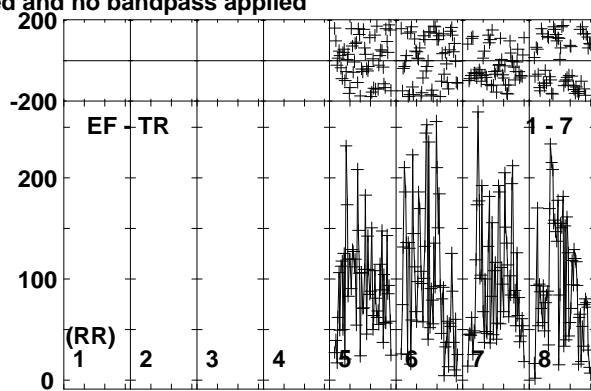
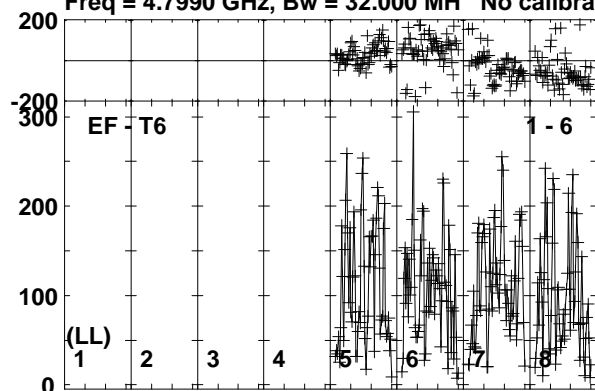

Lower frame: Micro Ampl Jy Top frame: Phas deg
Vector averaged cross-power spectrum Baseline: EF (01) - T6 (06)
Timerange: 00/22:16:34 to 00/22:20:18

Plot file version 191 created 03-OCT-2017 13:10:14

J2353+5518 RP028.UVDATA.1

Freq = 4.7990 GHz, Bw = 32.000 MH No calibration applied and no bandpass applied

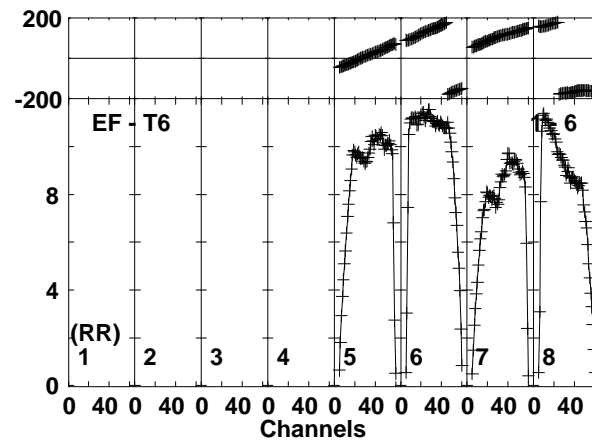
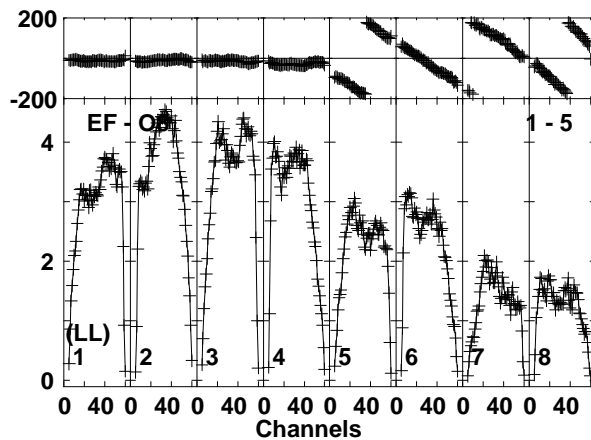
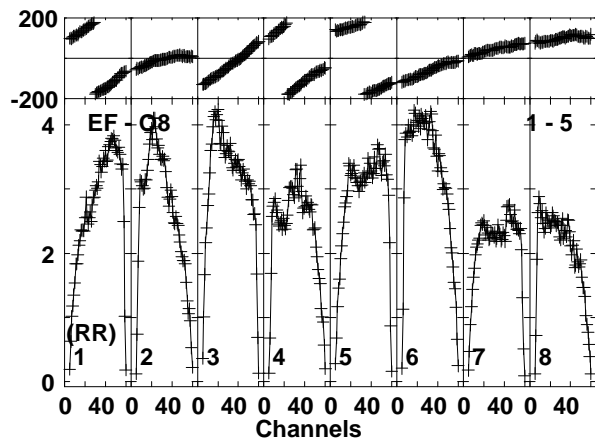
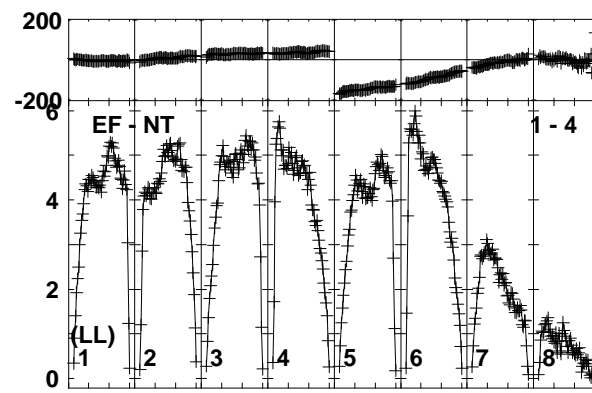
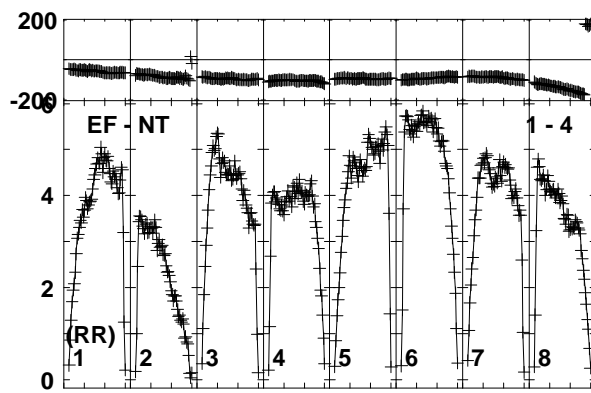
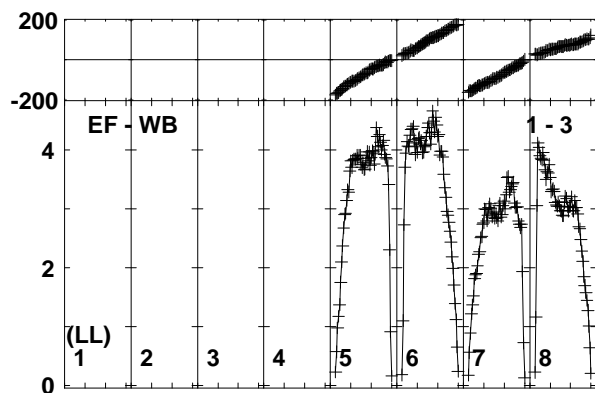
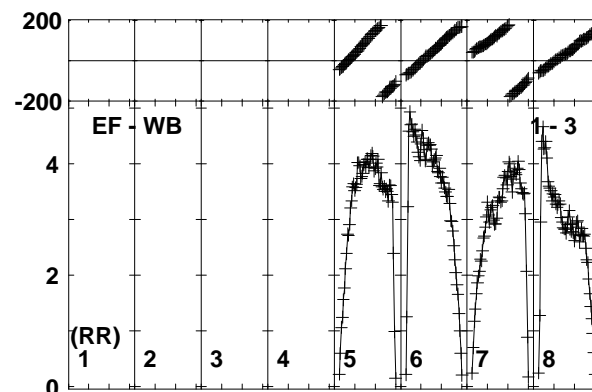
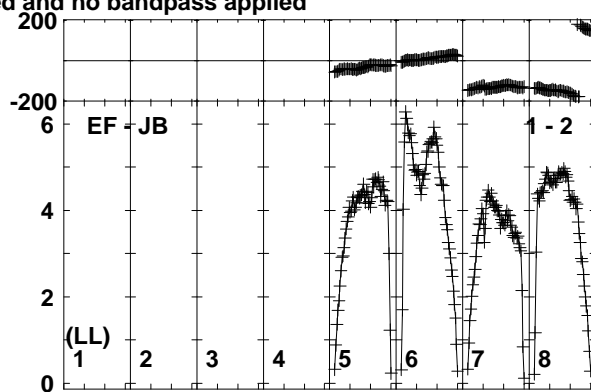
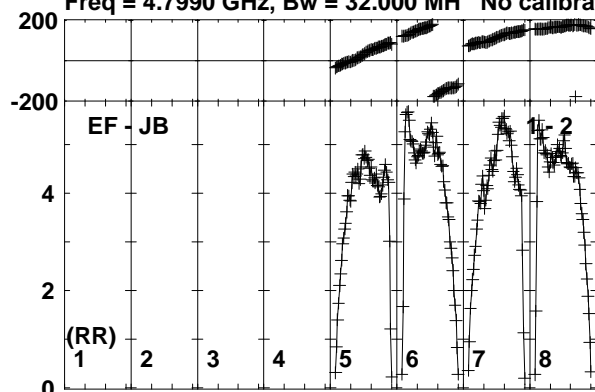

Lower frame: Milli Ampl Jy Top frame: Phas deg
Vector averaged cross-power spectrum Baseline: EF (01) - JB (02)
Timerange: 00/22:21:18 to 00/22:22:17

Plot file version 192 created 03-OCT-2017 13:10:14

J2353+5518 RP028.UVDATA.1

Freq = 4.7990 GHz, Bw = 32.000 MH No calibration applied and no bandpass applied

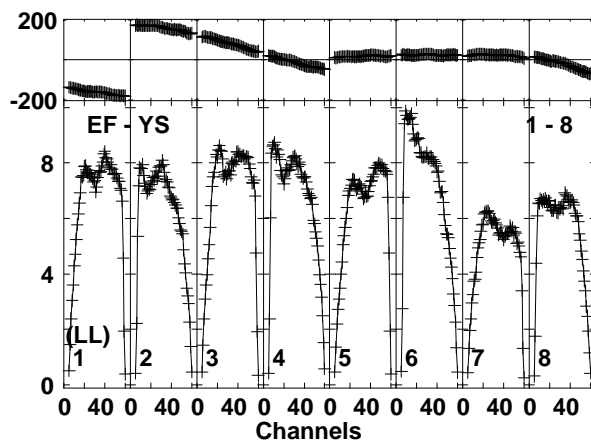
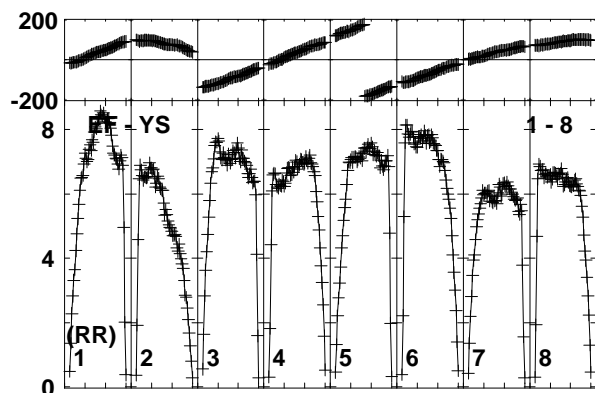
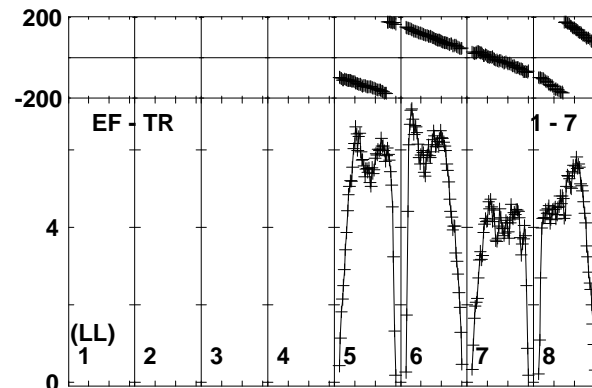
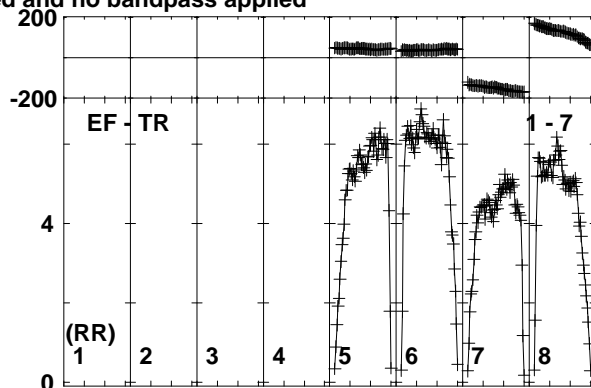
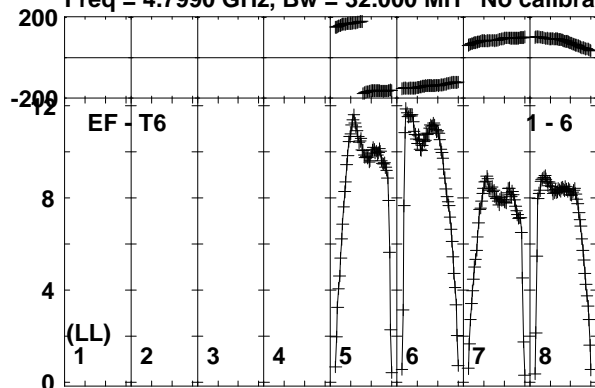

Lower frame: Milli Ampl Jy Top frame: Phas deg
Vector averaged cross-power spectrum Baseline: EF (01) - T6 (06)
Timerange: 00/22:21:18 to 00/22:22:17

Plot file version 193 created 03-OCT-2017 13:10:14

IRAS23436 RP028.UVDATA.1

Freq = 4.7990 GHz, Bw = 32.000 MH No calibration applied and no bandpass applied

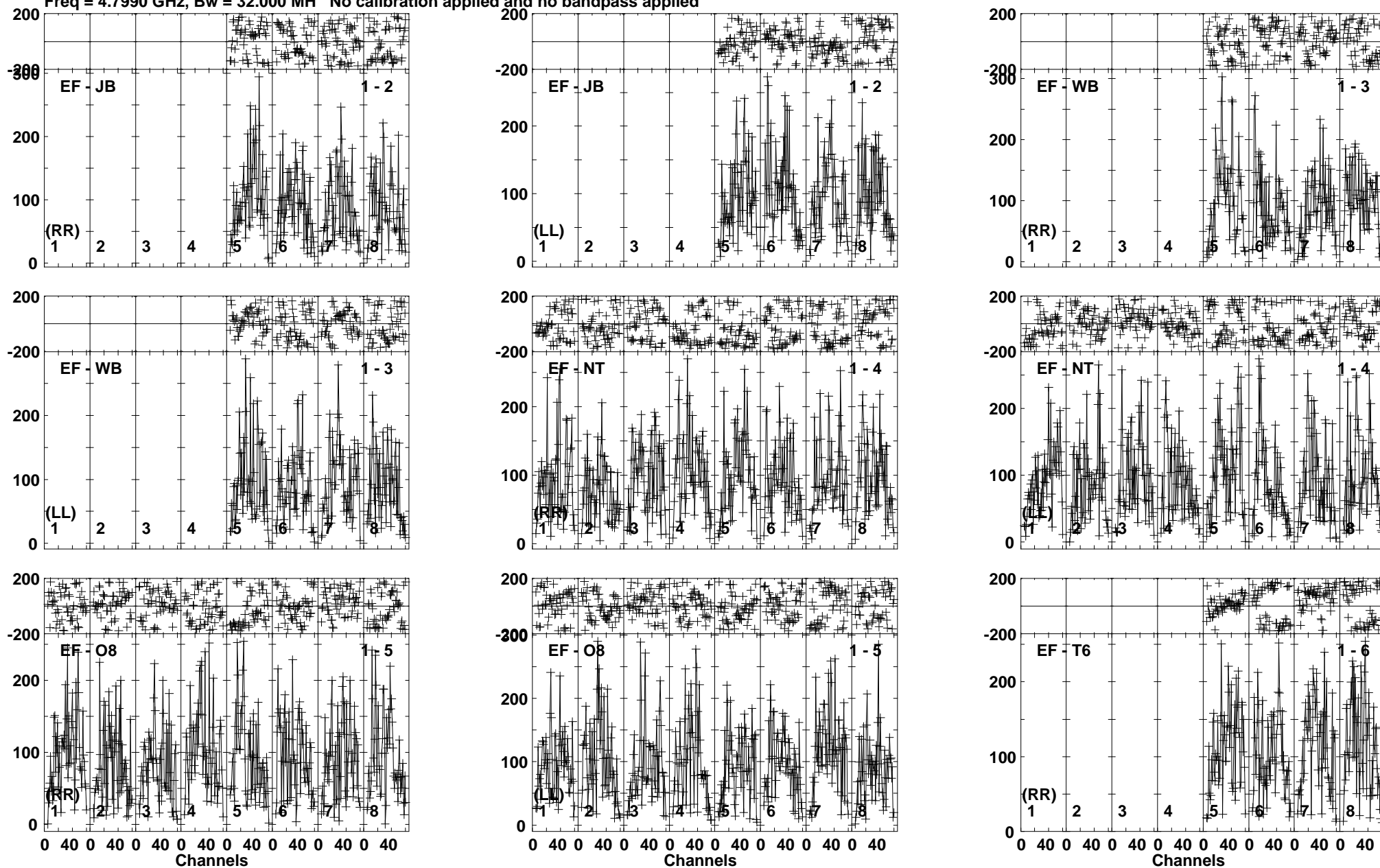

Lower frame: Micro Ampl Jy Top frame: Phas deg
Vector averaged cross-power spectrum Baseline: EF (01) - JB (02)
Timerange: 00/22:22:19 to 00/22:25:57

Plot file version 194 created 03-OCT-2017 13:10:14

IRAS23436 RP028.UVDATA.1

Freq = 4.7990 GHz, Bw = 32.000 MH No calibration applied and no bandpass applied

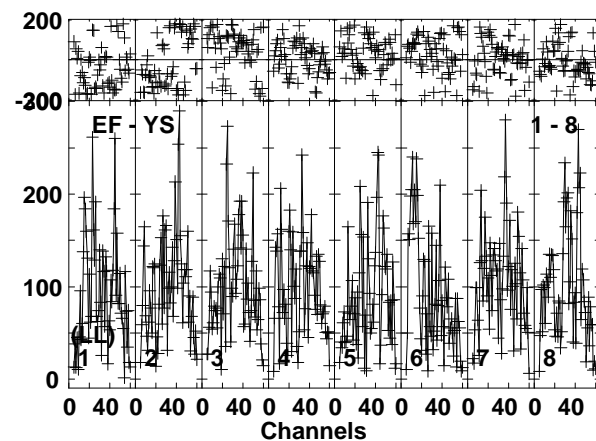
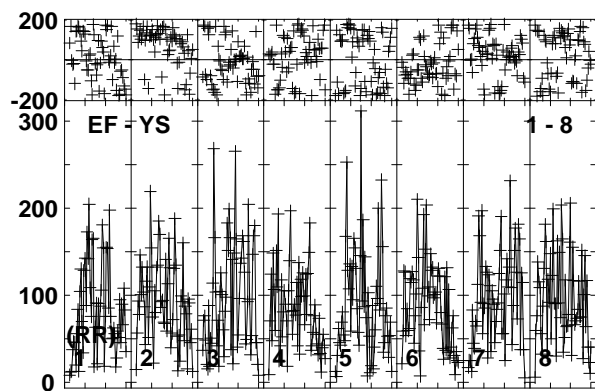
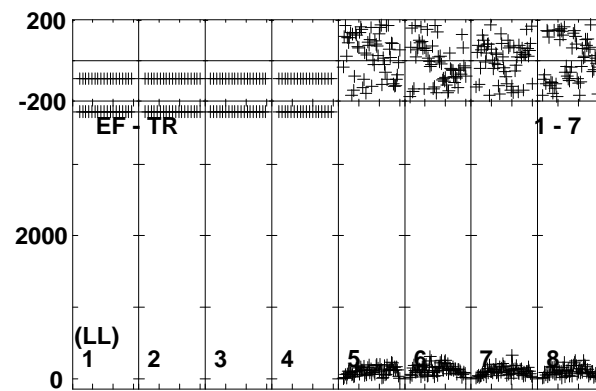
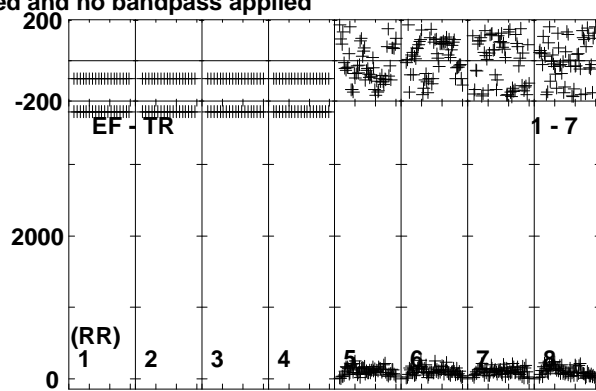
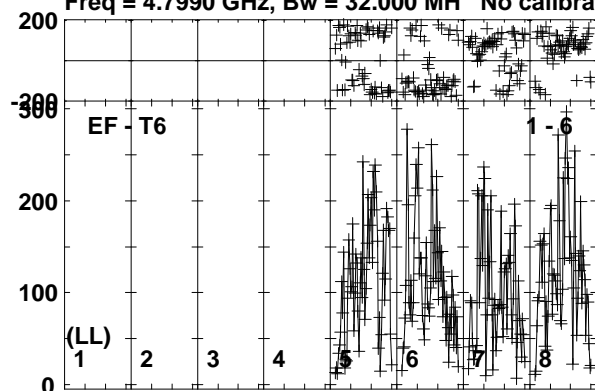

Lower frame: Micro Ampl Jy Top frame: Phas deg
Vector averaged cross-power spectrum Baseline: EF (01) - T6 (06)
Timerange: 00/22:22:19 to 00/22:25:57

Plot file version 195 created 03-OCT-2017 13:10:14

J2353+5518 RP028.UVDATA.1

Freq = 4.7990 GHz, Bw = 32.000 MH No calibration applied and no bandpass applied

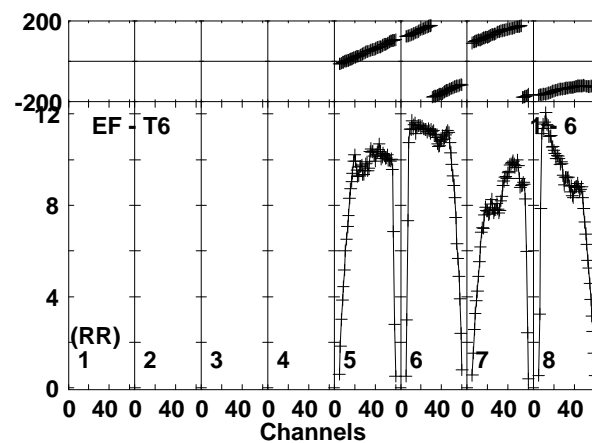
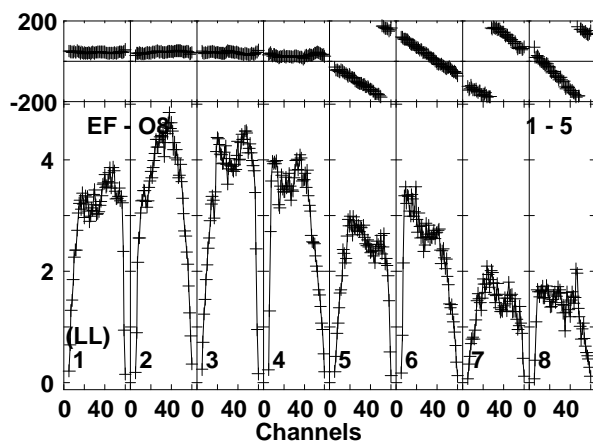
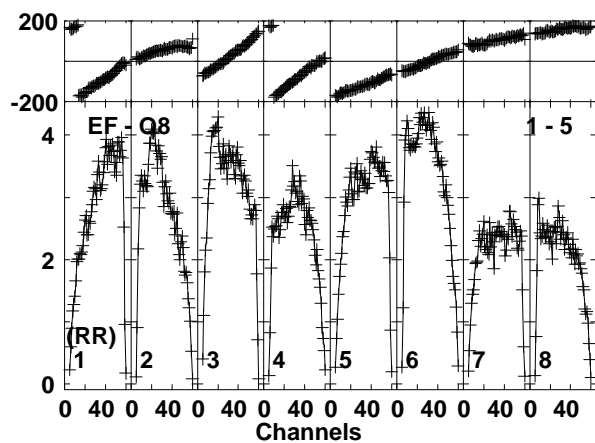
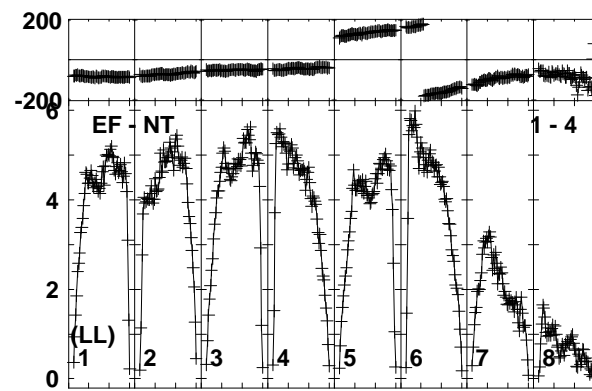
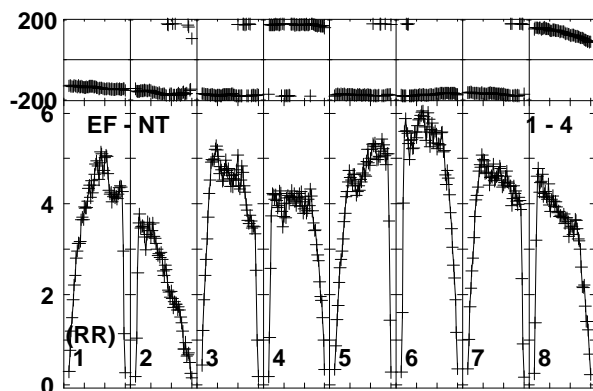
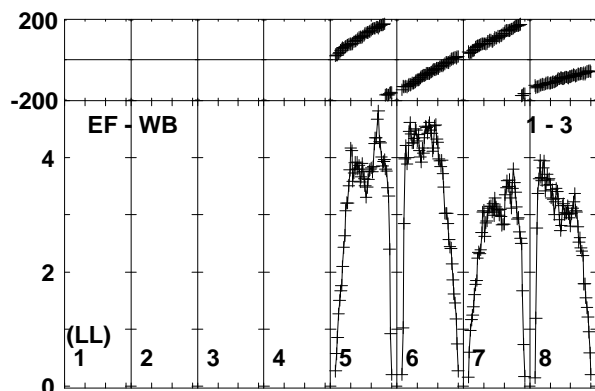
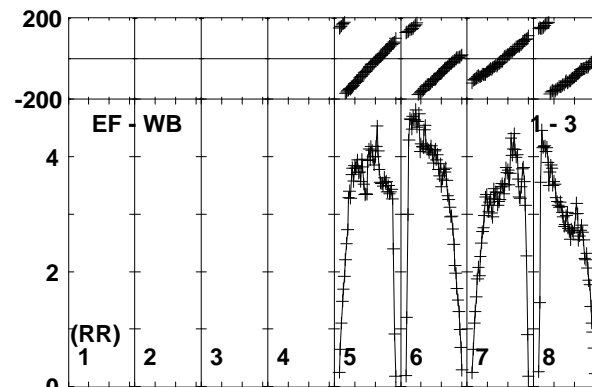
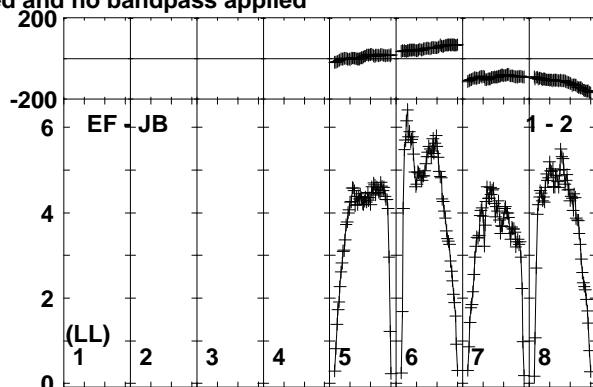
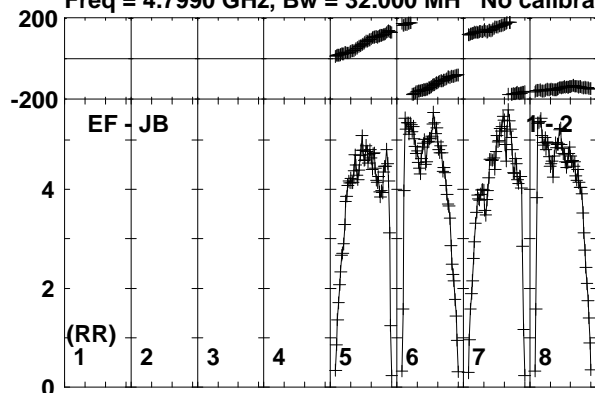

Lower frame: Milli Ampl Jy Top frame: Phas deg
Vector averaged cross-power spectrum Baseline: EF (01) - JB (02)
Timerange: 00/22:25:58 to 00/22:27:27

Plot file version 196 created 03-OCT-2017 13:10:14

J2353+5518 RP028.UVDATA.1

Freq = 4.7990 GHz, Bw = 32.000 MH No calibration applied and no bandpass applied

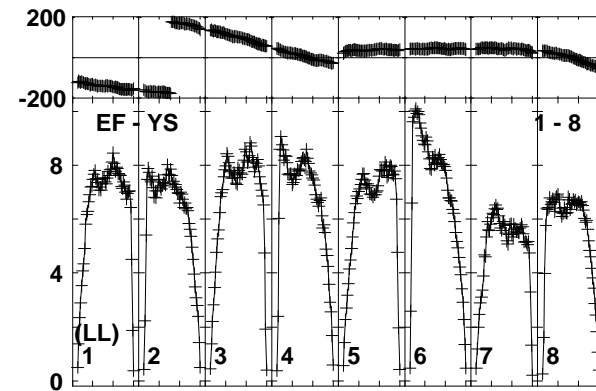
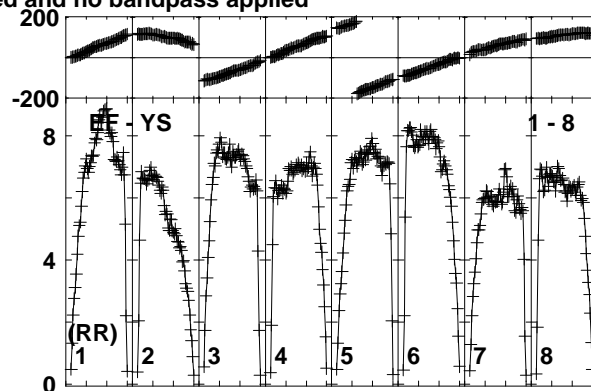
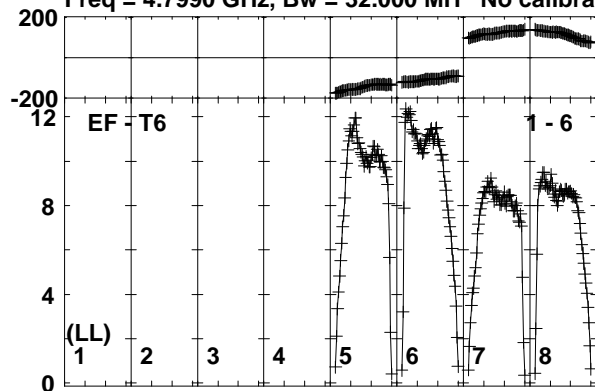

Lower frame: Milli Ampl Jy Top frame: Phas deg
Vector averaged cross-power spectrum Baseline: EF (01) - T6 (06)
Timerange: 00/22:25:58 to 00/22:27:27

Plot file version 197 created 03-OCT-2017 13:10:15

IRAS23436 RP028.UVDATA.1

Freq = 4.7990 GHz, Bw = 32.000 MH No calibration applied and no bandpass applied

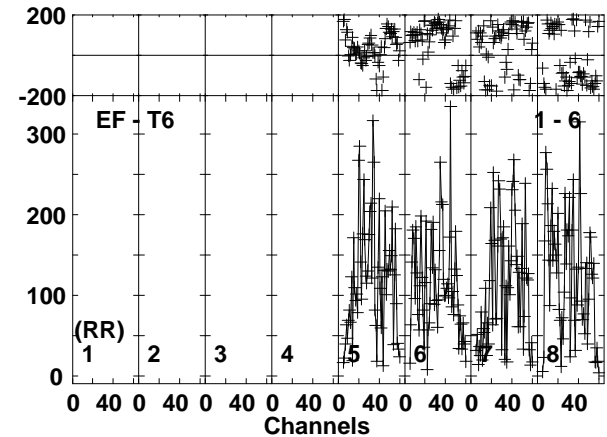
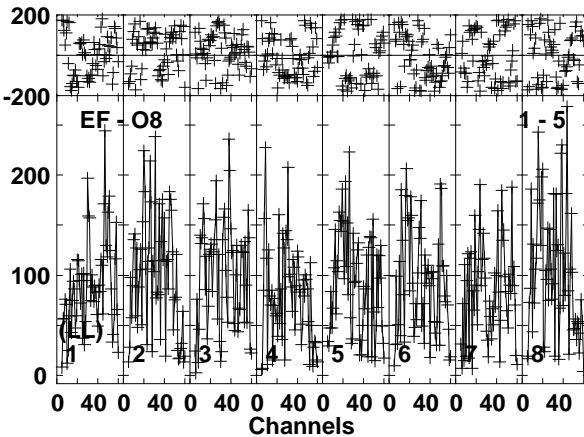
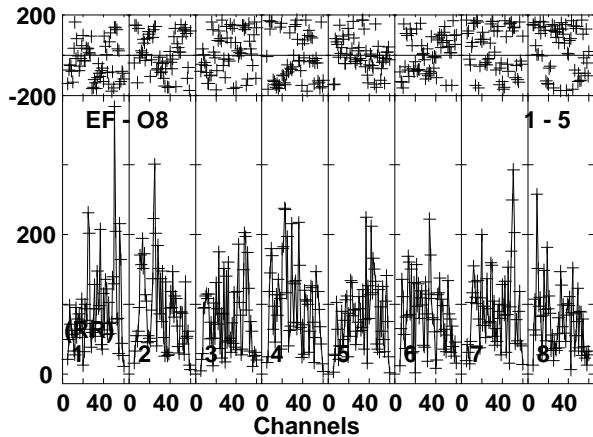
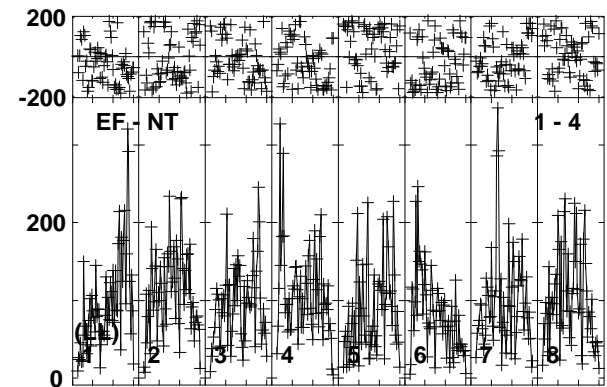
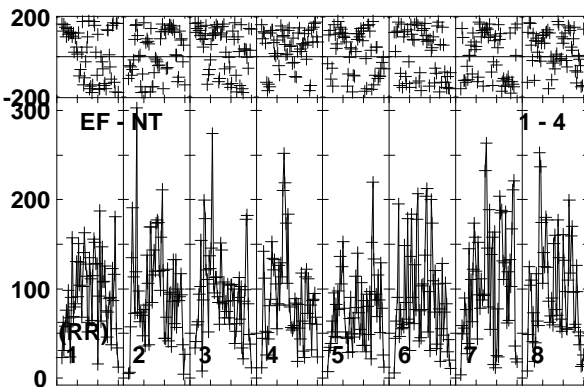
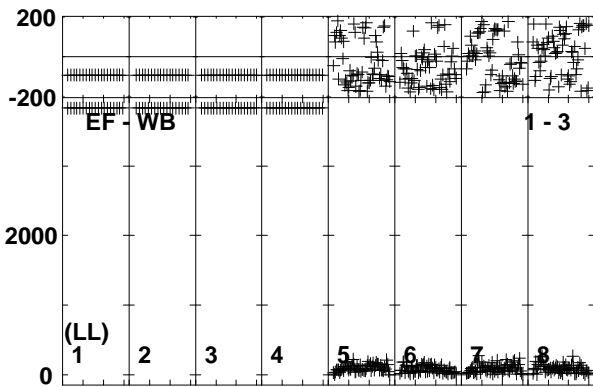
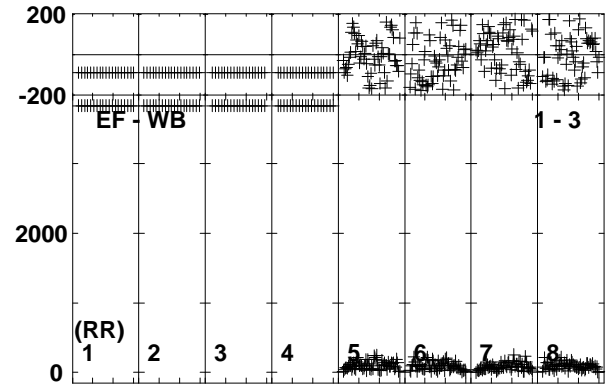
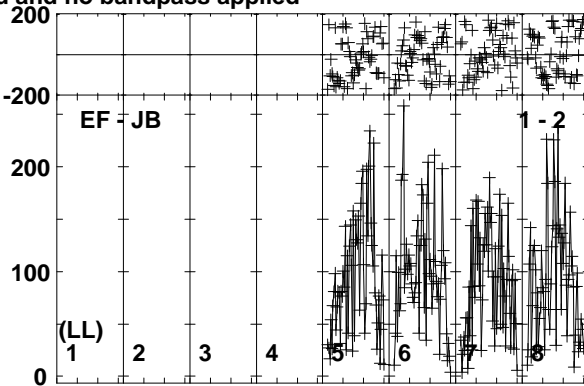
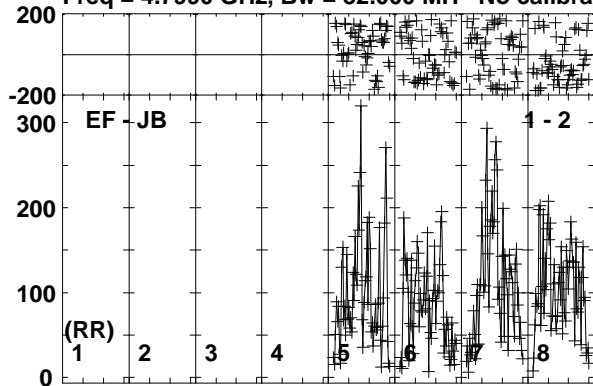

Lower frame: Micro Ampl Jy Top frame: Phas deg
Vector averaged cross-power spectrum Baseline: EF (01) - JB (02)
Timerange: 00/22:27:28 to 00/22:31:12

Plot file version 198 created 03-OCT-2017 13:10:15

IRAS23436 RP028.UVDATA.1

Freq = 4.7990 GHz, Bw = 32.000 MH No calibration applied and no bandpass applied

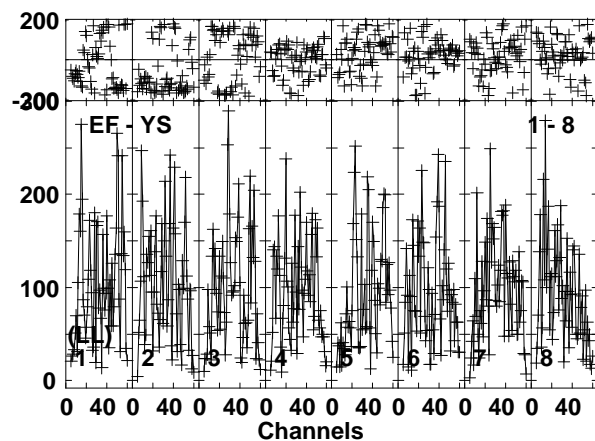
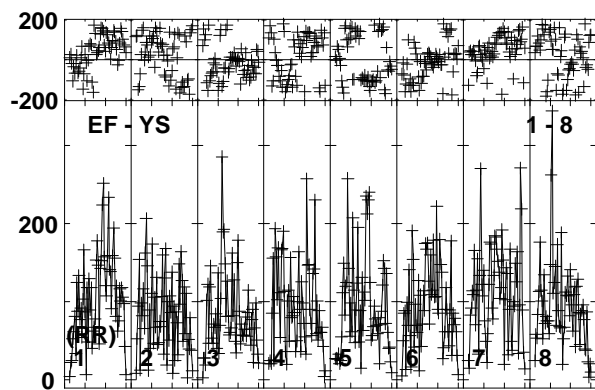
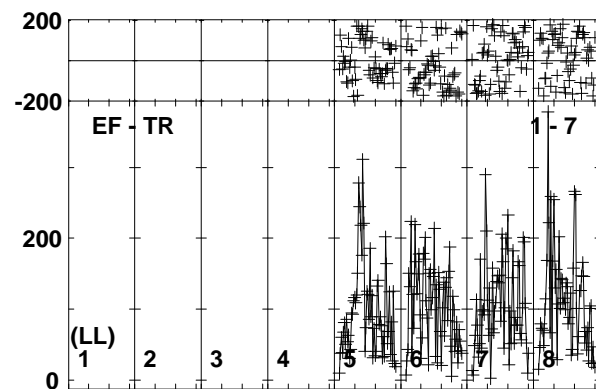
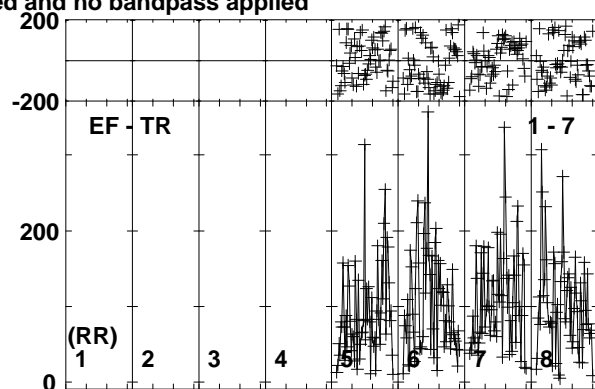
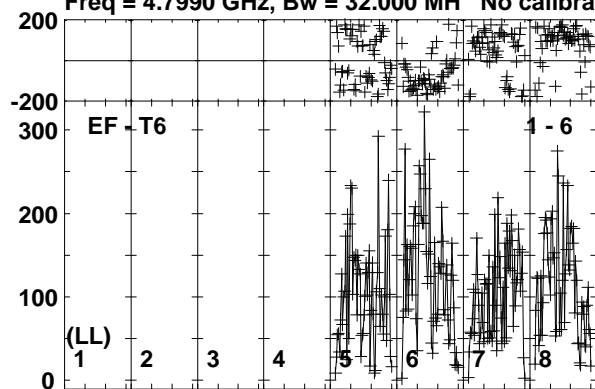

Lower frame: Micro Ampl Jy Top frame: Phas deg
Vector averaged cross-power spectrum Baseline: EF (01) - T6 (06)
Timerange: 00/22:27:28 to 00/22:31:12

Plot file version 199 created 03-OCT-2017 13:10:15

J2353+5518 RP028.UVDATA.1

Freq = 4.7990 GHz, Bw = 32.000 MH No calibration applied and no bandpass applied

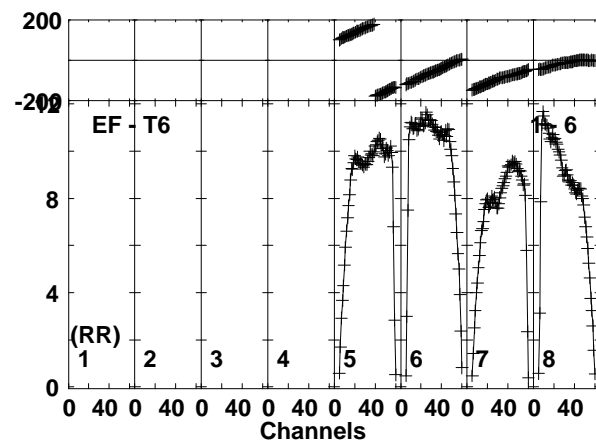
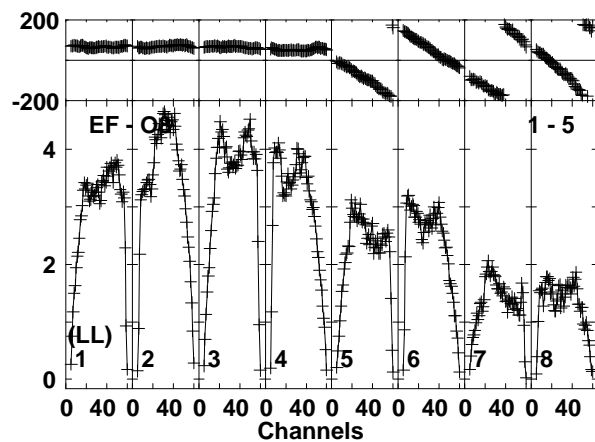
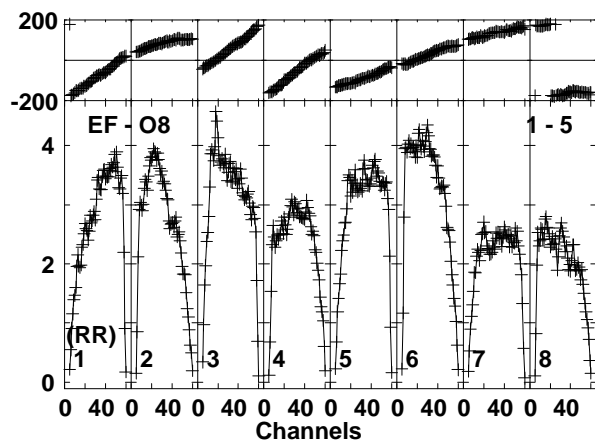
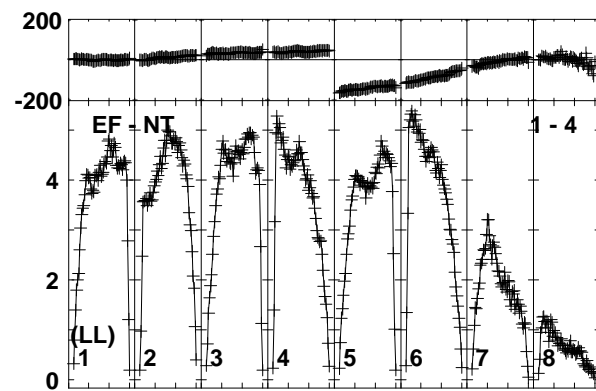
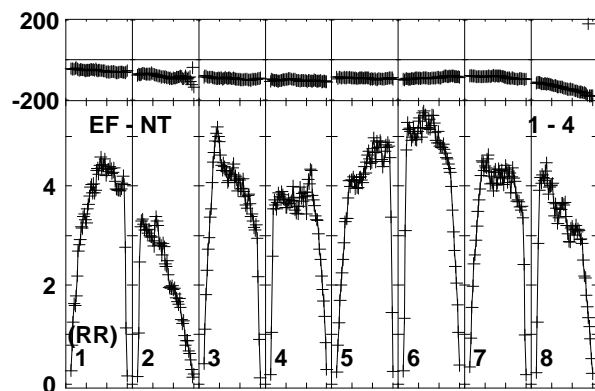
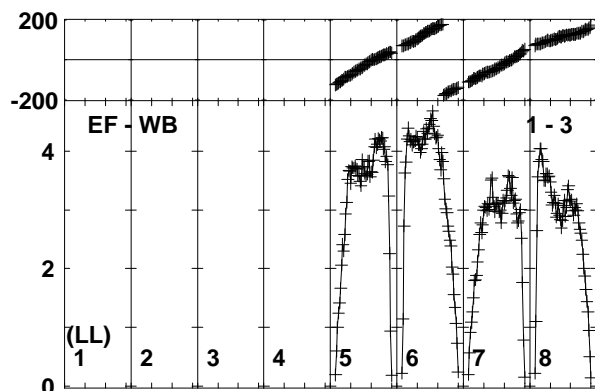
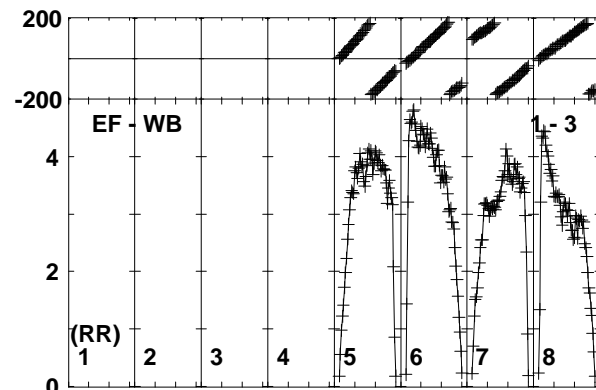
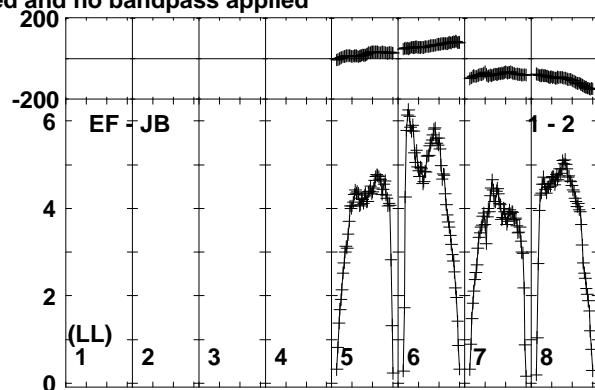
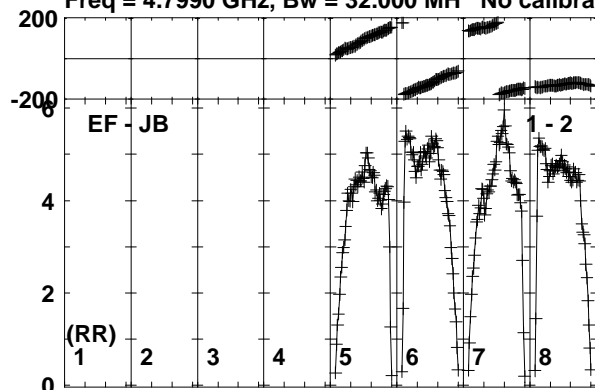

Lower frame: Milli Ampl Jy Top frame: Phas deg
Vector averaged cross-power spectrum Baseline: EF (01) - JB (02)
Timerange: 00:22:32:12 to 00:22:33:02

Plot file version 200 created 03-OCT-2017 13:10:15

J2353+5518 RP028.UVDATA.1

Freq = 4.7990 GHz, Bw = 32.000 MH No calibration applied and no bandpass applied

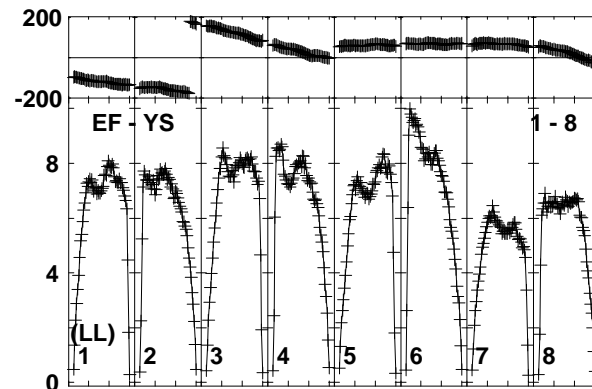
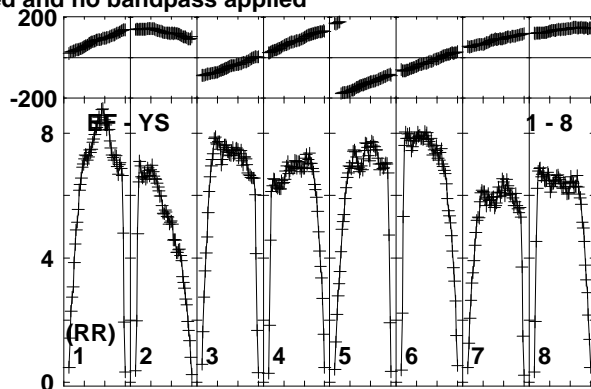
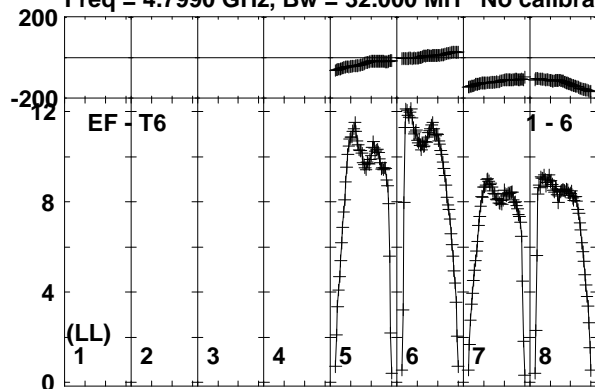

Lower frame: Milli Ampl Jy Top frame: Phas deg
Vector averaged cross-power spectrum Baseline: EF (01) - T6 (06)
Timerange: 00/22:32:12 to 00/22:33:02

Plot file version 201 created 03-OCT-2017 13:10:15

IRAS23436 RP028.UVDATA.1

Freq = 4.7990 GHz, Bw = 32.000 MH No calibration applied and no bandpass applied

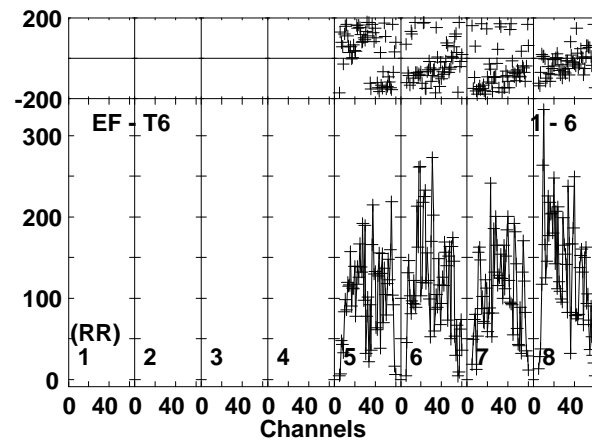
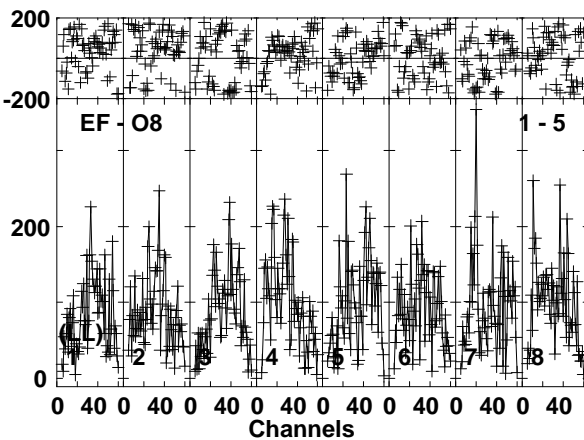
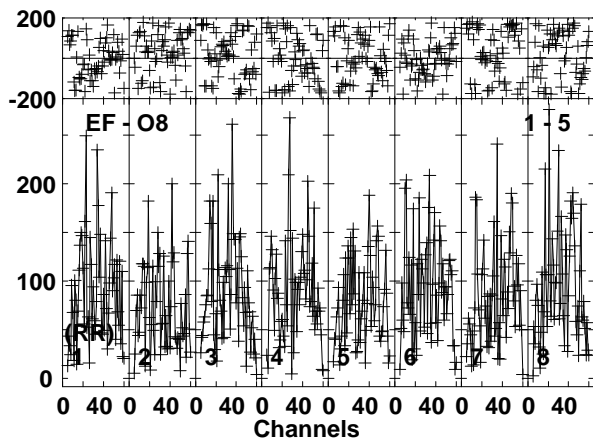
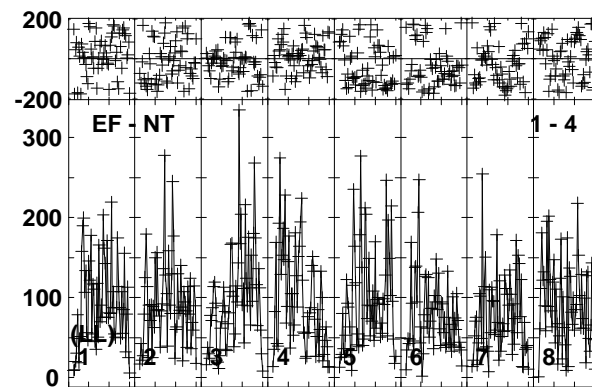
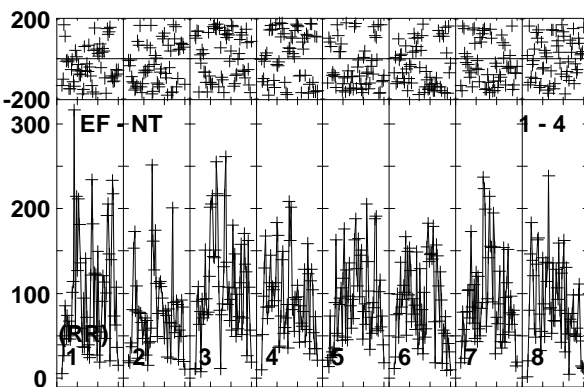
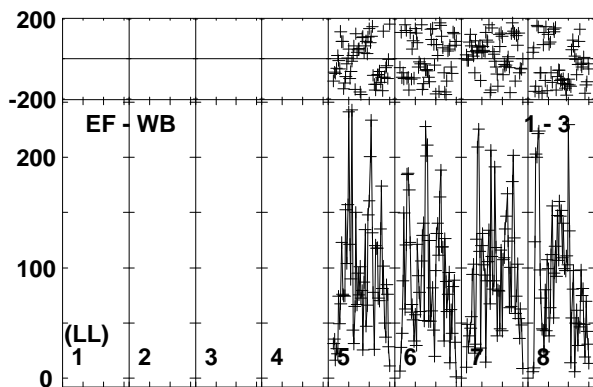
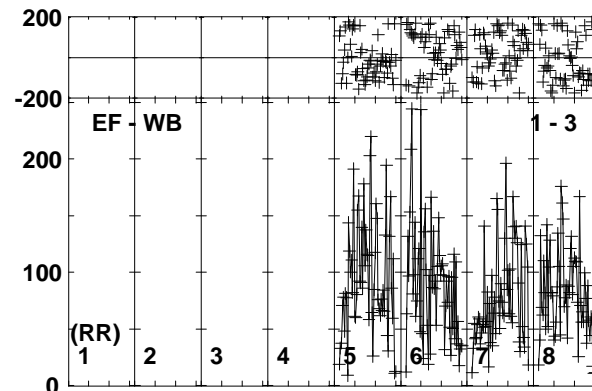
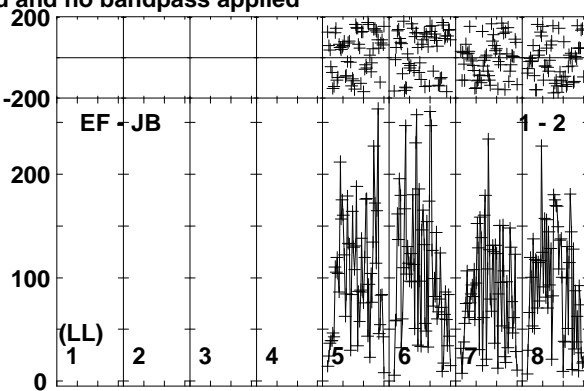
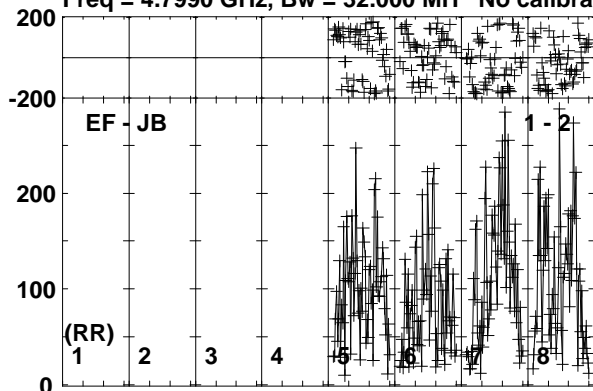

Lower frame: Micro Ampl Jy Top frame: Phas deg
Vector averaged cross-power spectrum Baseline: EF (01) - JB (02)
Timerange: 00/22:33:02 to 00/22:36:45

Plot file version 202 created 03-OCT-2017 13:10:16

IRAS23436 RP028.UVDATA.1

Freq = 4.7990 GHz, Bw = 32.000 MH No calibration applied and no bandpass applied

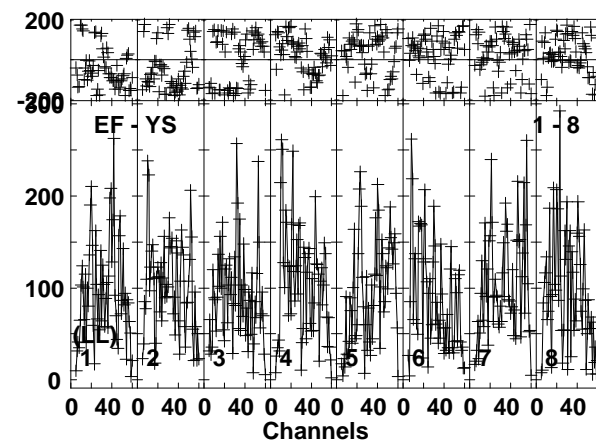
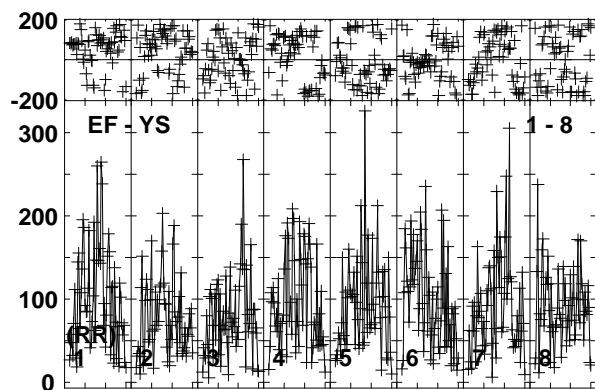
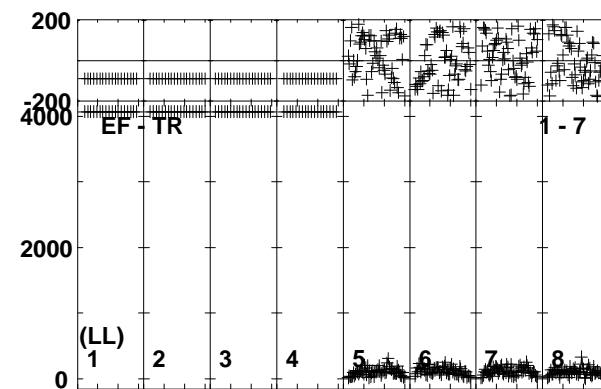
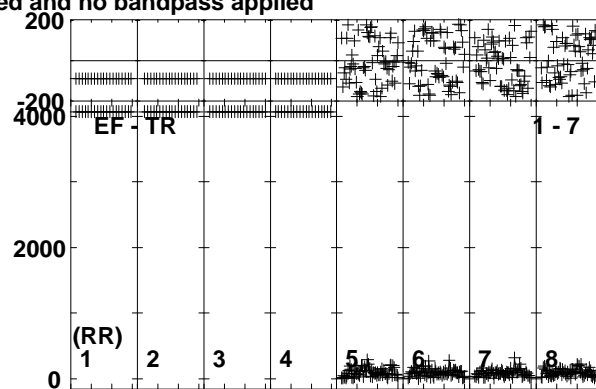
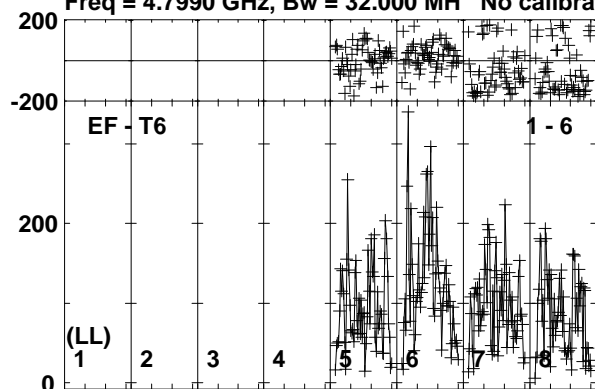

Lower frame: Micro Ampl Jy Top frame: Phas deg
Vector averaged cross-power spectrum Baseline: EF (01) - T6 (06)
Timerange: 00/22:33:02 to 00/22:36:45

Plot file version 203 created 03-OCT-2017 13:10:16

J2353+5518 RP028.UVDATA.1

Freq = 4.7990 GHz, Bw = 32.000 MH No calibration applied and no bandpass applied

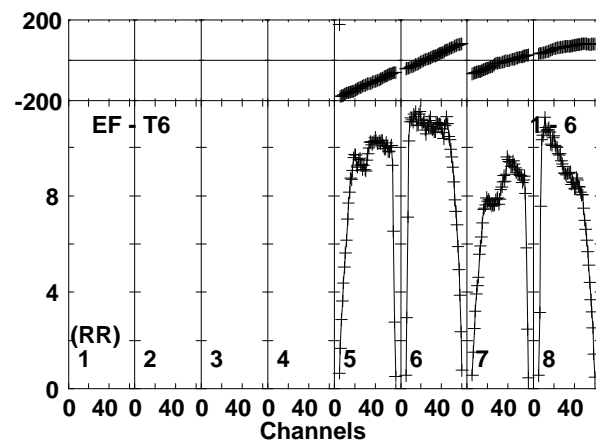
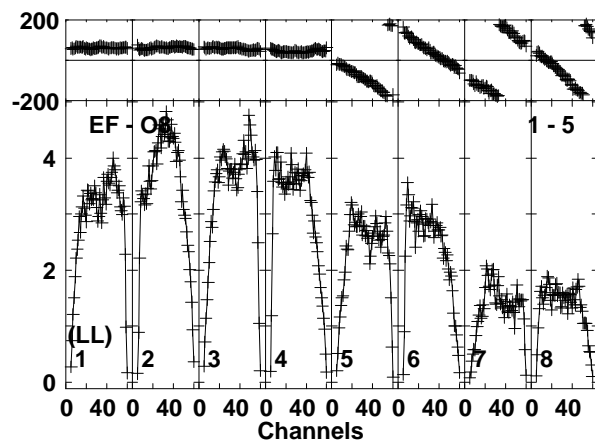
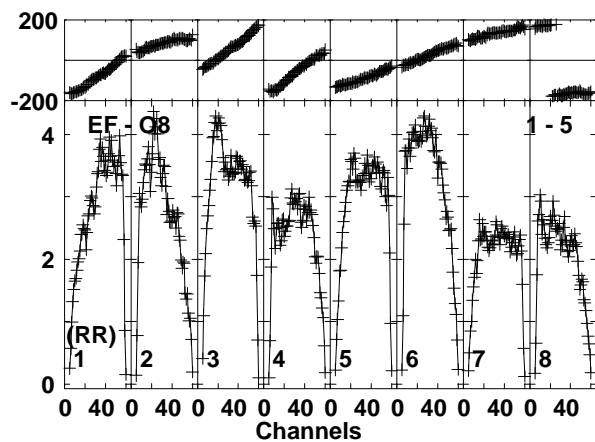
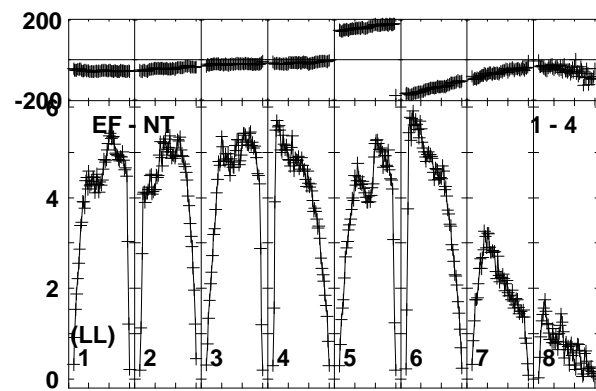
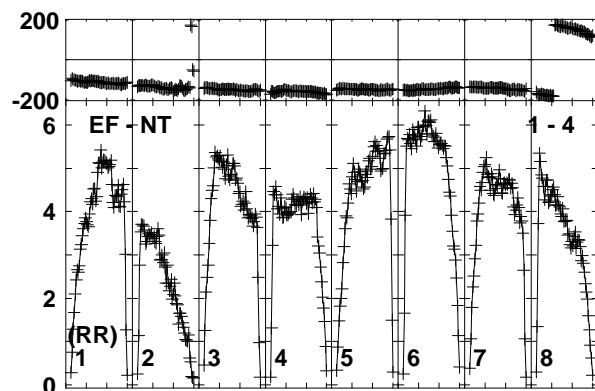
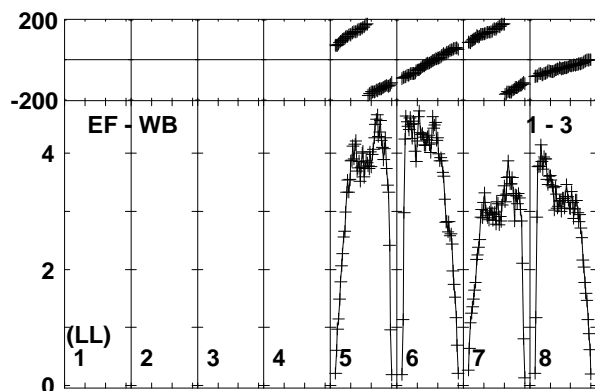
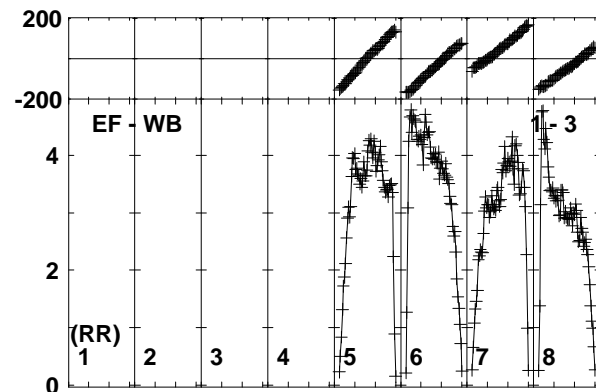
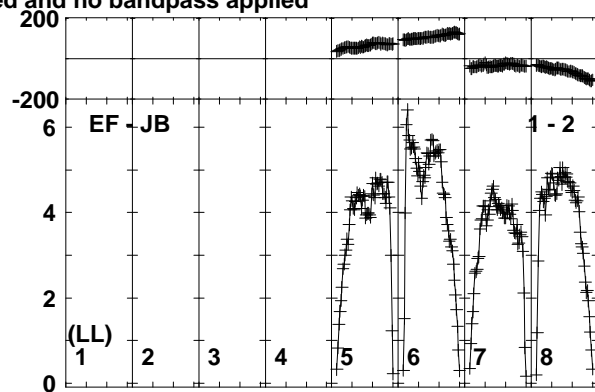
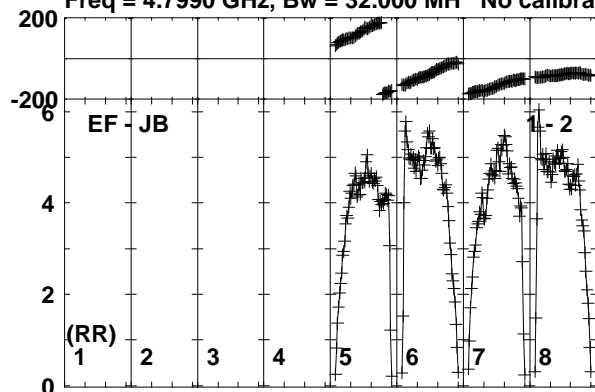

Lower frame: Milli Ampl Jy Top frame: Phas deg
Vector averaged cross-power spectrum Baseline: EF (01) - JB (02)
Timerange: 00:22:36:46 to 00:22:38:16

Plot file version 204 created 03-OCT-2017 13:10:16

J2353+5518 RP028.UVDATA.1

Freq = 4.7990 GHz, Bw = 32.000 MH No calibration applied and no bandpass applied

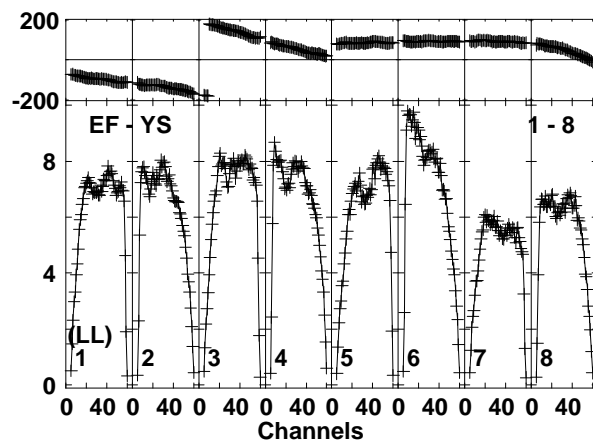
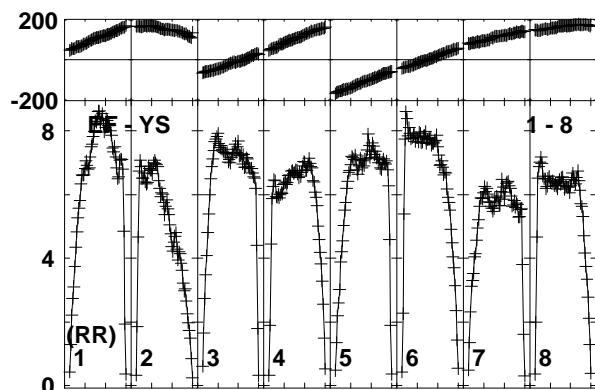
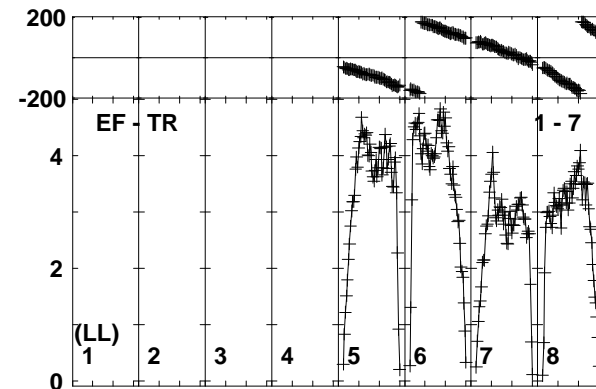
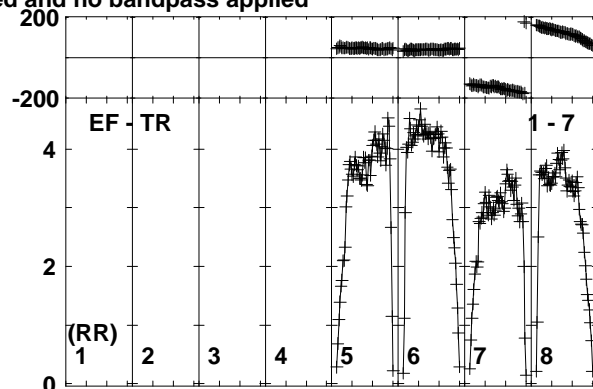
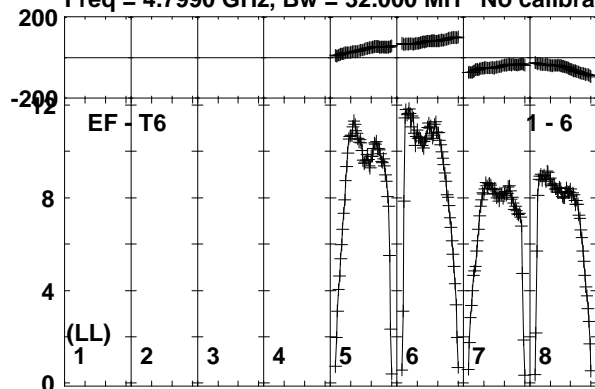

Lower frame: Milli Ampl Jy Top frame: Phas deg
Vector averaged cross-power spectrum Baseline: EF (01) - T6 (06)
Timerange: 00/22:36:46 to 00/22:38:16

Plot file version 205 created 03-OCT-2017 13:10:16

IRAS23436 RP028.UVDATA.1

Freq = 4.7990 GHz, Bw = 32.000 MH No calibration applied and no bandpass applied

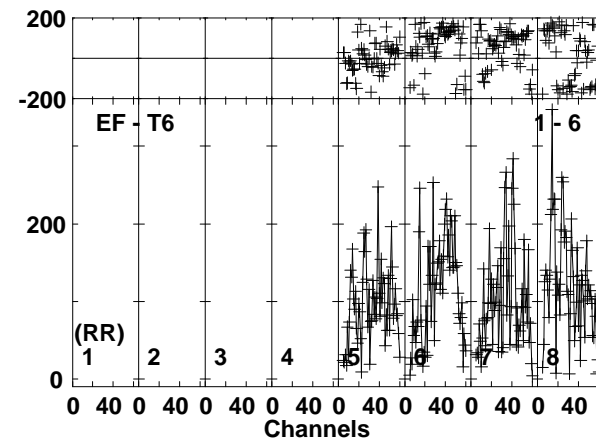
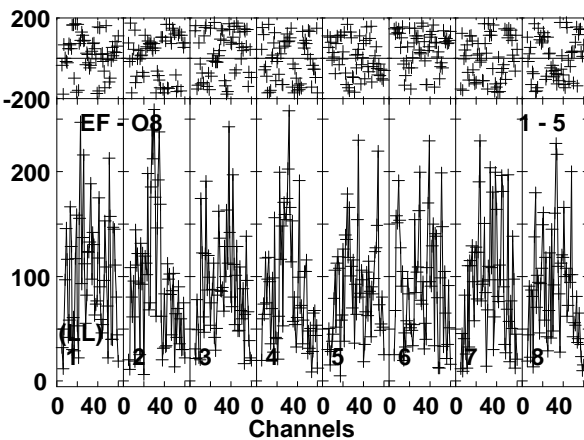
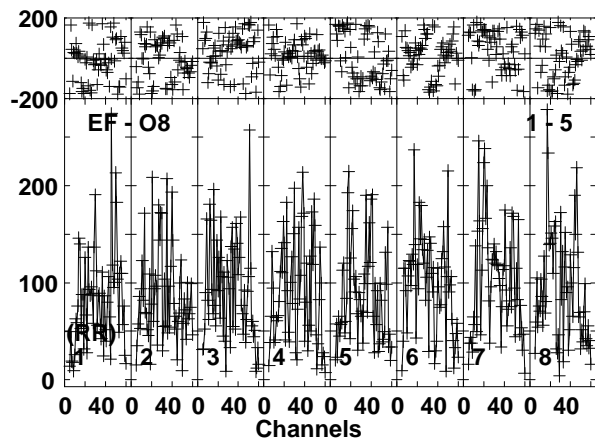
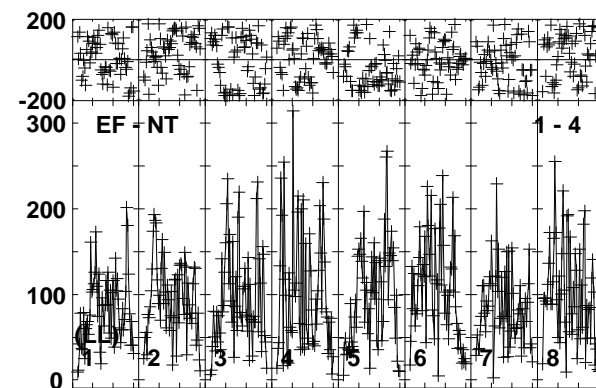
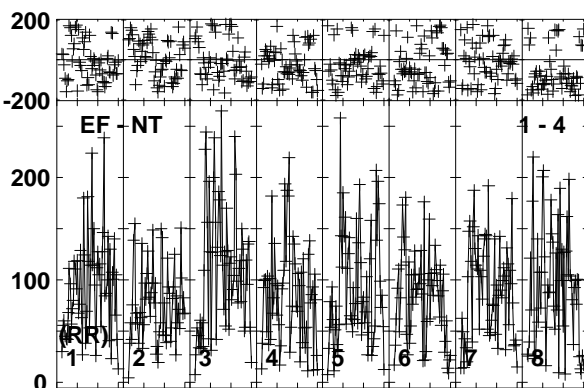
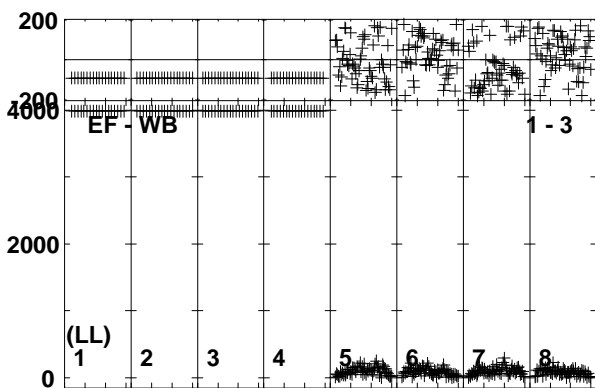
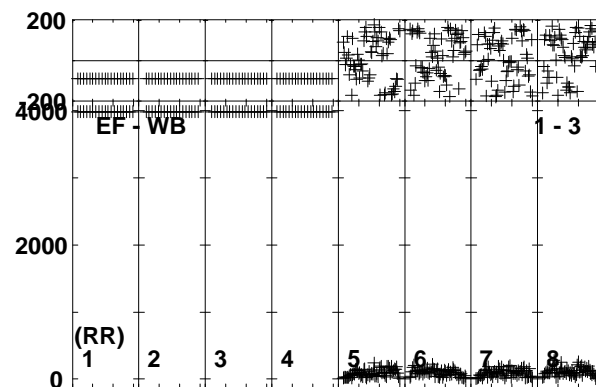
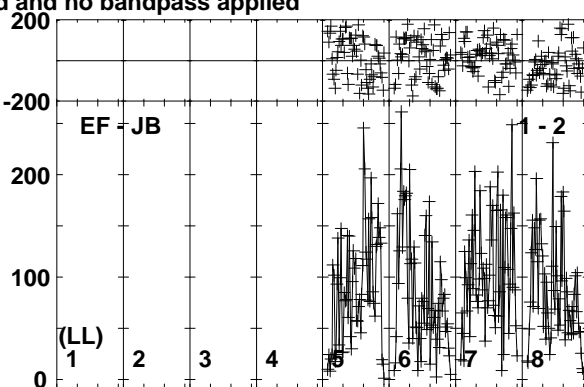
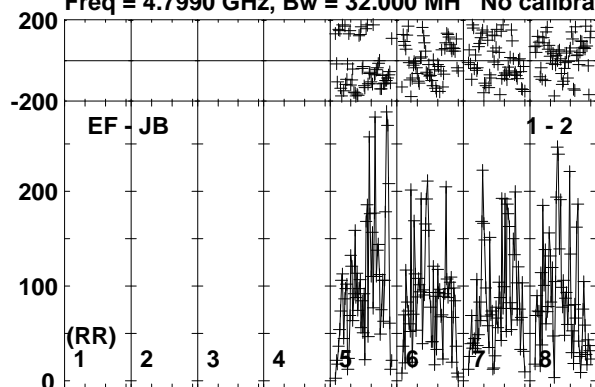

Lower frame: Micro Ampl Jy Top frame: Phas deg
Vector averaged cross-power spectrum Baseline: EF (01) - JB (02)
Timerange: 00:22:38:16 to 00:22:42:00

Plot file version 206 created 03-OCT-2017 13:10:16

IRAS23436 RP028.UVDATA.1

Freq = 4.7990 GHz, Bw = 32.000 MH No calibration applied and no bandpass applied

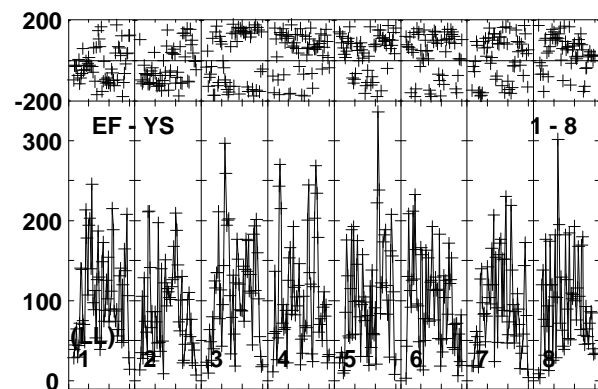
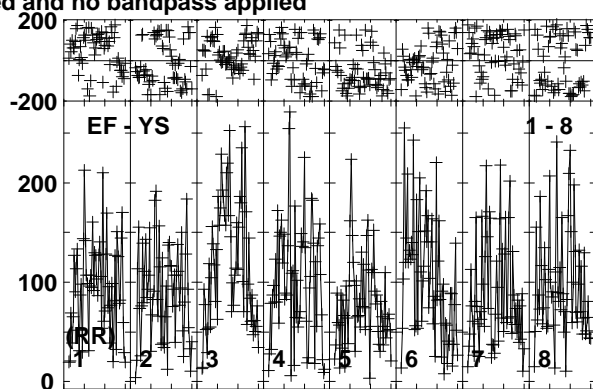
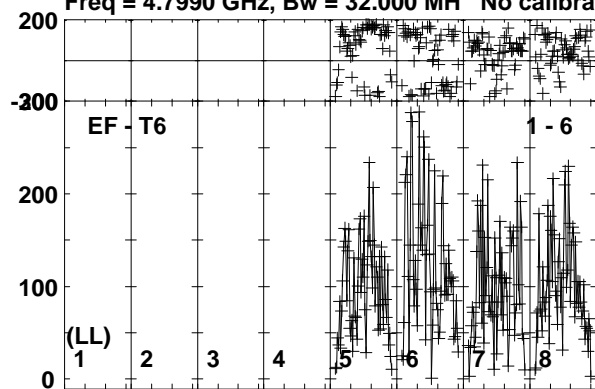

Lower frame: Micro Ampl Jy Top frame: Phas deg
Vector averaged cross-power spectrum Baseline: EF (01) - T6 (06)
Timerange: 00/22:38:16 to 00/22:42:00

Plot file version 207 created 03-OCT-2017 13:10:17

J2353+5518 RP028.UVDATA.1

Freq = 4.7990 GHz, Bw = 32.000 MH No calibration applied and no bandpass applied

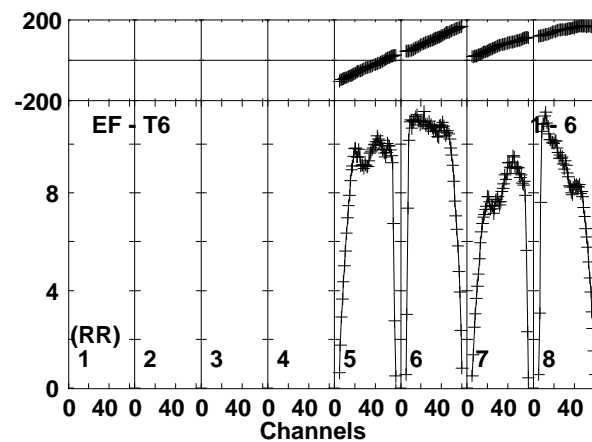
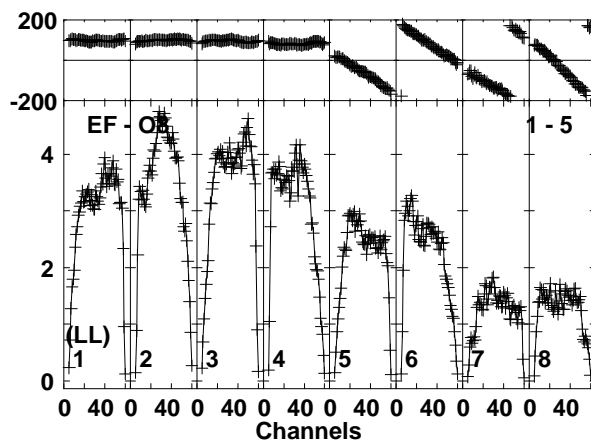
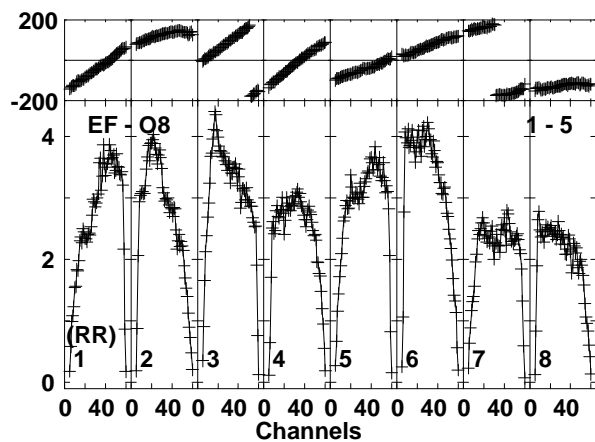
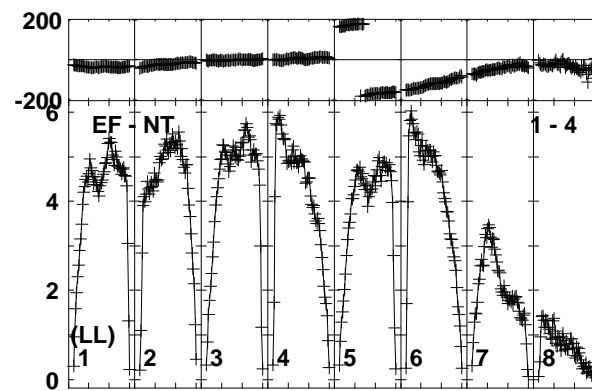
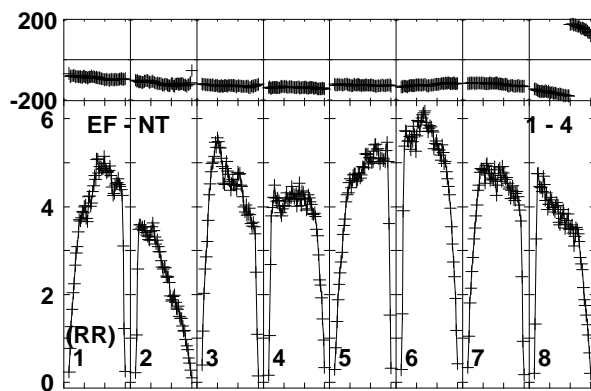
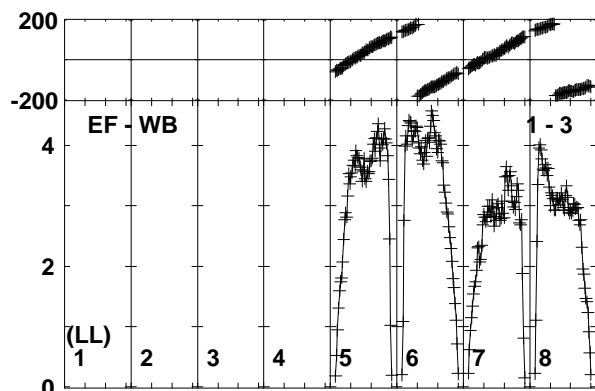
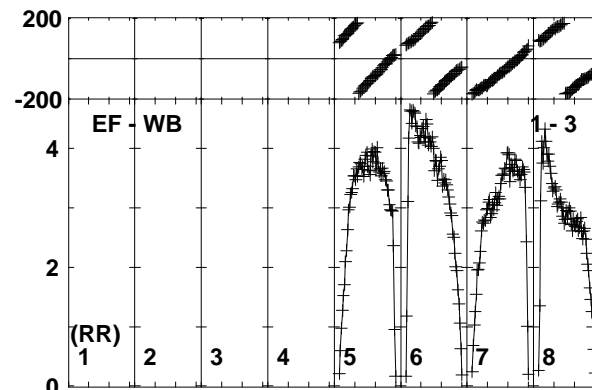
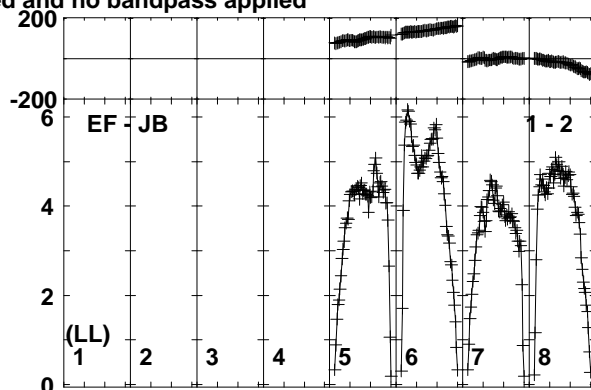
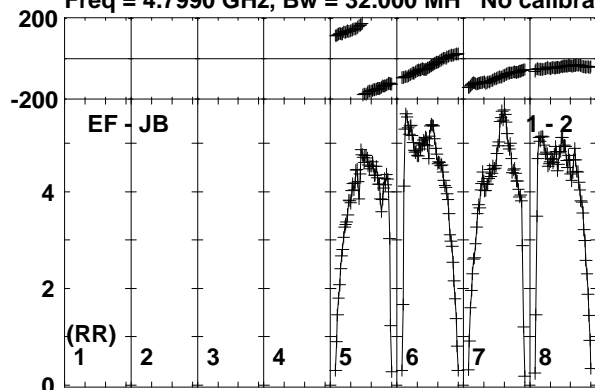

Lower frame: Milli Ampl Jy Top frame: Phas deg
Vector averaged cross-power spectrum Baseline: EF (01) - JB (02)
Timerange: 00/22:43:00 to 00/22:43:44

Plot file version 208 created 03-OCT-2017 13:10:17

J2353+5518 RP028.UVDATA.1

Freq = 4.7990 GHz, Bw = 32.000 MH No calibration applied and no bandpass applied

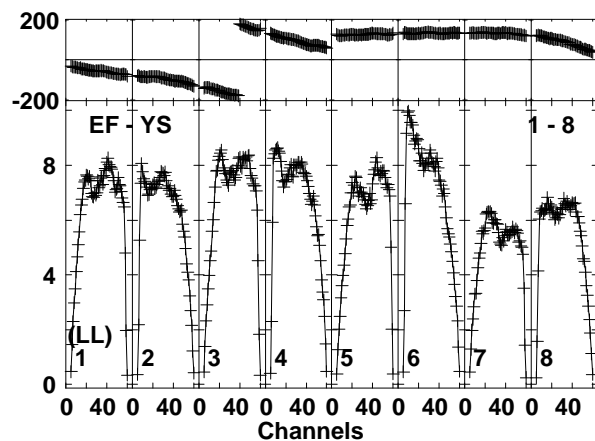
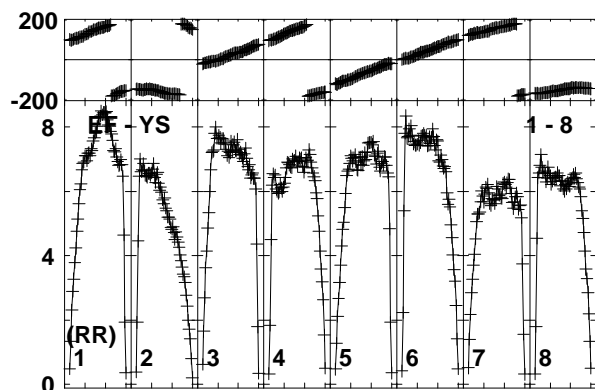
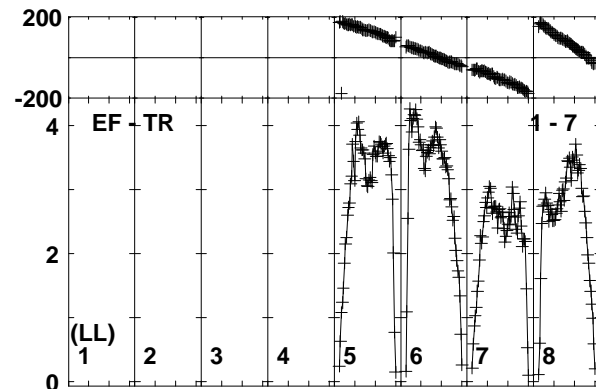
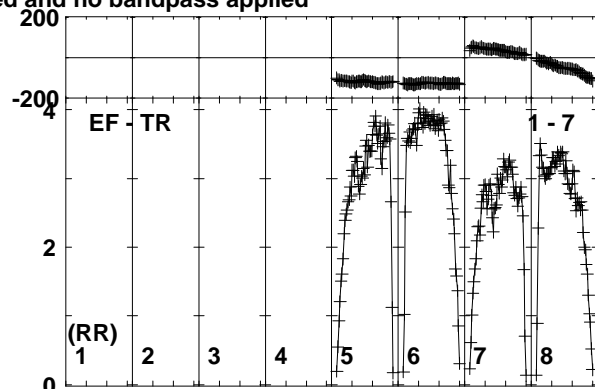
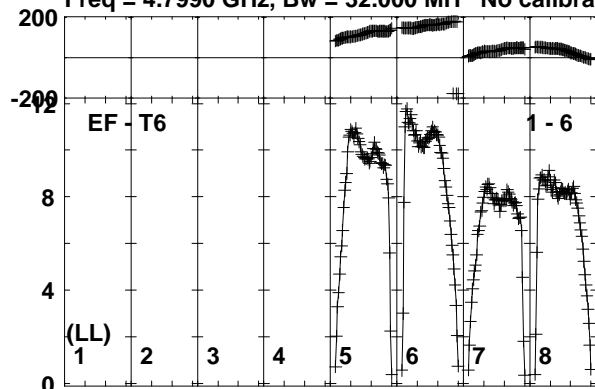

Lower frame: Milli Ampl Jy Top frame: Phas deg
Vector averaged cross-power spectrum Baseline: EF (01) - T6 (06)
Timerange: 00:22:43:00 to 00:22:43:44

Plot file version 209 created 03-OCT-2017 13:10:17

IRAS23436 RP028.UVDATA.1

Freq = 4.7990 GHz, Bw = 32.000 MH No calibration applied and no bandpass applied

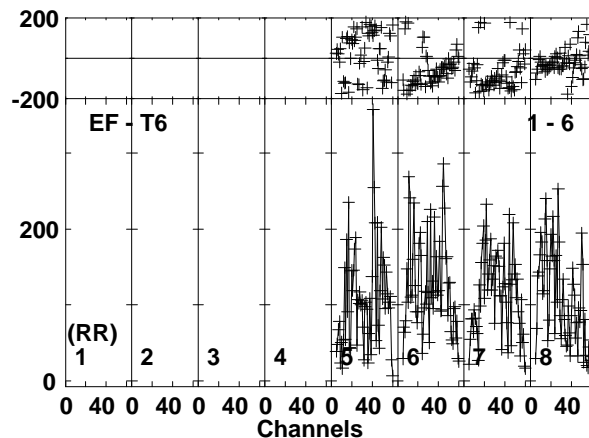
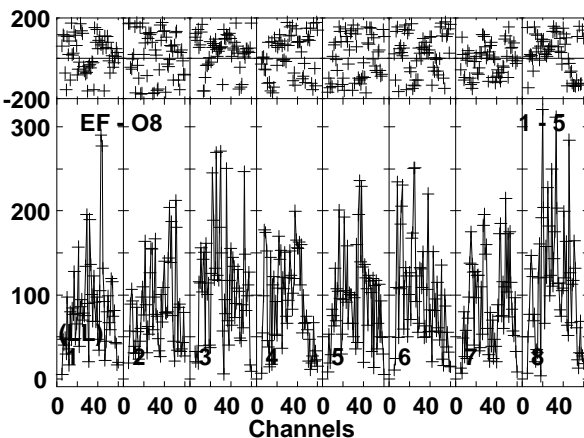
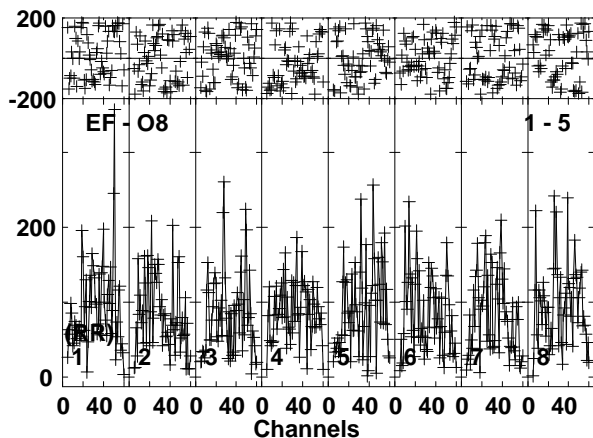
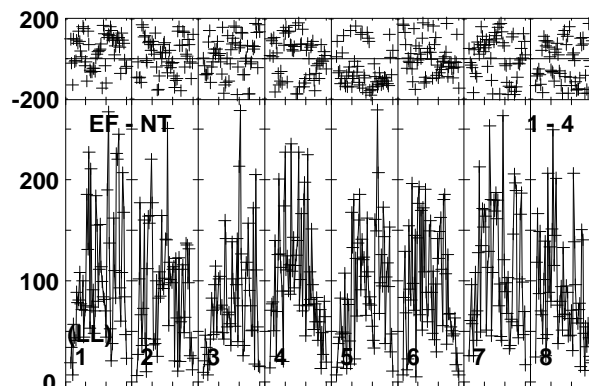
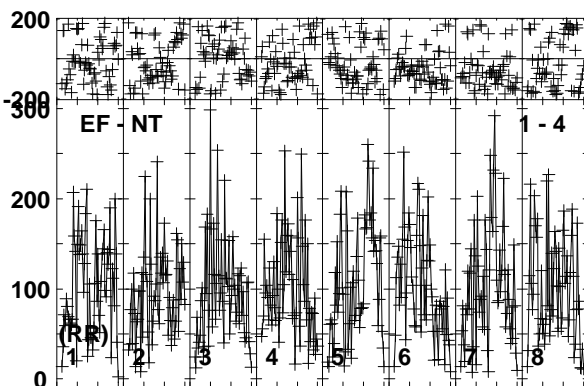
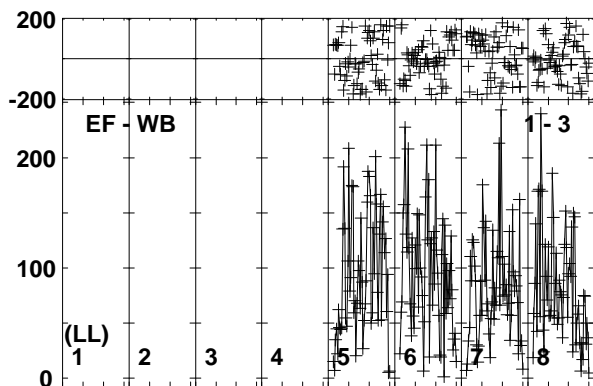
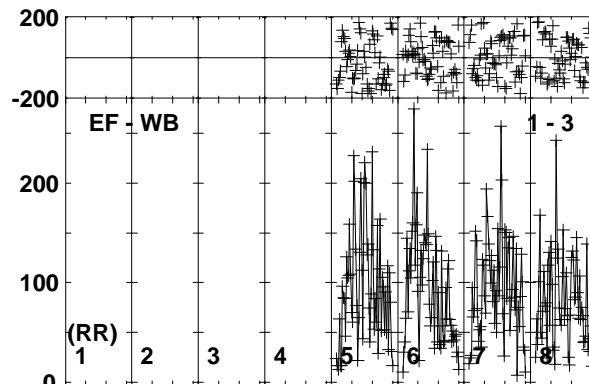
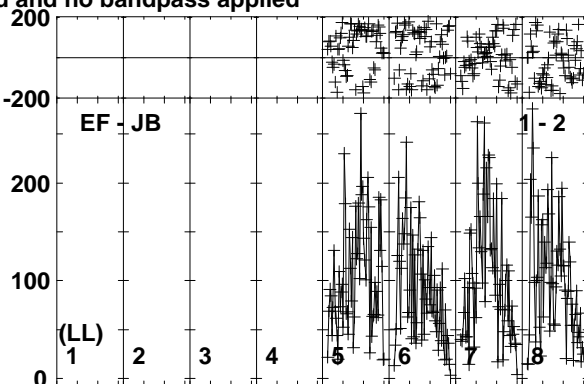
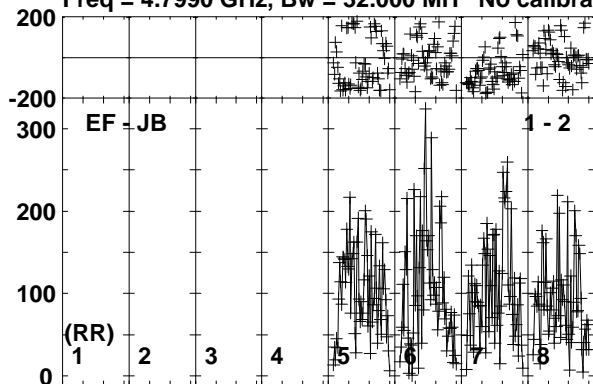

Lower frame: Micro Ampl Jy Top frame: Phas deg
Vector averaged cross-power spectrum Baseline: EF (01) - JB (02)
Timerange: 00/22:43:45 to 00/22:47:24

Plot file version 210 created 03-OCT-2017 13:10:17

IRAS23436 RP028.UVDATA.1

Freq = 4.7990 GHz, Bw = 32.000 MH No calibration applied and no bandpass applied

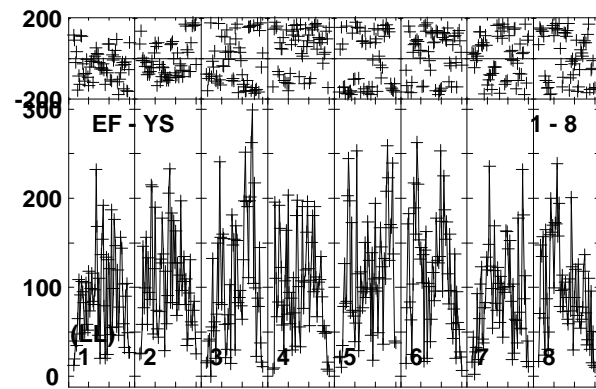
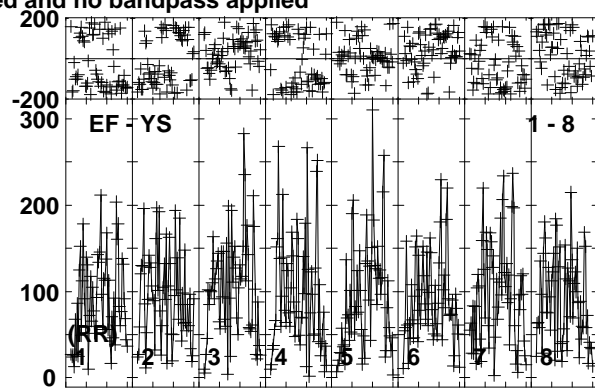
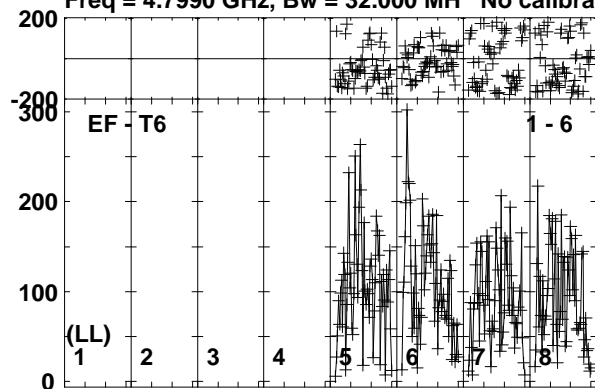

Lower frame: Micro Ampl Jy Top frame: Phas deg
Vector averaged cross-power spectrum Baseline: EF (01) - T6 (06)
Timerange: 00/22:43:45 to 00/22:47:24

Plot file version 211 created 03-OCT-2017 13:10:17

J2353+5518 RP028.UVDATA.1

Freq = 4.7990 GHz, Bw = 32.000 MH No calibration applied and no bandpass applied

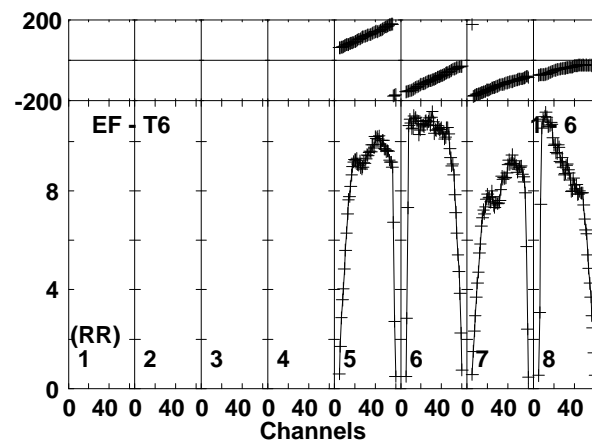
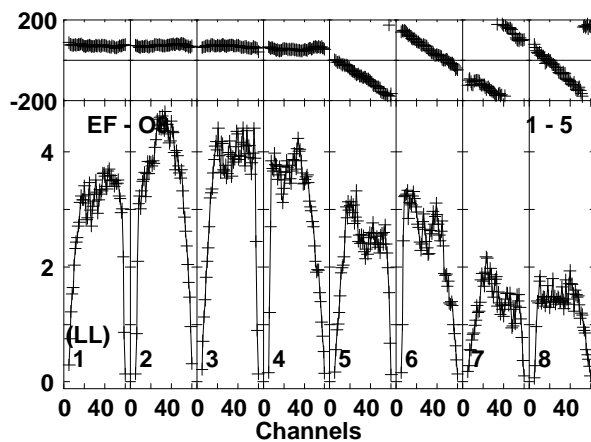
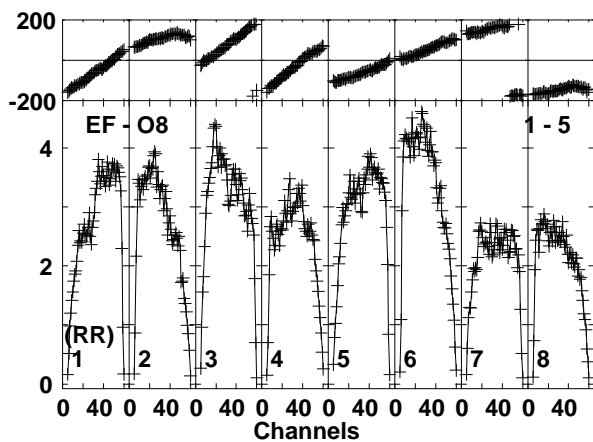
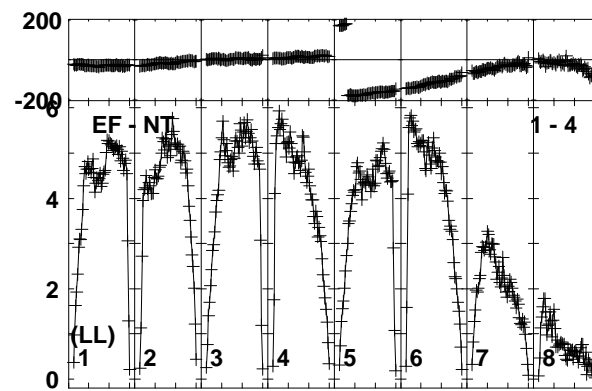
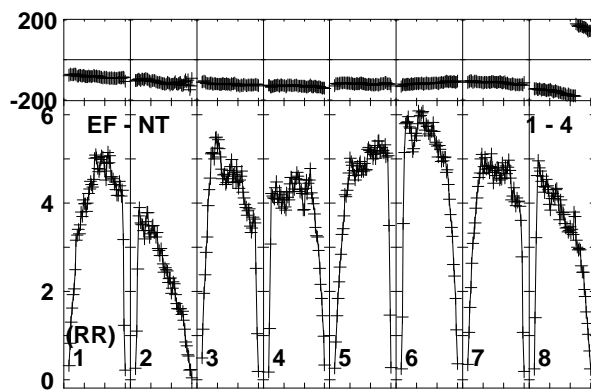
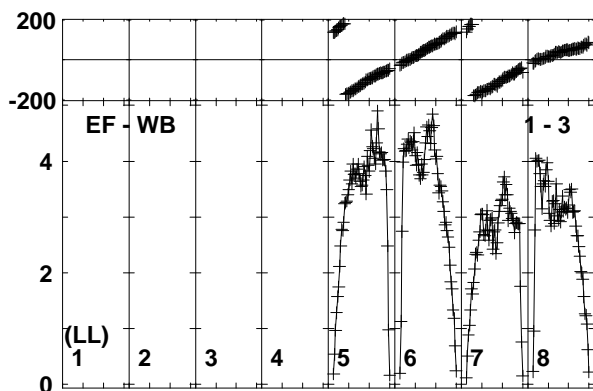
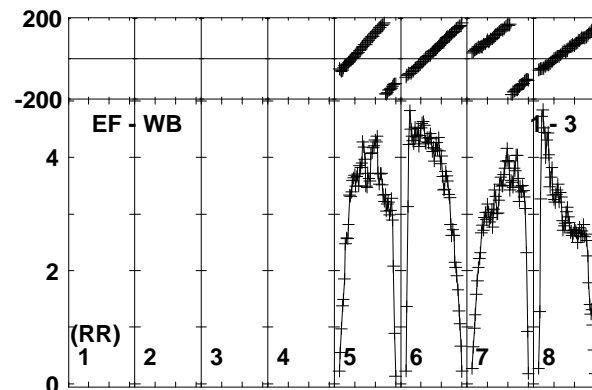
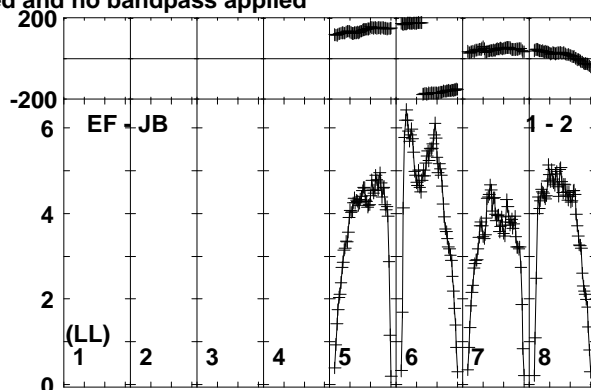
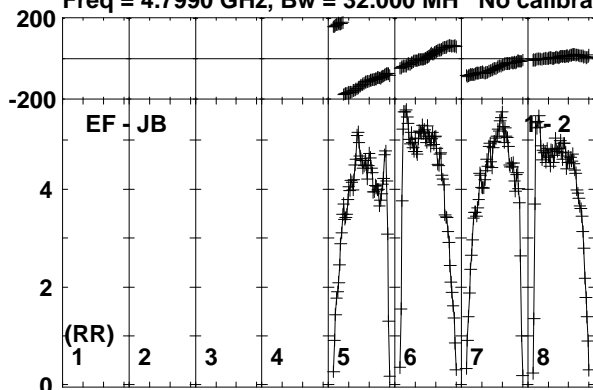

Lower frame: Milli Ampl Jy Top frame: Phas deg
Vector averaged cross-power spectrum Baseline: EF (01) - JB (02)
Timerange: 00:22:47:26 to 00:22:48:55

Plot file version 212 created 03-OCT-2017 13:10:17

J2353+5518 RP028.UVDATA.1

Freq = 4.7990 GHz, Bw = 32.000 MH No calibration applied and no bandpass applied

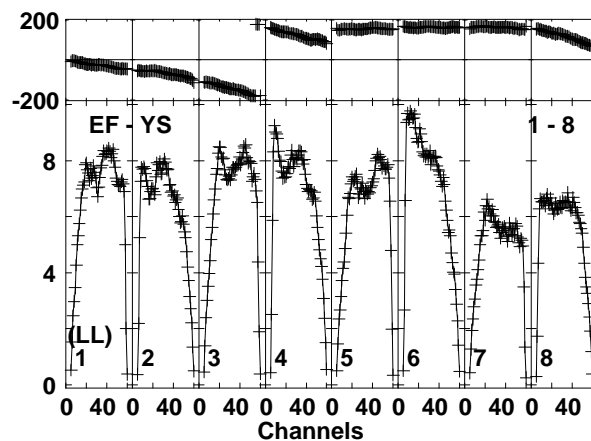
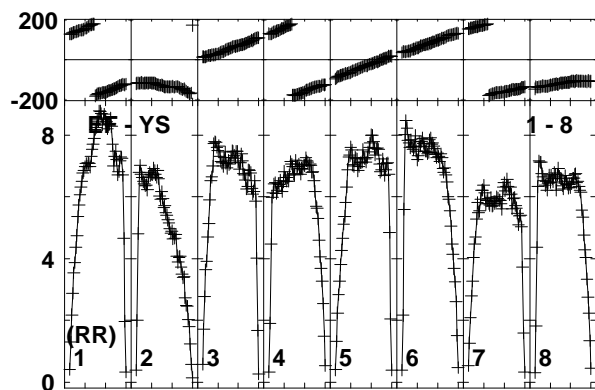
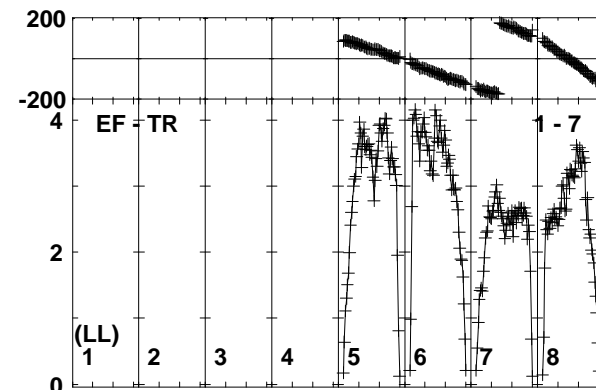
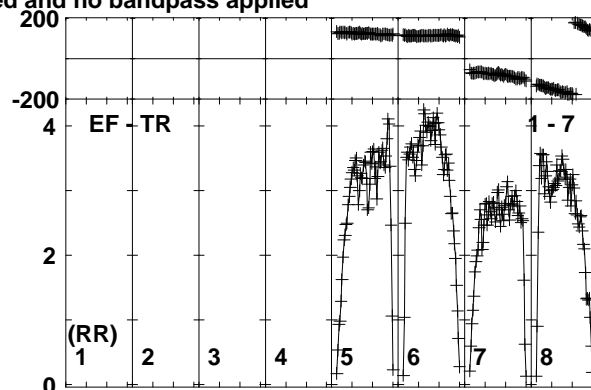
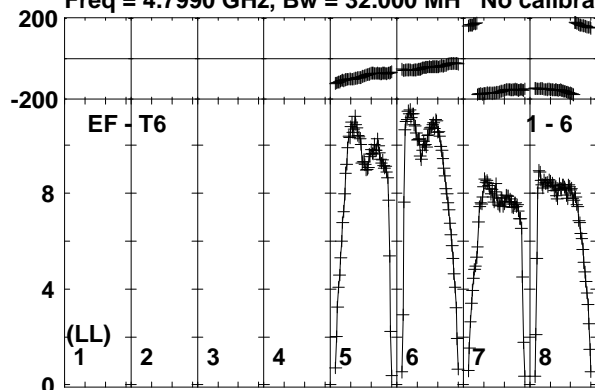

Lower frame: Milli Ampl Jy Top frame: Phas deg
Vector averaged cross-power spectrum Baseline: EF (01) - T6 (06)
Timerange: 00/22:47:26 to 00/22:48:55

Plot file version 213 created 03-OCT-2017 13:10:17

IRAS23436 RP028.UVDATA.1

Freq = 4.7990 GHz, Bw = 32.000 MH No calibration applied and no bandpass applied

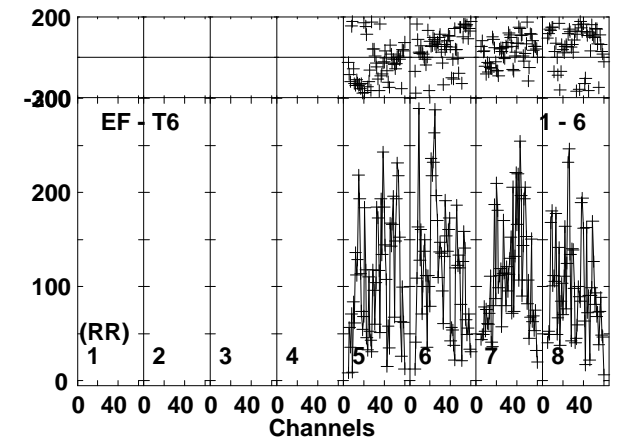
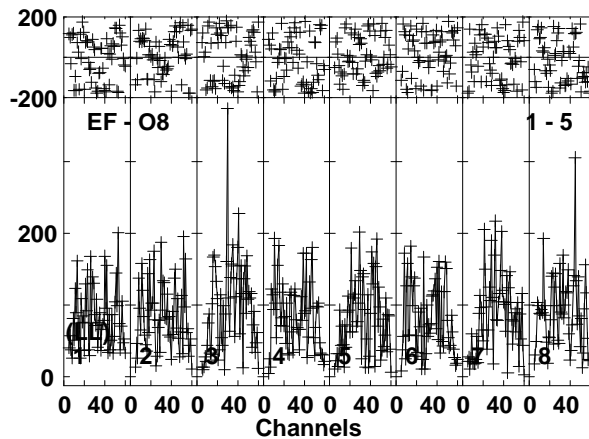
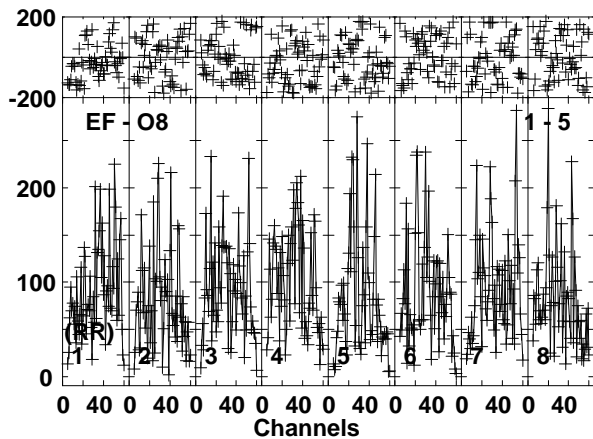
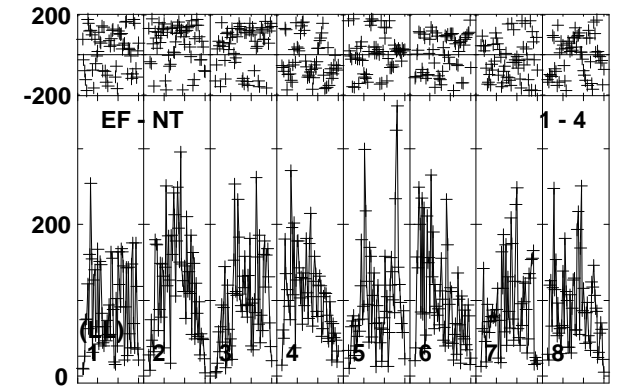
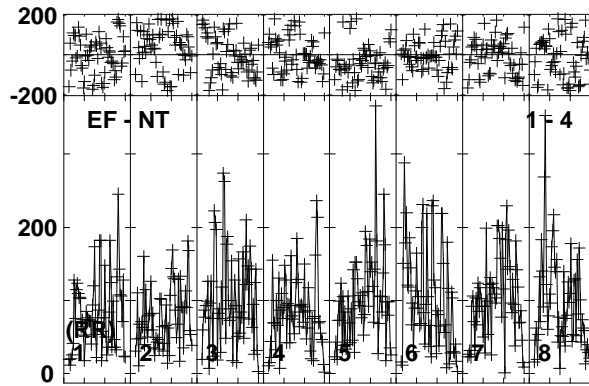
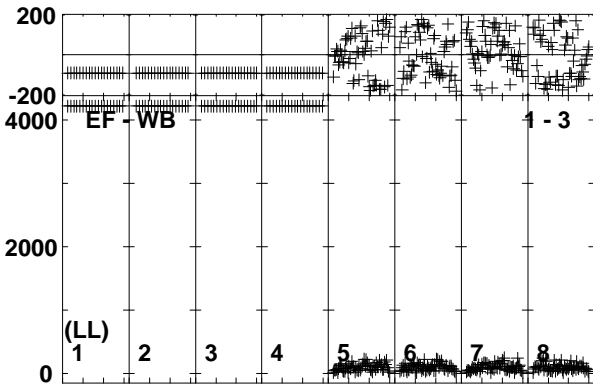
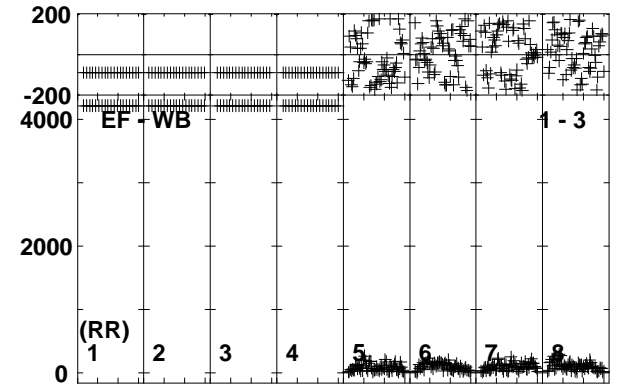
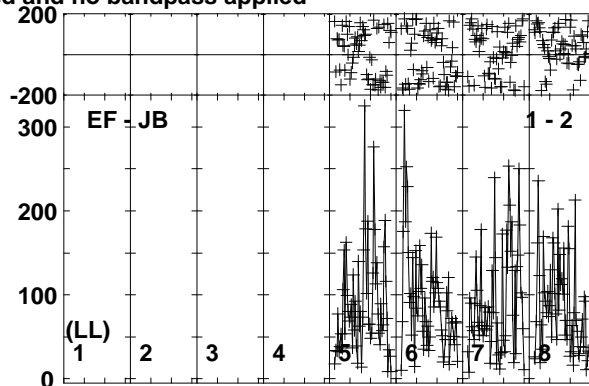
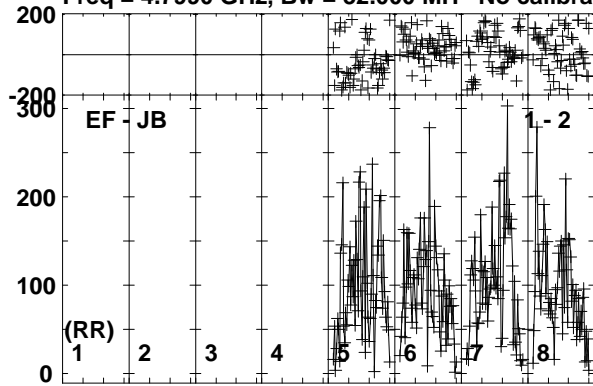

Lower frame: Micro Ampl Jy Top frame: Phas deg
Vector averaged cross-power spectrum Baseline: EF (01) - JB (02)
Timerange: 00:22:48:55 to 00:22:52:39

Plot file version 214 created 03-OCT-2017 13:10:18

IRAS23436 RP028.UVDATA.1

Freq = 4.7990 GHz, Bw = 32.000 MH No calibration applied and no bandpass applied

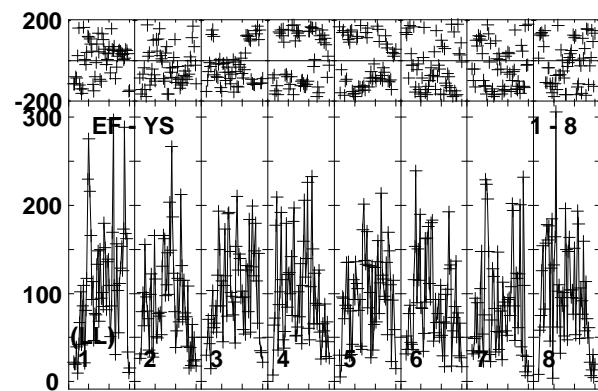
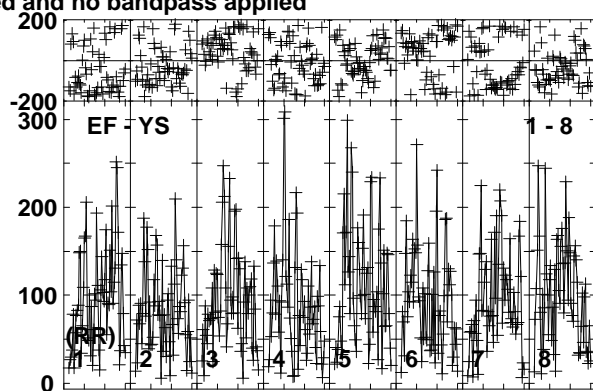
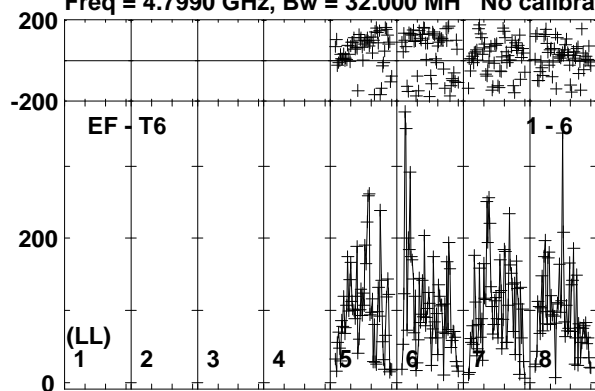

Lower frame: Micro Ampl Jy Top frame: Phas deg
Vector averaged cross-power spectrum Baseline: EF (01) - T6 (06)
Timerange: 00/22:48:55 to 00/22:52:39

Plot file version 215 created 03-OCT-2017 13:10:18

J2353+5518 RP028.UVDATA.1

Freq = 4.7990 GHz, Bw = 32.000 MH No calibration applied and no bandpass applied

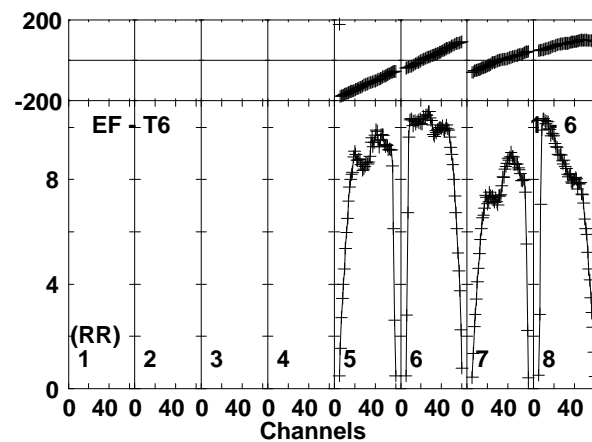
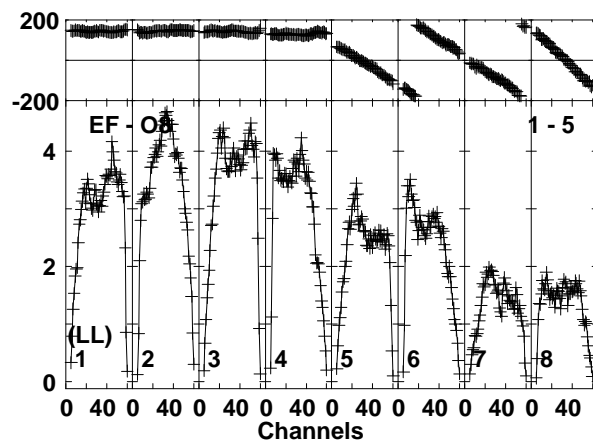
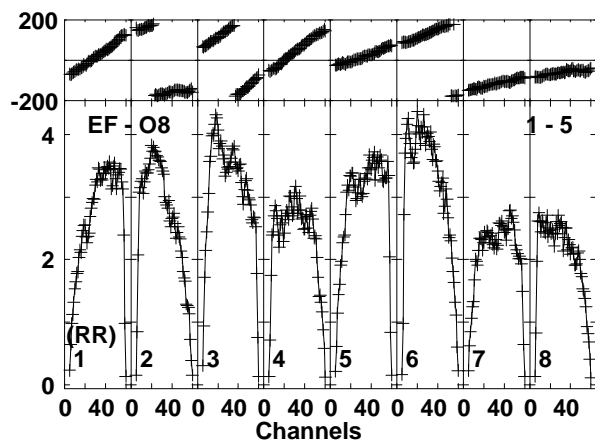
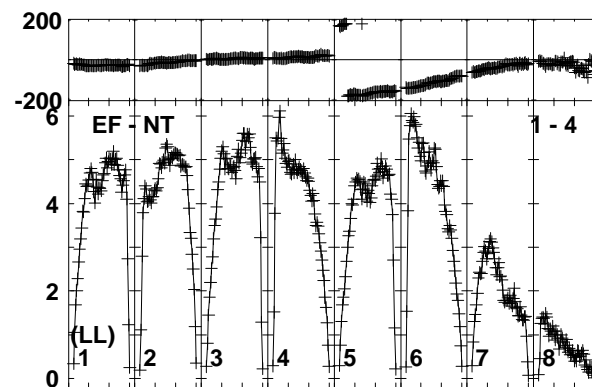
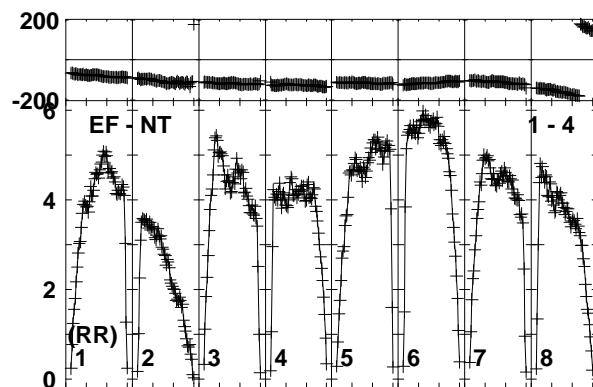
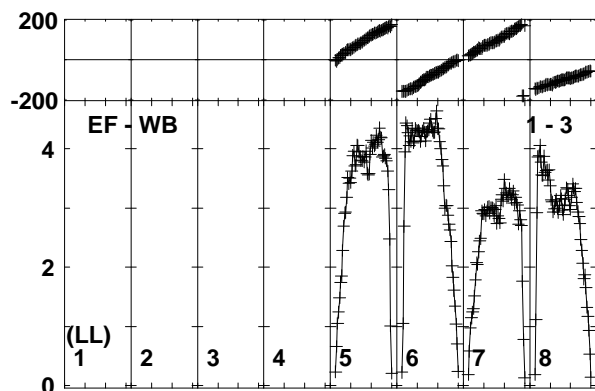
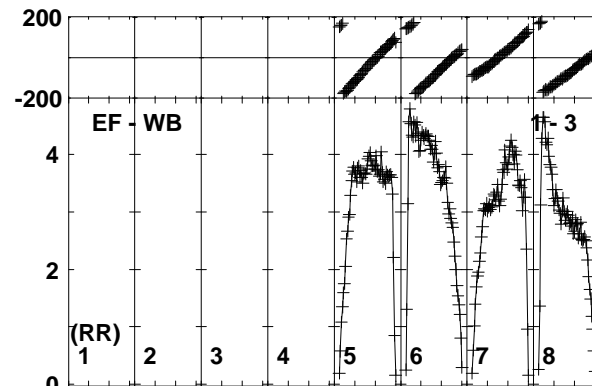
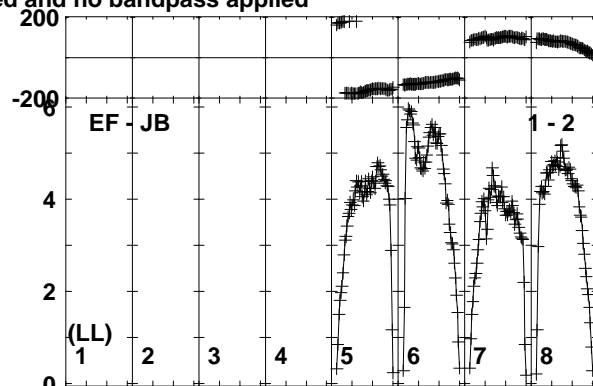
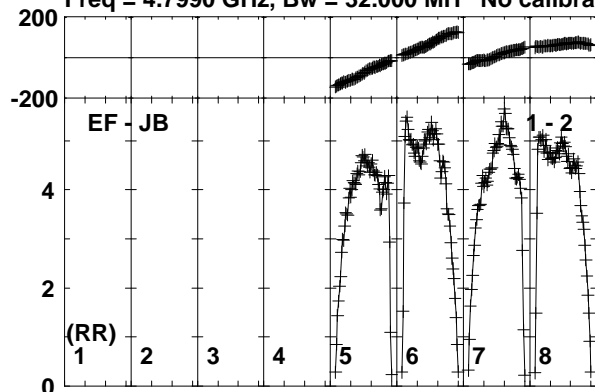

Lower frame: Milli Ampl Jy Top frame: Phas deg
Vector averaged cross-power spectrum Baseline: EF (01) - JB (02)
Timerange: 00:22:53:49 to 00:22:54:38

Plot file version 216 created 03-OCT-2017 13:10:18

J2353+5518 RP028.UVDATA.1

Freq = 4.7990 GHz, Bw = 32.000 MH No calibration applied and no bandpass applied

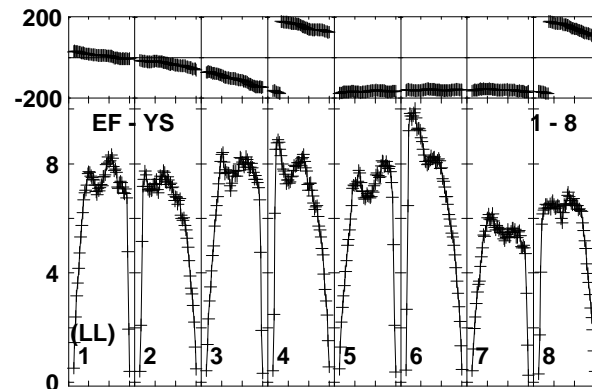
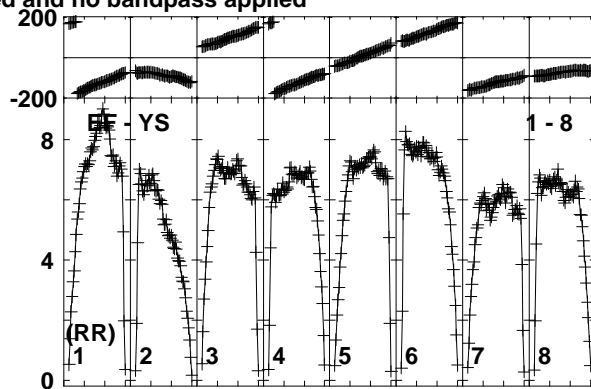
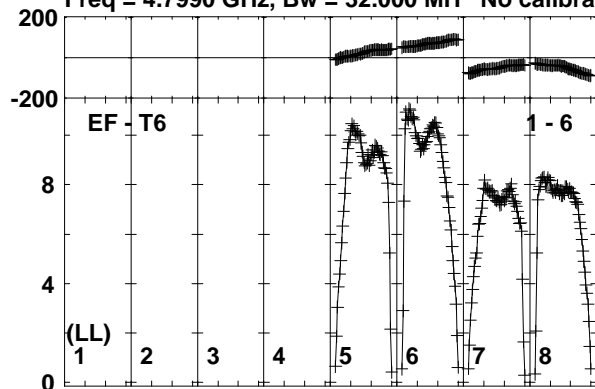

Lower frame: Milli Ampl Jy Top frame: Phas deg
Vector averaged cross-power spectrum Baseline: EF (01) - T6 (06)
Timerange: 00/22:53:49 to 00/22:54:38