

Plot file version 1 created 28-AUG-2017 13:18:59

J1303-2405 RP029A.UVDATA.1

Freq = 4.7990 GHz, Bw = 32.000 MH No calibration applied and no bandpass applied

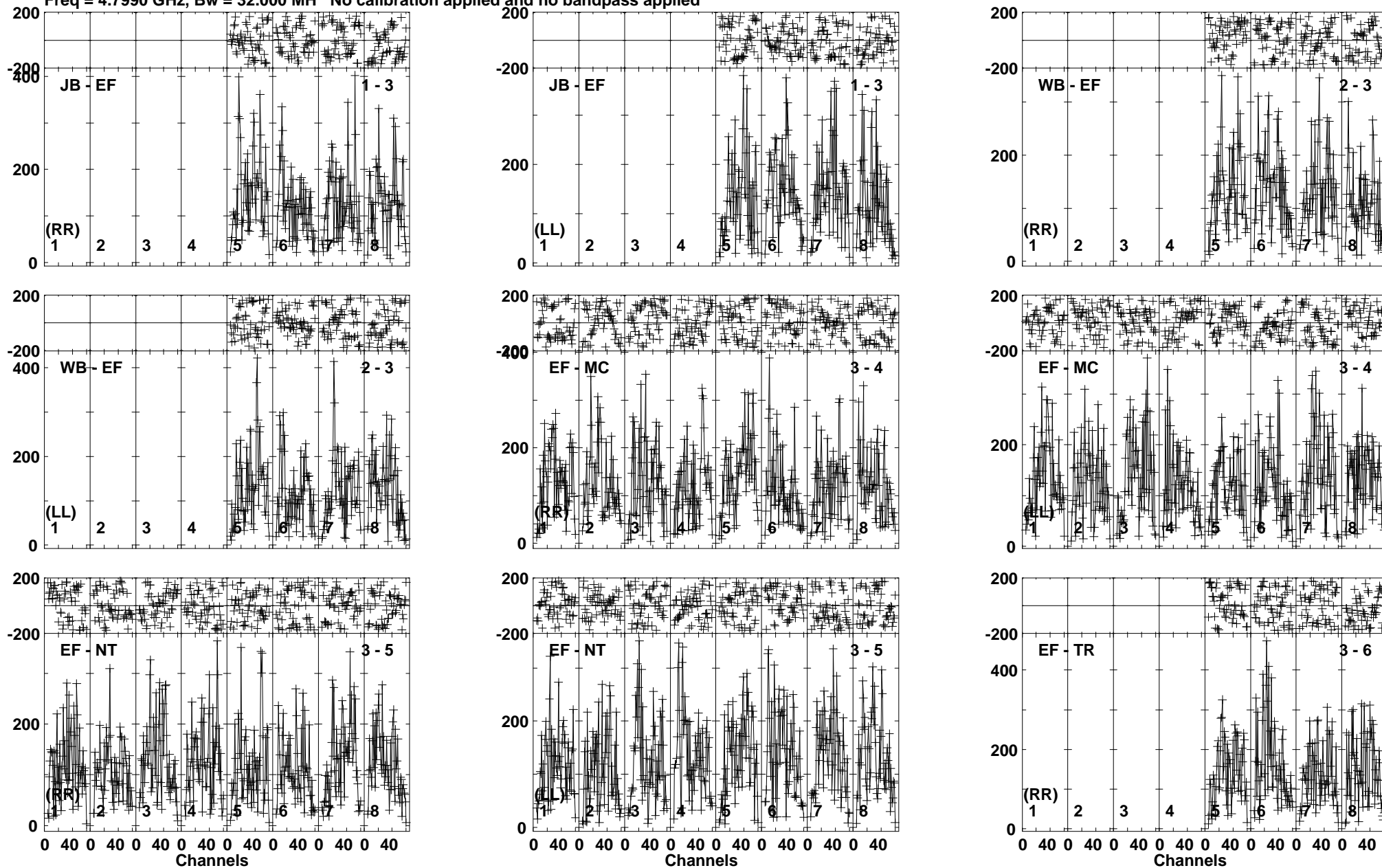

Lower frame: Micro Ampl Jy Top frame: Phas deg
Vector averaged cross-power spectrum Baseline: JB (01) - EF (03)
Timerange: 00:12:15:05 to 00:12:16:29

Plot file version 2 created 28-AUG-2017 13:18:59

J1303-2405 RP029A.UVDATA.1

Freq = 4.7990 GHz, Bw = 32.000 MH No calibration applied and no bandpass applied

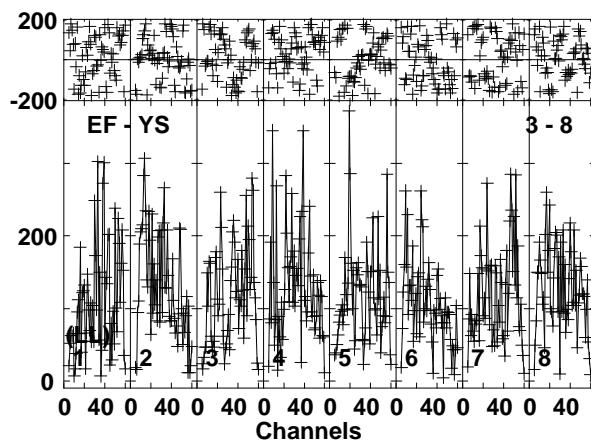
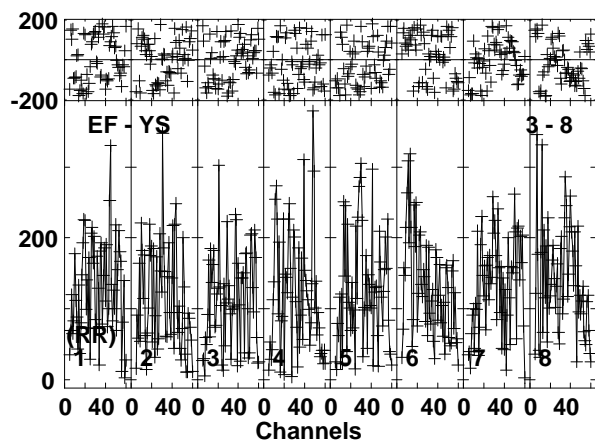
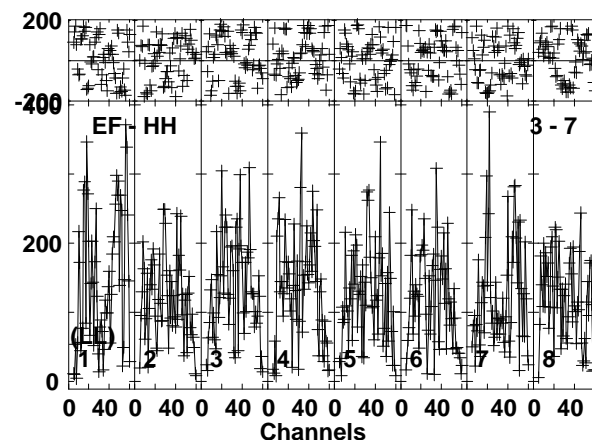
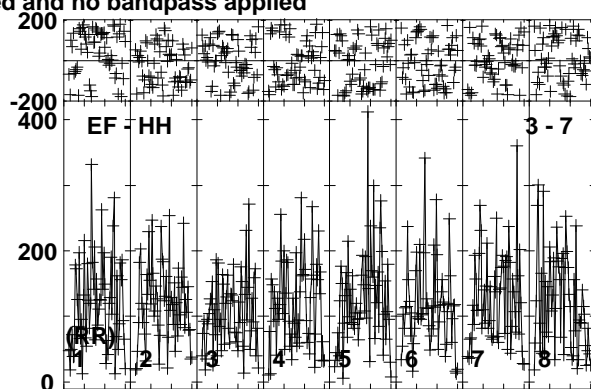
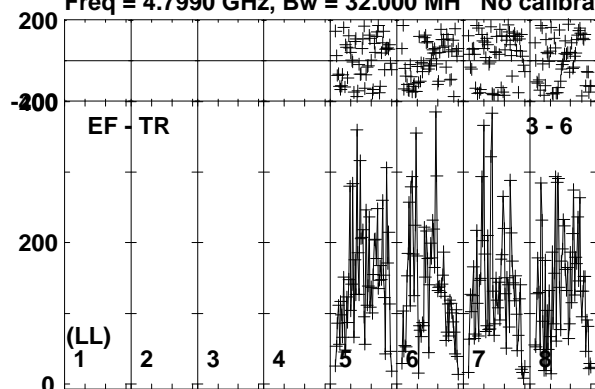

Lower frame: Micro Ampl Jy Top frame: Phas deg
Vector averaged cross-power spectrum Baseline: EF (03) - TR (06)
Timerange: 00:12:15:05 to 00:12:16:29

Plot file version 3 created 28-AUG-2017 13:18:59

NVSS1 RP029A.UVDATA.1

Freq = 4.7990 GHz, Bw = 32.000 MH No calibration applied and no bandpass applied

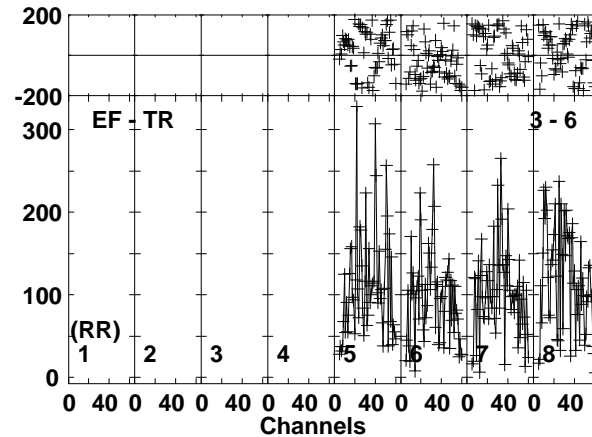
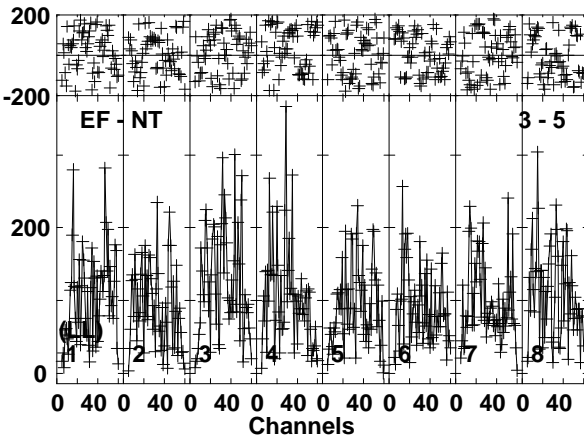
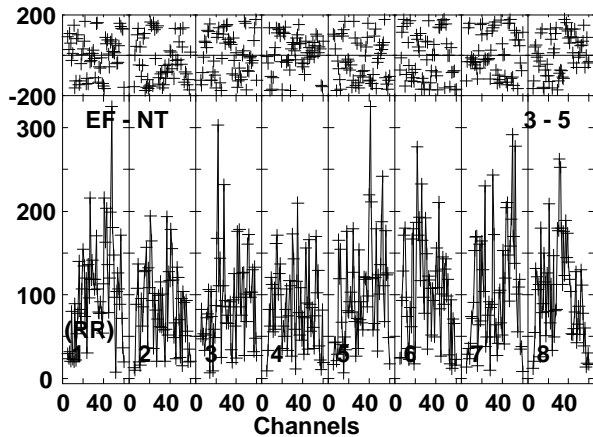
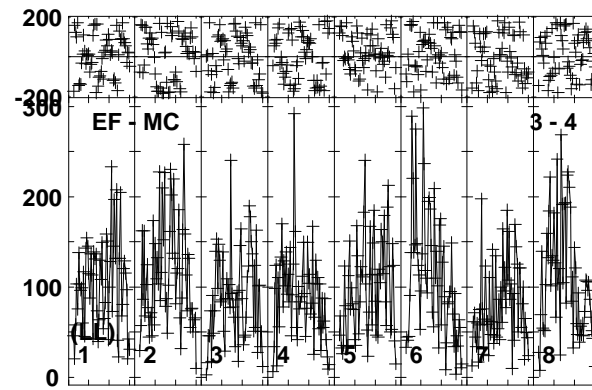
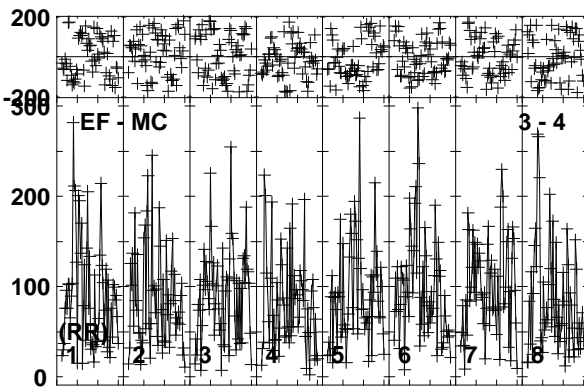
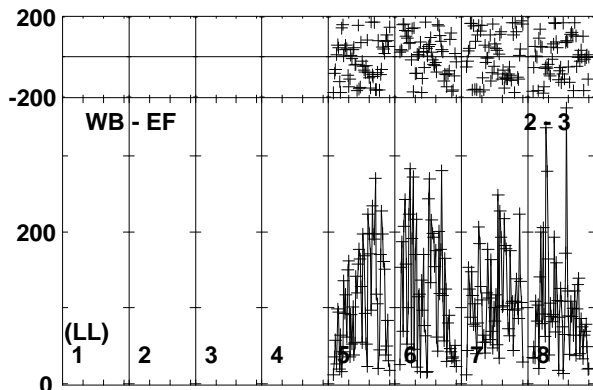
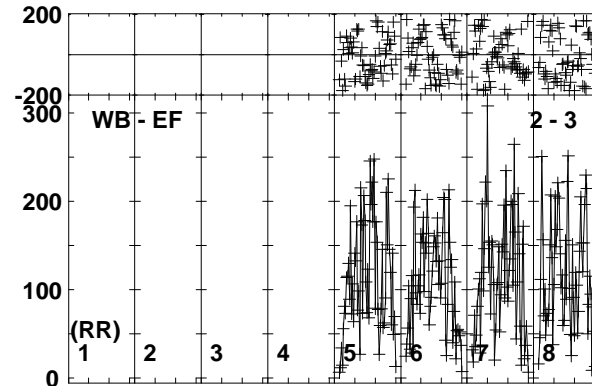
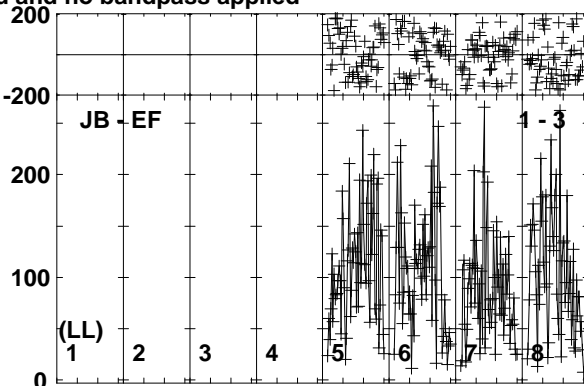
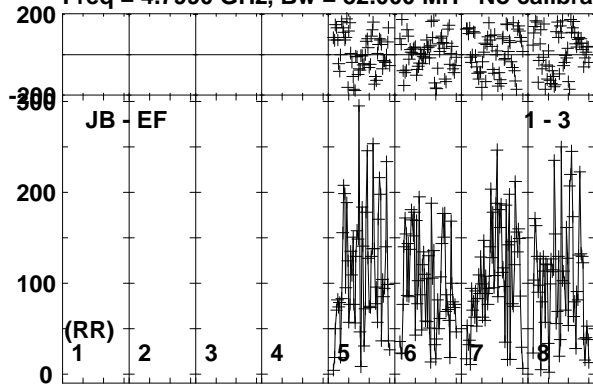

Lower frame: Micro Ampl Jy Top frame: Phas deg
Vector averaged cross-power spectrum Baseline: JB (01) - EF (03)
Timerange: 00/12:16:31 to 00/12:18:59

Plot file version 4 created 28-AUG-2017 13:18:59

NVSS1 RP029A.UVDATA.1

Freq = 4.7990 GHz, Bw = 32.000 MH No calibration applied and no bandpass applied

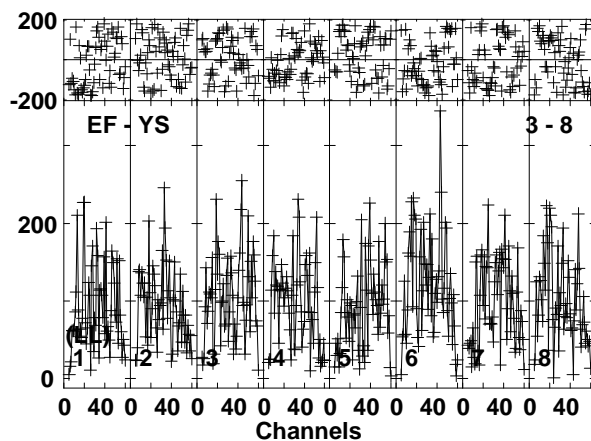
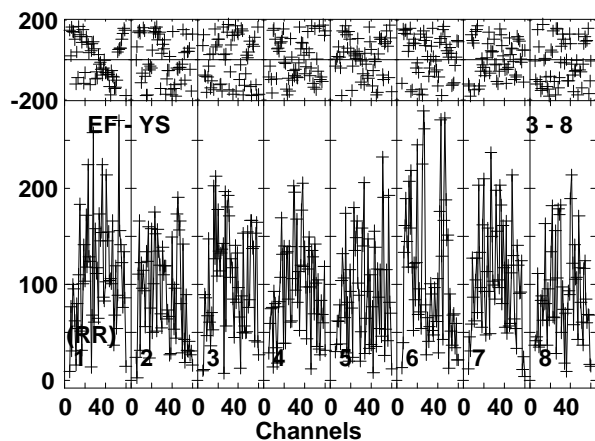
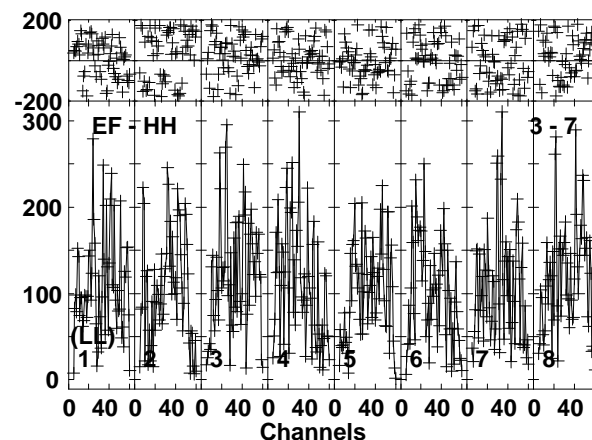
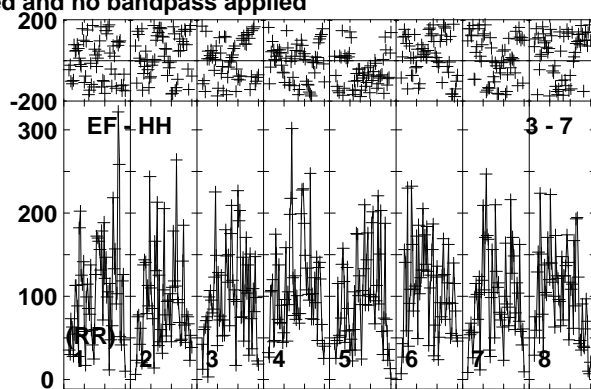
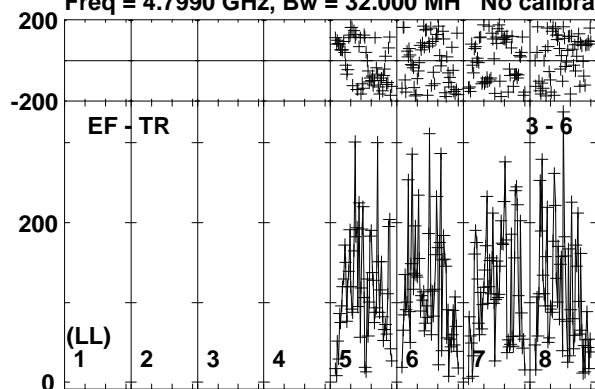

Lower frame: Micro Ampl Jy Top frame: Phas deg
Vector averaged cross-power spectrum Baseline: EF (03) - TR (06)
Timerange: 00:12:16:31 to 00:12:18:59

Plot file version 5 created 28-AUG-2017 13:18:59

J1303-2405 RP029A.UVDATA.1

Freq = 4.7990 GHz, Bw = 32.000 MH No calibration applied and no bandpass applied

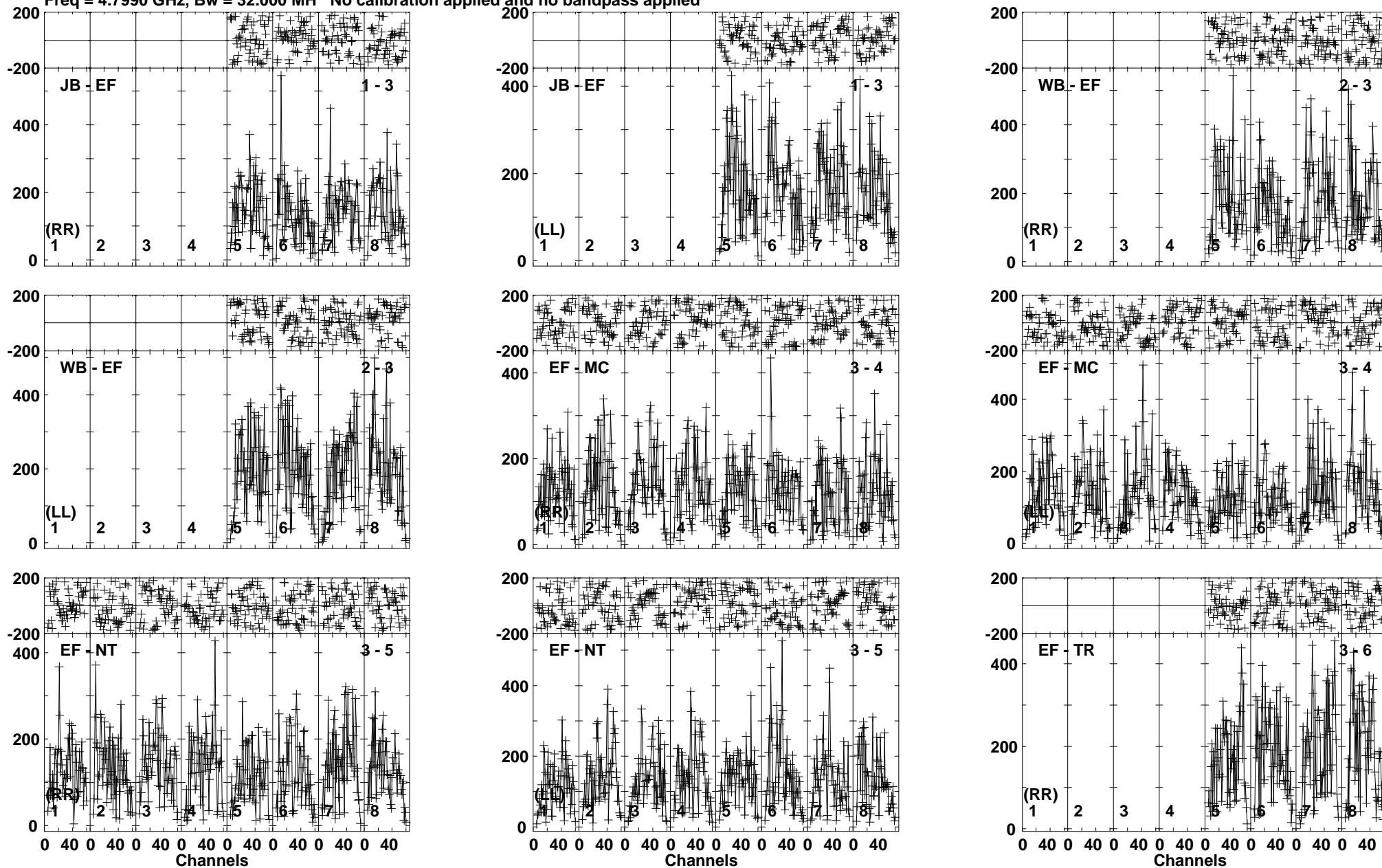

Lower frame: Micro Ampl Jy Top frame: Phas deg
Vector averaged cross-power spectrum Baseline: JB (01) - EF (03)
Timerange: 00:12:19:01 to 00:12:20:29

Plot file version 6 created 28-AUG-2017 13:18:59

J1303-2405 RP029A.UVDATA.1

Freq = 4.7990 GHz, Bw = 32.000 MH No calibration applied and no bandpass applied

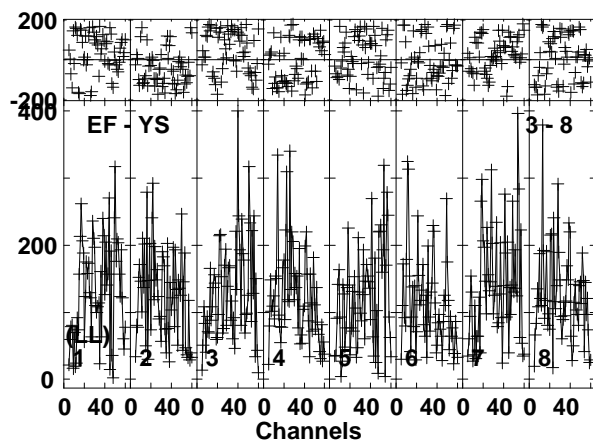
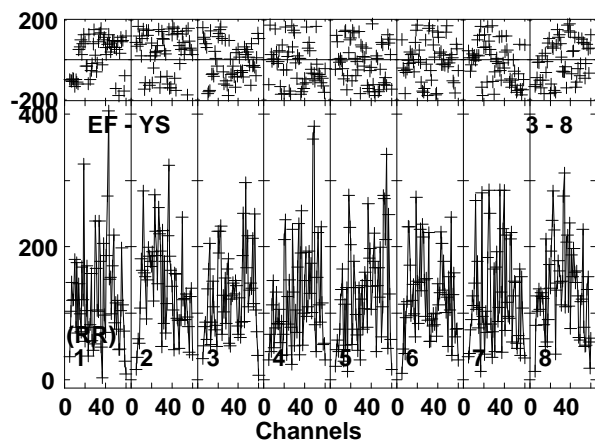
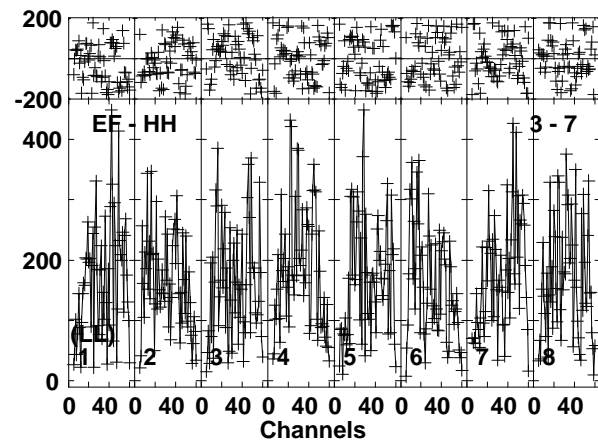
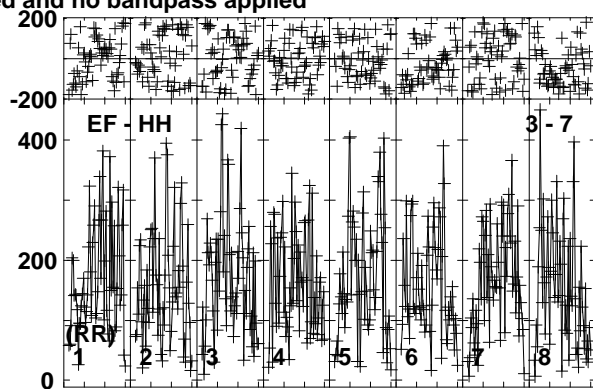
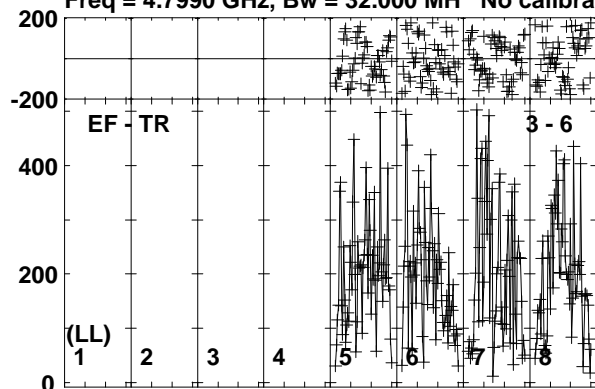

Lower frame: Micro Ampl Jy Top frame: Phas deg
Vector averaged cross-power spectrum Baseline: EF (03) - TR (06)
Timerange: 00:12:19:01 to 00:12:20:29

Plot file version 7 created 28-AUG-2017 13:18:59

NVSS2 RP029A.UVDATA.1

Freq = 4.7990 GHz, Bw = 32.000 MH No calibration applied and no bandpass applied

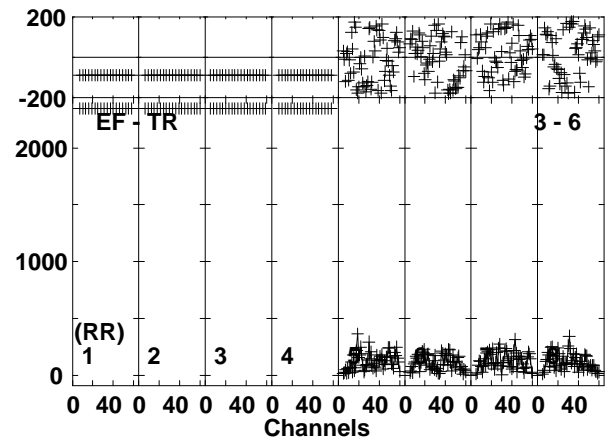
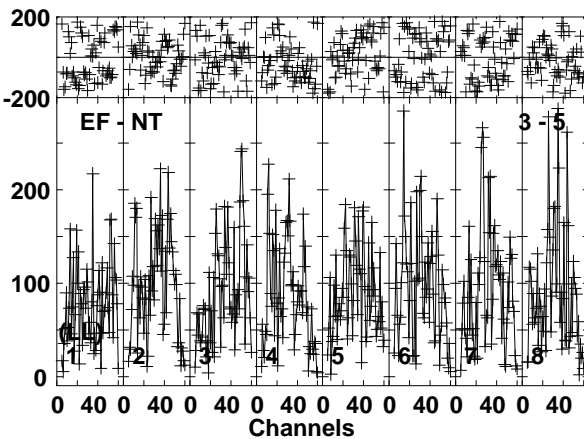
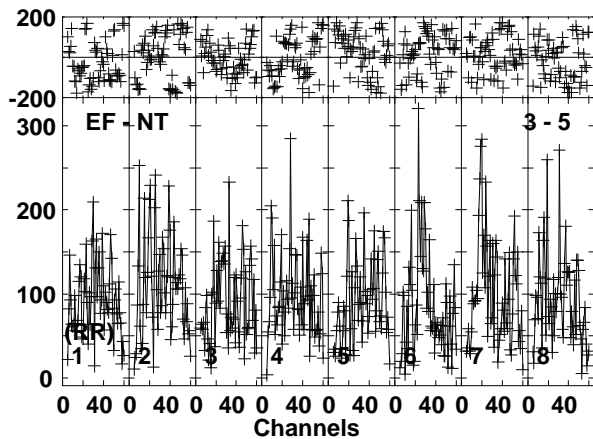
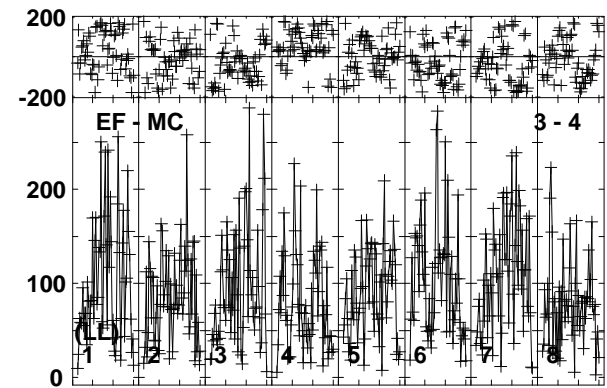
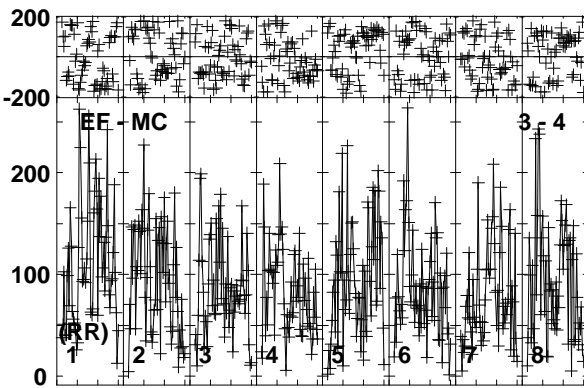
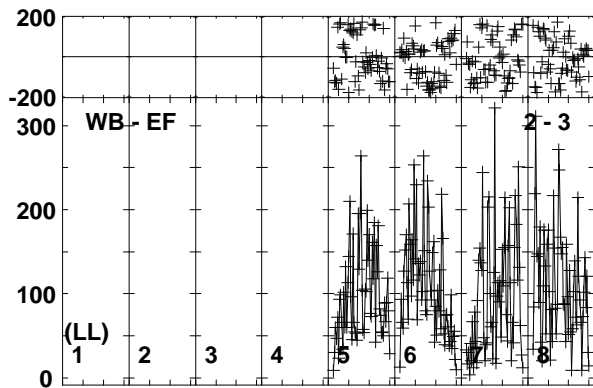
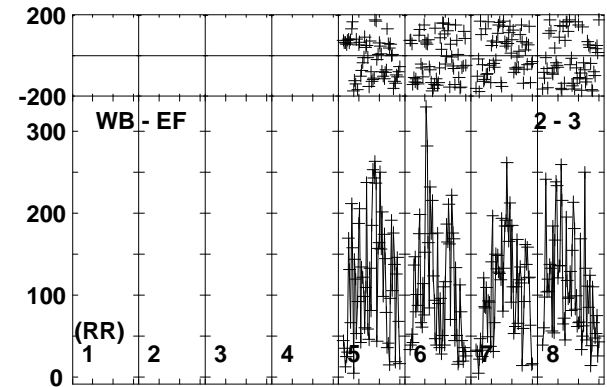
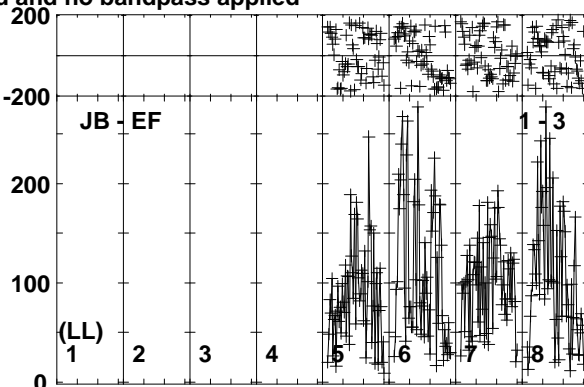
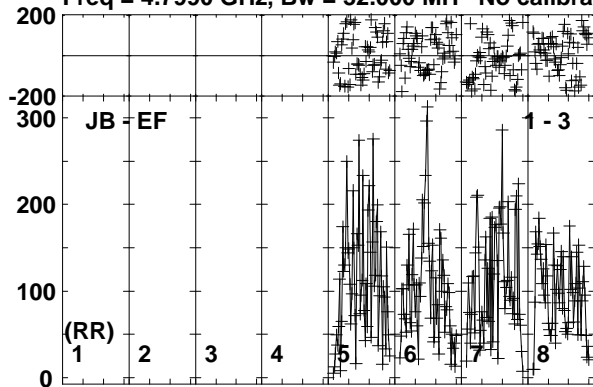

Lower frame: Micro Ampl Jy Top frame: Phas deg
Vector averaged cross-power spectrum Baseline: JB (01) - EF (03)
Timerange: 00/12:20:31 to 00/12:22:59

Plot file version 8 created 28-AUG-2017 13:18:59

NVSS2 RP029A.UVDATA.1

Freq = 4.7990 GHz, Bw = 32.000 MH No calibration applied and no bandpass applied

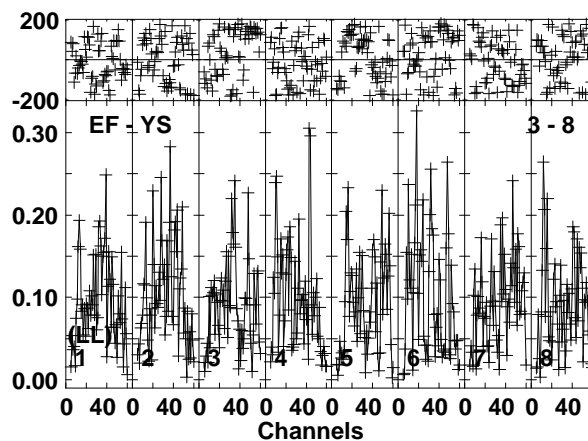
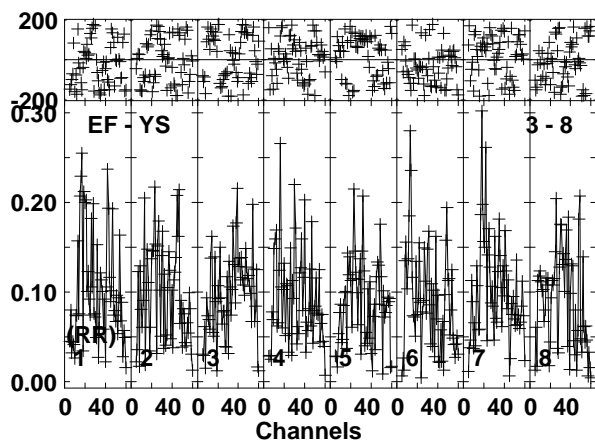
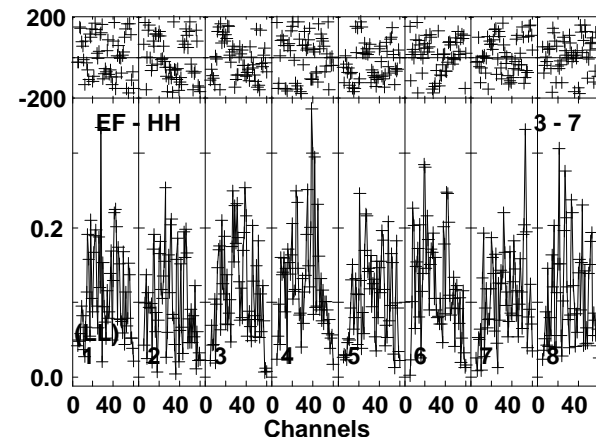
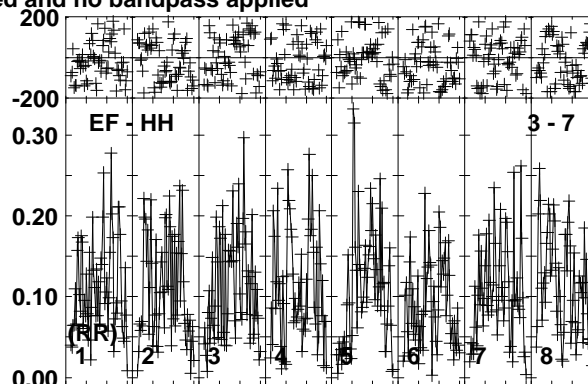
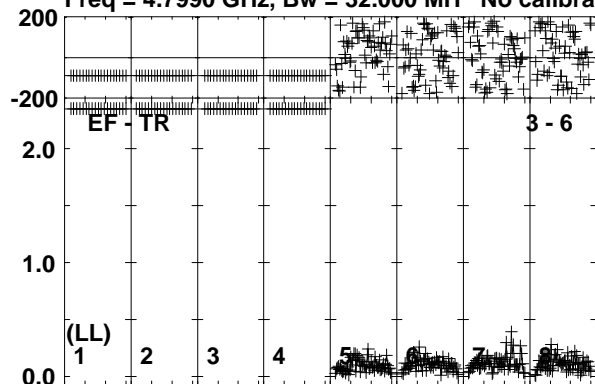

Lower frame: Milli Ampl Jy Top frame: Phas deg
Vector averaged cross-power spectrum Baseline: EF (03) - TR (06)
Timerange: 00:12:20:31 to 00:12:22:59

Plot file version 9 created 28-AUG-2017 13:18:59

J1303-2405 RP029A.UVDATA.1

Freq = 4.7990 GHz, Bw = 32.000 MH No calibration applied and no bandpass applied

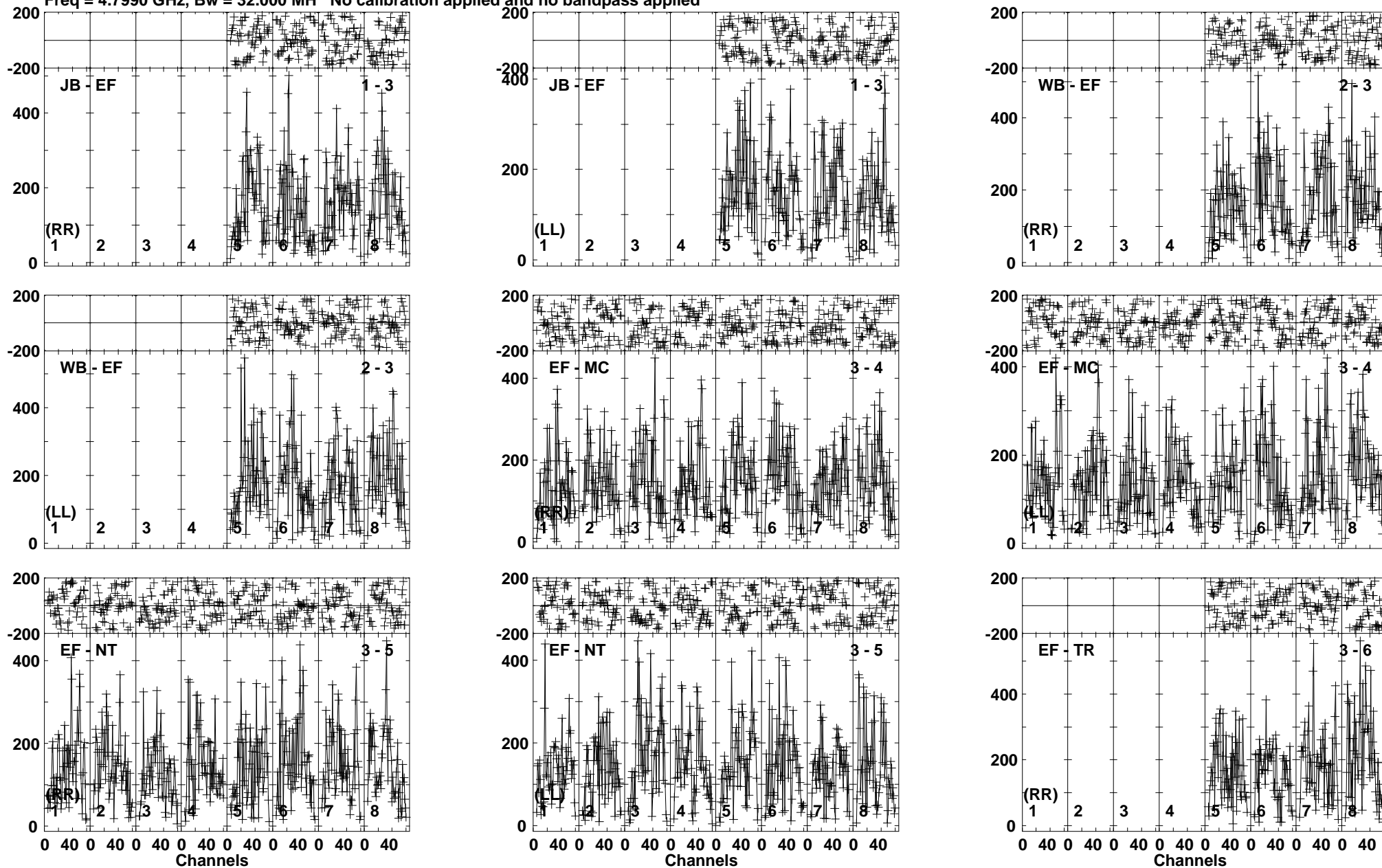

Lower frame: Micro Ampl Jy Top frame: Phas deg
Vector averaged cross-power spectrum Baseline: JB (01) - EF (03)
Timerange: 00/12:23:31 to 00/12:24:29

Plot file version 10 created 28-AUG-2017 13:18:59

J1303-2405 RP029A.UVDATA.1

Freq = 4.7990 GHz, Bw = 32.000 MH No calibration applied and no bandpass applied

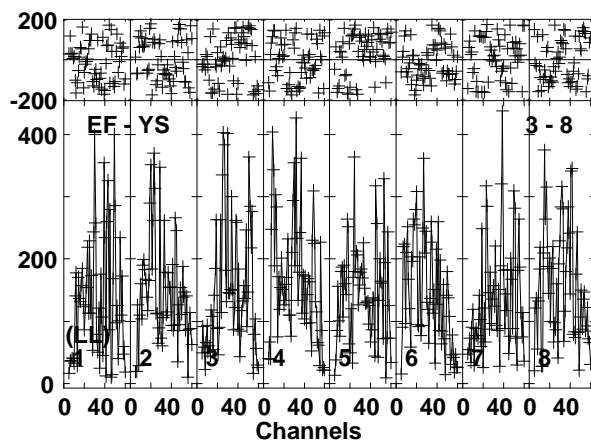
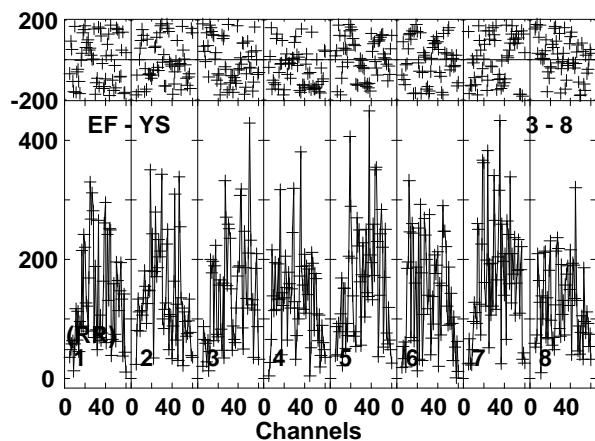
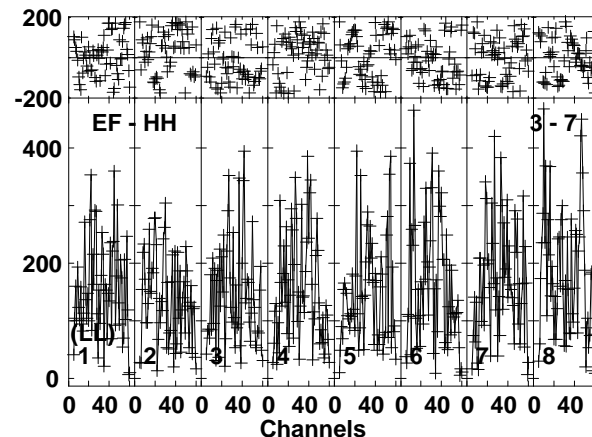
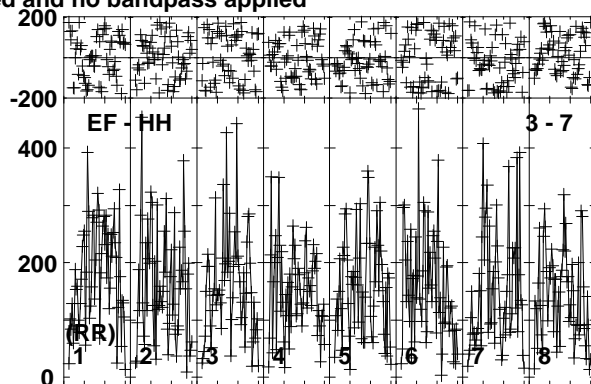
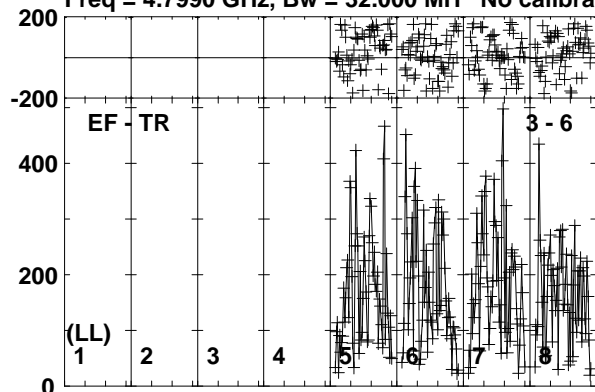

Lower frame: Micro Ampl Jy Top frame: Phas deg
Vector averaged cross-power spectrum Baseline: EF (03) - TR (06)
Timerange: 00/12:23:31 to 00/12:24:29

Plot file version 11 created 28-AUG-2017 13:19:00

NVSS3 RP029A.UVDATA.1

Freq = 4.7990 GHz, Bw = 32.000 MH No calibration applied and no bandpass applied

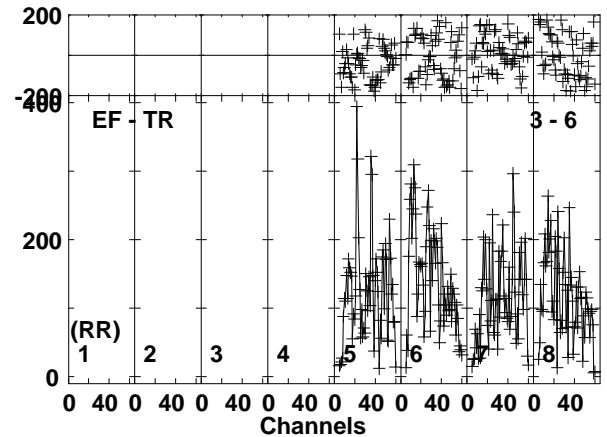
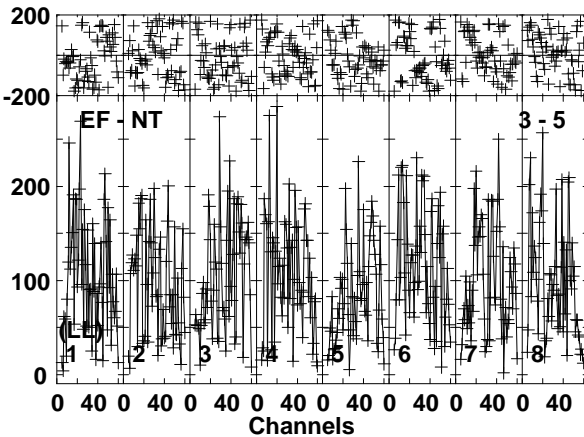
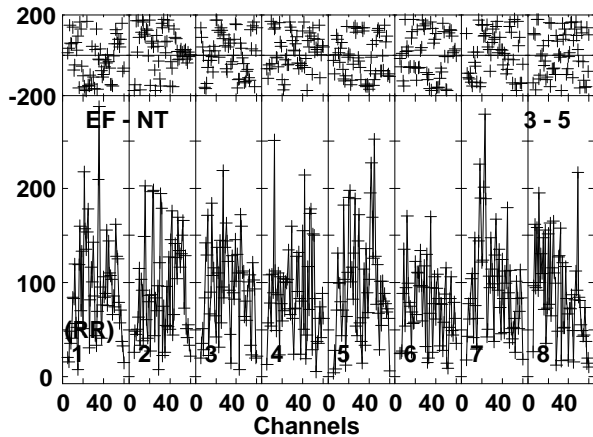
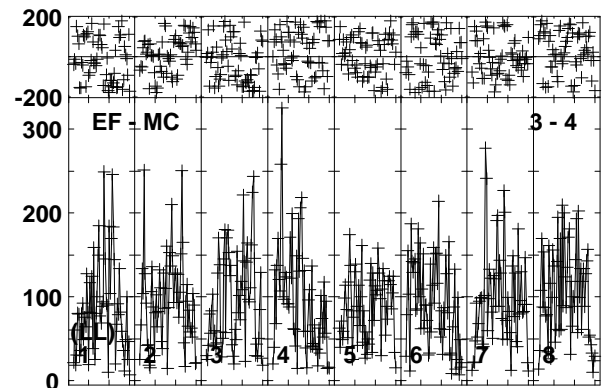
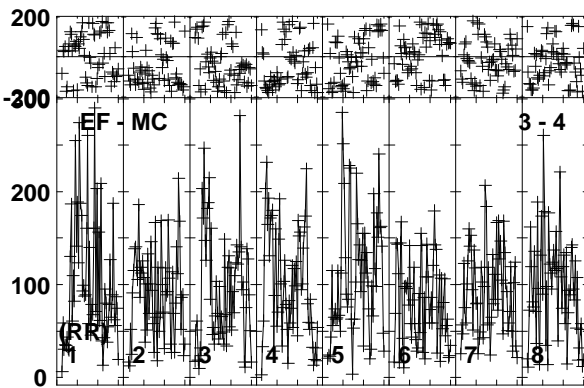
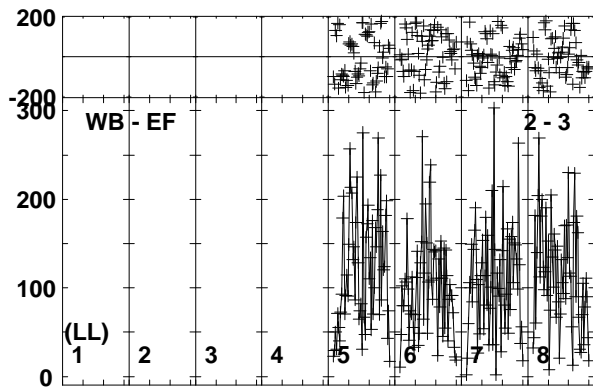
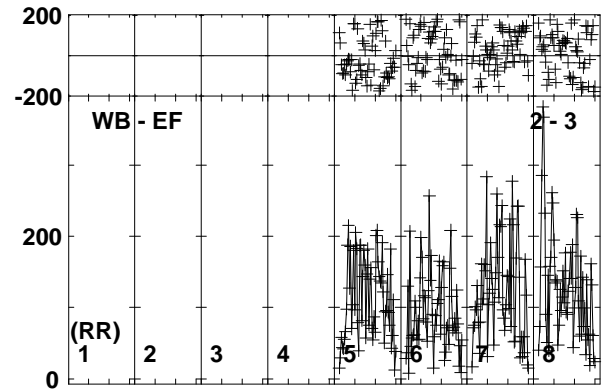
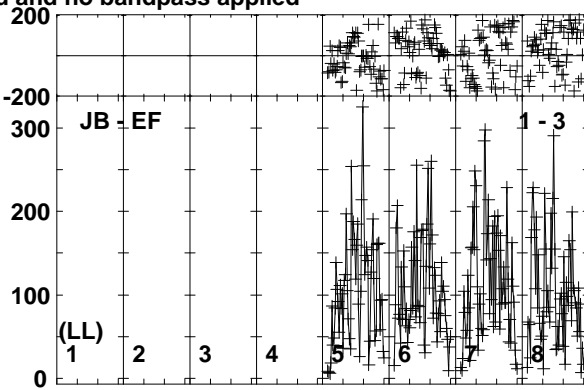
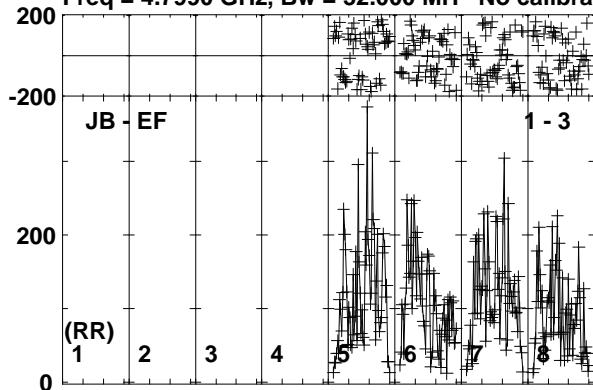

Lower frame: Micro Ampl Jy Top frame: Phas deg
Vector averaged cross-power spectrum Baseline: JB (01) - EF (03)
Timerange: 00/12:24:31 to 00/12:26:59

Plot file version 12 created 28-AUG-2017 13:19:00

NVSS3 RP029A.UVDATA.1

Freq = 4.7990 GHz, Bw = 32.000 MH No calibration applied and no bandpass applied

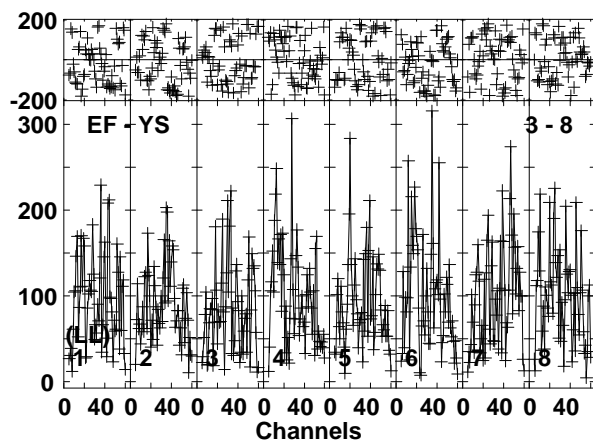
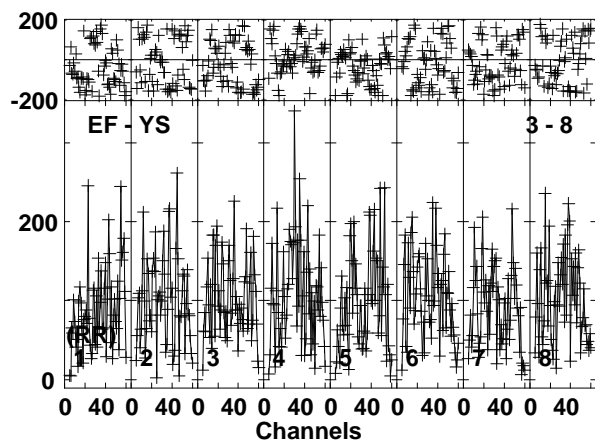
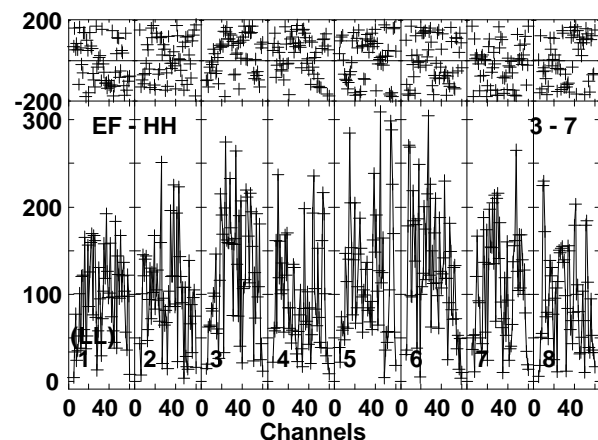
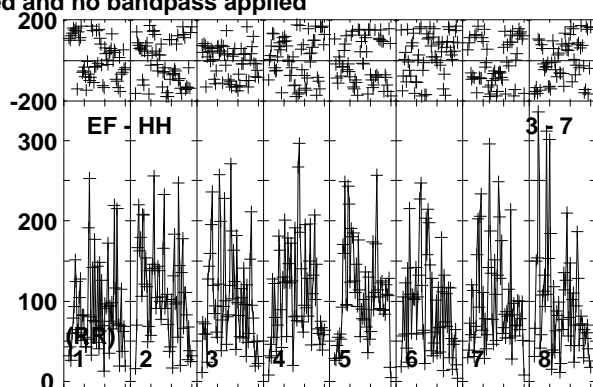
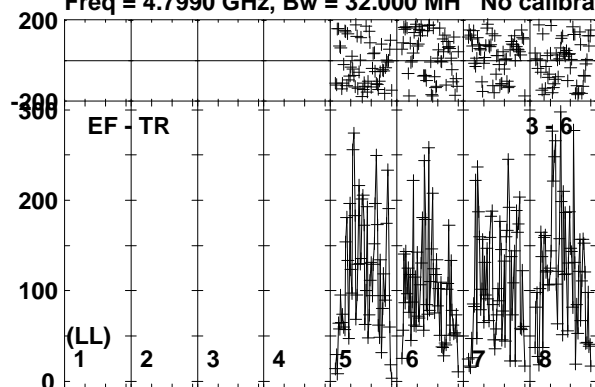

Lower frame: Micro Ampl Jy Top frame: Phas deg
Vector averaged cross-power spectrum Baseline: EF (03) - TR (06)
Timerange: 00/12:24:31 to 00/12:26:59

Plot file version 13 created 28-AUG-2017 13:19:00

J1303-2405 RP029A.UVDATA.1

Freq = 4.7990 GHz, Bw = 32.000 MH No calibration applied and no bandpass applied

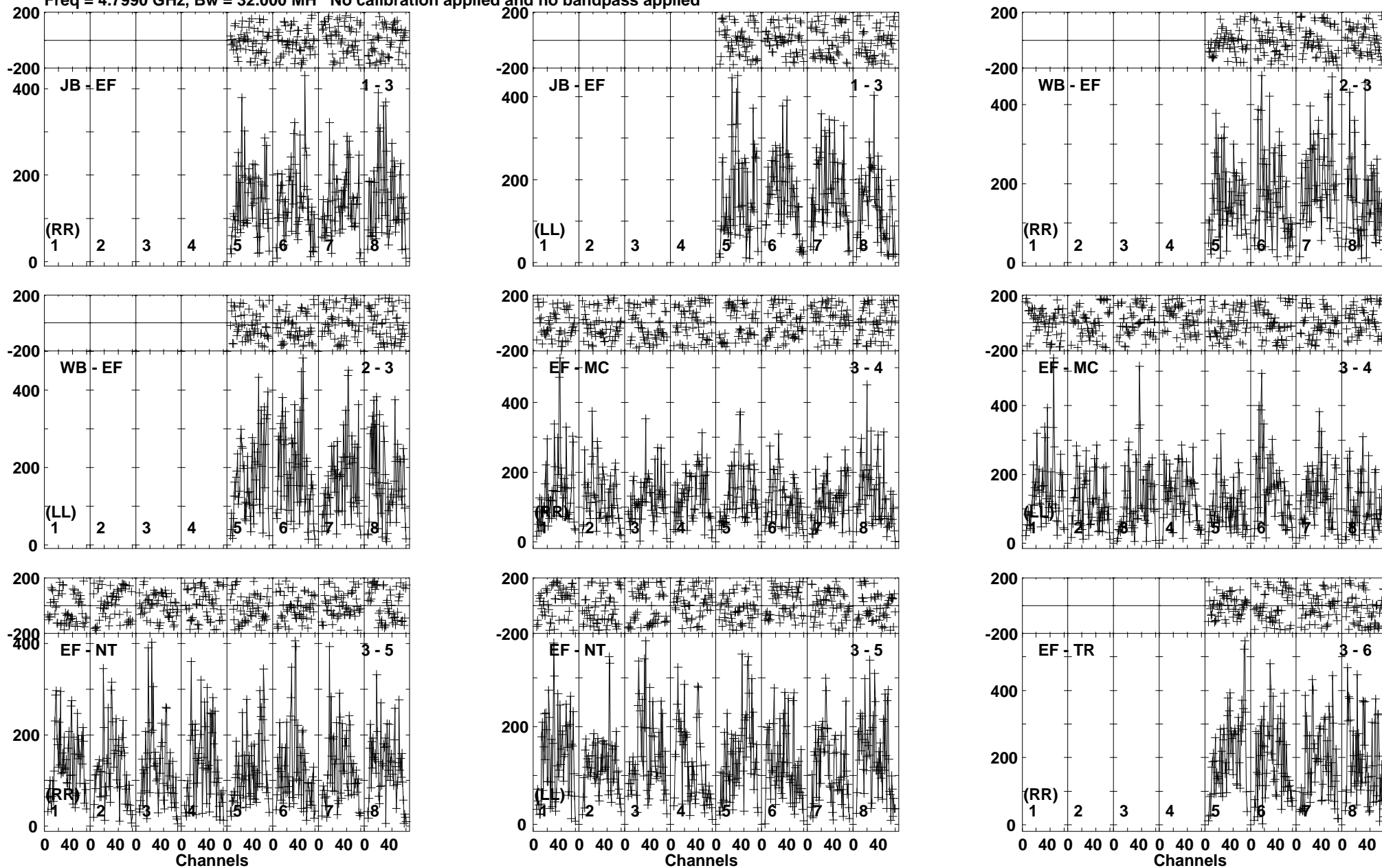

Lower frame: Micro Ampl Jy Top frame: Phas deg
Vector averaged cross-power spectrum Baseline: JB (01) - EF (03)
Timerange: 00/12:27:01 to 00/12:28:29

Plot file version 14 created 28-AUG-2017 13:19:00

J1303-2405 RP029A.UVDATA.1

Freq = 4.7990 GHz, Bw = 32.000 MH No calibration applied and no bandpass applied

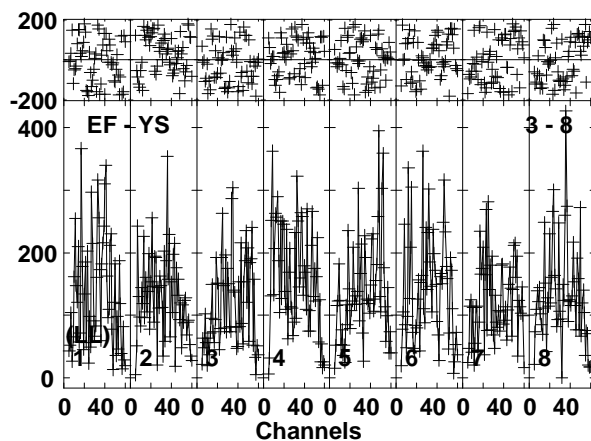
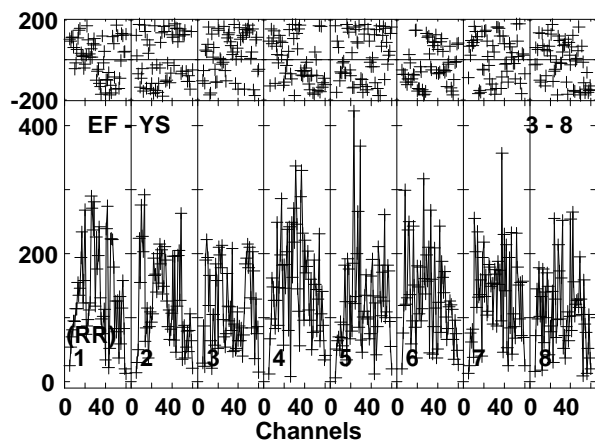
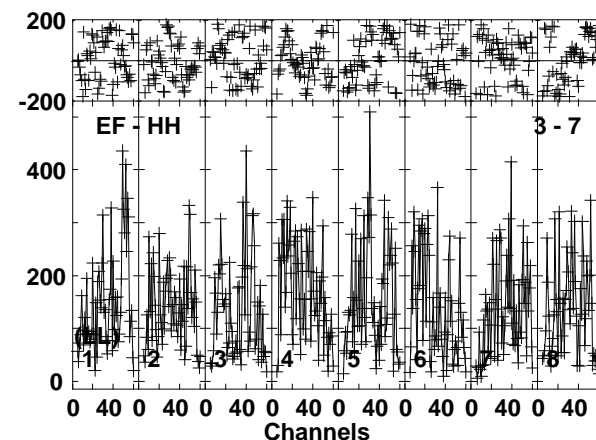
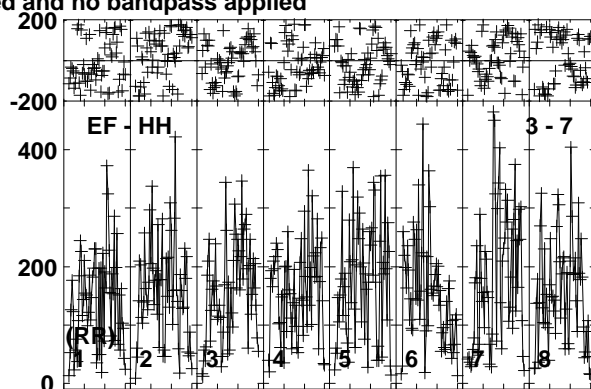
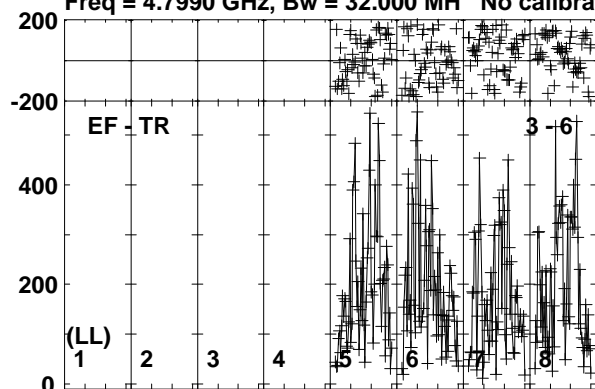

Lower frame: Micro Ampl Jy Top frame: Phas deg
Vector averaged cross-power spectrum Baseline: EF (03) - TR (06)
Timerange: 00:12:27:01 to 00:12:28:29

Plot file version 15 created 28-AUG-2017 13:19:00

SSS17A RP029A.UVDATA.1

Freq = 4.7990 GHz, Bw = 32.000 MH No calibration applied and no bandpass applied

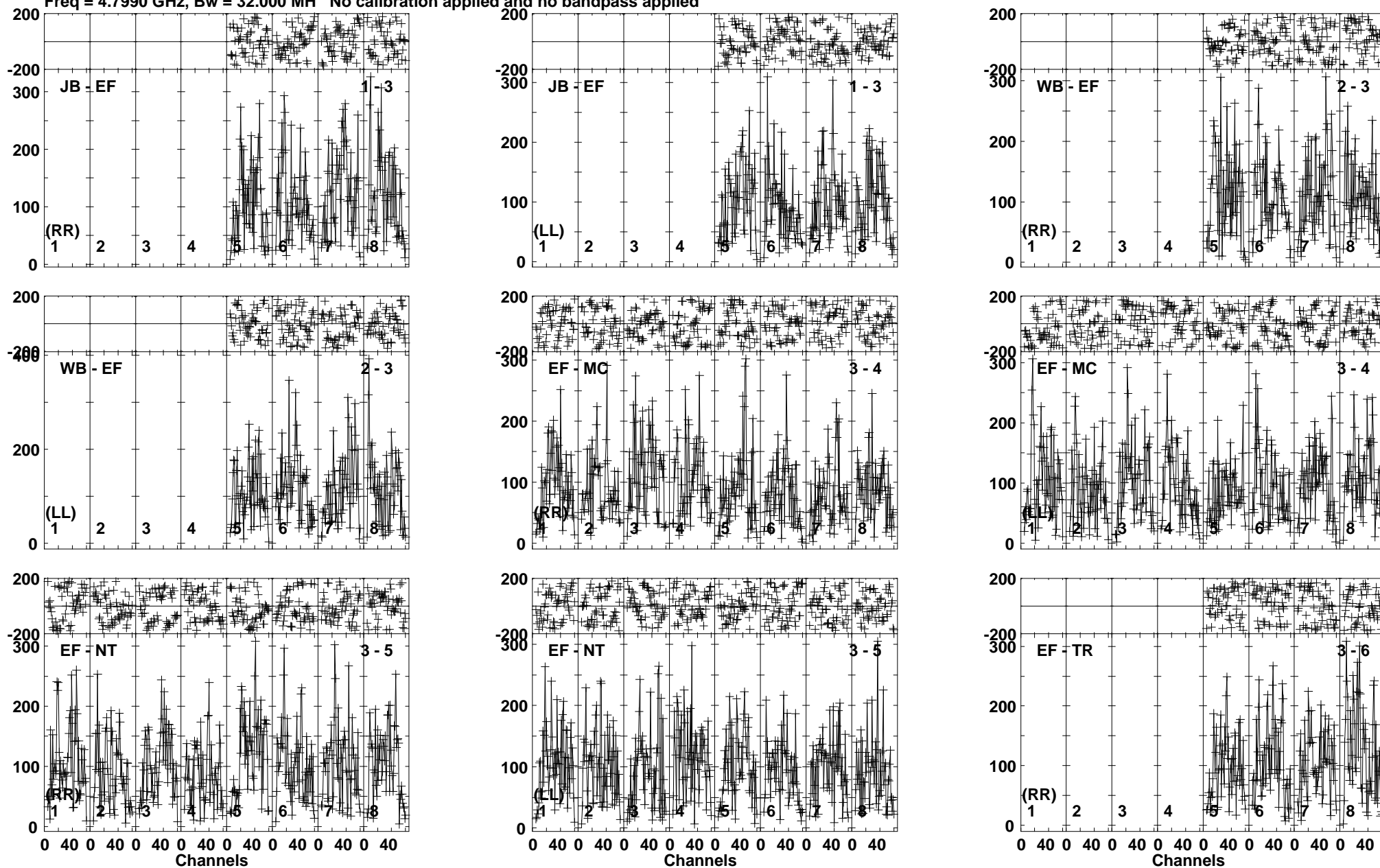

Lower frame: Micro Ampl Jy Top frame: Phas deg
Vector averaged cross-power spectrum Baseline: JB (01) - EF (03)
Timerange: 00/12:28:31 to 00/12:30:59

Plot file version 16 created 28-AUG-2017 13:19:00

SSS17A RP029A.UVDATA.1

Freq = 4.7990 GHz, Bw = 32.000 MH No calibration applied and no bandpass applied

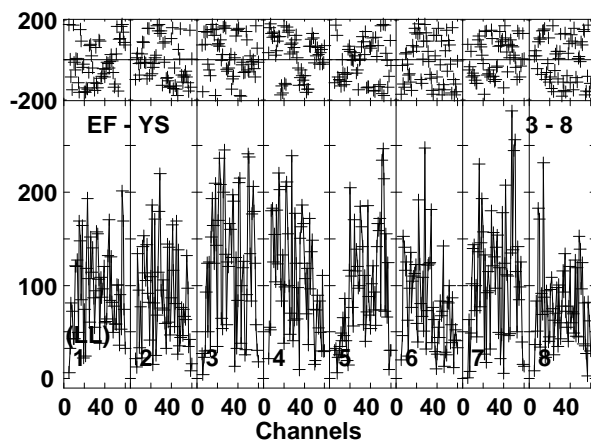
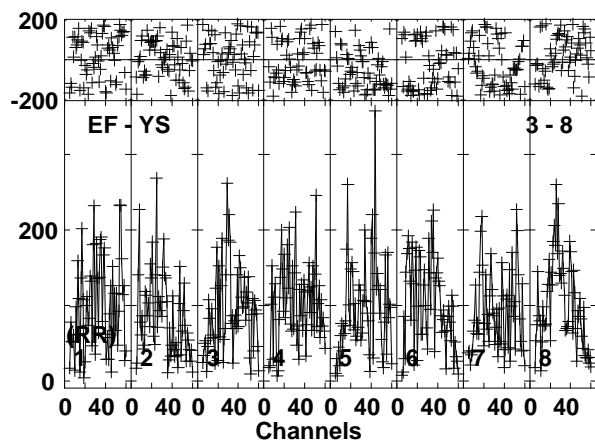
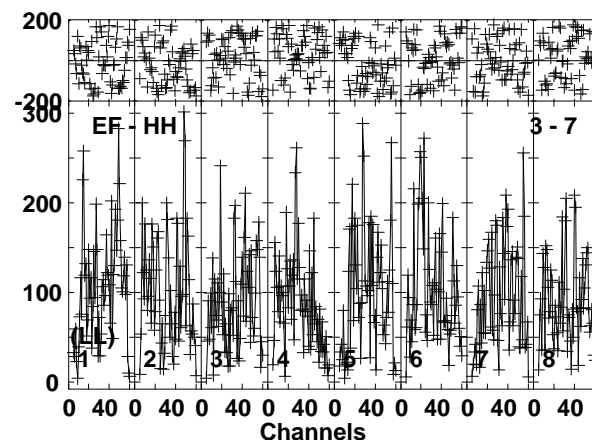
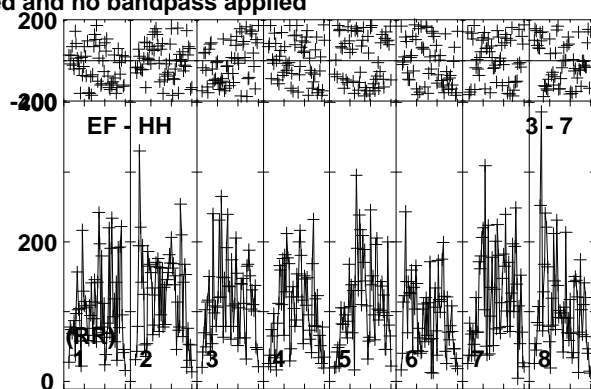
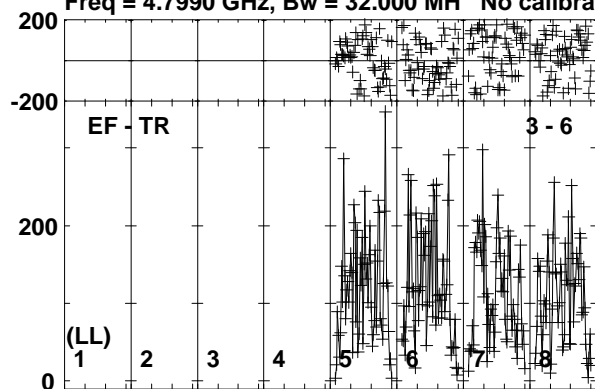

Lower frame: Micro Ampl Jy Top frame: Phas deg
Vector averaged cross-power spectrum Baseline: EF (03) - TR (06)
Timerange: 00/12:28:31 to 00/12:30:59

Plot file version 17 created 28-AUG-2017 13:19:00

J1303-2405 RP029A.UVDATA.1

Freq = 4.7990 GHz, Bw = 32.000 MH No calibration applied and no bandpass applied

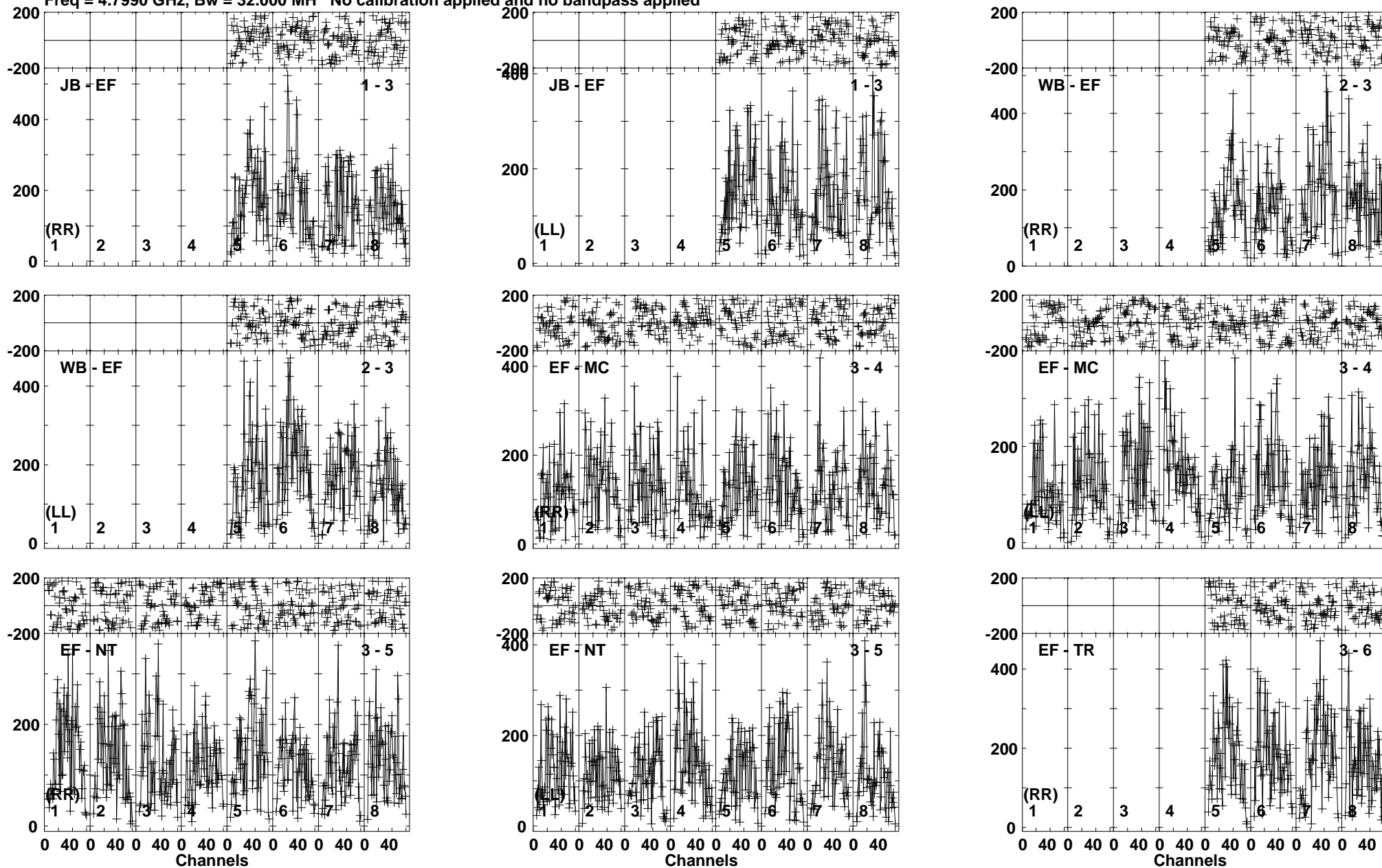

Lower frame: Micro Ampl Jy Top frame: Phas deg
Vector averaged cross-power spectrum Baseline: JB (01) - EF (03)
Timerange: 00:12:31:01 to 00:12:32:29

Plot file version 18 created 28-AUG-2017 13:19:00

J1303-2405 RP029A.UVDATA.1

Freq = 4.7990 GHz, Bw = 32.000 MH No calibration applied and no bandpass applied

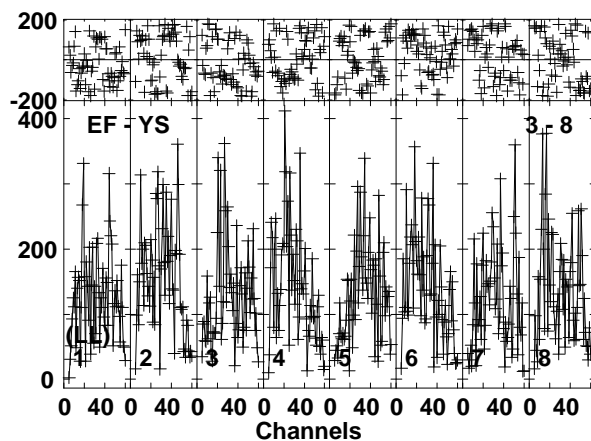
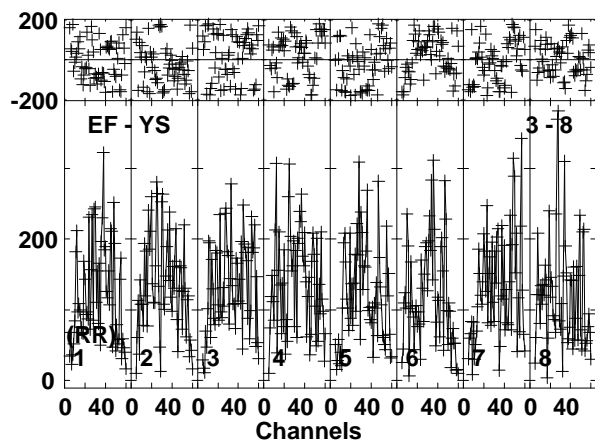
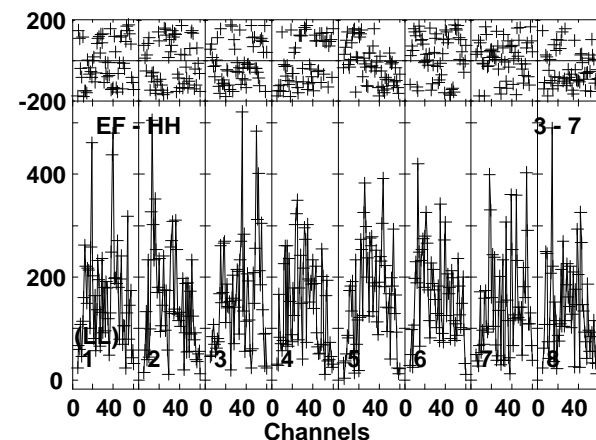
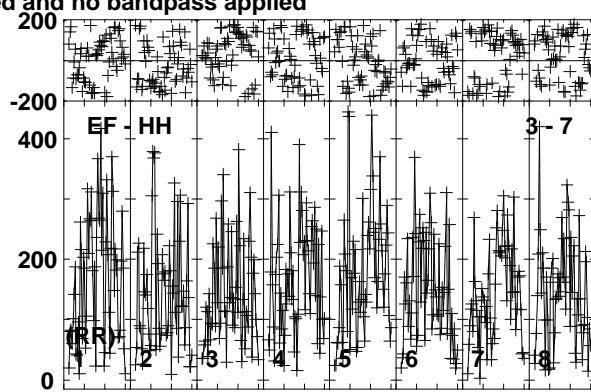
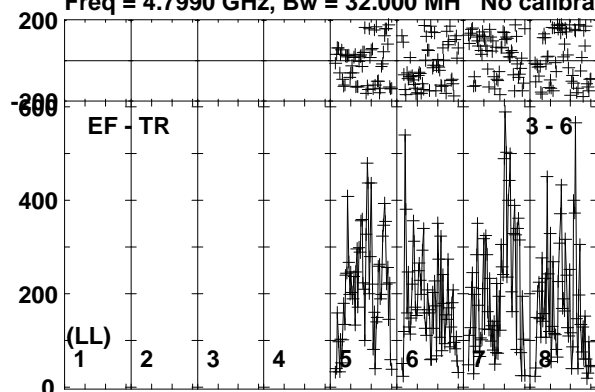

Lower frame: Micro Ampl Jy Top frame: Phas deg
Vector averaged cross-power spectrum Baseline: EF (03) - TR (06)
Timerange: 00:12:31:01 to 00:12:32:29

Plot file version 19 created 28-AUG-2017 13:19:00
 SSS17A RP029A.UVDATA.1
 Freq = 4.7990 GHz, Bw = 32.000 MH No calibration applied and no bandpass applied

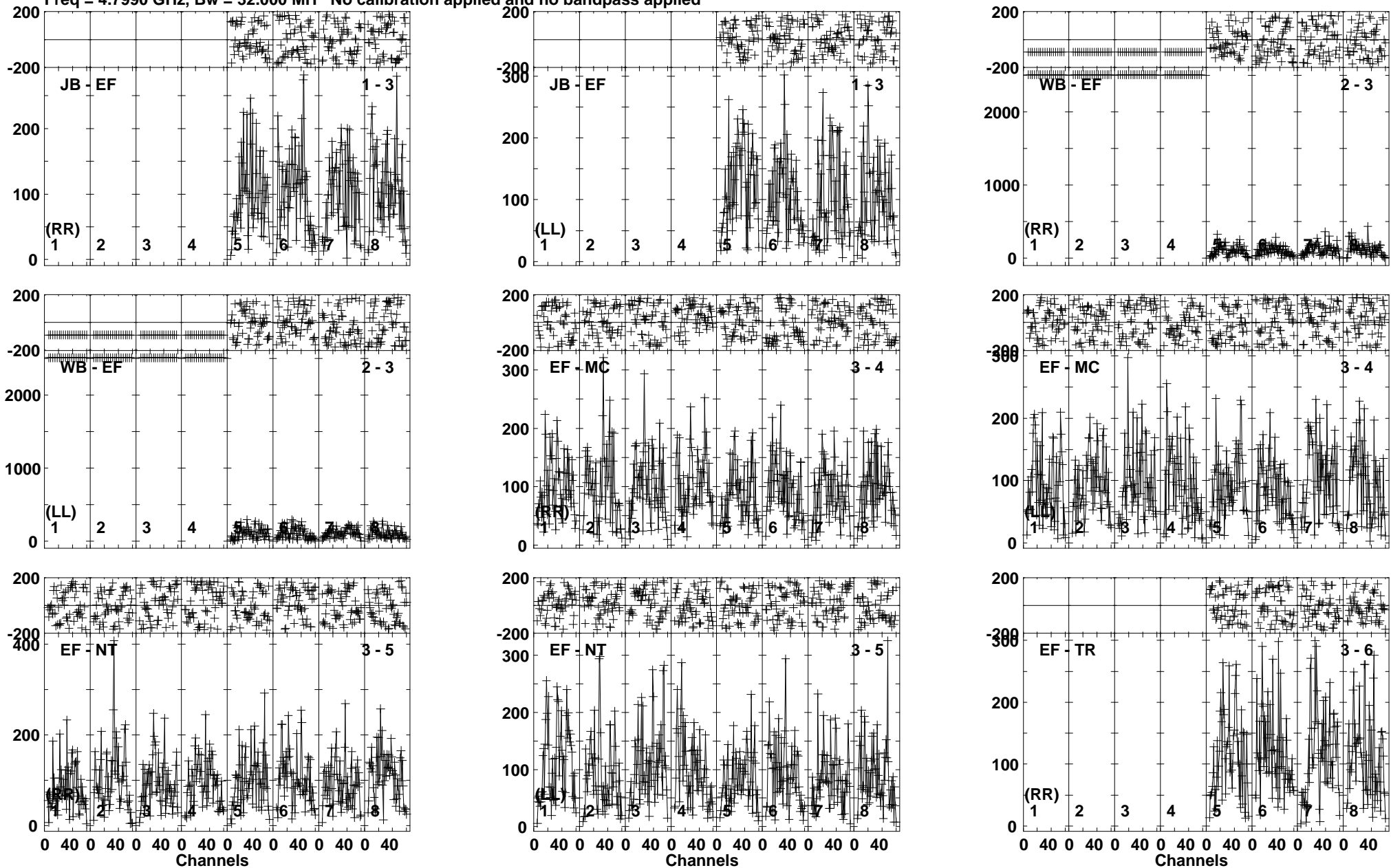

Lower frame: Micro Ampl Jy Top frame: Phas deg
 Vector averaged cross-power spectrum Baseline: JB (01) - EF (03)
 Timerange: 00/12:32:31 to 00/12:34:59

Plot file version 20 created 28-AUG-2017 13:19:00

SSS17A RP029A.UVDATA.1

Freq = 4.7990 GHz, Bw = 32.000 MH No calibration applied and no bandpass applied

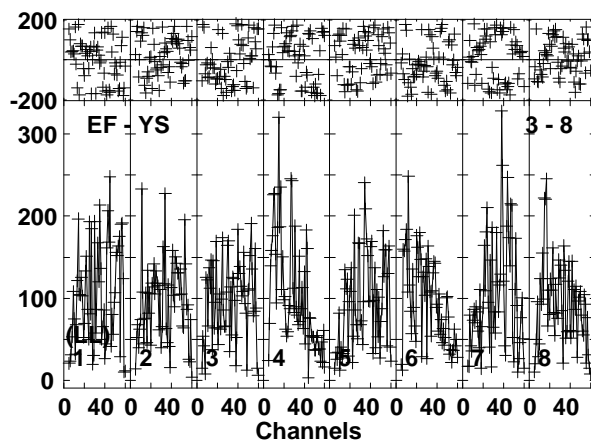
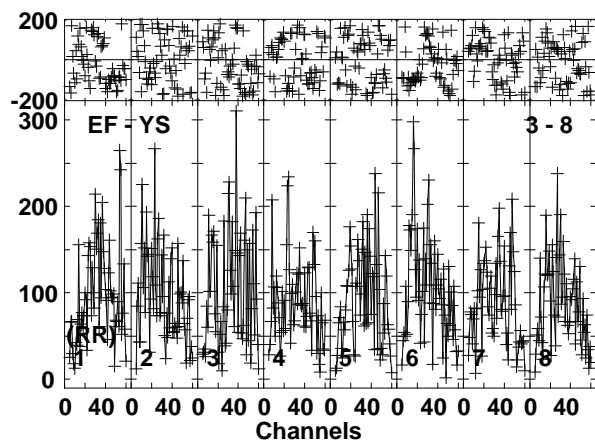
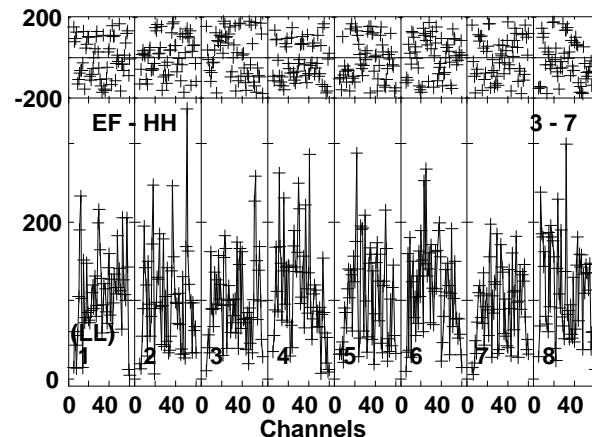
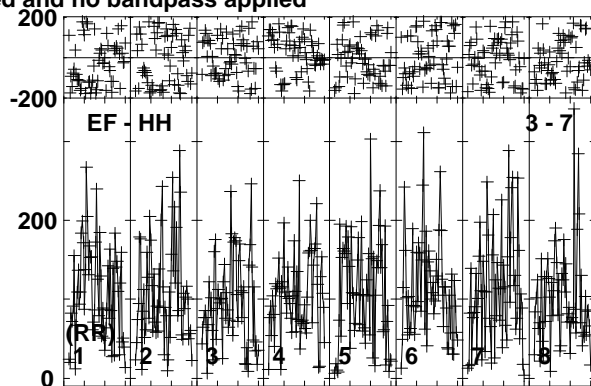
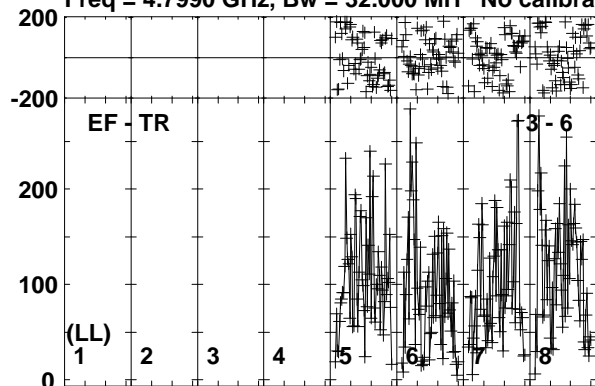

Lower frame: Micro Ampl Jy Top frame: Phas deg
Vector averaged cross-power spectrum Baseline: EF (03) - TR (06)
Timerange: 00:12:32:31 to 00:12:34:59

Plot file version 21 created 28-AUG-2017 13:19:00

J1303-2405 RP029A.UVDATA.1

Freq = 4.7990 GHz, Bw = 32.000 MH No calibration applied and no bandpass applied

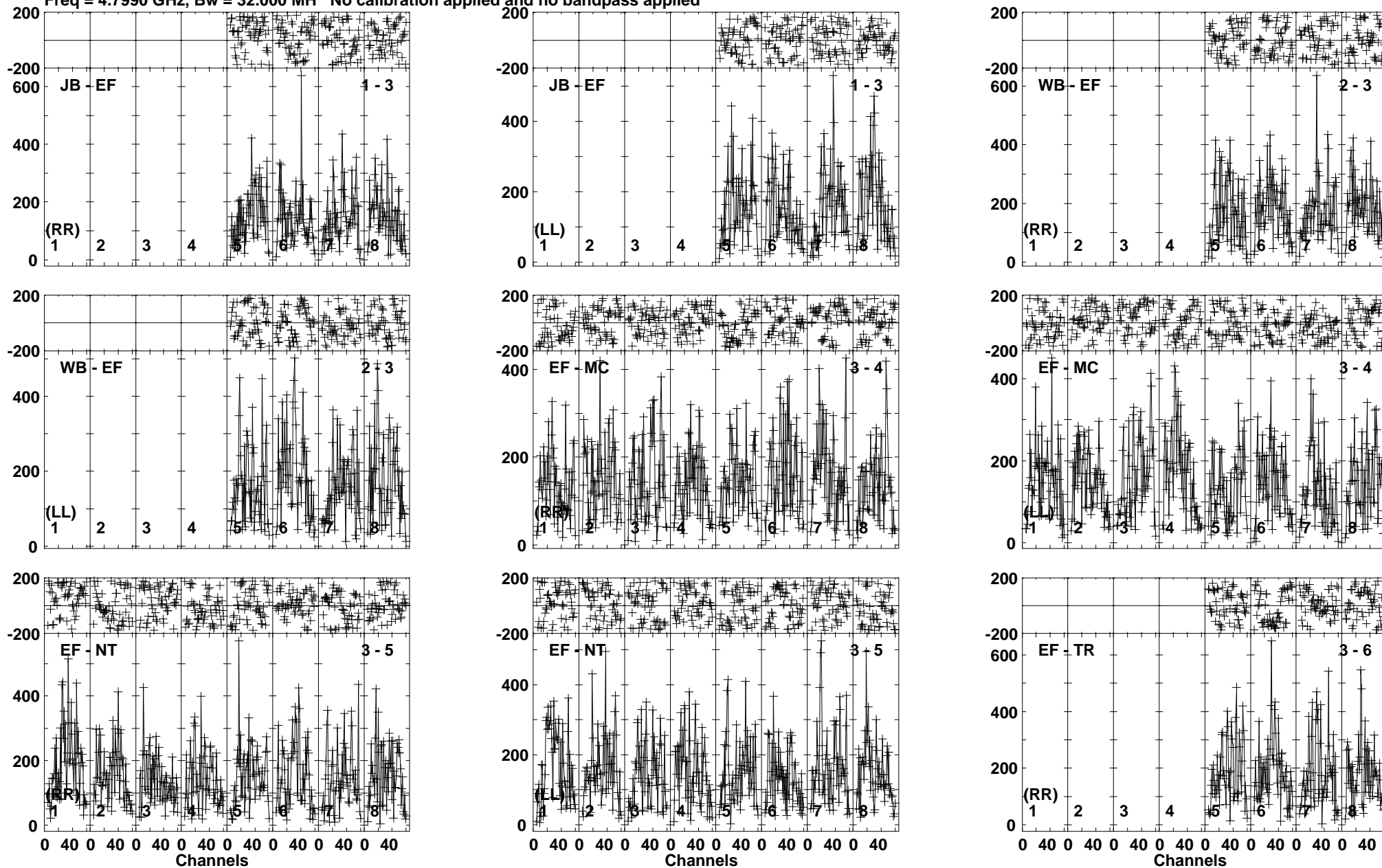

Lower frame: Micro Ampl Jy Top frame: Phas deg
Vector averaged cross-power spectrum Baseline: JB (01) - EF (03)
Timerange: 00/12:35:31 to 00/12:36:29

Plot file version 22 created 28-AUG-2017 13:19:01

J1303-2405 RP029A.UVDATA.1

Freq = 4.7990 GHz, Bw = 32.000 MH No calibration applied and no bandpass applied

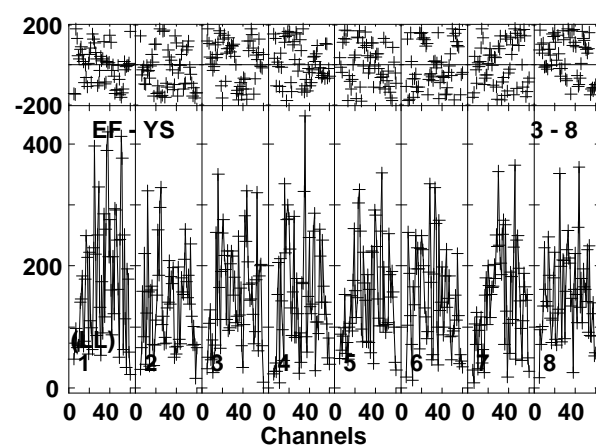
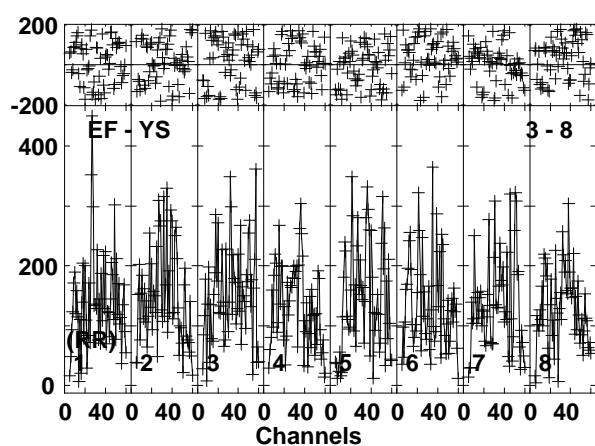
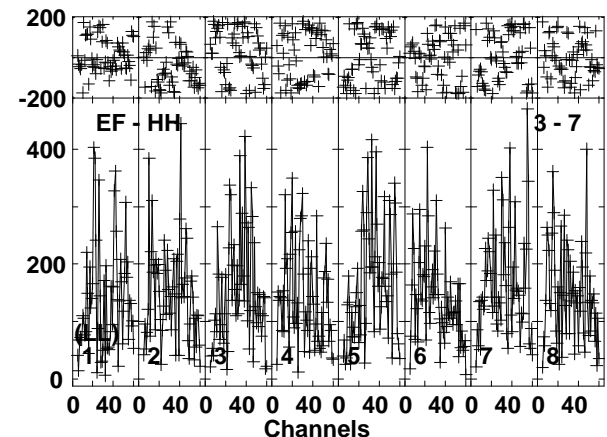
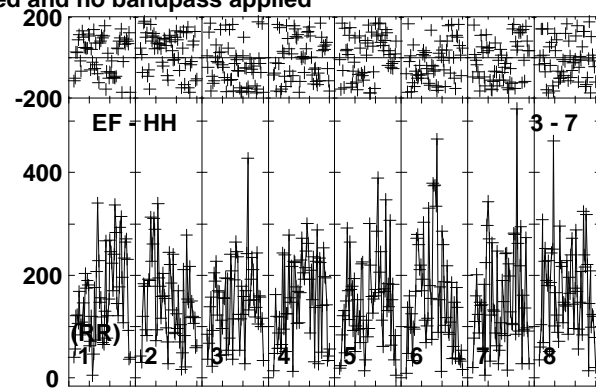
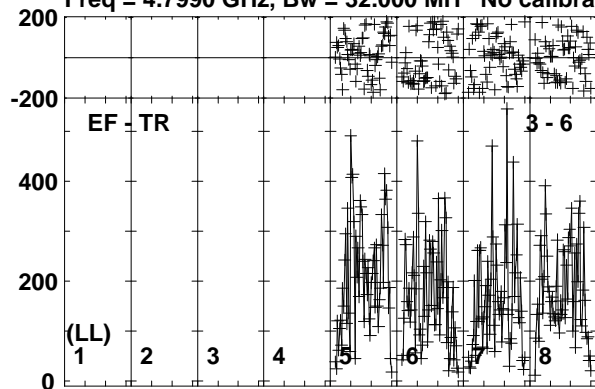

Lower frame: Micro Ampl Jy Top frame: Phas deg
Vector averaged cross-power spectrum Baseline: EF (03) - TR (06)
Timerange: 00/12:35:31 to 00/12:36:29

Plot file version 23 created 28-AUG-2017 13:19:01
 SSS17A RP029A.UVDATA.1
 Freq = 4.7990 GHz, Bw = 32.000 MH No calibration applied and no bandpass applied

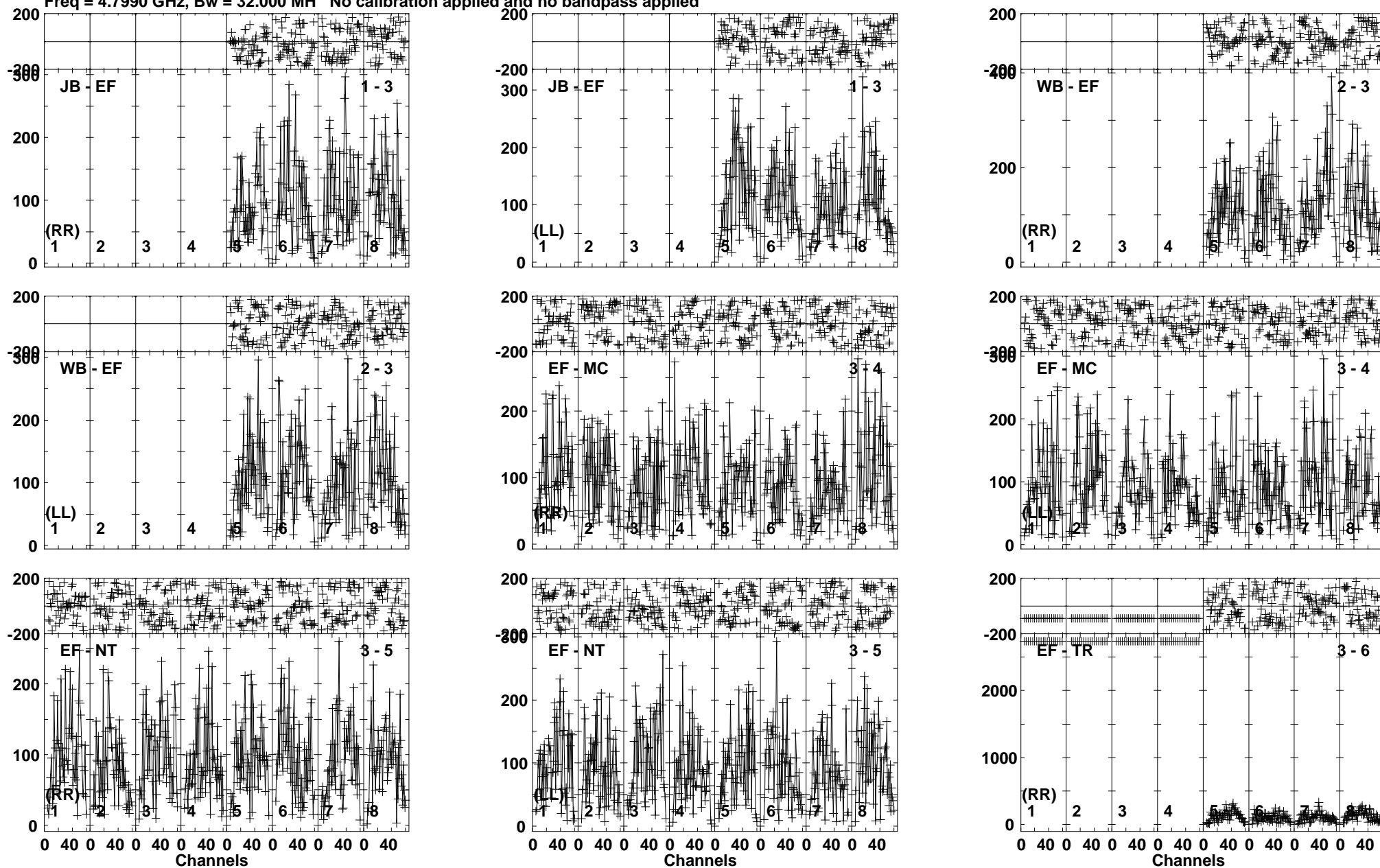

Lower frame: Micro Ampl Jy Top frame: Phas deg
 Vector averaged cross-power spectrum Baseline: JB (01) - EF (03)
 Timerange: 00/12:36:31 to 00/12:38:59

Plot file version 24 created 28-AUG-2017 13:19:01

SSS17A RP029A.UVDATA.1

Freq = 4.7990 GHz, Bw = 32.000 MH No calibration applied and no bandpass applied

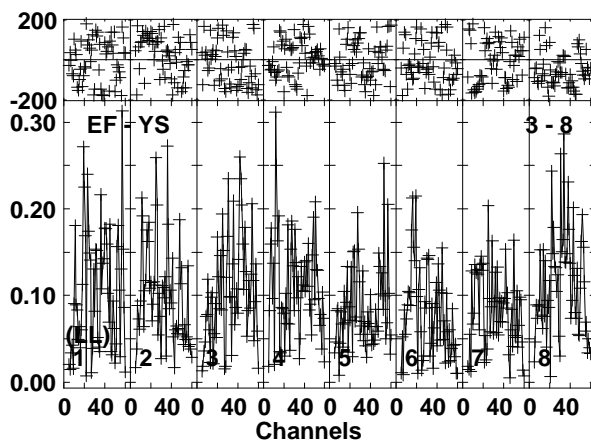
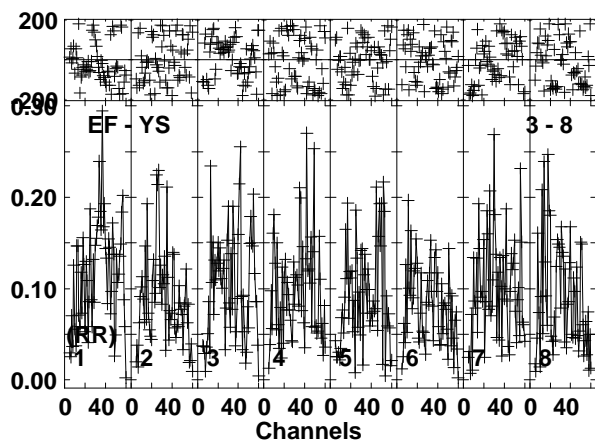
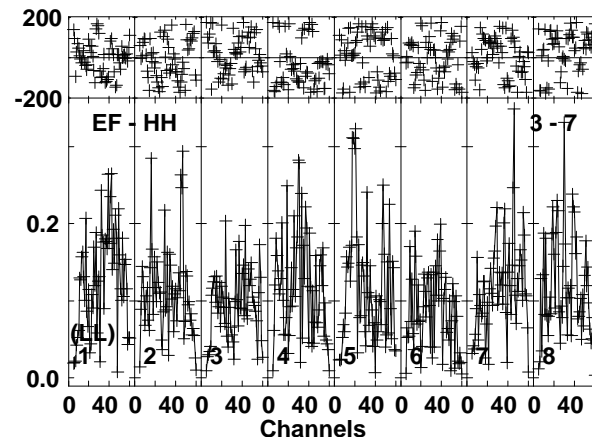
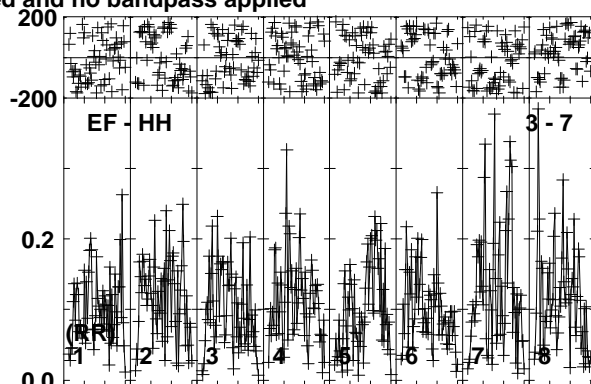
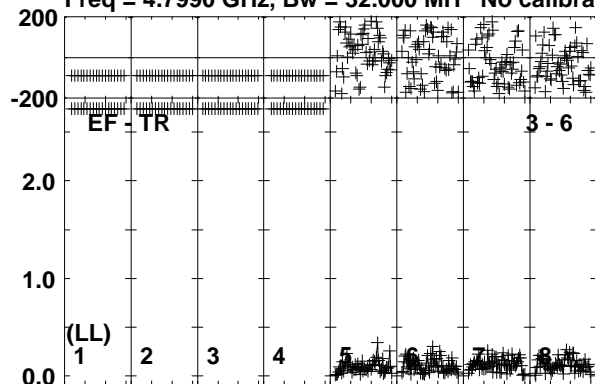

Lower frame: Milli Ampl Jy Top frame: Phas deg
Vector averaged cross-power spectrum Baseline: EF (03) - TR (06)
Timerange: 00:12:36:31 to 00:12:38:59

Plot file version 25 created 28-AUG-2017 13:19:01

J1303-2405 RP029A.UVDATA.1

Freq = 4.7990 GHz, Bw = 32.000 MH No calibration applied and no bandpass applied

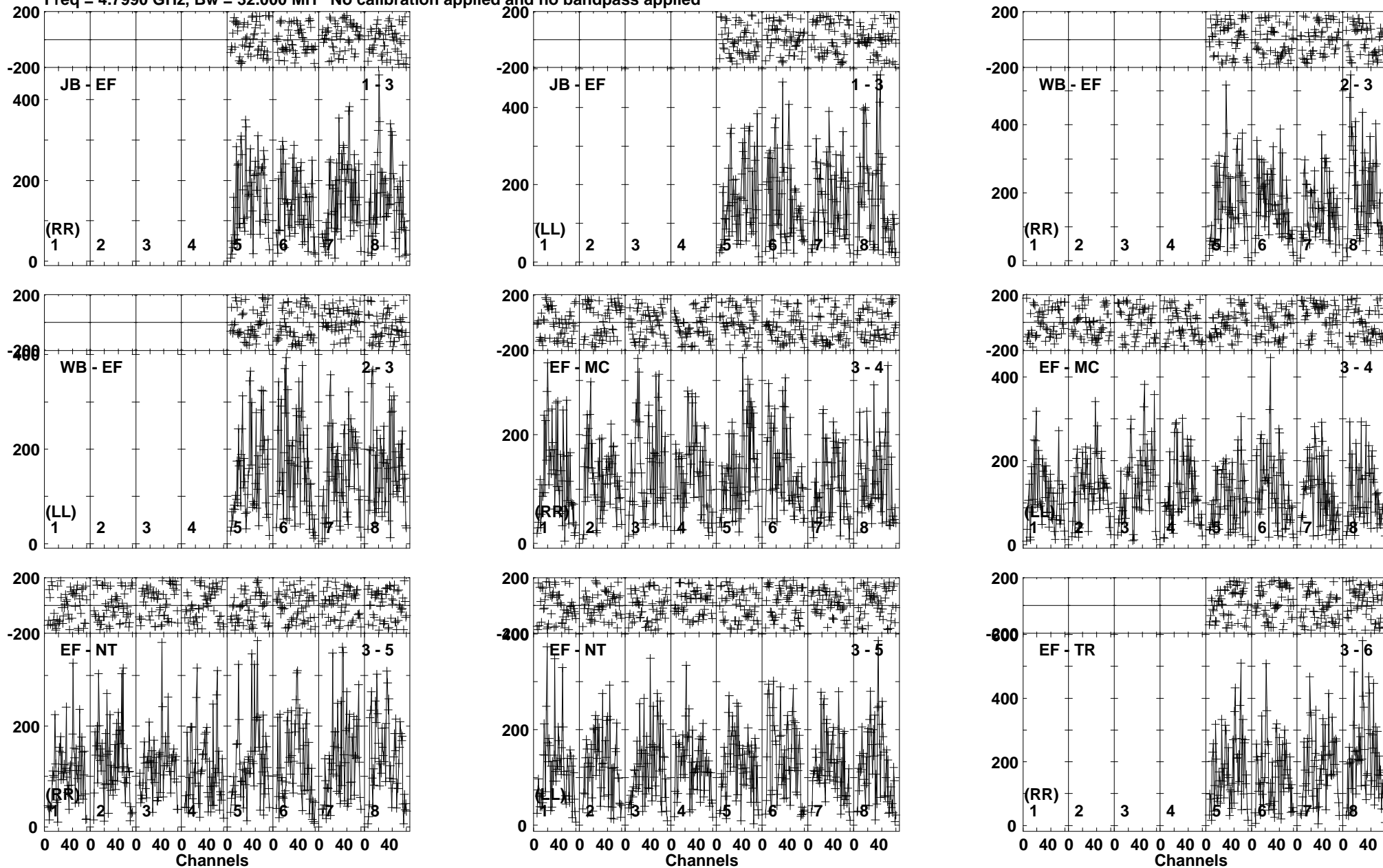

Lower frame: Micro Ampl Jy Top frame: Phas deg
Vector averaged cross-power spectrum Baseline: JB (01) - EF (03)
Timerange: 00:12:39:01 to 00:12:40:29

Plot file version 26 created 28-AUG-2017 13:19:01

J1303-2405 RP029A.UVDATA.1

Freq = 4.7990 GHz, Bw = 32.000 MH No calibration applied and no bandpass applied

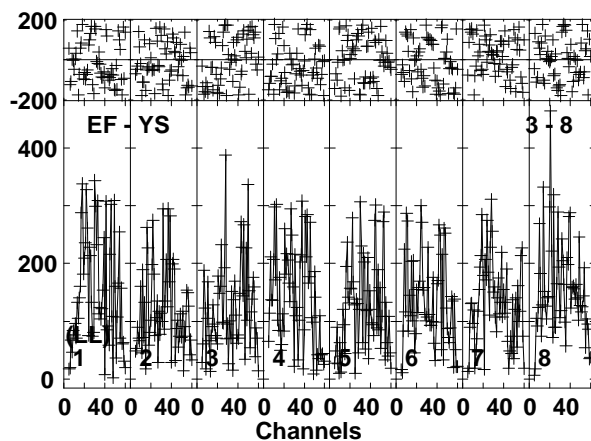
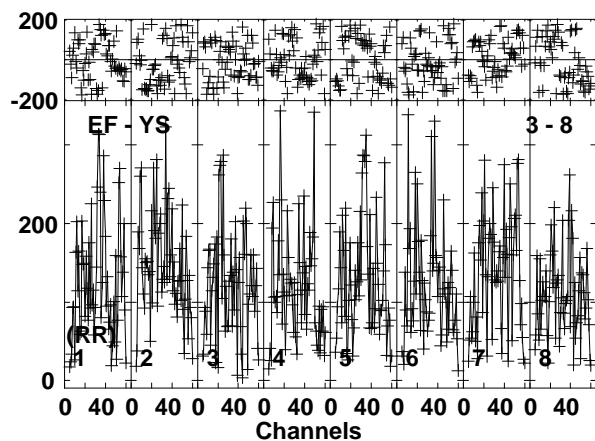
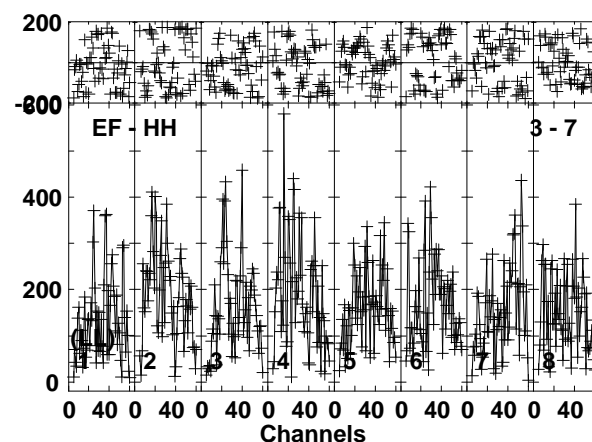
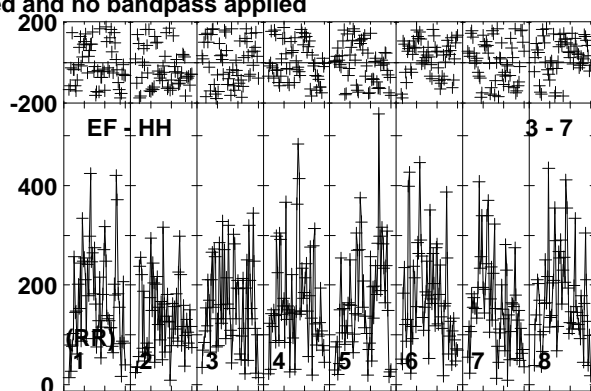
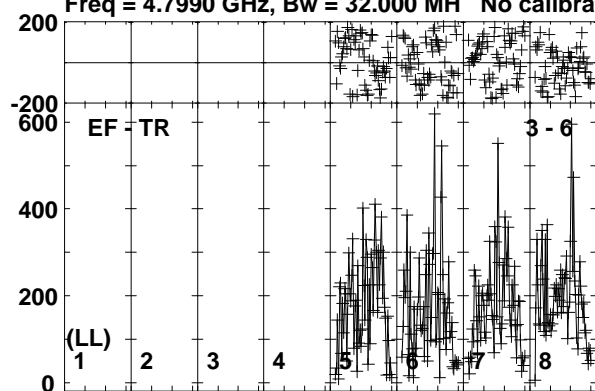

Lower frame: Micro Ampl Jy Top frame: Phas deg
Vector averaged cross-power spectrum Baseline: EF (03) - TR (06)
Timerange: 00:12:39:01 to 00:12:40:29

Plot file version 27 created 28-AUG-2017 13:19:01

J1312-2350 RP029A.UVDATA.1

Freq = 4.7990 GHz, Bw = 32.000 MH No calibration applied and no bandpass applied

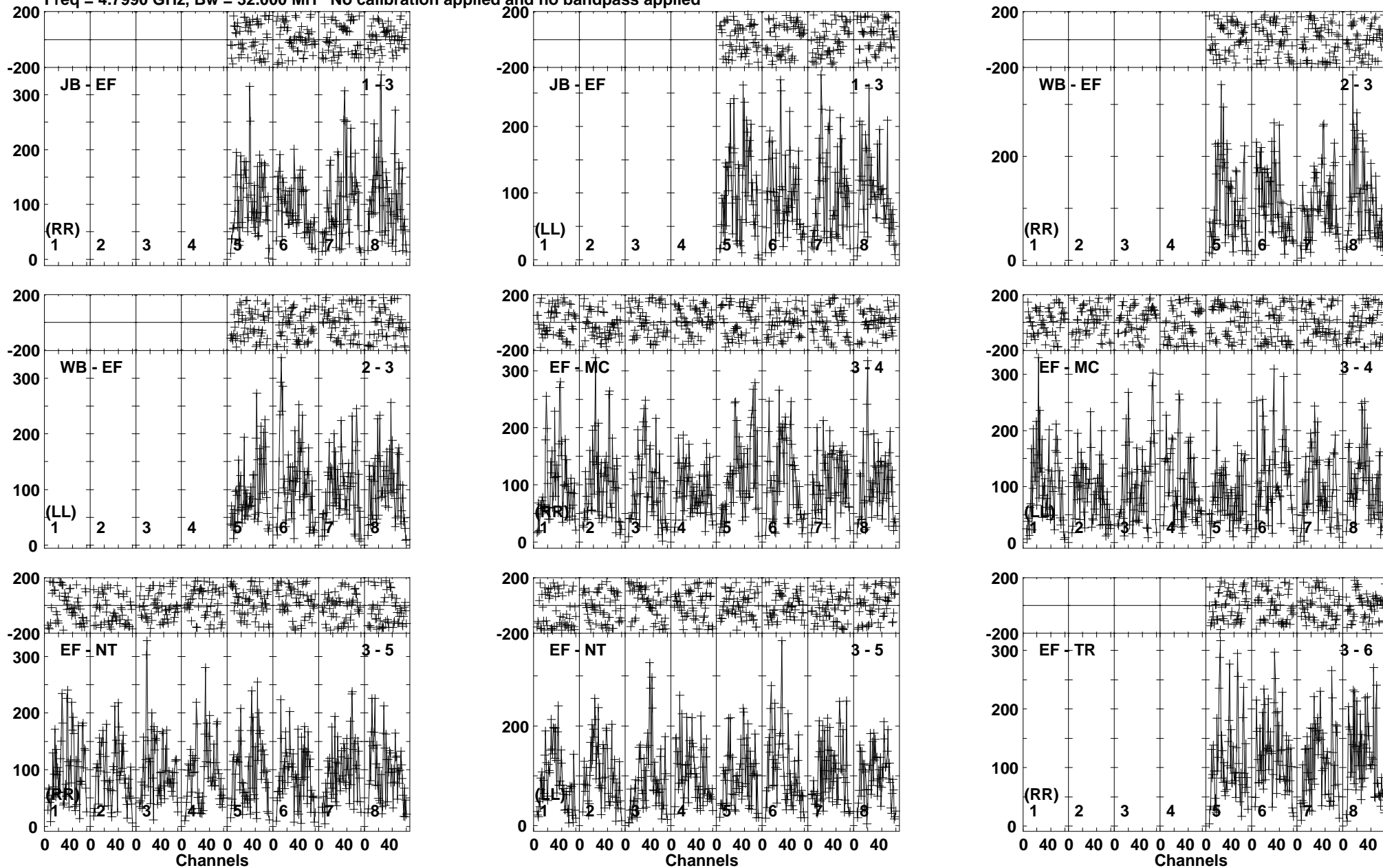

Lower frame: Micro Ampl Jy Top frame: Phas deg
Vector averaged cross-power spectrum Baseline: JB (01) - EF (03)
Timerange: 00:12:40:31 to 00:12:42:59

Plot file version 28 created 28-AUG-2017 13:19:01

J1312-2350 RP029A.UVDATA.1

Freq = 4.7990 GHz, Bw = 32.000 MH No calibration applied and no bandpass applied

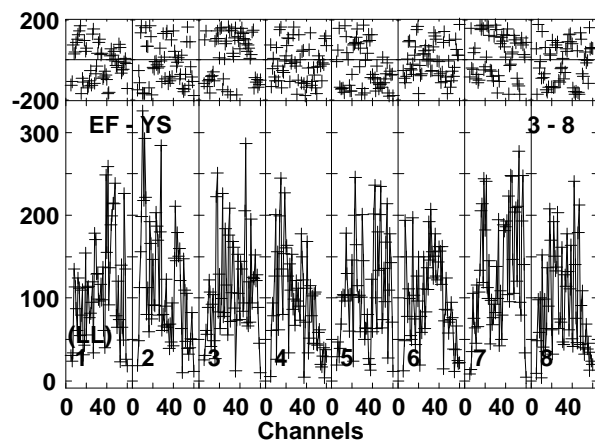
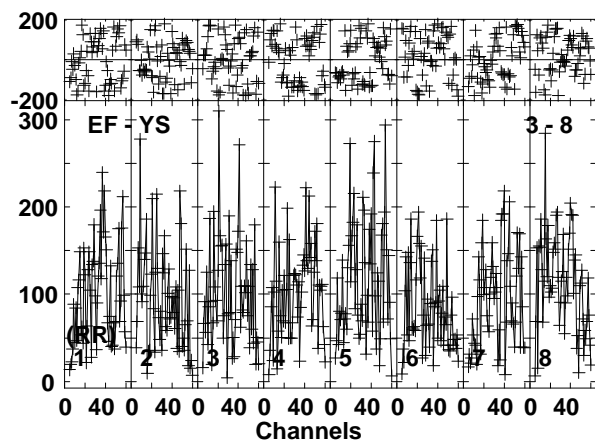
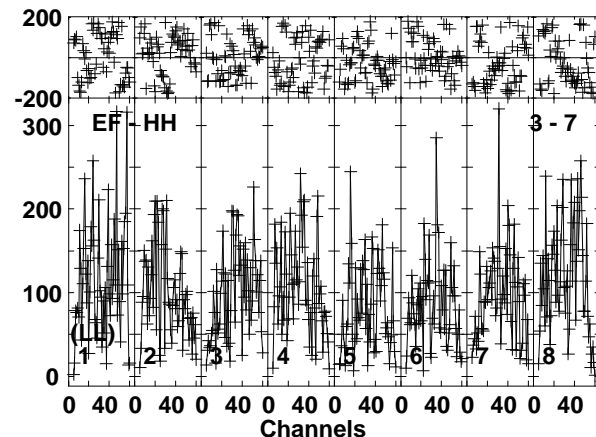
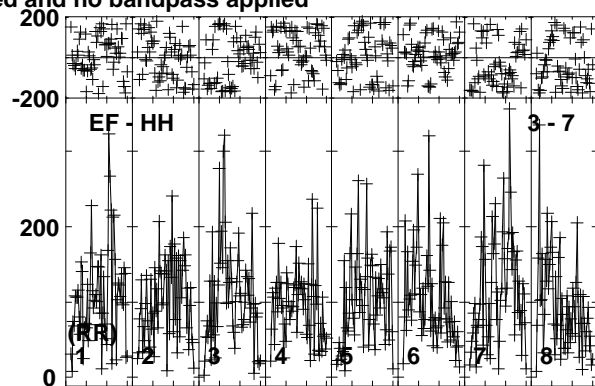
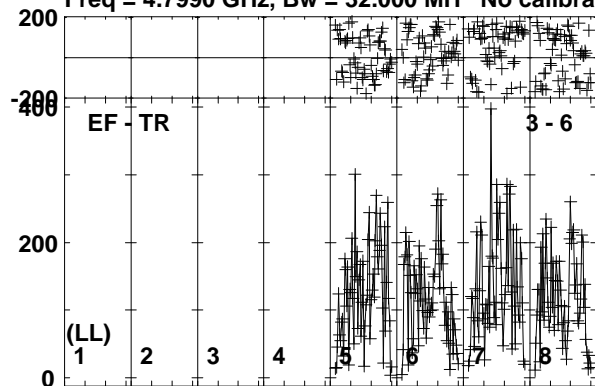

Lower frame: Micro Ampl Jy Top frame: Phas deg
Vector averaged cross-power spectrum Baseline: EF (03) - TR (06)
Timerange: 00:12:40:31 to 00:12:42:59

Plot file version 29 created 28-AUG-2017 13:19:01

J1303-2405 RP029A.UVDATA.1

Freq = 4.7990 GHz, Bw = 32.000 MH No calibration applied and no bandpass applied

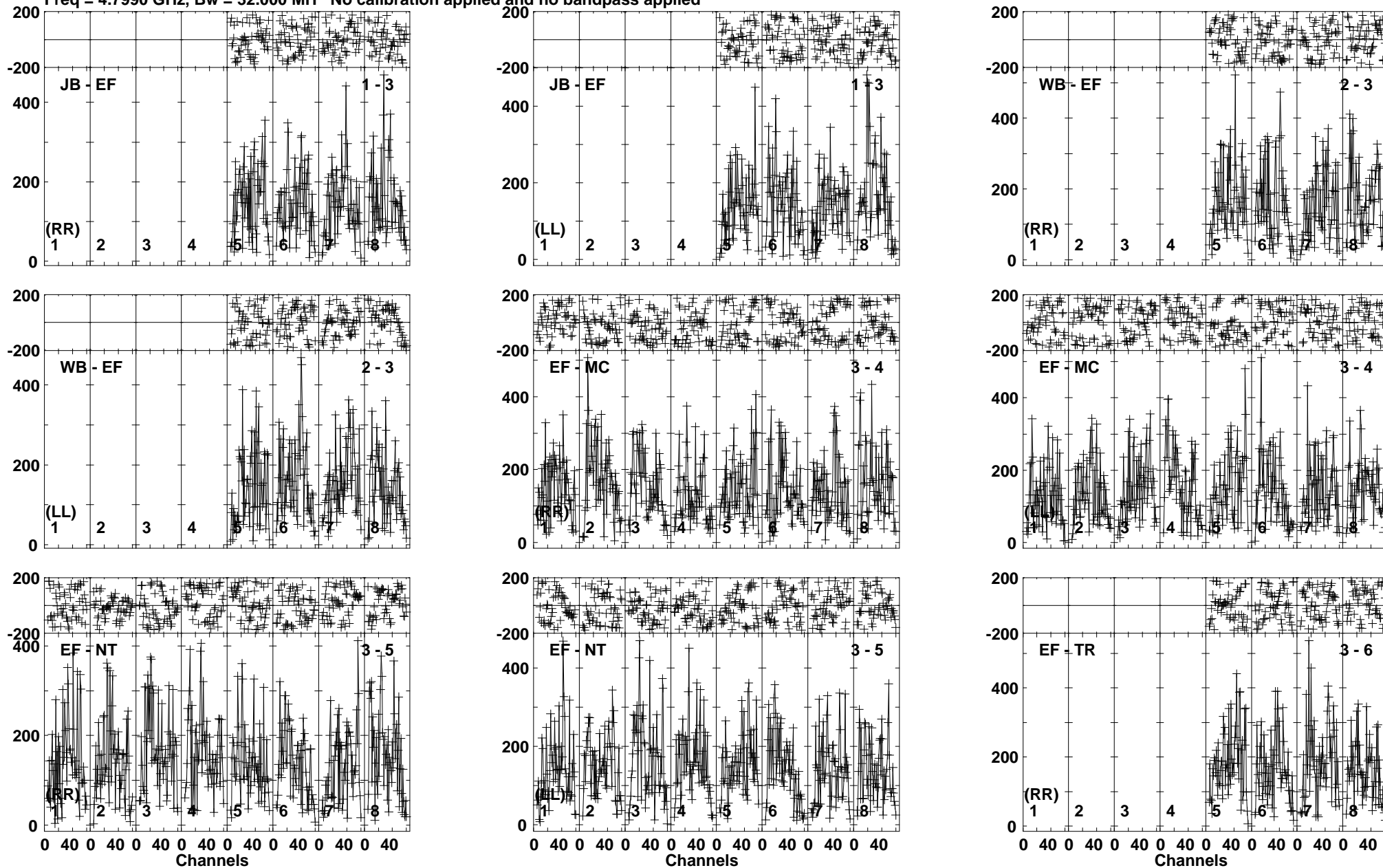

Lower frame: Micro Ampl Jy Top frame: Phas deg
Vector averaged cross-power spectrum Baseline: JB (01) - EF (03)
Timerange: 00:12:43:41 to 00:12:44:39

Plot file version 30 created 28-AUG-2017 13:19:01

J1303-2405 RP029A.UVDATA.1

Freq = 4.7990 GHz, Bw = 32.000 MH No calibration applied and no bandpass applied

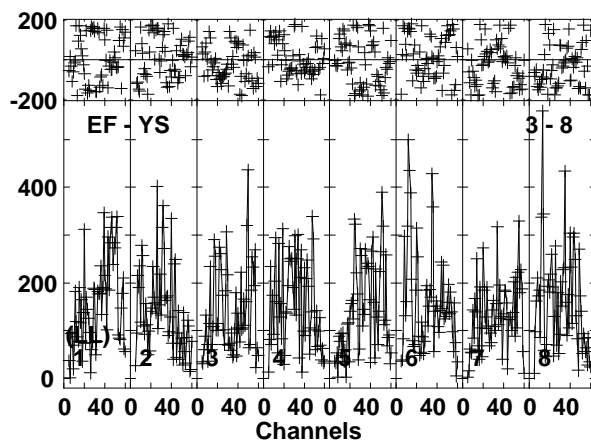
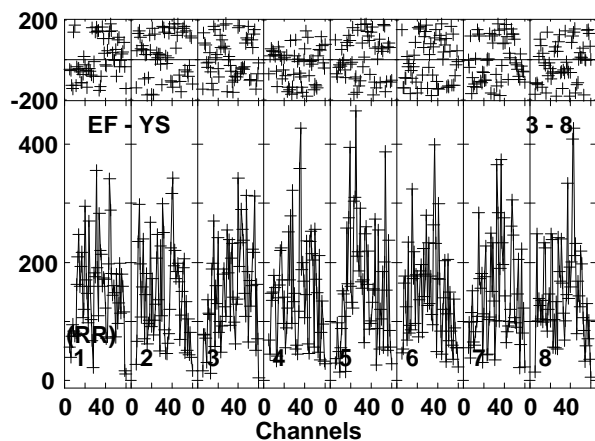
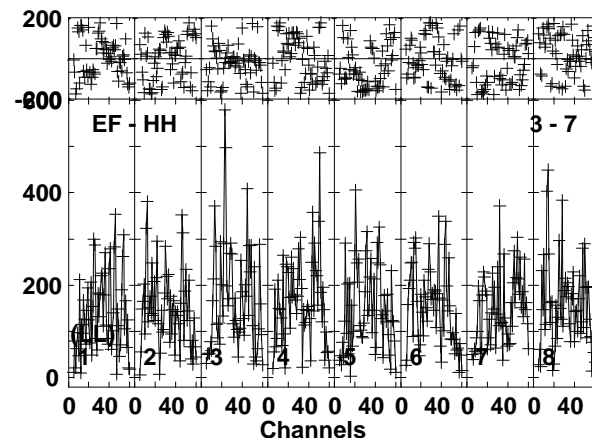
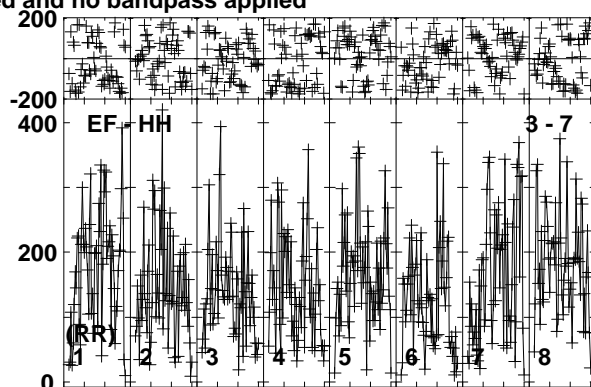
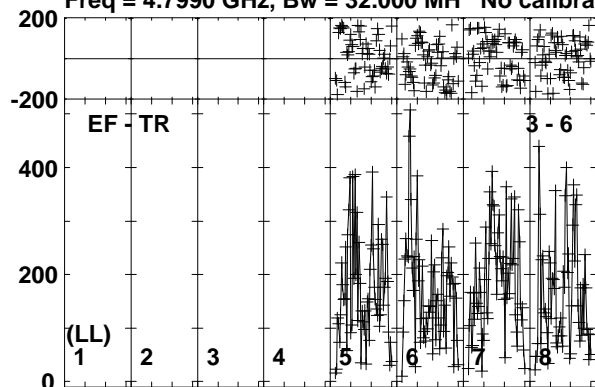

Lower frame: Micro Ampl Jy Top frame: Phas deg
Vector averaged cross-power spectrum Baseline: EF (03) - TR (06)
Timerange: 00:12:43:41 to 00:12:44:39

Plot file version 31 created 28-AUG-2017 13:19:01

SSS17A RP029A.UVDATA.1

Freq = 4.7990 GHz, Bw = 32.000 MH No calibration applied and no bandpass applied

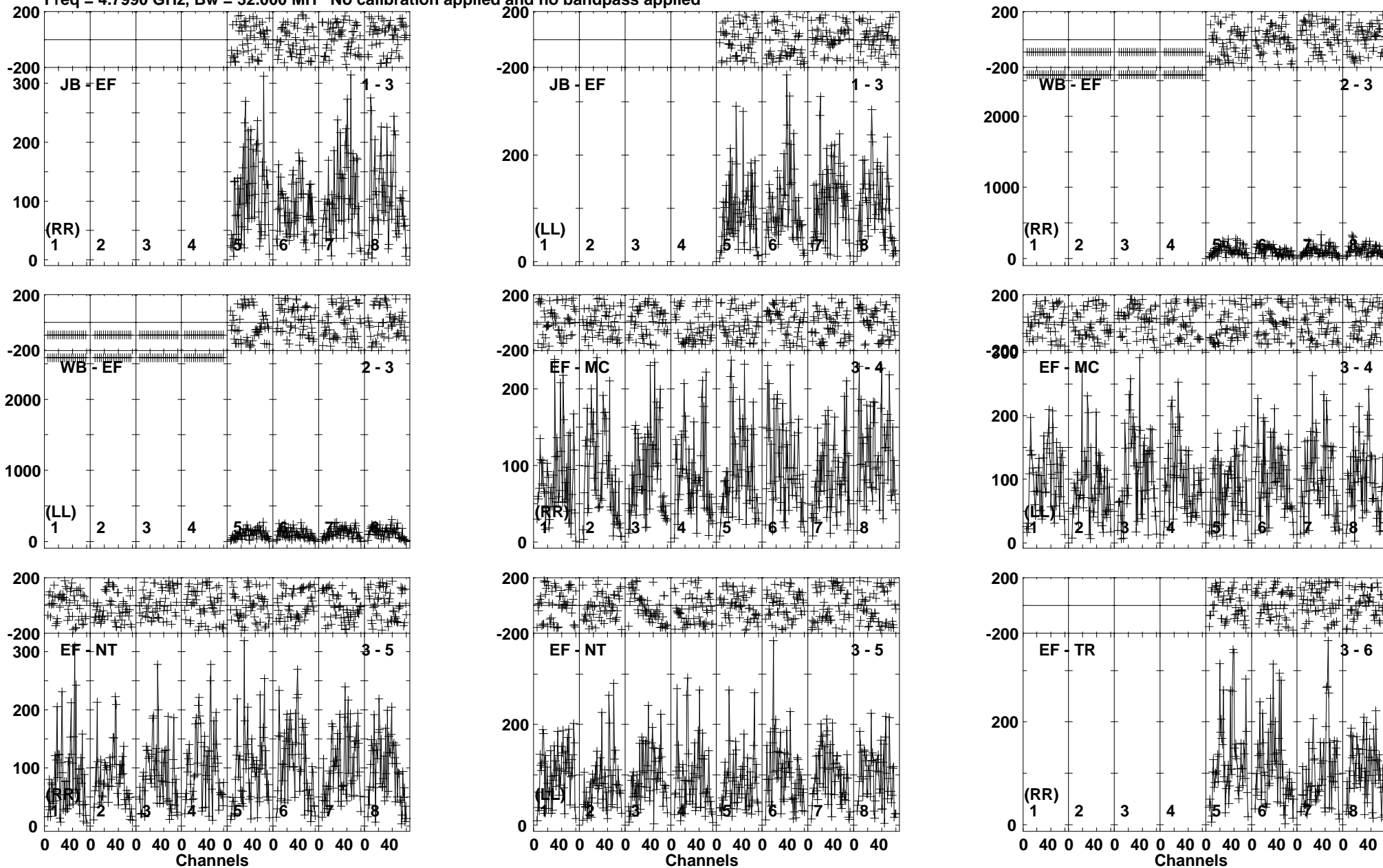

Lower frame: Micro Ampl Jy Top frame: Phas deg
Vector averaged cross-power spectrum Baseline: JB (01) - EF (03)
Timerange: 00/12:44:41 to 00/12:47:09

Plot file version 32 created 28-AUG-2017 13:19:01

SSS17A RP029A.UVDATA.1

Freq = 4.7990 GHz, Bw = 32.000 MH No calibration applied and no bandpass applied

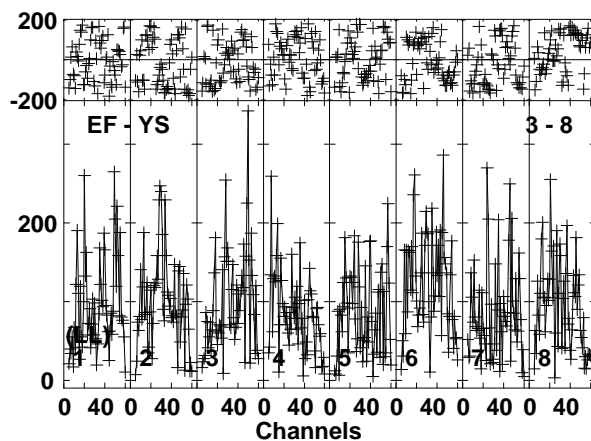
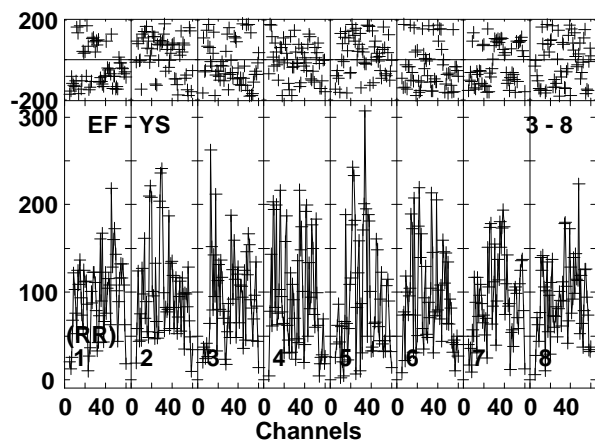
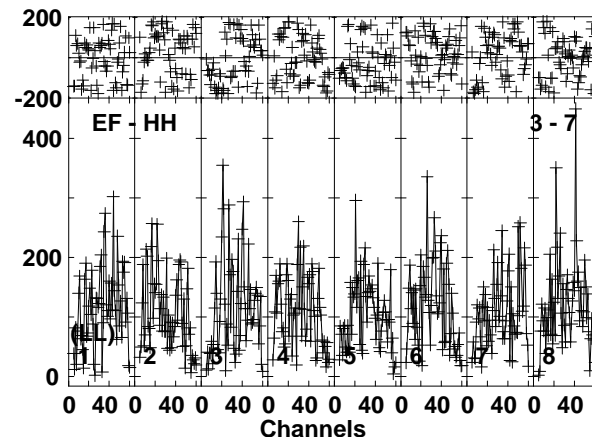
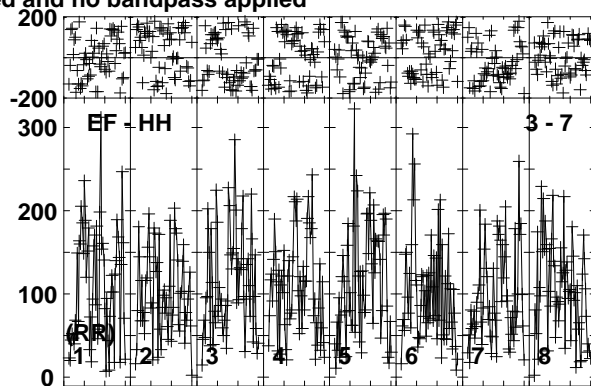
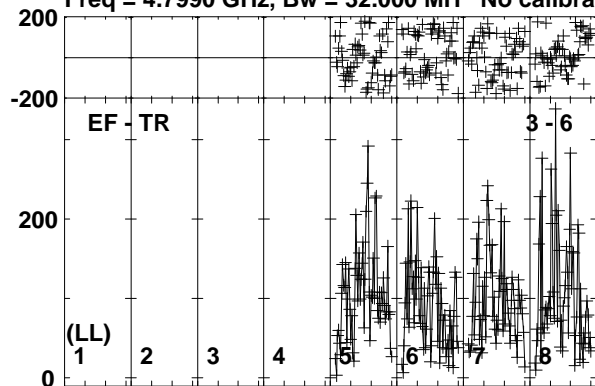

Lower frame: Micro Ampl Jy Top frame: Phas deg
Vector averaged cross-power spectrum Baseline: EF (03) - TR (06)
Timerange: 00:12:44:41 to 00:12:47:09

Plot file version 33 created 28-AUG-2017 13:19:01

J1303-2405 RP029A.UVDATA.1

Freq = 4.7990 GHz, Bw = 32.000 MH No calibration applied and no bandpass applied

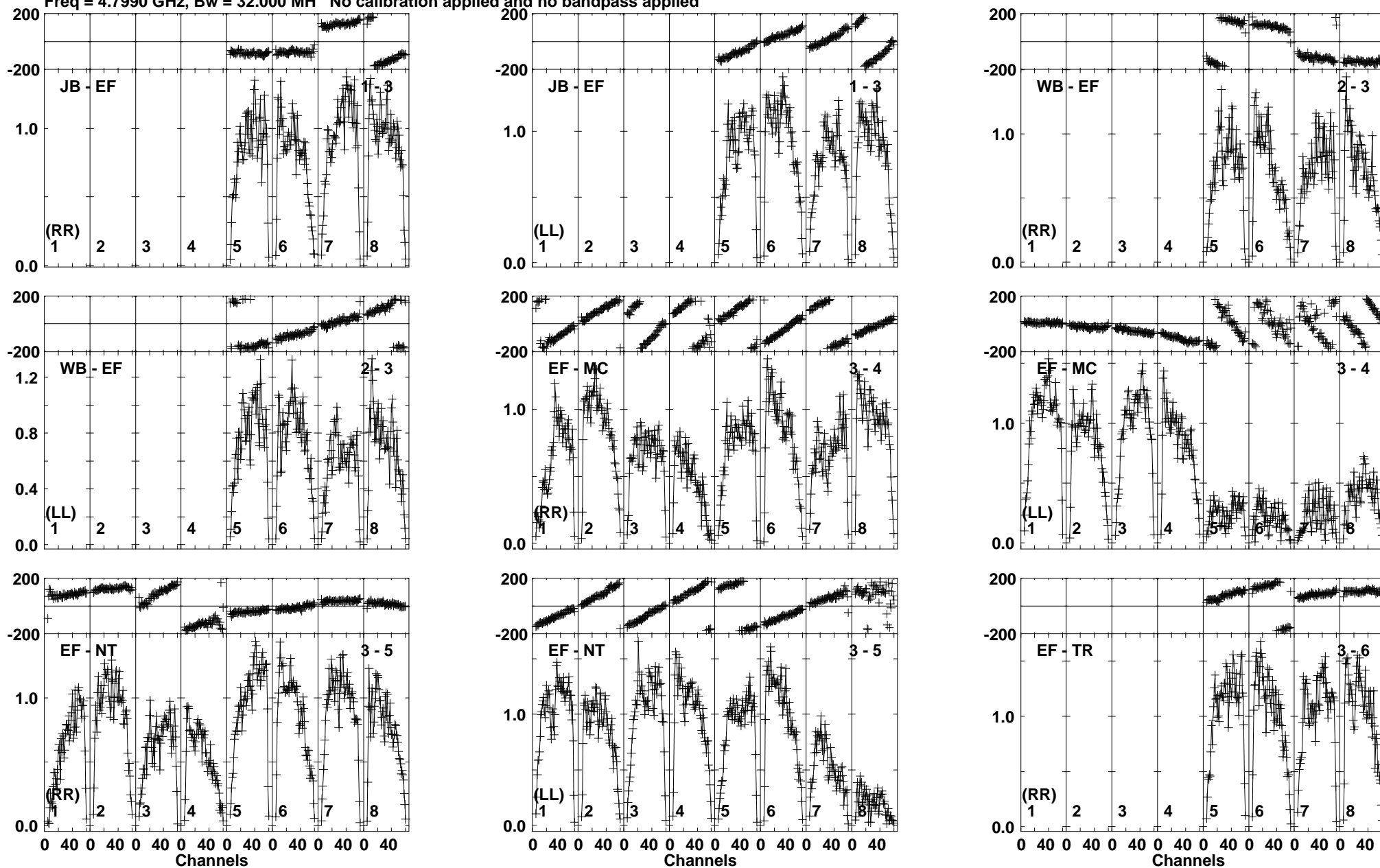

Lower frame: Milli Ampl Jy Top frame: Phas deg
Vector averaged cross-power spectrum Baseline: JB (01) - EF (03)
Timerange: 00:12:47:11 to 00:12:48:39

Plot file version 34 created 28-AUG-2017 13:19:02

J1303-2405 RP029A.UVDATA.1

Freq = 4.7990 GHz, Bw = 32.000 MH No calibration applied and no bandpass applied

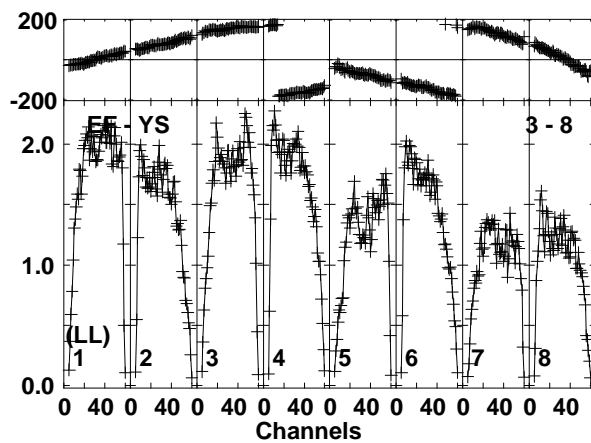
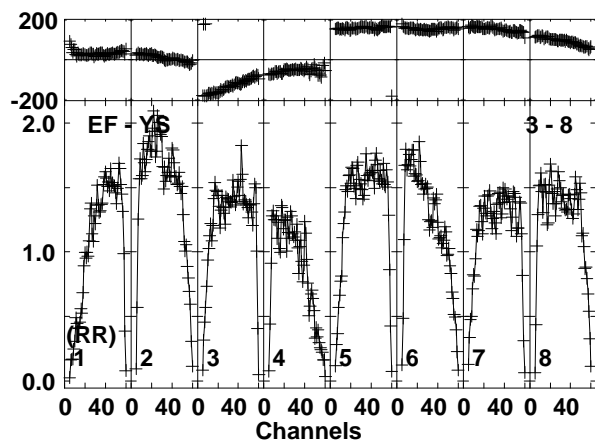
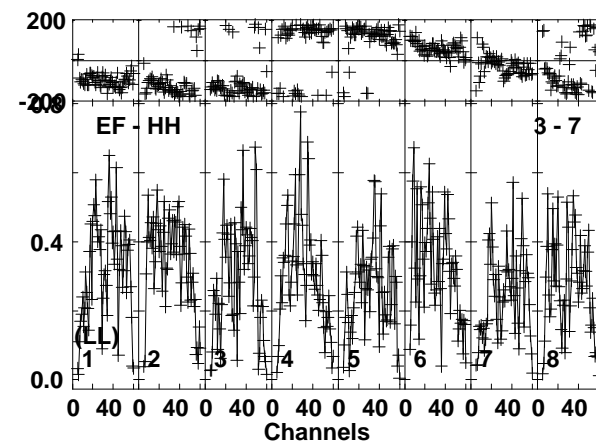
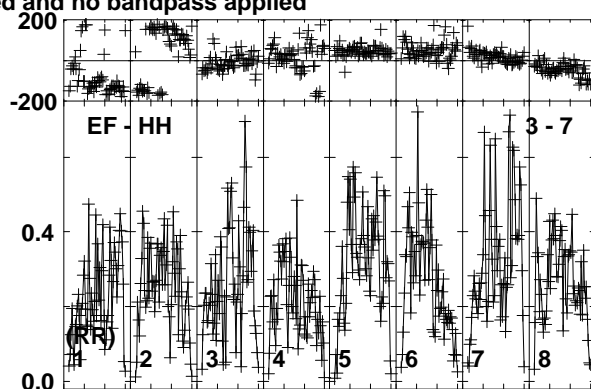
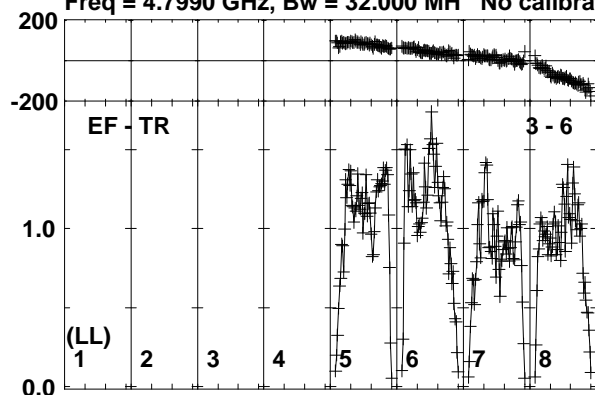

Lower frame: Milli Ampl Jy Top frame: Phas deg
Vector averaged cross-power spectrum Baseline: EF (03) - TR (06)
Timerange: 00:12:47:11 to 00:12:48:39

Plot file version 35 created 28-AUG-2017 13:19:02

SSS17A RP029A.UVDATA.1

Freq = 4.7990 GHz, Bw = 32.000 MH No calibration applied and no bandpass applied

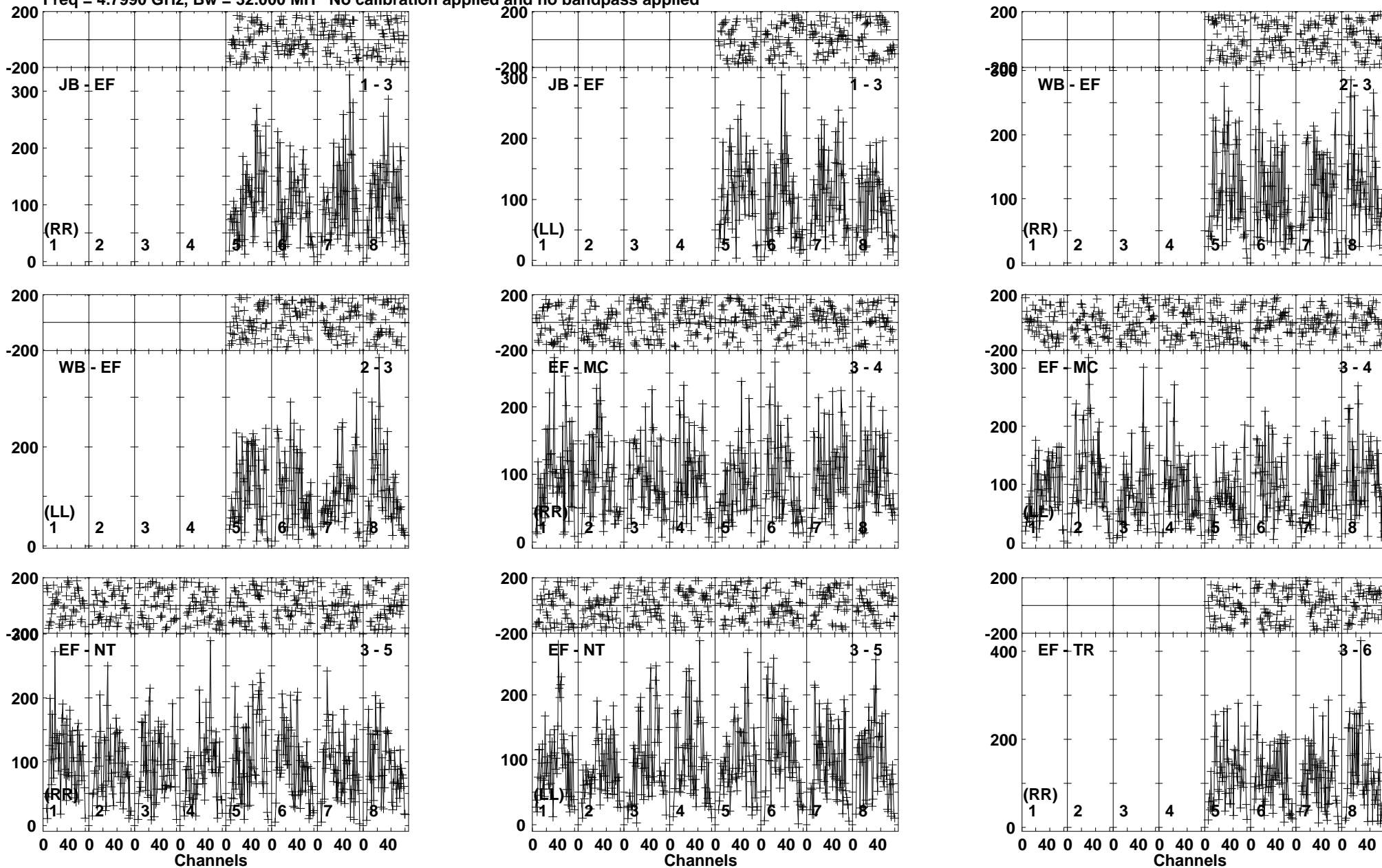

Lower frame: Micro Ampl Jy Top frame: Phas deg
Vector averaged cross-power spectrum Baseline: JB (01) - EF (03)
Timerange: 00/12:48:41 to 00/12:51:09

Plot file version 36 created 28-AUG-2017 13:19:02

SSS17A RP029A.UVDATA.1

Freq = 4.7990 GHz, Bw = 32.000 MH No calibration applied and no bandpass applied

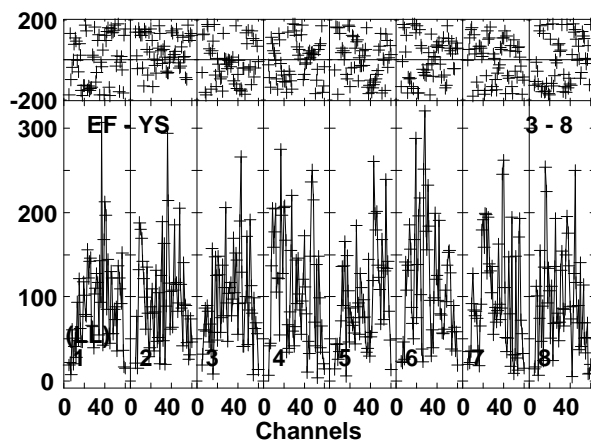
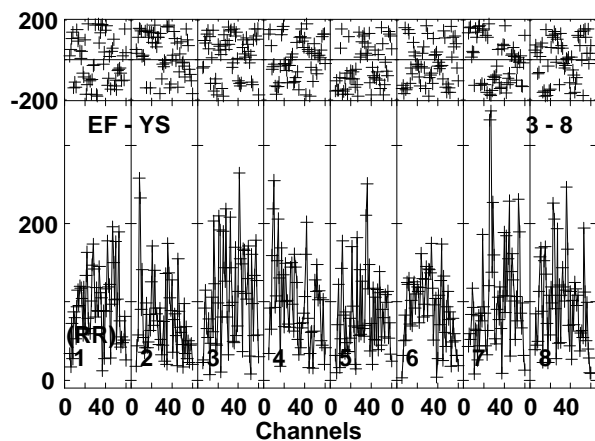
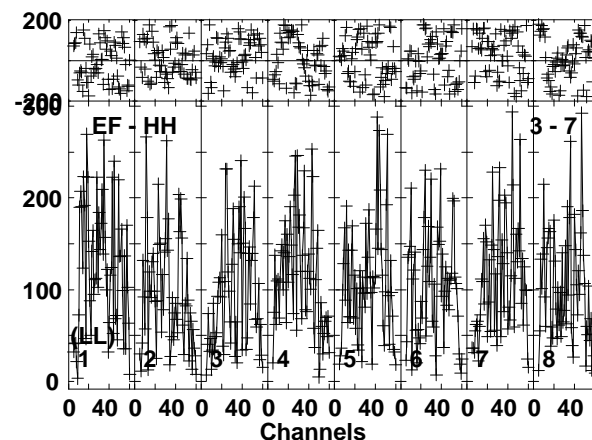
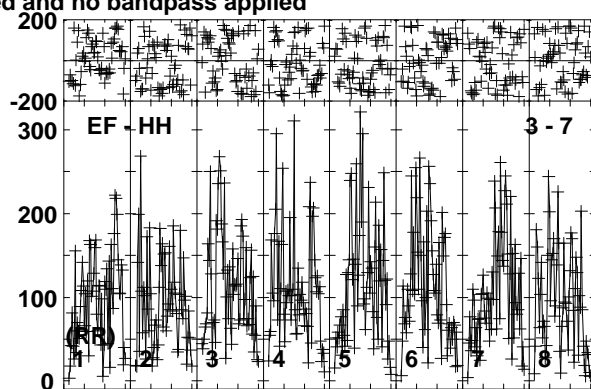
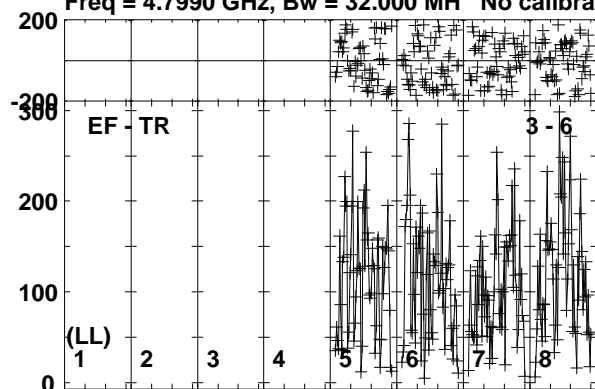

Lower frame: Micro Ampl Jy Top frame: Phas deg
Vector averaged cross-power spectrum Baseline: EF (03) - TR (06)
Timerange: 00:12:48:41 to 00:12:51:09

Plot file version 37 created 28-AUG-2017 13:19:02

J1303-2405 RP029A.UVDATA.1

Freq = 4.7990 GHz, Bw = 32.000 MH No calibration applied and no bandpass applied

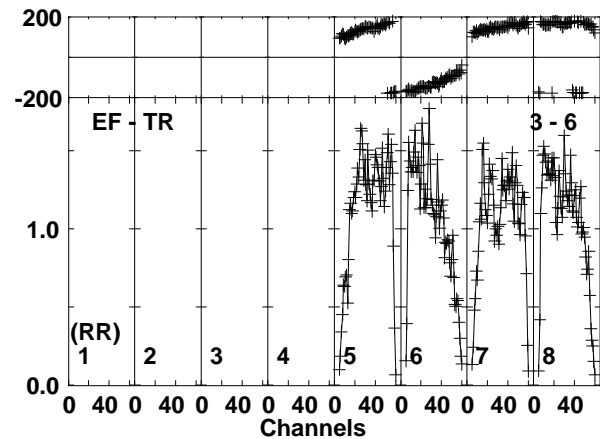
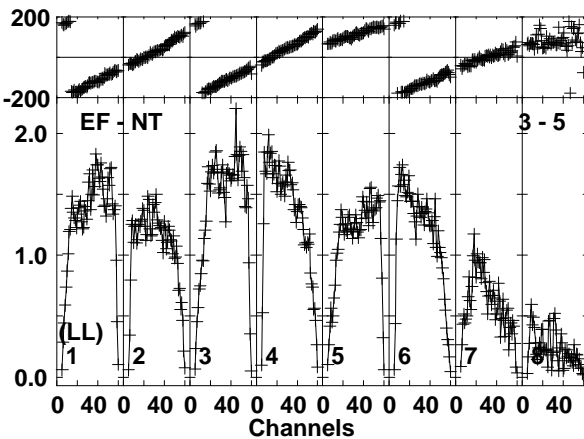
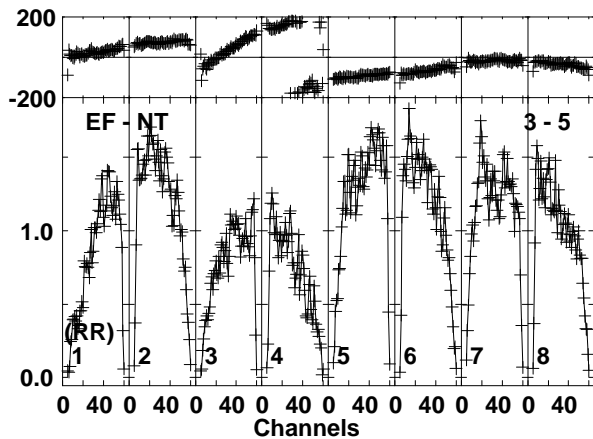
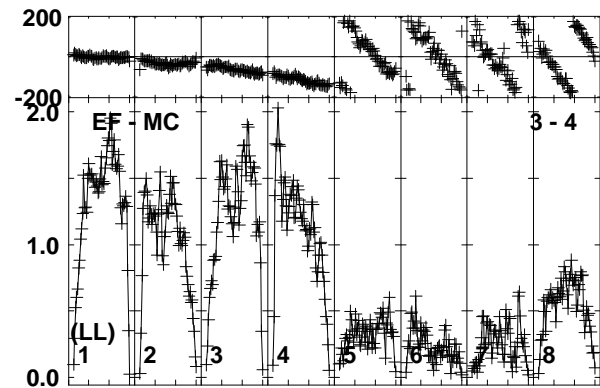
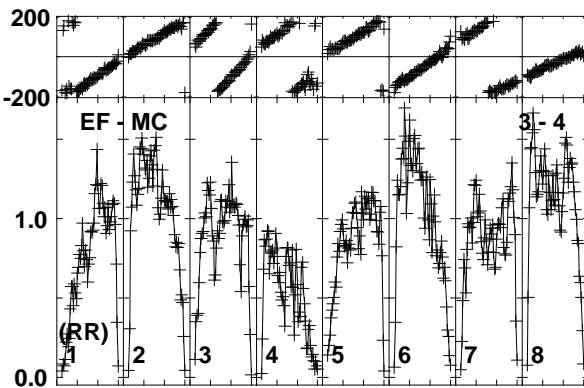
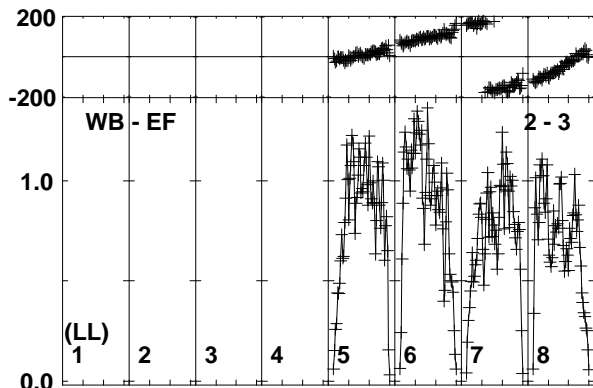
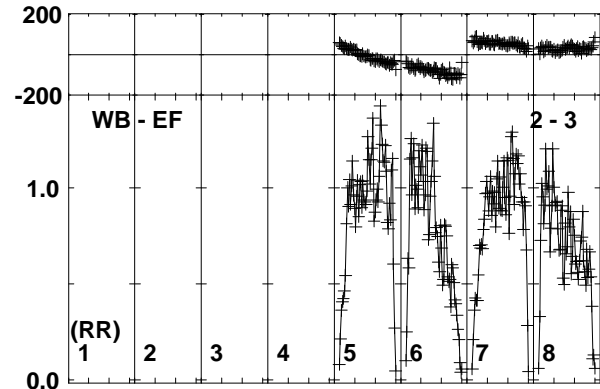
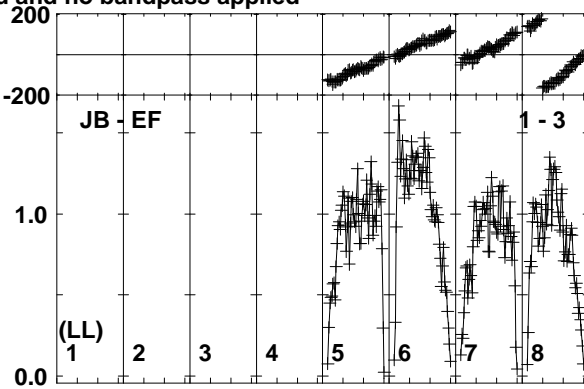
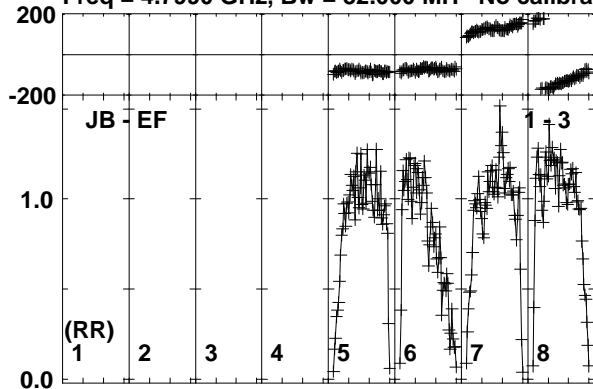

Lower frame: Milli Ampl Jy Top frame: Phas deg
Vector averaged cross-power spectrum Baseline: JB (01) - EF (03)
Timerange: 00:12:51:41 to 00:12:52:39

Plot file version 38 created 28-AUG-2017 13:19:02

J1303-2405 RP029A.UVDATA.1

Freq = 4.7990 GHz, Bw = 32.000 MH No calibration applied and no bandpass applied

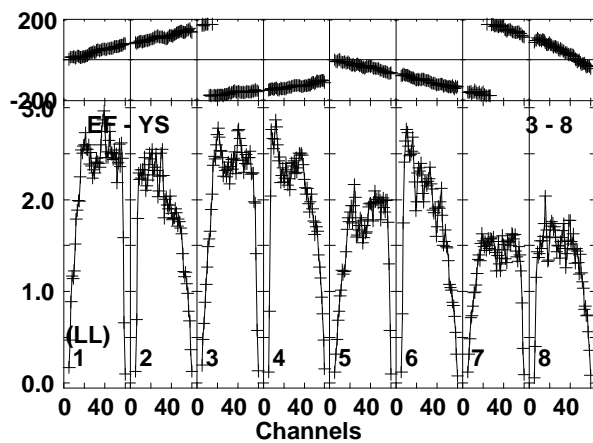
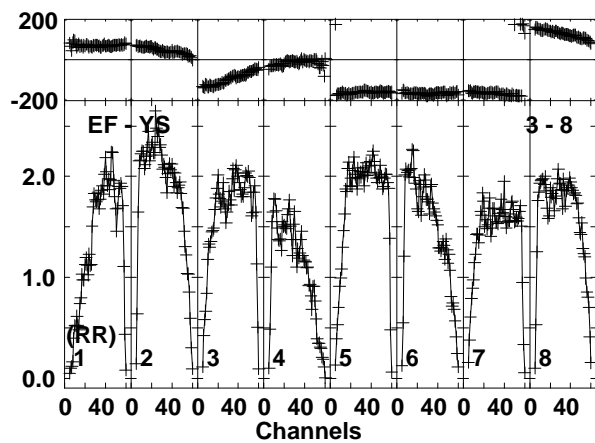
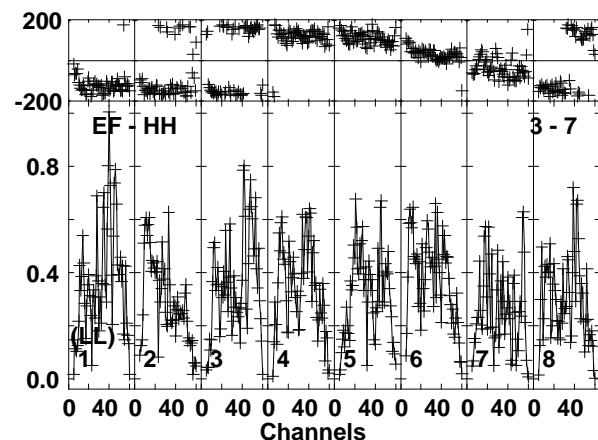
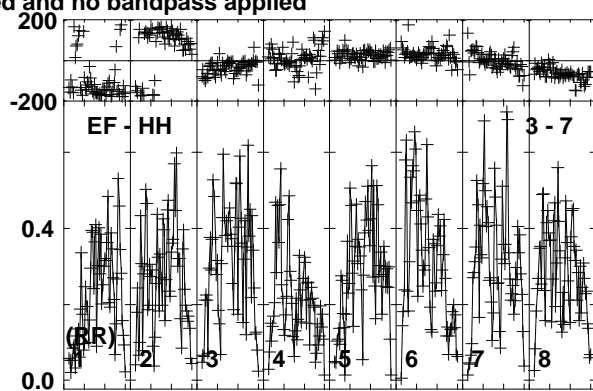
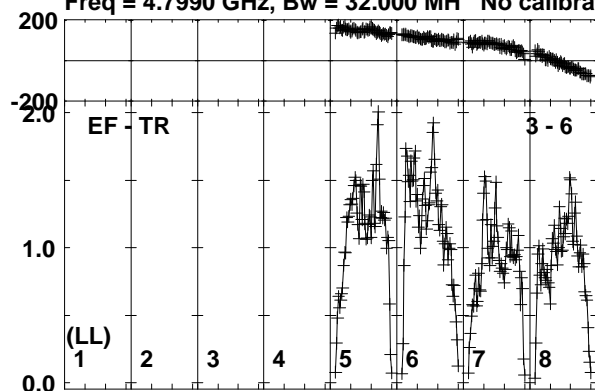

Lower frame: Milli Ampl Jy Top frame: Phas deg
Vector averaged cross-power spectrum Baseline: EF (03) - TR (06)
Timerange: 00/12:51:41 to 00/12:52:39

Plot file version 39 created 28-AUG-2017 13:19:02
 SSS17A RP029A.UVDATA.1
 Freq = 4.7990 GHz, Bw = 32.000 MH No calibration applied and no bandpass applied

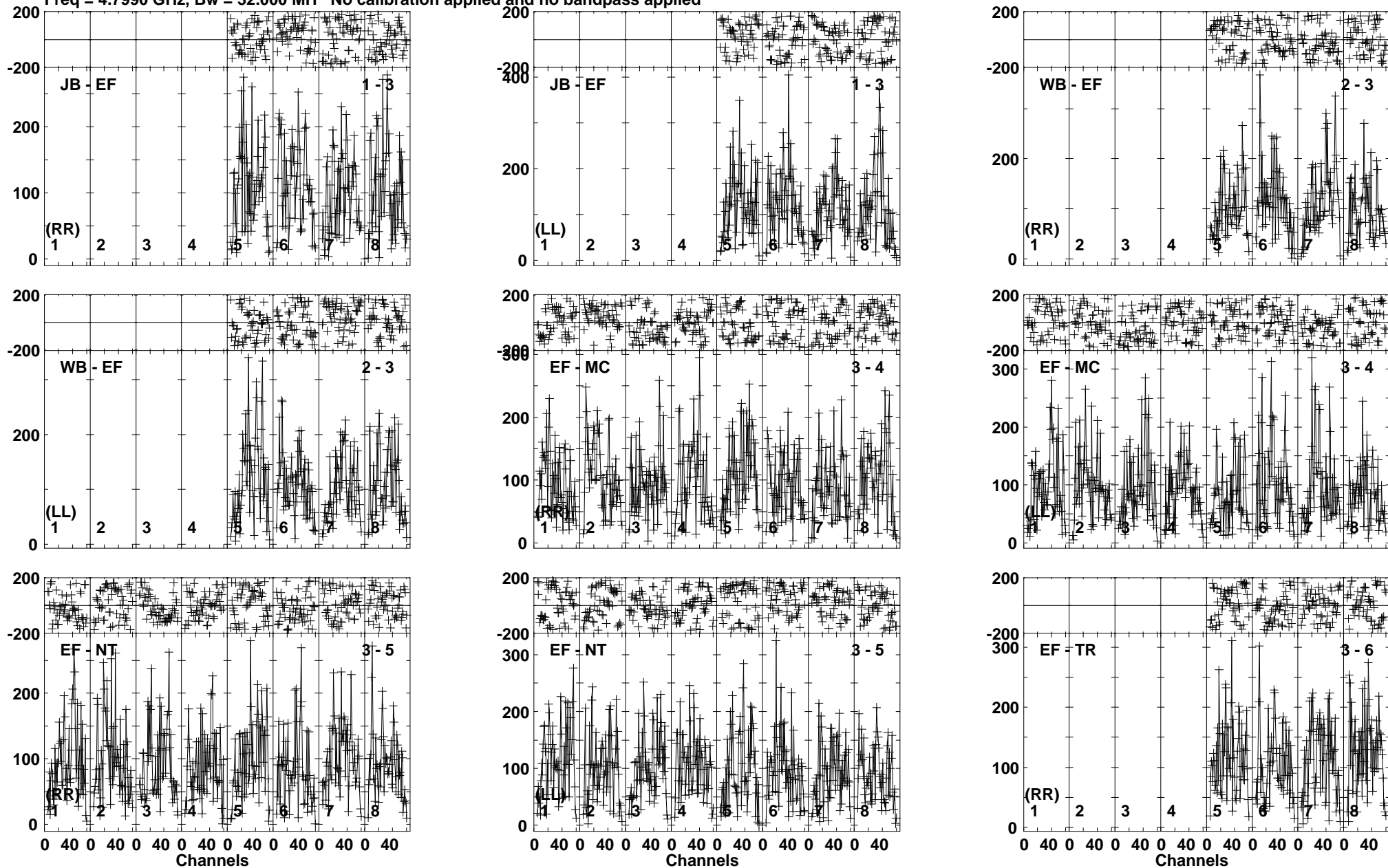

Lower frame: Micro Ampl Jy Top frame: Phas deg
 Vector averaged cross-power spectrum Baseline: JB (01) - EF (03)
 Timerange: 00/12:52:41 to 00/12:55:09

Plot file version 40 created 28-AUG-2017 13:19:02

SSS17A RP029A.UVDATA.1

Freq = 4.7990 GHz, Bw = 32.000 MH No calibration applied and no bandpass applied

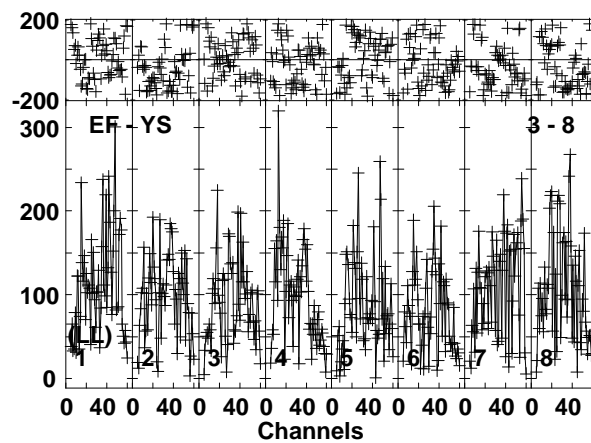
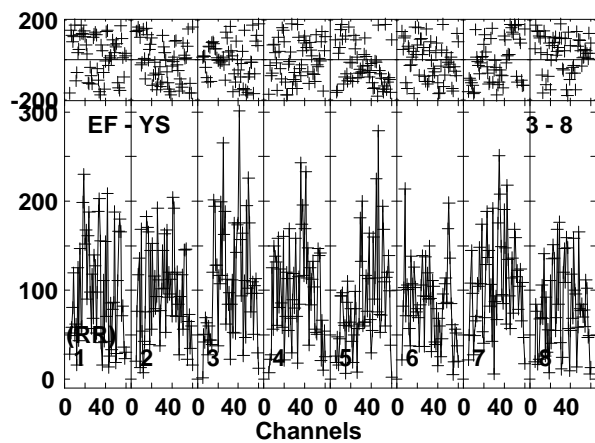
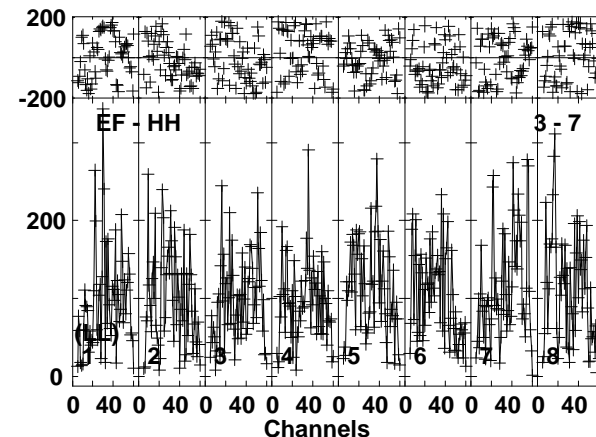
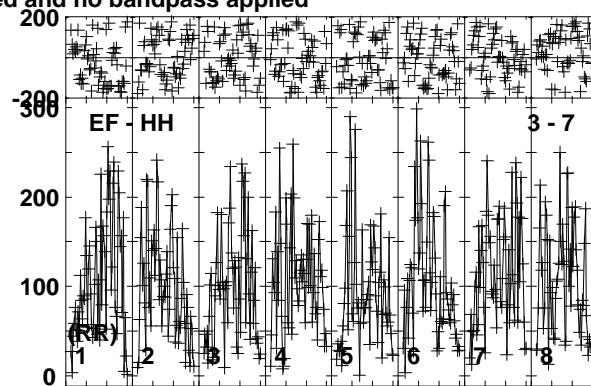
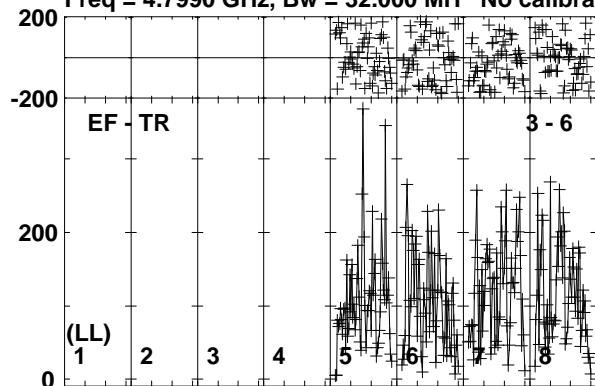

Lower frame: Micro Ampl Jy Top frame: Phas deg
Vector averaged cross-power spectrum Baseline: EF (03) - TR (06)
Timerange: 00:12:52:41 to 00:12:55:09

Plot file version 41 created 28-AUG-2017 13:19:02

J1303-2405 RP029A.UVDATA.1

Freq = 4.7990 GHz, Bw = 32.000 MH No calibration applied and no bandpass applied

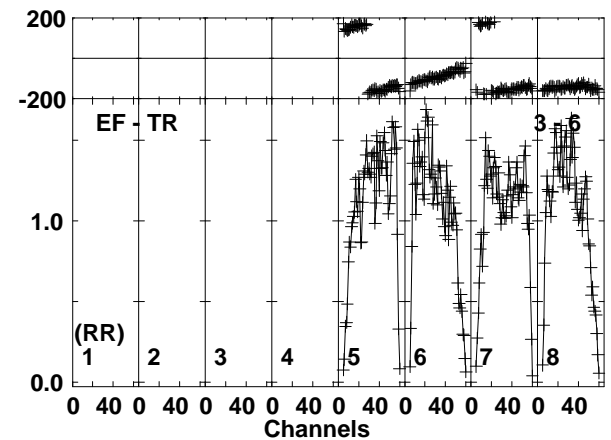
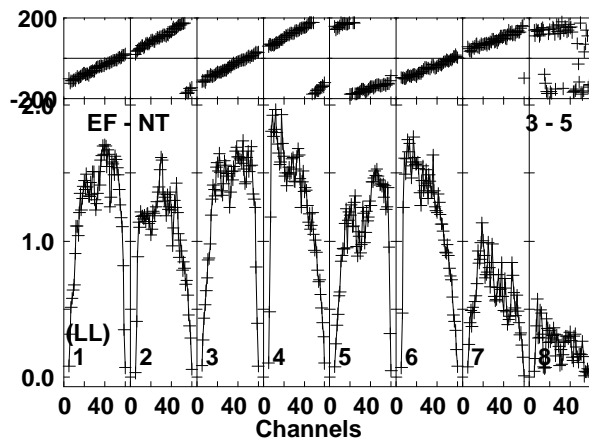
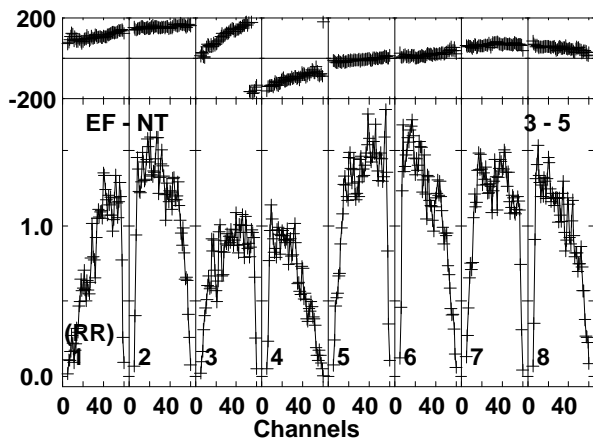
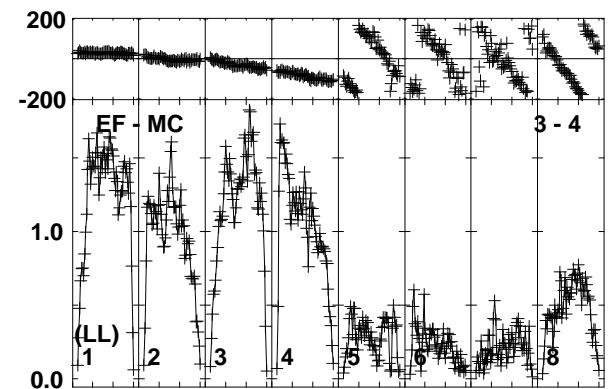
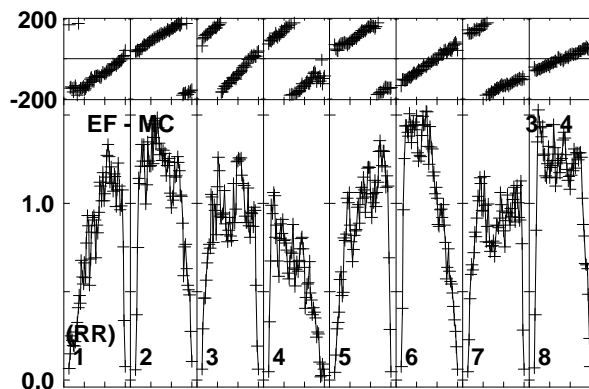
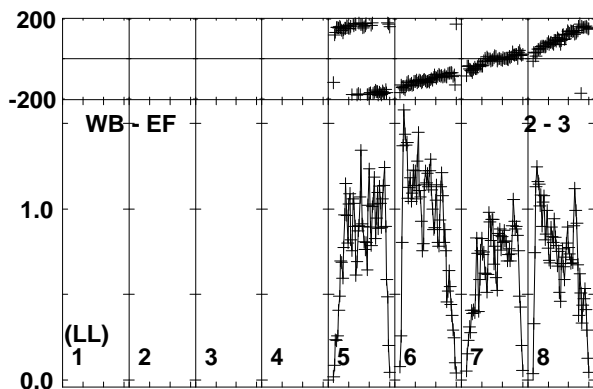
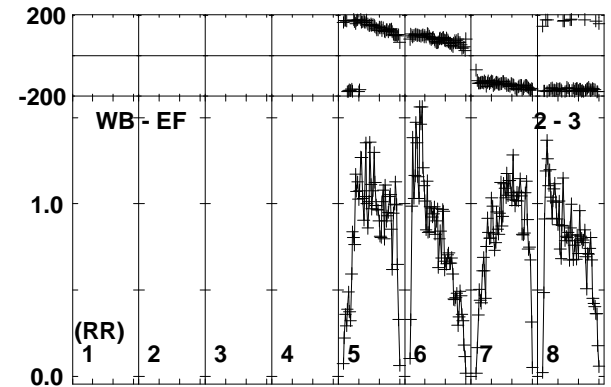
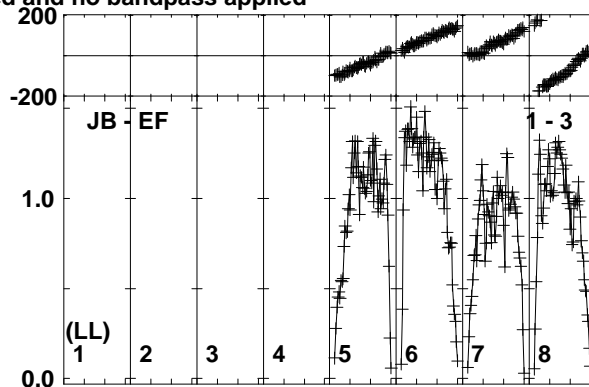
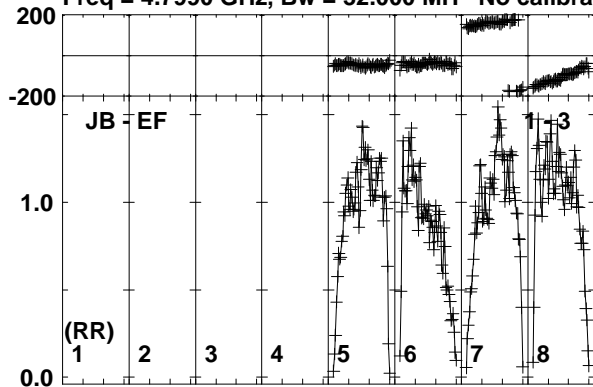

Lower frame: Milli Ampl Jy Top frame: Phas deg
Vector averaged cross-power spectrum Baseline: JB (01) - EF (03)
Timerange: 00:12:55:11 to 00:12:56:39

Plot file version 42 created 28-AUG-2017 13:19:02

J1303-2405 RP029A.UVDATA.1

Freq = 4.7990 GHz, Bw = 32.000 MH No calibration applied and no bandpass applied

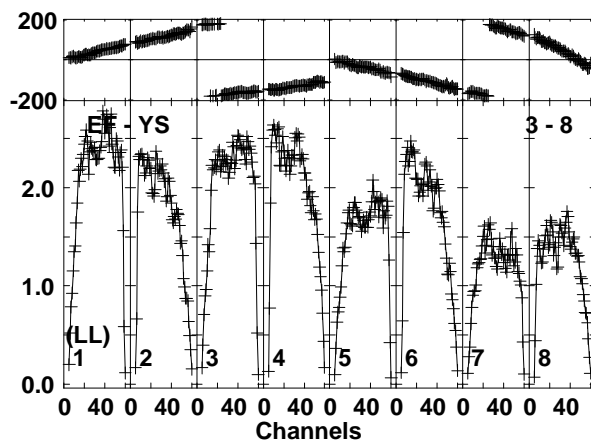
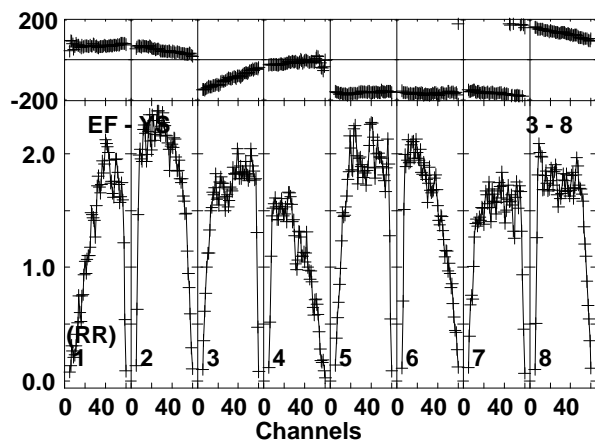
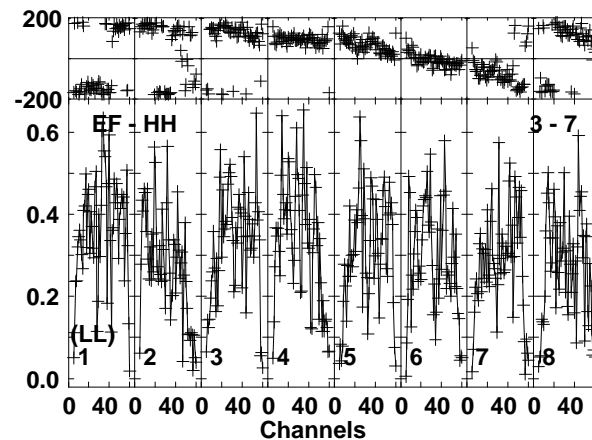
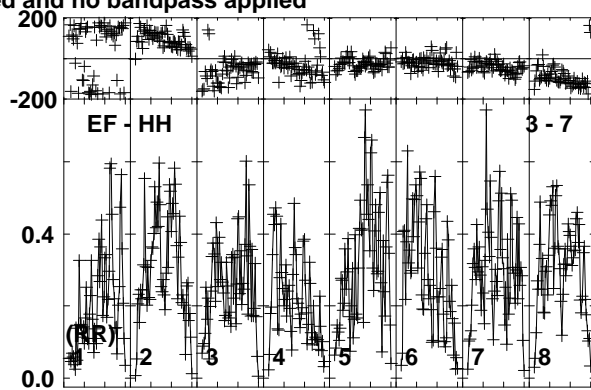
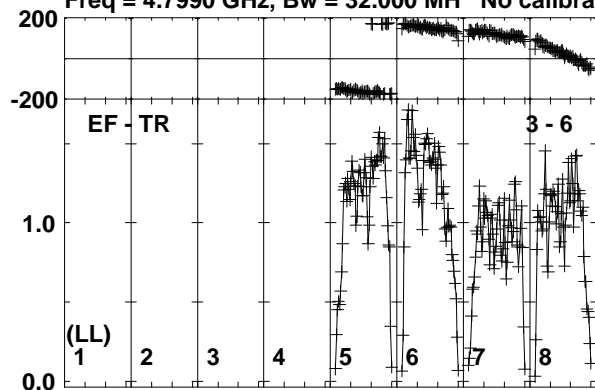

Lower frame: Milli Ampl Jy Top frame: Phas deg
Vector averaged cross-power spectrum Baseline: EF (03) - TR (06)
Timerange: 00:12:55:11 to 00:12:56:39

Plot file version 43 created 28-AUG-2017 13:19:02

J1312-2350 RP029A.UVDATA.1

Freq = 4.7990 GHz, Bw = 32.000 MH No calibration applied and no bandpass applied

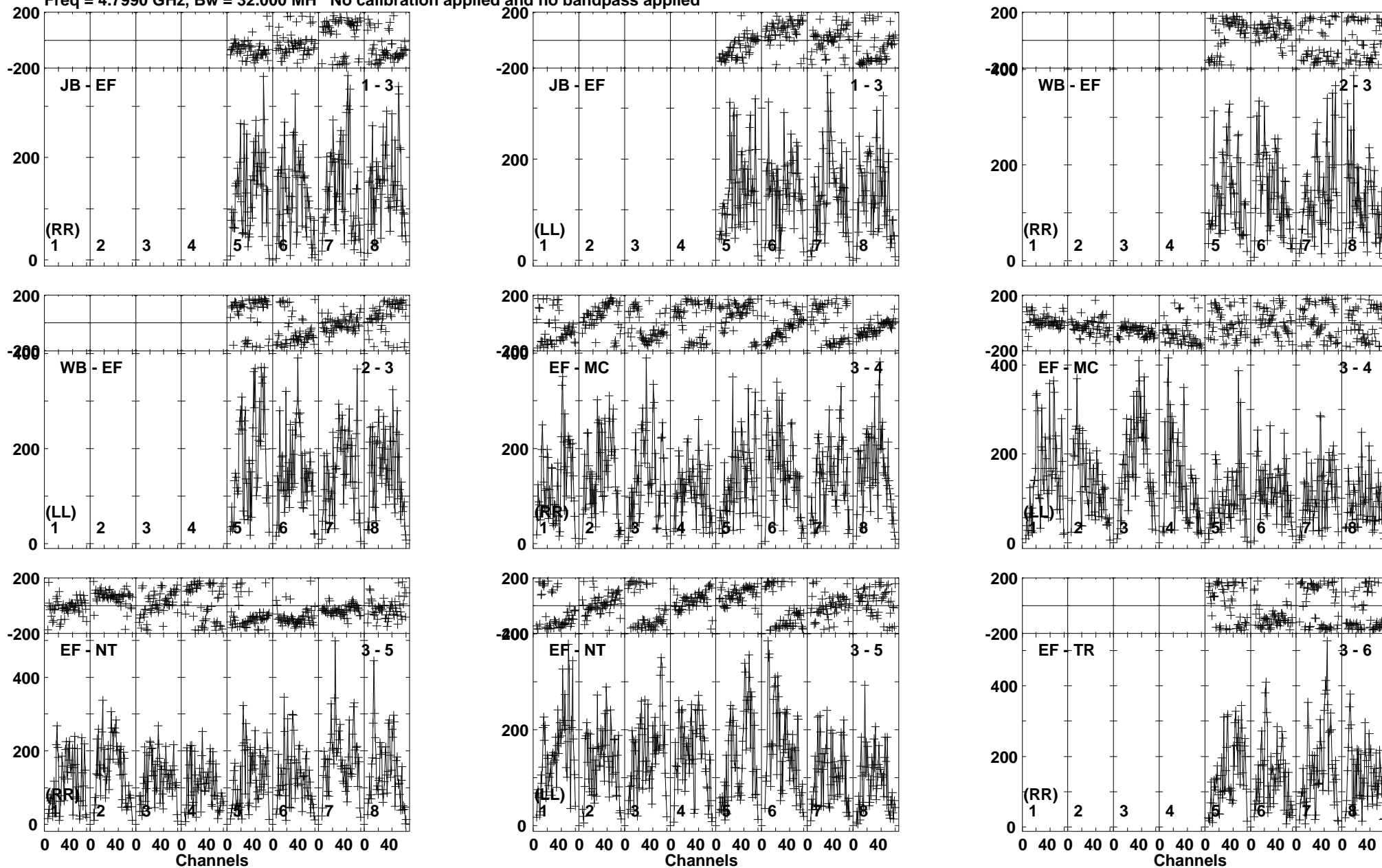

Lower frame: Micro Ampl Jy Top frame: Phas deg
Vector averaged cross-power spectrum Baseline: JB (01) - EF (03)
Timerange: 00/12:56:41 to 00/12:59:09

Plot file version 44 created 28-AUG-2017 13:19:02

J1312-2350 RP029A.UVDATA.1

Freq = 4.7990 GHz, Bw = 32.000 MH No calibration applied and no bandpass applied

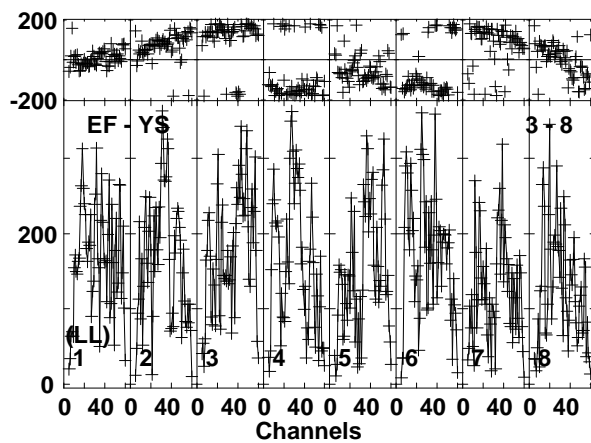
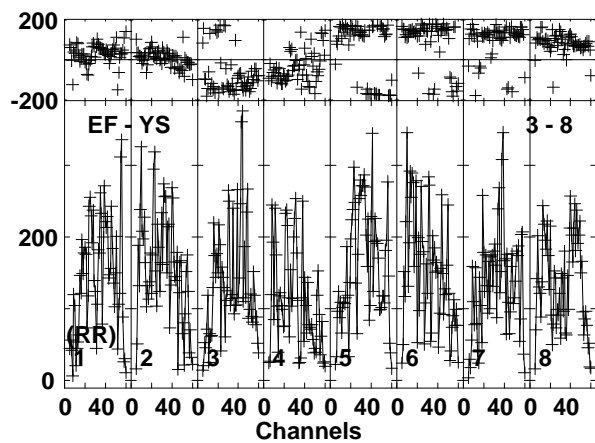
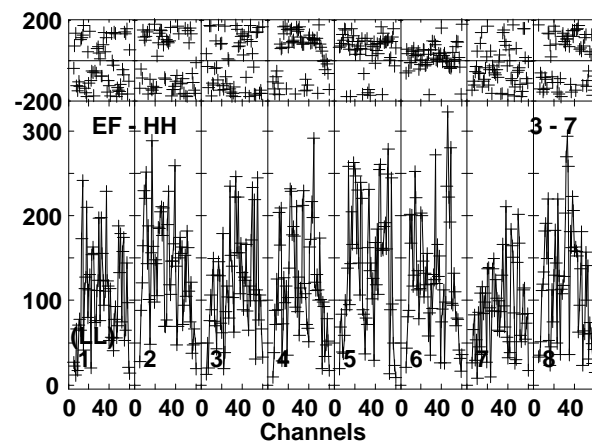
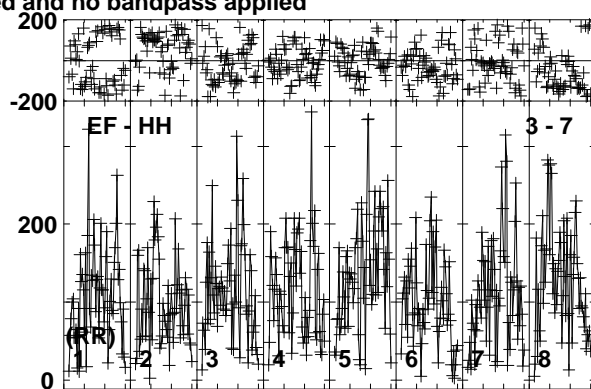
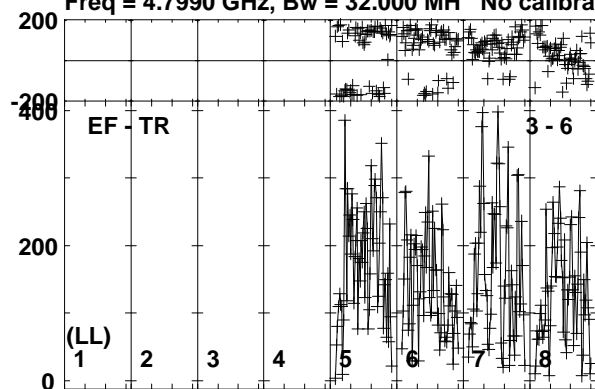

Lower frame: Micro Ampl Jy Top frame: Phas deg
Vector averaged cross-power spectrum Baseline: EF (03) - TR (06)
Timerange: 00/12:56:41 to 00/12:59:09

Plot file version 45 created 28-AUG-2017 13:19:03

J1303-2405 RP029A.UVDATA.1

Freq = 4.7990 GHz, Bw = 32.000 MH No calibration applied and no bandpass applied

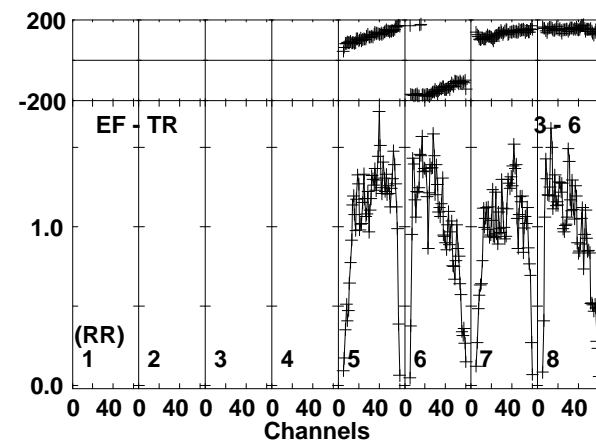
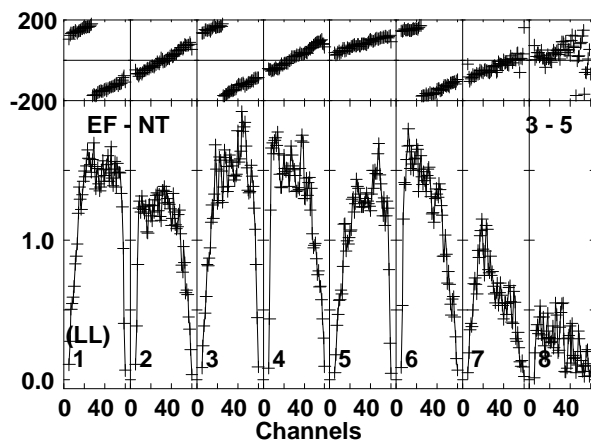
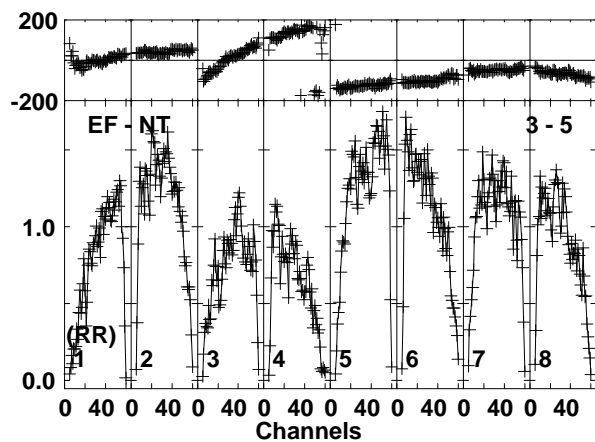
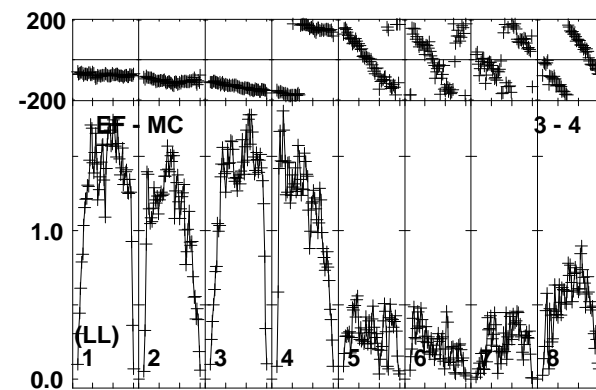
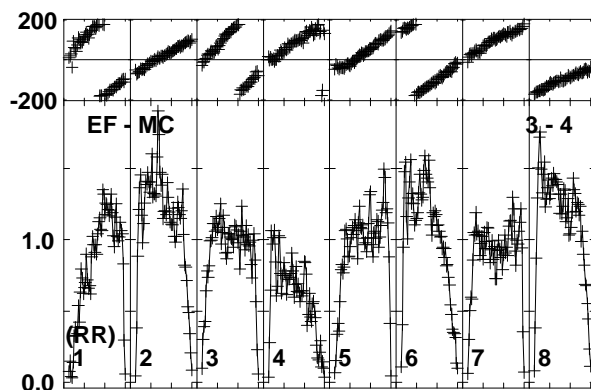
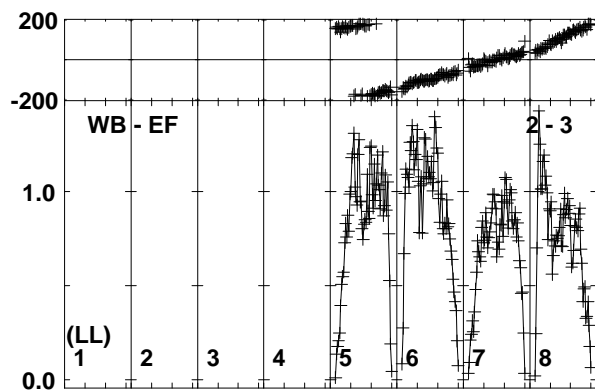
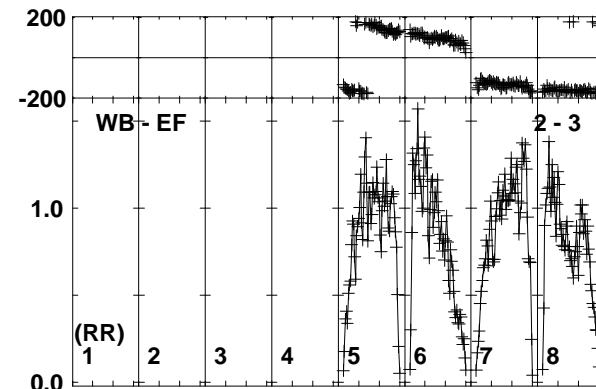
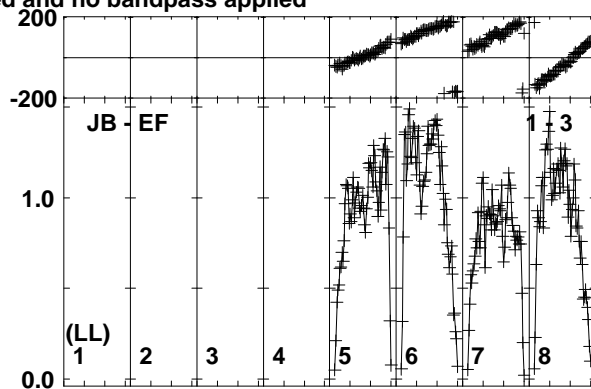
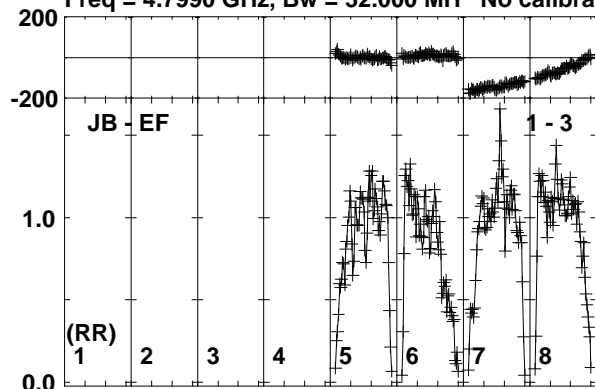

Lower frame: Milli Ampl Jy Top frame: Phas deg
Vector averaged cross-power spectrum Baseline: JB (01) - EF (03)
Timerange: 00/12:59:51 to 00/13:00:49

Plot file version 46 created 28-AUG-2017 13:19:03

J1303-2405 RP029A.UVDATA.1

Freq = 4.7990 GHz, Bw = 32.000 MH No calibration applied and no bandpass applied

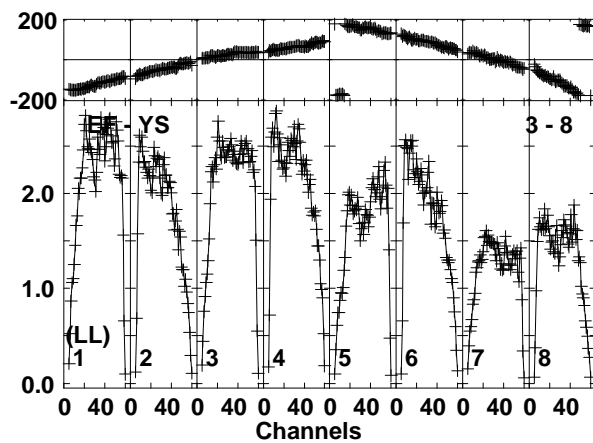
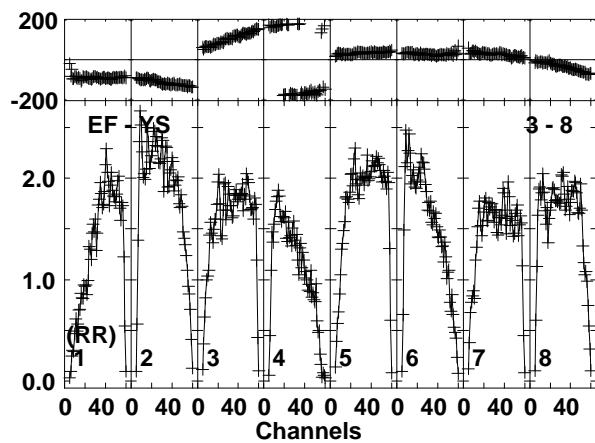
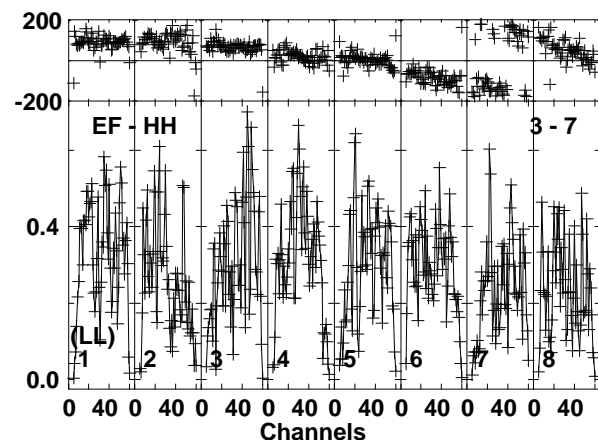
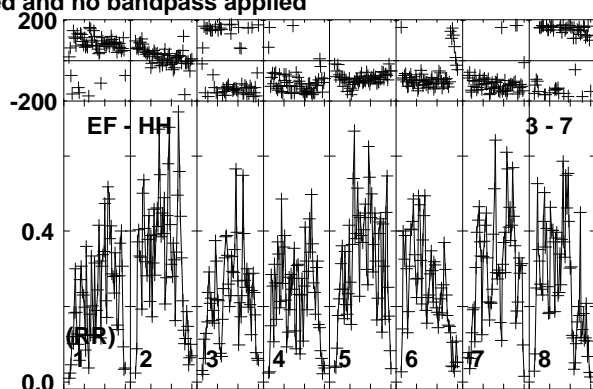
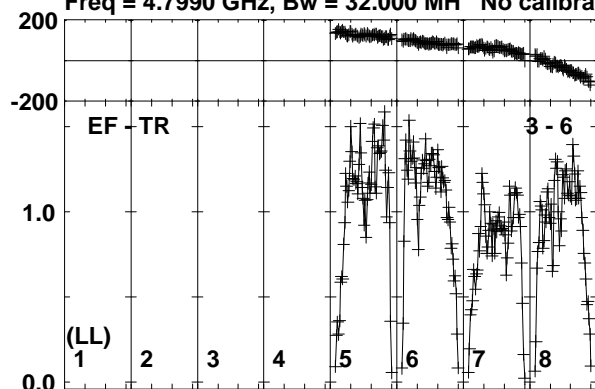

Lower frame: Milli Ampl Jy Top frame: Phas deg
Vector averaged cross-power spectrum Baseline: EF (03) - TR (06)
Timerange: 00:12:59:51 to 00:13:00:49

Plot file version 47 created 28-AUG-2017 13:19:03

SSS17A RP029A.UVDATA.1

Freq = 4.7990 GHz, Bw = 32.000 MH No calibration applied and no bandpass applied

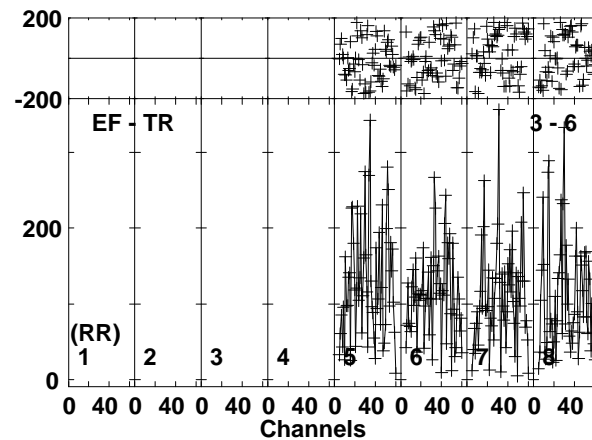
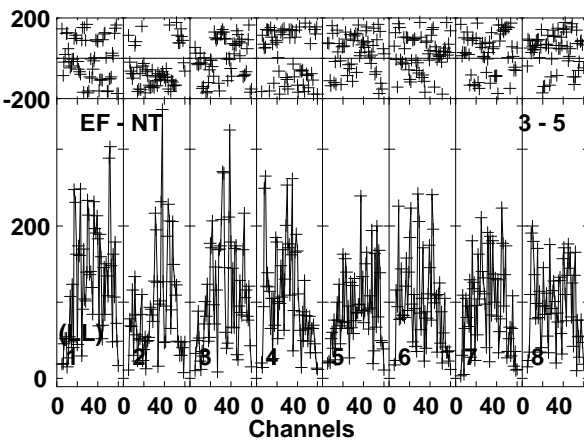
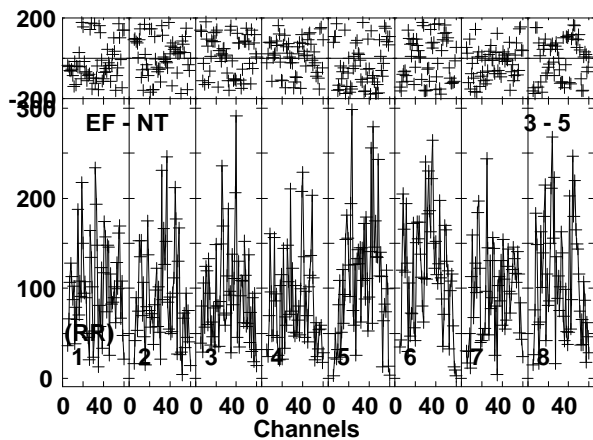
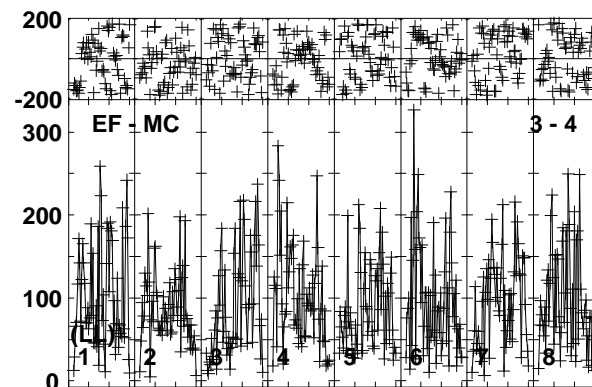
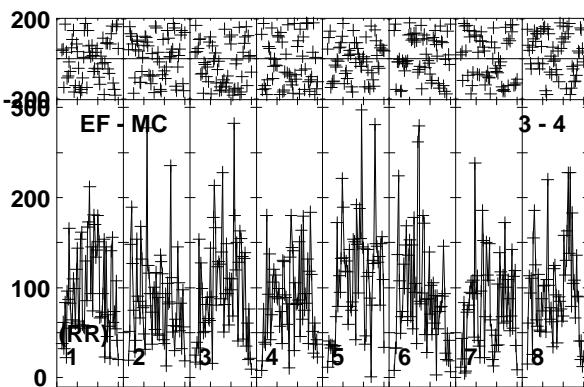
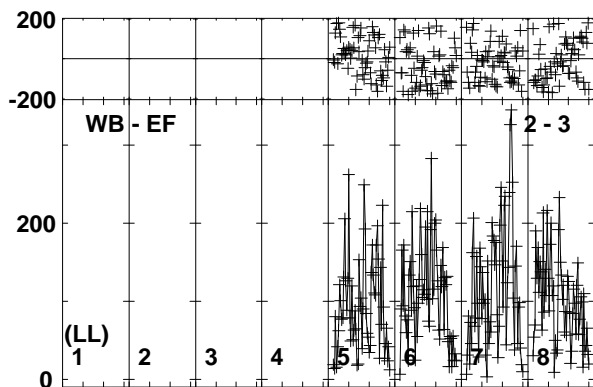
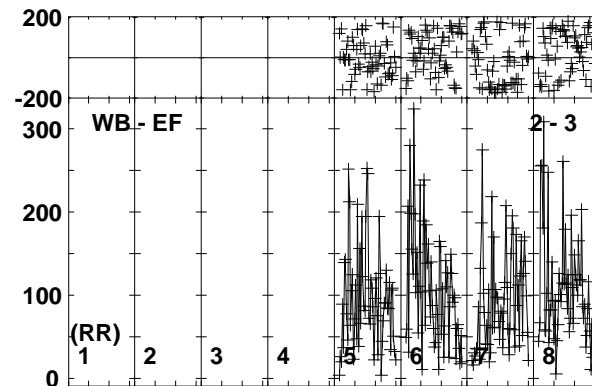
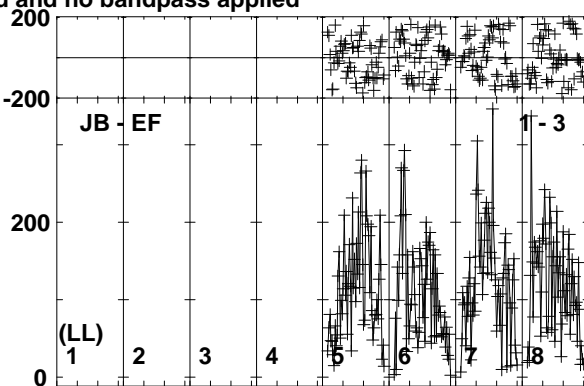
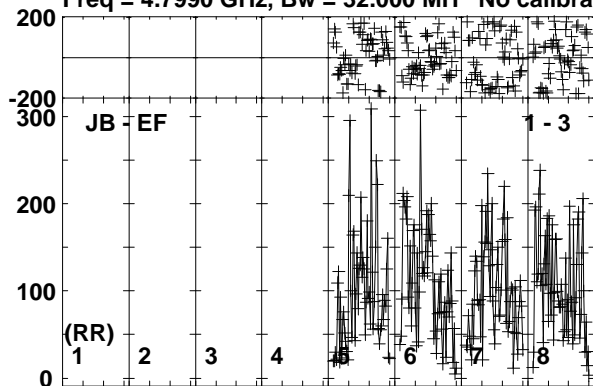

Lower frame: Micro Ampl Jy Top frame: Phas deg
Vector averaged cross-power spectrum Baseline: JB (01) - EF (03)
Timerange: 00/13:00:51 to 00/13:03:19

Plot file version 48 created 28-AUG-2017 13:19:03

SSS17A RP029A.UVDATA.1

Freq = 4.7990 GHz, Bw = 32.000 MH No calibration applied and no bandpass applied

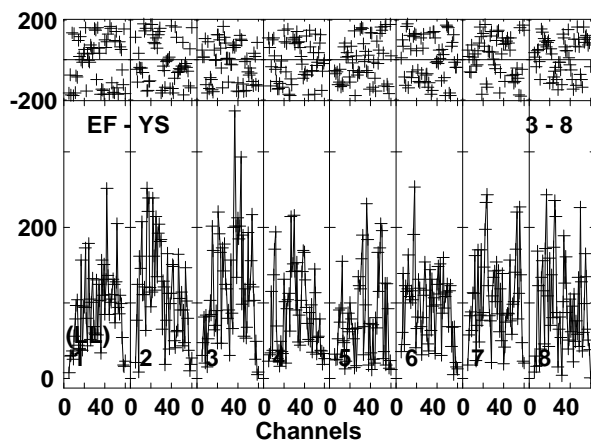
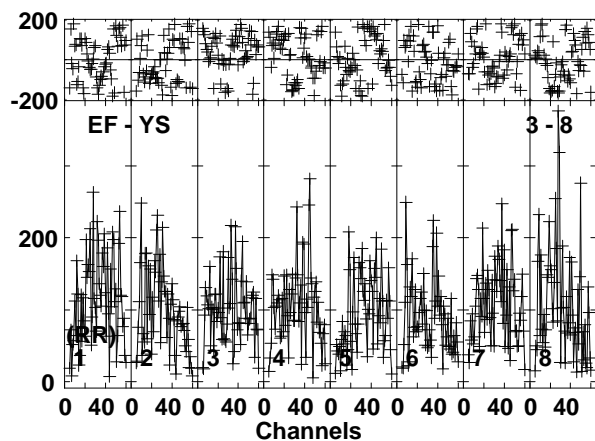
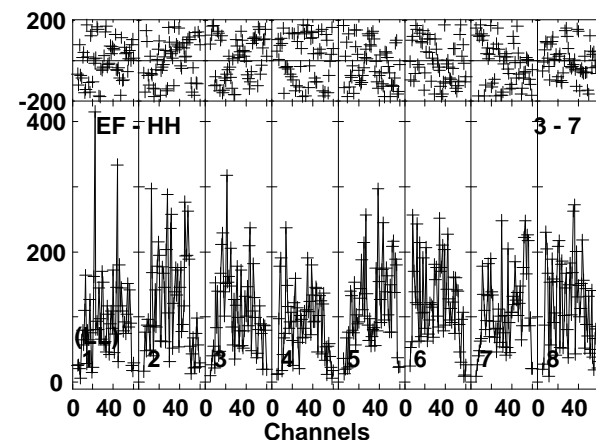
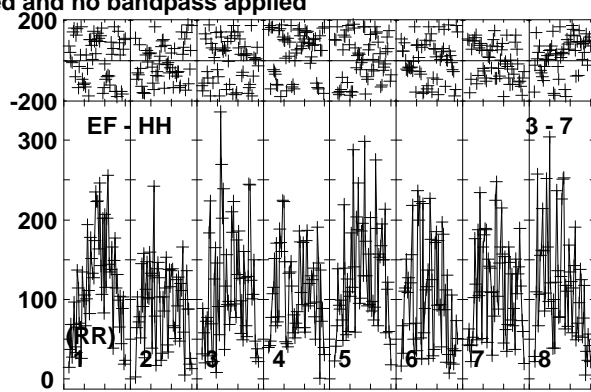
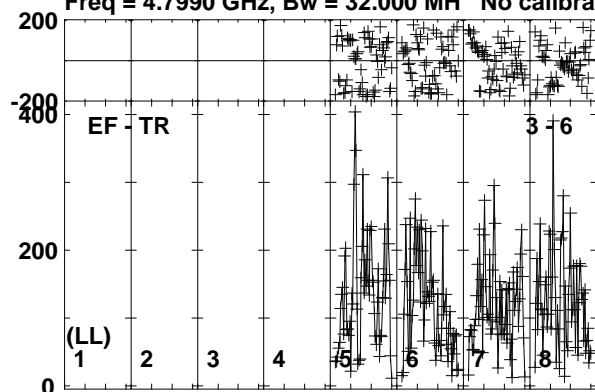

Lower frame: Micro Ampl Jy Top frame: Phas deg
Vector averaged cross-power spectrum Baseline: EF (03) - TR (06)
Timerange: 00/13:00:51 to 00/13:03:19

Plot file version 49 created 28-AUG-2017 13:19:03

J1303-2405 RP029A.UVDATA.1

Freq = 4.7990 GHz, Bw = 32.000 MH No calibration applied and no bandpass applied

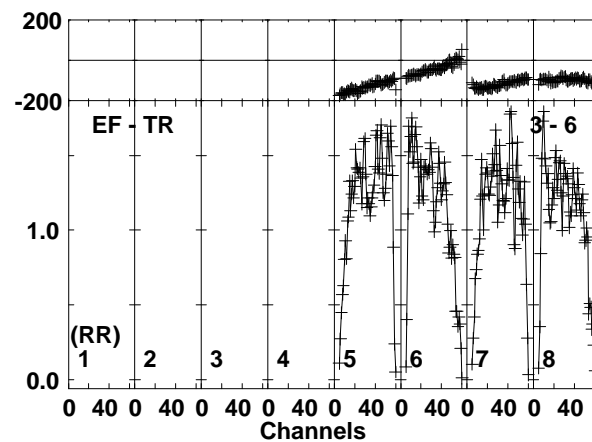
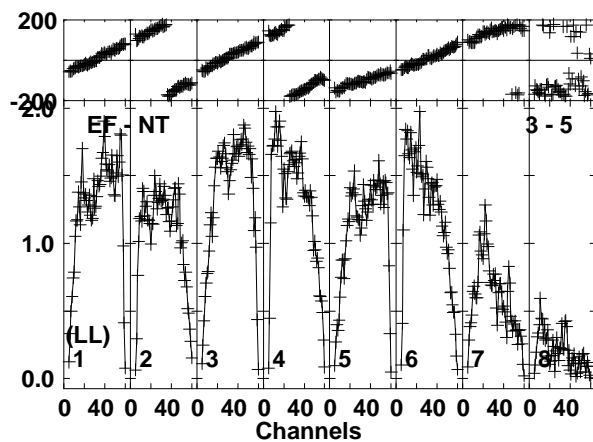
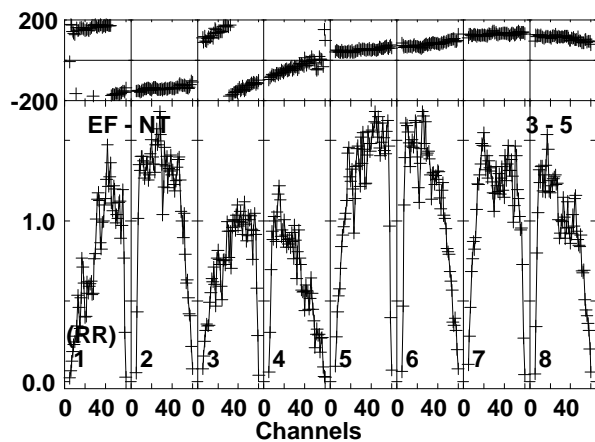
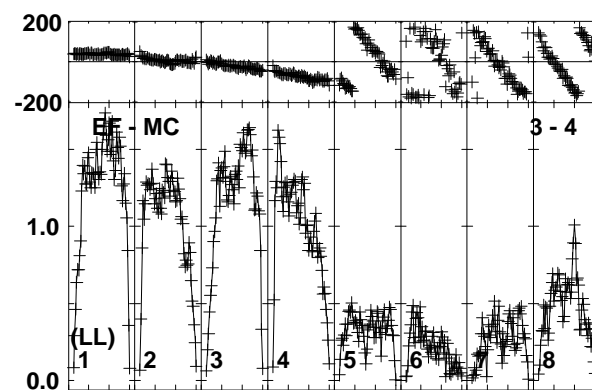
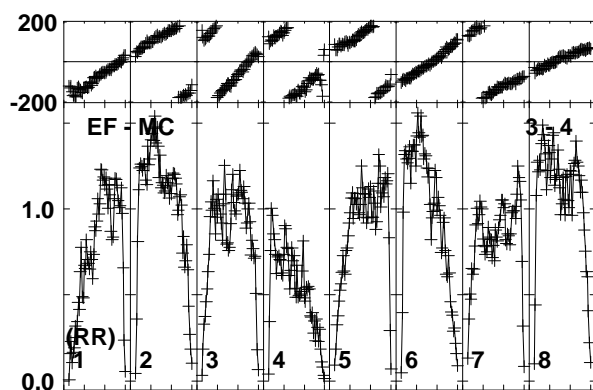
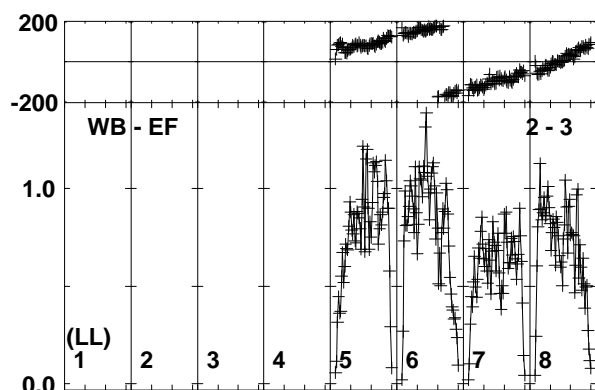
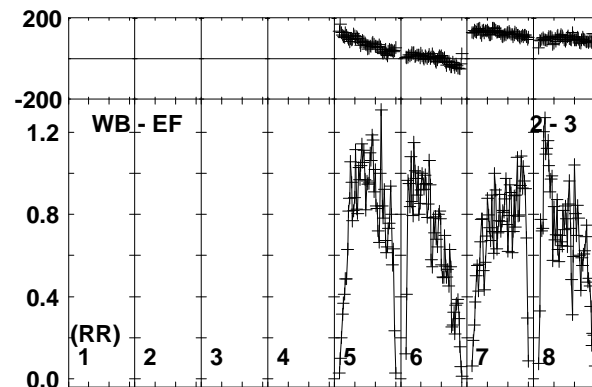
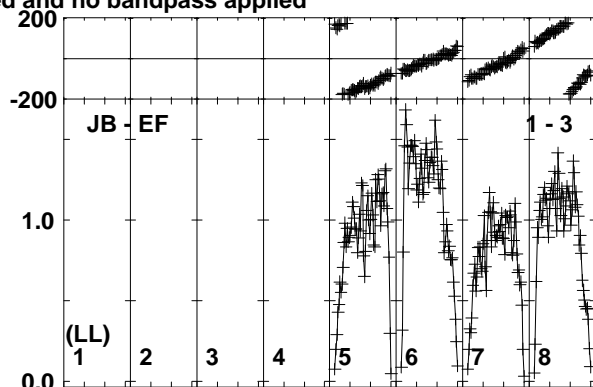
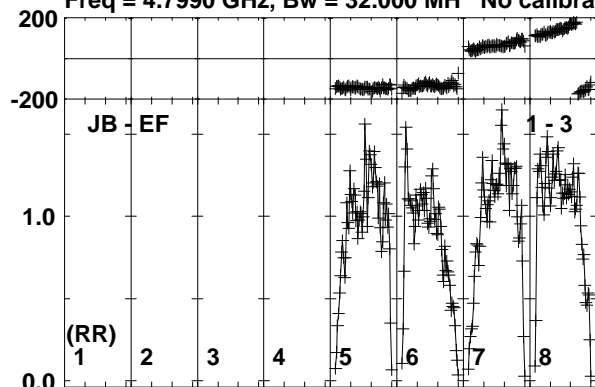

Lower frame: Milli Ampl Jy Top frame: Phas deg
Vector averaged cross-power spectrum Baseline: JB (01) - EF (03)
Timerange: 00/13:03:21 to 00/13:04:49

Plot file version 50 created 28-AUG-2017 13:19:03

J1303-2405 RP029A.UVDATA.1

Freq = 4.7990 GHz, Bw = 32.000 MH No calibration applied and no bandpass applied

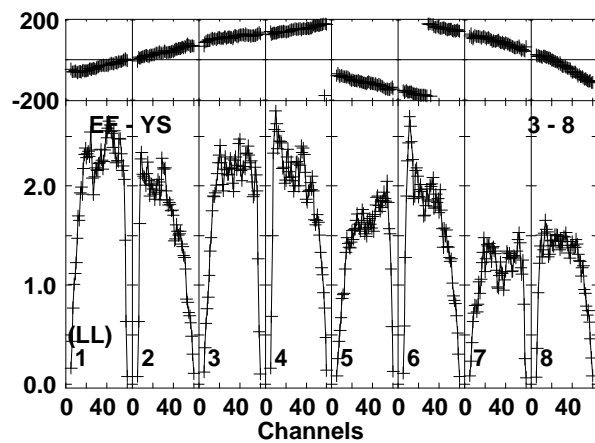
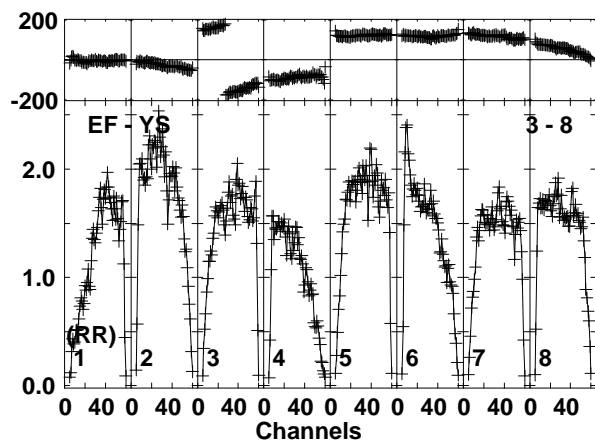
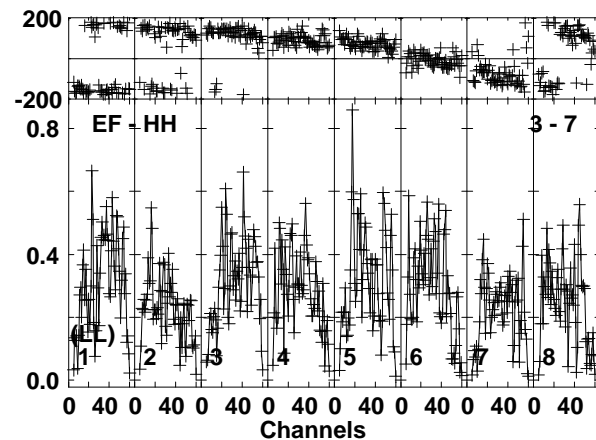
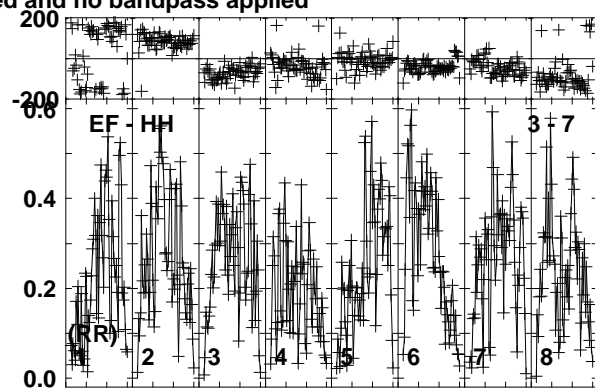
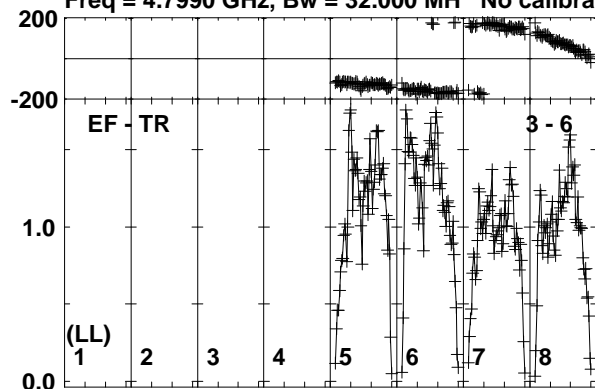

Lower frame: Milli Ampl Jy Top frame: Phas deg
Vector averaged cross-power spectrum Baseline: EF (03) - TR (06)
Timerange: 00/13:03:21 to 00/13:04:49

Plot file version 51 created 28-AUG-2017 13:19:03

SSS17A RP029A.UVDATA.1

Freq = 4.7990 GHz, Bw = 32.000 MH No calibration applied and no bandpass applied

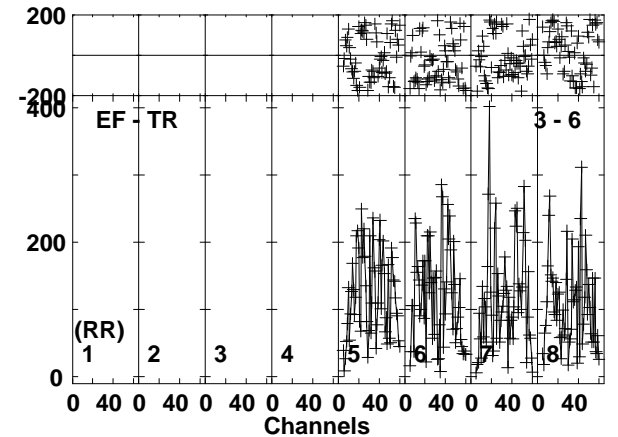
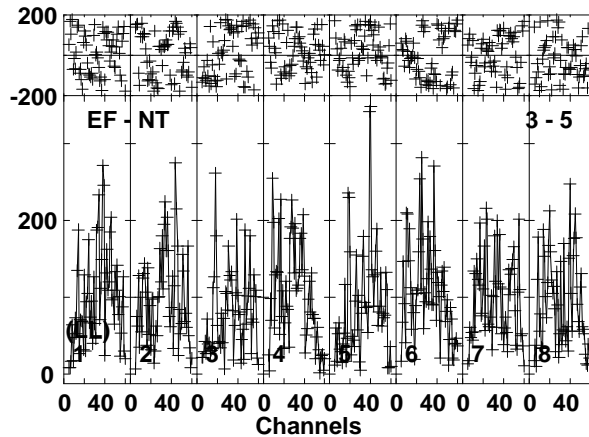
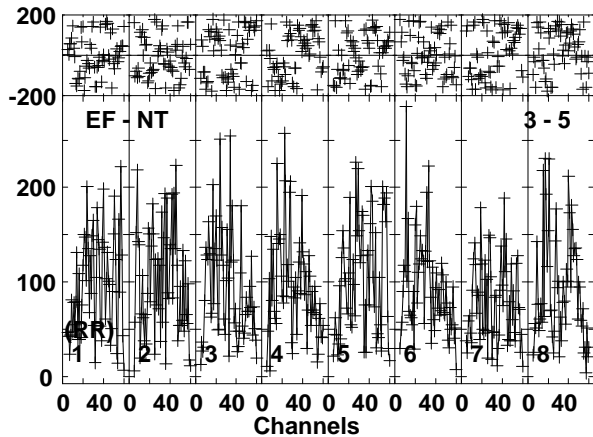
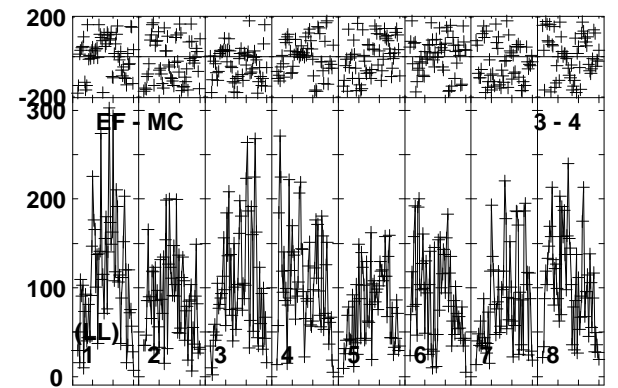
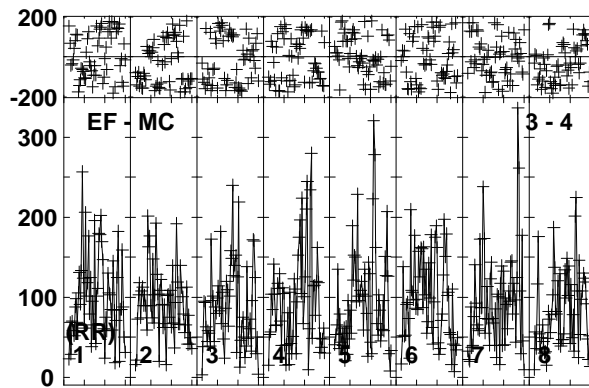
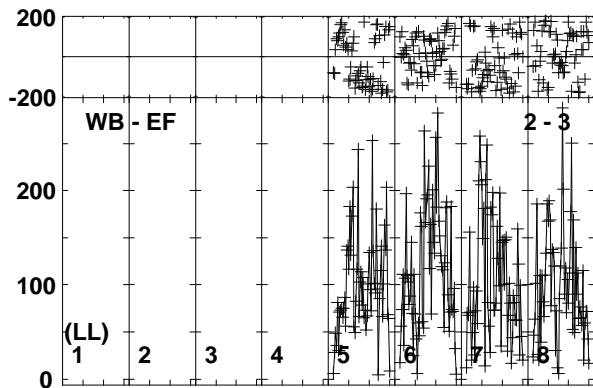
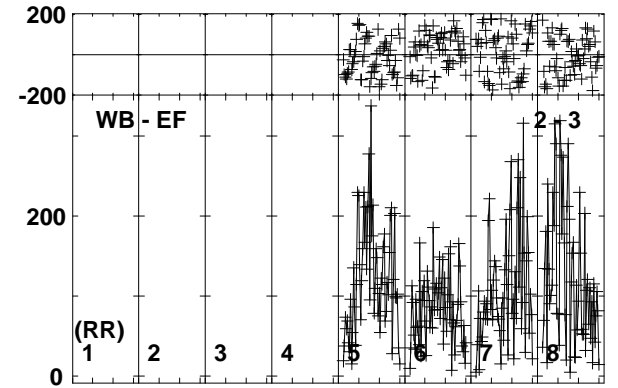
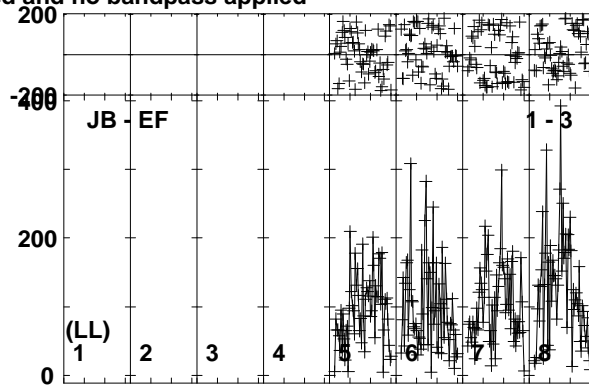
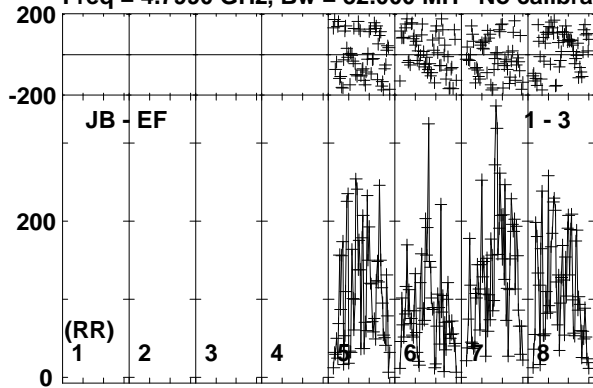

Lower frame: Micro Ampl Jy Top frame: Phas deg
Vector averaged cross-power spectrum Baseline: JB (01) - EF (03)
Timerange: 00/13:04:51 to 00/13:07:19

Plot file version 52 created 28-AUG-2017 13:19:03

SSS17A RP029A.UVDATA.1

Freq = 4.7990 GHz, Bw = 32.000 MH No calibration applied and no bandpass applied

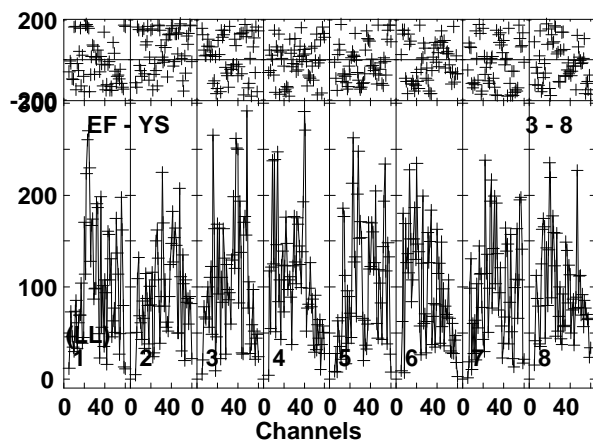
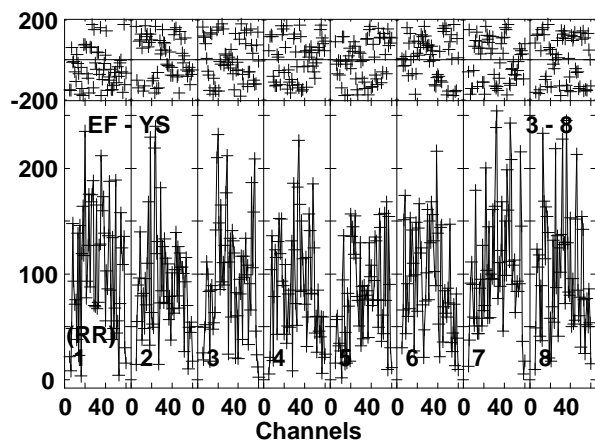
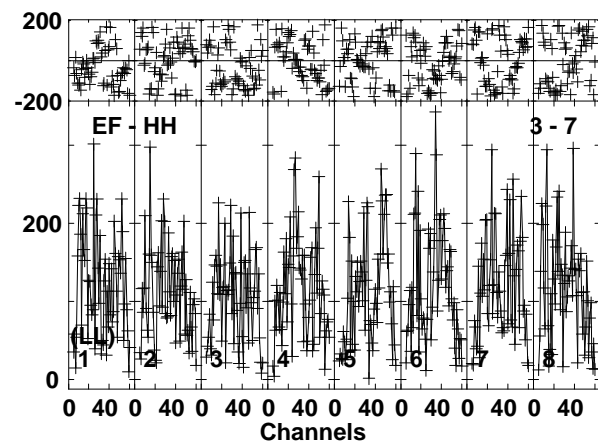
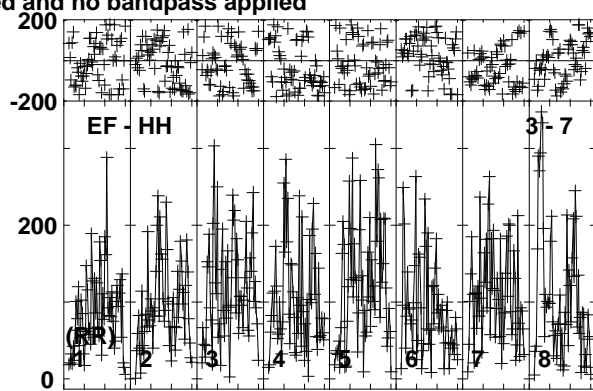
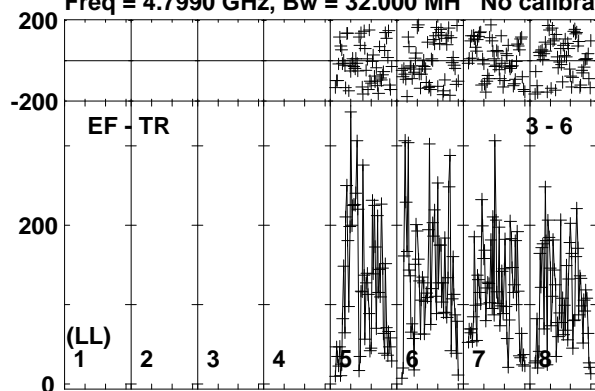

Lower frame: Micro Ampl Jy Top frame: Phas deg
Vector averaged cross-power spectrum Baseline: EF (03) - TR (06)
Timerange: 00/13:04:51 to 00/13:07:19

Plot file version 53 created 28-AUG-2017 13:19:03

J1303-2405 RP029A.UVDATA.1

Freq = 4.7990 GHz, Bw = 32.000 MH No calibration applied and no bandpass applied

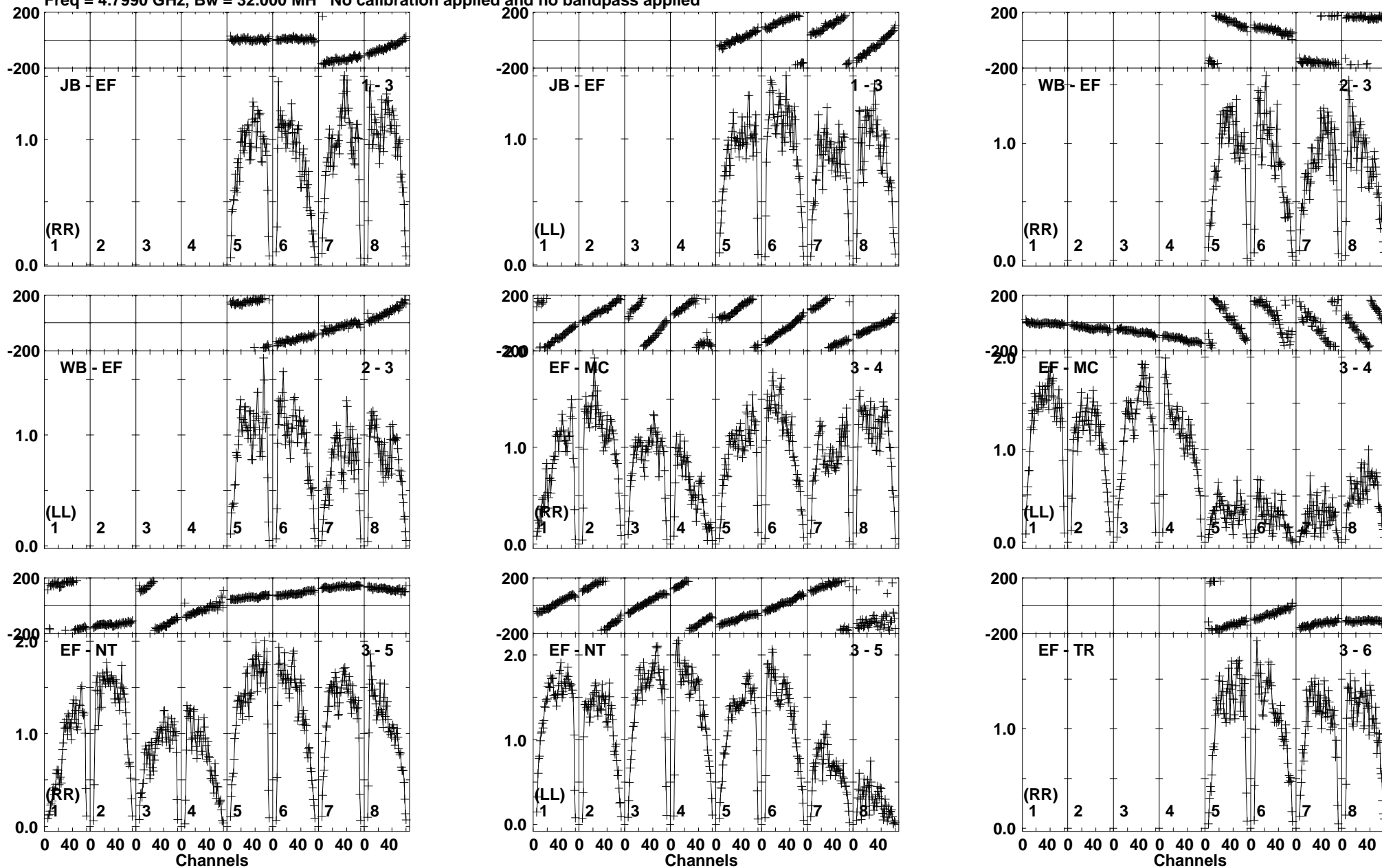

Lower frame: Milli Ampl Jy Top frame: Phas deg
Vector averaged cross-power spectrum Baseline: JB (01) - EF (03)
Timerange: 00/13:07:51 to 00/13:08:49

Plot file version 54 created 28-AUG-2017 13:19:03

J1303-2405 RP029A.UVDATA.1

Freq = 4.7990 GHz, Bw = 32.000 MH No calibration applied and no bandpass applied

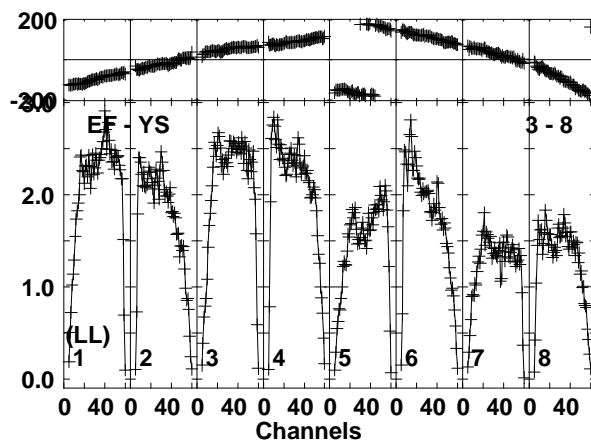
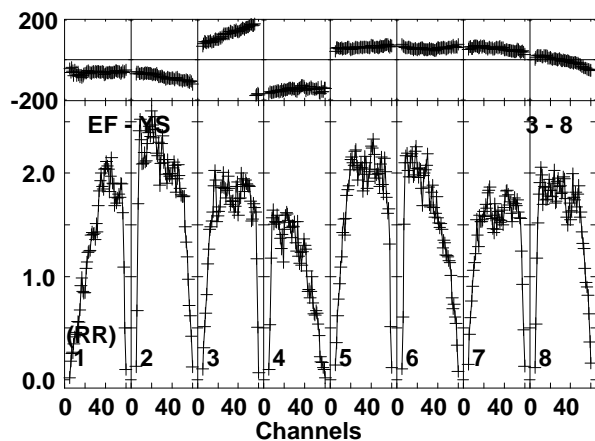
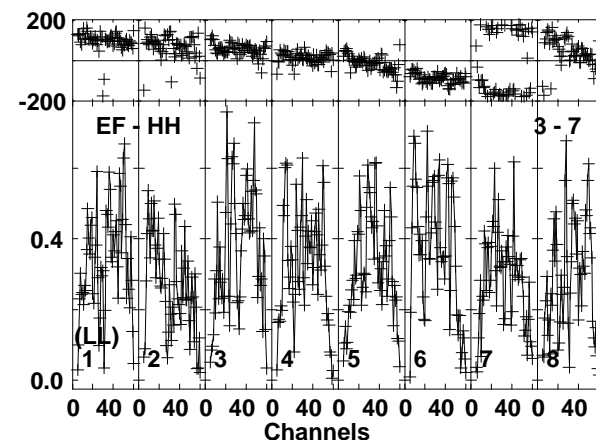
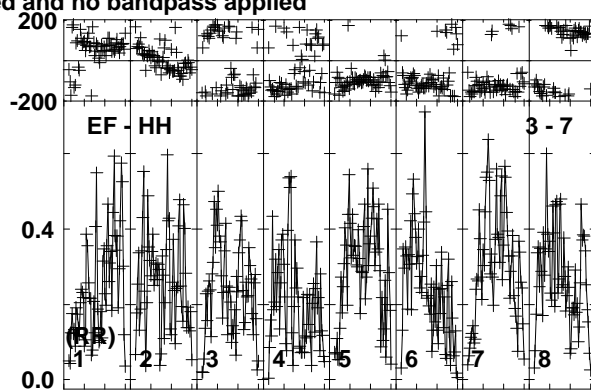
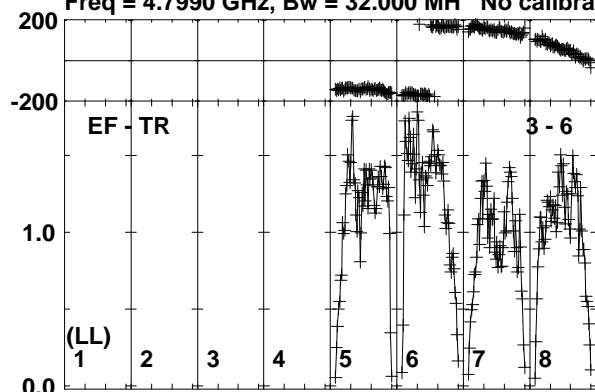

Lower frame: Milli Ampl Jy Top frame: Phas deg
Vector averaged cross-power spectrum Baseline: EF (03) - TR (06)
Timerange: 00/13:07:51 to 00/13:08:49

Plot file version 55 created 28-AUG-2017 13:19:03

SSS17A RP029A.UVDATA.1

Freq = 4.7990 GHz, Bw = 32.000 MH No calibration applied and no bandpass applied

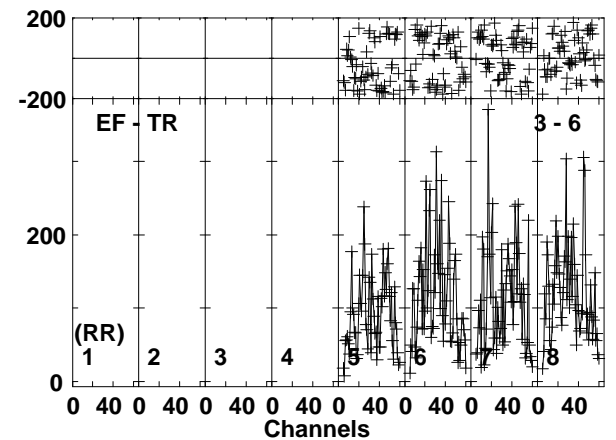
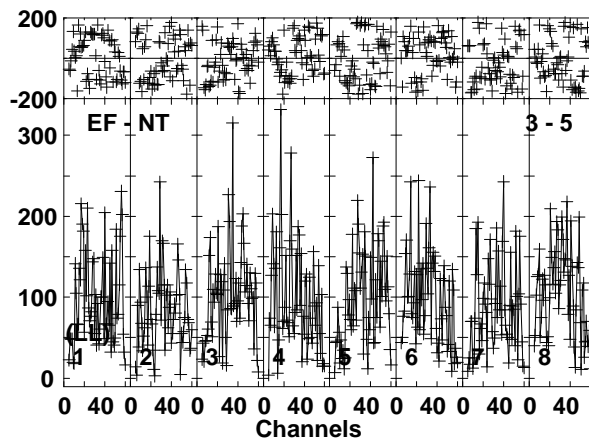
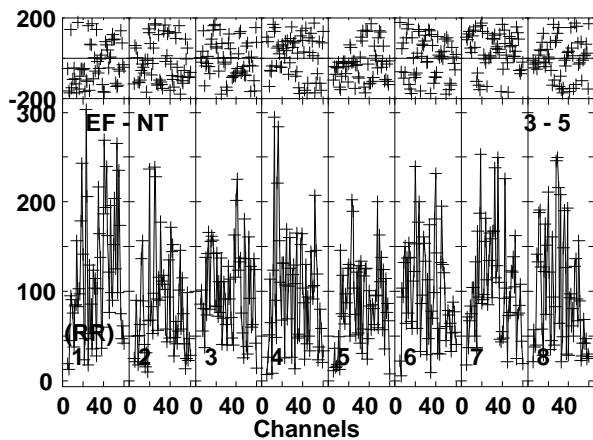
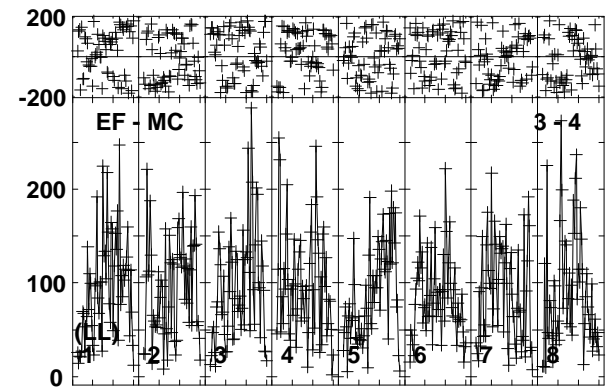
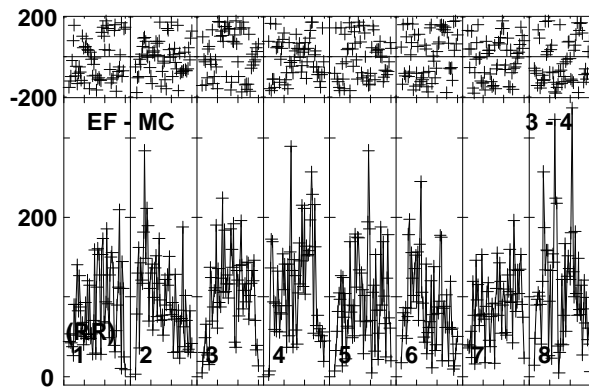
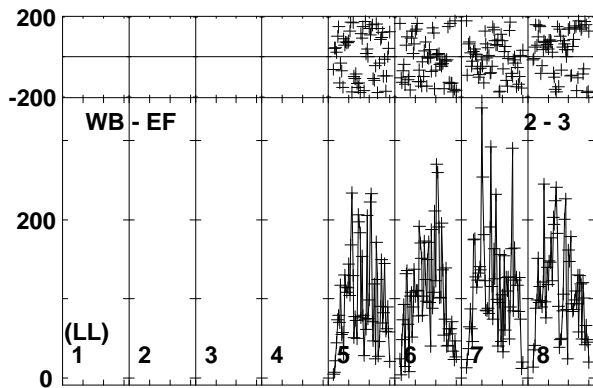
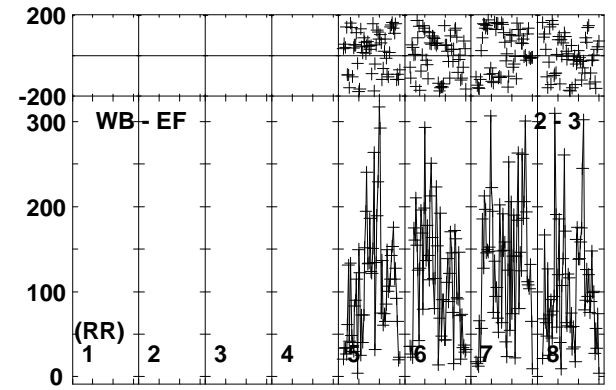
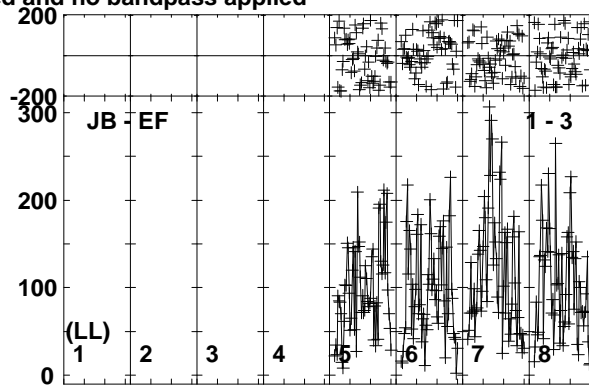
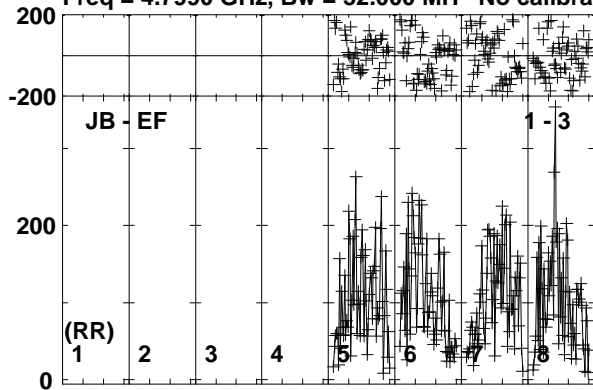

Lower frame: Micro Ampl Jy Top frame: Phas deg
Vector averaged cross-power spectrum Baseline: JB (01) - EF (03)
Timerange: 00/13:08:51 to 00/13:11:19

Plot file version 56 created 28-AUG-2017 13:19:03

SSS17A RP029A.UVDATA.1

Freq = 4.7990 GHz, Bw = 32.000 MH No calibration applied and no bandpass applied

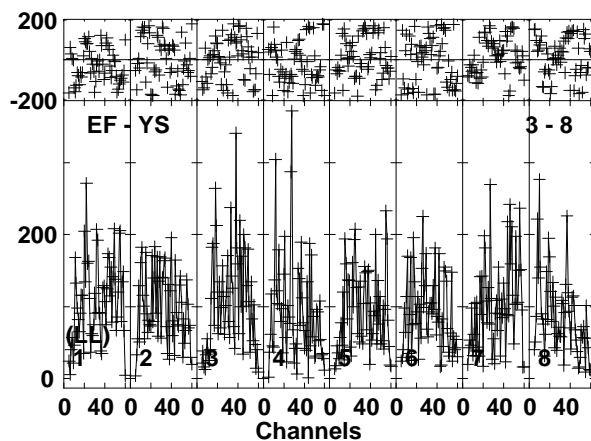
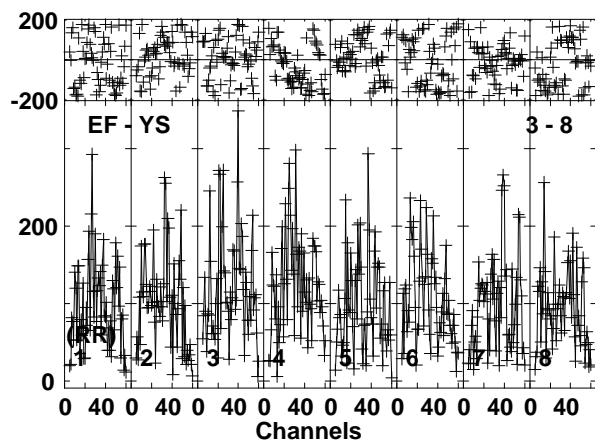
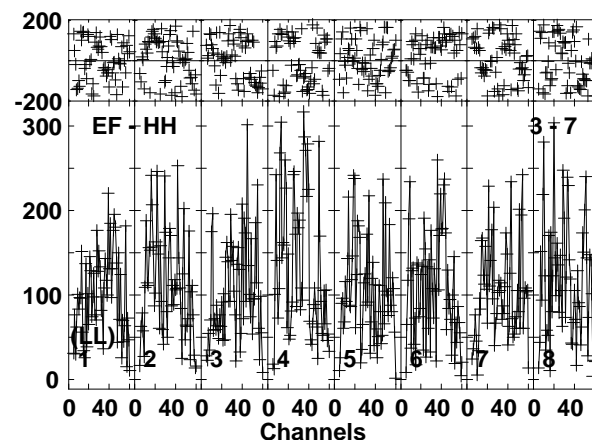
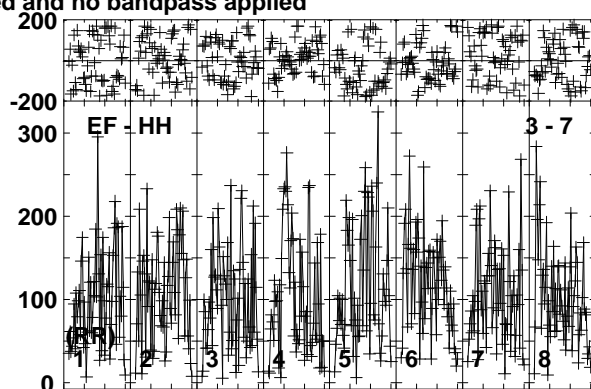
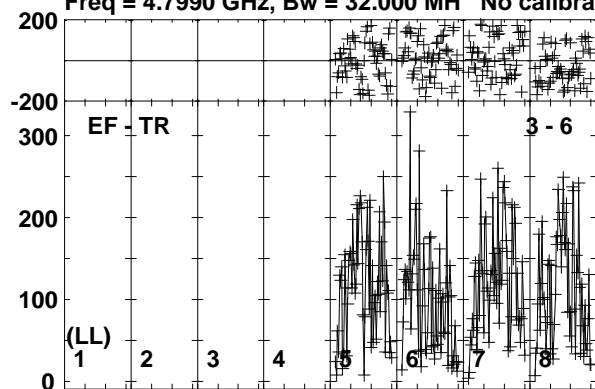

Lower frame: Micro Ampl Jy Top frame: Phas deg
Vector averaged cross-power spectrum Baseline: EF (03) - TR (06)
Timerange: 00/13:08:51 to 00/13:11:19

Plot file version 57 created 28-AUG-2017 13:19:03

J1303-2405 RP029A.UVDATA.1

Freq = 4.7990 GHz, Bw = 32.000 MH No calibration applied and no bandpass applied

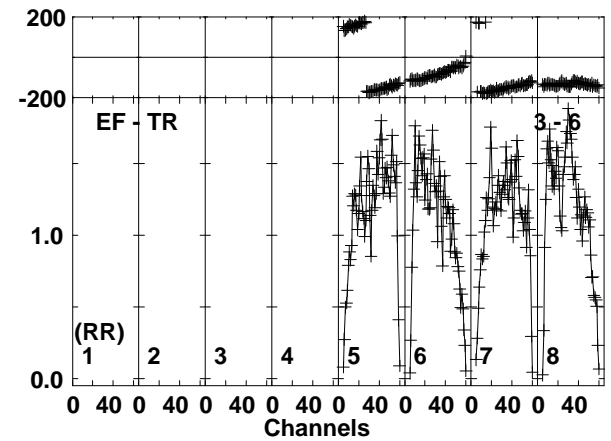
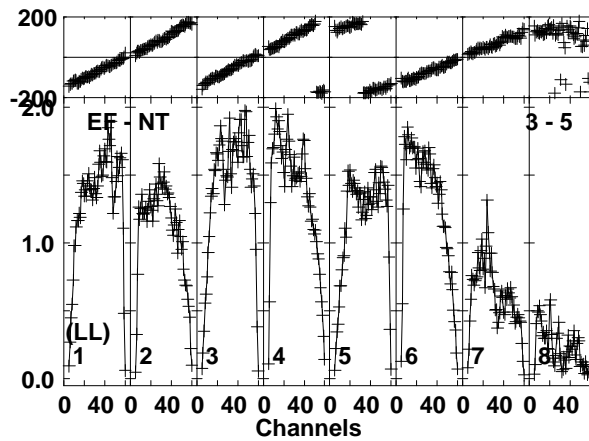
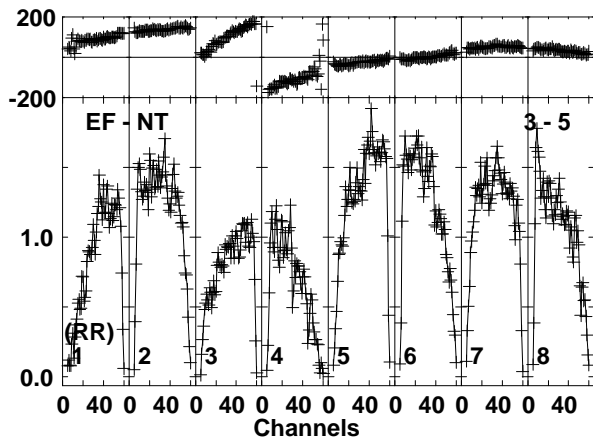
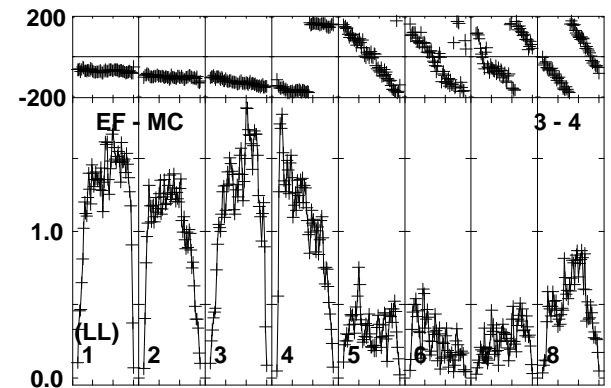
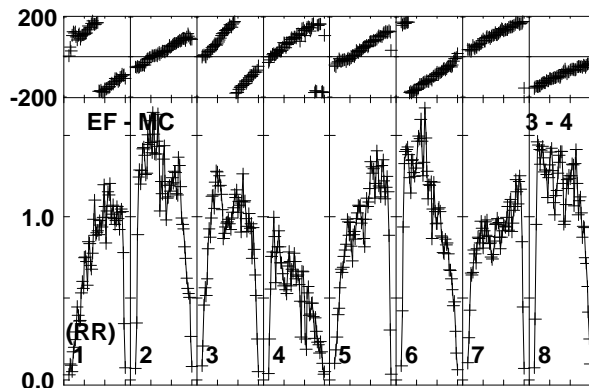
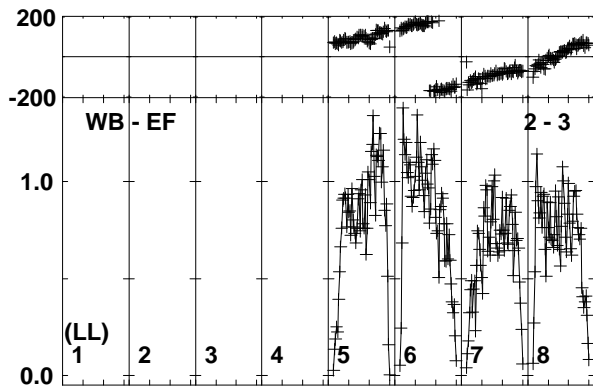
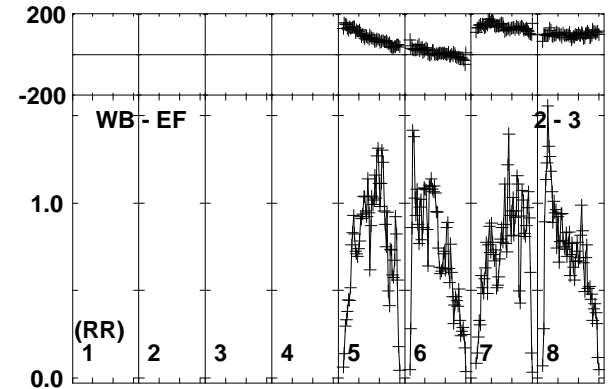
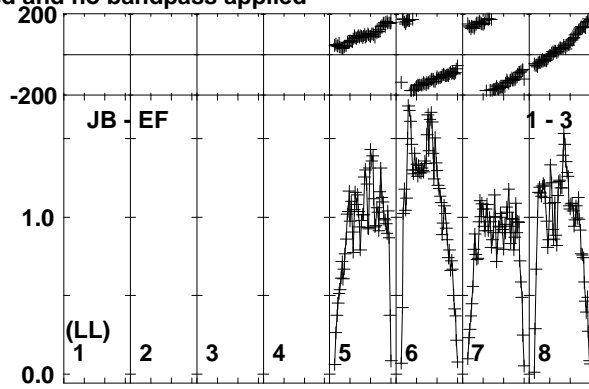
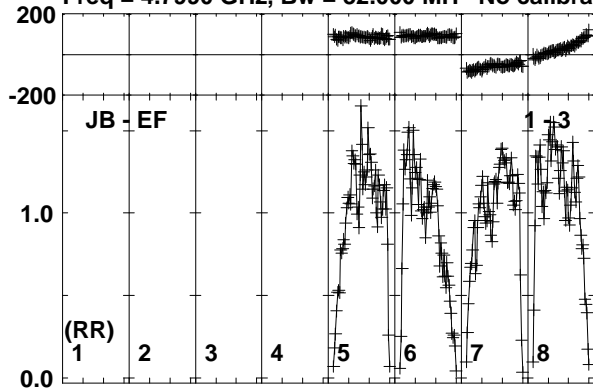

Lower frame: Milli Ampl Jy Top frame: Phas deg
Vector averaged cross-power spectrum Baseline: JB (01) - EF (03)
Timerange: 00/13:11:21 to 00/13:12:49

Plot file version 58 created 28-AUG-2017 13:19:04

J1303-2405 RP029A.UVDATA.1

Freq = 4.7990 GHz, Bw = 32.000 MH No calibration applied and no bandpass applied

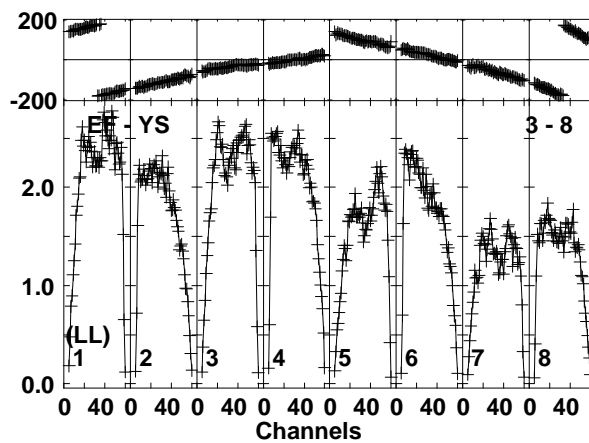
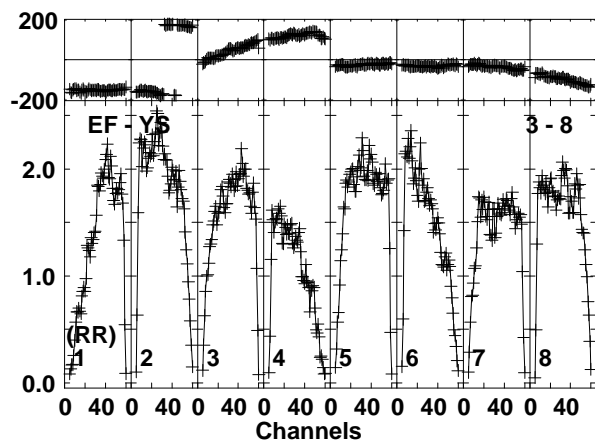
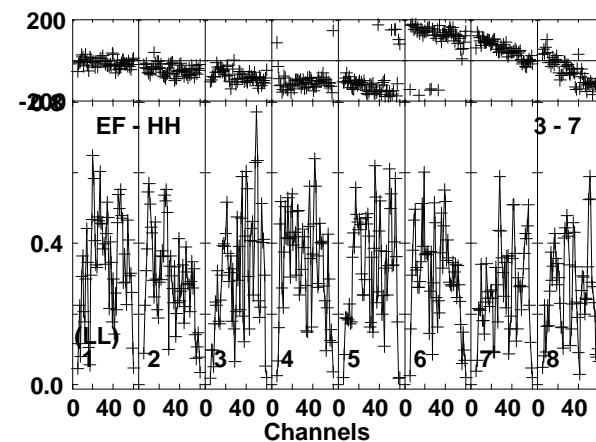
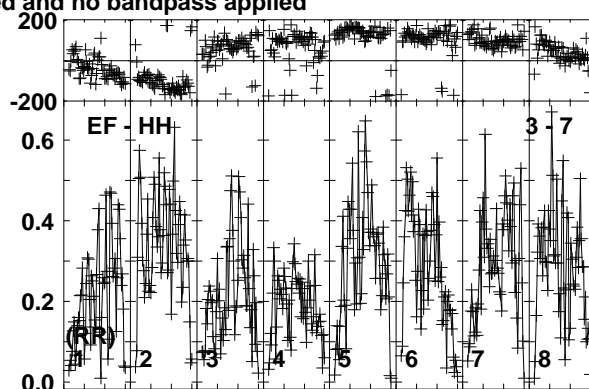
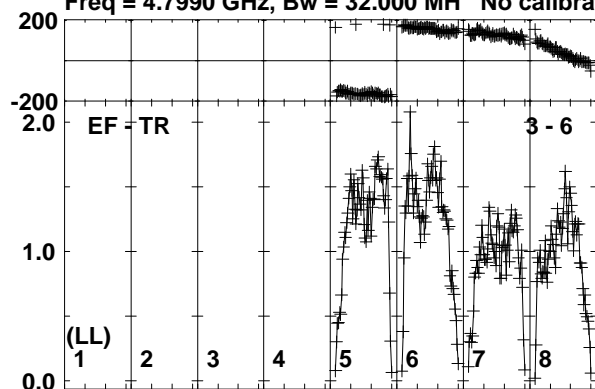

Lower frame: Milli Ampl Jy Top frame: Phas deg
Vector averaged cross-power spectrum Baseline: EF (03) - TR (06)
Timerange: 00/13:11:21 to 00/13:12:49

Plot file version 59 created 28-AUG-2017 13:19:04

J1312-2350 RP029A.UVDATA.1

Freq = 4.7990 GHz, Bw = 32.000 MH No calibration applied and no bandpass applied

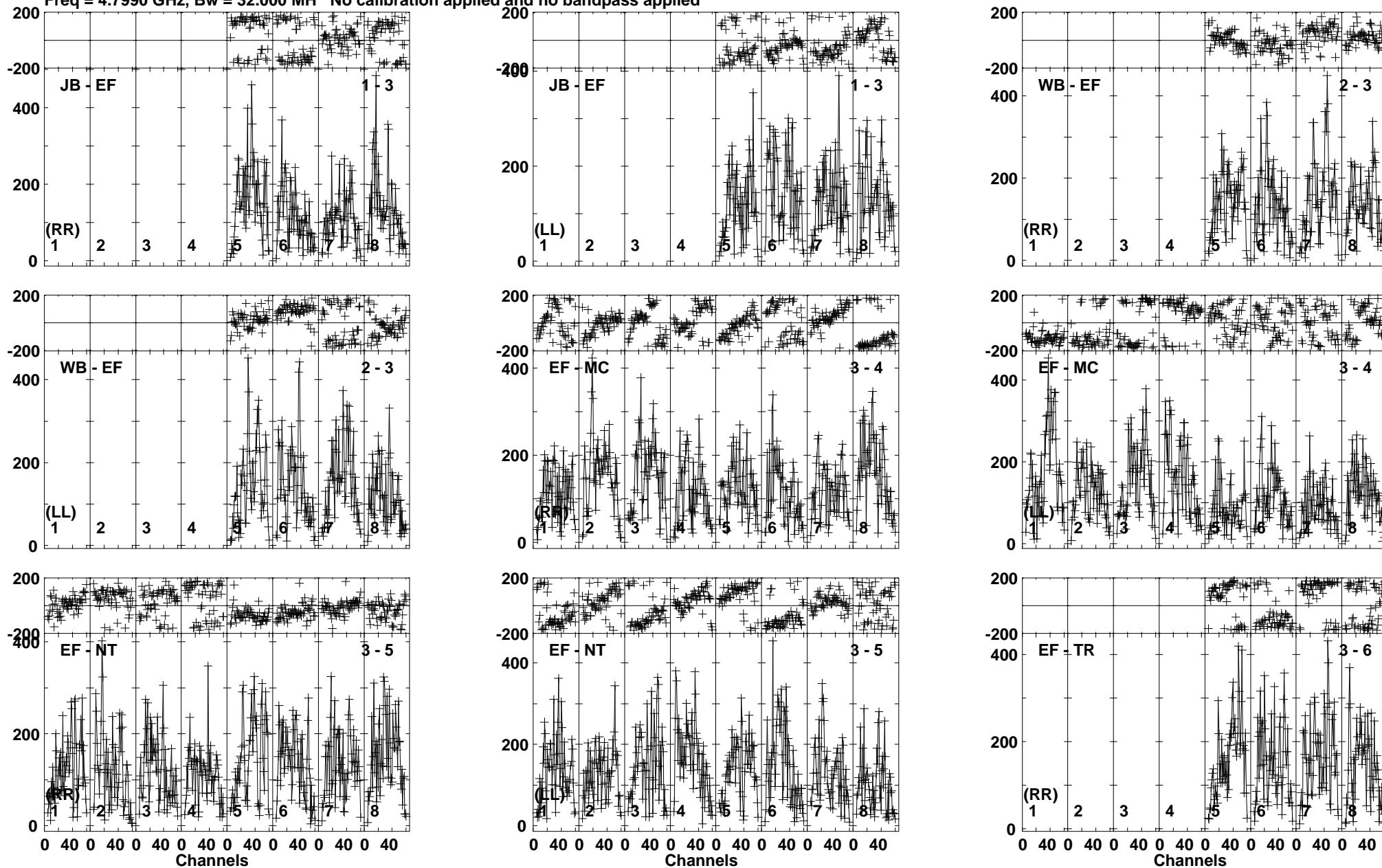

Lower frame: Micro Ampl Jy Top frame: Phas deg
Vector averaged cross-power spectrum Baseline: JB (01) - EF (03)
Timerange: 00/13:12:51 to 00/13:15:19

Plot file version 60 created 28-AUG-2017 13:19:04

J1312-2350 RP029A.UVDATA.1

Freq = 4.7990 GHz, Bw = 32.000 MH No calibration applied and no bandpass applied

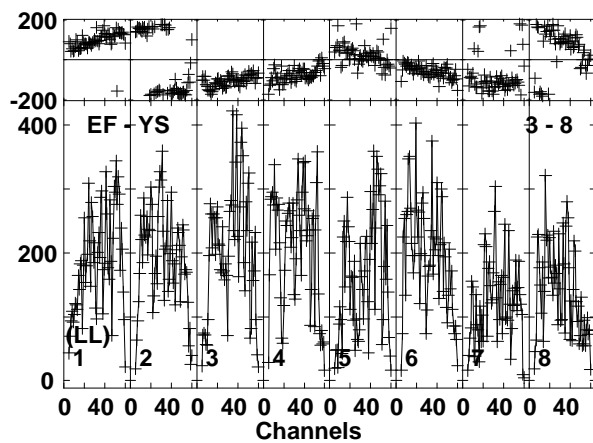
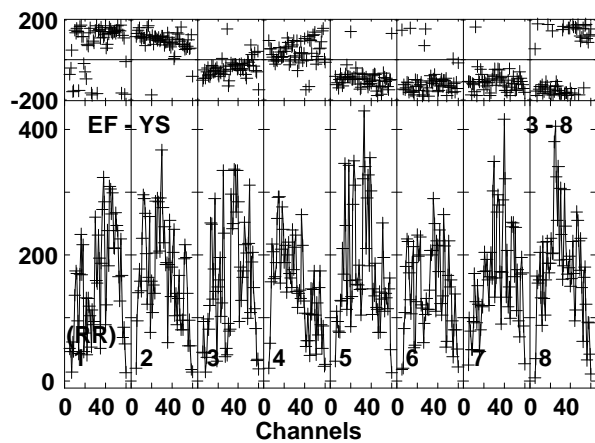
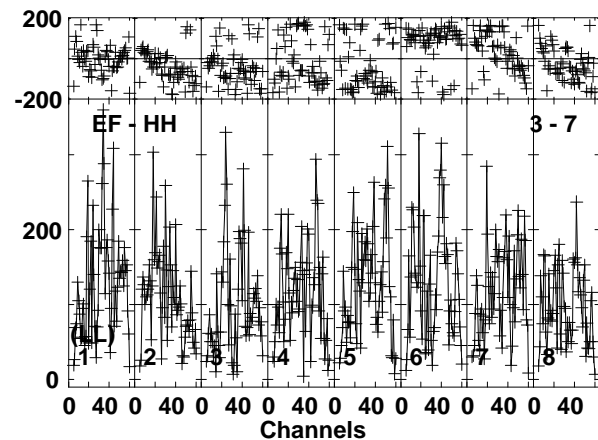
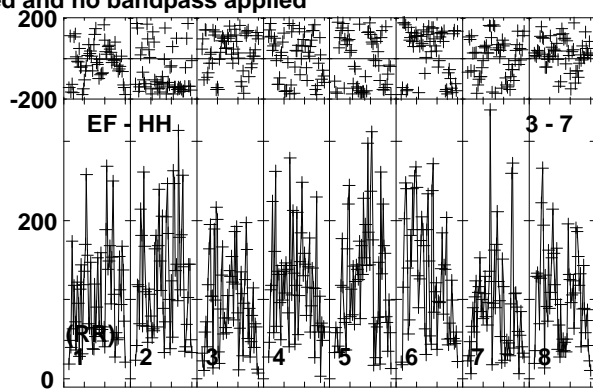
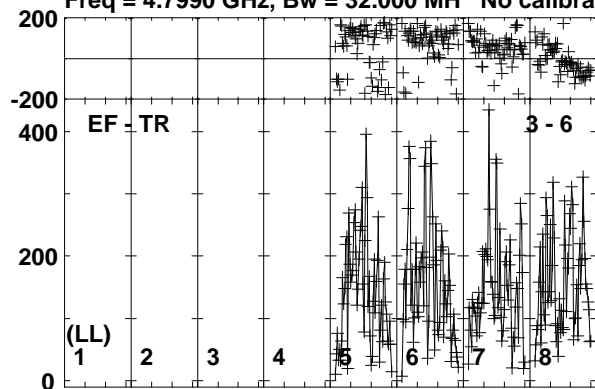

Lower frame: Micro Ampl Jy Top frame: Phas deg
Vector averaged cross-power spectrum Baseline: EF (03) - TR (06)
Timerange: 00/13:12:51 to 00/13:15:19

Plot file version 61 created 28-AUG-2017 13:19:04

J1303-2405 RP029A.UVDATA.1

Freq = 4.7990 GHz, Bw = 32.000 MH No calibration applied and no bandpass applied

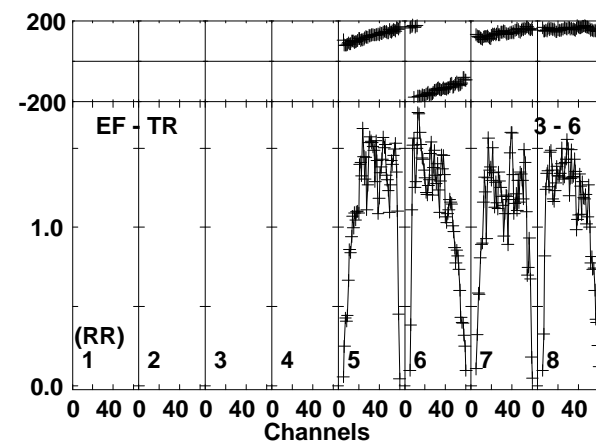
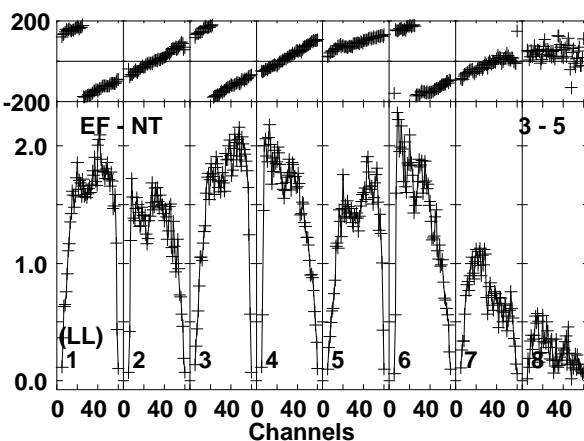
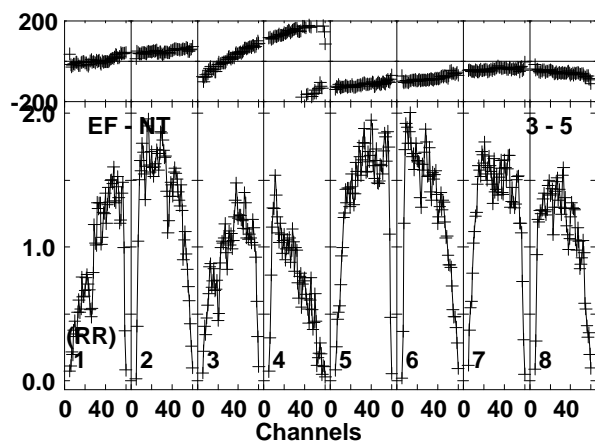
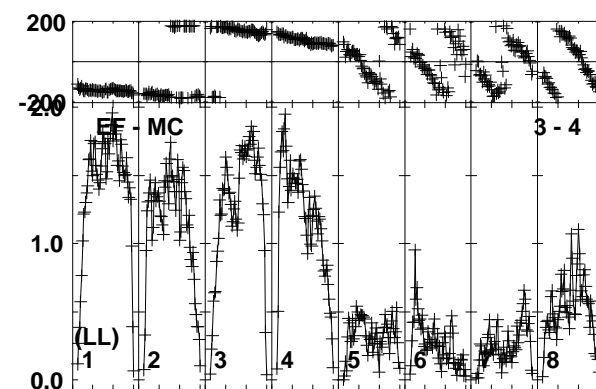
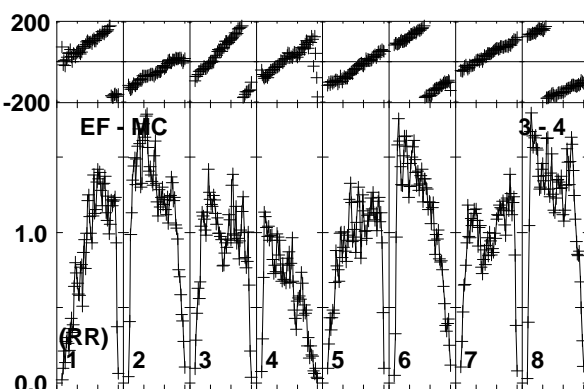
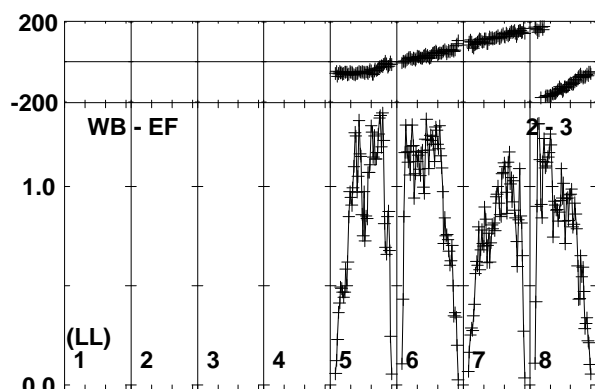
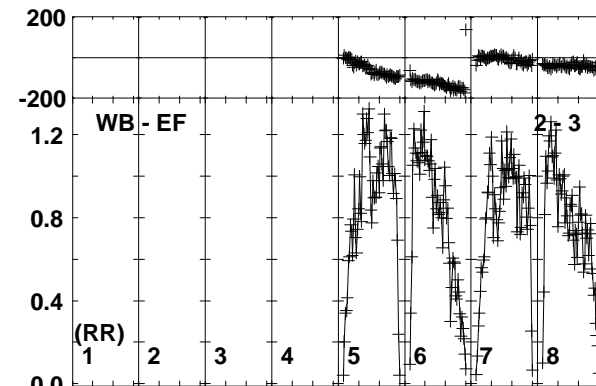
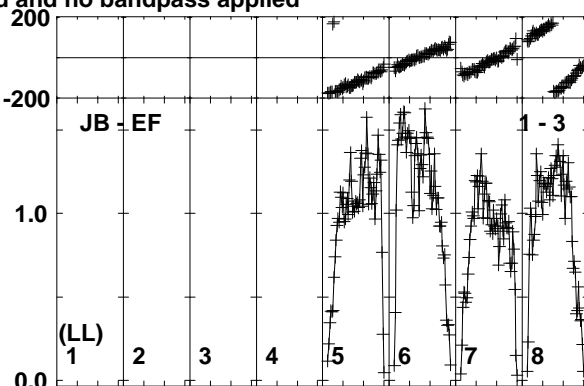
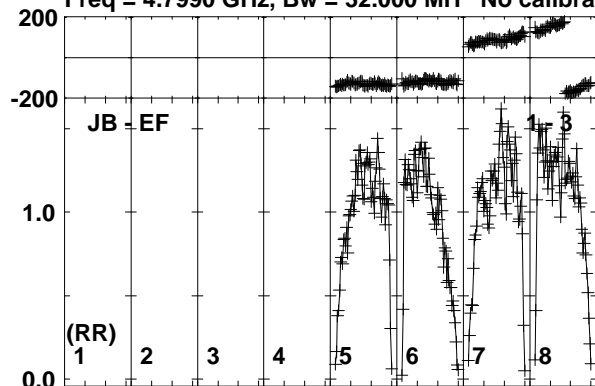

Lower frame: Milli Ampl Jy Top frame: Phas deg
Vector averaged cross-power spectrum Baseline: JB (01) - EF (03)
Timerange: 00/13:16:01 to 00/13:16:59

Plot file version 62 created 28-AUG-2017 13:19:04

J1303-2405 RP029A.UVDATA.1

Freq = 4.7990 GHz, Bw = 32.000 MH No calibration applied and no bandpass applied

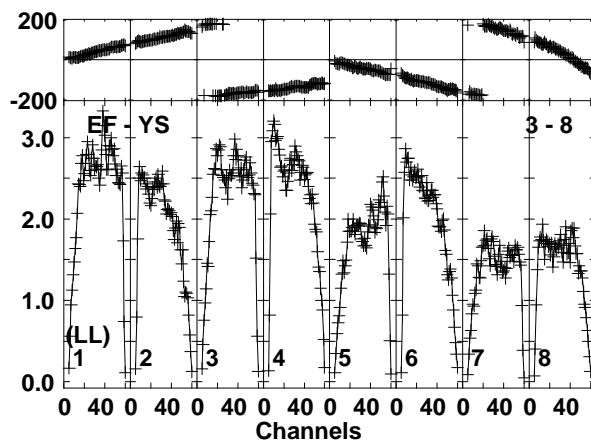
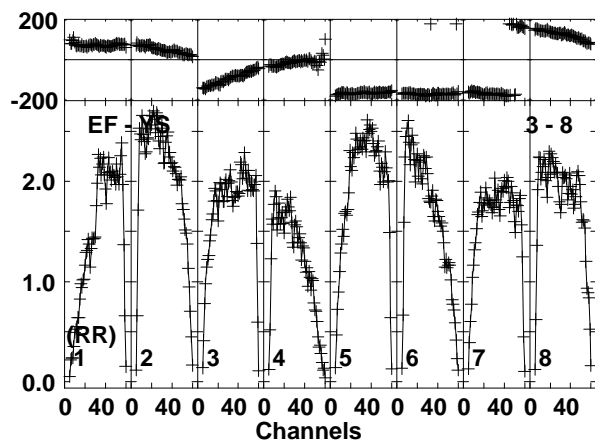
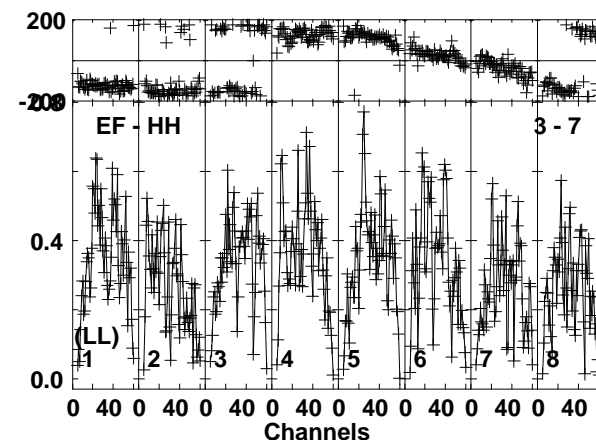
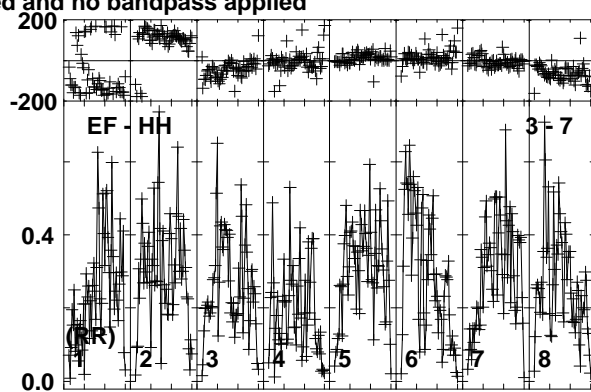
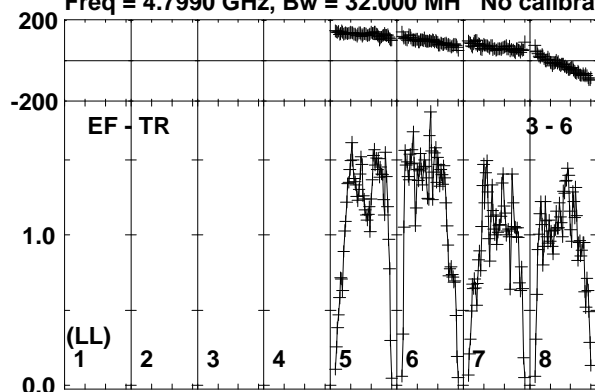

Lower frame: Milli Ampl Jy Top frame: Phas deg
Vector averaged cross-power spectrum Baseline: EF (03) - TR (06)
Timerange: 00/13:16:01 to 00/13:16:59

Plot file version 63 created 28-AUG-2017 13:19:04

SSS17A_RP029A.UVDATA.1

Freq = 4.7990 GHz, Bw = 32.000 MH No calibration applied and no bandpass applied

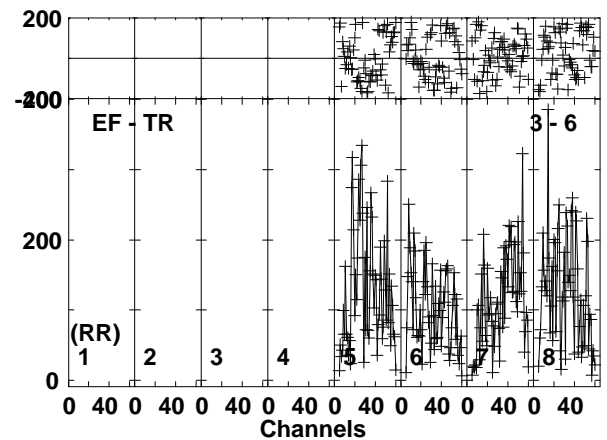
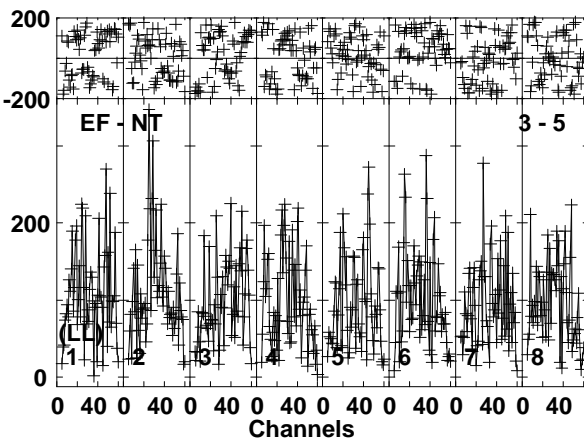
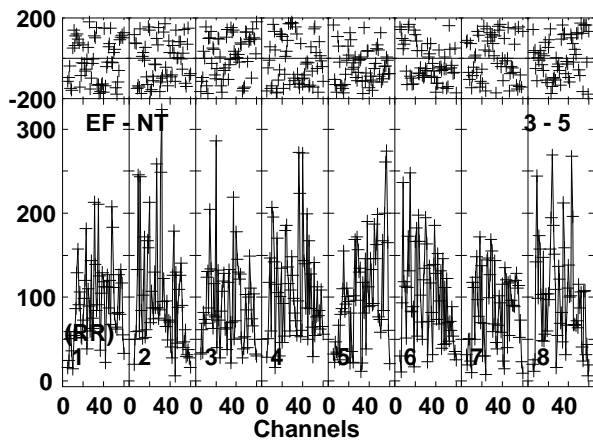
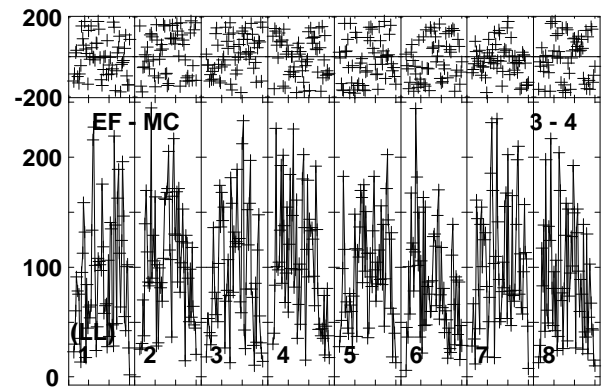
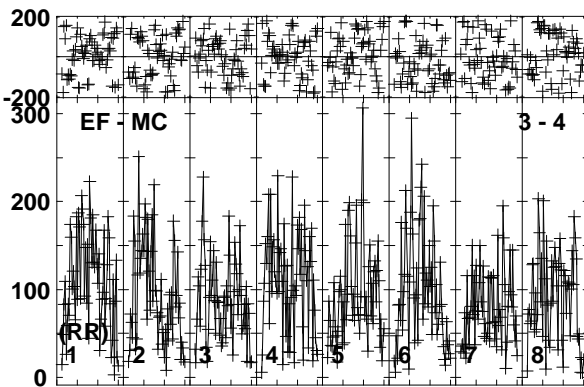
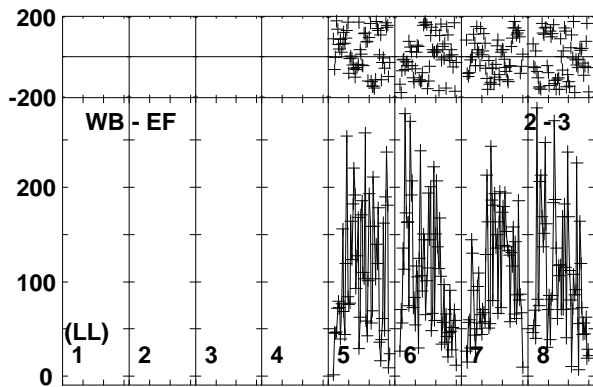
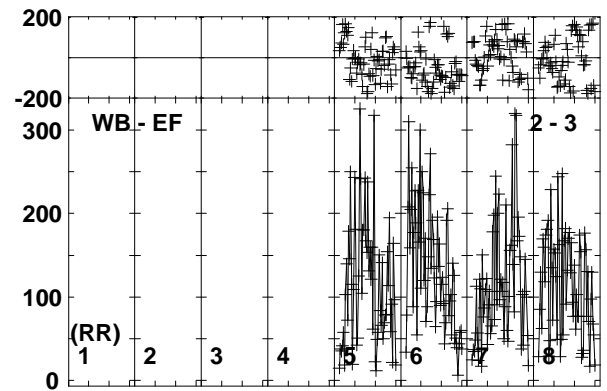
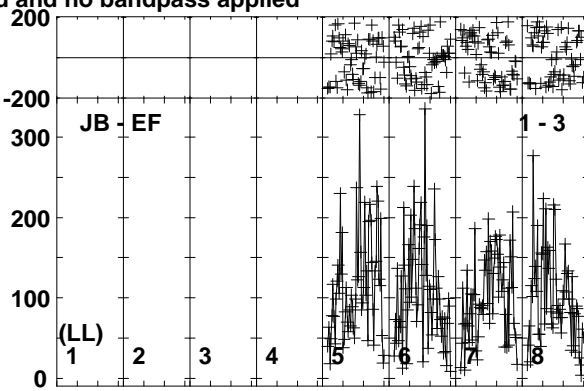
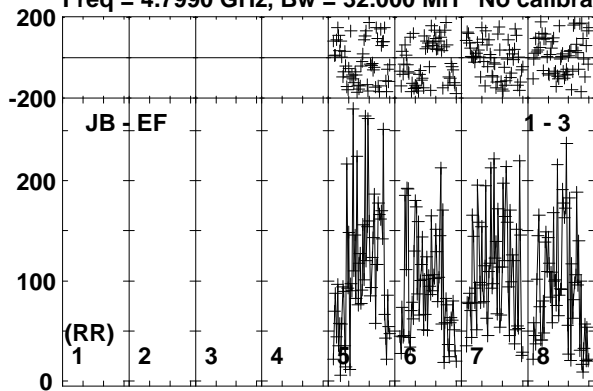

Lower frame: Micro Ampl Jy Top frame: Phas deg
Vector averaged cross-power spectrum Baseline: JB (01) - EF (03)
Timerange: 00/13:17:01 to 00/13:19:29

Plot file version 64 created 28-AUG-2017 13:19:04

SSS17A RP029A.UVDATA.1

Freq = 4.7990 GHz, Bw = 32.000 MH No calibration applied and no bandpass applied

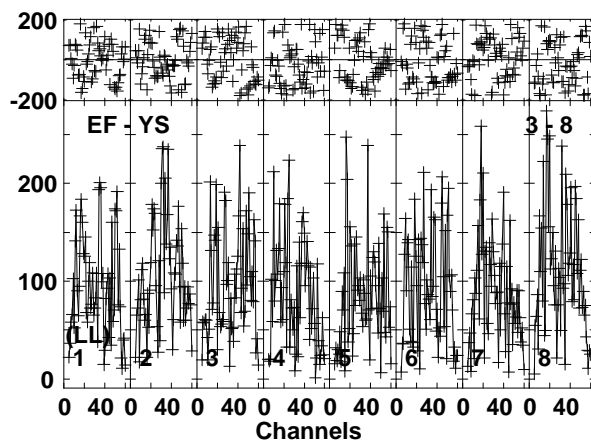
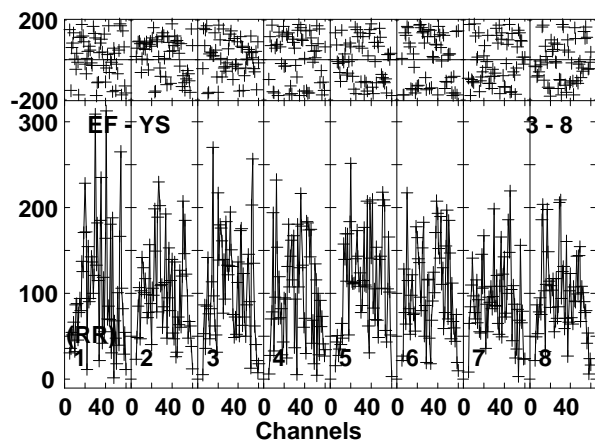
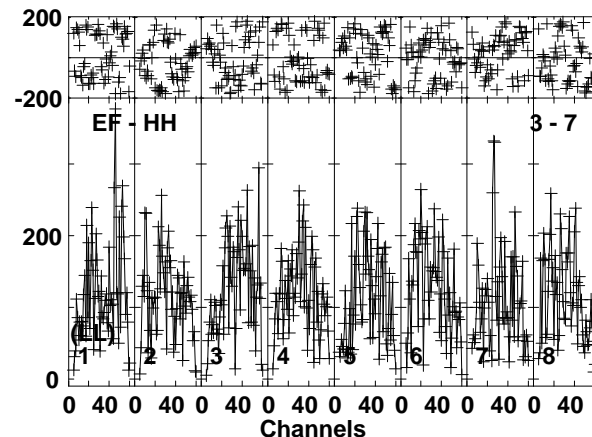
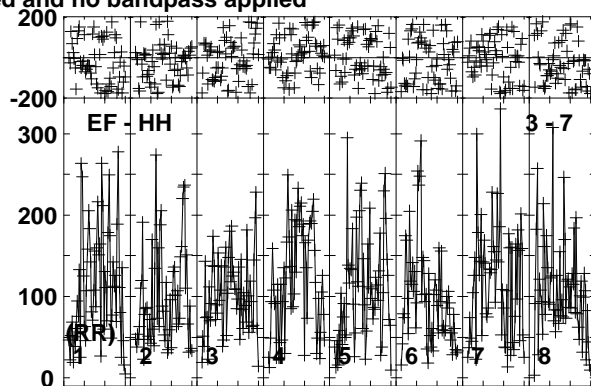
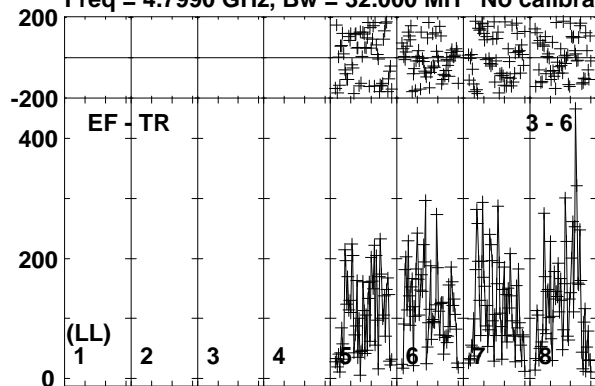

Lower frame: Micro Ampl Jy Top frame: Phas deg
Vector averaged cross-power spectrum Baseline: EF (03) - TR (06)
Timerange: 00/13:17:01 to 00/13:19:29

Plot file version 65 created 28-AUG-2017 13:19:04
J1303-2405 RP029A.UVDATA.1

Freq = 4.7990 GHz, Bw = 32.000 MH No calibration applied and no bandpass applied

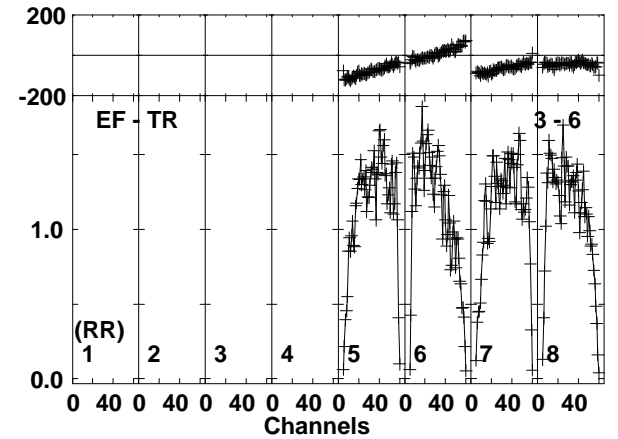
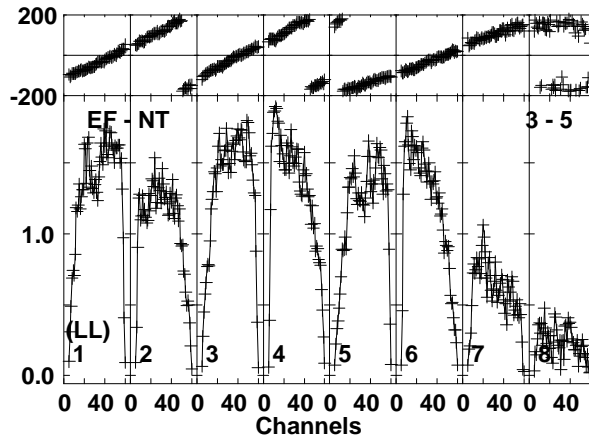
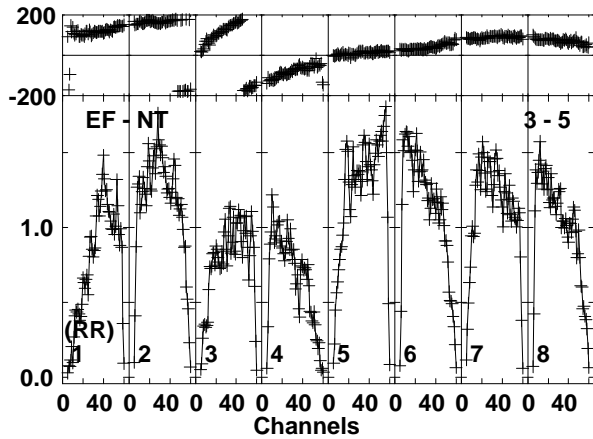
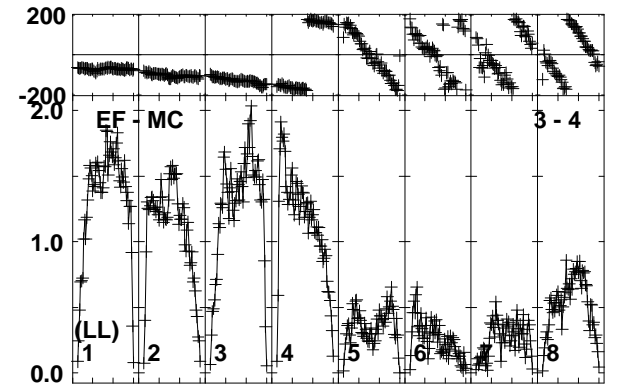
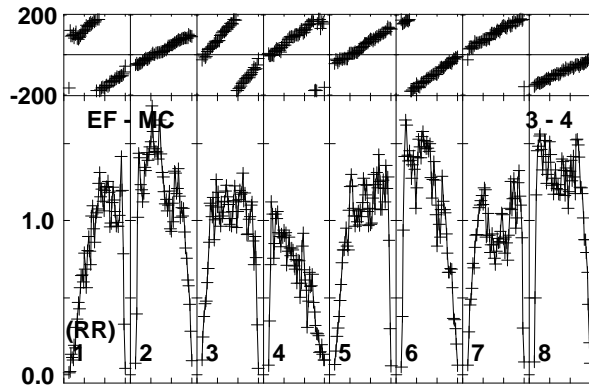
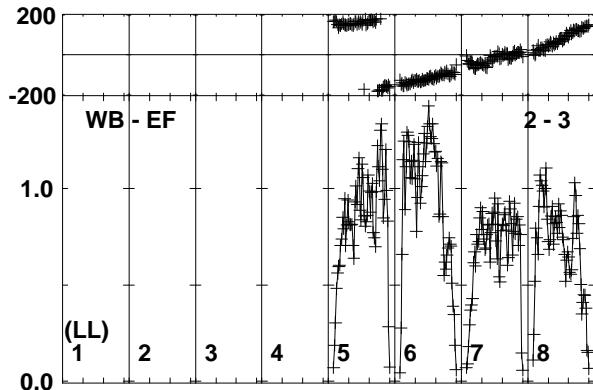
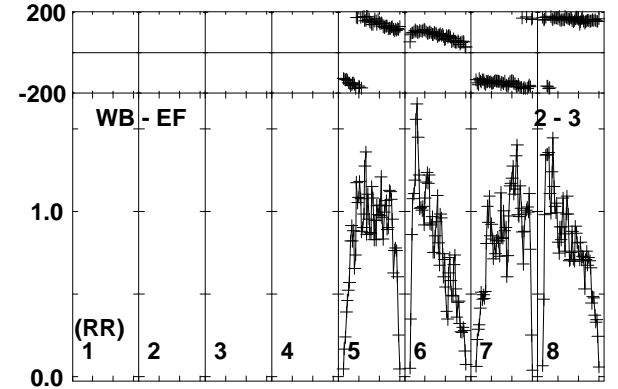
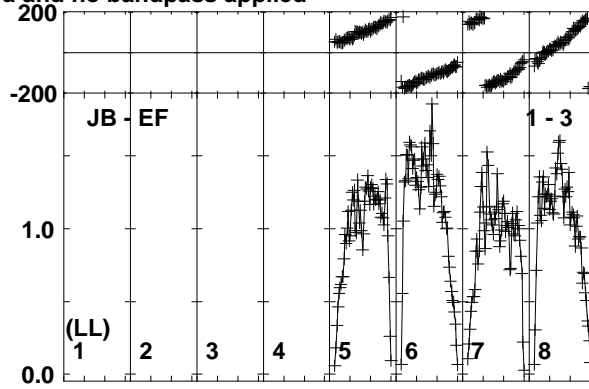
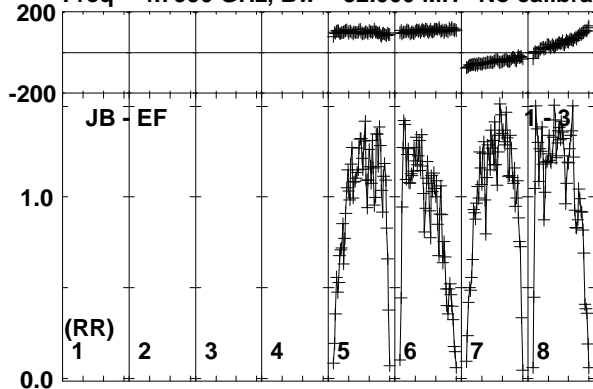

Lower frame: Milli Ampl Jy Top frame: Phas deg
Vector averaged cross-power spectrum Baseline: JB (01) - EF (03)
Timerange: 00/13:19:31 to 00/13:20:59

Plot file version 66 created 28-AUG-2017 13:19:04

J1303-2405 RP029A.UVDATA.1

Freq = 4.7990 GHz, Bw = 32.000 MH No calibration applied and no bandpass applied

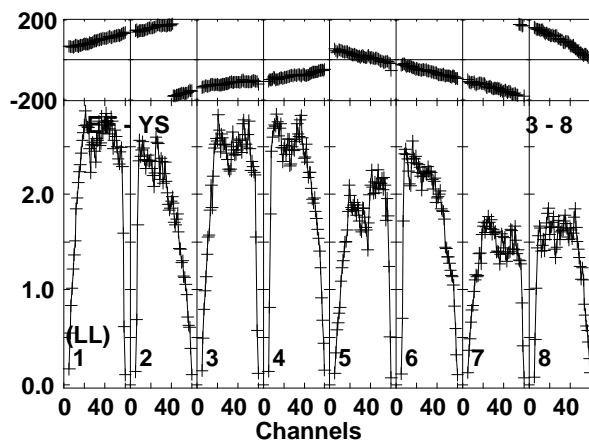
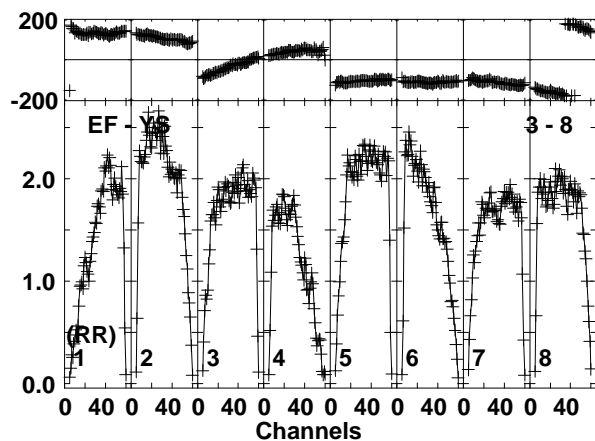
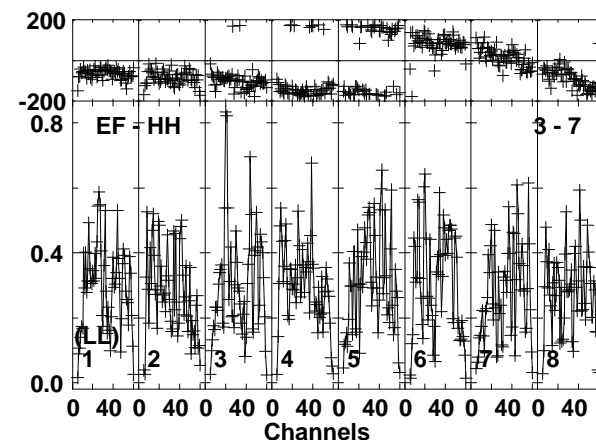
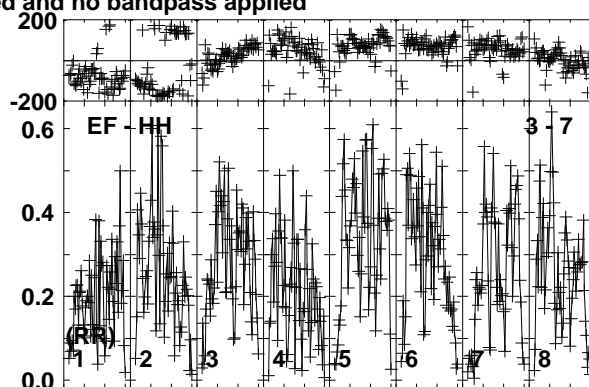
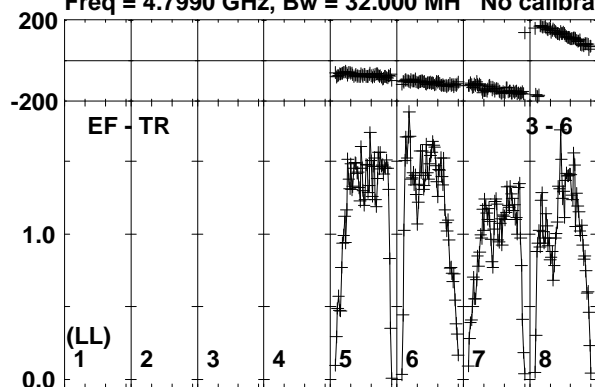

Lower frame: Milli Ampl Jy Top frame: Phas deg
Vector averaged cross-power spectrum Baseline: EF (03) - TR (06)
Timerange: 00/13:19:31 to 00/13:20:59

Plot file version 67 created 28-AUG-2017 13:19:04

SSS17A RP029A.UVDATA.1

Freq = 4.7990 GHz, Bw = 32.000 MH No calibration applied and no bandpass applied

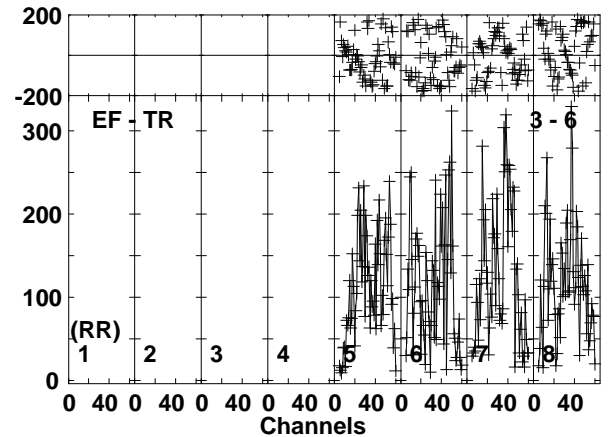
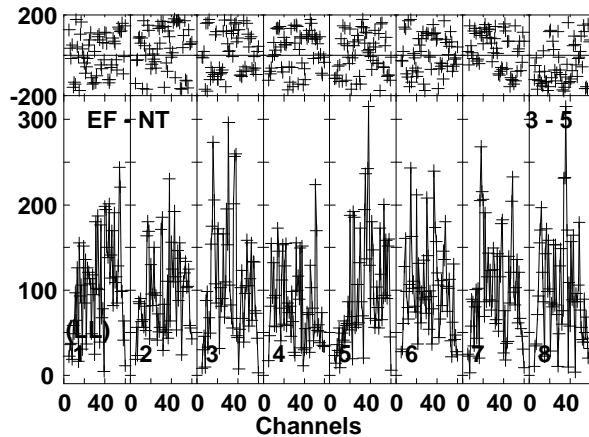
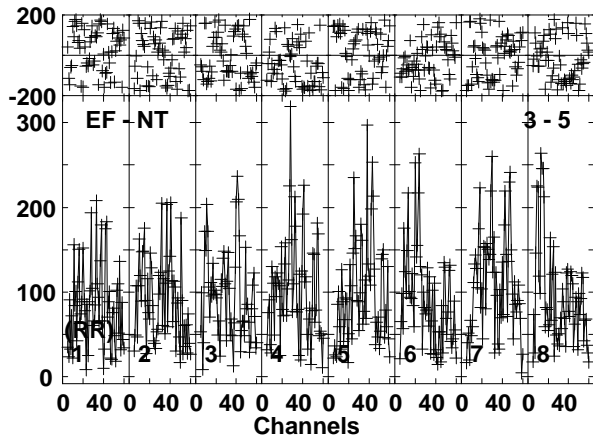
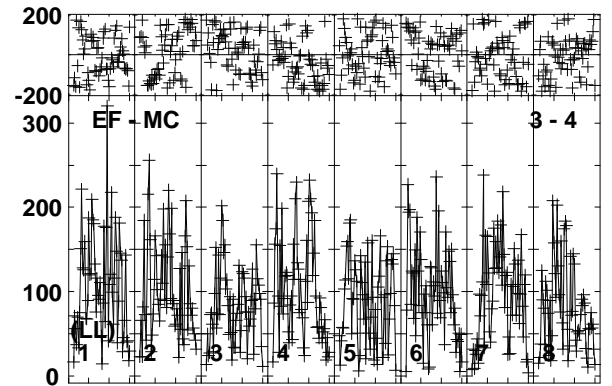
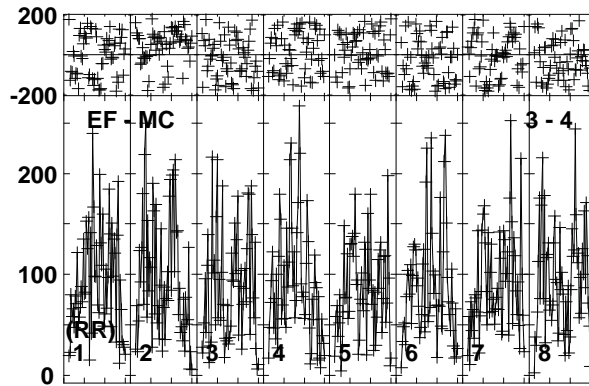
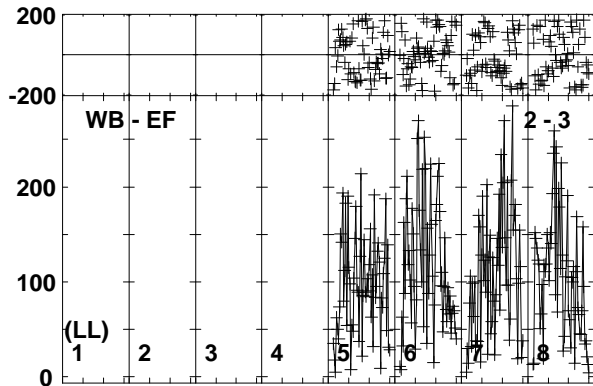
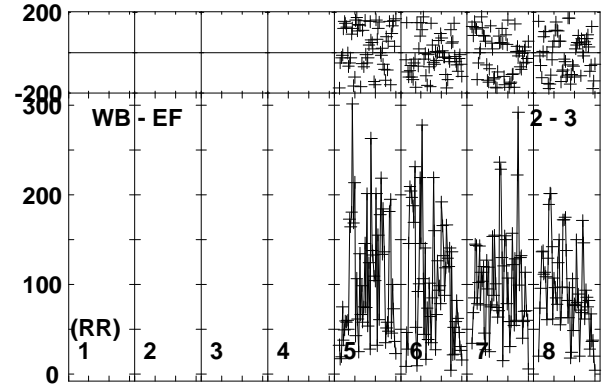
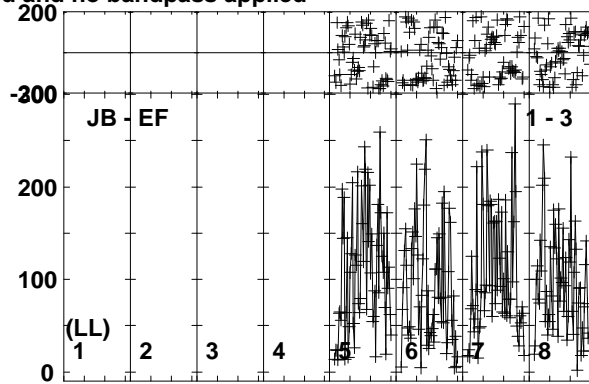
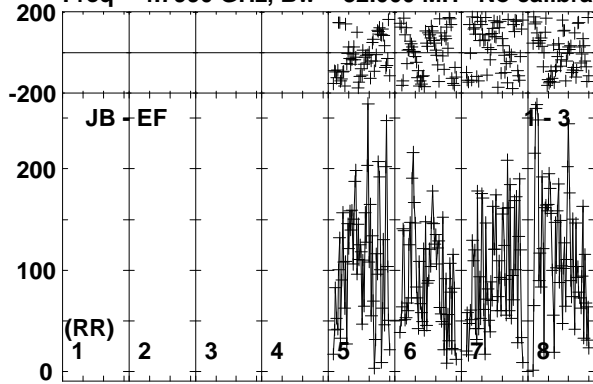

Lower frame: Micro Ampl Jy Top frame: Phas deg
Vector averaged cross-power spectrum Baseline: JB (01) - EF (03)
Timerange: 00/13:21:01 to 00/13:23:29

Plot file version 68 created 28-AUG-2017 13:19:04

SSS17A RP029A.UVDATA.1

Freq = 4.7990 GHz, Bw = 32.000 MH No calibration applied and no bandpass applied

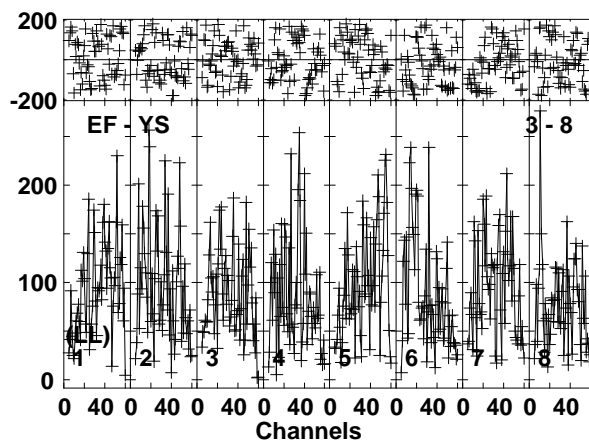
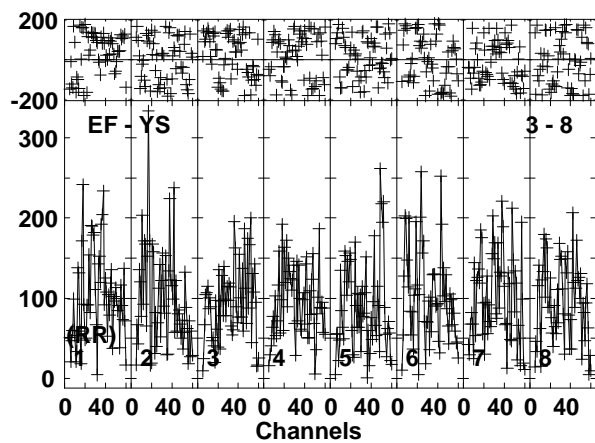
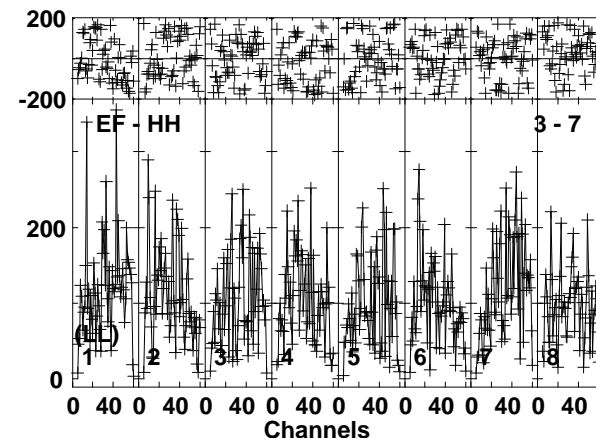
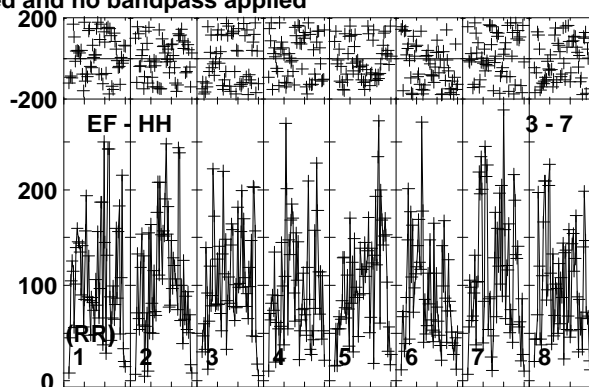
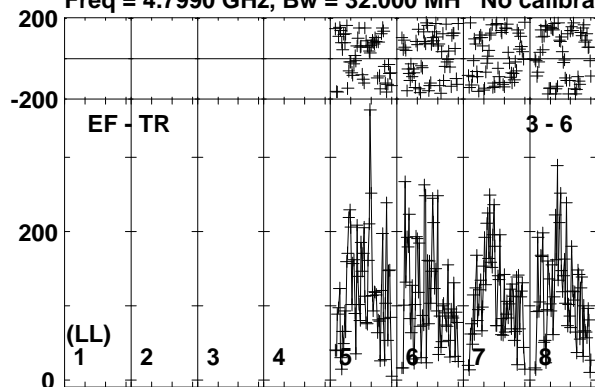

Lower frame: Micro Ampl Jy Top frame: Phas deg
Vector averaged cross-power spectrum Baseline: EF (03) - TR (06)
Timerange: 00/13:21:01 to 00/13:23:29

Plot file version 69 created 28-AUG-2017 13:19:04

J1303-2405 RP029A.UVDATA.1

Freq = 4.7990 GHz, Bw = 32.000 MH No calibration applied and no bandpass applied

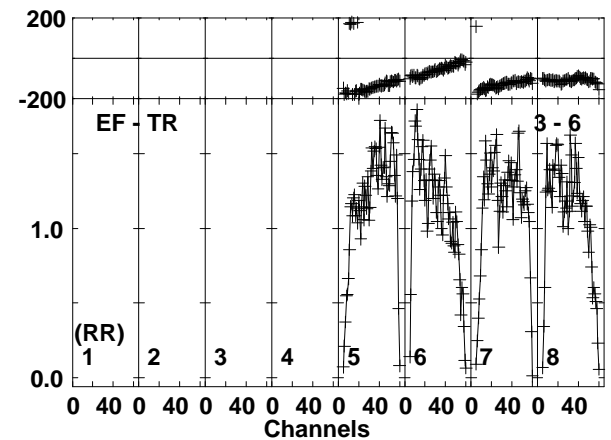
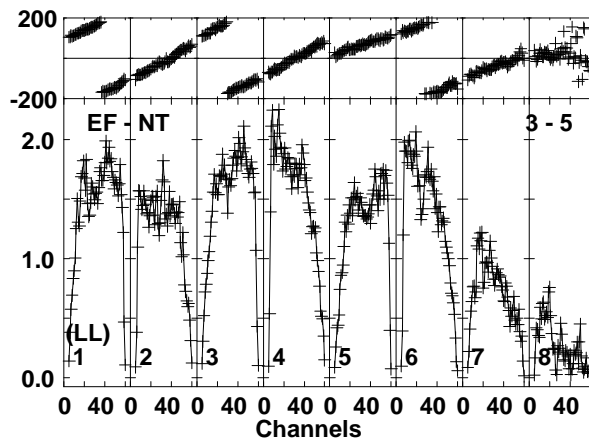
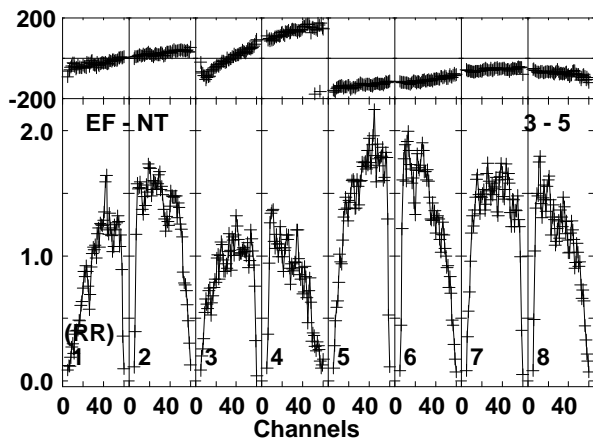
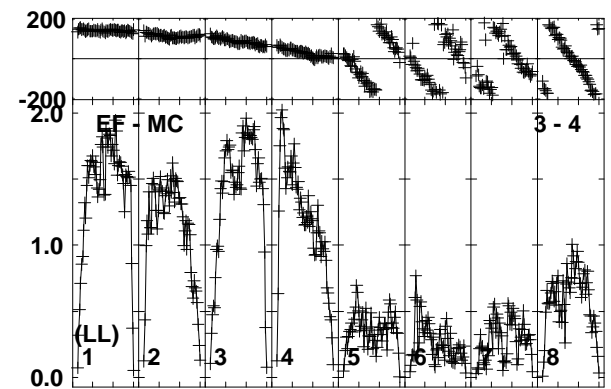
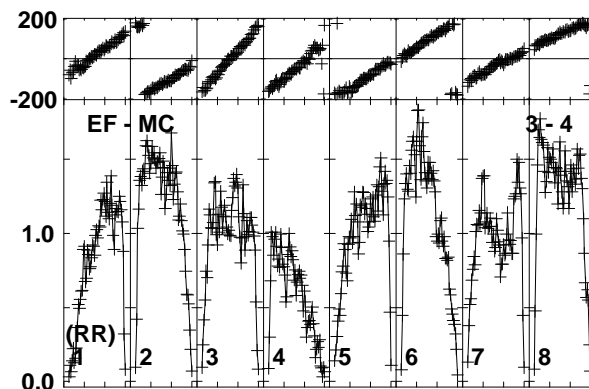
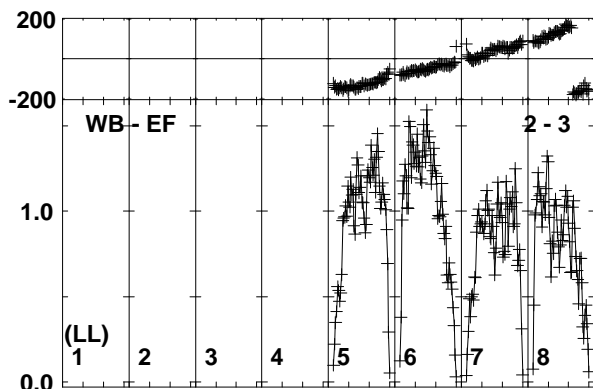
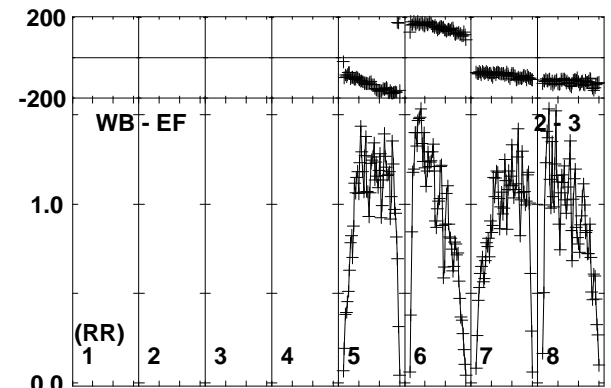
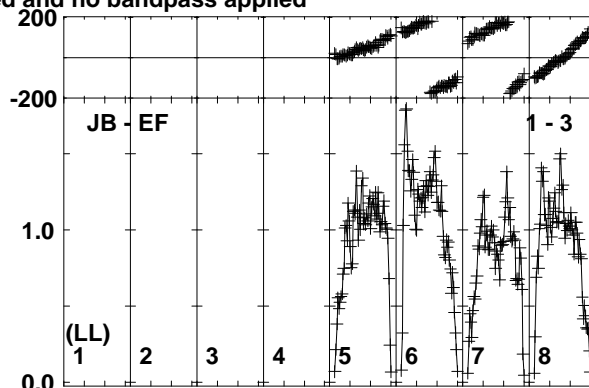
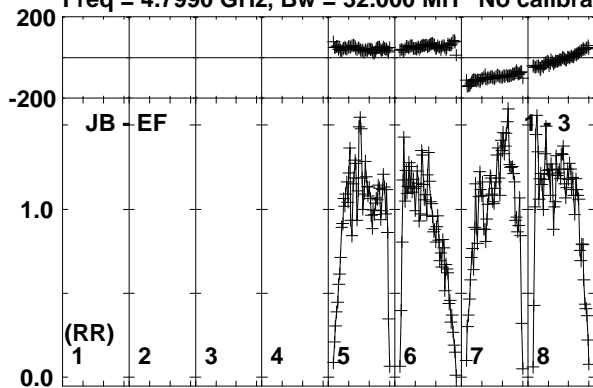

Lower frame: Milli Ampl Jy Top frame: Phas deg
Vector averaged cross-power spectrum Baseline: JB (01) - EF (03)
Timerange: 00/13:24:01 to 00/13:24:59

Plot file version 70 created 28-AUG-2017 13:19:04

J1303-2405 RP029A.UVDATA.1

Freq = 4.7990 GHz, Bw = 32.000 MH No calibration applied and no bandpass applied

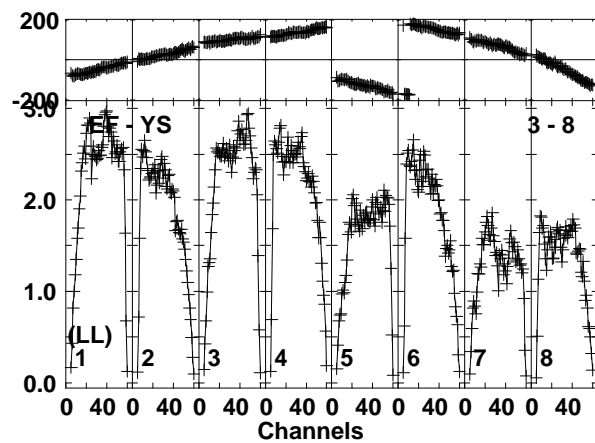
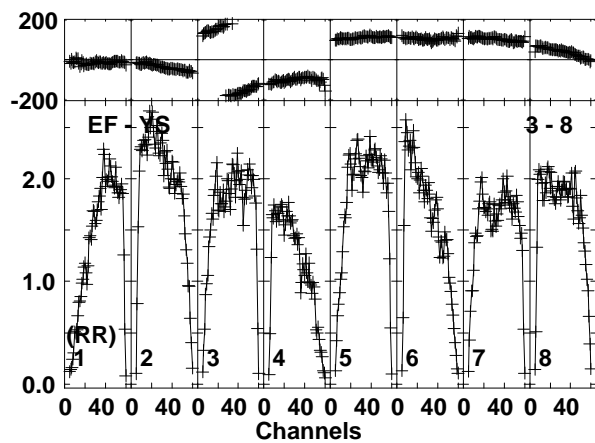
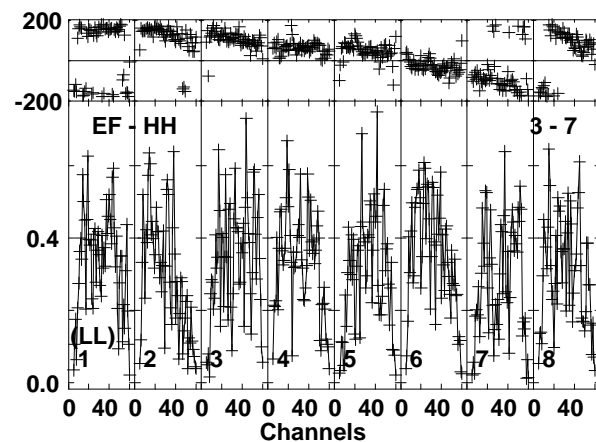
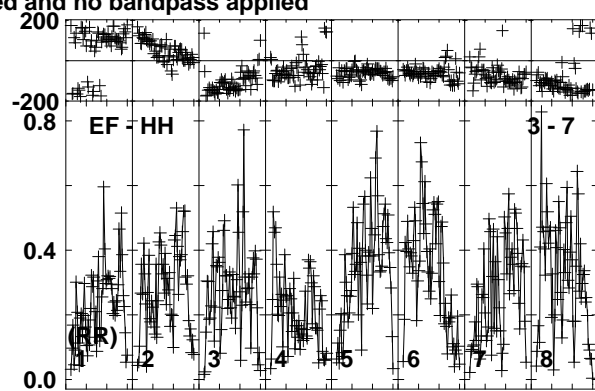
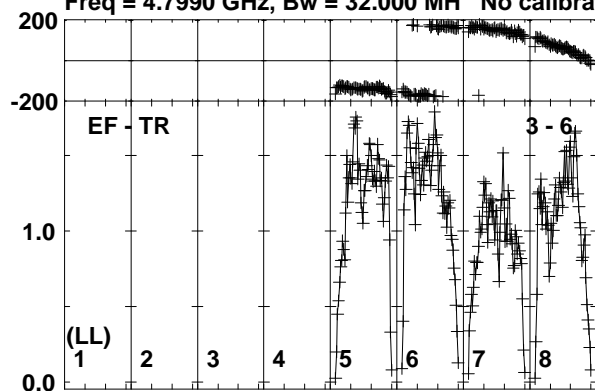

Lower frame: Milli Ampl Jy Top frame: Phas deg
Vector averaged cross-power spectrum Baseline: EF (03) - TR (06)
Timerange: 00/13:24:01 to 00/13:24:59

Plot file version 71 created 28-AUG-2017 13:19:05

SSS17A RP029A.UVDATA.1

Freq = 4.7990 GHz, Bw = 32.000 MH No calibration applied and no bandpass applied

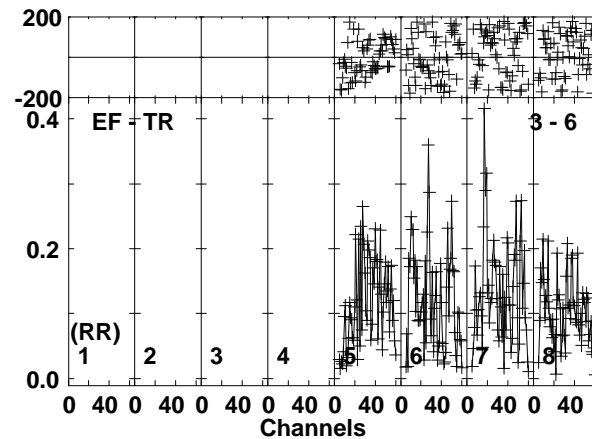
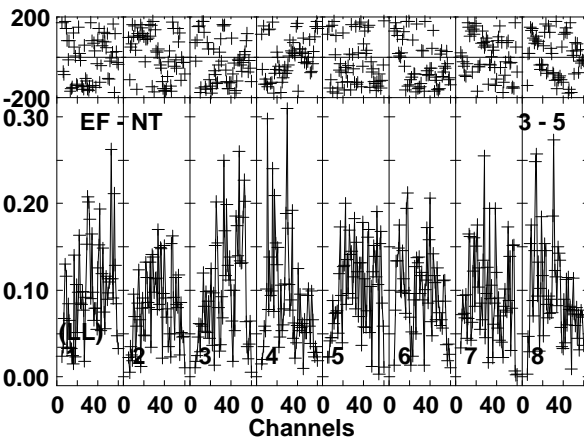
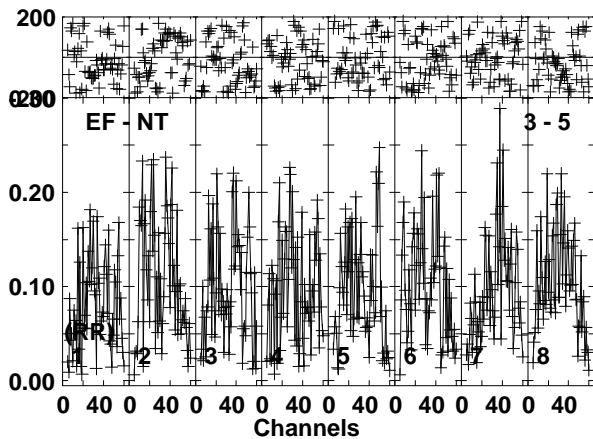
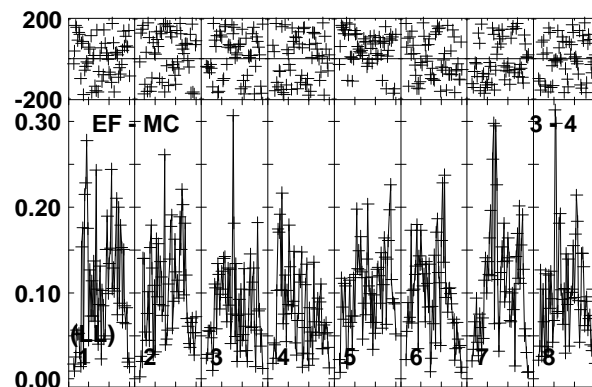
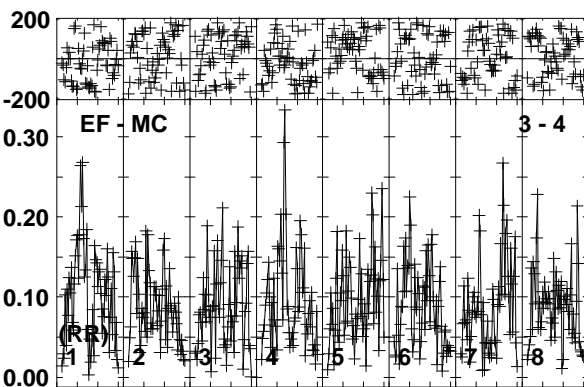
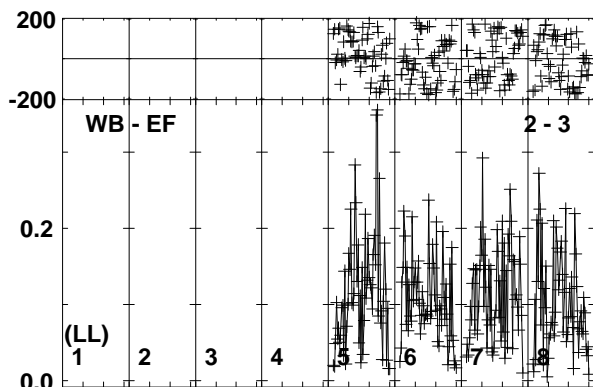
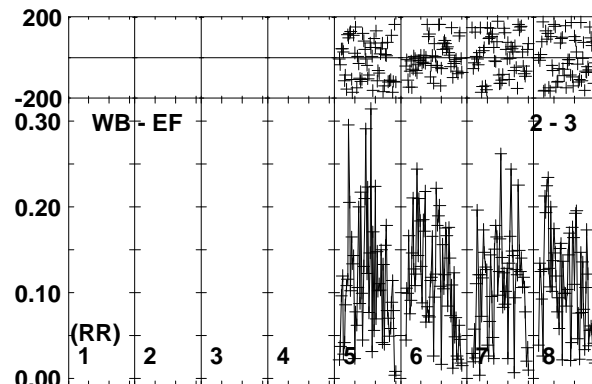
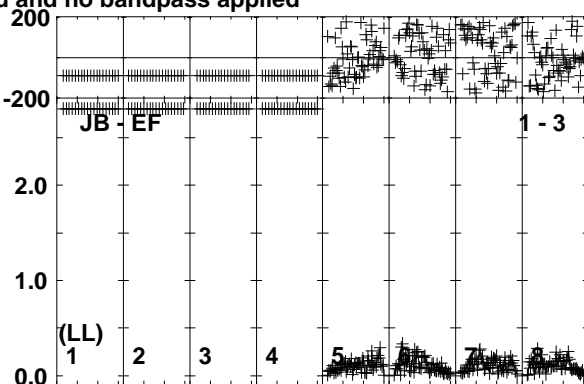
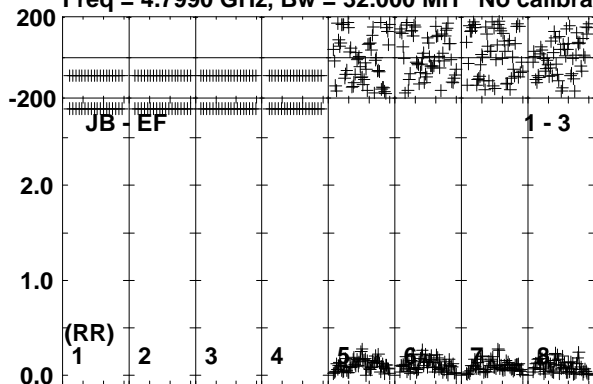

Lower frame: Milli Ampl Jy Top frame: Phas deg
Vector averaged cross-power spectrum Baseline: JB (01) - EF (03)
Timerange: 00/13:25:01 to 00/13:27:29

Plot file version 72 created 28-AUG-2017 13:19:05

SSS17A RP029A.UVDATA.1

Freq = 4.7990 GHz, Bw = 32.000 MH No calibration applied and no bandpass applied

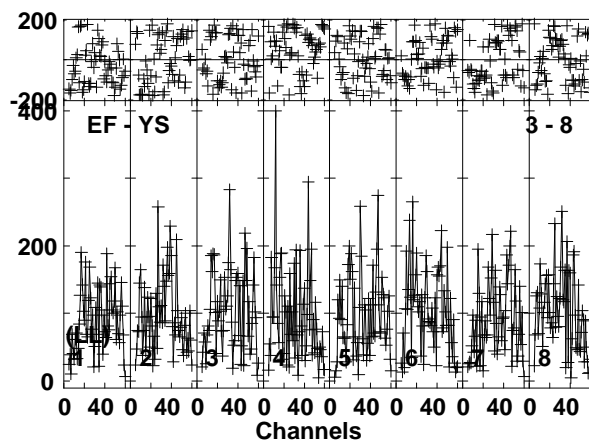
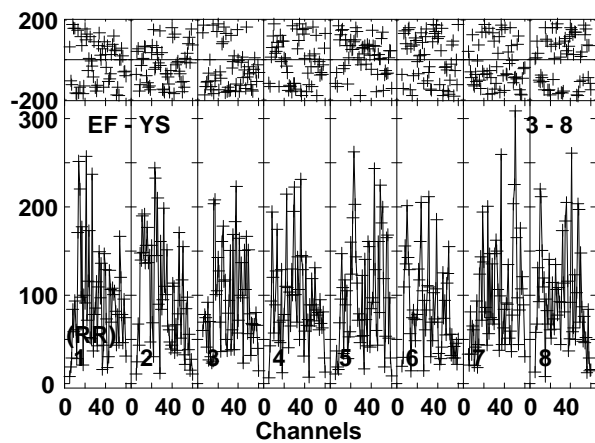
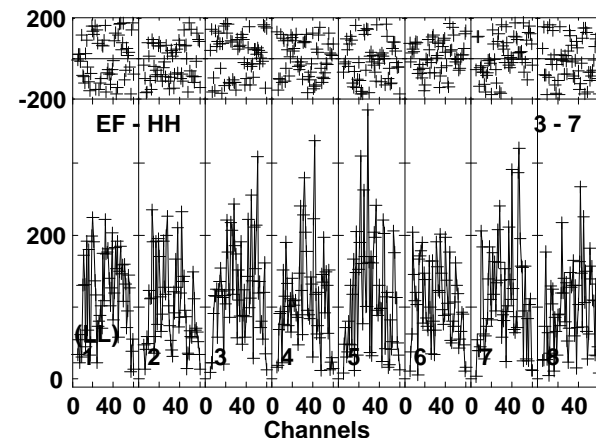
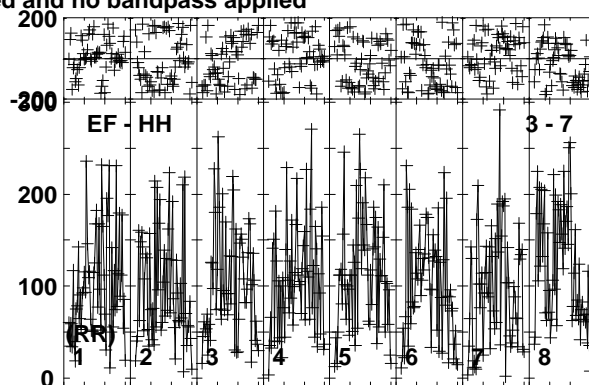
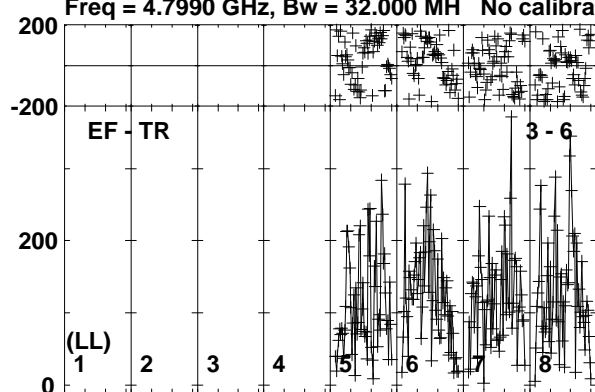

Lower frame: Micro Ampl Jy Top frame: Phas deg
Vector averaged cross-power spectrum Baseline: EF (03) - TR (06)
Timerange: 00/13:25:01 to 00/13:27:29

Plot file version 73 created 28-AUG-2017 13:19:05

J1303-2405 RP029A.UVDATA.1

Freq = 4.7990 GHz, Bw = 32.000 MH No calibration applied and no bandpass applied

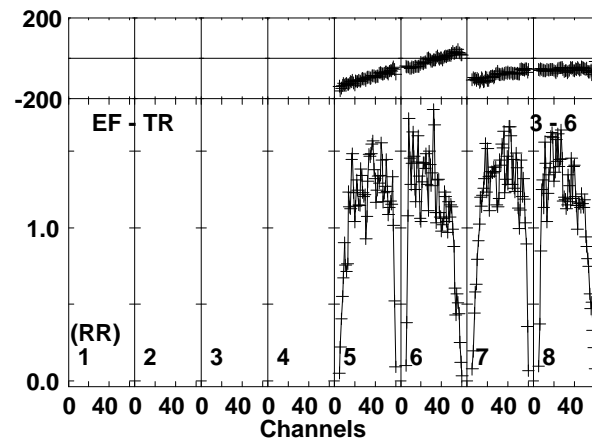
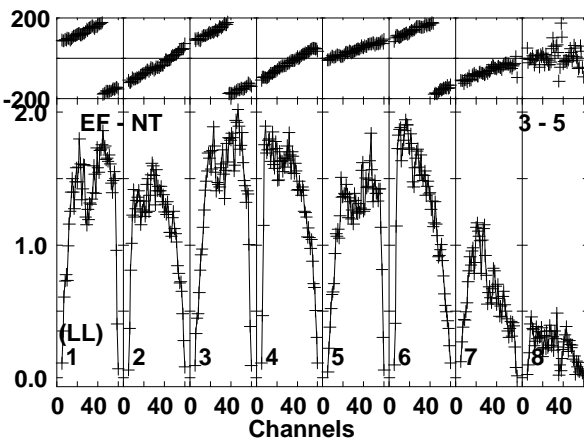
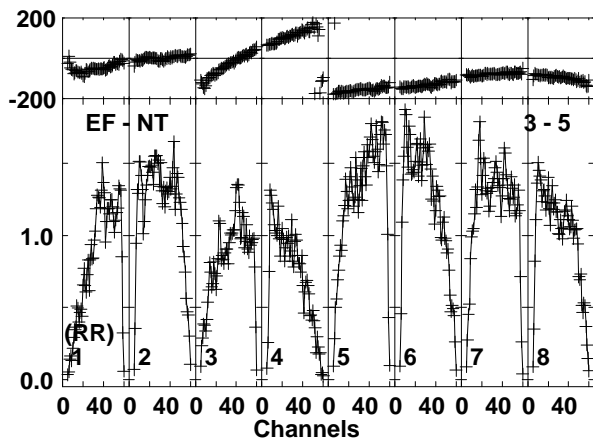
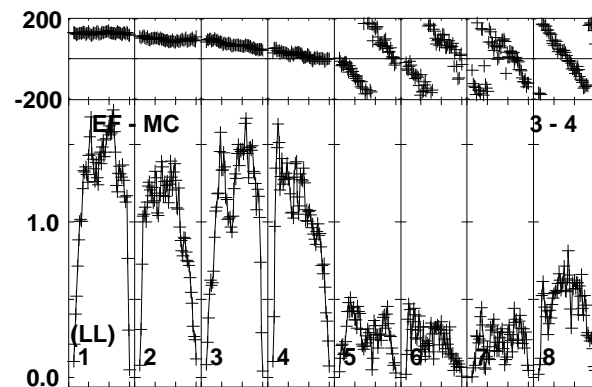
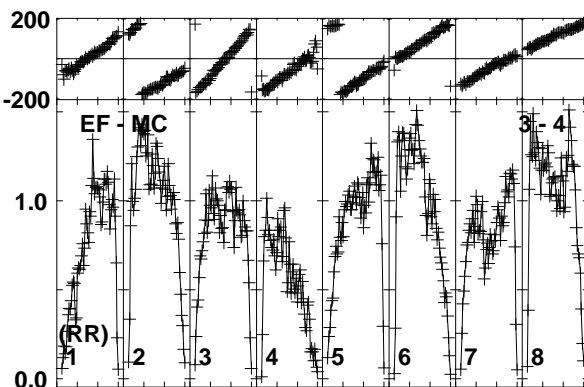
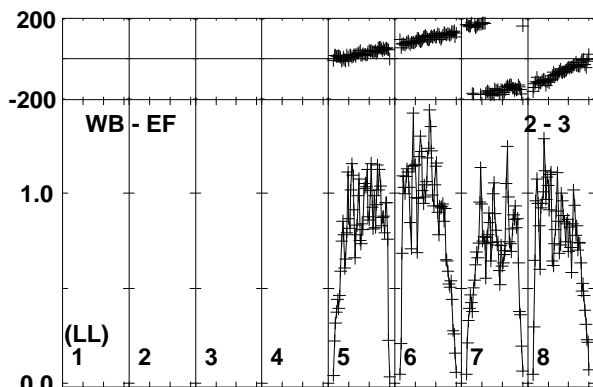
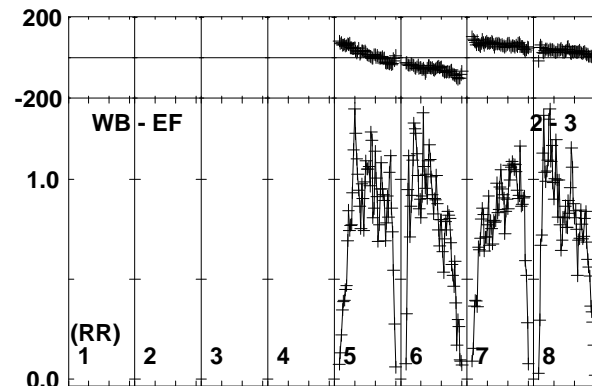
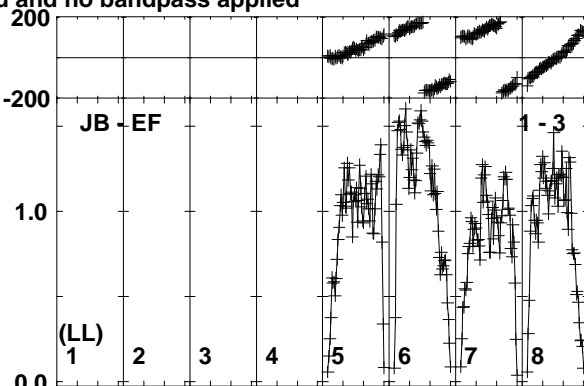
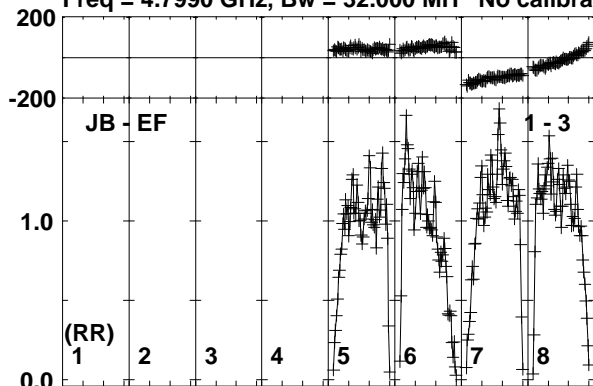

Lower frame: Milli Ampl Jy Top frame: Phas deg
Vector averaged cross-power spectrum Baseline: JB (01) - EF (03)
Timerange: 00/13:27:31 to 00/13:28:59

Plot file version 74 created 28-AUG-2017 13:19:05

J1303-2405 RP029A.UVDATA.1

Freq = 4.7990 GHz, Bw = 32.000 MH No calibration applied and no bandpass applied

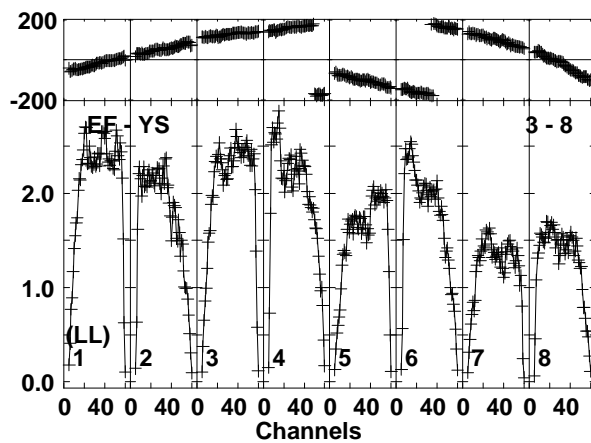
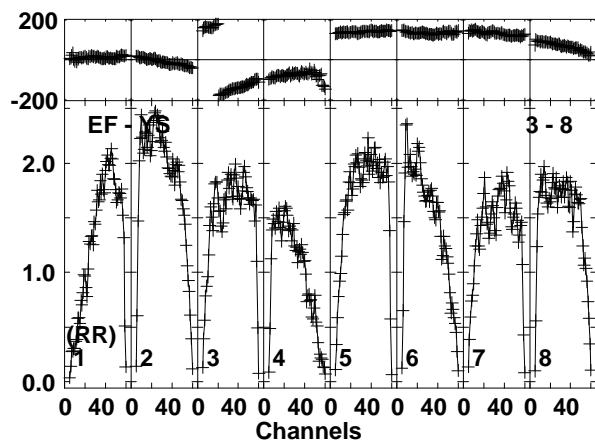
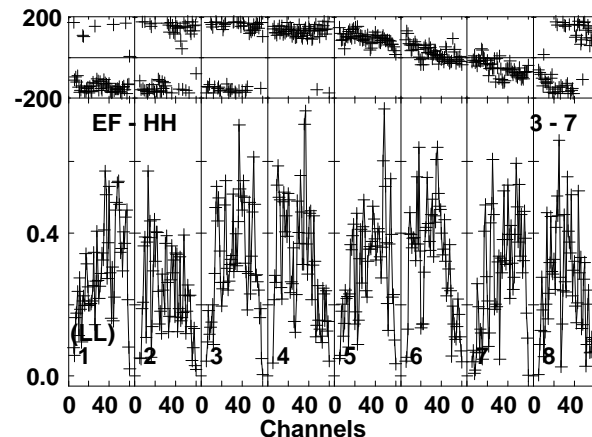
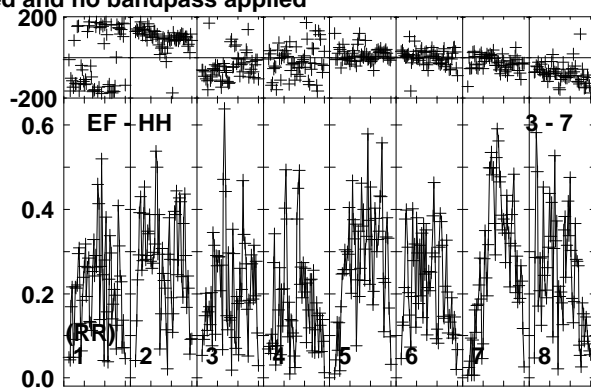
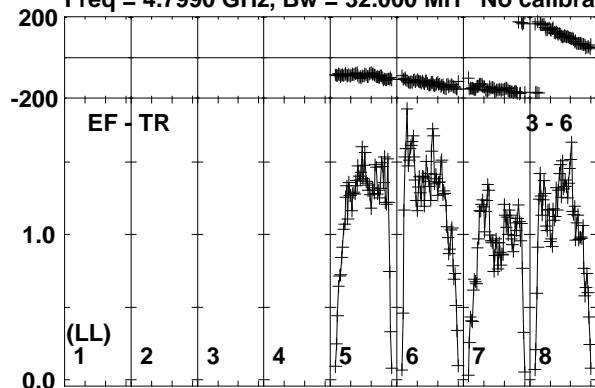

Lower frame: Milli Ampl Jy Top frame: Phas deg
Vector averaged cross-power spectrum Baseline: EF (03) - TR (06)
Timerange: 00/13:27:31 to 00/13:28:59

Plot file version 75 created 28-AUG-2017 13:19:05

J1312-2350 RP029A.UVDATA.1

Freq = 4.7990 GHz, Bw = 32.000 MH No calibration applied and no bandpass applied

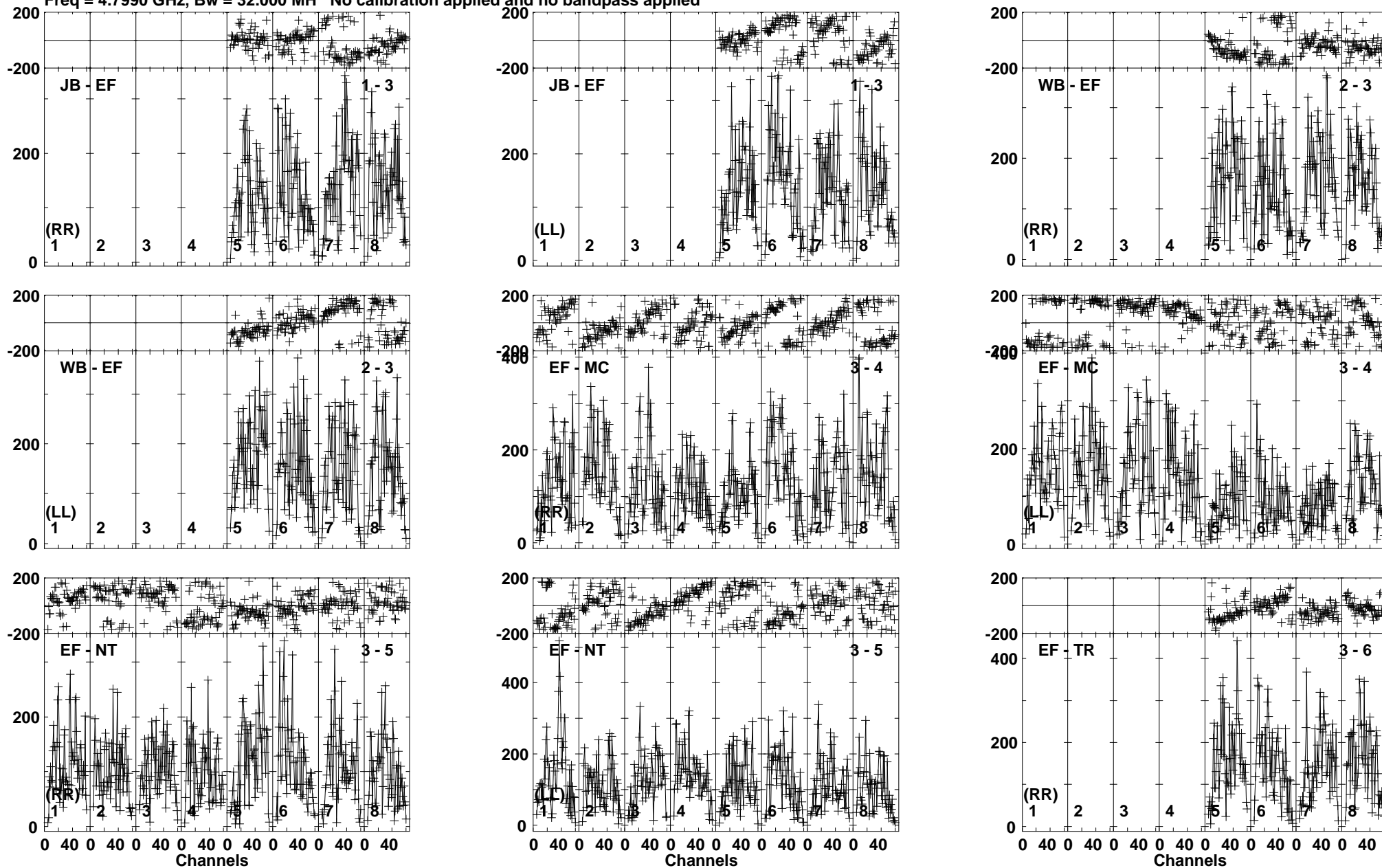

Lower frame: Micro Ampl Jy Top frame: Phas deg
Vector averaged cross-power spectrum Baseline: JB (01) - EF (03)
Timerange: 00/13:29:01 to 00/13:31:29

Plot file version 76 created 28-AUG-2017 13:19:05

J1312-2350 RP029A.UVDATA.1

Freq = 4.7990 GHz, Bw = 32.000 MH No calibration applied and no bandpass applied

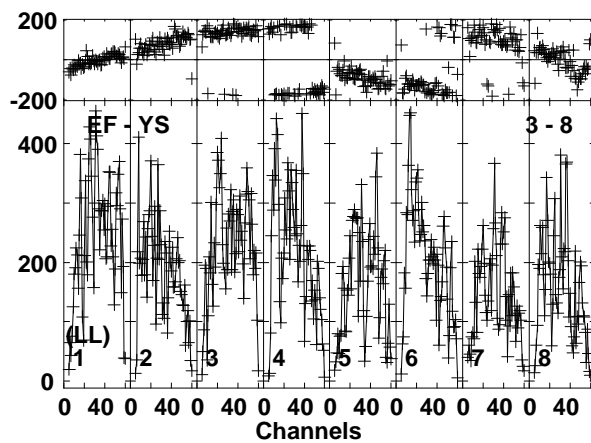
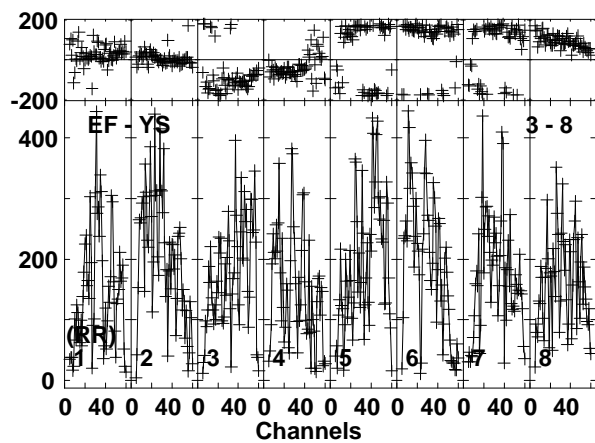
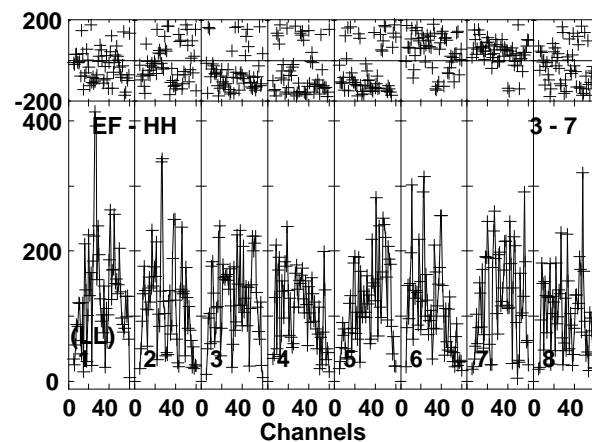
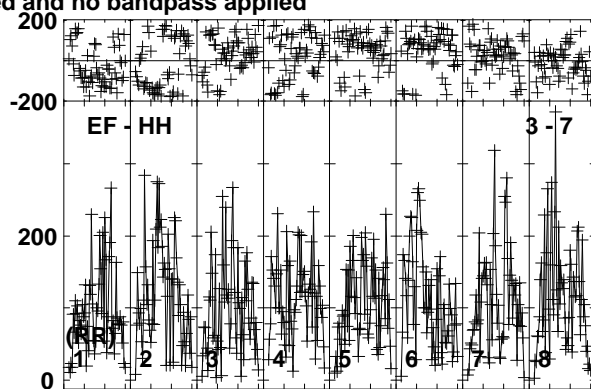
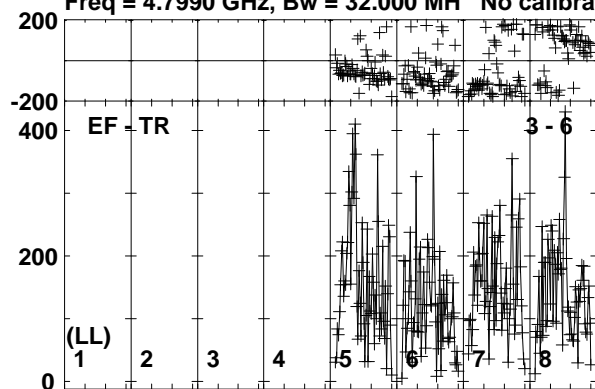

Lower frame: Micro Ampl Jy Top frame: Phas deg
Vector averaged cross-power spectrum Baseline: EF (03) - TR (06)
Timerange: 00/13:29:01 to 00/13:31:29

Plot file version 77 created 28-AUG-2017 13:19:05

J1303-2405 RP029A.UVDATA.1

Freq = 4.7990 GHz, Bw = 32.000 MH No calibration applied and no bandpass applied

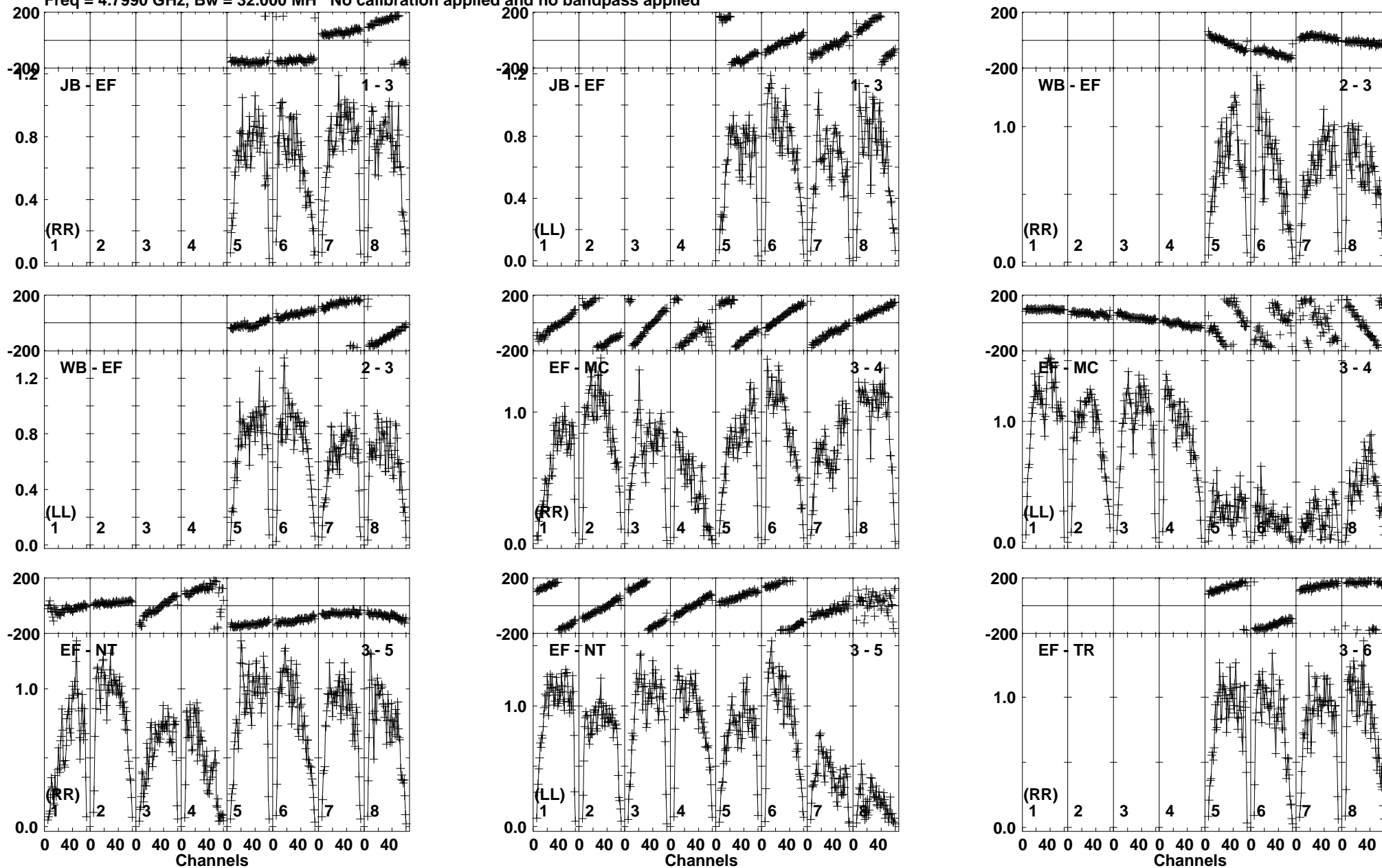

Lower frame: Milli Ampl Jy Top frame: Phas deg
Vector averaged cross-power spectrum Baseline: JB (01) - EF (03)
Timerange: 00/13:32:11 to 00/13:33:09

Plot file version 78 created 28-AUG-2017 13:19:05

J1303-2405 RP029A.UVDATA.1

Freq = 4.7990 GHz, Bw = 32.000 MH No calibration applied and no bandpass applied

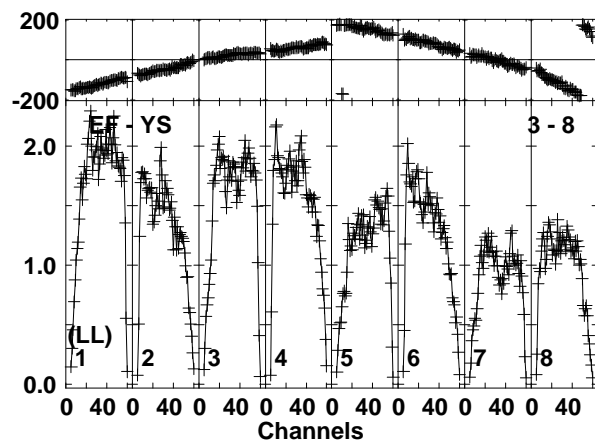
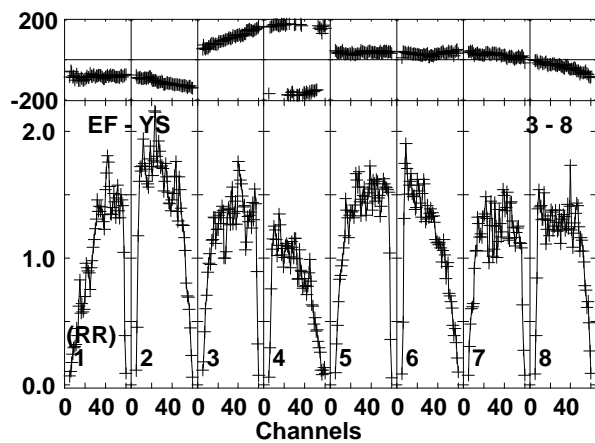
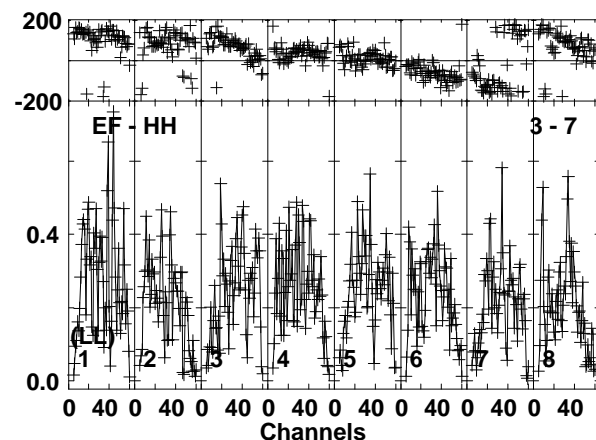
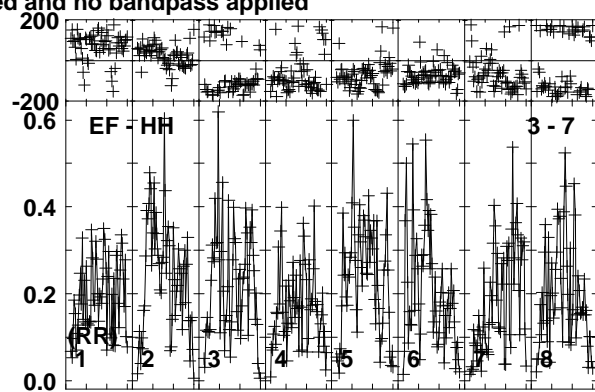
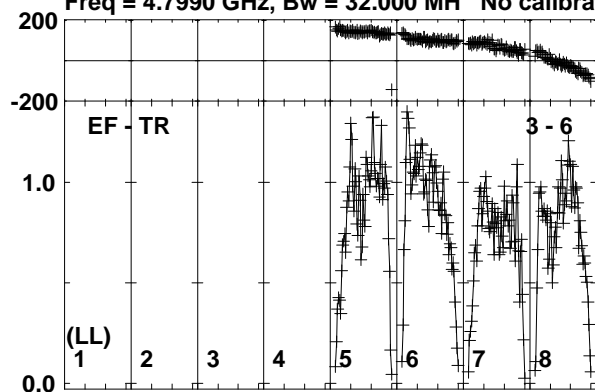

Lower frame: Milli Ampl Jy Top frame: Phas deg
Vector averaged cross-power spectrum Baseline: EF (03) - TR (06)
Timerange: 00/13:32:11 to 00/13:33:09

Plot file version 79 created 28-AUG-2017 13:19:05

SSS17A RP029A.UVDATA.1

Freq = 4.7990 GHz, Bw = 32.000 MH No calibration applied and no bandpass applied

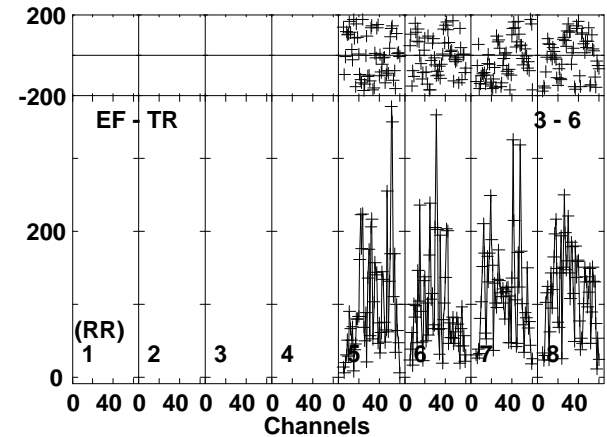
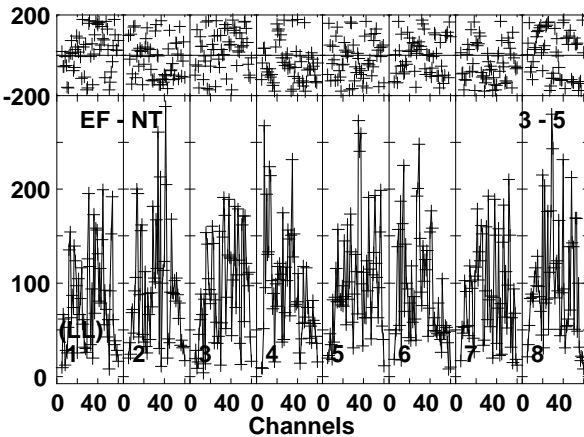
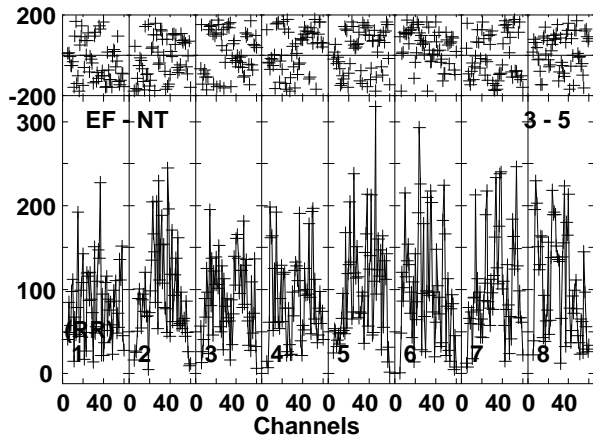
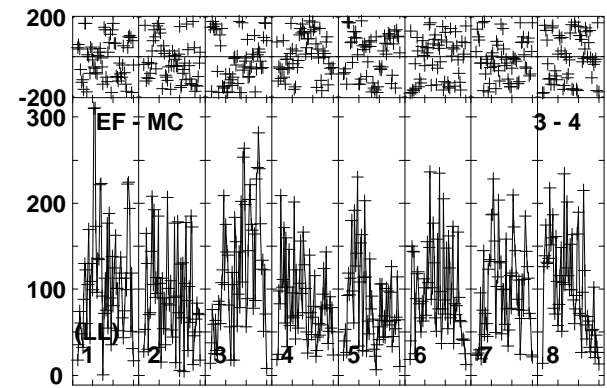
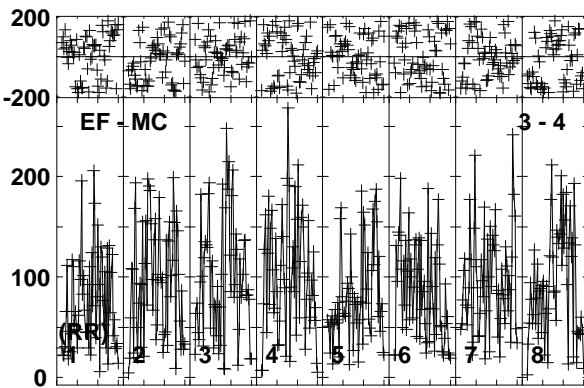
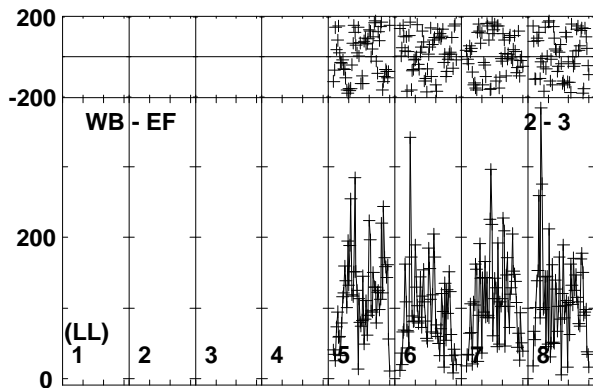
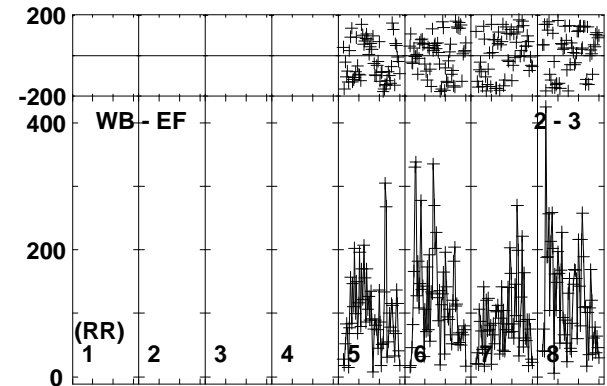
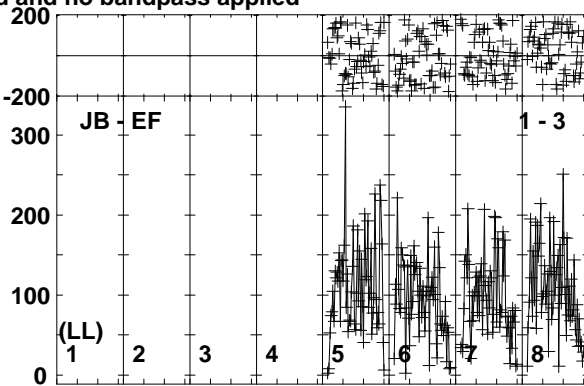
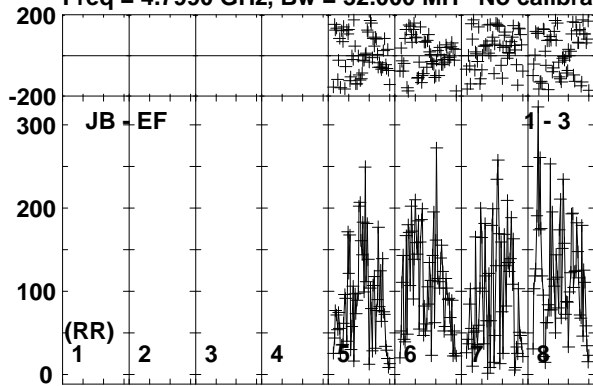

Lower frame: Micro Ampl Jy Top frame: Phas deg
Vector averaged cross-power spectrum Baseline: JB (01) - EF (03)
Timerange: 00/13:33:11 to 00/13:35:39

Plot file version 80 created 28-AUG-2017 13:19:05

SSS17A RP029A.UVDATA.1

Freq = 4.7990 GHz, Bw = 32.000 MH No calibration applied and no bandpass applied

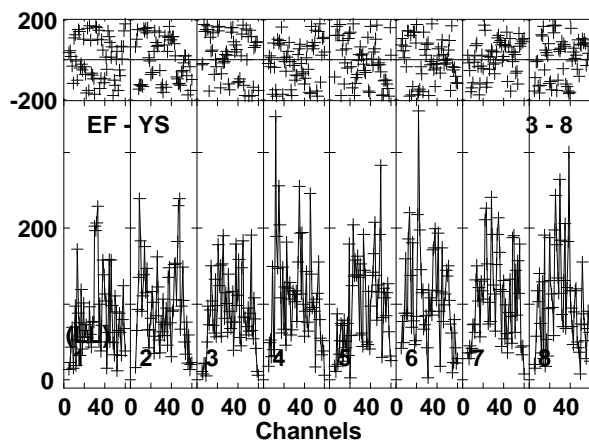
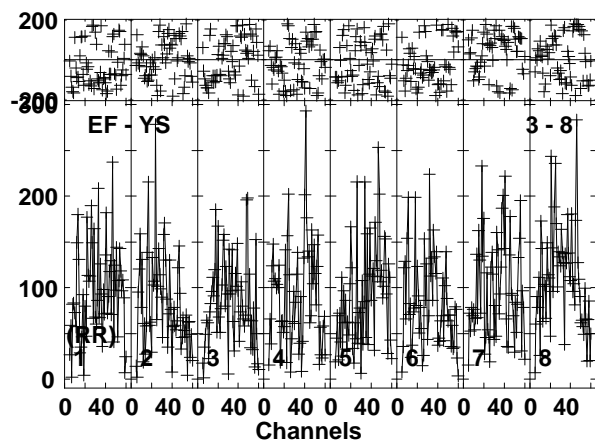
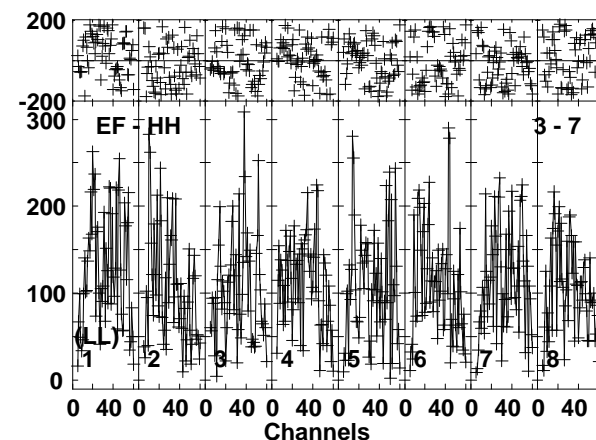
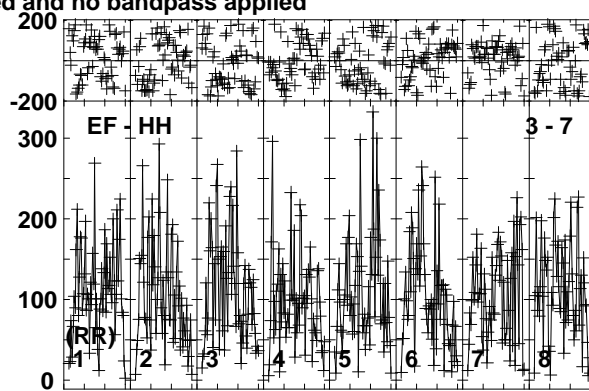
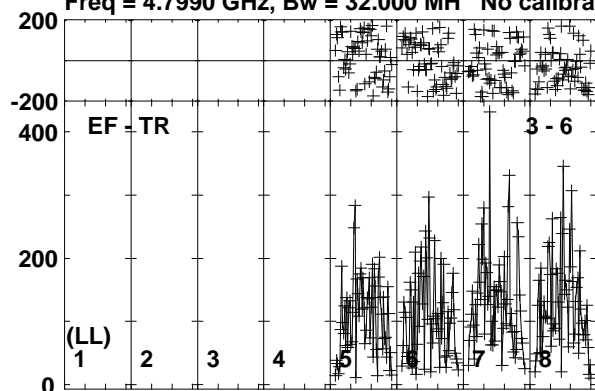

Lower frame: Micro Ampl Jy Top frame: Phas deg
Vector averaged cross-power spectrum Baseline: EF (03) - TR (06)
Timerange: 00/13:33:11 to 00/13:35:39

Plot file version 81 created 28-AUG-2017 13:19:05

J1303-2405 RP029A.UVDATA.1

Freq = 4.7990 GHz, Bw = 32.000 MH No calibration applied and no bandpass applied

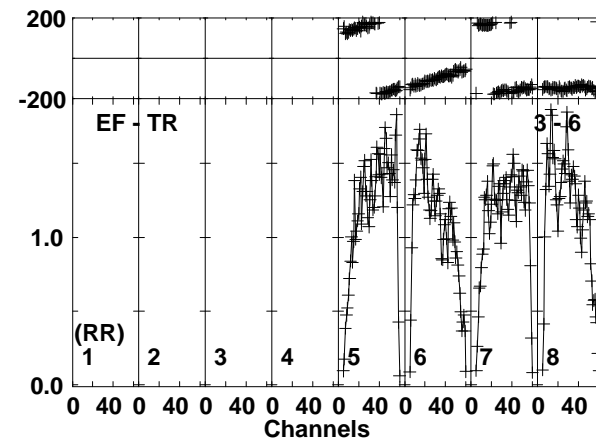
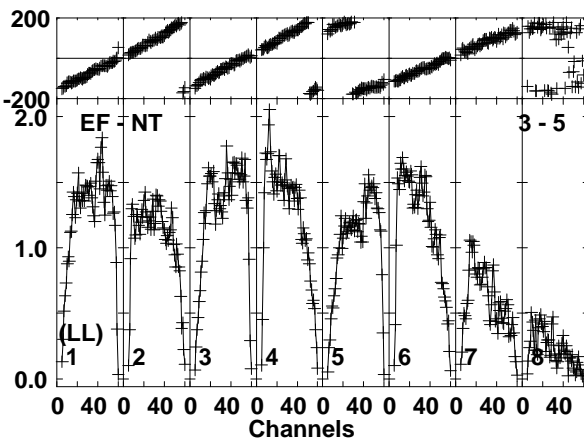
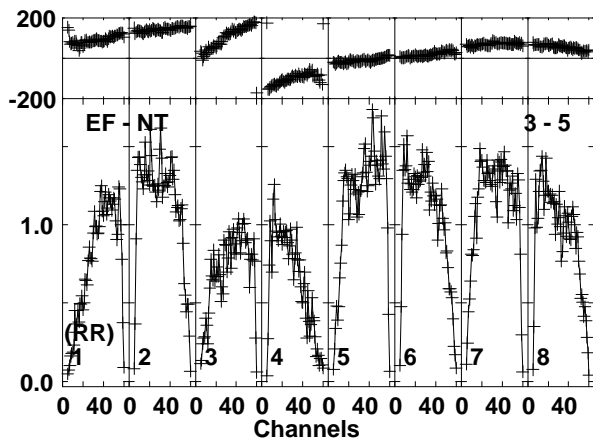
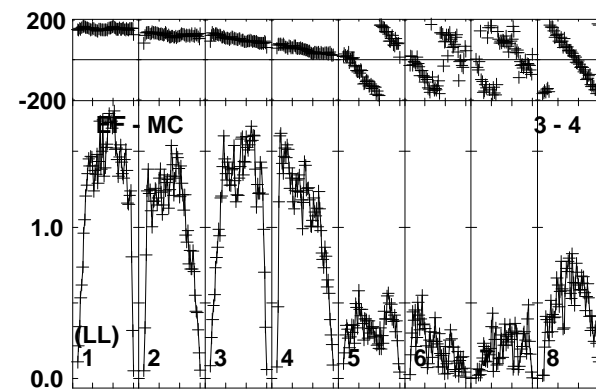
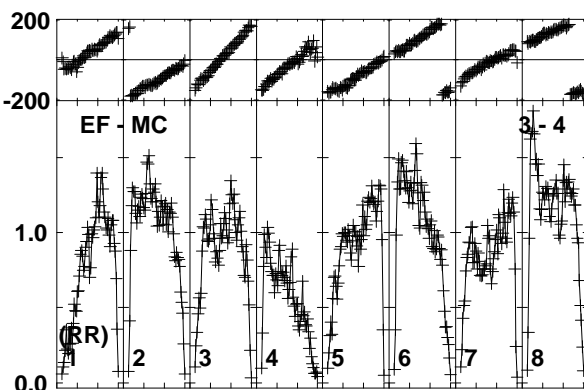
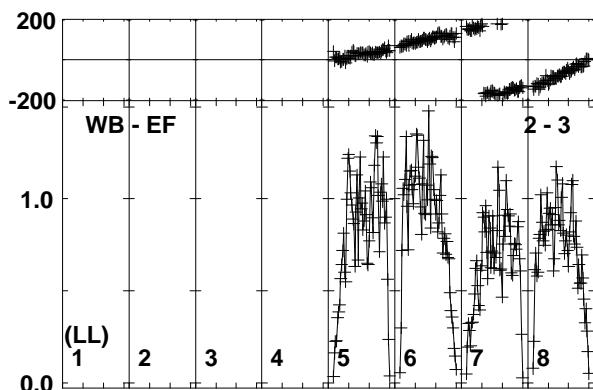
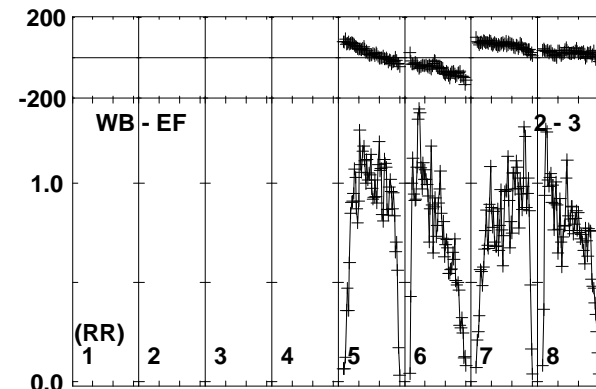
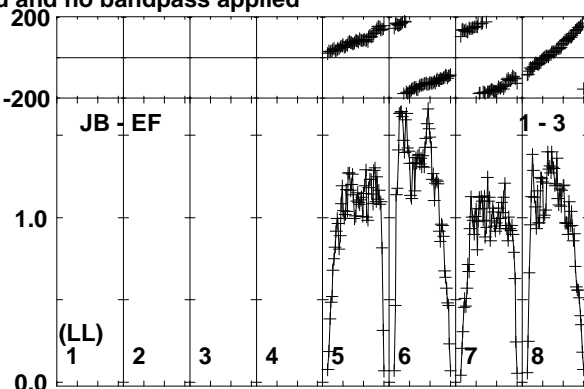
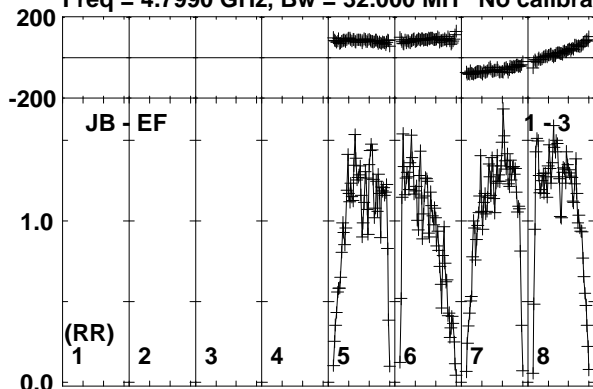

Lower frame: Milli Ampl Jy Top frame: Phas deg
Vector averaged cross-power spectrum Baseline: JB (01) - EF (03)
Timerange: 00/13:35:41 to 00/13:37:09

Plot file version 82 created 28-AUG-2017 13:19:06

J1303-2405 RP029A.UVDATA.1

Freq = 4.7990 GHz, Bw = 32.000 MH No calibration applied and no bandpass applied

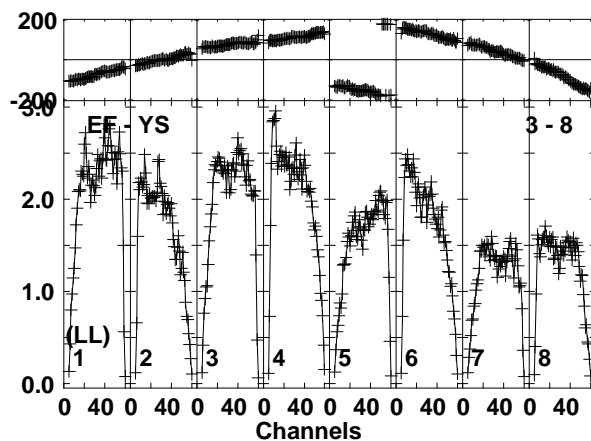
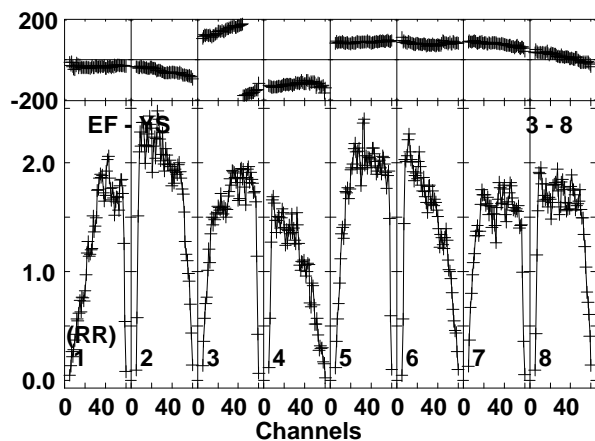
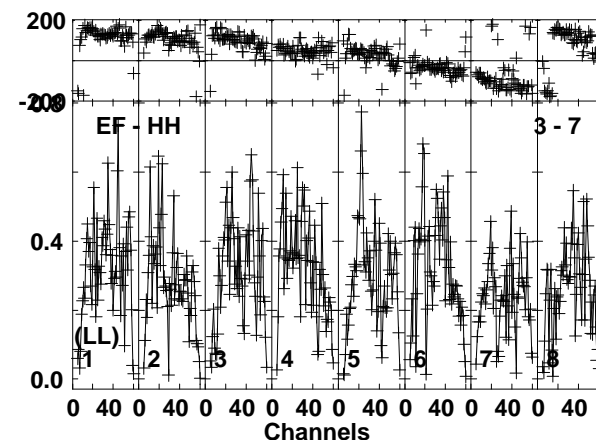
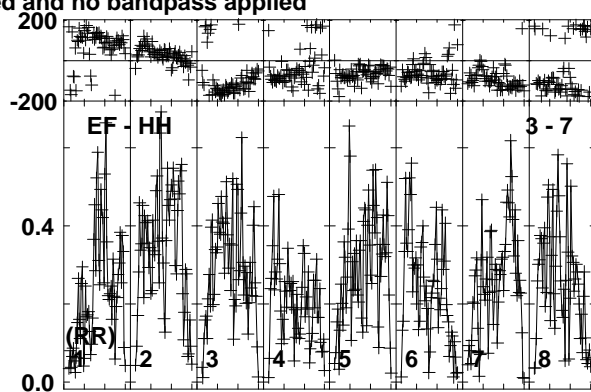
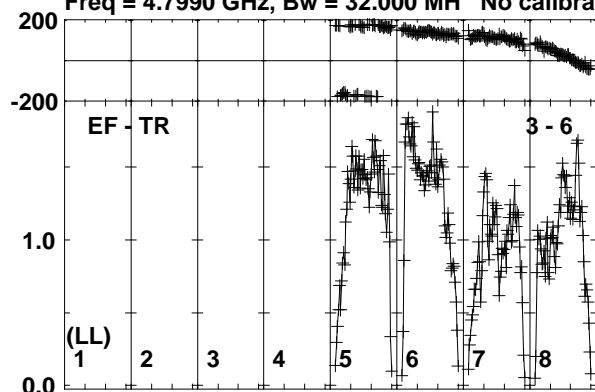

Lower frame: Milli Ampl Jy Top frame: Phas deg
Vector averaged cross-power spectrum Baseline: EF (03) - TR (06)
Timerange: 00/13:35:41 to 00/13:37:09

Plot file version 83 created 28-AUG-2017 13:19:06

SSS17A RP029A.UVDATA.1

Freq = 4.7990 GHz, Bw = 32.000 MH No calibration applied and no bandpass applied

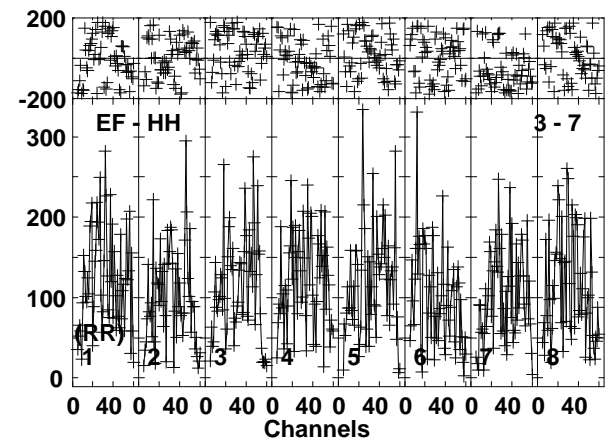
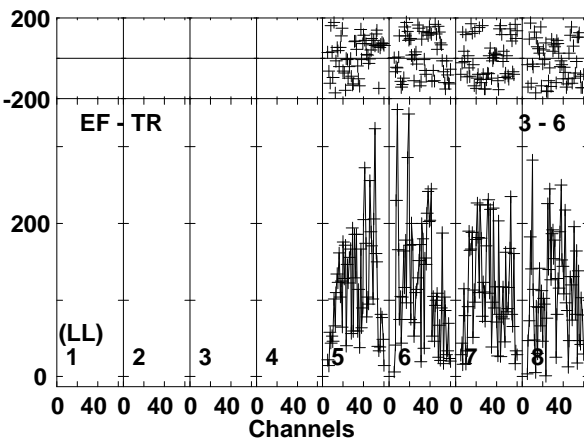
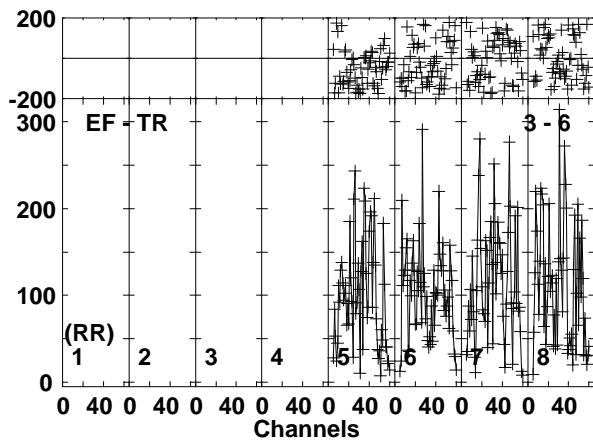
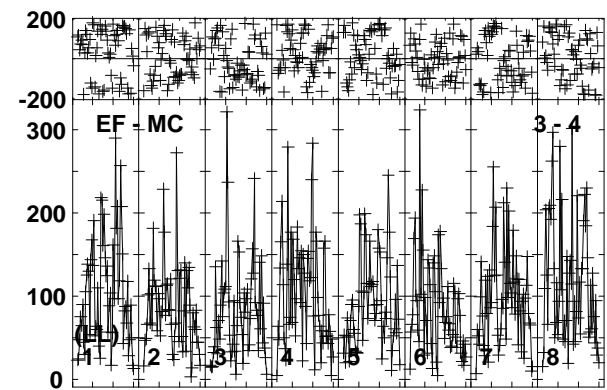
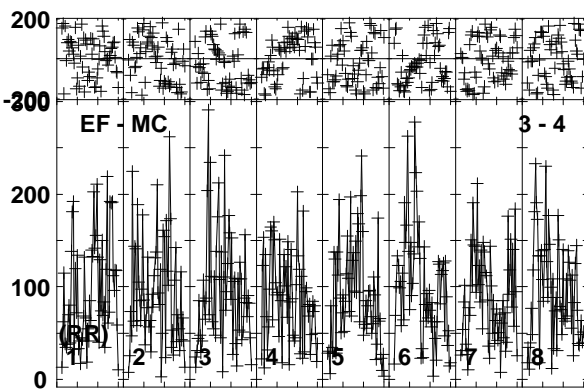
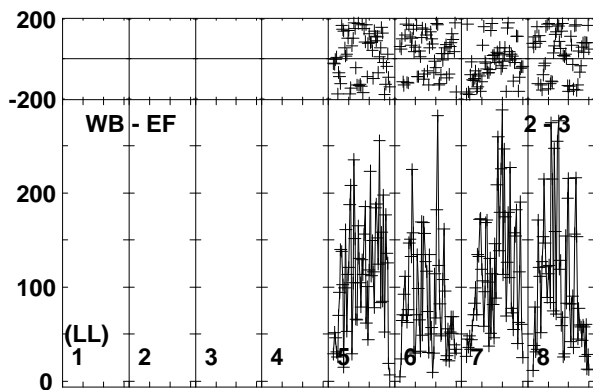
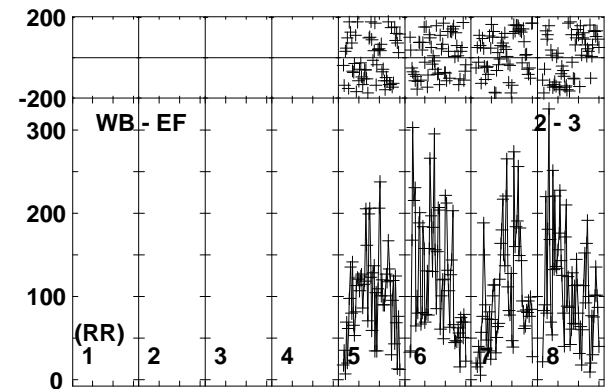
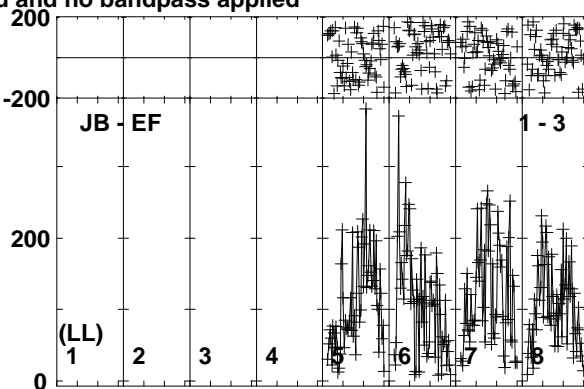
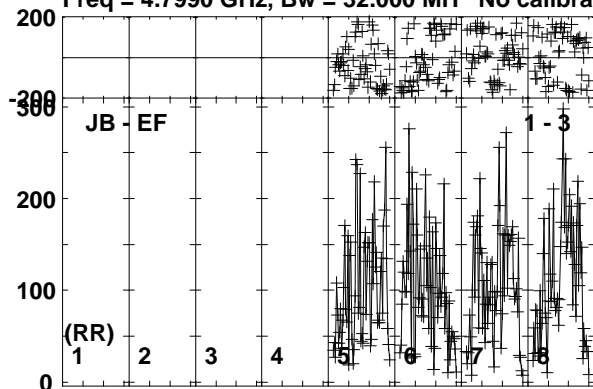

Lower frame: Micro Ampl Jy Top frame: Phas deg
Vector averaged cross-power spectrum Baseline: JB (01) - EF (03)
Timerange: 00/13:37:11 to 00/13:39:39

Plot file version 84 created 28-AUG-2017 13:19:06

SSS17A RP029A.UVDATA.1

Freq = 4.7990 GHz, Bw = 32.000 MH No calibration applied and no bandpass applied

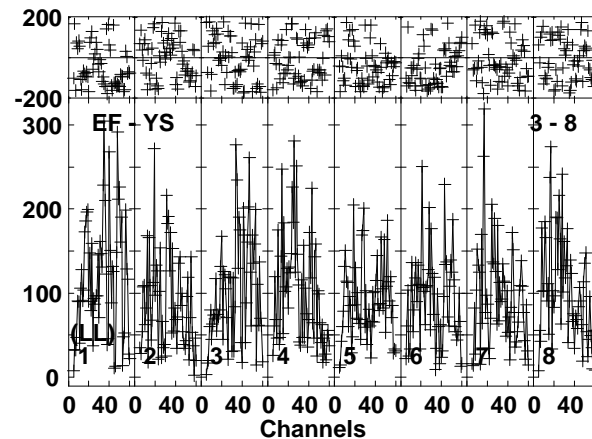
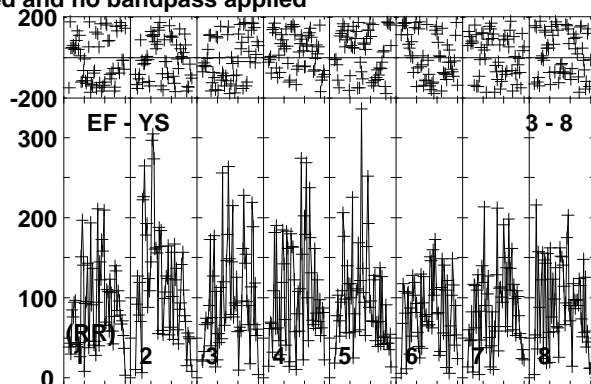
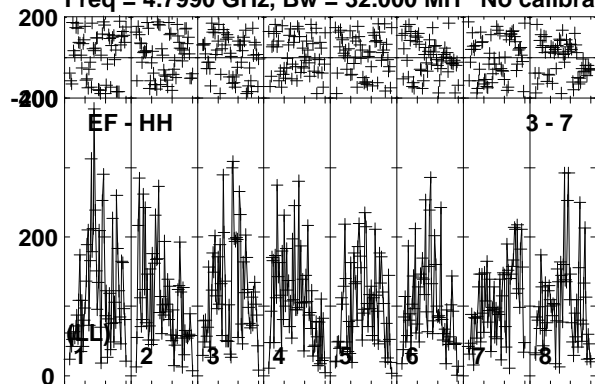

Lower frame: Micro Ampl Jy Top frame: Phas deg
Vector averaged cross-power spectrum Baseline: EF (03) - HH (07)
Timerange: 00/13:37:11 to 00/13:39:39

Plot file version 85 created 28-AUG-2017 13:19:06

J1303-2405 RP029A.UVDATA.1

Freq = 4.7990 GHz, Bw = 32.000 MH No calibration applied and no bandpass applied

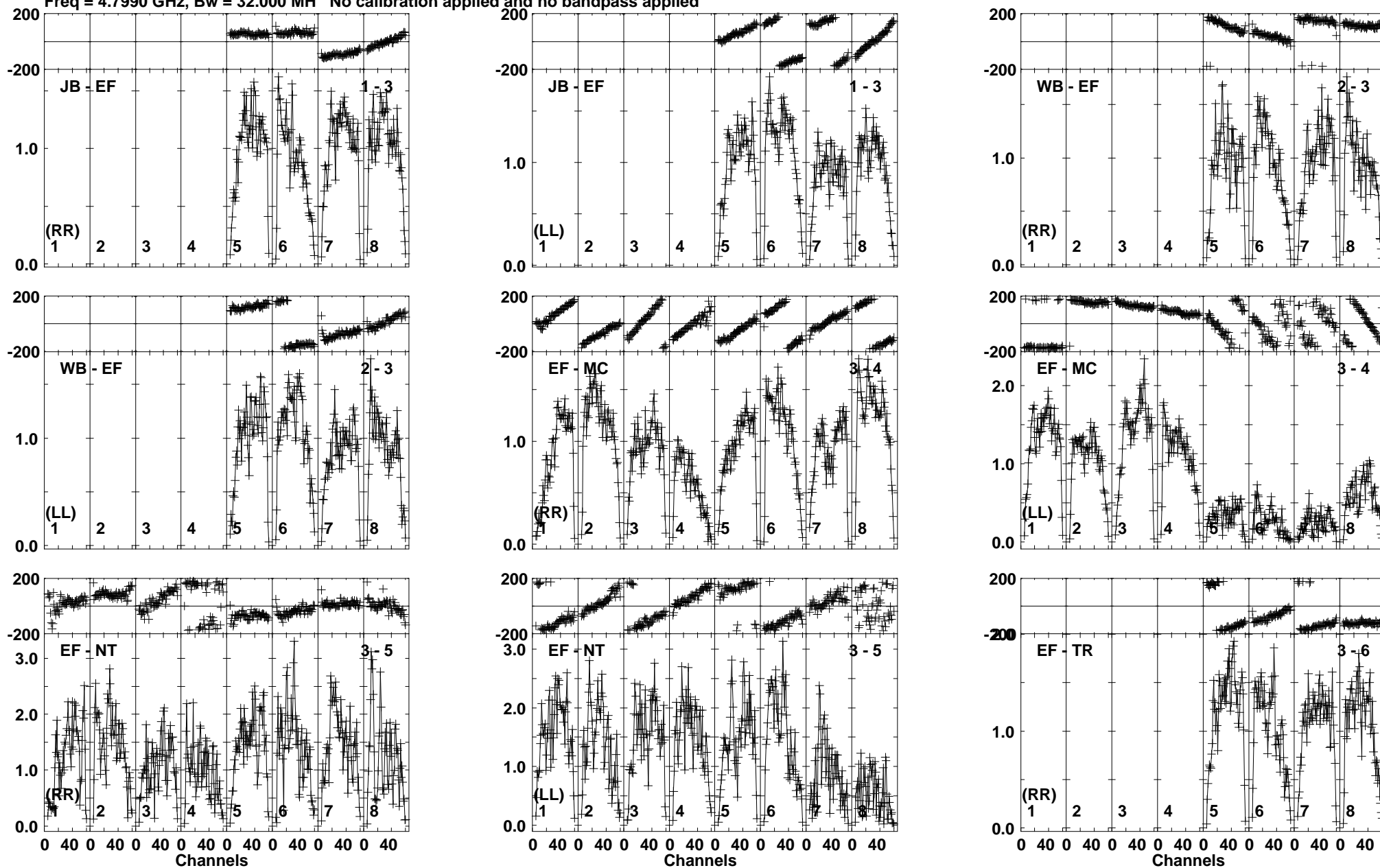

Lower frame: Milli Ampl Jy Top frame: Phas deg
Vector averaged cross-power spectrum Baseline: JB (01) - EF (03)
Timerange: 00/13:40:11 to 00/13:41:09

Plot file version 86 created 28-AUG-2017 13:19:06

J1303-2405 RP029A.UVDATA.1

Freq = 4.7990 GHz, Bw = 32.000 MH No calibration applied and no bandpass applied

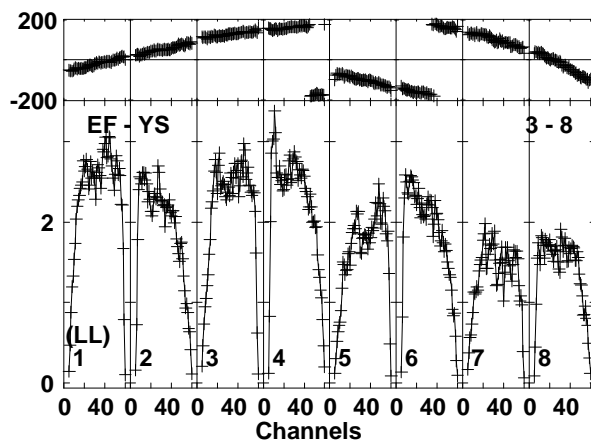
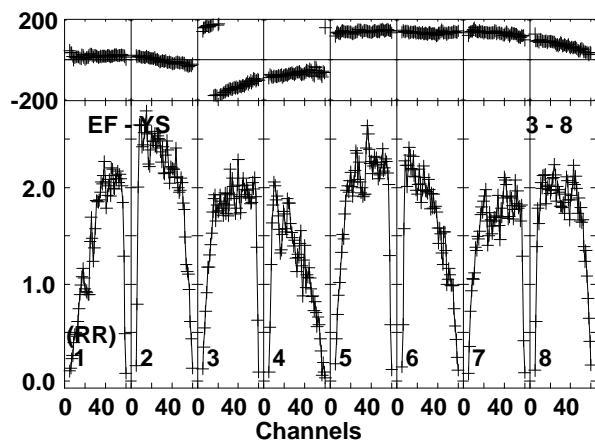
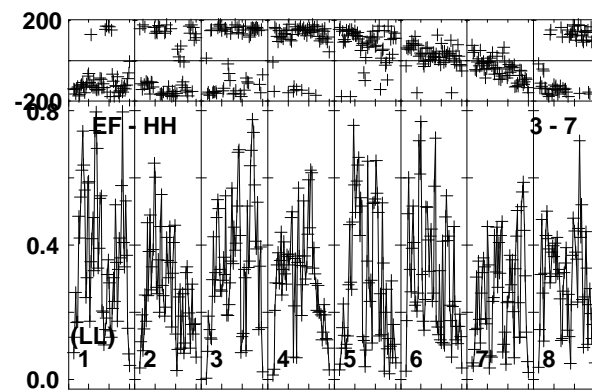
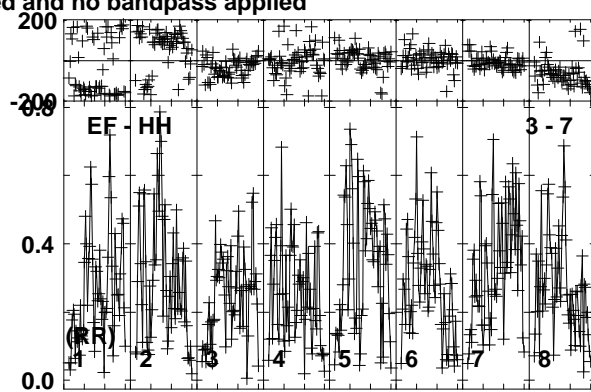
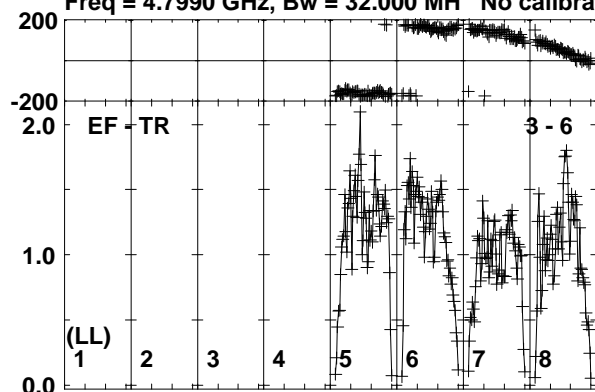

Lower frame: Milli Ampl Jy Top frame: Phas deg
Vector averaged cross-power spectrum Baseline: EF (03) - TR (06)
Timerange: 00/13:40:11 to 00/13:41:09

Plot file version 89 created 28-AUG-2017 13:19:06

J1303-2405 RP029A.UVDATA.1

Freq = 4.7990 GHz, Bw = 32.000 MH No calibration applied and no bandpass applied

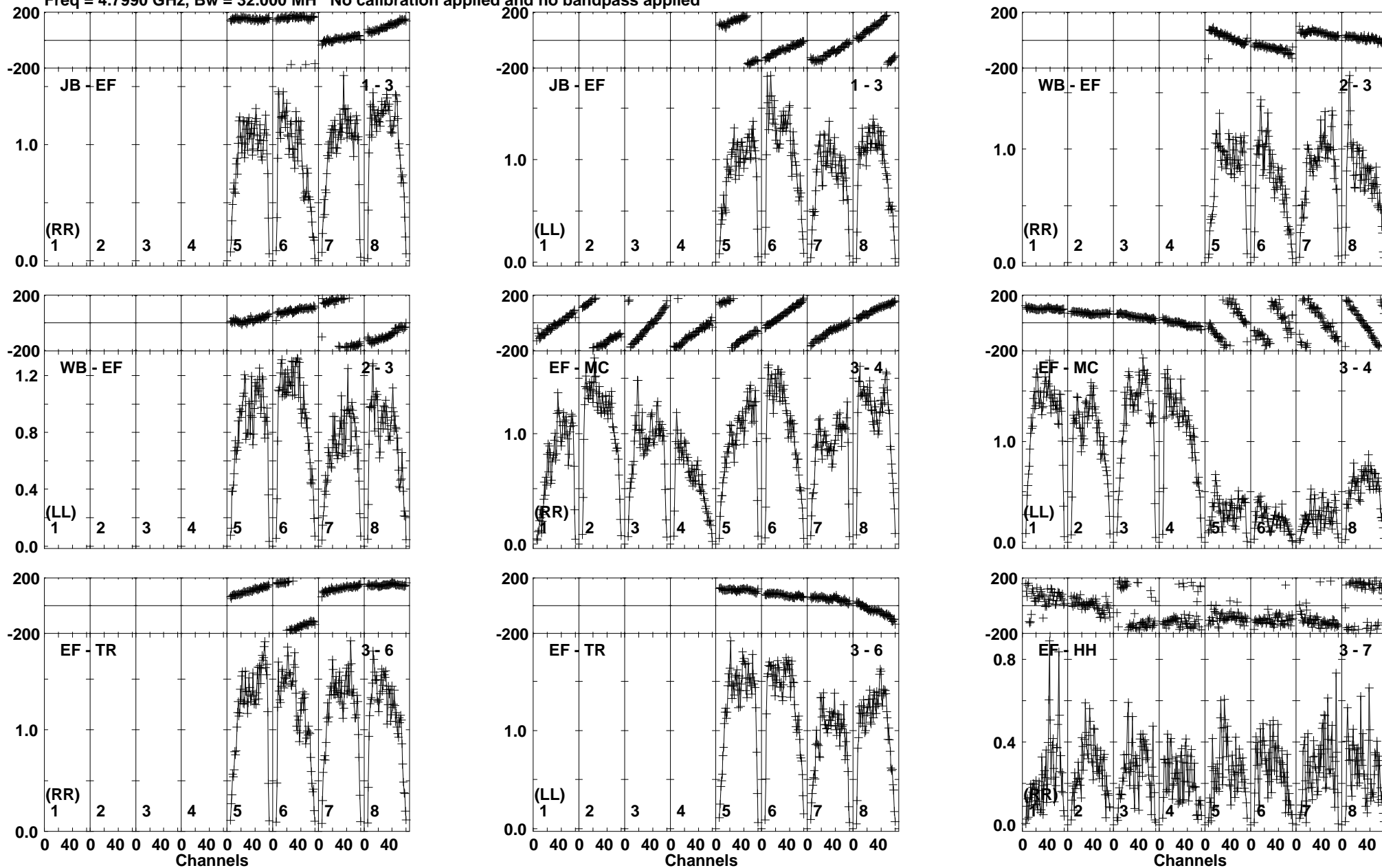

Lower frame: Milli Ampl Jy Top frame: Phas deg
Vector averaged cross-power spectrum Baseline: JB (01) - EF (03)
Timerange: 00/13:43:41 to 00/13:45:09

Plot file version 90 created 28-AUG-2017 13:19:06

J1303-2405 RP029A.UVDATA.1

Freq = 4.7990 GHz, Bw = 32.000 MH No calibration applied and no bandpass applied

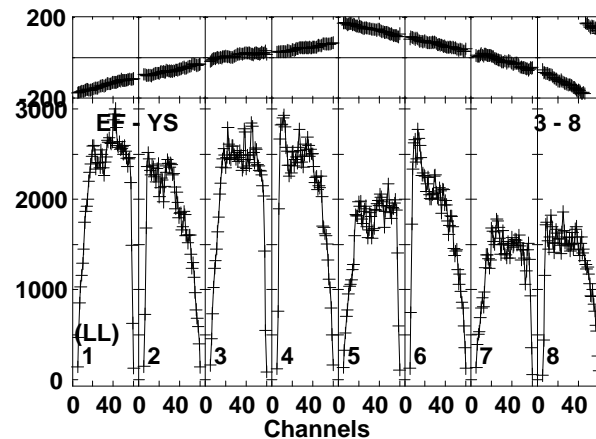
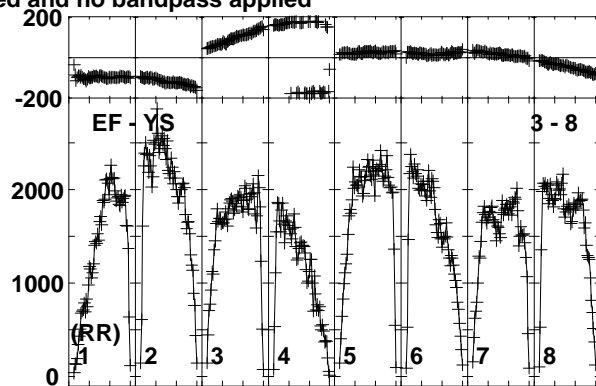
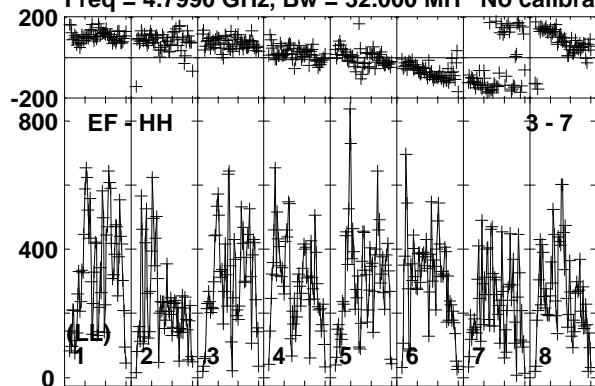

Lower frame: Micro Ampl Jy Top frame: Phas deg
Vector averaged cross-power spectrum Baseline: EF (03) - HH (07)
Timerange: 00/13:43:41 to 00/13:45:09

Plot file version 91 created 28-AUG-2017 13:19:06

J1312-2350 RP029A.UVDATA.1

Freq = 4.7990 GHz, Bw = 32.000 MH No calibration applied and no bandpass applied

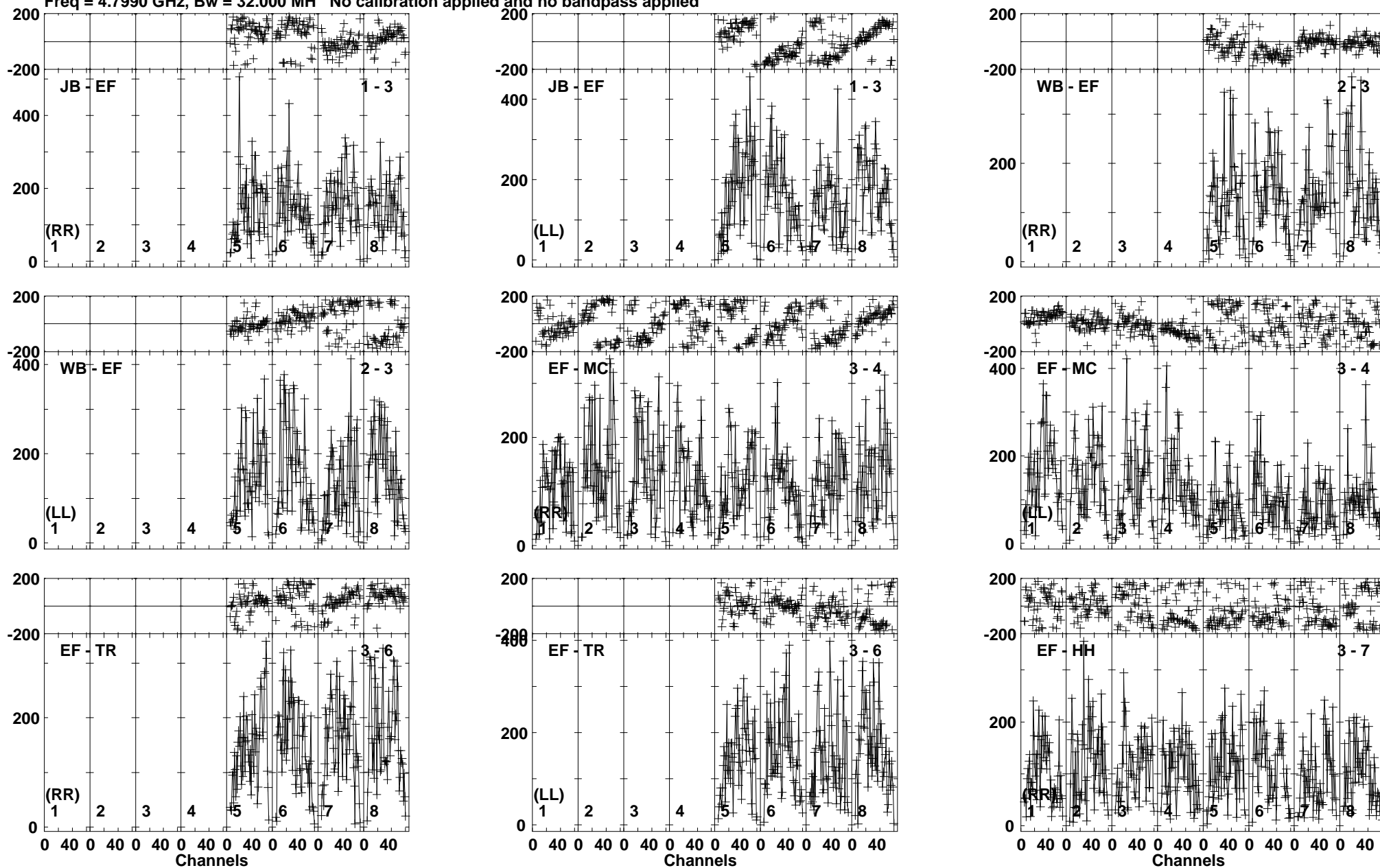

Lower frame: Micro Ampl Jy Top frame: Phas deg
Vector averaged cross-power spectrum Baseline: JB (01) - EF (03)
Timerange: 00/13:45:11 to 00/13:47:39

Plot file version 92 created 28-AUG-2017 13:19:06

J1312-2350 RP029A.UVDATA.1

Freq = 4.7990 GHz, Bw = 32.000 MH No calibration applied and no bandpass applied

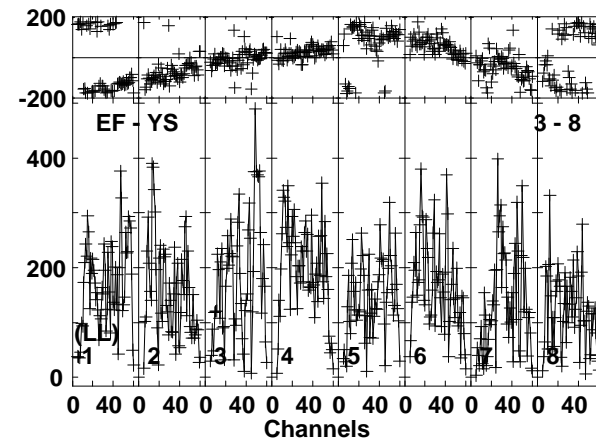
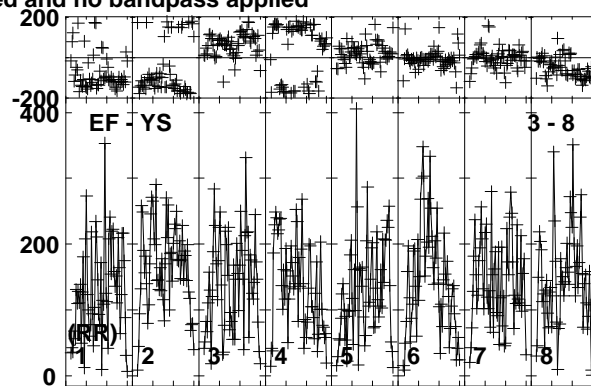
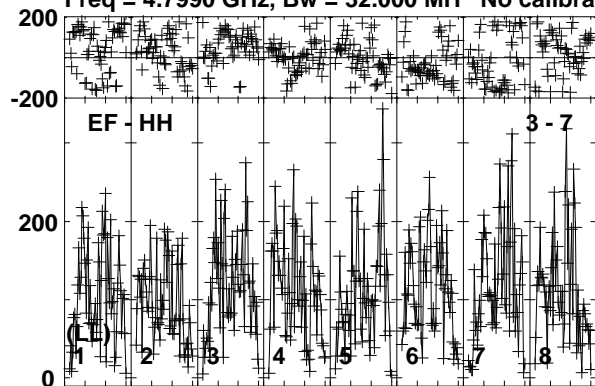

Lower frame: Micro Ampl Jy Top frame: Phas deg
Vector averaged cross-power spectrum Baseline: EF (03) - HH (07)
Timerange: 00/13:45:11 to 00/13:47:39

Plot file version 93 created 28-AUG-2017 13:19:06
 J1303-2405 RP029A.UVDATA.1
 Freq = 4.7990 GHz, Bw = 32.000 MH No calibration applied and no bandpass applied

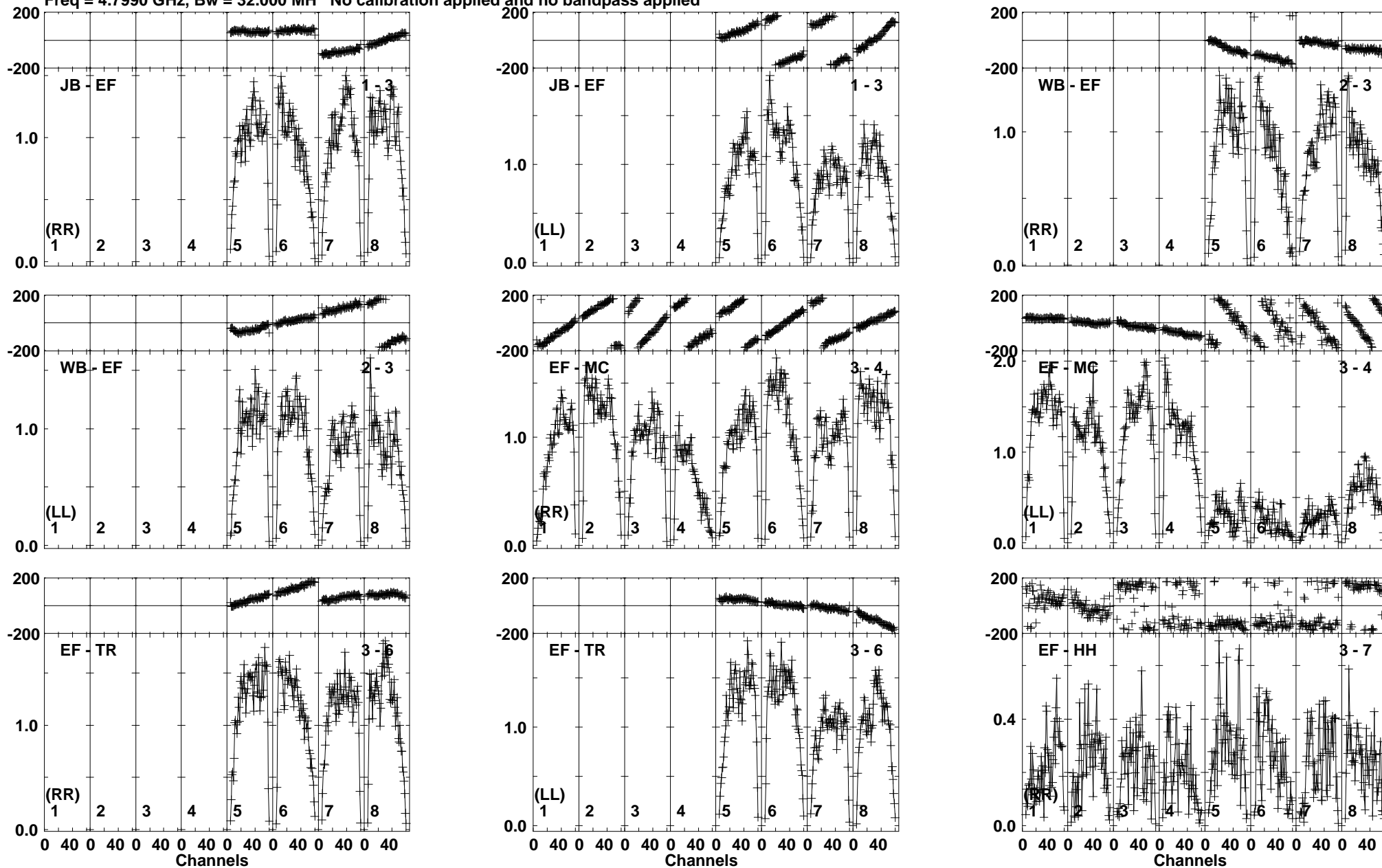

Lower frame: Milli Ampl Jy Top frame: Phas deg
 Vector averaged cross-power spectrum Baseline: JB (01) - EF (03)
 Timerange: 00/13:48:21 to 00/13:49:19

Plot file version 95 created 28-AUG-2017 13:19:07

SSS17A RP029A.UVDATA.1

Freq = 4.7990 GHz, Bw = 32.000 MH No calibration applied and no bandpass applied

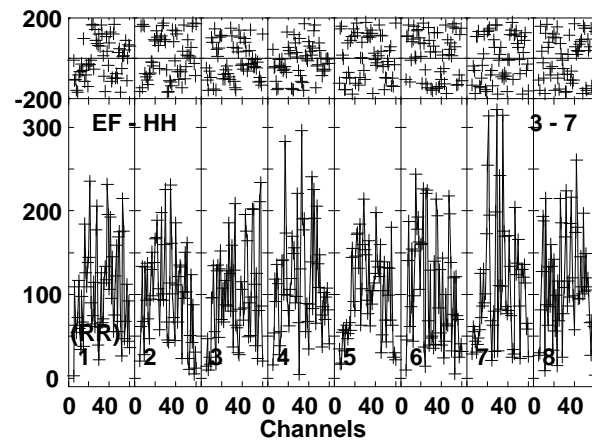
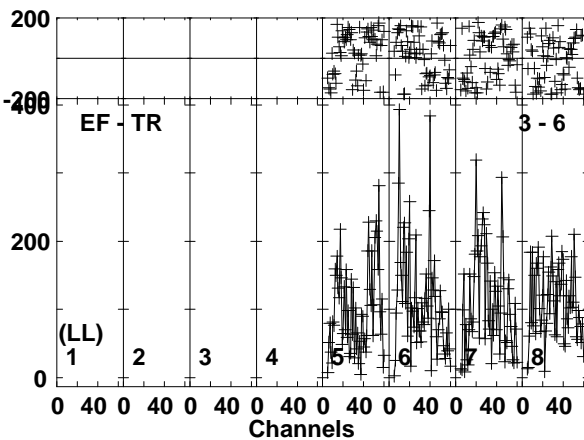
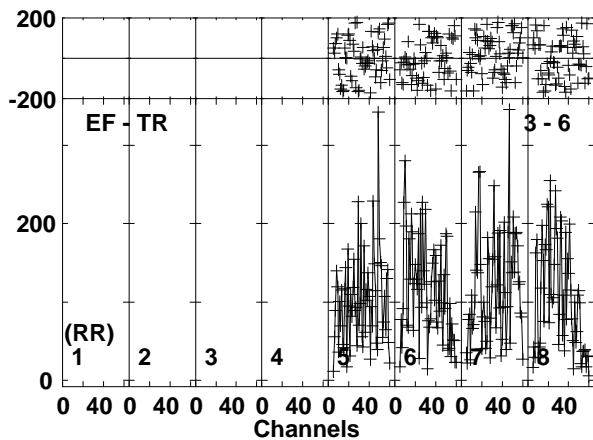
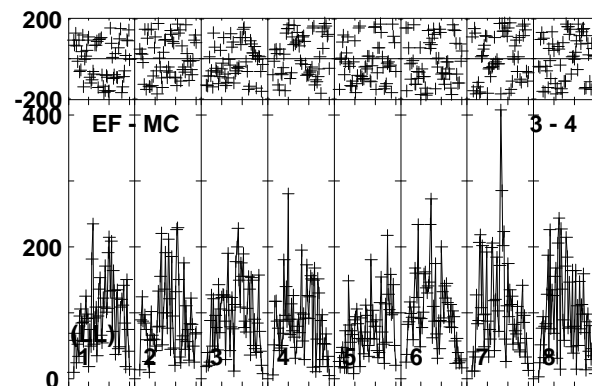
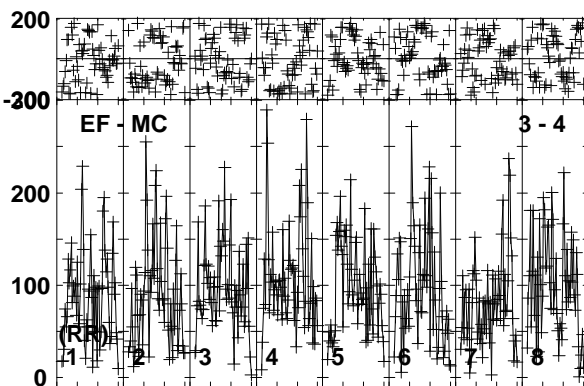
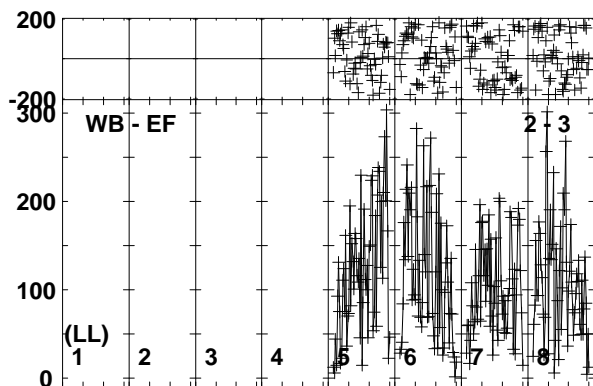
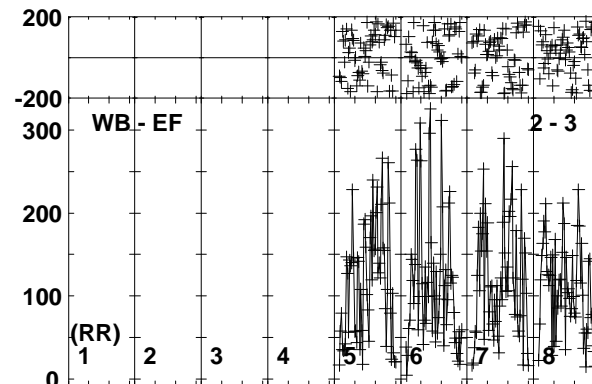
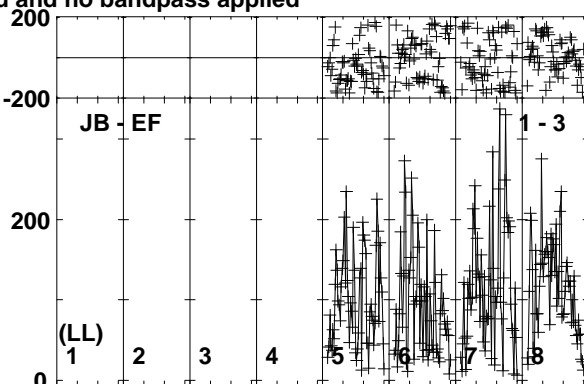
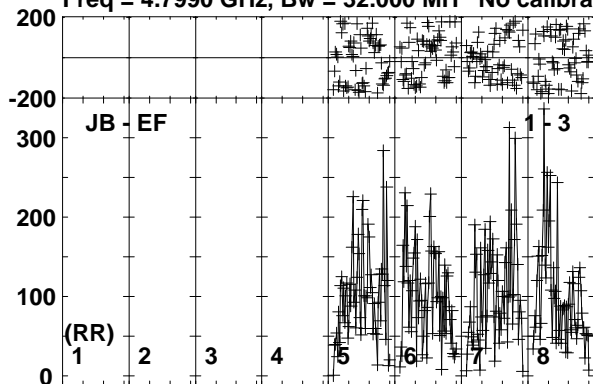

Lower frame: Micro Ampl Jy Top frame: Phas deg
Vector averaged cross-power spectrum Baseline: JB (01) - EF (03)
Timerange: 00/13:49:21 to 00/13:51:49

Plot file version 96 created 28-AUG-2017 13:19:07

SSS17A RP029A.UVDATA.1

Freq = 4.7990 GHz, Bw = 32.000 MH No calibration applied and no bandpass applied

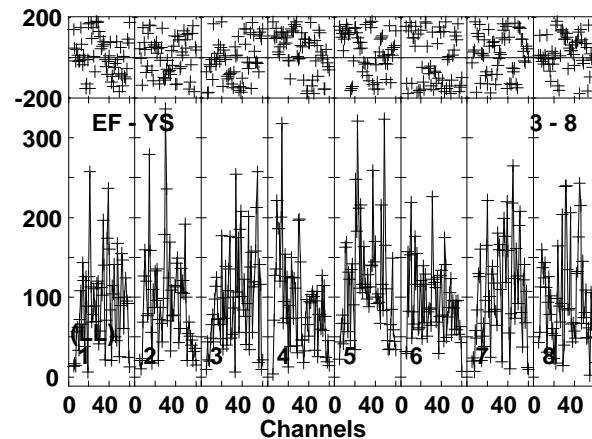
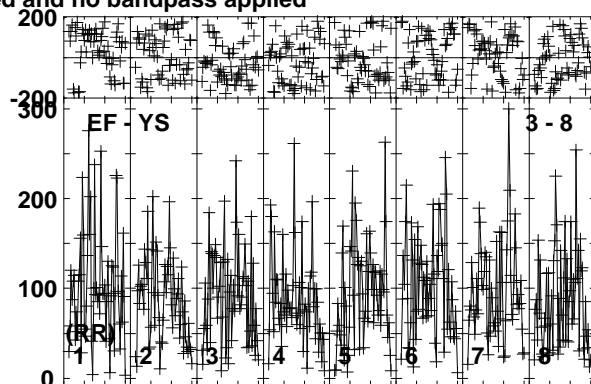
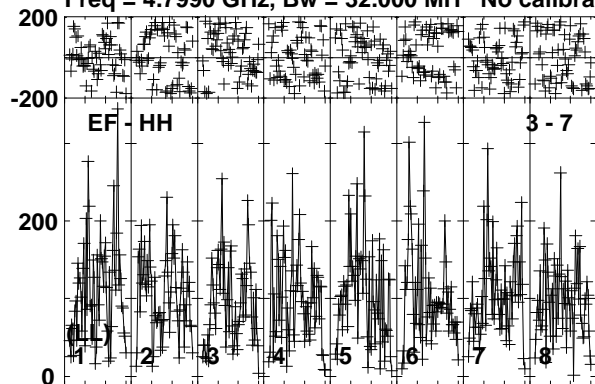

Lower frame: Micro Ampl Jy Top frame: Phas deg
Vector averaged cross-power spectrum Baseline: EF (03) - HH (07)
Timerange: 00/13:49:21 to 00/13:51:49

Plot file version 97 created 28-AUG-2017 13:19:07

J1303-2405 RP029A.UVDATA.1

Freq = 4.7990 GHz, Bw = 32.000 MH No calibration applied and no bandpass applied

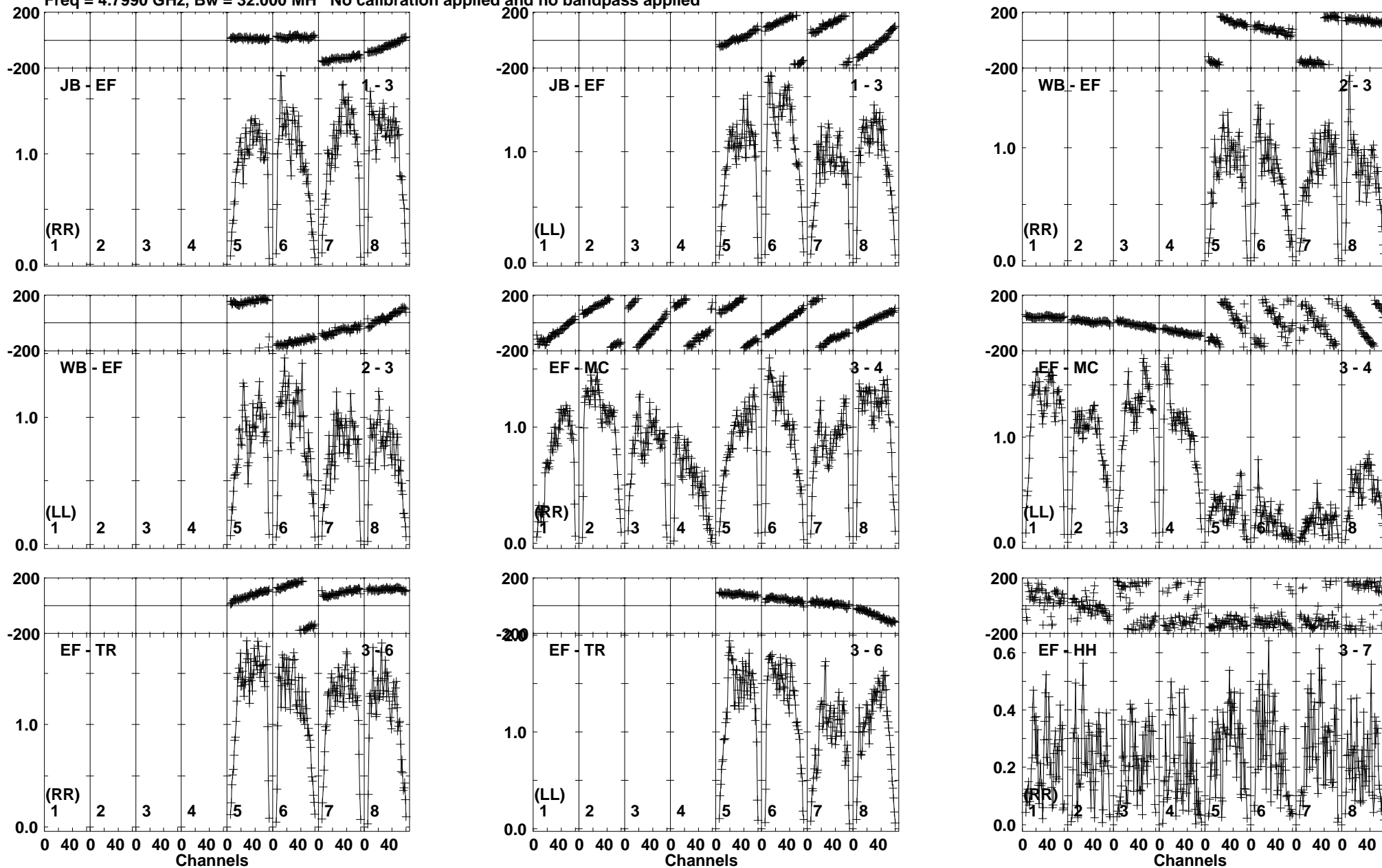

Lower frame: Milli Ampl Jy Top frame: Phas deg
Vector averaged cross-power spectrum Baseline: JB (01) - EF (03)
Timerange: 00/13:51:51 to 00/13:53:19

Plot file version 98 created 28-AUG-2017 13:19:07

J1303-2405 RP029A.UVDATA.1

Freq = 4.7990 GHz, Bw = 32.000 MH No calibration applied and no bandpass applied

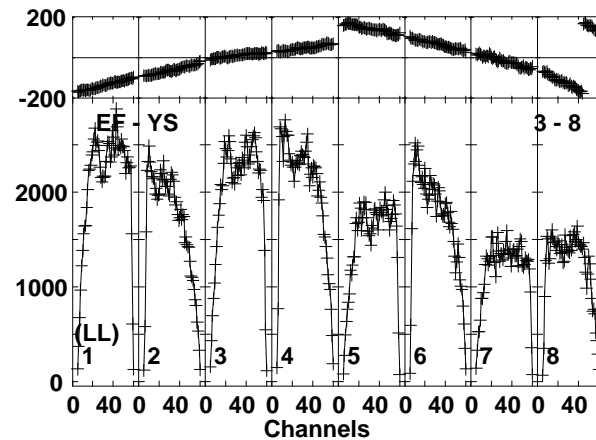
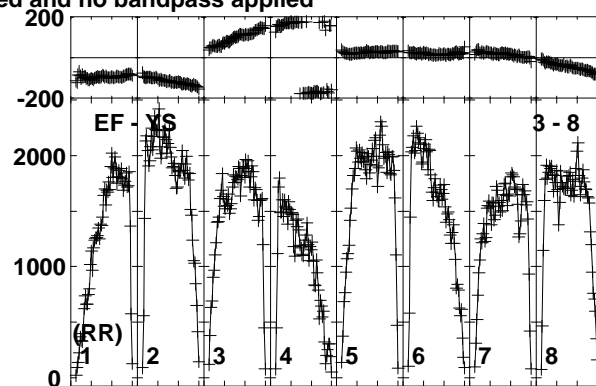
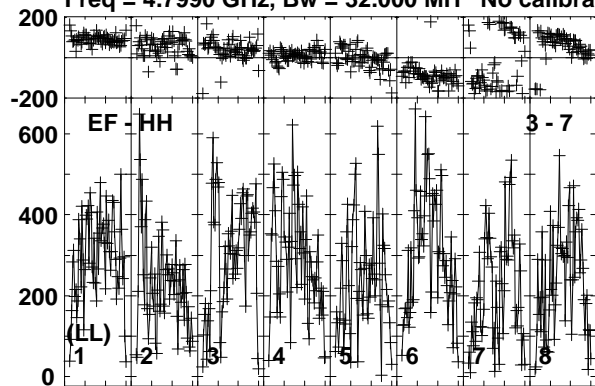

Lower frame: Micro Ampl Jy Top frame: Phas deg
Vector averaged cross-power spectrum Baseline: EF (03) - HH (07)
Timerange: 00/13:51:51 to 00/13:53:19

Plot file version 99 created 28-AUG-2017 13:19:07

SSS17A RP029A.UVDATA.1

Freq = 4.7990 GHz, Bw = 32.000 MH No calibration applied and no bandpass applied

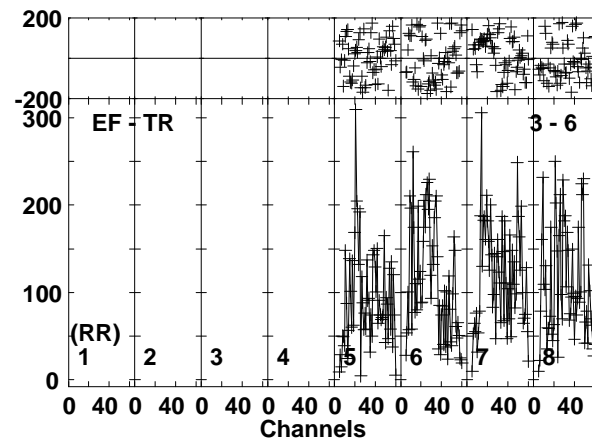
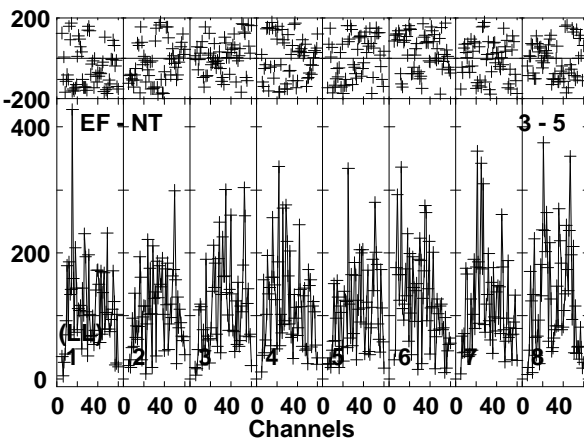
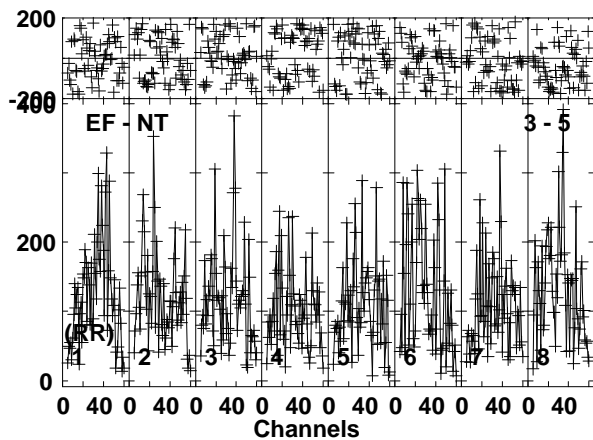
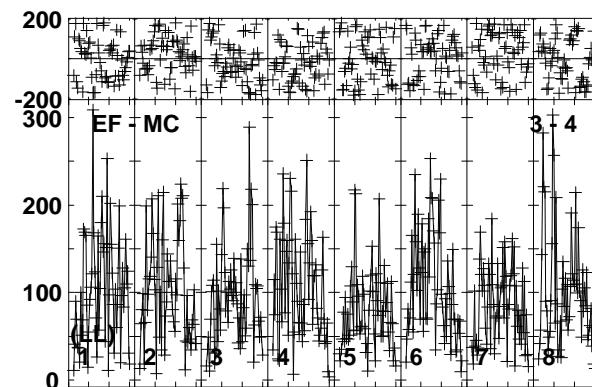
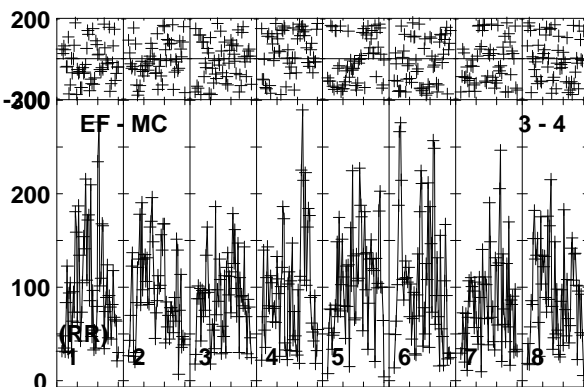
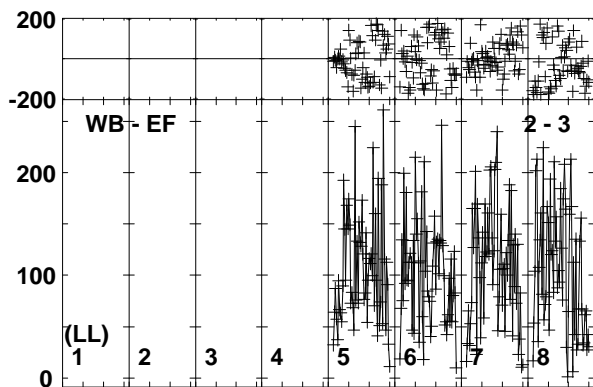
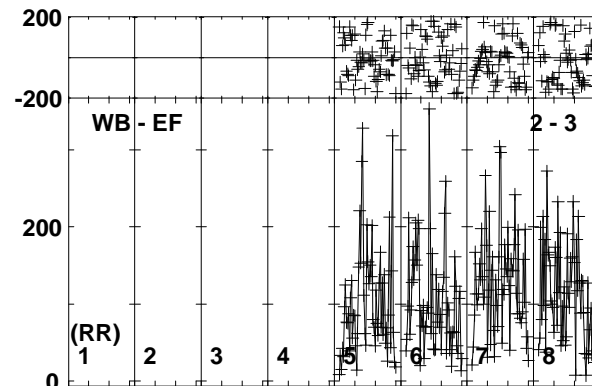
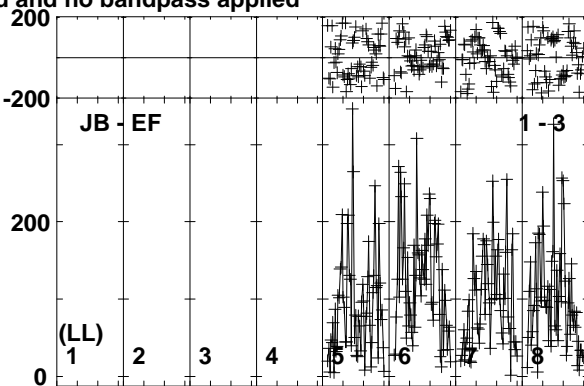
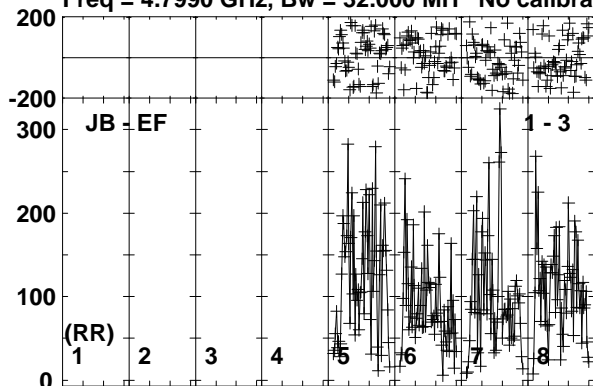

Lower frame: Micro Ampl Jy Top frame: Phas deg
Vector averaged cross-power spectrum Baseline: JB (01) - EF (03)
Timerange: 00/13:53:21 to 00/13:55:49

Plot file version 100 created 28-AUG-2017 13:19:07

SSS17A RP029A.UVDATA.1

Freq = 4.7990 GHz, Bw = 32.000 MH No calibration applied and no bandpass applied

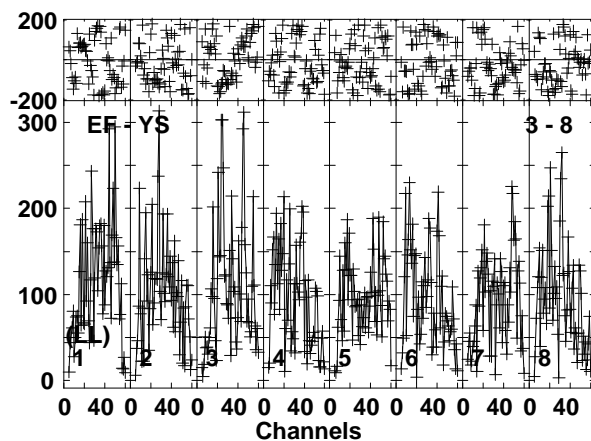
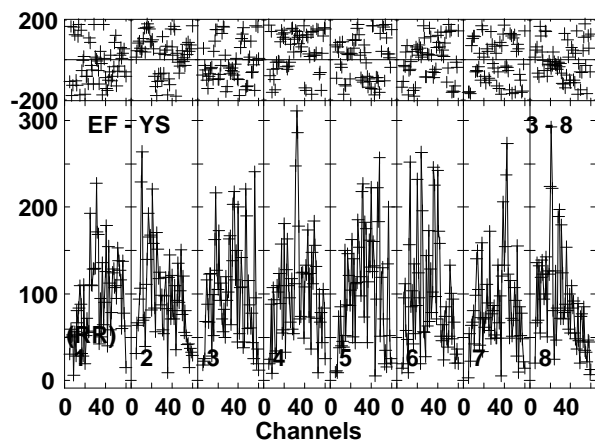
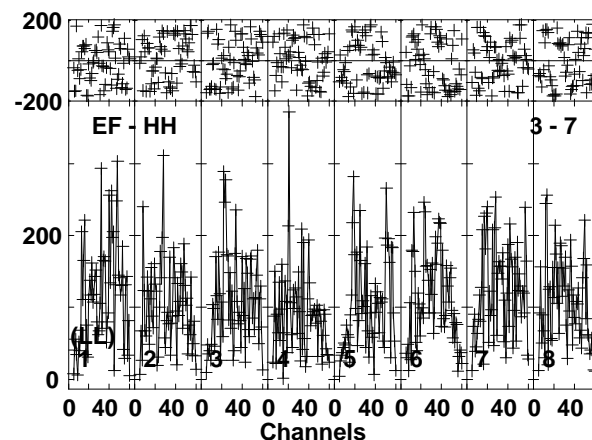
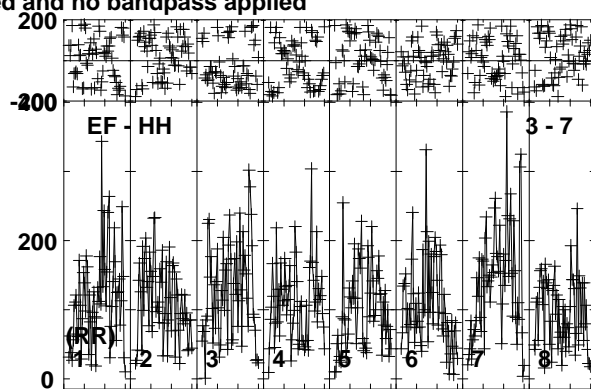
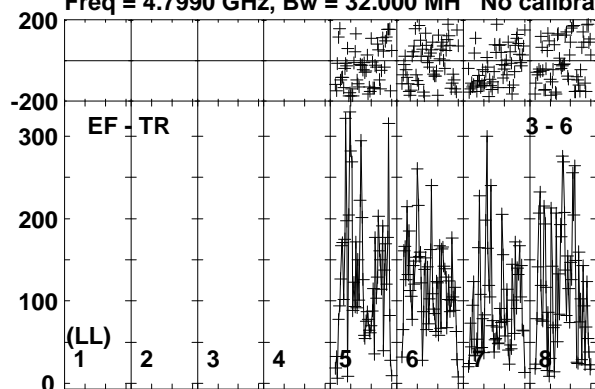

Lower frame: Micro Ampl Jy Top frame: Phas deg
Vector averaged cross-power spectrum Baseline: EF (03) - TR (06)
Timerange: 00/13:53:21 to 00/13:55:49

Plot file version 101 created 28-AUG-2017 13:19:07

J1303-2405 RP029A.UVDATA.1

Freq = 4.7990 GHz, Bw = 32.000 MH No calibration applied and no bandpass applied

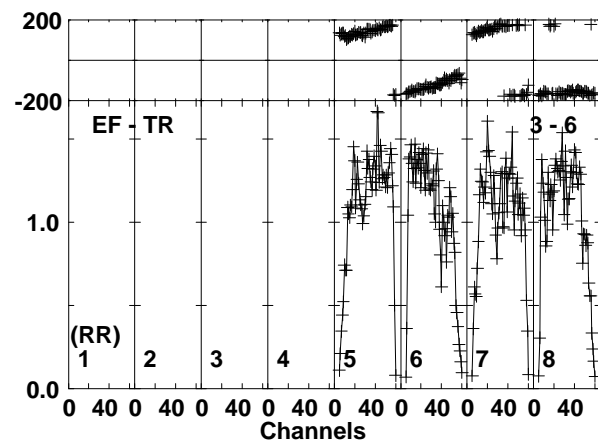
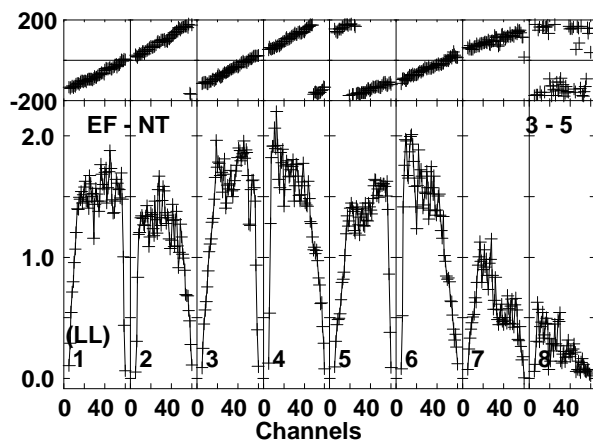
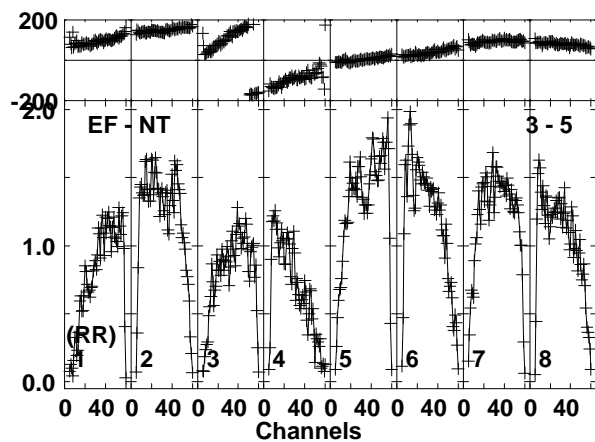
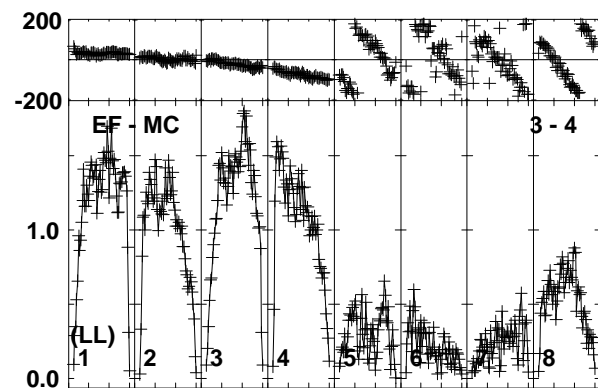
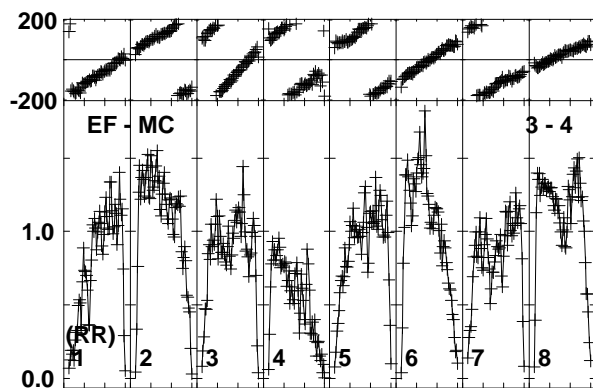
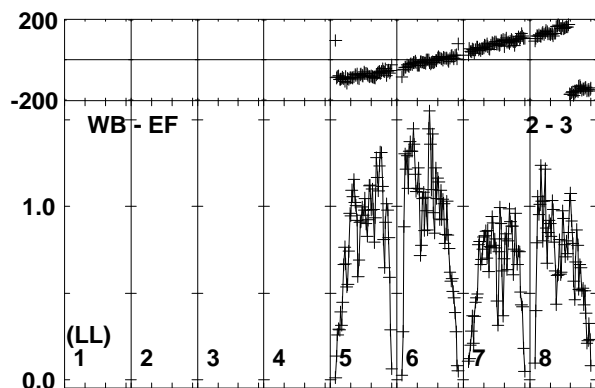
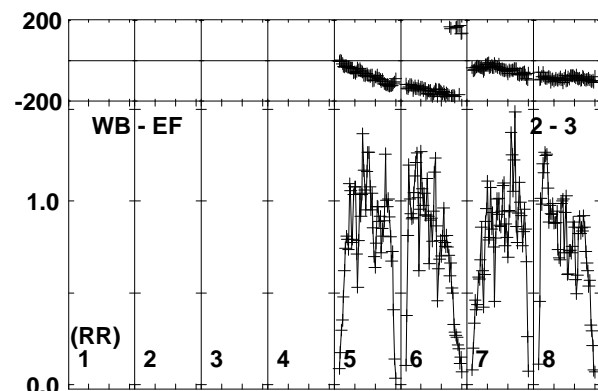
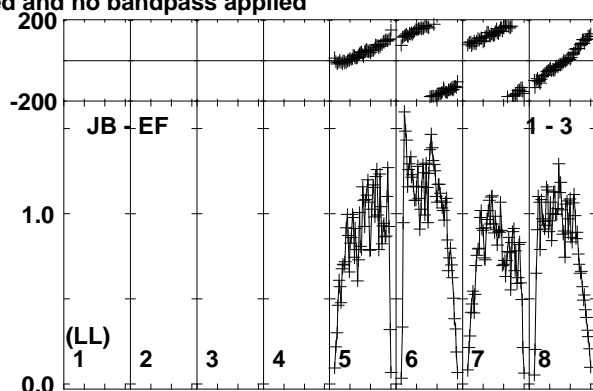
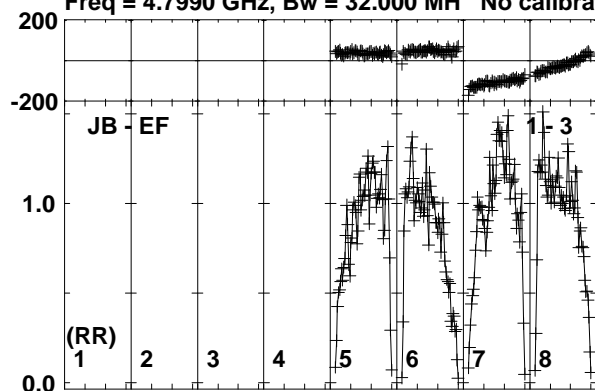

Lower frame: Milli Ampl Jy Top frame: Phas deg
Vector averaged cross-power spectrum Baseline: JB (01) - EF (03)
Timerange: 00/13:56:21 to 00/13:57:19

Plot file version 102 created 28-AUG-2017 13:19:07

J1303-2405 RP029A.UVDATA.1

Freq = 4.7990 GHz, Bw = 32.000 MH No calibration applied and no bandpass applied

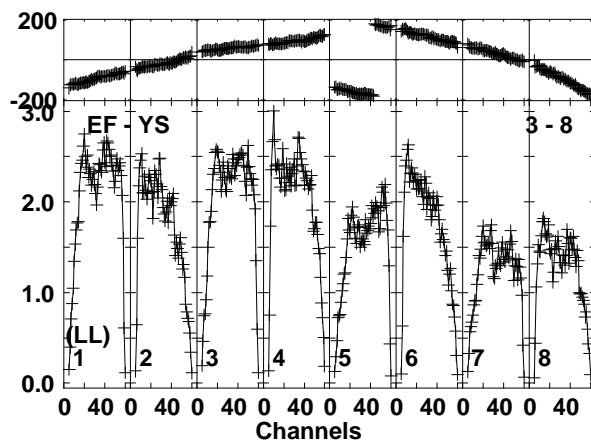
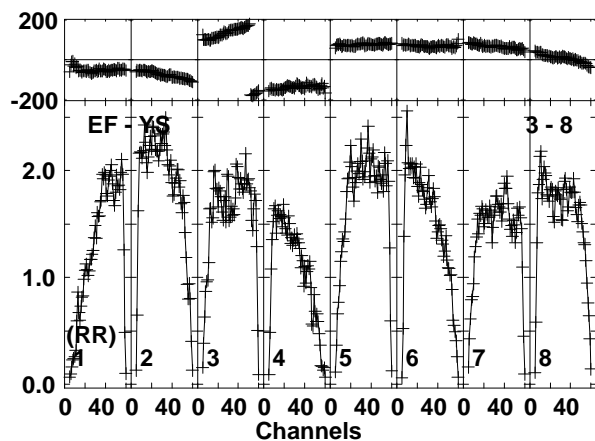
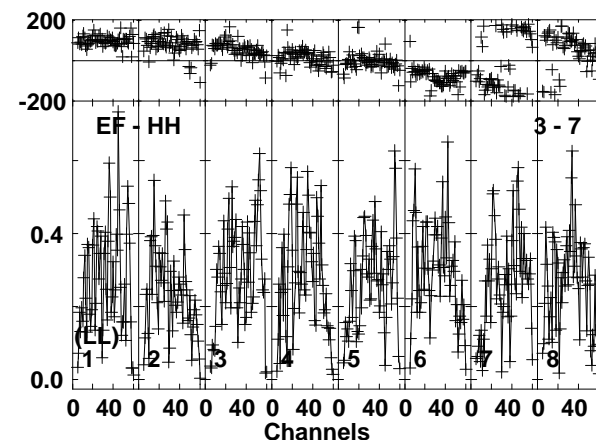
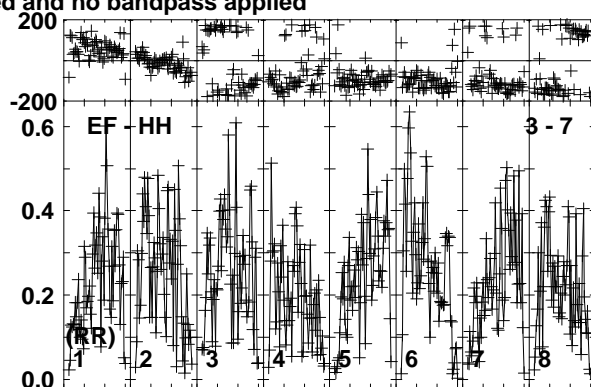
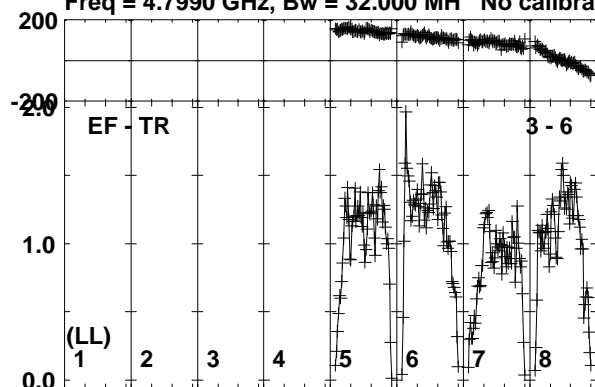

Lower frame: Milli Ampl Jy Top frame: Phas deg
Vector averaged cross-power spectrum Baseline: EF (03) - TR (06)
Timerange: 00/13:56:21 to 00/13:57:19

Plot file version 103 created 28-AUG-2017 13:19:07

SSS17A RP029A.UVDATA.1

Freq = 4.7990 GHz, Bw = 32.000 MH No calibration applied and no bandpass applied

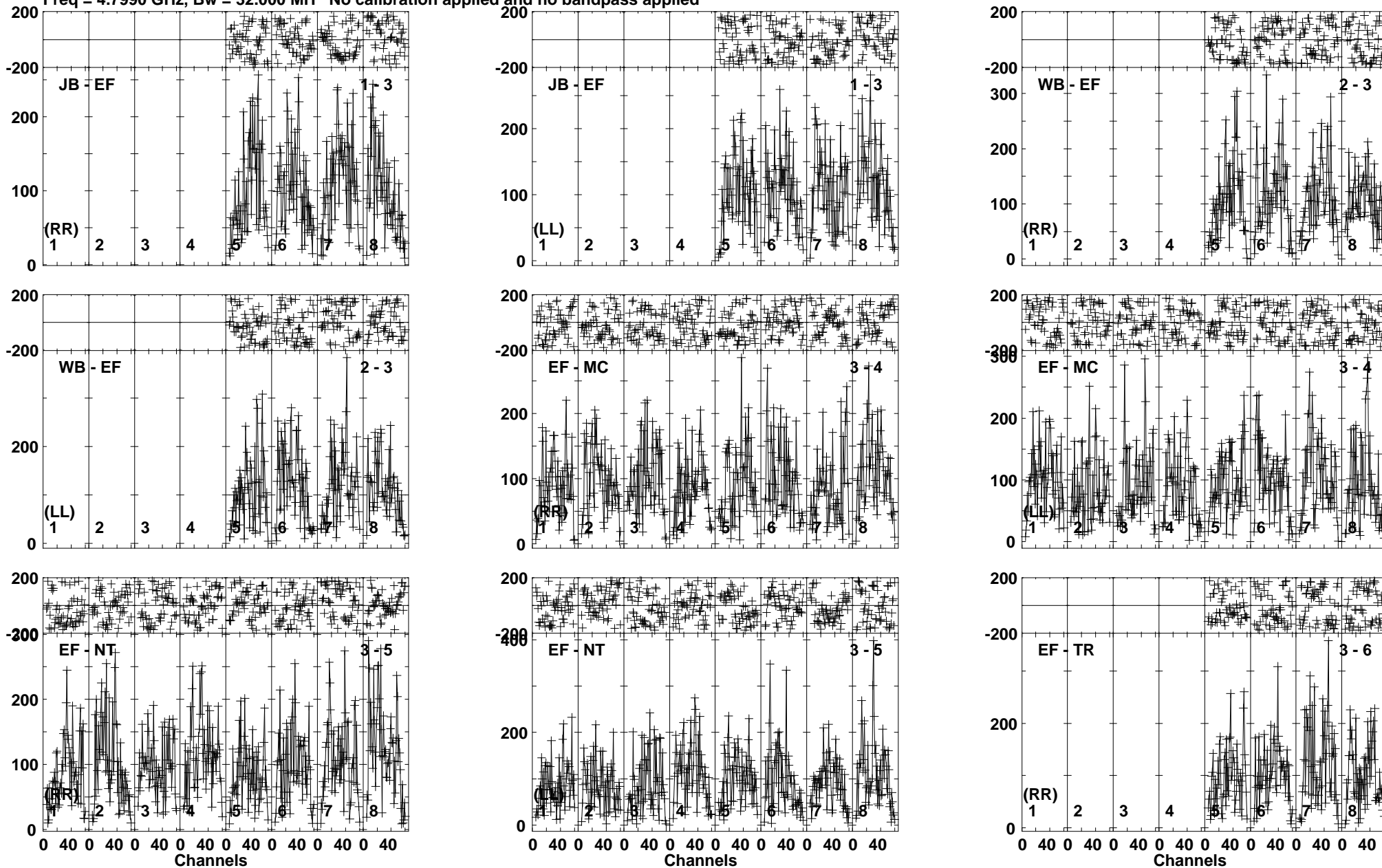

Lower frame: Micro Ampl Jy Top frame: Phas deg
Vector averaged cross-power spectrum Baseline: JB (01) - EF (03)
Timerange: 00/13:57:21 to 00/13:59:49

Plot file version 104 created 28-AUG-2017 13:19:07

SSS17A RP029A.UVDATA.1

Freq = 4.7990 GHz, Bw = 32.000 MH No calibration applied and no bandpass applied

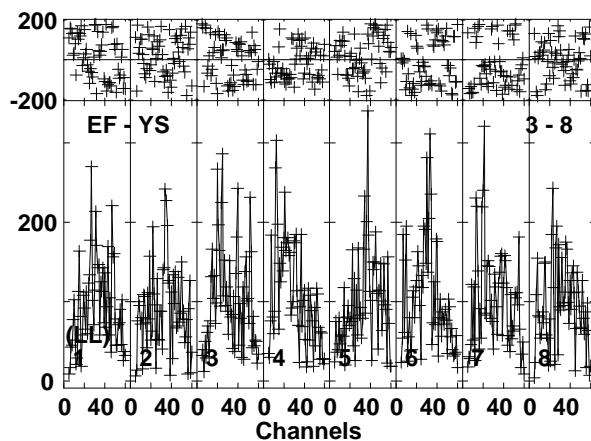
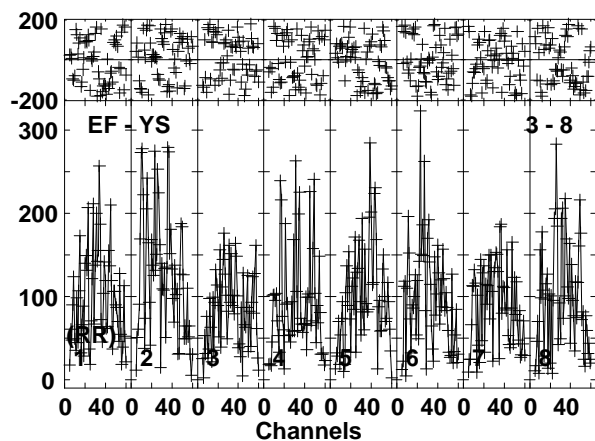
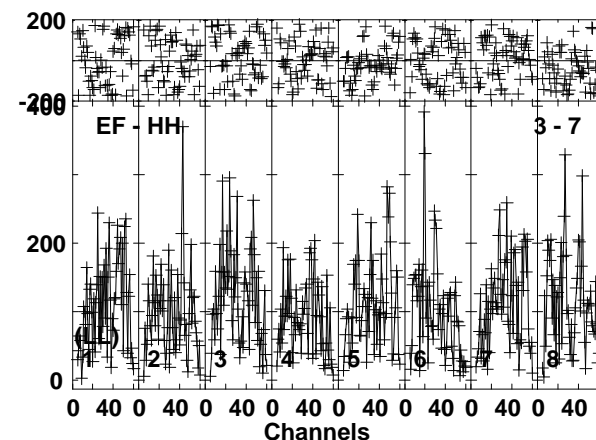
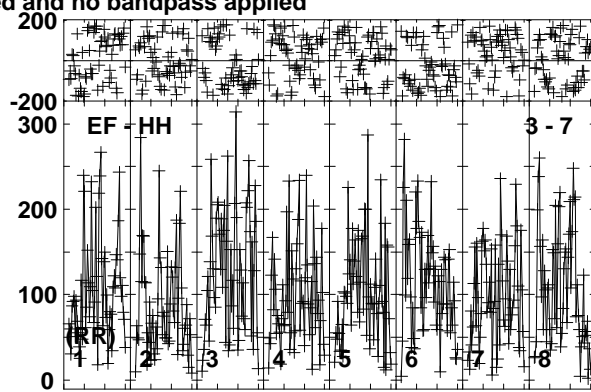
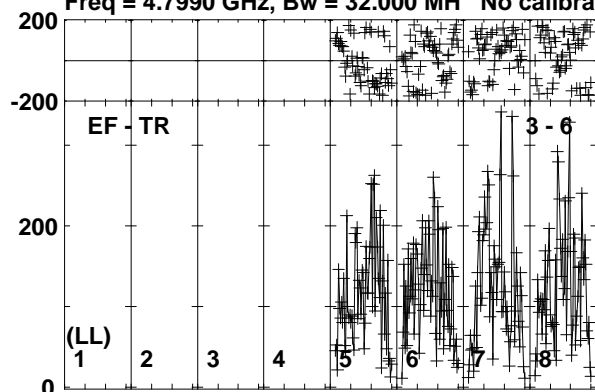

Lower frame: Micro Ampl Jy Top frame: Phas deg
Vector averaged cross-power spectrum Baseline: EF (03) - TR (06)
Timerange: 00/13:57:21 to 00/13:59:49

Plot file version 105 created 28-AUG-2017 13:19:07

J1303-2405 RP029A.UVDATA.1

Freq = 4.7990 GHz, Bw = 32.000 MH No calibration applied and no bandpass applied

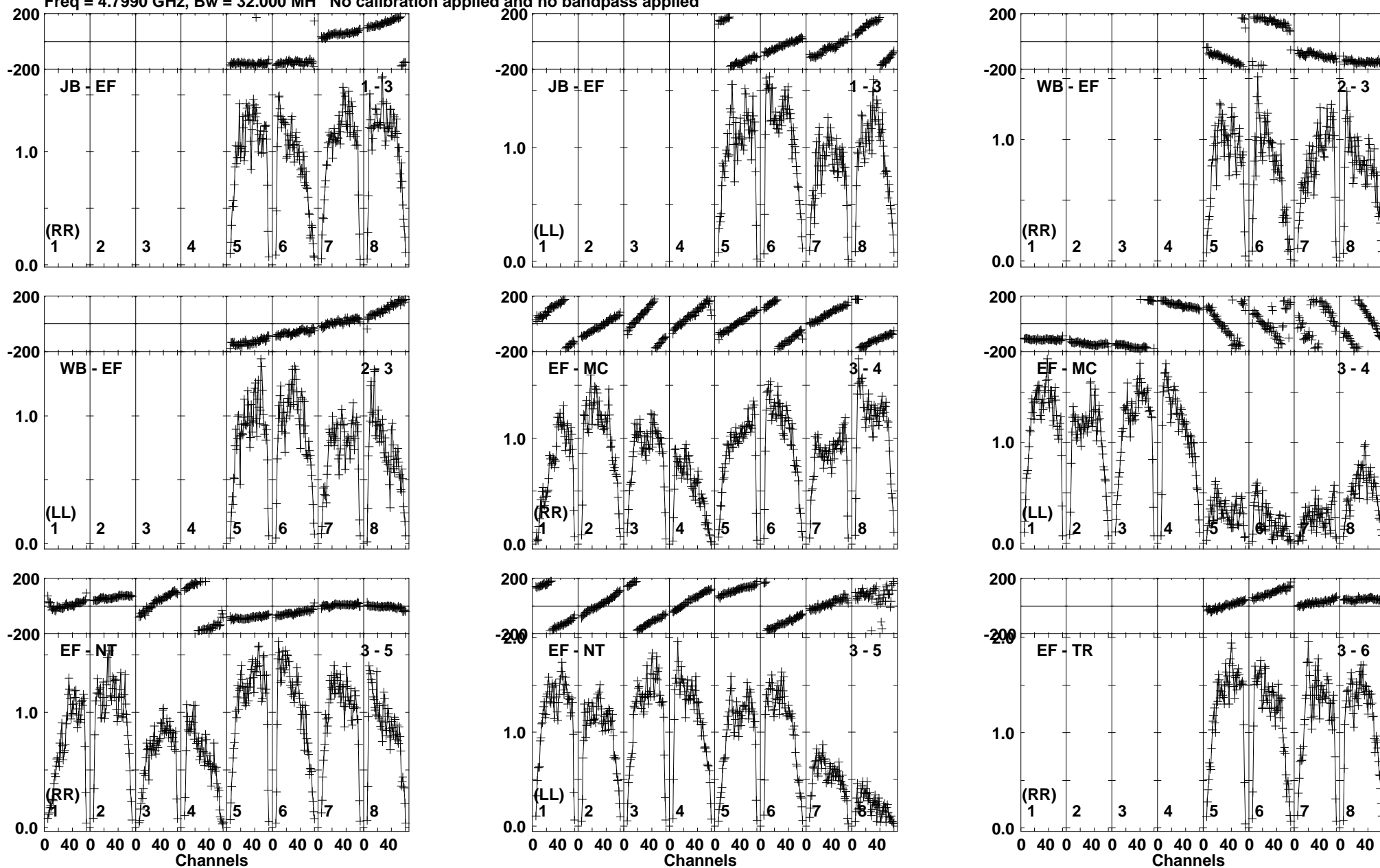

Lower frame: Milli Ampl Jy Top frame: Phas deg
Vector averaged cross-power spectrum Baseline: JB (01) - EF (03)
Timerange: 00/13:59:51 to 00/14:01:19

Plot file version 106 created 28-AUG-2017 13:19:07

J1303-2405 RP029A.UVDATA.1

Freq = 4.7990 GHz, Bw = 32.000 MH No calibration applied and no bandpass applied

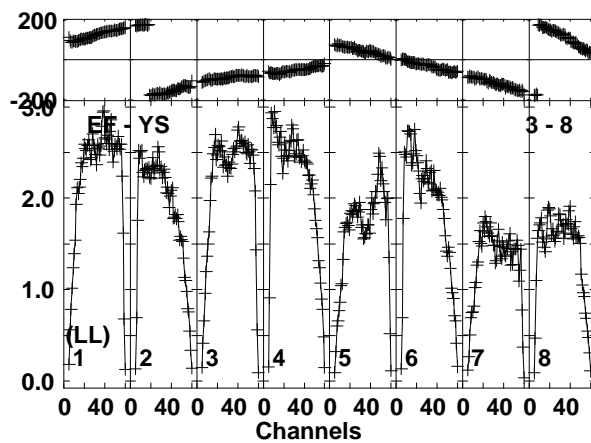
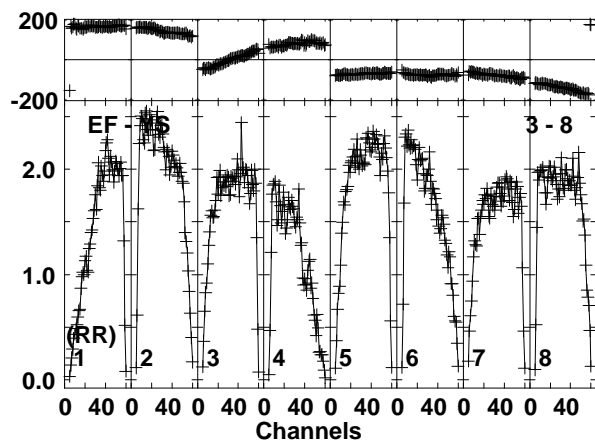
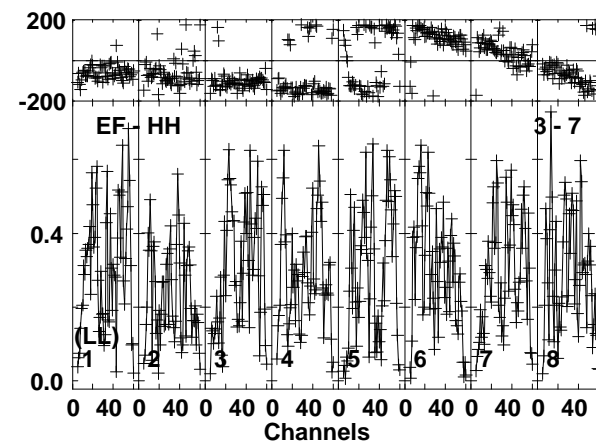
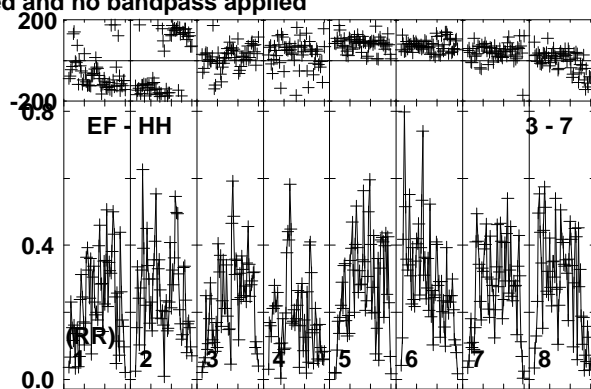
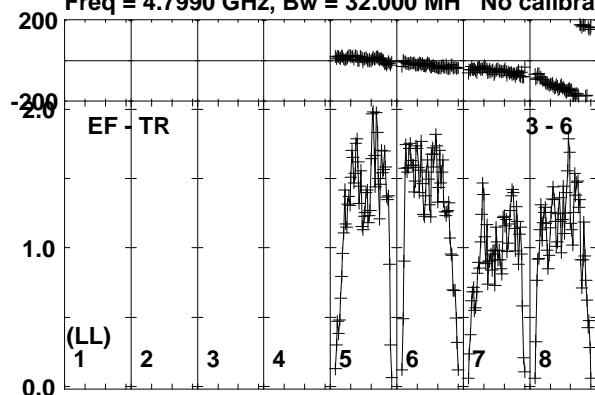

Lower frame: Milli Ampl Jy Top frame: Phas deg
Vector averaged cross-power spectrum Baseline: EF (03) - TR (06)
Timerange: 00:13:59:51 to 00:14:01:19

Plot file version 107 created 28-AUG-2017 13:19:08

J1312-2350 RP029A.UVDATA.1

Freq = 4.7990 GHz, Bw = 32.000 MH No calibration applied and no bandpass applied

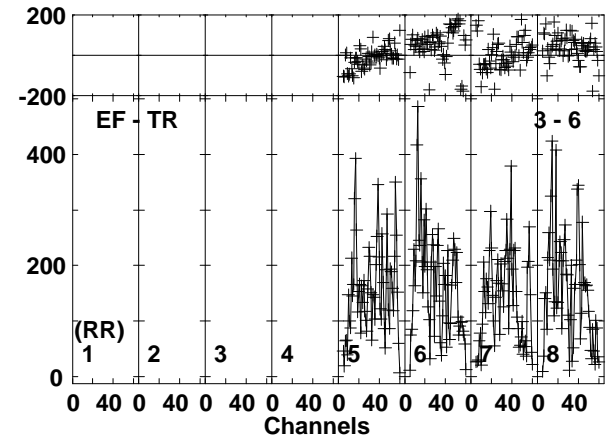
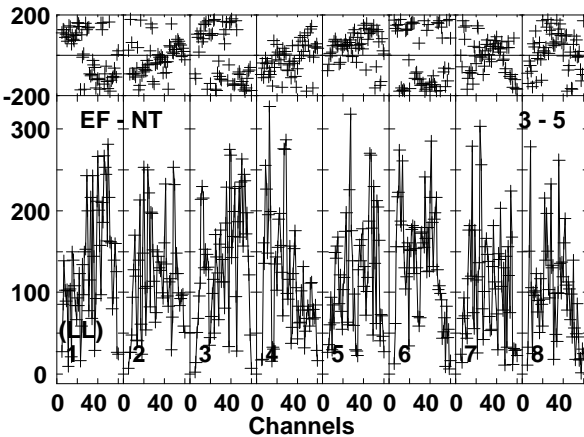
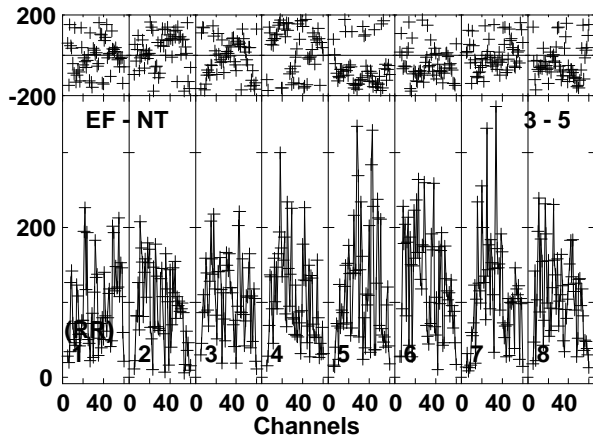
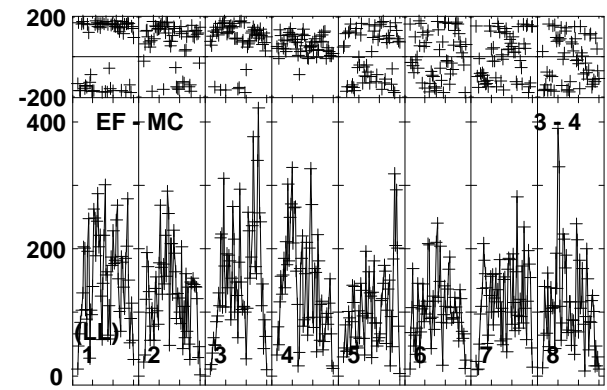
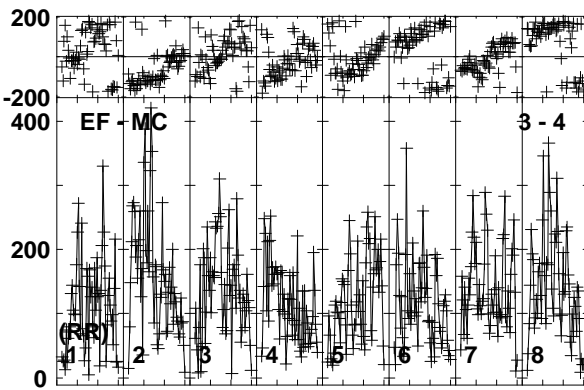
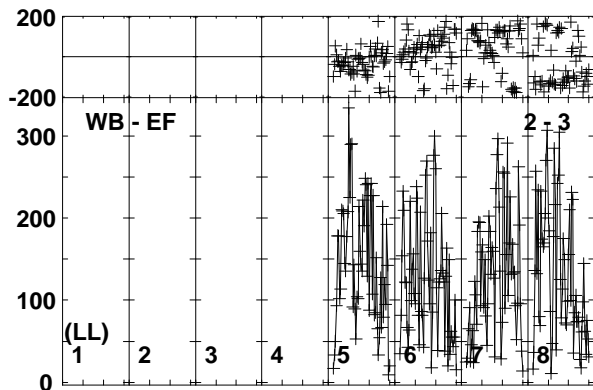
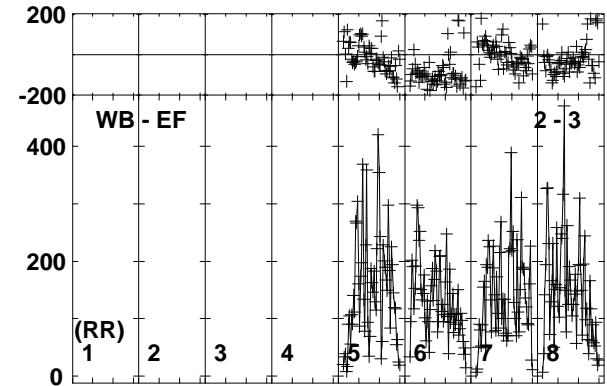
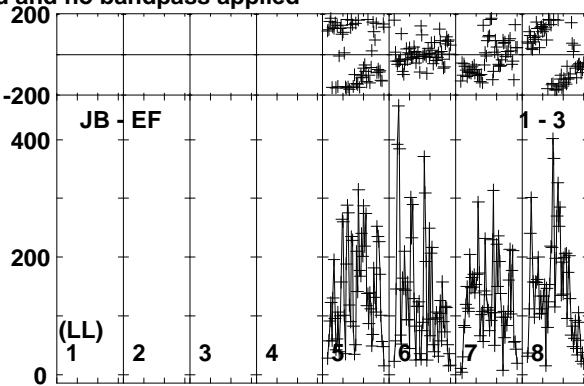
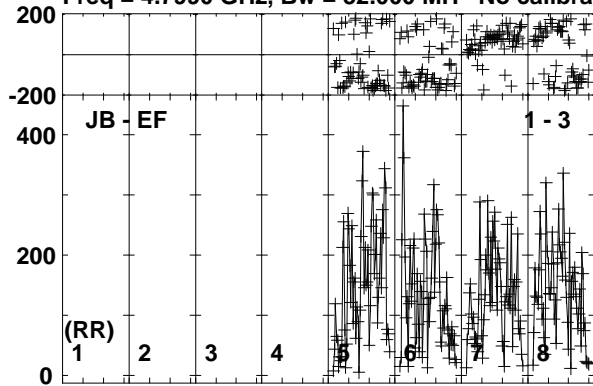

Lower frame: Micro Ampl Jy Top frame: Phas deg
Vector averaged cross-power spectrum Baseline: JB (01) - EF (03)
Timerange: 00/14:01:21 to 00/14:03:49

Plot file version 108 created 28-AUG-2017 13:19:08

J1312-2350 RP029A.UVDATA.1

Freq = 4.7990 GHz, Bw = 32.000 MH No calibration applied and no bandpass applied

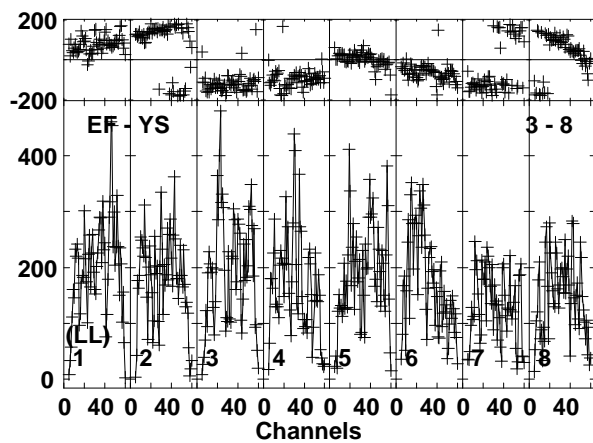
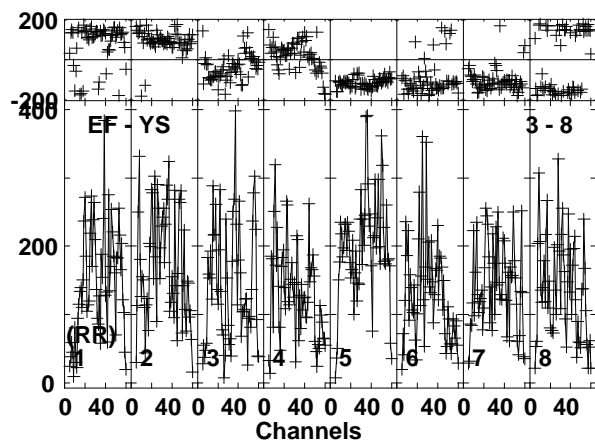
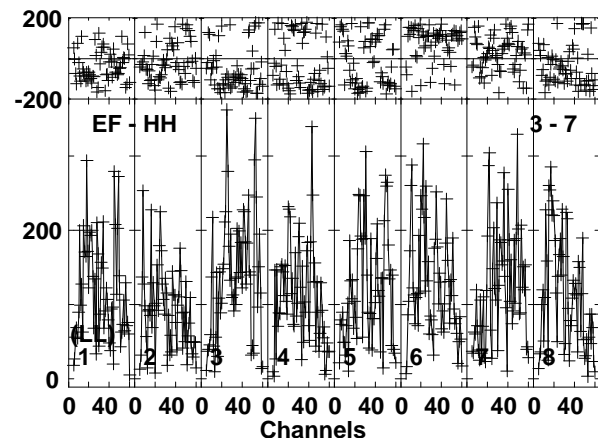
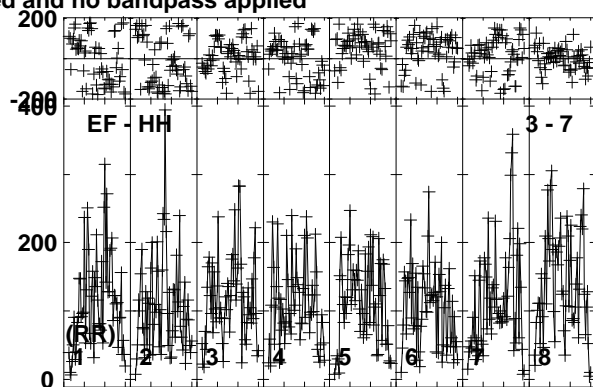
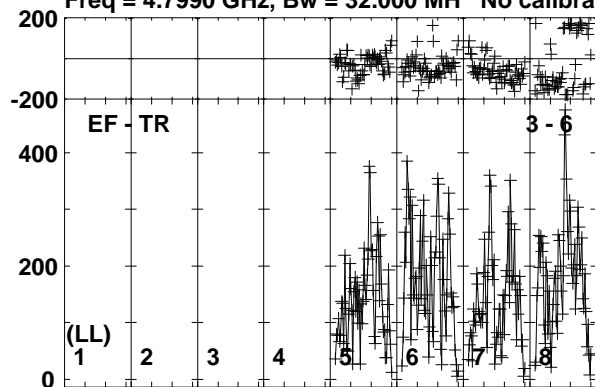

Lower frame: Micro Ampl Jy Top frame: Phas deg
Vector averaged cross-power spectrum Baseline: EF (03) - TR (06)
Timerange: 00/14:01:21 to 00/14:03:49

Plot file version 109 created 28-AUG-2017 13:19:08

J1303-2405 RP029A.UVDATA.1

Freq = 4.7990 GHz, Bw = 32.000 MH No calibration applied and no bandpass applied

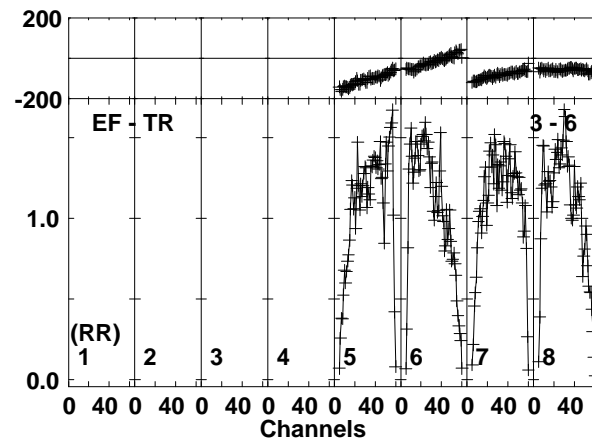
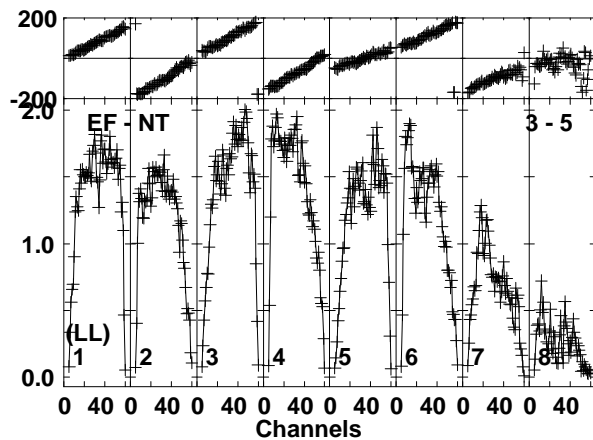
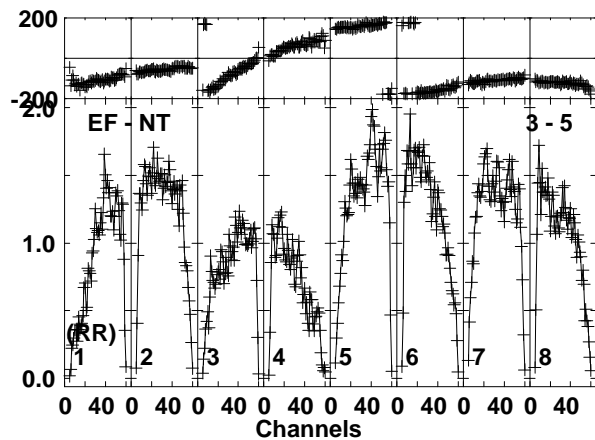
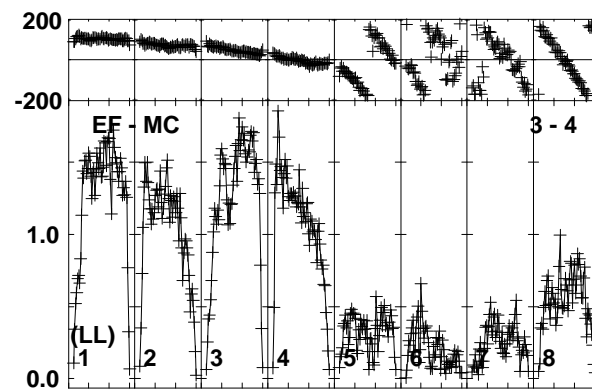
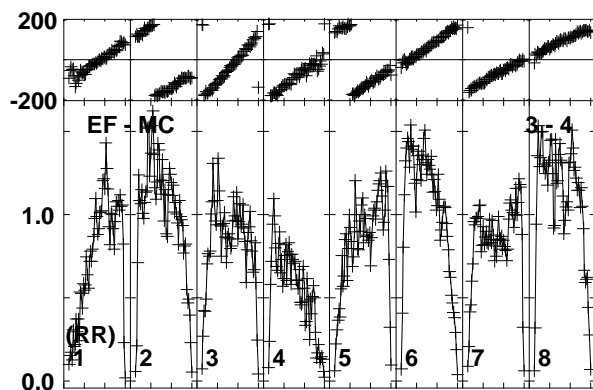
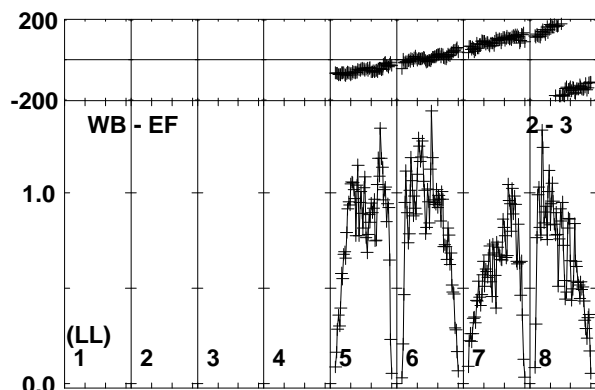
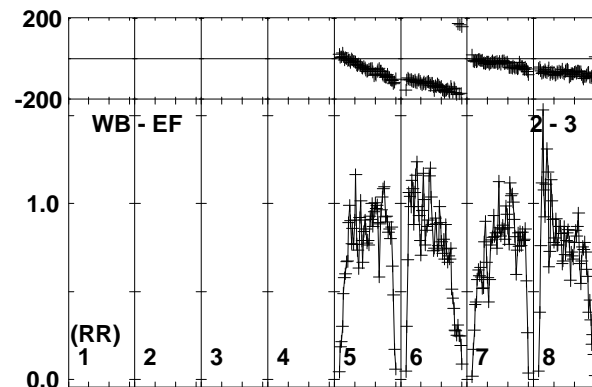
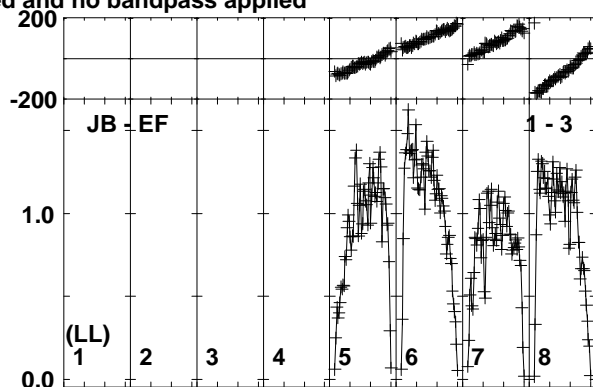
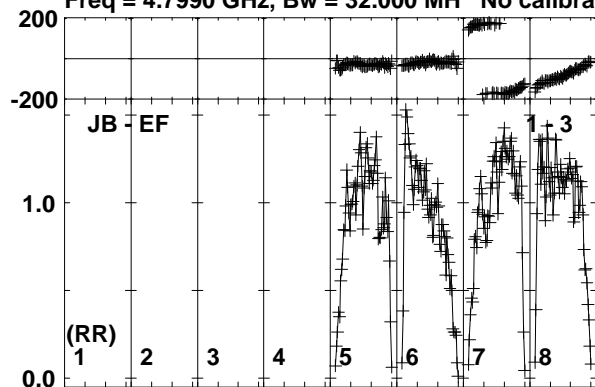

Lower frame: Milli Ampl Jy Top frame: Phas deg
Vector averaged cross-power spectrum Baseline: JB (01) - EF (03)
Timerange: 00/14:04:31 to 00/14:05:29

Plot file version 110 created 28-AUG-2017 13:19:08

J1303-2405 RP029A.UVDATA.1

Freq = 4.7990 GHz, Bw = 32.000 MH No calibration applied and no bandpass applied

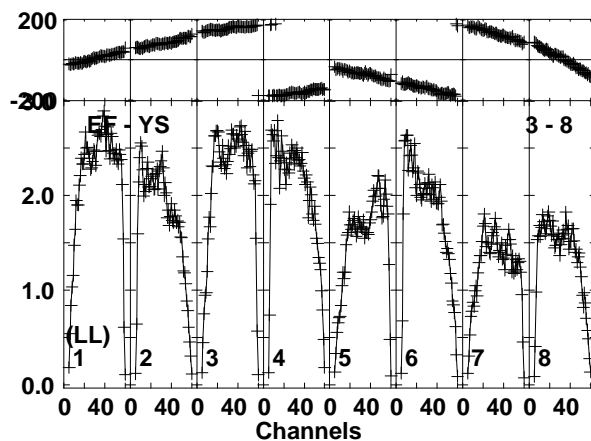
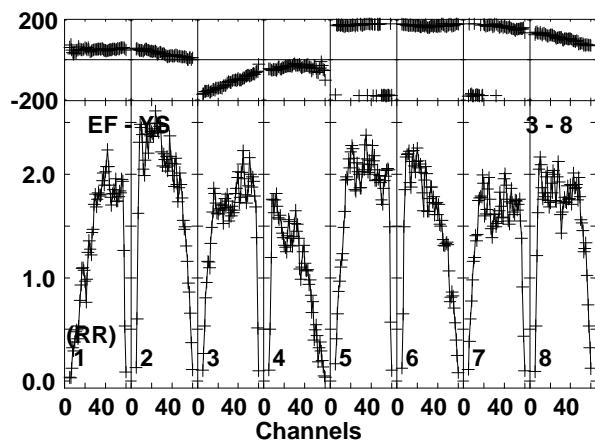
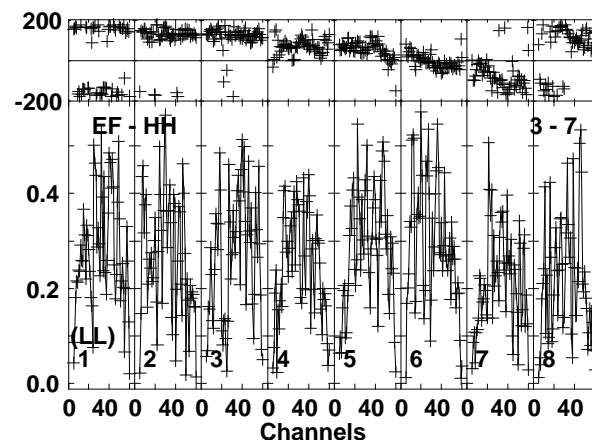
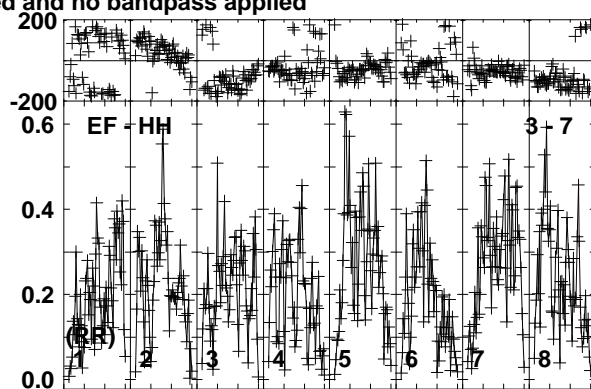
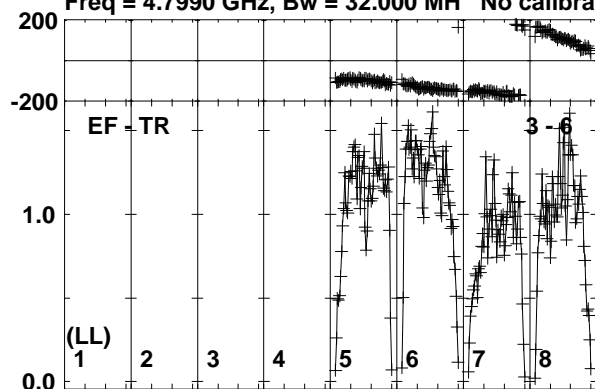

Lower frame: Milli Ampl Jy Top frame: Phas deg
Vector averaged cross-power spectrum Baseline: EF (03) - TR (06)
Timerange: 00/14:04:31 to 00/14:05:29

Plot file version 111 created 28-AUG-2017 13:19:08

SSS17A RP029A.UVDATA.1

Freq = 4.7990 GHz, Bw = 32.000 MH No calibration applied and no bandpass applied

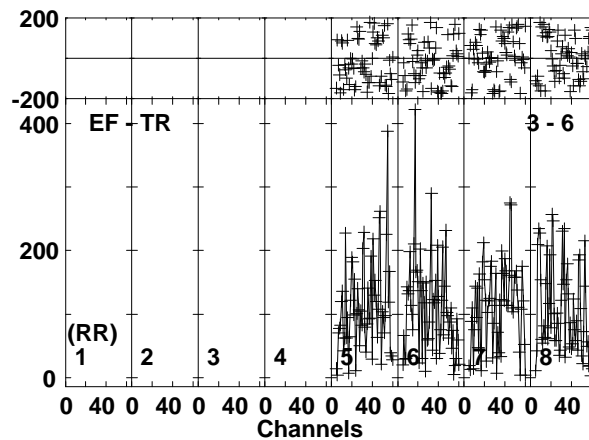
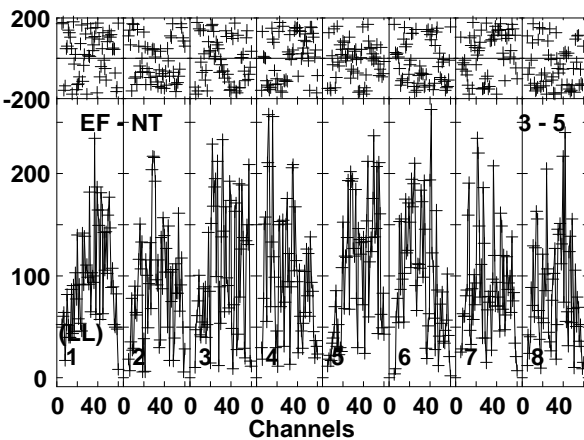
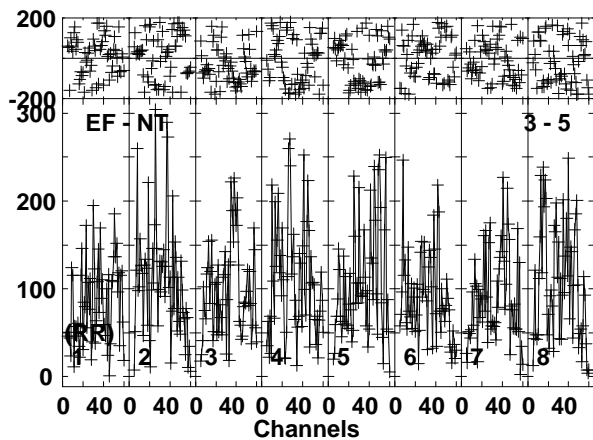
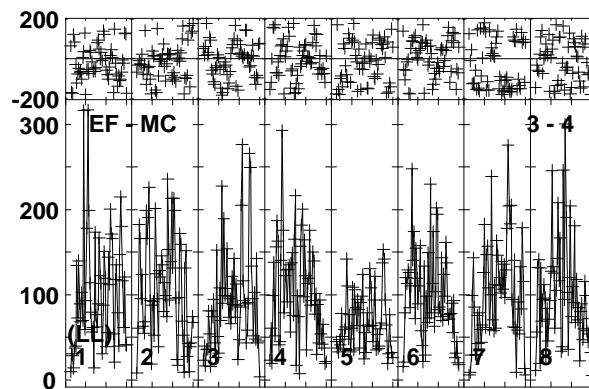
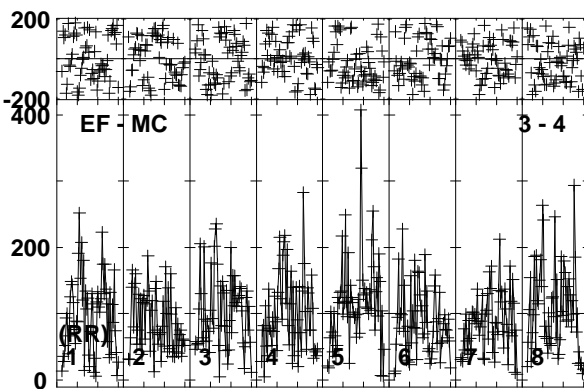
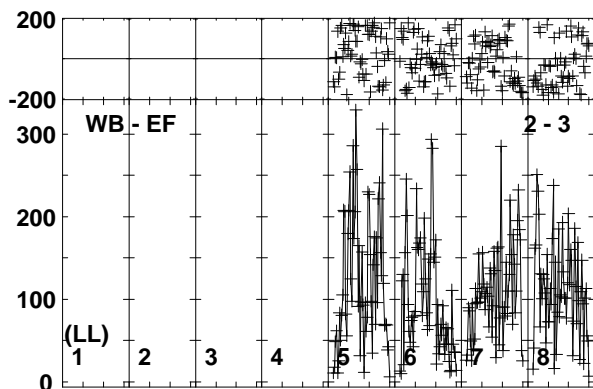
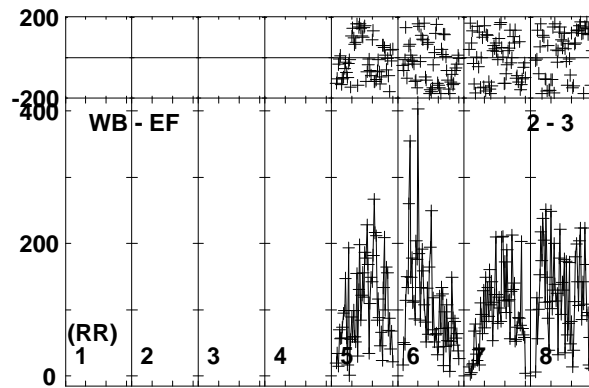
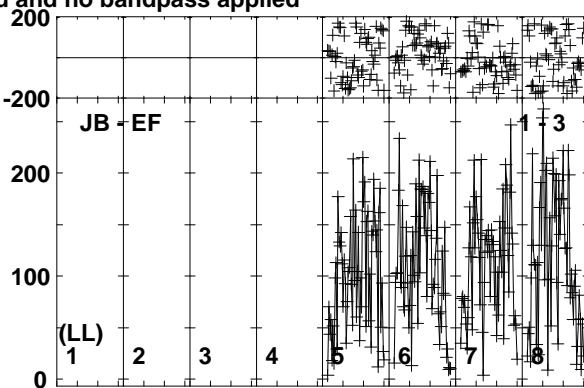
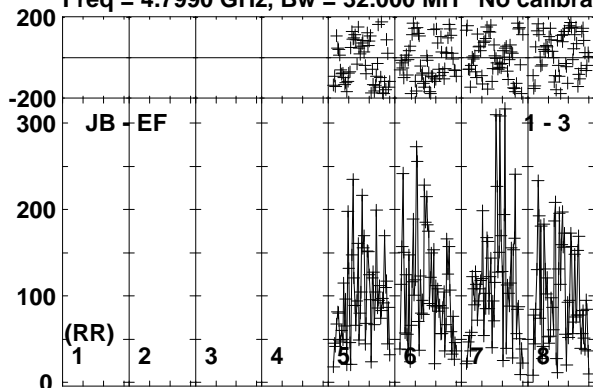

Lower frame: Micro Ampl Jy Top frame: Phas deg
Vector averaged cross-power spectrum Baseline: JB (01) - EF (03)
Timerange: 00/14:05:31 to 00/14:07:59

Plot file version 112 created 28-AUG-2017 13:19:08

SSS17A RP029A.UVDATA.1

Freq = 4.7990 GHz, Bw = 32.000 MH No calibration applied and no bandpass applied

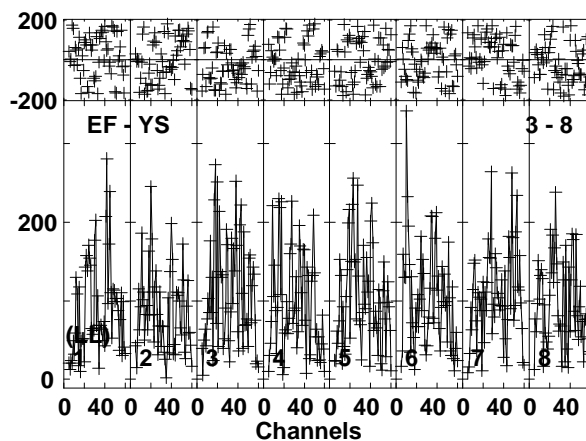
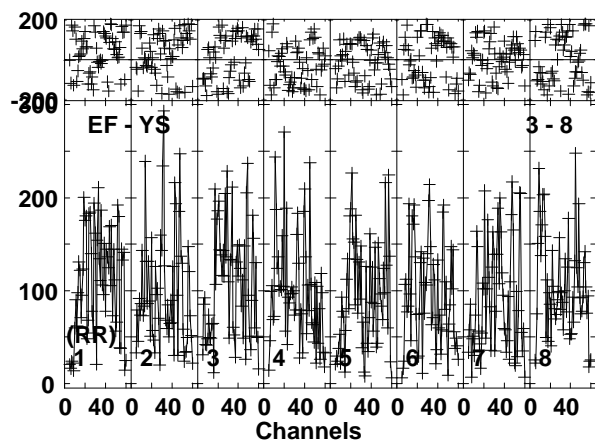
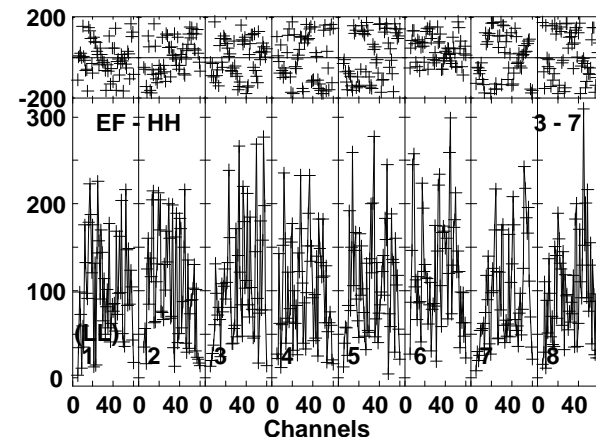
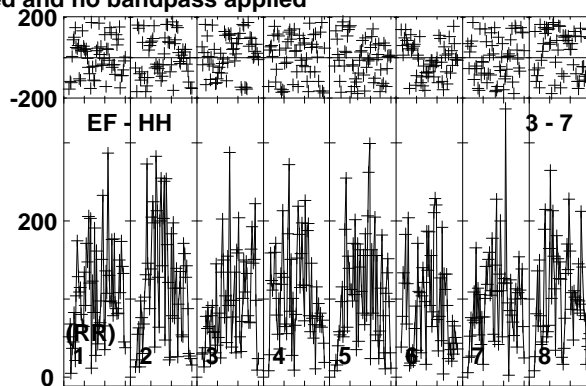
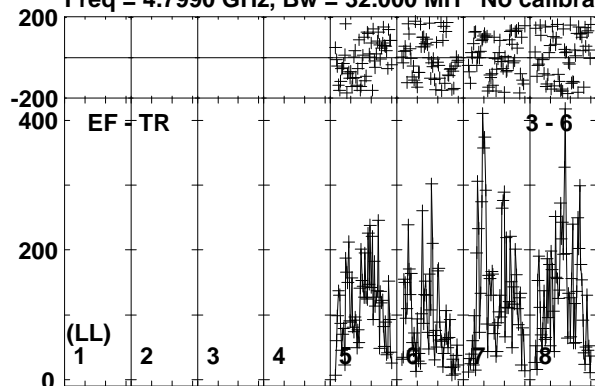

Lower frame: Micro Ampl Jy Top frame: Phas deg
Vector averaged cross-power spectrum Baseline: EF (03) - TR (06)
Timerange: 00/14:05:31 to 00/14:07:59

Plot file version 113 created 28-AUG-2017 13:19:08

J1303-2405 RP029A.UVDATA.1

Freq = 4.7990 GHz, Bw = 32.000 MH No calibration applied and no bandpass applied

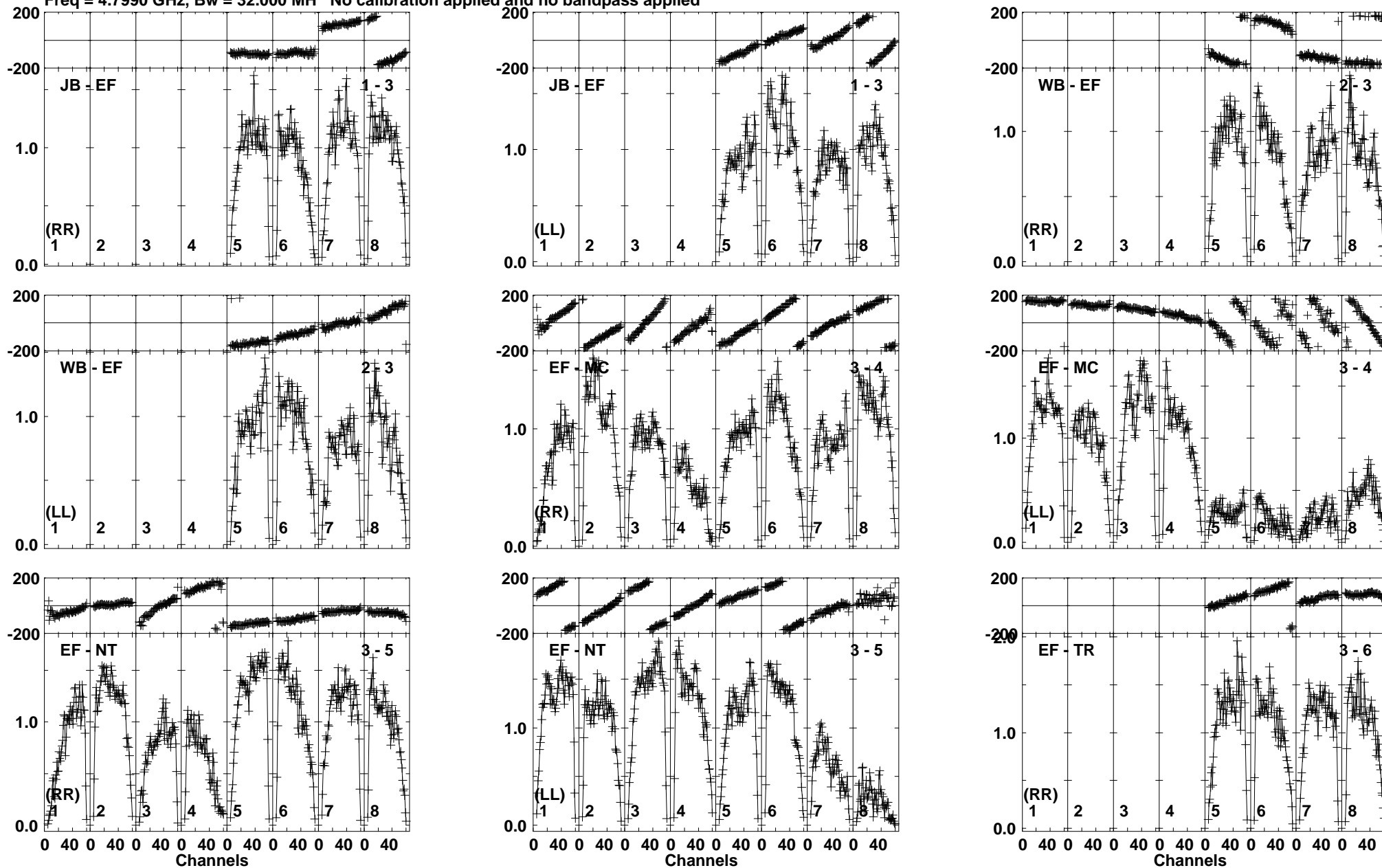

Lower frame: Milli Ampl Jy Top frame: Phas deg
Vector averaged cross-power spectrum Baseline: JB (01) - EF (03)
Timerange: 00/14:08:01 to 00/14:09:29

Plot file version 114 created 28-AUG-2017 13:19:08

J1303-2405 RP029A.UVDATA.1

Freq = 4.7990 GHz, Bw = 32.000 MH No calibration applied and no bandpass applied

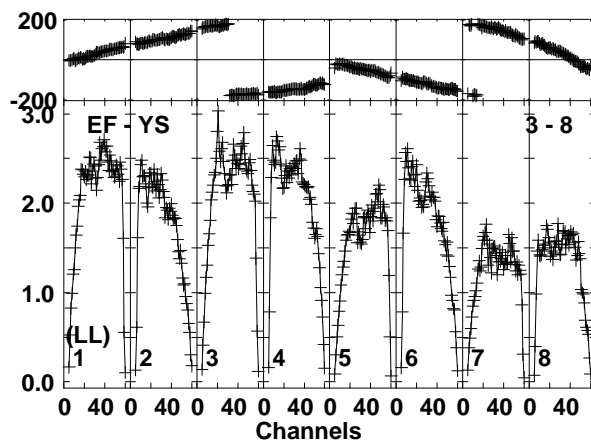
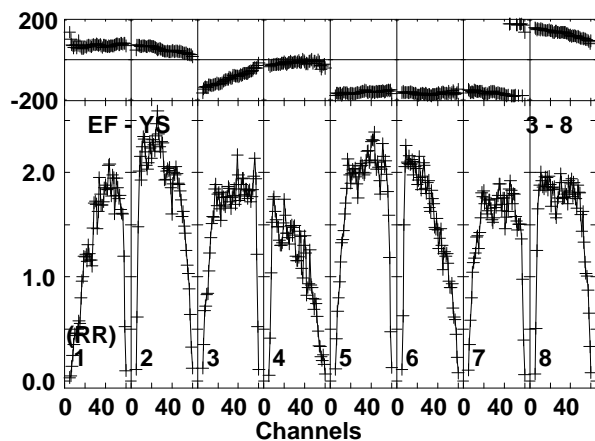
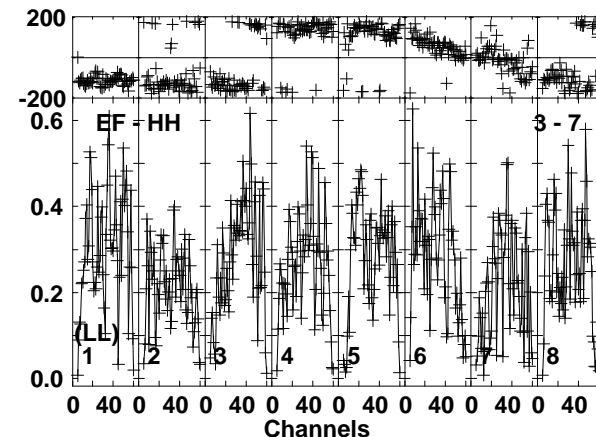
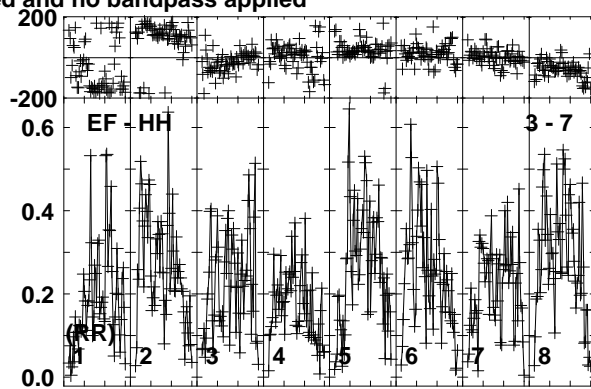
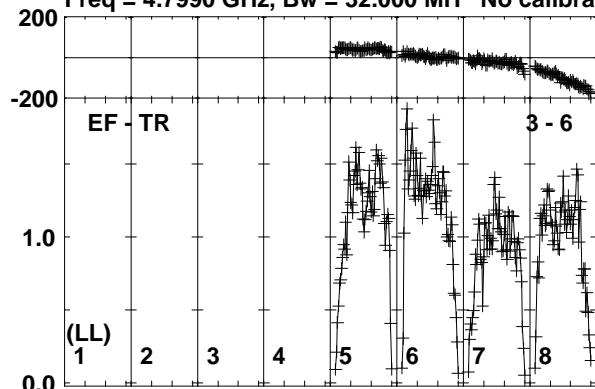

Lower frame: Milli Ampl Jy Top frame: Phas deg
Vector averaged cross-power spectrum Baseline: EF (03) - TR (06)
Timerange: 00/14:08:01 to 00/14:09:29

Plot file version 115 created 28-AUG-2017 13:19:08

SSS17A RP029A.UVDATA.1

Freq = 4.7990 GHz, Bw = 32.000 MH No calibration applied and no bandpass applied

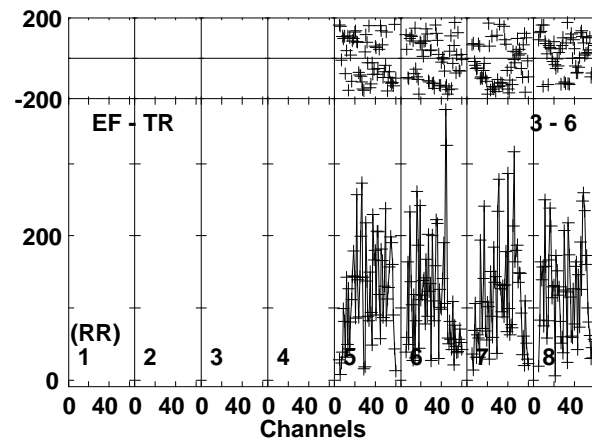
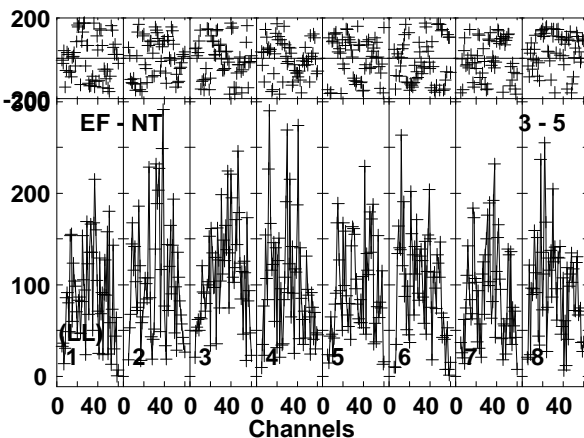
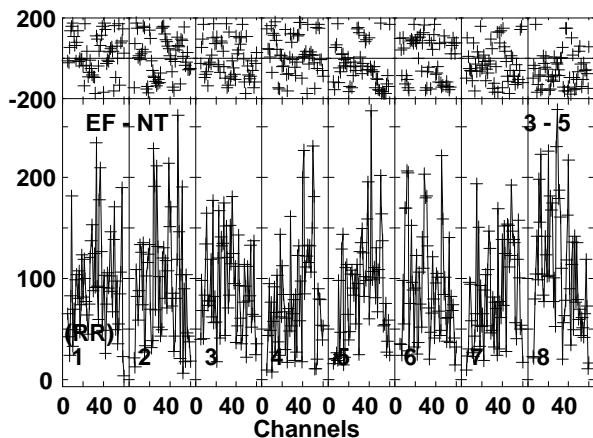
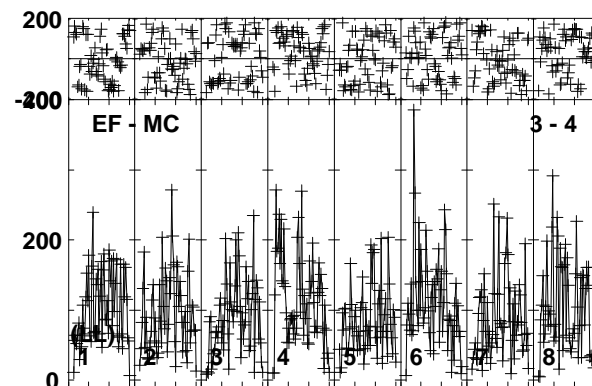
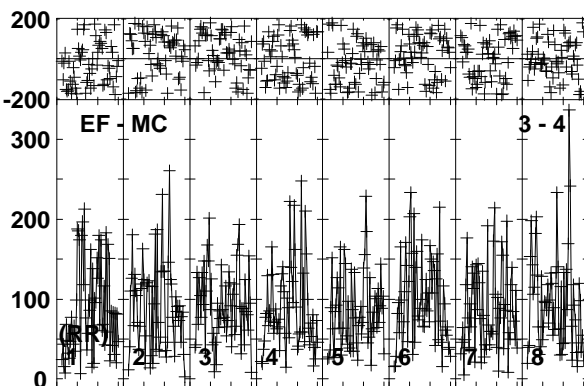
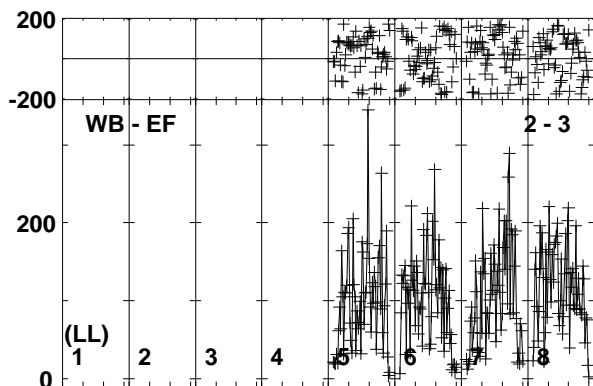
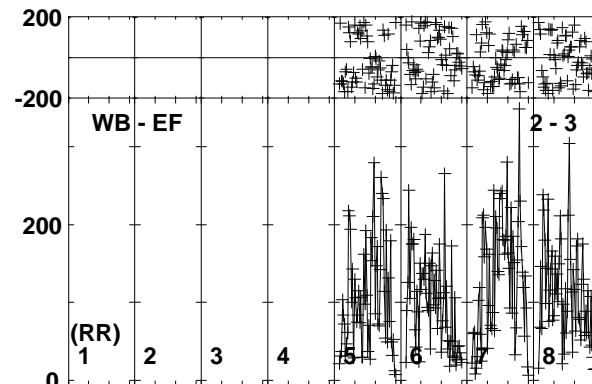
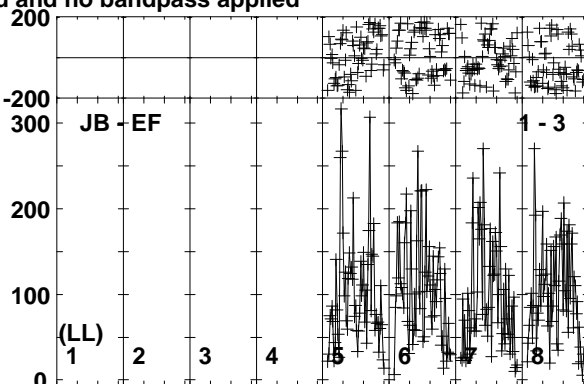
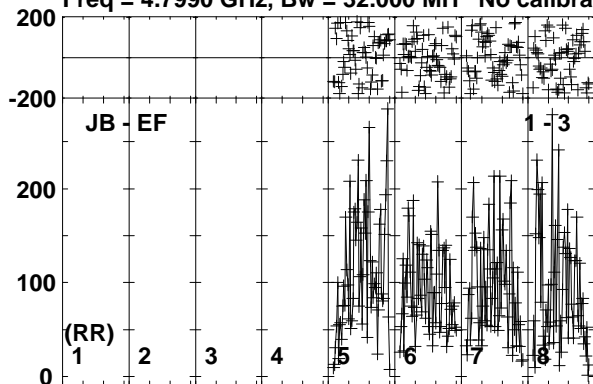

Lower frame: Micro Ampl Jy Top frame: Phas deg
Vector averaged cross-power spectrum Baseline: JB (01) - EF (03)
Timerange: 00/14:09:31 to 00/14:11:59

Plot file version 116 created 28-AUG-2017 13:19:08

SSS17A RP029A.UVDATA.1

Freq = 4.7990 GHz, Bw = 32.000 MH No calibration applied and no bandpass applied

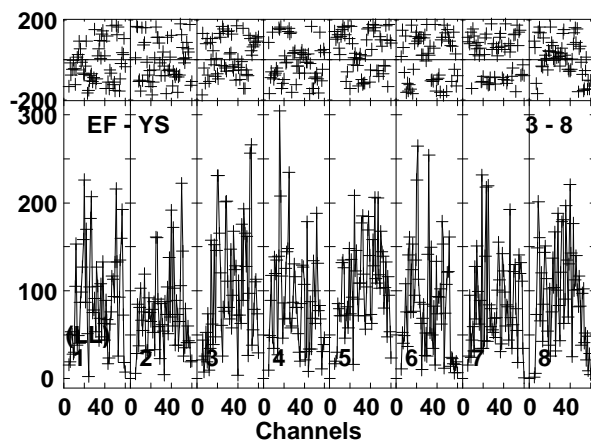
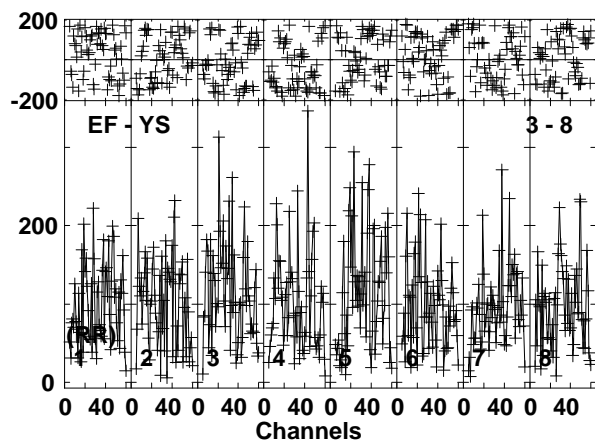
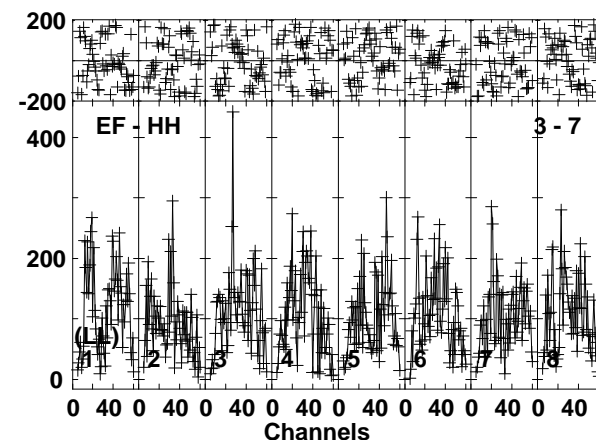
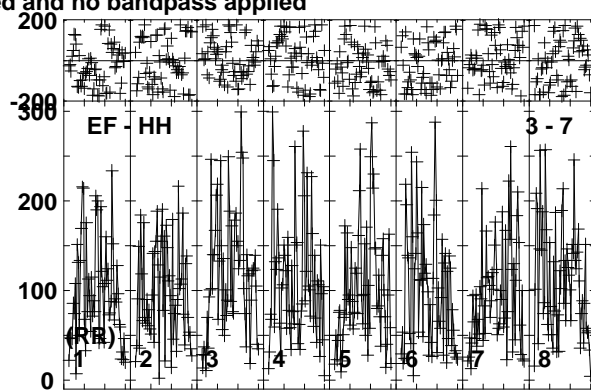
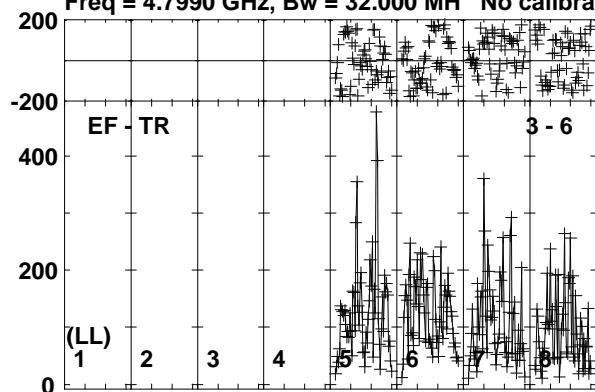

Lower frame: Micro Ampl Jy Top frame: Phas deg
Vector averaged cross-power spectrum Baseline: EF (03) - TR (06)
Timerange: 00/14:09:31 to 00/14:11:59

Plot file version 117 created 28-AUG-2017 13:19:08

J1303-2405 RP029A.UVDATA.1

Freq = 4.7990 GHz, Bw = 32.000 MH No calibration applied and no bandpass applied

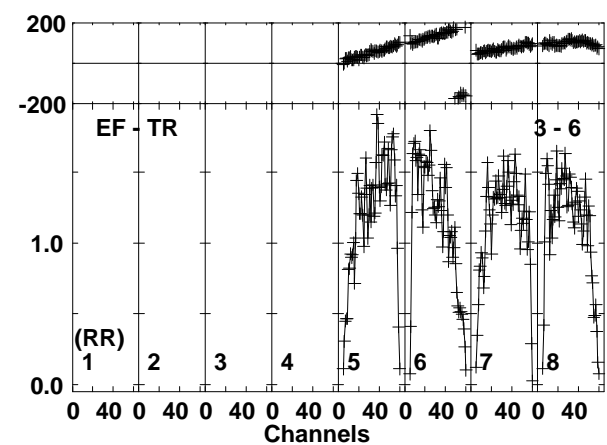
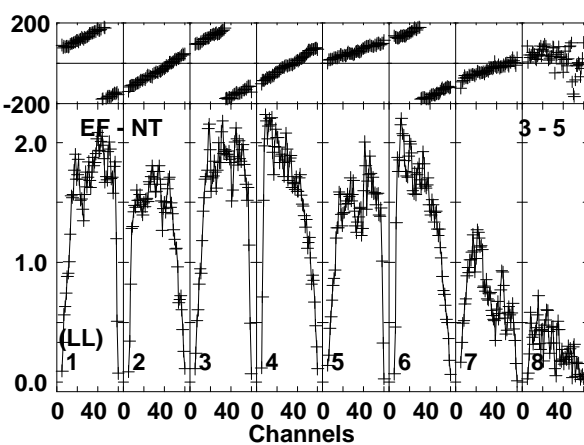
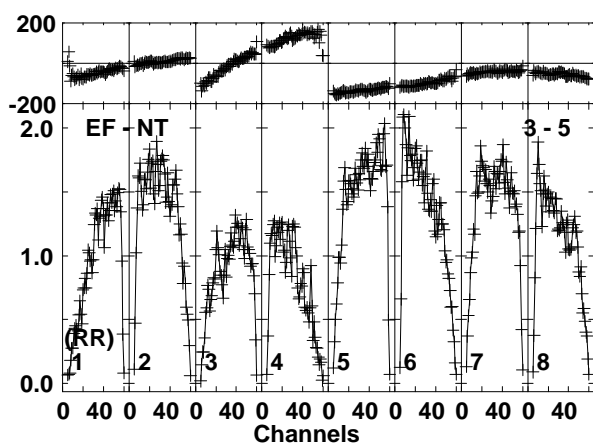
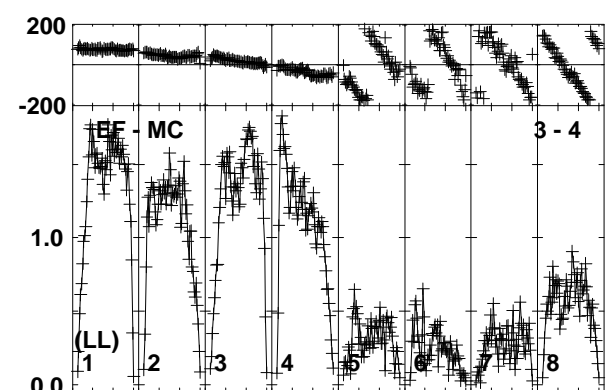
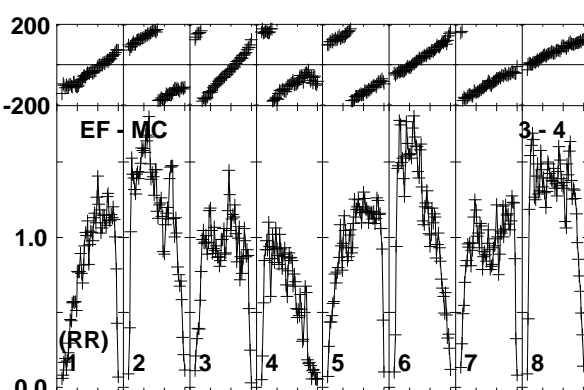
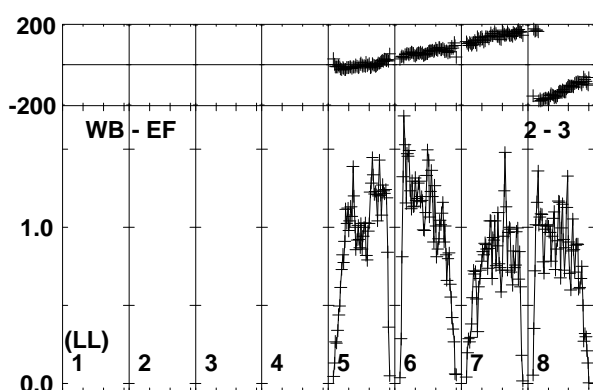
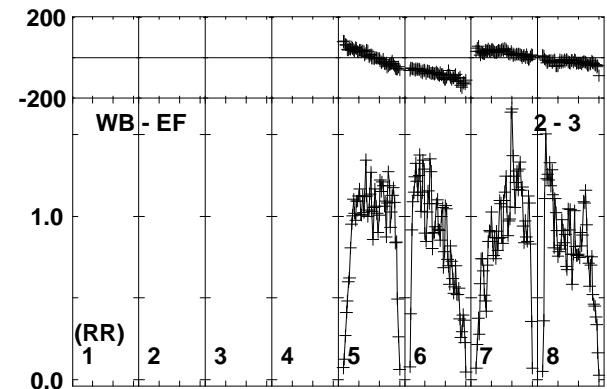
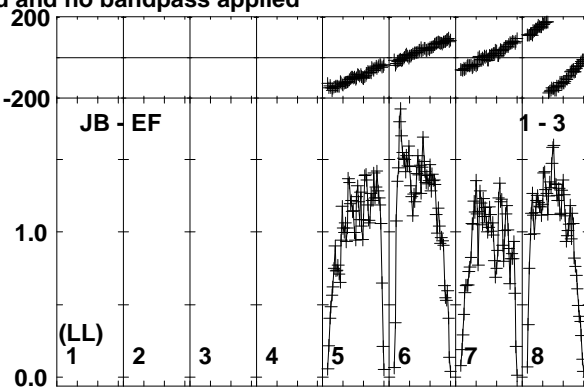
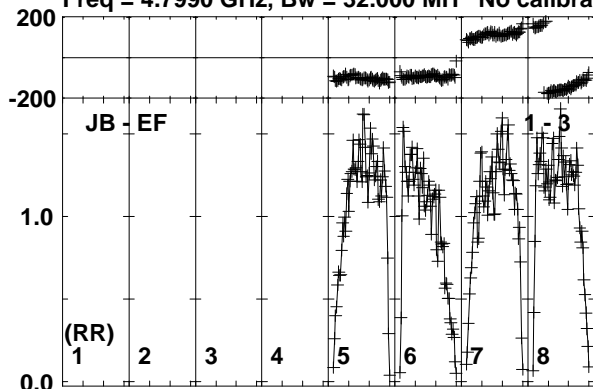

Lower frame: Milli Ampl Jy Top frame: Phas deg
Vector averaged cross-power spectrum Baseline: JB (01) - EF (03)
Timerange: 00/14:12:31 to 00/14:13:29

Plot file version 118 created 28-AUG-2017 13:19:08

J1303-2405 RP029A.UVDATA.1

Freq = 4.7990 GHz, Bw = 32.000 MH No calibration applied and no bandpass applied

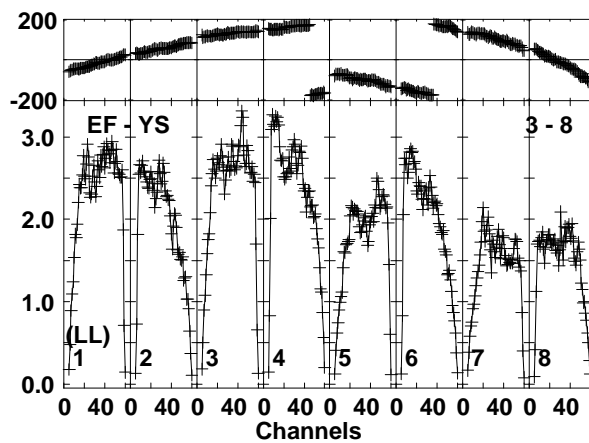
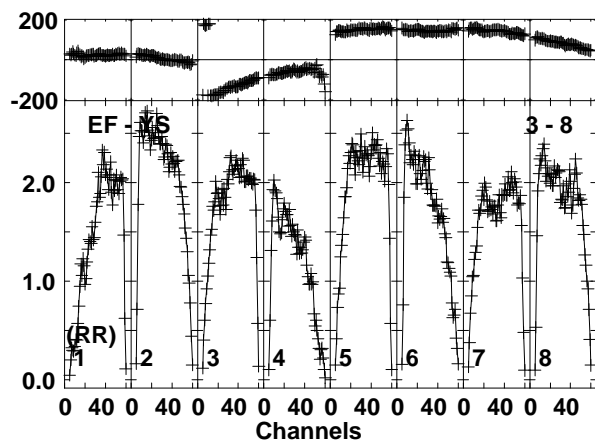
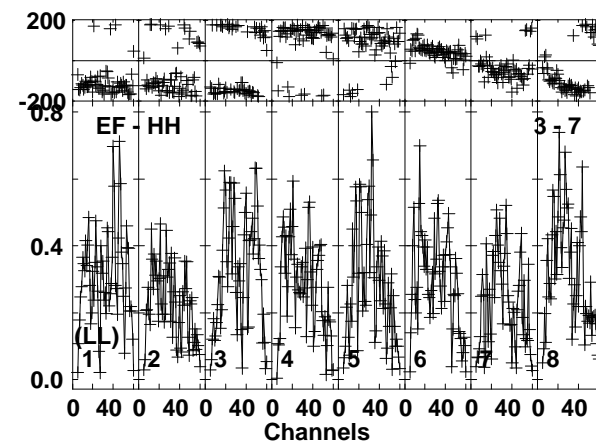
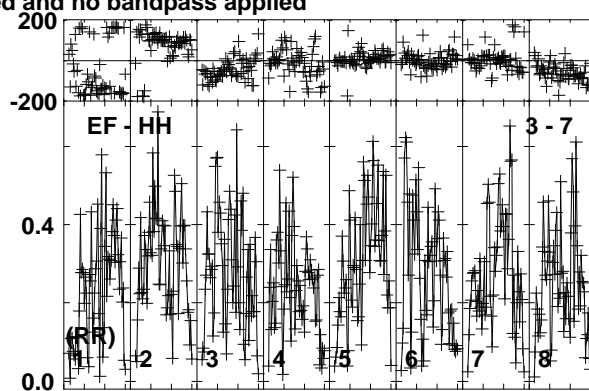
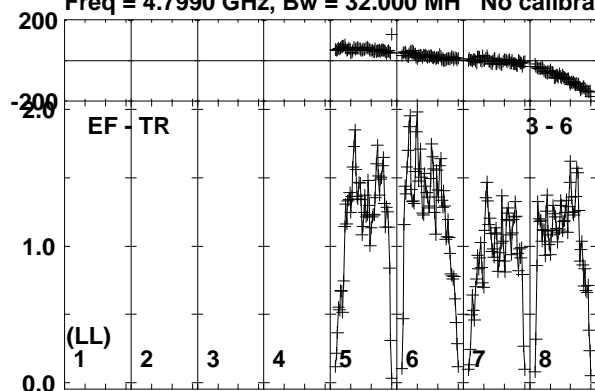

Lower frame: Milli Ampl Jy Top frame: Phas deg
Vector averaged cross-power spectrum Baseline: EF (03) - TR (06)
Timerange: 00/14:12:31 to 00/14:13:29

Plot file version 119 created 28-AUG-2017 13:19:08

SSS17A RP029A.UVDATA.1

Freq = 4.7990 GHz, Bw = 32.000 MH No calibration applied and no bandpass applied

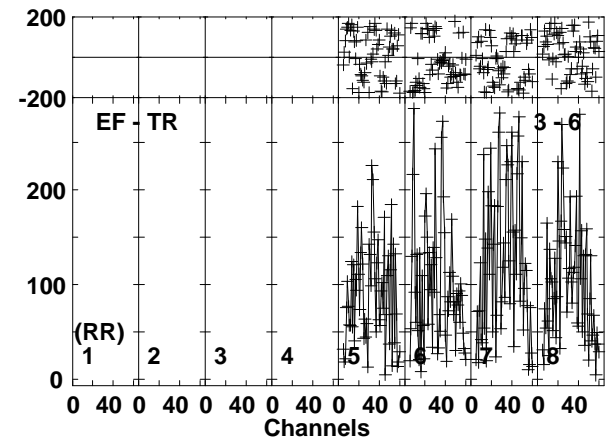
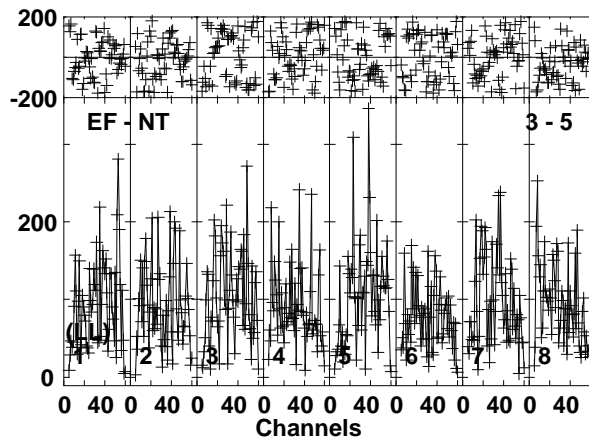
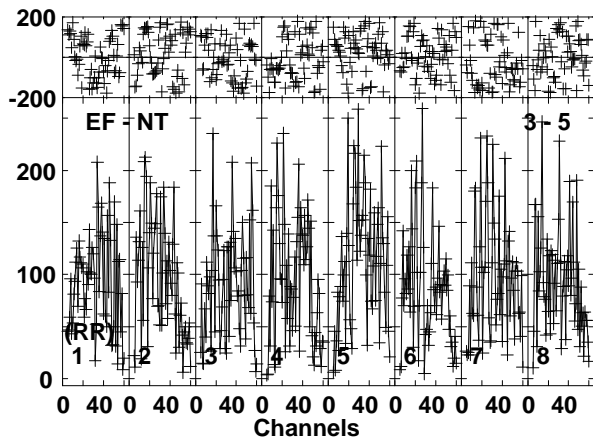
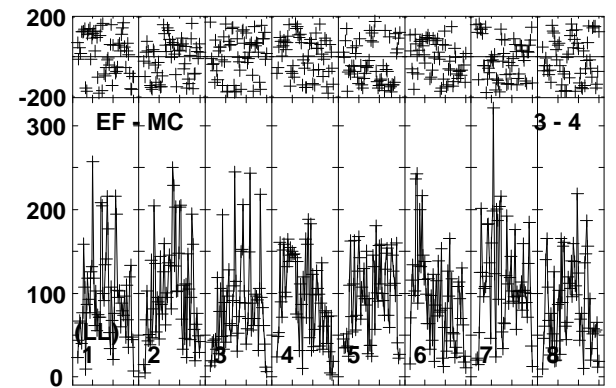
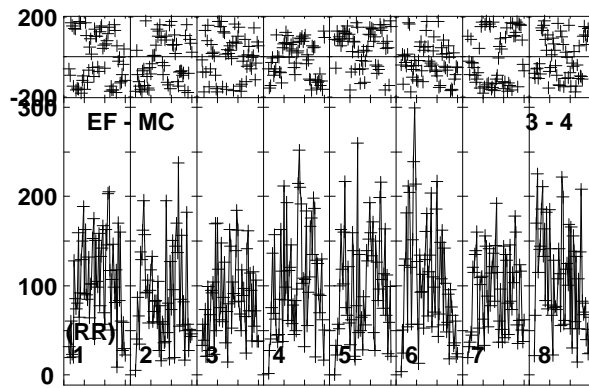
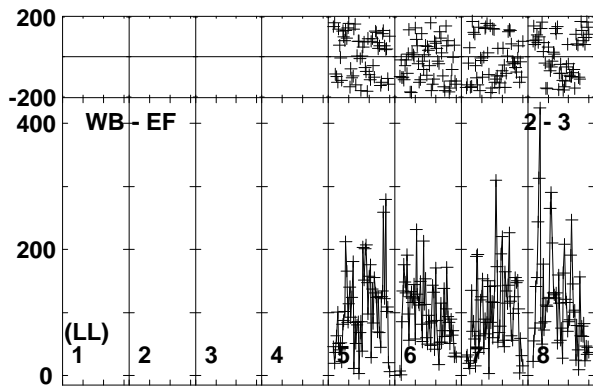
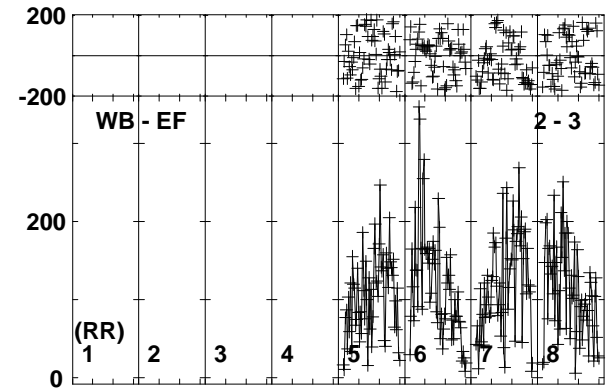
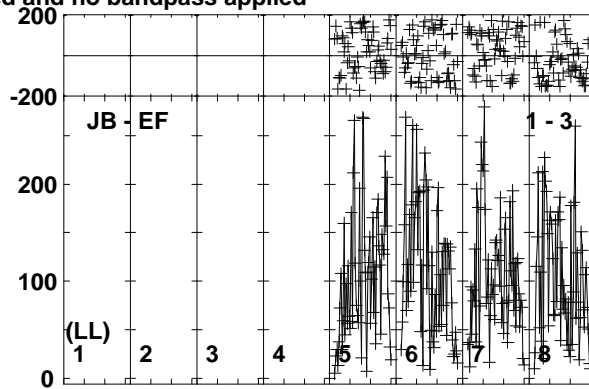
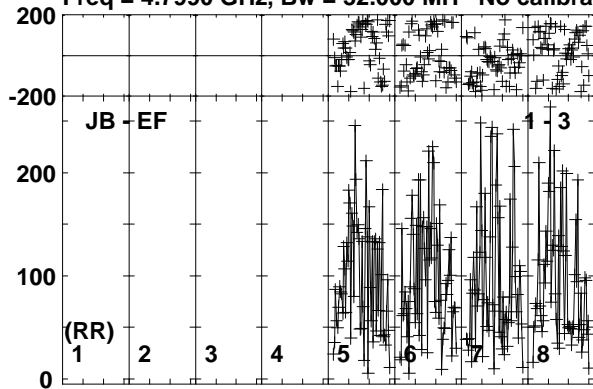

Lower frame: Micro Ampl Jy Top frame: Phas deg
Vector averaged cross-power spectrum Baseline: JB (01) - EF (03)
Timerange: 00/14:13:31 to 00/14:15:59

Plot file version 120 created 28-AUG-2017 13:19:09

SSS17A RP029A.UVDATA.1

Freq = 4.7990 GHz, Bw = 32.000 MH No calibration applied and no bandpass applied

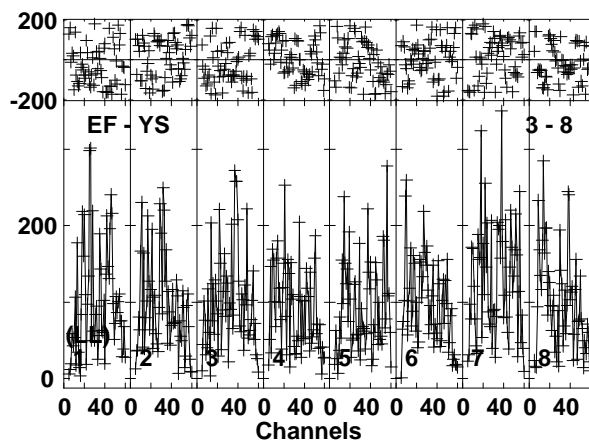
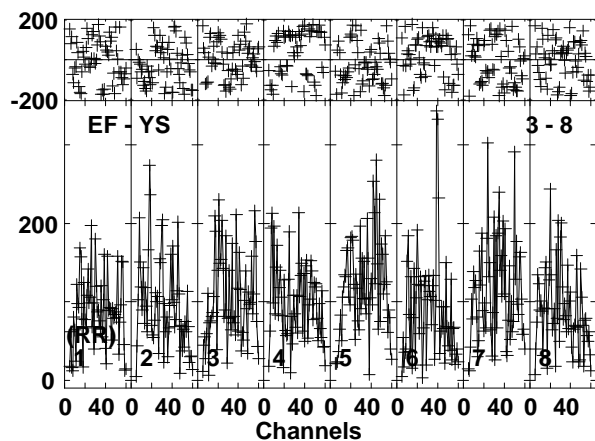
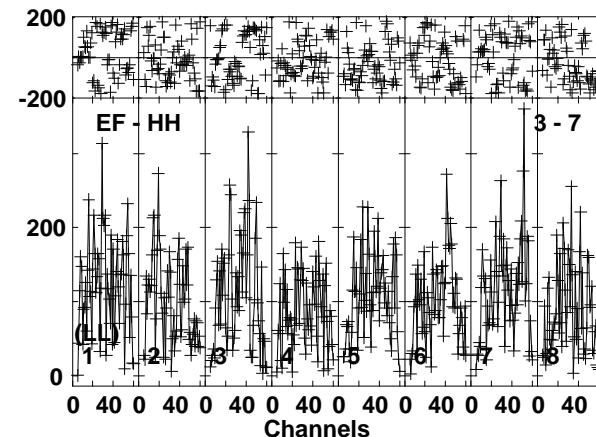
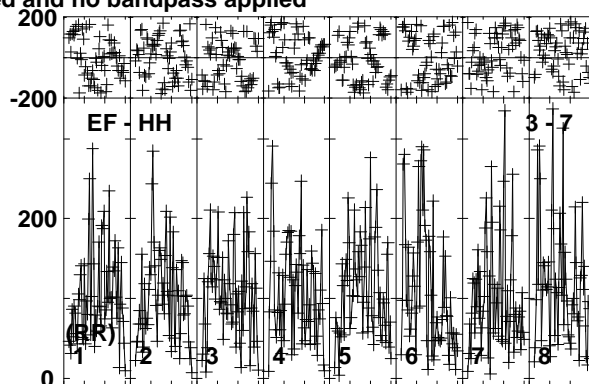
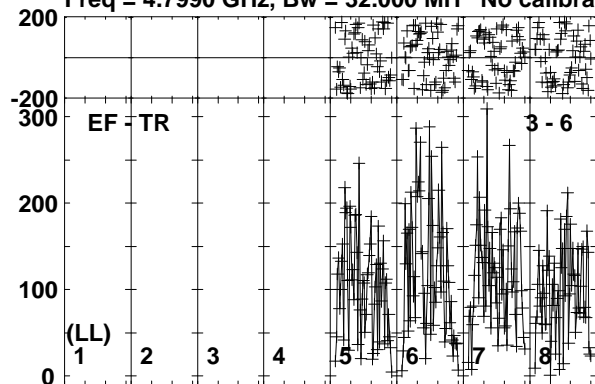

Lower frame: Micro Ampl Jy Top frame: Phas deg
Vector averaged cross-power spectrum Baseline: EF (03) - TR (06)
Timerange: 00/14:13:31 to 00/14:15:59

Plot file version 121 created 28-AUG-2017 13:19:09

J1303-2405 RP029A.UVDATA.1

Freq = 4.7990 GHz, Bw = 32.000 MH No calibration applied and no bandpass applied

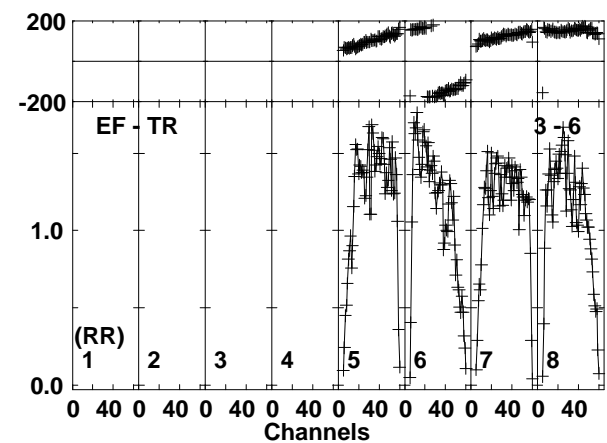
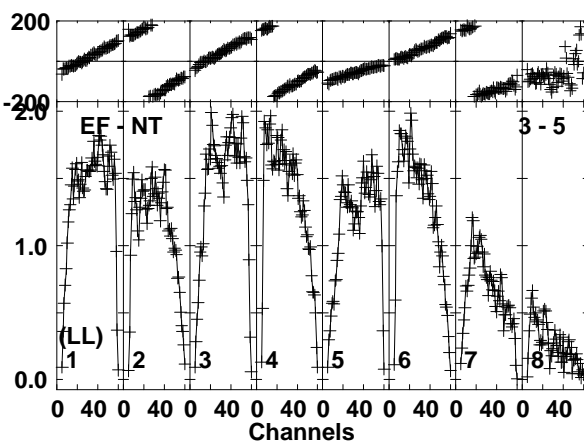
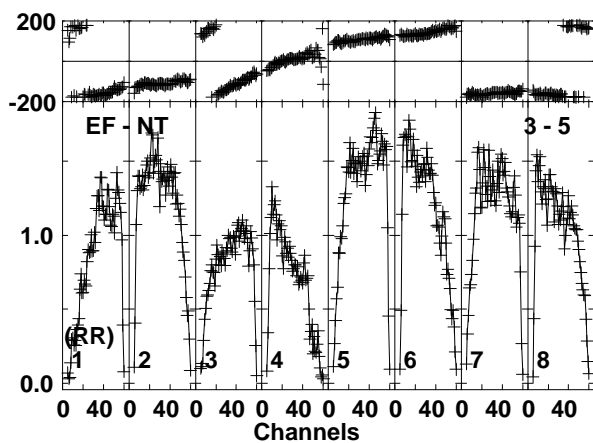
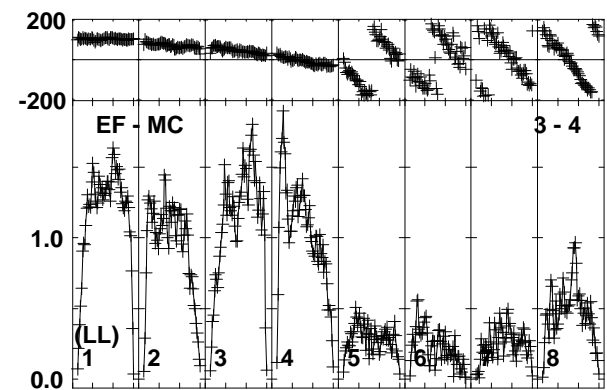
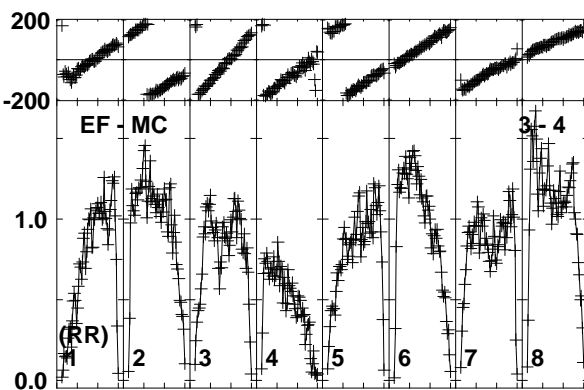
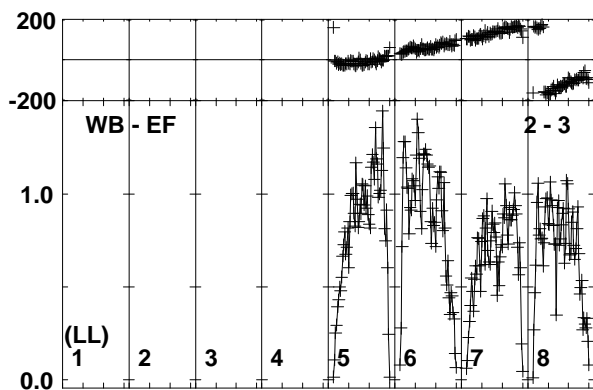
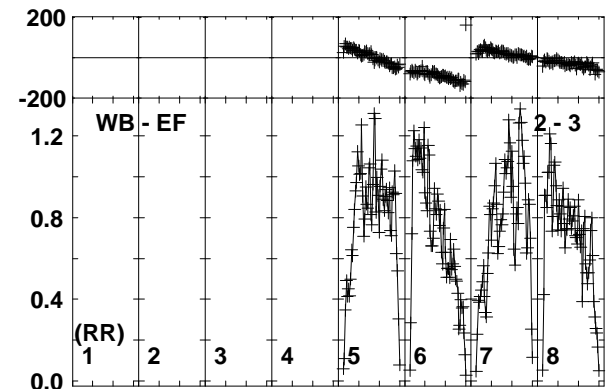
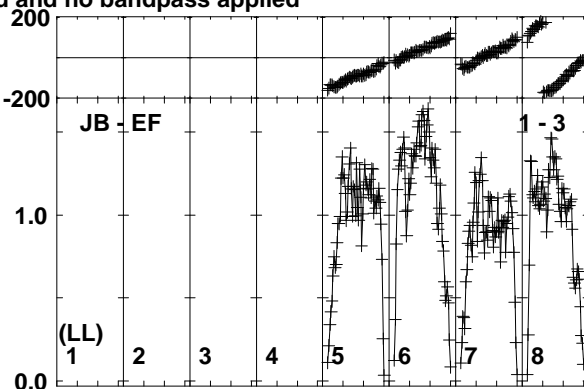
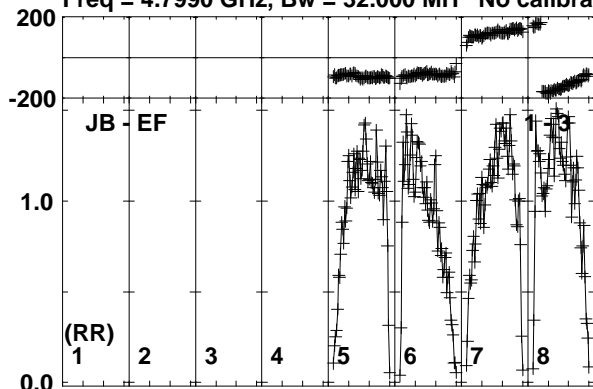

Lower frame: Milli Ampl Jy Top frame: Phas deg
Vector averaged cross-power spectrum Baseline: JB (01) - EF (03)
Timerange: 00/14:16:01 to 00/14:17:29

Plot file version 122 created 28-AUG-2017 13:19:09

J1303-2405 RP029A.UVDATA.1

Freq = 4.7990 GHz, Bw = 32.000 MH No calibration applied and no bandpass applied

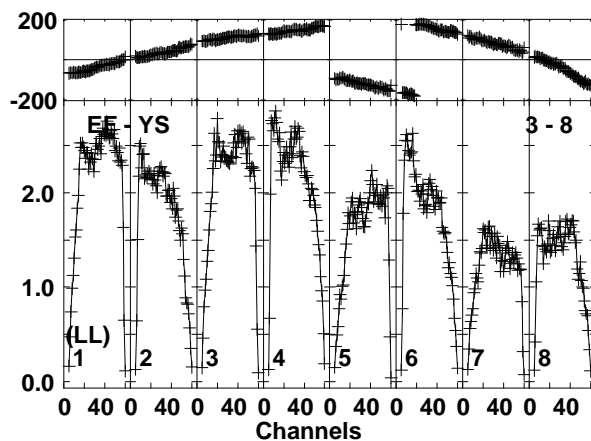
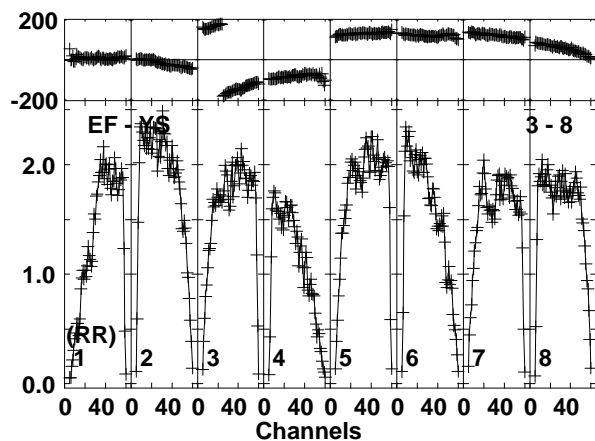
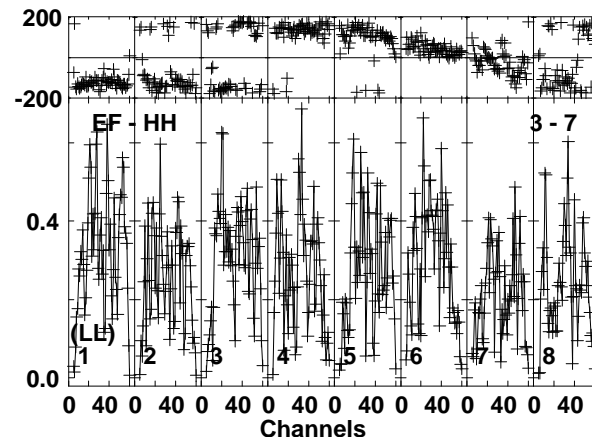
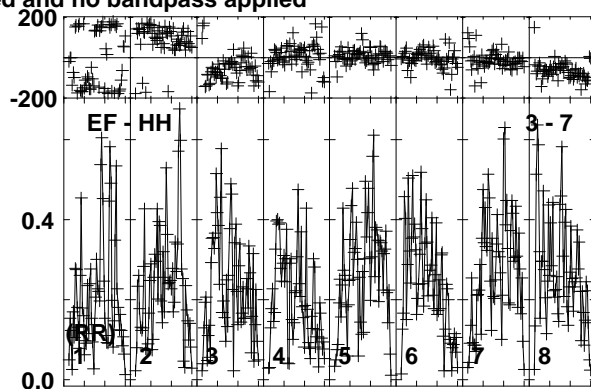
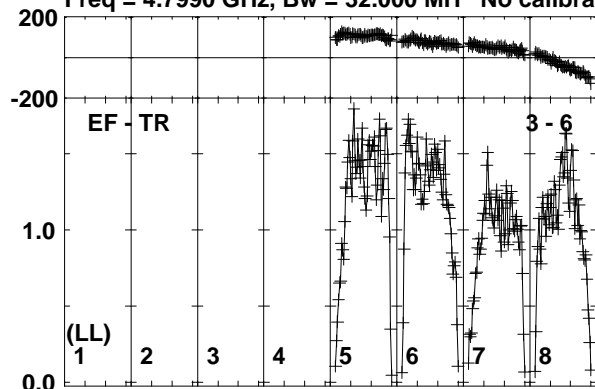

Lower frame: Milli Ampl Jy Top frame: Phas deg
Vector averaged cross-power spectrum Baseline: EF (03) - TR (06)
Timerange: 00/14:16:01 to 00/14:17:29

Plot file version 123 created 28-AUG-2017 13:19:09

J1312-2350 RP029A.UVDATA.1

Freq = 4.7990 GHz, Bw = 32.000 MH No calibration applied and no bandpass applied

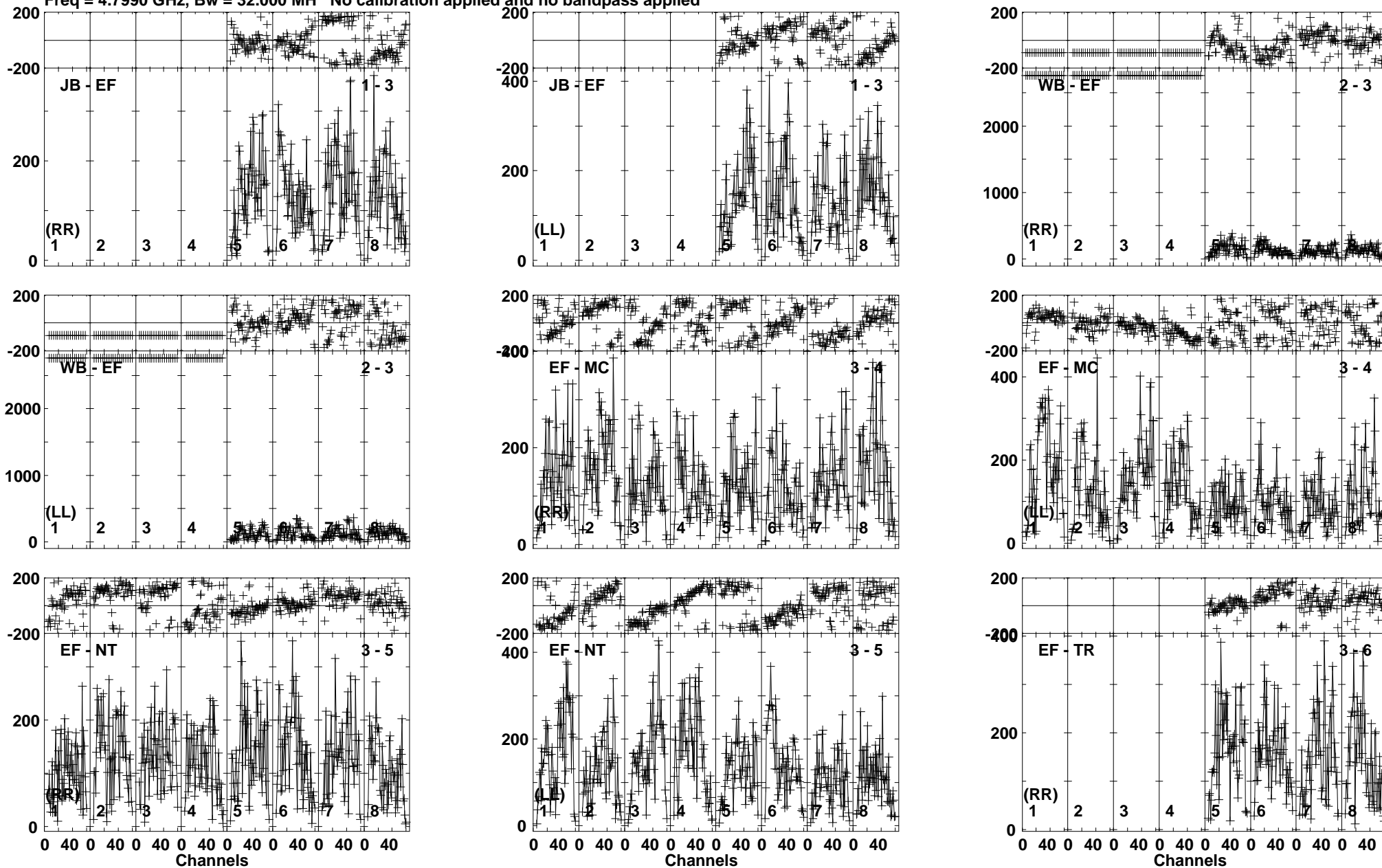

Lower frame: Micro Ampl Jy Top frame: Phas deg
Vector averaged cross-power spectrum Baseline: JB (01) - EF (03)
Timerange: 00/14:17:31 to 00/14:19:59

Plot file version 124 created 28-AUG-2017 13:19:09

J1312-2350 RP029A.UVDATA.1

Freq = 4.7990 GHz, Bw = 32.000 MH No calibration applied and no bandpass applied

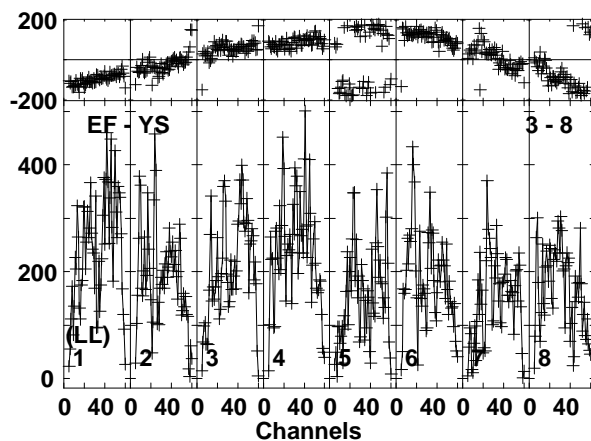
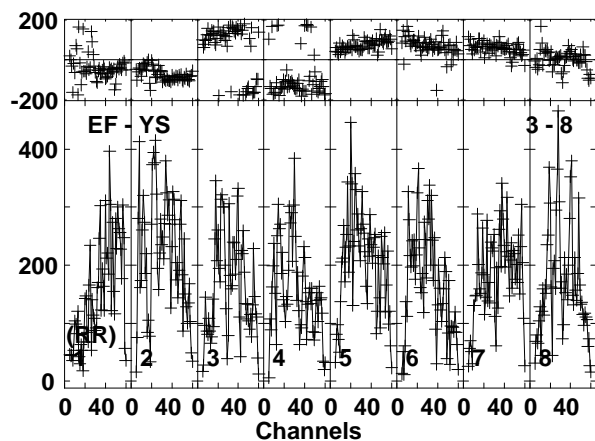
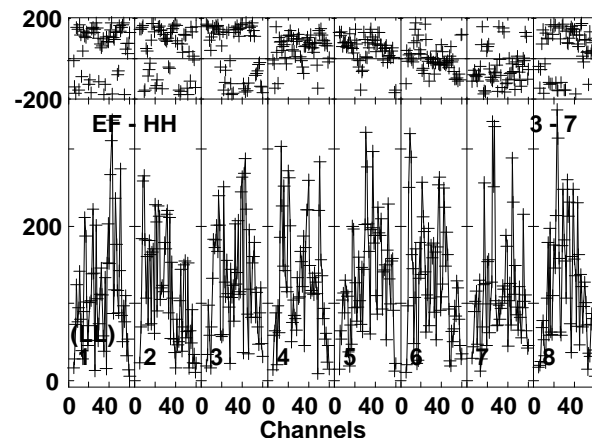
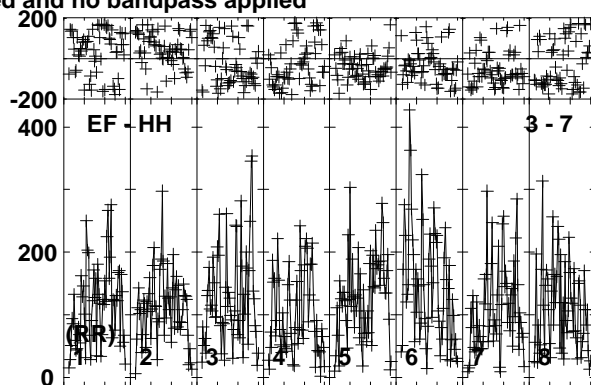
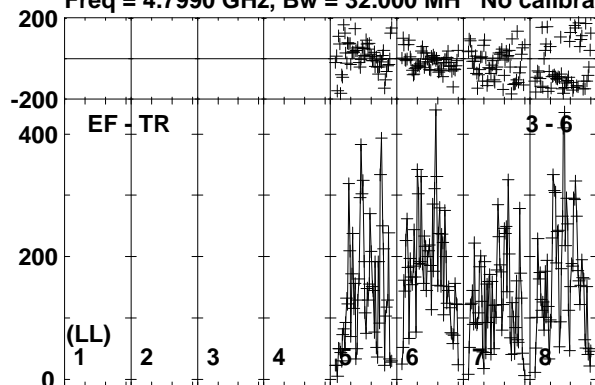

Lower frame: Micro Ampl Jy Top frame: Phas deg
Vector averaged cross-power spectrum Baseline: EF (03) - TR (06)
Timerange: 00/14:17:31 to 00/14:19:59

Plot file version 125 created 28-AUG-2017 13:19:09

J1303-2405 RP029A.UVDATA.1

Freq = 4.7990 GHz, Bw = 32.000 MH No calibration applied and no bandpass applied

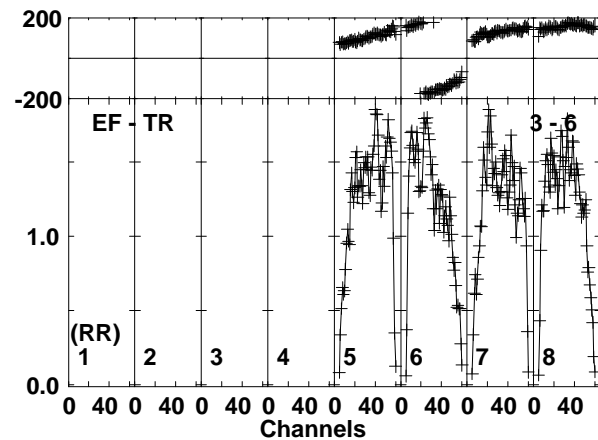
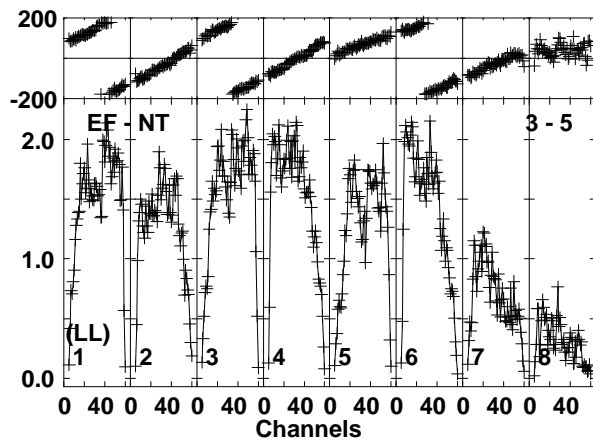
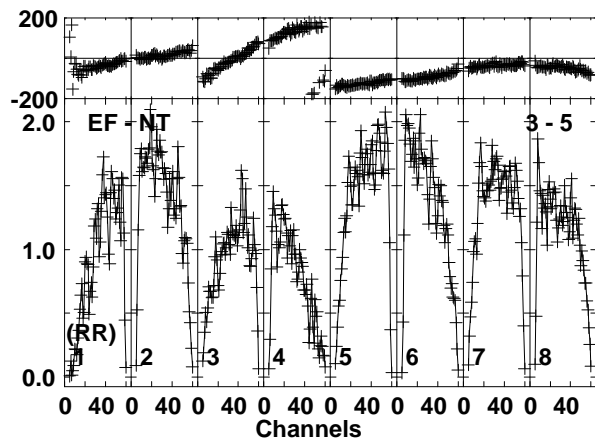
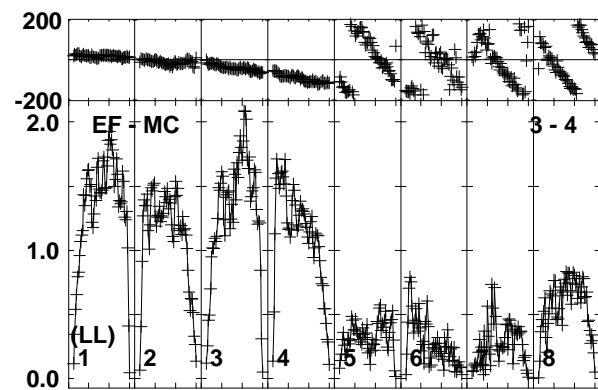
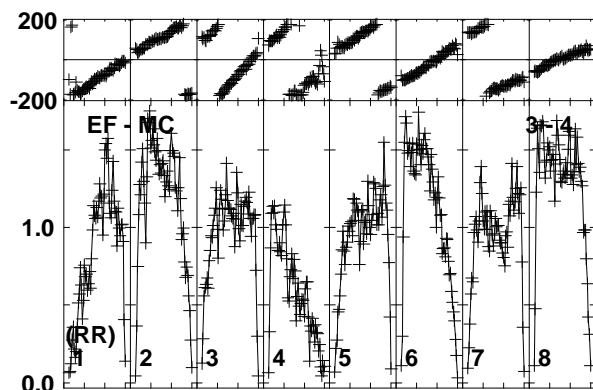
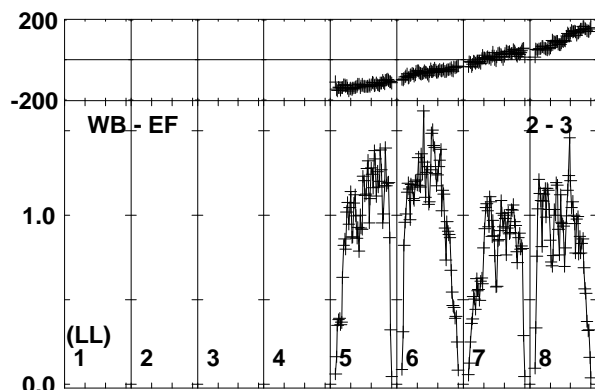
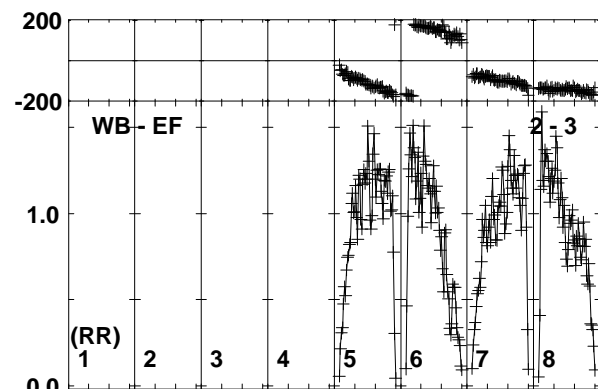
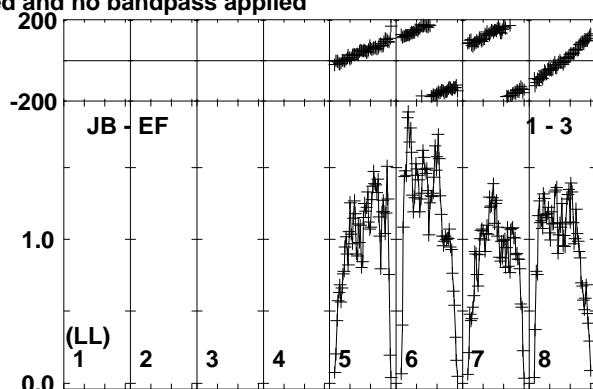
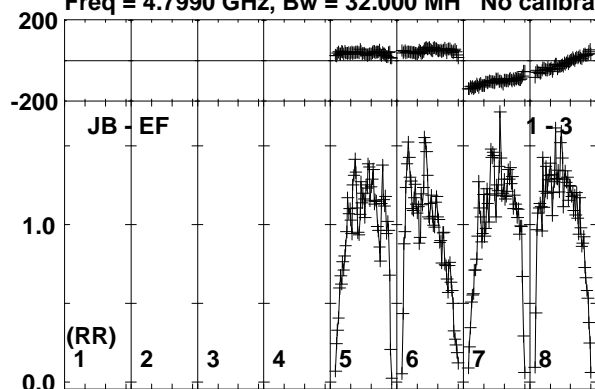

Lower frame: Milli Ampl Jy Top frame: Phas deg
Vector averaged cross-power spectrum Baseline: JB (01) - EF (03)
Timerange: 00/14:20:41 to 00/14:21:39

Plot file version 126 created 28-AUG-2017 13:19:09

J1303-2405 RP029A.UVDATA.1

Freq = 4.7990 GHz, Bw = 32.000 MH No calibration applied and no bandpass applied

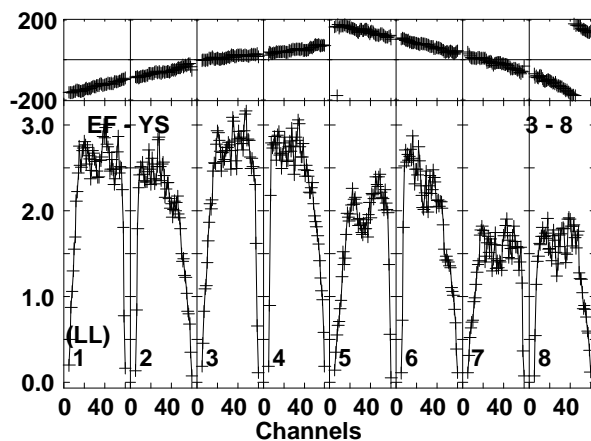
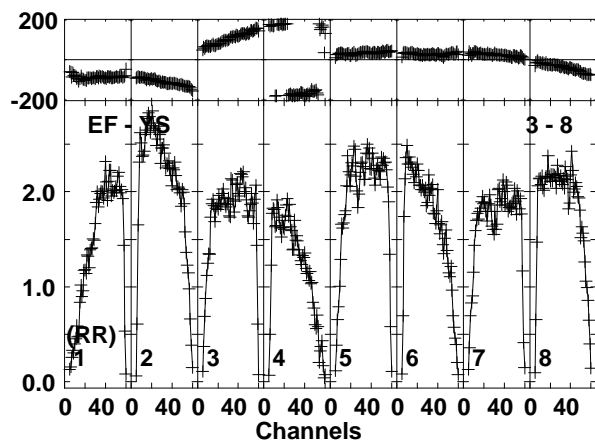
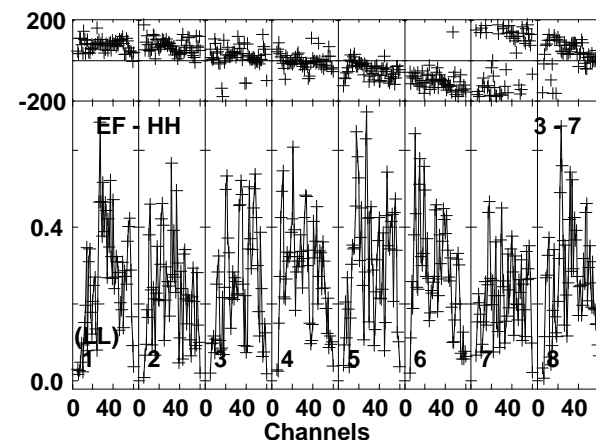
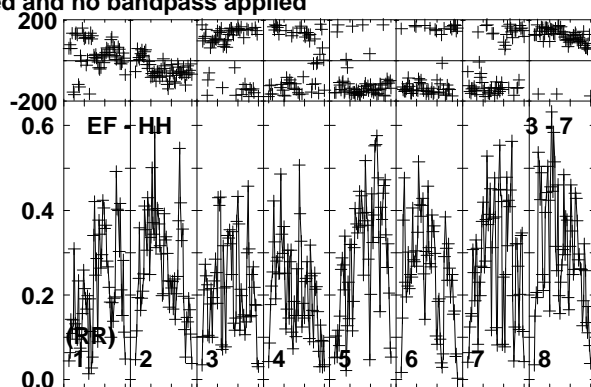
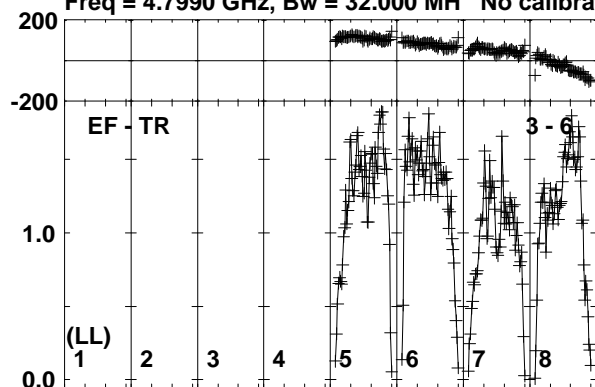

Lower frame: Milli Ampl Jy Top frame: Phas deg
Vector averaged cross-power spectrum Baseline: EF (03) - TR (06)
Timerange: 00:14:20:41 to 00:14:21:39

Plot file version 127 created 28-AUG-2017 13:19:09

SSS17A RP029A.UVDATA.1

Freq = 4.7990 GHz, Bw = 32.000 MH No calibration applied and no bandpass applied

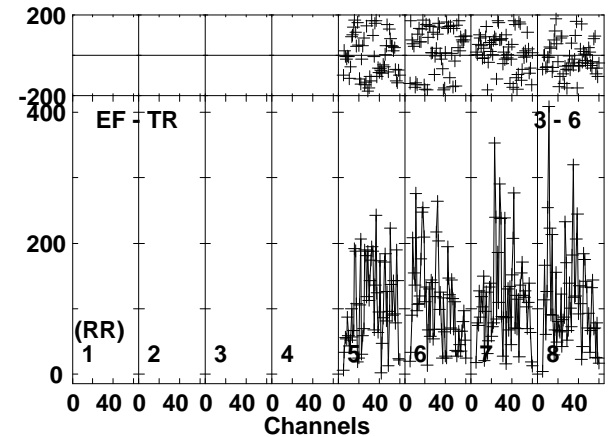
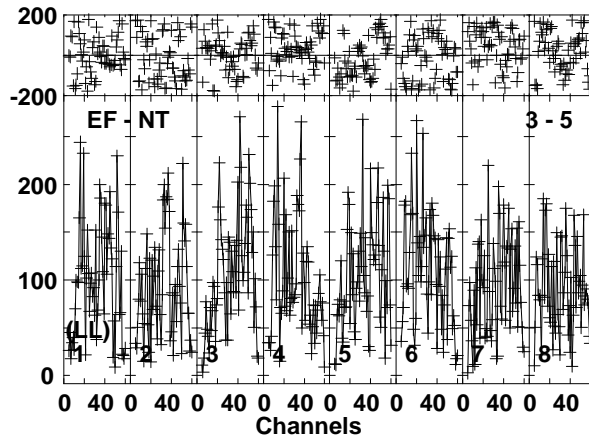
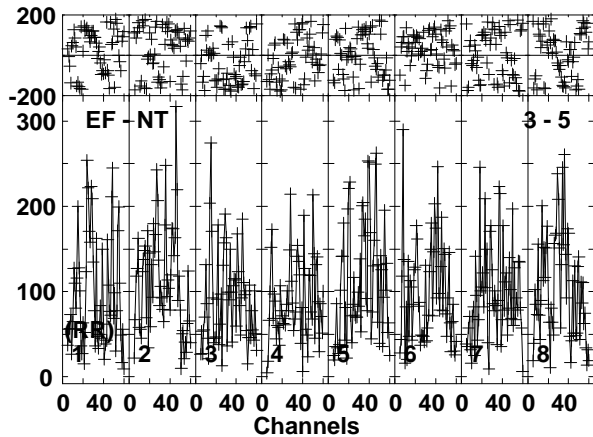
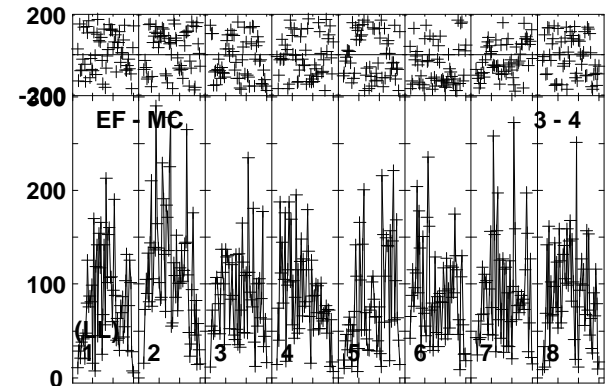
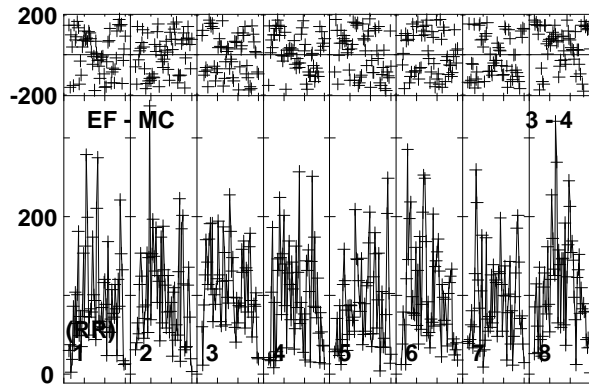
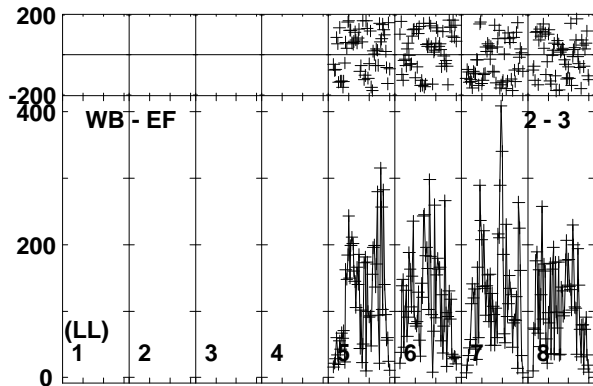
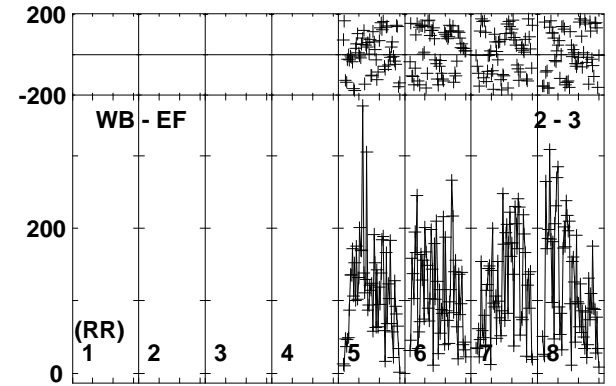
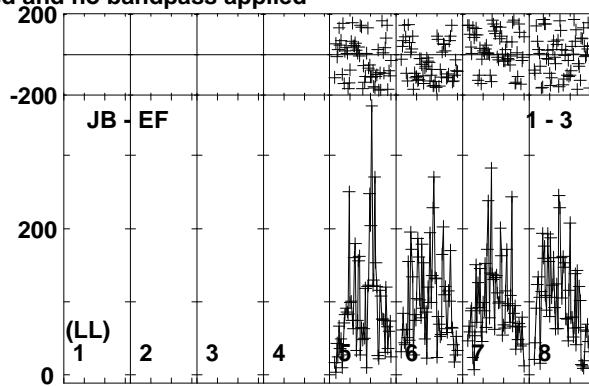
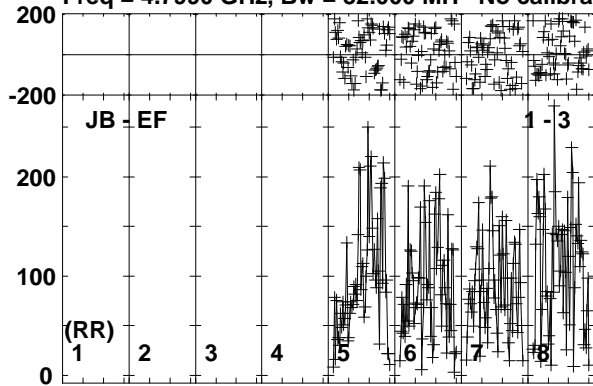

Lower frame: Micro Ampl Jy Top frame: Phas deg
Vector averaged cross-power spectrum Baseline: JB (01) - EF (03)
Timerange: 00/14:21:41 to 00/14:24:09

Plot file version 128 created 28-AUG-2017 13:19:09

SSS17A RP029A.UVDATA.1

Freq = 4.7990 GHz, Bw = 32.000 MH No calibration applied and no bandpass applied

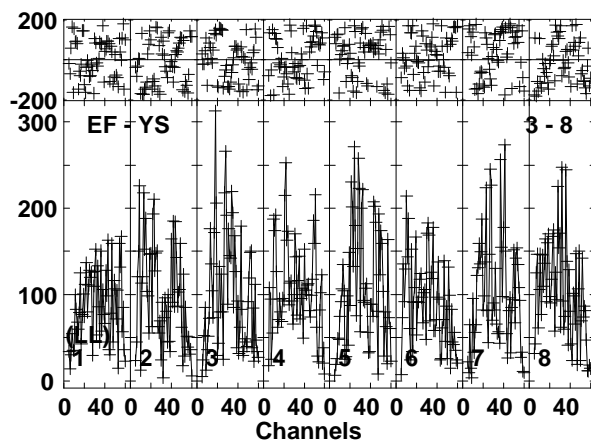
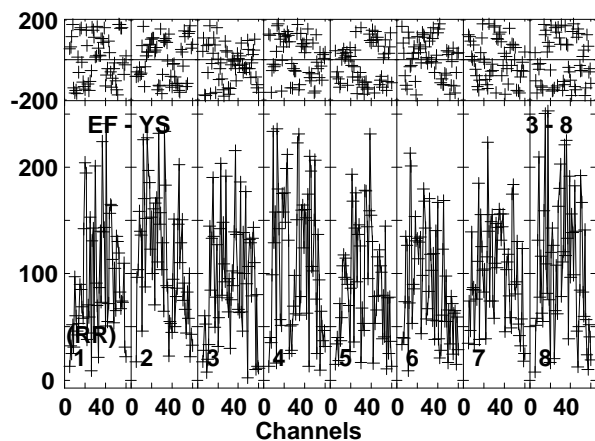
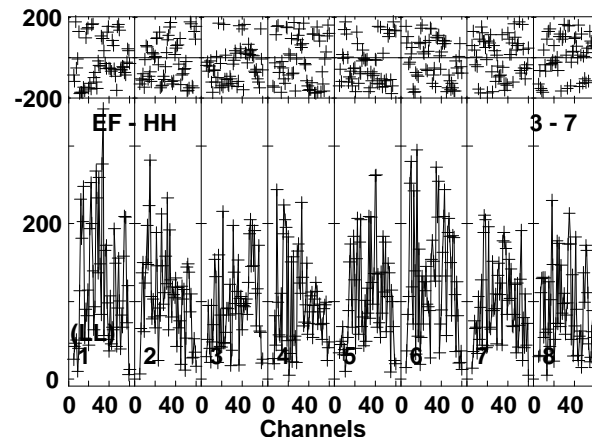
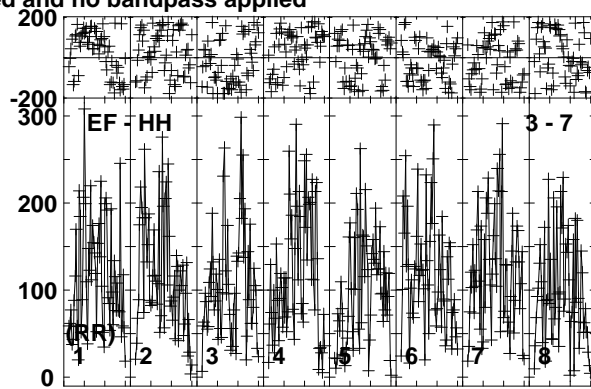
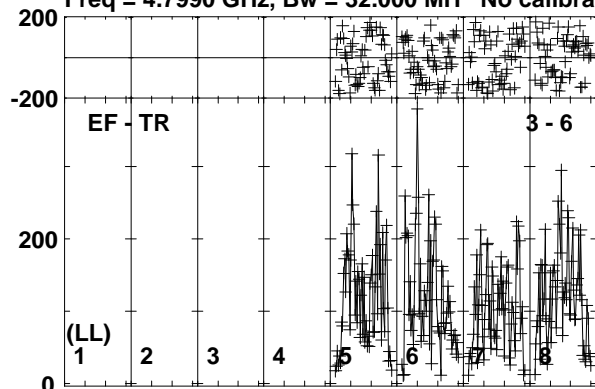

Lower frame: Micro Ampl Jy Top frame: Phas deg
Vector averaged cross-power spectrum Baseline: EF (03) - TR (06)
Timerange: 00/14:21:41 to 00/14:24:09

Plot file version 129 created 28-AUG-2017 13:19:09

J1303-2405 RP029A.UVDATA.1

Freq = 4.7990 GHz, Bw = 32.000 MH No calibration applied and no bandpass applied

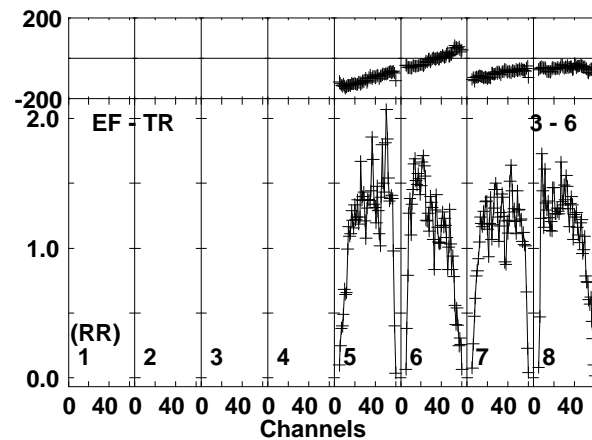
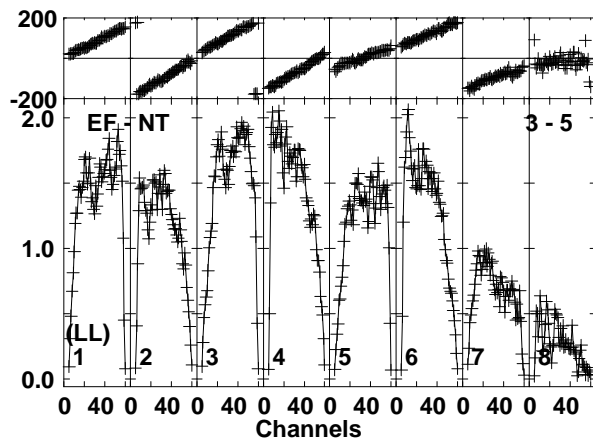
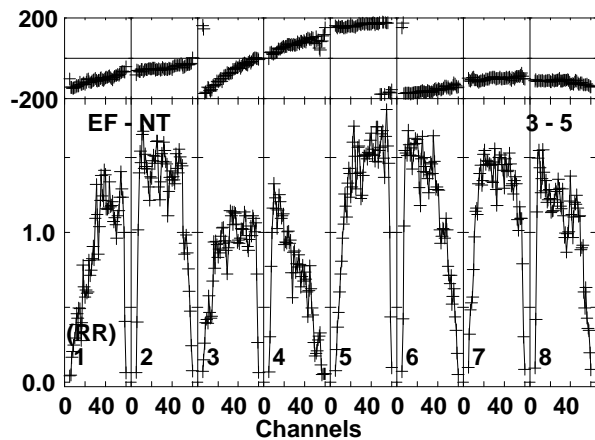
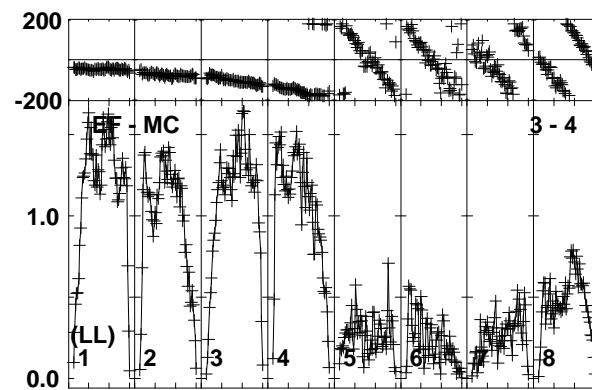
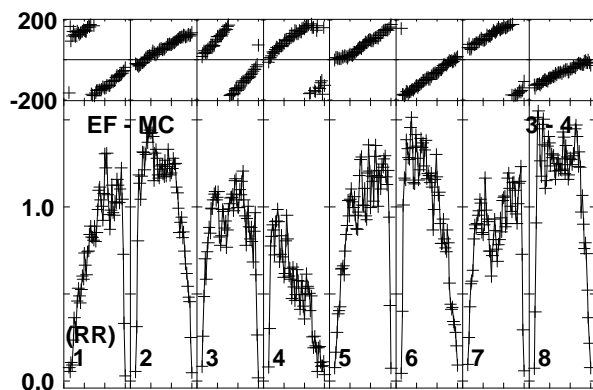
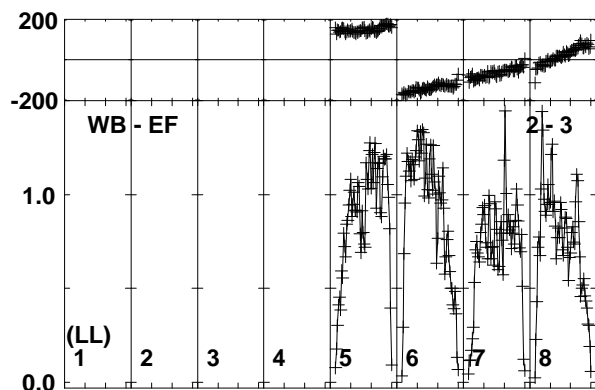
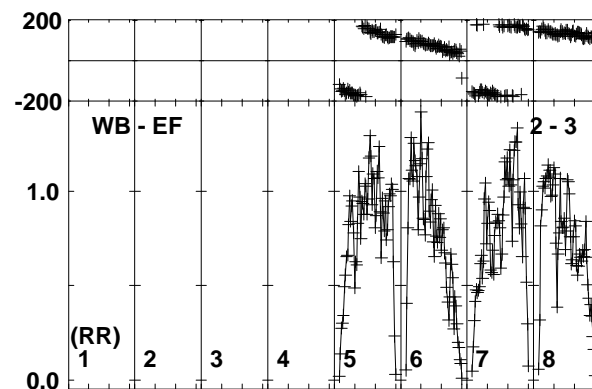
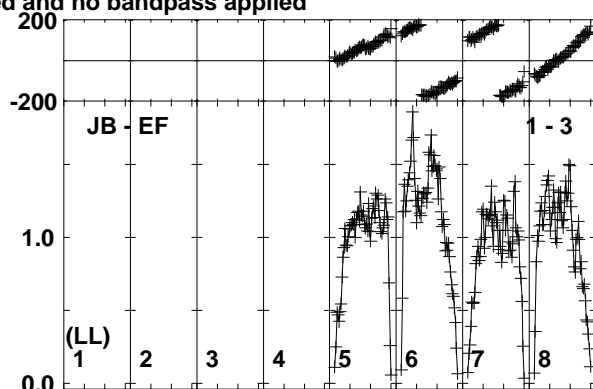
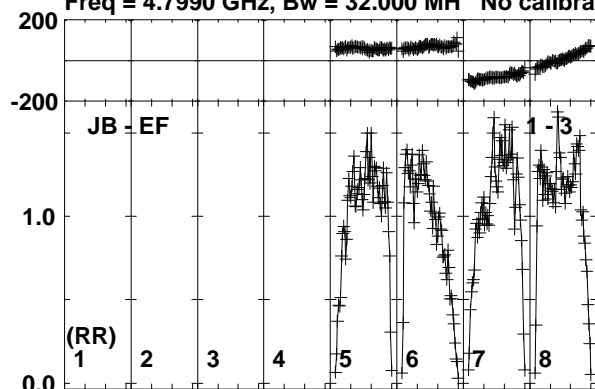

Lower frame: Milli Ampl Jy Top frame: Phas deg
Vector averaged cross-power spectrum Baseline: JB (01) - EF (03)
Timerange: 00/14:24:11 to 00/14:25:39

Plot file version 130 created 28-AUG-2017 13:19:09

J1303-2405 RP029A.UVDATA.1

Freq = 4.7990 GHz, Bw = 32.000 MH No calibration applied and no bandpass applied

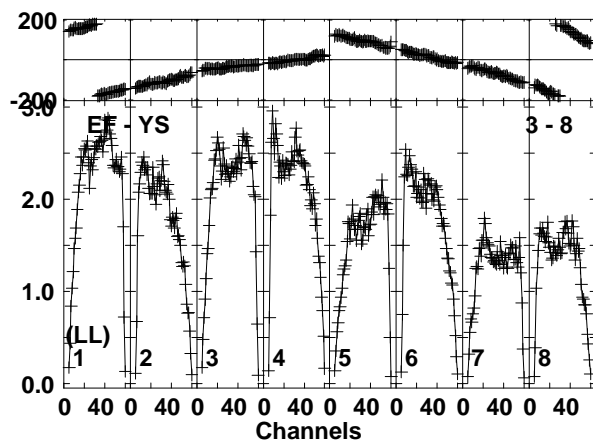
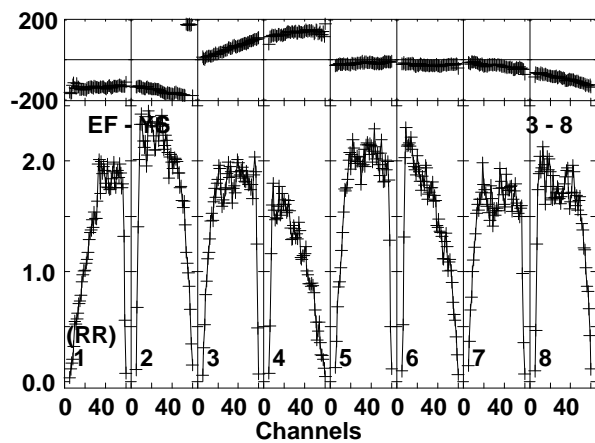
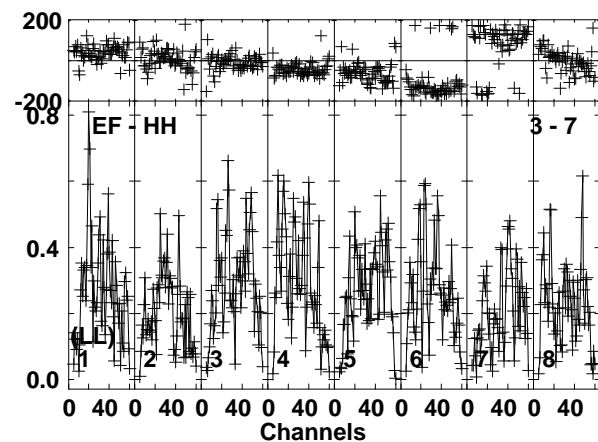
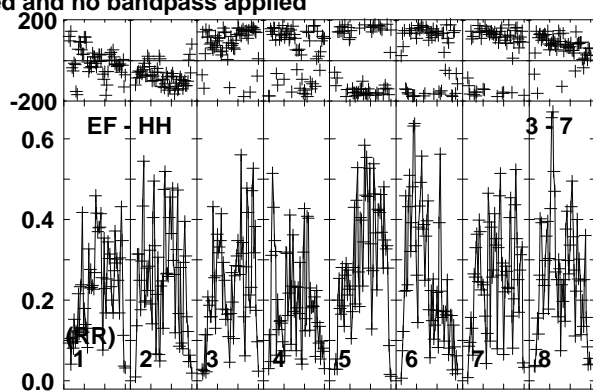
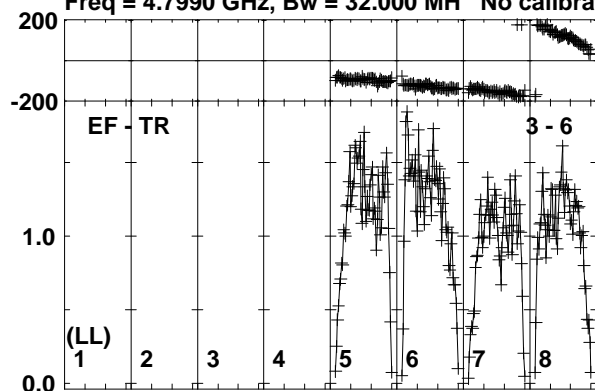

Lower frame: Milli Ampl Jy Top frame: Phas deg
Vector averaged cross-power spectrum Baseline: EF (03) - TR (06)
Timerange: 00/14:24:11 to 00/14:25:39

Plot file version 131 created 28-AUG-2017 13:19:09

SSS17A RP029A.UVDATA.1

Freq = 4.7990 GHz, Bw = 32.000 MH No calibration applied and no bandpass applied

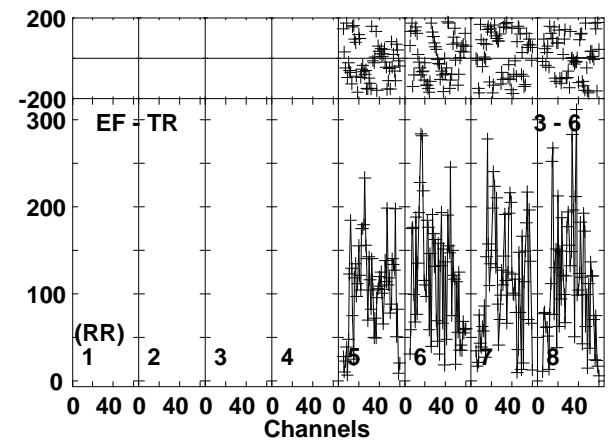
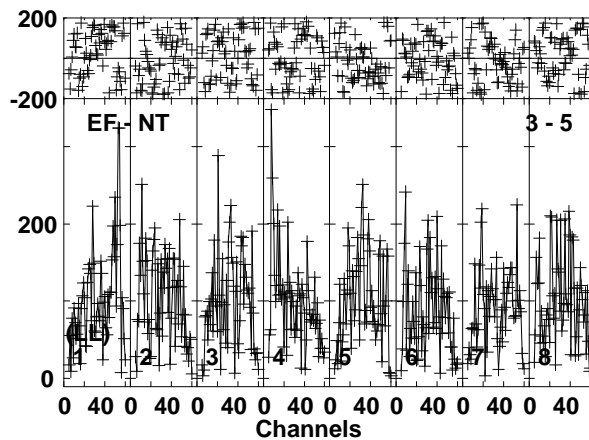
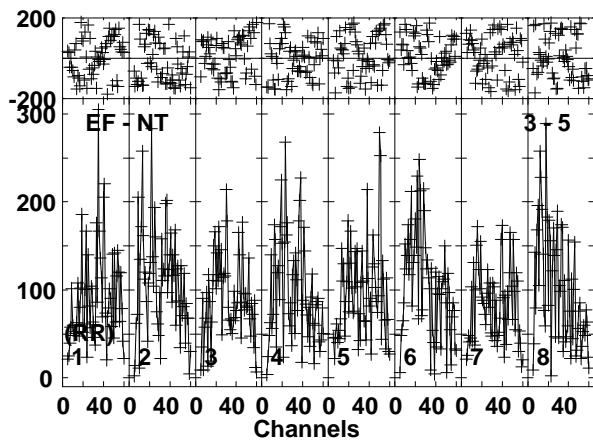
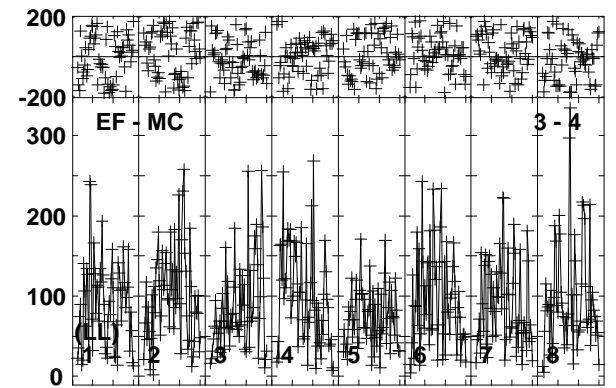
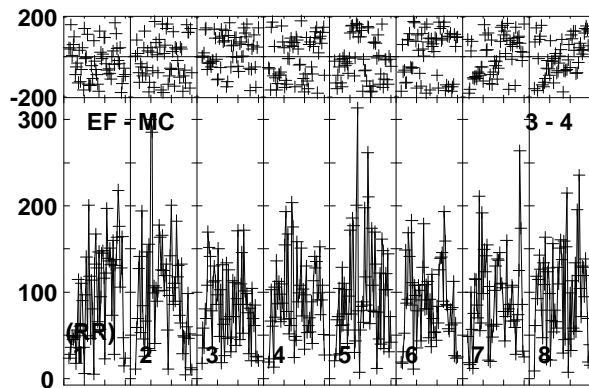
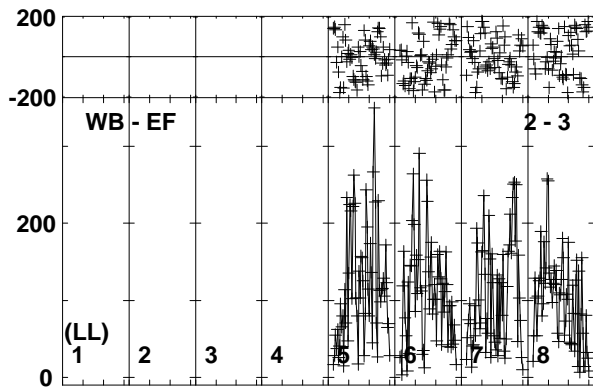
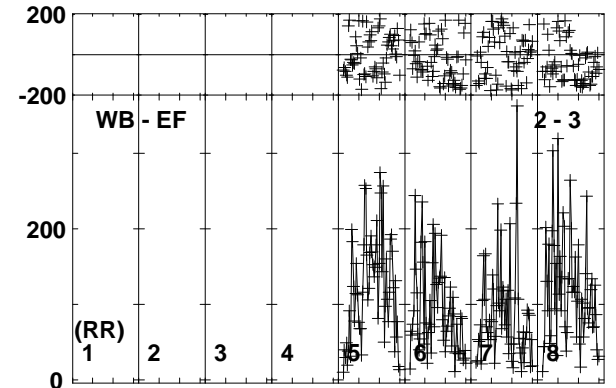
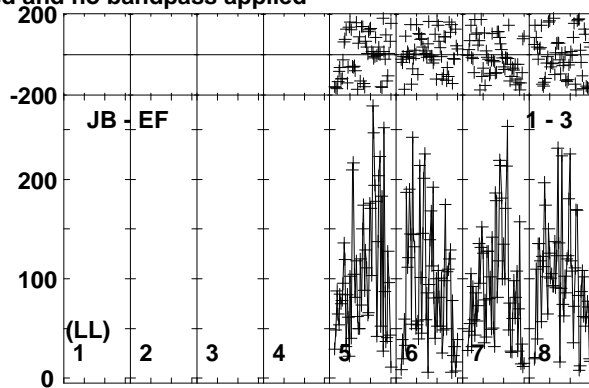
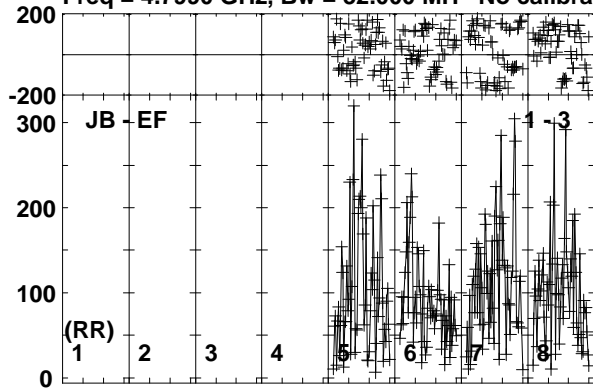

Lower frame: Micro Ampl Jy Top frame: Phas deg
Vector averaged cross-power spectrum Baseline: JB (01) - EF (03)
Timerange: 00/14:25:41 to 00/14:28:09

Plot file version 132 created 28-AUG-2017 13:19:09

SSS17A RP029A.UVDATA.1

Freq = 4.7990 GHz, Bw = 32.000 MH No calibration applied and no bandpass applied

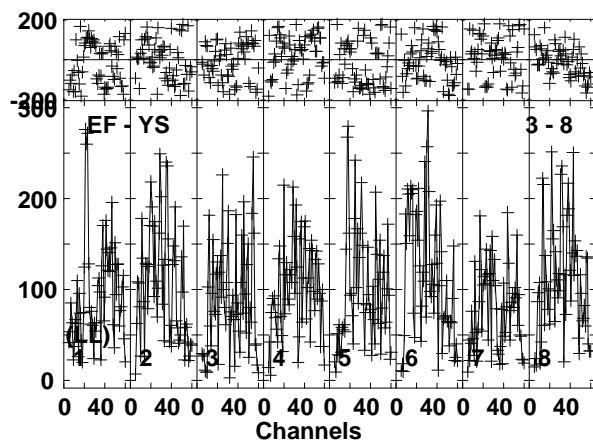
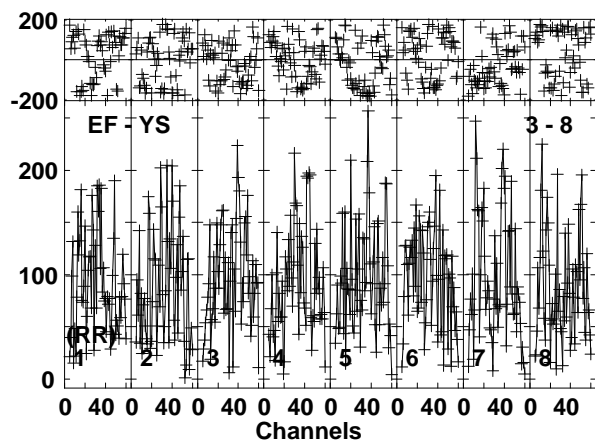
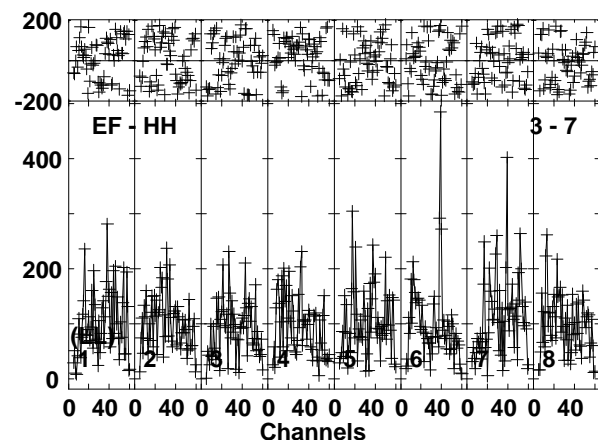
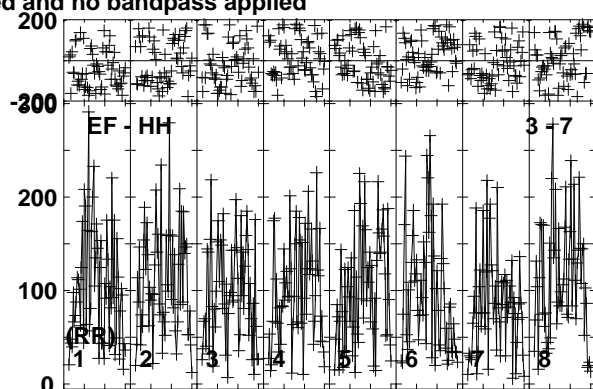
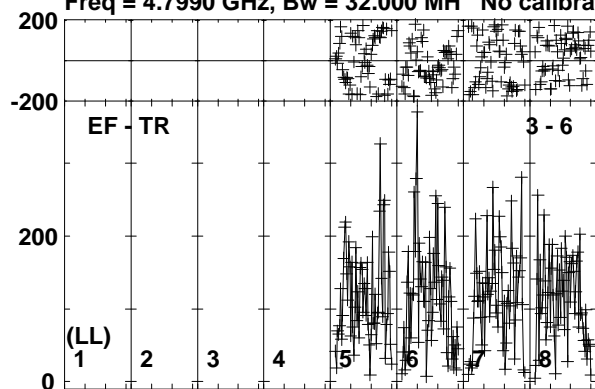

Lower frame: Micro Ampl Jy Top frame: Phas deg
Vector averaged cross-power spectrum Baseline: EF (03) - TR (06)
Timerange: 00/14:25:41 to 00/14:28:09

Plot file version 133 created 28-AUG-2017 13:19:09

J1303-2405 RP029A.UVDATA.1

Freq = 4.7990 GHz, Bw = 32.000 MH No calibration applied and no bandpass applied

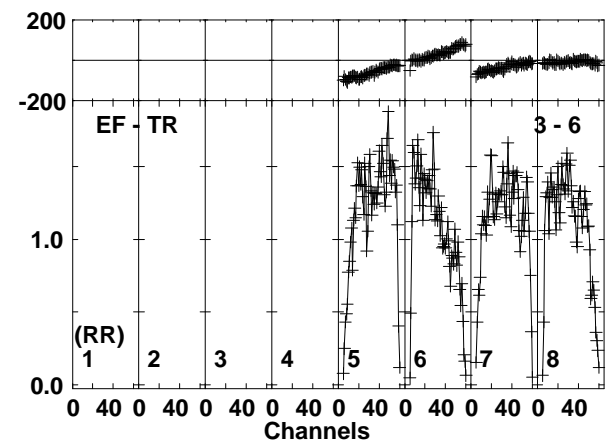
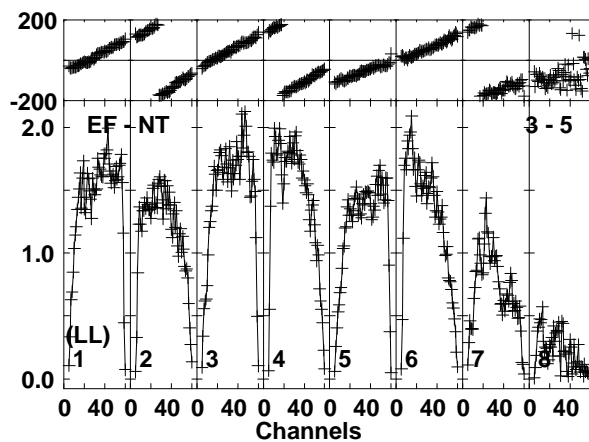
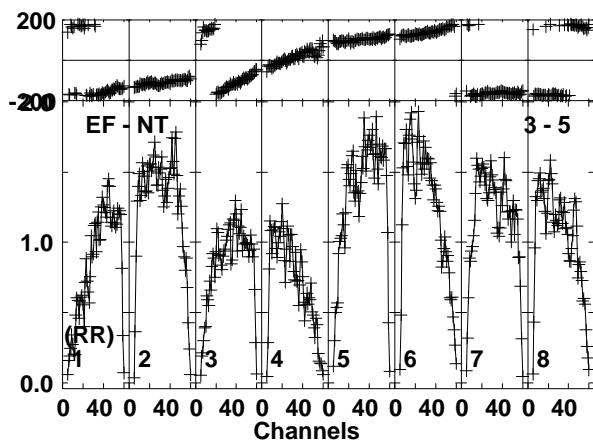
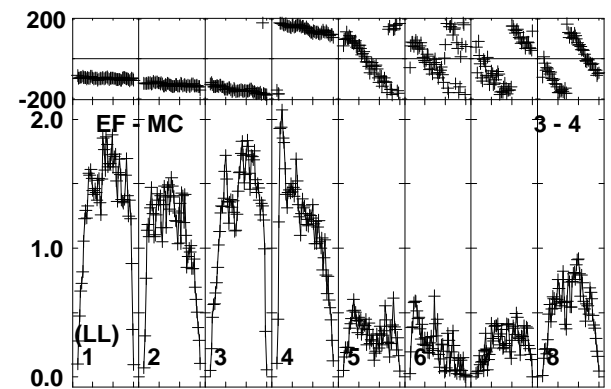
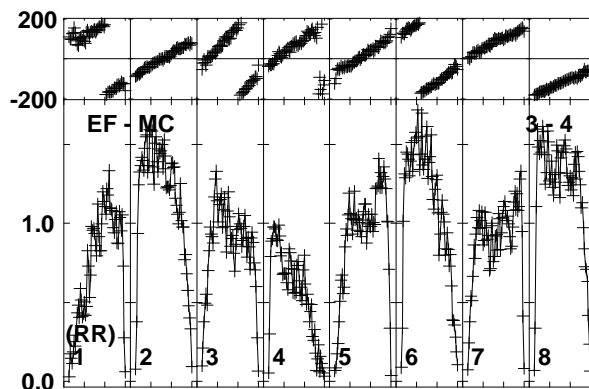
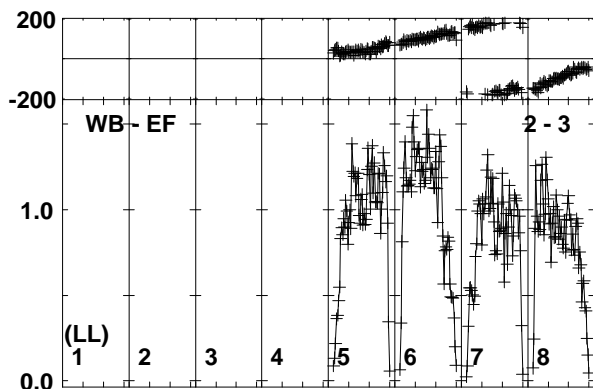
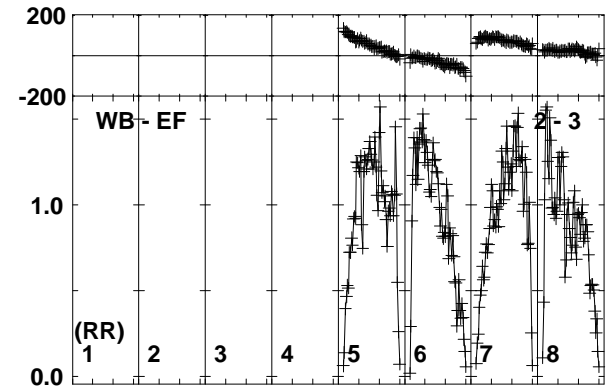
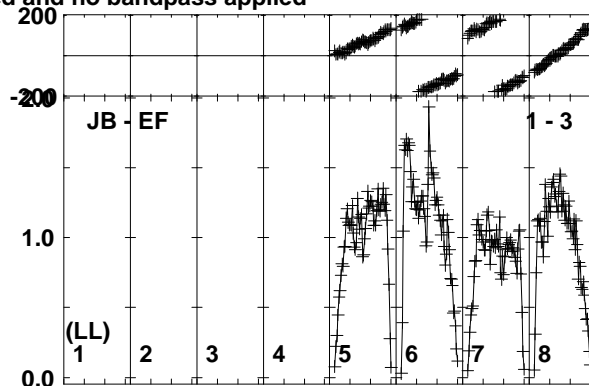
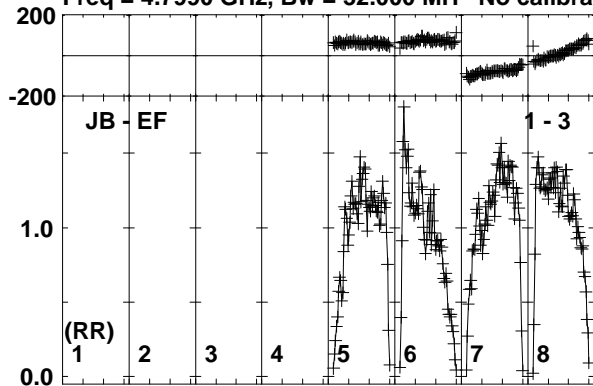

Lower frame: Milli Ampl Jy Top frame: Phas deg
Vector averaged cross-power spectrum Baseline: JB (01) - EF (03)
Timerange: 00/14:28:41 to 00/14:29:39

Plot file version 134 created 28-AUG-2017 13:19:10

J1303-2405 RP029A.UVDATA.1

Freq = 4.7990 GHz, Bw = 32.000 MH No calibration applied and no bandpass applied

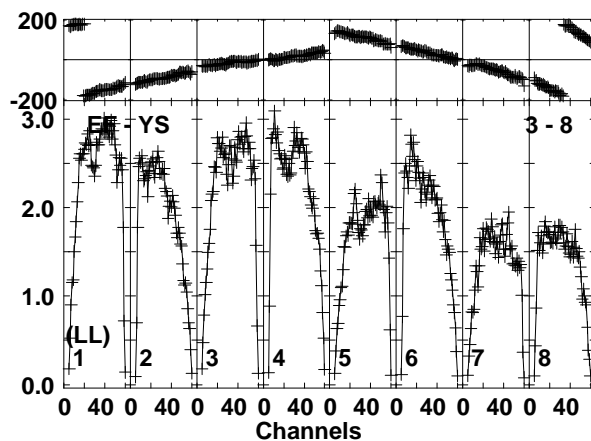
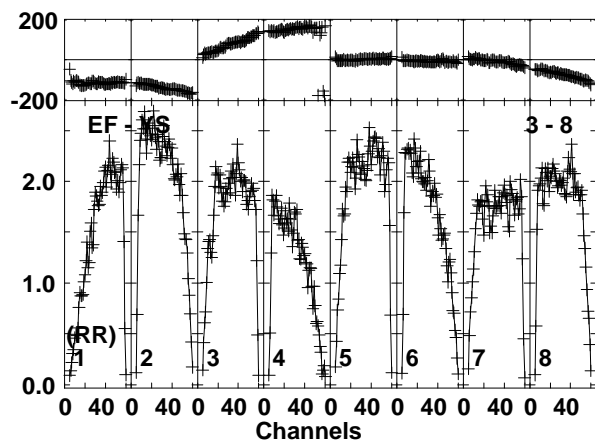
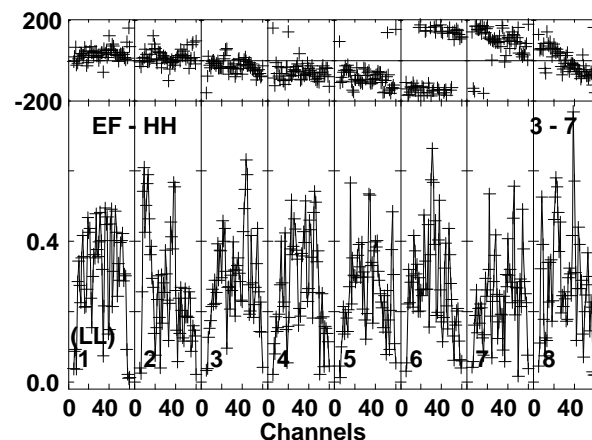
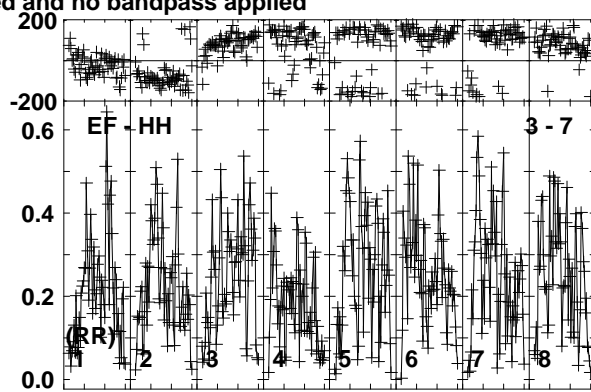
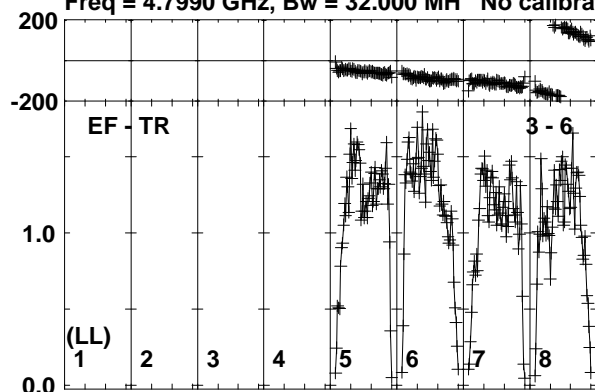

Lower frame: Milli Ampl Jy Top frame: Phas deg
Vector averaged cross-power spectrum Baseline: EF (03) - TR (06)
Timerange: 00/14:28:41 to 00/14:29:39

Plot file version 136 created 28-AUG-2017 13:19:10

SSS17A RP029A.UVDATA.1

Freq = 4.7990 GHz, Bw = 32.000 MH No calibration applied and no bandpass applied

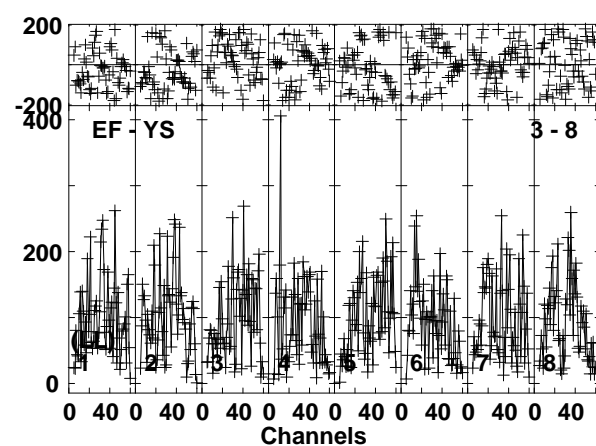
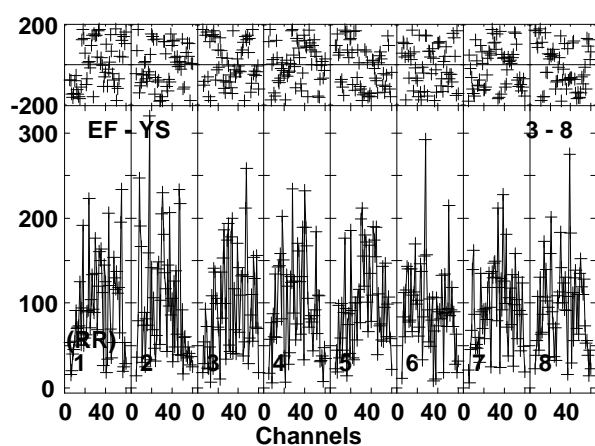
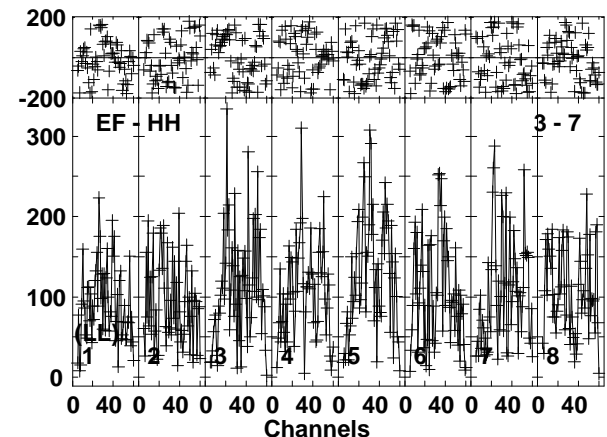
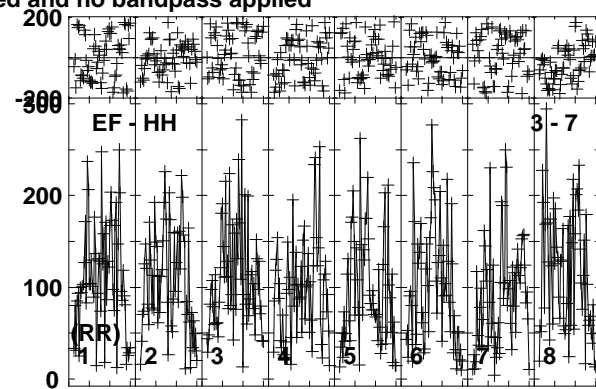
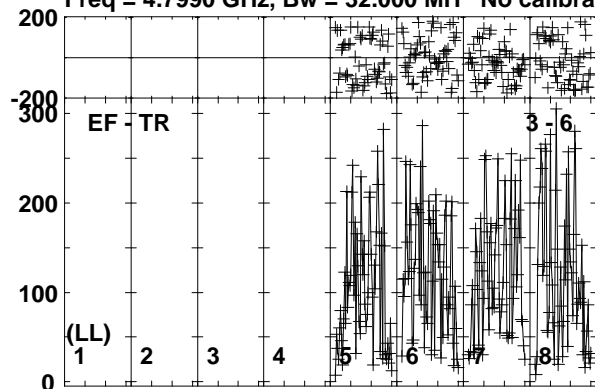

Lower frame: Micro Ampl Jy Top frame: Phas deg
Vector averaged cross-power spectrum Baseline: EF (03) - TR (06)
Timerange: 00/14:29:41 to 00/14:32:09

Plot file version 137 created 28-AUG-2017 13:19:10

J1303-2405 RP029A.UVDATA.1

Freq = 4.7990 GHz, Bw = 32.000 MH No calibration applied and no bandpass applied

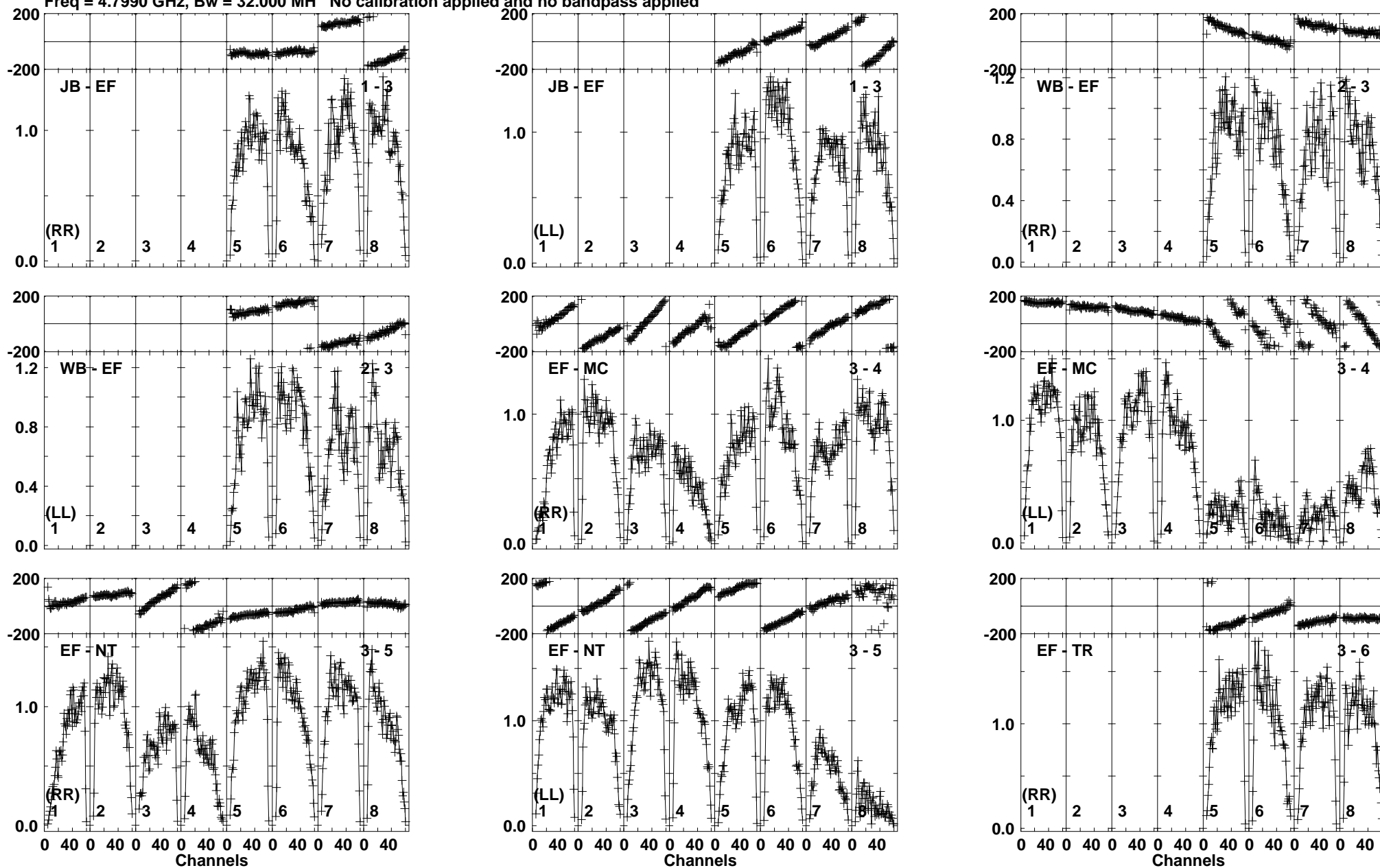

Lower frame: Milli Ampl Jy Top frame: Phas deg
Vector averaged cross-power spectrum Baseline: JB (01) - EF (03)
Timerange: 00/14:32:11 to 00/14:33:39

Plot file version 138 created 28-AUG-2017 13:19:10

J1303-2405 RP029A.UVDATA.1

Freq = 4.7990 GHz, Bw = 32.000 MH No calibration applied and no bandpass applied

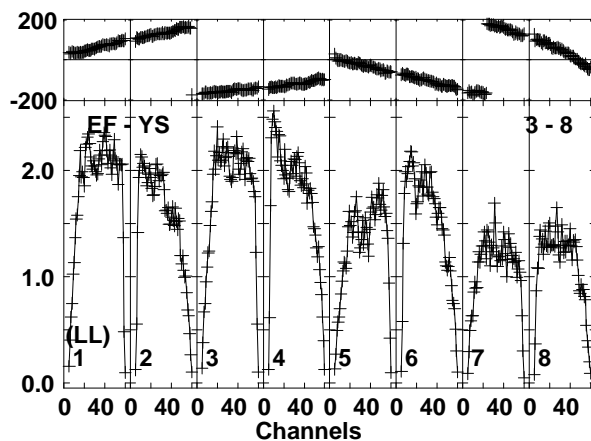
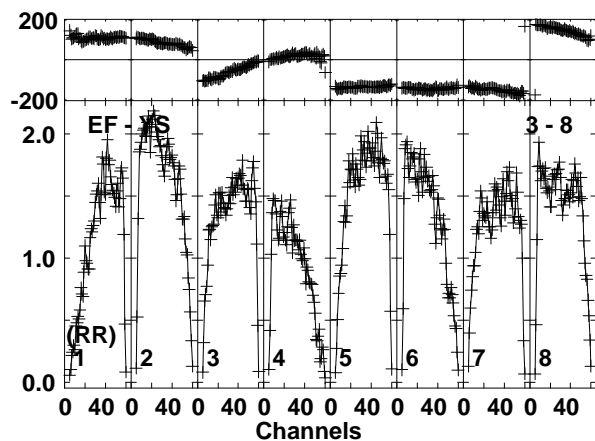
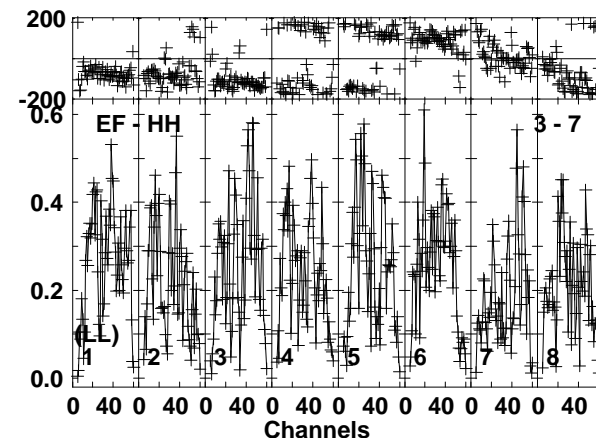
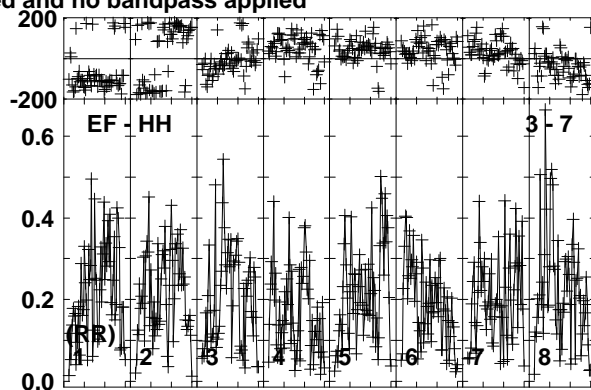
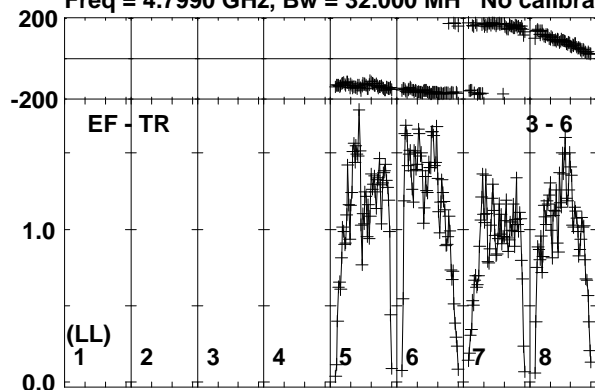

Lower frame: Milli Ampl Jy Top frame: Phas deg
Vector averaged cross-power spectrum Baseline: EF (03) - TR (06)
Timerange: 00/14:32:11 to 00/14:33:39

Plot file version 139 created 28-AUG-2017 13:19:10

J1312-2350 RP029A.UVDATA.1

Freq = 4.7990 GHz, Bw = 32.000 MH No calibration applied and no bandpass applied

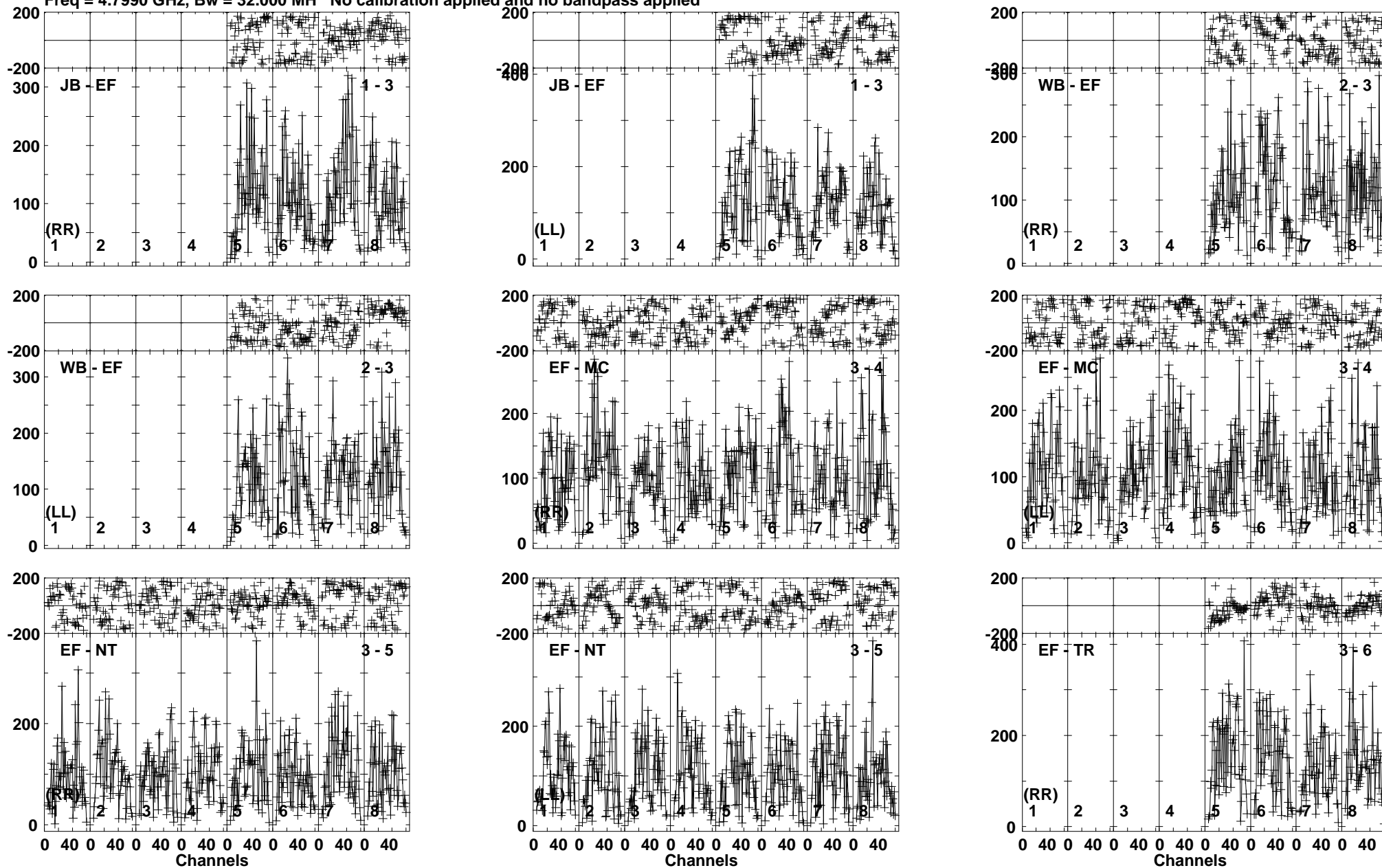

Lower frame: Micro Ampl Jy Top frame: Phas deg
Vector averaged cross-power spectrum Baseline: JB (01) - EF (03)
Timerange: 00/14:33:41 to 00/14:36:09

Plot file version 140 created 28-AUG-2017 13:19:10

J1312-2350 RP029A.UVDATA.1

Freq = 4.7990 GHz, Bw = 32.000 MH No calibration applied and no bandpass applied

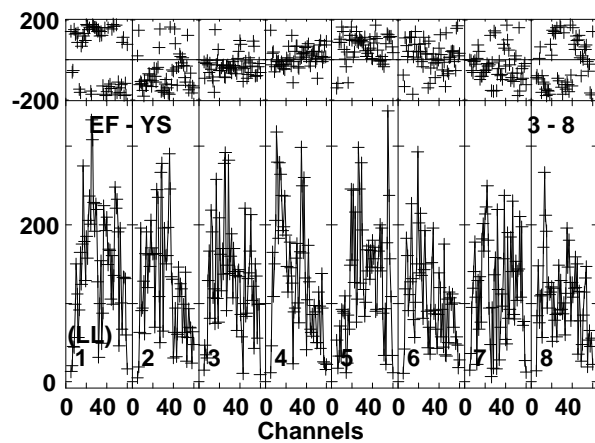
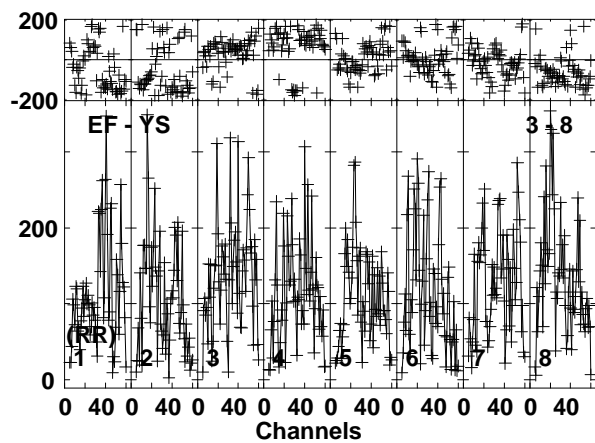
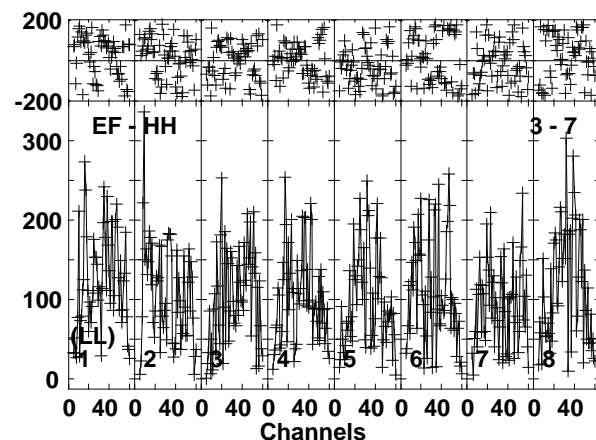
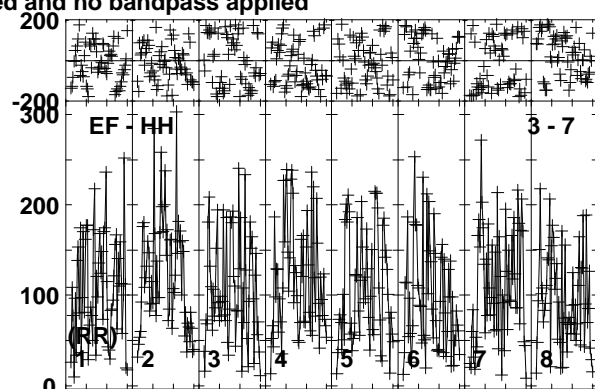
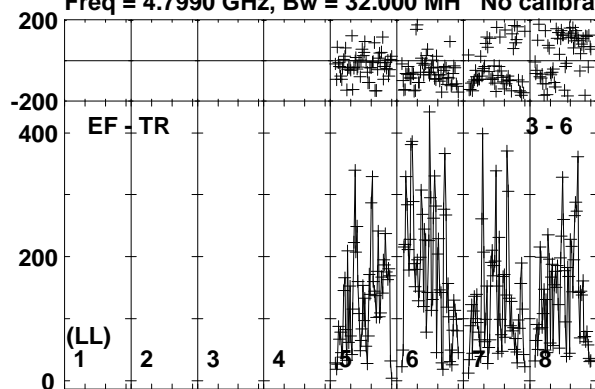

Lower frame: Micro Ampl Jy Top frame: Phas deg
Vector averaged cross-power spectrum Baseline: EF (03) - TR (06)
Timerange: 00/14:33:41 to 00/14:36:09

Plot file version 141 created 28-AUG-2017 13:19:10

J1303-2405 RP029A.UVDATA.1

Freq = 4.7990 GHz, Bw = 32.000 MH No calibration applied and no bandpass applied

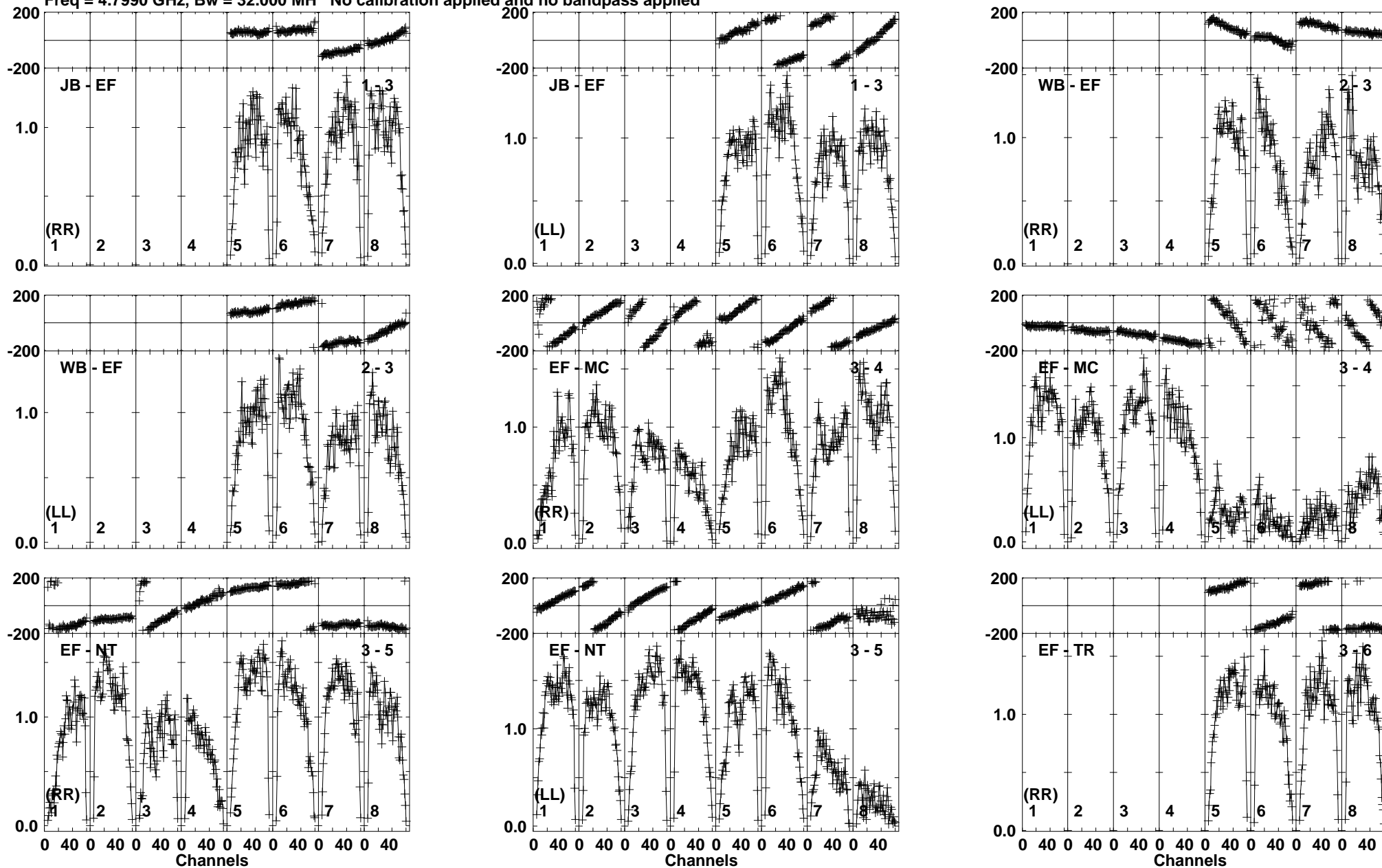

Lower frame: Milli Ampl Jy Top frame: Phas deg
Vector averaged cross-power spectrum Baseline: JB (01) - EF (03)
Timerange: 00:14:36:51 to 00:14:37:49

Plot file version 142 created 28-AUG-2017 13:19:10

J1303-2405 RP029A.UVDATA.1

Freq = 4.7990 GHz, Bw = 32.000 MH No calibration applied and no bandpass applied

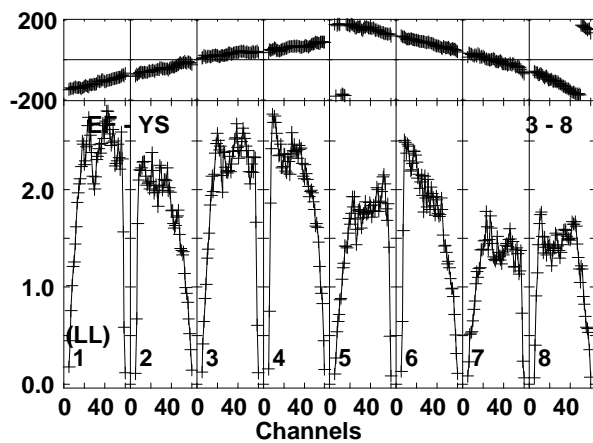
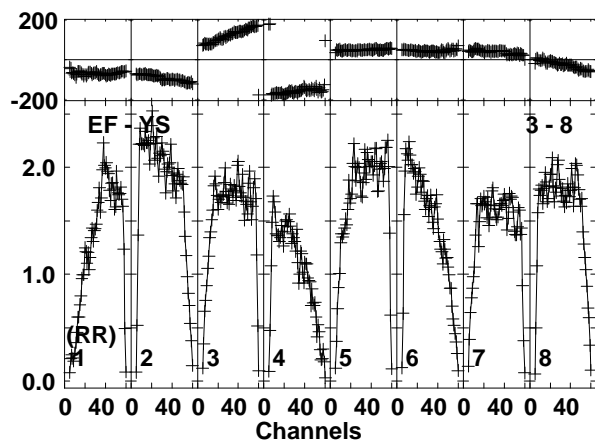
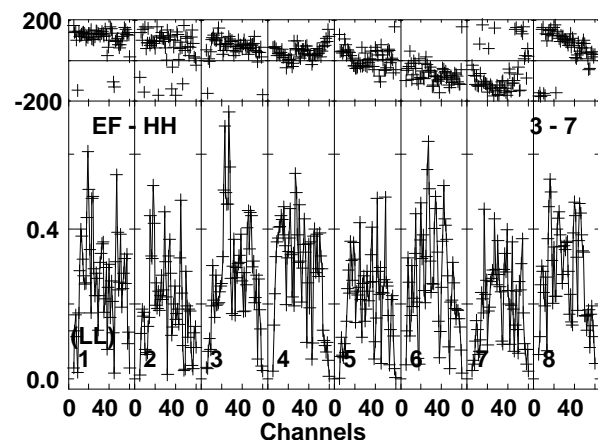
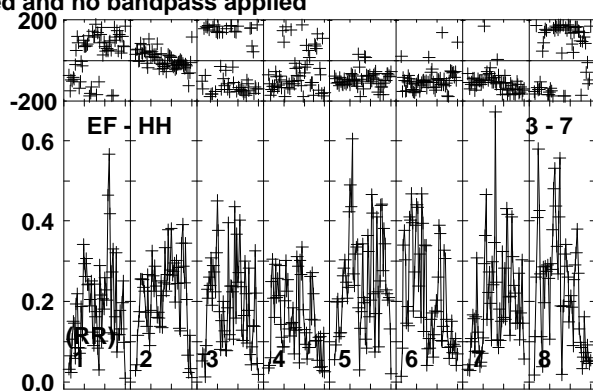
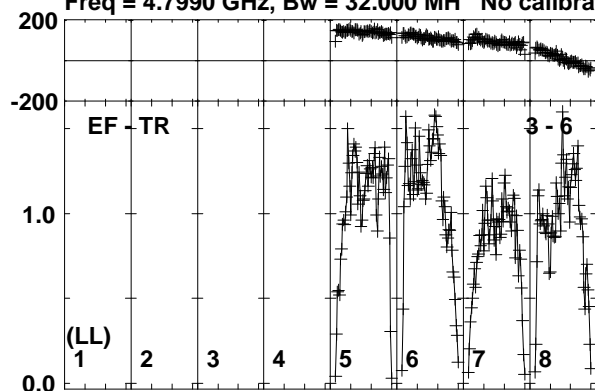

Lower frame: Milli Ampl Jy Top frame: Phas deg
Vector averaged cross-power spectrum Baseline: EF (03) - TR (06)
Timerange: 00/14:36:51 to 00/14:37:49

Plot file version 143 created 28-AUG-2017 13:19:10

SSS17A RP029A.UVDATA.1

Freq = 4.7990 GHz, Bw = 32.000 MH No calibration applied and no bandpass applied

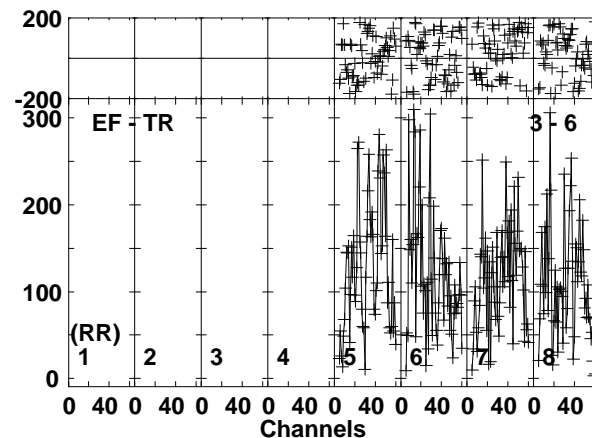
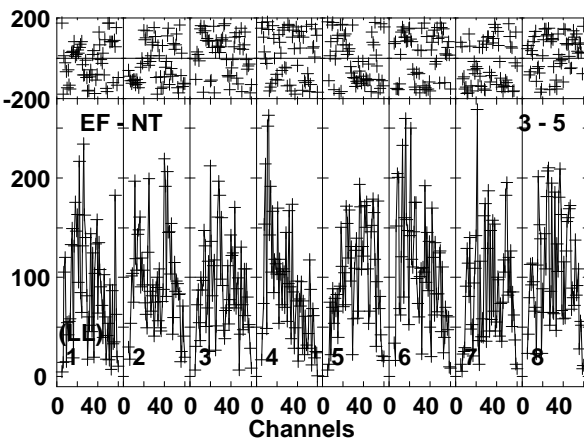
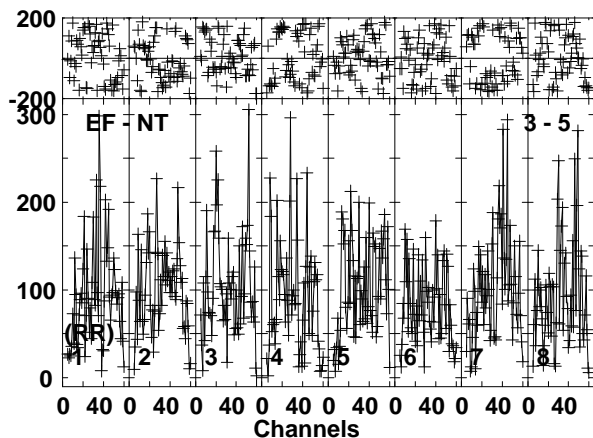
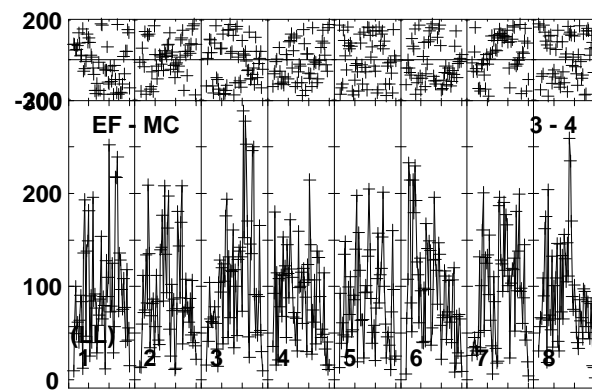
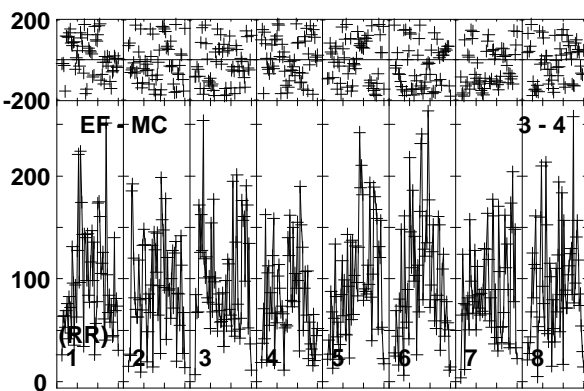
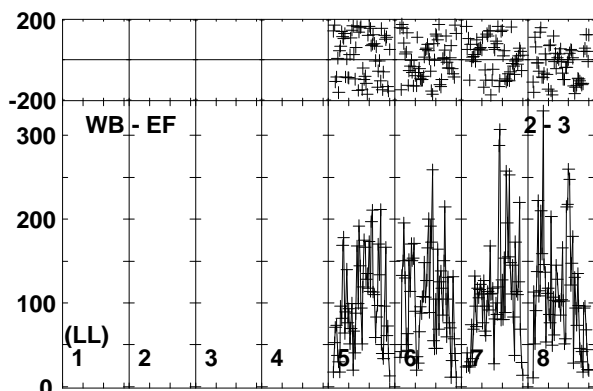
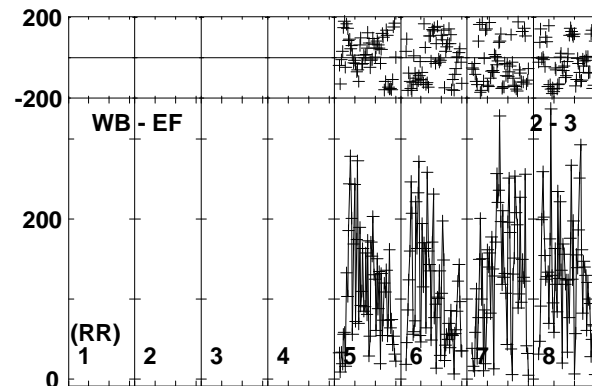
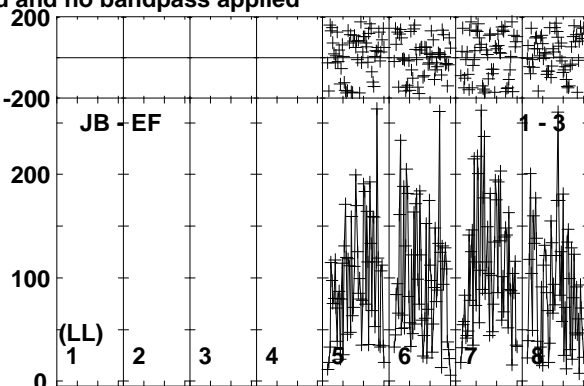
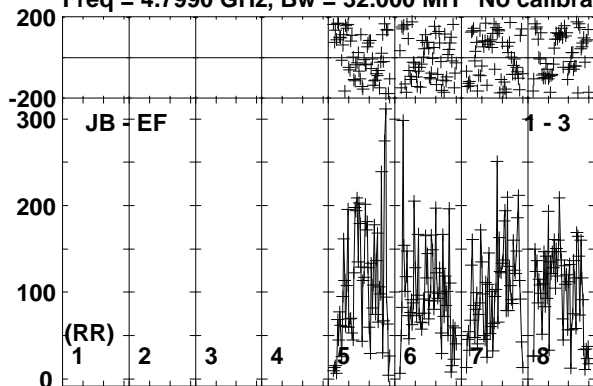

Lower frame: Micro Ampl Jy Top frame: Phas deg
Vector averaged cross-power spectrum Baseline: JB (01) - EF (03)
Timerange: 00/14:37:51 to 00/14:40:19

Plot file version 144 created 28-AUG-2017 13:19:10

SSS17A RP029A.UVDATA.1

Freq = 4.7990 GHz, Bw = 32.000 MH No calibration applied and no bandpass applied

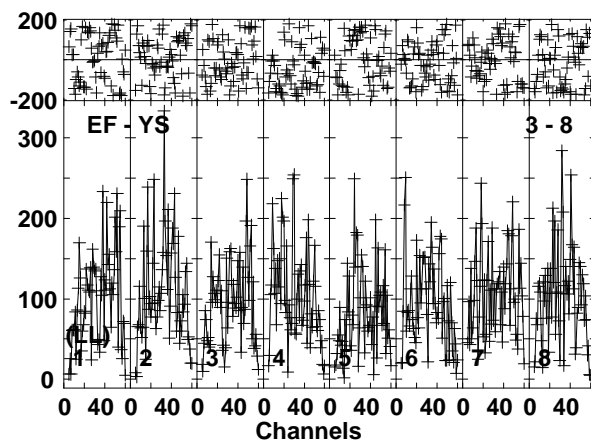
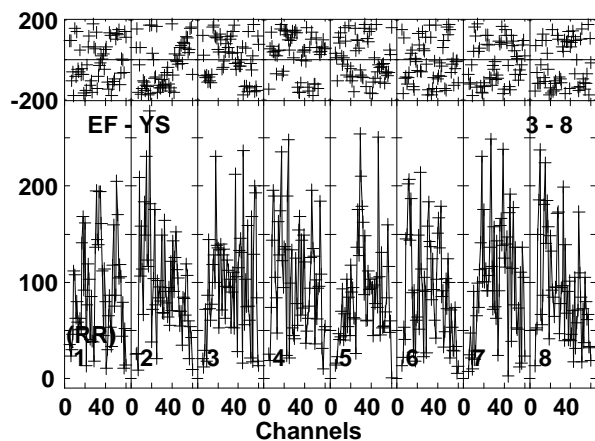
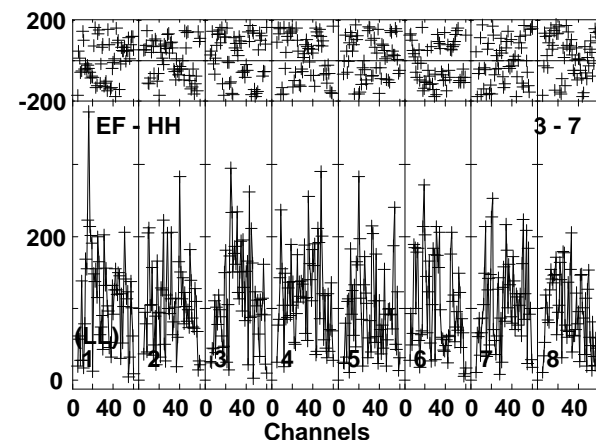
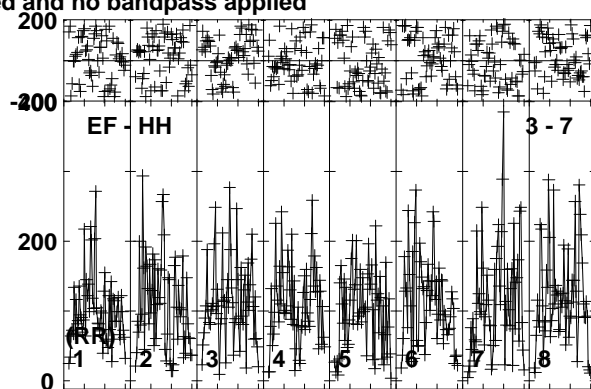
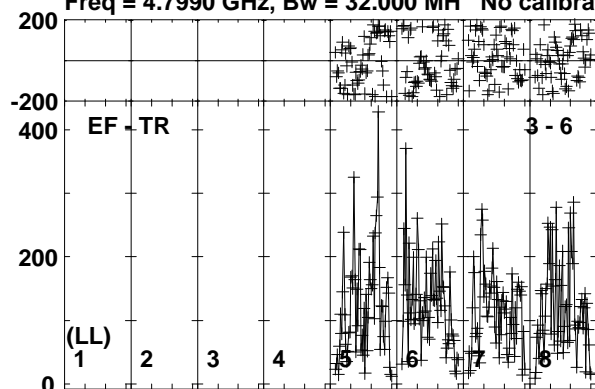

Lower frame: Micro Ampl Jy Top frame: Phas deg
Vector averaged cross-power spectrum Baseline: EF (03) - TR (06)
Timerange: 00/14:37:51 to 00/14:40:19

Plot file version 145 created 28-AUG-2017 13:19:10

J1303-2405 RP029A.UVDATA.1

Freq = 4.7990 GHz, Bw = 32.000 MH No calibration applied and no bandpass applied

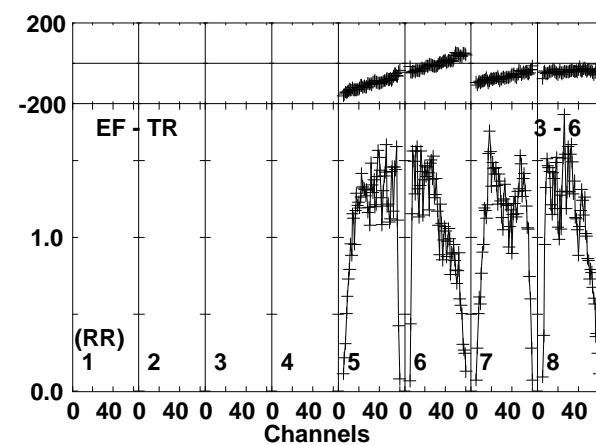
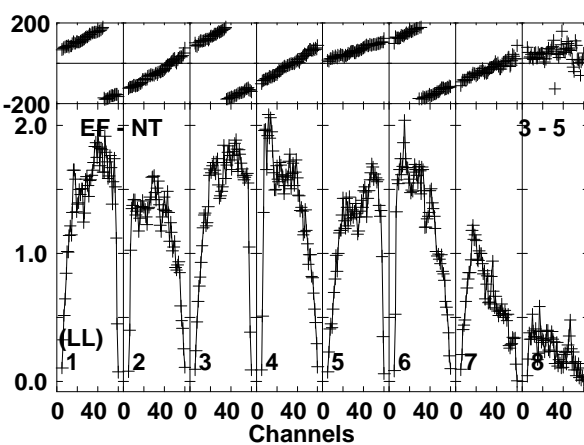
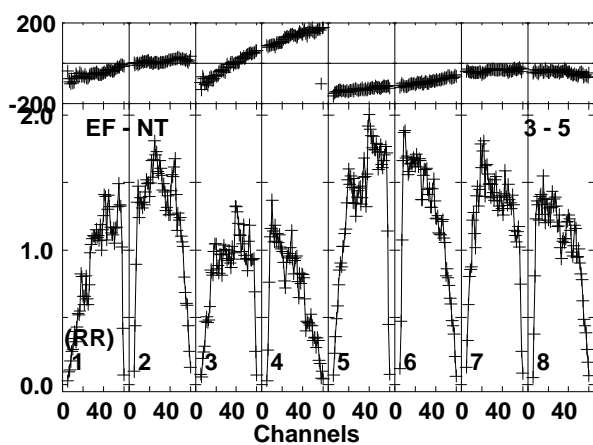
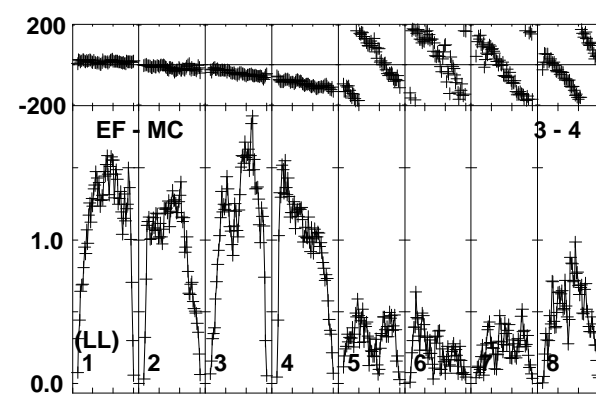
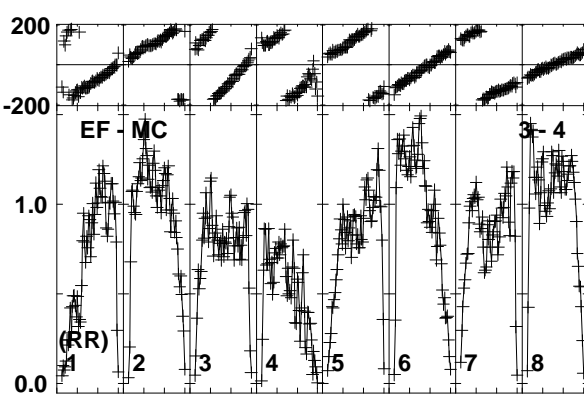
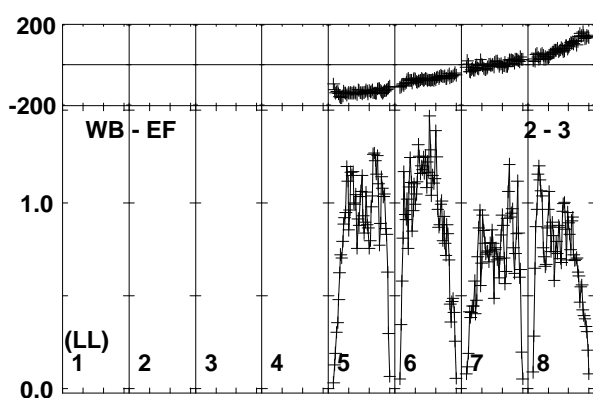
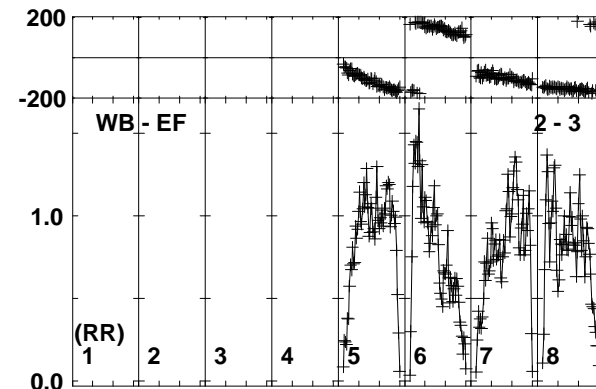
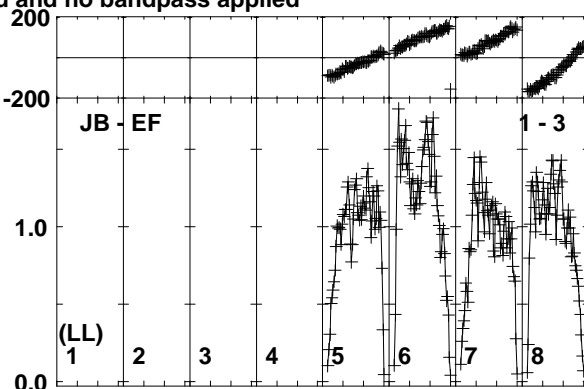
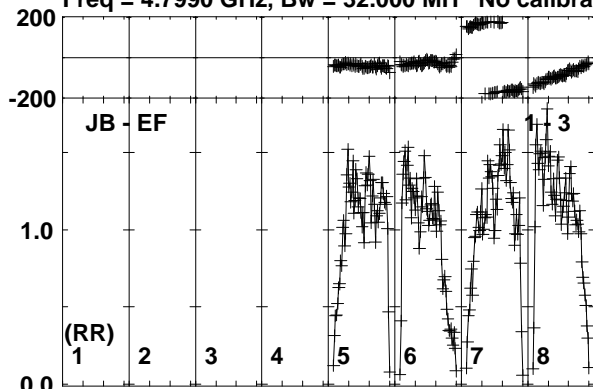

Lower frame: Milli Ampl Jy Top frame: Phas deg
Vector averaged cross-power spectrum Baseline: JB (01) - EF (03)
Timerange: 00/14:40:21 to 00/14:41:49

Plot file version 146 created 28-AUG-2017 13:19:10

J1303-2405 RP029A.UVDATA.1

Freq = 4.7990 GHz, Bw = 32.000 MH No calibration applied and no bandpass applied

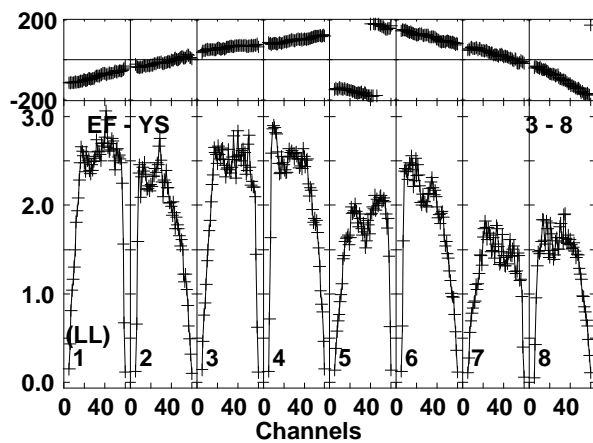
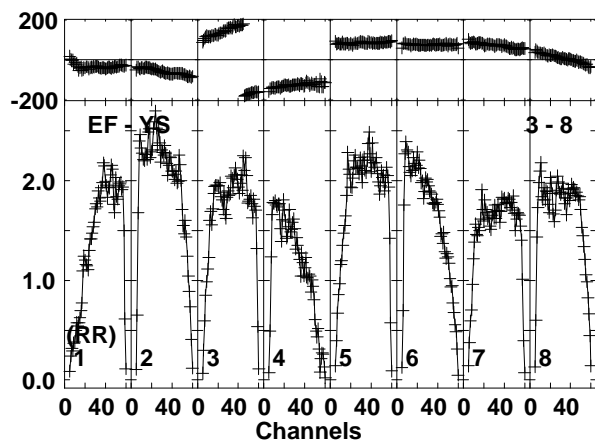
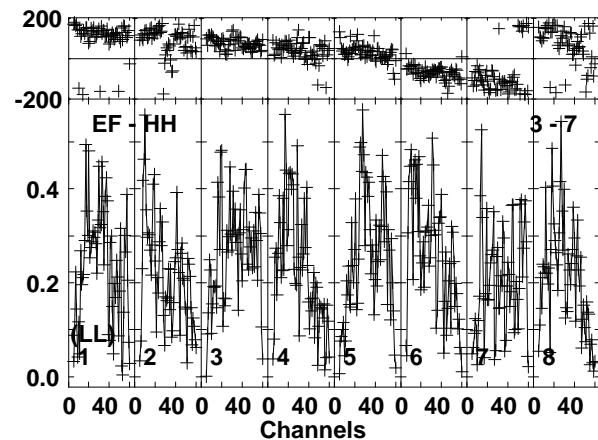
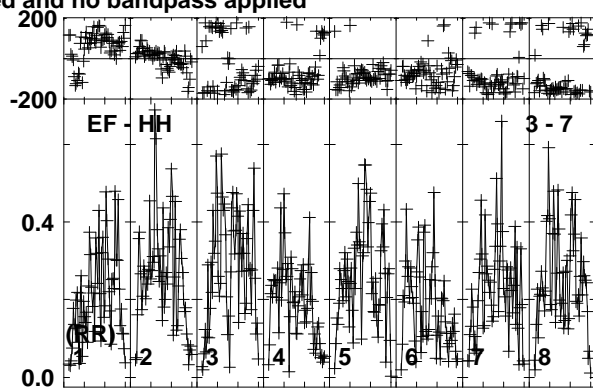
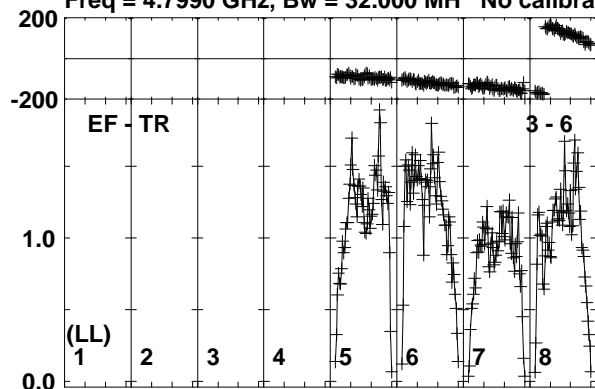

Lower frame: Milli Ampl Jy Top frame: Phas deg
Vector averaged cross-power spectrum Baseline: EF (03) - TR (06)
Timerange: 00/14:40:21 to 00/14:41:49

Plot file version 147 created 28-AUG-2017 13:19:11

SSS17A RP029A.UVDATA.1

Freq = 4.7990 GHz, Bw = 32.000 MH No calibration applied and no bandpass applied

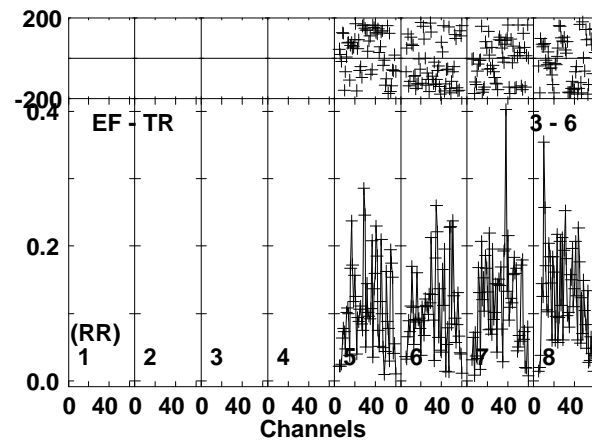
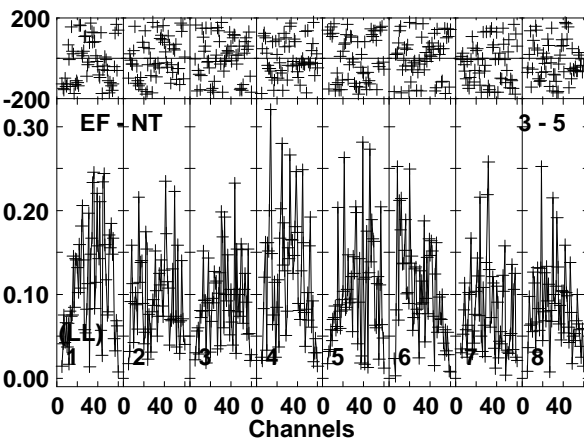
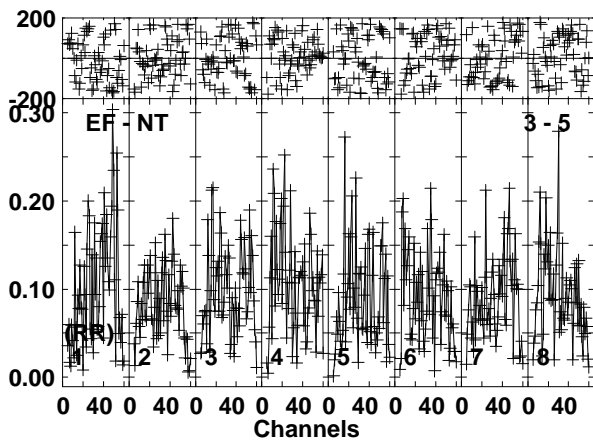
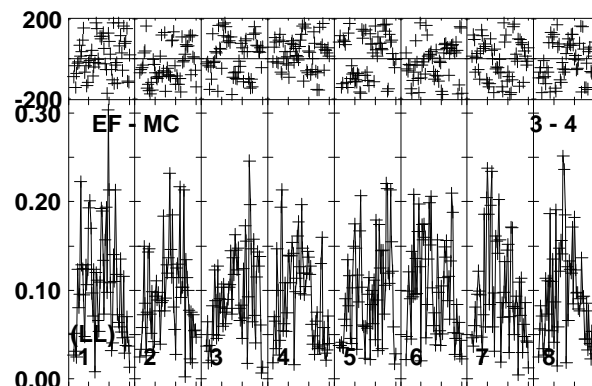
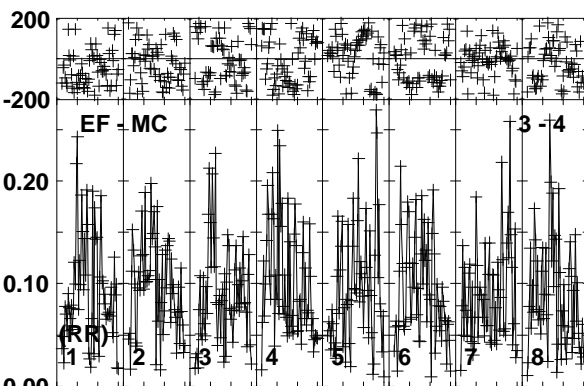
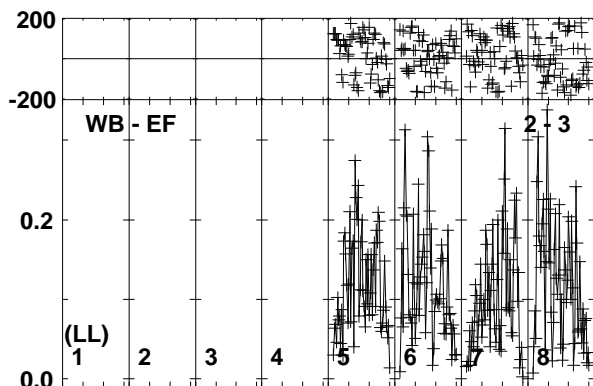
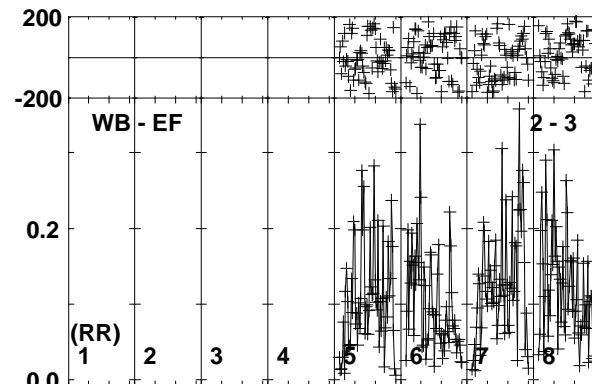
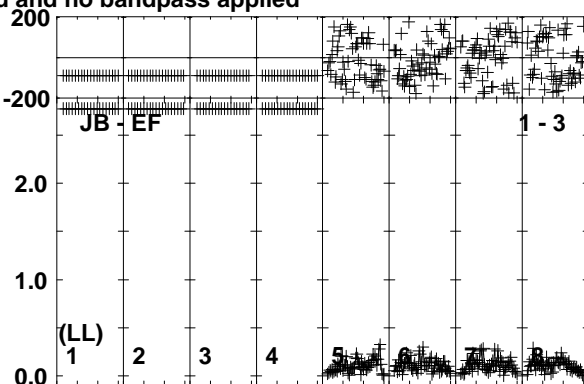
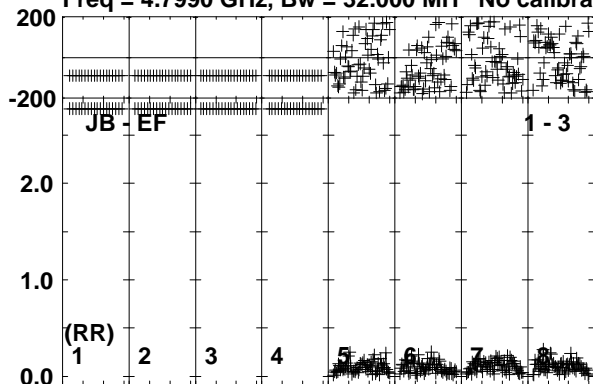

Lower frame: Milli Ampl Jy Top frame: Phas deg
Vector averaged cross-power spectrum Baseline: JB (01) - EF (03)
Timerange: 00/14:41:51 to 00/14:44:19

Plot file version 148 created 28-AUG-2017 13:19:11

SSS17A RP029A.UVDATA.1

Freq = 4.7990 GHz, Bw = 32.000 MH No calibration applied and no bandpass applied

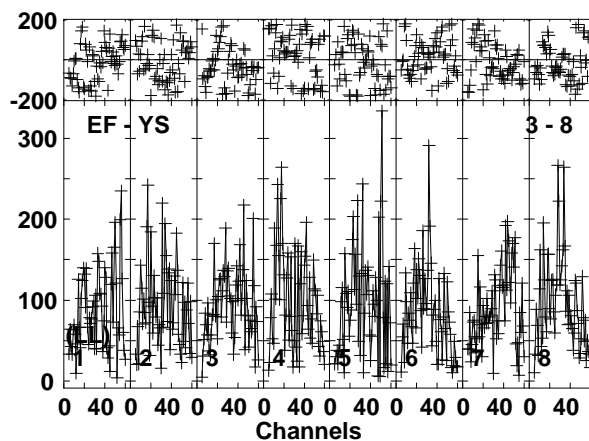
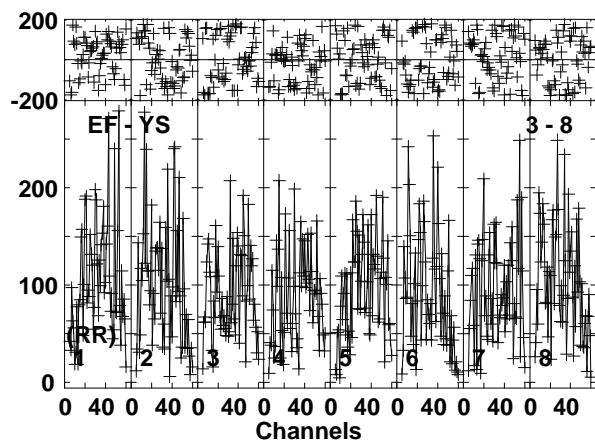
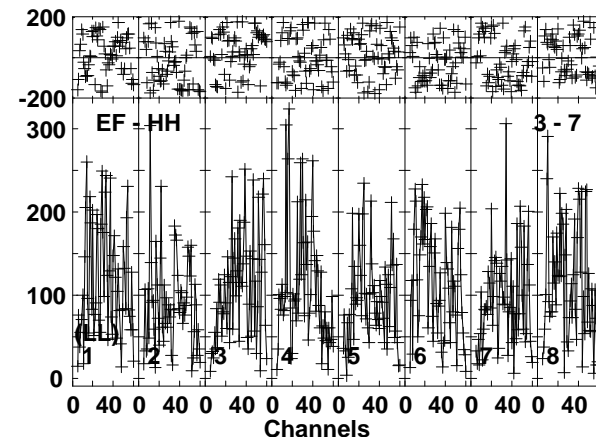
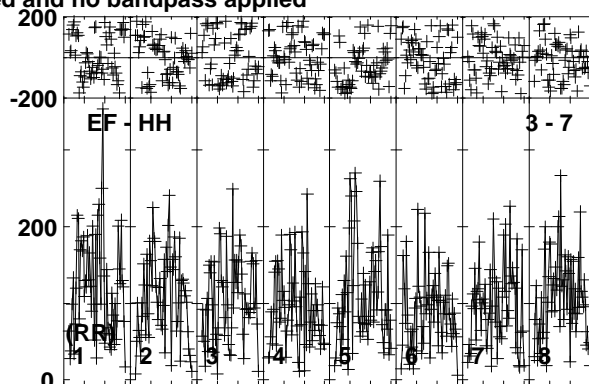
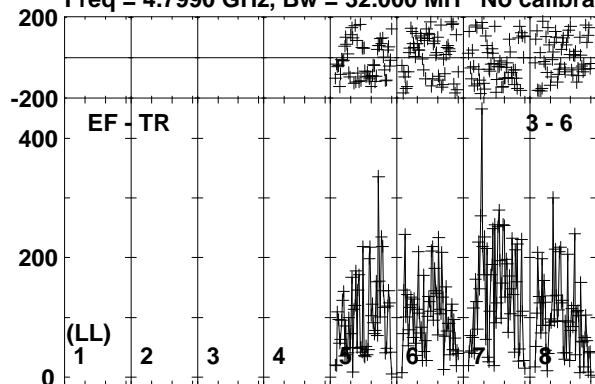

Lower frame: Micro Ampl Jy Top frame: Phas deg
Vector averaged cross-power spectrum Baseline: EF (03) - TR (06)
Timerange: 00/14:41:51 to 00/14:44:19

Plot file version 149 created 28-AUG-2017 13:19:11

J1303-2405 RP029A.UVDATA.1

Freq = 4.7990 GHz, Bw = 32.000 MH No calibration applied and no bandpass applied

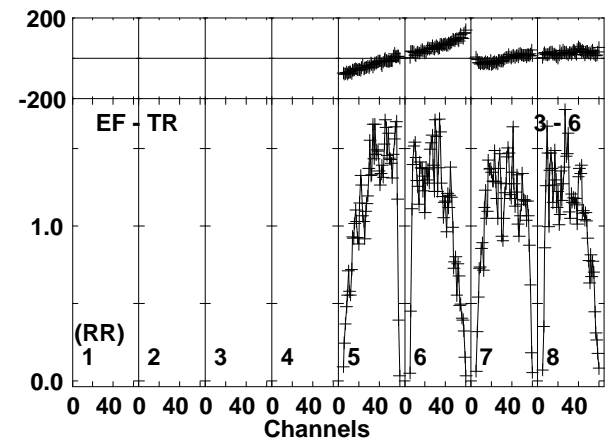
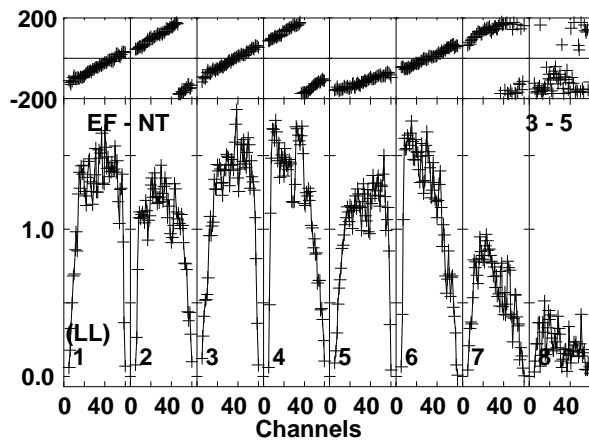
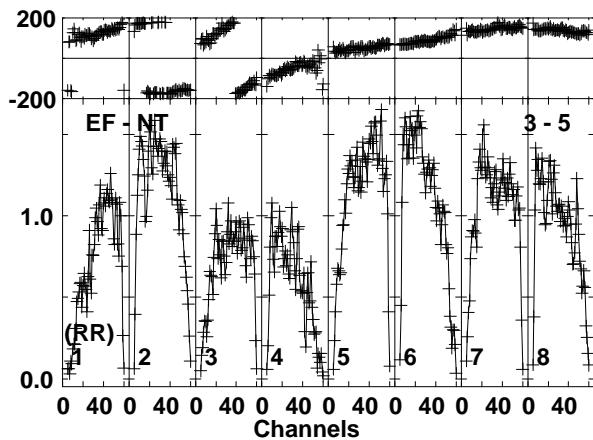
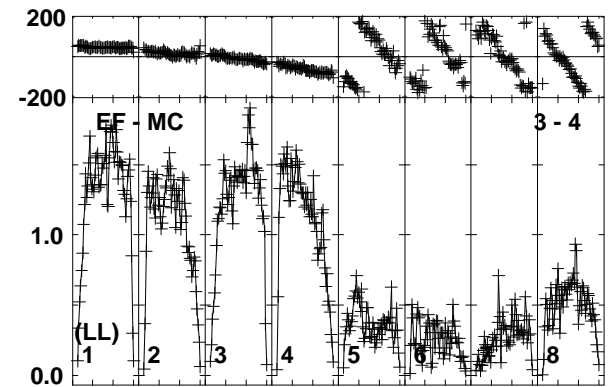
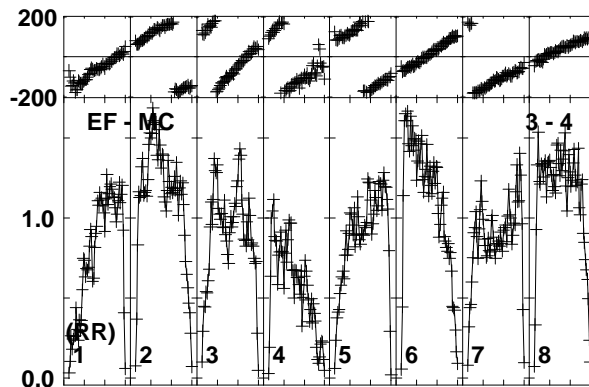
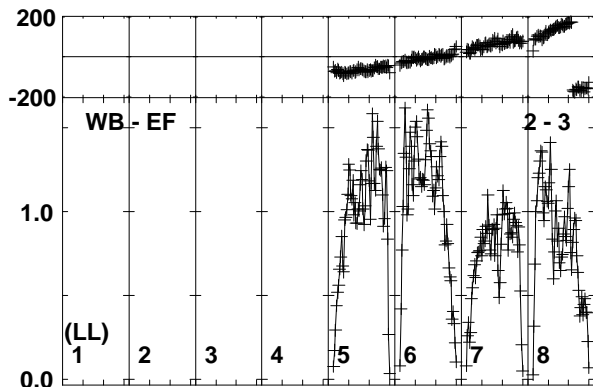
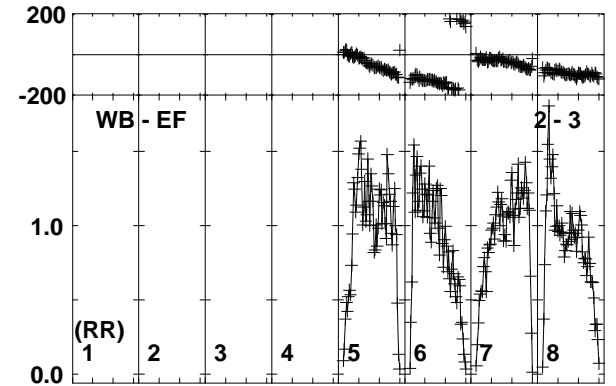
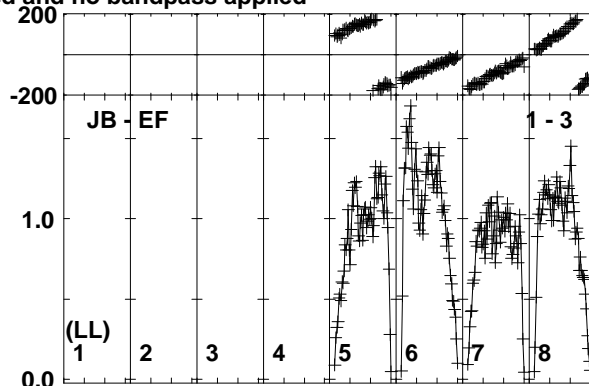
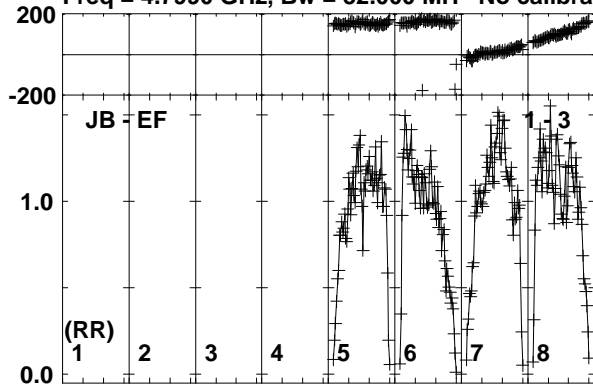

Lower frame: Milli Ampl Jy Top frame: Phas deg
Vector averaged cross-power spectrum Baseline: JB (01) - EF (03)
Timerange: 00/14:44:51 to 00/14:45:49

Plot file version 150 created 28-AUG-2017 13:19:11

J1303-2405 RP029A.UVDATA.1

Freq = 4.7990 GHz, Bw = 32.000 MH No calibration applied and no bandpass applied

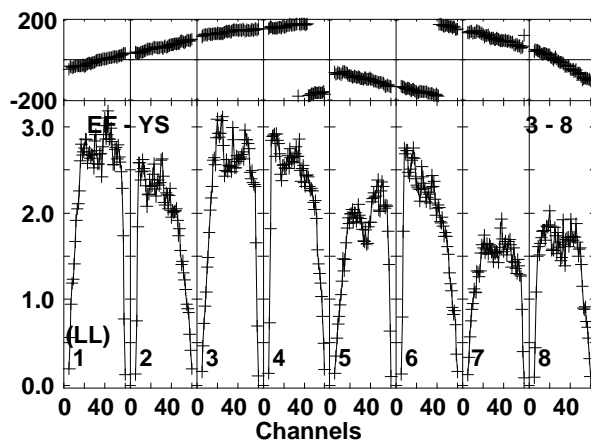
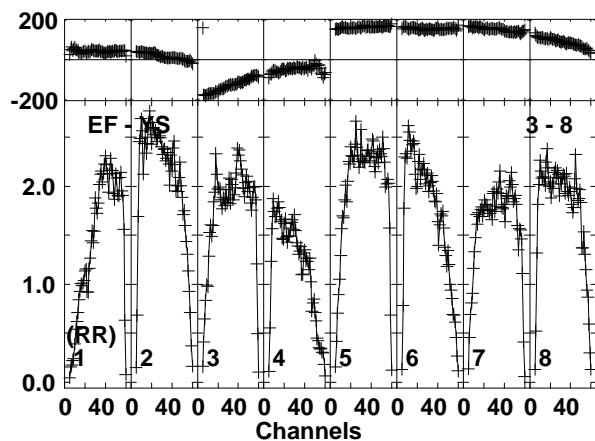
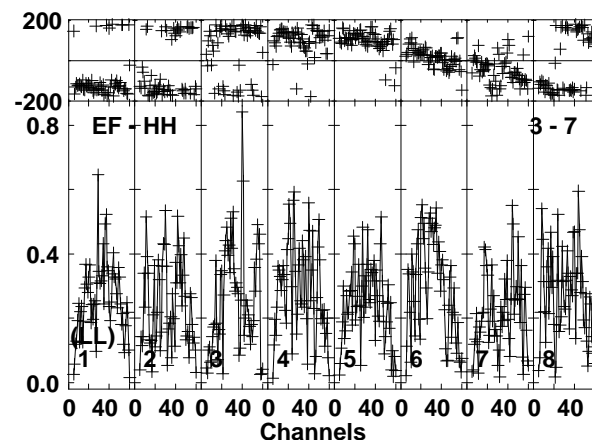
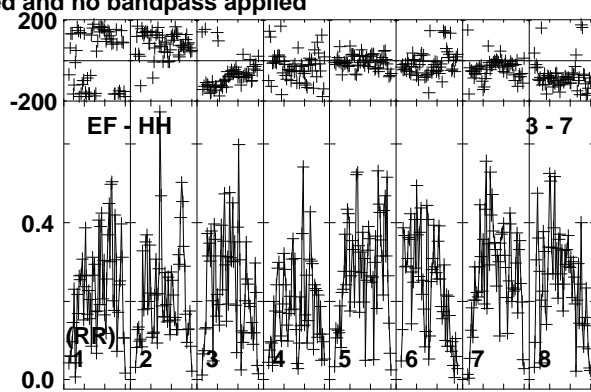
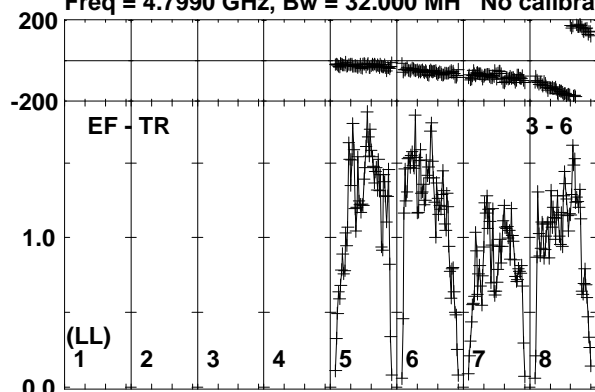

Lower frame: Milli Ampl Jy Top frame: Phas deg
Vector averaged cross-power spectrum Baseline: EF (03) - TR (06)
Timerange: 00/14:44:51 to 00/14:45:49

Plot file version 151 created 28-AUG-2017 13:19:11

SSS17A RP029A.UVDATA.1

Freq = 4.7990 GHz, Bw = 32.000 MH No calibration applied and no bandpass applied

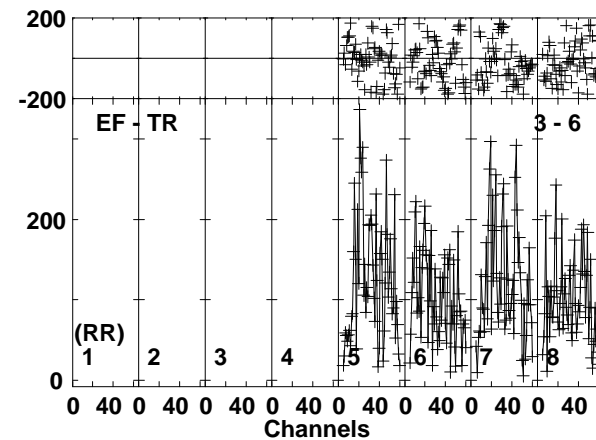
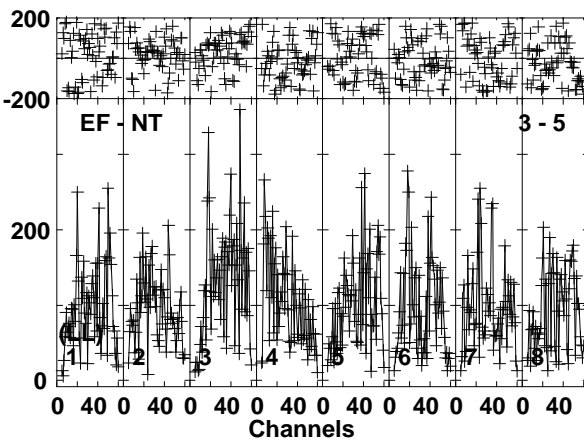
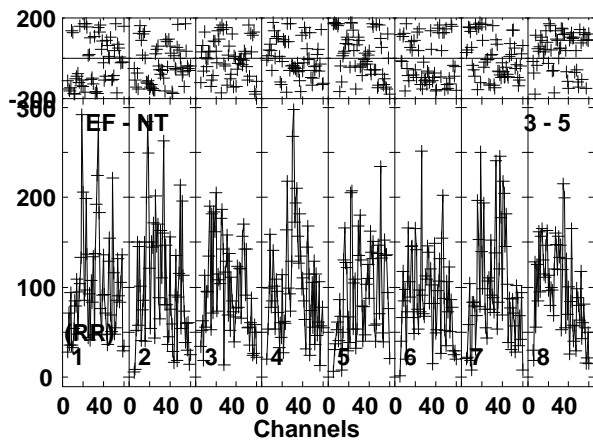
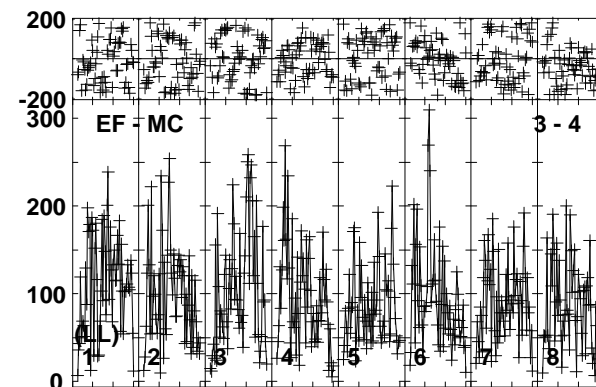
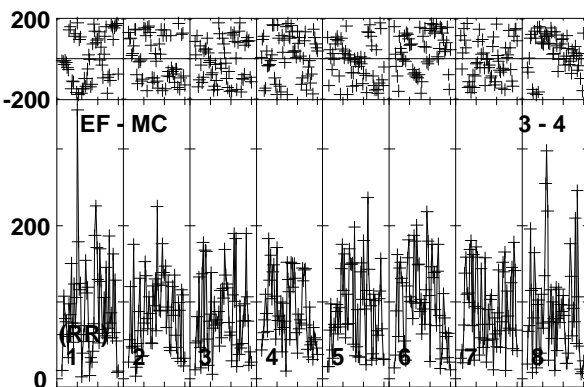
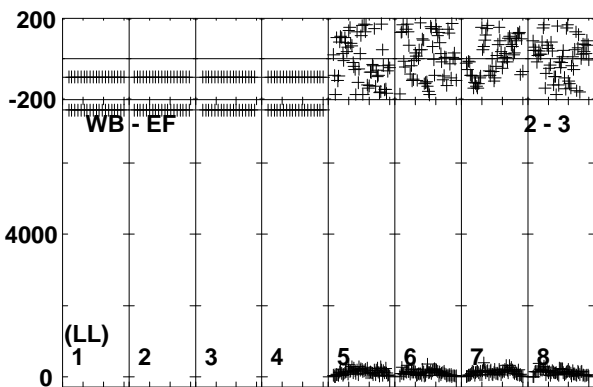
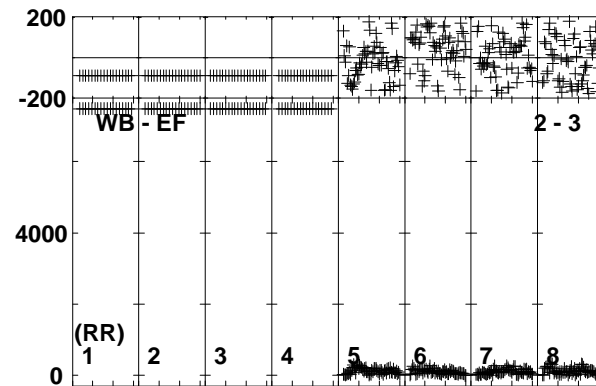
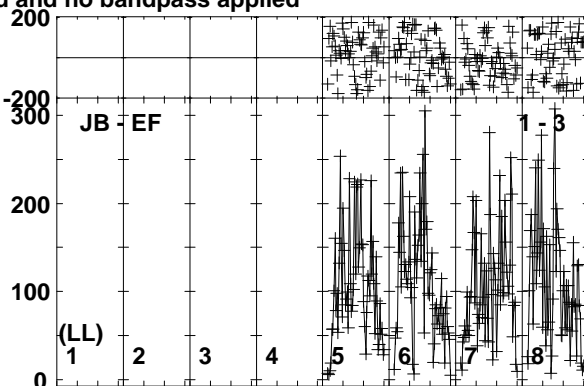
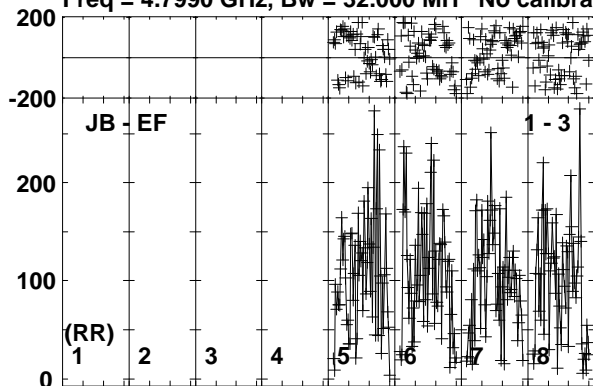

Lower frame: Micro Ampl Jy Top frame: Phas deg
Vector averaged cross-power spectrum Baseline: JB (01) - EF (03)
Timerange: 00:14:45:51 to 00:14:48:19

Plot file version 152 created 28-AUG-2017 13:19:11

SSS17A RP029A.UVDATA.1

Freq = 4.7990 GHz, Bw = 32.000 MH No calibration applied and no bandpass applied

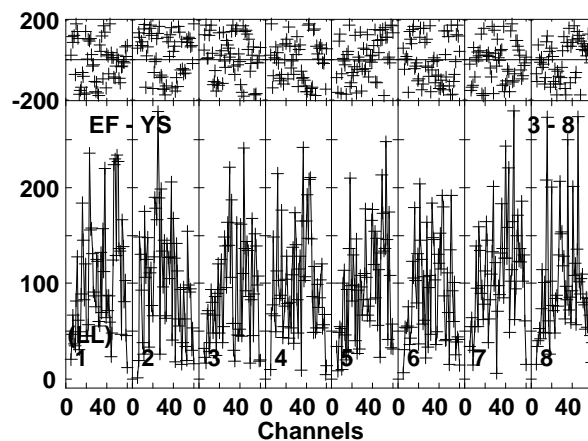
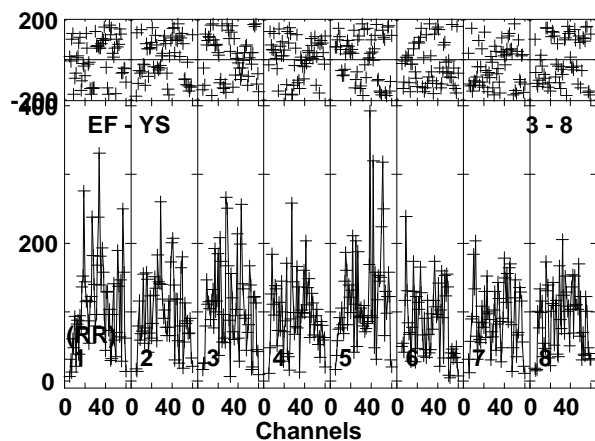
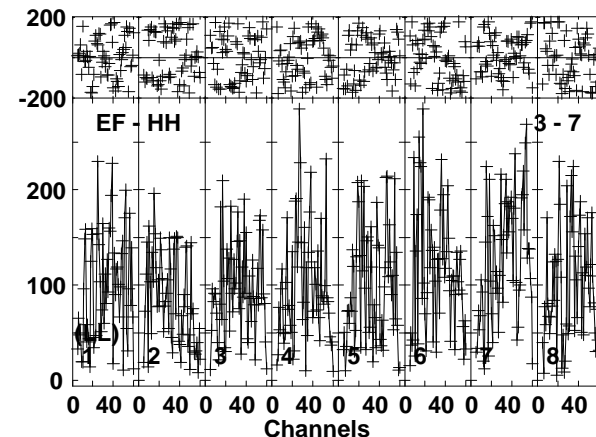
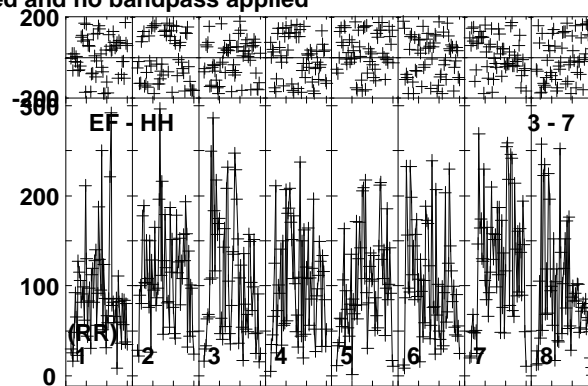
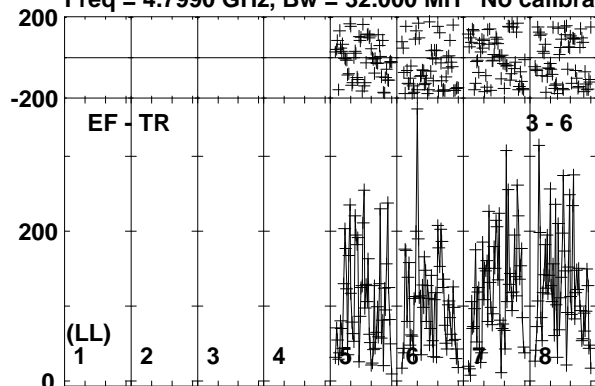

Lower frame: Micro Ampl Jy Top frame: Phas deg
Vector averaged cross-power spectrum Baseline: EF (03) - TR (06)
Timerange: 00/14:45:51 to 00/14:48:19

Plot file version 153 created 28-AUG-2017 13:19:11

J1303-2405 RP029A.UVDATA.1

Freq = 4.7990 GHz, Bw = 32.000 MH No calibration applied and no bandpass applied

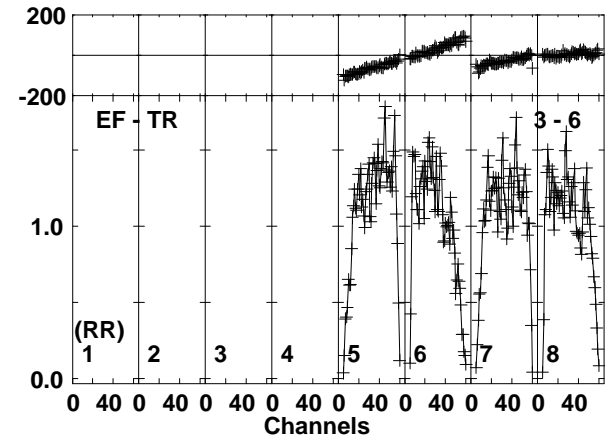
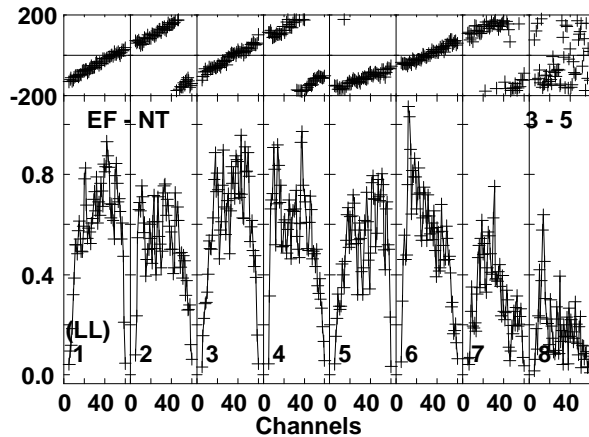
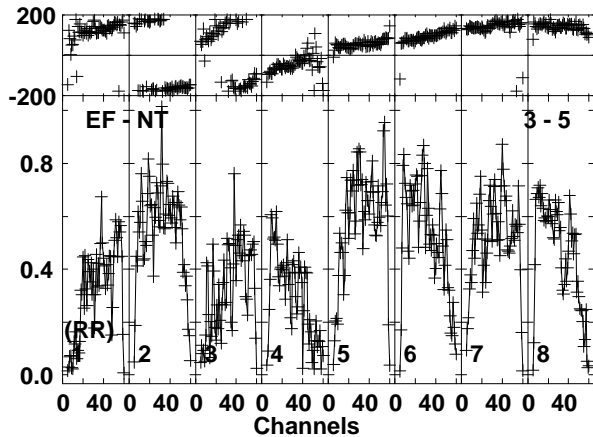
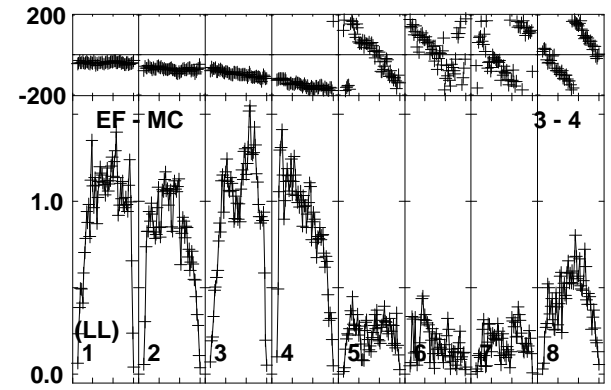
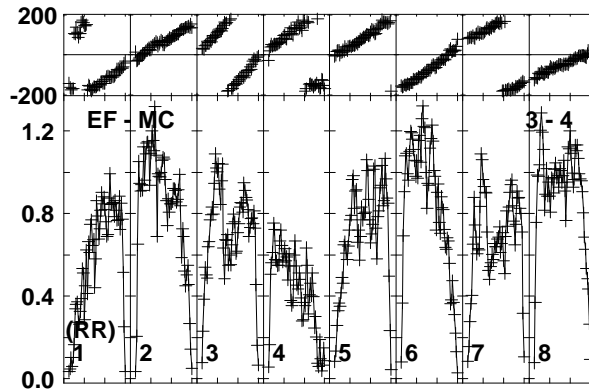
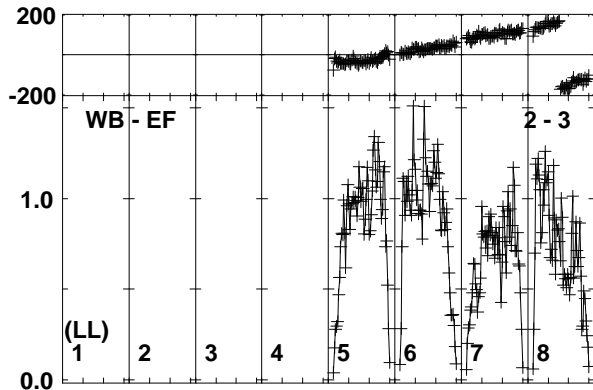
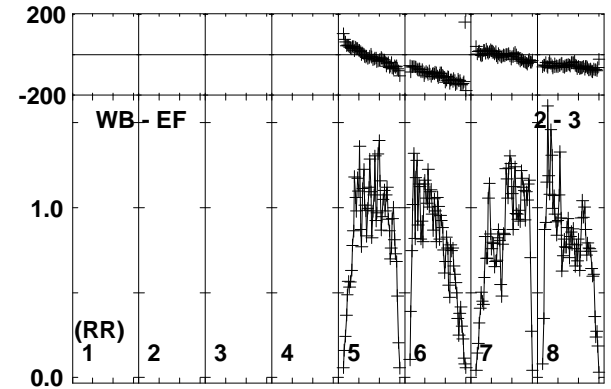
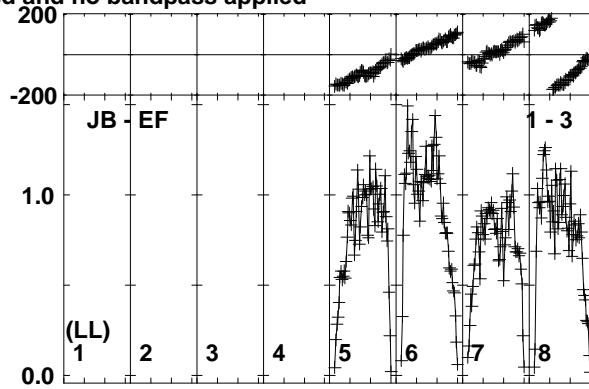
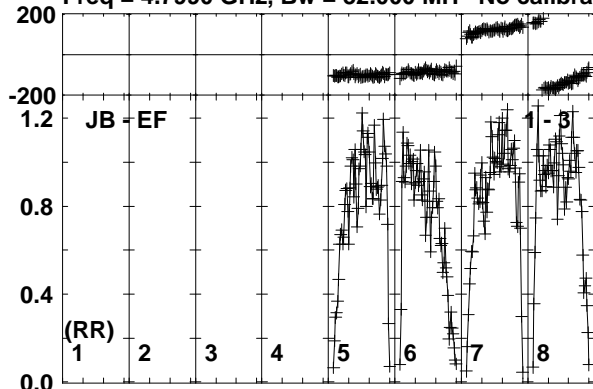

Lower frame: Milli Ampl Jy Top frame: Phas deg
Vector averaged cross-power spectrum Baseline: JB (01) - EF (03)
Timerange: 00/14:48:21 to 00/14:49:49

Plot file version 154 created 28-AUG-2017 13:19:11

J1303-2405 RP029A.UVDATA.1

Freq = 4.7990 GHz, Bw = 32.000 MH No calibration applied and no bandpass applied

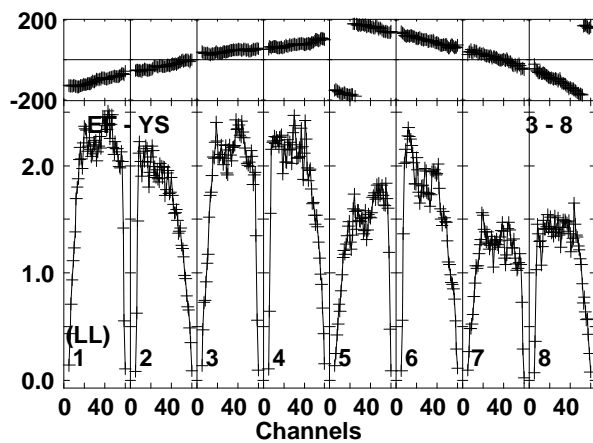
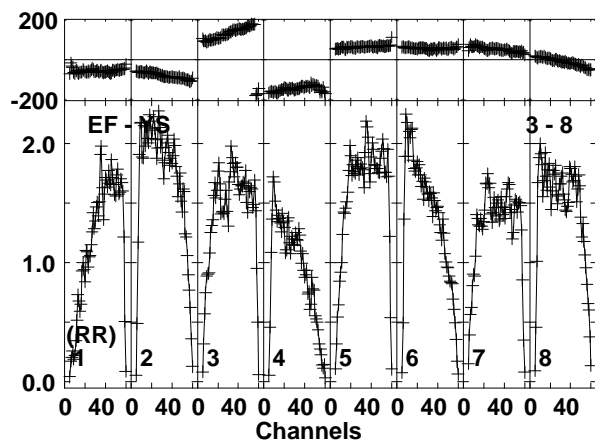
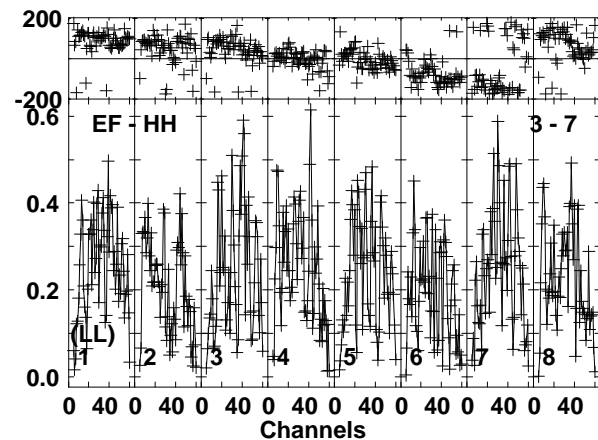
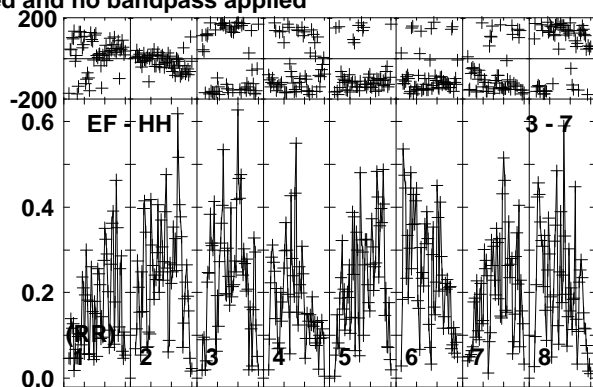
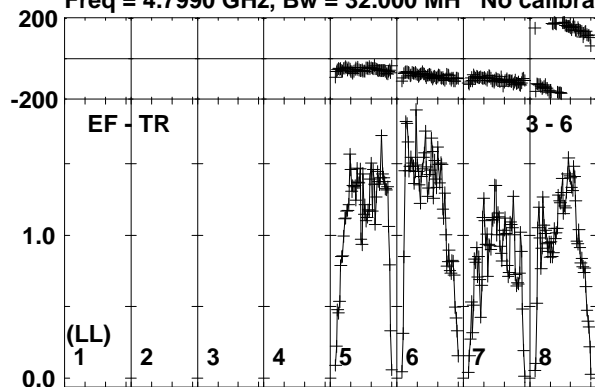

Lower frame: Milli Ampl Jy Top frame: Phas deg
Vector averaged cross-power spectrum Baseline: EF (03) - TR (06)
Timerange: 00/14:48:21 to 00/14:49:49

Plot file version 155 created 28-AUG-2017 13:19:11

J1312-2350 RP029A.UVDATA.1

Freq = 4.7990 GHz, Bw = 32.000 MH No calibration applied and no bandpass applied

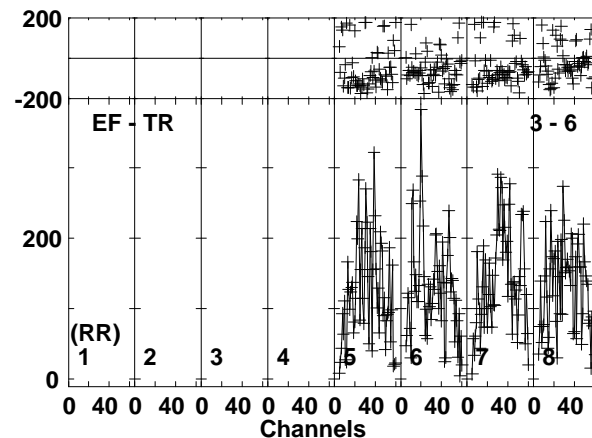
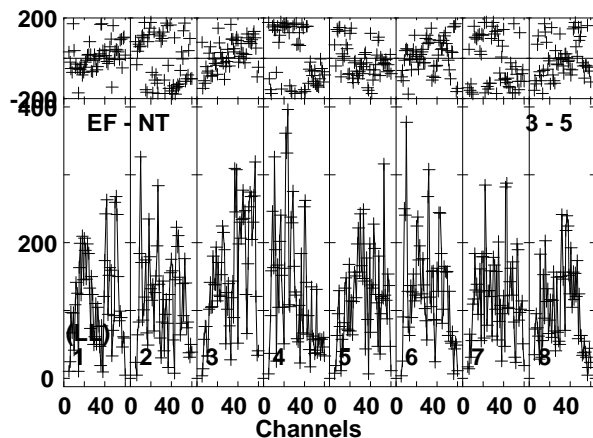
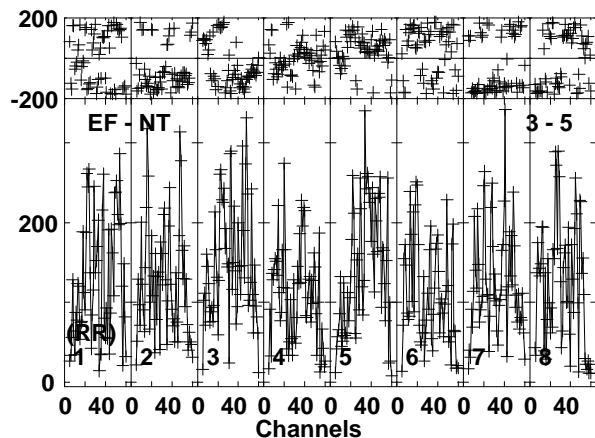
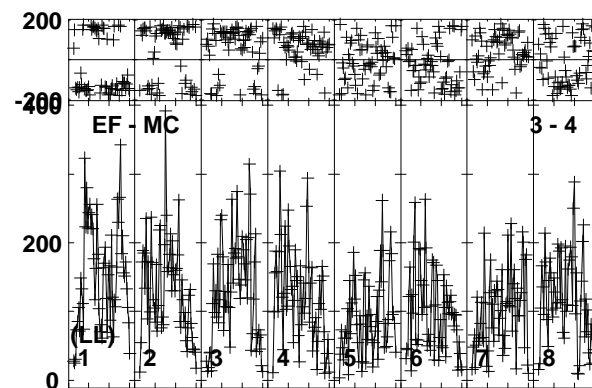
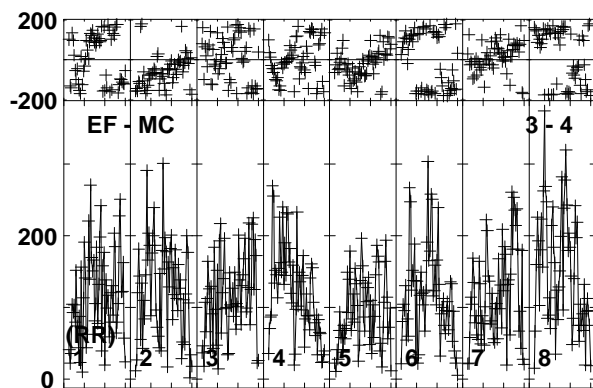
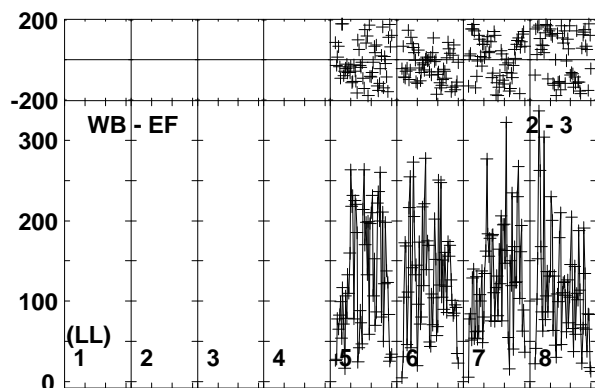
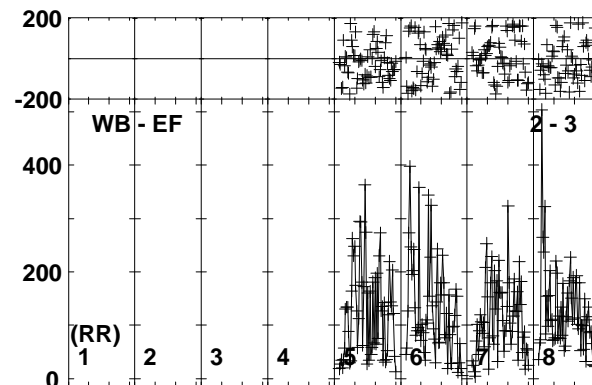
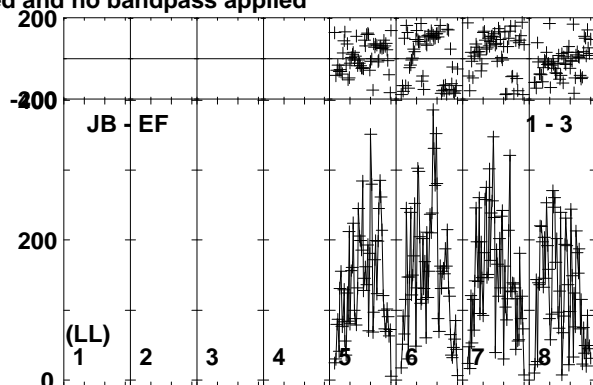
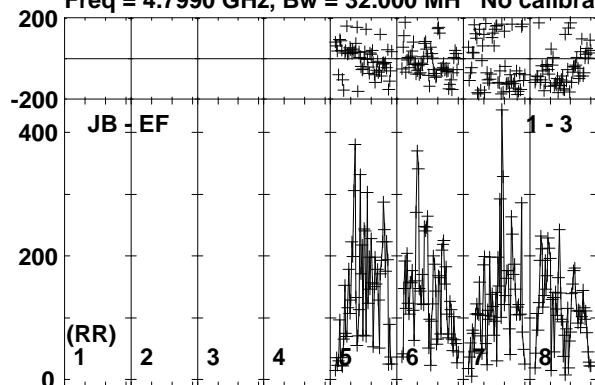

Lower frame: Micro Ampl Jy Top frame: Phas deg
Vector averaged cross-power spectrum Baseline: JB (01) - EF (03)
Timerange: 00/14:49:51 to 00/14:52:19

Plot file version 156 created 28-AUG-2017 13:19:11

J1312-2350 RP029A.UVDATA.1

Freq = 4.7990 GHz, Bw = 32.000 MH No calibration applied and no bandpass applied

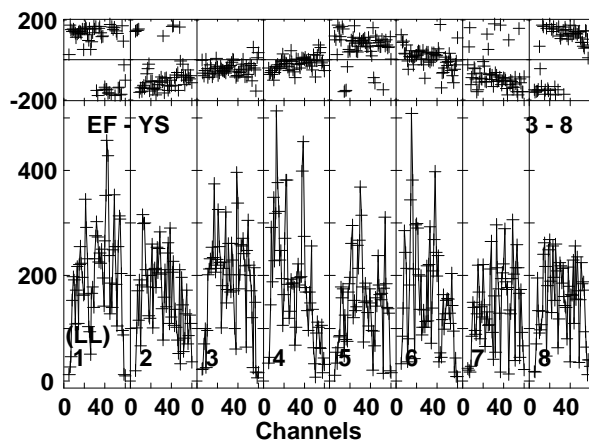
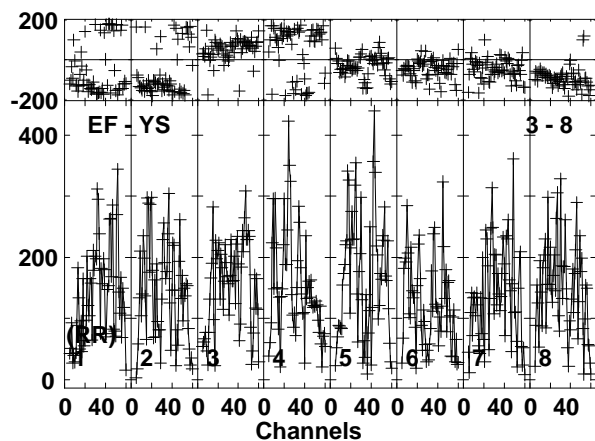
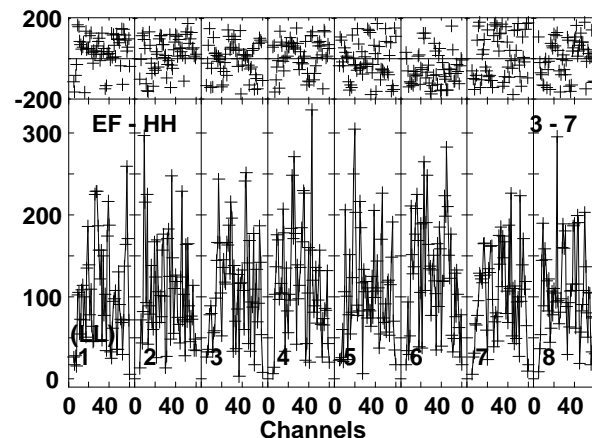
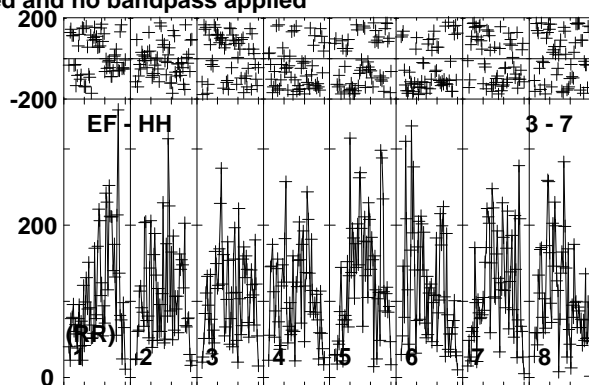
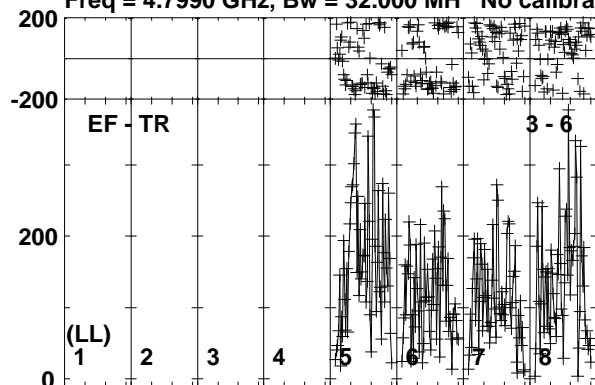

Lower frame: Micro Ampl Jy Top frame: Phas deg
Vector averaged cross-power spectrum Baseline: EF (03) - TR (06)
Timerange: 00/14:49:51 to 00/14:52:19

Plot file version 157 created 28-AUG-2017 13:19:11

J1303-2405 RP029A.UVDATA.1

Freq = 4.7990 GHz, Bw = 32.000 MH No calibration applied and no bandpass applied

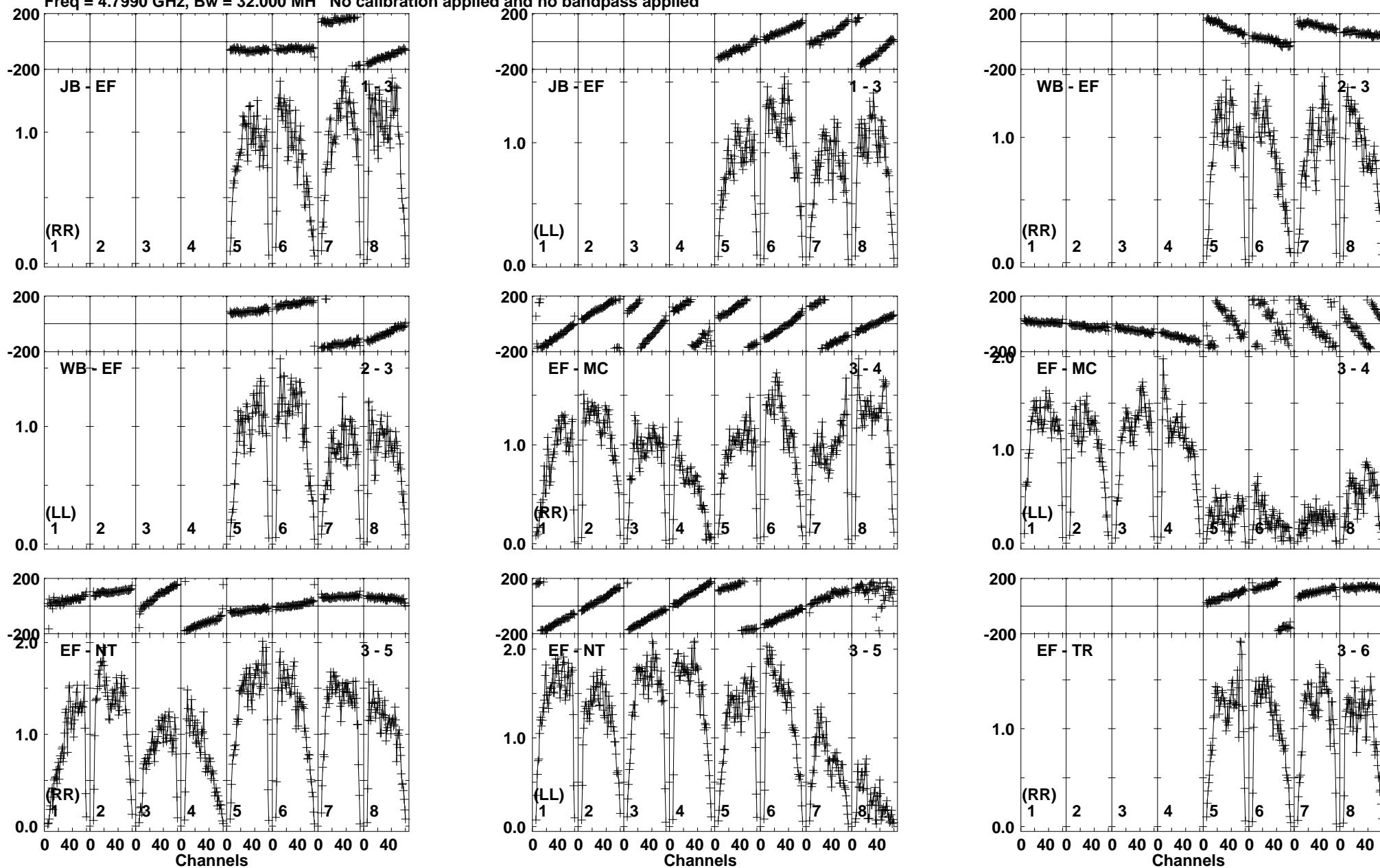

Lower frame: Milli Ampl Jy Top frame: Phas deg
Vector averaged cross-power spectrum Baseline: JB (01) - EF (03)
Timerange: 00/14:53:01 to 00/14:53:59

Plot file version 158 created 28-AUG-2017 13:19:11

J1303-2405 RP029A.UVDATA.1

Freq = 4.7990 GHz, Bw = 32.000 MH No calibration applied and no bandpass applied

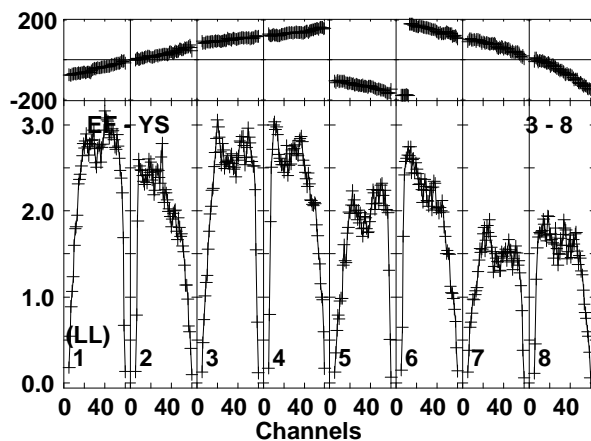
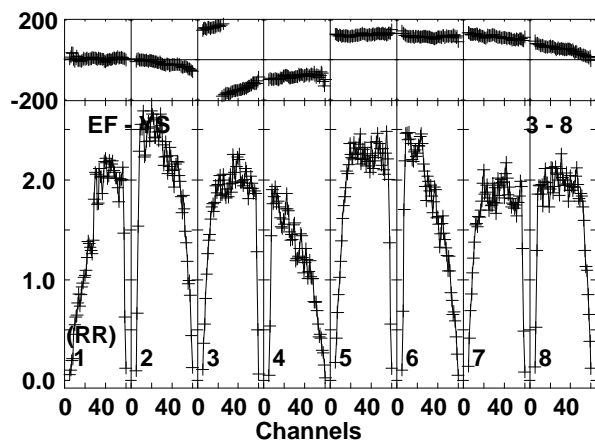
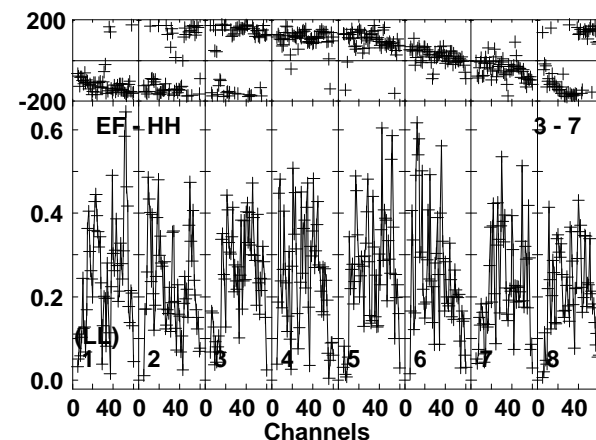
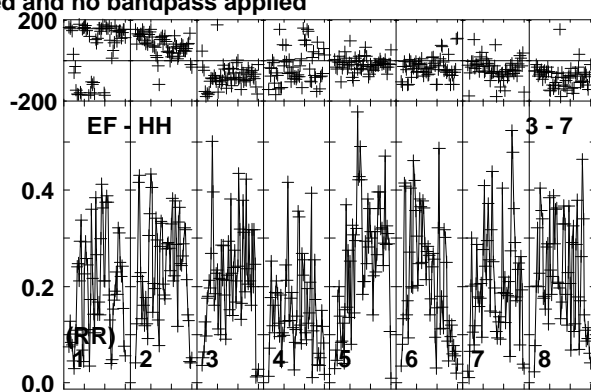
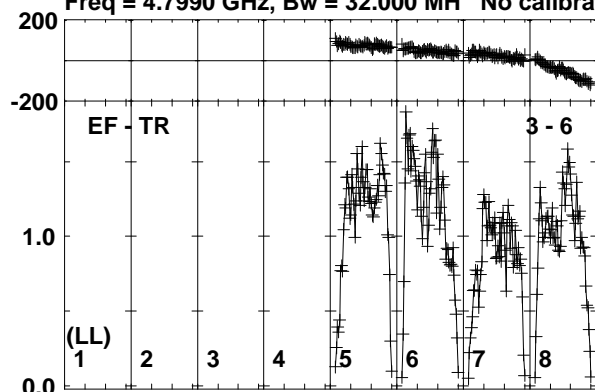

Lower frame: Milli Ampl Jy Top frame: Phas deg
Vector averaged cross-power spectrum Baseline: EF (03) - TR (06)
Timerange: 00/14:53:01 to 00/14:53:59

Plot file version 159 created 28-AUG-2017 13:19:11

SSS17A RP029A.UVDATA.1

Freq = 4.7990 GHz, Bw = 32.000 MH No calibration applied and no bandpass applied

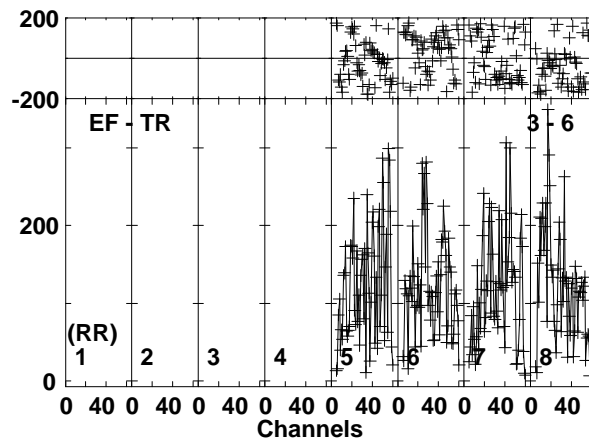
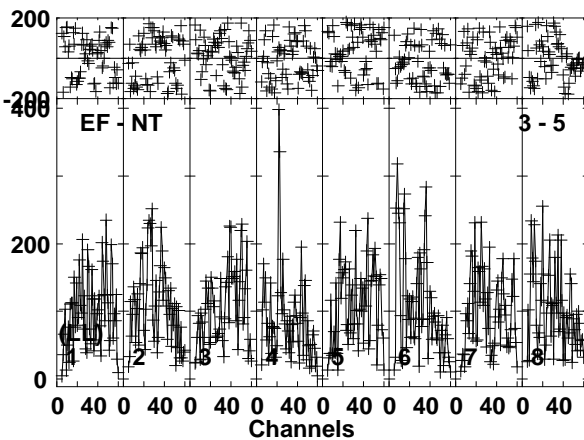
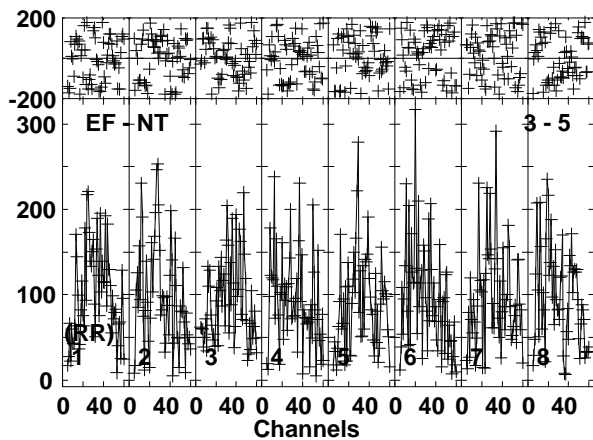
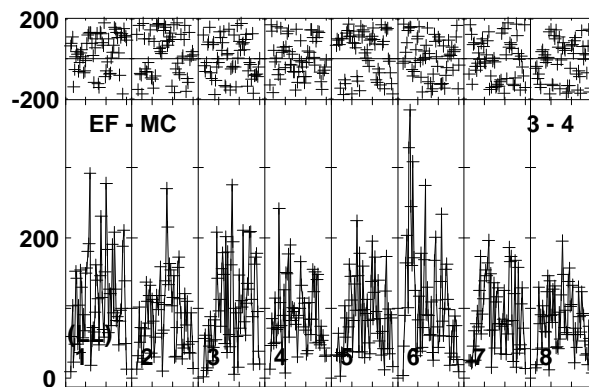
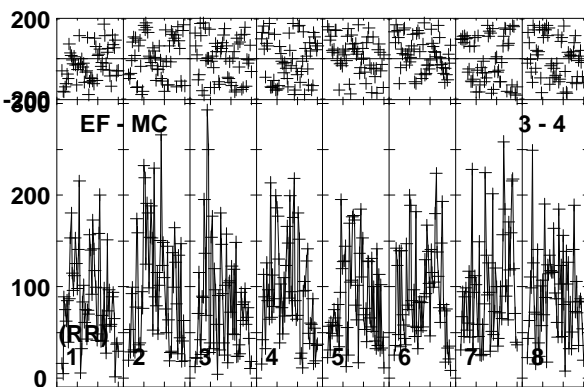
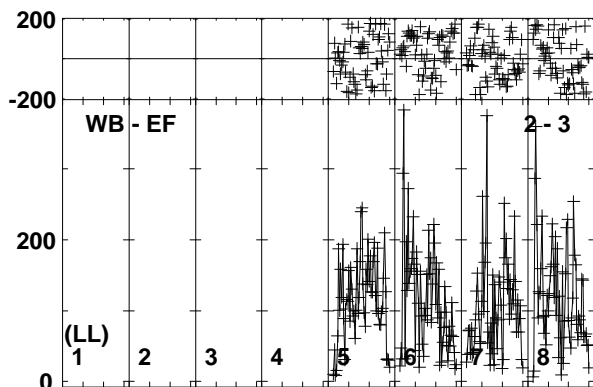
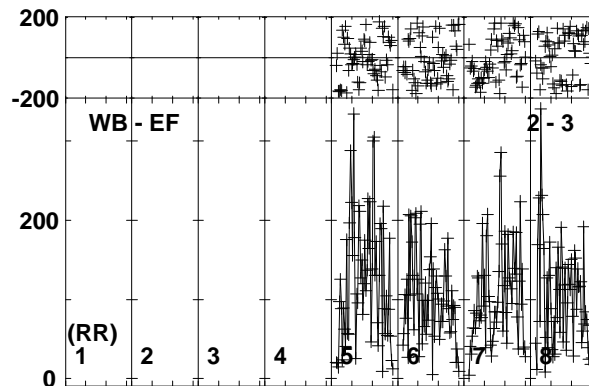
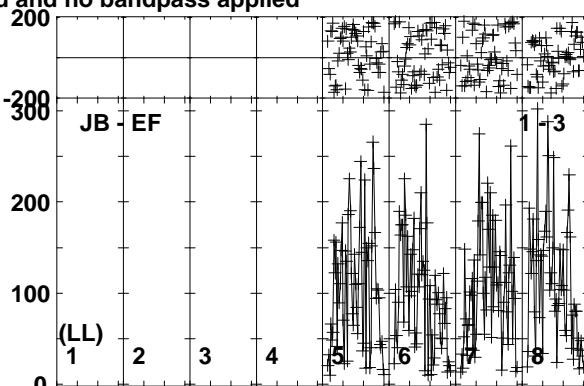
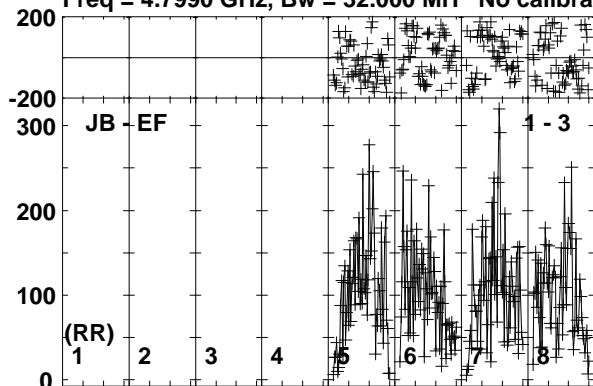

Lower frame: Micro Ampl Jy Top frame: Phas deg
Vector averaged cross-power spectrum Baseline: JB (01) - EF (03)
Timerange: 00/14:54:01 to 00/14:56:29

Plot file version 160 created 28-AUG-2017 13:19:12

SSS17A RP029A.UVDATA.1

Freq = 4.7990 GHz, Bw = 32.000 MH No calibration applied and no bandpass applied

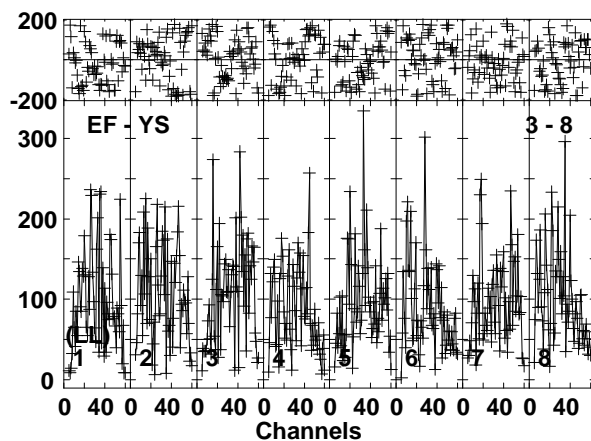
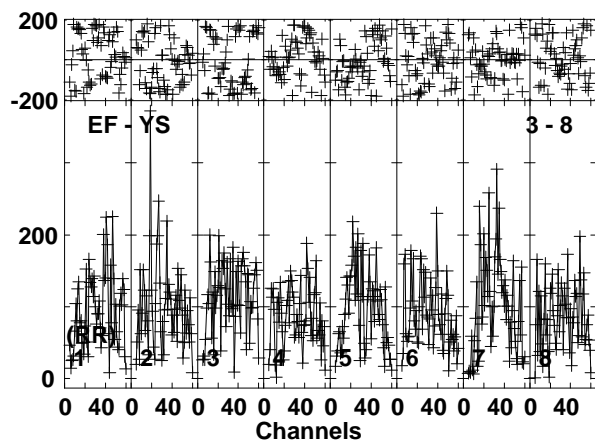
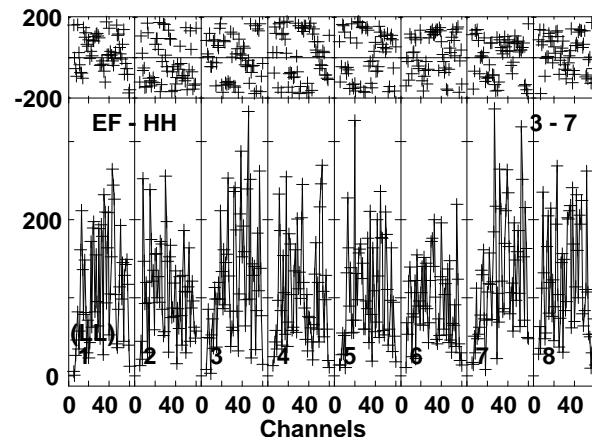
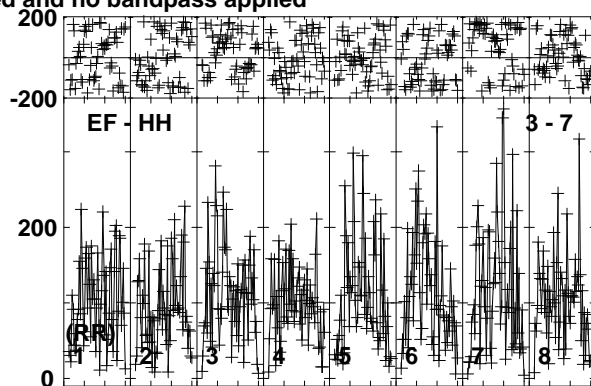
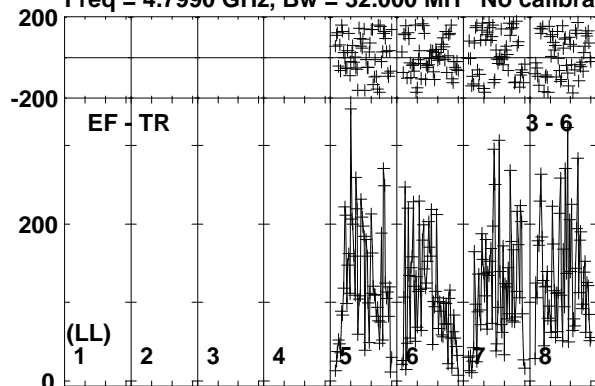

Lower frame: Micro Ampl Jy Top frame: Phas deg
Vector averaged cross-power spectrum Baseline: EF (03) - TR (06)
Timerange: 00/14:54:01 to 00/14:56:29

Plot file version 161 created 28-AUG-2017 13:19:12

J1303-2405 RP029A.UVDATA.1

Freq = 4.7990 GHz, Bw = 32.000 MH No calibration applied and no bandpass applied

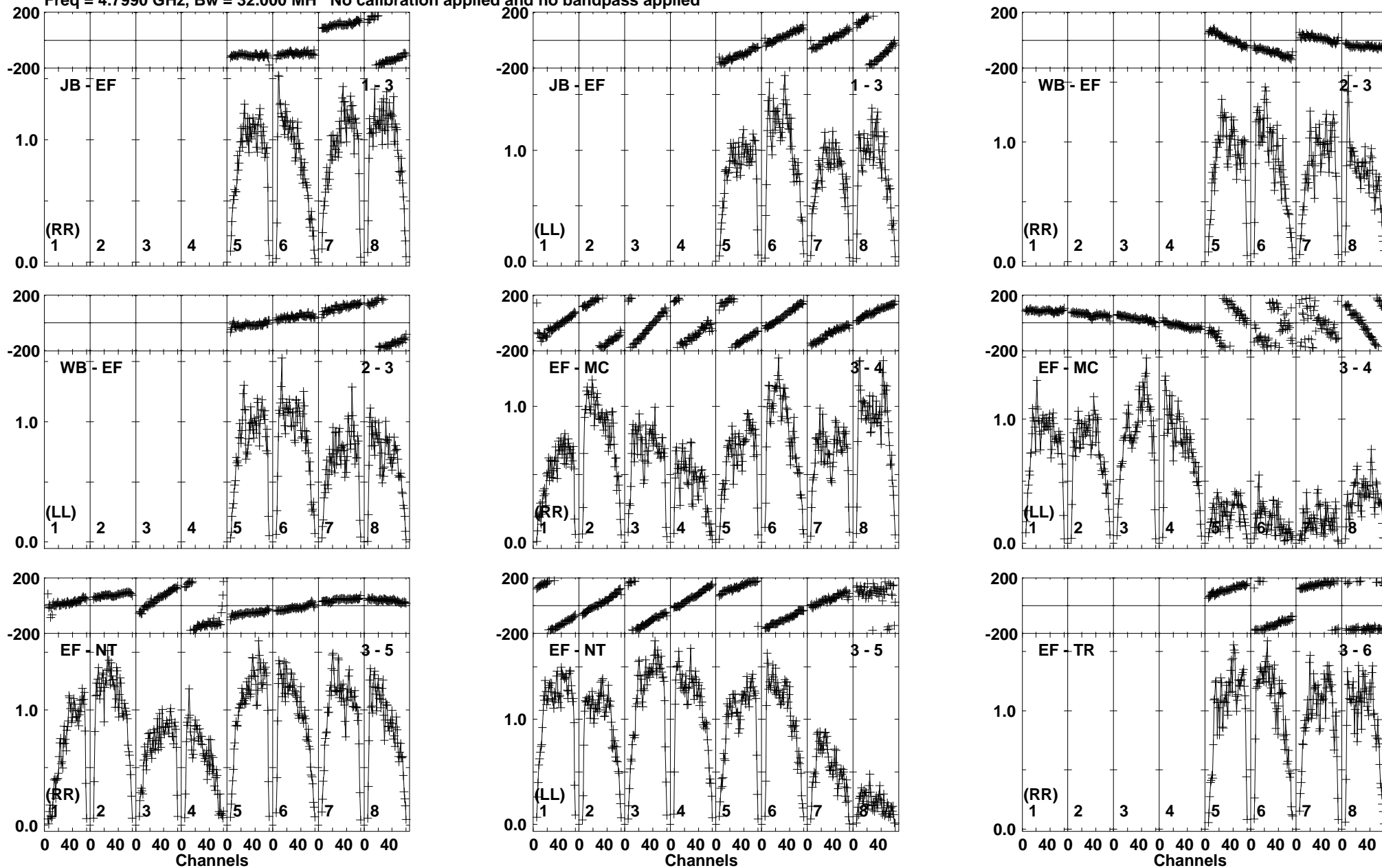

Lower frame: Milli Ampl Jy Top frame: Phas deg
Vector averaged cross-power spectrum Baseline: JB (01) - EF (03)
Timerange: 00/14:56:31 to 00/14:57:59

Plot file version 162 created 28-AUG-2017 13:19:12

J1303-2405 RP029A.UVDATA.1

Freq = 4.7990 GHz, Bw = 32.000 MH No calibration applied and no bandpass applied

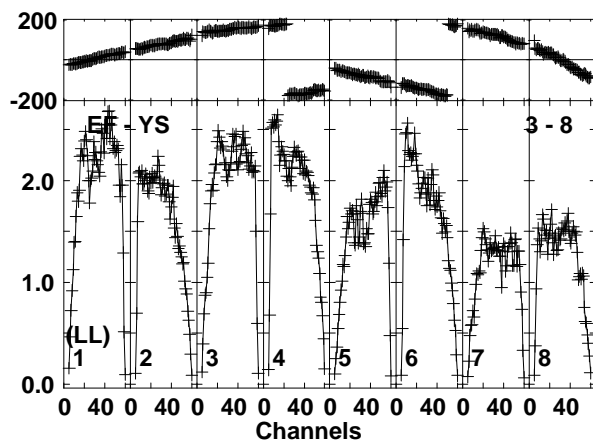
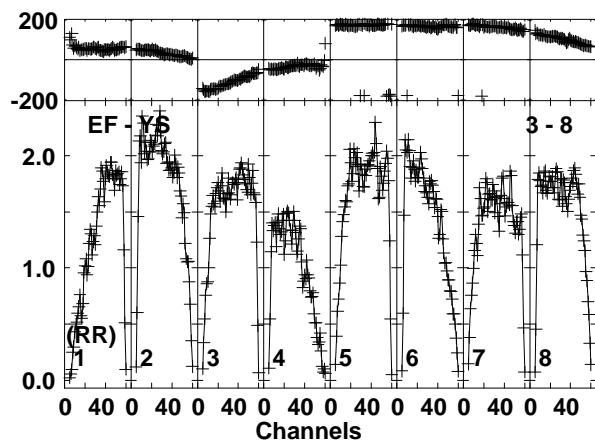
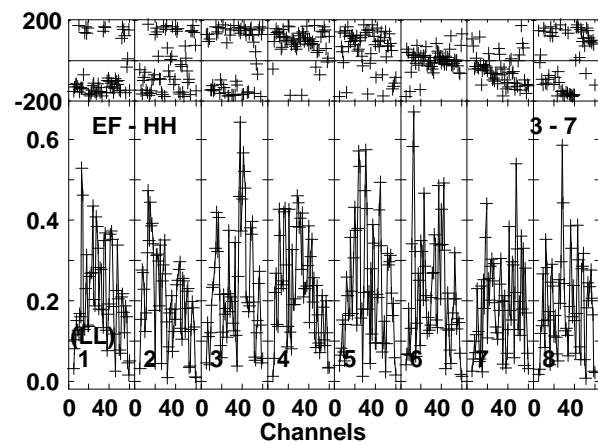
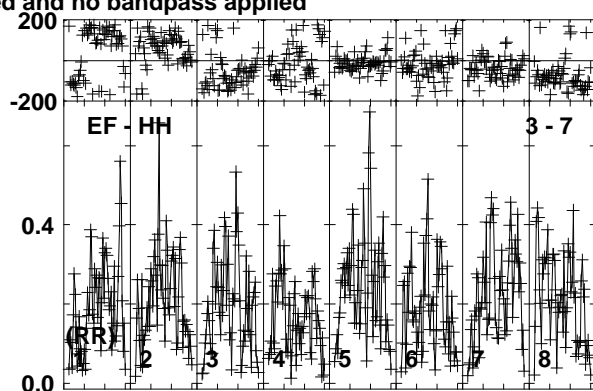
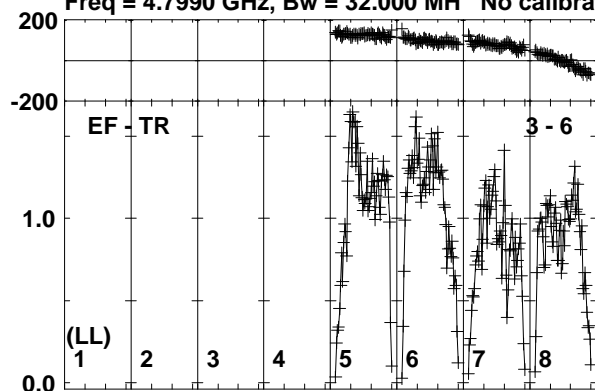

Lower frame: Milli Ampl Jy Top frame: Phas deg
Vector averaged cross-power spectrum Baseline: EF (03) - TR (06)
Timerange: 00/14:56:31 to 00/14:57:59

Plot file version 163 created 28-AUG-2017 13:19:12

SSS17A RP029A.UVDATA.1

Freq = 4.7990 GHz, Bw = 32.000 MH No calibration applied and no bandpass applied

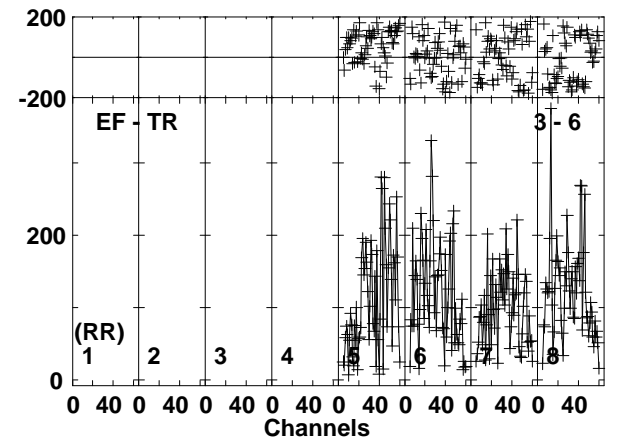
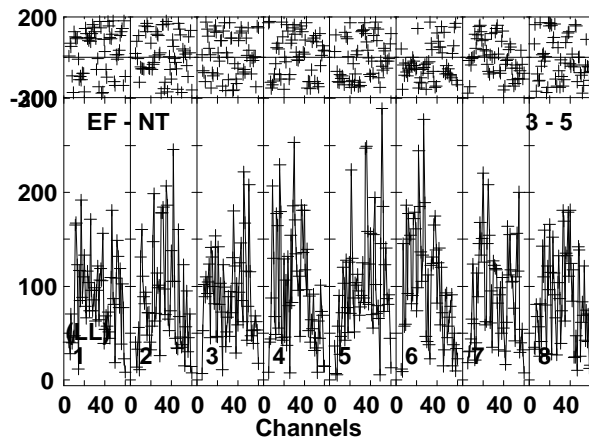
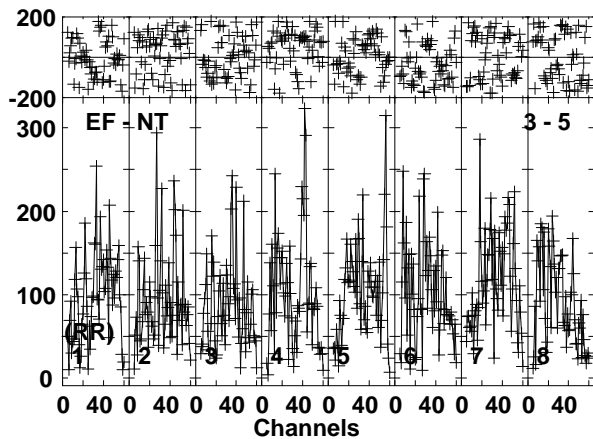
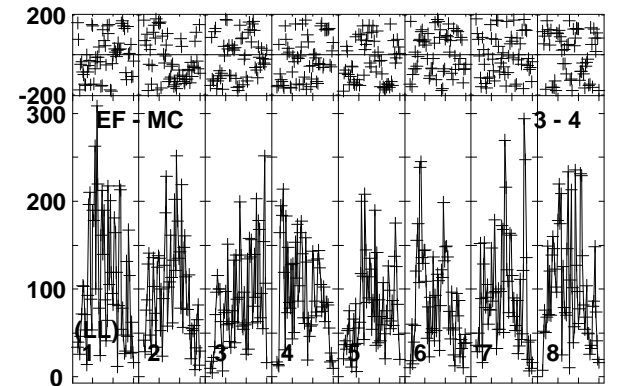
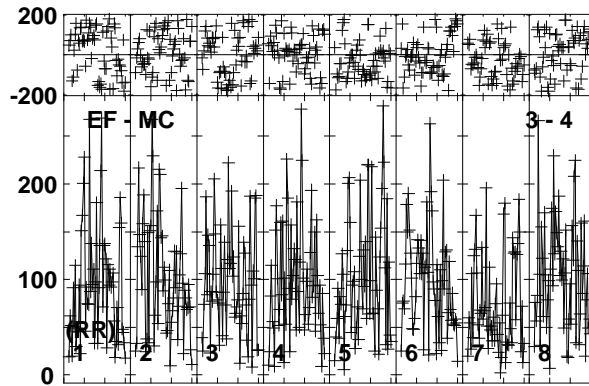
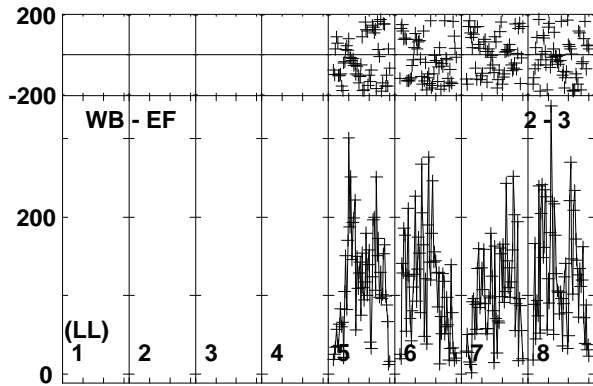
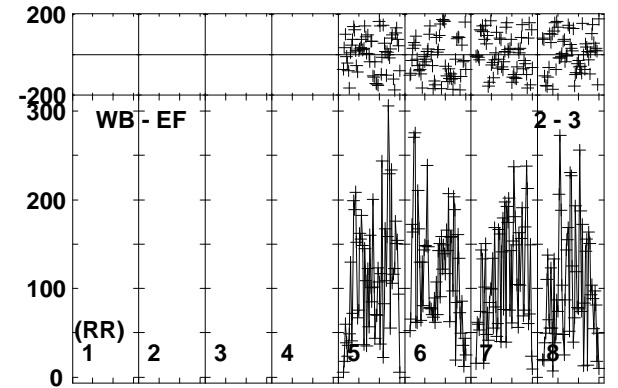
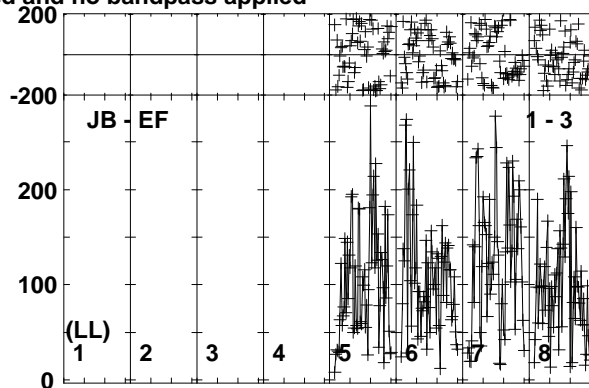
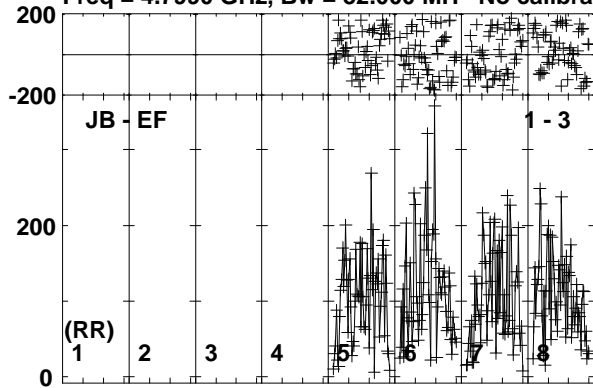

Lower frame: Micro Ampl Jy Top frame: Phas deg
Vector averaged cross-power spectrum Baseline: JB (01) - EF (03)
Timerange: 00/14:58:01 to 00/15:00:29

Plot file version 164 created 28-AUG-2017 13:19:12

SSS17A RP029A.UVDATA.1

Freq = 4.7990 GHz, Bw = 32.000 MH No calibration applied and no bandpass applied

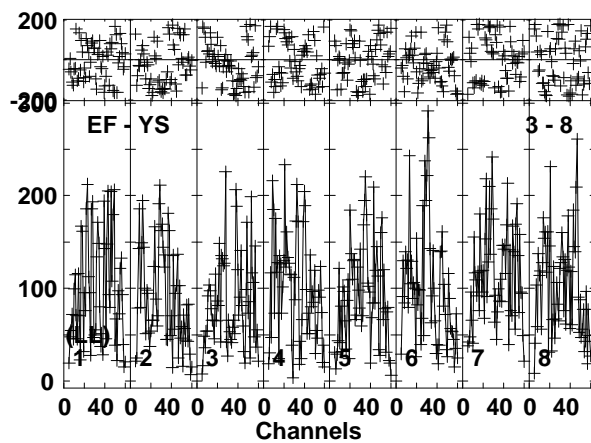
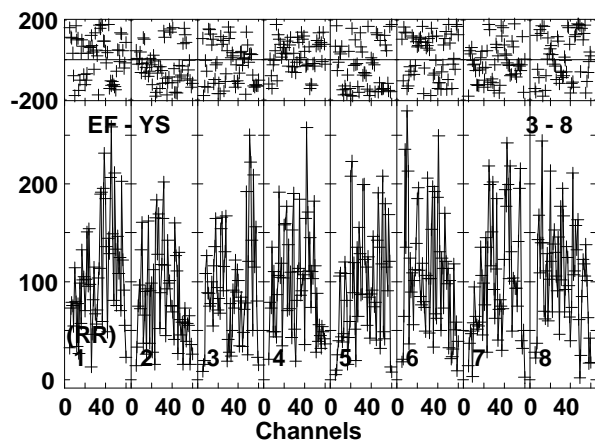
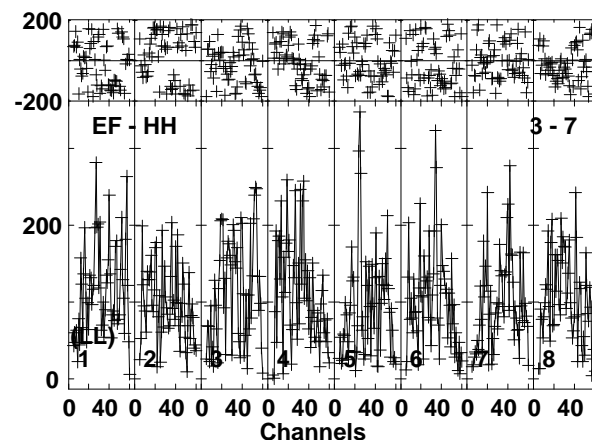
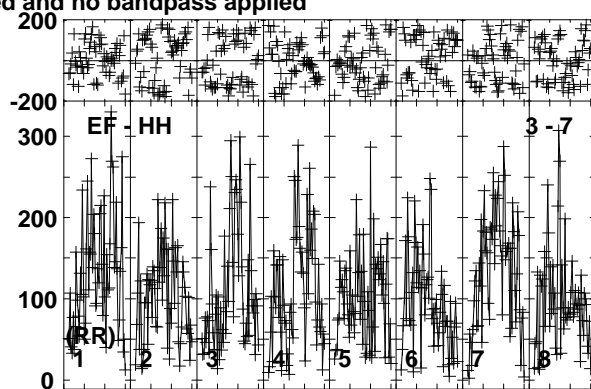
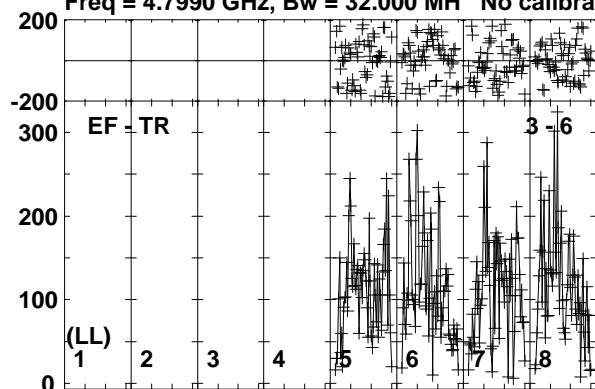

Lower frame: Micro Ampl Jy Top frame: Phas deg
Vector averaged cross-power spectrum Baseline: EF (03) - TR (06)
Timerange: 00/14:58:01 to 00/15:00:29

Plot file version 165 created 28-AUG-2017 13:19:12

J1303-2405 RP029A.UVDATA.1

Freq = 4.7990 GHz, Bw = 32.000 MH No calibration applied and no bandpass applied

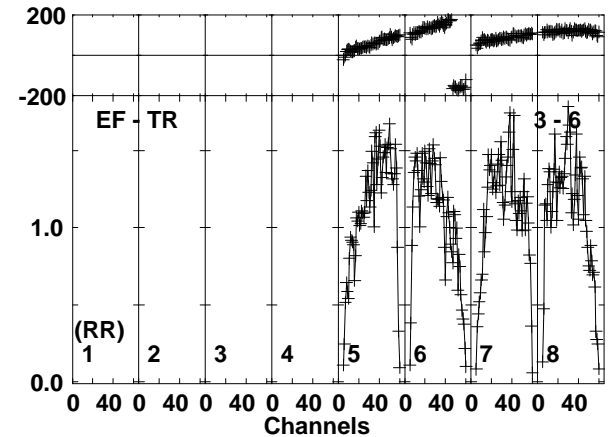
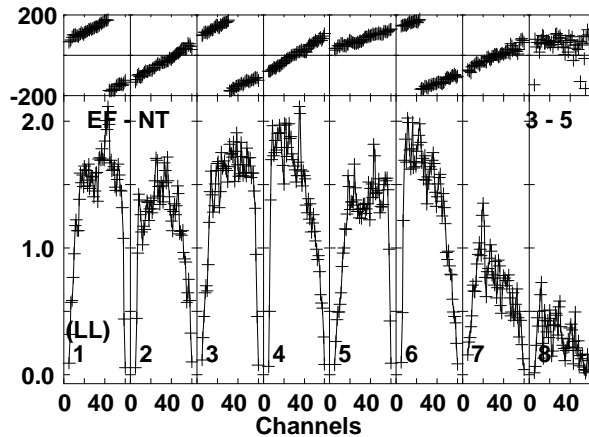
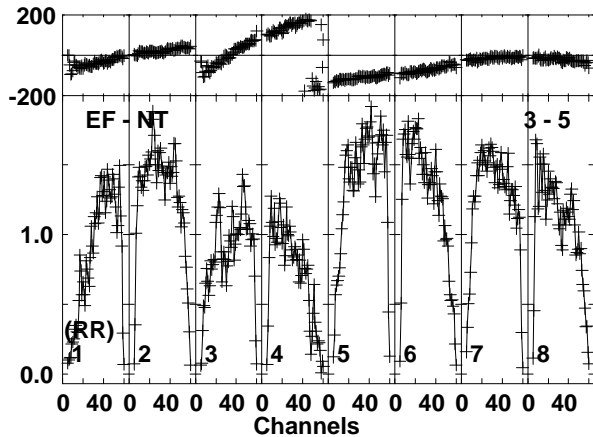
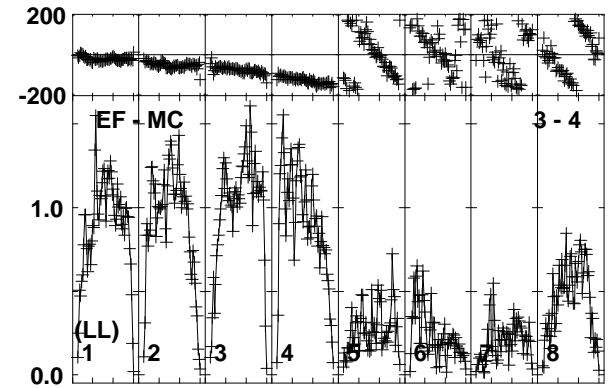
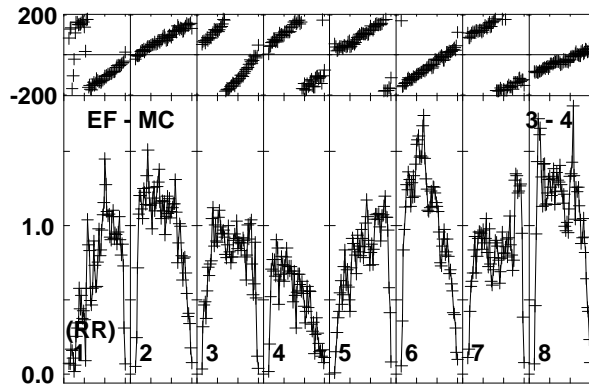
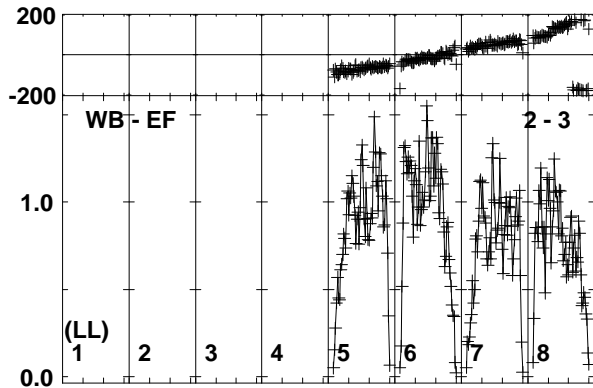
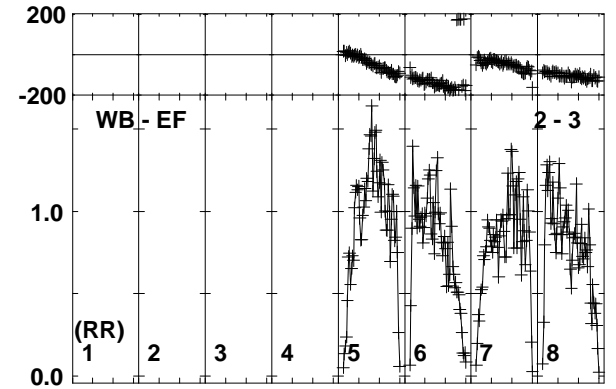
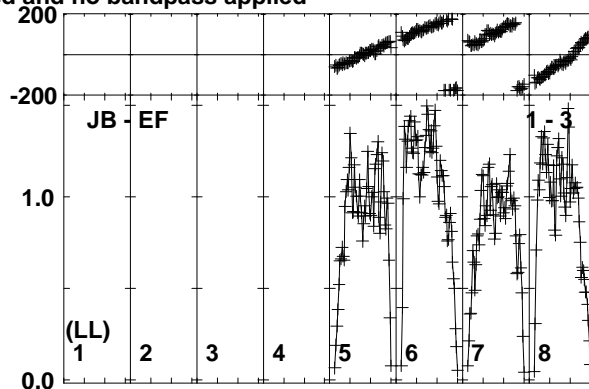
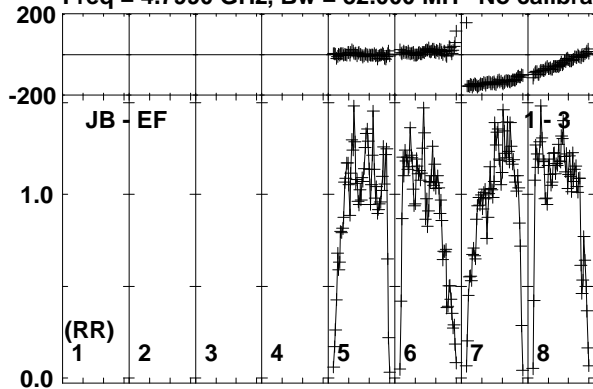

Lower frame: Milli Ampl Jy Top frame: Phas deg
Vector averaged cross-power spectrum Baseline: JB (01) - EF (03)
Timerange: 00/15:01:01 to 00/15:01:59

Plot file version 166 created 28-AUG-2017 13:19:12

J1303-2405 RP029A.UVDATA.1

Freq = 4.7990 GHz, Bw = 32.000 MH No calibration applied and no bandpass applied

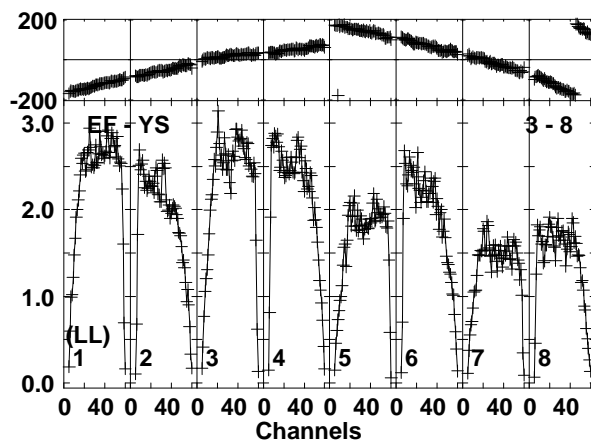
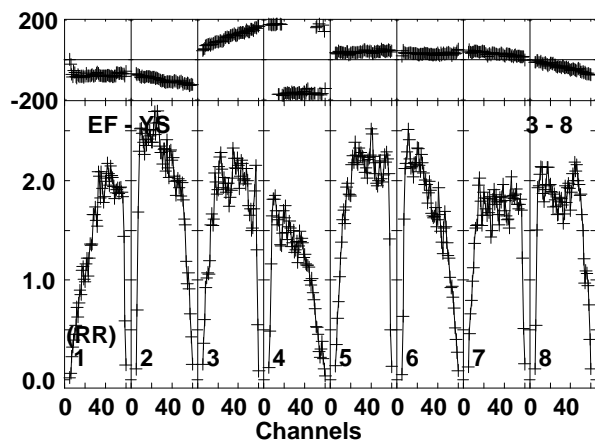
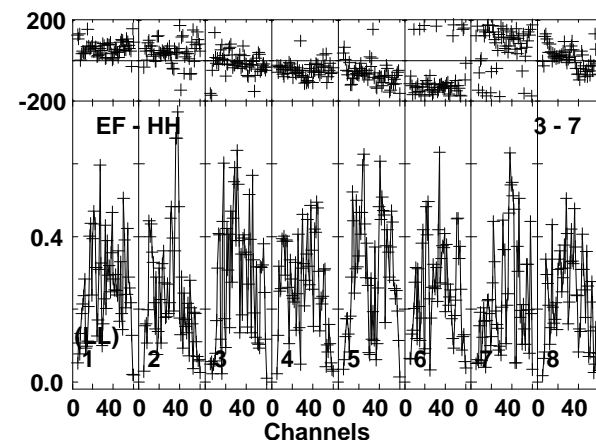
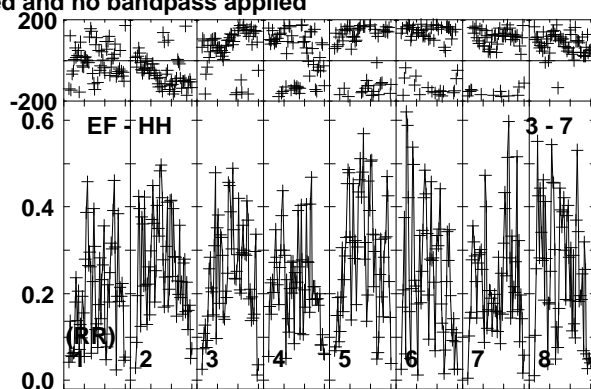
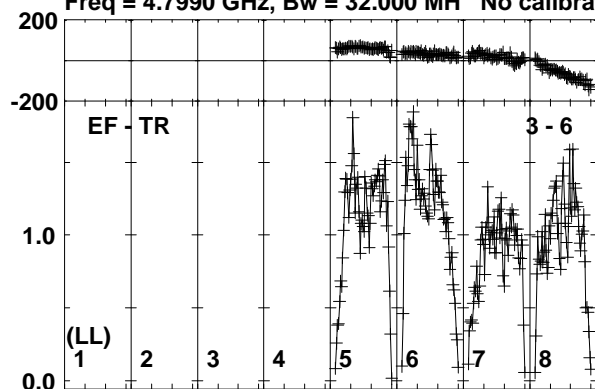

Lower frame: Milli Ampl Jy Top frame: Phas deg
Vector averaged cross-power spectrum Baseline: EF (03) - TR (06)
Timerange: 00/15:01:01 to 00/15:01:59

Plot file version 167 created 28-AUG-2017 13:19:12

SSS17A RP029A.UVDATA.1

Freq = 4.7990 GHz, Bw = 32.000 MH No calibration applied and no bandpass applied

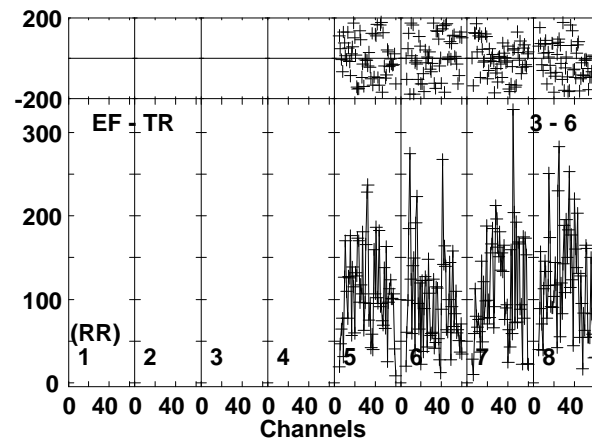
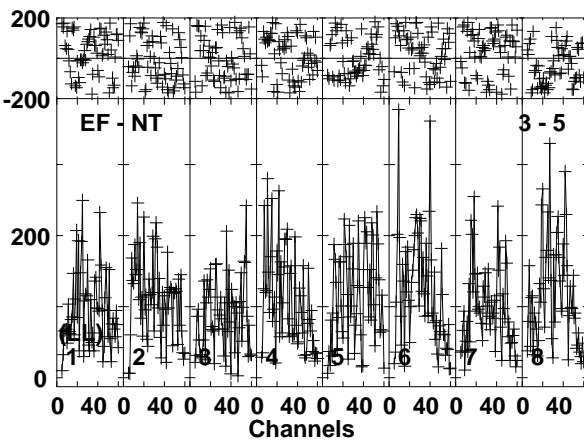
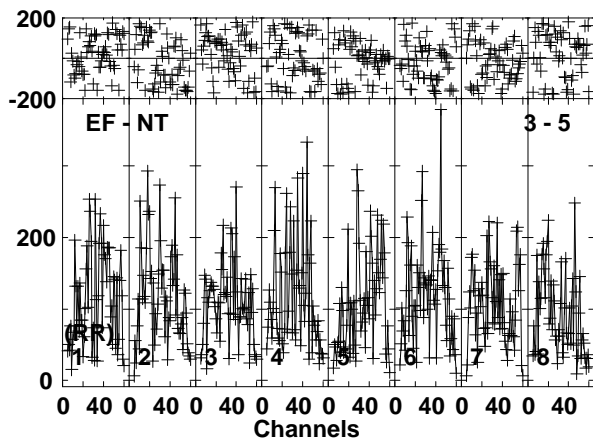
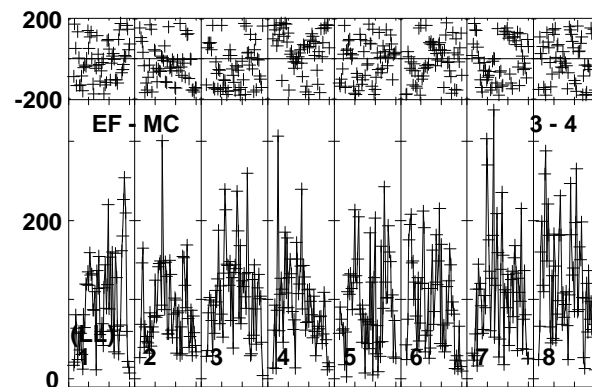
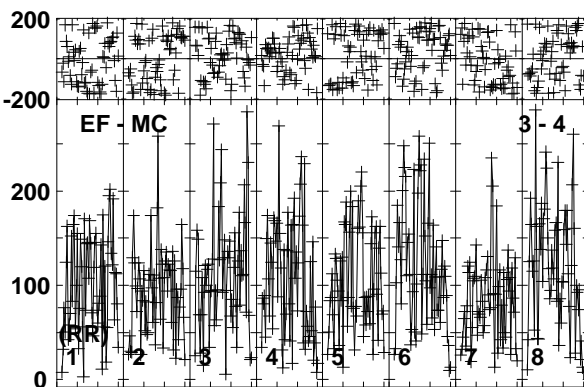
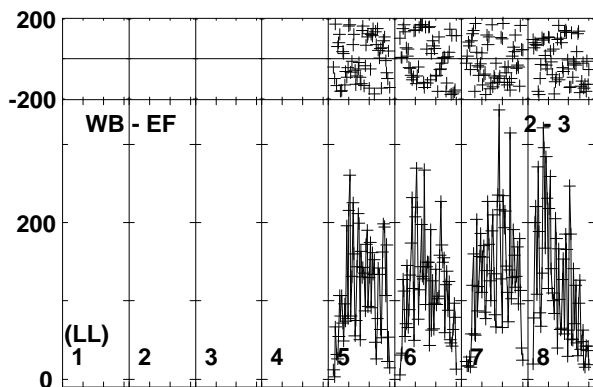
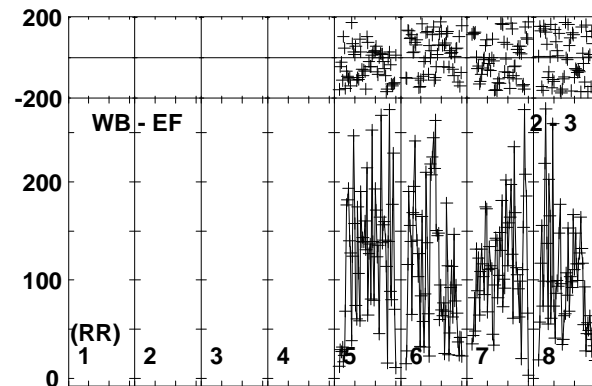
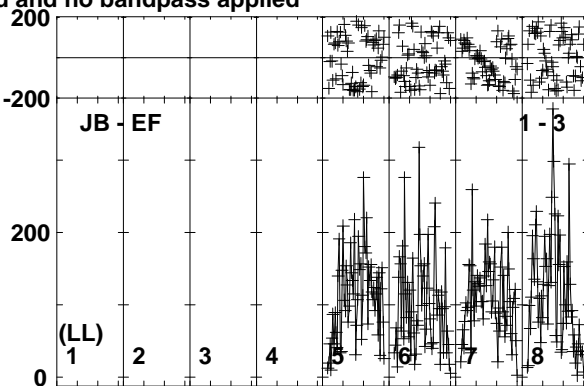
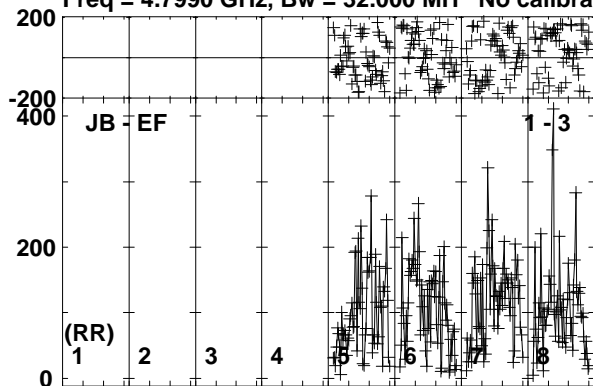

Lower frame: Micro Ampl Jy Top frame: Phas deg
Vector averaged cross-power spectrum Baseline: JB (01) - EF (03)
Timerange: 00/15:02:01 to 00/15:04:29

Plot file version 168 created 28-AUG-2017 13:19:12

SSS17A RP029A.UVDATA.1

Freq = 4.7990 GHz, Bw = 32.000 MH No calibration applied and no bandpass applied

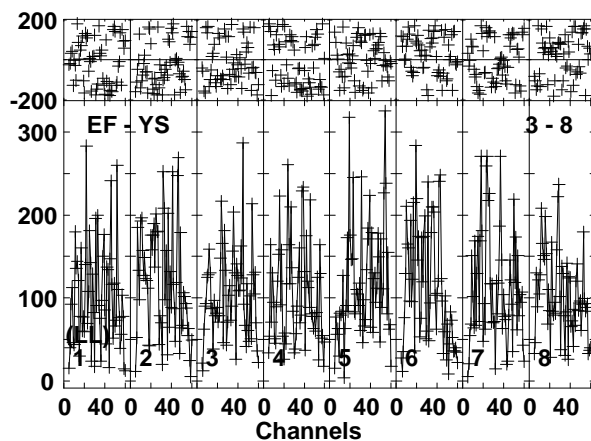
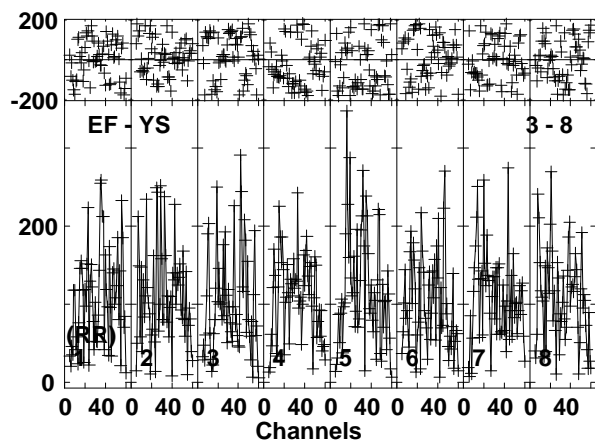
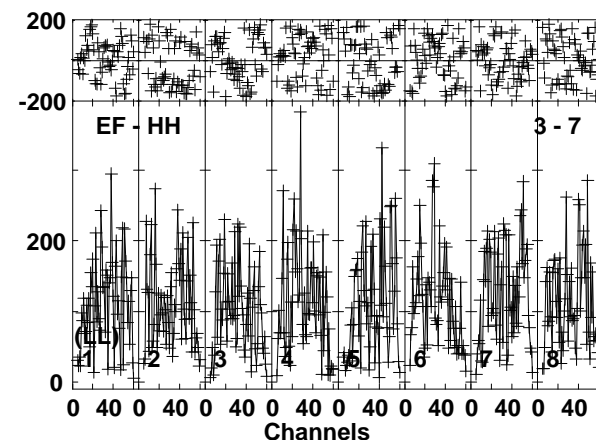
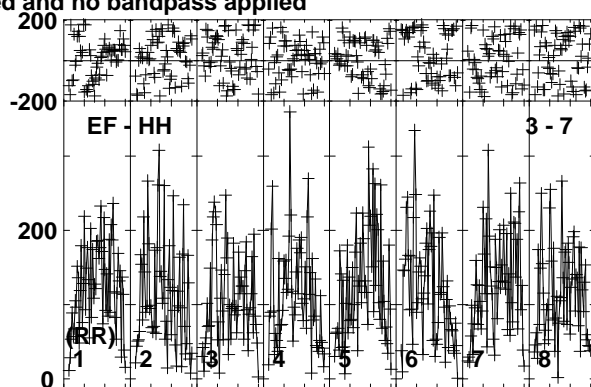
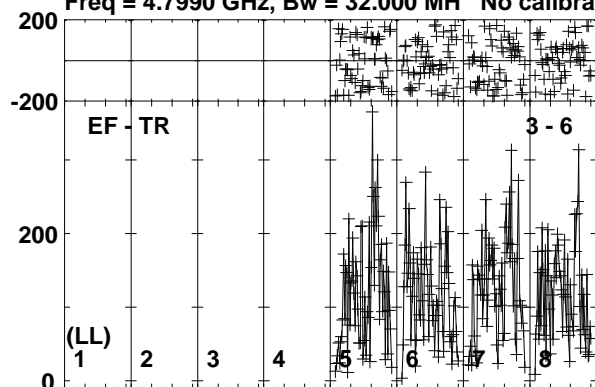

Lower frame: Micro Ampl Jy Top frame: Phas deg
Vector averaged cross-power spectrum Baseline: EF (03) - TR (06)
Timerange: 00/15:02:01 to 00/15:04:29

Plot file version 169 created 28-AUG-2017 13:19:12

J1303-2405 RP029A.UVDATA.1

Freq = 4.7990 GHz, Bw = 32.000 MH No calibration applied and no bandpass applied

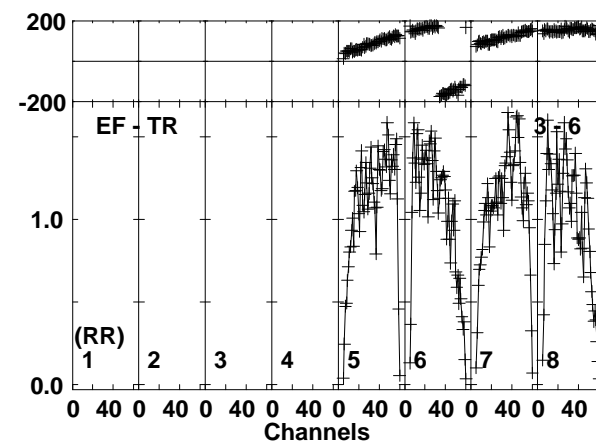
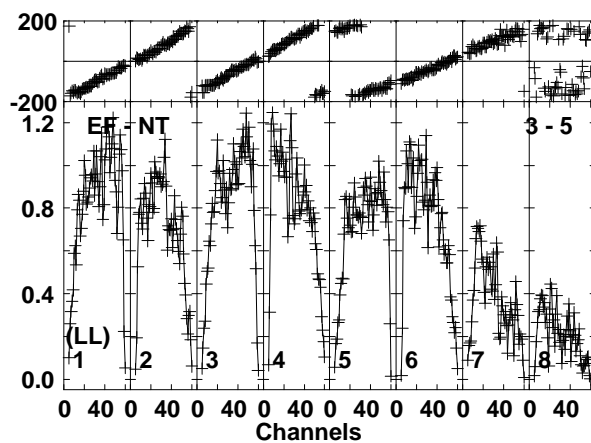
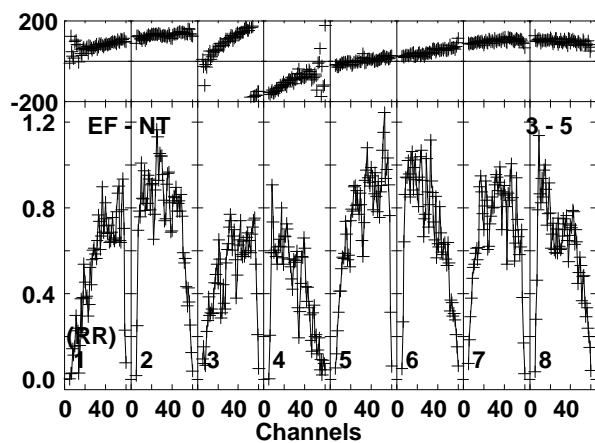
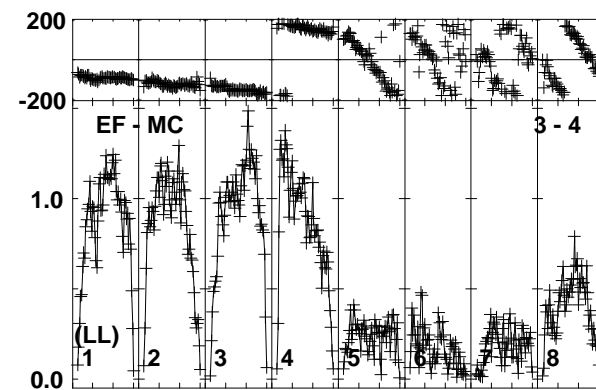
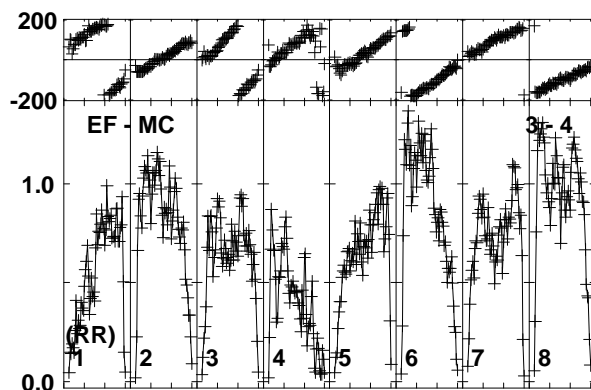
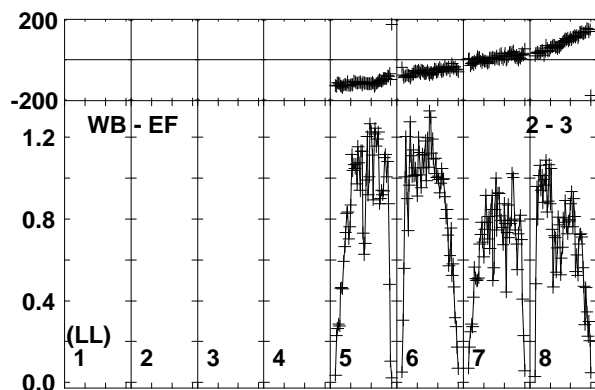
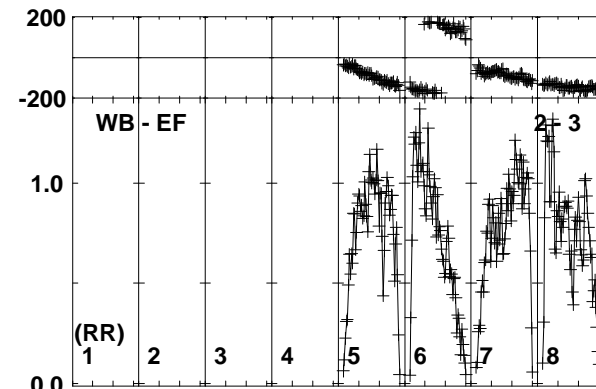
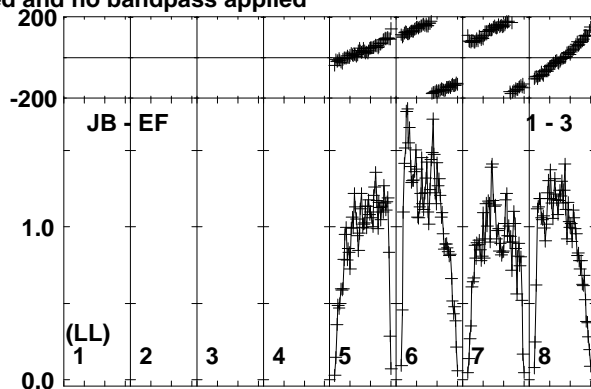
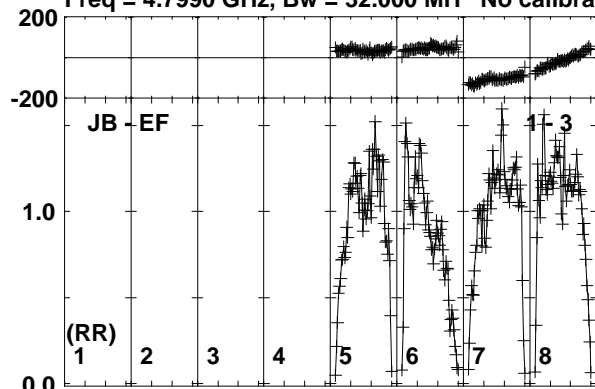

Lower frame: Milli Ampl Jy Top frame: Phas deg
Vector averaged cross-power spectrum Baseline: JB (01) - EF (03)
Timerange: 00/15:04:31 to 00/15:05:59

Plot file version 170 created 28-AUG-2017 13:19:12

J1303-2405 RP029A.UVDATA.1

Freq = 4.7990 GHz, Bw = 32.000 MH No calibration applied and no bandpass applied

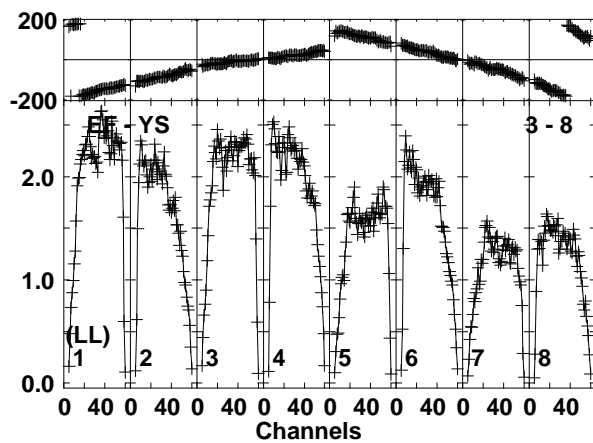
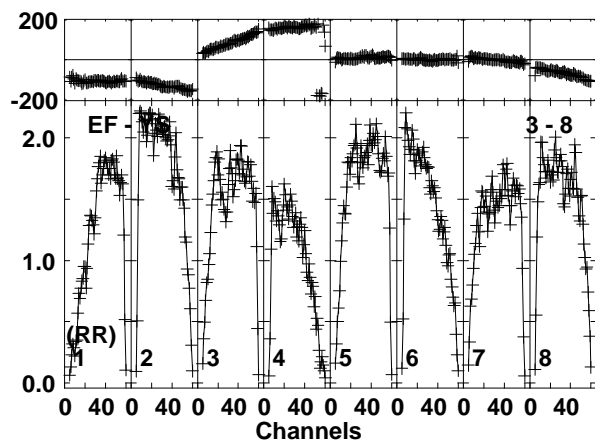
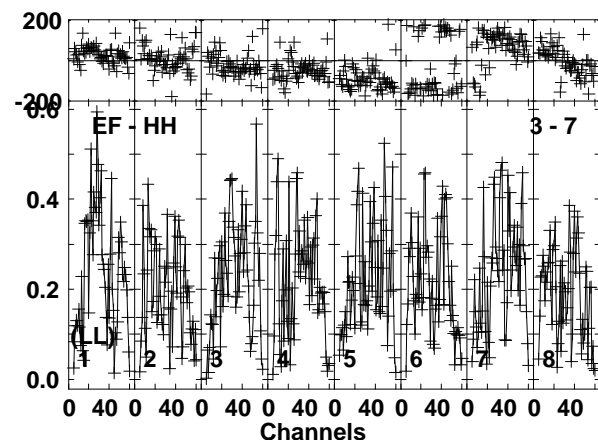
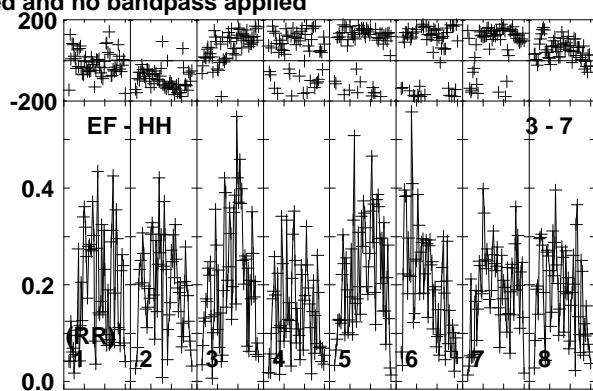
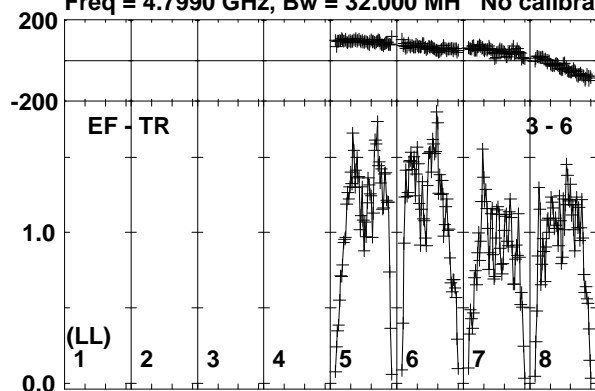

Lower frame: Milli Ampl Jy Top frame: Phas deg
Vector averaged cross-power spectrum Baseline: EF (03) - TR (06)
Timerange: 00/15:04:31 to 00/15:05:59

Plot file version 171 created 28-AUG-2017 13:19:12

J1312-2350 RP029A.UVDATA.1

Freq = 4.7990 GHz, Bw = 32.000 MH No calibration applied and no bandpass applied

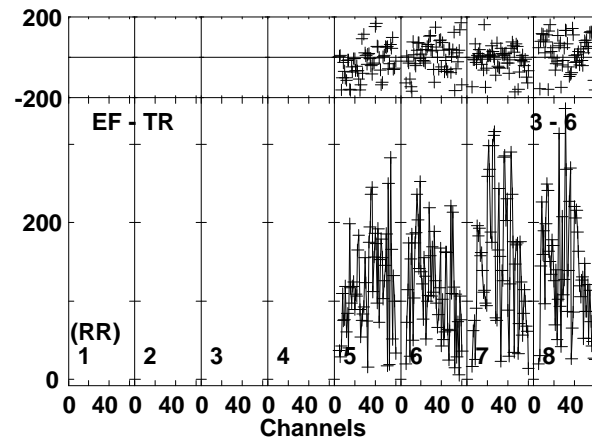
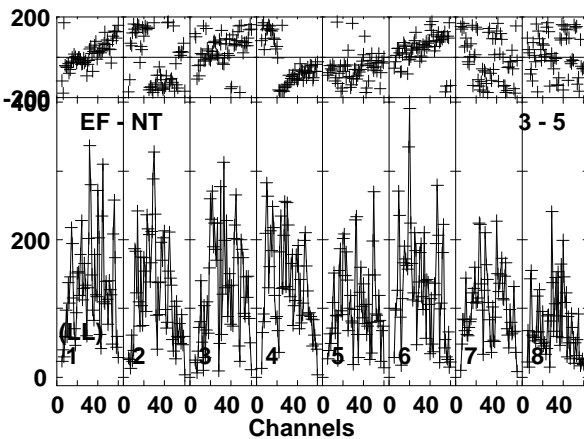
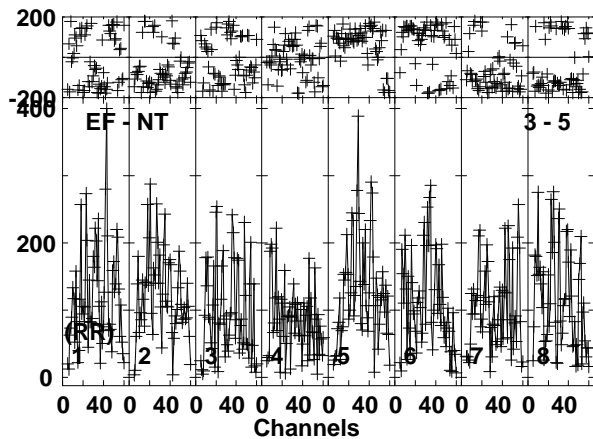
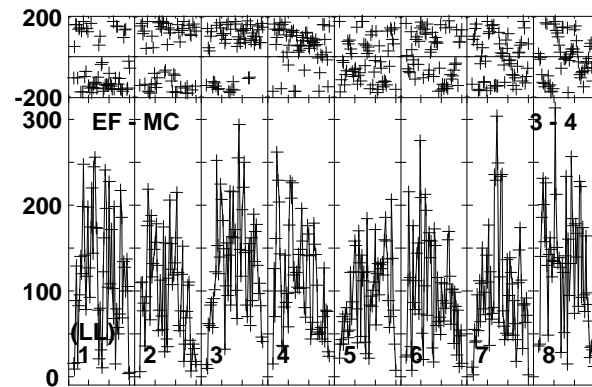
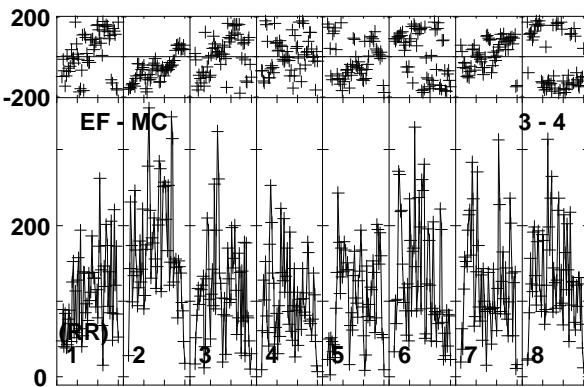
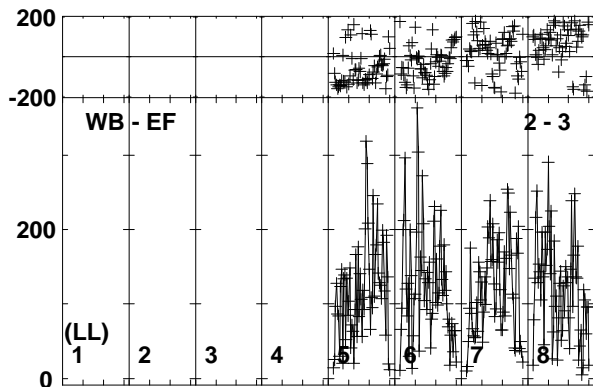
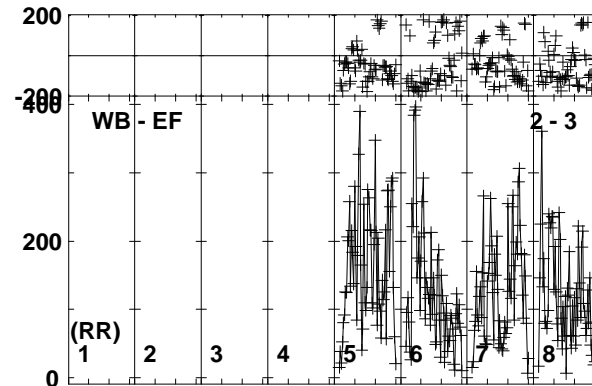
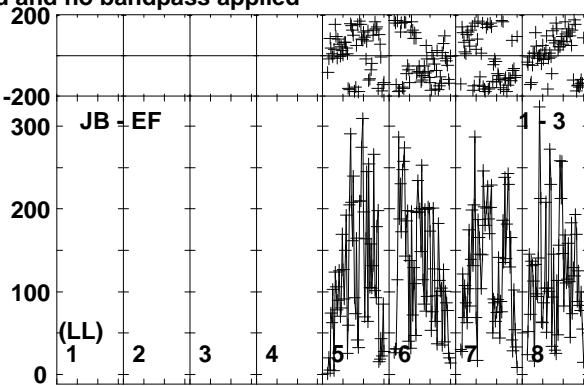
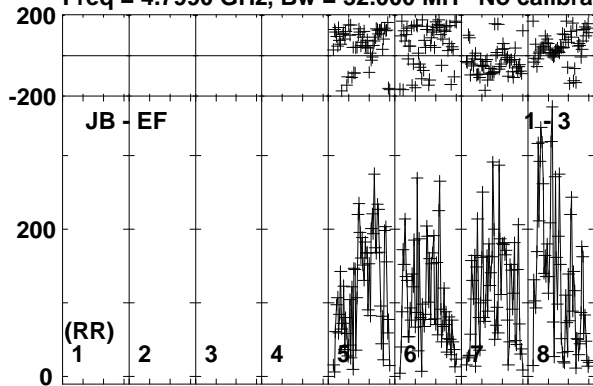

Lower frame: Micro Ampl Jy Top frame: Phas deg
Vector averaged cross-power spectrum Baseline: JB (01) - EF (03)
Timerange: 00/15:06:01 to 00/15:08:29

Plot file version 172 created 28-AUG-2017 13:19:12

J1312-2350 RP029A.UVDATA.1

Freq = 4.7990 GHz, Bw = 32.000 MH No calibration applied and no bandpass applied

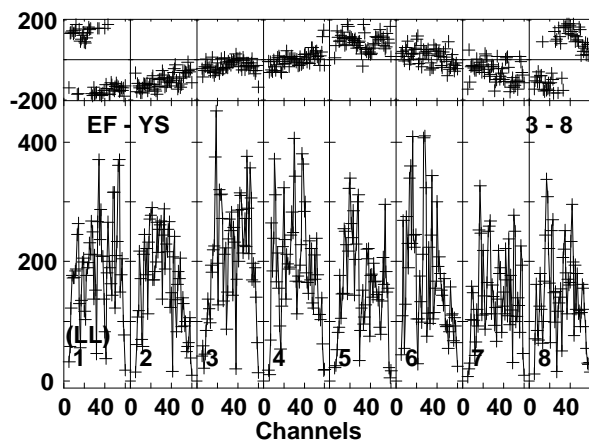
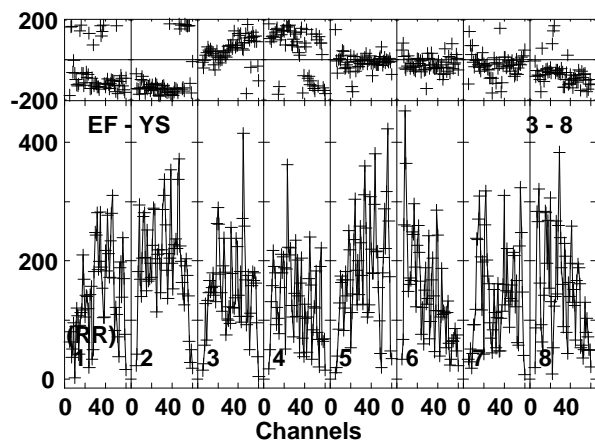
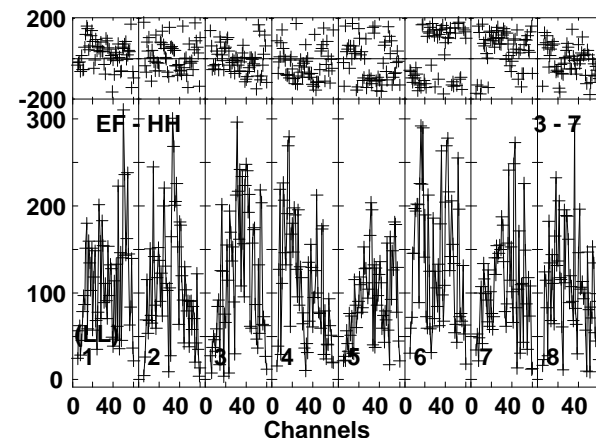
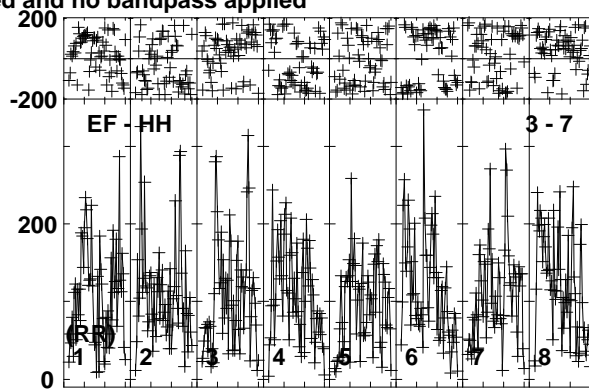
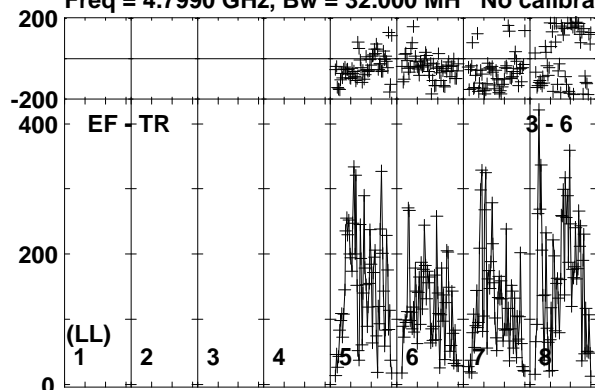

Lower frame: Micro Ampl Jy Top frame: Phas deg
Vector averaged cross-power spectrum Baseline: EF (03) - TR (06)
Timerange: 00/15:06:01 to 00/15:08:29

Plot file version 173 created 28-AUG-2017 13:19:12

J1303-2405 RP029A.UVDATA.1

Freq = 4.7990 GHz, Bw = 32.000 MH No calibration applied and no bandpass applied

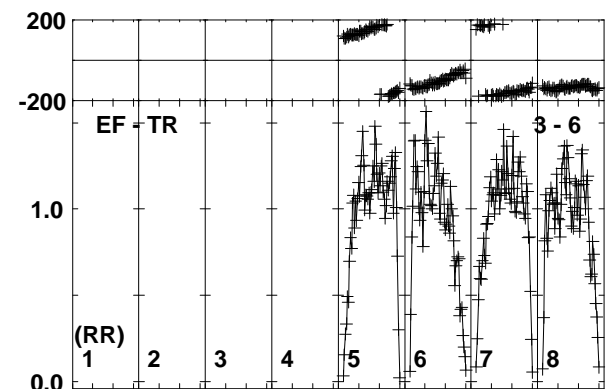
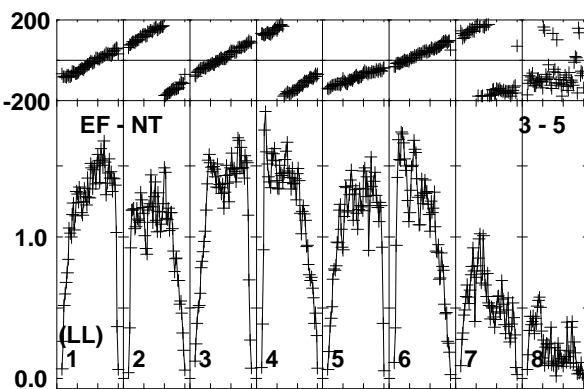
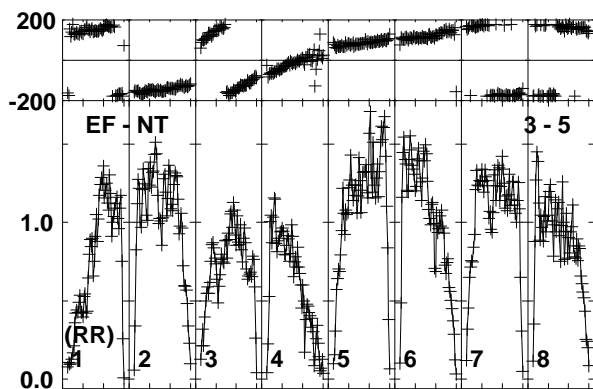
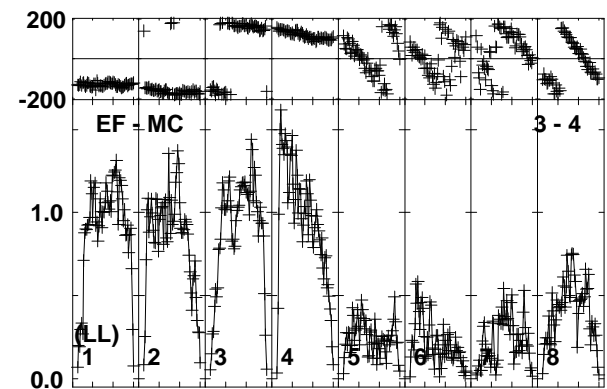
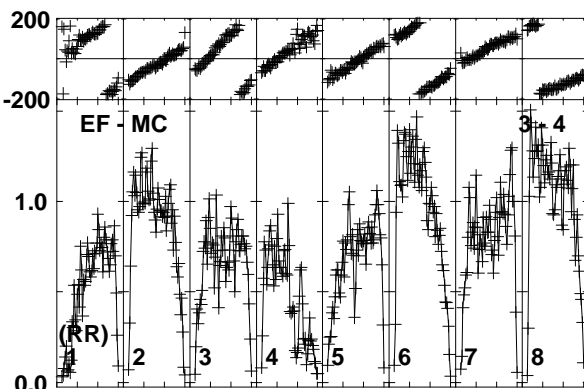
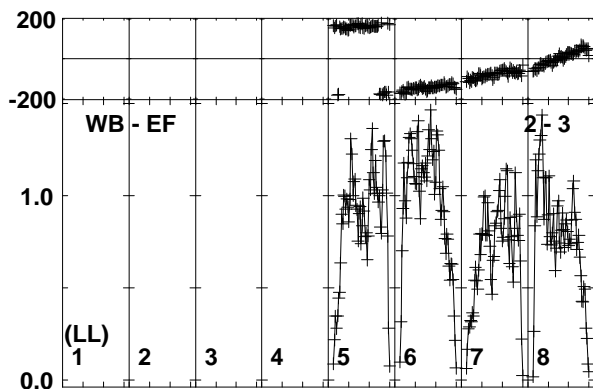
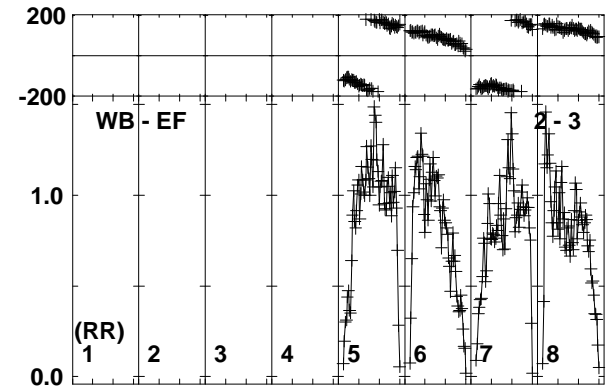
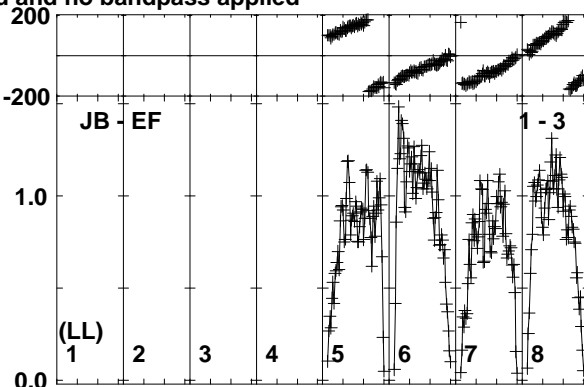
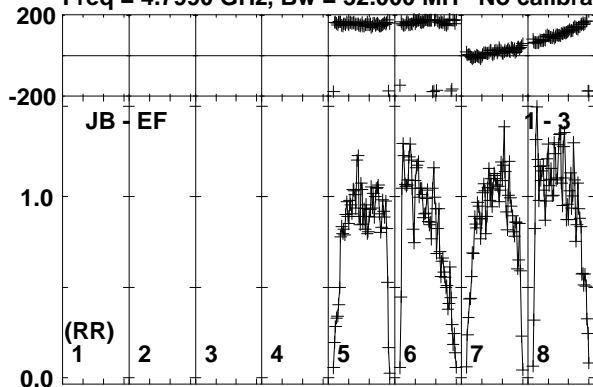

Lower frame: Milli Ampl Jy Top frame: Phas deg
Vector averaged cross-power spectrum Baseline: JB (01) - EF (03)
Timerange: 00/15:09:11 to 00/15:10:09

Plot file version 174 created 28-AUG-2017 13:19:13

J1303-2405 RP029A.UVDATA.1

Freq = 4.7990 GHz, Bw = 32.000 MH No calibration applied and no bandpass applied

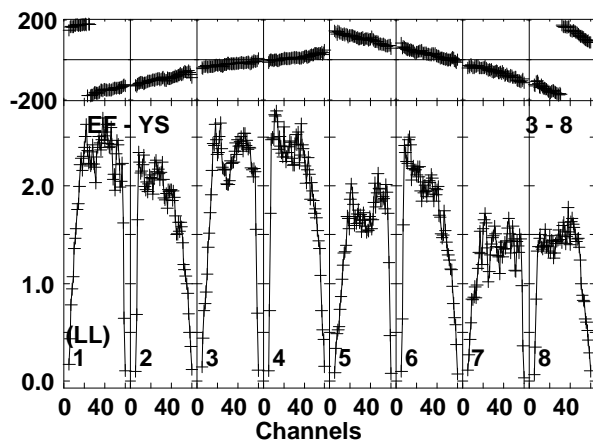
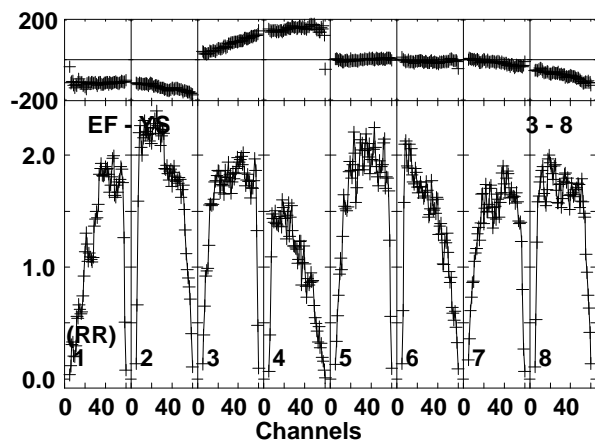
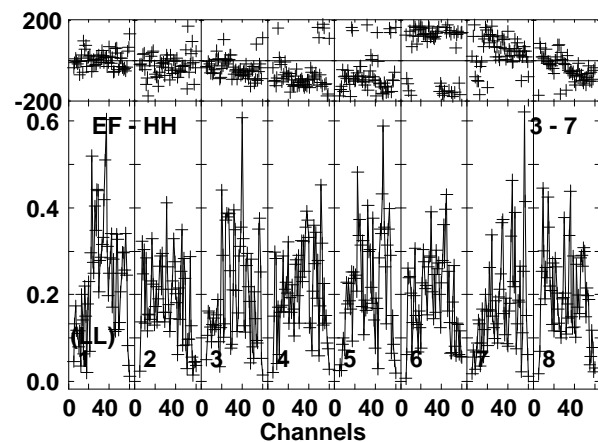
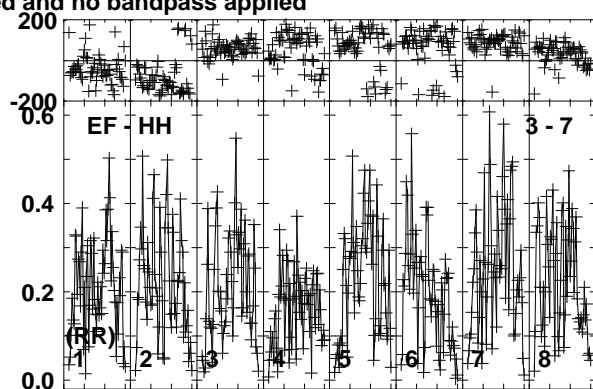
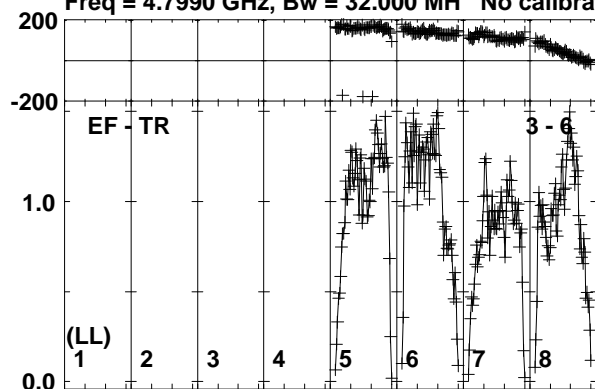

Lower frame: Milli Ampl Jy Top frame: Phas deg
Vector averaged cross-power spectrum Baseline: EF (03) - TR (06)
Timerange: 00/15:09:11 to 00/15:10:09

Plot file version 175 created 28-AUG-2017 13:19:13

SSS17A RP029A.UVDATA.1

Freq = 4.7990 GHz, Bw = 32.000 MH No calibration applied and no bandpass applied

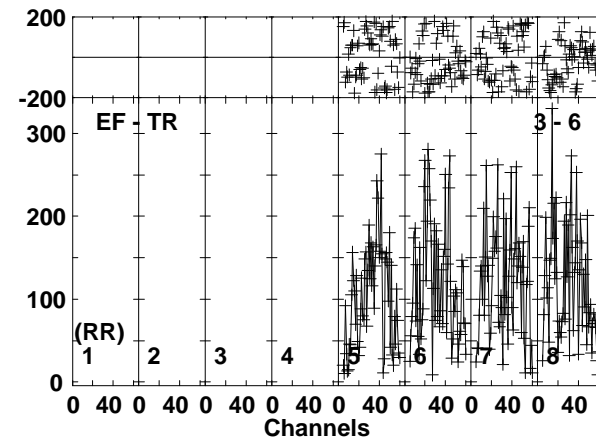
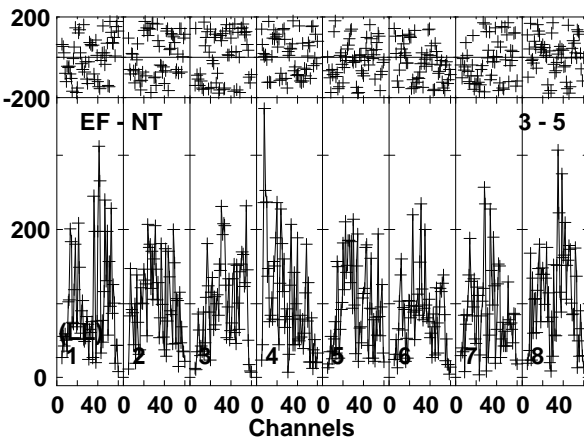
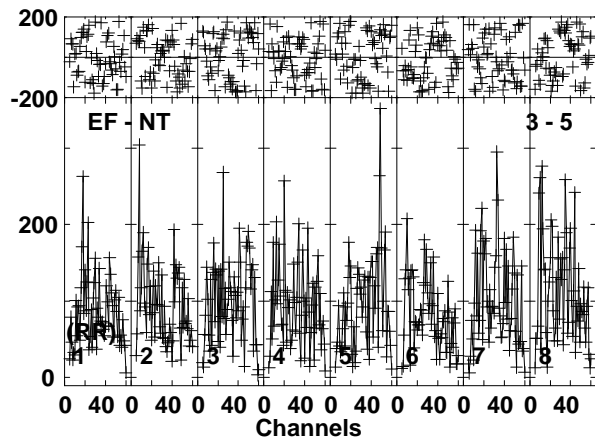
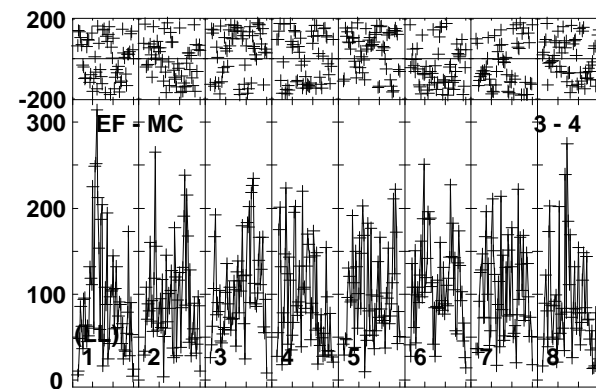
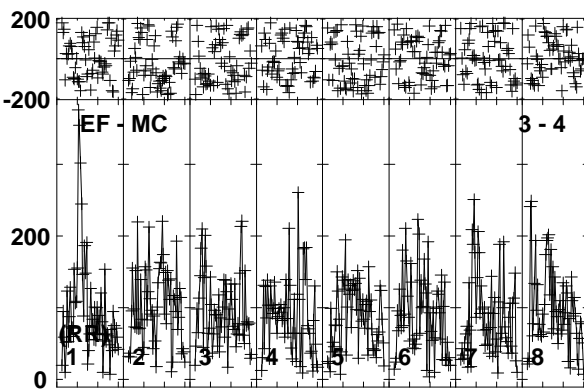
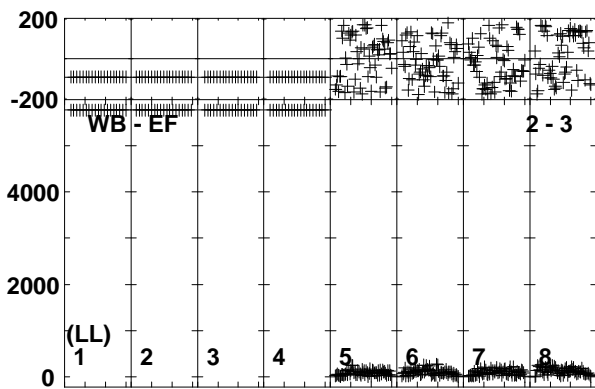
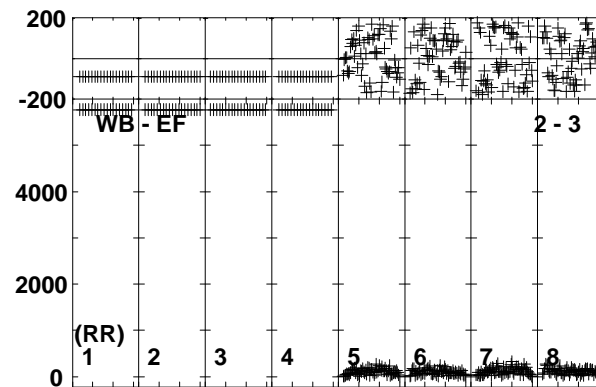
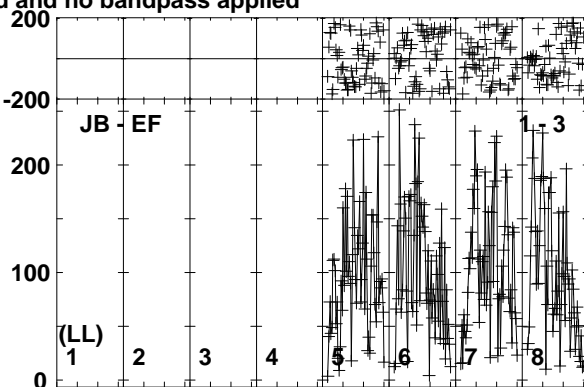
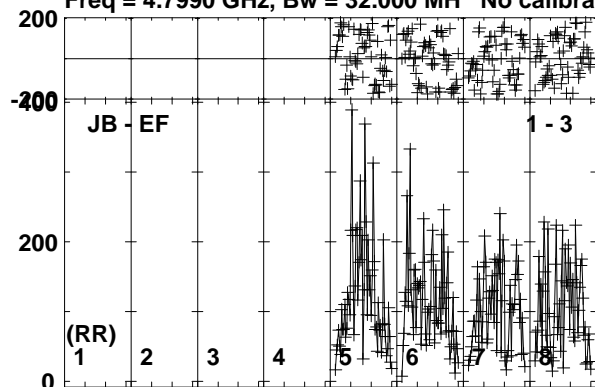

Lower frame: Micro Ampl Jy Top frame: Phas deg
Vector averaged cross-power spectrum Baseline: JB (01) - EF (03)
Timerange: 00/15:10:11 to 00/15:12:39

Plot file version 176 created 28-AUG-2017 13:19:13

SSS17A RP029A.UVDATA.1

Freq = 4.7990 GHz, Bw = 32.000 MH No calibration applied and no bandpass applied

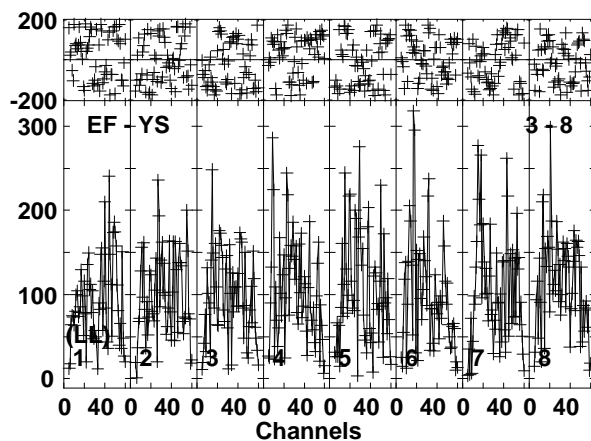
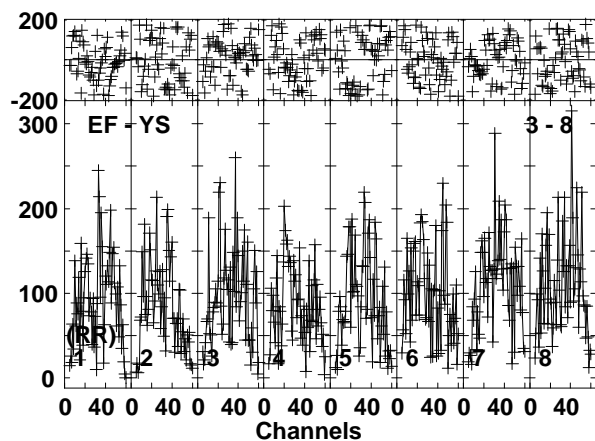
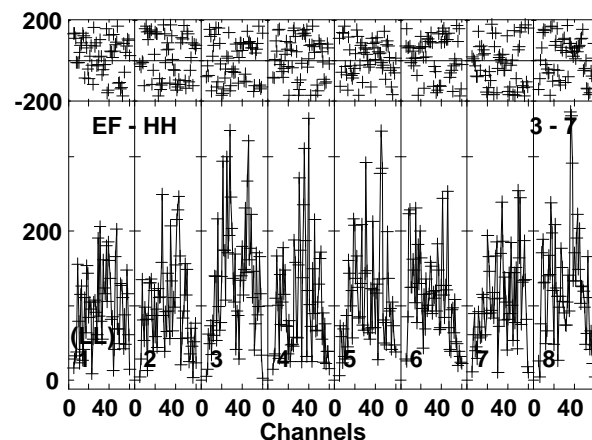
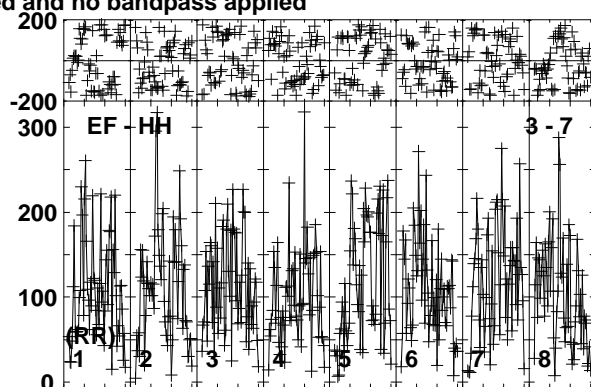
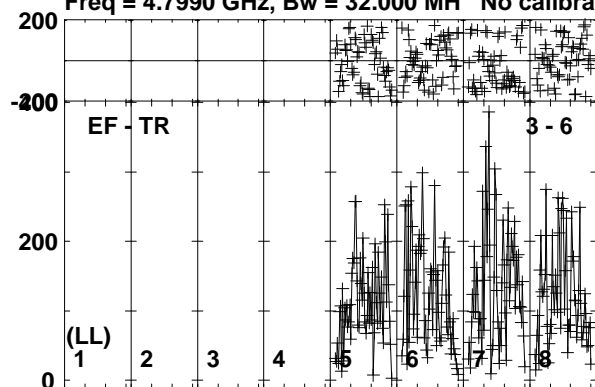

Lower frame: Micro Ampl Jy Top frame: Phas deg
Vector averaged cross-power spectrum Baseline: EF (03) - TR (06)
Timerange: 00/15:10:11 to 00/15:12:39

Plot file version 177 created 28-AUG-2017 13:19:13

J1303-2405 RP029A.UVDATA.1

Freq = 4.7990 GHz, Bw = 32.000 MH No calibration applied and no bandpass applied

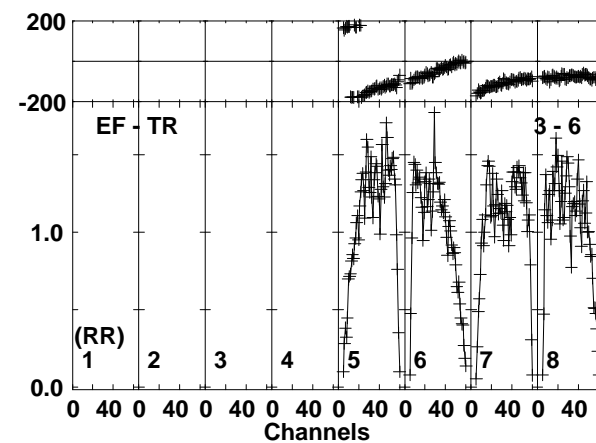
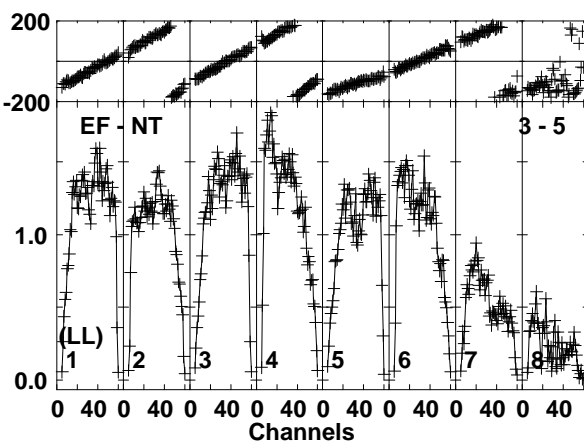
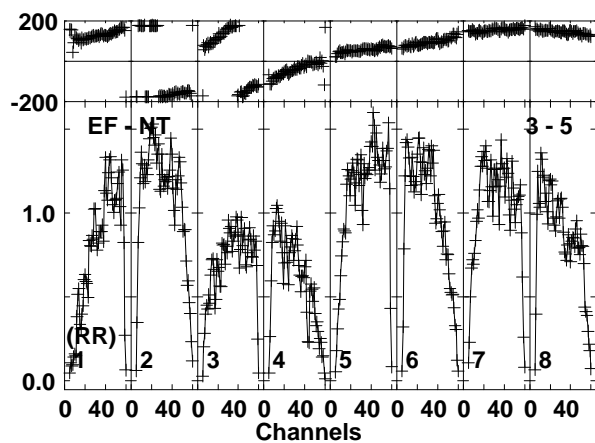
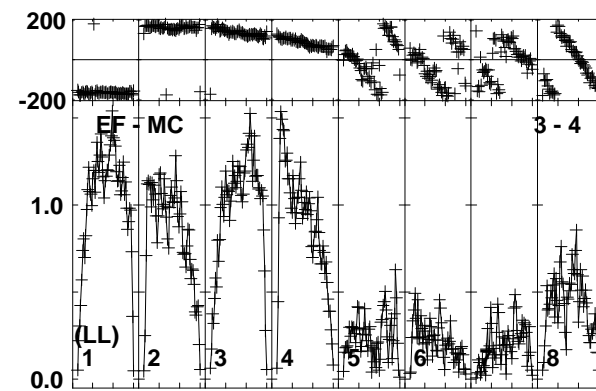
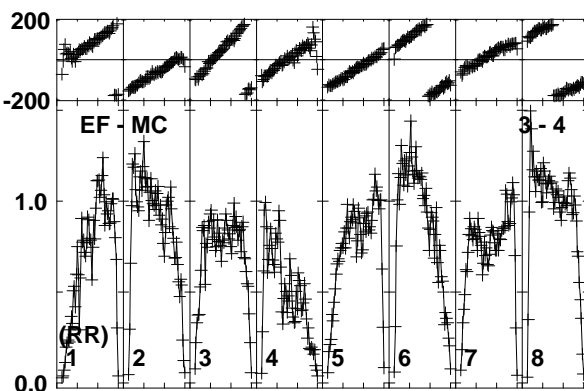
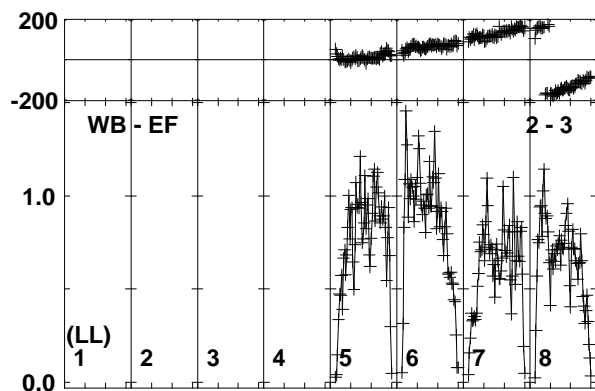
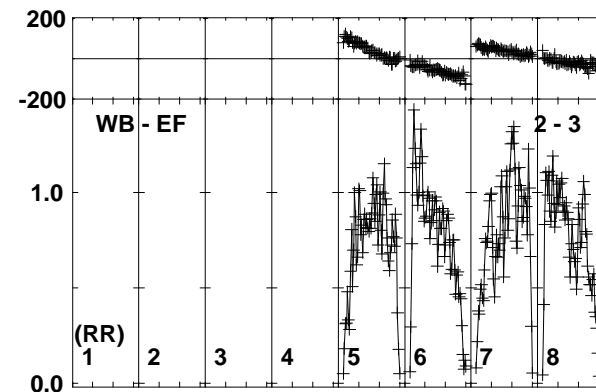
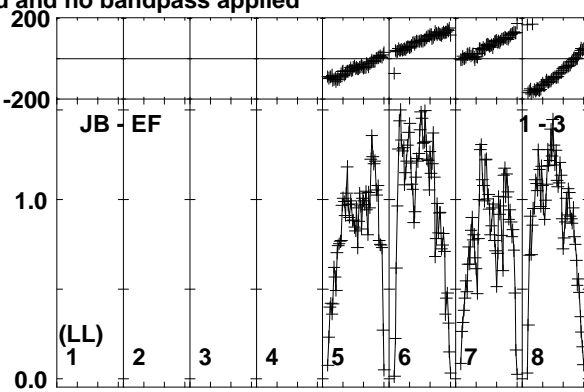
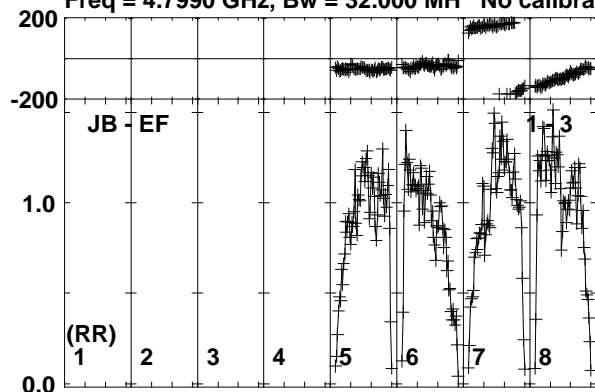

Lower frame: Milli Ampl Jy Top frame: Phas deg
Vector averaged cross-power spectrum Baseline: JB (01) - EF (03)
Timerange: 00:15:12:41 to 00:15:14:09

Plot file version 178 created 28-AUG-2017 13:19:13

J1303-2405 RP029A.UVDATA.1

Freq = 4.7990 GHz, Bw = 32.000 MH No calibration applied and no bandpass applied

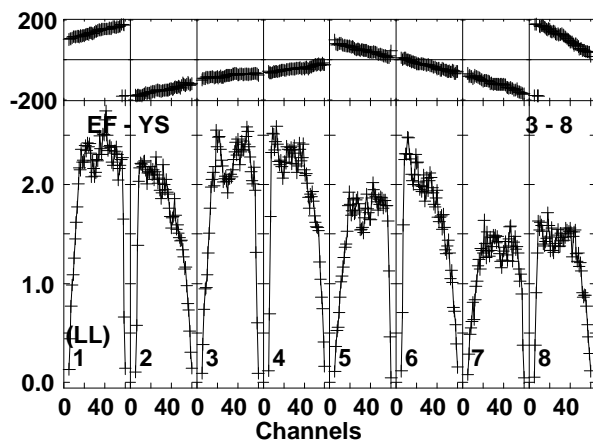
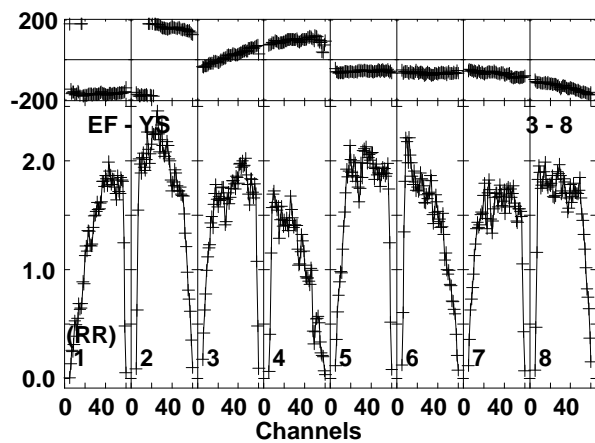
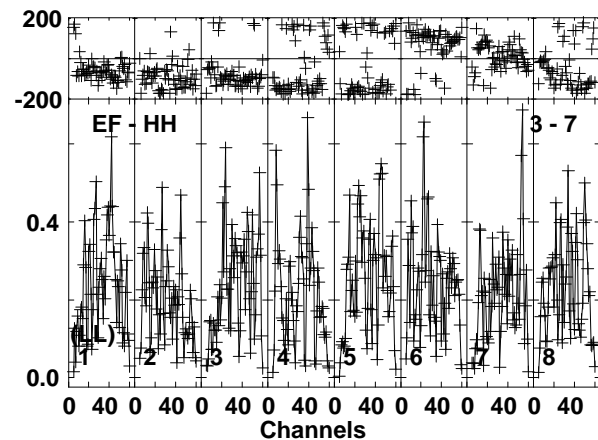
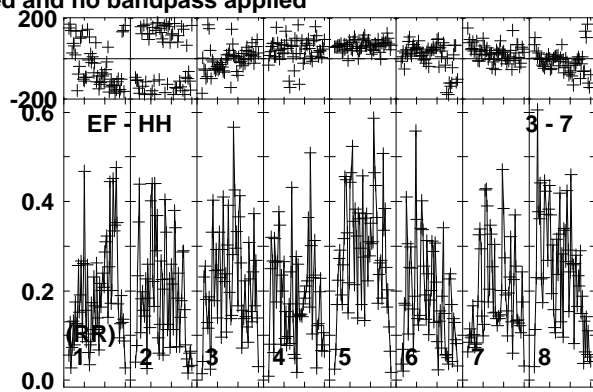
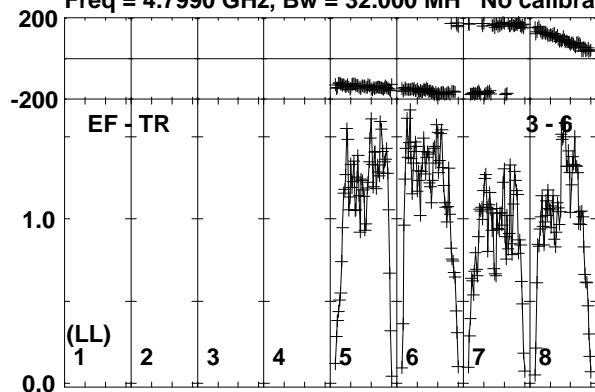

Lower frame: Milli Ampl Jy Top frame: Phas deg
Vector averaged cross-power spectrum Baseline: EF (03) - TR (06)
Timerange: 00:15:12:41 to 00:15:14:09

Plot file version 179 created 28-AUG-2017 13:19:13

SSS17A RP029A.UVDATA.1

Freq = 4.7990 GHz, Bw = 32.000 MH No calibration applied and no bandpass applied

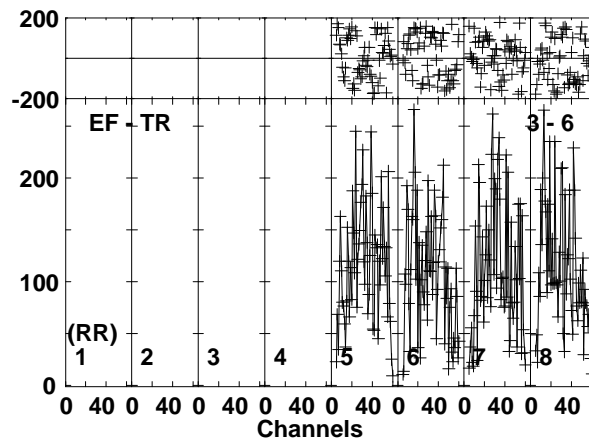
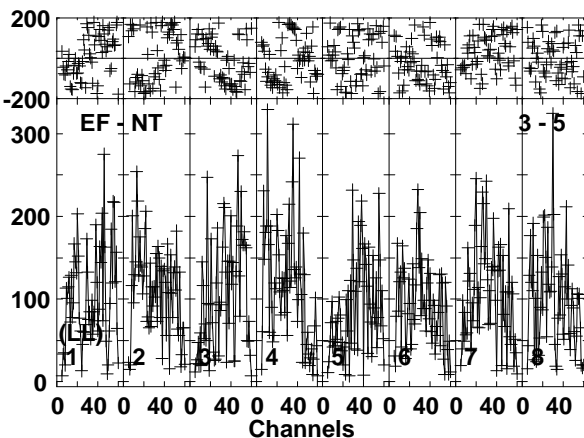
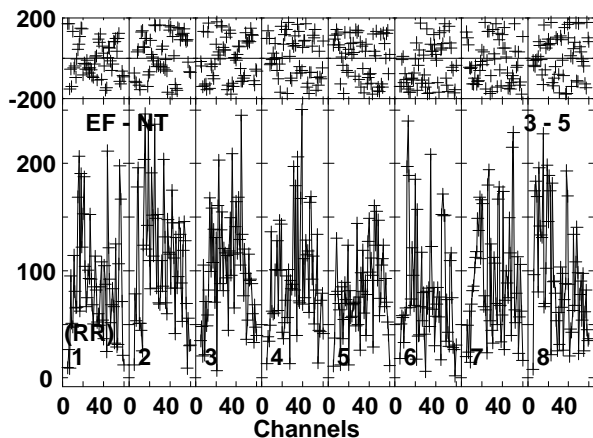
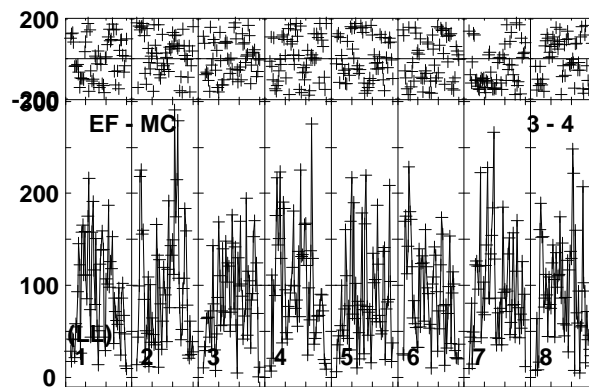
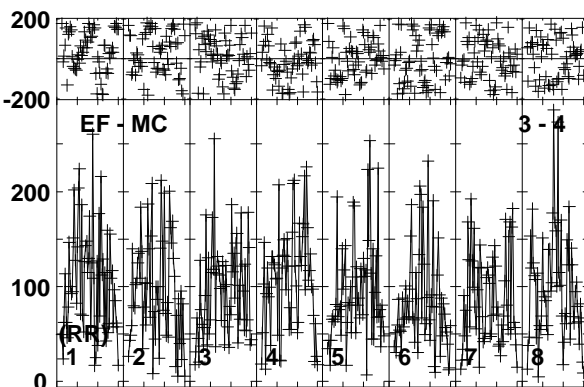
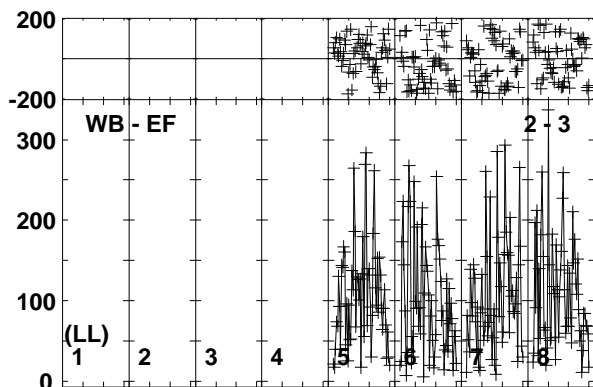
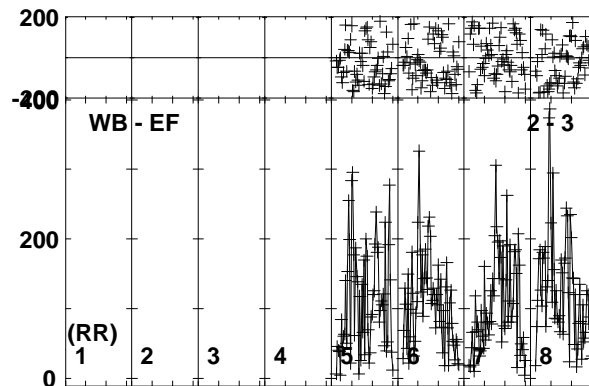
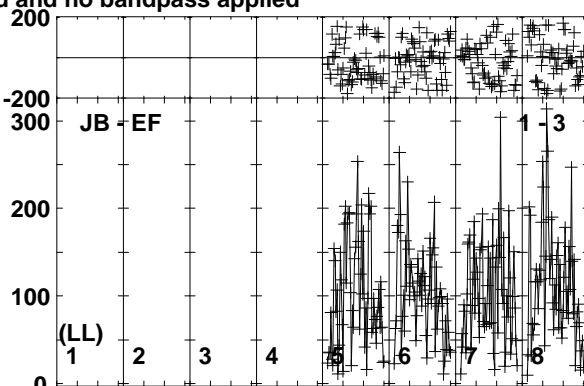
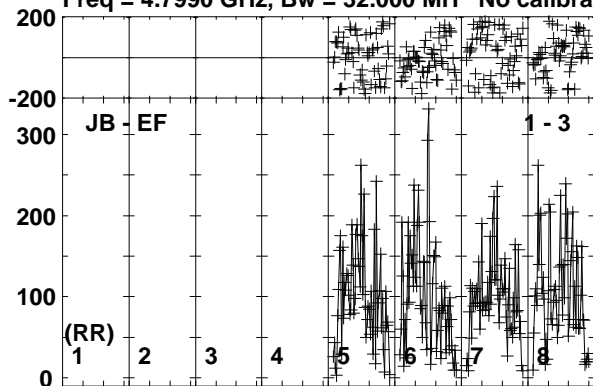

Lower frame: Micro Ampl Jy Top frame: Phas deg
Vector averaged cross-power spectrum Baseline: JB (01) - EF (03)
Timerange: 00/15:14:11 to 00/15:16:39

Plot file version 180 created 28-AUG-2017 13:19:13

SSS17A RP029A.UVDATA.1

Freq = 4.7990 GHz, Bw = 32.000 MH No calibration applied and no bandpass applied

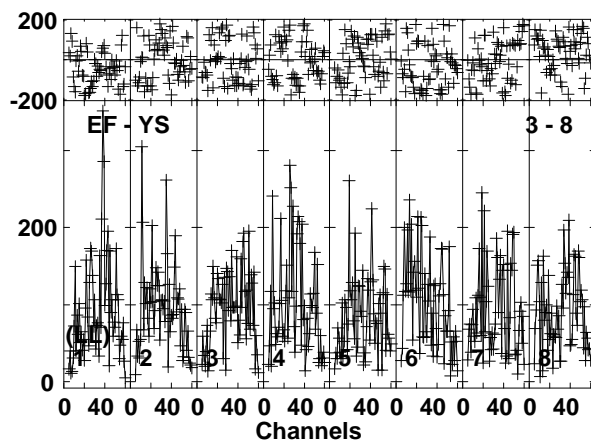
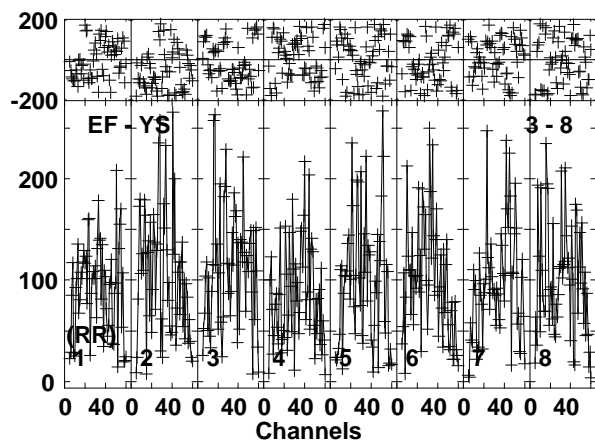
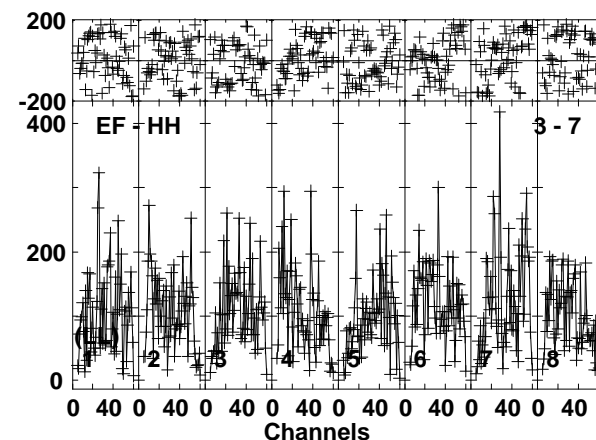
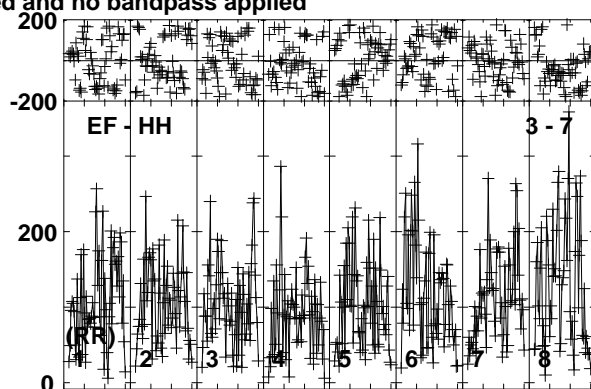
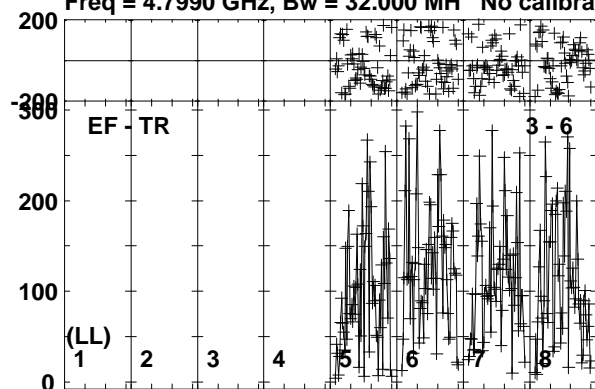

Lower frame: Micro Ampl Jy Top frame: Phas deg
Vector averaged cross-power spectrum Baseline: EF (03) - TR (06)
Timerange: 00/15:14:11 to 00/15:16:39

Plot file version 181 created 28-AUG-2017 13:19:13

J1303-2405 RP029A.UVDATA.1

Freq = 4.7990 GHz, Bw = 32.000 MH No calibration applied and no bandpass applied

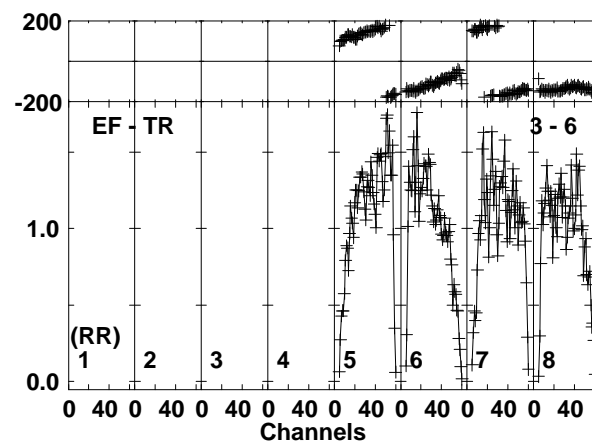
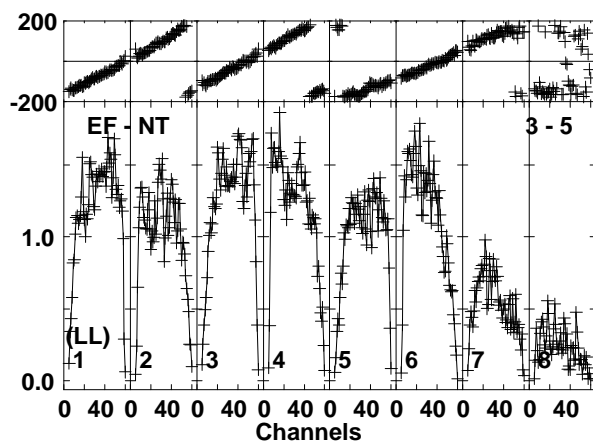
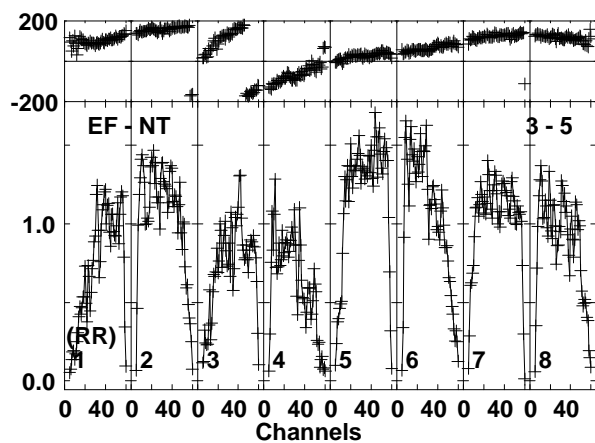
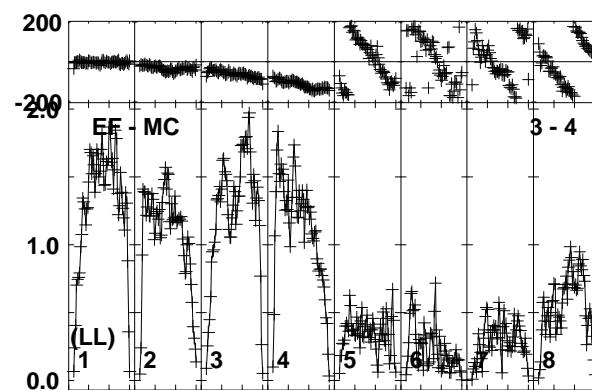
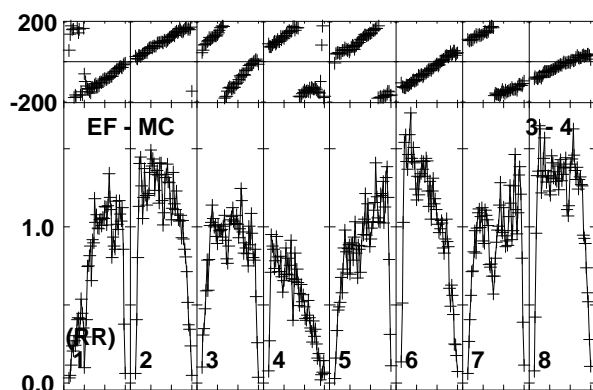
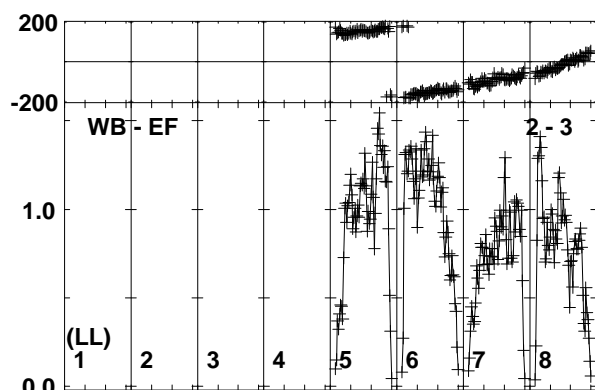
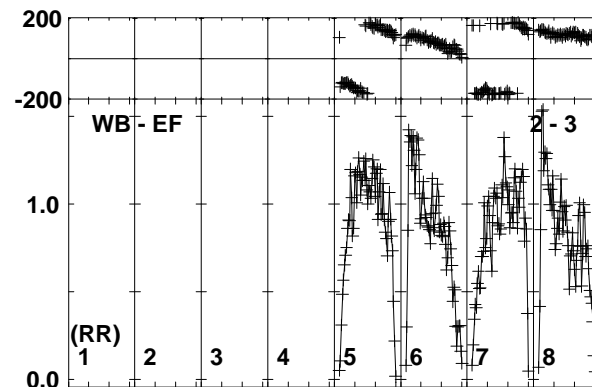
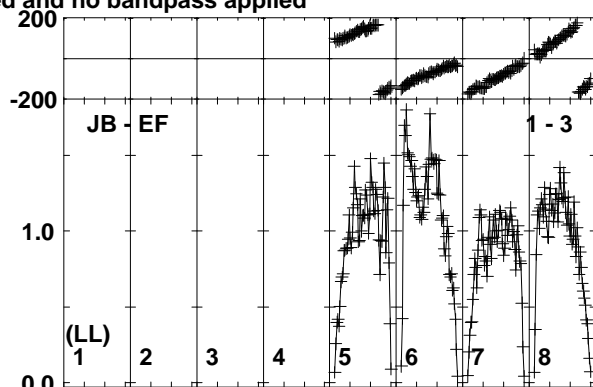
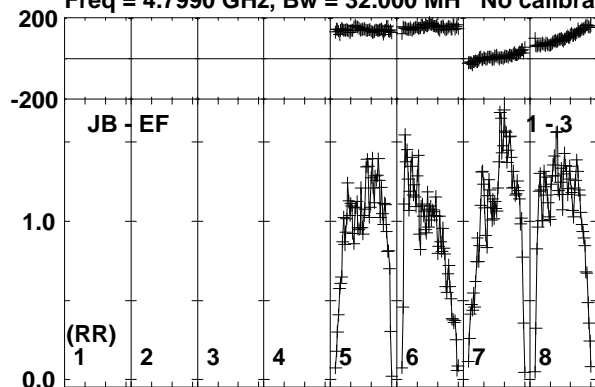

Lower frame: Milli Ampl Jy Top frame: Phas deg
Vector averaged cross-power spectrum Baseline: JB (01) - EF (03)
Timerange: 00:15:17:11 to 00:15:18:09

Plot file version 182 created 28-AUG-2017 13:19:13

J1303-2405 RP029A.UVDATA.1

Freq = 4.7990 GHz, Bw = 32.000 MH No calibration applied and no bandpass applied

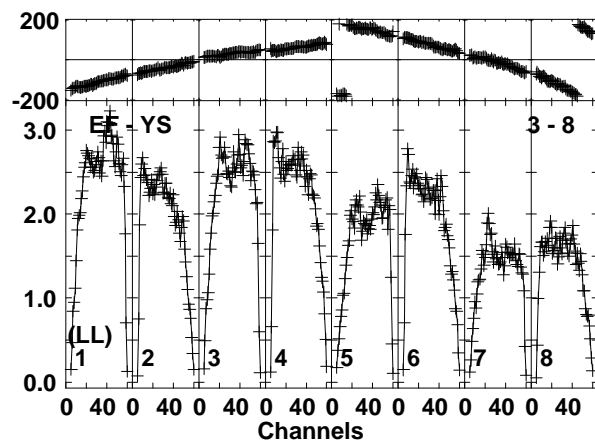
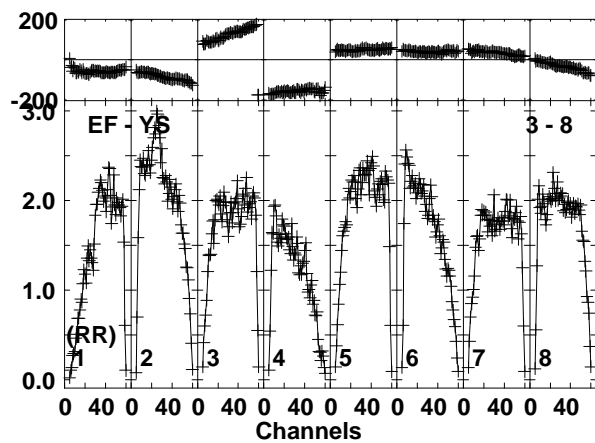
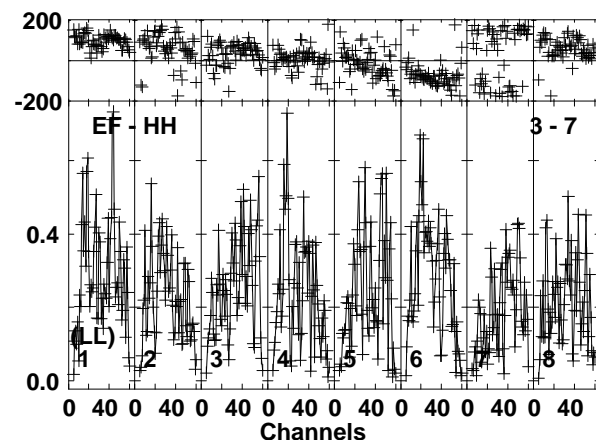
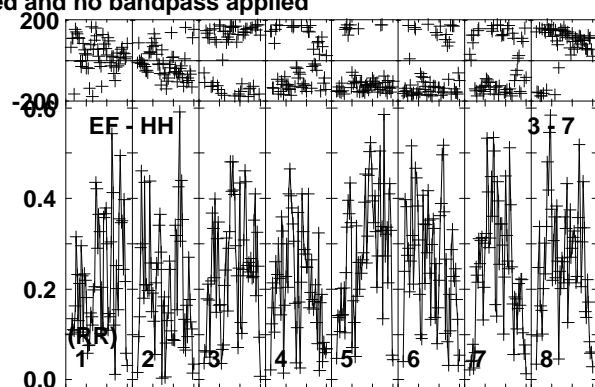
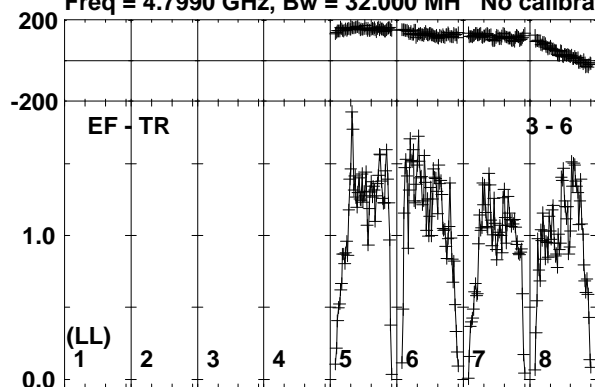

Lower frame: Milli Ampl Jy Top frame: Phas deg
Vector averaged cross-power spectrum Baseline: EF (03) - TR (06)
Timerange: 00/15:17:11 to 00/15:18:09

Plot file version 183 created 28-AUG-2017 13:19:13

SSS17A RP029A.UVDATA.1

Freq = 4.7990 GHz, Bw = 32.000 MH No calibration applied and no bandpass applied

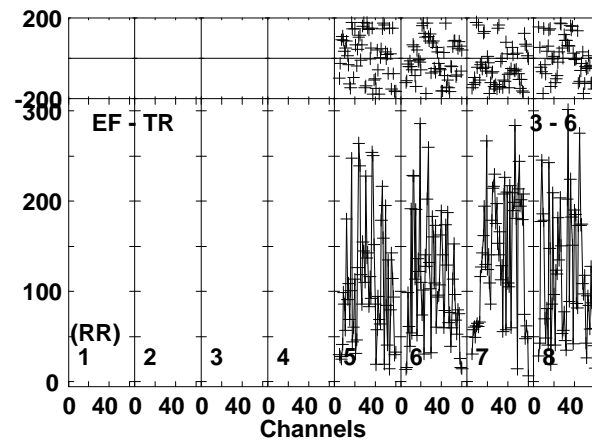
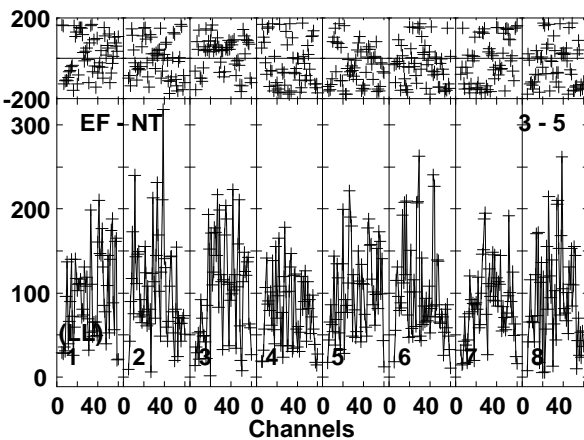
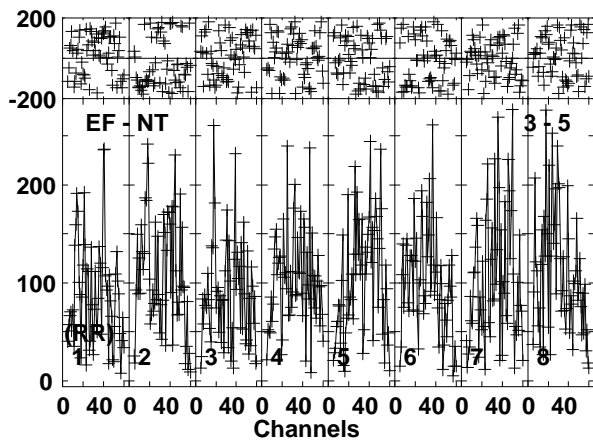
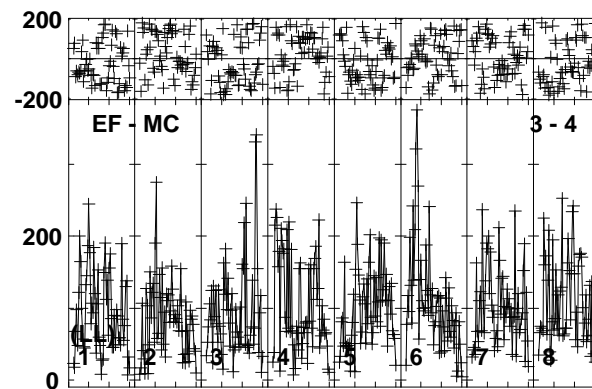
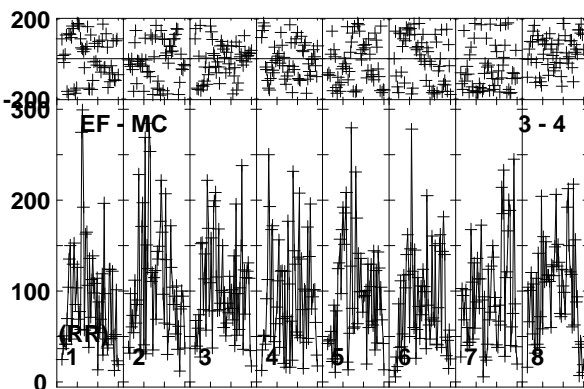
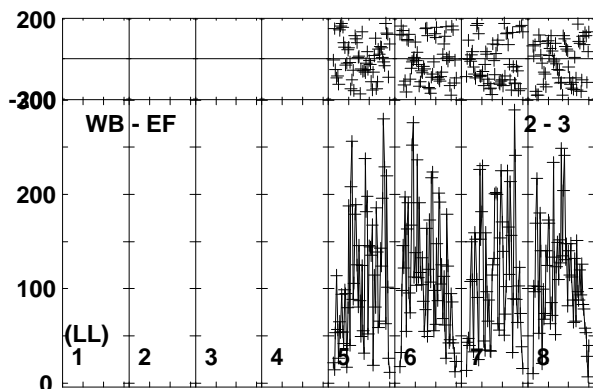
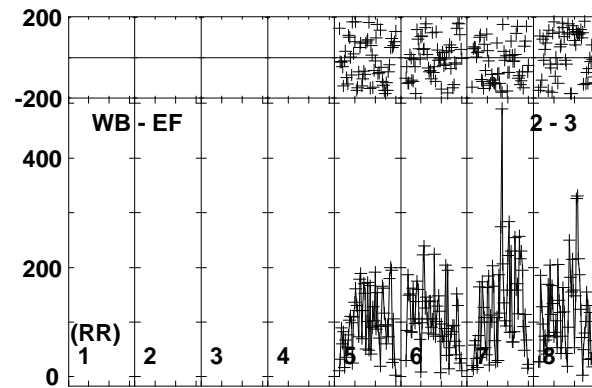
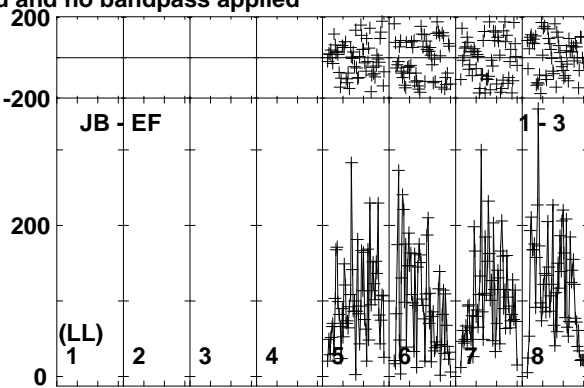
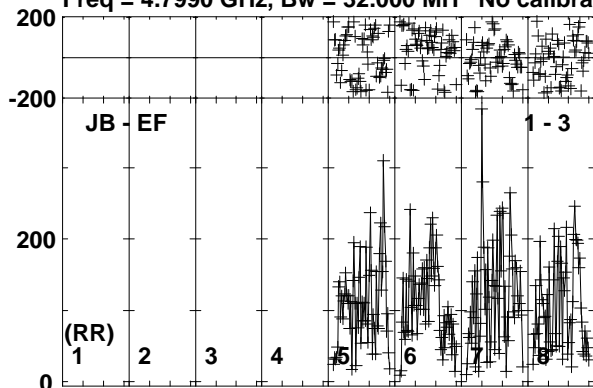

Lower frame: Micro Ampl Jy Top frame: Phas deg
Vector averaged cross-power spectrum Baseline: JB (01) - EF (03)
Timerange: 00/15:18:11 to 00/15:20:39

Plot file version 184 created 28-AUG-2017 13:19:13

SSS17A RP029A.UVDATA.1

Freq = 4.7990 GHz, Bw = 32.000 MH No calibration applied and no bandpass applied

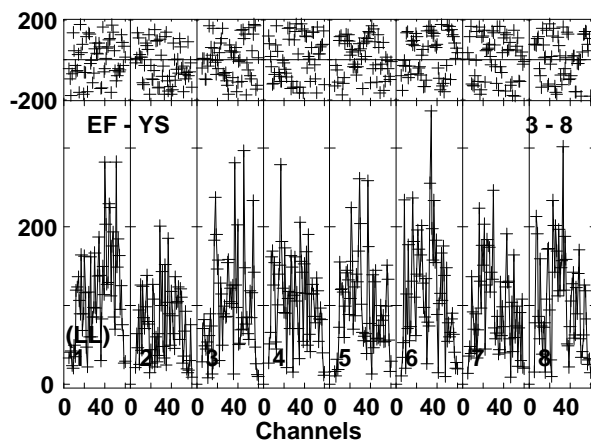
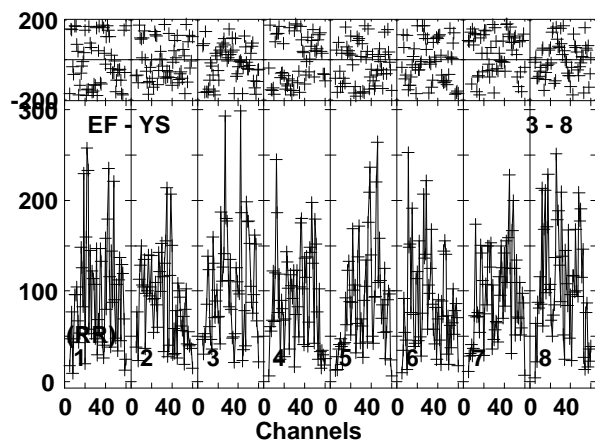
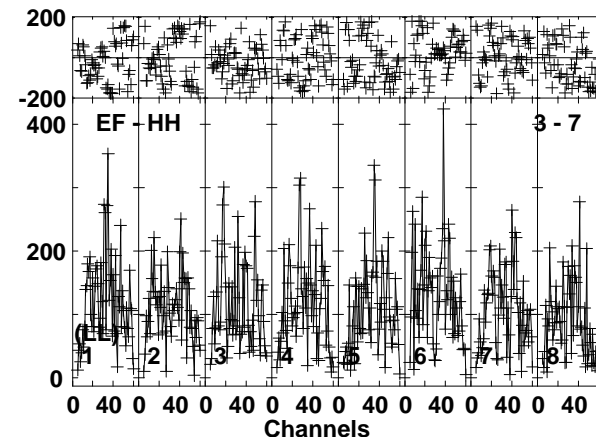
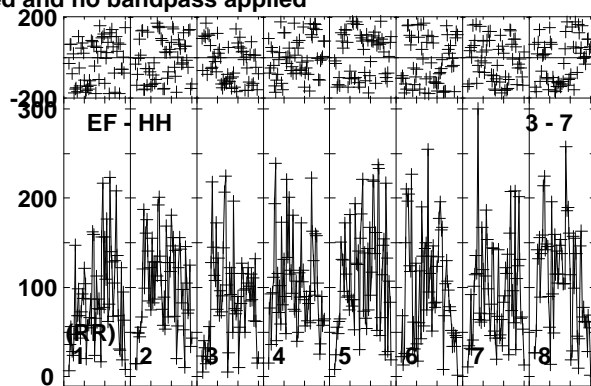
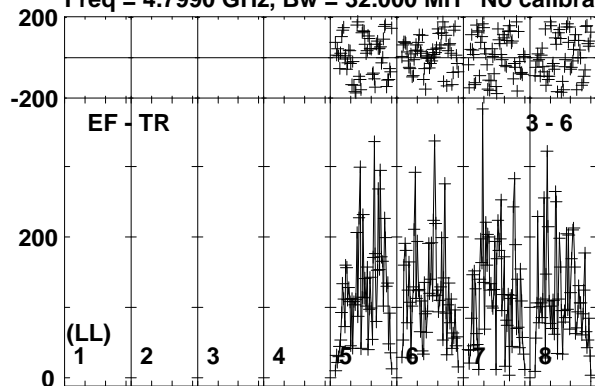

Lower frame: Micro Ampl Jy Top frame: Phas deg
Vector averaged cross-power spectrum Baseline: EF (03) - TR (06)
Timerange: 00/15:18:11 to 00/15:20:39

Plot file version 185 created 28-AUG-2017 13:19:13

J1303-2405 RP029A.UVDATA.1

Freq = 4.7990 GHz, Bw = 32.000 MH No calibration applied and no bandpass applied

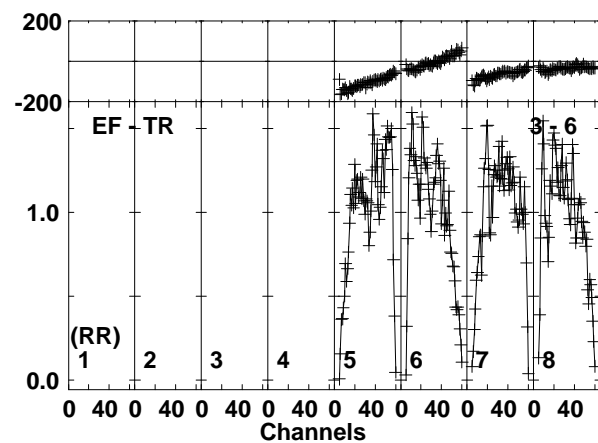
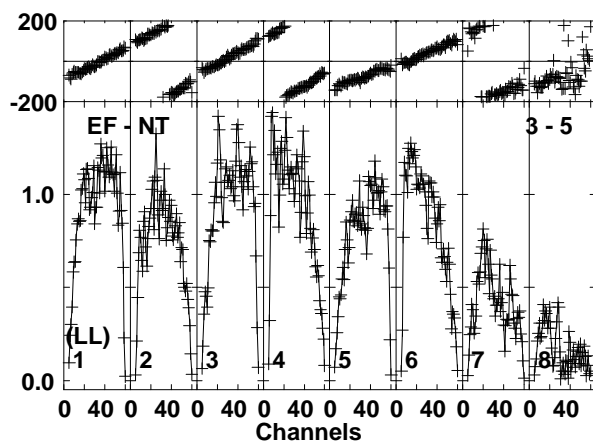
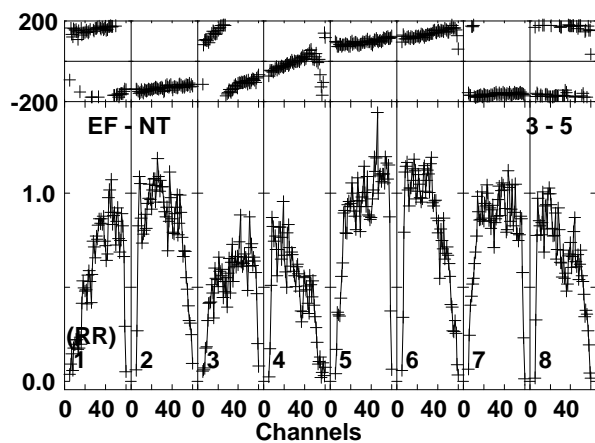
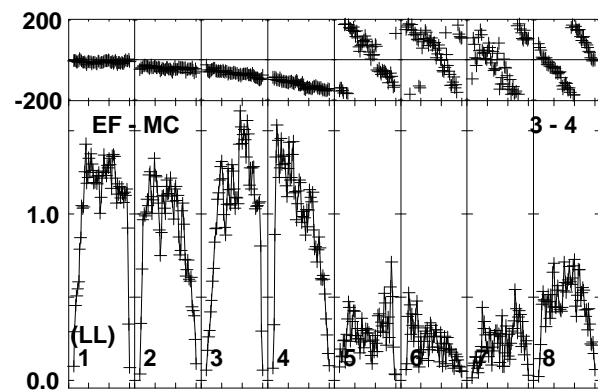
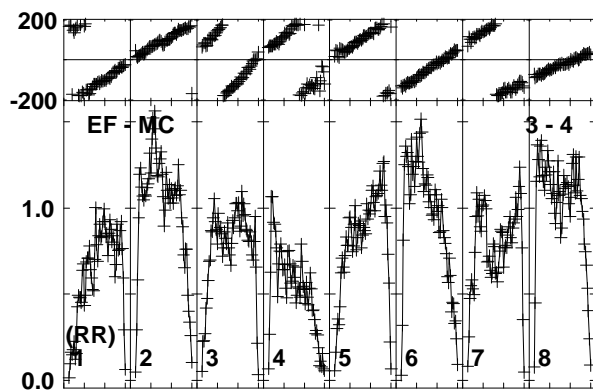
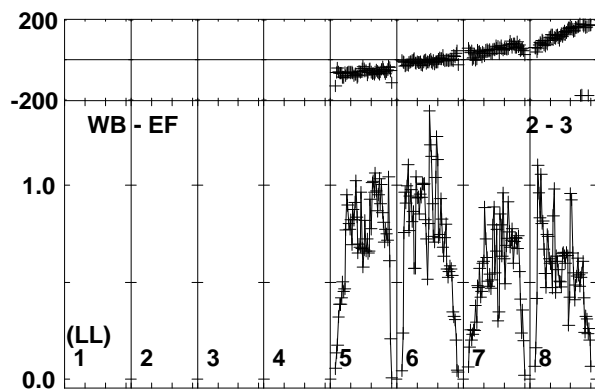
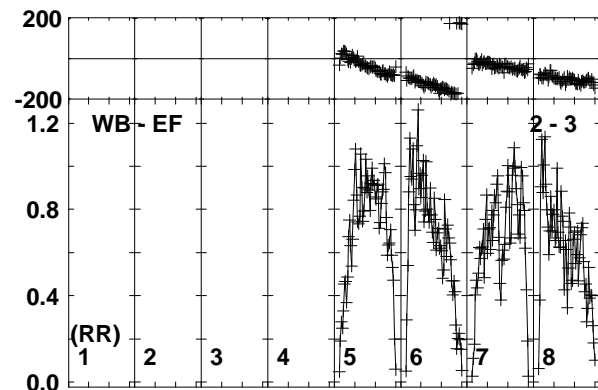
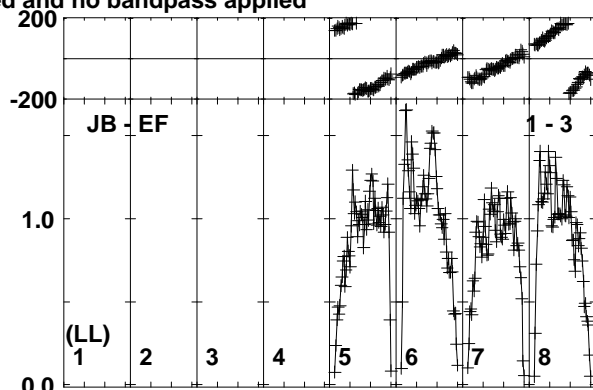
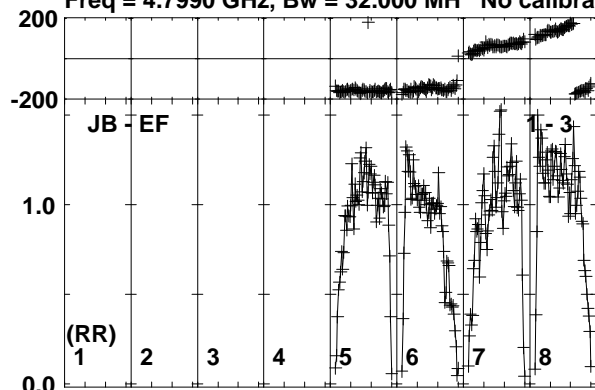

Lower frame: Milli Ampl Jy Top frame: Phas deg
Vector averaged cross-power spectrum Baseline: JB (01) - EF (03)
Timerange: 00/15:20:41 to 00/15:22:09

Plot file version 186 created 28-AUG-2017 13:19:13

J1303-2405 RP029A.UVDATA.1

Freq = 4.7990 GHz, Bw = 32.000 MH No calibration applied and no bandpass applied

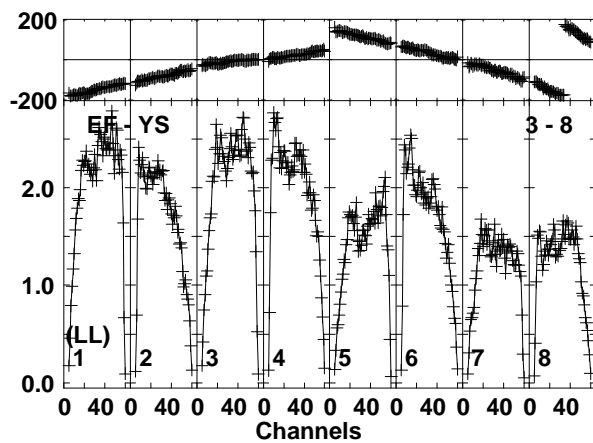
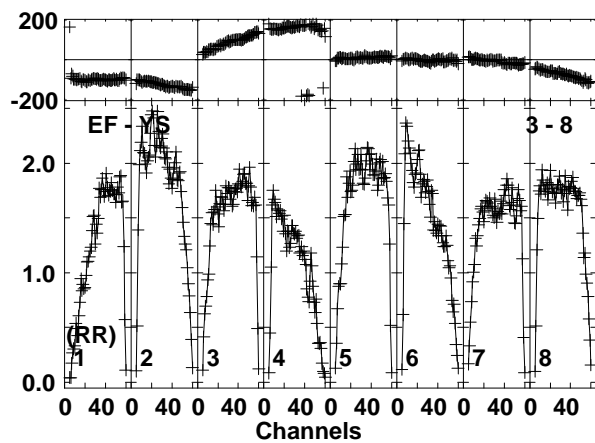
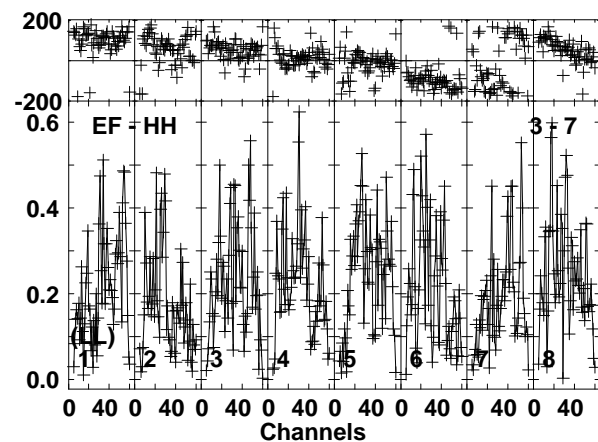
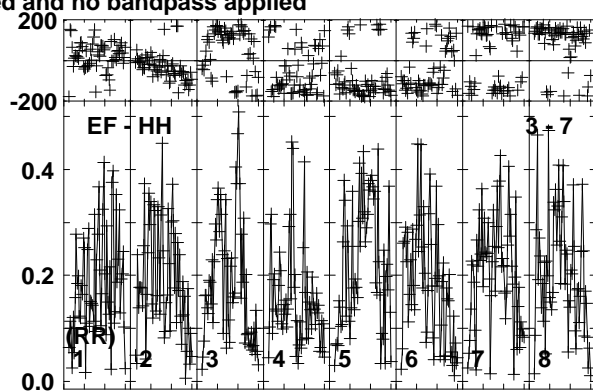
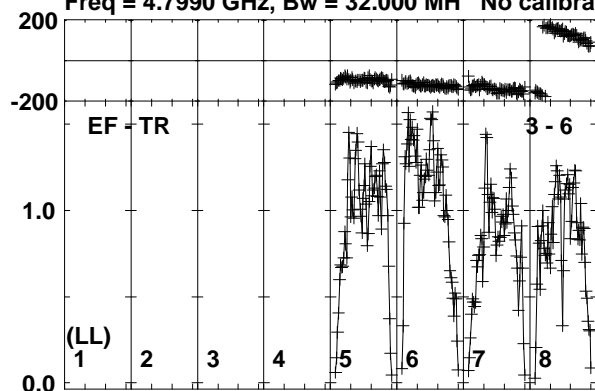

Lower frame: Milli Ampl Jy Top frame: Phas deg
Vector averaged cross-power spectrum Baseline: EF (03) - TR (06)
Timerange: 00/15:20:41 to 00/15:22:09

Plot file version 187 created 28-AUG-2017 13:19:13

J1312-2350 RP029A.UVDATA.1

Freq = 4.7990 GHz, Bw = 32.000 MH No calibration applied and no bandpass applied

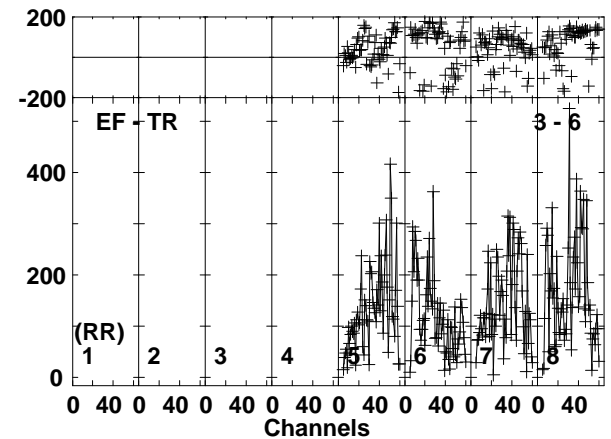
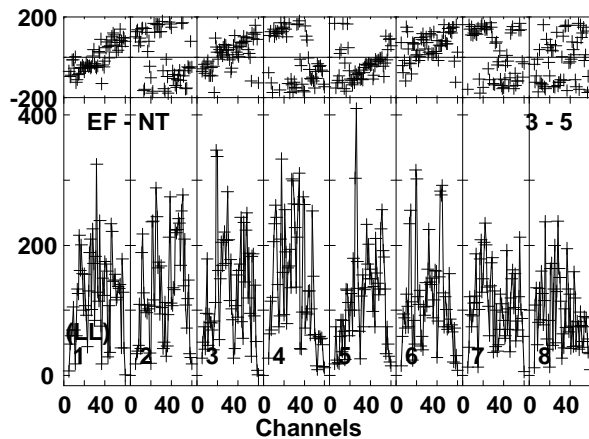
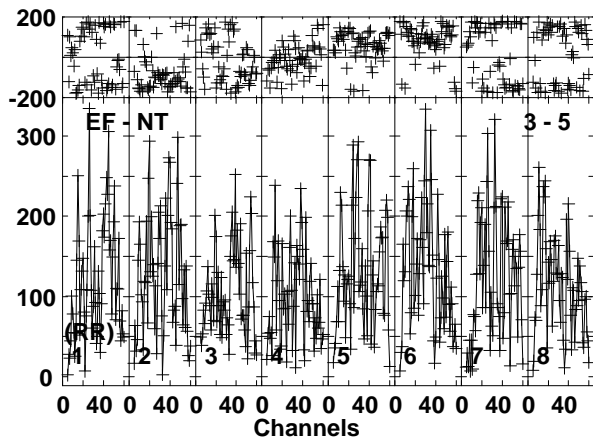
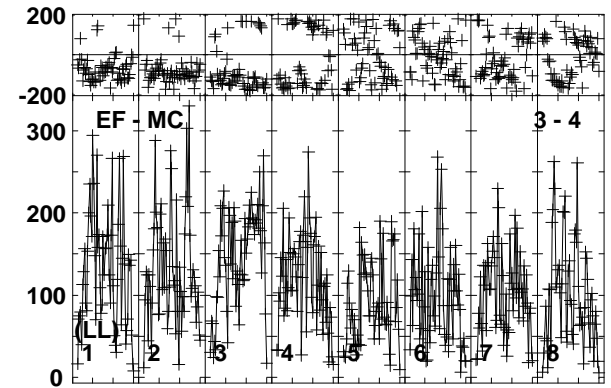
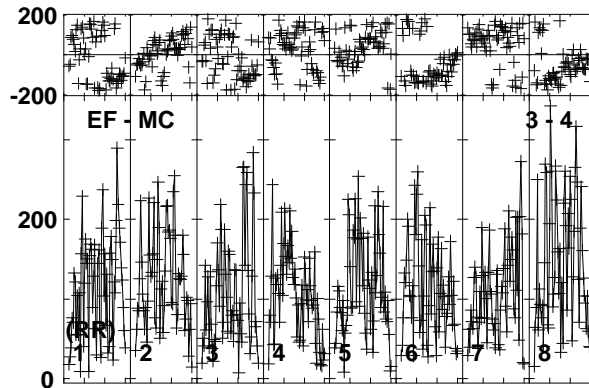
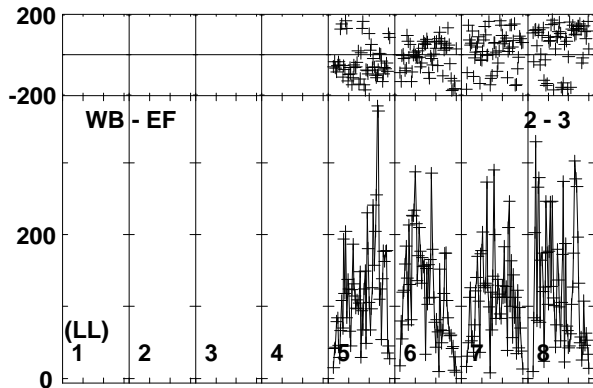
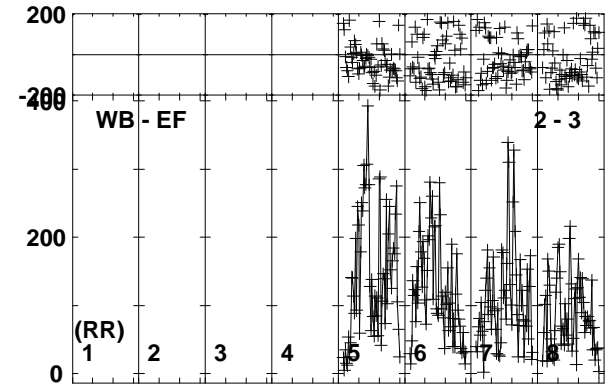
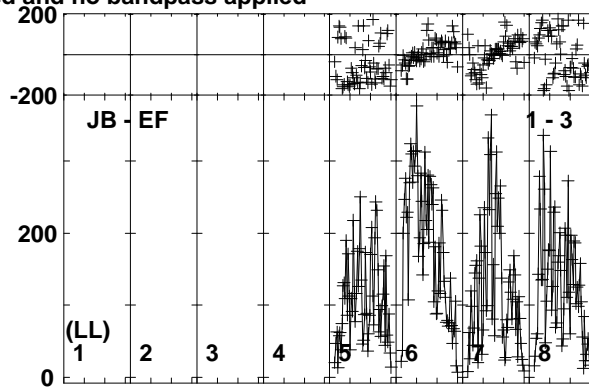
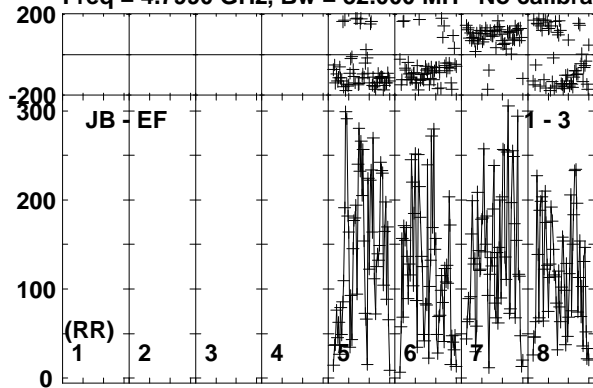

Lower frame: Micro Ampl Jy Top frame: Phas deg
Vector averaged cross-power spectrum Baseline: JB (01) - EF (03)
Timerange: 00/15:22:11 to 00/15:24:39

Plot file version 188 created 28-AUG-2017 13:19:14

J1312-2350 RP029A.UVDATA.1

Freq = 4.7990 GHz, Bw = 32.000 MH No calibration applied and no bandpass applied

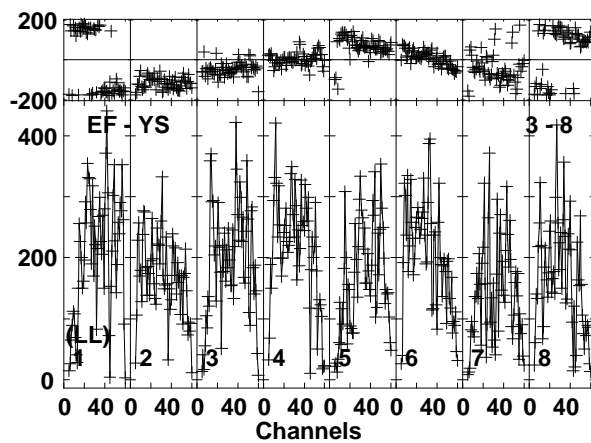
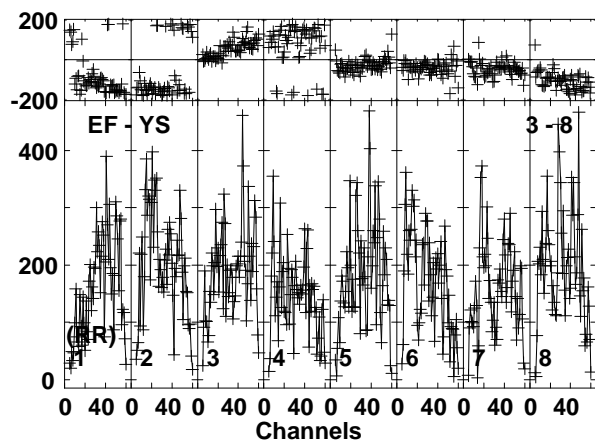
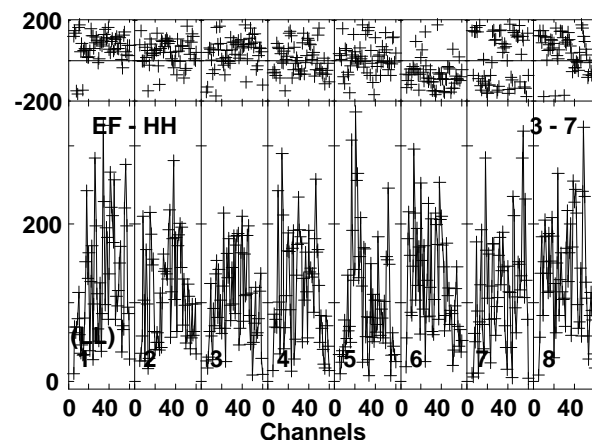
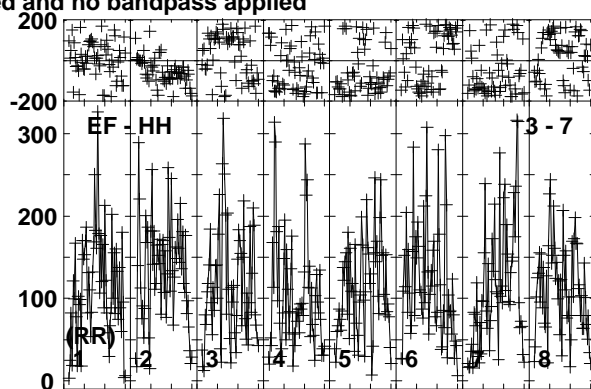
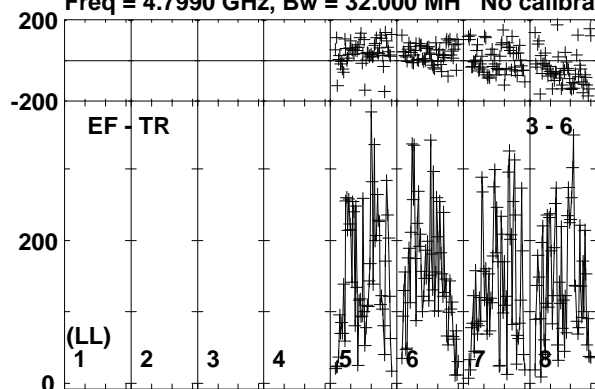

Lower frame: Micro Ampl Jy Top frame: Phas deg
Vector averaged cross-power spectrum Baseline: EF (03) - TR (06)
Timerange: 00/15:22:11 to 00/15:24:39

Plot file version 189 created 28-AUG-2017 13:19:14

J1303-2405 RP029A.UVDATA.1

Freq = 4.7990 GHz, Bw = 32.000 MH No calibration applied and no bandpass applied

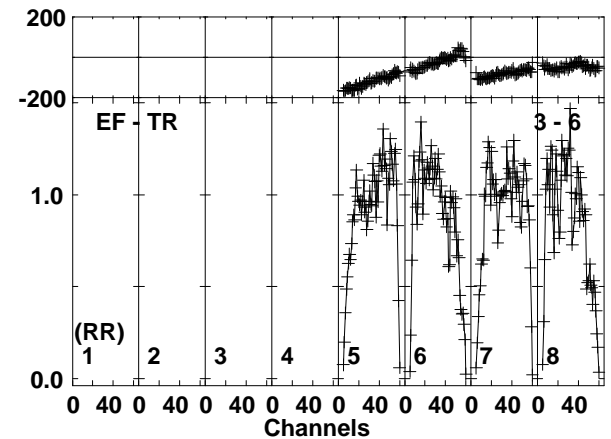
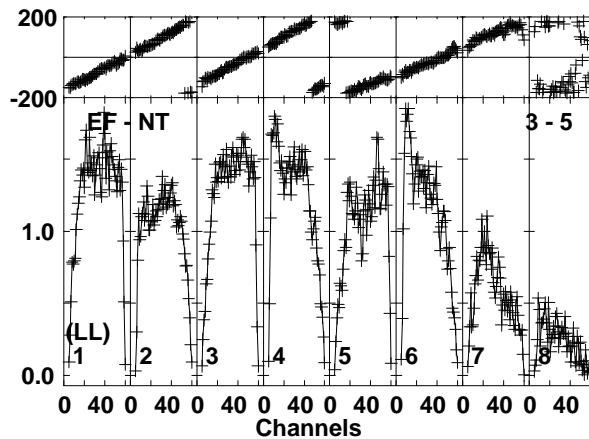
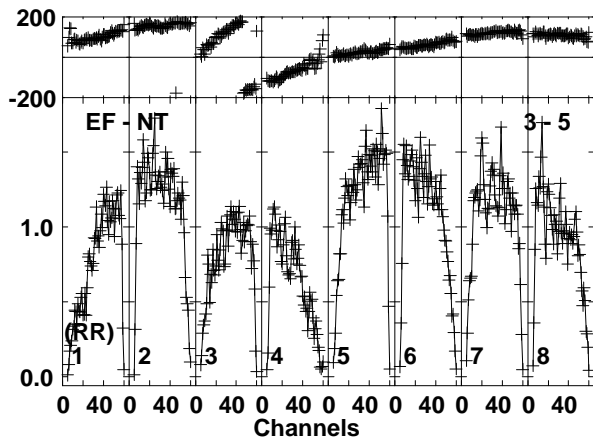
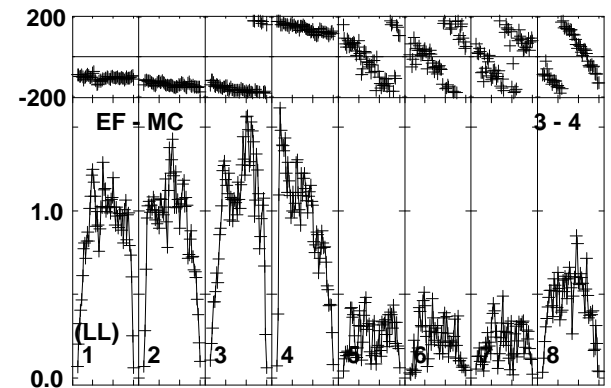
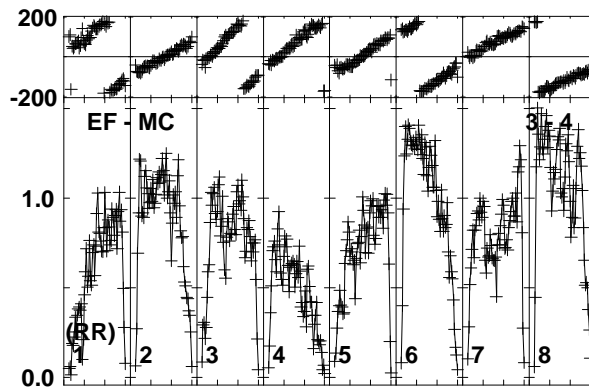
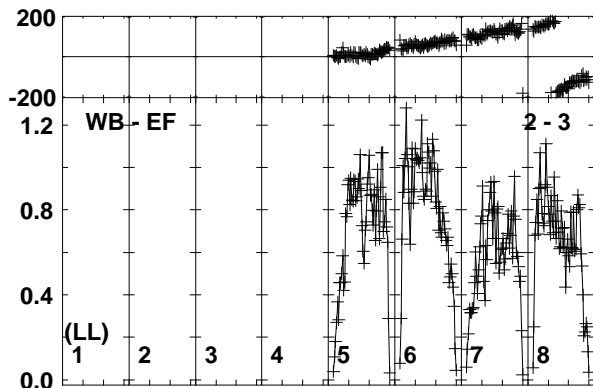
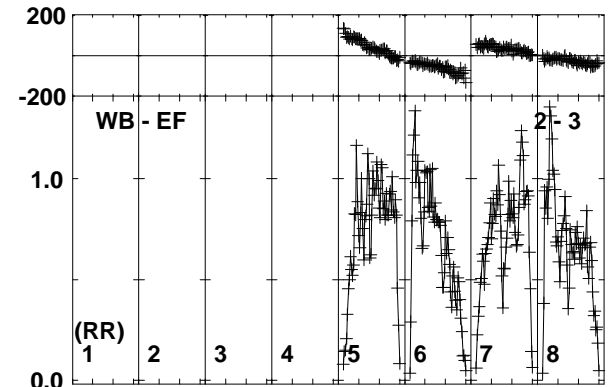
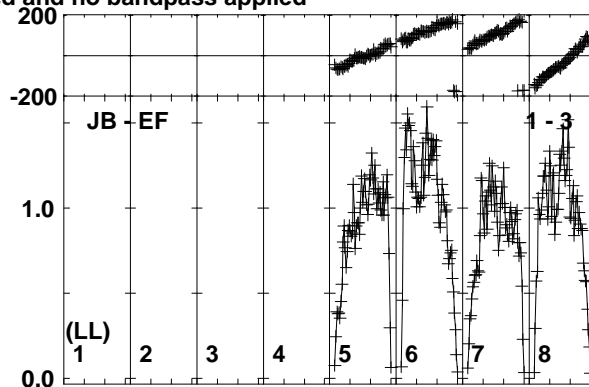
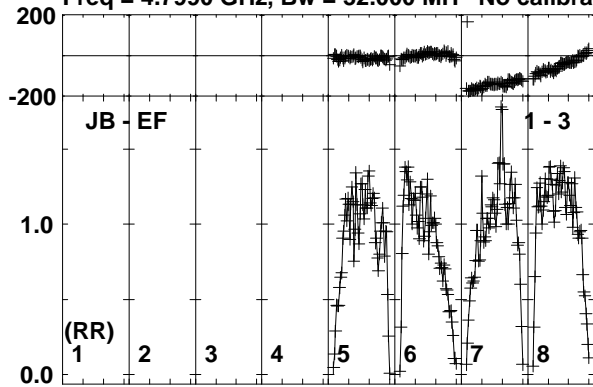

Lower frame: Milli Ampl Jy Top frame: Phas deg
Vector averaged cross-power spectrum Baseline: JB (01) - EF (03)
Timerange: 00/15:25:21 to 00/15:26:19

Plot file version 190 created 28-AUG-2017 13:19:14

J1303-2405 RP029A.UVDATA.1

Freq = 4.7990 GHz, Bw = 32.000 MH No calibration applied and no bandpass applied

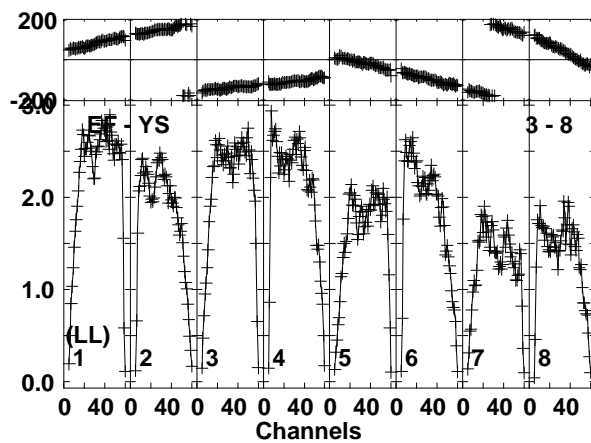
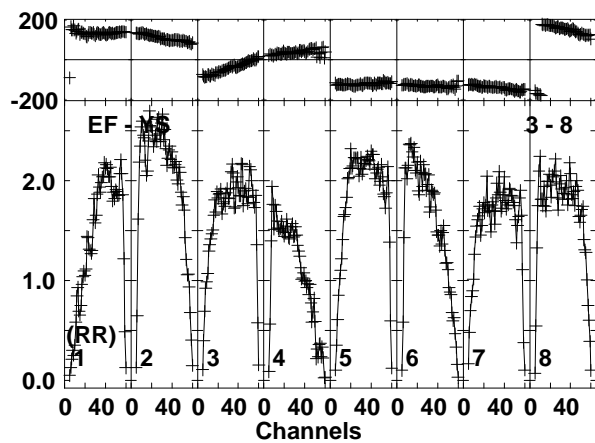
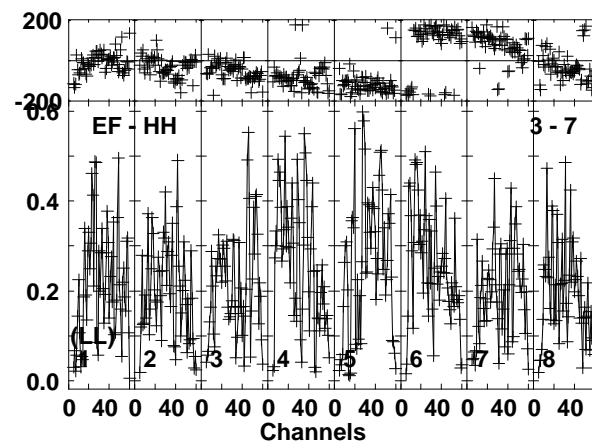
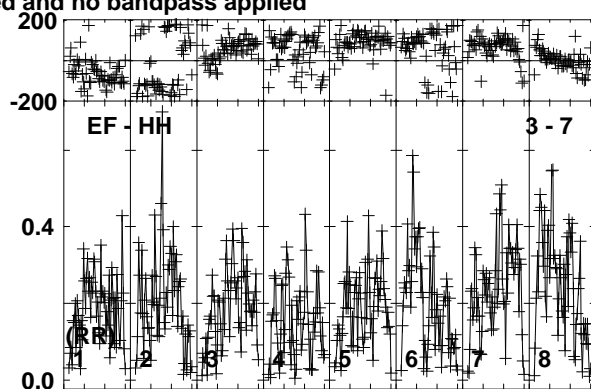
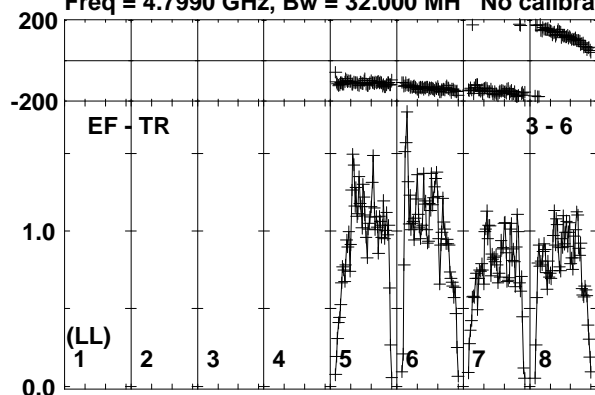

Lower frame: Milli Ampl Jy Top frame: Phas deg
Vector averaged cross-power spectrum Baseline: EF (03) - TR (06)
Timerange: 00/15:25:21 to 00/15:26:19

Plot file version 191 created 28-AUG-2017 13:19:14

SSS17A RP029A.UVDATA.1

Freq = 4.7990 GHz, Bw = 32.000 MH No calibration applied and no bandpass applied

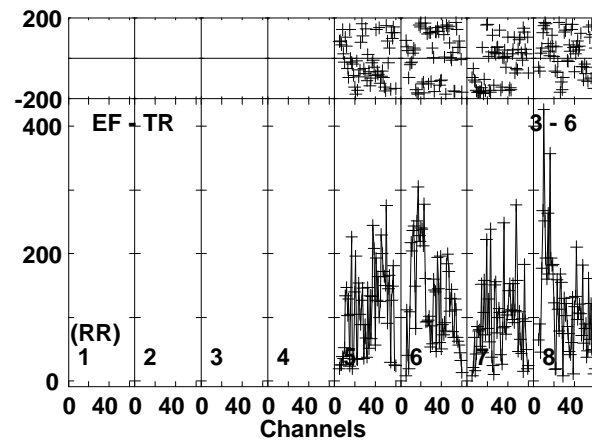
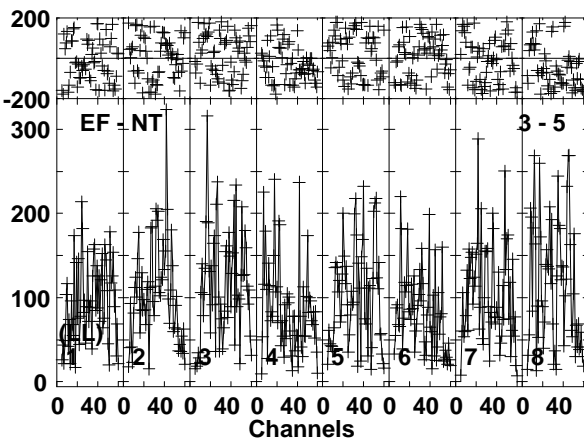
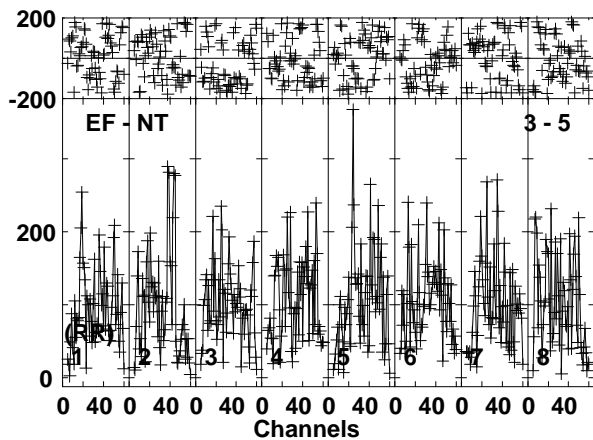
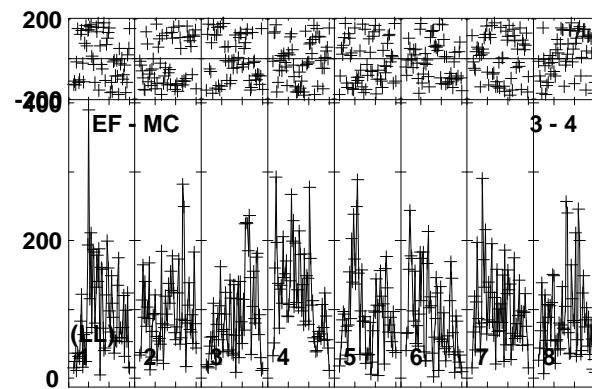
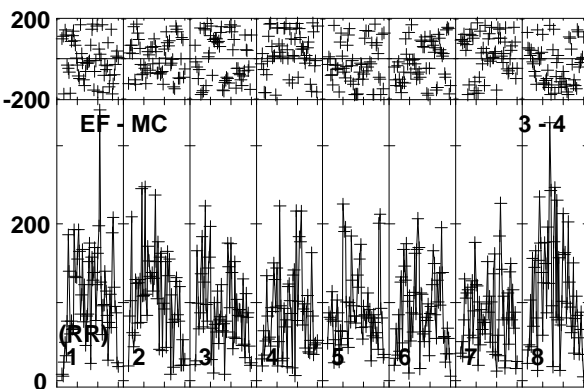
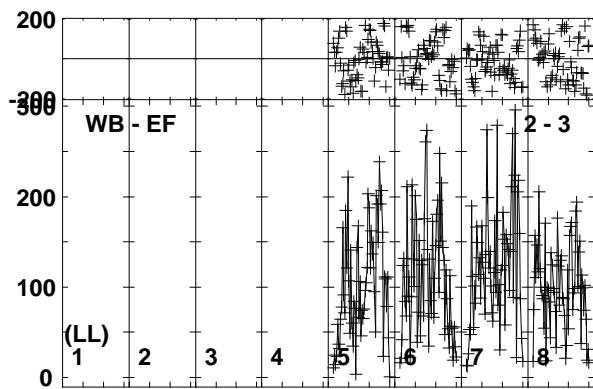
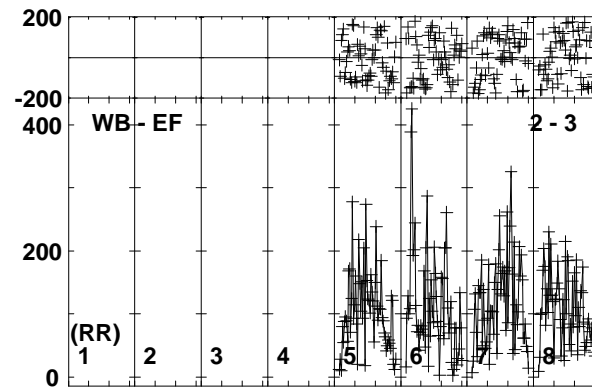
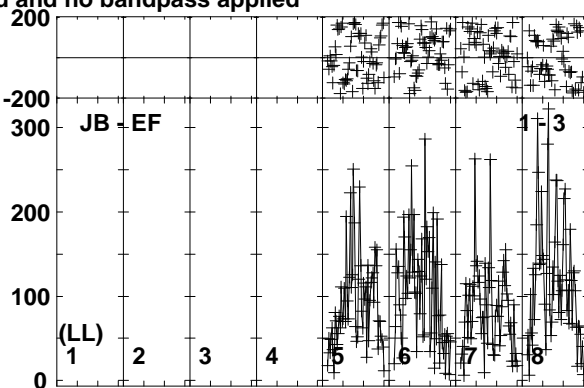
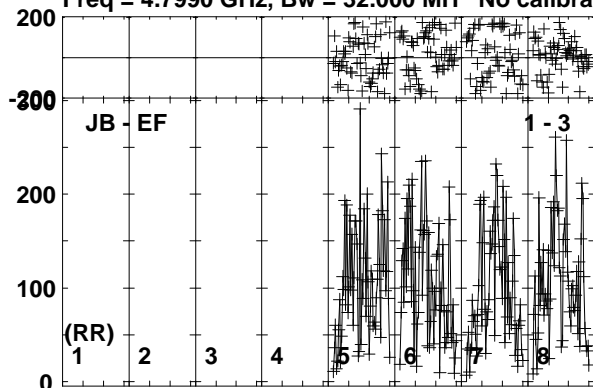

Lower frame: Micro Ampl Jy Top frame: Phas deg
Vector averaged cross-power spectrum Baseline: JB (01) - EF (03)
Timerange: 00/15:26:21 to 00/15:28:49

Plot file version 192 created 28-AUG-2017 13:19:14

SSS17A RP029A.UVDATA.1

Freq = 4.7990 GHz, Bw = 32.000 MH No calibration applied and no bandpass applied

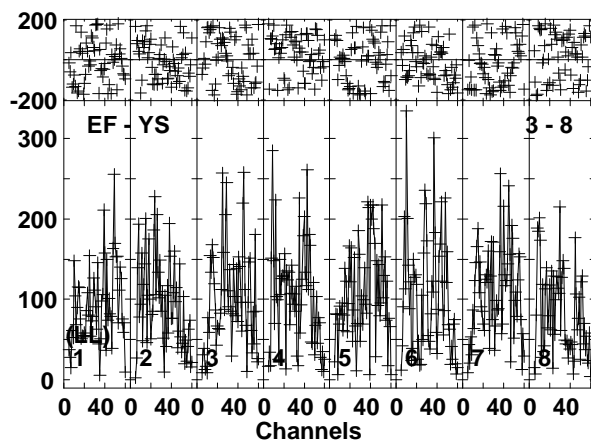
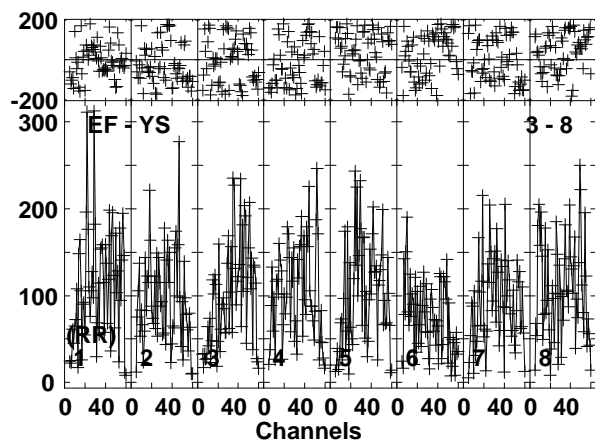
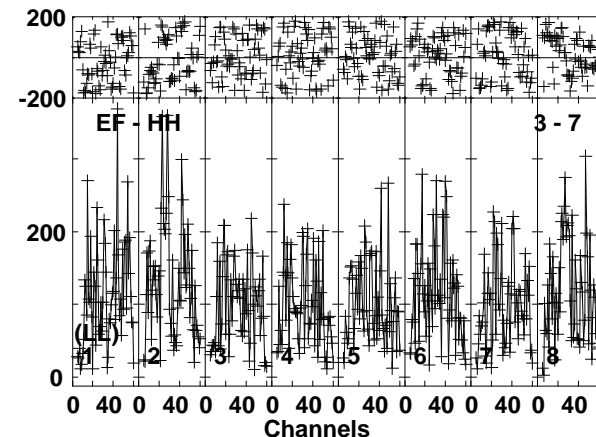
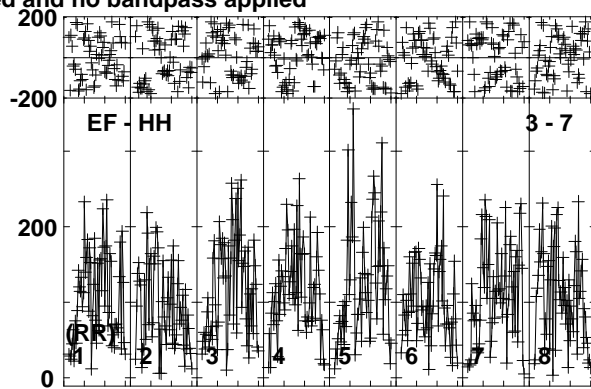
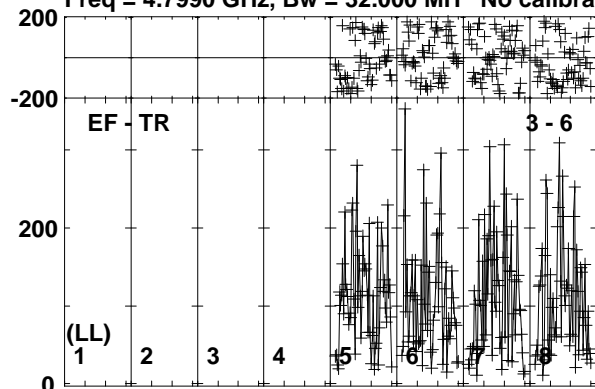

Lower frame: Micro Ampl Jy Top frame: Phas deg
Vector averaged cross-power spectrum Baseline: EF (03) - TR (06)
Timerange: 00/15:26:21 to 00/15:28:49

Plot file version 193 created 28-AUG-2017 13:19:14

J1303-2405 RP029A.UVDATA.1

Freq = 4.7990 GHz, Bw = 32.000 MH No calibration applied and no bandpass applied

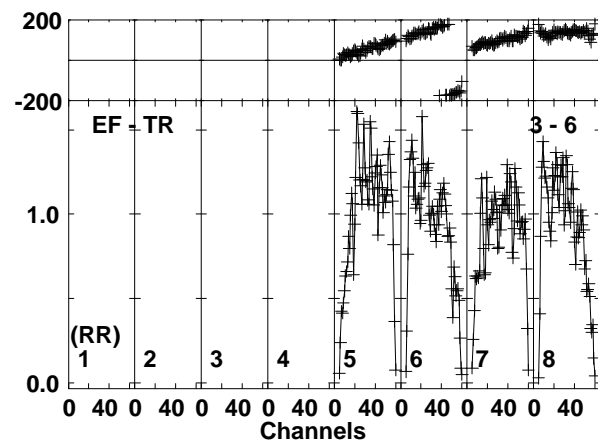
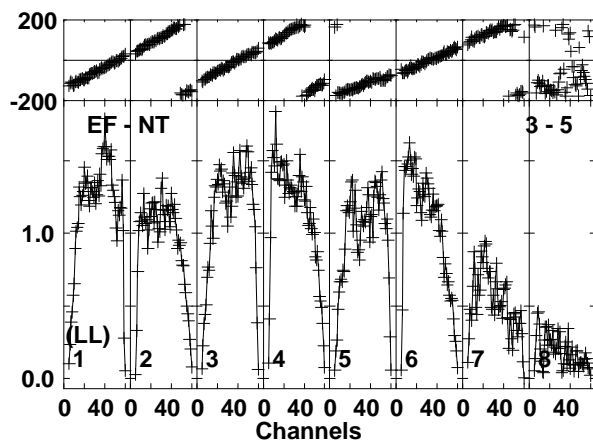
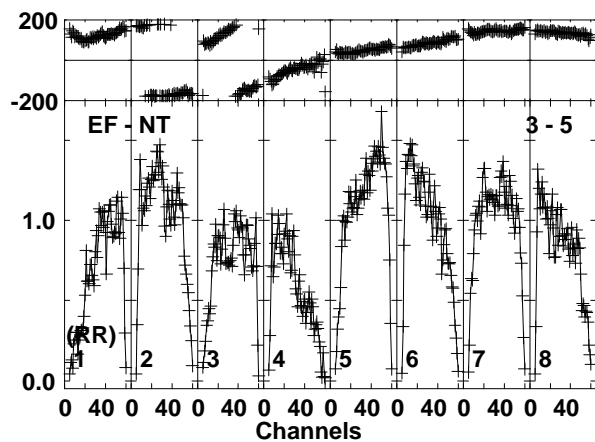
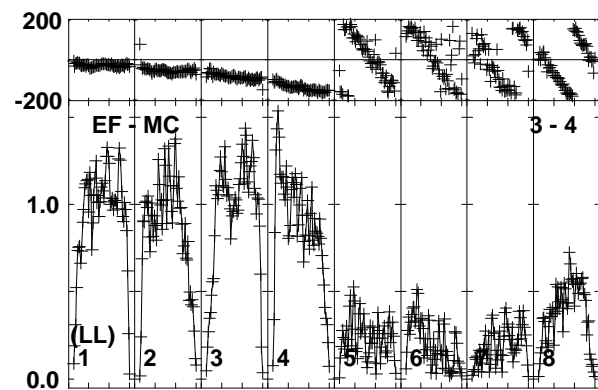
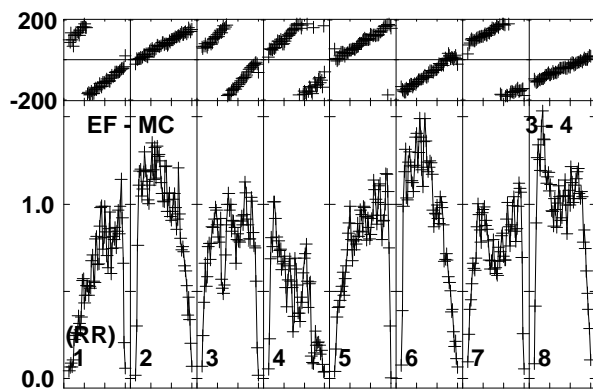
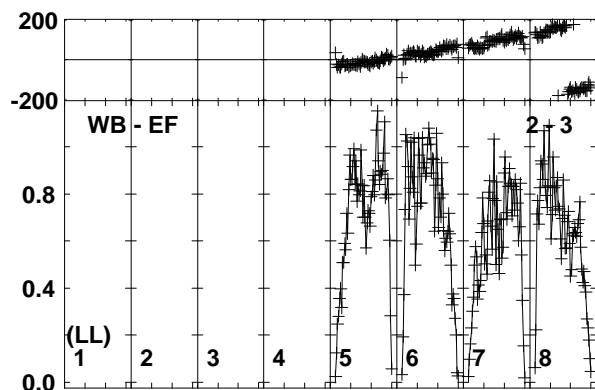
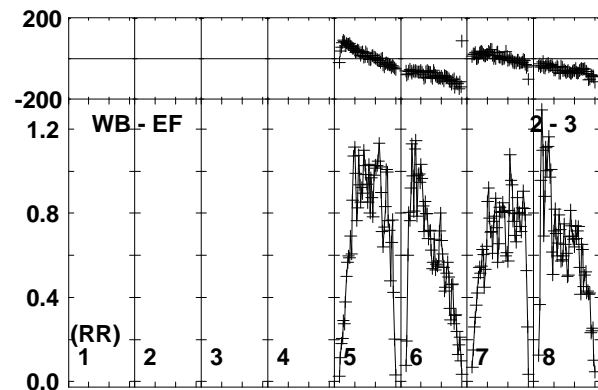
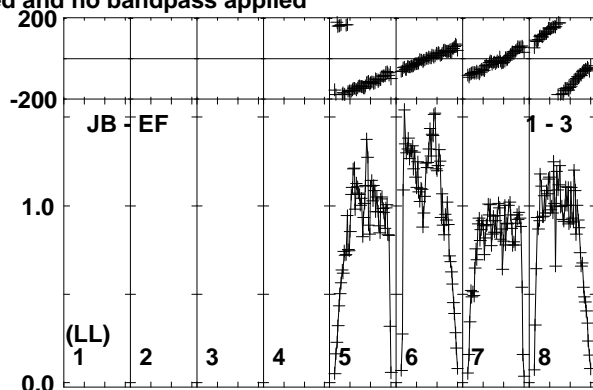
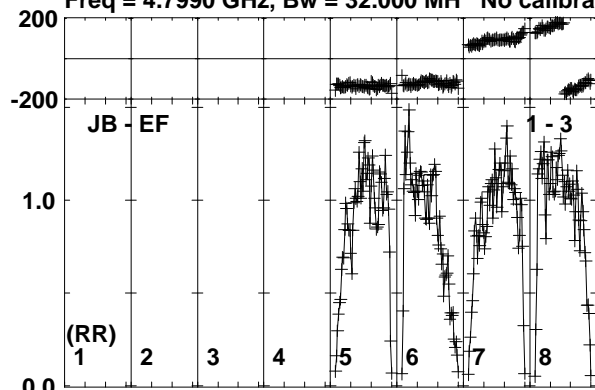

Lower frame: Milli Ampl Jy Top frame: Phas deg
Vector averaged cross-power spectrum Baseline: JB (01) - EF (03)
Timerange: 00/15:28:51 to 00/15:30:19

Plot file version 194 created 28-AUG-2017 13:19:14

J1303-2405 RP029A.UVDATA.1

Freq = 4.7990 GHz, Bw = 32.000 MH No calibration applied and no bandpass applied

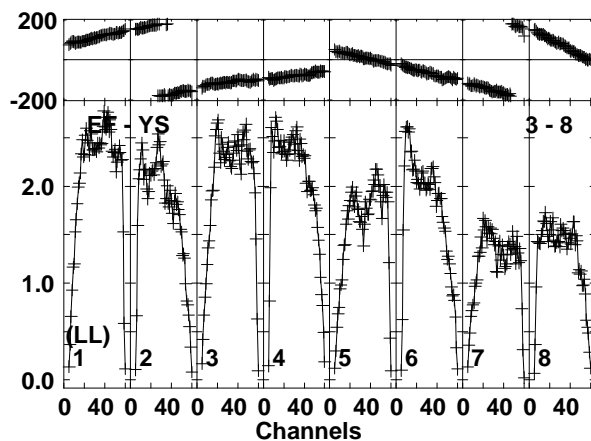
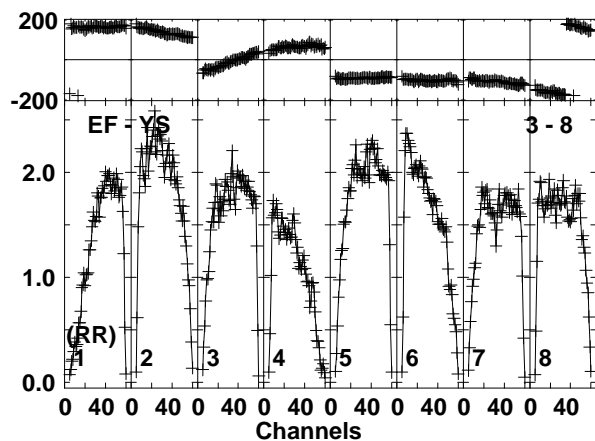
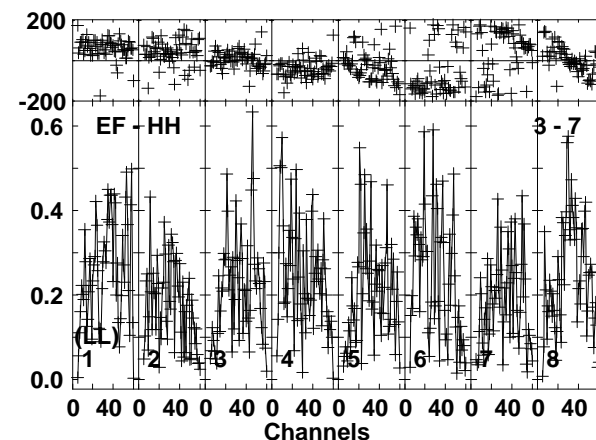
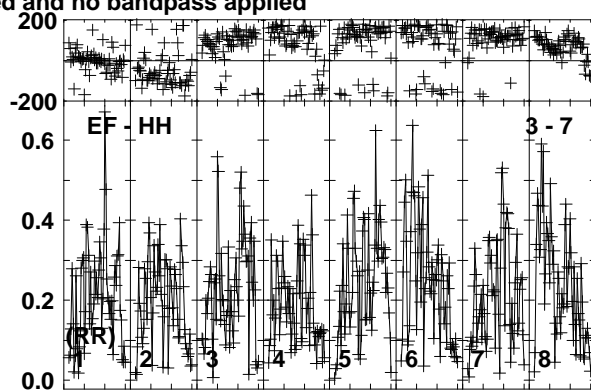
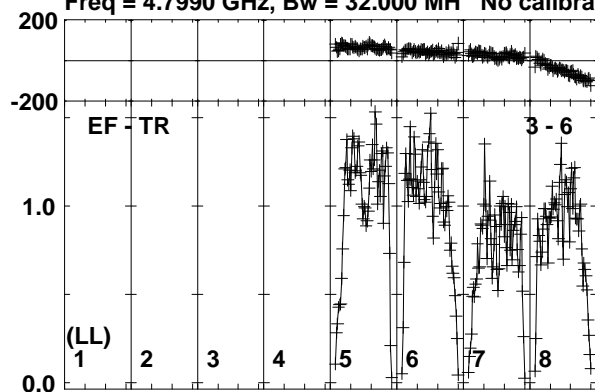

Lower frame: Milli Ampl Jy Top frame: Phas deg
Vector averaged cross-power spectrum Baseline: EF (03) - TR (06)
Timerange: 00/15:28:51 to 00/15:30:19

Plot file version 195 created 28-AUG-2017 13:19:14

SSS17A RP029A.UVDATA.1

Freq = 4.7990 GHz, Bw = 32.000 MH No calibration applied and no bandpass applied

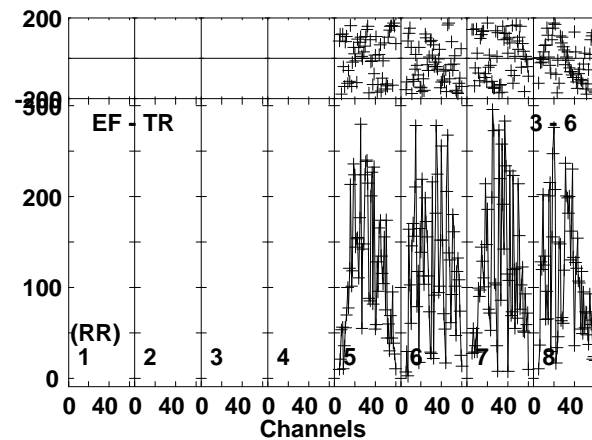
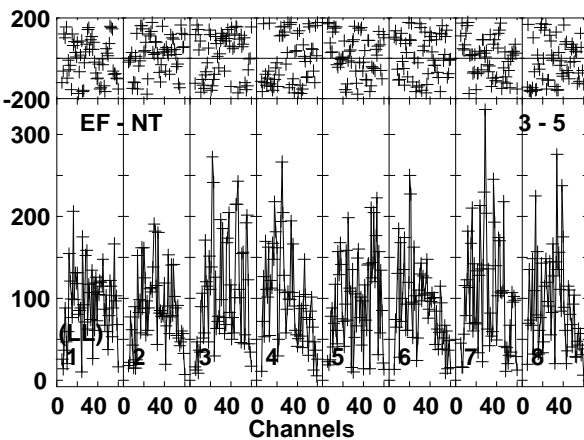
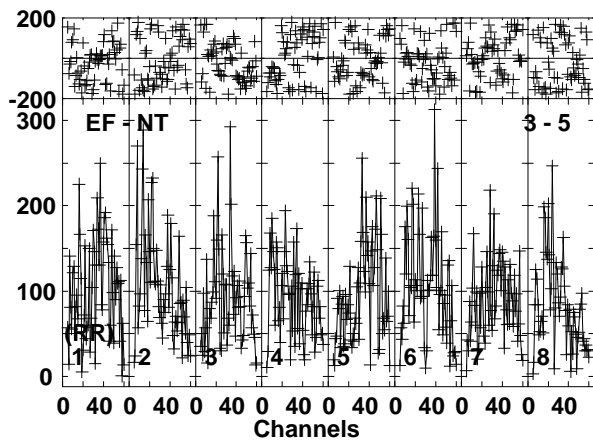
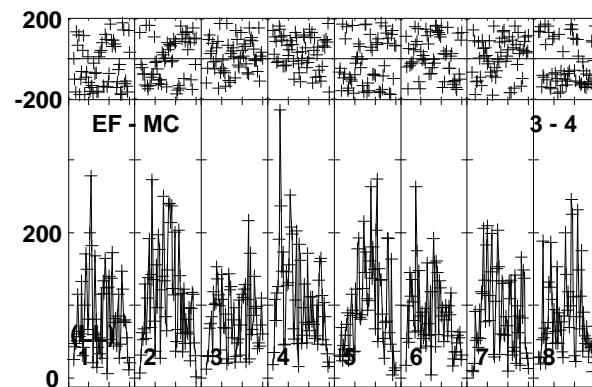
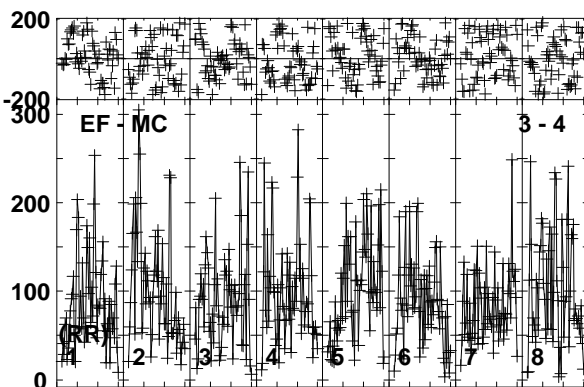
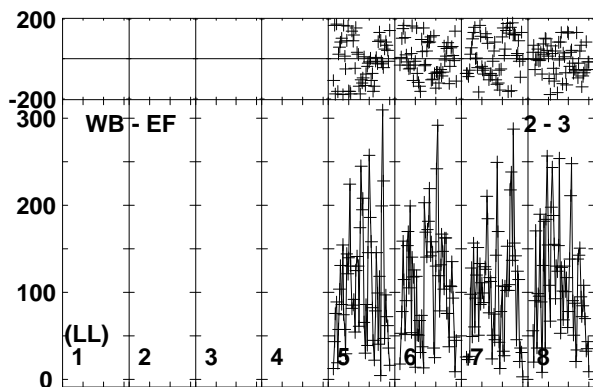
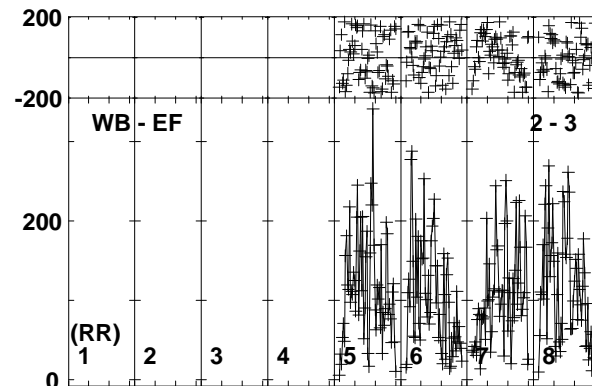
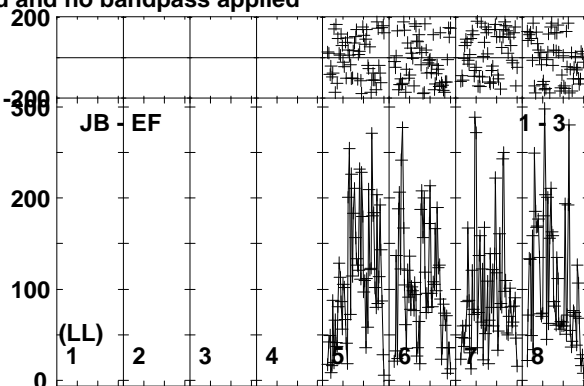
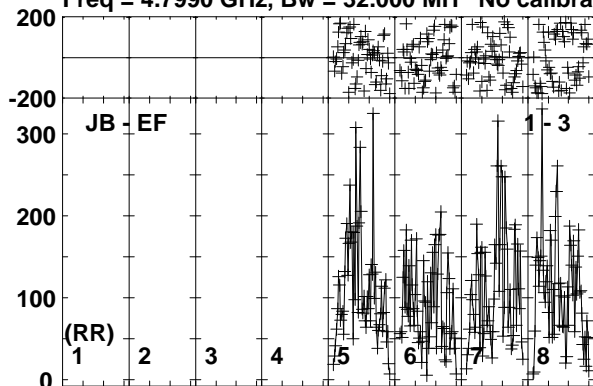

Lower frame: Micro Ampl Jy Top frame: Phas deg
Vector averaged cross-power spectrum Baseline: JB (01) - EF (03)
Timerange: 00/15:30:21 to 00/15:32:49

Plot file version 196 created 28-AUG-2017 13:19:14

SSS17A RP029A.UVDATA.1

Freq = 4.7990 GHz, Bw = 32.000 MH No calibration applied and no bandpass applied

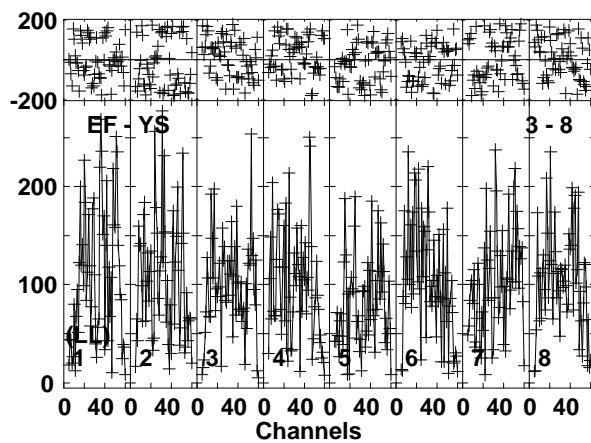
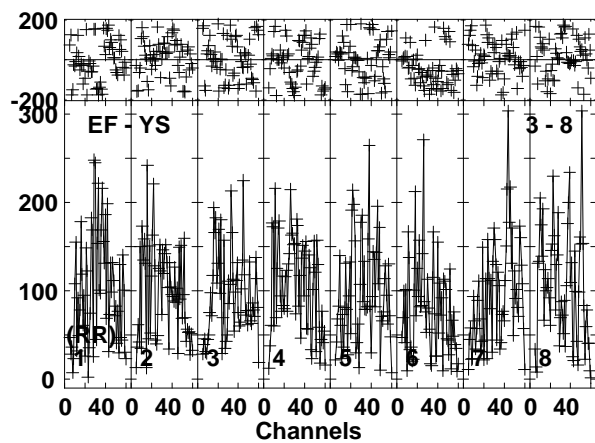
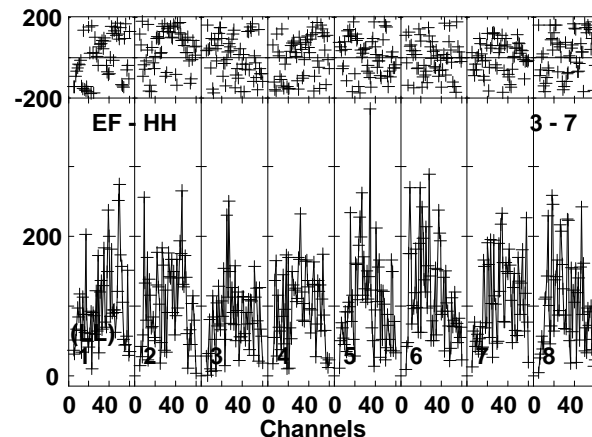
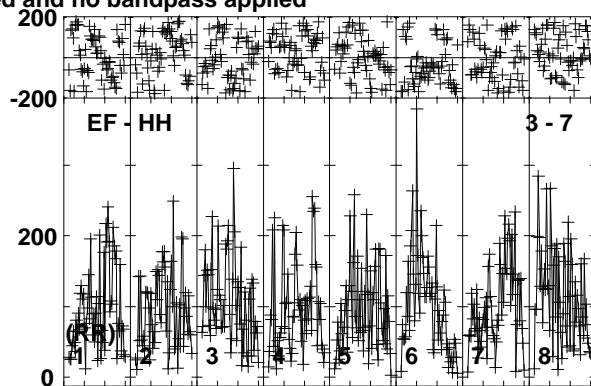
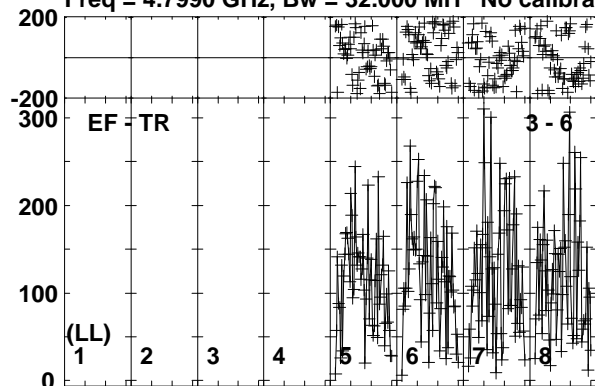

Lower frame: Micro Ampl Jy Top frame: Phas deg
Vector averaged cross-power spectrum Baseline: EF (03) - TR (06)
Timerange: 00:15:30:21 to 00:15:32:49

Plot file version 197 created 28-AUG-2017 13:19:14
 J1303-2405 RP029A.UVDATA.1

Freq = 4.7990 GHz, Bw = 32.000 MH No calibration applied and no bandpass applied

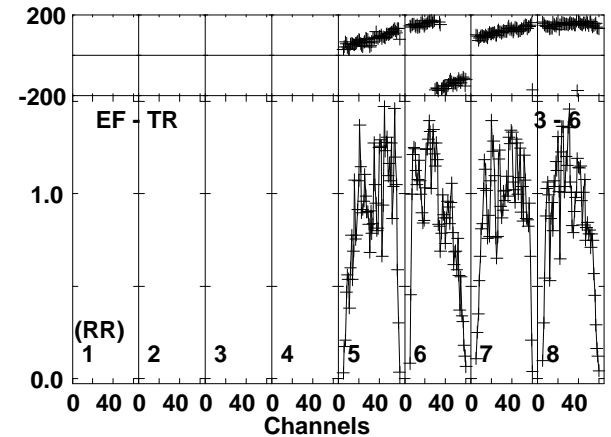
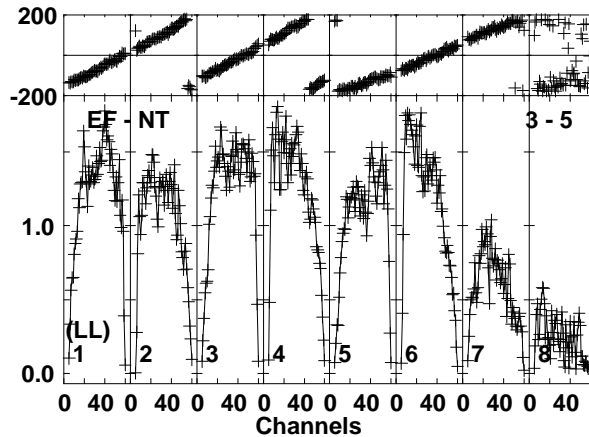
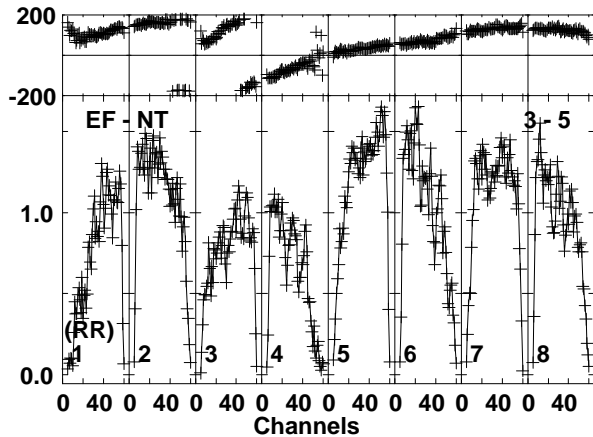
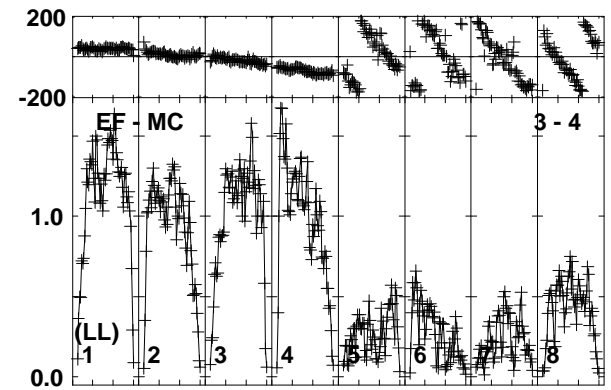
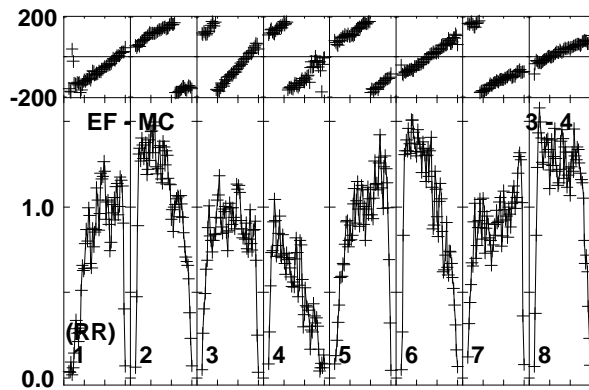
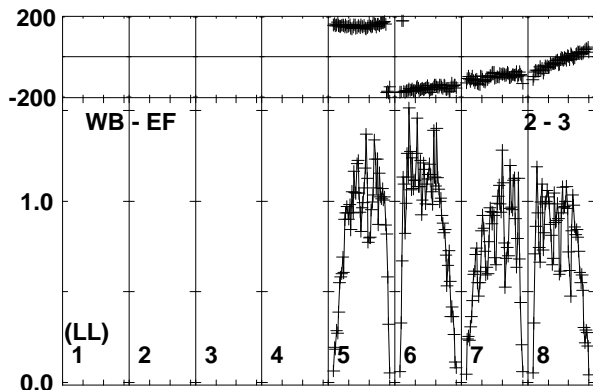
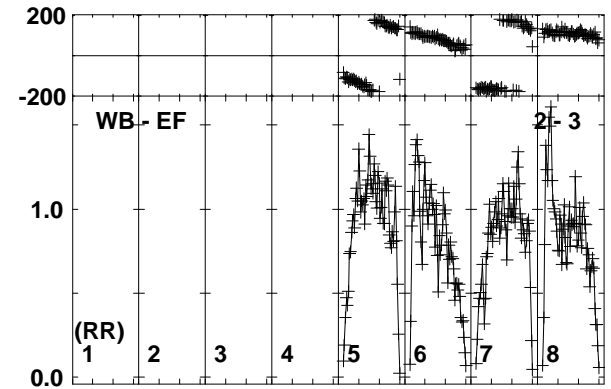
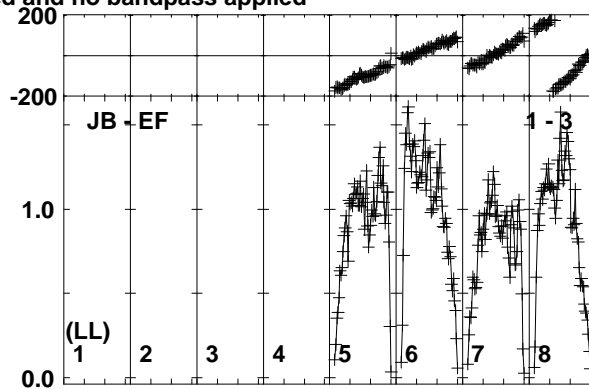
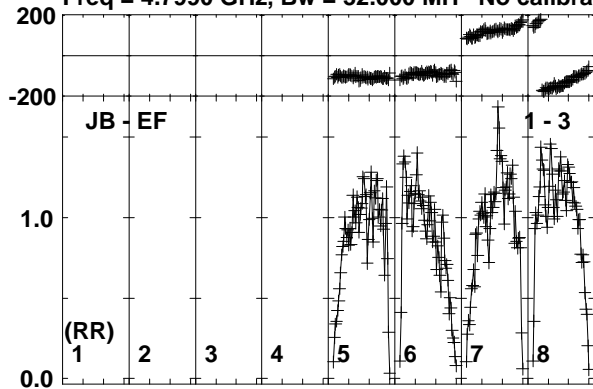

Lower frame: Milli Ampl Jy Top frame: Phas deg
 Vector averaged cross-power spectrum Baseline: JB (01) - EF (03)
 Timerange: 00/15:33:21 to 00/15:34:19

Plot file version 198 created 28-AUG-2017 13:19:14

J1303-2405 RP029A.UVDATA.1

Freq = 4.7990 GHz, Bw = 32.000 MH No calibration applied and no bandpass applied

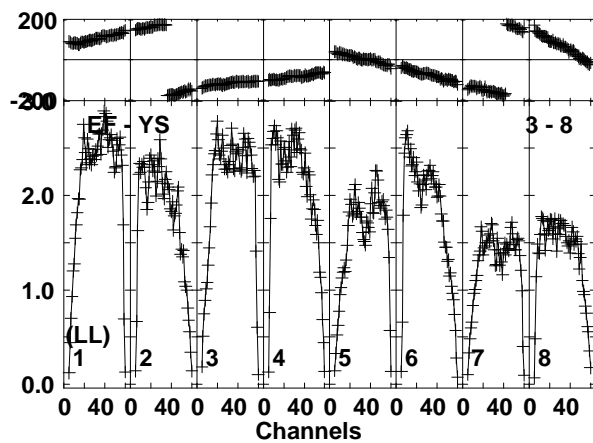
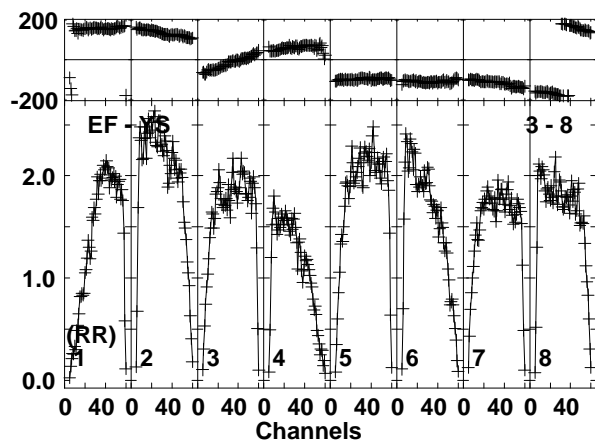
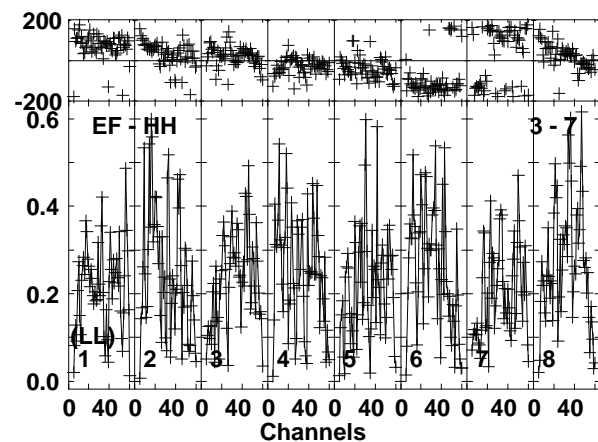
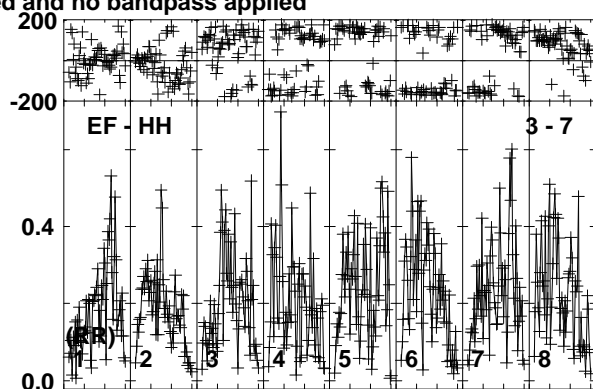
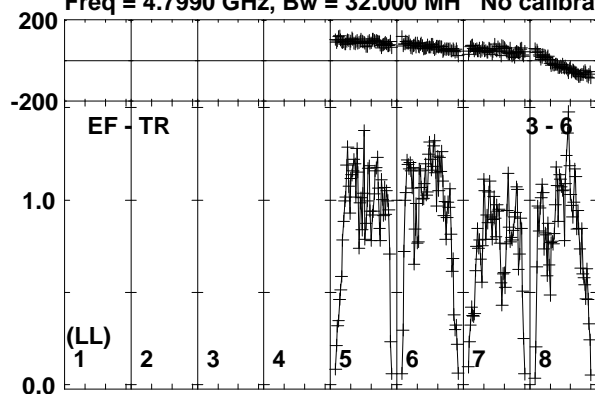

Lower frame: Milli Ampl Jy Top frame: Phas deg
Vector averaged cross-power spectrum Baseline: EF (03) - TR (06)
Timerange: 00/15:33:21 to 00/15:34:19

Plot file version 199 created 28-AUG-2017 13:19:14

SSS17A RP029A.UVDATA.1

Freq = 4.7990 GHz, Bw = 32.000 MH No calibration applied and no bandpass applied

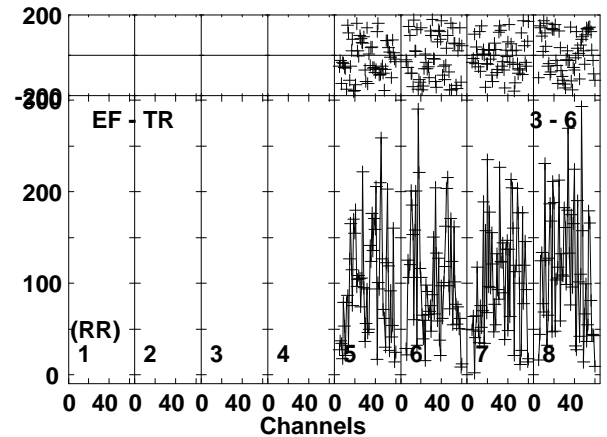
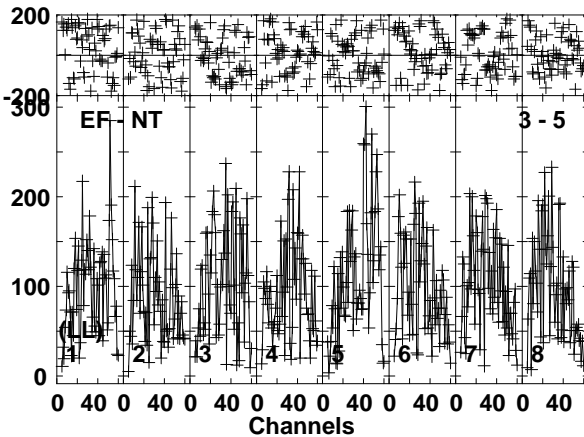
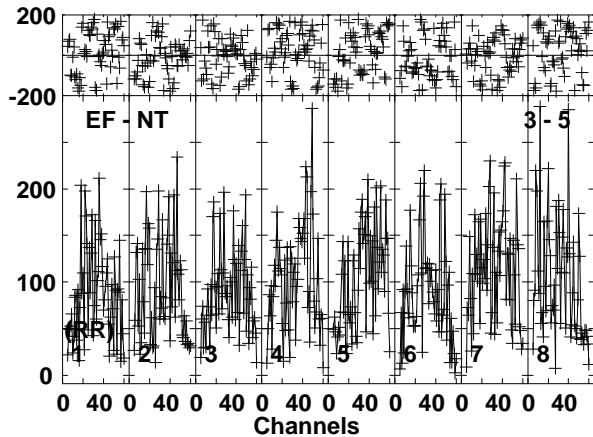
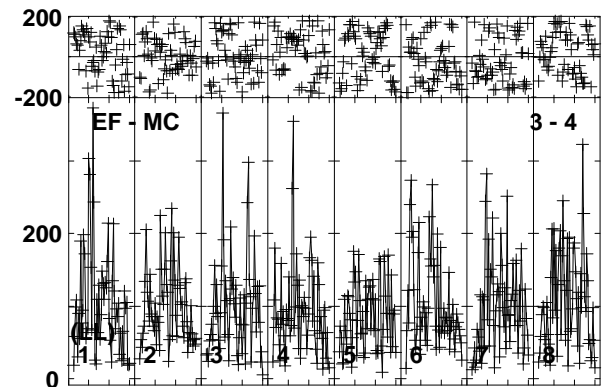
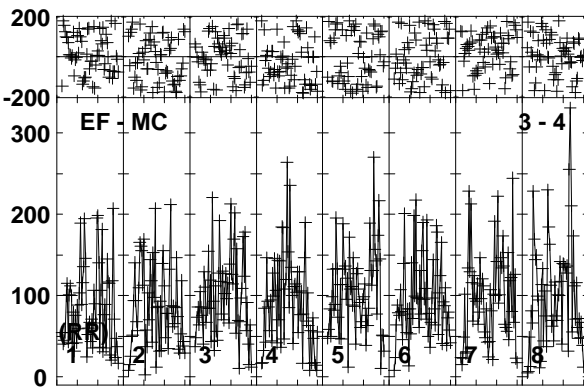
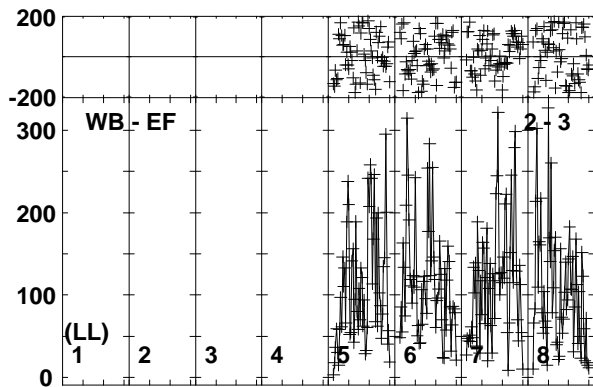
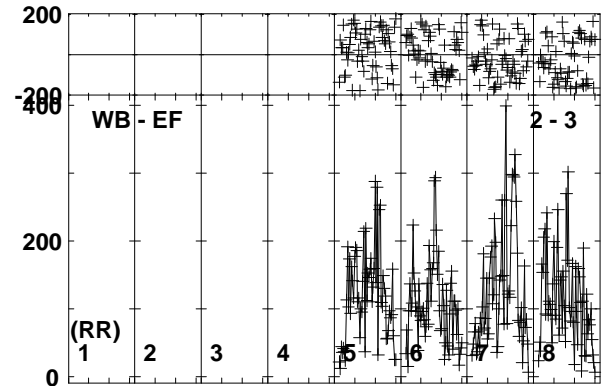
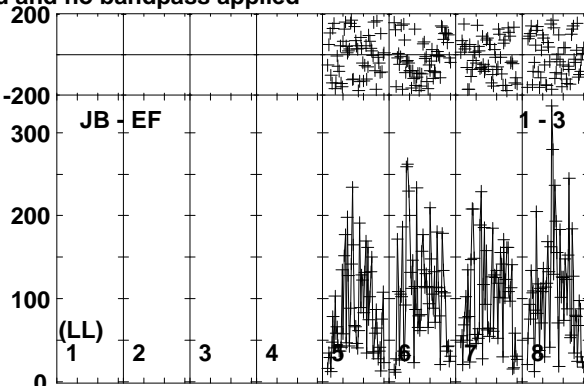
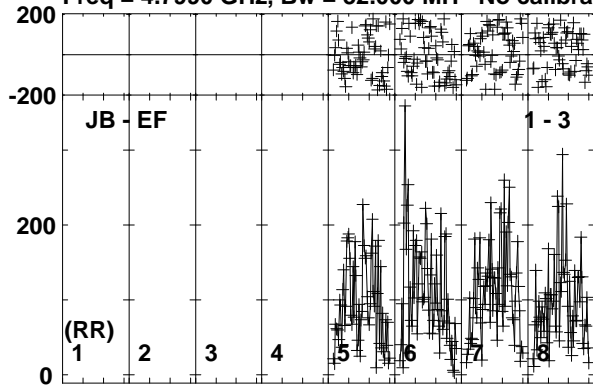

Lower frame: Micro Ampl Jy Top frame: Phas deg
Vector averaged cross-power spectrum Baseline: JB (01) - EF (03)
Timerange: 00/15:34:21 to 00/15:36:49

Plot file version 200 created 28-AUG-2017 13:19:14

SSS17A RP029A.UVDATA.1

Freq = 4.7990 GHz, Bw = 32.000 MH No calibration applied and no bandpass applied

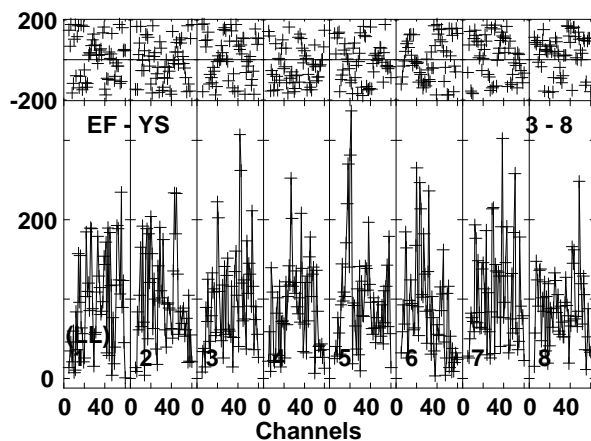
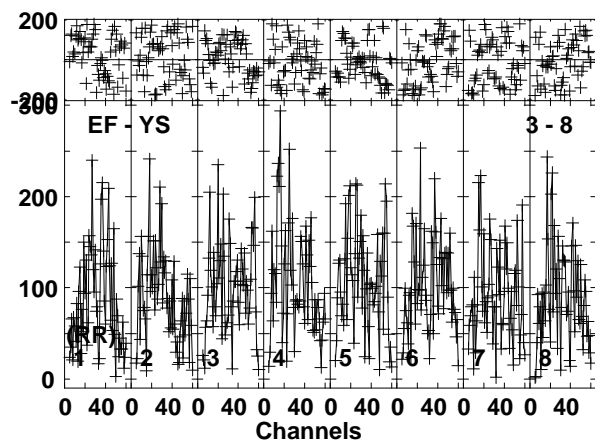
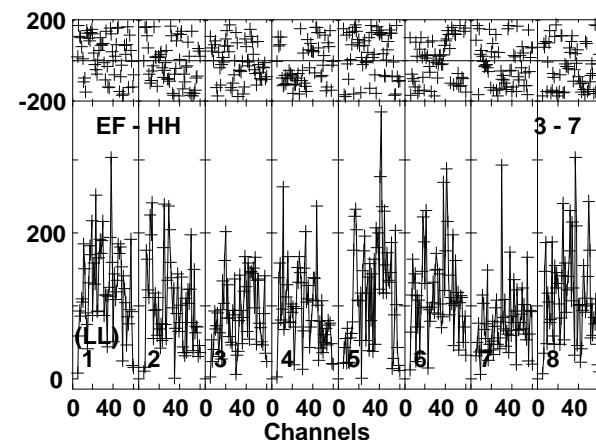
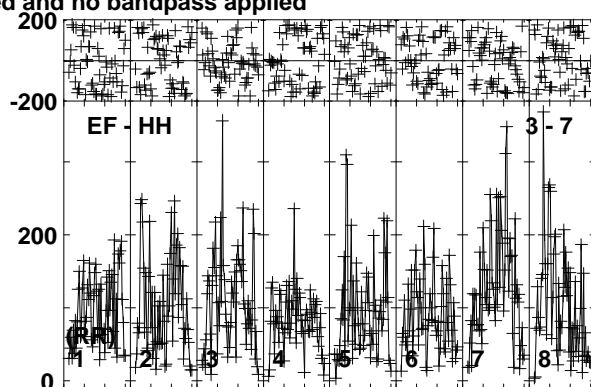
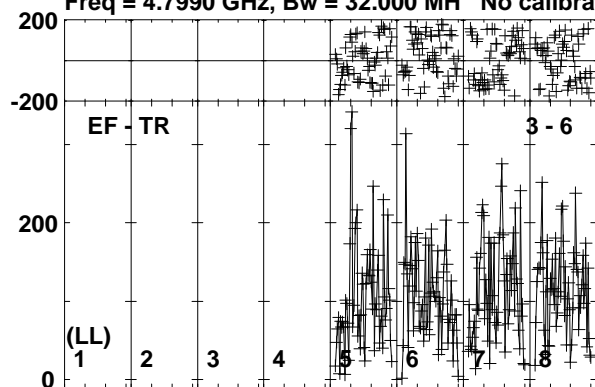

Lower frame: Micro Ampl Jy Top frame: Phas deg
Vector averaged cross-power spectrum Baseline: EF (03) - TR (06)
Timerange: 00/15:34:21 to 00/15:36:49

Plot file version 201 created 28-AUG-2017 13:19:15

J1303-2405 RP029A.UVDATA.1

Freq = 4.7990 GHz, Bw = 32.000 MH No calibration applied and no bandpass applied

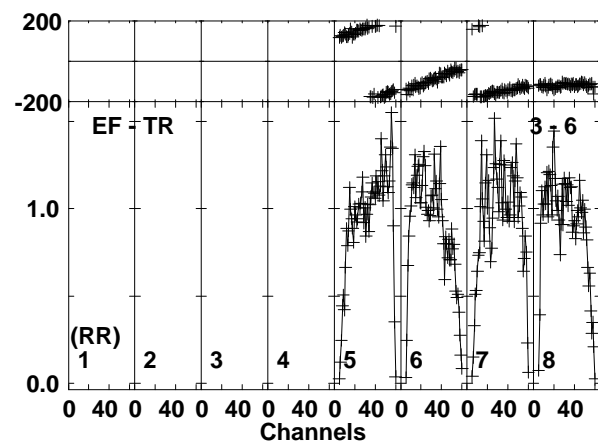
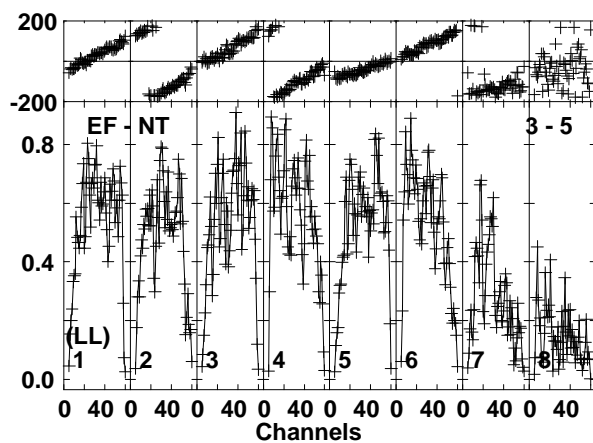
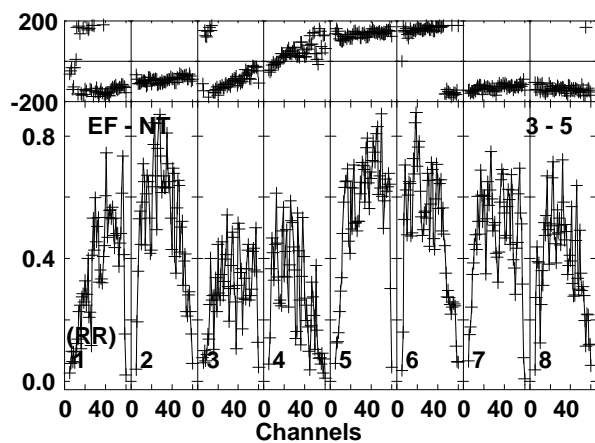
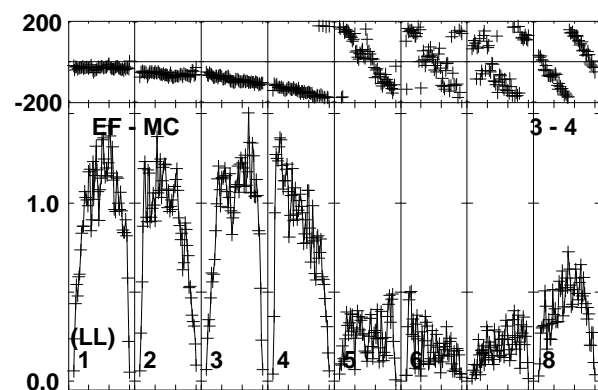
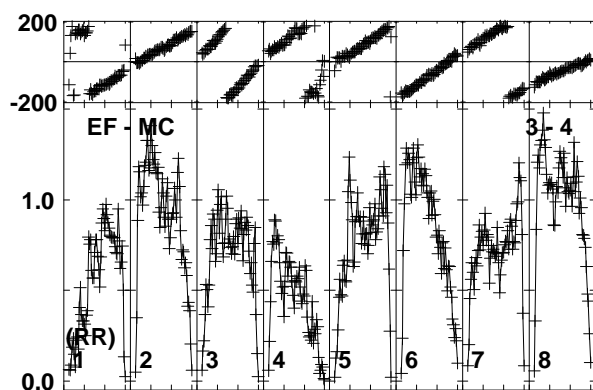
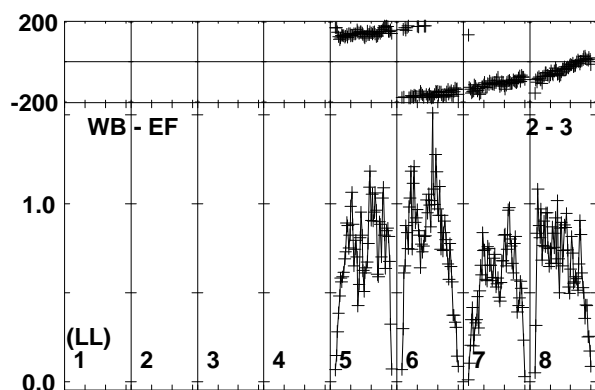
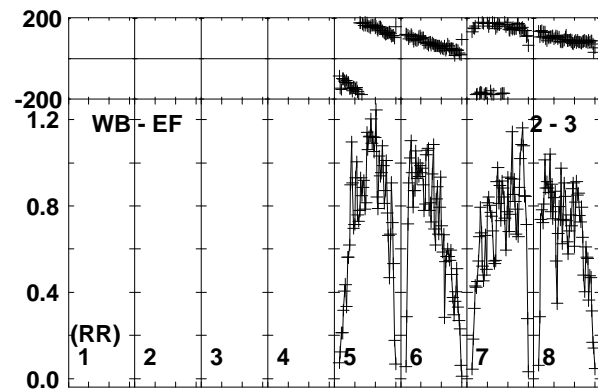
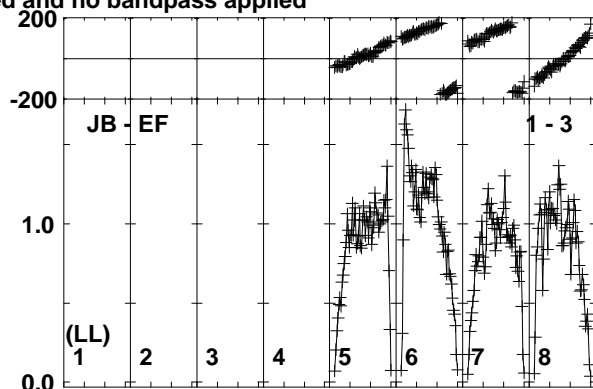
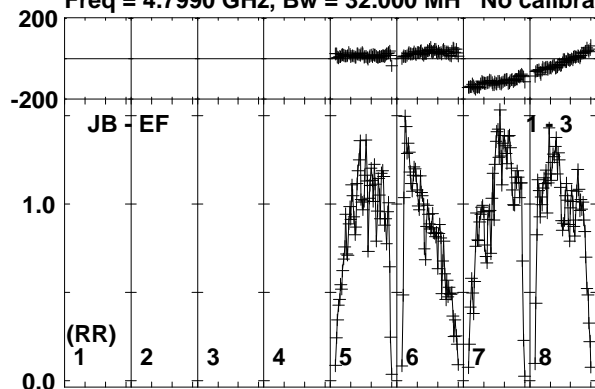

Lower frame: Milli Ampl Jy Top frame: Phas deg
Vector averaged cross-power spectrum Baseline: JB (01) - EF (03)
Timerange: 00/15:36:51 to 00/15:38:19

Plot file version 202 created 28-AUG-2017 13:19:15

J1303-2405 RP029A.UVDATA.1

Freq = 4.7990 GHz, Bw = 32.000 MH No calibration applied and no bandpass applied

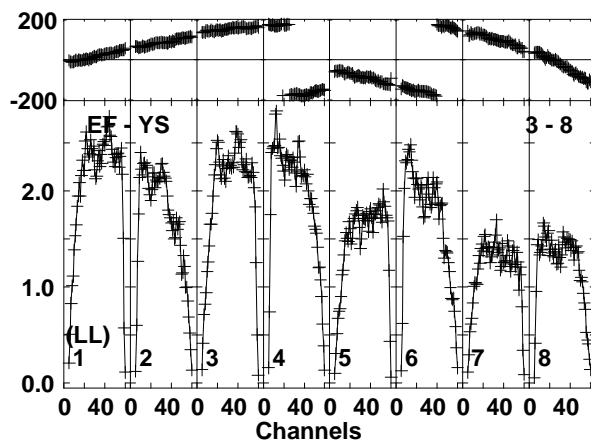
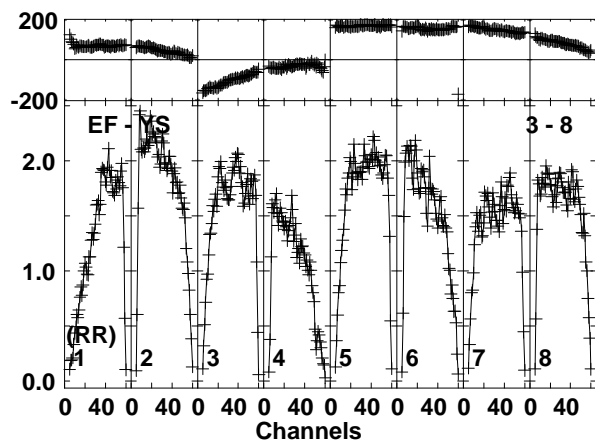
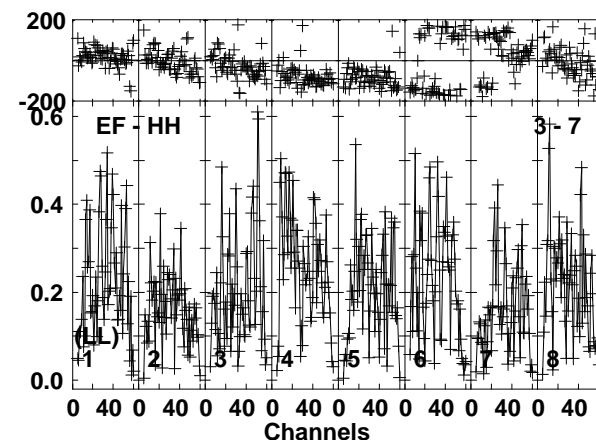
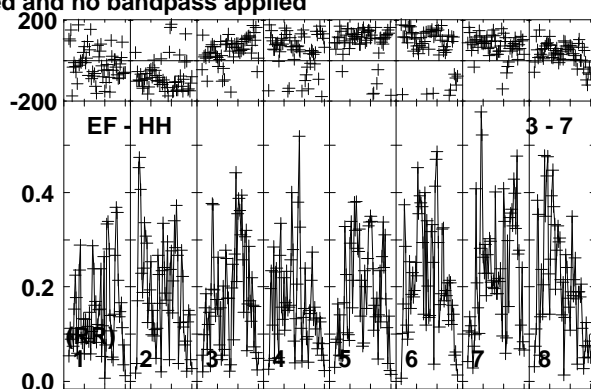
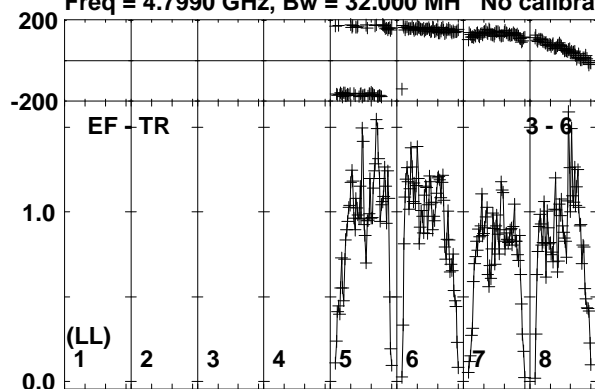

Lower frame: Milli Ampl Jy Top frame: Phas deg
Vector averaged cross-power spectrum Baseline: EF (03) - TR (06)
Timerange: 00:15:36:51 to 00:15:38:19

Plot file version 203 created 28-AUG-2017 13:19:15

J1312-2350 RP029A.UVDATA.1

Freq = 4.7990 GHz, Bw = 32.000 MH No calibration applied and no bandpass applied

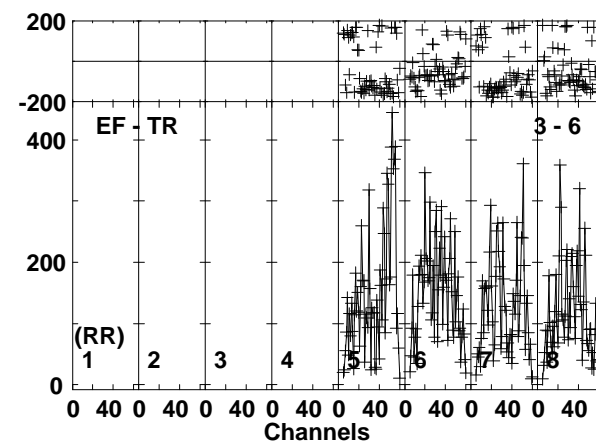
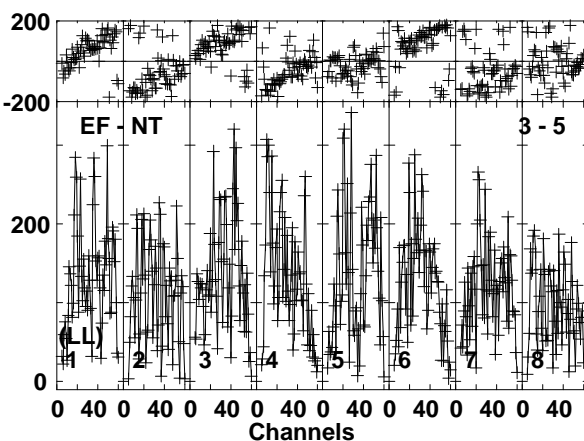
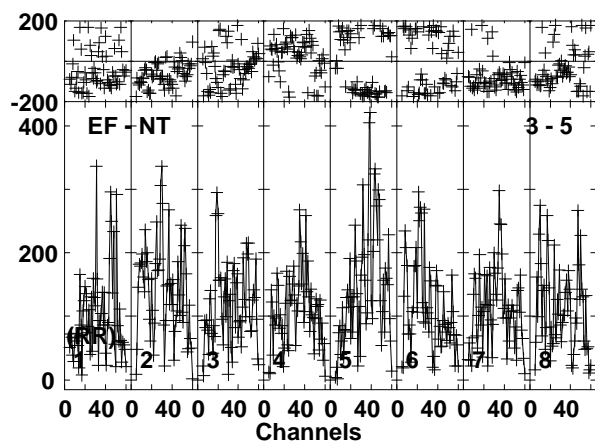
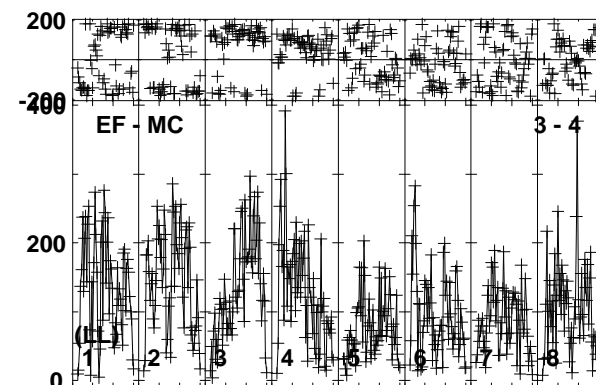
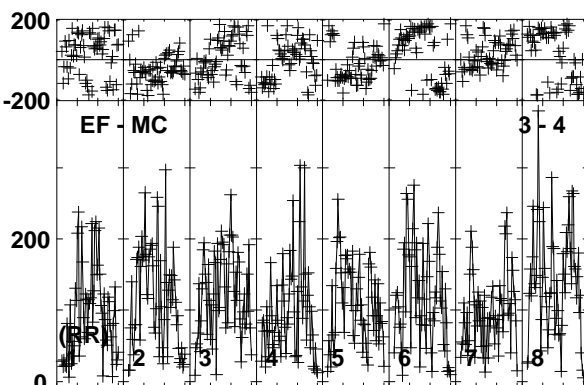
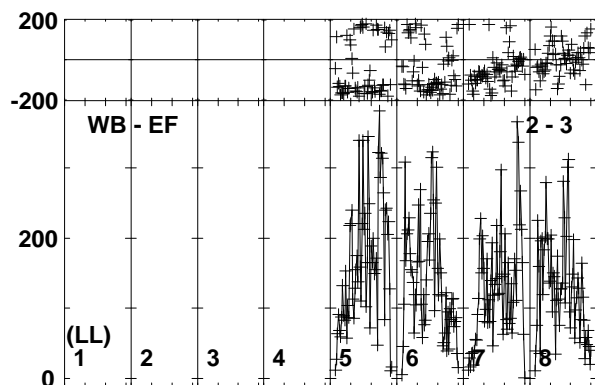
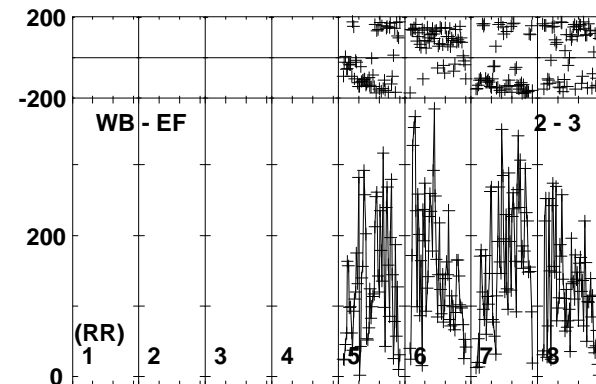
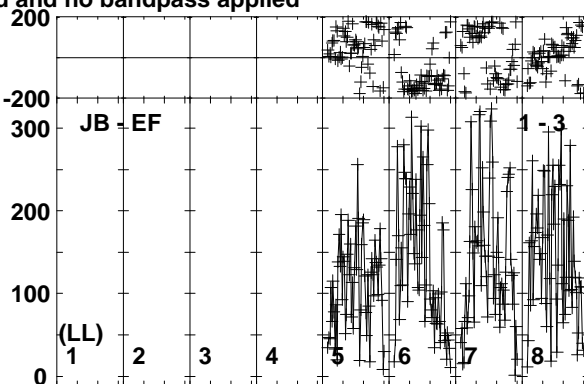
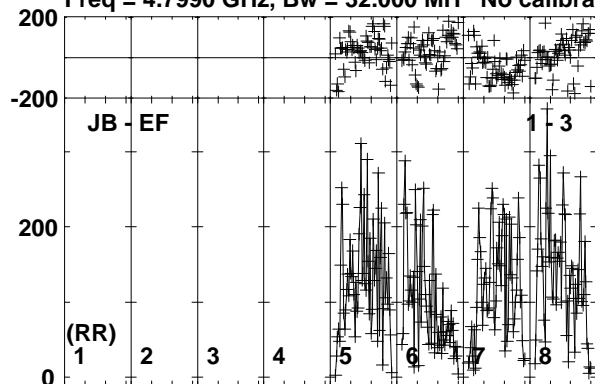

Lower frame: Micro Ampl Jy Top frame: Phas deg
Vector averaged cross-power spectrum Baseline: JB (01) - EF (03)
Timerange: 00/15:38:21 to 00/15:40:49

Plot file version 204 created 28-AUG-2017 13:19:15

J1312-2350 RP029A.UVDATA.1

Freq = 4.7990 GHz, Bw = 32.000 MH No calibration applied and no bandpass applied

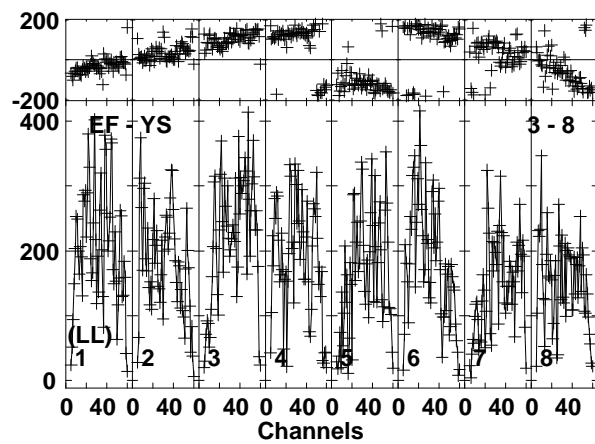
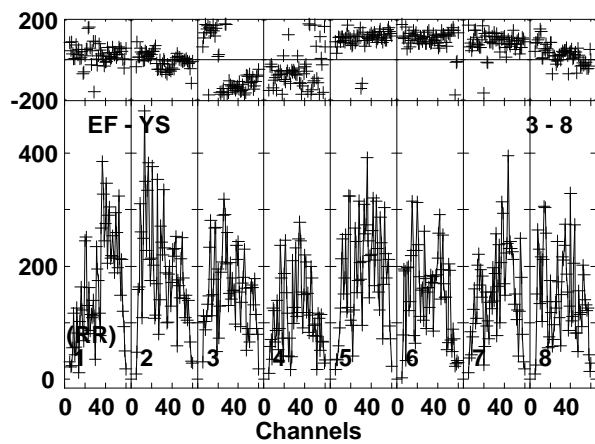
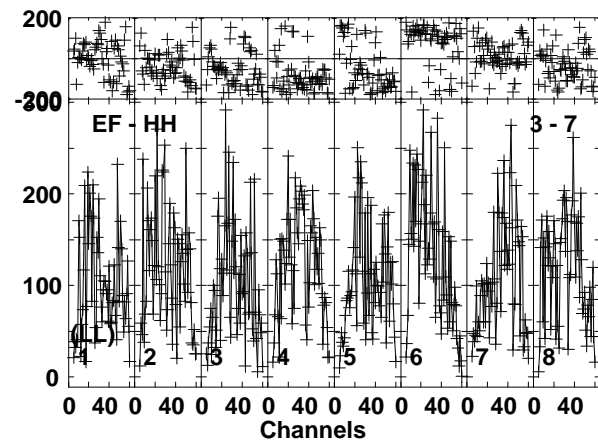
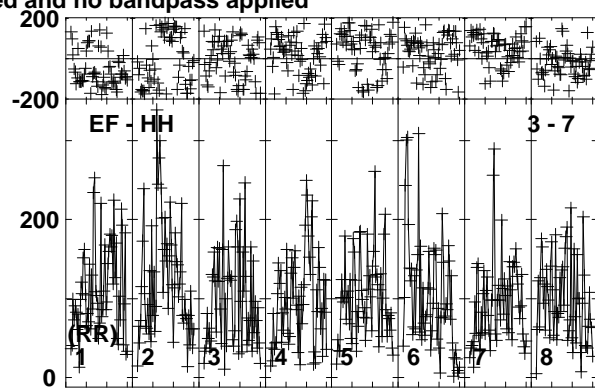
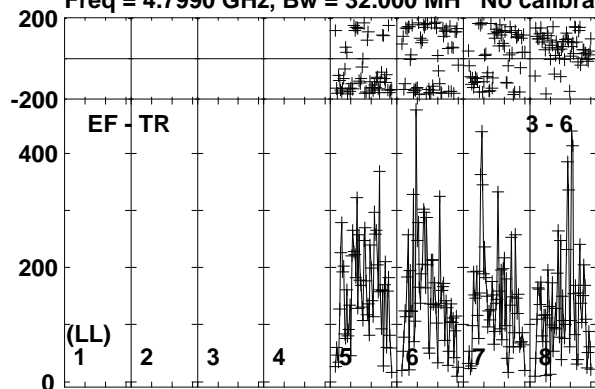

Lower frame: Micro Ampl Jy Top frame: Phas deg
Vector averaged cross-power spectrum Baseline: EF (03) - TR (06)
Timerange: 00/15:38:21 to 00/15:40:49

Plot file version 205 created 28-AUG-2017 13:19:15

J1303-2405 RP029A.UVDATA.1

Freq = 4.7990 GHz, Bw = 32.000 MH No calibration applied and no bandpass applied

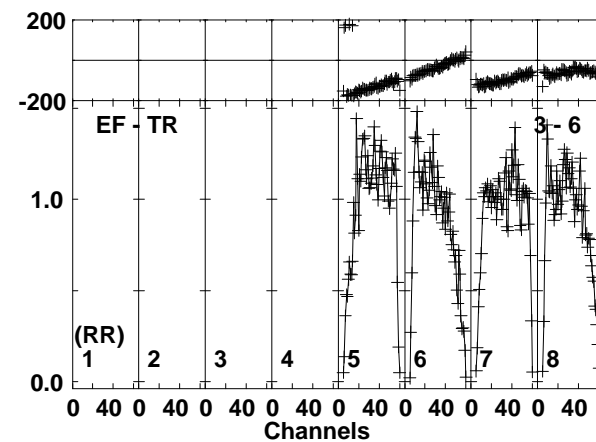
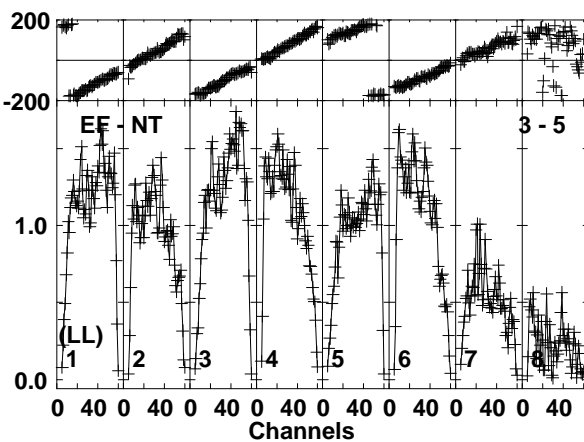
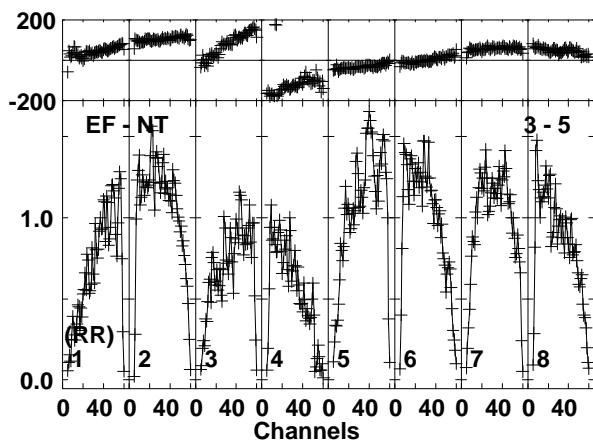
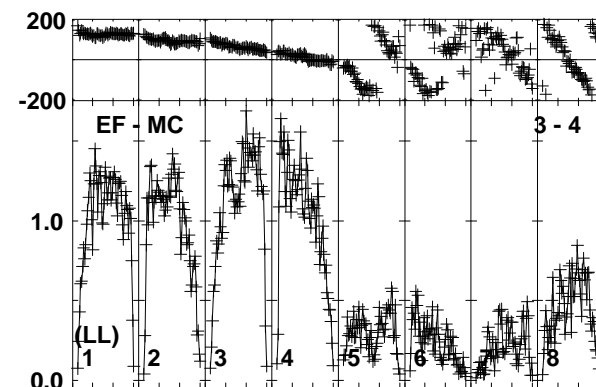
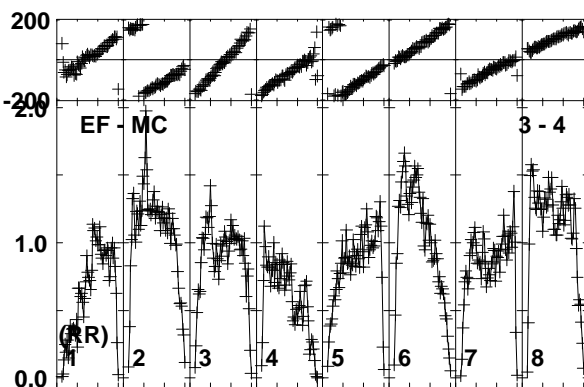
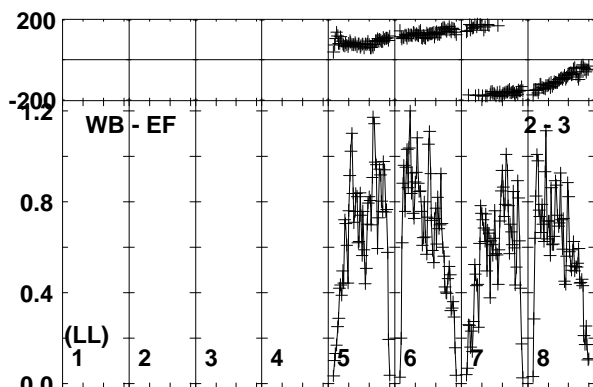
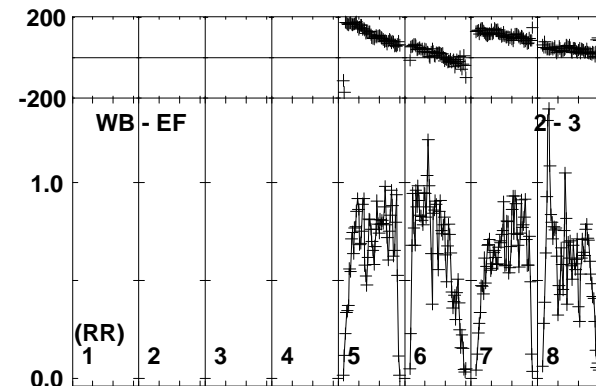
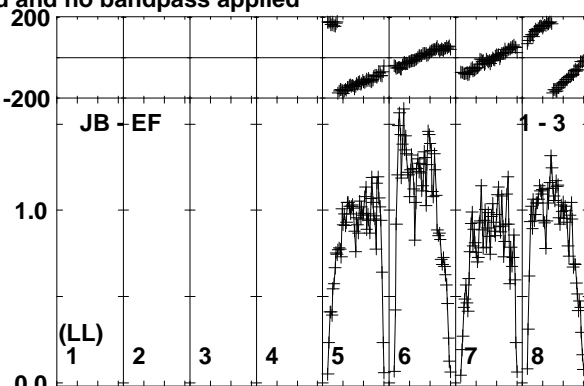
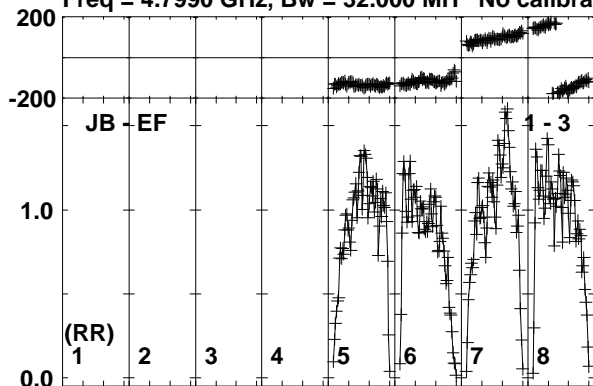

Lower frame: Milli Ampl Jy Top frame: Phas deg
Vector averaged cross-power spectrum Baseline: JB (01) - EF (03)
Timerange: 00:15:41:31 to 00:15:42:29

Plot file version 206 created 28-AUG-2017 13:19:15

J1303-2405 RP029A.UVDATA.1

Freq = 4.7990 GHz, Bw = 32.000 MH No calibration applied and no bandpass applied

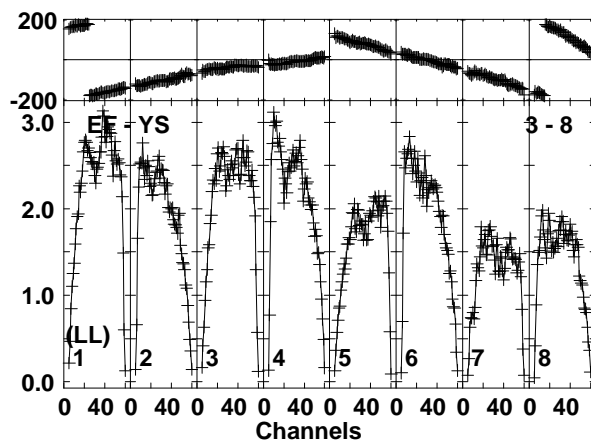
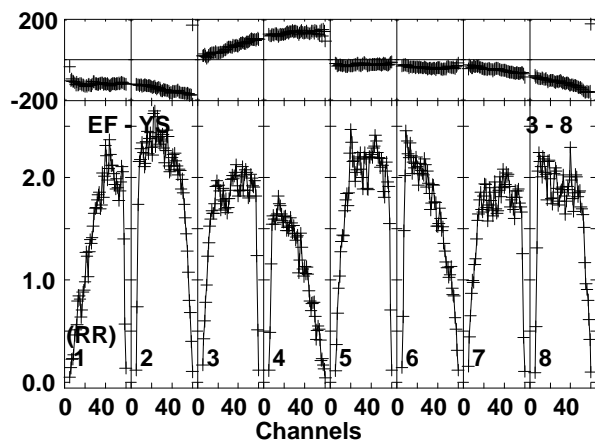
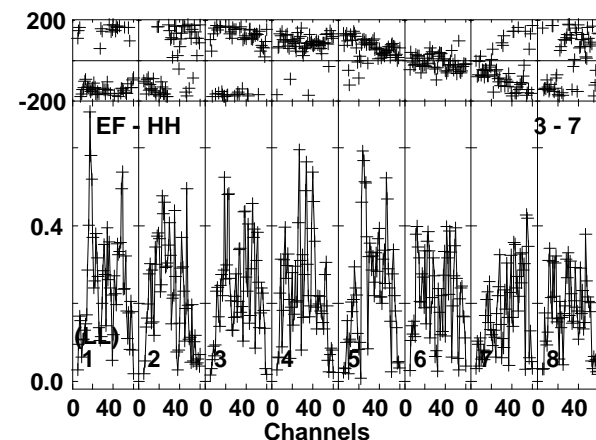
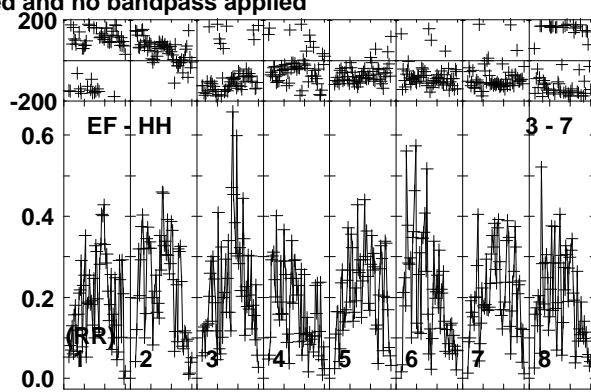
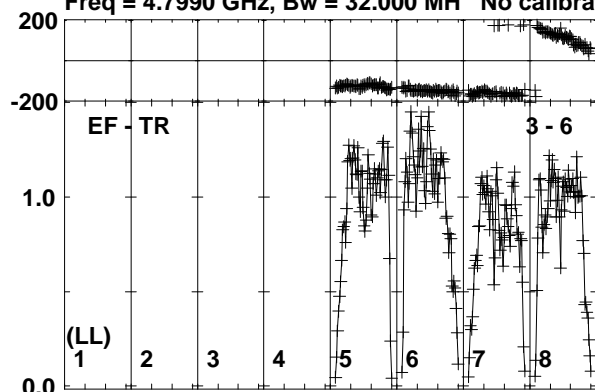

Lower frame: Milli Ampl Jy Top frame: Phas deg
Vector averaged cross-power spectrum Baseline: EF (03) - TR (06)
Timerange: 00/15:41:31 to 00/15:42:29

Plot file version 207 created 28-AUG-2017 13:19:15

SSS17A RP029A.UVDATA.1

Freq = 4.7990 GHz, Bw = 32.000 MH No calibration applied and no bandpass applied

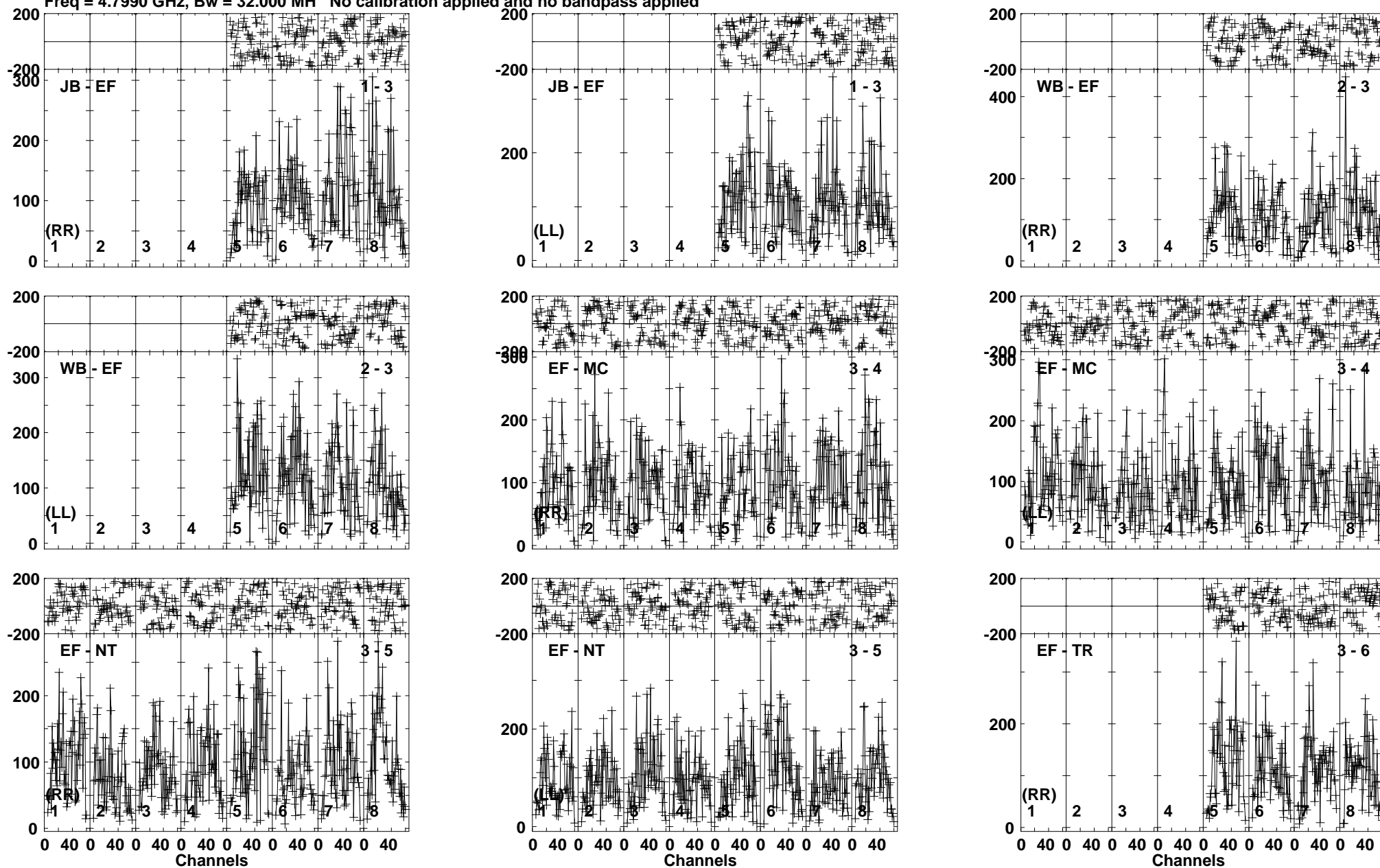

Lower frame: Micro Ampl Jy Top frame: Phas deg
Vector averaged cross-power spectrum Baseline: JB (01) - EF (03)
Timerange: 00/15:42:31 to 00/15:44:59

Plot file version 208 created 28-AUG-2017 13:19:15

SSS17A RP029A.UVDATA.1

Freq = 4.7990 GHz, Bw = 32.000 MH No calibration applied and no bandpass applied

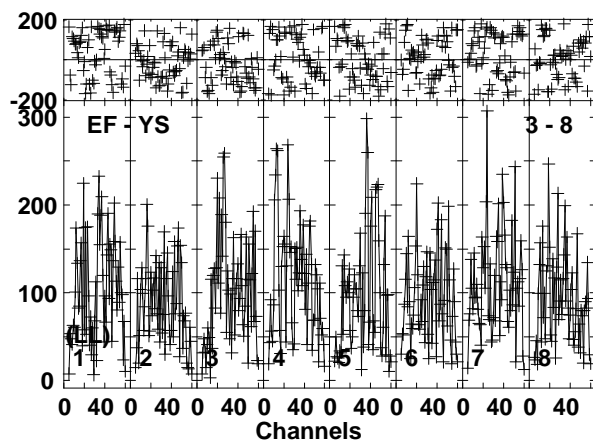
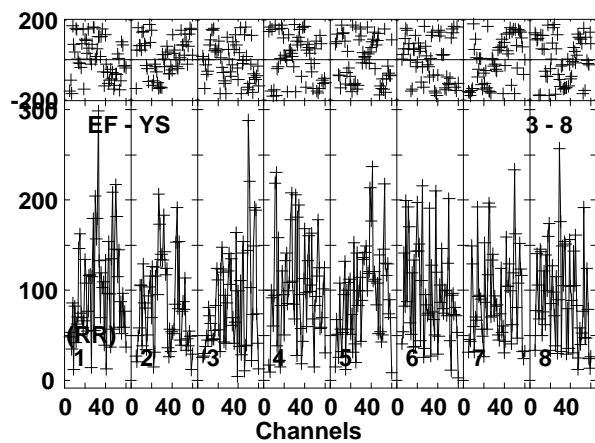
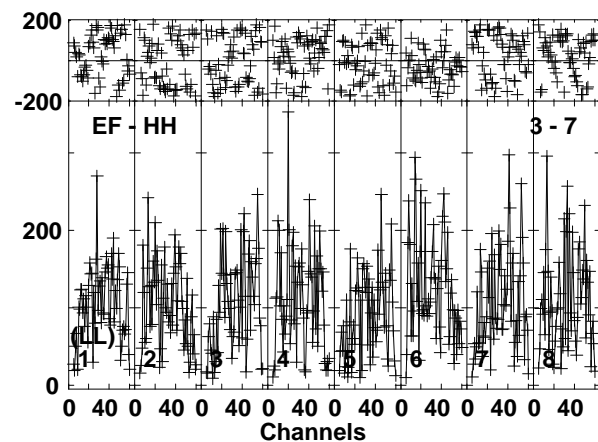
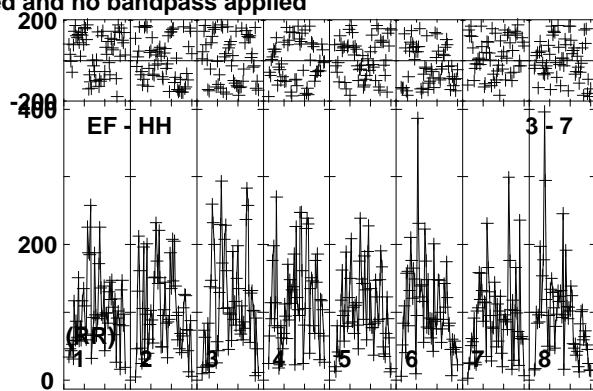
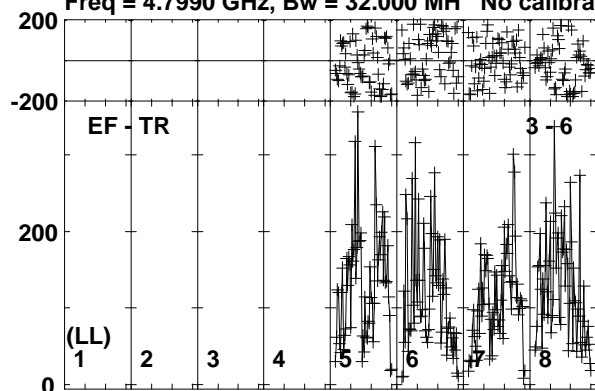

Lower frame: Micro Ampl Jy Top frame: Phas deg
Vector averaged cross-power spectrum Baseline: EF (03) - TR (06)
Timerange: 00/15:42:31 to 00/15:44:59

Plot file version 209 created 28-AUG-2017 13:19:15

J1303-2405 RP029A.UVDATA.1

Freq = 4.7990 GHz, Bw = 32.000 MH No calibration applied and no bandpass applied

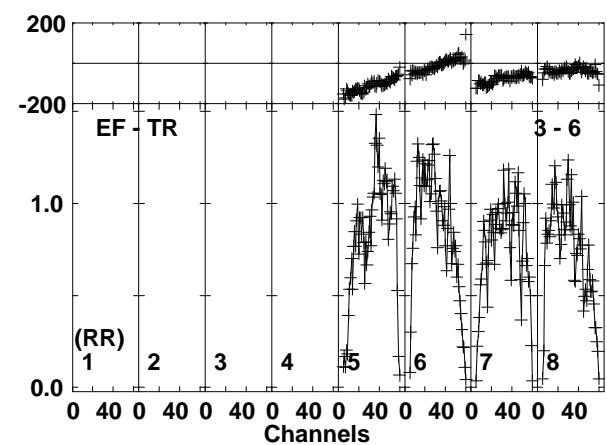
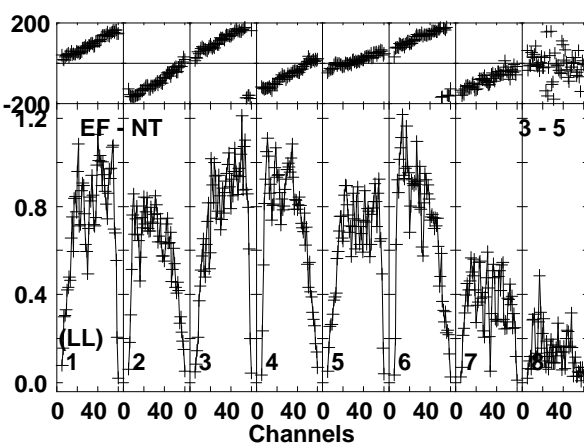
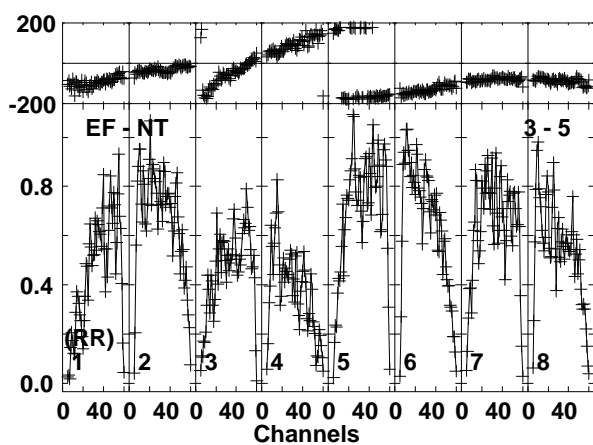
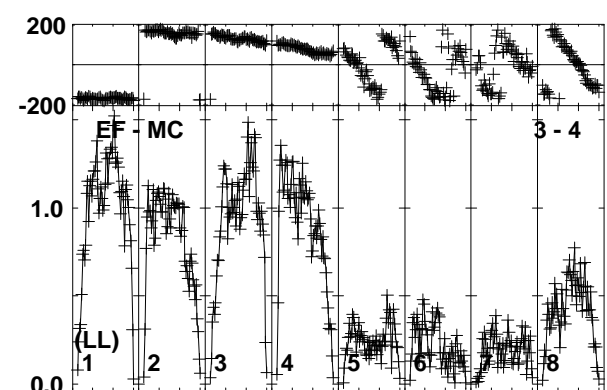
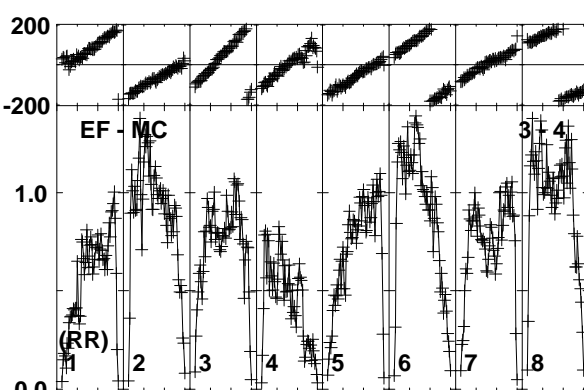
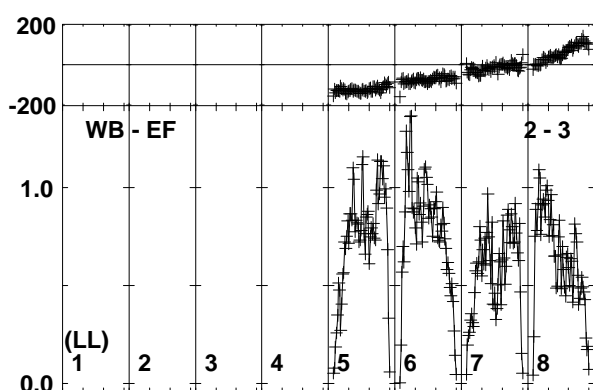
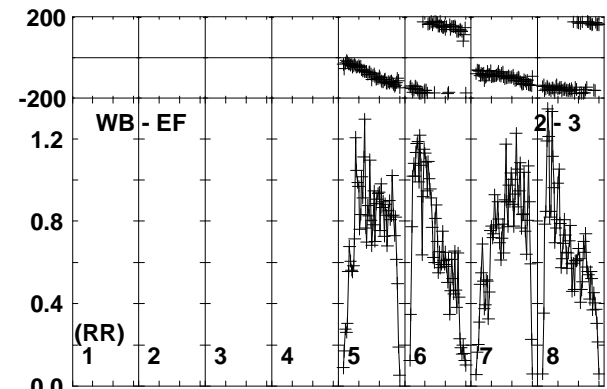
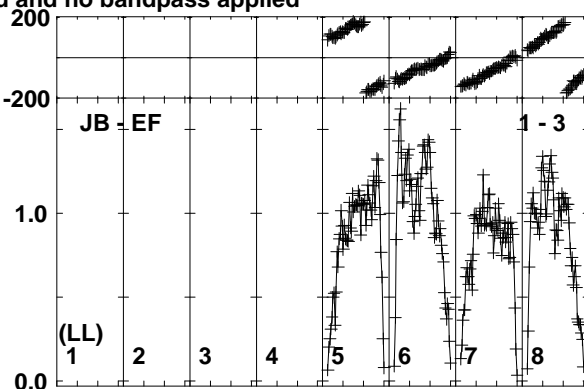
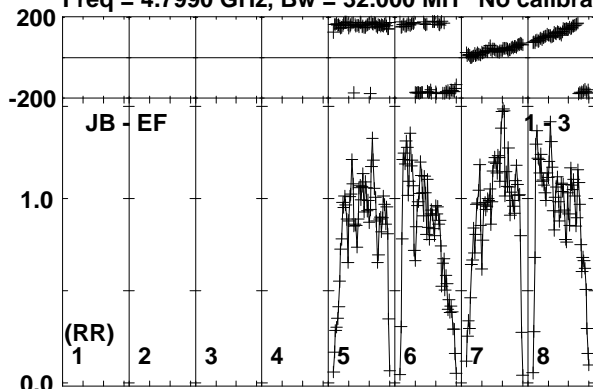

Lower frame: Milli Ampl Jy Top frame: Phas deg
Vector averaged cross-power spectrum Baseline: JB (01) - EF (03)
Timerange: 00:15:45:01 to 00:15:46:29

Plot file version 210 created 28-AUG-2017 13:19:15

J1303-2405 RP029A.UVDATA.1

Freq = 4.7990 GHz, Bw = 32.000 MH No calibration applied and no bandpass applied

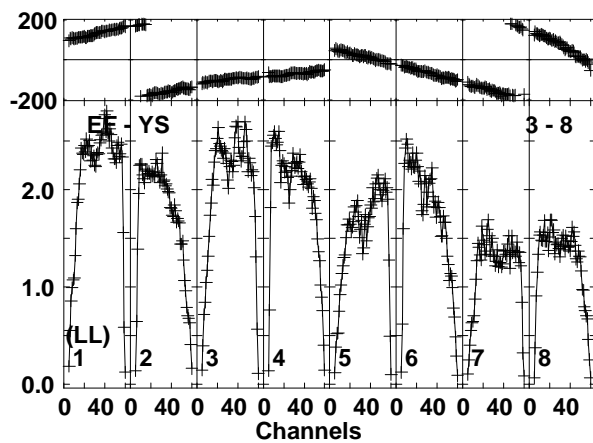
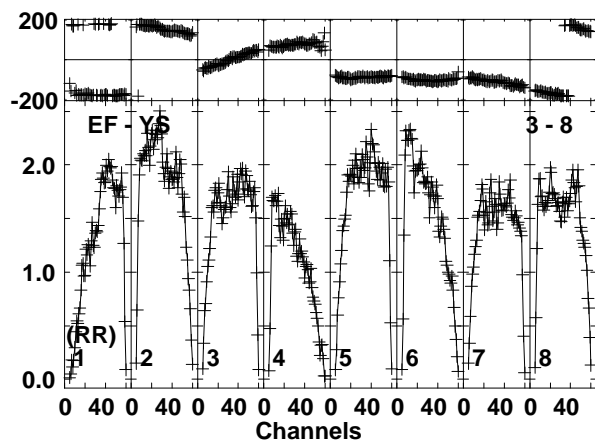
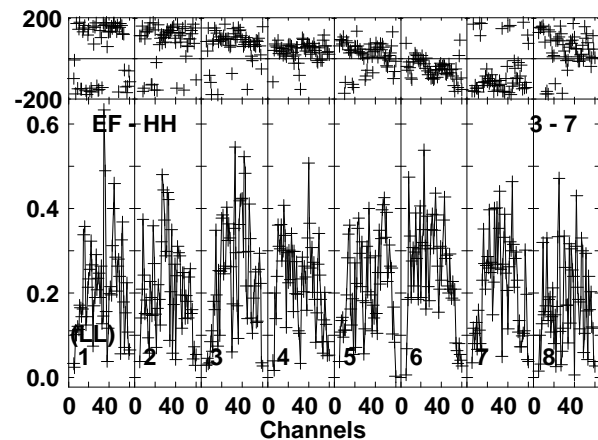
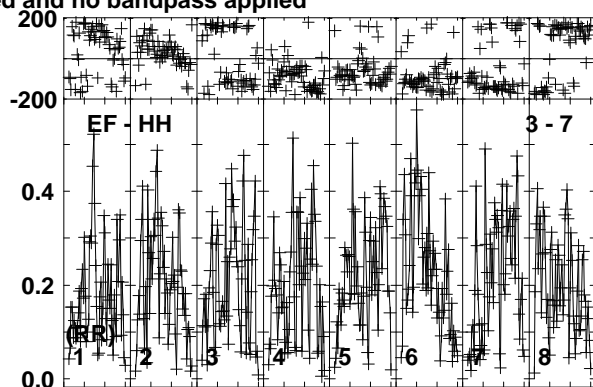
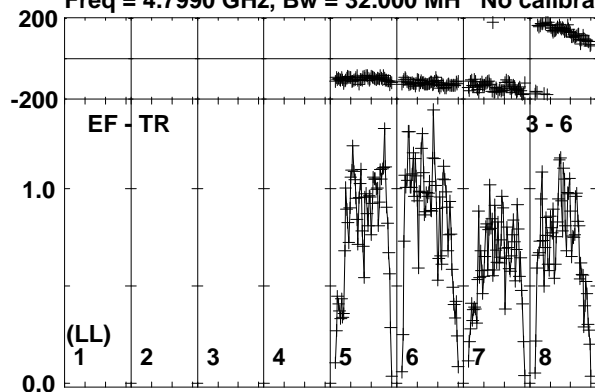

Lower frame: Milli Ampl Jy Top frame: Phas deg
Vector averaged cross-power spectrum Baseline: EF (03) - TR (06)
Timerange: 00/15:45:01 to 00/15:46:29

Plot file version 211 created 28-AUG-2017 13:19:15

SSS17A RP029A.UVDATA.1

Freq = 4.7990 GHz, Bw = 32.000 MH No calibration applied and no bandpass applied

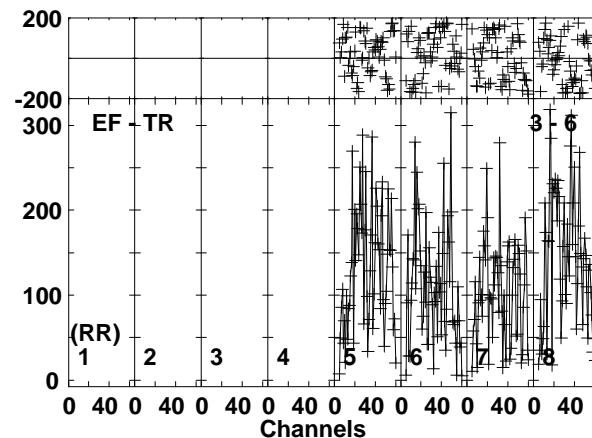
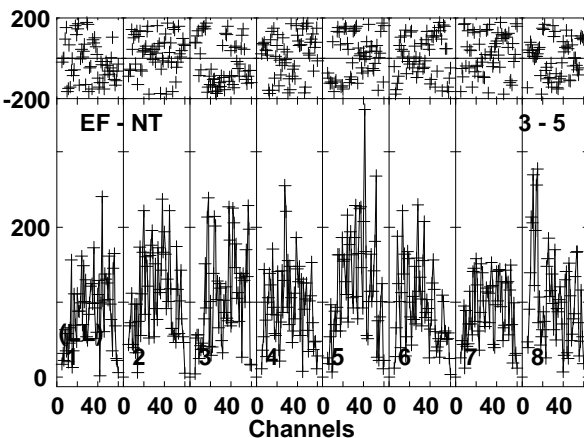
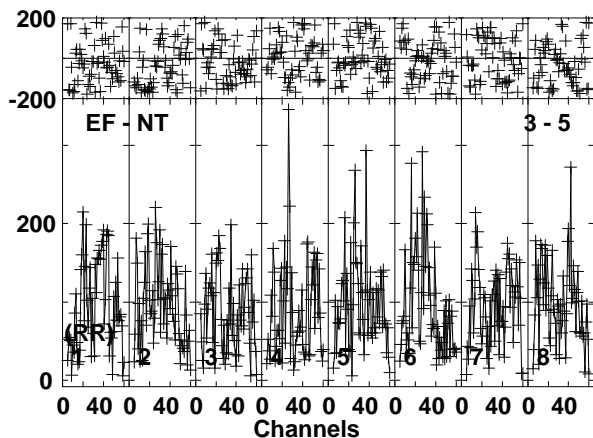
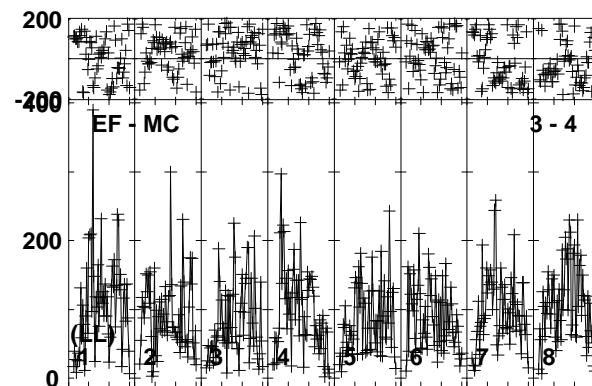
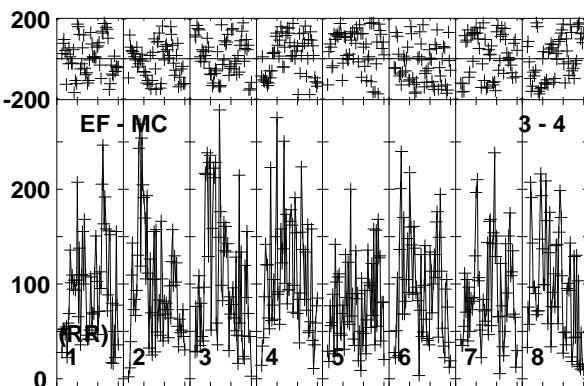
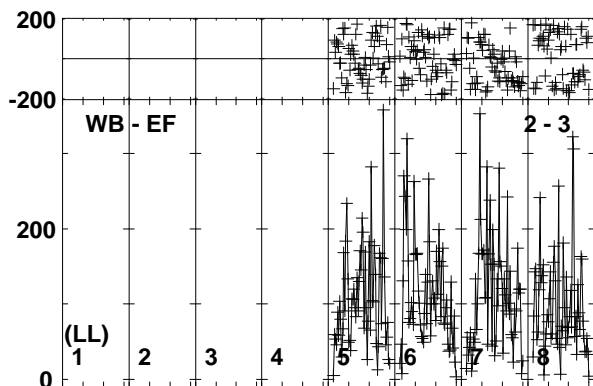
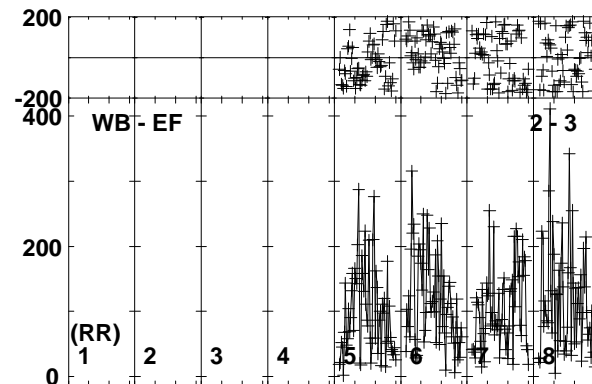
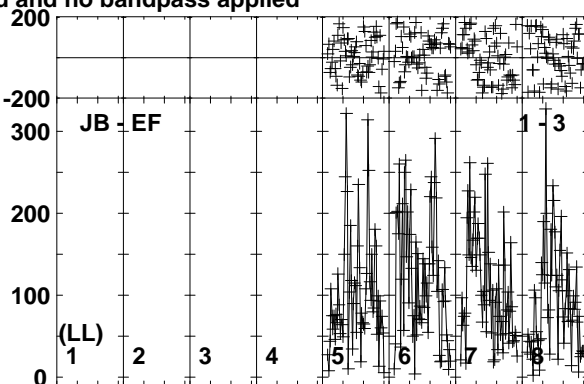
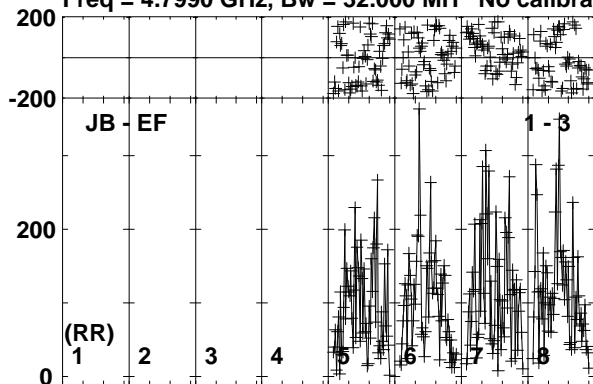

Lower frame: Micro Ampl Jy Top frame: Phas deg
Vector averaged cross-power spectrum Baseline: JB (01) - EF (03)
Timerange: 00/15:46:31 to 00/15:48:59

Plot file version 212 created 28-AUG-2017 13:19:15

SSS17A RP029A.UVDATA.1

Freq = 4.7990 GHz, Bw = 32.000 MH No calibration applied and no bandpass applied

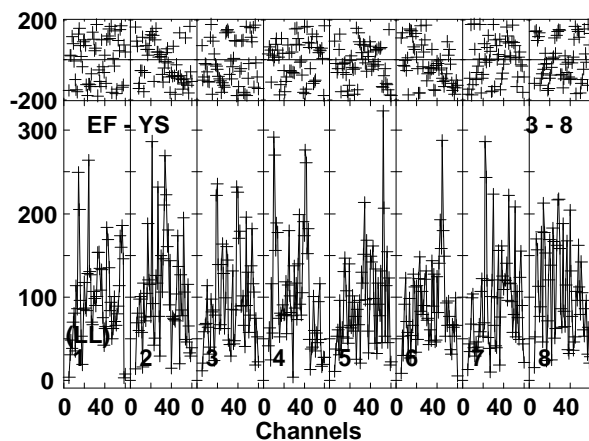
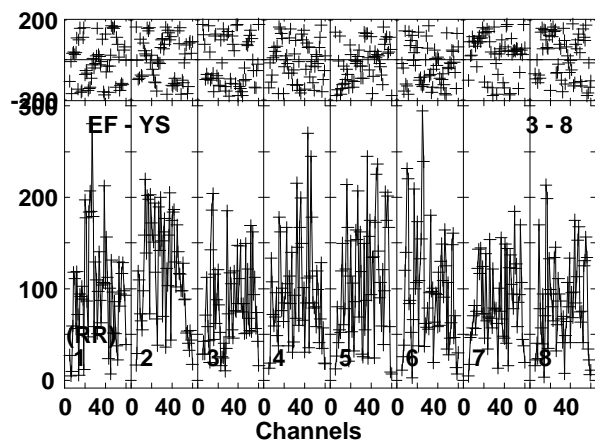
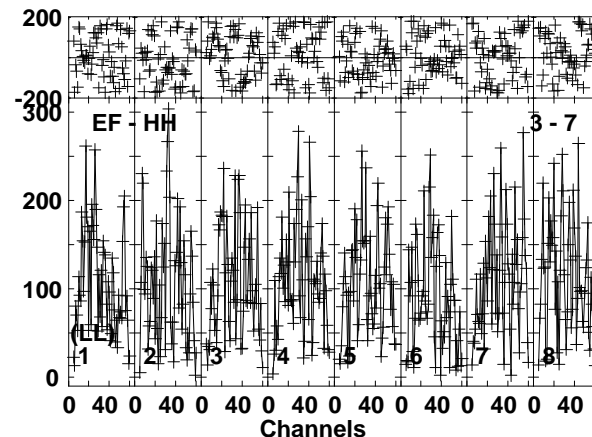
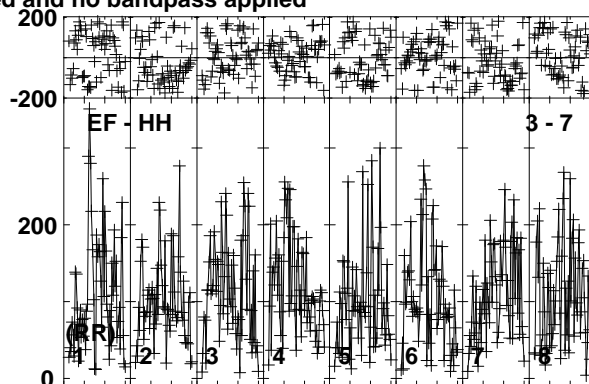
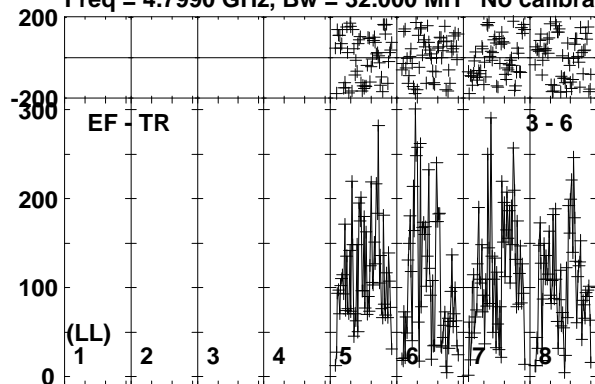

Lower frame: Micro Ampl Jy Top frame: Phas deg
Vector averaged cross-power spectrum Baseline: EF (03) - TR (06)
Timerange: 00/15:46:31 to 00/15:48:59

Plot file version 213 created 28-AUG-2017 13:19:15

J1303-2405 RP029A.UVDATA.1

Freq = 4.7990 GHz, Bw = 32.000 MH No calibration applied and no bandpass applied

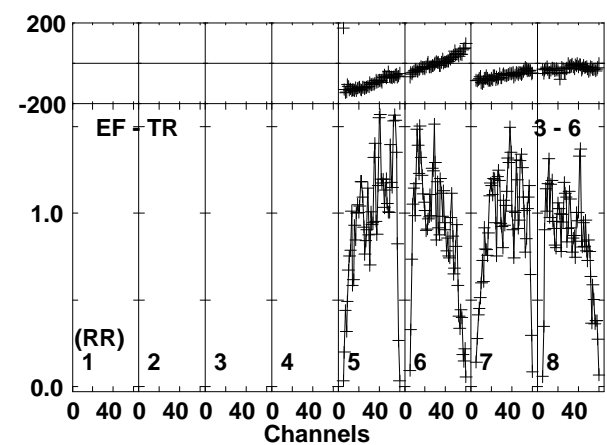
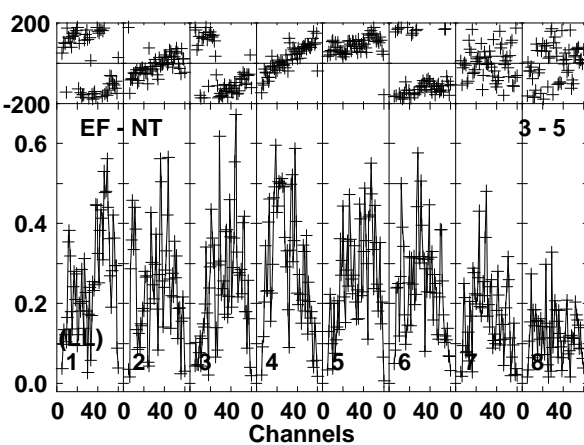
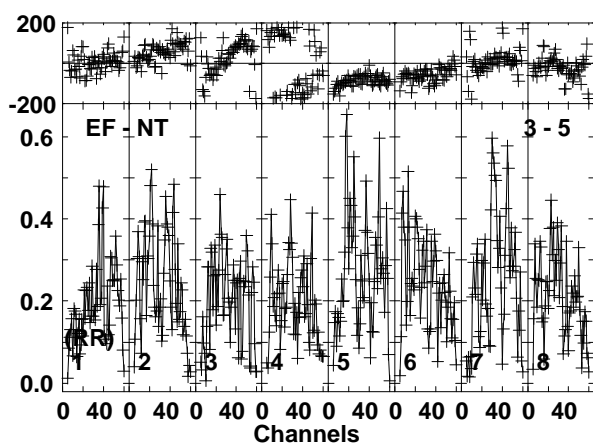
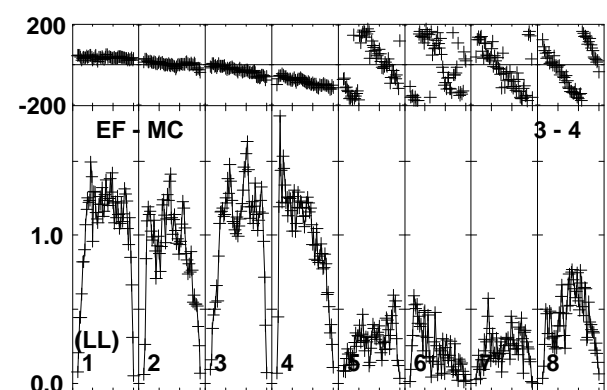
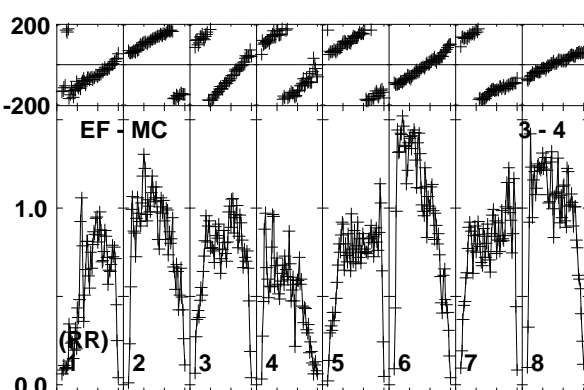
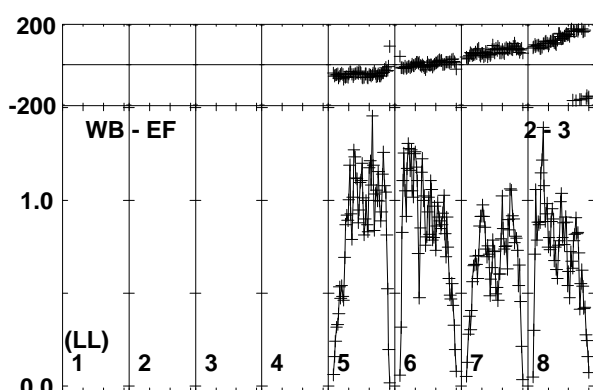
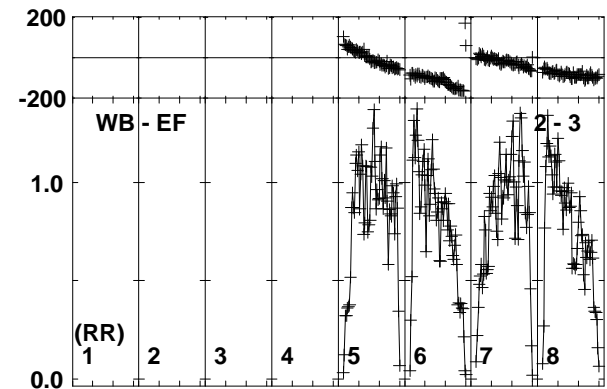
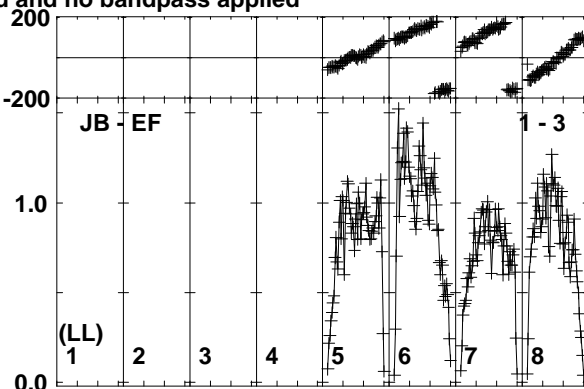
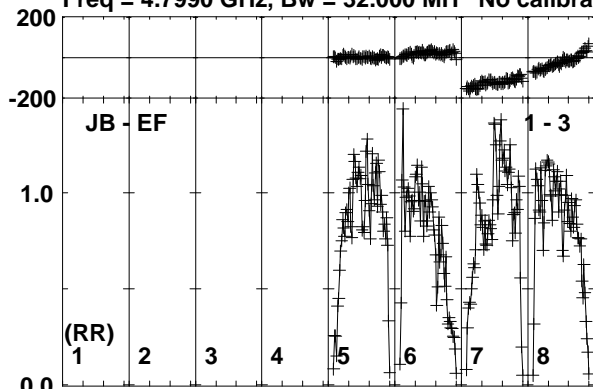

Lower frame: Milli Ampl Jy Top frame: Phas deg
Vector averaged cross-power spectrum Baseline: JB (01) - EF (03)
Timerange: 00/15:49:31 to 00/15:50:29

Plot file version 214 created 28-AUG-2017 13:19:16

J1303-2405 RP029A.UVDATA.1

Freq = 4.7990 GHz, Bw = 32.000 MH No calibration applied and no bandpass applied

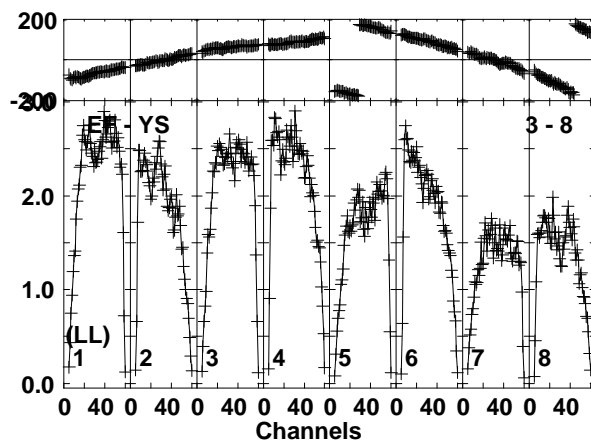
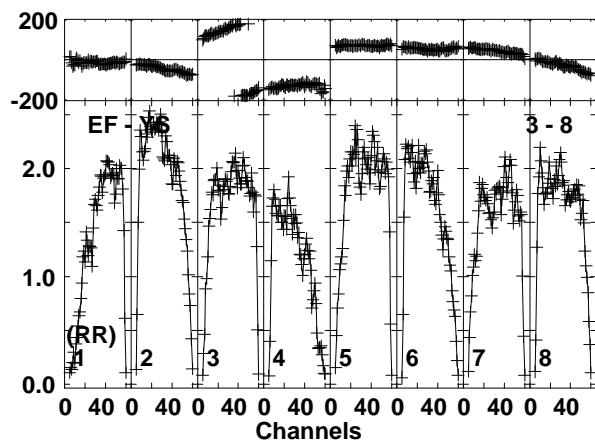
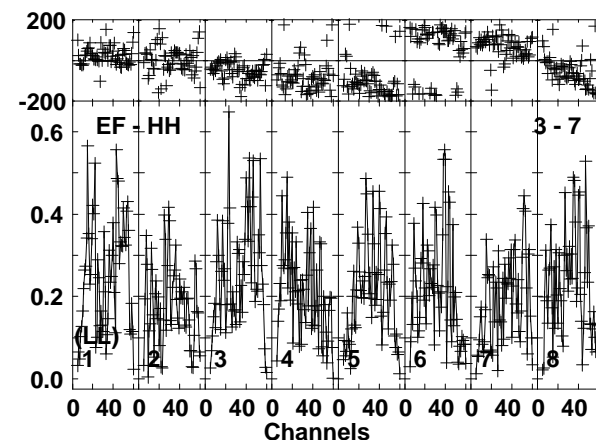
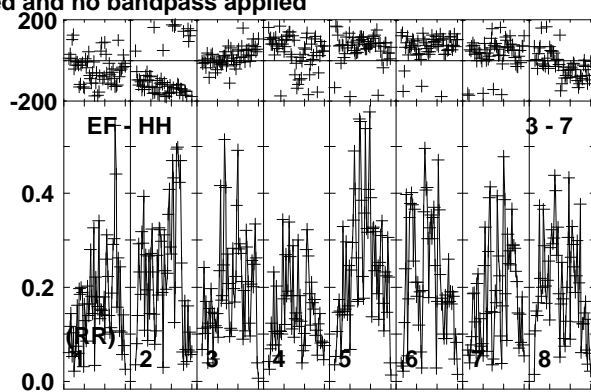
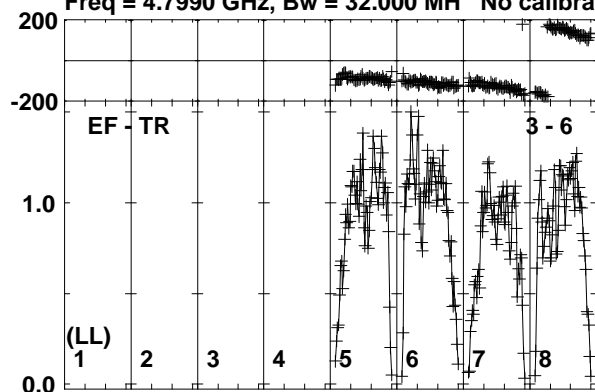

Lower frame: Milli Ampl Jy Top frame: Phas deg
Vector averaged cross-power spectrum Baseline: EF (03) - TR (06)
Timerange: 00/15:49:31 to 00/15:50:29

Plot file version 215 created 28-AUG-2017 13:19:16

NVSS1 RP029A.UVDATA.1

Freq = 4.7990 GHz, Bw = 32.000 MH No calibration applied and no bandpass applied

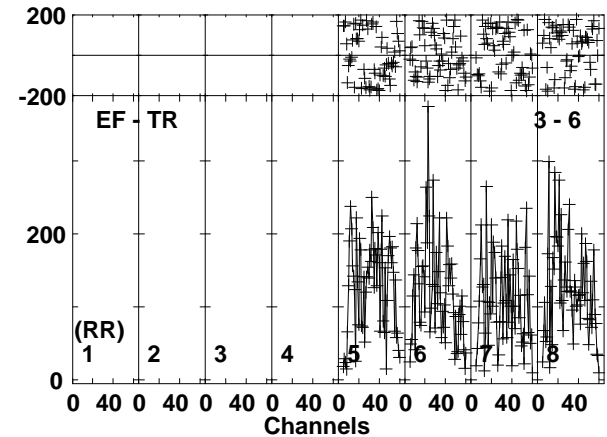
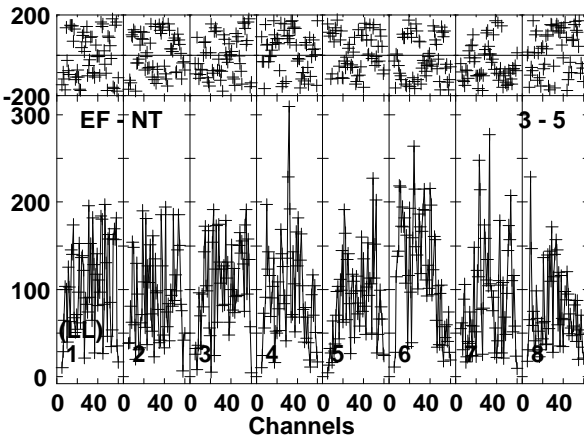
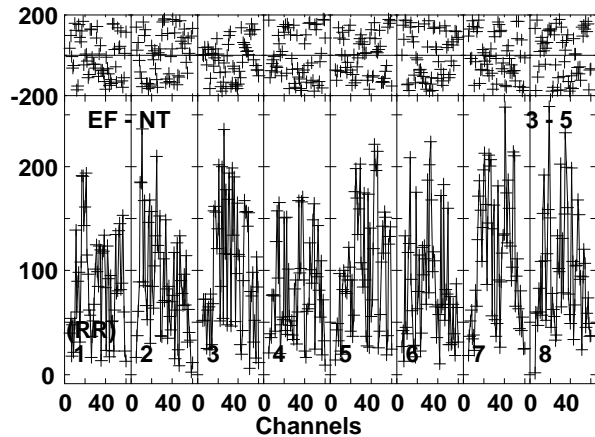
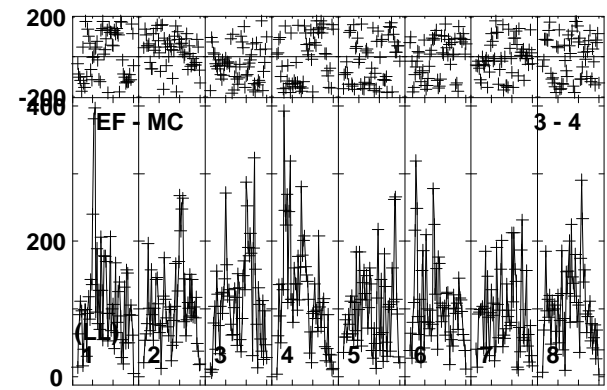
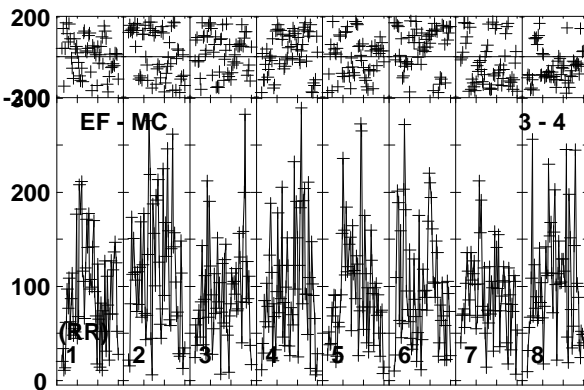
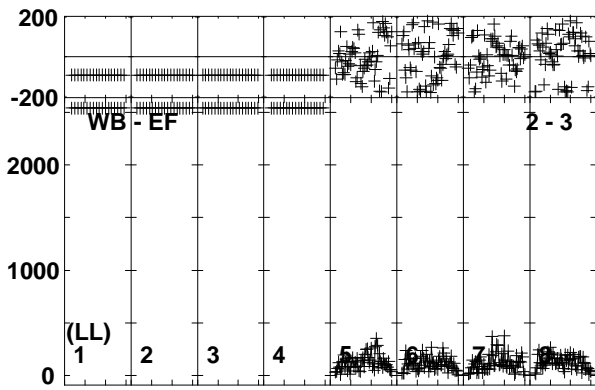
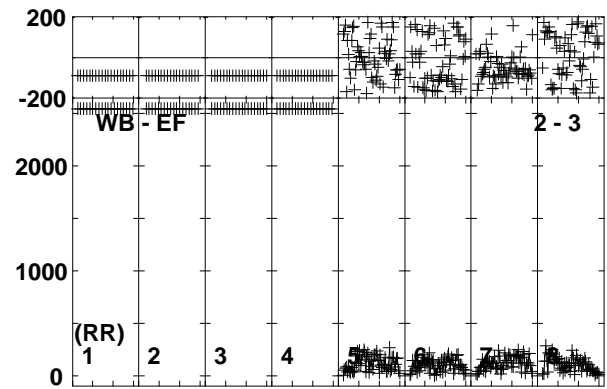
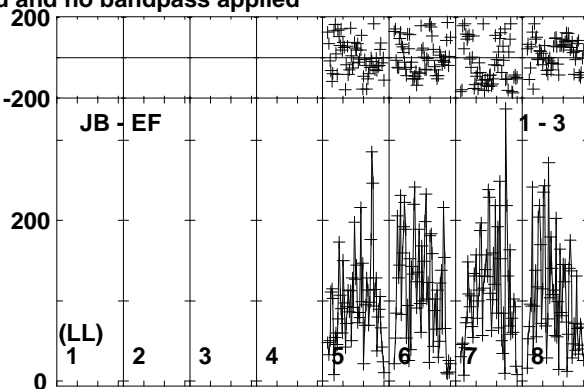
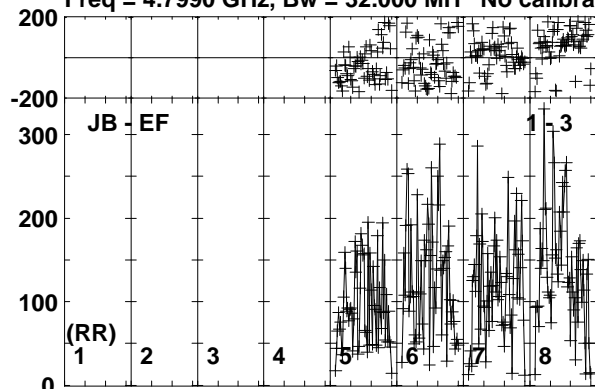

Lower frame: Micro Ampl Jy Top frame: Phas deg
Vector averaged cross-power spectrum Baseline: JB (01) - EF (03)
Timerange: 00:15:50:31 to 00:15:52:59

Plot file version 216 created 28-AUG-2017 13:19:16

NVSS1 RP029A.UVDATA.1

Freq = 4.7990 GHz, Bw = 32.000 MH No calibration applied and no bandpass applied

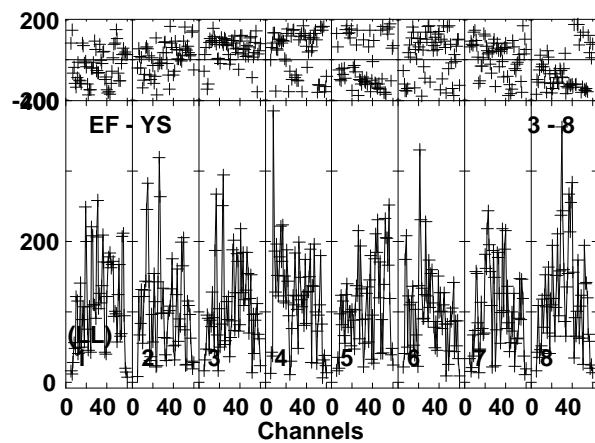
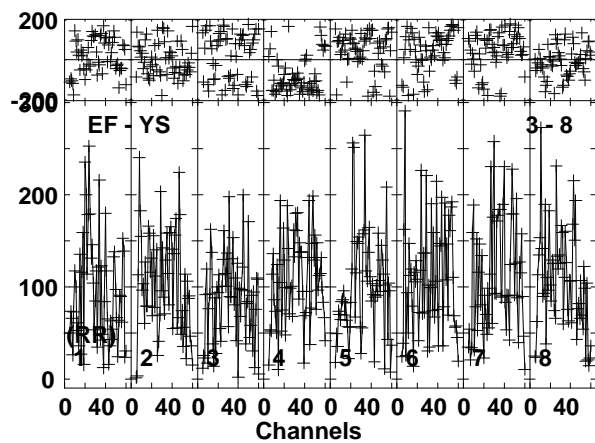
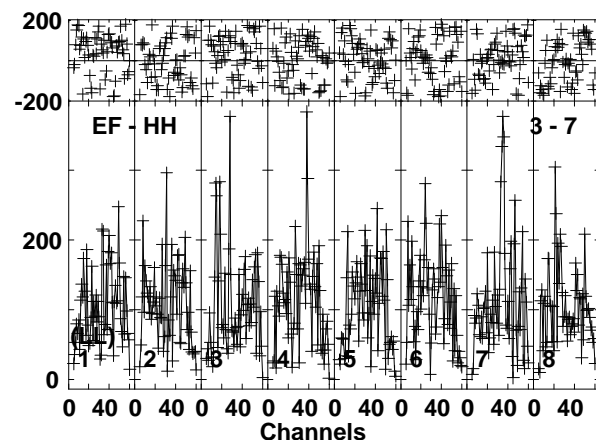
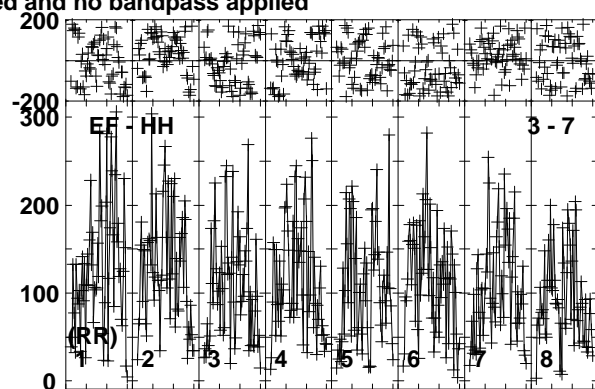
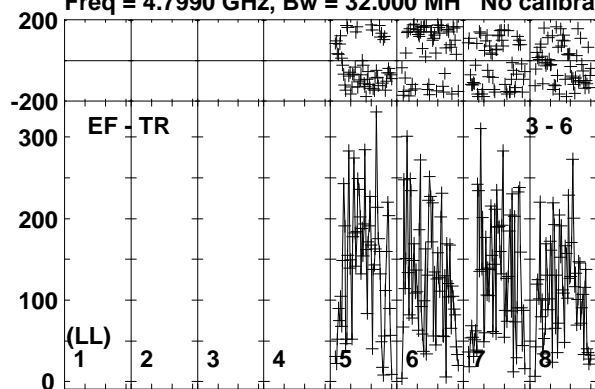

Lower frame: Micro Ampl Jy Top frame: Phas deg
Vector averaged cross-power spectrum Baseline: EF (03) - TR (06)
Timerange: 00:15:50:31 to 00:15:52:59

Plot file version 217 created 28-AUG-2017 13:19:16

J1303-2405 RP029A.UVDATA.1

Freq = 4.7990 GHz, Bw = 32.000 MH No calibration applied and no bandpass applied

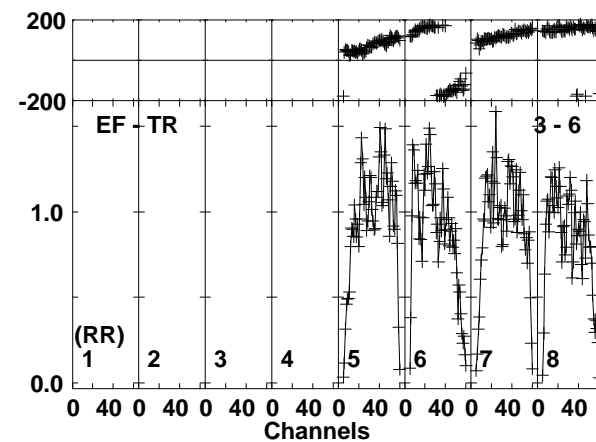
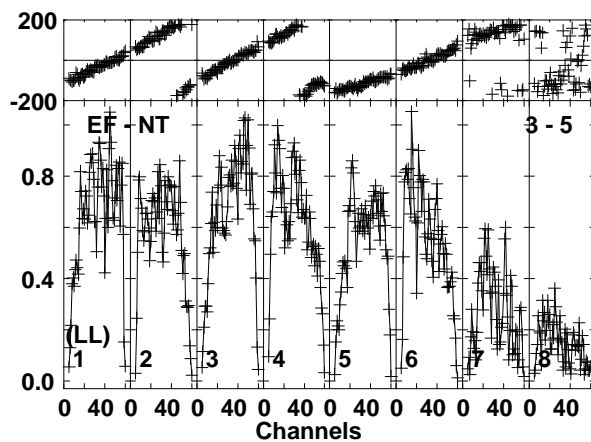
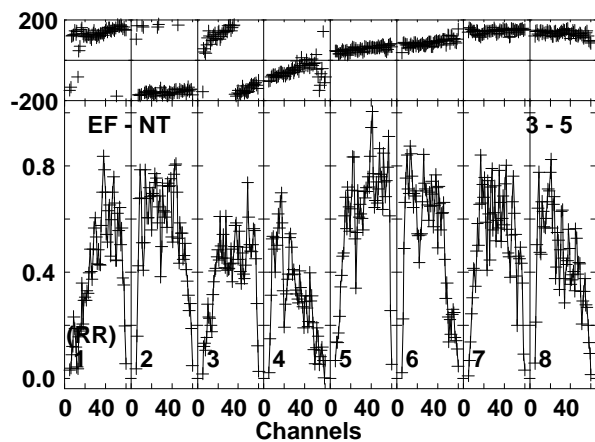
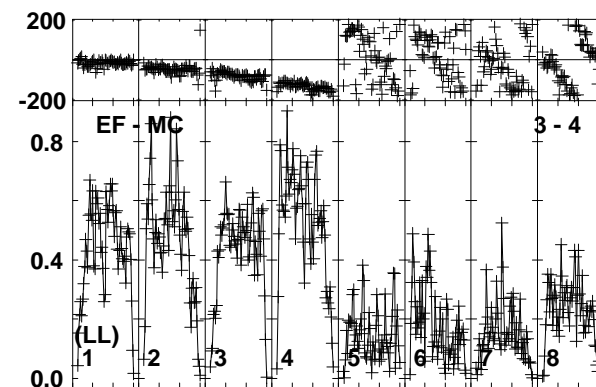
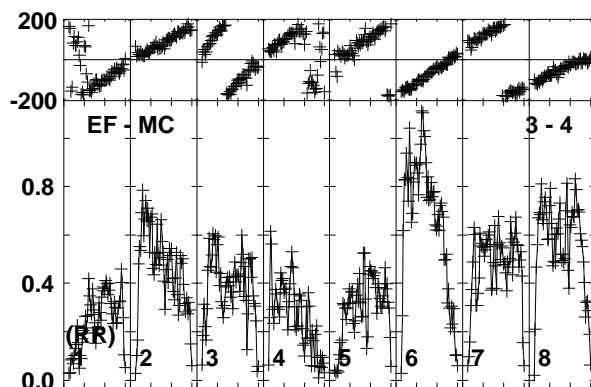
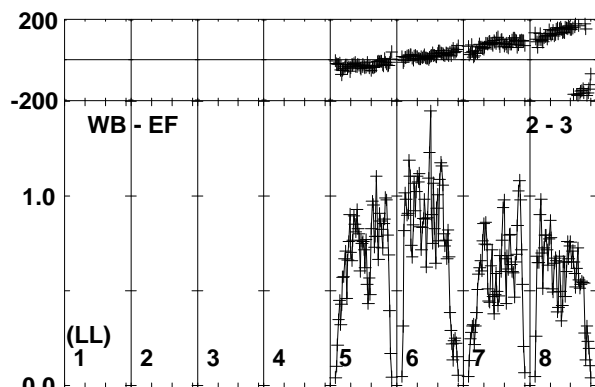
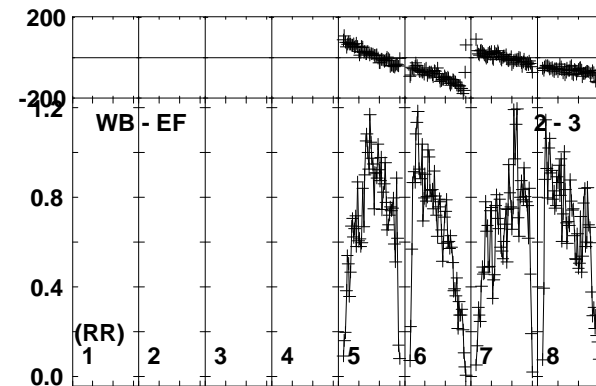
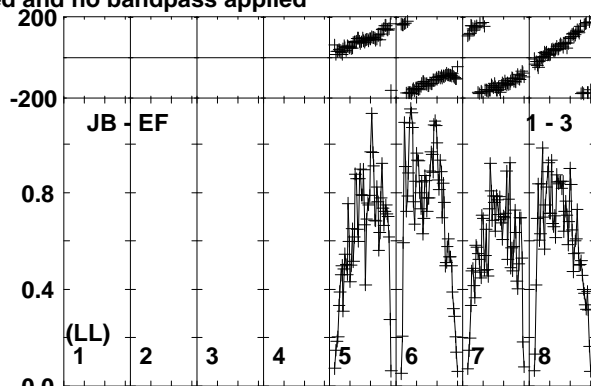
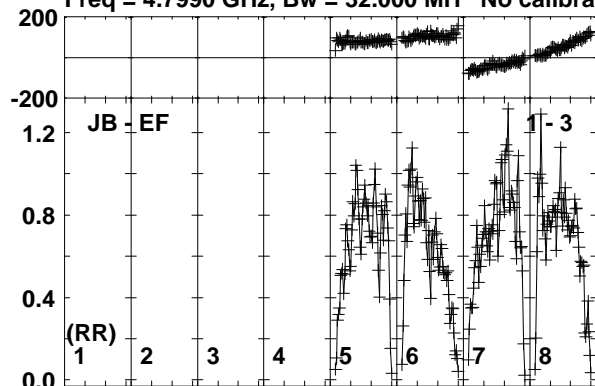

Lower frame: Milli Ampl Jy Top frame: Phas deg
Vector averaged cross-power spectrum Baseline: JB (01) - EF (03)
Timerange: 00/15:53:01 to 00/15:54:29

Plot file version 218 created 28-AUG-2017 13:19:16

J1303-2405 RP029A.UVDATA.1

Freq = 4.7990 GHz, Bw = 32.000 MH No calibration applied and no bandpass applied

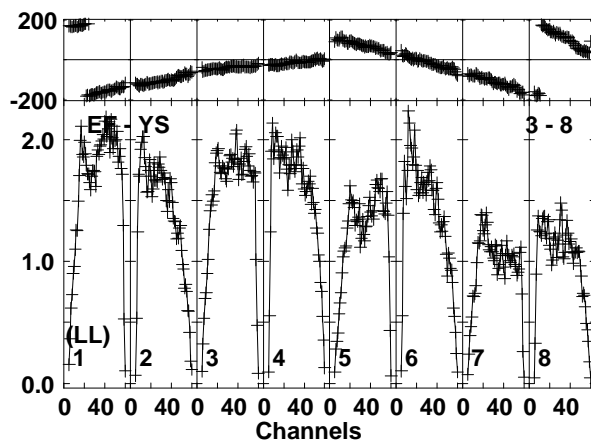
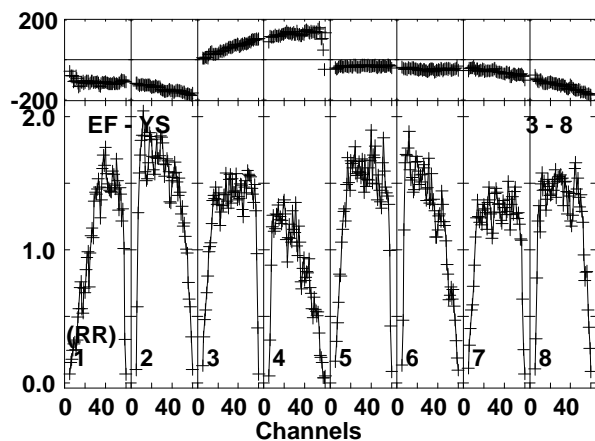
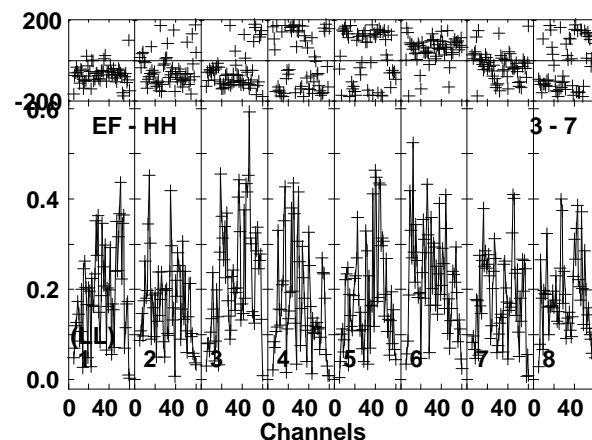
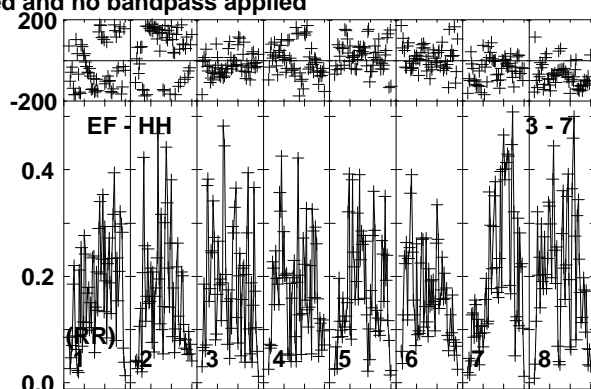
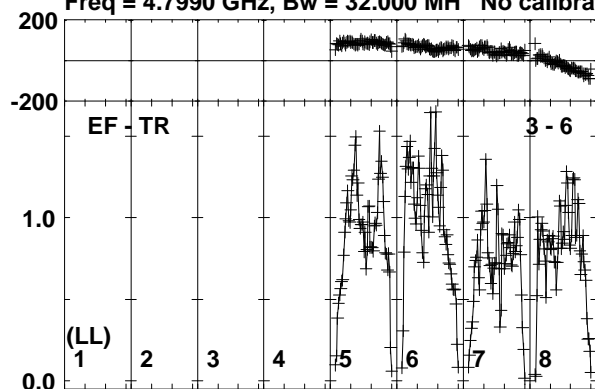

Lower frame: Milli Ampl Jy Top frame: Phas deg
Vector averaged cross-power spectrum Baseline: EF (03) - TR (06)
Timerange: 00/15:53:01 to 00/15:54:29

Plot file version 219 created 28-AUG-2017 13:19:16

NVSS2 RP029A.UVDATA.1

Freq = 4.7990 GHz, Bw = 32.000 MH No calibration applied and no bandpass applied

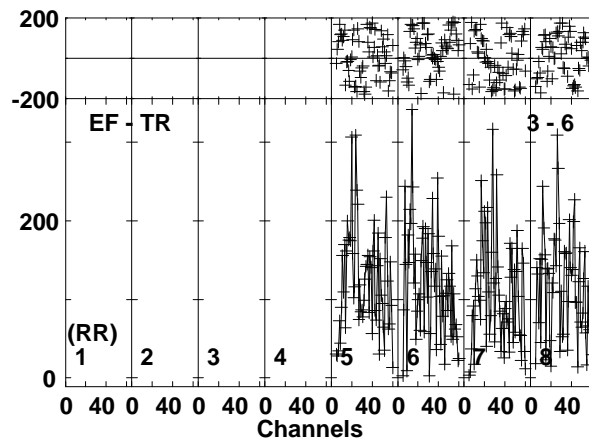
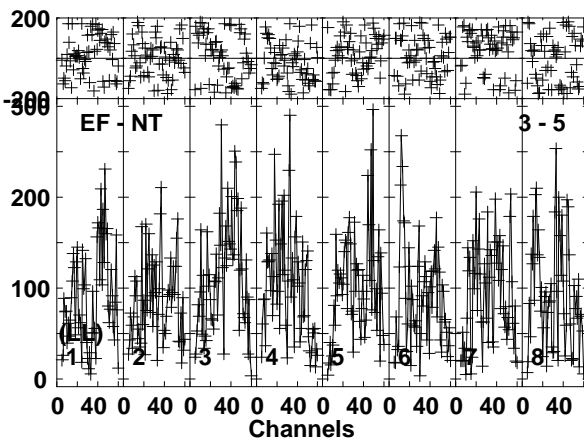
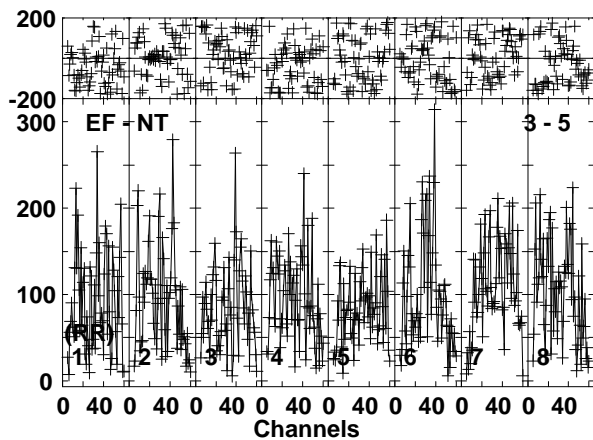
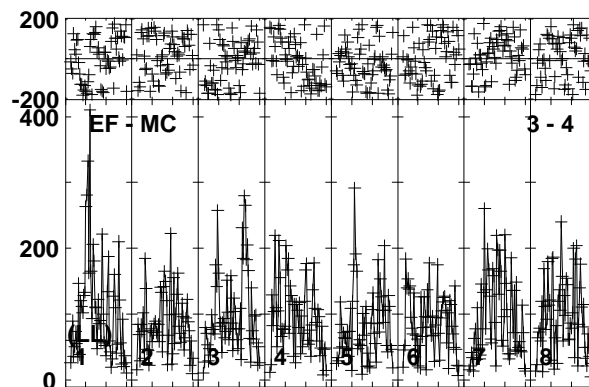
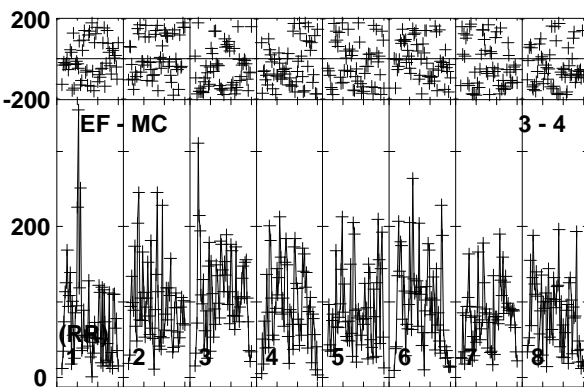
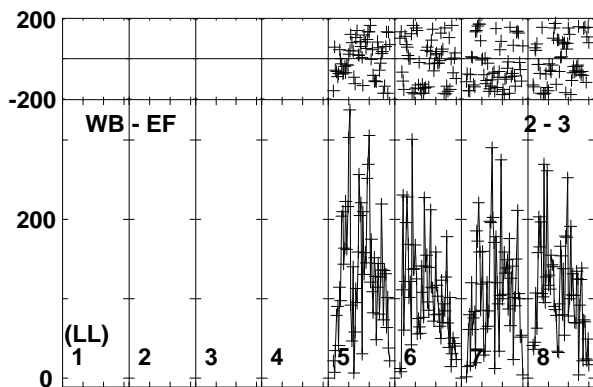
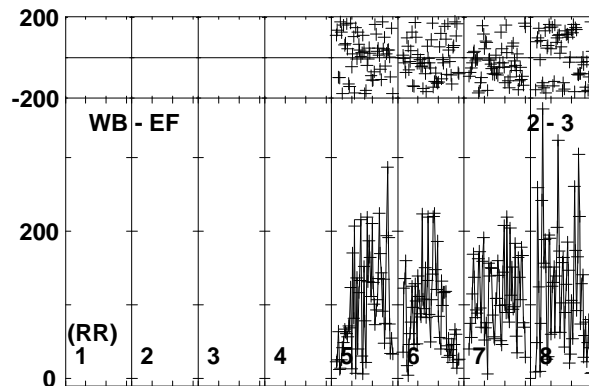
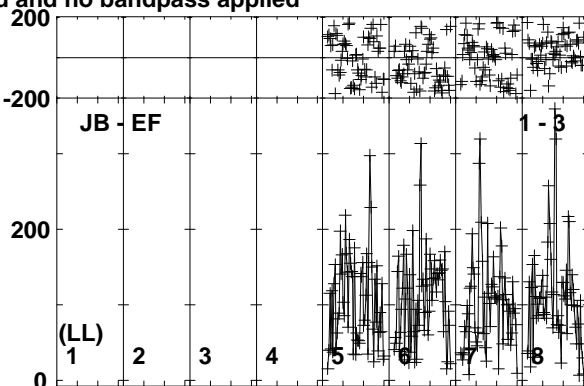
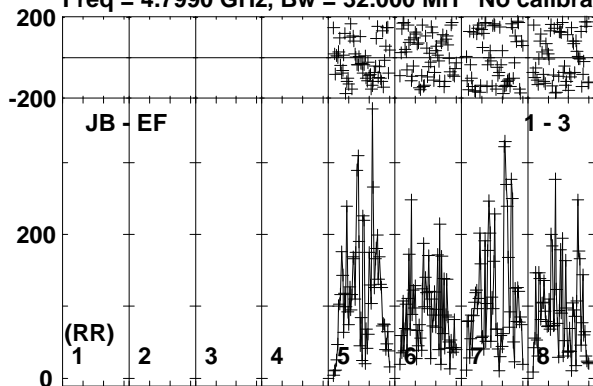

Lower frame: Micro Ampl Jy Top frame: Phas deg
Vector averaged cross-power spectrum Baseline: JB (01) - EF (03)
Timerange: 00/15:54:31 to 00/15:56:59

Plot file version 220 created 28-AUG-2017 13:19:16

NVSS2 RP029A.UVDATA.1

Freq = 4.7990 GHz, Bw = 32.000 MH No calibration applied and no bandpass applied

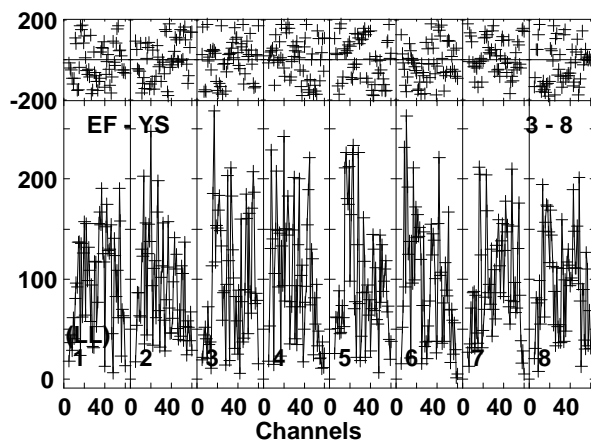
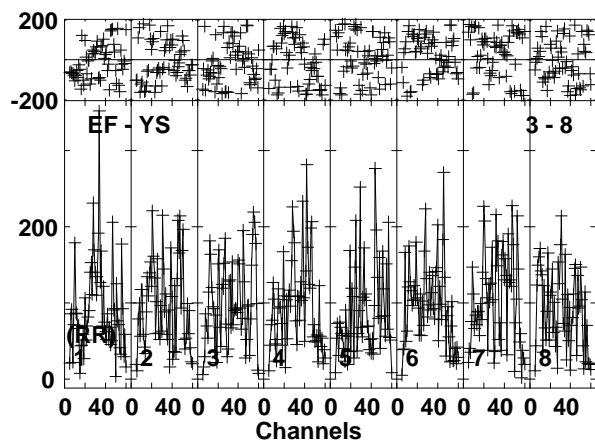
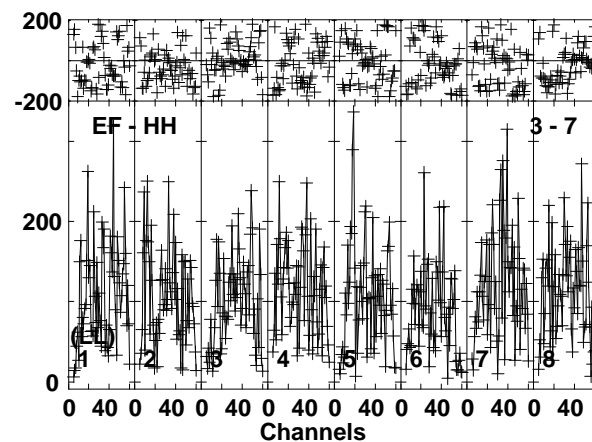
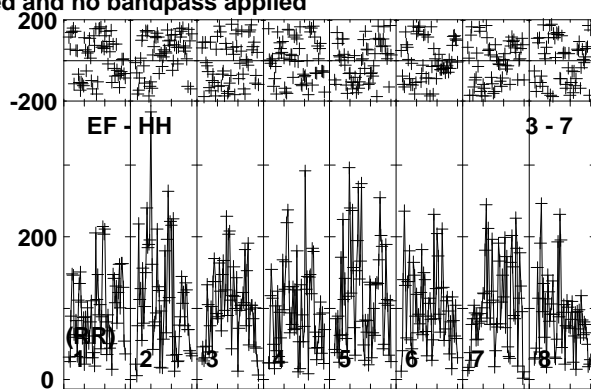
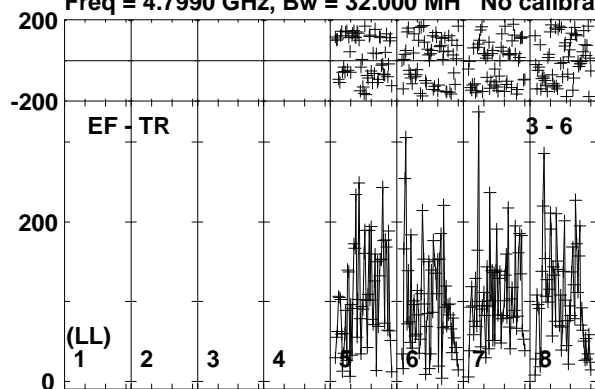

Lower frame: Micro Ampl Jy Top frame: Phas deg
Vector averaged cross-power spectrum Baseline: EF (03) - TR (06)
Timerange: 00:15:54:31 to 00:15:56:59

Plot file version 221 created 28-AUG-2017 13:19:16

J1303-2405 RP029A.UVDATA.1

Freq = 4.7990 GHz, Bw = 32.000 MH No calibration applied and no bandpass applied

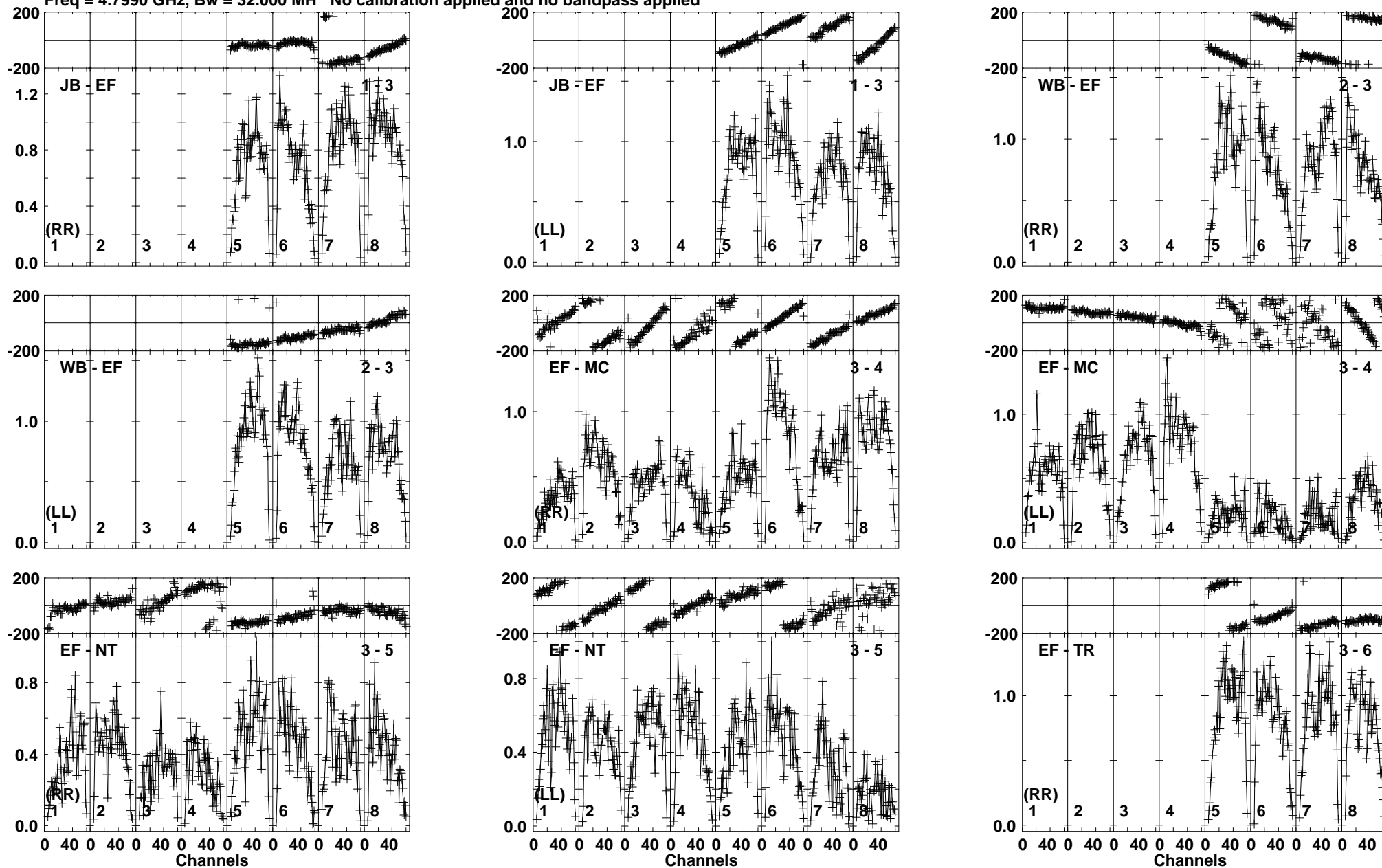

Lower frame: Milli Ampl Jy Top frame: Phas deg
Vector averaged cross-power spectrum Baseline: JB (01) - EF (03)
Timerange: 00/15:57:31 to 00/15:58:29

Plot file version 222 created 28-AUG-2017 13:19:16

J1303-2405 RP029A.UVDATA.1

Freq = 4.7990 GHz, Bw = 32.000 MH No calibration applied and no bandpass applied

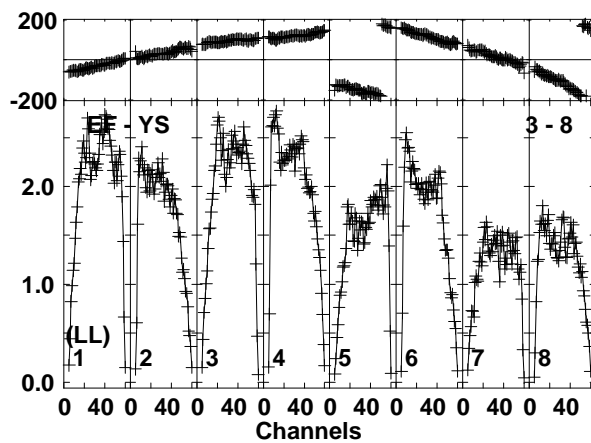
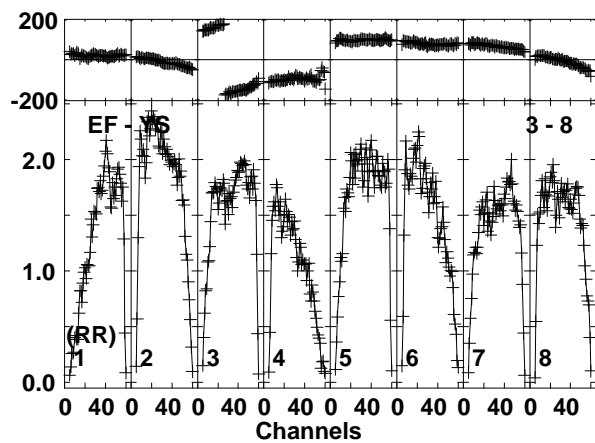
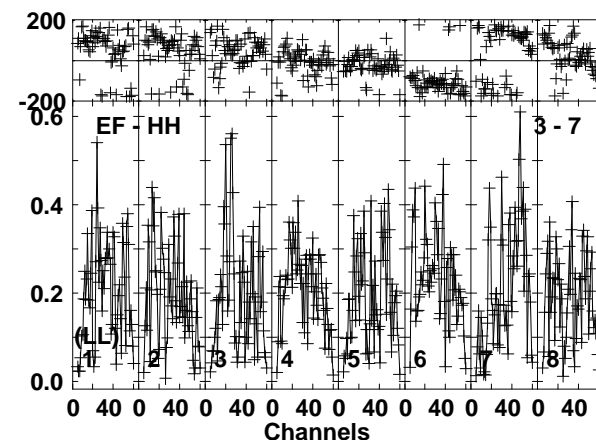
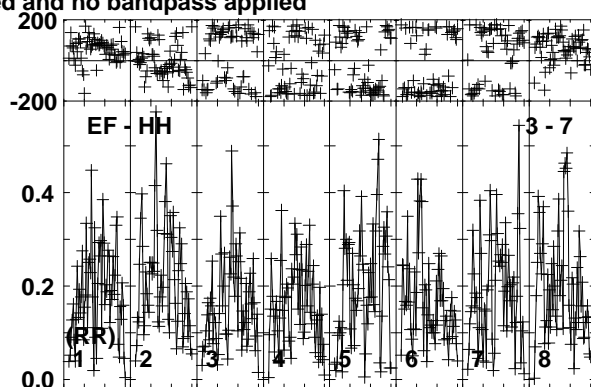
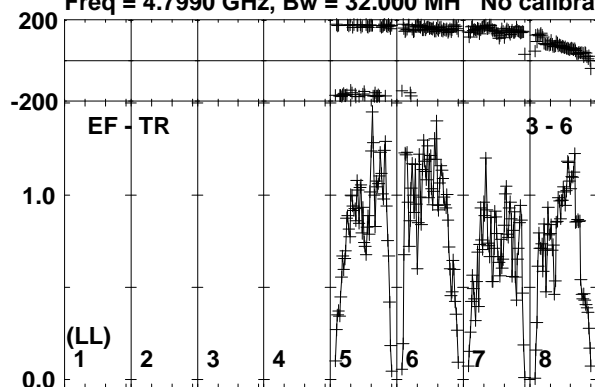

Lower frame: Milli Ampl Jy Top frame: Phas deg
Vector averaged cross-power spectrum Baseline: EF (03) - TR (06)
Timerange: 00/15:57:31 to 00/15:58:29

Plot file version 223 created 28-AUG-2017 13:19:16

NVSS3 RP029A.UVDATA.1

Freq = 4.7990 GHz, Bw = 32.000 MH No calibration applied and no bandpass applied

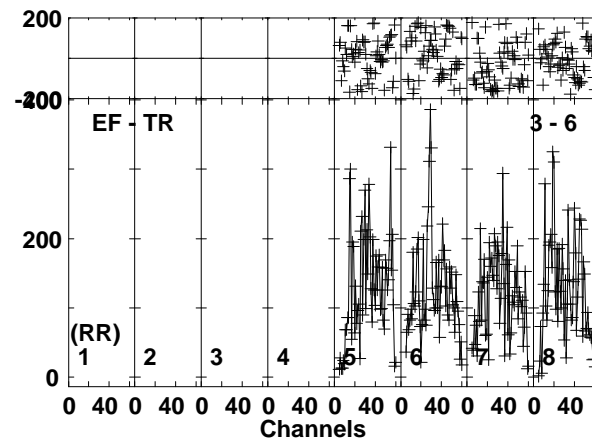
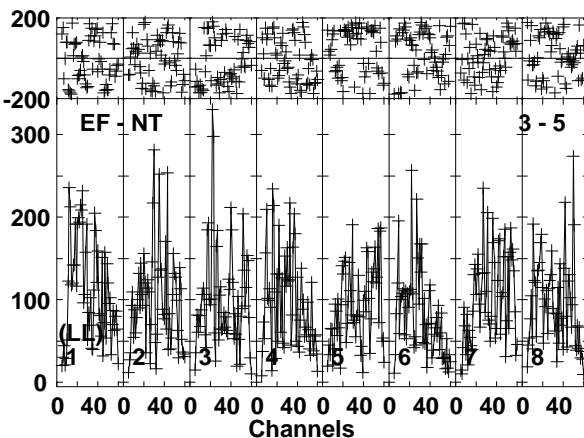
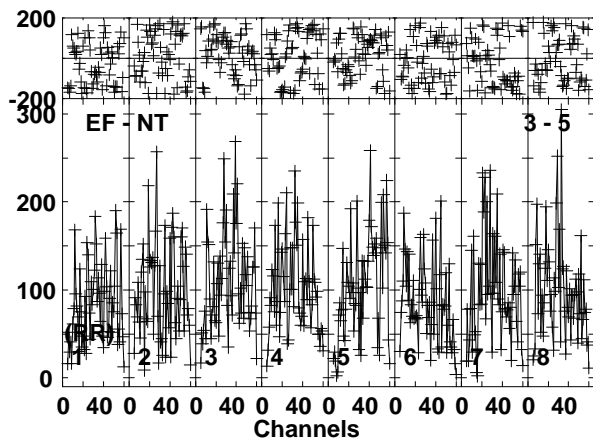
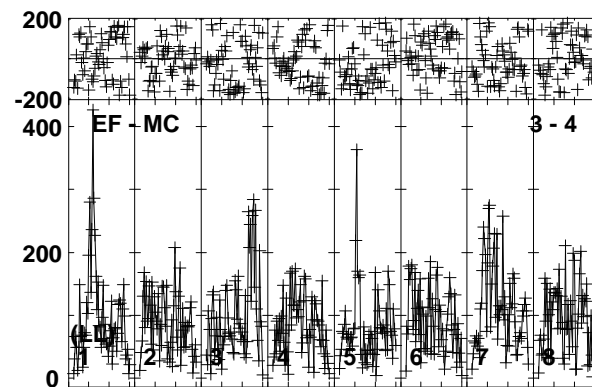
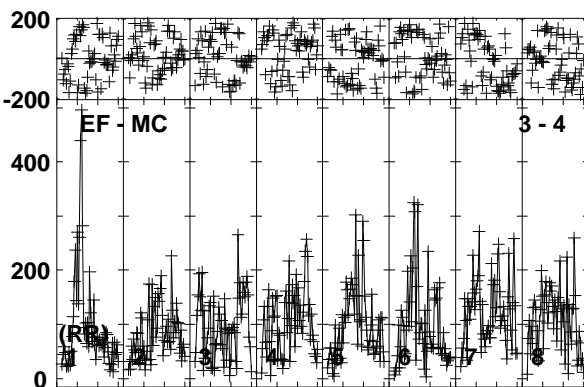
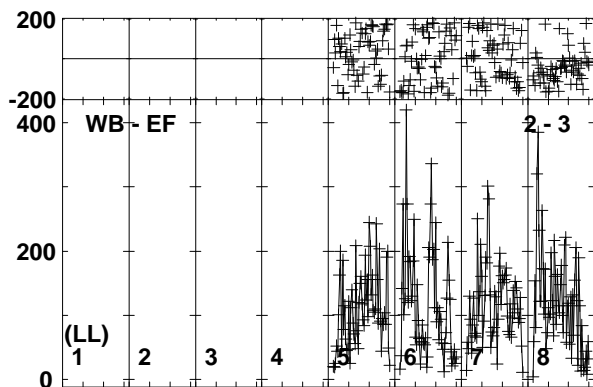
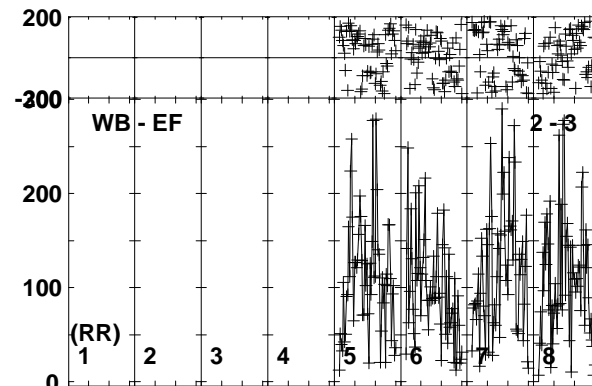
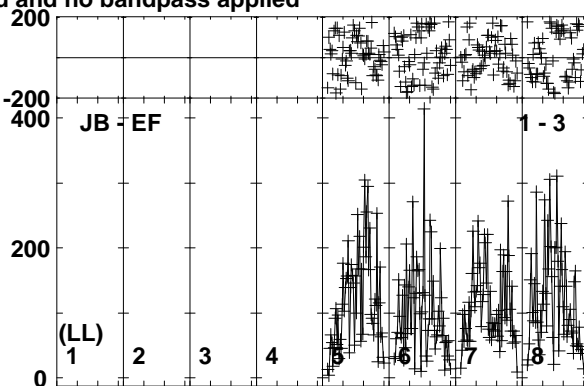
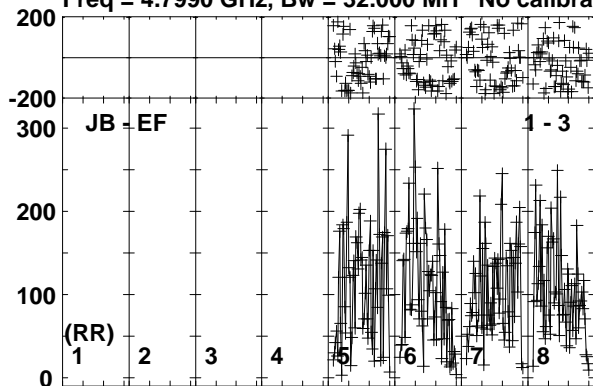

Lower frame: Micro Ampl Jy Top frame: Phas deg
Vector averaged cross-power spectrum Baseline: JB (01) - EF (03)
Timerange: 00/15:58:31 to 00/16:00:59

Plot file version 224 created 28-AUG-2017 13:19:16

NVSS3 RP029A.UVDATA.1

Freq = 4.7990 GHz, Bw = 32.000 MH No calibration applied and no bandpass applied

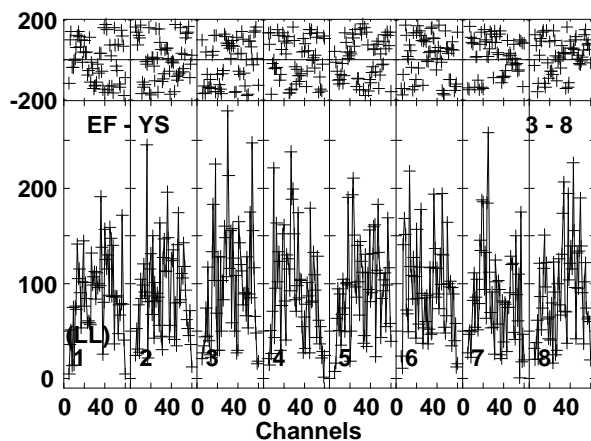
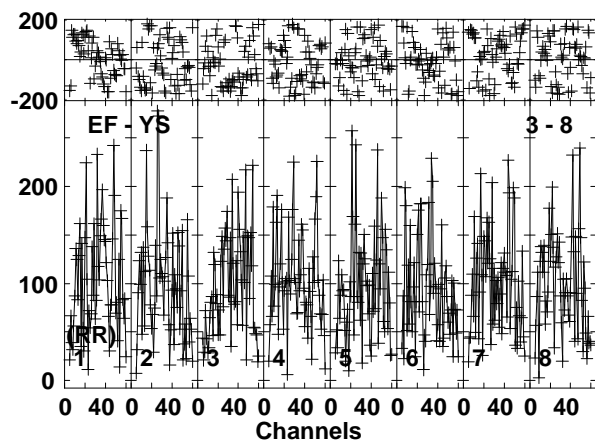
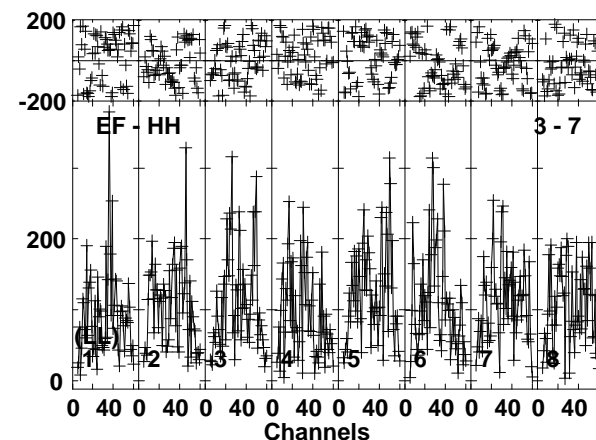
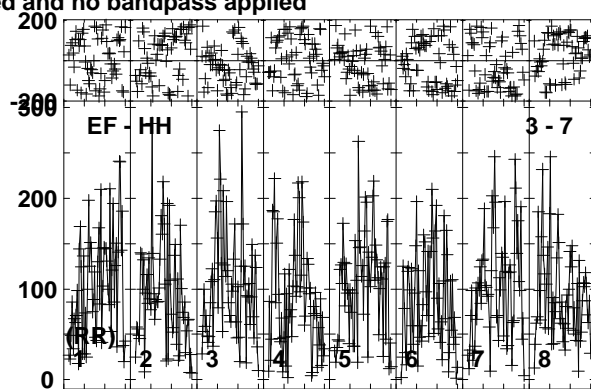
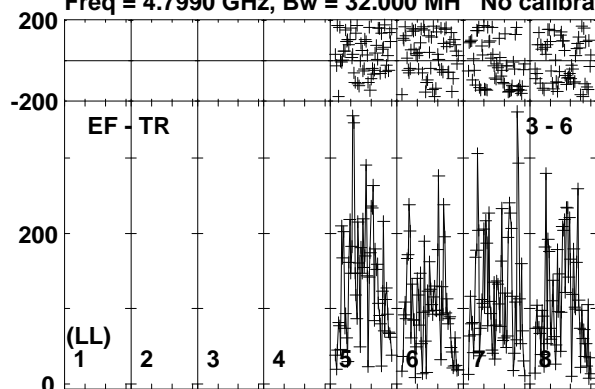

Lower frame: Micro Ampl Jy Top frame: Phas deg
Vector averaged cross-power spectrum Baseline: EF (03) - TR (06)
Timerange: 00/15:58:31 to 00/16:00:59

Plot file version 225 created 28-AUG-2017 13:19:16

J1303-2405 RP029A.UVDATA.1

Freq = 4.7990 GHz, Bw = 32.000 MH No calibration applied and no bandpass applied

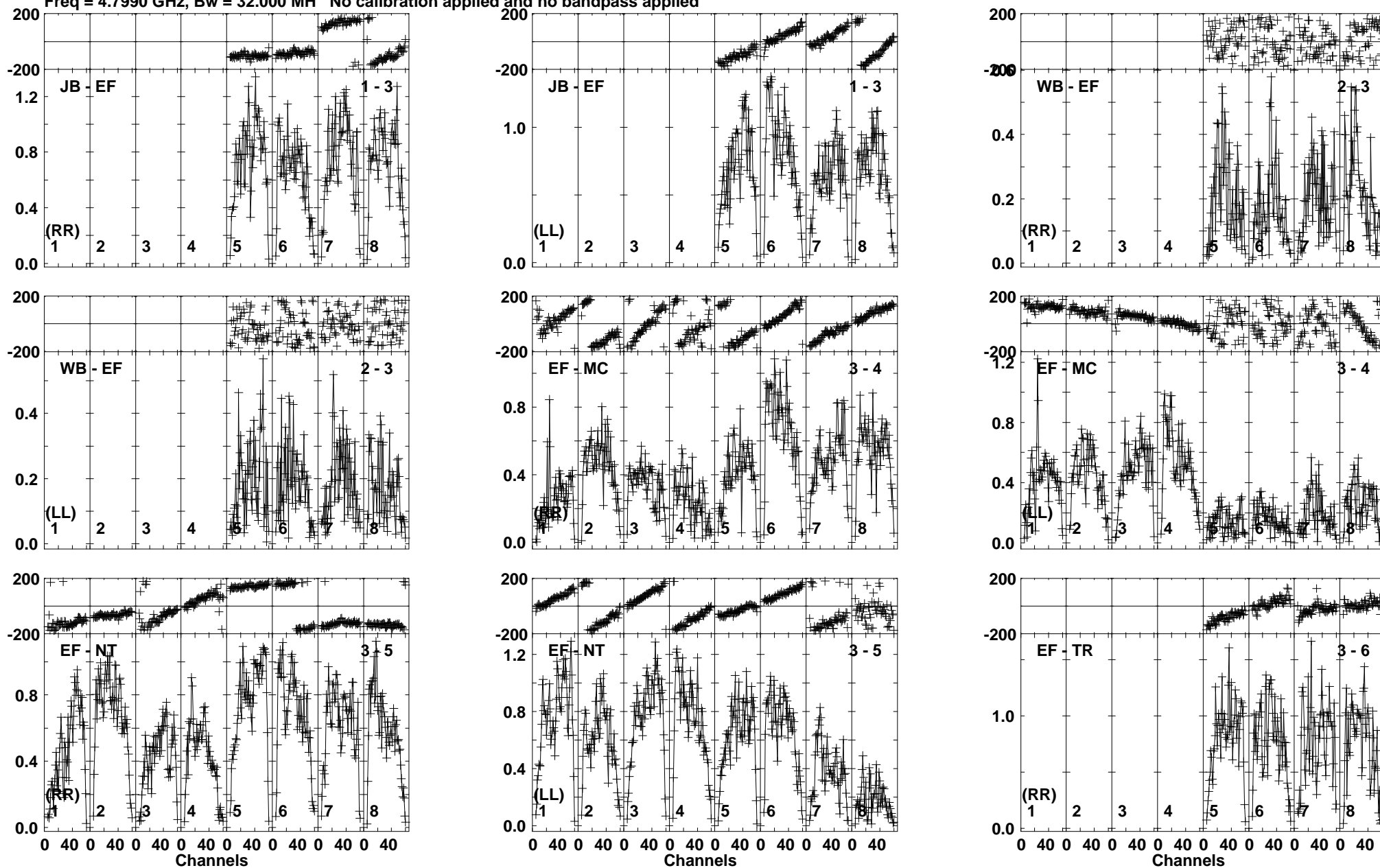

Lower frame: Milli Ampl Jy Top frame: Phas deg
Vector averaged cross-power spectrum Baseline: JB (01) - EF (03)
Timerange: 00/16:01:01 to 00/16:02:29

Plot file version 226 created 28-AUG-2017 13:19:16

J1303-2405 RP029A.UVDATA.1

Freq = 4.7990 GHz, Bw = 32.000 MH No calibration applied and no bandpass applied

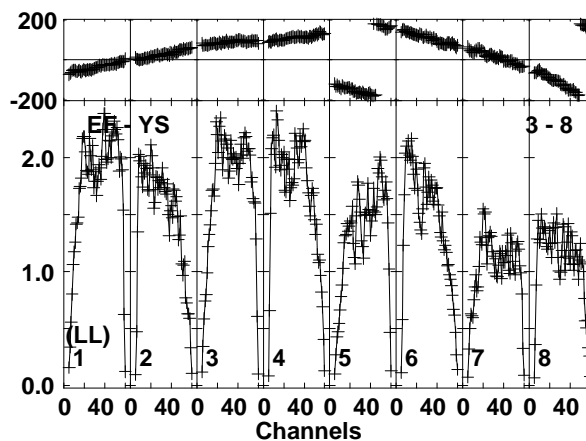
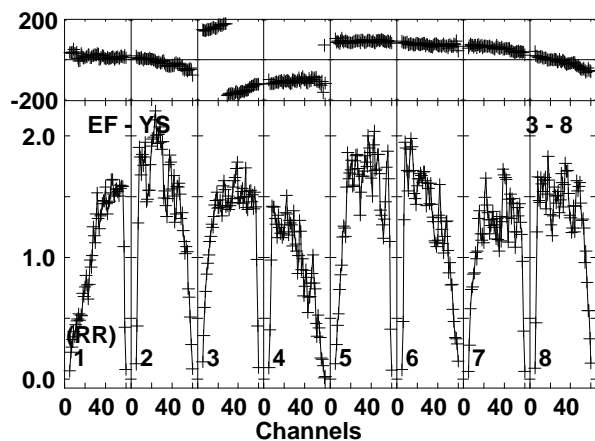
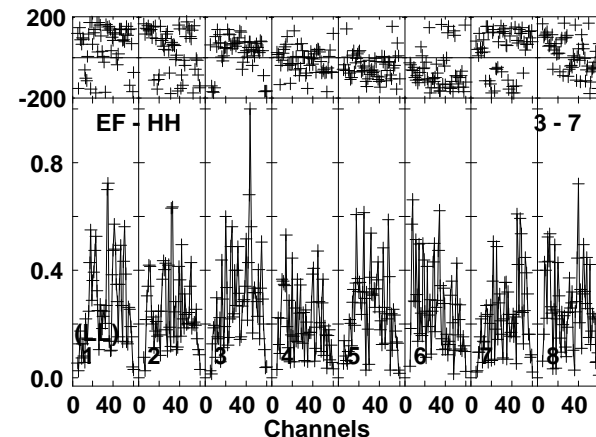
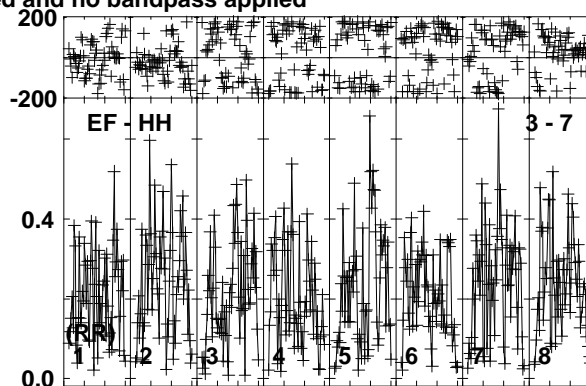
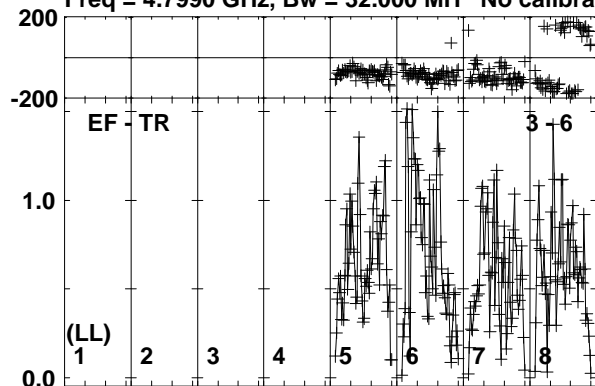

Lower frame: Milli Ampl Jy Top frame: Phas deg
Vector averaged cross-power spectrum Baseline: EF (03) - TR (06)
Timerange: 00/16:01:01 to 00/16:02:29

Plot file version 227 created 28-AUG-2017 13:19:16

SSS17A RP029A.UVDATA.1

Freq = 4.7990 GHz, Bw = 32.000 MH No calibration applied and no bandpass applied

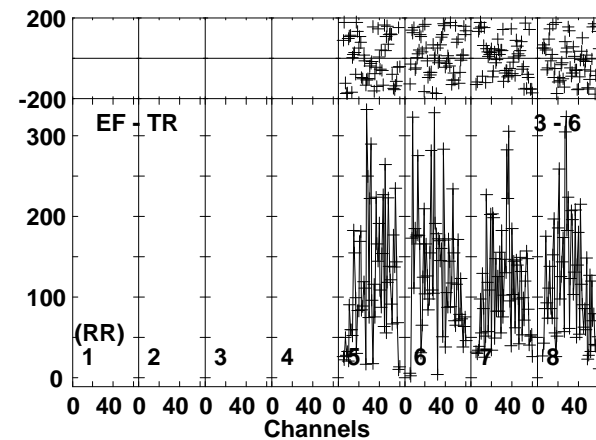
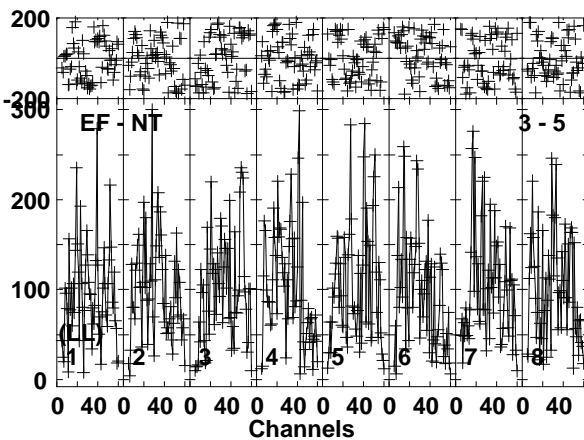
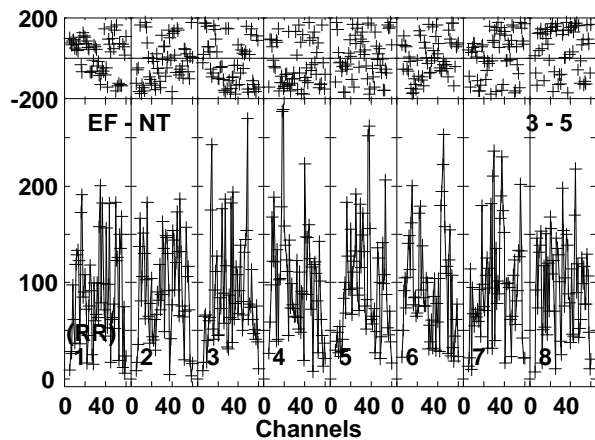
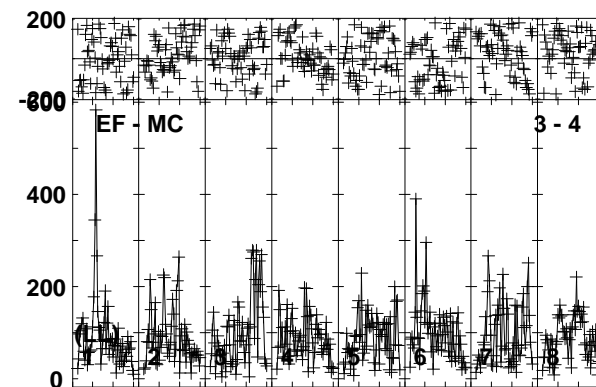
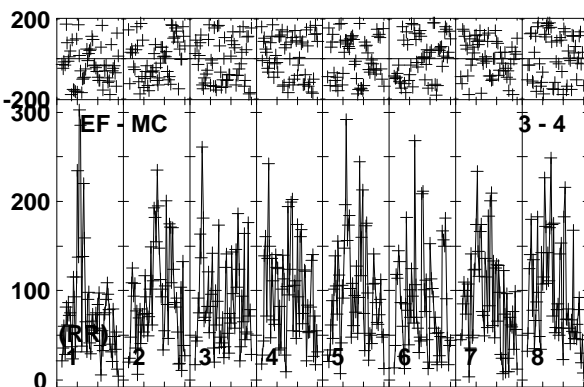
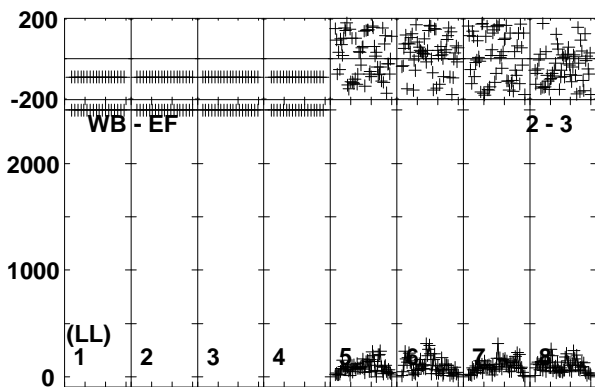
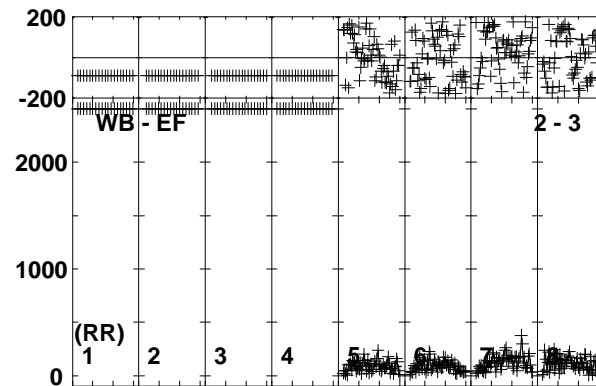
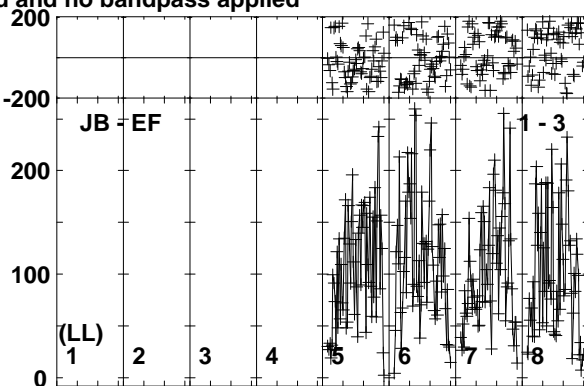
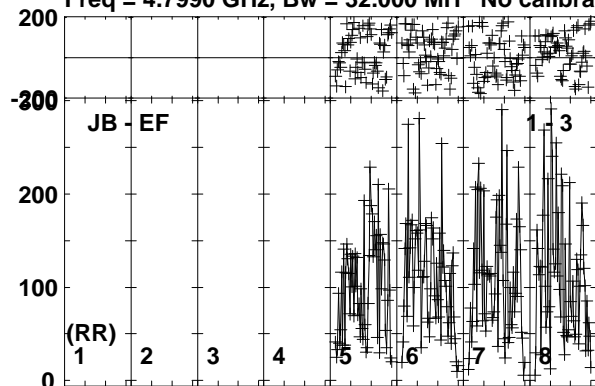

Lower frame: Micro Ampl Jy Top frame: Phas deg
Vector averaged cross-power spectrum Baseline: JB (01) - EF (03)
Timerange: 00/16:02:31 to 00/16:04:59

Plot file version 228 created 28-AUG-2017 13:19:17

SSS17A RP029A.UVDATA.1

Freq = 4.7990 GHz, Bw = 32.000 MH No calibration applied and no bandpass applied

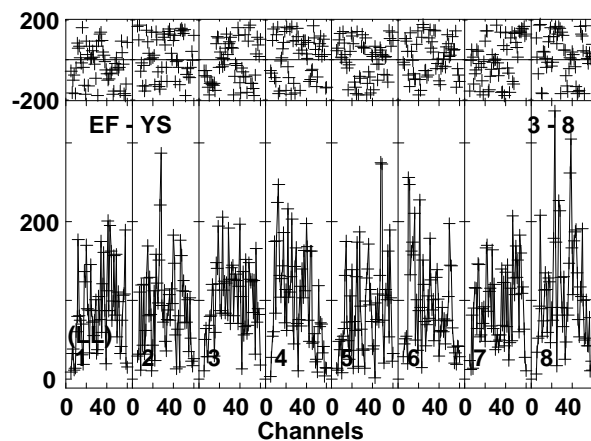
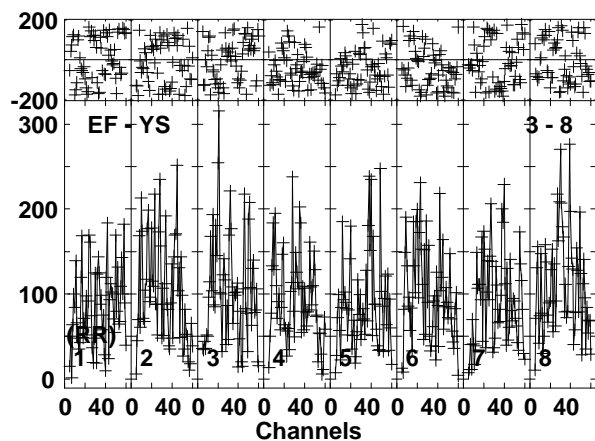
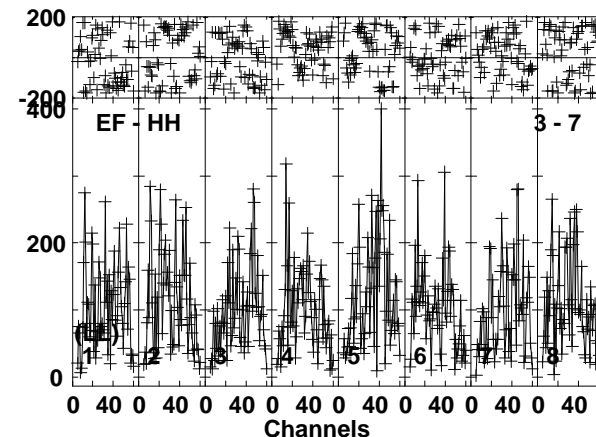
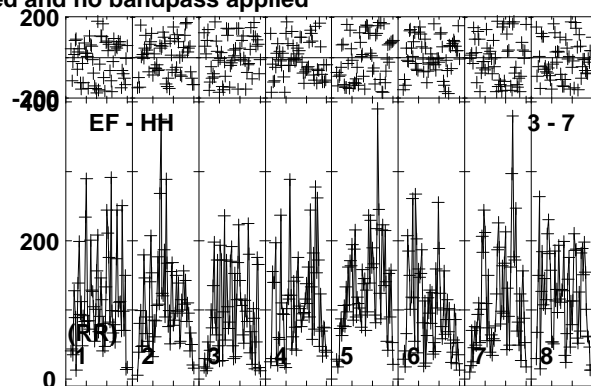
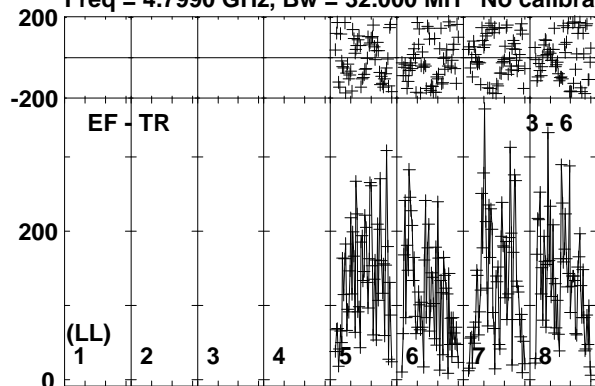

Lower frame: Micro Ampl Jy Top frame: Phas deg
Vector averaged cross-power spectrum Baseline: EF (03) - TR (06)
Timerange: 00/16:02:31 to 00/16:04:59

Plot file version 229 created 28-AUG-2017 13:19:17

J1303-2405 RP029A.UVDATA.1

Freq = 4.7990 GHz, Bw = 32.000 MH No calibration applied and no bandpass applied

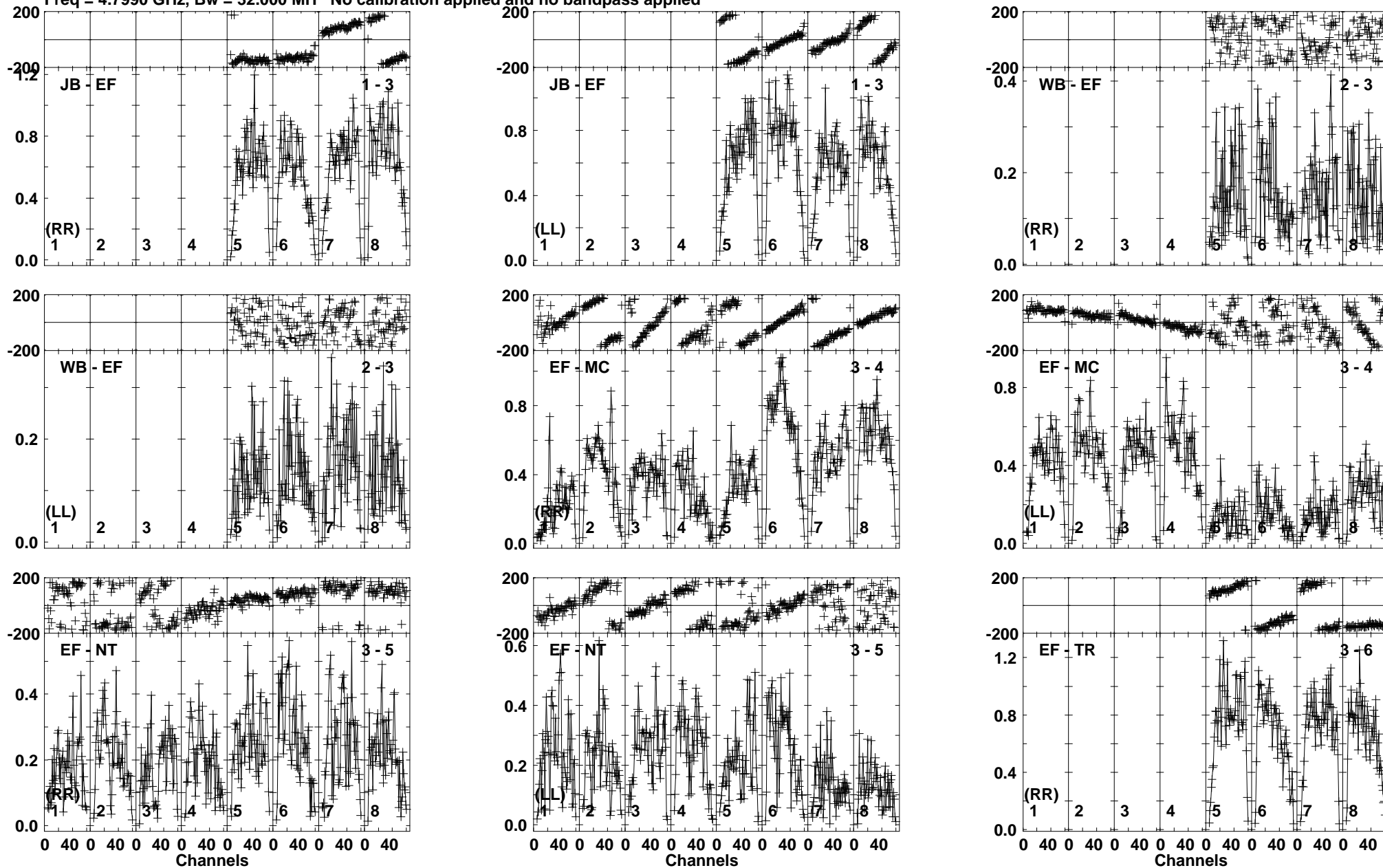

Lower frame: Milli Ampl Jy Top frame: Phas deg
Vector averaged cross-power spectrum Baseline: JB (01) - EF (03)
Timerange: 00/16:05:01 to 00/16:06:29

Plot file version 230 created 28-AUG-2017 13:19:17

J1303-2405 RP029A.UVDATA.1

Freq = 4.7990 GHz, Bw = 32.000 MH No calibration applied and no bandpass applied

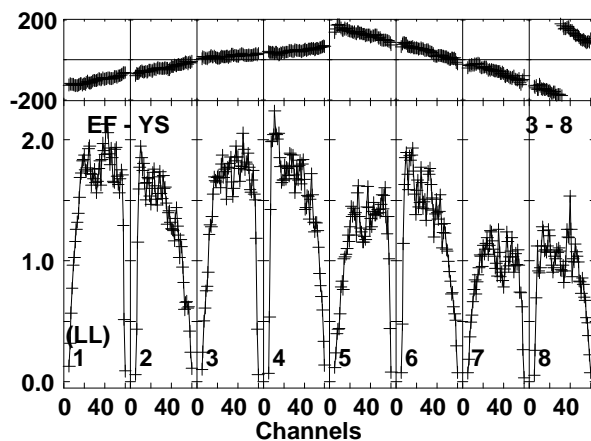
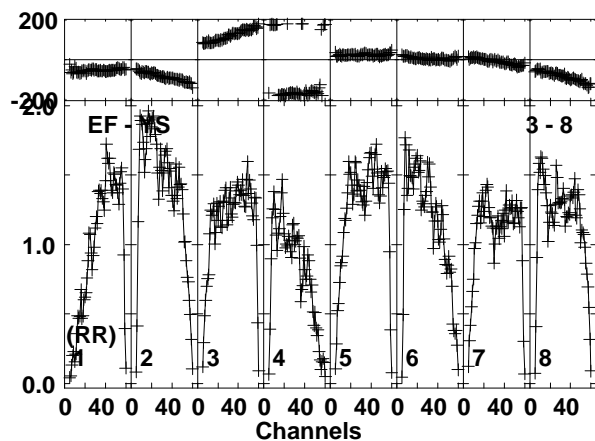
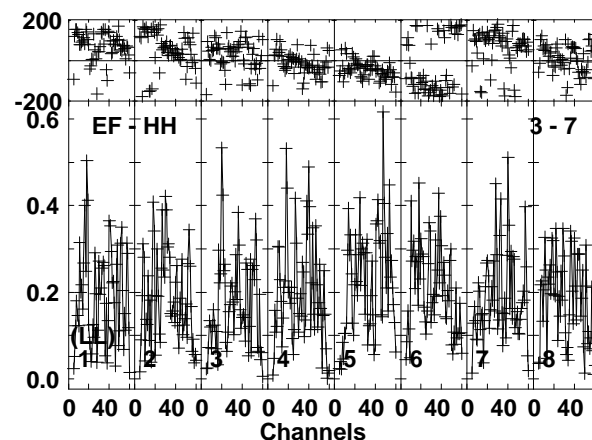
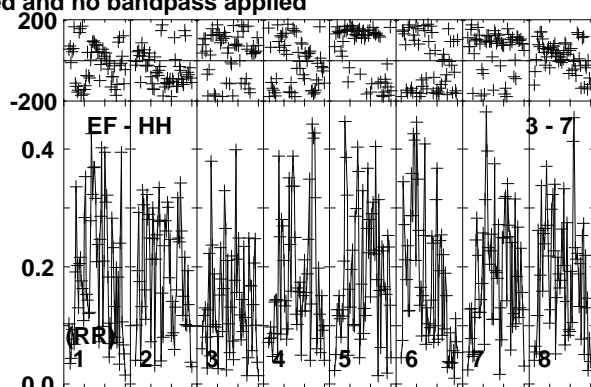
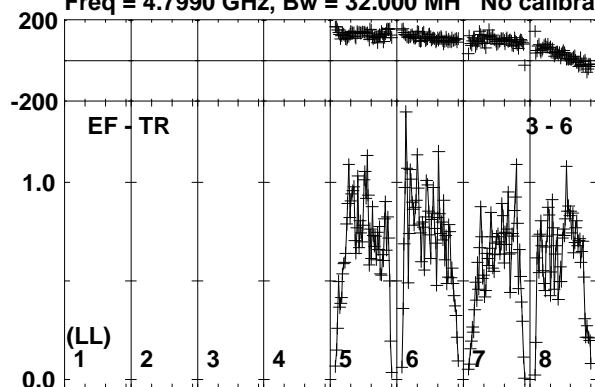

Lower frame: Milli Ampl Jy Top frame: Phas deg
Vector averaged cross-power spectrum Baseline: EF (03) - TR (06)
Timerange: 00:16:05:01 to 00:16:06:29

Plot file version 231 created 28-AUG-2017 13:19:17

SSS17A RP029A.UVDATA.1

Freq = 4.7990 GHz, Bw = 32.000 MH No calibration applied and no bandpass applied

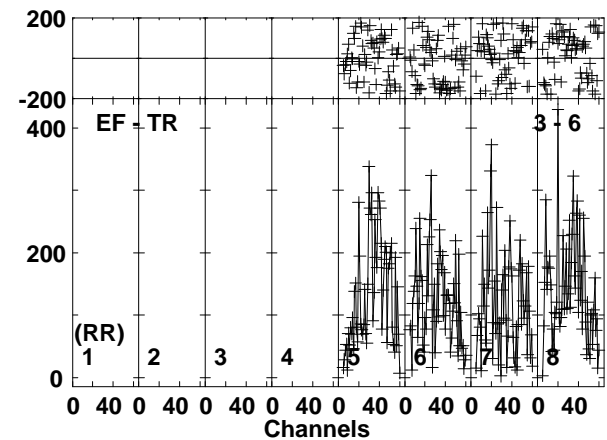
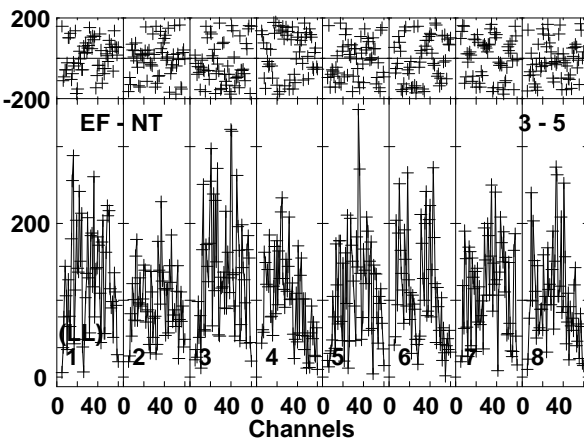
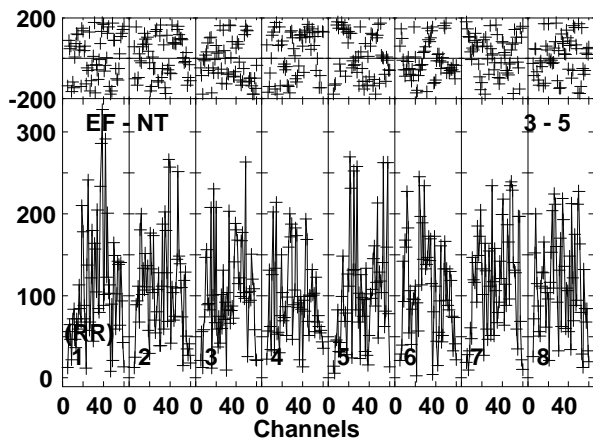
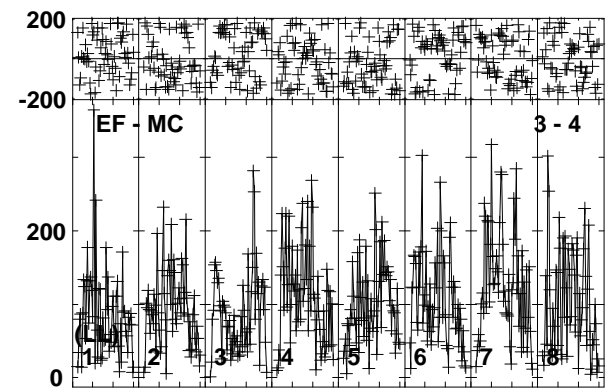
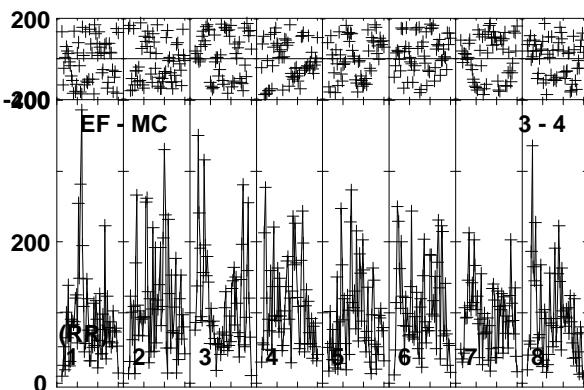
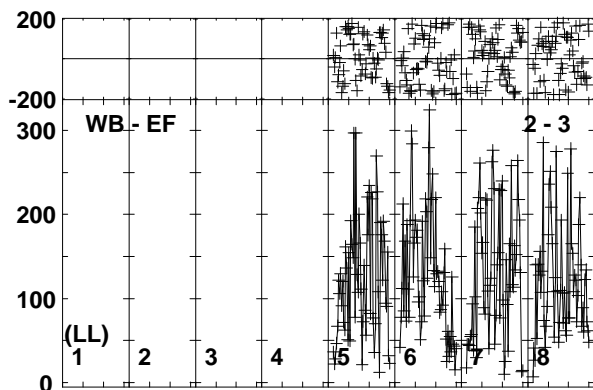
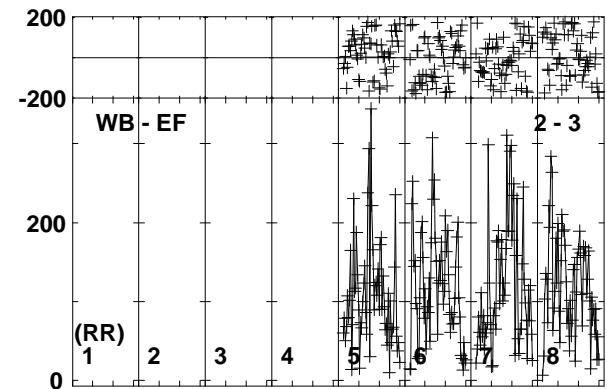
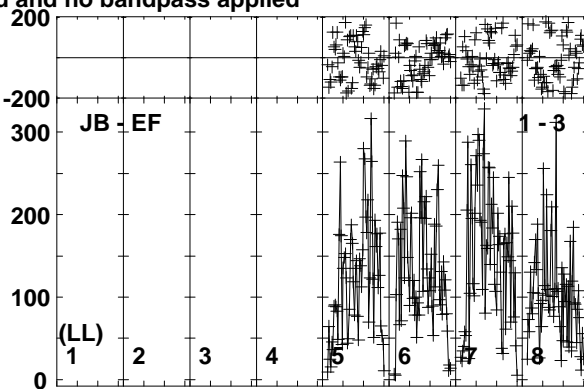
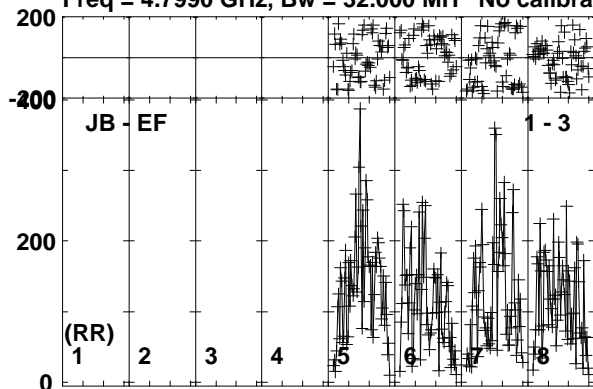

Lower frame: Micro Ampl Jy Top frame: Phas deg
Vector averaged cross-power spectrum Baseline: JB (01) - EF (03)
Timerange: 00/16:06:31 to 00/16:08:29

Plot file version 232 created 28-AUG-2017 13:19:17

SSS17A RP029A.UVDATA.1

Freq = 4.7990 GHz, Bw = 32.000 MH No calibration applied and no bandpass applied

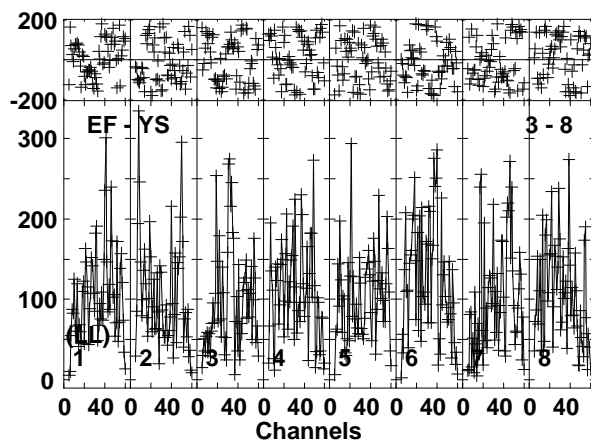
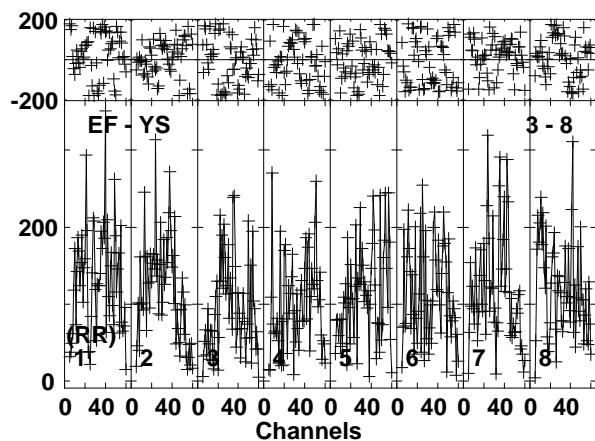
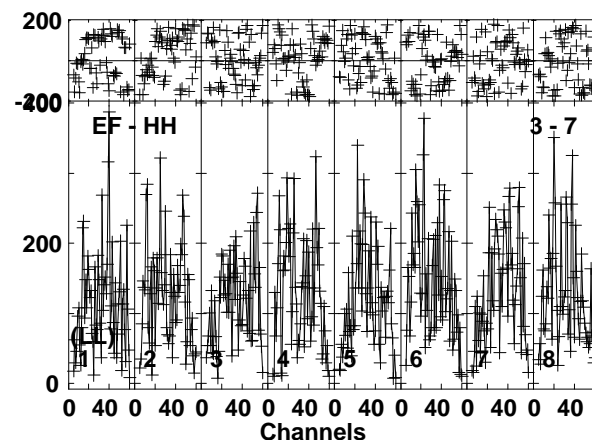
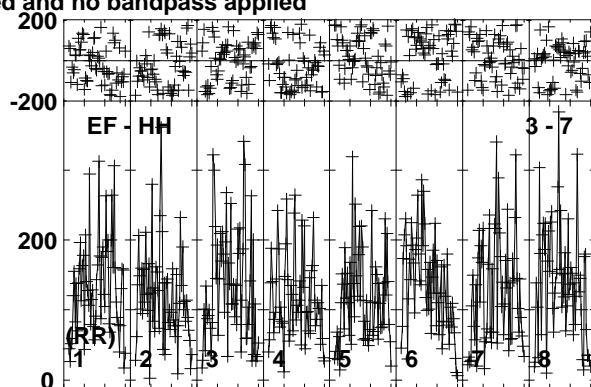
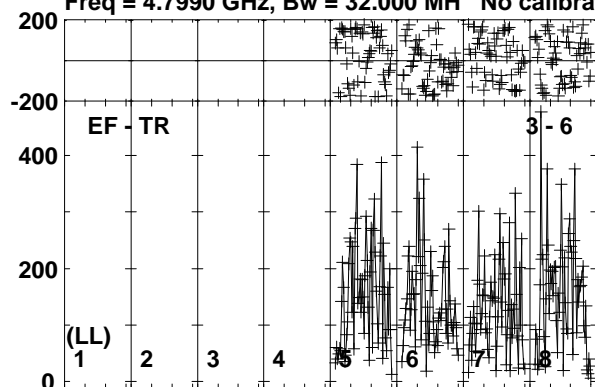

Lower frame: Micro Ampl Jy Top frame: Phas deg
Vector averaged cross-power spectrum Baseline: EF (03) - TR (06)
Timerange: 00/16:06:31 to 00/16:08:29

Plot file version 233 created 28-AUG-2017 13:19:17

J1303-2405 RP029A.UVDATA.1

Freq = 4.7990 GHz, Bw = 32.000 MH No calibration applied and no bandpass applied

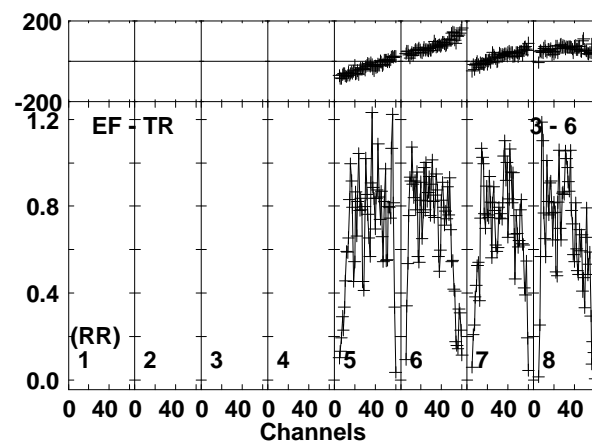
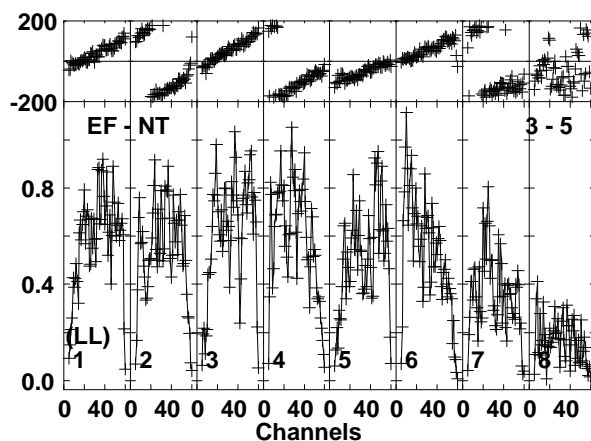
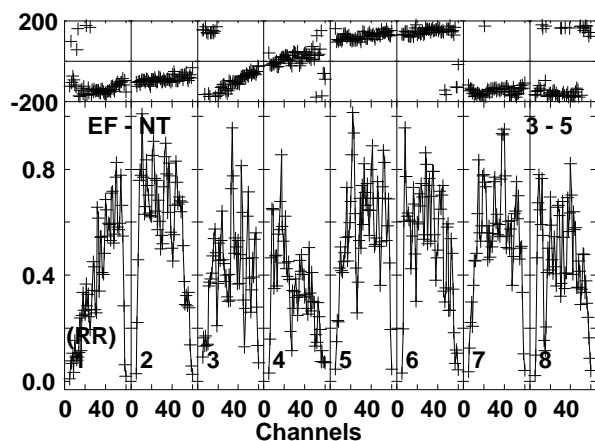
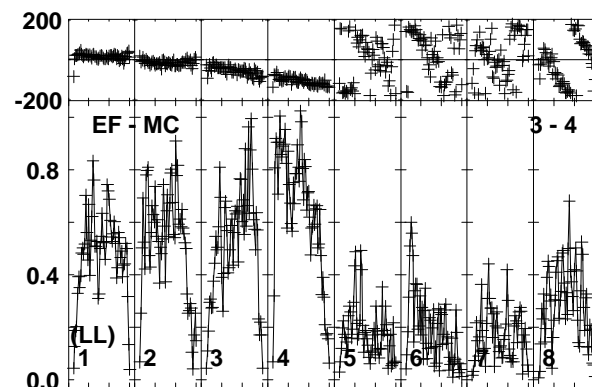
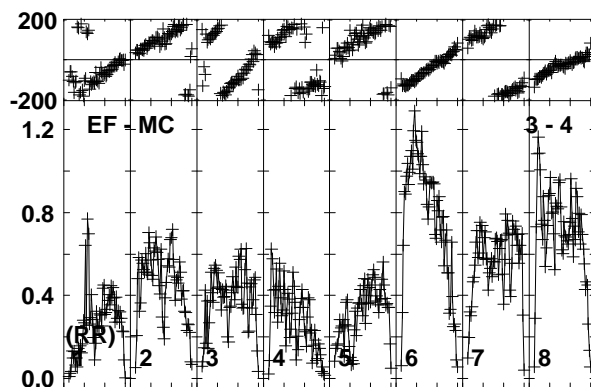
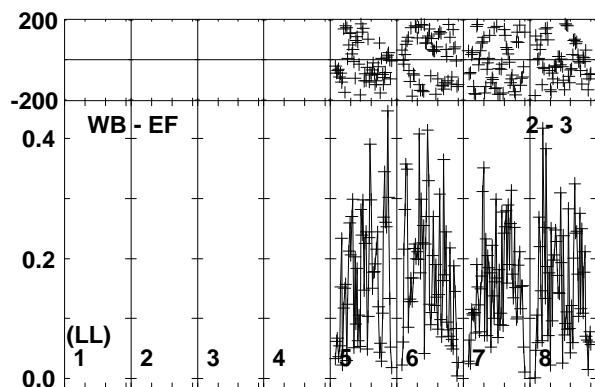
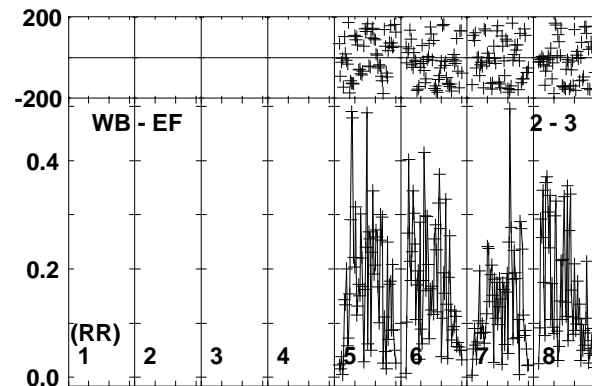
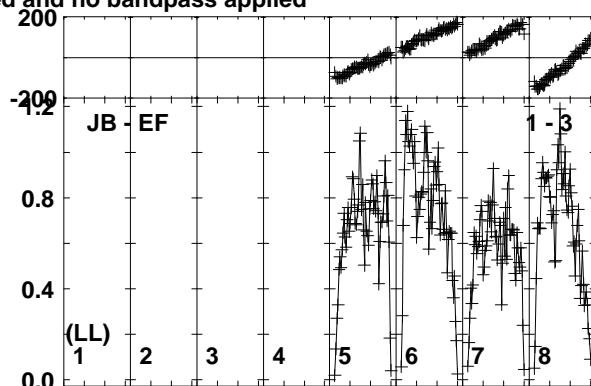
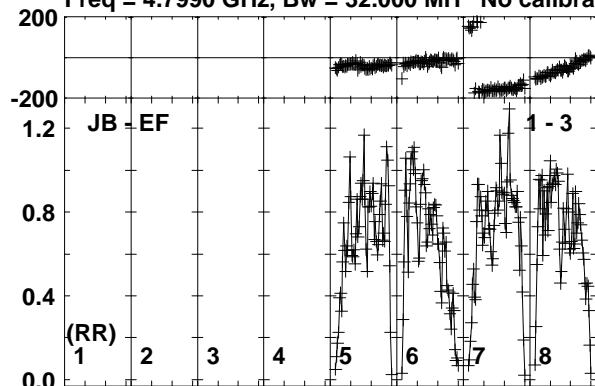

Lower frame: Milli Ampl Jy Top frame: Phas deg
Vector averaged cross-power spectrum Baseline: JB (01) - EF (03)
Timerange: 00/16:09:01 to 00/16:09:59

Plot file version 234 created 28-AUG-2017 13:19:17

J1303-2405 RP029A.UVDATA.1

Freq = 4.7990 GHz, Bw = 32.000 MH No calibration applied and no bandpass applied

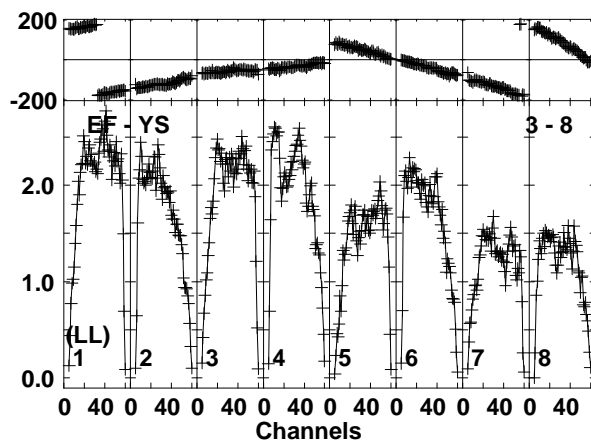
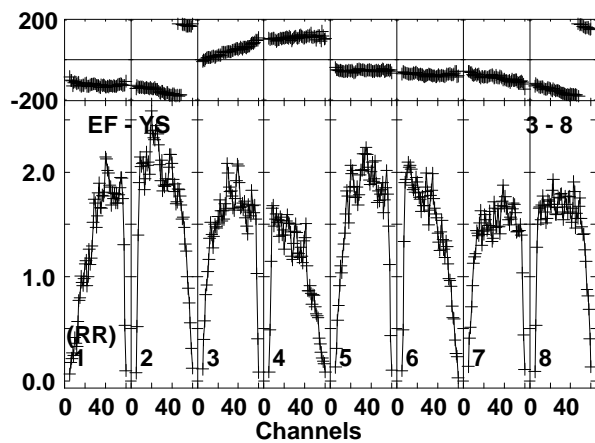
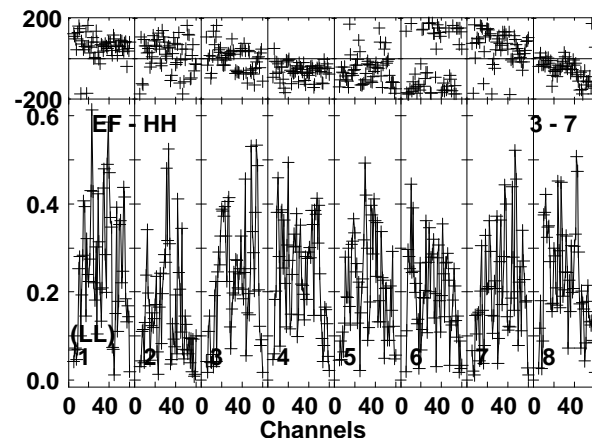
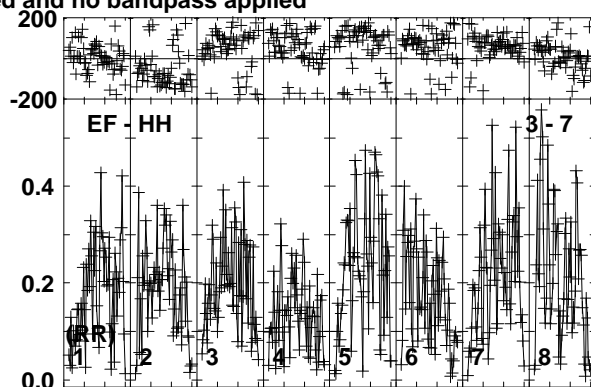
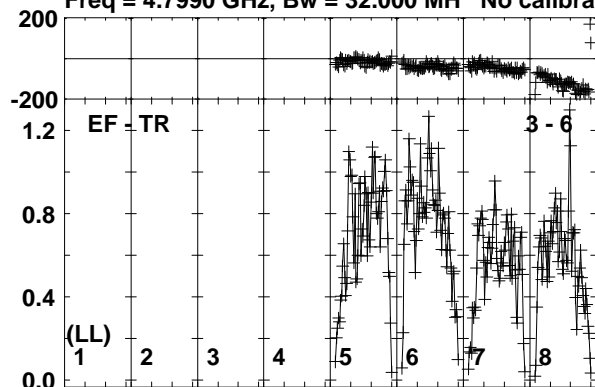

Lower frame: Milli Ampl Jy Top frame: Phas deg
Vector averaged cross-power spectrum Baseline: EF (03) - TR (06)
Timerange: 00/16:09:01 to 00/16:09:59

Plot file version 235 created 28-AUG-2017 13:19:17

J1310+3220 RP029A.UVDATA.1

Freq = 4.7990 GHz, Bw = 32.000 MH No calibration applied and no bandpass applied

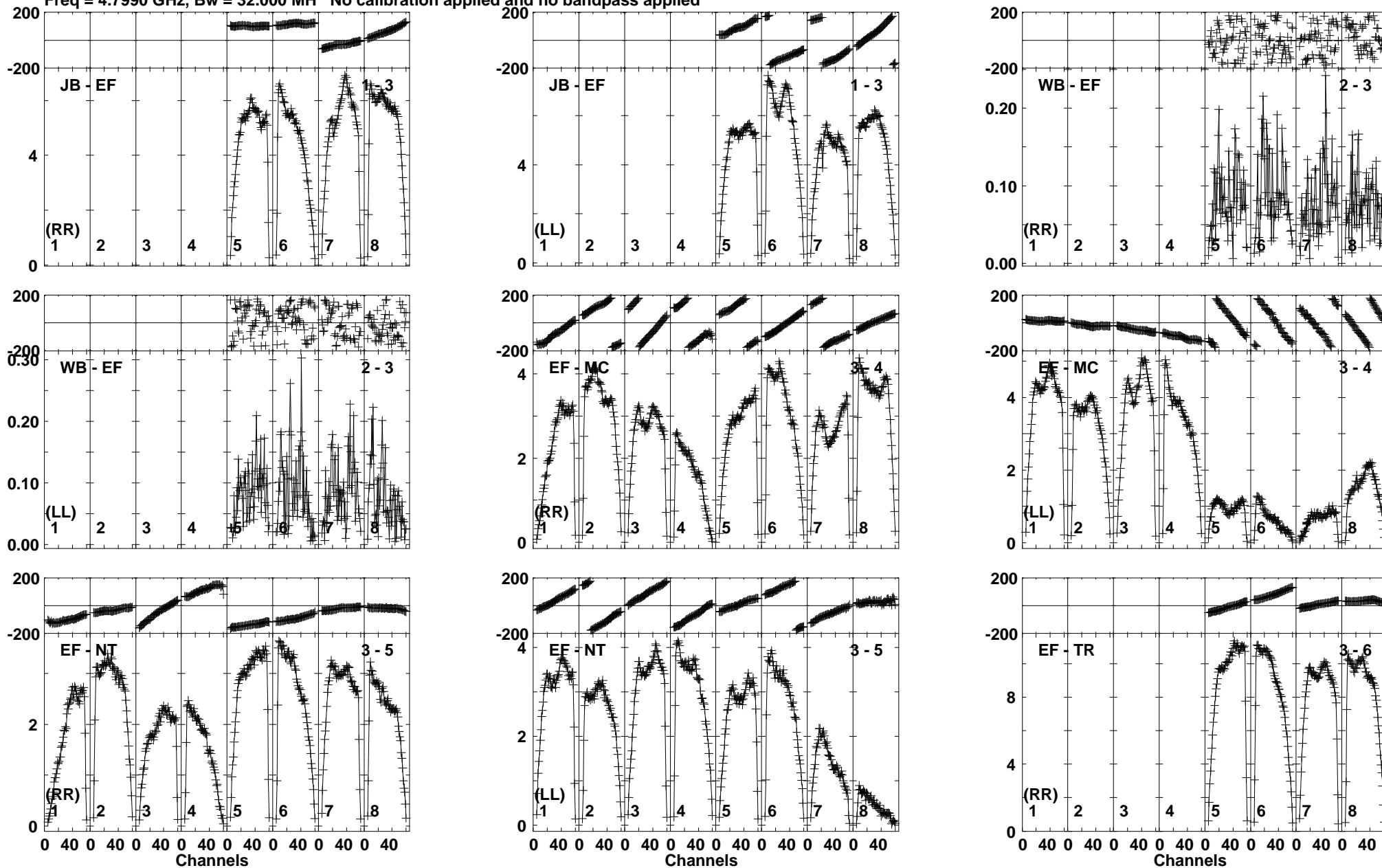

Lower frame: Milli Ampl Jy Top frame: Phas deg
Vector averaged cross-power spectrum Baseline: JB (01) - EF (03)
Timerange: 00/16:12:01 to 00/16:14:59

Plot file version 236 created 28-AUG-2017 13:19:17

J1310+3220 RP029A.UVDATA.1

Freq = 4.7990 GHz, Bw = 32.000 MH No calibration applied and no bandpass applied

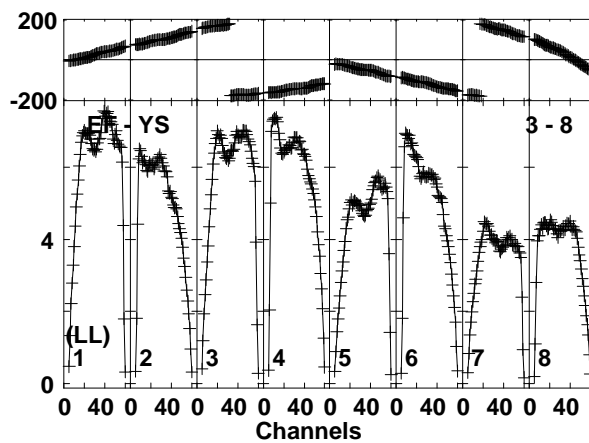
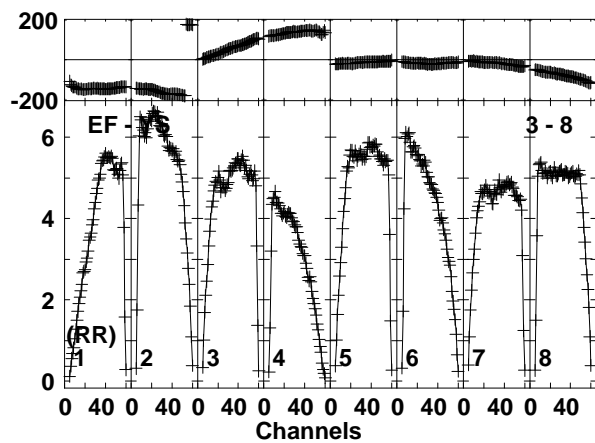
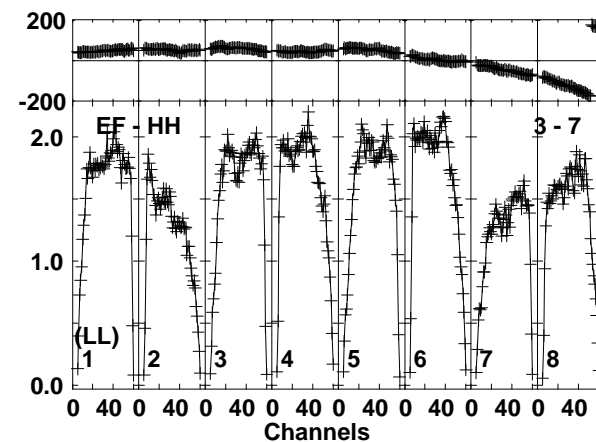
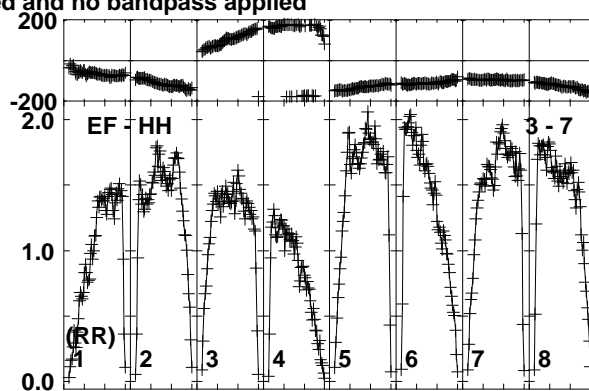
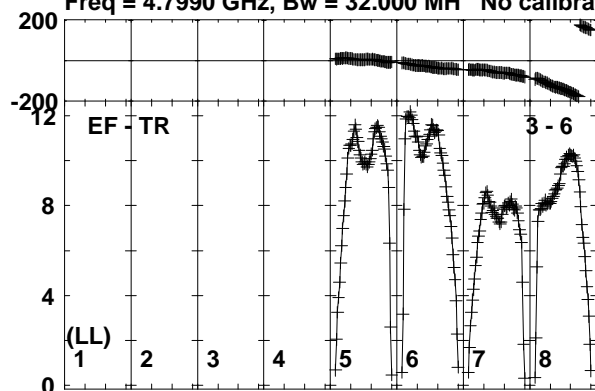

Lower frame: Milli Ampl Jy Top frame: Phas deg
Vector averaged cross-power spectrum Baseline: EF (03) - TR (06)
Timerange: 00/16:12:01 to 00/16:14:59