

Plot file version 1 created 25-SEP-2017 10:02:13

J1310+3220 RP029B.UVDATA.1

Freq = 4.7990 GHz, Bw = 32.000 MH No calibration applied and no bandpass applied

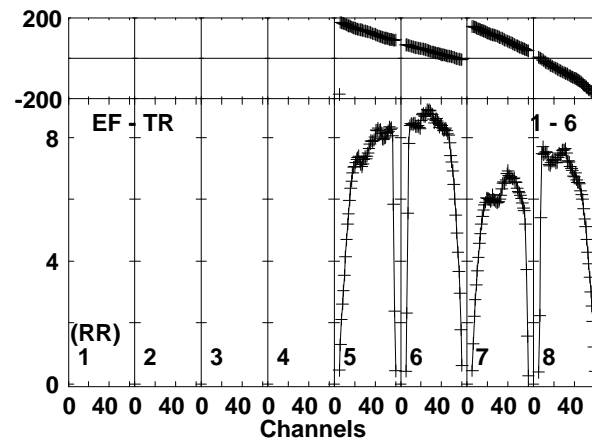
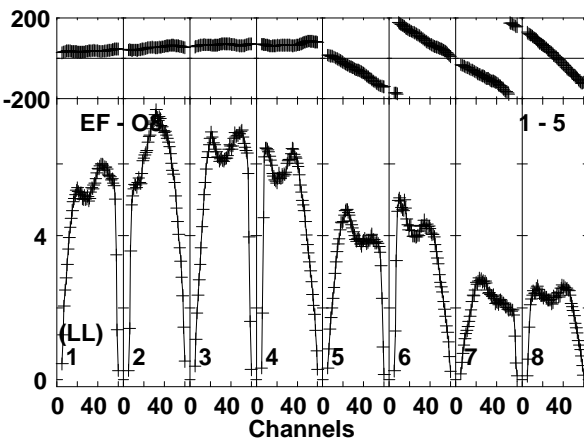
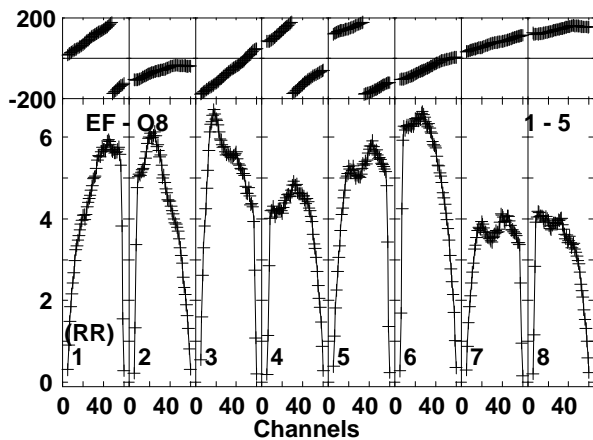
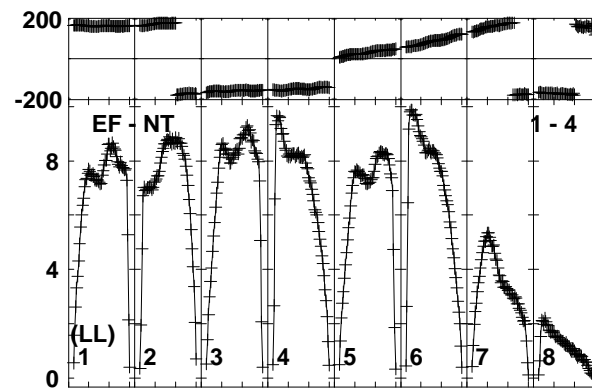
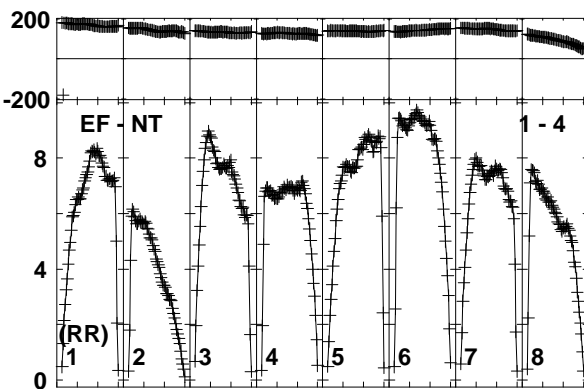
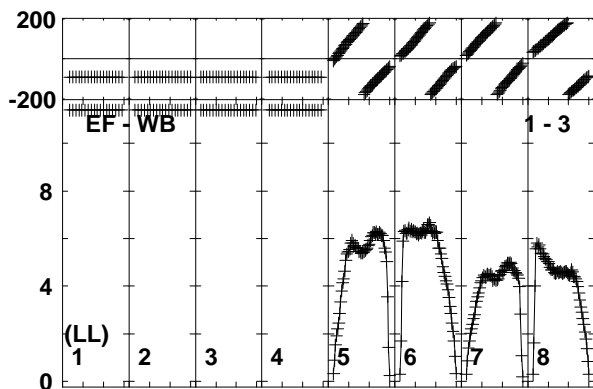
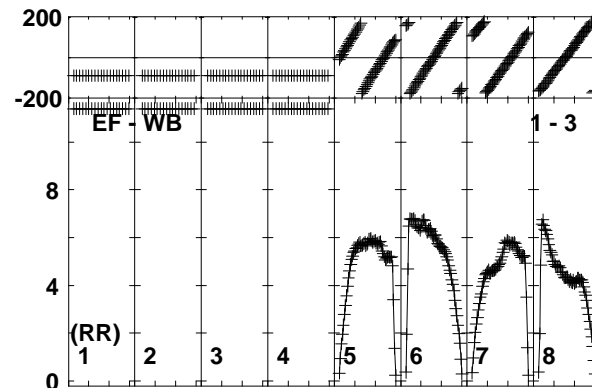
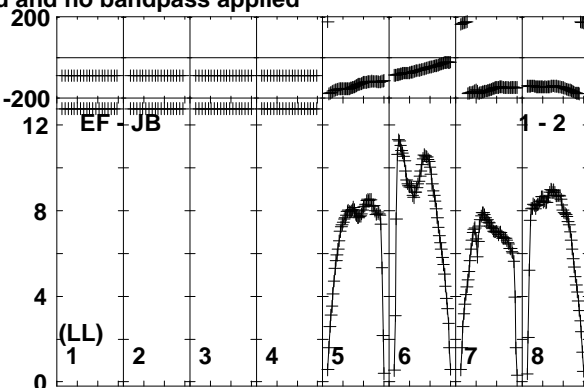
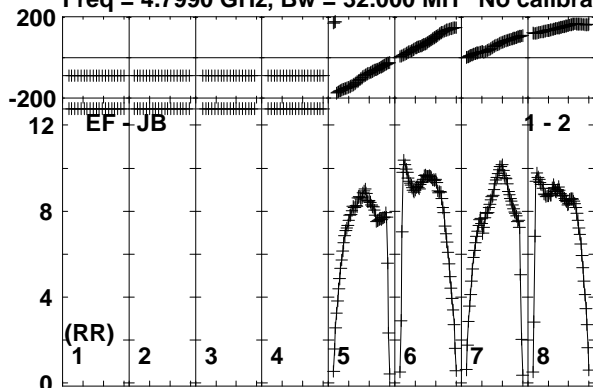

Lower frame: Milli Ampl Jy Top frame: Phas deg  
Vector averaged cross-power spectrum Baseline: EF (01) - JB (02)  
Timerange: 00/10/00:33 to 00/10/04:19

Plot file version 2 created 25-SEP-2017 10:02:14  
J1310+3220 RP029B.UVDATA.1

Freq = 4.7990 GHz, Bw = 32.000 MH No calibration applied and no bandpass applied

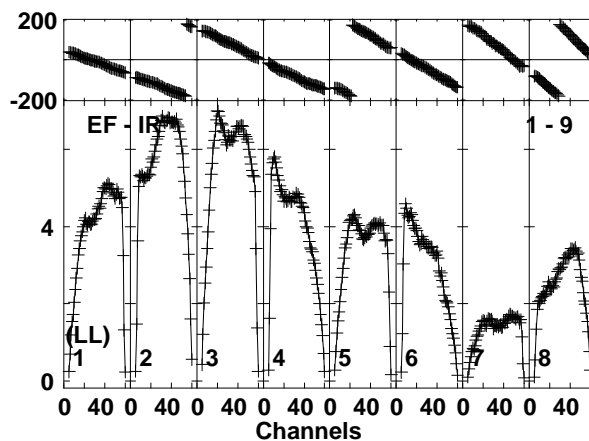
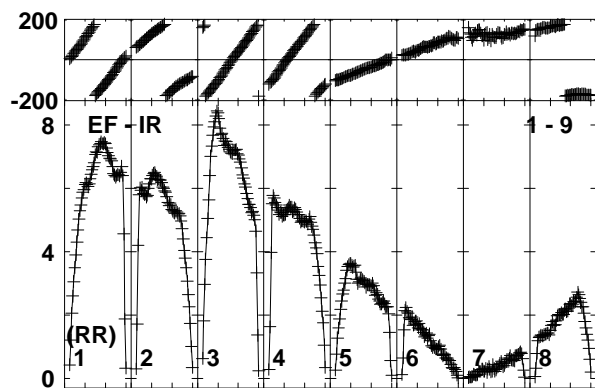
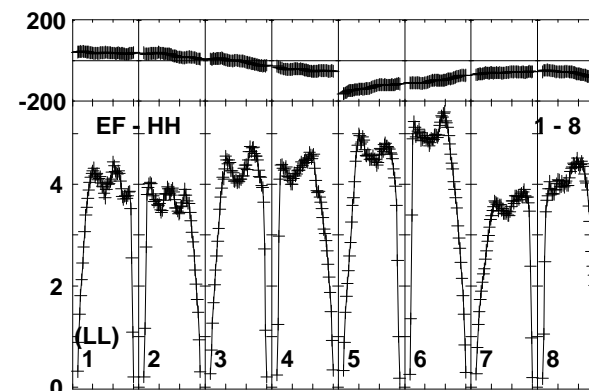
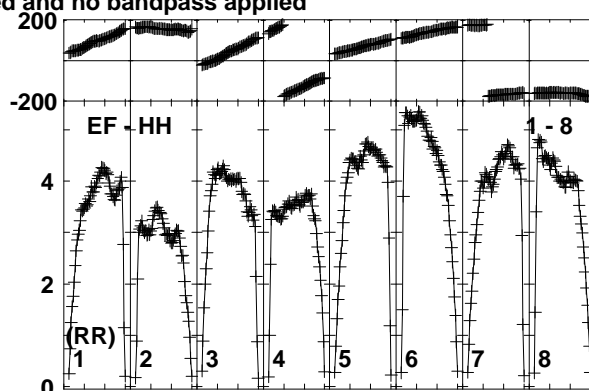
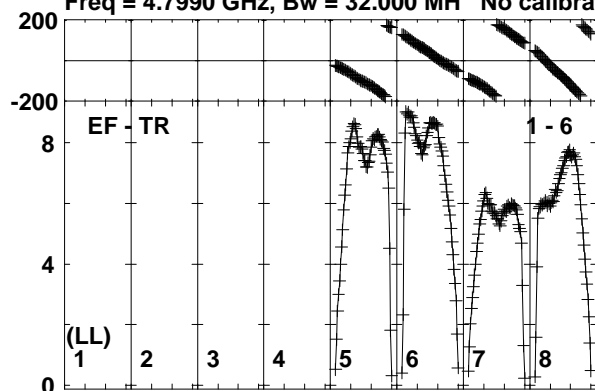

Lower frame: Milli Ampl Jy Top frame: Phas deg  
Vector averaged cross-power spectrum Baseline: EF (01) - TR (06)  
Timerange: 00/10:00:33 to 00/10:04:19

Plot file version 3 created 25-SEP-2017 10:02:15

J1303-2405 RP029B.UVDATA.1

Freq = 4.7990 GHz, Bw = 32.000 MH No calibration applied and no bandpass applied

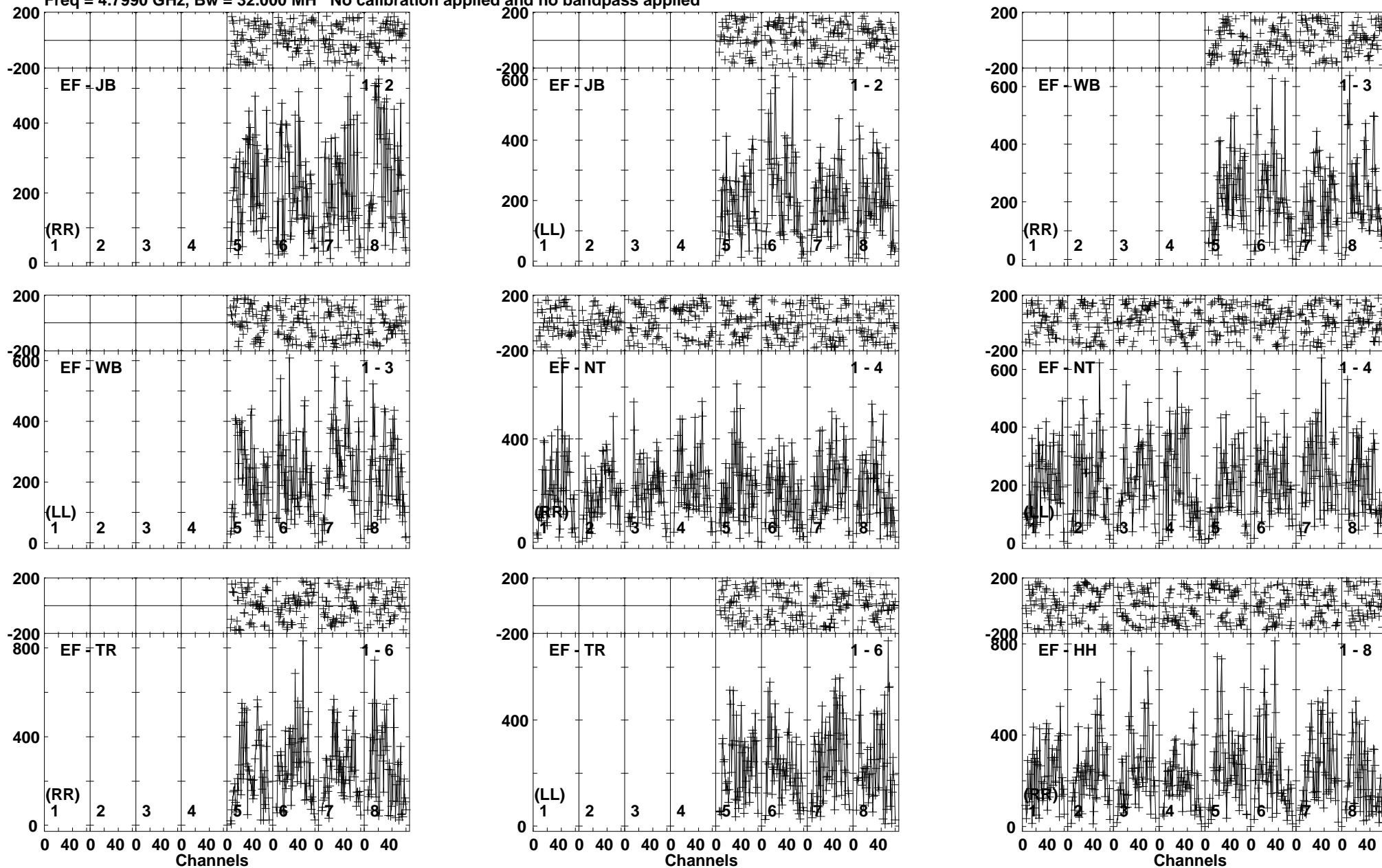

Lower frame: Micro Ampl Jy Top frame: Phas deg  
Vector averaged cross-power spectrum Baseline: EF (01) - JB (02)  
Timerange: 00/10:16:30 to 00/10:17:29

Plot file version 4 created 25-SEP-2017 10:02:15

J1303-2405 RP029B.UVDATA.1

Freq = 4.7990 GHz, Bw = 32.000 MH No calibration applied and no bandpass applied

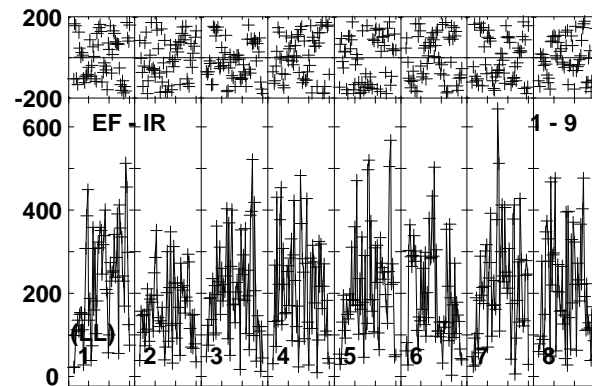
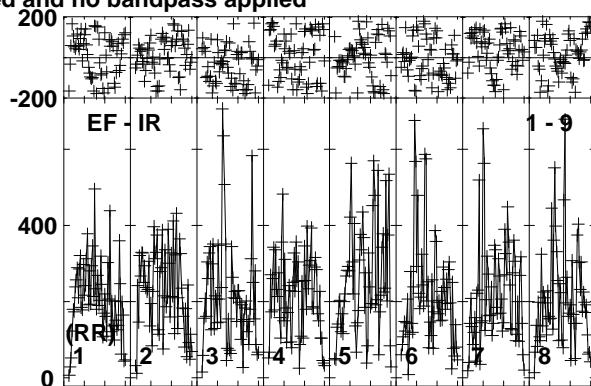
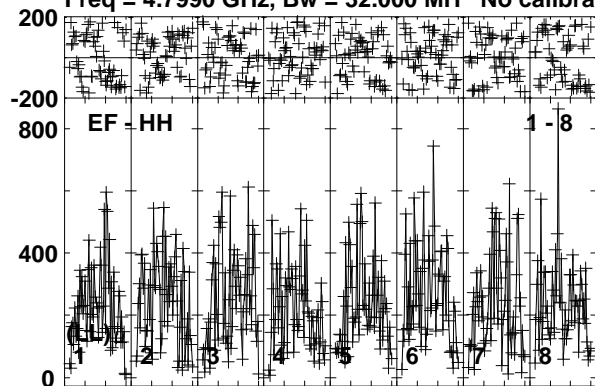

Lower frame: Micro Ampl Jy Top frame: Phas deg  
Vector averaged cross-power spectrum Baseline: EF (01) - HH (08)  
Timerange: 00/10:16:30 to 00/10:17:29

Plot file version 5 created 25-SEP-2017 10:02:15

SSS17A RP029B.UVDATA.1

Freq = 4.7990 GHz, Bw = 32.000 MH No calibration applied and no bandpass applied

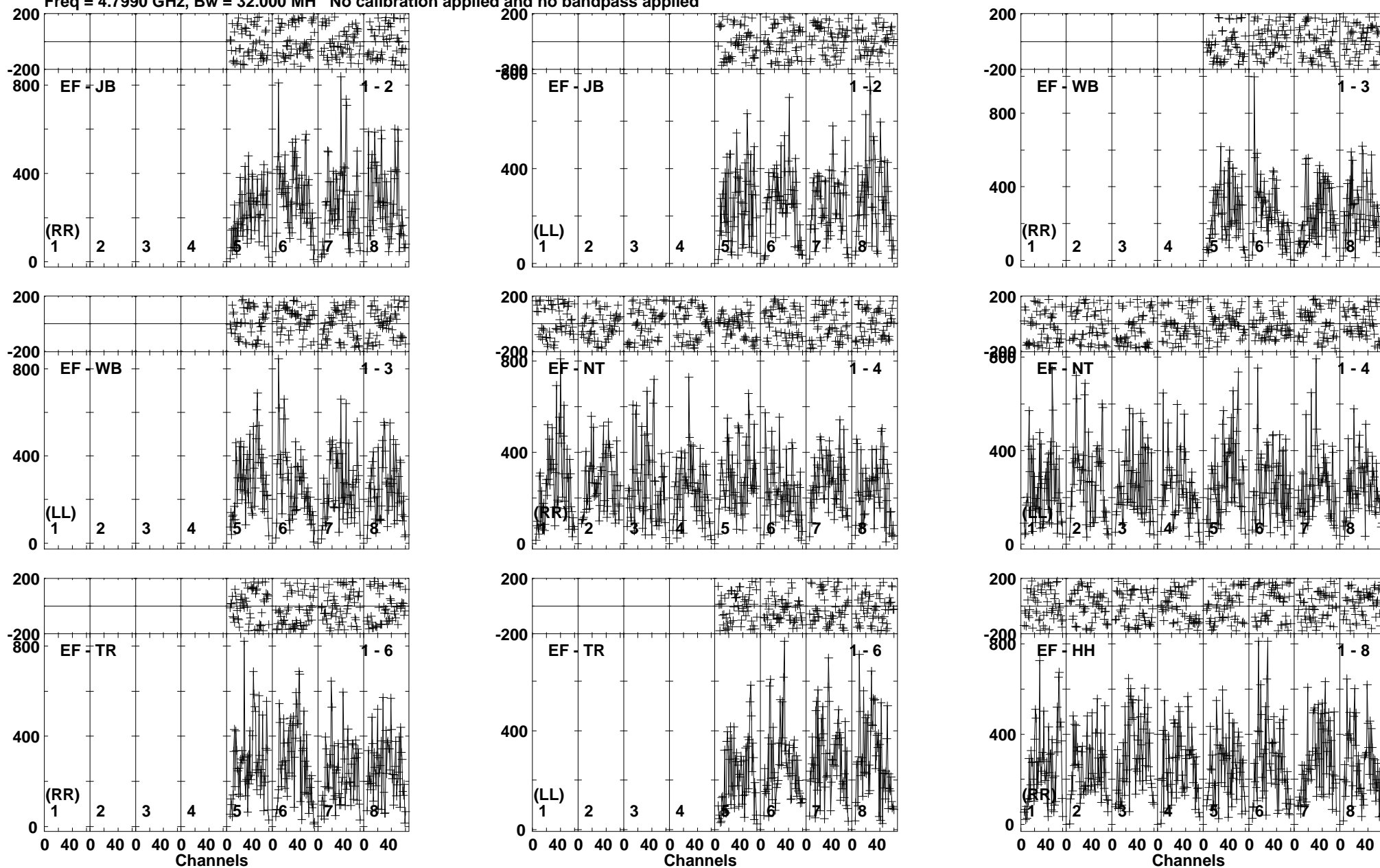

Lower frame: Micro Ampl Jy Top frame: Phas deg  
Vector averaged cross-power spectrum Baseline: EF (01) - JB (02)  
Timerange: 00/10:17:29 to 00/10:19:59

Plot file version 6 created 25-SEP-2017 10:02:15

SSS17A RP029B.UVDATA.1

Freq = 4.7990 GHz, Bw = 32.000 MH No calibration applied and no bandpass applied

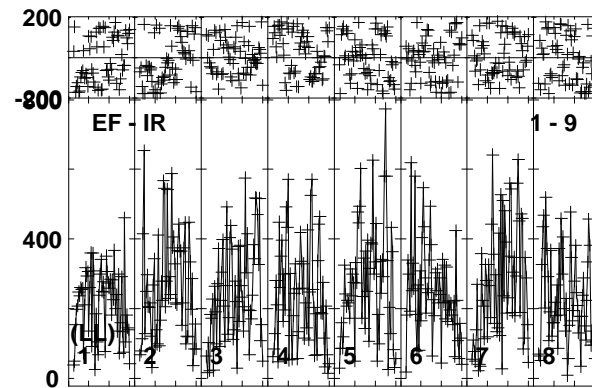
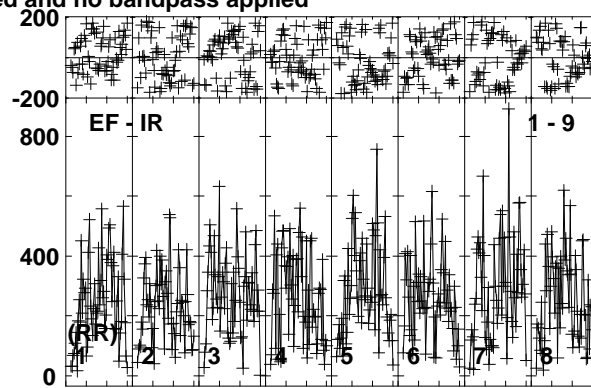
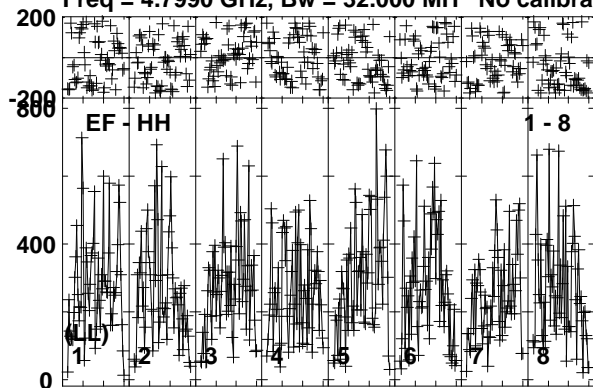

Lower frame: Micro Ampl Jy Top frame: Phas deg  
Vector averaged cross-power spectrum Baseline: EF (01) - HH (08)  
Timerange: 00/10:17:29 to 00/10:19:59

Plot file version 7 created 25-SEP-2017 10:02:16

J1303-2405 RP029B.UVDATA.1

Freq = 4.7990 GHz, Bw = 32.000 MH No calibration applied and no bandpass applied

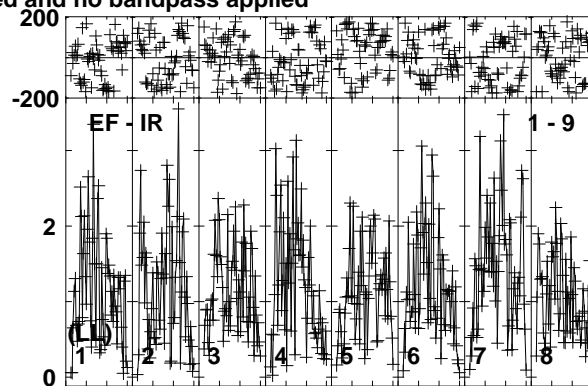
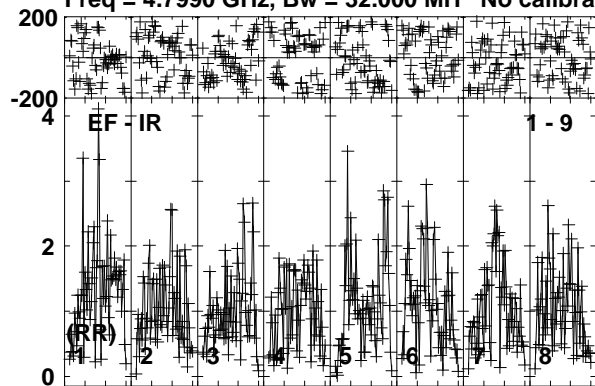

Lower frame: Milli Ampl Jy Top frame: Phas deg  
Vector averaged cross-power spectrum Baseline: EF (01) - IR (09)  
Timerange: 00/10:20:00 to 00/10:21:29

Plot file version 8 created 25-SEP-2017 10:02:16  
J1303-2405 RP029B.UVDATA.1

Freq = 4.7990 GHz, Bw = 32.000 MH No calibration applied and no bandpass applied

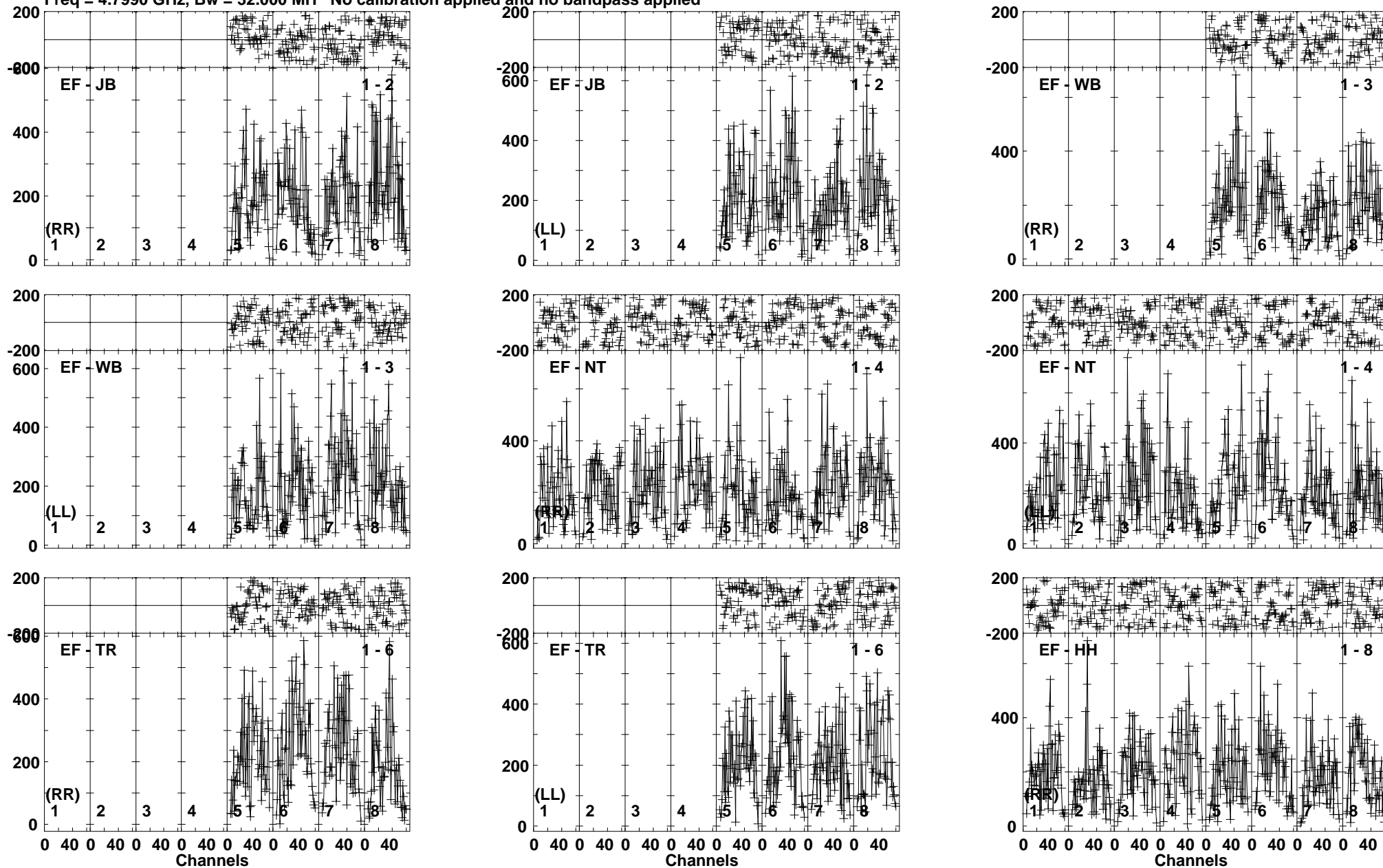

Lower frame: Micro Ampl Jy Top frame: Phas deg  
Vector averaged cross-power spectrum Baseline: EF (01) - JB (02)  
Timerange: 00/10:24:40 to 00/10:25:38



Plot file version 9 created 25-SEP-2017 10:02:16  
J1303-2405 RP029B.UVDATA.1

Freq = 4.7990 GHz, Bw = 32.000 MH No calibration applied and no bandpass applied

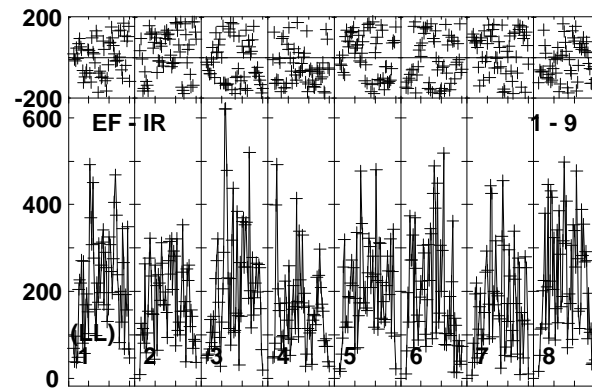
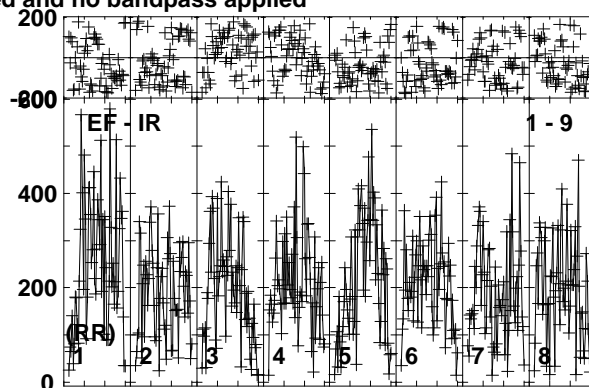
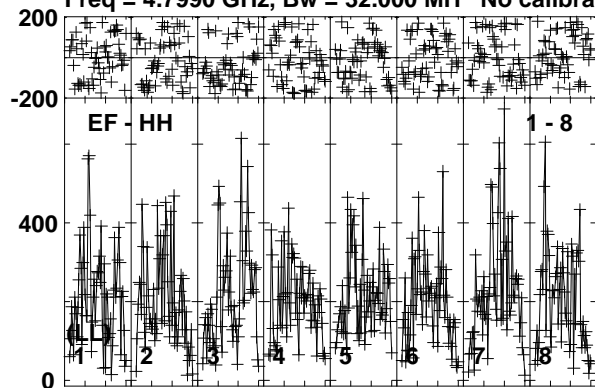

Lower frame: Micro Ampl Jy Top frame: Phas deg  
Vector averaged cross-power spectrum Baseline: EF (01) - HH (08)  
Timerange: 00/10:24:40 to 00/10:25:38

Plot file version 10 created 25-SEP-2017 10:02:16

SSS17A RP029B.UVDATA.1

Freq = 4.7990 GHz, Bw = 32.000 MH No calibration applied and no bandpass applied

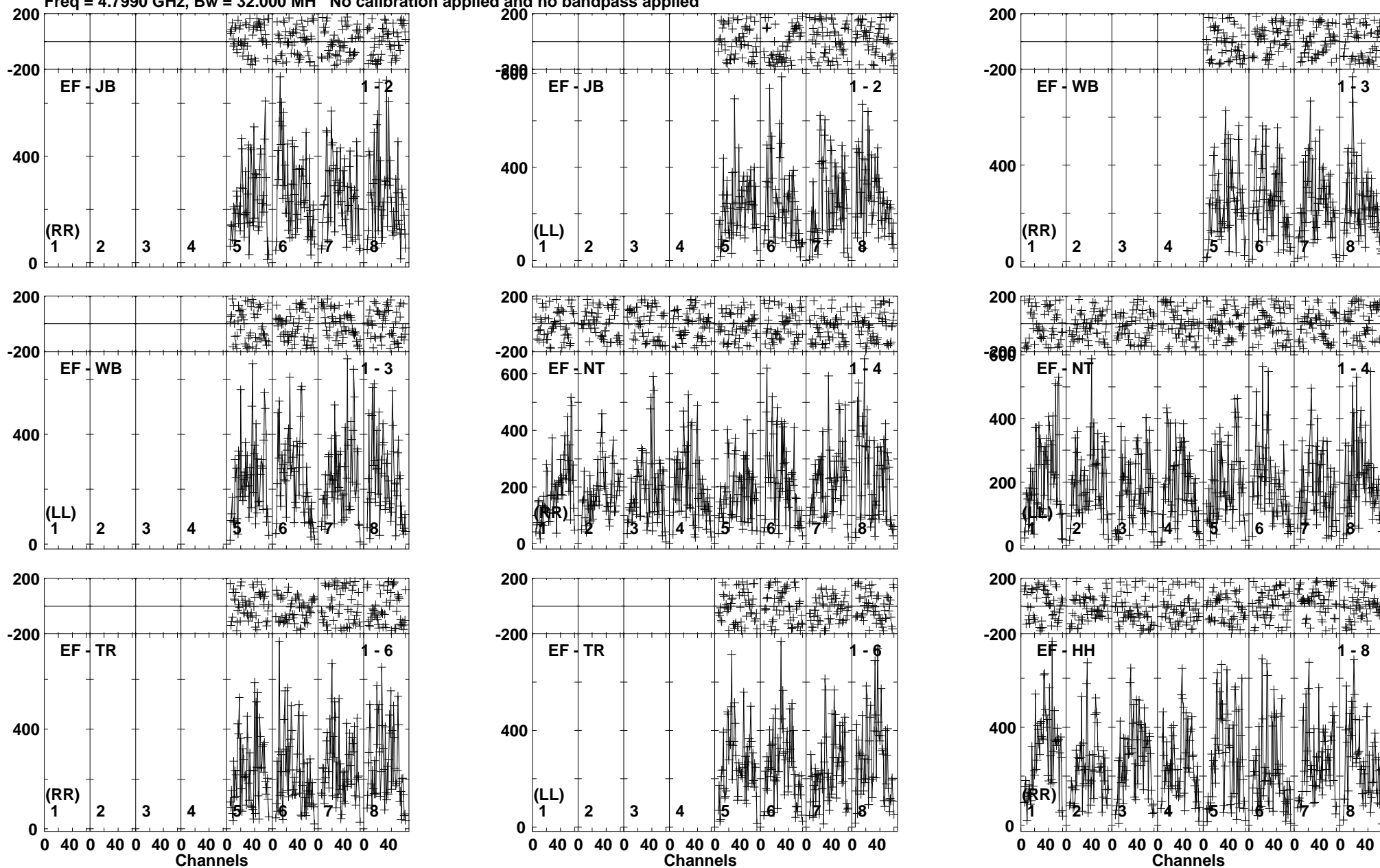

Lower frame: Micro Ampl Jy Top frame: Phas deg  
Vector averaged cross-power spectrum Baseline: EF (01) - JB (02)  
Timerange: 00/10:25:40 to 00/10:28:09

Plot file version 11 created 25-SEP-2017 10:02:16

SSS17A RP029B.UVDATA.1

Freq = 4.7990 GHz, Bw = 32.000 MH No calibration applied and no bandpass applied

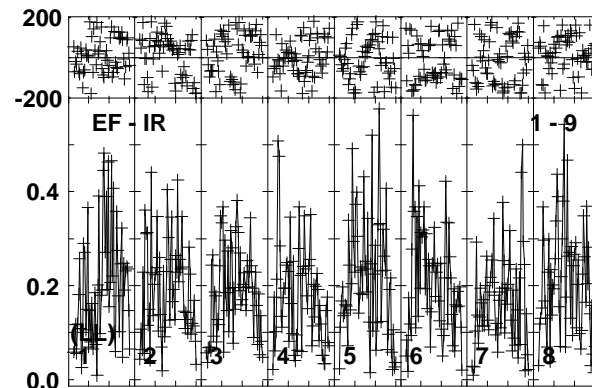
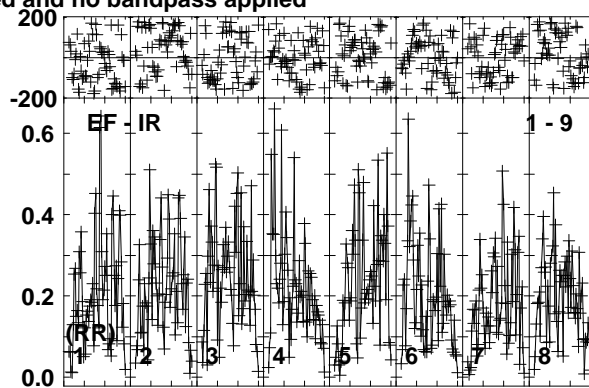
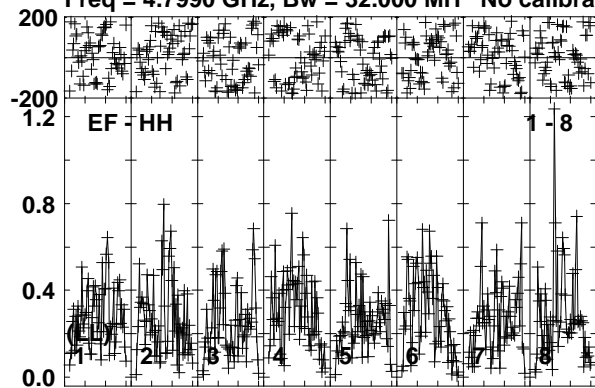

Lower frame: Milli Ampl Jy Top frame: Phas deg  
Vector averaged cross-power spectrum Baseline: EF (01) - HH (08)  
Timerange: 00/10:25:40 to 00/10:28:09

Plot file version 12 created 25-SEP-2017 10:02:17

J1303-2405 RP029B.UVDATA.1

Freq = 4.7990 GHz, Bw = 32.000 MH No calibration applied and no bandpass applied

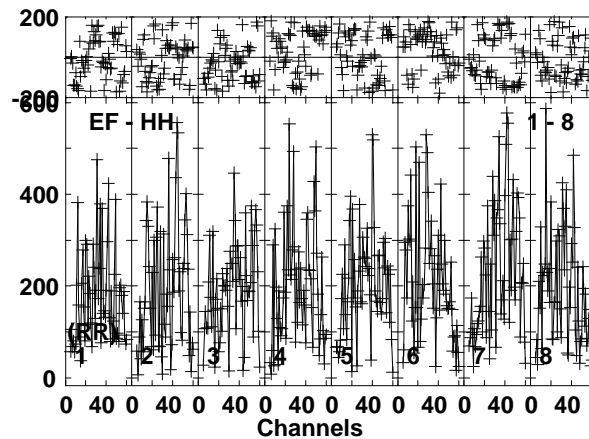
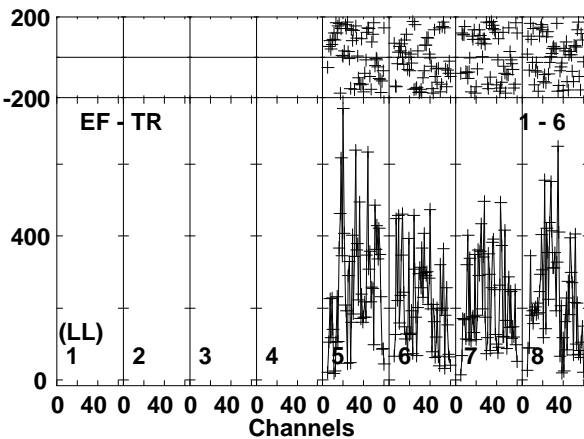
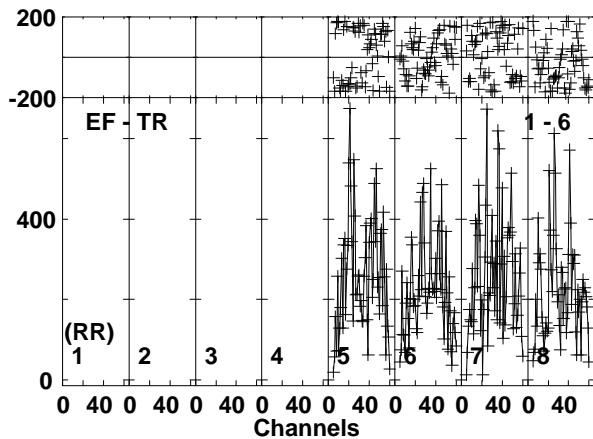
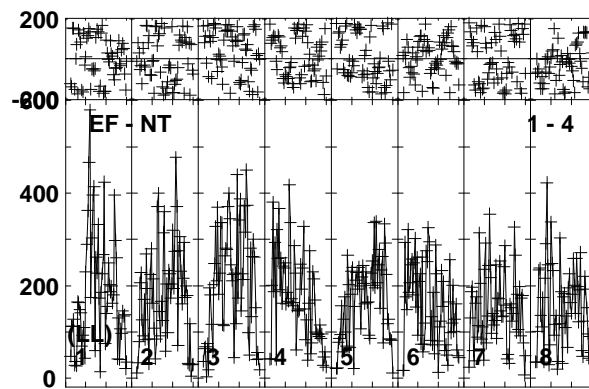
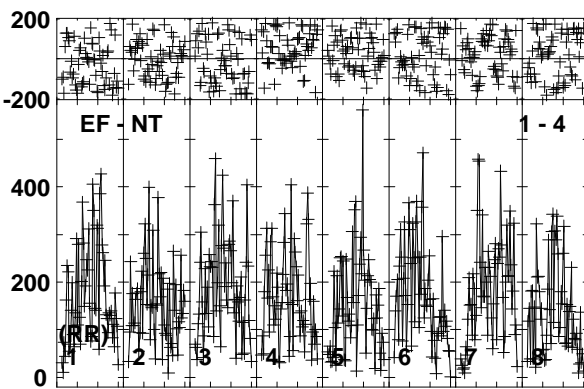
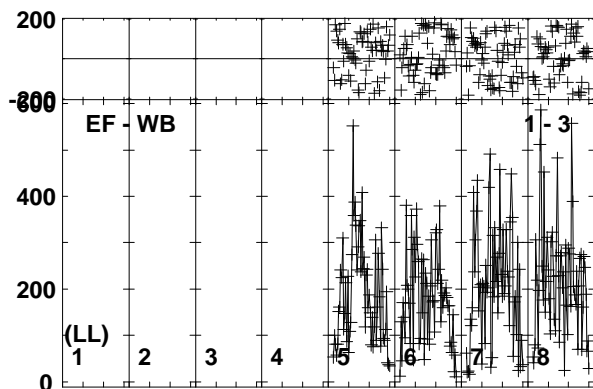
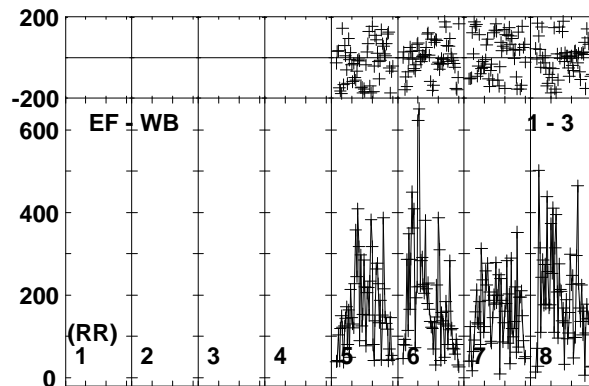
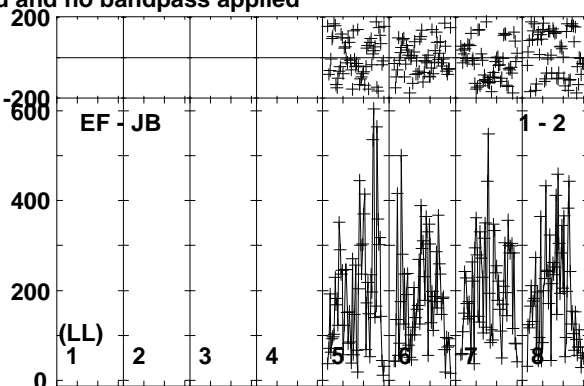
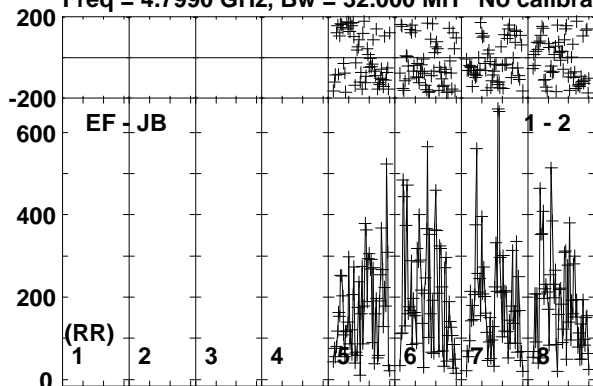

Lower frame: Micro Ampl Jy Top frame: Phas deg  
Vector averaged cross-power spectrum Baseline: EF (01) - JB (02)  
Timerange: 00/10:28:09 to 00/10:29:39

Plot file version 13 created 25-SEP-2017 10:02:17

J1303-2405 RP029B.UVDATA.1

Freq = 4.7990 GHz, Bw = 32.000 MH No calibration applied and no bandpass applied

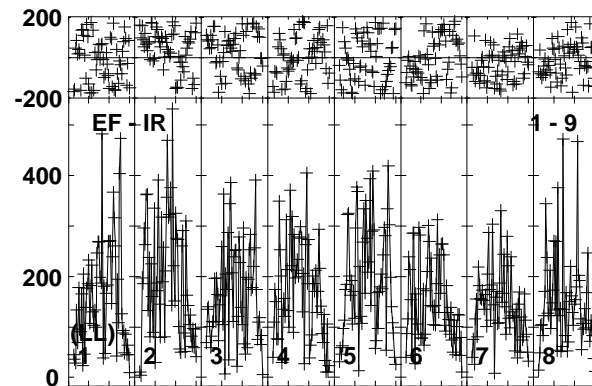
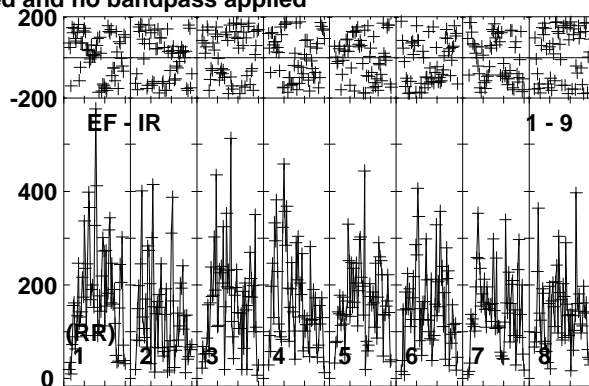
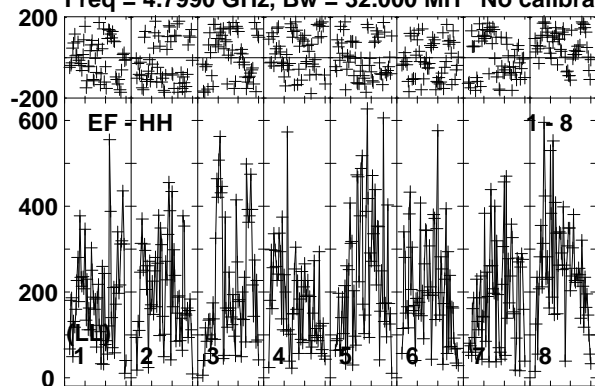

Lower frame: Micro Ampl Jy Top frame: Phas deg  
Vector averaged cross-power spectrum Baseline: EF (01) - HH (08)  
Timerange: 00/10:28:09 to 00/10:29:39

Plot file version 14 created 25-SEP-2017 10:02:17

J1303-2405 RP029B.UVDATA.1

Freq = 4.7990 GHz, Bw = 32.000 MH No calibration applied and no bandpass applied

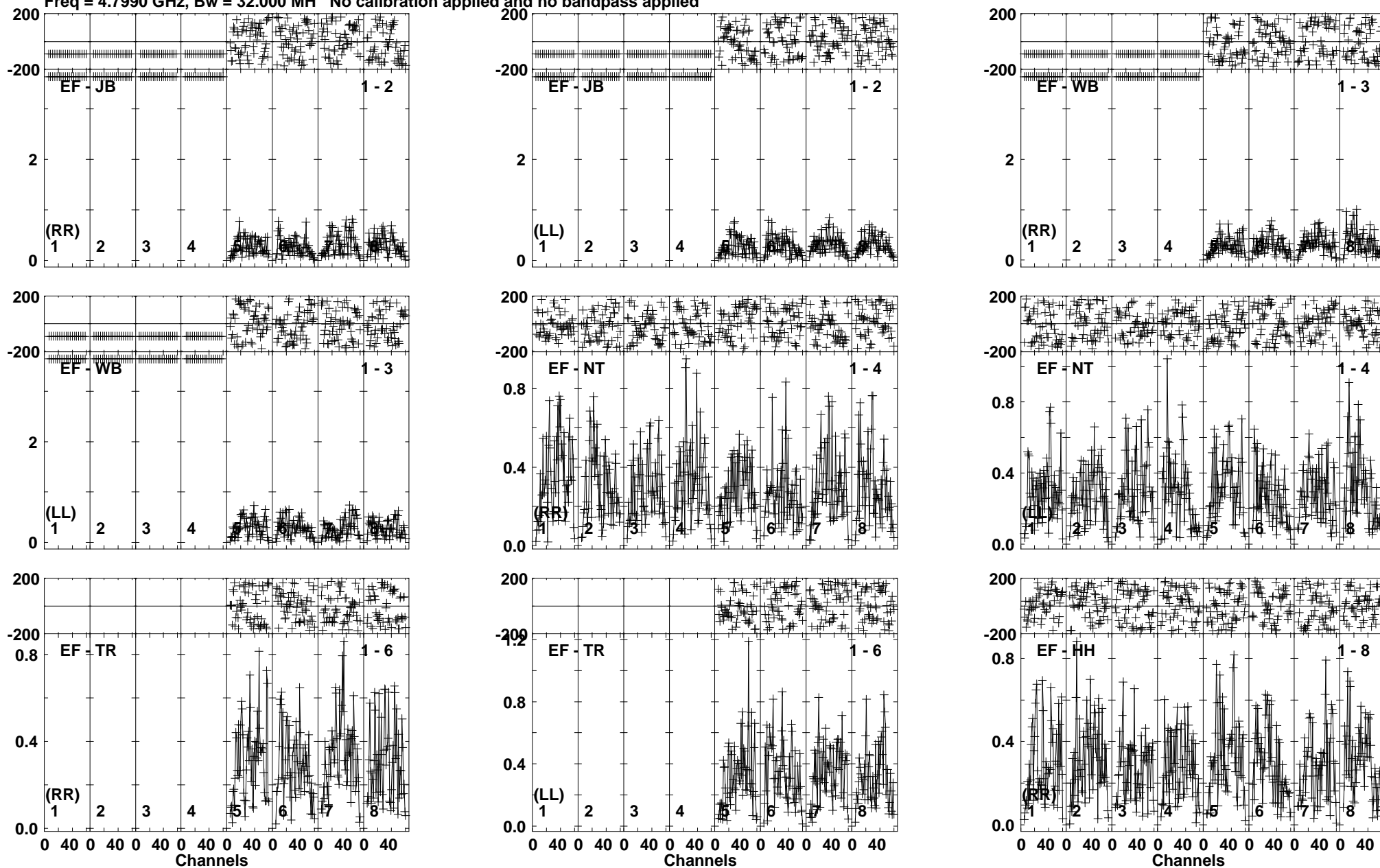

Lower frame: Milli Ampl Jy Top frame: Phas deg  
Vector averaged cross-power spectrum Baseline: EF (01) - JB (02)  
Timerange: 00/10:32:40 to 00/10:33:38

Plot file version 15 created 25-SEP-2017 10:02:17

J1303-2405 RP029B.UVDATA.1

Freq = 4.7990 GHz, Bw = 32.000 MH No calibration applied and no bandpass applied

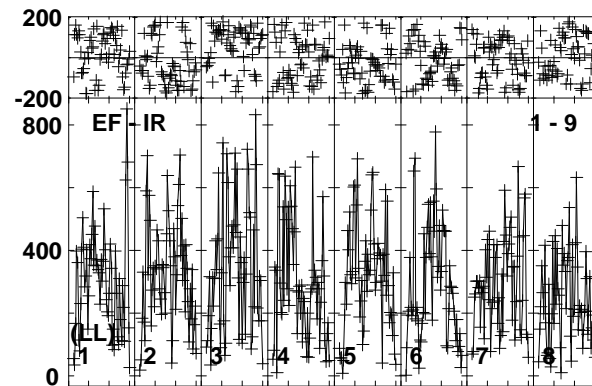
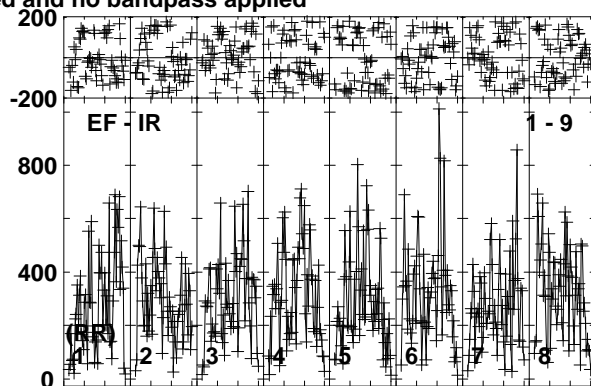
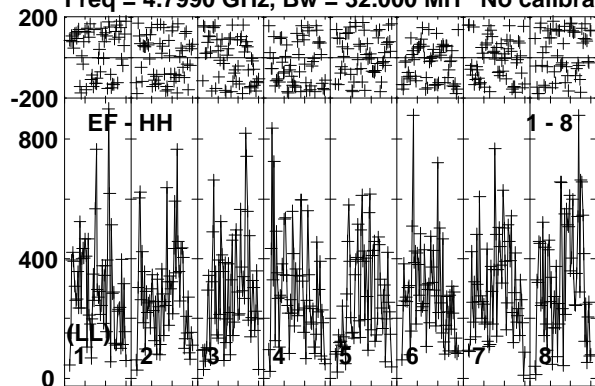

Lower frame: Micro Ampl Jy Top frame: Phas deg  
Vector averaged cross-power spectrum Baseline: EF (01) - HH (08)  
Timerange: 00/10:32:40 to 00/10:33:38

Plot file version 16 created 25-SEP-2017 10:02:18

J1312-2350 RP029B.UVDATA.1

Freq = 4.7990 GHz, Bw = 32.000 MH No calibration applied and no bandpass applied

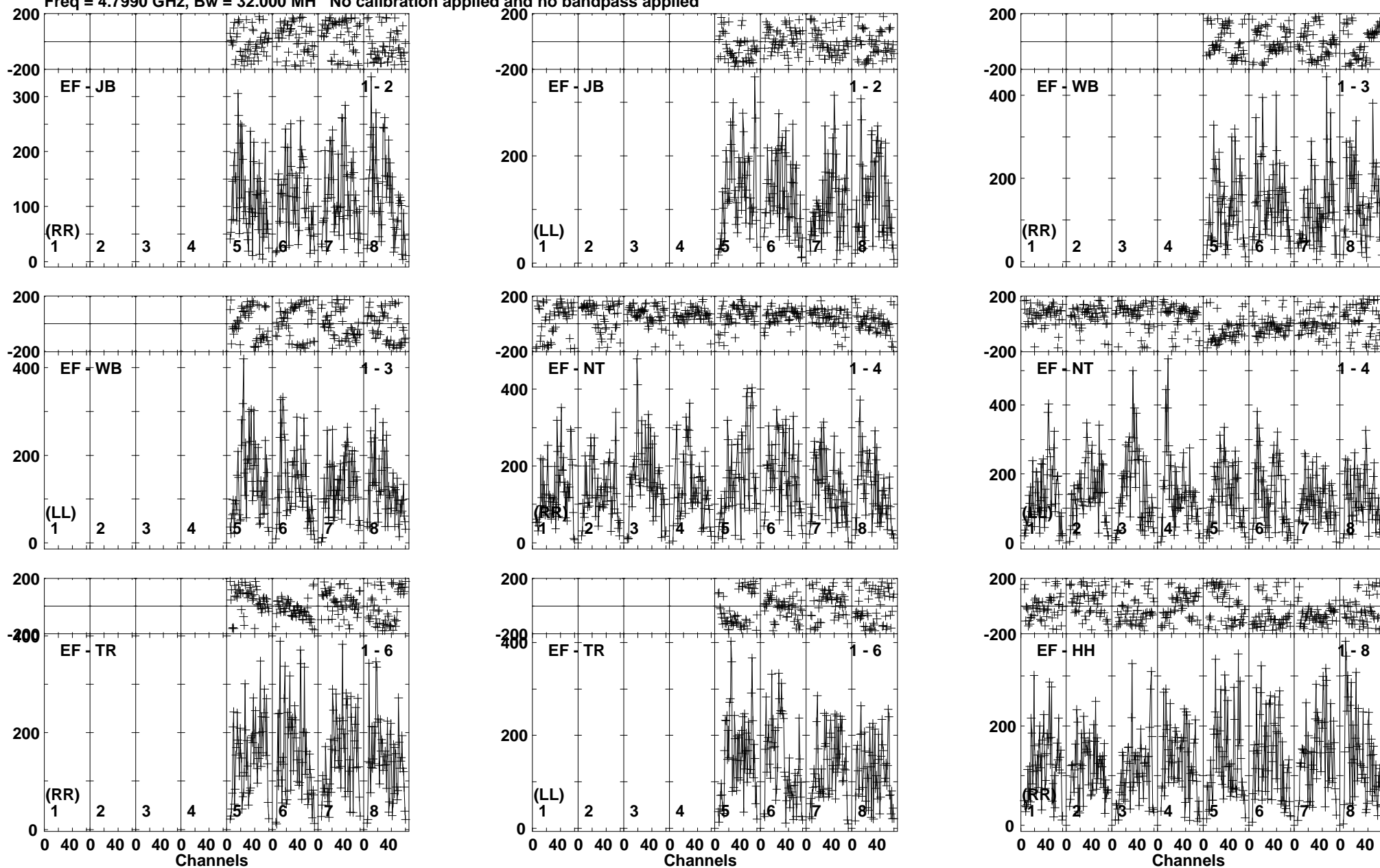

Lower frame: Micro Ampl Jy Top frame: Phas deg  
Vector averaged cross-power spectrum Baseline: EF (01) - JB (02)  
Timerange: 00/10:37:39 to 00/10:40:08



Plot file version 17 created 25-SEP-2017 10:02:18

J1312-2350 RP029B.UVDATA.1

Freq = 4.7990 GHz, Bw = 32.000 MH No calibration applied and no bandpass applied

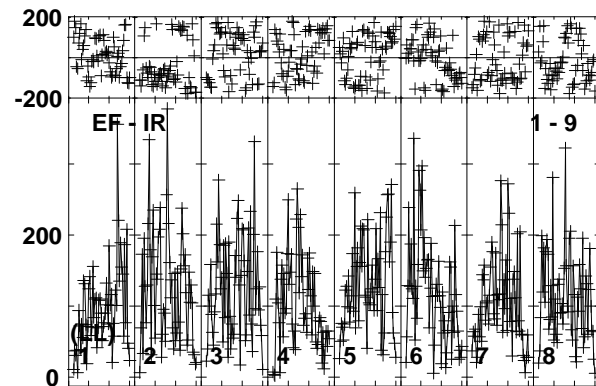
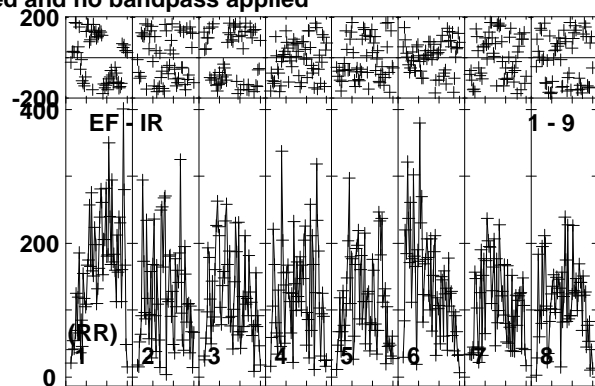
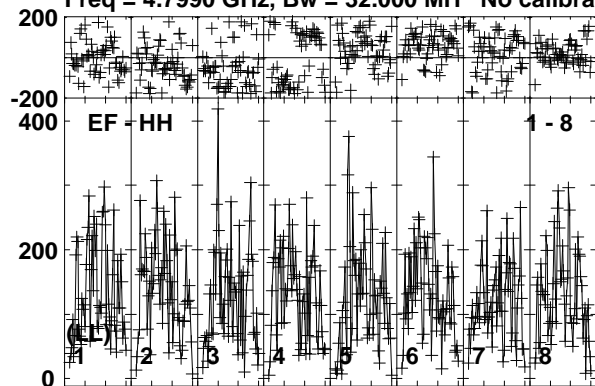

Lower frame: Micro Ampl Jy Top frame: Phas deg  
Vector averaged cross-power spectrum Baseline: EF (01) - HH (08)  
Timerange: 00/10:37:39 to 00/10:40:08

Plot file version 18 created 25-SEP-2017 10:02:18

J1303-2405 RP029B.UVDATA.1

Freq = 4.7990 GHz, Bw = 32.000 MH No calibration applied and no bandpass applied

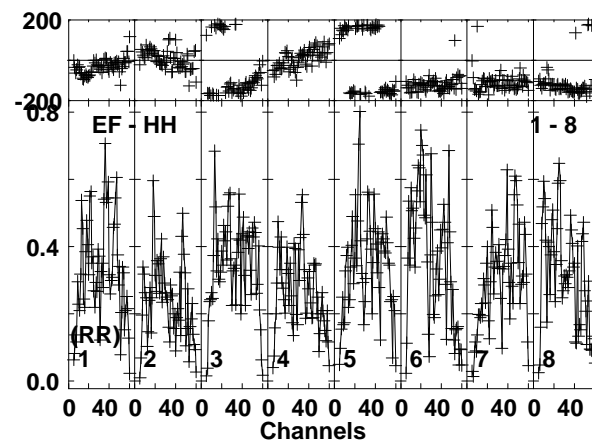
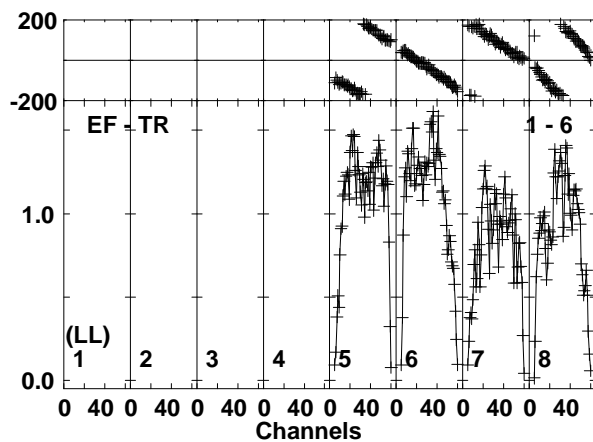
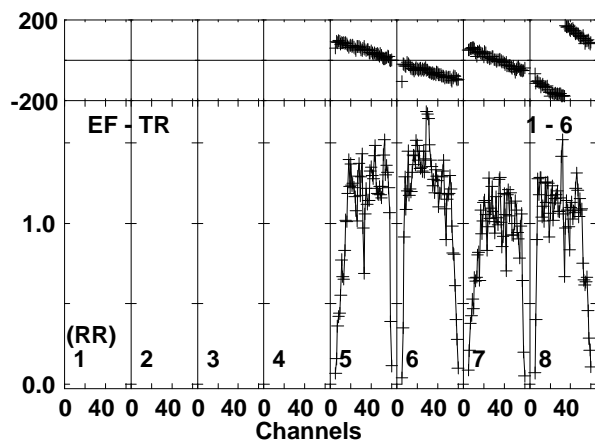
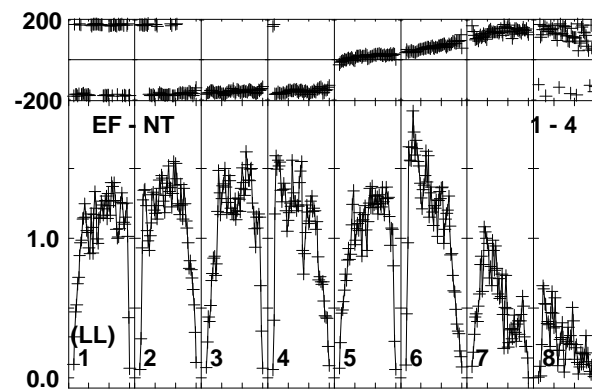
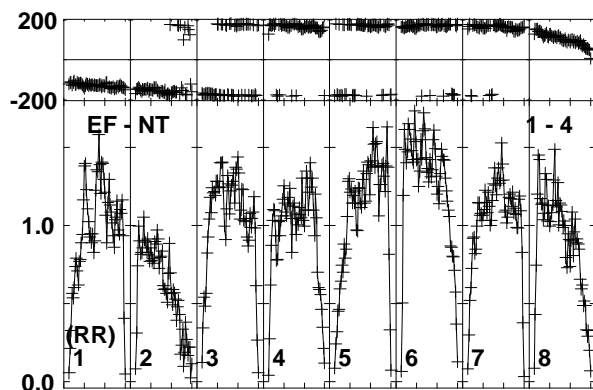
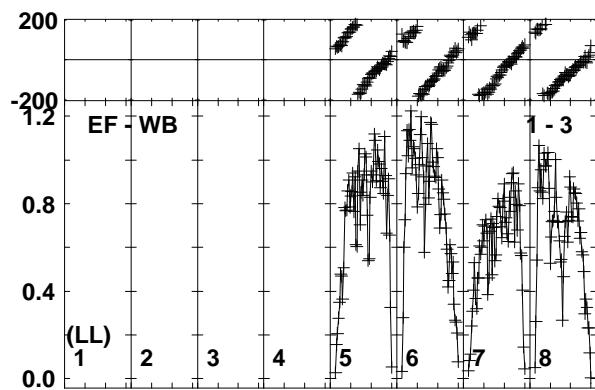
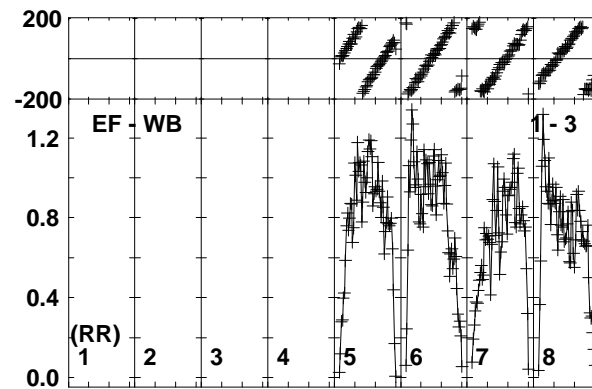
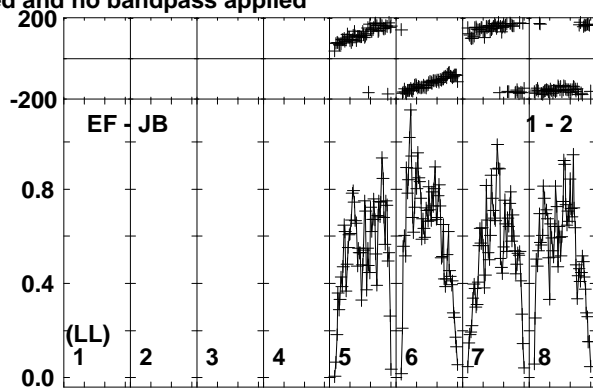
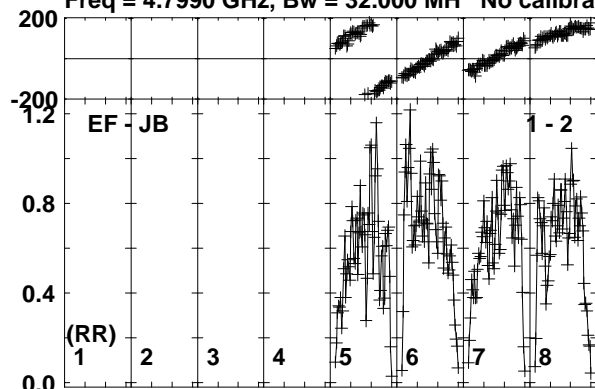

Lower frame: Milli Ampl Jy Top frame: Phas deg  
Vector averaged cross-power spectrum Baseline: EF (01) - JB (02)  
Timerange: 00/10:40:50 to 00/10:41:49

Plot file version 19 created 25-SEP-2017 10:02:18

J1303-2405 RP029B.UVDATA.1

Freq = 4.7990 GHz, Bw = 32.000 MH No calibration applied and no bandpass applied

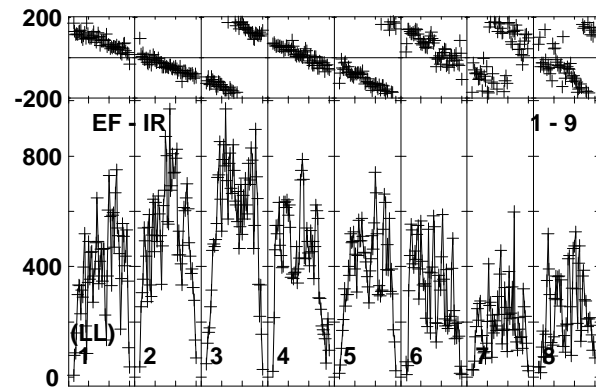
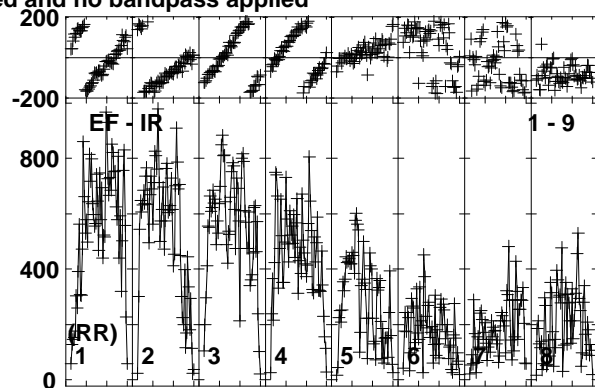
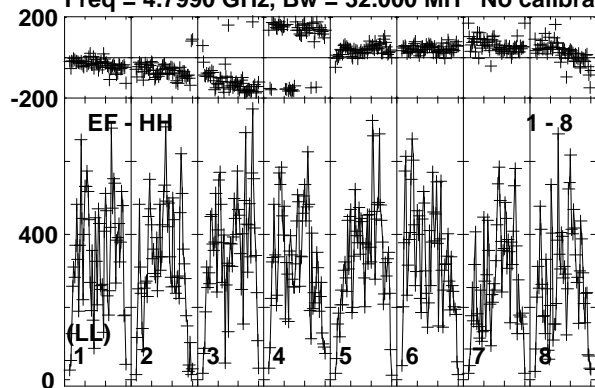

Lower frame: Micro Ampl Jy Top frame: Phas deg  
Vector averaged cross-power spectrum Baseline: EF (01) - HH (08)  
Timerange: 00/10:40:50 to 00/10:41:49

Plot file version 20 created 25-SEP-2017 10:02:19  
SSS17A RP029B.UVDATA.1  
Freq = 4.7990 GHz, Bw = 32.000 MH No calibration applied and no bandpass applied

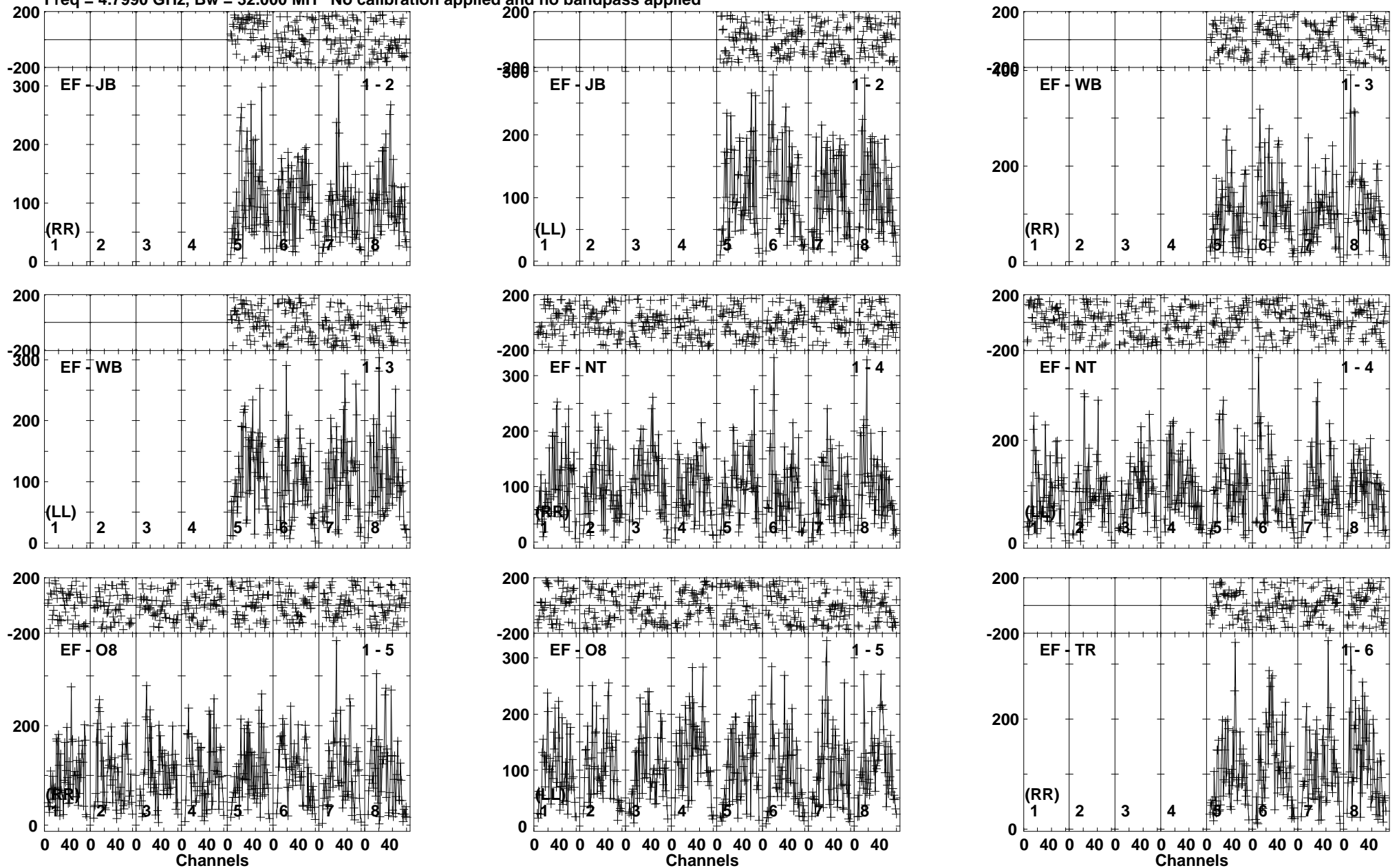

Lower frame: Micro Ampl Jy Top frame: Phas deg  
Vector averaged cross-power spectrum Baseline: EF (01) - JB (02)  
Timerange: 00/10:41:49 to 00/10:44:18

Plot file version 21 created 25-SEP-2017 10:02:19

SSS17A RP029B.UVDATA.1

Freq = 4.7990 GHz, Bw = 32.000 MH No calibration applied and no bandpass applied

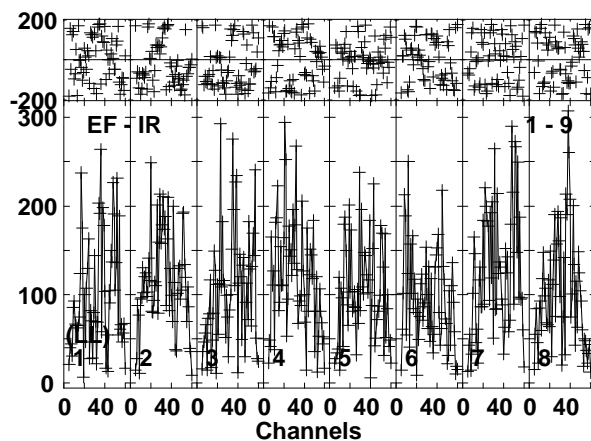
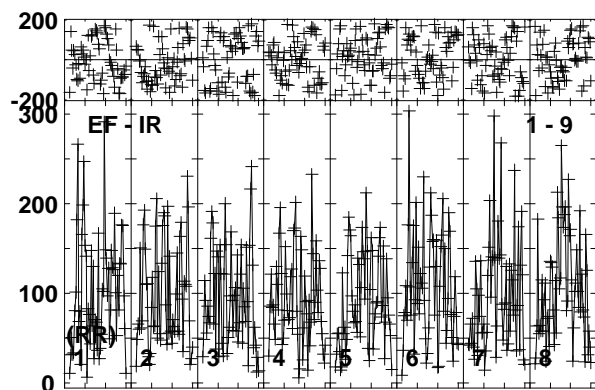
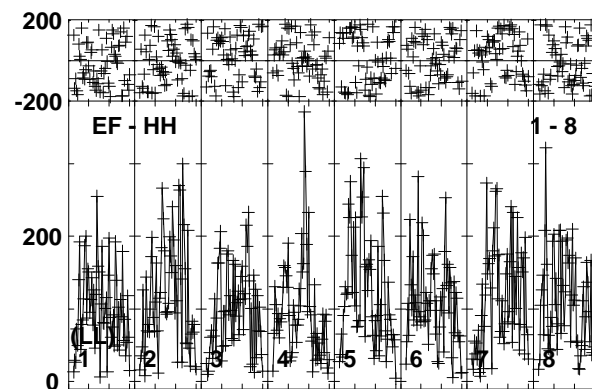
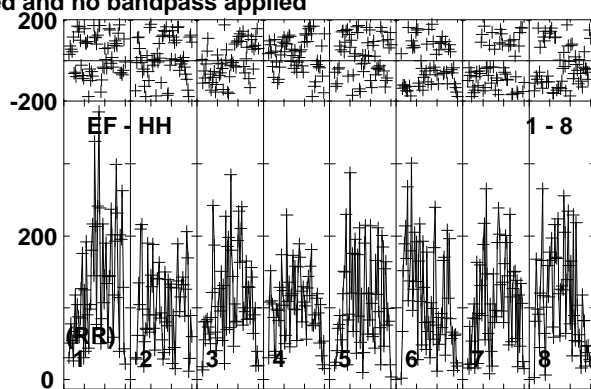
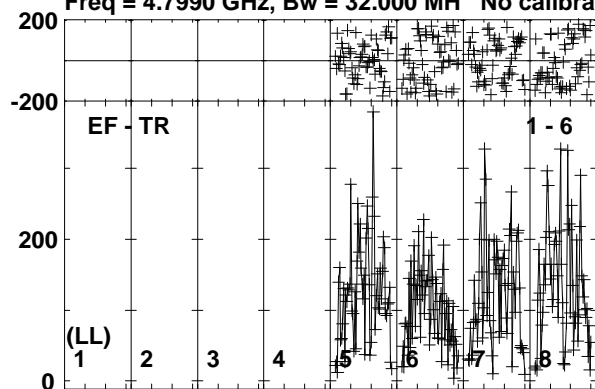

Lower frame: Micro Ampl Jy Top frame: Phas deg  
Vector averaged cross-power spectrum Baseline: EF (01) - TR (06)  
Timerange: 00/10:41:49 to 00/10:44:18

Plot file version 22 created 25-SEP-2017 10:02:19

J1303-2405 RP029B.UVDATA.1

Freq = 4.7990 GHz, Bw = 32.000 MH No calibration applied and no bandpass applied

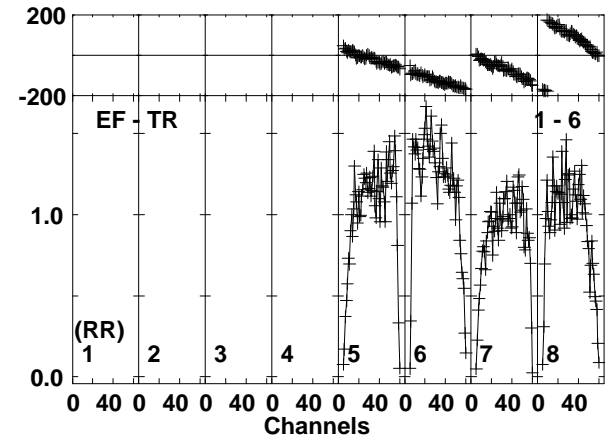
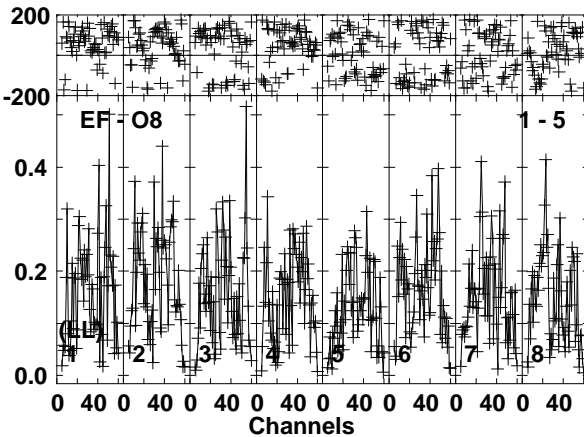
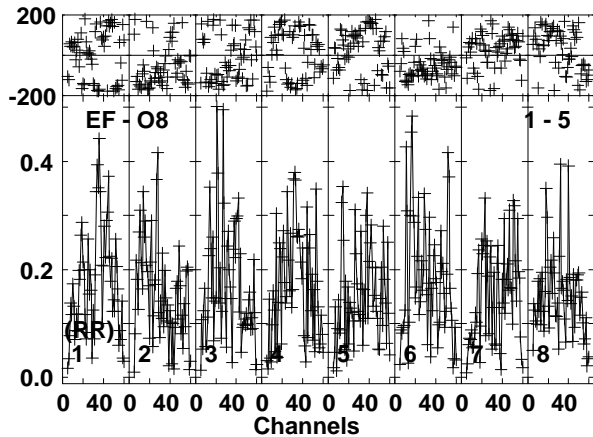
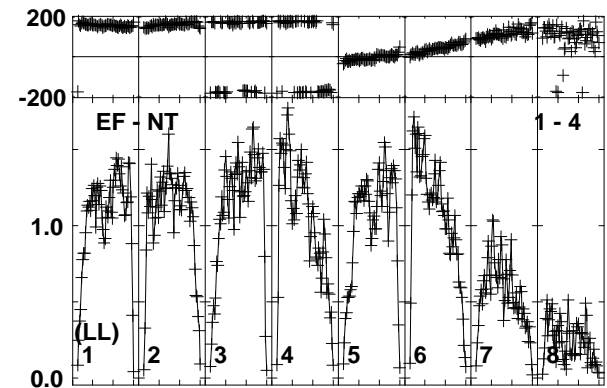
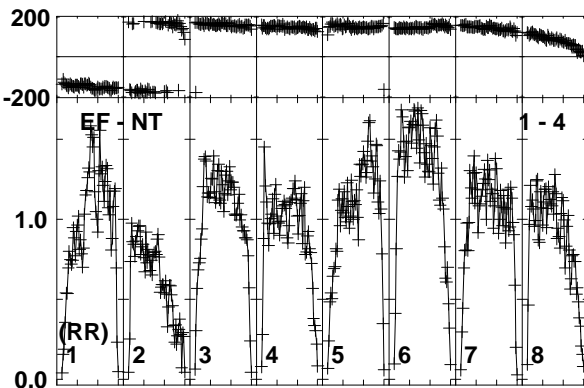
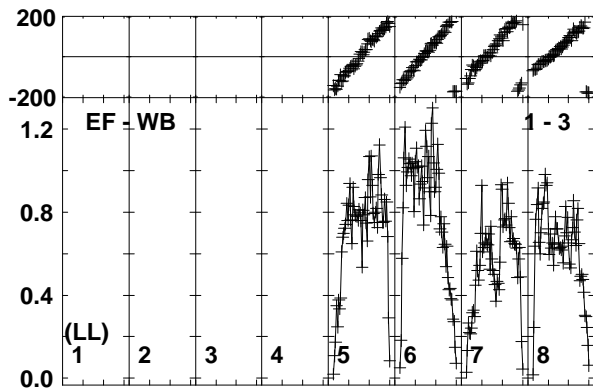
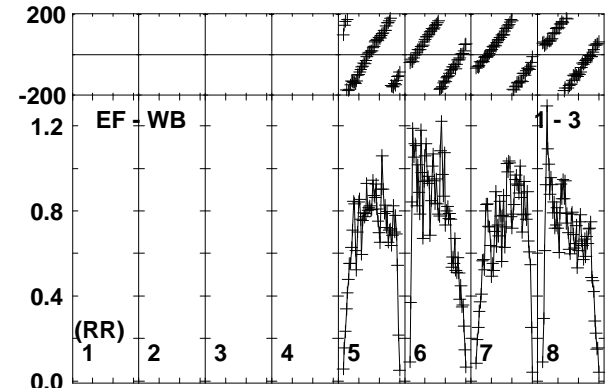
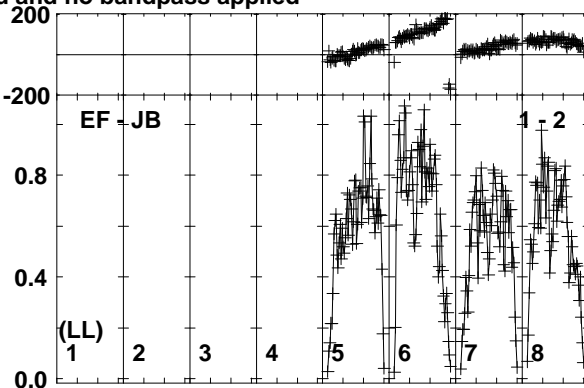
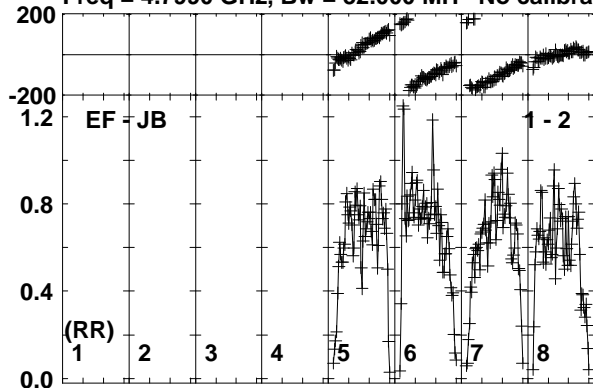

Lower frame: Milli Ampl Jy Top frame: Phas deg  
Vector averaged cross-power spectrum Baseline: EF (01) - JB (02)  
Timerange: 00/10:44:20 to 00/10:45:49

Plot file version 23 created 25-SEP-2017 10:02:19

J1303-2405 RP029B.UVDATA.1

Freq = 4.7990 GHz, Bw = 32.000 MH No calibration applied and no bandpass applied

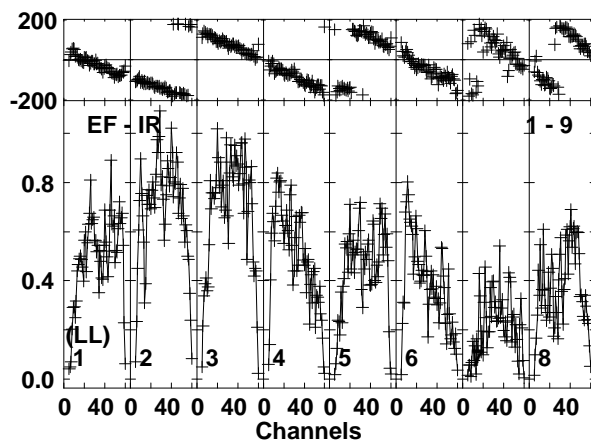
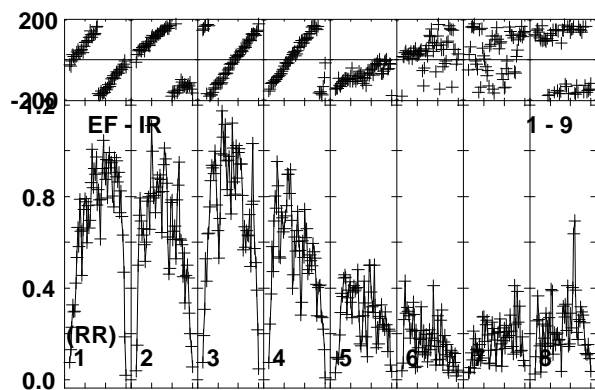
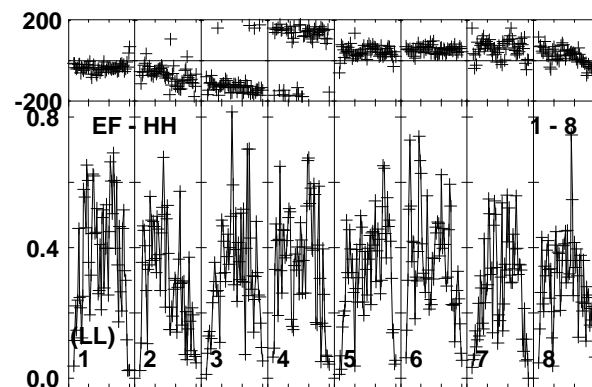
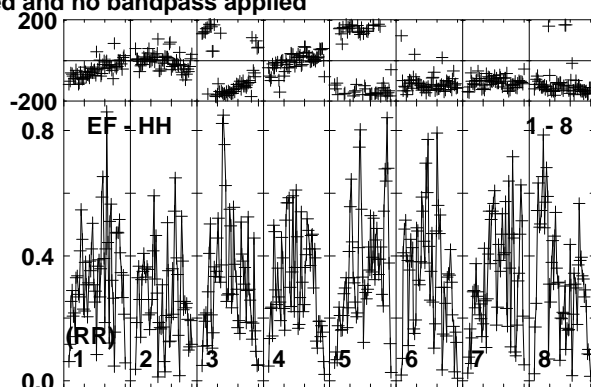
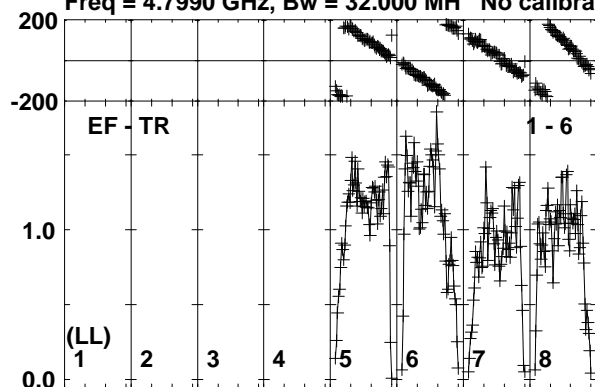

Lower frame: Milli Ampl Jy Top frame: Phas deg  
Vector averaged cross-power spectrum Baseline: EF (01) - TR (06)  
Timerange: 00/10:44:20 to 00/10:45:49

Plot file version 24 created 25-SEP-2017 10:02:19

SSS17A RP029B.UVDATA.1

Freq = 4.7990 GHz, Bw = 32.000 MH No calibration applied and no bandpass applied

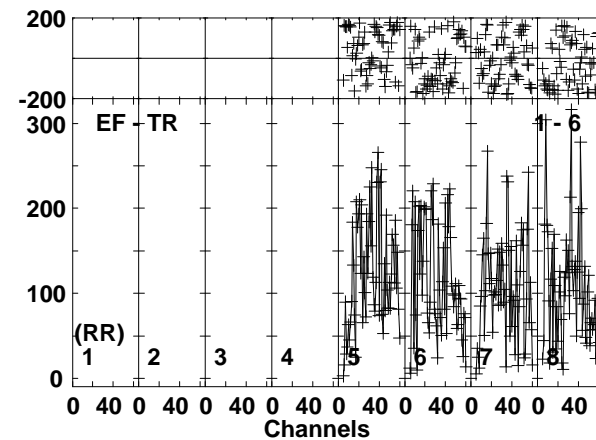
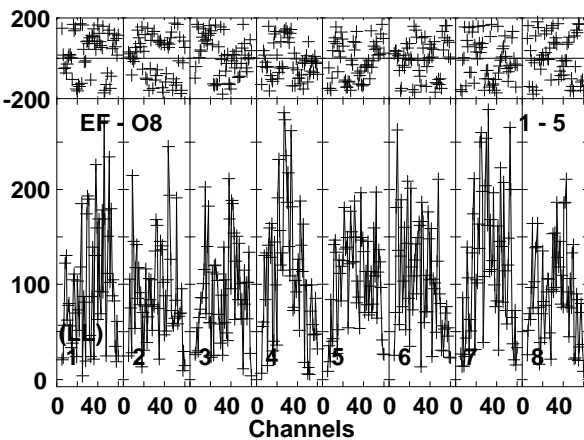
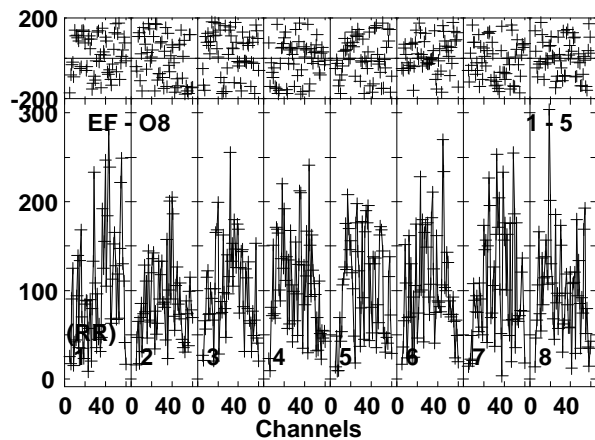
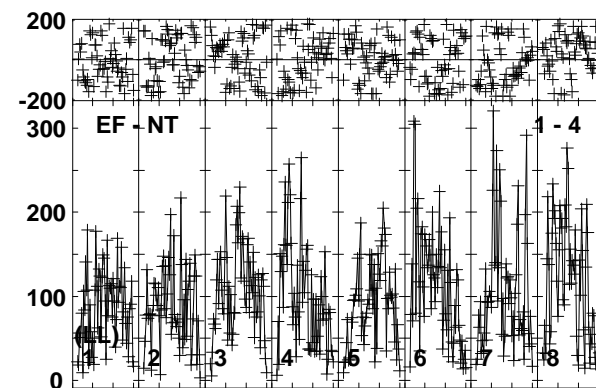
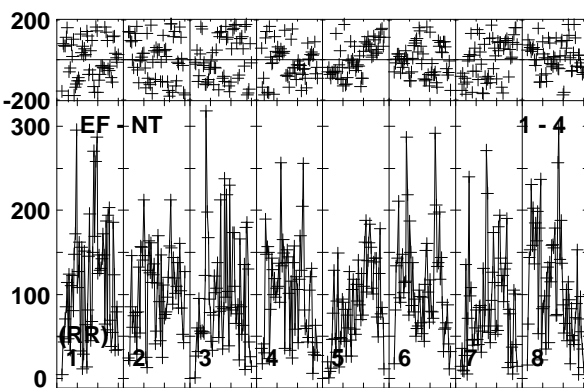
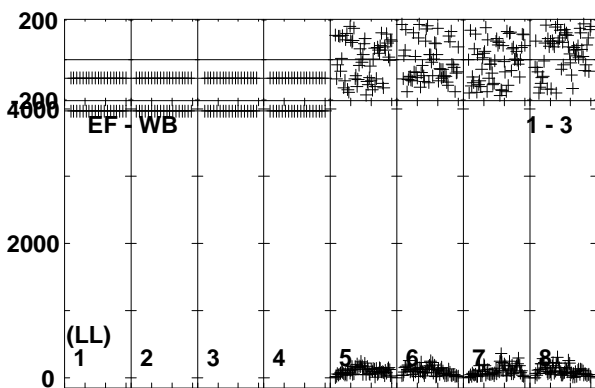
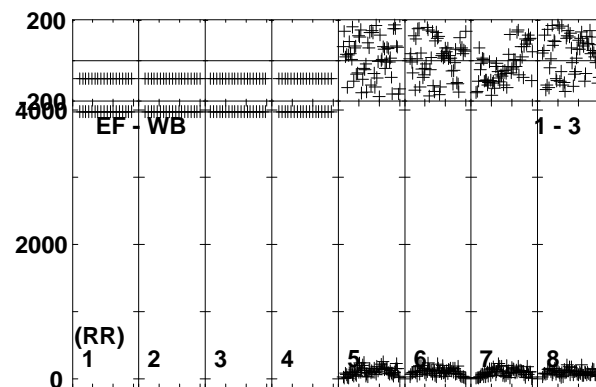
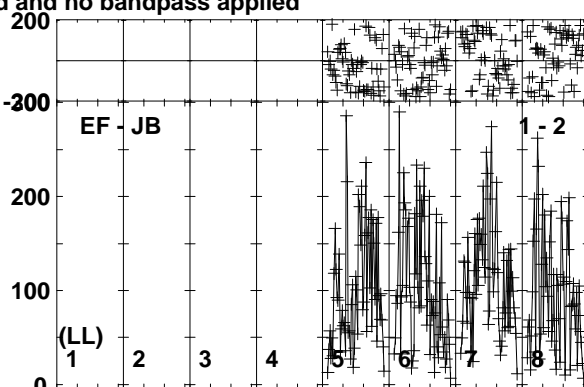
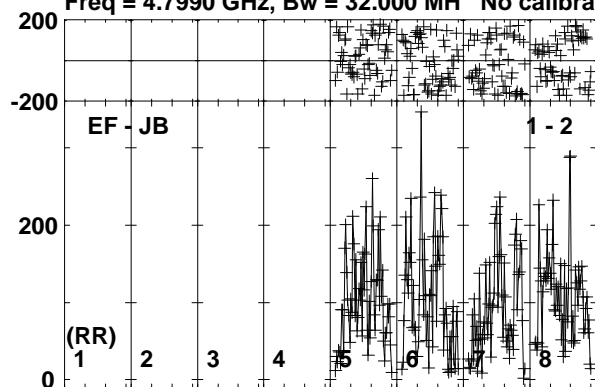

Lower frame: Micro Ampl Jy Top frame: Phas deg  
Vector averaged cross-power spectrum Baseline: EF (01) - JB (02)  
Timerange: 00/10:45:50 to 00/10:48:18



Plot file version 25 created 25-SEP-2017 10:02:19

SSS17A RP029B.UVDATA.1

Freq = 4.7990 GHz, Bw = 32.000 MH No calibration applied and no bandpass applied

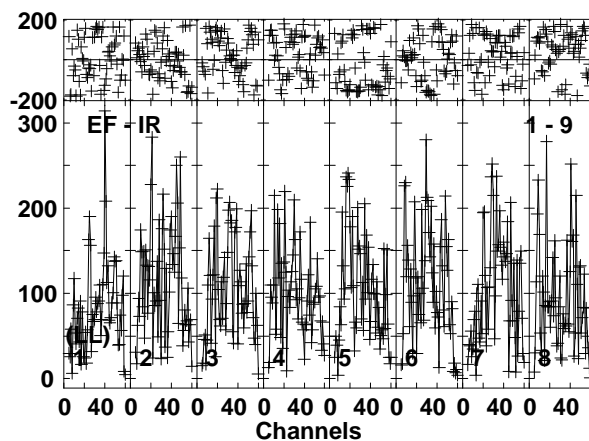
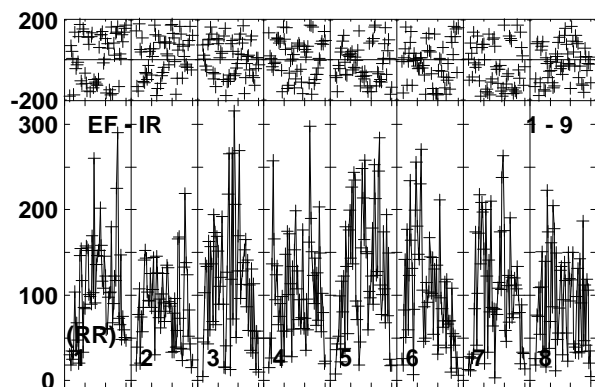
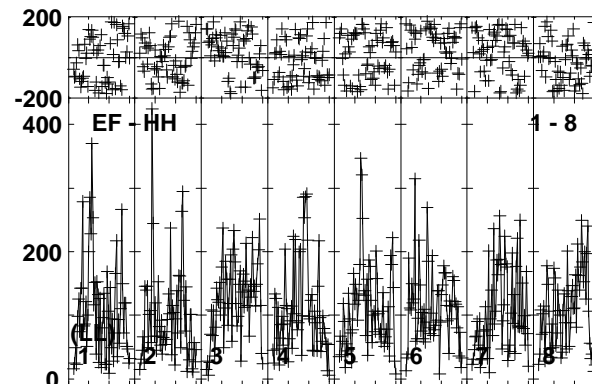
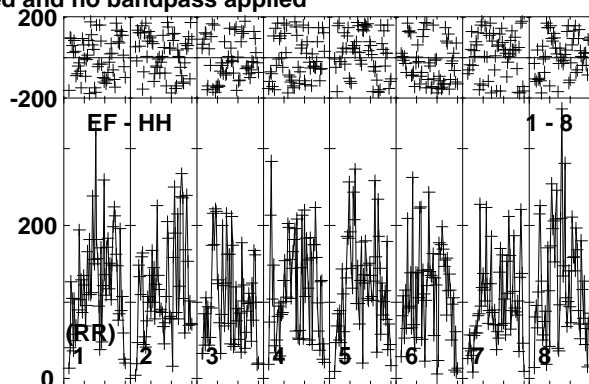
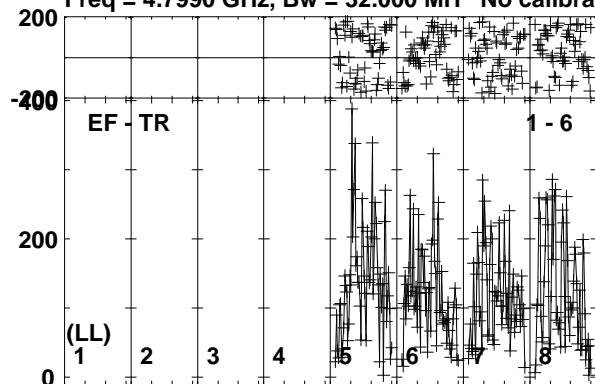

Lower frame: Micro Ampl Jy Top frame: Phas deg  
Vector averaged cross-power spectrum Baseline: EF (01) - TR (06)  
Timerange: 00/10:45:50 to 00/10:48:18

Plot file version 26 created 25-SEP-2017 10:02:20  
 J1303-2405 RP029B.UVDATA.1

Freq = 4.7990 GHz, Bw = 32.000 MH No calibration applied and no bandpass applied

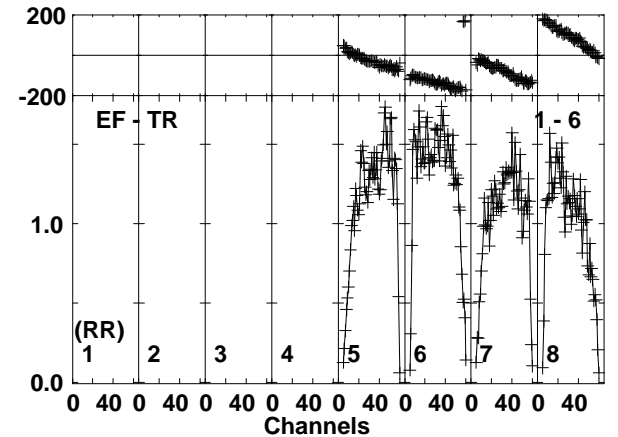
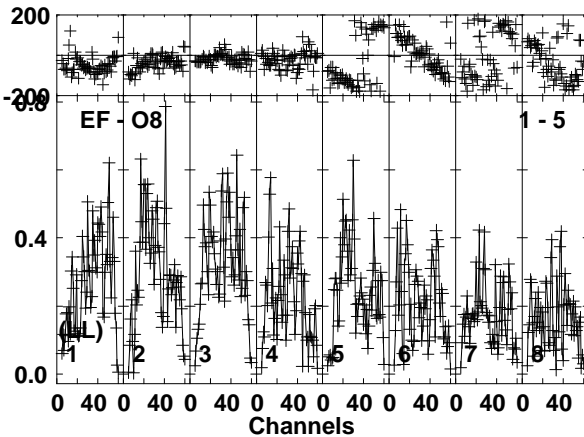
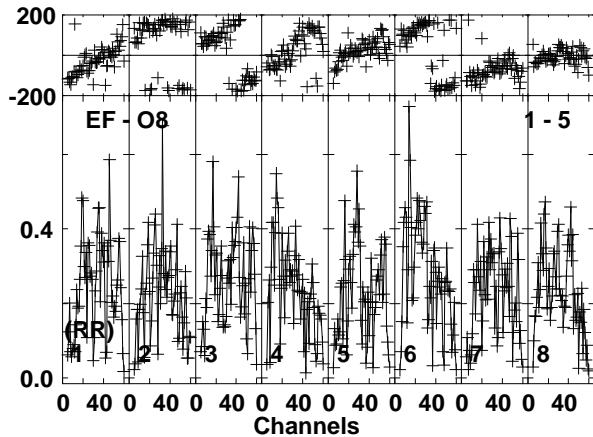
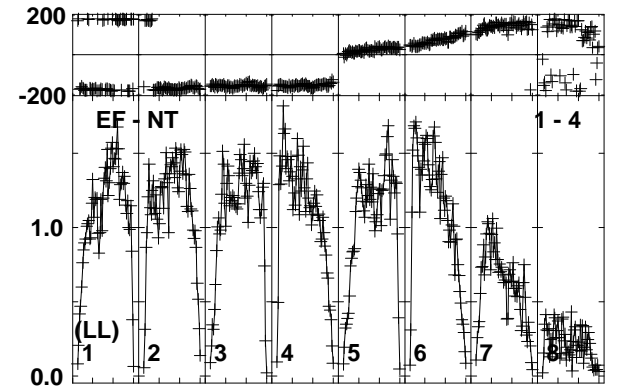
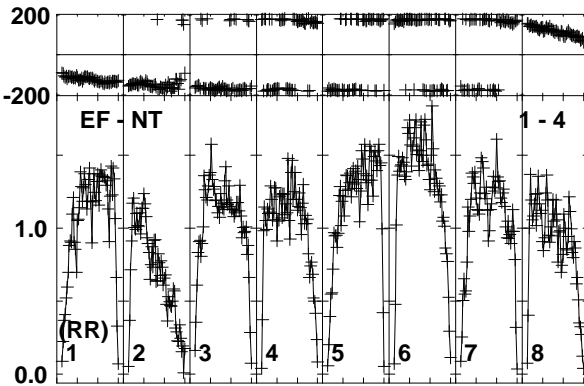
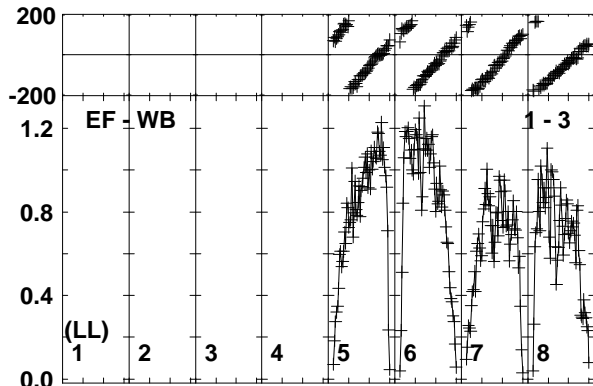
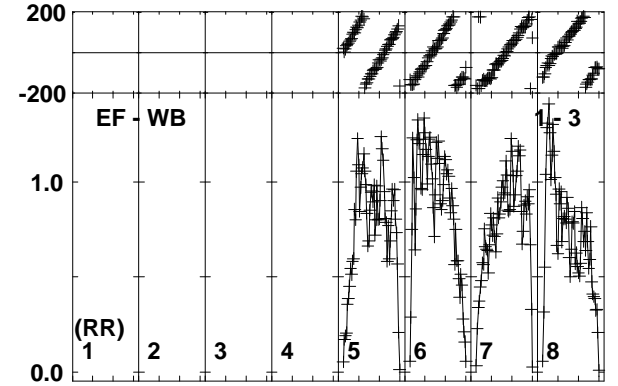
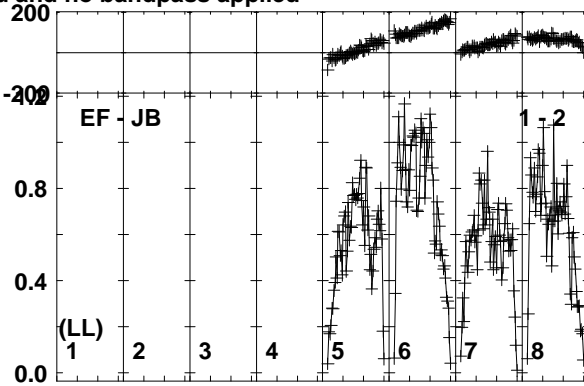
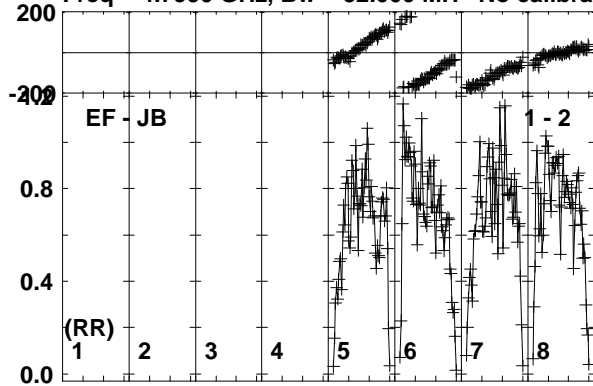

Lower frame: Milli Ampl Jy Top frame: Phas deg  
 Vector averaged cross-power spectrum Baseline: EF (01) - JB (02)  
 Timerange: 00/10:48:49 to 00/10:49:49

Plot file version 27 created 25-SEP-2017 10:02:20

J1303-2405 RP029B.UVDATA.1

Freq = 4.7990 GHz, Bw = 32.000 MH No calibration applied and no bandpass applied

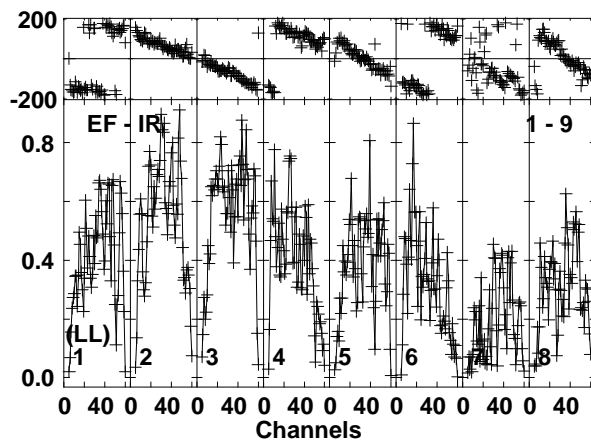
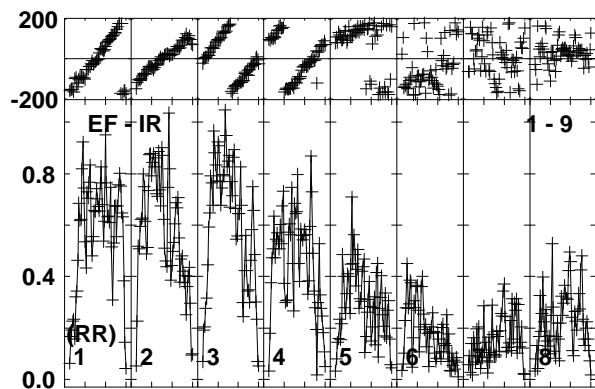
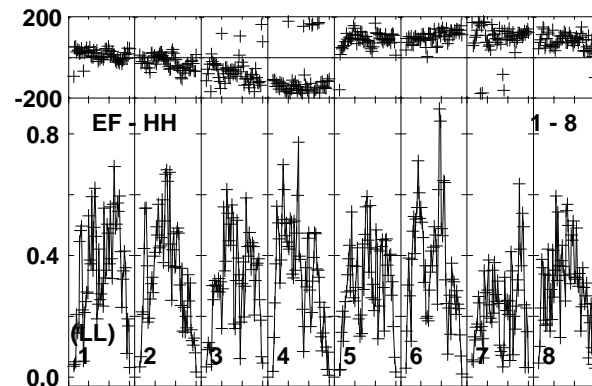
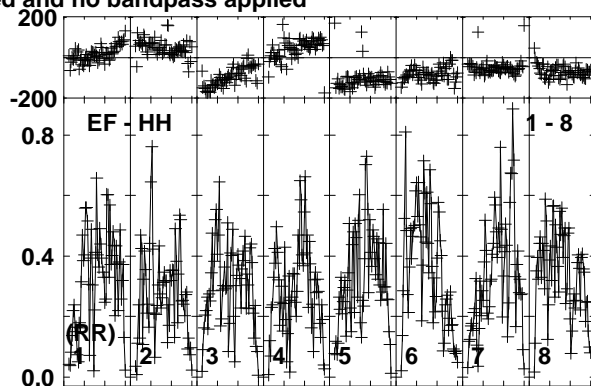
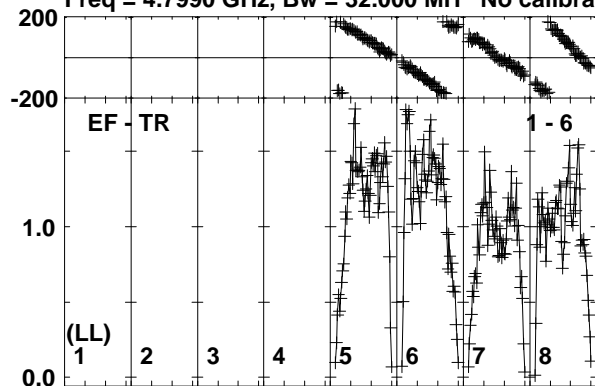

Lower frame: Milli Ampl Jy Top frame: Phas deg  
Vector averaged cross-power spectrum Baseline: EF (01) - TR (06)  
Timerange: 00/10:48:49 to 00/10:49:49

Plot file version 28 created 25-SEP-2017 10:02:20

SSS17A RP029B.UVDATA.1

Freq = 4.7990 GHz, Bw = 32.000 MH No calibration applied and no bandpass applied

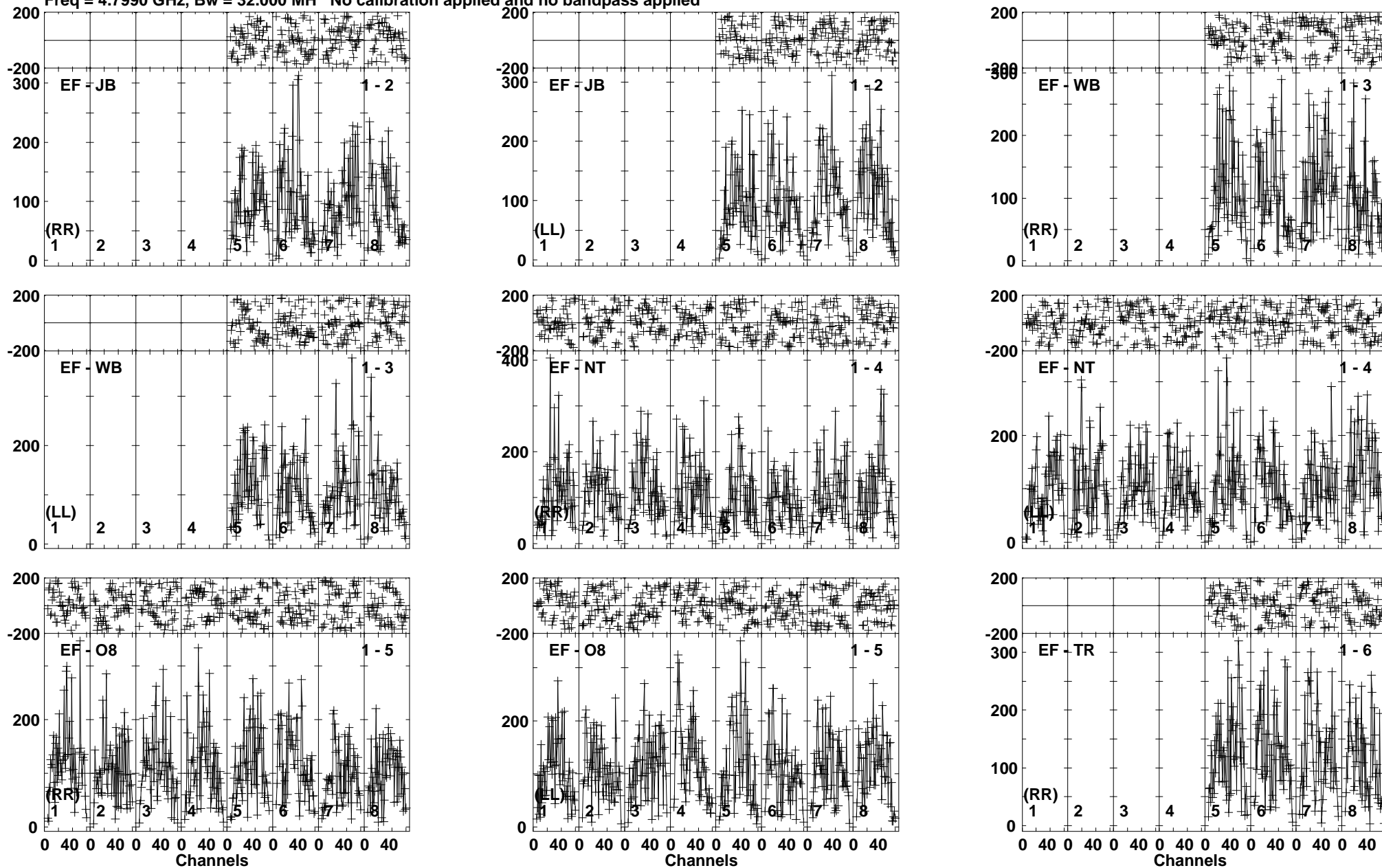

Plot file version 29 created 25-SEP-2017 10:02:20  
SSS17A RP029B.UVDATA.1  
Freq = 4.7990 GHz, Bw = 32.000 MH No calibration applied and no bandpass applied

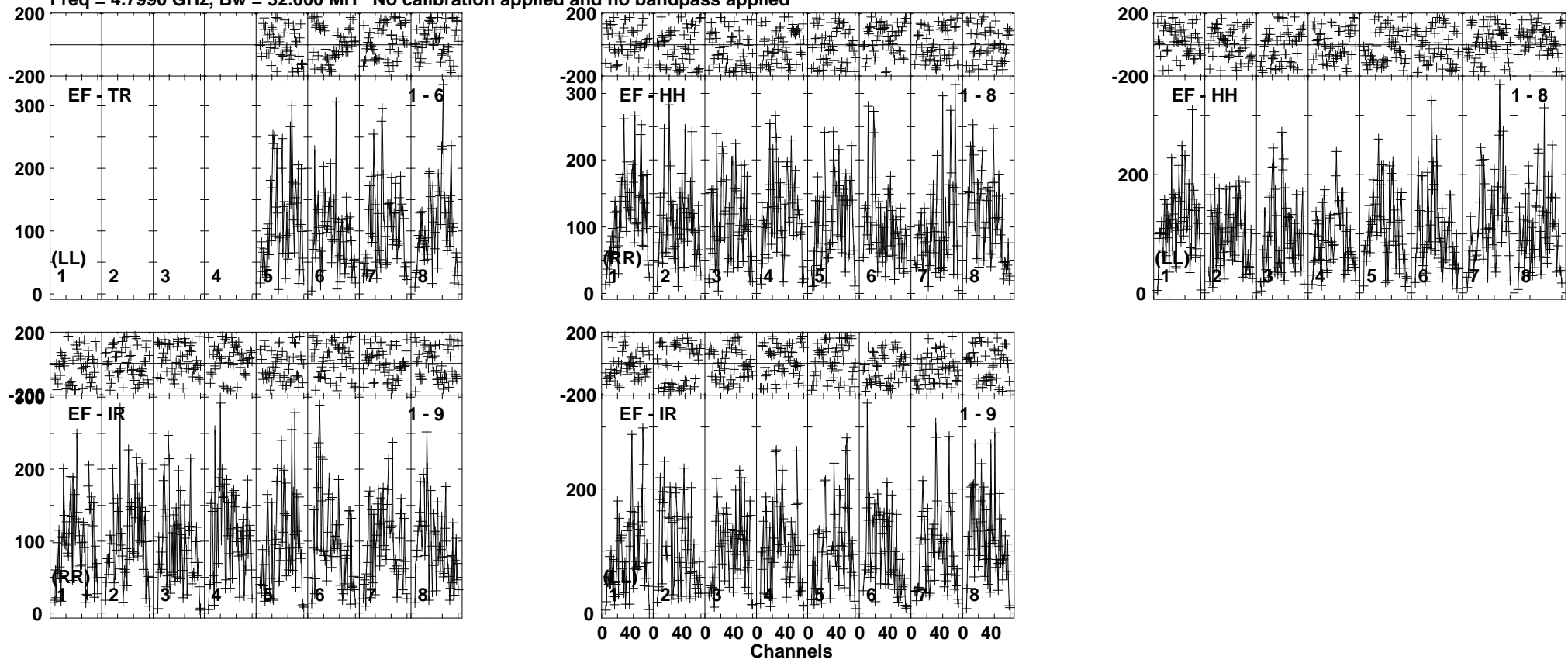

Lower frame: Micro Ampl Jy Top frame: Phas deg  
Vector averaged cross-power spectrum Baseline: EF (01) - TR (06)  
Timerange: 00/10:49:50 to 00/10:52:18

Plot file version 30 created 25-SEP-2017 10:02:20

J1303-2405 RP029B.UVDATA.1

Freq = 4.7990 GHz, Bw = 32.000 MH No calibration applied and no bandpass applied

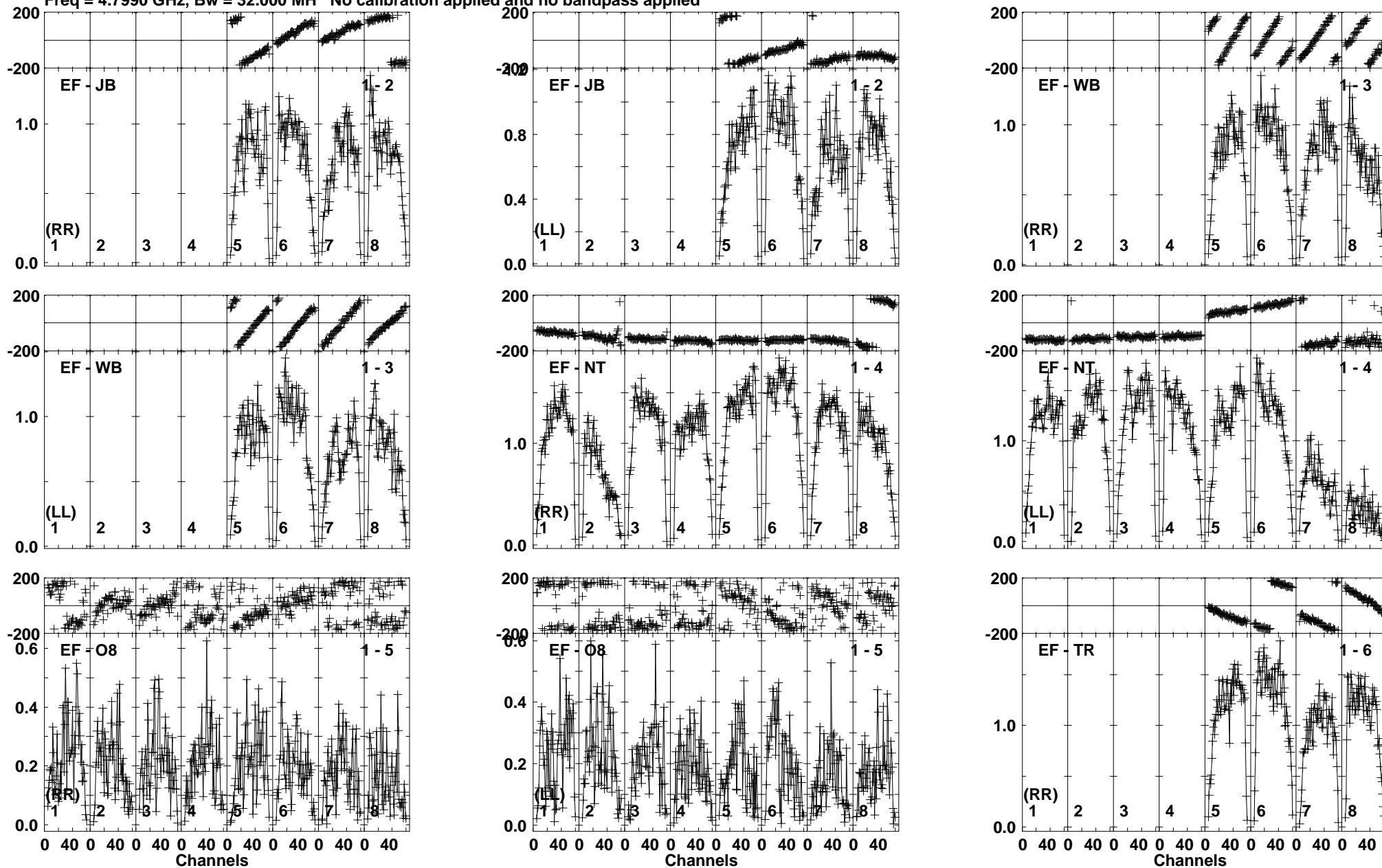

Lower frame: Milli Ampl Jy Top frame: Phas deg  
Vector averaged cross-power spectrum Baseline: EF (01) - JB (02)  
Timerange: 00/10:52:20 to 00/10:53:48

Plot file version 31 created 25-SEP-2017 10:02:20

J1303-2405 RP029B.UVDATA.1

Freq = 4.7990 GHz, Bw = 32.000 MH No calibration applied and no bandpass applied

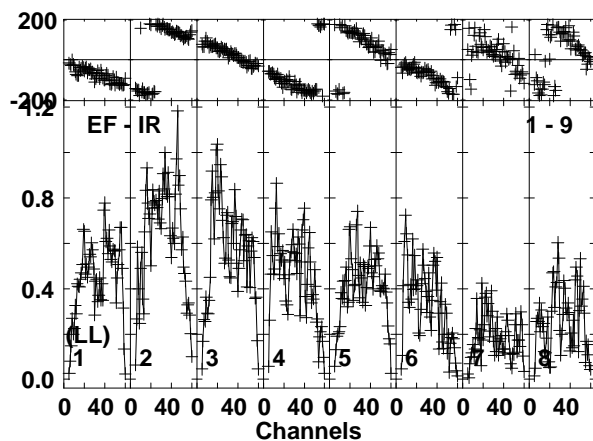
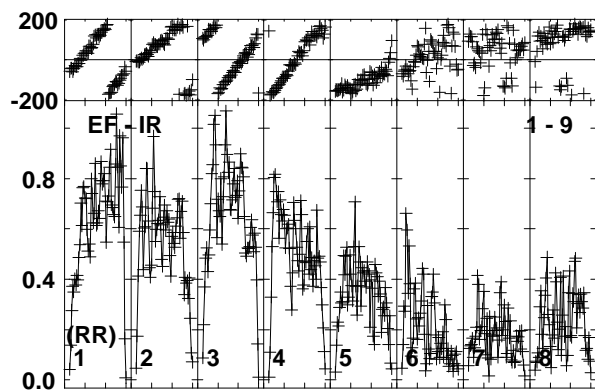
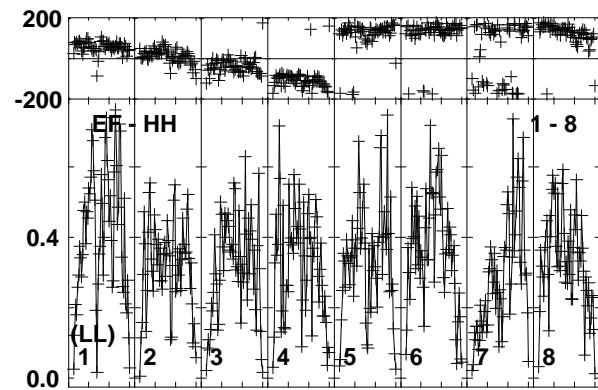
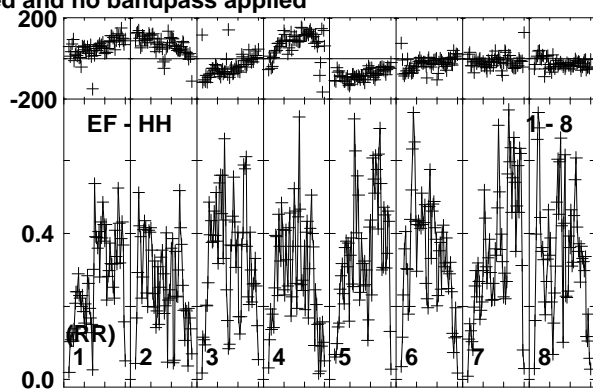
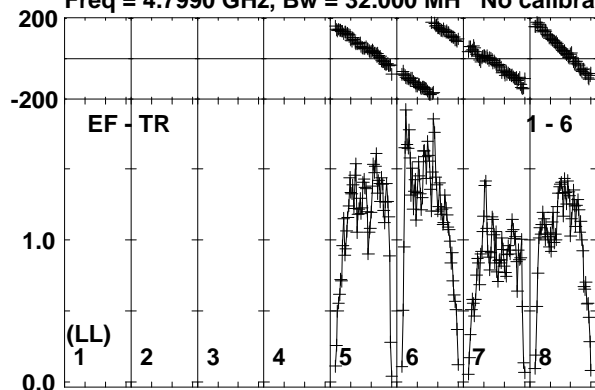

Lower frame: Milli Ampl Jy Top frame: Phas deg  
Vector averaged cross-power spectrum Baseline: EF (01) - TR (06)  
Timerange: 00/10:52:20 to 00/10:53:48

Plot file version 32 created 25-SEP-2017 10:02:21

J1312-2350 RP029B.UVDATA.1

Freq = 4.7990 GHz, Bw = 32.000 MH No calibration applied and no bandpass applied

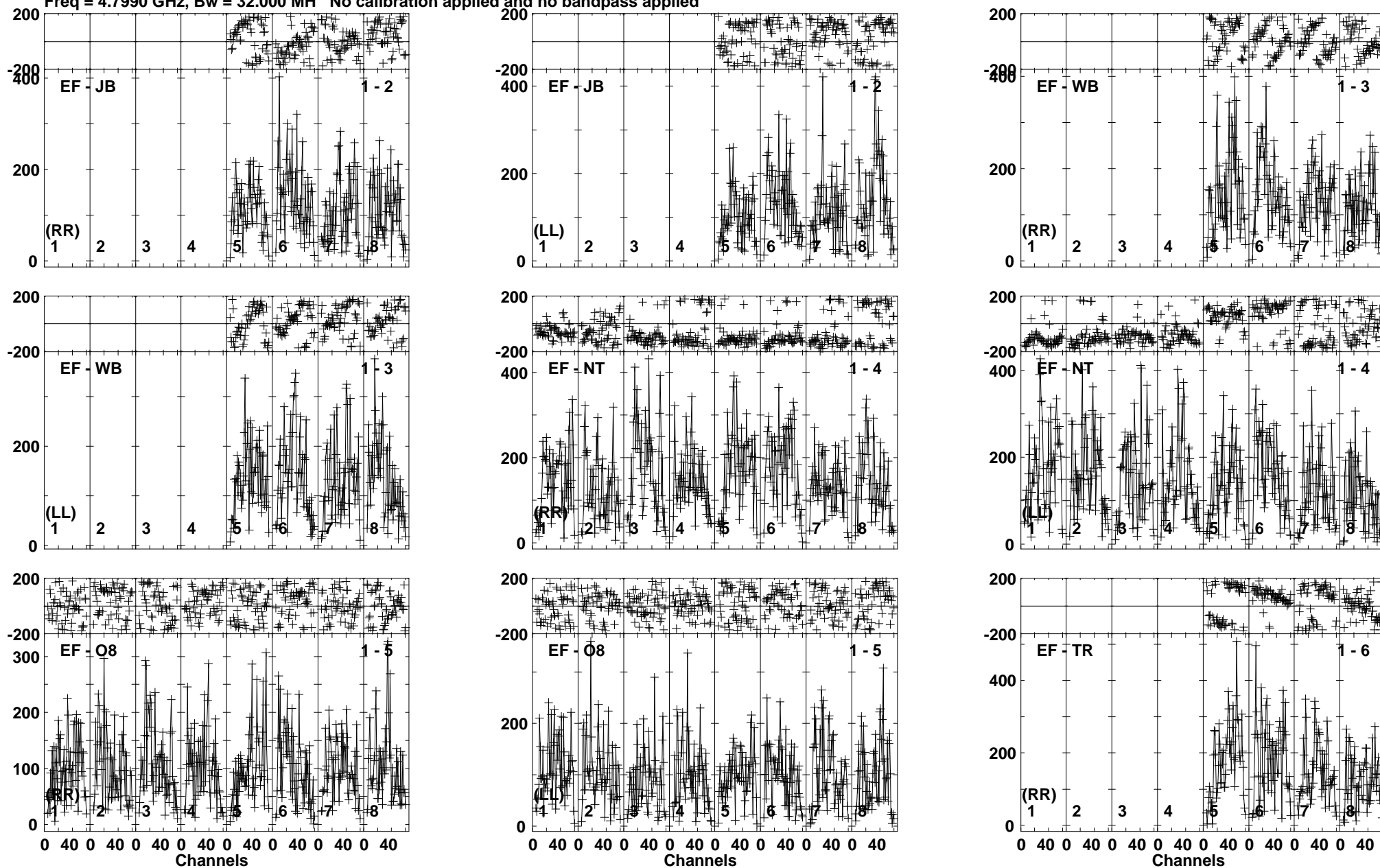

Lower frame: Micro Ampl Jy Top frame: Phas deg  
Vector averaged cross-power spectrum Baseline: EF (01) - JB (02)  
Timerange: 00/10:53:49 to 00/10:56:19



Plot file version 33 created 25-SEP-2017 10:02:21

J1312-2350 RP029B.UVDATA.1

Freq = 4.7990 GHz, Bw = 32.000 MH No calibration applied and no bandpass applied

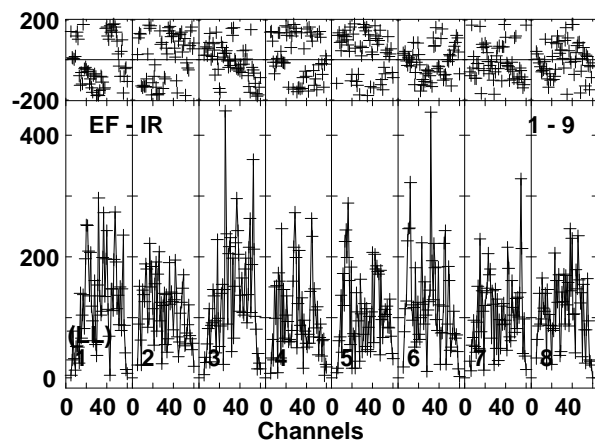
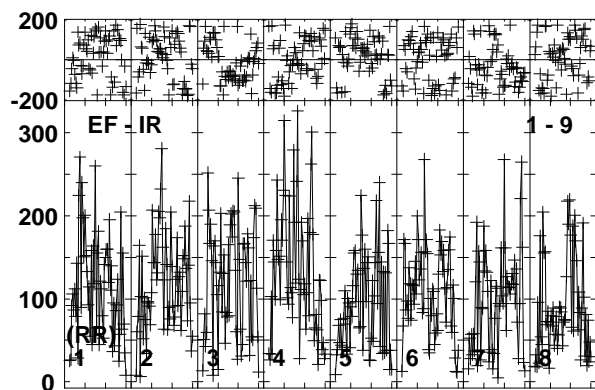
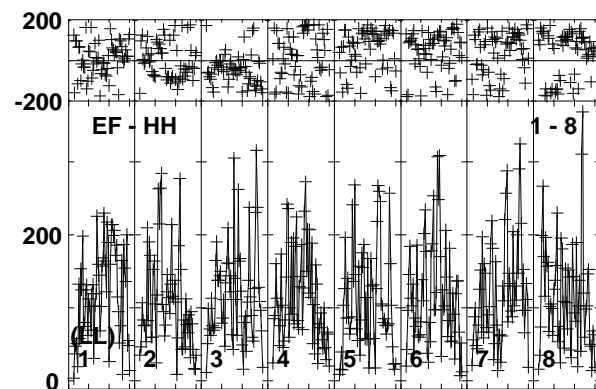
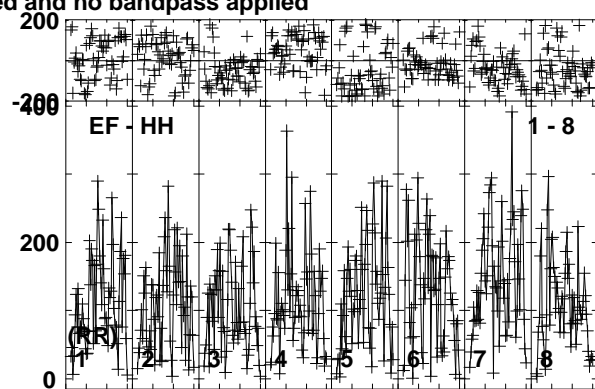
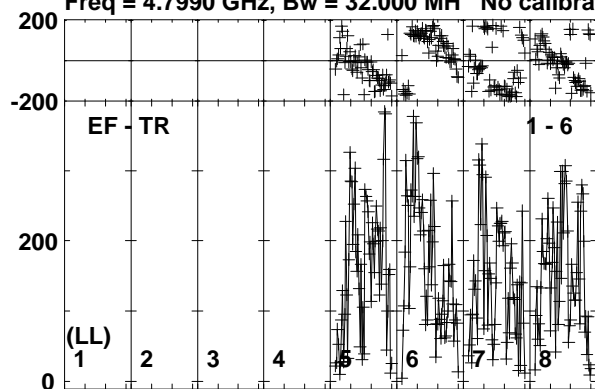

Lower frame: Micro Ampl Jy Top frame: Phas deg  
Vector averaged cross-power spectrum Baseline: EF (01) - TR (06)  
Timerange: 00/10:53:49 to 00/10:56:19

Plot file version 34 created 25-SEP-2017 10:02:21

J1303-2405 RP029B.UVDATA.1

Freq = 4.7990 GHz, Bw = 32.000 MH No calibration applied and no bandpass applied

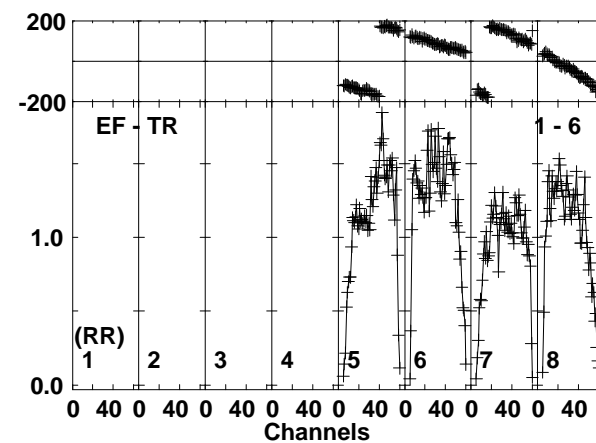
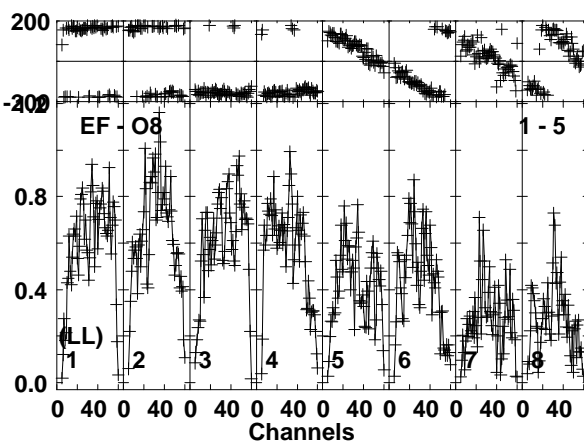
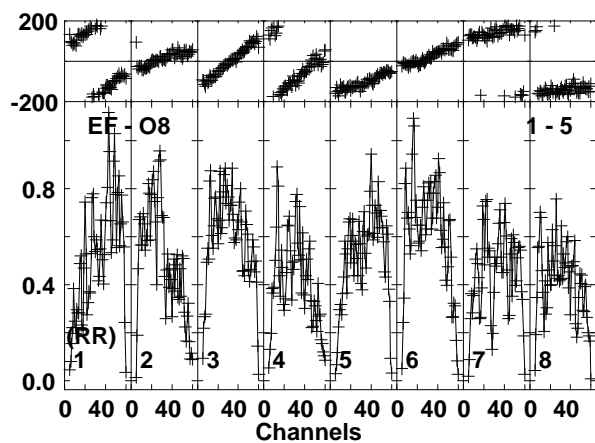
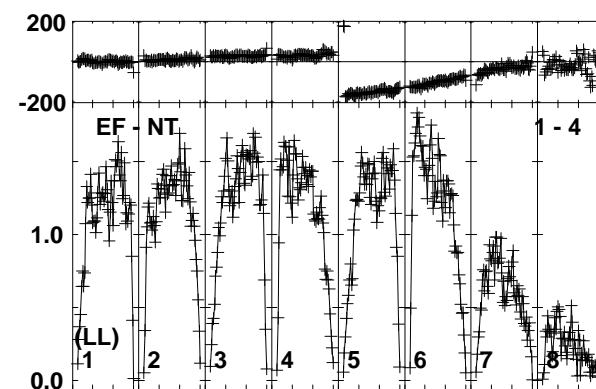
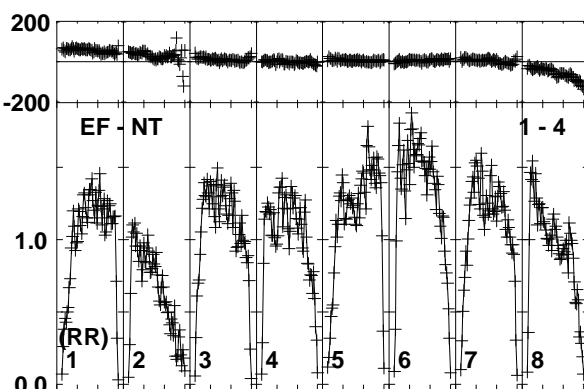
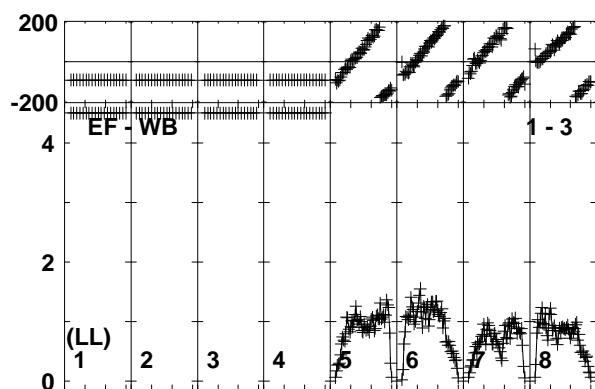
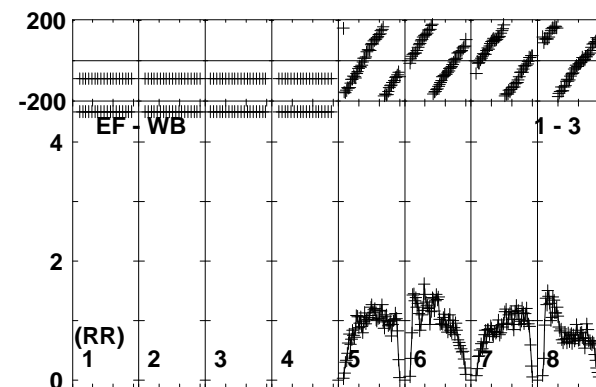
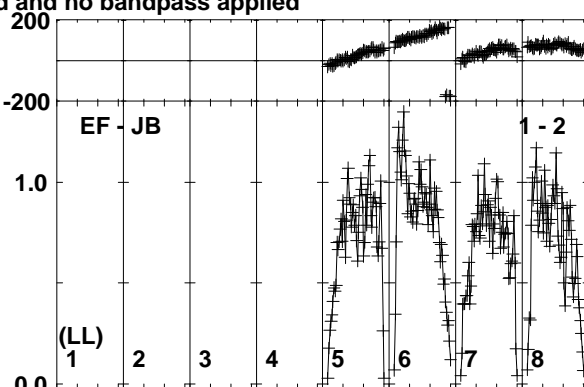
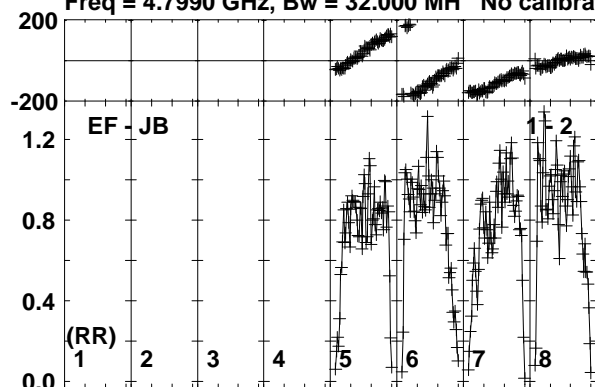

Lower frame: Milli Ampl Jy Top frame: Phas deg  
Vector averaged cross-power spectrum Baseline: EF (01) - JB (02)  
Timerange: 00/10:56:59 to 00/10:57:59

Plot file version 35 created 25-SEP-2017 10:02:21

J1303-2405 RP029B.UVDATA.1

Freq = 4.7990 GHz, Bw = 32.000 MH No calibration applied and no bandpass applied

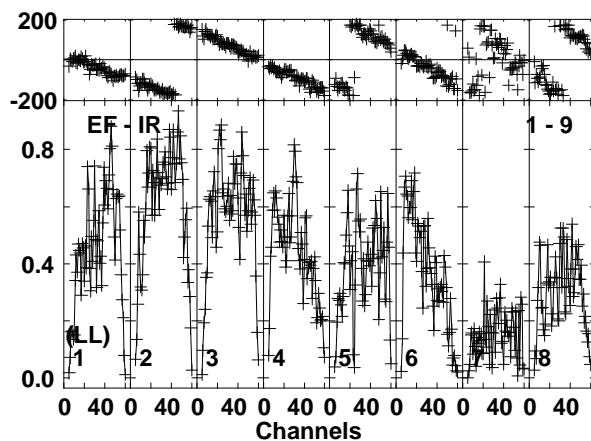
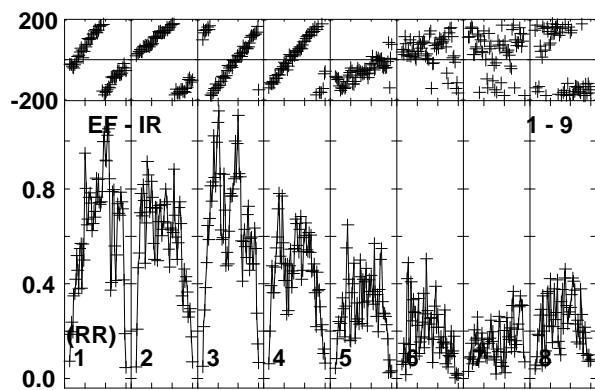
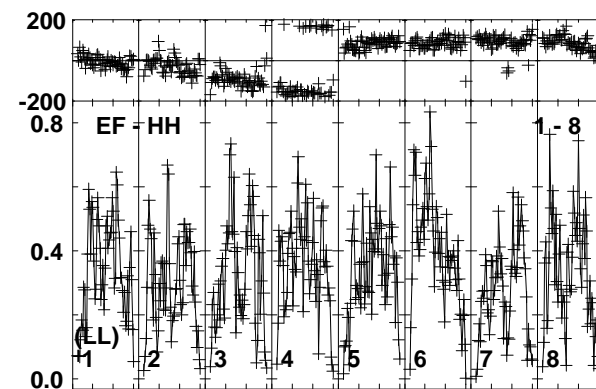
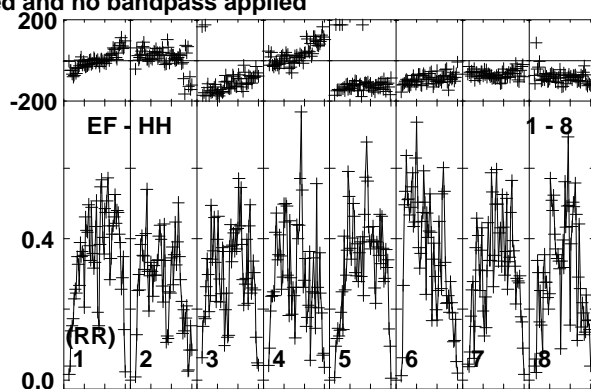
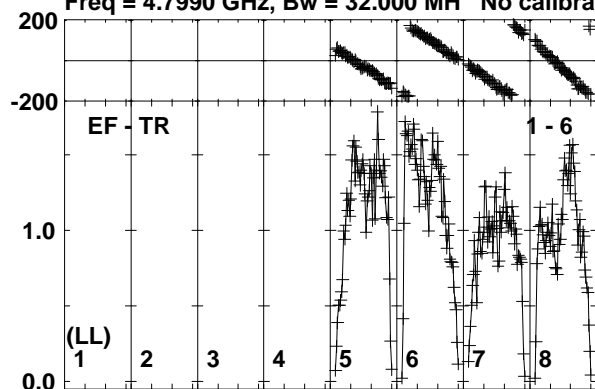

Lower frame: Milli Ampl Jy Top frame: Phas deg  
Vector averaged cross-power spectrum Baseline: EF (01) - TR (06)  
Timerange: 00/10:56:59 to 00/10:57:59

Plot file version 36 created 25-SEP-2017 10:02:21

SSS17A RP029B.UVDATA.1

Freq = 4.7990 GHz, Bw = 32.000 MH No calibration applied and no bandpass applied

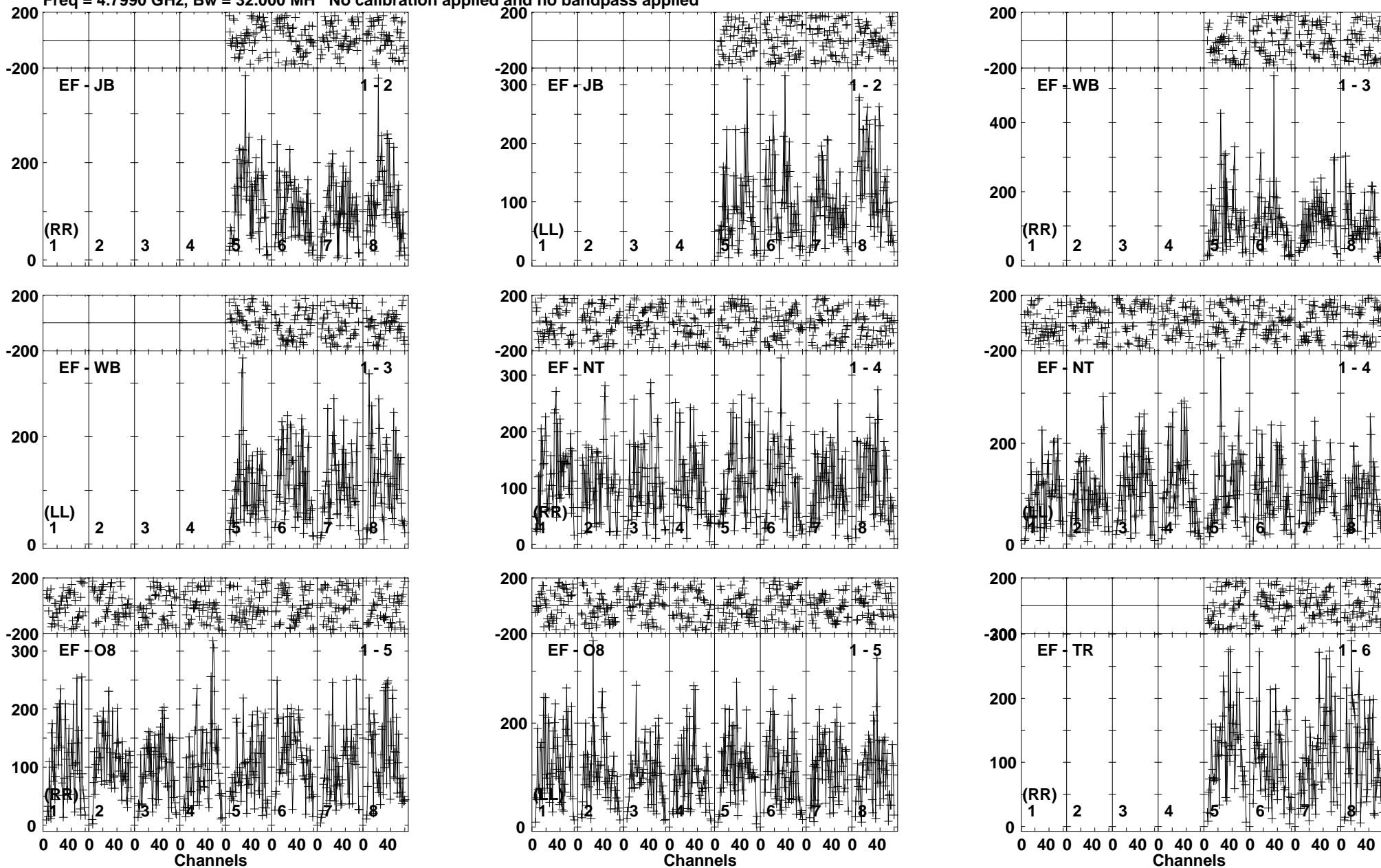

Lower frame: Micro Ampl Jy Top frame: Phas deg  
Vector averaged cross-power spectrum Baseline: EF (01) - JB (02)  
Timerange: 00/10:58:00 to 00/11:00:28

Plot file version 37 created 25-SEP-2017 10:02:21

SSS17A RP029B.UVDATA.1

Freq = 4.7990 GHz, Bw = 32.000 MH No calibration applied and no bandpass applied

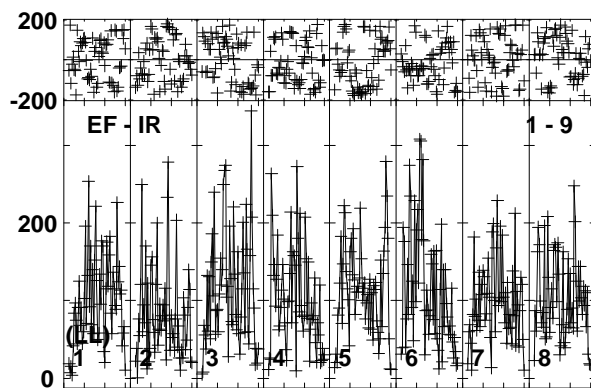
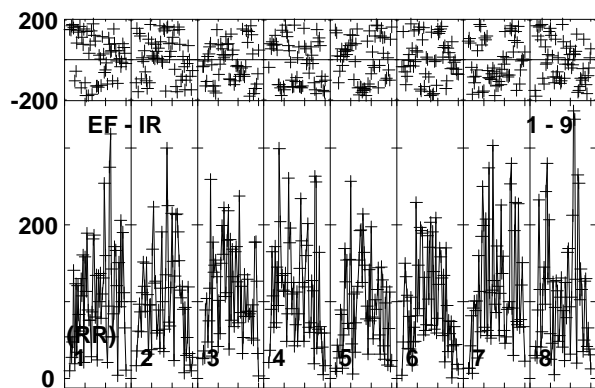
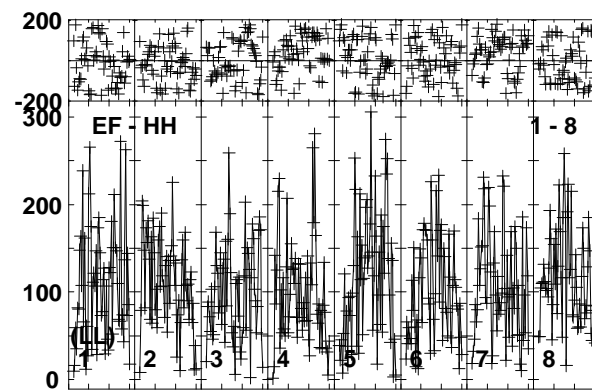
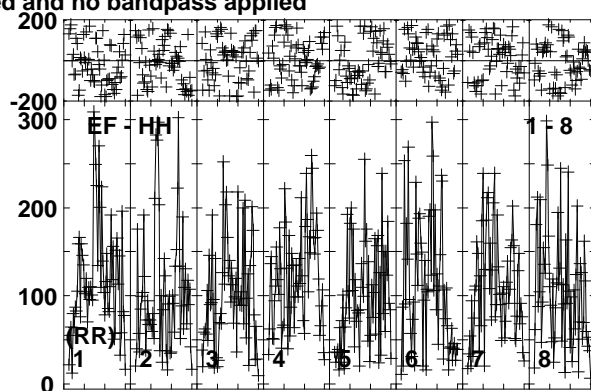
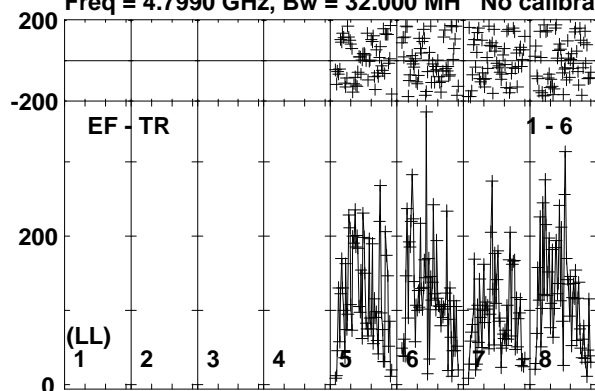

0 40 0 40 0 40 0 40 0 40 0 40 0 40 0 40 0 40 0 40 0 40  
Channels

Lower frame: Micro Ampl Jy Top frame: Phas deg  
Vector averaged cross-power spectrum Baseline: EF (01) - TR (06)  
Timerange: 00/10:58:00 to 00/11:00:28

Plot file version 38 created 25-SEP-2017 10:02:21

J1303-2405 RP029B.UVDATA.1

Freq = 4.7990 GHz, Bw = 32.000 MH No calibration applied and no bandpass applied

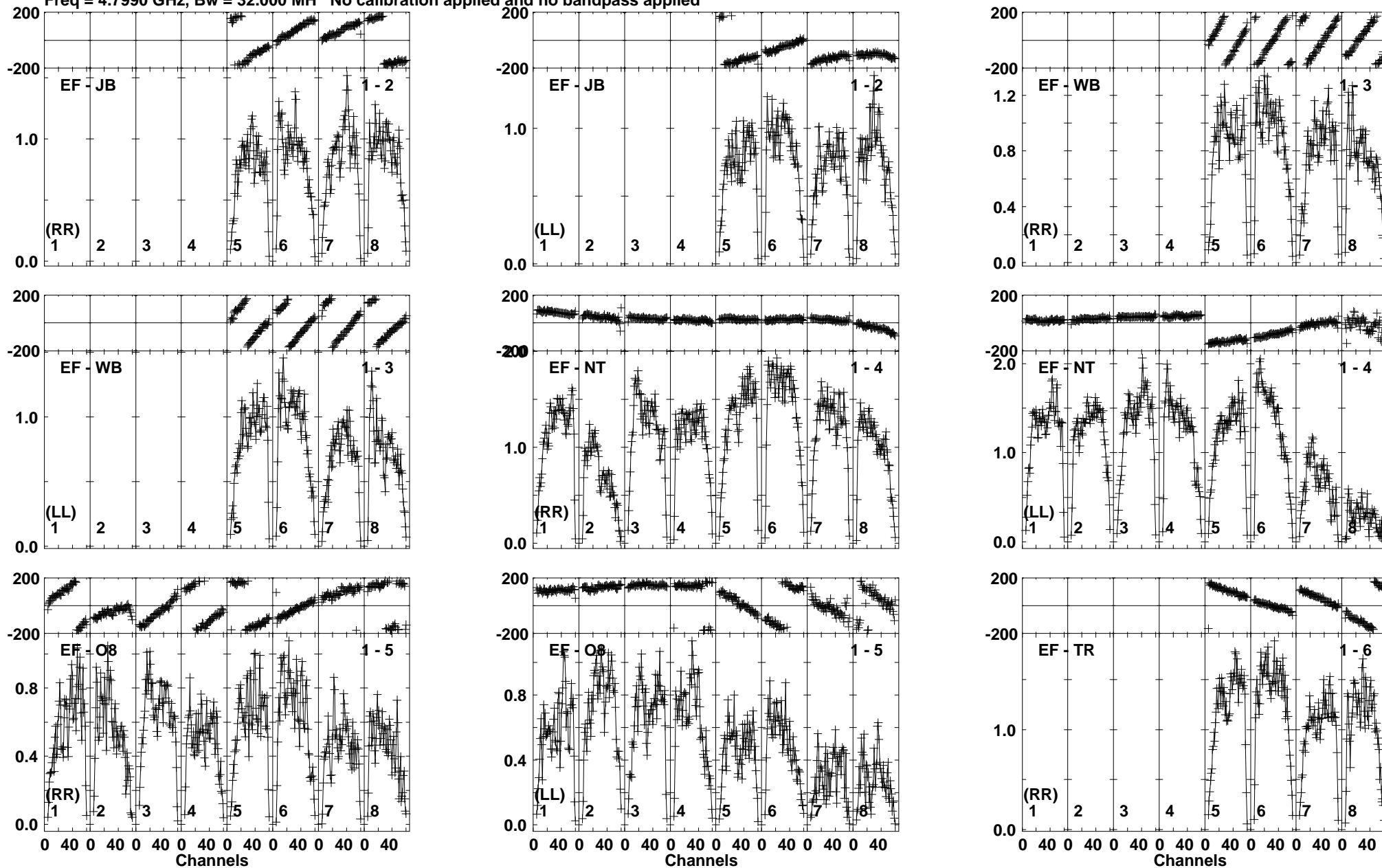

Lower frame: Milli Ampl Jy Top frame: Phas deg  
Vector averaged cross-power spectrum Baseline: EF (01) - JB (02)  
Timerange: 00/11:00:30 to 00/11:01:59

Plot file version 39 created 25-SEP-2017 10:02:22

J1303-2405 RP029B.UVDATA.1

Freq = 4.7990 GHz, Bw = 32.000 MH No calibration applied and no bandpass applied

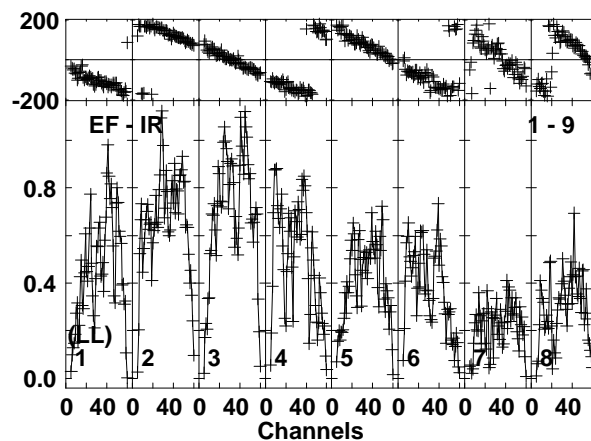
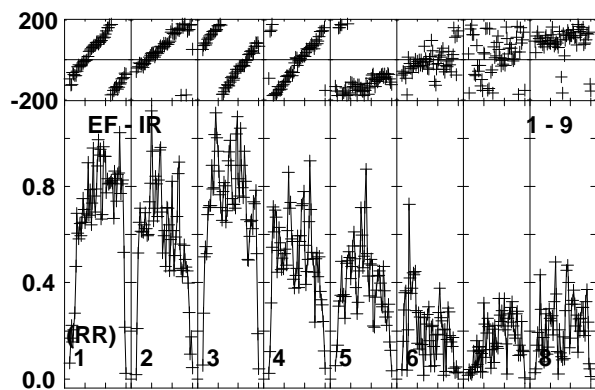
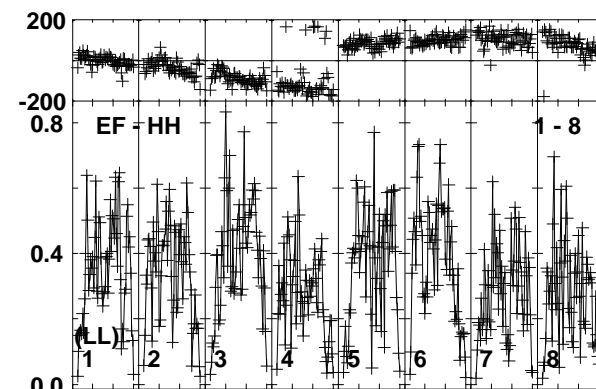
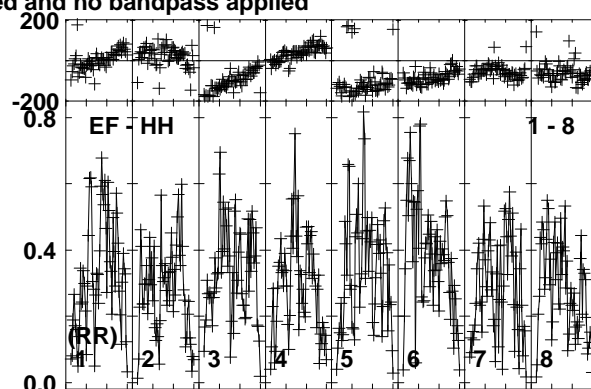
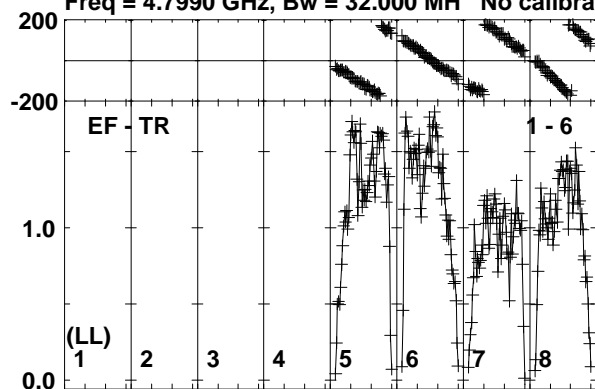

Lower frame: Milli Ampl Jy Top frame: Phas deg  
Vector averaged cross-power spectrum Baseline: EF (01) - TR (06)  
Timerange: 00/11:00:30 to 00/11:01:59

Plot file version 40 created 25-SEP-2017 10:02:22

SSS17A RP029B.UVDATA.1

Freq = 4.7990 GHz, Bw = 32.000 MH No calibration applied and no bandpass applied

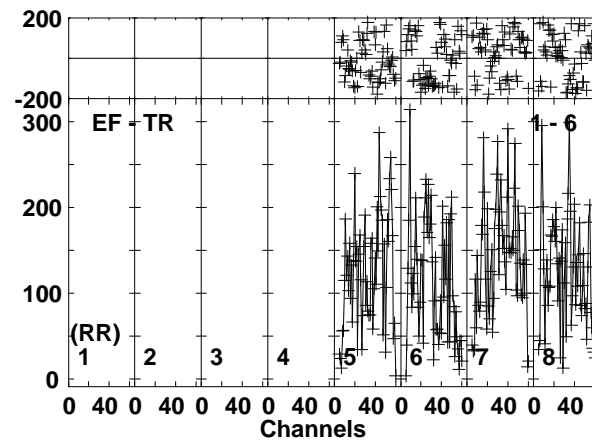
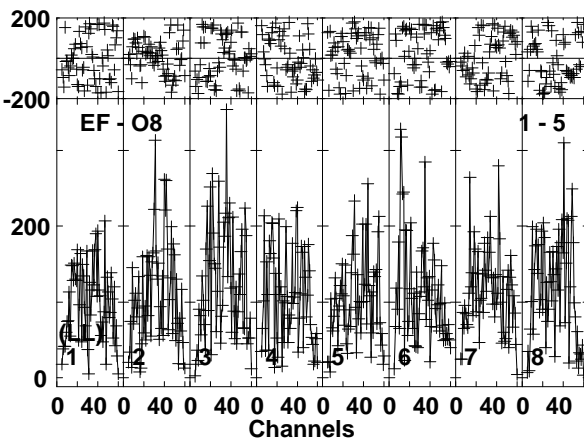
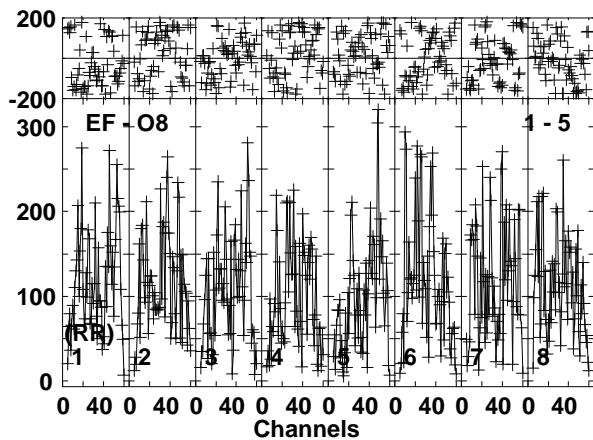
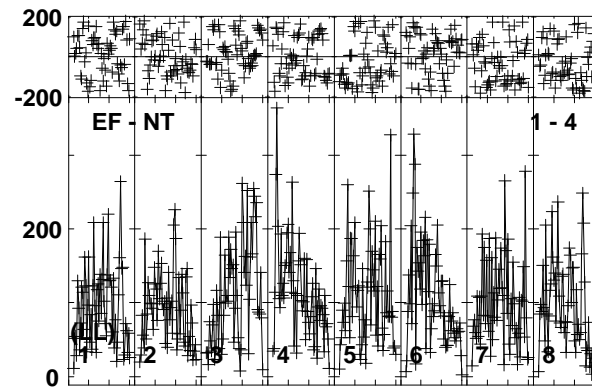
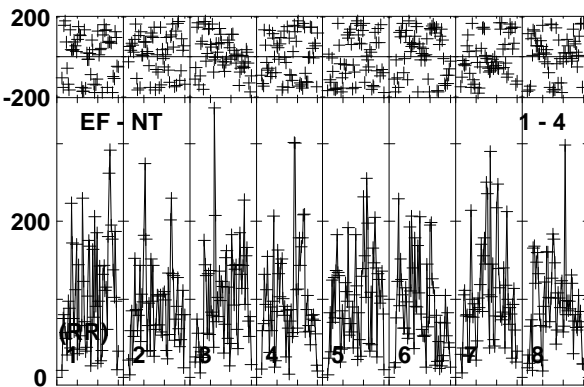
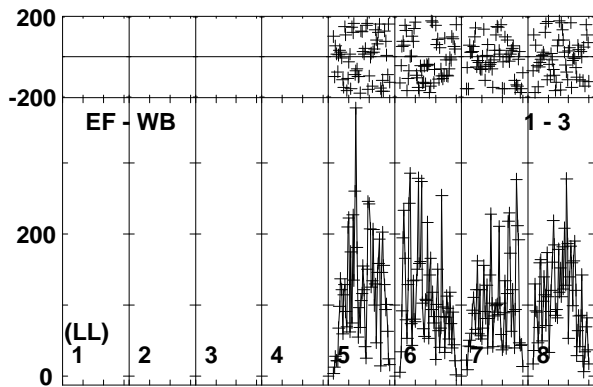
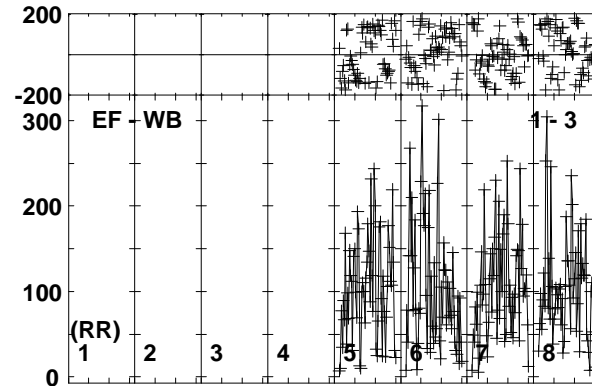
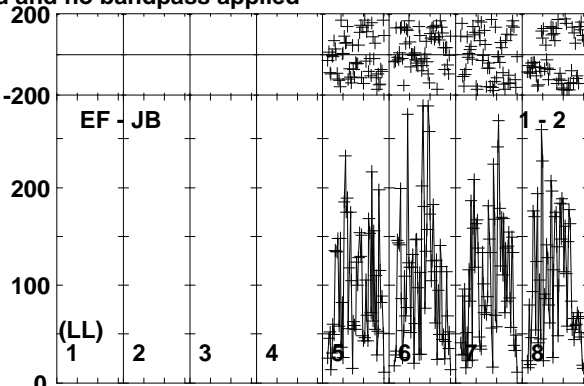
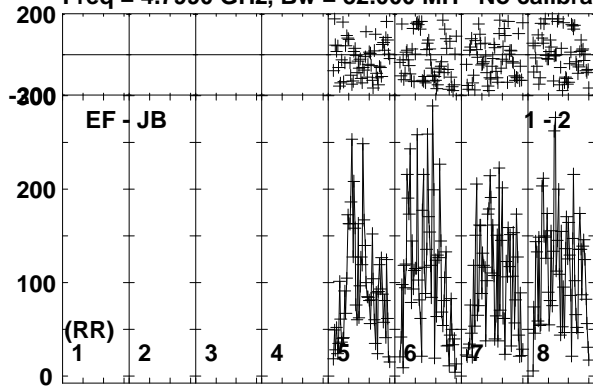

Lower frame: Micro Ampl Jy Top frame: Phas deg  
Vector averaged cross-power spectrum Baseline: EF (01) - JB (02)  
Timerange: 00/11:02:00 to 00/11:04:28



Plot file version 41 created 25-SEP-2017 10:02:22

SSS17A RP029B.UVDATA.1

Freq = 4.7990 GHz, Bw = 32.000 MH No calibration applied and no bandpass applied

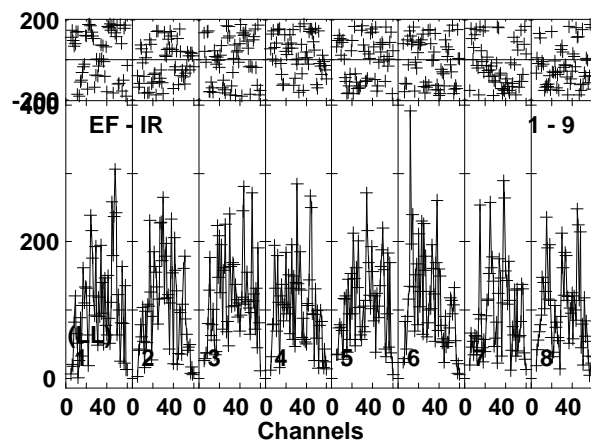
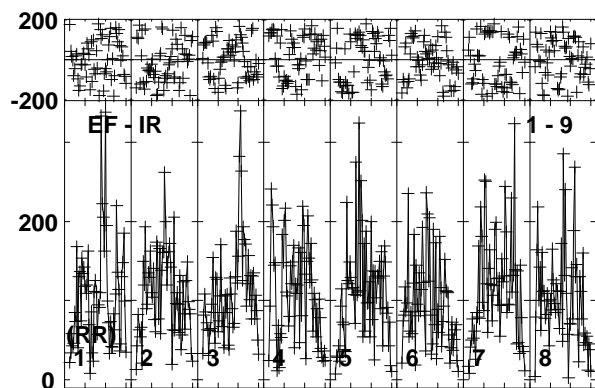
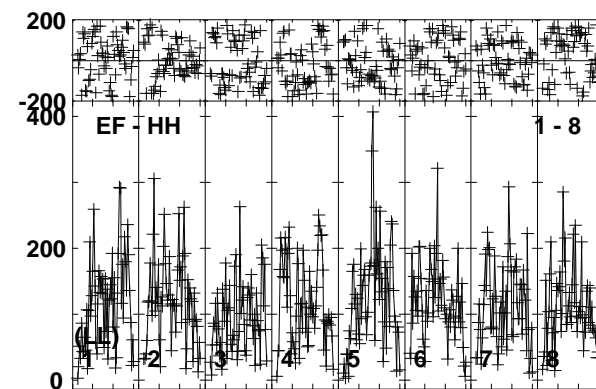
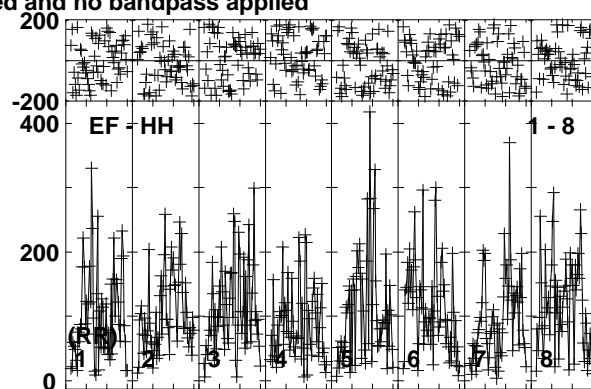
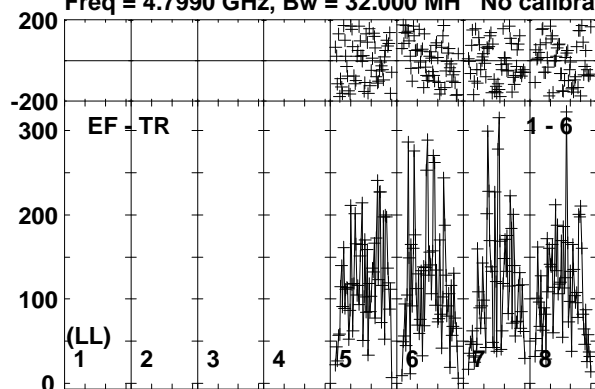

Lower frame: Micro Ampl Jy Top frame: Phas deg  
Vector averaged cross-power spectrum Baseline: EF (01) - TR (06)  
Timerange: 00/11:02:00 to 00/11:04:28

Plot file version 42 created 25-SEP-2017 10:02:22

J1303-2405 RP029B.UVDATA.1

Freq = 4.7990 GHz, Bw = 32.000 MH No calibration applied and no bandpass applied

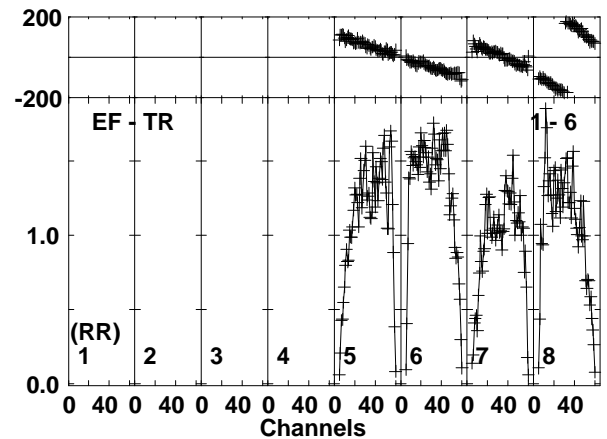
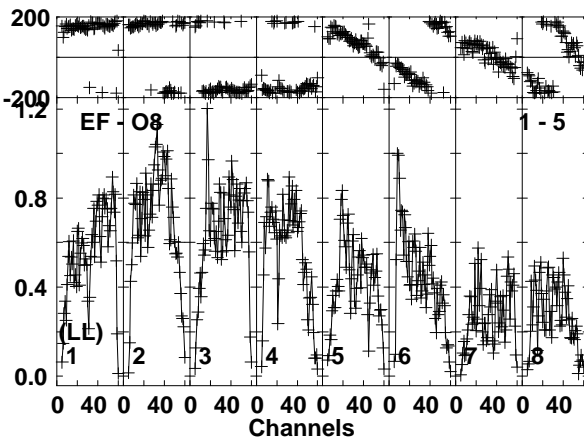
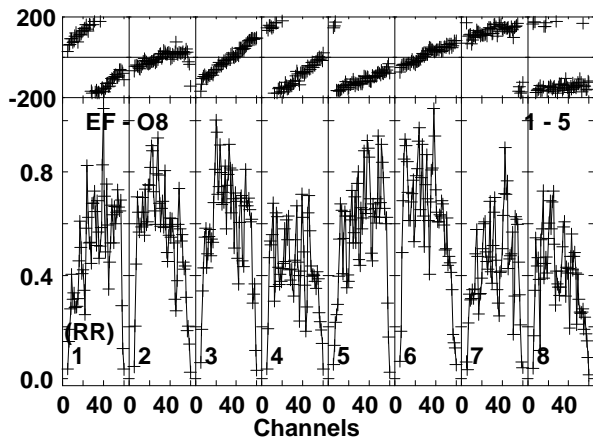
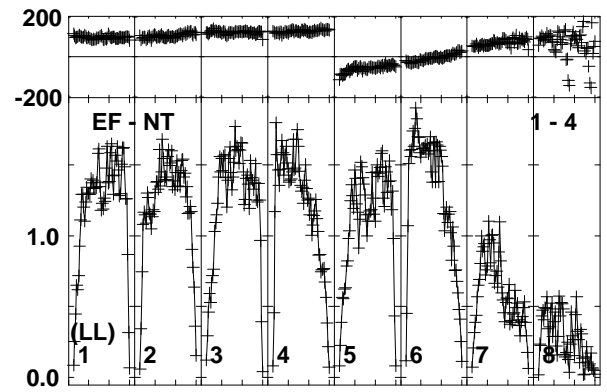
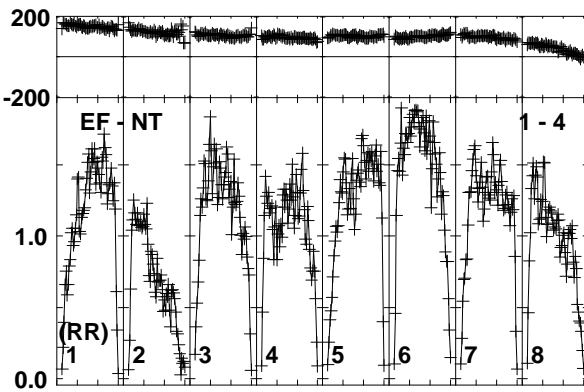
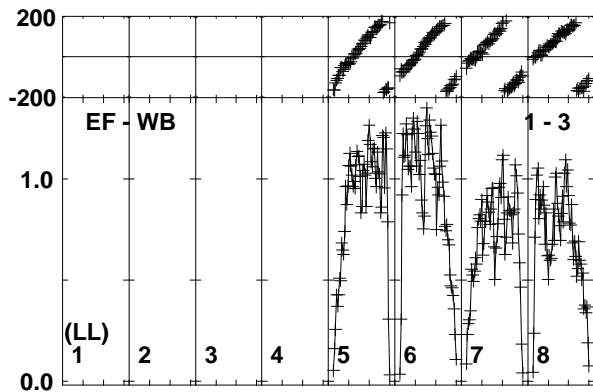
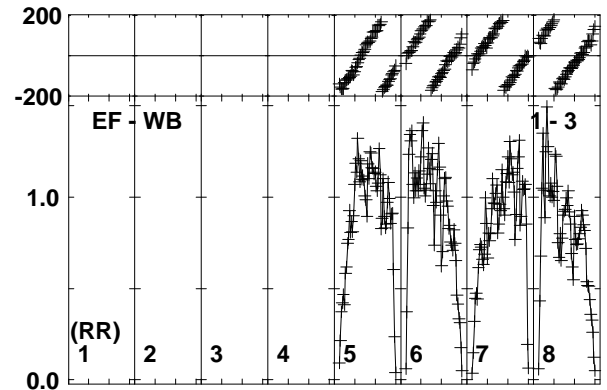
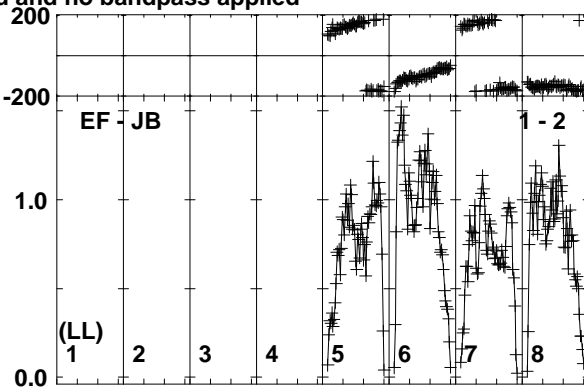
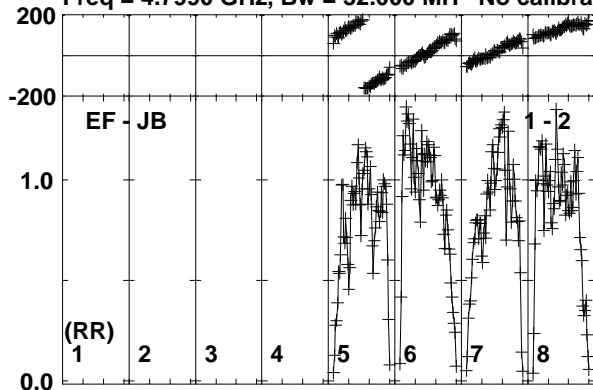

Lower frame: Milli Ampl Jy Top frame: Phas deg  
Vector averaged cross-power spectrum Baseline: EF (01) - JB (02)  
Timerange: 00/11:05:00 to 00/11:05:58

Plot file version 43 created 25-SEP-2017 10:02:22

J1303-2405 RP029B.UVDATA.1

Freq = 4.7990 GHz, Bw = 32.000 MH No calibration applied and no bandpass applied

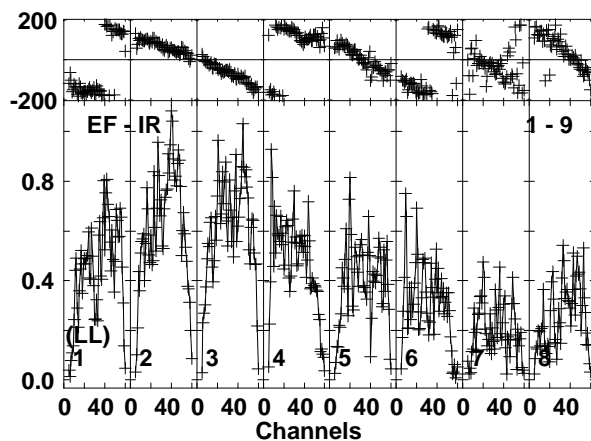
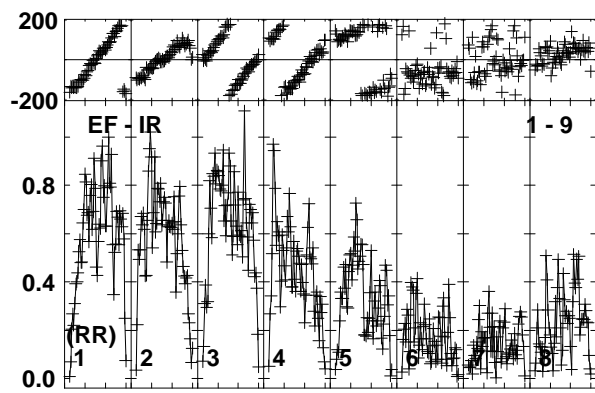
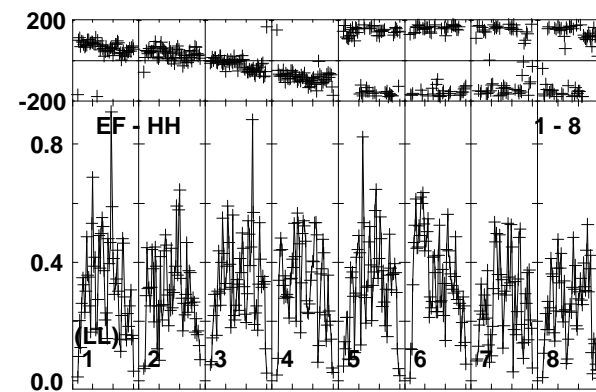
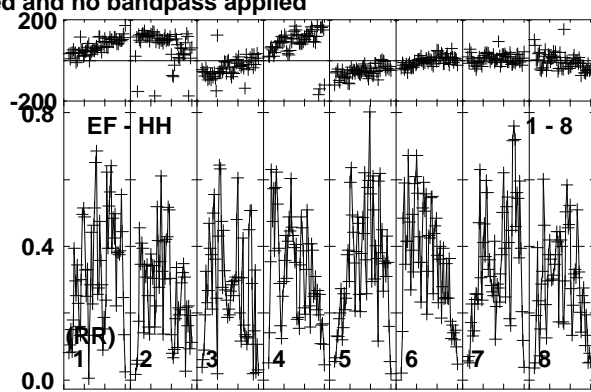
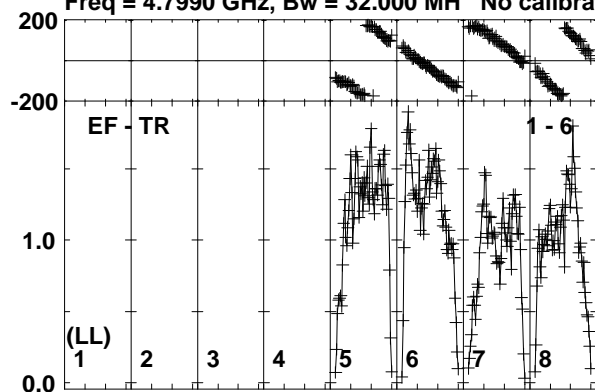

Lower frame: Milli Ampl Jy Top frame: Phas deg  
Vector averaged cross-power spectrum Baseline: EF (01) - TR (06)  
Timerange: 00/11:05:00 to 00/11:05:58

Plot file version 44 created 25-SEP-2017 10:02:22

SSS17A RP029B.UVDATA.1

Freq = 4.7990 GHz, Bw = 32.000 MH No calibration applied and no bandpass applied

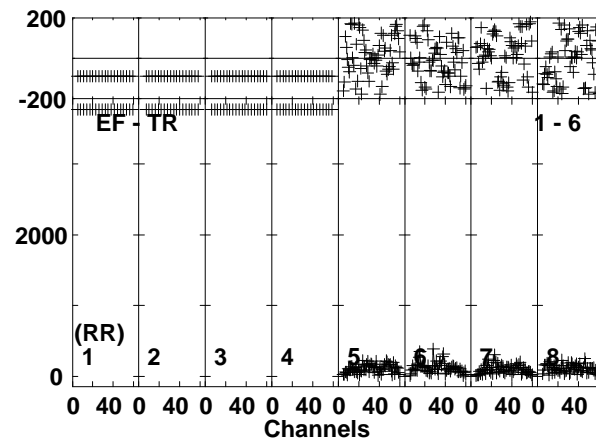
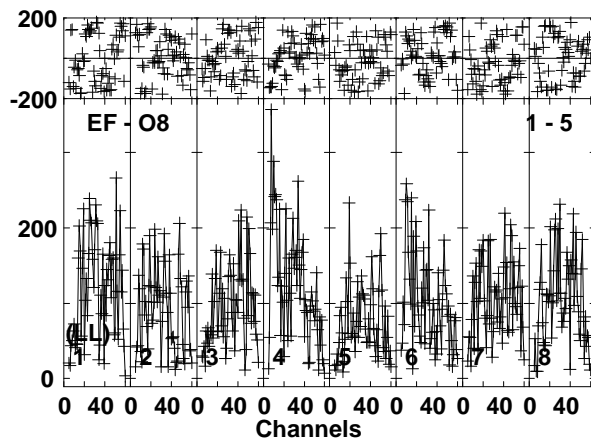
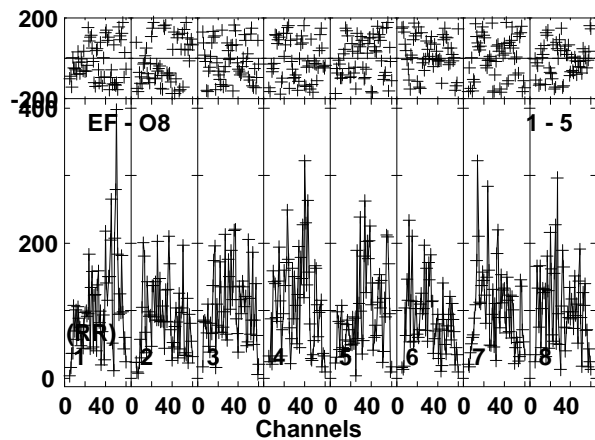
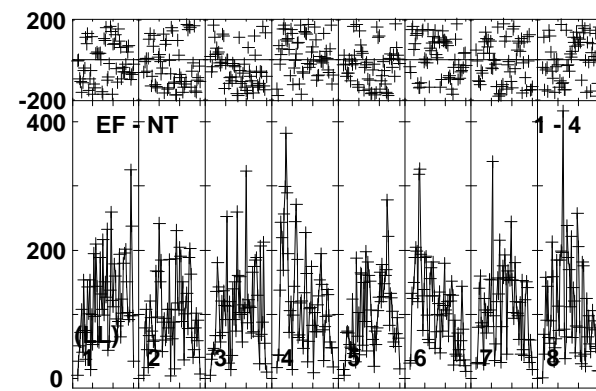
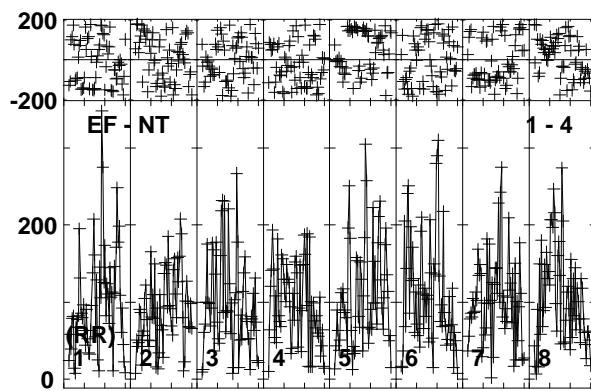
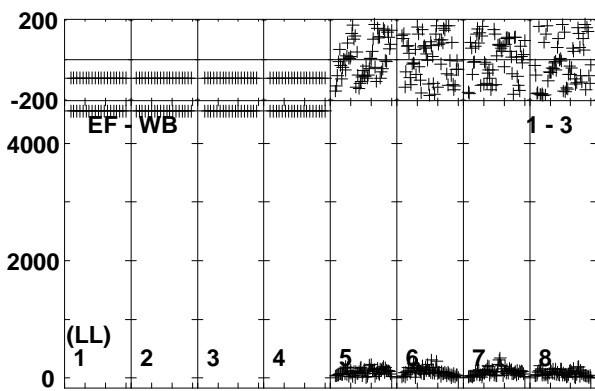
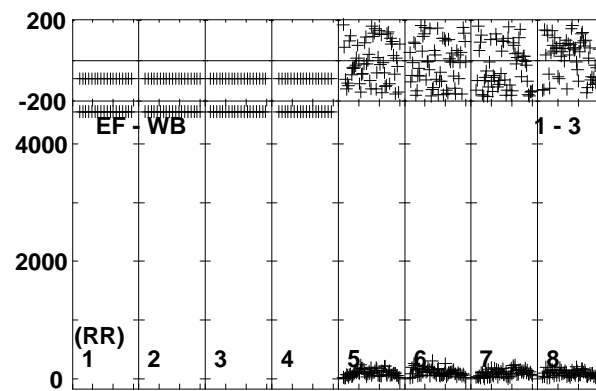
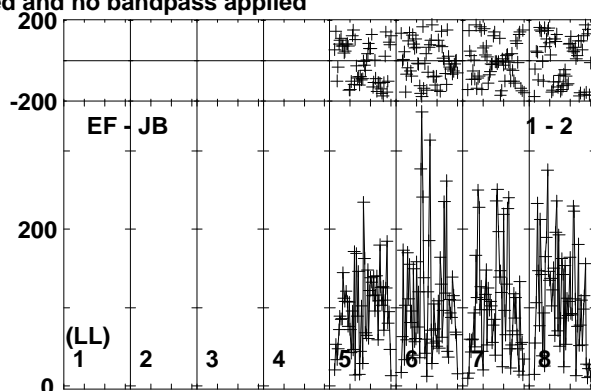
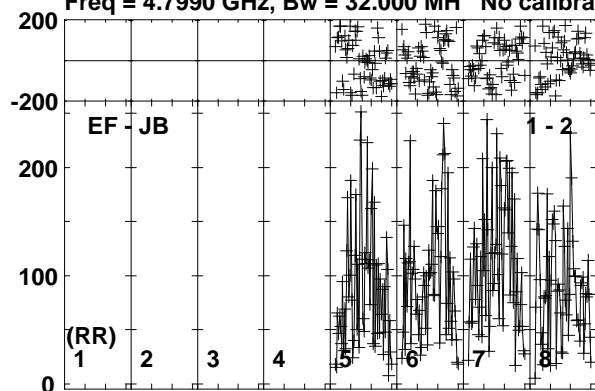

Lower frame: Micro Ampl Jy Top frame: Phas deg  
Vector averaged cross-power spectrum Baseline: EF (01) - JB (02)  
Timerange: 00/11:06:00 to 00/11:08:28

Plot file version 45 created 25-SEP-2017 10:02:23

SSS17A RP029B.UVDATA.1

Freq = 4.7990 GHz, Bw = 32.000 MH No calibration applied and no bandpass applied

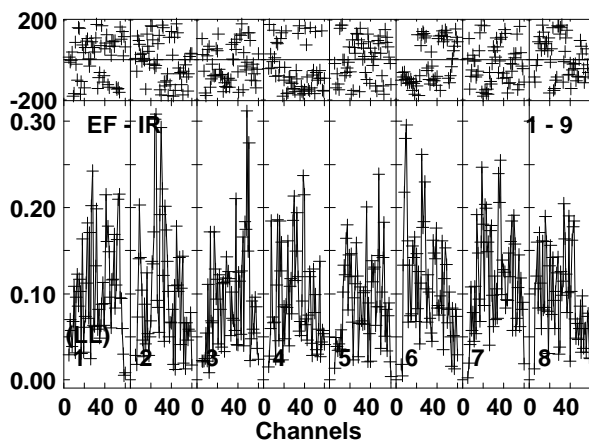
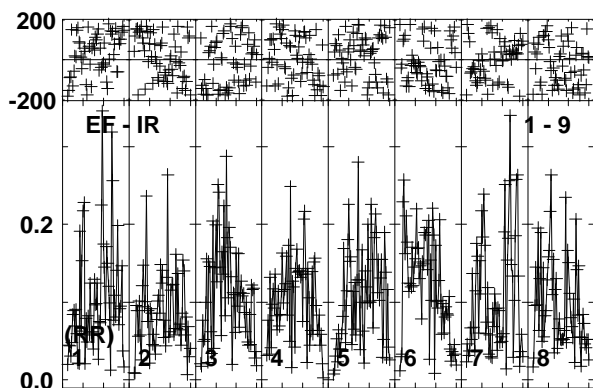
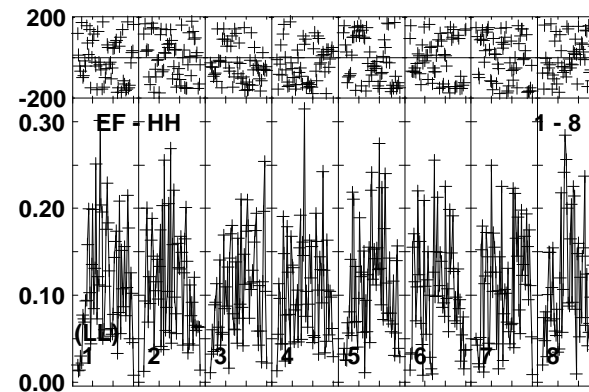
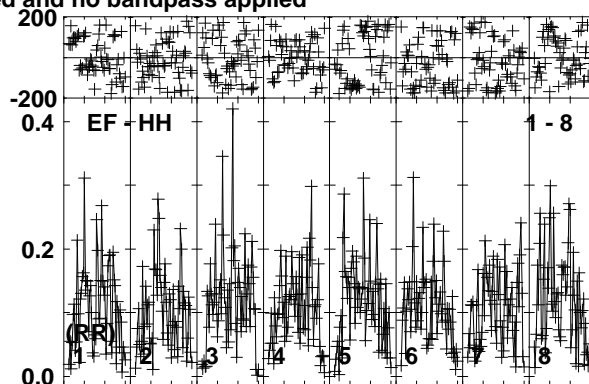
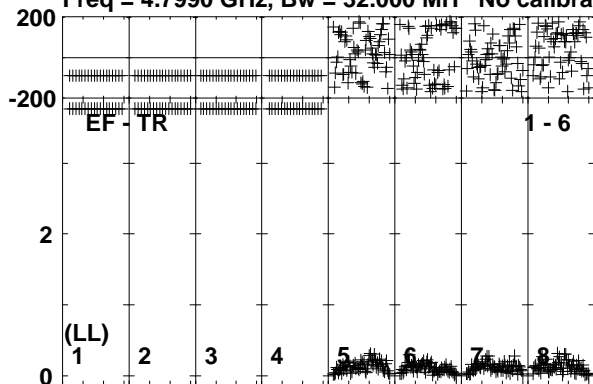

Lower frame: Milli Ampl Jy Top frame: Phas deg  
Vector averaged cross-power spectrum Baseline: EF (01) - TR (06)  
Timerange: 00/11:06:00 to 00/11:08:28

Plot file version 46 created 25-SEP-2017 10:02:23

J1303-2405 RP029B.UVDATA.1

Freq = 4.7990 GHz, Bw = 32.000 MH No calibration applied and no bandpass applied

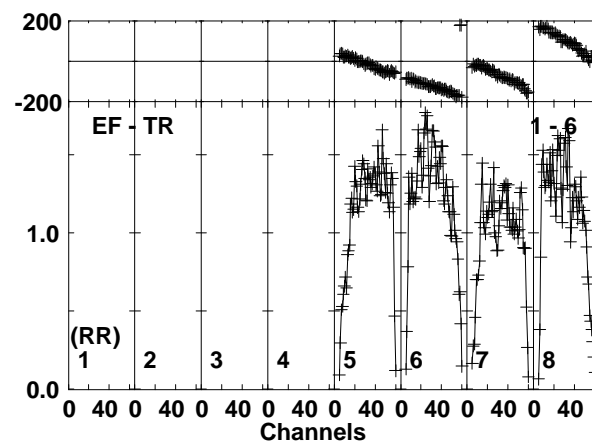
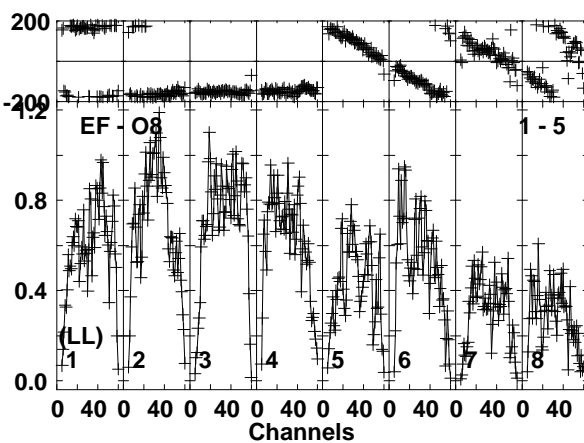
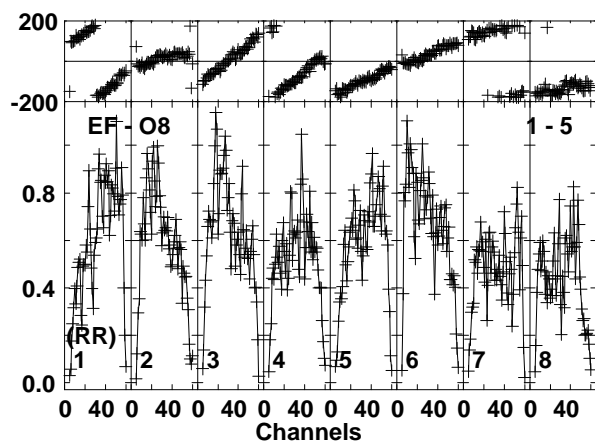
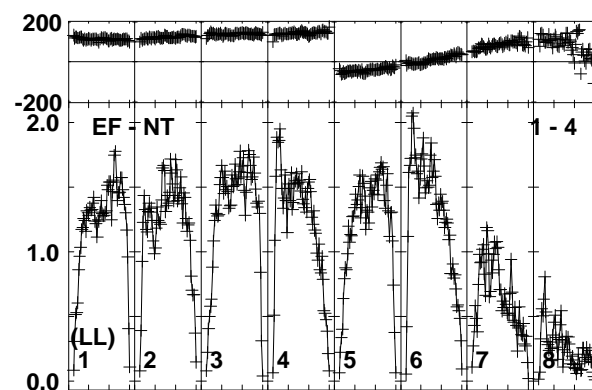
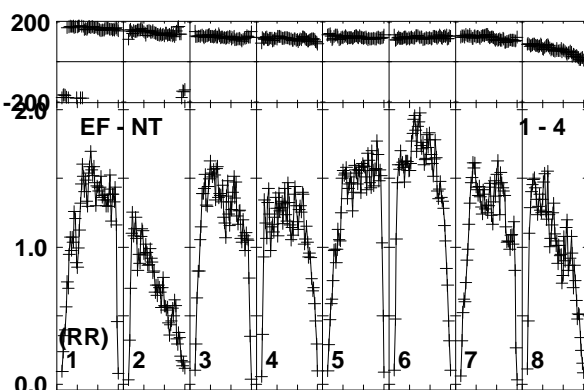
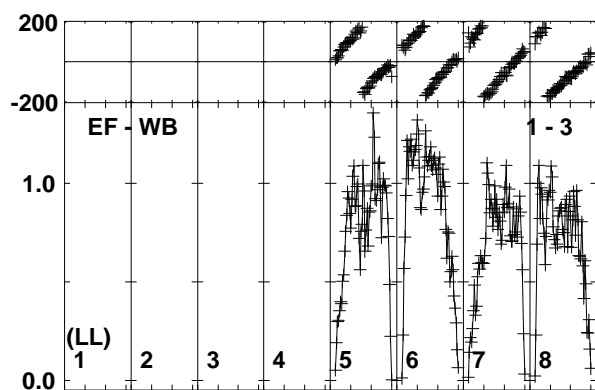
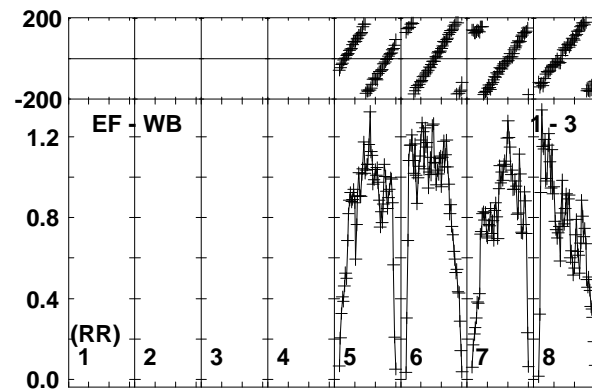
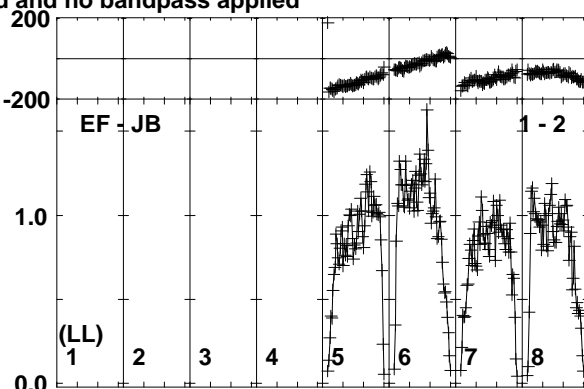
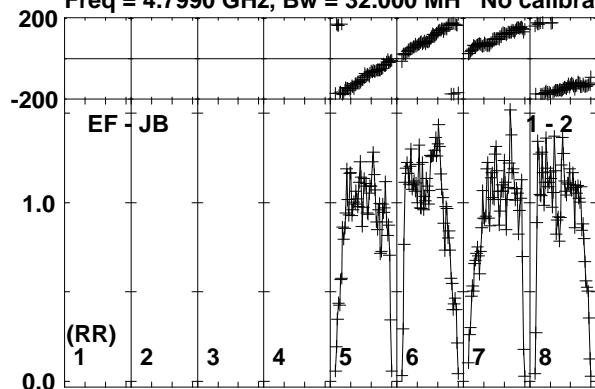

Lower frame: Milli Ampl Jy Top frame: Phas deg  
Vector averaged cross-power spectrum Baseline: EF (01) - JB (02)  
Timerange: 00/11:08:30 to 00/11:09:59

Plot file version 47 created 25-SEP-2017 10:02:23

J1303-2405 RP029B.UVDATA.1

Freq = 4.7990 GHz, Bw = 32.000 MH No calibration applied and no bandpass applied

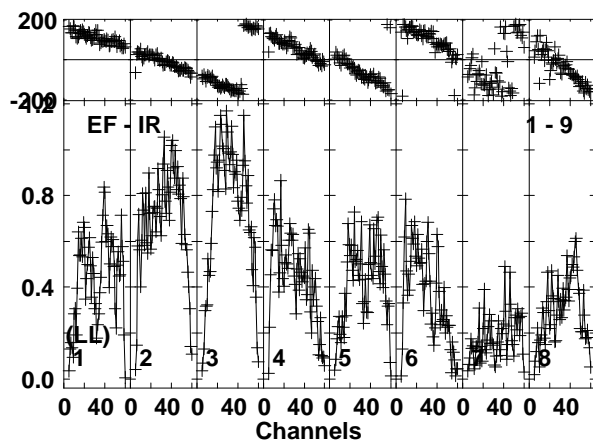
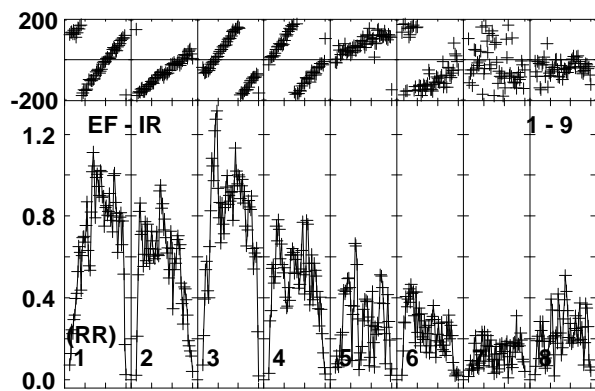
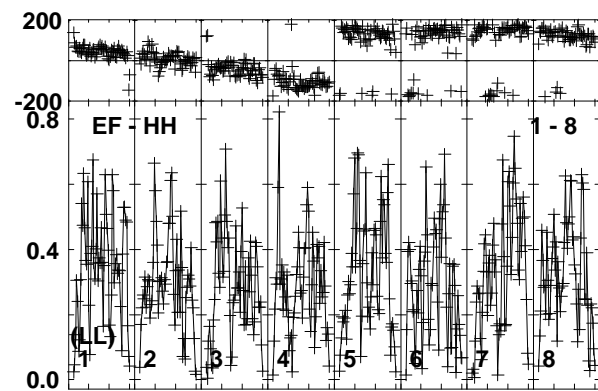
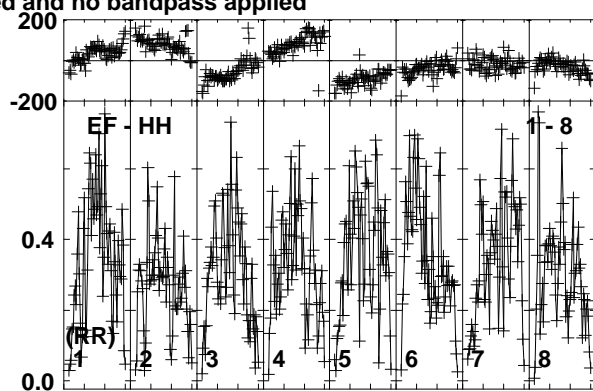
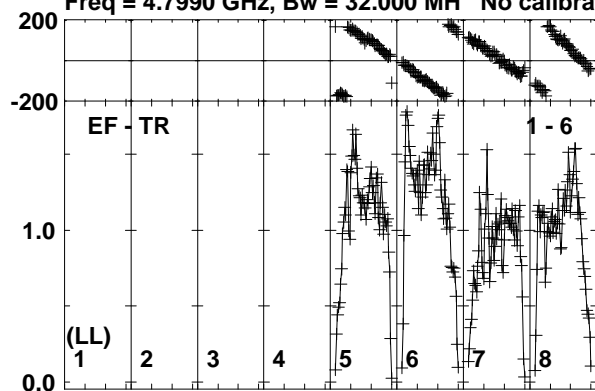

Lower frame: Milli Ampl Jy Top frame: Phas deg  
Vector averaged cross-power spectrum Baseline: EF (01) - TR (06)  
Timerange: 00/11:08:30 to 00/11:09:59

Plot file version 48 created 25-SEP-2017 10:02:23

J1312-2350 RP029B.UVDATA.1

Freq = 4.7990 GHz, Bw = 32.000 MH No calibration applied and no bandpass applied

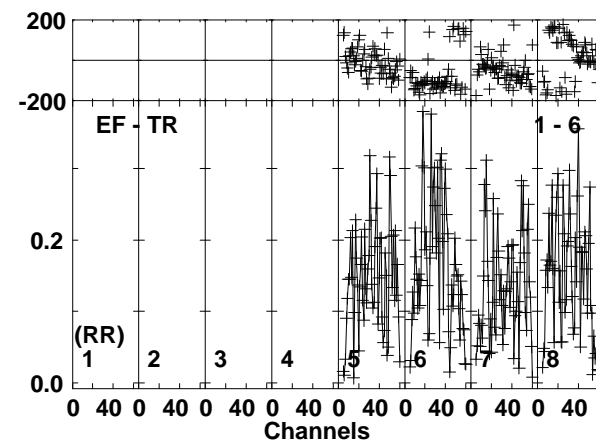
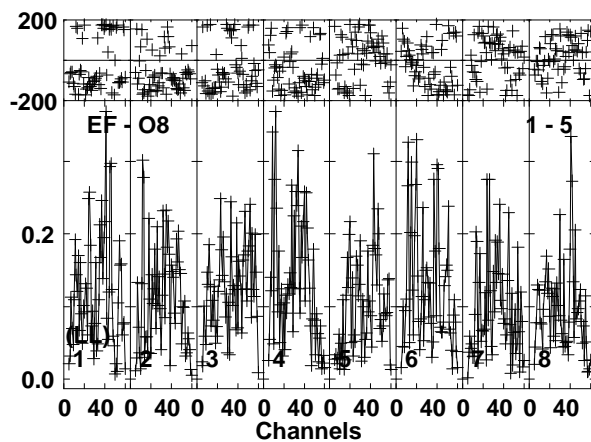
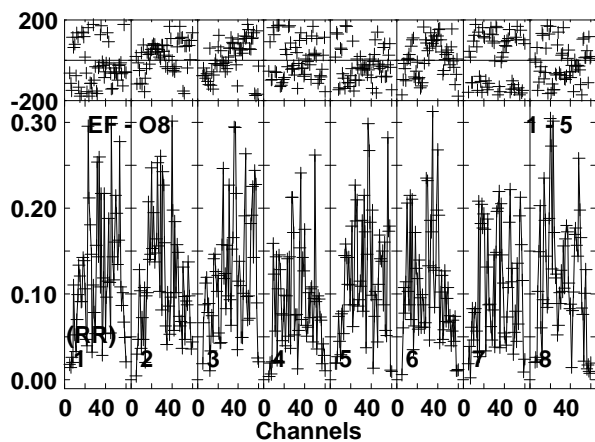
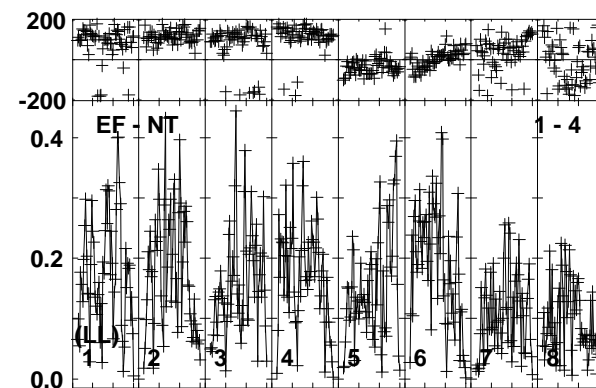
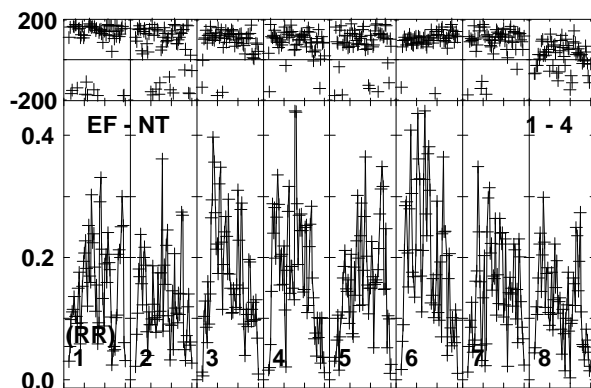
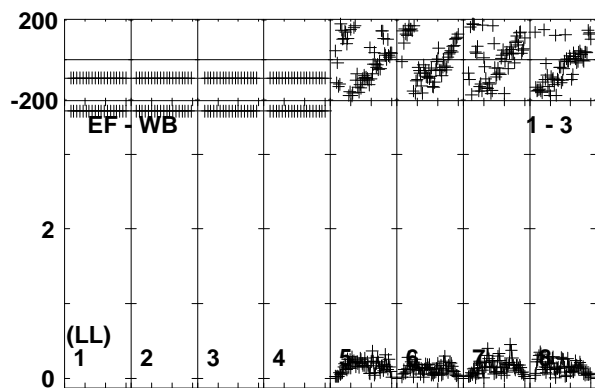
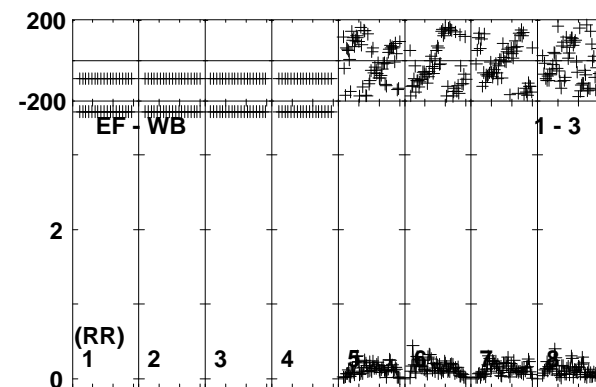
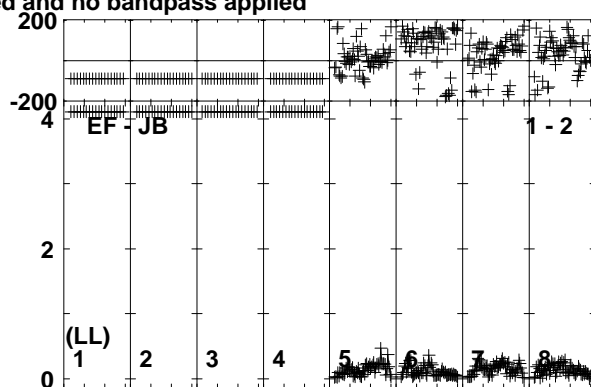
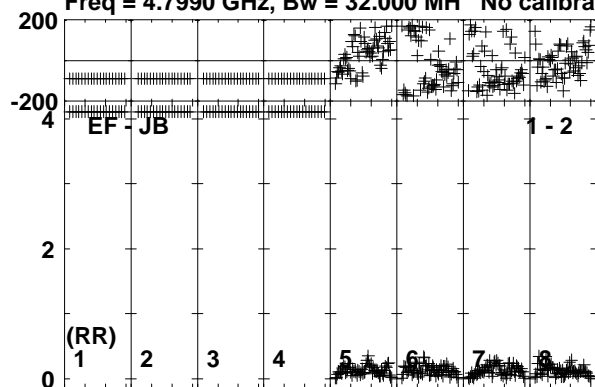

Lower frame: Milli Ampl Jy Top frame: Phas deg  
Vector averaged cross-power spectrum Baseline: EF (01) - JB (02)  
Timerange: 00/11:09:59 to 00/11:12:28



Plot file version 49 created 25-SEP-2017 10:02:23

J1312-2350 RP029B.UVDATA.1

Freq = 4.7990 GHz, Bw = 32.000 MH No calibration applied and no bandpass applied

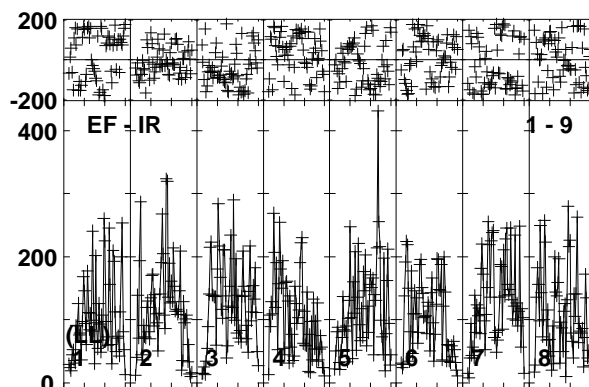
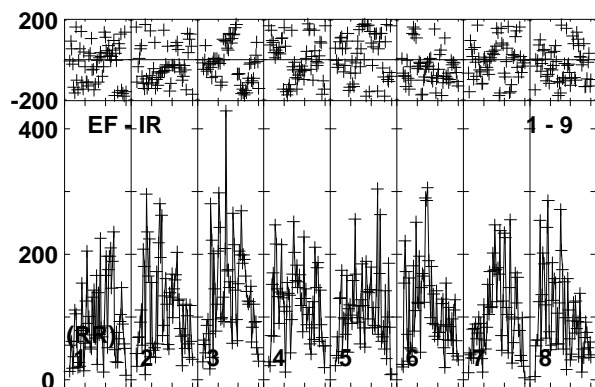
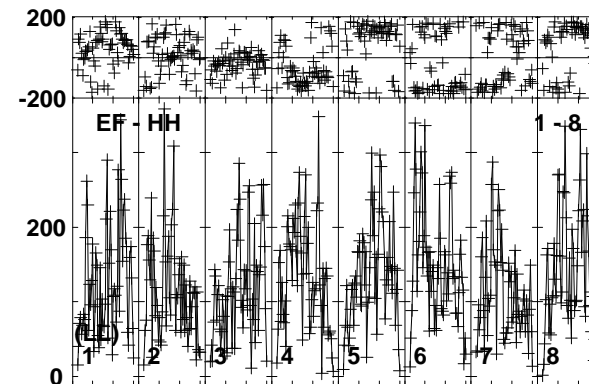
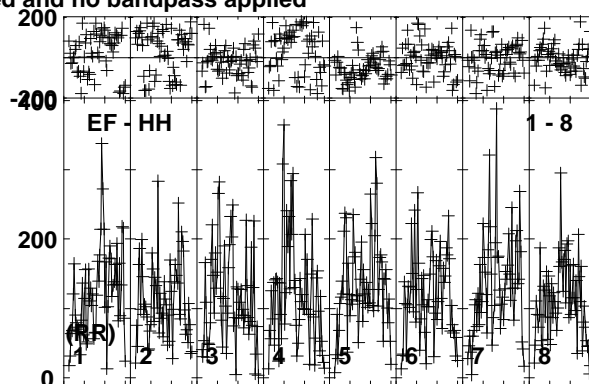
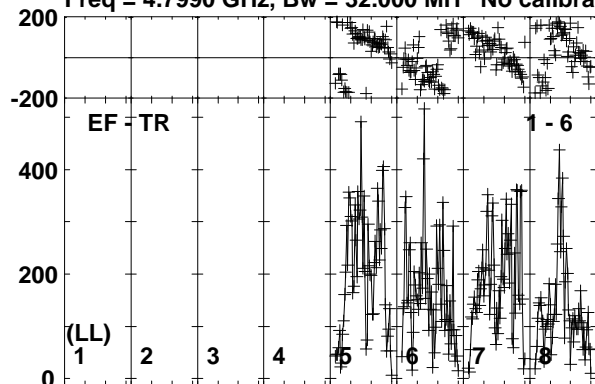

Channels

Lower frame: Micro Ampl Jy Top frame: Phas deg  
Vector averaged cross-power spectrum Baseline: EF (01) - TR (06)  
Timerange: 00/11:09:59 to 00/11:12:28

Plot file version 50 created 25-SEP-2017 10:02:23

J1303-2405 RP029B.UVDATA.1

Freq = 4.7990 GHz, Bw = 32.000 MH No calibration applied and no bandpass applied

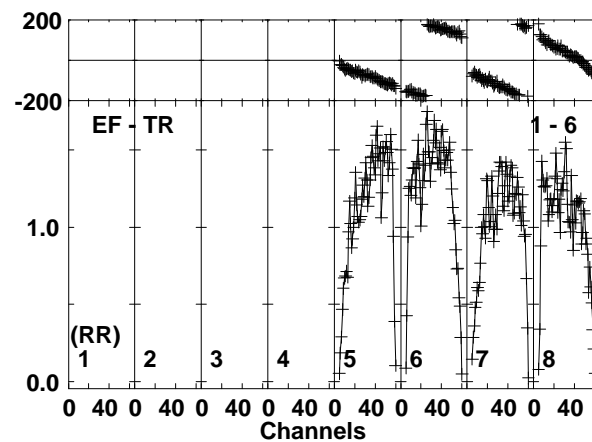
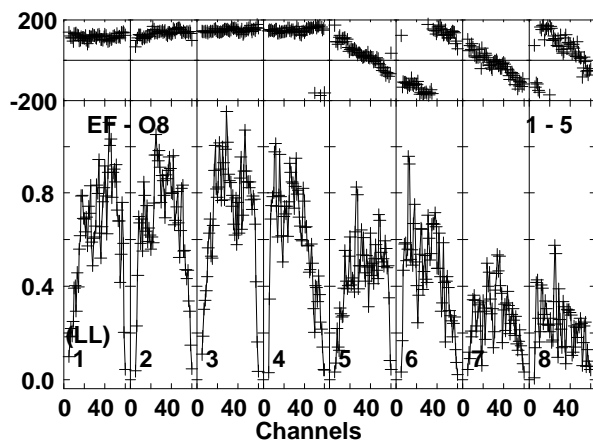
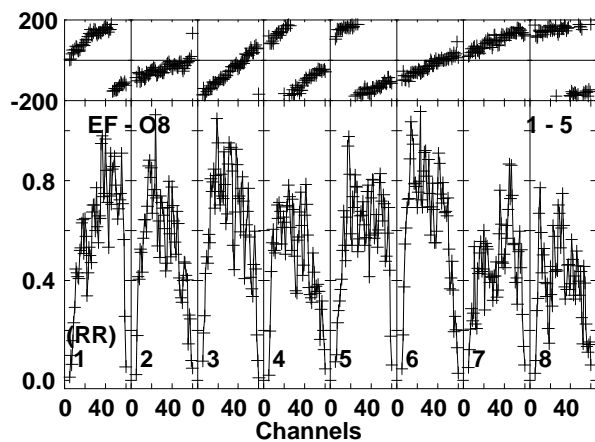
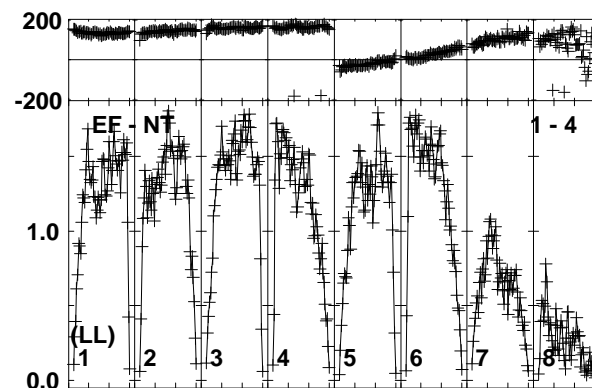
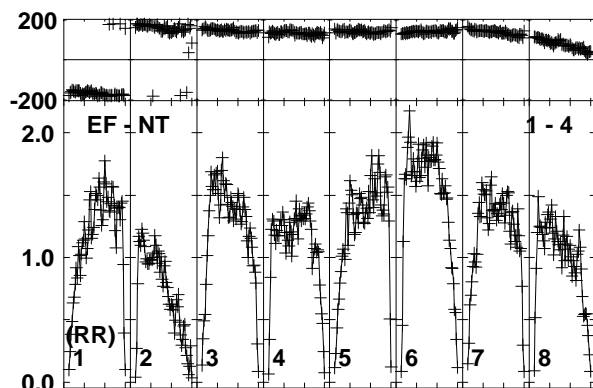
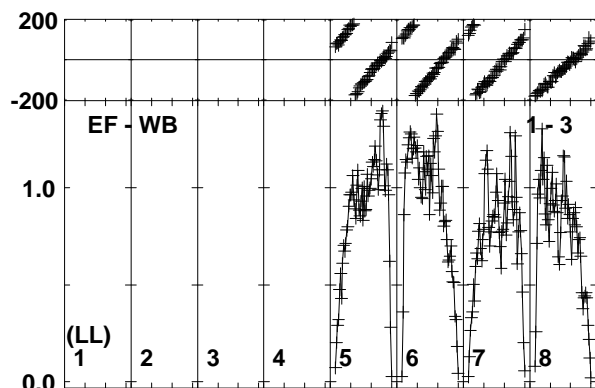
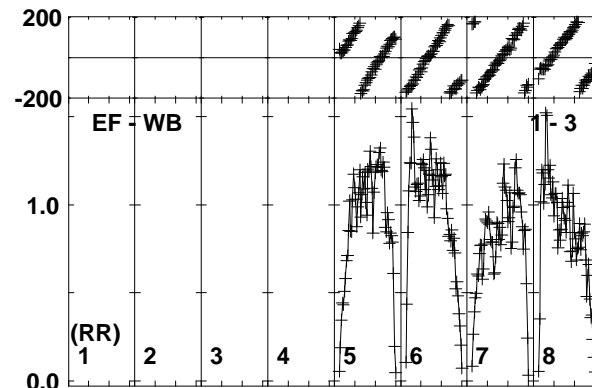
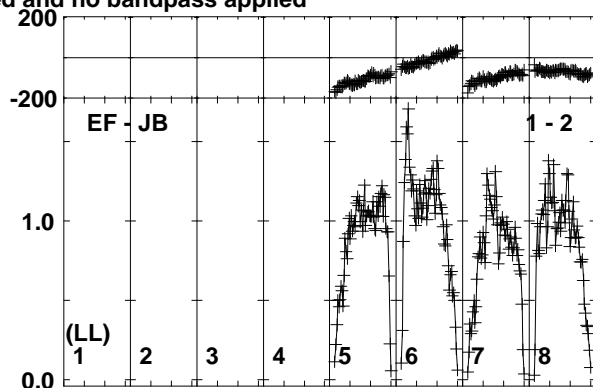
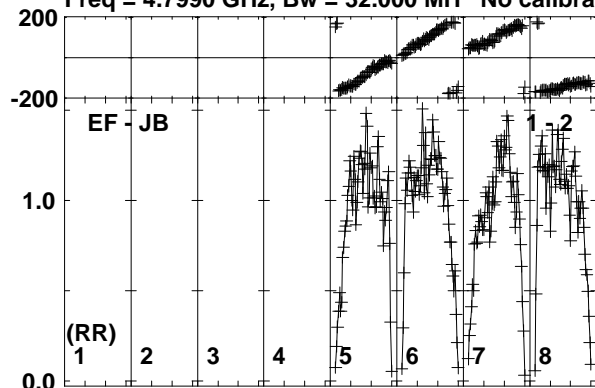

Lower frame: Milli Ampl Jy Top frame: Phas deg  
Vector averaged cross-power spectrum Baseline: EF (01) - JB (02)  
Timerange: 00/11:13:09 to 00/11:14:08

Plot file version 51 created 25-SEP-2017 10:02:23

J1303-2405 RP029B.UVDATA.1

Freq = 4.7990 GHz, Bw = 32.000 MH No calibration applied and no bandpass applied

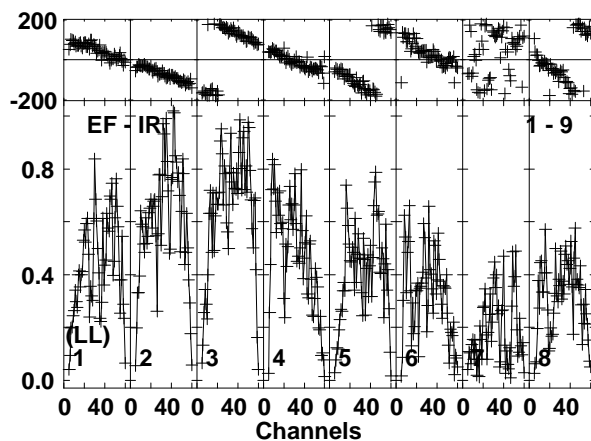
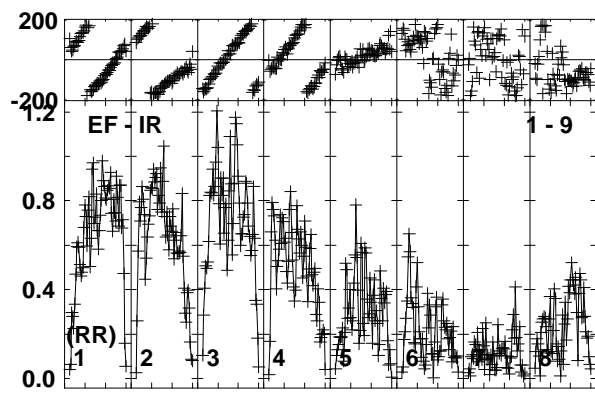
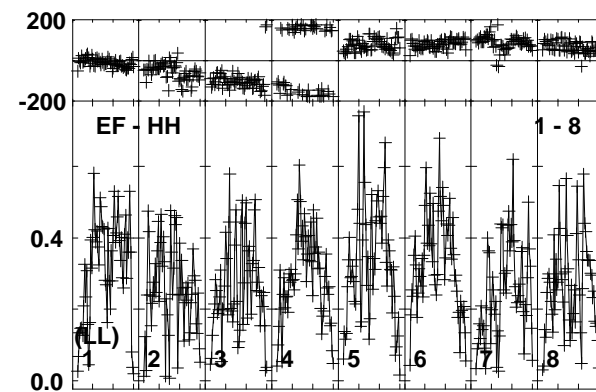
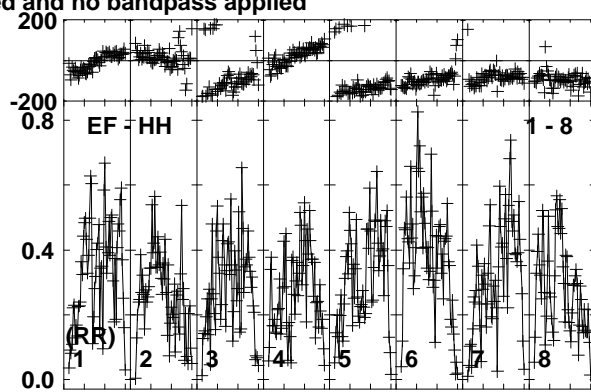
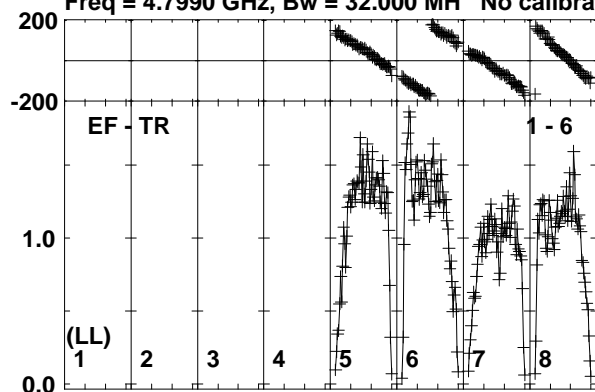

Lower frame: Milli Ampl Jy Top frame: Phas deg  
Vector averaged cross-power spectrum Baseline: EF (01) - TR (06)  
Timerange: 00/11:13:09 to 00/11:14:08

Plot file version 52 created 25-SEP-2017 10:02:24

SSS17A RP029B.UVDATA.1

Freq = 4.7990 GHz, Bw = 32.000 MH No calibration applied and no bandpass applied

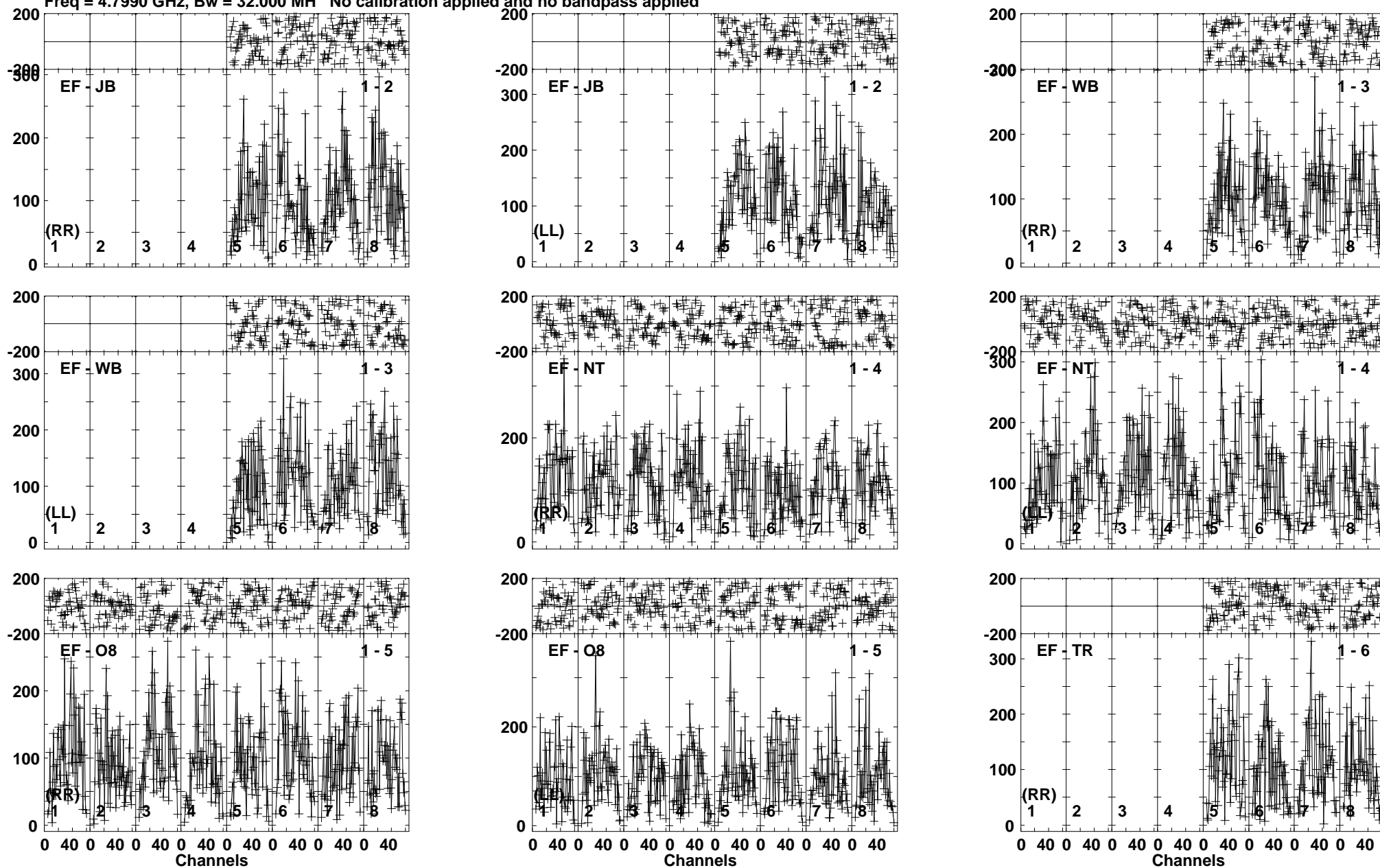

Lower frame: Micro Ampl Jy Top frame: Phas deg  
Vector averaged cross-power spectrum Baseline: EF (01) - JB (02)  
Timerange: 00/11:14:10 to 00/11:16:38

Plot file version 53 created 25-SEP-2017 10:02:24

SSS17A RP029B.UVDATA.1

Freq = 4.7990 GHz, Bw = 32.000 MH No calibration applied and no bandpass applied

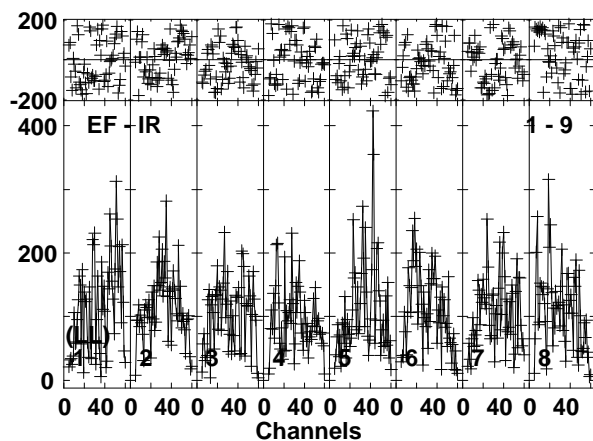
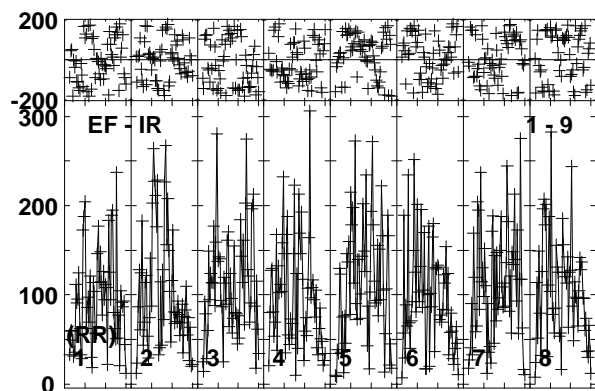
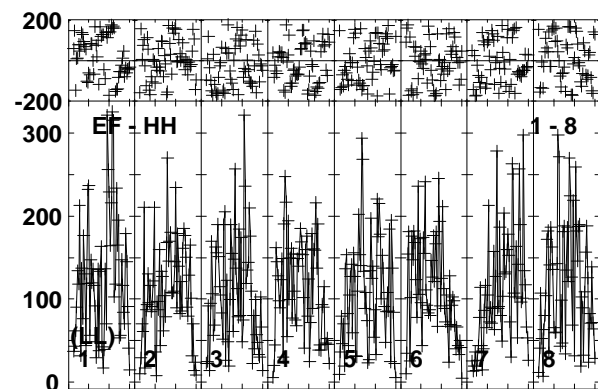
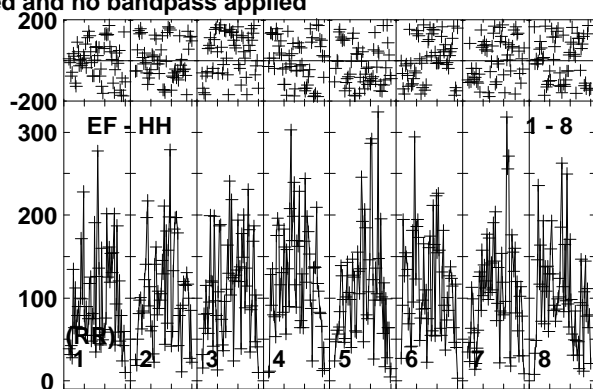
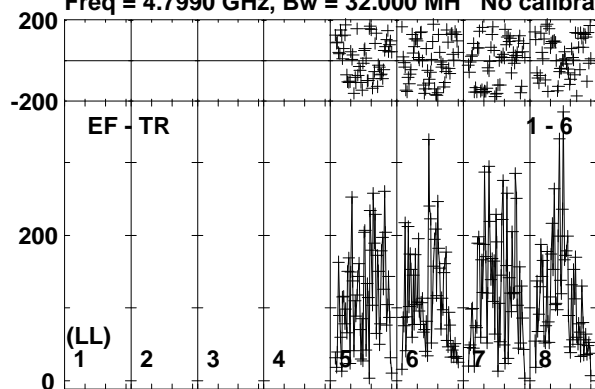

Lower frame: Micro Ampl Jy Top frame: Phas deg  
Vector averaged cross-power spectrum Baseline: EF (01) - TR (06)  
Timerange: 00/11:14:10 to 00/11:16:38

Plot file version 54 created 25-SEP-2017 10:02:24

J1303-2405 RP029B.UVDATA.1

Freq = 4.7990 GHz, Bw = 32.000 MH No calibration applied and no bandpass applied

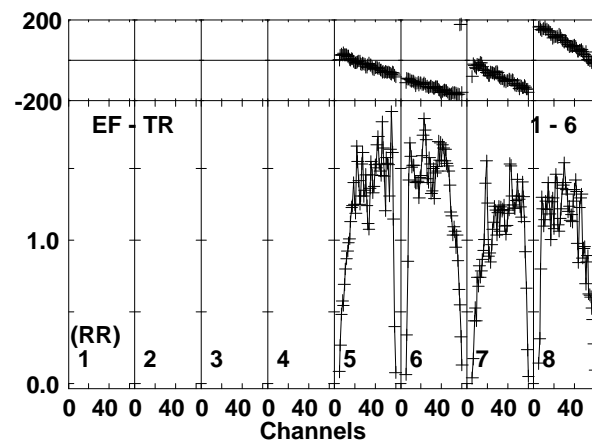
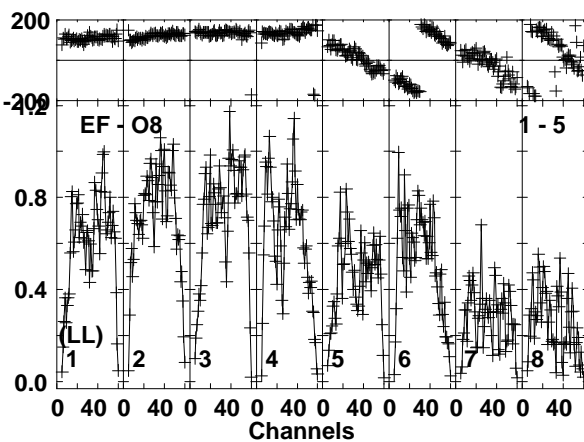
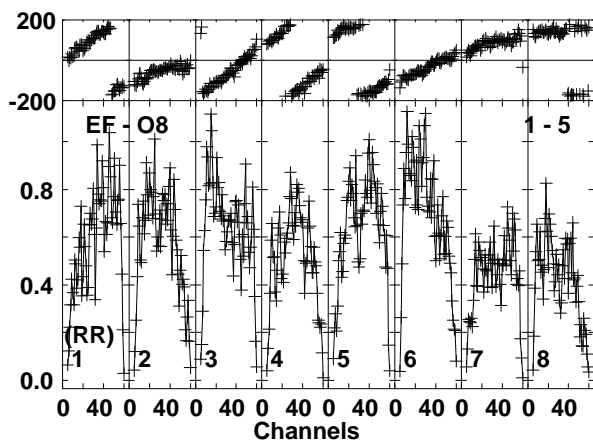
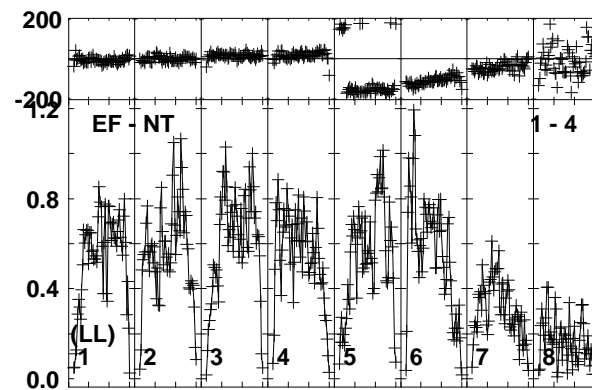
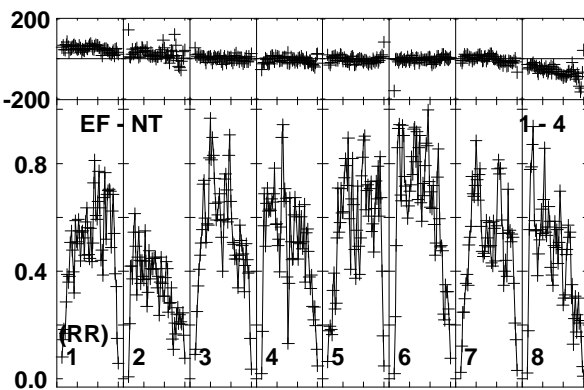
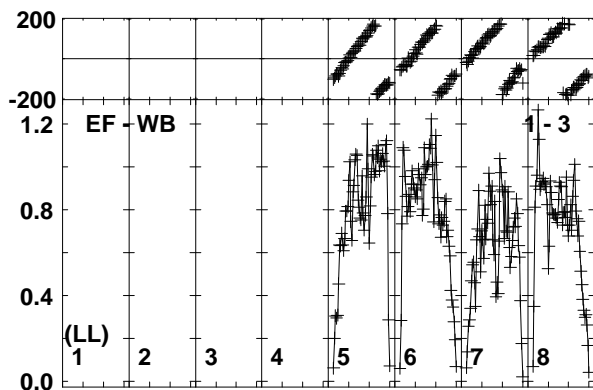
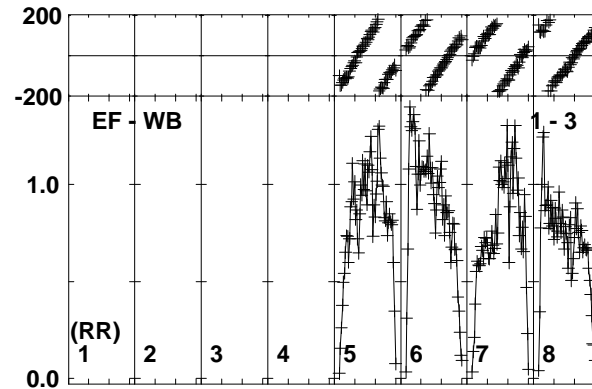
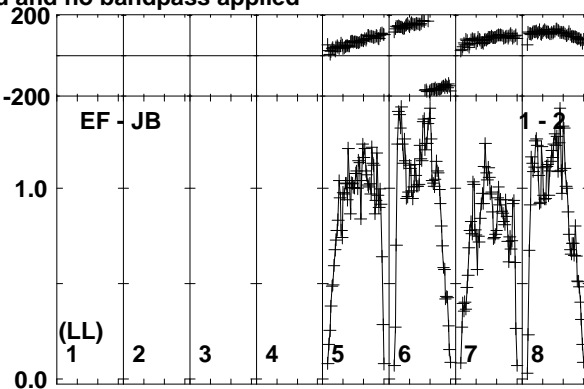
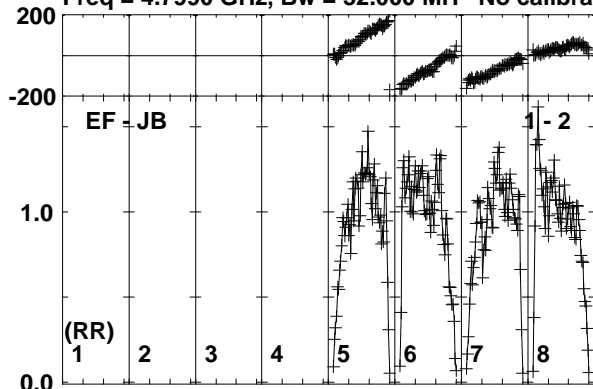

Lower frame: Milli Ampl Jy Top frame: Phas deg  
Vector averaged cross-power spectrum Baseline: EF (01) - JB (02)  
Timerange: 00/11:16:40 to 00/11:18:08

Plot file version 55 created 25-SEP-2017 10:02:24

J1303-2405 RP029B.UVDATA.1

Freq = 4.7990 GHz, Bw = 32.000 MH No calibration applied and no bandpass applied

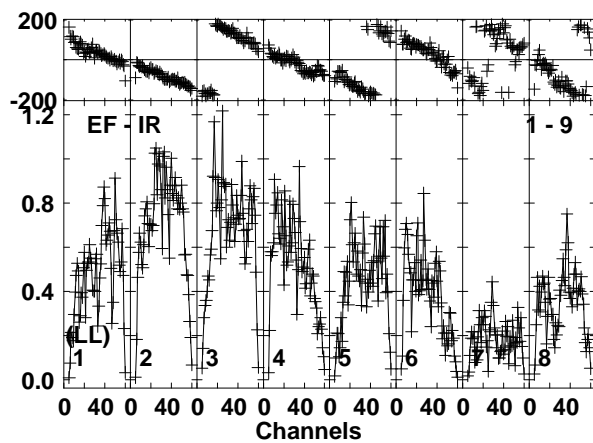
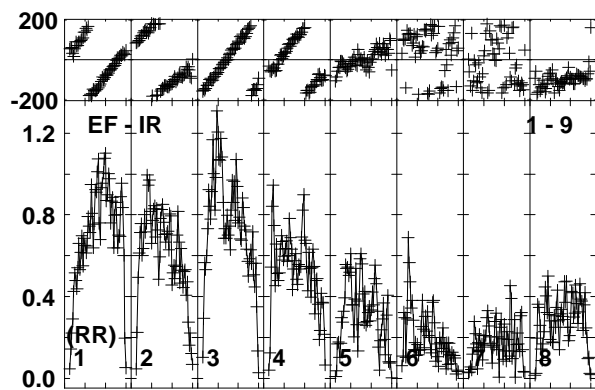
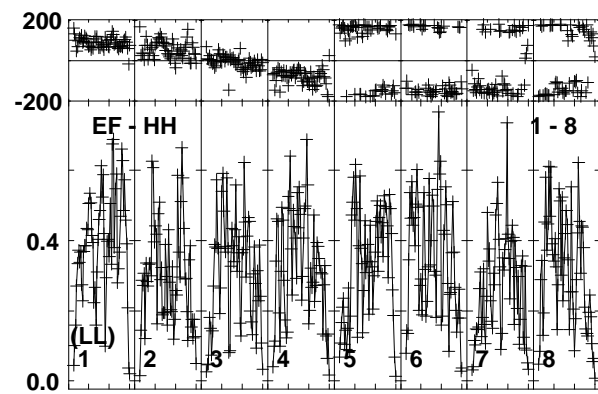
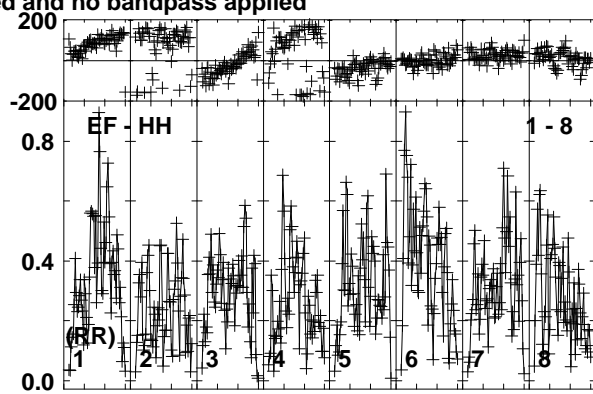
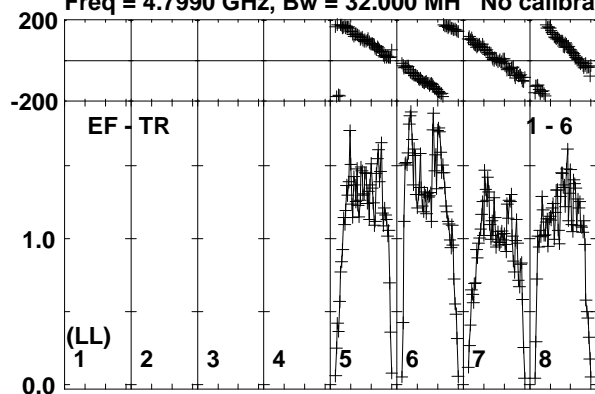

Lower frame: Milli Ampl Jy Top frame: Phas deg  
Vector averaged cross-power spectrum Baseline: EF (01) - TR (06)  
Timerange: 00/11:16:40 to 00/11:18:08

Plot file version 56 created 25-SEP-2017 10:02:24  
 SSS17A\_RP029B.UVDATA.1  
 Freq = 4.7990 GHz, Bw = 32.000 MH No calibration applied and no bandpass applied

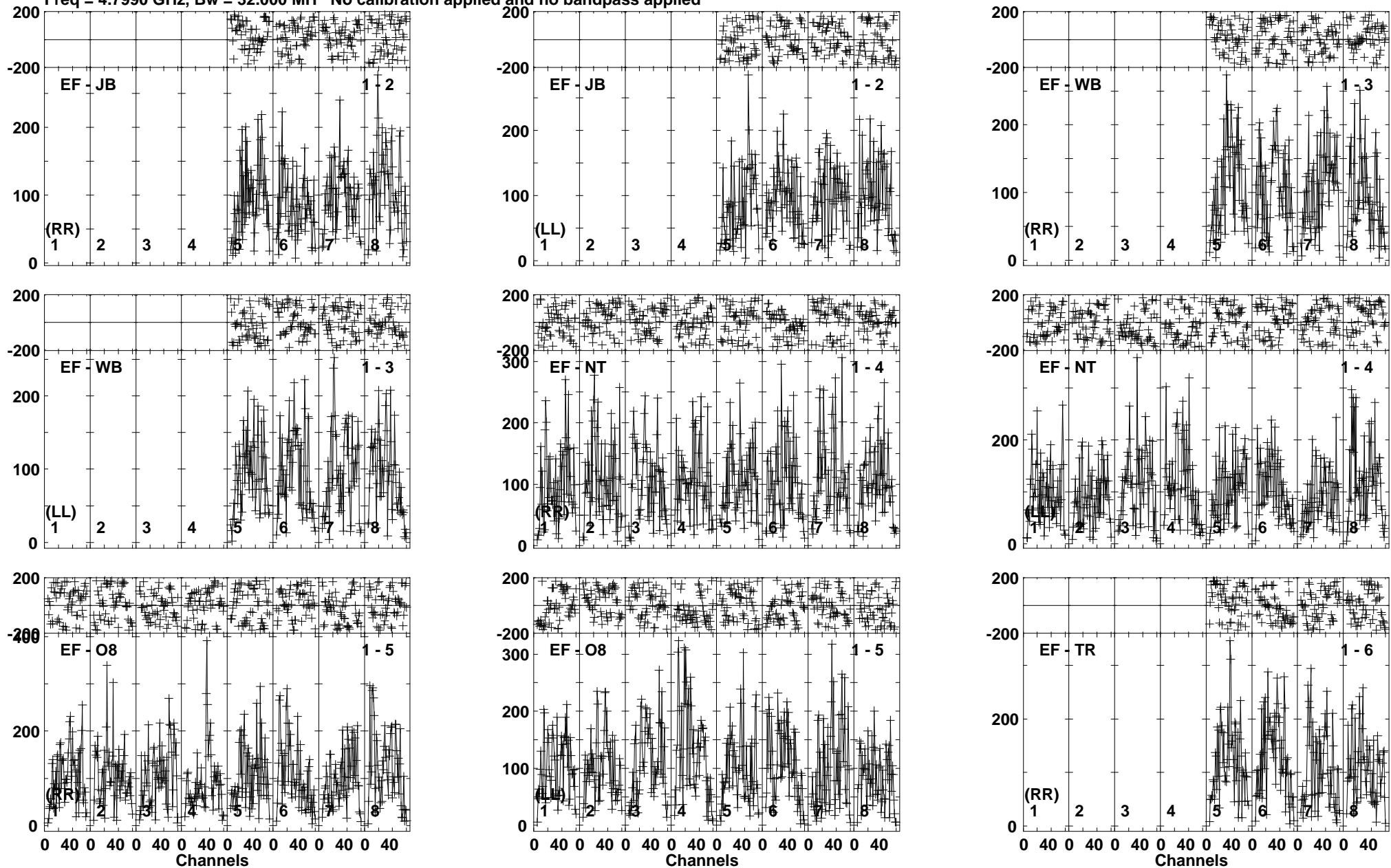

Lower frame: Micro Ampl Jy Top frame: Phas deg  
 Vector averaged cross-power spectrum Baseline: EF (01) - JB (02)  
 Timerange: 00/11:18:10 to 00/11:20:38



Plot file version 57 created 25-SEP-2017 10:02:24

SSS17A RP029B.UVDATA.1

Freq = 4.7990 GHz, Bw = 32.000 MH No calibration applied and no bandpass applied

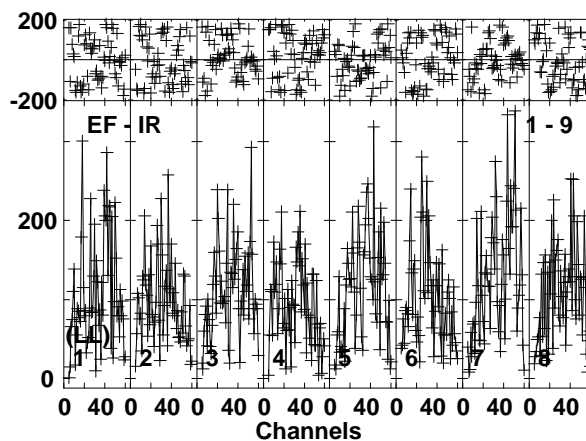
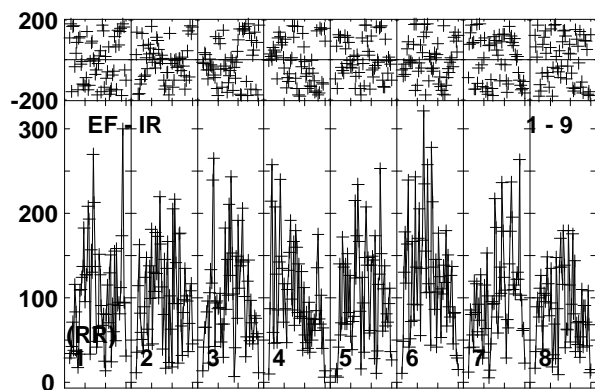
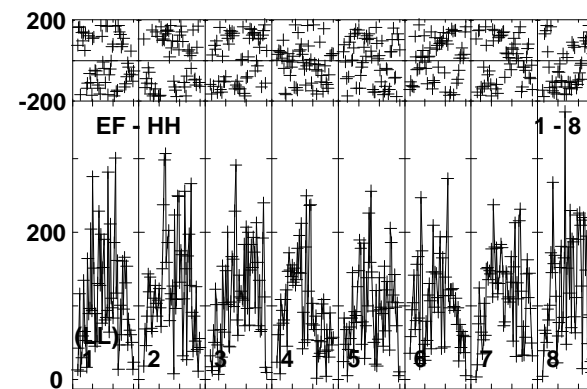
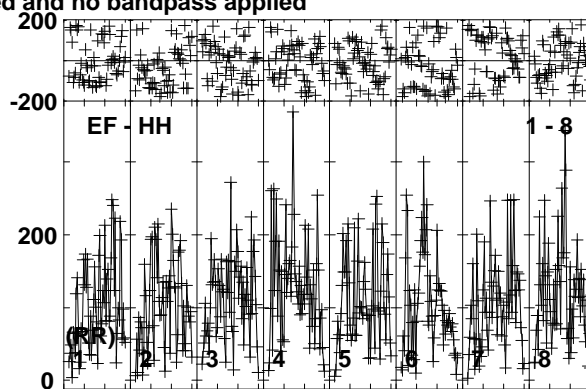
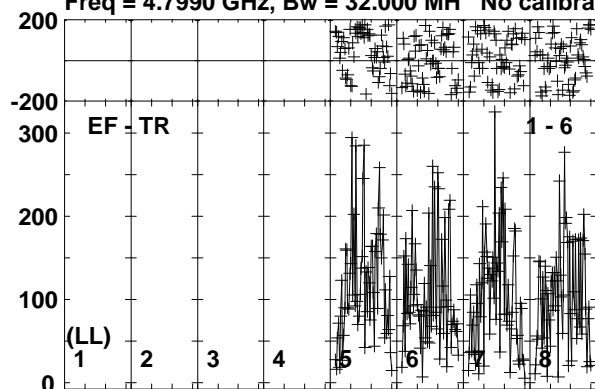

Lower frame: Micro Ampl Jy Top frame: Phas deg  
Vector averaged cross-power spectrum Baseline: EF (01) - TR (06)  
Timerange: 00/11:18:10 to 00/11:20:38

Plot file version 58 created 25-SEP-2017 10:02:25

J1303-2405 RP029B.UVDATA.1

Freq = 4.7990 GHz, Bw = 32.000 MH No calibration applied and no bandpass applied

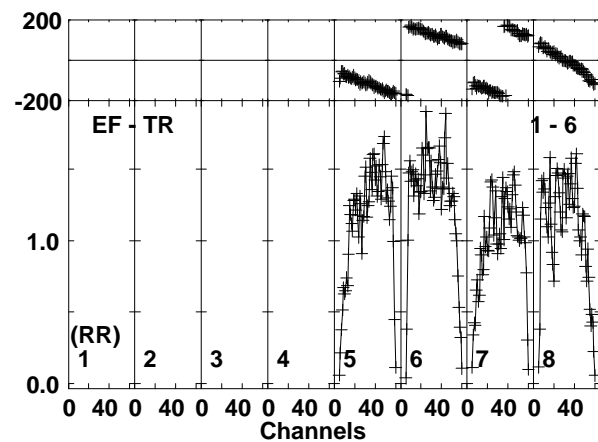
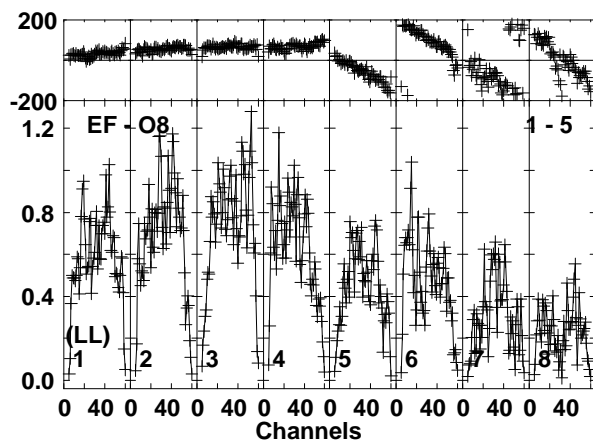
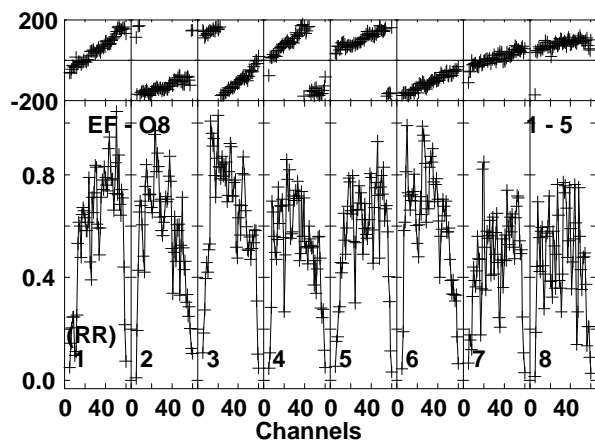
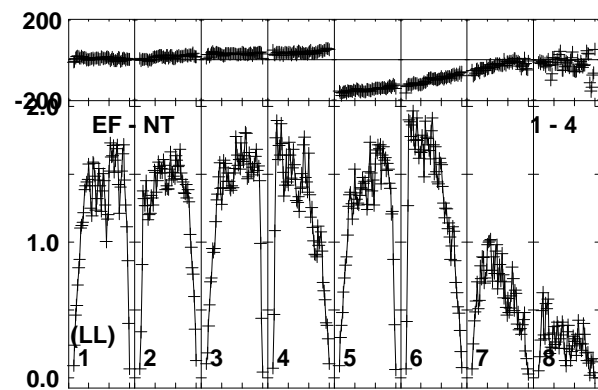
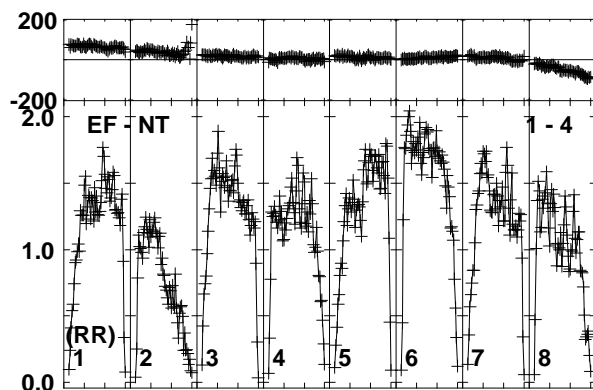
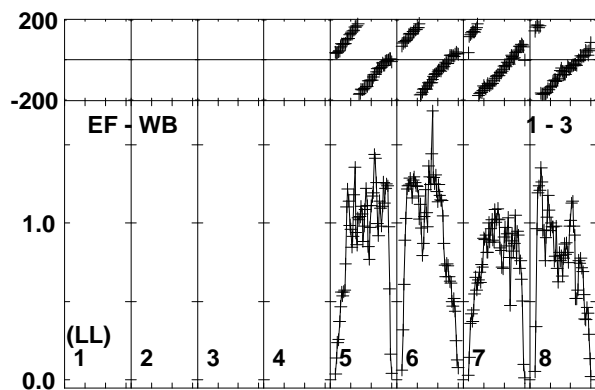
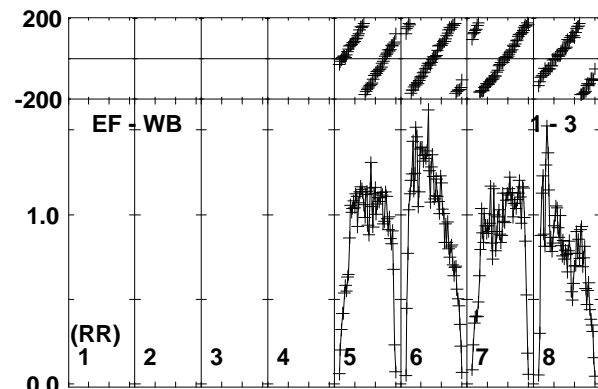
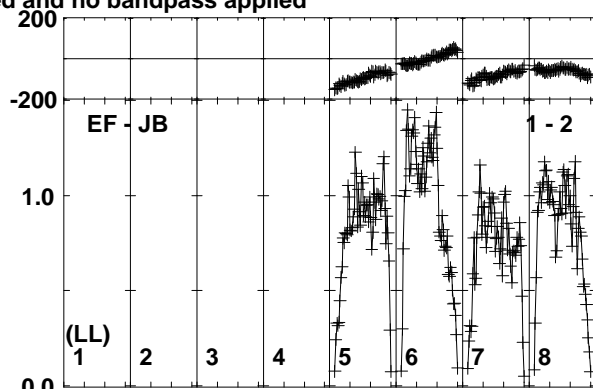
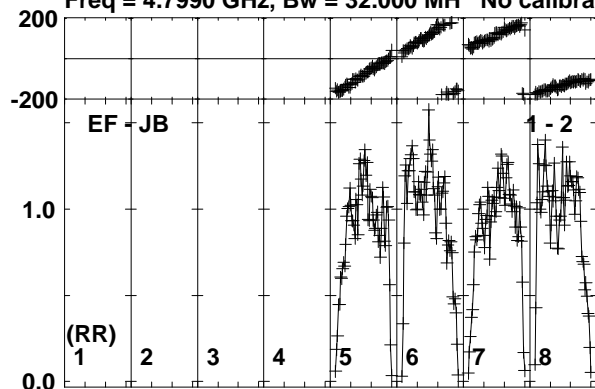

Lower frame: Milli Ampl Jy Top frame: Phas deg  
Vector averaged cross-power spectrum Baseline: EF (01) - JB (02)  
Timerange: 00/11:21:10 to 00/11:22:08

Plot file version 59 created 25-SEP-2017 10:02:25

J1303-2405 RP029B.UVDATA.1

Freq = 4.7990 GHz, Bw = 32.000 MH No calibration applied and no bandpass applied

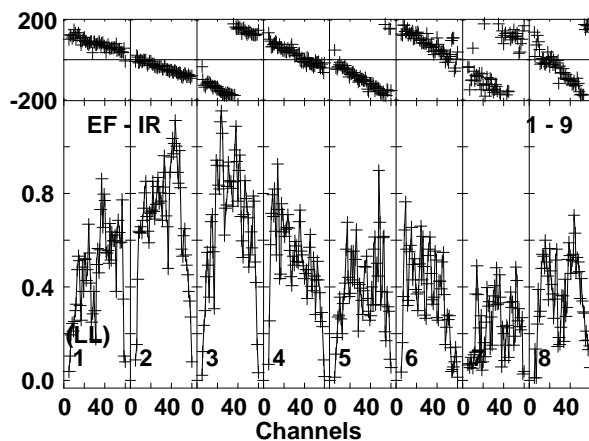
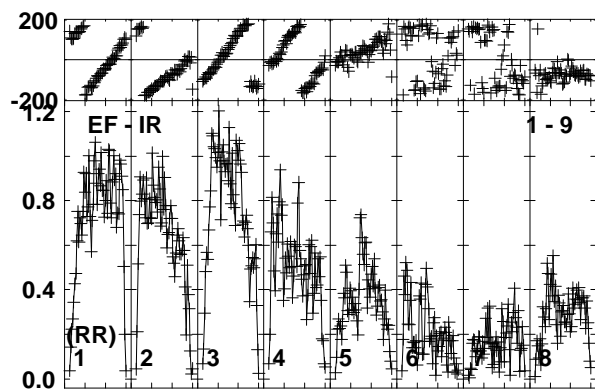
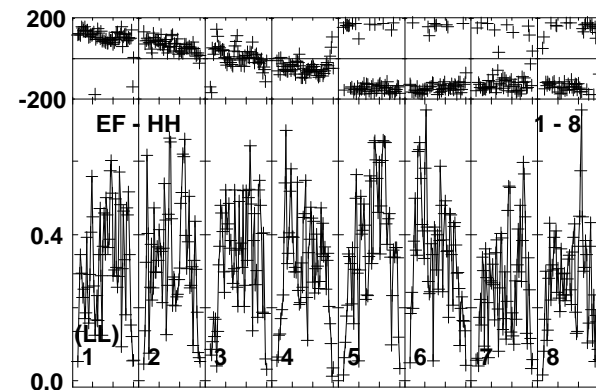
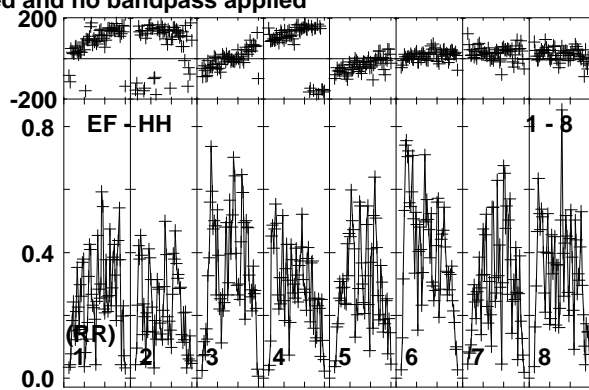
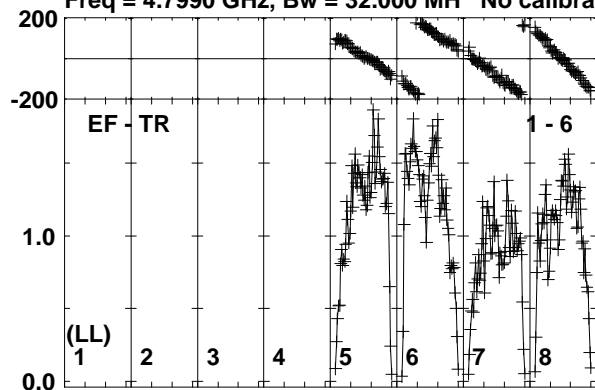

Lower frame: Milli Ampl Jy Top frame: Phas deg  
Vector averaged cross-power spectrum Baseline: EF (01) - TR (06)  
Timerange: 00/11:21:10 to 00/11:22:08

Plot file version 60 created 25-SEP-2017 10:02:25

SSS17A RP029B.UVDATA.1

Freq = 4.7990 GHz, Bw = 32.000 MH No calibration applied and no bandpass applied

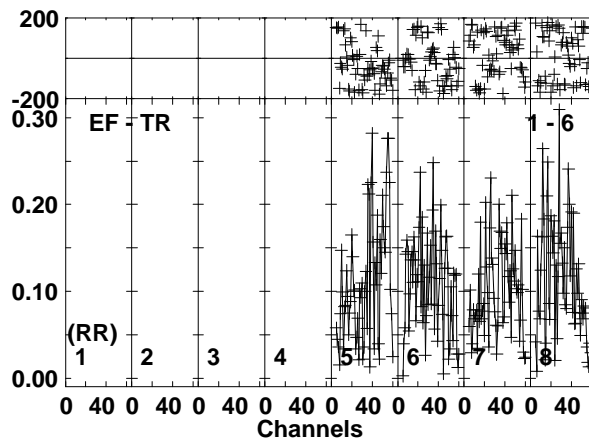
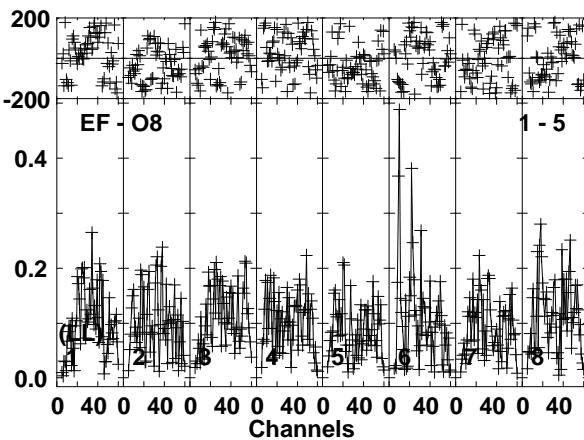
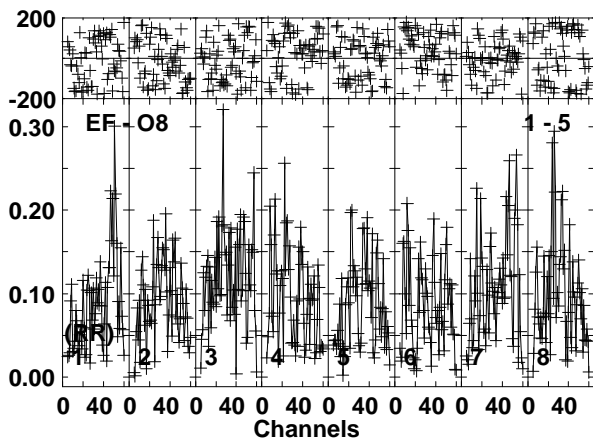
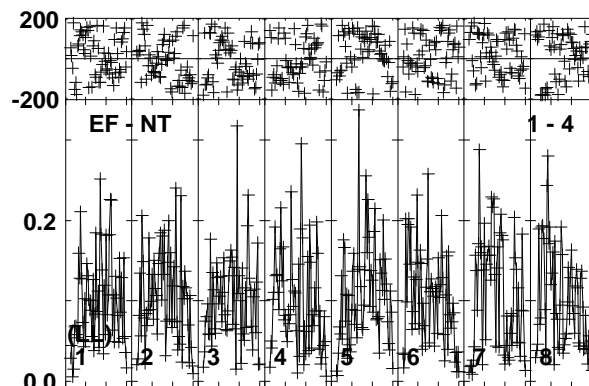
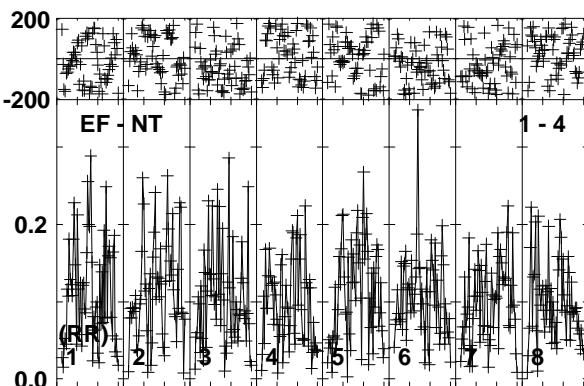
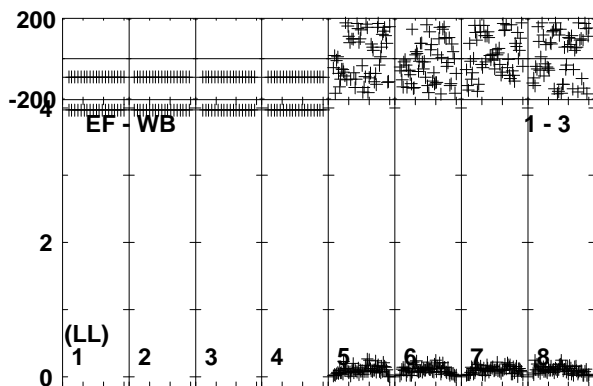
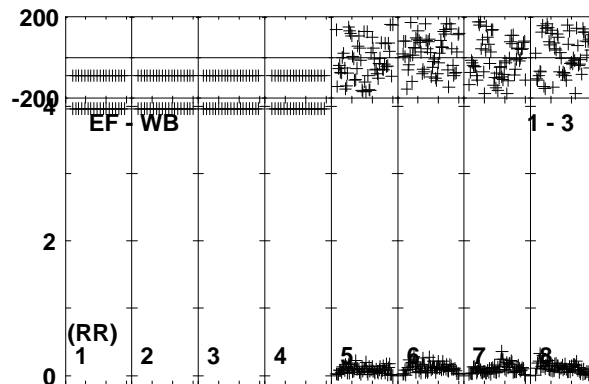
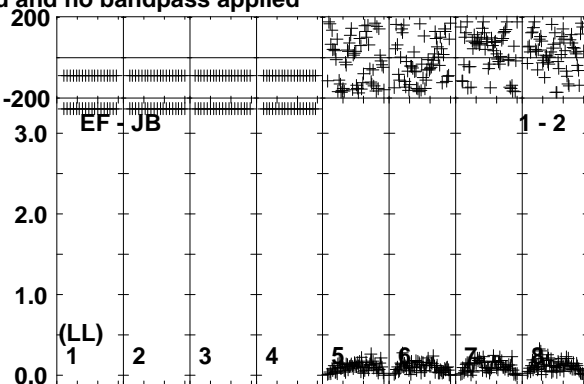
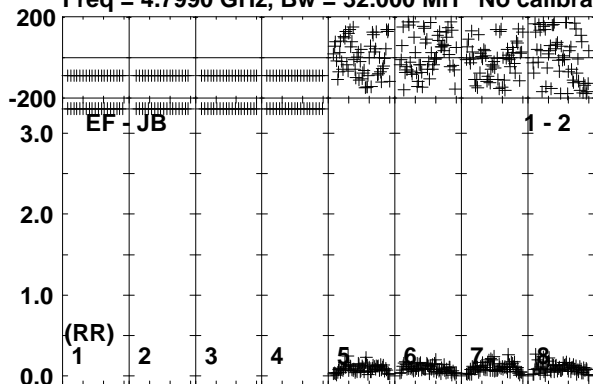

Lower frame: Milli Ampl Jy Top frame: Phas deg  
Vector averaged cross-power spectrum Baseline: EF (01) - JB (02)  
Timerange: 00/11:22:10 to 00/11:24:38

Plot file version 61 created 25-SEP-2017 10:02:25

SSS17A RP029B.UVDATA.1

Freq = 4.7990 GHz, Bw = 32.000 MH No calibration applied and no bandpass applied

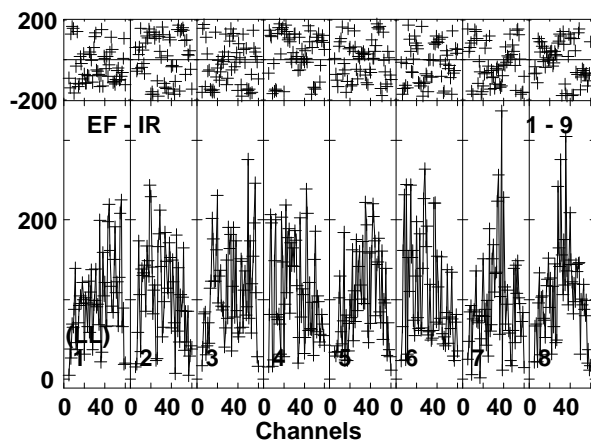
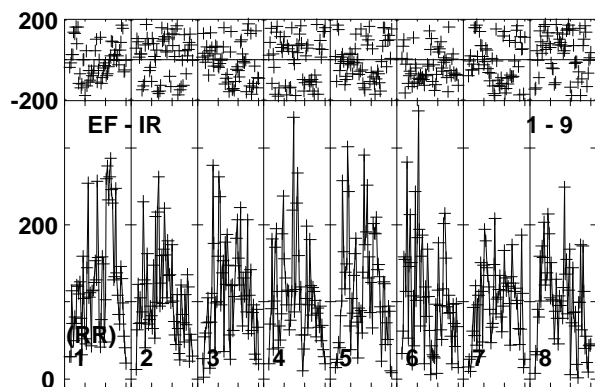
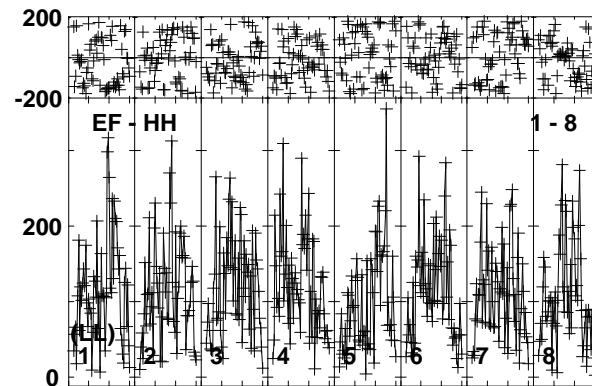
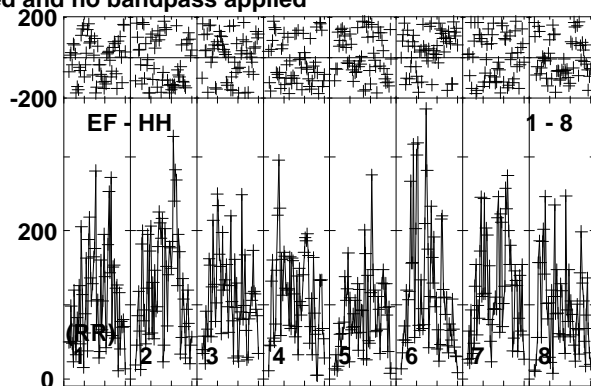
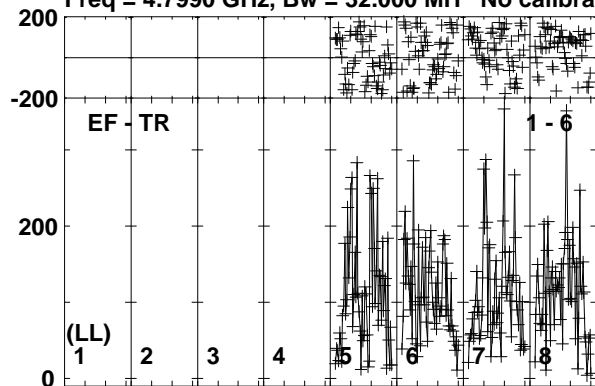

Lower frame: Micro Ampl Jy Top frame: Phas deg  
Vector averaged cross-power spectrum Baseline: EF (01) - TR (06)  
Timerange: 00/11:22:10 to 00/11:24:38

Plot file version 62 created 25-SEP-2017 10:02:25

J1303-2405 RP029B.UVDATA.1

Freq = 4.7990 GHz, Bw = 32.000 MH No calibration applied and no bandpass applied

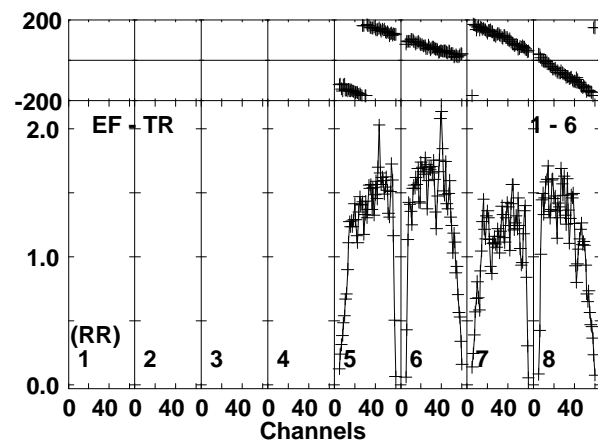
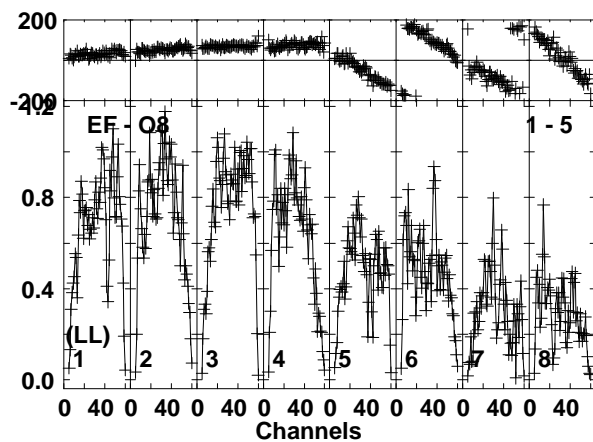
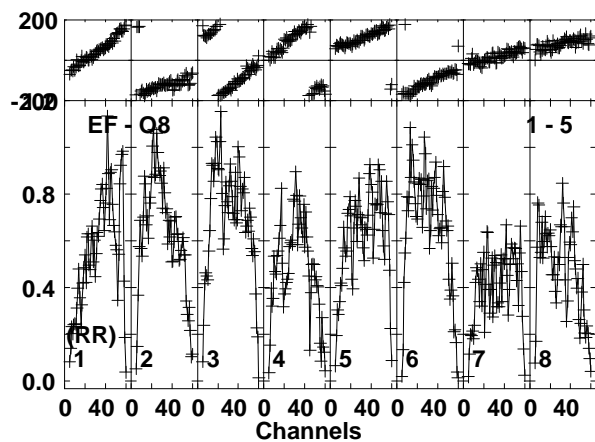
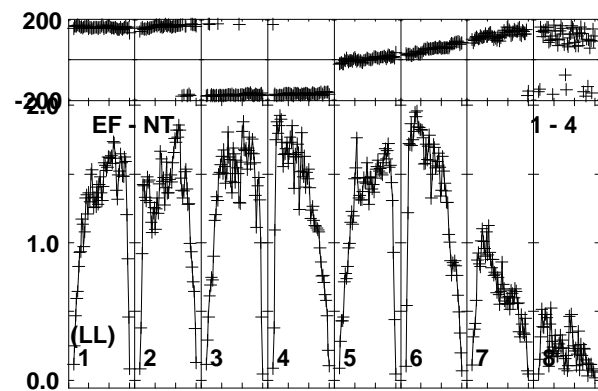
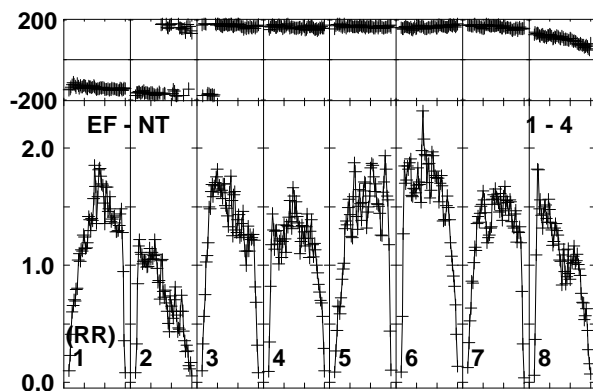
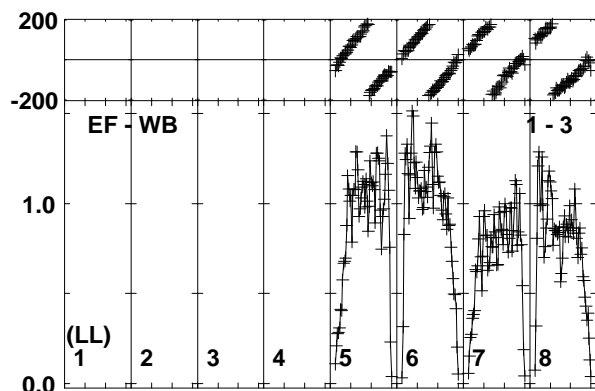
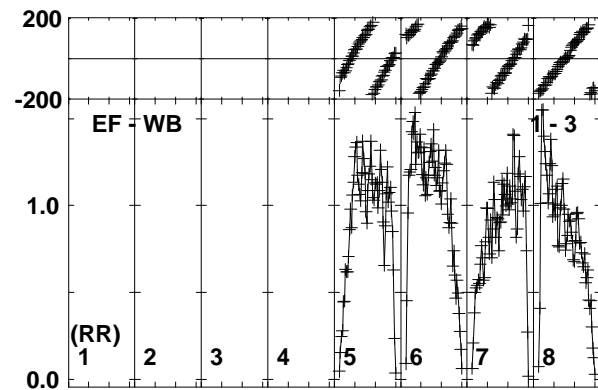
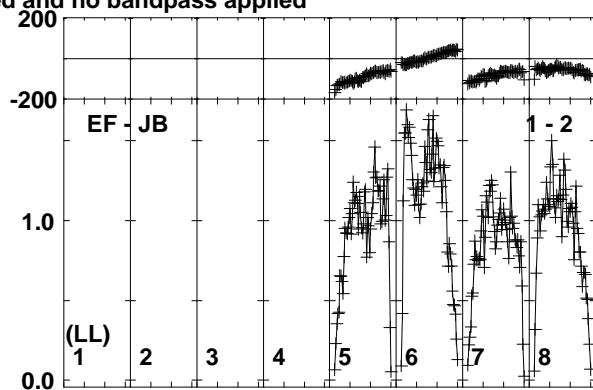
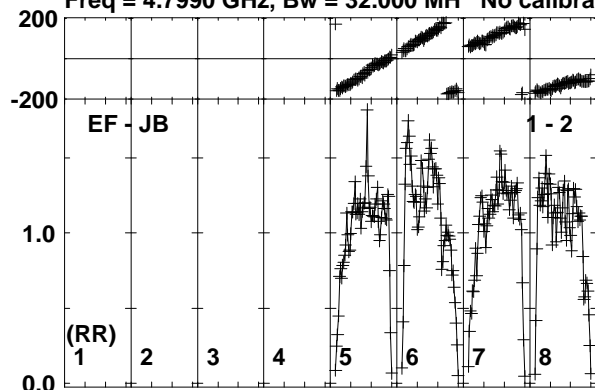

Lower frame: Milli Ampl Jy Top frame: Phas deg  
Vector averaged cross-power spectrum Baseline: EF (01) - JB (02)  
Timerange: 00/11:24:40 to 00/11:26:09

Plot file version 63 created 25-SEP-2017 10:02:25

J1303-2405 RP029B.UVDATA.1

Freq = 4.7990 GHz, Bw = 32.000 MH No calibration applied and no bandpass applied

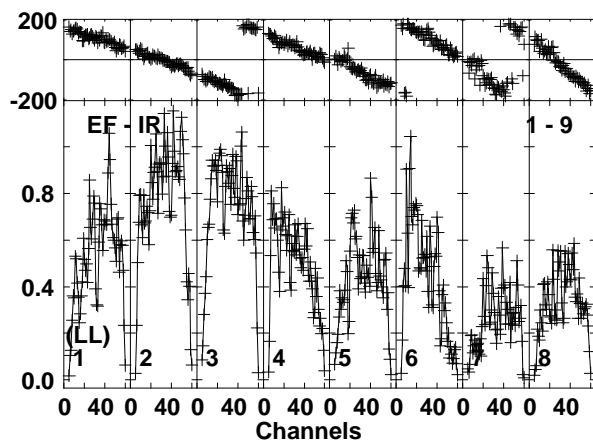
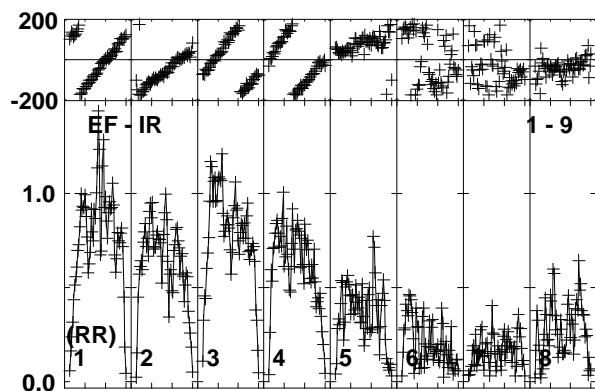
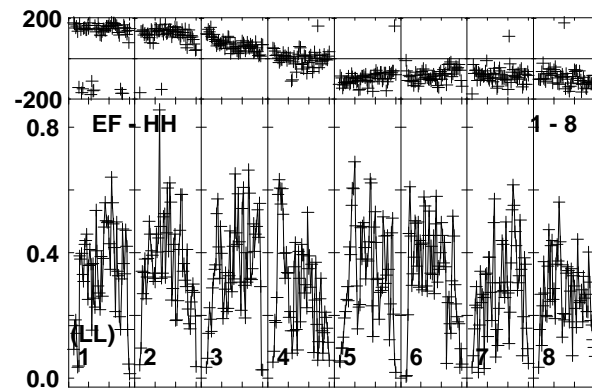
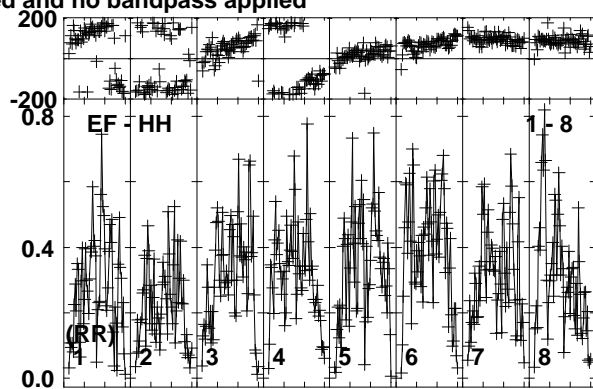
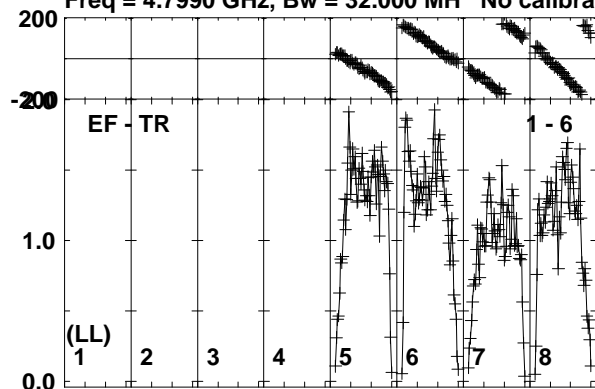

Lower frame: Milli Ampl Jy Top frame: Phas deg  
Vector averaged cross-power spectrum Baseline: EF (01) - TR (06)  
Timerange: 00/11:24:40 to 00/11:26:09

Plot file version 64 created 25-SEP-2017 10:02:25

J1312-2350 RP029B.UVDATA.1

Freq = 4.7990 GHz, Bw = 32.000 MH No calibration applied and no bandpass applied

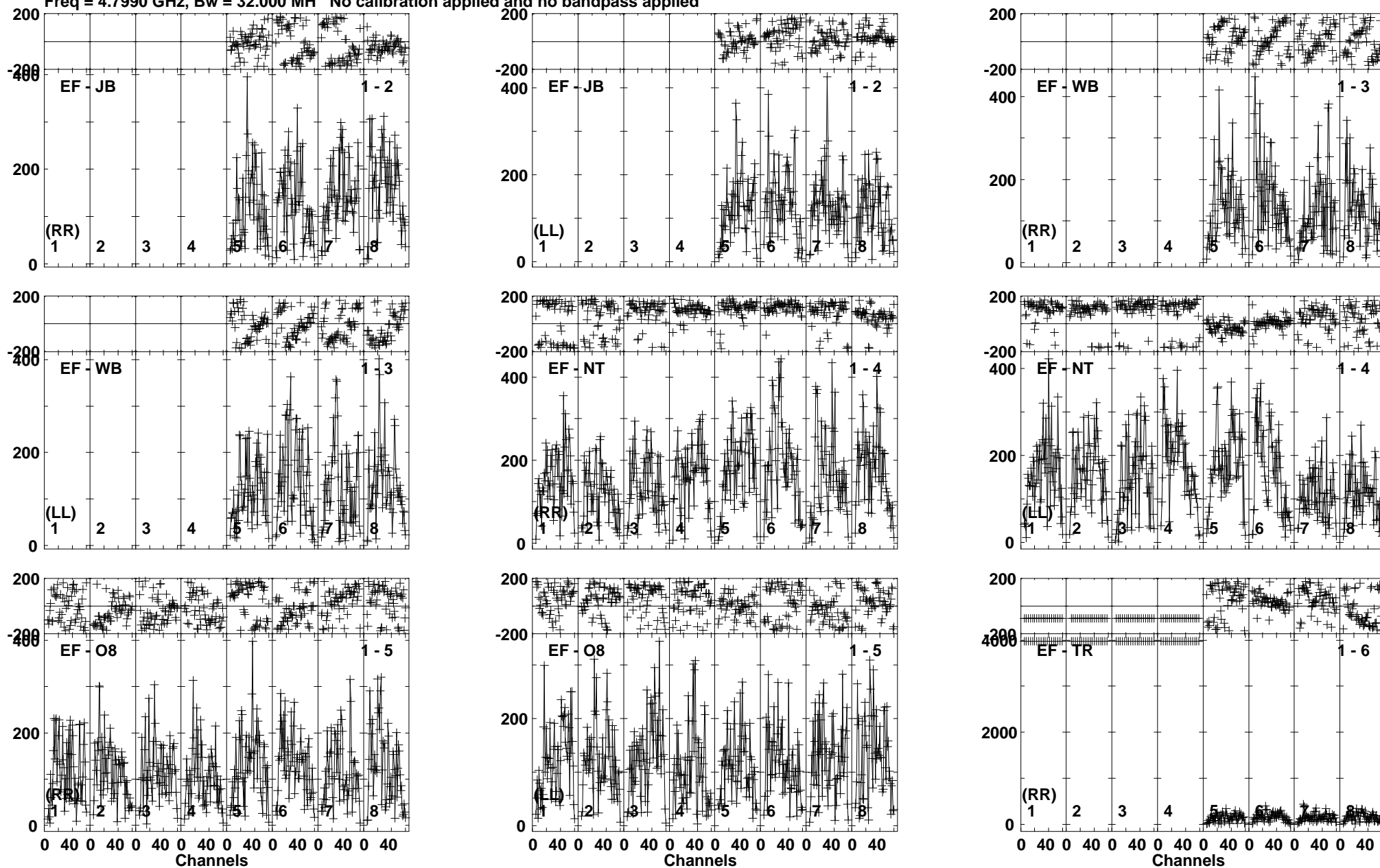

Lower frame: Micro Ampl Jy Top frame: Phas deg  
Vector averaged cross-power spectrum Baseline: EF (01) - JB (02)  
Timerange: 00/11:26:09 to 00/11:28:39



Plot file version 65 created 25-SEP-2017 10:02:26

J1312-2350 RP029B.UVDATA.1

Freq = 4.7990 GHz, Bw = 32.000 MH No calibration applied and no bandpass applied

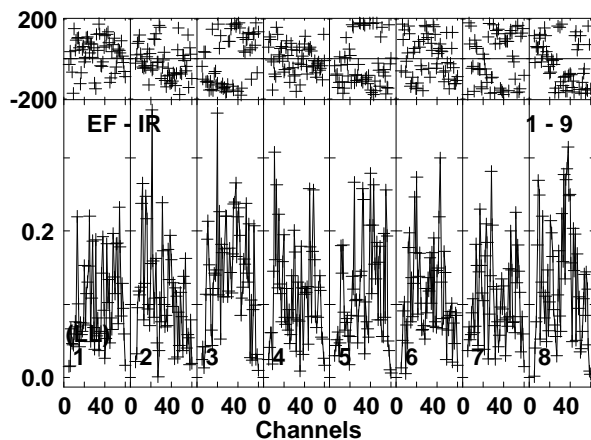
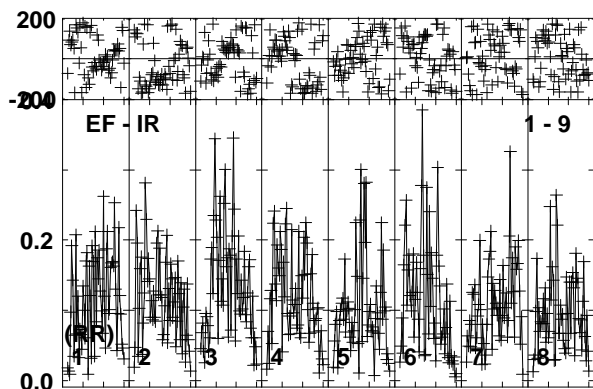
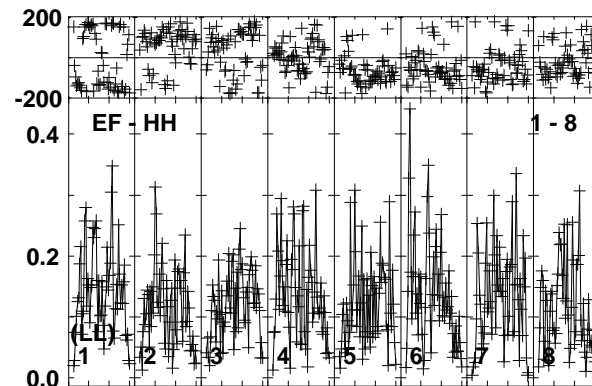
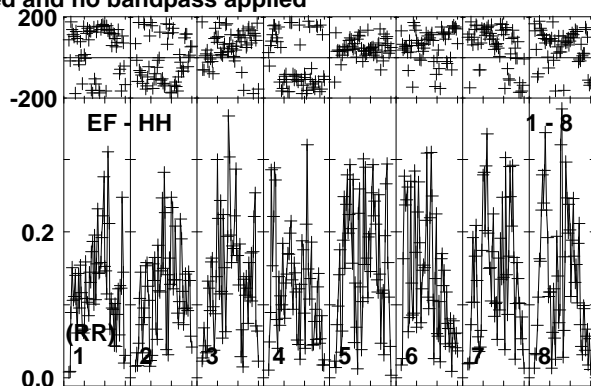
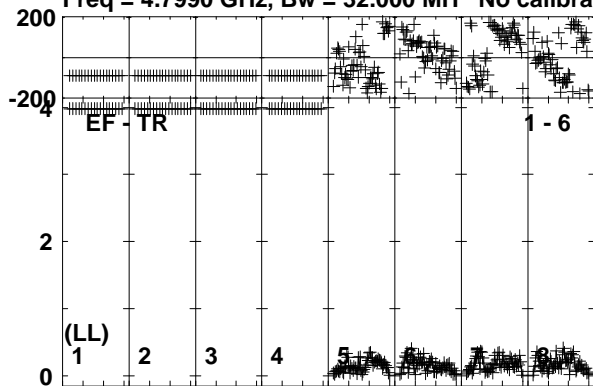

Lower frame: Milli Ampl Jy Top frame: Phas deg  
Vector averaged cross-power spectrum Baseline: EF (01) - TR (06)  
Timerange: 00/11:26:09 to 00/11:28:39

Plot file version 66 created 25-SEP-2017 10:02:26

J1303-2405 RP029B.UVDATA.1

Freq = 4.7990 GHz, Bw = 32.000 MH No calibration applied and no bandpass applied

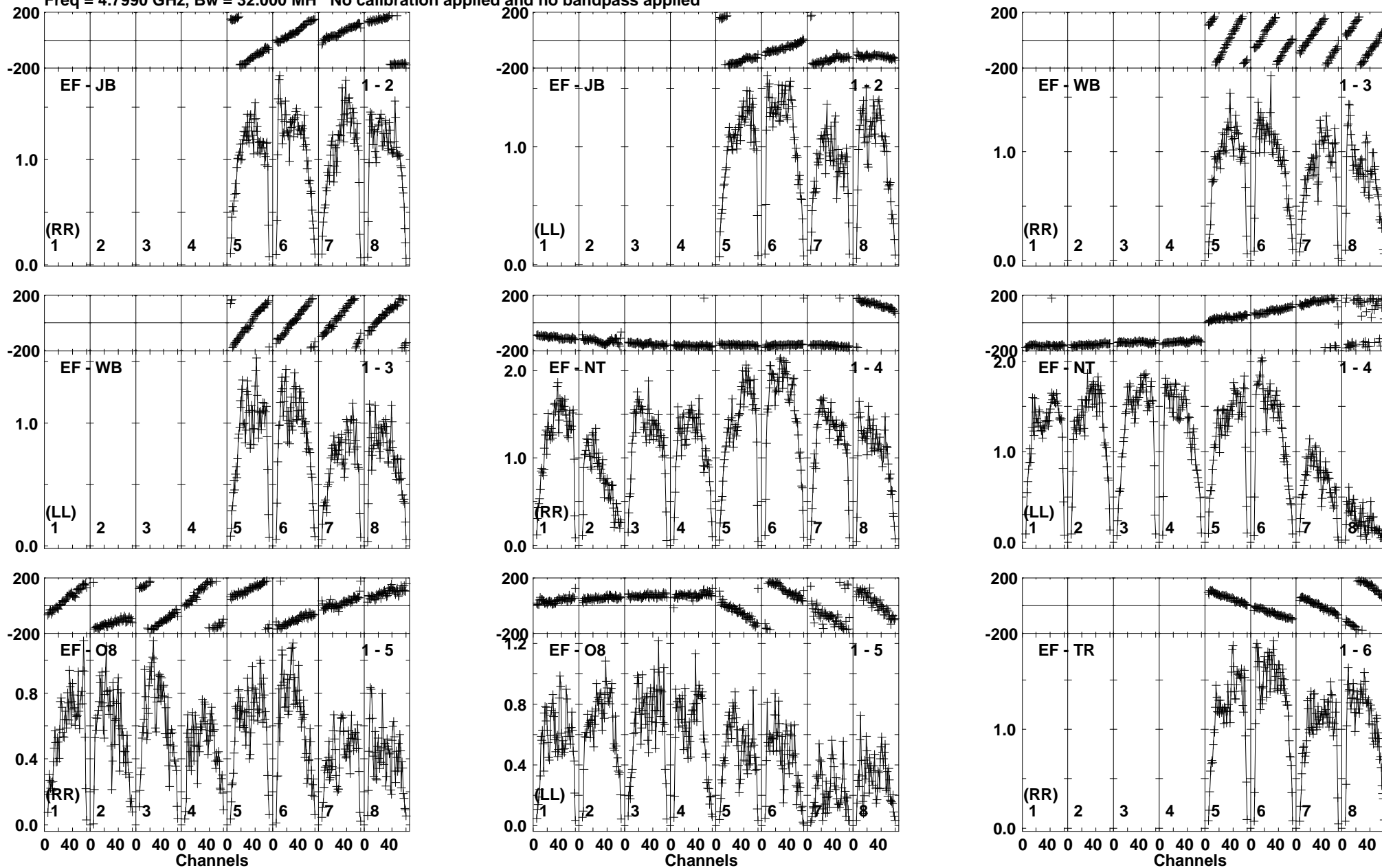

Lower frame: Milli Ampl Jy Top frame: Phas deg  
Vector averaged cross-power spectrum Baseline: EF (01) - JB (02)  
Timerange: 00/11:29:20 to 00/11:30:18

Plot file version 67 created 25-SEP-2017 10:02:26

J1303-2405 RP029B.UVDATA.1

Freq = 4.7990 GHz, Bw = 32.000 MH No calibration applied and no bandpass applied

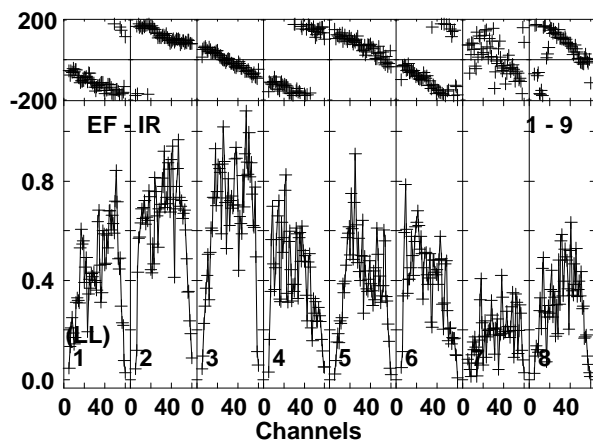
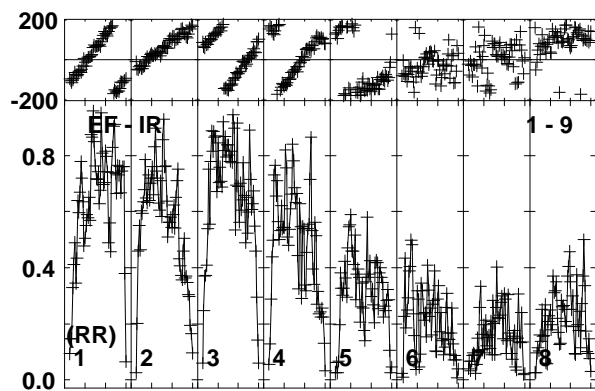
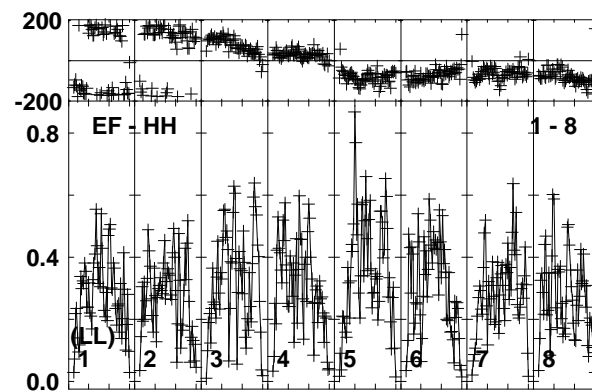
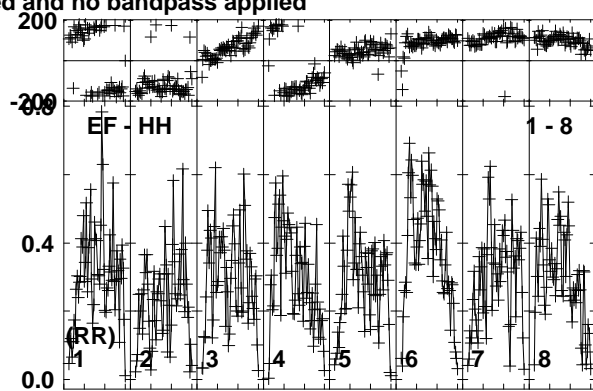
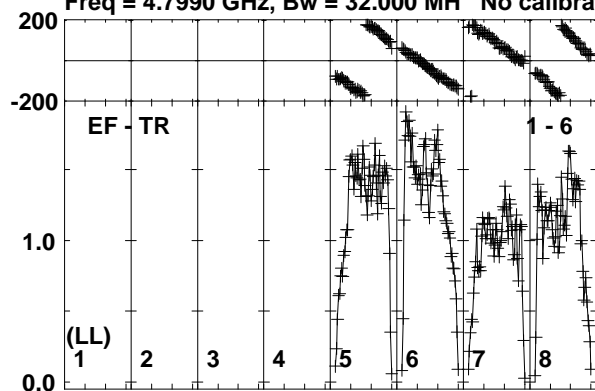

Lower frame: Milli Ampl Jy Top frame: Phas deg  
Vector averaged cross-power spectrum Baseline: EF (01) - TR (06)  
Timerange: 00/11:29:20 to 00/11:30:18

Plot file version 68 created 25-SEP-2017 10:02:26

SSS17A RP029B.UVDATA.1

Freq = 4.7990 GHz, Bw = 32.000 MH No calibration applied and no bandpass applied

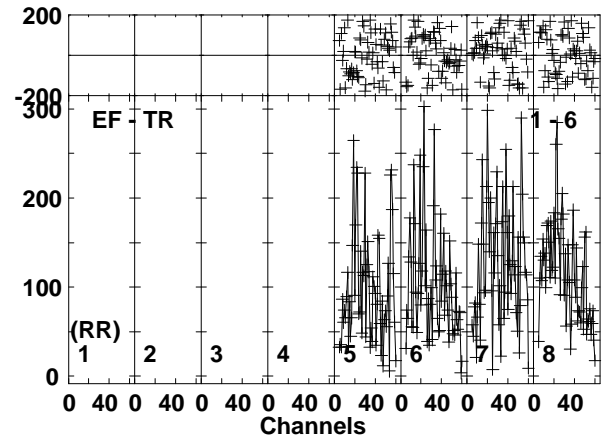
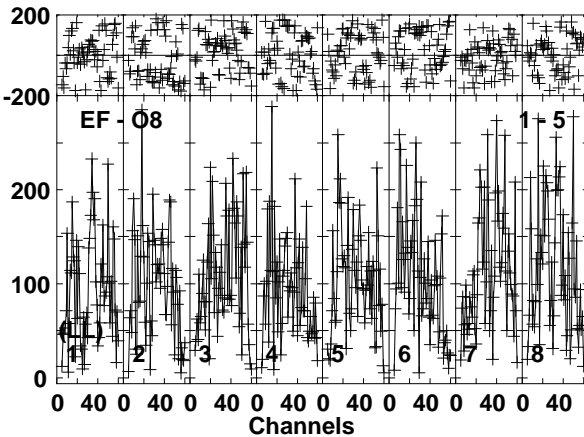
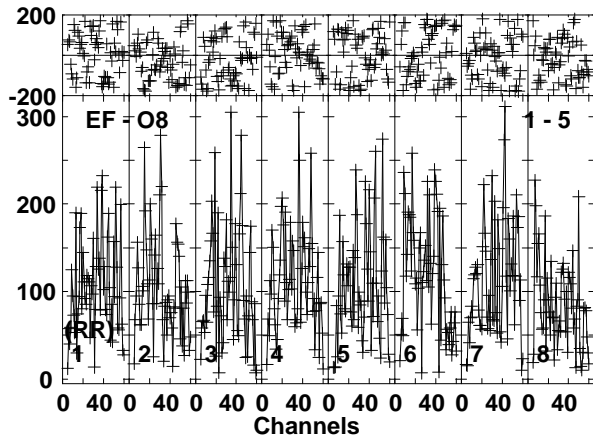
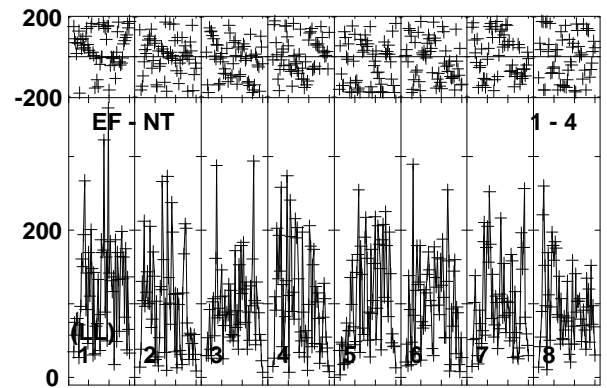
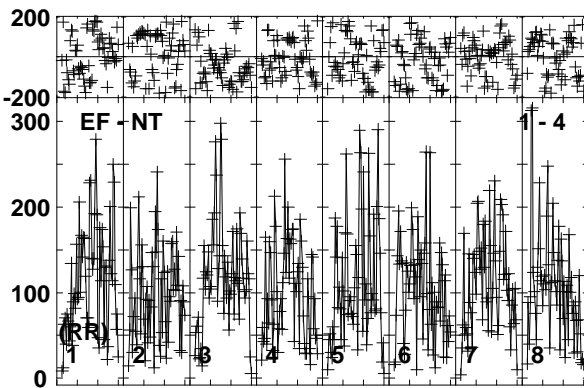
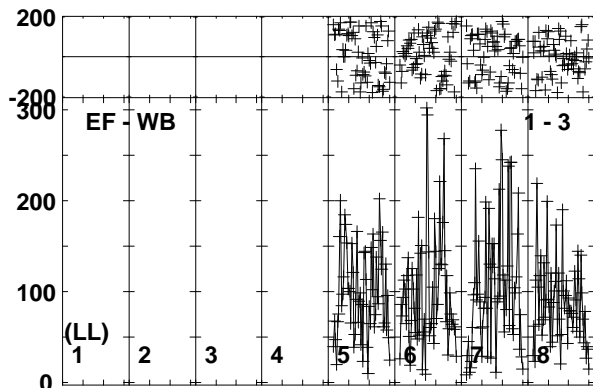
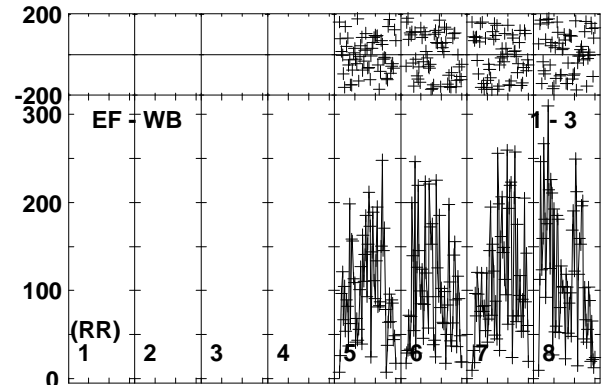
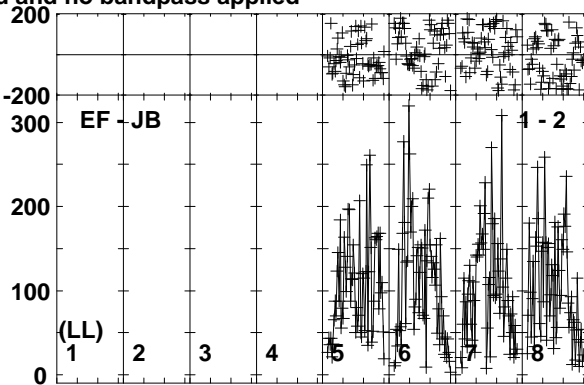
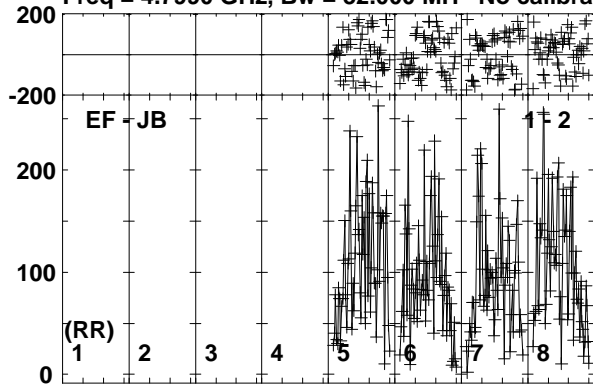

Lower frame: Micro Ampl Jy Top frame: Phas deg  
Vector averaged cross-power spectrum Baseline: EF (01) - JB (02)  
Timerange: 00/11:30:20 to 00/11:32:48

Plot file version 69 created 25-SEP-2017 10:02:26

SSS17A RP029B.UVDATA.1

Freq = 4.7990 GHz, Bw = 32.000 MH No calibration applied and no bandpass applied

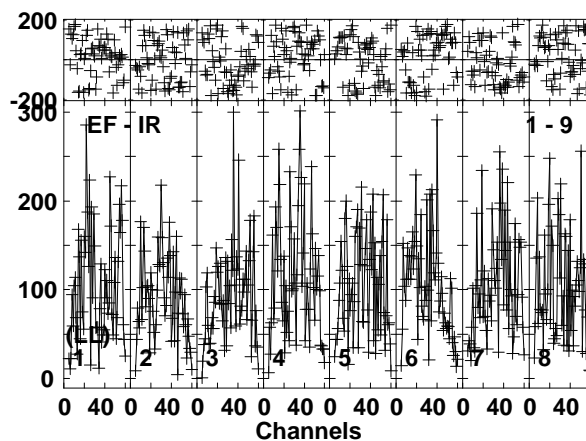
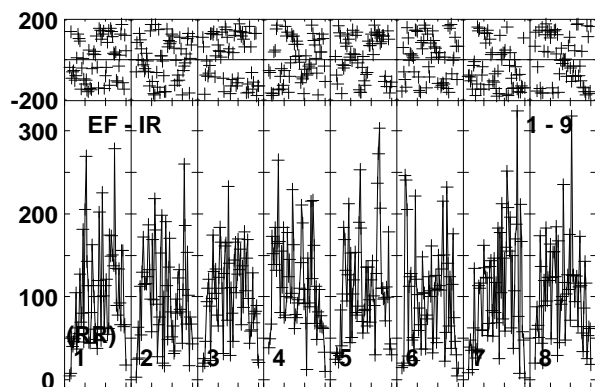
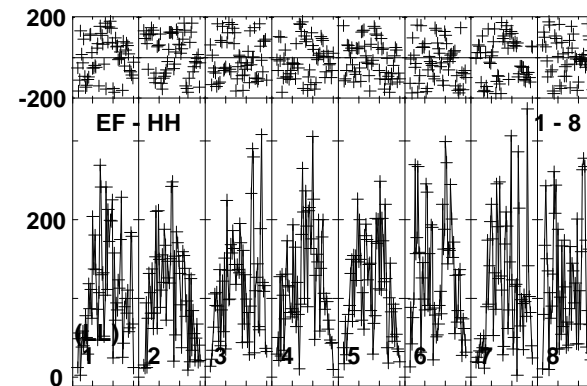
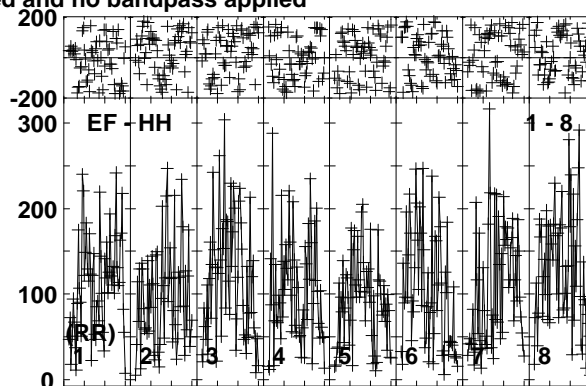
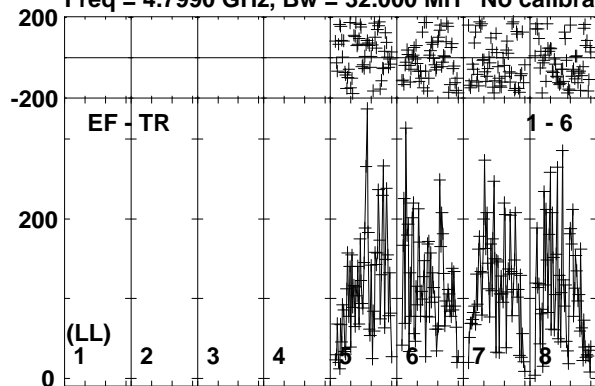

Lower frame: Micro Ampl Jy Top frame: Phas deg  
Vector averaged cross-power spectrum Baseline: EF (01) - TR (06)  
Timerange: 00/11:30:20 to 00/11:32:48

Plot file version 70 created 25-SEP-2017 10:02:26

J1303-2405 RP029B.UVDATA.1

Freq = 4.7990 GHz, Bw = 32.000 MH No calibration applied and no bandpass applied

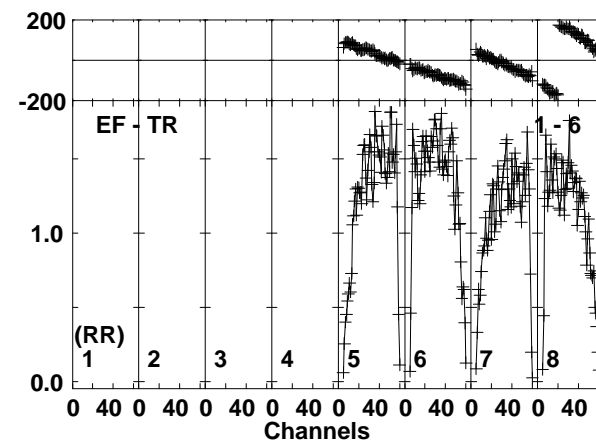
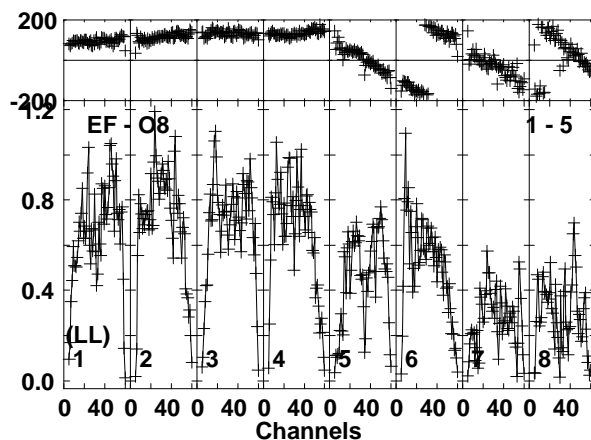
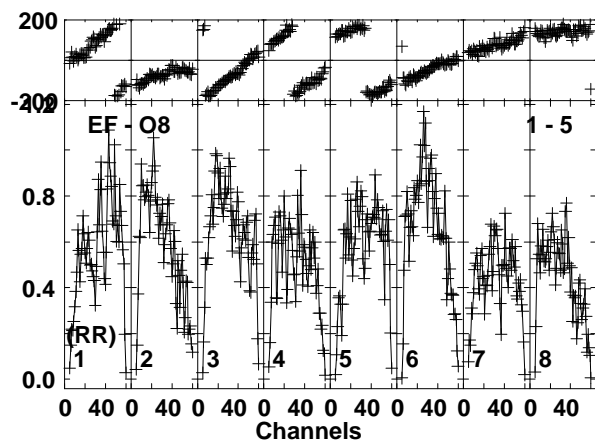
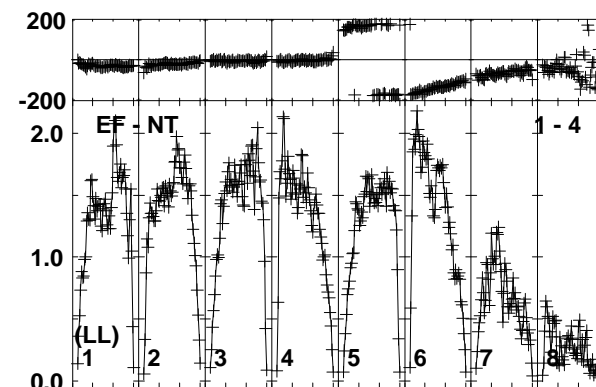
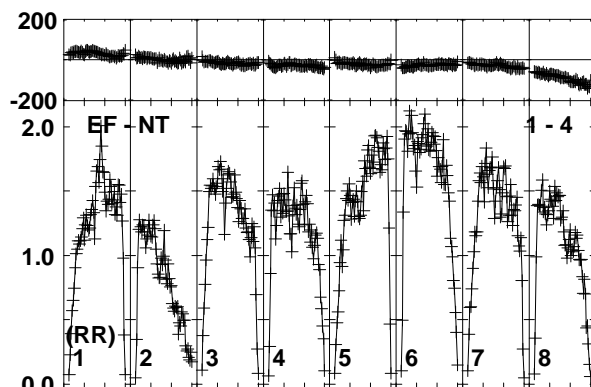
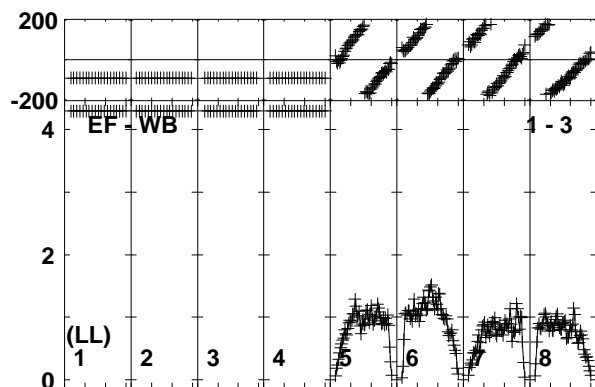
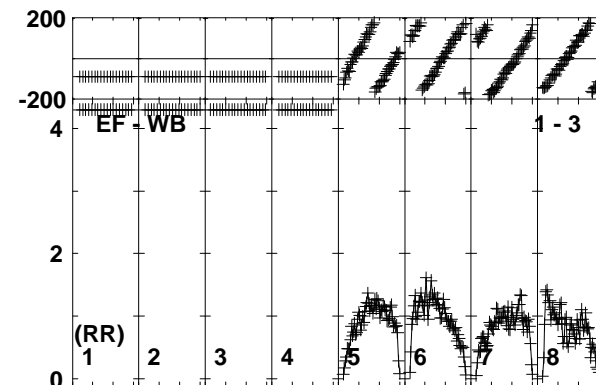
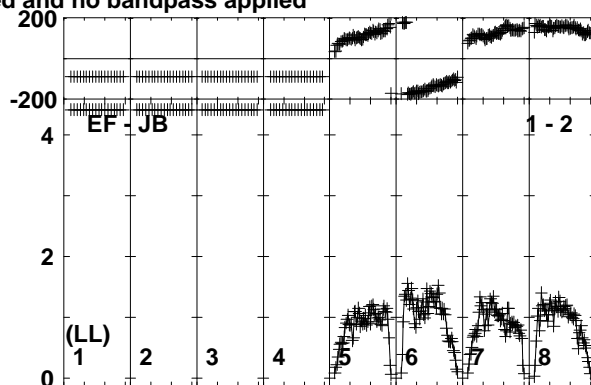
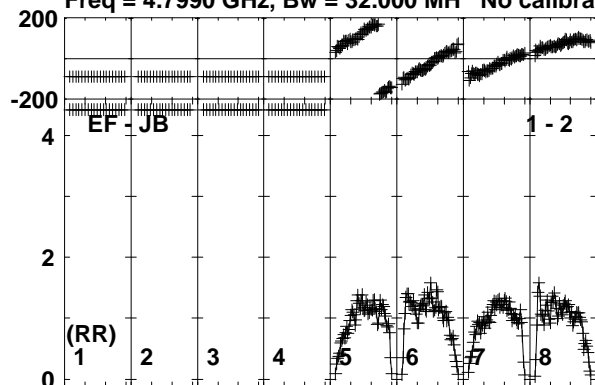

Lower frame: Milli Ampl Jy Top frame: Phas deg  
Vector averaged cross-power spectrum Baseline: EF (01) - JB (02)  
Timerange: 00/11:32:50 to 00/11:34:19

Plot file version 71 created 25-SEP-2017 10:02:26

J1303-2405 RP029B.UVDATA.1

Freq = 4.7990 GHz, Bw = 32.000 MH No calibration applied and no bandpass applied

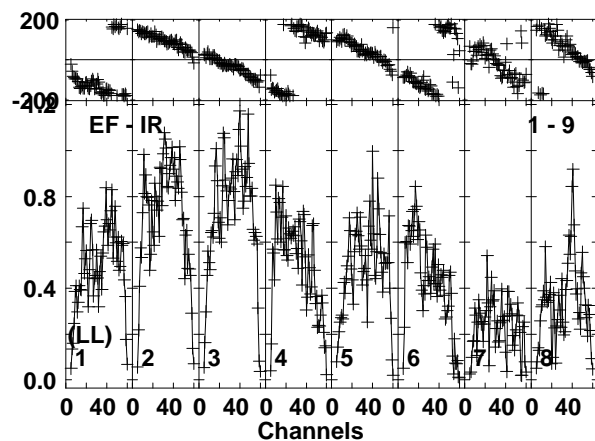
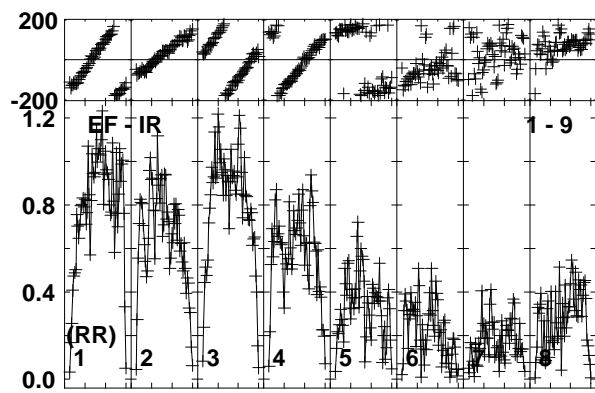
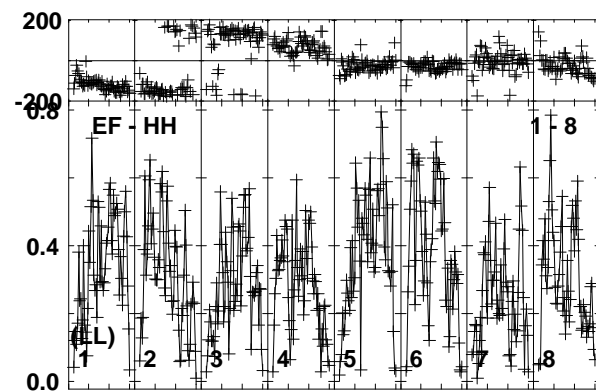
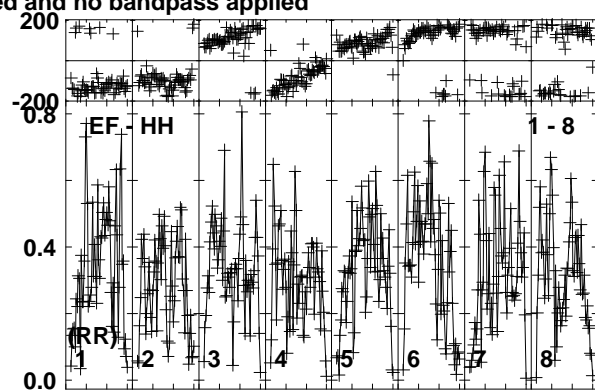
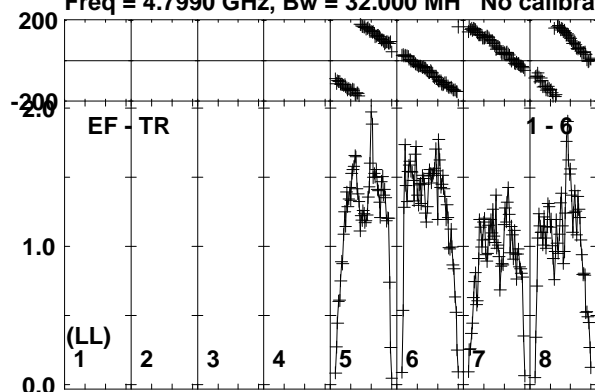

Lower frame: Milli Ampl Jy Top frame: Phas deg  
Vector averaged cross-power spectrum Baseline: EF (01) - TR (06)  
Timerange: 00/11:32:50 to 00/11:34:19

Plot file version 72 created 25-SEP-2017 10:02:27

SSS17A RP029B.UVDATA.1

Freq = 4.7990 GHz, Bw = 32.000 MH No calibration applied and no bandpass applied

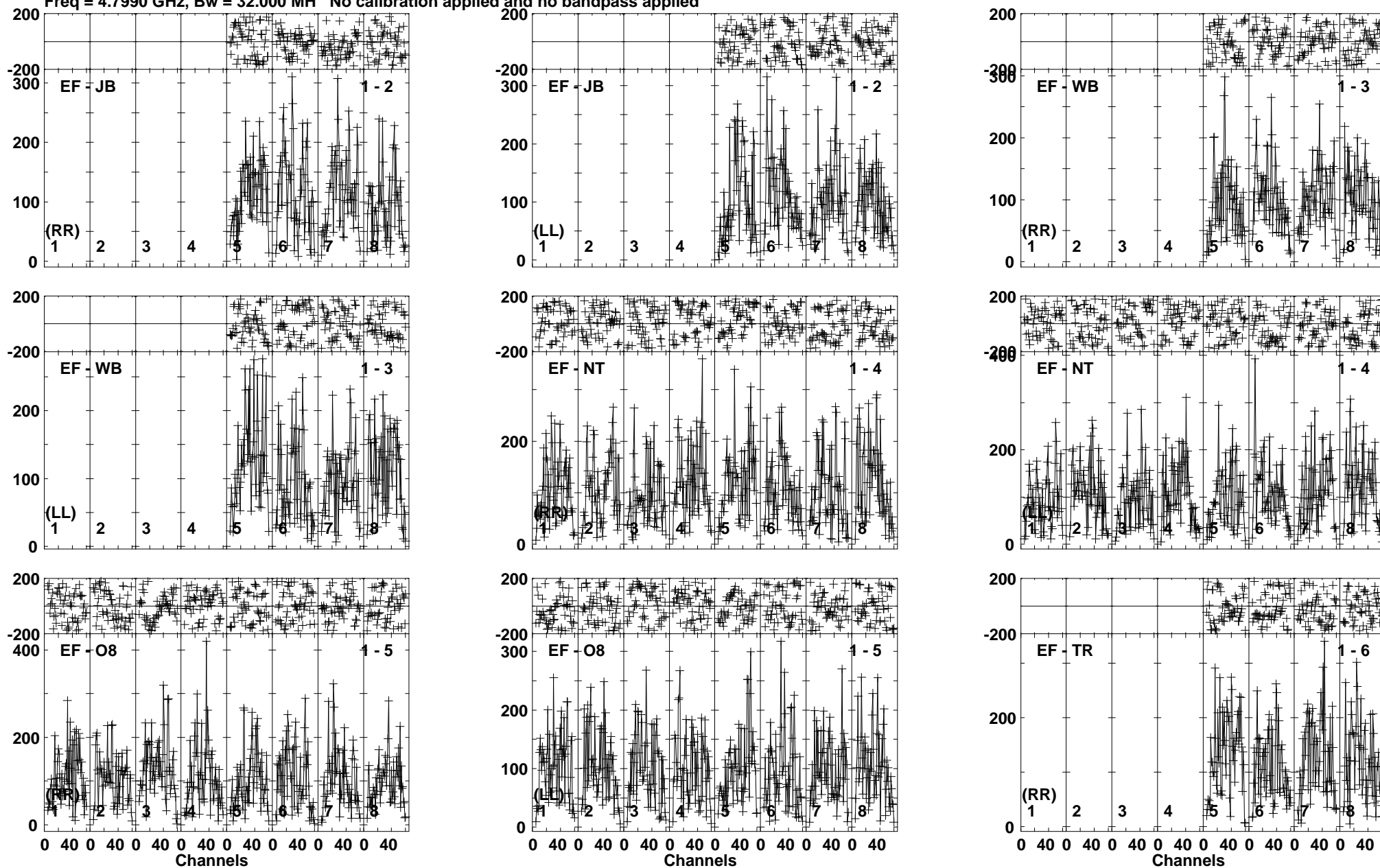

Lower frame: Micro Ampl Jy Top frame: Phas deg  
Vector averaged cross-power spectrum Baseline: EF (01) - JB (02)  
Timerange: 00/11:34:20 to 00/11:36:48



Plot file version 73 created 25-SEP-2017 10:02:27  
SSS17A RP029B.UVDATA.1  
Freq = 4.7990 GHz, Bw = 32.000 MH No calibration applied and no bandpass applied

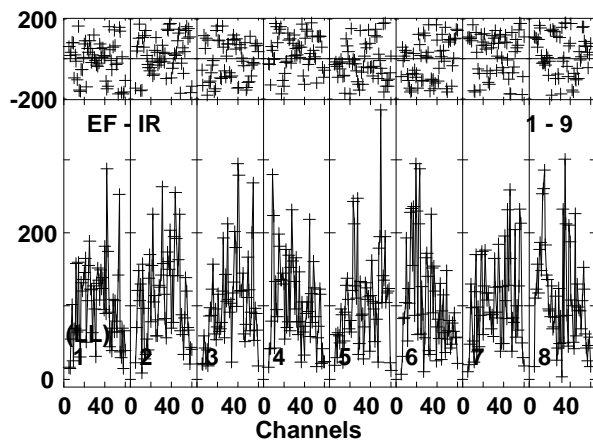
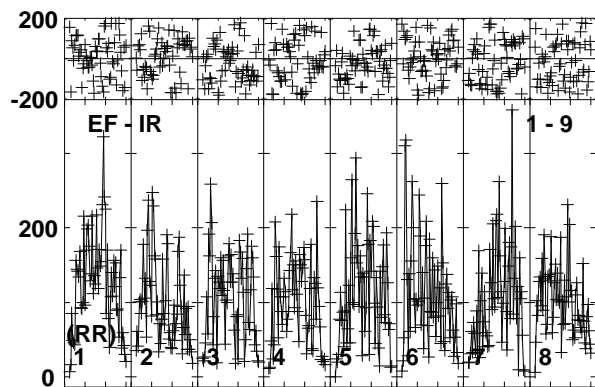
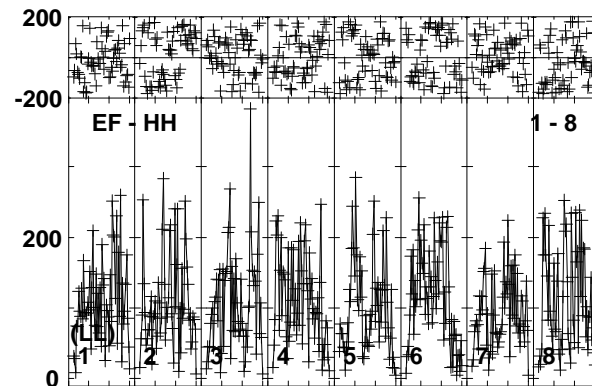
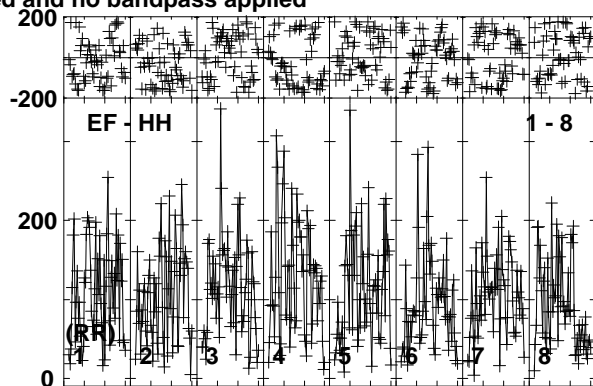
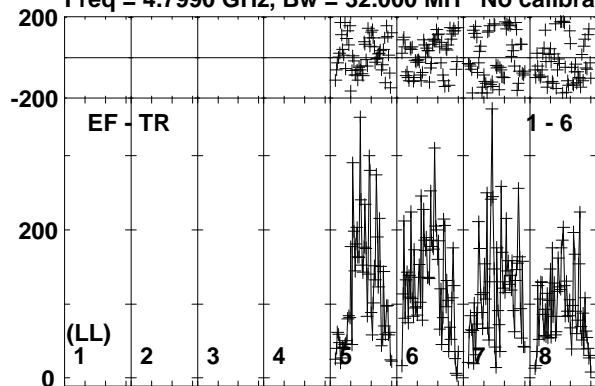

Lower frame: Micro Ampl Jy Top frame: Phas deg  
Vector averaged cross-power spectrum Baseline: EF (01) - TR (06)  
Timerange: 00/11:34:20 to 00/11:36:48

Plot file version 74 created 25-SEP-2017 10:02:27

J1303-2405 RP029B.UVDATA.1

Freq = 4.7990 GHz, Bw = 32.000 MH No calibration applied and no bandpass applied

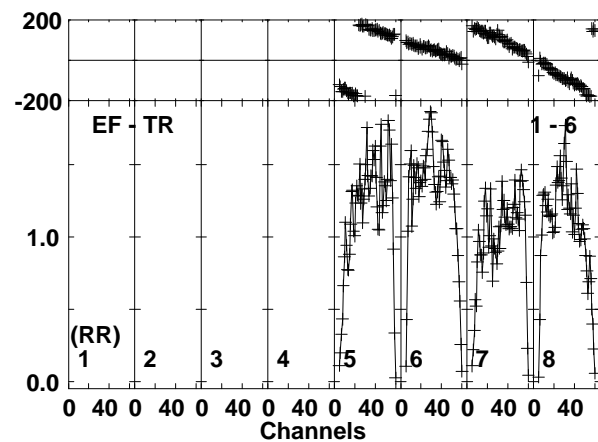
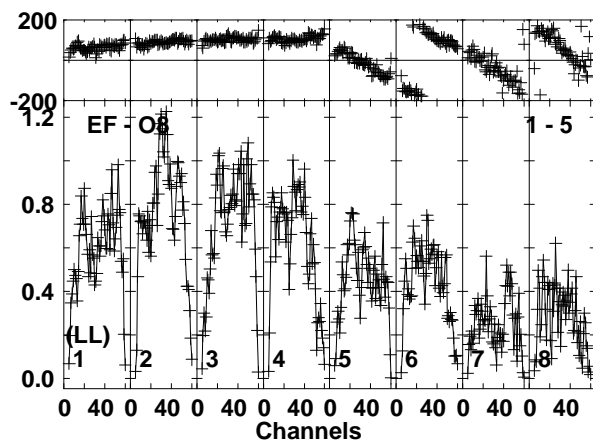
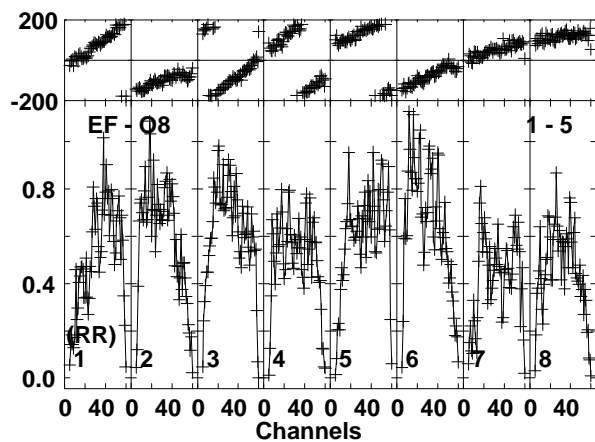
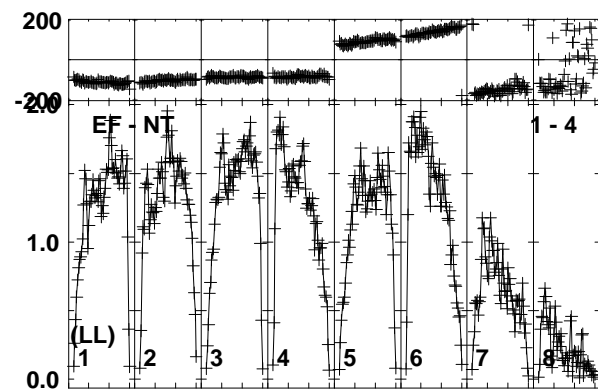
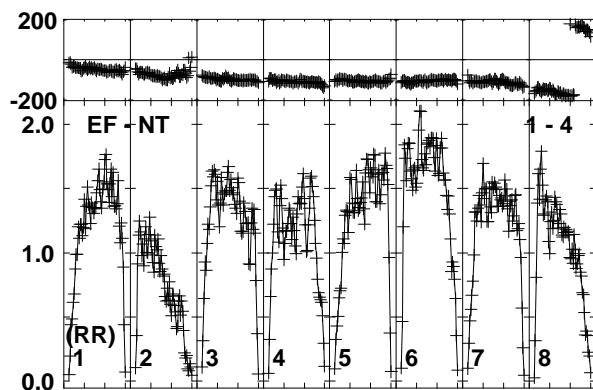
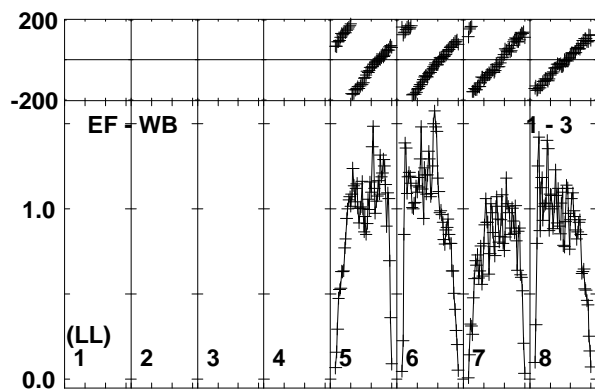
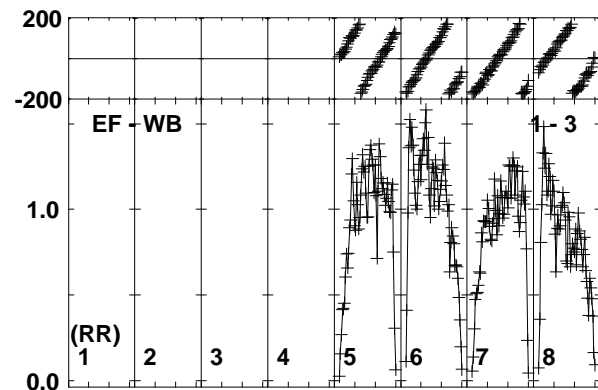
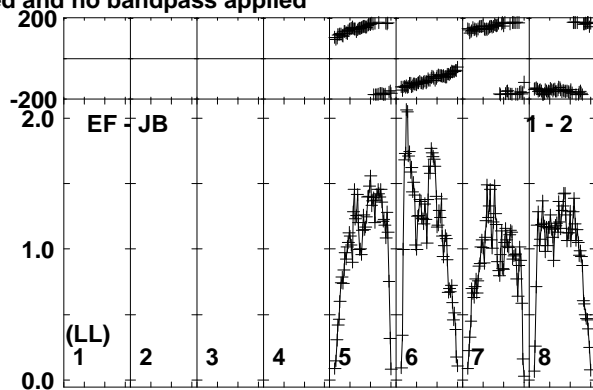
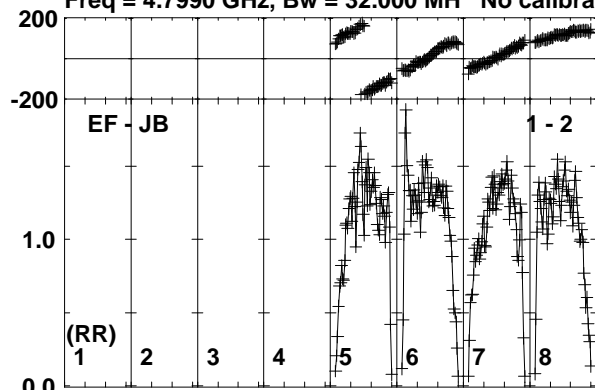

Lower frame: Milli Ampl Jy Top frame: Phas deg  
Vector averaged cross-power spectrum Baseline: EF (01) - JB (02)  
Timerange: 00/11:37:20 to 00/11:38:19

Plot file version 75 created 25-SEP-2017 10:02:27

J1303-2405 RP029B.UVDATA.1

Freq = 4.7990 GHz, Bw = 32.000 MH No calibration applied and no bandpass applied

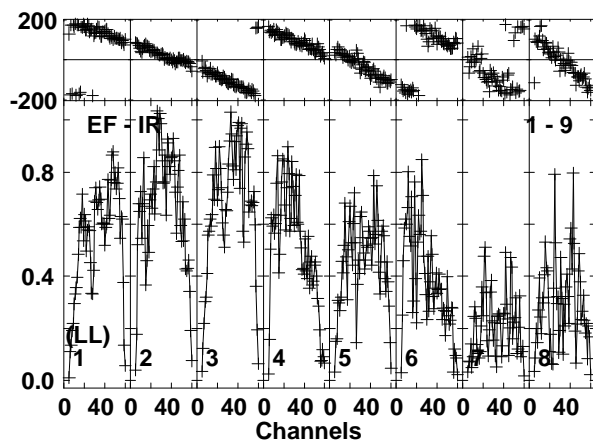
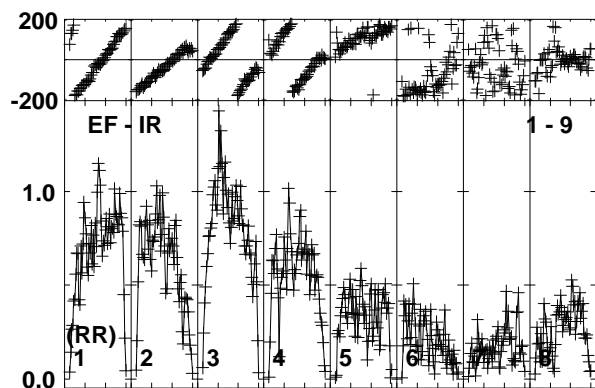
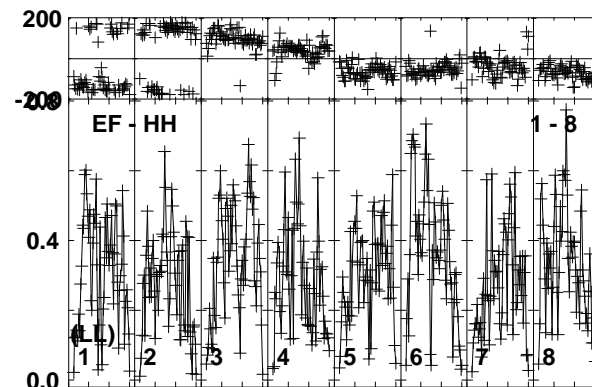
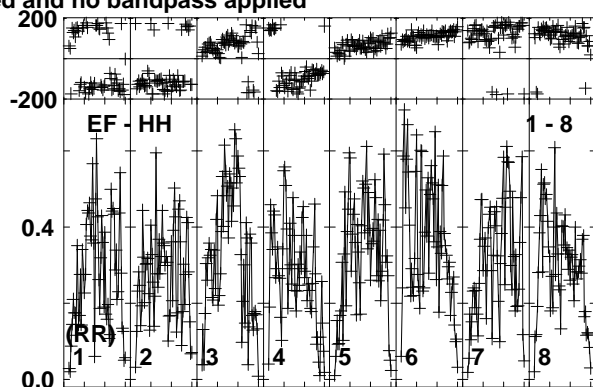
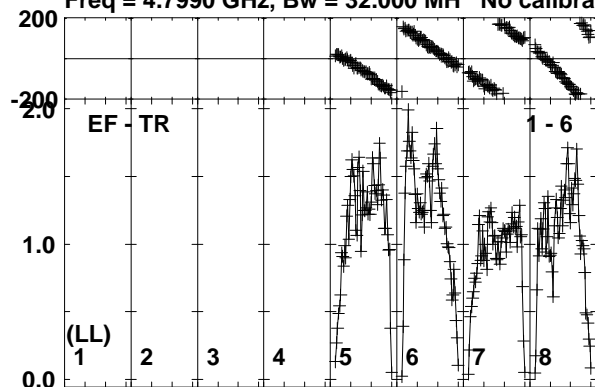

Lower frame: Milli Ampl Jy Top frame: Phas deg  
Vector averaged cross-power spectrum Baseline: EF (01) - TR (06)  
Timerange: 00/11:37:20 to 00/11:38:19

Plot file version 76 created 25-SEP-2017 10:02:27

SSS17A RP029B.UVDATA.1

Freq = 4.7990 GHz, Bw = 32.000 MH No calibration applied and no bandpass applied

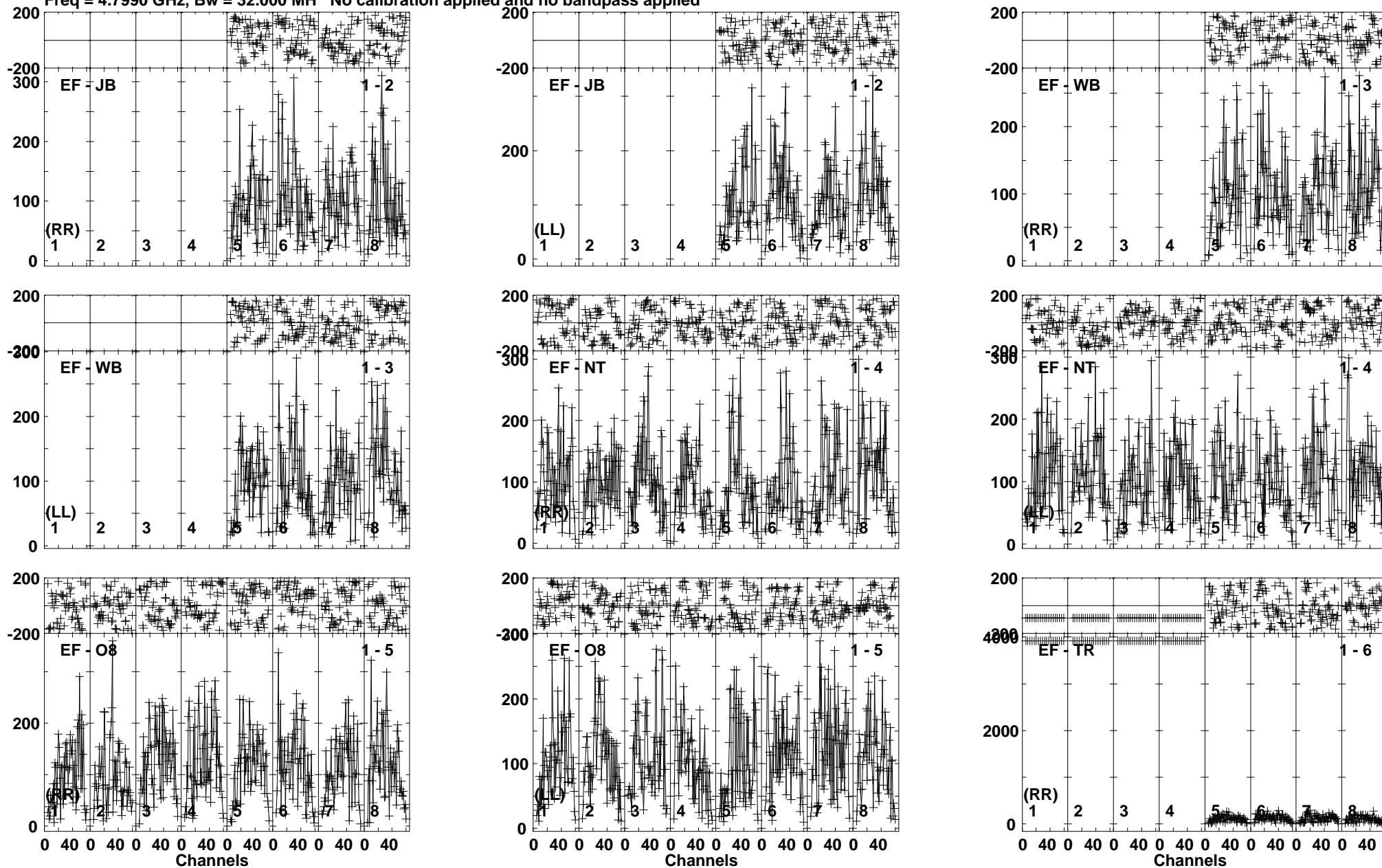

Lower frame: Micro Ampl Jy Top frame: Phas deg  
Vector averaged cross-power spectrum Baseline: EF (01) - JB (02)  
Timerange: 00/11:38:20 to 00/11:40:49

Plot file version 77 created 25-SEP-2017 10:02:27  
 SSS17A RP029B.UVDATA.1  
 Freq = 4.7990 GHz, Bw = 32.000 MH No calibration applied and no bandpass applied

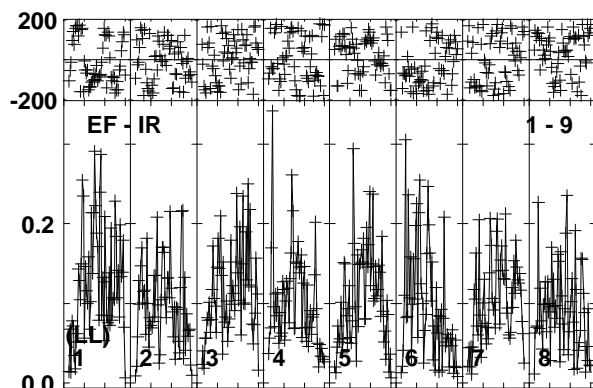
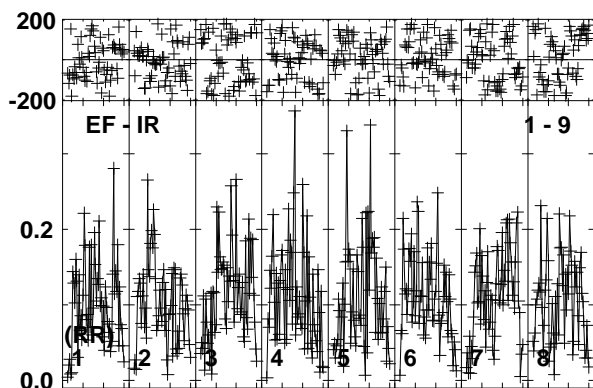
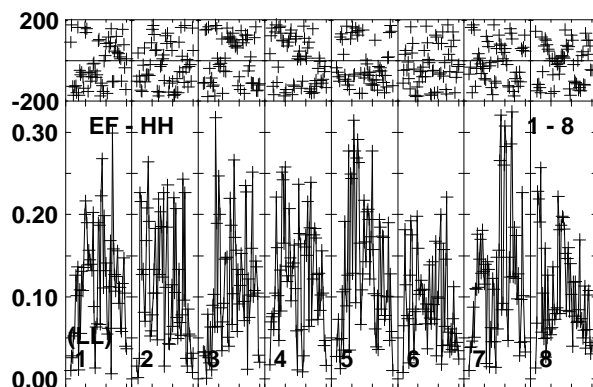
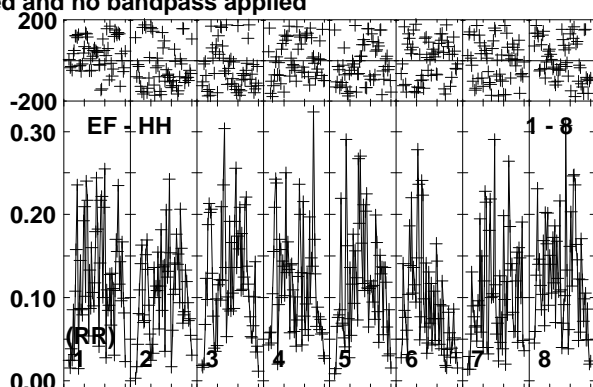
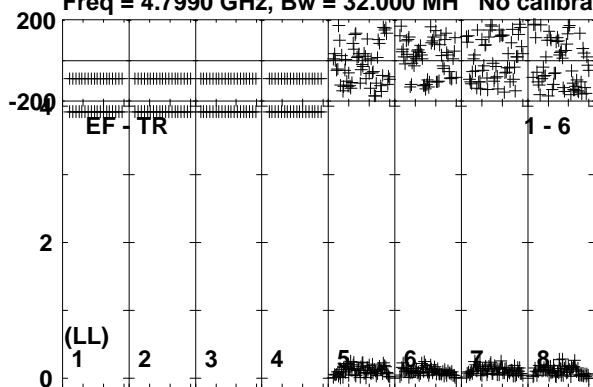

0 40 0 40 0 40 0 40 0 40 0 40 0 40 0 40 0 40  
 Channels

Lower frame: Milli Ampl Jy Top frame: Phas deg  
 Vector averaged cross-power spectrum Baseline: EF (01) - TR (06)  
 Timerange: 00/11:38:20 to 00/11:40:49

Plot file version 78 created 25-SEP-2017 10:02:27

J1303-2405 RP029B.UVDATA.1

Freq = 4.7990 GHz, Bw = 32.000 MH No calibration applied and no bandpass applied

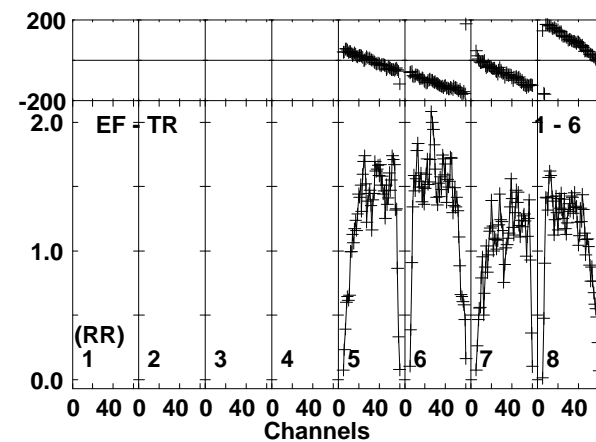
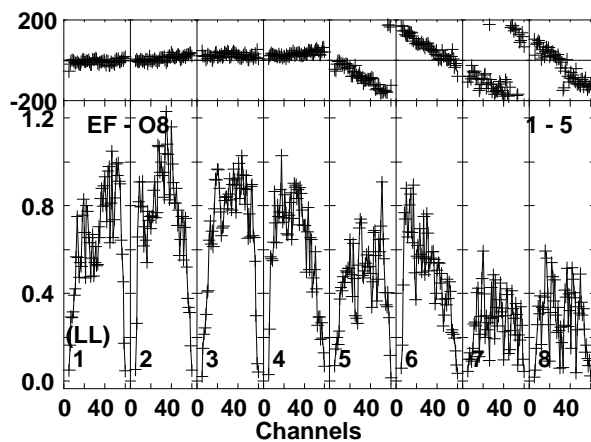
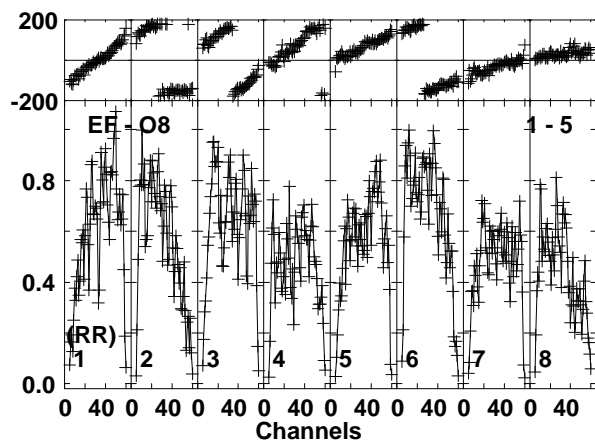
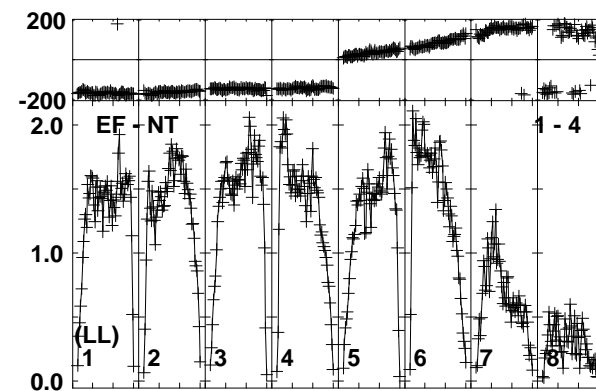
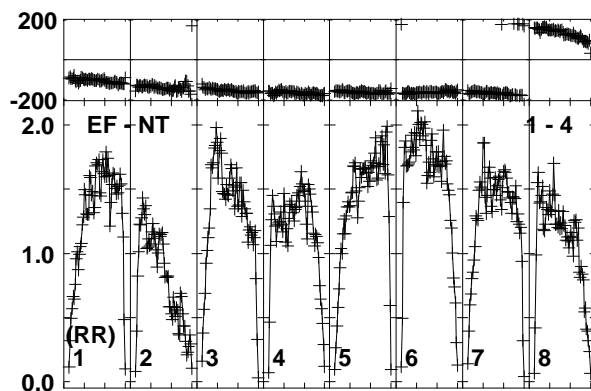
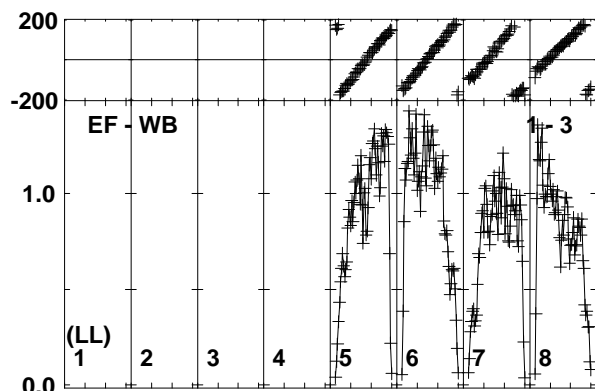
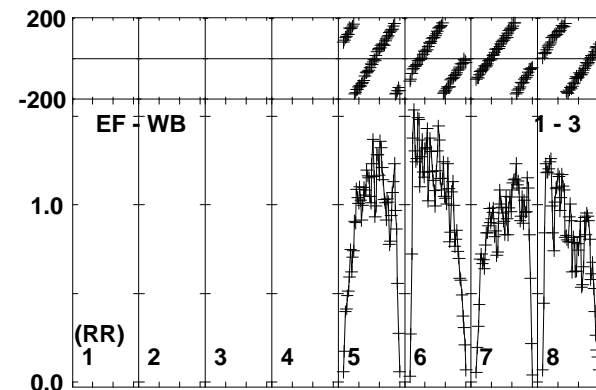
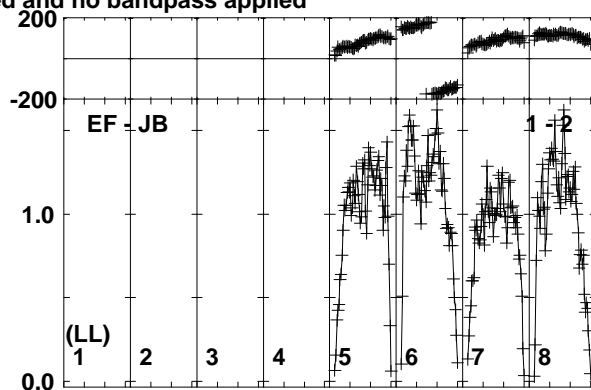
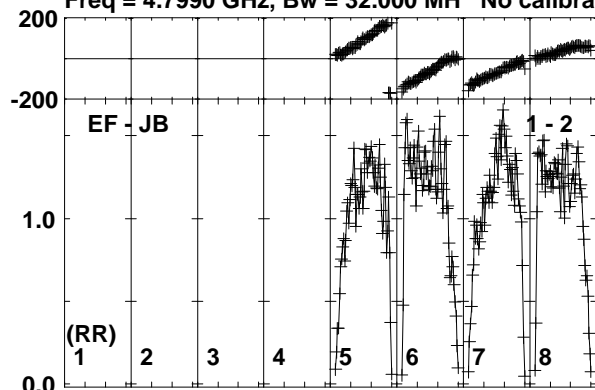

Lower frame: Milli Ampl Jy Top frame: Phas deg  
Vector averaged cross-power spectrum Baseline: EF (01) - JB (02)  
Timerange: 00/11:40:49 to 00/11:42:19

Plot file version 79 created 25-SEP-2017 10:02:28

J1303-2405 RP029B.UVDATA.1

Freq = 4.7990 GHz, Bw = 32.000 MH No calibration applied and no bandpass applied

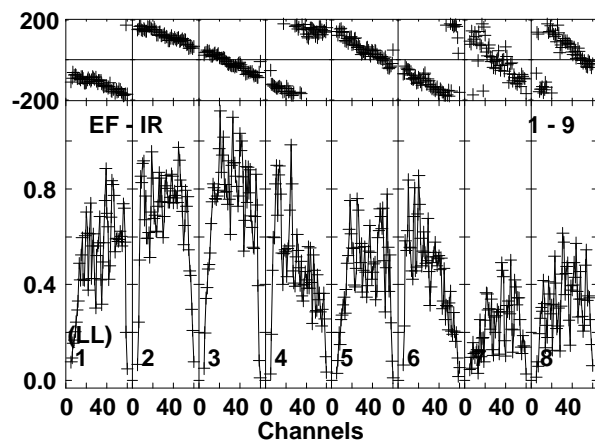
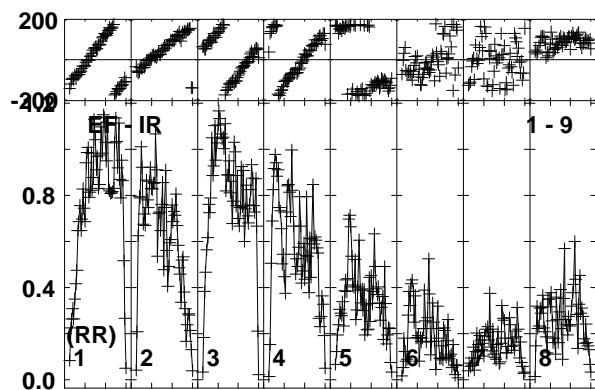
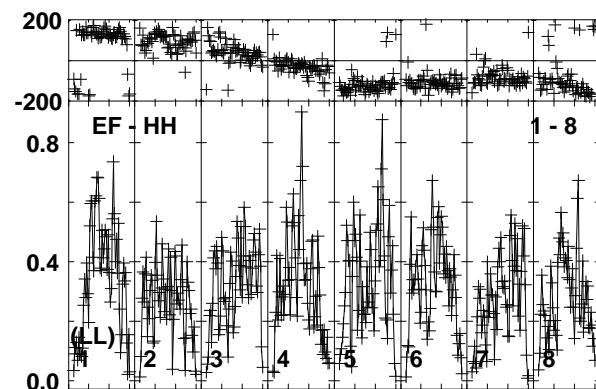
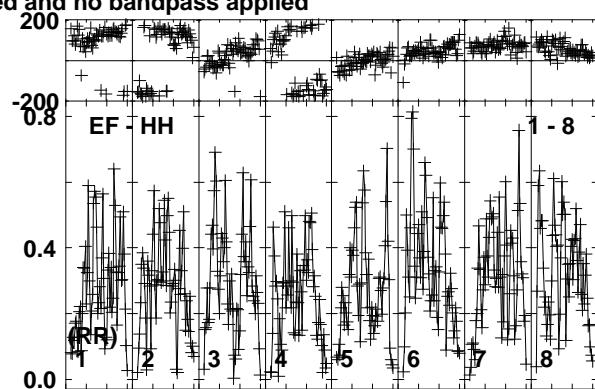
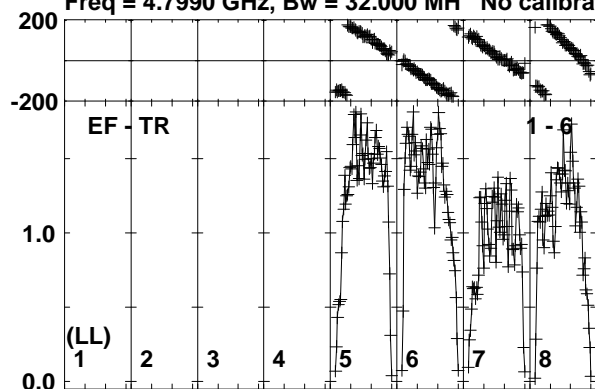

Lower frame: Milli Ampl Jy Top frame: Phas deg  
Vector averaged cross-power spectrum Baseline: EF (01) - TR (06)  
Timerange: 00/11:40:49 to 00/11:42:19

Plot file version 80 created 25-SEP-2017 10:02:28

J1312-2350 RP029B.UVDATA.1

Freq = 4.7990 GHz, Bw = 32.000 MH No calibration applied and no bandpass applied

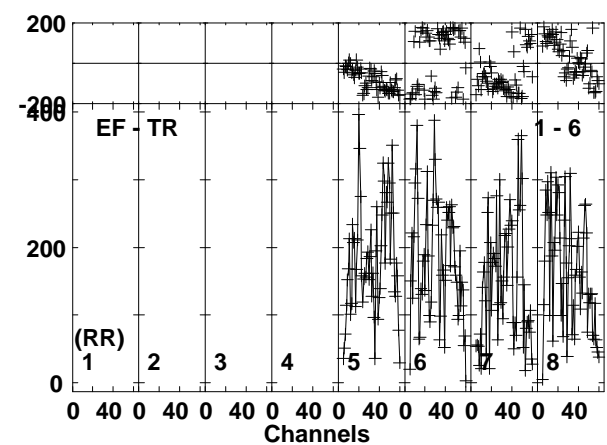
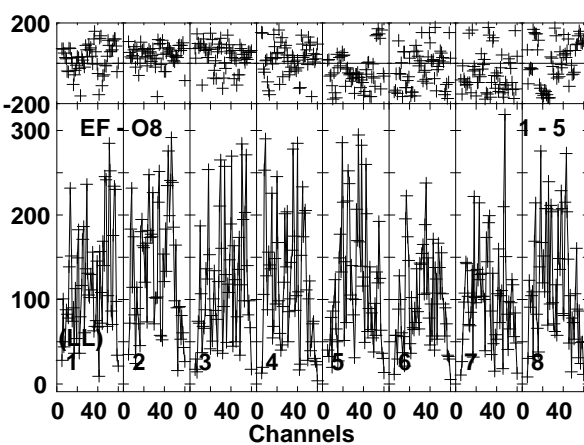
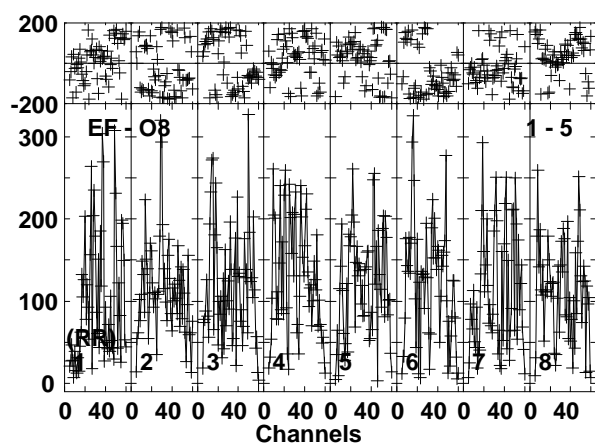
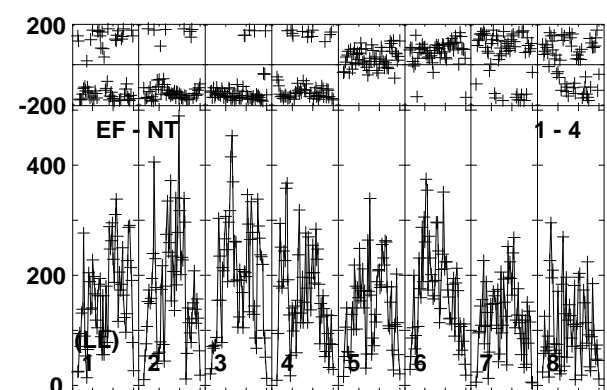
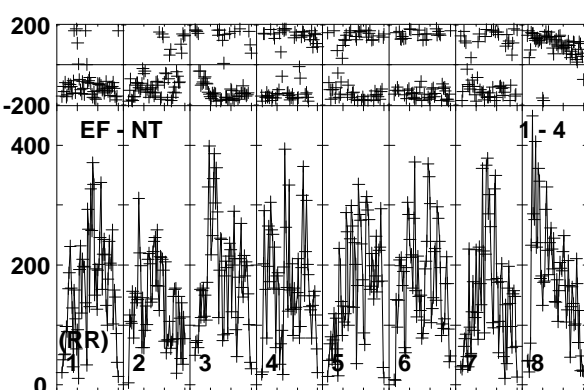
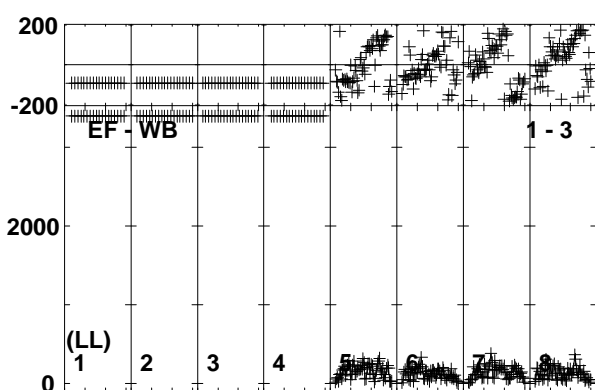
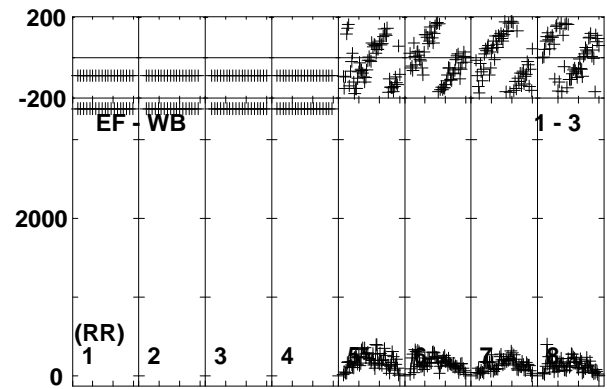
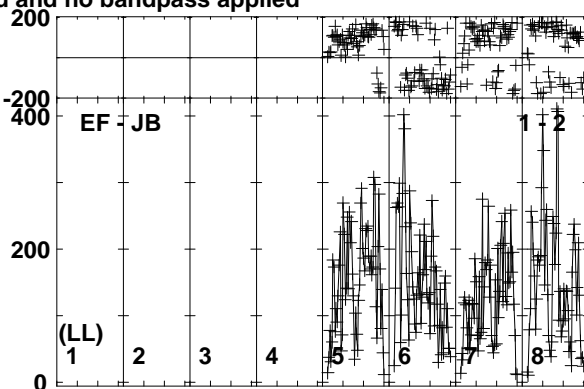
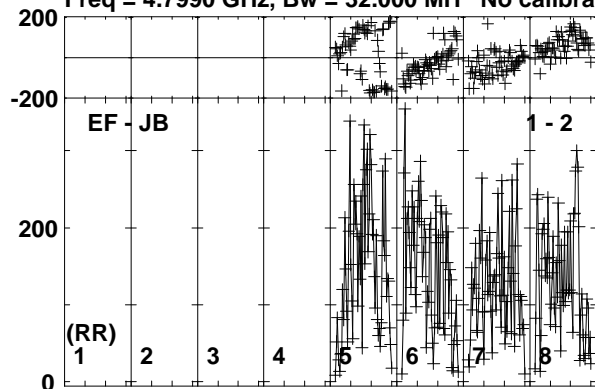

Lower frame: Micro Ampl Jy Top frame: Phas deg  
Vector averaged cross-power spectrum Baseline: EF (01) - JB (02)  
Timerange: 00/11:42:20 to 00/11:44:49



Plot file version 81 created 25-SEP-2017 10:02:28

J1312-2350 RP029B.UVDATA.1

Freq = 4.7990 GHz, Bw = 32.000 MH No calibration applied and no bandpass applied

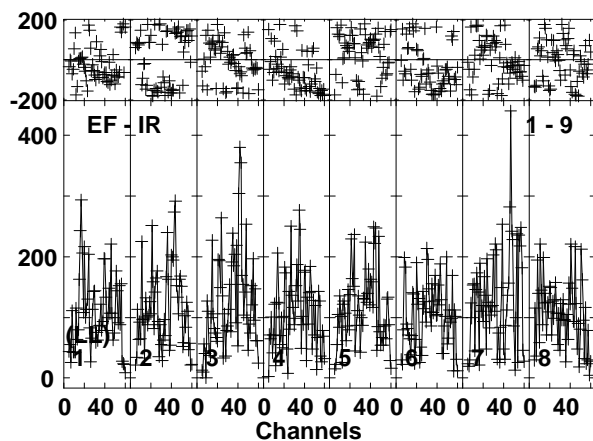
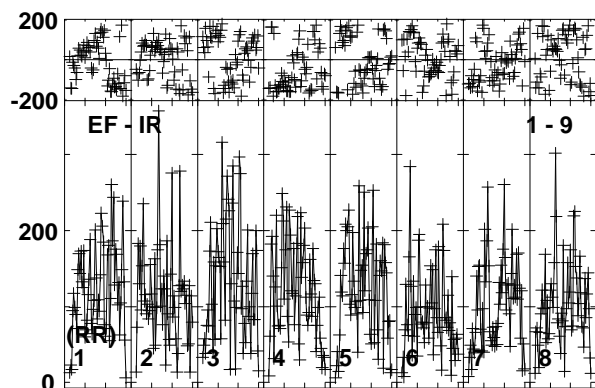
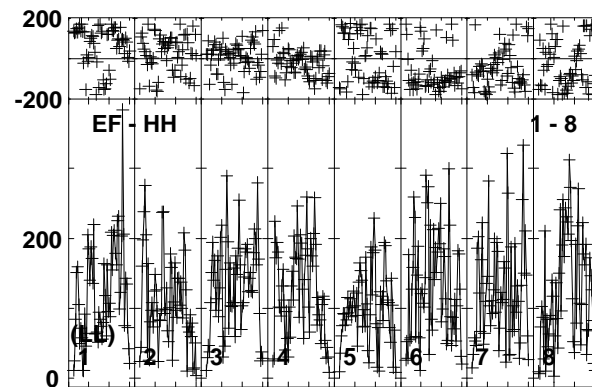
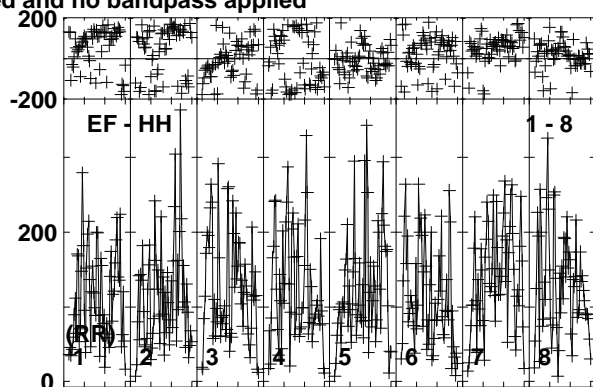
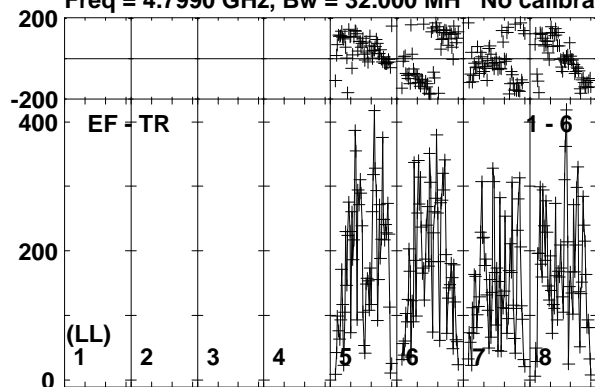

Lower frame: Micro Ampl Jy Top frame: Phas deg  
Vector averaged cross-power spectrum Baseline: EF (01) - TR (06)  
Timerange: 00/11:42:20 to 00/11:44:49

Plot file version 82 created 25-SEP-2017 10:02:28

J1303-2405 RP029B.UVDATA.1

Freq = 4.7990 GHz, Bw = 32.000 MH No calibration applied and no bandpass applied

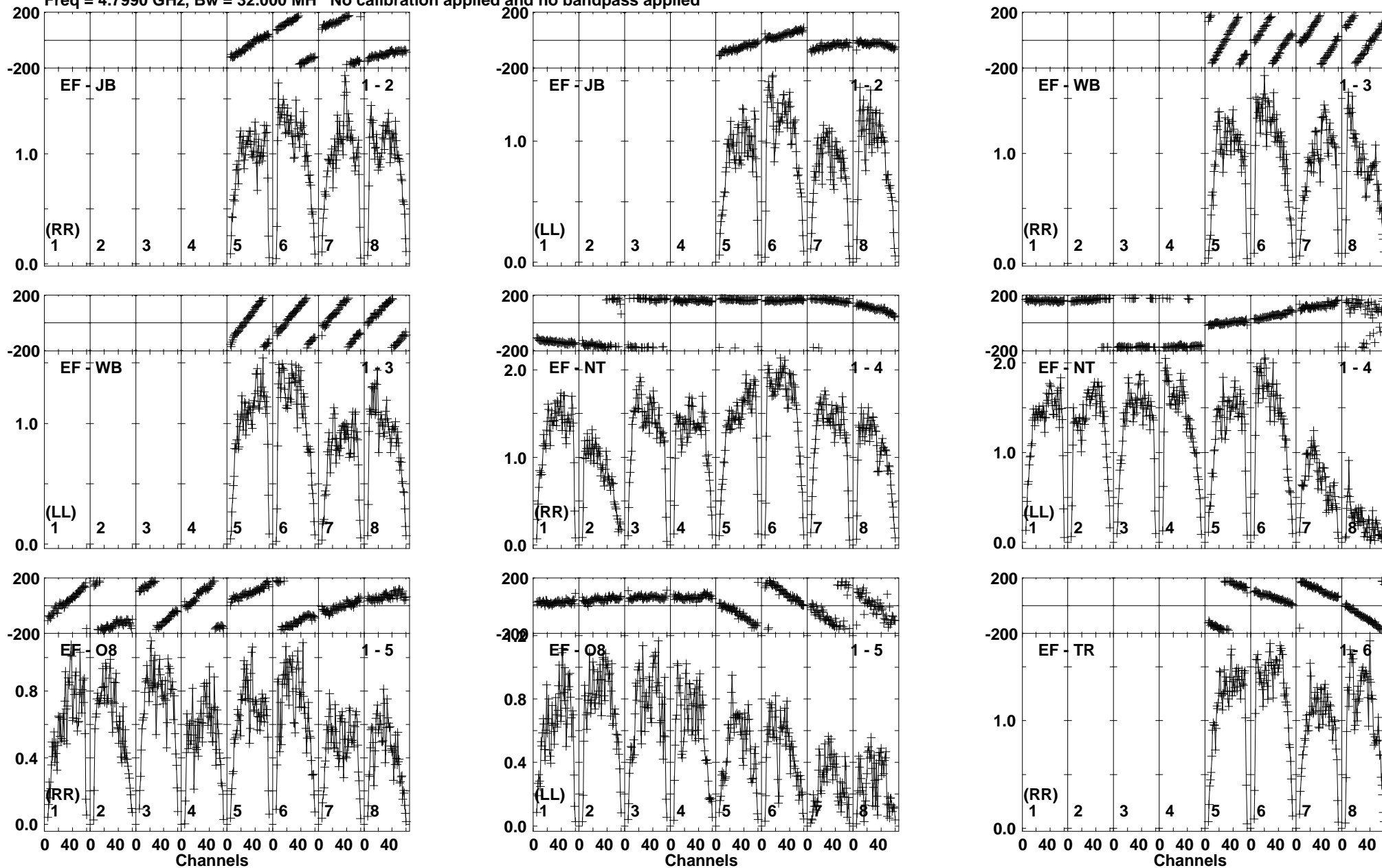

Lower frame: Milli Ampl Jy Top frame: Phas deg  
Vector averaged cross-power spectrum Baseline: EF (01) - JB (02)  
Timerange: 00/11:45:29 to 00/11:46:29

Plot file version 83 created 25-SEP-2017 10:02:28

J1303-2405 RP029B.UVDATA.1

Freq = 4.7990 GHz, Bw = 32.000 MH No calibration applied and no bandpass applied

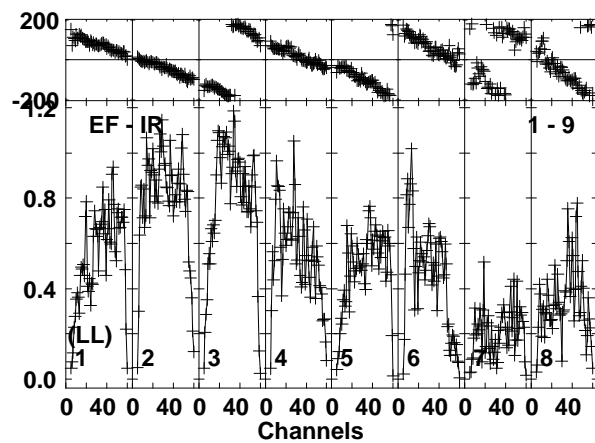
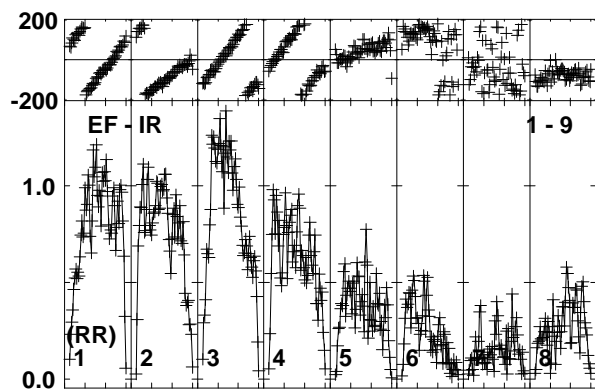
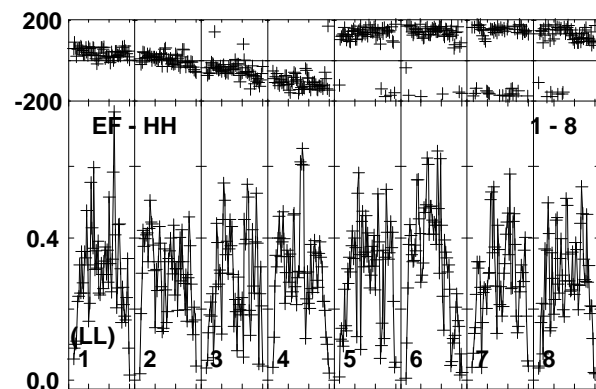
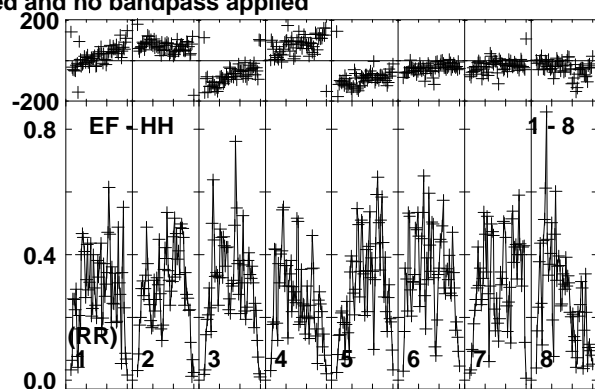
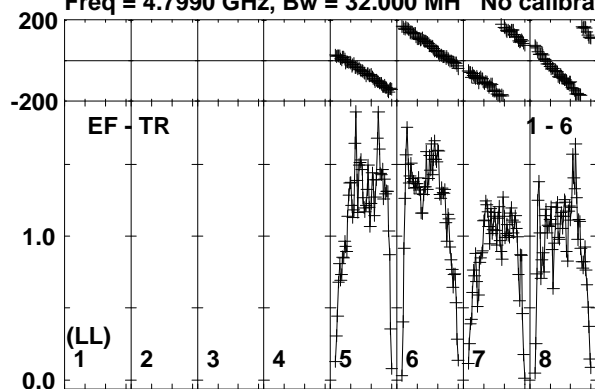

Lower frame: Milli Ampl Jy Top frame: Phas deg  
Vector averaged cross-power spectrum Baseline: EF (01) - TR (06)  
Timerange: 00/11:45:29 to 00/11:46:29



Plot file version 85 created 25-SEP-2017 10:02:28

SSS17A RP029B.UVDATA.1

Freq = 4.7990 GHz, Bw = 32.000 MH No calibration applied and no bandpass applied

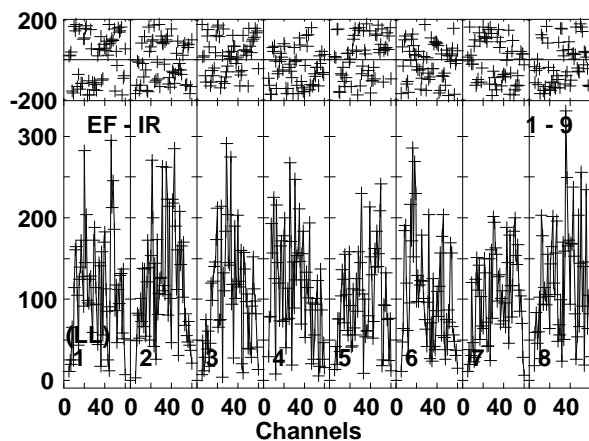
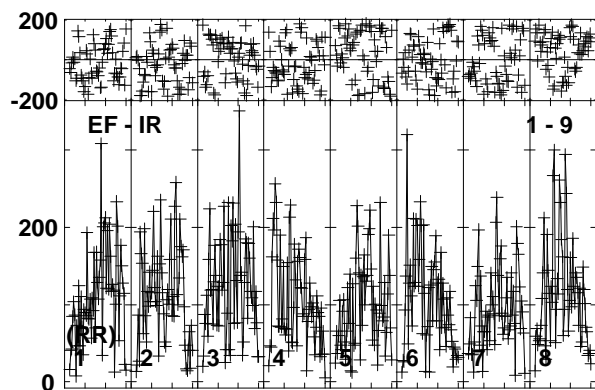
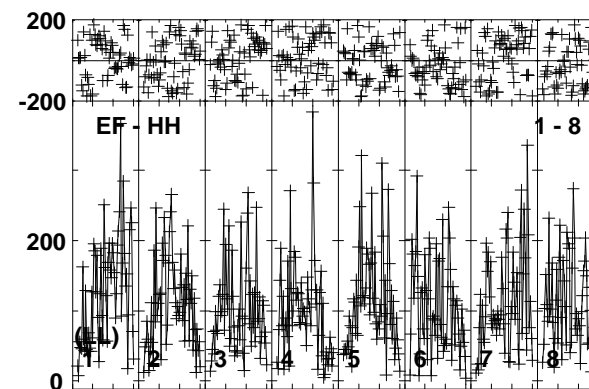
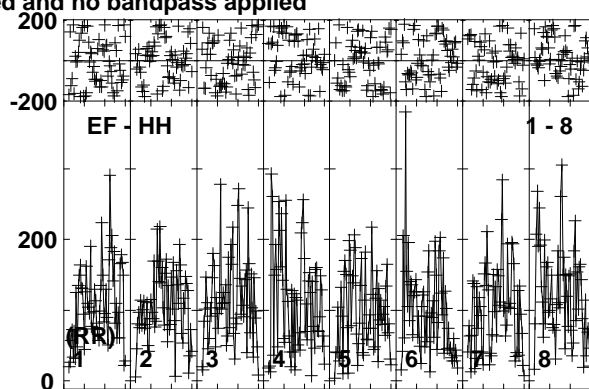
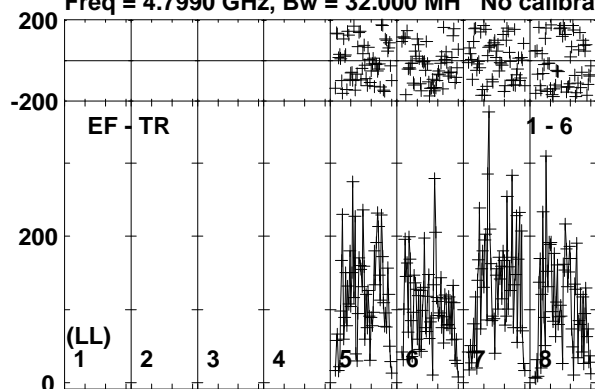

Lower frame: Micro Ampl Jy Top frame: Phas deg  
Vector averaged cross-power spectrum Baseline: EF (01) - TR (06)  
Timerange: 00/11:46:30 to 00/11:48:58

Plot file version 86 created 25-SEP-2017 10:02:29

J1303-2405 RP029B.UVDATA.1

Freq = 4.7990 GHz, Bw = 32.000 MH No calibration applied and no bandpass applied

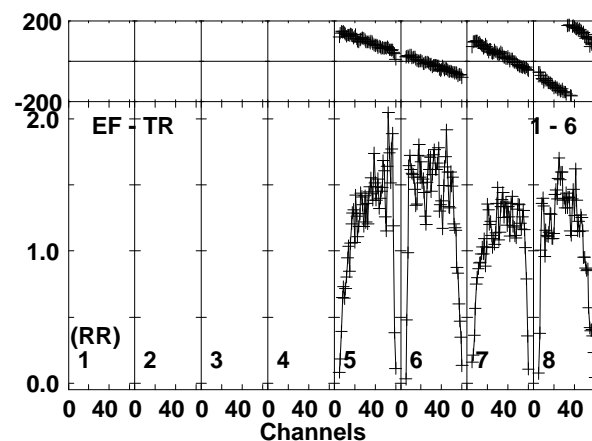
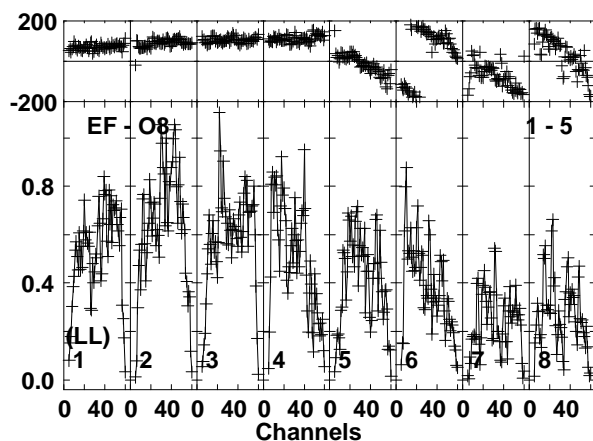
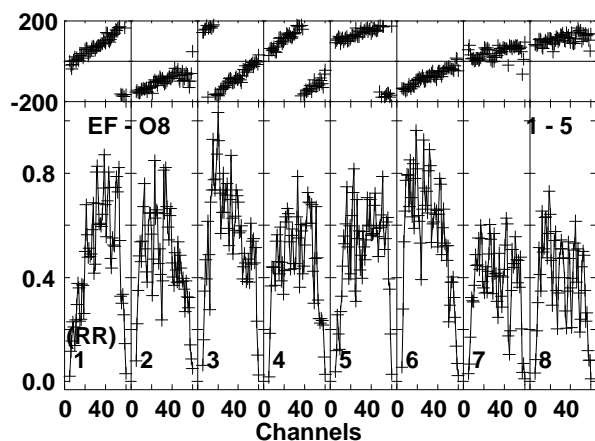
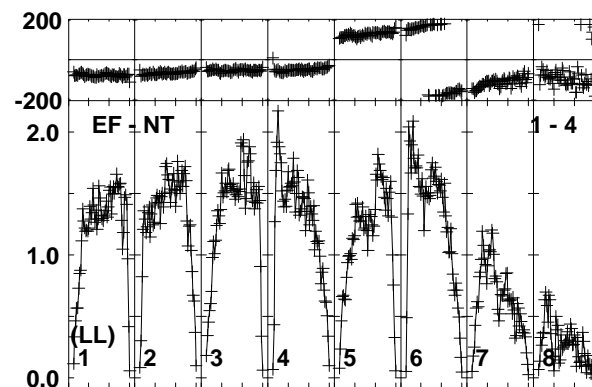
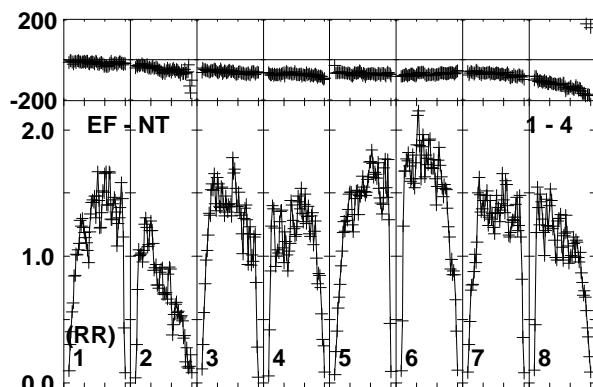
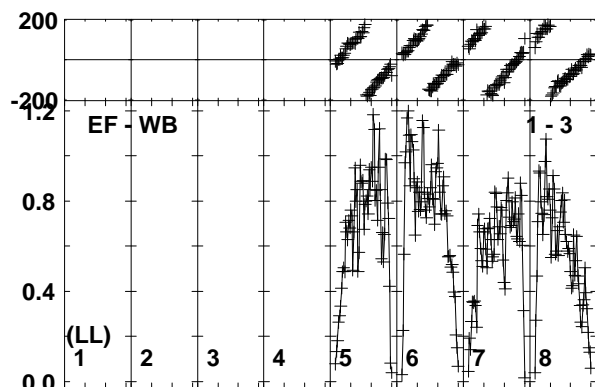
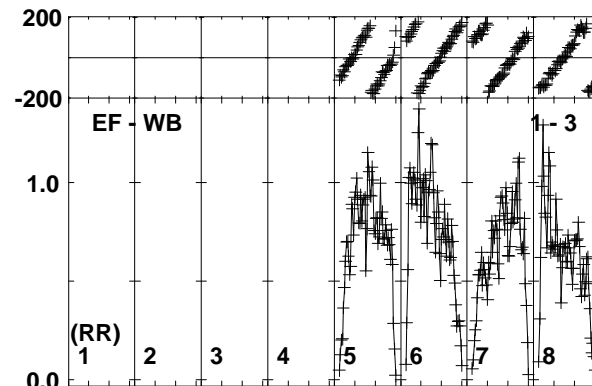
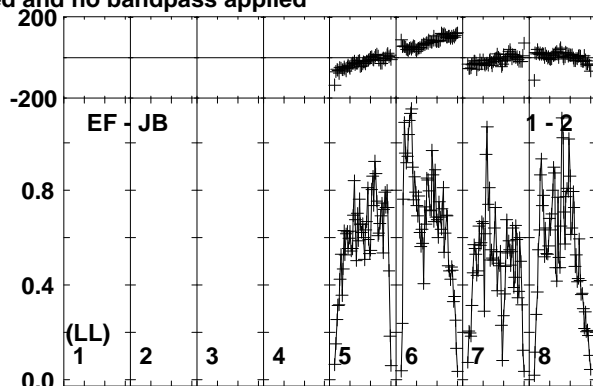
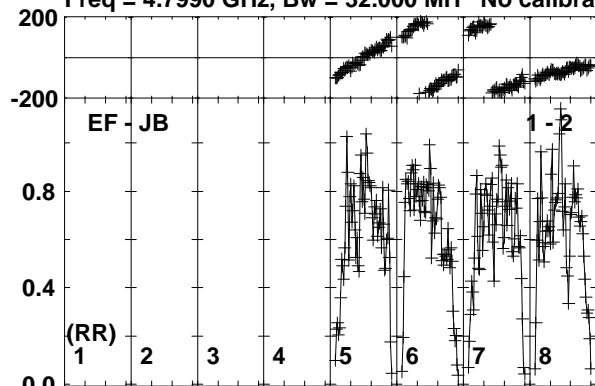

Lower frame: Milli Ampl Jy Top frame: Phas deg  
Vector averaged cross-power spectrum Baseline: EF (01) - JB (02)  
Timerange: 00/11:48:59 to 00/11:50:28

Plot file version 87 created 25-SEP-2017 10:02:29

J1303-2405 RP029B.UVDATA.1

Freq = 4.7990 GHz, Bw = 32.000 MH No calibration applied and no bandpass applied

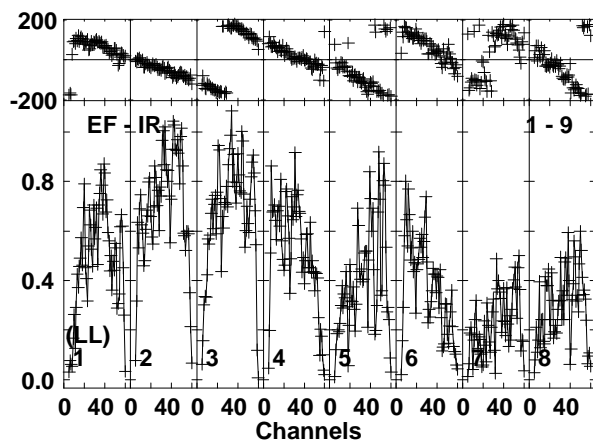
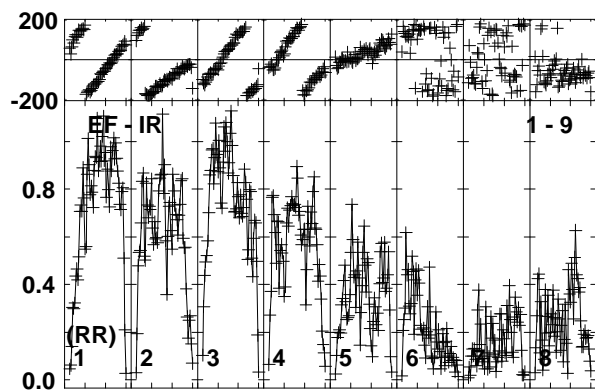
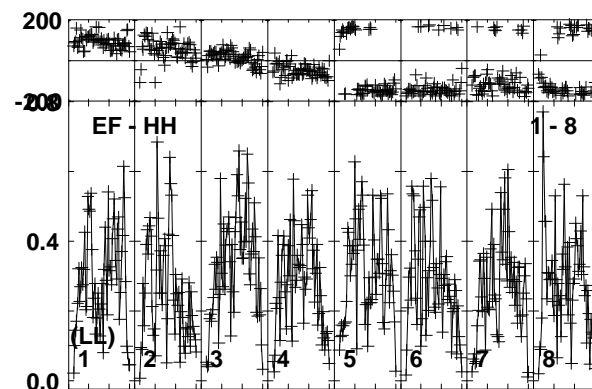
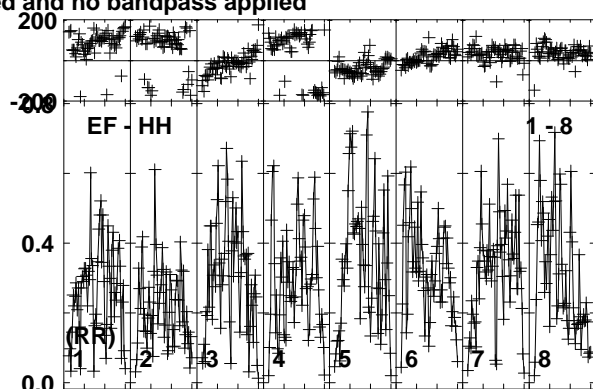
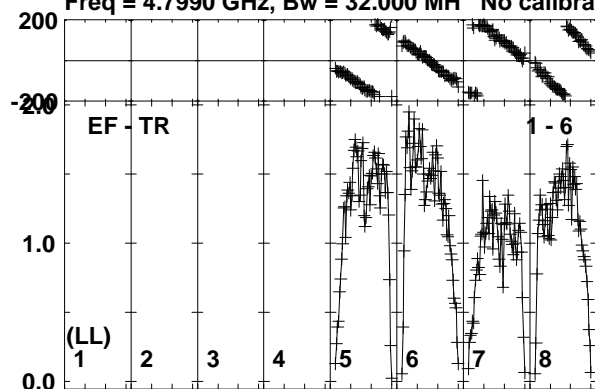

Lower frame: Milli Ampl Jy Top frame: Phas deg  
Vector averaged cross-power spectrum Baseline: EF (01) - TR (06)  
Timerange: 00/11:48:59 to 00/11:50:28

Plot file version 88 created 25-SEP-2017 10:02:29

SSS17A RP029B.UVDATA.1

Freq = 4.7990 GHz, Bw = 32.000 MH No calibration applied and no bandpass applied

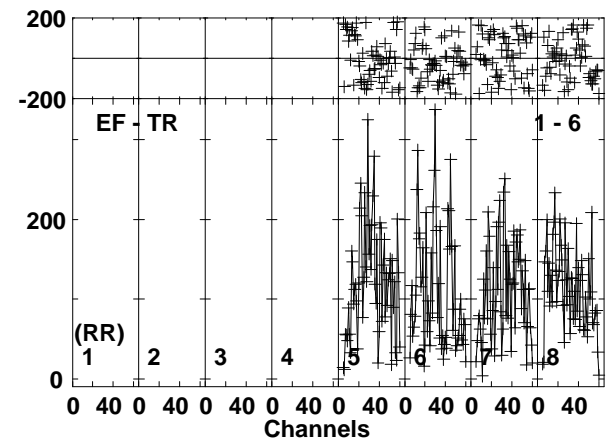
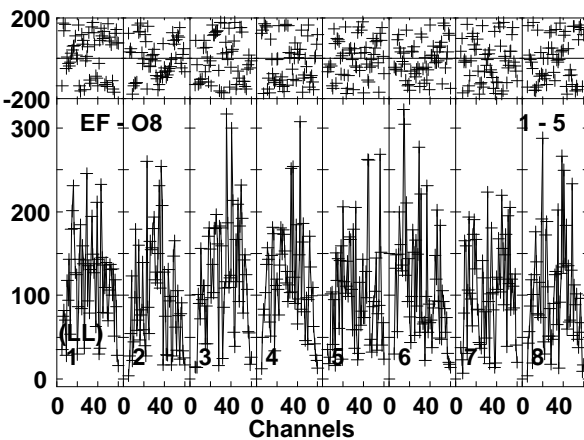
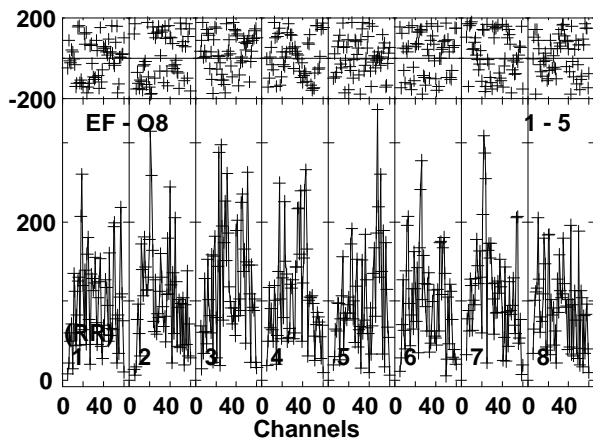
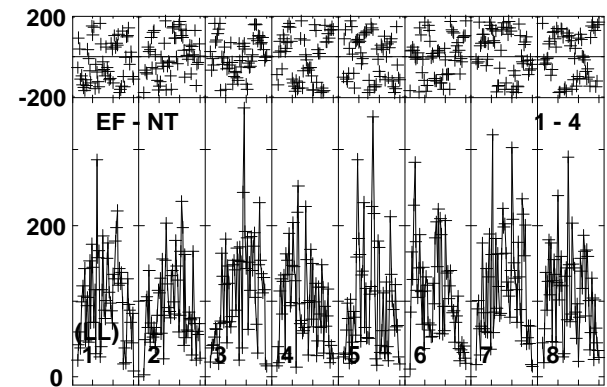
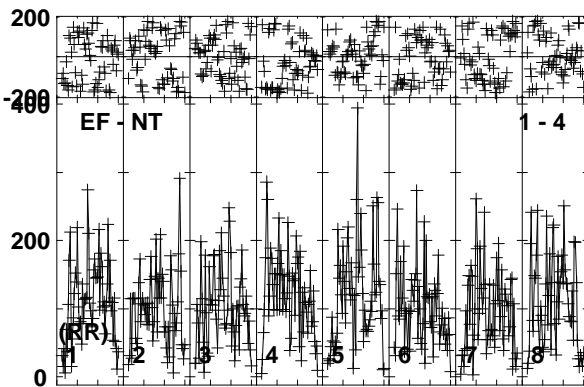
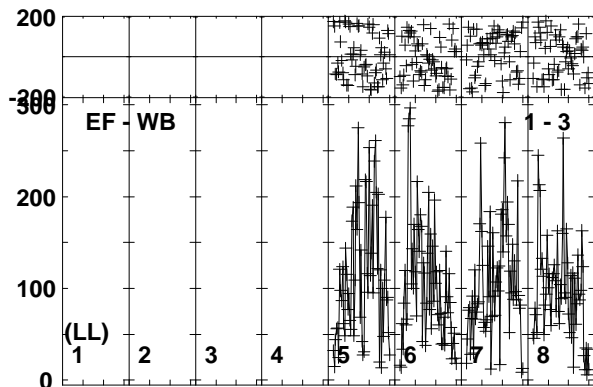
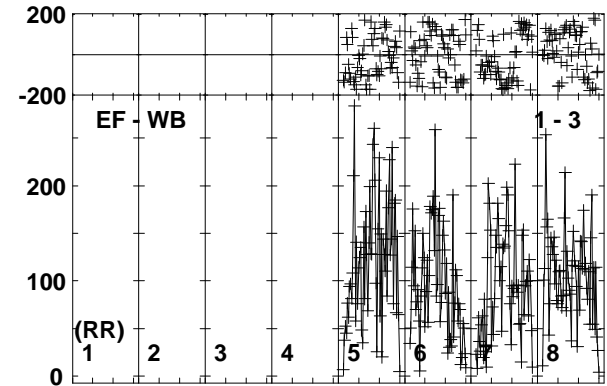
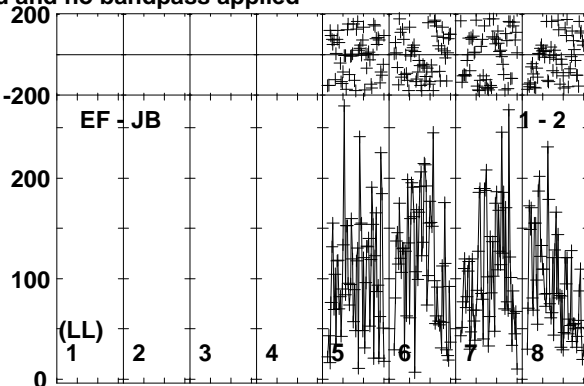
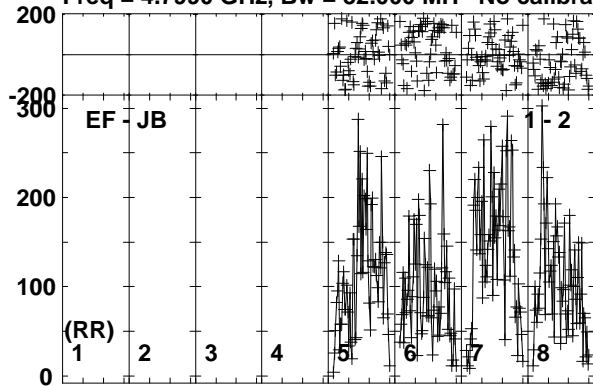

Lower frame: Micro Ampl Jy Top frame: Phas deg  
Vector averaged cross-power spectrum Baseline: EF (01) - JB (02)  
Timerange: 00/11:50:30 to 00/11:52:59



Plot file version 89 created 25-SEP-2017 10:02:29

SSS17A RP029B.UVDATA.1

Freq = 4.7990 GHz, Bw = 32.000 MH No calibration applied and no bandpass applied

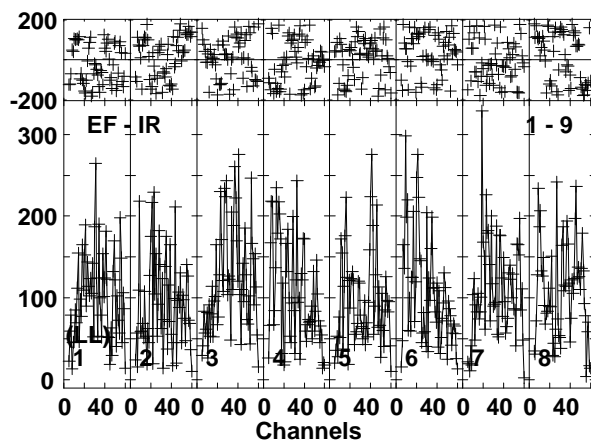
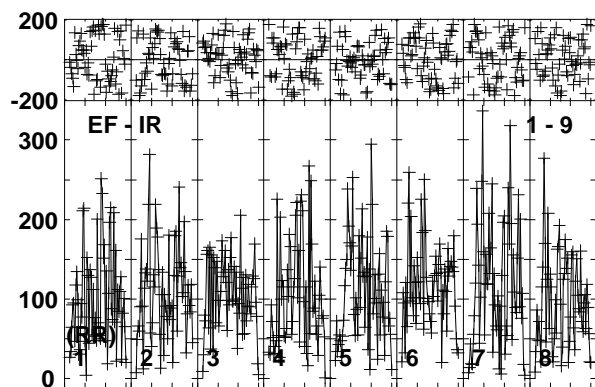
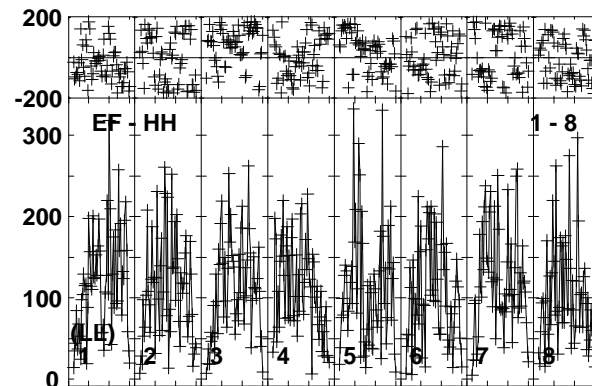
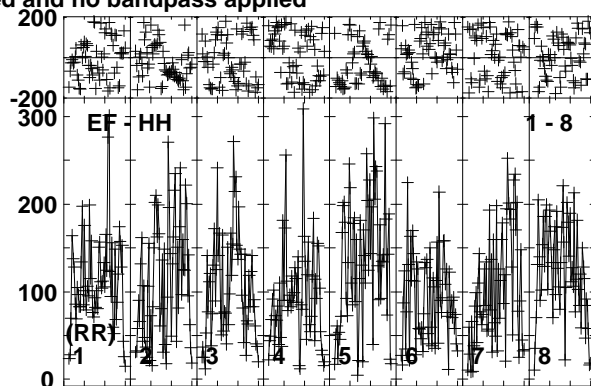
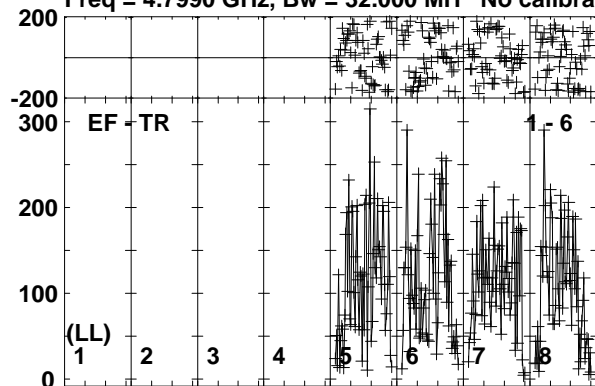

Lower frame: Micro Ampl Jy Top frame: Phas deg  
Vector averaged cross-power spectrum Baseline: EF (01) - TR (06)  
Timerange: 00/11:50:30 to 00/11:52:59

Plot file version 90 created 25-SEP-2017 10:02:29

J1303-2405 RP029B.UVDATA.1

Freq = 4.7990 GHz, Bw = 32.000 MH No calibration applied and no bandpass applied

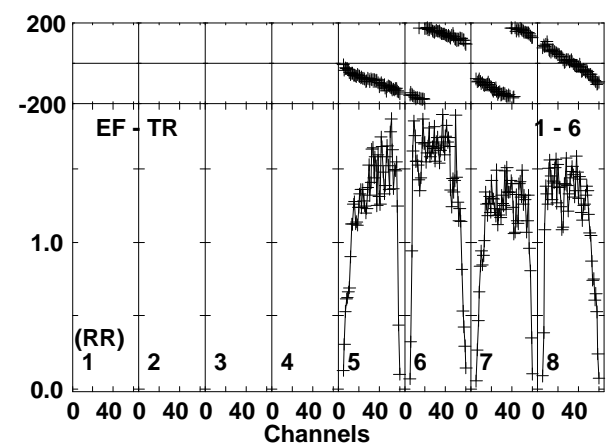
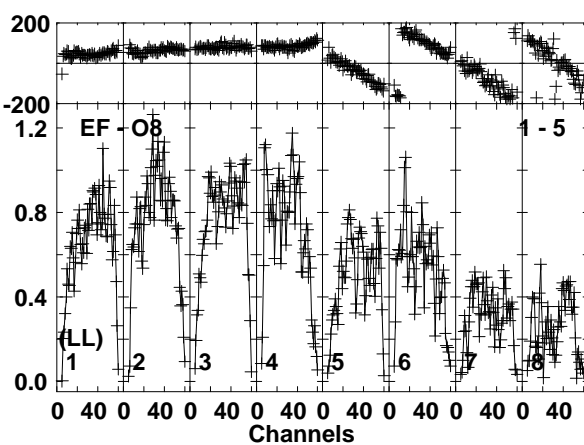
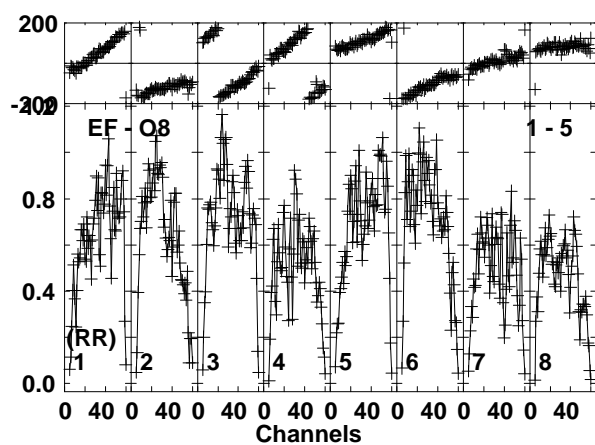
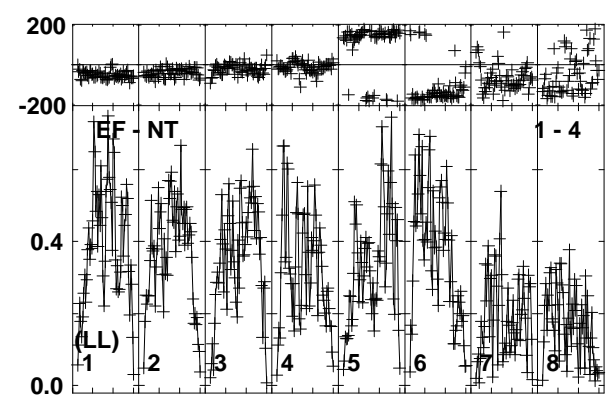
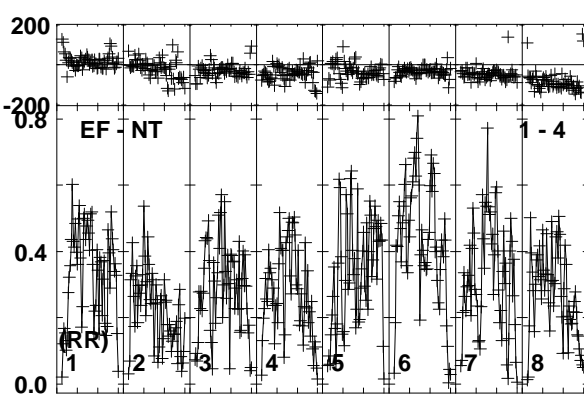
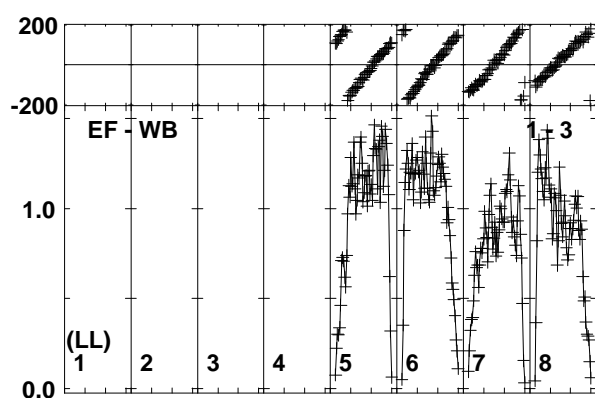
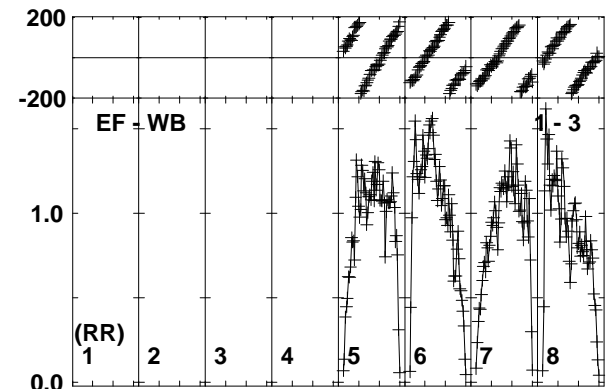
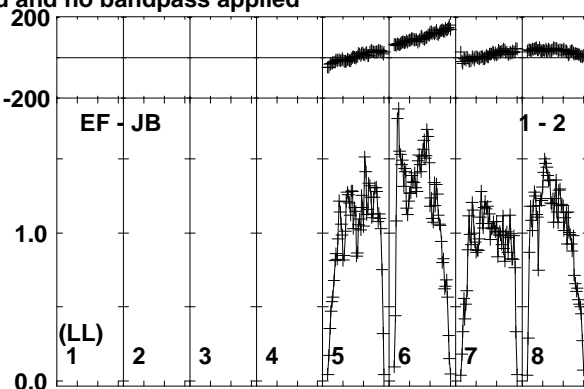
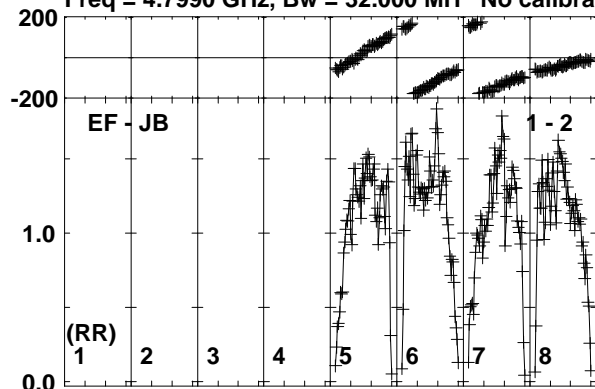

Lower frame: Milli Ampl Jy Top frame: Phas deg  
Vector averaged cross-power spectrum Baseline: EF (01) - JB (02)  
Timerange: 00/11:53:30 to 00/11:54:29

Plot file version 91 created 25-SEP-2017 10:02:29

J1303-2405 RP029B.UVDATA.1

Freq = 4.7990 GHz, Bw = 32.000 MH No calibration applied and no bandpass applied

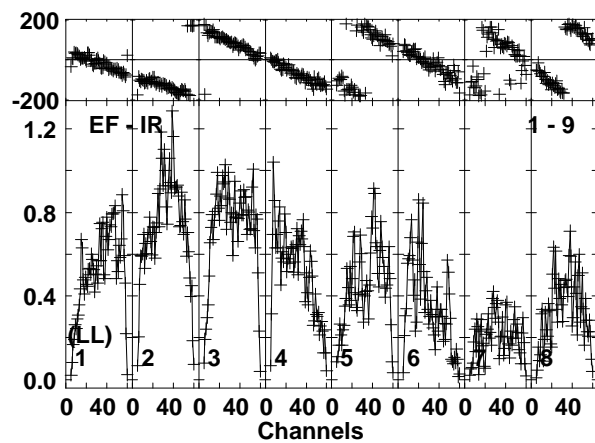
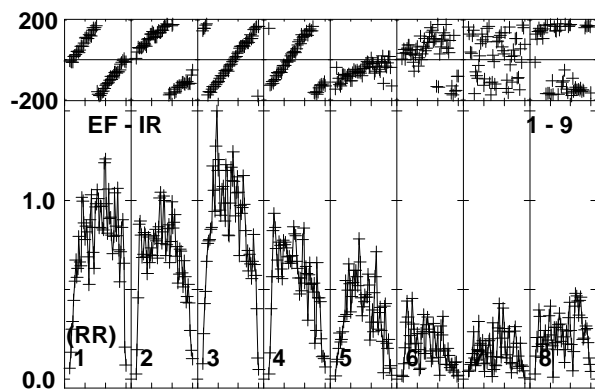
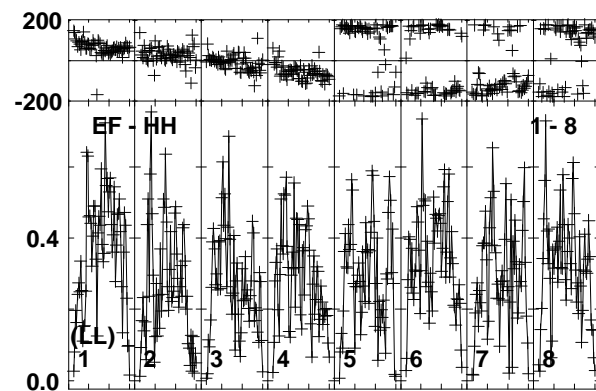
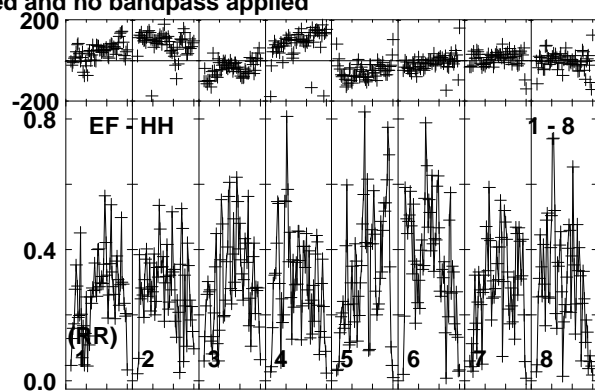
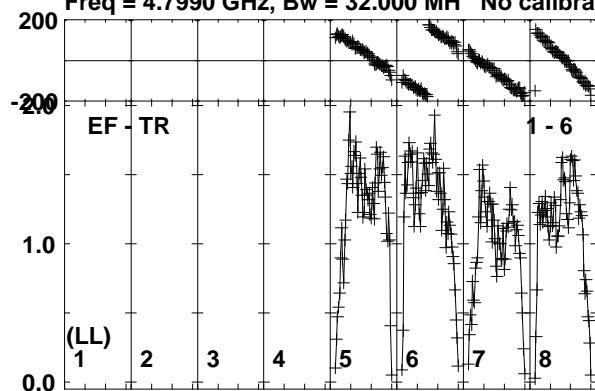

Lower frame: Milli Ampl Jy Top frame: Phas deg  
Vector averaged cross-power spectrum Baseline: EF (01) - TR (06)  
Timerange: 00/11:53:30 to 00/11:54:29

Plot file version 92 created 25-SEP-2017 10:02:29

SSS17A RP029B.UVDATA.1

Freq = 4.7990 GHz, Bw = 32.000 MH No calibration applied and no bandpass applied

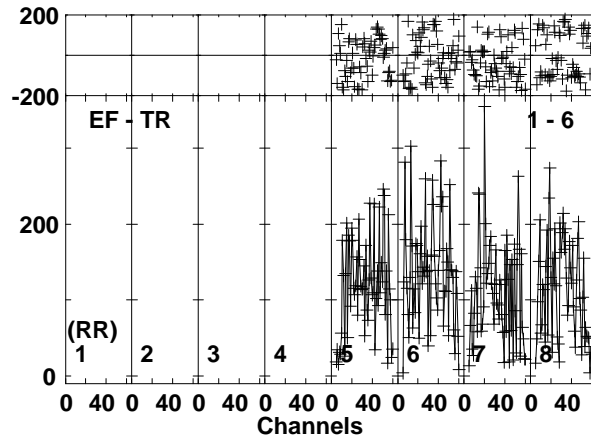
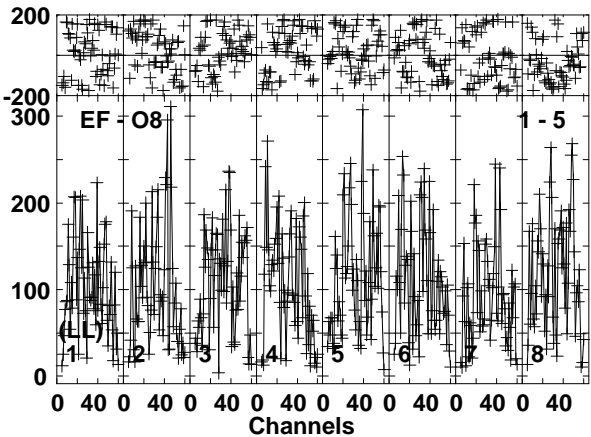
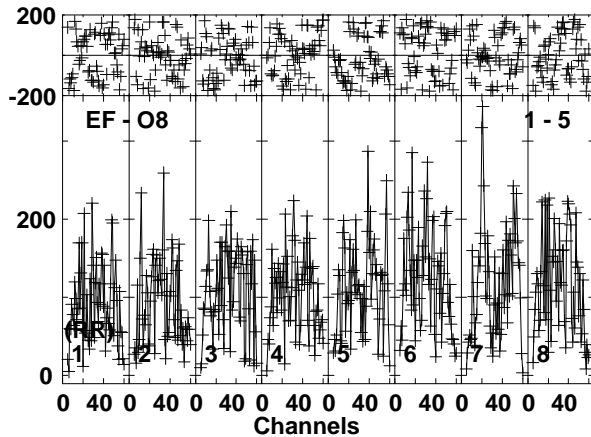
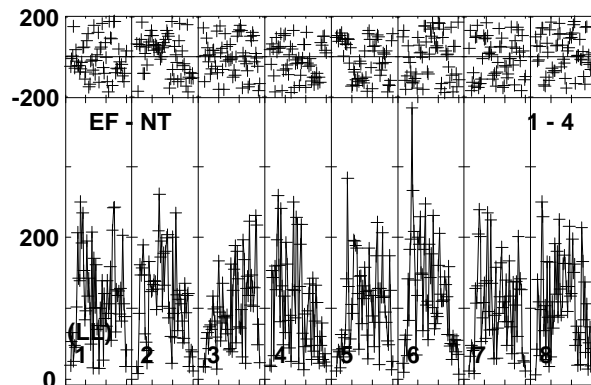
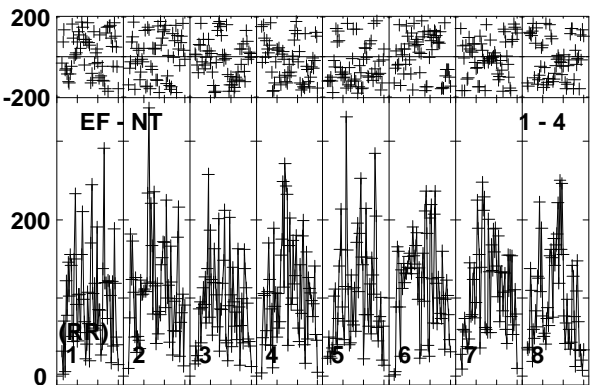
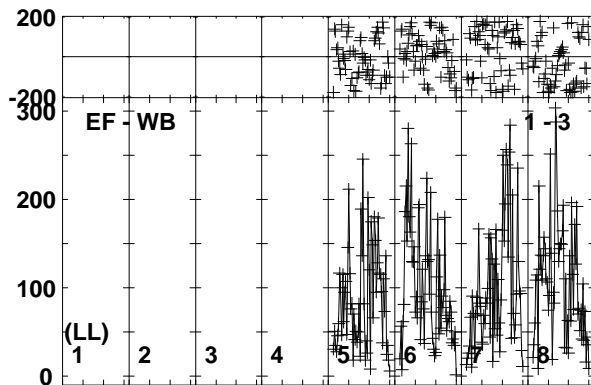
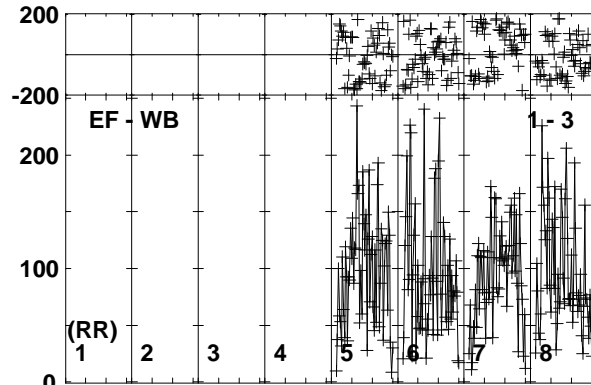
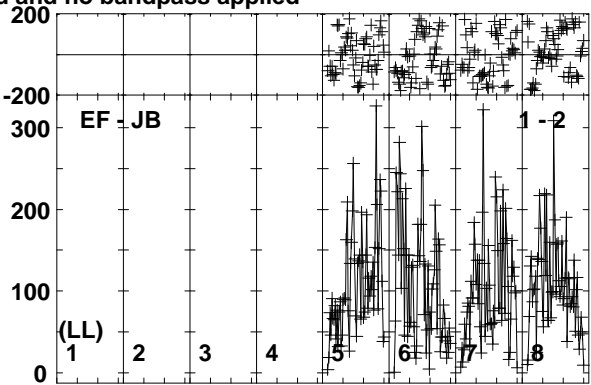
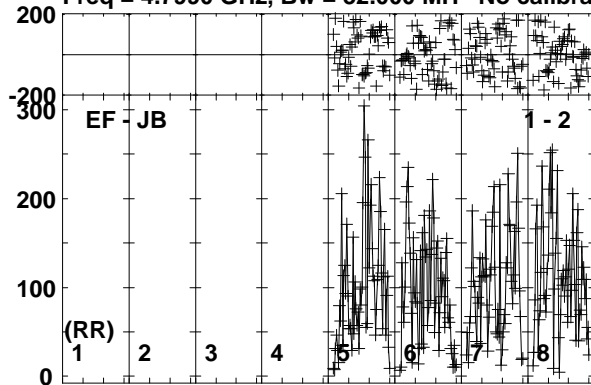

Lower frame: Micro Ampl Jy Top frame: Phas deg  
Vector averaged cross-power spectrum Baseline: EF (01) - JB (02)  
Timerange: 00/11:54:30 to 00/11:56:58

Plot file version 93 created 25-SEP-2017 10:02:30

SSS17A RP029B.UVDATA.1

Freq = 4.7990 GHz, Bw = 32.000 MH No calibration applied and no bandpass applied

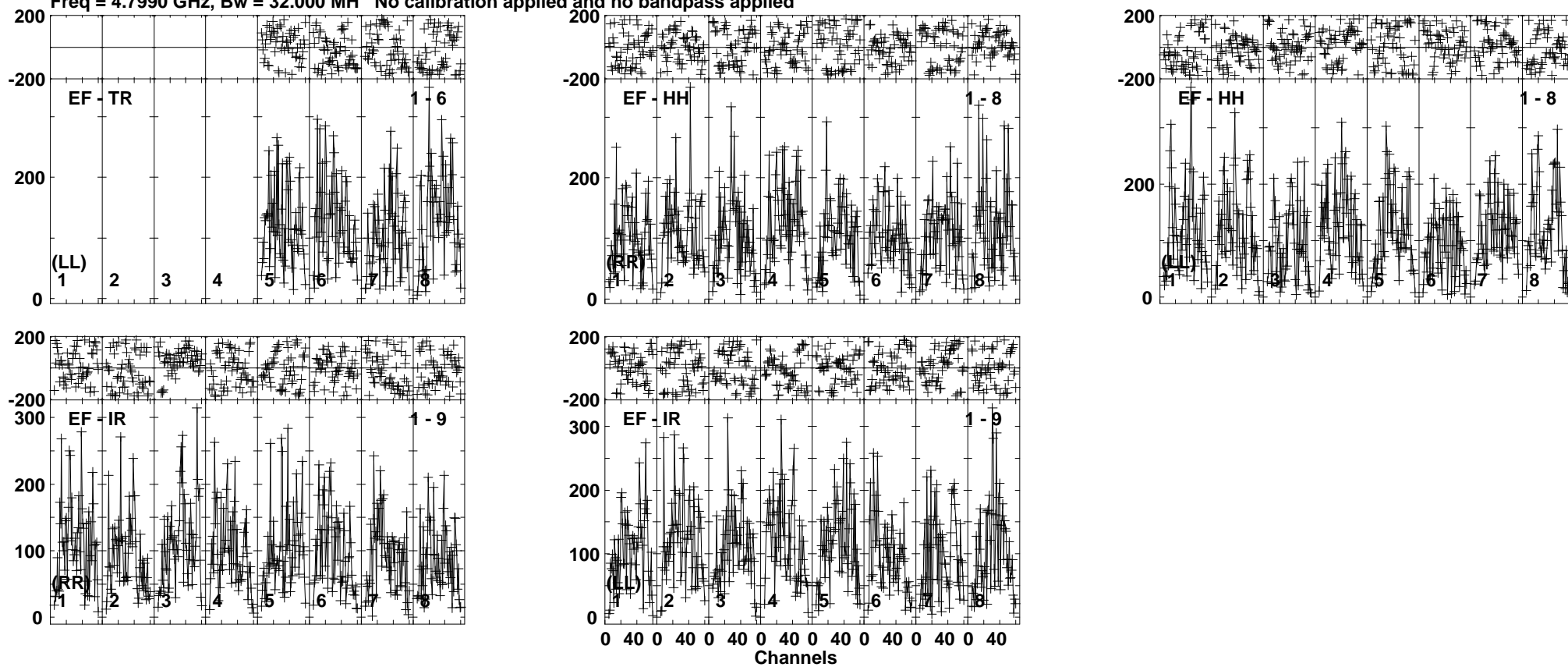

Lower frame: Micro Ampl Jy Top frame: Phas deg  
Vector averaged cross-power spectrum Baseline: EF (01) - TR (06)  
Timerange: 00/11:54:30 to 00/11:56:58

Plot file version 94 created 25-SEP-2017 10:02:30

J1303-2405 RP029B.UVDATA.1

Freq = 4.7990 GHz, Bw = 32.000 MH No calibration applied and no bandpass applied

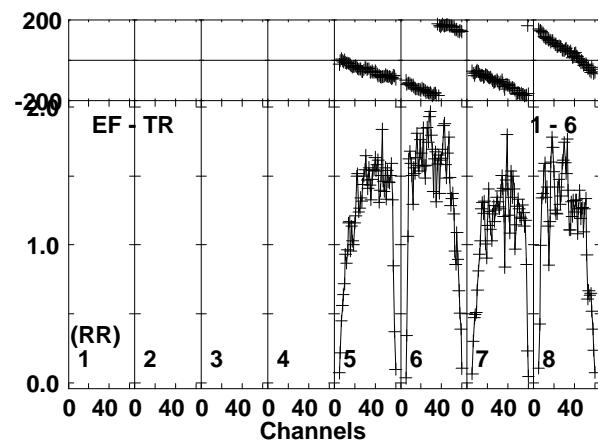
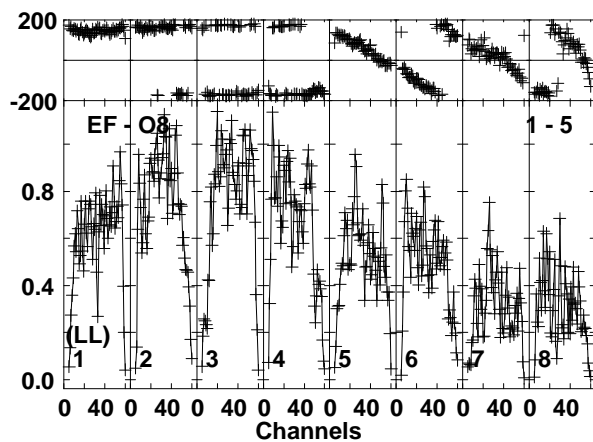
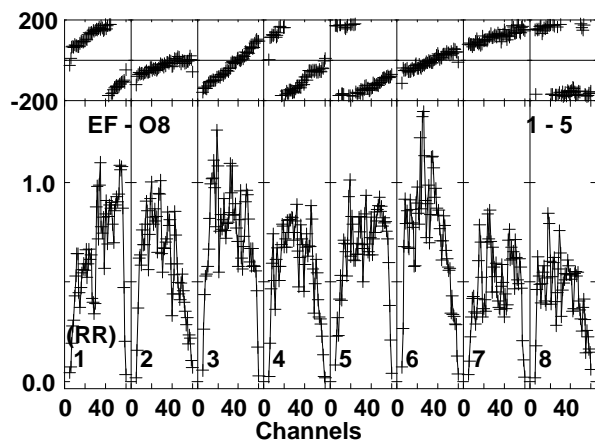
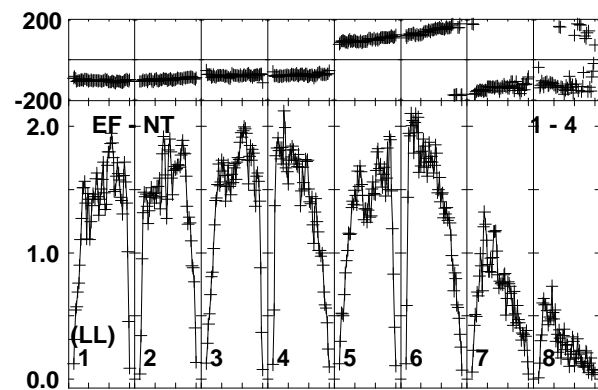
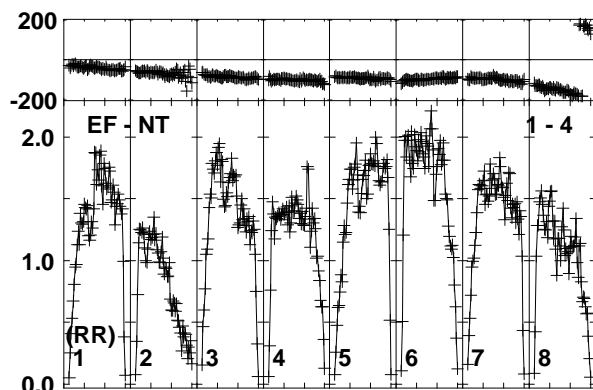
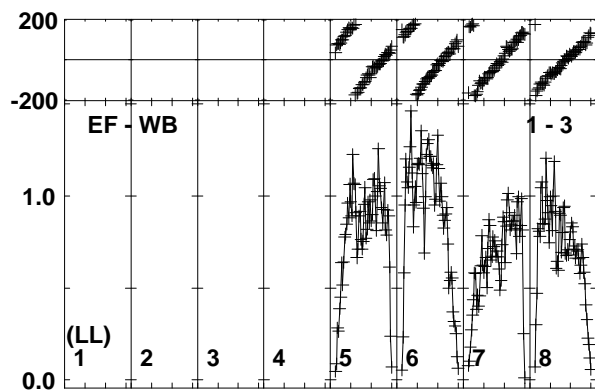
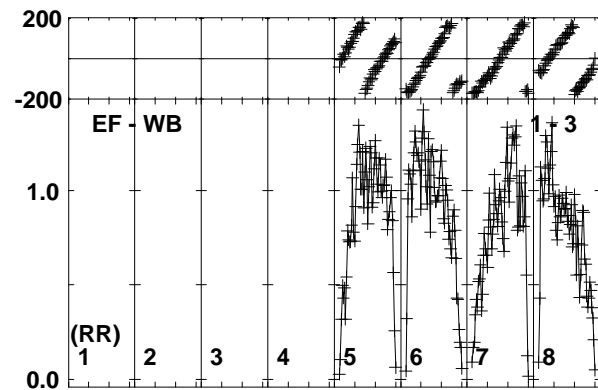
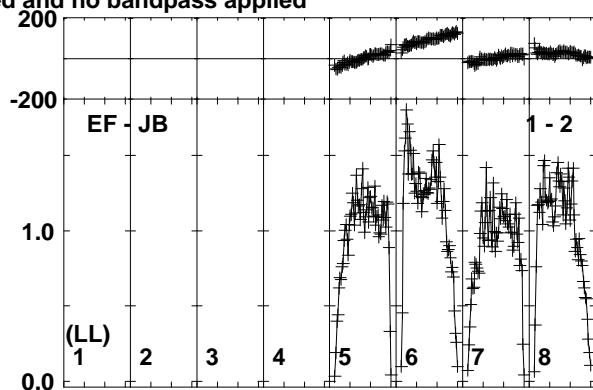
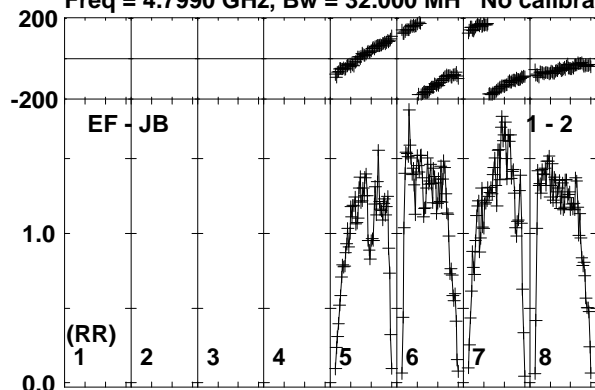

Lower frame: Milli Ampl Jy Top frame: Phas deg  
Vector averaged cross-power spectrum Baseline: EF (01) - JB (02)  
Timerange: 00/11:57:00 to 00/11:58:29

Plot file version 95 created 25-SEP-2017 10:02:30

J1303-2405 RP029B.UVDATA.1

Freq = 4.7990 GHz, Bw = 32.000 MH No calibration applied and no bandpass applied

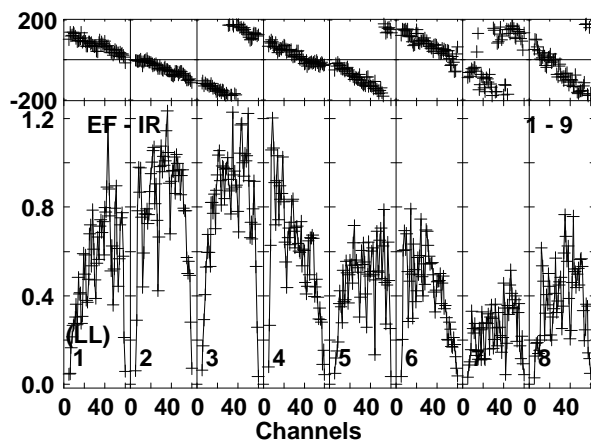
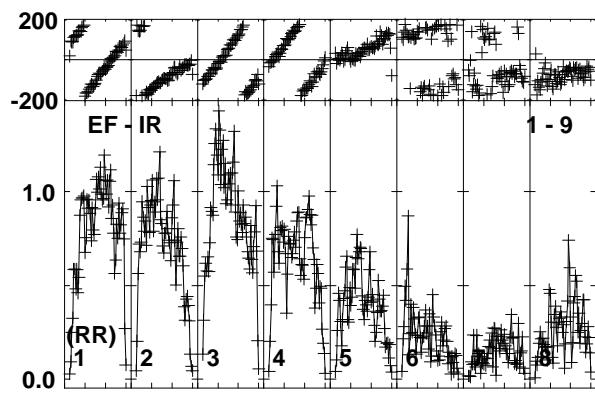
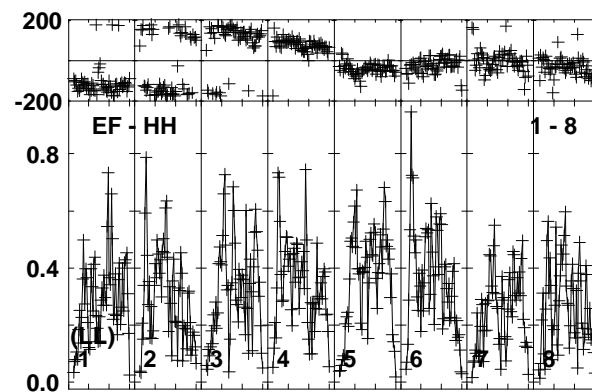
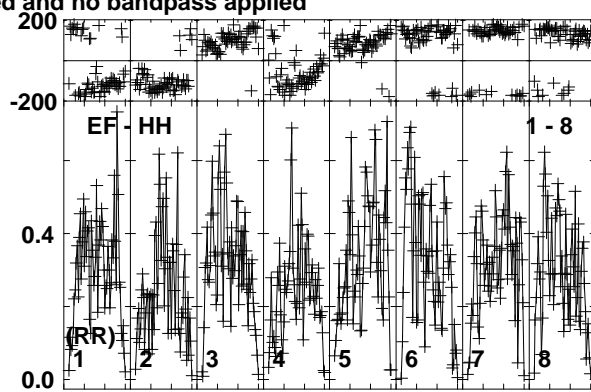
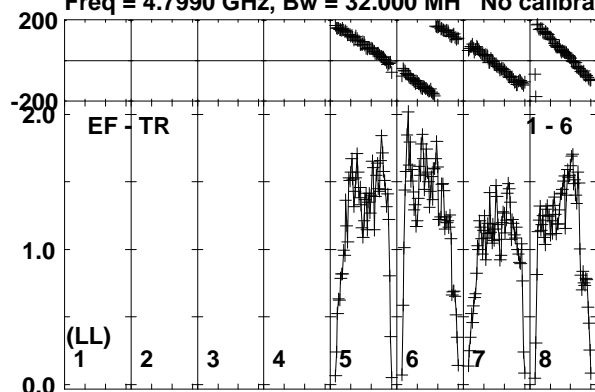

Lower frame: Milli Ampl Jy Top frame: Phas deg  
Vector averaged cross-power spectrum Baseline: EF (01) - TR (06)  
Timerange: 00/11:57:00 to 00/11:58:29

Plot file version 96 created 25-SEP-2017 10:02:30

J1312-2350 RP029B.UVDATA.1

Freq = 4.7990 GHz, Bw = 32.000 MH No calibration applied and no bandpass applied

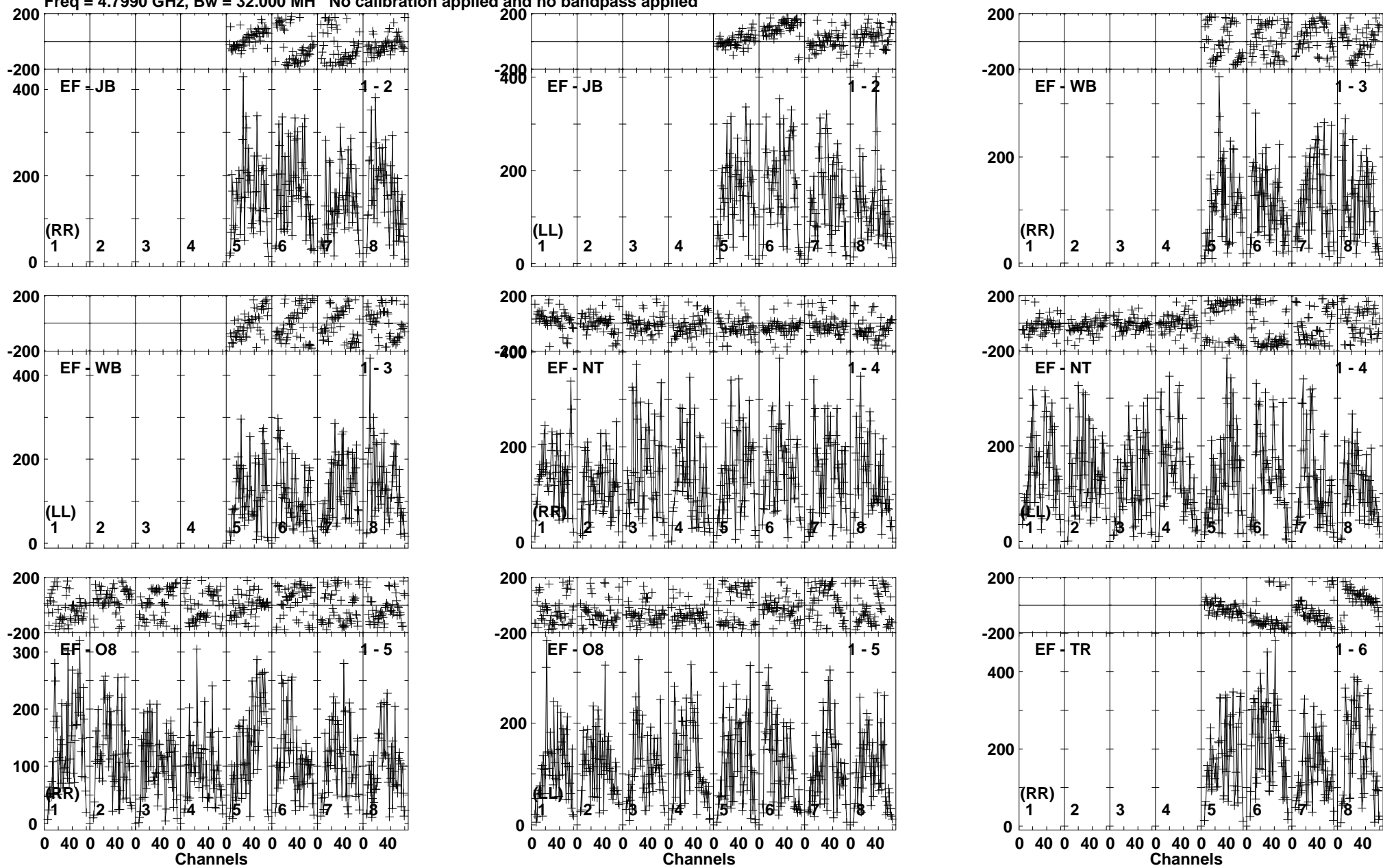

Lower frame: Micro Ampl Jy Top frame: Phas deg  
Vector averaged cross-power spectrum Baseline: EF (01) - JB (02)  
Timerange: 00/11:58:29 to 00/12:00:59



Plot file version 97 created 25-SEP-2017 10:02:30

J1312-2350 RP029B.UVDATA.1

Freq = 4.7990 GHz, Bw = 32.000 MH No calibration applied and no bandpass applied

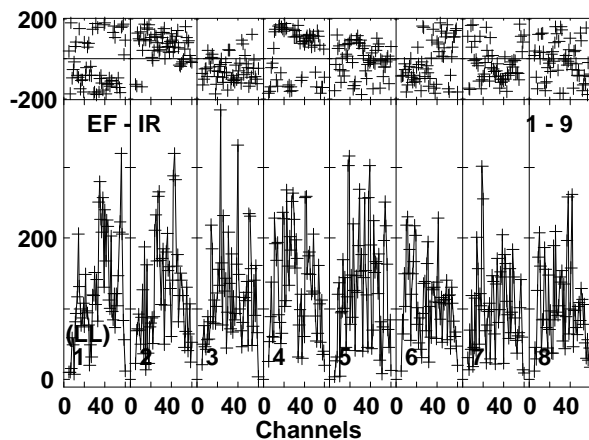
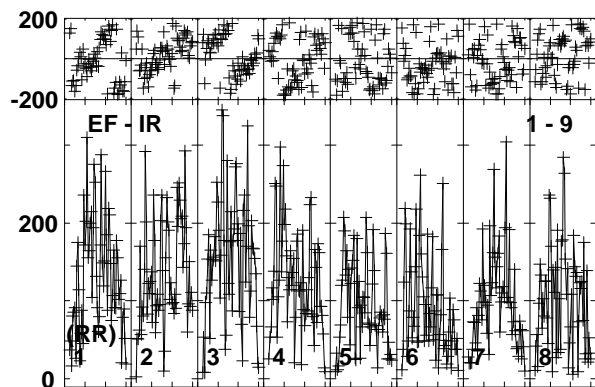
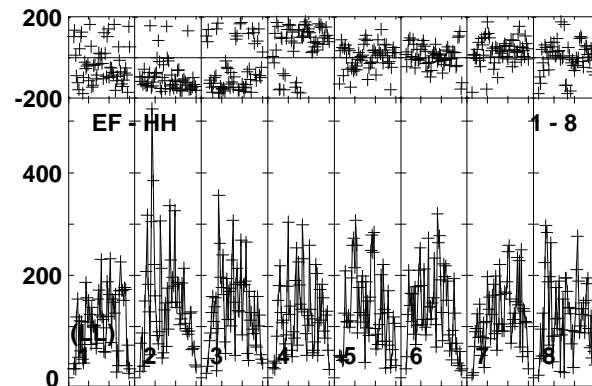
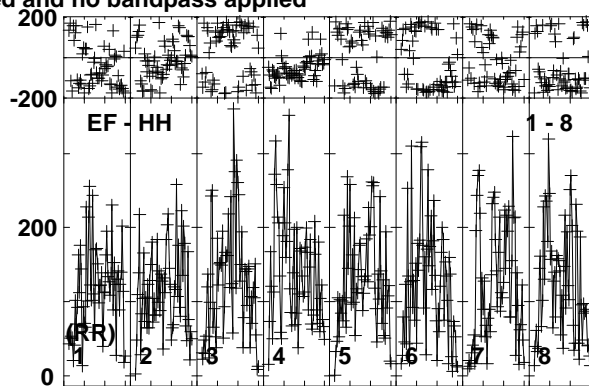
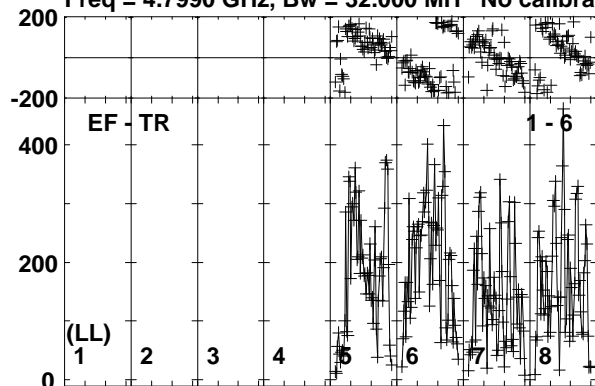

Lower frame: Micro Ampl Jy Top frame: Phas deg  
Vector averaged cross-power spectrum Baseline: EF (01) - TR (06)  
Timerange: 00/11:58:29 to 00/12:00:59

Plot file version 98 created 25-SEP-2017 10:02:30

J1303-2405 RP029B.UVDATA.1

Freq = 4.7990 GHz, Bw = 32.000 MH No calibration applied and no bandpass applied

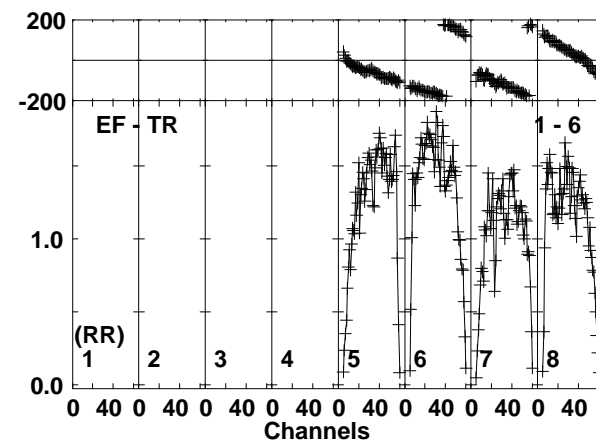
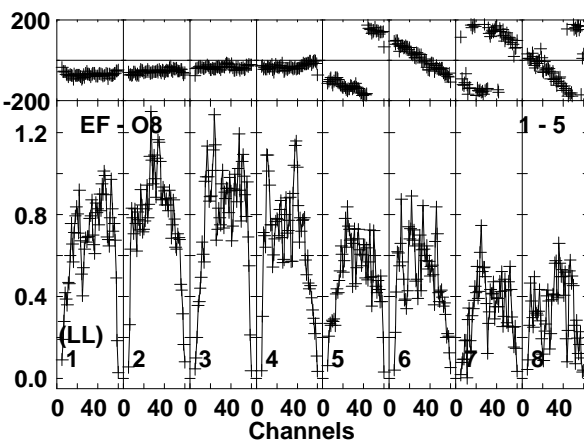
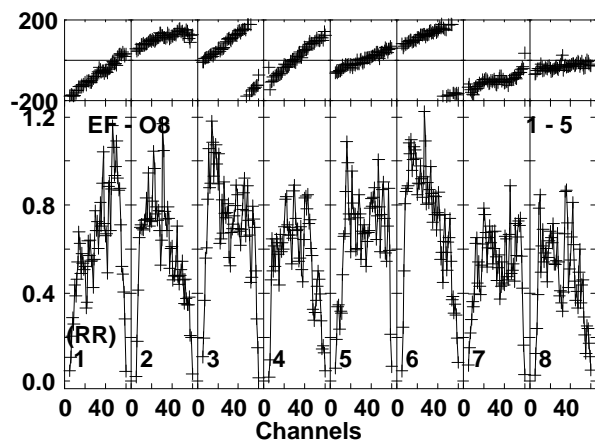
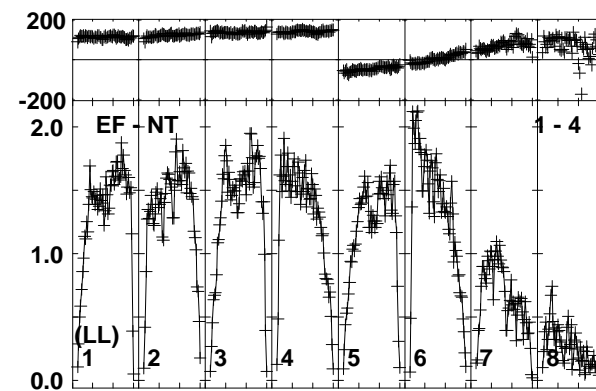
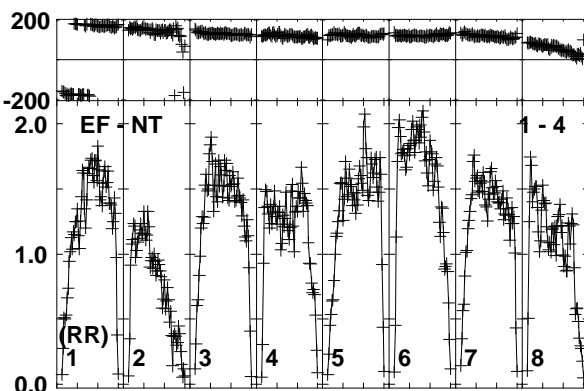
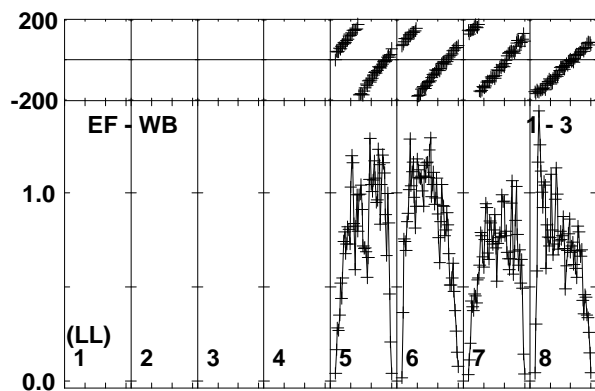
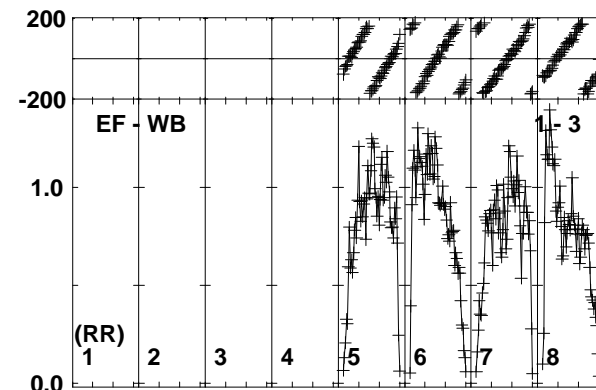
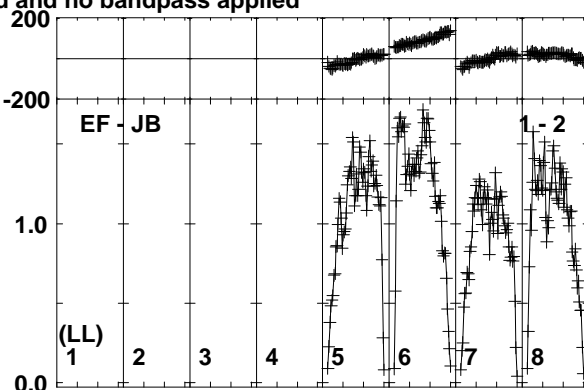
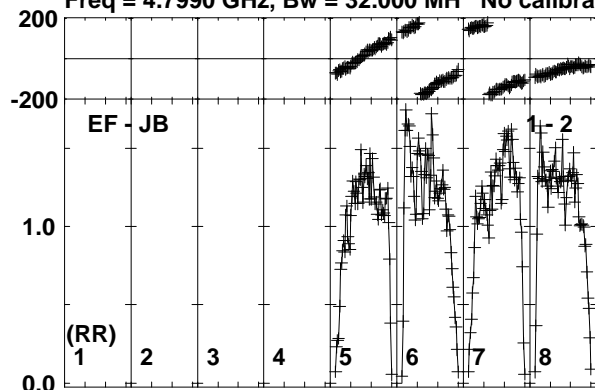

Lower frame: Milli Ampl Jy Top frame: Phas deg  
Vector averaged cross-power spectrum Baseline: EF (01) - JB (02)  
Timerange: 00:12:01:40 to 00:12:02:39



Plot file version 100 created 25-SEP-2017 10:02:31

SSS17A RP029B.UVDATA.1

Freq = 4.7990 GHz, Bw = 32.000 MH No calibration applied and no bandpass applied

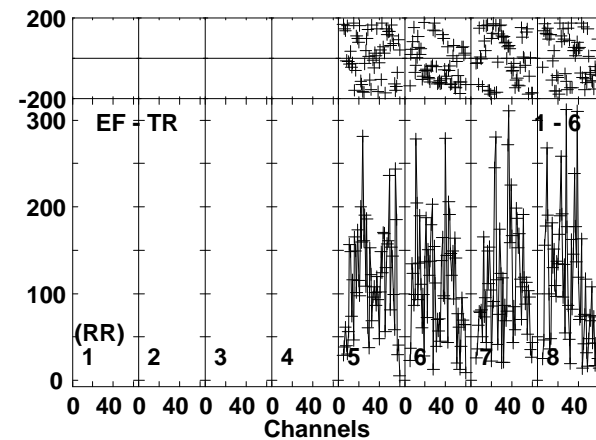
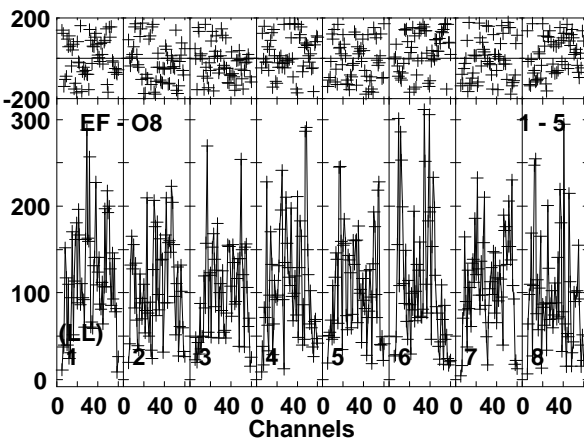
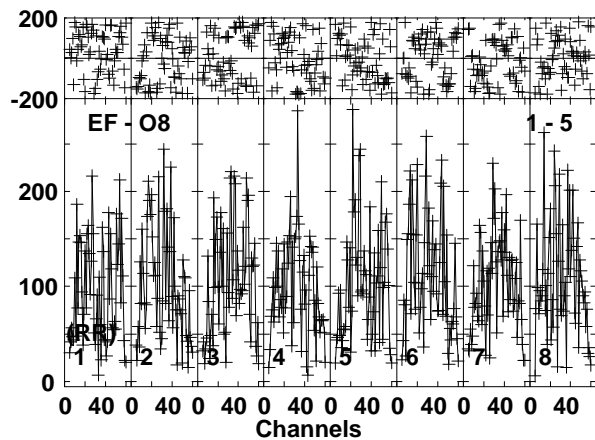
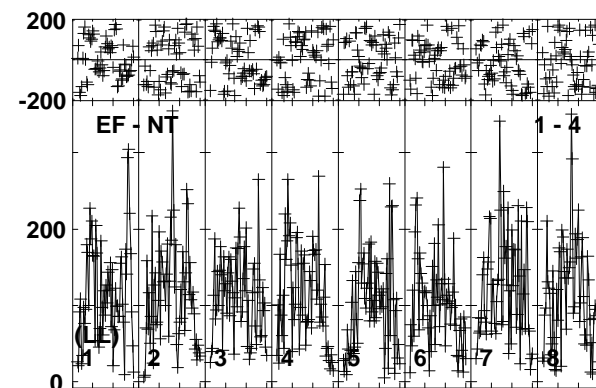
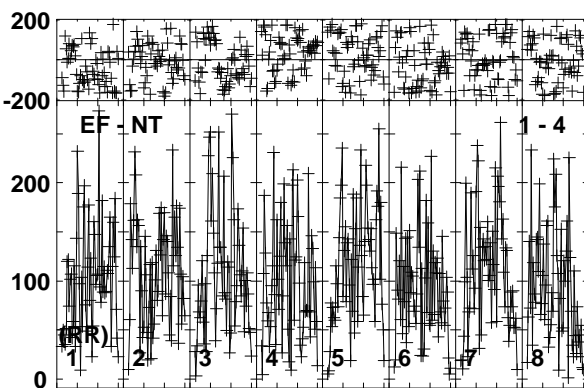
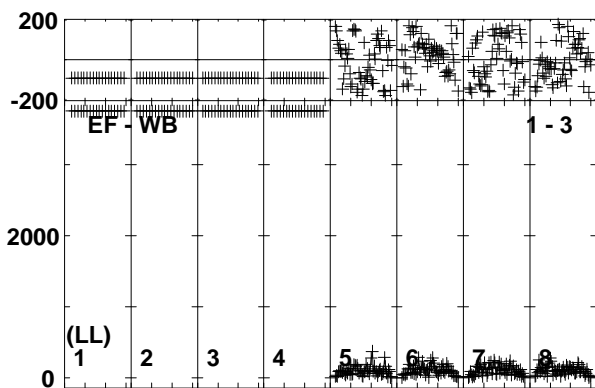
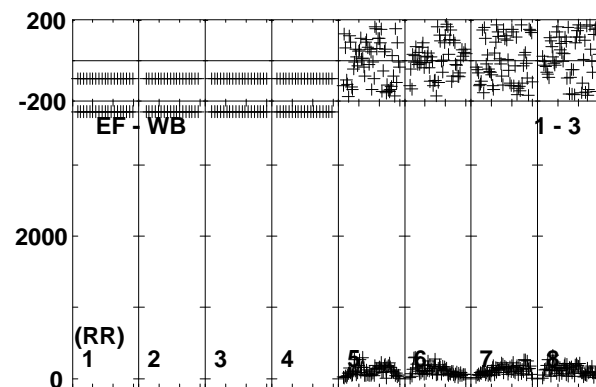
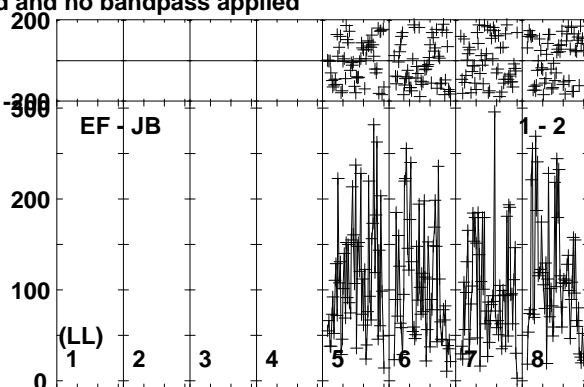
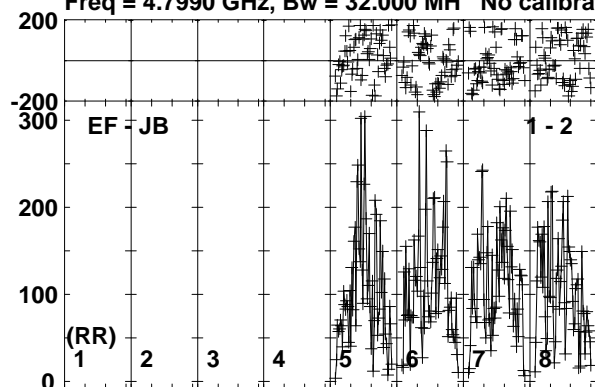

Lower frame: Micro Ampl Jy Top frame: Phas deg  
Vector averaged cross-power spectrum Baseline: EF (01) - JB (02)  
Timerange: 00/12:02:40 to 00/12:05:08

Plot file version 101 created 25-SEP-2017 10:02:31

SSS17A RP029B.UVDATA.1

Freq = 4.7990 GHz, Bw = 32.000 MH No calibration applied and no bandpass applied

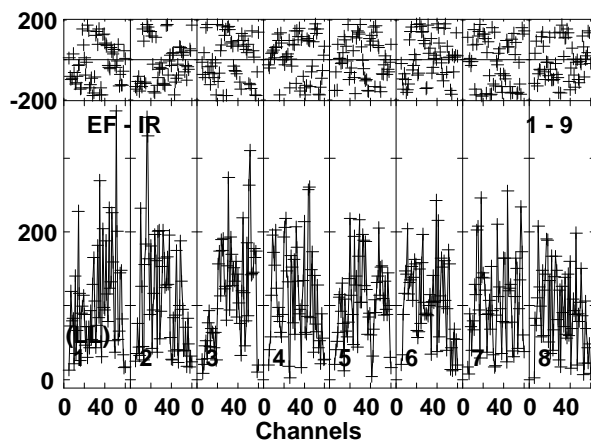
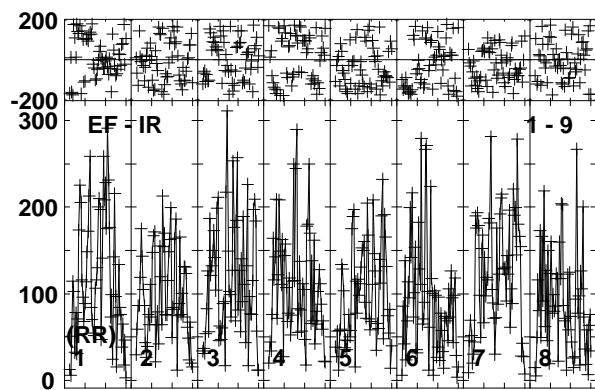
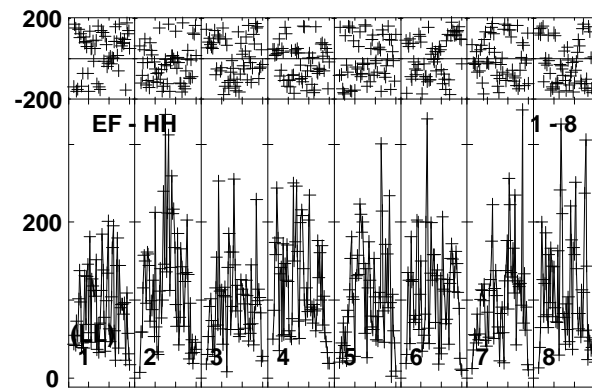
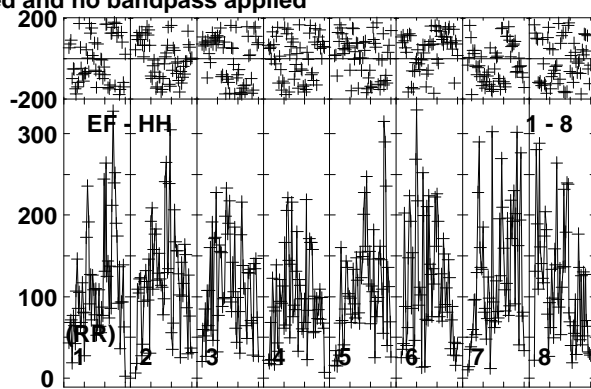
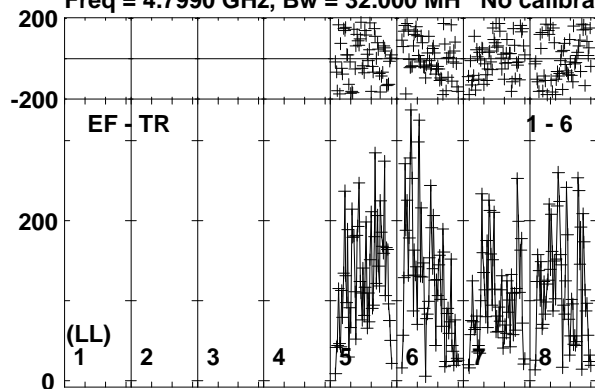

Lower frame: Micro Ampl Jy Top frame: Phas deg  
Vector averaged cross-power spectrum Baseline: EF (01) - TR (06)  
Timerange: 00/12:02:40 to 00/12:05:08

Plot file version 102 created 25-SEP-2017 10:02:31

J1303-2405 RP029B.UVDATA.1

Freq = 4.7990 GHz, Bw = 32.000 MH No calibration applied and no bandpass applied

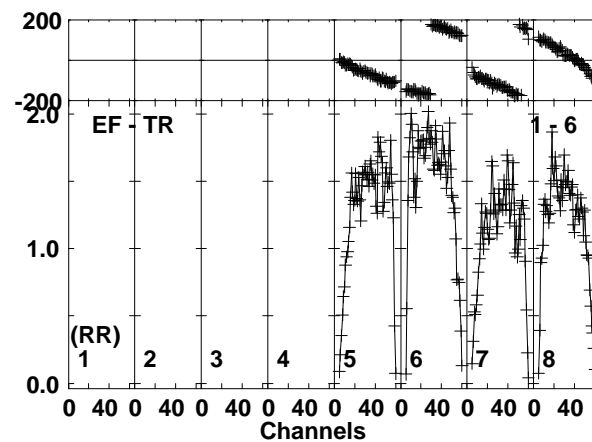
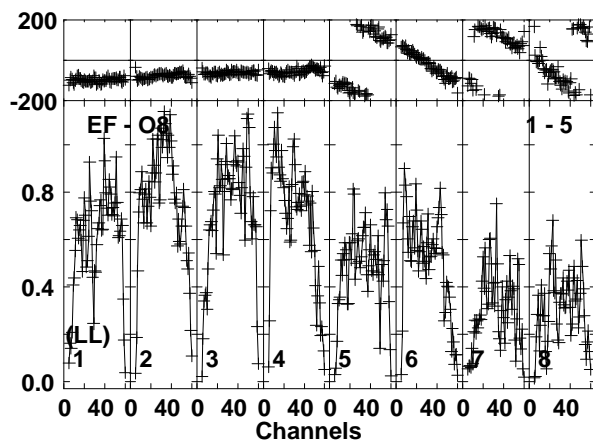
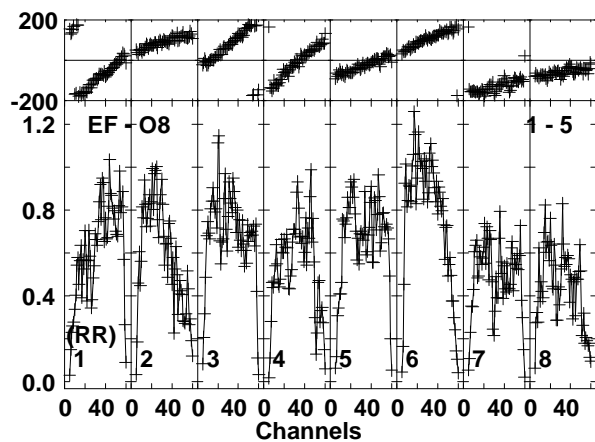
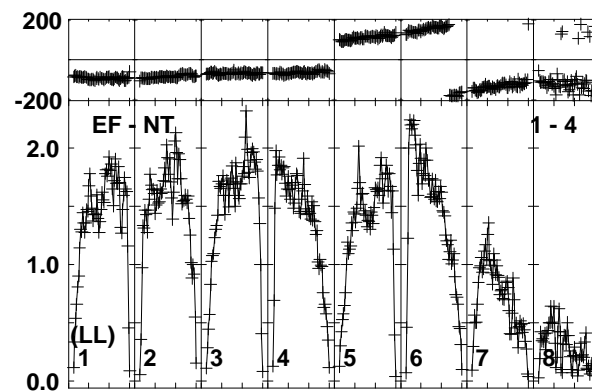
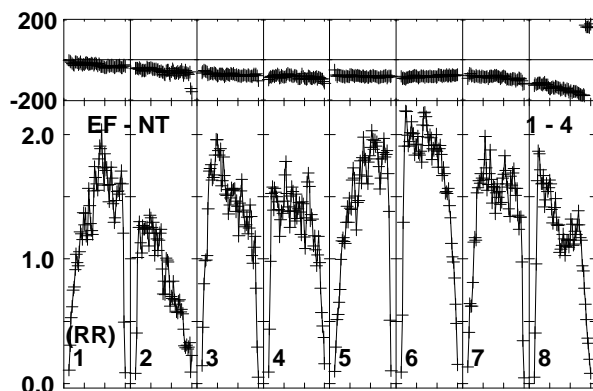
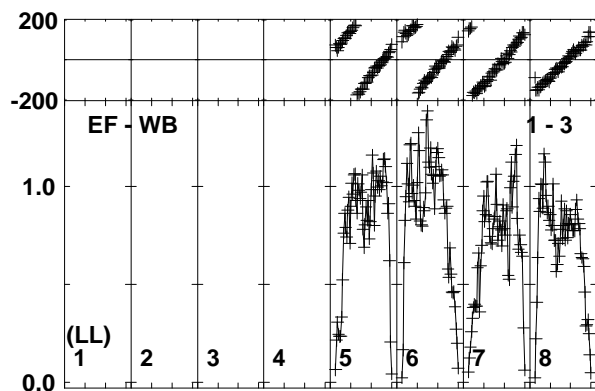
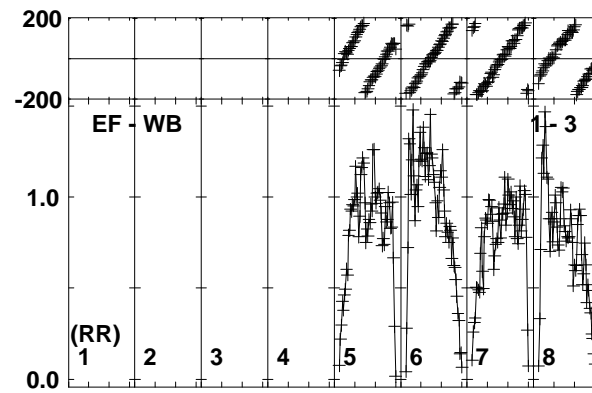
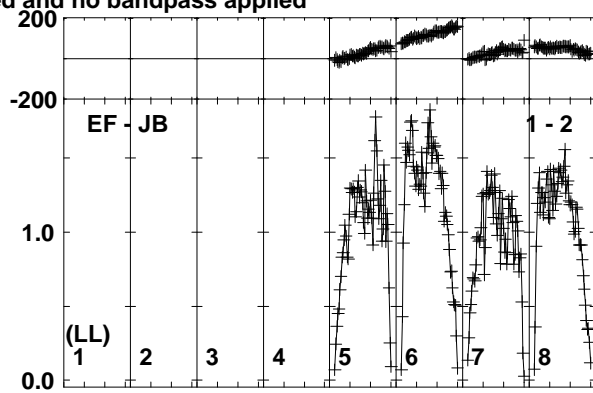
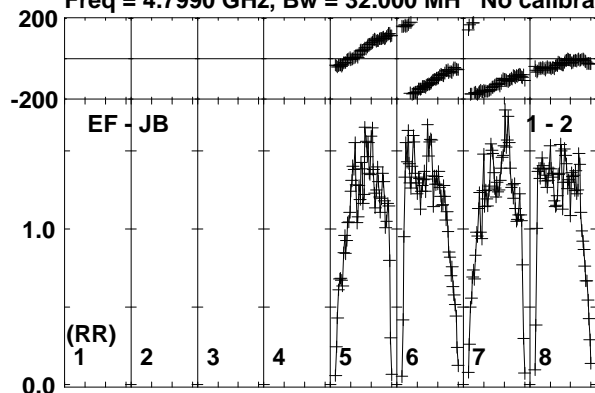

Lower frame: Milli Ampl Jy Top frame: Phas deg  
Vector averaged cross-power spectrum Baseline: EF (01) - JB (02)  
Timerange: 00/12:05:09 to 00/12:06:39

Plot file version 103 created 25-SEP-2017 10:02:31

J1303-2405 RP029B.UVDATA.1

Freq = 4.7990 GHz, Bw = 32.000 MH No calibration applied and no bandpass applied

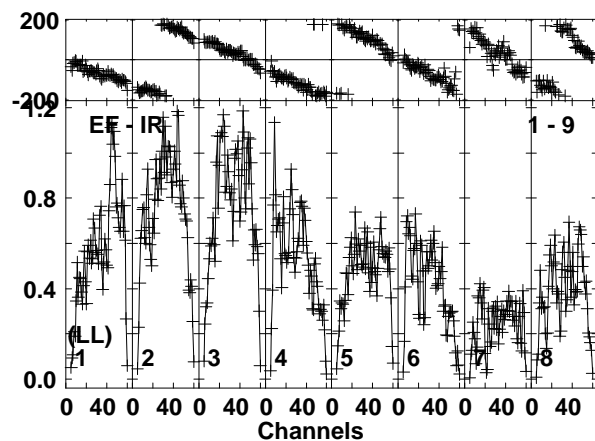
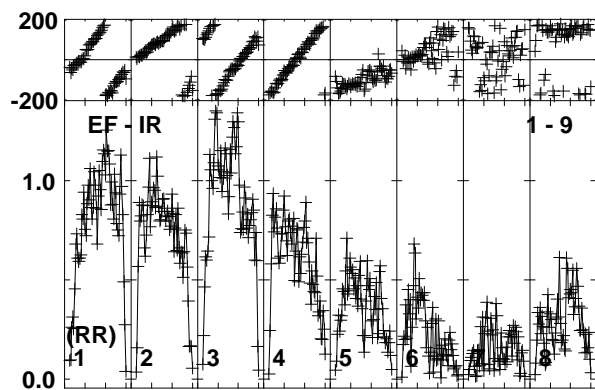
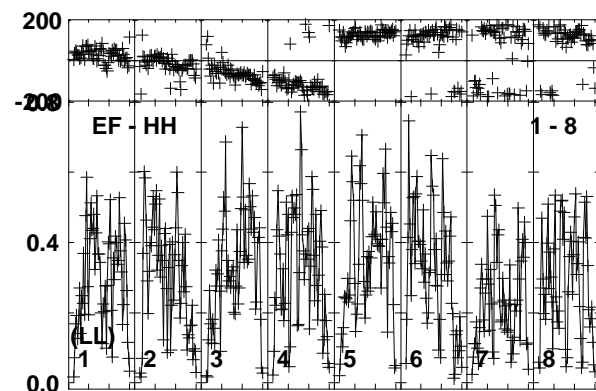
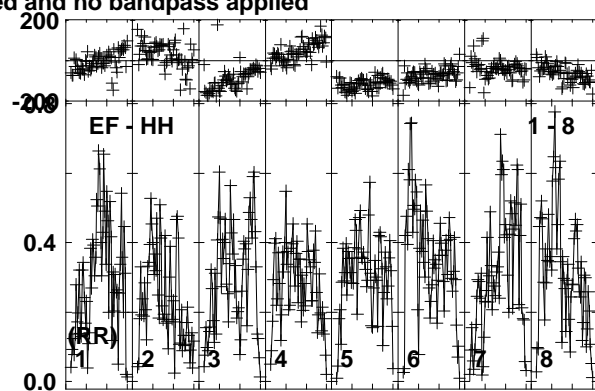
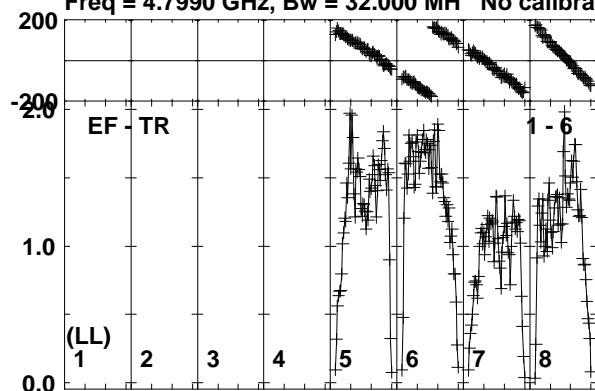

Lower frame: Milli Ampl Jy Top frame: Phas deg  
Vector averaged cross-power spectrum Baseline: EF (01) - TR (06)  
Timerange: 00/12:05:09 to 00/12:06:39

Plot file version 104 created 25-SEP-2017 10:02:31

SSS17A RP029B.UVDATA.1

Freq = 4.7990 GHz, Bw = 32.000 MH No calibration applied and no bandpass applied

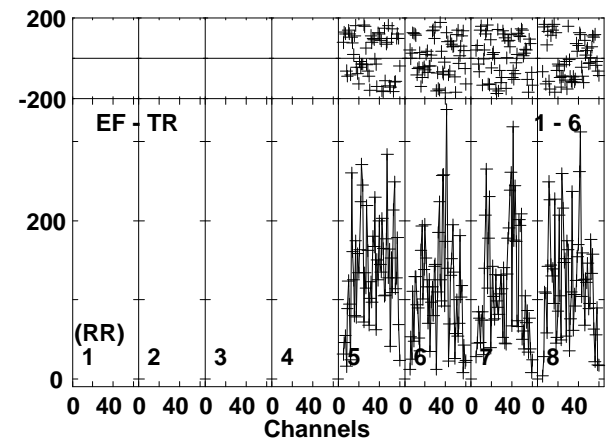
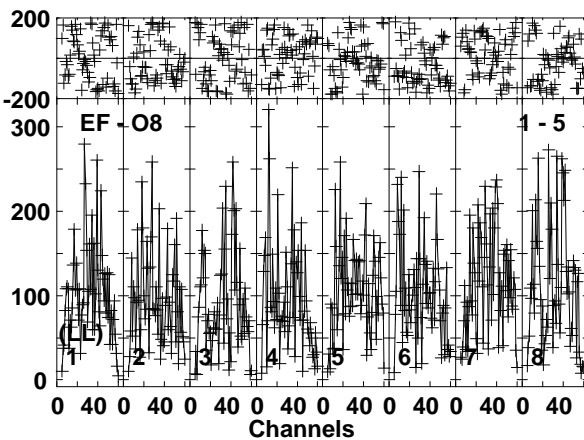
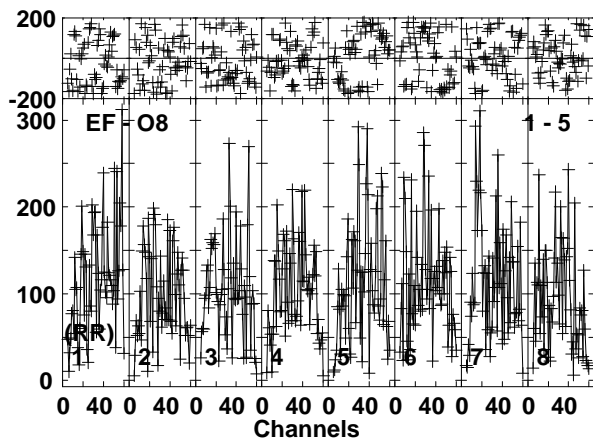
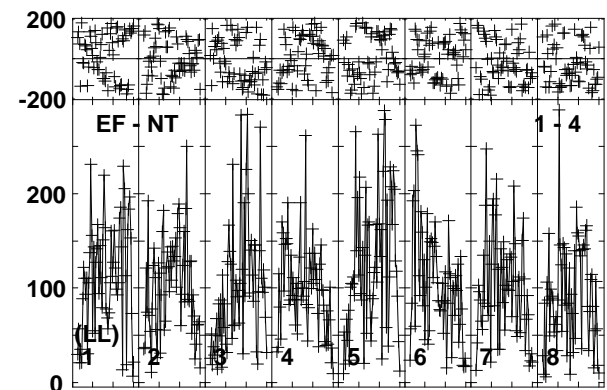
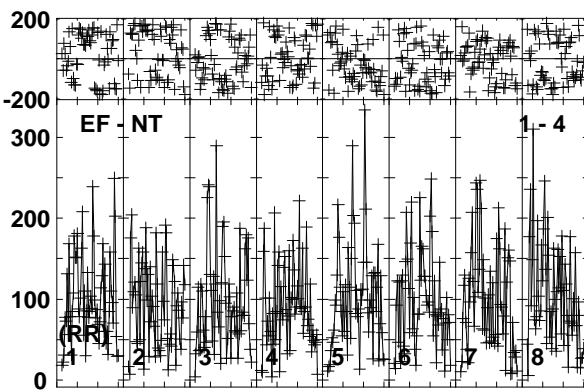
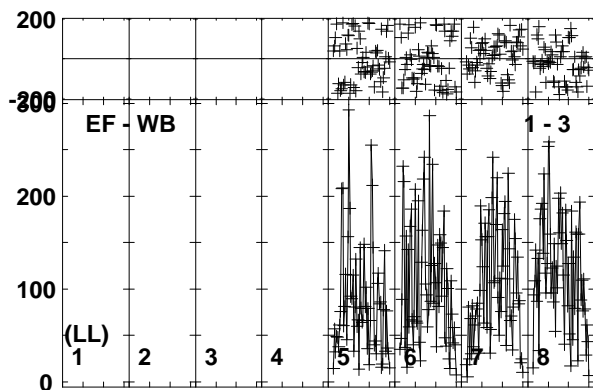
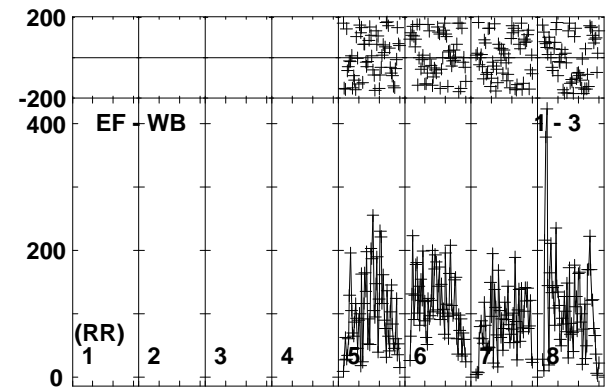
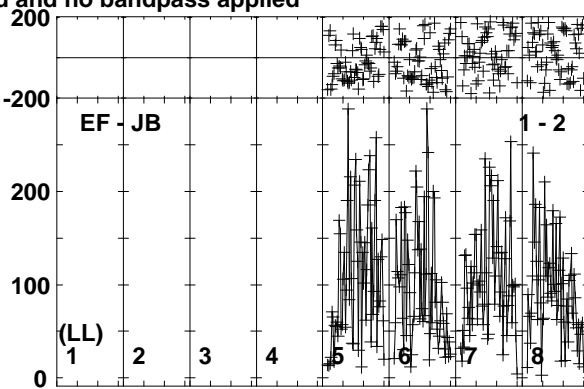
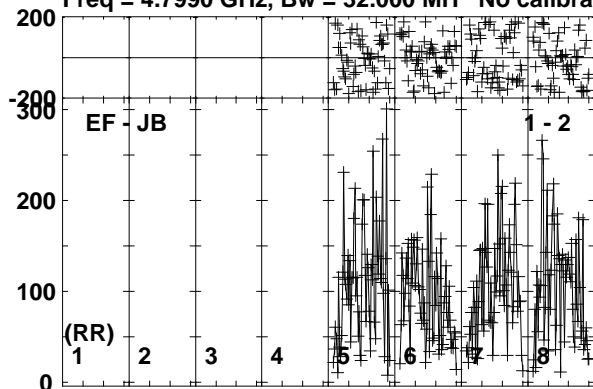

Lower frame: Micro Ampl Jy Top frame: Phas deg  
Vector averaged cross-power spectrum Baseline: EF (01) - JB (02)  
Timerange: 00:12:06:40 to 00:12:09:08



Plot file version 105 created 25-SEP-2017 10:02:31

SSS17A RP029B.UVDATA.1

Freq = 4.7990 GHz, Bw = 32.000 MH No calibration applied and no bandpass applied

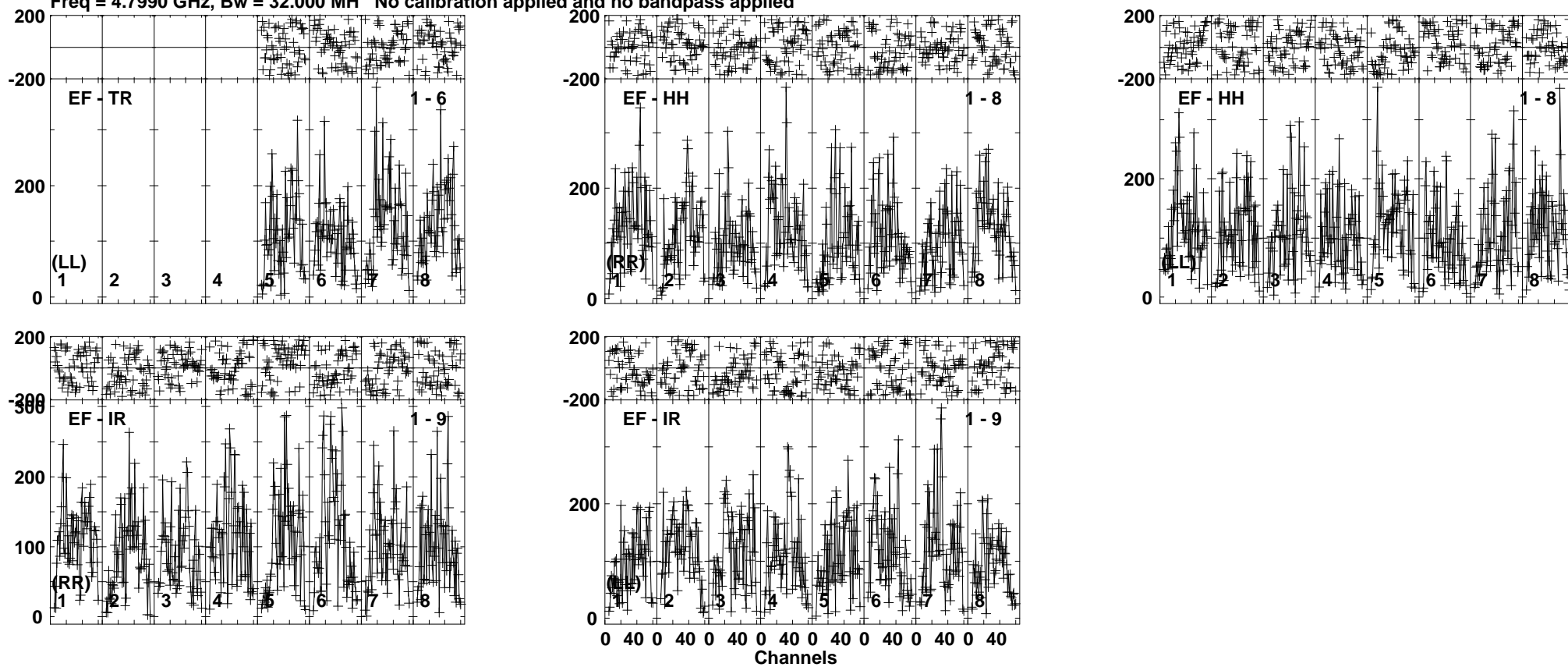

Lower frame: Micro Ampl Jy Top frame: Phas deg  
Vector averaged cross-power spectrum Baseline: EF (01) - TR (06)  
Timerange: 00/12:06:40 to 00/12:09:08

Plot file version 106 created 25-SEP-2017 10:02:31

J1303-2405 RP029B.UVDATA.1

Freq = 4.7990 GHz, Bw = 32.000 MH No calibration applied and no bandpass applied

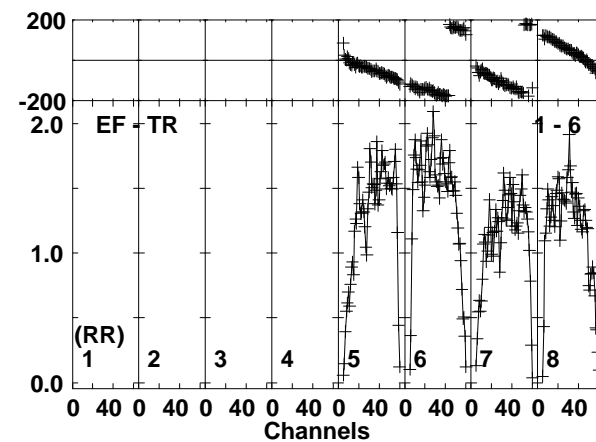
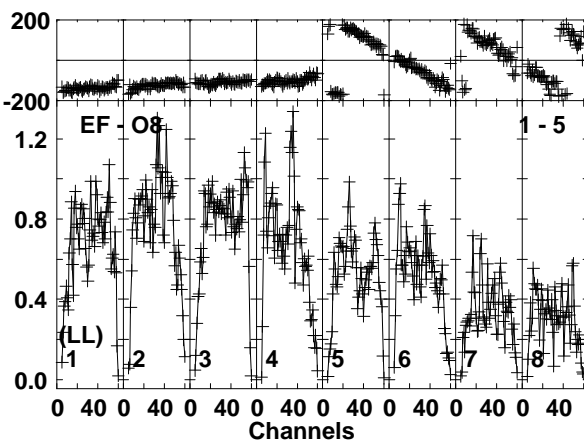
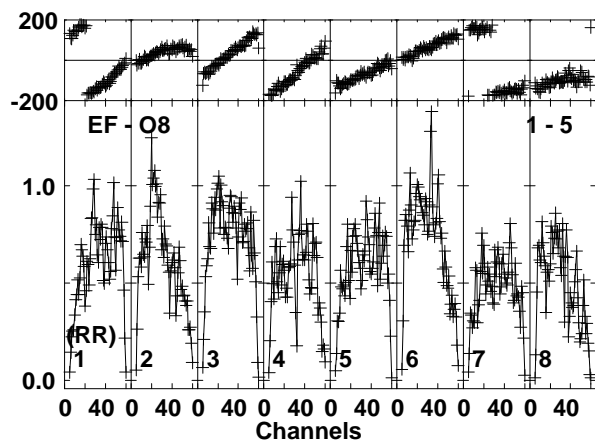
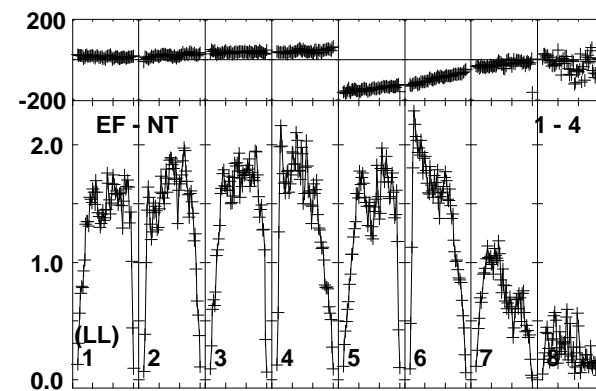
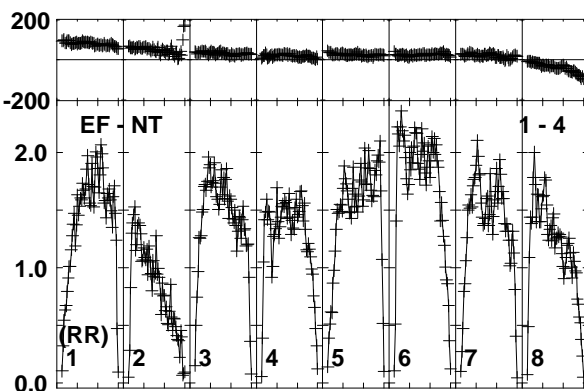
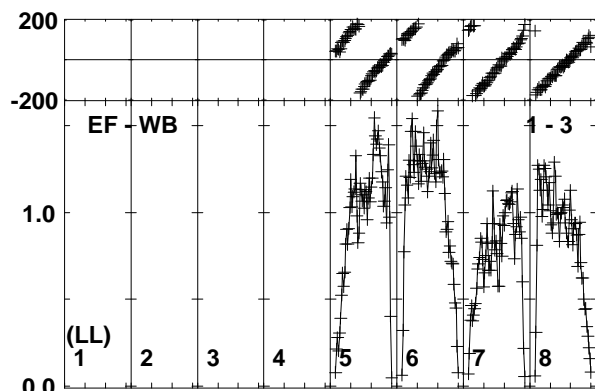
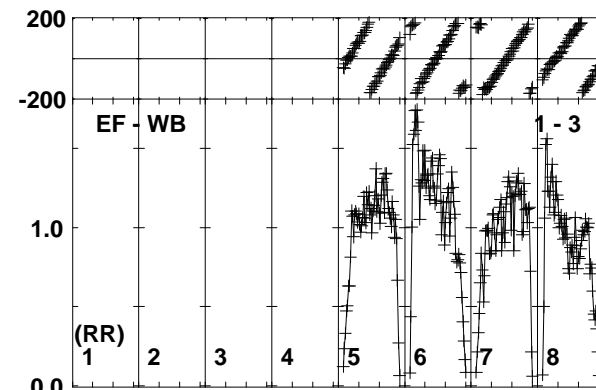
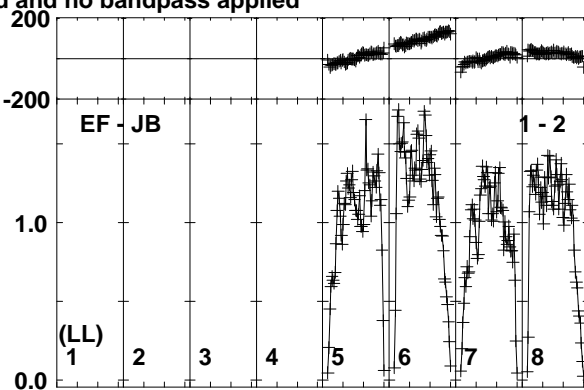
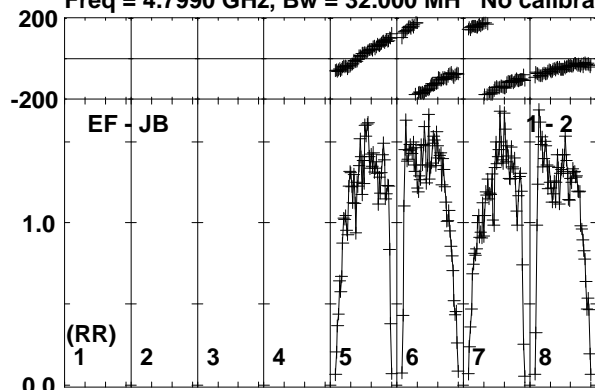

Lower frame: Milli Ampl Jy Top frame: Phas deg  
Vector averaged cross-power spectrum Baseline: EF (01) - JB (02)  
Timerange: 00:12:09:40 to 00:12:10:38

Plot file version 107 created 25-SEP-2017 10:02:32

J1303-2405 RP029B.UVDATA.1

Freq = 4.7990 GHz, Bw = 32.000 MH No calibration applied and no bandpass applied

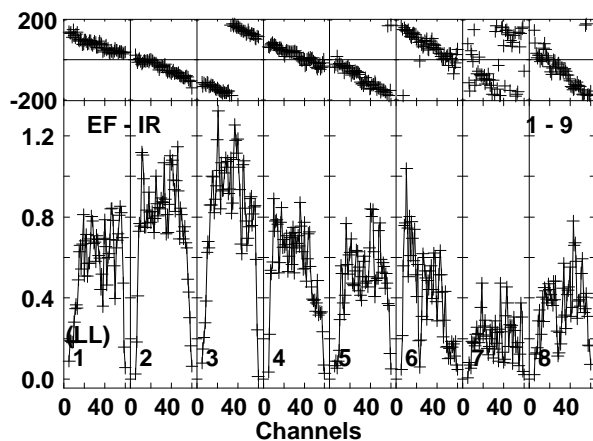
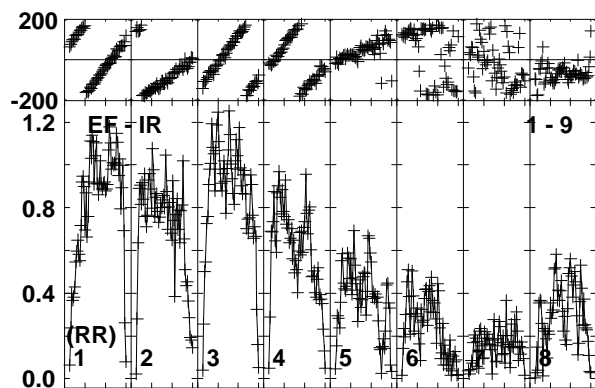
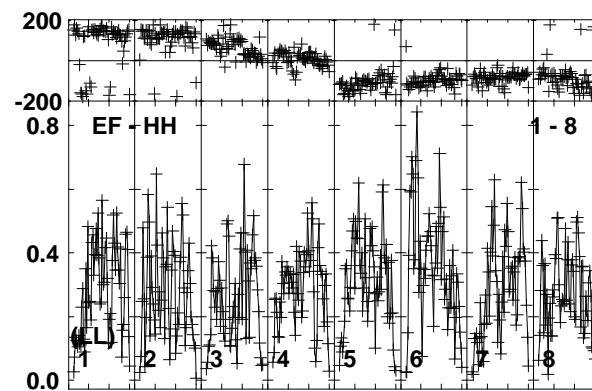
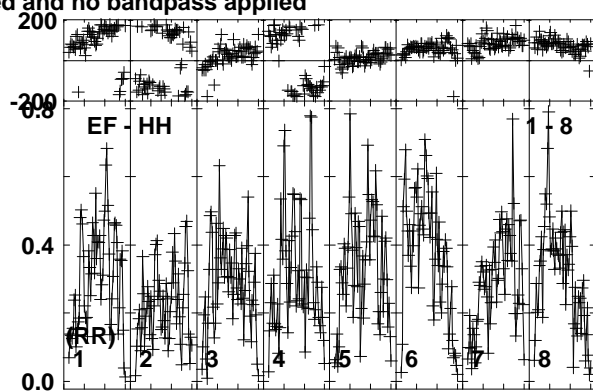
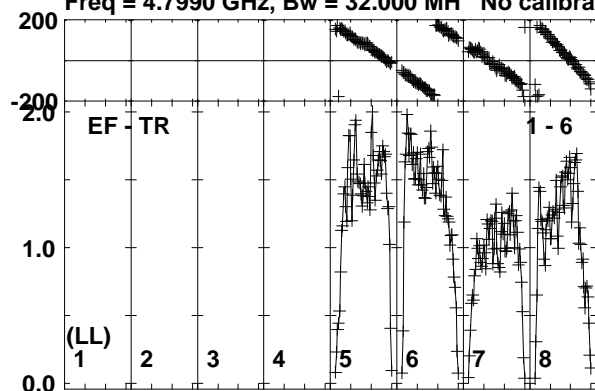

Lower frame: Milli Ampl Jy Top frame: Phas deg  
Vector averaged cross-power spectrum Baseline: EF (01) - TR (06)  
Timerange: 00:12:09:40 to 00:12:10:38

Plot file version 108 created 25-SEP-2017 10:02:32

SSS17A RP029B.UVDATA.1

Freq = 4.7990 GHz, Bw = 32.000 MH No calibration applied and no bandpass applied

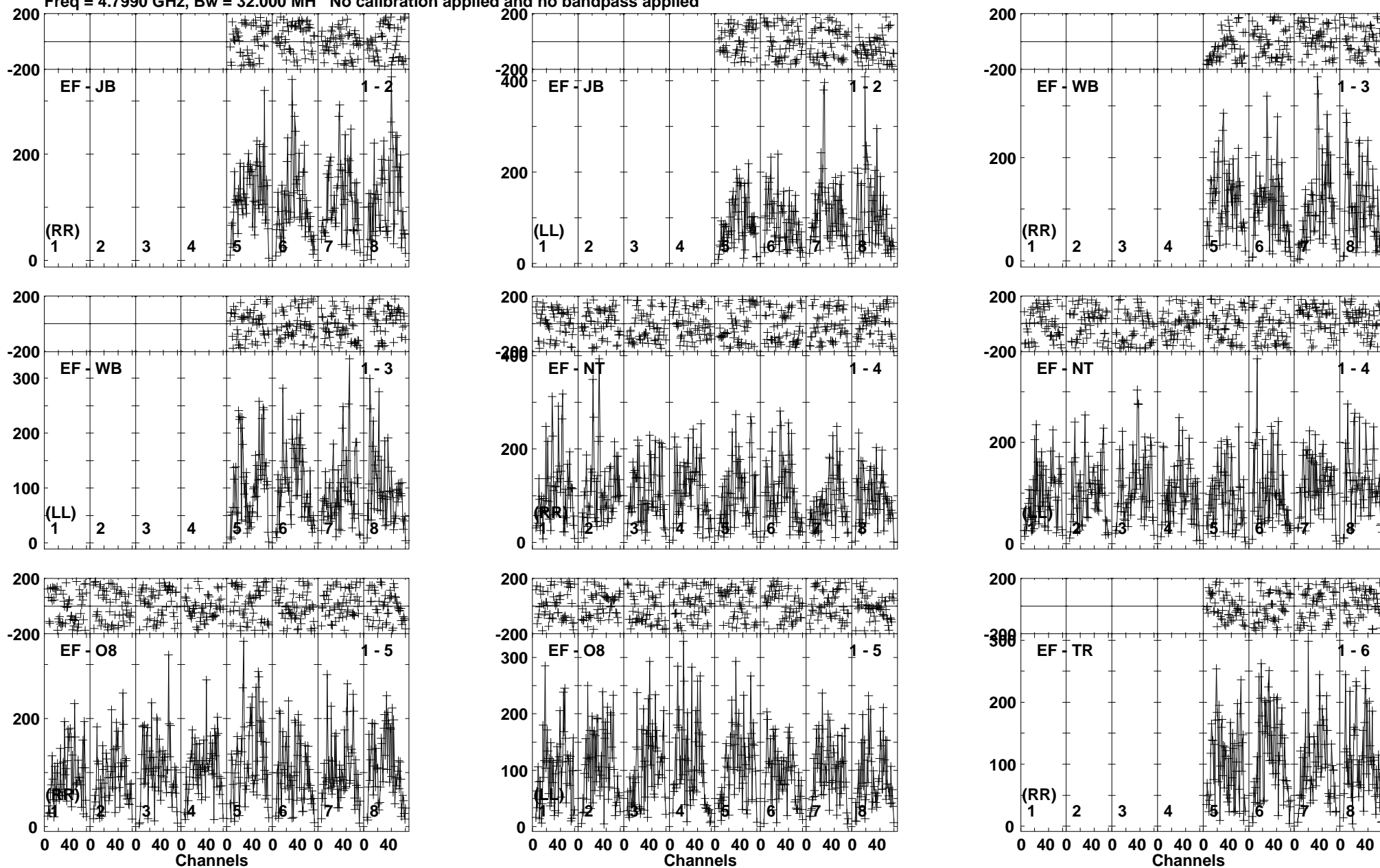

Lower frame: Micro Ampl Jy Top frame: Phas deg  
Vector averaged cross-power spectrum Baseline: EF (01) - JB (02)  
Timerange: 00/12:10:40 to 00/12:13:09



Plot file version 110 created 25-SEP-2017 10:02:32

J1303-2405 RP029B.UVDATA.1

Freq = 4.7990 GHz, Bw = 32.000 MH No calibration applied and no bandpass applied

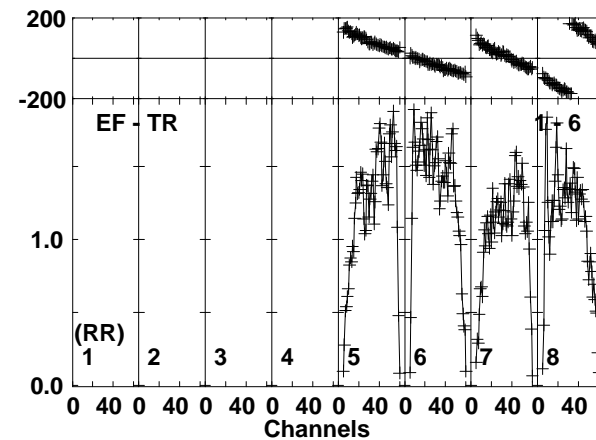
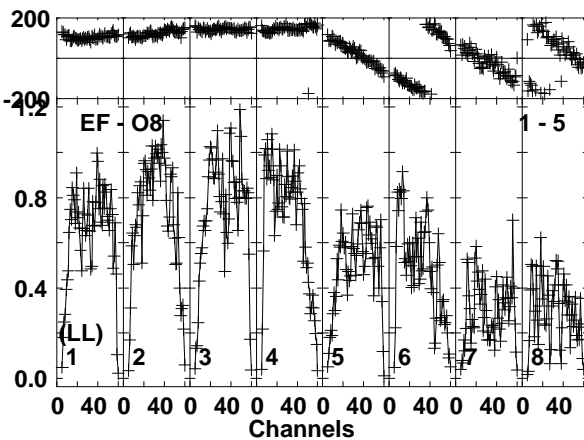
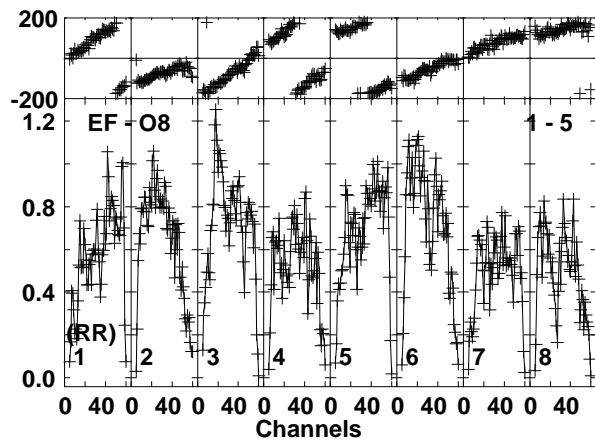
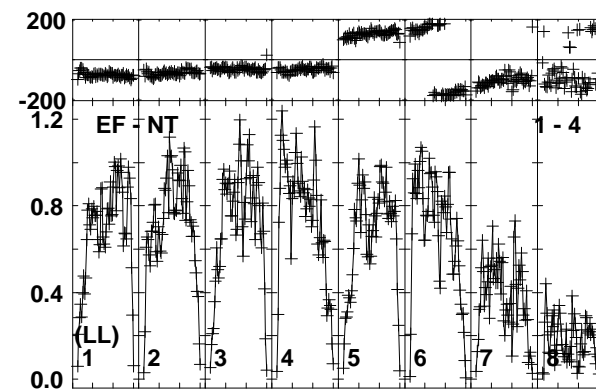
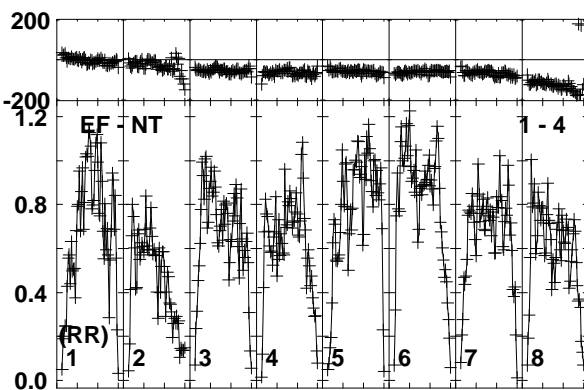
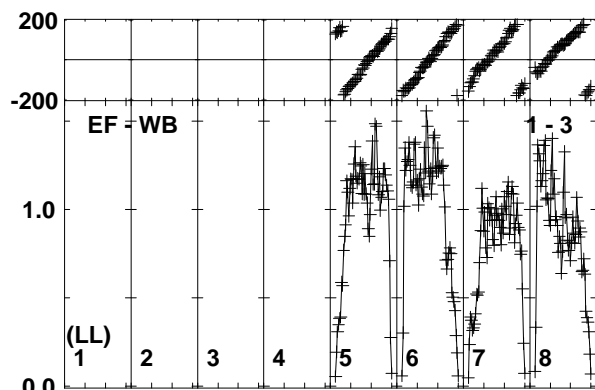
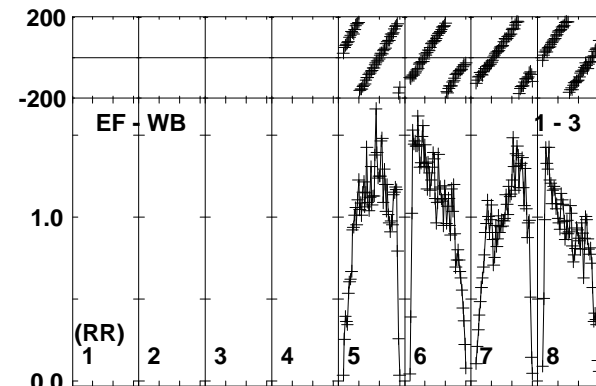
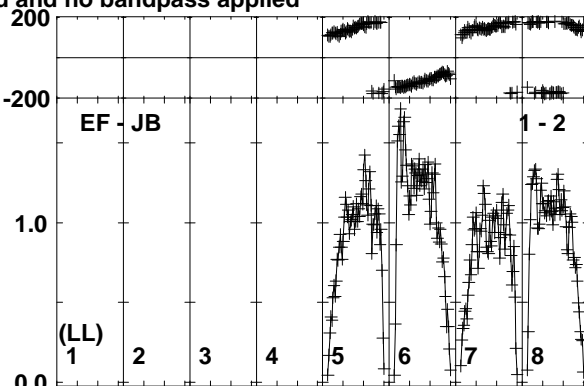
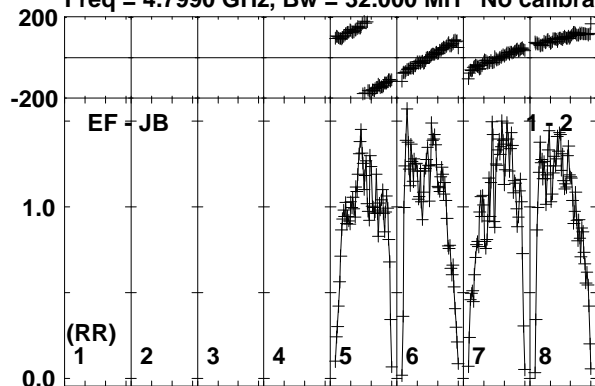

Lower frame: Milli Ampl Jy Top frame: Phas deg  
Vector averaged cross-power spectrum Baseline: EF (01) - JB (02)  
Timerange: 00/12:13:10 to 00/12:14:39

Plot file version 111 created 25-SEP-2017 10:02:32

J1303-2405 RP029B.UVDATA.1

Freq = 4.7990 GHz, Bw = 32.000 MH No calibration applied and no bandpass applied

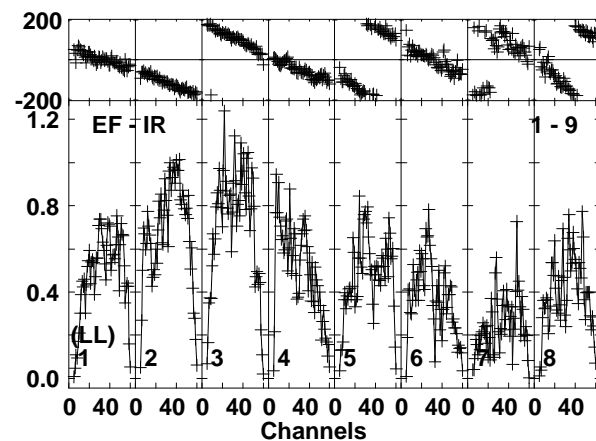
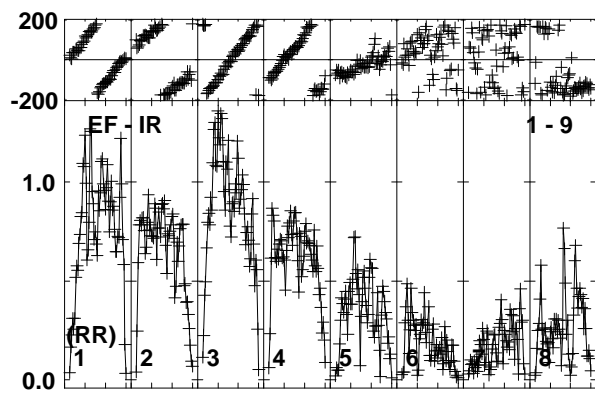
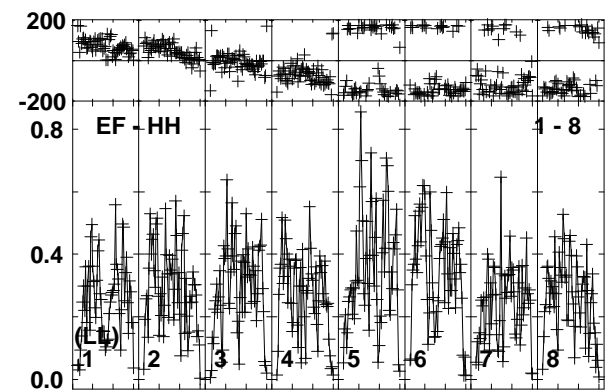
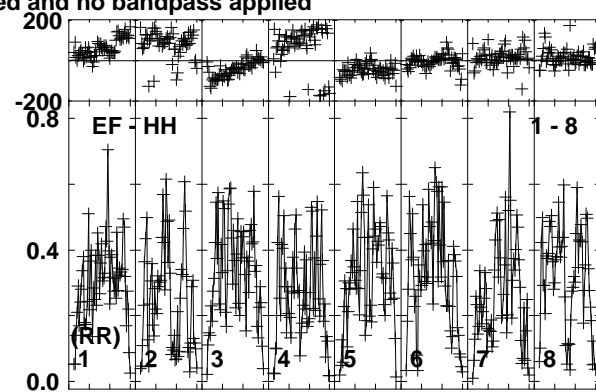
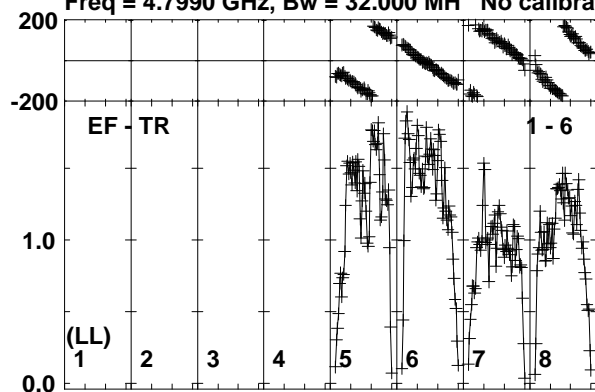

Lower frame: Milli Ampl Jy Top frame: Phas deg  
Vector averaged cross-power spectrum Baseline: EF (01) - TR (06)  
Timerange: 00/12:13:10 to 00/12:14:39





Plot file version 113 created 25-SEP-2017 10:02:32

J1312-2350 RP029B.UVDATA.1

Freq = 4.7990 GHz, Bw = 32.000 MH No calibration applied and no bandpass applied

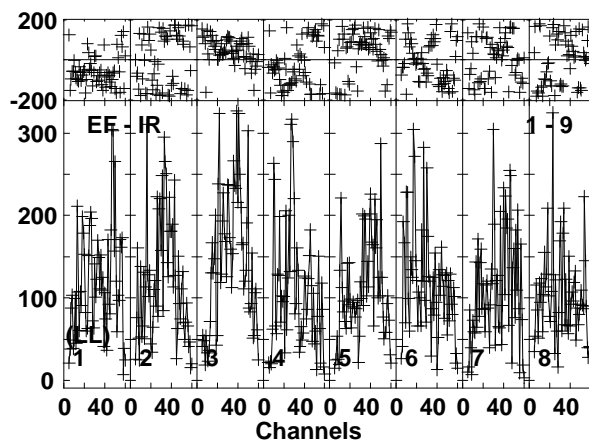
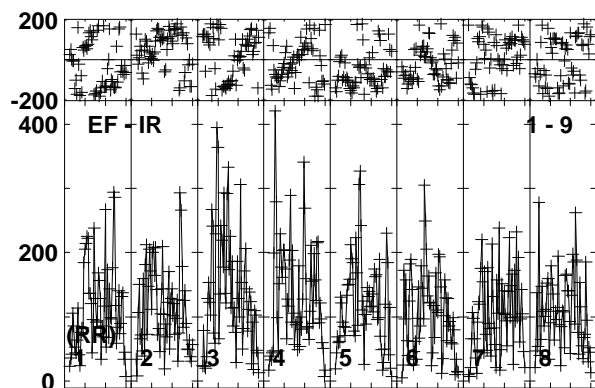
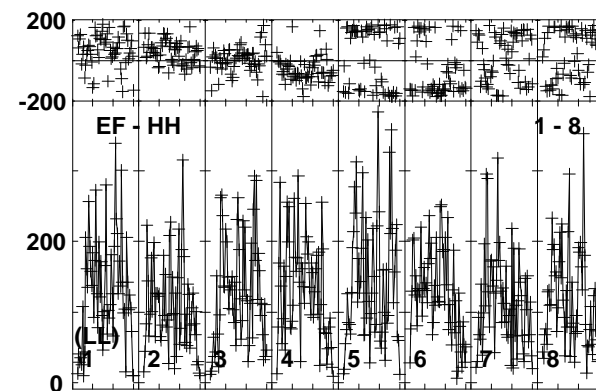
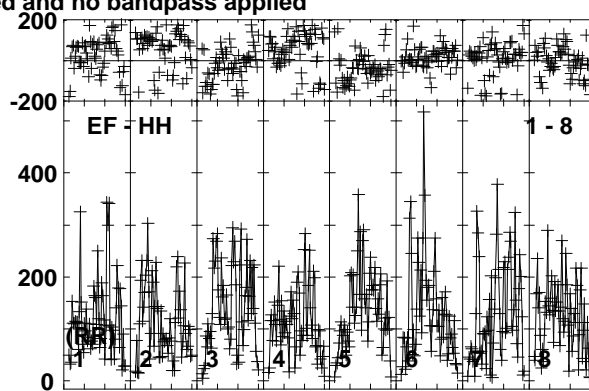
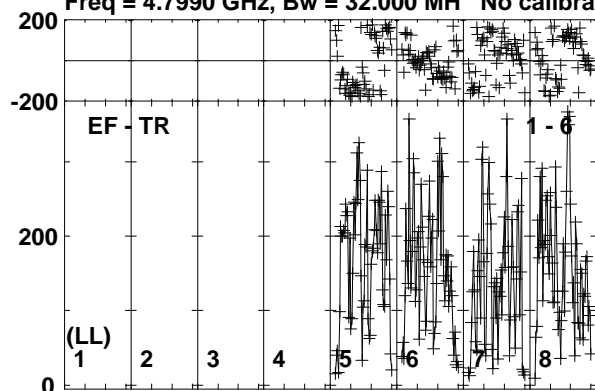

Lower frame: Micro Ampl Jy Top frame: Phas deg  
Vector averaged cross-power spectrum Baseline: EF (01) - TR (06)  
Timerange: 00:12:14:40 to 00:12:17:08

Plot file version 114 created 25-SEP-2017 10:02:33

J1303-2405 RP029B.UVDATA.1

Freq = 4.7990 GHz, Bw = 32.000 MH No calibration applied and no bandpass applied

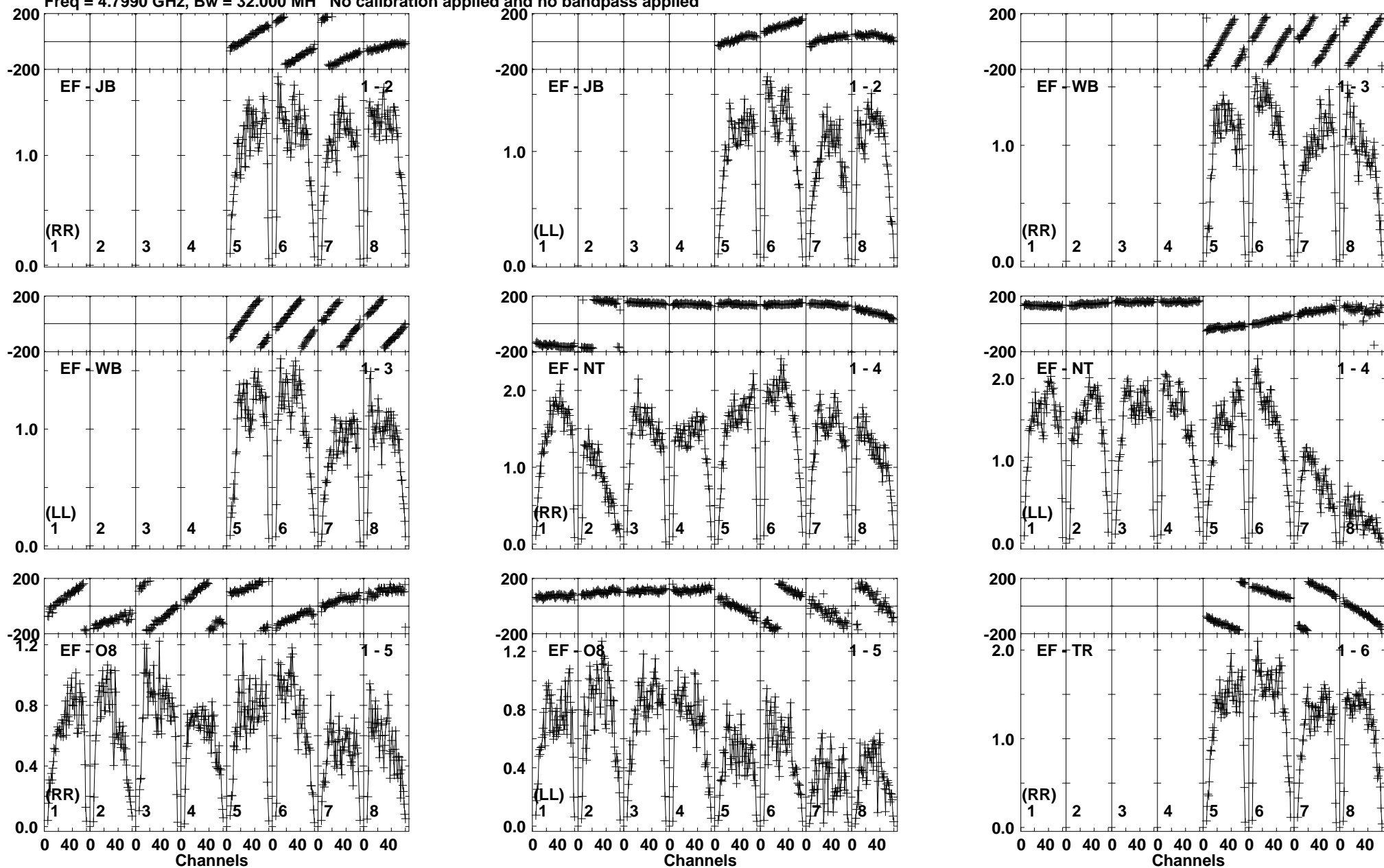

Lower frame: Milli Ampl Jy Top frame: Phas deg  
Vector averaged cross-power spectrum Baseline: EF (01) - JB (02)  
Timerange: 00:12:17:49 to 00:12:18:48

Plot file version 115 created 25-SEP-2017 10:02:33

J1303-2405 RP029B.UVDATA.1

Freq = 4.7990 GHz, Bw = 32.000 MH No calibration applied and no bandpass applied

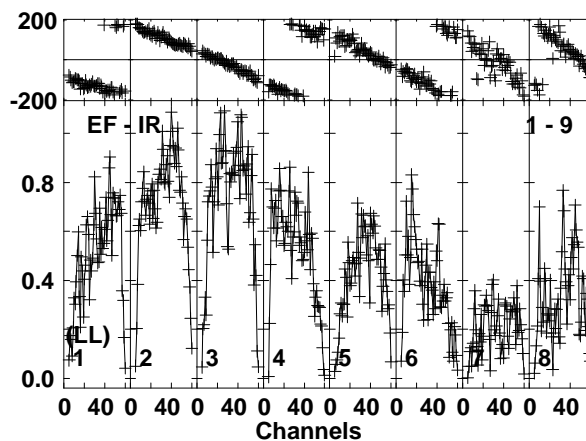
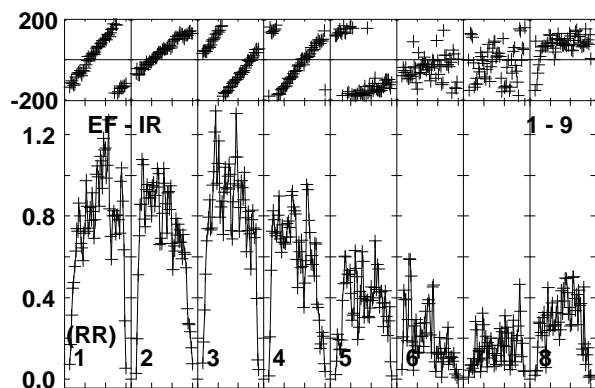
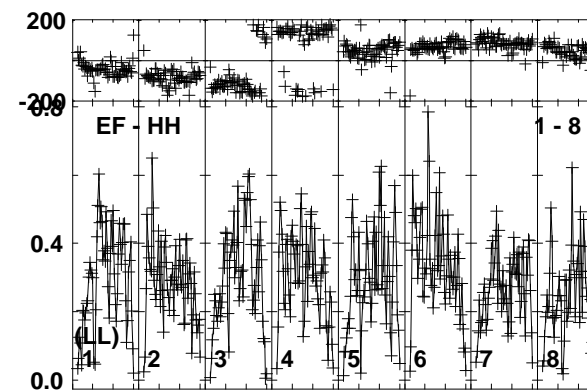
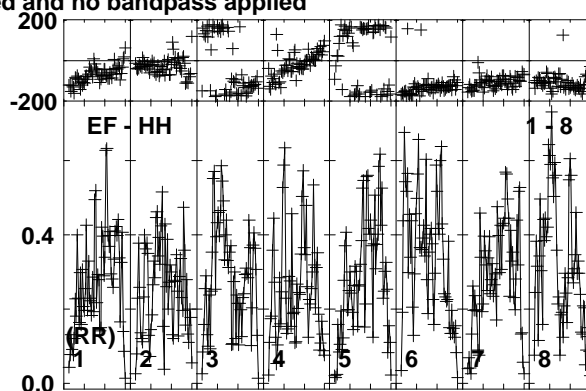
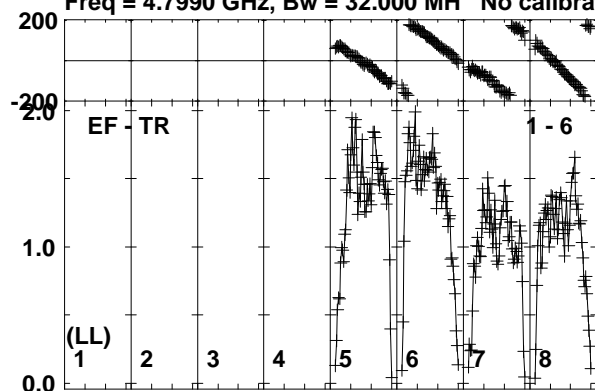

Lower frame: Milli Ampl Jy Top frame: Phas deg  
Vector averaged cross-power spectrum Baseline: EF (01) - TR (06)  
Timerange: 00/12:17:49 to 00/12:18:48

Plot file version 116 created 25-SEP-2017 10:02:33

J1337-1257 RP029B.UVDATA.1

Freq = 4.7990 GHz, Bw = 32.000 MH No calibration applied and no bandpass applied

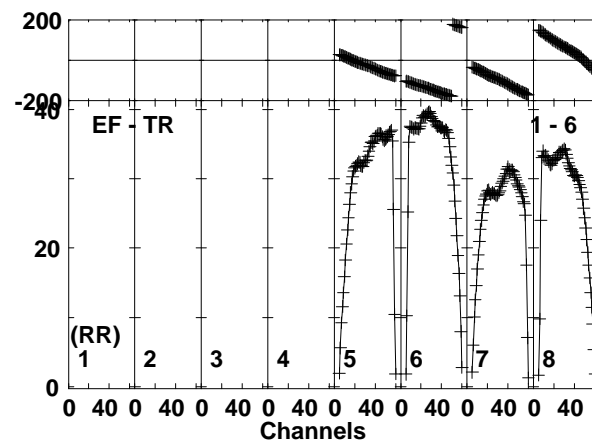
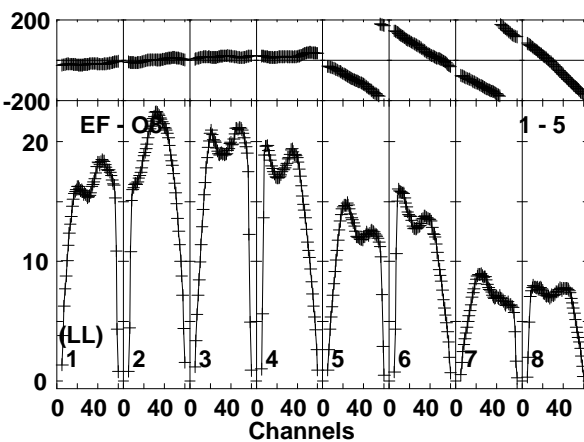
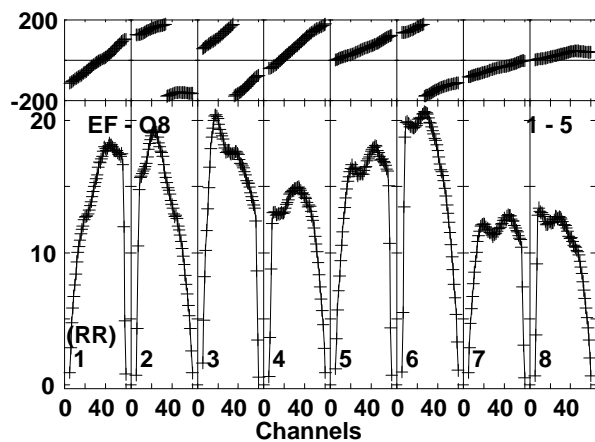
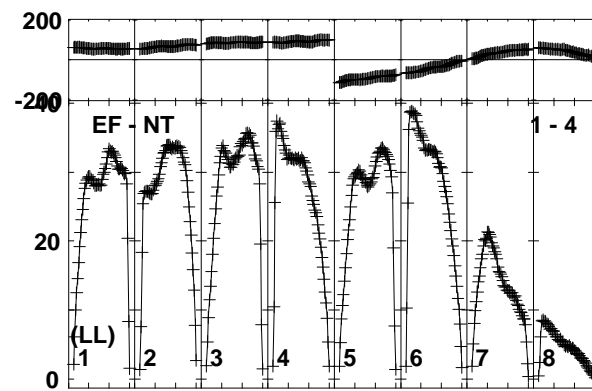
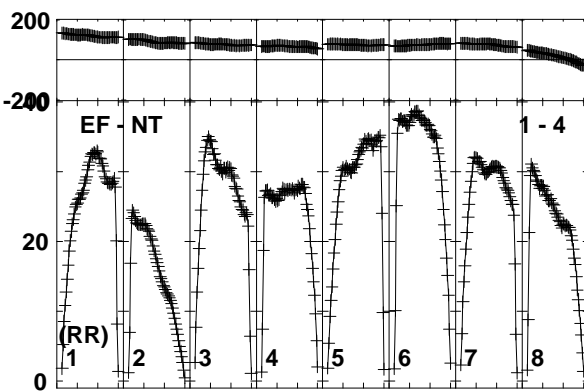
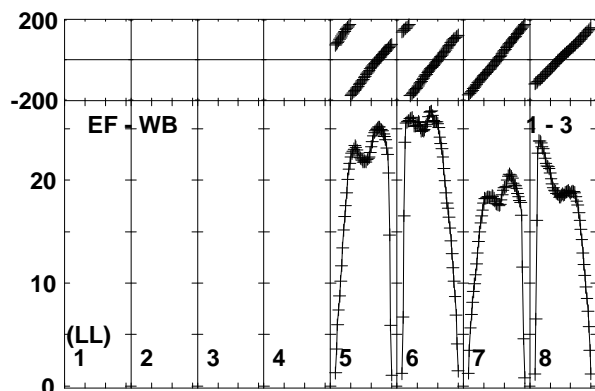
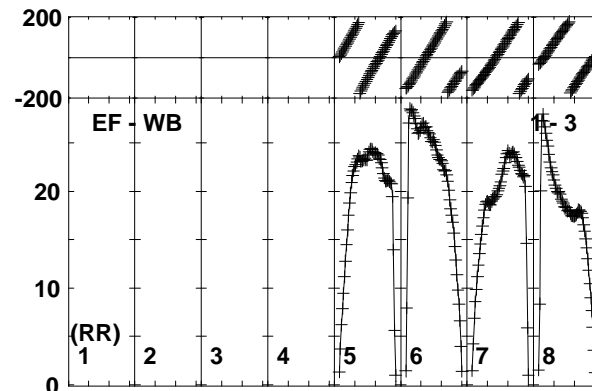
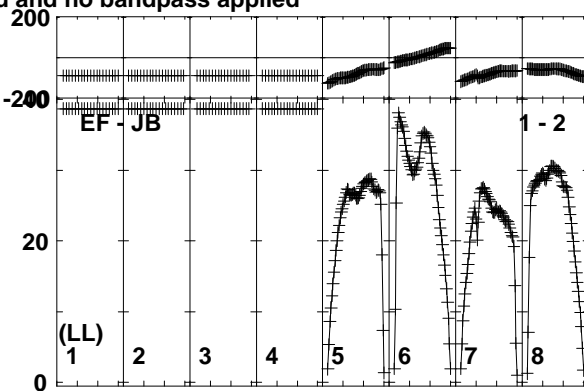
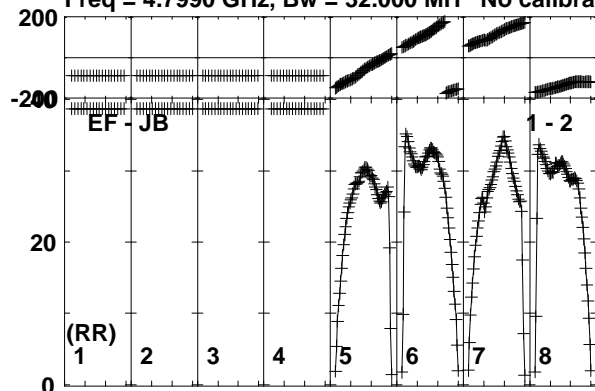

Lower frame: Milli Ampl Jy Top frame: Phas deg  
Vector averaged cross-power spectrum Baseline: EF (01) - JB (02)  
Timerange: 00:12:19:50 to 00:12:22:48

Plot file version 117 created 25-SEP-2017 10:02:33

J1337-1257 RP029B.UVDATA.1

Freq = 4.7990 GHz, Bw = 32.000 MH No calibration applied and no bandpass applied

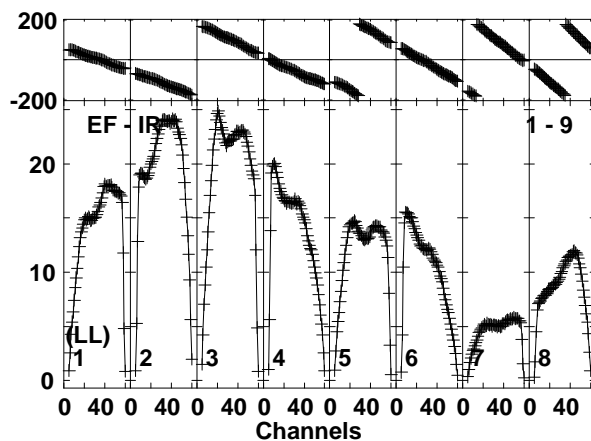
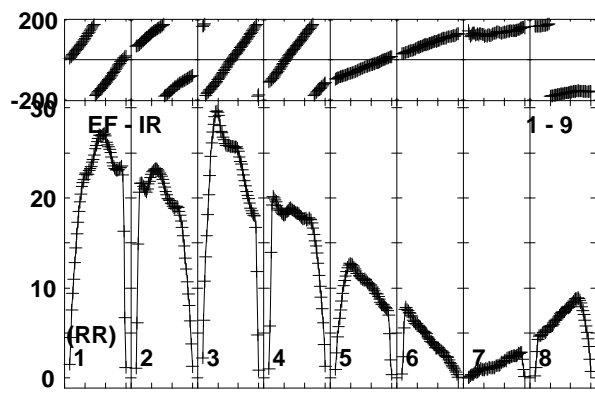
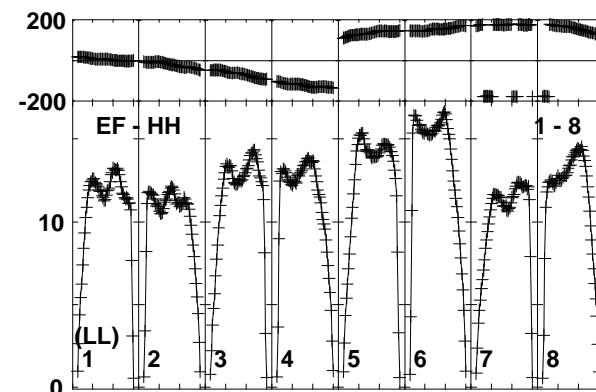
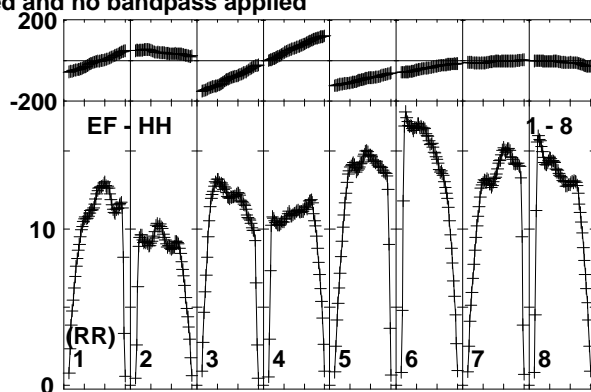
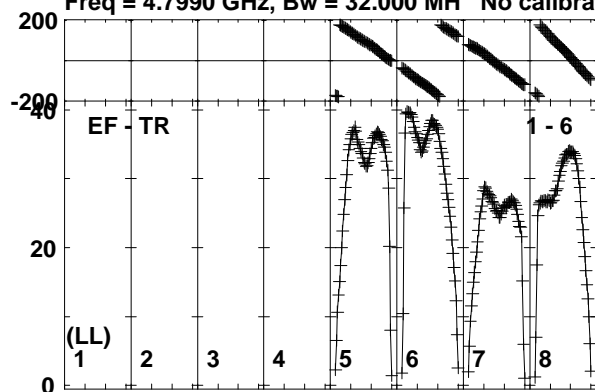

Lower frame: Milli Ampl Jy Top frame: Phas deg  
Vector averaged cross-power spectrum Baseline: EF (01) - TR (06)  
Timerange: 00/12:19:50 to 00/12:22:48

Plot file version 118 created 25-SEP-2017 10:02:33

J1303-2405 RP029B.UVDATA.1

Freq = 4.7990 GHz, Bw = 32.000 MH No calibration applied and no bandpass applied

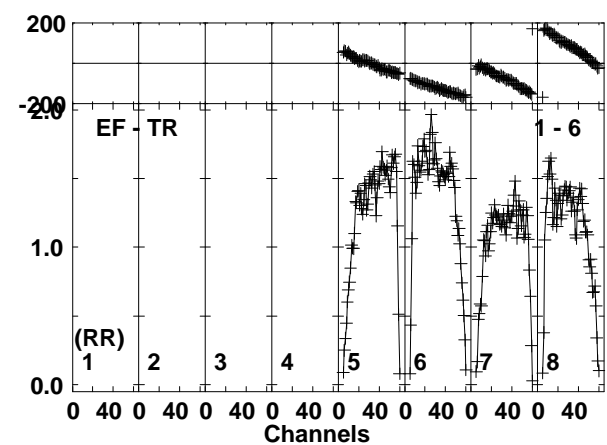
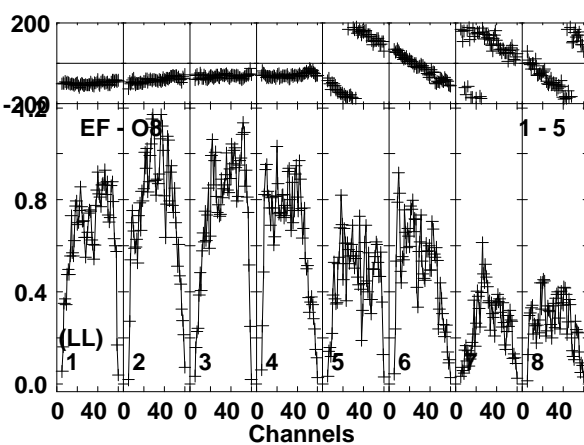
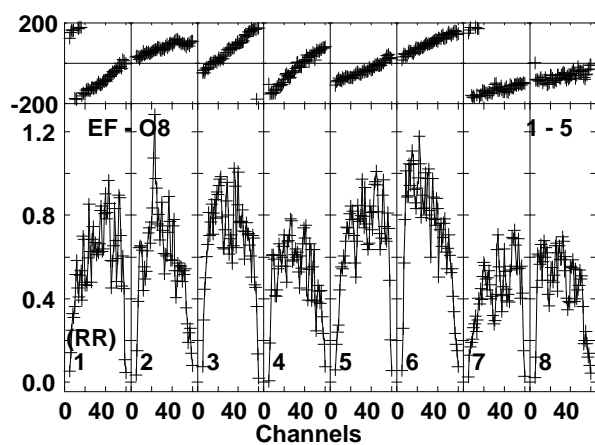
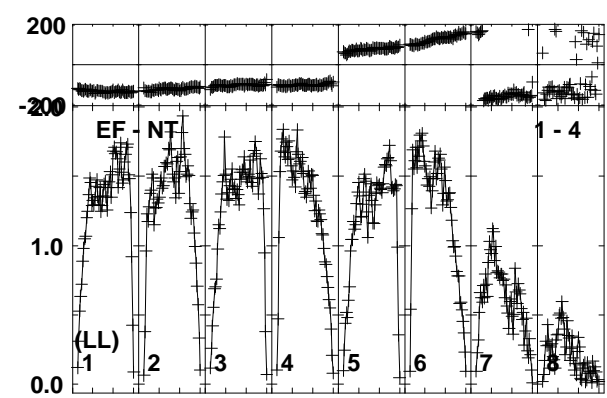
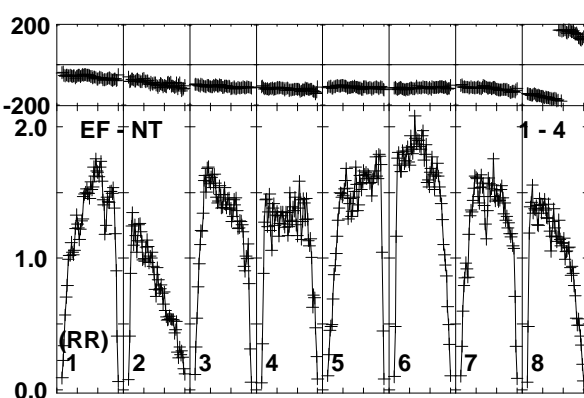
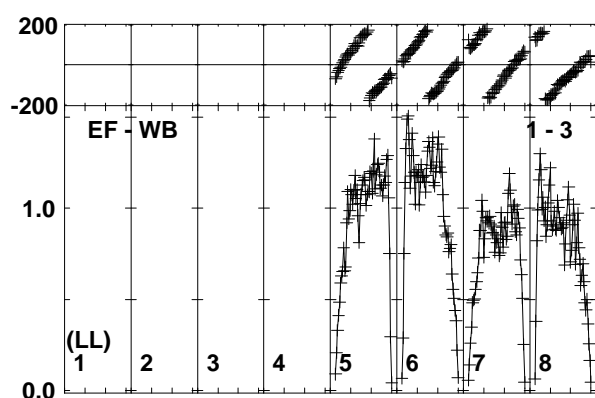
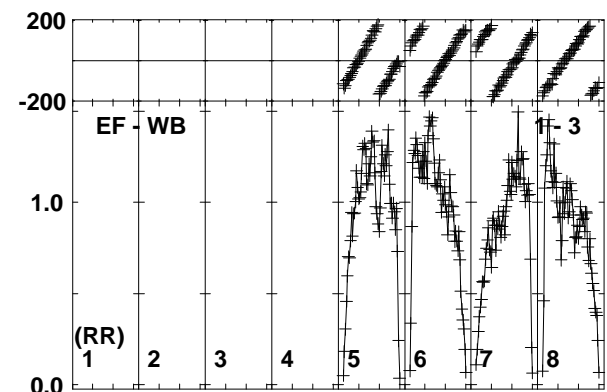
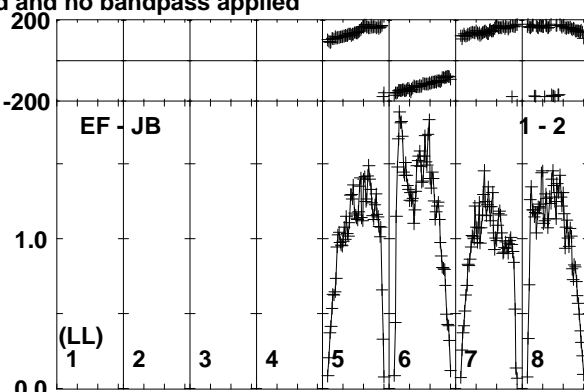
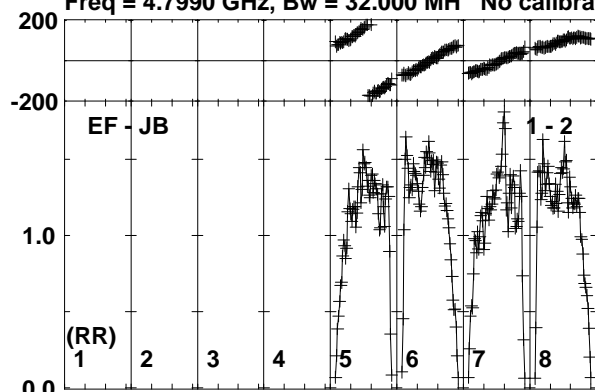

Lower frame: Milli Ampl Jy Top frame: Phas deg  
Vector averaged cross-power spectrum Baseline: EF (01) - JB (02)  
Timerange: 00/12:23:59 to 00/12:25:58

Plot file version 119 created 25-SEP-2017 10:02:33

J1303-2405 RP029B.UVDATA.1

Freq = 4.7990 GHz, Bw = 32.000 MH No calibration applied and no bandpass applied

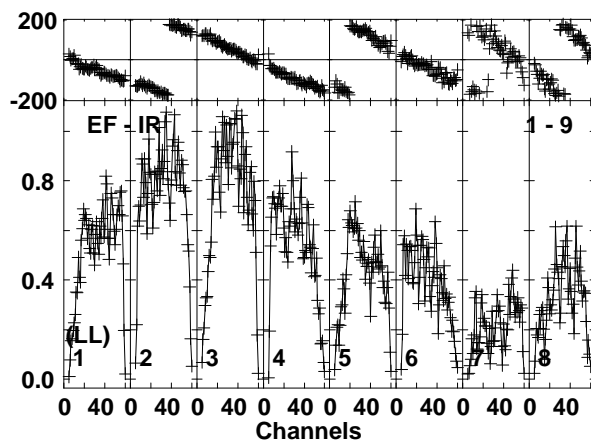
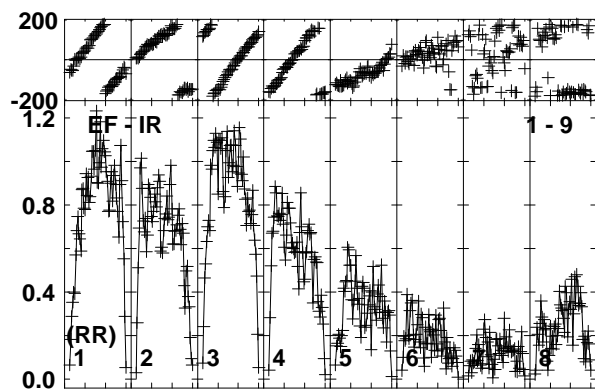
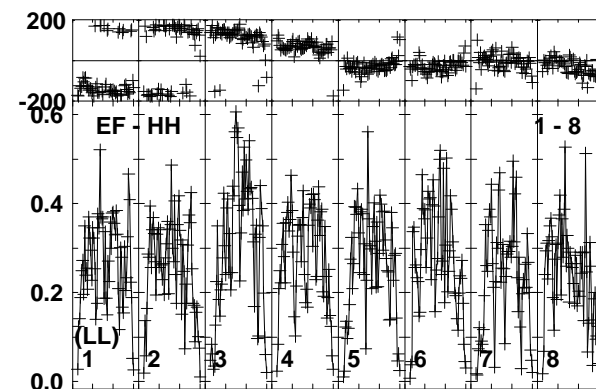
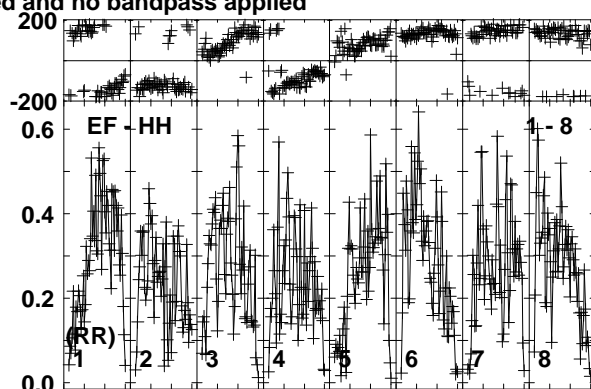
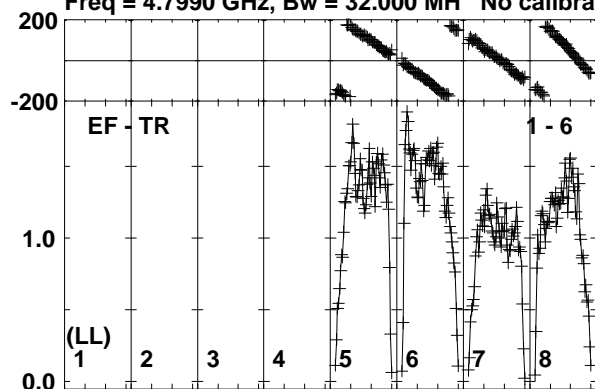

Lower frame: Milli Ampl Jy Top frame: Phas deg  
Vector averaged cross-power spectrum Baseline: EF (01) - TR (06)  
Timerange: 00/12:23:59 to 00/12:25:58

Plot file version 120 created 25-SEP-2017 10:02:34

SSS17A RP029B.UVDATA.1

Freq = 4.7990 GHz, Bw = 32.000 MH No calibration applied and no bandpass applied

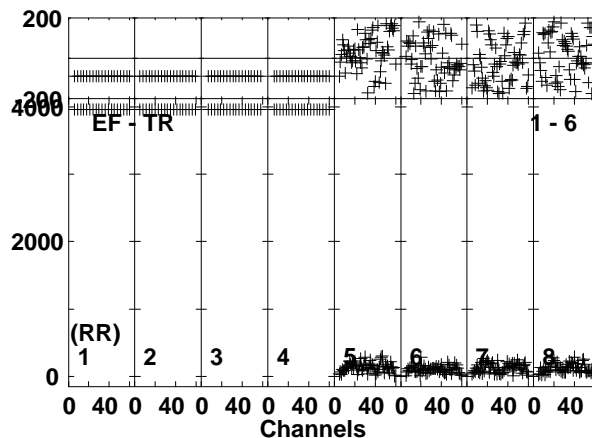
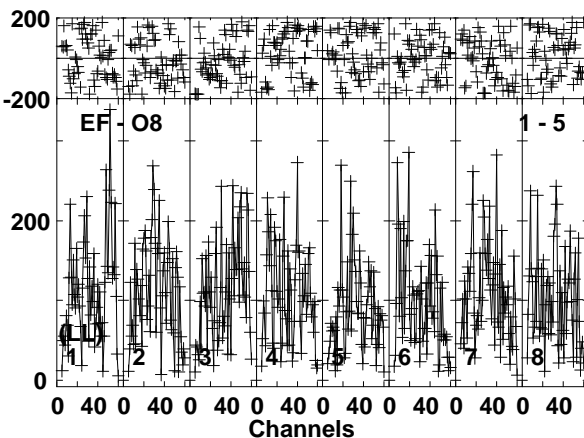
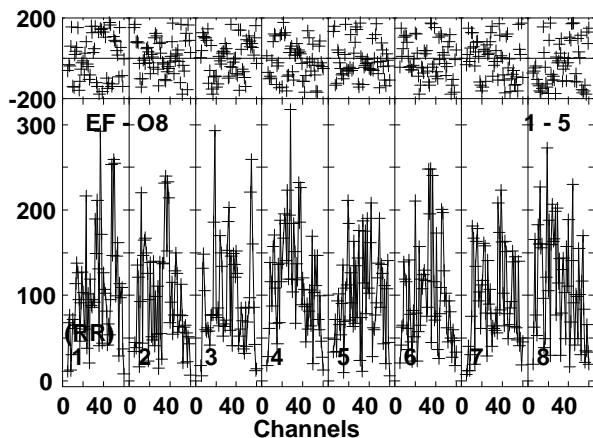
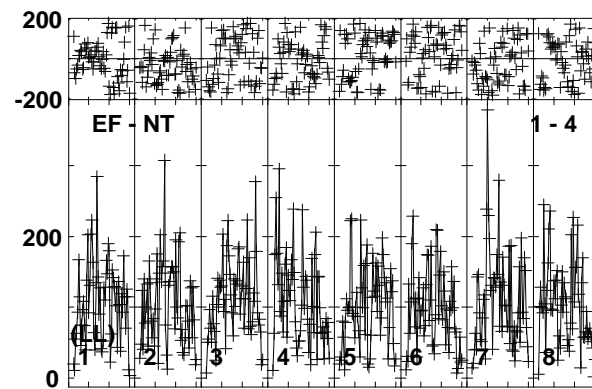
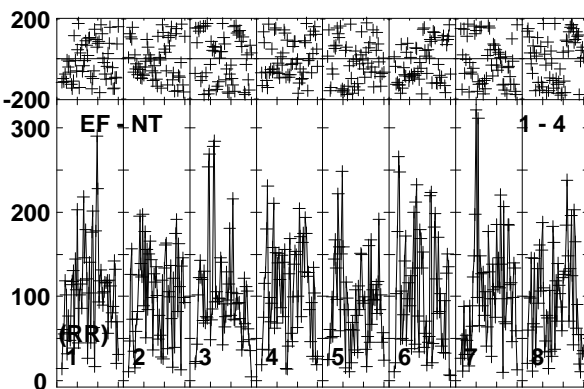
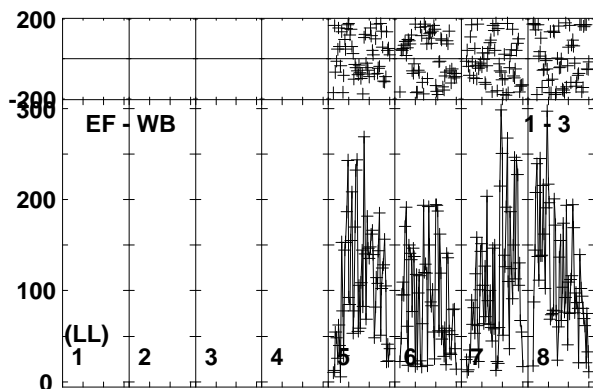
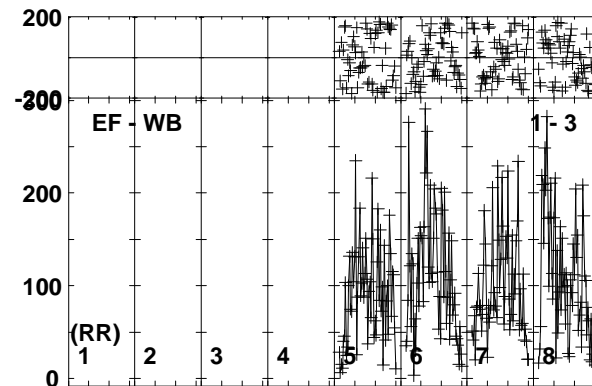
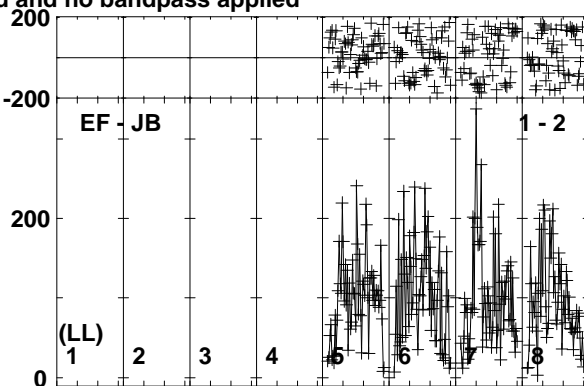
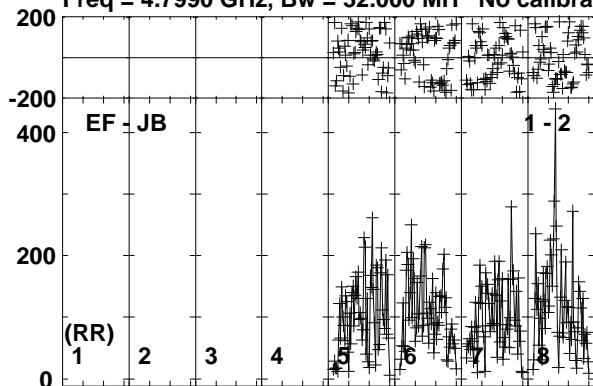

Lower frame: Micro Ampl Jy Top frame: Phas deg  
Vector averaged cross-power spectrum Baseline: EF (01) - JB (02)  
Timerange: 00/12:26:00 to 00/12:28:29





Plot file version 122 created 25-SEP-2017 10:02:34

J1303-2405 RP029B.UVDATA.1

Freq = 4.7990 GHz, Bw = 32.000 MH No calibration applied and no bandpass applied

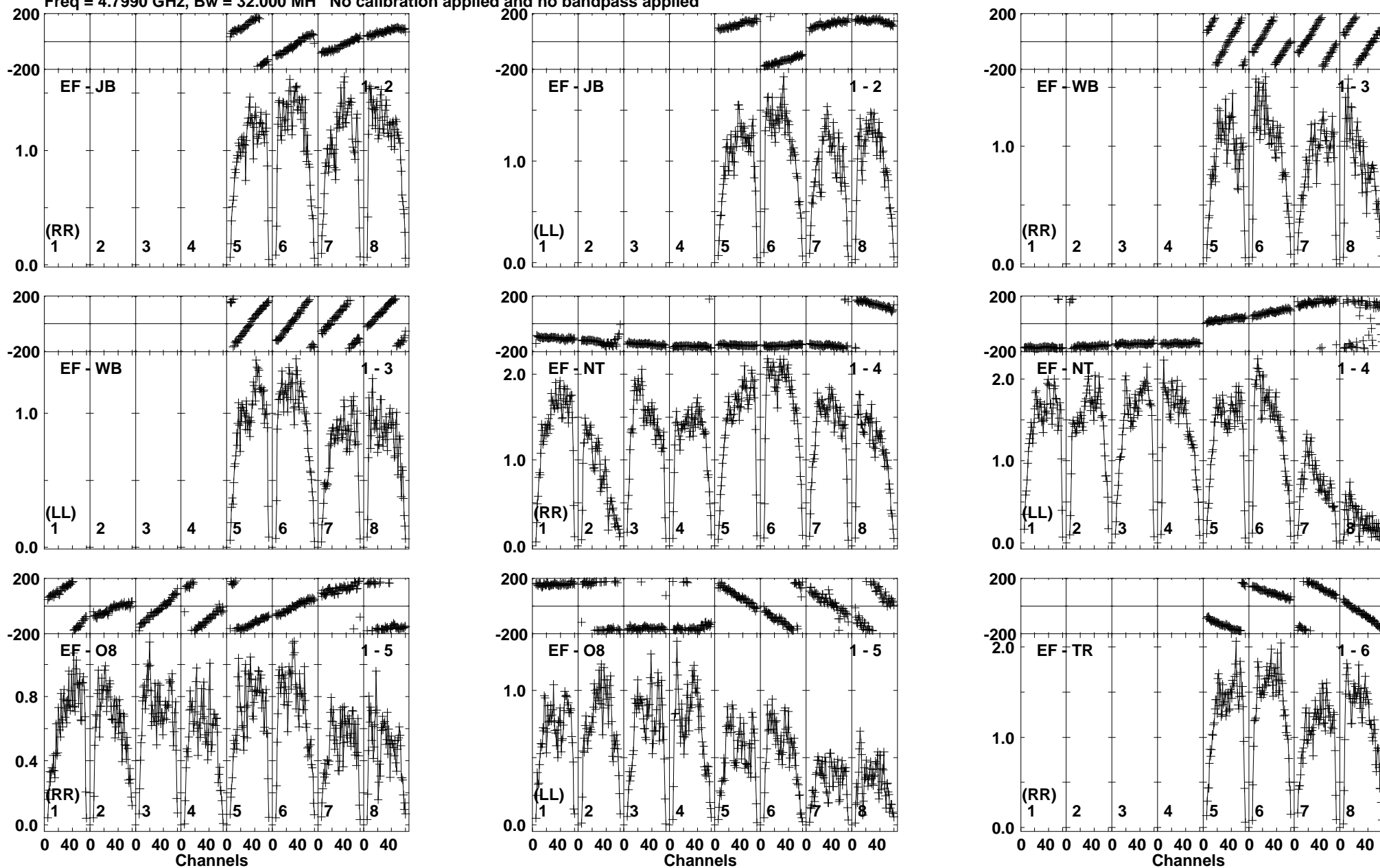

Lower frame: Milli Ampl Jy Top frame: Phas deg  
Vector averaged cross-power spectrum Baseline: EF (01) - JB (02)  
Timerange: 00/12:28:30 to 00/12:29:58

Plot file version 123 created 25-SEP-2017 10:02:34

J1303-2405 RP029B.UVDATA.1

Freq = 4.7990 GHz, Bw = 32.000 MH No calibration applied and no bandpass applied

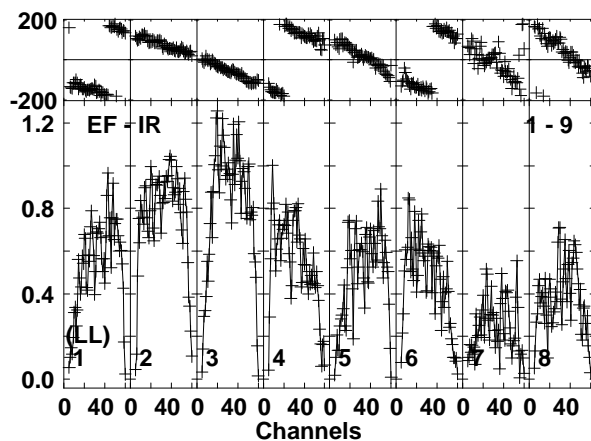
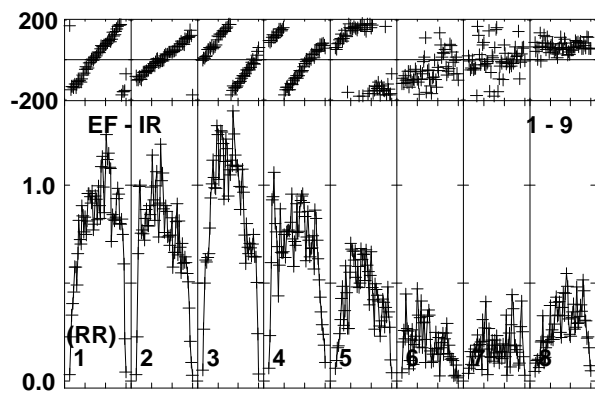
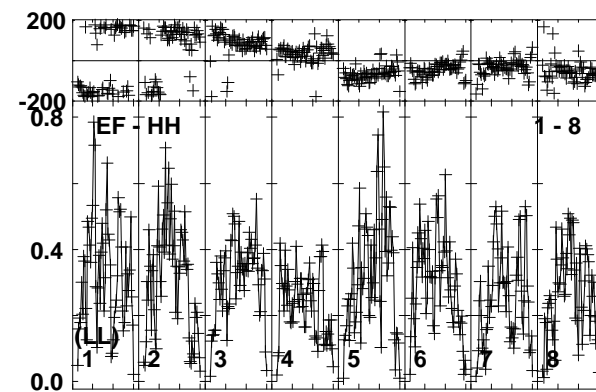
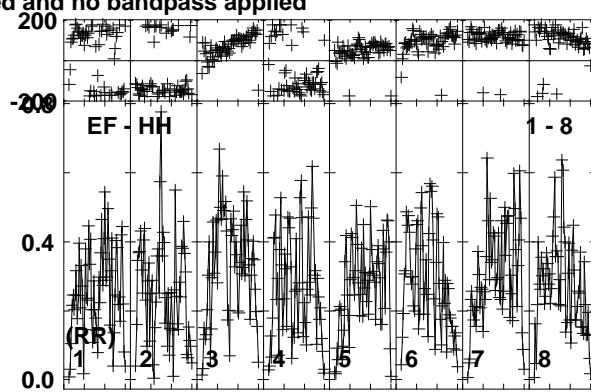
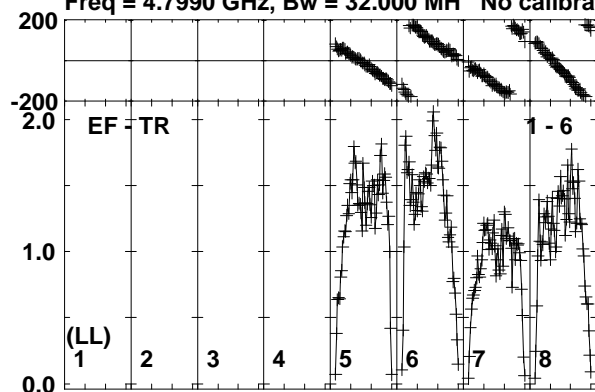

Lower frame: Milli Ampl Jy Top frame: Phas deg  
Vector averaged cross-power spectrum Baseline: EF (01) - TR (06)  
Timerange: 00/12:28:30 to 00/12:29:58

Plot file version 124 created 25-SEP-2017 10:02:34

SSS17A RP029B.UVDATA.1

Freq = 4.7990 GHz, Bw = 32.000 MH No calibration applied and no bandpass applied

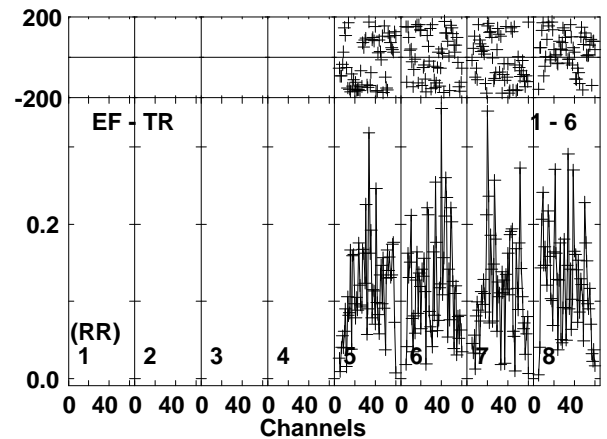
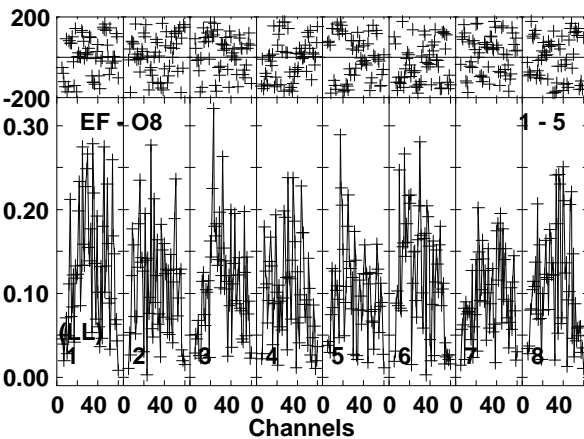
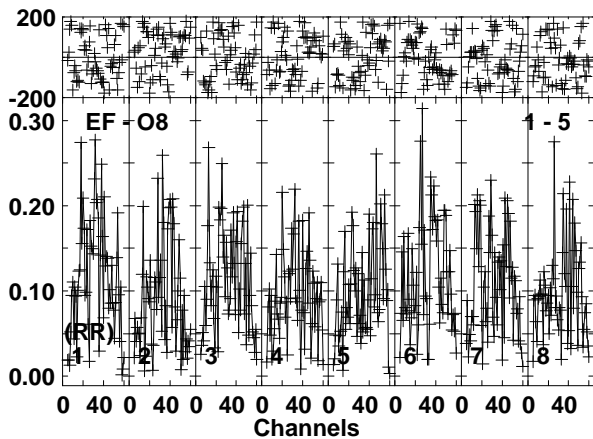
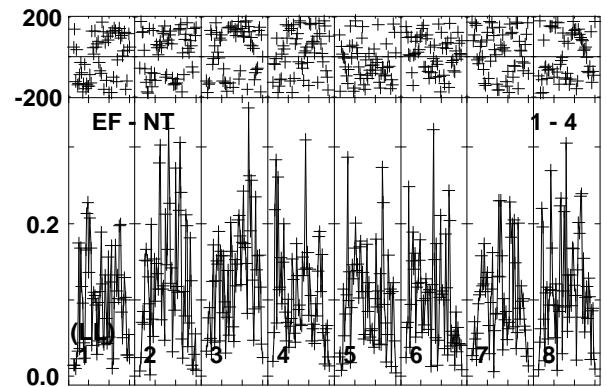
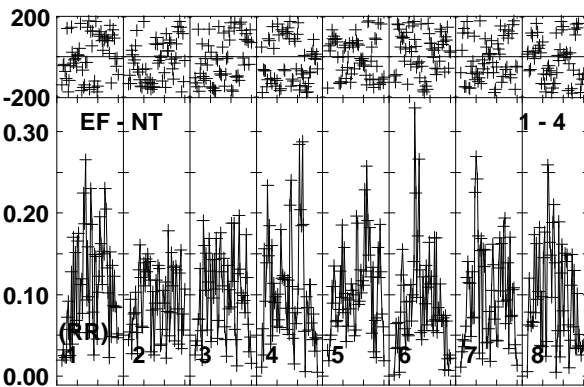
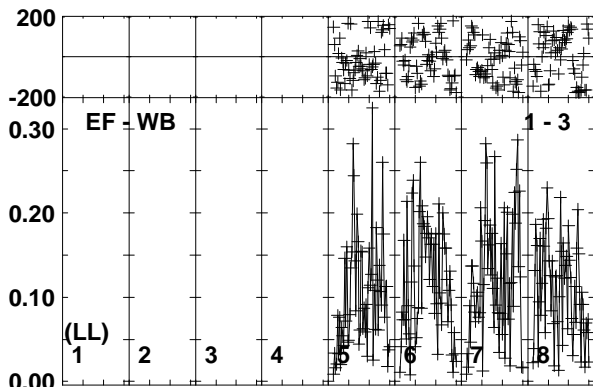
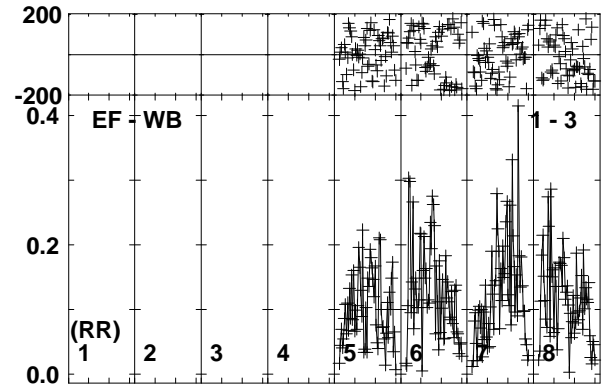
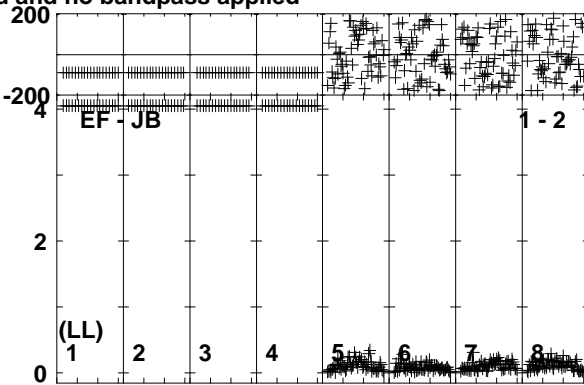
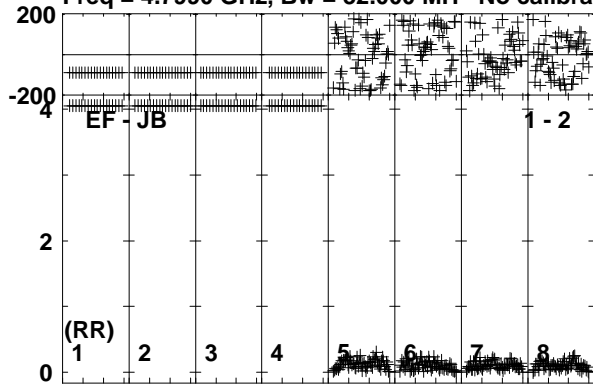

Lower frame: Milli Ampl Jy Top frame: Phas deg  
Vector averaged cross-power spectrum Baseline: EF (01) - JB (02)  
Timerange: 00/12:29:59 to 00/12:32:28



Plot file version 126 created 25-SEP-2017 10:02:34

J1303-2405 RP029B.UVDATA.1

Freq = 4.7990 GHz, Bw = 32.000 MH No calibration applied and no bandpass applied

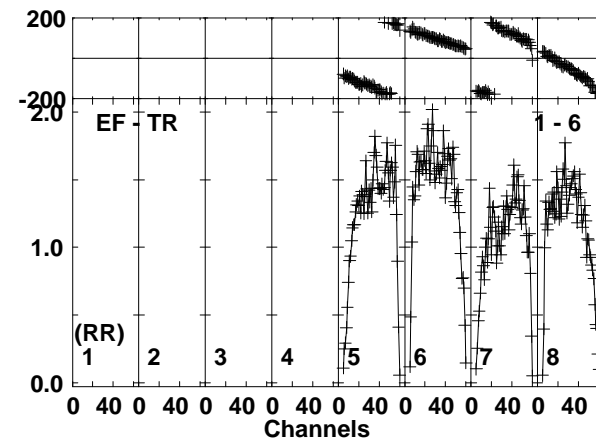
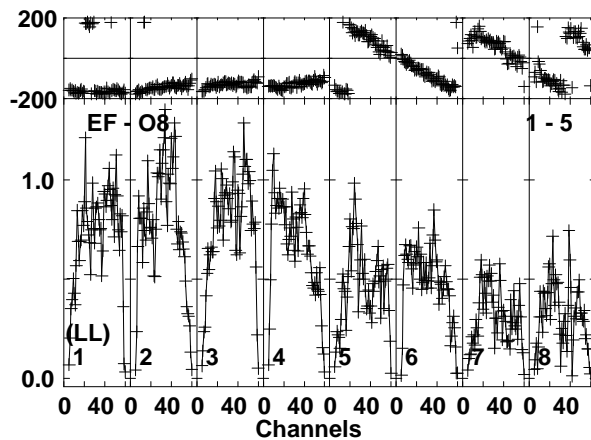
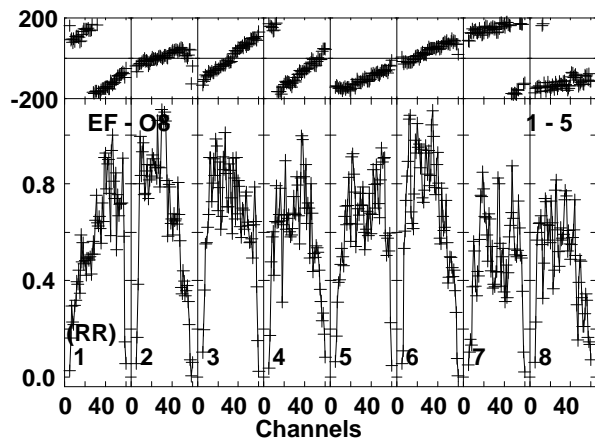
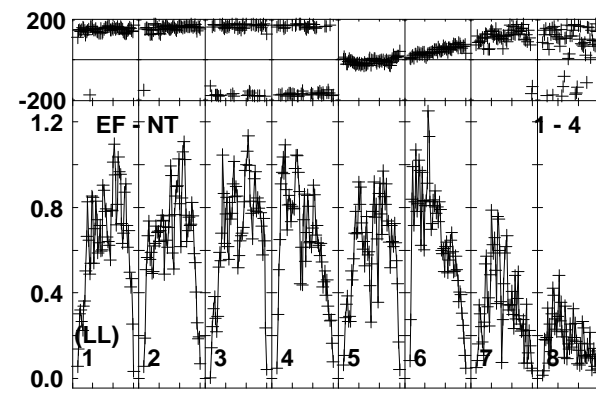
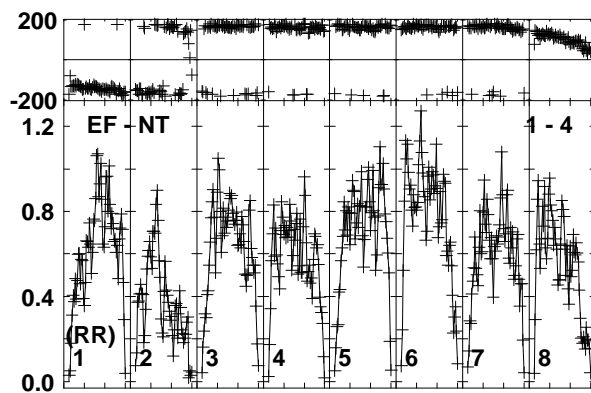
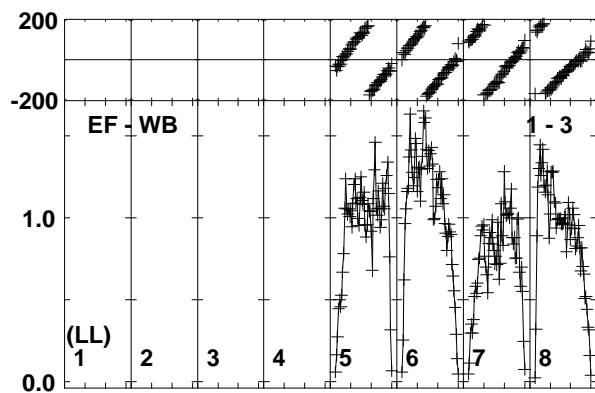
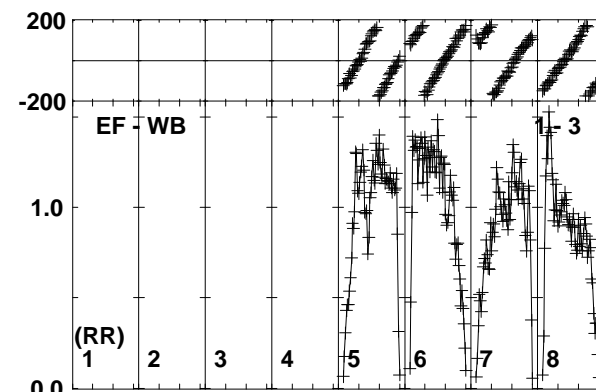
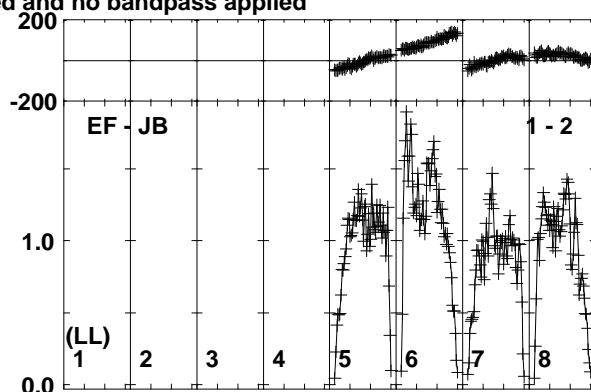
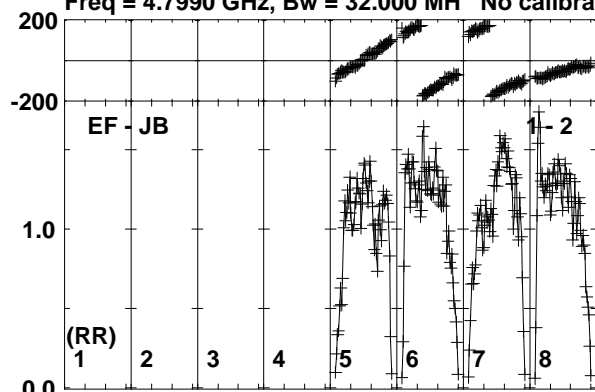

Lower frame: Milli Ampl Jy Top frame: Phas deg  
Vector averaged cross-power spectrum Baseline: EF (01) - JB (02)  
Timerange: 00:12:33:00 to 00:12:33:58

Plot file version 127 created 25-SEP-2017 10:02:35

J1303-2405 RP029B.UVDATA.1

Freq = 4.7990 GHz, Bw = 32.000 MH No calibration applied and no bandpass applied

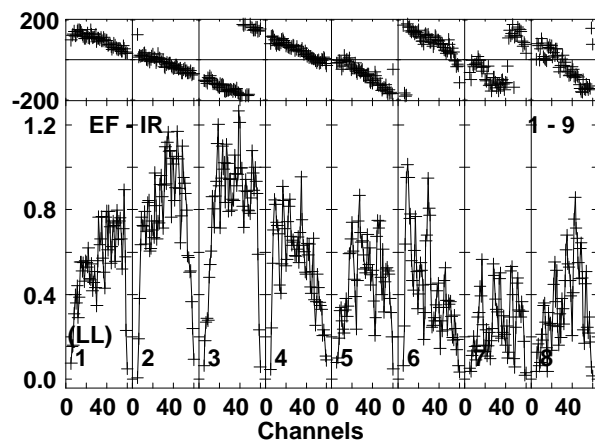
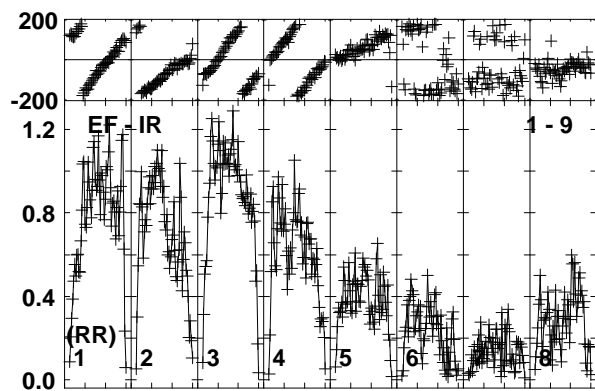
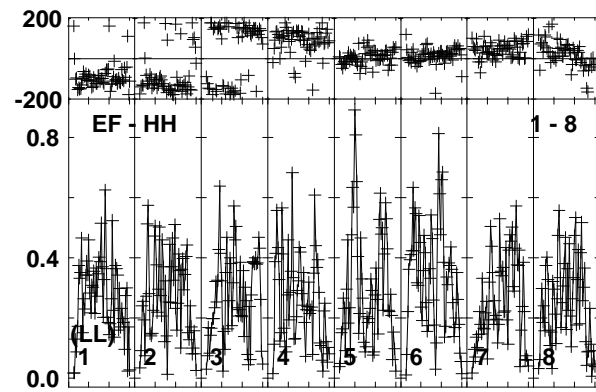
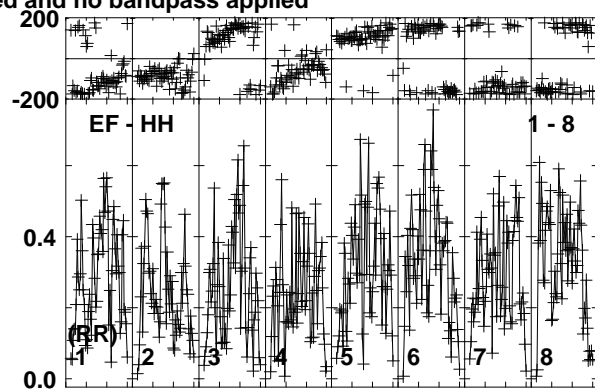
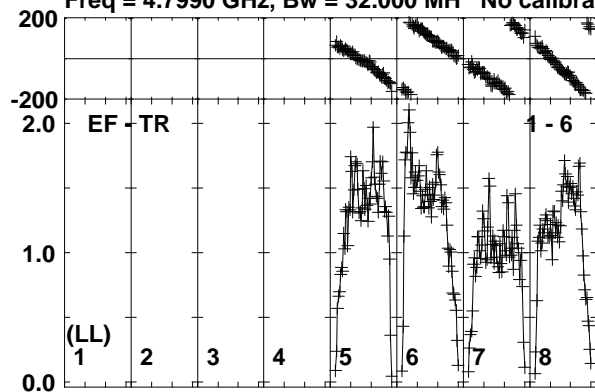

Lower frame: Milli Ampl Jy Top frame: Phas deg  
Vector averaged cross-power spectrum Baseline: EF (01) - TR (06)  
Timerange: 00/12:33:00 to 00/12:33:58

Plot file version 128 created 25-SEP-2017 10:02:35

SSS17A RP029B.UVDATA.1

Freq = 4.7990 GHz, Bw = 32.000 MH No calibration applied and no bandpass applied

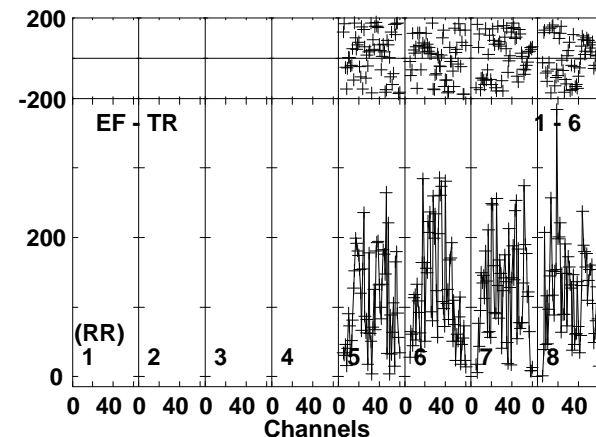
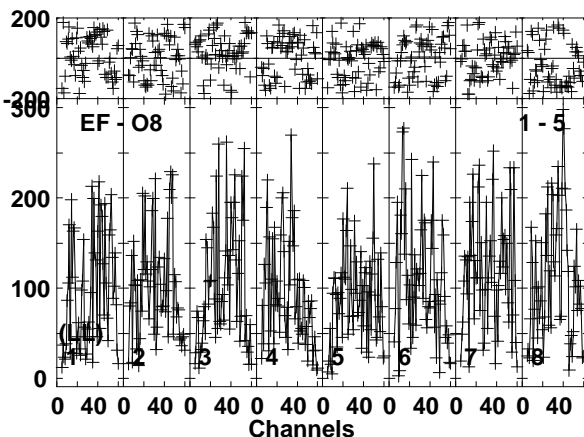
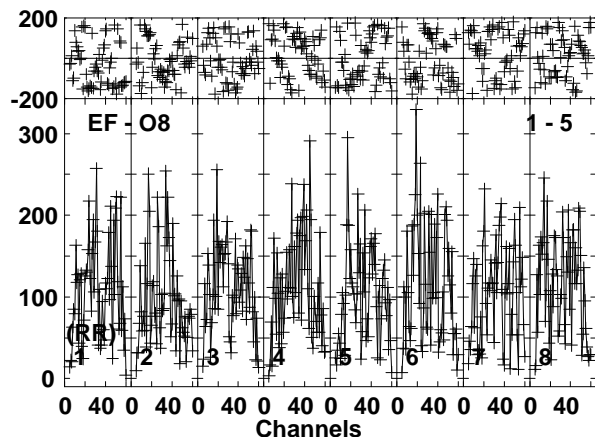
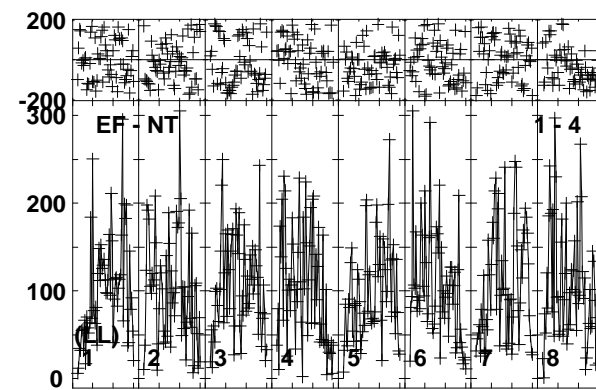
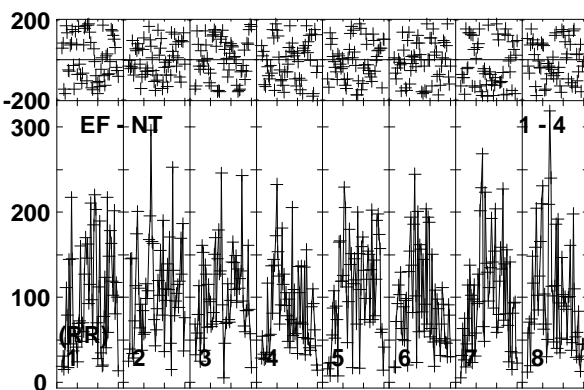
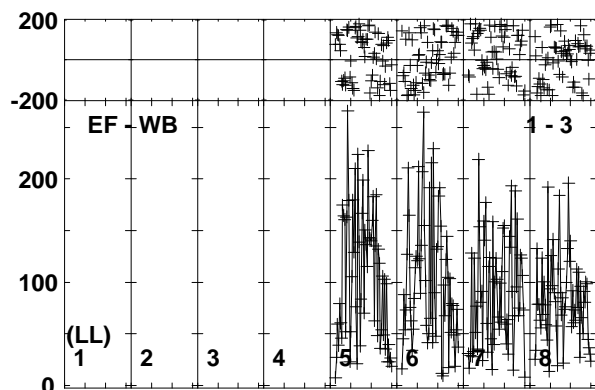
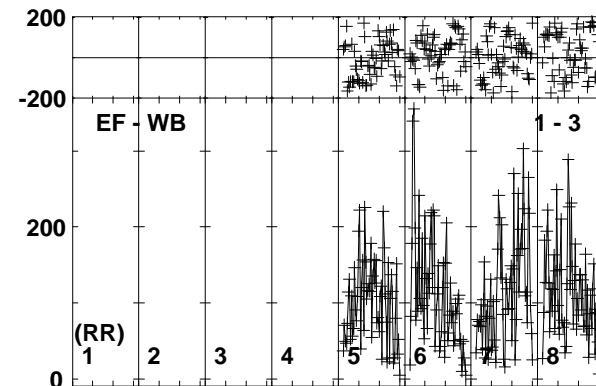
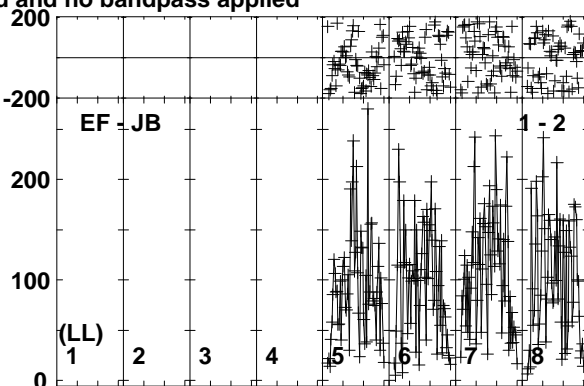
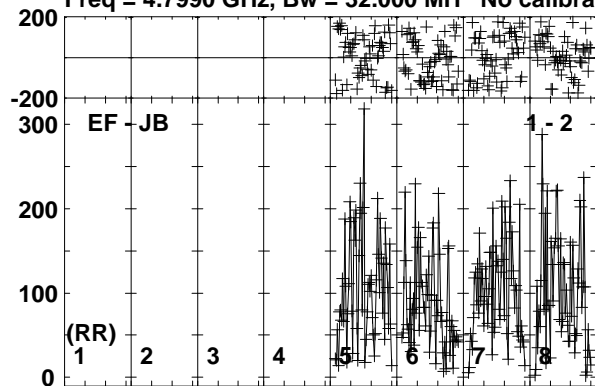

Lower frame: Micro Ampl Jy Top frame: Phas deg  
Vector averaged cross-power spectrum Baseline: EF (01) - JB (02)  
Timerange: 00/12:34:00 to 00/12:36:28



Plot file version 129 created 25-SEP-2017 10:02:35

SSS17A RP029B.UVDATA.1

Freq = 4.7990 GHz, Bw = 32.000 MH No calibration applied and no bandpass applied

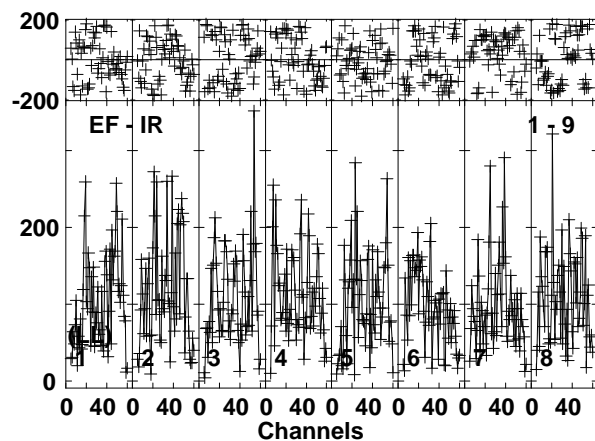
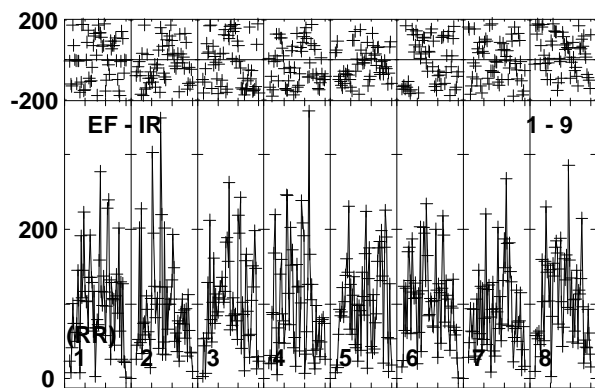
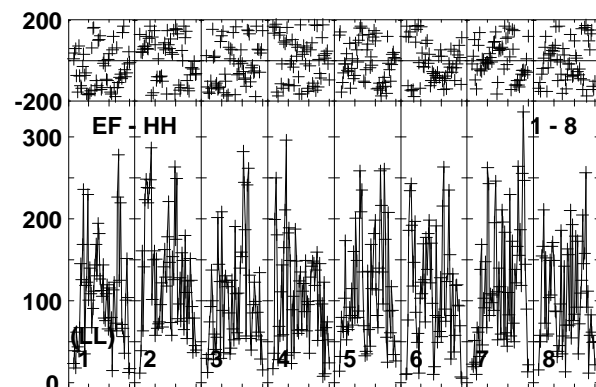
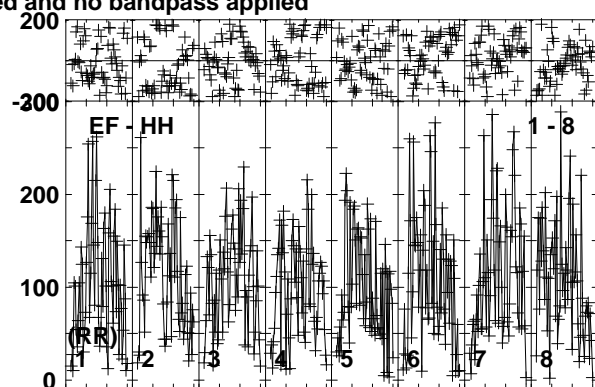
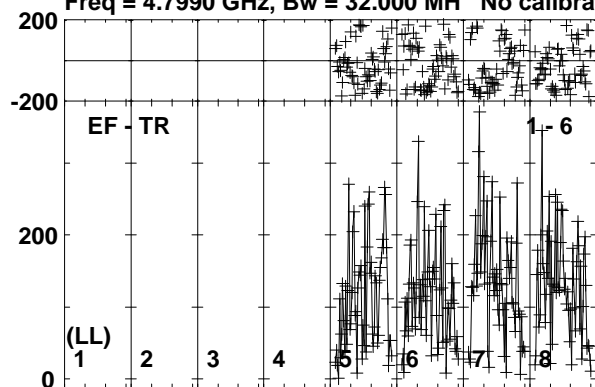

Lower frame: Micro Ampl Jy Top frame: Phas deg  
Vector averaged cross-power spectrum Baseline: EF (01) - TR (06)  
Timerange: 00/12:34:00 to 00/12:36:28

Plot file version 130 created 25-SEP-2017 10:02:35

J1303-2405 RP029B.UVDATA.1

Freq = 4.7990 GHz, Bw = 32.000 MH No calibration applied and no bandpass applied

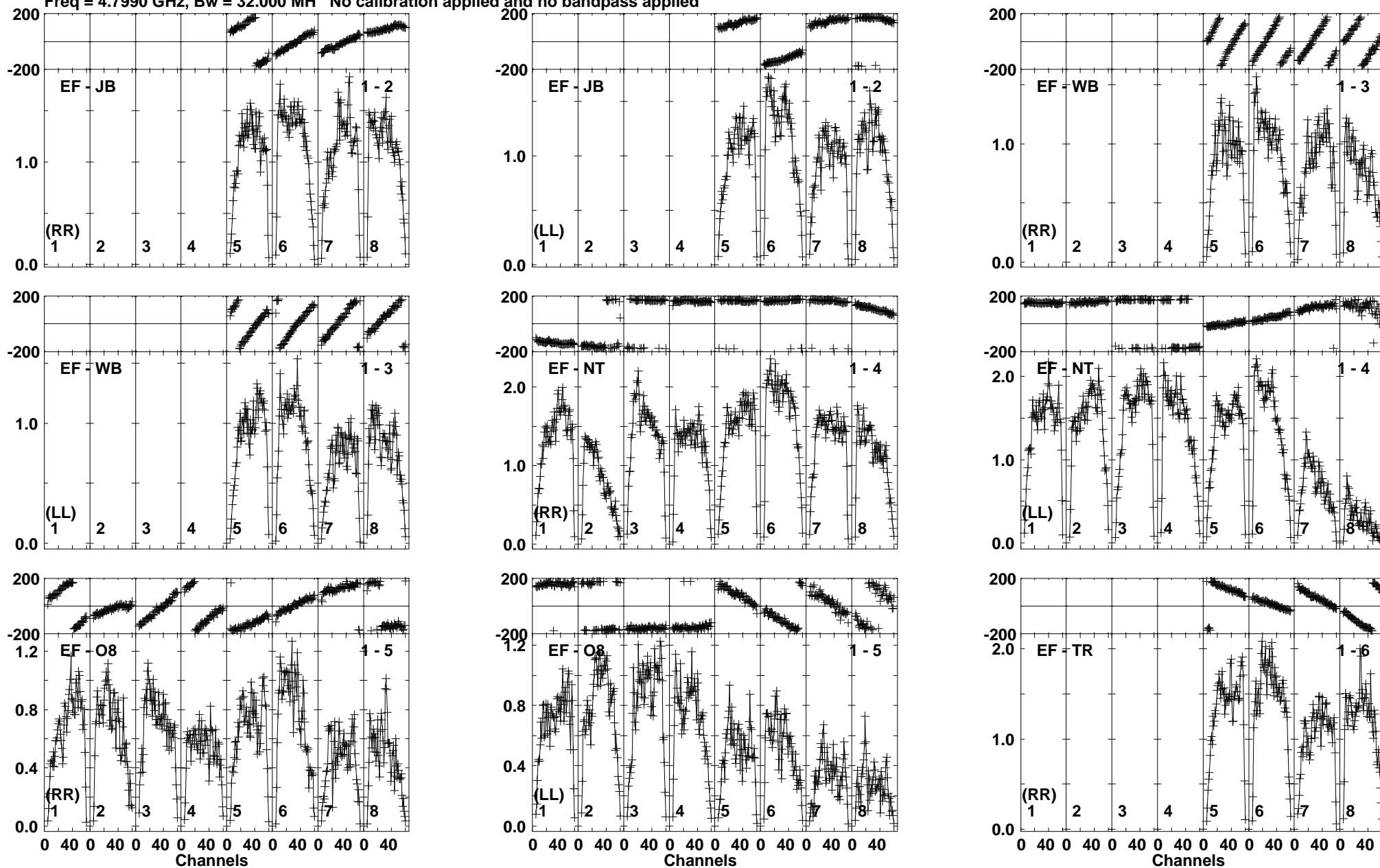

Lower frame: Milli Ampl Jy Top frame: Phas deg  
Vector averaged cross-power spectrum Baseline: EF (01) - JB (02)  
Timerange: 00/12:36:29 to 00/12:37:59

Plot file version 131 created 25-SEP-2017 10:02:35

J1303-2405 RP029B.UVDATA.1

Freq = 4.7990 GHz, Bw = 32.000 MH No calibration applied and no bandpass applied

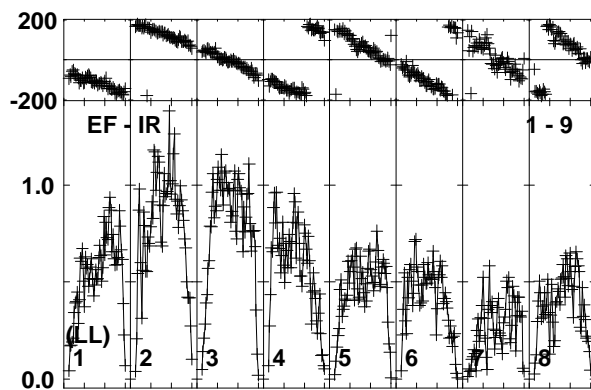
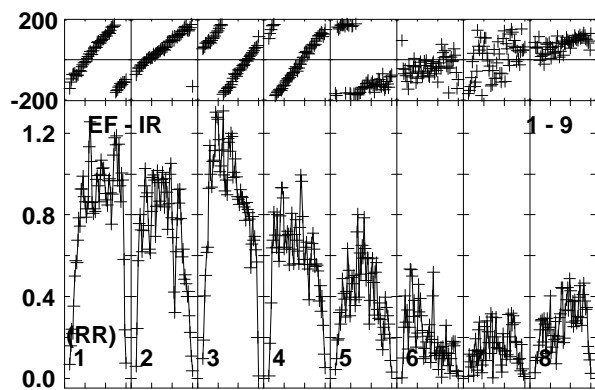
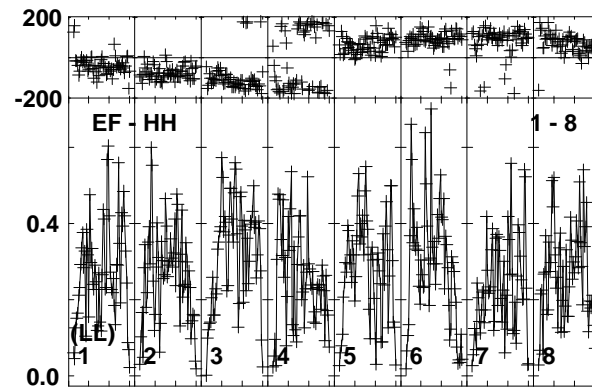
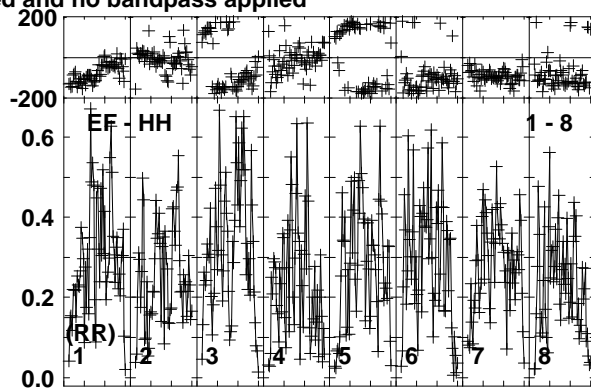
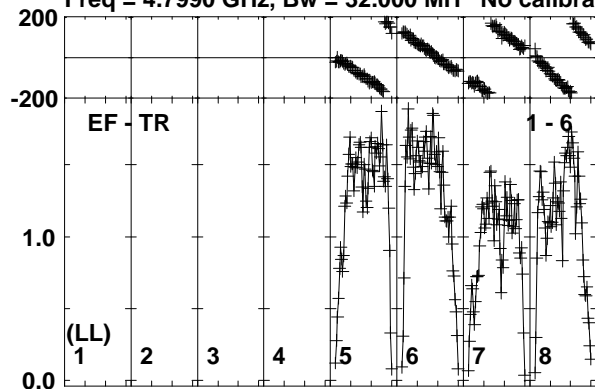

Channels

Lower frame: Milli Ampl Jy Top frame: Phas deg  
Vector averaged cross-power spectrum Baseline: EF (01) - TR (06)  
Timerange: 00/12:36:29 to 00/12:37:59



Plot file version 133 created 25-SEP-2017 10:02:36

J1312-2350 RP029B.UVDATA.1

Freq = 4.7990 GHz, Bw = 32.000 MH No calibration applied and no bandpass applied

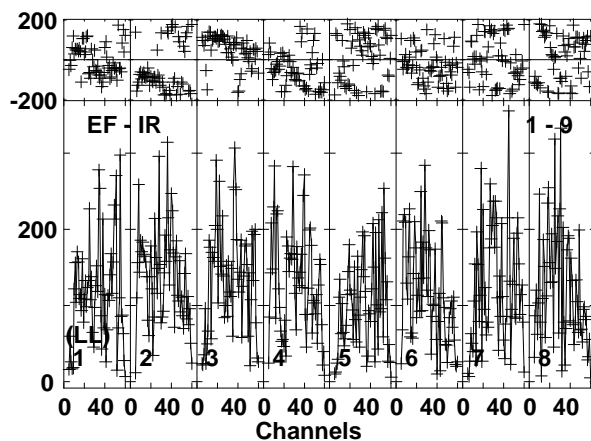
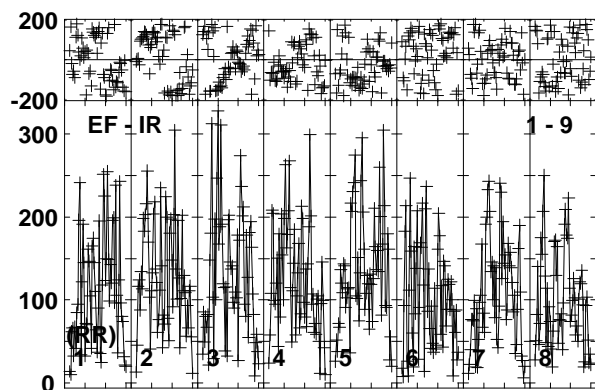
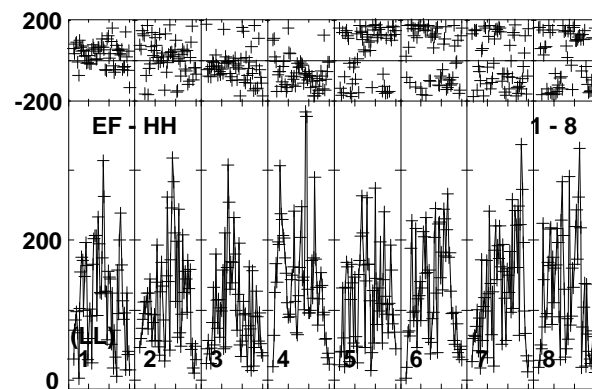
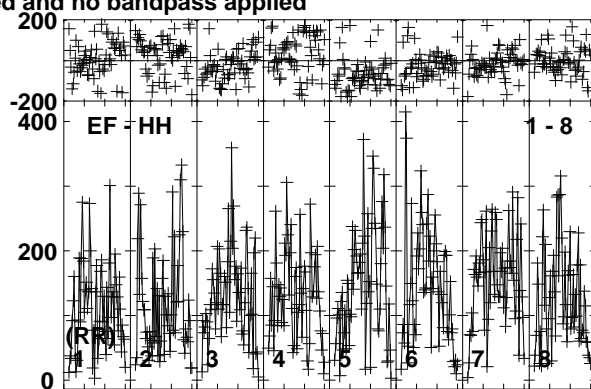
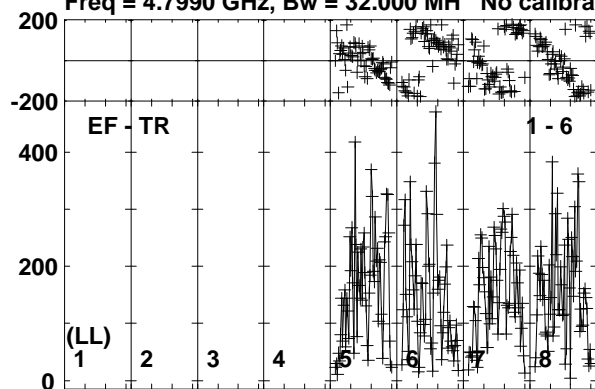

Lower frame: Micro Ampl Jy Top frame: Phas deg  
Vector averaged cross-power spectrum Baseline: EF (01) - TR (06)  
Timerange: 00:12:38:00 to 00:12:40:29

Plot file version 134 created 25-SEP-2017 10:02:36

J1303-2405 RP029B.UVDATA.1

Freq = 4.7990 GHz, Bw = 32.000 MH No calibration applied and no bandpass applied

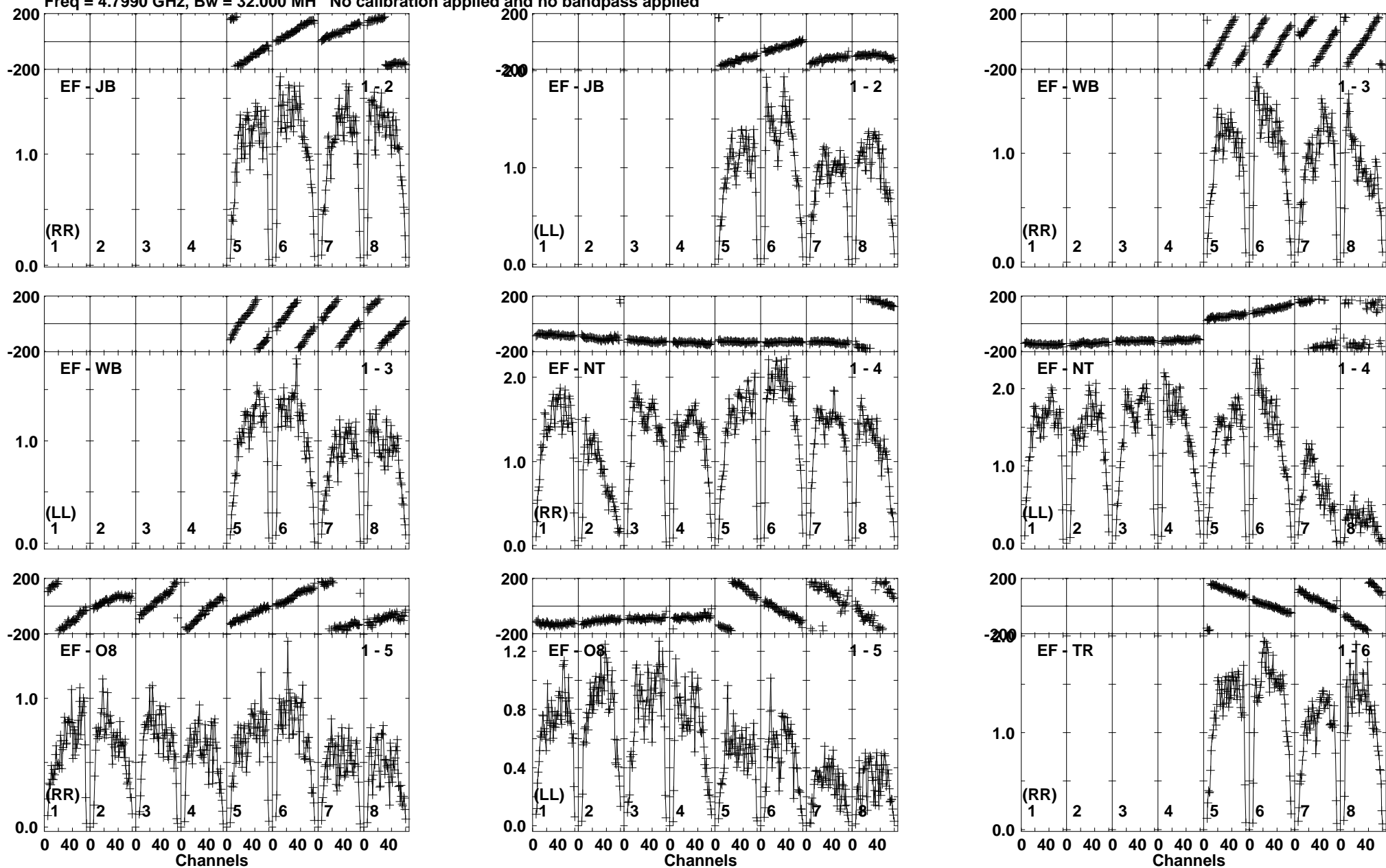

Lower frame: Milli Ampl Jy Top frame: Phas deg  
Vector averaged cross-power spectrum Baseline: EF (01) - JB (02)  
Timerange: 00:12:41:10 to 00:12:42:08

Plot file version 135 created 25-SEP-2017 10:02:36

J1303-2405 RP029B.UVDATA.1

Freq = 4.7990 GHz, Bw = 32.000 MH No calibration applied and no bandpass applied

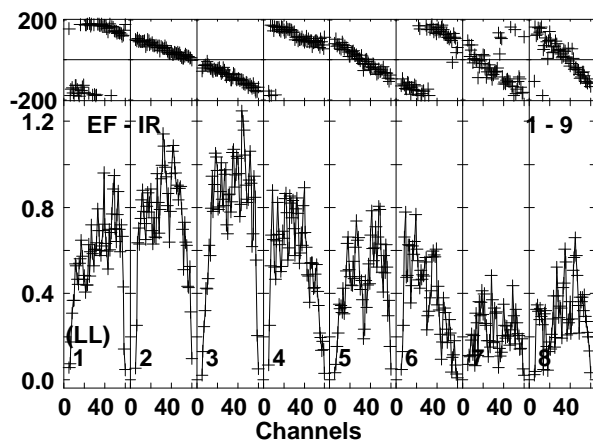
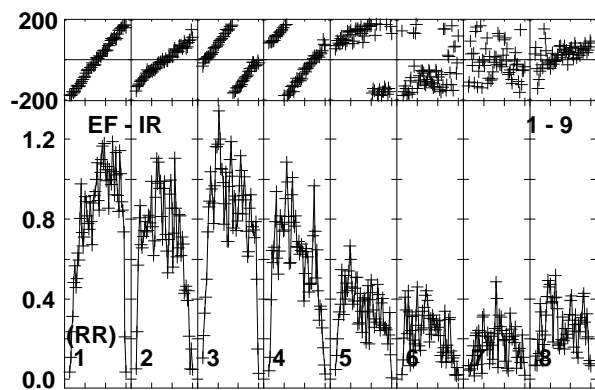
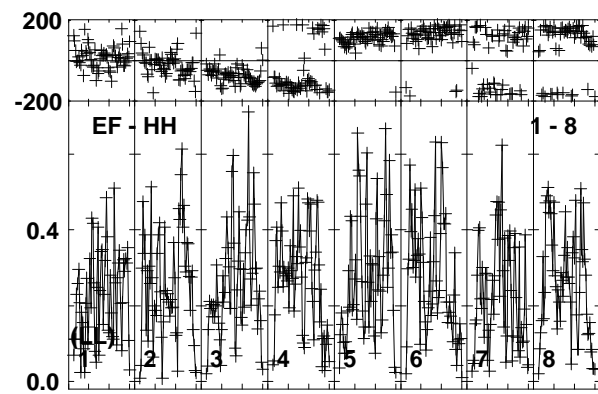
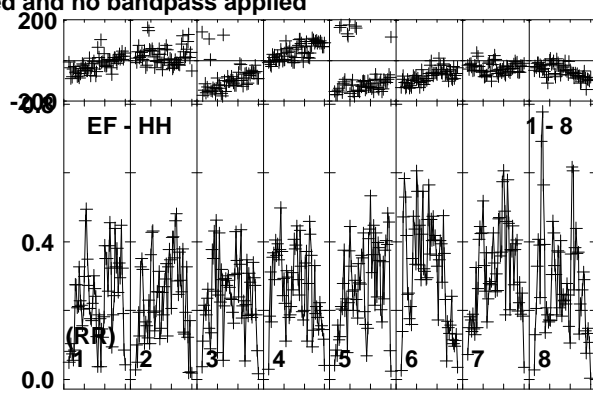
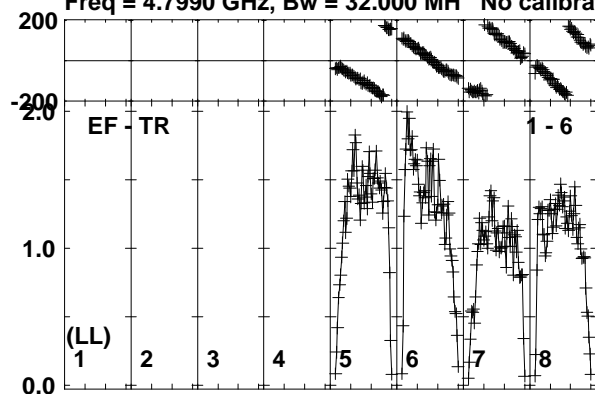

Lower frame: Milli Ampl Jy Top frame: Phas deg  
Vector averaged cross-power spectrum Baseline: EF (01) - TR (06)  
Timerange: 00/12:41:10 to 00/12:42:08

Plot file version 136 created 25-SEP-2017 10:02:36

SSS17A RP029B.UVDATA.1

Freq = 4.7990 GHz, Bw = 32.000 MH No calibration applied and no bandpass applied

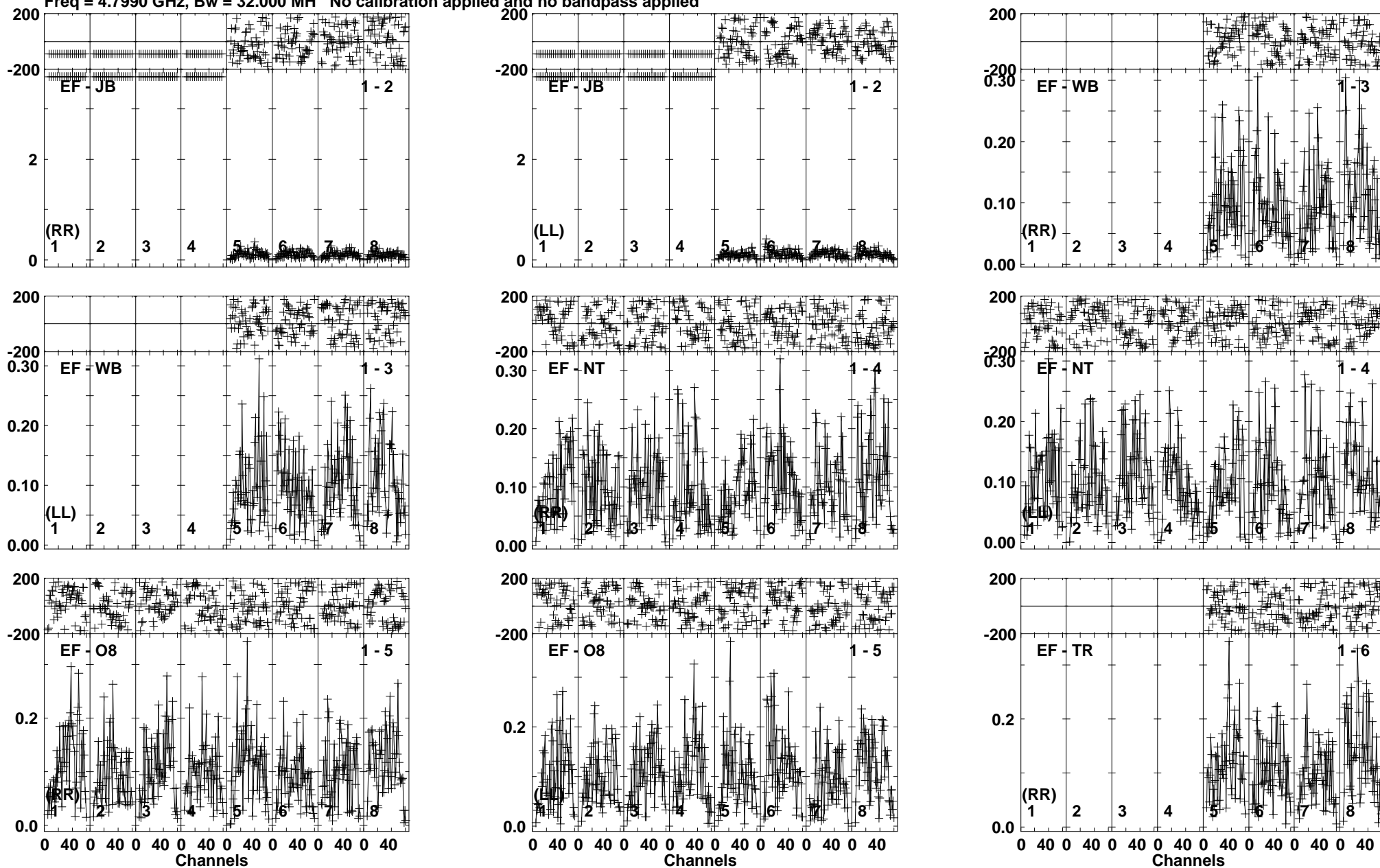

Lower frame: Milli Ampl Jy Top frame: Phas deg  
Vector averaged cross-power spectrum Baseline: EF (01) - JB (02)  
Timerange: 00:12:42:09 to 00:12:44:38



Plot file version 137 created 25-SEP-2017 10:02:36

SSS17A RP029B.UVDATA.1

Freq = 4.7990 GHz, Bw = 32.000 MH No calibration applied and no bandpass applied

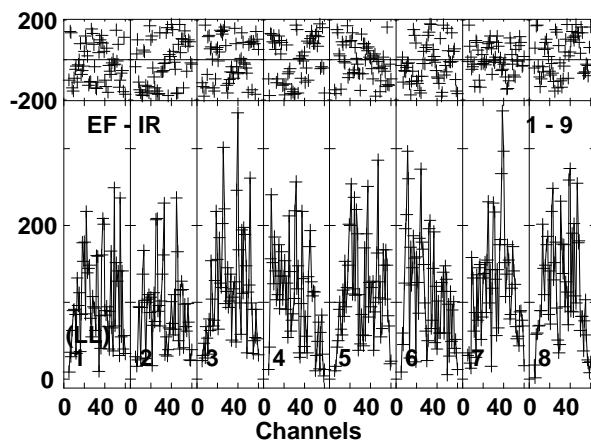
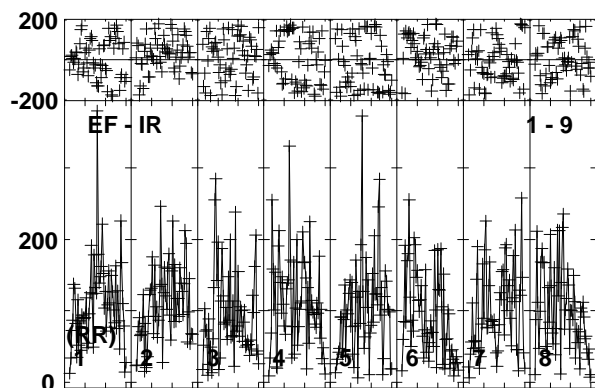
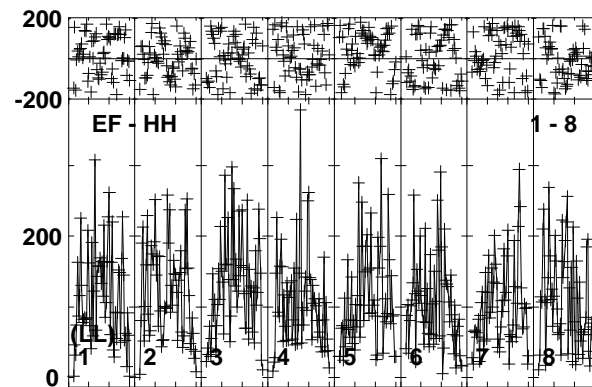
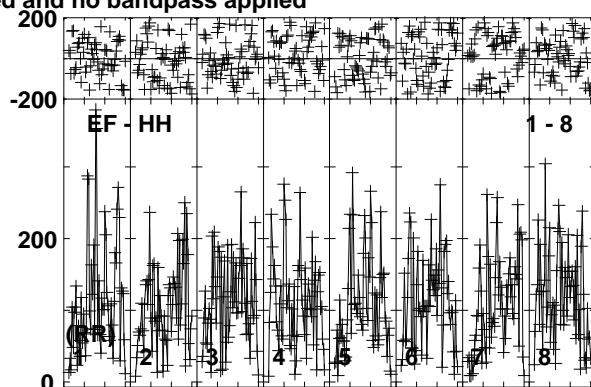
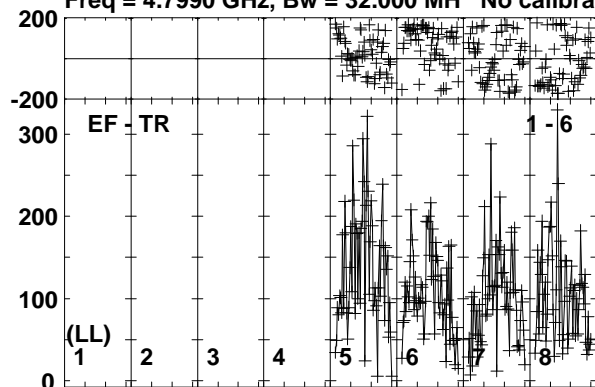

Lower frame: Micro Ampl Jy Top frame: Phas deg  
Vector averaged cross-power spectrum Baseline: EF (01) - TR (06)  
Timerange: 00/12:42:09 to 00/12:44:38

Plot file version 138 created 25-SEP-2017 10:02:36

J1303-2405 RP029B.UVDATA.1

Freq = 4.7990 GHz, Bw = 32.000 MH No calibration applied and no bandpass applied

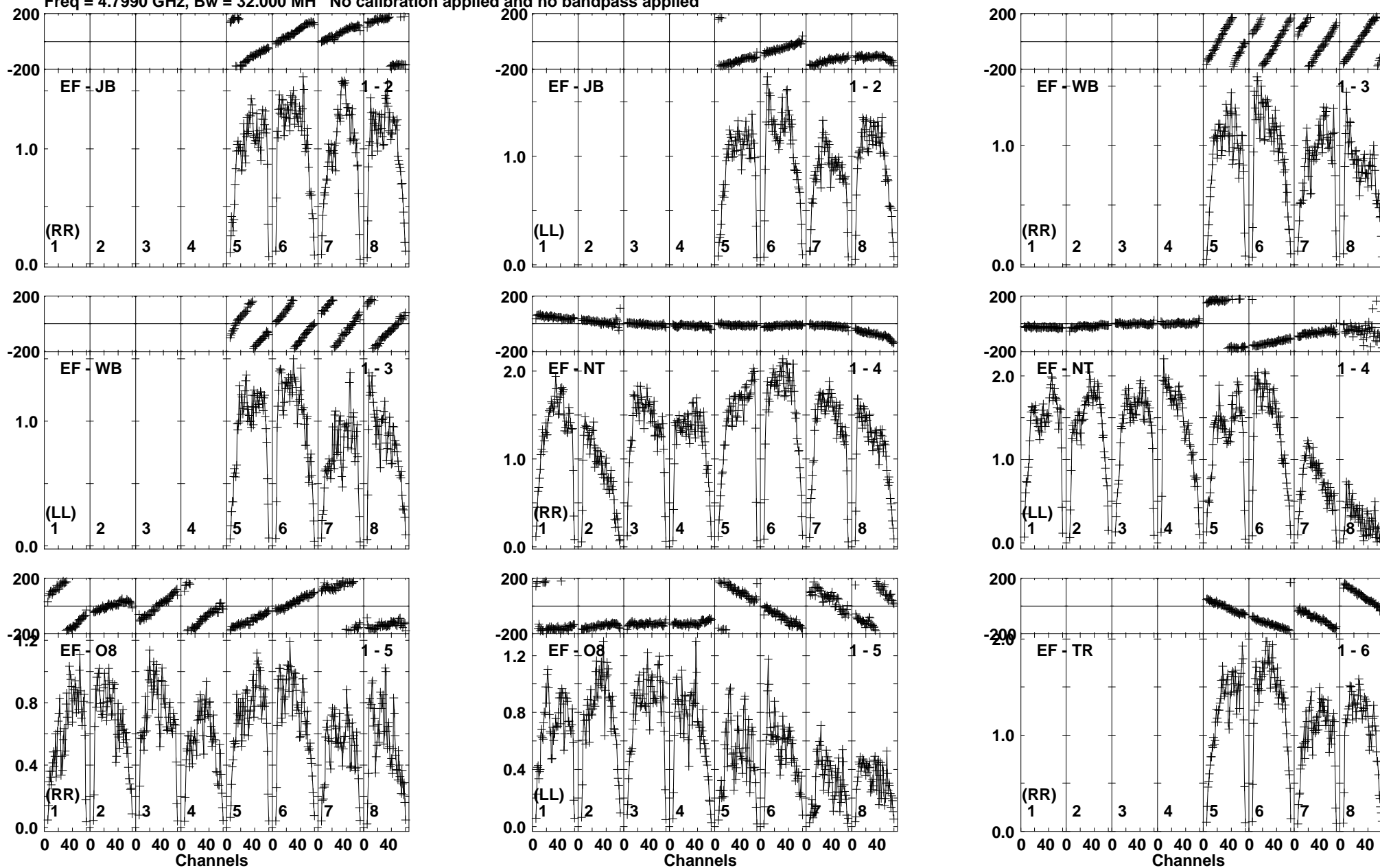

Lower frame: Milli Ampl Jy Top frame: Phas deg  
Vector averaged cross-power spectrum Baseline: EF (01) - JB (02)  
Timerange: 00:12:44:39 to 00:12:46:08

Plot file version 139 created 25-SEP-2017 10:02:36

J1303-2405 RP029B.UVDATA.1

Freq = 4.7990 GHz, Bw = 32.000 MH No calibration applied and no bandpass applied

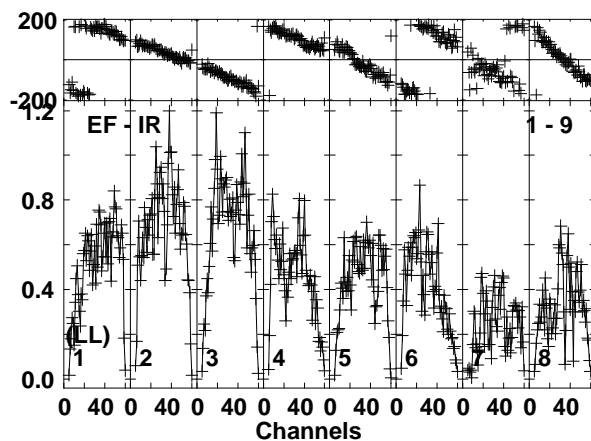
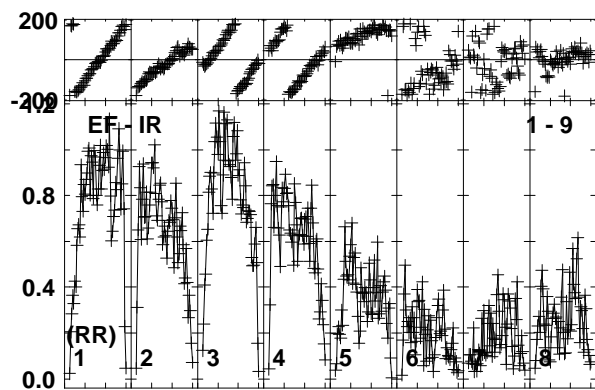
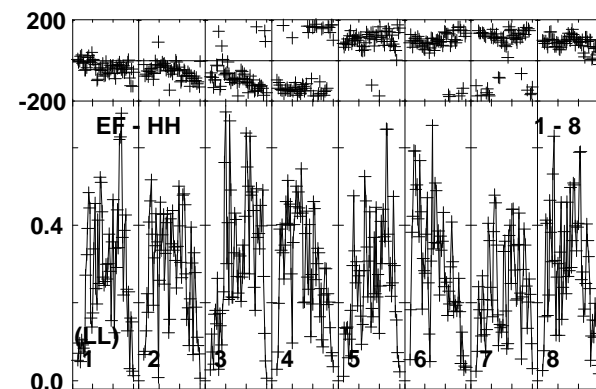
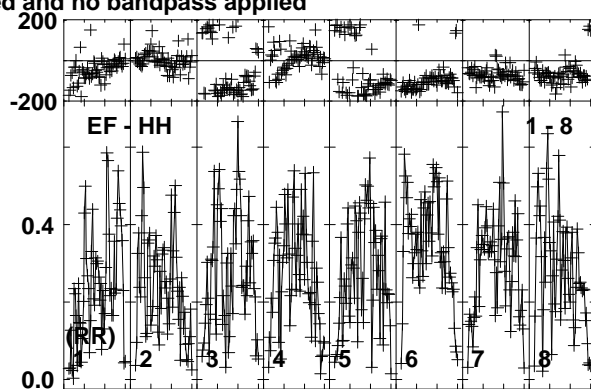
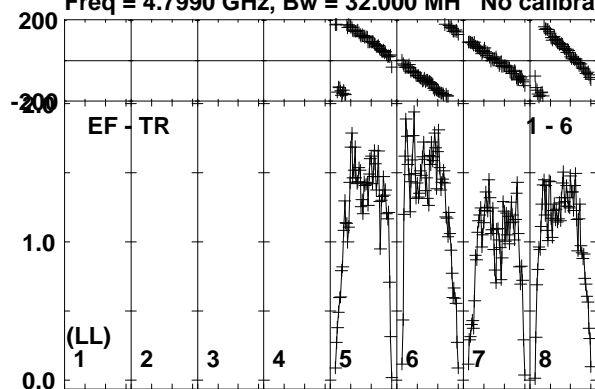

Lower frame: Milli Ampl Jy Top frame: Phas deg

Vector averaged cross-power spectrum Baseline: EF (01) - TR (06)

Timerange: 00:12:44:39 to 00:12:46:08

Plot file version 140 created 25-SEP-2017 10:02:37

SSS17A RP029B.UVDATA.1

Freq = 4.7990 GHz, Bw = 32.000 MH No calibration applied and no bandpass applied

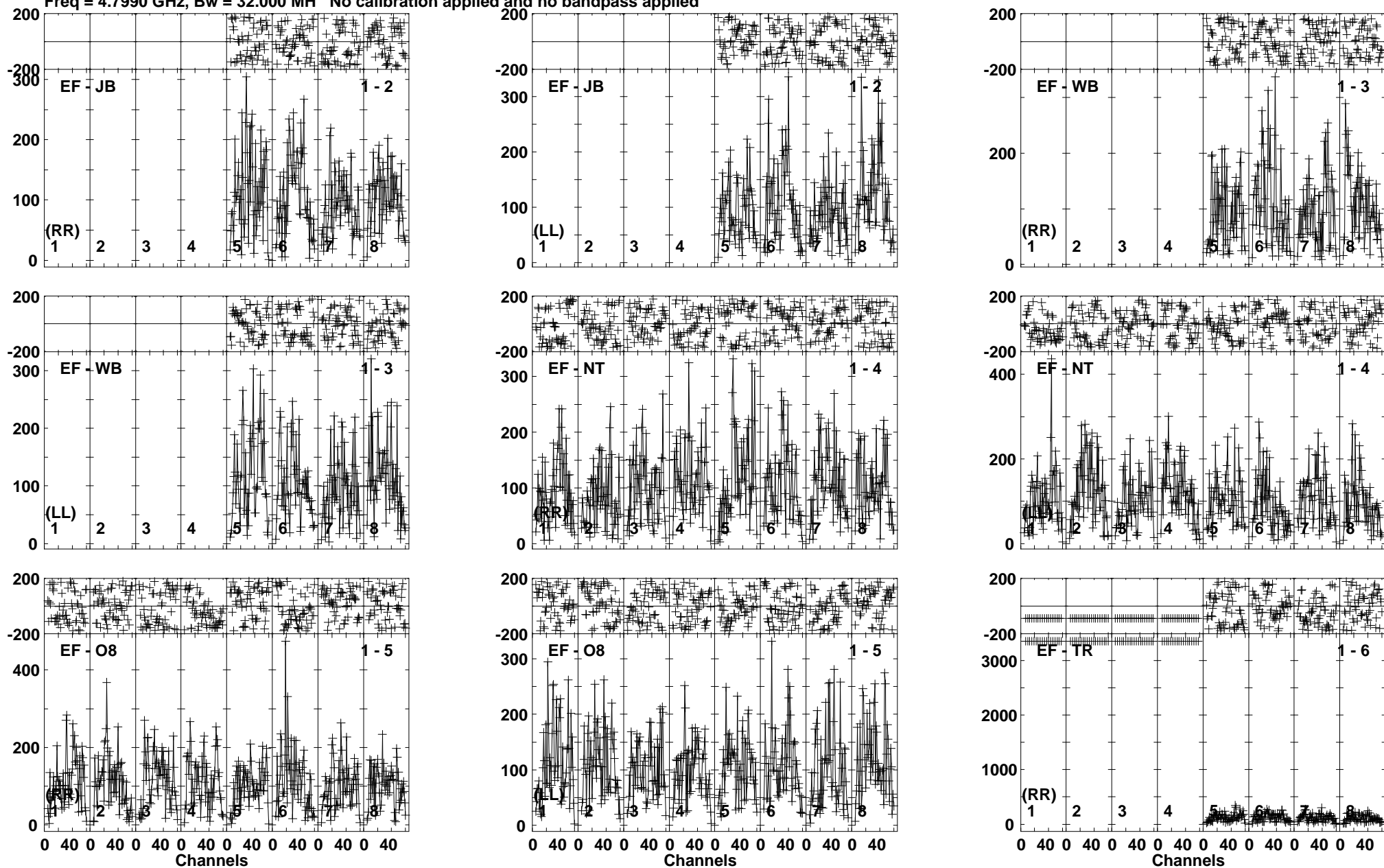

Lower frame: Micro Ampl Jy Top frame: Phas deg  
Vector averaged cross-power spectrum Baseline: EF (01) - JB (02)  
Timerange: 00:12:46:10 to 00:12:48:38

Plot file version 141 created 25-SEP-2017 10:02:37

SSS17A RP029B.UVDATA.1

Freq = 4.7990 GHz, Bw = 32.000 MH No calibration applied and no bandpass applied

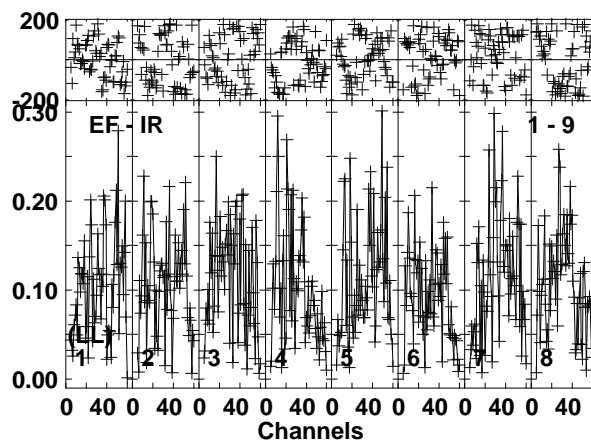
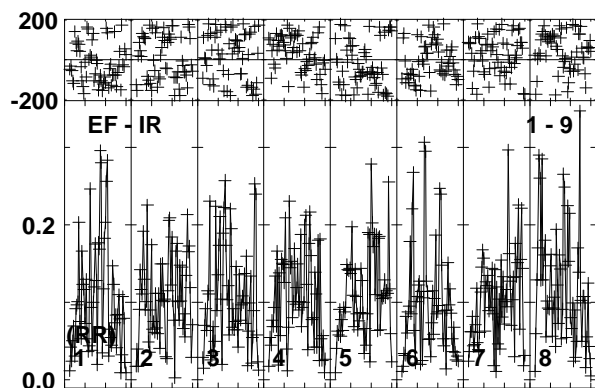
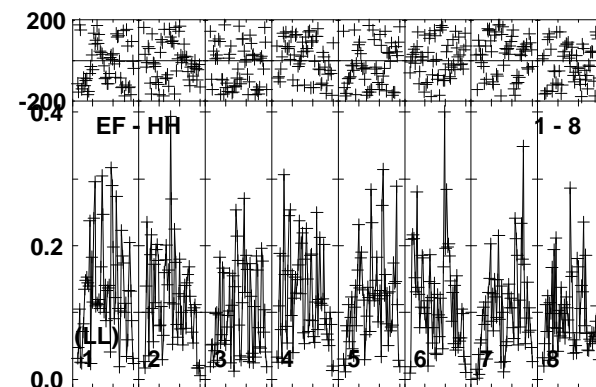
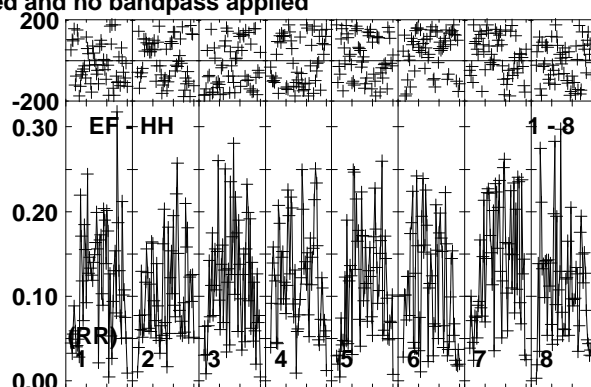
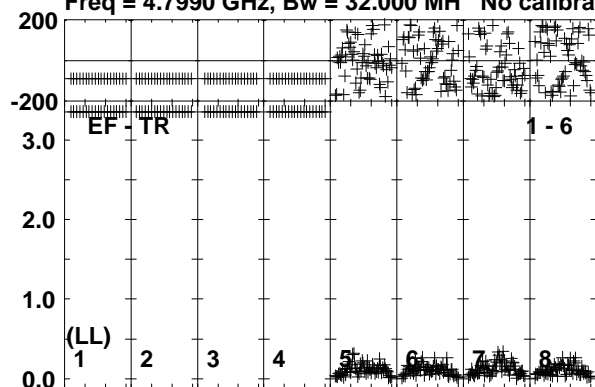

Lower frame: Milli Ampl Jy Top frame: Phas deg  
Vector averaged cross-power spectrum Baseline: EF (01) - TR (06)  
Timerange: 00:12:46:10 to 00:12:48:38

Plot file version 142 created 25-SEP-2017 10:02:37

J1303-2405 RP029B.UVDATA.1

Freq = 4.7990 GHz, Bw = 32.000 MH No calibration applied and no bandpass applied

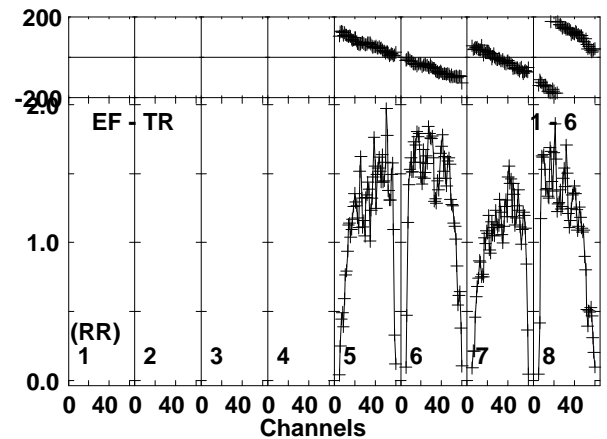
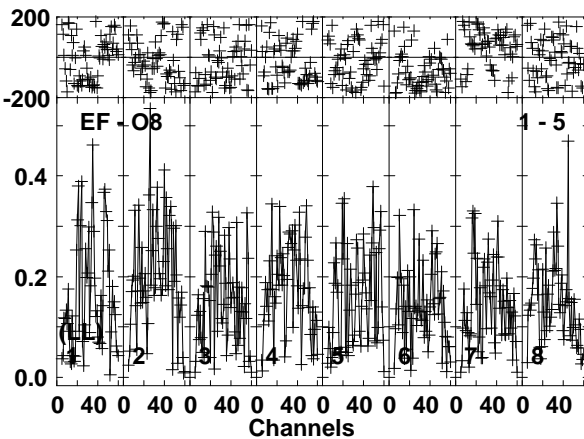
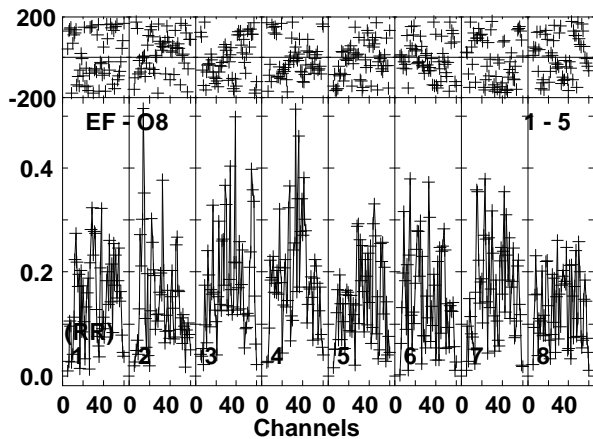
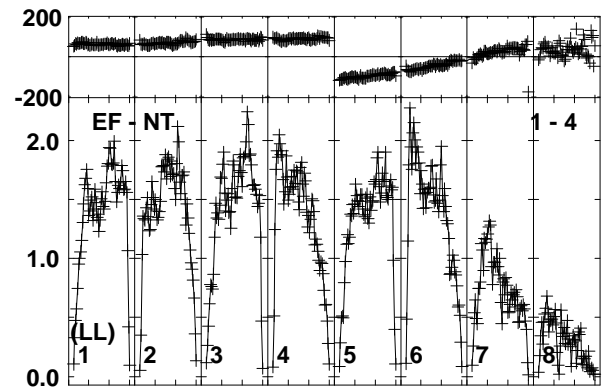
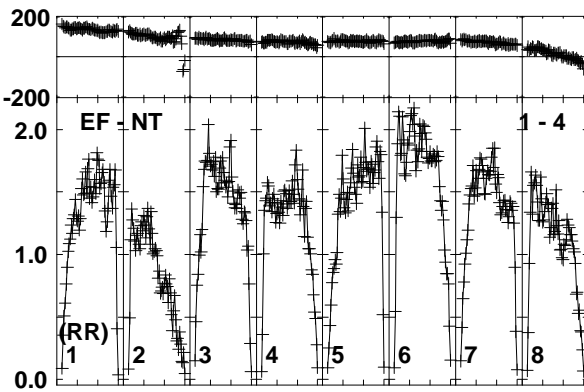
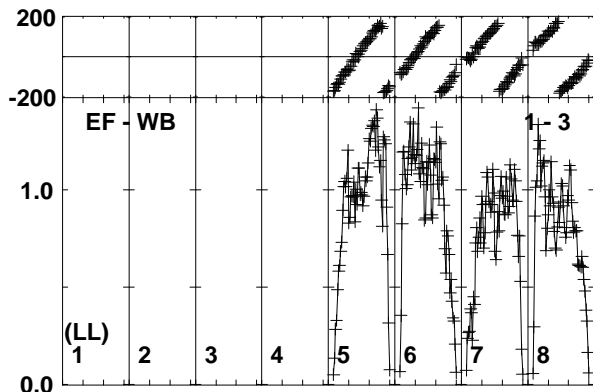
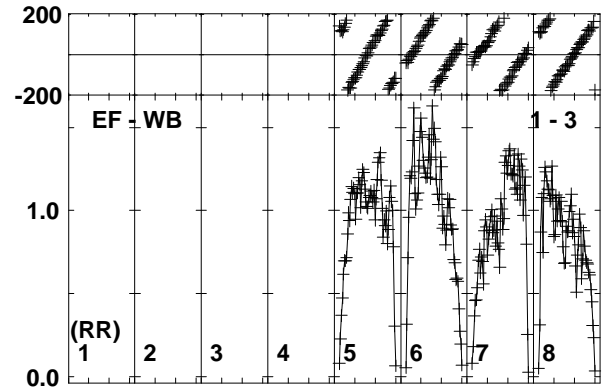
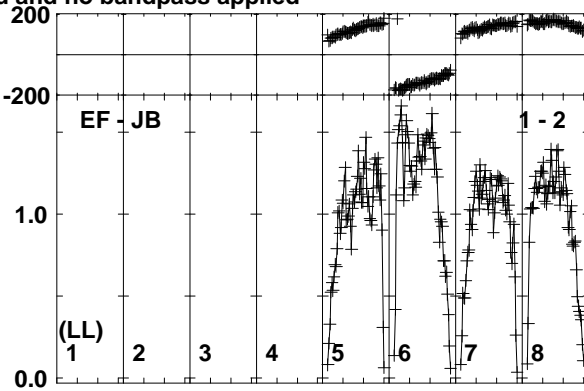
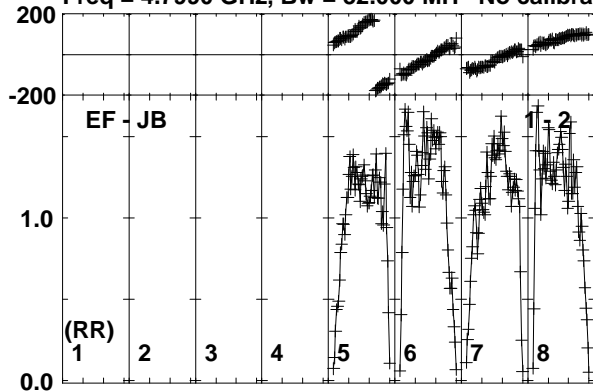

Lower frame: Milli Ampl Jy Top frame: Phas deg  
Vector averaged cross-power spectrum Baseline: EF (01) - JB (02)  
Timerange: 00:12:49:09 to 00:12:50:08

Plot file version 143 created 25-SEP-2017 10:02:37

J1303-2405 RP029B.UVDATA.1

Freq = 4.7990 GHz, Bw = 32.000 MH No calibration applied and no bandpass applied

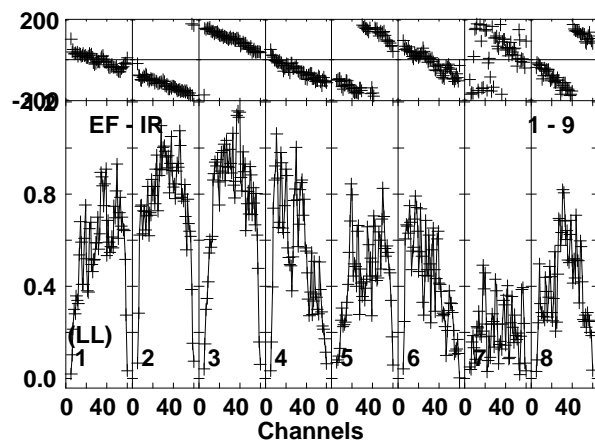
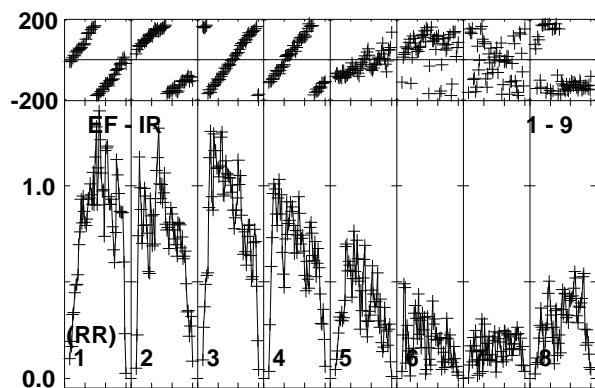
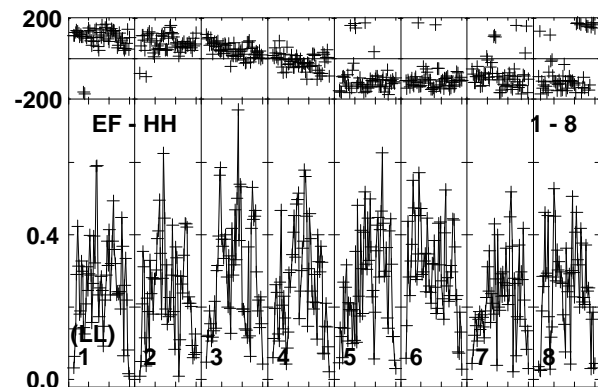
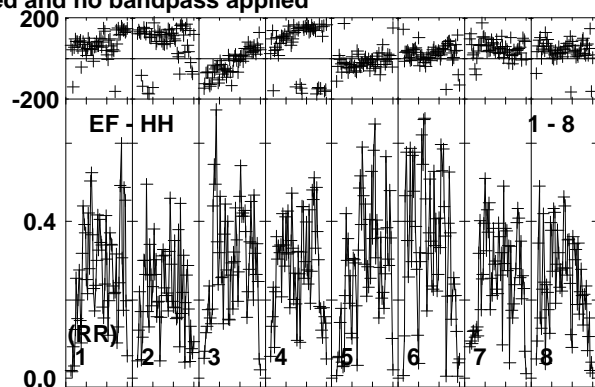
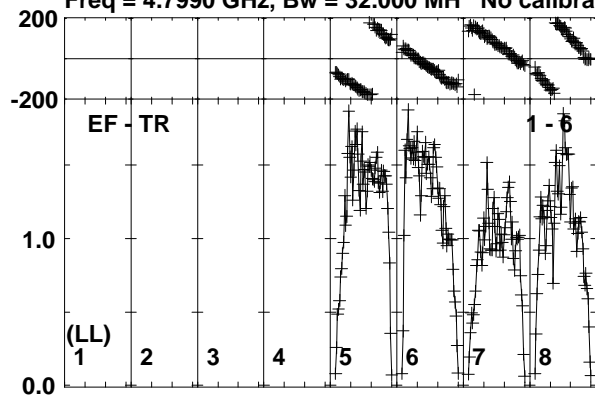

Lower frame: Milli Ampl Jy Top frame: Phas deg  
Vector averaged cross-power spectrum Baseline: EF (01) - TR (06)  
Timerange: 00:12:49:09 to 00:12:50:08

Plot file version 144 created 25-SEP-2017 10:02:37

SSS17A RP029B.UVDATA.1

Freq = 4.7990 GHz, Bw = 32.000 MH No calibration applied and no bandpass applied

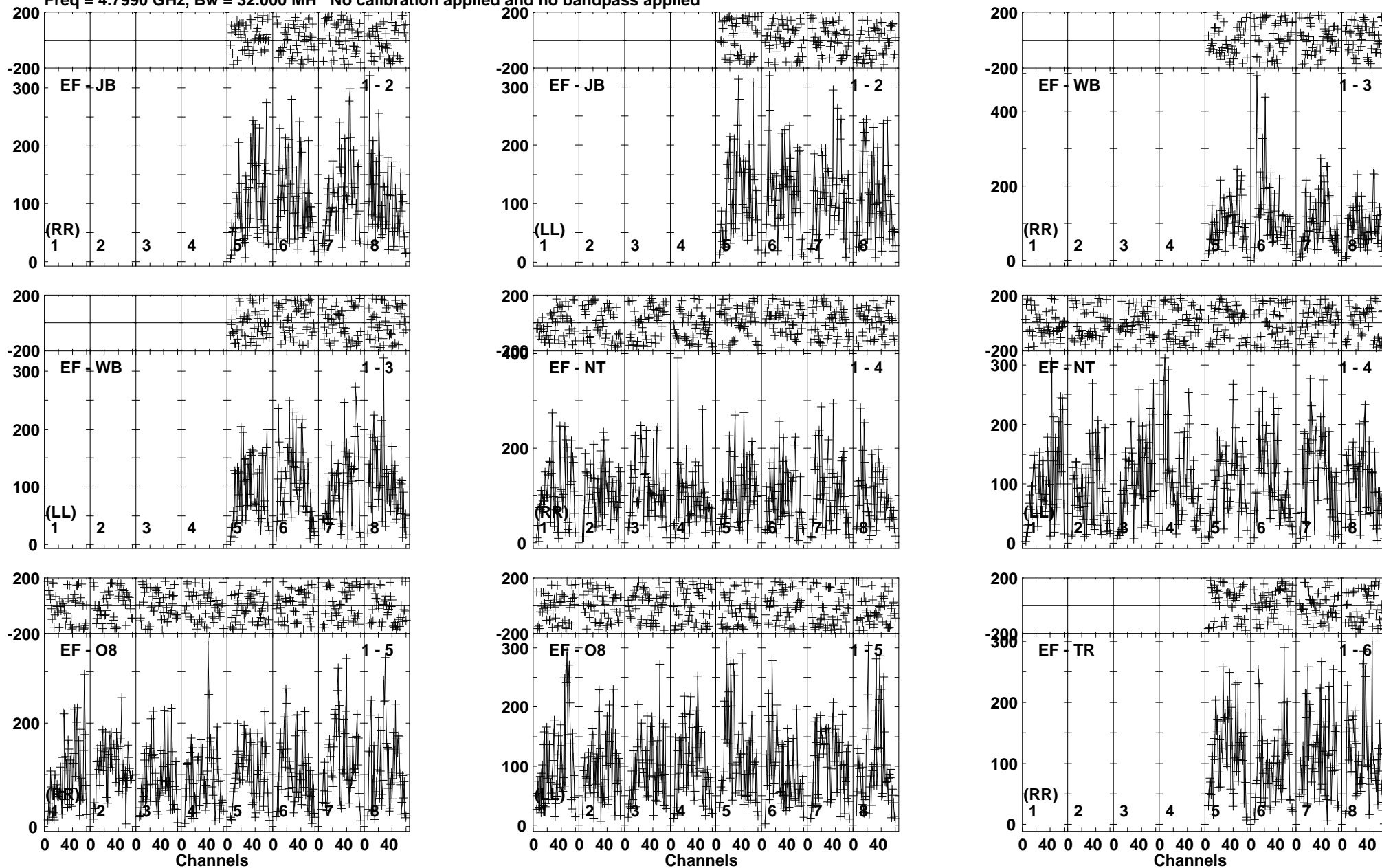

Lower frame: Micro Ampl Jy Top frame: Phas deg  
Vector averaged cross-power spectrum Baseline: EF (01) - JB (02)  
Timerange: 00/12:50:10 to 00/12:52:39



Plot file version 145 created 25-SEP-2017 10:02:37

SSS17A RP029B.UVDATA.1

Freq = 4.7990 GHz, Bw = 32.000 MH No calibration applied and no bandpass applied

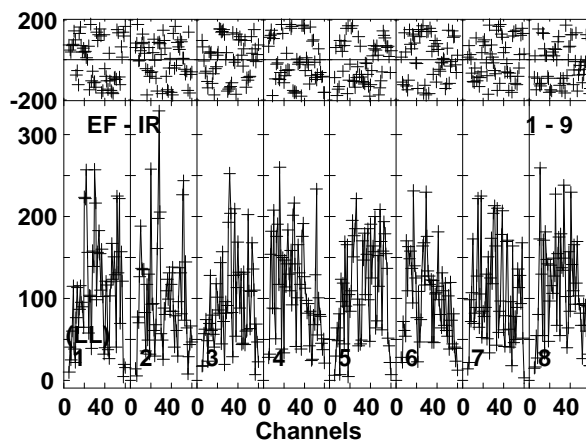
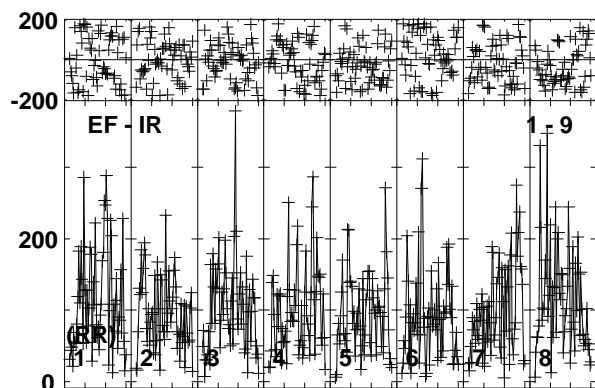
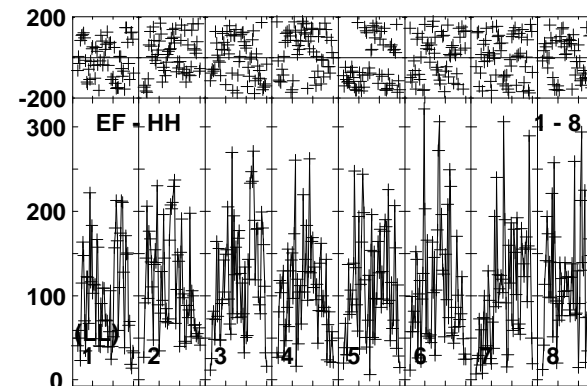
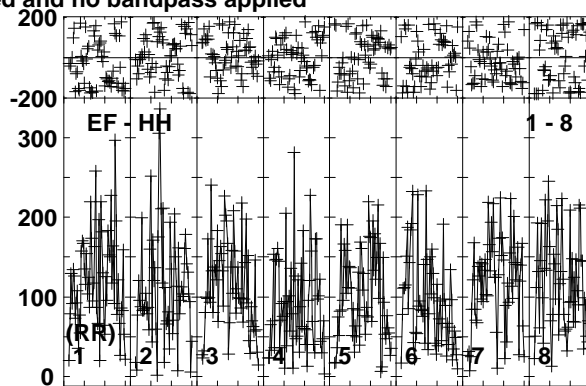
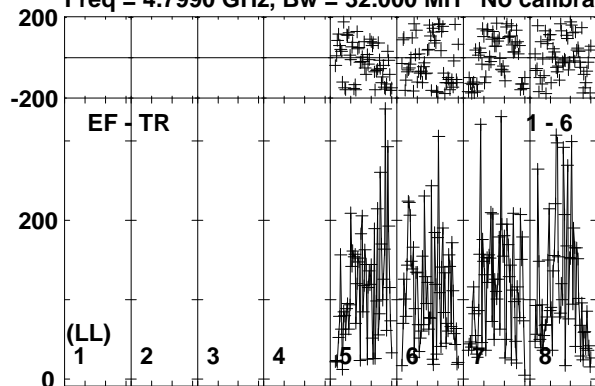

Lower frame: Micro Ampl Jy Top frame: Phas deg  
Vector averaged cross-power spectrum Baseline: EF (01) - TR (06)  
Timerange: 00/12:50:10 to 00/12:52:39

Plot file version 146 created 25-SEP-2017 10:02:37

J1303-2405 RP029B.UVDATA.1

Freq = 4.7990 GHz, Bw = 32.000 MH No calibration applied and no bandpass applied

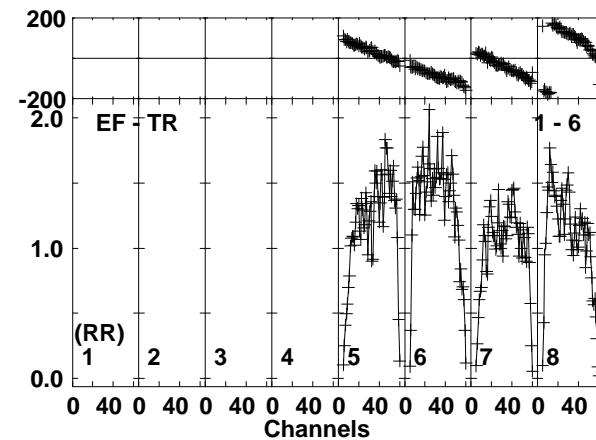
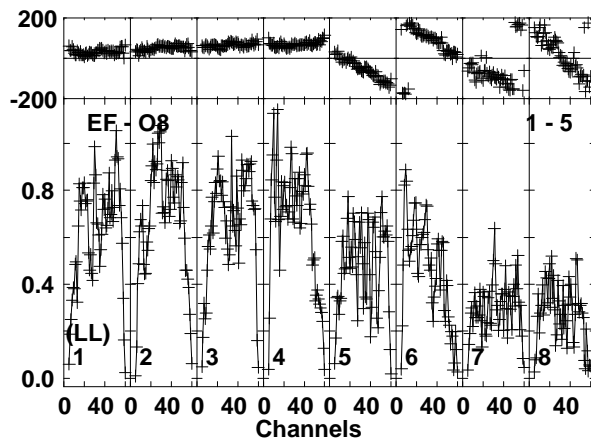
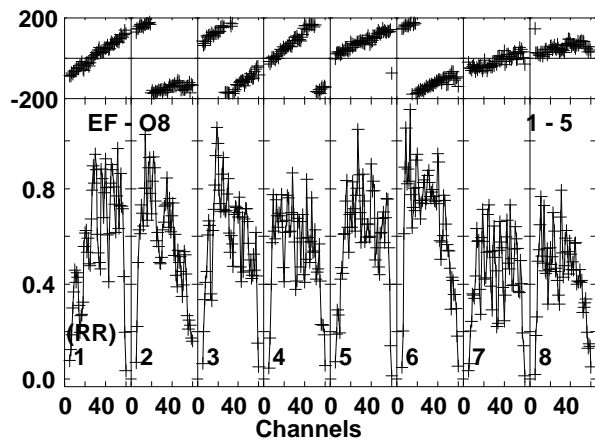
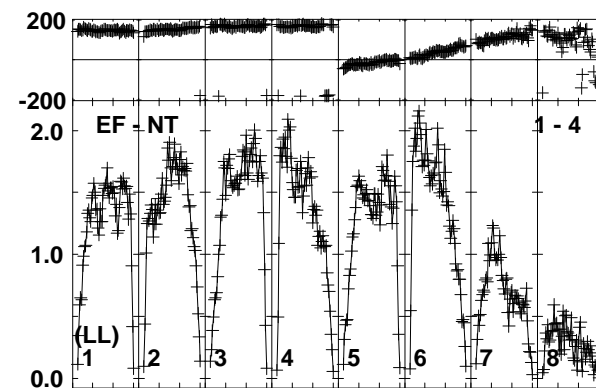
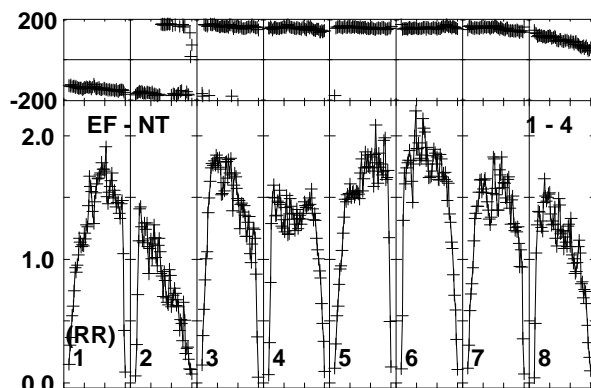
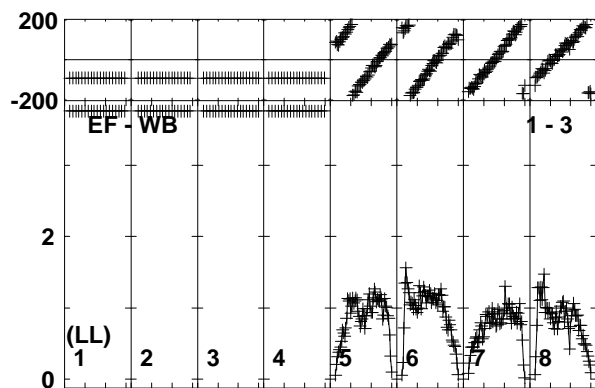
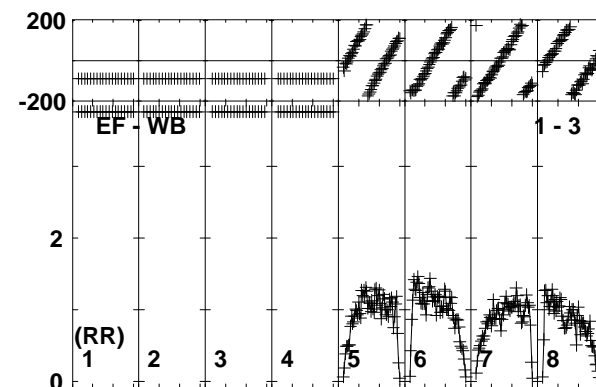
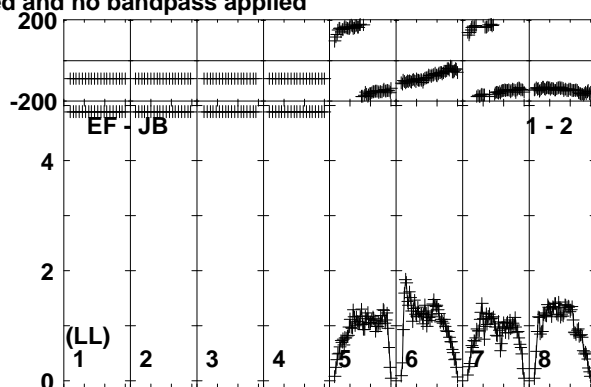
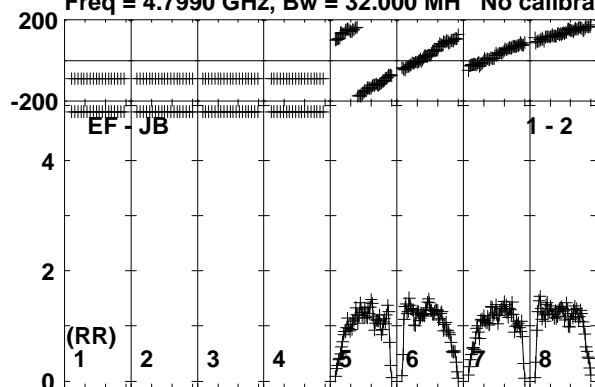

Lower frame: Milli Ampl Jy Top frame: Phas deg  
Vector averaged cross-power spectrum Baseline: EF (01) - JB (02)  
Timerange: 00:12:52:39 to 00:12:54:08

Plot file version 147 created 25-SEP-2017 10:02:38

J1303-2405 RP029B.UVDATA.1

Freq = 4.7990 GHz, Bw = 32.000 MH No calibration applied and no bandpass applied

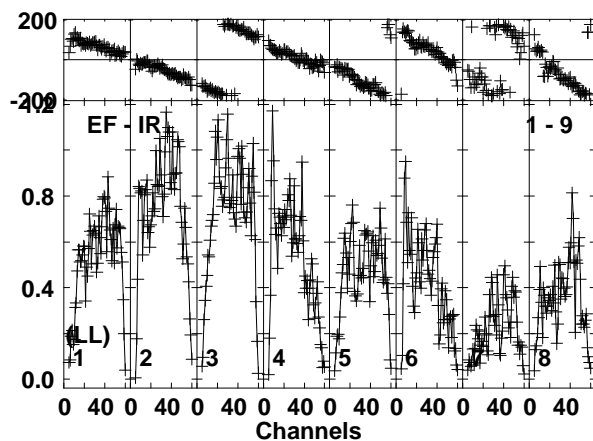
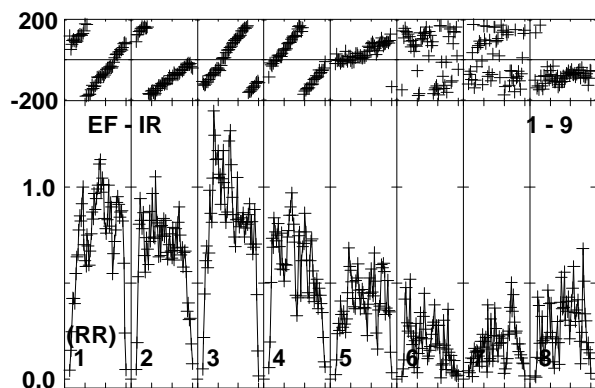
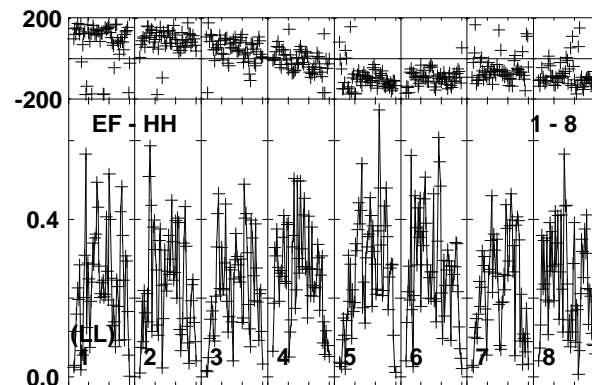
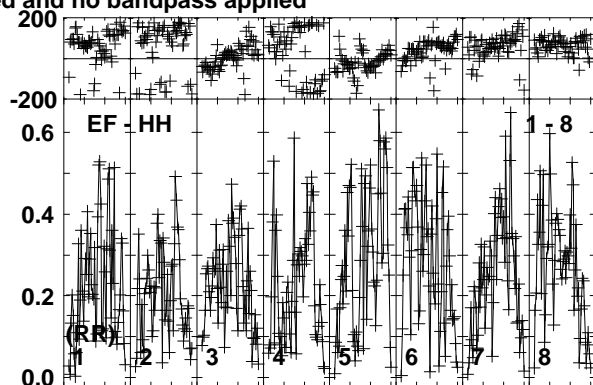
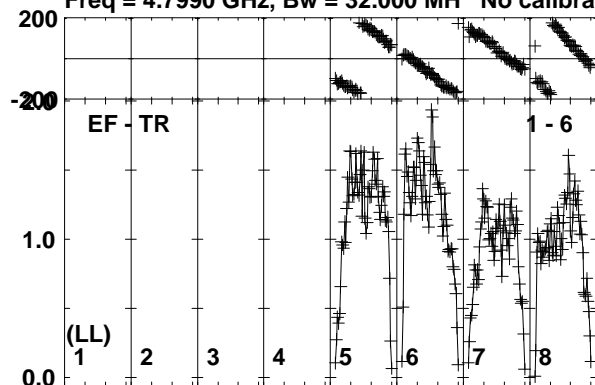

Lower frame: Milli Ampl Jy Top frame: Phas deg  
Vector averaged cross-power spectrum Baseline: EF (01) - TR (06)  
Timerange: 00:12:52:39 to 00:12:54:08

Plot file version 148 created 25-SEP-2017 10:02:38

J1312-2350 RP029B.UVDATA.1

Freq = 4.7990 GHz, Bw = 32.000 MH No calibration applied and no bandpass applied

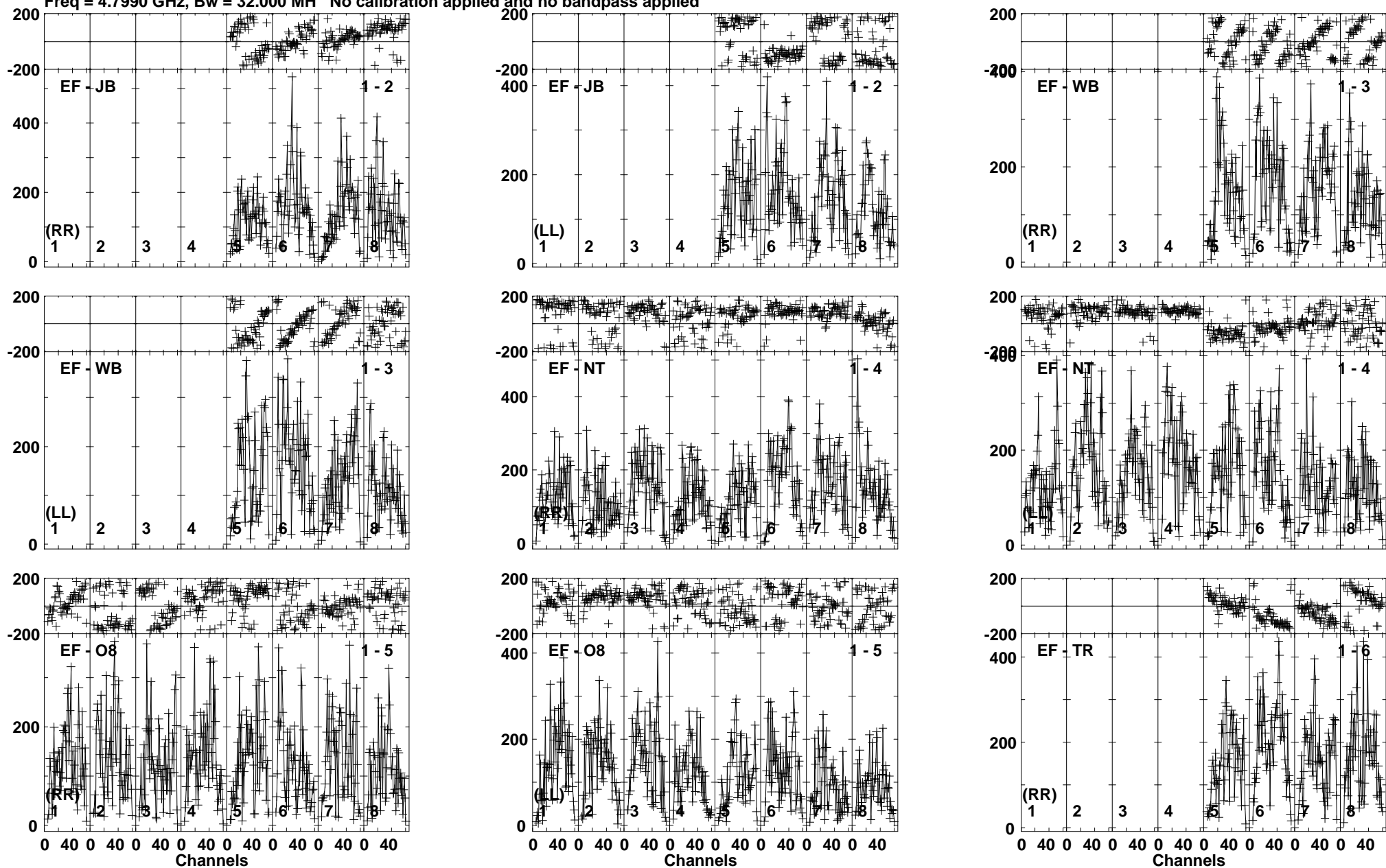

Lower frame: Micro Ampl Jy Top frame: Phas deg  
Vector averaged cross-power spectrum Baseline: EF (01) - JB (02)  
Timerange: 00/12:54:09 to 00/12:56:38

Plot file version 149 created 25-SEP-2017 10:02:38

J1312-2350 RP029B.UVDATA.1

Freq = 4.7990 GHz, Bw = 32.000 MH No calibration applied and no bandpass applied

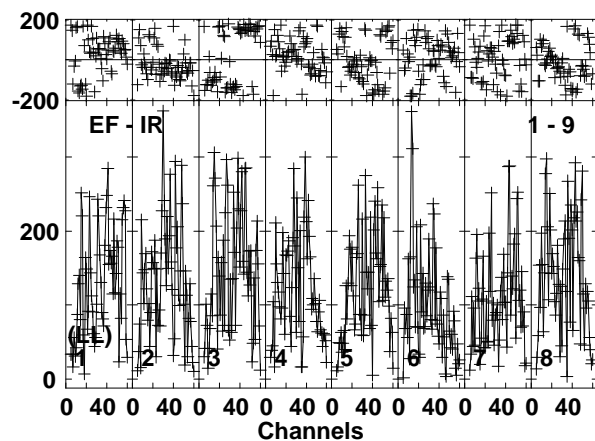
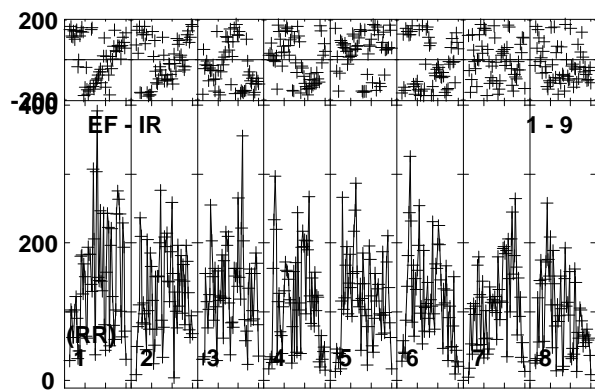
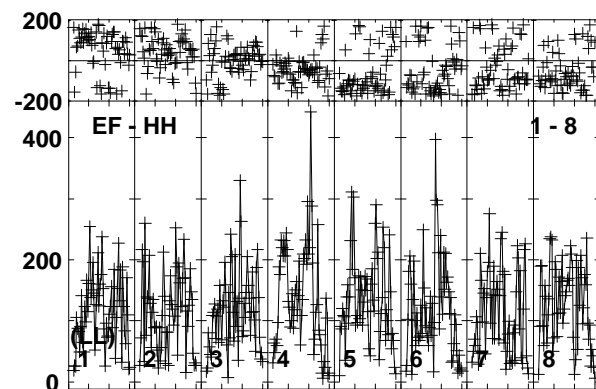
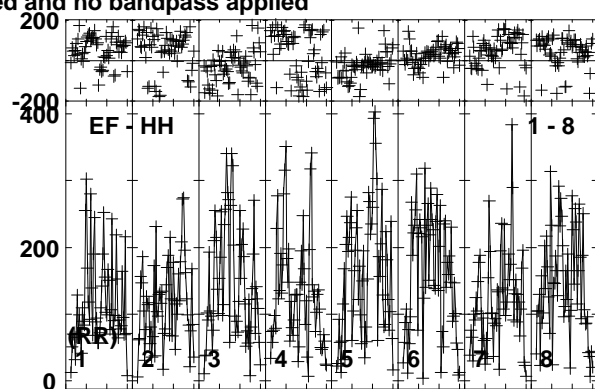
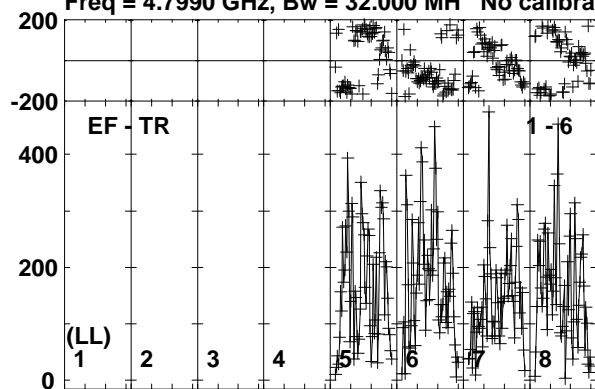

Lower frame: Micro Ampl Jy Top frame: Phas deg  
Vector averaged cross-power spectrum Baseline: EF (01) - TR (06)  
Timerange: 00:12:54:09 to 00:12:56:38

Plot file version 150 created 25-SEP-2017 10:02:38

J1303-2405 RP029B.UVDATA.1

Freq = 4.7990 GHz, Bw = 32.000 MH No calibration applied and no bandpass applied

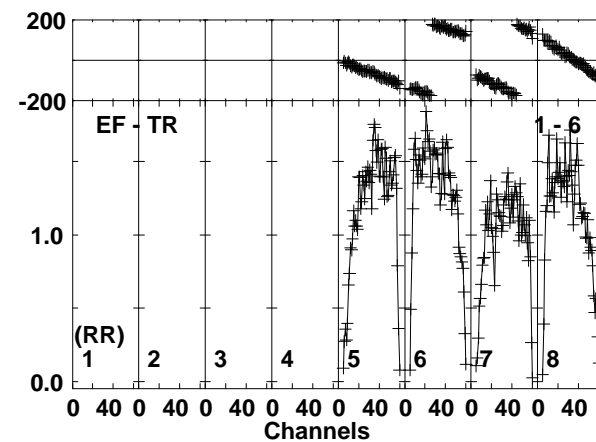
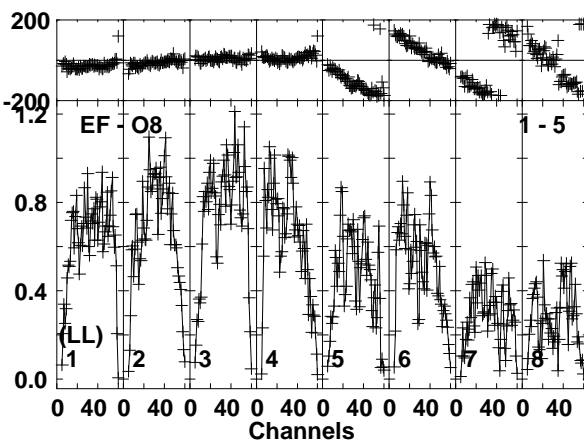
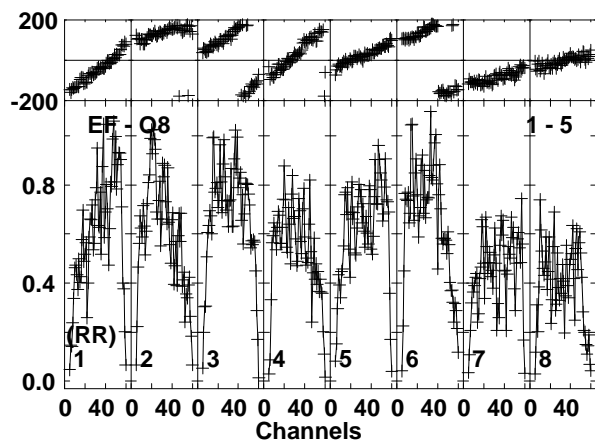
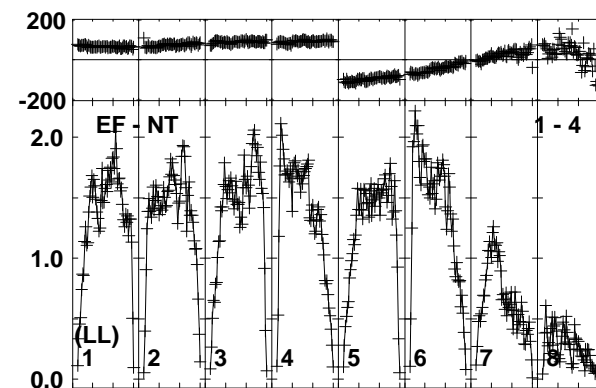
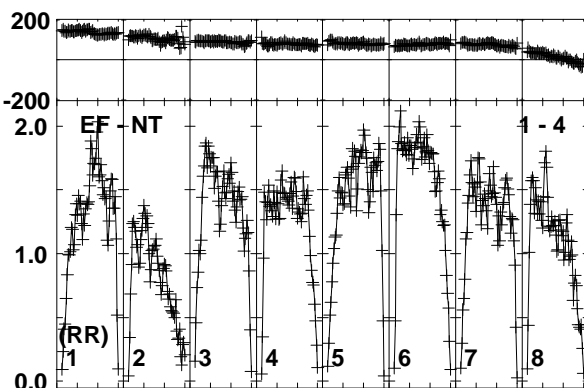
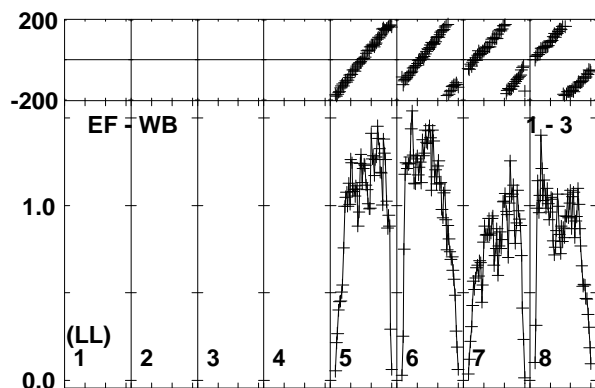
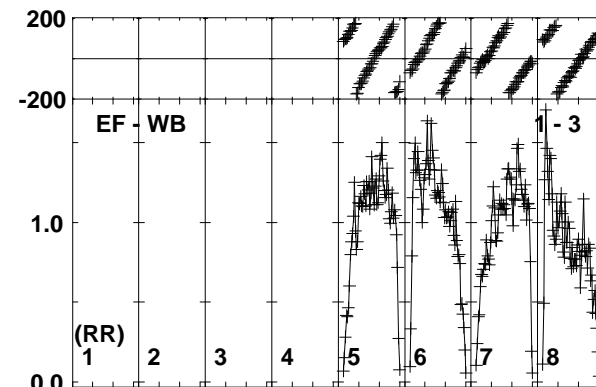
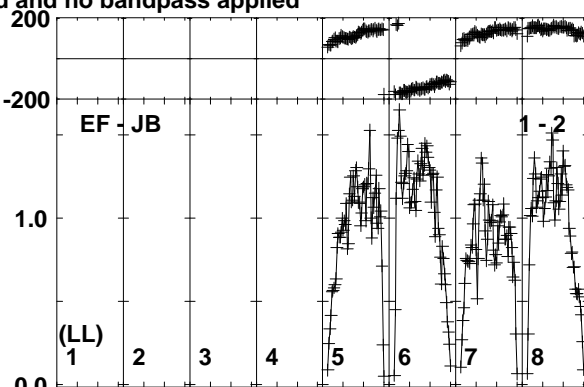
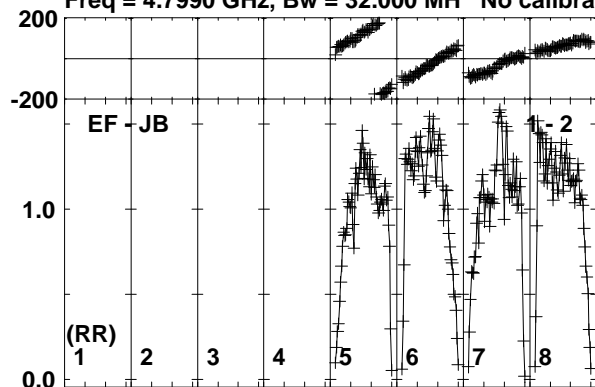

Lower frame: Milli Ampl Jy Top frame: Phas deg  
Vector averaged cross-power spectrum Baseline: EF (01) - JB (02)  
Timerange: 00:12:57:20 to 00:12:58:19

Plot file version 151 created 25-SEP-2017 10:02:38

J1303-2405 RP029B.UVDATA.1

Freq = 4.7990 GHz, Bw = 32.000 MH No calibration applied and no bandpass applied

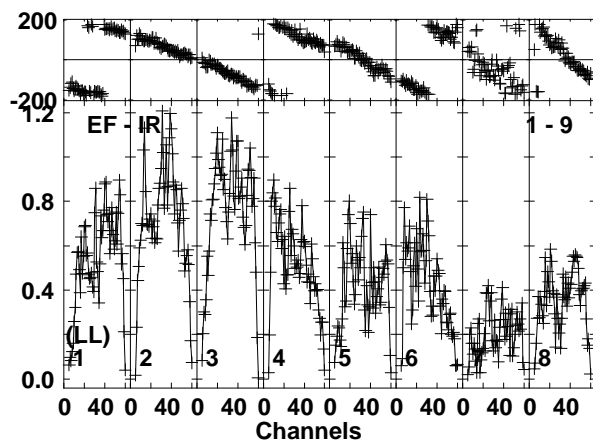
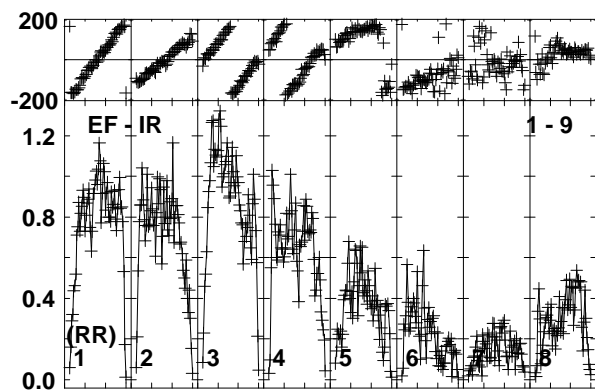
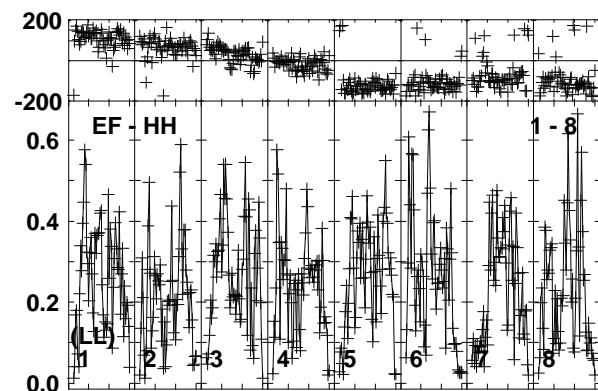
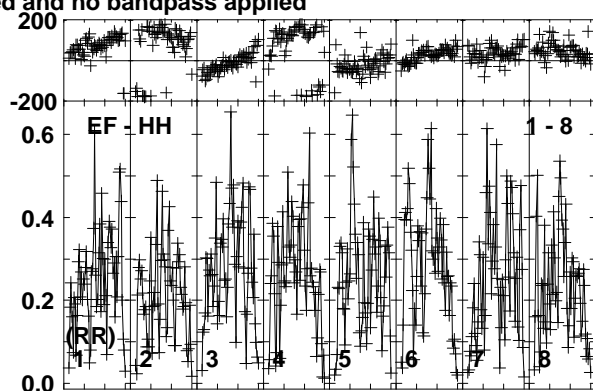
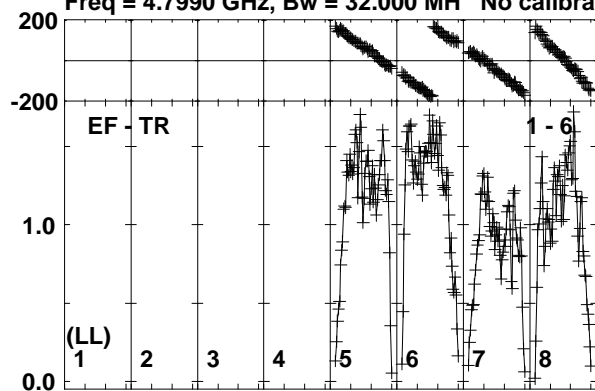

Lower frame: Milli Ampl Jy Top frame: Phas deg  
Vector averaged cross-power spectrum Baseline: EF (01) - TR (06)  
Timerange: 00/12:57:20 to 00/12:58:19

Plot file version 152 created 25-SEP-2017 10:02:38

SSS17A RP029B.UVDATA.1

Freq = 4.7990 GHz, Bw = 32.000 MH No calibration applied and no bandpass applied

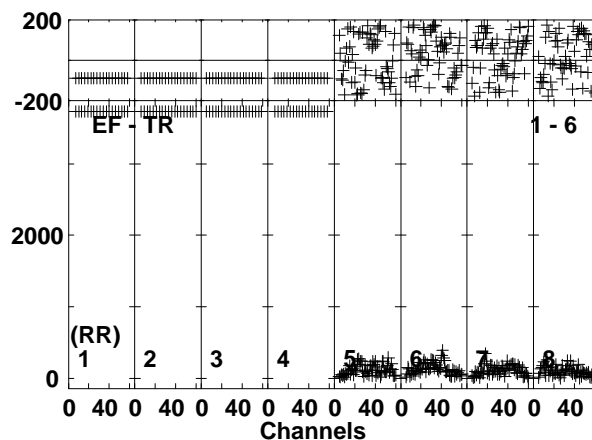
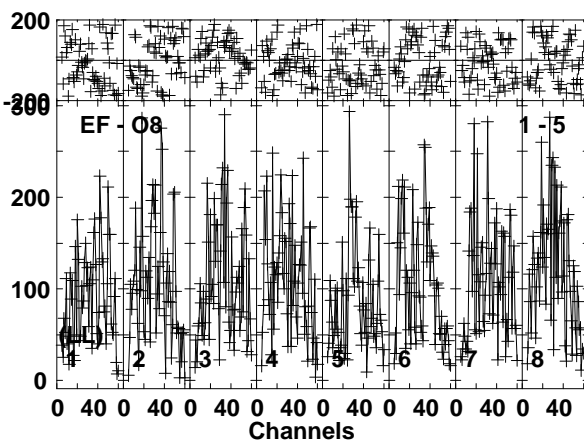
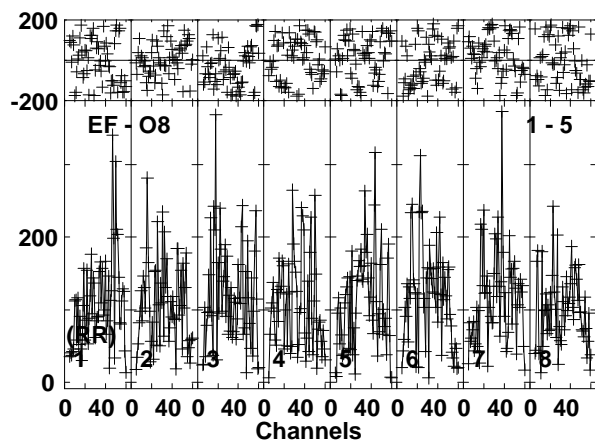
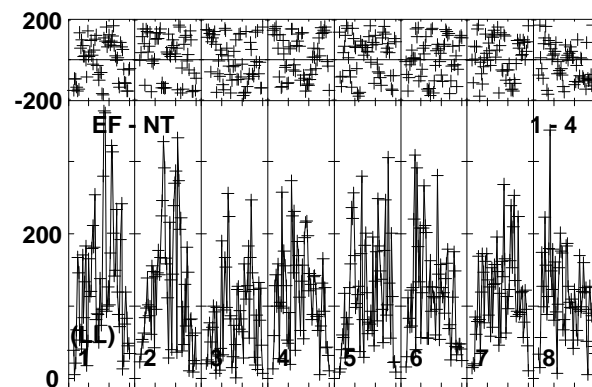
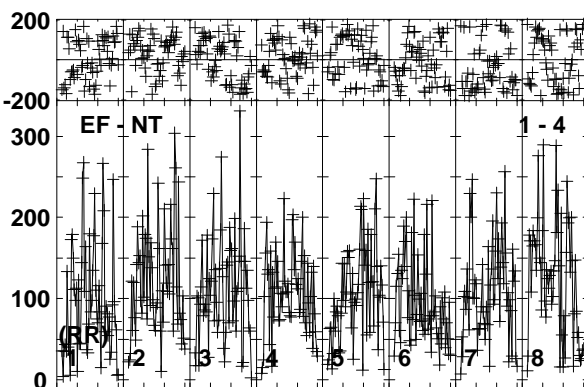
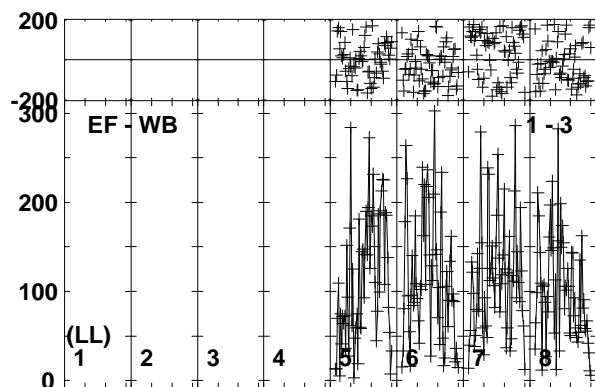
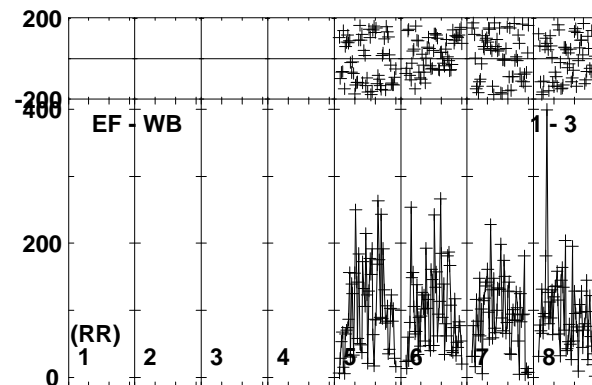
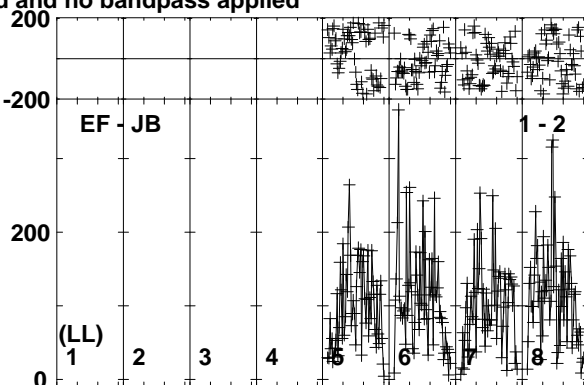
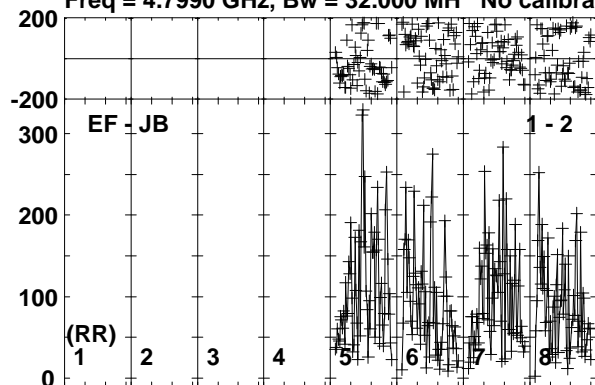

Lower frame: Micro Ampl Jy Top frame: Phas deg  
Vector averaged cross-power spectrum Baseline: EF (01) - JB (02)  
Timerange: 00/12:58:20 to 00/13:00:48



Plot file version 153 created 25-SEP-2017 10:02:39

SSS17A RP029B.UVDATA.1

Freq = 4.7990 GHz, Bw = 32.000 MH No calibration applied and no bandpass applied

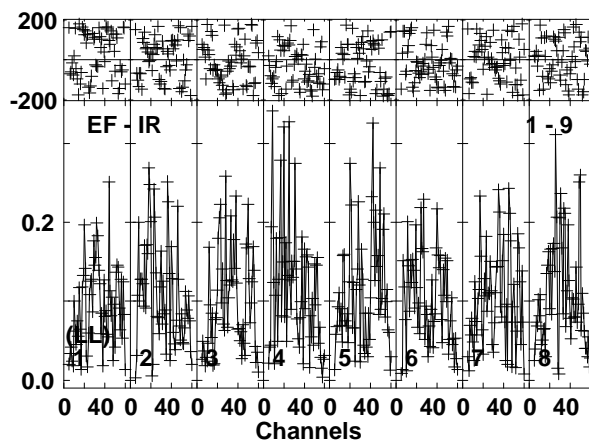
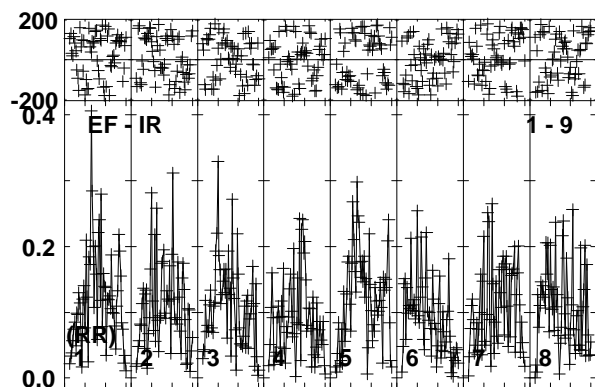
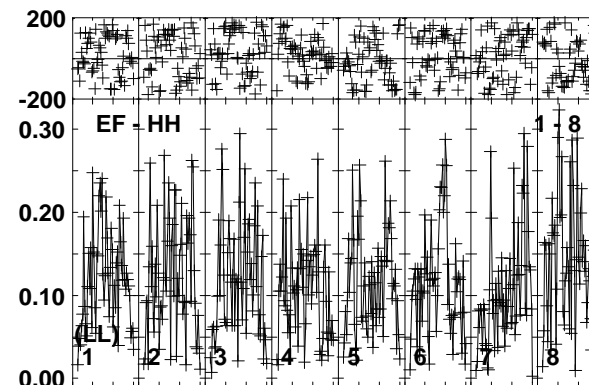
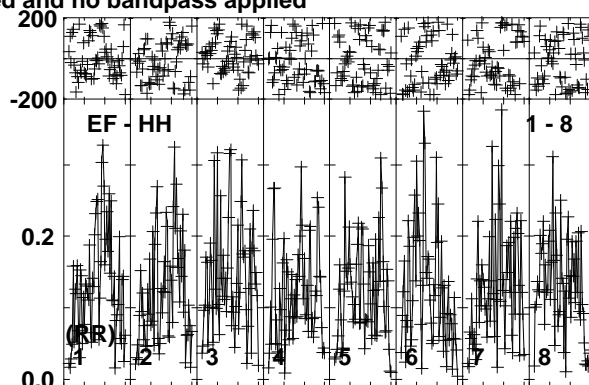
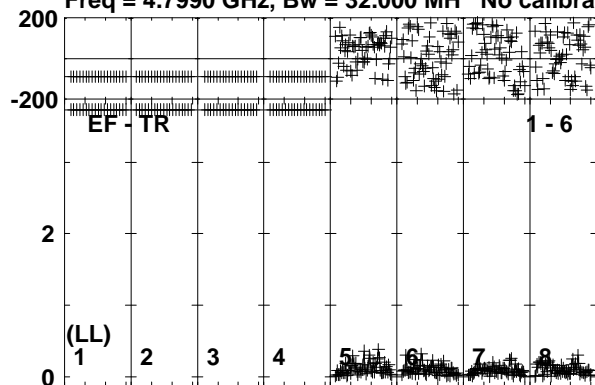

Lower frame: Milli Ampl Jy Top frame: Phas deg  
Vector averaged cross-power spectrum Baseline: EF (01) - TR (06)  
Timerange: 00/12:58:20 to 00/13:00:48

Plot file version 154 created 25-SEP-2017 10:02:39

J1303-2405 RP029B.UVDATA.1

Freq = 4.7990 GHz, Bw = 32.000 MH No calibration applied and no bandpass applied

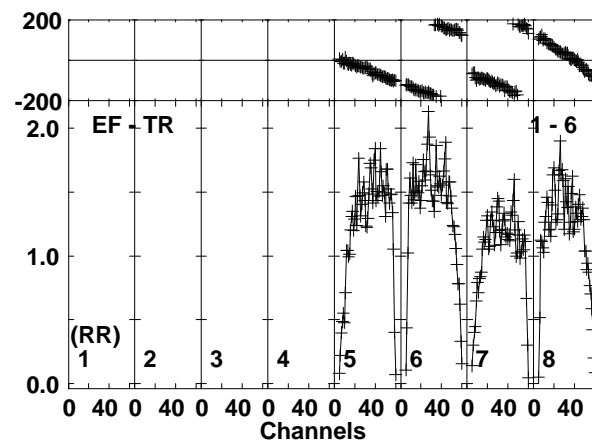
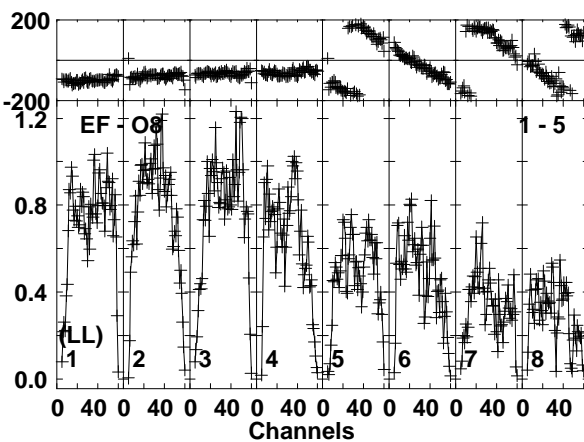
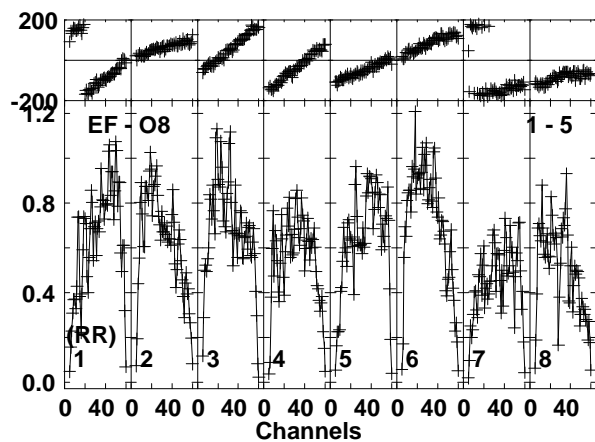
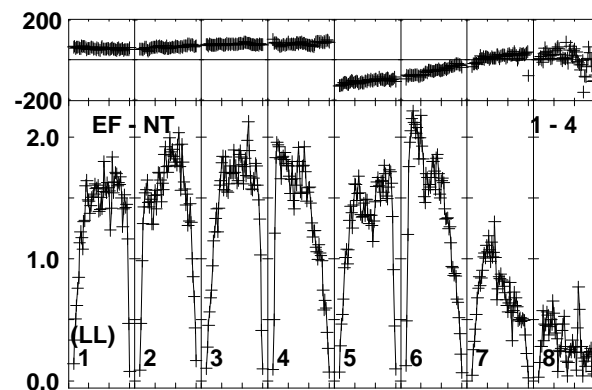
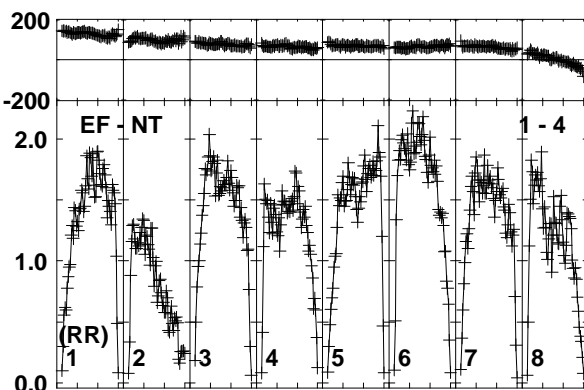
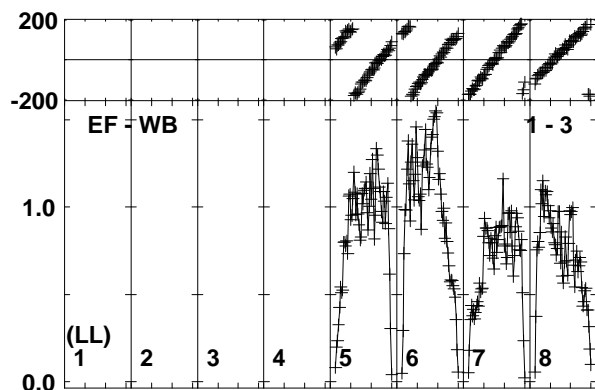
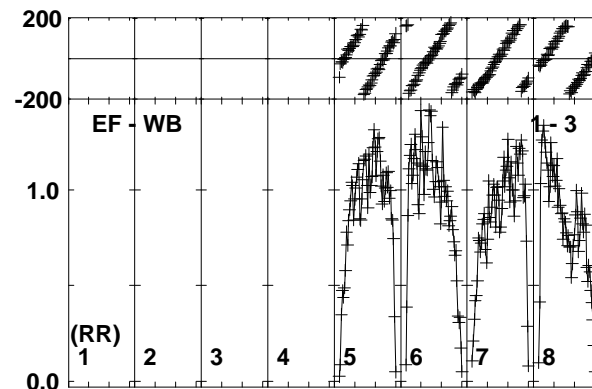
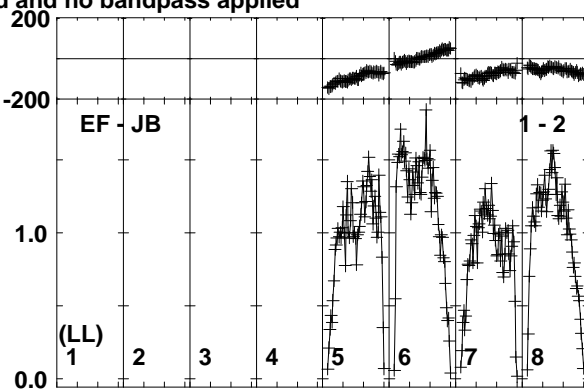
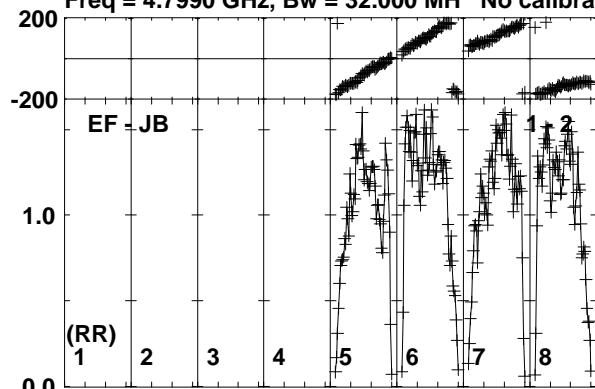

Lower frame: Milli Ampl Jy Top frame: Phas deg  
Vector averaged cross-power spectrum Baseline: EF (01) - JB (02)  
Timerange: 00/13:00:50 to 00/13:02:19

Plot file version 155 created 25-SEP-2017 10:02:39

J1303-2405 RP029B.UVDATA.1

Freq = 4.7990 GHz, Bw = 32.000 MH No calibration applied and no bandpass applied

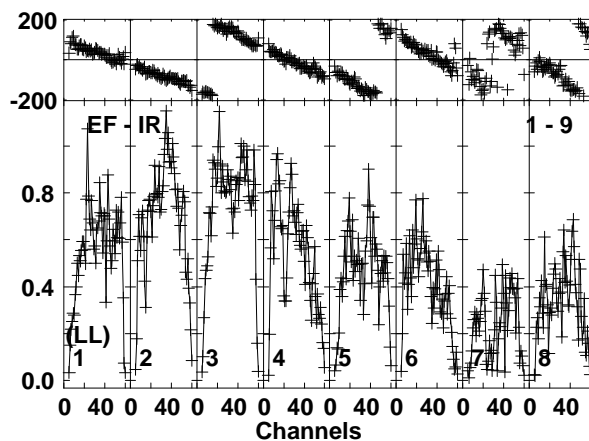
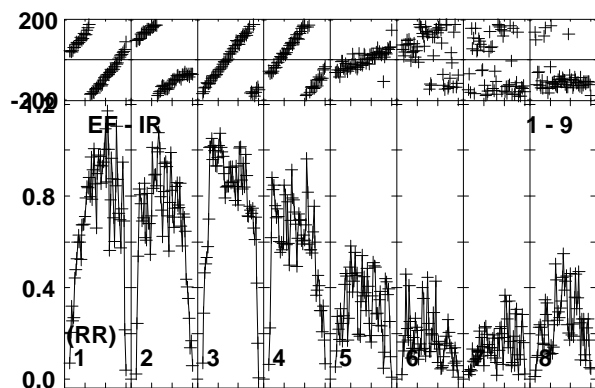
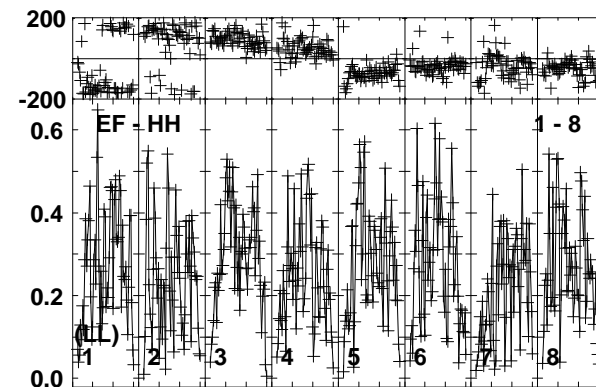
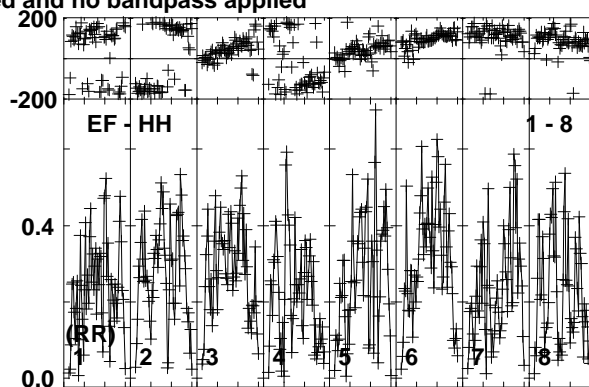
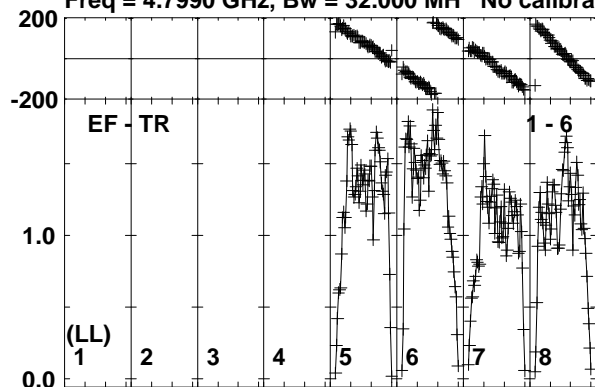

Lower frame: Milli Ampl Jy Top frame: Phas deg  
Vector averaged cross-power spectrum Baseline: EF (01) - TR (06)  
Timerange: 00/13:00:50 to 00/13:02:19

Plot file version 156 created 25-SEP-2017 10:02:39

SSS17A RP029B.UVDATA.1

Freq = 4.7990 GHz, Bw = 32.000 MH No calibration applied and no bandpass applied

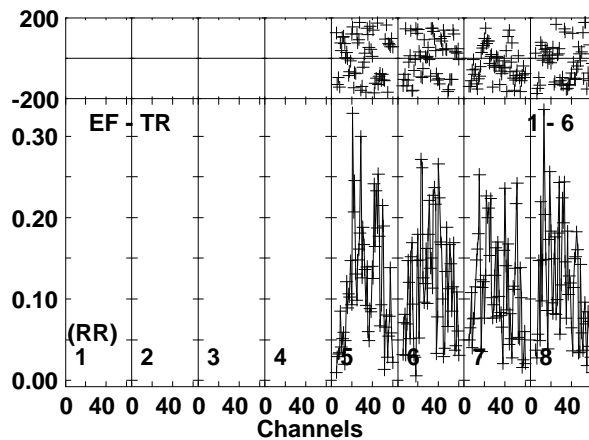
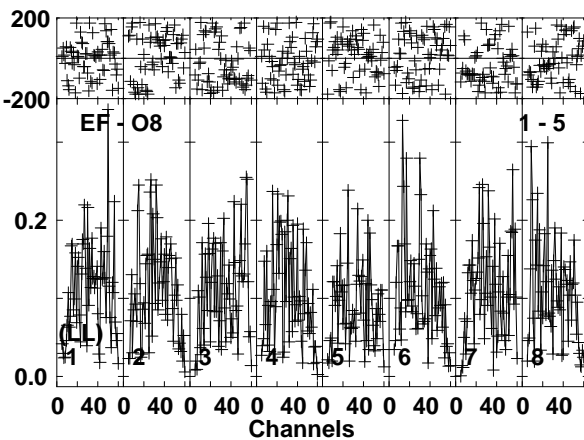
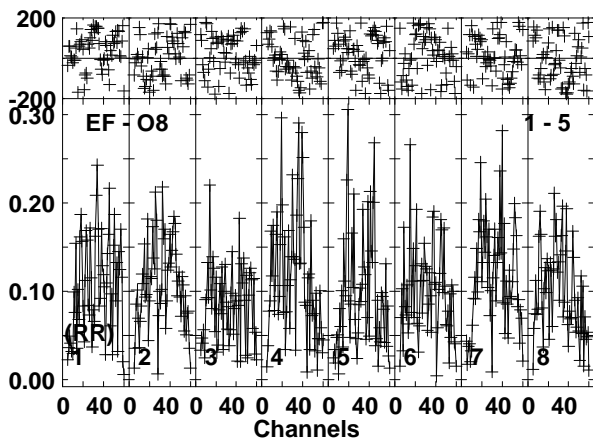
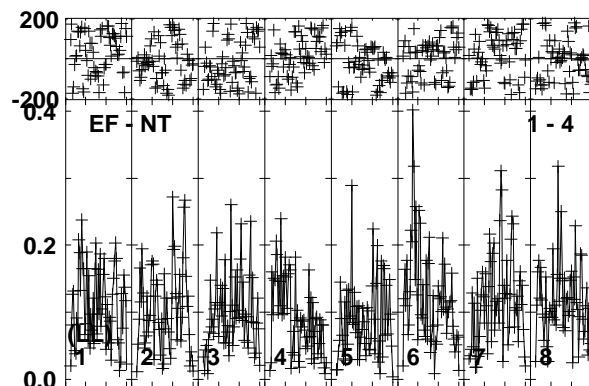
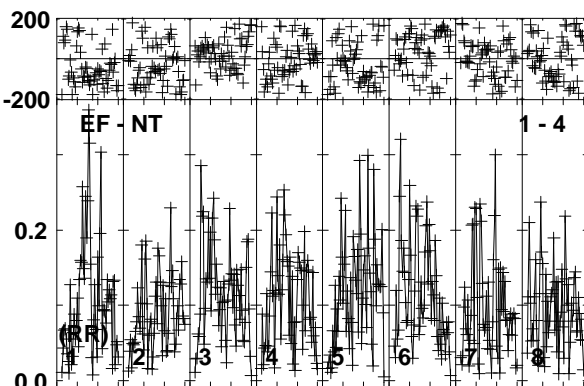
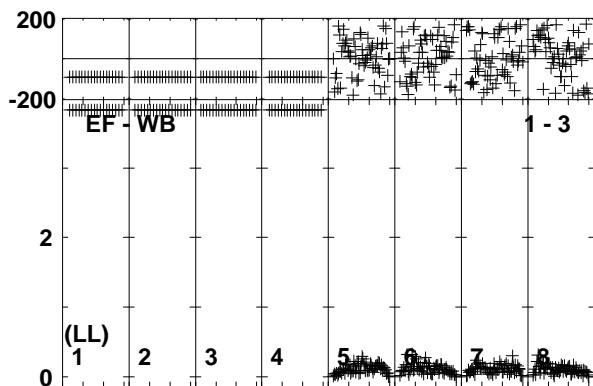
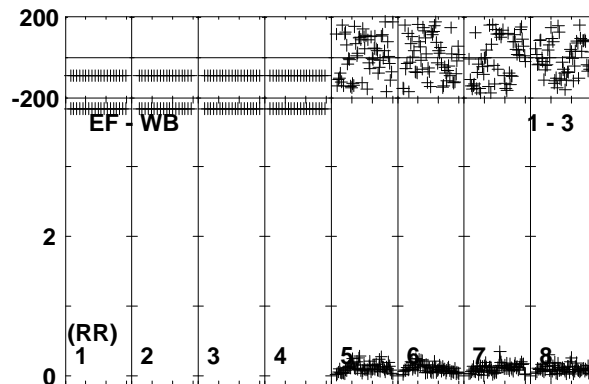
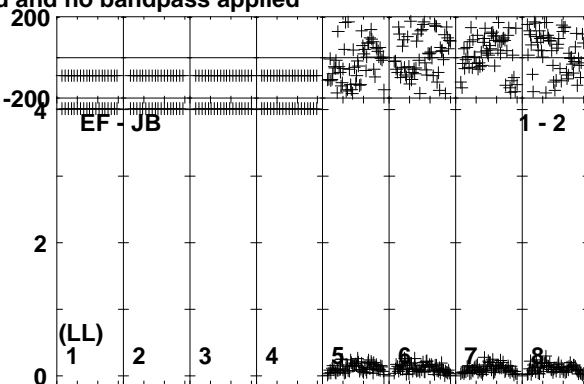
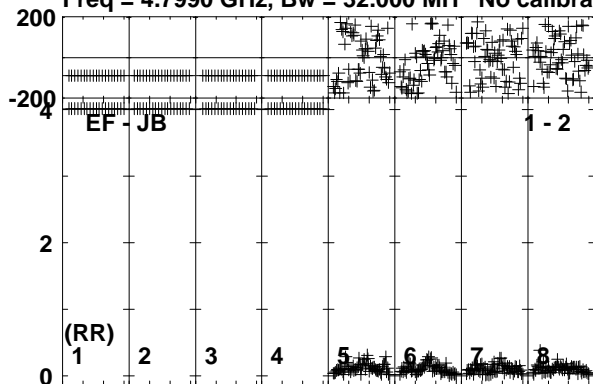

Lower frame: Milli Ampl Jy Top frame: Phas deg  
Vector averaged cross-power spectrum Baseline: EF (01) - JB (02)  
Timerange: 00/13:02:20 to 00/13:04:49

Plot file version 157 created 25-SEP-2017 10:02:39

SSS17A RP029B.UVDATA.1

Freq = 4.7990 GHz, Bw = 32.000 MH No calibration applied and no bandpass applied

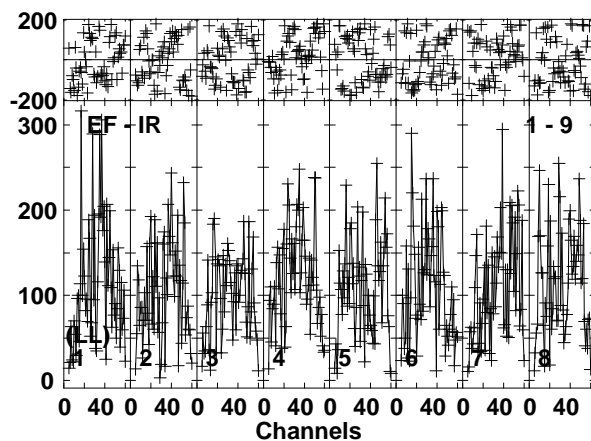
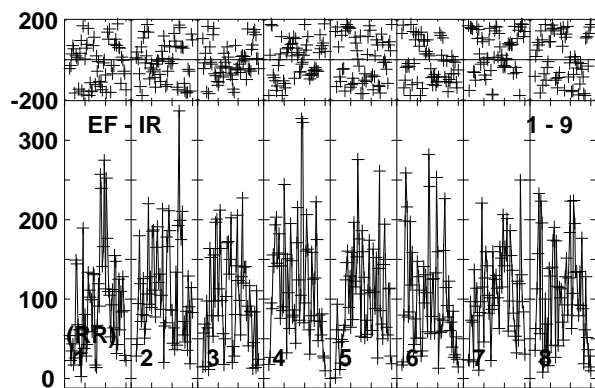
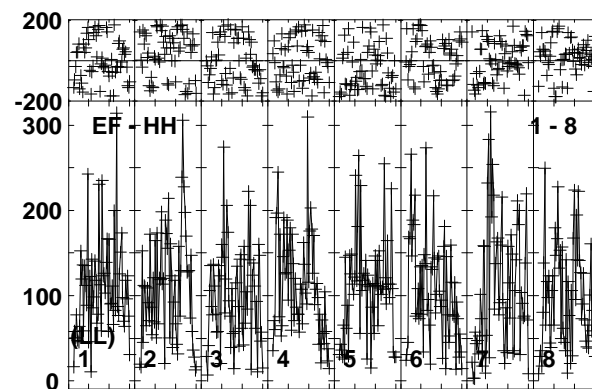
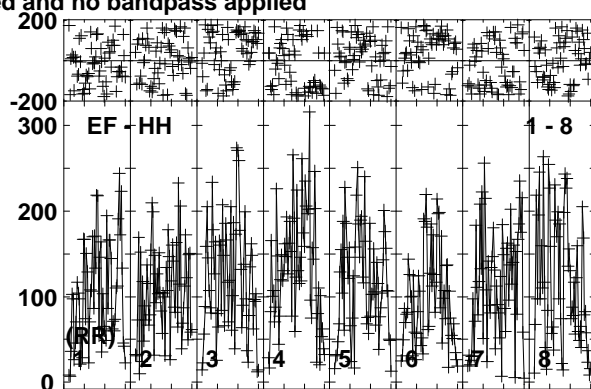
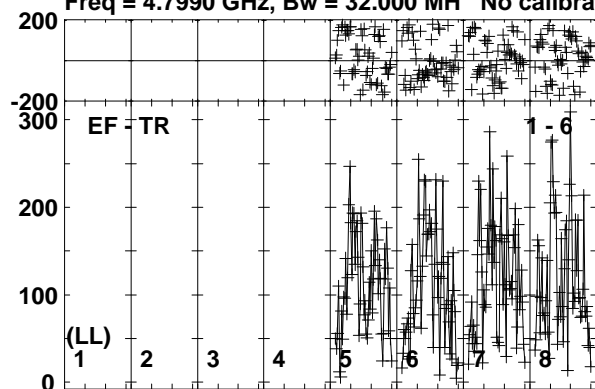

Lower frame: Micro Ampl Jy Top frame: Phas deg  
Vector averaged cross-power spectrum Baseline: EF (01) - TR (06)  
Timerange: 00/13:02:20 to 00/13:04:49

Plot file version 158 created 25-SEP-2017 10:02:39

J1303-2405 RP029B.UVDATA.1

Freq = 4.7990 GHz, Bw = 32.000 MH No calibration applied and no bandpass applied

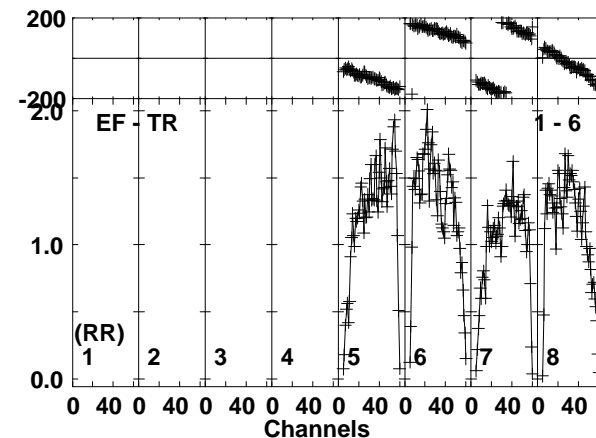
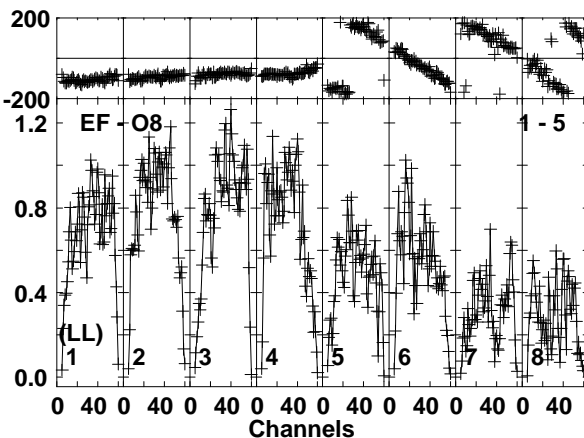
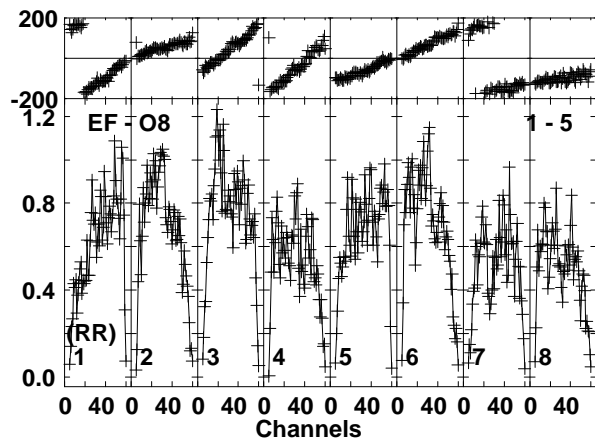
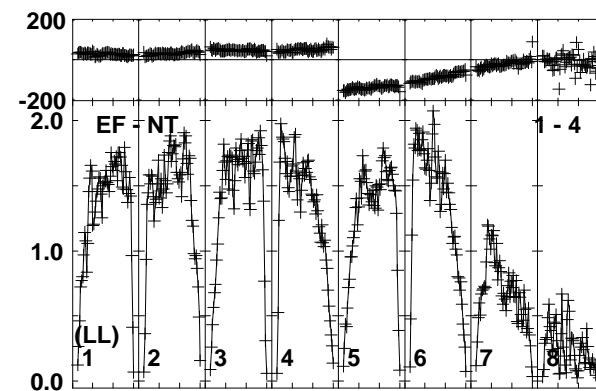
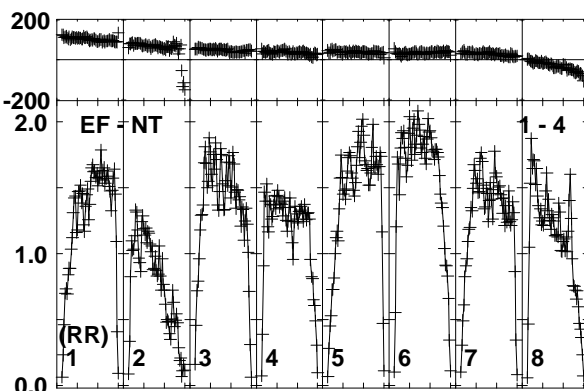
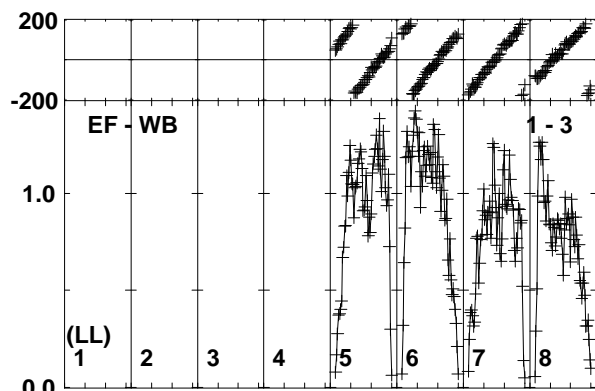
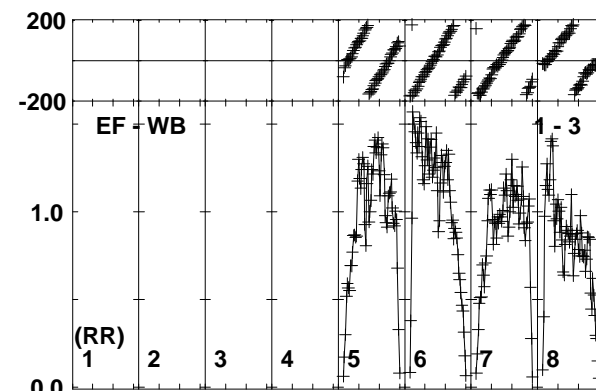
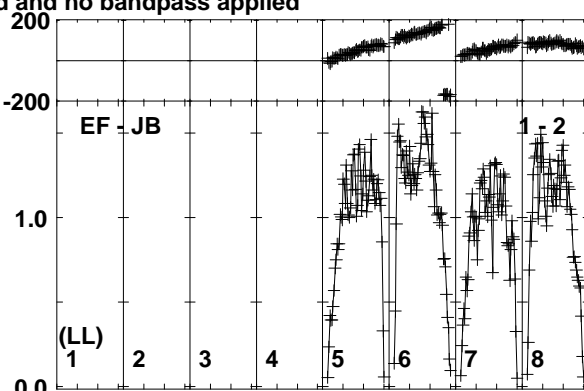
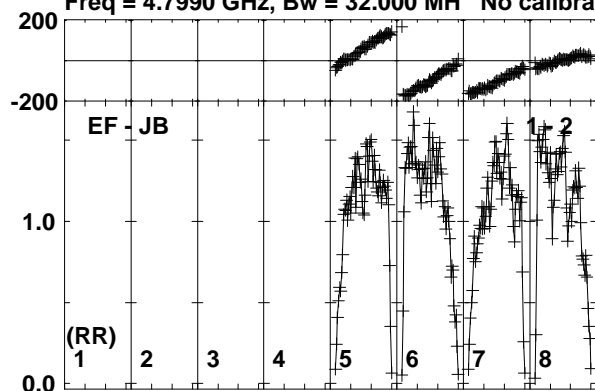

Lower frame: Milli Ampl Jy Top frame: Phas deg  
Vector averaged cross-power spectrum Baseline: EF (01) - JB (02)  
Timerange: 00/13:05:20 to 00/13:06:18

Plot file version 159 created 25-SEP-2017 10:02:40

J1303-2405 RP029B.UVDATA.1

Freq = 4.7990 GHz, Bw = 32.000 MH No calibration applied and no bandpass applied

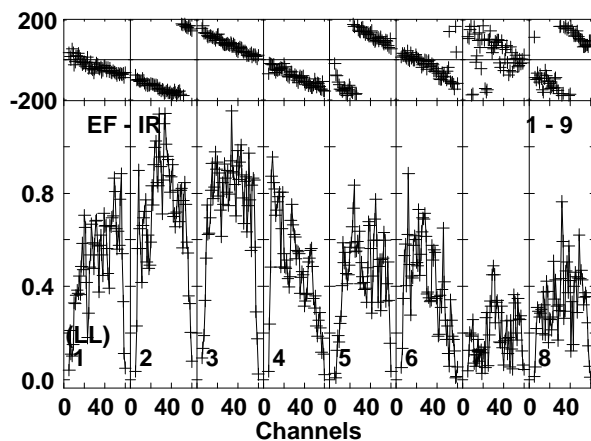
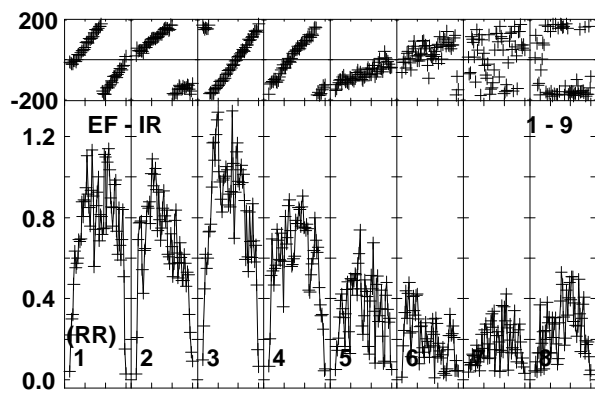
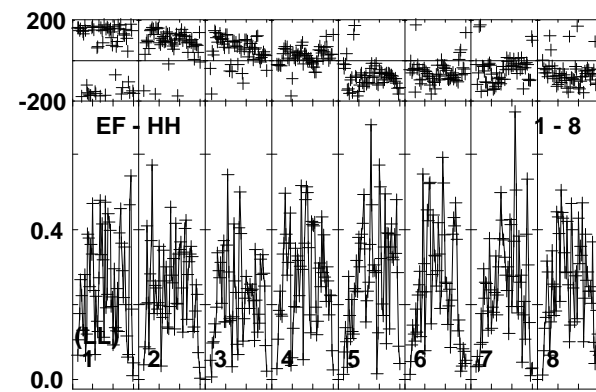
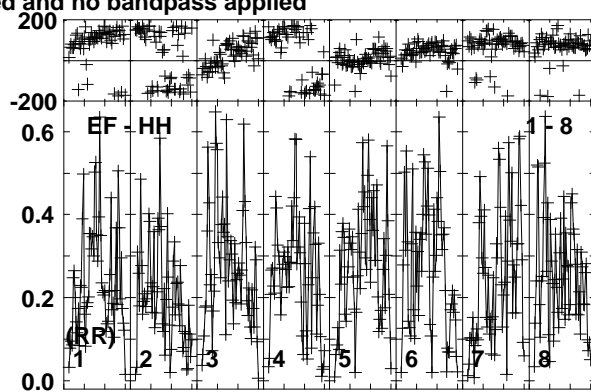
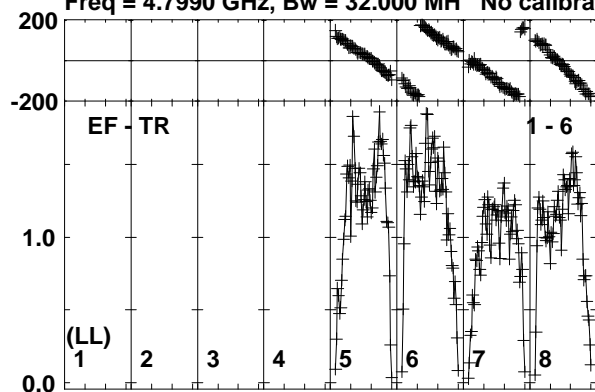

Lower frame: Milli Ampl Jy Top frame: Phas deg  
Vector averaged cross-power spectrum Baseline: EF (01) - TR (06)  
Timerange: 00/13:05:20 to 00/13:06:18





Plot file version 161 created 25-SEP-2017 10:02:40

SSS17A RP029B.UVDATA.1

Freq = 4.7990 GHz, Bw = 32.000 MH No calibration applied and no bandpass applied

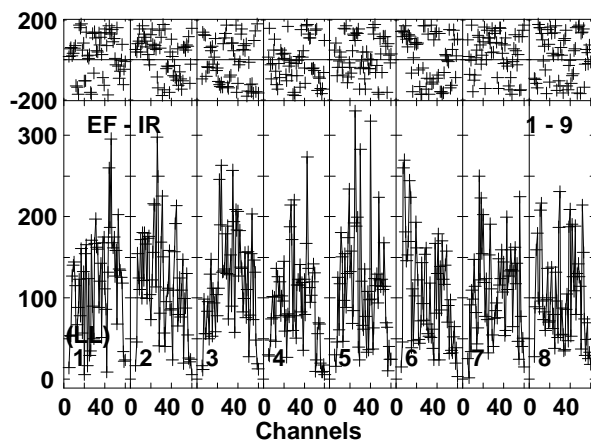
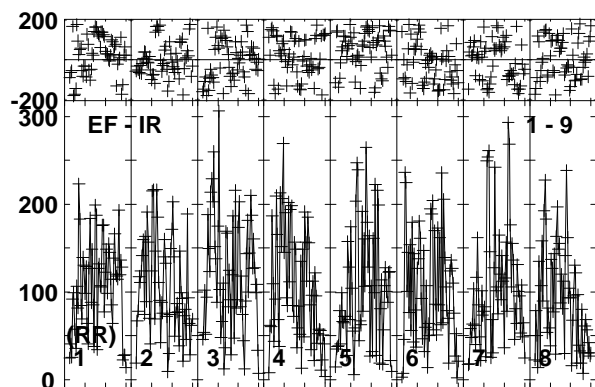
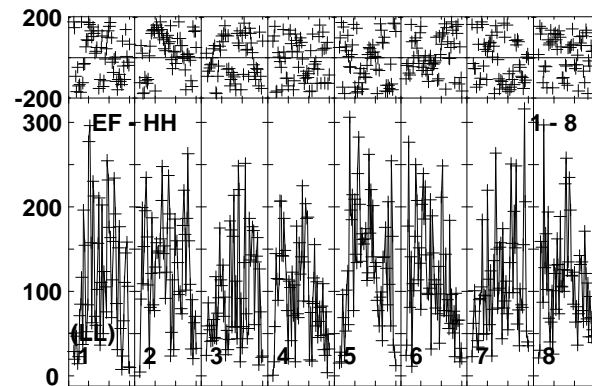
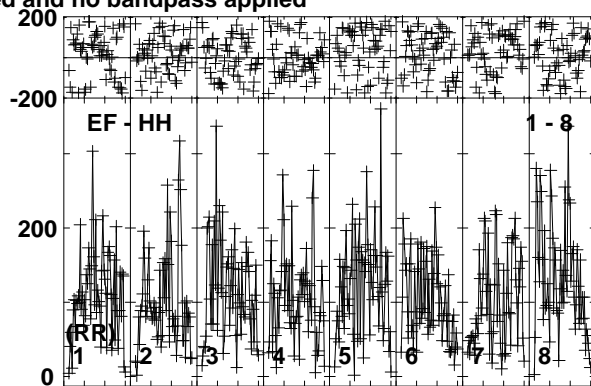
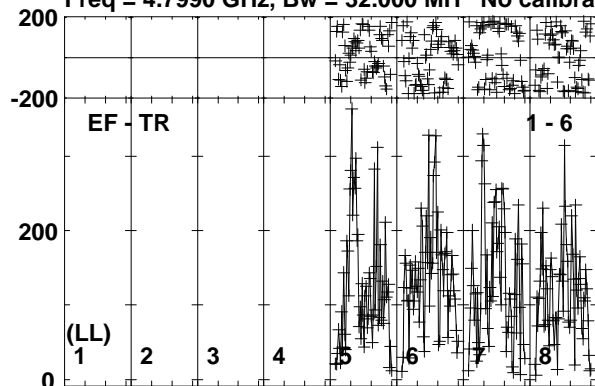

Lower frame: Micro Ampl Jy Top frame: Phas deg  
Vector averaged cross-power spectrum Baseline: EF (01) - TR (06)  
Timerange: 00/13:06:19 to 00/13:08:48

Plot file version 162 created 25-SEP-2017 10:02:40

J1303-2405 RP029B.UVDATA.1

Freq = 4.7990 GHz, Bw = 32.000 MH No calibration applied and no bandpass applied

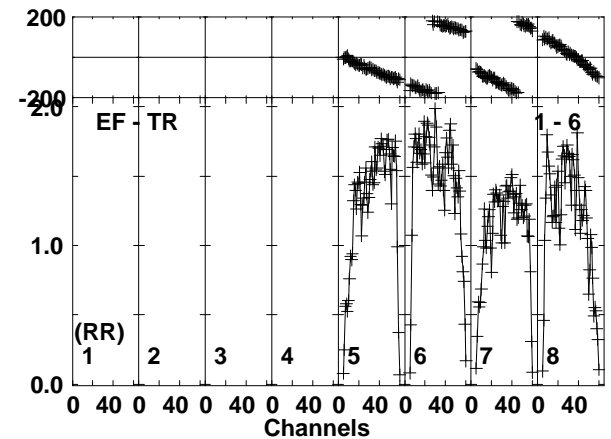
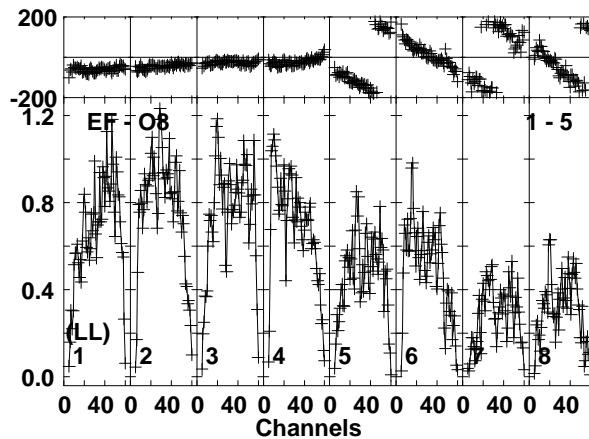
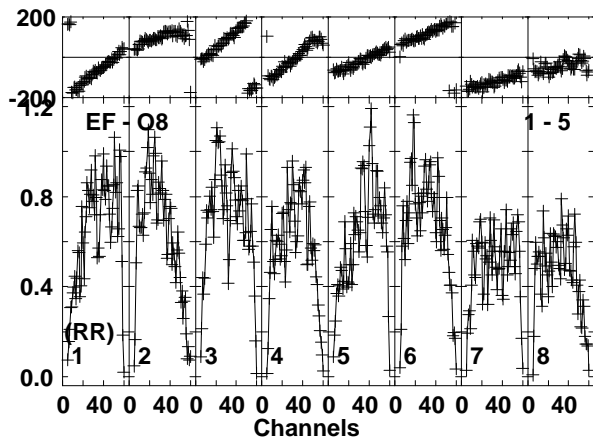
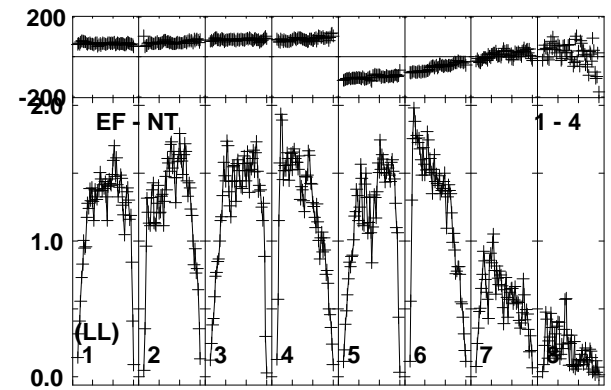
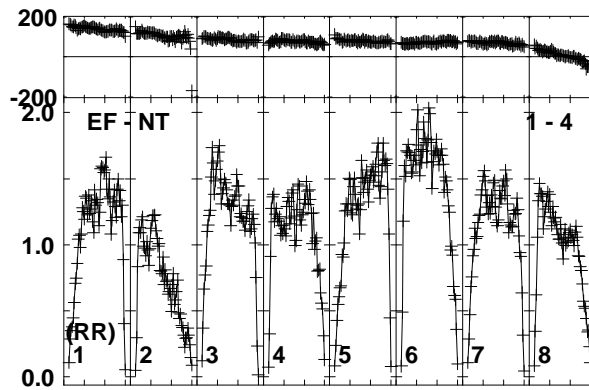
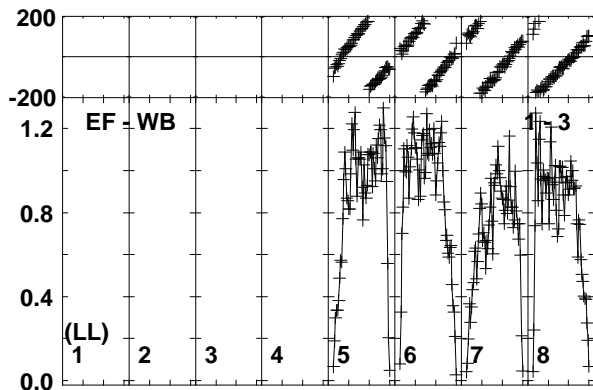
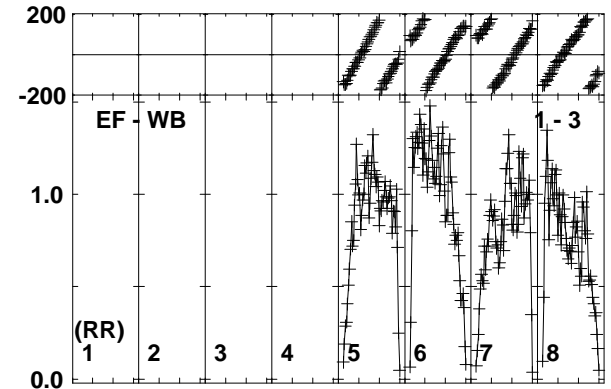
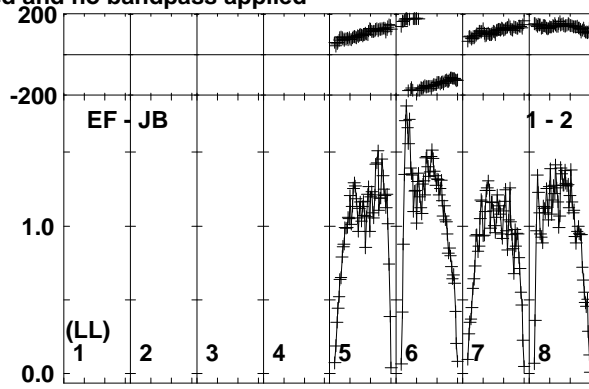
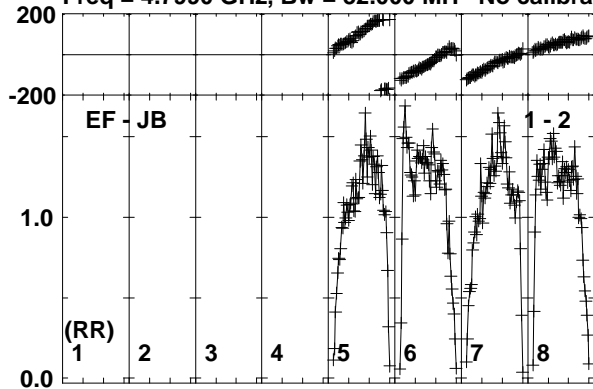

Lower frame: Milli Ampl Jy Top frame: Phas deg  
Vector averaged cross-power spectrum Baseline: EF (01) - JB (02)  
Timerange: 00/13:08:49 to 00/13:10:18

Plot file version 163 created 25-SEP-2017 10:02:40

J1303-2405 RP029B.UVDATA.1

Freq = 4.7990 GHz, Bw = 32.000 MH No calibration applied and no bandpass applied

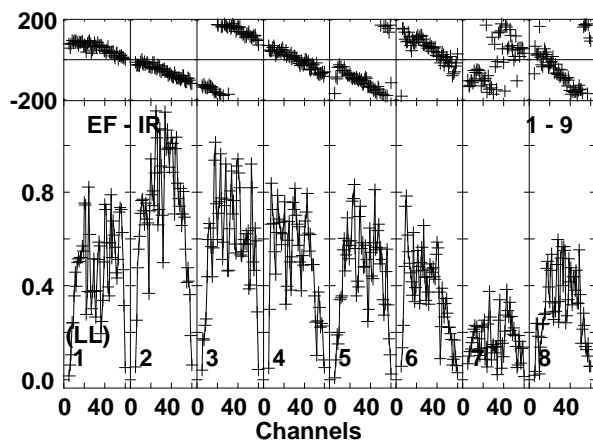
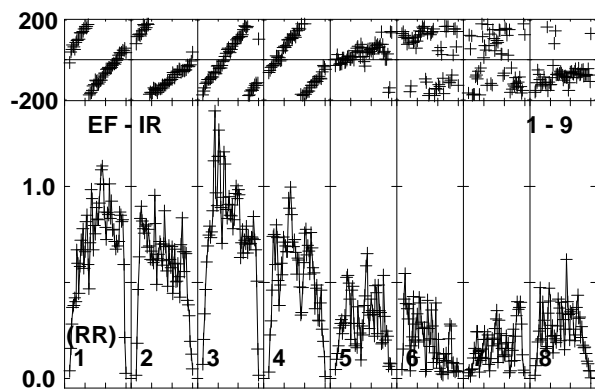
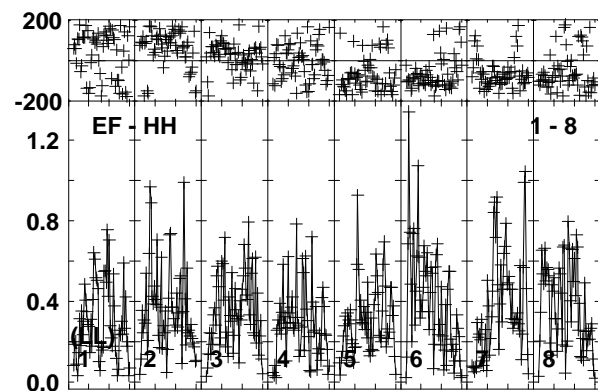
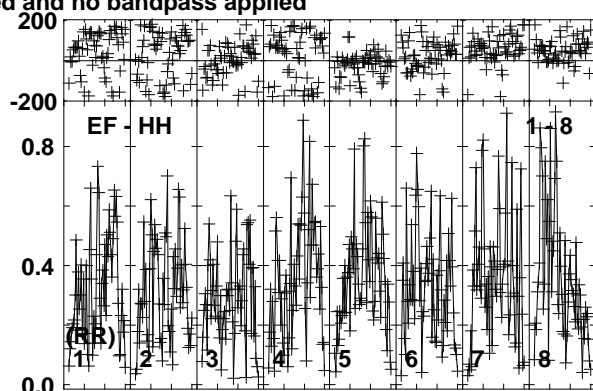
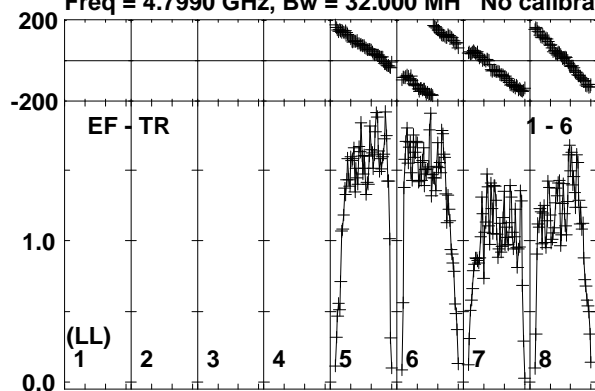

Lower frame: Milli Ampl Jy Top frame: Phas deg  
Vector averaged cross-power spectrum Baseline: EF (01) - TR (06)  
Timerange: 00/13:08:49 to 00/13:10:18

Plot file version 164 created 25-SEP-2017 10:02:41

J1312-2350 RP029B.UVDATA.1

Freq = 4.7990 GHz, Bw = 32.000 MH No calibration applied and no bandpass applied

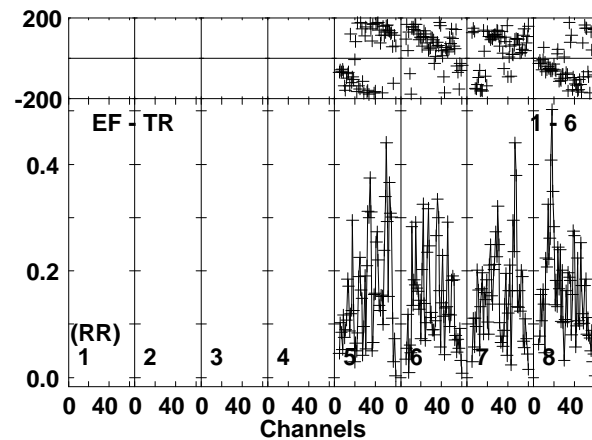
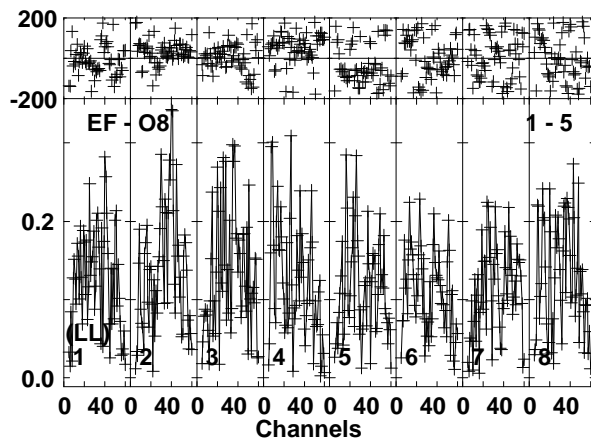
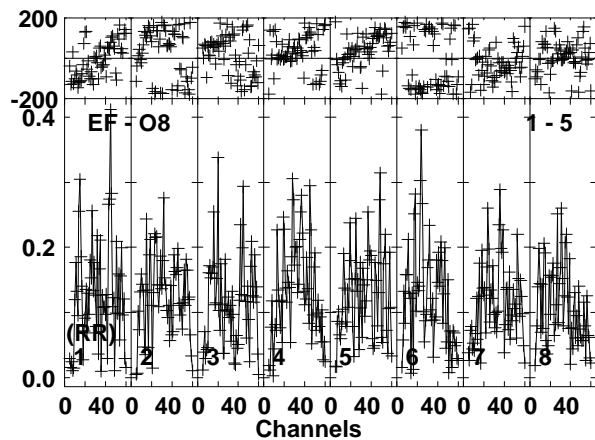
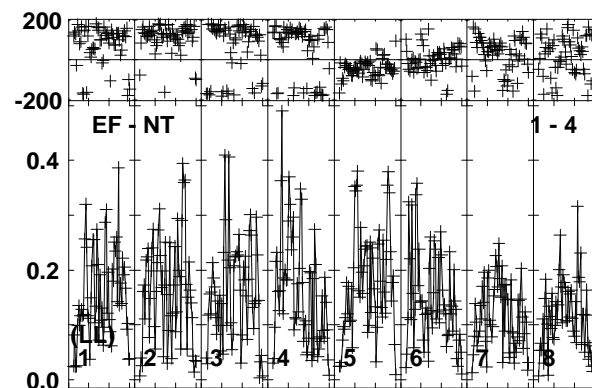
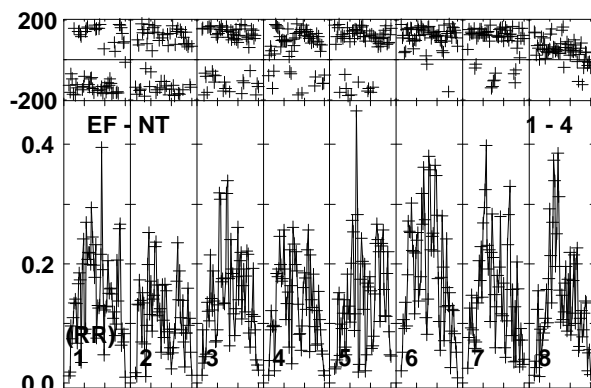
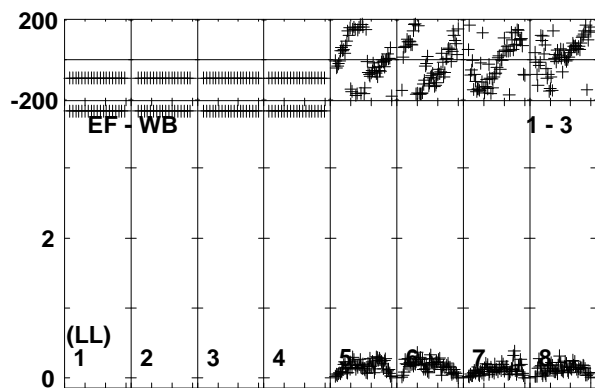
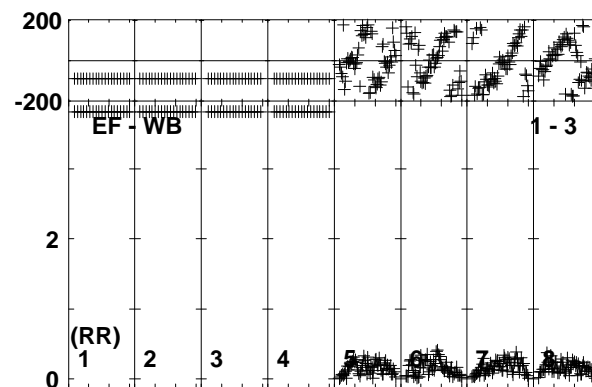
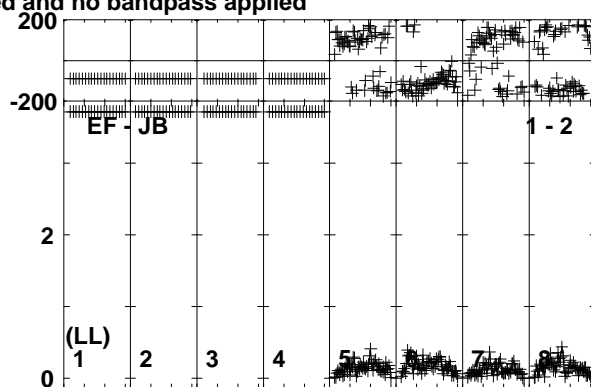
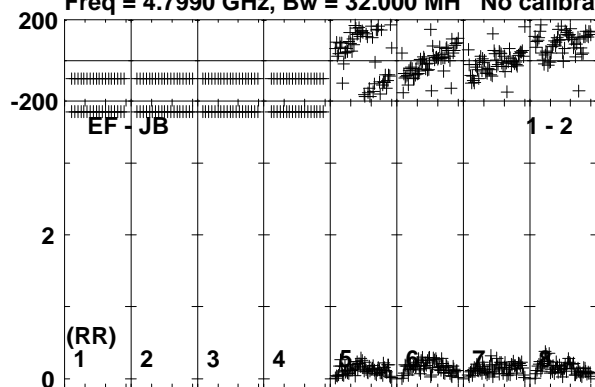

Lower frame: Milli Ampl Jy Top frame: Phas deg  
Vector averaged cross-power spectrum Baseline: EF (01) - JB (02)  
Timerange: 00/13:10:20 to 00/13:12:48



Plot file version 166 created 25-SEP-2017 10:02:41

J1303-2405 RP029B.UVDATA.1

Freq = 4.7990 GHz, Bw = 32.000 MH No calibration applied and no bandpass applied

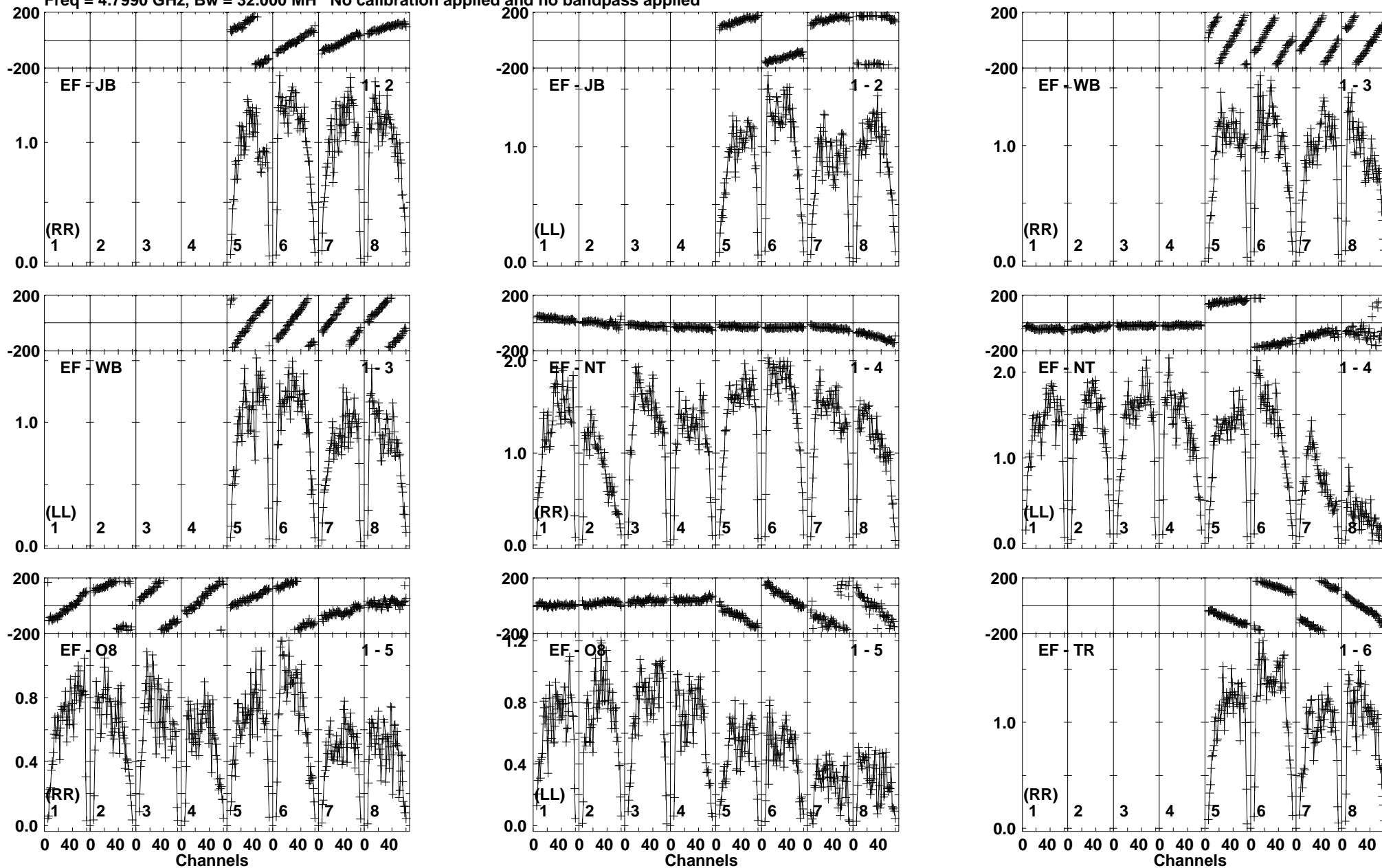

Lower frame: Milli Ampl Jy Top frame: Phas deg  
Vector averaged cross-power spectrum Baseline: EF (01) - JB (02)  
Timerange: 00/13:13:30 to 00/13:14:28

Plot file version 167 created 25-SEP-2017 10:02:41

J1303-2405 RP029B.UVDATA.1

Freq = 4.7990 GHz, Bw = 32.000 MH No calibration applied and no bandpass applied

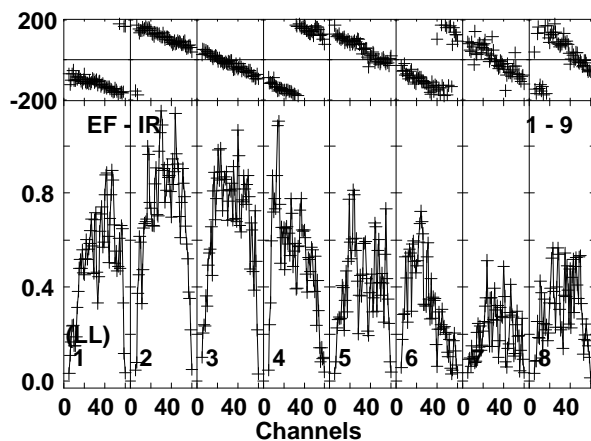
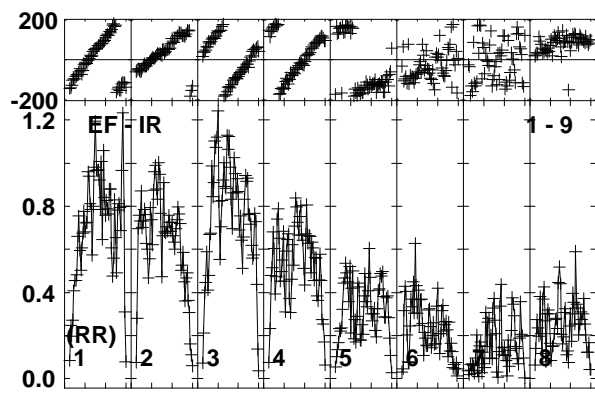
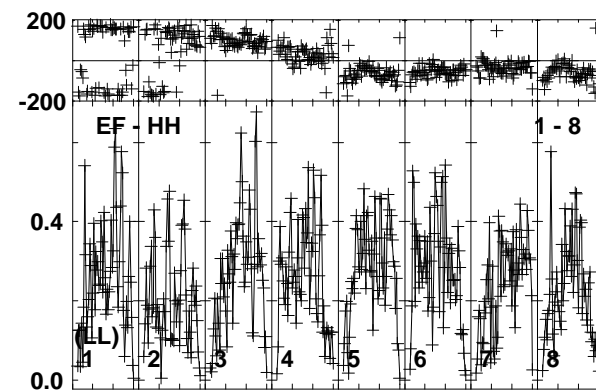
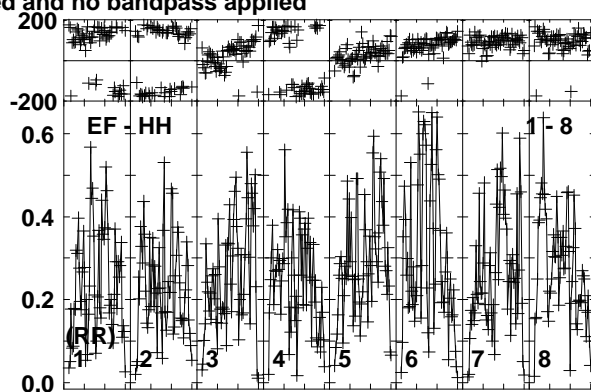
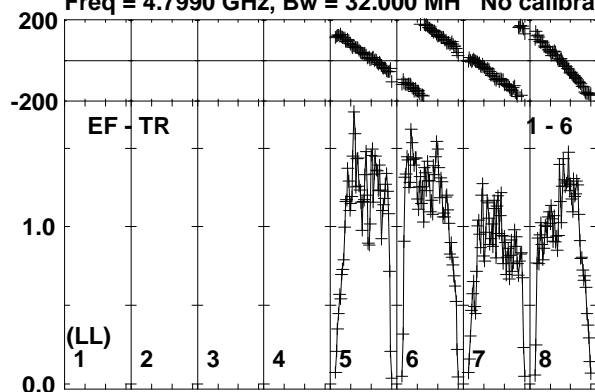

Lower frame: Milli Ampl Jy Top frame: Phas deg  
Vector averaged cross-power spectrum Baseline: EF (01) - TR (06)  
Timerange: 00/13:13:30 to 00/13:14:28

Plot file version 168 created 25-SEP-2017 10:02:41

SSS17A RP029B.UVDATA.1

Freq = 4.7990 GHz, Bw = 32.000 MH No calibration applied and no bandpass applied

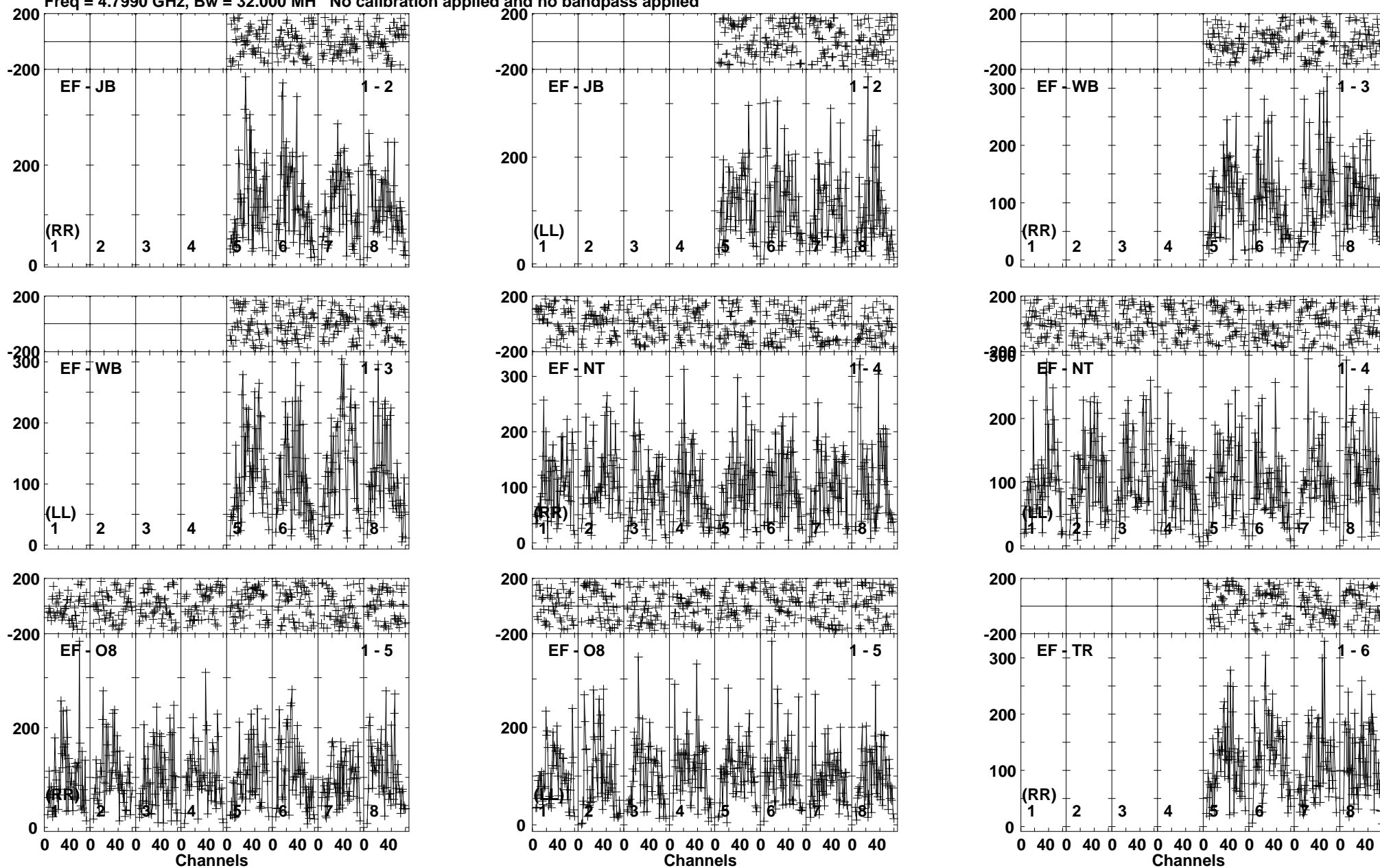

Lower frame: Micro Ampl Jy Top frame: Phas deg  
Vector averaged cross-power spectrum Baseline: EF (01) - JB (02)  
Timerange: 00/13:14:30 to 00/13:16:59





Plot file version 170 created 25-SEP-2017 10:02:42

J1303-2405 RP029B.UVDATA.1

Freq = 4.7990 GHz, Bw = 32.000 MH No calibration applied and no bandpass applied

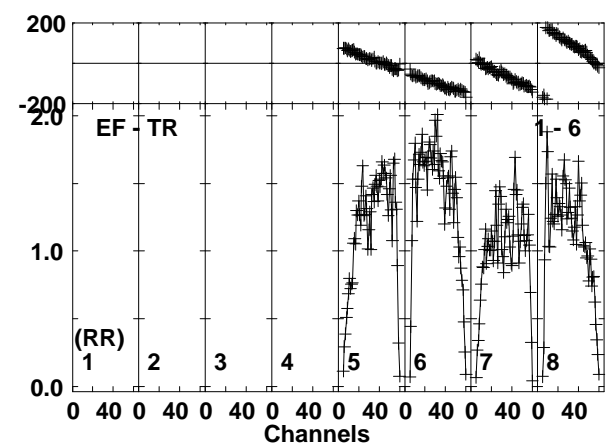
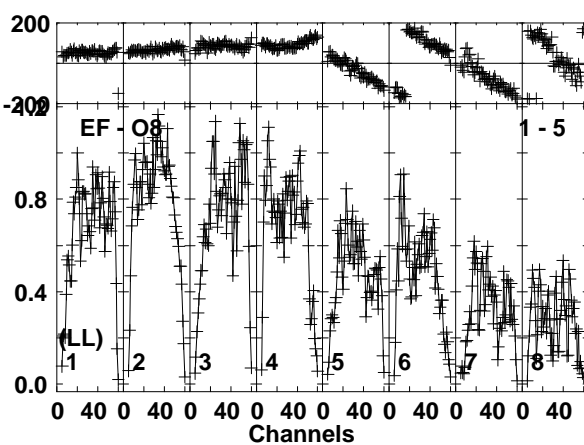
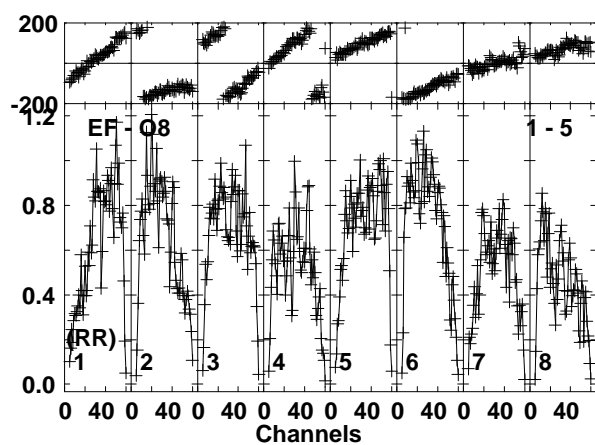
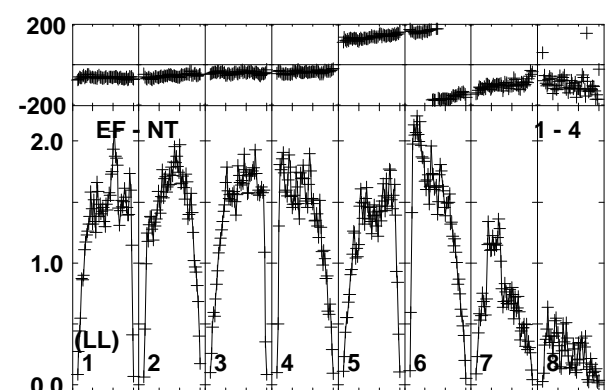
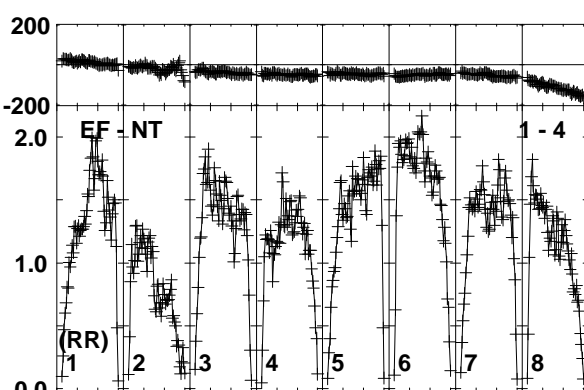
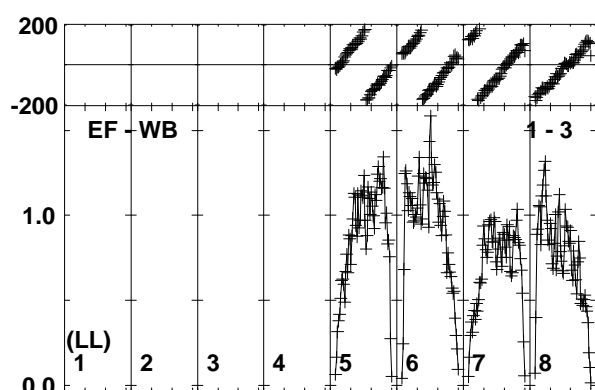
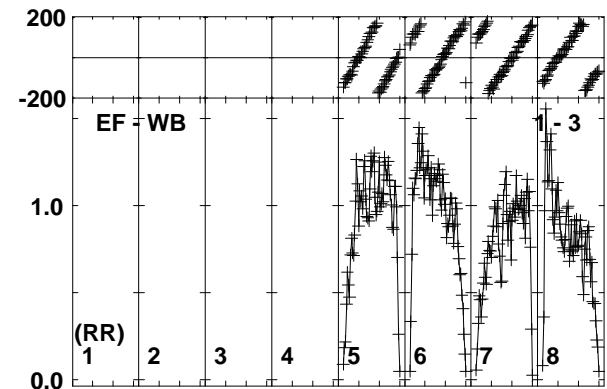
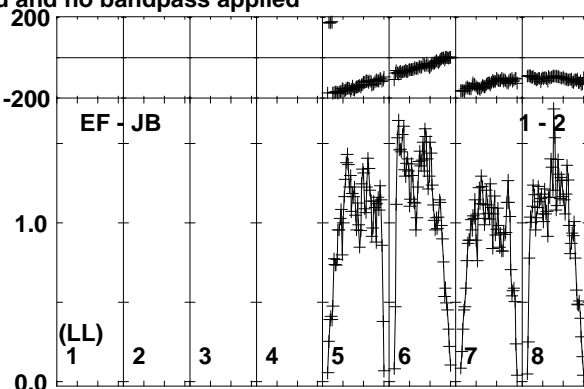
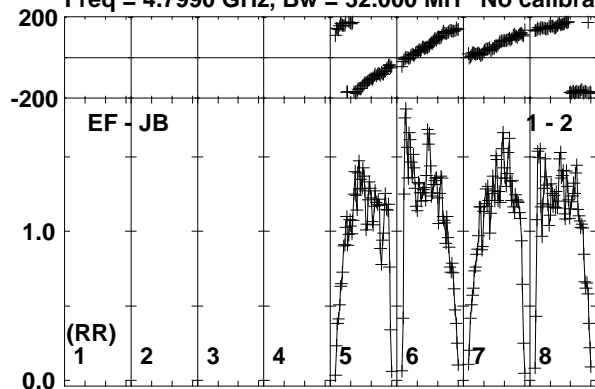

Lower frame: Milli Ampl Jy Top frame: Phas deg  
Vector averaged cross-power spectrum Baseline: EF (01) - JB (02)  
Timerange: 00/13:17:00 to 00/13:18:28

Plot file version 171 created 25-SEP-2017 10:02:42

J1303-2405 RP029B.UVDATA.1

Freq = 4.7990 GHz, Bw = 32.000 MH No calibration applied and no bandpass applied

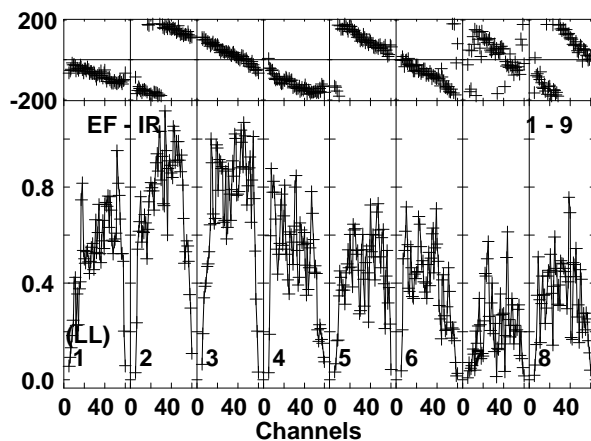
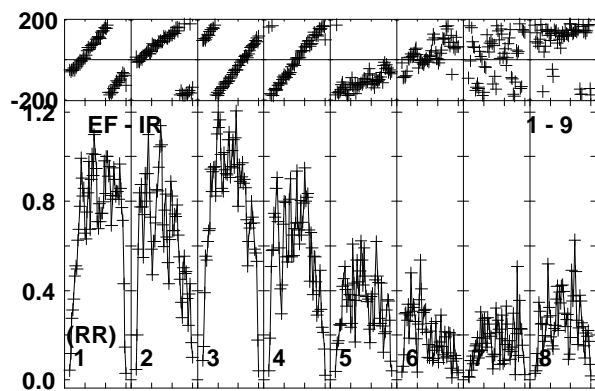
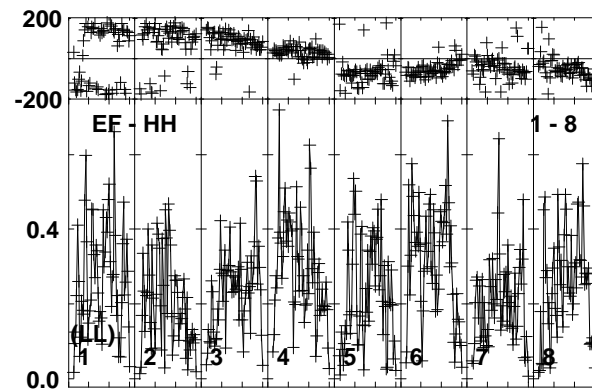
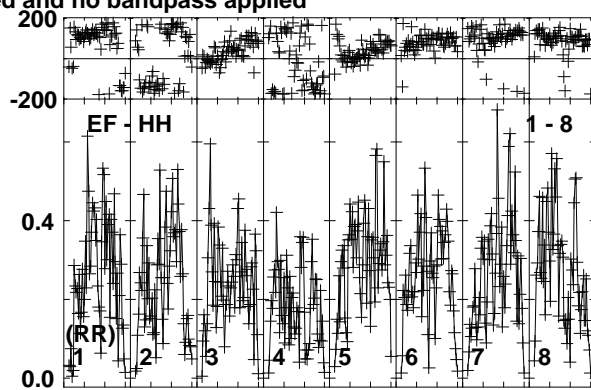
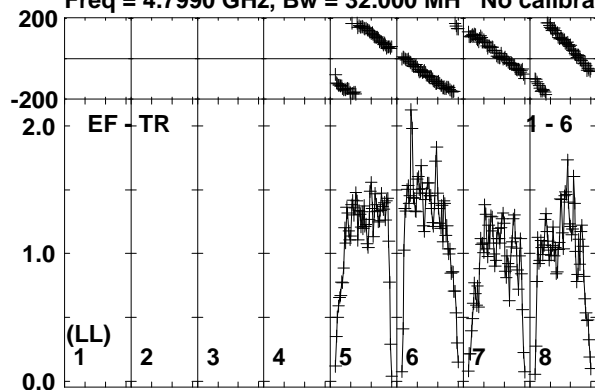

Lower frame: Milli Ampl Jy Top frame: Phas deg  
Vector averaged cross-power spectrum Baseline: EF (01) - TR (06)  
Timerange: 00/13:17:00 to 00/13:18:28

Plot file version 172 created 25-SEP-2017 10:02:42

SSS17A RP029B.UVDATA.1

Freq = 4.7990 GHz, Bw = 32.000 MH No calibration applied and no bandpass applied

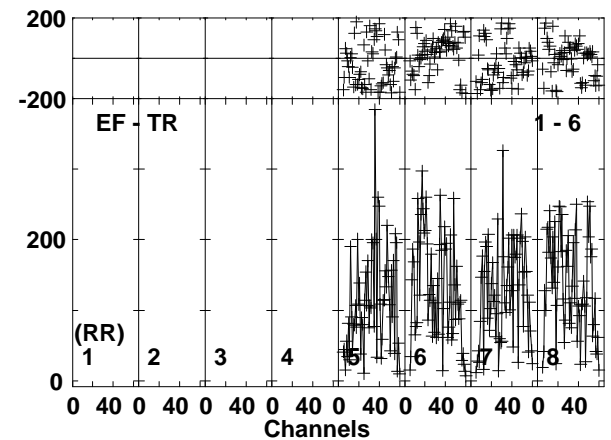
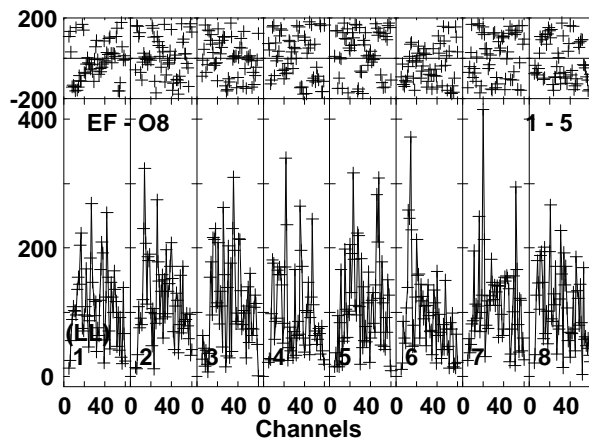
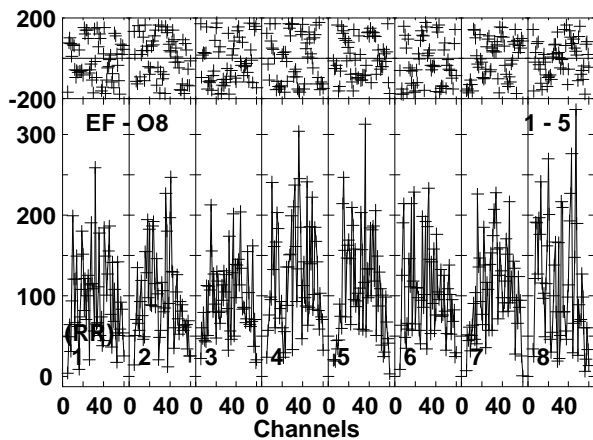
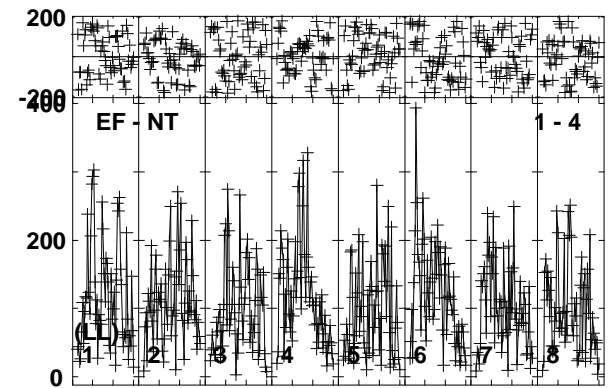
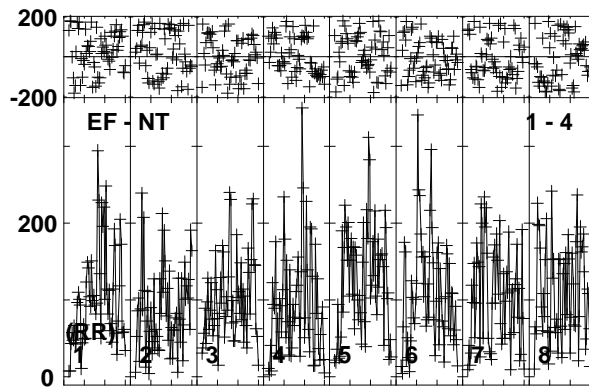
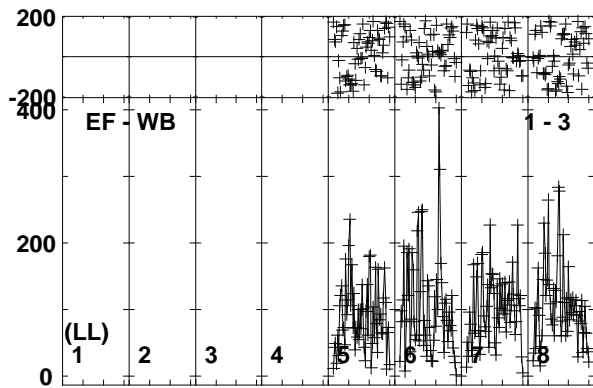
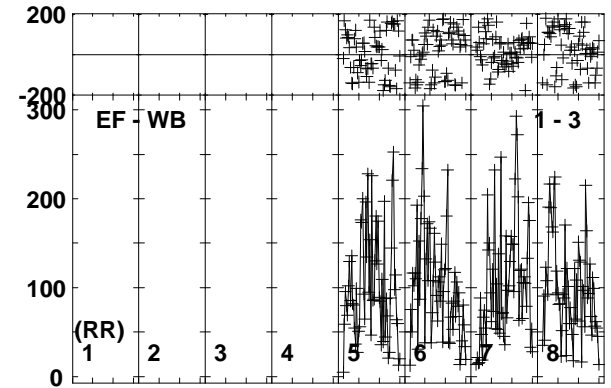
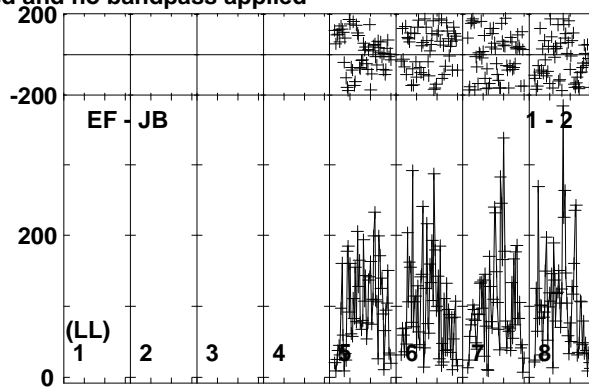
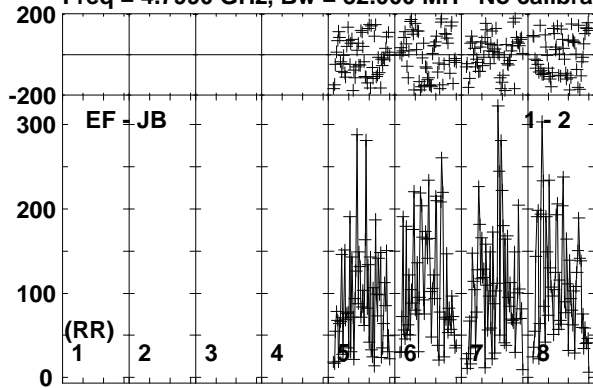

Lower frame: Micro Ampl Jy Top frame: Phas deg  
Vector averaged cross-power spectrum Baseline: EF (01) - JB (02)  
Timerange: 00/13:18:29 to 00/13:20:58

Plot file version 173 created 25-SEP-2017 10:02:42

SSS17A RP029B.UVDATA.1

Freq = 4.7990 GHz, Bw = 32.000 MH No calibration applied and no bandpass applied

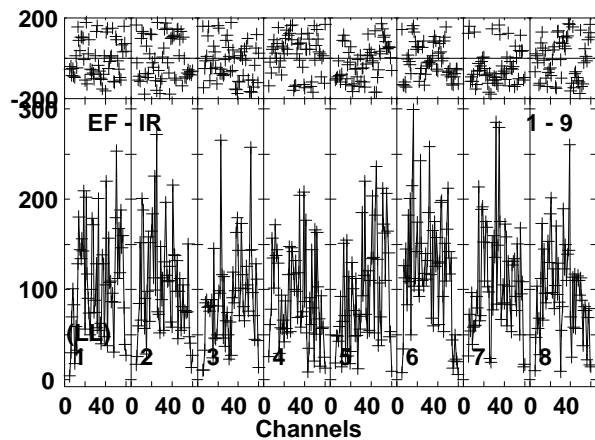
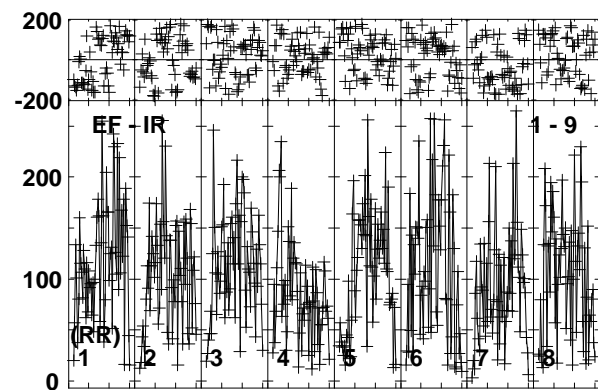
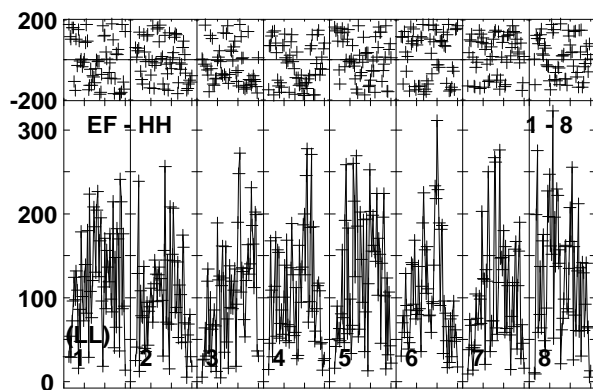
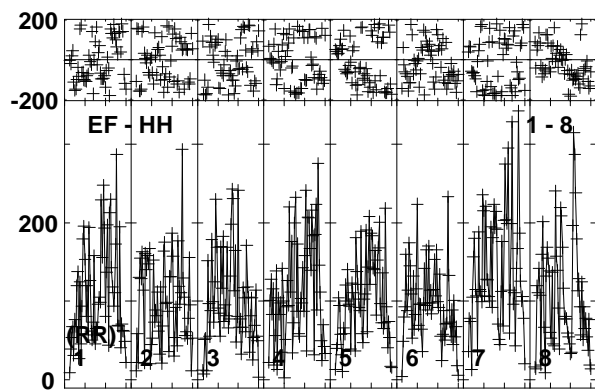
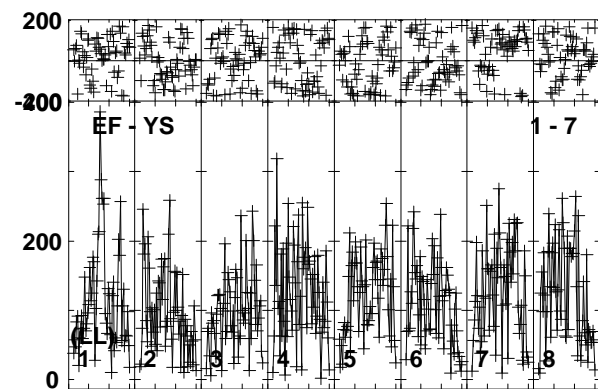
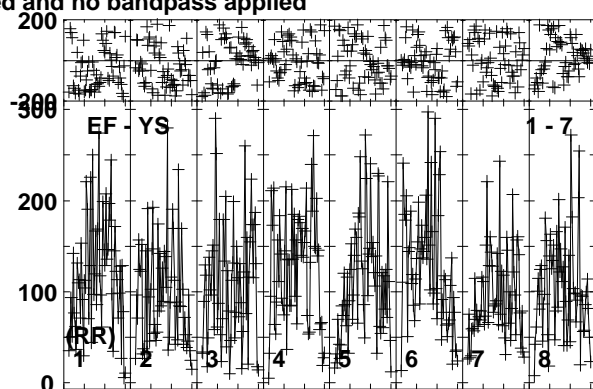
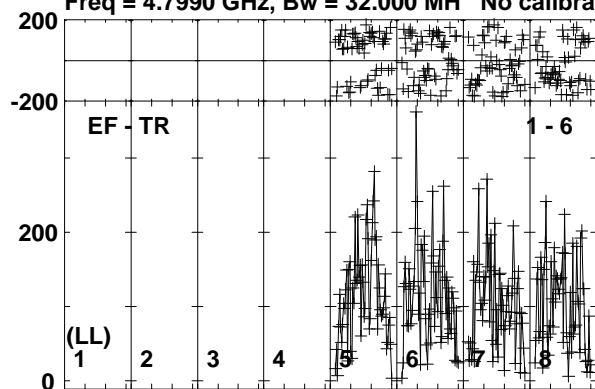

Lower frame: Micro Ampl Jy Top frame: Phas deg  
Vector averaged cross-power spectrum Baseline: EF (01) - TR (06)  
Timerange: 00/13:18:29 to 00/13:20:58

Plot file version 174 created 25-SEP-2017 10:02:42

J1303-2405 RP029B.UVDATA.1

Freq = 4.7990 GHz, Bw = 32.000 MH No calibration applied and no bandpass applied

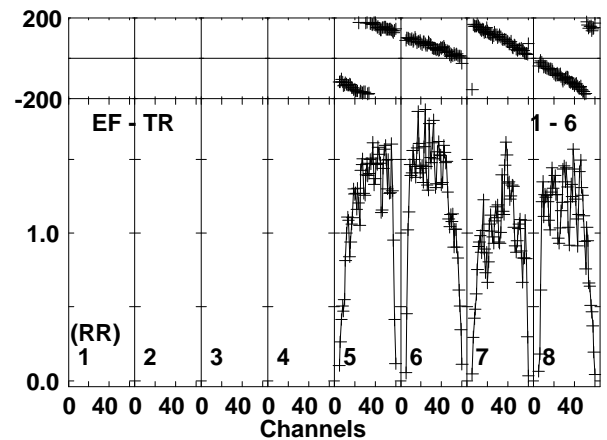
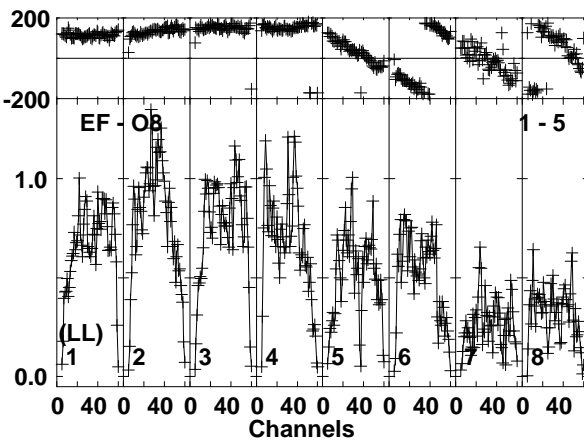
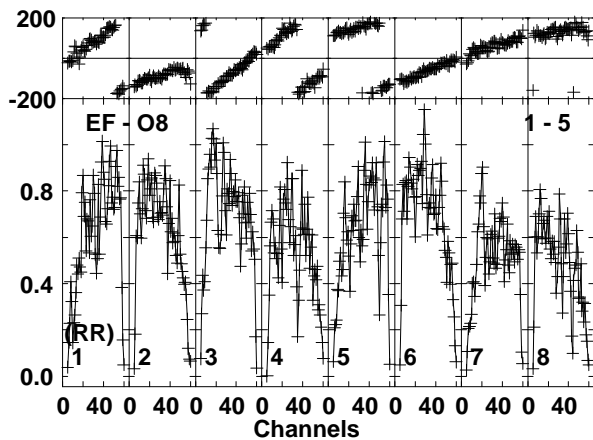
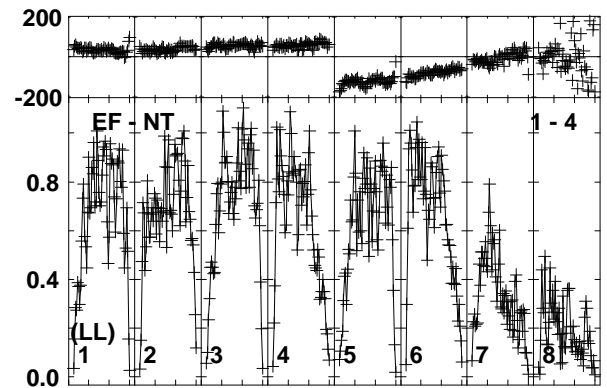
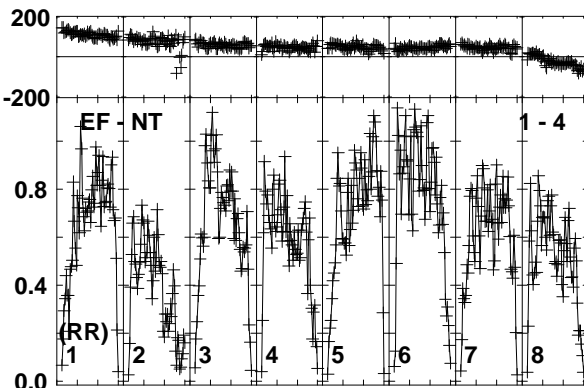
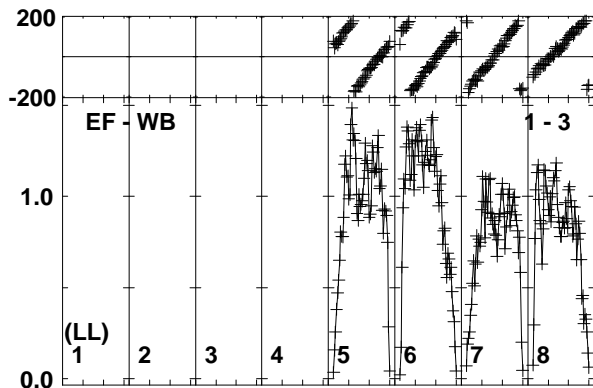
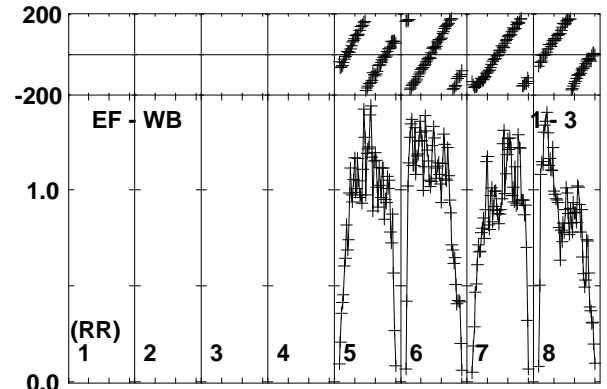
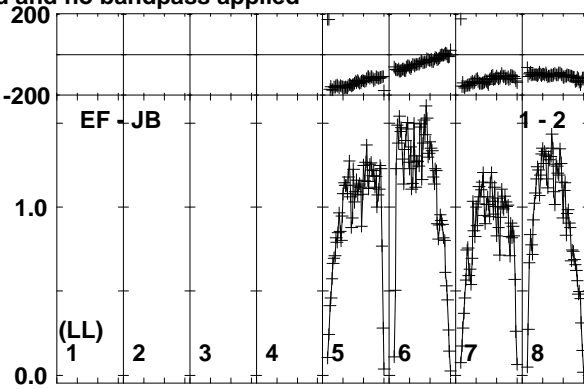
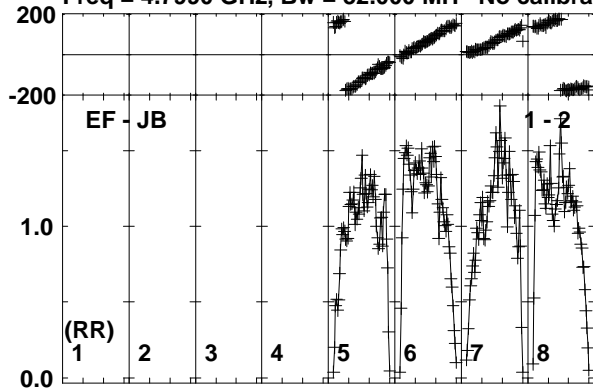

Lower frame: Milli Ampl Jy Top frame: Phas deg  
Vector averaged cross-power spectrum Baseline: EF (01) - JB (02)  
Timerange: 00/13:21:29 to 00/13:22:28

Plot file version 175 created 25-SEP-2017 10:02:43

J1303-2405 RP029B.UVDATA.1

Freq = 4.7990 GHz, Bw = 32.000 MH No calibration applied and no bandpass applied

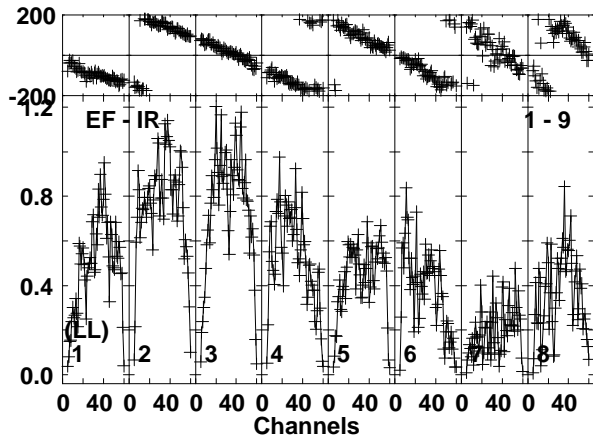
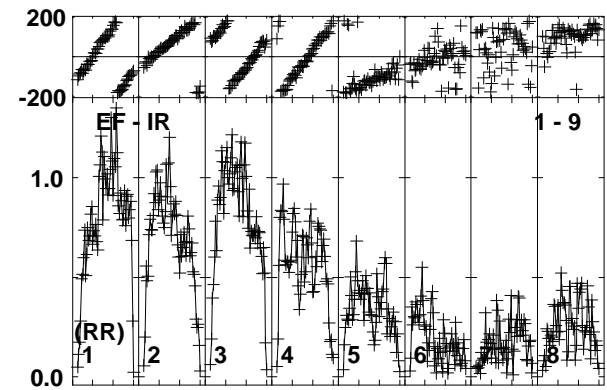
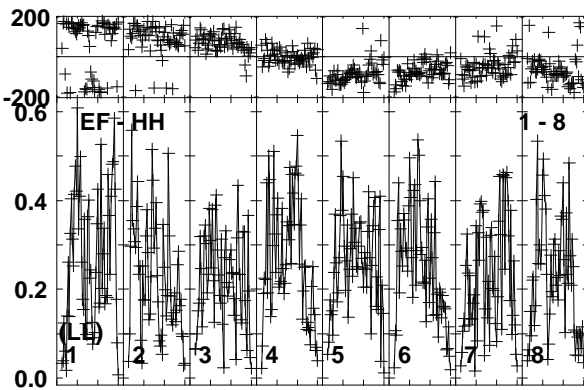
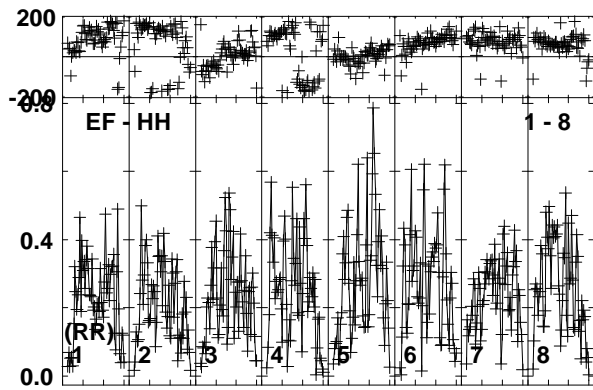
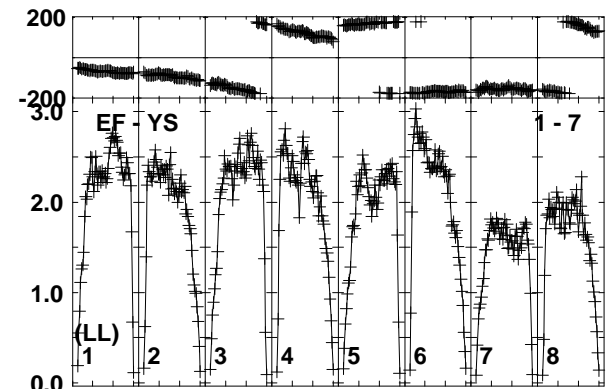
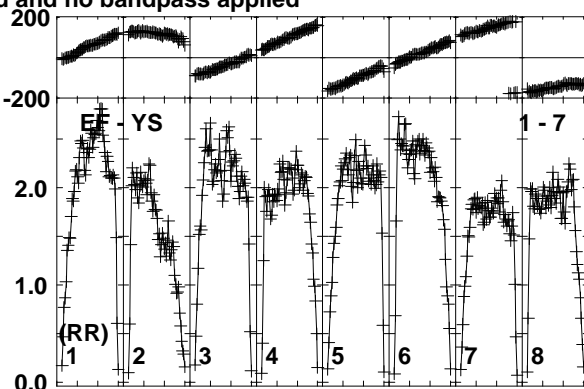
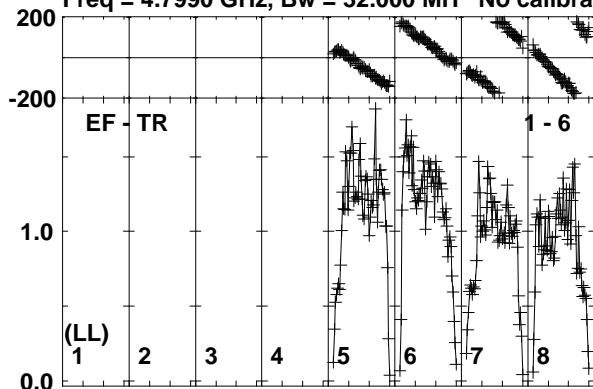

Lower frame: Milli Ampl Jy Top frame: Phas deg  
Vector averaged cross-power spectrum Baseline: EF (01) - TR (06)  
Timerange: 00/13:21:29 to 00/13:22:28





Plot file version 177 created 25-SEP-2017 10:02:43

SSS17A RP029B.UVDATA.1

Freq = 4.7990 GHz, Bw = 32.000 MH No calibration applied and no bandpass applied

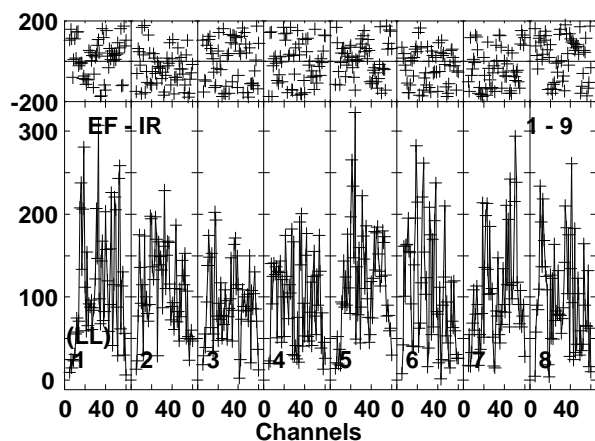
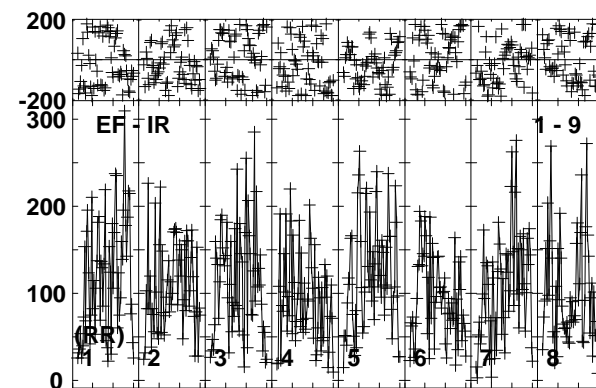
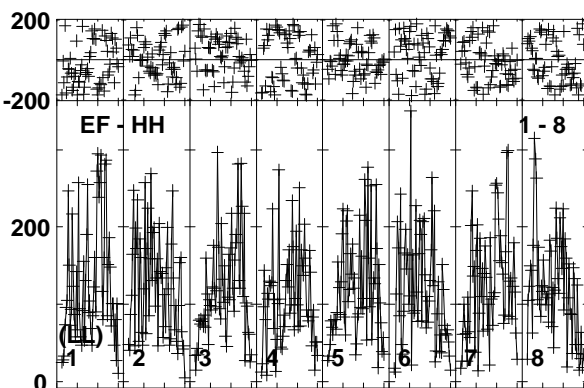
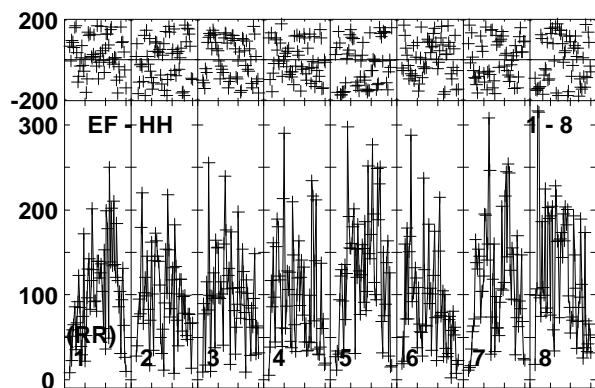
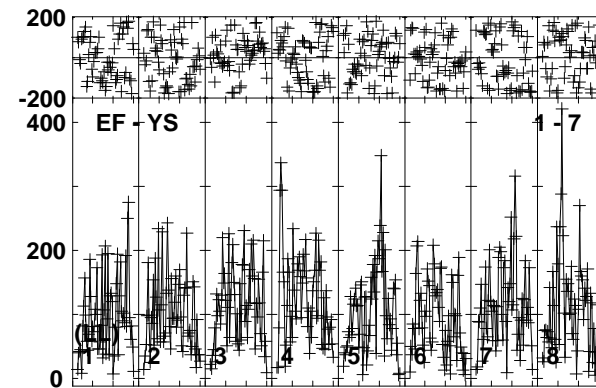
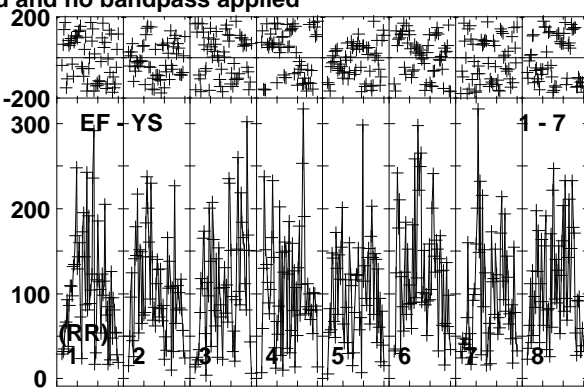
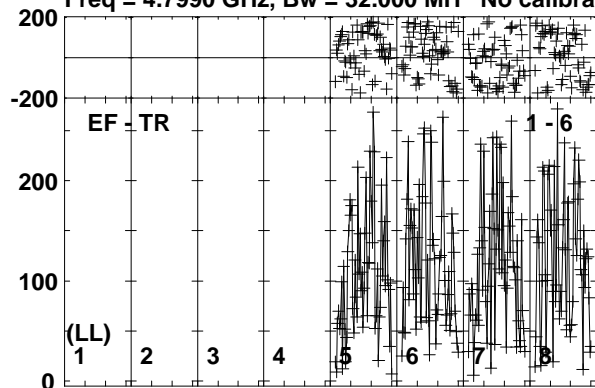

Lower frame: Micro Ampl Jy Top frame: Phas deg  
Vector averaged cross-power spectrum Baseline: EF (01) - TR (06)  
Timerange: 00/13:22:30 to 00/13:24:58

Plot file version 178 created 25-SEP-2017 10:02:43

J1303-2405 RP029B.UVDATA.1

Freq = 4.7990 GHz, Bw = 32.000 MH No calibration applied and no bandpass applied

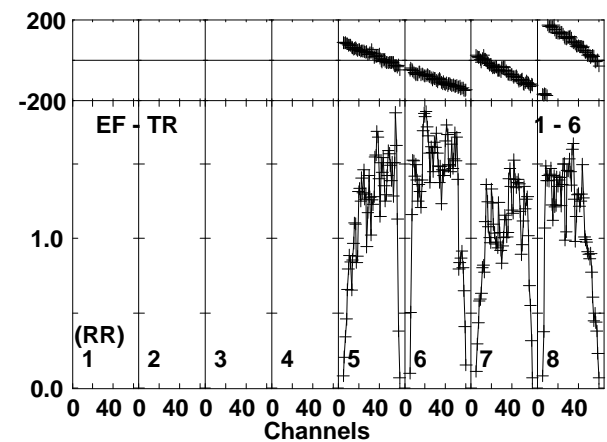
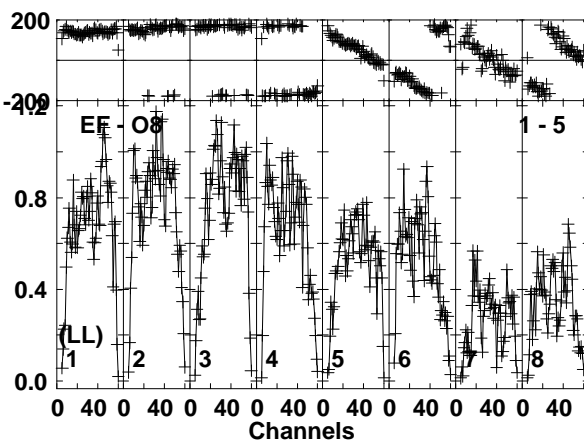
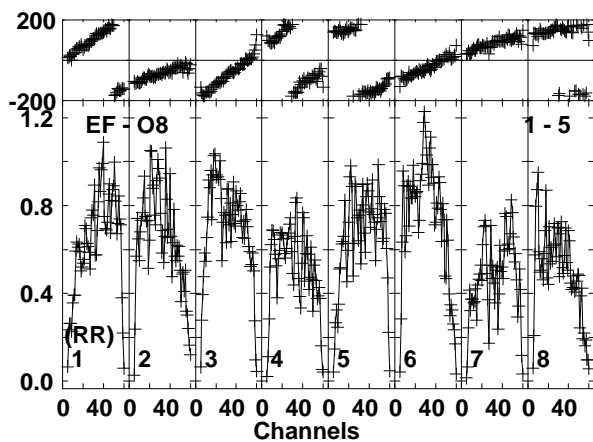
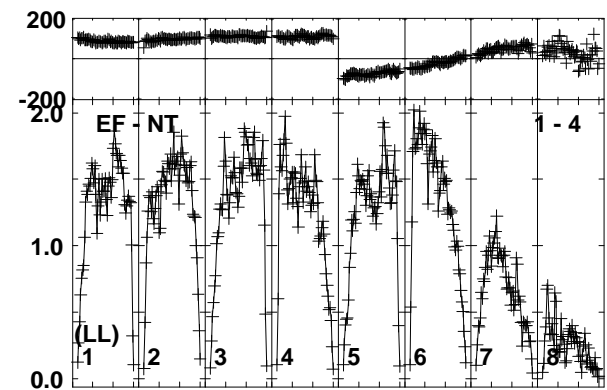
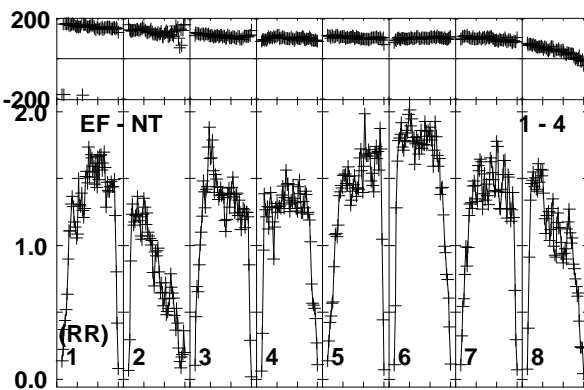
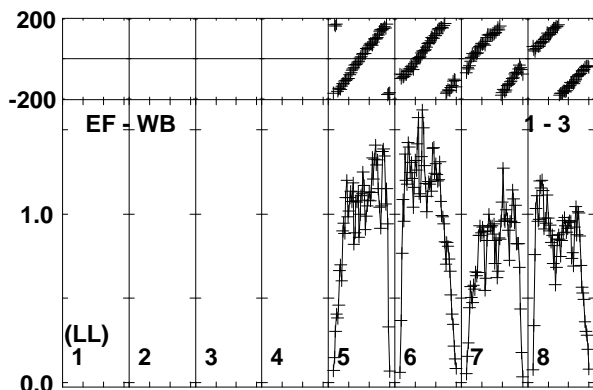
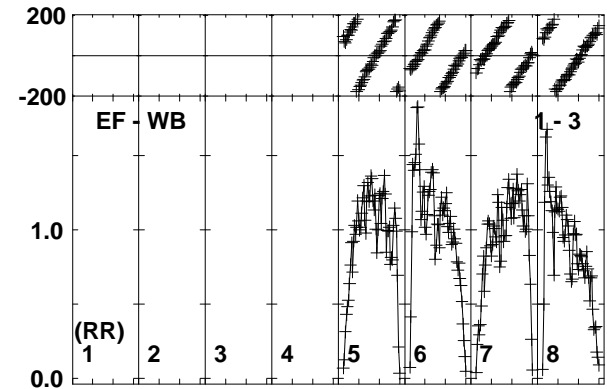
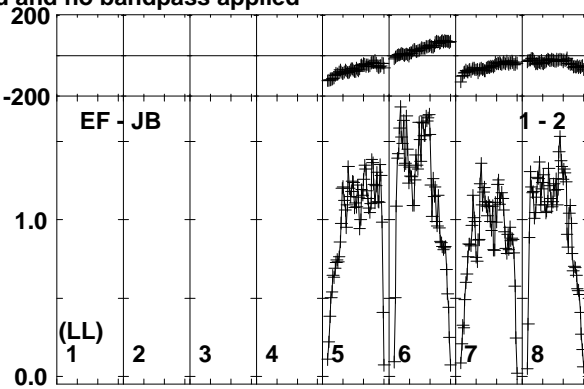
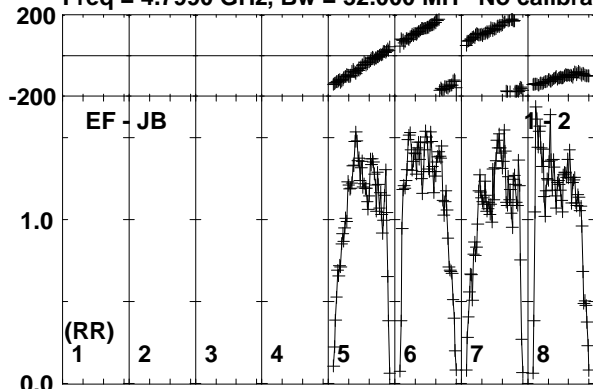

Lower frame: Milli Ampl Jy Top frame: Phas deg  
Vector averaged cross-power spectrum Baseline: EF (01) - JB (02)  
Timerange: 00/13:25:00 to 00/13:26:28

Plot file version 179 created 25-SEP-2017 10:02:43

J1303-2405 RP029B.UVDATA.1

Freq = 4.7990 GHz, Bw = 32.000 MH No calibration applied and no bandpass applied

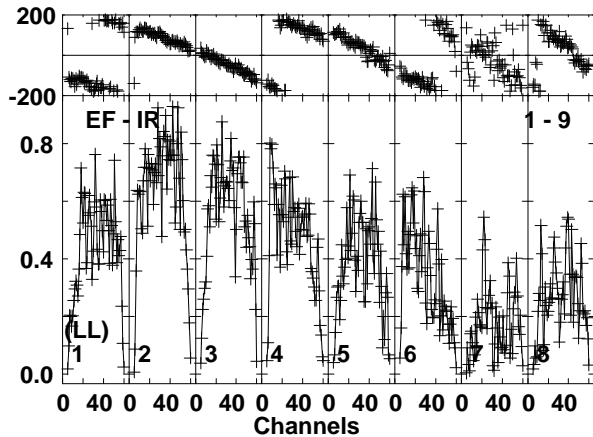
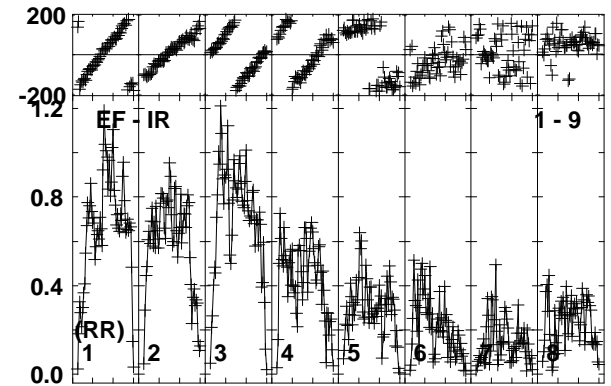
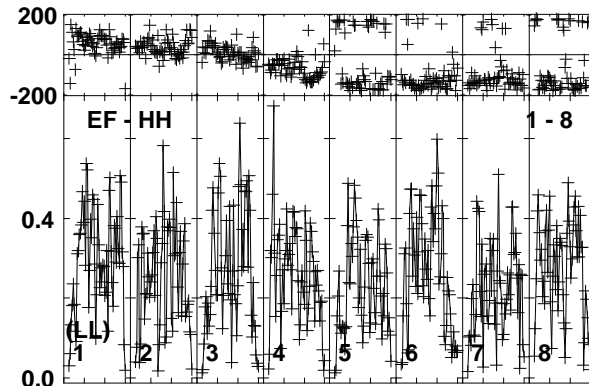
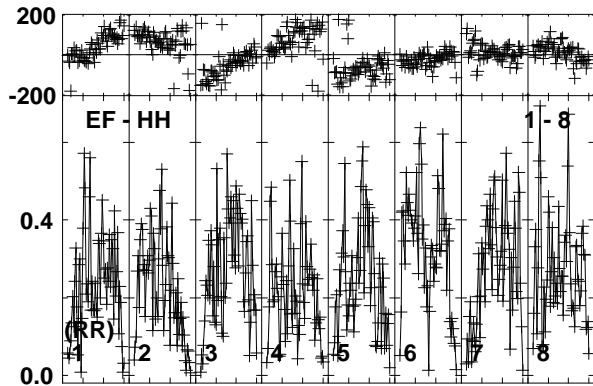
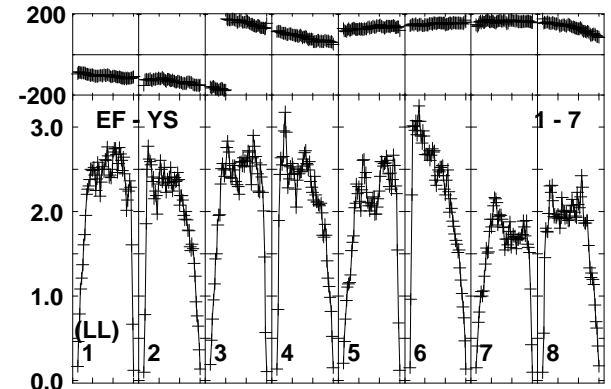
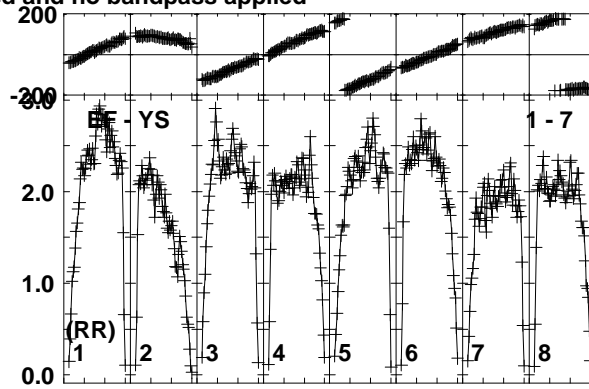
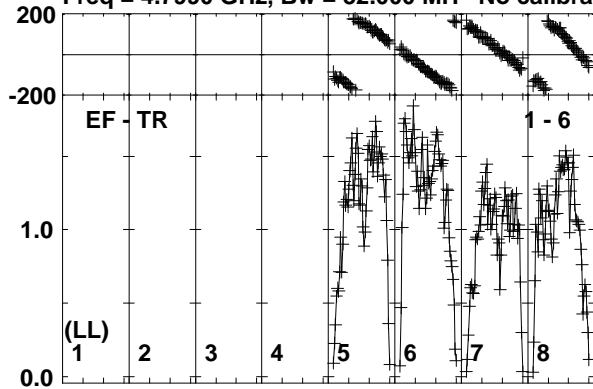

Lower frame: Milli Ampl Jy Top frame: Phas deg  
Vector averaged cross-power spectrum Baseline: EF (01) - TR (06)  
Timerange: 00/13:25:00 to 00/13:26:28

Plot file version 180 created 25-SEP-2017 10:02:43

J1312-2350 RP029B.UVDATA.1

Freq = 4.7990 GHz, Bw = 32.000 MH No calibration applied and no bandpass applied

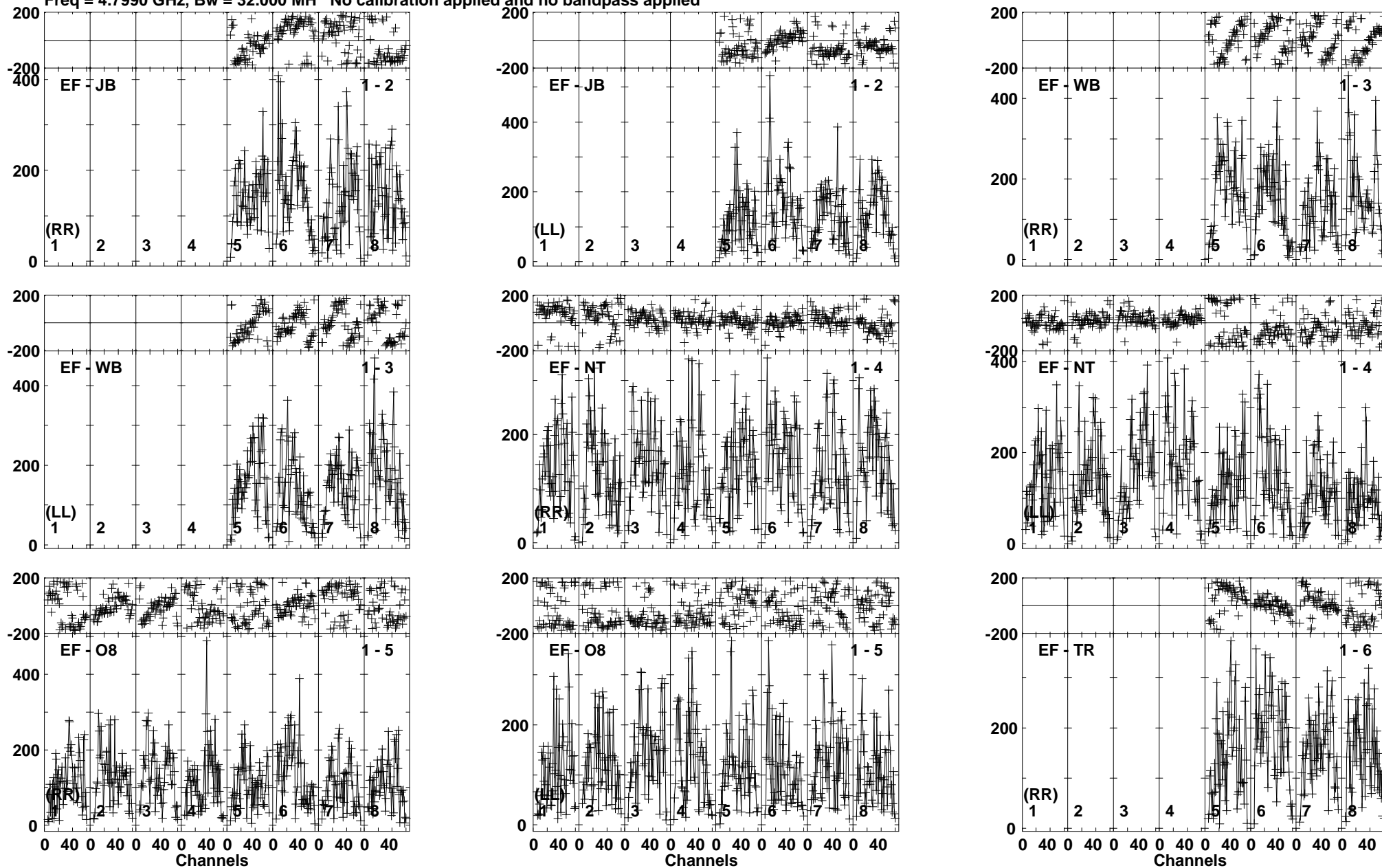

Lower frame: Micro Ampl Jy Top frame: Phas deg  
Vector averaged cross-power spectrum Baseline: EF (01) - JB (02)  
Timerange: 00/13:26:30 to 00/13:28:59

Plot file version 181 created 25-SEP-2017 10:02:44

J1312-2350 RP029B.UVDATA.1

Freq = 4.7990 GHz, Bw = 32.000 MH No calibration applied and no bandpass applied

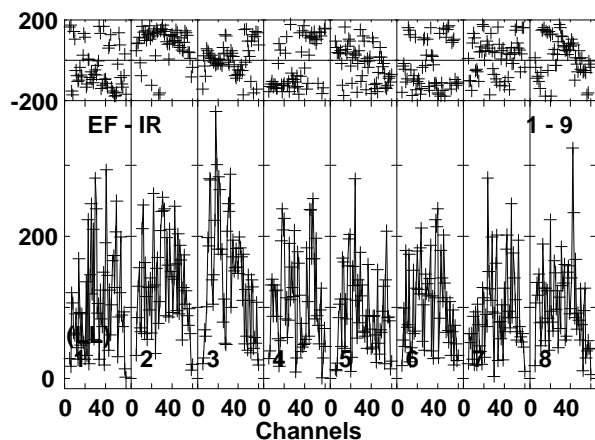
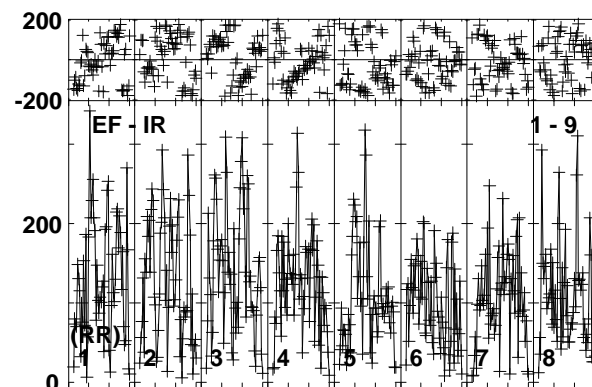
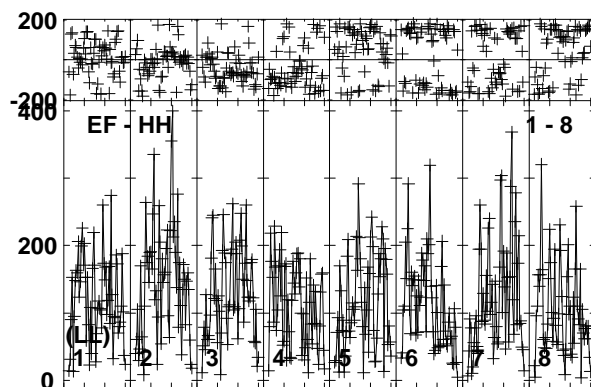
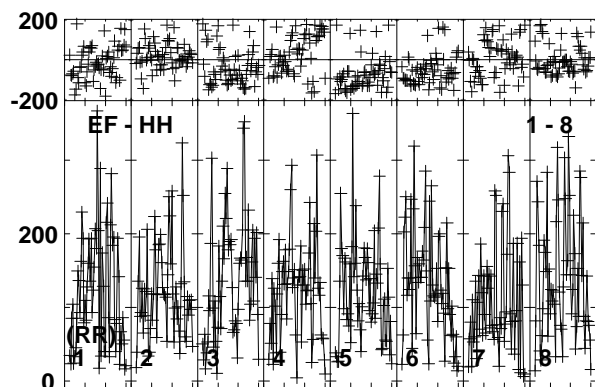
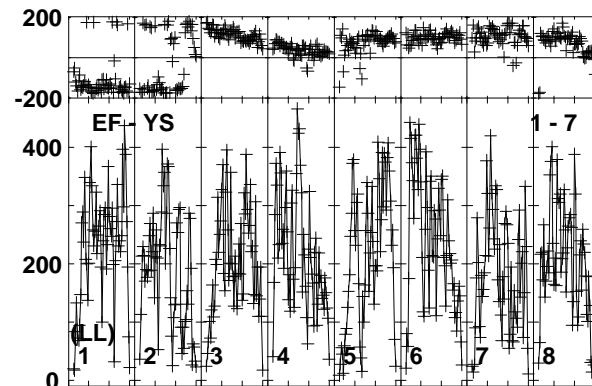
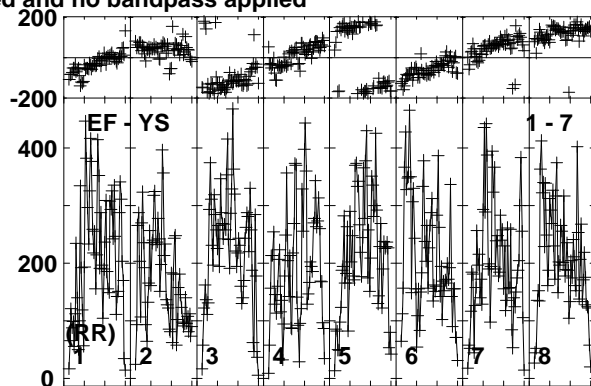
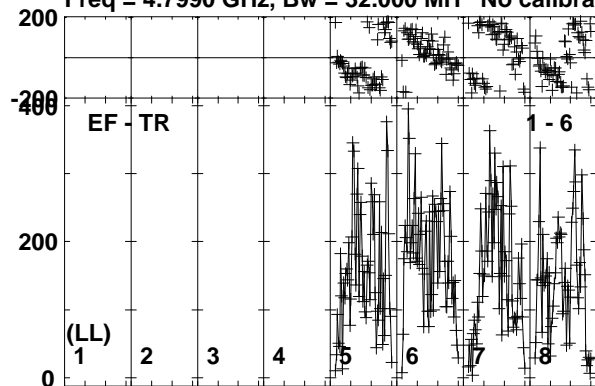

Lower frame: Micro Ampl Jy Top frame: Phas deg  
Vector averaged cross-power spectrum Baseline: EF (01) - TR (06)  
Timerange: 00/13:26:30 to 00/13:28:59

Plot file version 182 created 25-SEP-2017 10:02:44

J1303-2405 RP029B.UVDATA.1

Freq = 4.7990 GHz, Bw = 32.000 MH No calibration applied and no bandpass applied

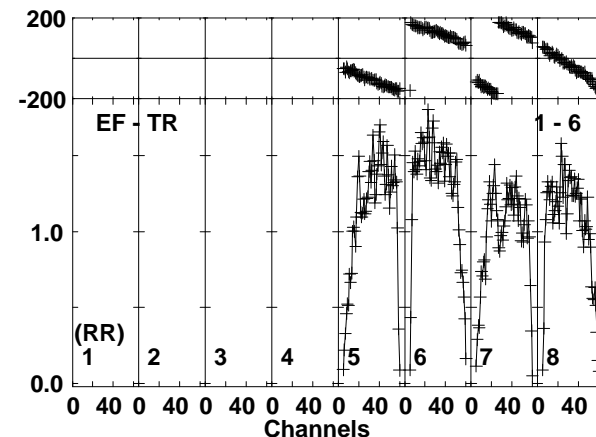
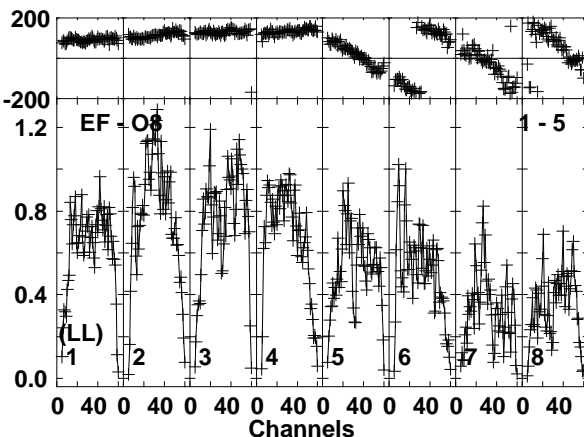
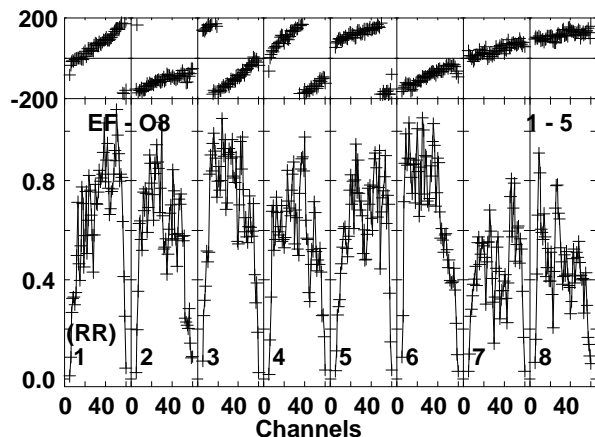
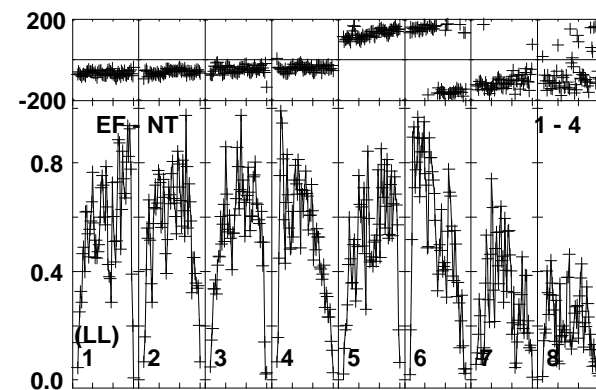
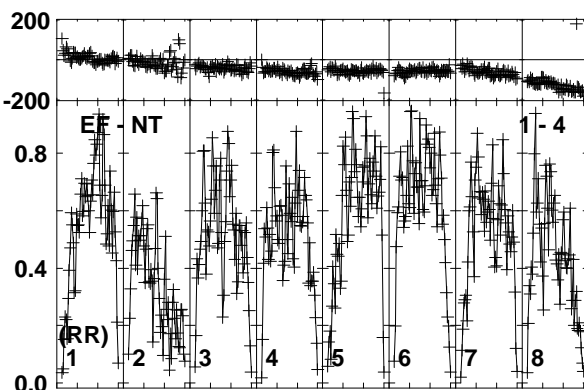
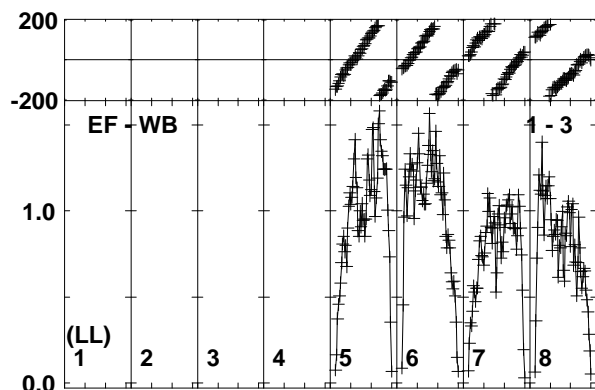
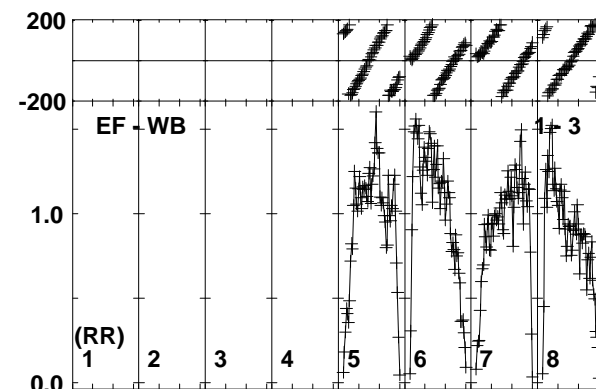
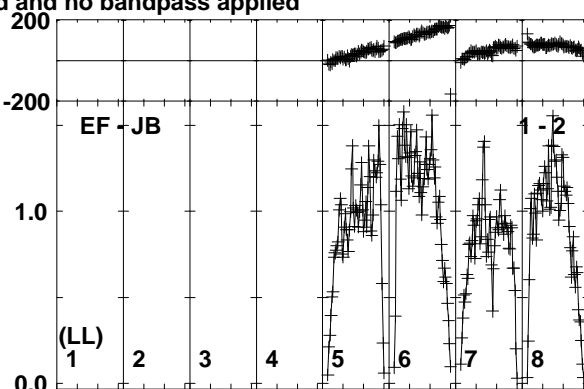
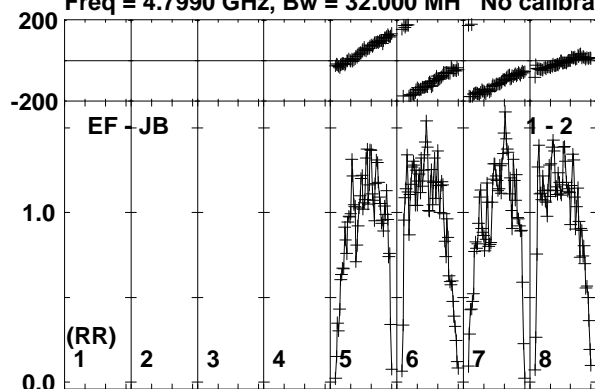

Lower frame: Milli Ampl Jy Top frame: Phas deg  
Vector averaged cross-power spectrum Baseline: EF (01) - JB (02)  
Timerange: 00/13:29:40 to 00/13:30:39

Plot file version 183 created 25-SEP-2017 10:02:44

J1303-2405 RP029B.UVDATA.1

Freq = 4.7990 GHz, Bw = 32.000 MH No calibration applied and no bandpass applied

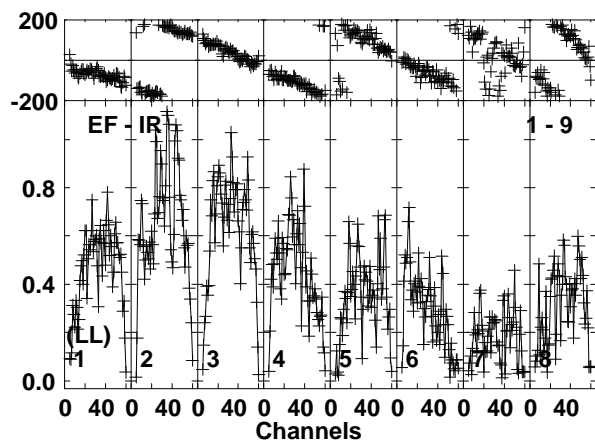
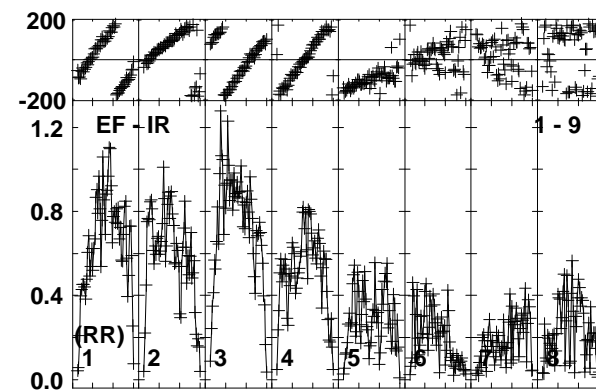
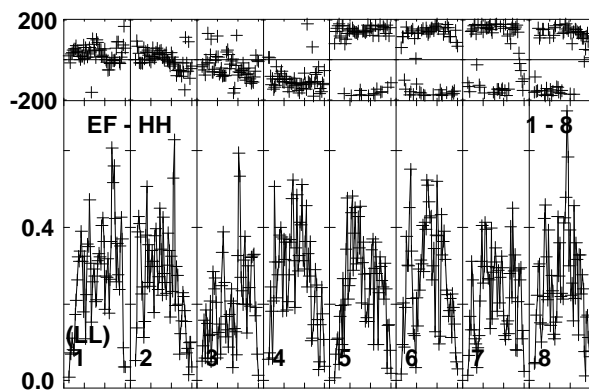
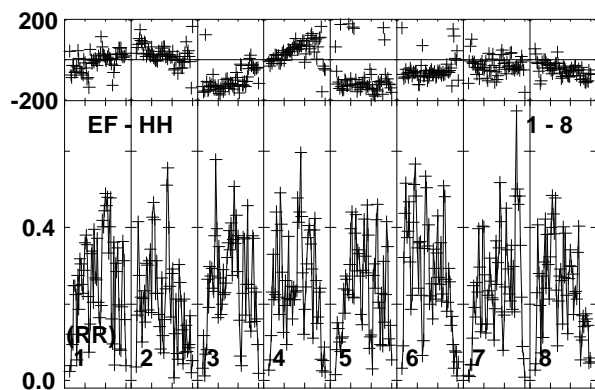
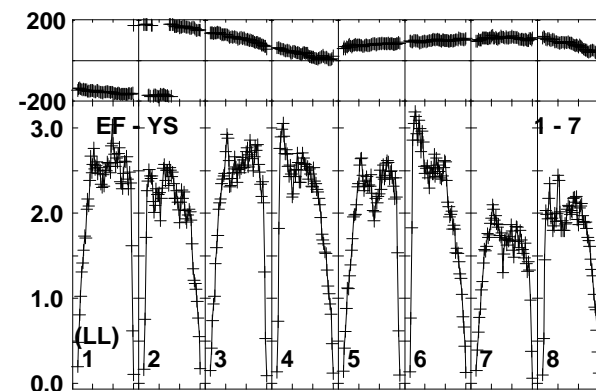
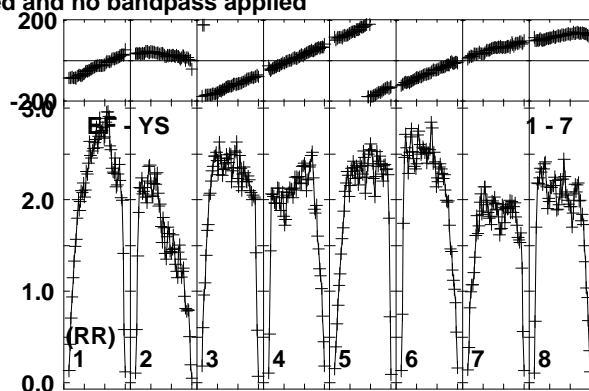
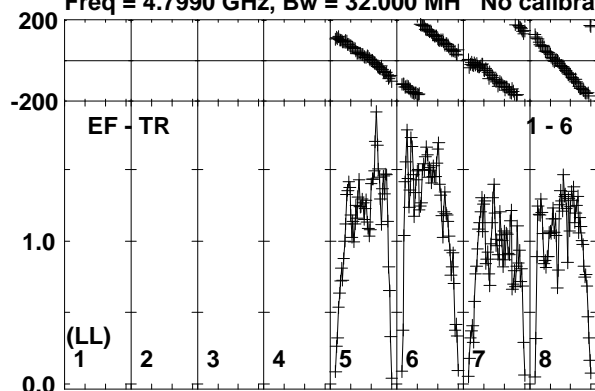

Lower frame: Milli Ampl Jy Top frame: Phas deg  
Vector averaged cross-power spectrum Baseline: EF (01) - TR (06)  
Timerange: 00/13:29:40 to 00/13:30:39

Plot file version 184 created 25-SEP-2017 10:02:44

SSS17A RP029B.UVDATA.1

Freq = 4.7990 GHz, Bw = 32.000 MH No calibration applied and no bandpass applied

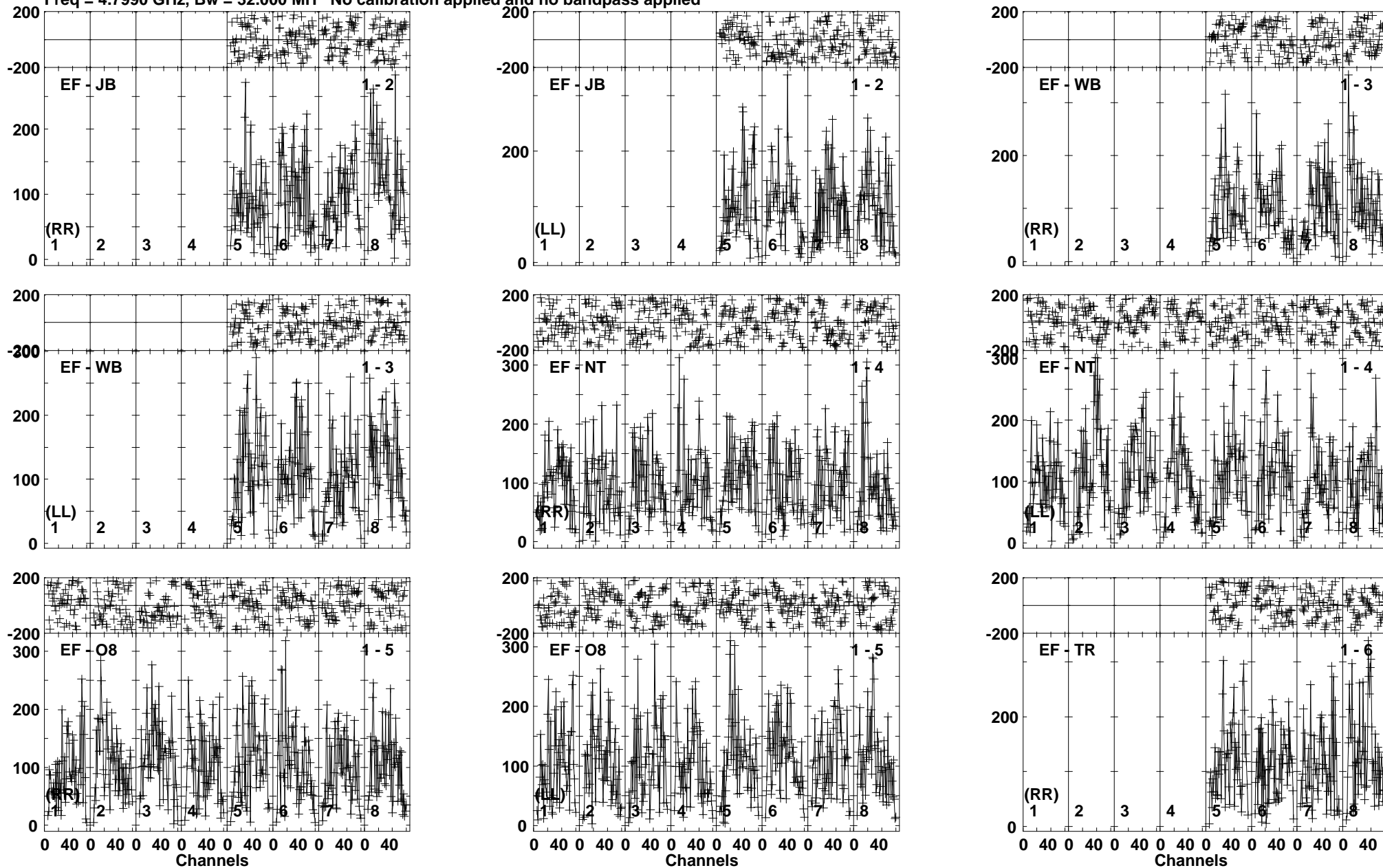

Lower frame: Micro Ampl Jy Top frame: Phas deg  
Vector averaged cross-power spectrum Baseline: EF (01) - JB (02)  
Timerange: 00/13:30:39 to 00/13:33:08



Plot file version 185 created 25-SEP-2017 10:02:44

SSS17A RP029B.UVDATA.1

Freq = 4.7990 GHz, Bw = 32.000 MH No calibration applied and no bandpass applied

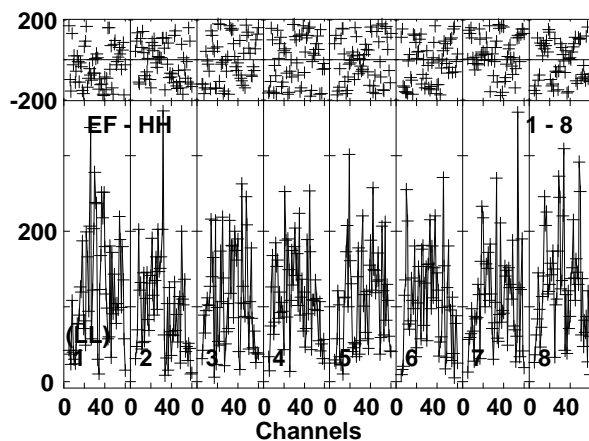
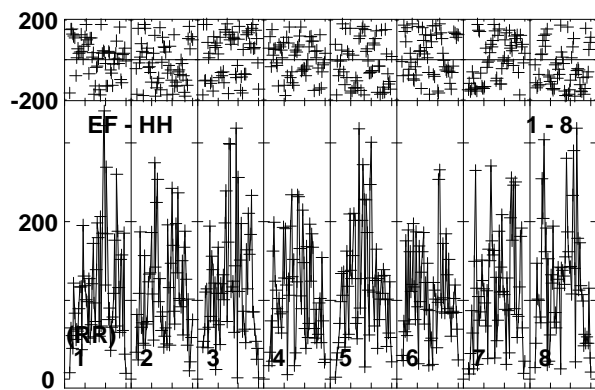
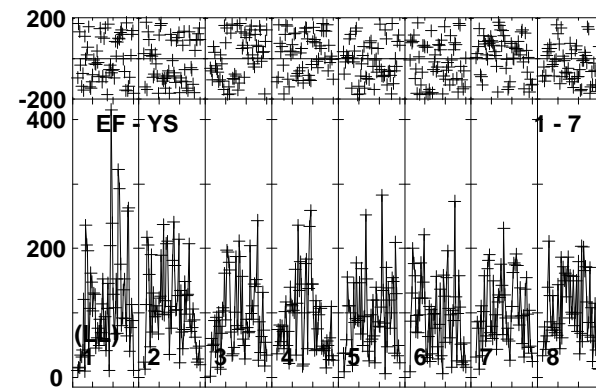
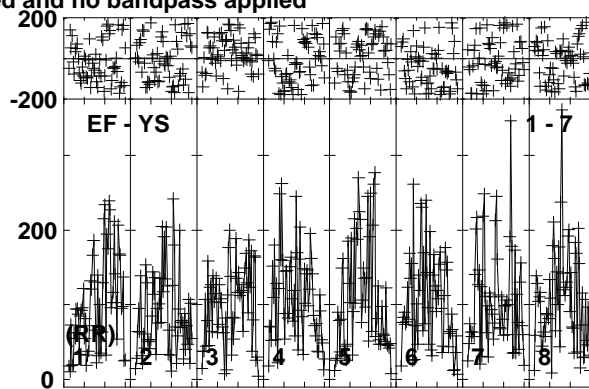
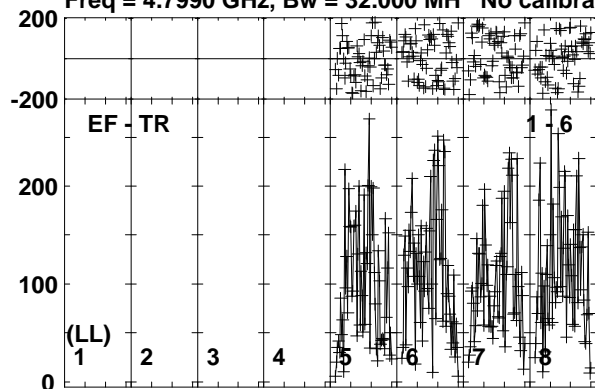

Lower frame: Micro Ampl Jy Top frame: Phas deg  
Vector averaged cross-power spectrum Baseline: EF (01) - TR (06)  
Timerange: 00/13:30:39 to 00/13:33:08

Plot file version 186 created 25-SEP-2017 10:02:44

J1303-2405 RP029B.UVDATA.1

Freq = 4.7990 GHz, Bw = 32.000 MH No calibration applied and no bandpass applied

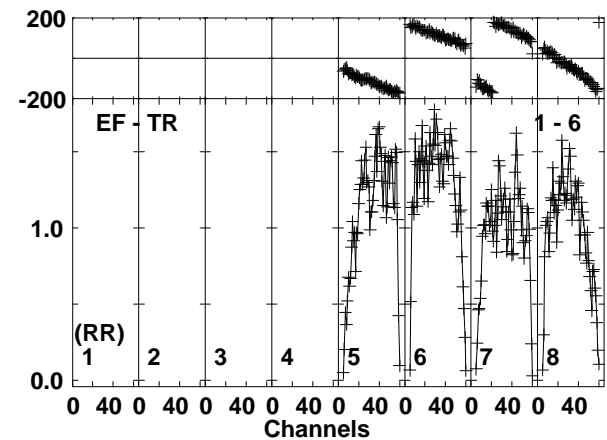
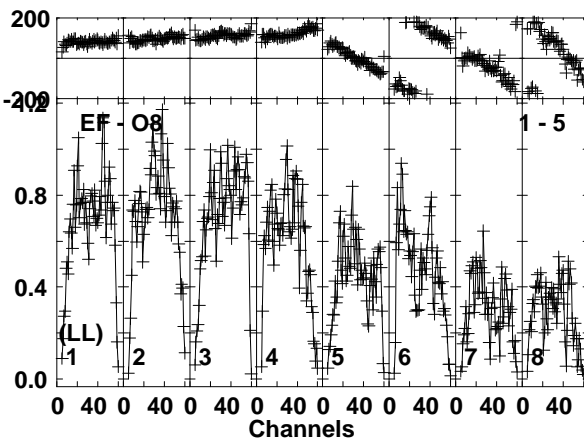
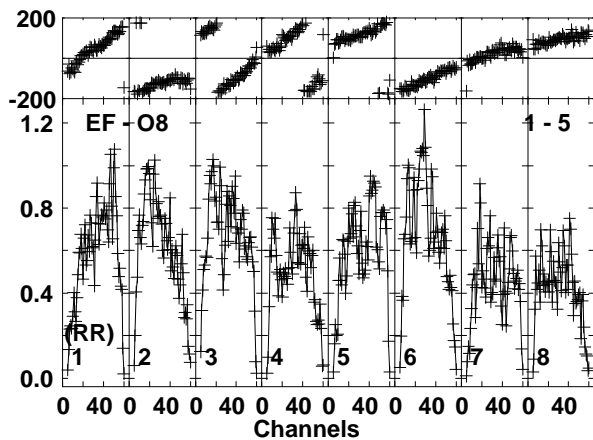
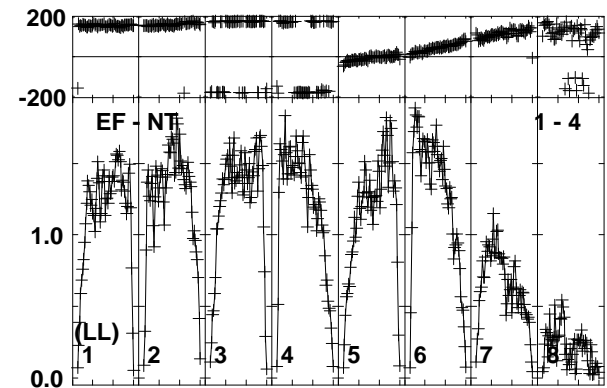
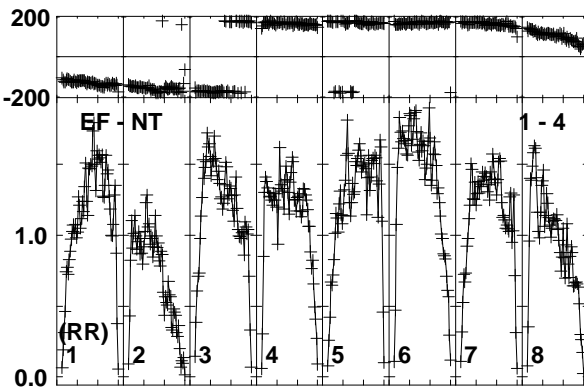
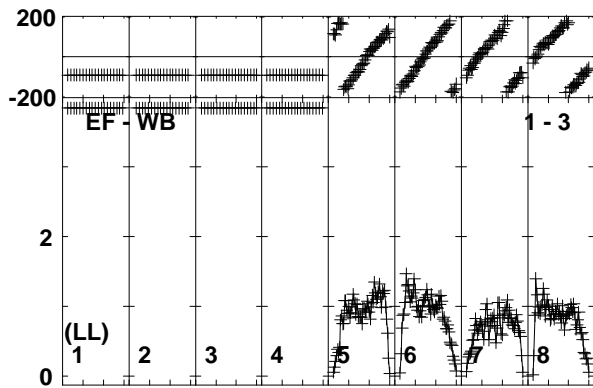
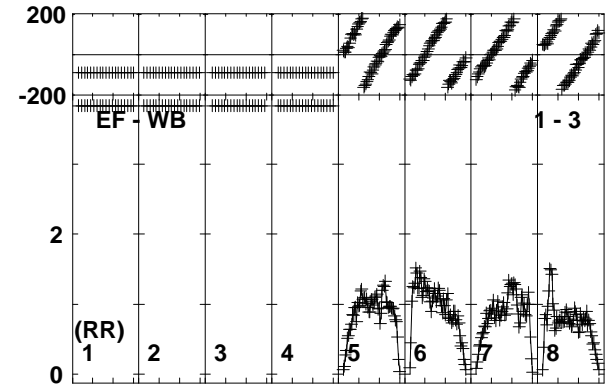
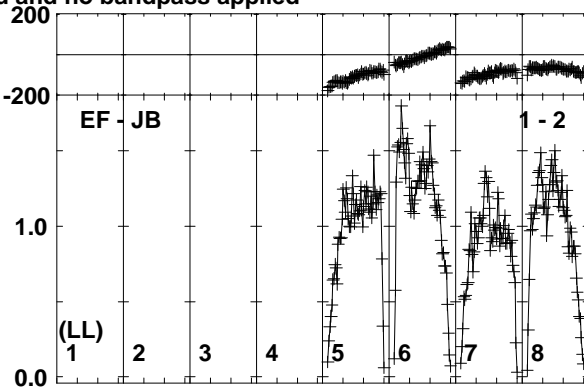
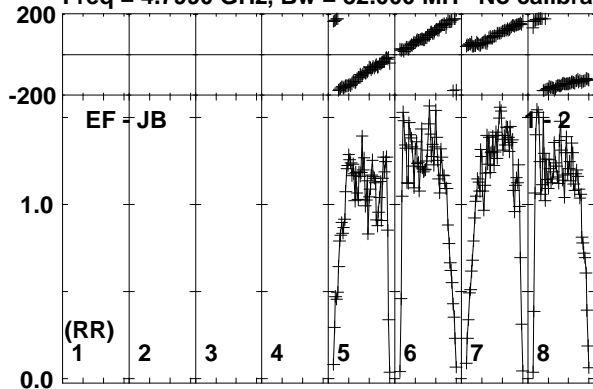

Lower frame: Milli Ampl Jy Top frame: Phas deg  
Vector averaged cross-power spectrum Baseline: EF (01) - JB (02)  
Timerange: 00/13:33:10 to 00/13:34:38

Plot file version 187 created 25-SEP-2017 10:02:45

J1303-2405 RP029B.UVDATA.1

Freq = 4.7990 GHz, Bw = 32.000 MH No calibration applied and no bandpass applied

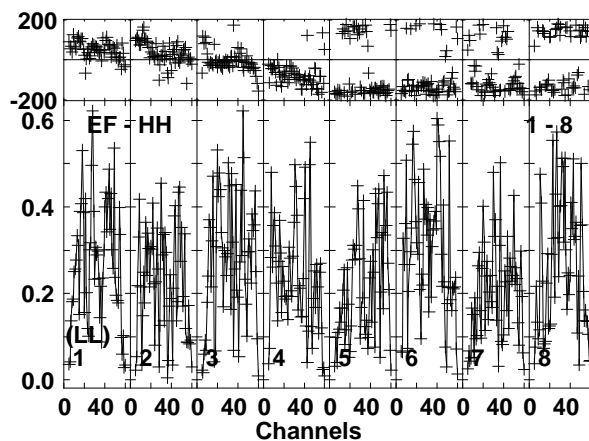
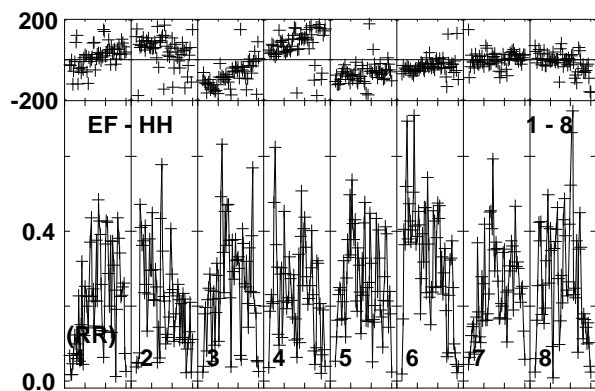
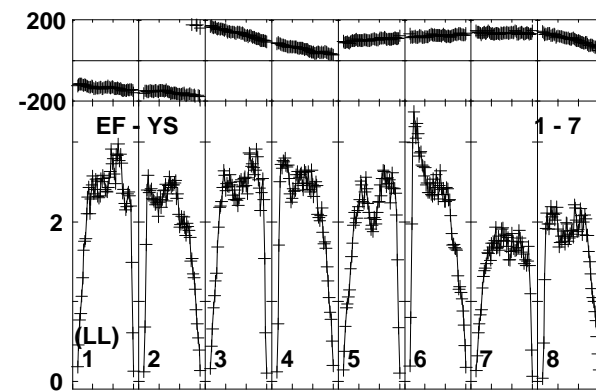
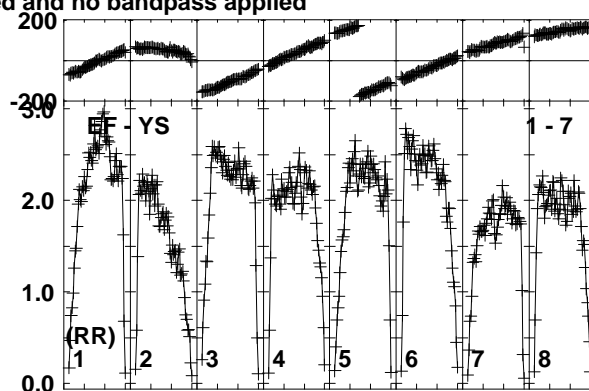
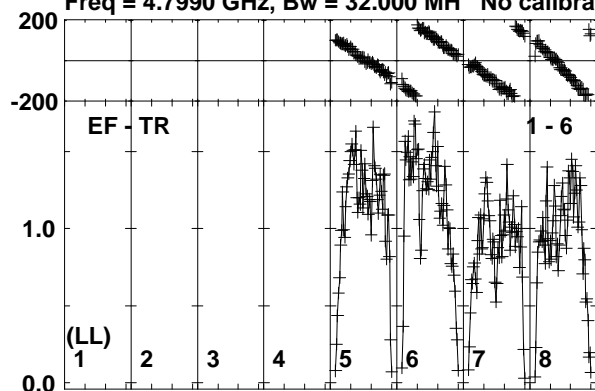

Lower frame: Milli Ampl Jy Top frame: Phas deg  
Vector averaged cross-power spectrum Baseline: EF (01) - TR (06)  
Timerange: 00/13:33:10 to 00/13:34:38

Plot file version 188 created 25-SEP-2017 10:02:45  
 SSS17A RP029B.UVDATA.1  
 Freq = 4.7990 GHz, Bw = 32.000 MH No calibration applied and no bandpass applied

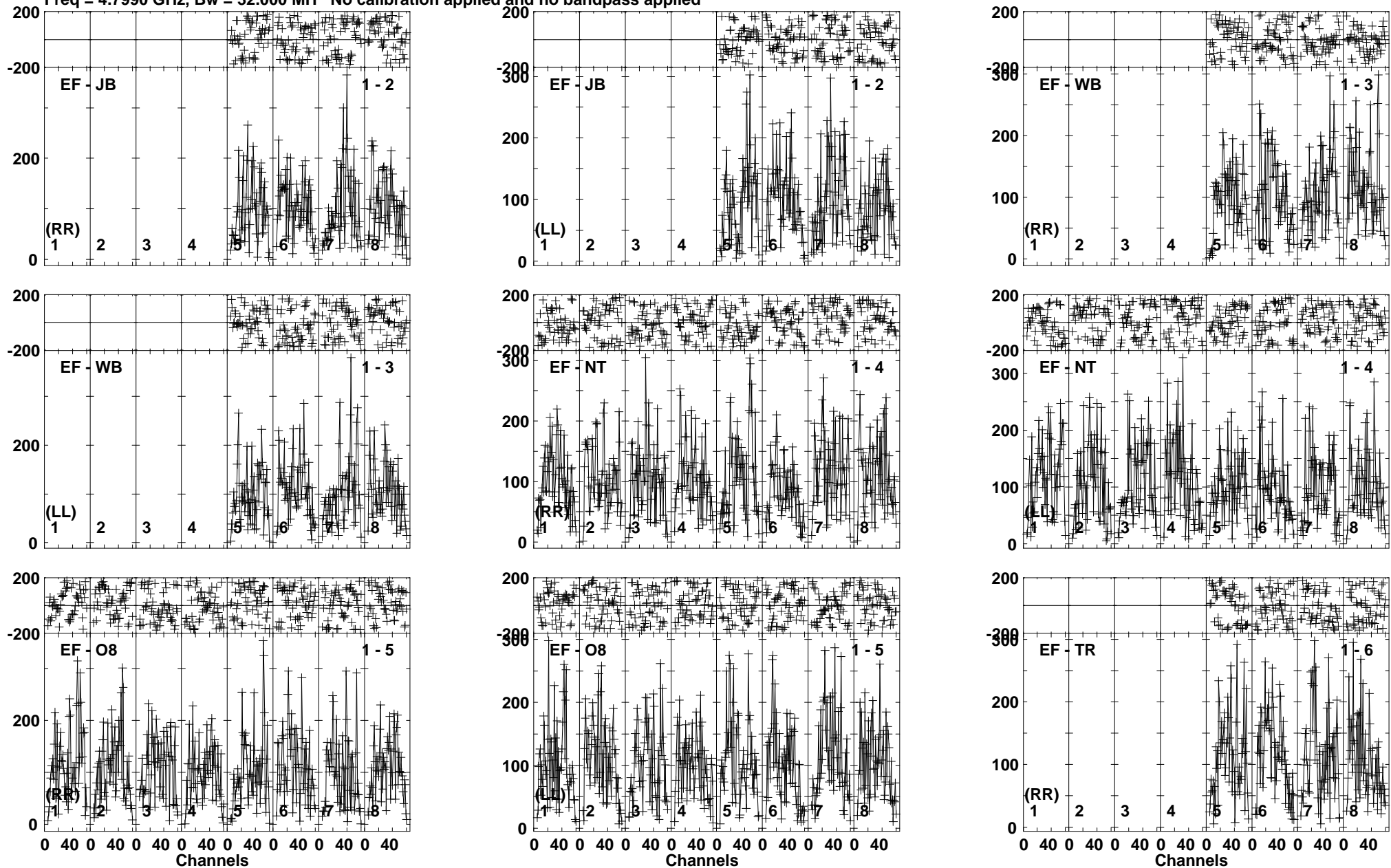

Lower frame: Micro Ampl Jy Top frame: Phas deg  
 Vector averaged cross-power spectrum Baseline: EF (01) - JB (02)  
 Timerange: 00/13:34:40 to 00/13:37:08

Plot file version 189 created 25-SEP-2017 10:02:45

SSS17A RP029B.UVDATA.1

Freq = 4.7990 GHz, Bw = 32.000 MH No calibration applied and no bandpass applied

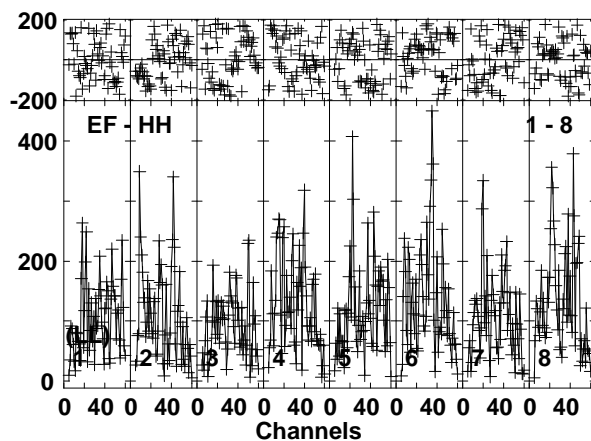
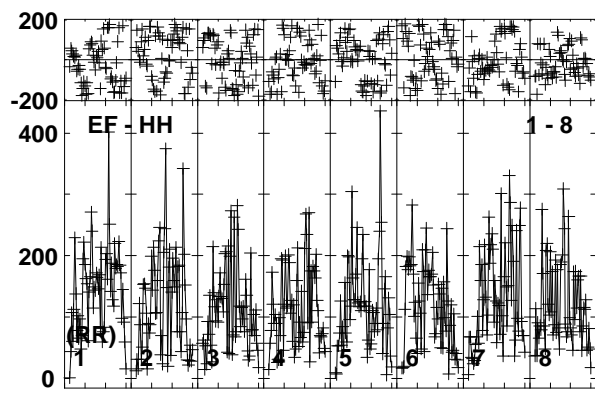
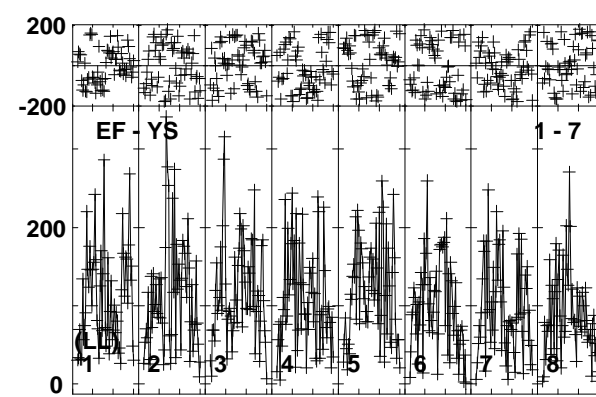
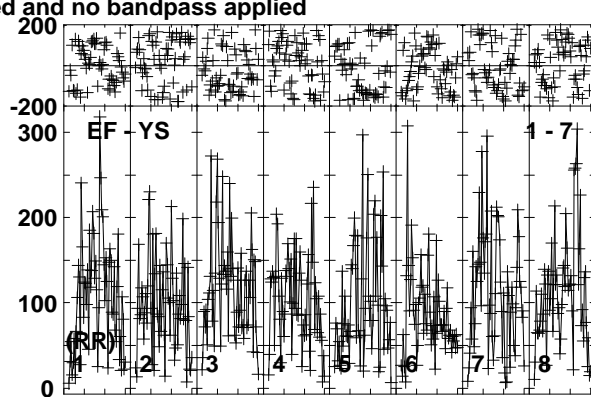
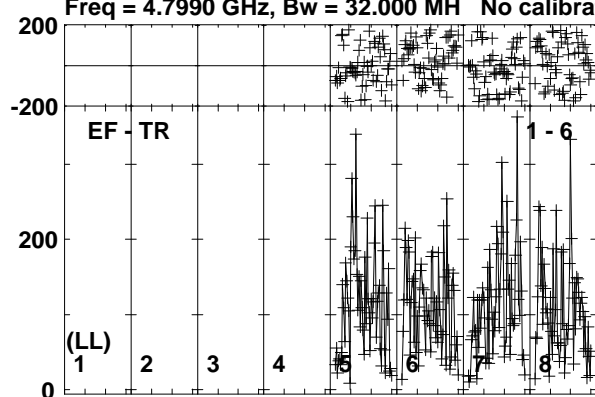

Lower frame: Micro Ampl Jy Top frame: Phas deg  
Vector averaged cross-power spectrum Baseline: EF (01) - TR (06)  
Timerange: 00/13:34:40 to 00/13:37:08

Plot file version 190 created 25-SEP-2017 10:02:45

J1303-2405 RP029B.UVDATA.1

Freq = 4.7990 GHz, Bw = 32.000 MH No calibration applied and no bandpass applied

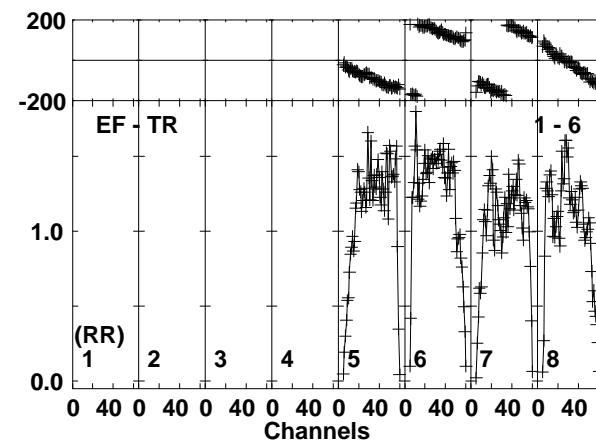
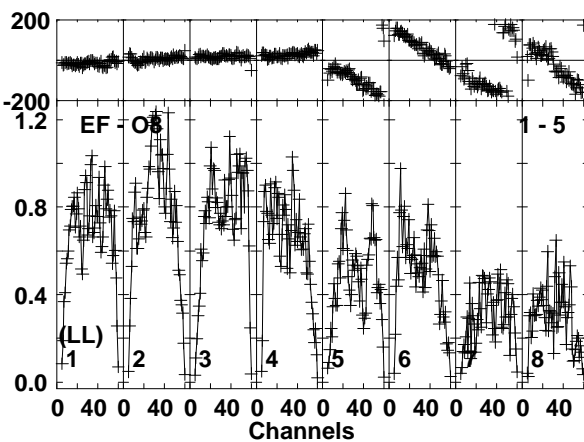
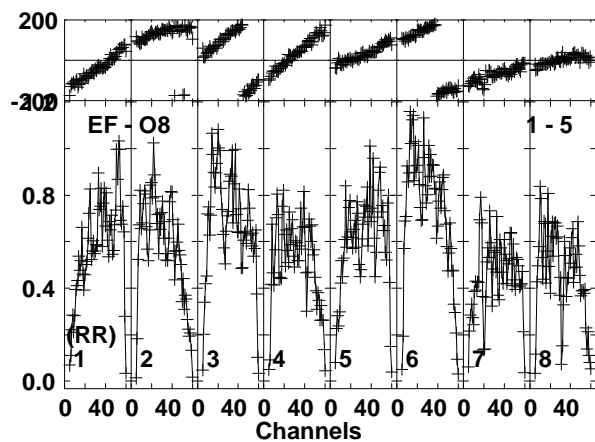
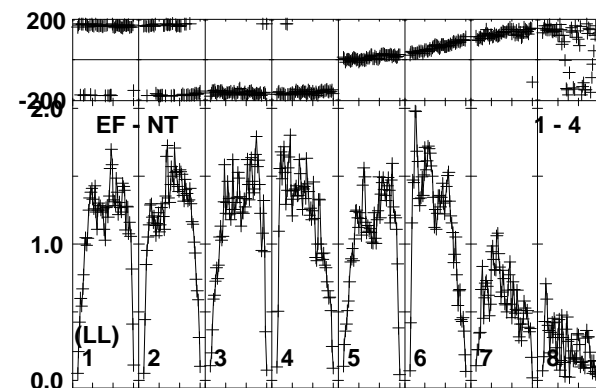
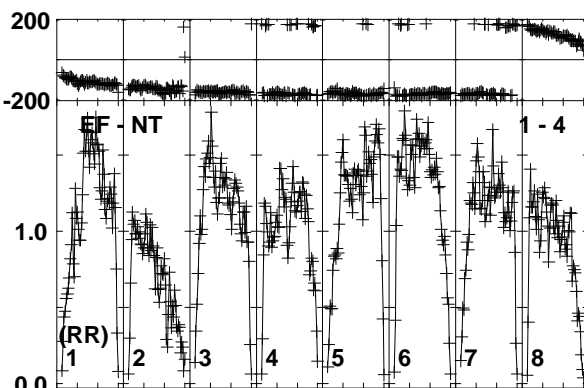
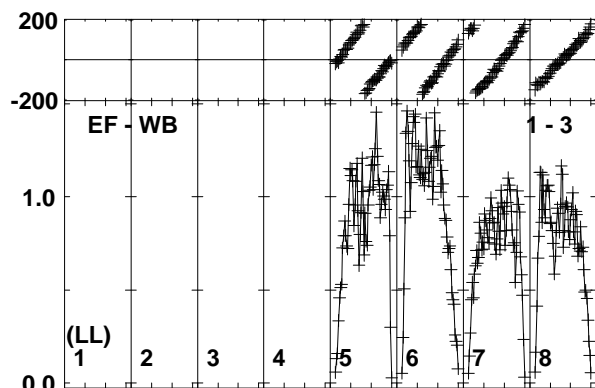
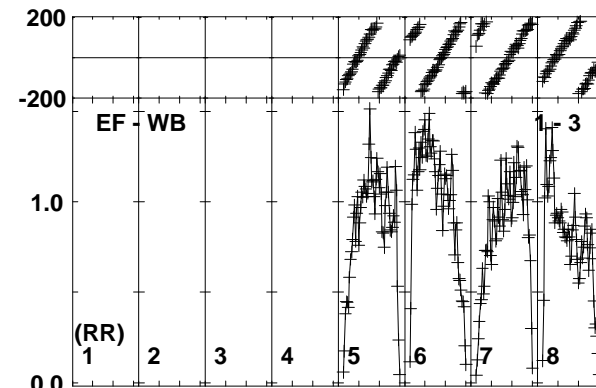
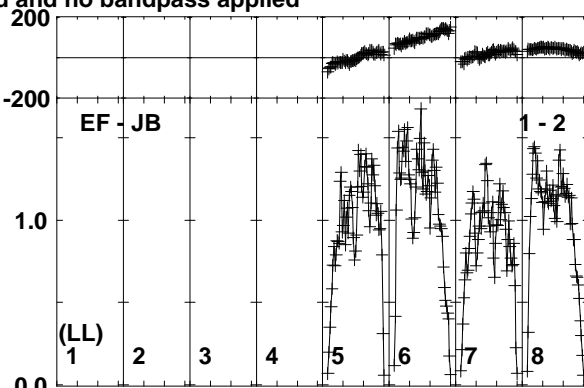
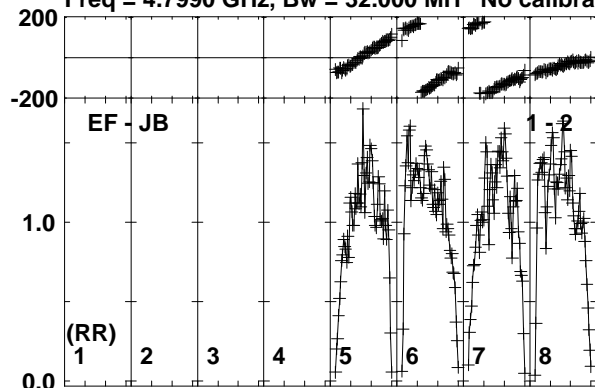

Lower frame: Milli Ampl Jy Top frame: Phas deg  
Vector averaged cross-power spectrum Baseline: EF (01) - JB (02)  
Timerange: 00/13:37:39 to 00/13:38:38

Plot file version 191 created 25-SEP-2017 10:02:45

J1303-2405 RP029B.UVDATA.1

Freq = 4.7990 GHz, Bw = 32.000 MH No calibration applied and no bandpass applied

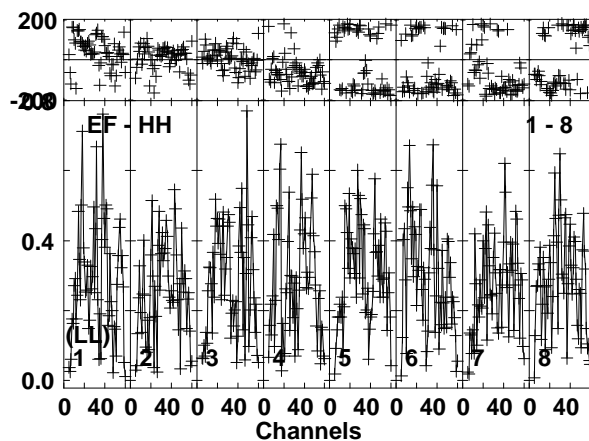
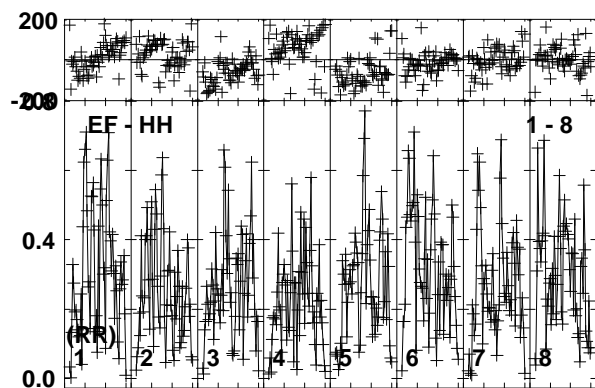
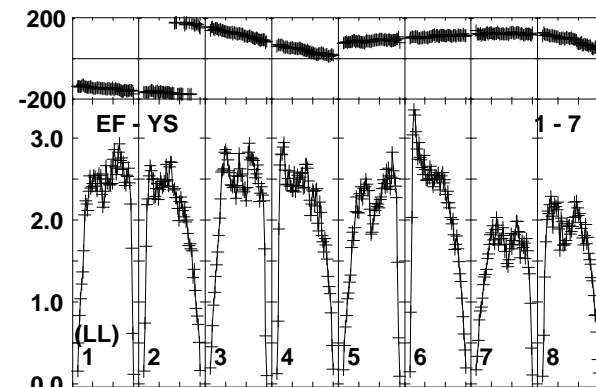
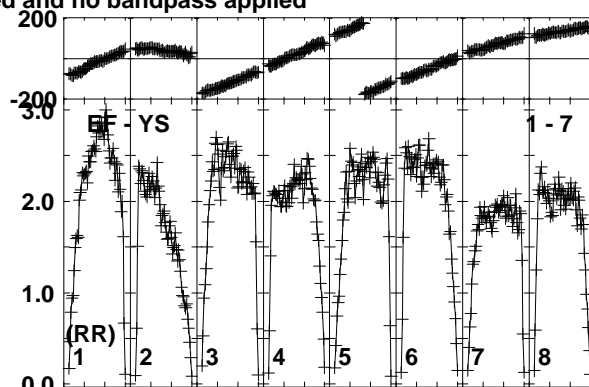
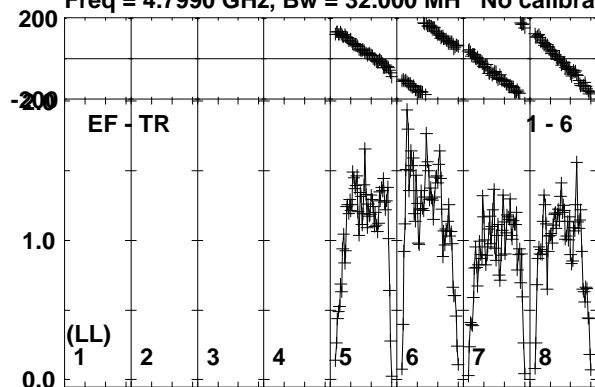

Lower frame: Milli Ampl Jy Top frame: Phas deg  
Vector averaged cross-power spectrum Baseline: EF (01) - TR (06)  
Timerange: 00/13:37:39 to 00/13:38:38

Plot file version 192 created 25-SEP-2017 10:02:45  
 SSS17A RP029B.UVDATA.1  
 Freq = 4.7990 GHz, Bw = 32.000 MH No calibration applied and no bandpass applied

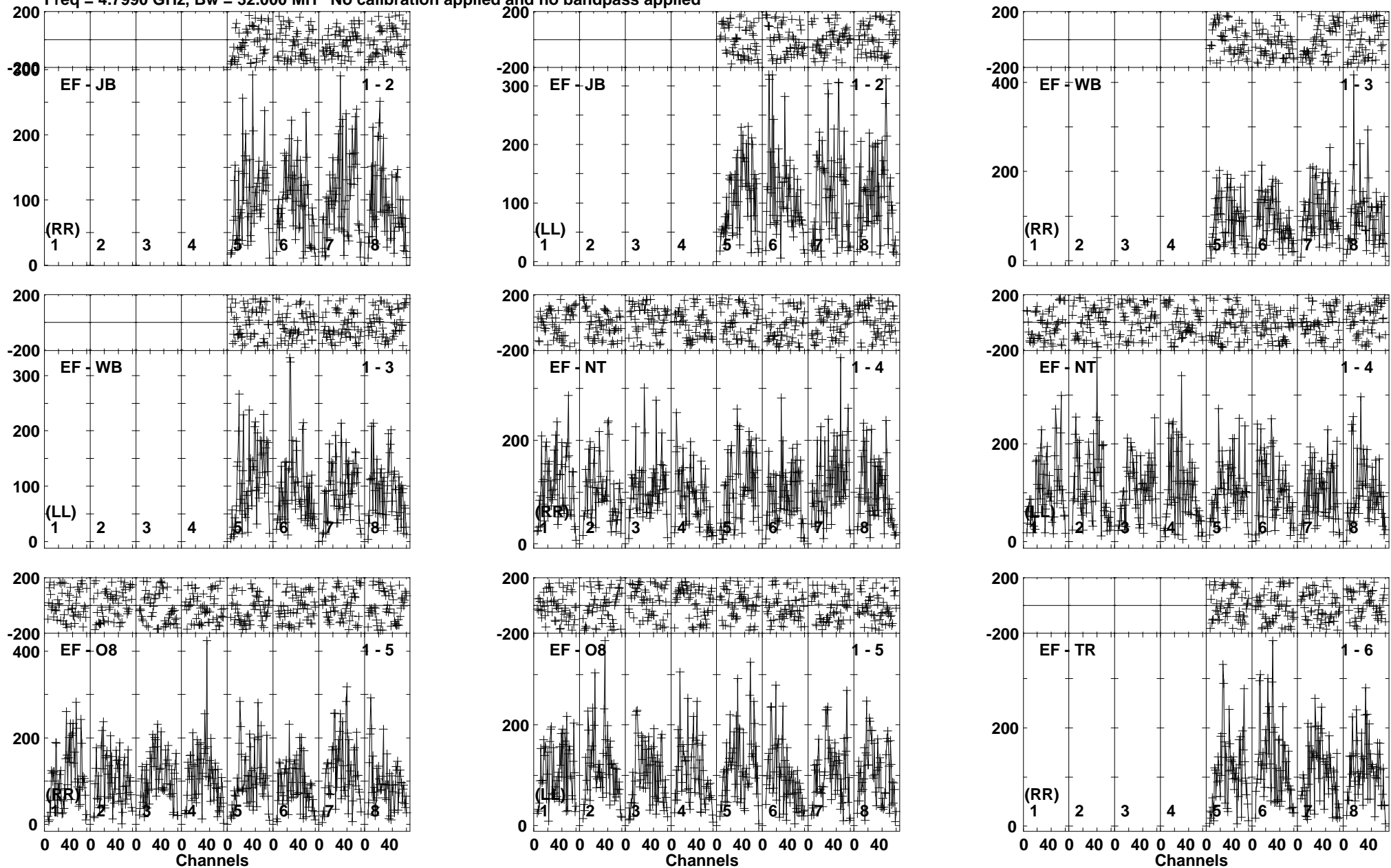

Lower frame: Micro Ampl Jy Top frame: Phas deg  
 Vector averaged cross-power spectrum Baseline: EF (01) - JB (02)  
 Timerange: 00/13:38:40 to 00/13:41:09



Plot file version 193 created 25-SEP-2017 10:02:46

SSS17A RP029B.UVDATA.1

Freq = 4.7990 GHz, Bw = 32.000 MH No calibration applied and no bandpass applied

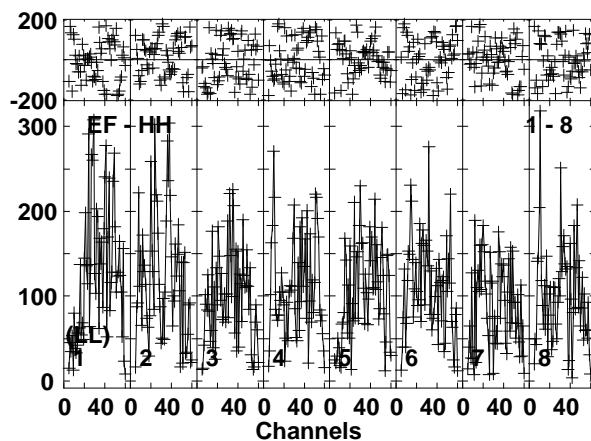
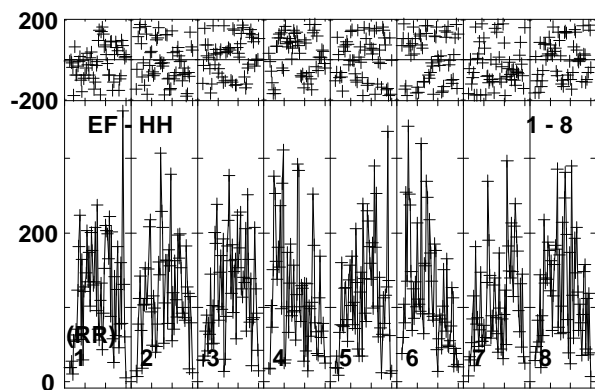
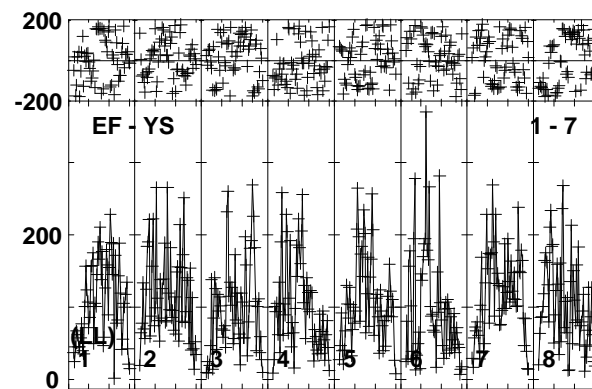
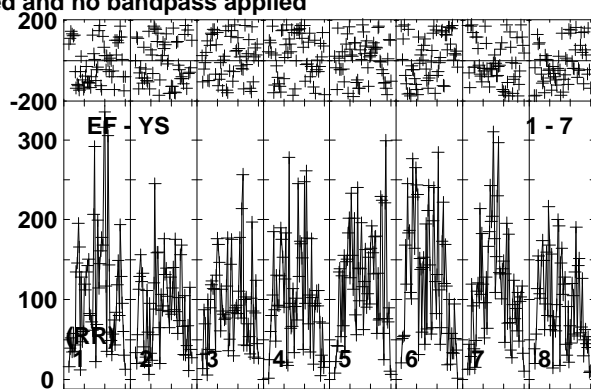
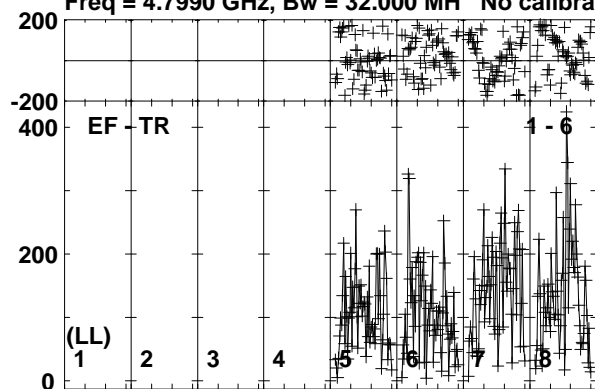

Lower frame: Micro Ampl Jy Top frame: Phas deg  
Vector averaged cross-power spectrum Baseline: EF (01) - TR (06)  
Timerange: 00/13:38:40 to 00/13:41:09

Plot file version 194 created 25-SEP-2017 10:02:46

J1303-2405 RP029B.UVDATA.1

Freq = 4.7990 GHz, Bw = 32.000 MH No calibration applied and no bandpass applied

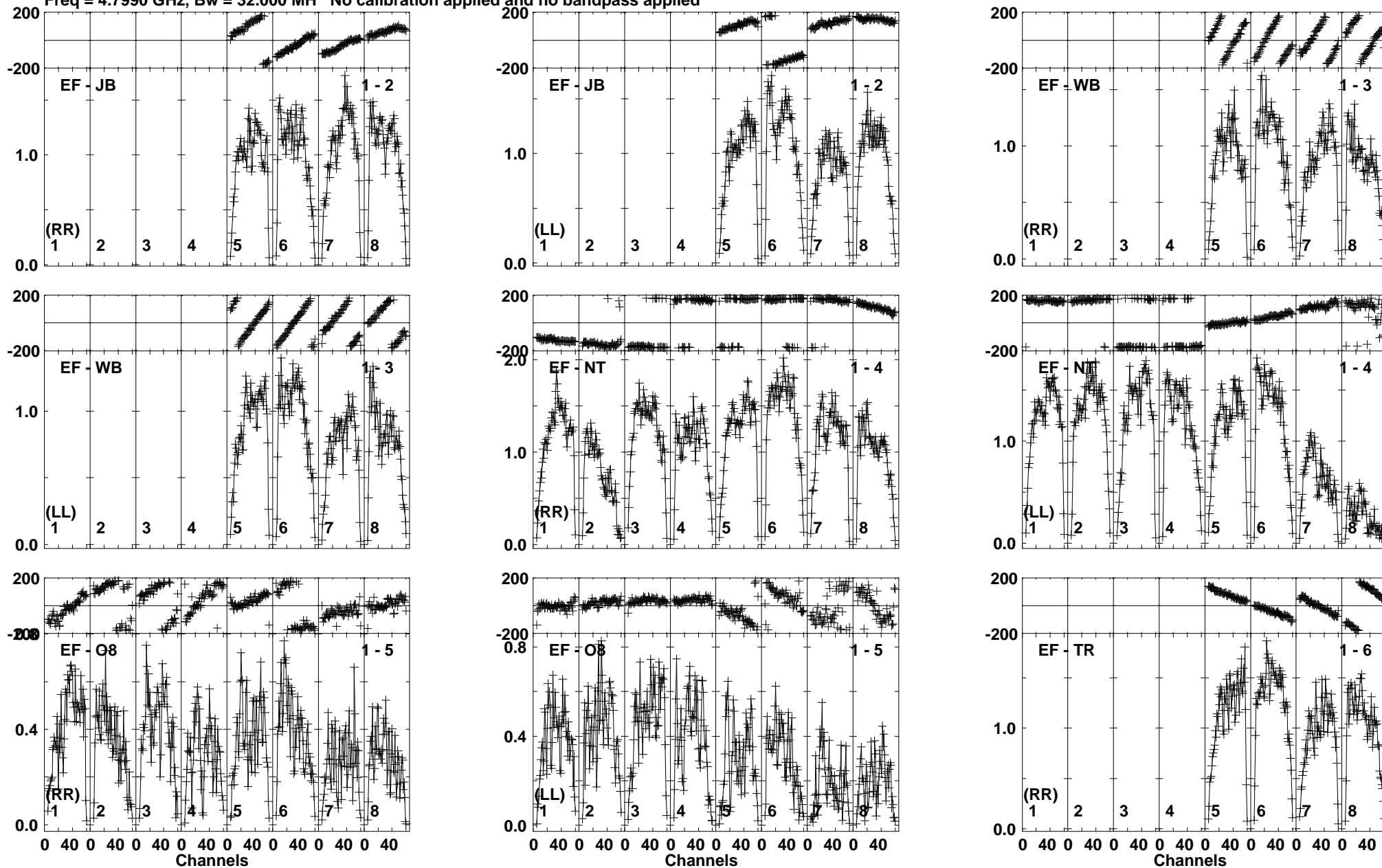

Lower frame: Milli Ampl Jy Top frame: Phas deg  
Vector averaged cross-power spectrum Baseline: EF (01) - JB (02)  
Timerange: 00:13:41:09 to 00:13:42:38



Plot file version 196 created 25-SEP-2017 10:02:46

J1312-2350 RP029B.UVDATA.1

Freq = 4.7990 GHz, Bw = 32.000 MH No calibration applied and no bandpass applied

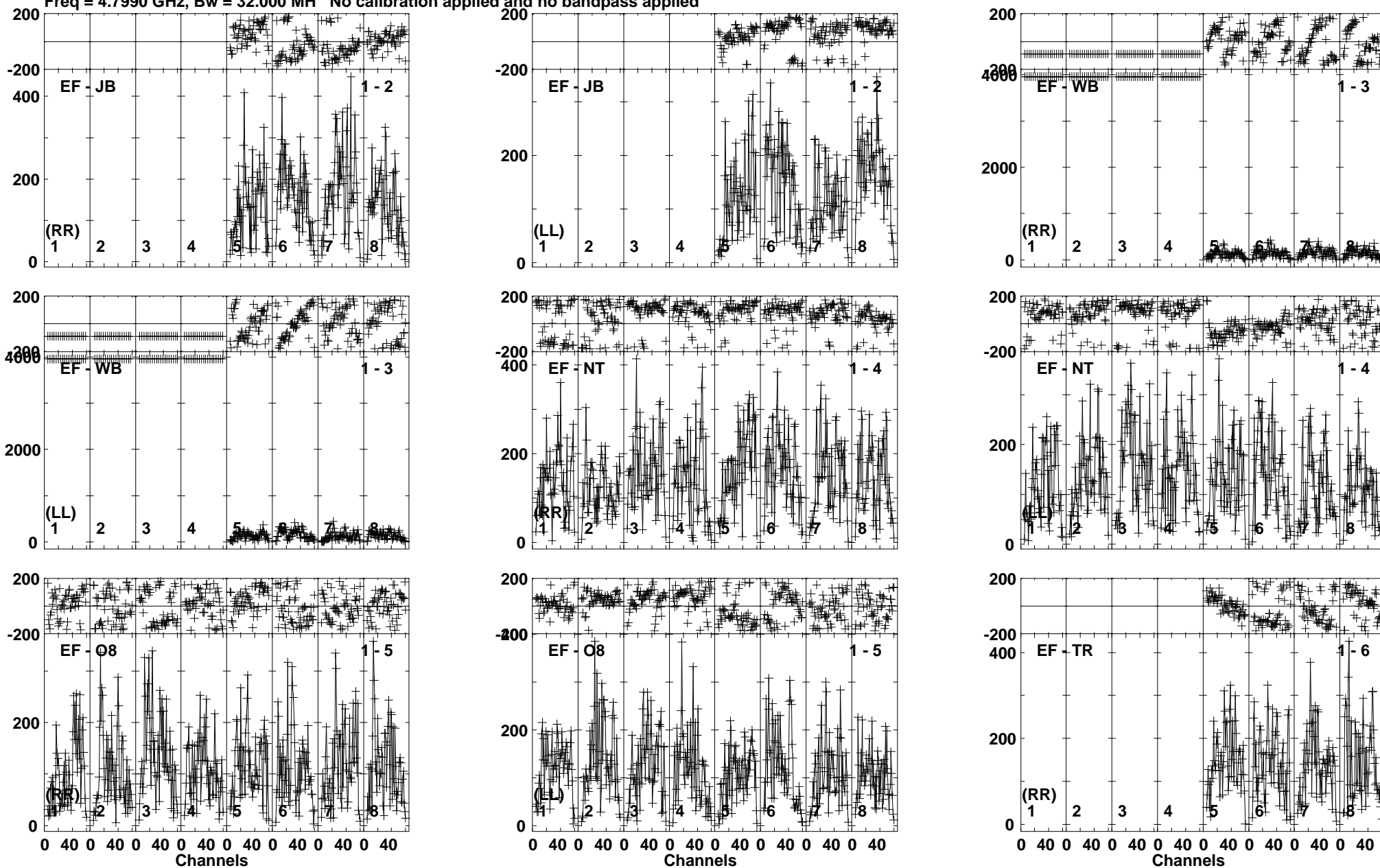

Lower frame: Micro Ampl Jy Top frame: Phas deg  
Vector averaged cross-power spectrum Baseline: EF (01) - JB (02)  
Timerange: 00/13:42:39 to 00/13:45:08

Plot file version 197 created 25-SEP-2017 10:02:46

J1312-2350 RP029B.UVDATA.1

Freq = 4.7990 GHz, Bw = 32.000 MH No calibration applied and no bandpass applied

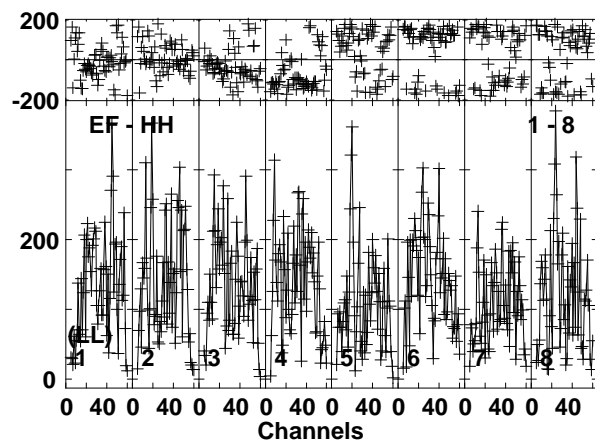
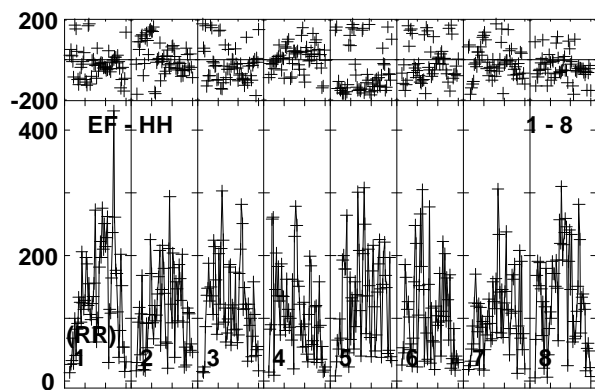
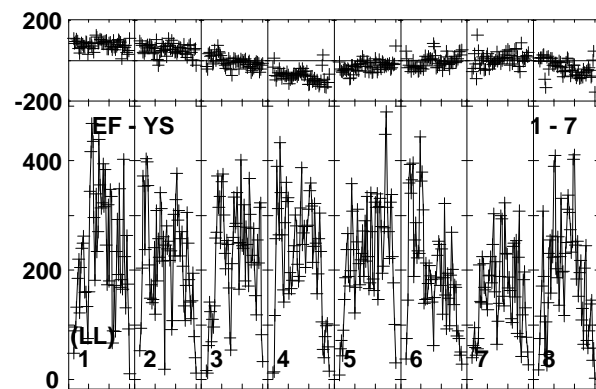
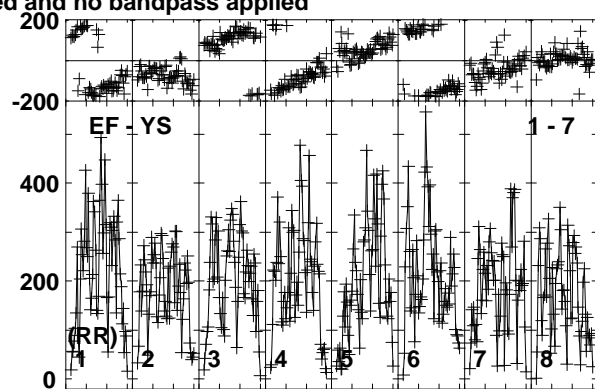
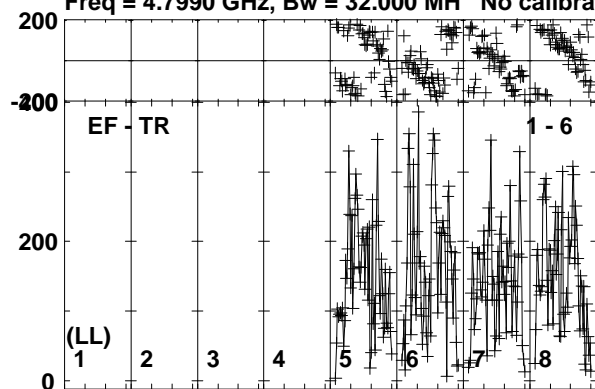

Lower frame: Micro Ampl Jy Top frame: Phas deg  
Vector averaged cross-power spectrum Baseline: EF (01) - TR (06)  
Timerange: 00/13:42:39 to 00/13:45:08

Plot file version 198 created 25-SEP-2017 10:02:46

J1303-2405 RP029B.UVDATA.1

Freq = 4.7990 GHz, Bw = 32.000 MH No calibration applied and no bandpass applied

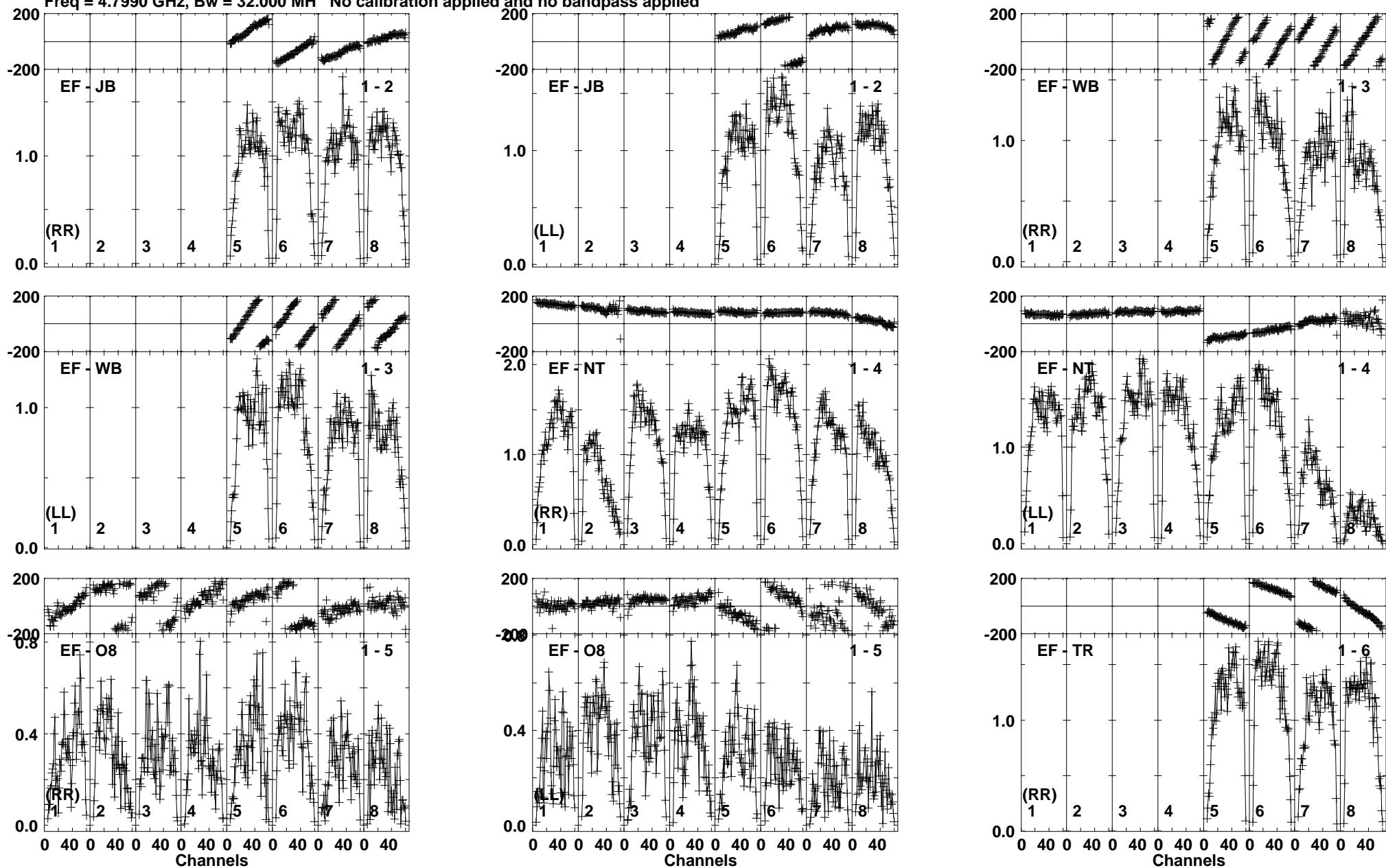

Lower frame: Milli Ampl Jy Top frame: Phas deg  
Vector averaged cross-power spectrum Baseline: EF (01) - JB (02)  
Timerange: 00/13:45:50 to 00/13:46:48

Plot file version 199 created 25-SEP-2017 10:02:46

J1303-2405 RP029B.UVDATA.1

Freq = 4.7990 GHz, Bw = 32.000 MH No calibration applied and no bandpass applied

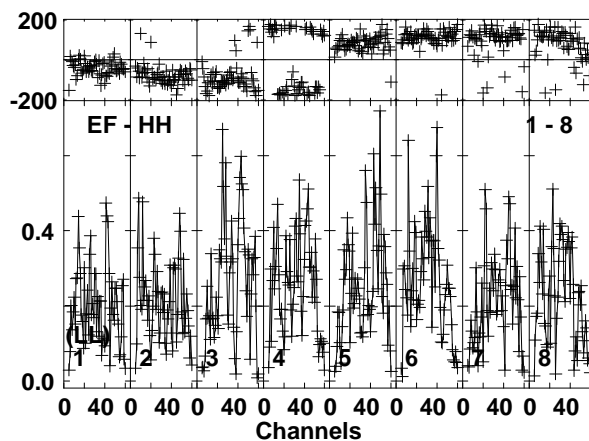
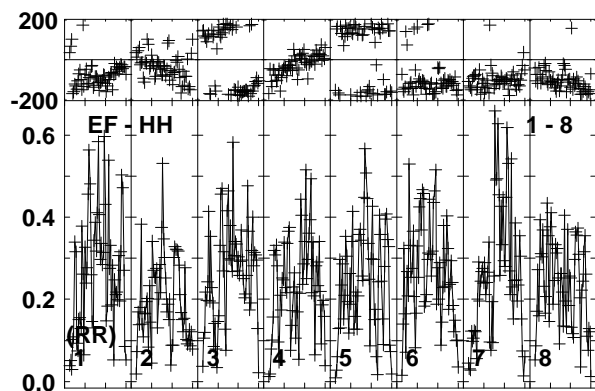
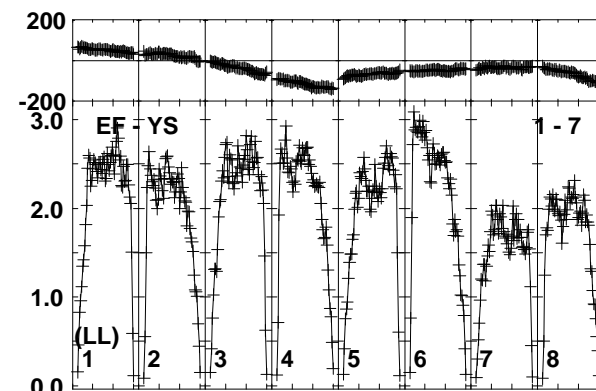
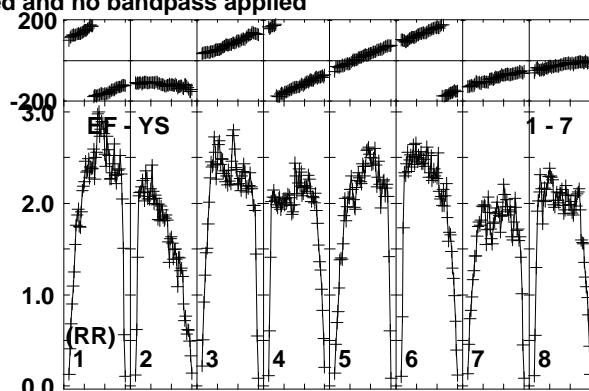
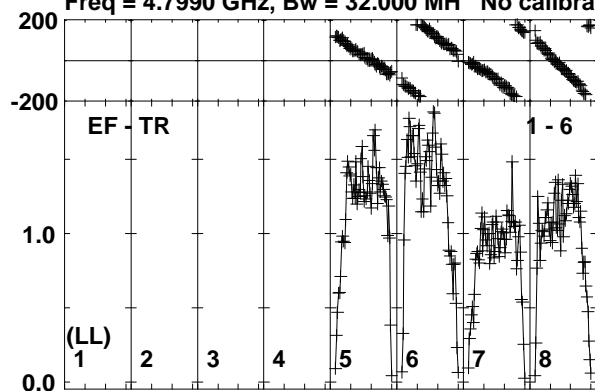

Lower frame: Milli Ampl Jy Top frame: Phas deg  
Vector averaged cross-power spectrum Baseline: EF (01) - TR (06)  
Timerange: 00/13:45:50 to 00/13:46:48





Plot file version 201 created 25-SEP-2017 10:02:47

SSS17A RP029B.UVDATA.1

Freq = 4.7990 GHz, Bw = 32.000 MH No calibration applied and no bandpass applied

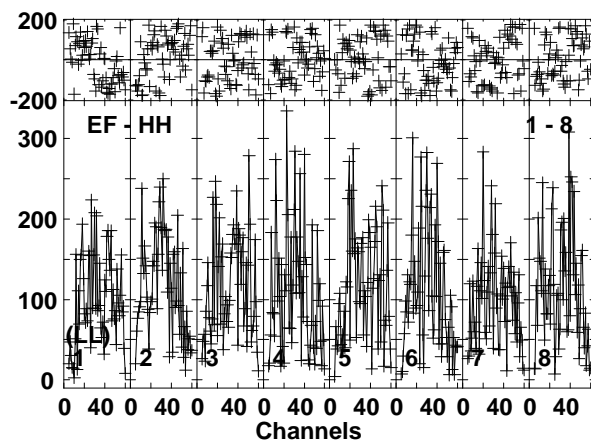
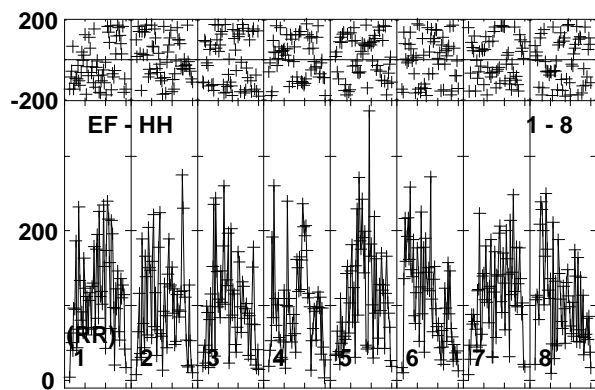
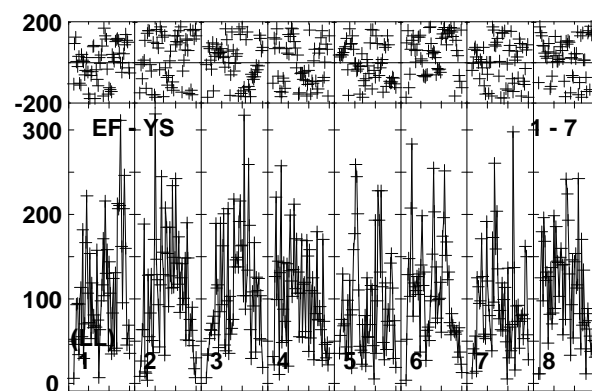
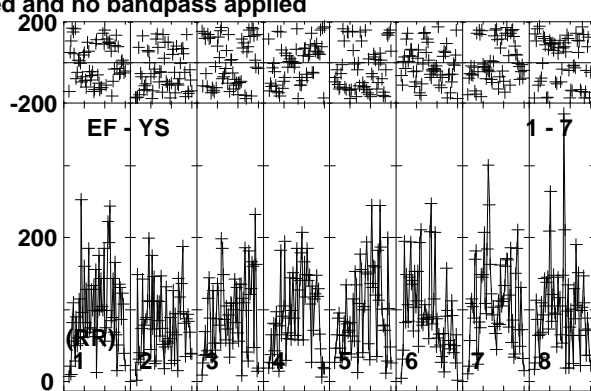
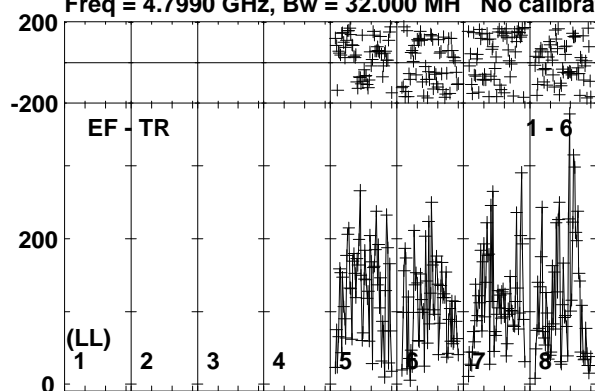

Lower frame: Micro Ampl Jy Top frame: Phas deg  
Vector averaged cross-power spectrum Baseline: EF (01) - TR (06)  
Timerange: 00/13:46:50 to 00/13:49:18

Plot file version 202 created 25-SEP-2017 10:02:47

J1303-2405 RP029B.UVDATA.1

Freq = 4.7990 GHz, Bw = 32.000 MH No calibration applied and no bandpass applied

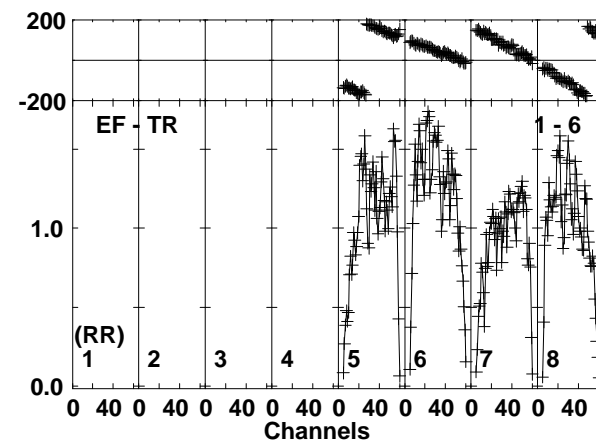
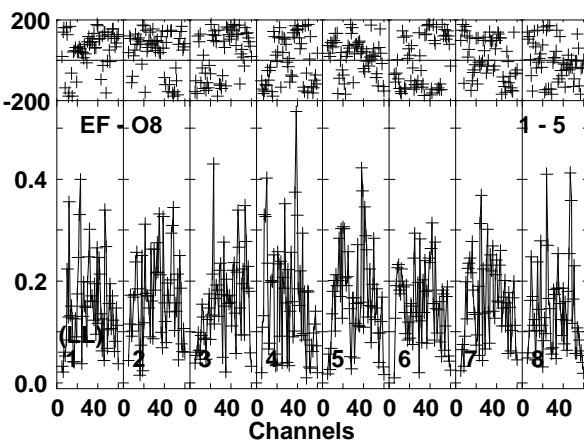
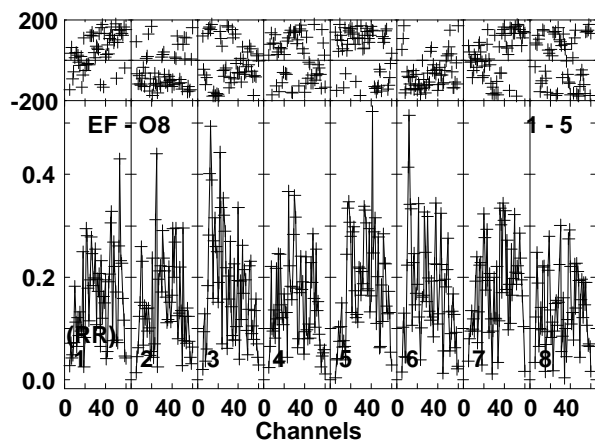
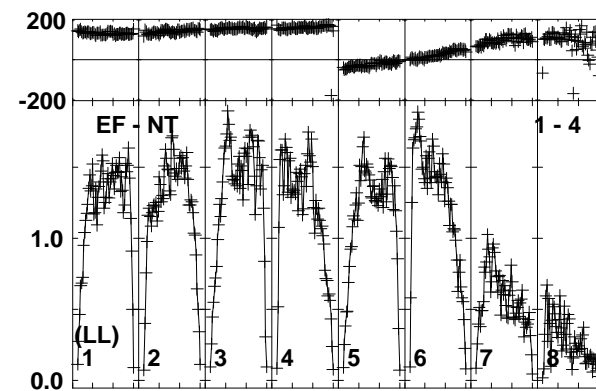
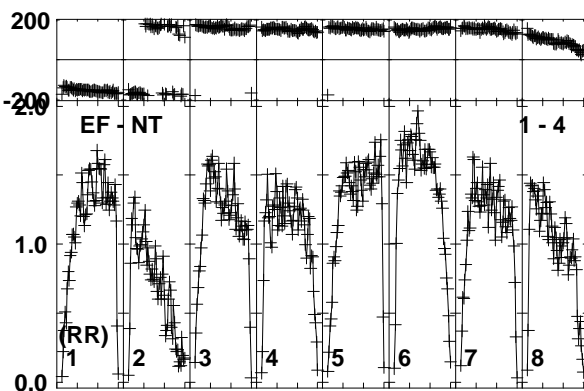
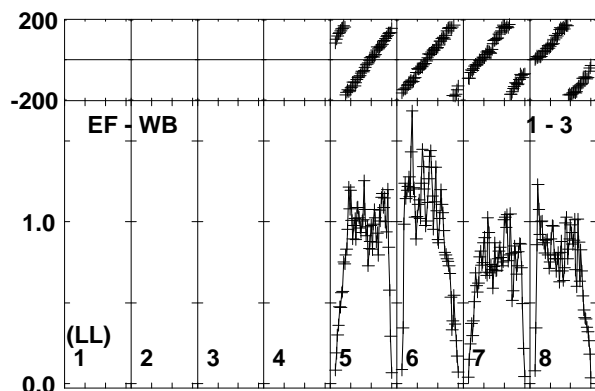
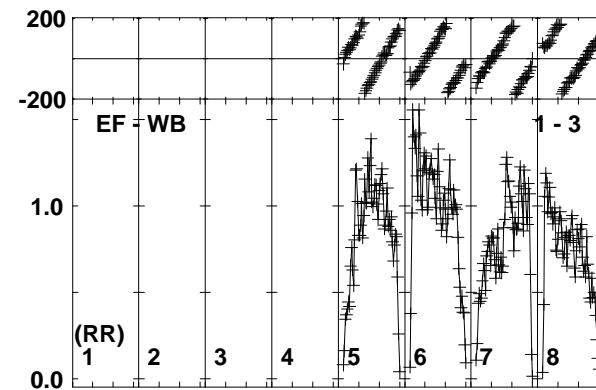
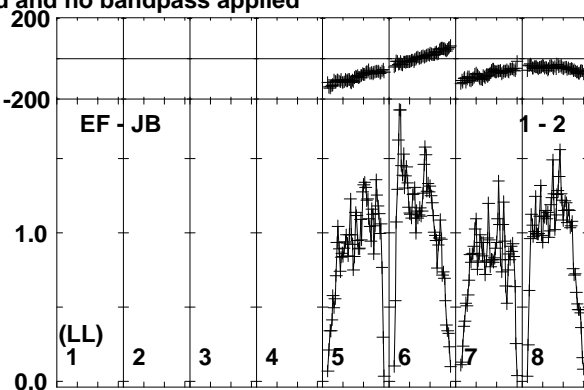
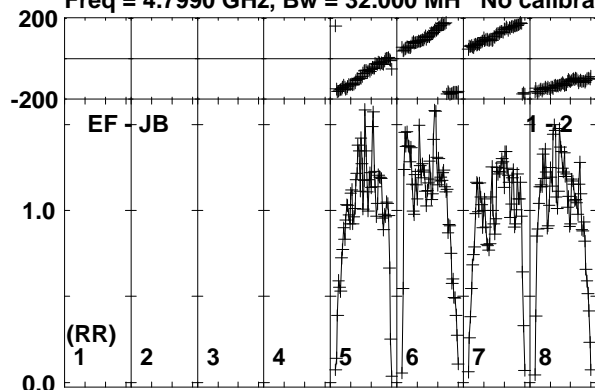

Lower frame: Milli Ampl Jy Top frame: Phas deg  
Vector averaged cross-power spectrum Baseline: EF (01) - JB (02)  
Timerange: 00/13:49:20 to 00/13:50:49

Plot file version 203 created 25-SEP-2017 10:02:47

J1303-2405 RP029B.UVDATA.1

Freq = 4.7990 GHz, Bw = 32.000 MH No calibration applied and no bandpass applied

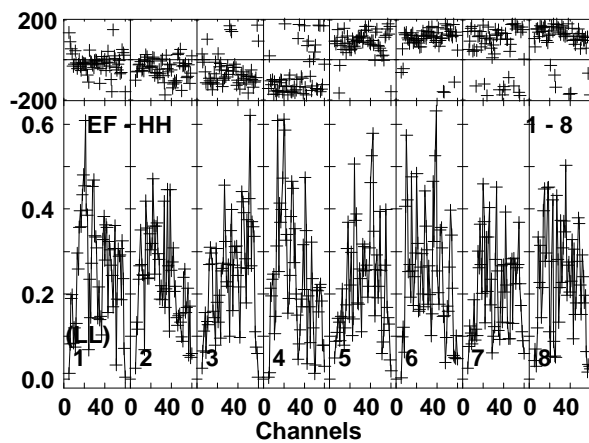
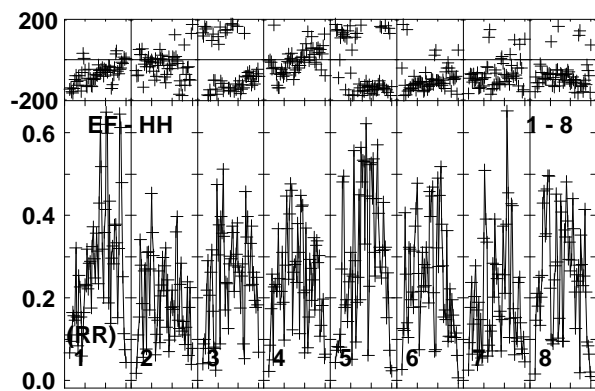
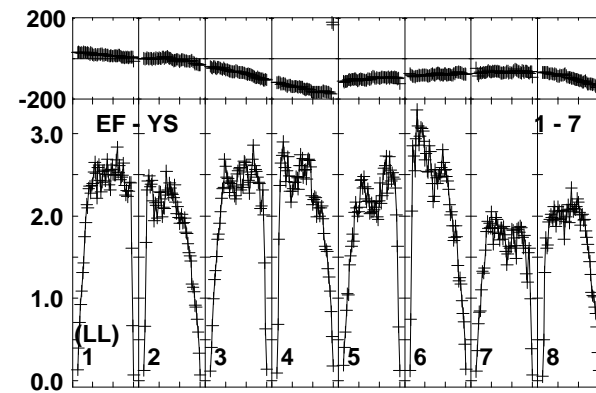
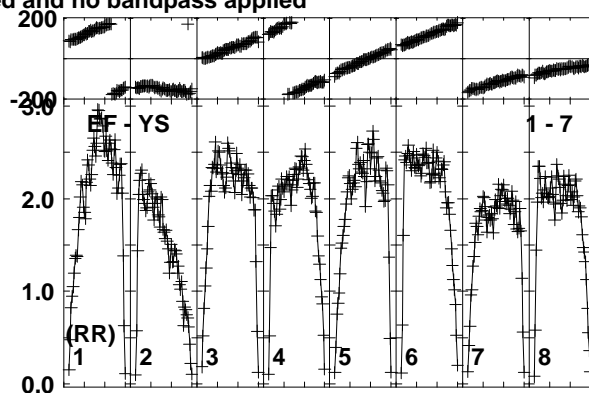
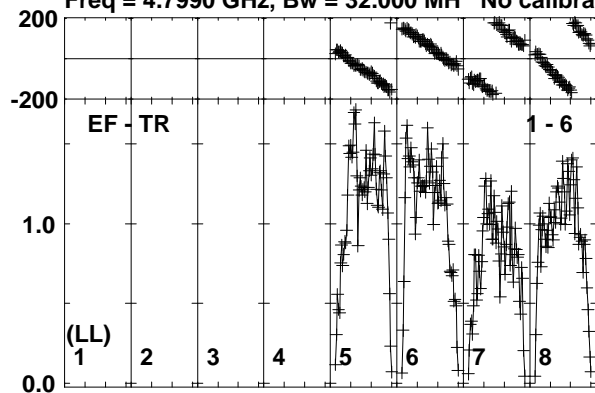

Lower frame: Milli Ampl Jy Top frame: Phas deg  
Vector averaged cross-power spectrum Baseline: EF (01) - TR (06)  
Timerange: 00/13:49:20 to 00/13:50:49

Plot file version 204 created 25-SEP-2017 10:02:47

SSS17A RP029B.UVDATA.1

Freq = 4.7990 GHz, Bw = 32.000 MH No calibration applied and no bandpass applied

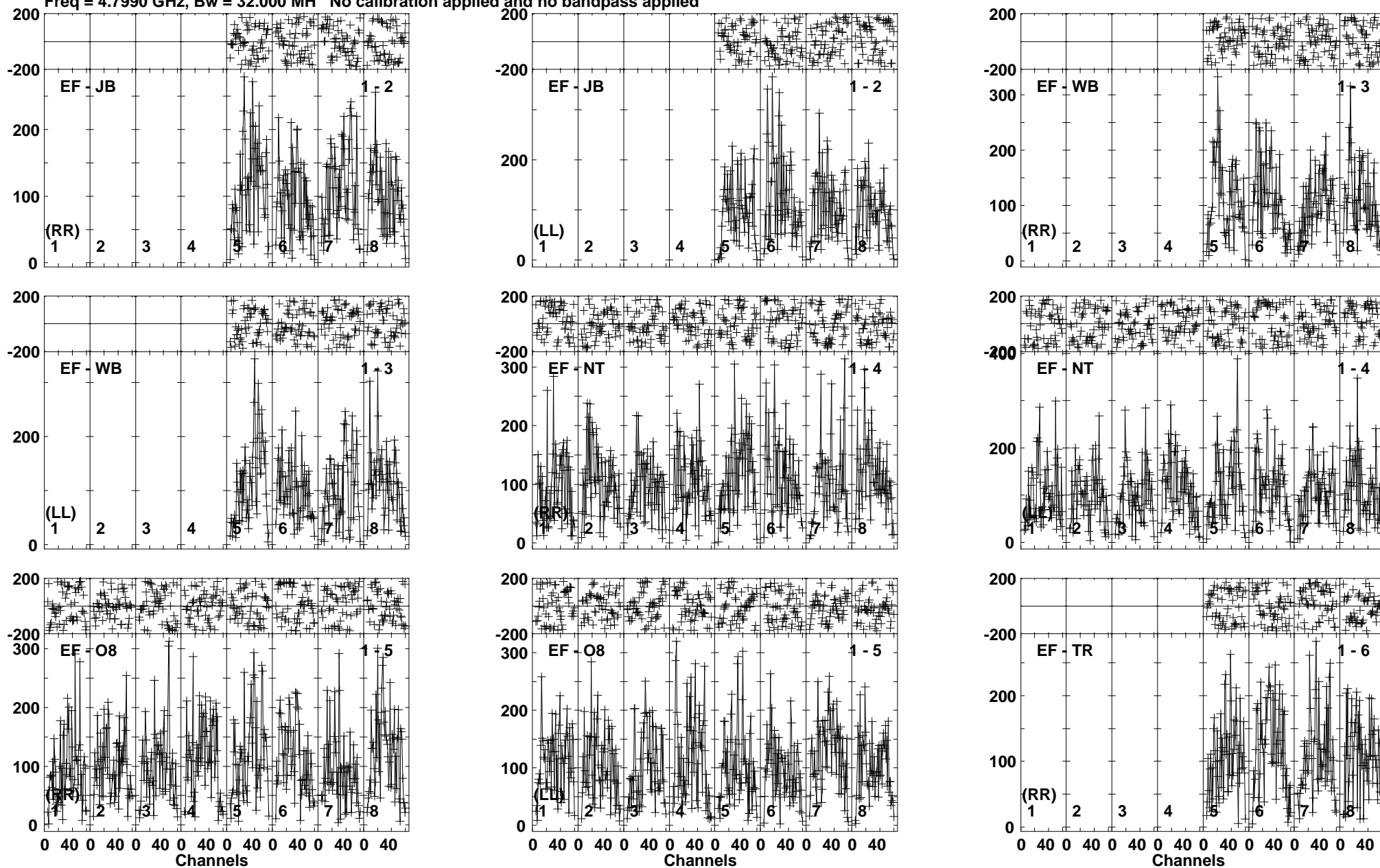

Lower frame: Micro Ampl Jy Top frame: Phas deg  
Vector averaged cross-power spectrum Baseline: EF (01) - JB (02)  
Timerange: 00/13:50:50 to 00/13:53:19

Plot file version 205 created 25-SEP-2017 10:02:47

SSS17A RP029B.UVDATA.1

Freq = 4.7990 GHz, Bw = 32.000 MH No calibration applied and no bandpass applied

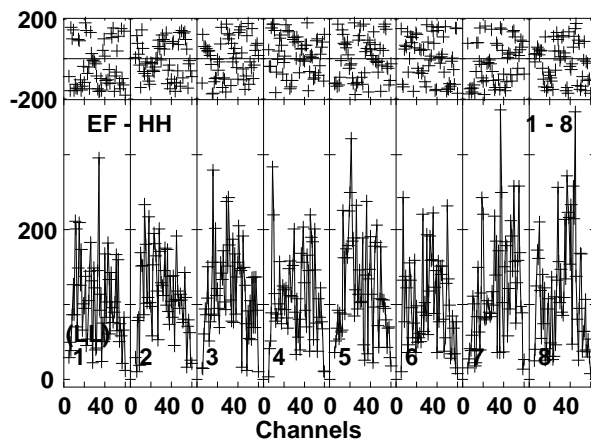
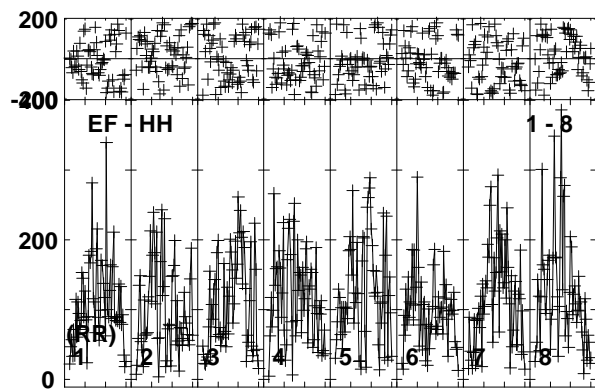
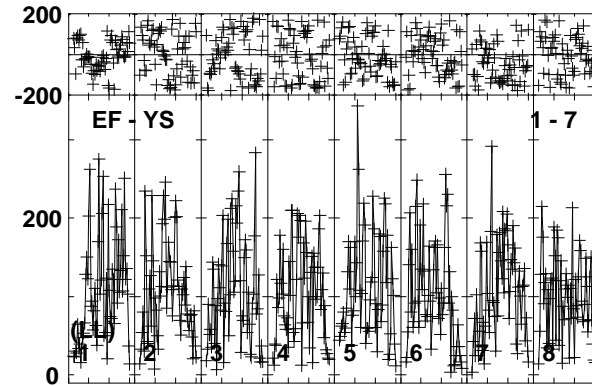
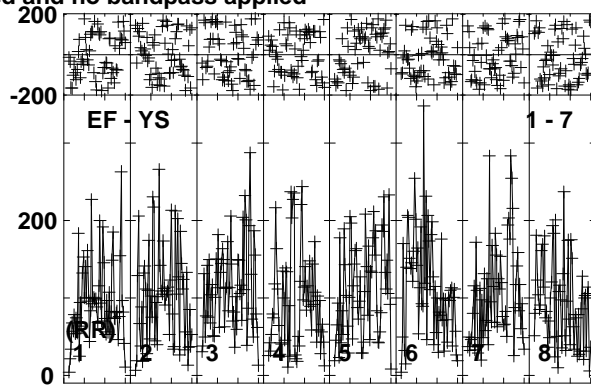
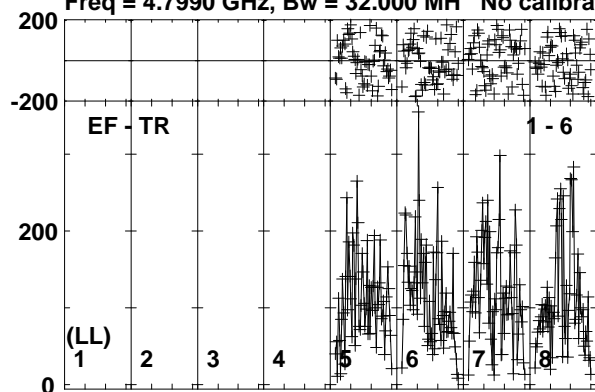

Lower frame: Micro Ampl Jy Top frame: Phas deg  
Vector averaged cross-power spectrum Baseline: EF (01) - TR (06)  
Timerange: 00/13:50:50 to 00/13:53:19

Plot file version 206 created 25-SEP-2017 10:02:48

J1303-2405 RP029B.UVDATA.1

Freq = 4.7990 GHz, Bw = 32.000 MH No calibration applied and no bandpass applied

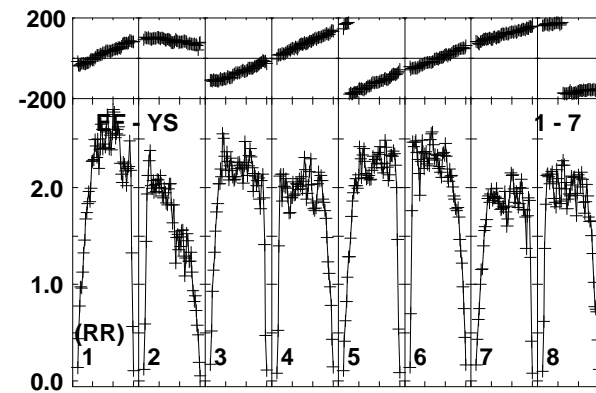
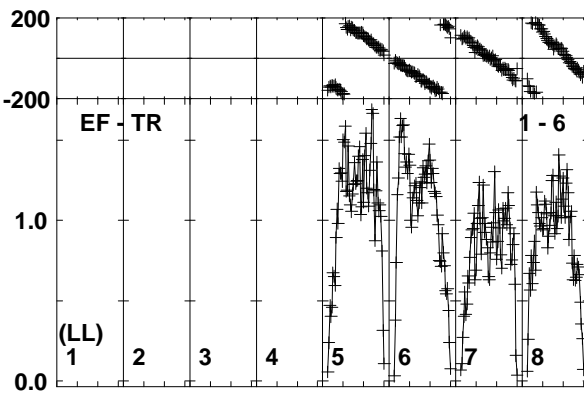
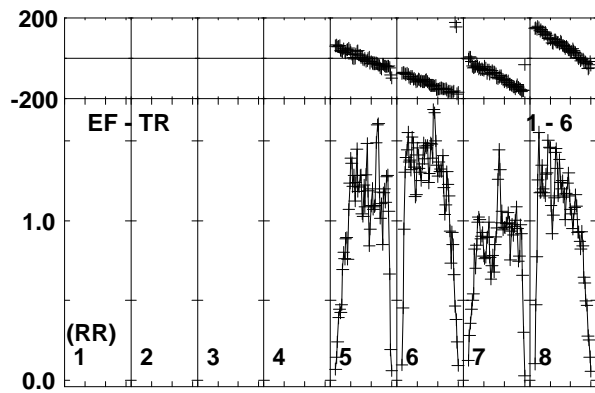
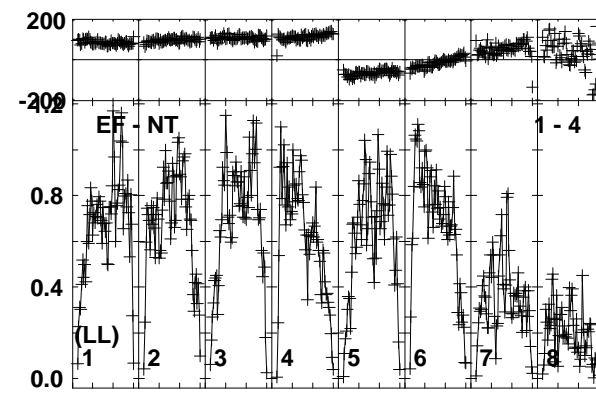
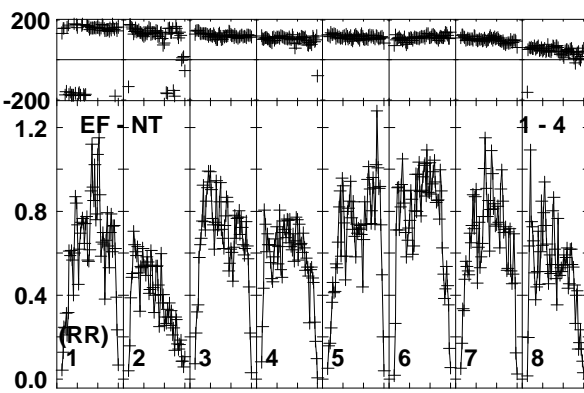
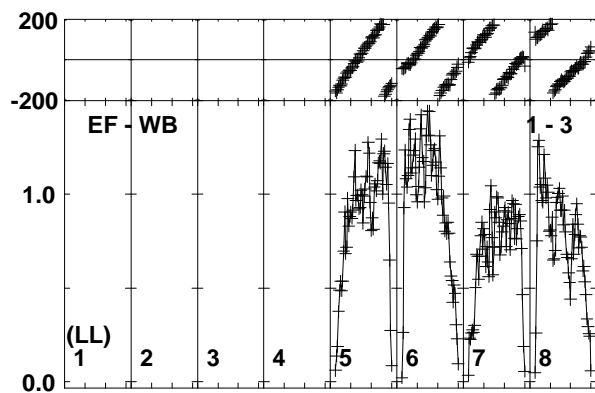
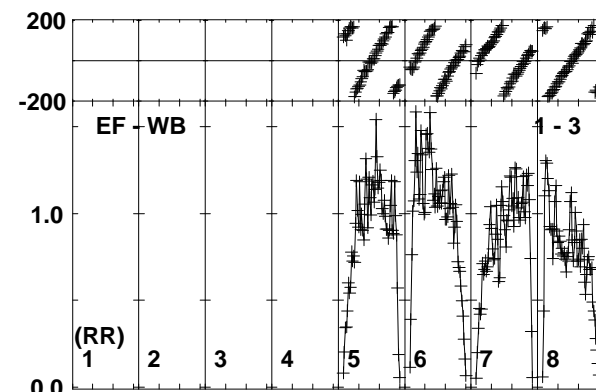
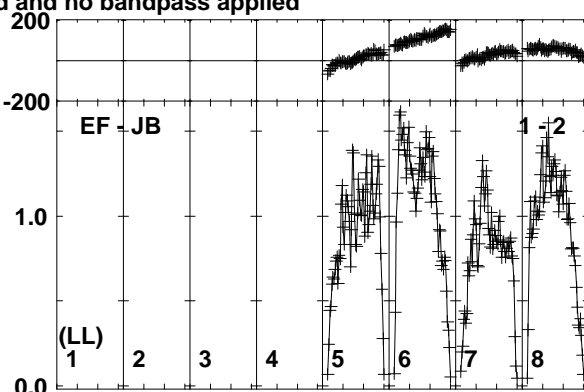
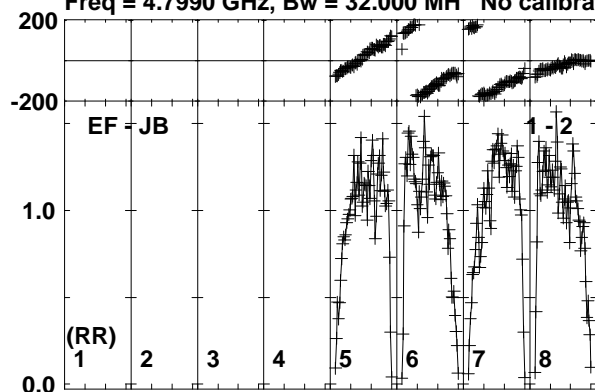

Lower frame: Milli Ampl Jy Top frame: Phas deg  
Vector averaged cross-power spectrum Baseline: EF (01) - JB (02)  
Timerange: 00/13:53:50 to 00/13:54:48

Plot file version 207 created 25-SEP-2017 10:02:48

J1303-2405 RP029B.UVDATA.1

Freq = 4.7990 GHz, Bw = 32.000 MH No calibration applied and no bandpass applied

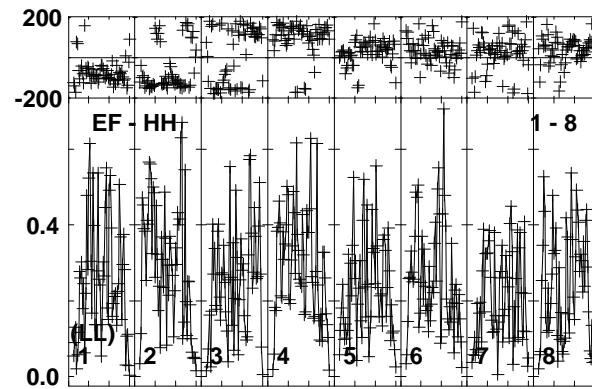
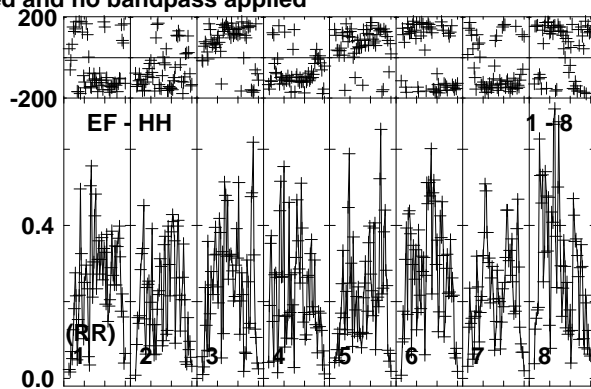
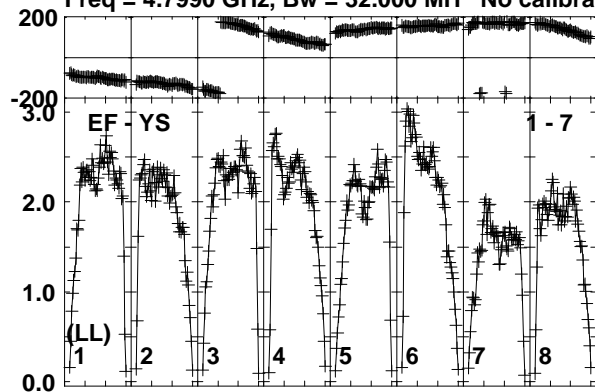

Lower frame: Milli Ampl Jy Top frame: Phas deg  
Vector averaged cross-power spectrum Baseline: EF (01) - YS (07)  
Timerange: 00/13:53:50 to 00/13:54:48

Plot file version 208 created 25-SEP-2017 10:02:48

SSS17A RP029B.UVDATA.1

Freq = 4.7990 GHz, Bw = 32.000 MH No calibration applied and no bandpass applied

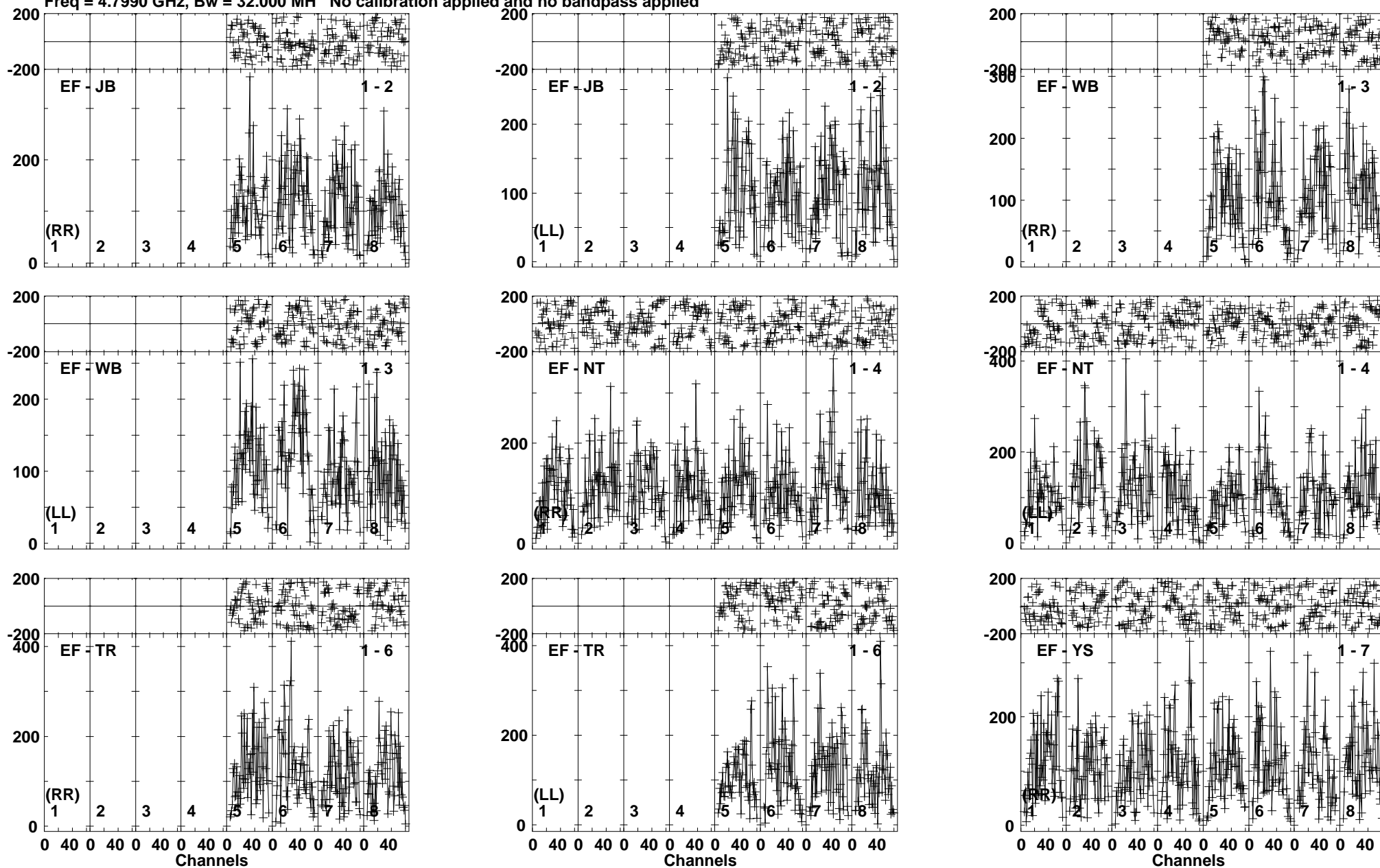

Lower frame: Micro Ampl Jy Top frame: Phas deg  
Vector averaged cross-power spectrum Baseline: EF (01) - JB (02)  
Timerange: 00/13:54:49 to 00/13:57:18



Plot file version 209 created 25-SEP-2017 10:02:48

SSS17A RP029B.UVDATA.1

Freq = 4.7990 GHz, Bw = 32.000 MH No calibration applied and no bandpass applied

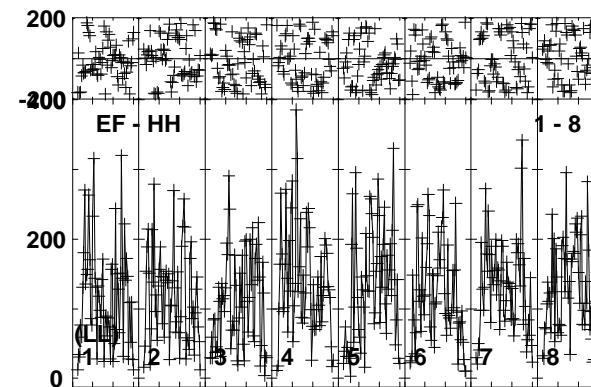
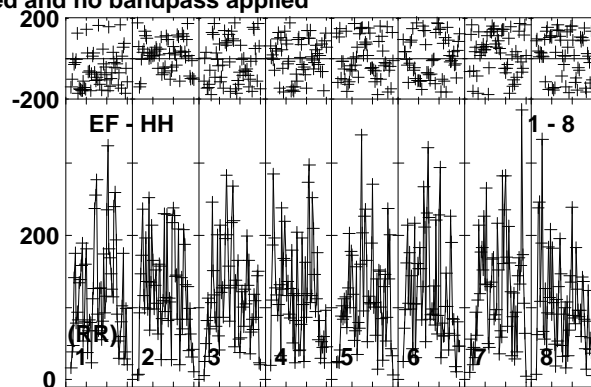
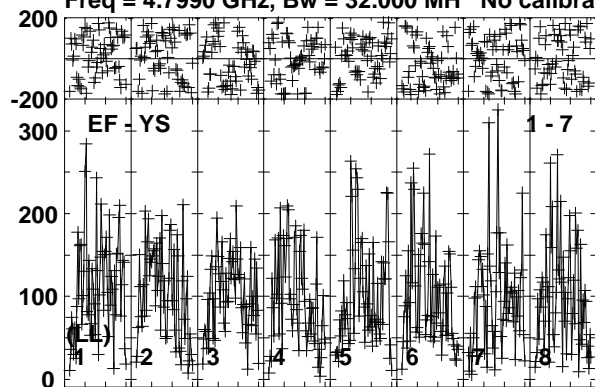

Lower frame: Micro Ampl Jy Top frame: Phas deg  
Vector averaged cross-power spectrum Baseline: EF (01) - YS (07)  
Timerange: 00/13:54:49 to 00/13:57:18

Plot file version 210 created 25-SEP-2017 10:02:48

J1303-2405 RP029B.UVDATA.1

Freq = 4.7990 GHz, Bw = 32.000 MH No calibration applied and no bandpass applied

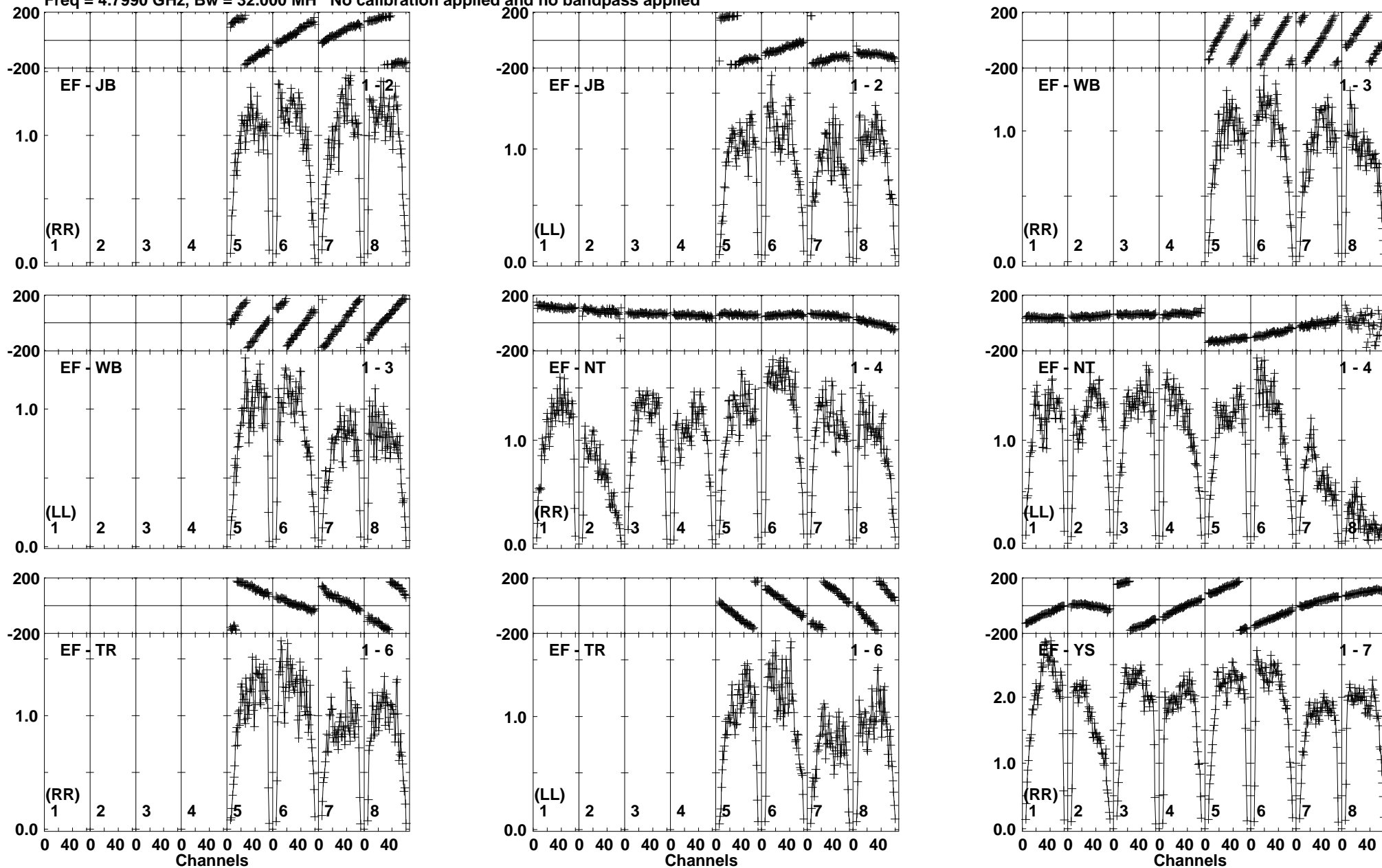

Lower frame: Milli Ampl Jy Top frame: Phas deg  
Vector averaged cross-power spectrum Baseline: EF (01) - JB (02)  
Timerange: 00/13:57:19 to 00/13:58:48

Plot file version 211 created 25-SEP-2017 10:02:48

J1303-2405 RP029B.UVDATA.1

Freq = 4.7990 GHz, Bw = 32.000 MH No calibration applied and no bandpass applied

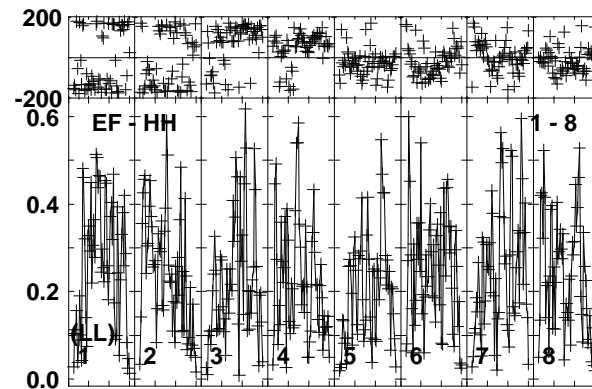
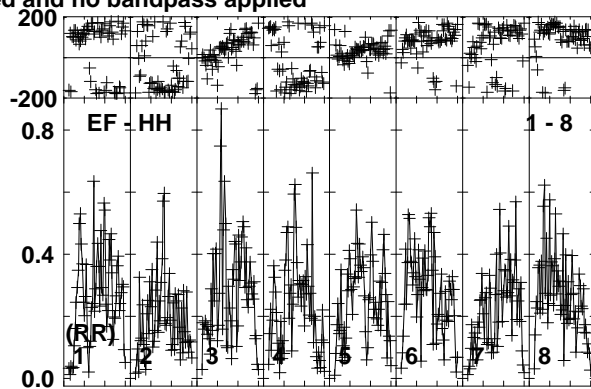
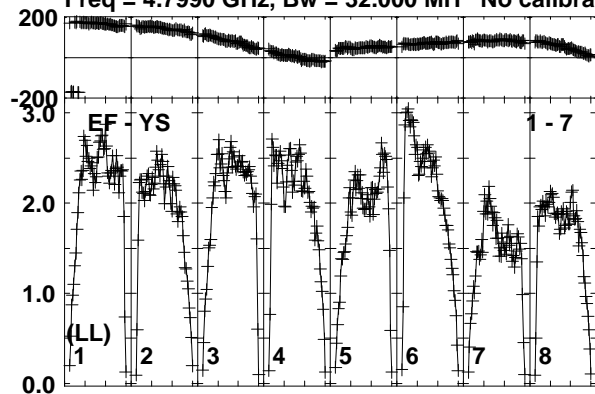

Lower frame: Milli Ampl Jy Top frame: Phas deg  
Vector averaged cross-power spectrum Baseline: EF (01) - YS (07)  
Timerange: 00/13:57:19 to 00/13:58:48

Plot file version 212 created 25-SEP-2017 10:02:48

J1312-2350 RP029B.UVDATA.1

Freq = 4.7990 GHz, Bw = 32.000 MH No calibration applied and no bandpass applied

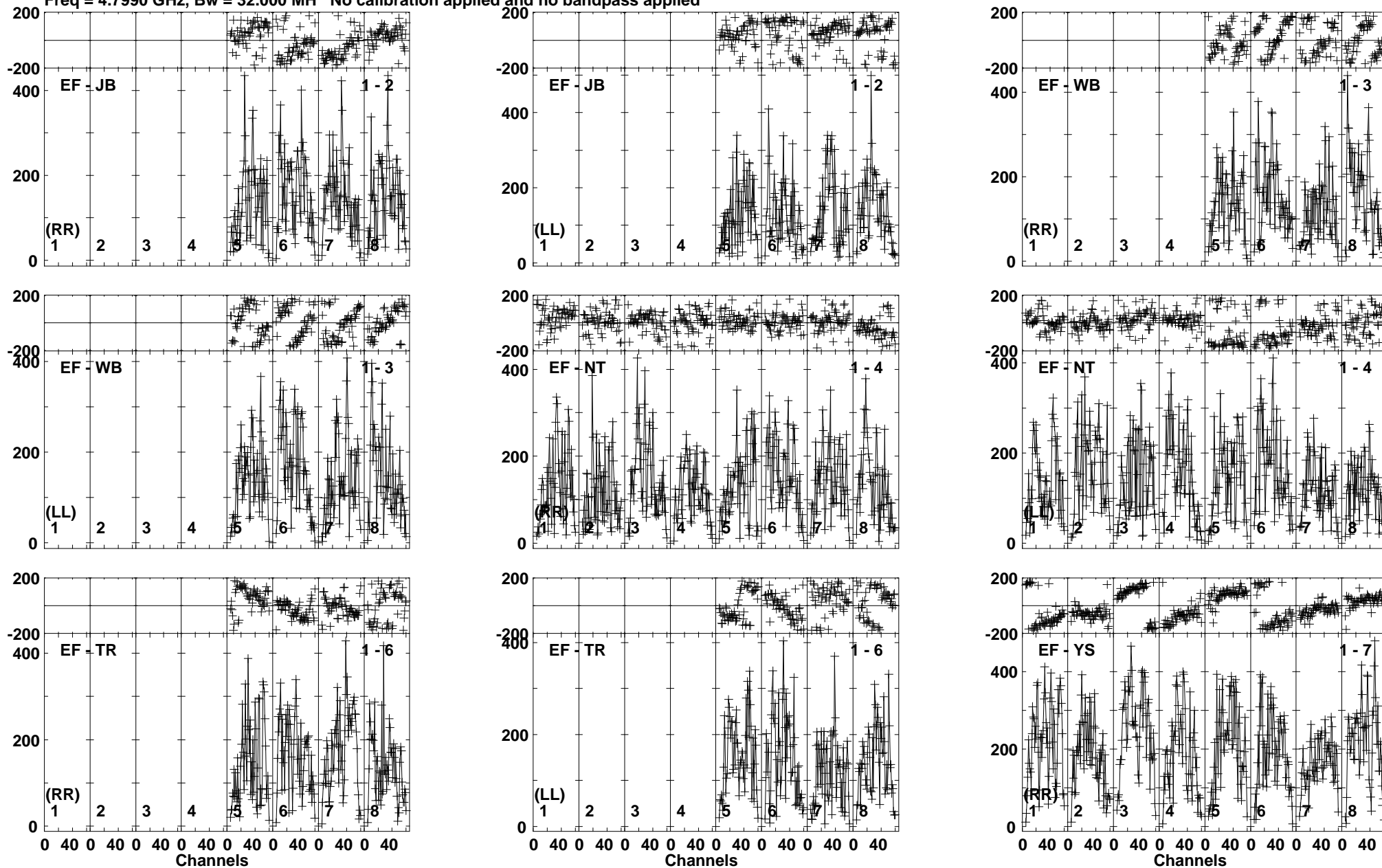

Lower frame: Micro Ampl Jy Top frame: Phas deg  
Vector averaged cross-power spectrum Baseline: EF (01) - JB (02)  
Timerange: 00/13:58:50 to 00/14:01:18

Plot file version 213 created 25-SEP-2017 10:02:49

J1312-2350 RP029B.UVDATA.1

Freq = 4.7990 GHz, Bw = 32.000 MH No calibration applied and no bandpass applied

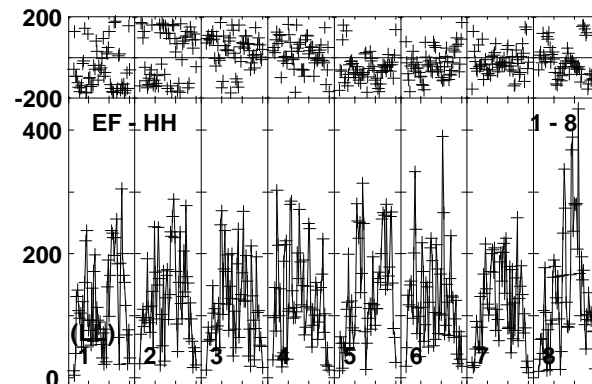
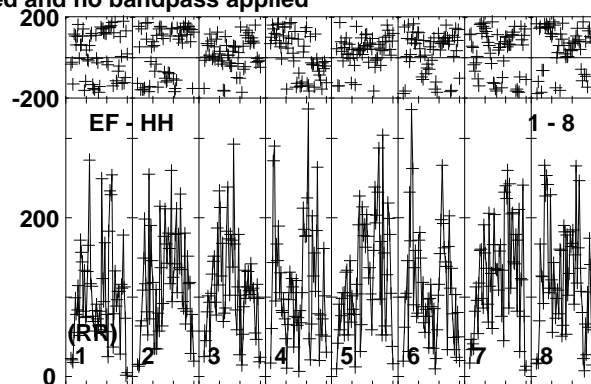
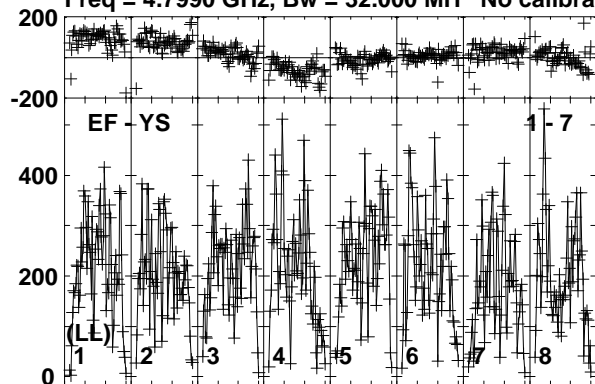

Lower frame: Micro Ampl Jy Top frame: Phas deg  
Vector averaged cross-power spectrum Baseline: EF (01) - YS (07)  
Timerange: 00/13:58:50 to 00/14:01:18

Plot file version 214 created 25-SEP-2017 10:02:49

J1303-2405 RP029B.UVDATA.1

Freq = 4.7990 GHz, Bw = 32.000 MH No calibration applied and no bandpass applied

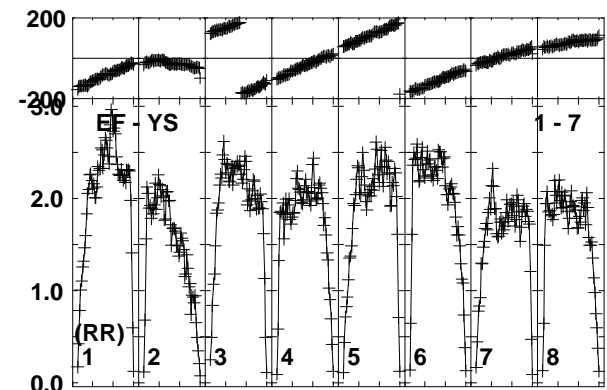
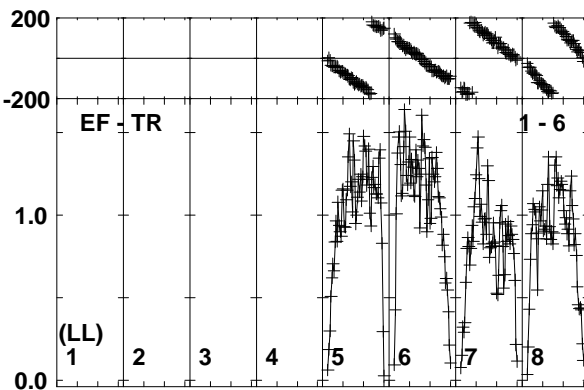
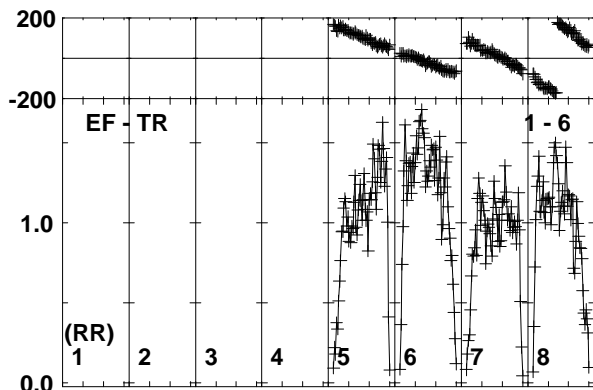
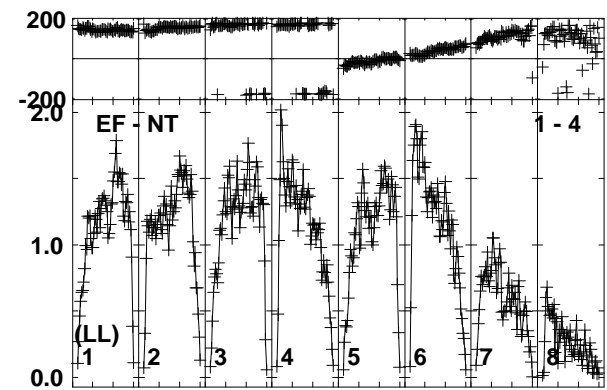
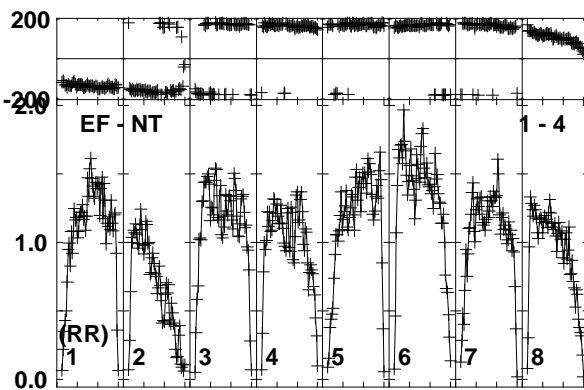
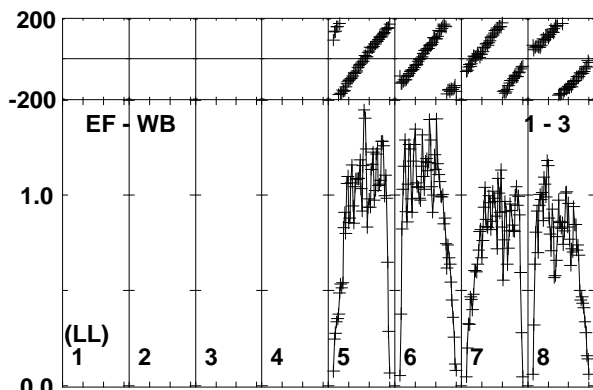
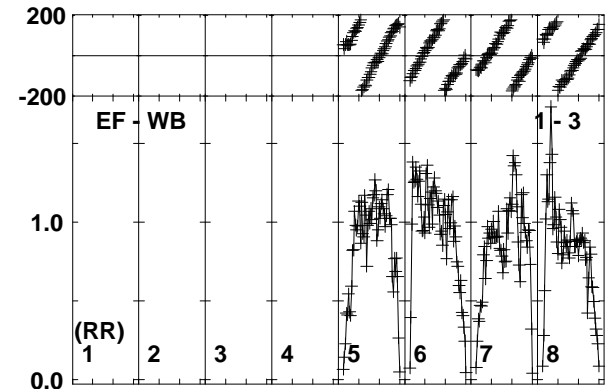
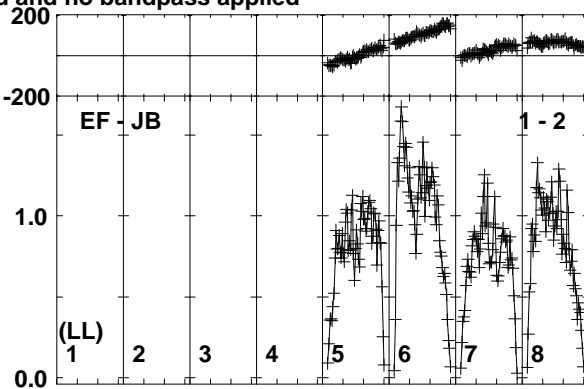
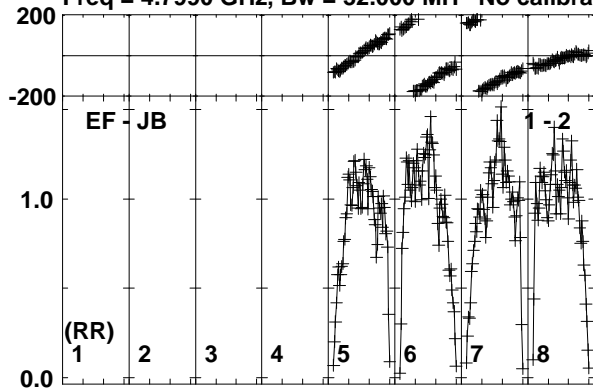

Lower frame: Milli Ampl Jy Top frame: Phas deg  
Vector averaged cross-power spectrum Baseline: EF (01) - JB (02)  
Timerange: 00/14:02:00 to 00/14:02:58

Plot file version 215 created 25-SEP-2017 10:02:49

J1303-2405 RP029B.UVDATA.1

Freq = 4.7990 GHz, Bw = 32.000 MH No calibration applied and no bandpass applied

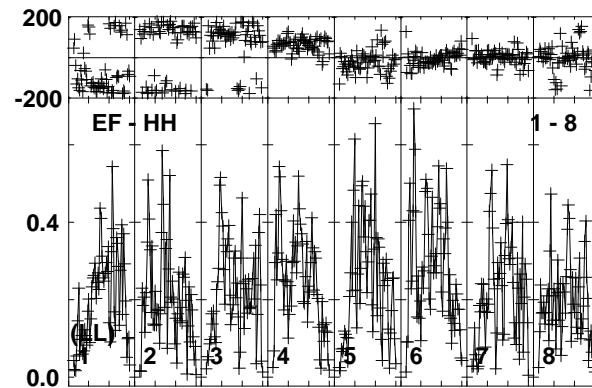
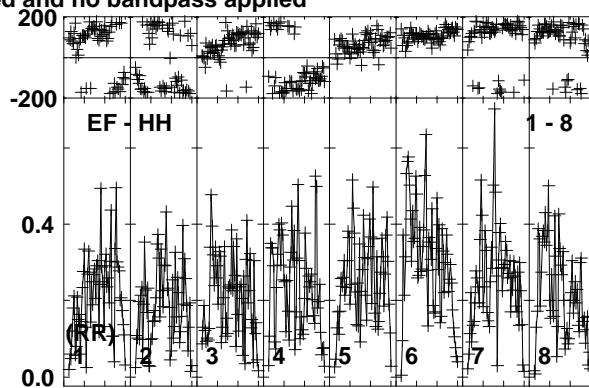
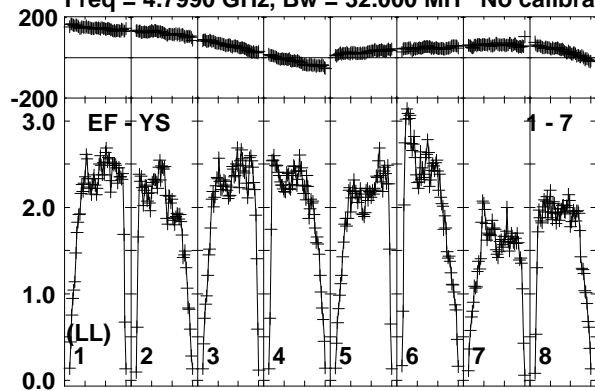

Lower frame: Milli Ampl Jy Top frame: Phas deg  
Vector averaged cross-power spectrum Baseline: EF (01) - YS (07)  
Timerange: 00/14:02:00 to 00/14:02:58

Plot file version 216 created 25-SEP-2017 10:02:49

SSS17A RP029B.UVDATA.1

Freq = 4.7990 GHz, Bw = 32.000 MH No calibration applied and no bandpass applied

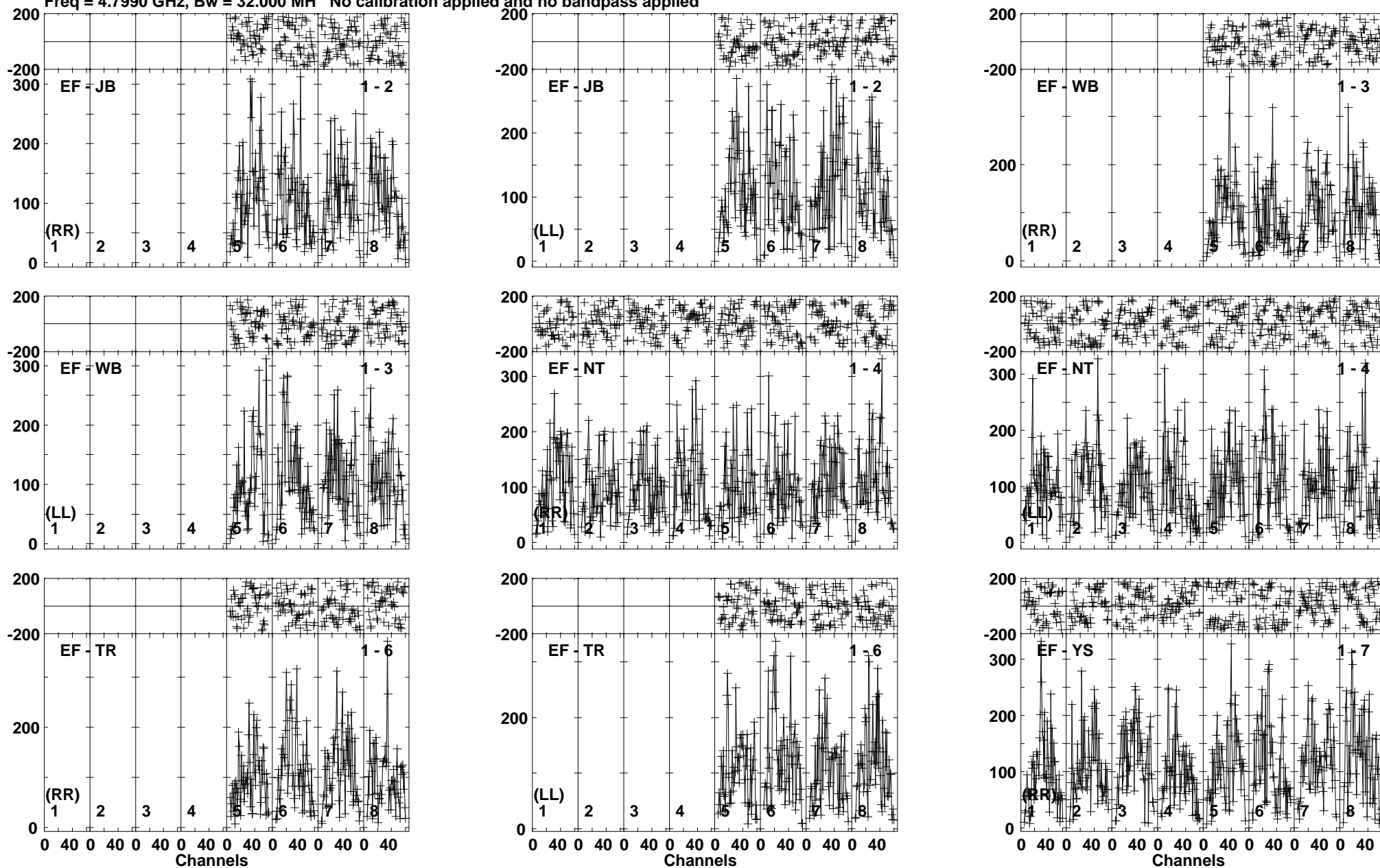

Lower frame: Micro Ampl Jy Top frame: Phas deg  
Vector averaged cross-power spectrum Baseline: EF (01) - JB (02)  
Timerange: 00/14:03:00 to 00/14:05:29



Plot file version 217 created 25-SEP-2017 10:02:49

SSS17A RP029B.UVDATA.1

Freq = 4.7990 GHz, Bw = 32.000 MH No calibration applied and no bandpass applied

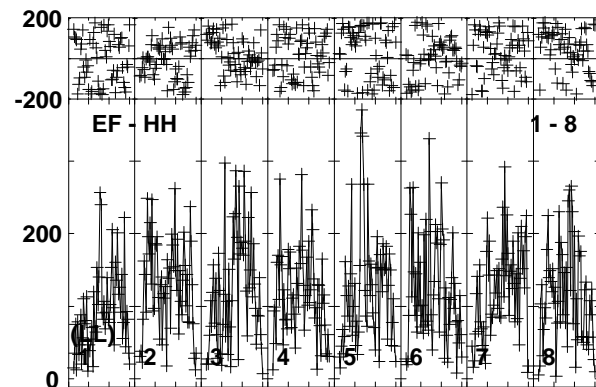
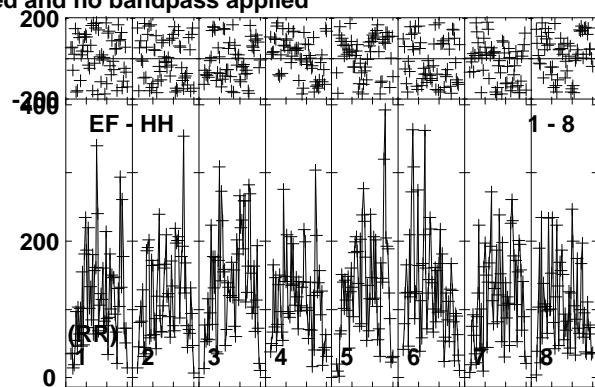
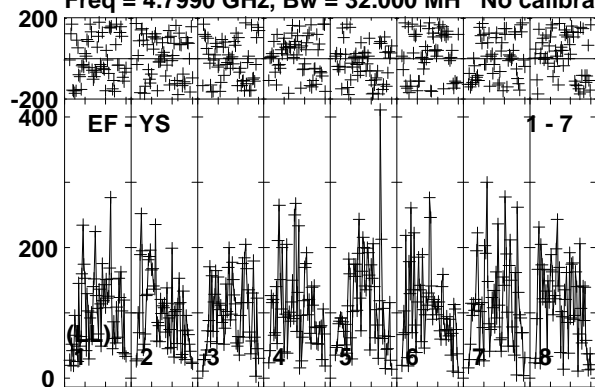

Lower frame: Micro Ampl Jy Top frame: Phas deg  
Vector averaged cross-power spectrum Baseline: EF (01) - YS (07)  
Timerange: 00/14:03:00 to 00/14:05:29

Plot file version 218 created 25-SEP-2017 10:02:49

J1303-2405 RP029B.UVDATA.1

Freq = 4.7990 GHz, Bw = 32.000 MH No calibration applied and no bandpass applied

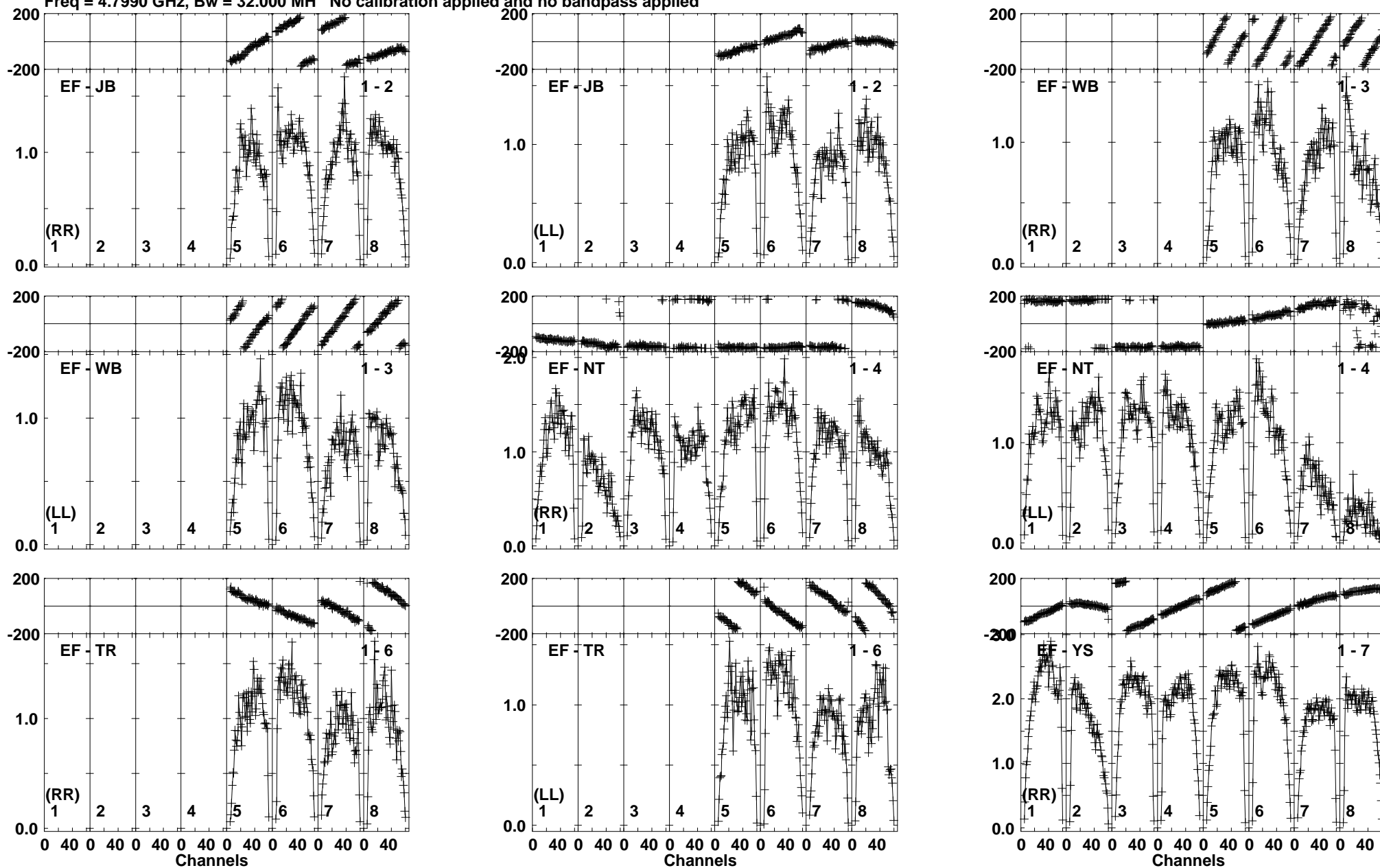

Lower frame: Milli Ampl Jy Top frame: Phas deg  
Vector averaged cross-power spectrum Baseline: EF (01) - JB (02)  
Timerange: 00/14:05:30 to 00/14:06:59

Plot file version 219 created 25-SEP-2017 10:02:49

J1303-2405 RP029B.UVDATA.1

Freq = 4.7990 GHz, Bw = 32.000 MH No calibration applied and no bandpass applied

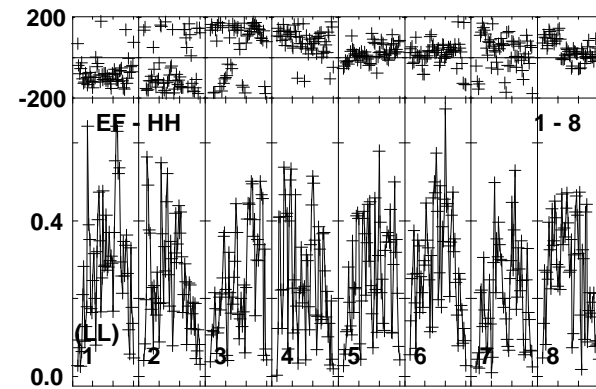
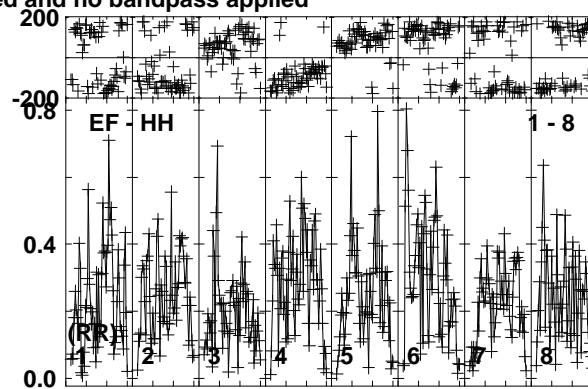
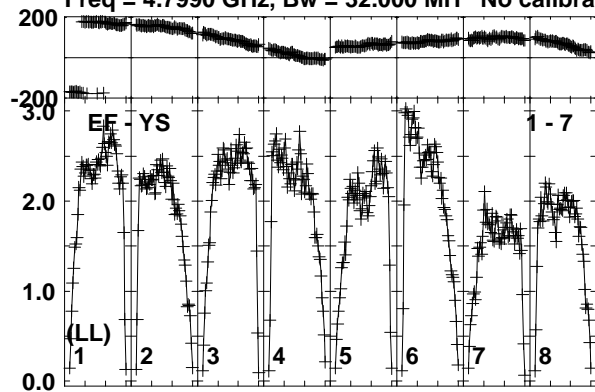

Lower frame: Milli Ampl Jy Top frame: Phas deg  
Vector averaged cross-power spectrum Baseline: EF (01) - YS (07)  
Timerange: 00/14:05:30 to 00/14:06:59

Plot file version 220 created 25-SEP-2017 10:02:49

SSS17A RP029B.UVDATA.1

Freq = 4.7990 GHz, Bw = 32.000 MH No calibration applied and no bandpass applied

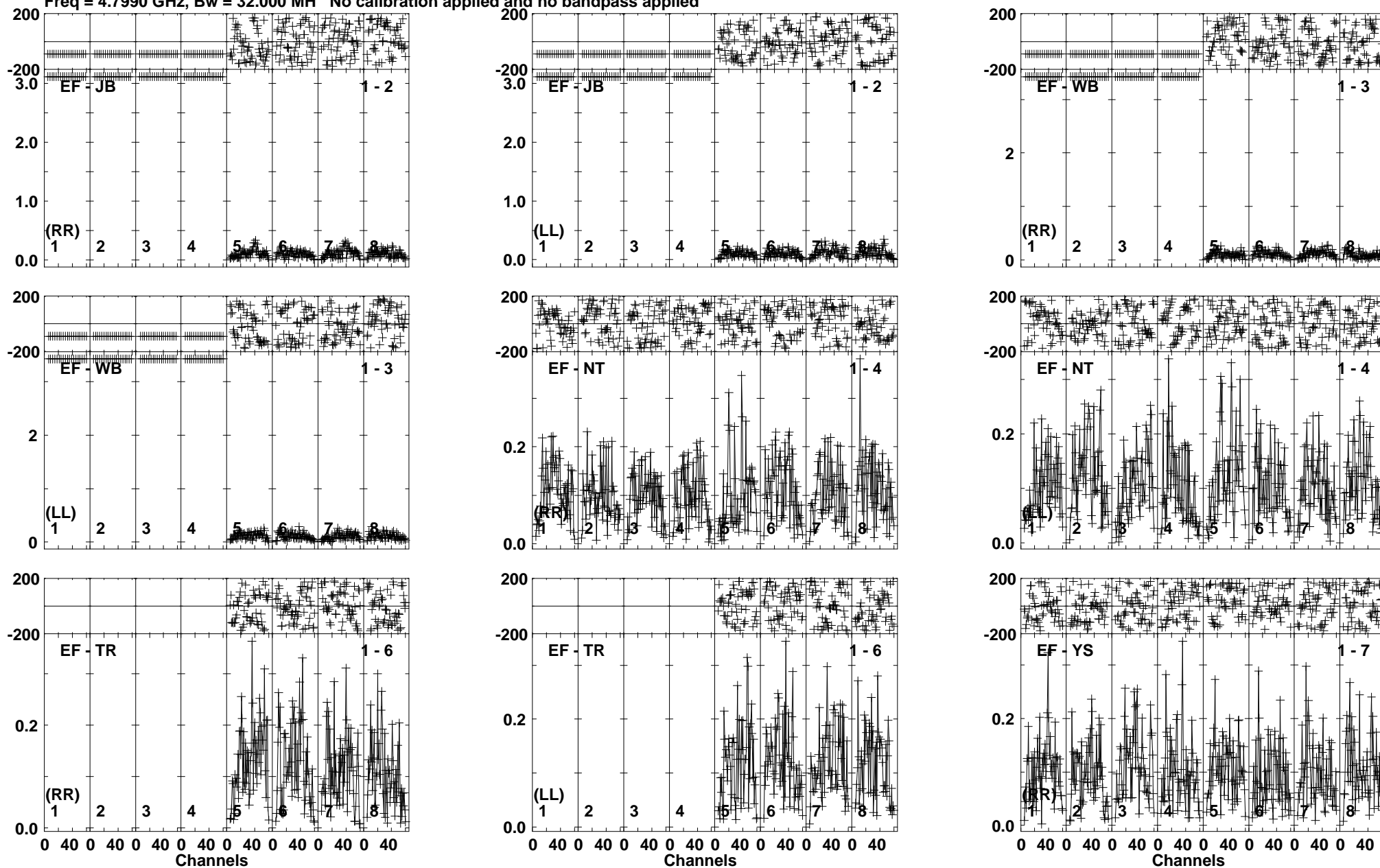

Lower frame: Milli Ampl Jy Top frame: Phas deg  
Vector averaged cross-power spectrum Baseline: EF (01) - JB (02)  
Timerange: 00/14:06:59 to 00/14:09:28

Plot file version 221 created 25-SEP-2017 10:02:50

SSS17A RP029B.UVDATA.1

Freq = 4.7990 GHz, Bw = 32.000 MH No calibration applied and no bandpass applied

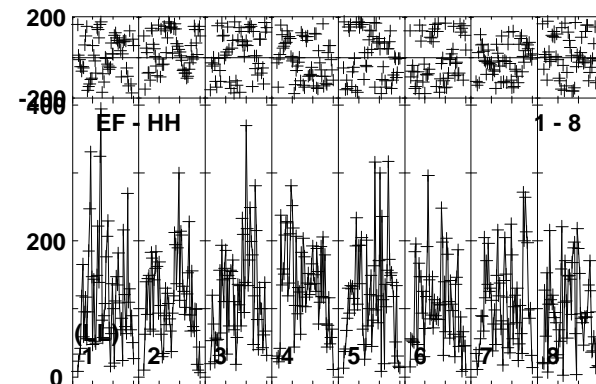
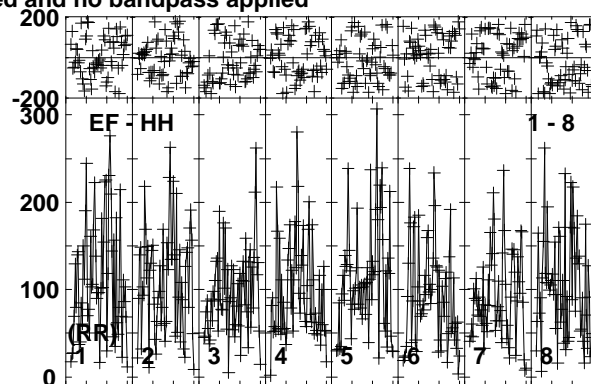
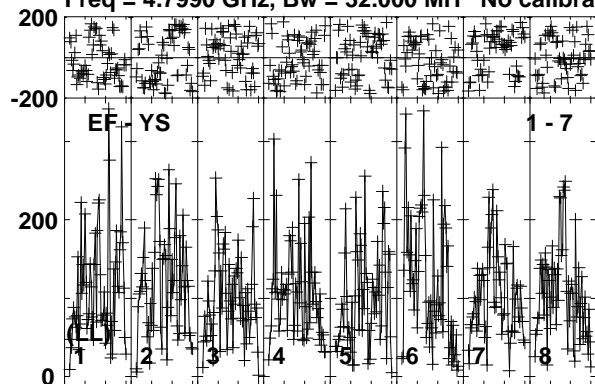

Lower frame: Micro Ampl Jy Top frame: Phas deg  
Vector averaged cross-power spectrum Baseline: EF (01) - YS (07)  
Timerange: 00/14:06:59 to 00/14:09:28

Plot file version 222 created 25-SEP-2017 10:02:50

J1303-2405 RP029B.UVDATA.1

Freq = 4.7990 GHz, Bw = 32.000 MH No calibration applied and no bandpass applied

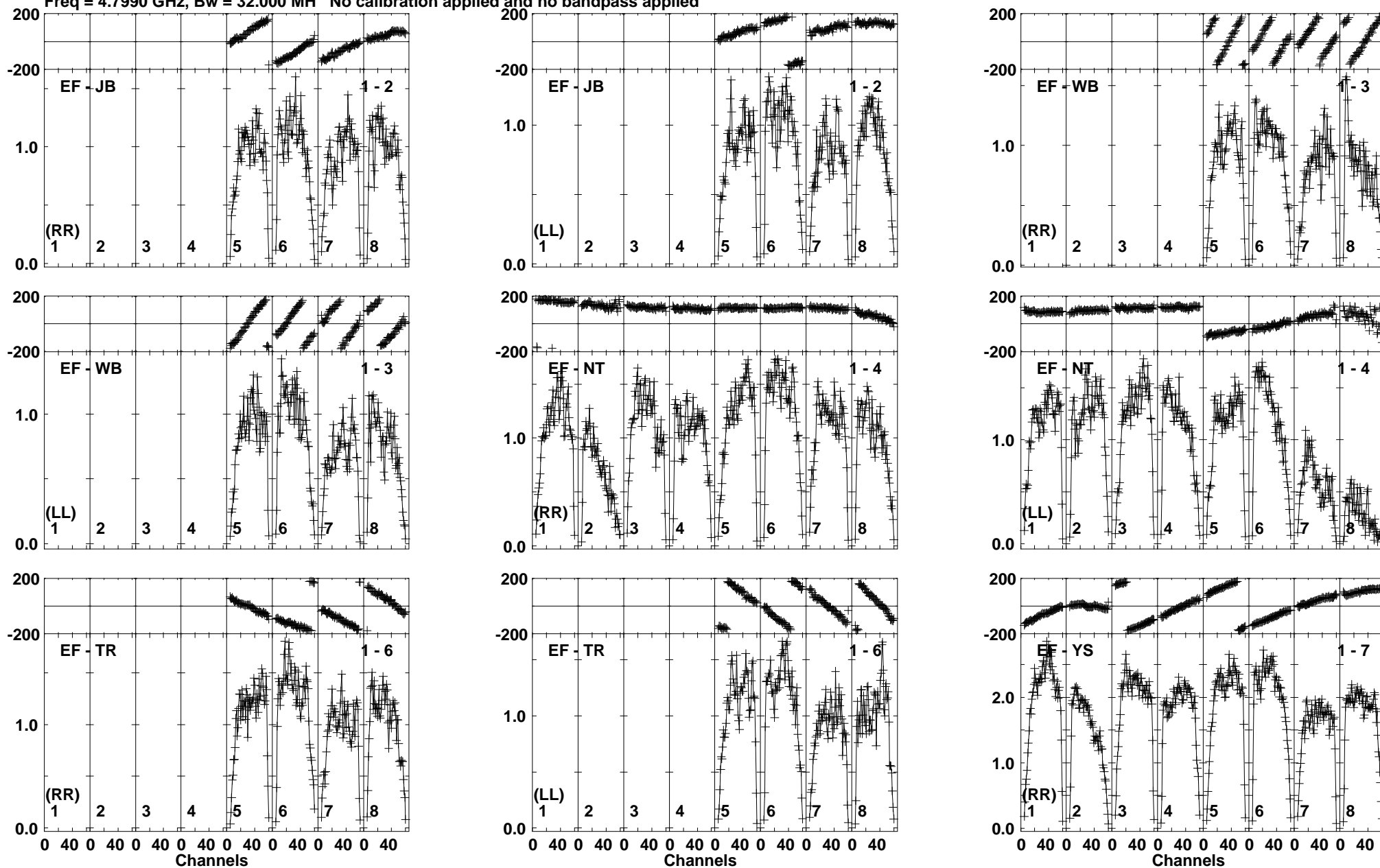

Lower frame: Milli Ampl Jy Top frame: Phas deg  
Vector averaged cross-power spectrum Baseline: EF (01) - JB (02)  
Timerange: 00/14:10:00 to 00/14:10:58

Plot file version 223 created 25-SEP-2017 10:02:50

J1303-2405 RP029B.UVDATA.1

Freq = 4.7990 GHz, Bw = 32.000 MH No calibration applied and no bandpass applied

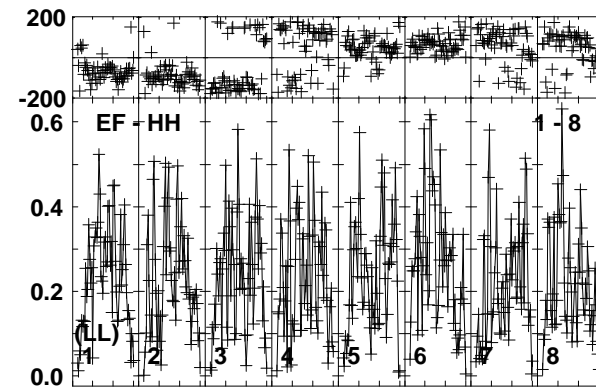
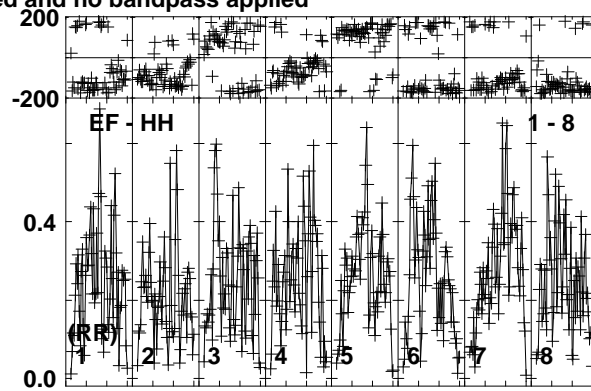
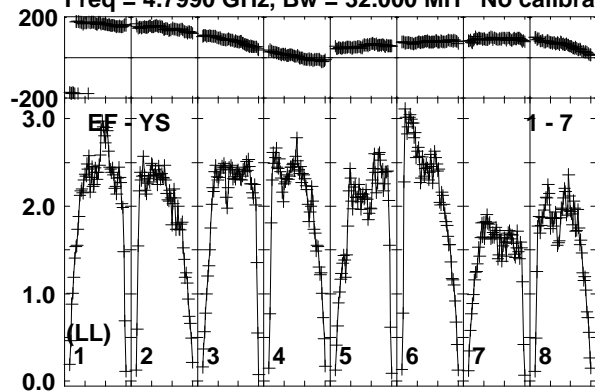

Lower frame: Milli Ampl Jy Top frame: Phas deg  
Vector averaged cross-power spectrum Baseline: EF (01) - YS (07)  
Timerange: 00/14:10:00 to 00/14:10:58

Plot file version 224 created 25-SEP-2017 10:02:50

SSS17A RP029B.UVDATA.1

Freq = 4.7990 GHz, Bw = 32.000 MH No calibration applied and no bandpass applied

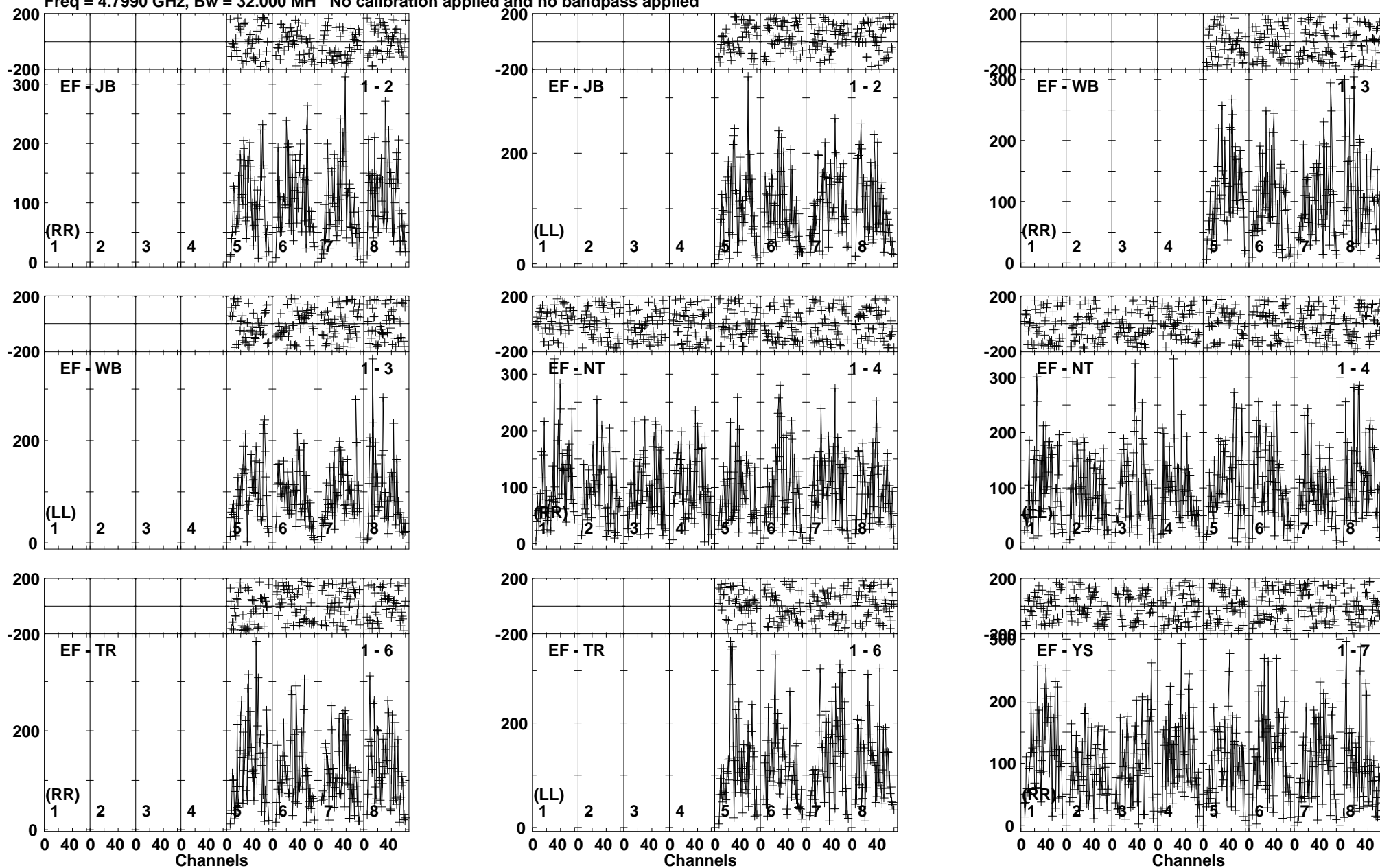

Lower frame: Micro Ampl Jy Top frame: Phas deg  
Vector averaged cross-power spectrum Baseline: EF (01) - JB (02)  
Timerange: 00/14:11:00 to 00/14:13:28



Plot file version 225 created 25-SEP-2017 10:02:50

SSS17A RP029B.UVDATA.1

Freq = 4.7990 GHz, Bw = 32.000 MH No calibration applied and no bandpass applied

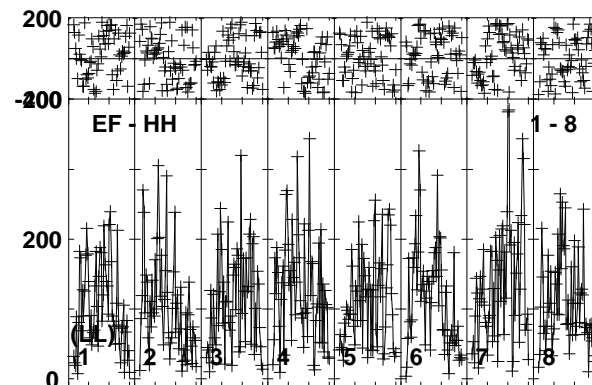
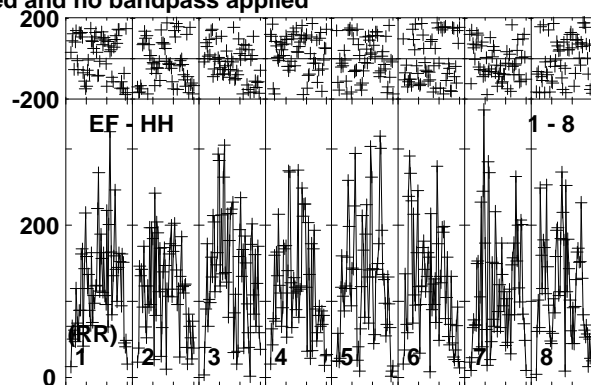
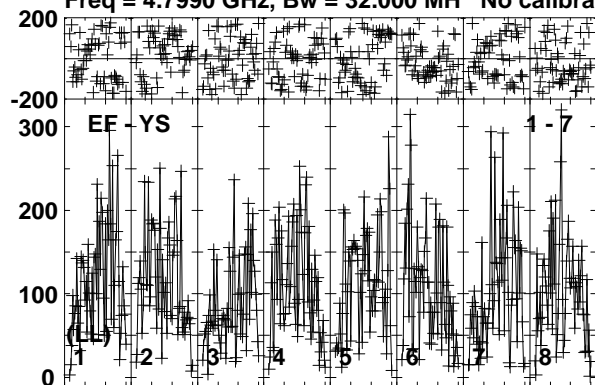

Lower frame: Micro Ampl Jy Top frame: Phas deg  
Vector averaged cross-power spectrum Baseline: EF (01) - YS (07)  
Timerange: 00/14:11:00 to 00/14:13:28

Plot file version 226 created 25-SEP-2017 10:02:50

J1303-2405 RP029B.UVDATA.1

Freq = 4.7990 GHz, Bw = 32.000 MH No calibration applied and no bandpass applied

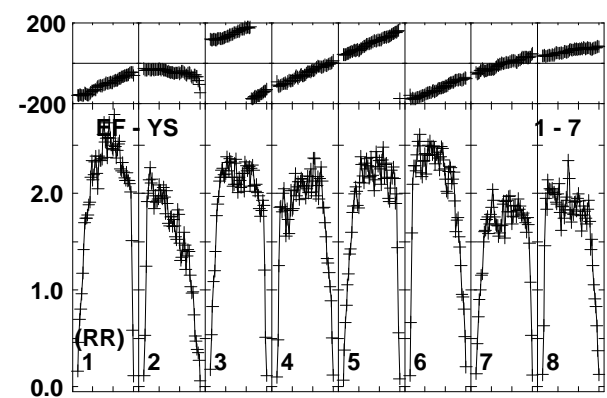
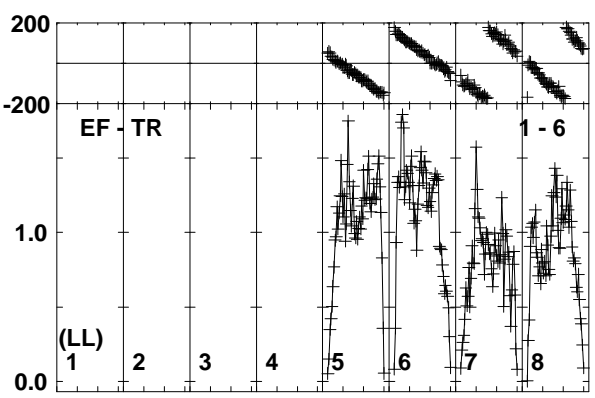
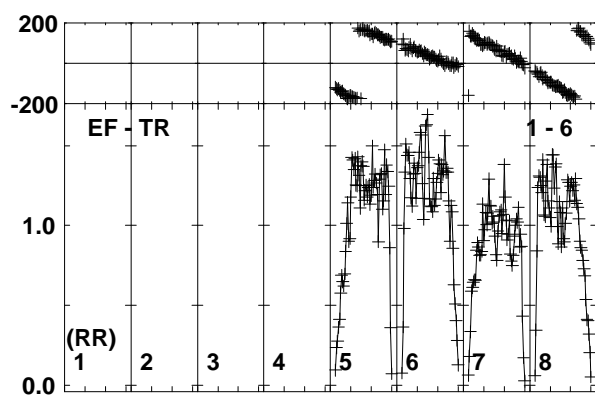
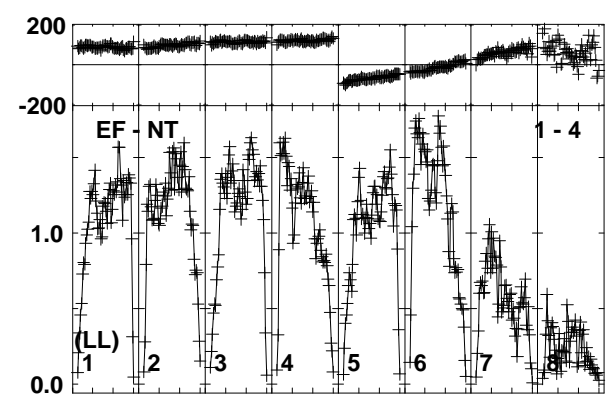
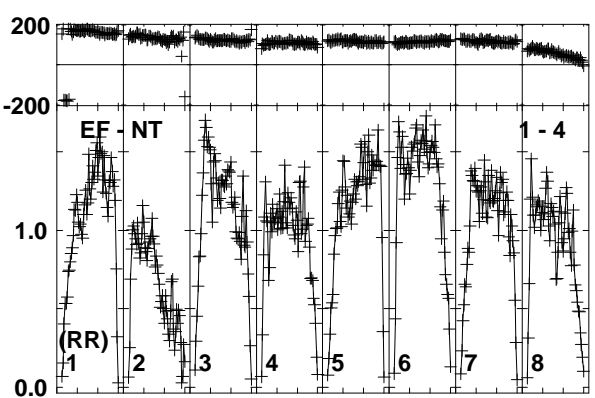
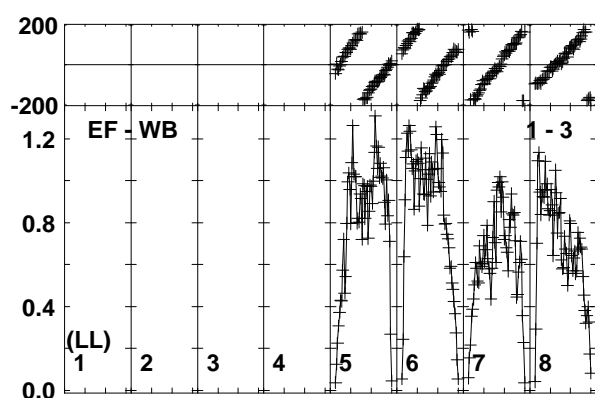
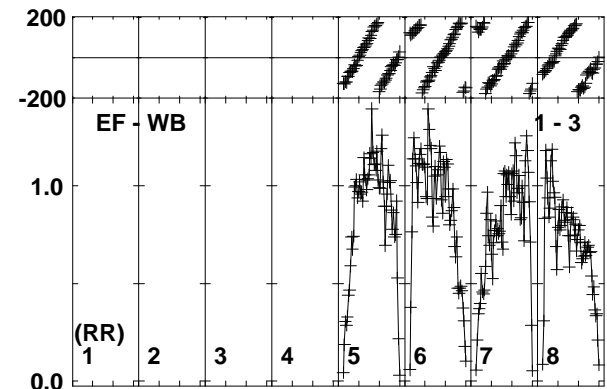
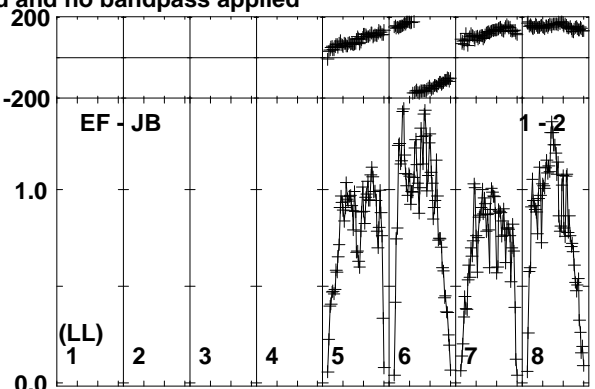
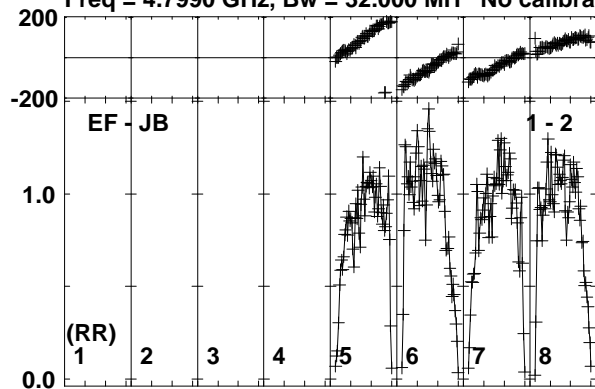

Lower frame: Milli Ampl Jy Top frame: Phas deg  
Vector averaged cross-power spectrum Baseline: EF (01) - JB (02)  
Timerange: 00/14:13:30 to 00/14:14:59

Plot file version 227 created 25-SEP-2017 10:02:50

J1303-2405 RP029B.UVDATA.1

Freq = 4.7990 GHz, Bw = 32.000 MH No calibration applied and no bandpass applied

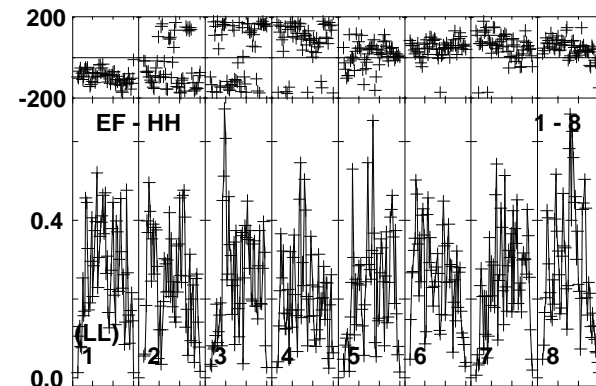
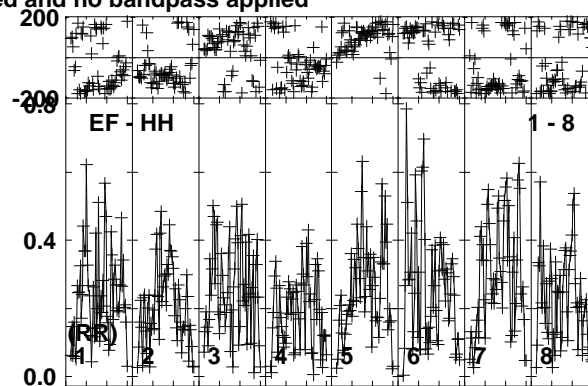
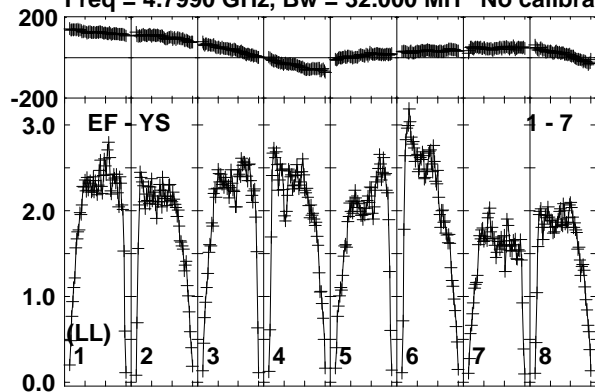

Lower frame: Milli Ampl Jy Top frame: Phas deg  
Vector averaged cross-power spectrum Baseline: EF (01) - YS (07)  
Timerange: 00/14:13:30 to 00/14:14:59

Plot file version 228 created 25-SEP-2017 10:02:50

J1312-2350 RP029B.UVDATA.1

Freq = 4.7990 GHz, Bw = 32.000 MH No calibration applied and no bandpass applied

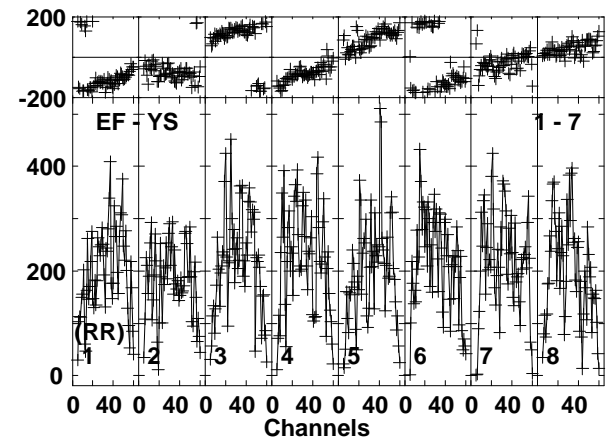
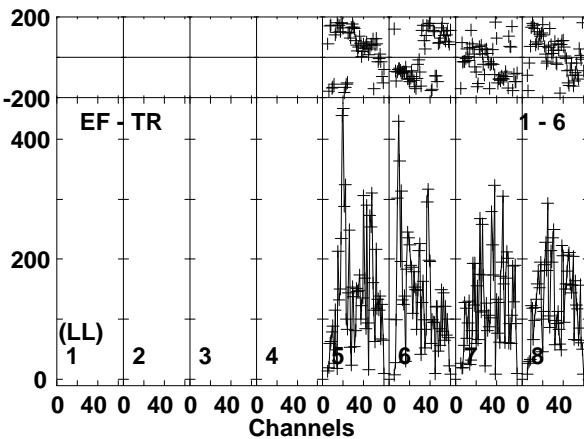
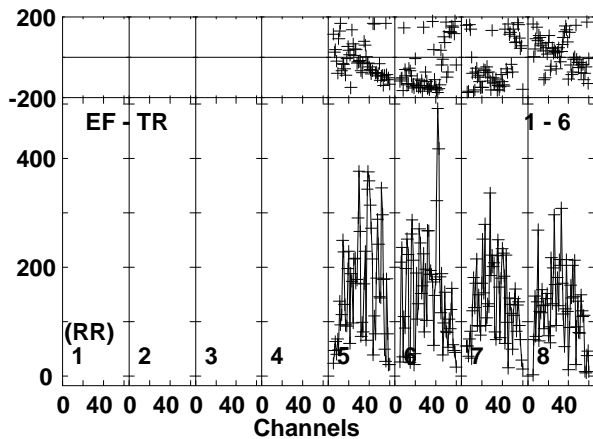
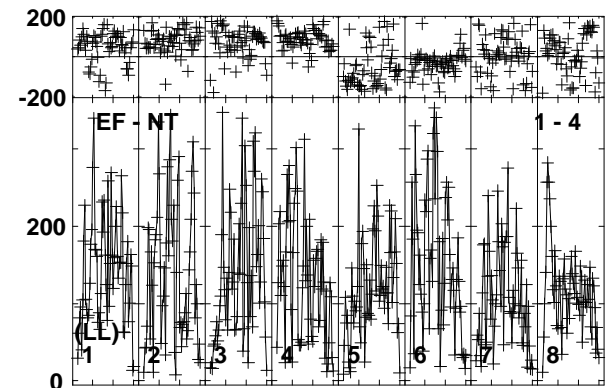
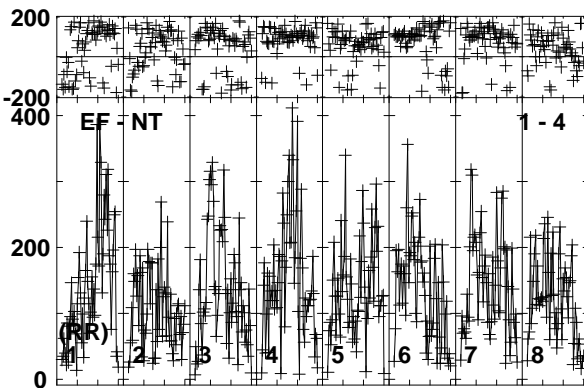
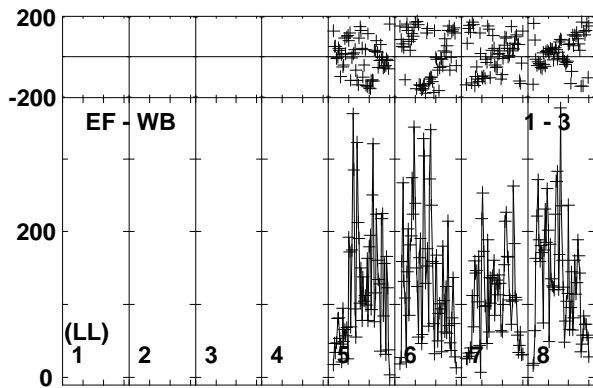
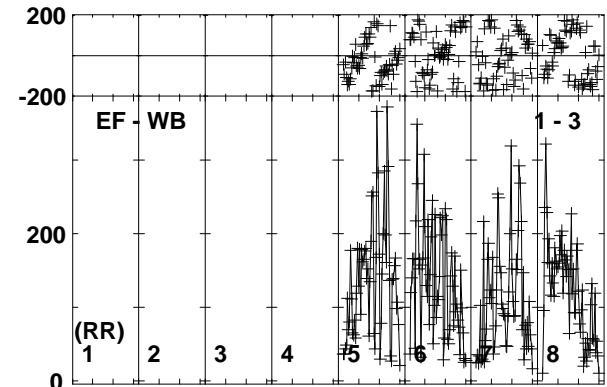
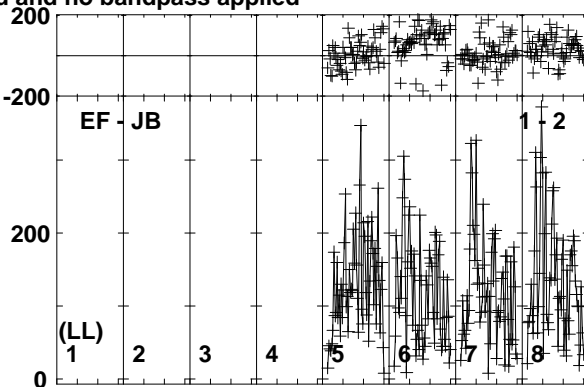
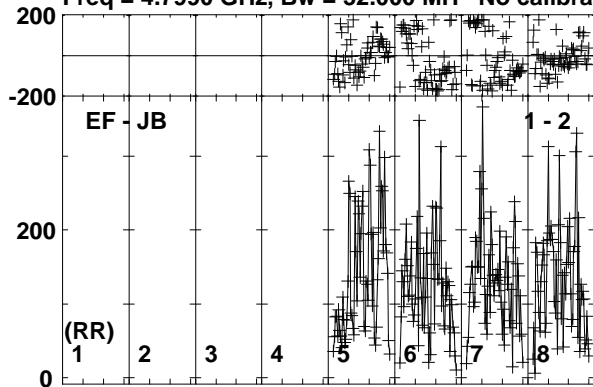

Lower frame: Micro Ampl Jy Top frame: Phas deg  
Vector averaged cross-power spectrum Baseline: EF (01) - JB (02)  
Timerange: 00/14:15:00 to 00/14:17:29

Plot file version 229 created 25-SEP-2017 10:02:51

J1312-2350 RP029B.UVDATA.1

Freq = 4.7990 GHz, Bw = 32.000 MH No calibration applied and no bandpass applied

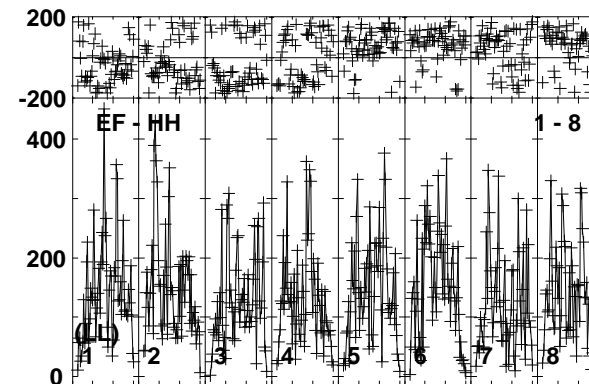
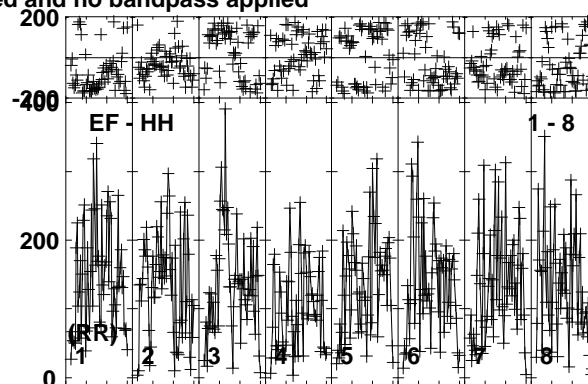
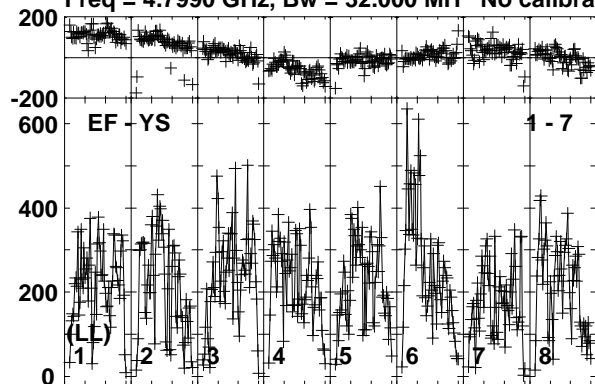

Lower frame: Micro Ampl Jy Top frame: Phas deg  
Vector averaged cross-power spectrum Baseline: EF (01) - YS (07)  
Timerange: 00/14:15:00 to 00/14:17:29

Plot file version 230 created 25-SEP-2017 10:02:51

J1303-2405 RP029B.UVDATA.1

Freq = 4.7990 GHz, Bw = 32.000 MH No calibration applied and no bandpass applied

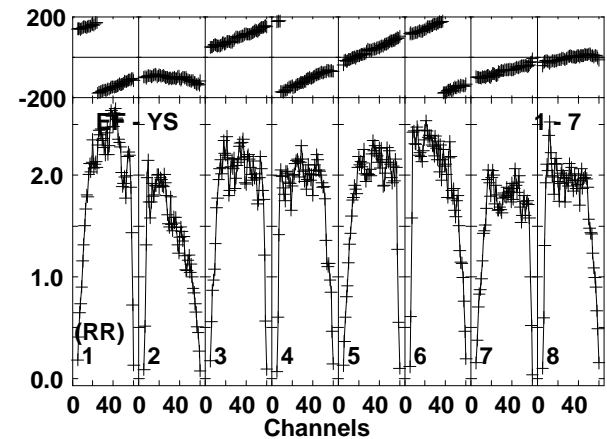
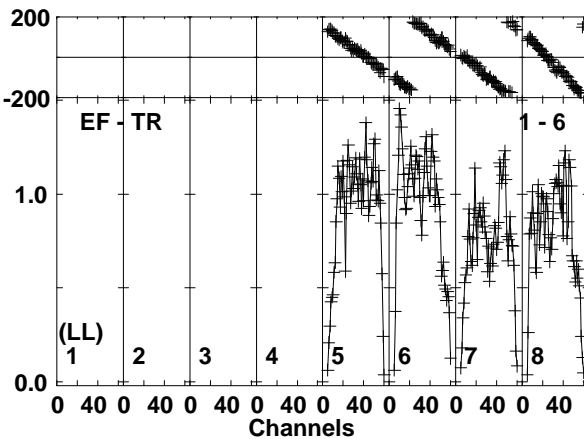
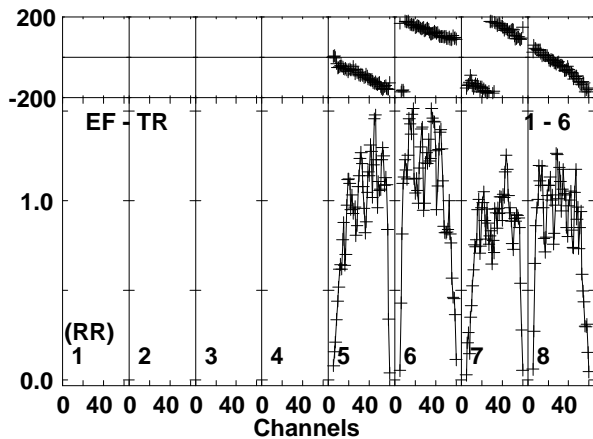
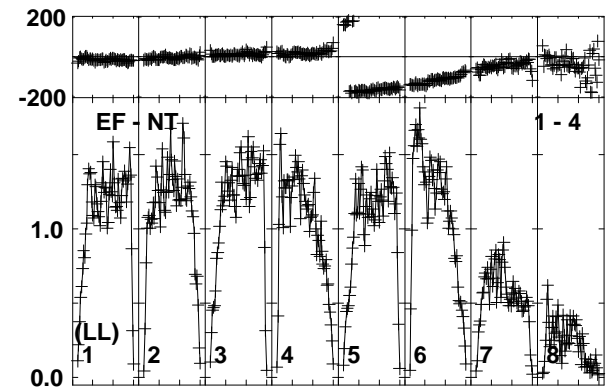
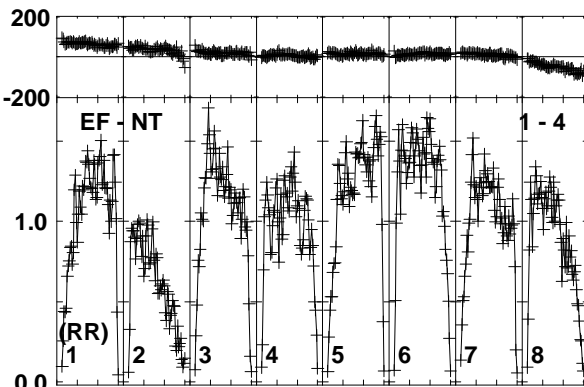
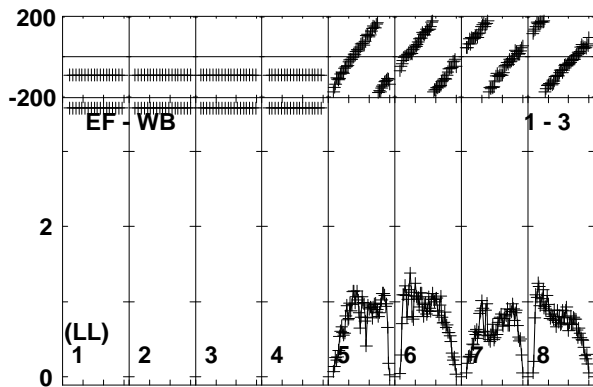
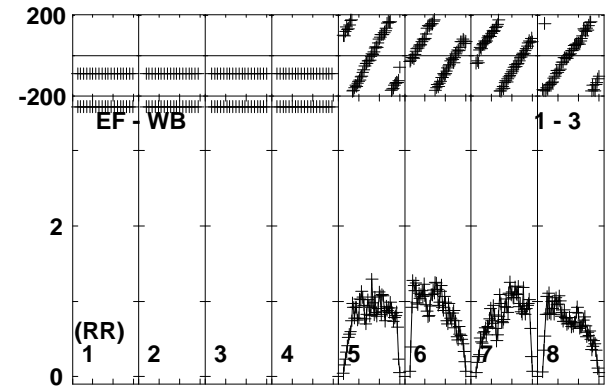
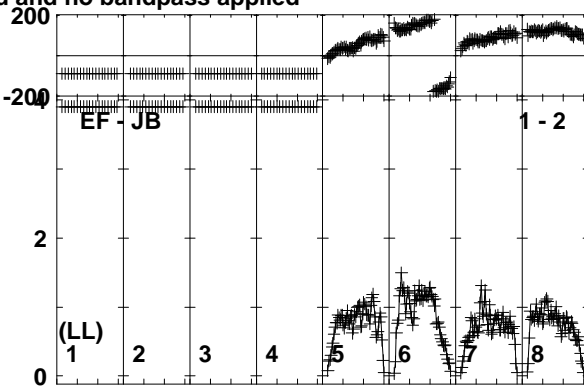
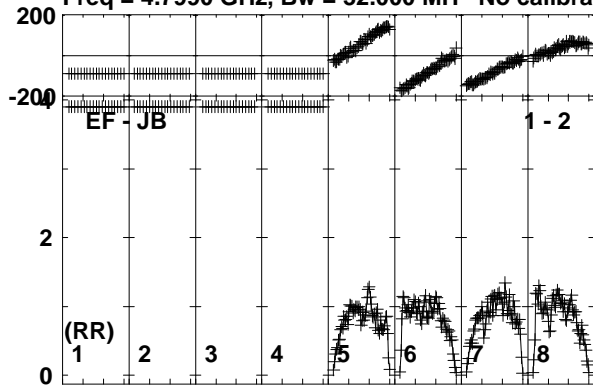

Lower frame: Milli Ampl Jy Top frame: Phas deg  
Vector averaged cross-power spectrum Baseline: EF (01) - JB (02)  
Timerange: 00/14:18:10 to 00/14:19:09

Plot file version 231 created 25-SEP-2017 10:02:51

J1303-2405 RP029B.UVDATA.1

Freq = 4.7990 GHz, Bw = 32.000 MH No calibration applied and no bandpass applied

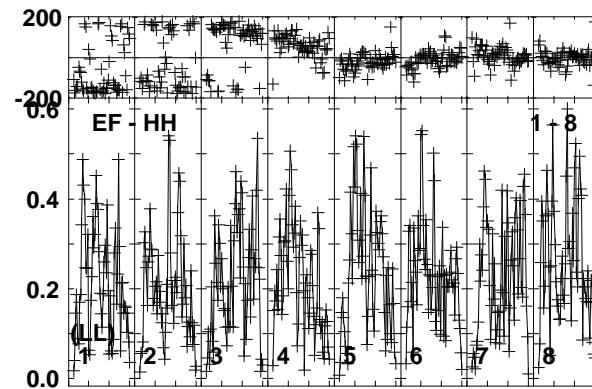
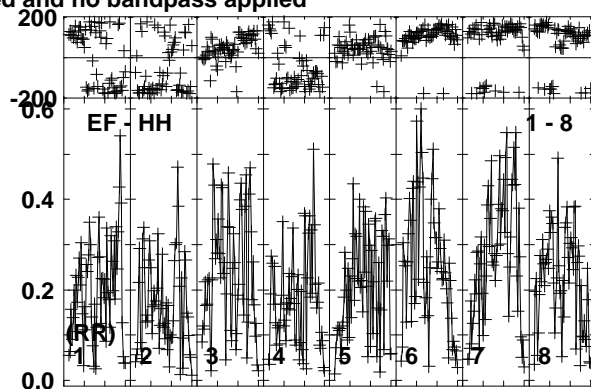
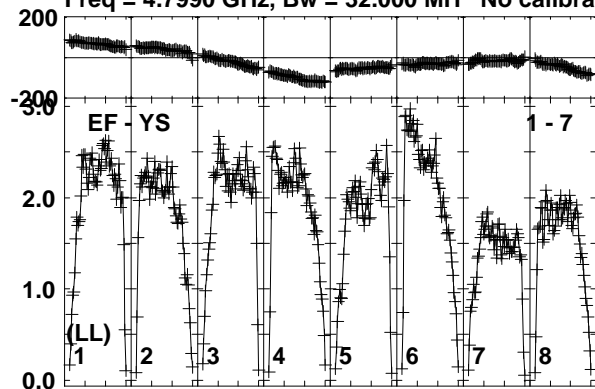

Lower frame: Milli Ampl Jy Top frame: Phas deg  
Vector averaged cross-power spectrum Baseline: EF (01) - YS (07)  
Timerange: 00/14:18:10 to 00/14:19:09

Plot file version 232 created 25-SEP-2017 10:02:51  
 SSS17A RP029B.UVDATA.1  
 Freq = 4.7990 GHz, Bw = 32.000 MH No calibration applied and no bandpass applied

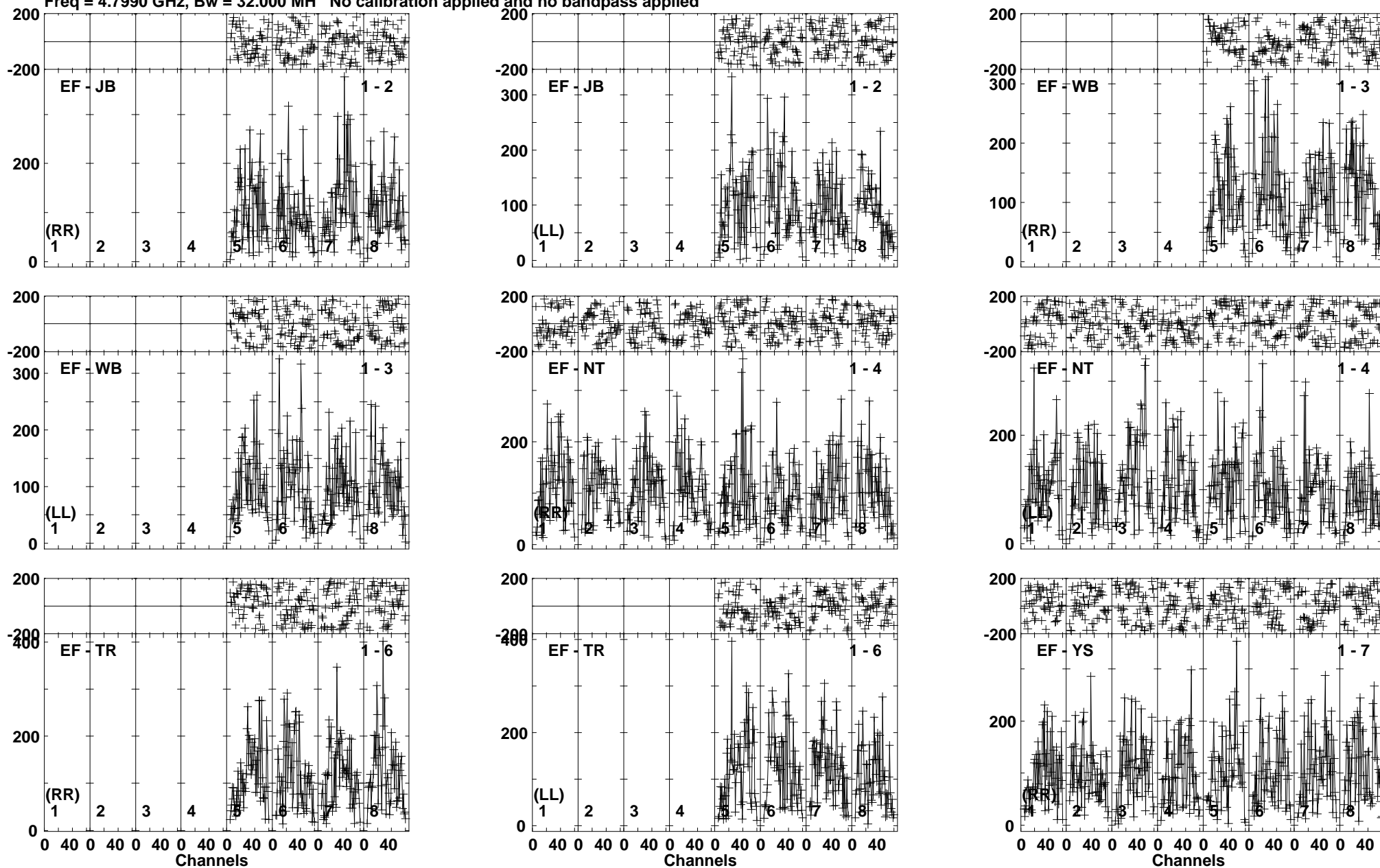

Lower frame: Micro Ampl Jy Top frame: Phas deg  
 Vector averaged cross-power spectrum Baseline: EF (01) - JB (02)  
 Timerange: 00/14:19:09 to 00/14:21:38



Plot file version 233 created 25-SEP-2017 10:02:51

SSS17A RP029B.UVDATA.1

Freq = 4.7990 GHz, Bw = 32.000 MH No calibration applied and no bandpass applied

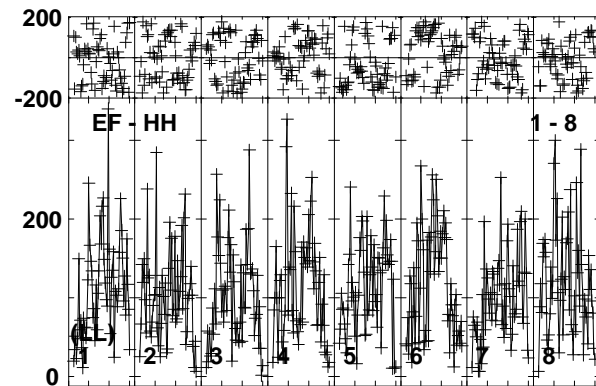
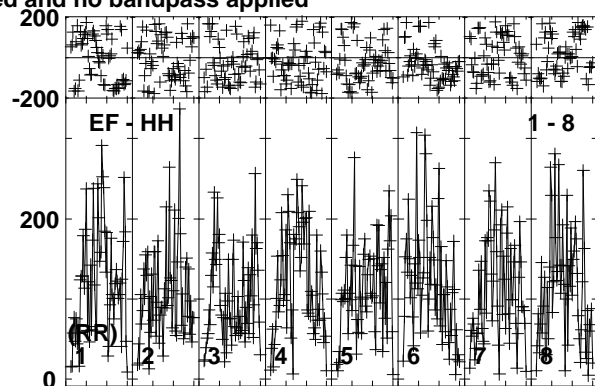
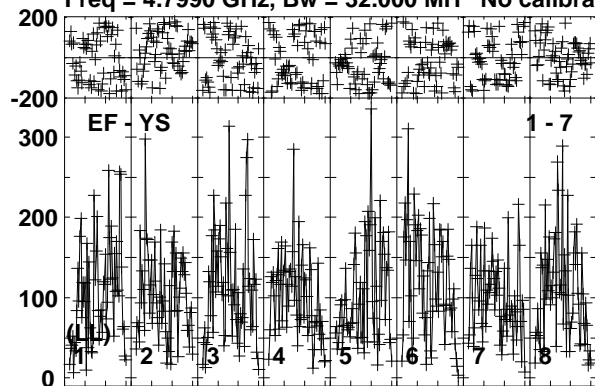

Lower frame: Micro Ampl Jy Top frame: Phas deg  
Vector averaged cross-power spectrum Baseline: EF (01) - YS (07)  
Timerange: 00/14:19:09 to 00/14:21:38

Plot file version 234 created 25-SEP-2017 10:02:51  
 J1303-2405 RP029B.UVDATA.1  
 Freq = 4.7990 GHz, Bw = 32.000 MH No calibration applied and no bandpass applied

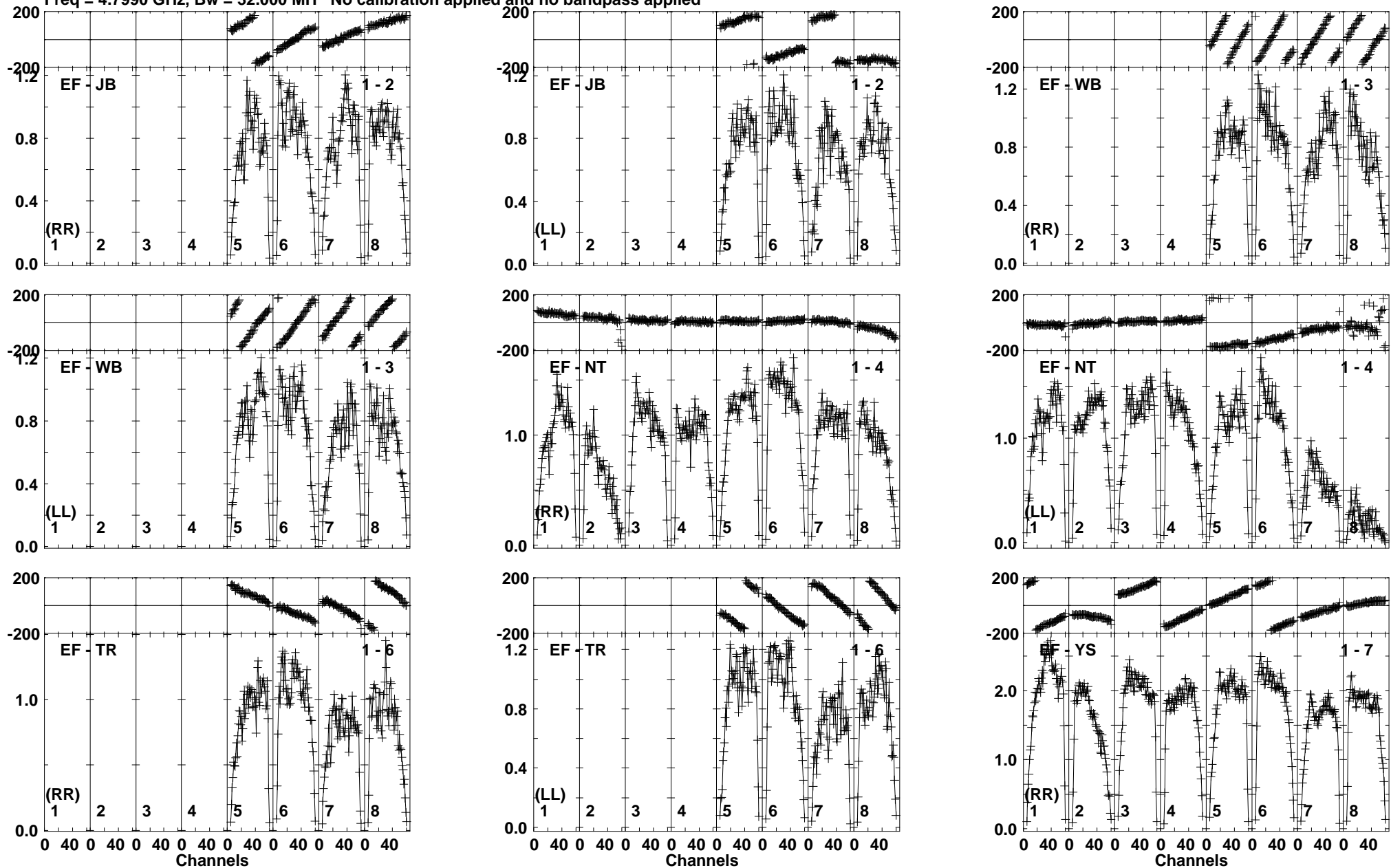

Lower frame: Milli Ampl Jy Top frame: Phas deg  
 Vector averaged cross-power spectrum Baseline: EF (01) - JB (02)  
 Timerange: 00/14:21:39 to 00/14:23:38

Plot file version 235 created 25-SEP-2017 10:02:51

J1303-2405 RP029B.UVDATA.1

Freq = 4.7990 GHz, Bw = 32.000 MH No calibration applied and no bandpass applied

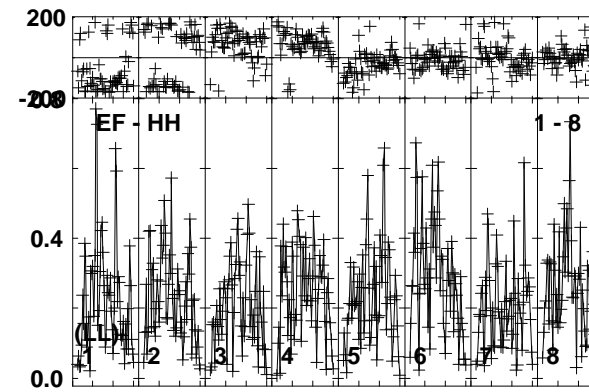
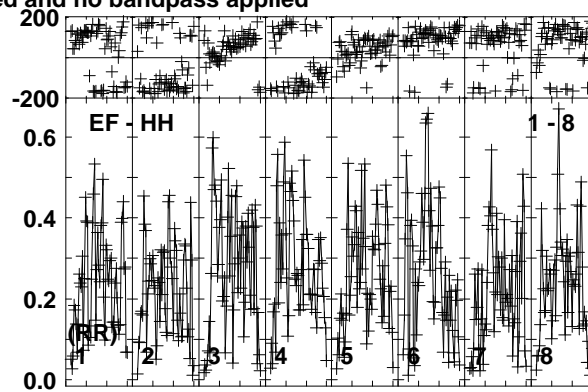
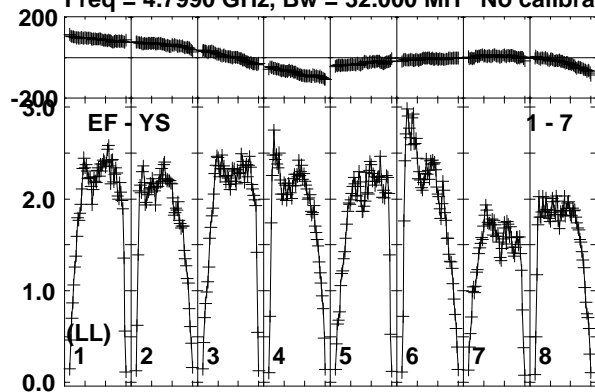

Lower frame: Milli Ampl Jy Top frame: Phas deg  
Vector averaged cross-power spectrum Baseline: EF (01) - YS (07)  
Timerange: 00/14:21:39 to 00/14:23:38

Plot file version 236 created 25-SEP-2017 10:02:51

J1310+3220 RP029B.UVDATA.1

Freq = 4.7990 GHz, Bw = 32.000 MH No calibration applied and no bandpass applied

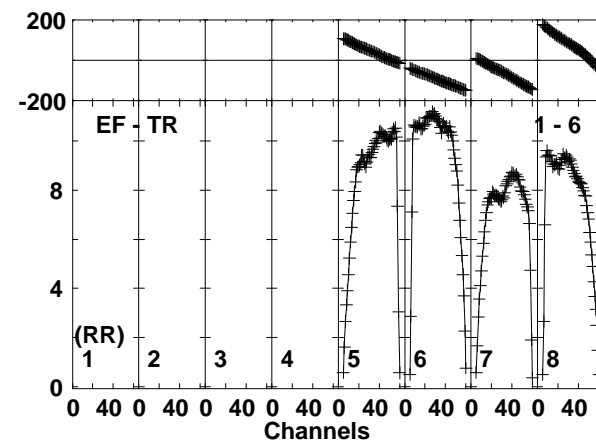
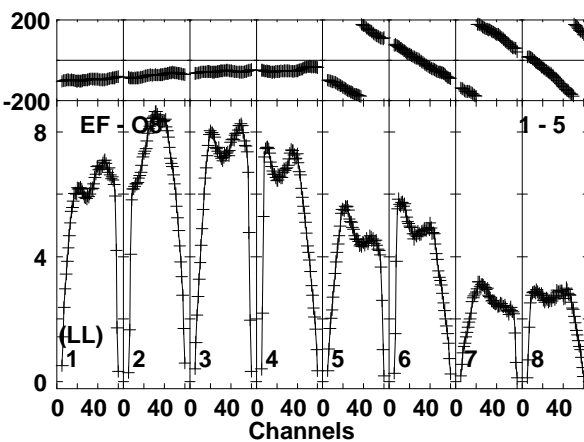
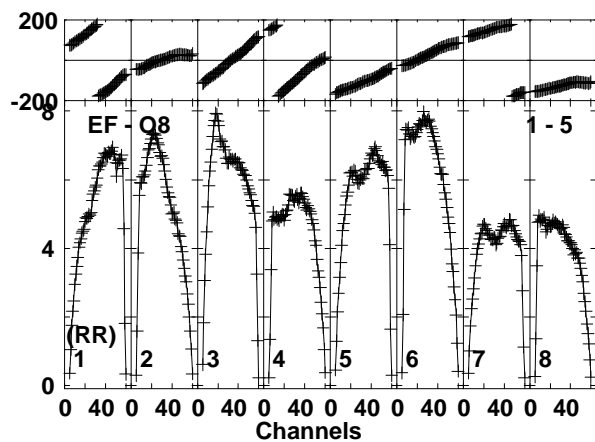
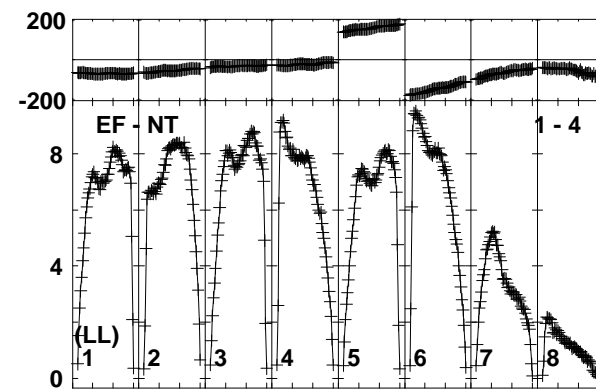
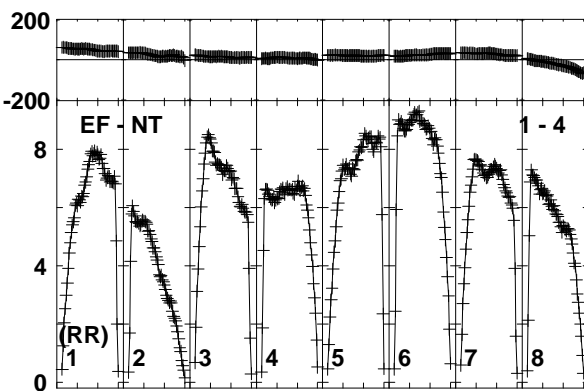
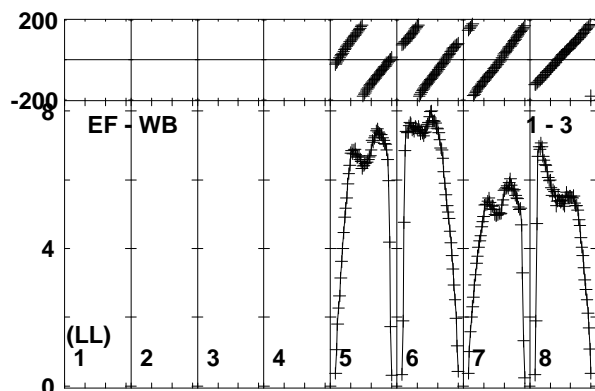
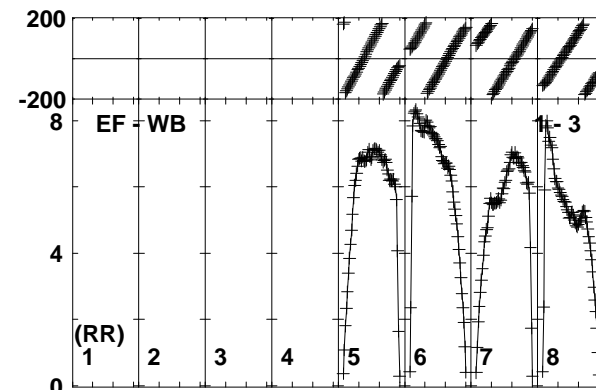
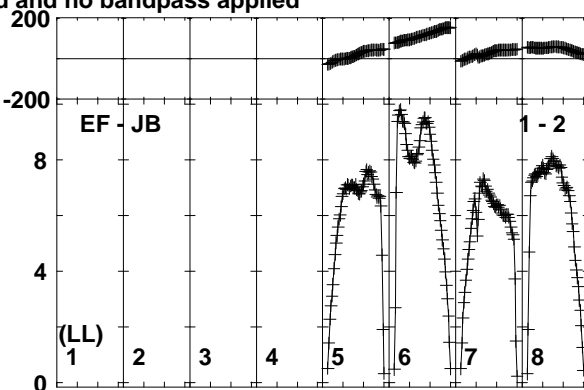
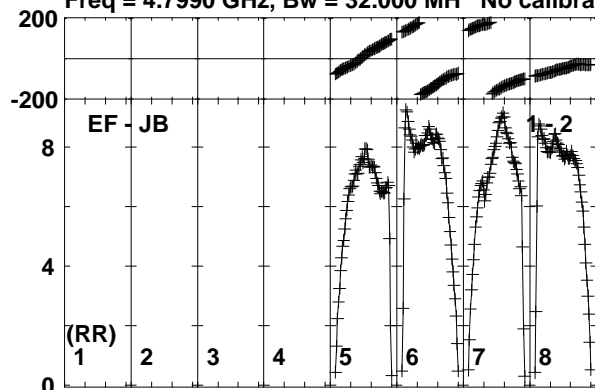

Lower frame: Milli Ampl Jy Top frame: Phas deg  
Vector averaged cross-power spectrum Baseline: EF (01) - JB (02)  
Timerange: 00/14:27:09 to 00/14:30:09

Plot file version 237 created 25-SEP-2017 10:02:52

J1310+3220 RP029B.UVDATA.1

Freq = 4.7990 GHz, Bw = 32.000 MH No calibration applied and no bandpass applied

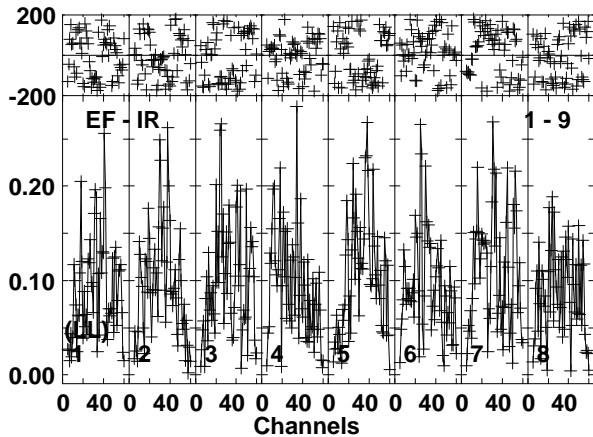
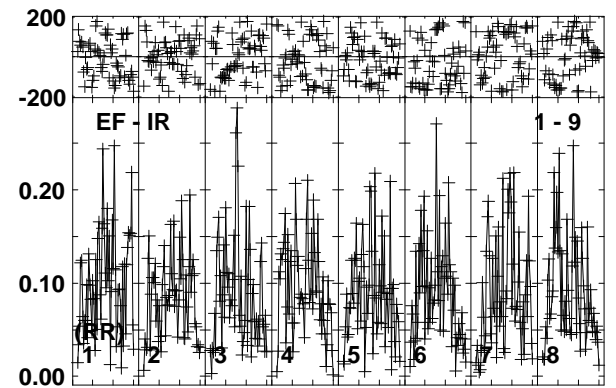
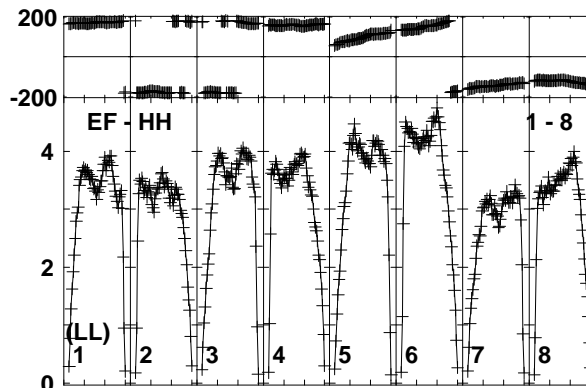
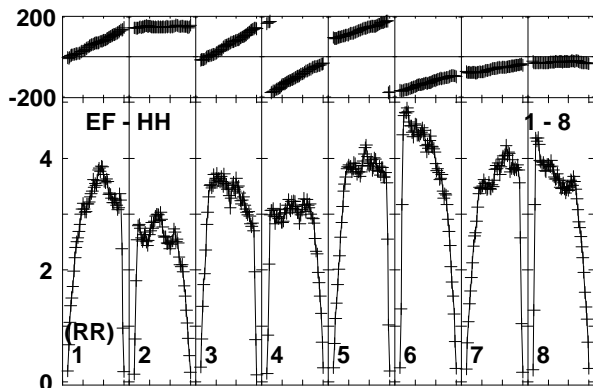
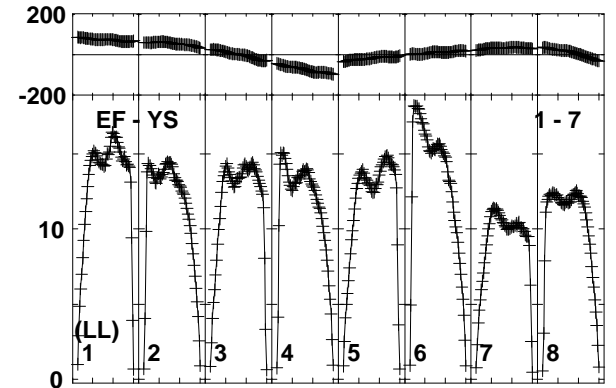
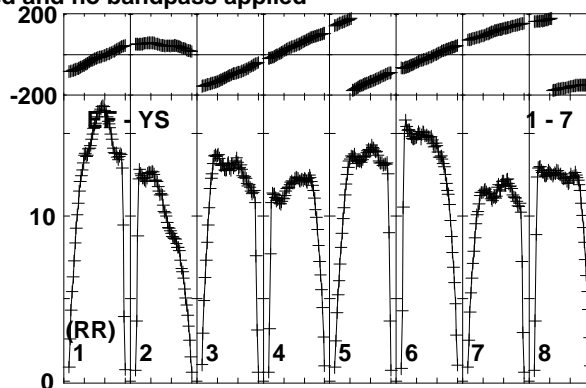
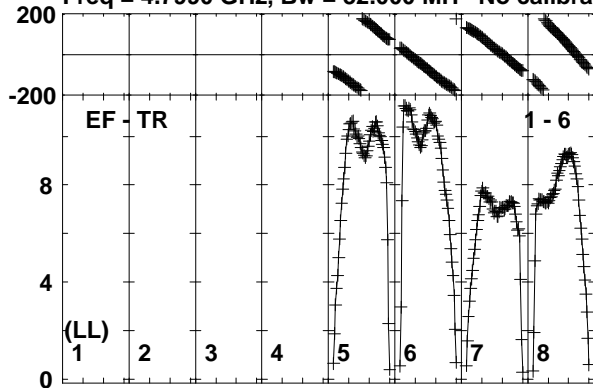

Lower frame: Milli Ampl Jy Top frame: Phas deg  
Vector averaged cross-power spectrum Baseline: EF (01) - TR (06)  
Timerange: 00/14:27:09 to 00/14:30:09