

Plot file version 1 created 14-JUL-2010 16:33:55

3C345 RR004A.UVDATA.1

Freq = 4.9415 GHz, Bw = 16.000 MH No calibration applied and no bandpass applied

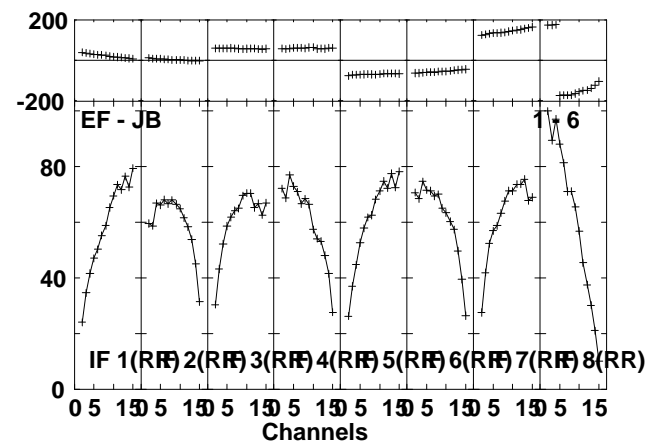
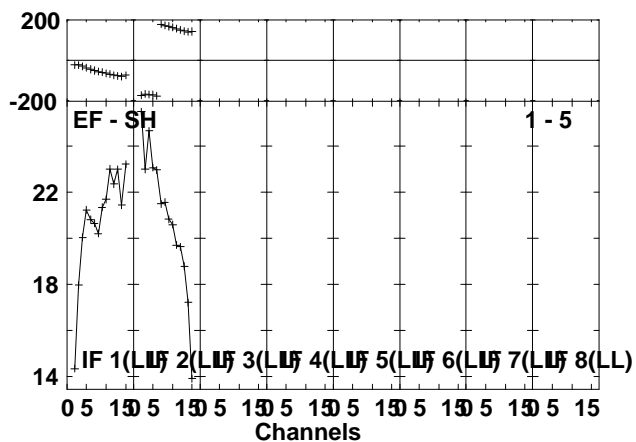
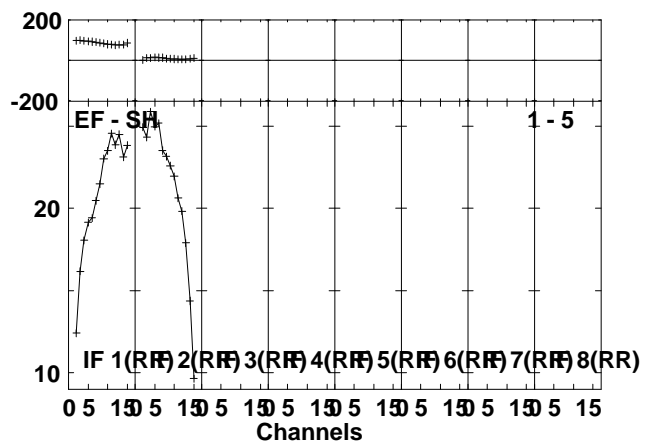
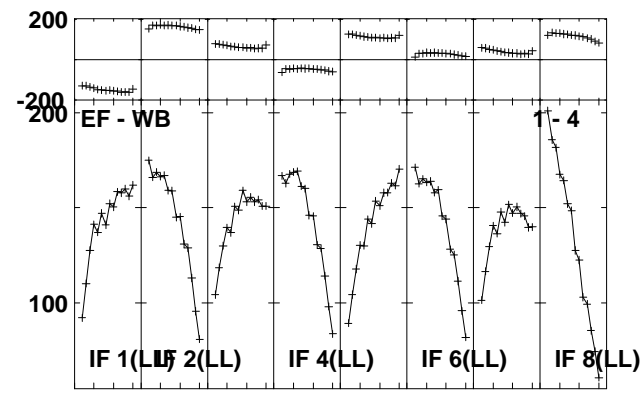
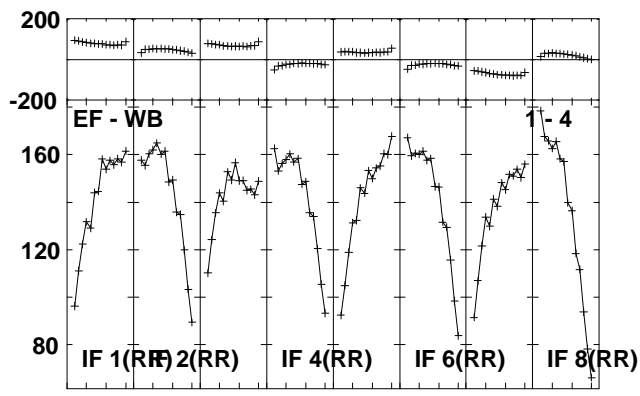
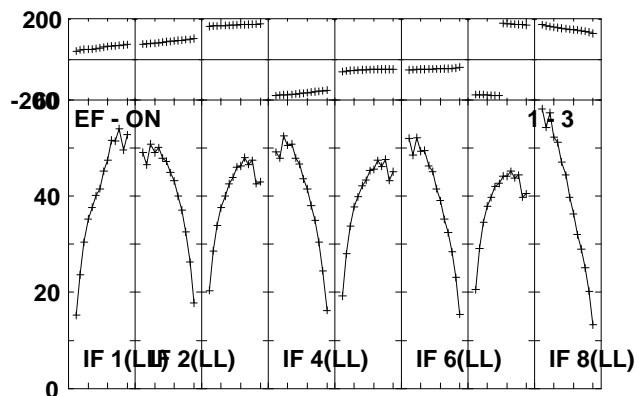
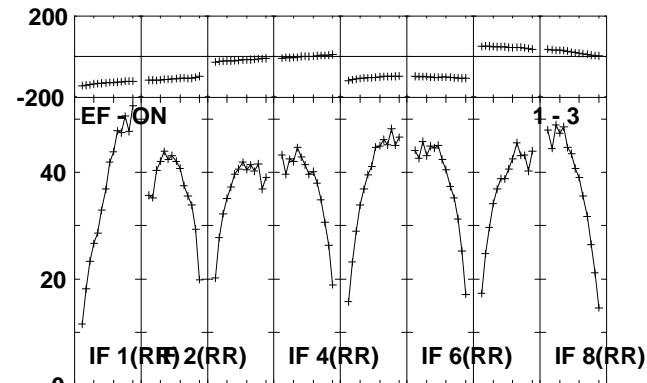
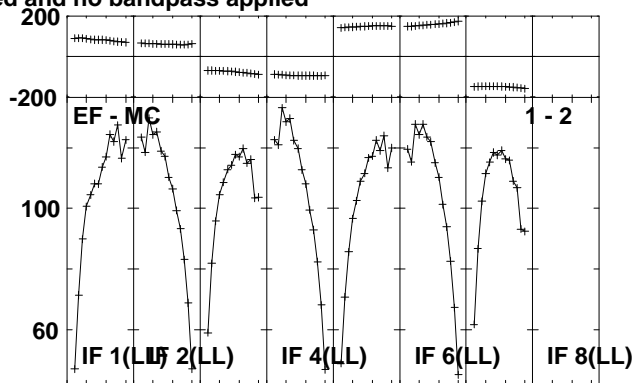
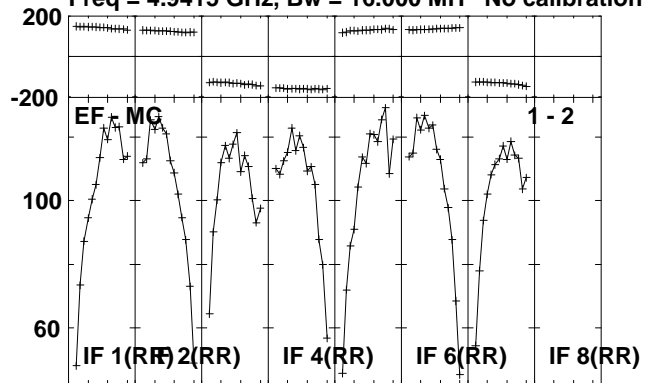

Lower frame: Milli Ampl Jy Top frame: Phas deg
Scalar averaged cross-power spectrum Several baselines displayed
Timerange: 00/17:16:57 to 00/17:38:55

Plot file version 2 created 14-JUL-2010 16:34:00

3C345 RR004A.UVDATA.1

Freq = 4.9415 GHz, Bw = 16.000 MH No calibration applied and no bandpass applied

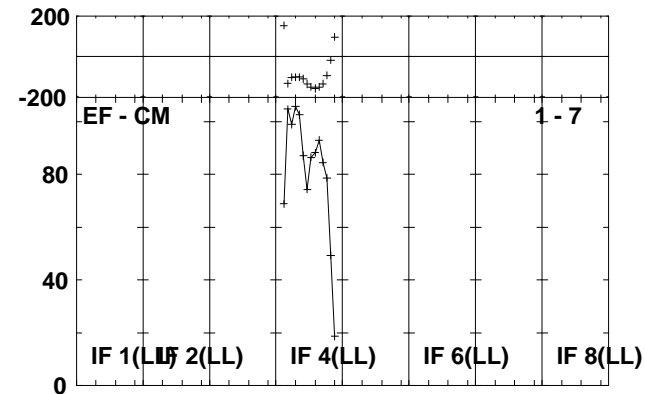
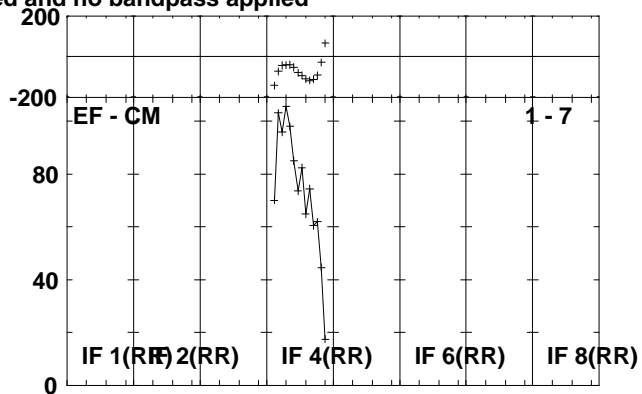
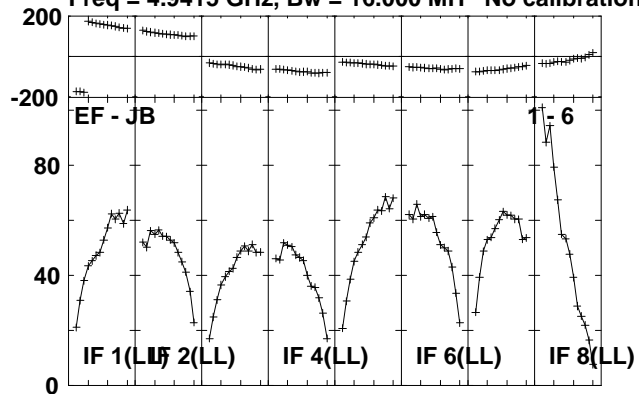

Lower frame: Milli Ampl Jy Top frame: Phas deg
Scalar averaged cross-power spectrum Several baselines displayed
Timerange: 00/17:16:57 to 00/17:38:55

Plot file version 3 created 14-JUL-2010 16:34:05

3C345 RR004A.UVDATA.1

Freq = 4.9415 GHz, Bw = 16.000 MH No calibration applied and no bandpass applied

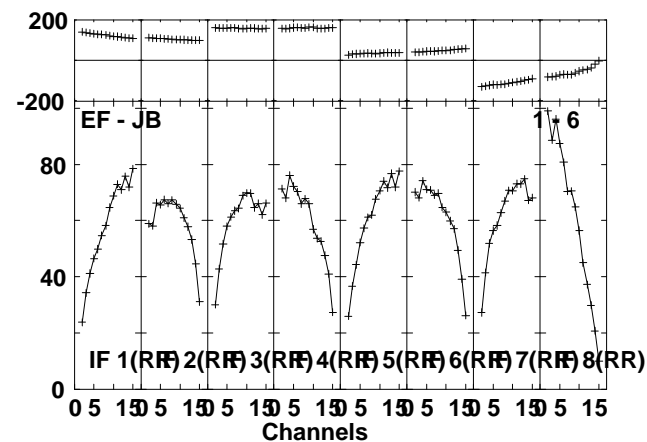
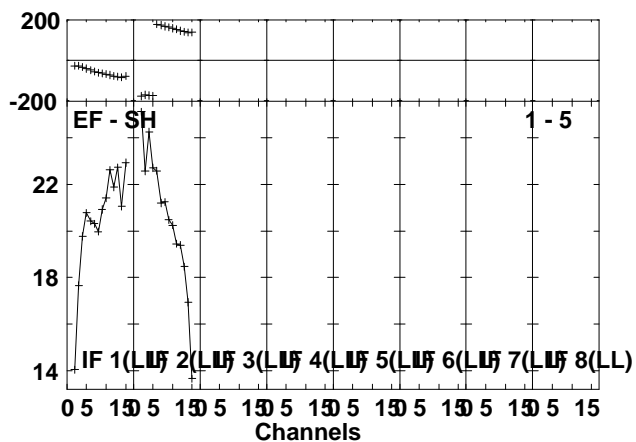
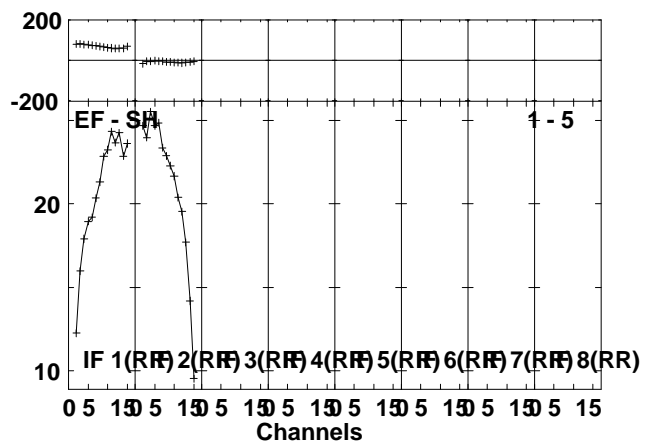
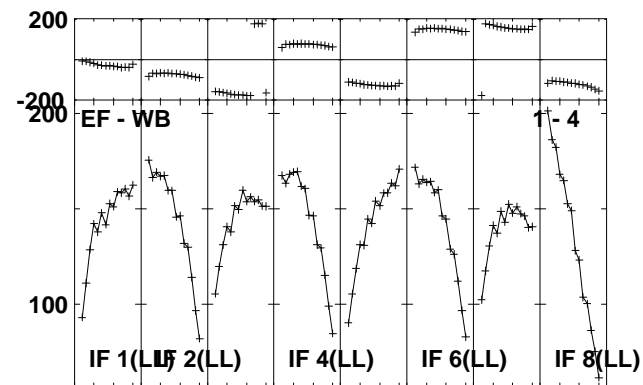
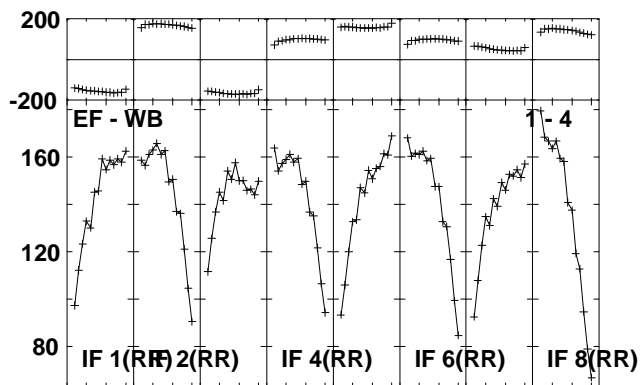
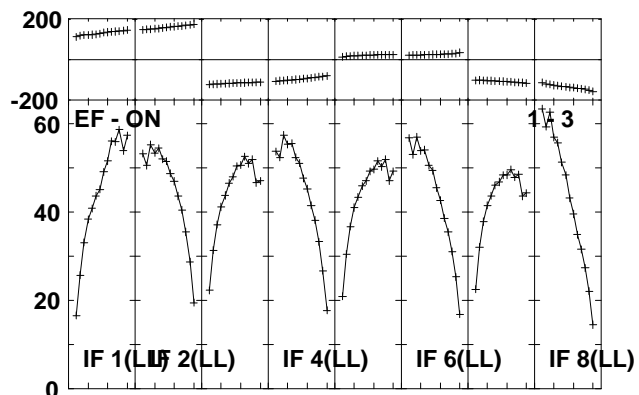
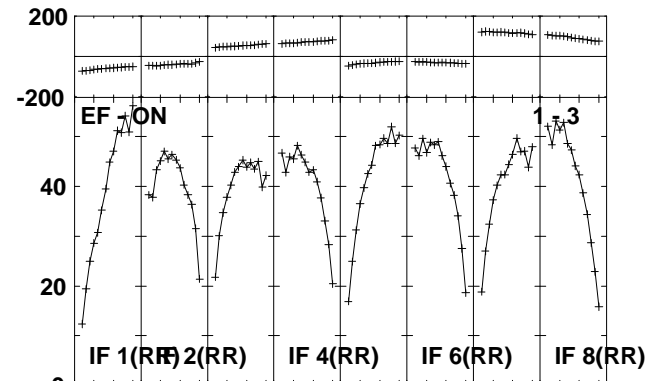
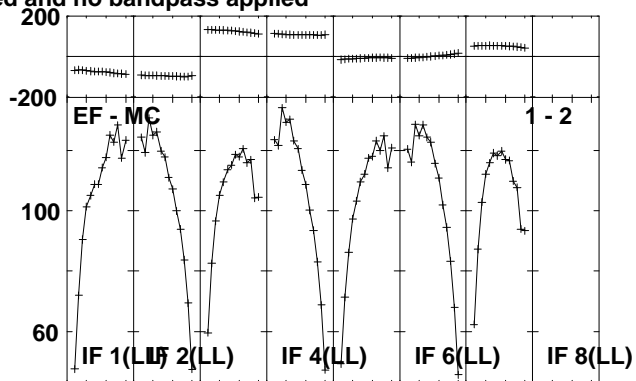
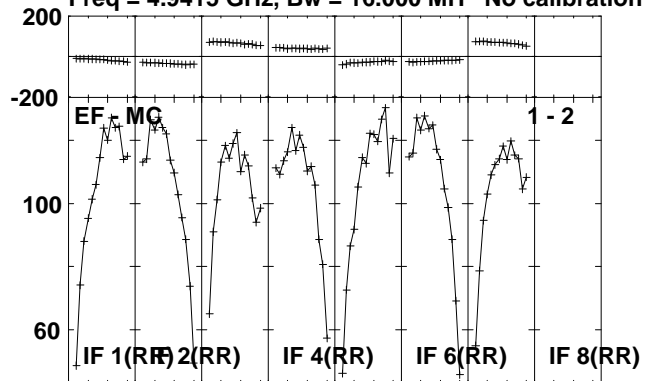

Lower frame: Milli Ampl Jy Top frame: Phas deg
Scalar averaged cross-power spectrum Several baselines displayed
Timerange: 00/17:38:57 to 00/18:00:57

Plot file version 4 created 14-JUL-2010 16:34:11

3C345 RR004A.UVDATA.1

Freq = 4.9415 GHz, Bw = 16.000 MH No calibration applied and no bandpass applied

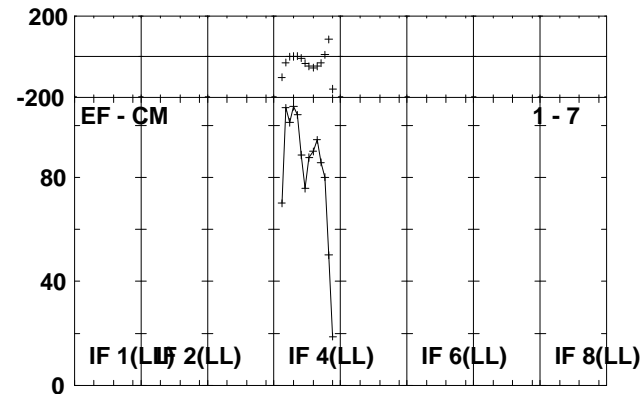
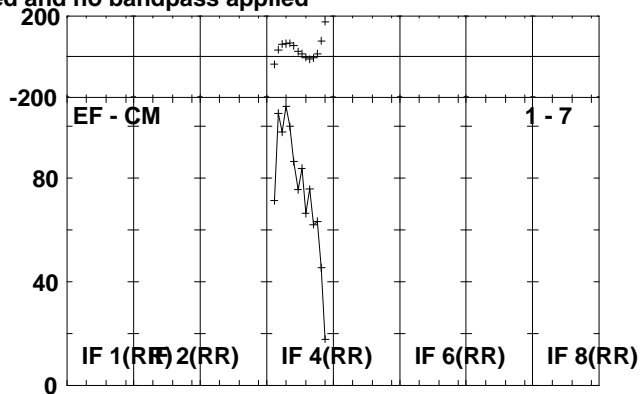
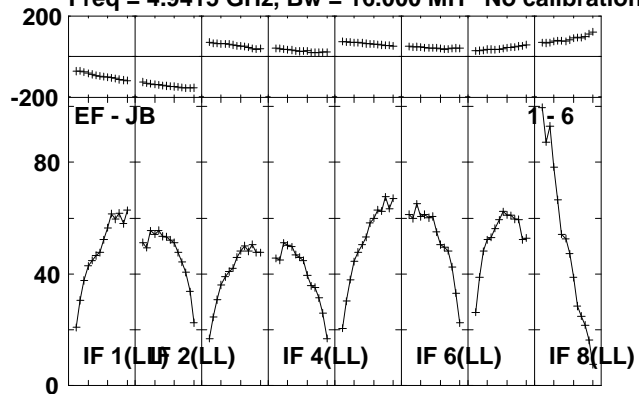

Lower frame: Milli Ampl Jy Top frame: Phas deg
Scalar averaged cross-power spectrum Several baselines displayed
Timerange: 00/17:38:57 to 00/18:00:57

Plot file version 5 created 14-JUL-2010 16:34:15

3C345 RR004A.UVDATA.1

Freq = 4.9415 GHz, Bw = 16.000 MH No calibration applied and no bandpass applied

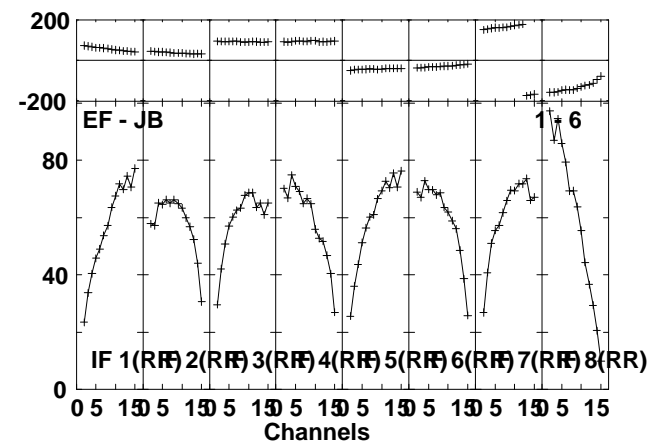
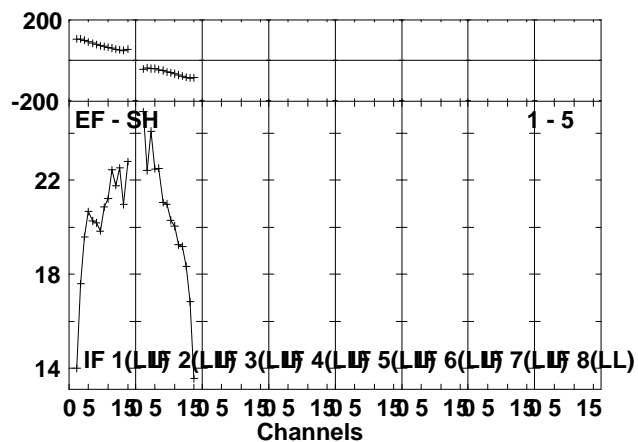
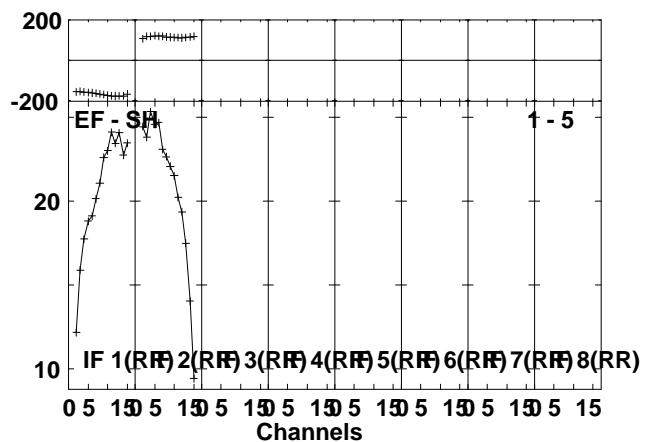
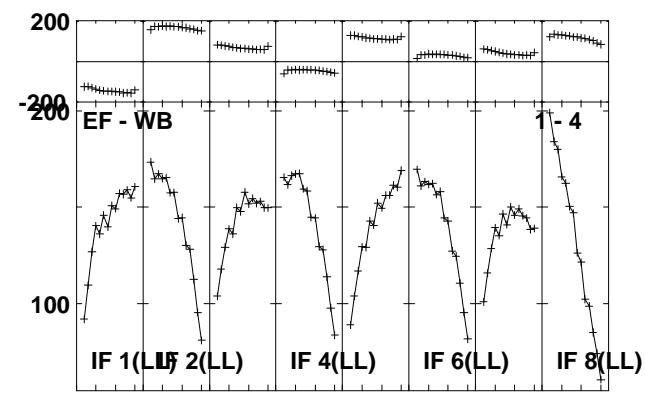
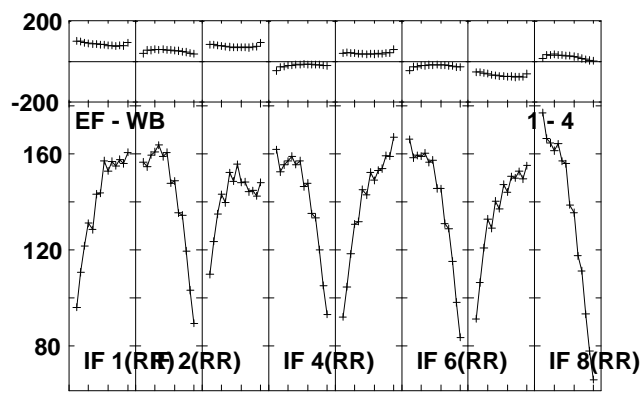
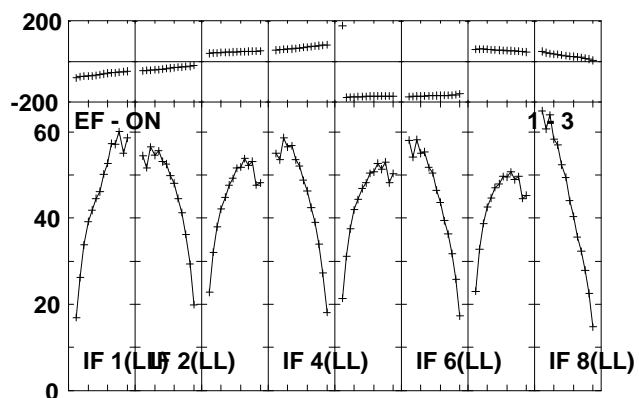
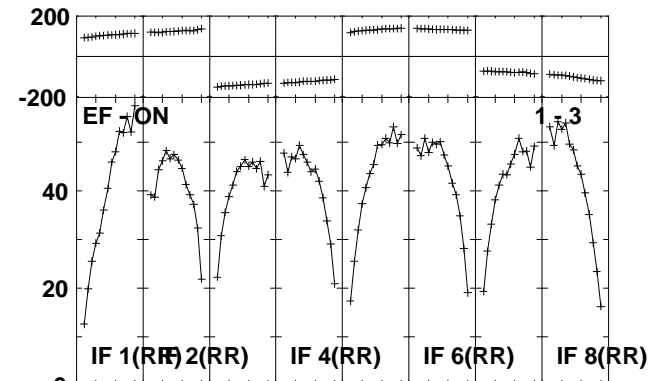
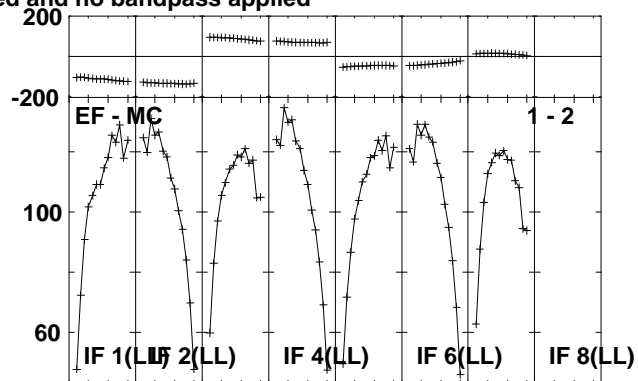
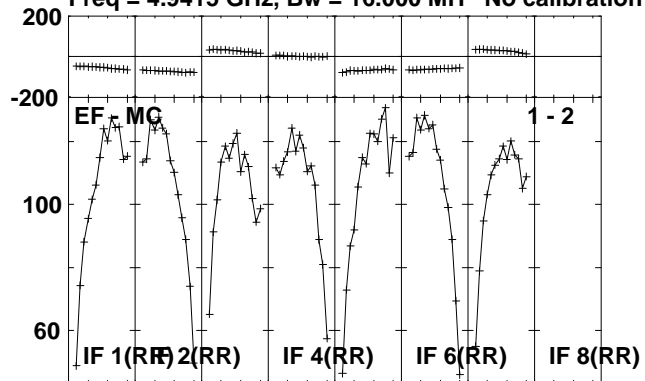

Lower frame: Milli Ampl Jy Top frame: Phas deg
Scalar averaged cross-power spectrum Several baselines displayed
Timerange: 00:18:00:59 to 00:18:14:19

Plot file version 6 created 14-JUL-2010 16:34:19

3C345 RR004A.UVDATA.1

Freq = 4.9415 GHz, Bw = 16.000 MH No calibration applied and no bandpass applied

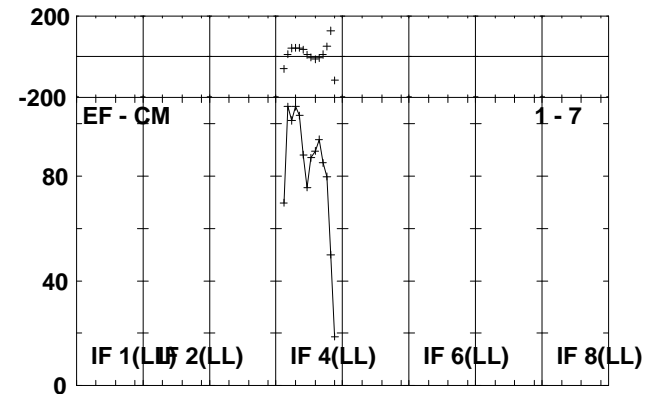
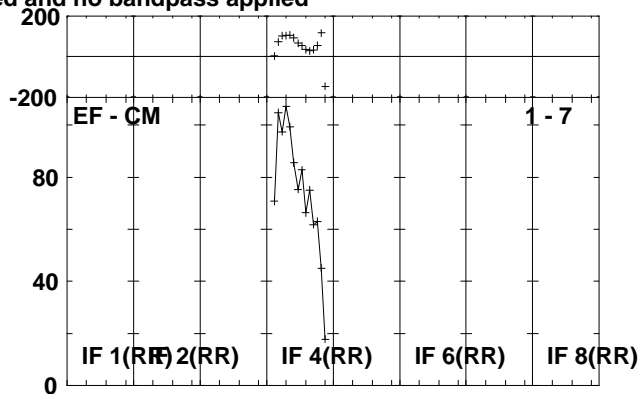
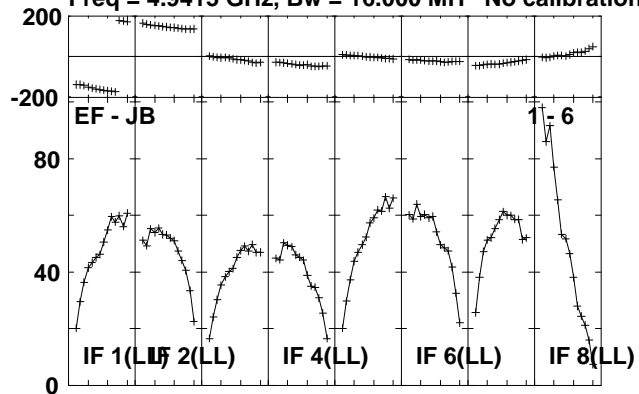

Lower frame: Milli Ampl Jy Top frame: Phas deg
Scalar averaged cross-power spectrum Several baselines displayed
Timerange: 00/18:00:59 to 00/18:14:19

Plot file version 7 created 14-JUL-2010 16:34:22

J2002+47 RR004A.UVDATA.1

Freq = 4.9415 GHz, Bw = 16.000 MH No calibration applied and no bandpass applied

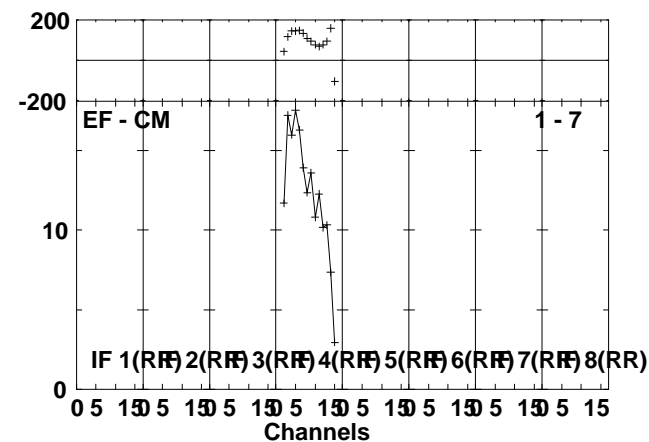
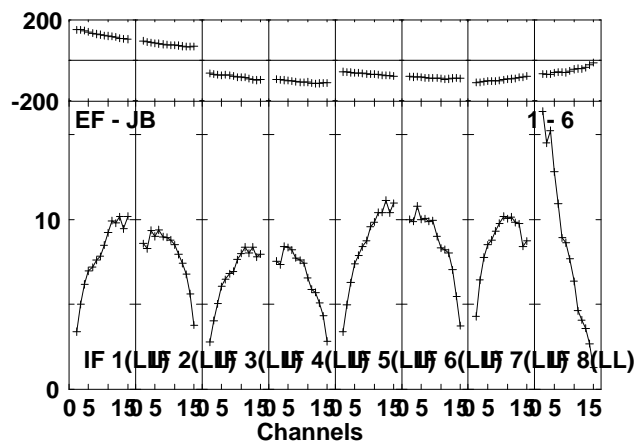
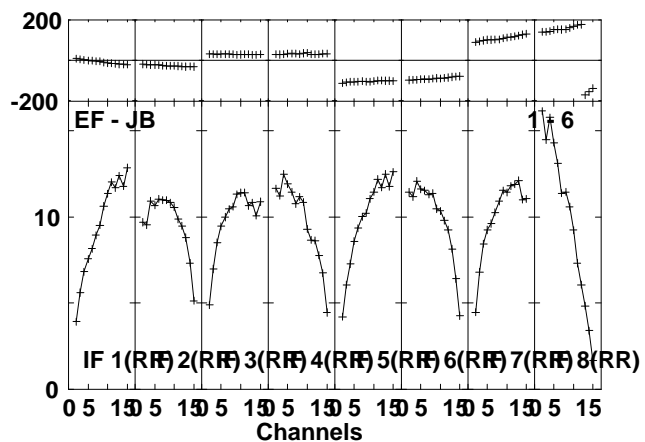
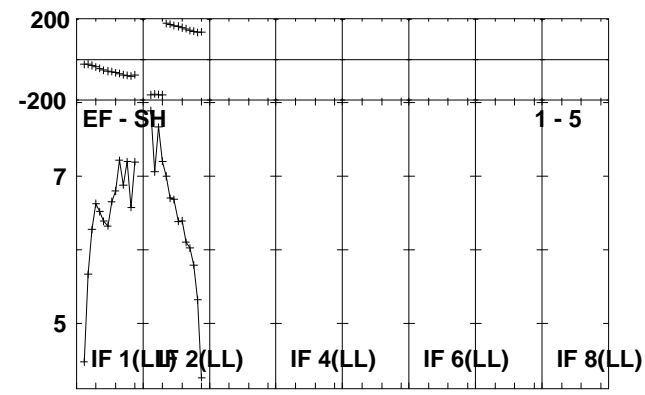
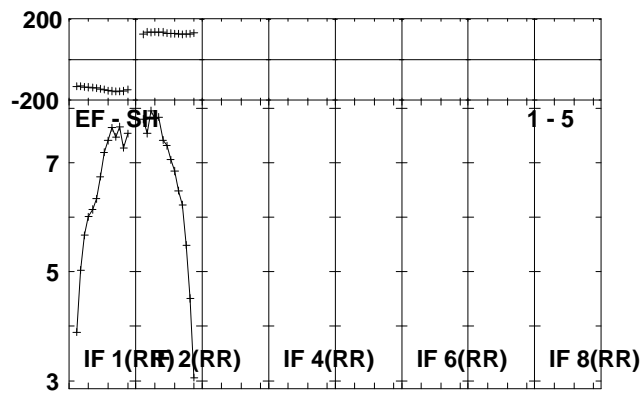
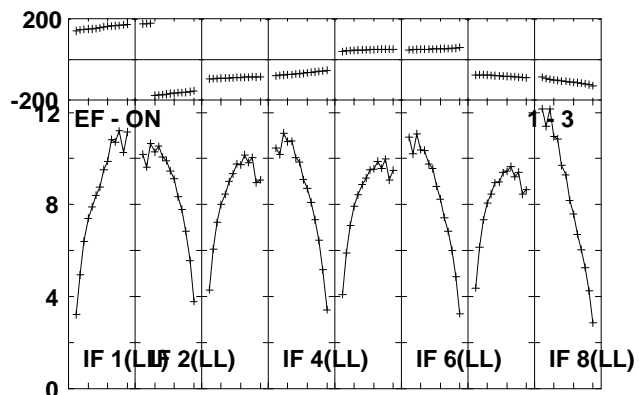
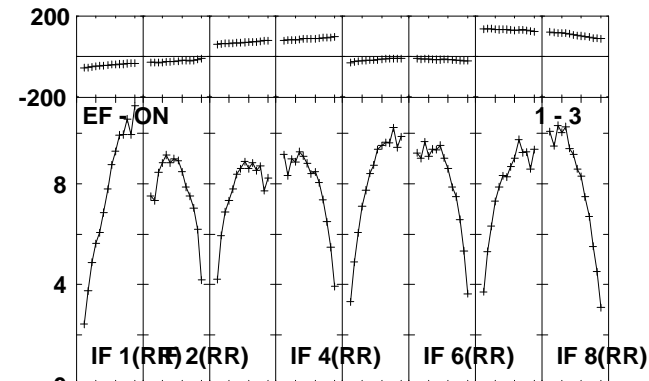
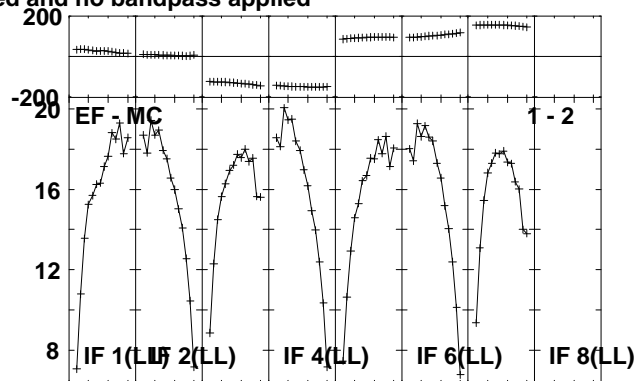
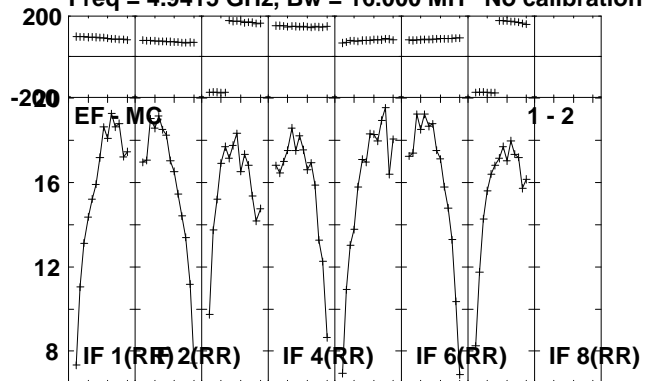

Lower frame: Milli Ampl Jy Top frame: Phas deg
Scalar averaged cross-power spectrum Several baselines displayed
Timerange: 00/18:16:21 to 00/18:24:19

Plot file version 8 created 14-JUL-2010 16:34:24

J2002+47 RR004A.UVDATA.1

Freq = 4.9415 GHz, Bw = 16.000 MH No calibration applied and no bandpass applied

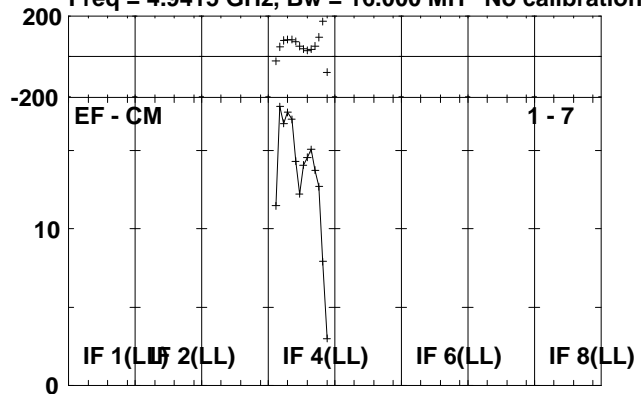

Lower frame: Milli Ampl Jy Top frame: Phas deg
Scalar averaged cross-power spectrum Several baselines displayed
Timerange: 00/18:16:21 to 00/18:24:19

Plot file version 9 created 14-JUL-2010 16:34:26

J1953+35 RR004A.UVDATA.1

Freq = 4.9415 GHz, Bw = 16.000 MH No calibration applied and no bandpass applied

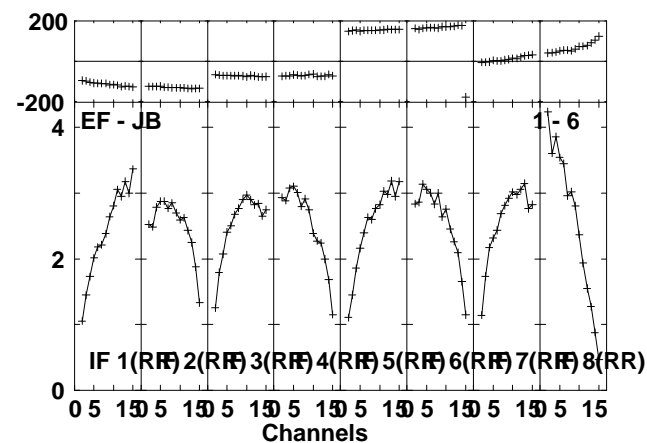
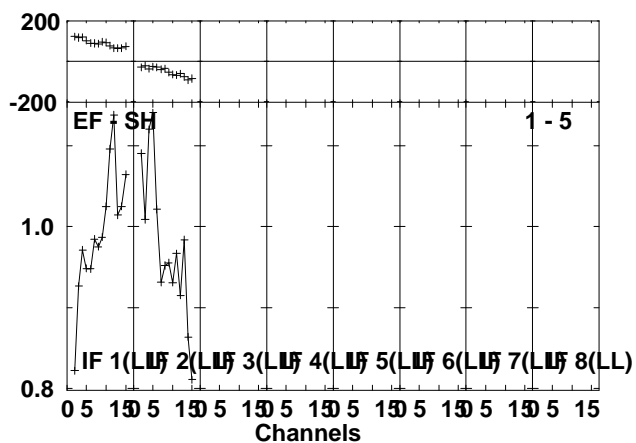
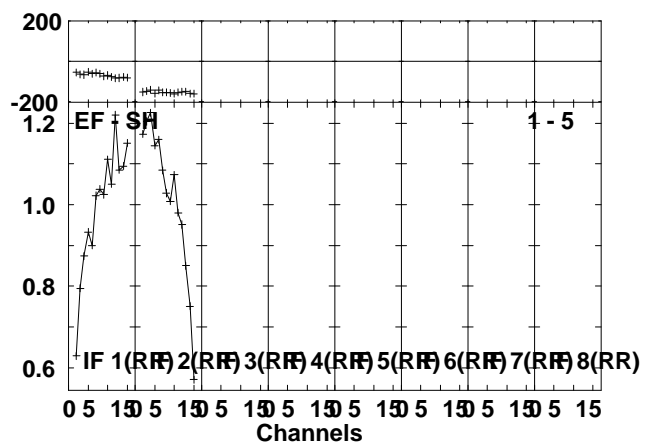
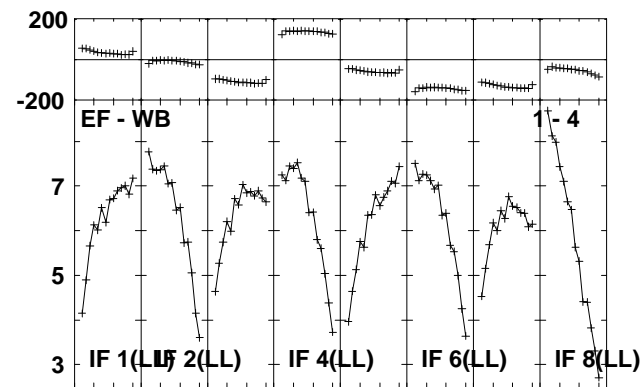
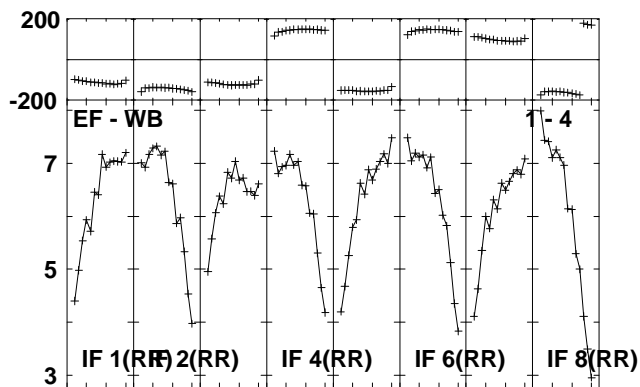
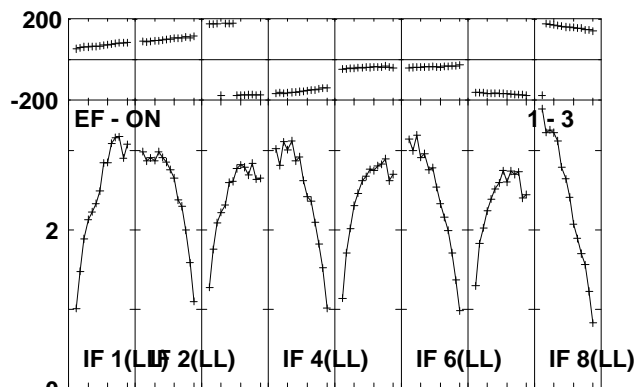
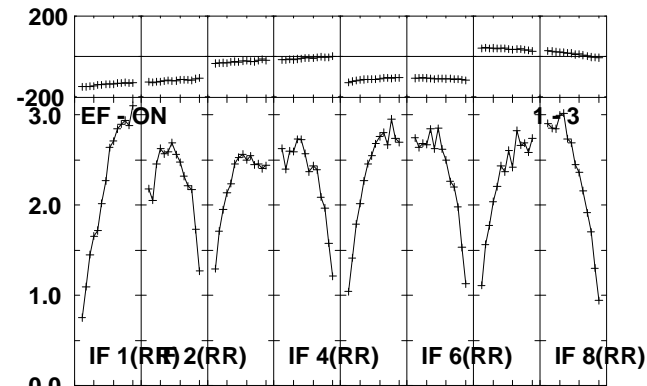
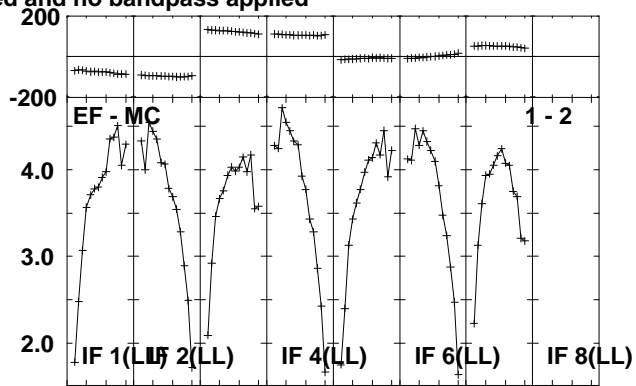
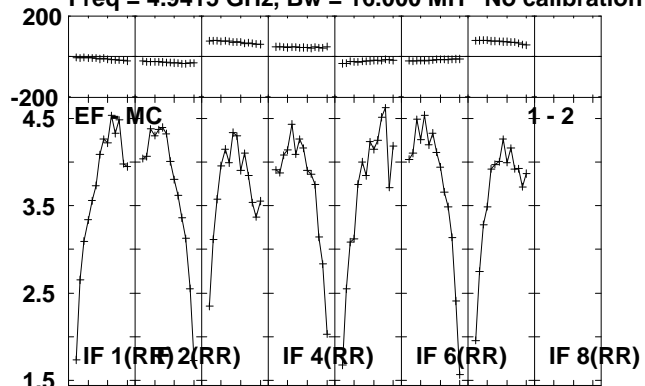

Lower frame: Milli Ampl Jy Top frame: Phas deg
Scalar averaged cross-power spectrum Several baselines displayed
Timerange: 00/18:24:21 to 00/18:31:29

Plot file version 10 created 14-JUL-2010 16:34:28
J1953+35 RR004A.UVDATA.1

Freq = 4.9415 GHz, Bw = 16.000 MH No calibration applied and no bandpass applied

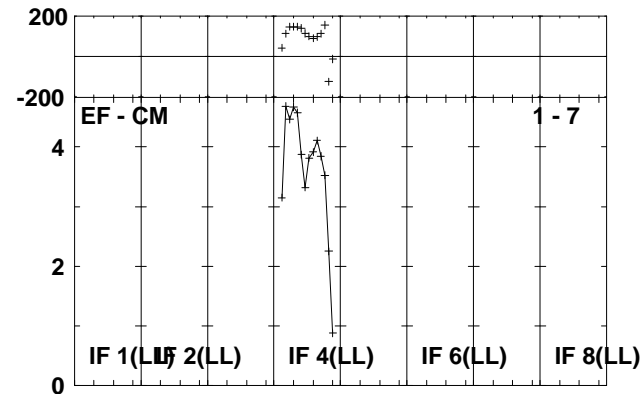
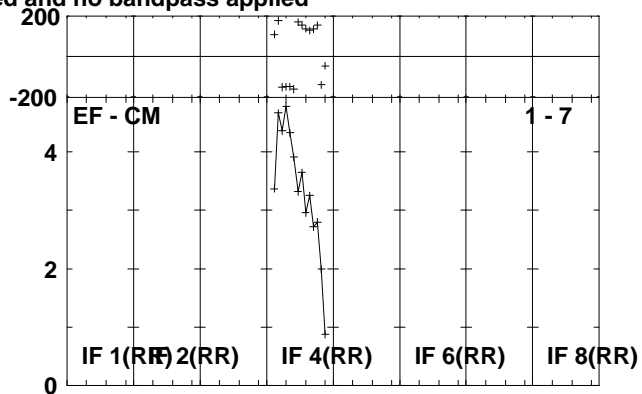
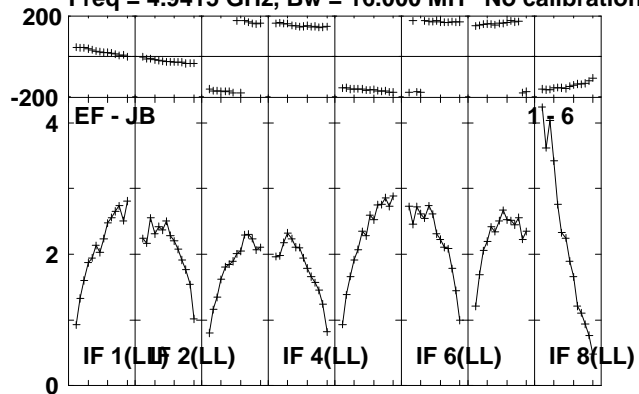

Lower frame: Milli Ampl Jy Top frame: Phas deg
Scalar averaged cross-power spectrum Several baselines displayed
Timerange: 00/18:24:21 to 00/18:31:29

Plot file version 11 created 14-JUL-2010 16:34:29

CYGX-1 RR004A.UVDATA.1

Freq = 4.9415 GHz, Bw = 16.000 MH No calibration applied and no bandpass applied

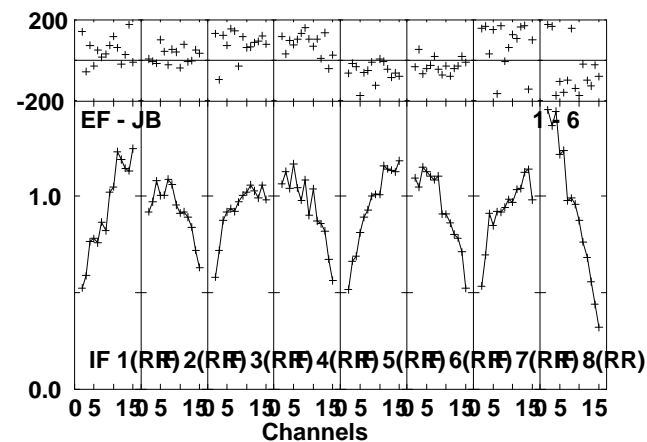
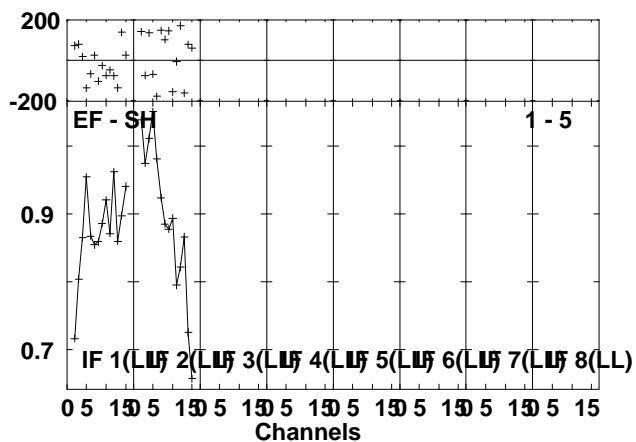
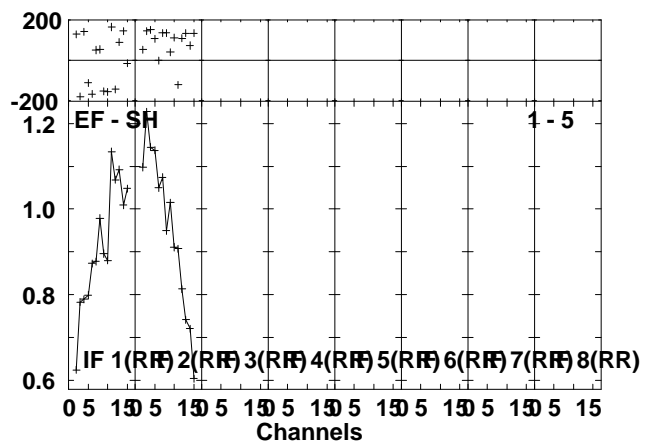
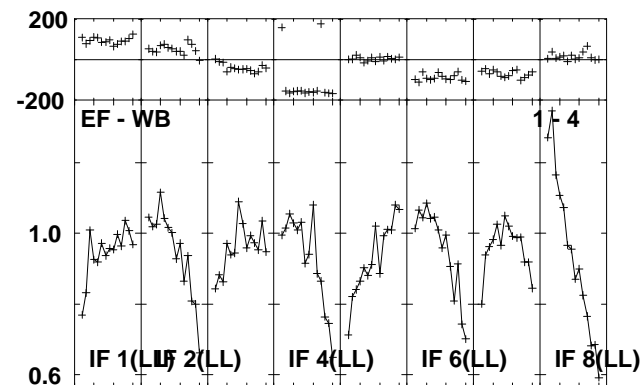
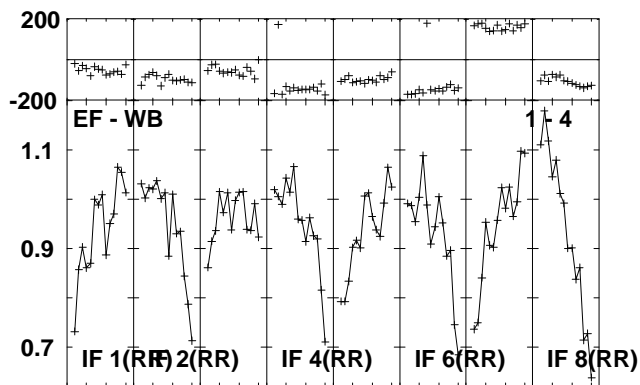
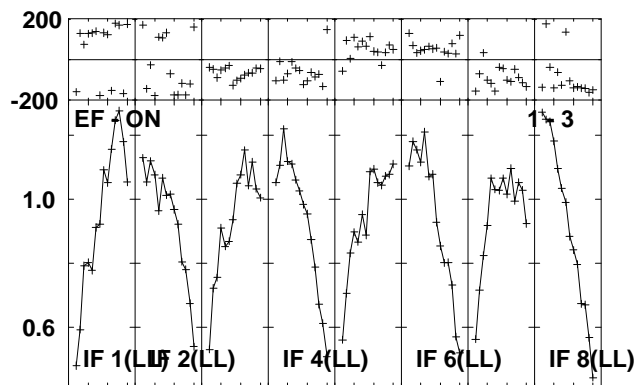
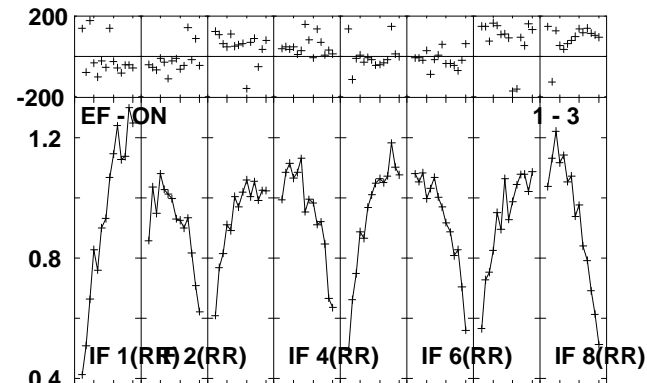
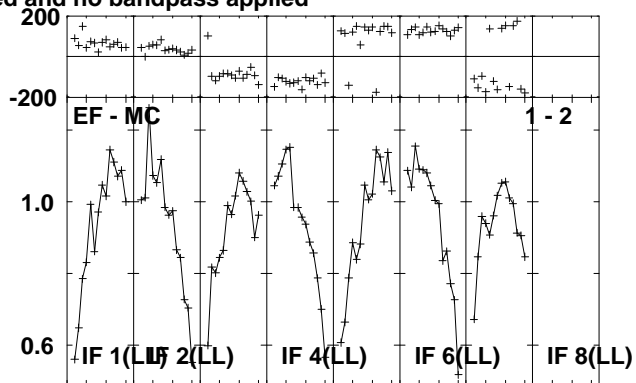
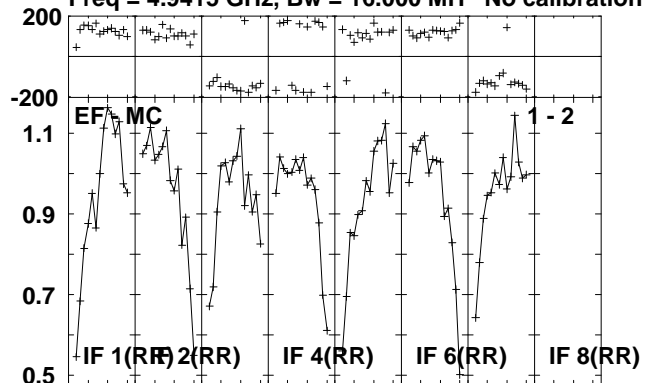

Lower frame: Milli Ampl Jy Top frame: Phas deg
Scalar averaged cross-power spectrum Several baselines displayed
Timerange: 00/18:31:31 to 00/18:36:29

Plot file version 12 created 14-JUL-2010 16:34:30

CYGX-1 RR004A.UVDATA.1

Freq = 4.9415 GHz, Bw = 16.000 MH No calibration applied and no bandpass applied

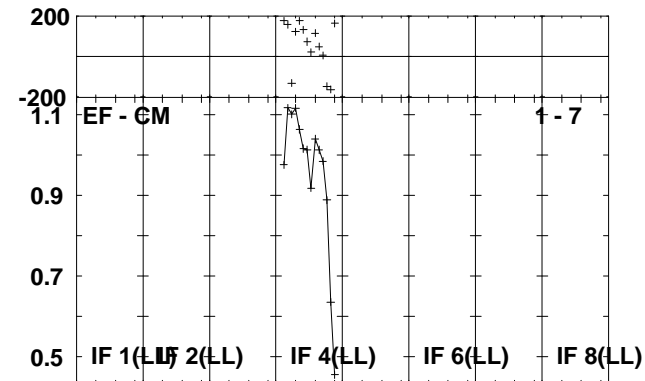
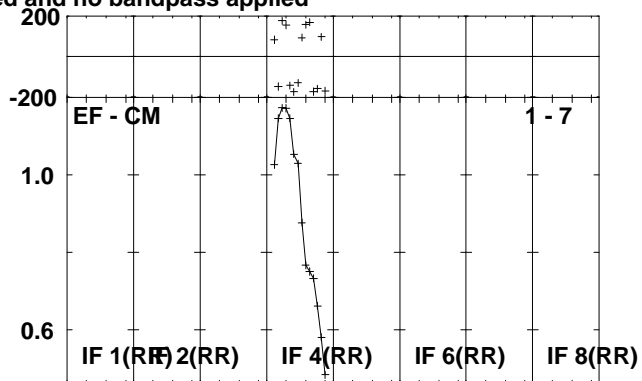
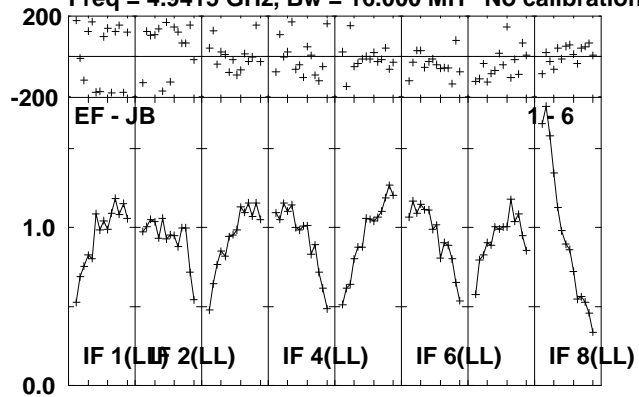

Lower frame: Milli Ampl Jy Top frame: Phas deg
Scalar averaged cross-power spectrum Several baselines displayed
Timerange: 00/18:31:31 to 00/18:36:29

Plot file version 13 created 14-JUL-2010 16:34:31

J1953+35 RR004A.UVDATA.1

Freq = 4.9415 GHz, Bw = 16.000 MH No calibration applied and no bandpass applied

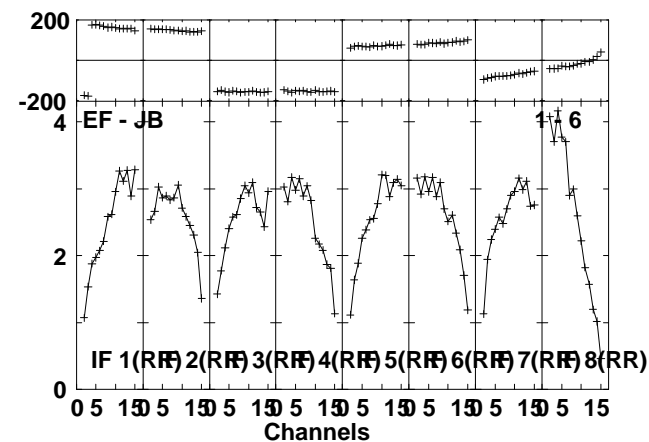
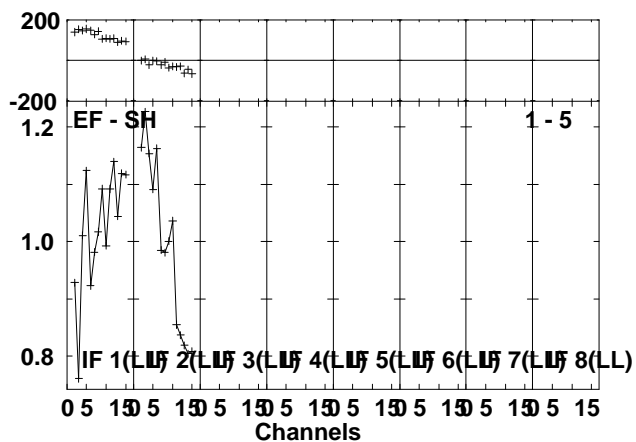
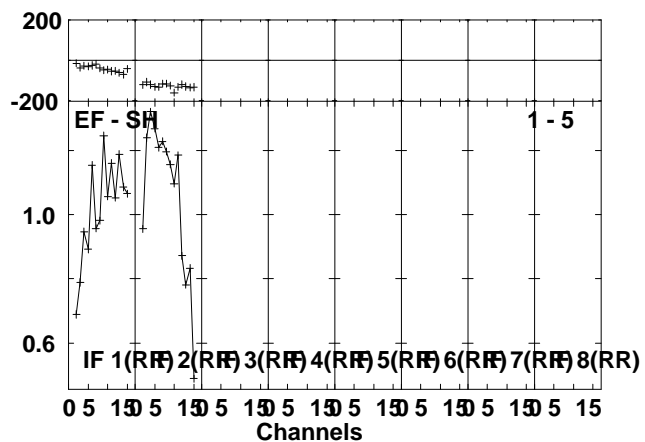
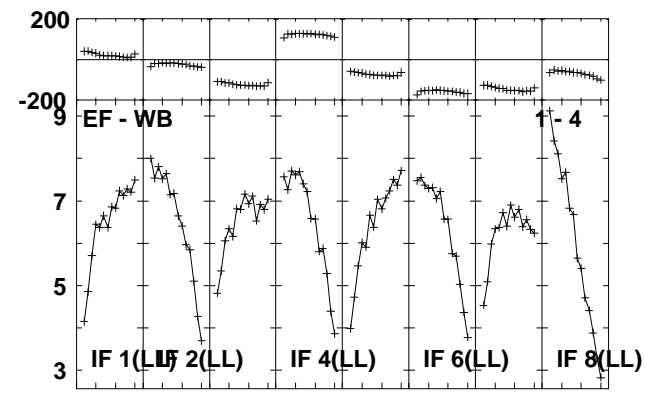
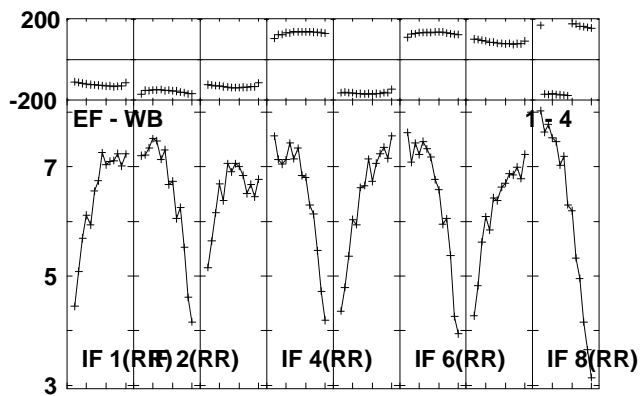
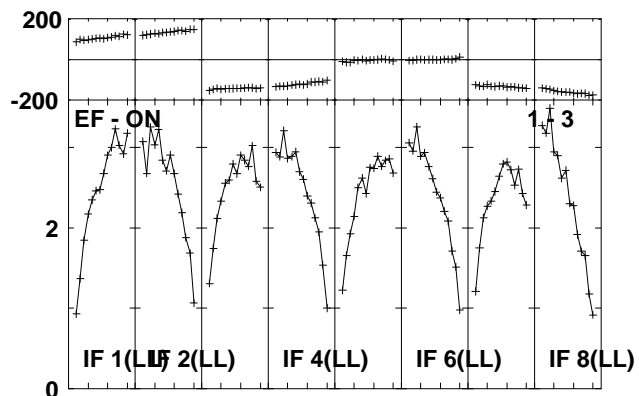
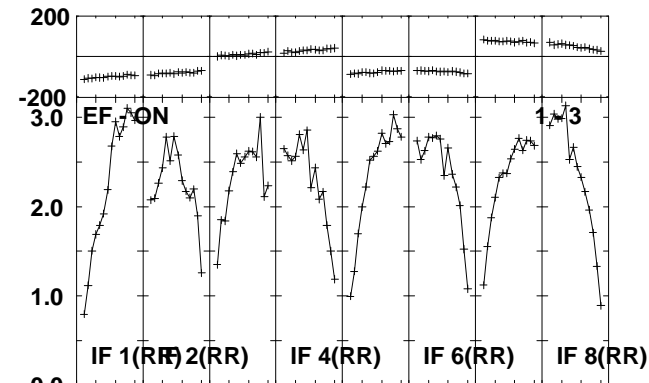
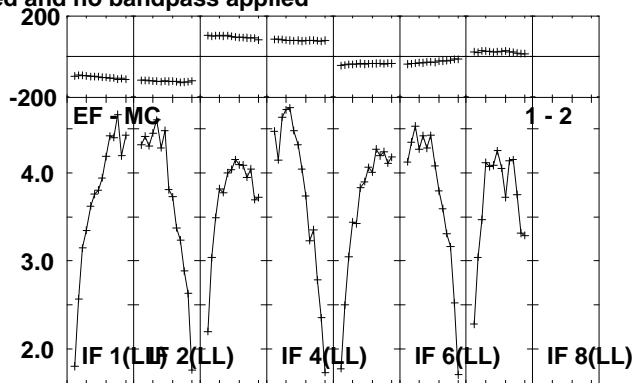
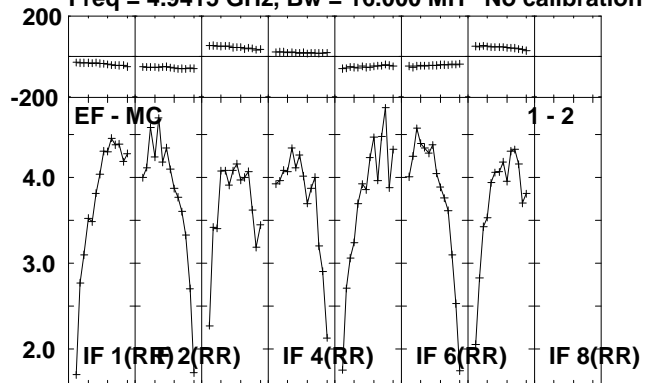

Lower frame: Milli Ampl Jy Top frame: Phas deg
Scalar averaged cross-power spectrum Several baselines displayed
Timerange: 00:18:36:31 to 00:18:38:29

Plot file version 14 created 14-JUL-2010 16:34:32

J1953+35 RR004A.UVDATA.1

Freq = 4.9415 GHz, Bw = 16.000 MH No calibration applied and no bandpass applied

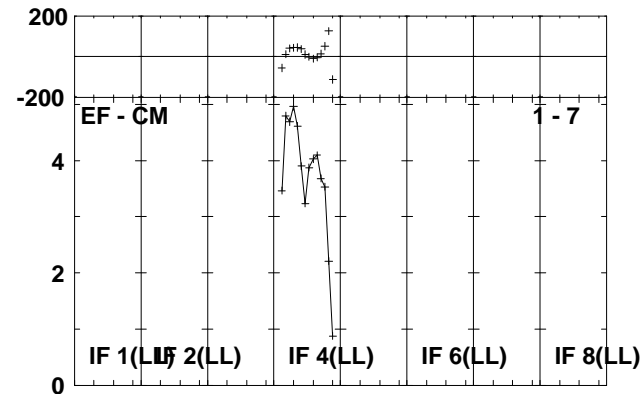
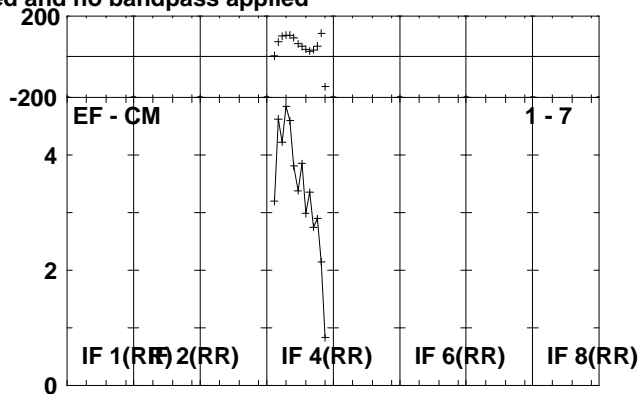
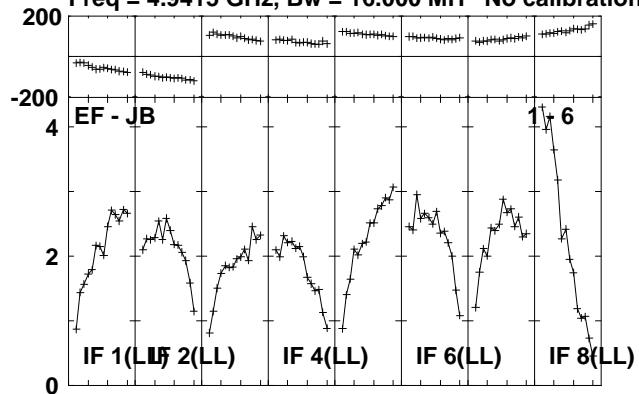

Lower frame: Milli Ampl Jy Top frame: Phas deg
Scalar averaged cross-power spectrum Several baselines displayed
Timerange: 00/18:36:31 to 00/18:38:29

Plot file version 15 created 14-JUL-2010 16:34:33

CYGX-1 RR004A.UVDATA.1

Freq = 4.9415 GHz, Bw = 16.000 MH No calibration applied and no bandpass applied

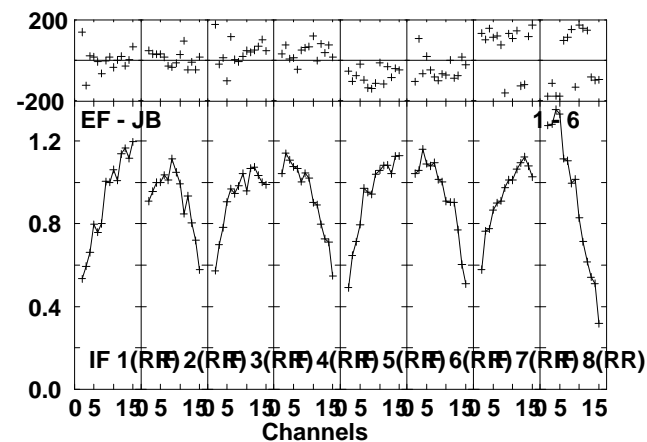
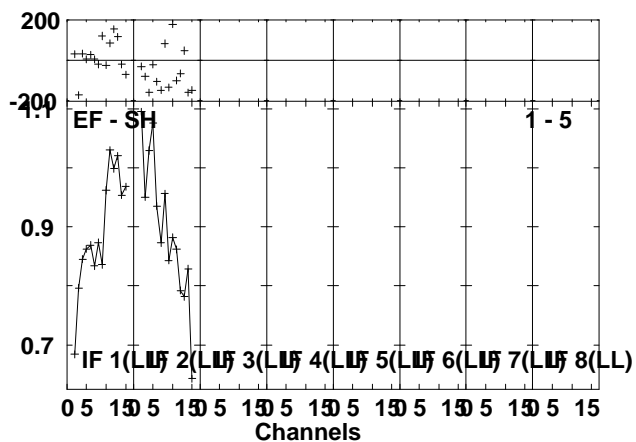
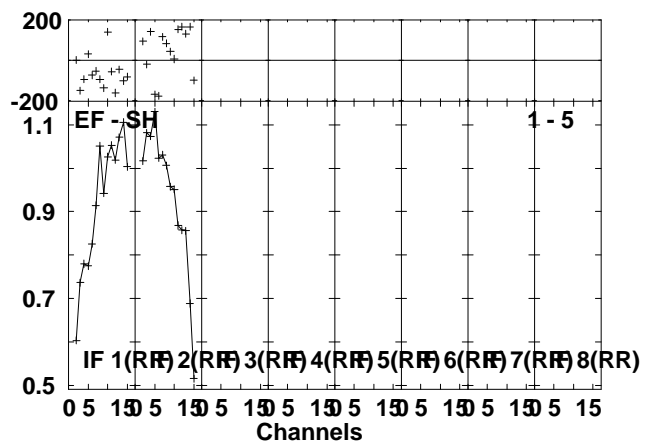
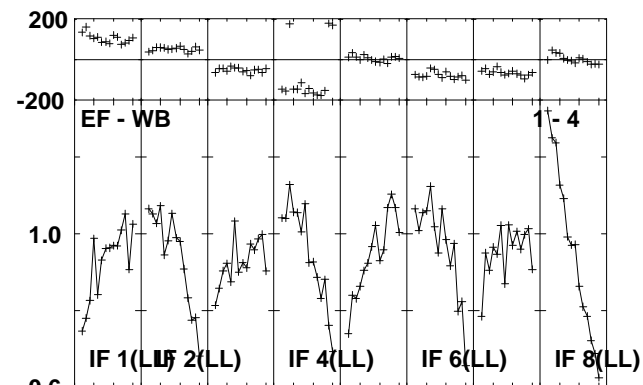
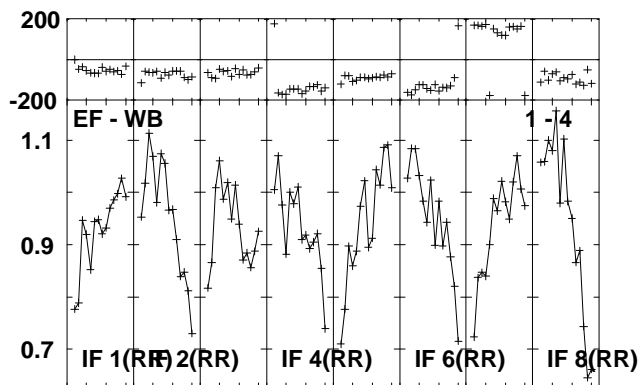
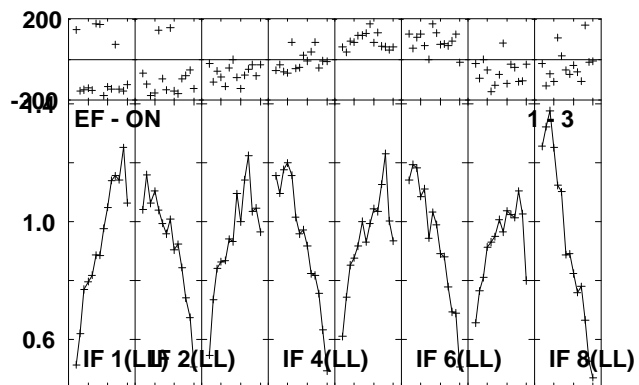
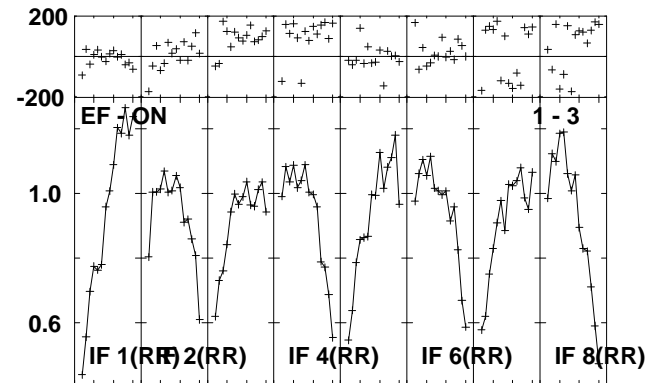
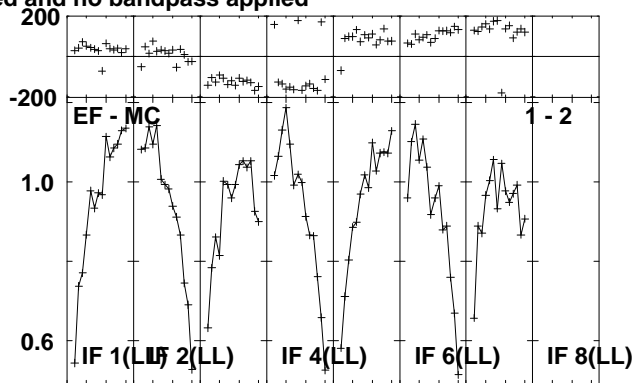
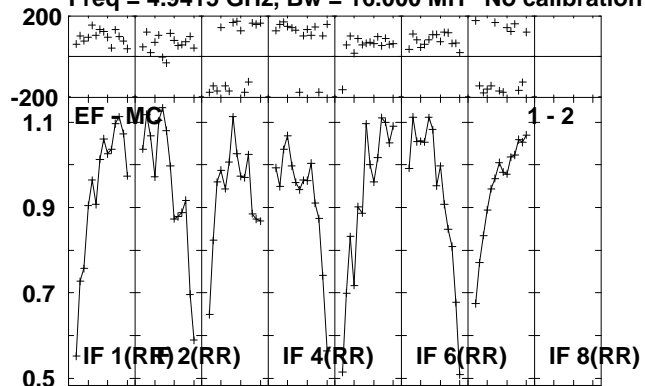

Lower frame: Milli Ampl Jy Top frame: Phas deg
Scalar averaged cross-power spectrum Several baselines displayed
Timerange: 00/18:38:31 to 00/18:43:29

Plot file version 16 created 14-JUL-2010 16:34:34

CYGX-1 RR004A.UVDATA.1

Freq = 4.9415 GHz, Bw = 16.000 MH No calibration applied and no bandpass applied

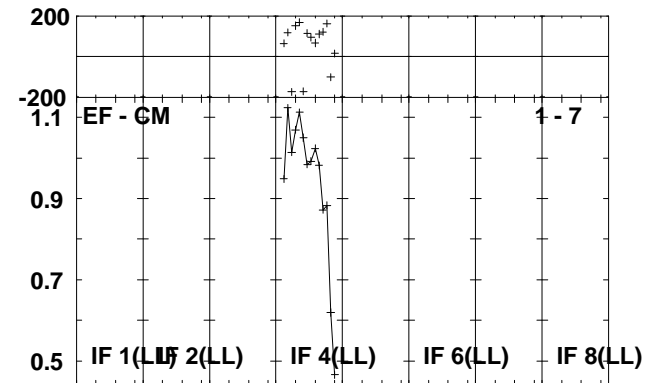
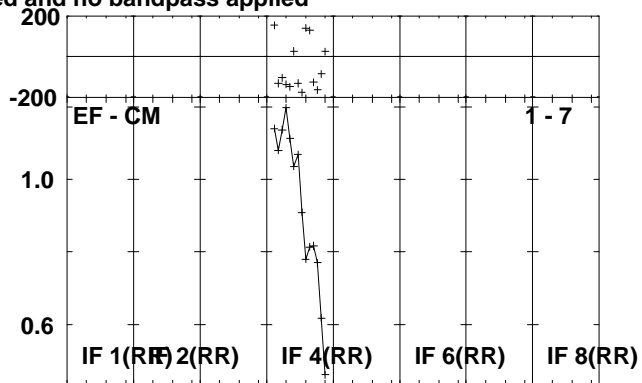
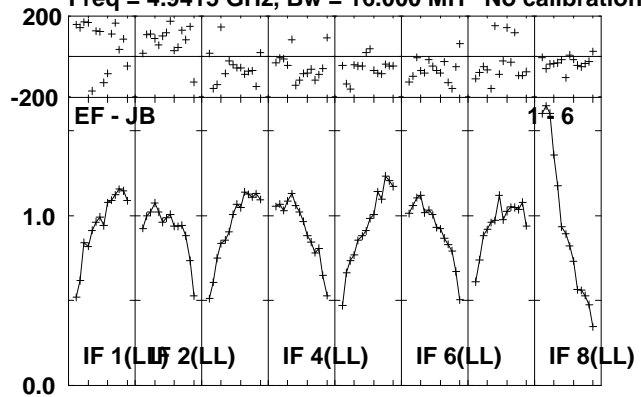

Lower frame: Milli Ampl Jy Top frame: Phas deg
Scalar averaged cross-power spectrum Several baselines displayed
Timerange: 00/18:38:31 to 00/18:43:29

Plot file version 17 created 14-JUL-2010 16:34:35

J1953+35 RR004A.UVDATA.1

Freq = 4.9415 GHz, Bw = 16.000 MH No calibration applied and no bandpass applied

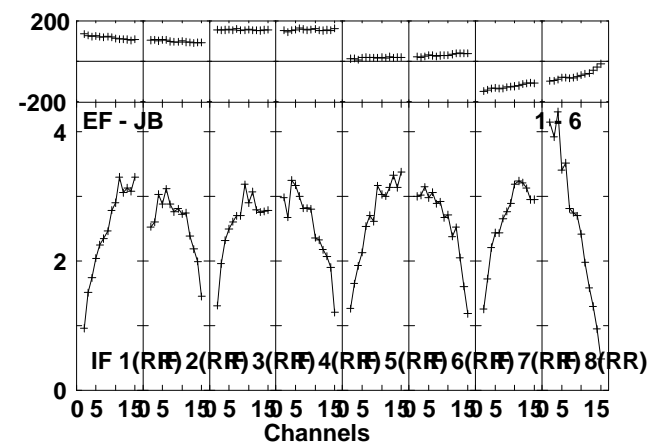
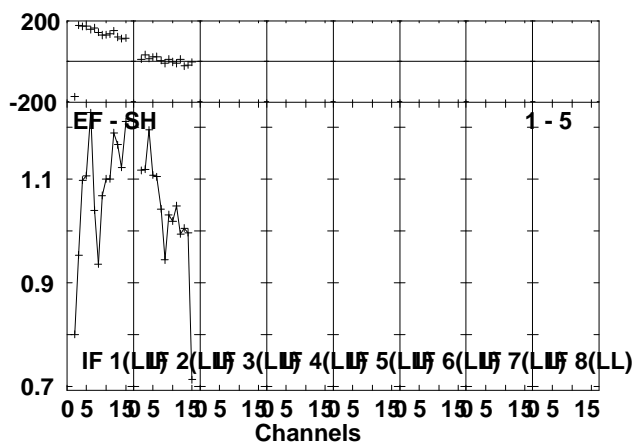
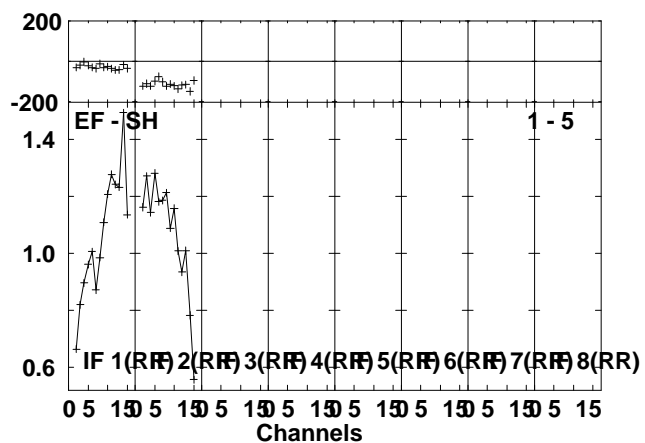
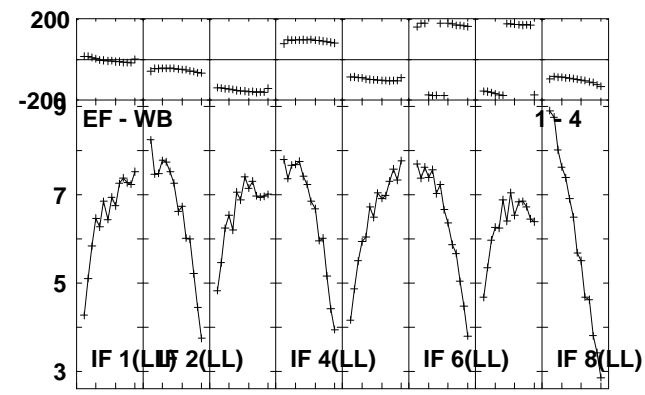
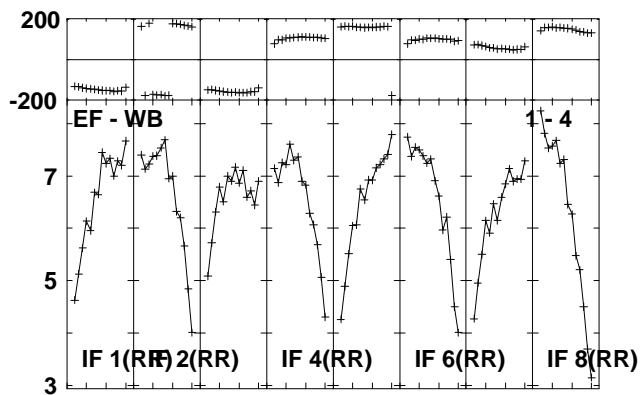
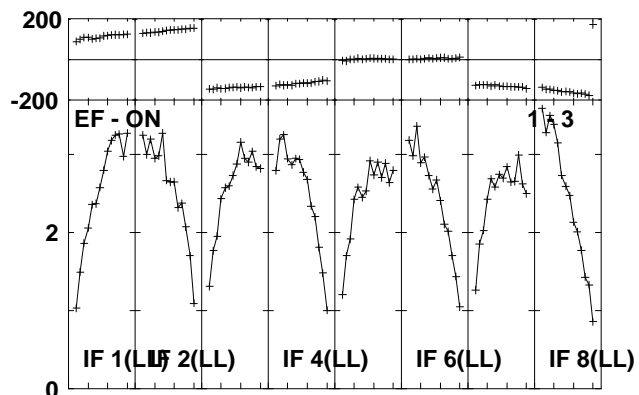
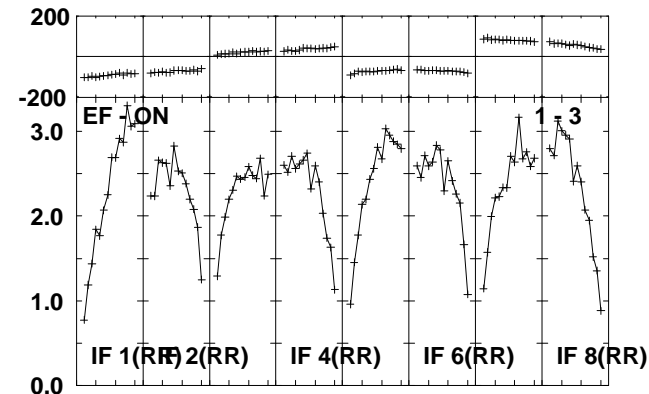
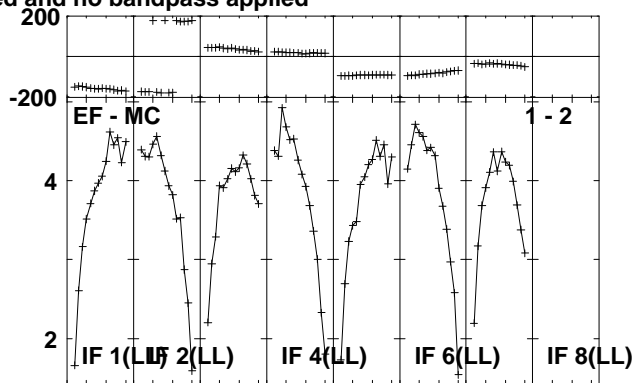
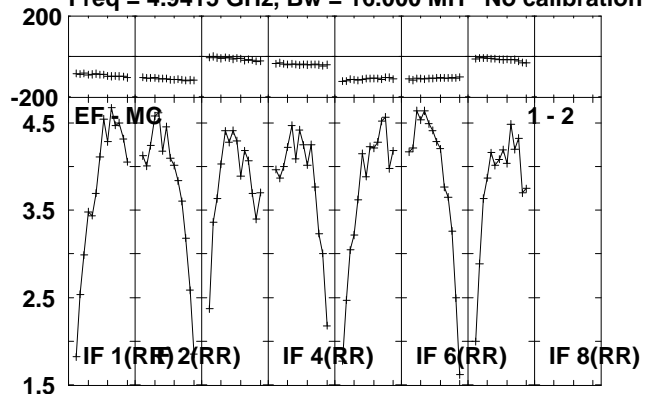

Lower frame: Milli Ampl Jy Top frame: Phas deg
Scalar averaged cross-power spectrum Several baselines displayed
Timerange: 00:18:44:11 to 00:18:45:39

Plot file version 18 created 14-JUL-2010 16:34:36
J1953+35 RR004A.UVDATA.1

Freq = 4.9415 GHz, Bw = 16.000 MH No calibration applied and no bandpass applied

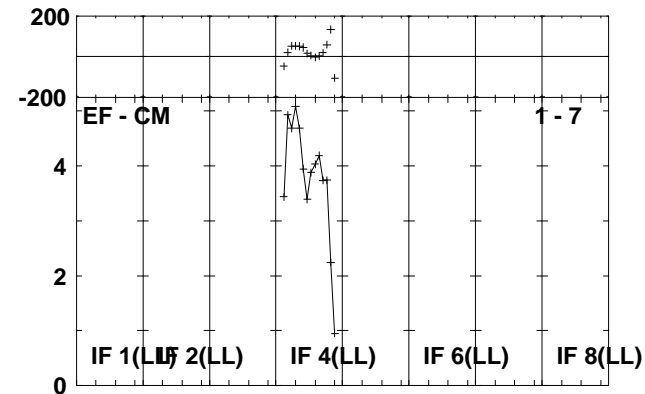
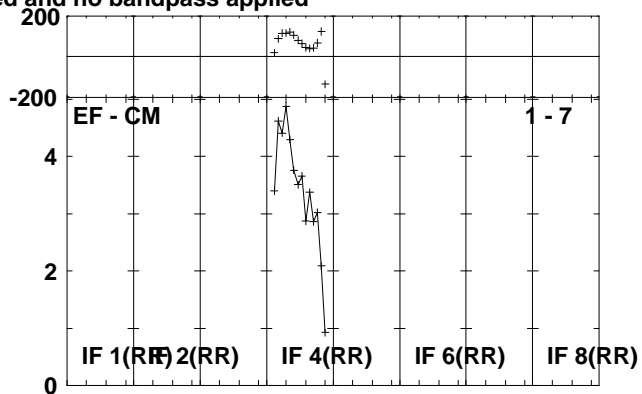
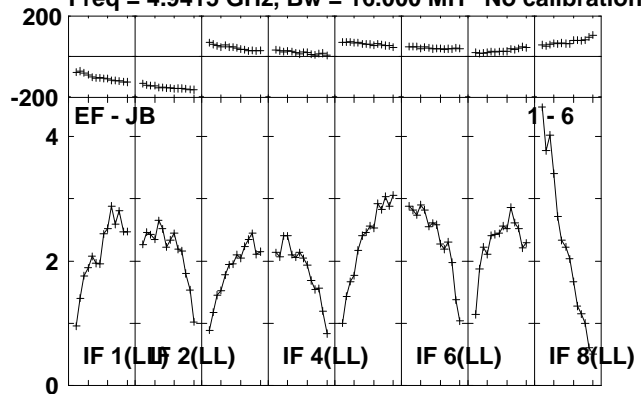

Lower frame: Milli Ampl Jy Top frame: Phas deg
Scalar averaged cross-power spectrum Several baselines displayed
Timerange: 00/18:44:11 to 00/18:45:39

Plot file version 19 created 14-JUL-2010 16:34:36

CYGX-1 RR004A.UVDATA.1

Freq = 4.9415 GHz, Bw = 16.000 MH No calibration applied and no bandpass applied

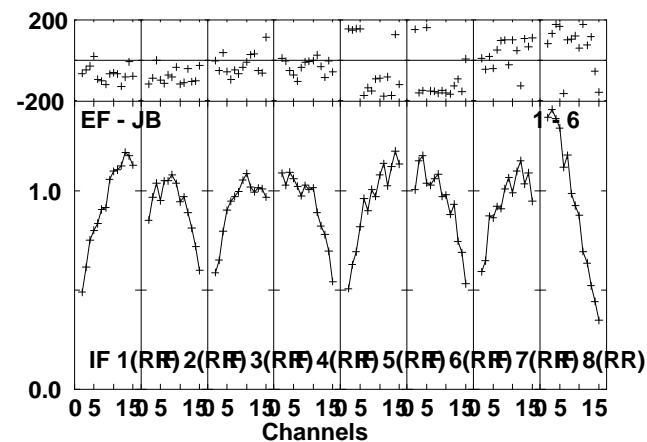
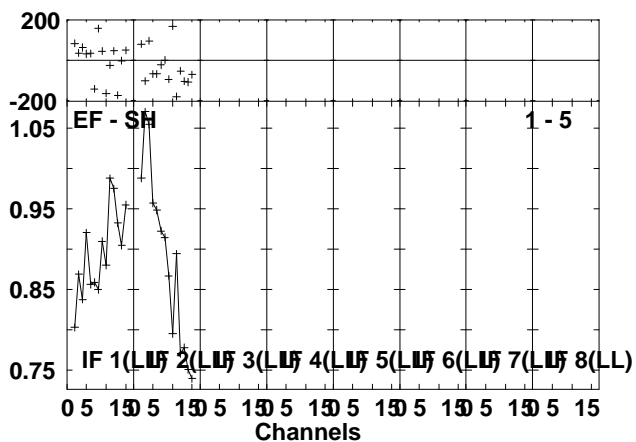
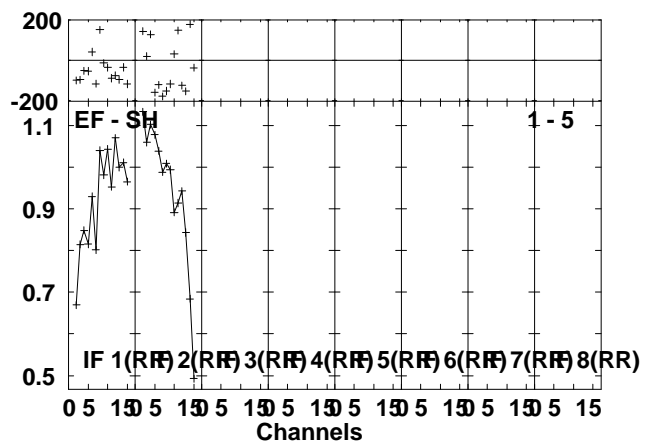
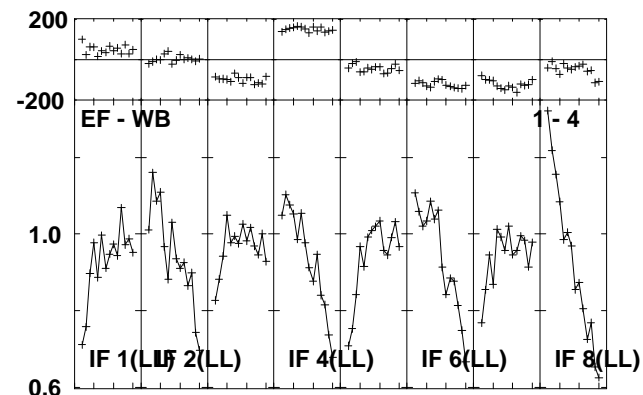
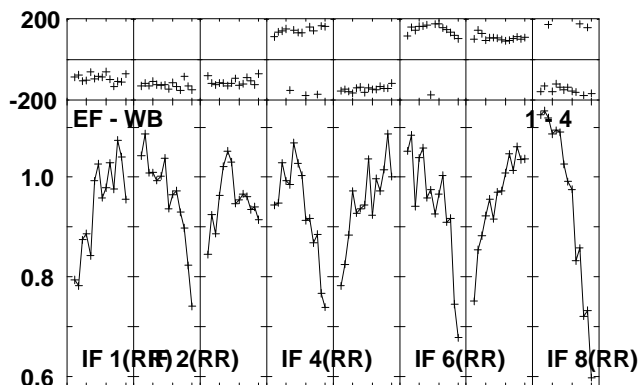
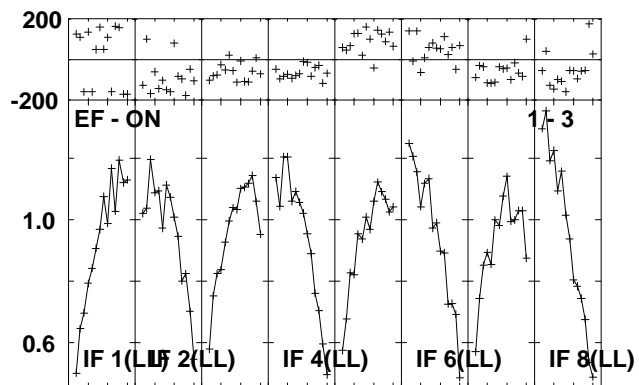
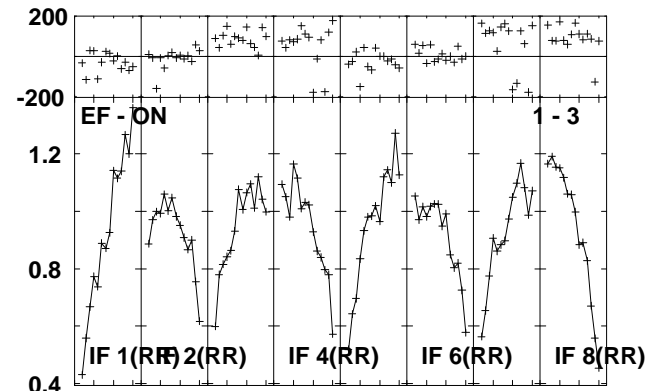
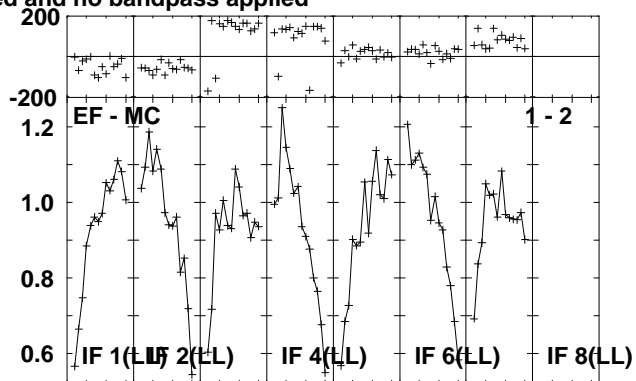
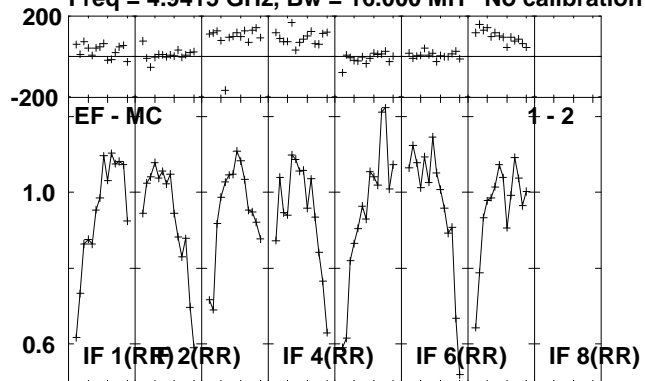

Lower frame: Milli Ampl Jy Top frame: Phas deg
Scalar averaged cross-power spectrum Several baselines displayed
Timerange: 00:18:45:41 to 00:18:50:39

Plot file version 20 created 14-JUL-2010 16:34:37

CYGX-1 RR004A.UVDATA.1

Freq = 4.9415 GHz, Bw = 16.000 MH No calibration applied and no bandpass applied

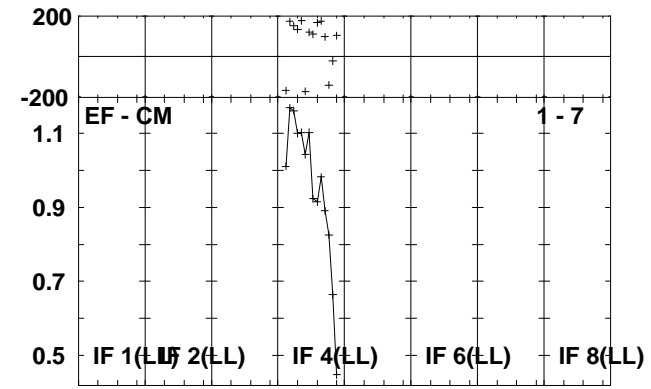
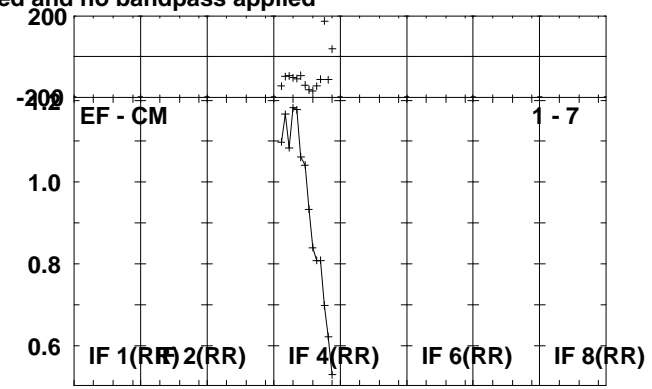
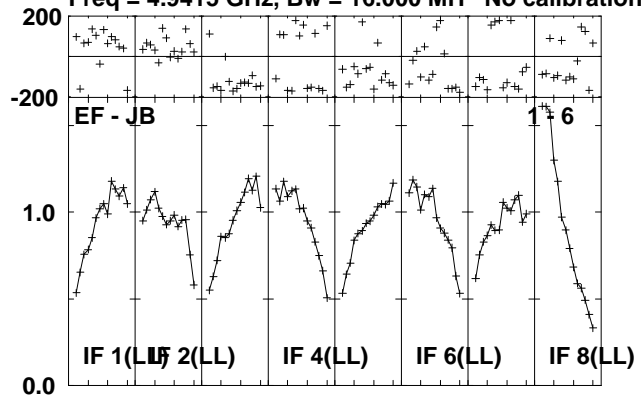

Lower frame: Milli Ampl Jy Top frame: Phas deg
Scalar averaged cross-power spectrum Several baselines displayed
Timerange: 00/18:45:41 to 00/18:50:39

Plot file version 21 created 14-JUL-2010 16:34:39

J1953+35 RR004A.UVDATA.1

Freq = 4.9415 GHz, Bw = 16.000 MH No calibration applied and no bandpass applied

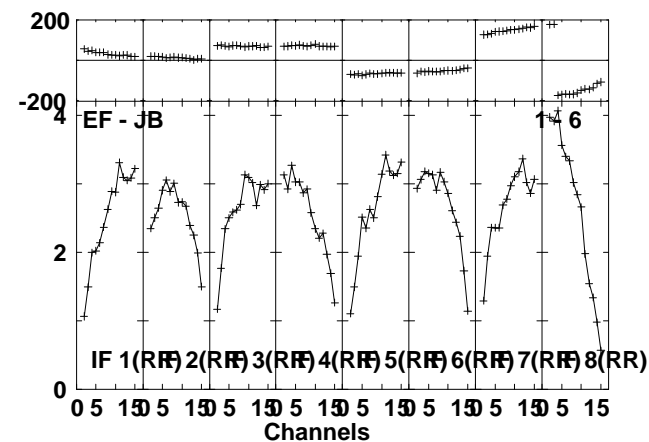
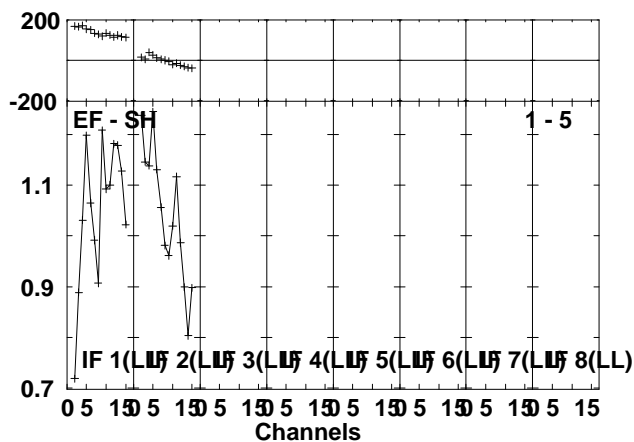
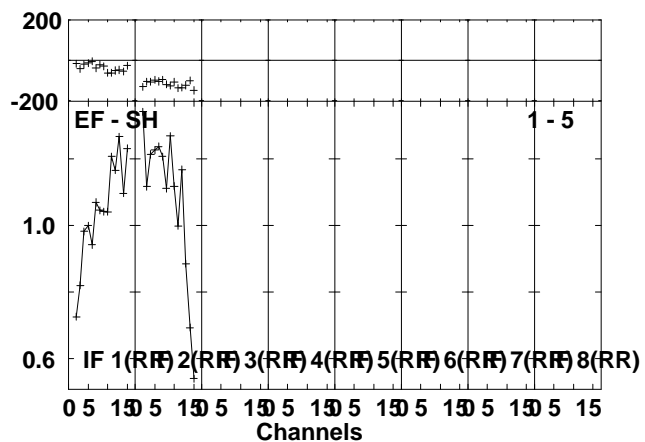
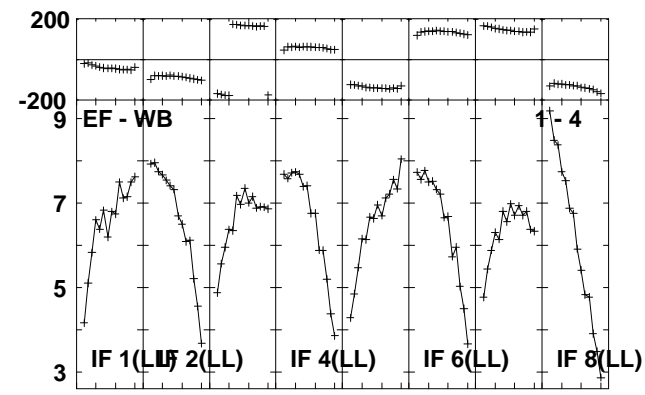
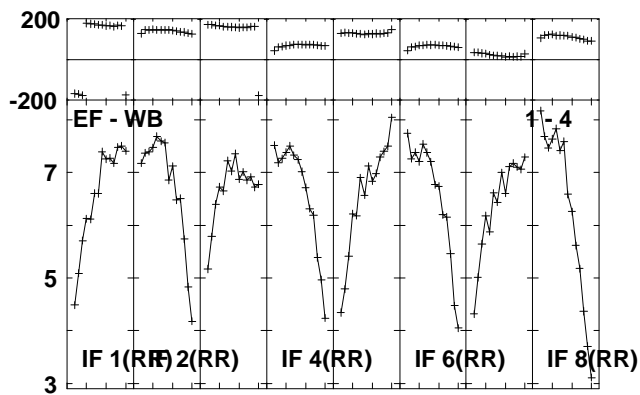
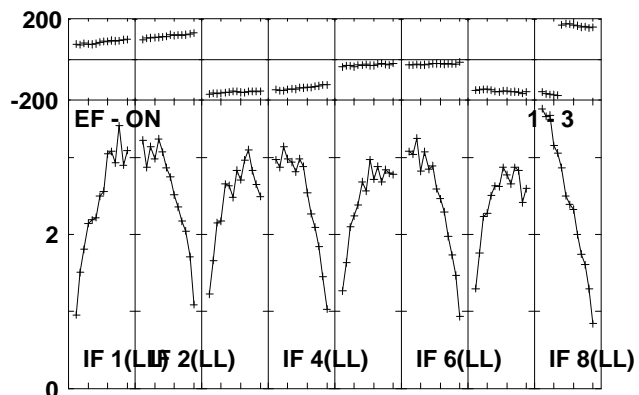
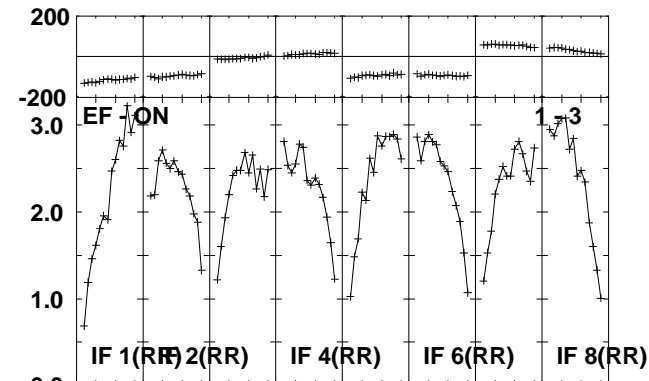
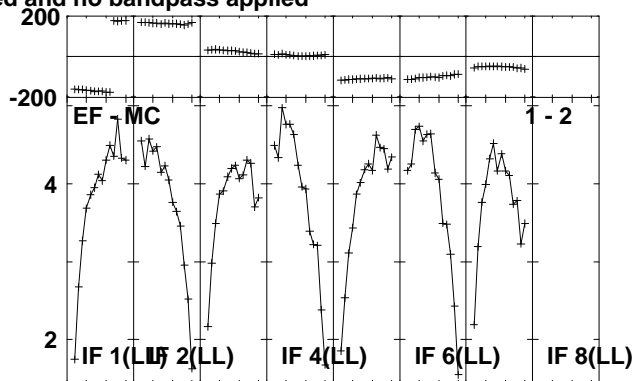
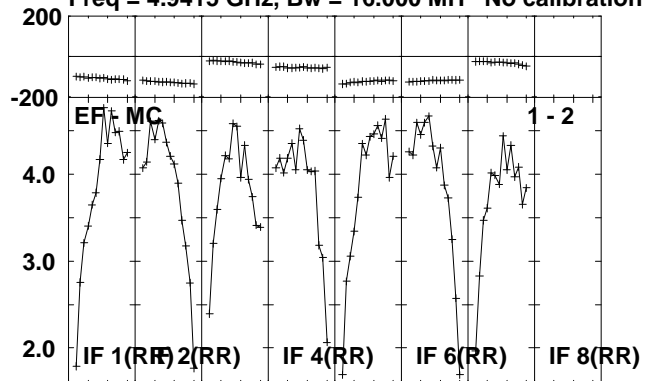

Lower frame: Milli Ampl Jy Top frame: Phas deg
Scalar averaged cross-power spectrum Several baselines displayed
Timerange: 00:18:50:41 to 00:18:52:39

Plot file version 22 created 14-JUL-2010 16:34:39
J1953+35 RR004A.UVDATA.1

Freq = 4.9415 GHz, Bw = 16.000 MH No calibration applied and no bandpass applied

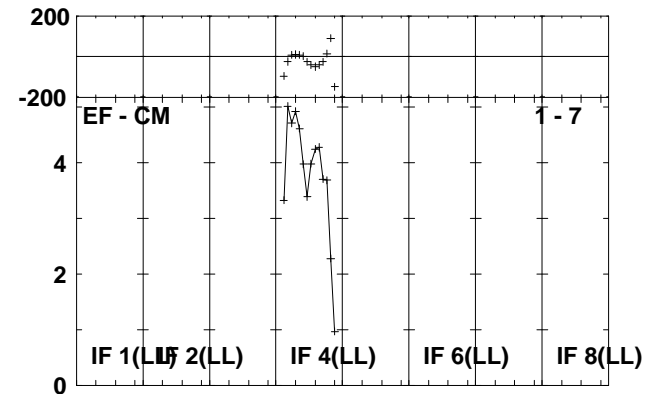
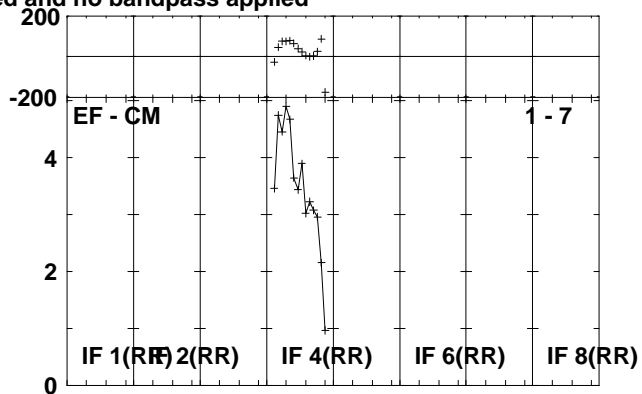
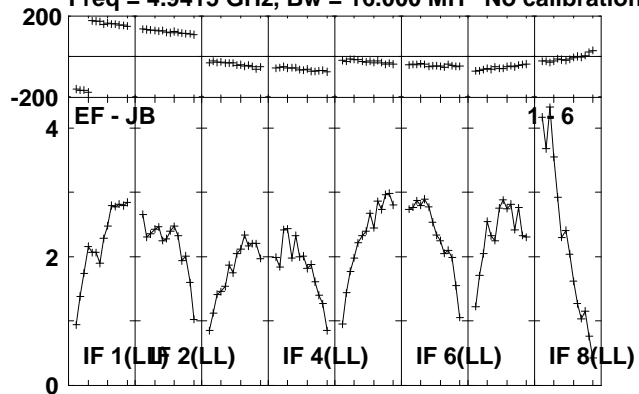

Lower frame: Milli Ampl Jy Top frame: Phas deg
Scalar averaged cross-power spectrum Several baselines displayed
Timerange: 00/18:50:41 to 00/18:52:39

Plot file version 23 created 14-JUL-2010 16:34:40
 CYGX-1 RR004A.UVDATA.1

Freq = 4.9415 GHz, Bw = 16.000 MH No calibration applied and no bandpass applied

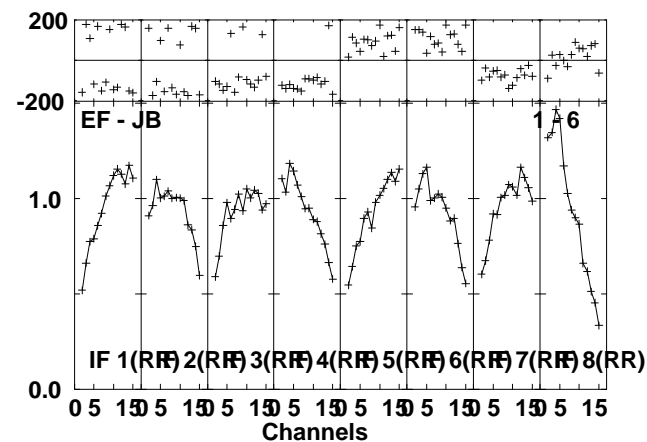
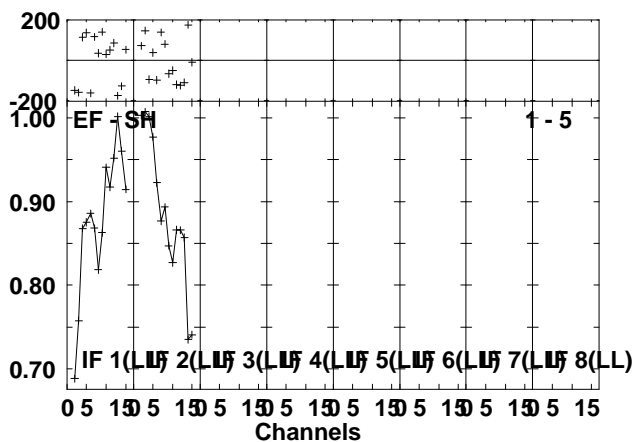
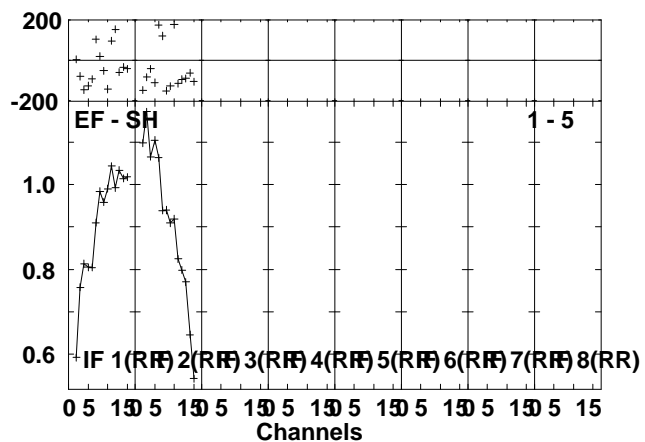
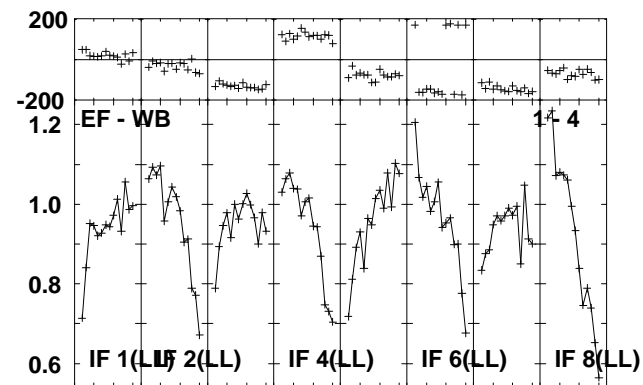
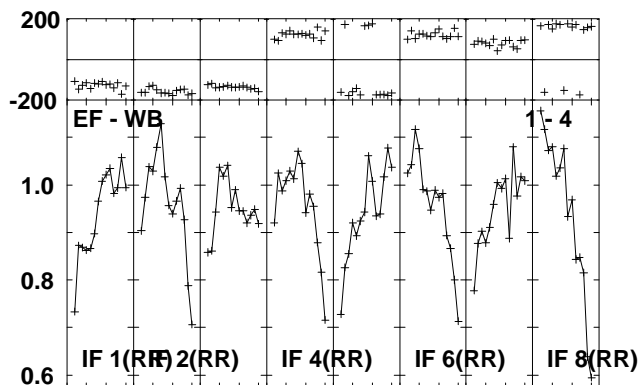
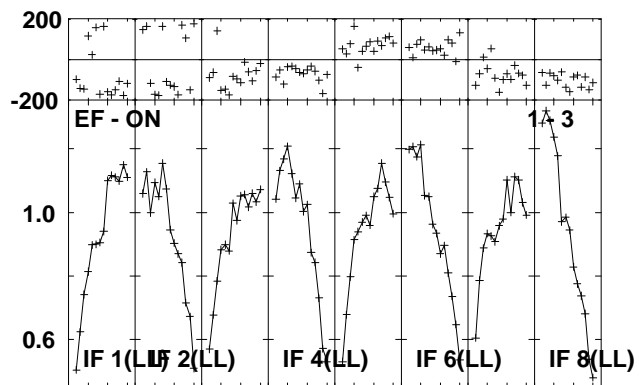
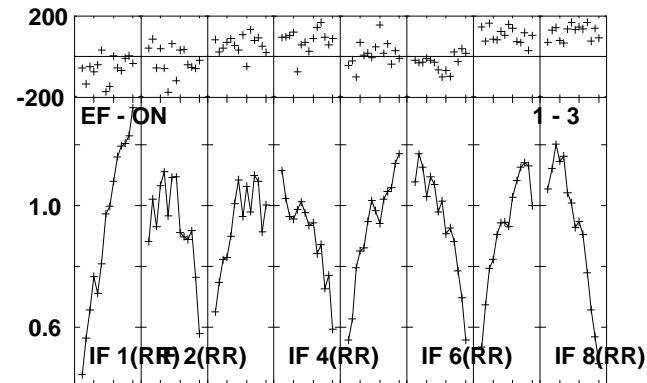
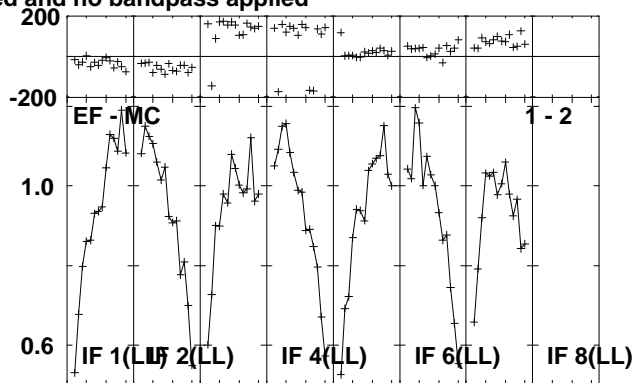
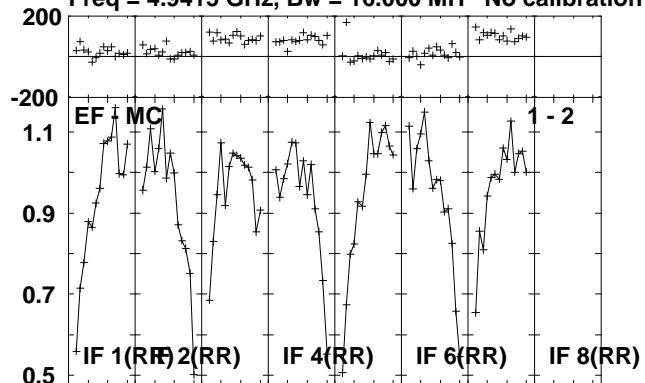

Lower frame: Milli Ampl Jy Top frame: Phas deg
 Scalar averaged cross-power spectrum Several baselines displayed
 Timerange: 00:18:52:41 to 00:18:57:39

Plot file version 24 created 14-JUL-2010 16:34:41

CYGX-1 RR004A.UVDATA.1

Freq = 4.9415 GHz, Bw = 16.000 MH No calibration applied and no bandpass applied

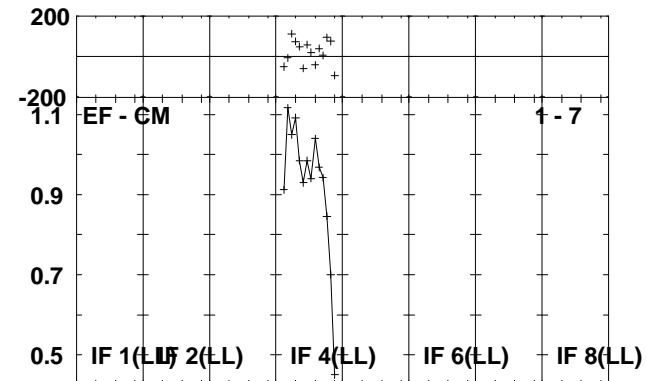
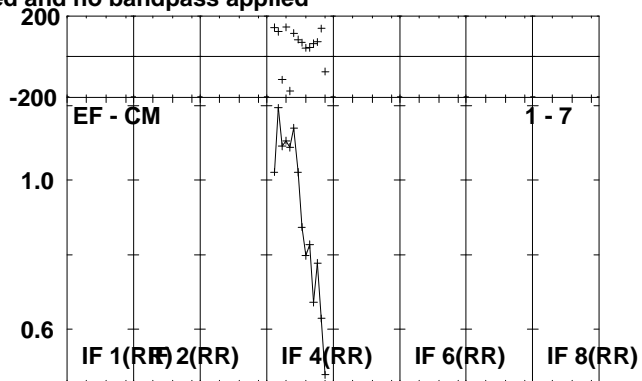
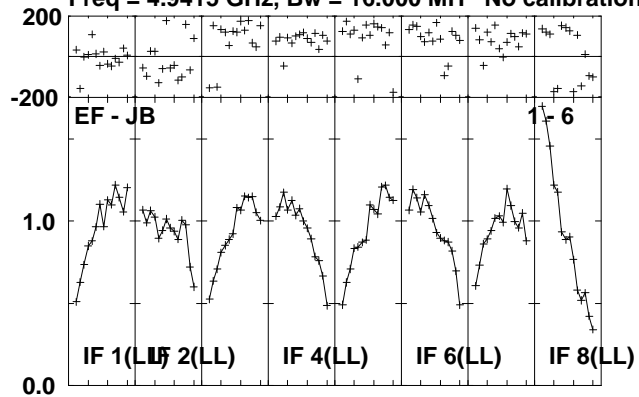

Lower frame: Milli Ampl Jy Top frame: Phas deg
Scalar averaged cross-power spectrum Several baselines displayed
Timerange: 00/18:52:41 to 00/18:57:39

Plot file version 25 created 14-JUL-2010 16:34:42

J1953+35 RR004A.UVDATA.1

Freq = 4.9415 GHz, Bw = 16.000 MH No calibration applied and no bandpass applied

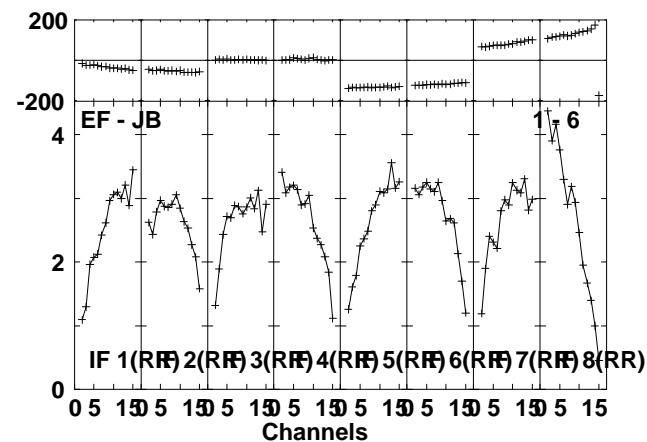
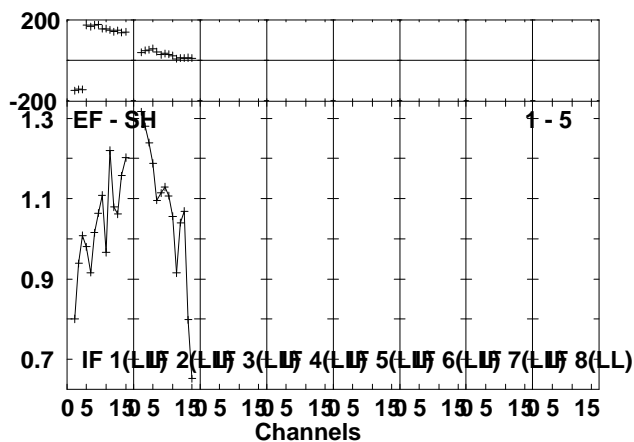
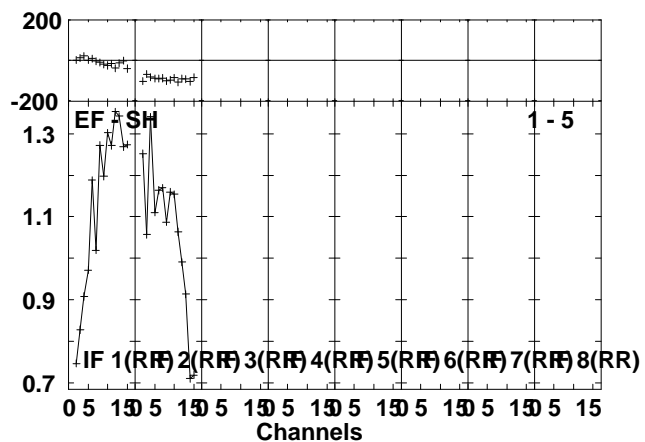
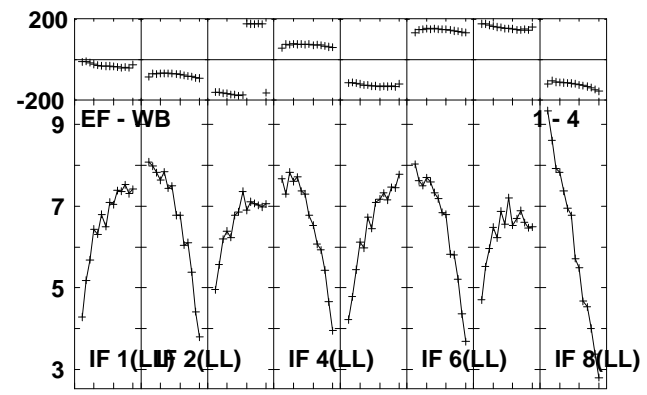
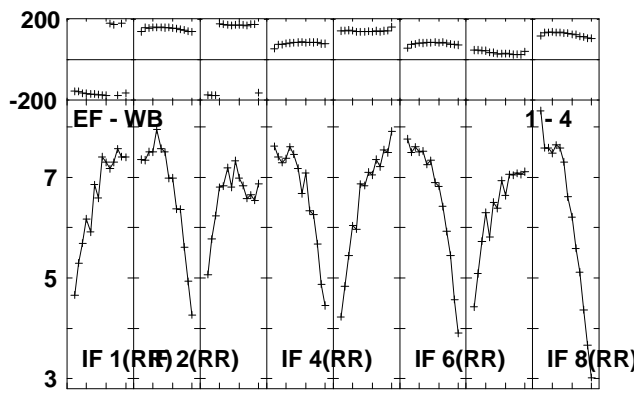
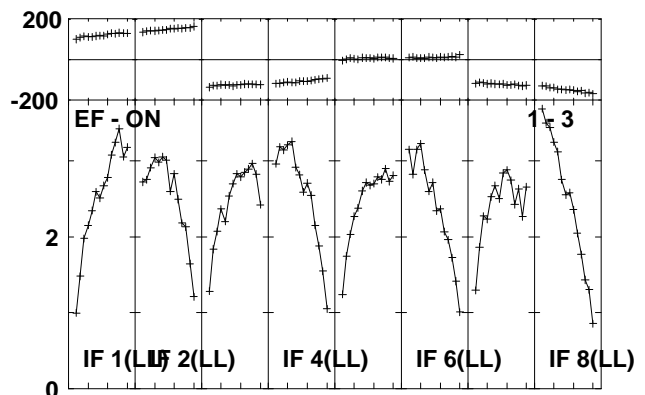
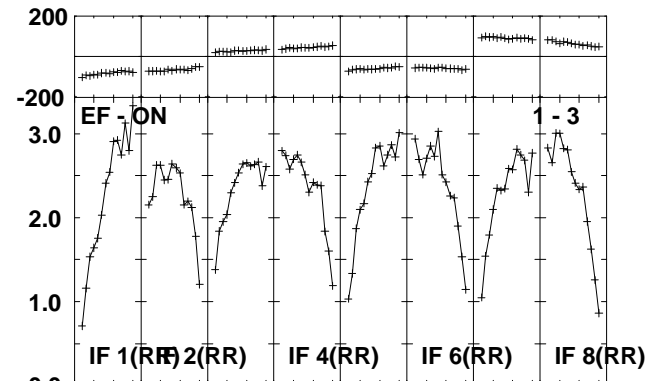
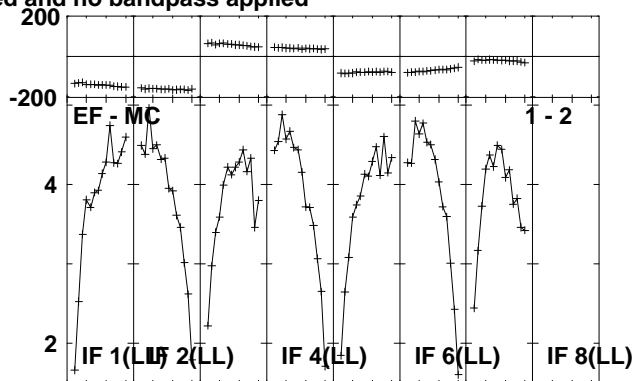
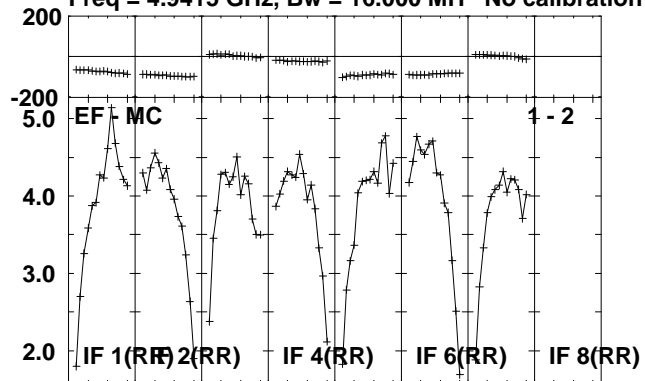

Lower frame: Milli Ampl Jy Top frame: Phas deg
Scalar averaged cross-power spectrum Several baselines displayed
Timerange: 00:18:58:21 to 00:18:59:49

Plot file version 26 created 14-JUL-2010 16:34:43
J1953+35 RR004A.UVDATA.1

Freq = 4.9415 GHz, Bw = 16.000 MH No calibration applied and no bandpass applied

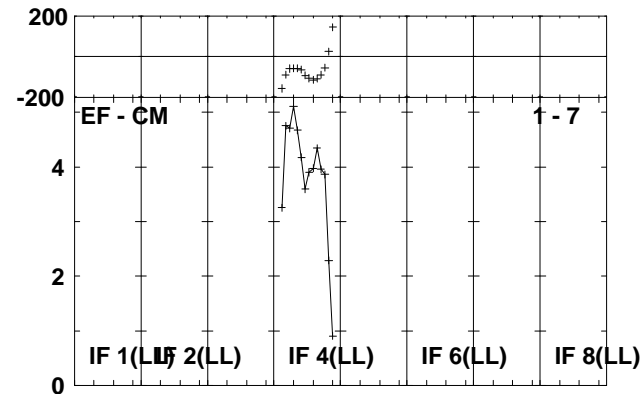
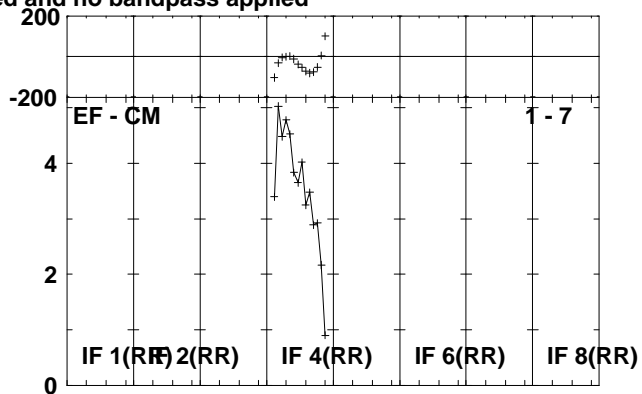
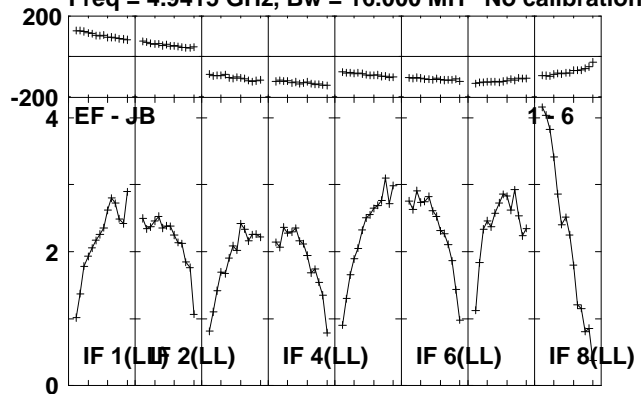

Lower frame: Milli Ampl Jy Top frame: Phas deg
Scalar averaged cross-power spectrum Several baselines displayed
Timerange: 00/18:58:21 to 00/18:59:49

Plot file version 27 created 14-JUL-2010 16:34:43

CYGX-1 RR004A.UVDATA.1

Freq = 4.9415 GHz, Bw = 16.000 MH No calibration applied and no bandpass applied

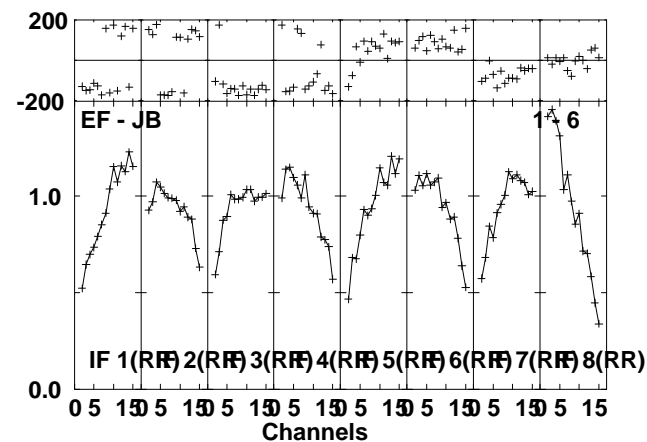
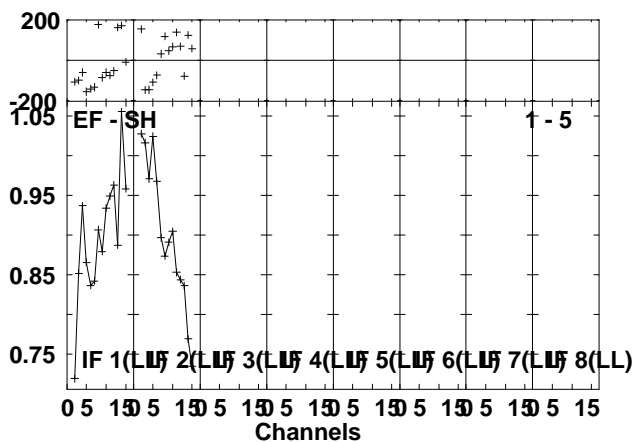
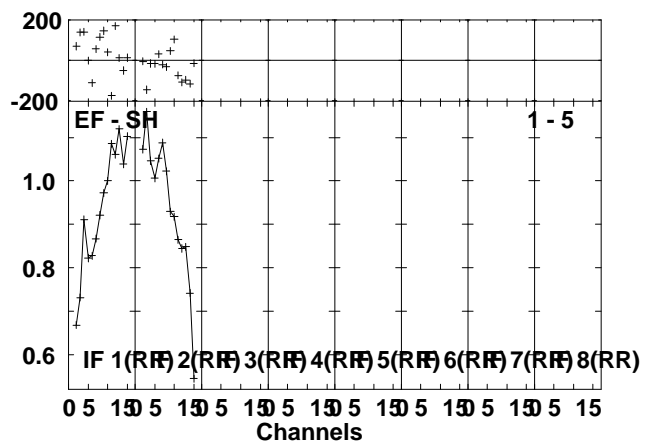
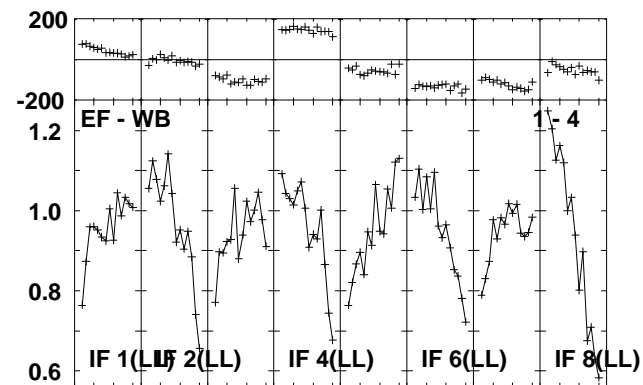
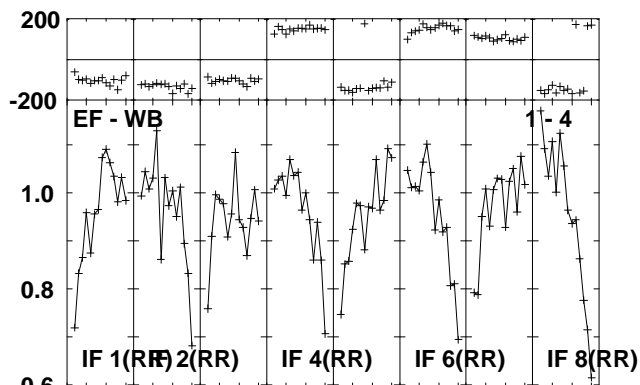
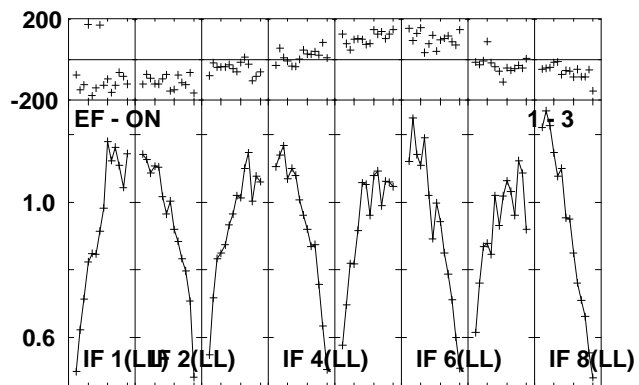
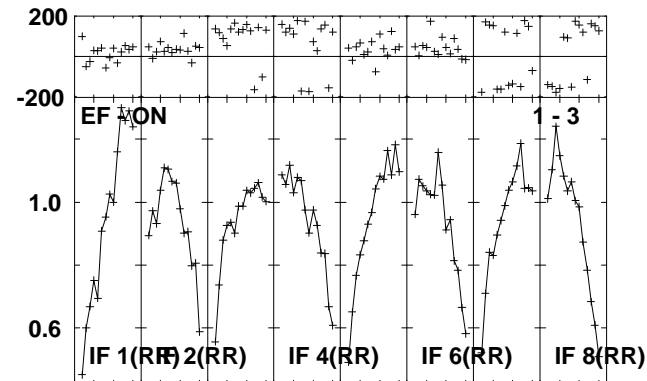
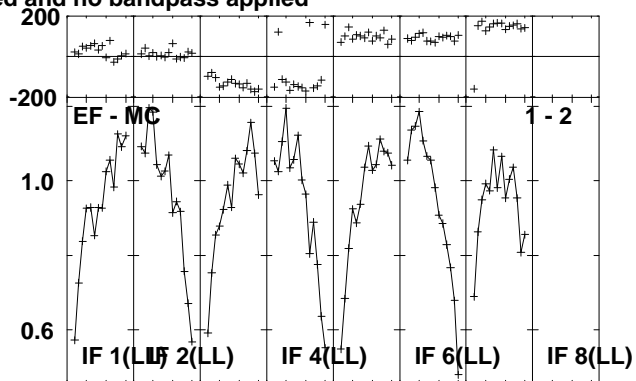
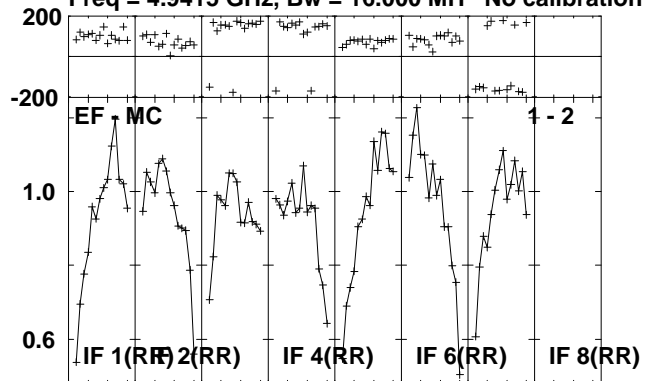

Lower frame: Milli Ampl Jy Top frame: Phas deg
Scalar averaged cross-power spectrum Several baselines displayed
Timerange: 00/18:59:51 to 00/19:04:49

Plot file version 28 created 14-JUL-2010 16:34:45

CYGX-1 RR004A.UVDATA.1

Freq = 4.9415 GHz, Bw = 16.000 MH No calibration applied and no bandpass applied

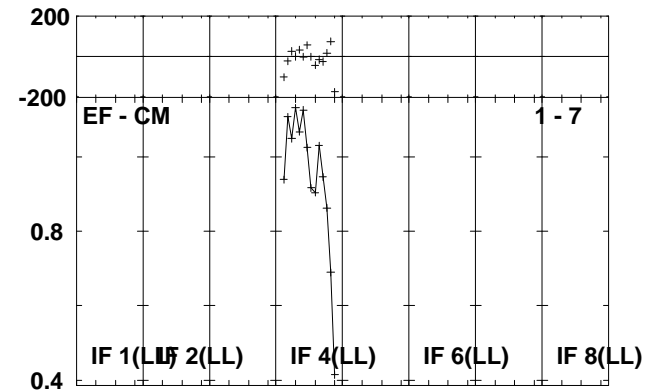
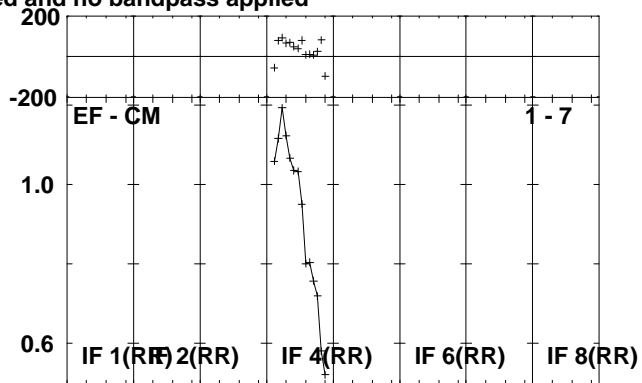
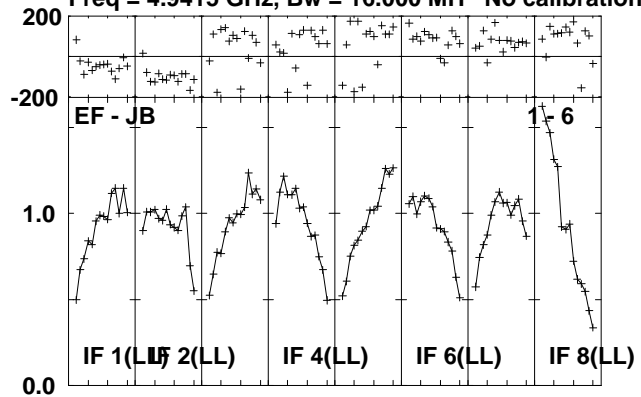

Lower frame: Milli Ampl Jy Top frame: Phas deg
Scalar averaged cross-power spectrum Several baselines displayed
Timerange: 00/18:59:51 to 00/19:04:49

Plot file version 29 created 14-JUL-2010 16:34:46

J1953+35 RR004A.UVDATA.1

Freq = 4.9415 GHz, Bw = 16.000 MH No calibration applied and no bandpass applied

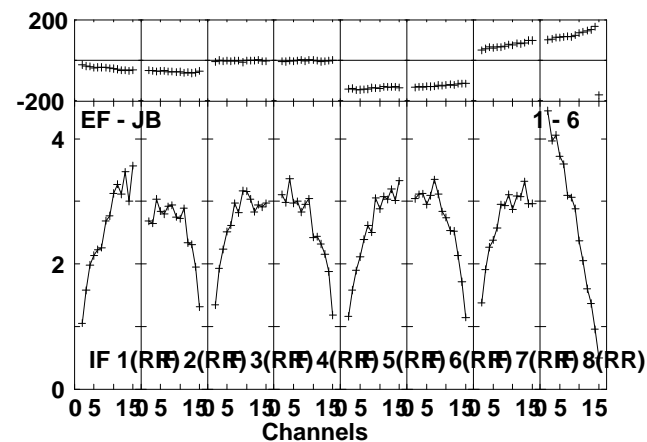
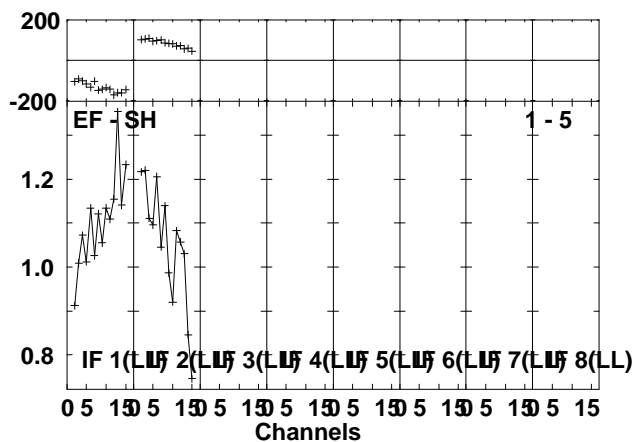
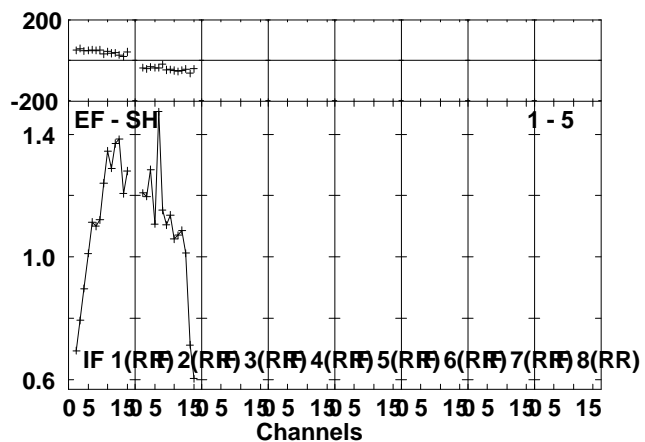
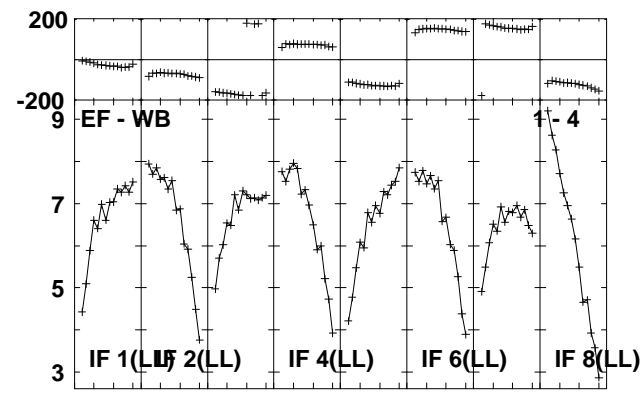
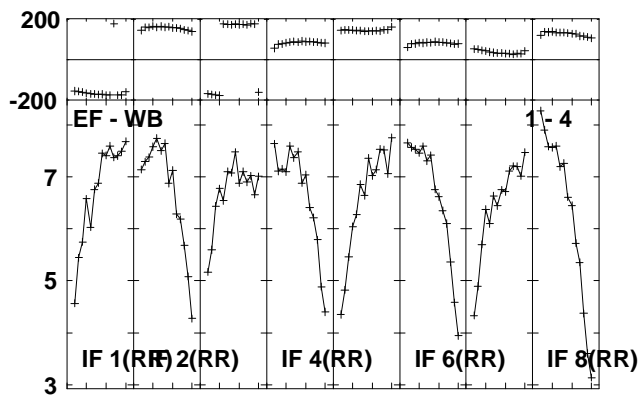
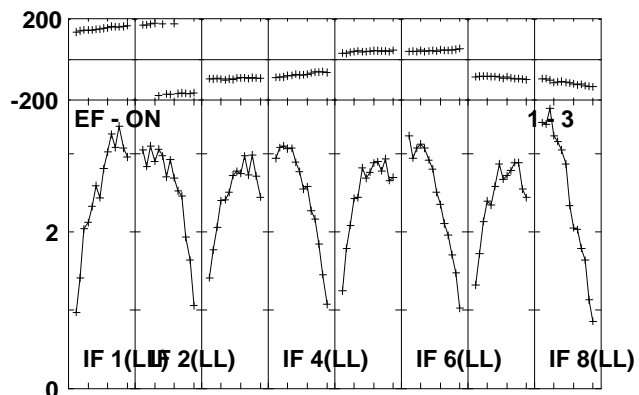
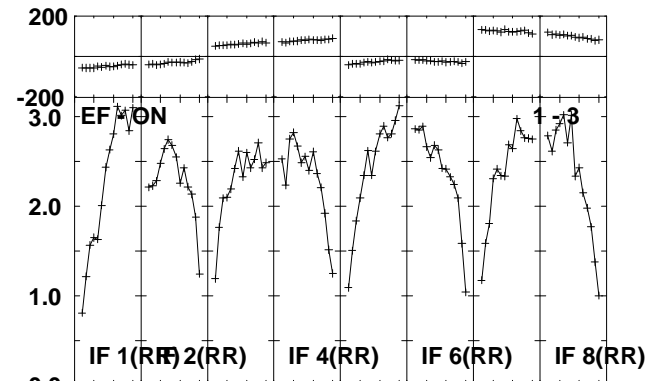
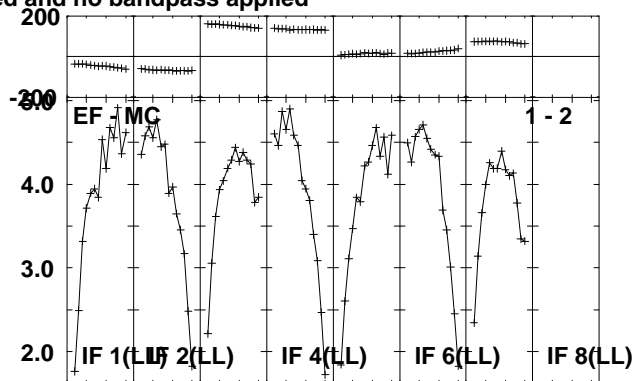
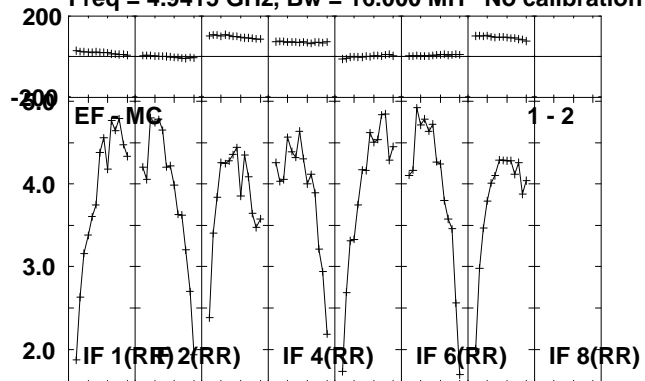

Lower frame: Milli Ampl Jy Top frame: Phas deg
Scalar averaged cross-power spectrum Several baselines displayed
Timerange: 00/19:04:51 to 00/19:06:49

Plot file version 30 created 14-JUL-2010 16:34:46
J1953+35 RR004A.UVDATA.1

Freq = 4.9415 GHz, Bw = 16.000 MH No calibration applied and no bandpass applied

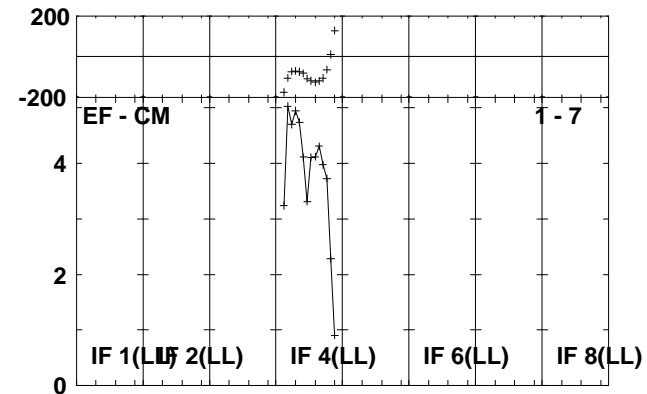
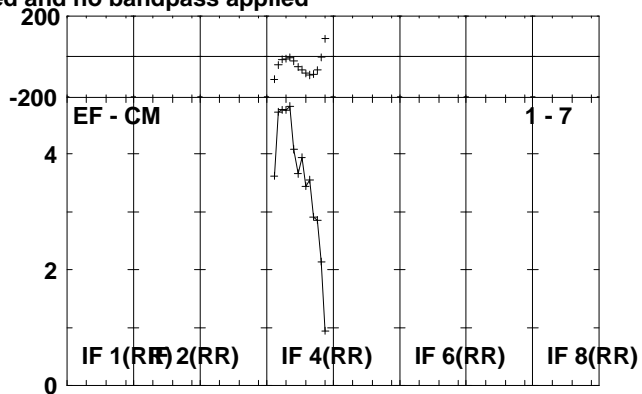
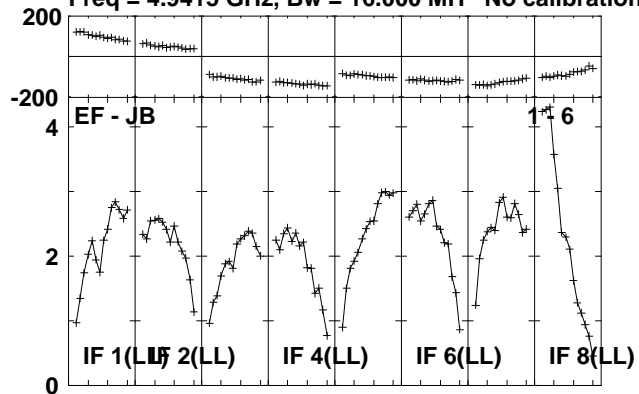

Lower frame: Milli Ampl Jy Top frame: Phas deg
Scalar averaged cross-power spectrum Several baselines displayed
Timerange: 00/19:04:51 to 00/19:06:49

Plot file version 31 created 14-JUL-2010 16:34:47

CYGX-1 RR004A.UVDATA.1

Freq = 4.9415 GHz, Bw = 16.000 MH No calibration applied and no bandpass applied

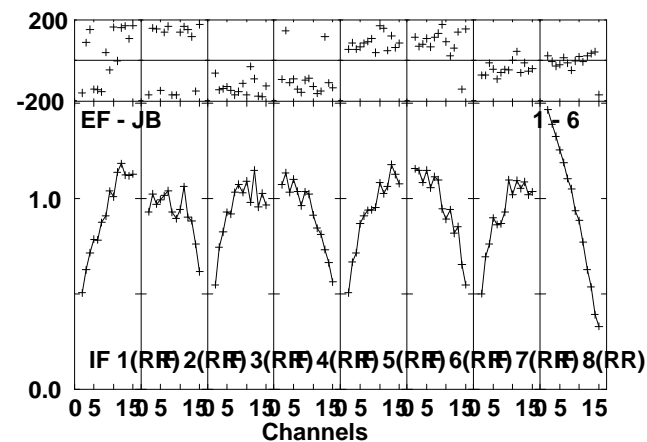
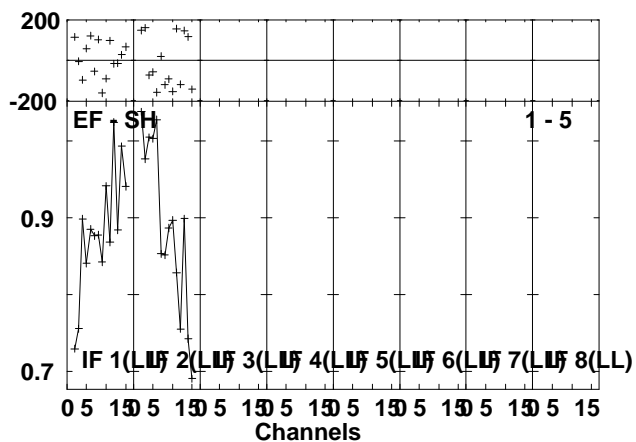
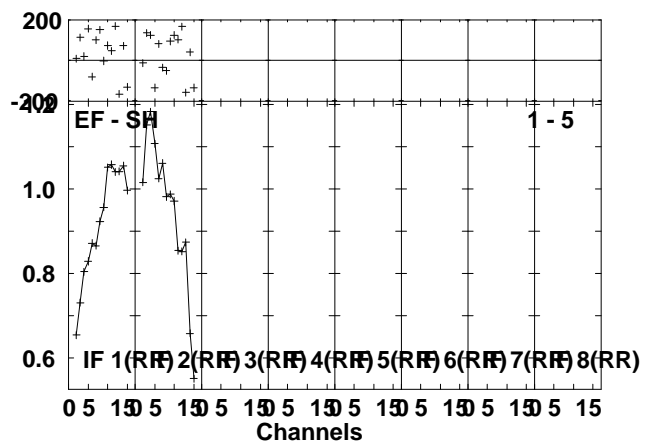
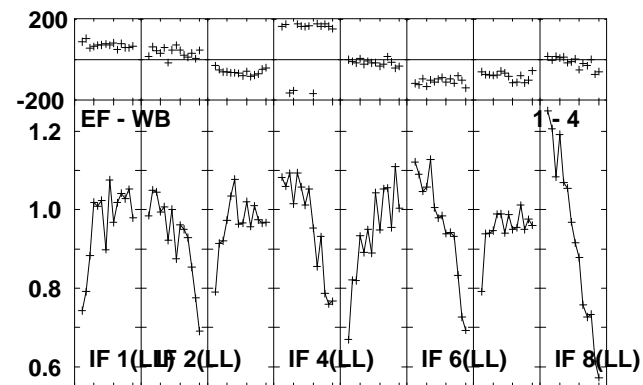
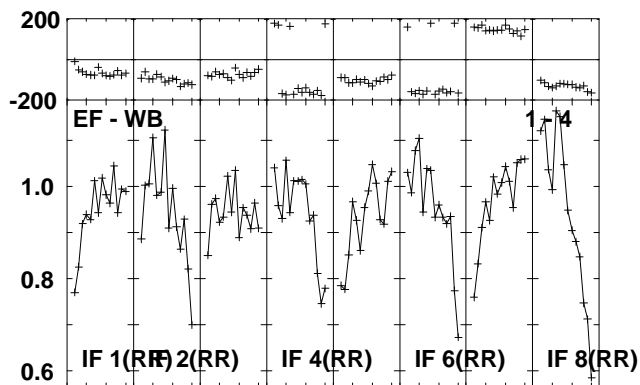
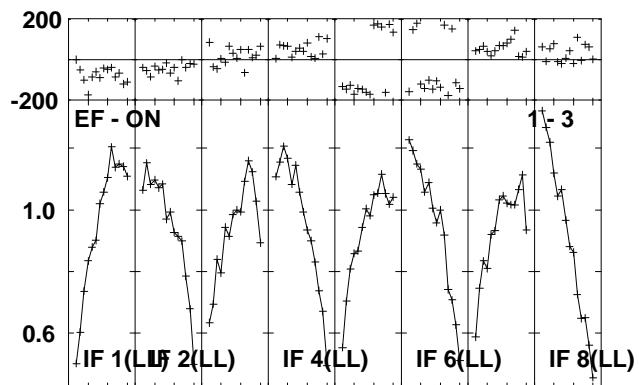
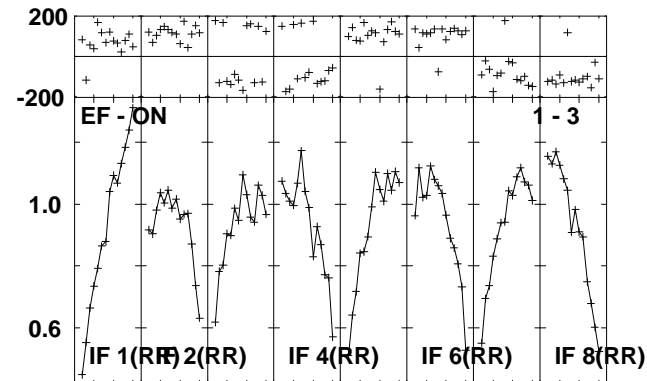
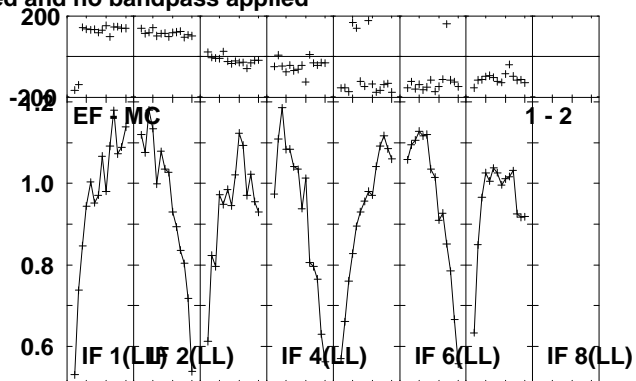
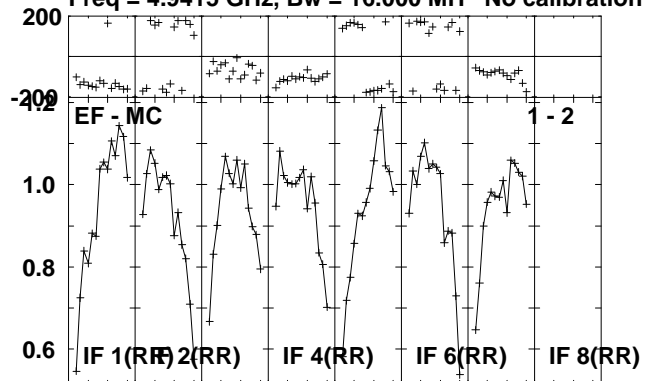

Lower frame: Milli Ampl Jy Top frame: Phas deg
Scalar averaged cross-power spectrum Several baselines displayed
Timerange: 00/19:06:51 to 00/19:11:49

Plot file version 32 created 14-JUL-2010 16:34:48

CYGX-1 RR004A.UVDATA.1

Freq = 4.9415 GHz, Bw = 16.000 MH No calibration applied and no bandpass applied

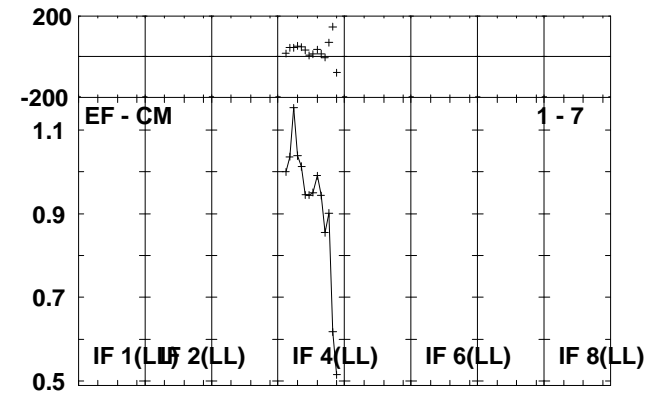
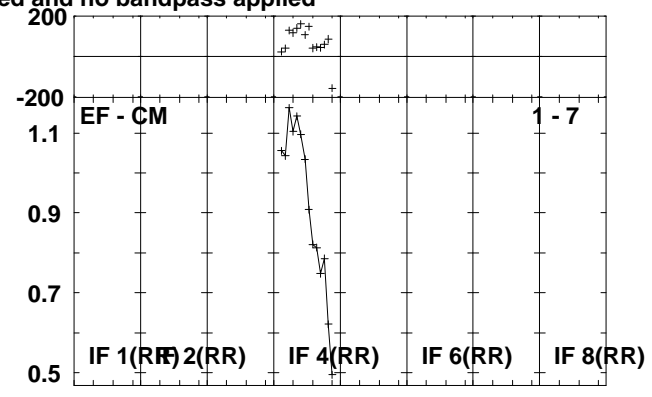
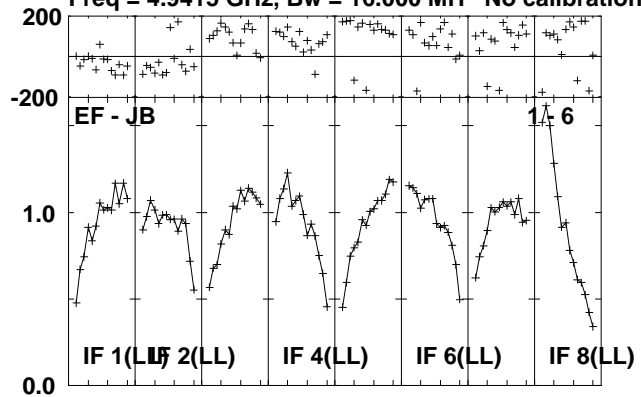

Lower frame: Milli Ampl Jy Top frame: Phas deg
Scalar averaged cross-power spectrum Several baselines displayed
Timerange: 00/19:06:51 to 00/19:11:49

Plot file version 33 created 14-JUL-2010 16:34:49

J1953+35 RR004A.UVDATA.1

Freq = 4.9415 GHz, Bw = 16.000 MH No calibration applied and no bandpass applied

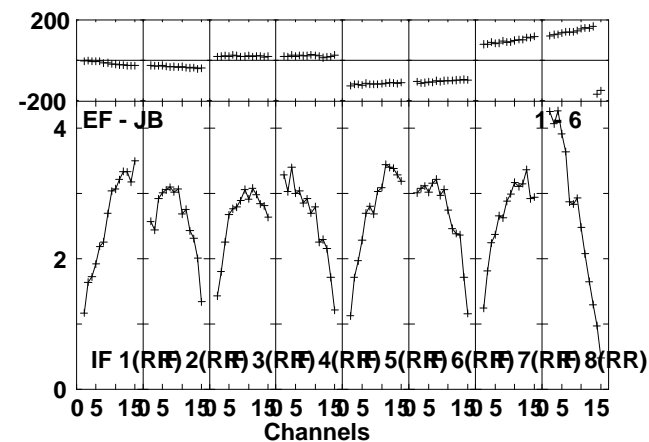
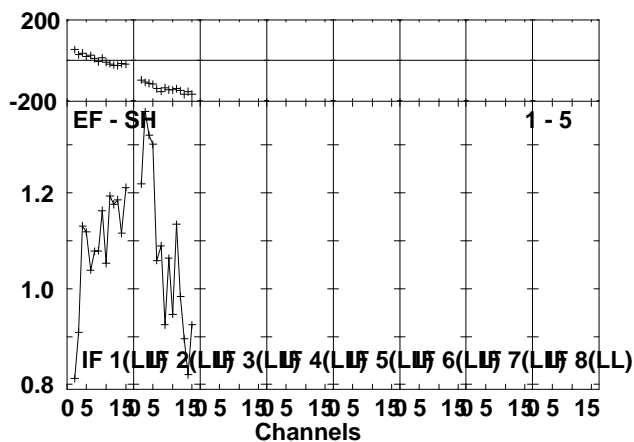
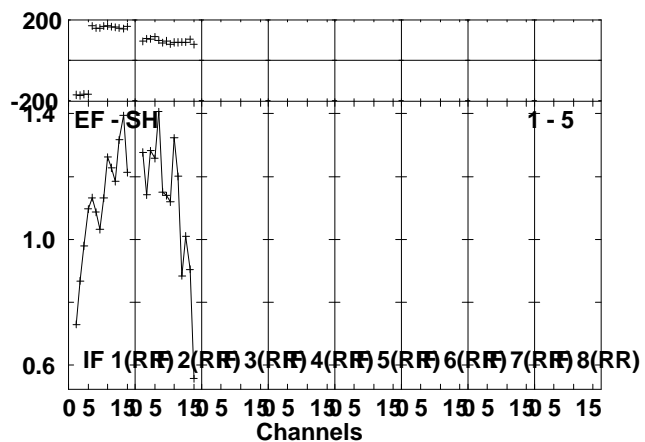
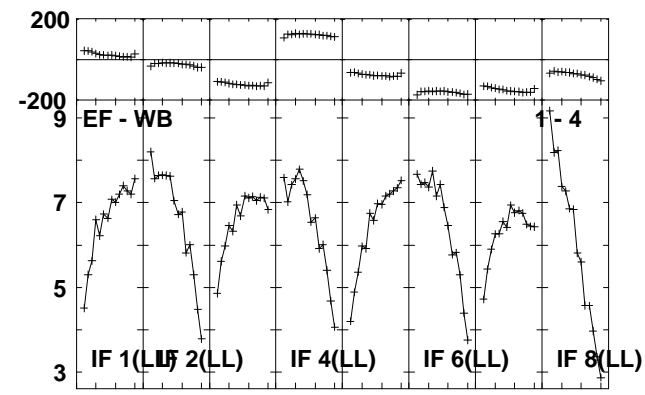
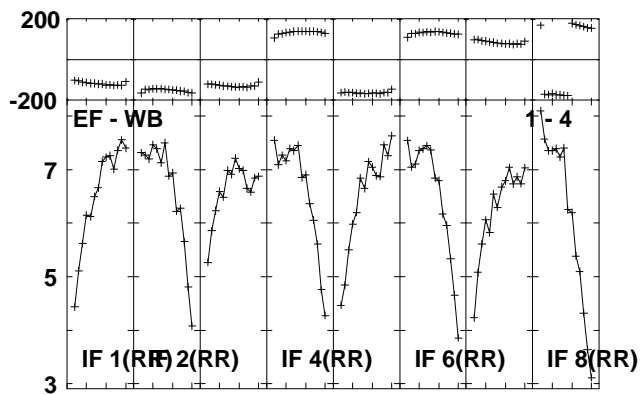
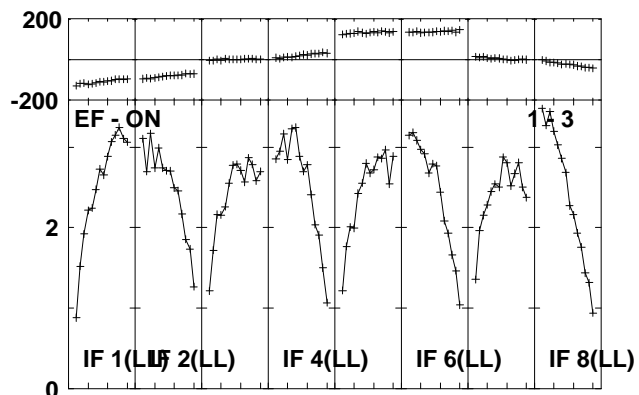
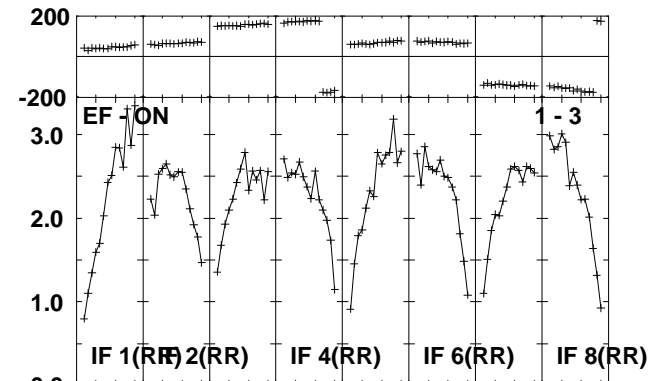
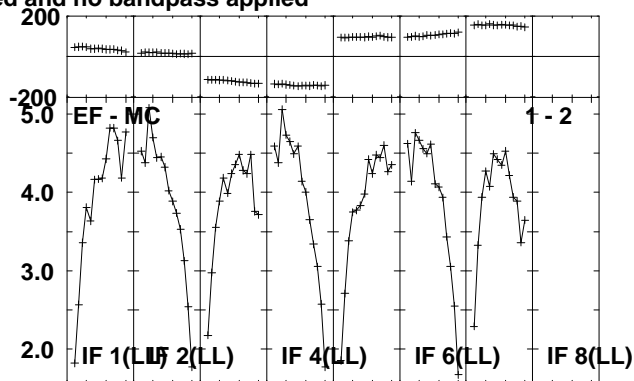
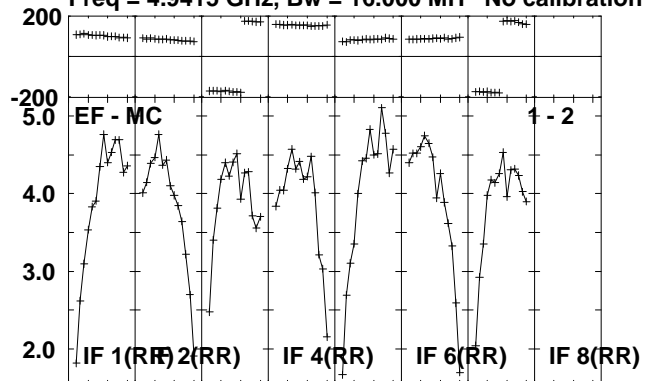

Lower frame: Milli Ampl Jy Top frame: Phas deg
Scalar averaged cross-power spectrum Several baselines displayed
Timerange: 00/19:12:31 to 00/19:13:59

Plot file version 34 created 14-JUL-2010 16:34:50
J1953+35 RR004A.UVDATA.1

Freq = 4.9415 GHz, Bw = 16.000 MH No calibration applied and no bandpass applied

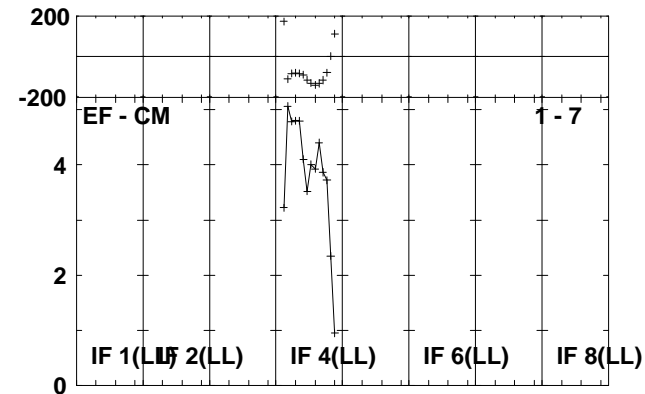
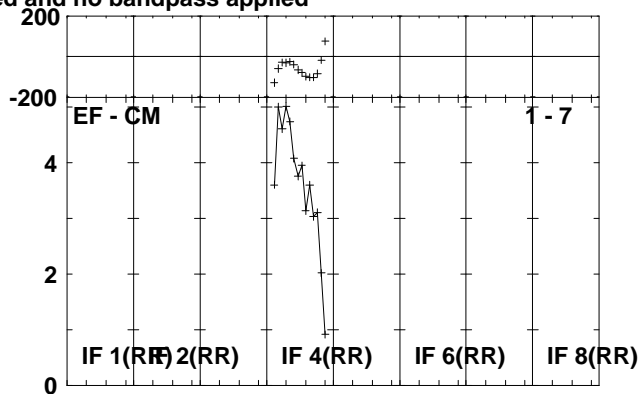
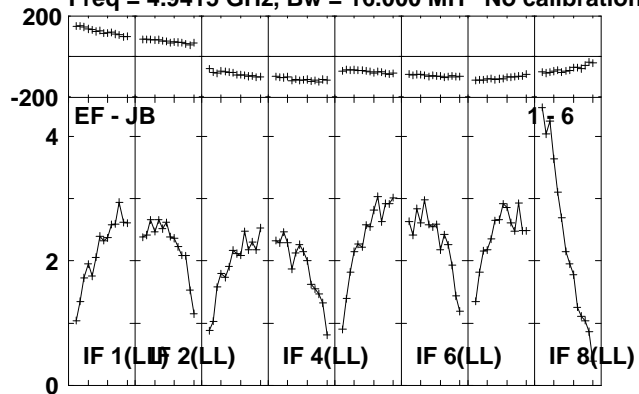

Lower frame: Milli Ampl Jy Top frame: Phas deg
Scalar averaged cross-power spectrum Several baselines displayed
Timerange: 00/19:12:31 to 00/19:13:59

Plot file version 35 created 14-JUL-2010 16:34:50

CYGX-1 RR004A.UVDATA.1

Freq = 4.9415 GHz, Bw = 16.000 MH No calibration applied and no bandpass applied

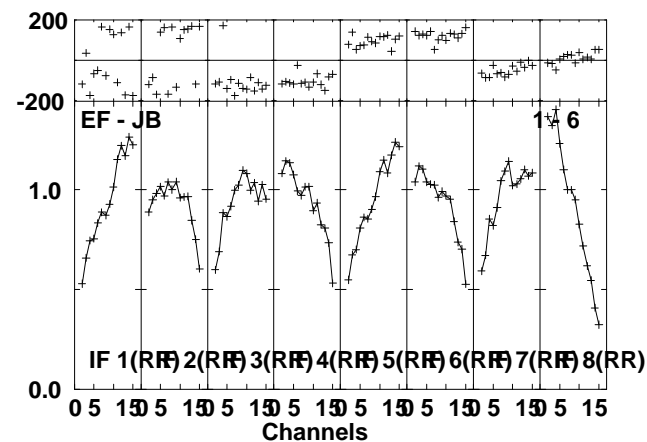
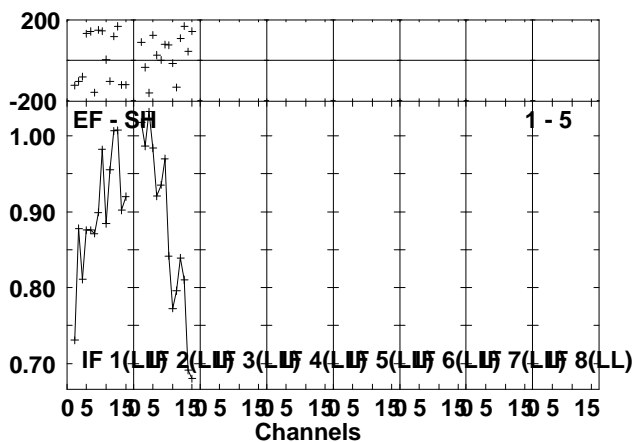
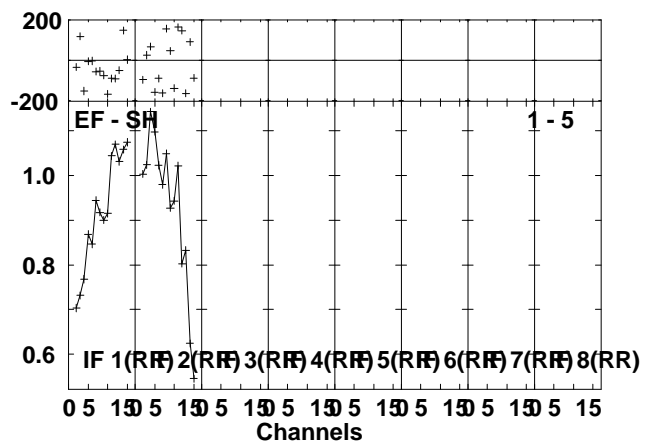
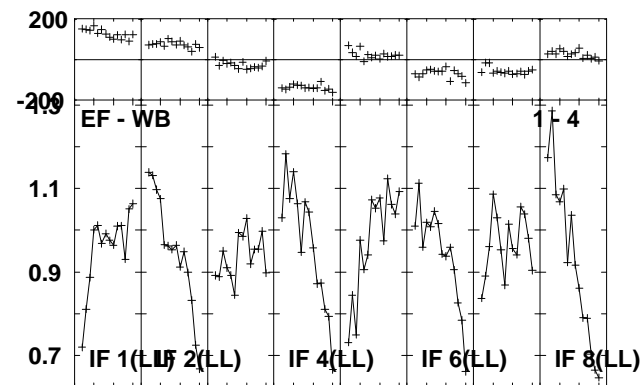
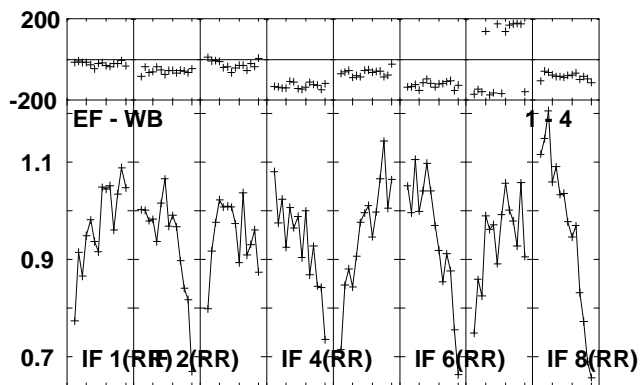
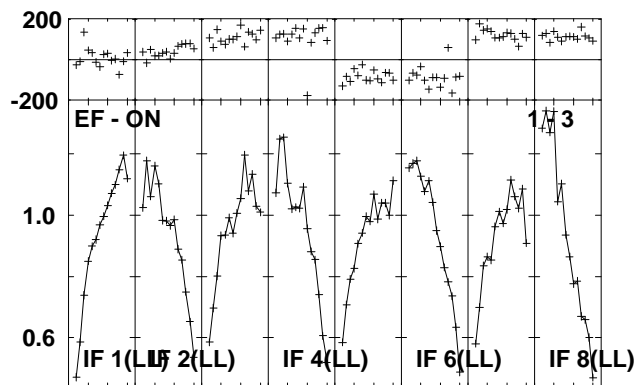
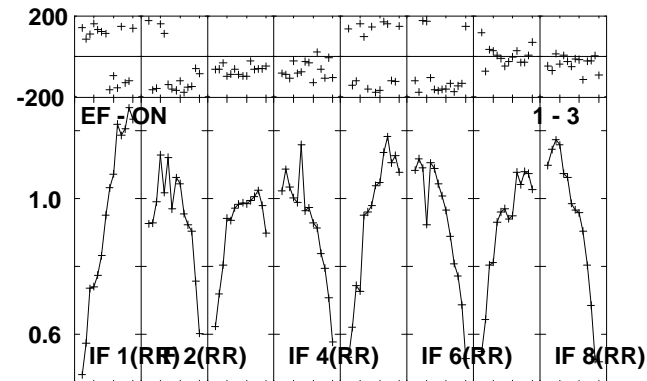
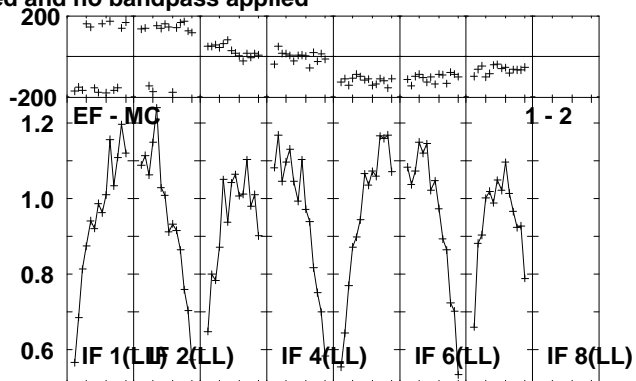
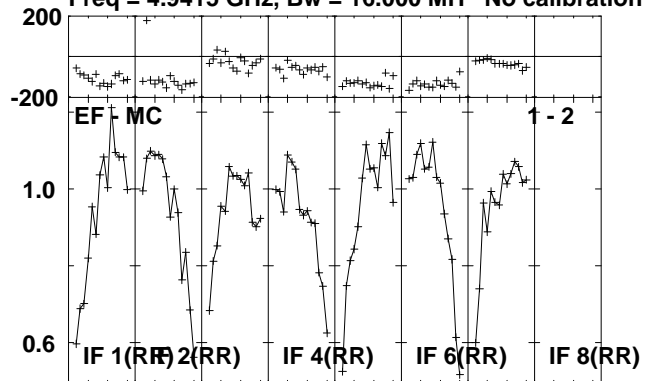

Lower frame: Milli Ampl Jy Top frame: Phas deg
Scalar averaged cross-power spectrum Several baselines displayed
Timerange: 00/19:14:01 to 00/19:18:59

Plot file version 36 created 14-JUL-2010 16:34:52

CYGX-1 RR004A.UVDATA.1

Freq = 4.9415 GHz, Bw = 16.000 MH No calibration applied and no bandpass applied

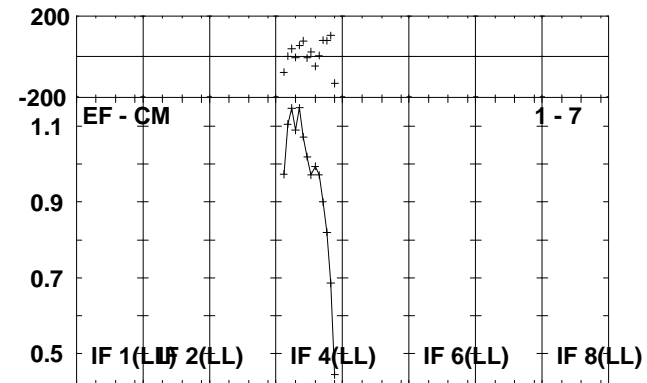
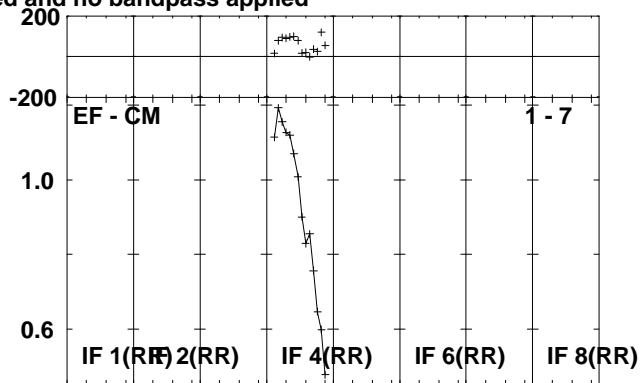
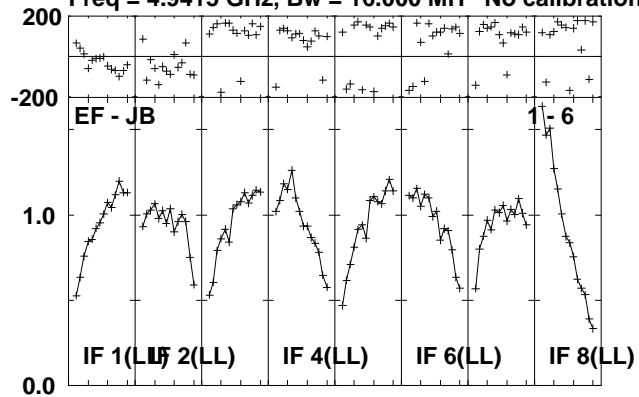

Lower frame: Milli Ampl Jy Top frame: Phas deg
Scalar averaged cross-power spectrum Several baselines displayed
Timerange: 00/19:14:01 to 00/19:18:59

Plot file version 37 created 14-JUL-2010 16:34:53

J1953+35 RR004A.UVDATA.1

Freq = 4.9415 GHz, Bw = 16.000 MH No calibration applied and no bandpass applied

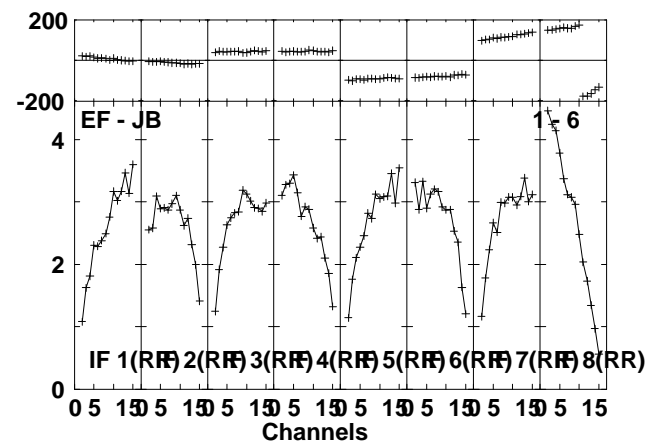
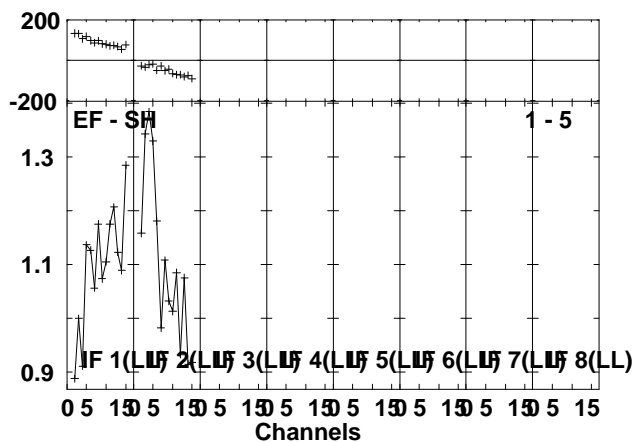
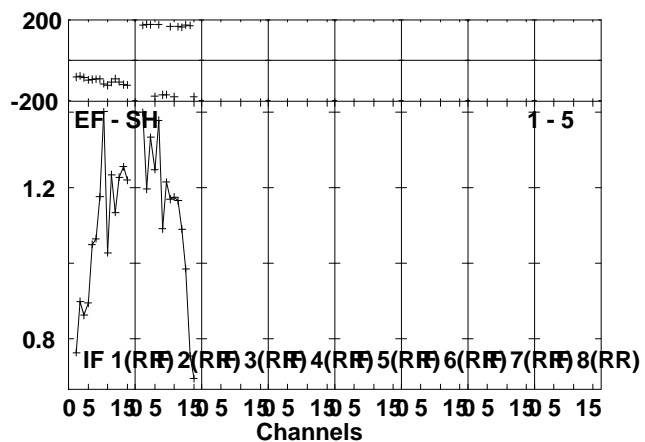
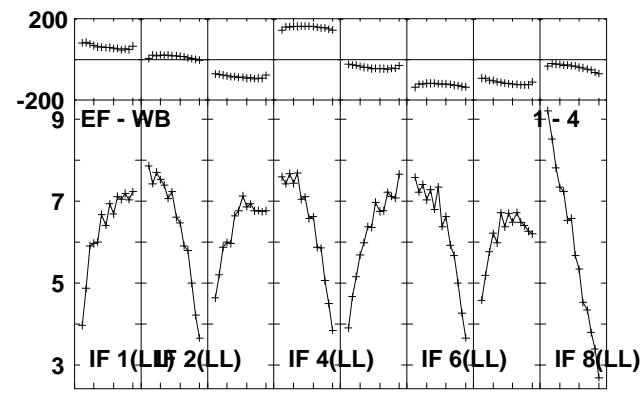
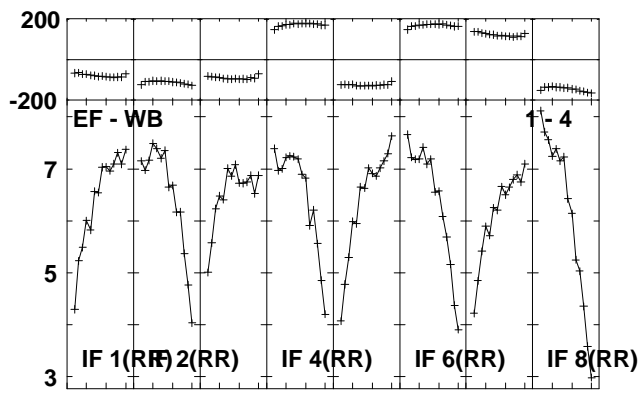
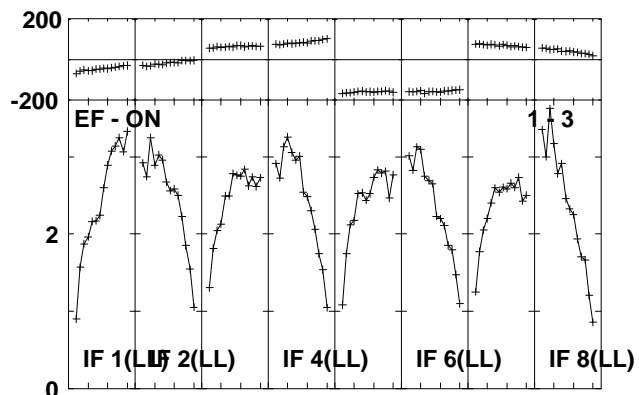
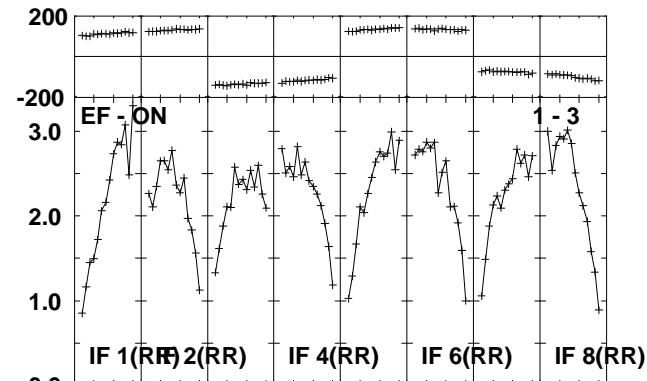
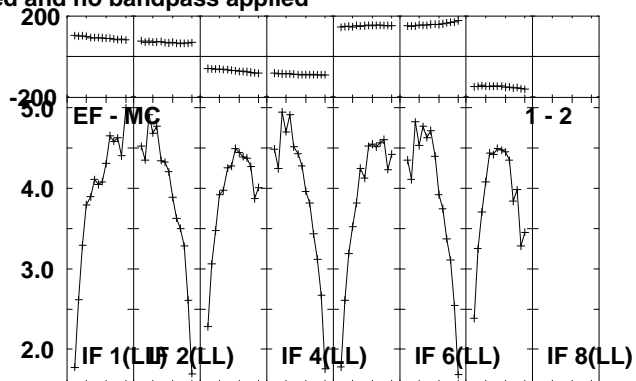
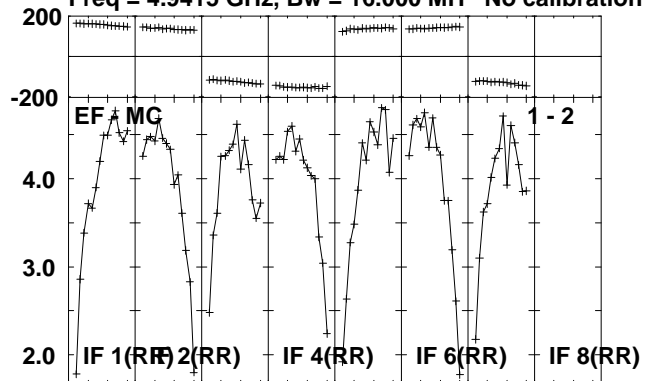

Lower frame: Milli Ampl Jy Top frame: Phas deg
Scalar averaged cross-power spectrum Several baselines displayed
Timerange: 00/19:19:01 to 00/19:20:59

Plot file version 38 created 14-JUL-2010 16:34:53
J1953+35 RR004A.UVDATA.1

Freq = 4.9415 GHz, Bw = 16.000 MH No calibration applied and no bandpass applied

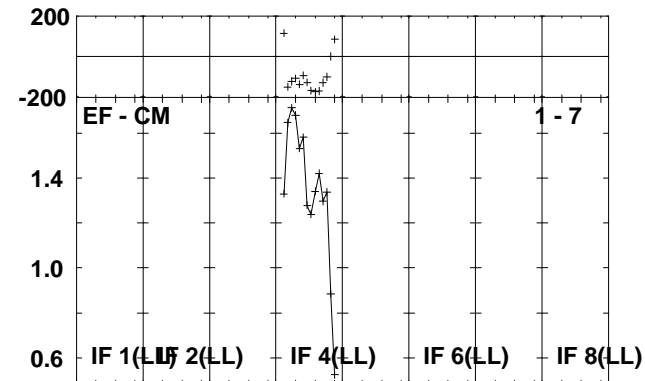
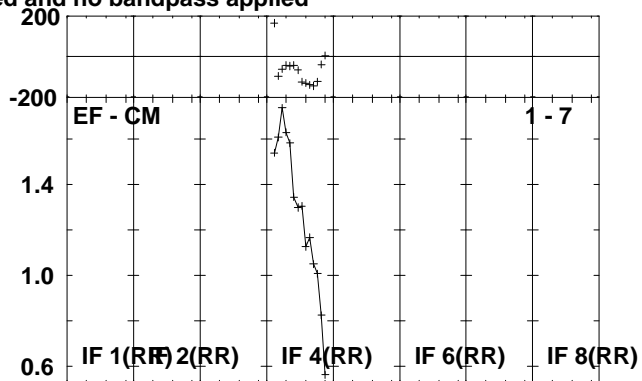
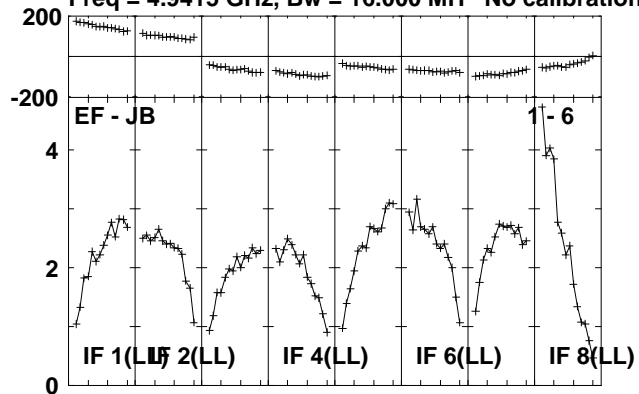

Lower frame: Milli Ampl Jy Top frame: Phas deg
Scalar averaged cross-power spectrum Several baselines displayed
Timerange: 00/19:19:01 to 00/19:20:59

Plot file version 39 created 14-JUL-2010 16:34:54

CYGX-1 RR004A.UVDATA.1

Freq = 4.9415 GHz, Bw = 16.000 MH No calibration applied and no bandpass applied

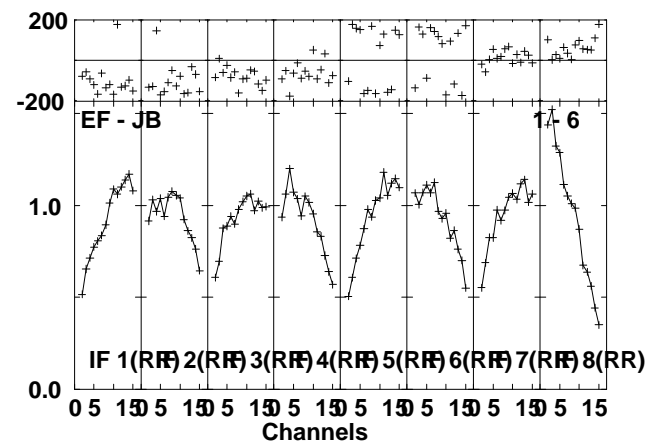
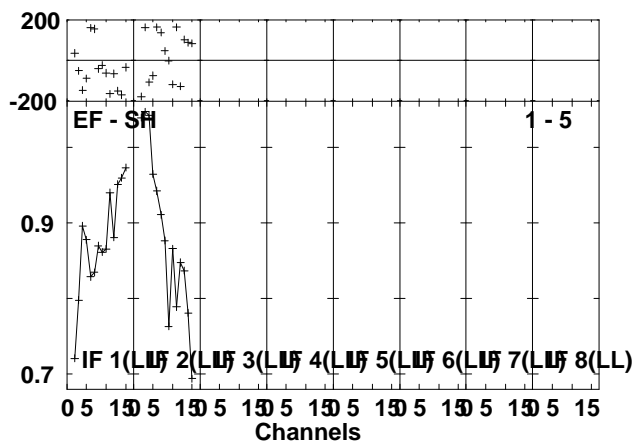
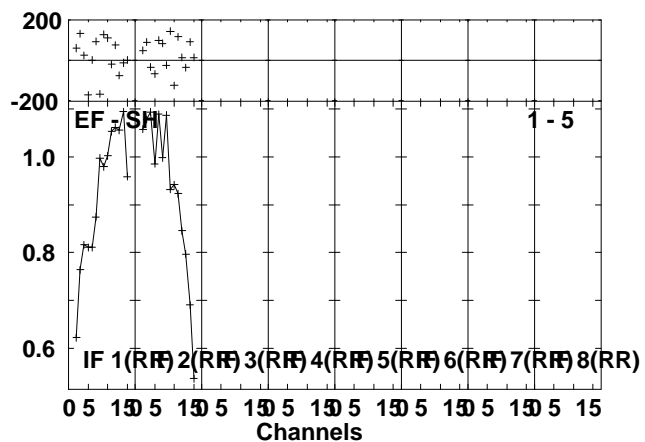
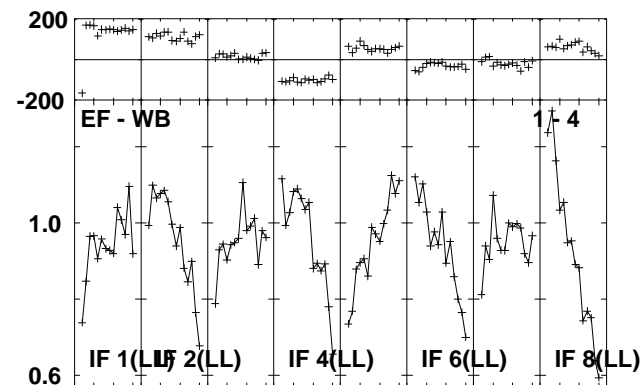
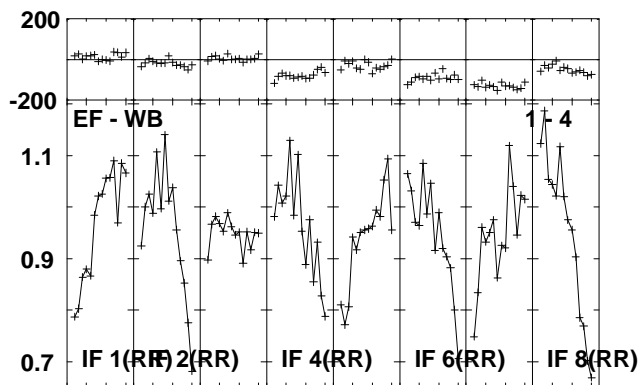
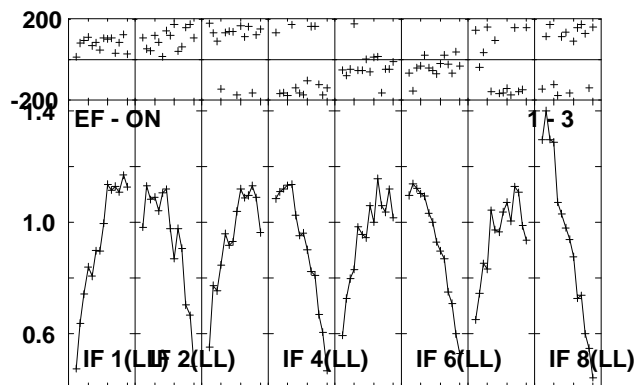
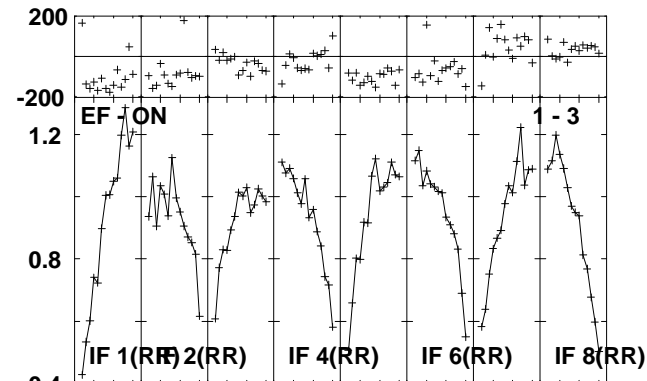
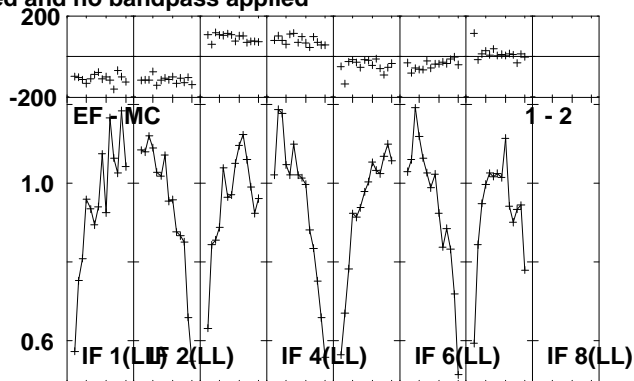
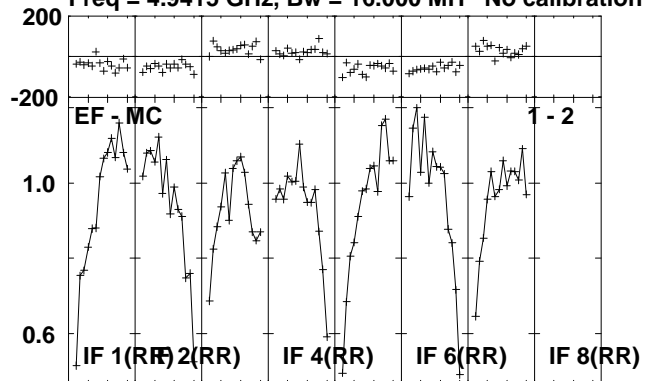

Lower frame: Milli Ampl Jy Top frame: Phas deg
Scalar averaged cross-power spectrum Several baselines displayed
Timerange: 00/19:21:01 to 00/19:25:59

Plot file version 40 created 14-JUL-2010 16:34:55

CYGX-1 RR004A.UVDATA.1

Freq = 4.9415 GHz, Bw = 16.000 MH No calibration applied and no bandpass applied

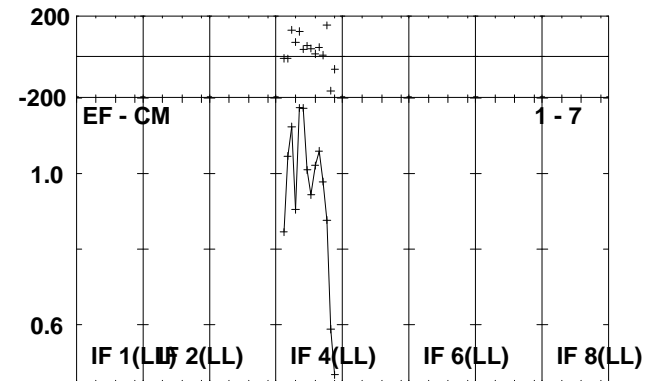
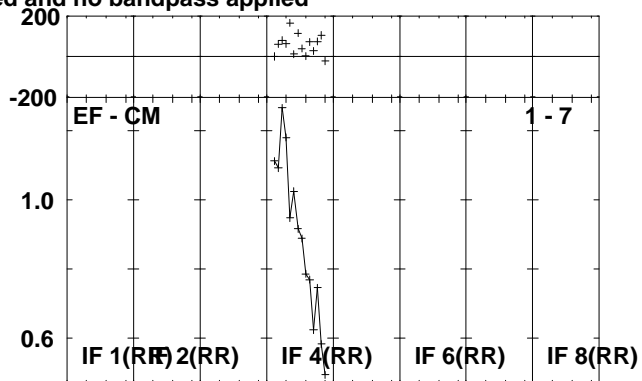
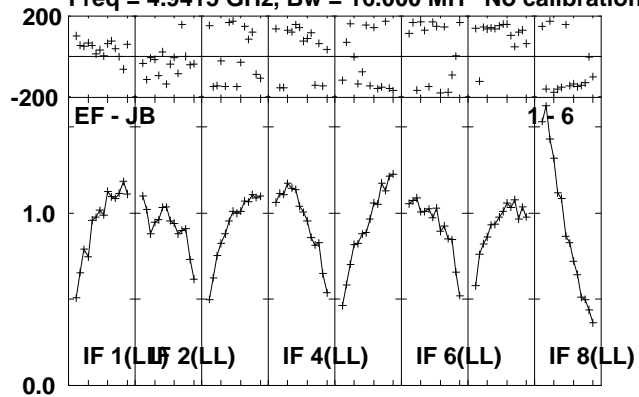

Lower frame: Milli Ampl Jy Top frame: Phas deg
Scalar averaged cross-power spectrum Several baselines displayed
Timerange: 00/19:21:01 to 00/19:25:59

Plot file version 41 created 14-JUL-2010 16:34:56

J2002+47 RR004A.UVDATA.1

Freq = 4.9415 GHz, Bw = 16.000 MH No calibration applied and no bandpass applied

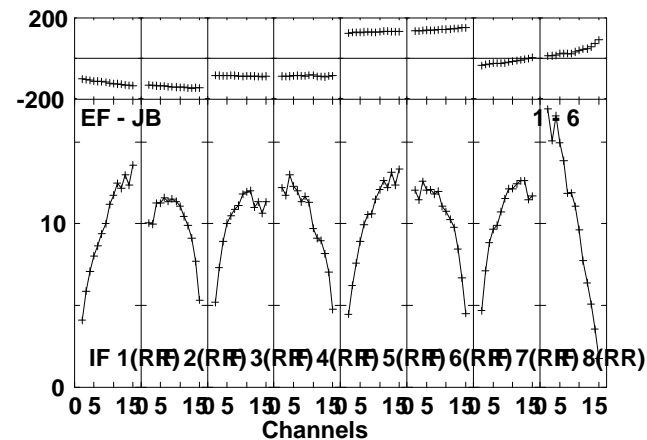
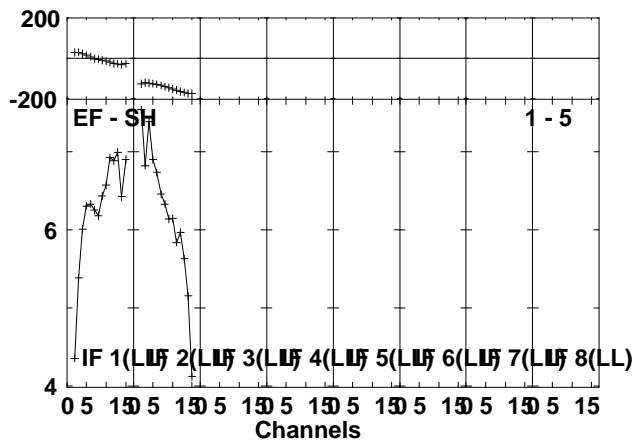
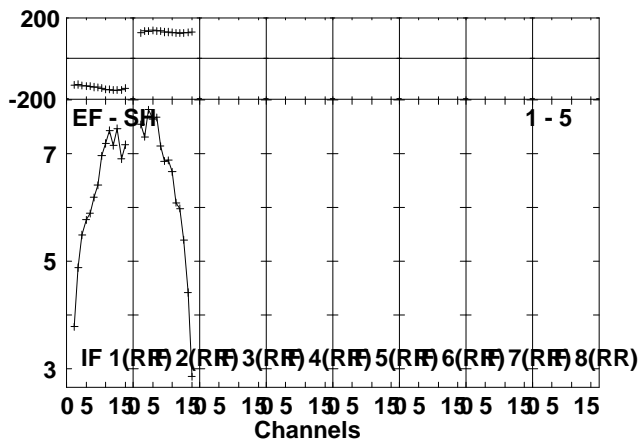
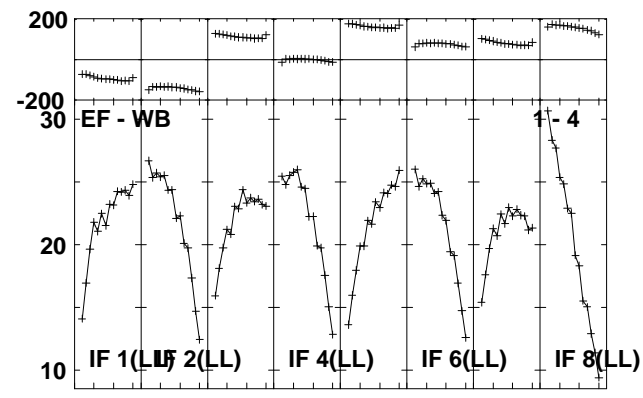
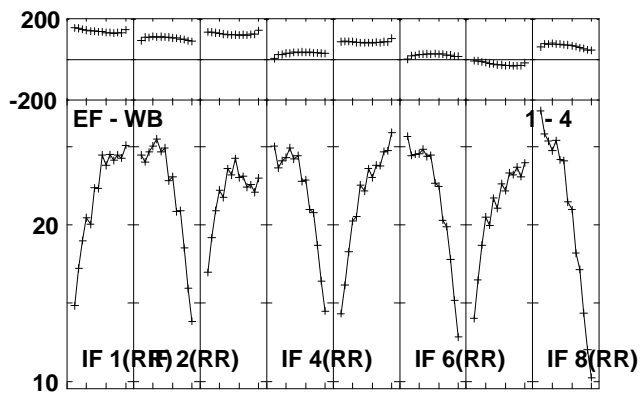
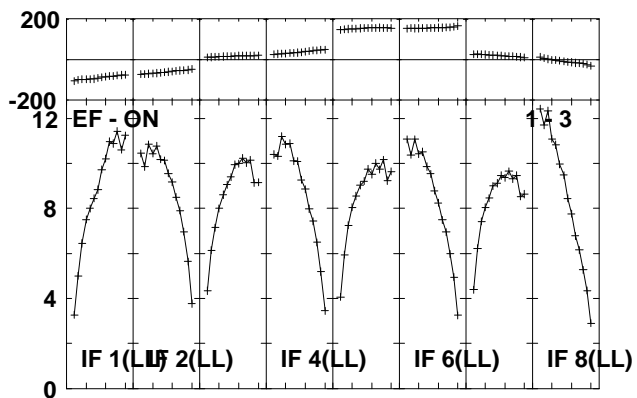
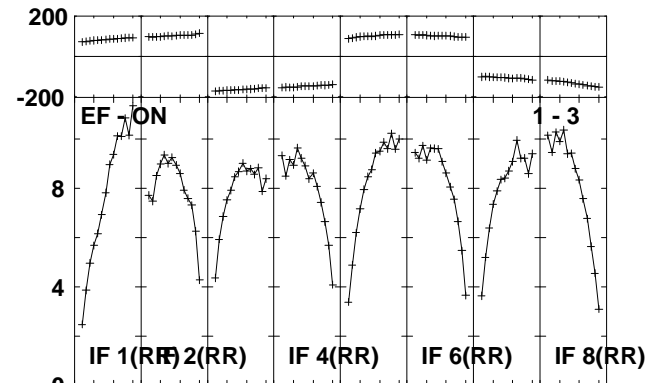
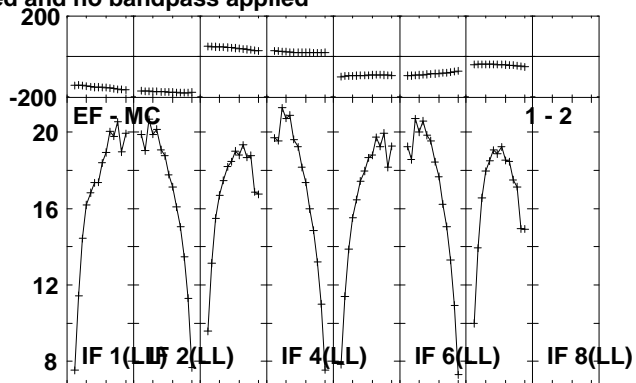
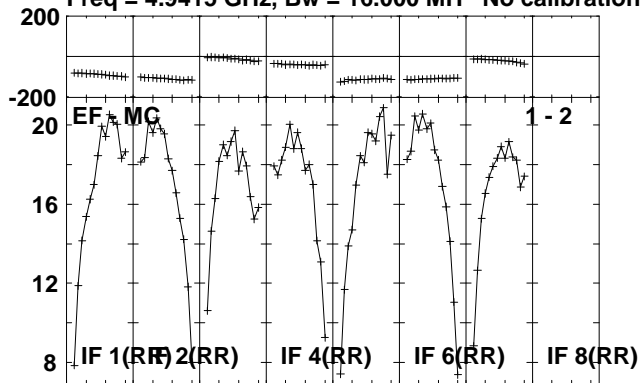

Lower frame: Milli Ampl Jy Top frame: Phas deg
Scalar averaged cross-power spectrum Several baselines displayed
Timerange: 00/19:28:01 to 00/19:32:59

Plot file version 42 created 14-JUL-2010 16:34:57
J2002+47 RR004A.UVDATA.1

Freq = 4.9415 GHz, Bw = 16.000 MH No calibration applied and no bandpass applied

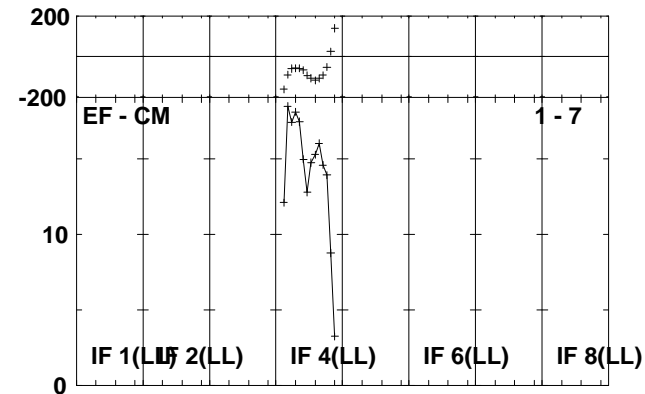
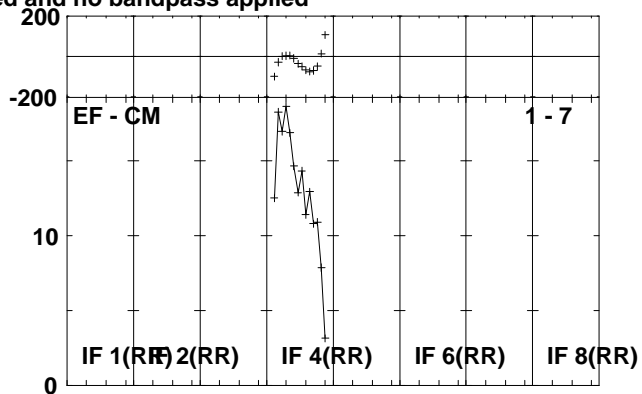
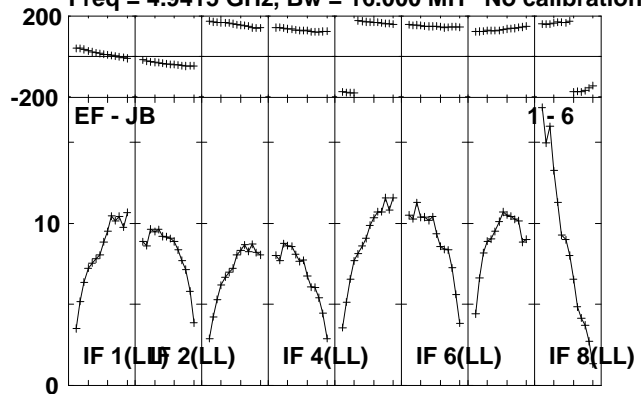

Lower frame: Milli Ampl Jy Top frame: Phas deg
Scalar averaged cross-power spectrum Several baselines displayed
Timerange: 00/19:28:01 to 00/19:32:59

Plot file version 43 created 14-JUL-2010 16:34:58

J1953+35 RR004A.UVDATA.1

Freq = 4.9415 GHz, Bw = 16.000 MH No calibration applied and no bandpass applied

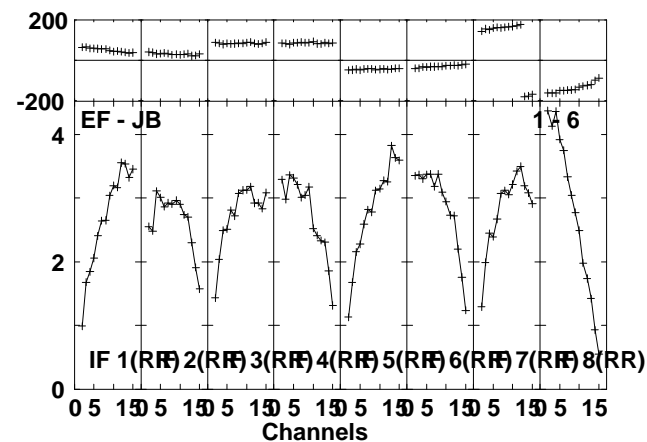
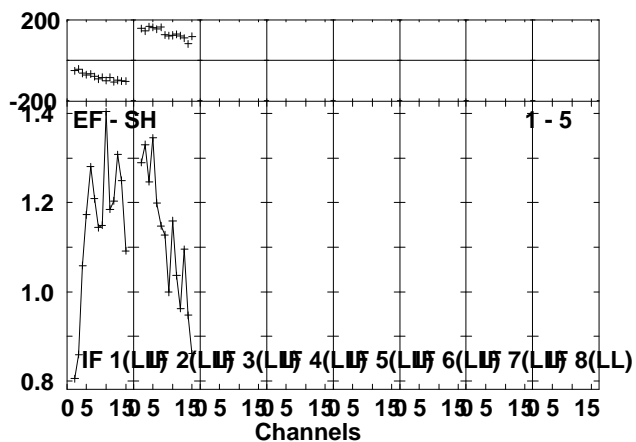
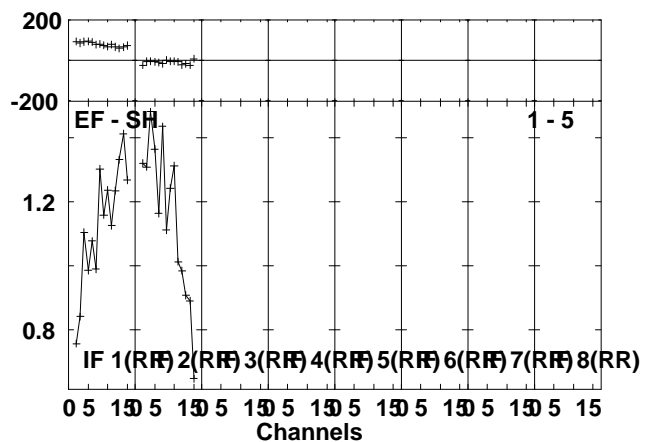
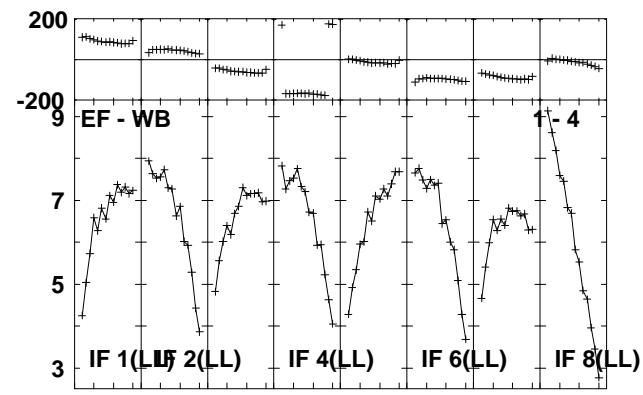
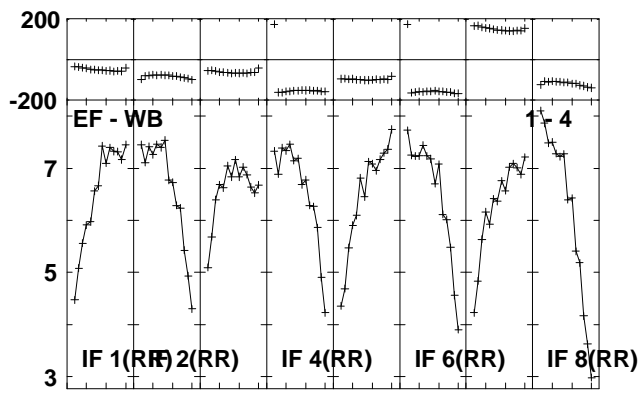
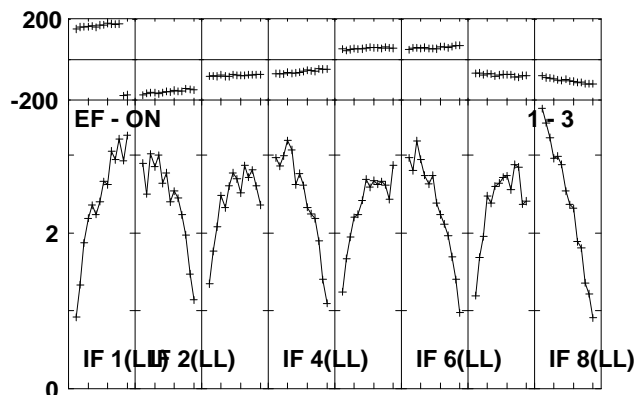
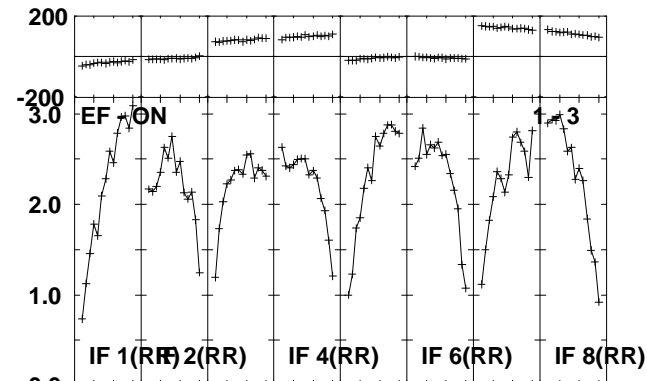
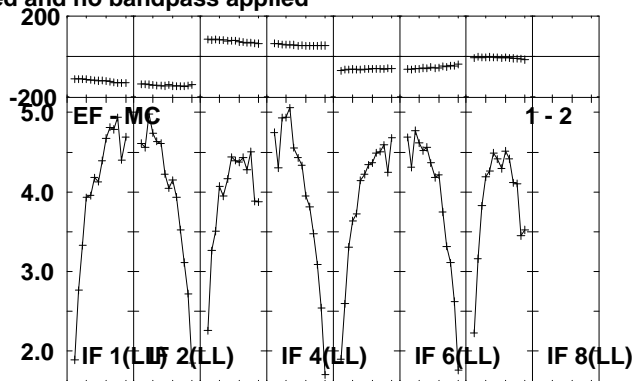
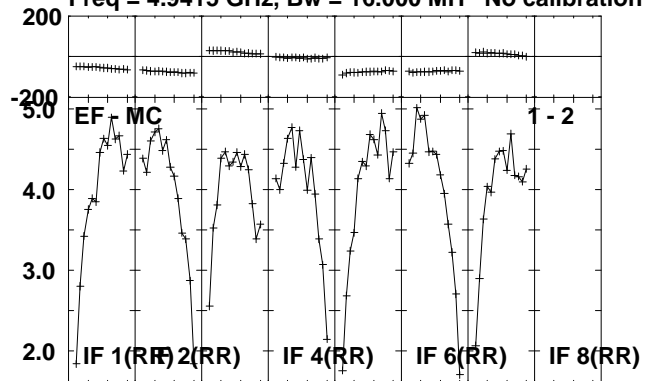

Lower frame: Milli Ampl Jy Top frame: Phas deg
Scalar averaged cross-power spectrum Several baselines displayed
Timerange: 00/19:34:31 to 00/19:35:59

Plot file version 44 created 14-JUL-2010 16:34:59
J1953+35 RR004A.UVDATA.1

Freq = 4.9415 GHz, Bw = 16.000 MH No calibration applied and no bandpass applied

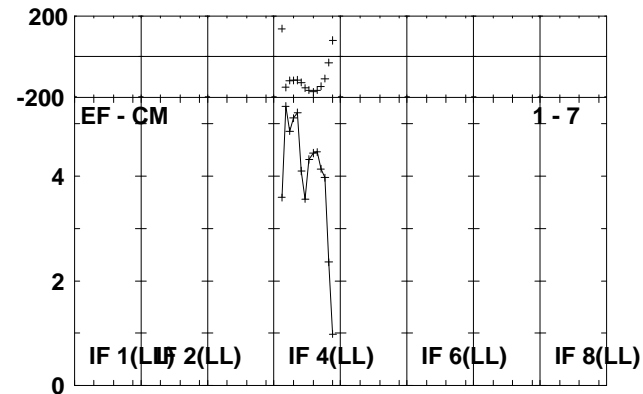
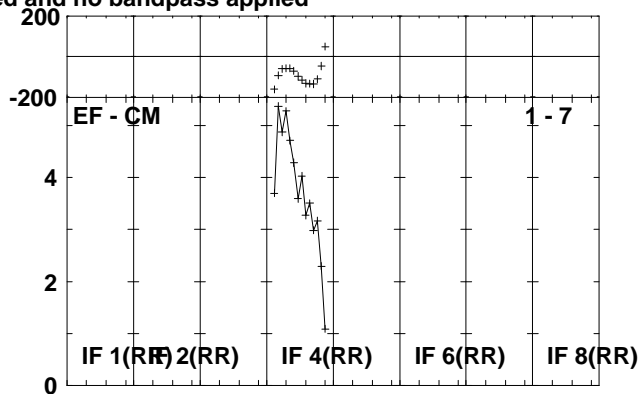
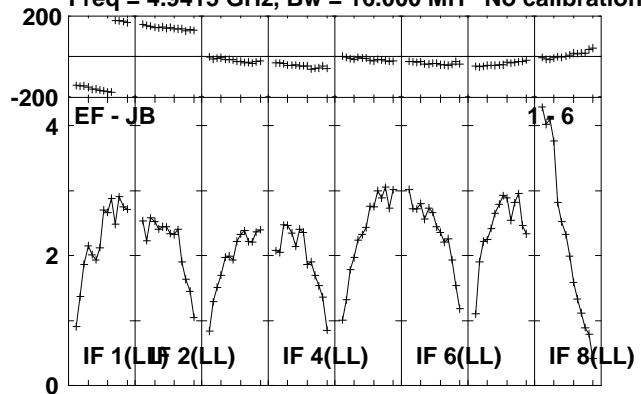

Lower frame: Milli Ampl Jy Top frame: Phas deg
Scalar averaged cross-power spectrum Several baselines displayed
Timerange: 00/19:34:31 to 00/19:35:59

Plot file version 45 created 14-JUL-2010 16:34:59

CYGX-1 RR004A.UVDATA.1

Freq = 4.9415 GHz, Bw = 16.000 MH No calibration applied and no bandpass applied

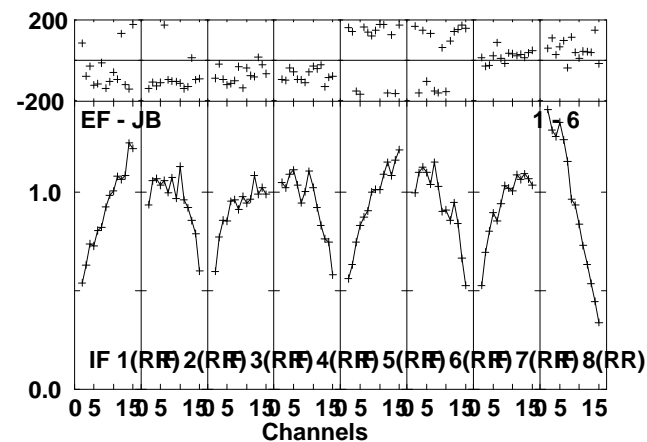
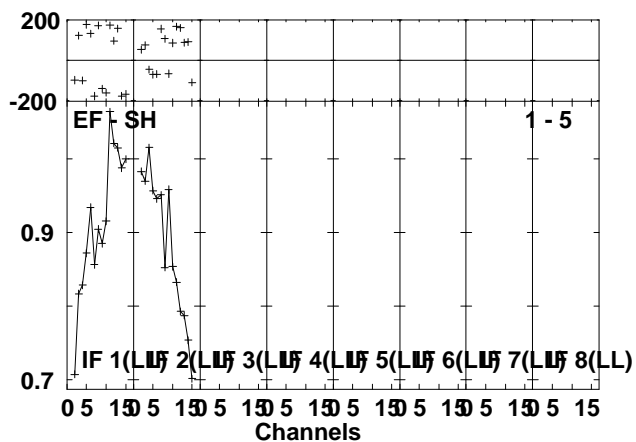
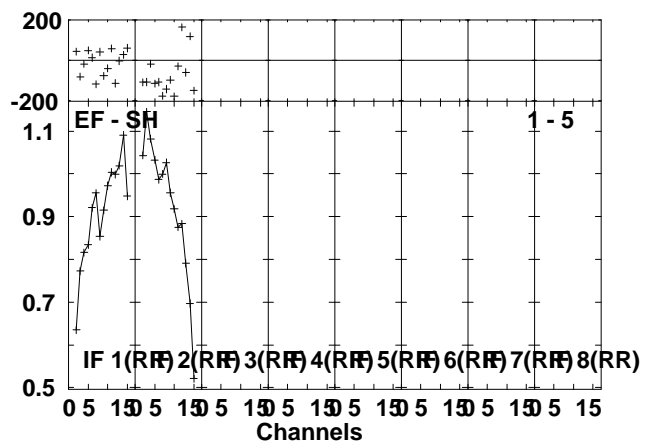
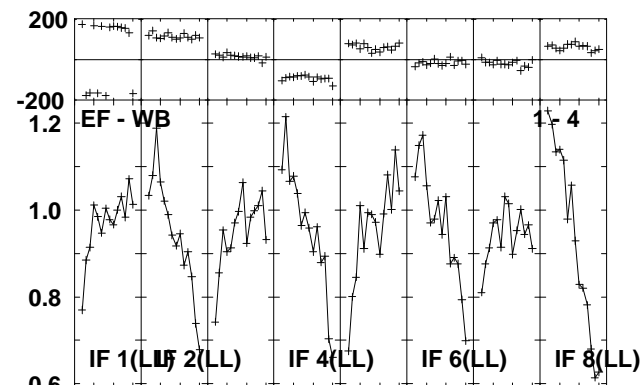
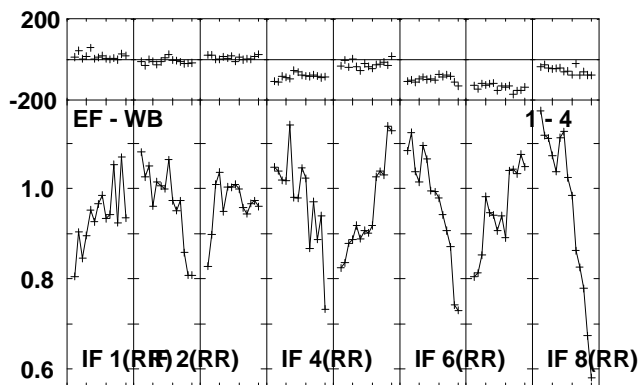
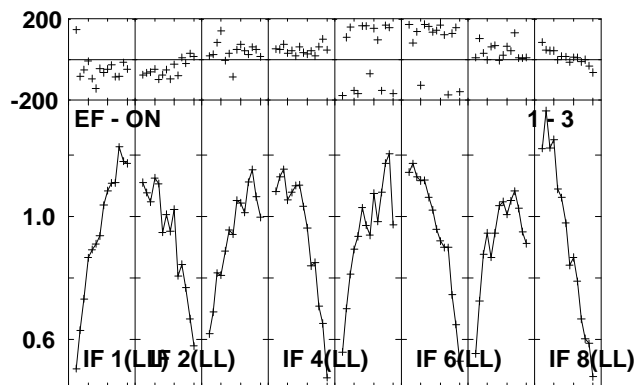
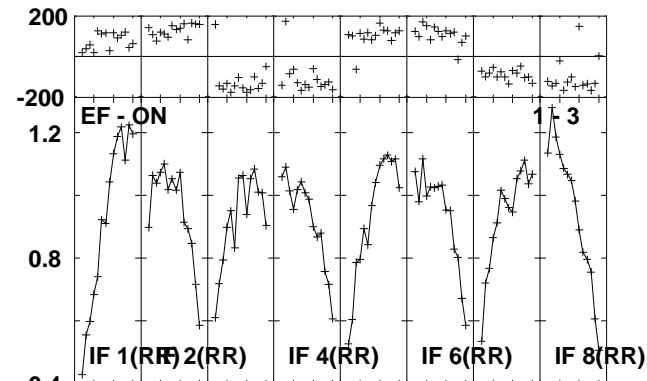
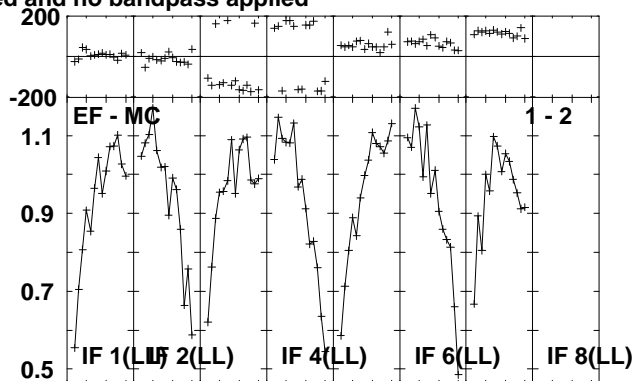
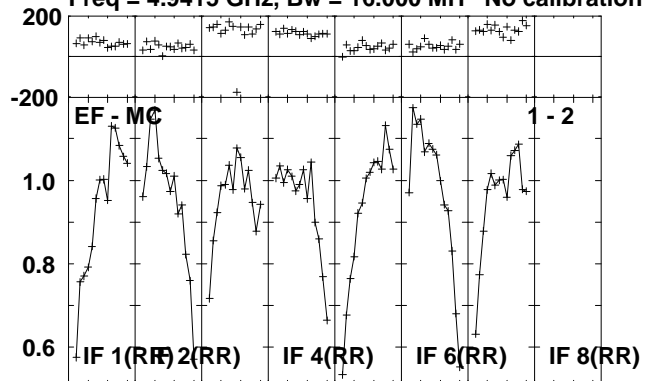

Lower frame: Milli Ampl Jy Top frame: Phas deg
Scalar averaged cross-power spectrum Several baselines displayed
Timerange: 00/19:36:01 to 00/19:40:59

Plot file version 46 created 14-JUL-2010 16:35:00

CYGX-1 RR004A.UVDATA.1

Freq = 4.9415 GHz, Bw = 16.000 MH No calibration applied and no bandpass applied

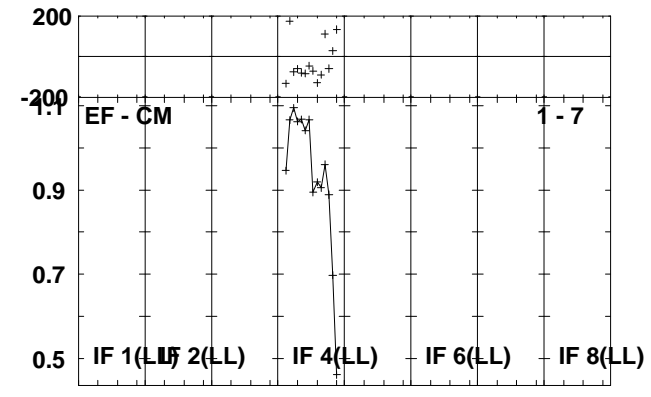
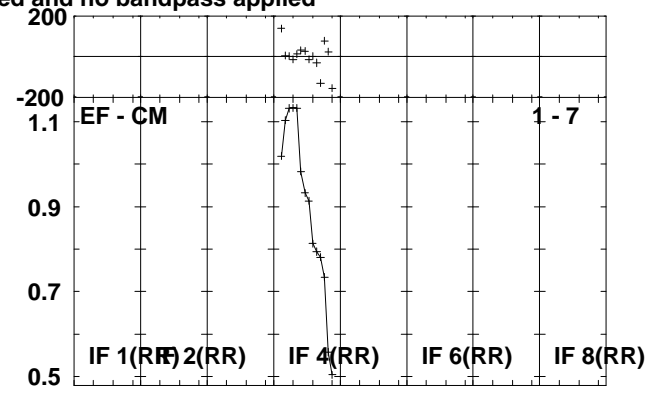
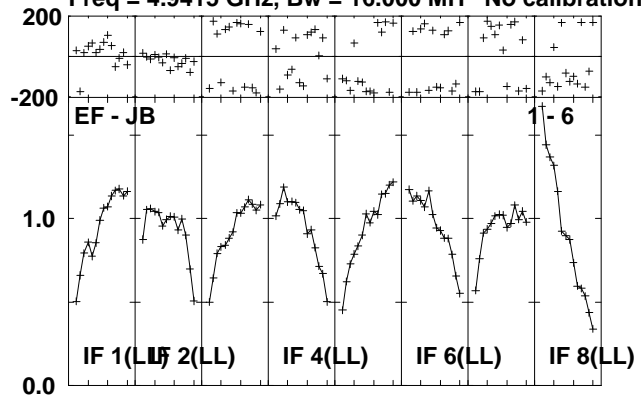

Lower frame: Milli Ampl Jy Top frame: Phas deg
Scalar averaged cross-power spectrum Several baselines displayed
Timerange: 00/19:36:01 to 00/19:40:59

Plot file version 47 created 14-JUL-2010 16:35:02

J1953+35 RR004A.UVDATA.1

Freq = 4.9415 GHz, Bw = 16.000 MH No calibration applied and no bandpass applied

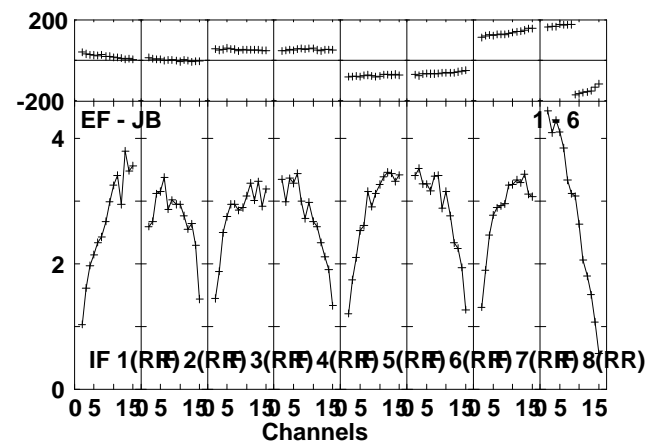
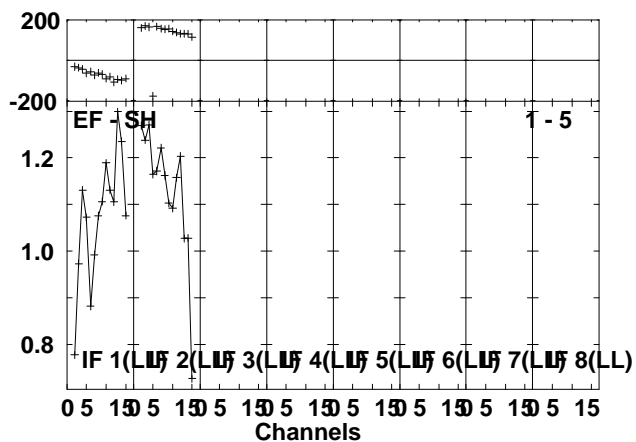
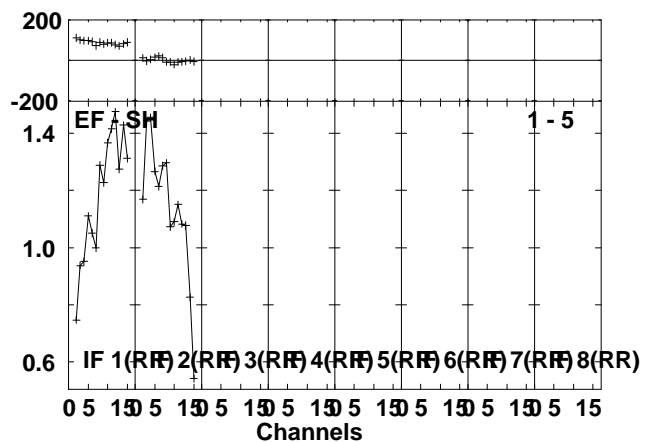
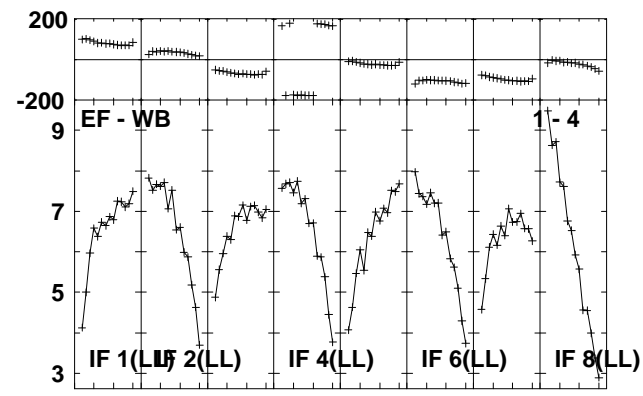
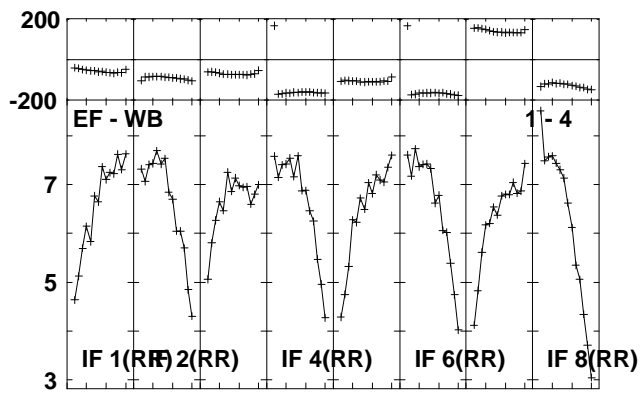
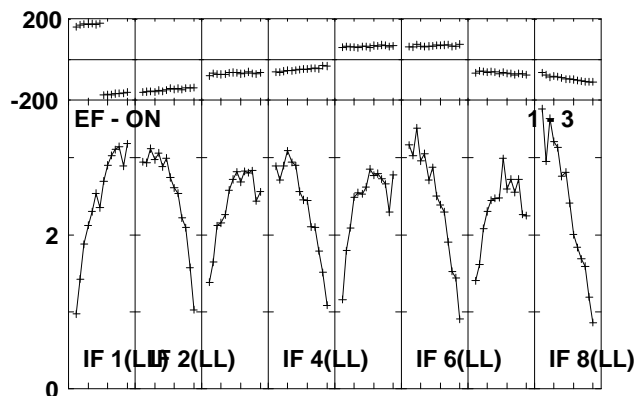
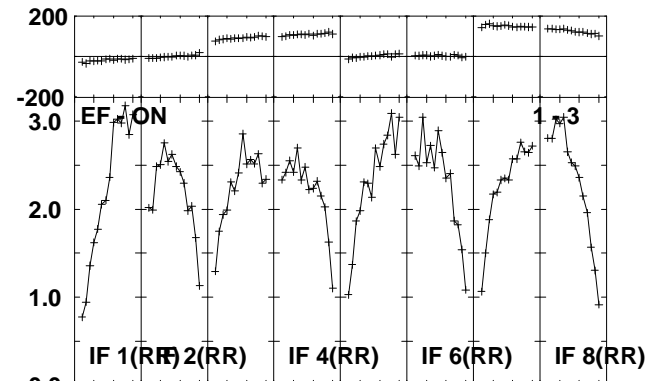
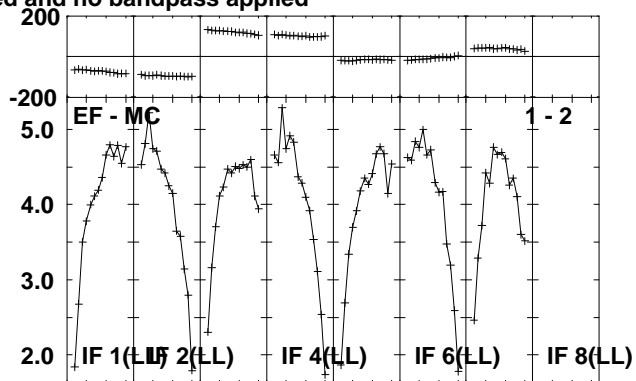
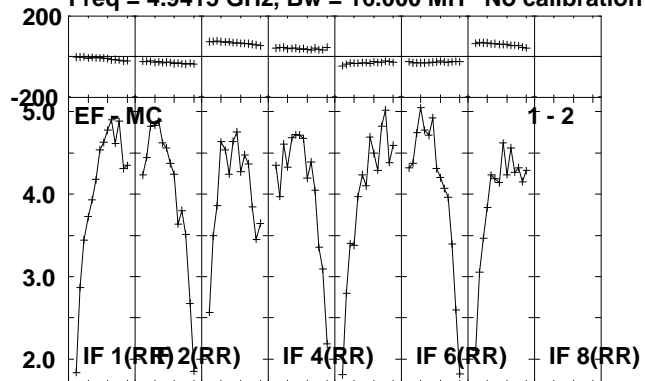

Lower frame: Milli Ampl Jy Top frame: Phas deg
Scalar averaged cross-power spectrum Several baselines displayed
Timerange: 00/19:41:01 to 00/19:42:59

Plot file version 48 created 14-JUL-2010 16:35:02
J1953+35 RR004A.UVDATA.1
Freq = 4.9415 GHz, Bw = 16.000 MH No calibration applied and no bandpass applied

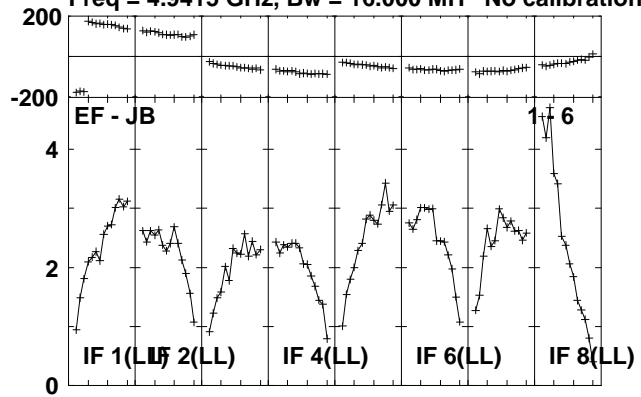

Lower frame: Milli Ampl Jy Top frame: Phas deg
Scalar averaged cross-power spectrum Several baselines displayed
Timerange: 00/19:41:01 to 00/19:42:59

Plot file version 49 created 14-JUL-2010 16:35:03

CYGX-1 RR004A.UVDATA.1

Freq = 4.9415 GHz, Bw = 16.000 MH No calibration applied and no bandpass applied

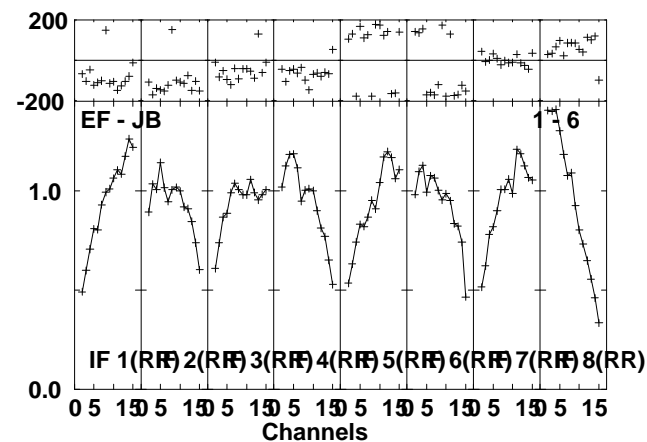
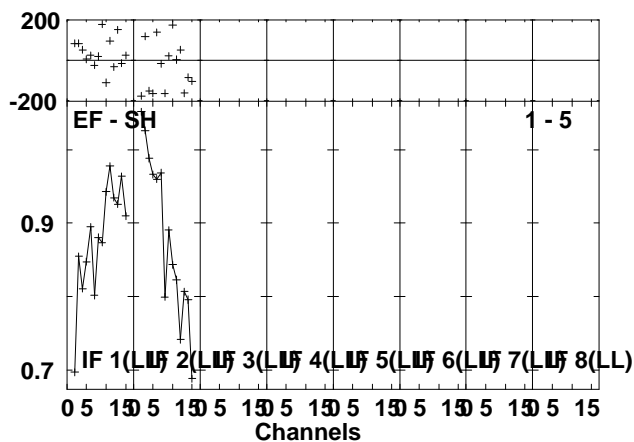
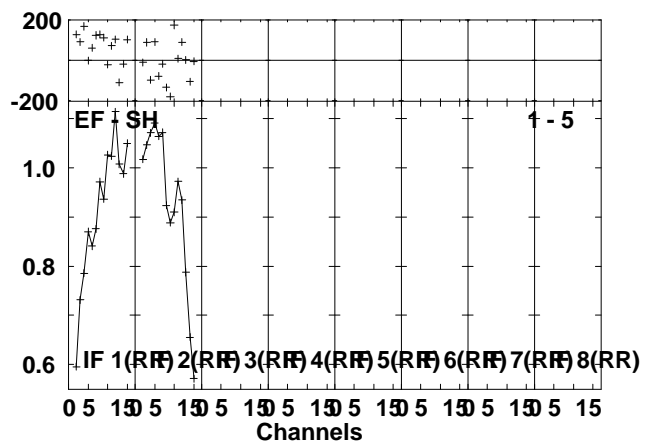
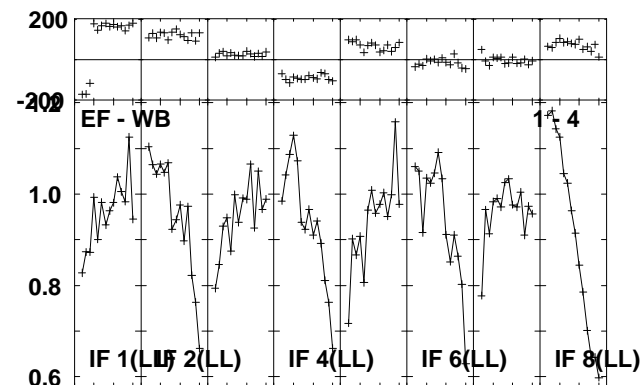
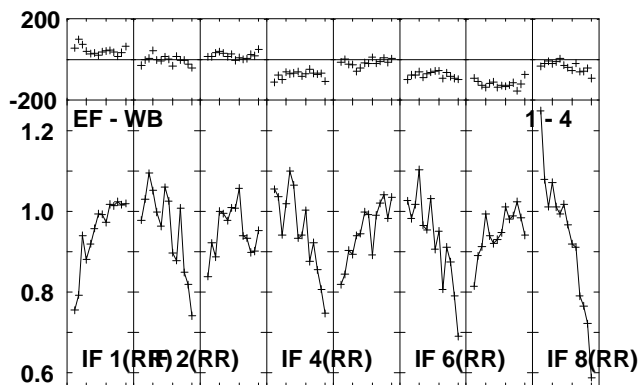
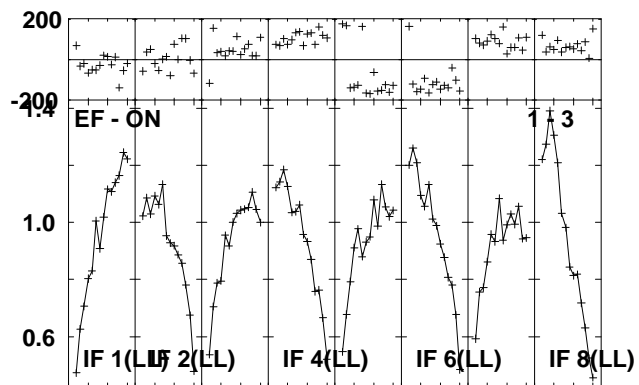
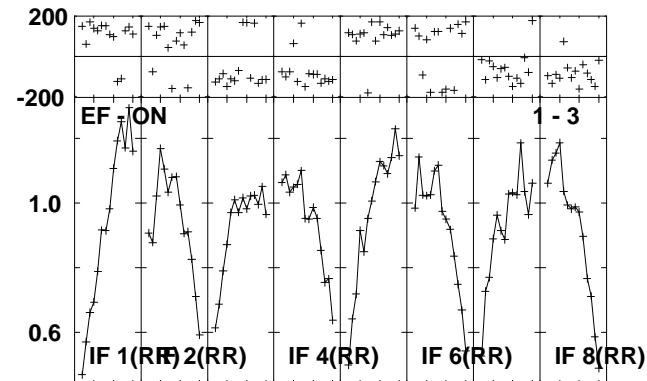
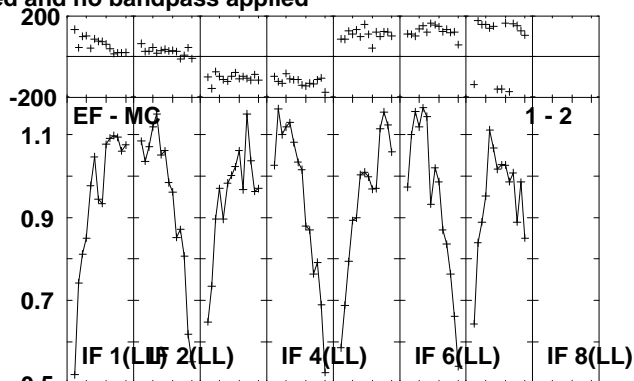
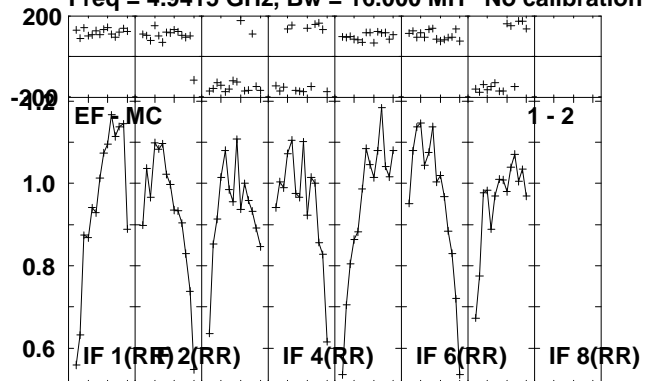

Lower frame: Milli Ampl Jy Top frame: Phas deg
Scalar averaged cross-power spectrum Several baselines displayed
Timerange: 00/19:43:01 to 00/19:47:59

Plot file version 50 created 14-JUL-2010 16:35:04
CYGX-1 RR004A.UVDATA.1

Freq = 4.9415 GHz, Bw = 16.000 MH No calibration applied and no bandpass applied

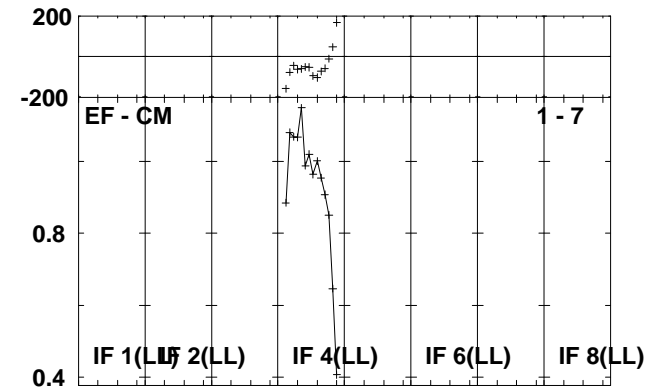
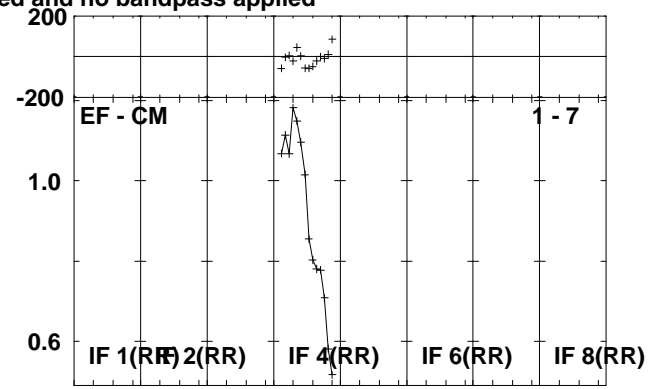
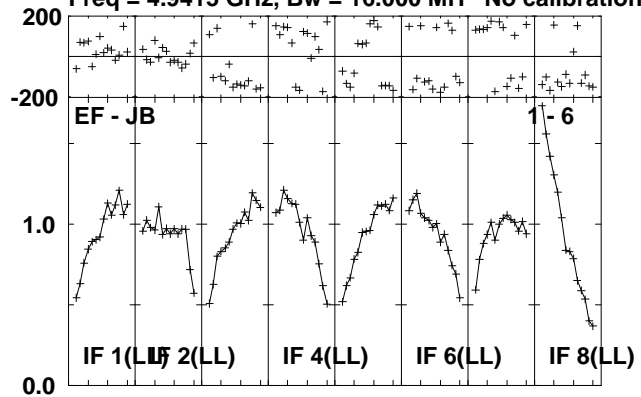

Lower frame: Milli Ampl Jy Top frame: Phas deg
Scalar averaged cross-power spectrum Several baselines displayed
Timerange: 00/19:43:01 to 00/19:47:59

Plot file version 51 created 14-JUL-2010 16:35:05

J1953+35 RR004A.UVDATA.1

Freq = 4.9415 GHz, Bw = 16.000 MH No calibration applied and no bandpass applied

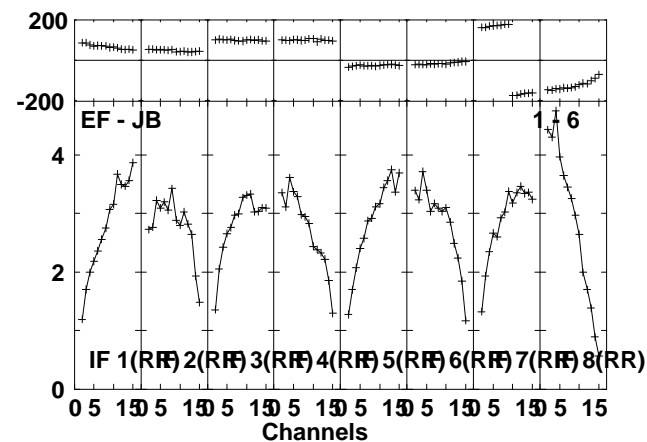
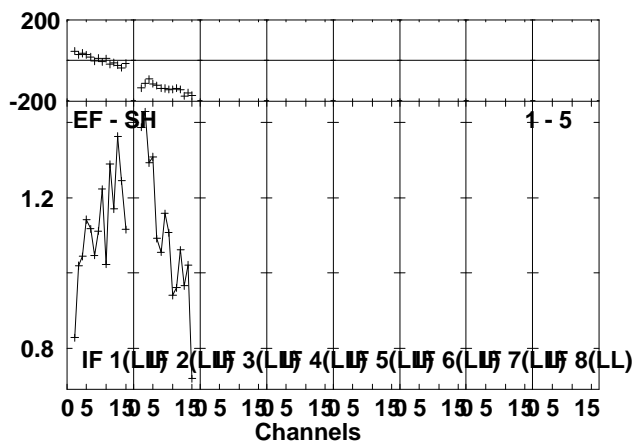
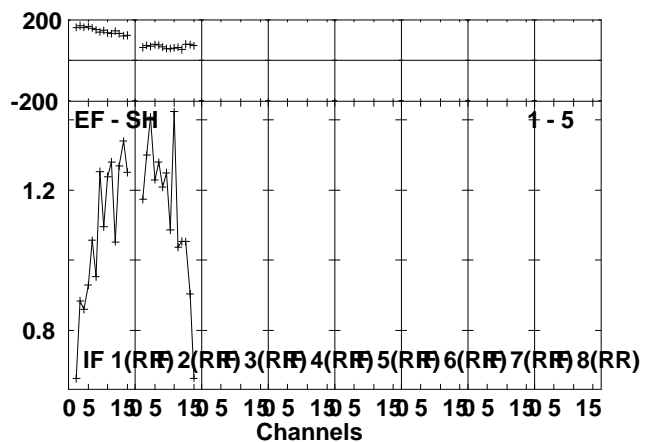
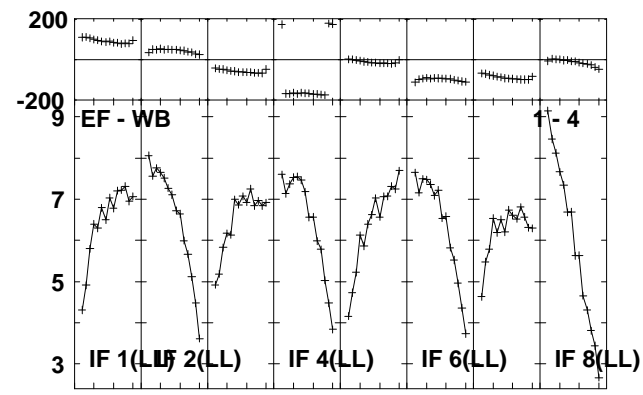
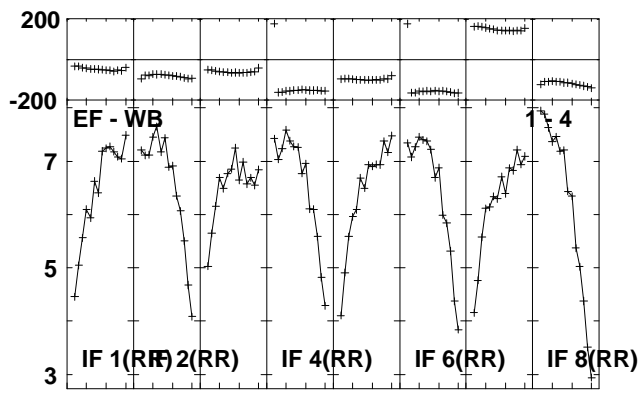
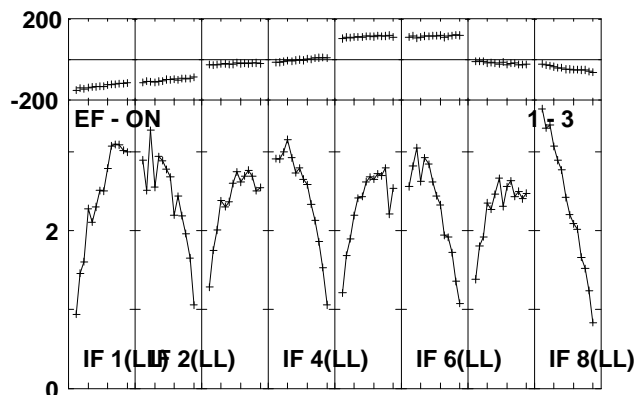
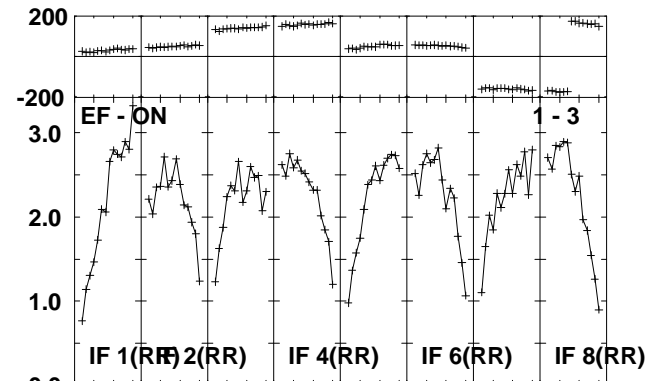
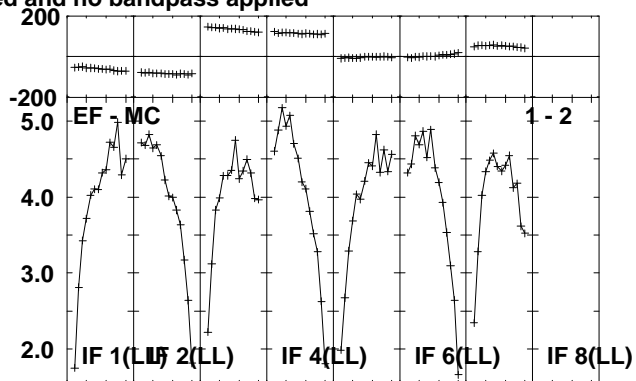
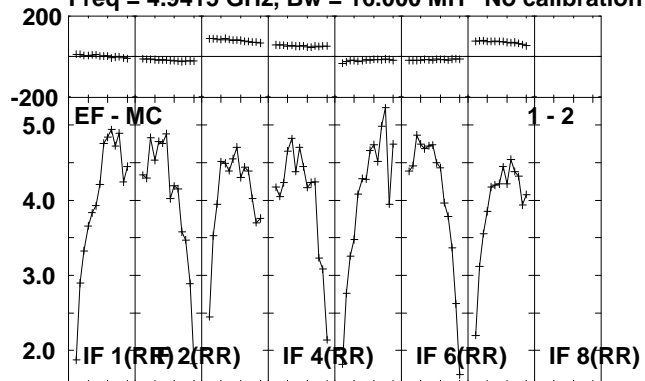

Lower frame: Milli Ampl Jy Top frame: Phas deg
Scalar averaged cross-power spectrum Several baselines displayed
Timerange: 00/19:48:41 to 00/19:50:09

Plot file version 52 created 14-JUL-2010 16:35:05
J1953+35 RR004A.UVDATA.1

Freq = 4.9415 GHz, Bw = 16.000 MH No calibration applied and no bandpass applied

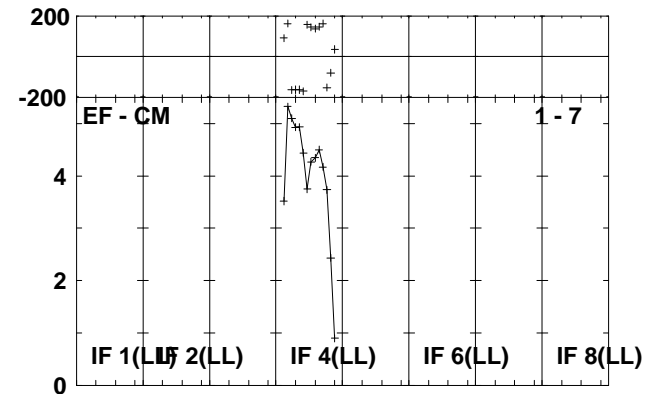
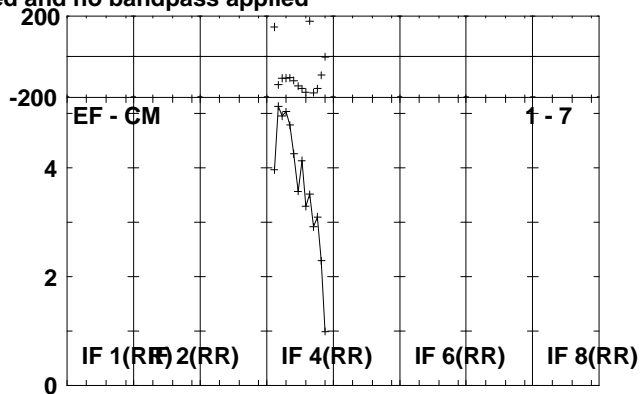
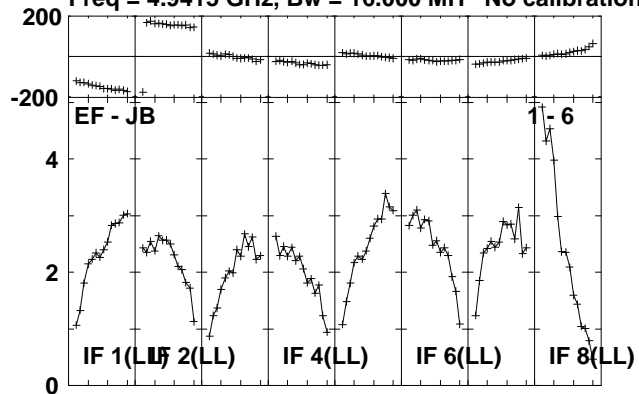

Lower frame: Milli Ampl Jy Top frame: Phas deg
Scalar averaged cross-power spectrum Several baselines displayed
Timerange: 00/19:48:41 to 00/19:50:09

Plot file version 53 created 14-JUL-2010 16:35:06

CYGX-1 RR004A.UVDATA.1

Freq = 4.9415 GHz, Bw = 16.000 MH No calibration applied and no bandpass applied

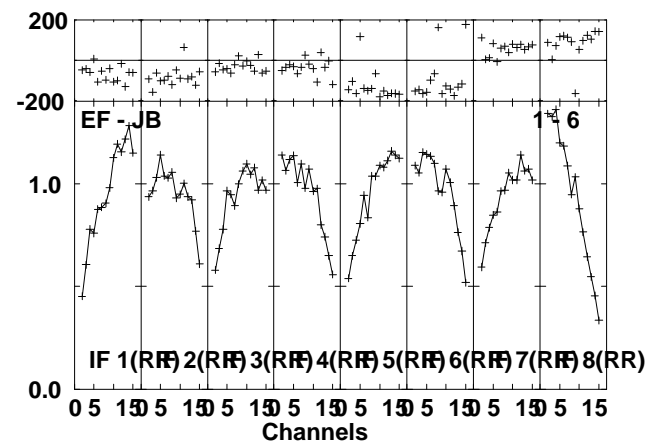
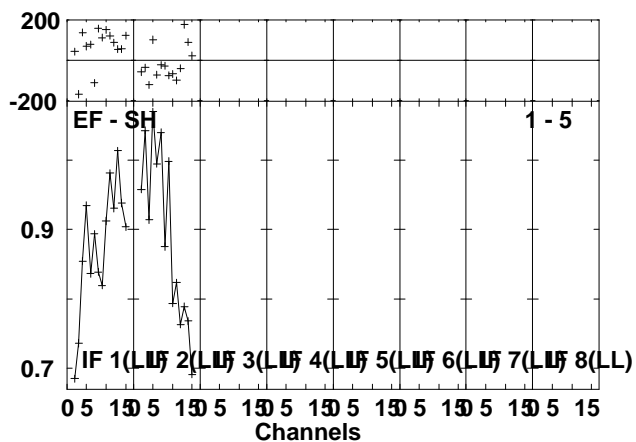
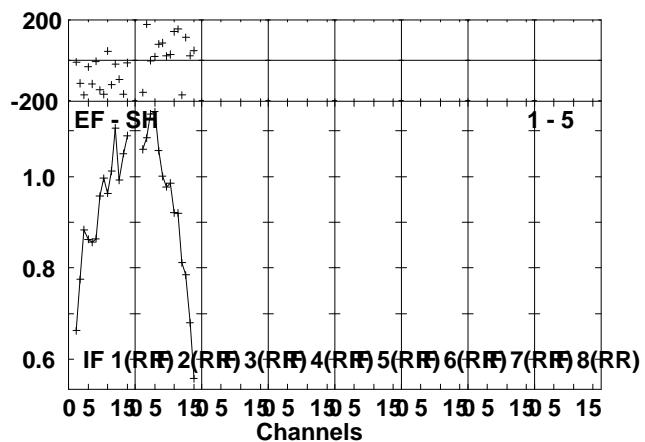
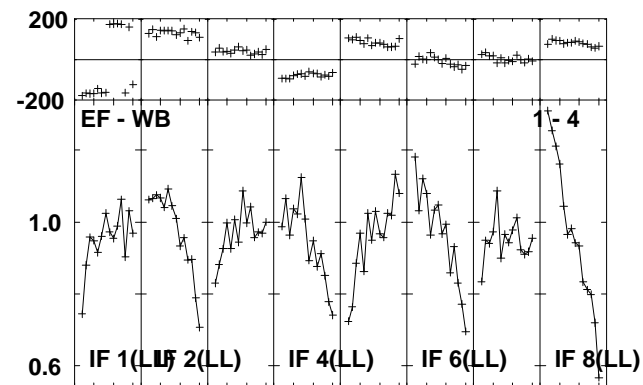
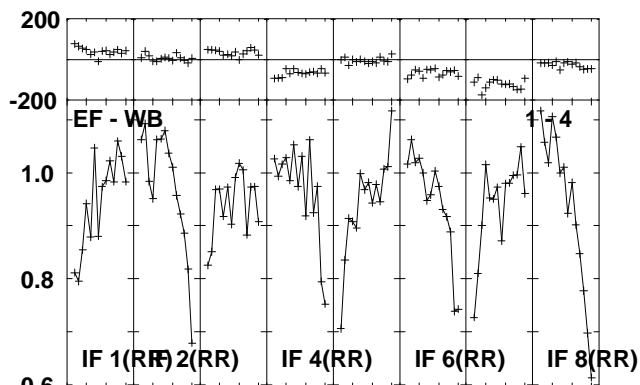
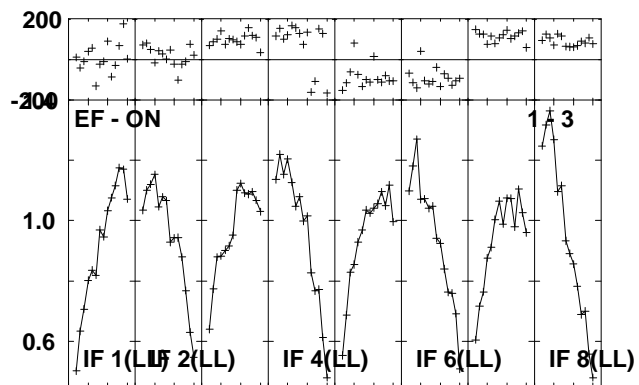
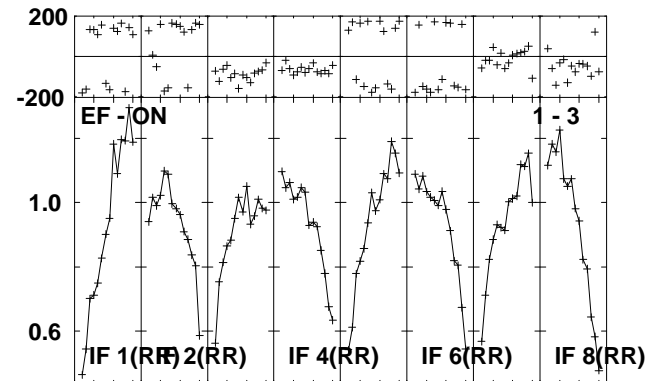
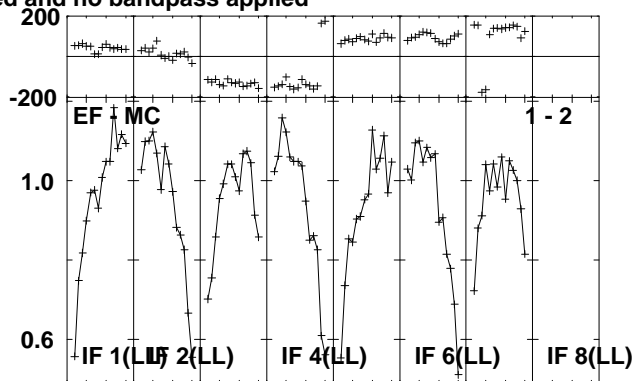
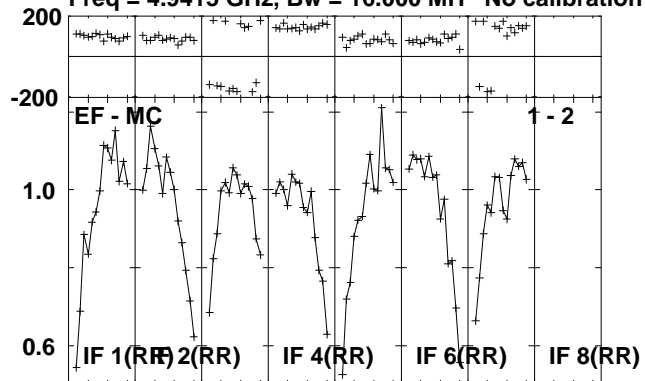

Lower frame: Milli Ampl Jy Top frame: Phas deg
Scalar averaged cross-power spectrum Several baselines displayed
Timerange: 00/19:50:11 to 00/19:55:09

Plot file version 54 created 14-JUL-2010 16:35:07

CYGX-1 RR004A.UVDATA.1

Freq = 4.9415 GHz, Bw = 16.000 MH No calibration applied and no bandpass applied

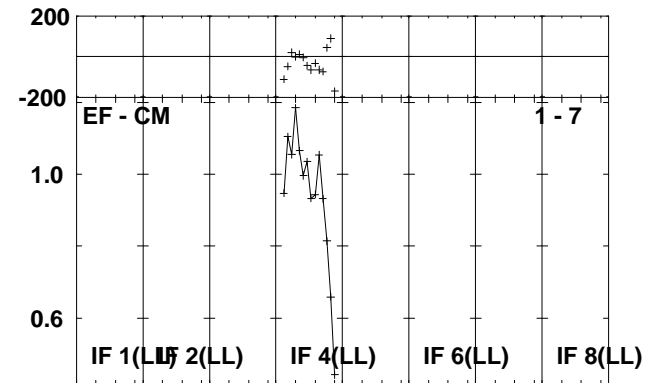
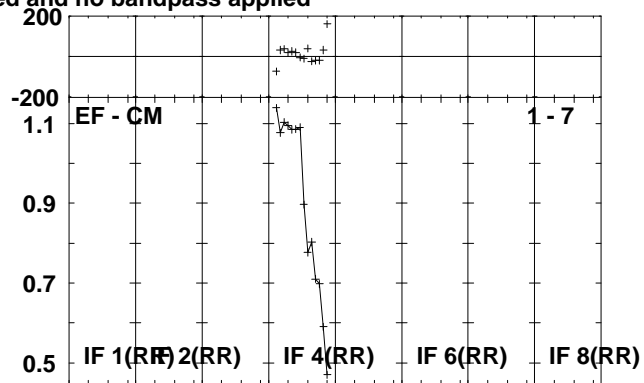
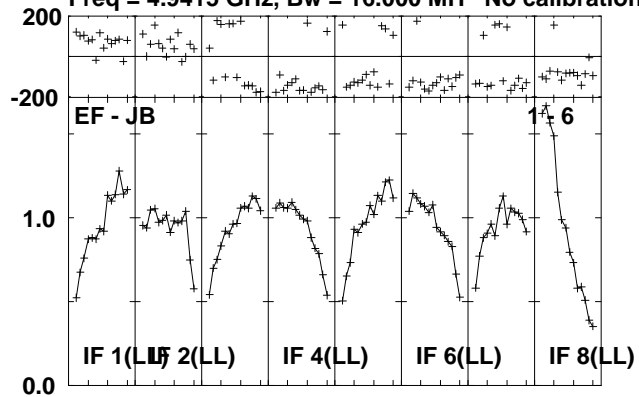

Lower frame: Milli Ampl Jy Top frame: Phas deg
Scalar averaged cross-power spectrum Several baselines displayed
Timerange: 00/19:50:11 to 00/19:55:09

Plot file version 55 created 14-JUL-2010 16:35:14

J1953+35 RR004A.UVDATA.1

Freq = 4.9415 GHz, Bw = 16.000 MH No calibration applied and no bandpass applied

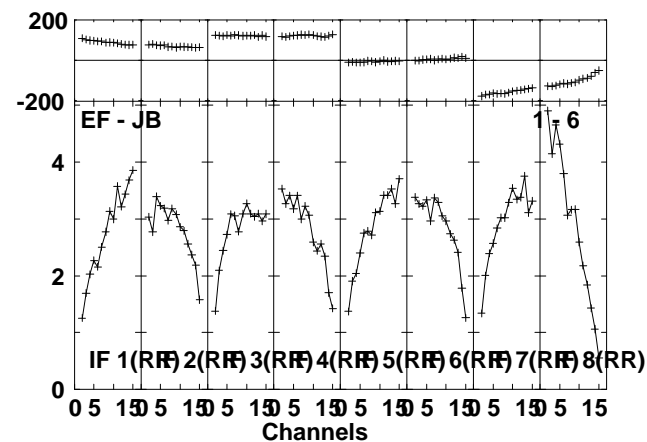
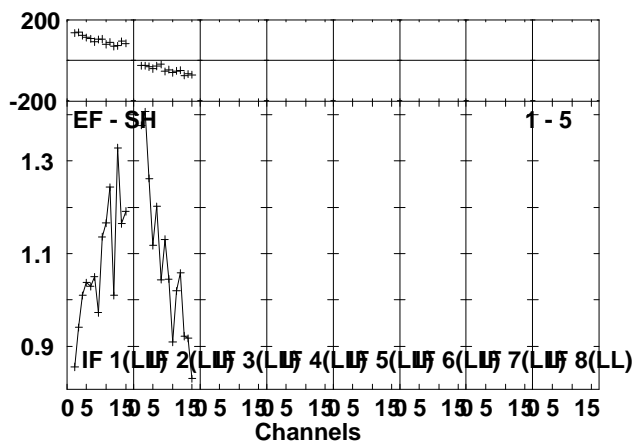
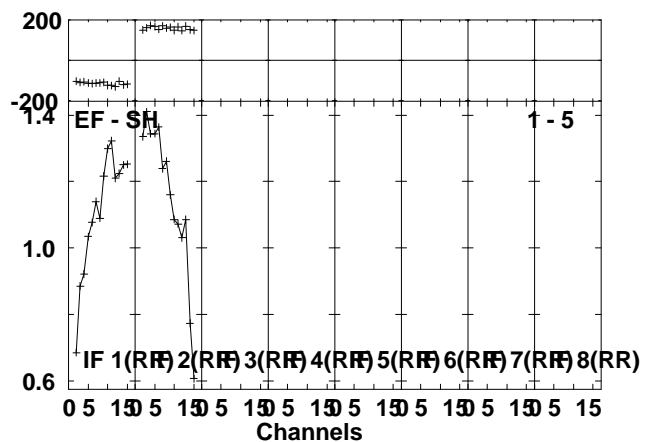
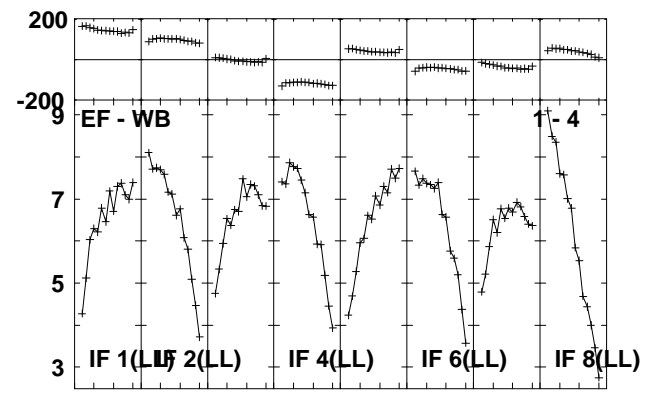
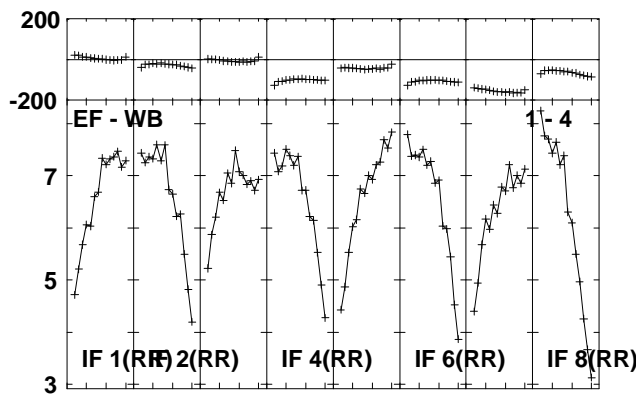
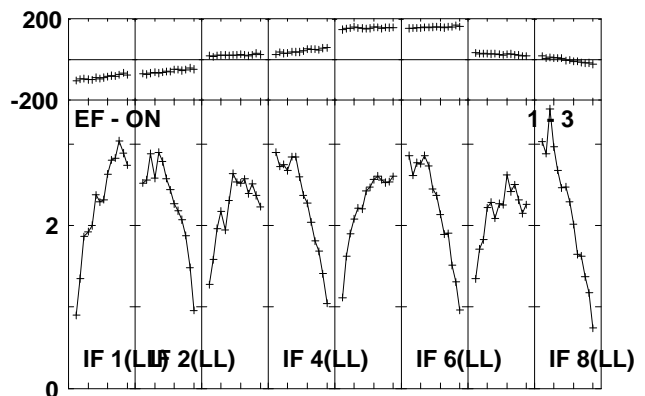
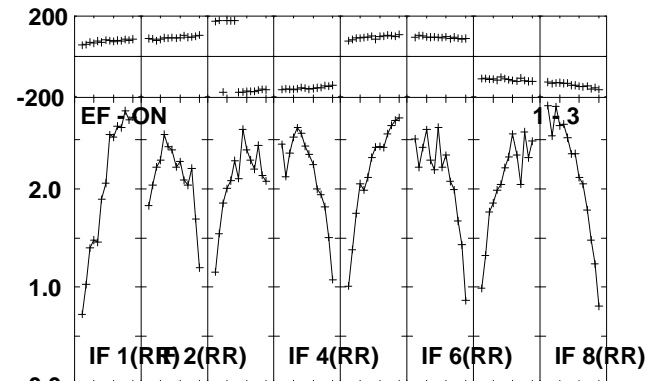
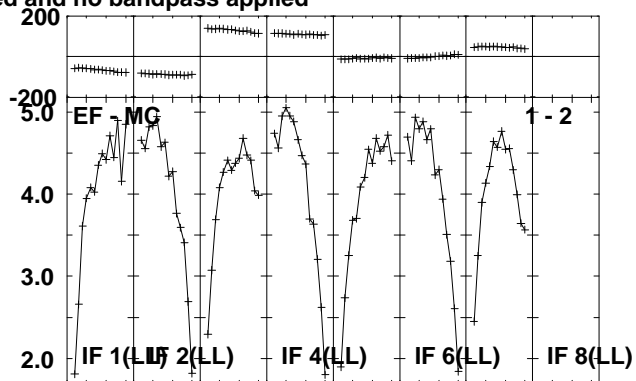
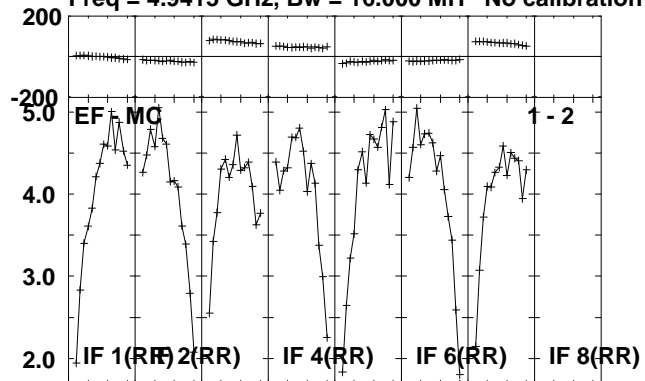

Lower frame: Milli Ampl Jy Top frame: Phas deg
Scalar averaged cross-power spectrum Several baselines displayed
Timerange: 00/19:55:11 to 00/19:57:09

Plot file version 56 created 14-JUL-2010 16:35:15
J1953+35 RR004A.UVDATA.1

Freq = 4.9415 GHz, Bw = 16.000 MH No calibration applied and no bandpass applied

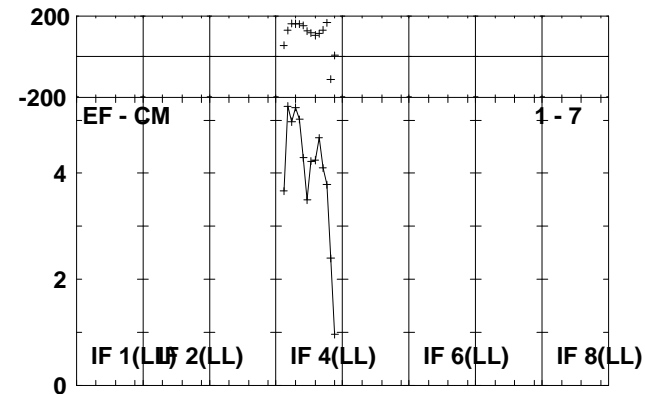
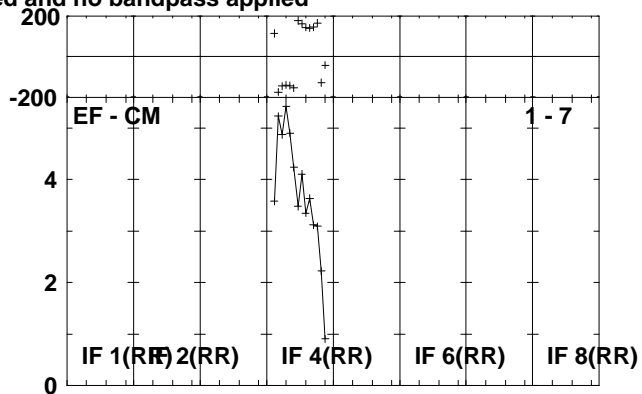
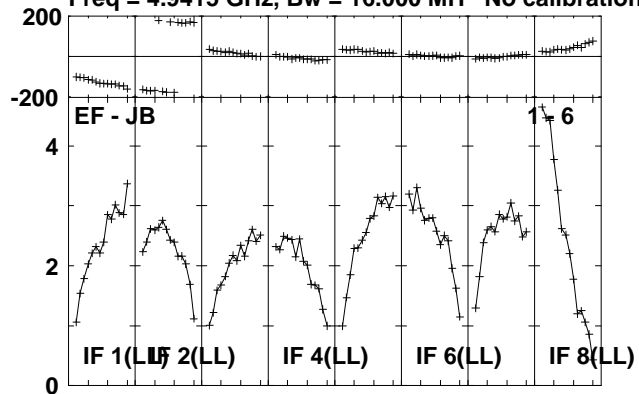

Lower frame: Milli Ampl Jy Top frame: Phas deg
Scalar averaged cross-power spectrum Several baselines displayed
Timerange: 00/19:55:11 to 00/19:57:09

Plot file version 57 created 14-JUL-2010 16:35:15

CYGX-1 RR004A.UVDATA.1

Freq = 4.9415 GHz, Bw = 16.000 MH No calibration applied and no bandpass applied

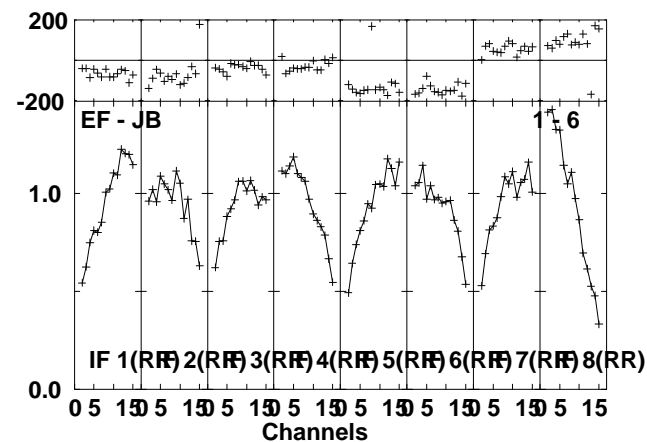
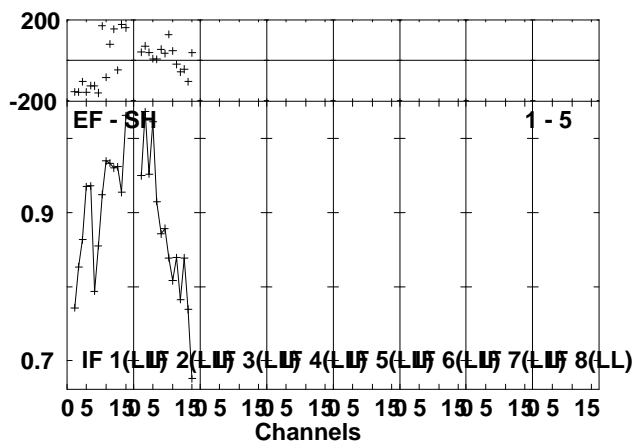
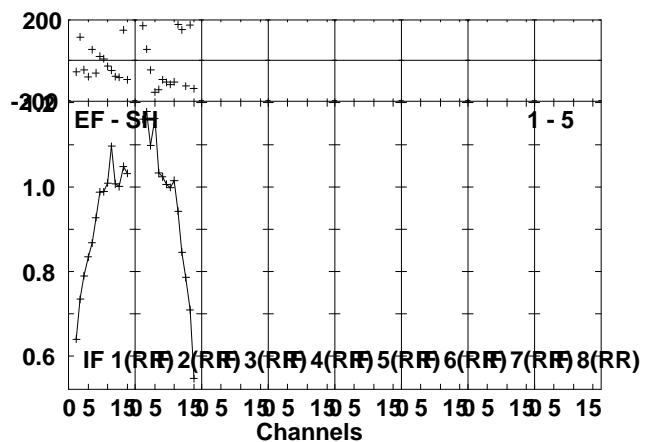
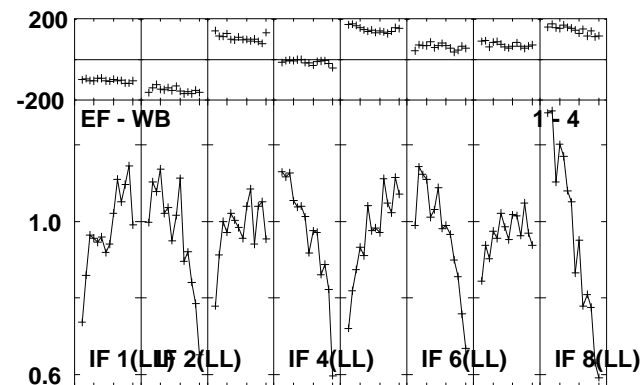
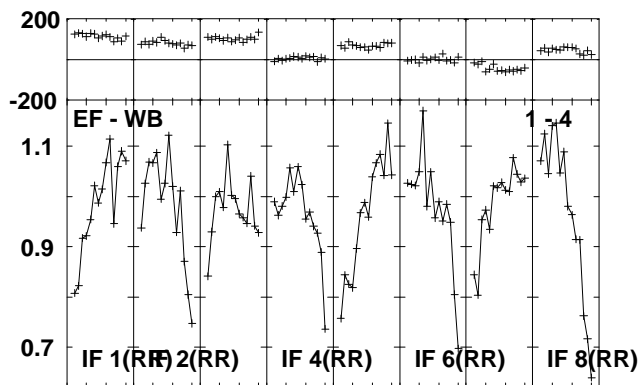
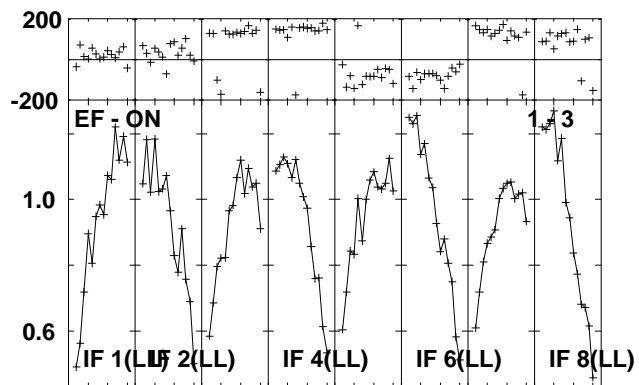
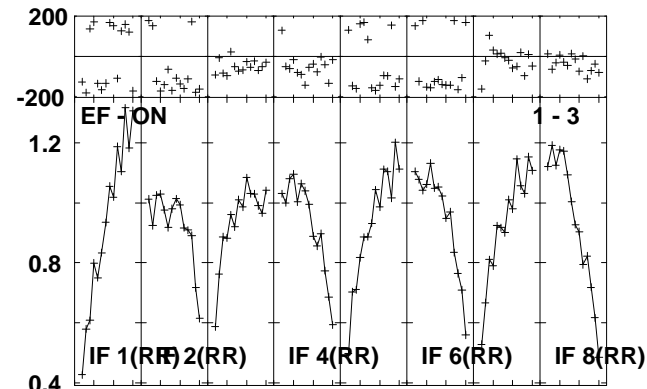
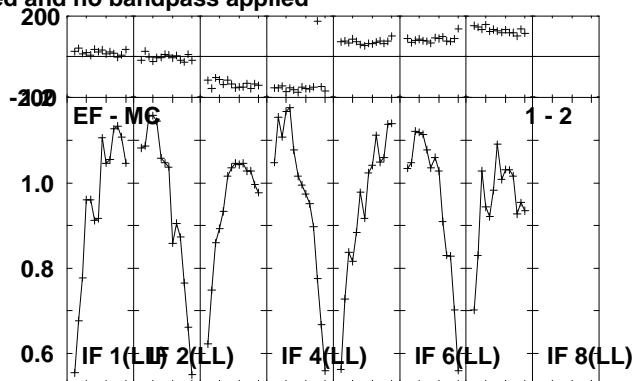
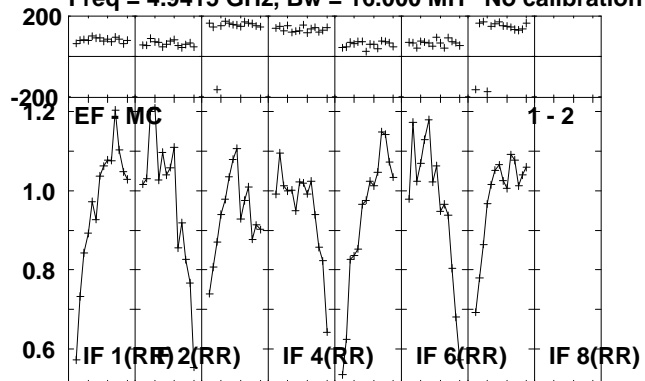

Lower frame: Milli Ampl Jy Top frame: Phas deg
Scalar averaged cross-power spectrum Several baselines displayed
Timerange: 00/19:57:11 to 00/20:02:09

Plot file version 58 created 14-JUL-2010 16:35:17
CYGX-1 RR004A.UVDATA.1

Freq = 4.9415 GHz, Bw = 16.000 MH No calibration applied and no bandpass applied

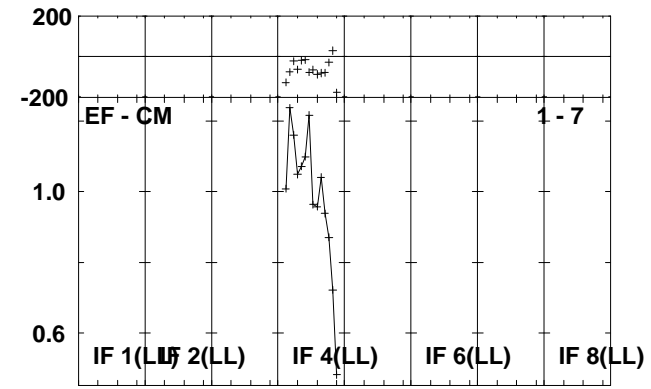
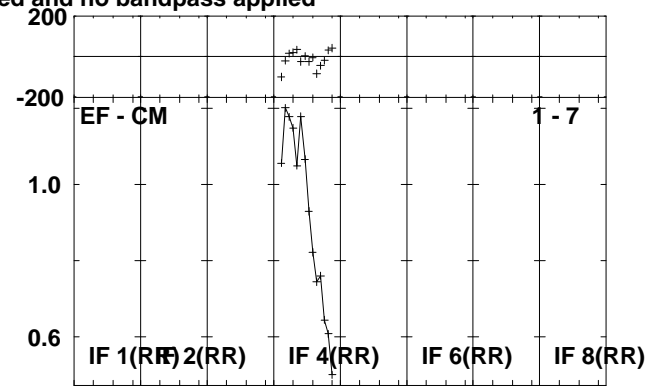
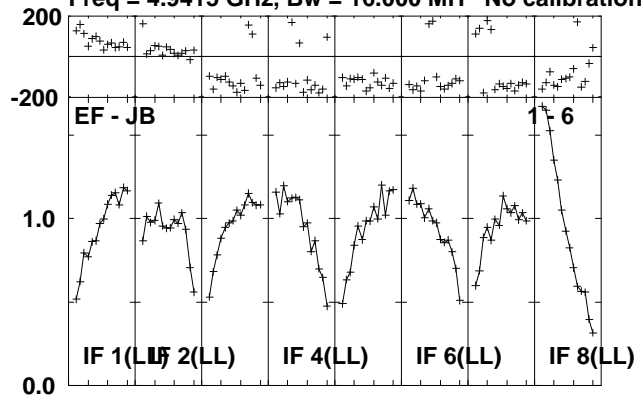

Lower frame: Milli Ampl Jy Top frame: Phas deg
Scalar averaged cross-power spectrum Several baselines displayed
Timerange: 00/19:57:11 to 00/20:02:09

Plot file version 59 created 14-JUL-2010 16:35:18

J1953+35 RR004A.UVDATA.1

Freq = 4.9415 GHz, Bw = 16.000 MH No calibration applied and no bandpass applied

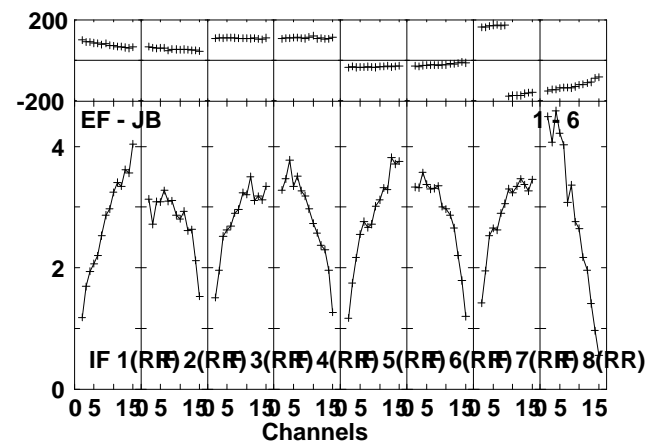
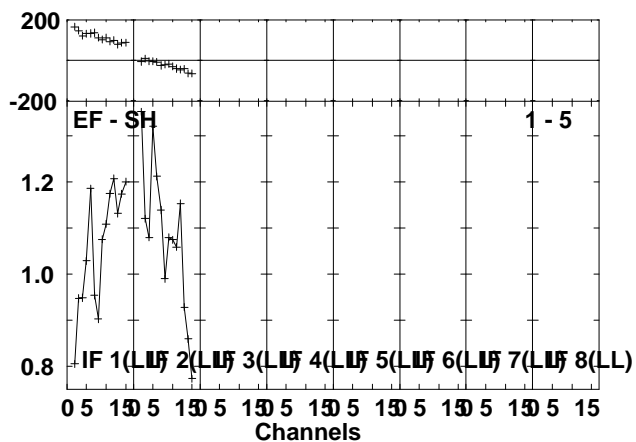
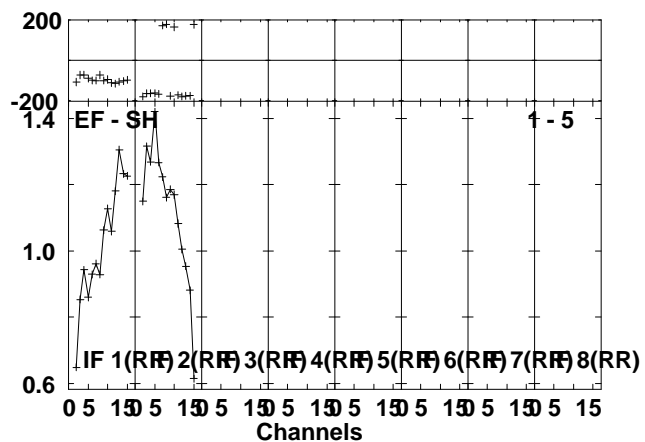
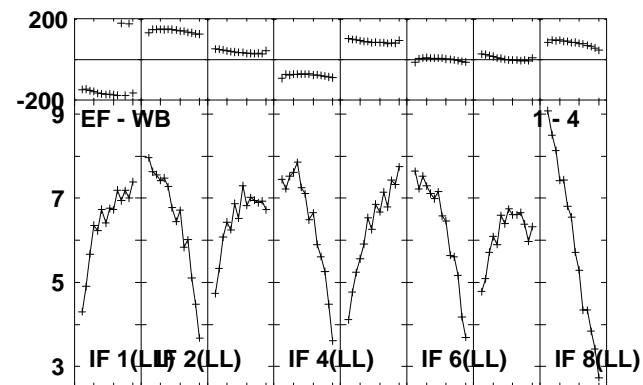
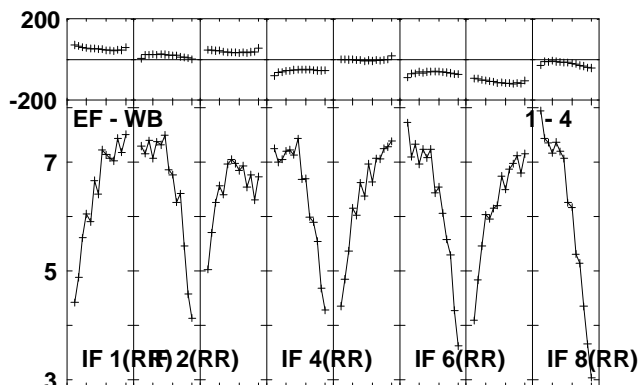
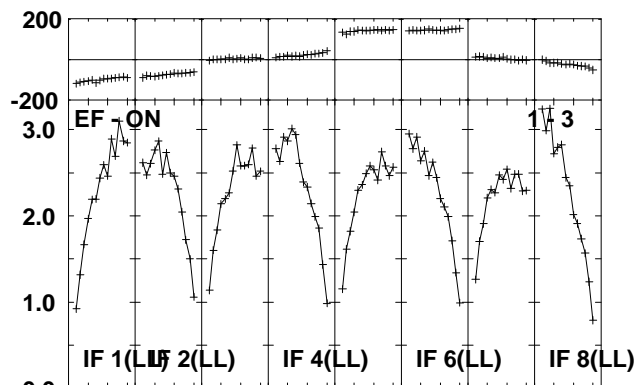
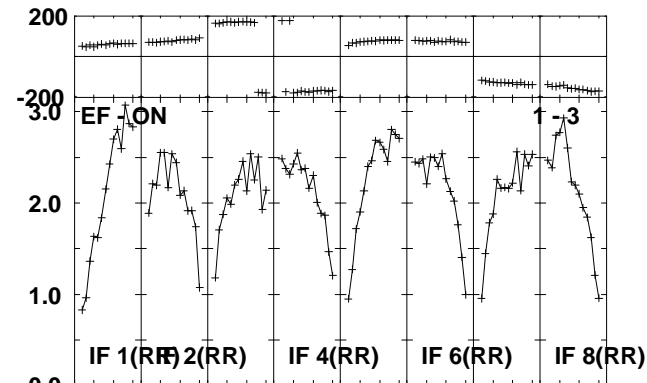
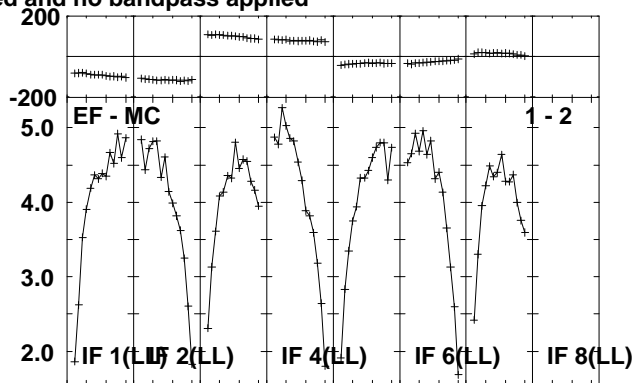
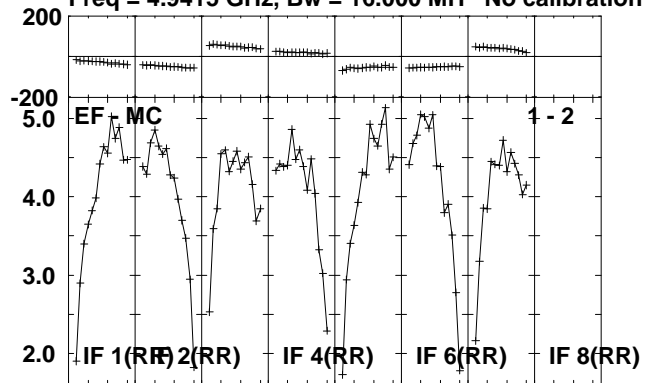

Lower frame: Milli Ampl Jy Top frame: Phas deg
Scalar averaged cross-power spectrum Several baselines displayed
Timerange: 00/20:02:51 to 00/20:04:19

Plot file version 60 created 14-JUL-2010 16:35:18
J1953+35 RR004A.UVDATA.1

Freq = 4.9415 GHz, Bw = 16.000 MH No calibration applied and no bandpass applied

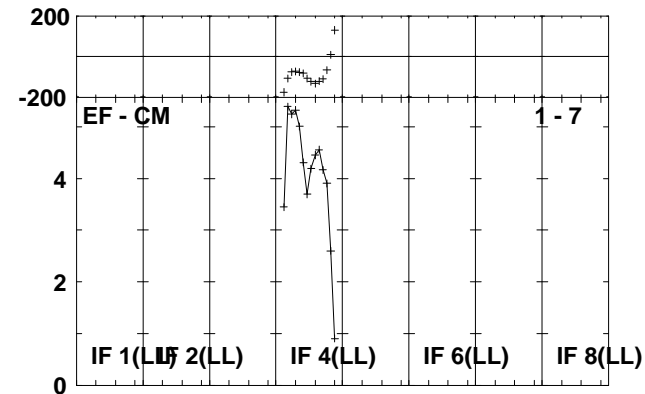
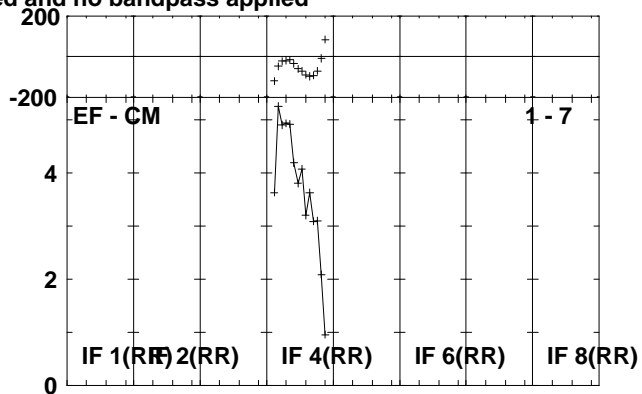
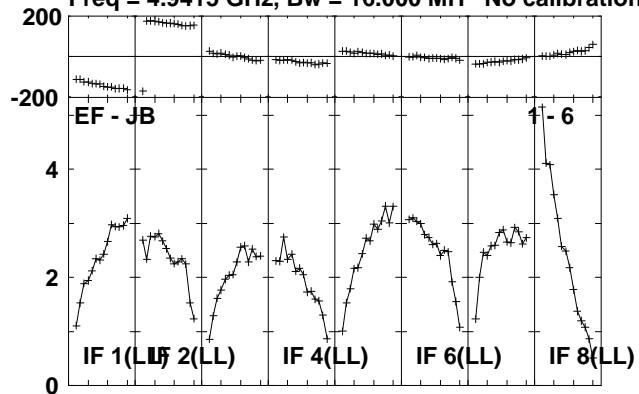

Lower frame: Milli Ampl Jy Top frame: Phas deg
Scalar averaged cross-power spectrum Several baselines displayed
Timerange: 00/20:02:51 to 00/20:04:19

Plot file version 61 created 14-JUL-2010 16:35:19

CYGX-1 RR004A.UVDATA.1

Freq = 4.9415 GHz, Bw = 16.000 MH No calibration applied and no bandpass applied

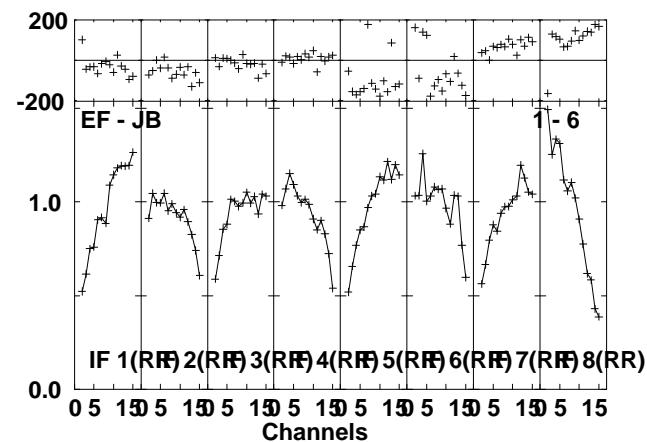
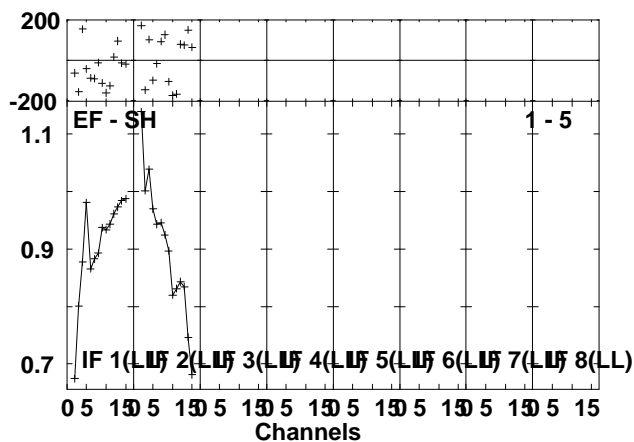
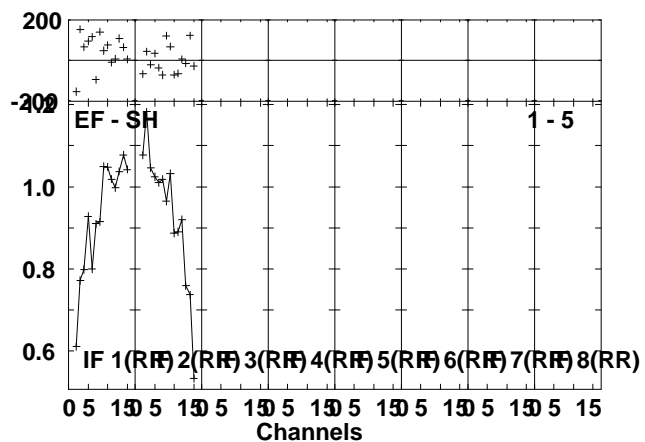
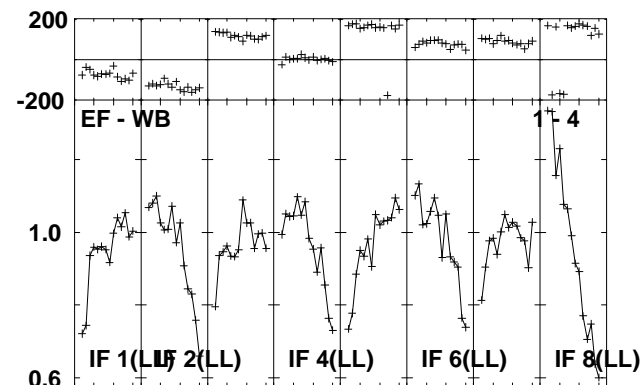
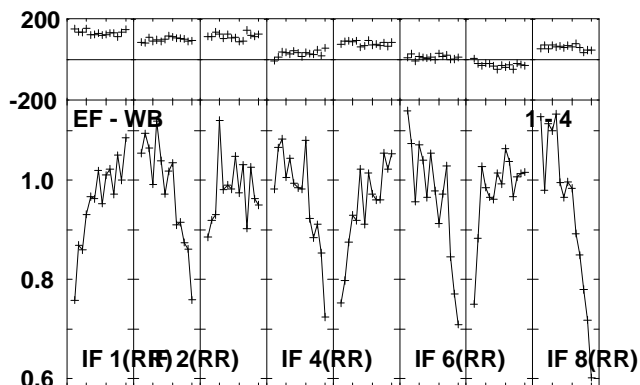
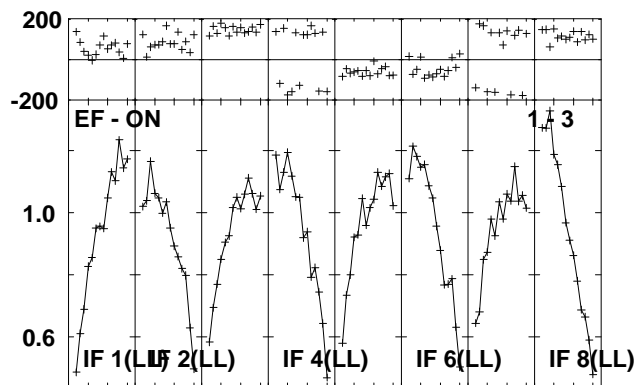
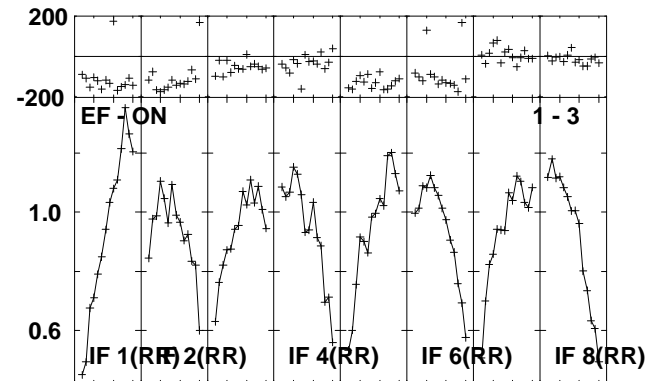
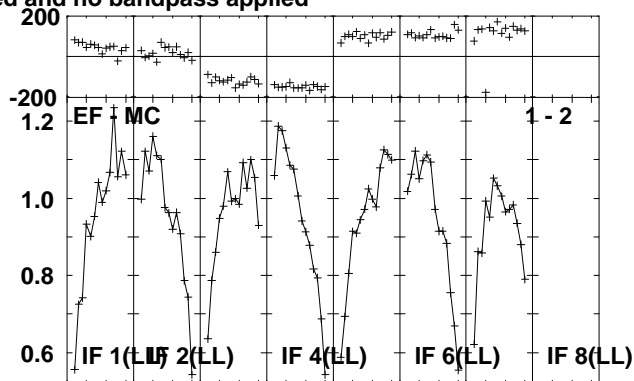
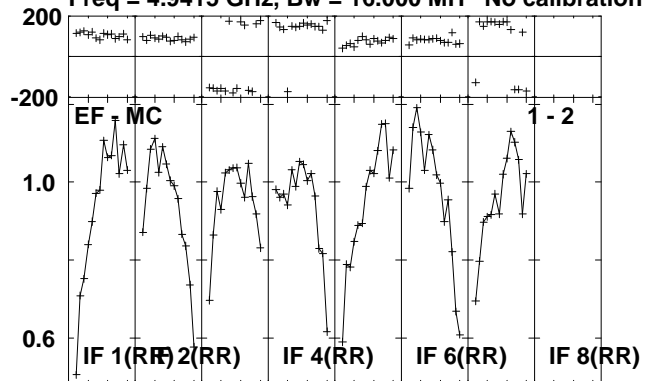

Lower frame: Milli Ampl Jy Top frame: Phas deg
Scalar averaged cross-power spectrum Several baselines displayed
Timerange: 00/20:04:21 to 00/20:09:19

Plot file version 62 created 14-JUL-2010 16:35:20

CYGX-1 RR004A.UVDATA.1

Freq = 4.9415 GHz, Bw = 16.000 MH No calibration applied and no bandpass applied

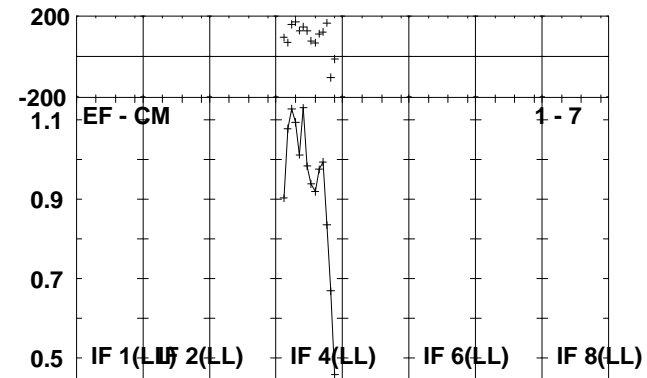
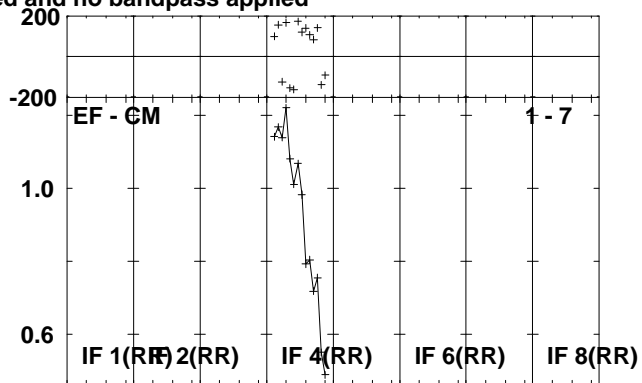
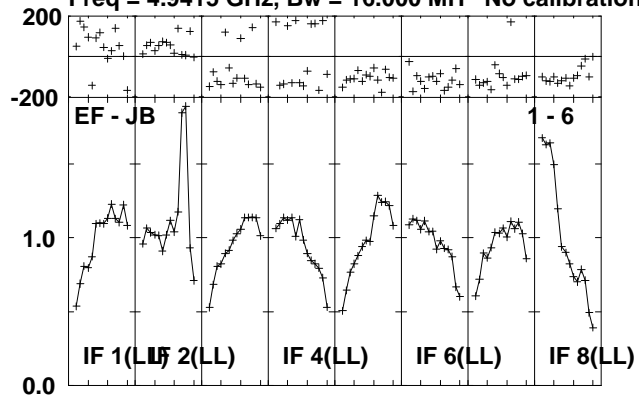

Lower frame: Milli Ampl Jy Top frame: Phas deg
Scalar averaged cross-power spectrum Several baselines displayed
Timerange: 00/20:04:21 to 00/20:09:19

Plot file version 63 created 14-JUL-2010 16:35:21

J1953+35 RR004A.UVDATA.1

Freq = 4.9415 GHz, Bw = 16.000 MH No calibration applied and no bandpass applied

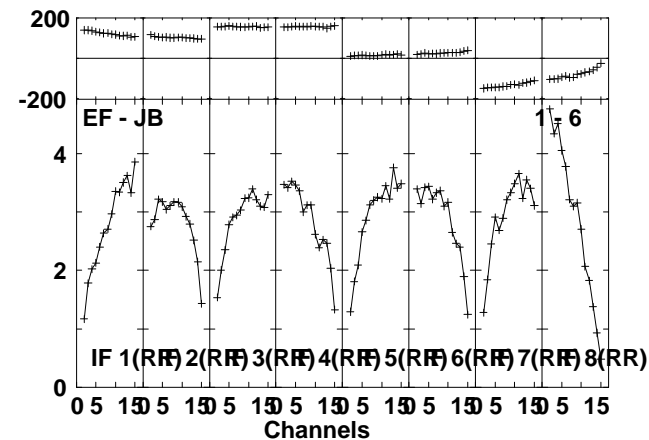
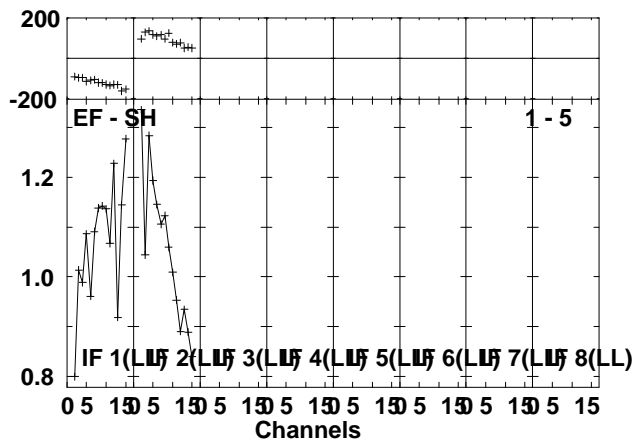
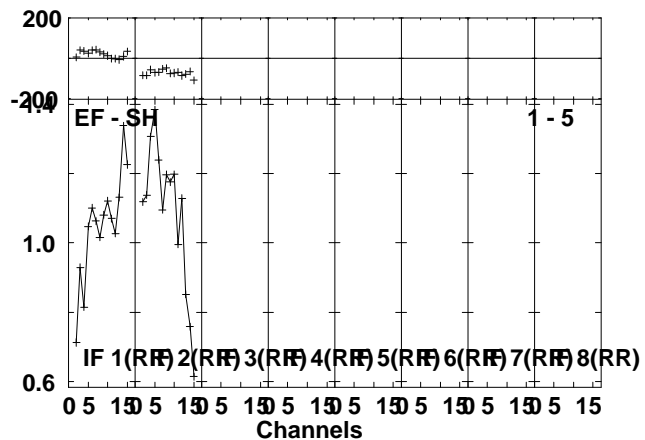
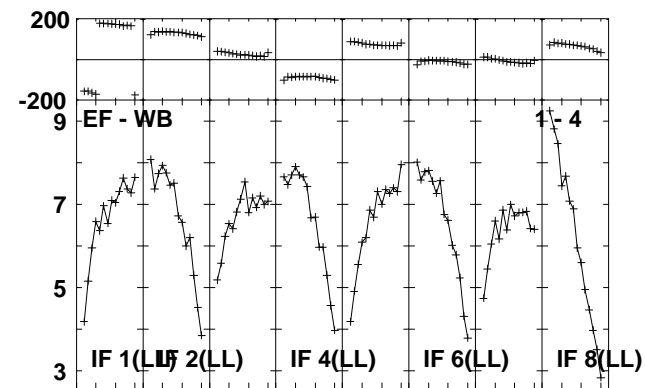
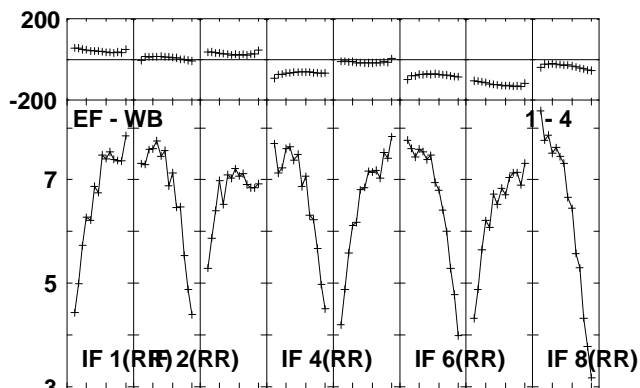
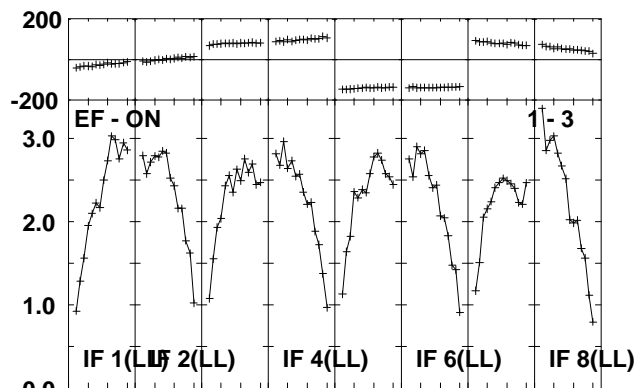
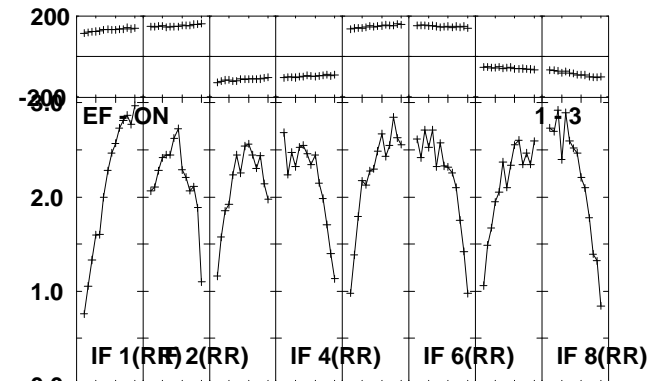
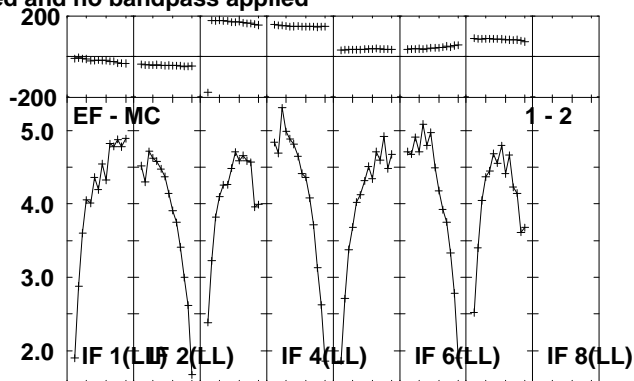
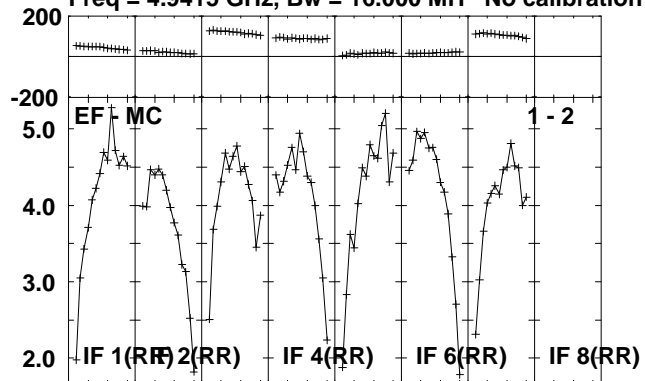

Lower frame: Milli Ampl Jy Top frame: Phas deg
Scalar averaged cross-power spectrum Several baselines displayed
Timerange: 00/20:09:21 to 00/20:11:19

Plot file version 64 created 14-JUL-2010 16:35:22
J1953+35 RR004A.UVDATA.1

Freq = 4.9415 GHz, Bw = 16.000 MH No calibration applied and no bandpass applied

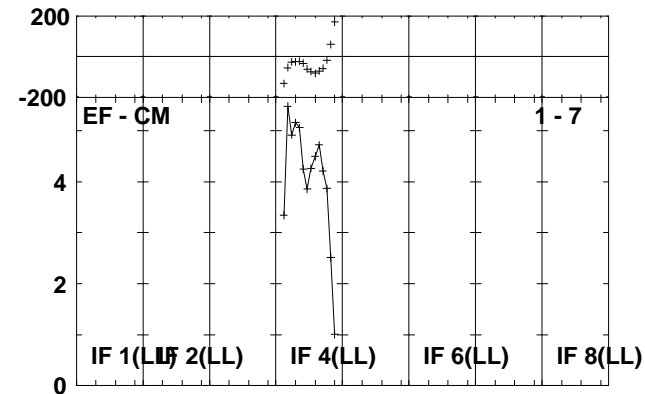
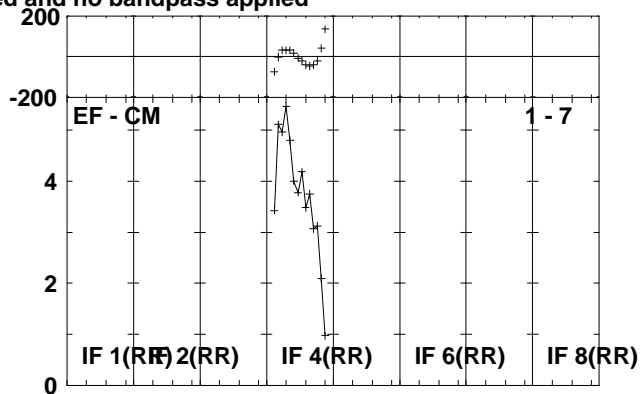
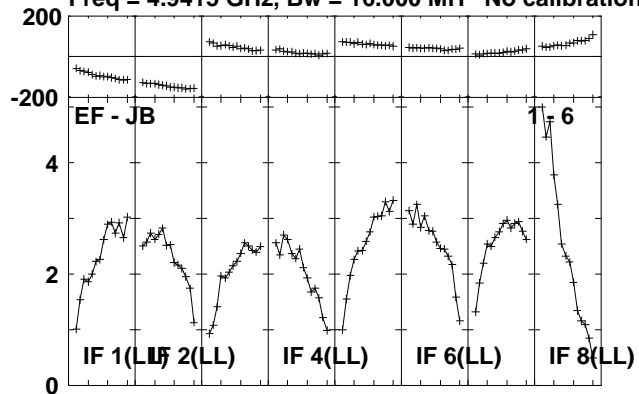

Lower frame: Milli Ampl Jy Top frame: Phas deg
Scalar averaged cross-power spectrum Several baselines displayed
Timerange: 00/20:09:21 to 00/20:11:19

Plot file version 65 created 14-JUL-2010 16:35:23

CYGX-1 RR004A.UVDATA.1

Freq = 4.9415 GHz, Bw = 16.000 MH No calibration applied and no bandpass applied

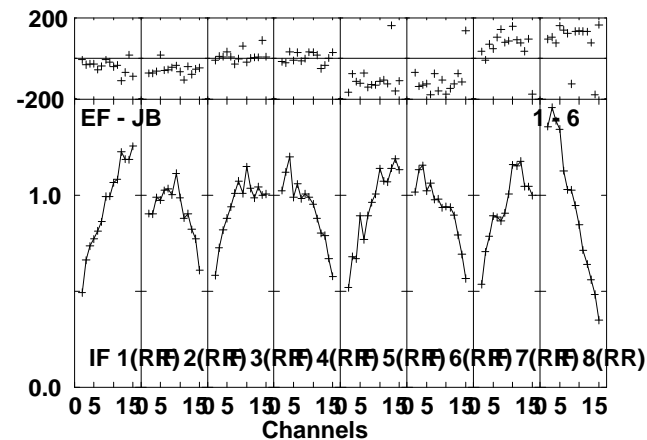
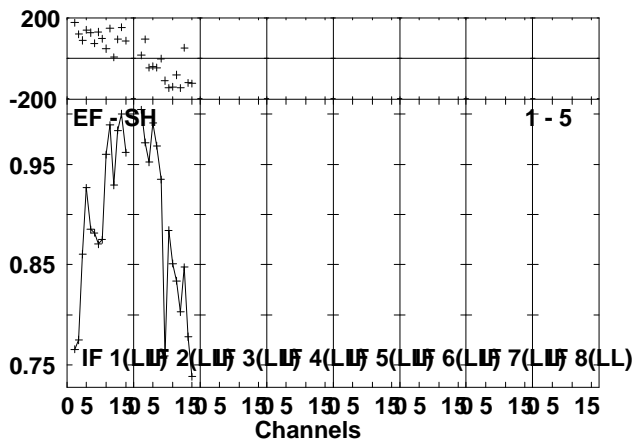
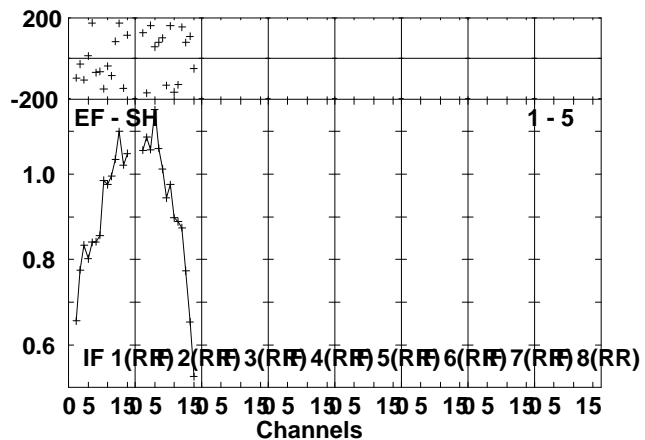
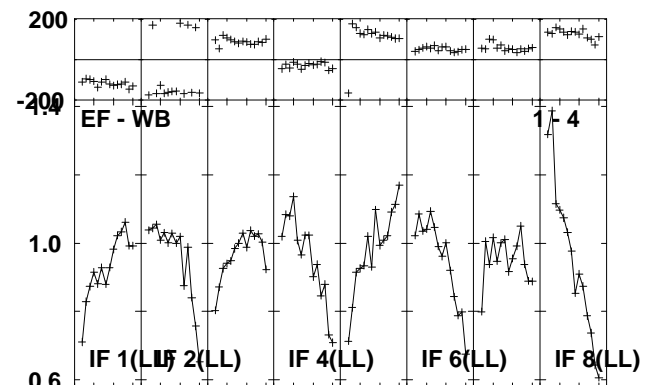
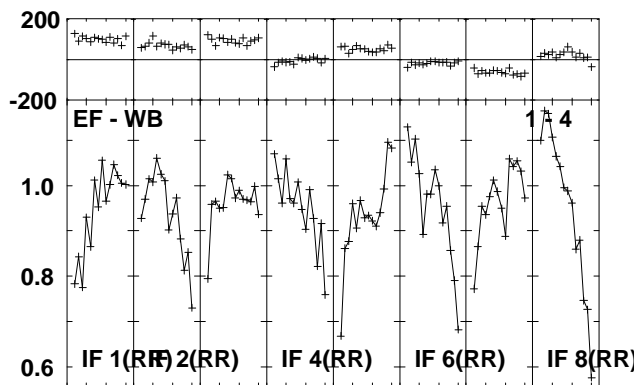
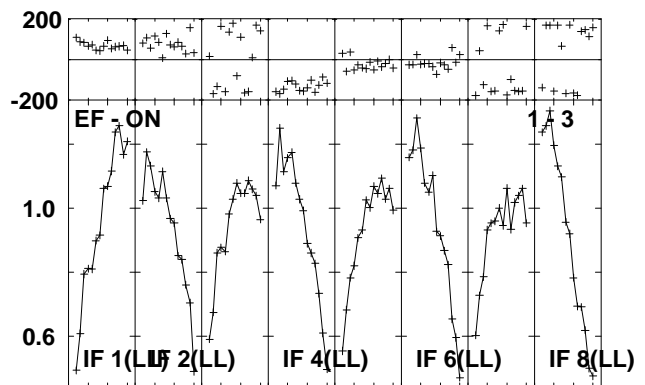
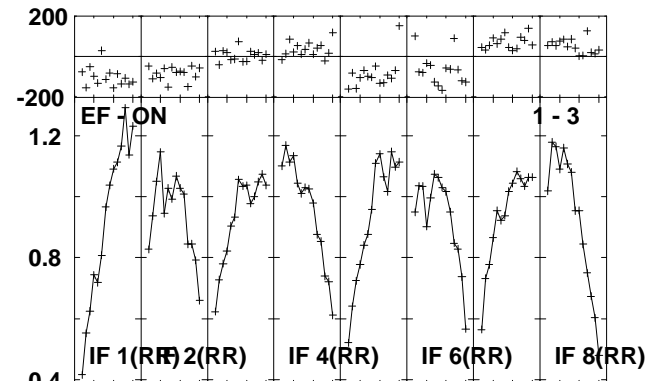
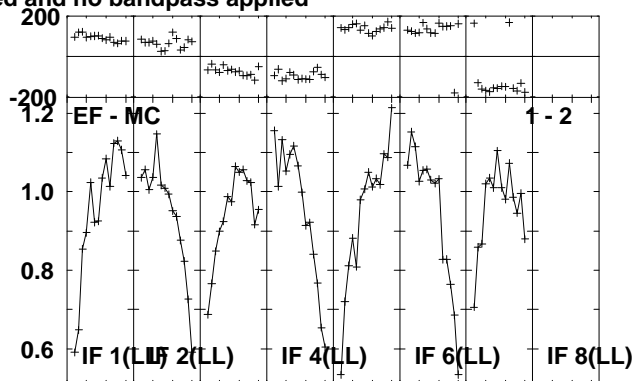
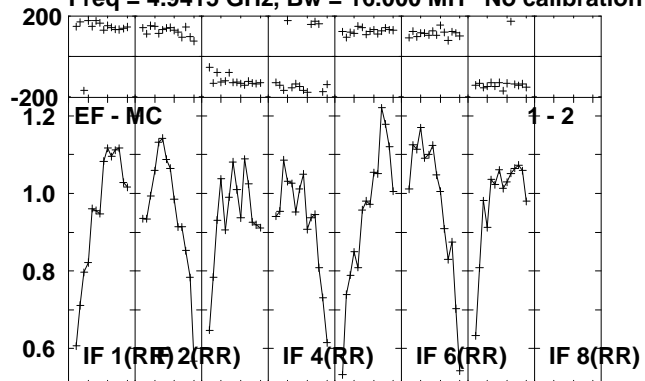

Lower frame: Milli Ampl Jy Top frame: Phas deg
Scalar averaged cross-power spectrum Several baselines displayed
Timerange: 00/20:11:21 to 00/20:16:19

Plot file version 66 created 14-JUL-2010 16:35:24

CYGX-1 RR004A.UVDATA.1

Freq = 4.9415 GHz, Bw = 16.000 MH No calibration applied and no bandpass applied

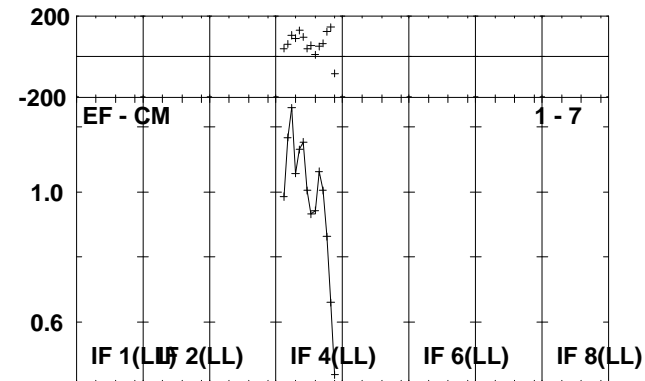
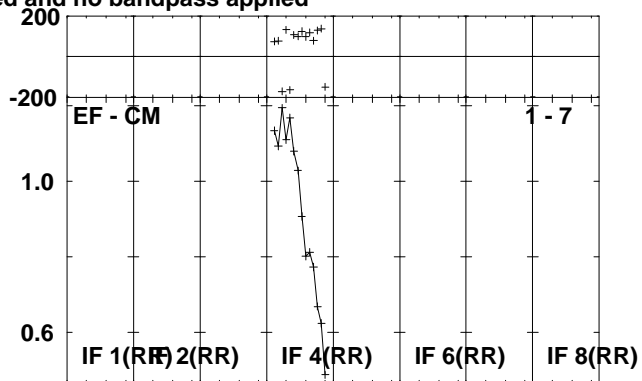
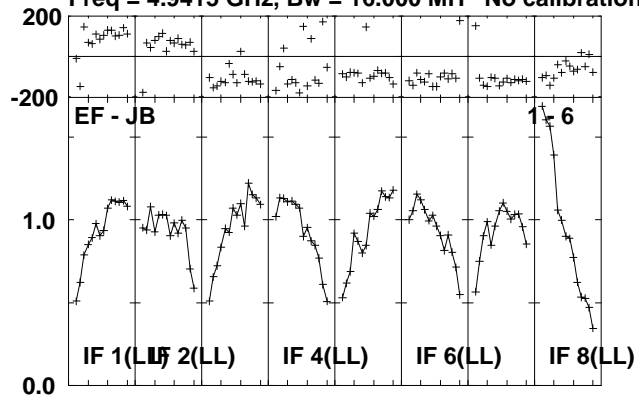

Lower frame: Milli Ampl Jy Top frame: Phas deg
Scalar averaged cross-power spectrum Several baselines displayed
Timerange: 00/20:11:21 to 00/20:16:19

Plot file version 67 created 14-JUL-2010 16:35:25

J1953+35 RR004A.UVDATA.1

Freq = 4.9415 GHz, Bw = 16.000 MH No calibration applied and no bandpass applied

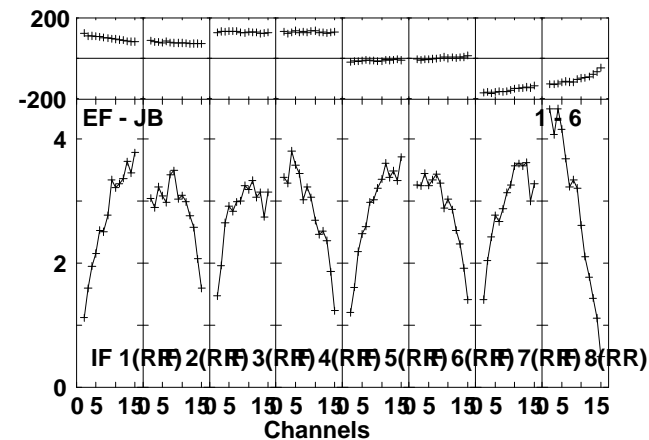
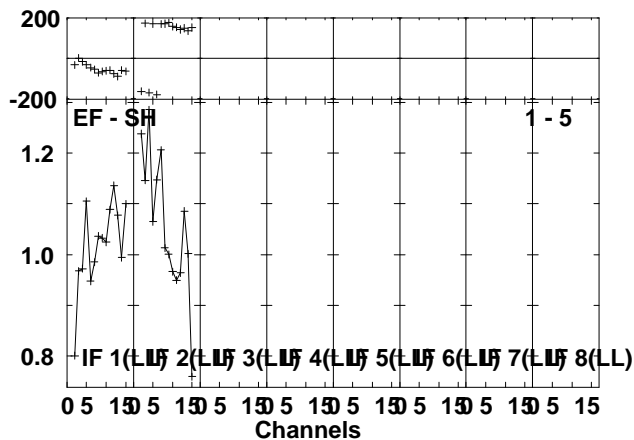
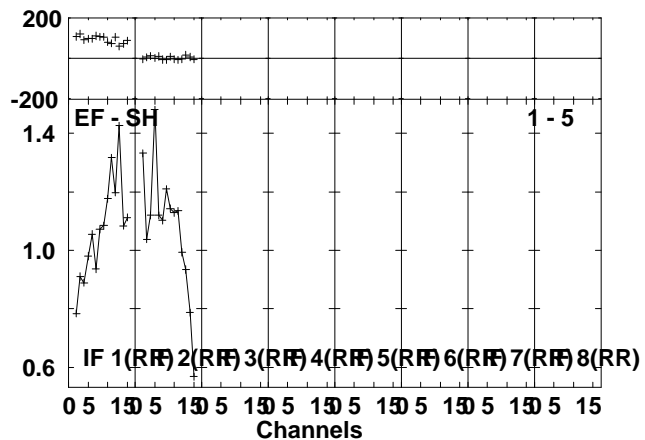
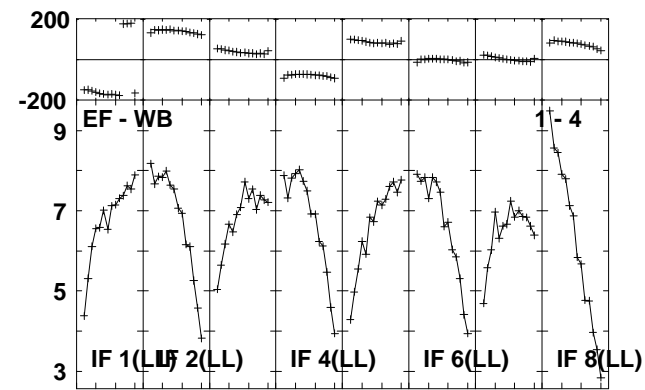
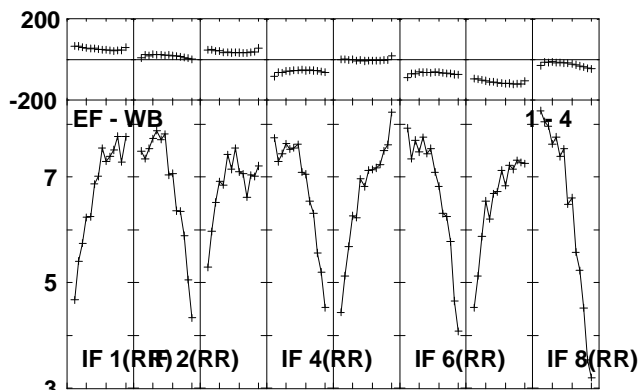
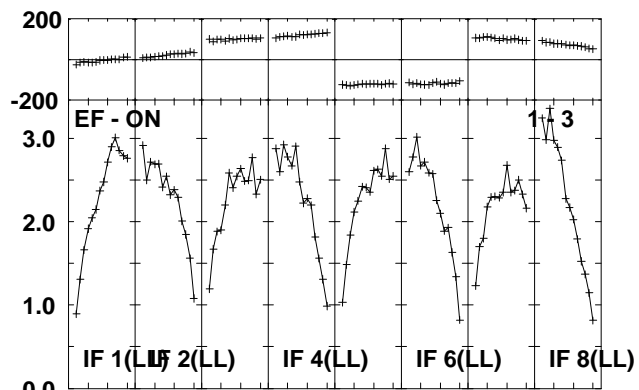
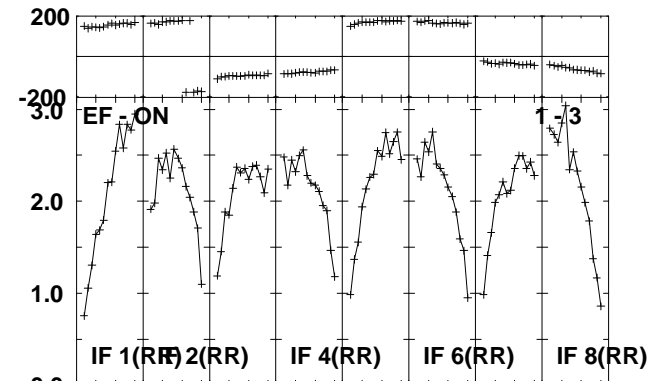
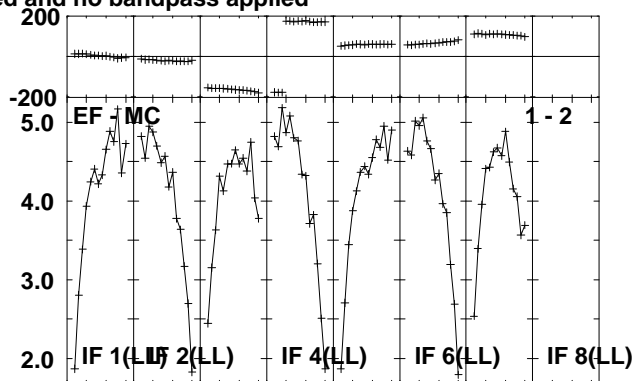
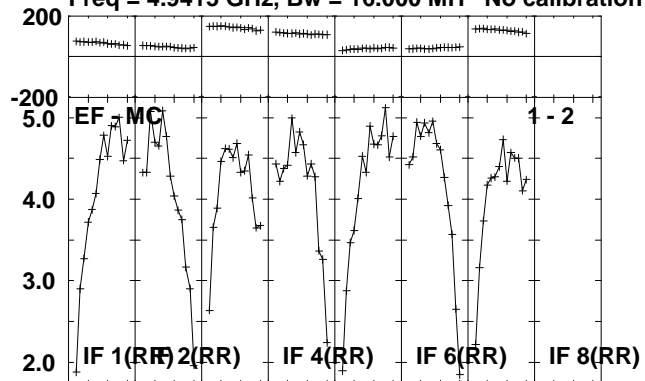

Lower frame: Milli Ampl Jy Top frame: Phas deg
Scalar averaged cross-power spectrum Several baselines displayed
Timerange: 00/20:17:01 to 00/20:18:29

Plot file version 68 created 14-JUL-2010 16:35:25
J1953+35 RR004A.UVDATA.1

Freq = 4.9415 GHz, Bw = 16.000 MH No calibration applied and no bandpass applied

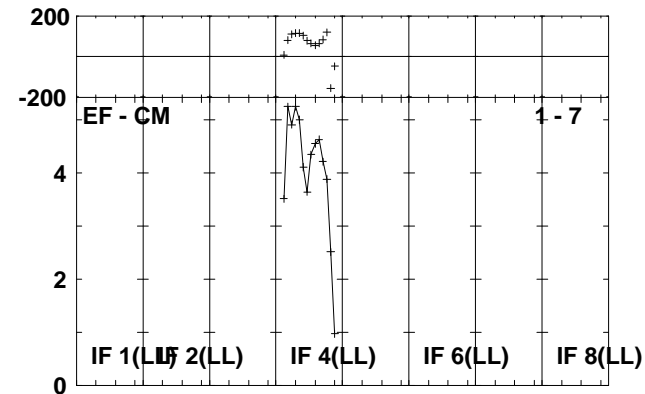
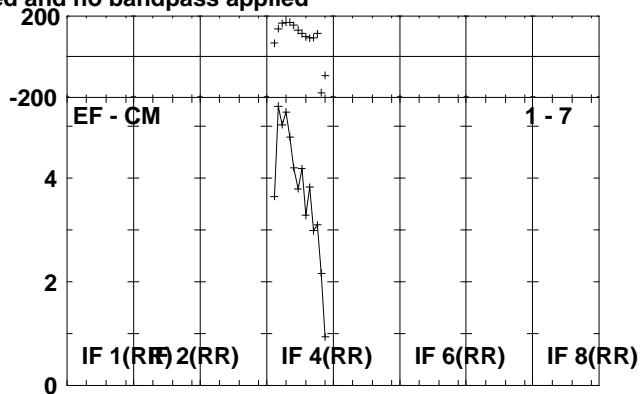
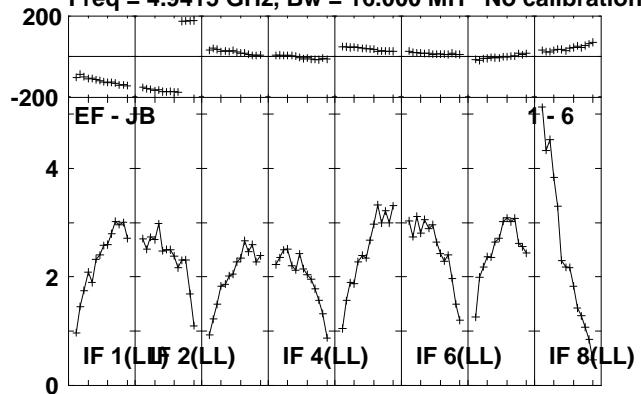

Lower frame: Milli Ampl Jy Top frame: Phas deg
Scalar averaged cross-power spectrum Several baselines displayed
Timerange: 00/20:17:01 to 00/20:18:29

Plot file version 69 created 14-JUL-2010 16:35:26

CYGX-1 RR004A.UVDATA.1

Freq = 4.9415 GHz, Bw = 16.000 MH No calibration applied and no bandpass applied

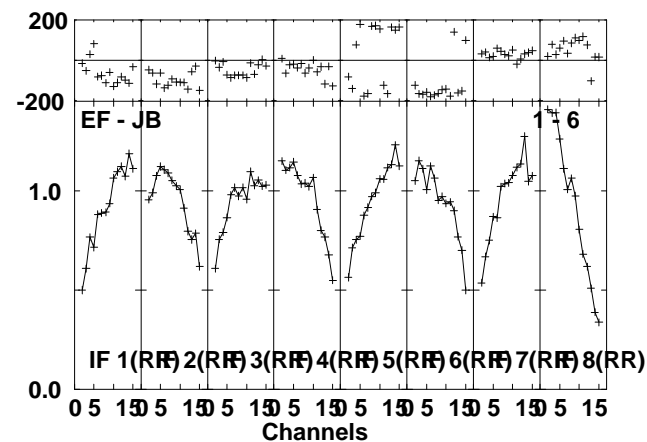
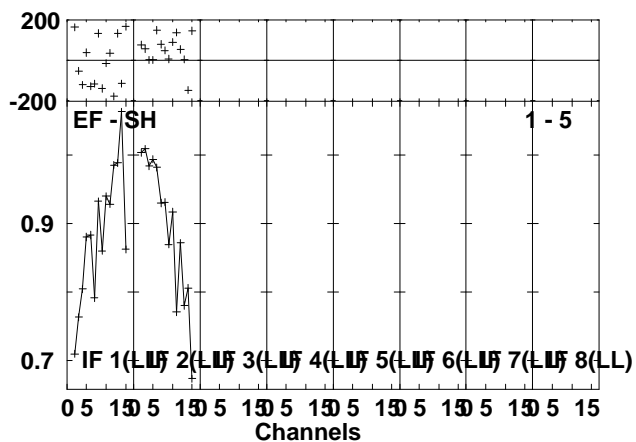
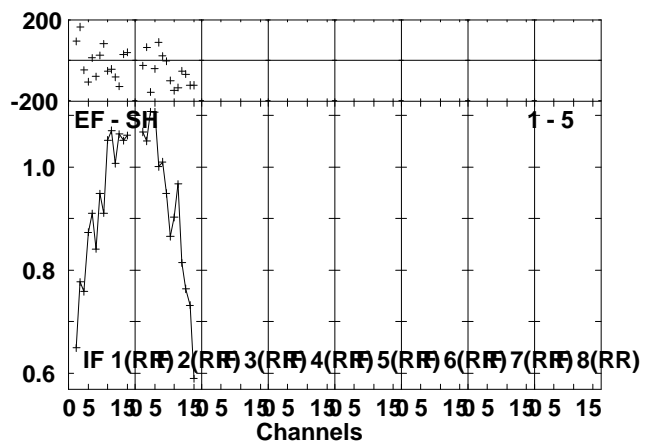
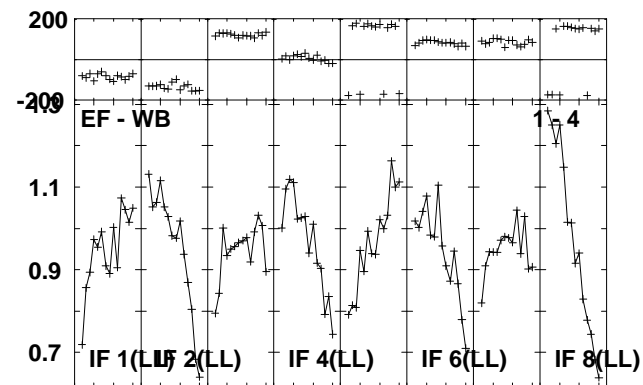
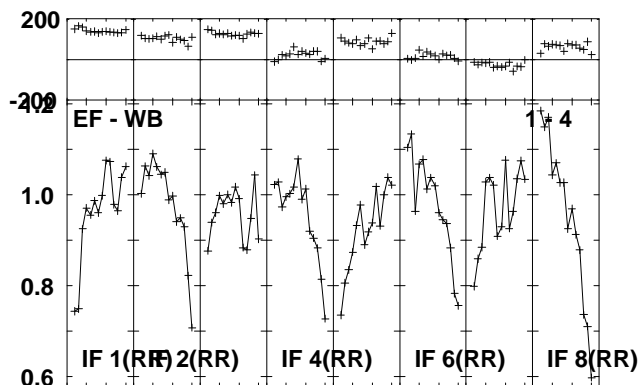
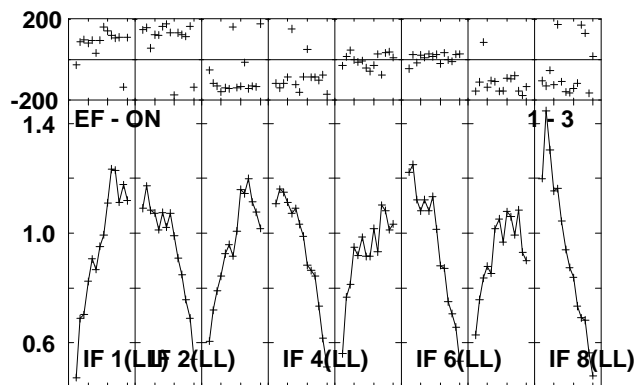
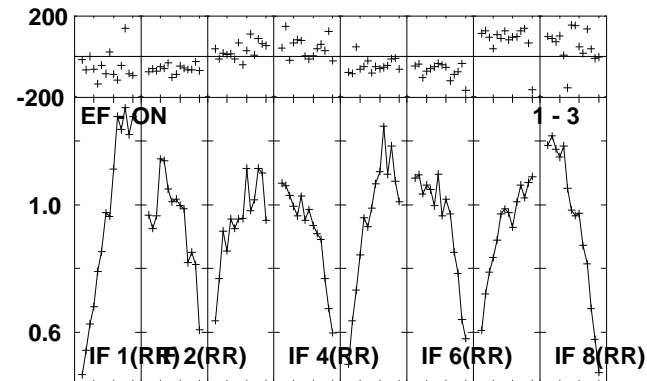
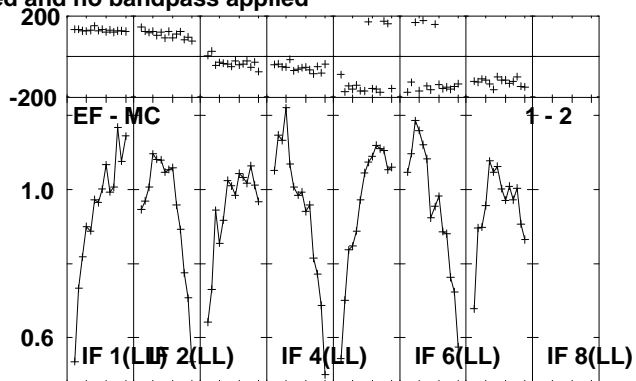
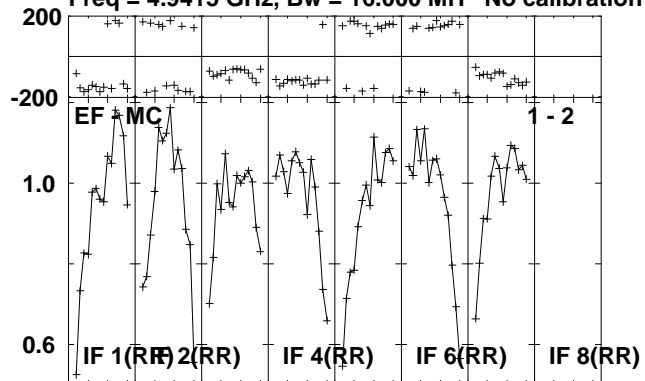

Lower frame: Milli Ampl Jy Top frame: Phas deg
Scalar averaged cross-power spectrum Several baselines displayed
Timerange: 00/20:18:31 to 00/20:23:29

Plot file version 70 created 14-JUL-2010 16:35:27

CYGX-1 RR004A.UVDATA.1

Freq = 4.9415 GHz, Bw = 16.000 MH No calibration applied and no bandpass applied

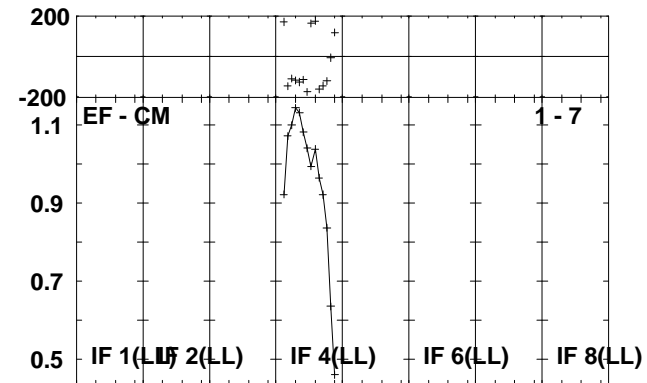
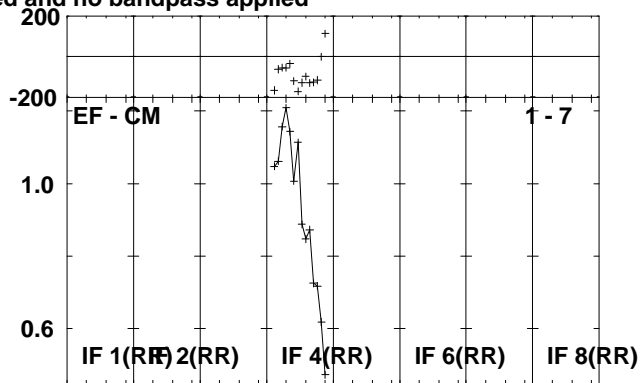
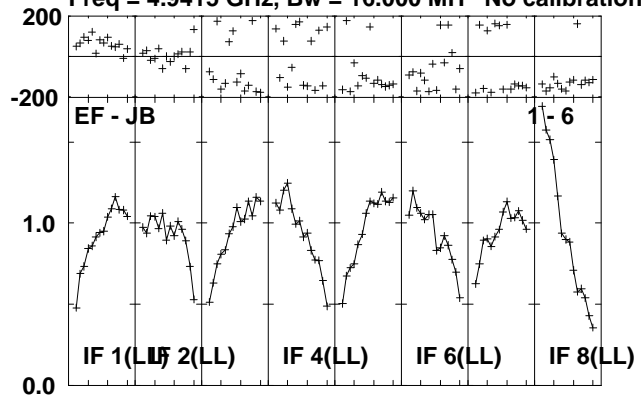

Lower frame: Milli Ampl Jy Top frame: Phas deg
Scalar averaged cross-power spectrum Several baselines displayed
Timerange: 00/20:18:31 to 00/20:23:29

Plot file version 71 created 14-JUL-2010 16:35:28

J1953+35 RR004A.UVDATA.1

Freq = 4.9415 GHz, Bw = 16.000 MH No calibration applied and no bandpass applied

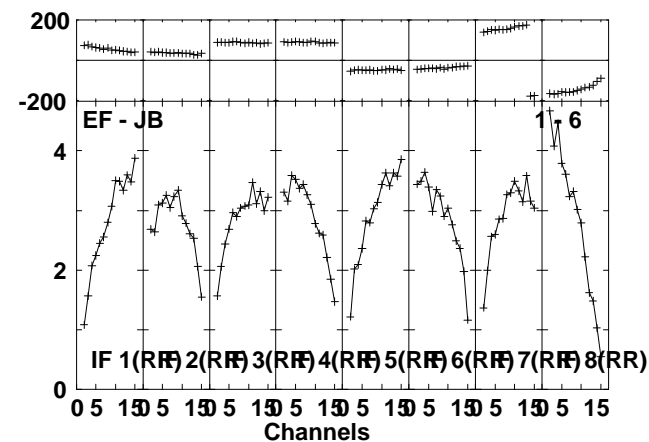
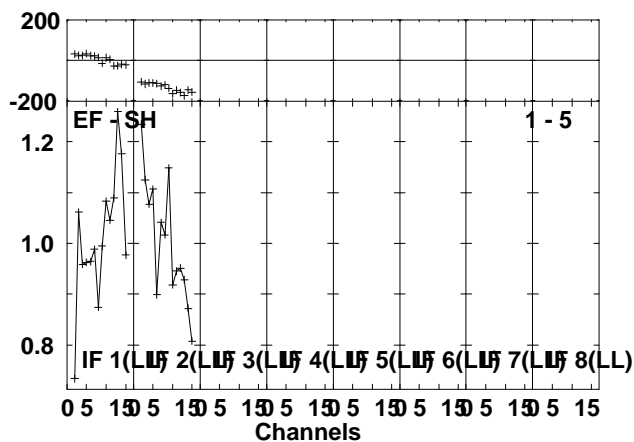
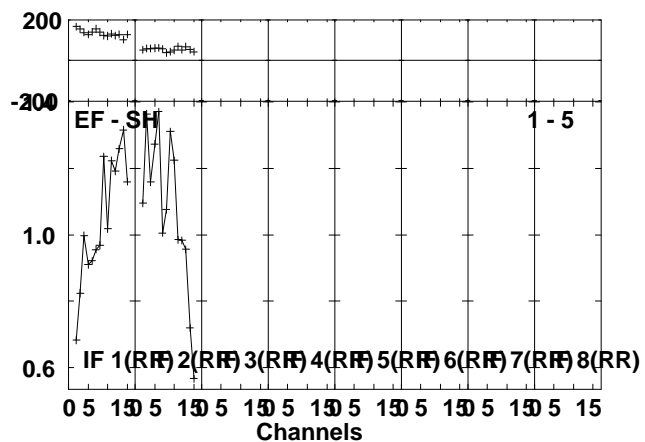
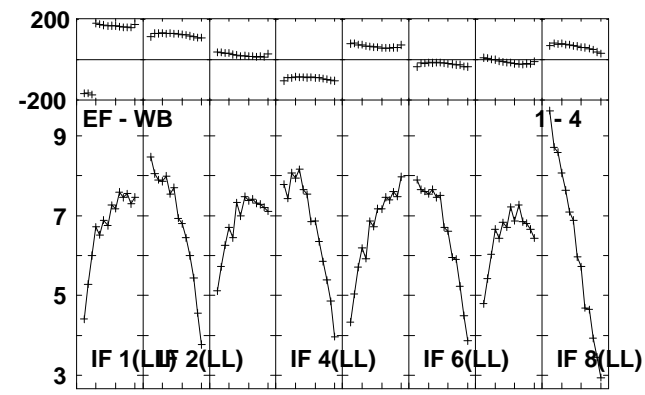
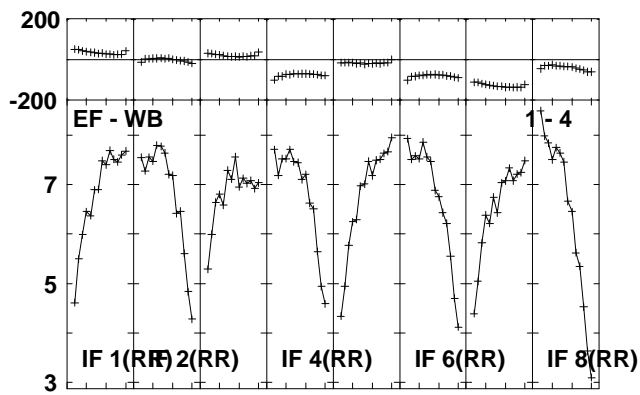
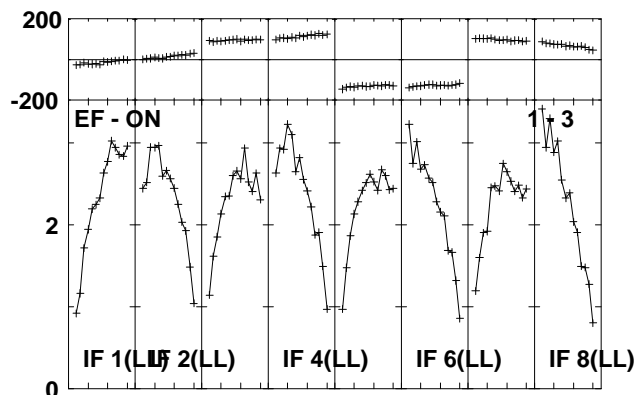
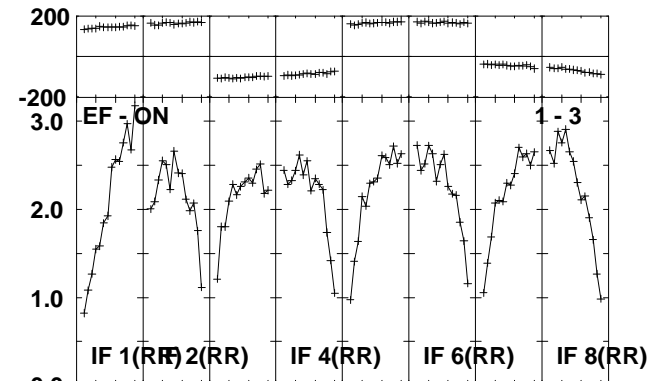
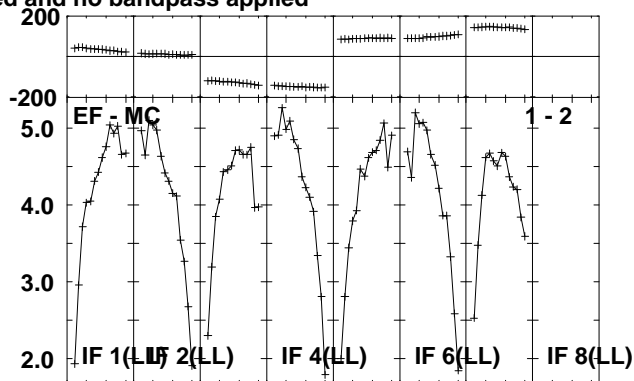
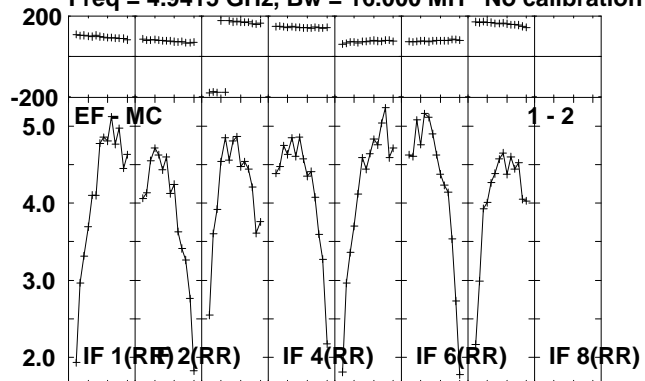

Lower frame: Milli Ampl Jy Top frame: Phas deg
Scalar averaged cross-power spectrum Several baselines displayed
Timerange: 00/20:23:31 to 00/20:25:29

Plot file version 72 created 14-JUL-2010 16:35:29
J1953+35 RR004A.UVDATA.1

Freq = 4.9415 GHz, Bw = 16.000 MH No calibration applied and no bandpass applied

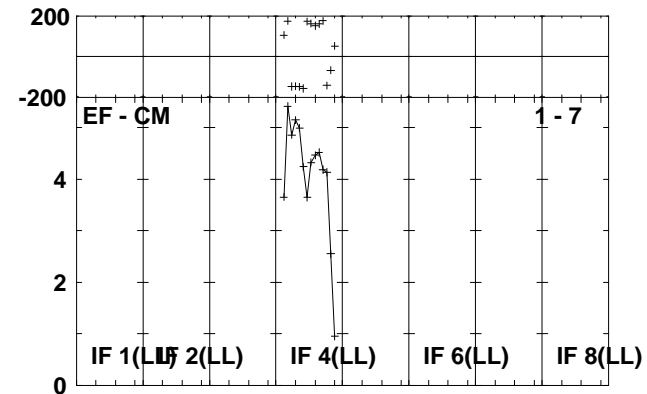
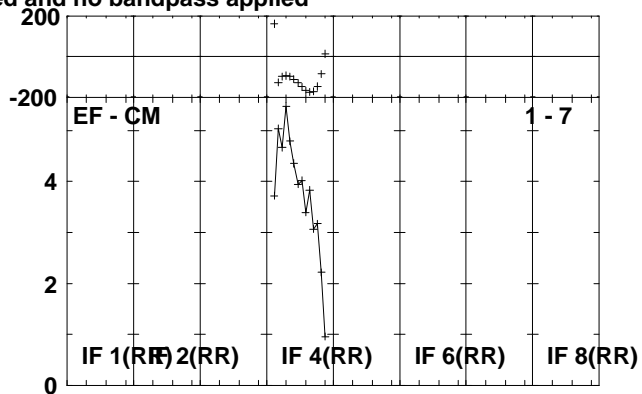
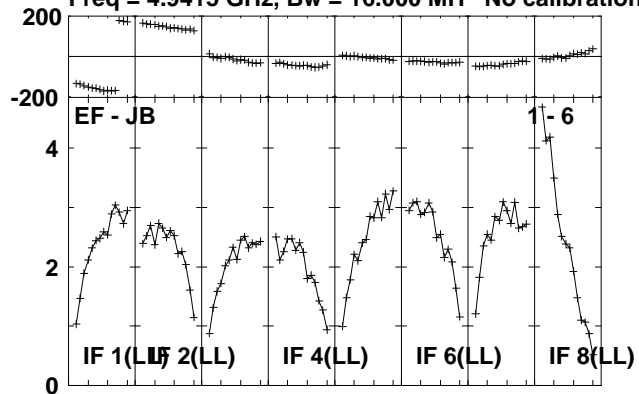

Lower frame: Milli Ampl Jy Top frame: Phas deg
Scalar averaged cross-power spectrum Several baselines displayed
Timerange: 00/20:23:31 to 00/20:25:29

Plot file version 73 created 14-JUL-2010 16:35:30

CYGX-1 RR004A.UVDATA.1

Freq = 4.9415 GHz, Bw = 16.000 MH No calibration applied and no bandpass applied

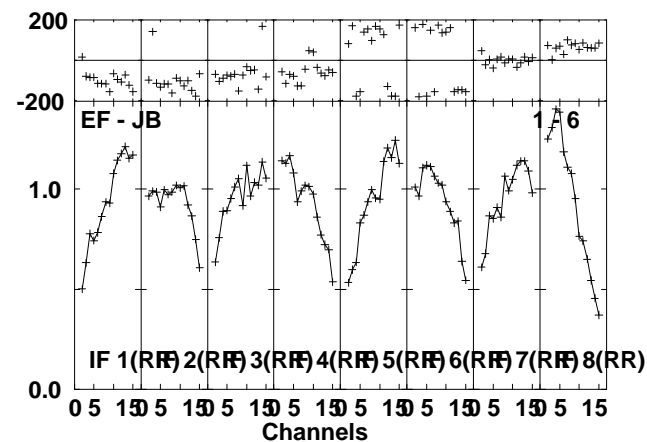
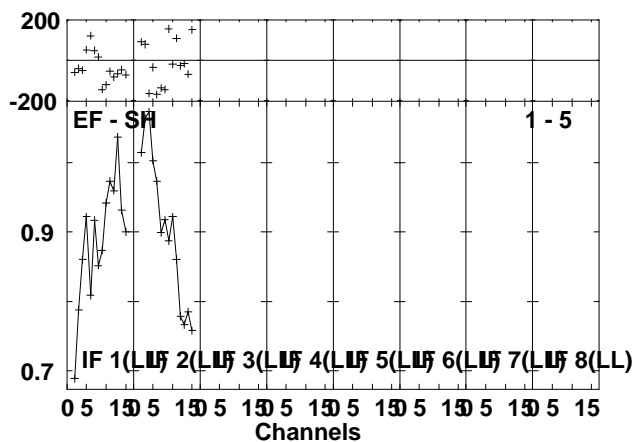
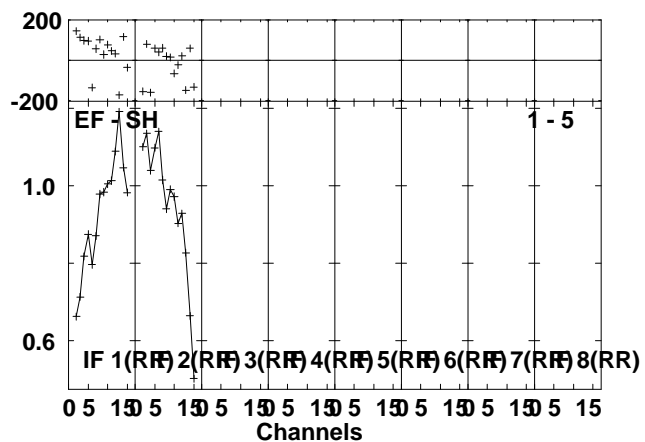
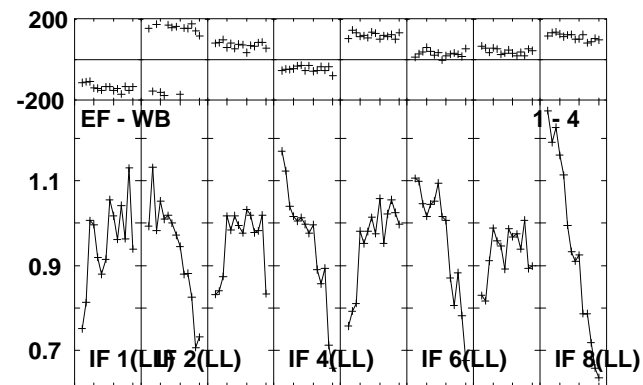
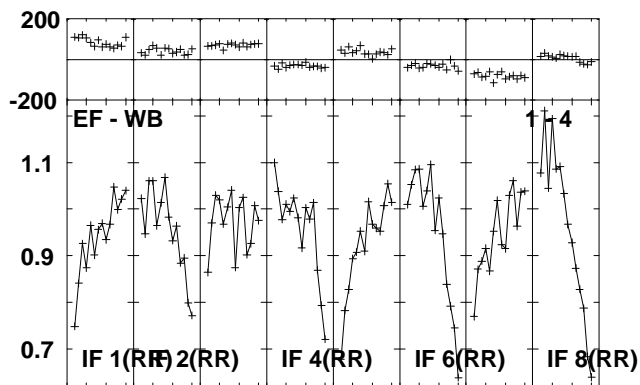
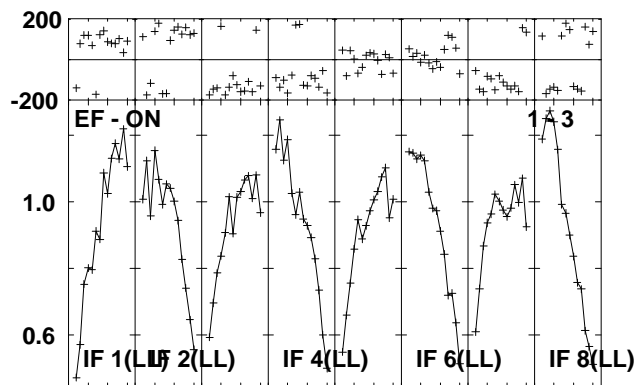
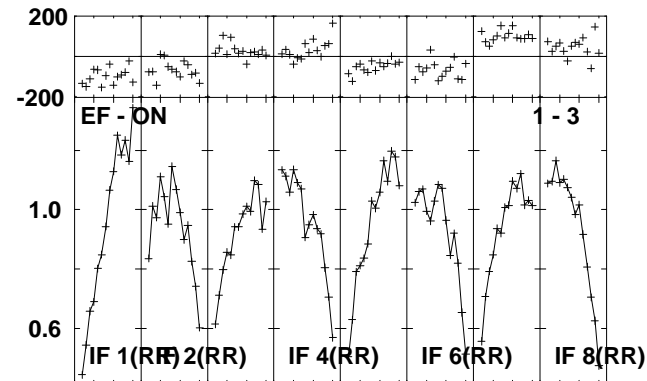
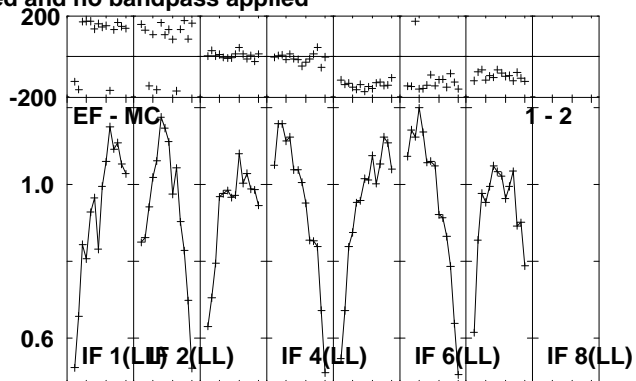
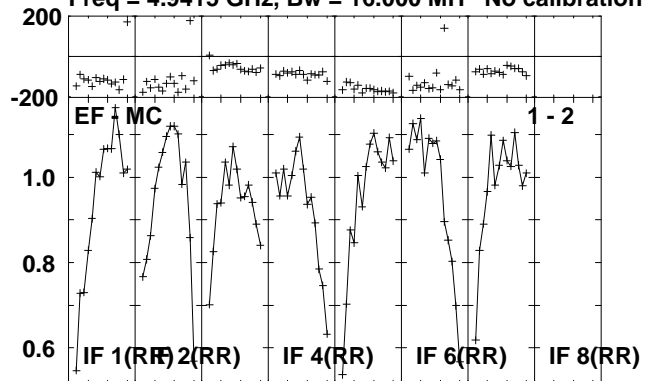

Lower frame: Milli Ampl Jy Top frame: Phas deg
Scalar averaged cross-power spectrum Several baselines displayed
Timerange: 00/20:25:31 to 00/20:30:29

Plot file version 74 created 14-JUL-2010 16:35:31

CYGX-1 RR004A.UVDATA.1

Freq = 4.9415 GHz, Bw = 16.000 MH No calibration applied and no bandpass applied

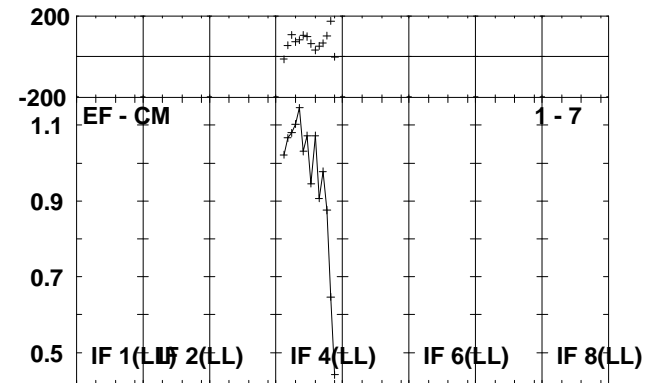
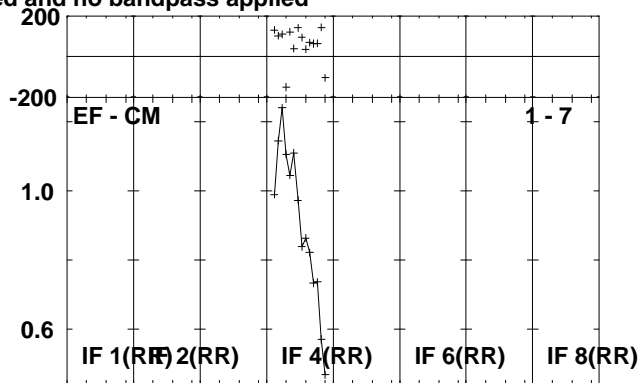
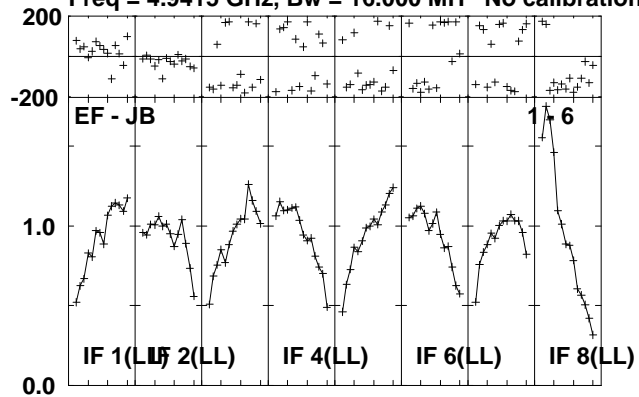

Lower frame: Milli Ampl Jy Top frame: Phas deg
Scalar averaged cross-power spectrum Several baselines displayed
Timerange: 00/20:25:31 to 00/20:30:29

Plot file version 75 created 14-JUL-2010 16:35:32

J1953+35 RR004A.UVDATA.1

Freq = 4.9415 GHz, Bw = 16.000 MH No calibration applied and no bandpass applied

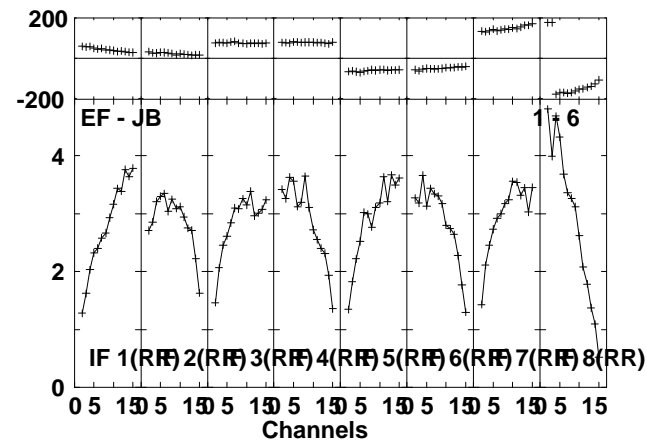
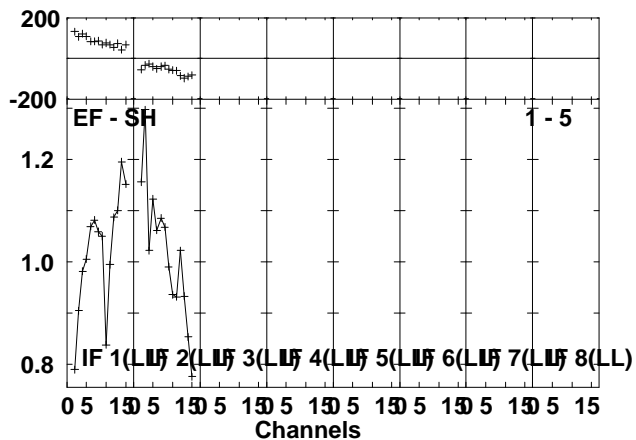
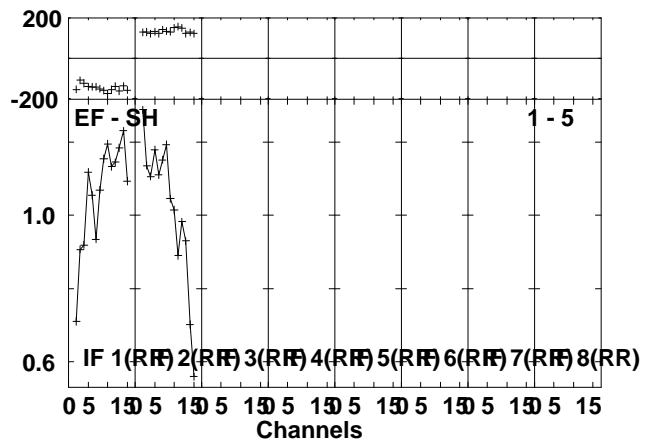
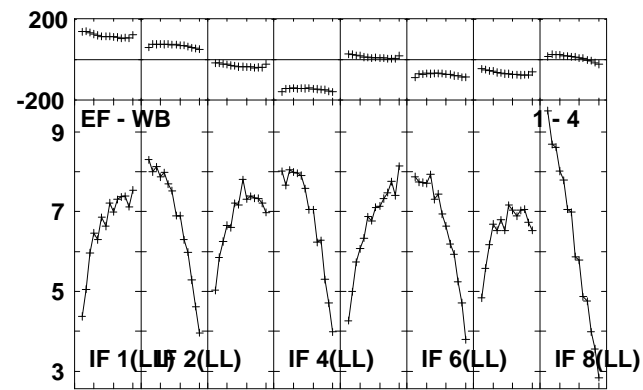
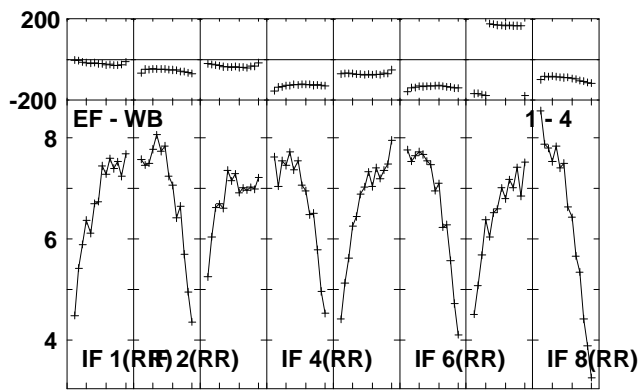
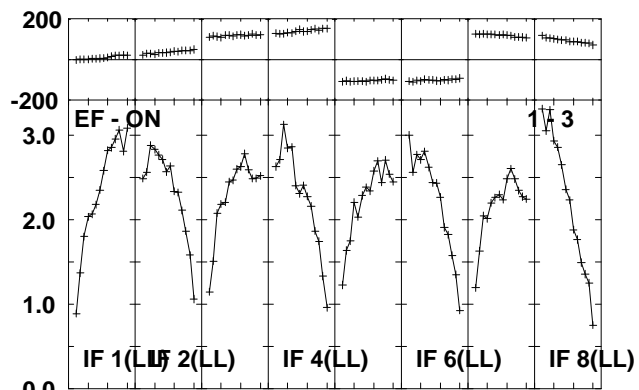
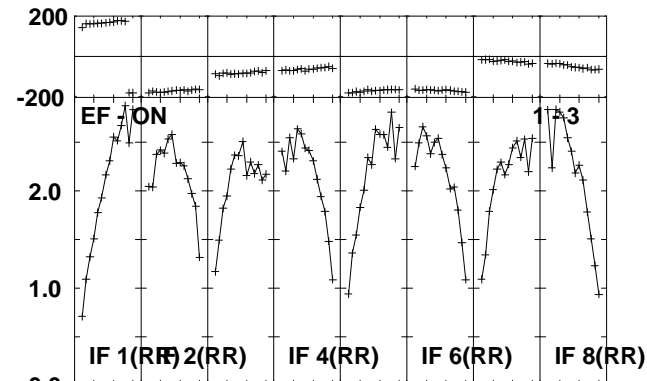
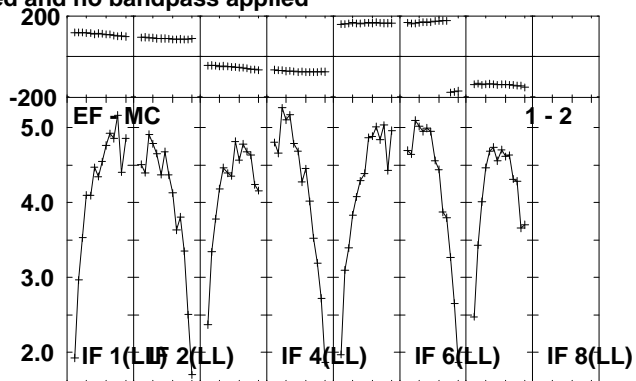
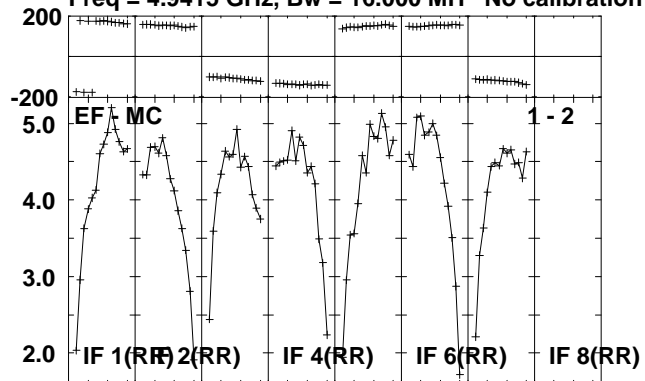

Lower frame: Milli Ampl Jy Top frame: Phas deg
Scalar averaged cross-power spectrum Several baselines displayed
Timerange: 00/20:31:11 to 00/20:32:39

Plot file version 76 created 14-JUL-2010 16:35:33
J1953+35 RR004A.UVDATA.1

Freq = 4.9415 GHz, Bw = 16.000 MH No calibration applied and no bandpass applied

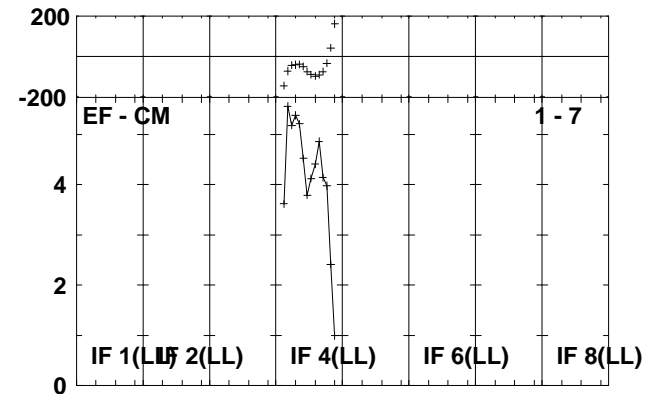
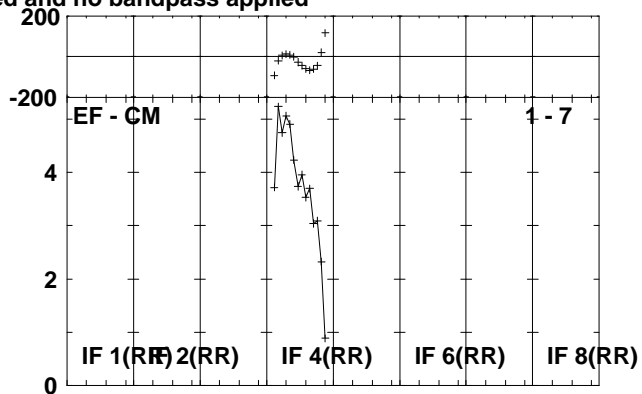
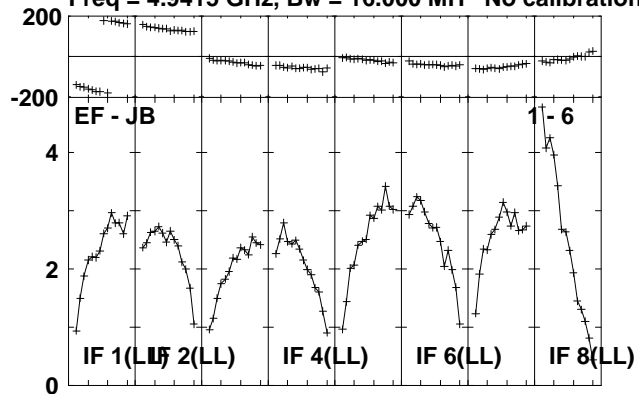

Lower frame: Milli Ampl Jy Top frame: Phas deg
Scalar averaged cross-power spectrum Several baselines displayed
Timerange: 00/20:31:11 to 00/20:32:39

Plot file version 77 created 14-JUL-2010 16:35:33

CYGX-1 RR004A.UVDATA.1

Freq = 4.9415 GHz, Bw = 16.000 MH No calibration applied and no bandpass applied

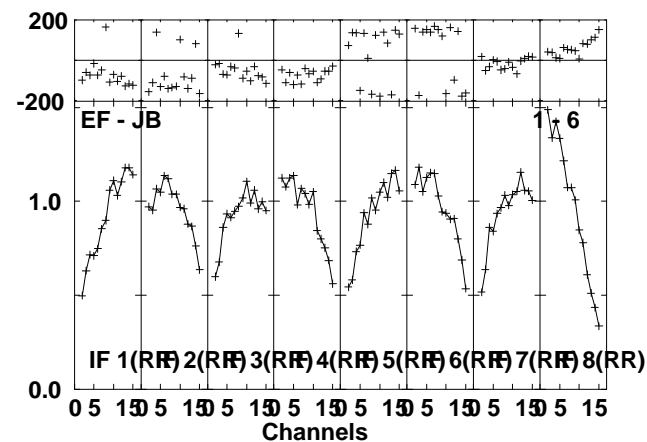
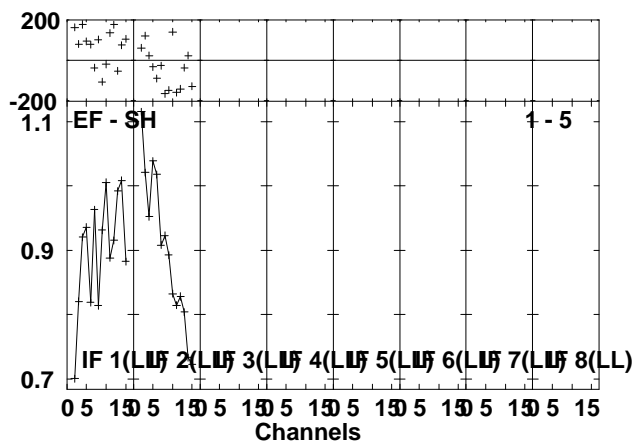
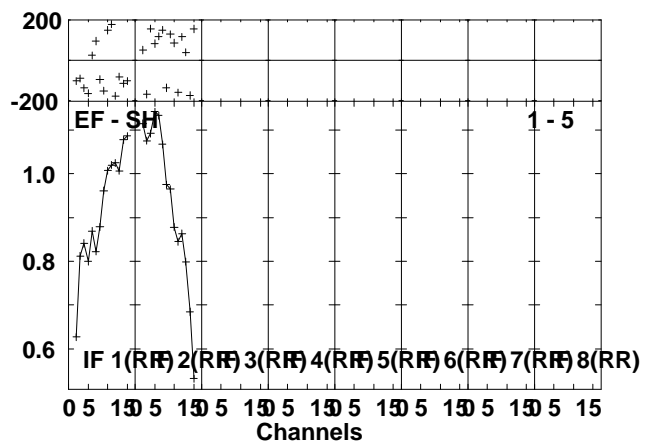
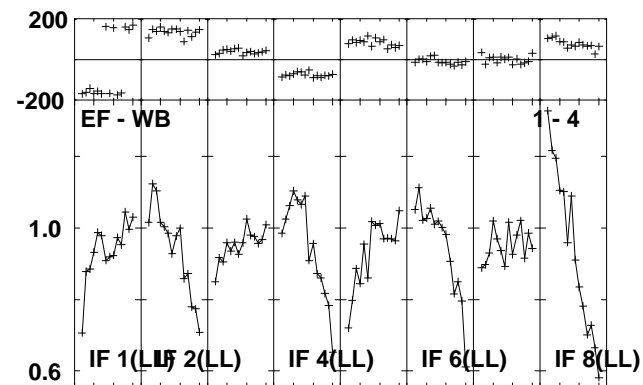
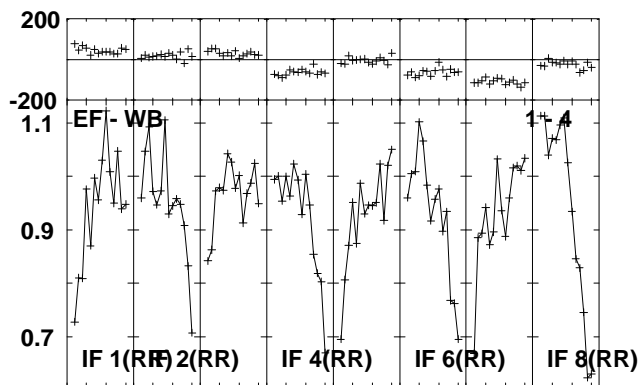
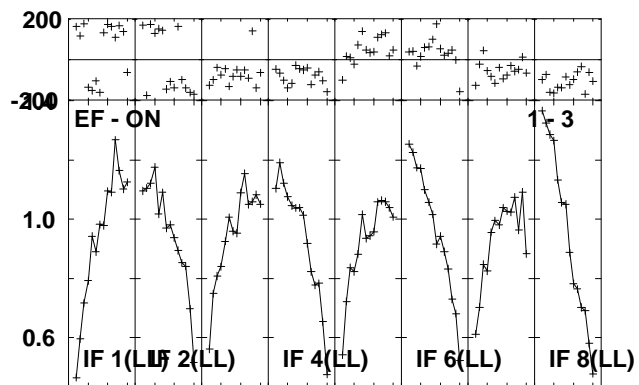
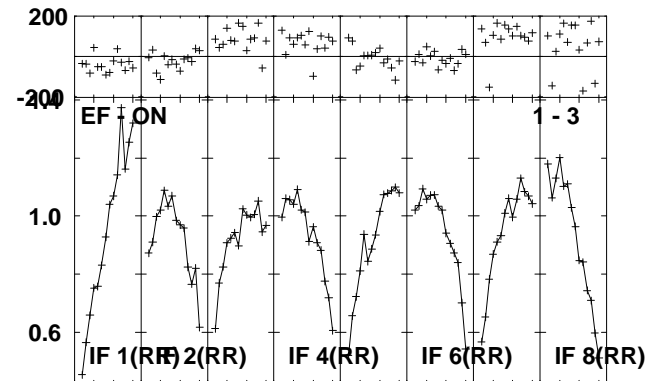
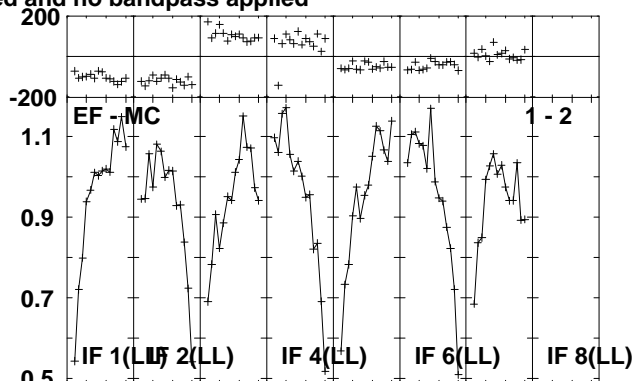
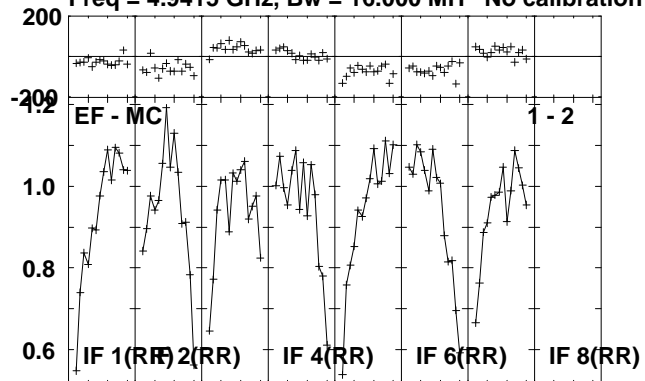

Lower frame: Milli Ampl Jy Top frame: Phas deg
Scalar averaged cross-power spectrum Several baselines displayed
Timerange: 00/20:32:41 to 00/20:37:39

Plot file version 78 created 14-JUL-2010 16:35:35

CYGX-1 RR004A.UVDATA.1

Freq = 4.9415 GHz, Bw = 16.000 MH No calibration applied and no bandpass applied

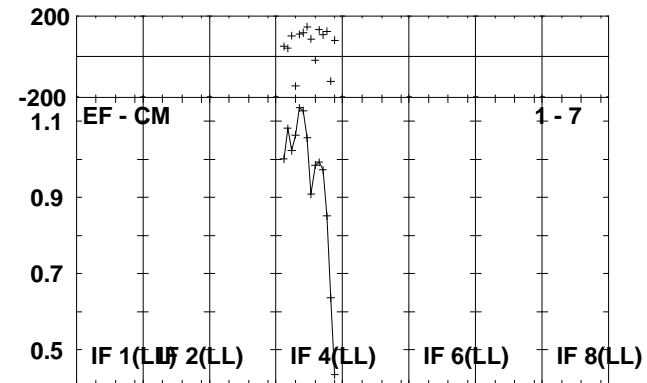
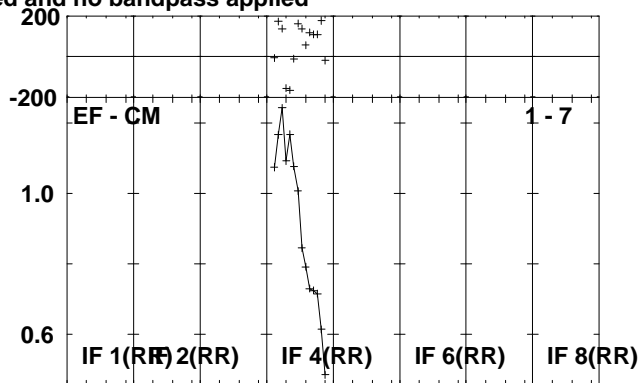
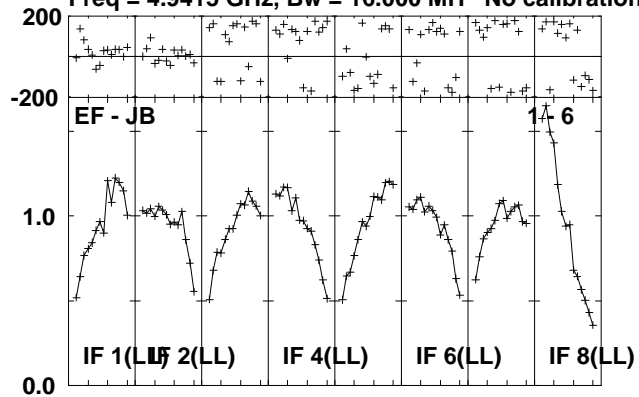

Lower frame: Milli Ampl Jy Top frame: Phas deg
Scalar averaged cross-power spectrum Several baselines displayed
Timerange: 00/20:32:41 to 00/20:37:39

Plot file version 79 created 14-JUL-2010 16:35:36

J1953+35 RR004A.UVDATA.1

Freq = 4.9415 GHz, Bw = 16.000 MH No calibration applied and no bandpass applied

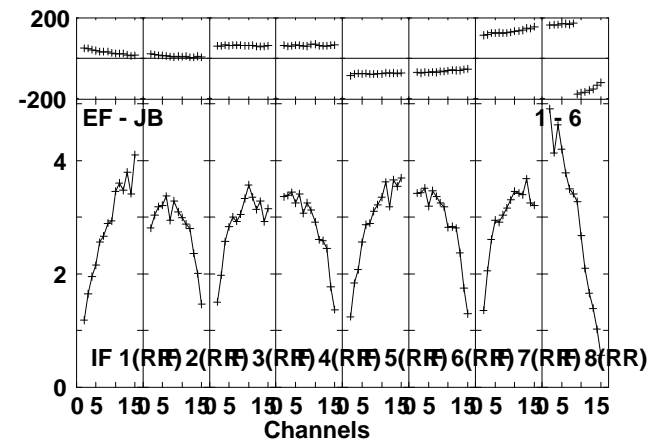
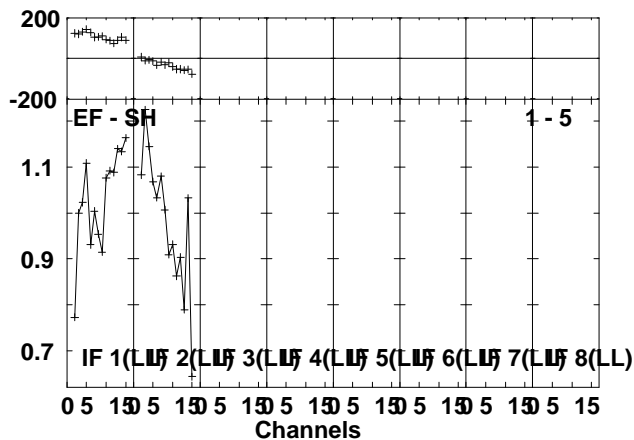
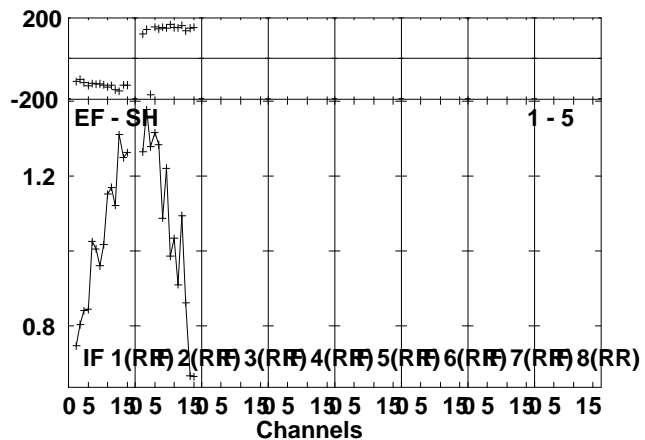
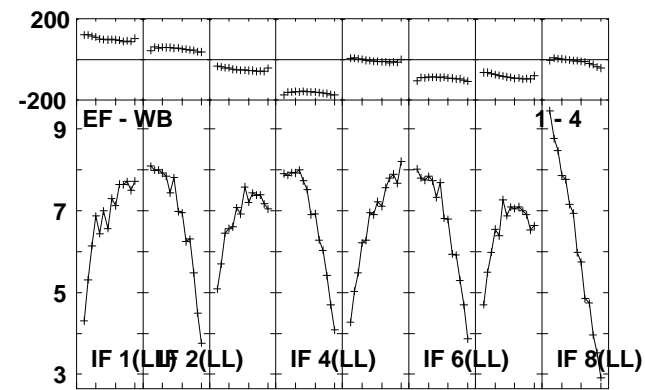
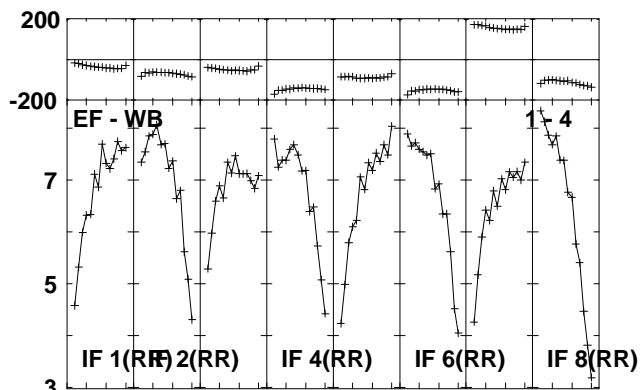
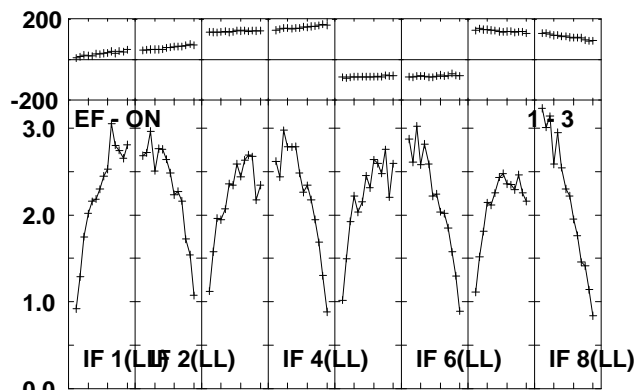
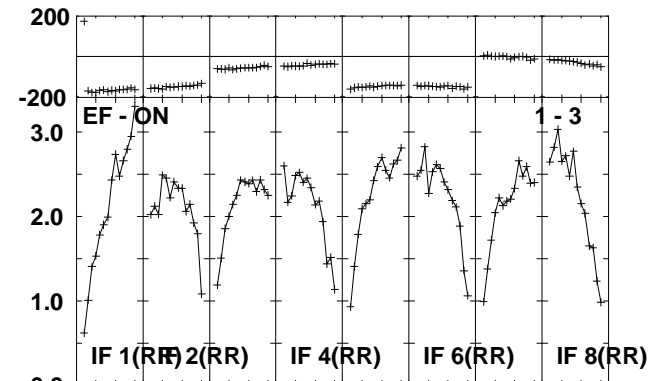
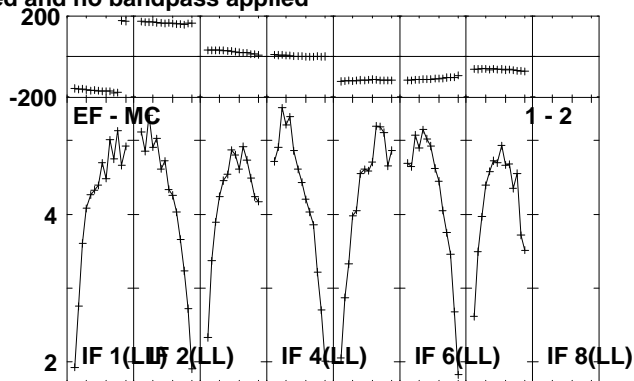
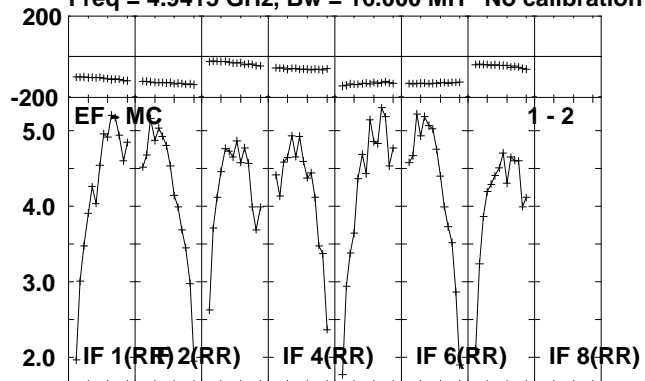

Lower frame: Milli Ampl Jy Top frame: Phas deg
Scalar averaged cross-power spectrum Several baselines displayed
Timerange: 00/20:37:41 to 00/20:39:39

Plot file version 80 created 14-JUL-2010 16:35:36
J1953+35 RR004A.UVDATA.1

Freq = 4.9415 GHz, Bw = 16.000 MH No calibration applied and no bandpass applied

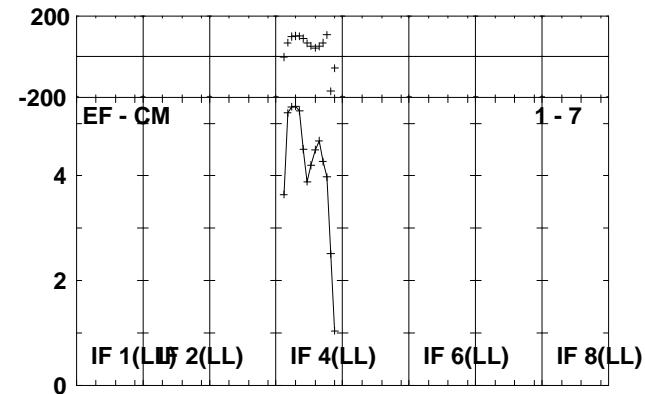
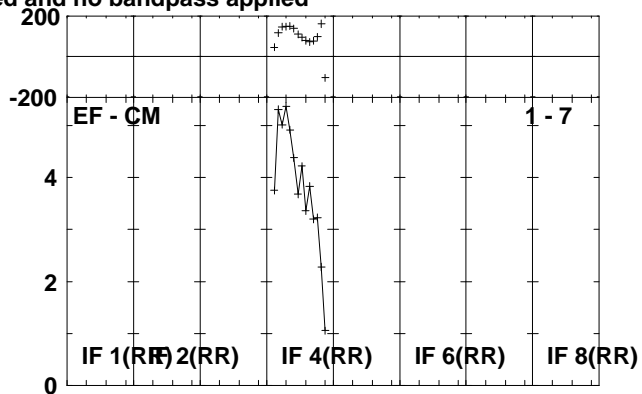
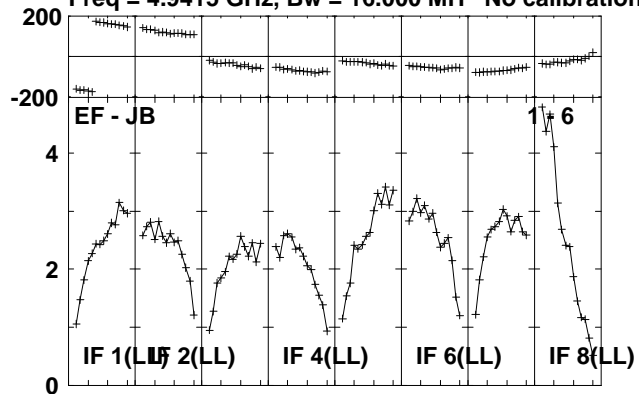

Lower frame: Milli Ampl Jy Top frame: Phas deg
Scalar averaged cross-power spectrum Several baselines displayed
Timerange: 00/20:37:41 to 00/20:39:39

Plot file version 81 created 14-JUL-2010 16:35:37

CYGX-1 RR004A.UVDATA.1

Freq = 4.9415 GHz, Bw = 16.000 MH No calibration applied and no bandpass applied

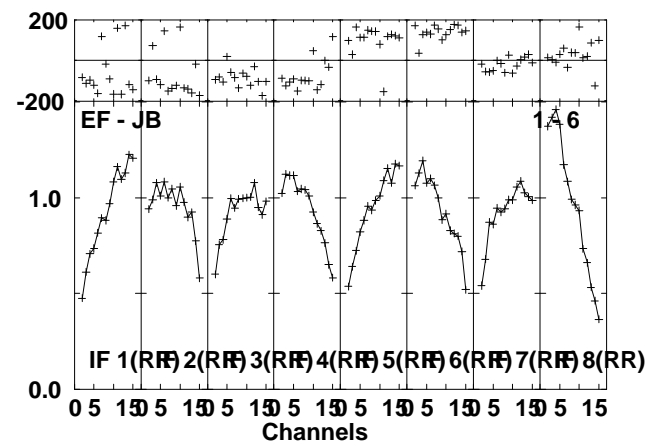
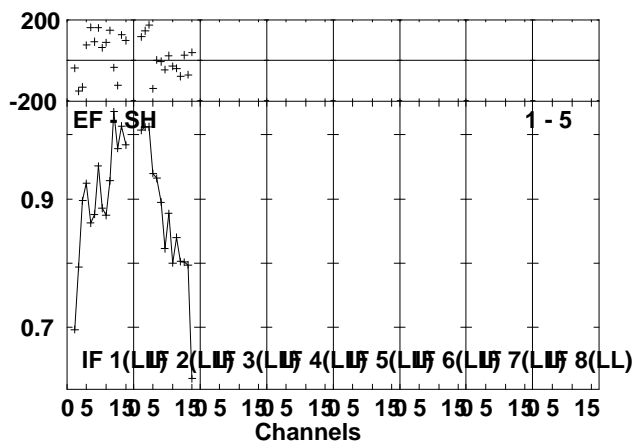
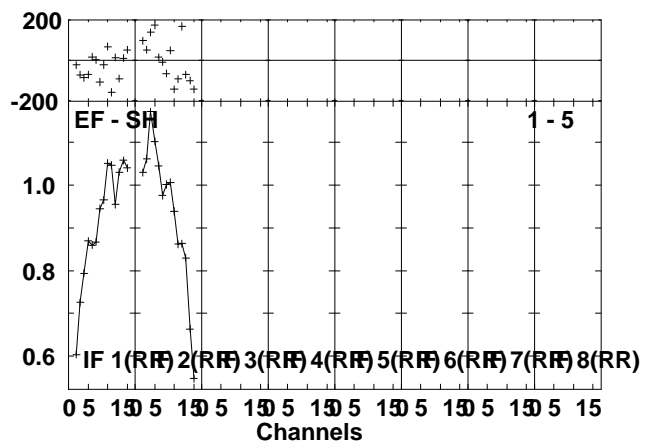
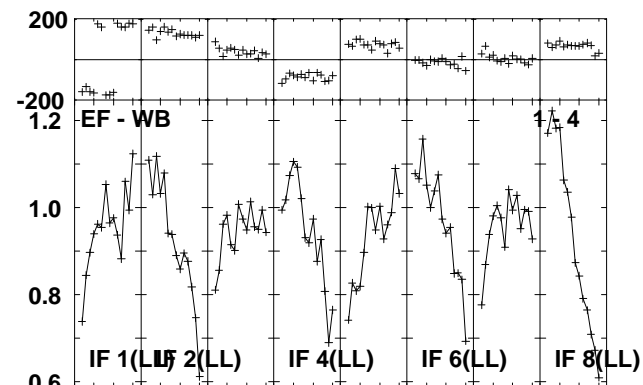
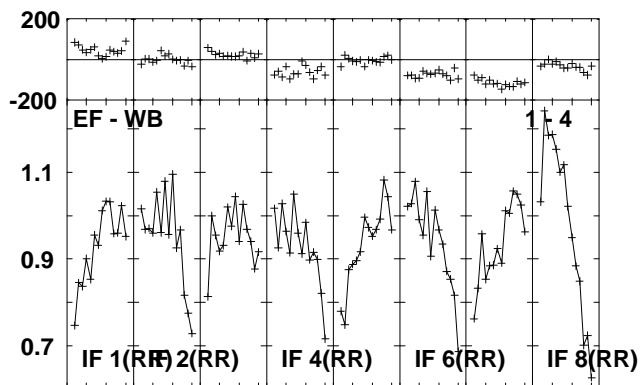
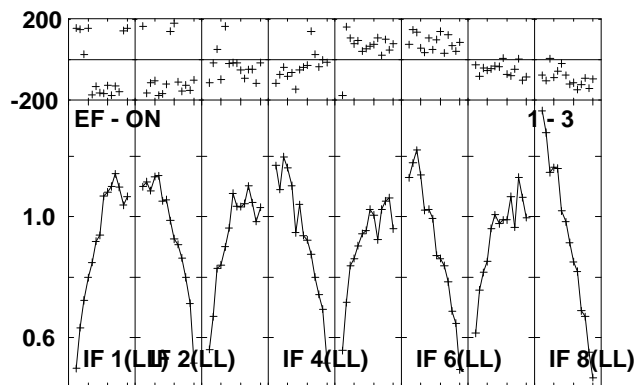
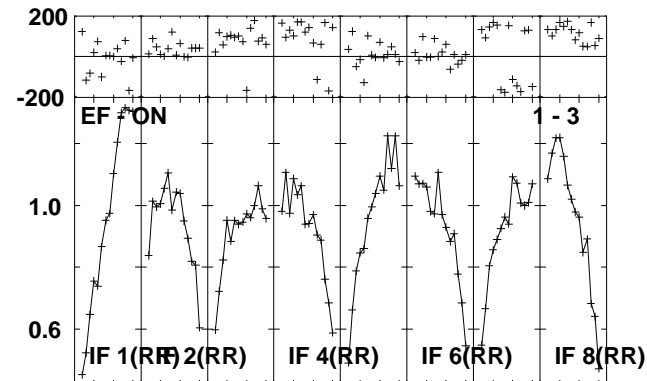
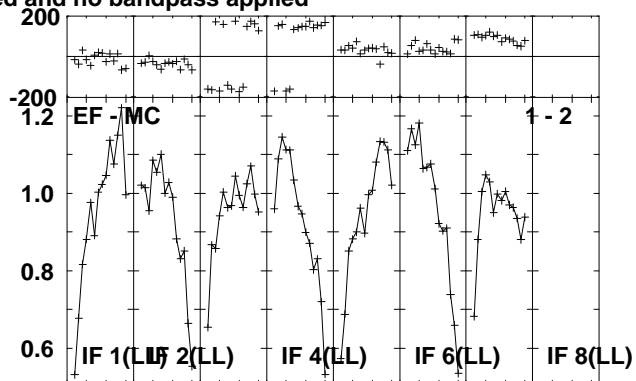
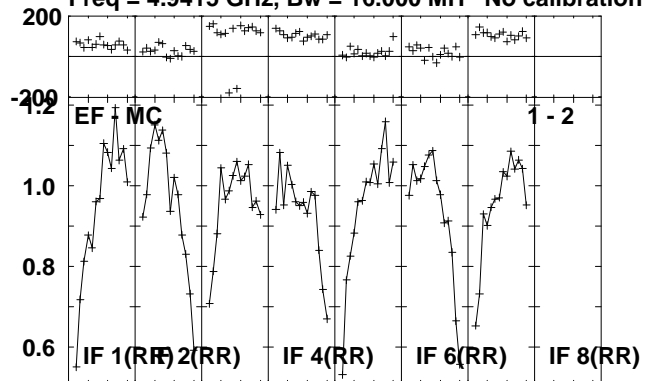

Lower frame: Milli Ampl Jy Top frame: Phas deg
Scalar averaged cross-power spectrum Several baselines displayed
Timerange: 00/20:39:41 to 00/20:44:39

Plot file version 82 created 14-JUL-2010 16:35:38

CYGX-1 RR004A.UVDATA.1

Freq = 4.9415 GHz, Bw = 16.000 MH No calibration applied and no bandpass applied

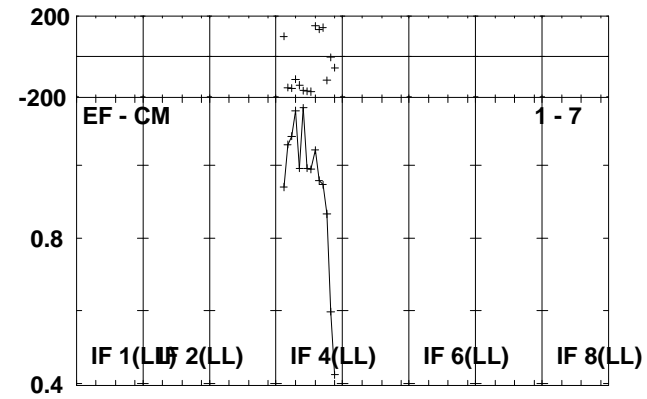
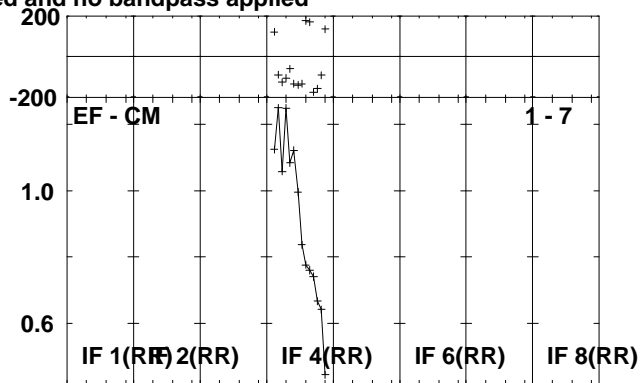
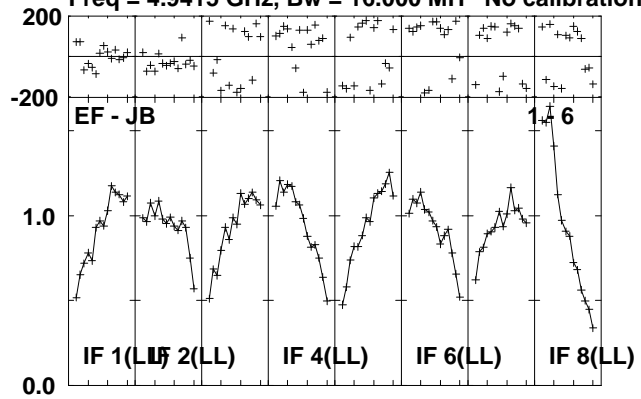

Lower frame: Milli Ampl Jy Top frame: Phas deg
Scalar averaged cross-power spectrum Several baselines displayed
Timerange: 00/20:39:41 to 00/20:44:39

Plot file version 83 created 14-JUL-2010 16:35:39

J1953+35 RR004A.UVDATA.1

Freq = 4.9415 GHz, Bw = 16.000 MH No calibration applied and no bandpass applied

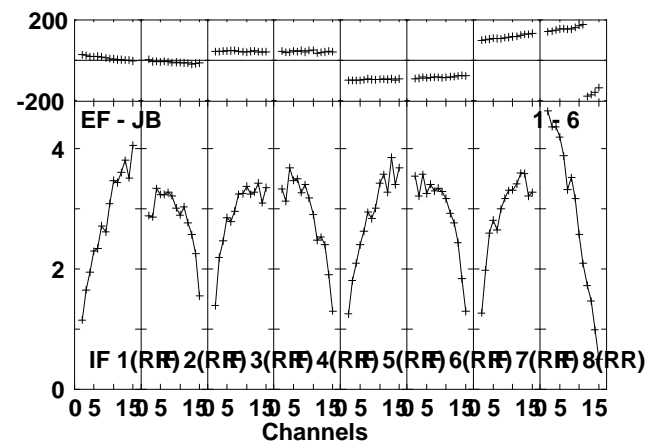
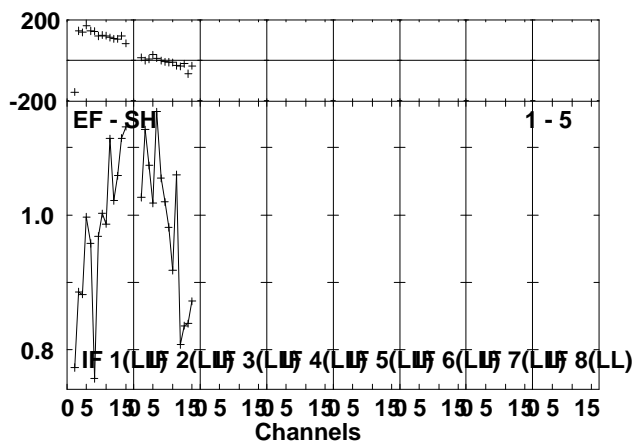
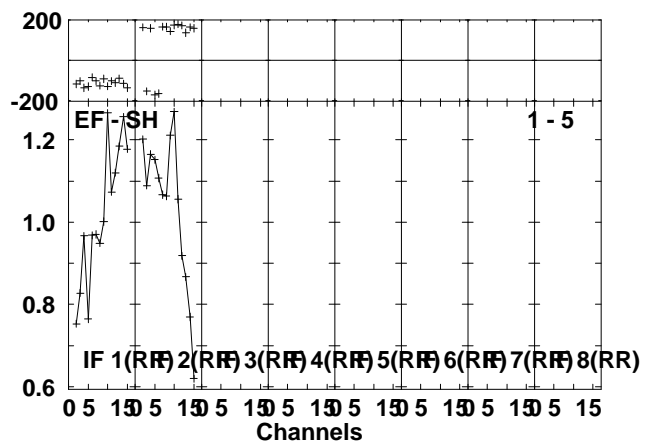
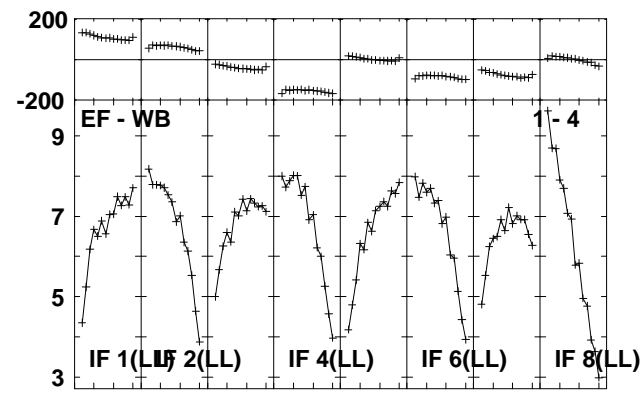
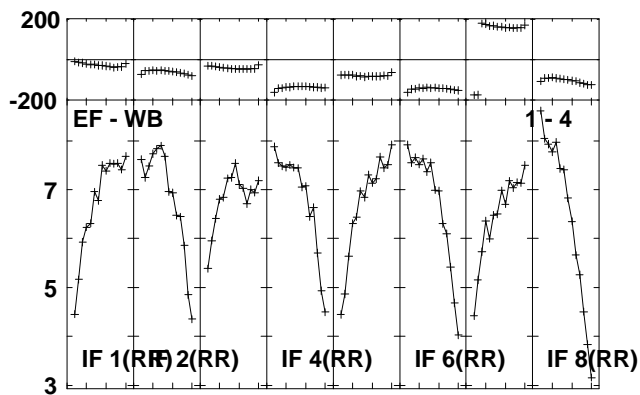
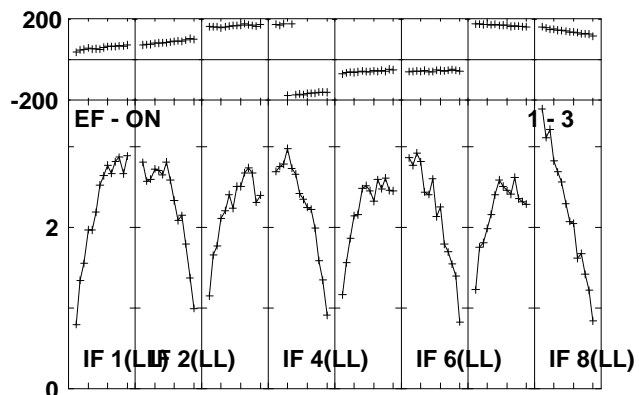
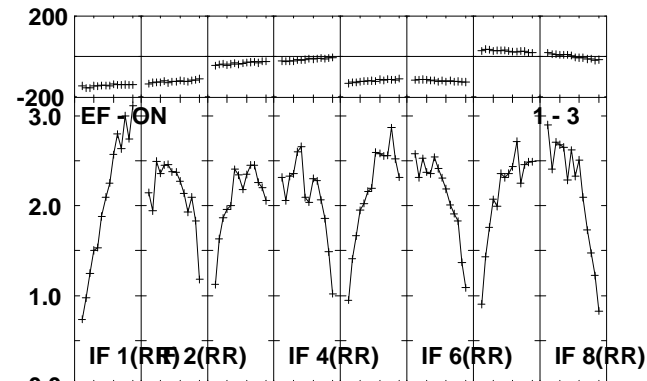
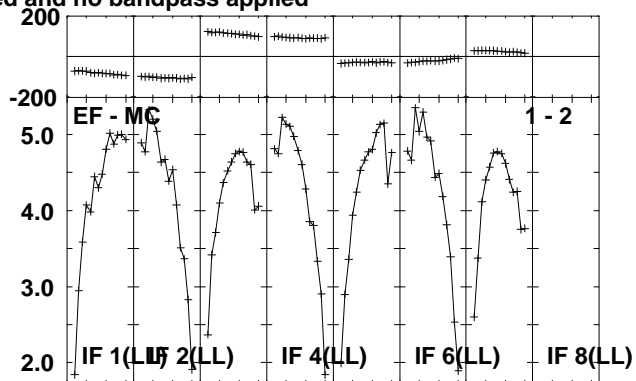
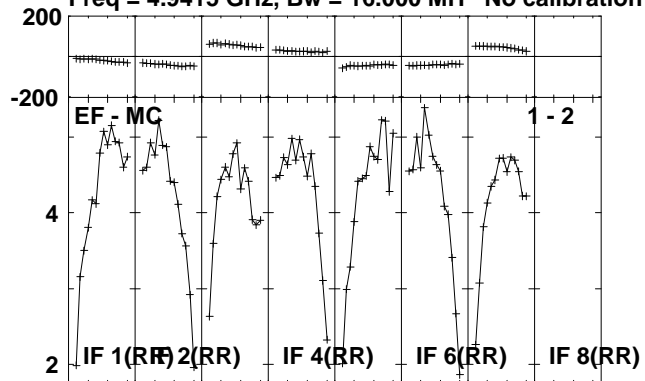

Lower frame: Milli Ampl Jy Top frame: Phas deg
Scalar averaged cross-power spectrum Several baselines displayed
Timerange: 00/20:45:21 to 00/20:46:49

Plot file version 84 created 14-JUL-2010 16:35:40
J1953+35 RR004A.UVDATA.1

Freq = 4.9415 GHz, Bw = 16.000 MH No calibration applied and no bandpass applied

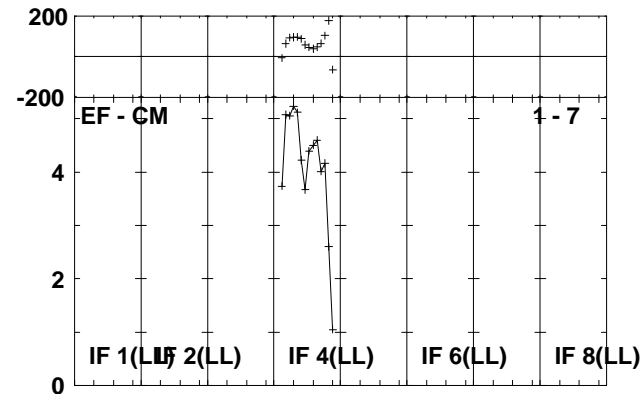
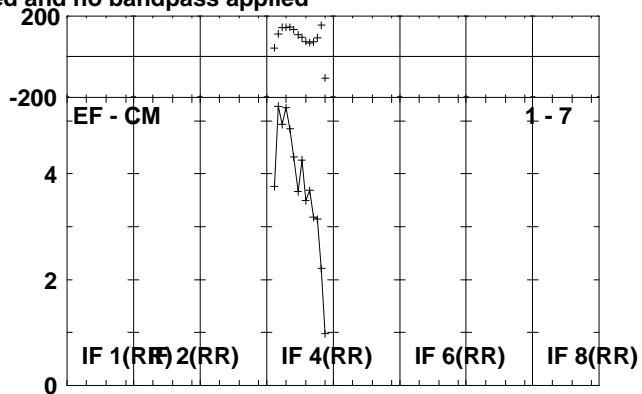
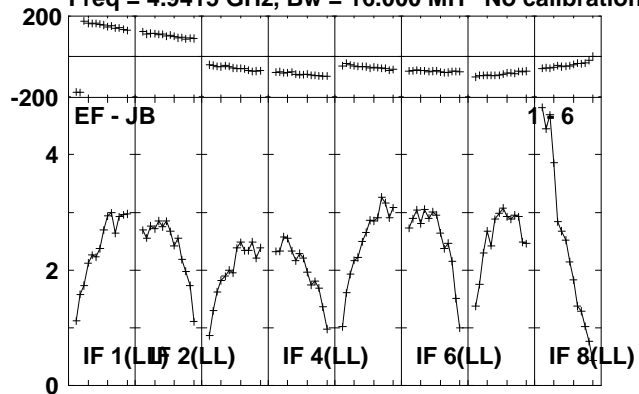

Lower frame: Milli Ampl Jy Top frame: Phas deg
Scalar averaged cross-power spectrum Several baselines displayed
Timerange: 00/20:45:21 to 00/20:46:49

Plot file version 85 created 14-JUL-2010 16:35:40

CYGX-1 RR004A.UVDATA.1

Freq = 4.9415 GHz, Bw = 16.000 MH No calibration applied and no bandpass applied

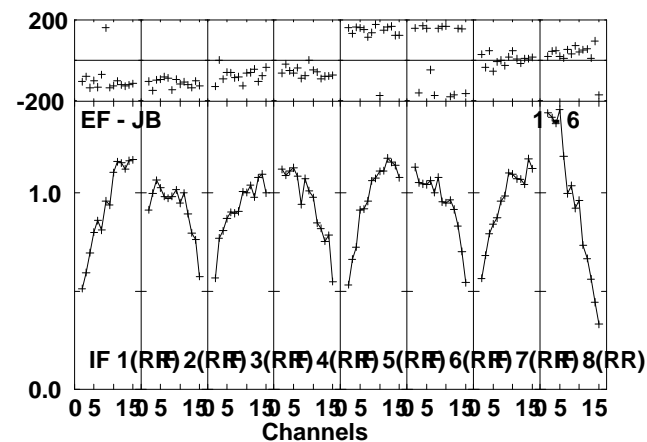
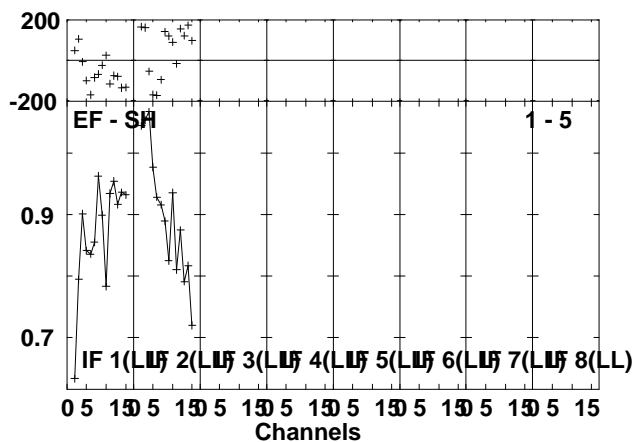
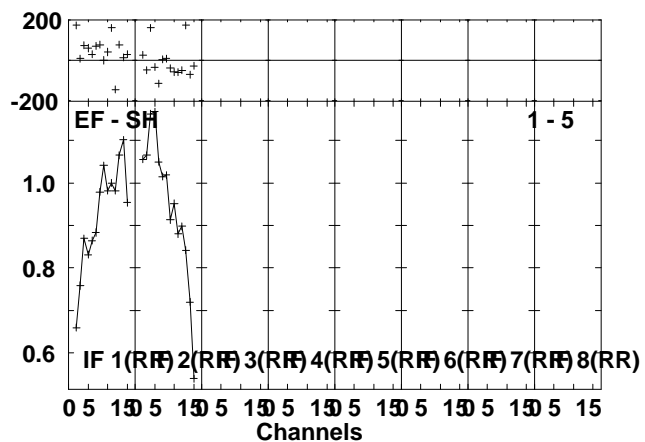
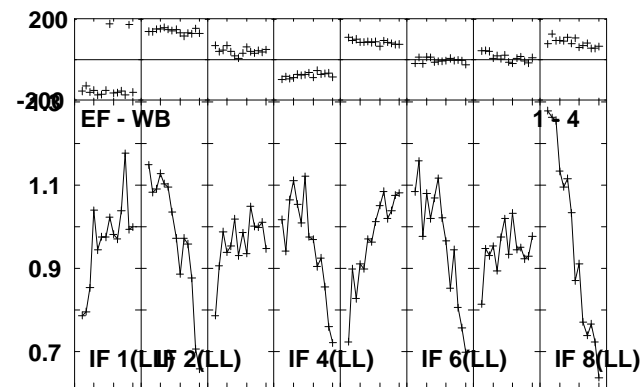
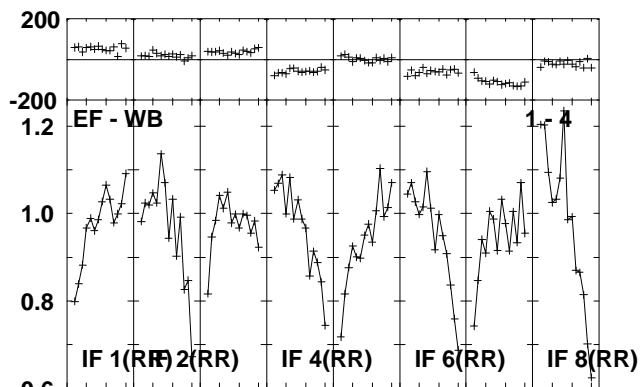
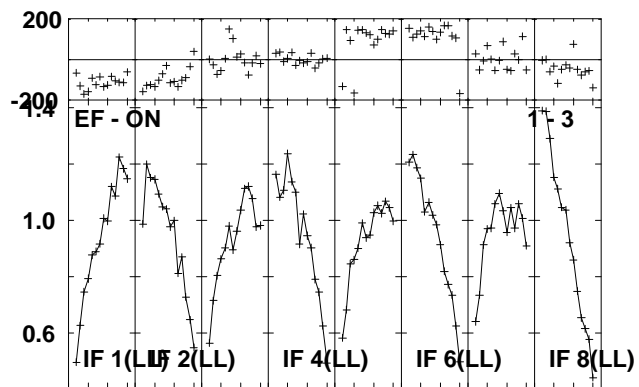
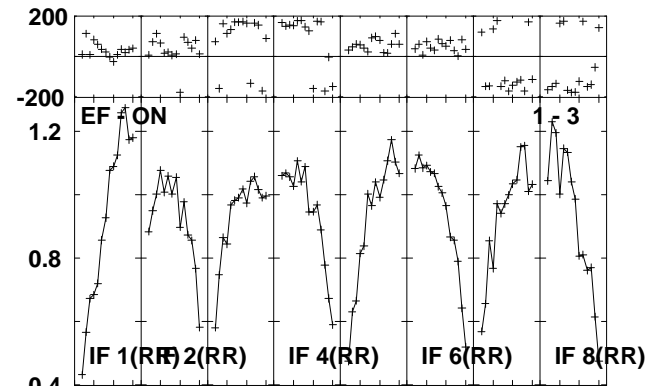
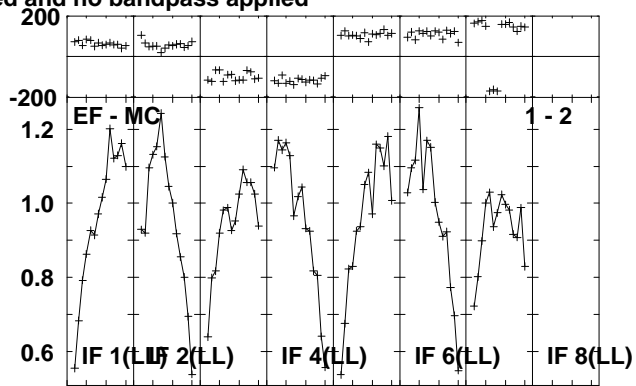
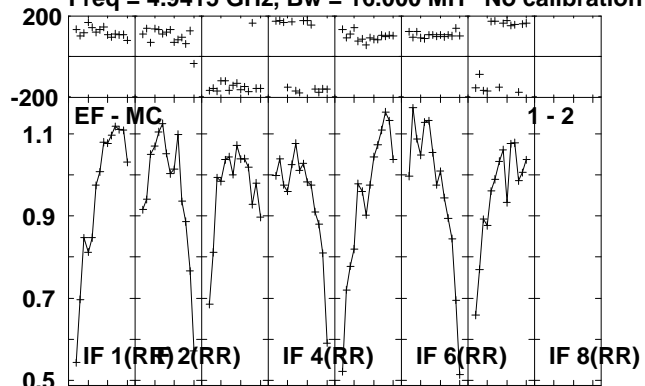

Lower frame: Milli Ampl Jy Top frame: Phas deg
Scalar averaged cross-power spectrum Several baselines displayed
Timerange: 00/20:46:51 to 00/20:51:49

Plot file version 86 created 14-JUL-2010 16:35:42

CYGX-1 RR004A.UVDATA.1

Freq = 4.9415 GHz, Bw = 16.000 MH No calibration applied and no bandpass applied

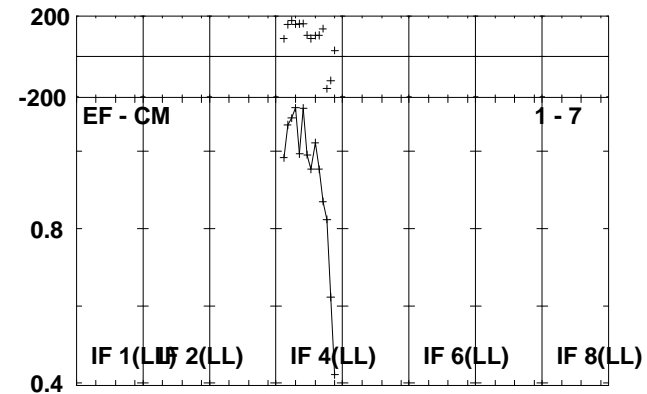
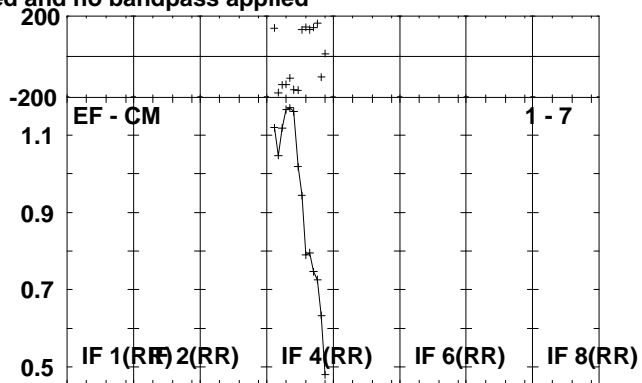
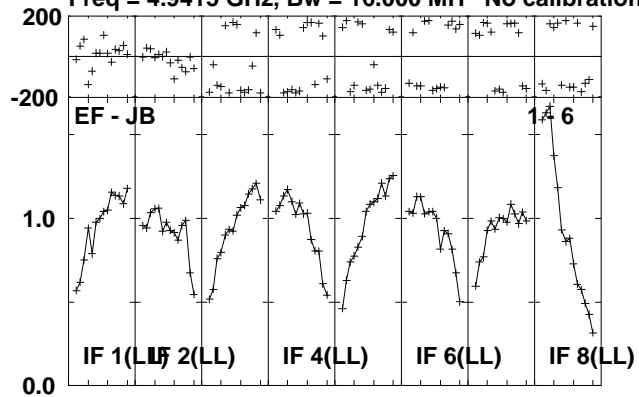

Lower frame: Milli Ampl Jy Top frame: Phas deg
Scalar averaged cross-power spectrum Several baselines displayed
Timerange: 00/20:46:51 to 00/20:51:49

Plot file version 87 created 14-JUL-2010 16:35:43

J1953+35 RR004A.UVDATA.1

Freq = 4.9415 GHz, Bw = 16.000 MH No calibration applied and no bandpass applied

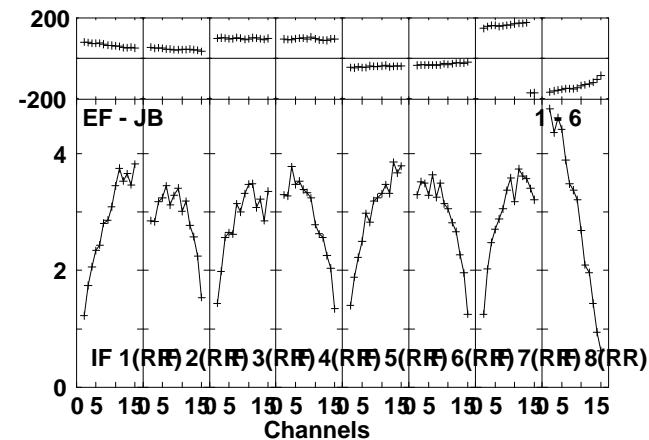
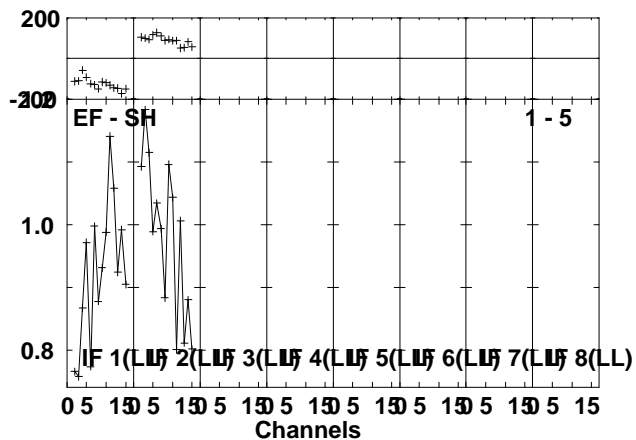
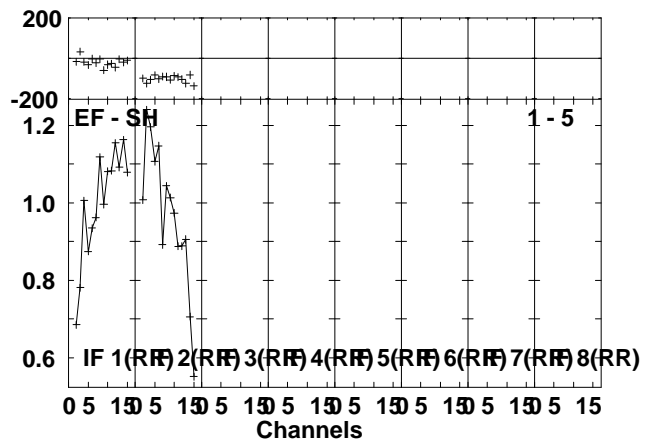
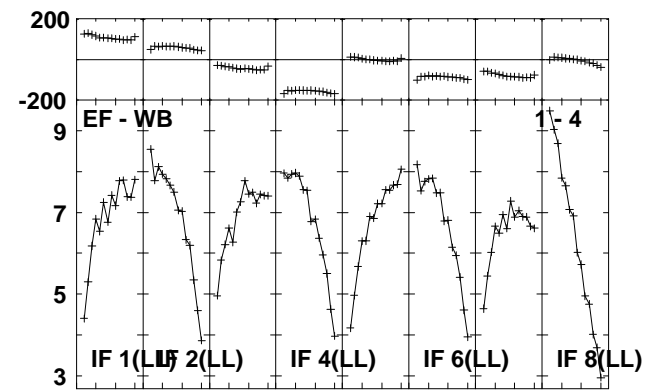
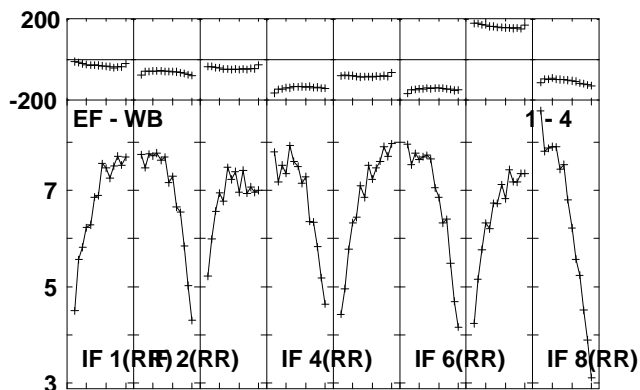
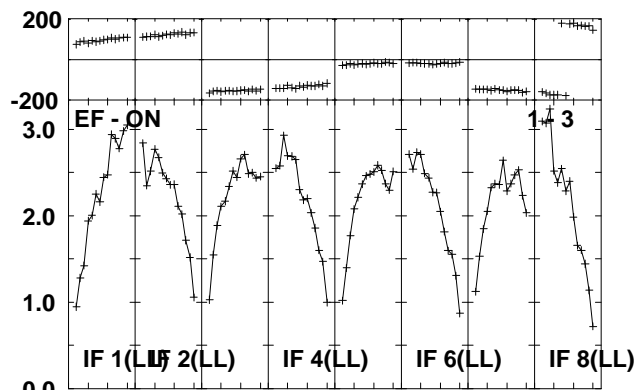
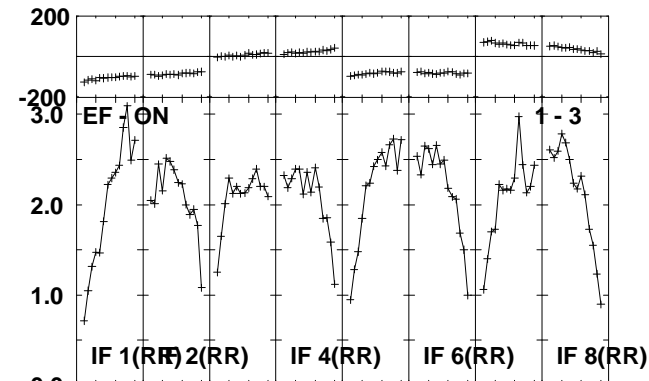
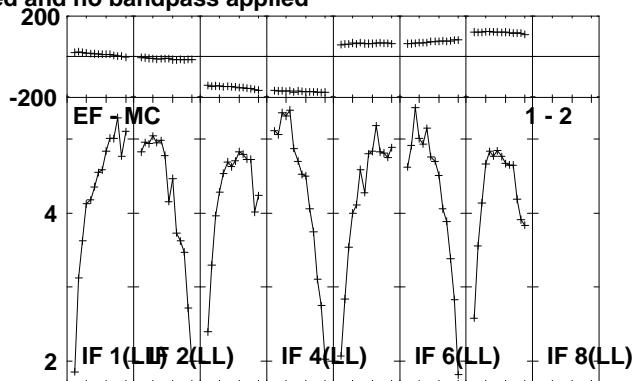
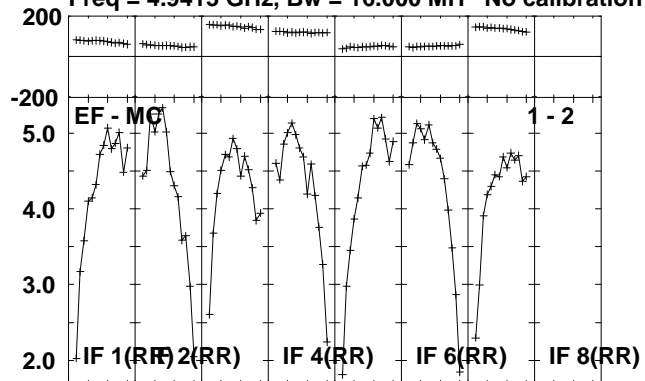

Lower frame: Milli Ampl Jy Top frame: Phas deg
Scalar averaged cross-power spectrum Several baselines displayed
Timerange: 00/20:51:51 to 00/20:53:49

Plot file version 88 created 14-JUL-2010 16:35:43
J1953+35 RR004A.UVDATA.1
Freq = 4.9415 GHz, Bw = 16.000 MH No calibration applied and no bandpass applied

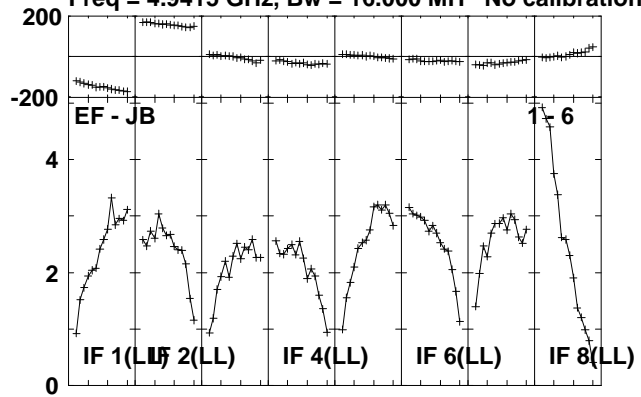

Lower frame: Milli Ampl Jy Top frame: Phas deg
Scalar averaged cross-power spectrum Several baselines displayed
Timerange: 00/20:51:51 to 00/20:53:49

Plot file version 89 created 14-JUL-2010 16:35:44

CYGX-1 RR004A.UVDATA.1

Freq = 4.9415 GHz, Bw = 16.000 MH No calibration applied and no bandpass applied

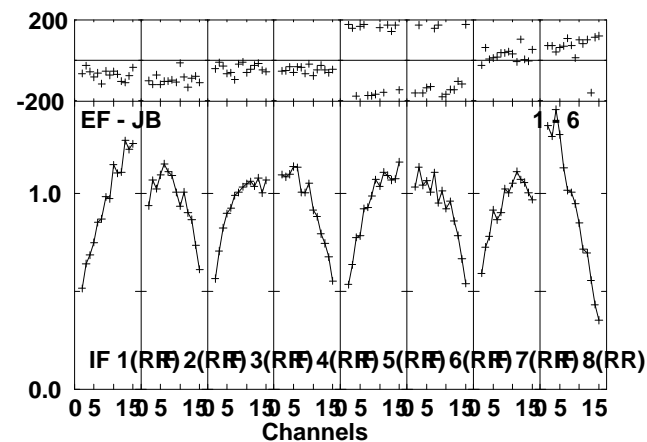
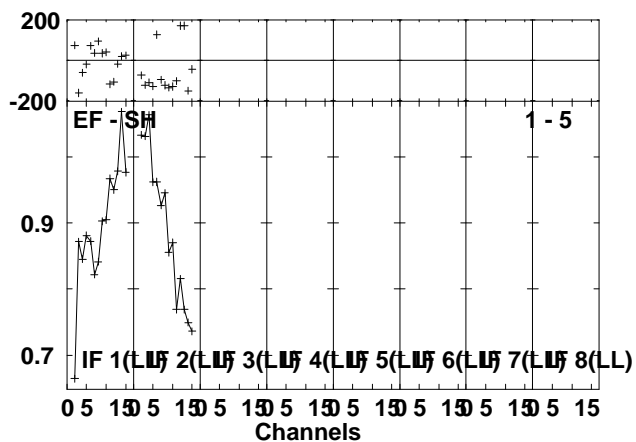
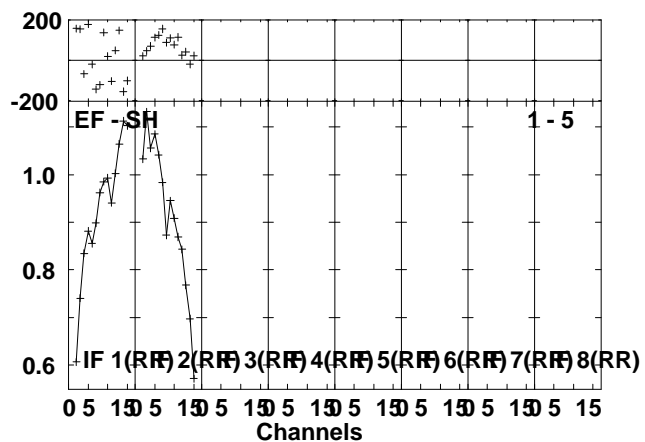
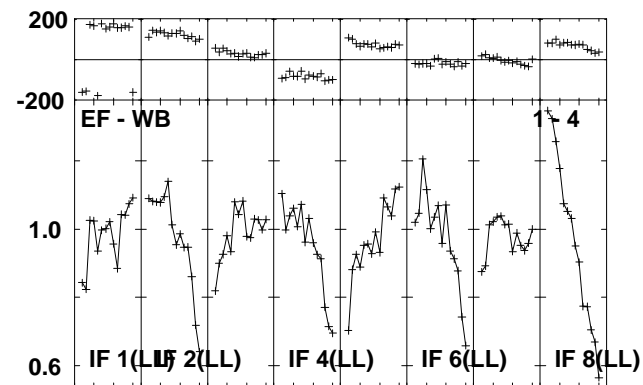
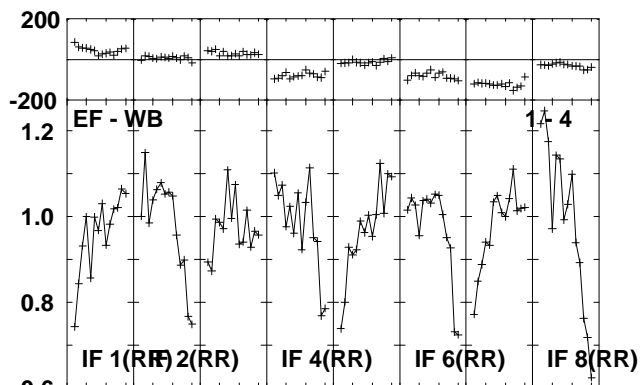
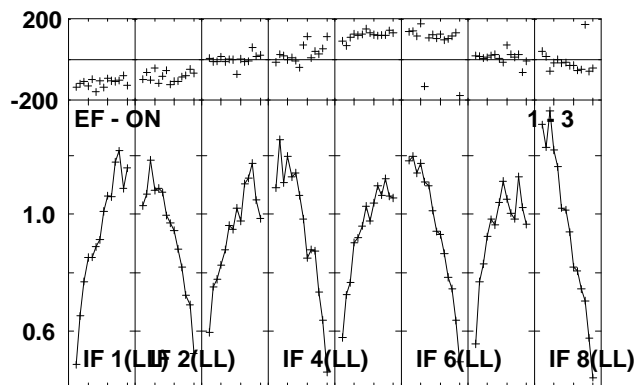
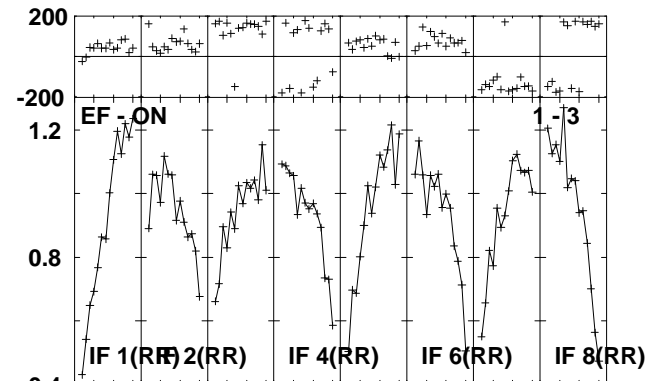
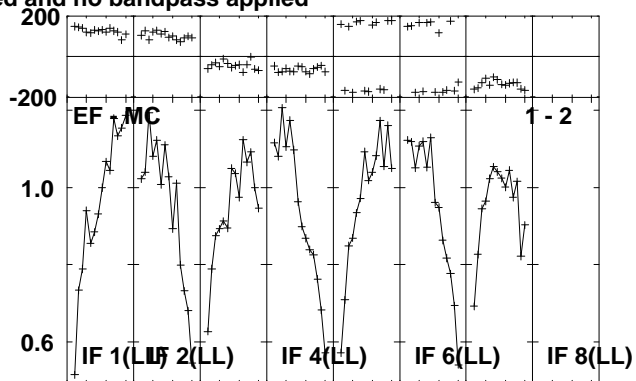
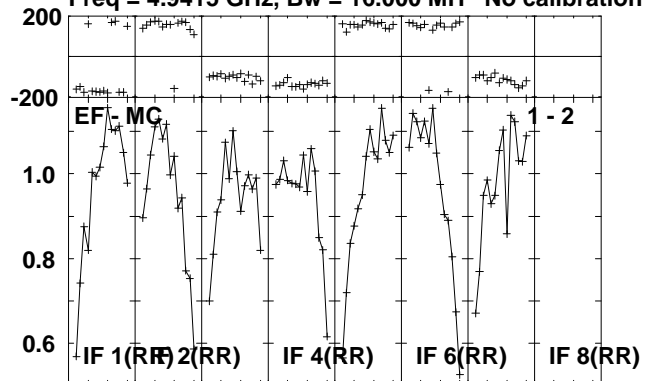

Lower frame: Milli Ampl Jy Top frame: Phas deg
Scalar averaged cross-power spectrum Several baselines displayed
Timerange: 00/20:53:51 to 00/20:58:49

Plot file version 90 created 14-JUL-2010 16:35:45

CYGX-1 RR004A.UVDATA.1

Freq = 4.9415 GHz, Bw = 16.000 MH No calibration applied and no bandpass applied

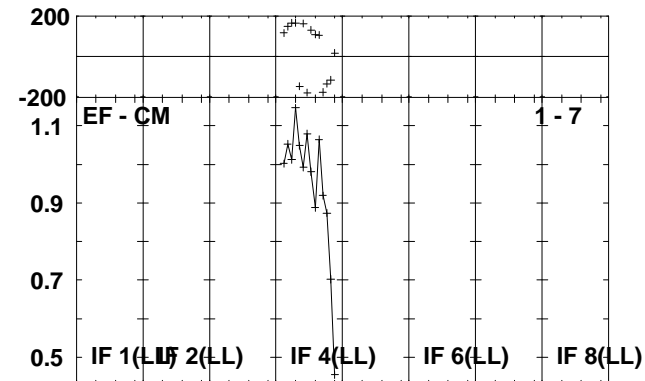
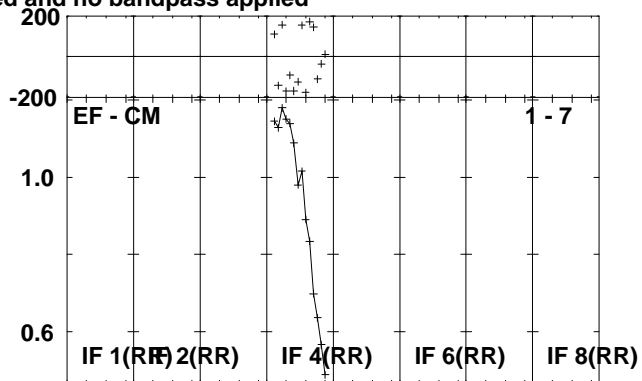
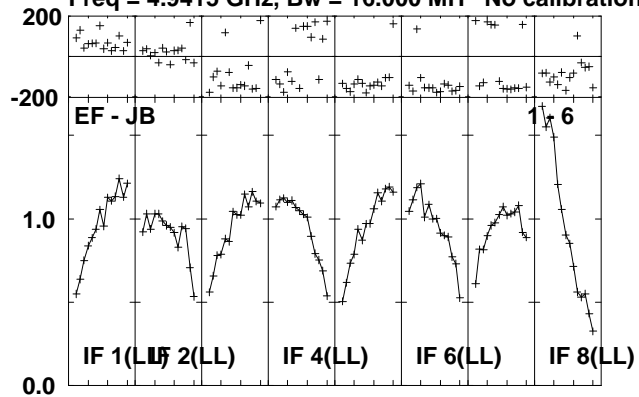

Lower frame: Milli Ampl Jy Top frame: Phas deg
Scalar averaged cross-power spectrum Several baselines displayed
Timerange: 00/20:53:51 to 00/20:58:49

Plot file version 91 created 14-JUL-2010 16:35:46

J1953+35 RR004A.UVDATA.1

Freq = 4.9415 GHz, Bw = 16.000 MH No calibration applied and no bandpass applied

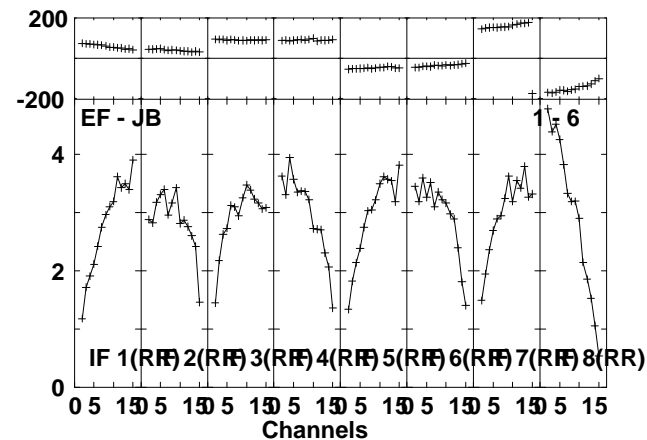
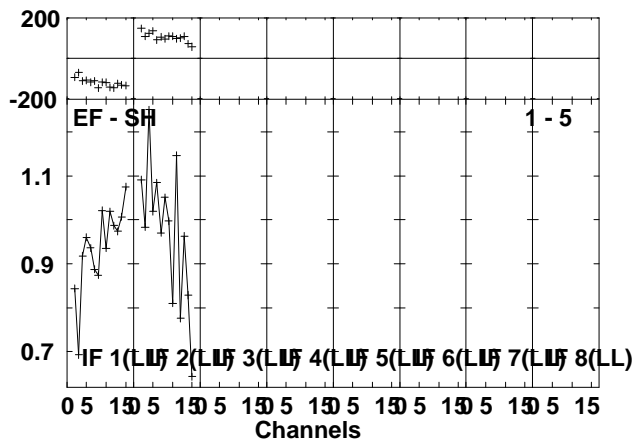
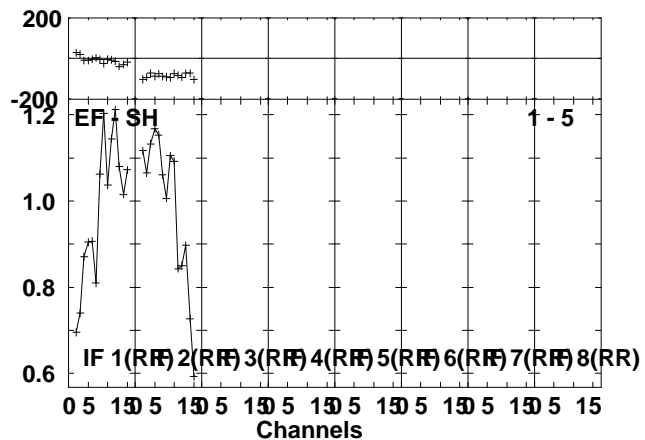
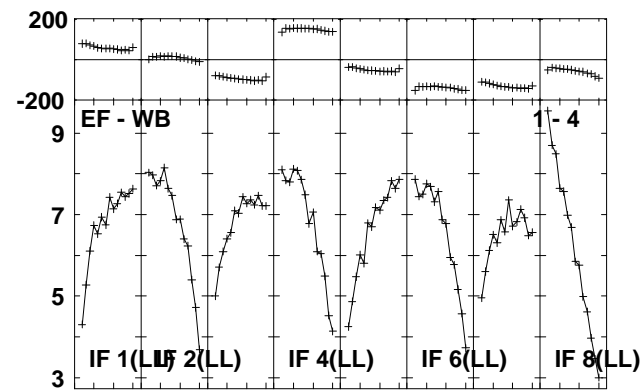
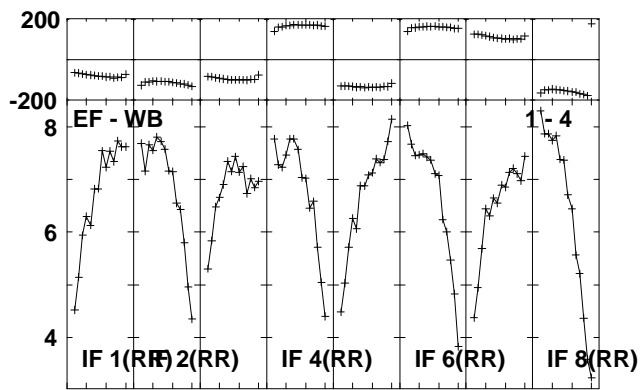
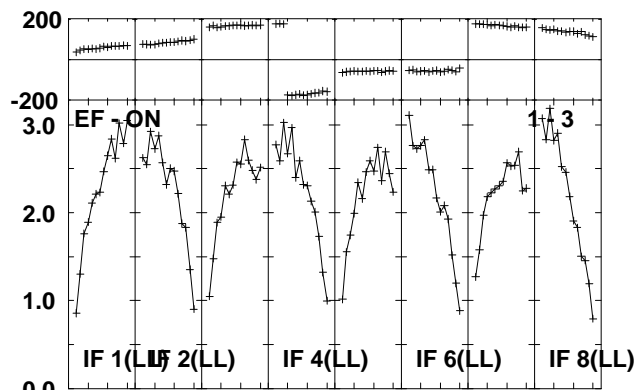
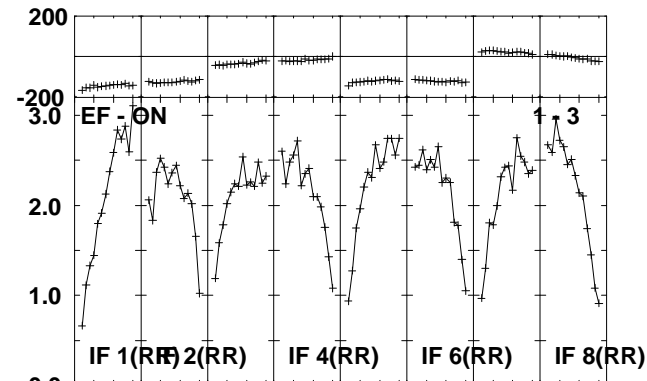
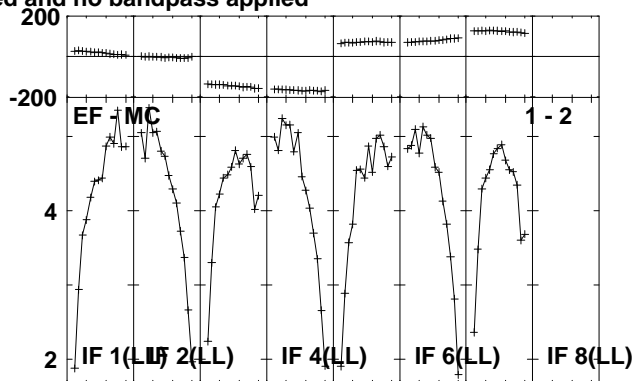
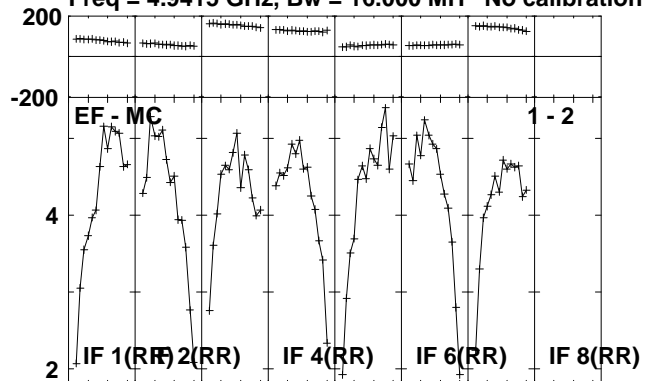

Lower frame: Milli Ampl Jy Top frame: Phas deg
Scalar averaged cross-power spectrum Several baselines displayed
Timerange: 00/20:59:31 to 00/21:00:59

Plot file version 92 created 14-JUL-2010 16:35:47
J1953+35 RR004A.UVDATA.1

Freq = 4.9415 GHz, Bw = 16.000 MH No calibration applied and no bandpass applied

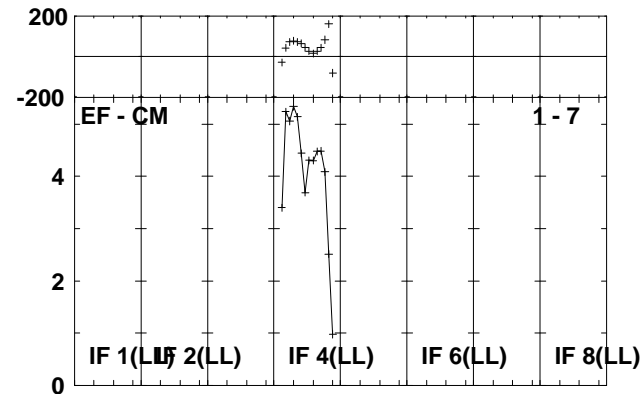
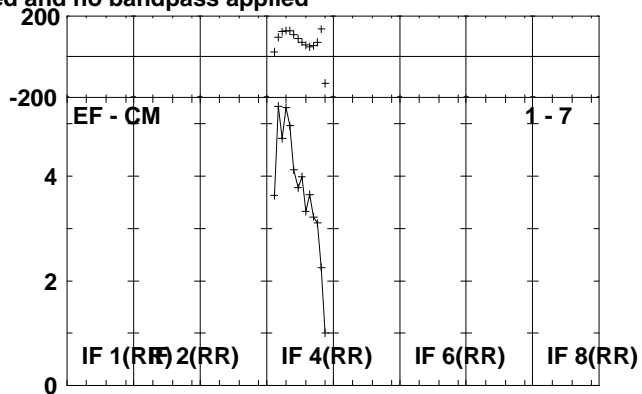
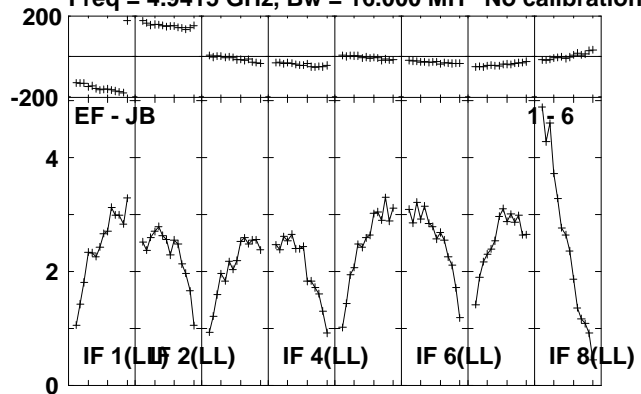

Lower frame: Milli Ampl Jy Top frame: Phas deg
Scalar averaged cross-power spectrum Several baselines displayed
Timerange: 00/20:59:31 to 00/21:00:59

Plot file version 93 created 14-JUL-2010 16:35:47

CYGX-1 RR004A.UVDATA.1

Freq = 4.9415 GHz, Bw = 16.000 MH No calibration applied and no bandpass applied

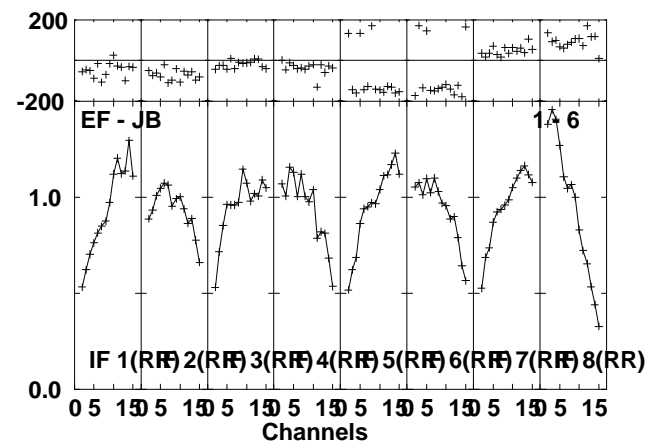
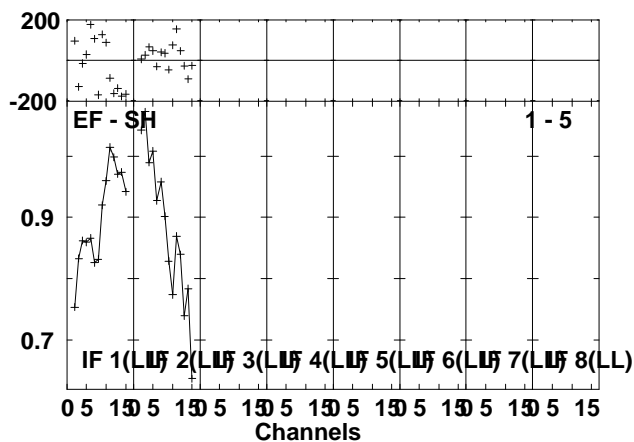
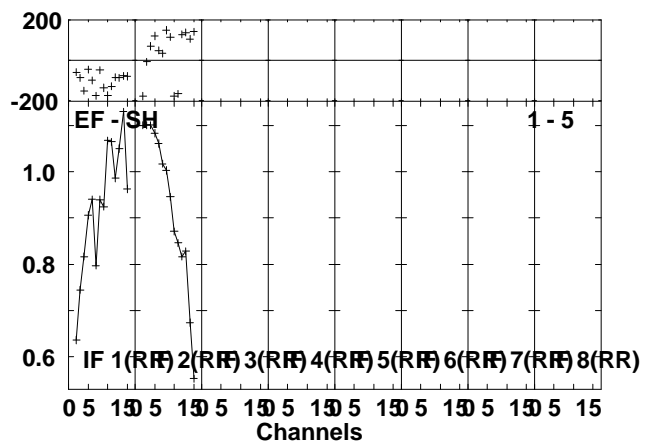
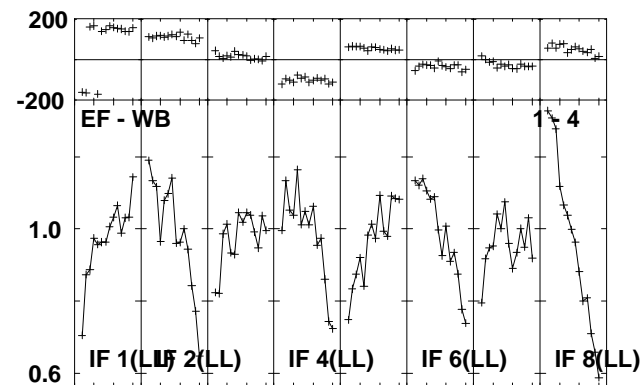
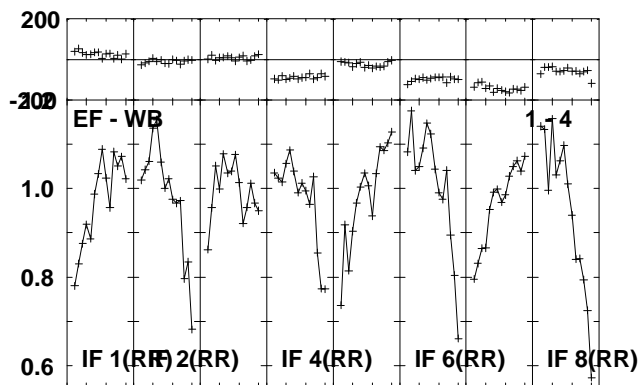
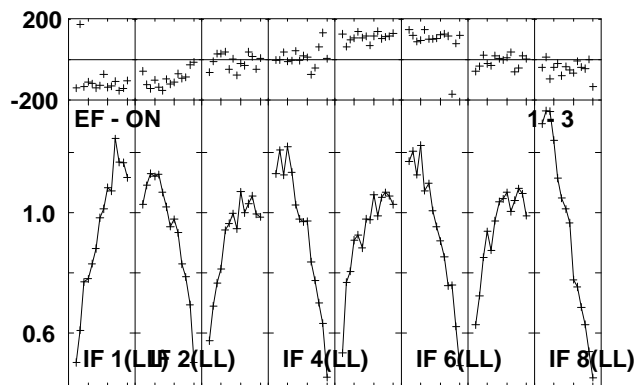
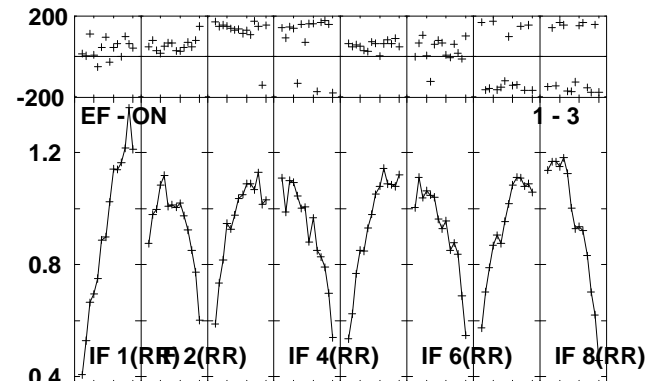
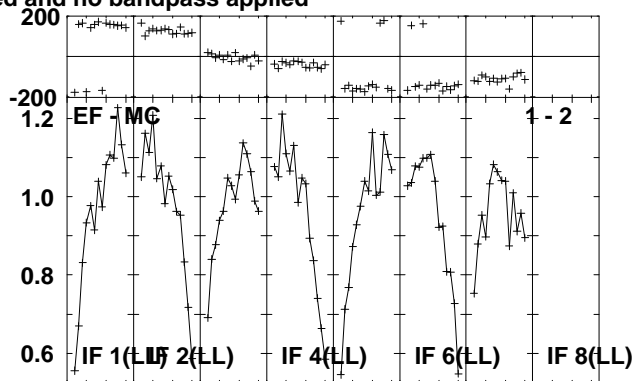
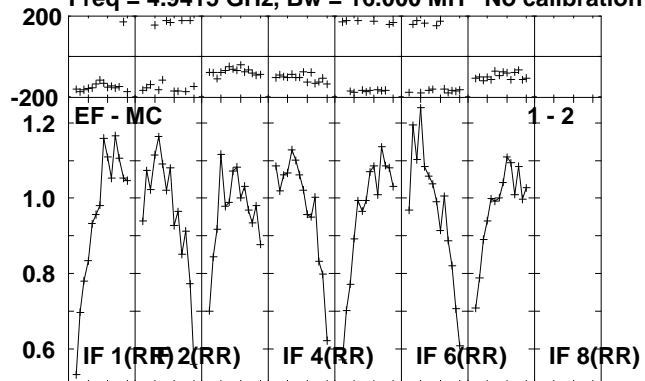

Lower frame: Milli Ampl Jy Top frame: Phas deg
Scalar averaged cross-power spectrum Several baselines displayed
Timerange: 00/21:01:01 to 00/21:05:59

Plot file version 94 created 14-JUL-2010 16:35:49
CYGX-1 RR004A.UVDATA.1

Freq = 4.9415 GHz, Bw = 16.000 MH No calibration applied and no bandpass applied

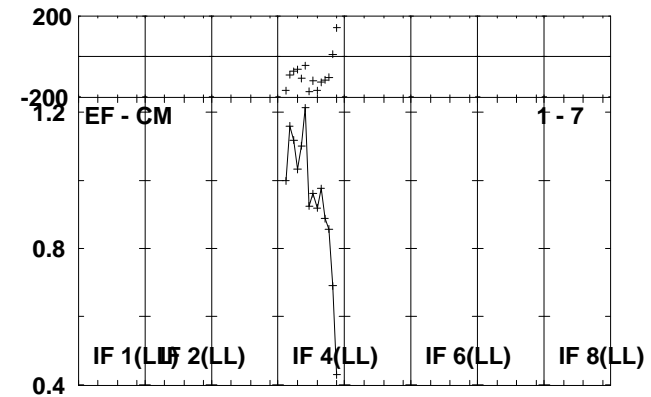
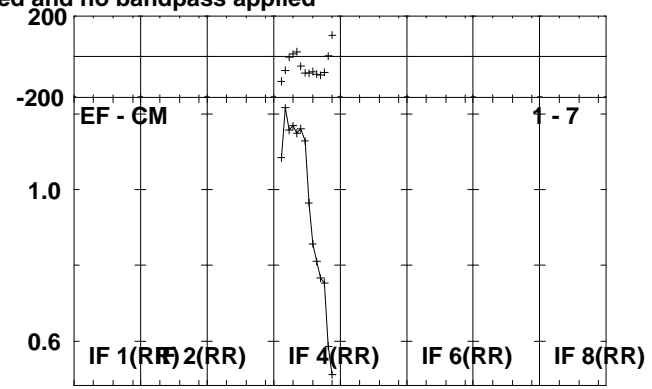
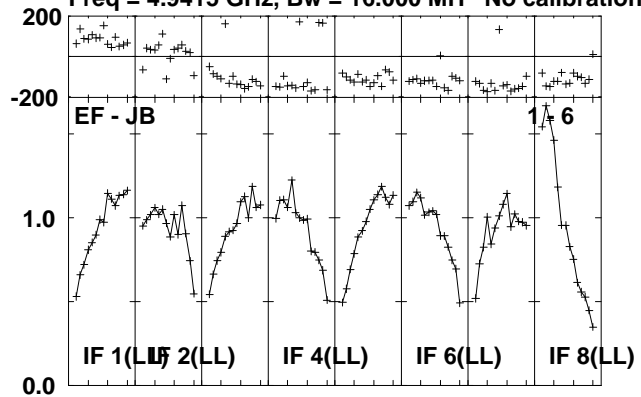

Lower frame: Milli Ampl Jy Top frame: Phas deg
Scalar averaged cross-power spectrum Several baselines displayed
Timerange: 00/21:01:01 to 00/21:05:59

Plot file version 95 created 14-JUL-2010 16:35:50

J1953+35 RR004A.UVDATA.1

Freq = 4.9415 GHz, Bw = 16.000 MH No calibration applied and no bandpass applied

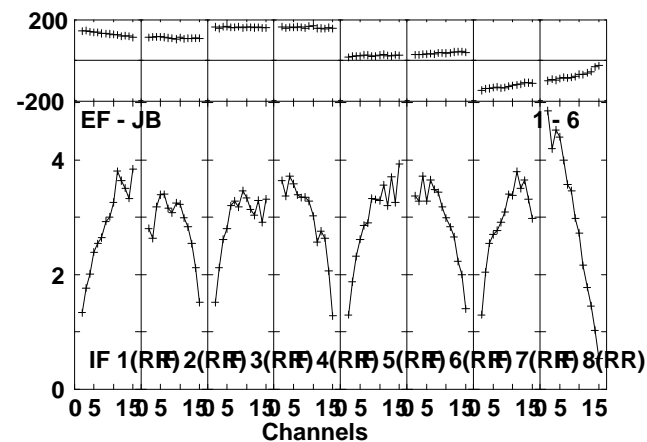
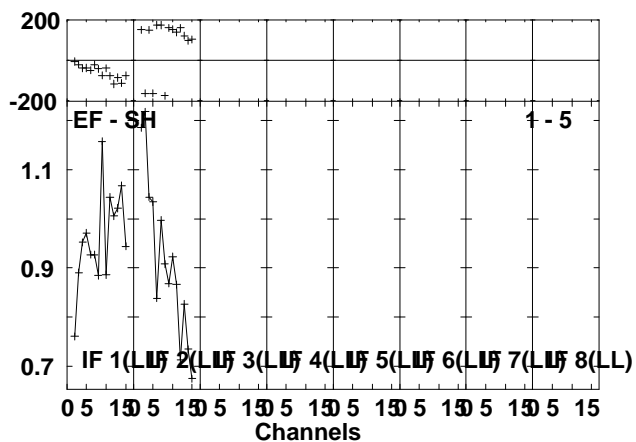
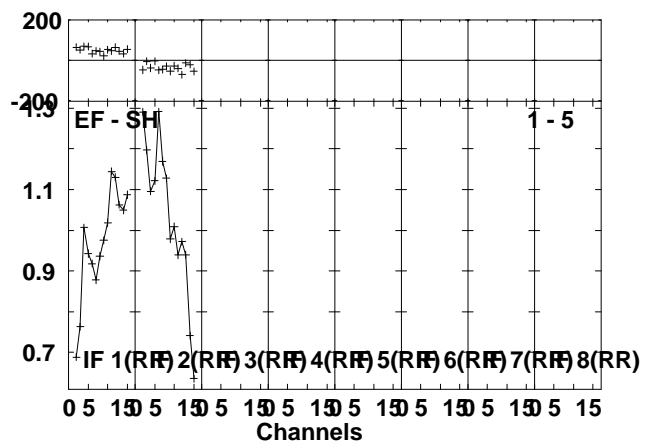
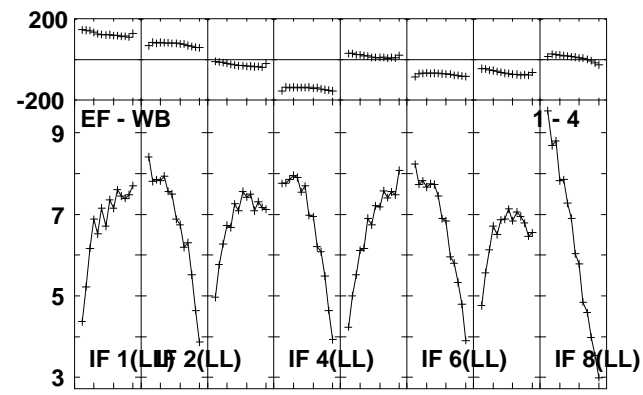
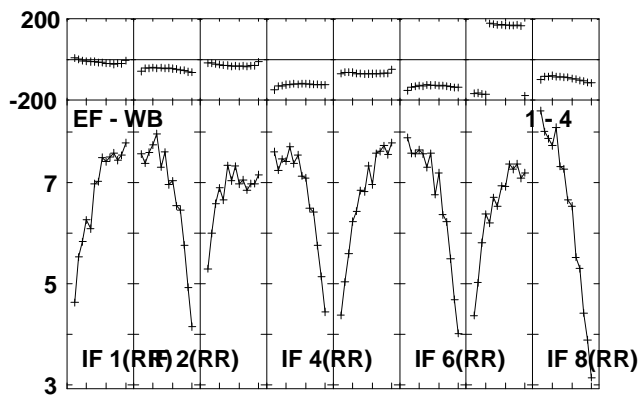
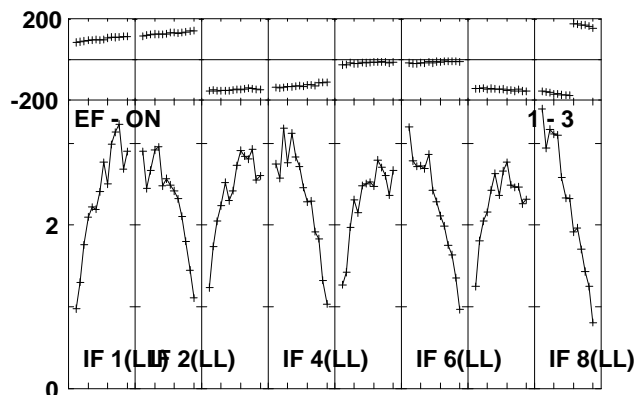
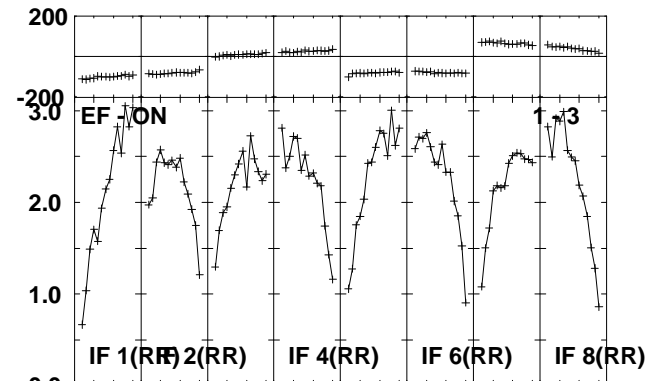
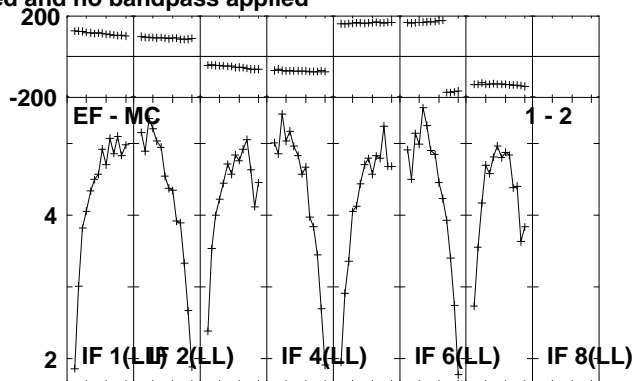
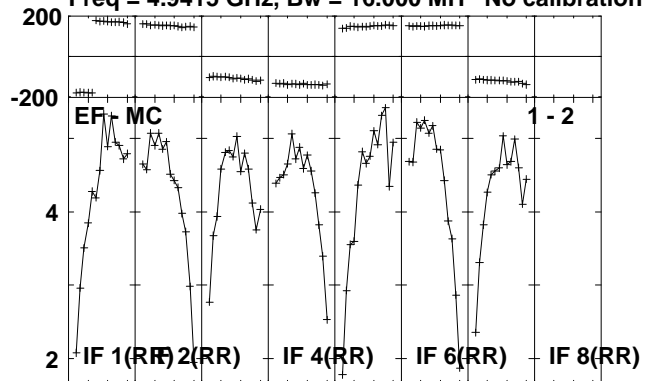

Lower frame: Milli Ampl Jy Top frame: Phas deg
Scalar averaged cross-power spectrum Several baselines displayed
Timerange: 00/21:06:01 to 00/21:07:59

Plot file version 96 created 14-JUL-2010 16:35:50
J1953+35 RR004A.UVDATA.1

Freq = 4.9415 GHz, Bw = 16.000 MH No calibration applied and no bandpass applied

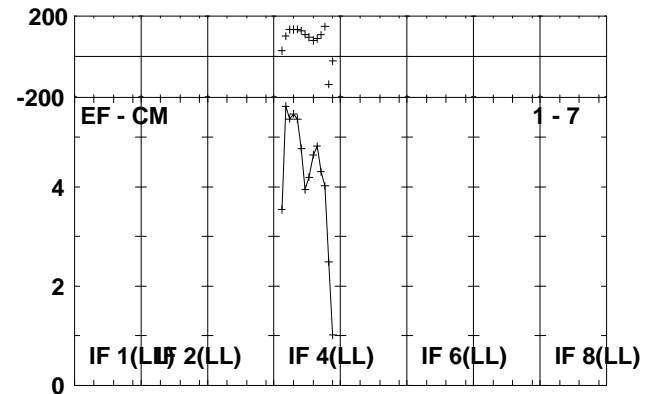
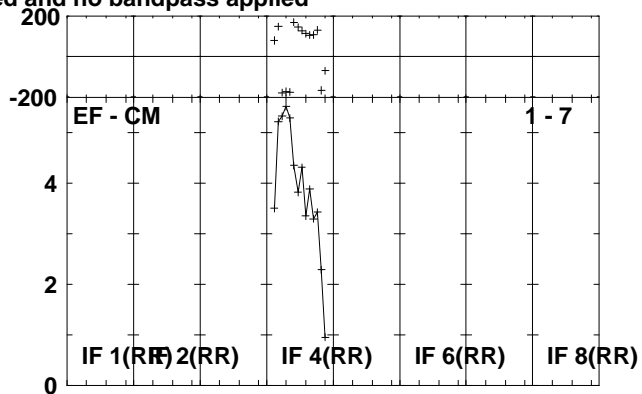
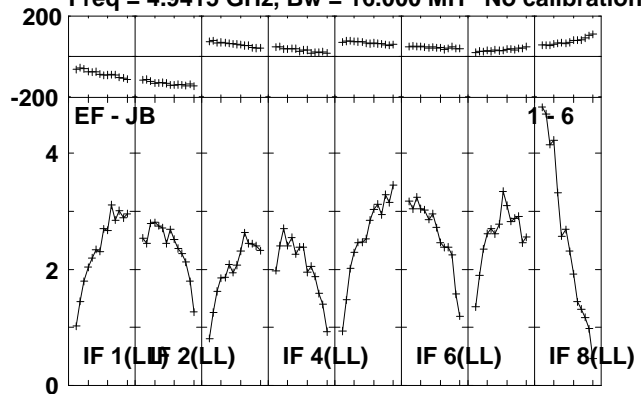

Lower frame: Milli Ampl Jy Top frame: Phas deg
Scalar averaged cross-power spectrum Several baselines displayed
Timerange: 00/21:06:01 to 00/21:07:59

Plot file version 97 created 14-JUL-2010 16:35:51

CYGX-1 RR004A.UVDATA.1

Freq = 4.9415 GHz, Bw = 16.000 MH No calibration applied and no bandpass applied

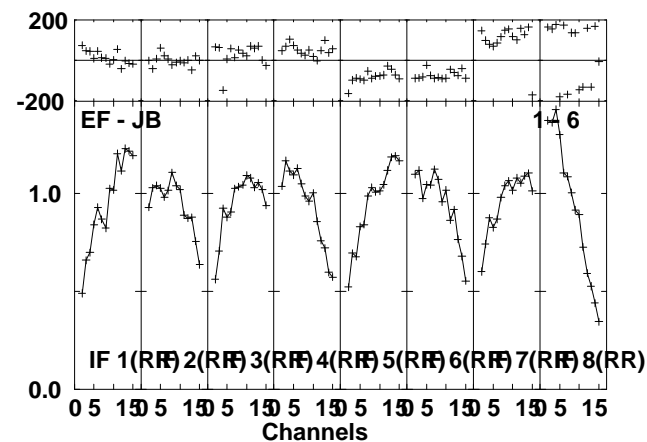
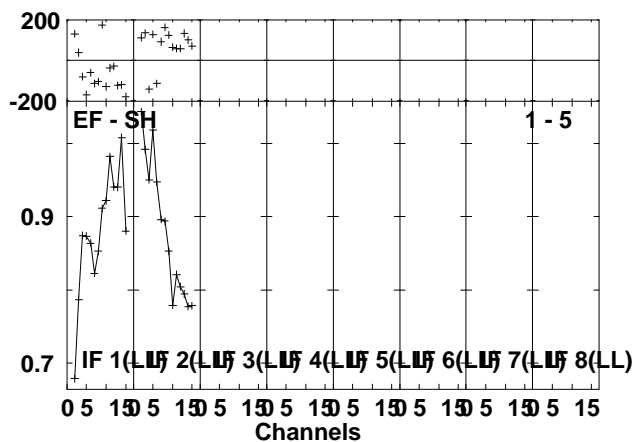
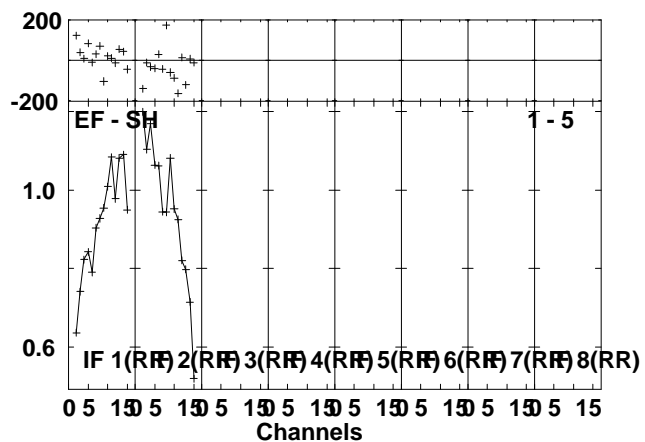
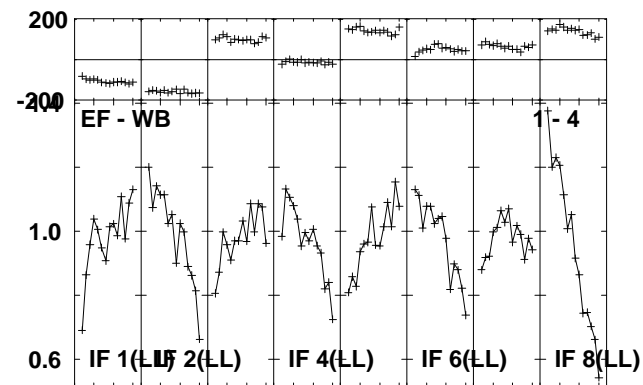
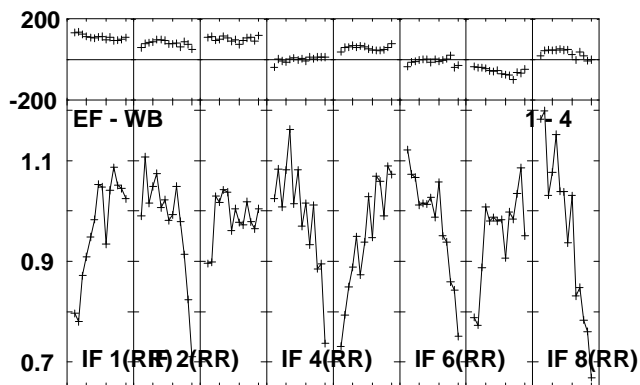
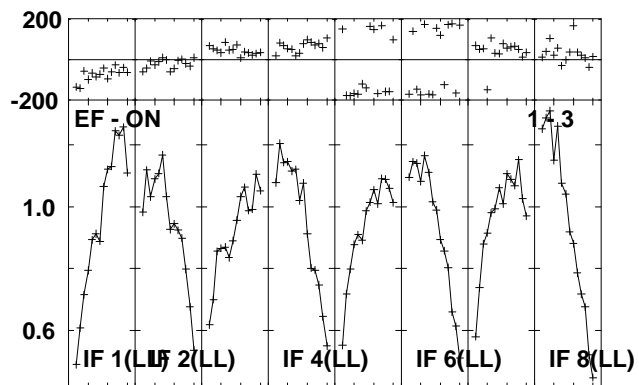
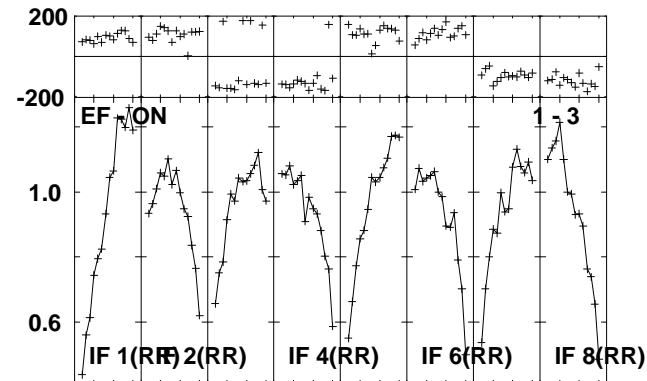
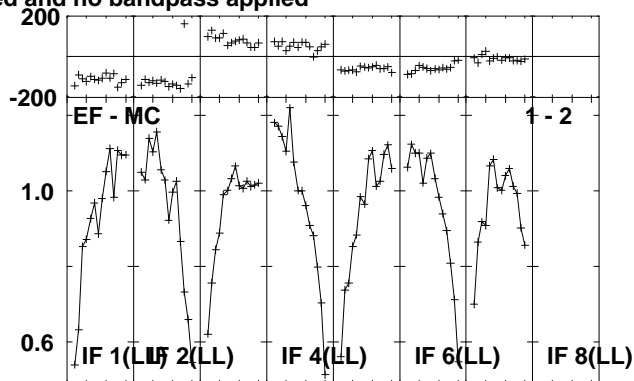
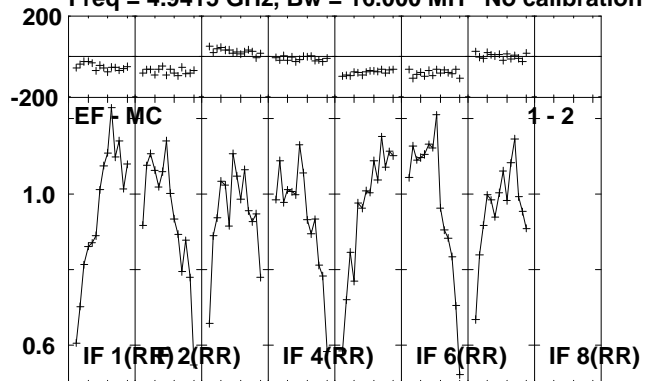

Lower frame: Milli Ampl Jy Top frame: Phas deg
Scalar averaged cross-power spectrum Several baselines displayed
Timerange: 00/21:08:01 to 00/21:12:59

Plot file version 98 created 14-JUL-2010 16:35:52

CYGX-1 RR004A.UVDATA.1

Freq = 4.9415 GHz, Bw = 16.000 MH No calibration applied and no bandpass applied

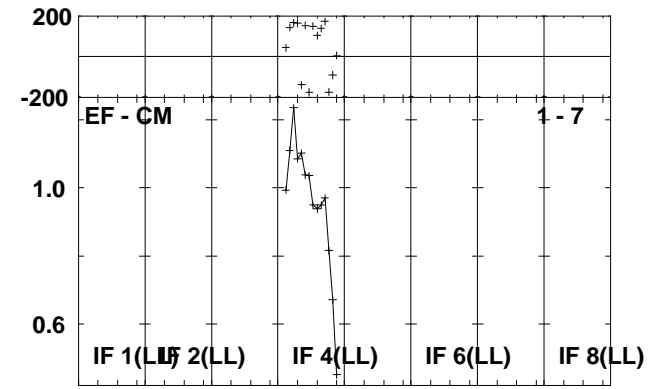
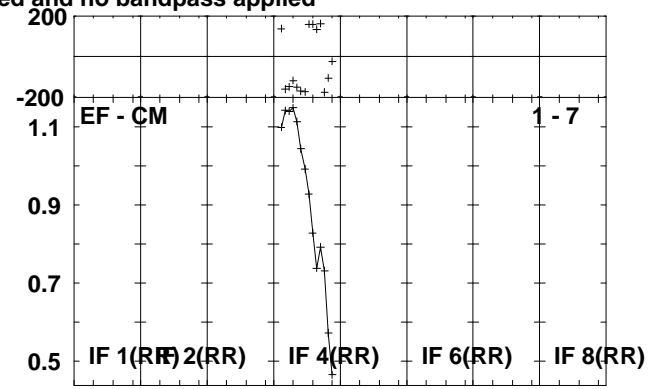
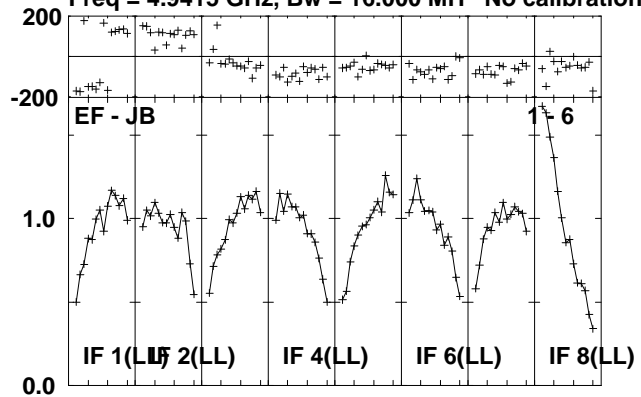

Lower frame: Milli Ampl Jy Top frame: Phas deg
Scalar averaged cross-power spectrum Several baselines displayed
Timerange: 00/21:08:01 to 00/21:12:59

Plot file version 99 created 14-JUL-2010 16:35:54

J1953+35 RR004A.UVDATA.1

Freq = 4.9415 GHz, Bw = 16.000 MH No calibration applied and no bandpass applied

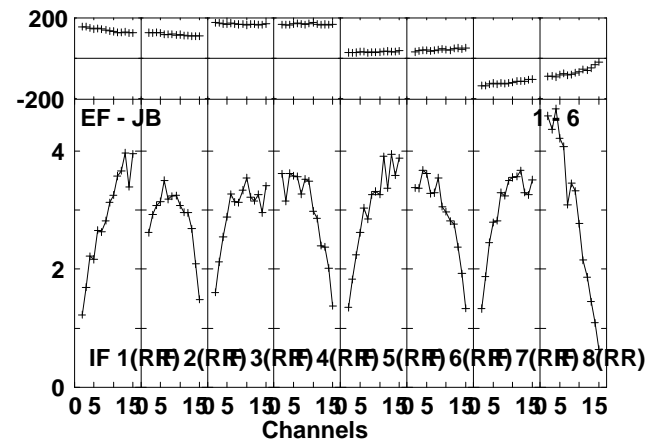
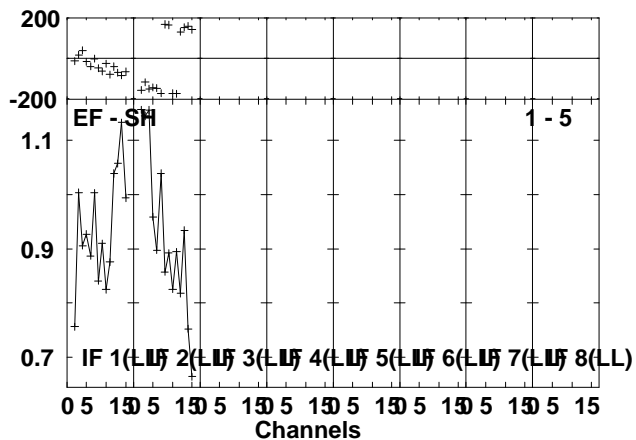
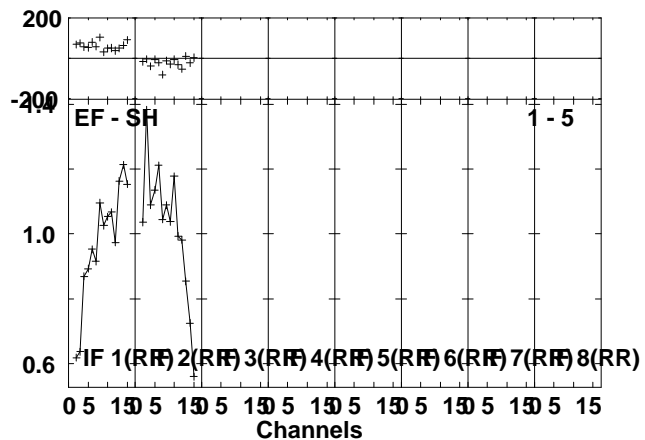
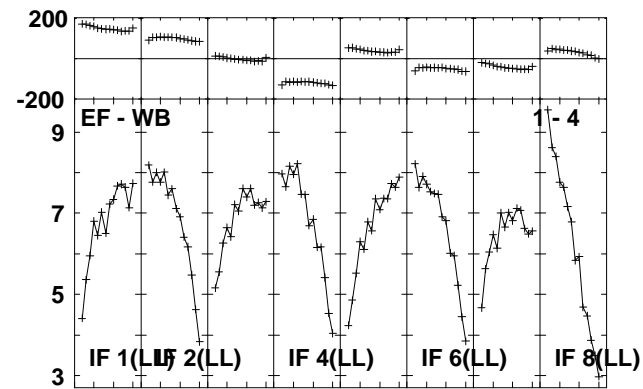
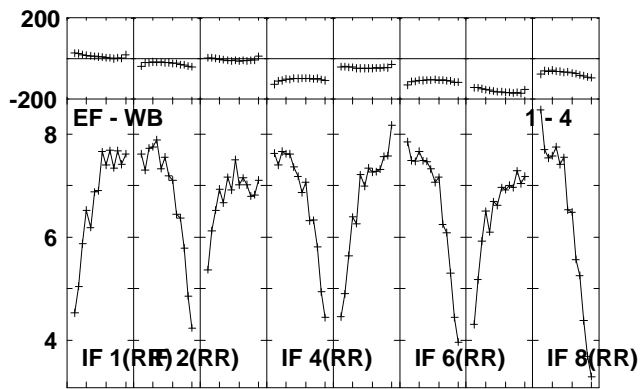
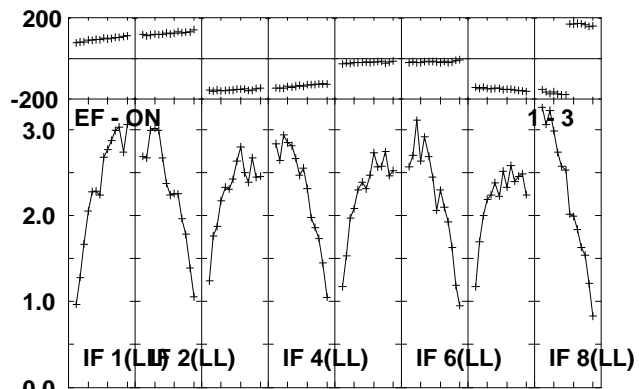
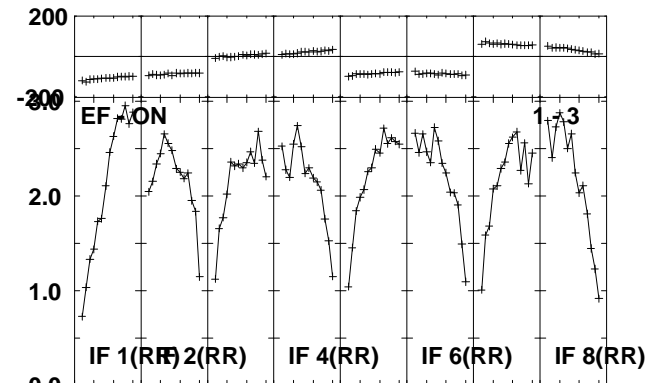
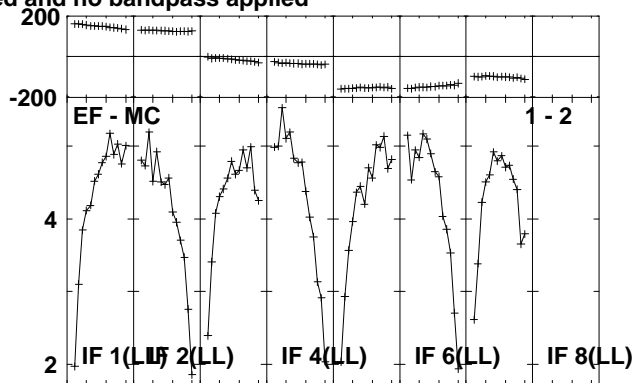
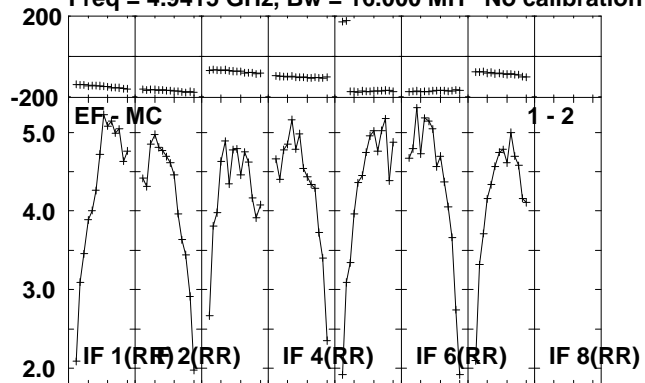

Lower frame: Milli Ampl Jy Top frame: Phas deg
Scalar averaged cross-power spectrum Several baselines displayed
Timerange: 00/21:13:41 to 00/21:15:09

Plot file version 100 created 14-JUL-2010 16:35:54
J1953+35 RR004A.UVDATA.1

Freq = 4.9415 GHz, Bw = 16.000 MH No calibration applied and no bandpass applied

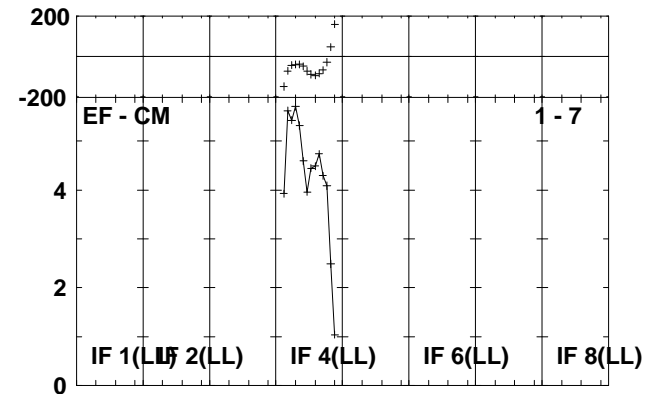
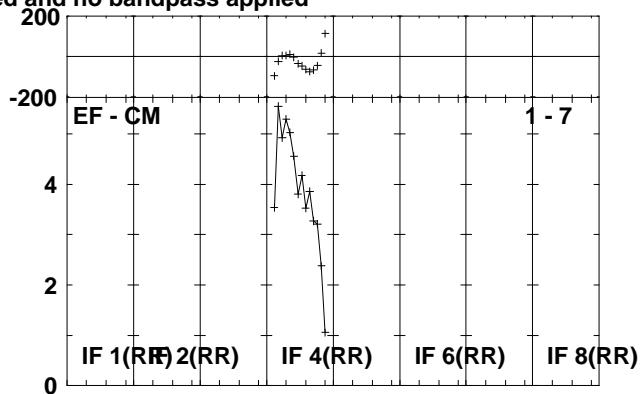
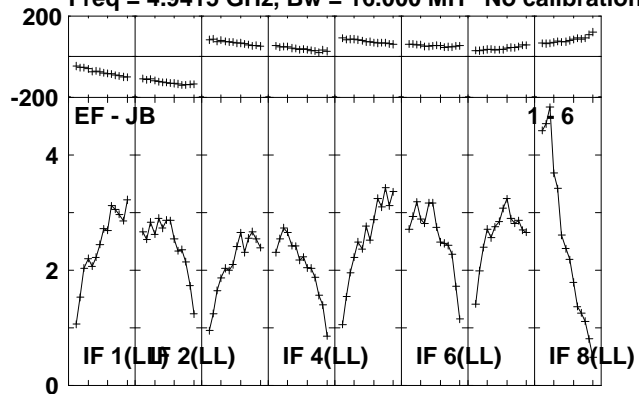

Lower frame: Milli Ampl Jy Top frame: Phas deg
Scalar averaged cross-power spectrum Several baselines displayed
Timerange: 00/21:13:41 to 00/21:15:09

Plot file version 101 created 14-JUL-2010 16:35:55

CYGX-1 RR004A.UVDATA.1

Freq = 4.9415 GHz, Bw = 16.000 MH No calibration applied and no bandpass applied

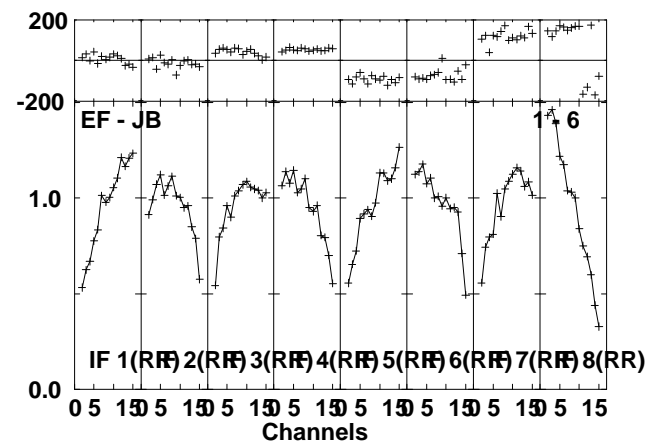
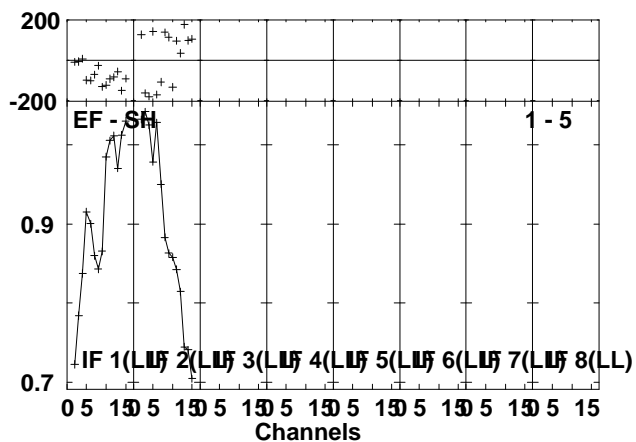
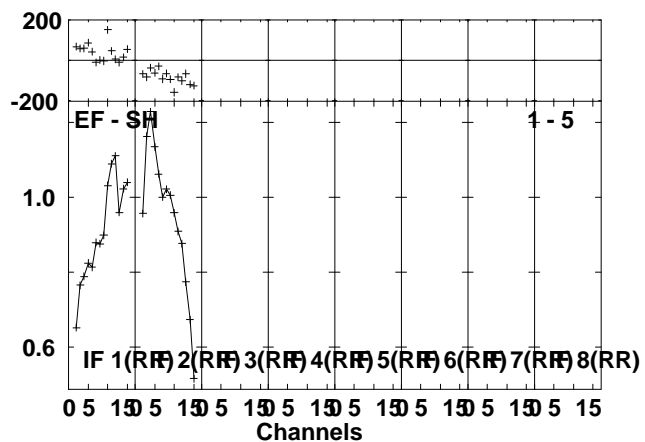
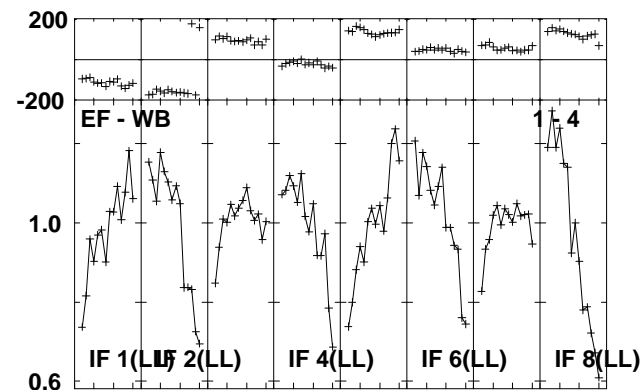
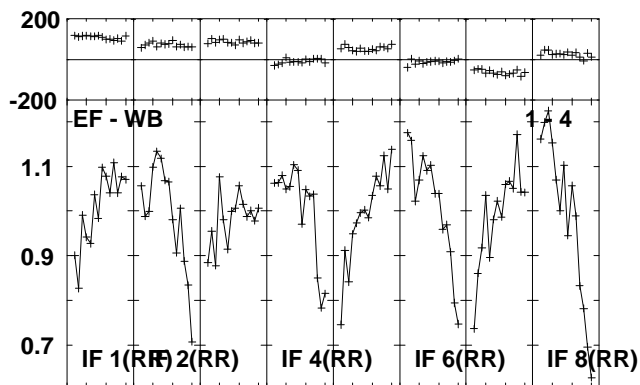
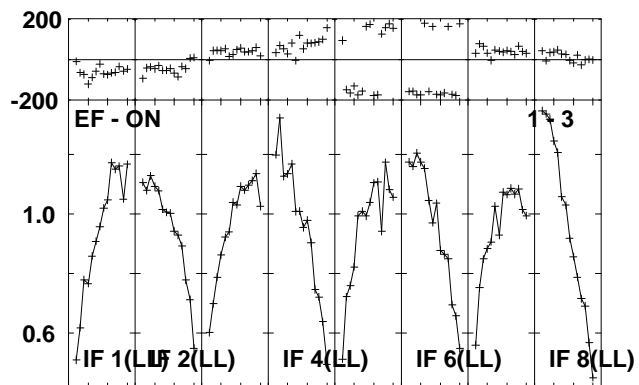
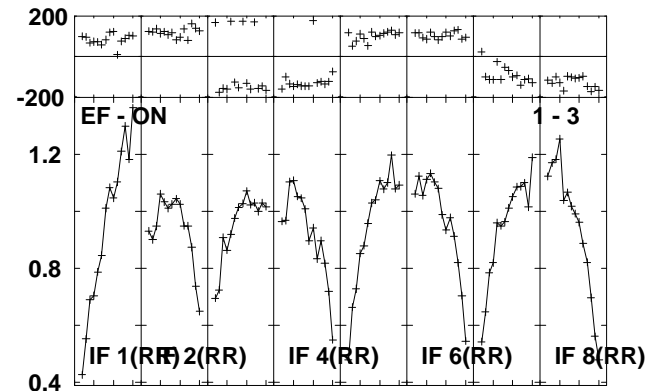
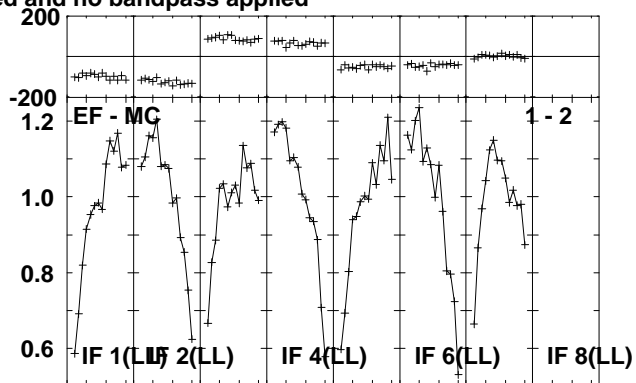
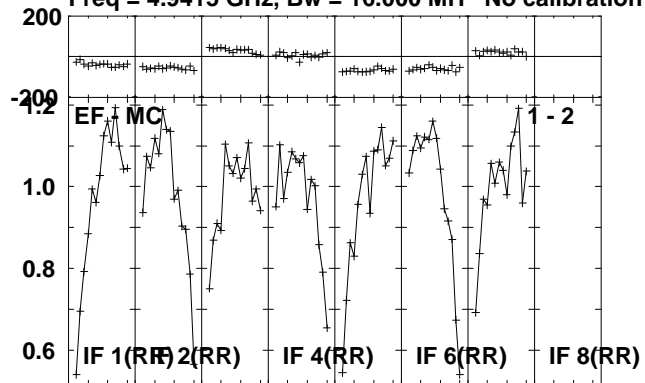

Lower frame: Milli Ampl Jy Top frame: Phas deg
Scalar averaged cross-power spectrum Several baselines displayed
Timerange: 00/21:15:11 to 00/21:20:09

Plot file version 102 created 14-JUL-2010 16:35:56

CYGX-1 RR004A.UVDATA.1

Freq = 4.9415 GHz, Bw = 16.000 MH No calibration applied and no bandpass applied

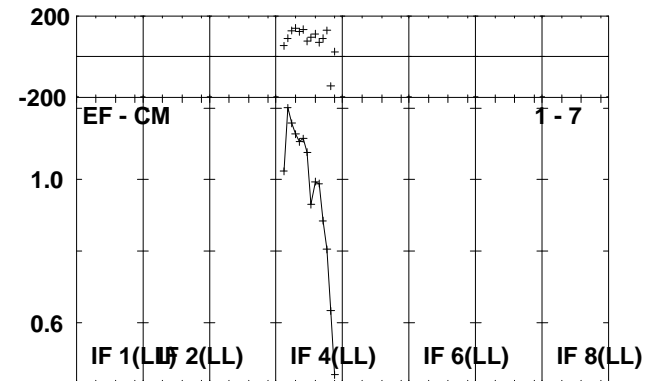
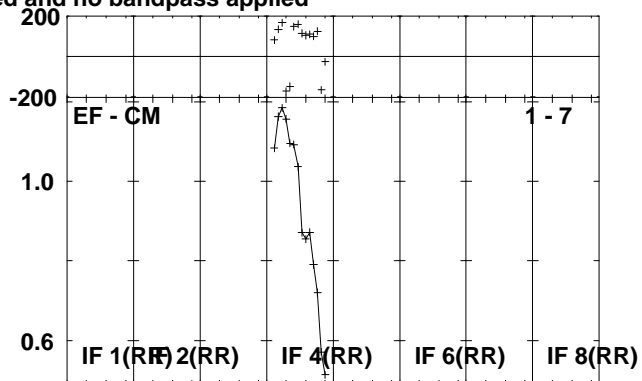
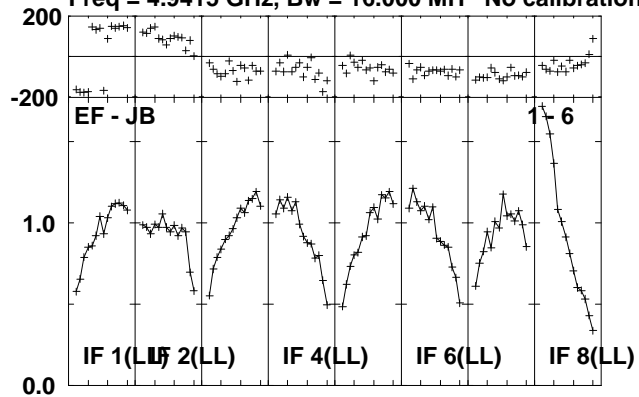

Lower frame: Milli Ampl Jy Top frame: Phas deg
Scalar averaged cross-power spectrum Several baselines displayed
Timerange: 00/21:15:11 to 00/21:20:09

Plot file version 103 created 14-JUL-2010 16:35:57

J1953+35 RR004A.UVDATA.1

Freq = 4.9415 GHz, Bw = 16.000 MH No calibration applied and no bandpass applied

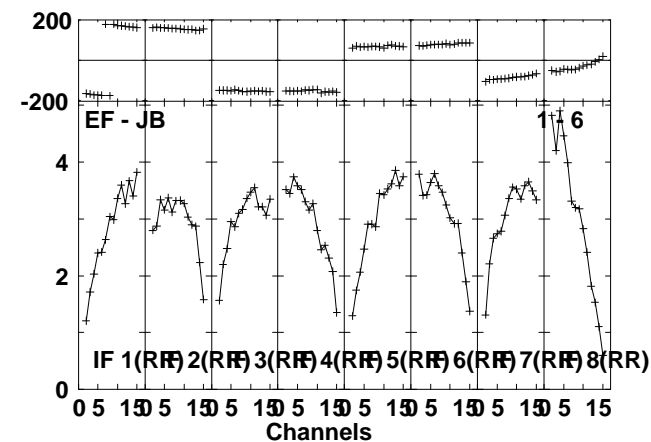
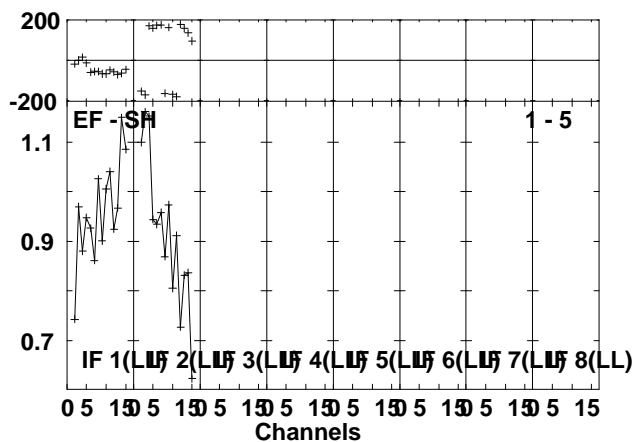
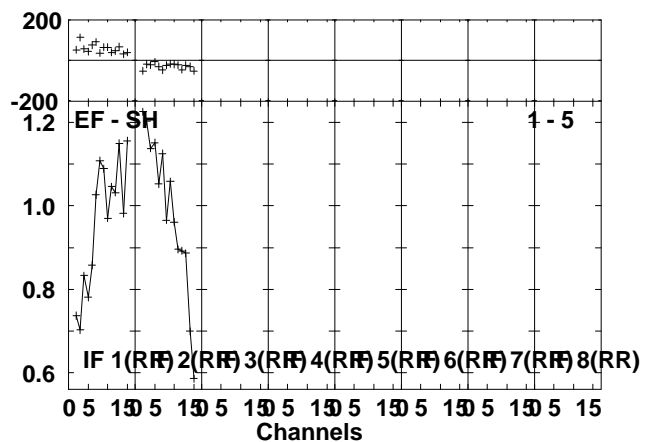
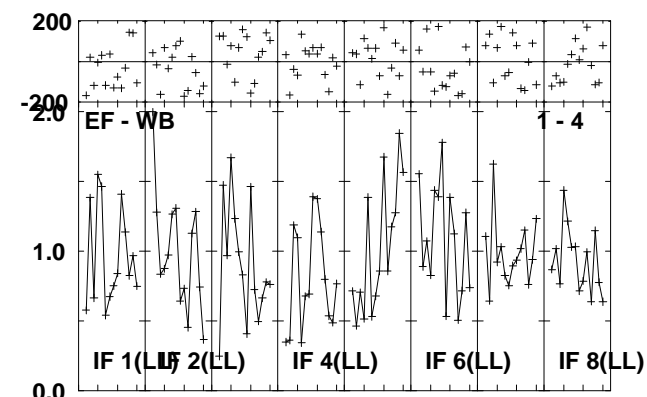
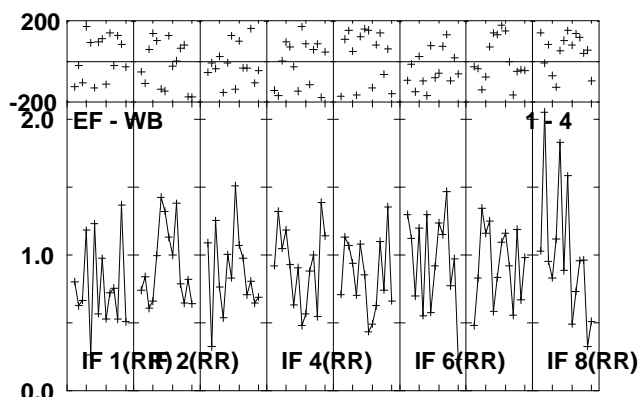
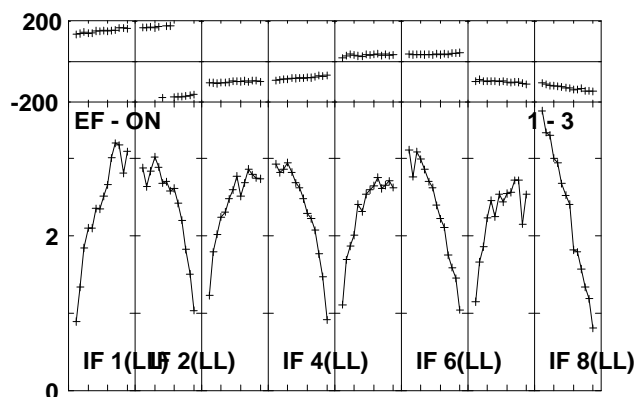
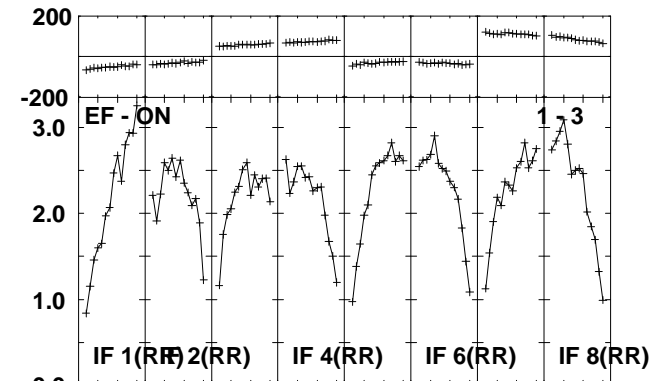
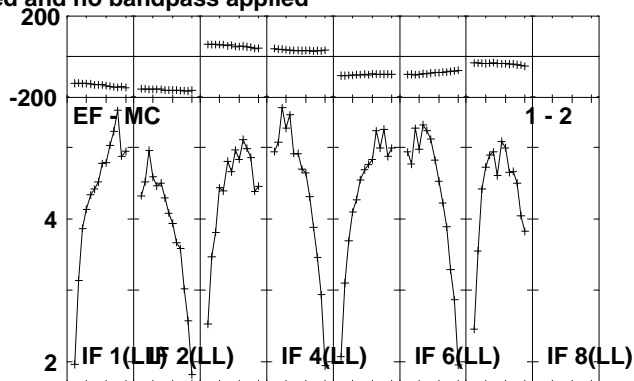
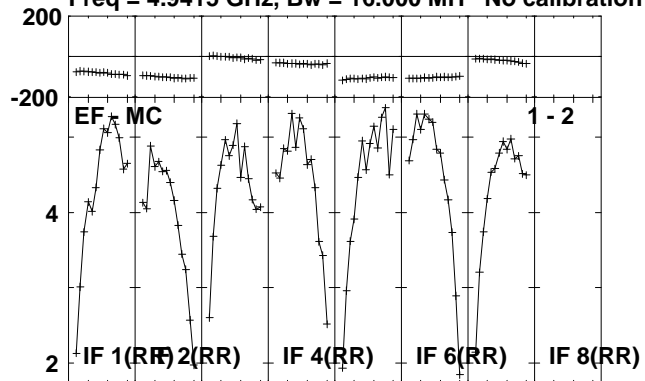

Lower frame: Milli Ampl Jy Top frame: Phas deg
Scalar averaged cross-power spectrum Several baselines displayed
Timerange: 00/21:20:11 to 00/21:22:09

Plot file version 104 created 14-JUL-2010 16:35:58
J1953+35 RR004A.UVDATA.1

Freq = 4.9415 GHz, Bw = 16.000 MH No calibration applied and no bandpass applied

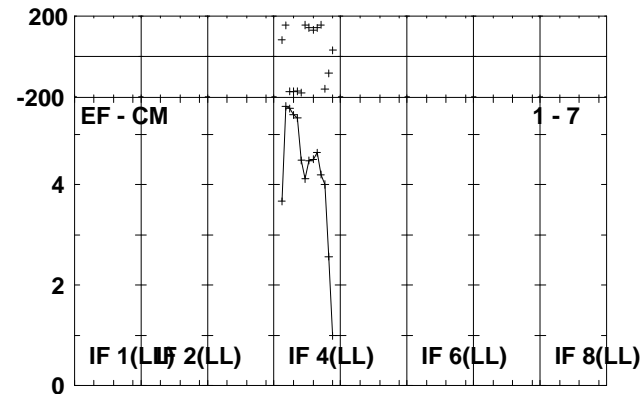
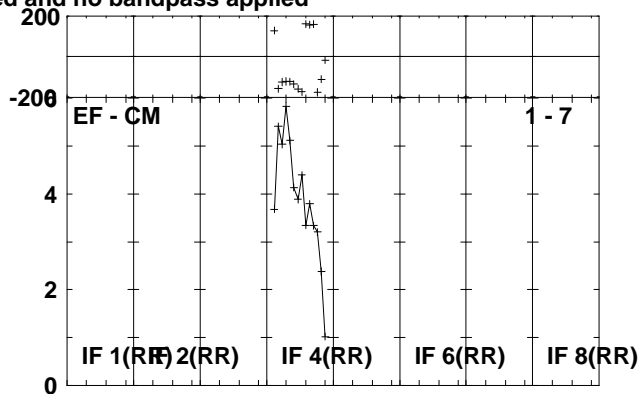
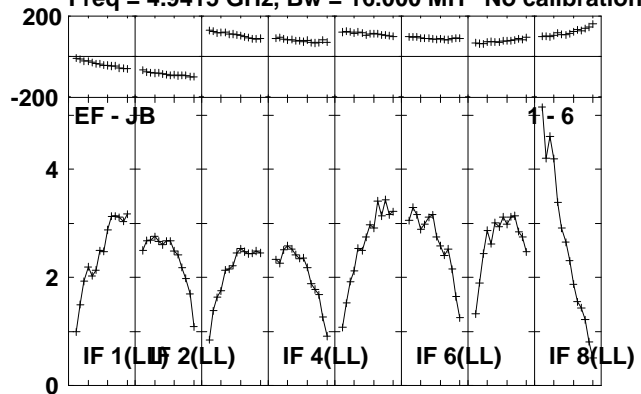

Lower frame: Milli Ampl Jy Top frame: Phas deg
Scalar averaged cross-power spectrum Several baselines displayed
Timerange: 00/21:20:11 to 00/21:22:09

Plot file version 105 created 14-JUL-2010 16:35:58

CYGX-1 RR004A.UVDATA.1

Freq = 4.9415 GHz, Bw = 16.000 MH No calibration applied and no bandpass applied

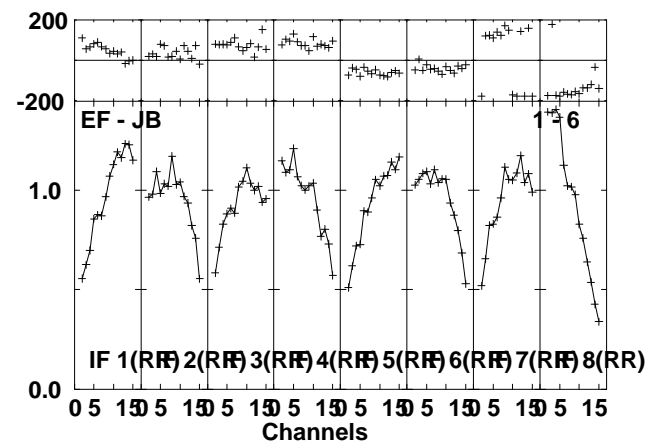
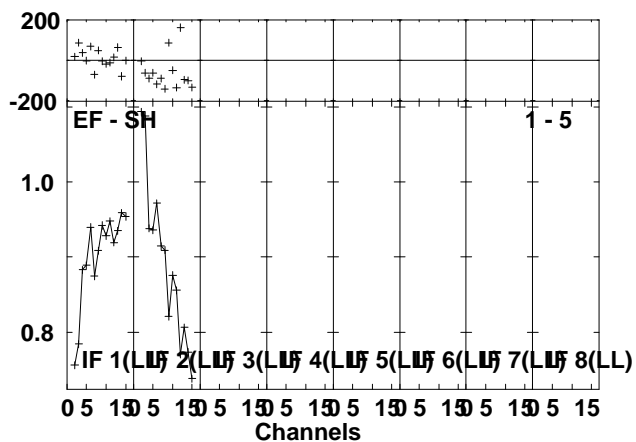
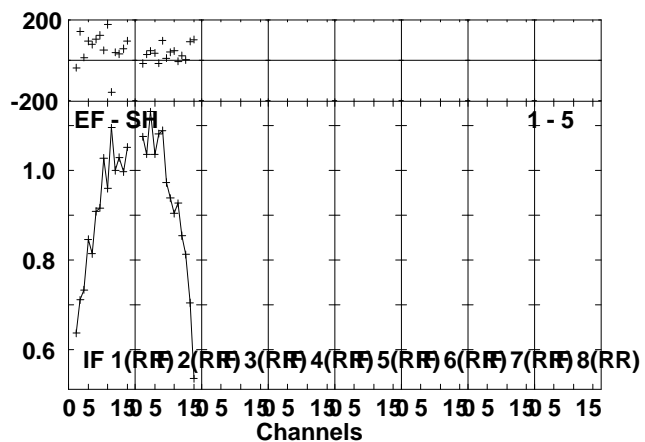
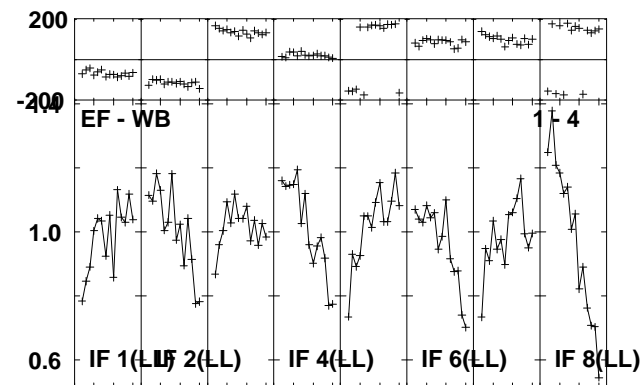
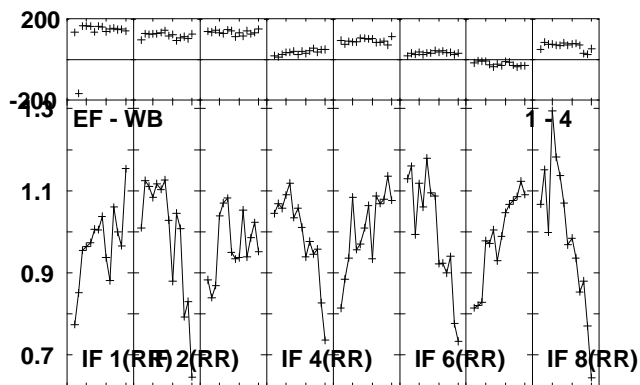
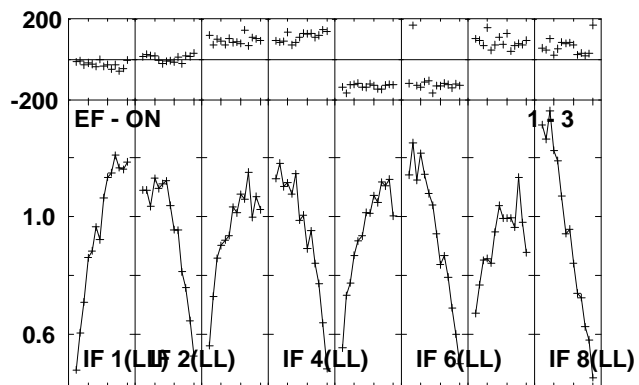
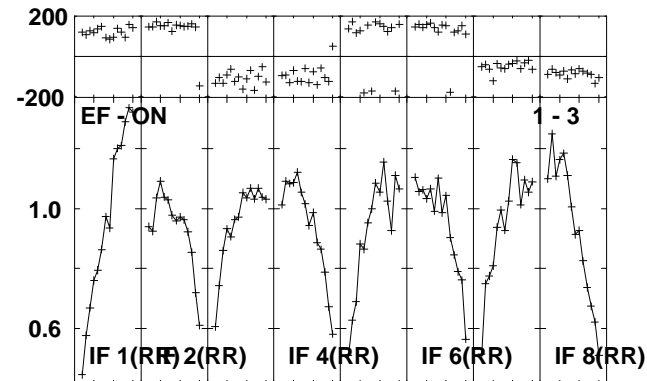
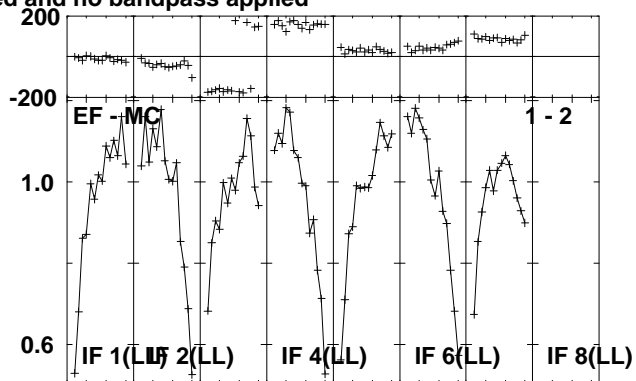
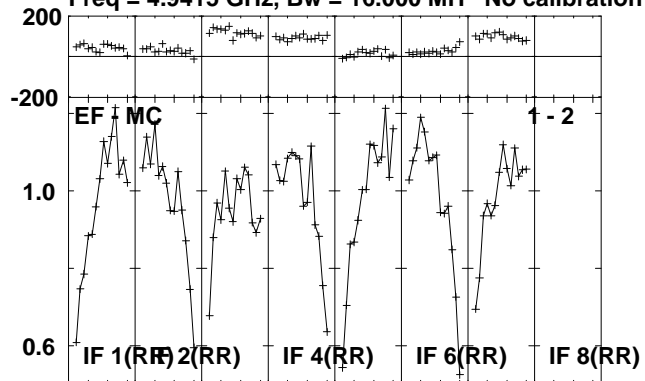

Lower frame: Milli Ampl Jy Top frame: Phas deg
Scalar averaged cross-power spectrum Several baselines displayed
Timerange: 00/21:22:11 to 00/21:27:09

Plot file version 106 created 14-JUL-2010 16:35:59

CYGX-1 RR004A.UVDATA.1

Freq = 4.9415 GHz, Bw = 16.000 MH No calibration applied and no bandpass applied

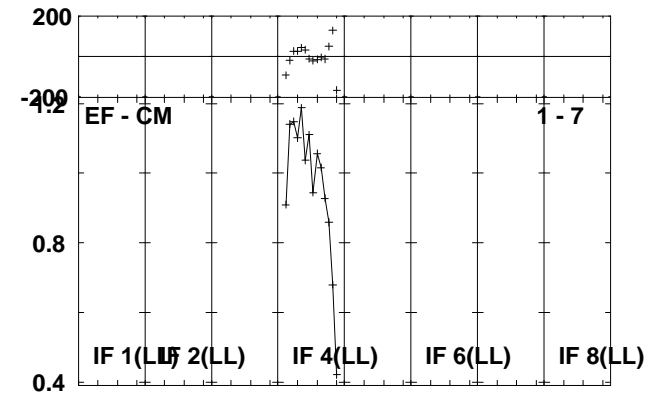
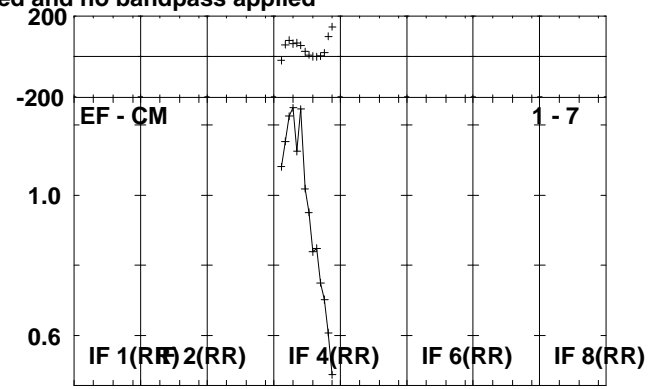
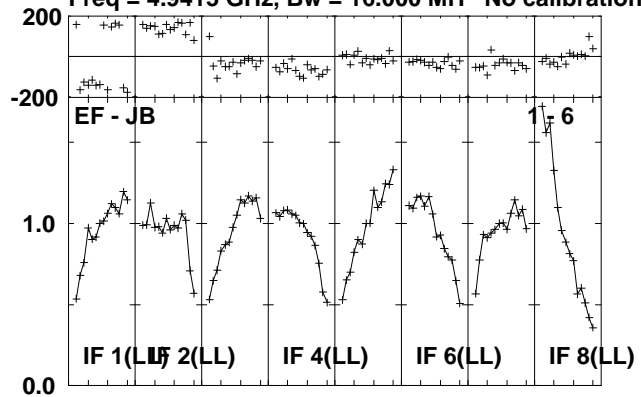

Lower frame: Milli Ampl Jy Top frame: Phas deg
Scalar averaged cross-power spectrum Several baselines displayed
Timerange: 00/21:22:11 to 00/21:27:09

Plot file version 107 created 14-JUL-2010 16:36:00

J1953+35 RR004A.UVDATA.1

Freq = 4.9415 GHz, Bw = 16.000 MH No calibration applied and no bandpass applied

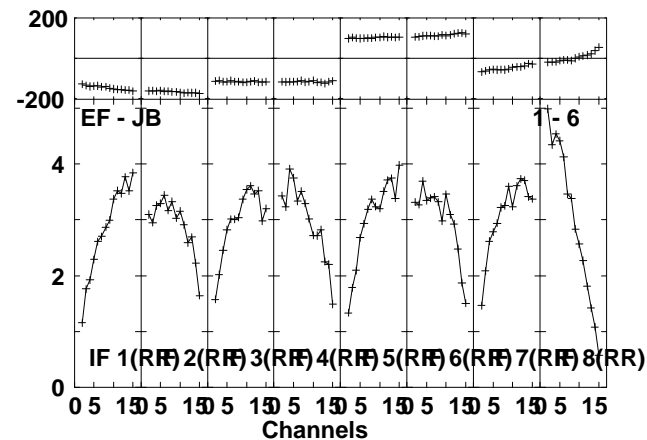
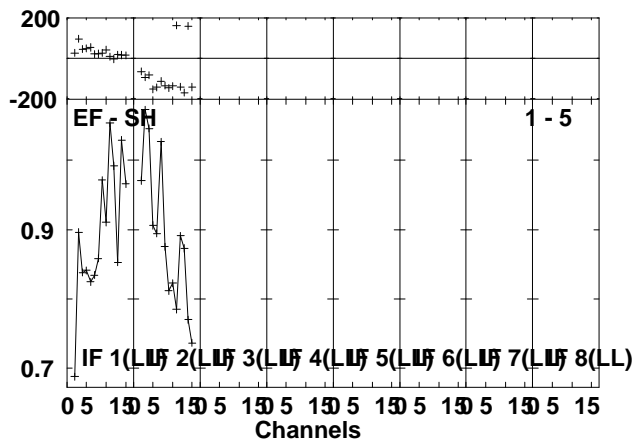
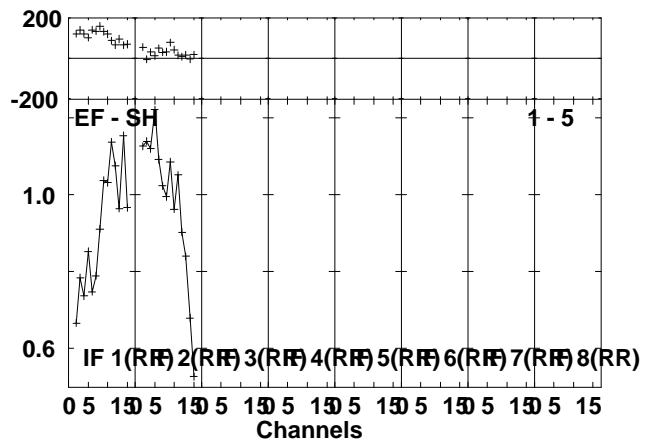
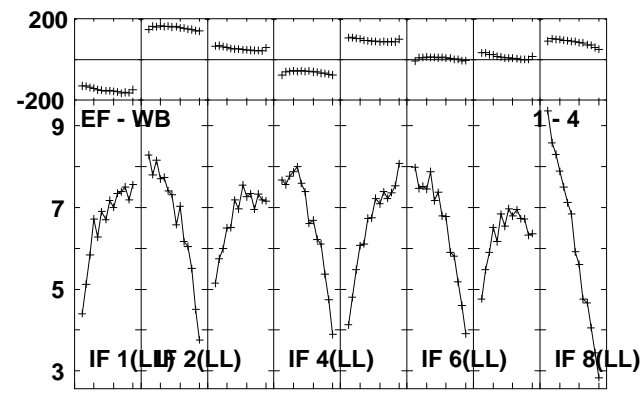
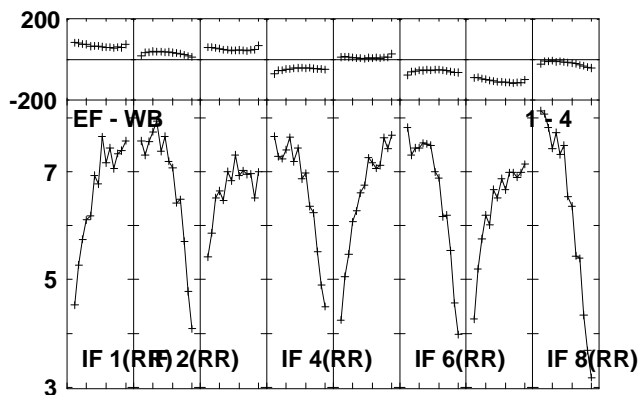
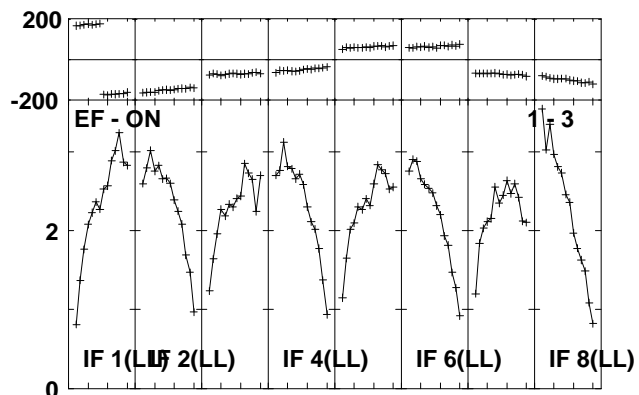
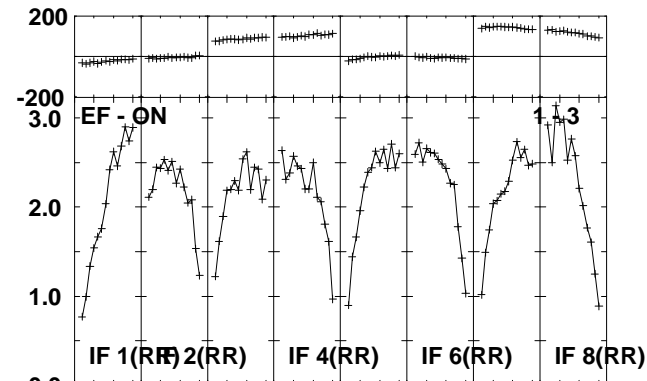
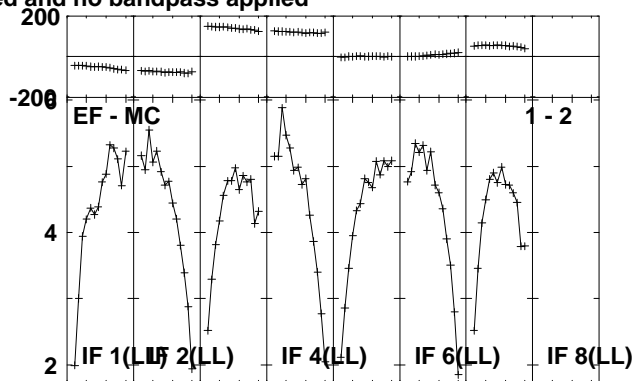
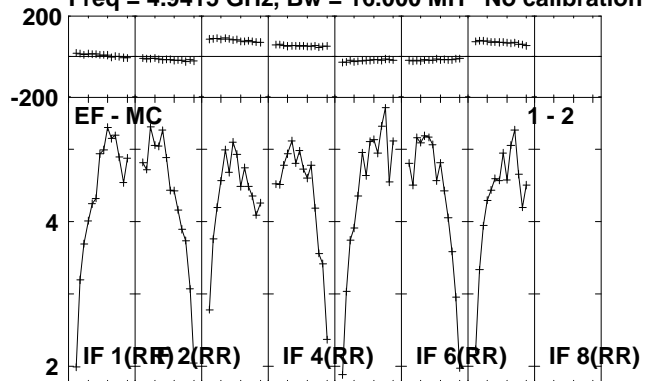

Lower frame: Milli Ampl Jy Top frame: Phas deg
Scalar averaged cross-power spectrum Several baselines displayed
Timerange: 00/21:27:51 to 00/21:29:19

Plot file version 108 created 14-JUL-2010 16:36:01

J1953+35 RR004A.UVDATA.1

Freq = 4.9415 GHz, Bw = 16.000 MH No calibration applied and no bandpass applied

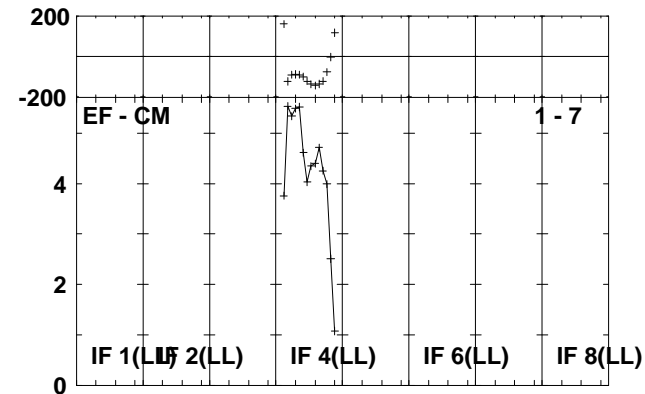
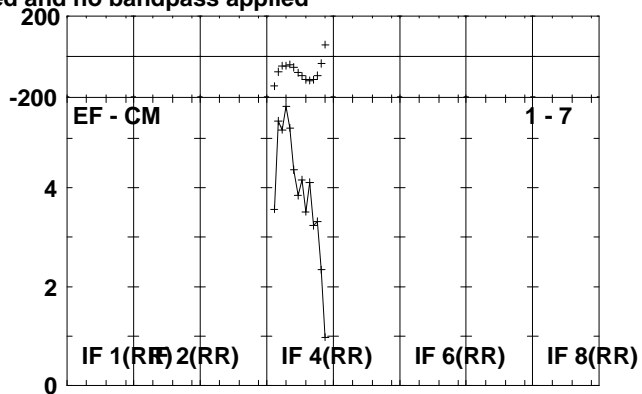
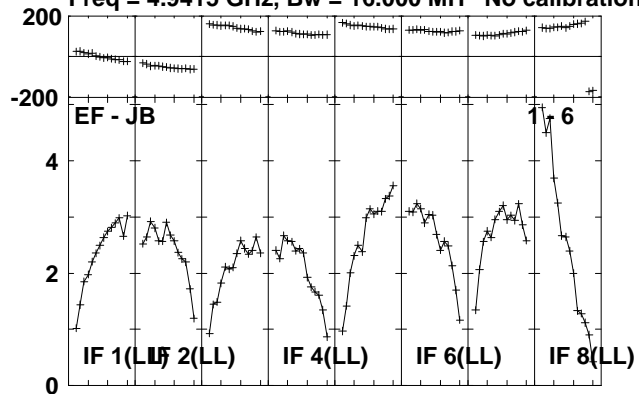

Lower frame: Milli Ampl Jy Top frame: Phas deg
Scalar averaged cross-power spectrum Several baselines displayed
Timerange: 00/21:27:51 to 00/21:29:19

Plot file version 109 created 14-JUL-2010 16:36:01

J2002+47 RR004A.UVDATA.1

Freq = 4.9415 GHz, Bw = 16.000 MH No calibration applied and no bandpass applied

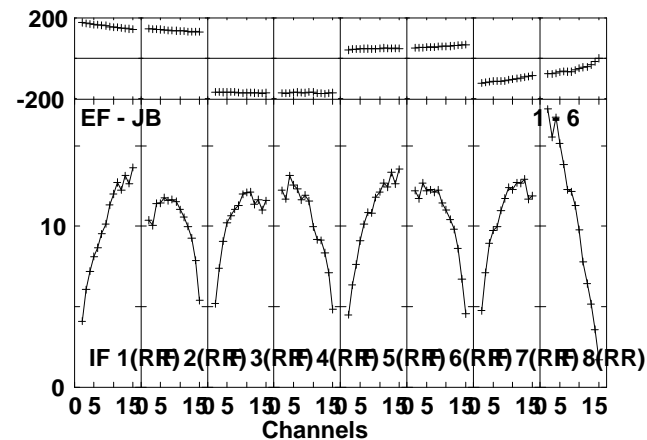
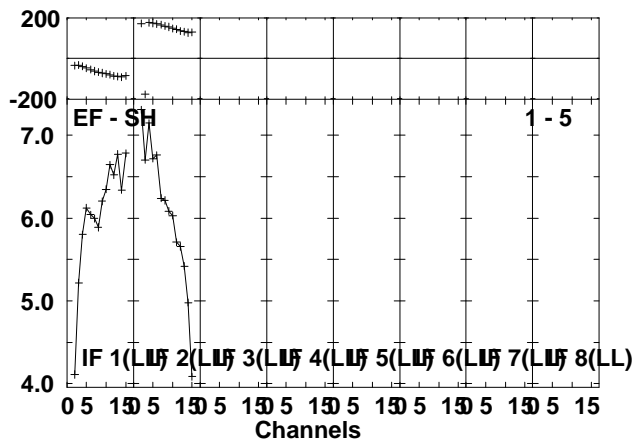
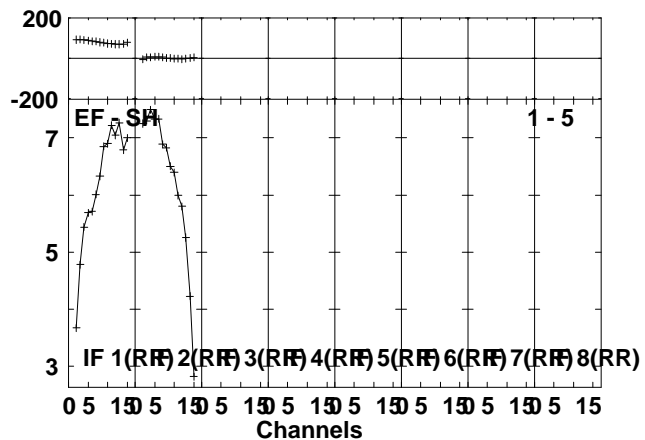
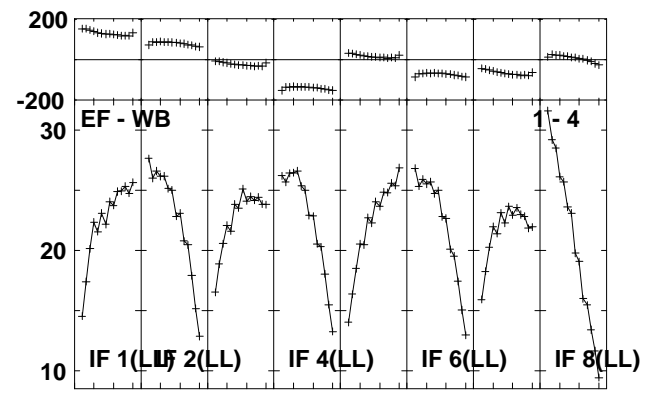
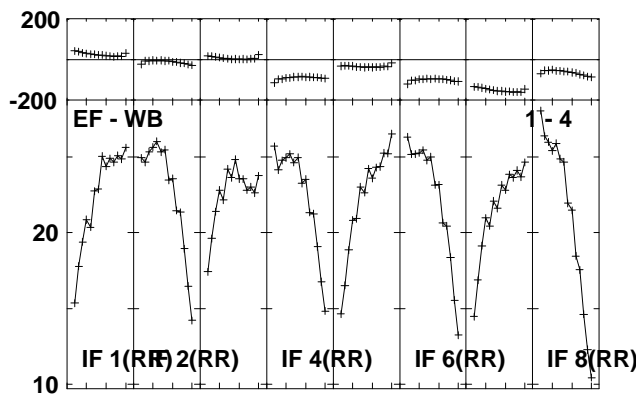
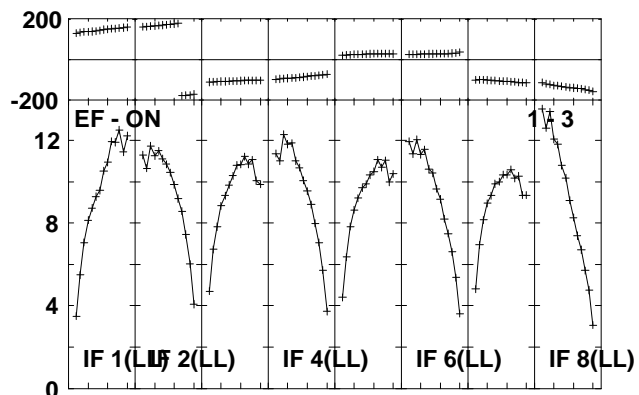
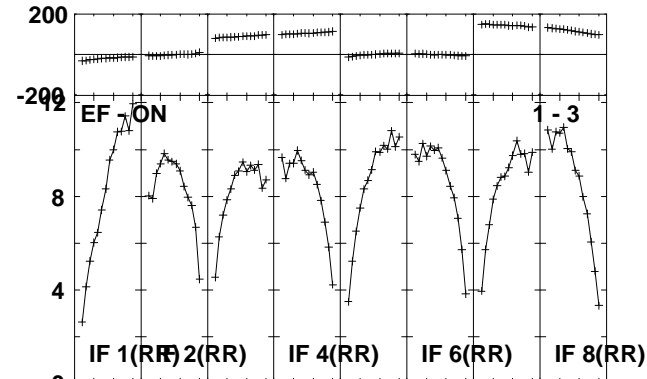
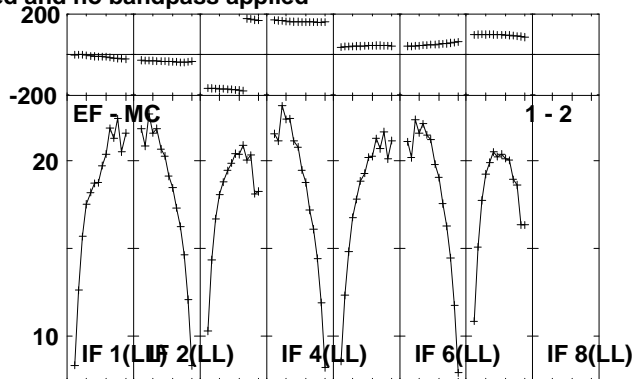
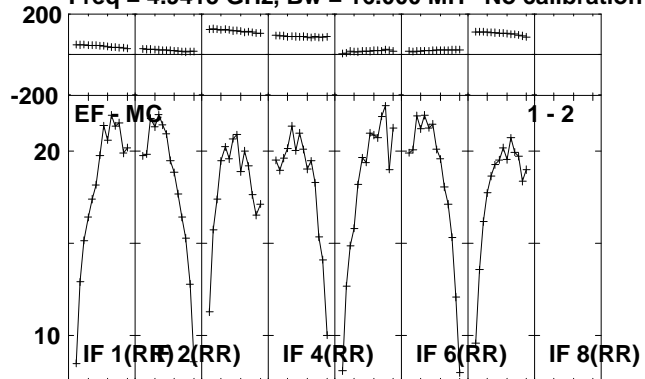

Lower frame: Milli Ampl Jy Top frame: Phas deg
Scalar averaged cross-power spectrum Several baselines displayed
Timerange: 00/21:31:21 to 00/21:36:19

Plot file version 110 created 14-JUL-2010 16:36:03

J2002+47 RR004A.UVDATA.1

Freq = 4.9415 GHz, Bw = 16.000 MH No calibration applied and no bandpass applied

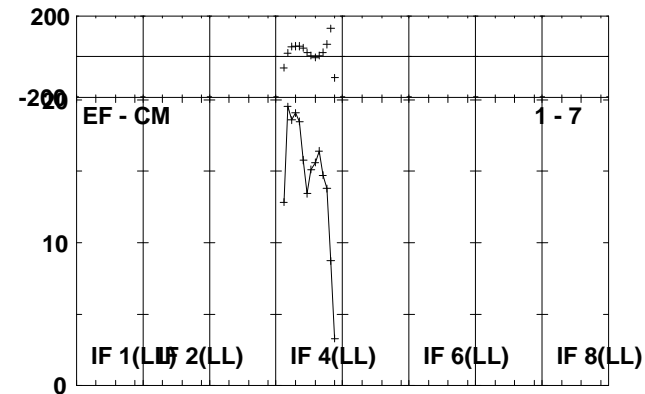
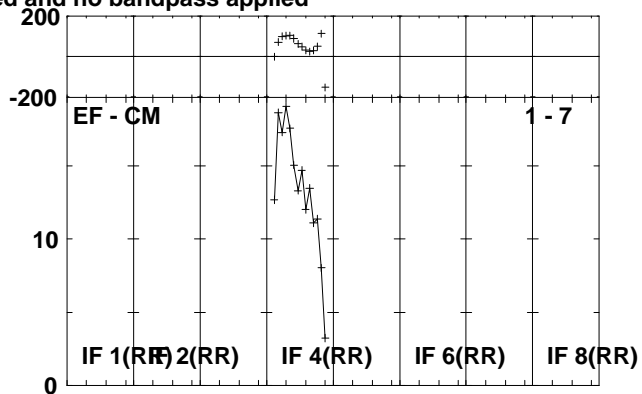
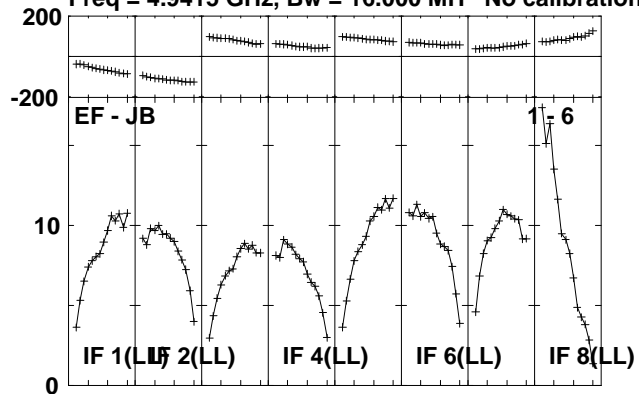

Lower frame: Milli Ampl Jy Top frame: Phas deg
Scalar averaged cross-power spectrum Several baselines displayed
Timerange: 00/21:31:21 to 00/21:36:19

Plot file version 111 created 14-JUL-2010 16:36:04

J1953+35 RR004A.UVDATA.1

Freq = 4.9415 GHz, Bw = 16.000 MH No calibration applied and no bandpass applied

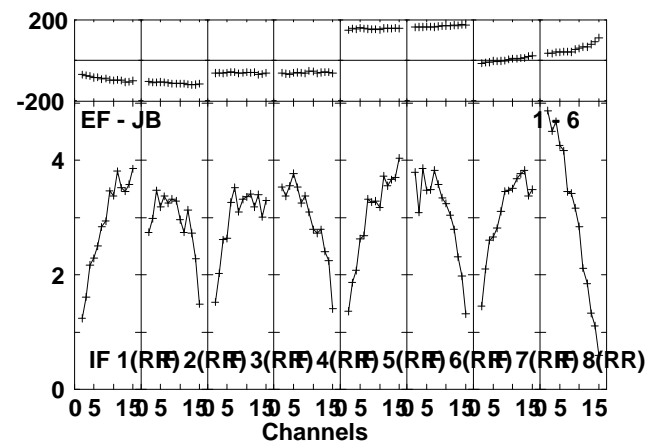
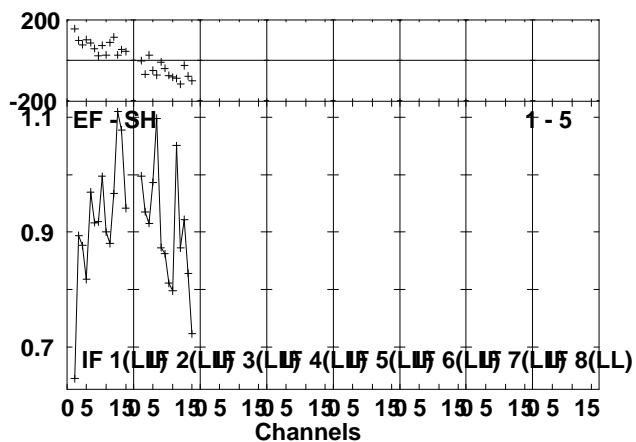
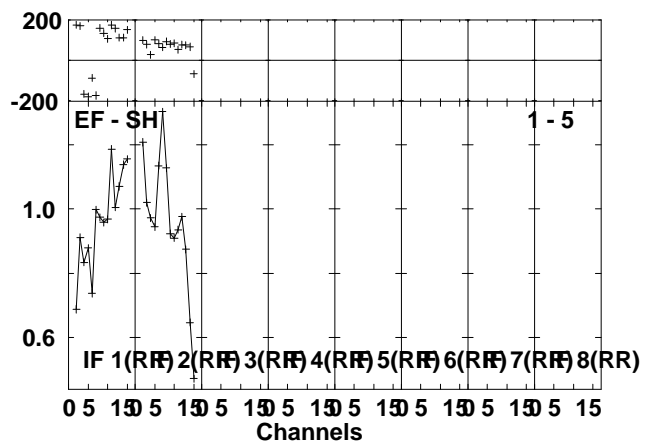
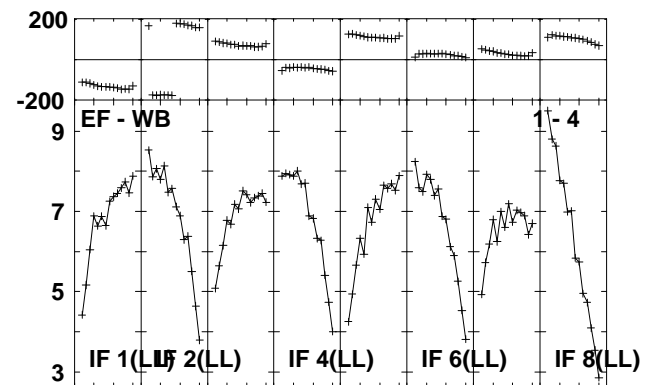
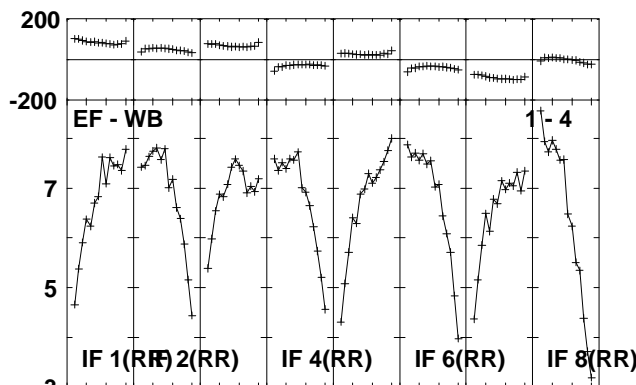
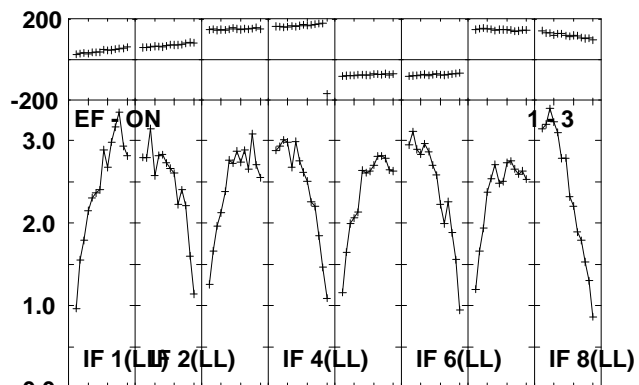
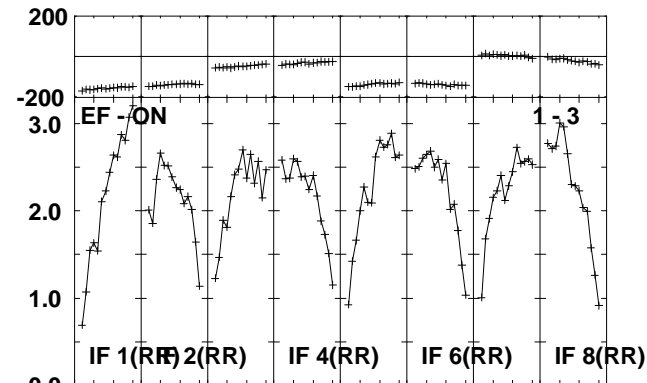
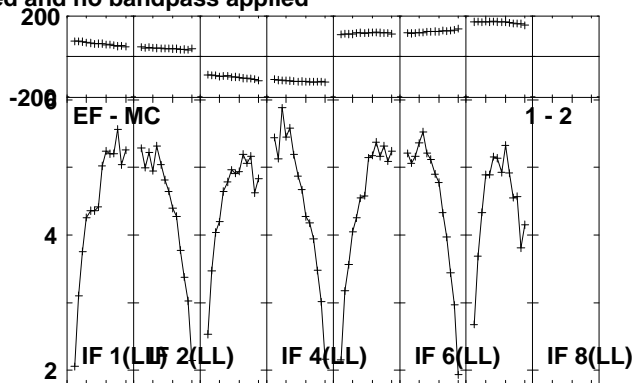
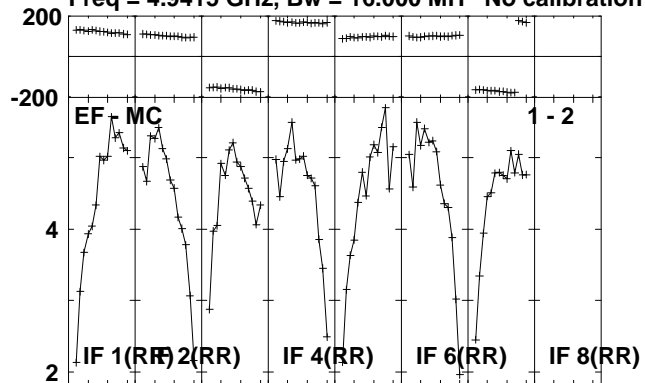

Lower frame: Milli Ampl Jy Top frame: Phas deg
Scalar averaged cross-power spectrum Several baselines displayed
Timerange: 00/21:37:51 to 00/21:39:19

Plot file version 112 created 14-JUL-2010 16:36:04
J1953+35 RR004A.UVDATA.1

Freq = 4.9415 GHz, Bw = 16.000 MH No calibration applied and no bandpass applied

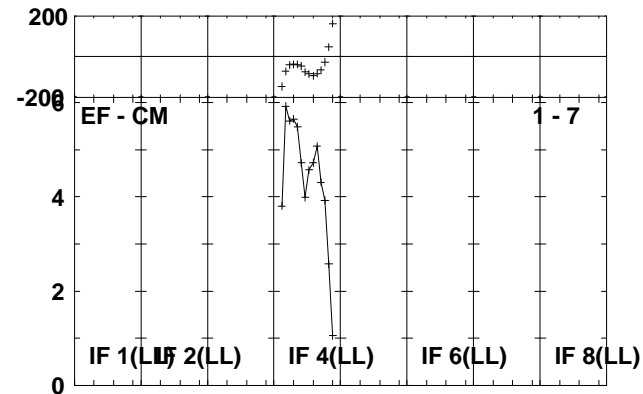
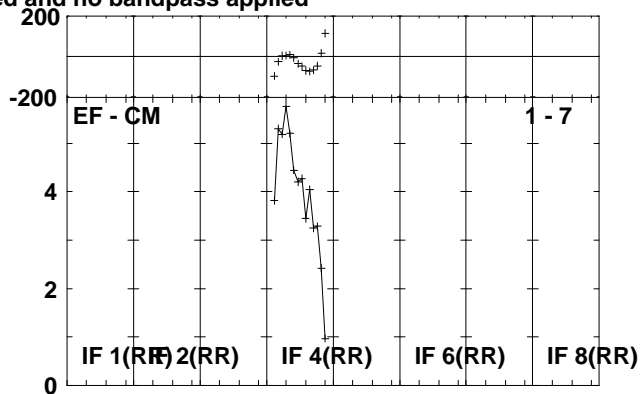
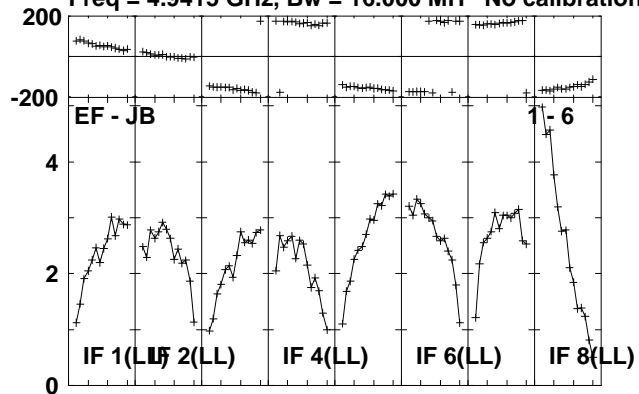

Lower frame: Milli Ampl Jy Top frame: Phas deg
Scalar averaged cross-power spectrum Several baselines displayed
Timerange: 00/21:37:51 to 00/21:39:19

Plot file version 113 created 14-JUL-2010 16:36:05

CYGX-1 RR004A.UVDATA.1

Freq = 4.9415 GHz, Bw = 16.000 MH No calibration applied and no bandpass applied

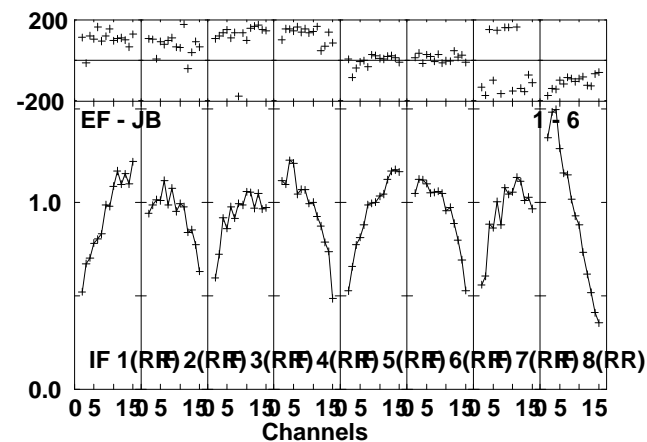
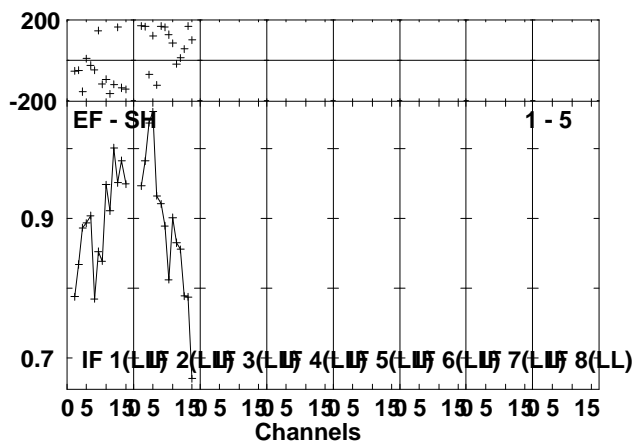
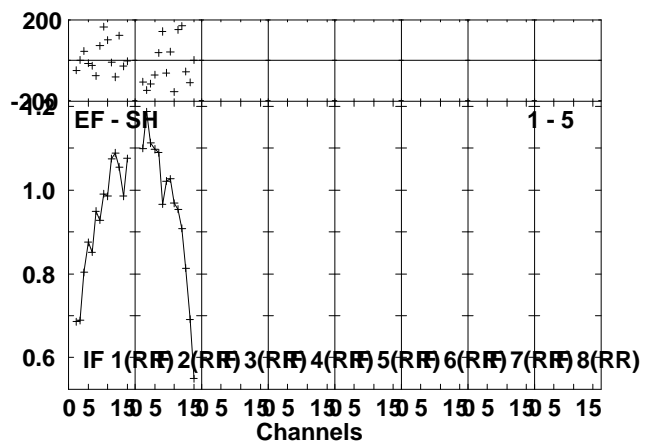
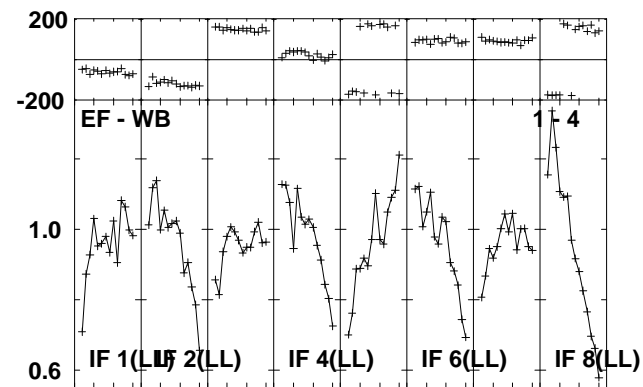
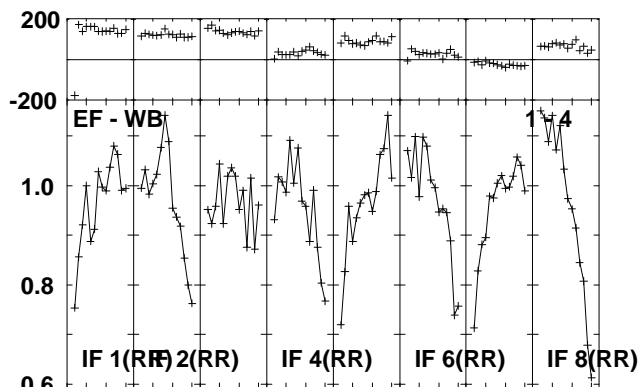
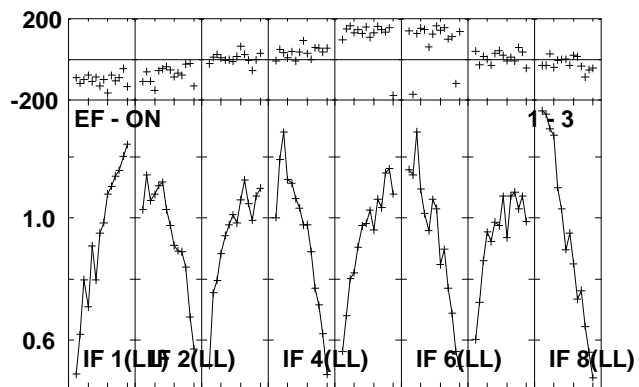
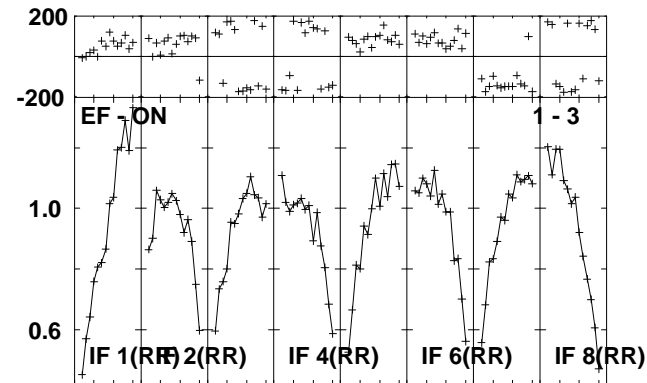
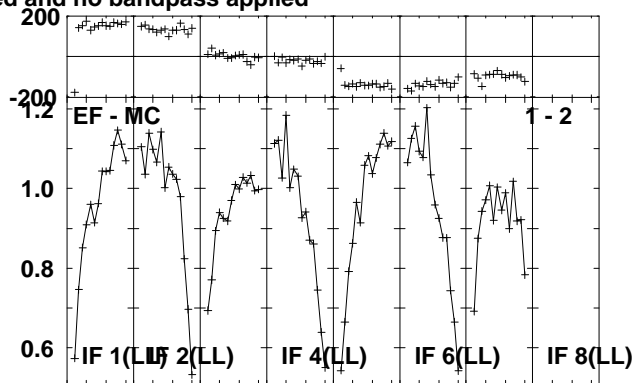
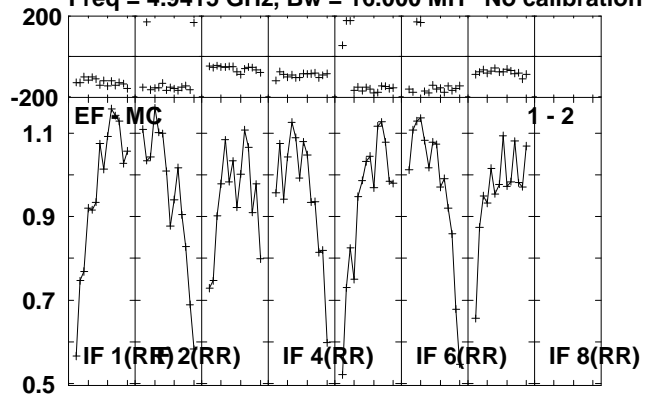

Lower frame: Milli Ampl Jy Top frame: Phas deg
Scalar averaged cross-power spectrum Several baselines displayed
Timerange: 00/21:39:21 to 00/21:44:19

Plot file version 114 created 14-JUL-2010 16:36:06
CYGX-1 RR004A.UVDATA.1

Freq = 4.9415 GHz, Bw = 16.000 MH No calibration applied and no bandpass applied

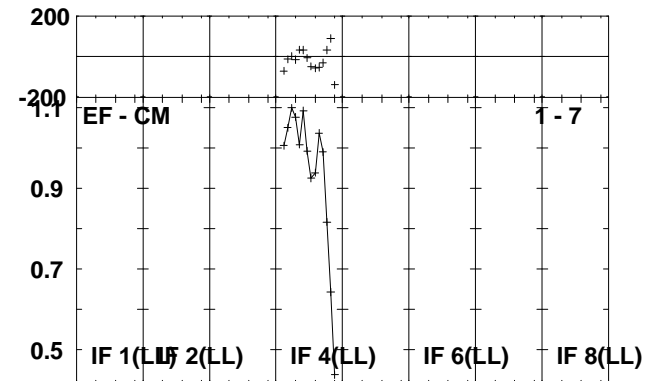
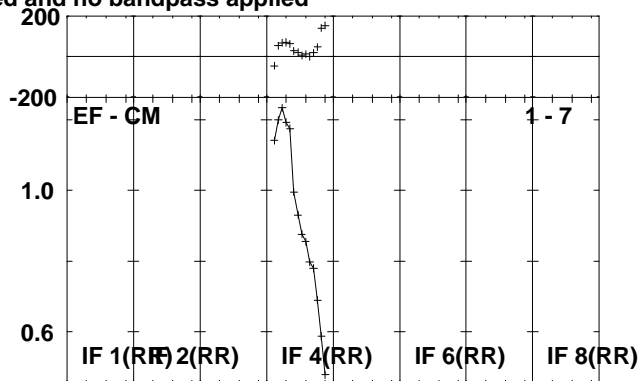
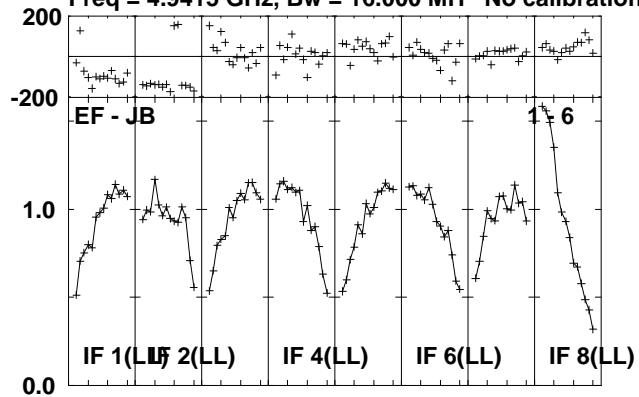

Lower frame: Milli Ampl Jy Top frame: Phas deg
Scalar averaged cross-power spectrum Several baselines displayed
Timerange: 00/21:39:21 to 00/21:44:19

Plot file version 115 created 14-JUL-2010 16:36:08

J1953+35 RR004A.UVDATA.1

Freq = 4.9415 GHz, Bw = 16.000 MH No calibration applied and no bandpass applied

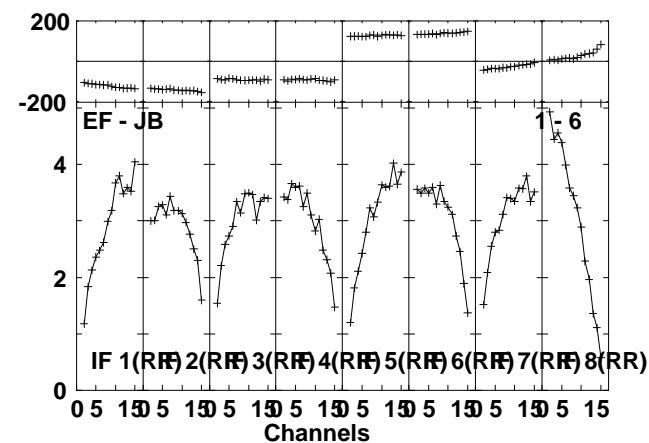
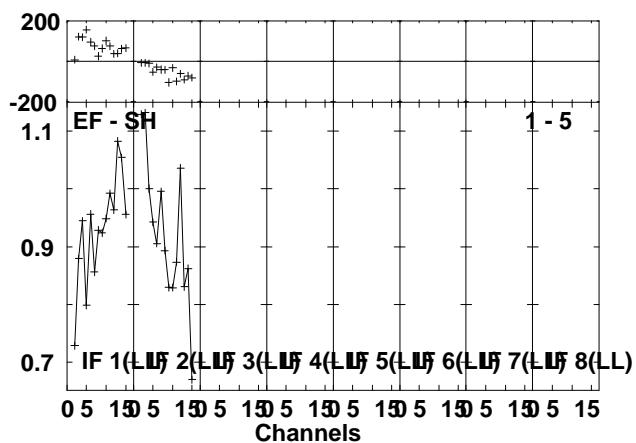
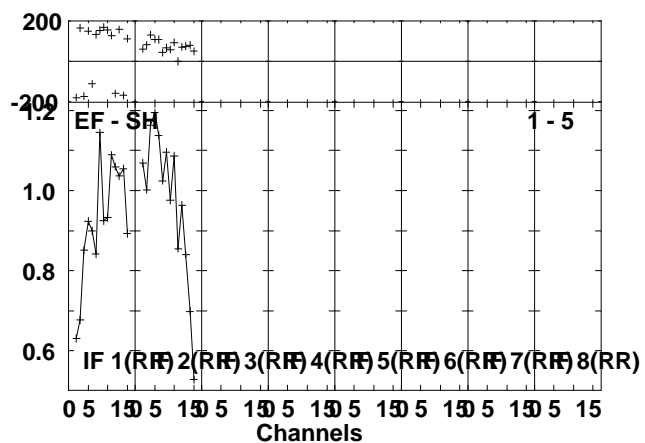
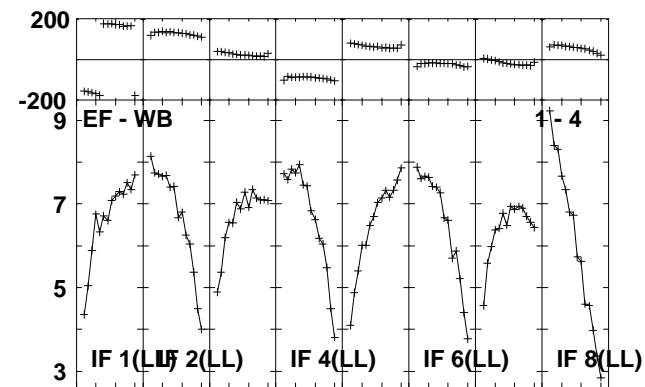
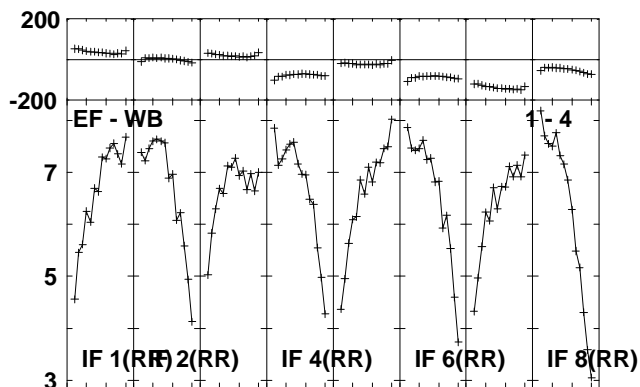
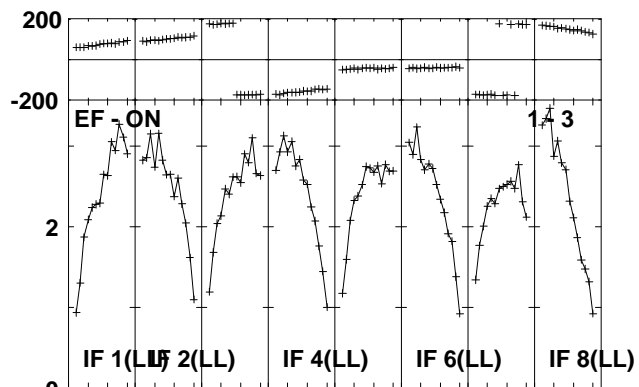
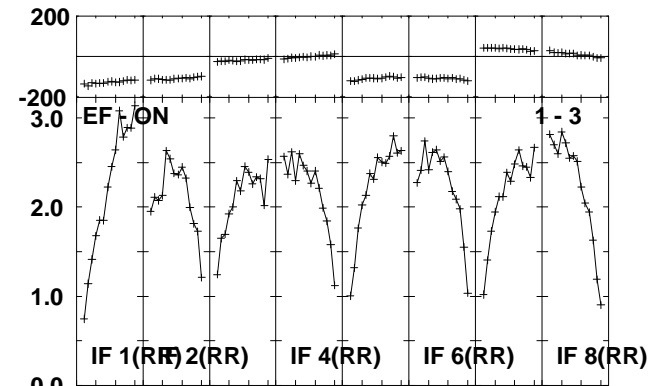
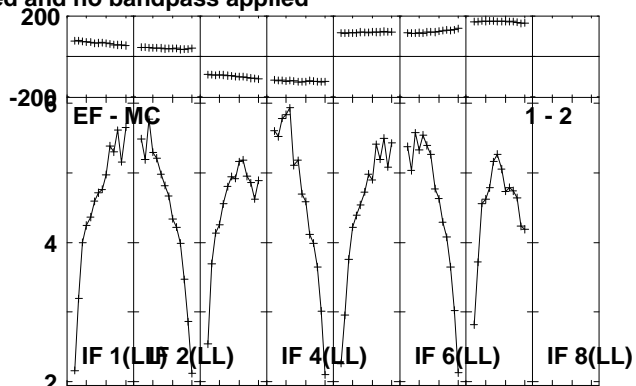
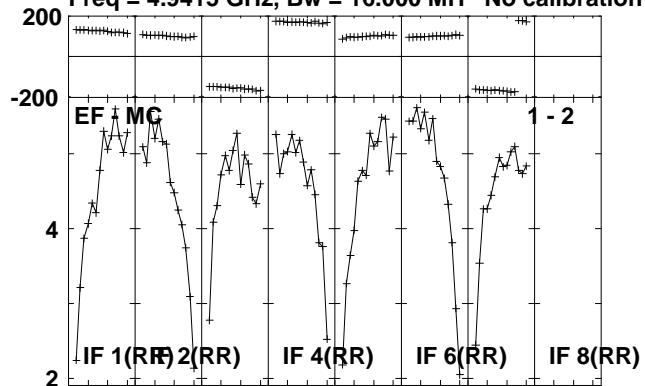

Lower frame: Milli Ampl Jy Top frame: Phas deg
Scalar averaged cross-power spectrum Several baselines displayed
Timerange: 00/21:44:21 to 00/21:46:19

Plot file version 116 created 14-JUL-2010 16:36:08

J1953+35 RR004A.UVDATA.1

Freq = 4.9415 GHz, Bw = 16.000 MH No calibration applied and no bandpass applied

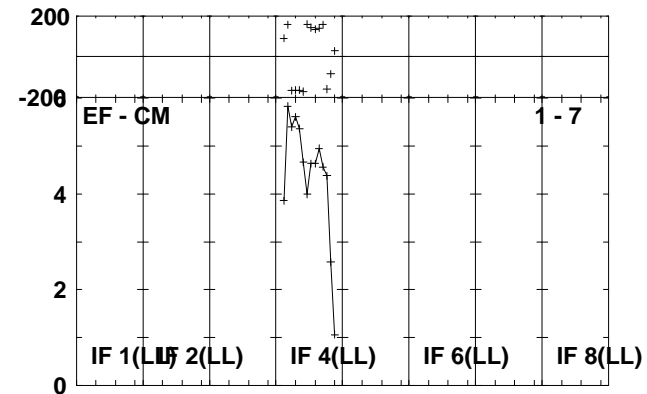
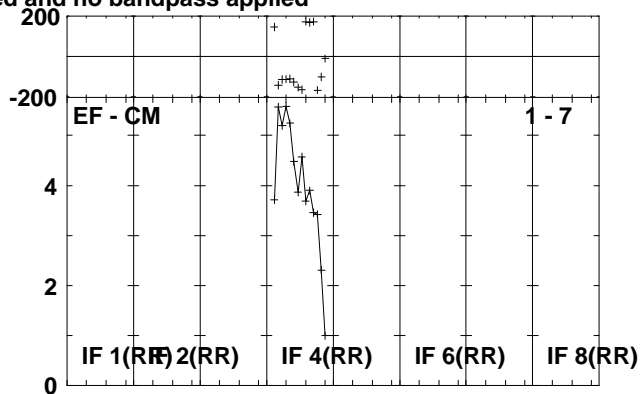
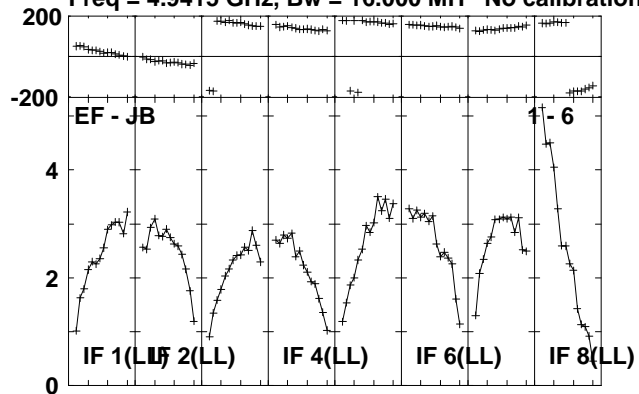

Lower frame: Milli Ampl Jy Top frame: Phas deg
Scalar averaged cross-power spectrum Several baselines displayed
Timerange: 00/21:44:21 to 00/21:46:19

Plot file version 117 created 14-JUL-2010 16:36:09

CYGX-1 RR004A.UVDATA.1

Freq = 4.9415 GHz, Bw = 16.000 MH No calibration applied and no bandpass applied

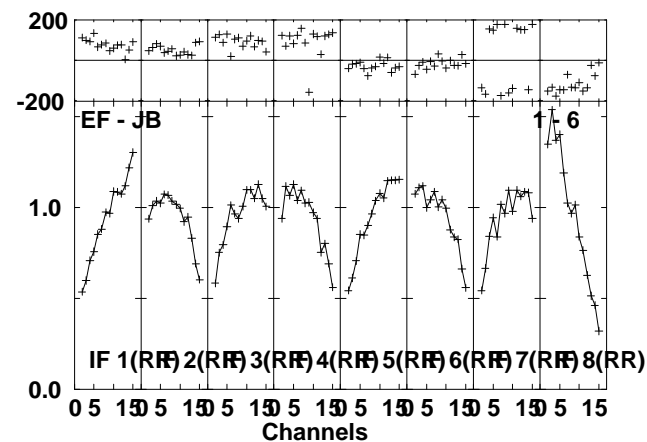
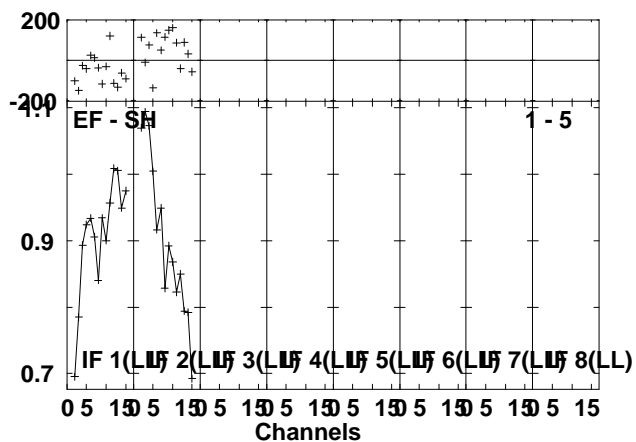
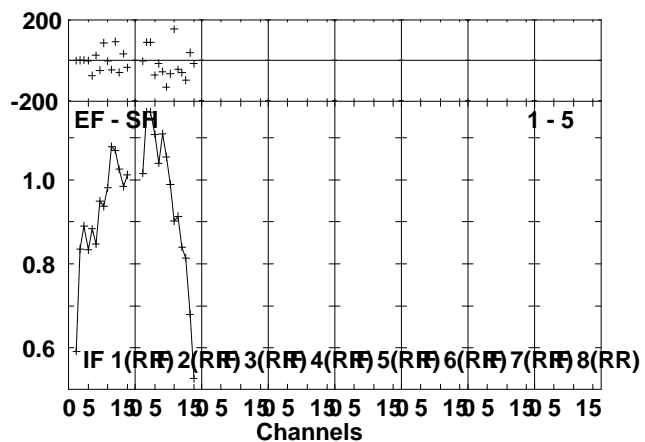
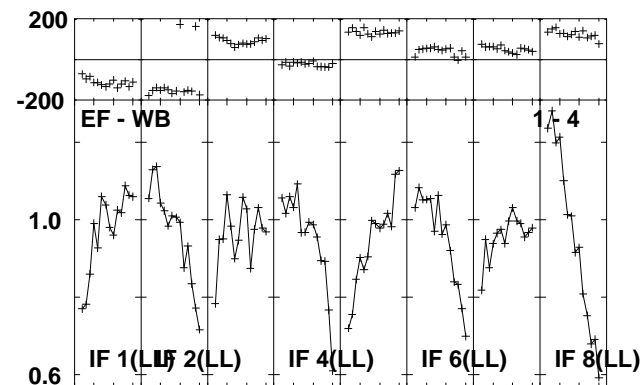
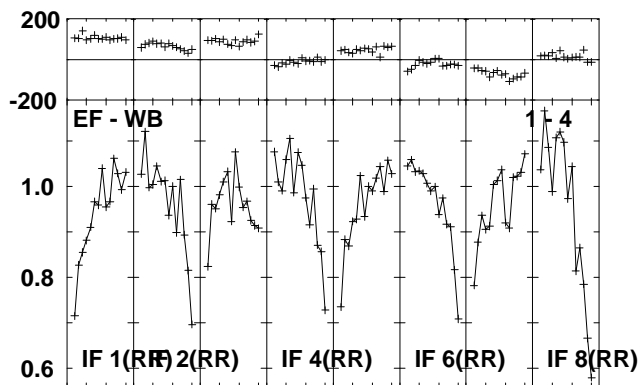
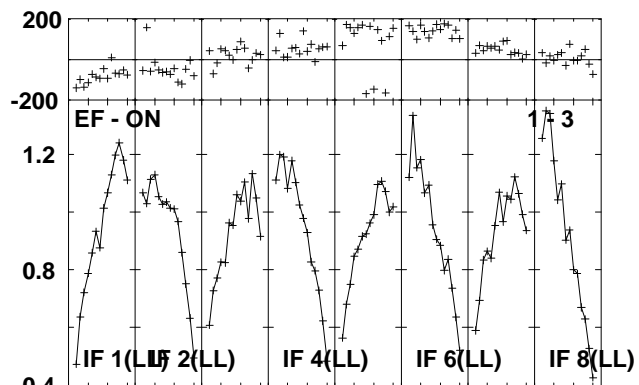
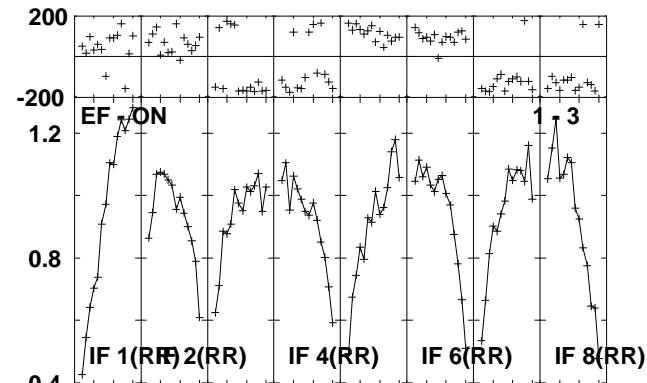
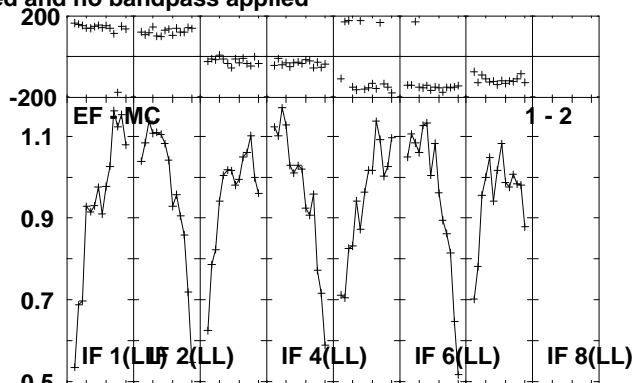
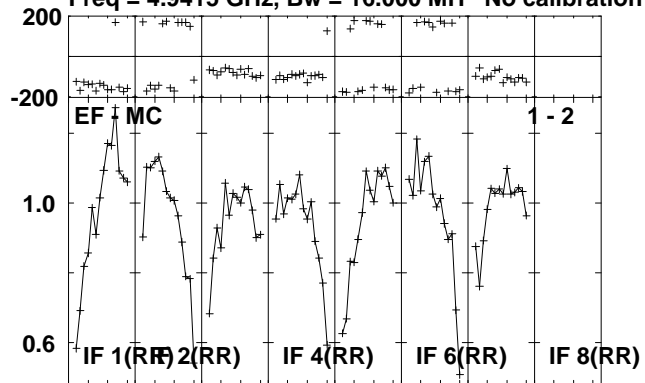

Lower frame: Milli Ampl Jy Top frame: Phas deg
Scalar averaged cross-power spectrum Several baselines displayed
Timerange: 00/21:46:21 to 00/21:51:19

Plot file version 118 created 14-JUL-2010 16:36:10

CYGX-1 RR004A.UVDATA.1

Freq = 4.9415 GHz, Bw = 16.000 MH No calibration applied and no bandpass applied

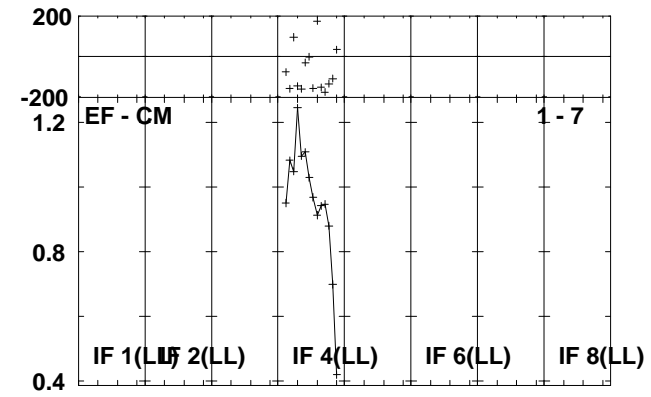
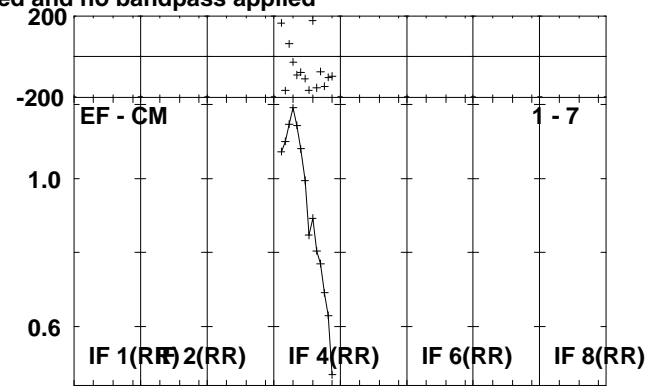
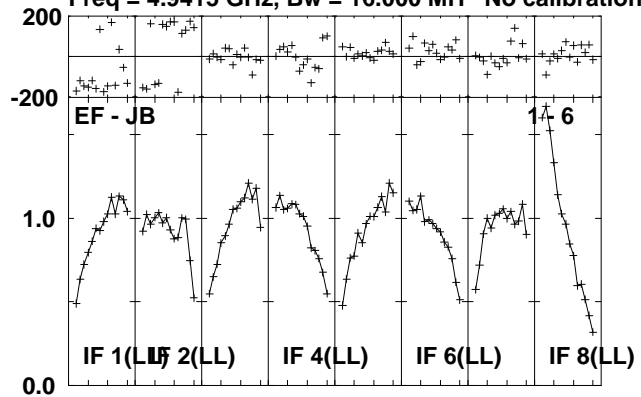

Lower frame: Milli Ampl Jy Top frame: Phas deg
Scalar averaged cross-power spectrum Several baselines displayed
Timerange: 00/21:46:21 to 00/21:51:19

Plot file version 119 created 14-JUL-2010 16:36:11

J1953+35 RR004A.UVDATA.1

Freq = 4.9415 GHz, Bw = 16.000 MH No calibration applied and no bandpass applied

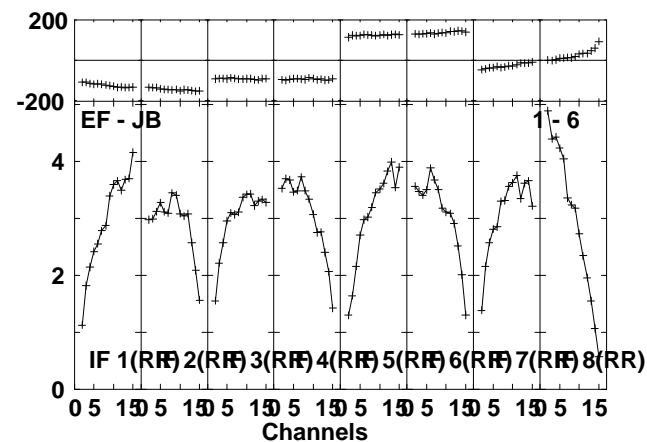
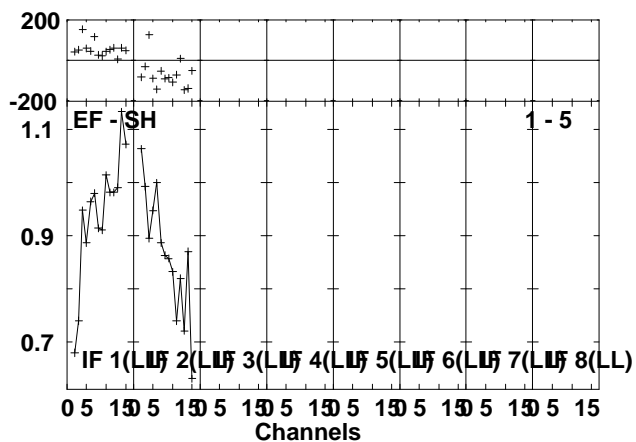
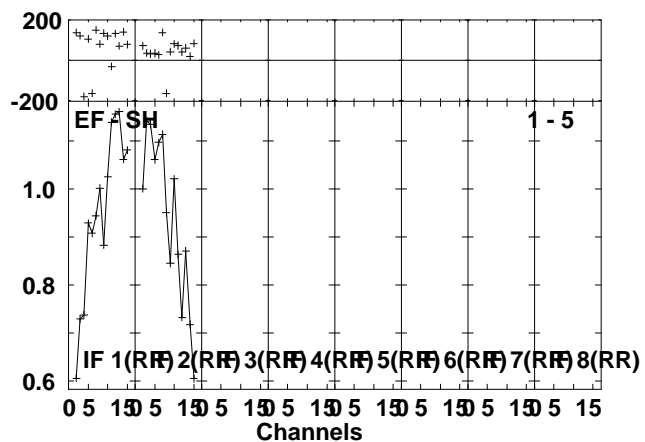
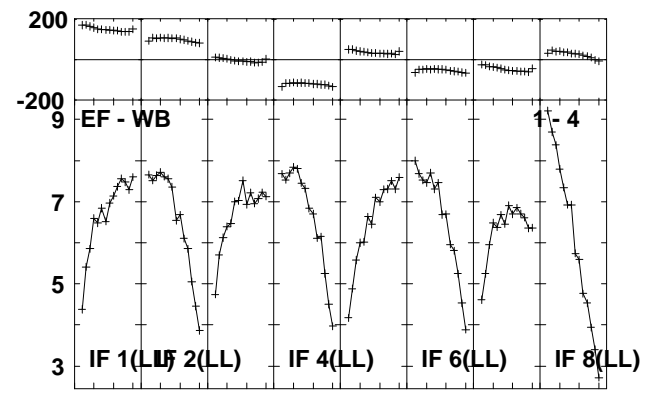
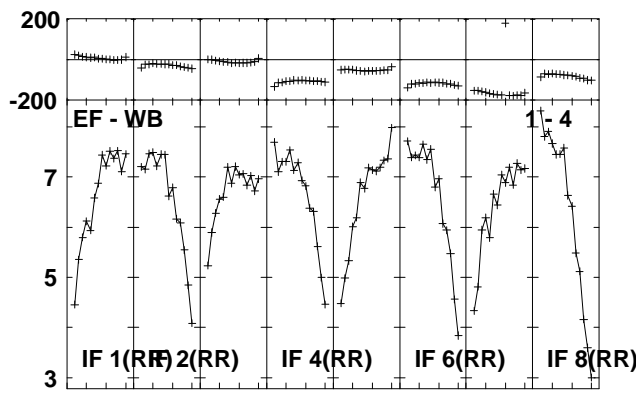
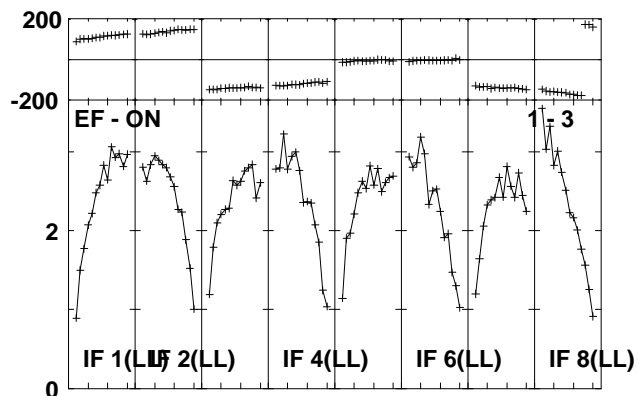
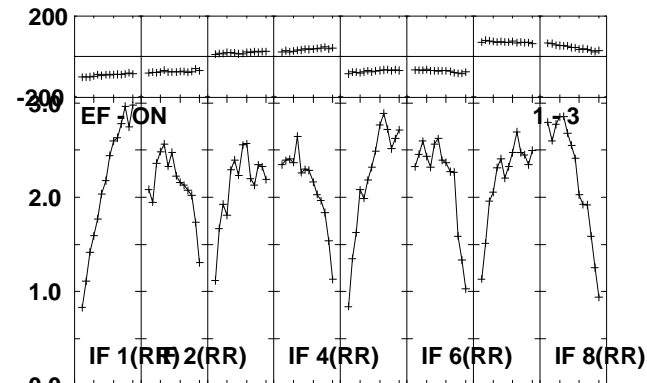
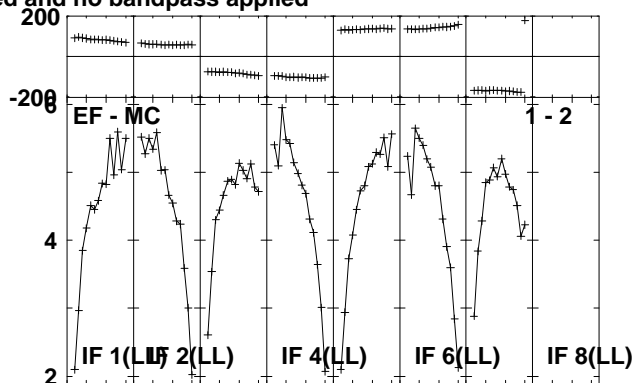
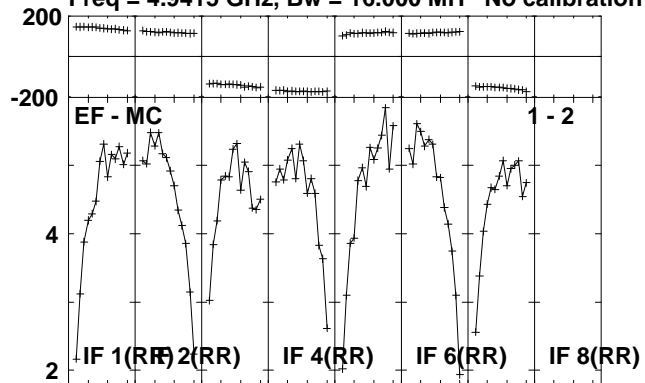

Lower frame: Milli Ampl Jy Top frame: Phas deg
Scalar averaged cross-power spectrum Several baselines displayed
Timerange: 00/21:52:01 to 00/21:53:29

Plot file version 120 created 14-JUL-2010 16:36:12

J1953+35 RR004A.UVDATA.1

Freq = 4.9415 GHz, Bw = 16.000 MH No calibration applied and no bandpass applied

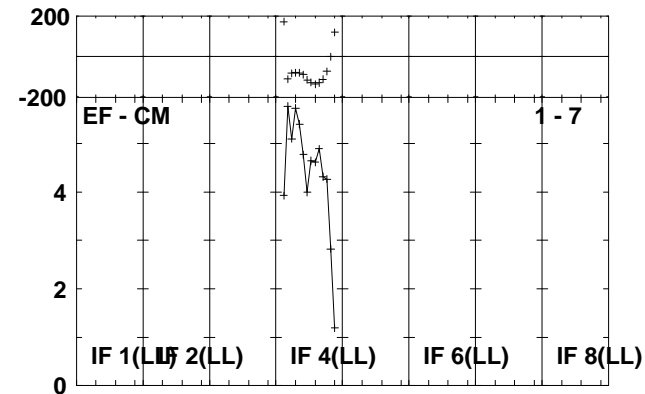
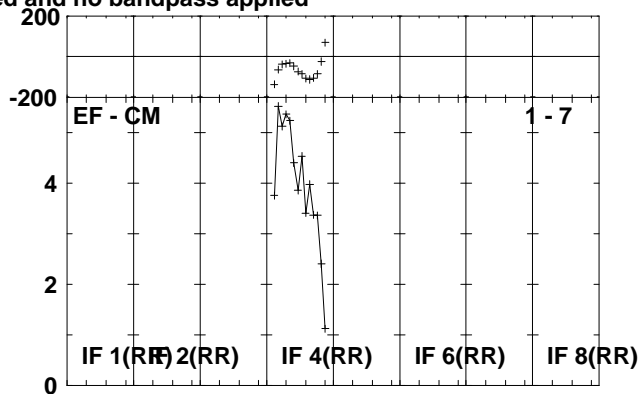
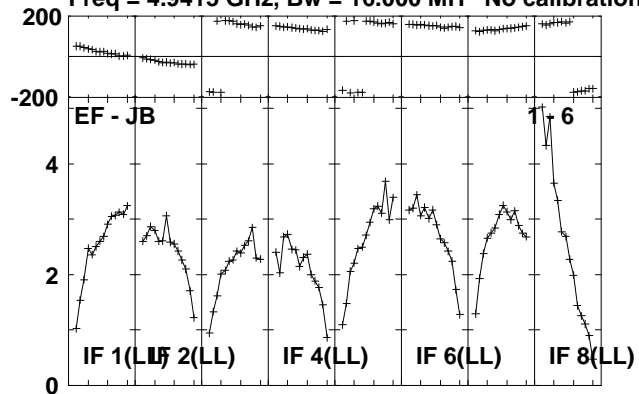

Lower frame: Milli Ampl Jy Top frame: Phas deg
Scalar averaged cross-power spectrum Several baselines displayed
Timerange: 00/21:52:01 to 00/21:53:29

Plot file version 121 created 14-JUL-2010 16:36:12

CYGX-1 RR004A.UVDATA.1

Freq = 4.9415 GHz, Bw = 16.000 MH No calibration applied and no bandpass applied

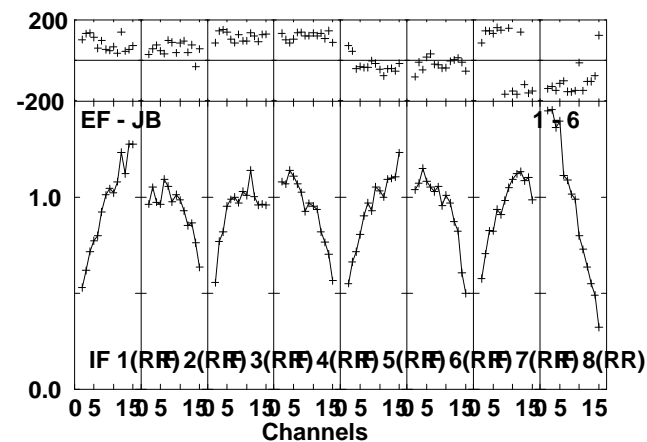
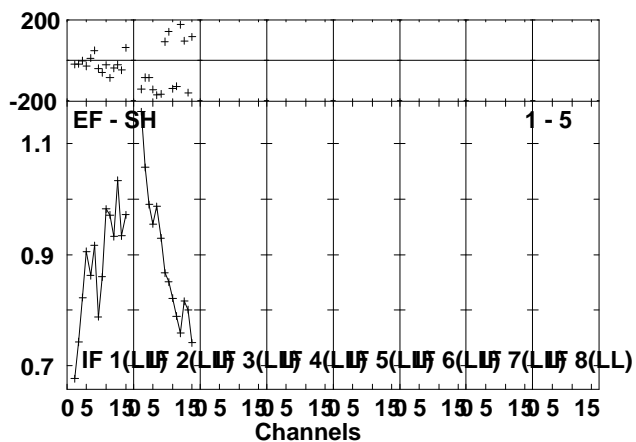
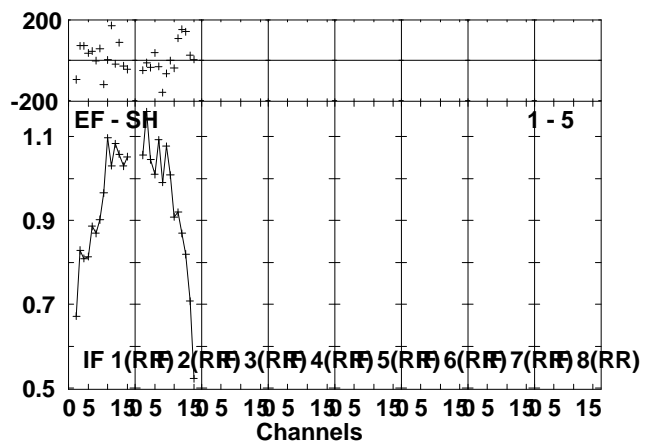
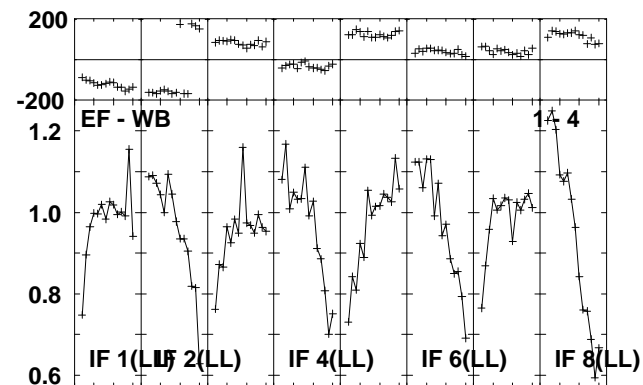
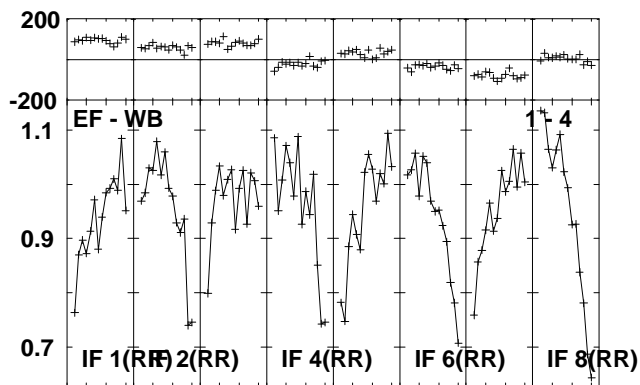
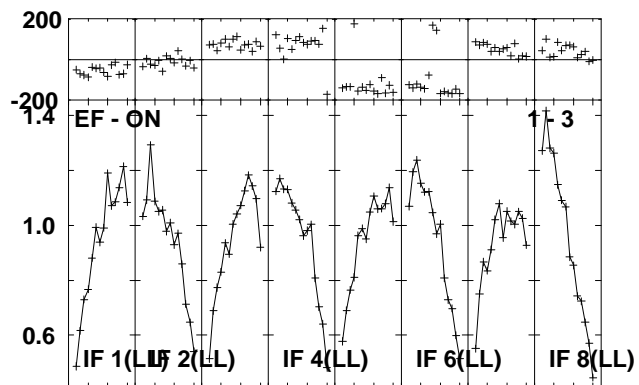
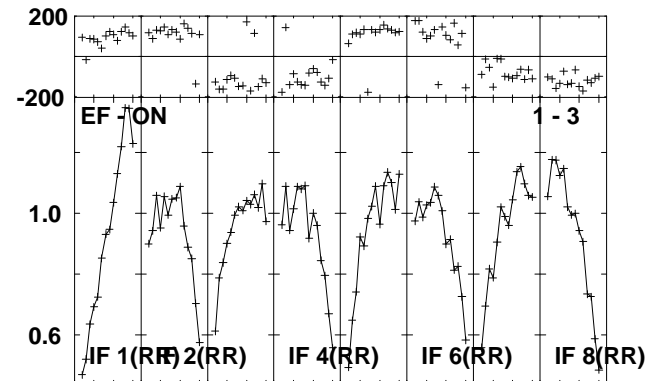
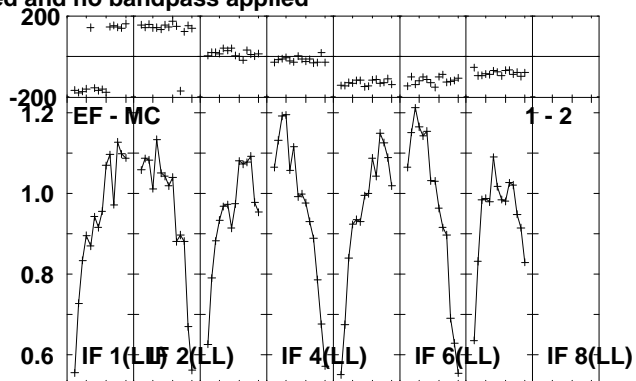
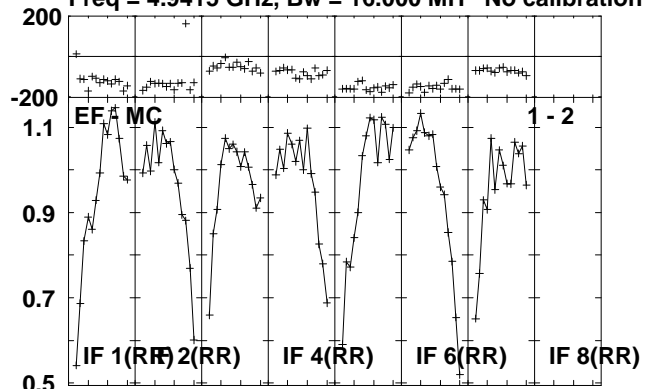

Lower frame: Milli Ampl Jy Top frame: Phas deg
Scalar averaged cross-power spectrum Several baselines displayed
Timerange: 00/21:53:31 to 00/21:58:29

Plot file version 122 created 14-JUL-2010 16:36:13

CYGX-1 RR004A.UVDATA.1

Freq = 4.9415 GHz, Bw = 16.000 MH No calibration applied and no bandpass applied

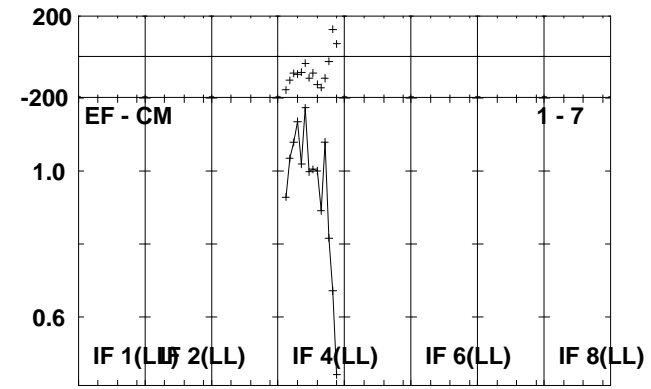
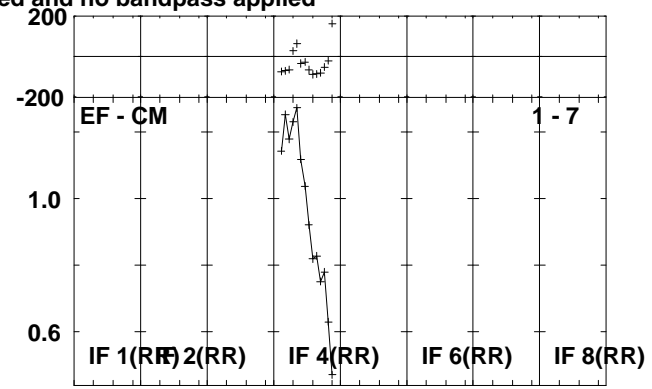
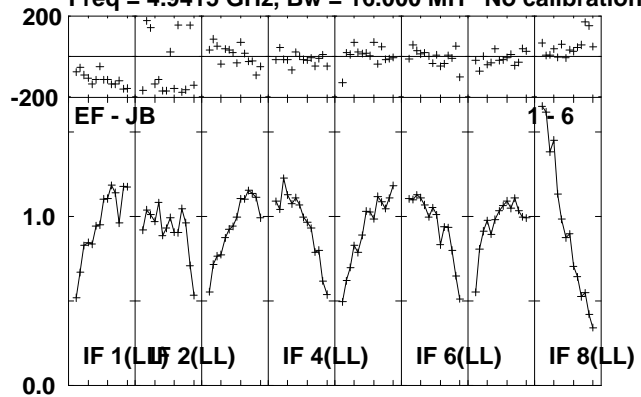

Lower frame: Milli Ampl Jy Top frame: Phas deg
Scalar averaged cross-power spectrum Several baselines displayed
Timerange: 00/21:53:31 to 00/21:58:29

Plot file version 123 created 14-JUL-2010 16:36:20

J1953+35 RR004A.UVDATA.1

Freq = 4.9415 GHz, Bw = 16.000 MH No calibration applied and no bandpass applied

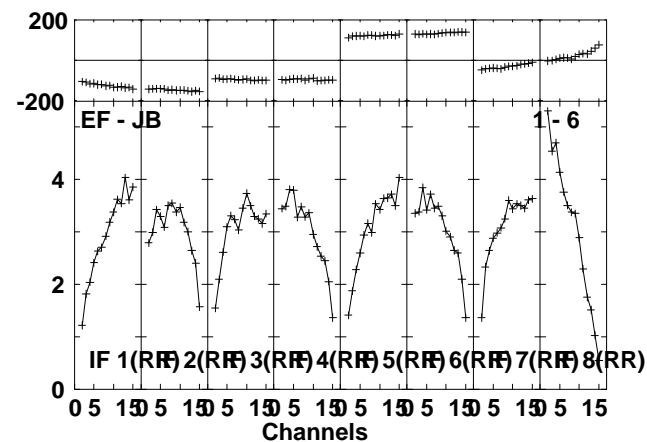
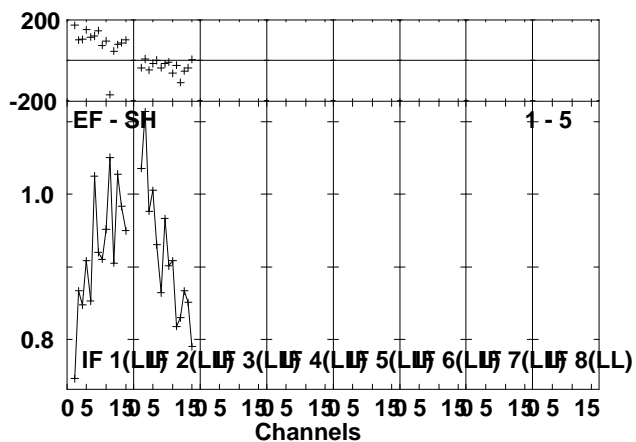
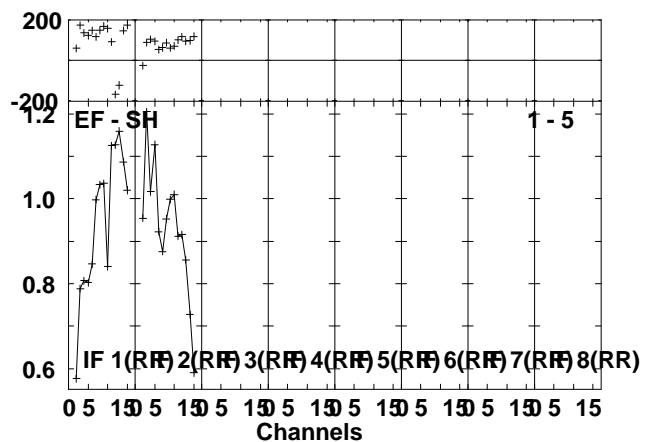
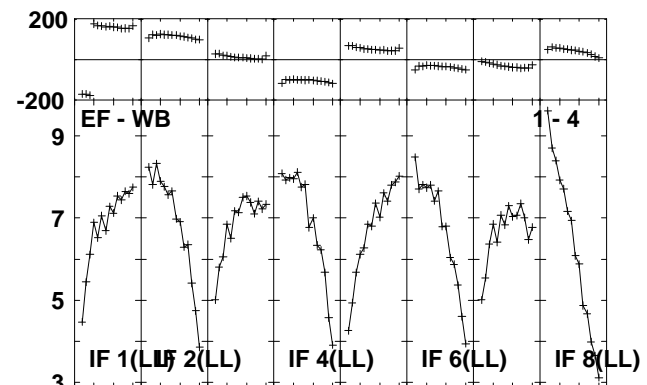
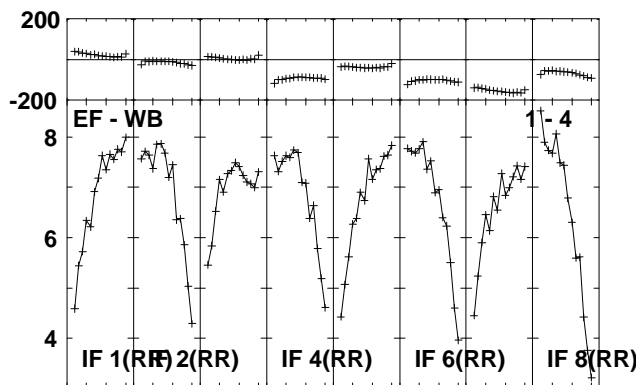
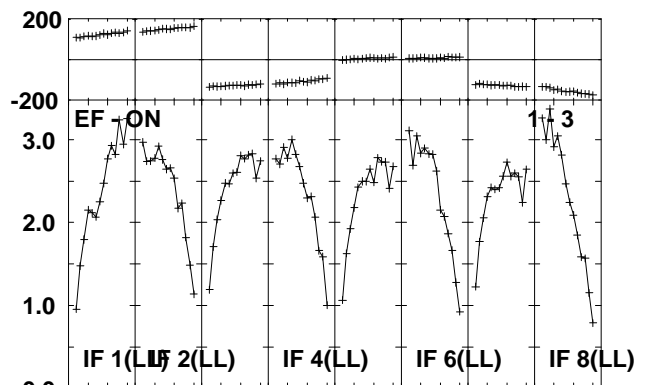
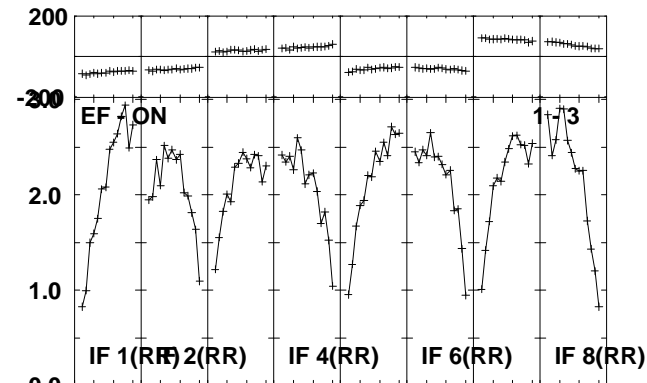
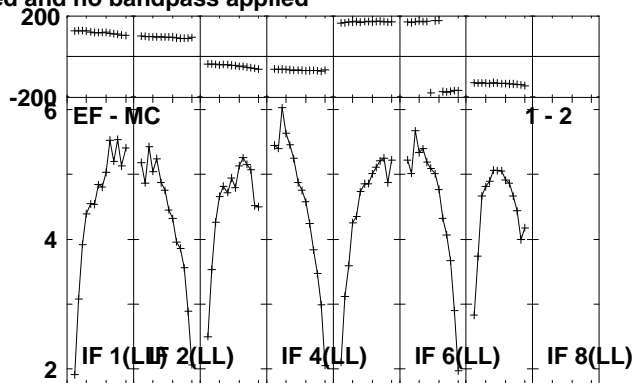
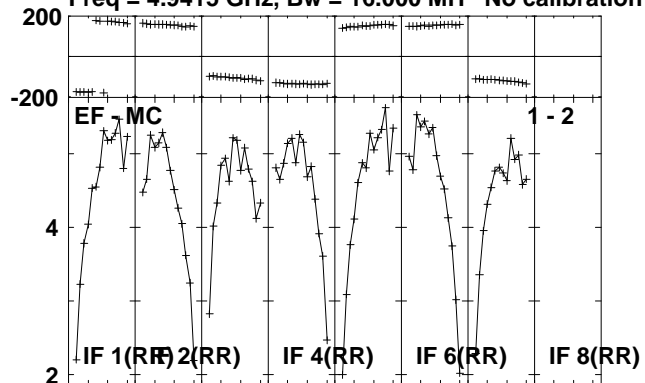

Lower frame: Milli Ampl Jy Top frame: Phas deg
Scalar averaged cross-power spectrum Several baselines displayed
Timerange: 00/21:58:31 to 00/22:00:29

Plot file version 124 created 14-JUL-2010 16:36:21

J1953+35 RR004A.UVDATA.1

Freq = 4.9415 GHz, Bw = 16.000 MH No calibration applied and no bandpass applied

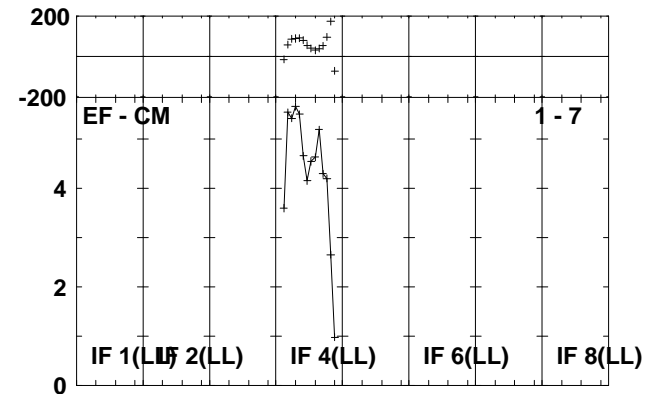
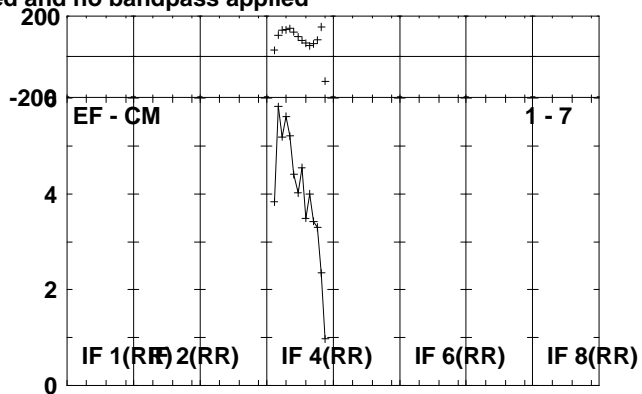
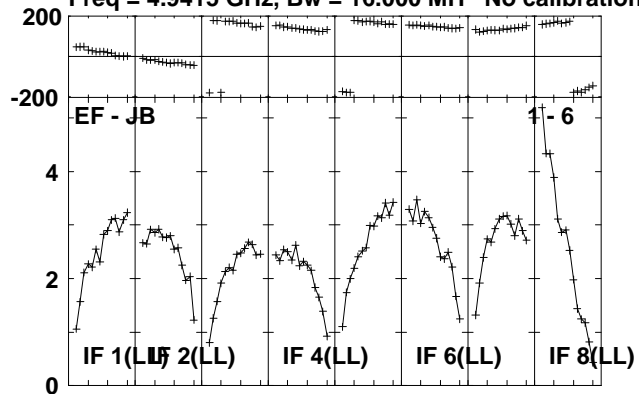

Lower frame: Milli Ampl Jy Top frame: Phas deg
Scalar averaged cross-power spectrum Several baselines displayed
Timerange: 00/21:58:31 to 00/22:00:29

Plot file version 125 created 14-JUL-2010 16:36:21

CYGX-1 RR004A.UVDATA.1

Freq = 4.9415 GHz, Bw = 16.000 MH No calibration applied and no bandpass applied

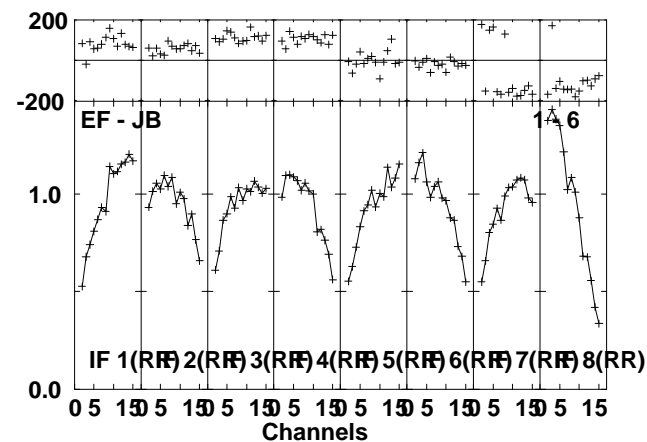
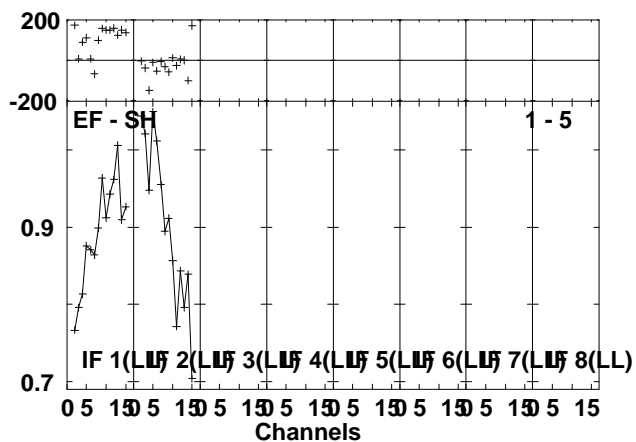
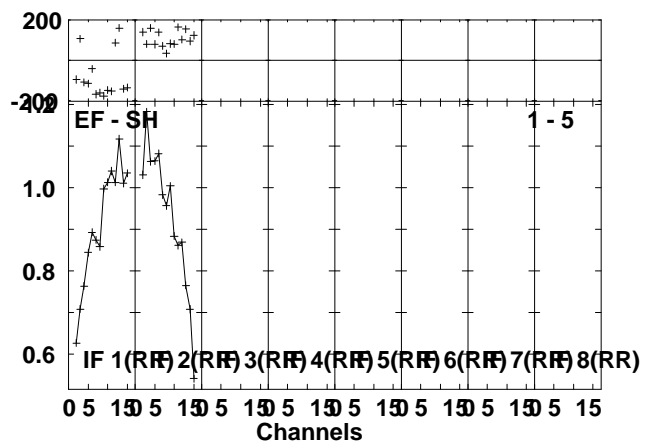
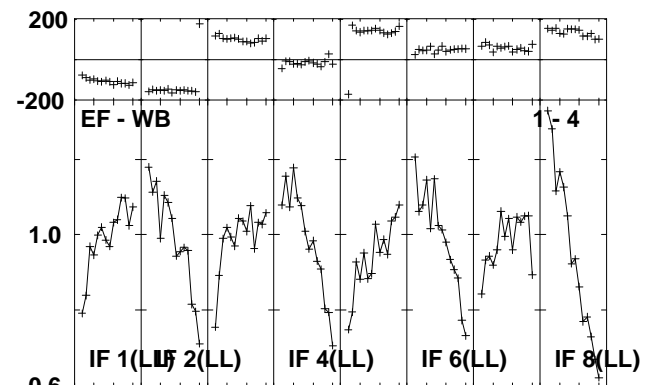
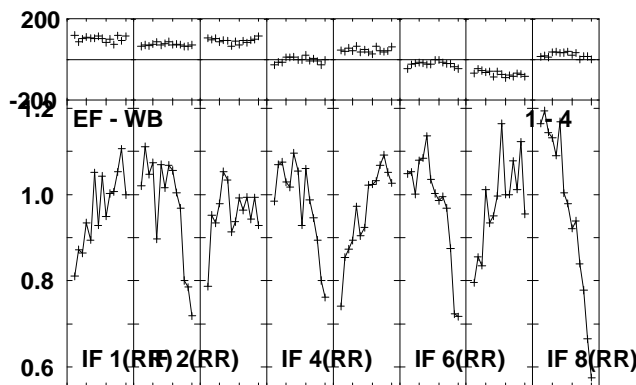
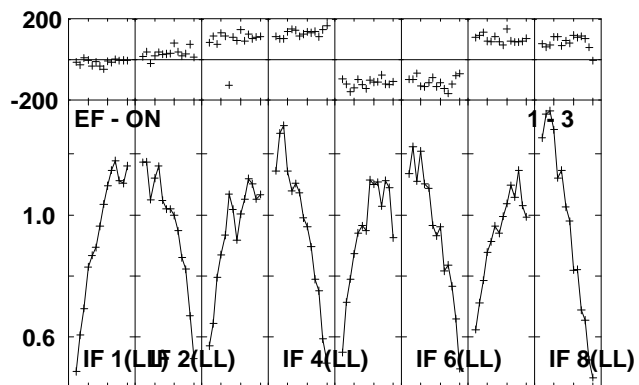
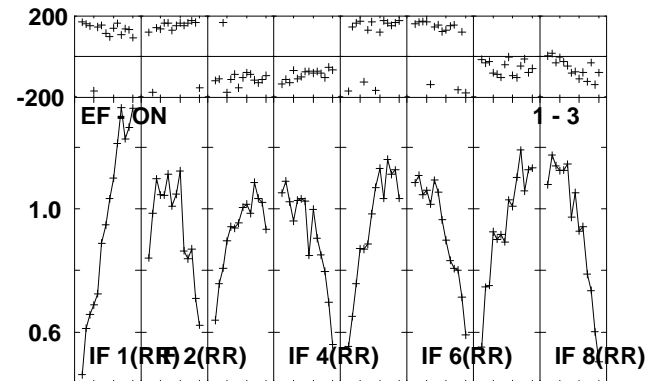
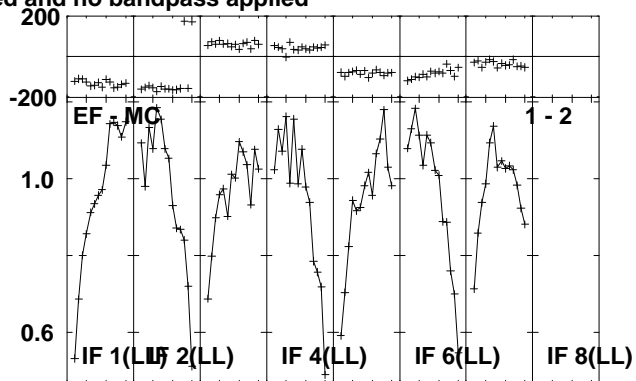
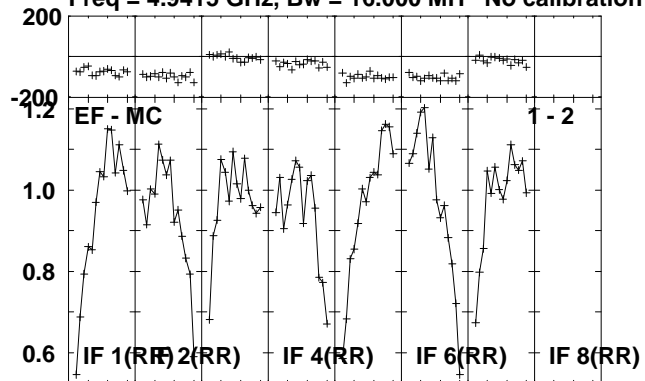

Lower frame: Milli Ampl Jy Top frame: Phas deg
Scalar averaged cross-power spectrum Several baselines displayed
Timerange: 00/22:00:31 to 00/22:05:29

Plot file version 126 created 14-JUL-2010 16:36:23

CYGX-1 RR004A.UVDATA.1

Freq = 4.9415 GHz, Bw = 16.000 MH No calibration applied and no bandpass applied

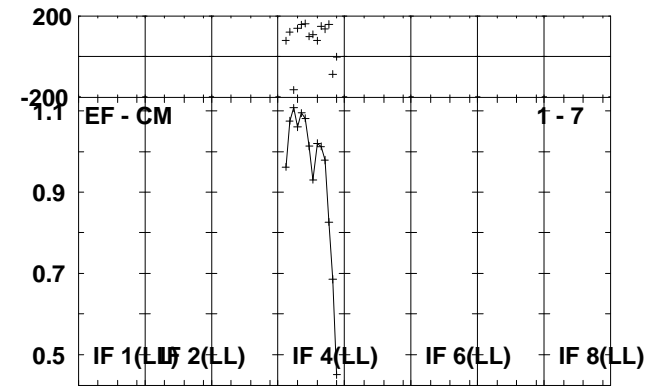
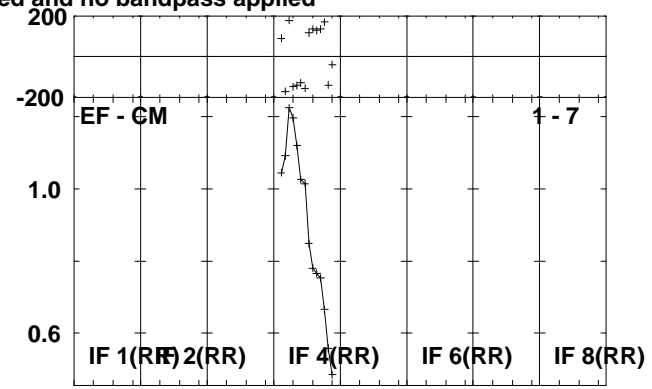
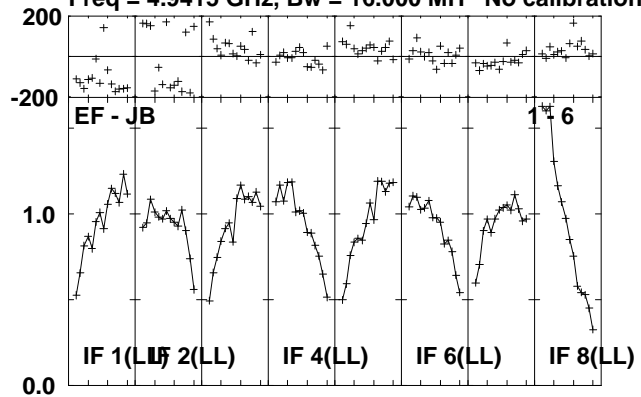

Lower frame: Milli Ampl Jy Top frame: Phas deg
Scalar averaged cross-power spectrum Several baselines displayed
Timerange: 00/22:00:31 to 00/22:05:29

Plot file version 127 created 14-JUL-2010 16:36:24

J1953+35 RR004A.UVDATA.1

Freq = 4.9415 GHz, Bw = 16.000 MH No calibration applied and no bandpass applied

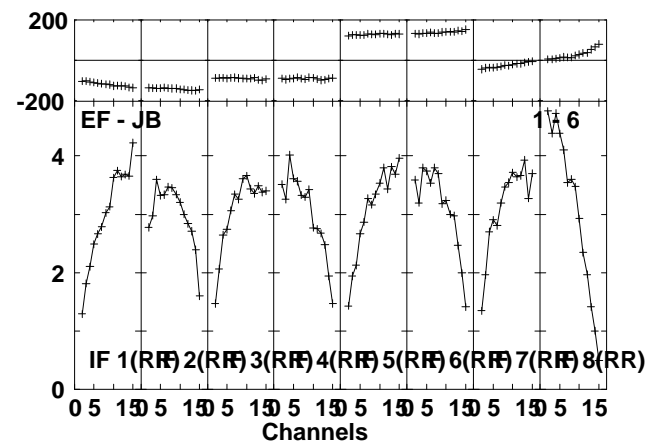
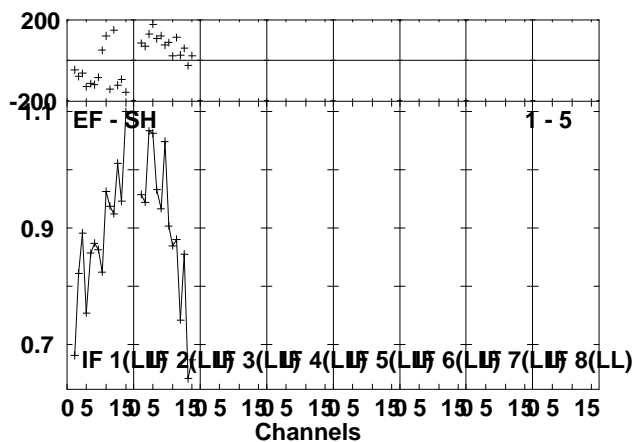
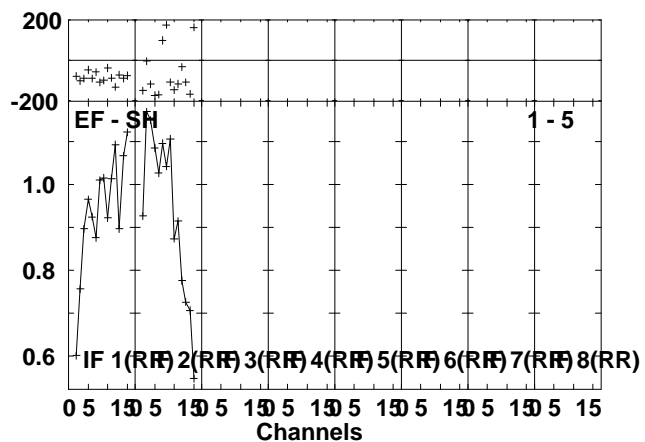
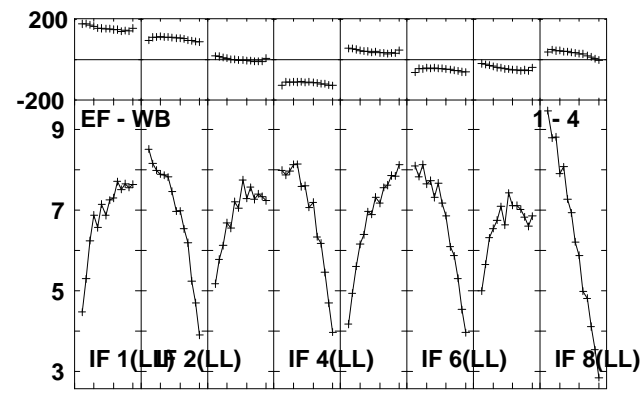
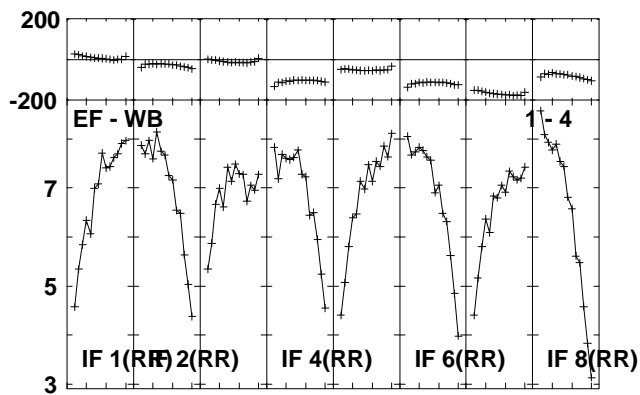
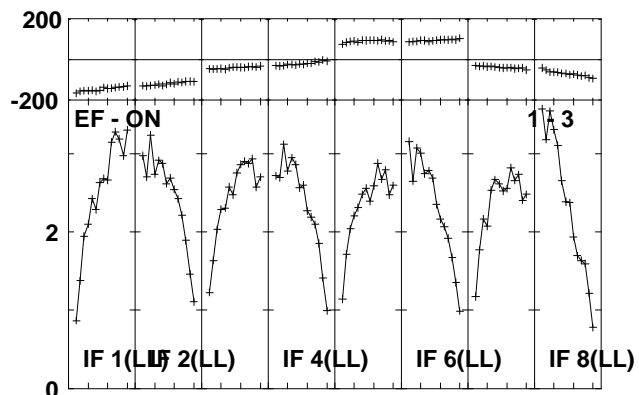
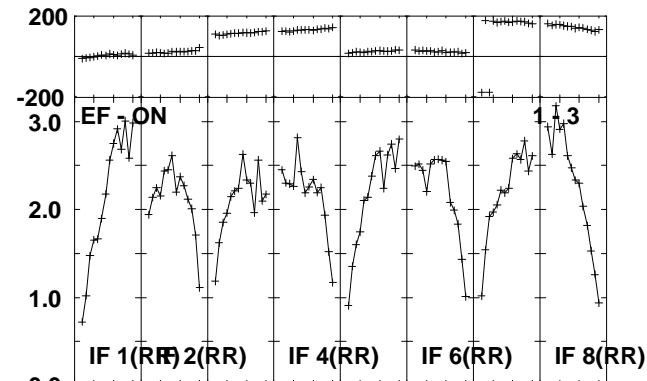
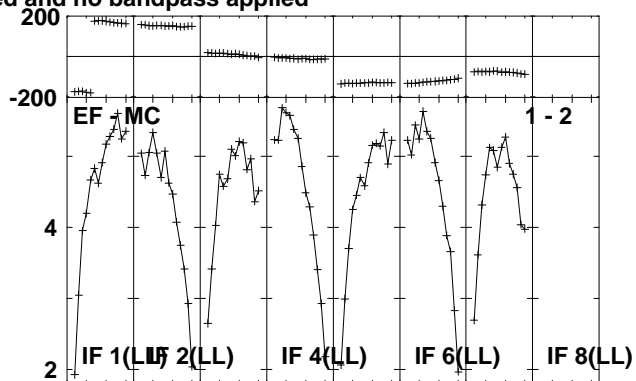
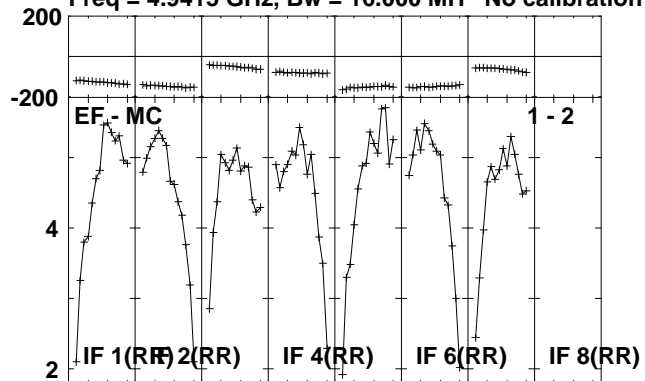

Lower frame: Milli Ampl Jy Top frame: Phas deg
Scalar averaged cross-power spectrum Several baselines displayed
Timerange: 00/22:06:11 to 00/22:07:39

Plot file version 128 created 14-JUL-2010 16:36:24
J1953+35 RR004A.UVDATA.1

Freq = 4.9415 GHz, Bw = 16.000 MH No calibration applied and no bandpass applied

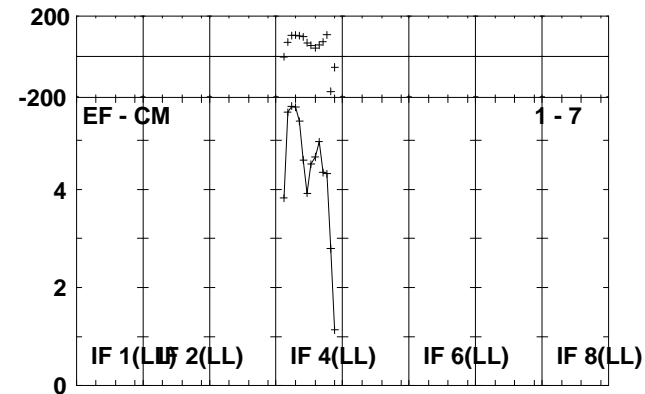
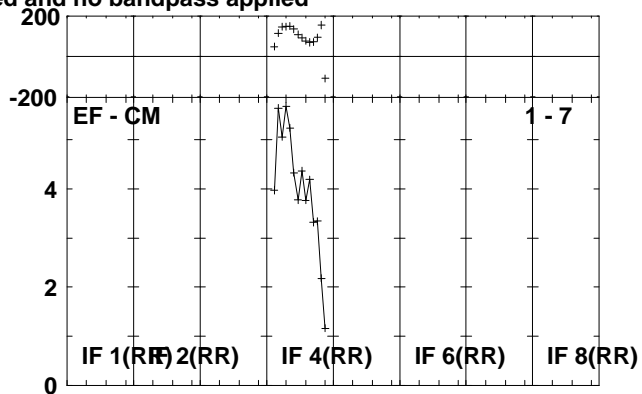
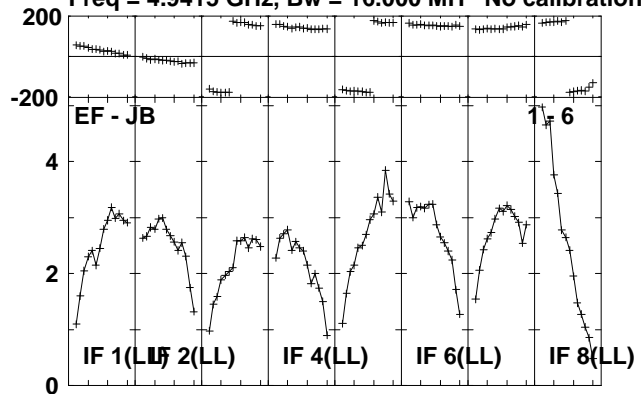

Lower frame: Milli Ampl Jy Top frame: Phas deg
Scalar averaged cross-power spectrum Several baselines displayed
Timerange: 00/22:06:11 to 00/22:07:39

Plot file version 129 created 14-JUL-2010 16:36:25

CYGX-1 RR004A.UVDATA.1

Freq = 4.9415 GHz, Bw = 16.000 MH No calibration applied and no bandpass applied

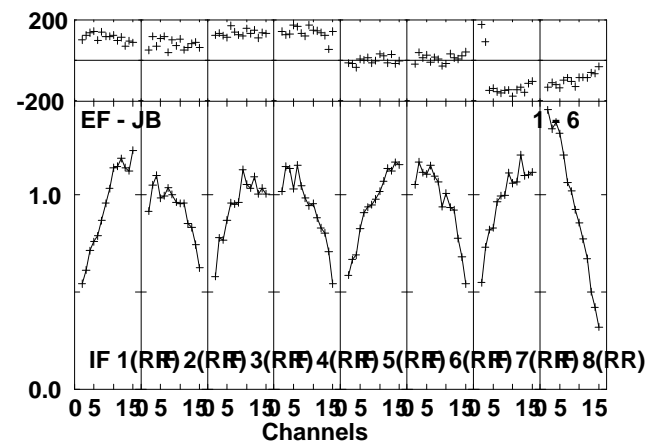
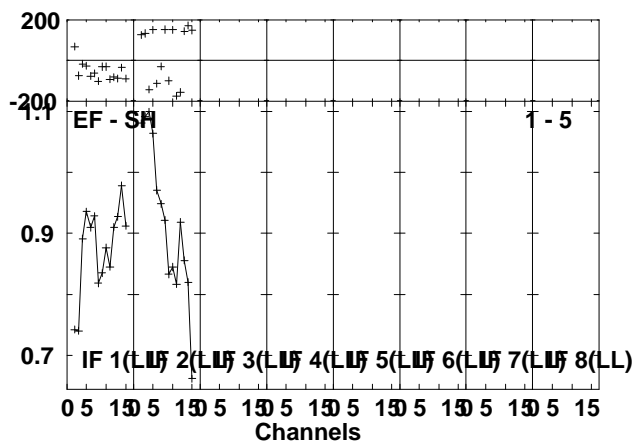
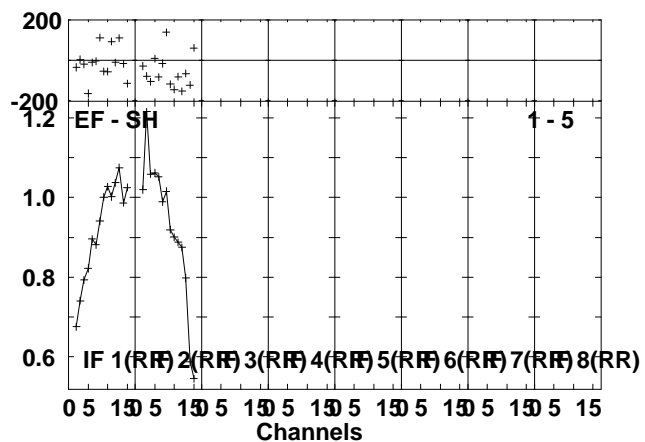
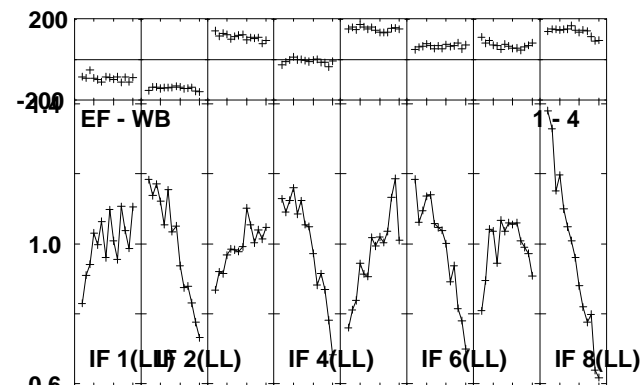
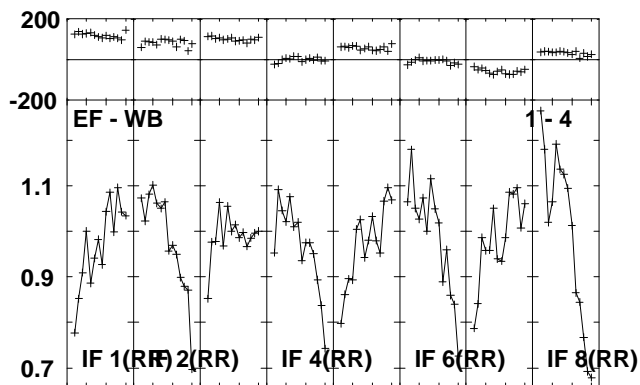
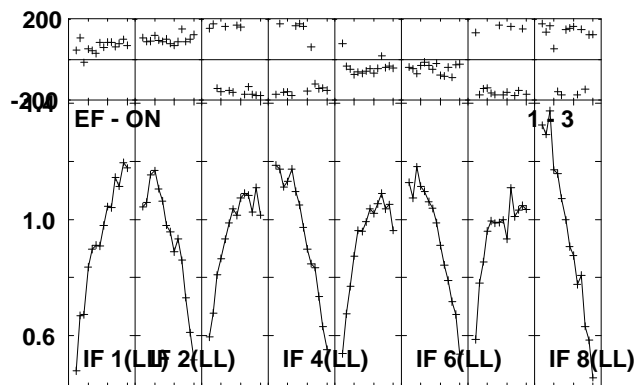
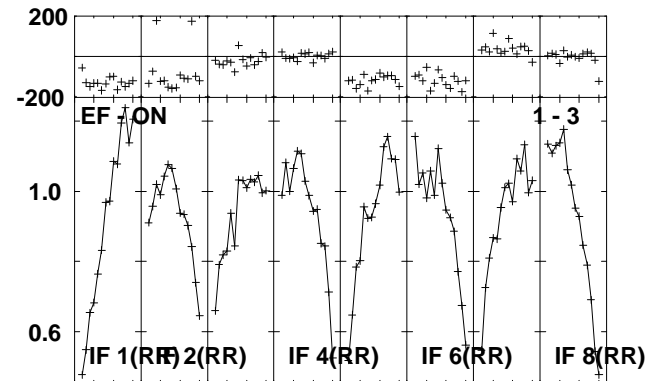
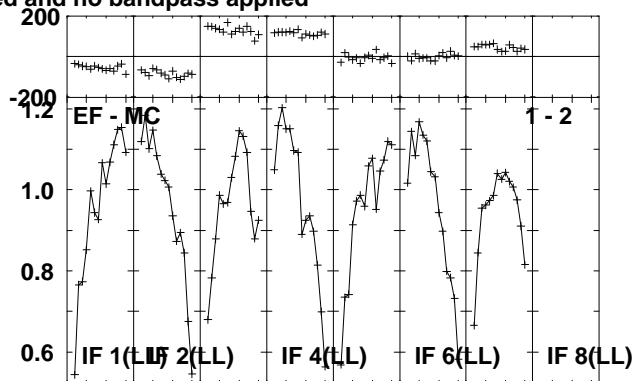
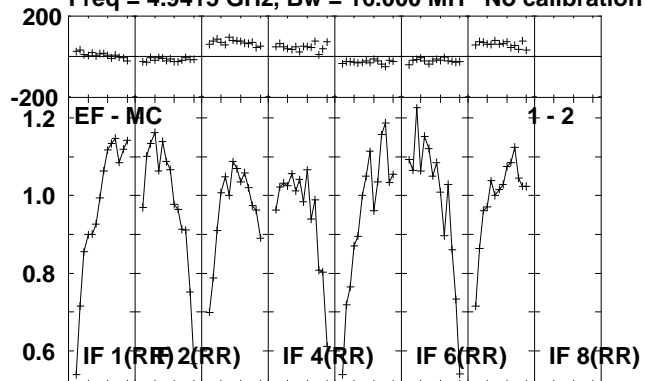

Lower frame: Milli Ampl Jy Top frame: Phas deg
Scalar averaged cross-power spectrum Several baselines displayed
Timerange: 00/22:07:41 to 00/22:12:39

Plot file version 130 created 14-JUL-2010 16:36:26

CYGX-1 RR004A.UVDATA.1

Freq = 4.9415 GHz, Bw = 16.000 MH No calibration applied and no bandpass applied

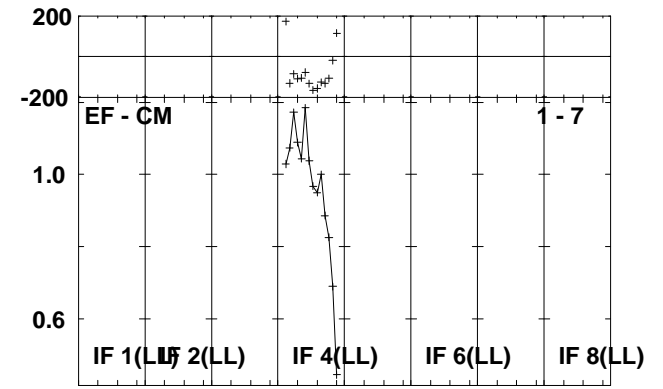
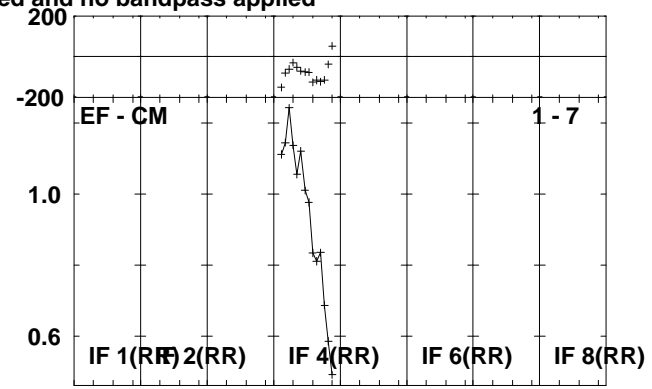
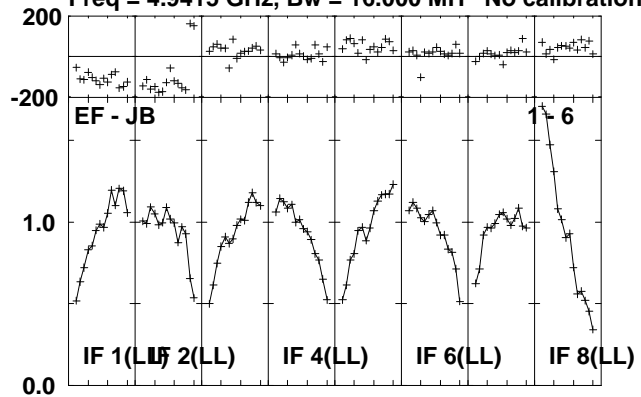

Lower frame: Milli Ampl Jy Top frame: Phas deg
Scalar averaged cross-power spectrum Several baselines displayed
Timerange: 00/22:07:41 to 00/22:12:39

Plot file version 131 created 14-JUL-2010 16:36:27

J1953+35 RR004A.UVDATA.1

Freq = 4.9415 GHz, Bw = 16.000 MH No calibration applied and no bandpass applied

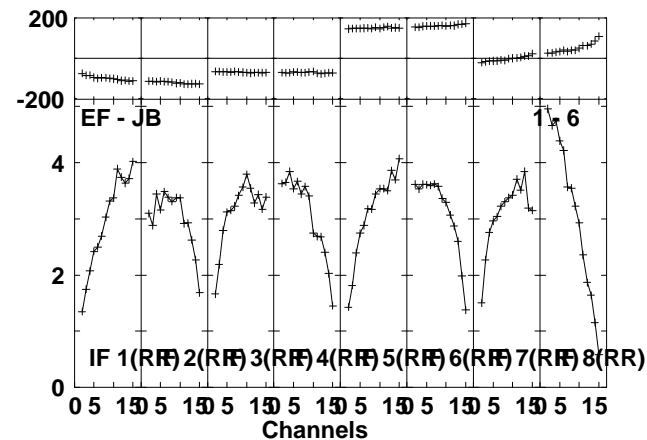
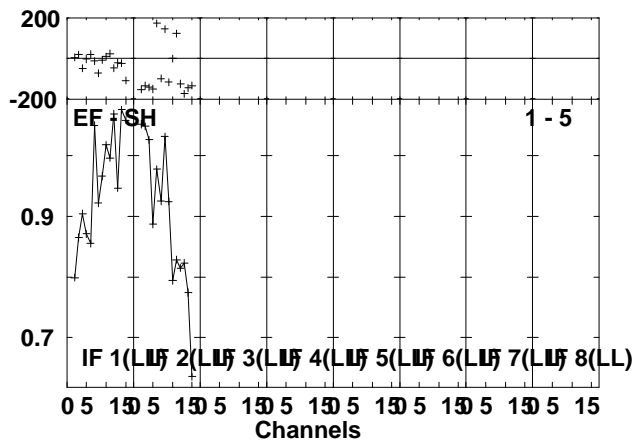
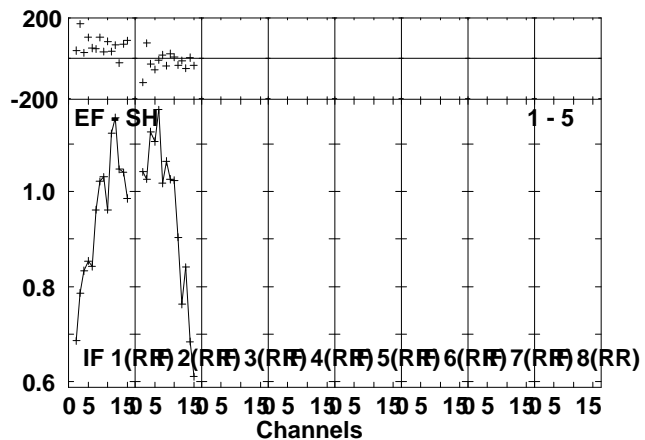
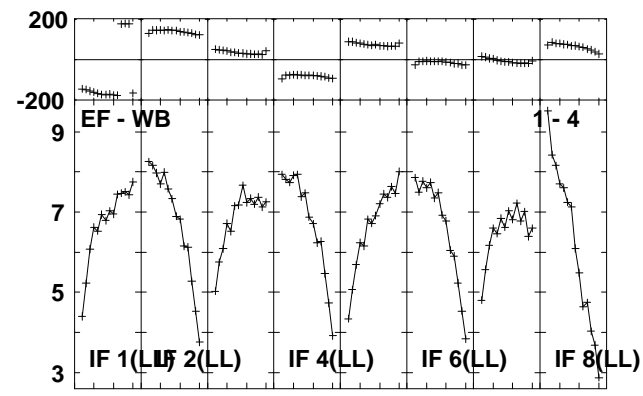
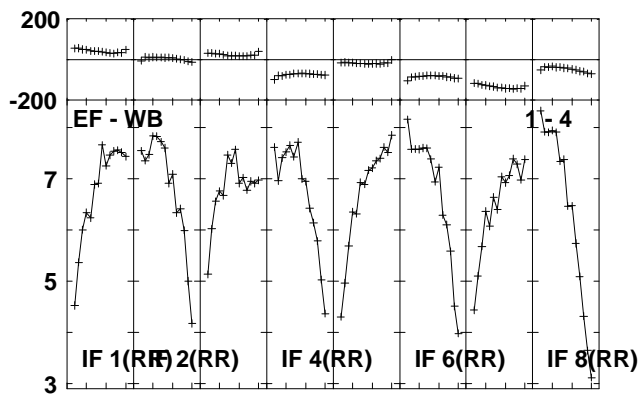
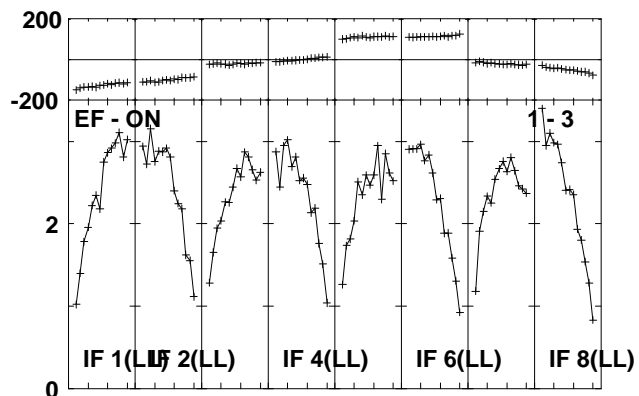
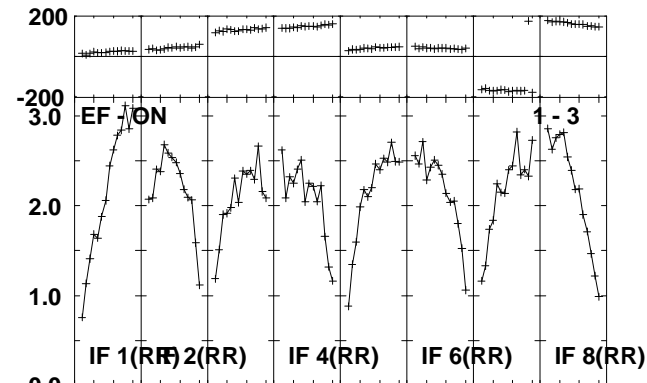
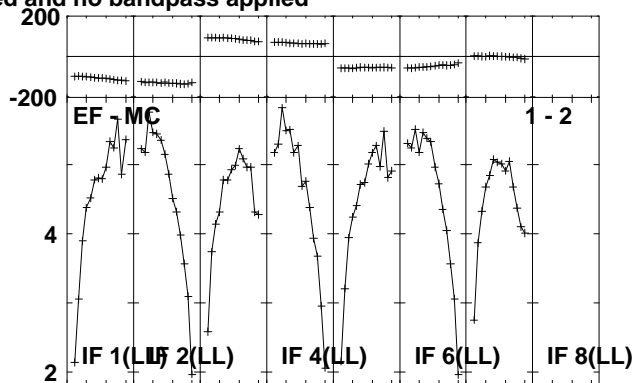
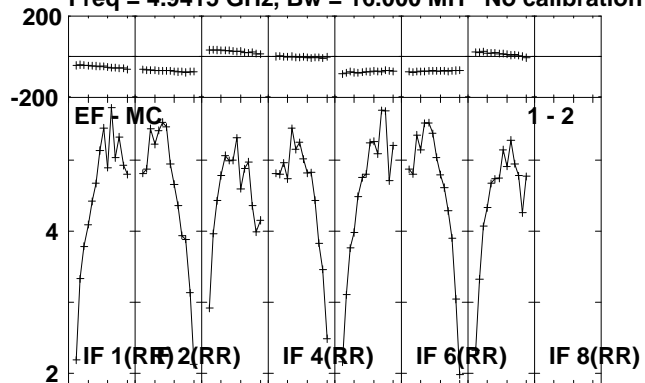

Lower frame: Milli Ampl Jy Top frame: Phas deg
Scalar averaged cross-power spectrum Several baselines displayed
Timerange: 00/22:12:41 to 00/22:14:39

Plot file version 132 created 14-JUL-2010 16:36:28

J1953+35 RR004A.UVDATA.1

Freq = 4.9415 GHz, Bw = 16.000 MH No calibration applied and no bandpass applied

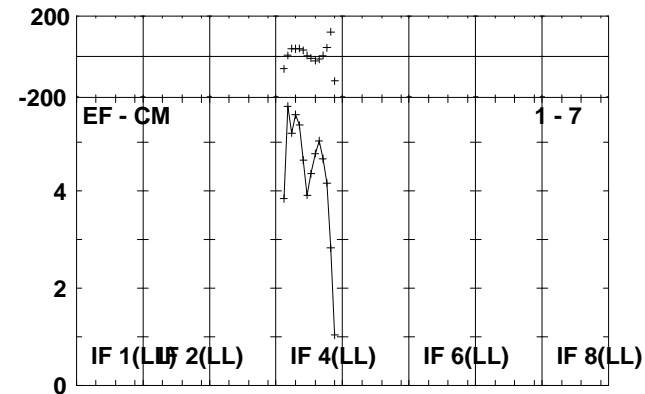
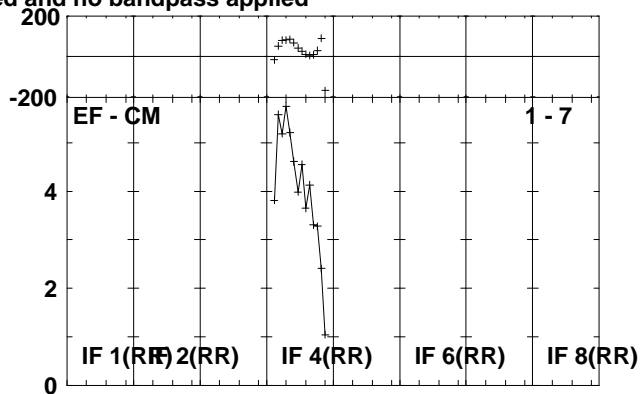
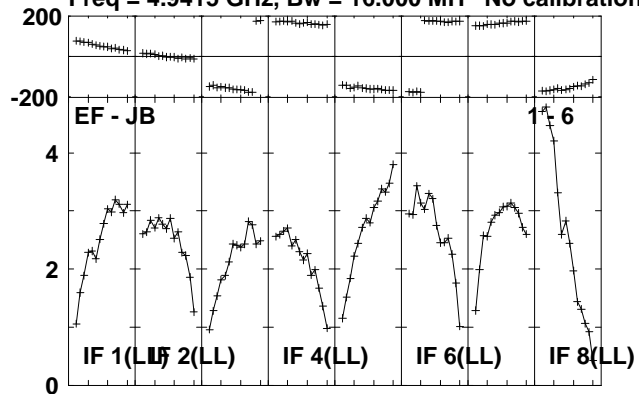

Lower frame: Milli Ampl Jy Top frame: Phas deg
Scalar averaged cross-power spectrum Several baselines displayed
Timerange: 00/22:12:41 to 00/22:14:39

Plot file version 133 created 14-JUL-2010 16:36:28

CYGX-1 RR004A.UVDATA.1

Freq = 4.9415 GHz, Bw = 16.000 MH No calibration applied and no bandpass applied

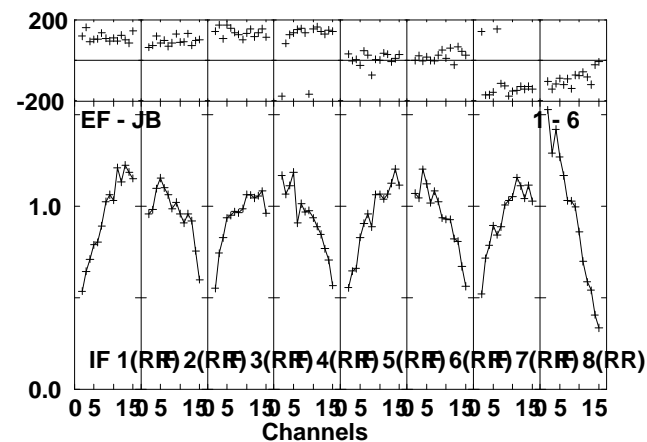
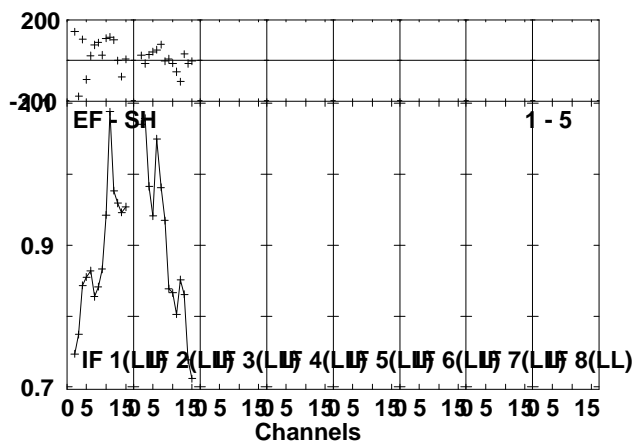
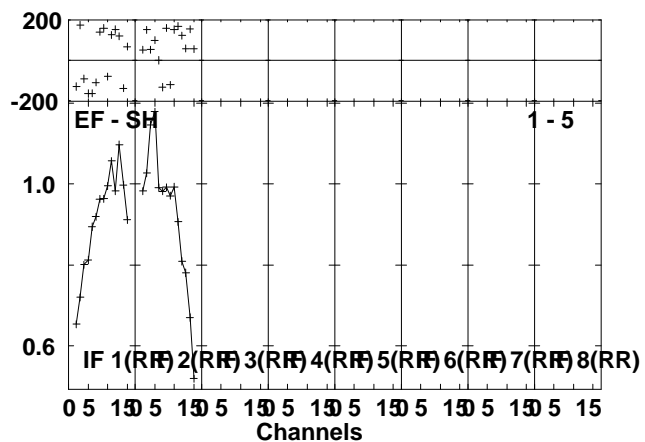
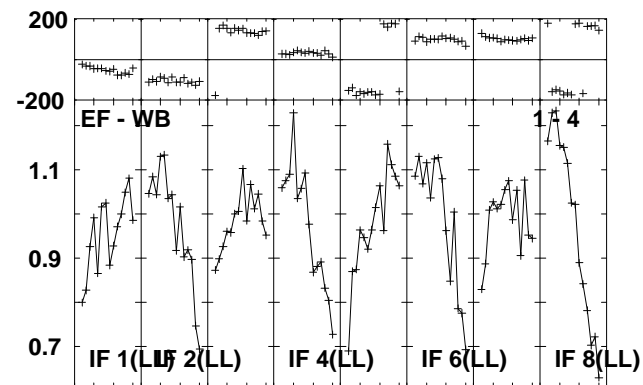
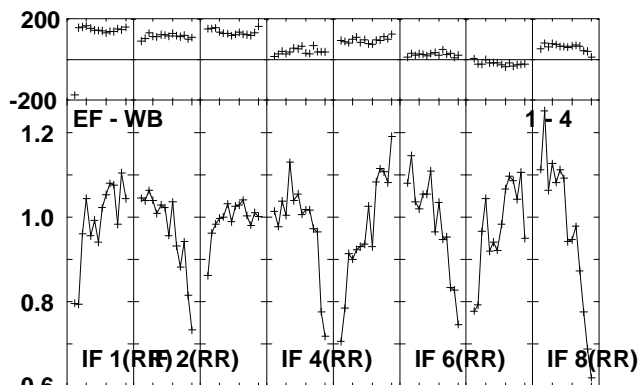
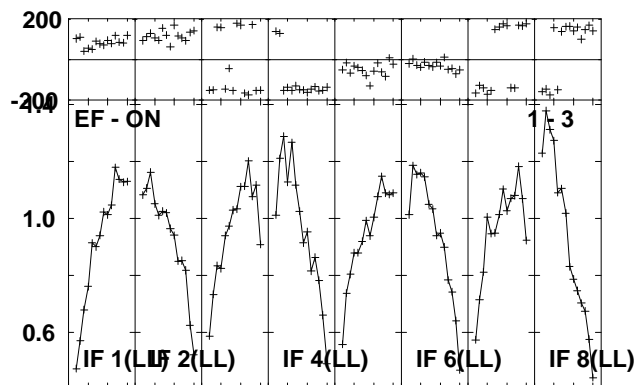
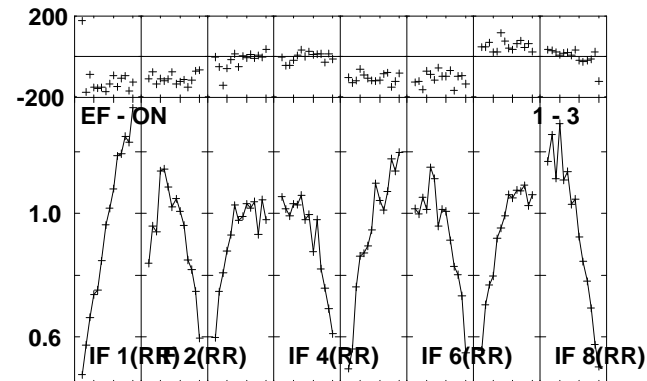
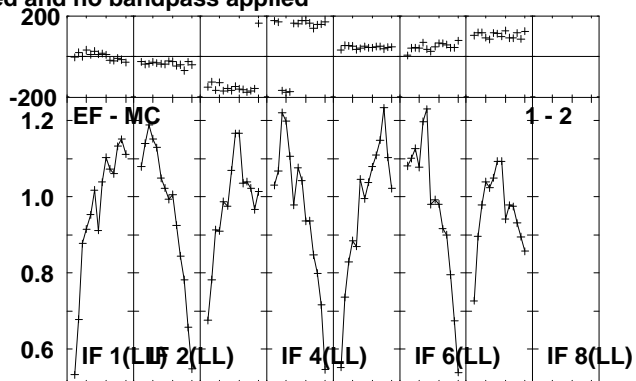
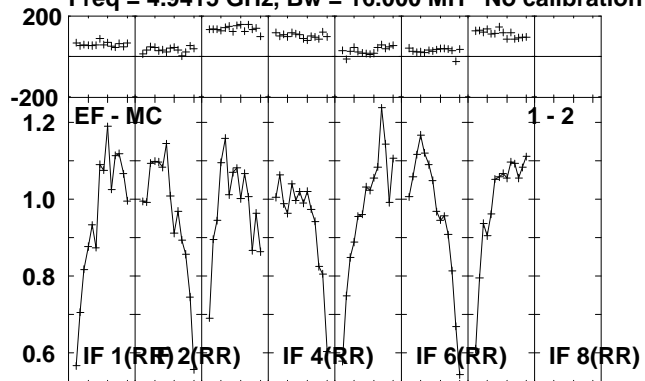

Lower frame: Milli Ampl Jy Top frame: Phas deg
Scalar averaged cross-power spectrum Several baselines displayed
Timerange: 00/22:14:41 to 00/22:19:39

Plot file version 134 created 14-JUL-2010 16:36:30

CYGX-1 RR004A.UVDATA.1

Freq = 4.9415 GHz, Bw = 16.000 MH No calibration applied and no bandpass applied

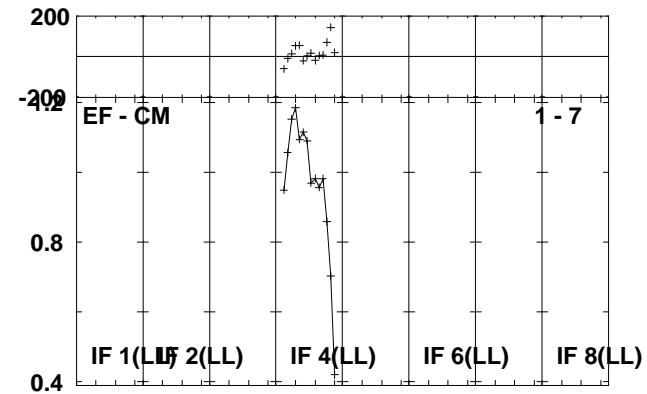
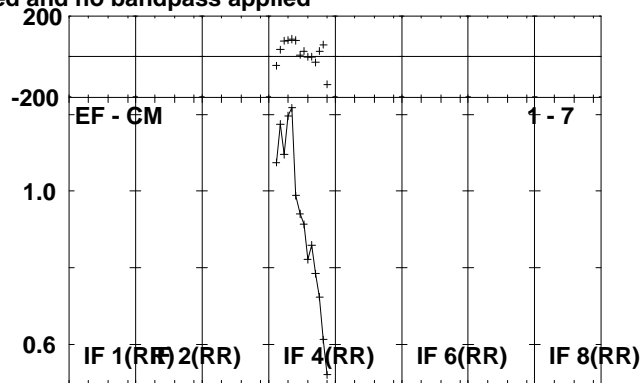
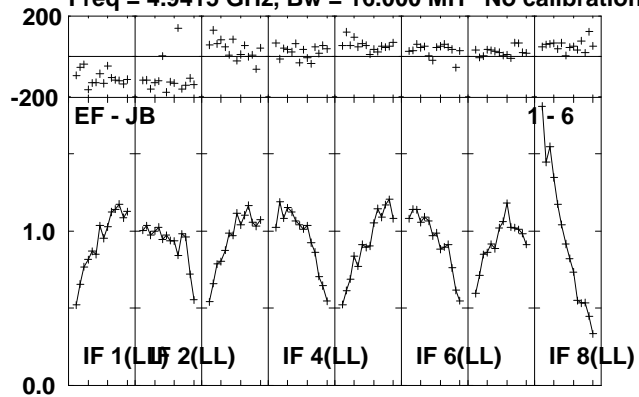

Lower frame: Milli Ampl Jy Top frame: Phas deg
Scalar averaged cross-power spectrum Several baselines displayed
Timerange: 00/22:14:41 to 00/22:19:39

Plot file version 135 created 14-JUL-2010 16:36:31

J1953+35 RR004A.UVDATA.1

Freq = 4.9415 GHz, Bw = 16.000 MH No calibration applied and no bandpass applied

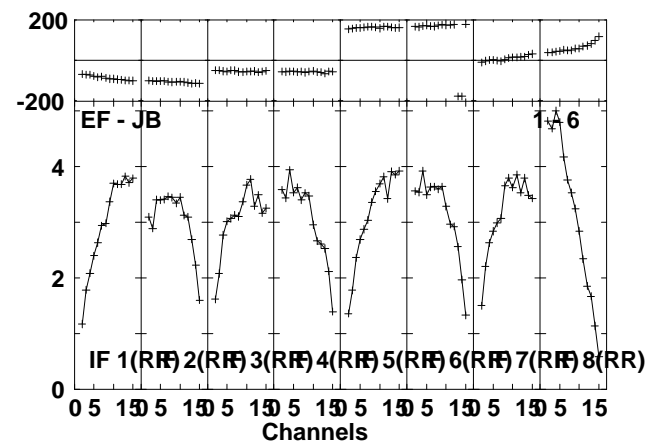
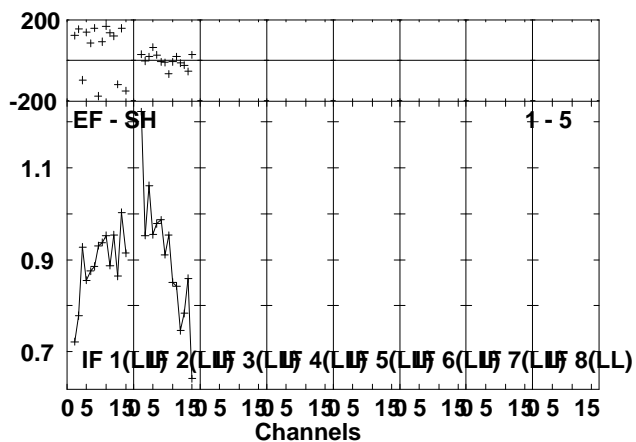
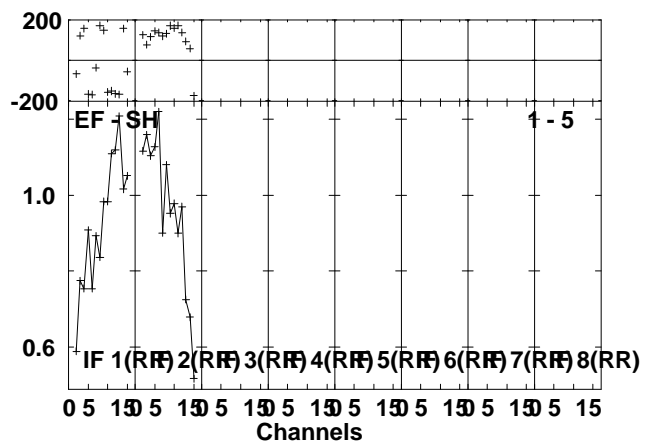
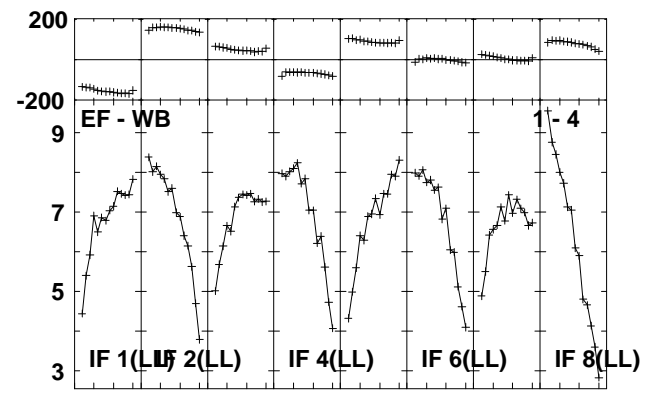
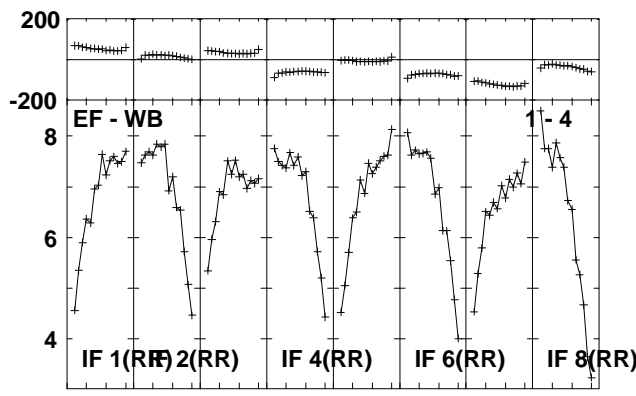
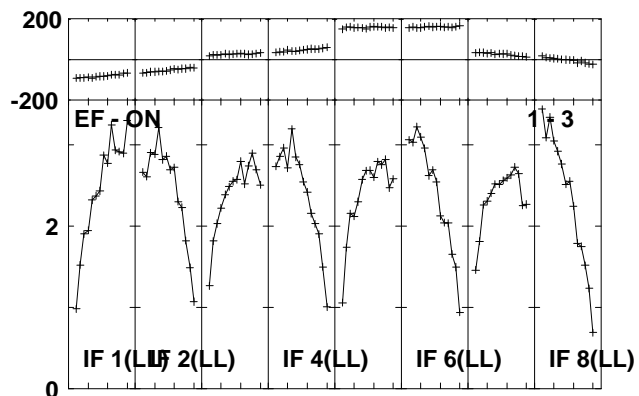
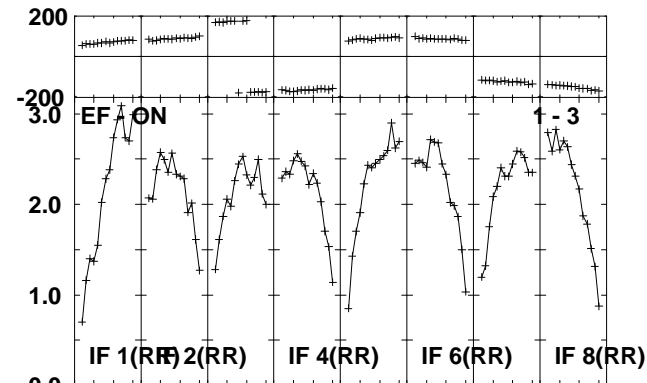
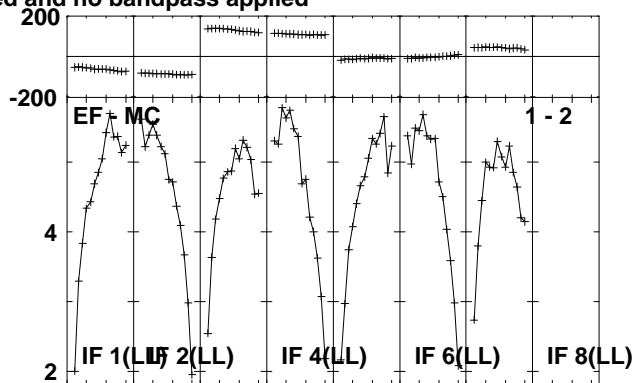
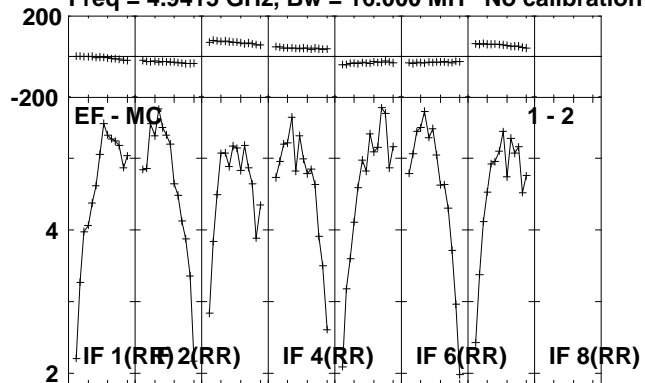

Lower frame: Milli Ampl Jy Top frame: Phas deg
Scalar averaged cross-power spectrum Several baselines displayed
Timerange: 00/22:20:21 to 00/22:21:49

Plot file version 136 created 14-JUL-2010 16:36:31

J1953+35 RR004A.UVDATA.1

Freq = 4.9415 GHz, Bw = 16.000 MH No calibration applied and no bandpass applied

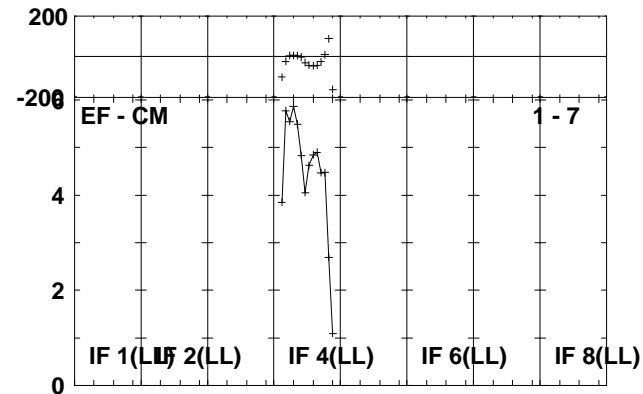
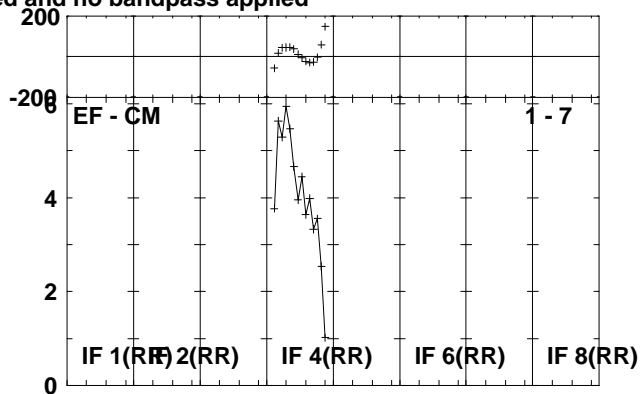
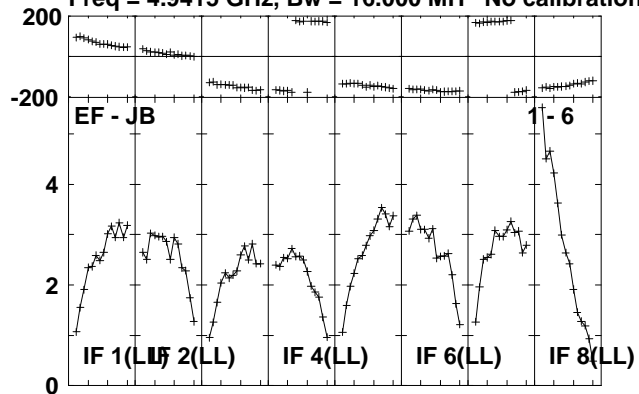

Lower frame: Milli Ampl Jy Top frame: Phas deg
Scalar averaged cross-power spectrum Several baselines displayed
Timerange: 00/22:20:21 to 00/22:21:49

Plot file version 137 created 14-JUL-2010 16:36:32

CYGX-1 RR004A.UVDATA.1

Freq = 4.9415 GHz, Bw = 16.000 MH No calibration applied and no bandpass applied

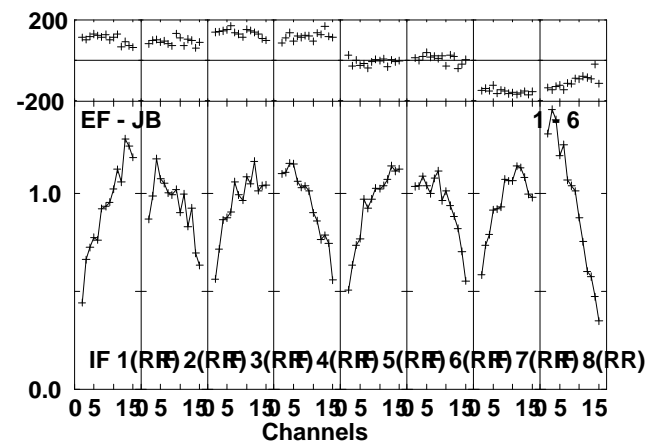
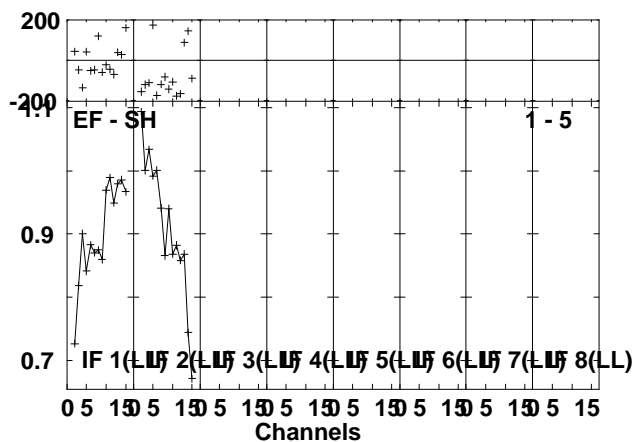
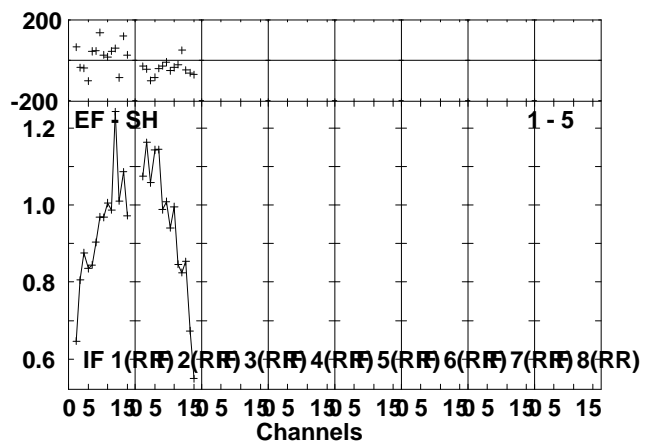
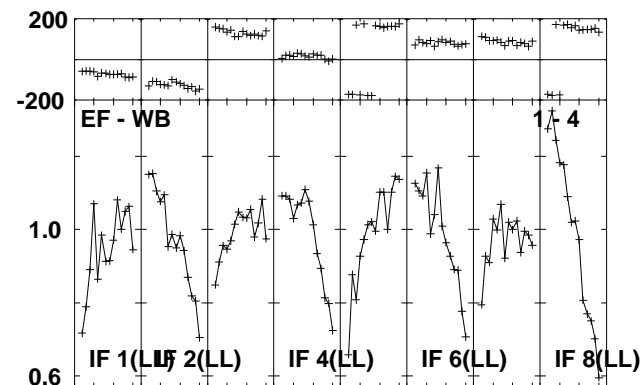
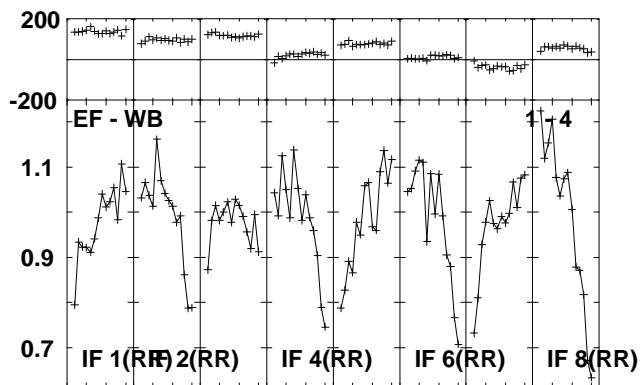
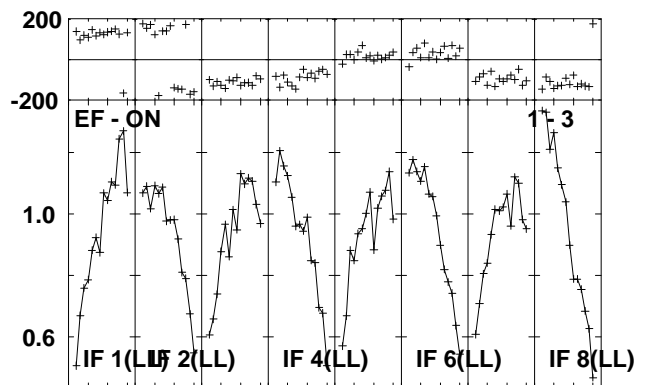
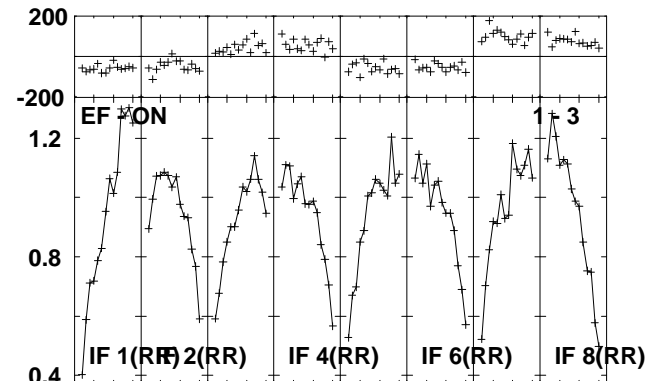
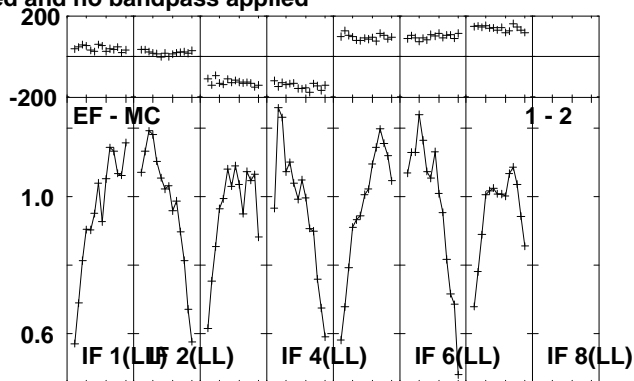
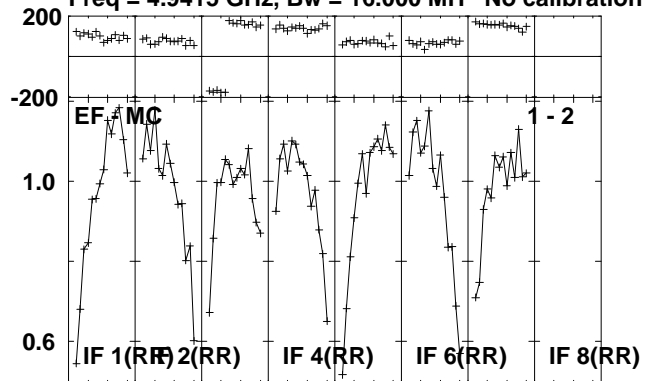

Lower frame: Milli Ampl Jy Top frame: Phas deg
Scalar averaged cross-power spectrum Several baselines displayed
Timerange: 00/22:21:51 to 00/22:26:49

Plot file version 138 created 14-JUL-2010 16:36:33

CYGX-1 RR004A.UVDATA.1

Freq = 4.9415 GHz, Bw = 16.000 MH No calibration applied and no bandpass applied

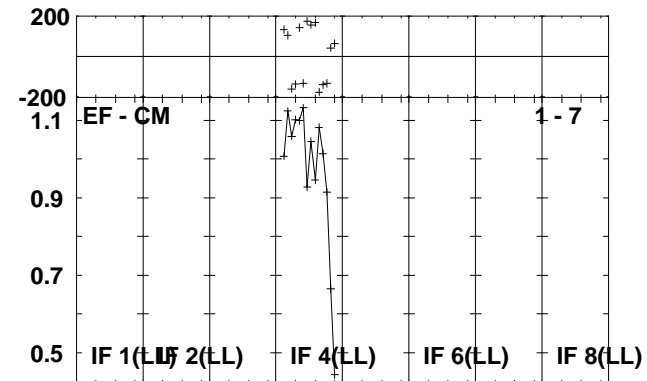
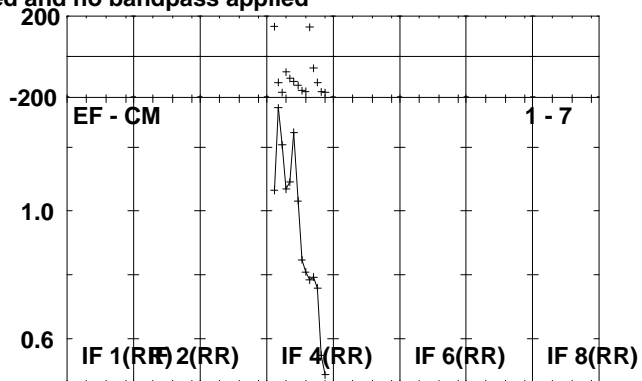
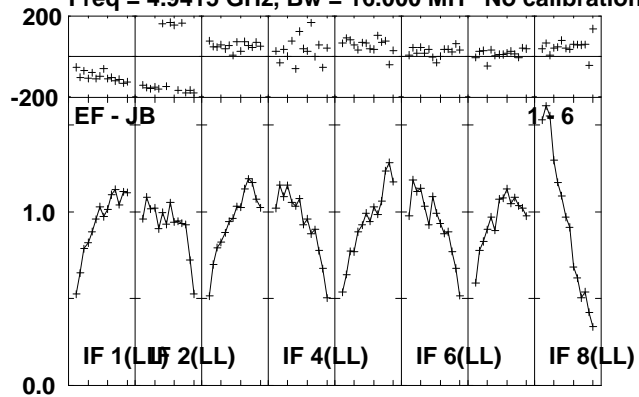

Lower frame: Milli Ampl Jy Top frame: Phas deg
Scalar averaged cross-power spectrum Several baselines displayed
Timerange: 00/22:21:51 to 00/22:26:49

Plot file version 139 created 14-JUL-2010 16:36:34

J1953+35 RR004A.UVDATA.1

Freq = 4.9415 GHz, Bw = 16.000 MH No calibration applied and no bandpass applied

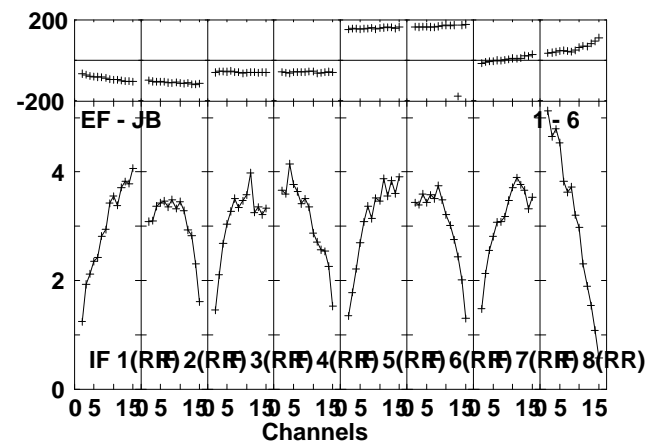
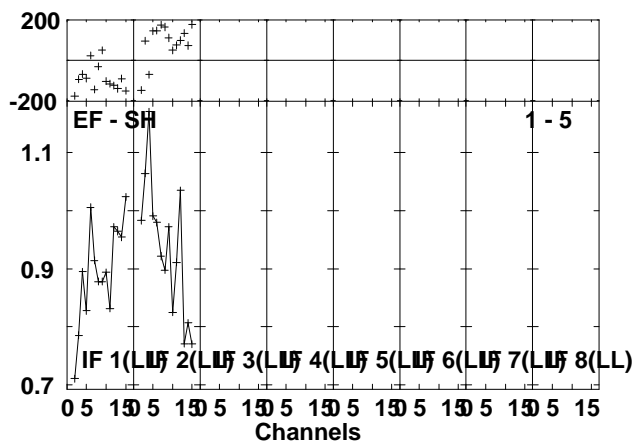
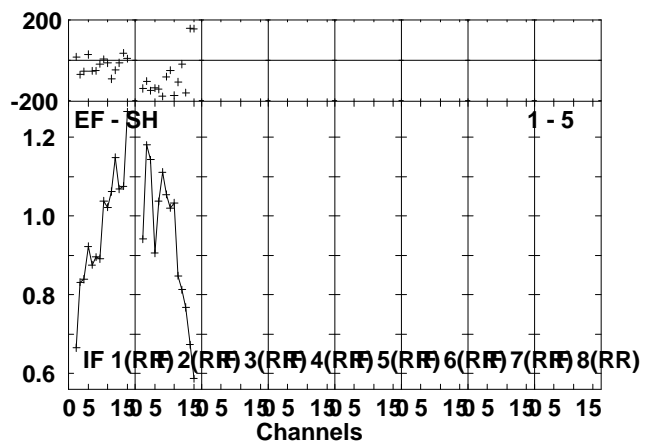
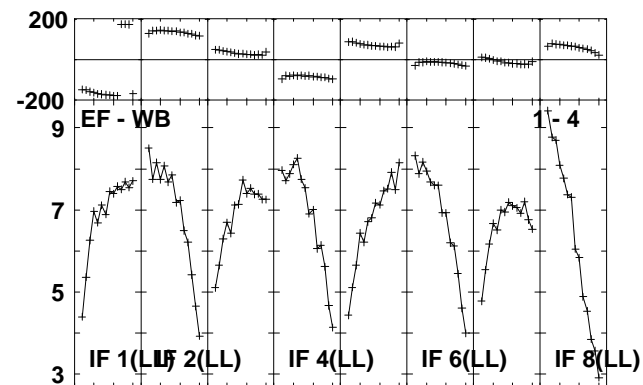
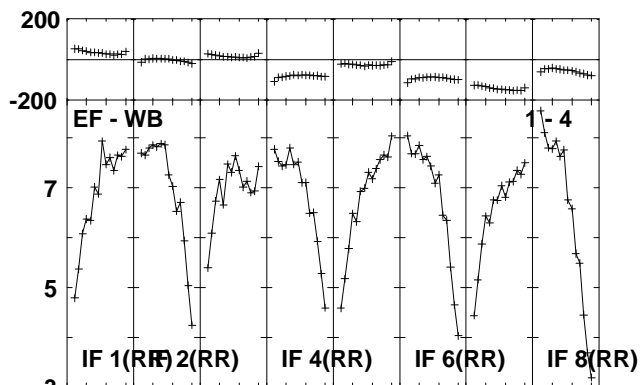
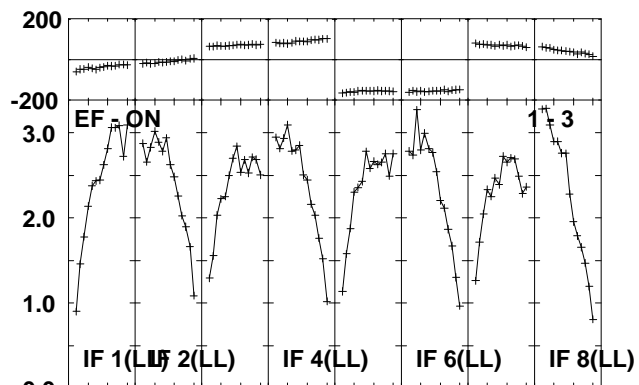
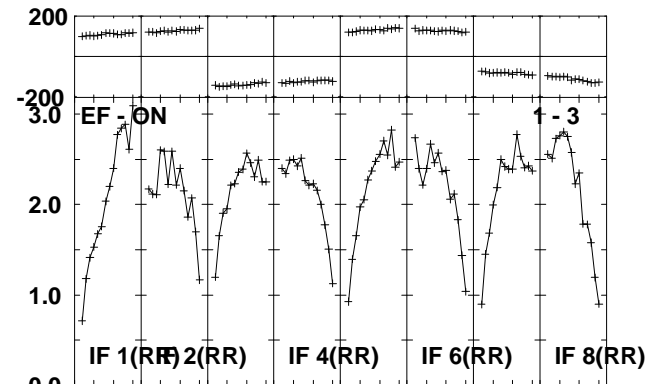
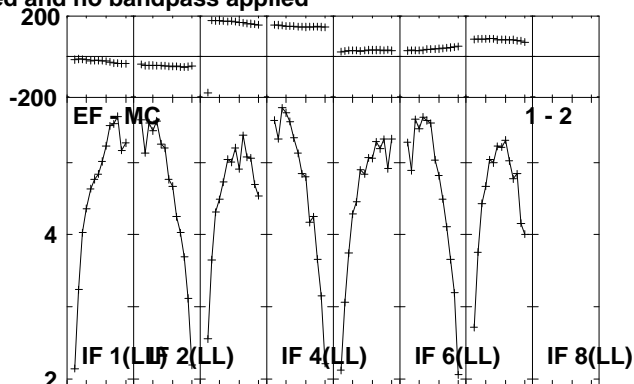
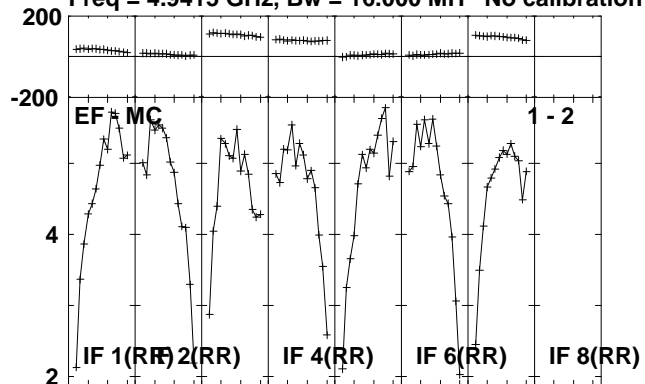

Lower frame: Milli Ampl Jy Top frame: Phas deg
Scalar averaged cross-power spectrum Several baselines displayed
Timerange: 00/22:26:51 to 00/22:28:49

Plot file version 140 created 14-JUL-2010 16:36:35

J1953+35 RR004A.UVDATA.1

Freq = 4.9415 GHz, Bw = 16.000 MH No calibration applied and no bandpass applied

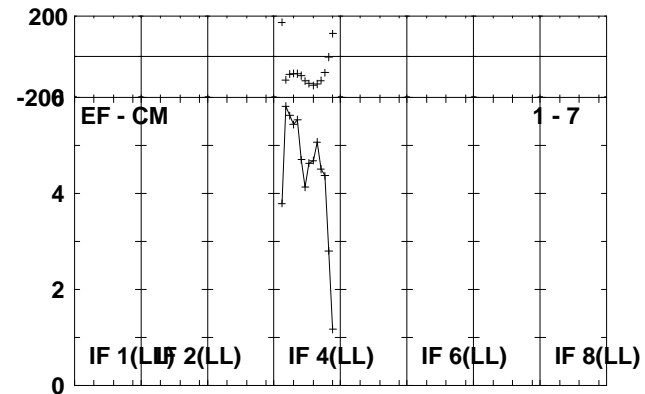
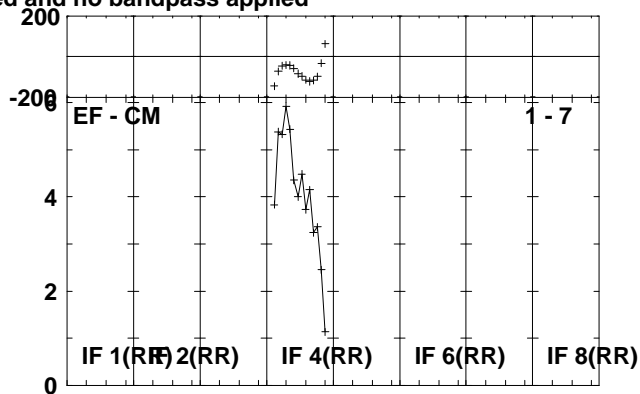
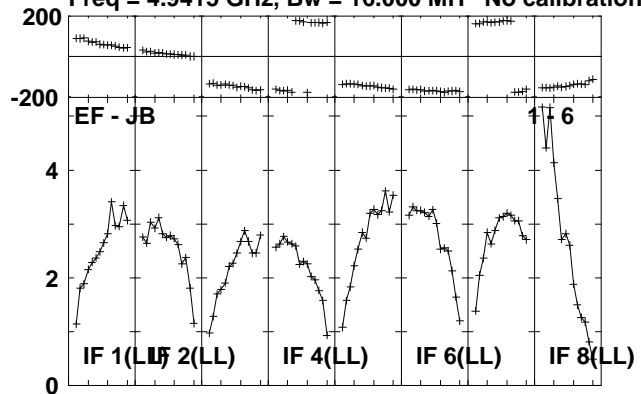

Lower frame: Milli Ampl Jy Top frame: Phas deg
Scalar averaged cross-power spectrum Several baselines displayed
Timerange: 00/22:26:51 to 00/22:28:49

Plot file version 141 created 14-JUL-2010 16:36:36

CYGX-1 RR004A.UVDATA.1

Freq = 4.9415 GHz, Bw = 16.000 MH No calibration applied and no bandpass applied

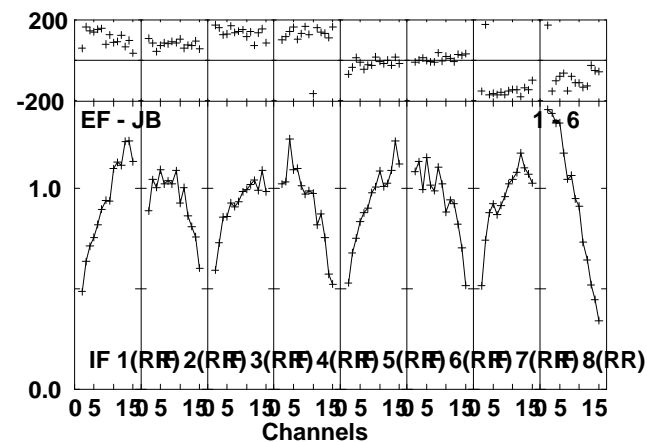
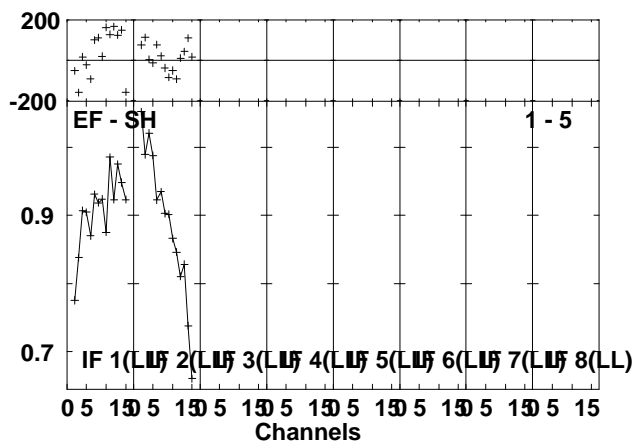
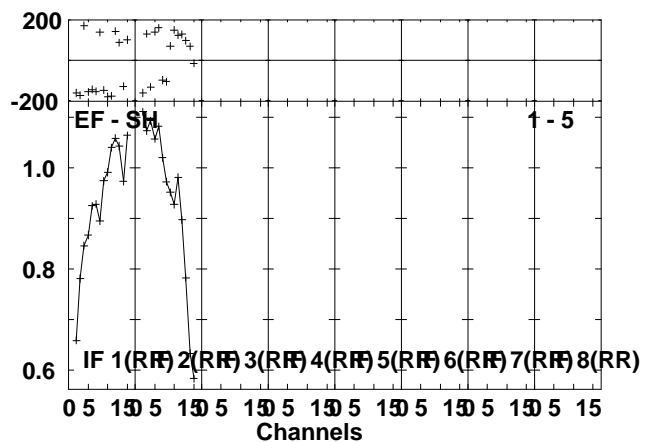
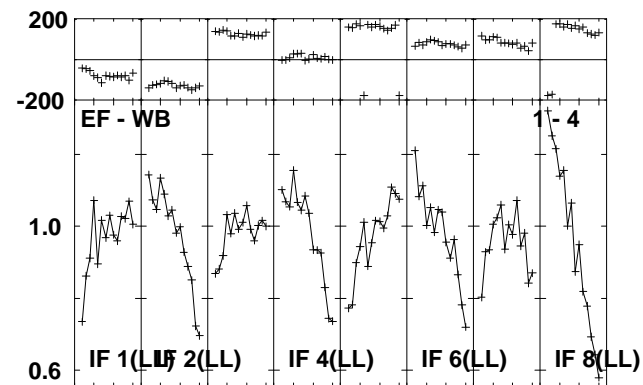
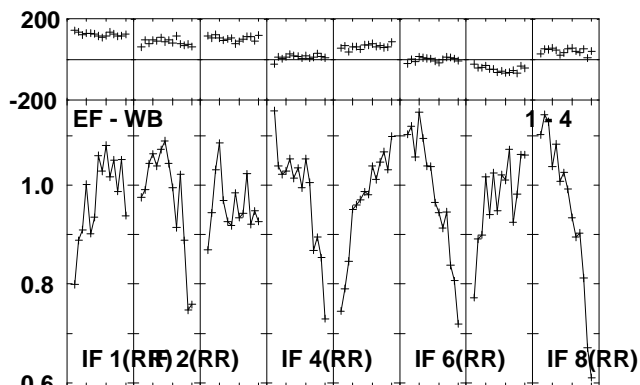
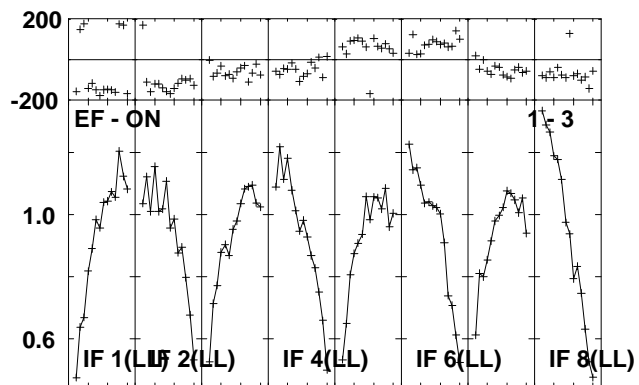
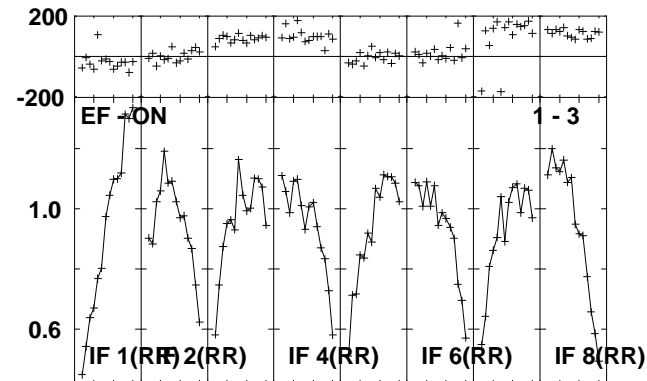
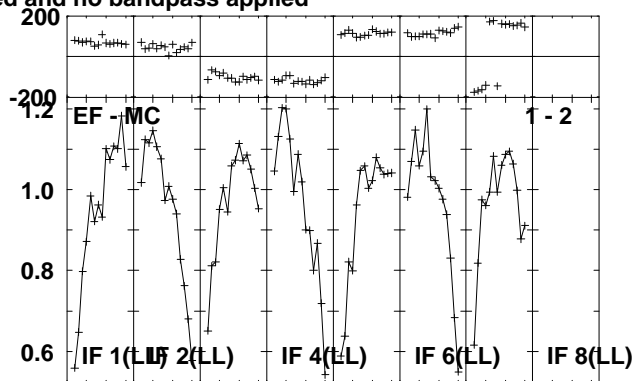
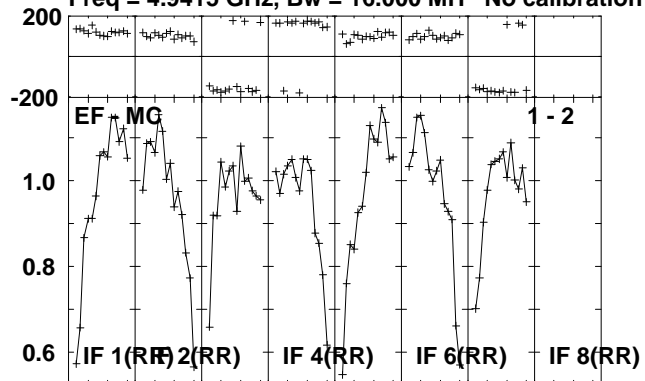

Lower frame: Milli Ampl Jy Top frame: Phas deg
Scalar averaged cross-power spectrum Several baselines displayed
Timerange: 00/22:28:51 to 00/22:33:49

Plot file version 142 created 14-JUL-2010 16:36:37

CYGX-1 RR004A.UVDATA.1

Freq = 4.9415 GHz, Bw = 16.000 MH No calibration applied and no bandpass applied

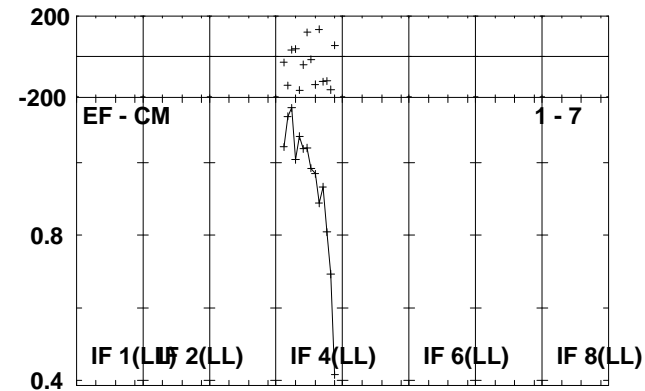
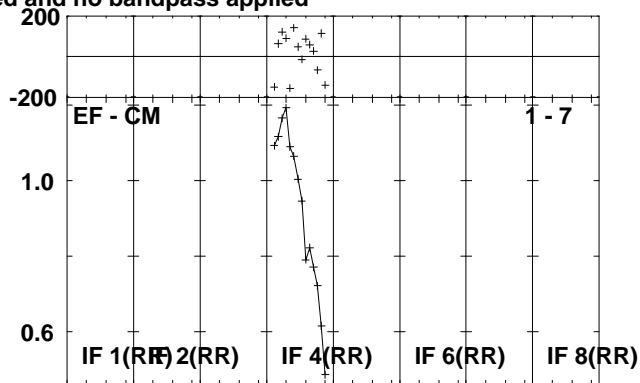
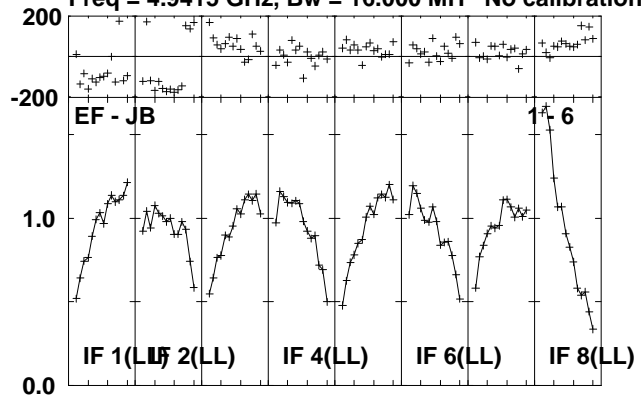

Lower frame: Milli Ampl Jy Top frame: Phas deg
Scalar averaged cross-power spectrum Several baselines displayed
Timerange: 00/22:28:51 to 00/22:33:49

Plot file version 143 created 14-JUL-2010 16:36:38

J1953+35 RR004A.UVDATA.1

Freq = 4.9415 GHz, Bw = 16.000 MH No calibration applied and no bandpass applied

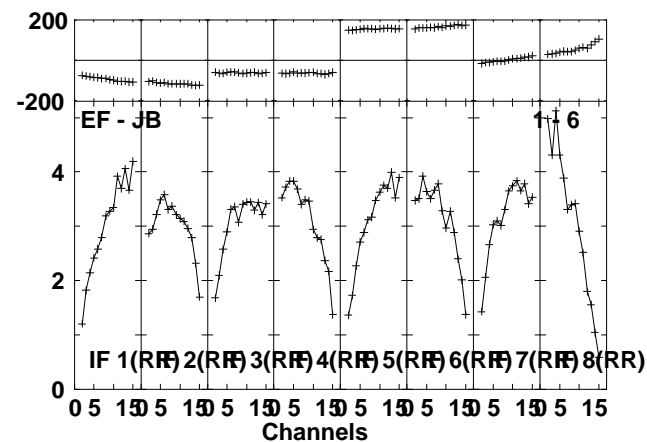
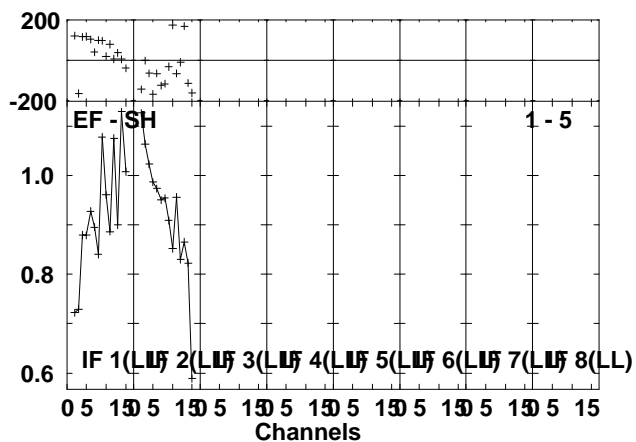
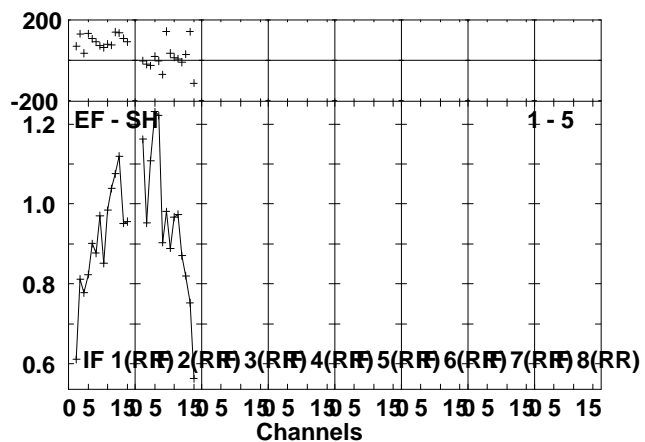
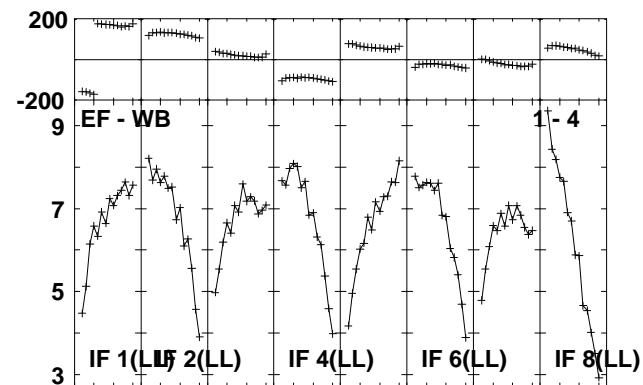
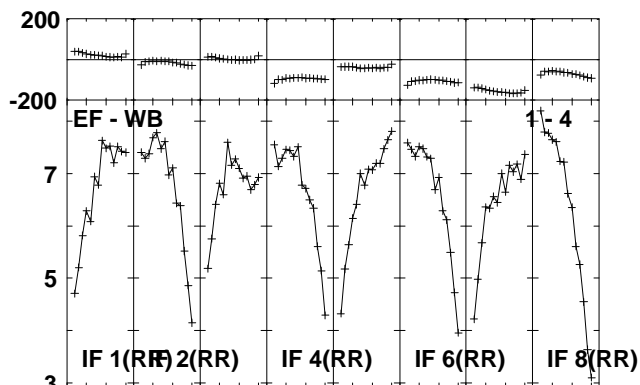
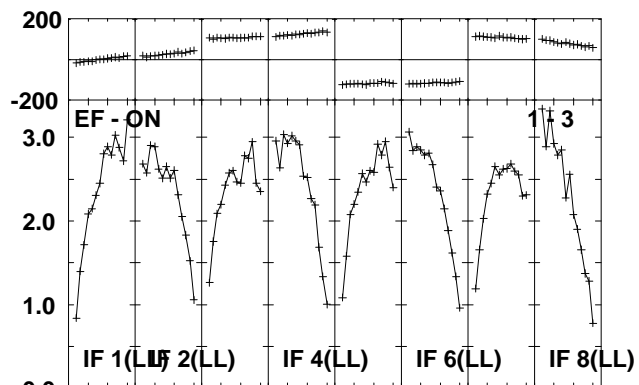
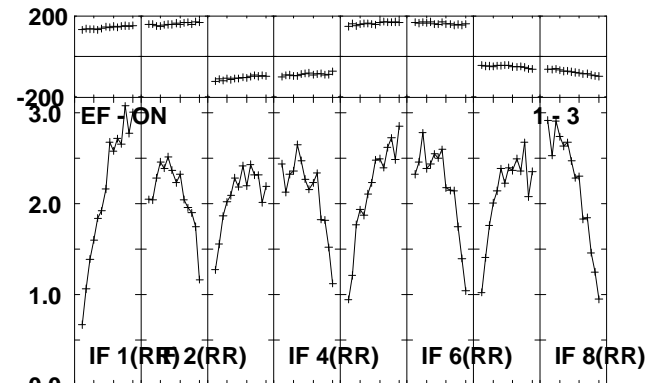
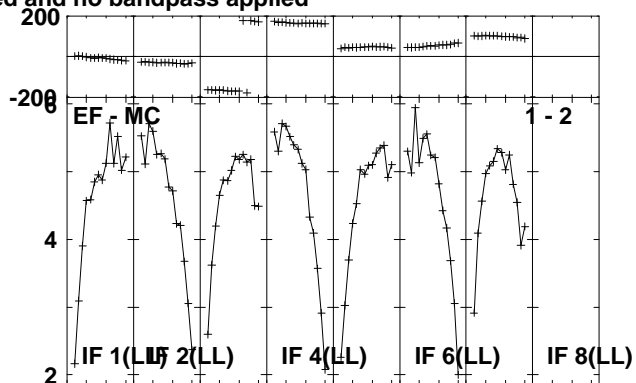
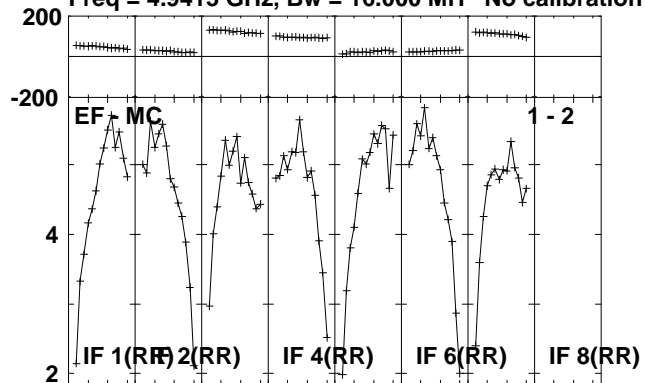

Lower frame: Milli Ampl Jy Top frame: Phas deg
Scalar averaged cross-power spectrum Several baselines displayed
Timerange: 00/22:34:31 to 00/22:35:59

Plot file version 144 created 14-JUL-2010 16:36:39
J1953+35 RR004A.UVDATA.1

Freq = 4.9415 GHz, Bw = 16.000 MH No calibration applied and no bandpass applied

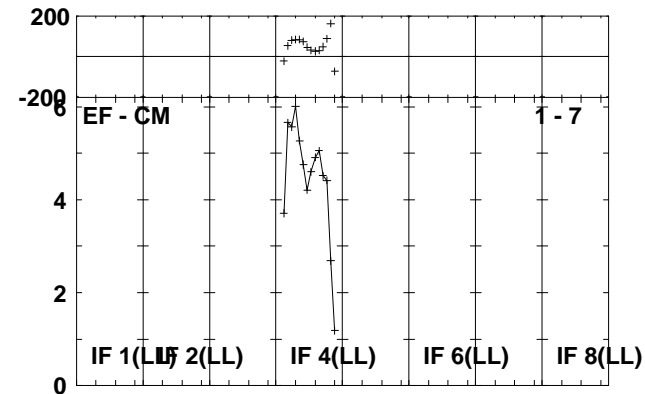
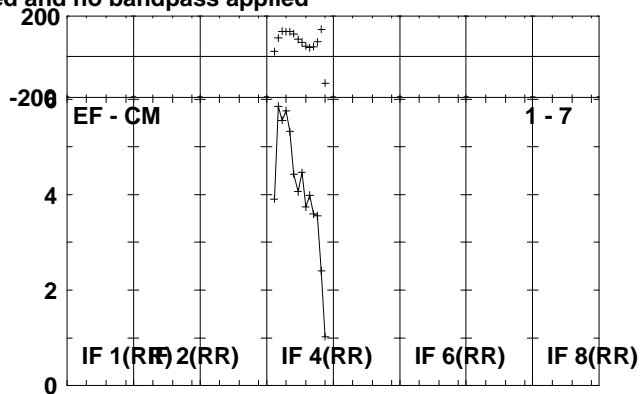
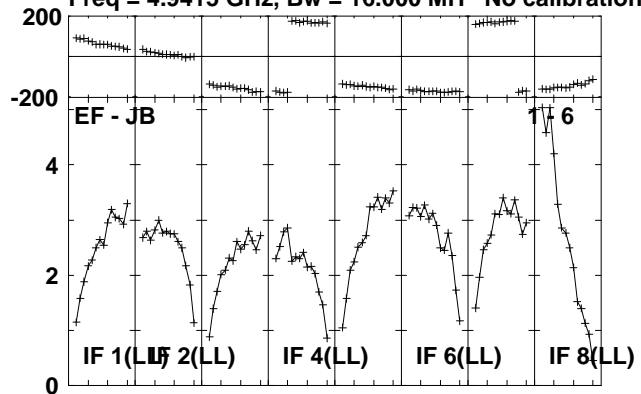

Lower frame: Milli Ampl Jy Top frame: Phas deg
Scalar averaged cross-power spectrum Several baselines displayed
Timerange: 00/22:34:31 to 00/22:35:59

Plot file version 145 created 14-JUL-2010 16:36:39

CYGX-1 RR004A.UVDATA.1

Freq = 4.9415 GHz, Bw = 16.000 MH No calibration applied and no bandpass applied

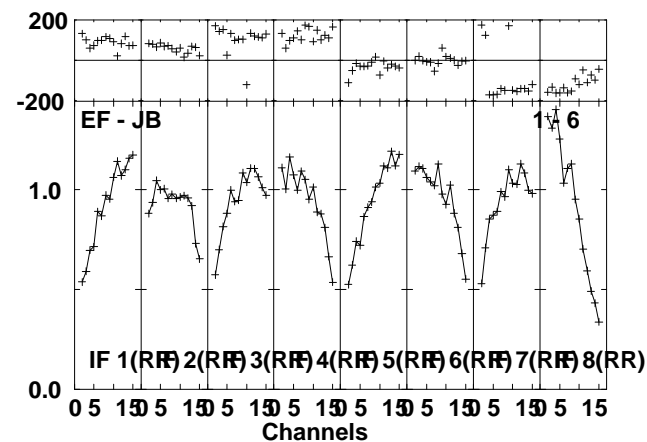
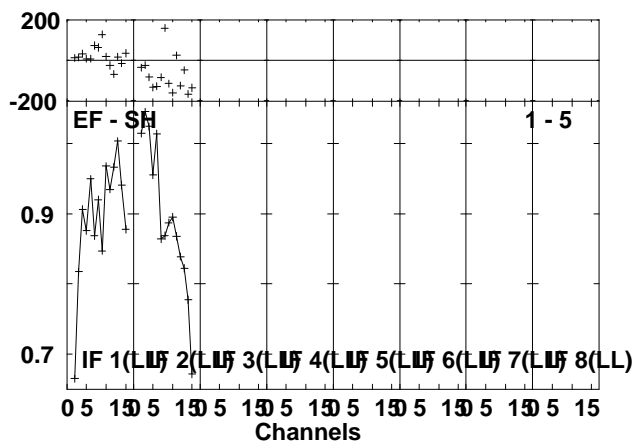
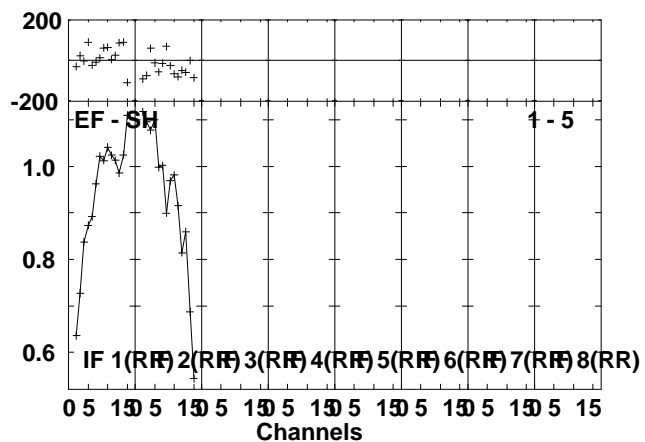
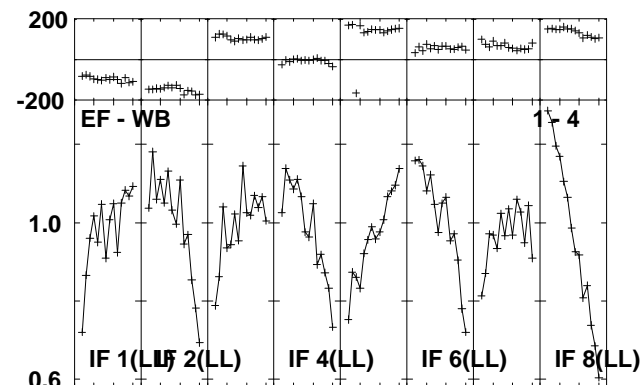
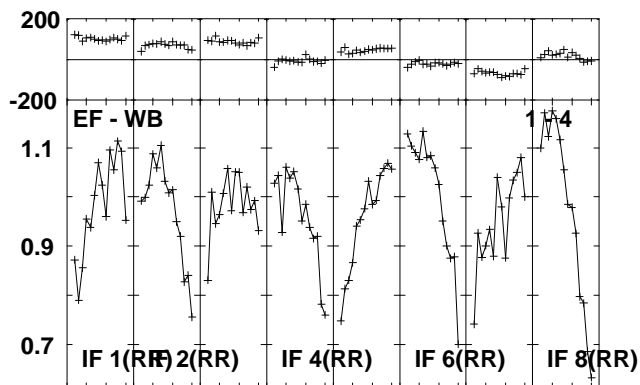
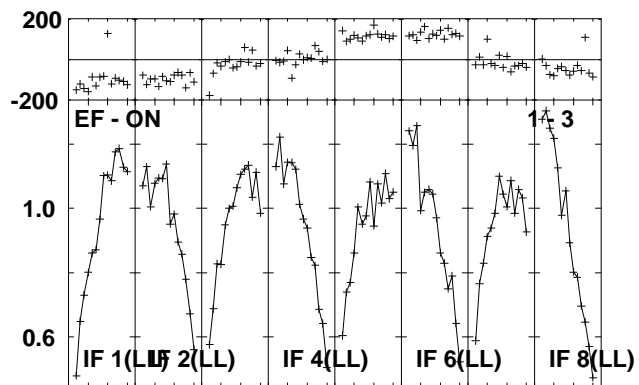
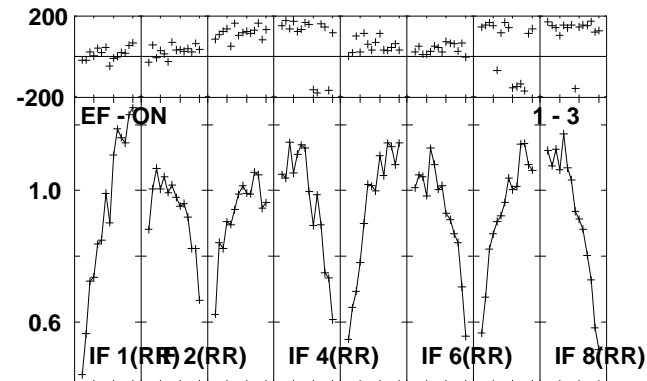
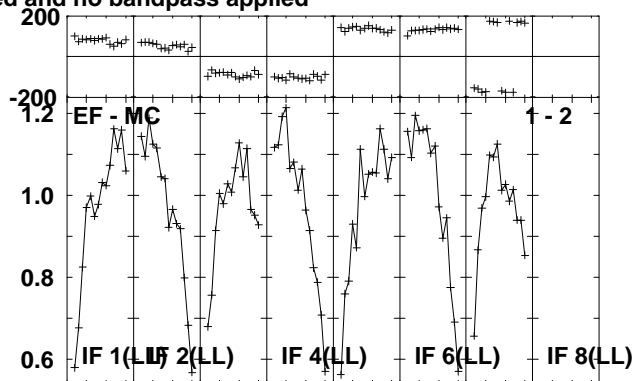
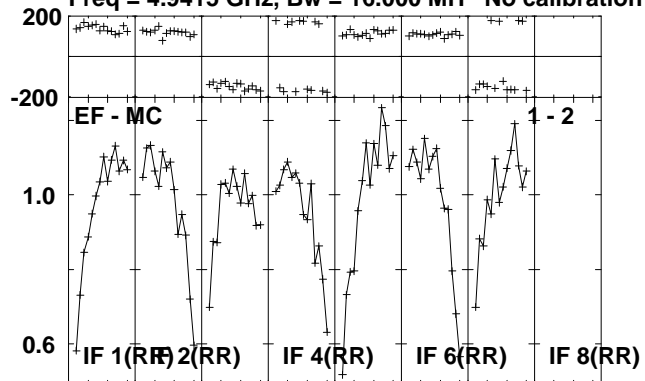

Lower frame: Milli Ampl Jy Top frame: Phas deg
Scalar averaged cross-power spectrum Several baselines displayed
Timerange: 00:22:36:01 to 00:22:40:59

Plot file version 146 created 14-JUL-2010 16:36:41

CYGX-1 RR004A.UVDATA.1

Freq = 4.9415 GHz, Bw = 16.000 MH No calibration applied and no bandpass applied

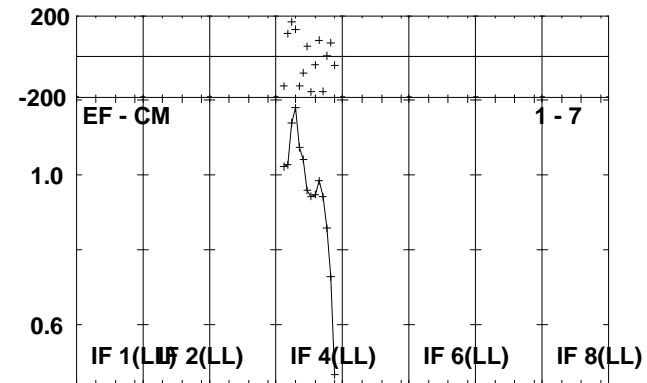
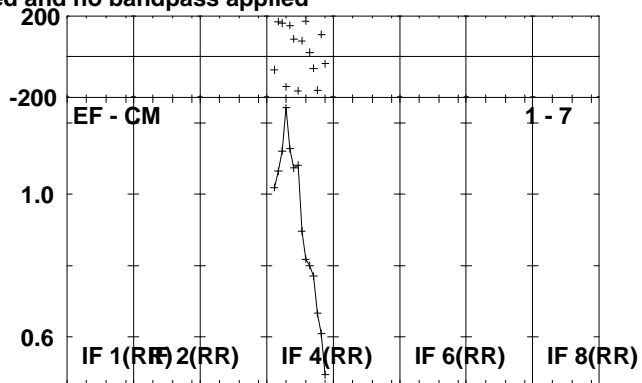
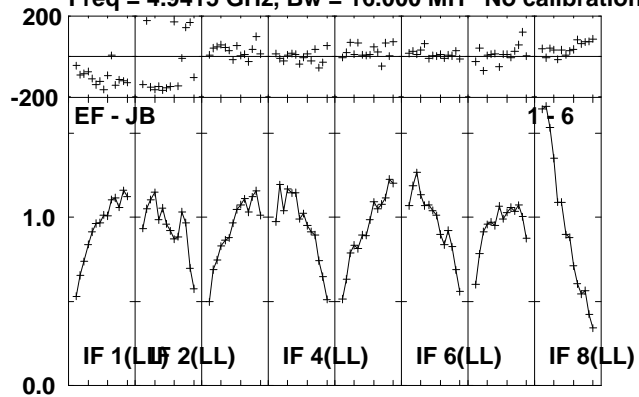

Lower frame: Milli Ampl Jy Top frame: Phas deg
Scalar averaged cross-power spectrum Several baselines displayed
Timerange: 00/22:36:01 to 00/22:40:59

Plot file version 147 created 14-JUL-2010 16:36:42

J1953+35 RR004A.UVDATA.1

Freq = 4.9415 GHz, Bw = 16.000 MH No calibration applied and no bandpass applied

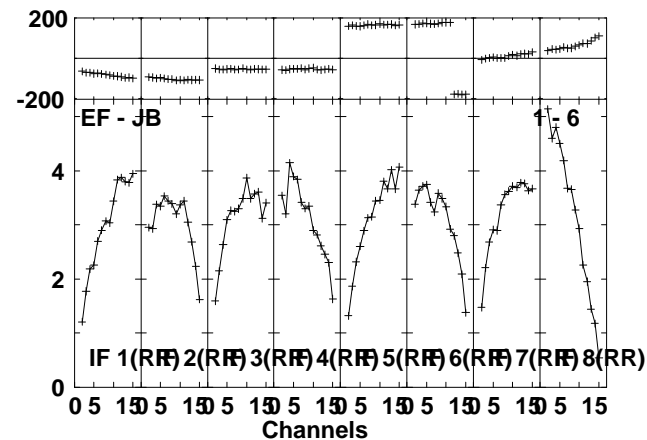
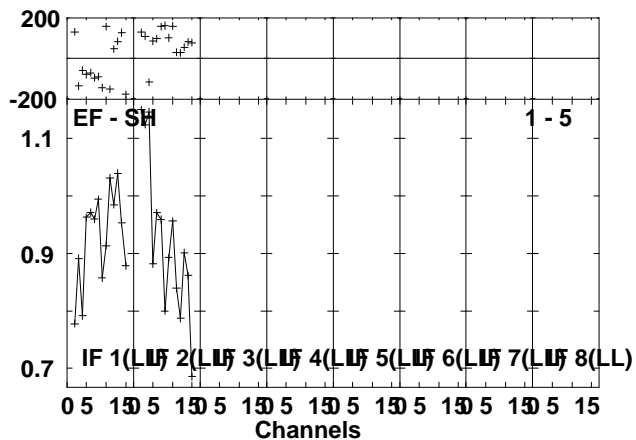
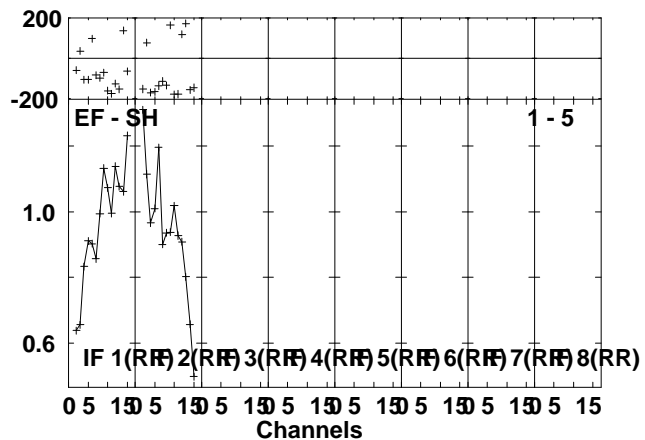
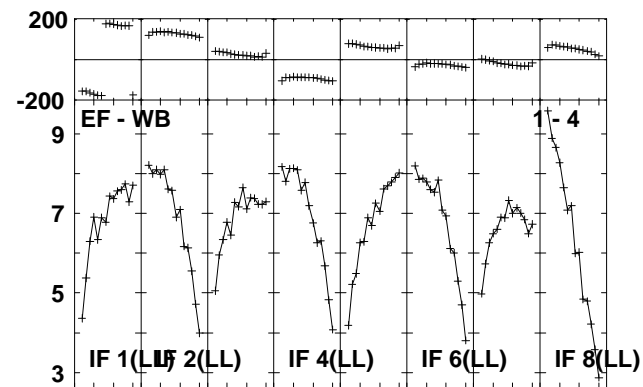
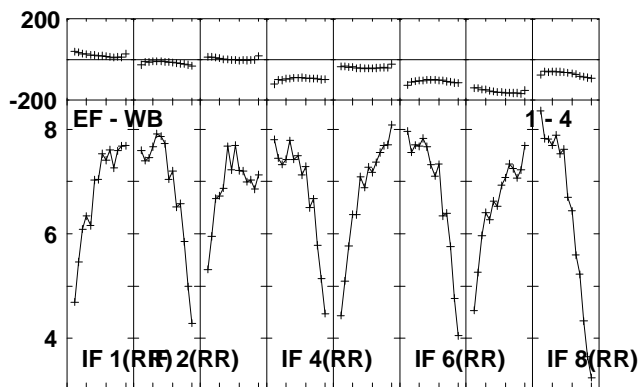
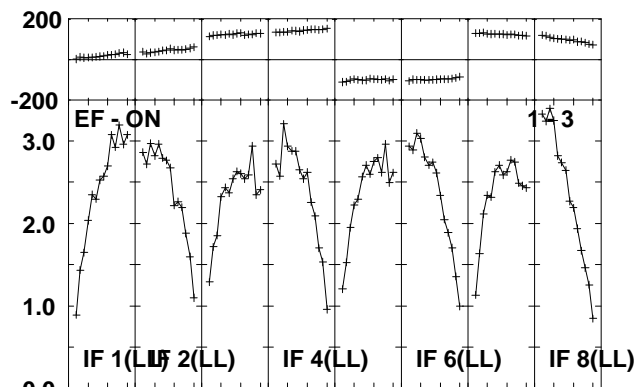
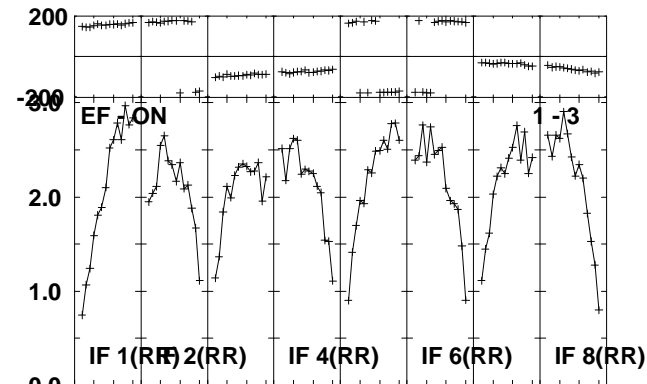
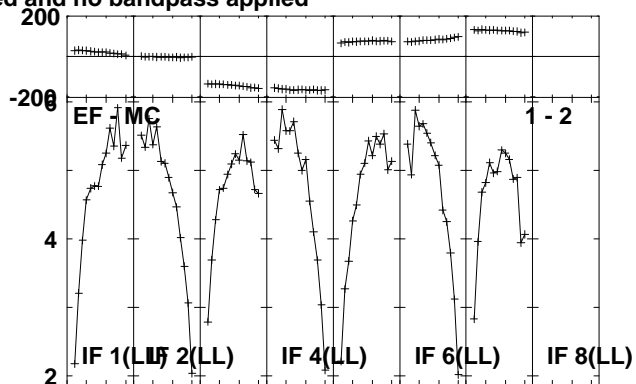
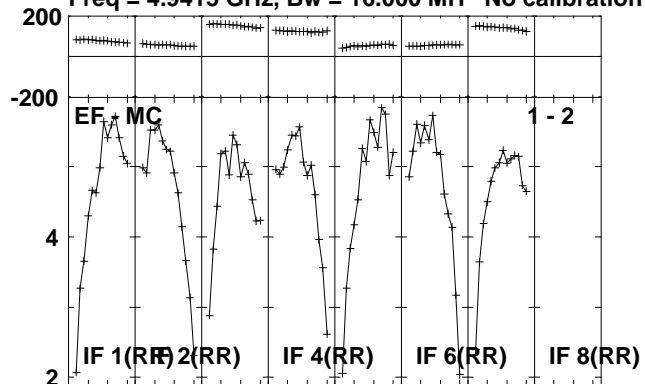

Lower frame: Milli Ampl Jy Top frame: Phas deg
Scalar averaged cross-power spectrum Several baselines displayed
Timerange: 00/22:41:01 to 00/22:42:59

Plot file version 148 created 14-JUL-2010 16:36:42

J1953+35 RR004A.UVDATA.1

Freq = 4.9415 GHz, Bw = 16.000 MH No calibration applied and no bandpass applied

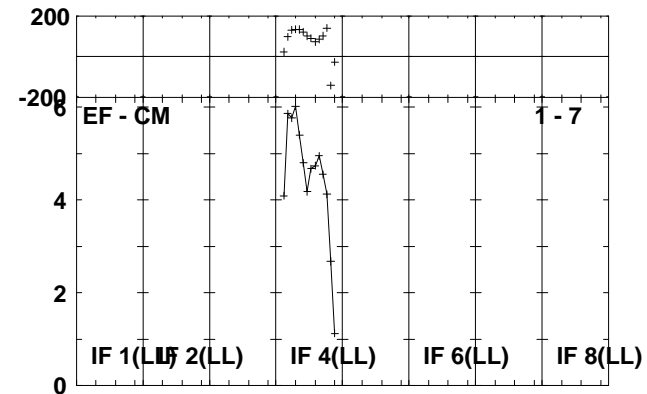
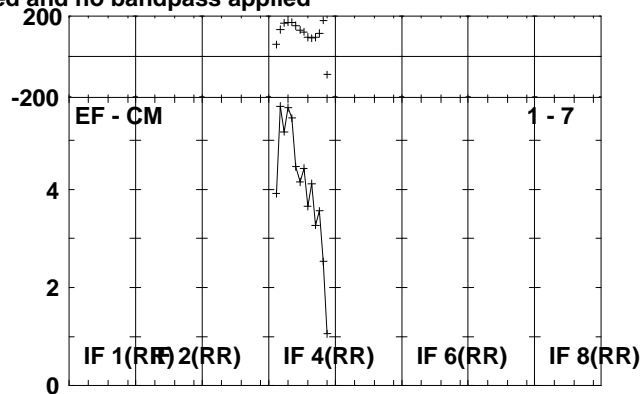
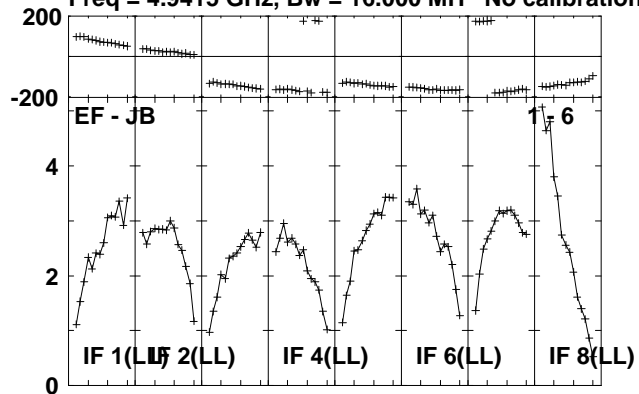

Lower frame: Milli Ampl Jy Top frame: Phas deg
Scalar averaged cross-power spectrum Several baselines displayed
Timerange: 00:22:41:01 to 00:22:42:59

Plot file version 149 created 14-JUL-2010 16:36:43

CYGX-1 RR004A.UVDATA.1

Freq = 4.9415 GHz, Bw = 16.000 MH No calibration applied and no bandpass applied

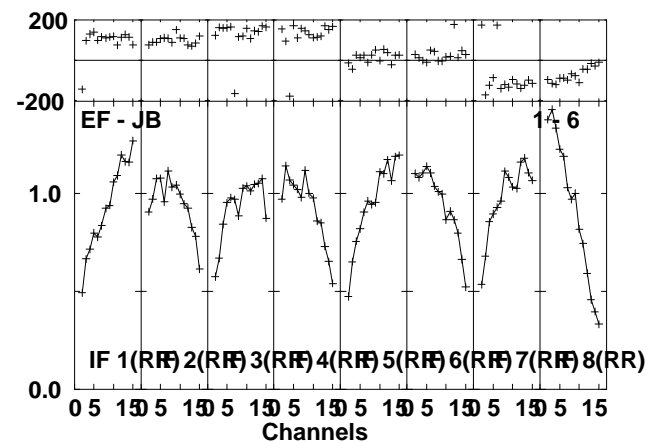
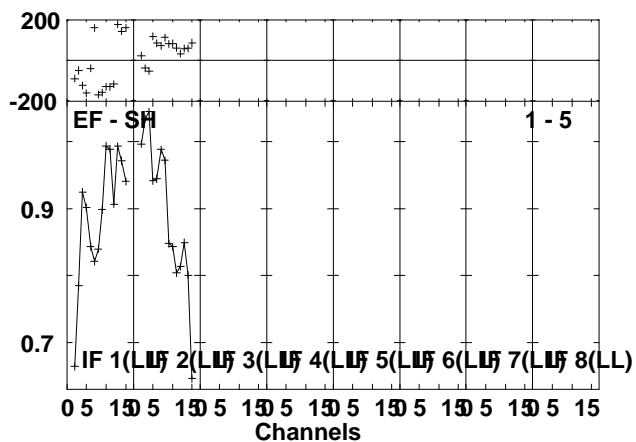
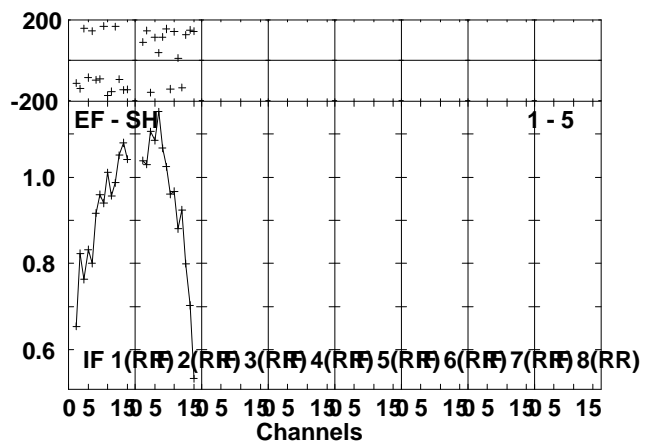
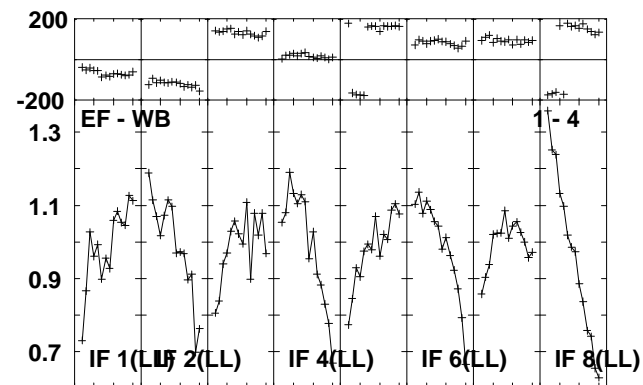
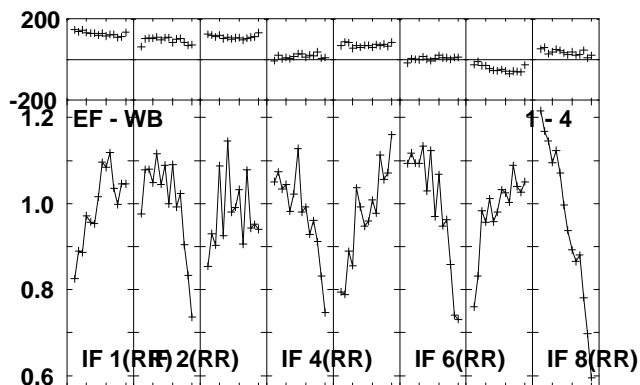
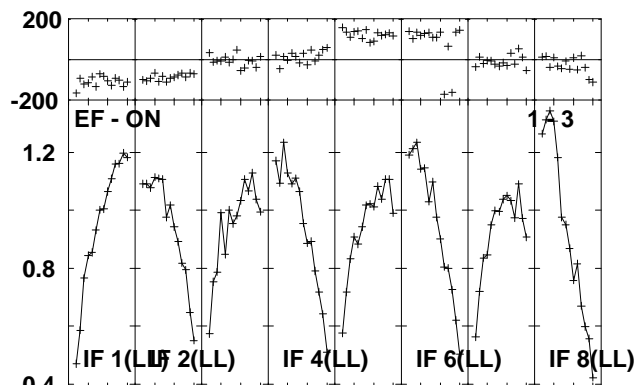
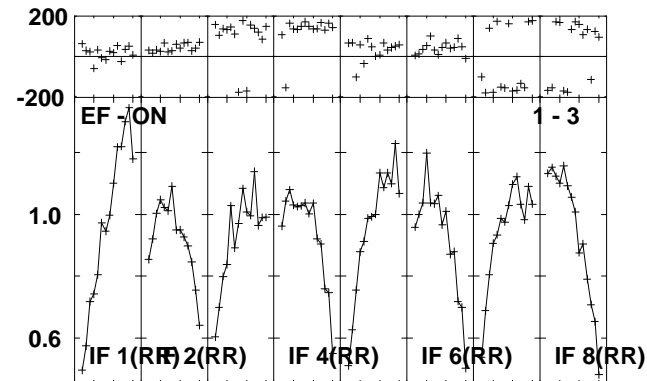
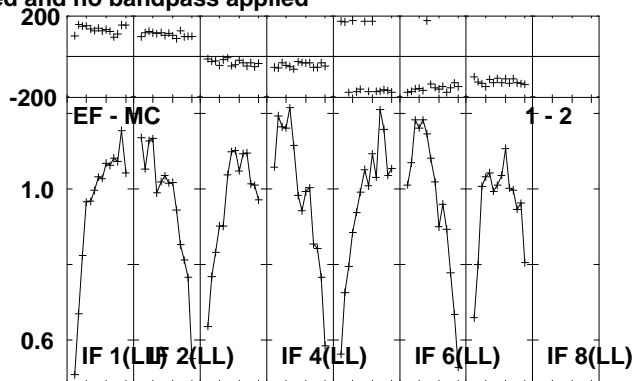
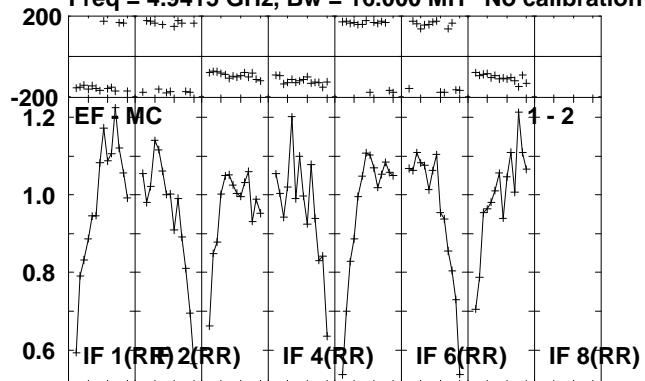

Lower frame: Milli Ampl Jy Top frame: Phas deg
Scalar averaged cross-power spectrum Several baselines displayed
Timerange: 00/22:43:01 to 00/22:47:59

Plot file version 150 created 14-JUL-2010 16:36:44

CYGX-1 RR004A.UVDATA.1

Freq = 4.9415 GHz, Bw = 16.000 MH No calibration applied and no bandpass applied

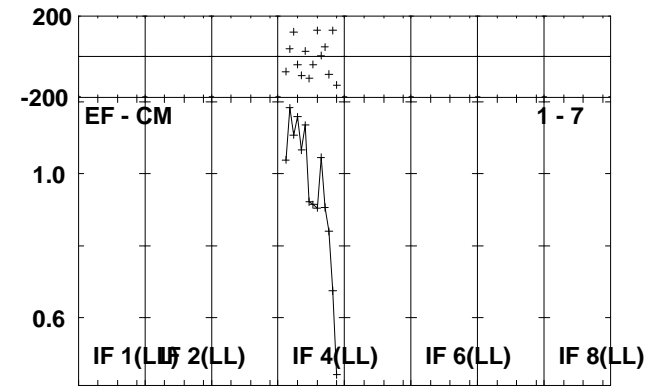
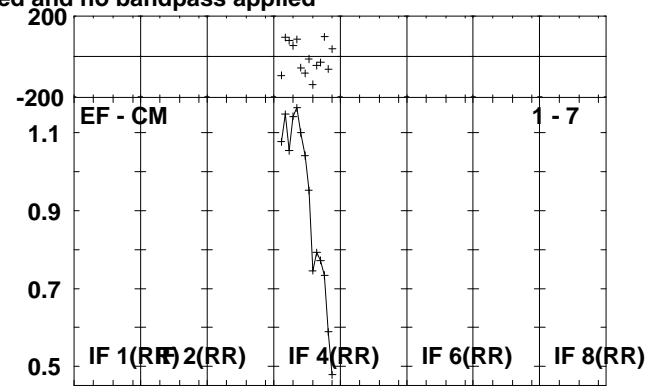
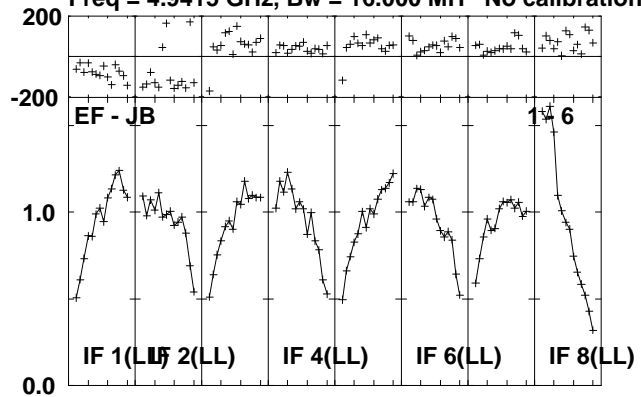

Lower frame: Milli Ampl Jy Top frame: Phas deg
Scalar averaged cross-power spectrum Several baselines displayed
Timerange: 00/22:43:01 to 00/22:47:59

Plot file version 151 created 14-JUL-2010 16:36:46

J1953+35 RR004A.UVDATA.1

Freq = 4.9415 GHz, Bw = 16.000 MH No calibration applied and no bandpass applied

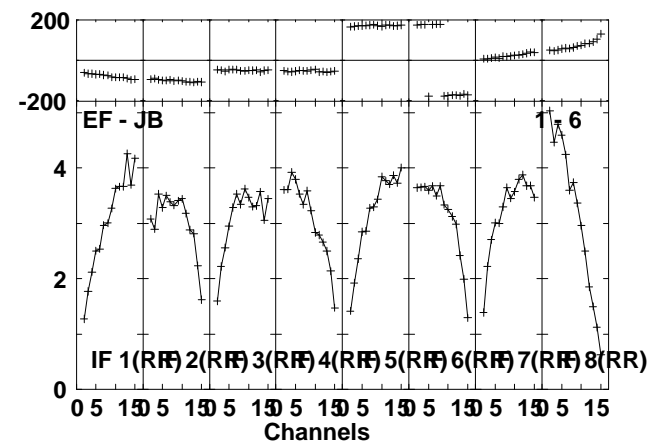
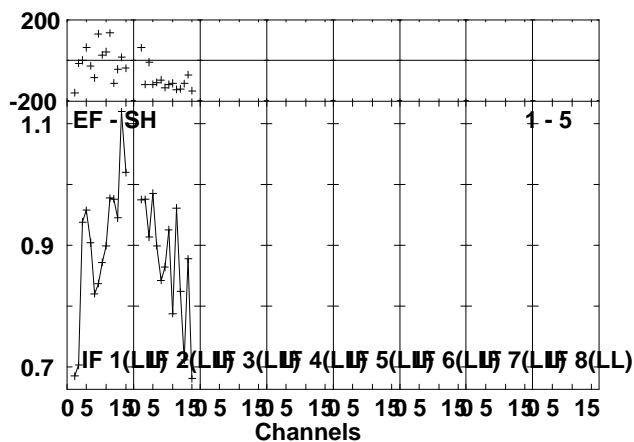
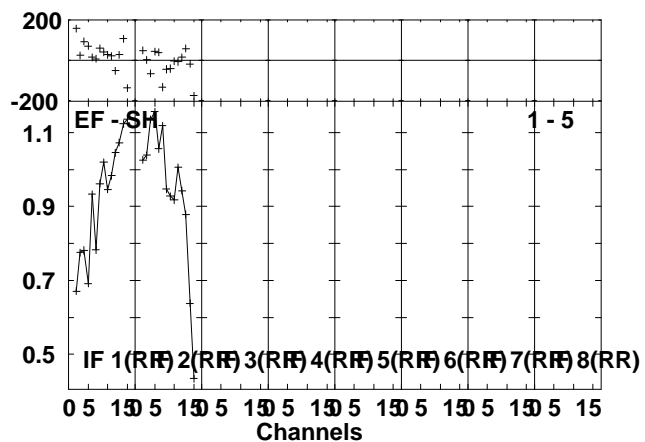
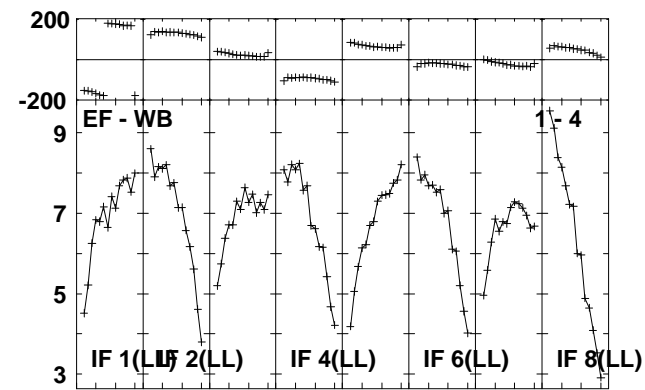
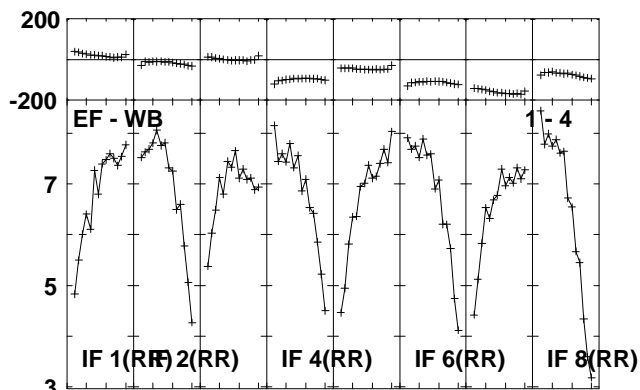
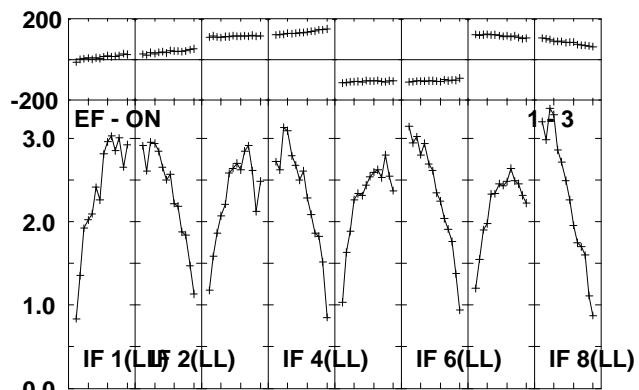
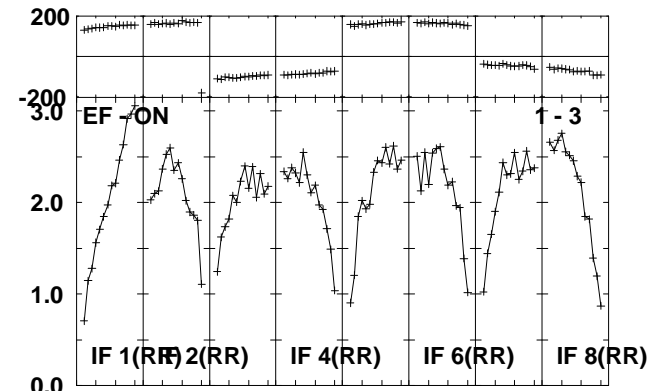
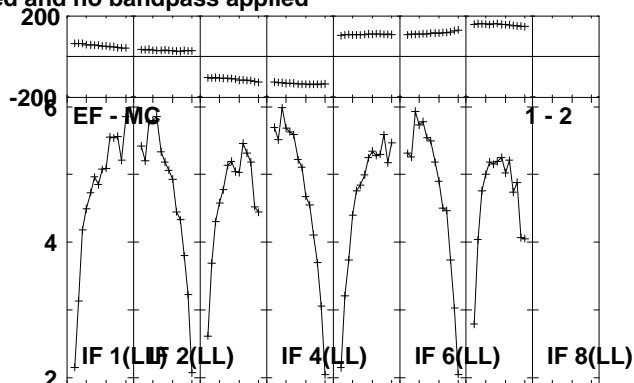
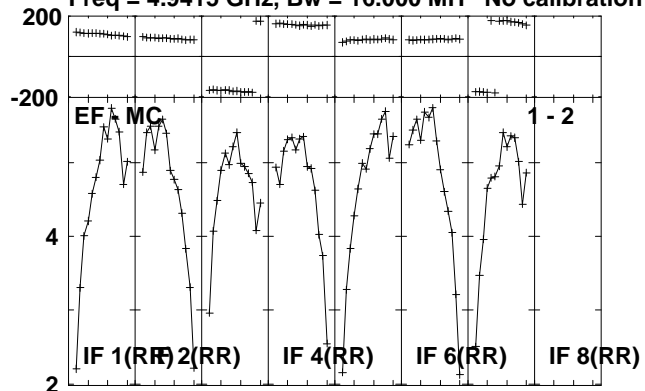

Lower frame: Milli Ampl Jy Top frame: Phas deg
Scalar averaged cross-power spectrum Several baselines displayed
Timerange: 00/22:48:41 to 00/22:50:09

Plot file version 152 created 14-JUL-2010 16:36:46
J1953+35 RR004A.UVDATA.1

Freq = 4.9415 GHz, Bw = 16.000 MH No calibration applied and no bandpass applied

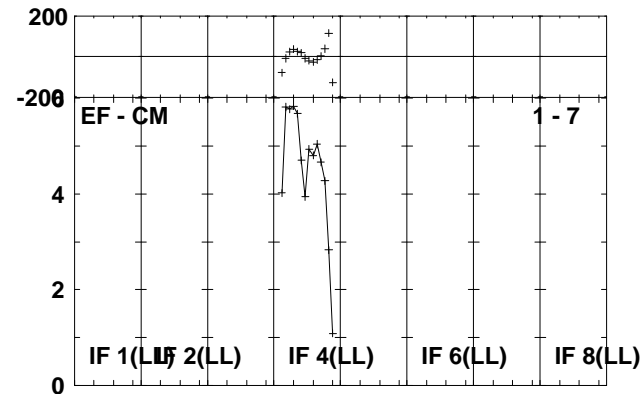
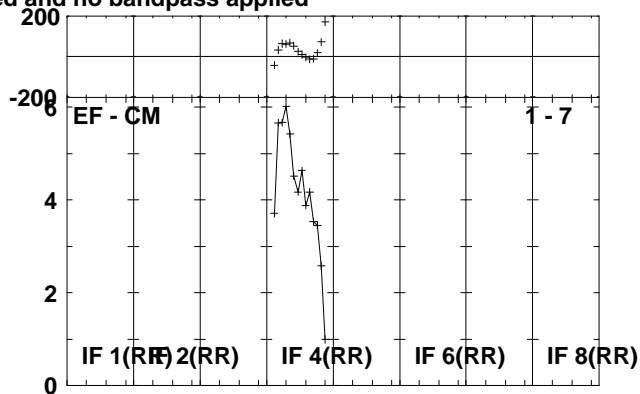
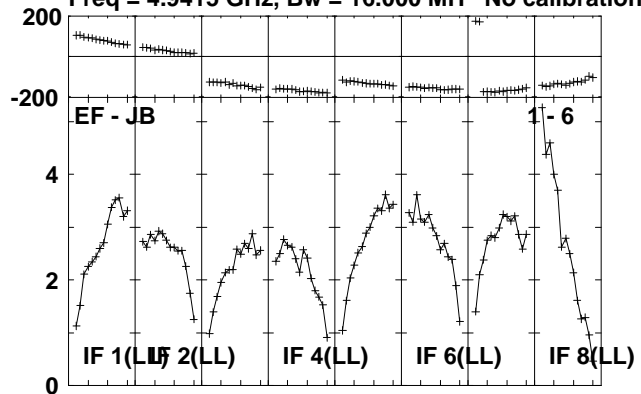

Lower frame: Milli Ampl Jy Top frame: Phas deg
Scalar averaged cross-power spectrum Several baselines displayed
Timerange: 00/22:48:41 to 00/22:50:09

Plot file version 153 created 14-JUL-2010 16:36:47

CYGX-1 RR004A.UVDATA.1

Freq = 4.9415 GHz, Bw = 16.000 MH No calibration applied and no bandpass applied

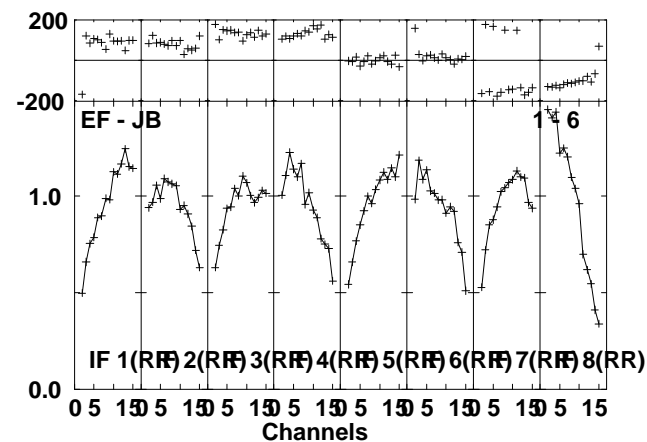
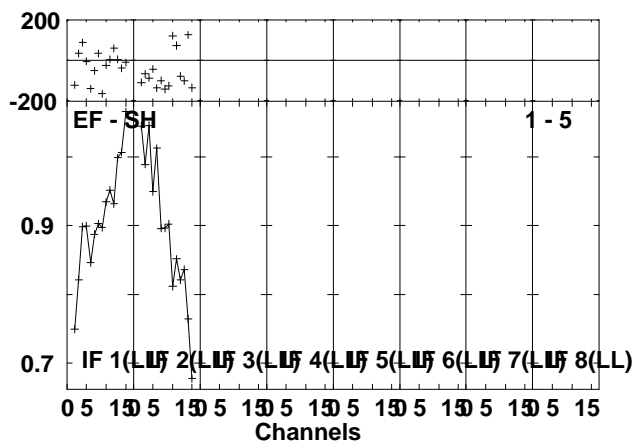
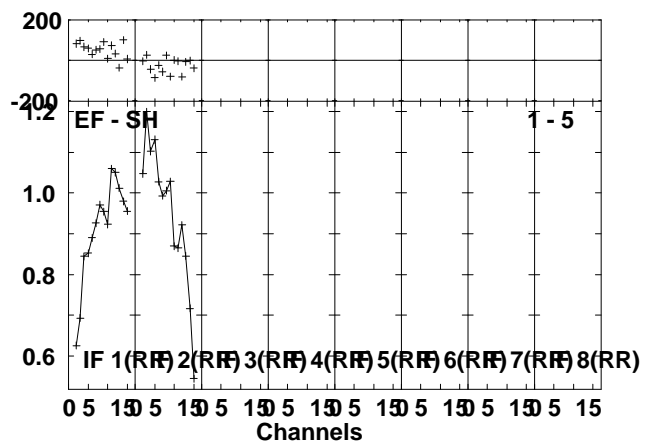
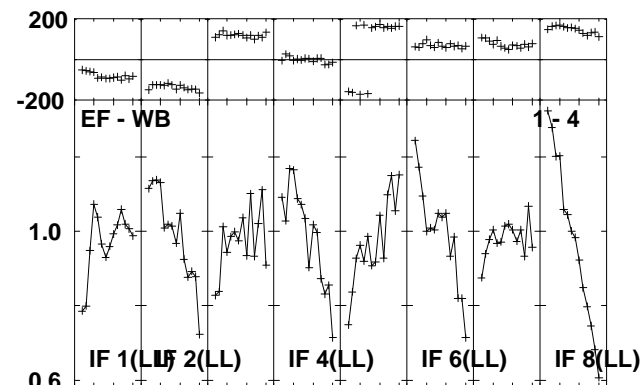
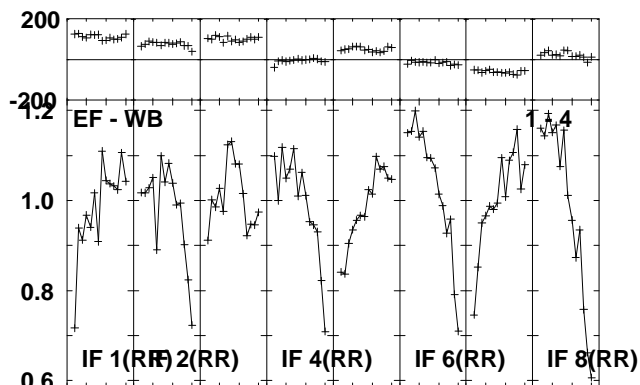
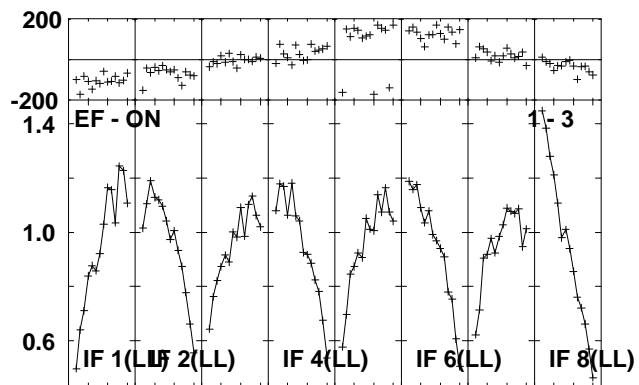
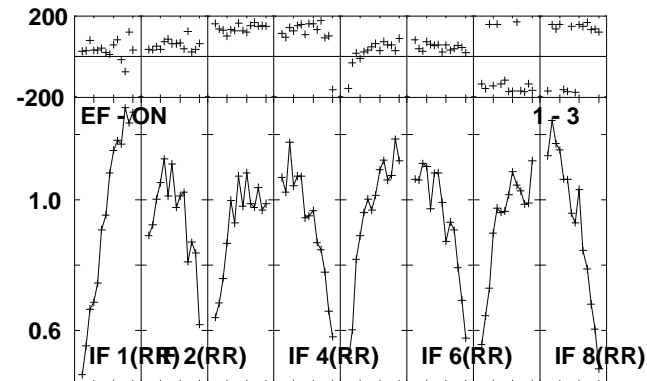
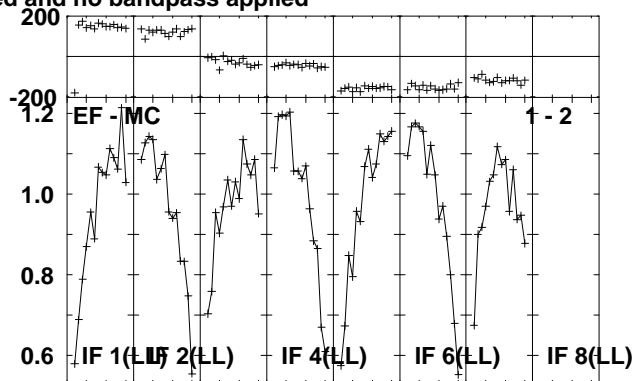
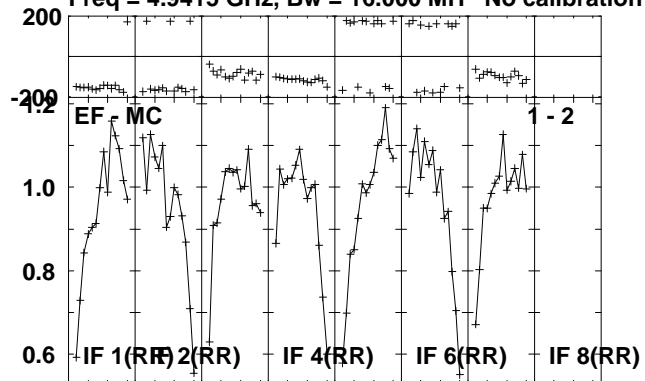

Lower frame: Milli Ampl Jy Top frame: Phas deg
Scalar averaged cross-power spectrum Several baselines displayed
Timerange: 00/22:50:11 to 00/22:55:09

Plot file version 154 created 14-JUL-2010 16:36:48

CYGX-1 RR004A.UVDATA.1

Freq = 4.9415 GHz, Bw = 16.000 MH No calibration applied and no bandpass applied

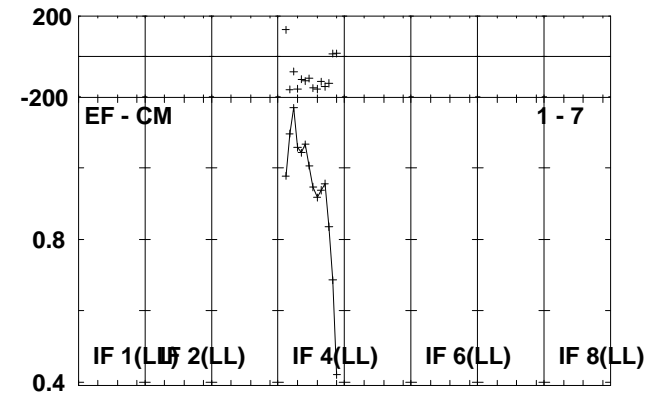
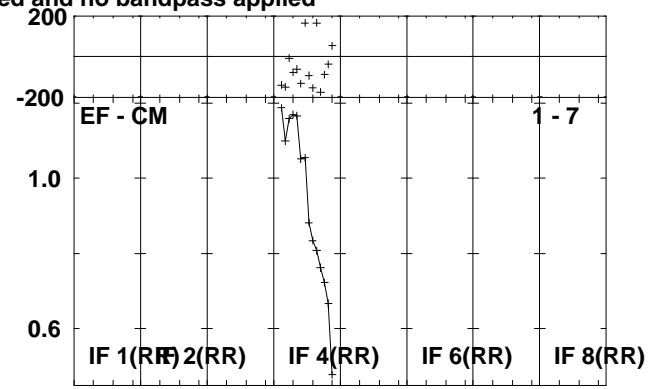
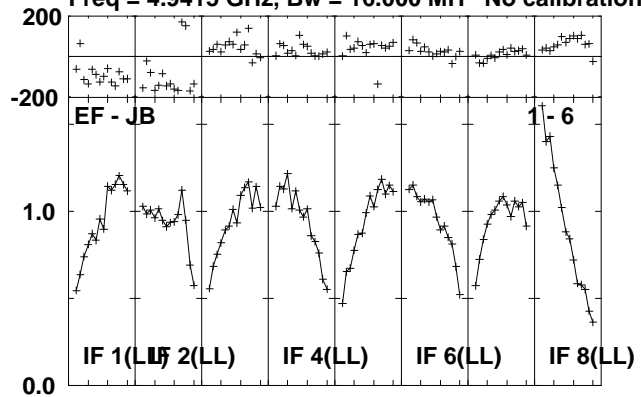

Lower frame: Milli Ampl Jy Top frame: Phas deg
Scalar averaged cross-power spectrum Several baselines displayed
Timerange: 00/22:50:11 to 00/22:55:09

Plot file version 155 created 14-JUL-2010 16:36:49

J1953+35 RR004A.UVDATA.1

Freq = 4.9415 GHz, Bw = 16.000 MH No calibration applied and no bandpass applied

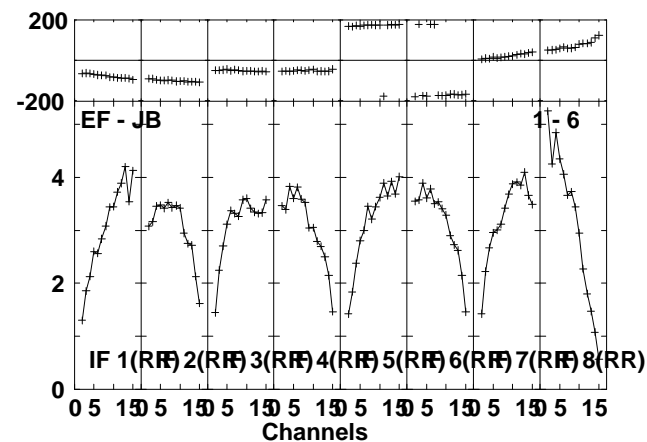
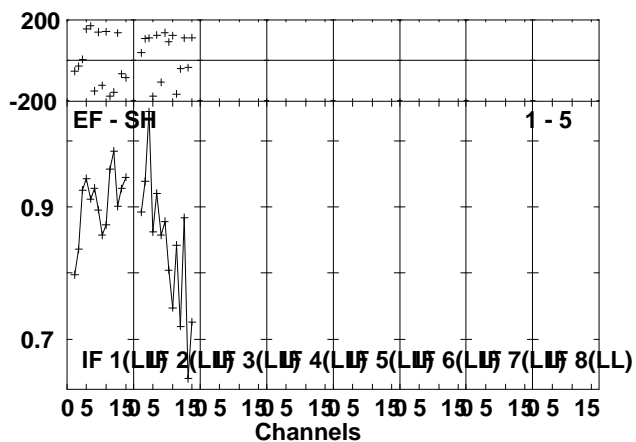
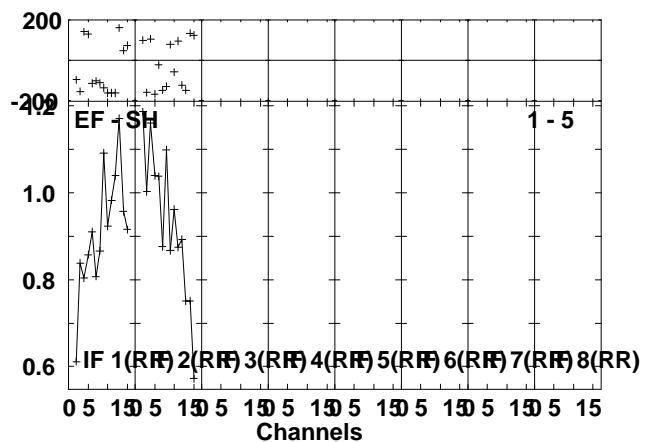
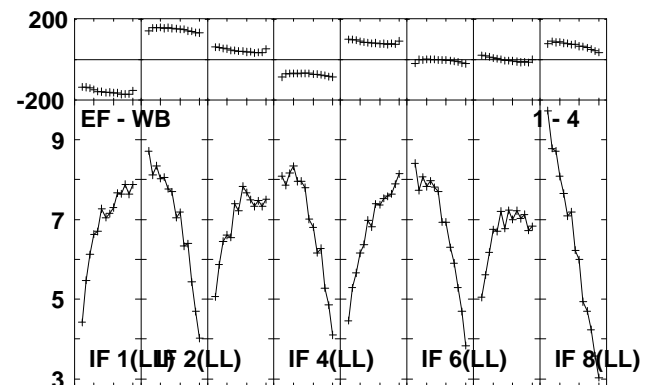
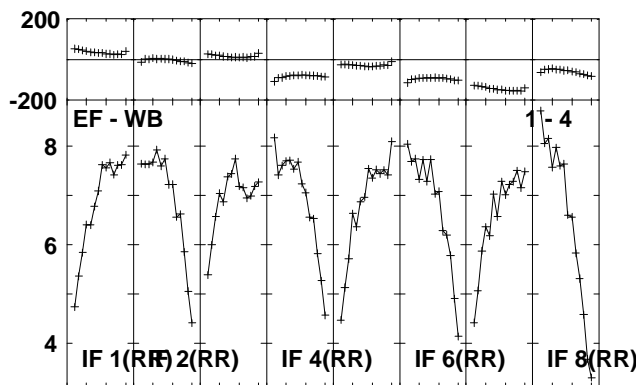
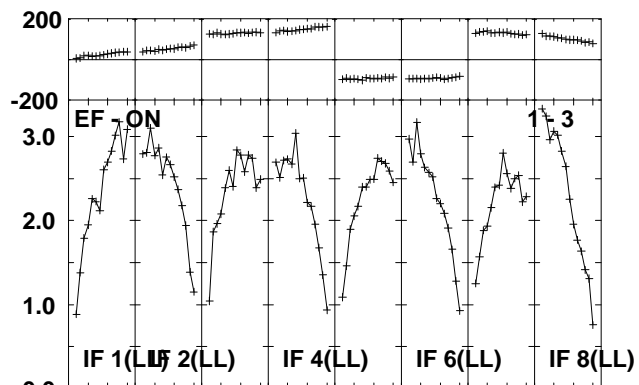
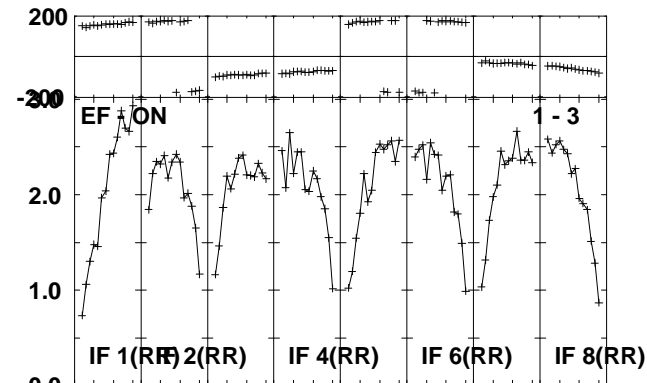
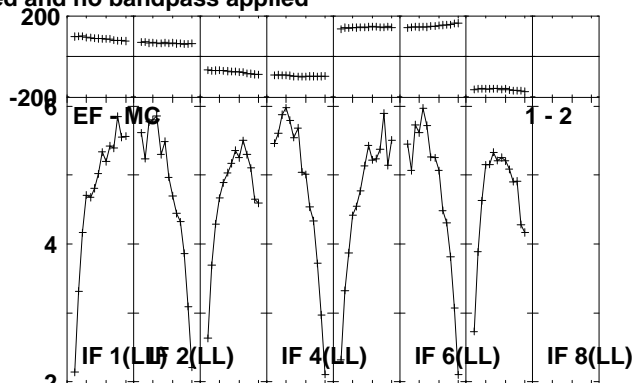
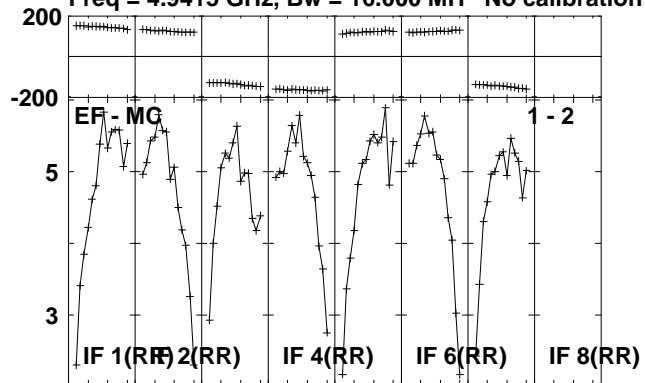

Lower frame: Milli Ampl Jy Top frame: Phas deg
Scalar averaged cross-power spectrum Several baselines displayed
Timerange: 00/22:55:11 to 00/22:57:09

Plot file version 156 created 14-JUL-2010 16:36:50

J1953+35 RR004A.UVDATA.1

Freq = 4.9415 GHz, Bw = 16.000 MH No calibration applied and no bandpass applied

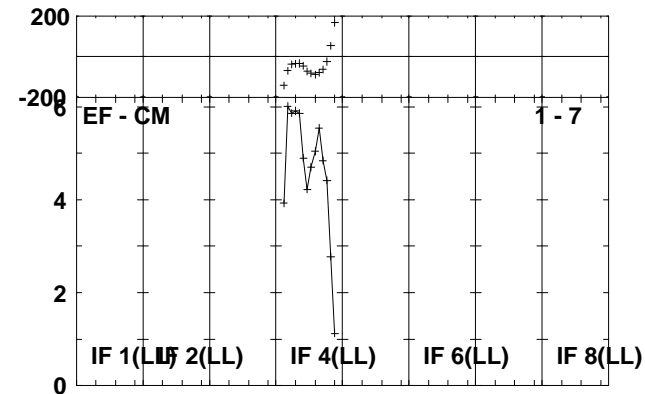
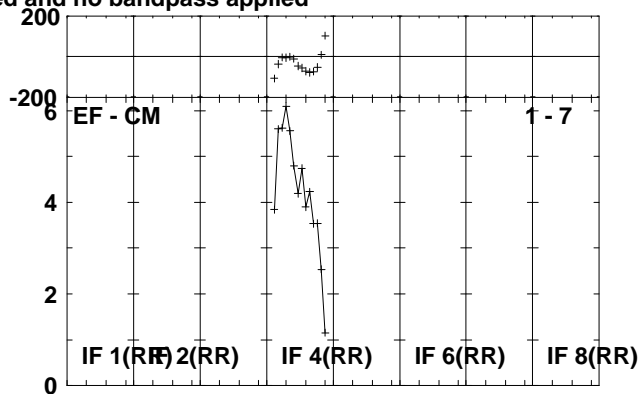
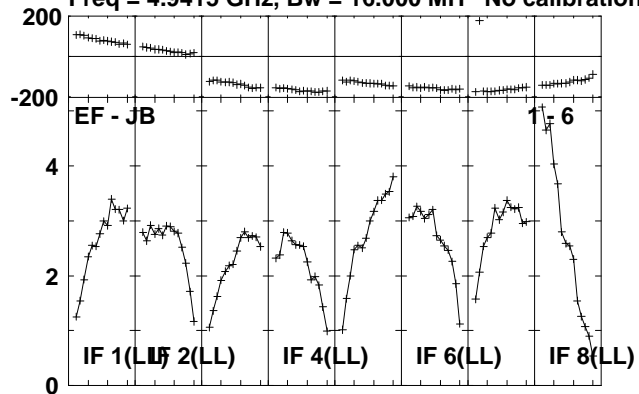

Lower frame: Milli Ampl Jy Top frame: Phas deg
Scalar averaged cross-power spectrum Several baselines displayed
Timerange: 00/22:55:11 to 00/22:57:09

Plot file version 157 created 14-JUL-2010 16:36:50

CYGX-1 RR004A.UVDATA.1

Freq = 4.9415 GHz, Bw = 16.000 MH No calibration applied and no bandpass applied

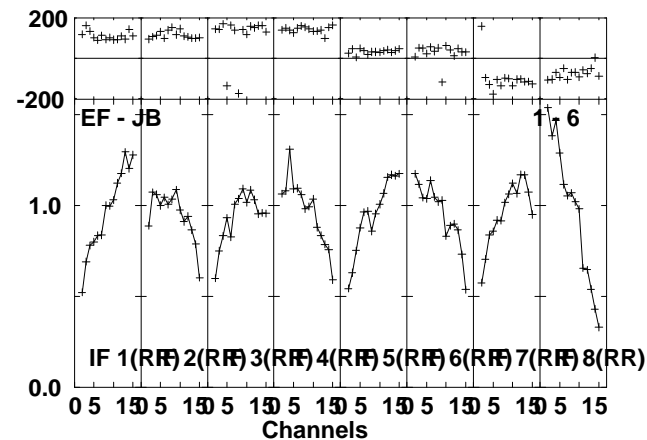
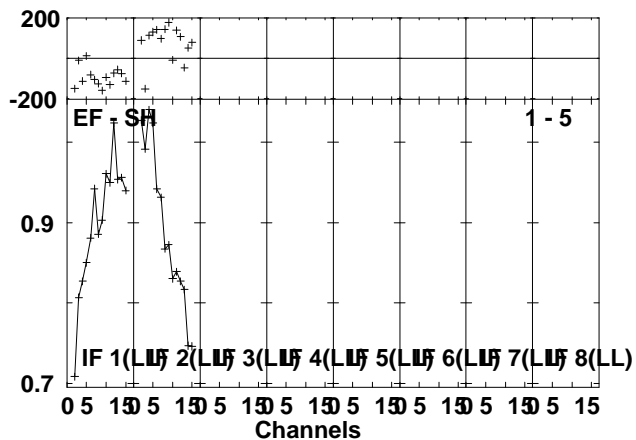
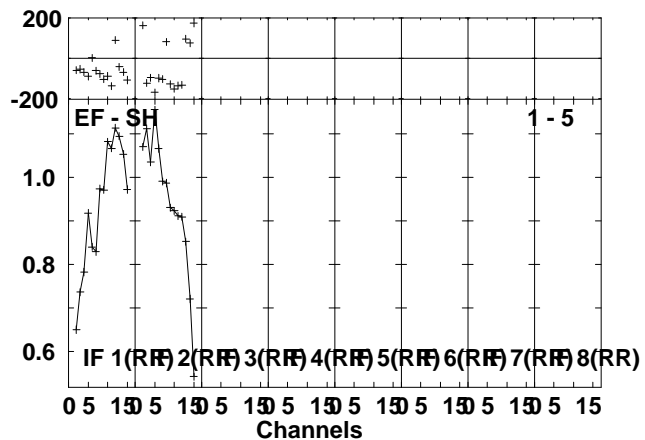
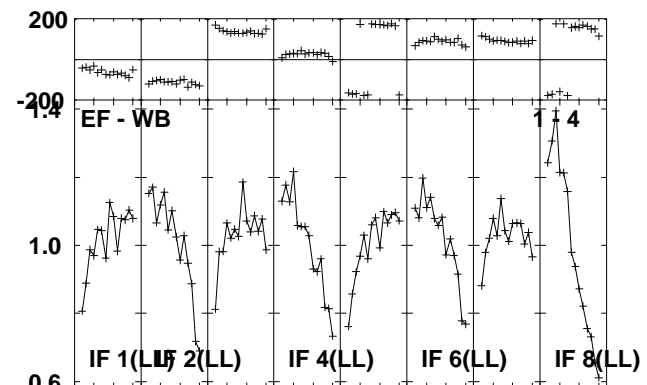
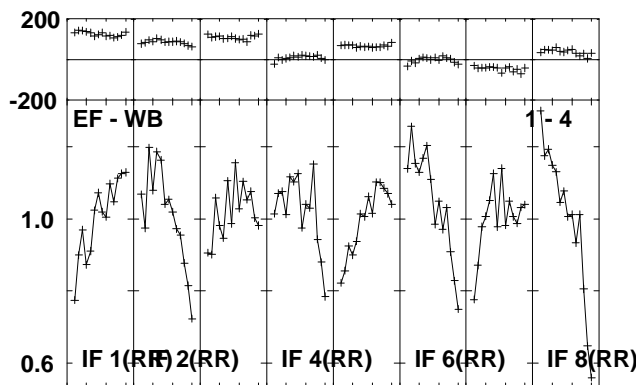
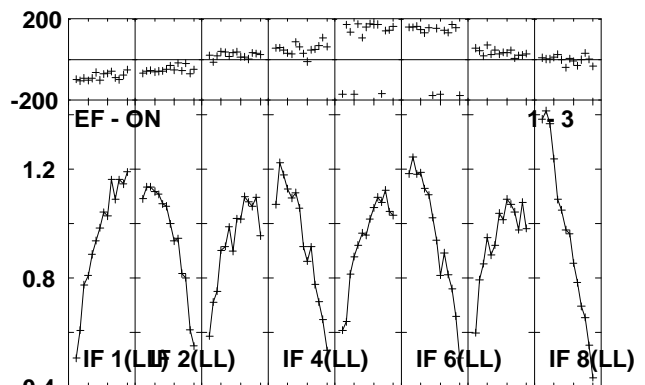
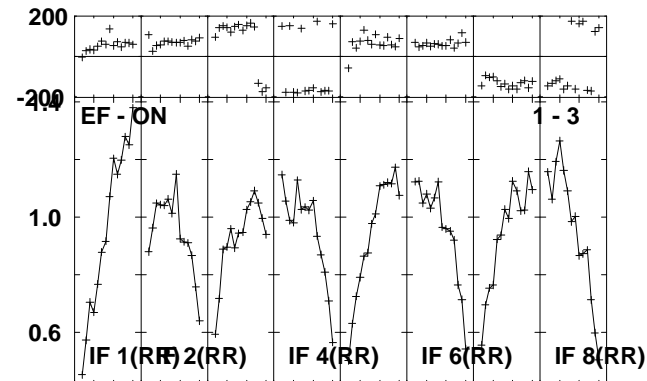
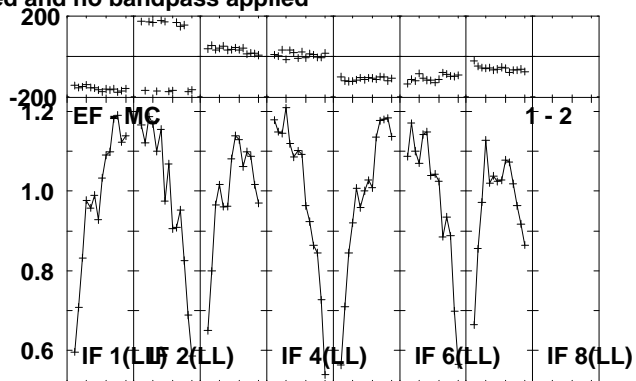
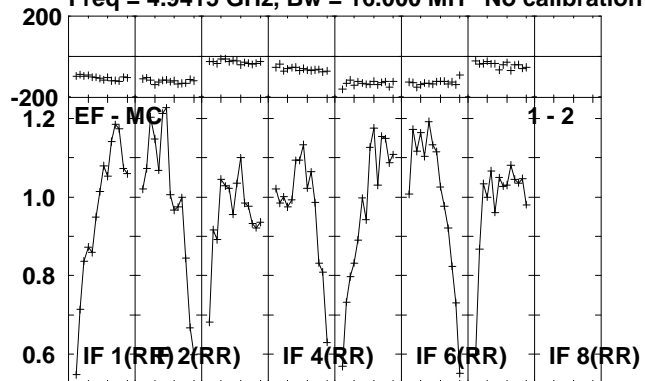

Lower frame: Milli Ampl Jy Top frame: Phas deg
Scalar averaged cross-power spectrum Several baselines displayed
Timerange: 00/22:57:11 to 00/23:02:09

Plot file version 158 created 14-JUL-2010 16:36:52

CYGX-1 RR004A.UVDATA.1

Freq = 4.9415 GHz, Bw = 16.000 MH No calibration applied and no bandpass applied

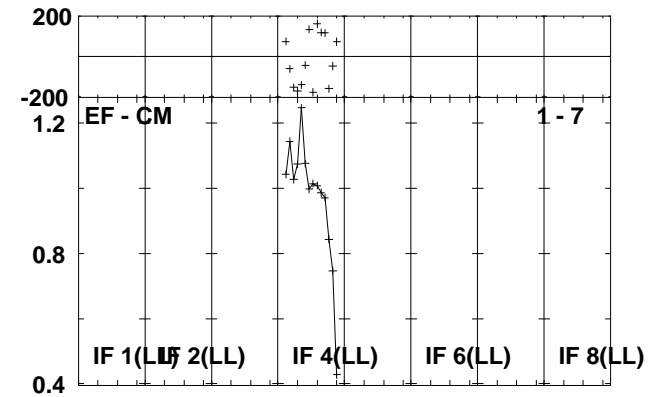
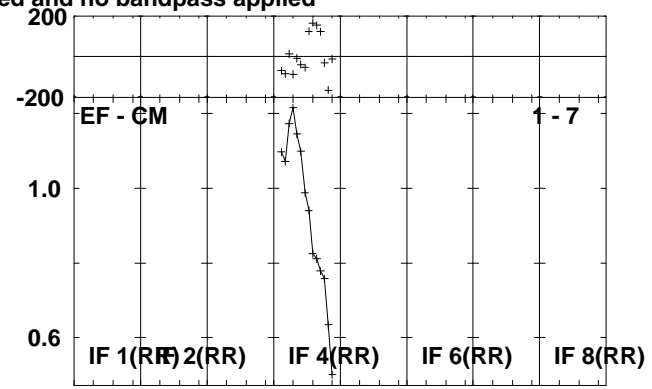
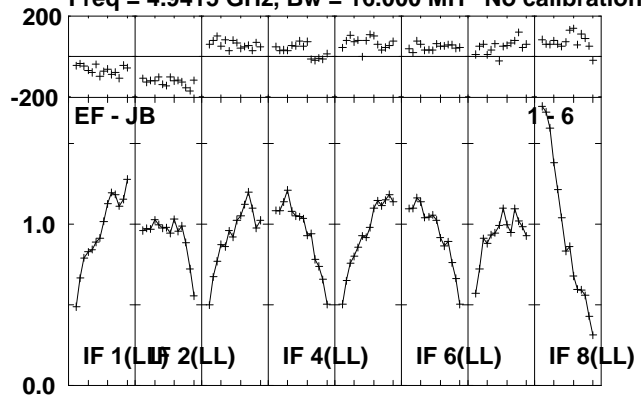

Lower frame: Milli Ampl Jy Top frame: Phas deg
Scalar averaged cross-power spectrum Several baselines displayed
Timerange: 00/22:57:11 to 00/23:02:09

Plot file version 159 created 14-JUL-2010 16:36:53

J1953+35 RR004A.UVDATA.1

Freq = 4.9415 GHz, Bw = 16.000 MH No calibration applied and no bandpass applied

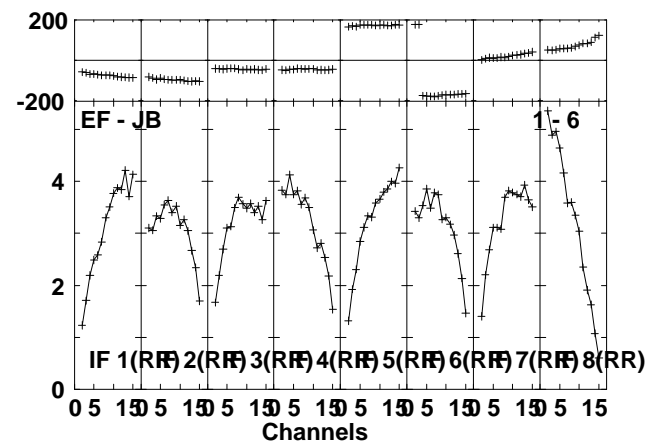
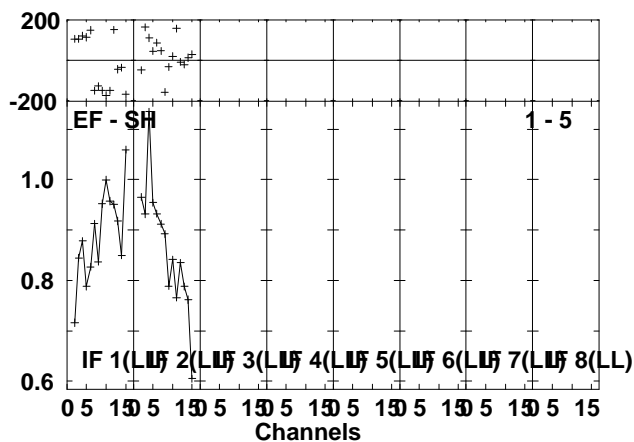
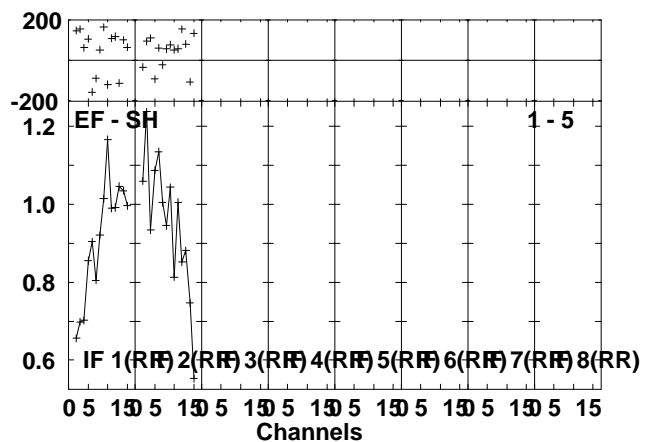
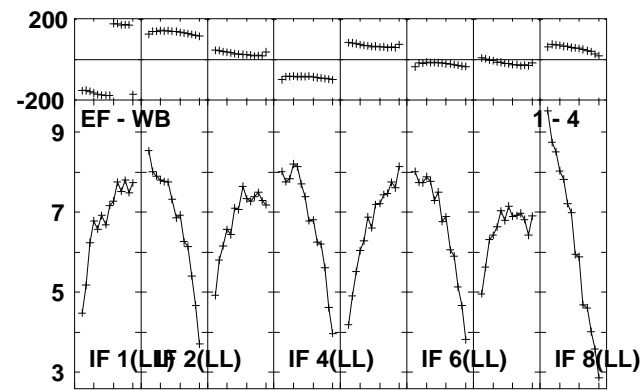
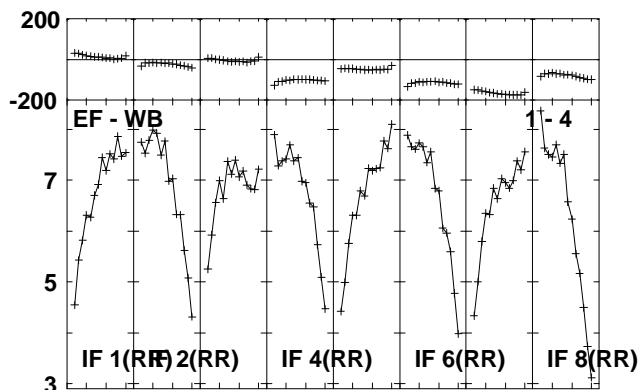
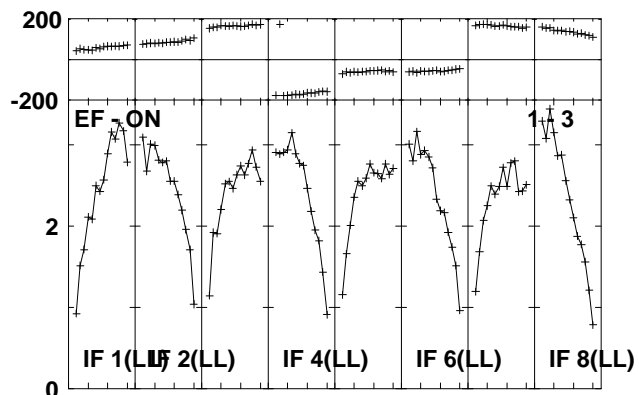
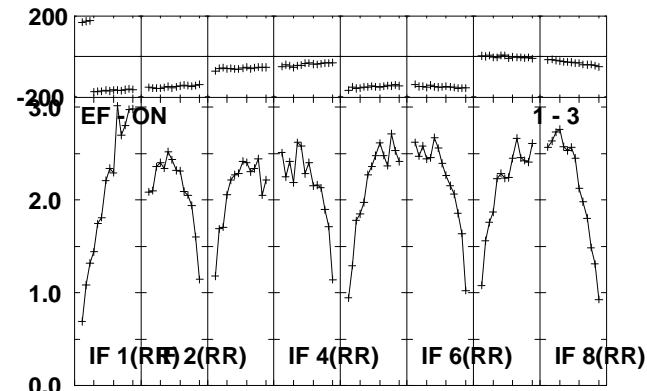
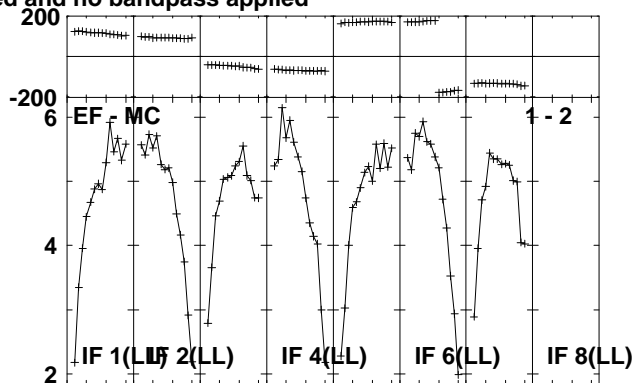
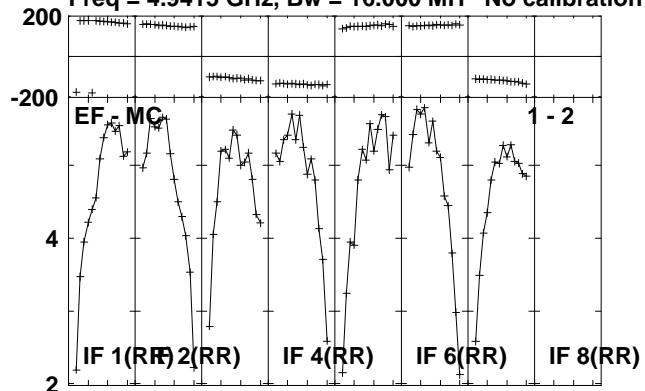

Lower frame: Milli Ampl Jy Top frame: Phas deg
Scalar averaged cross-power spectrum Several baselines displayed
Timerange: 00/23:02:51 to 00/23:04:19

Plot file version 160 created 14-JUL-2010 16:36:53

J1953+35 RR004A.UVDATA.1

Freq = 4.9415 GHz, Bw = 16.000 MH No calibration applied and no bandpass applied

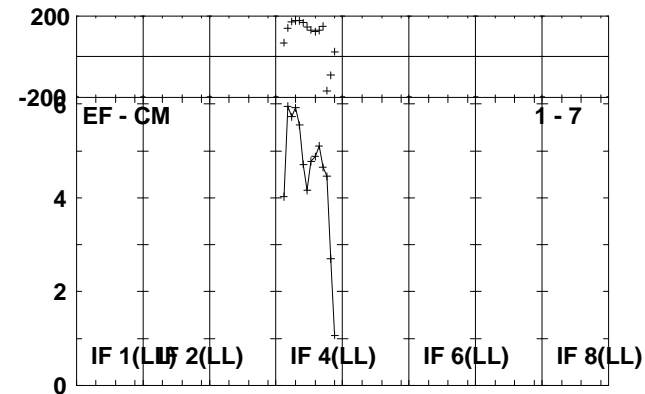
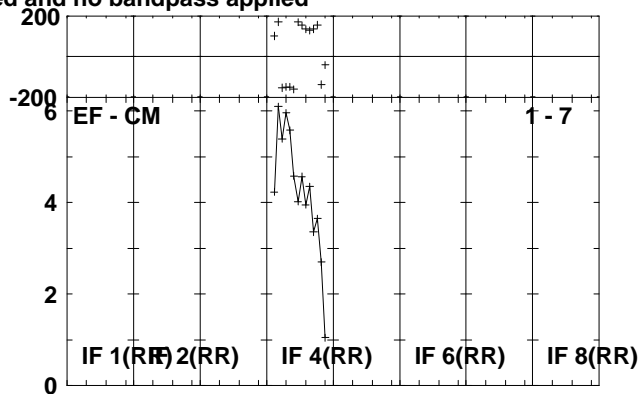
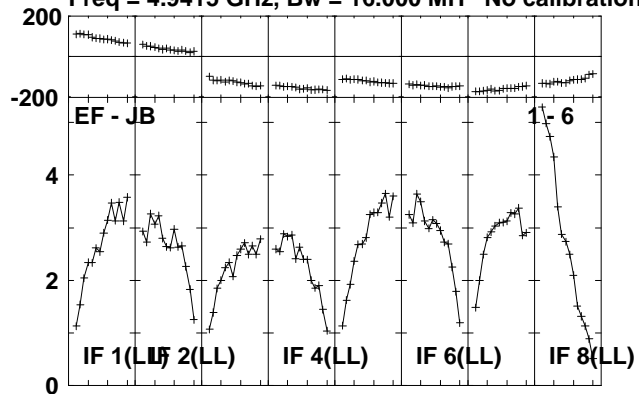

Lower frame: Milli Ampl Jy Top frame: Phas deg
Scalar averaged cross-power spectrum Several baselines displayed
Timerange: 00/23:02:51 to 00/23:04:19

Plot file version 161 created 14-JUL-2010 16:36:54

CYGX-1 RR004A.UVDATA.1

Freq = 4.9415 GHz, Bw = 16.000 MH No calibration applied and no bandpass applied

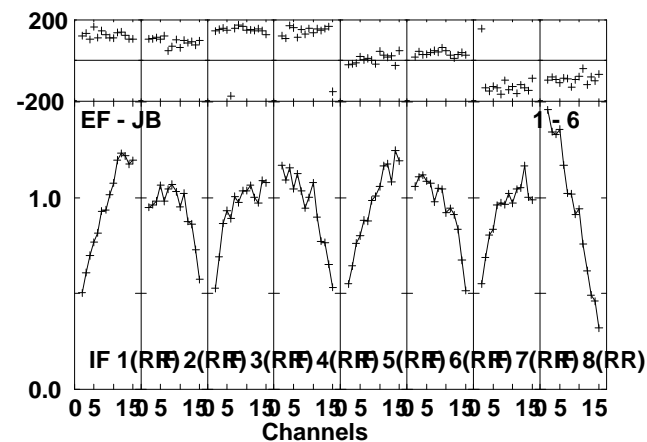
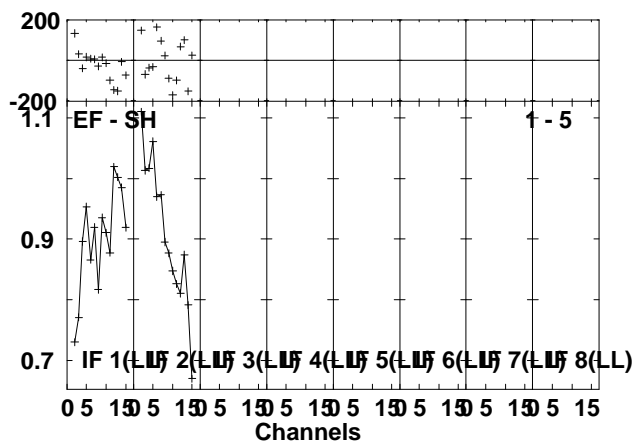
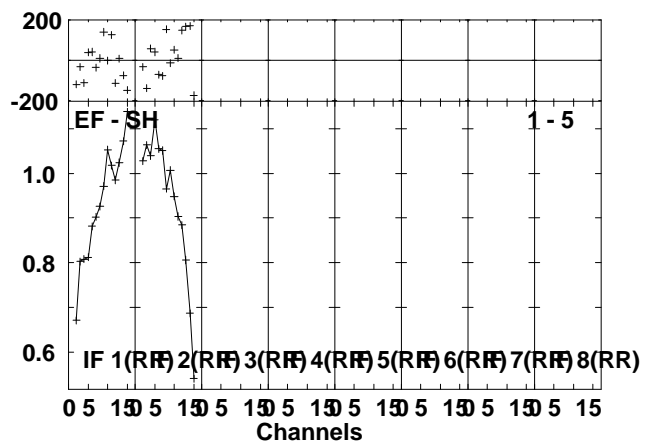
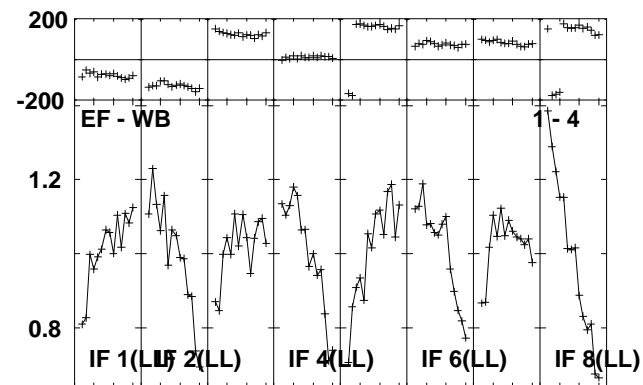
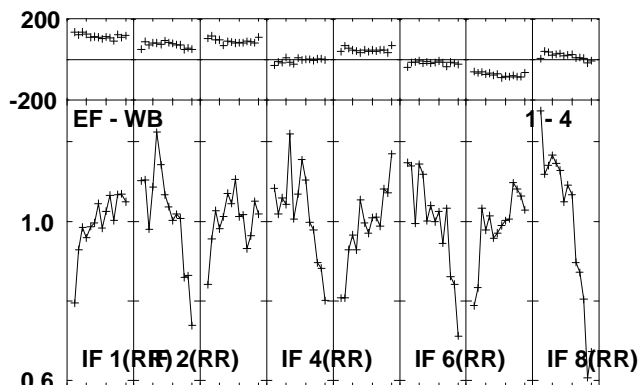
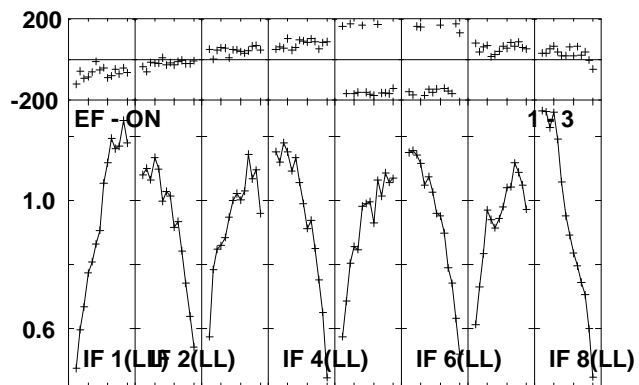
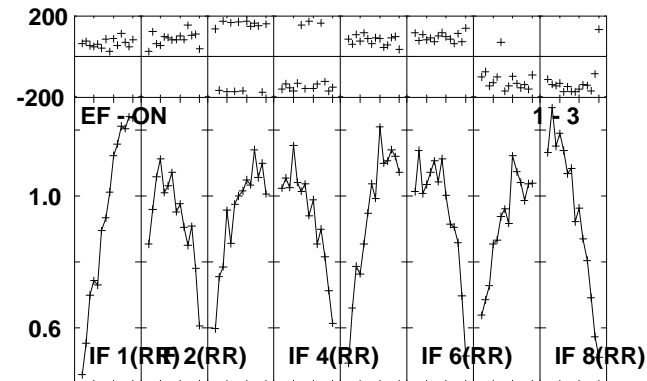
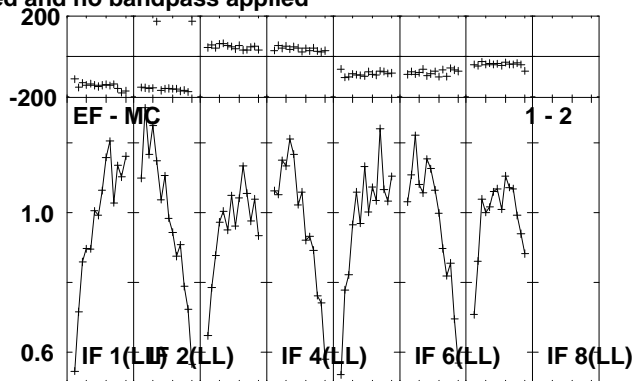
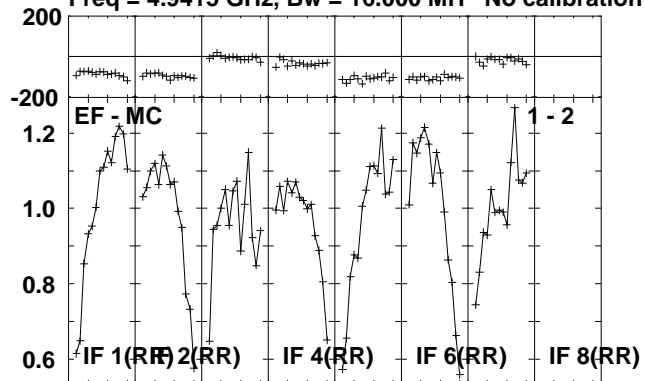

Lower frame: Milli Ampl Jy Top frame: Phas deg
Scalar averaged cross-power spectrum Several baselines displayed
Timerange: 00/23:04:21 to 00/23:09:19

Plot file version 162 created 14-JUL-2010 16:36:55

CYGX-1 RR004A.UVDATA.1

Freq = 4.9415 GHz, Bw = 16.000 MH No calibration applied and no bandpass applied

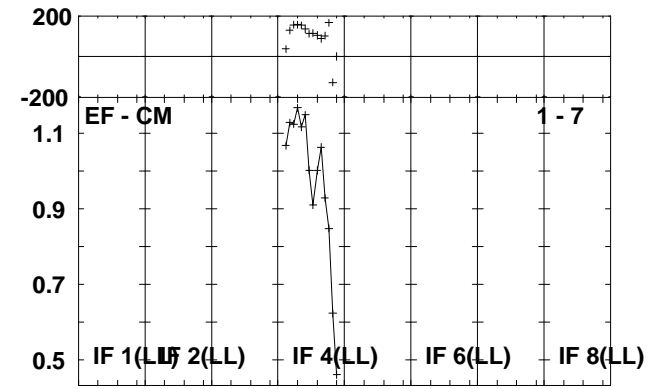
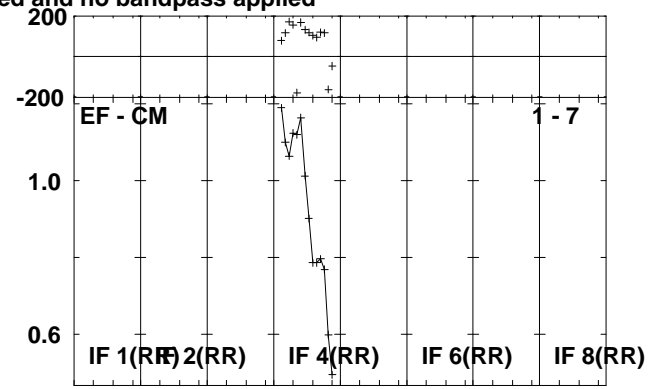
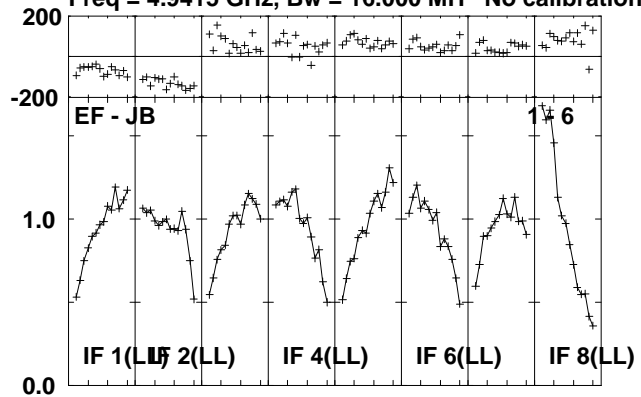

Lower frame: Milli Ampl Jy Top frame: Phas deg
Scalar averaged cross-power spectrum Several baselines displayed
Timerange: 00/23:04:21 to 00/23:09:19

Plot file version 163 created 14-JUL-2010 16:36:56

J1953+35 RR004A.UVDATA.1

Freq = 4.9415 GHz, Bw = 16.000 MH No calibration applied and no bandpass applied

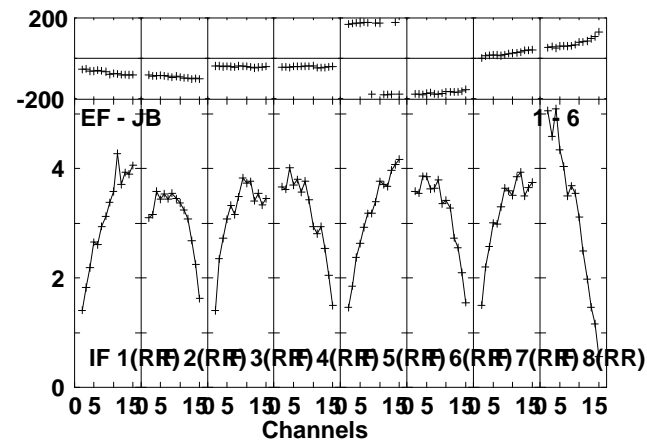
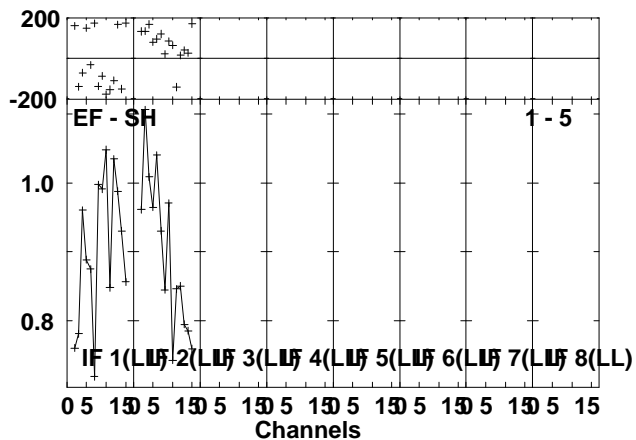
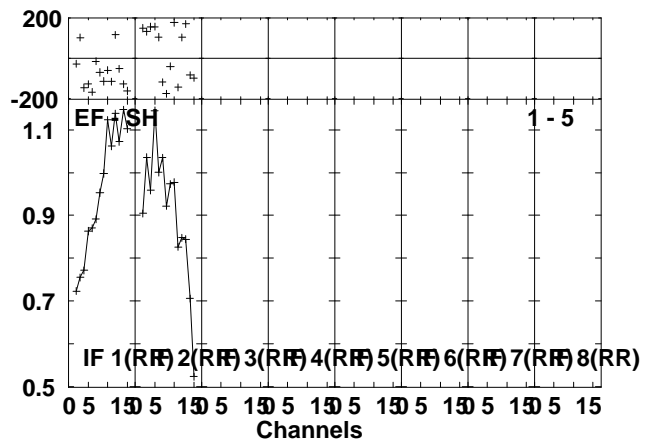
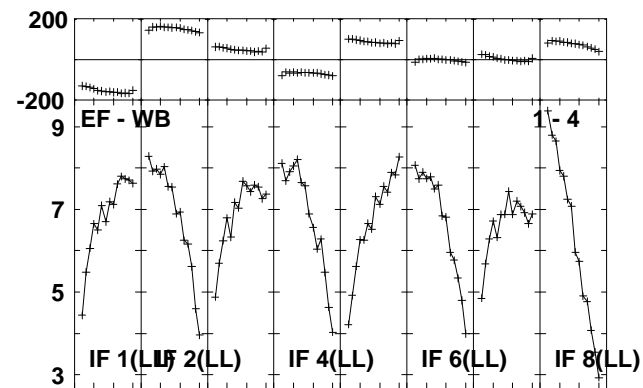
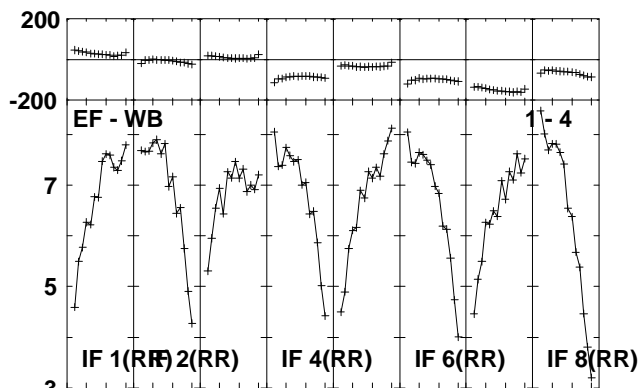
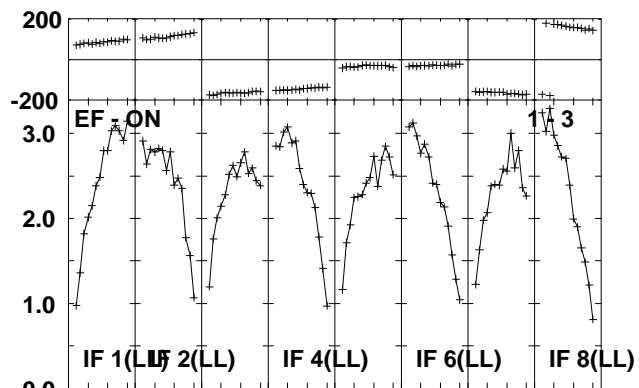
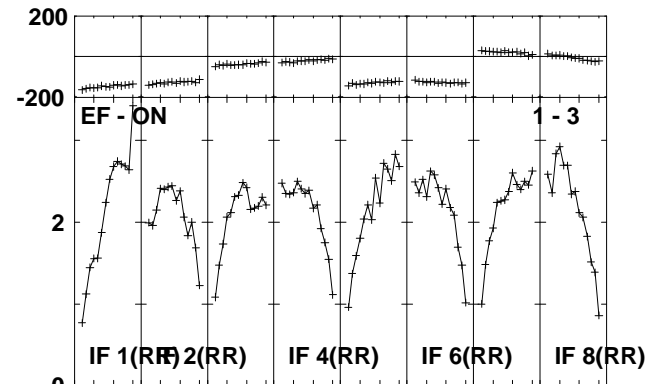
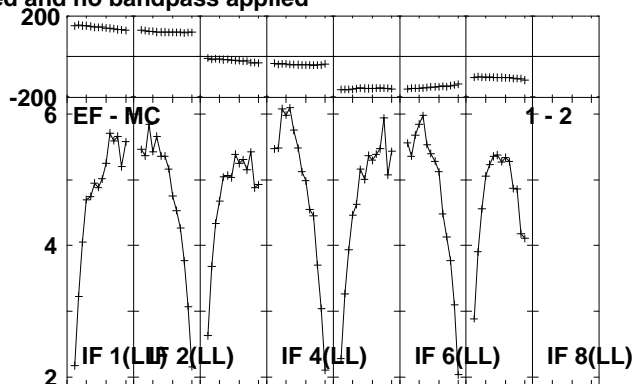
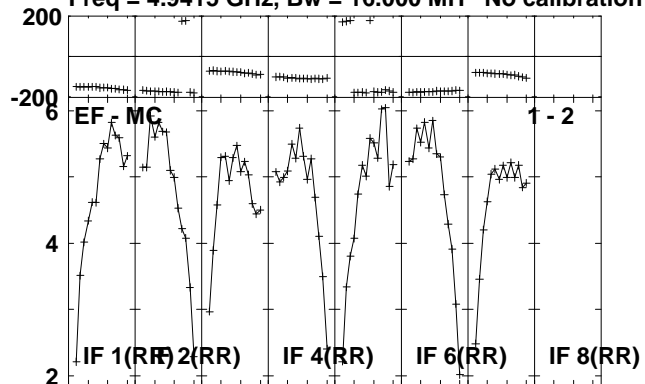

Lower frame: Milli Ampl Jy Top frame: Phas deg
Scalar averaged cross-power spectrum Several baselines displayed
Timerange: 00/23:09:21 to 00/23:11:19

Plot file version 164 created 14-JUL-2010 16:36:57

J1953+35 RR004A.UVDATA.1

Freq = 4.9415 GHz, Bw = 16.000 MH No calibration applied and no bandpass applied

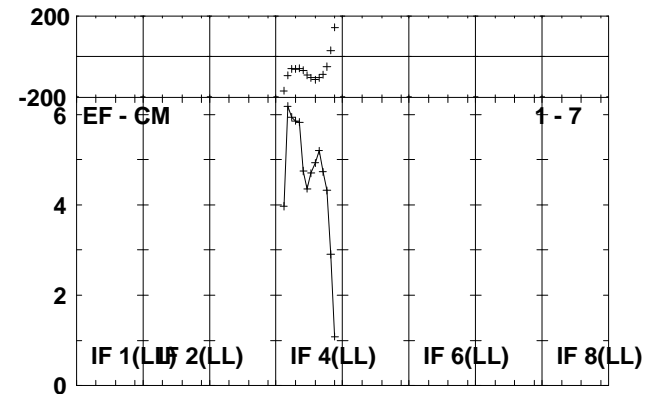
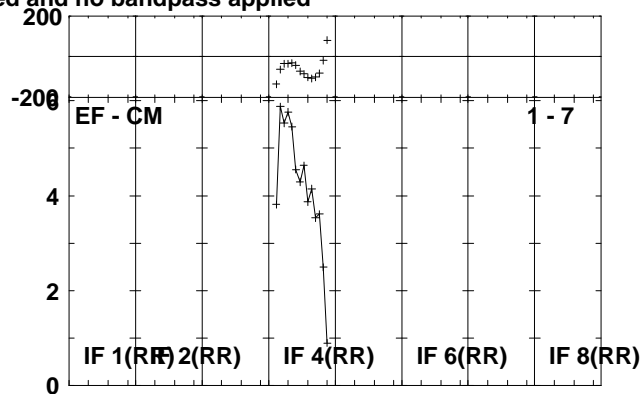
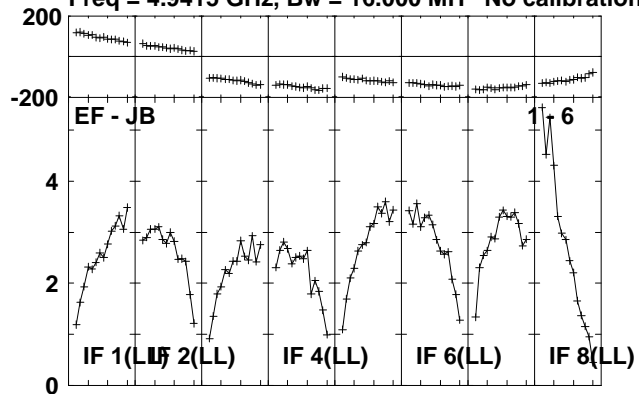

Lower frame: Milli Ampl Jy Top frame: Phas deg
Scalar averaged cross-power spectrum Several baselines displayed
Timerange: 00/23:09:21 to 00/23:11:19

Plot file version 165 created 14-JUL-2010 16:36:58

CYGX-1 RR004A.UVDATA.1

Freq = 4.9415 GHz, Bw = 16.000 MH No calibration applied and no bandpass applied

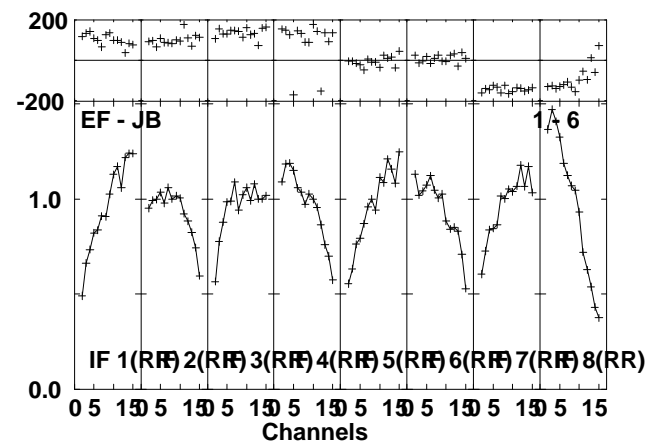
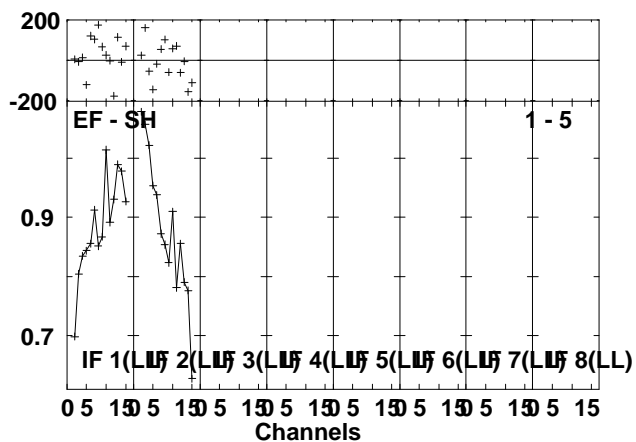
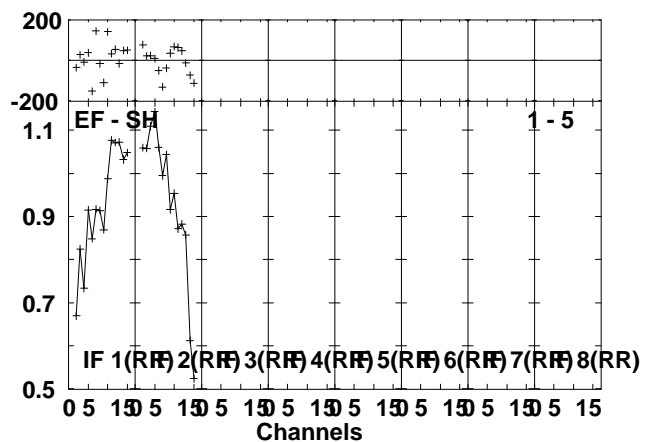
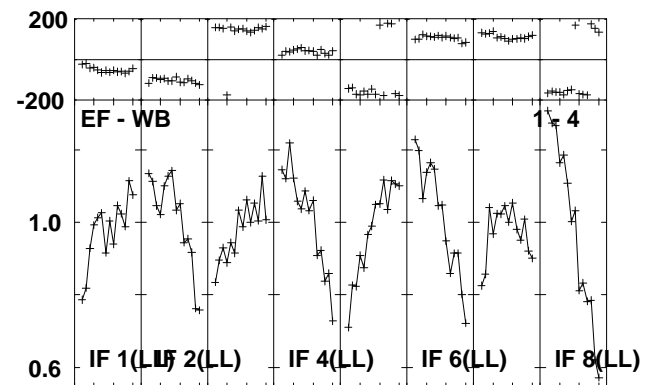
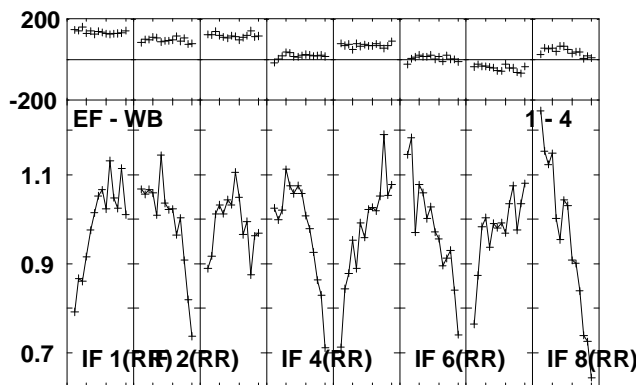
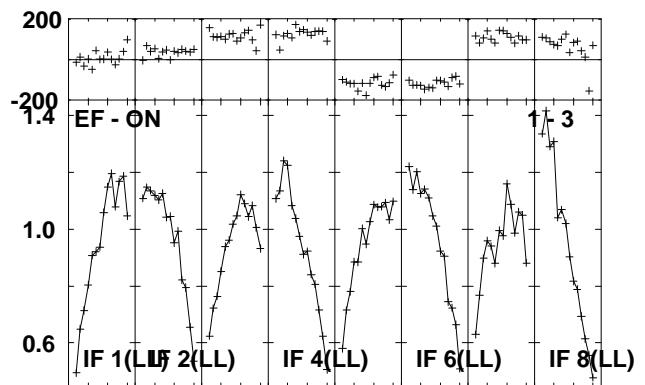
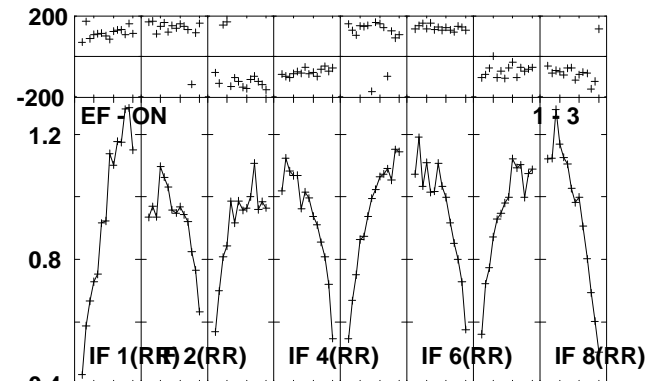
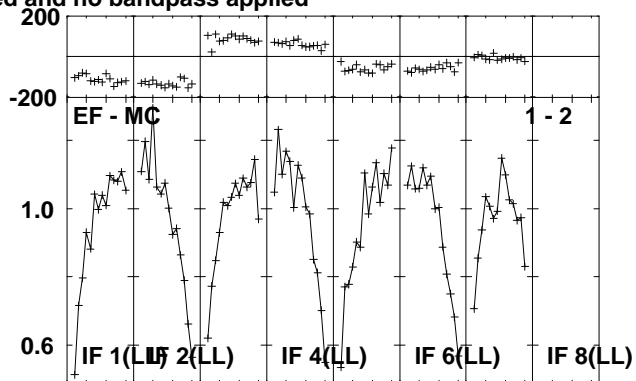
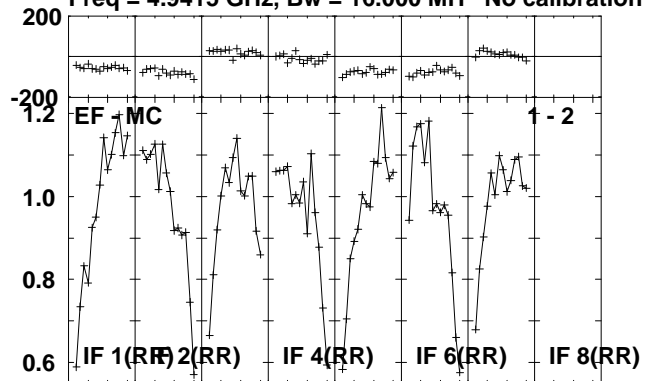

Lower frame: Milli Ampl Jy Top frame: Phas deg
Scalar averaged cross-power spectrum Several baselines displayed
Timerange: 00/23:11:21 to 00/23:16:19

Plot file version 166 created 14-JUL-2010 16:36:59

CYGX-1 RR004A.UVDATA.1

Freq = 4.9415 GHz, Bw = 16.000 MH No calibration applied and no bandpass applied

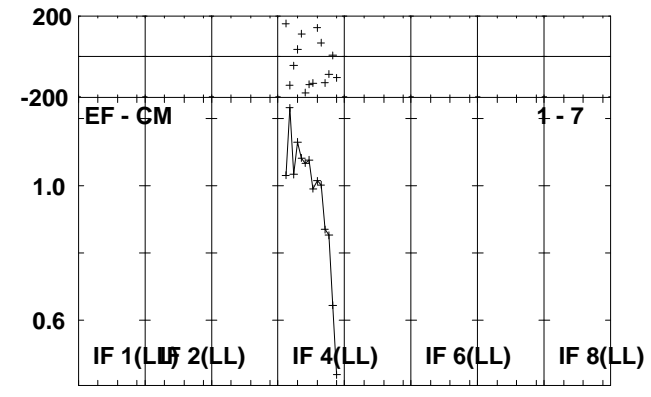
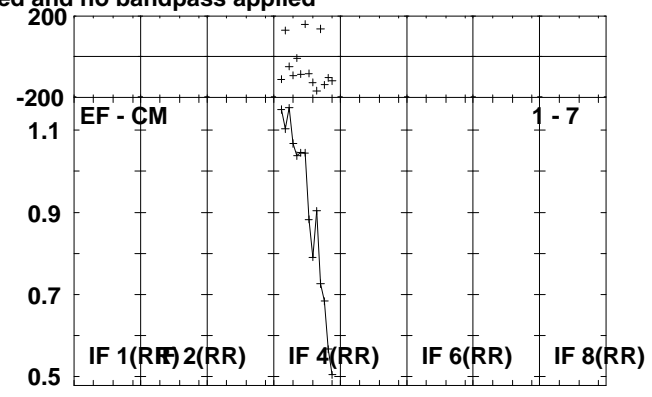
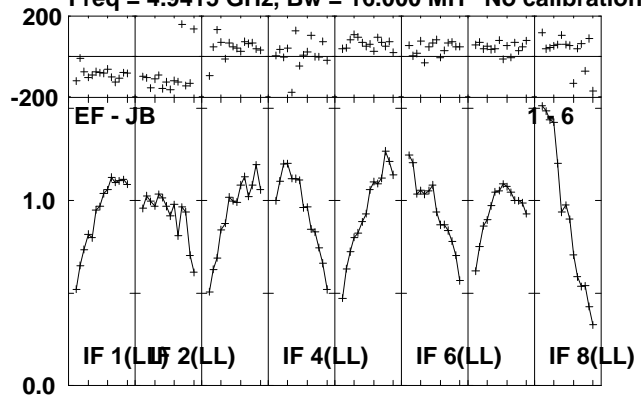

Lower frame: Milli Ampl Jy Top frame: Phas deg
Scalar averaged cross-power spectrum Several baselines displayed
Timerange: 00/23:11:21 to 00/23:16:19

Plot file version 167 created 14-JUL-2010 16:37:00

J1953+35 RR004A.UVDATA.1

Freq = 4.9415 GHz, Bw = 16.000 MH No calibration applied and no bandpass applied

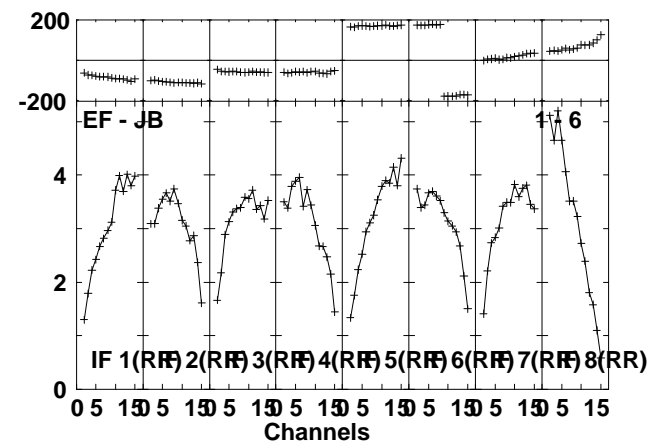
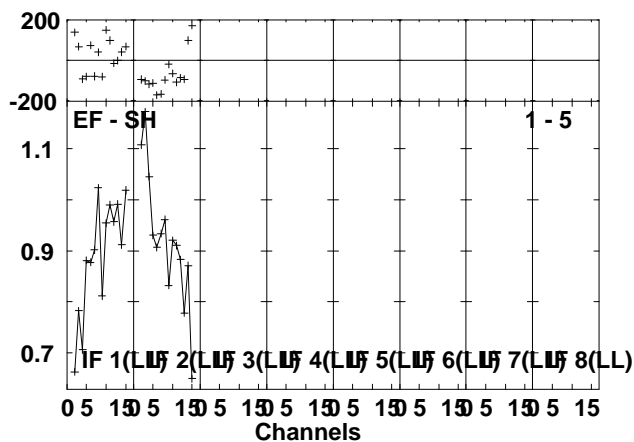
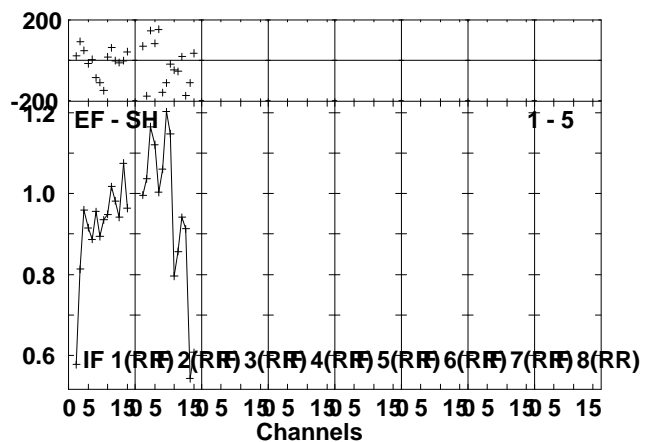
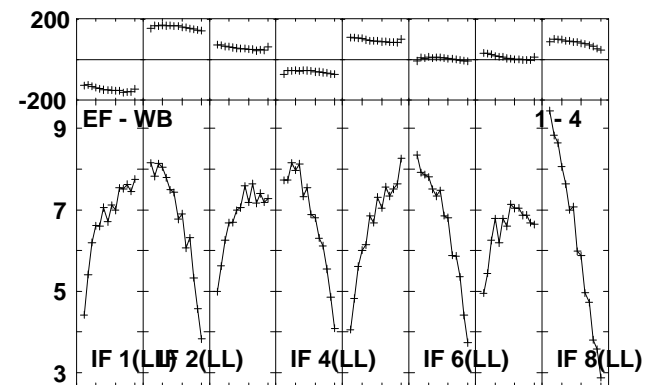
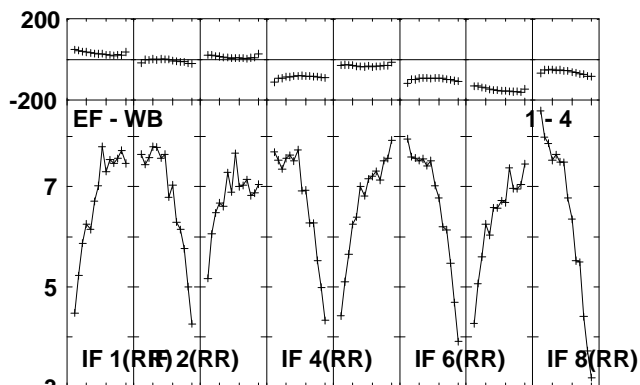
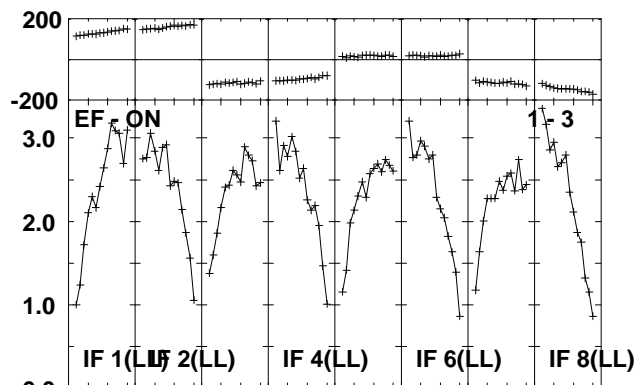
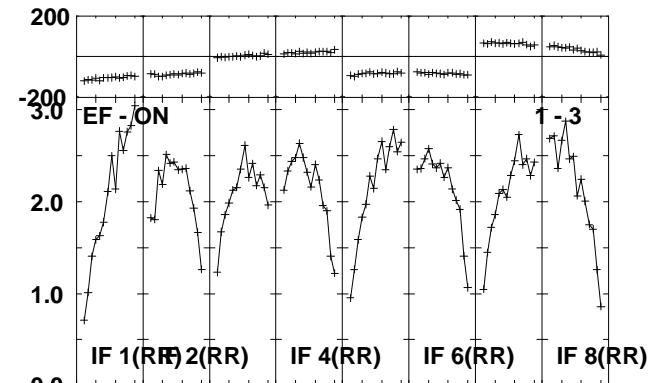
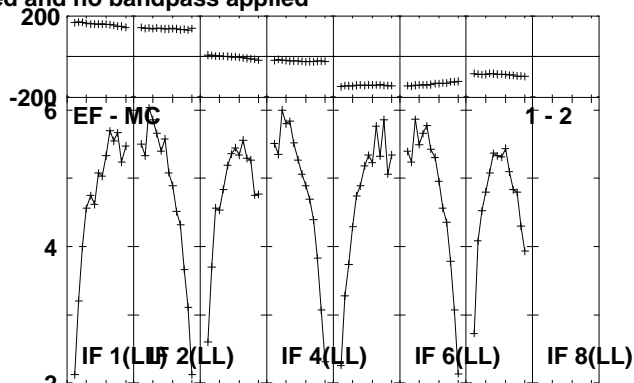
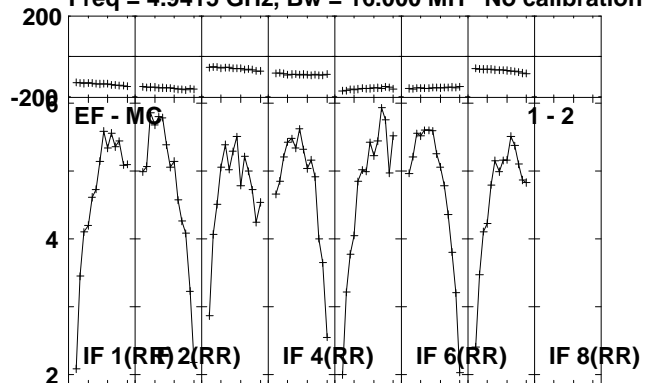

Lower frame: Milli Ampl Jy Top frame: Phas deg
Scalar averaged cross-power spectrum Several baselines displayed
Timerange: 00/23:17:01 to 00/23:18:29

Plot file version 168 created 14-JUL-2010 16:37:01

J1953+35 RR004A.UVDATA.1

Freq = 4.9415 GHz, Bw = 16.000 MH No calibration applied and no bandpass applied

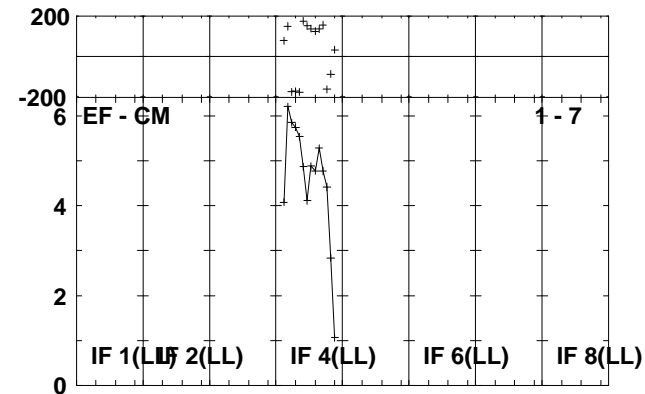
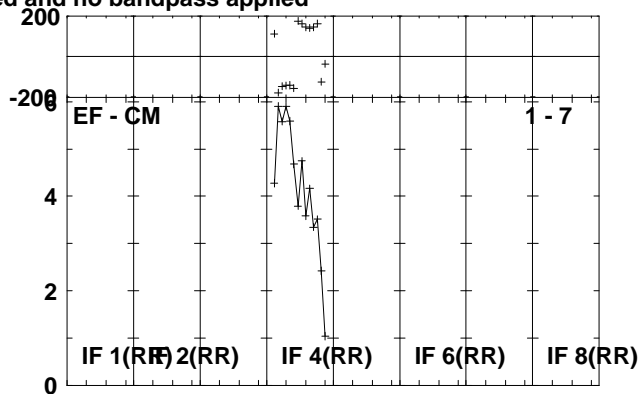
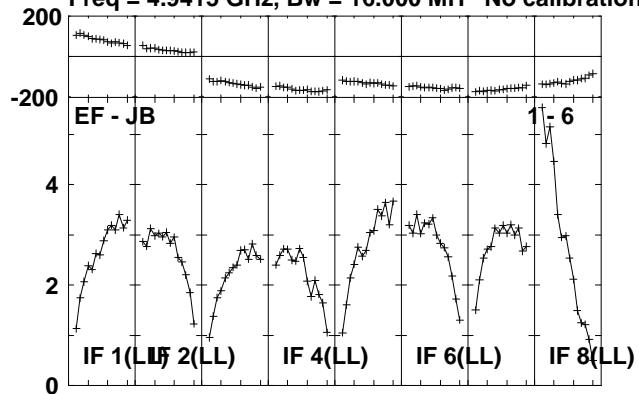

Lower frame: Milli Ampl Jy Top frame: Phas deg
Scalar averaged cross-power spectrum Several baselines displayed
Timerange: 00/23:17:01 to 00/23:18:29

Plot file version 169 created 14-JUL-2010 16:37:01

CYGX-1 RR004A.UVDATA.1

Freq = 4.9415 GHz, Bw = 16.000 MH No calibration applied and no bandpass applied

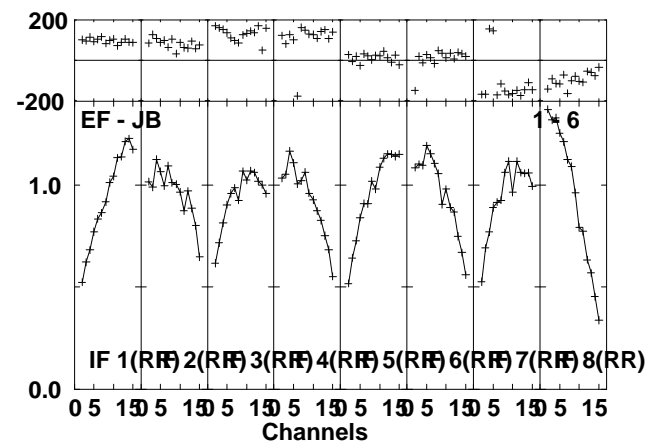
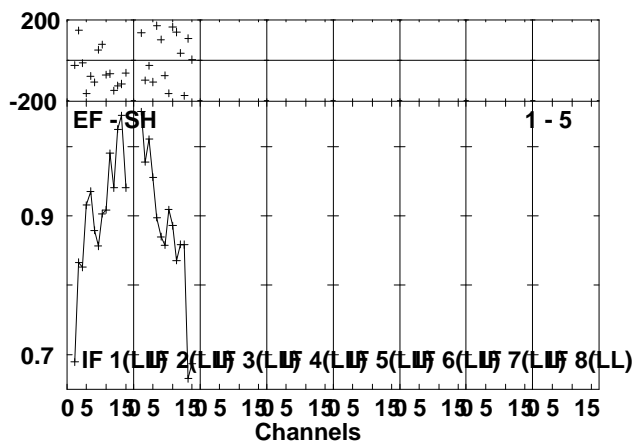
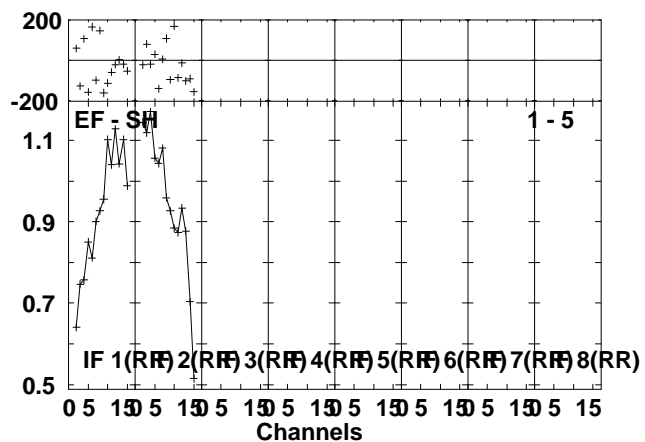
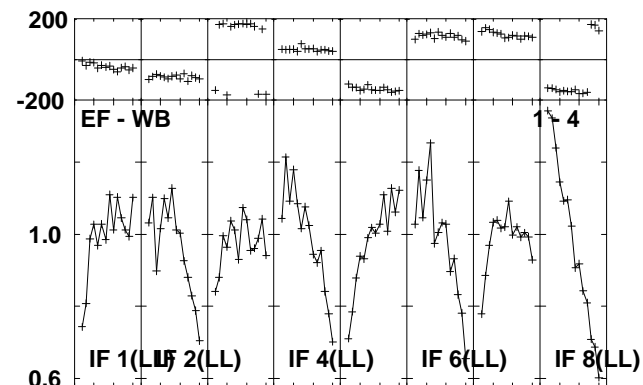
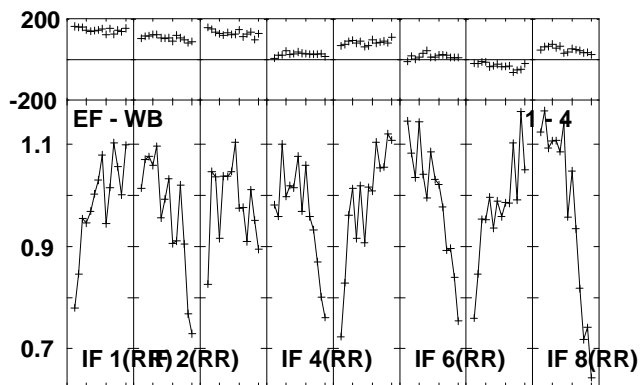
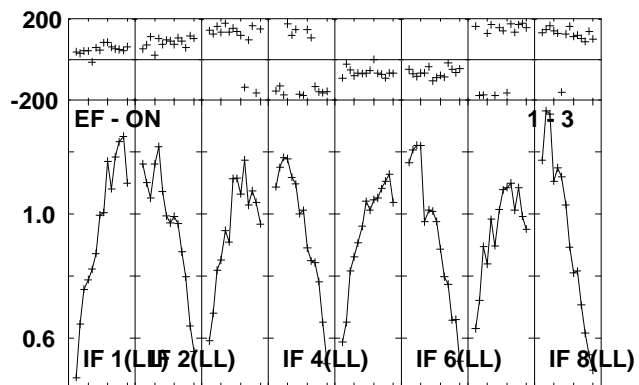
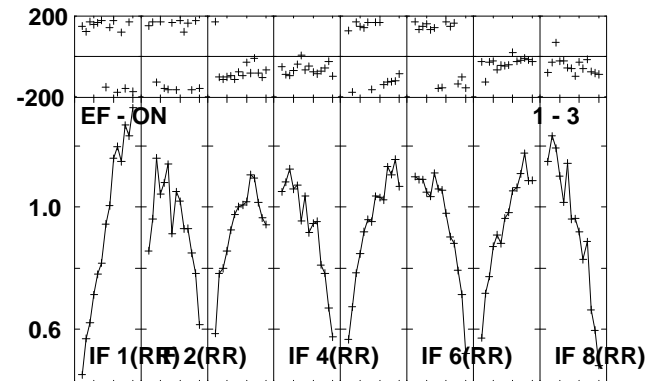
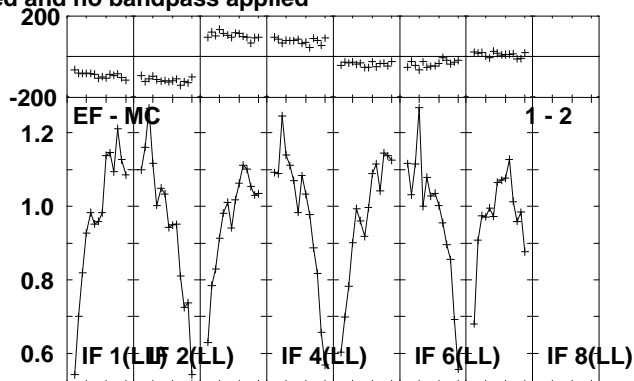
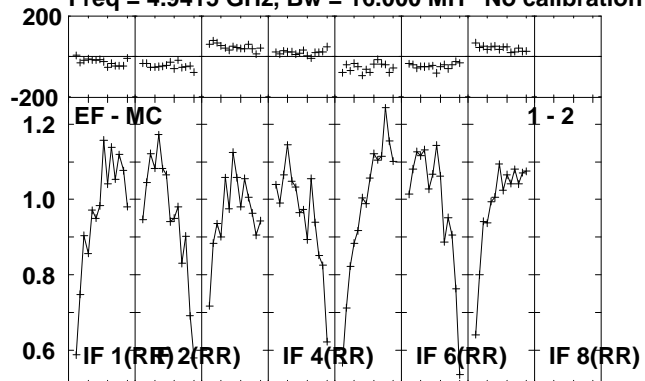

Lower frame: Milli Ampl Jy Top frame: Phas deg
Scalar averaged cross-power spectrum Several baselines displayed
Timerange: 00/23:18:31 to 00/23:23:29

Plot file version 170 created 14-JUL-2010 16:37:03

CYGX-1 RR004A.UVDATA.1

Freq = 4.9415 GHz, Bw = 16.000 MH No calibration applied and no bandpass applied

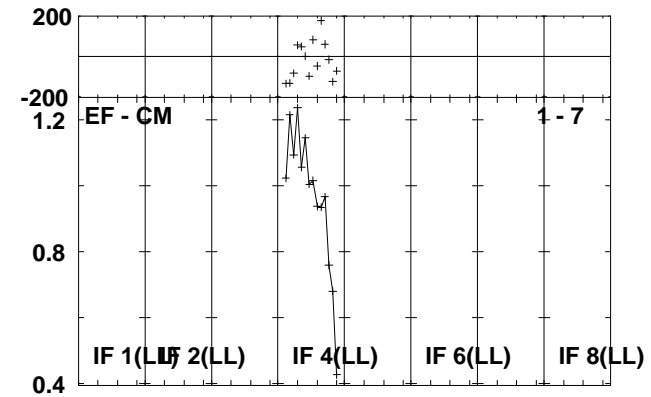
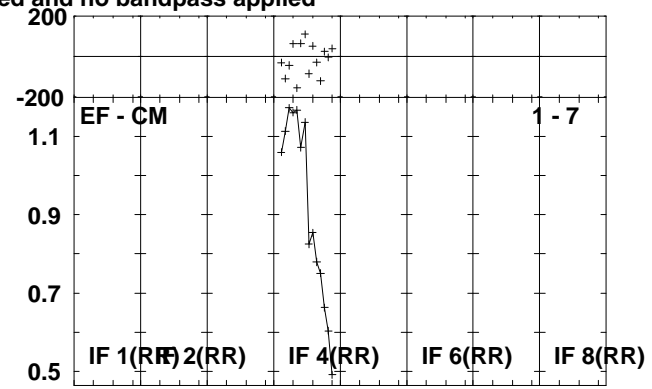
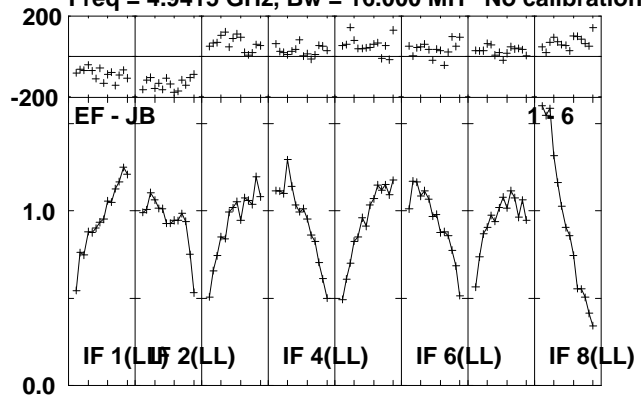

Lower frame: Milli Ampl Jy Top frame: Phas deg
Scalar averaged cross-power spectrum Several baselines displayed
Timerange: 00/23:18:31 to 00/23:23:29

Plot file version 171 created 14-JUL-2010 16:37:04

J1953+35 RR004A.UVDATA.1

Freq = 4.9415 GHz, Bw = 16.000 MH No calibration applied and no bandpass applied

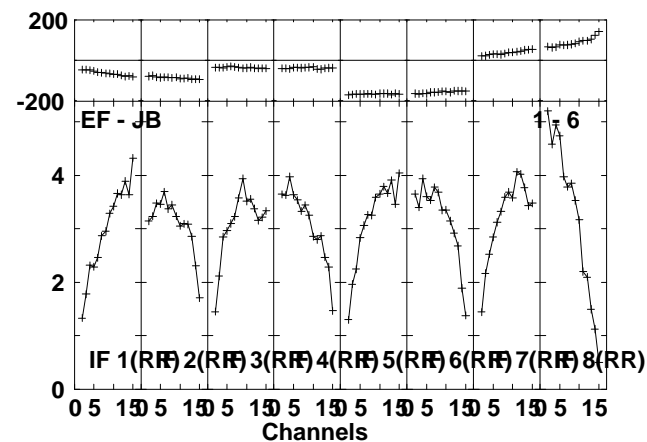
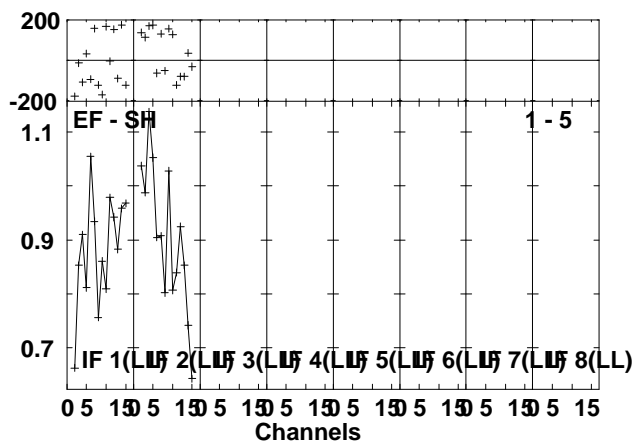
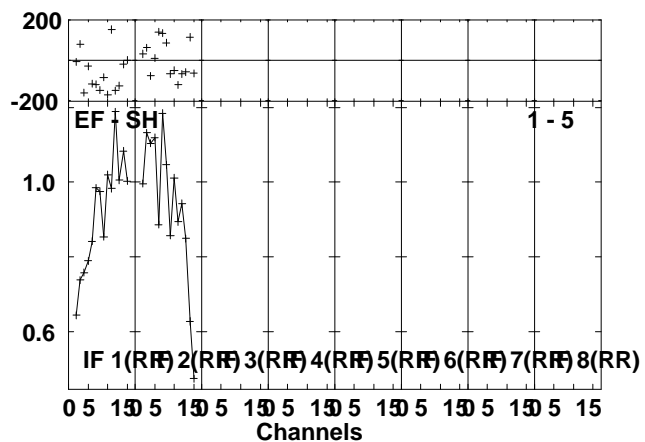
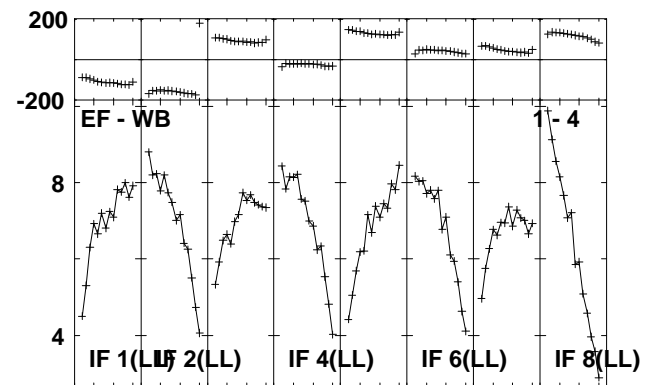
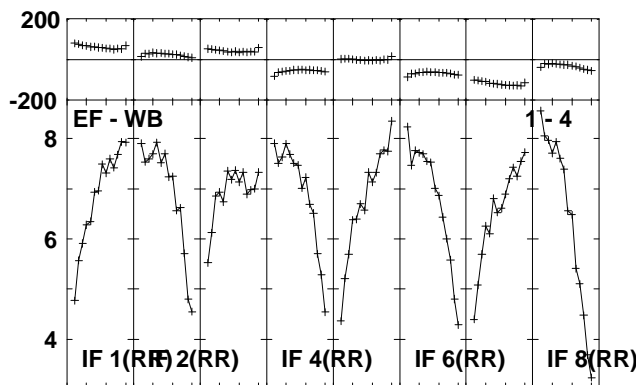
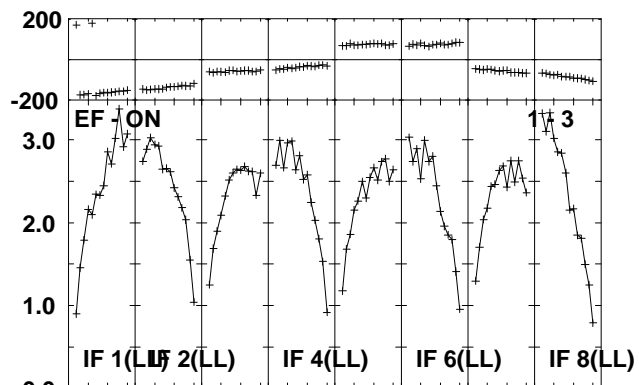
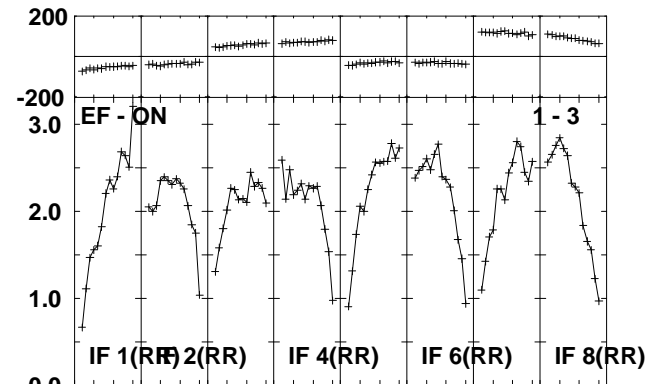
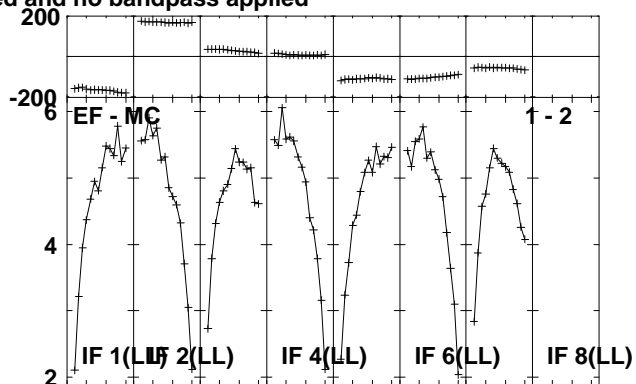
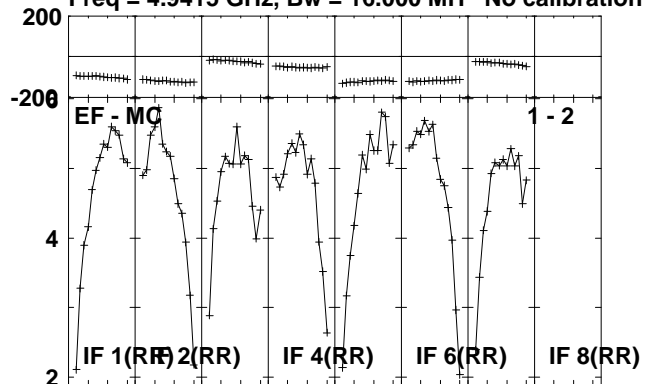

Lower frame: Milli Ampl Jy Top frame: Phas deg
Scalar averaged cross-power spectrum Several baselines displayed
Timerange: 00/23:23:31 to 00/23:25:29

Plot file version 172 created 14-JUL-2010 16:37:04

J1953+35 RR004A.UVDATA.1

Freq = 4.9415 GHz, Bw = 16.000 MH No calibration applied and no bandpass applied

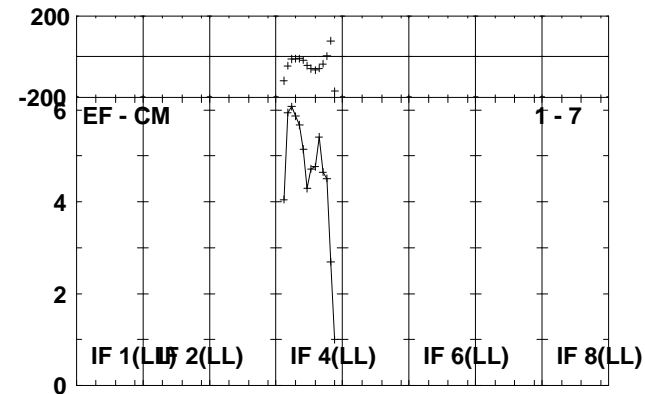
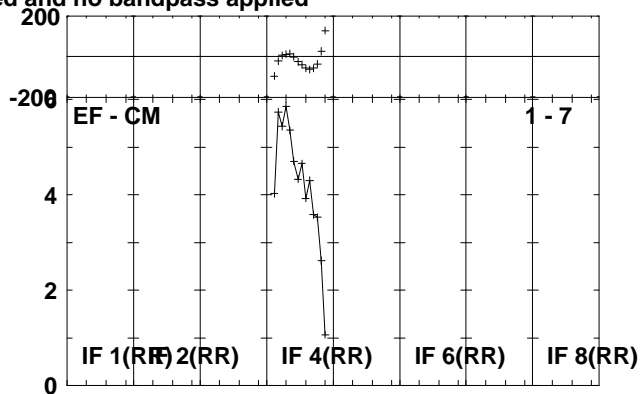
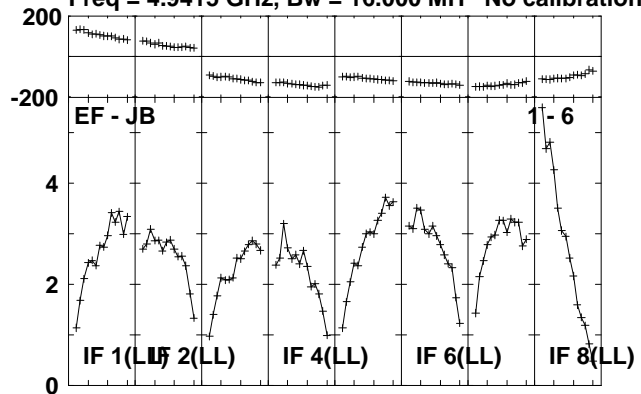

Lower frame: Milli Ampl Jy Top frame: Phas deg
Scalar averaged cross-power spectrum Several baselines displayed
Timerange: 00/23:23:31 to 00/23:25:29

Plot file version 173 created 14-JUL-2010 16:37:05

CYGX-1 RR004A.UVDATA.1

Freq = 4.9415 GHz, Bw = 16.000 MH No calibration applied and no bandpass applied

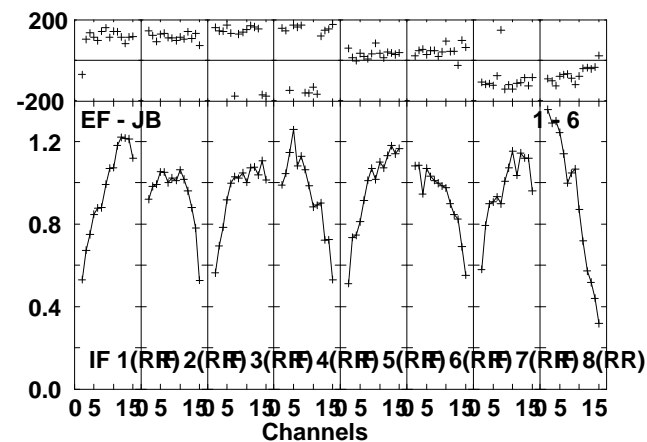
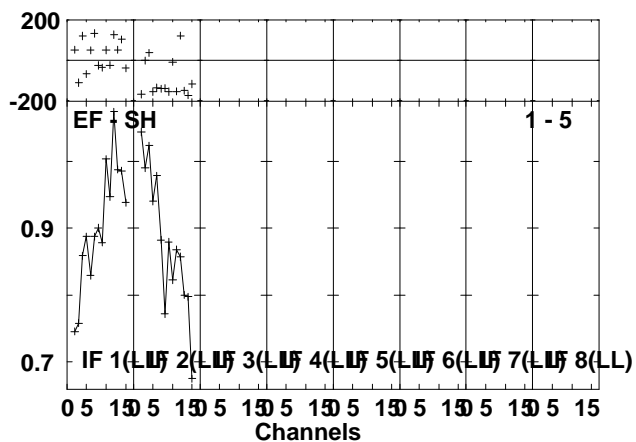
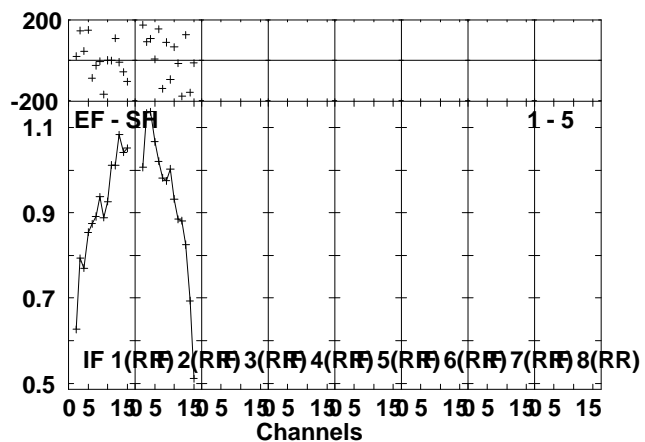
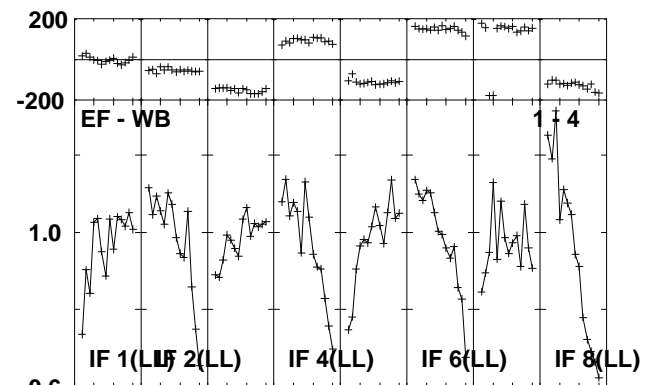
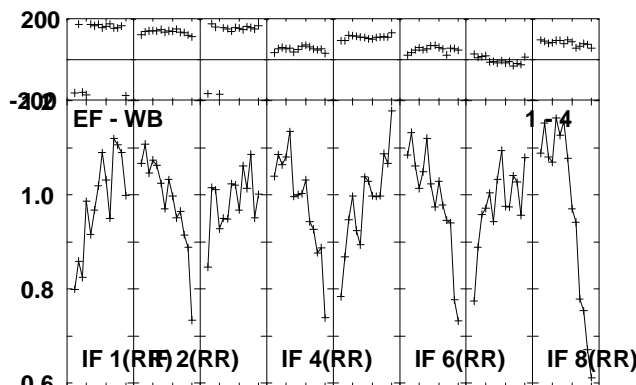
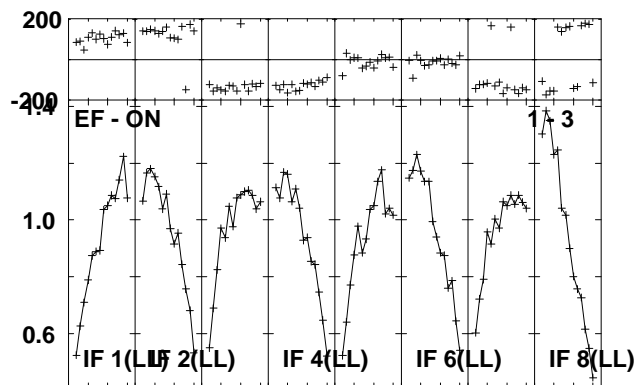
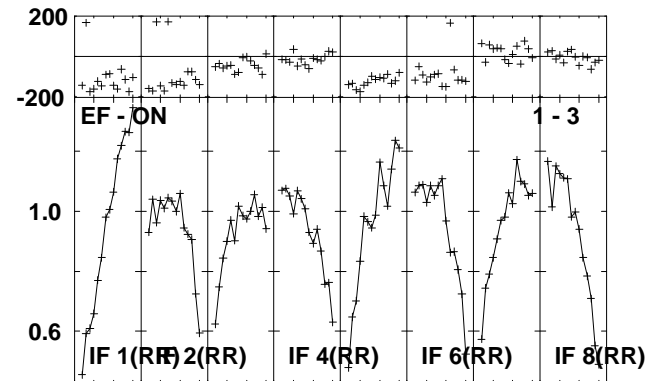
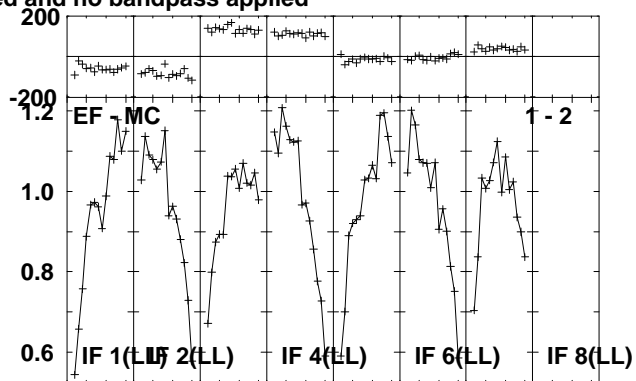
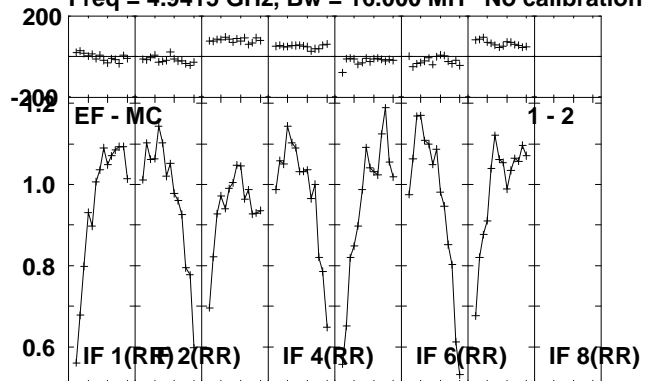

Lower frame: Milli Ampl Jy Top frame: Phas deg
Scalar averaged cross-power spectrum Several baselines displayed
Timerange: 00/23:25:31 to 00/23:30:29

Plot file version 174 created 14-JUL-2010 16:37:07

CYGX-1 RR004A.UVDATA.1

Freq = 4.9415 GHz, Bw = 16.000 MH No calibration applied and no bandpass applied

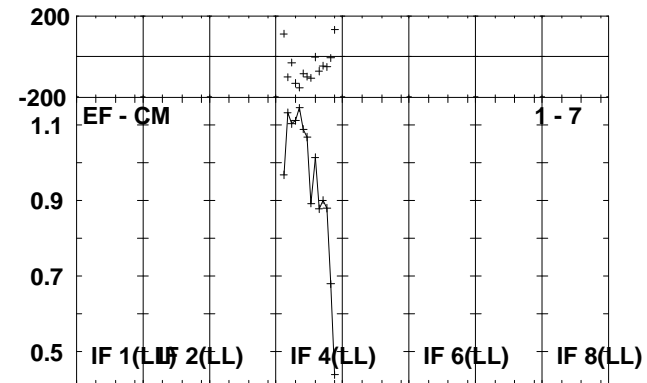
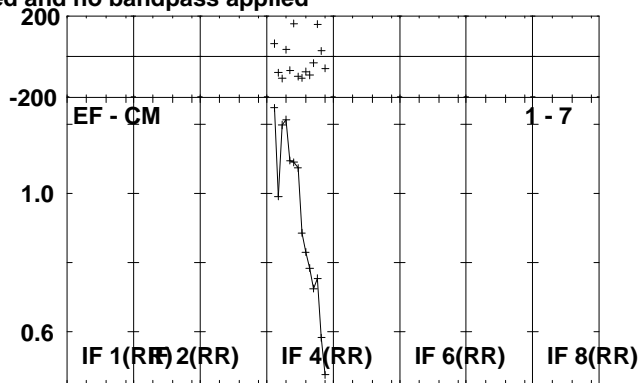
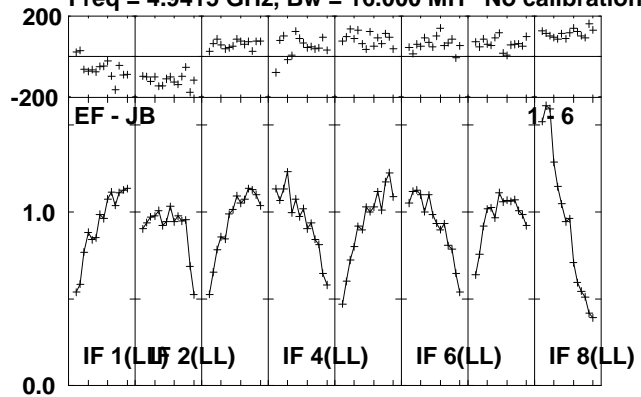

Lower frame: Milli Ampl Jy Top frame: Phas deg
Scalar averaged cross-power spectrum Several baselines displayed
Timerange: 00/23:25:31 to 00/23:30:29

Plot file version 175 created 14-JUL-2010 16:37:08

J1953+35 RR004A.UVDATA.1

Freq = 4.9415 GHz, Bw = 16.000 MH No calibration applied and no bandpass applied

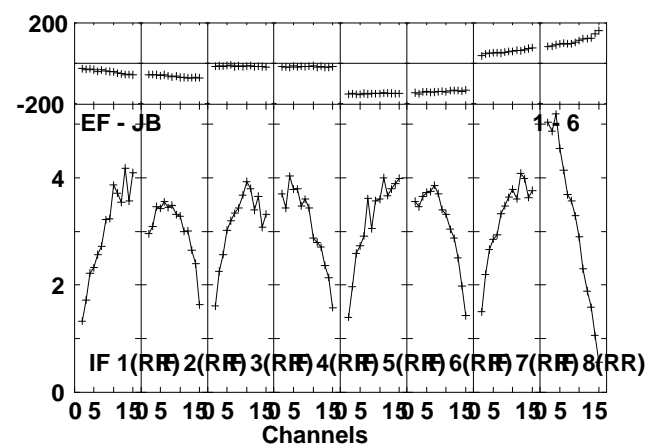
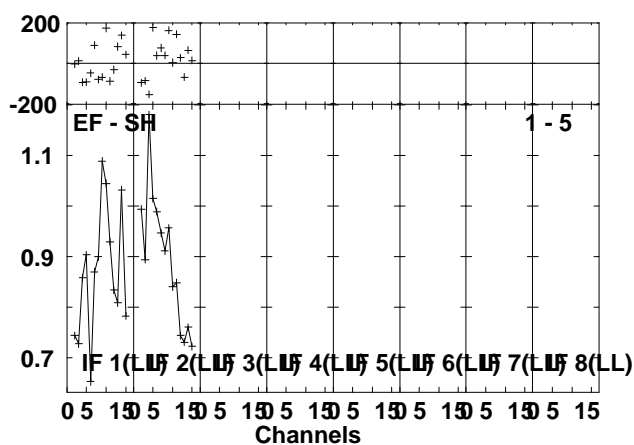
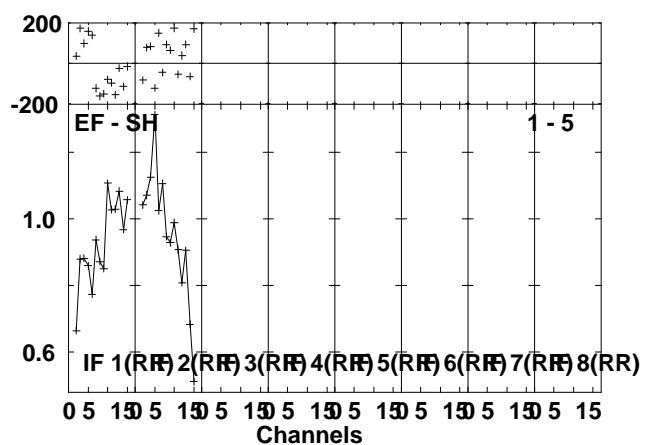
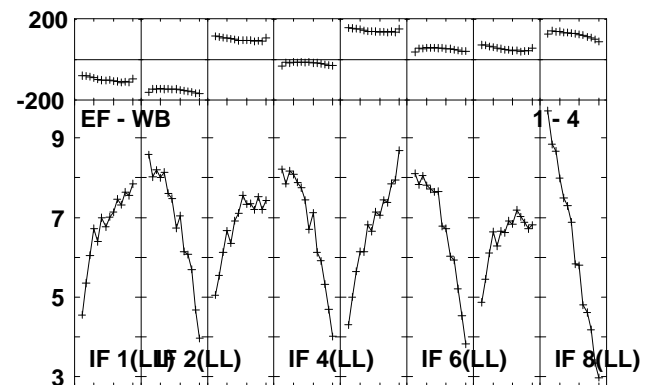
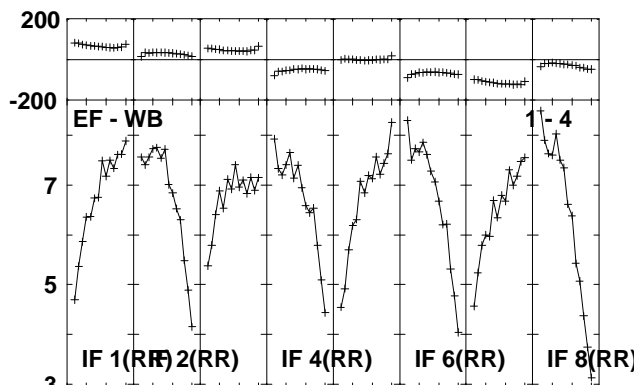
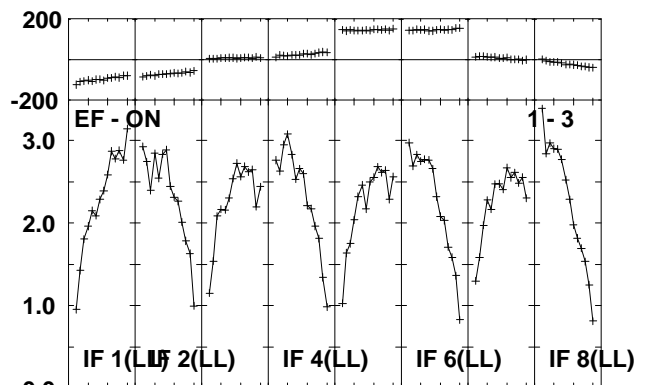
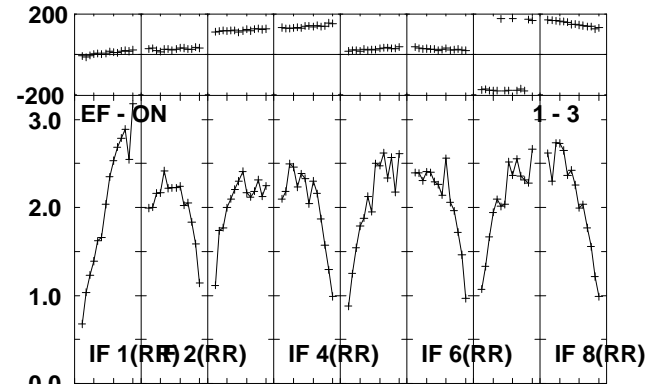
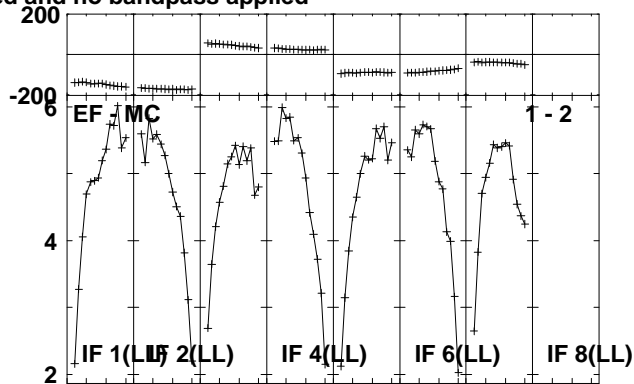
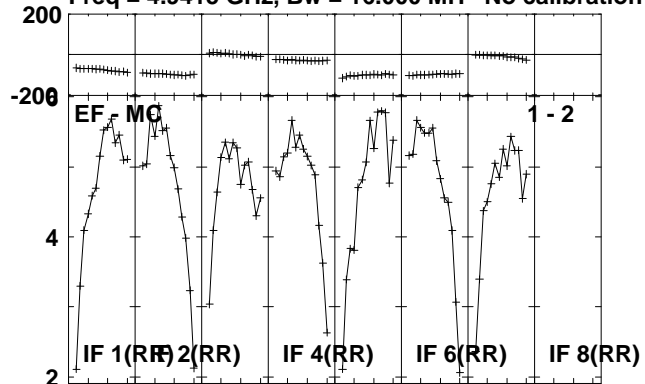

Lower frame: Milli Ampl Jy Top frame: Phas deg
Scalar averaged cross-power spectrum Several baselines displayed
Timerange: 00/23:31:11 to 00/23:32:37

Plot file version 176 created 14-JUL-2010 16:37:08

J1953+35 RR004A.UVDATA.1

Freq = 4.9415 GHz, Bw = 16.000 MH No calibration applied and no bandpass applied

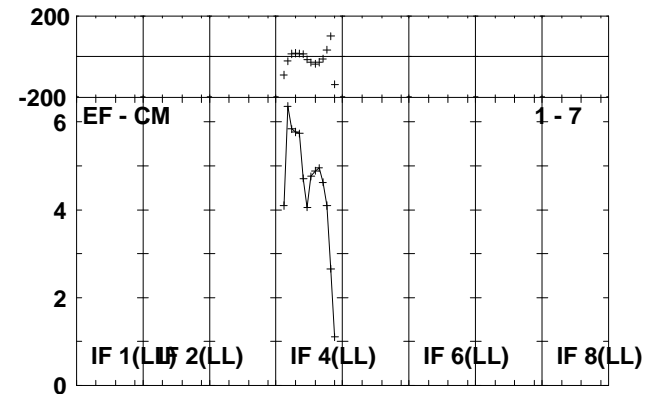
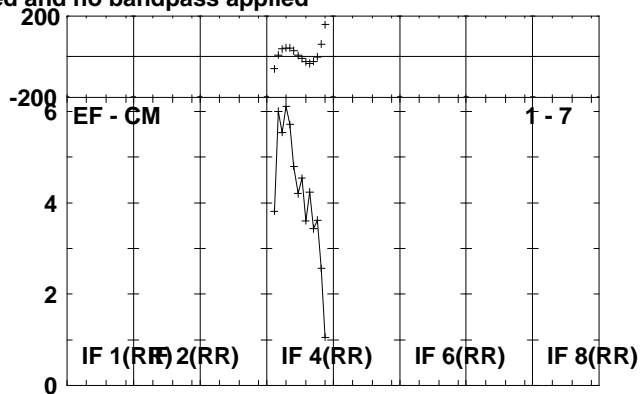
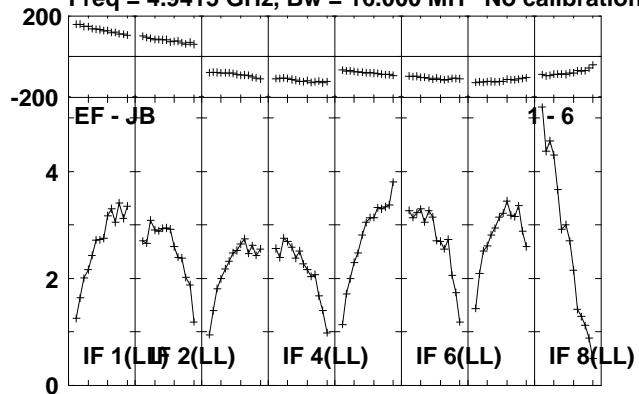

Lower frame: Milli Ampl Jy Top frame: Phas deg
Scalar averaged cross-power spectrum Several baselines displayed
Timerange: 00/23:31:11 to 00/23:32:37

Plot file version 177 created 14-JUL-2010 16:37:08

CYGX-1 RR004A.UVDATA.1

Freq = 4.9415 GHz, Bw = 16.000 MH No calibration applied and no bandpass applied

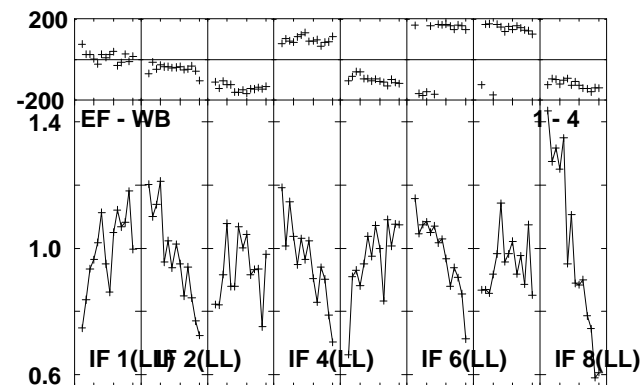
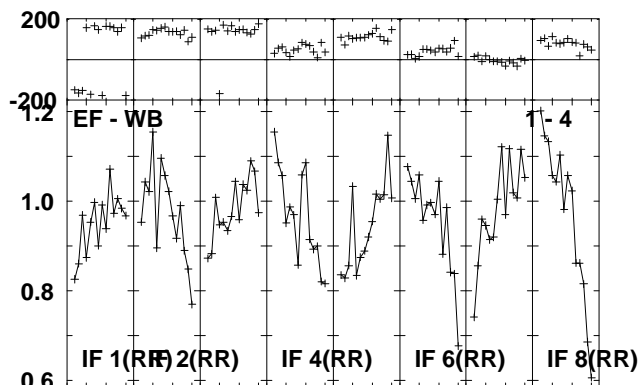
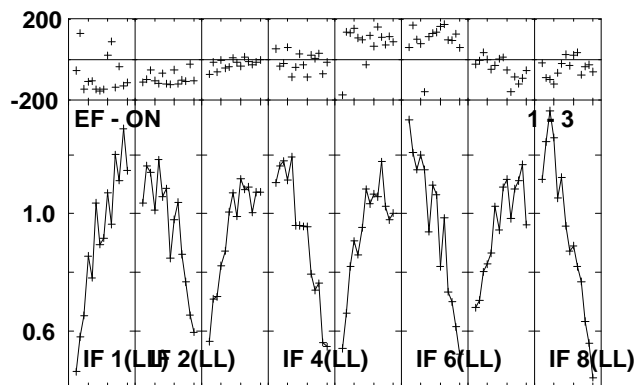
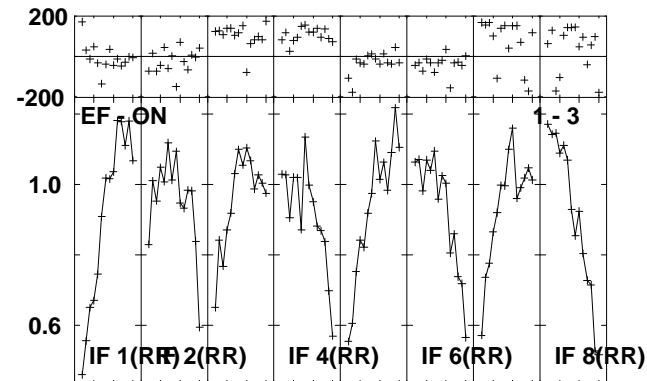
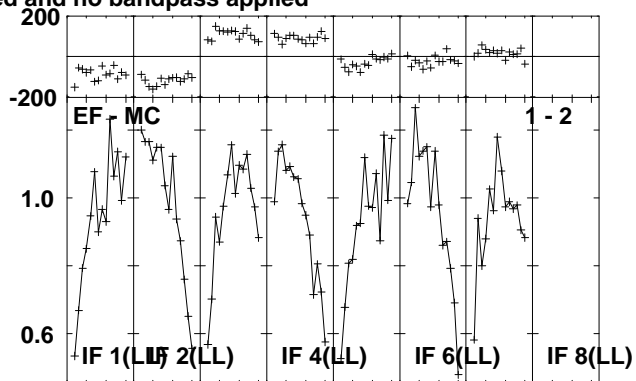
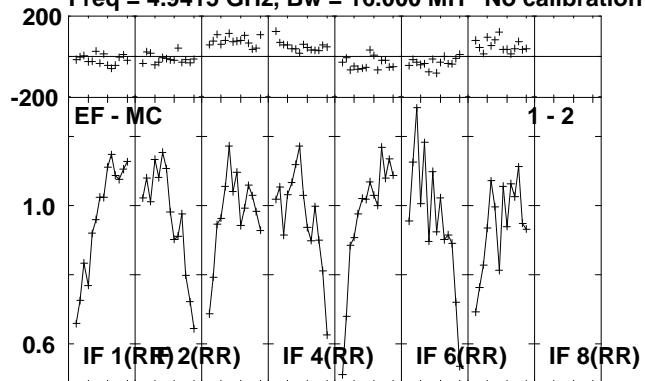

Lower frame: Milli Ampl Jy Top frame: Phas deg
Scalar averaged cross-power spectrum Several baselines displayed
Timerange: 00/23:42:31 to 00/23:44:39

Plot file version 178 created 14-JUL-2010 16:37:09

J1953+35 RR004A.UVDATA.1

Freq = 4.9415 GHz, Bw = 16.000 MH No calibration applied and no bandpass applied

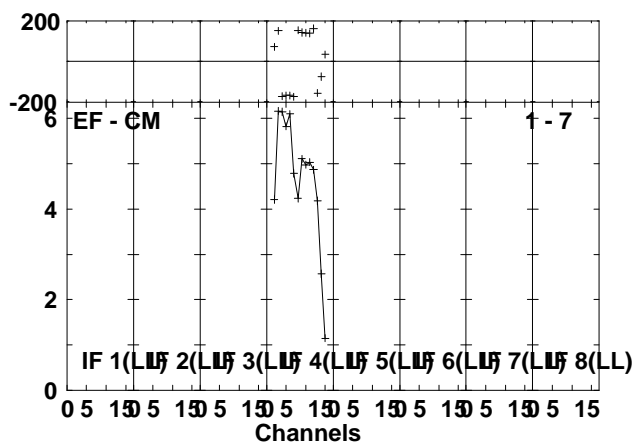
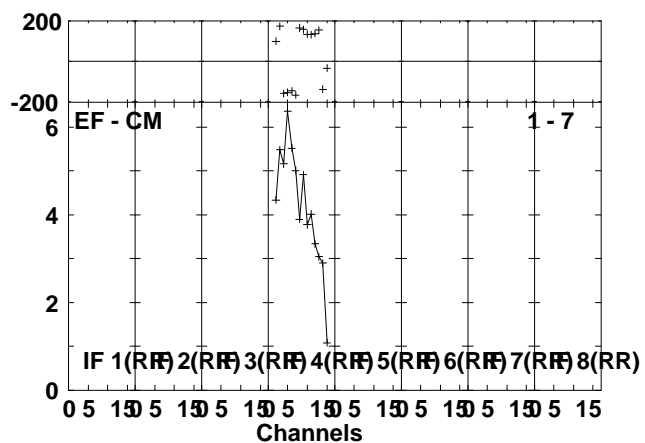
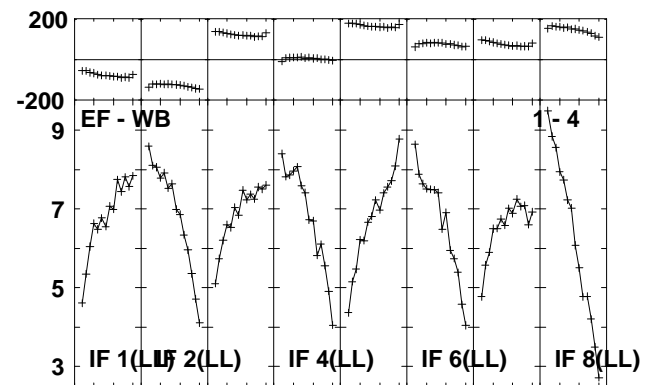
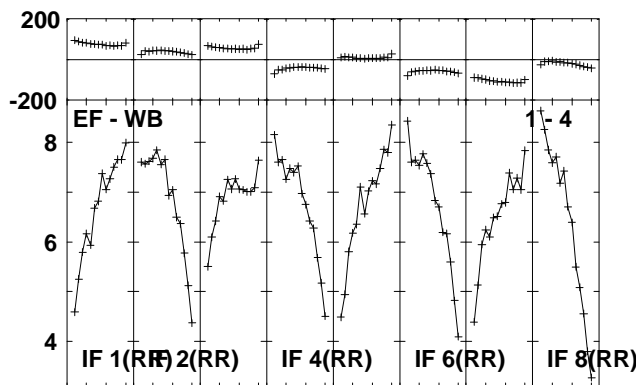
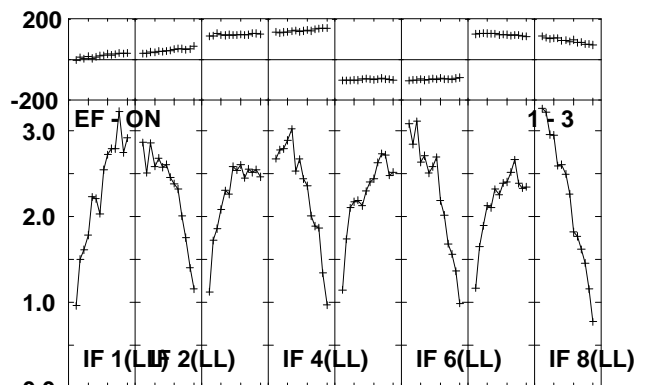
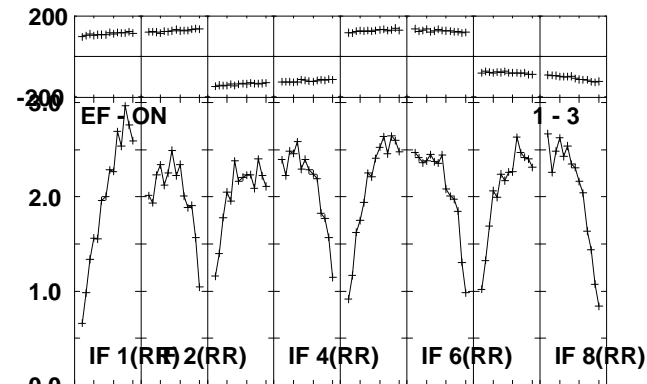
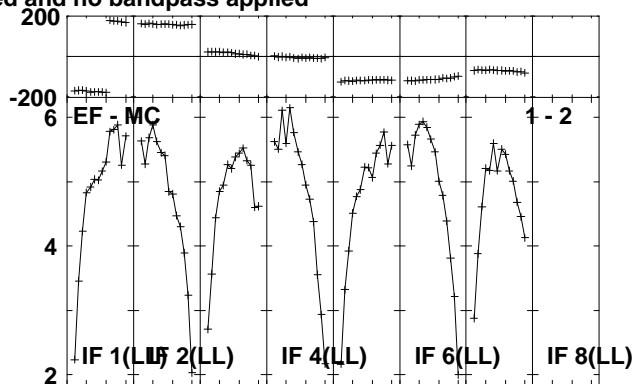
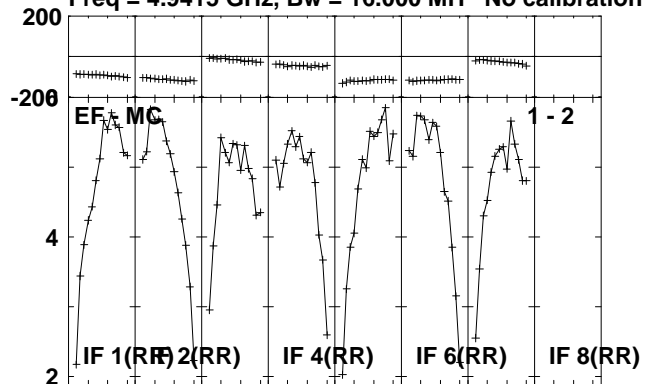

Lower frame: Milli Ampl Jy Top frame: Phas deg
Scalar averaged cross-power spectrum Several baselines displayed
Timerange: 00/23:45:41 to 00/23:47:09

Plot file version 179 created 14-JUL-2010 16:37:09

CYGX-1 RR004A.UVDATA.1

Freq = 4.9415 GHz, Bw = 16.000 MH No calibration applied and no bandpass applied

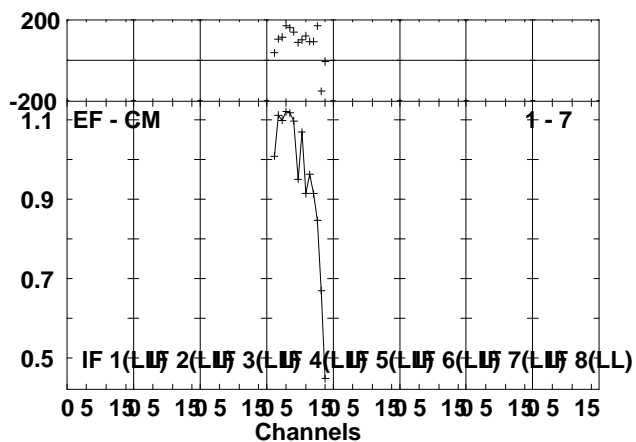
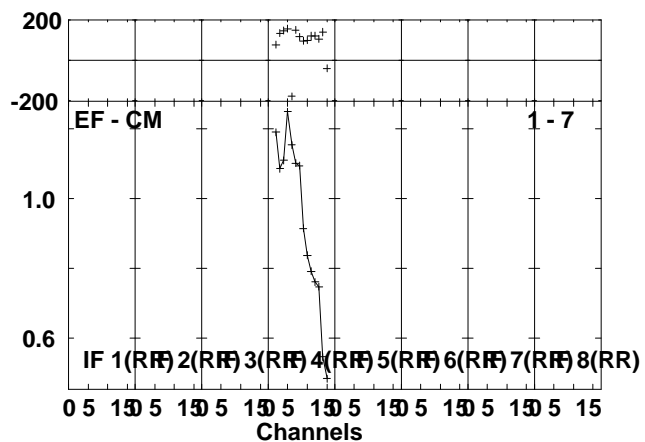
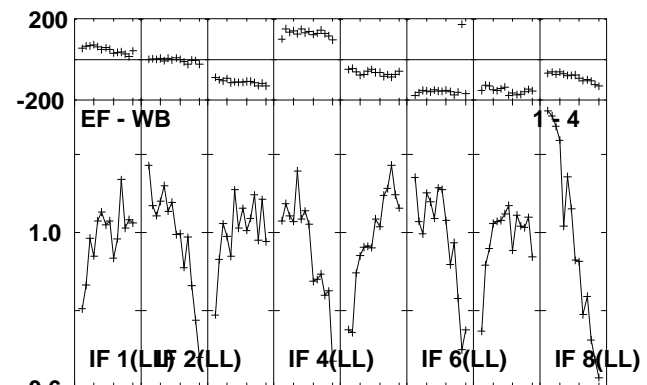
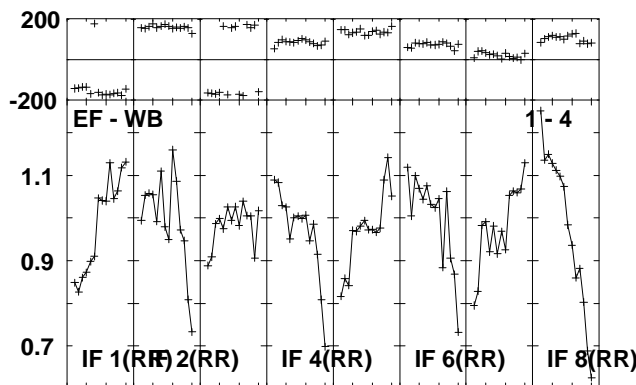
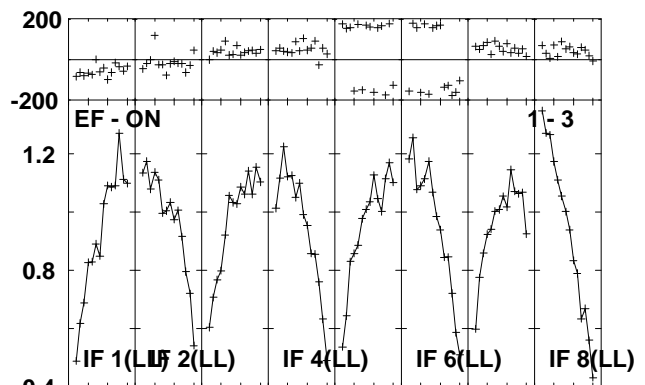
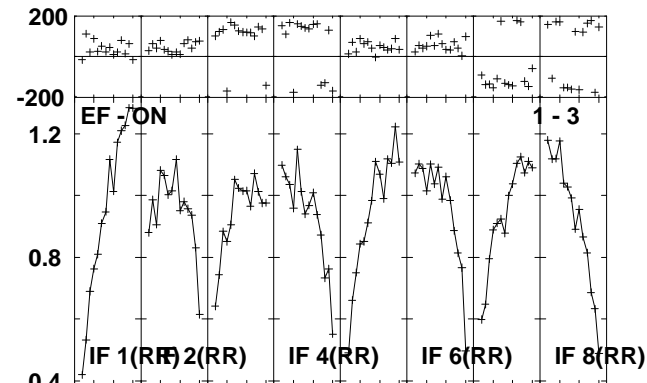
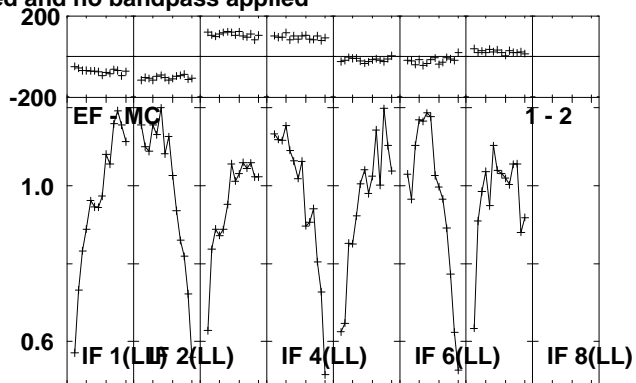
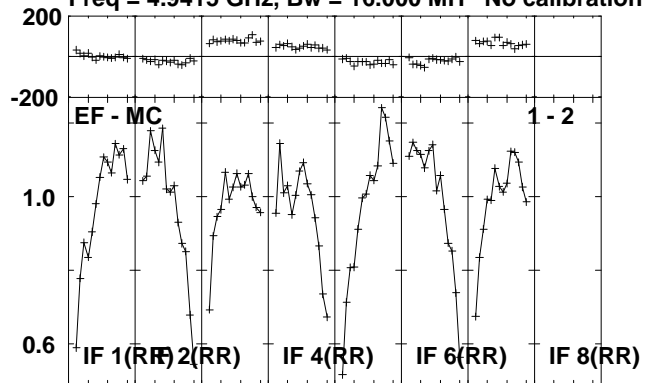

Lower frame: Milli Ampl Jy Top frame: Phas deg
Scalar averaged cross-power spectrum Several baselines displayed
Timerange: 00:23:47:11 to 00:23:52:09

Plot file version 180 created 14-JUL-2010 16:37:10

J1953+35 RR004A.UVDATA.1

Freq = 4.9415 GHz, Bw = 16.000 MH No calibration applied and no bandpass applied

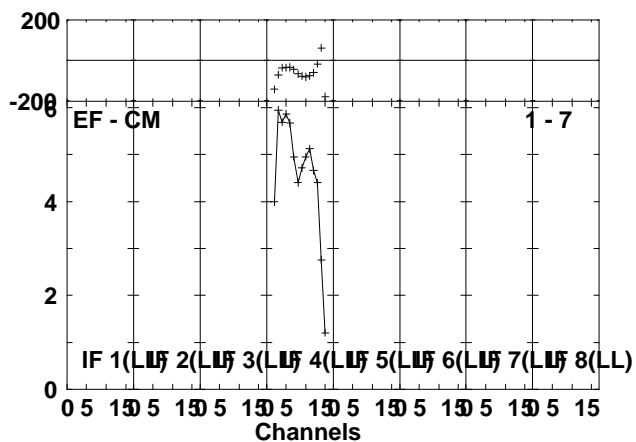
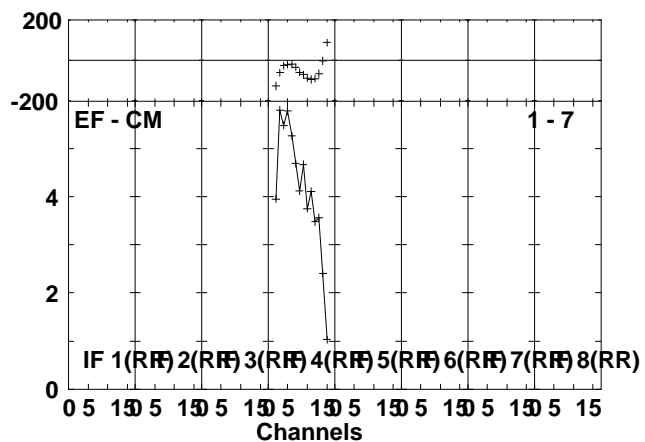
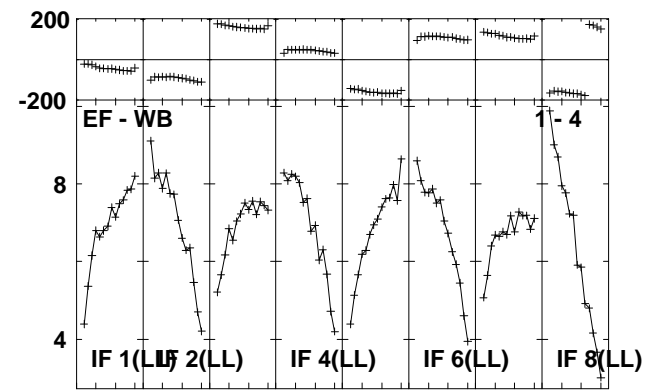
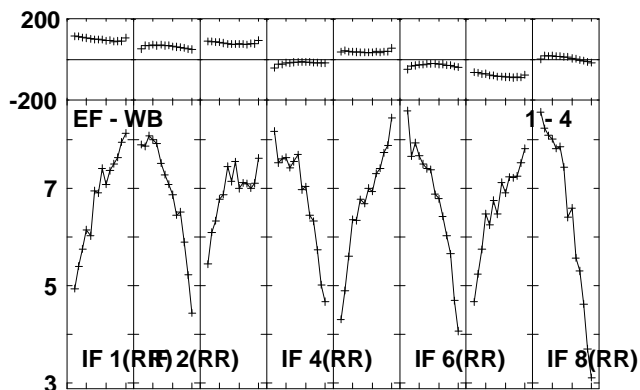
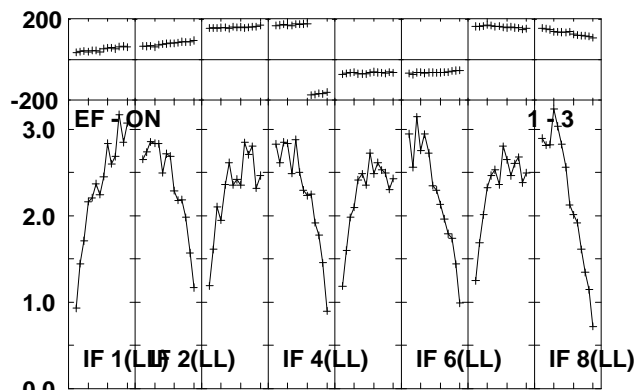
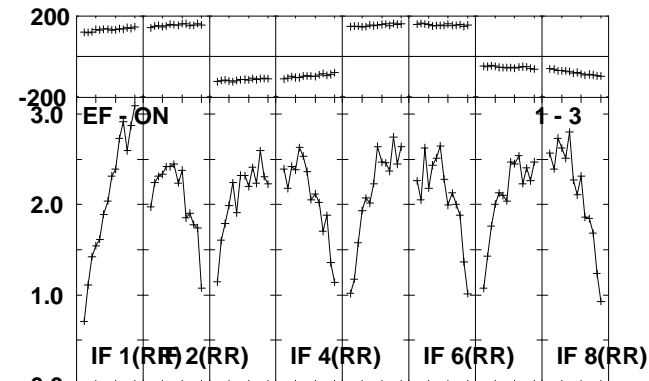
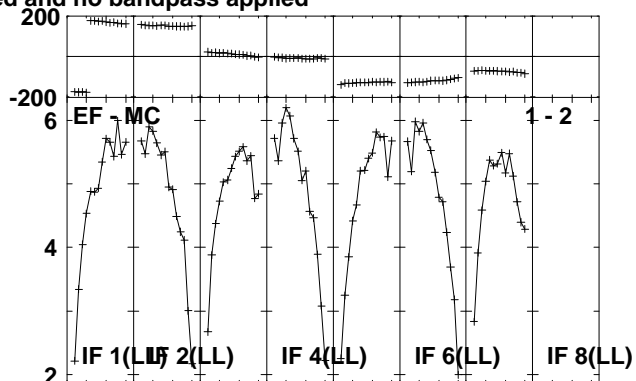
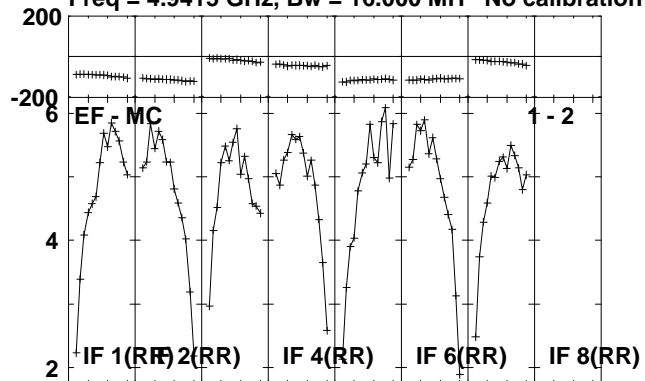

Lower frame: Milli Ampl Jy Top frame: Phas deg
Scalar averaged cross-power spectrum Several baselines displayed
Timerange: 00/23:52:11 to 00/23:54:09

Plot file version 181 created 14-JUL-2010 16:37:11

CYGX-1 RR004A.UVDATA.1

Freq = 4.9415 GHz, Bw = 16.000 MH No calibration applied and no bandpass applied

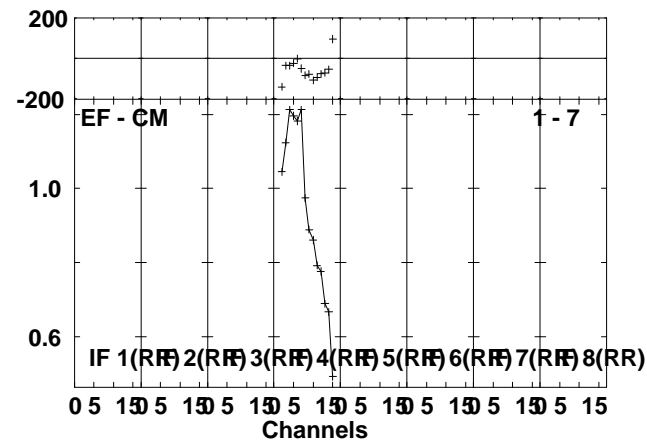
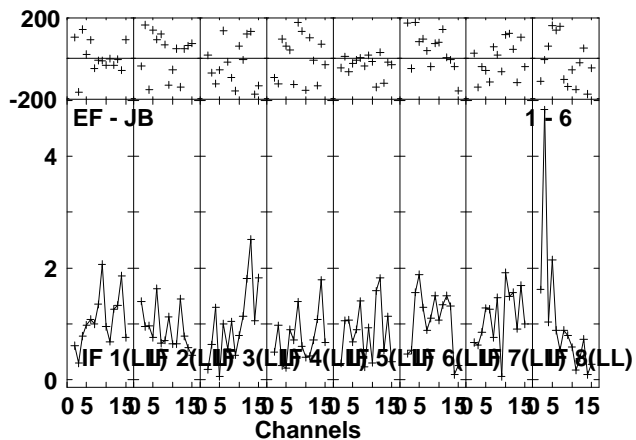
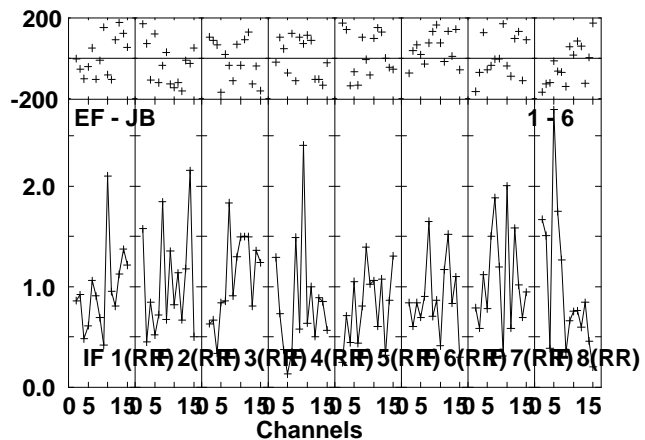
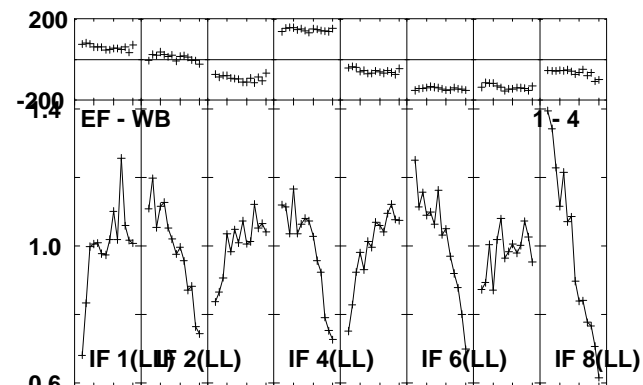
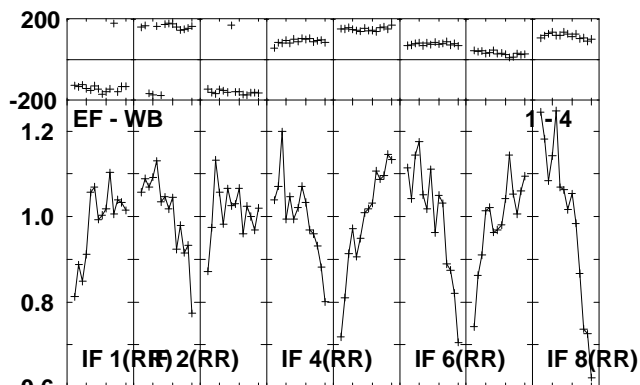
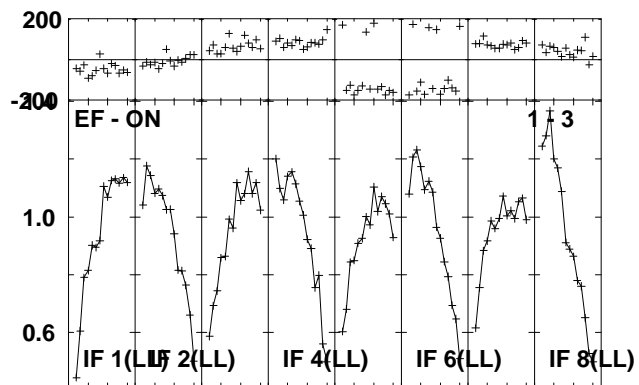
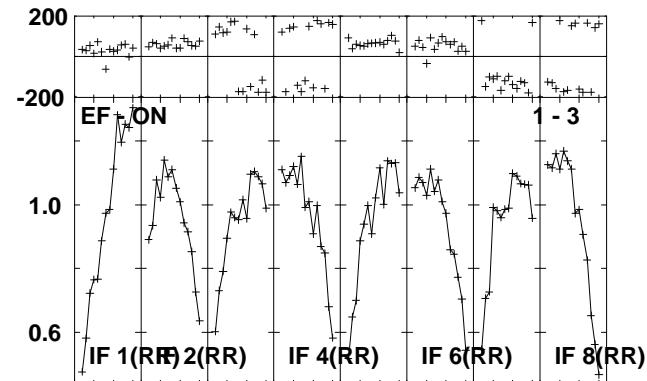
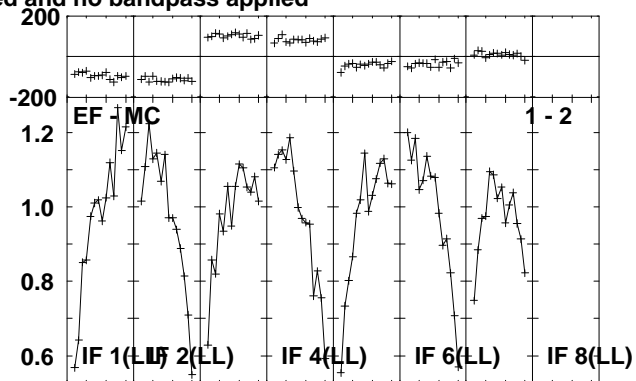
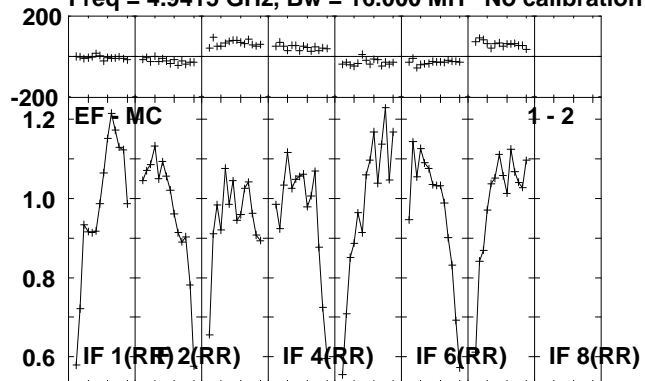

Lower frame: Milli Ampl Jy Top frame: Phas deg
Scalar averaged cross-power spectrum Several baselines displayed
Timerange: 00/23:54:11 to 00/23:59:09

Plot file version 182 created 14-JUL-2010 16:37:12

CYGX-1 RR004A.UVDATA.1

Freq = 4.9415 GHz, Bw = 16.000 MH No calibration applied and no bandpass applied

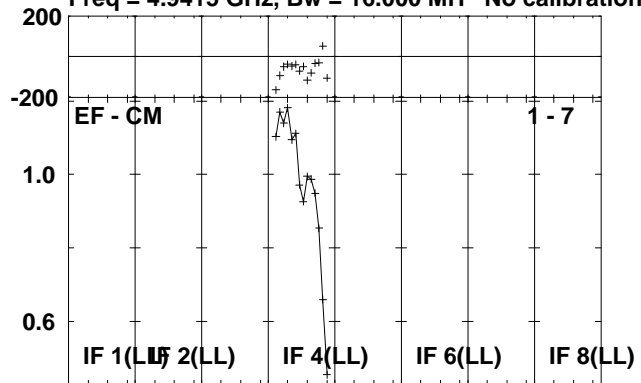

Lower frame: Milli Ampl Jy Top frame: Phas deg
Scalar averaged cross-power spectrum Several baselines displayed
Timerange: 00/23:54:11 to 00/23:59:09

Plot file version 183 created 14-JUL-2010 16:37:12

J1953+35 RR004A.UVDATA.1

Freq = 4.9415 GHz, Bw = 16.000 MH No calibration applied and no bandpass applied

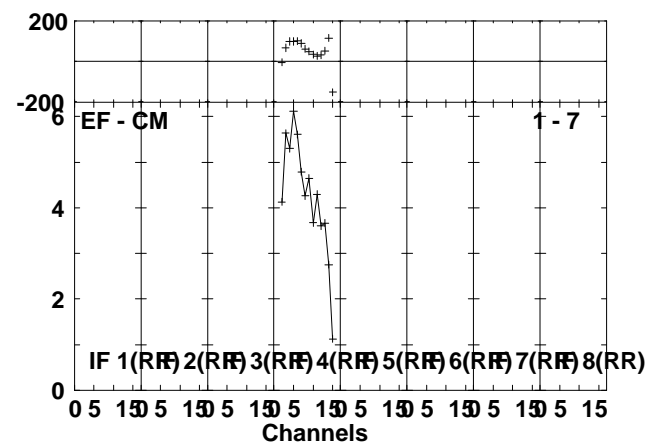
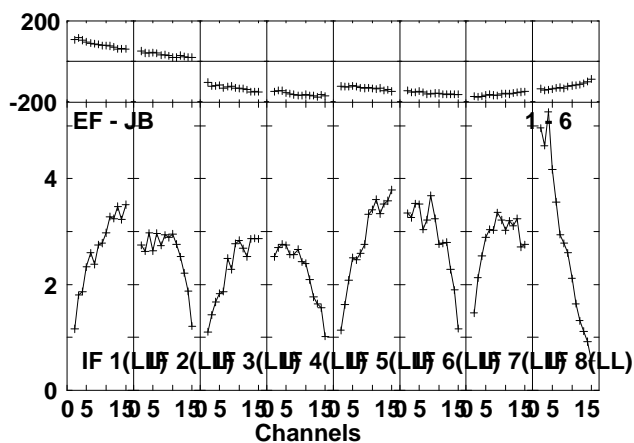
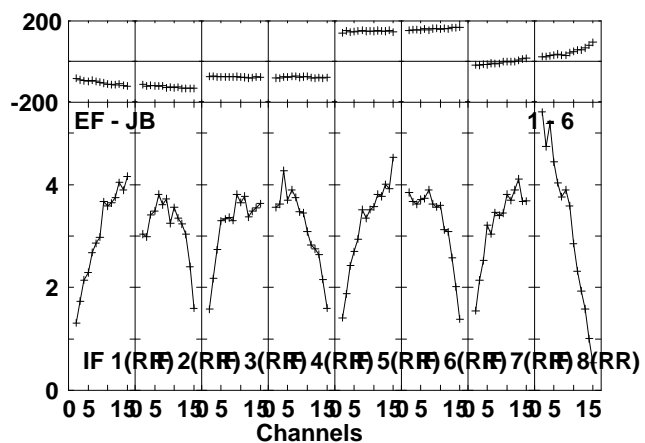
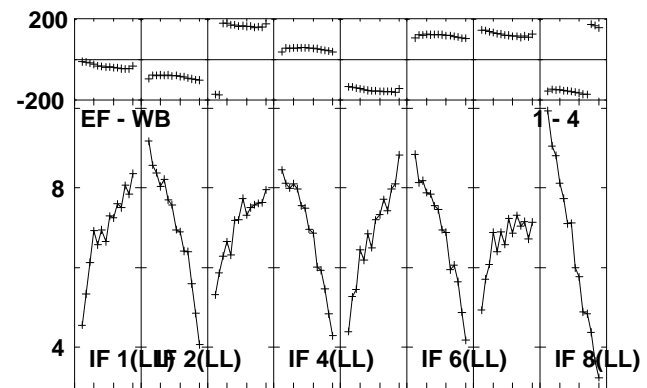
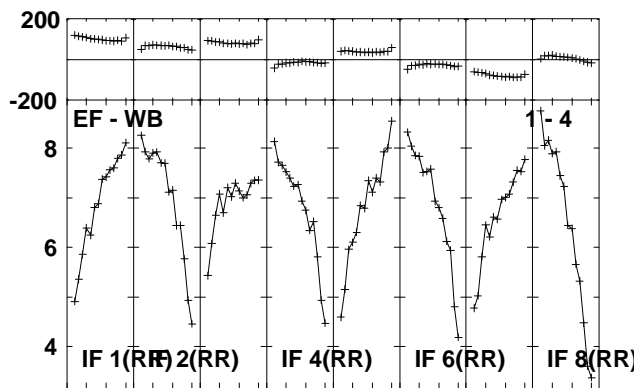
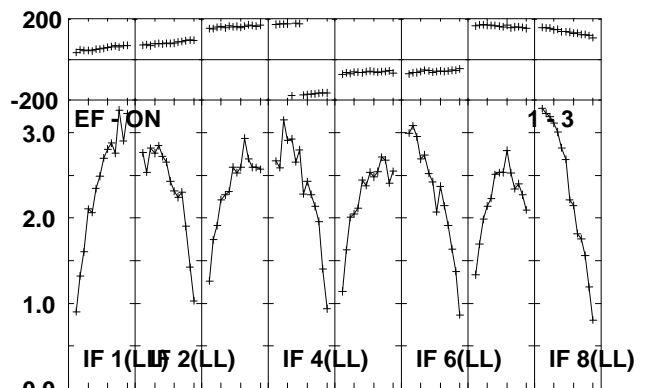
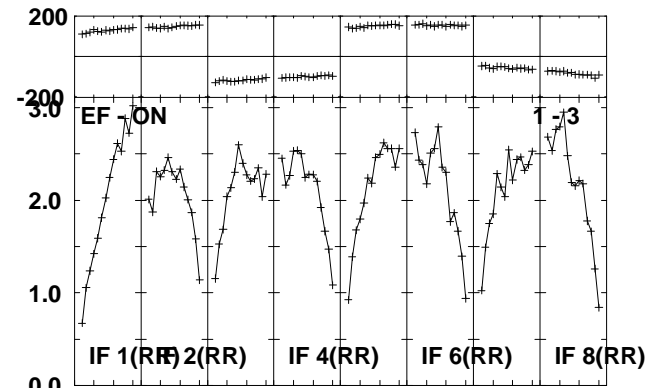
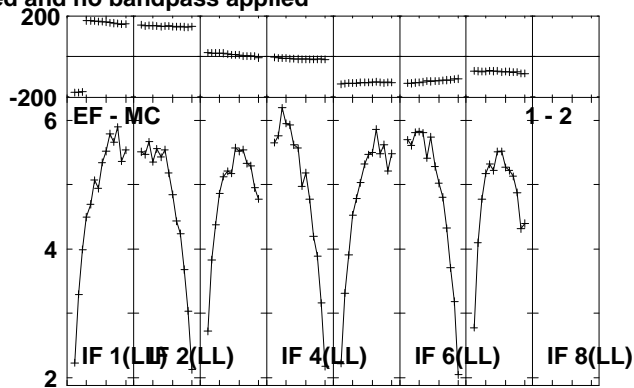
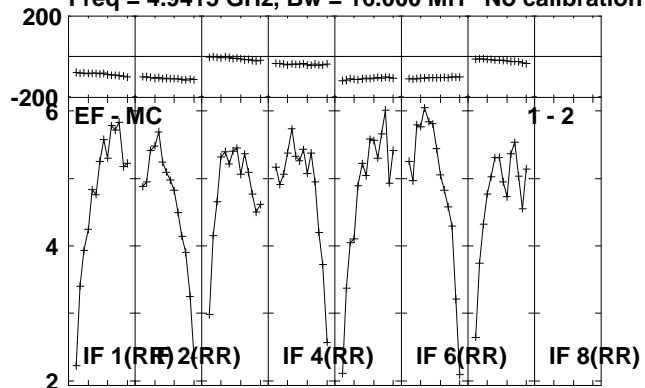

Lower frame: Milli Ampl Jy Top frame: Phas deg
Scalar averaged cross-power spectrum Several baselines displayed
Timerange: 01/00:00:11 to 01/00:01:39

Plot file version 184 created 14-JUL-2010 16:37:13
J1953+35 RR004A.UVDATA.1
Freq = 4.9415 GHz, Bw = 16.000 MH No calibration applied and no bandpass applied

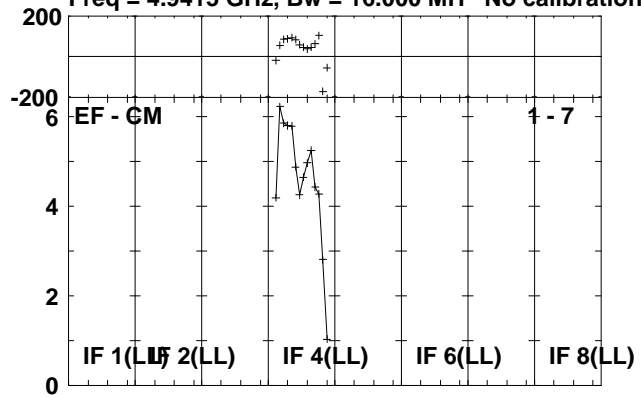

Lower frame: Milli Ampl Jy Top frame: Phas deg
Scalar averaged cross-power spectrum Several baselines displayed
Timerange: 01/00:00:11 to 01/00:01:39

Plot file version 185 created 14-JUL-2010 16:37:13

CYGX-1 RR004A.UVDATA.1

Freq = 4.9415 GHz, Bw = 16.000 MH No calibration applied and no bandpass applied

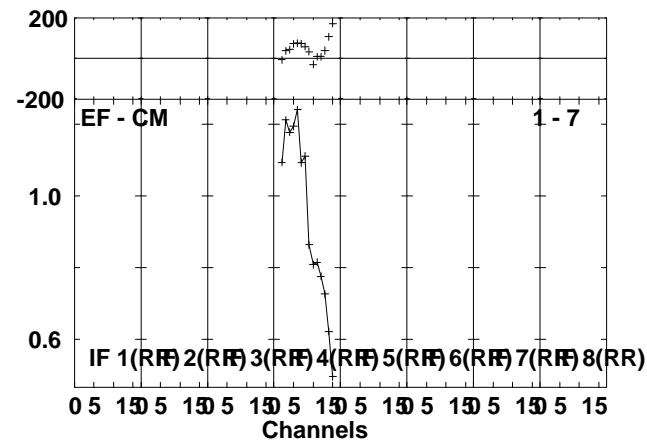
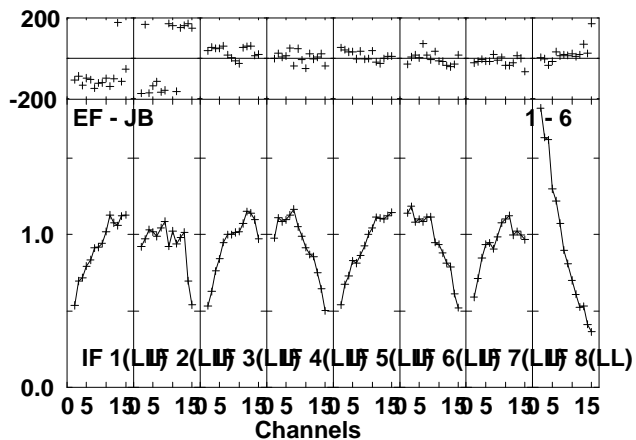
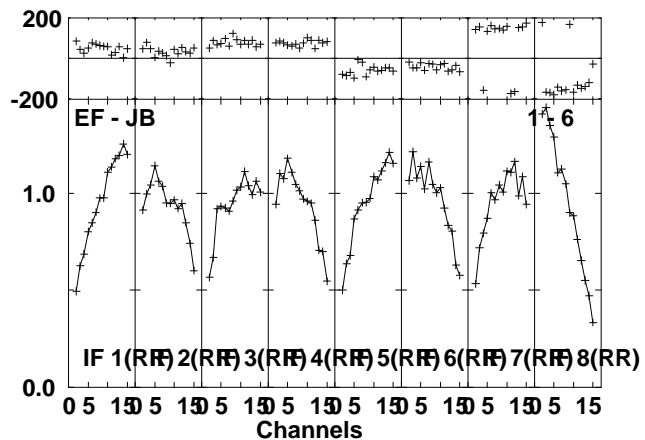
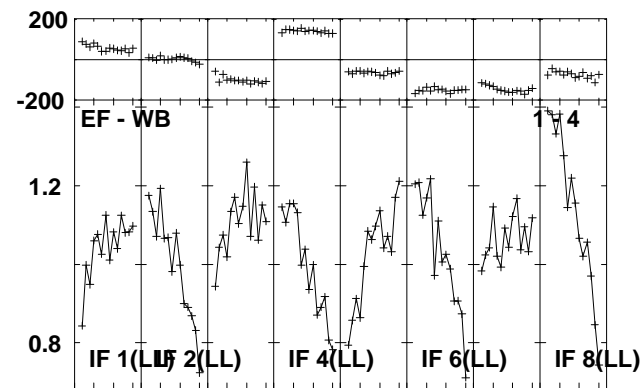
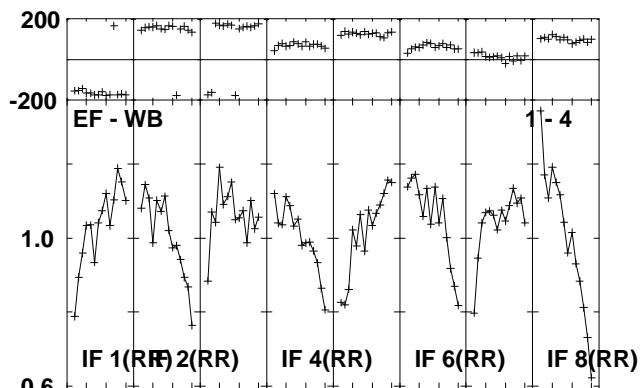
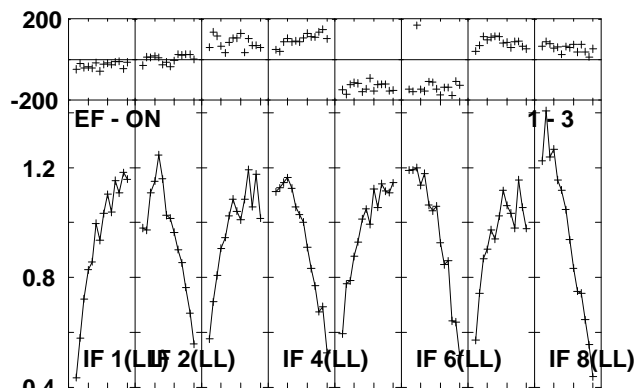
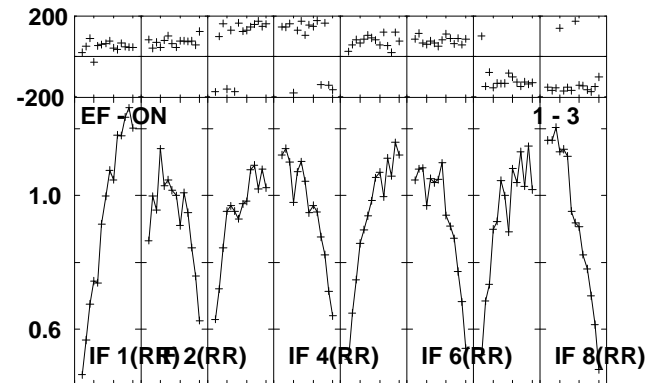
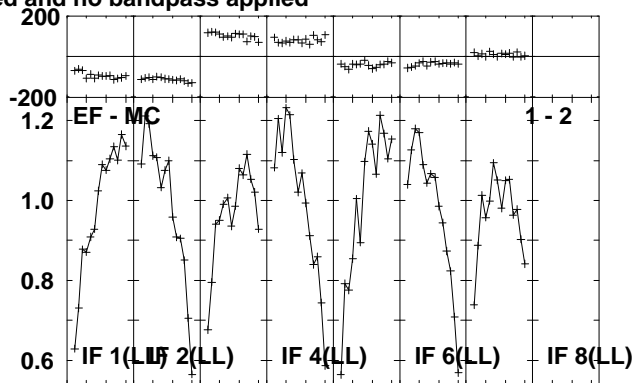
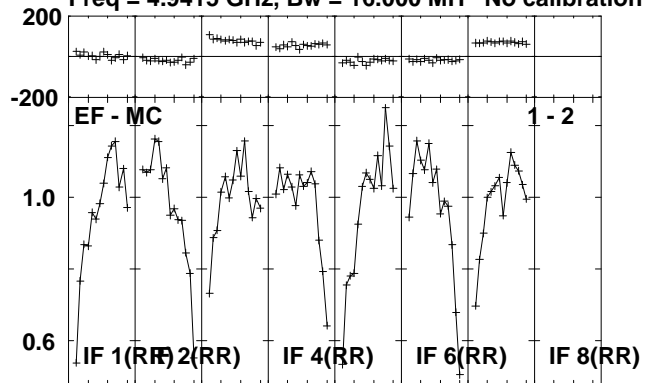

Lower frame: Milli Ampl Jy Top frame: Phas deg
Scalar averaged cross-power spectrum Several baselines displayed
Timerange: 01/00:01:41 to 01/00:06:39

Plot file version 186 created 14-JUL-2010 16:37:14
CYGX-1 RR004A.UVDATA.1
Freq = 4.9415 GHz, Bw = 16.000 MH No calibration applied and no bandpass applied

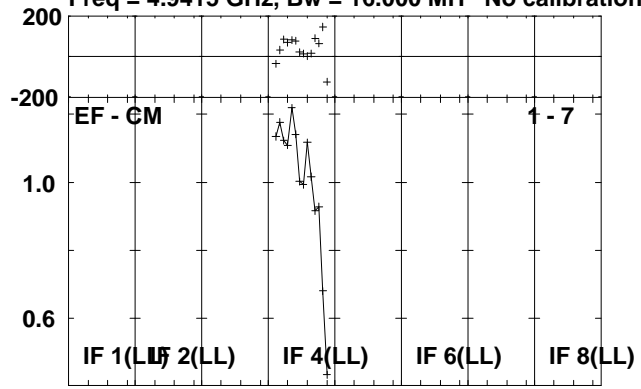

Lower frame: Milli Ampl Jy Top frame: Phas deg
Scalar averaged cross-power spectrum Several baselines displayed
Timerange: 01/00:01:41 to 01/00:06:39

Plot file version 187 created 14-JUL-2010 16:37:15

J1953+35 RR004A.UVDATA.1

Freq = 4.9415 GHz, Bw = 16.000 MH No calibration applied and no bandpass applied

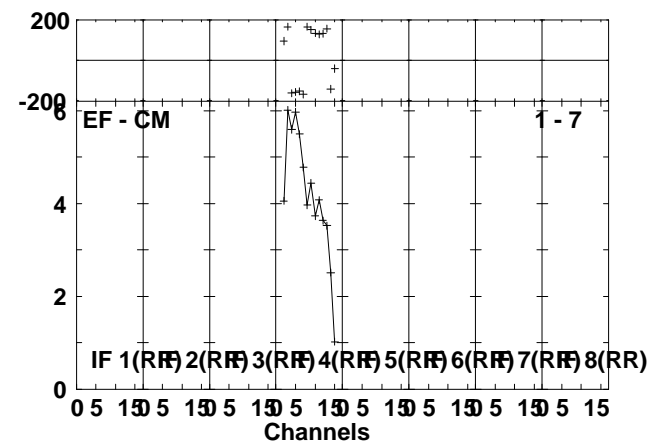
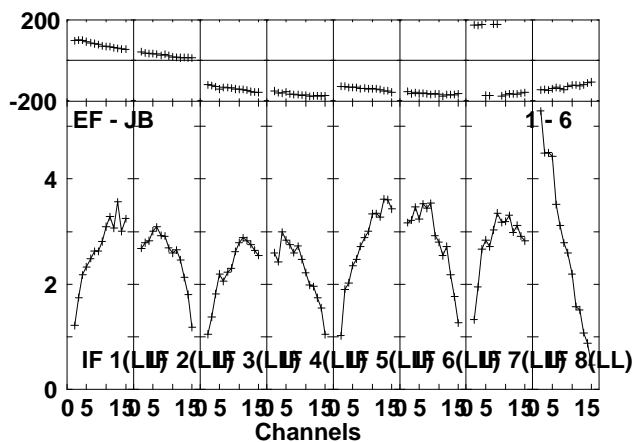
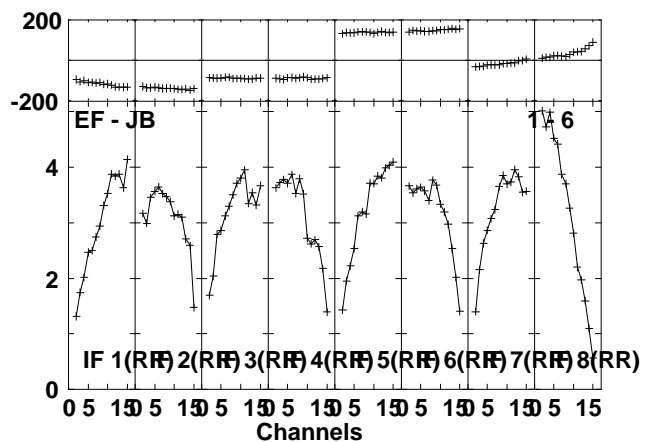
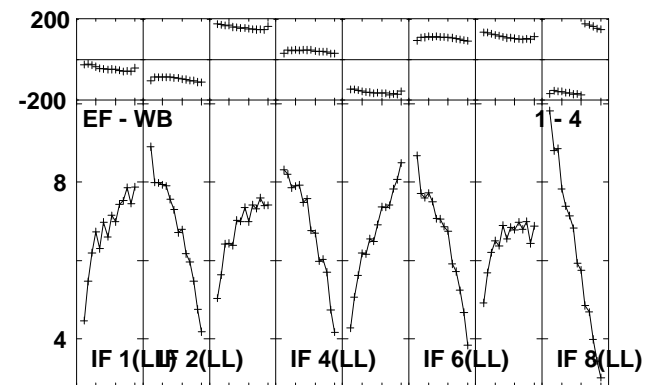
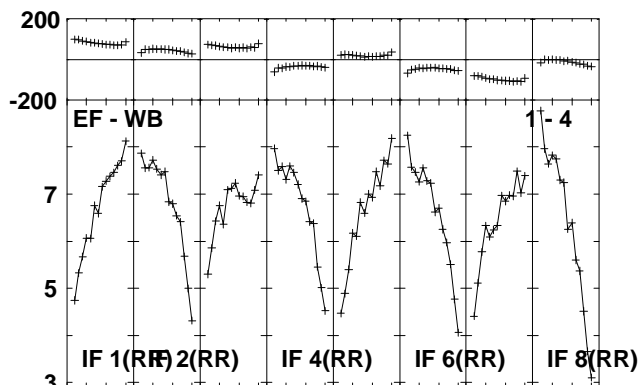
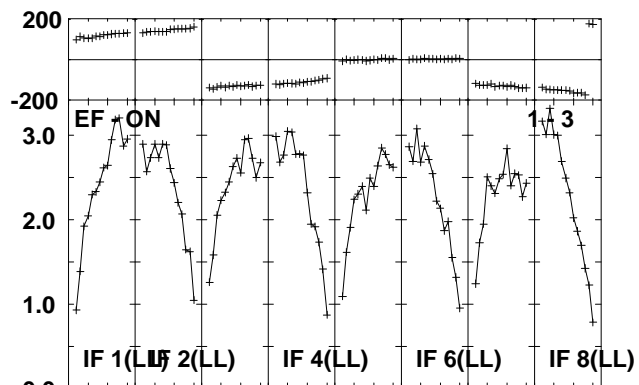
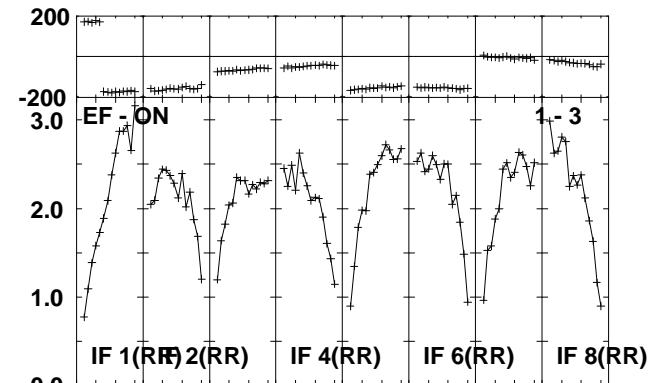
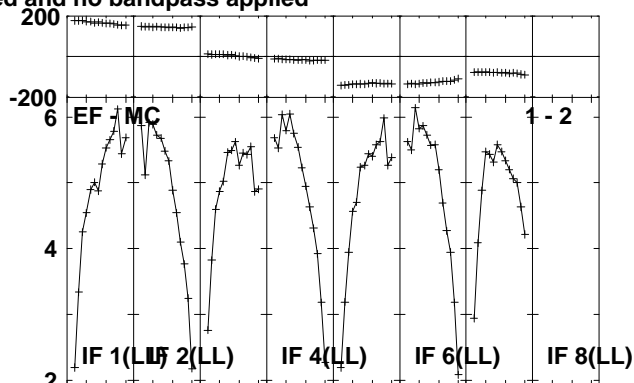
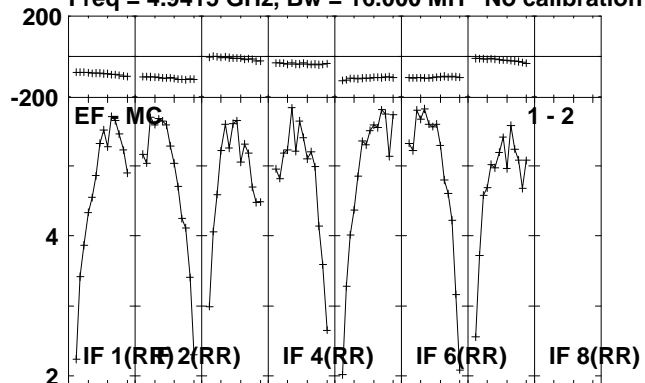

Lower frame: Milli Ampl Jy Top frame: Phas deg
Scalar averaged cross-power spectrum Several baselines displayed
Timerange: 01/00:06:41 to 01/00:08:39

Plot file version 188 created 14-JUL-2010 16:37:15
J1953+35 RR004A.UVDATA.1
Freq = 4.9415 GHz, Bw = 16.000 MH No calibration applied and no bandpass applied

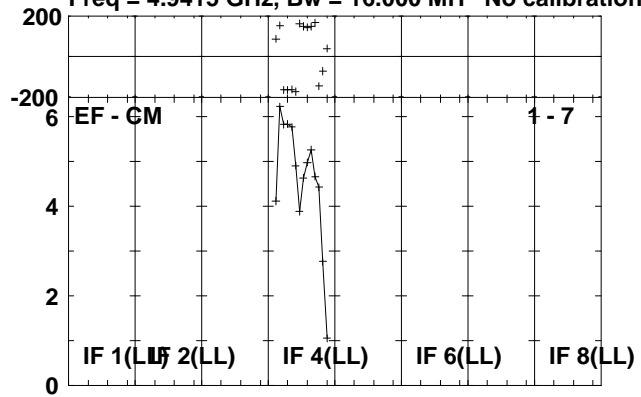

Lower frame: Milli Ampl Jy Top frame: Phas deg
Scalar averaged cross-power spectrum Several baselines displayed
Timerange: 01/00:06:41 to 01/00:08:39

Plot file version 189 created 14-JUL-2010 16:37:16

CYGX-1 RR004A.UVDATA.1

Freq = 4.9415 GHz, Bw = 16.000 MH No calibration applied and no bandpass applied

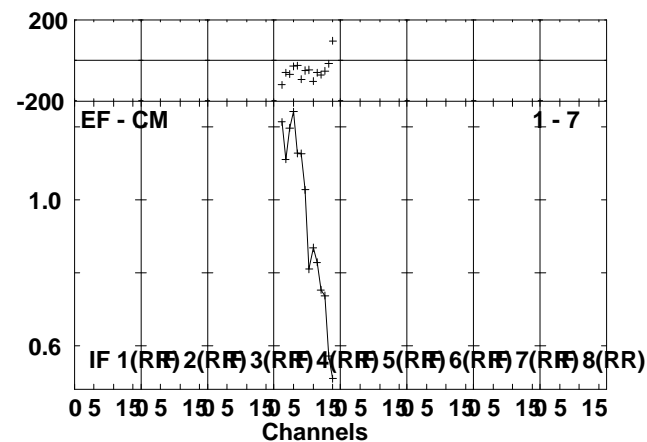
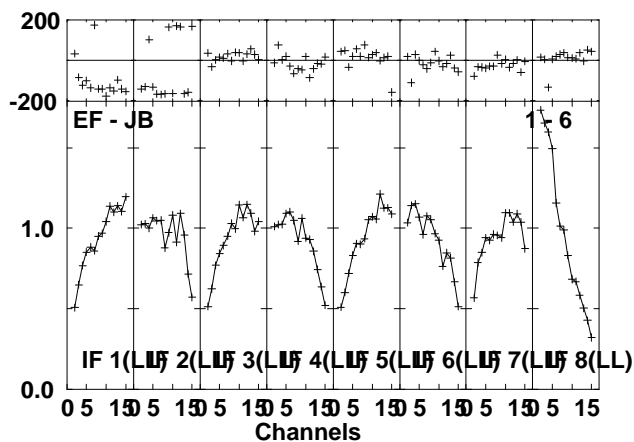
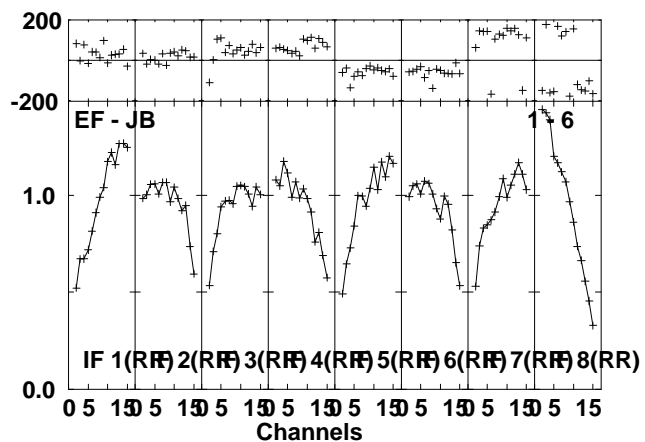
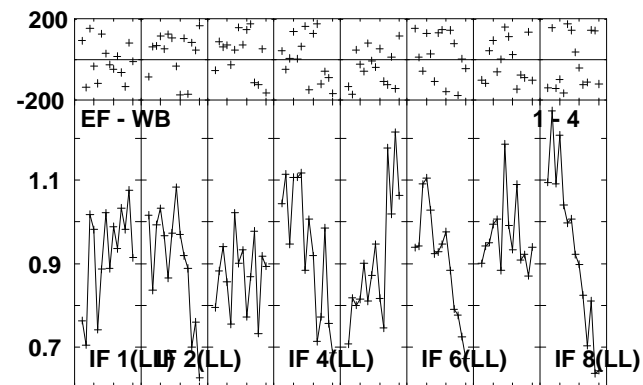
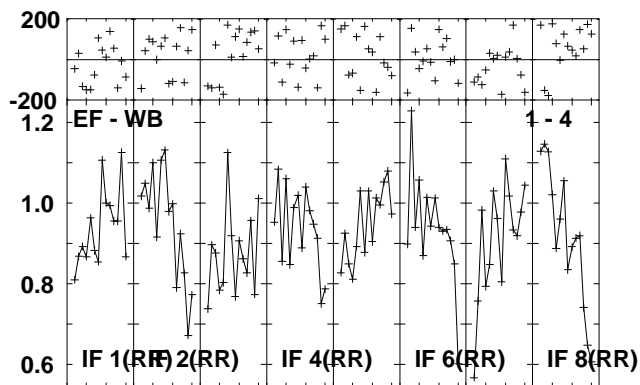
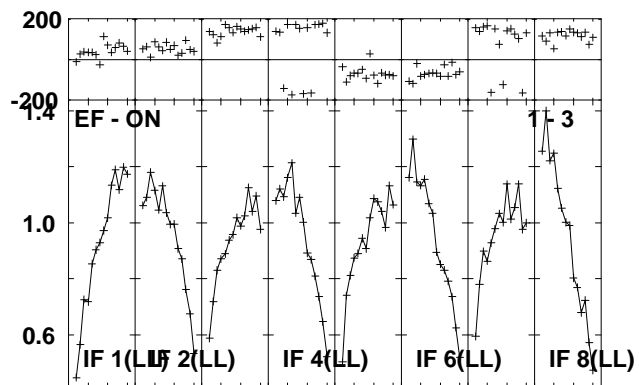
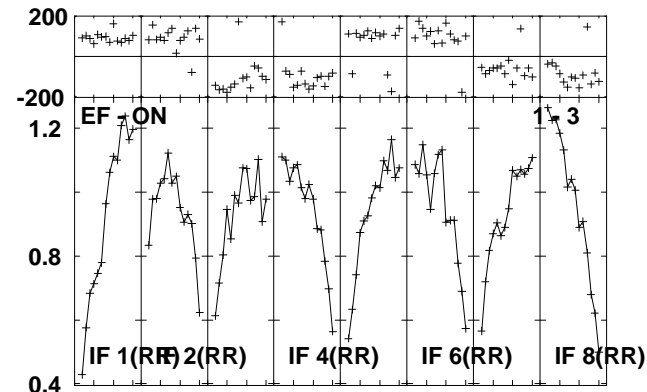
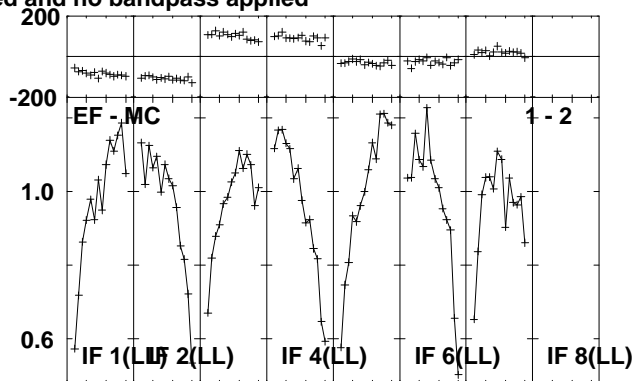
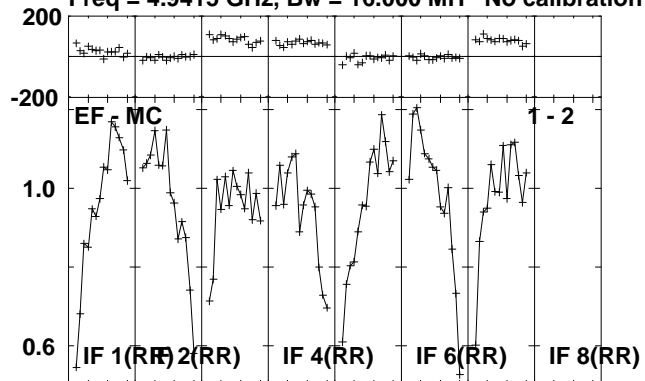

Lower frame: Milli Ampl Jy Top frame: Phas deg
Scalar averaged cross-power spectrum Several baselines displayed
Timerange: 01/00:08:41 to 01/00:13:39

Plot file version 190 created 14-JUL-2010 16:37:17
CYGX-1 RR004A.UVDATA.1
Freq = 4.9415 GHz, Bw = 16.000 MH No calibration applied and no bandpass applied

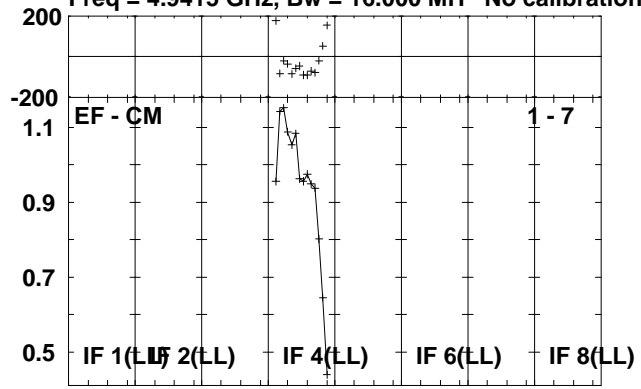

Lower frame: Milli Ampl Jy Top frame: Phas deg
Scalar averaged cross-power spectrum Several baselines displayed
Timerange: 01/00:08:41 to 01/00:13:39

Plot file version 191 created 14-JUL-2010 16:37:17

J1953+35 RR004A.UVDATA.1

Freq = 4.9415 GHz, Bw = 16.000 MH No calibration applied and no bandpass applied

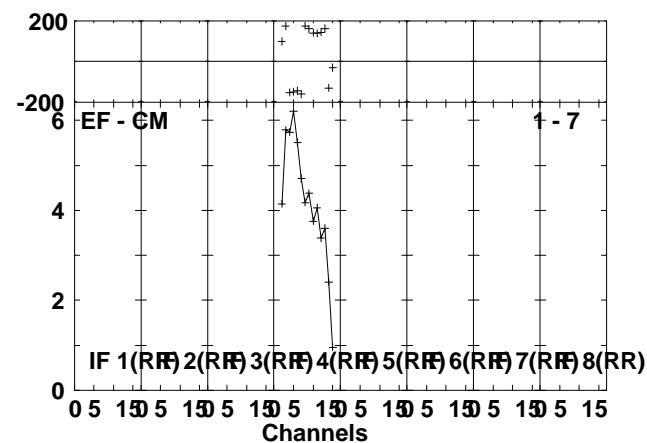
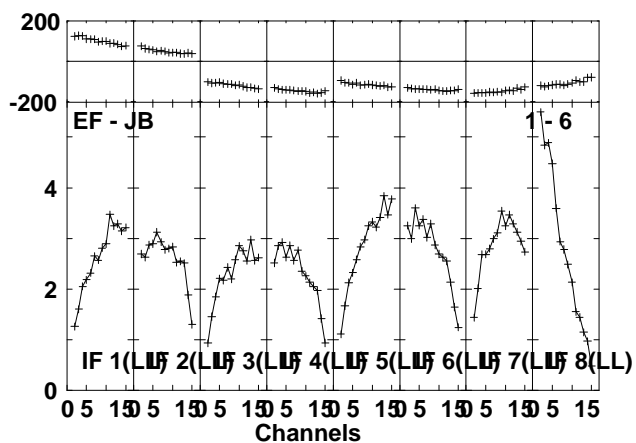
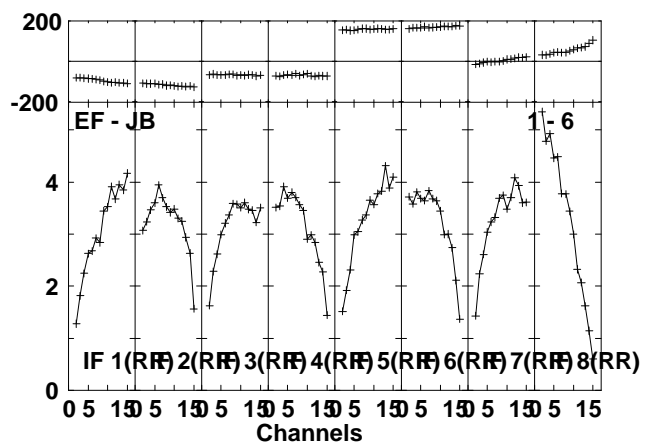
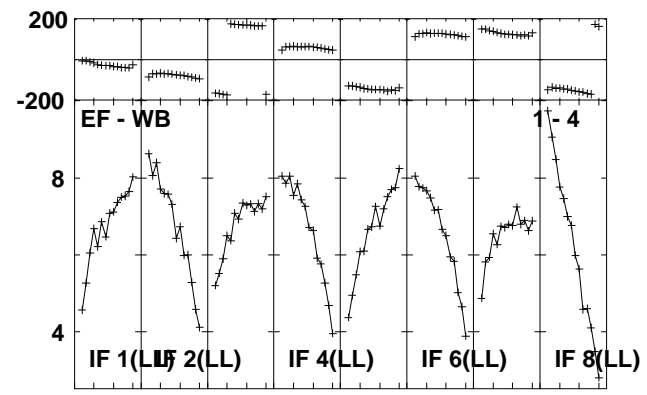
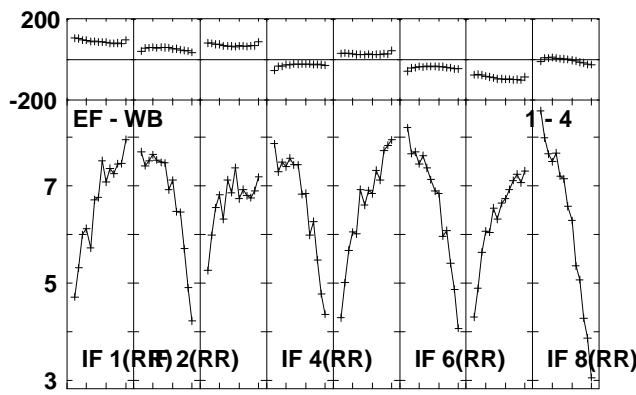
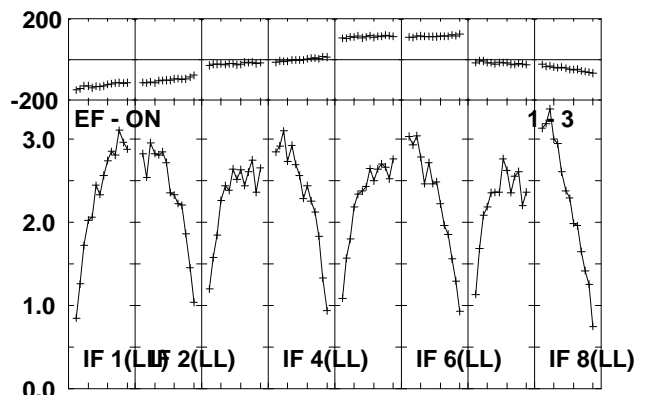
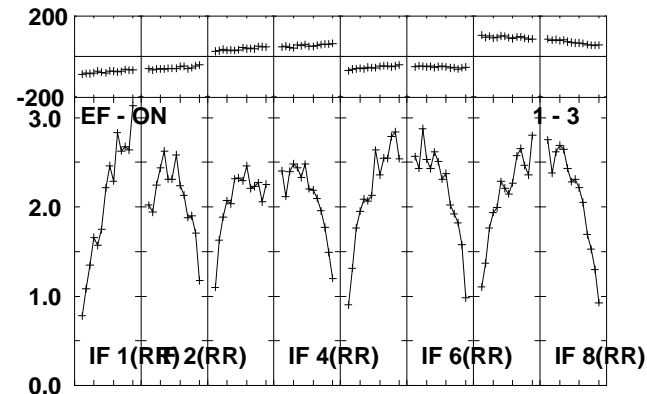
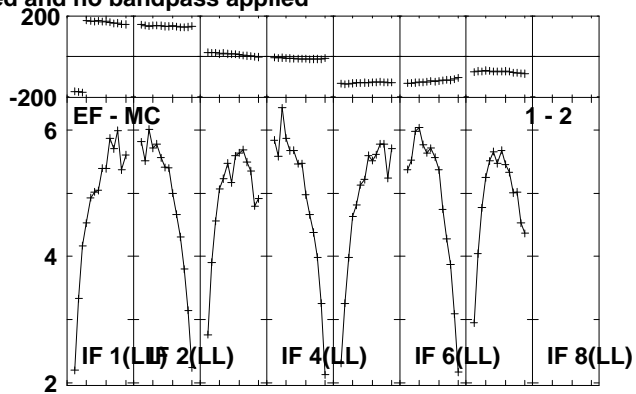
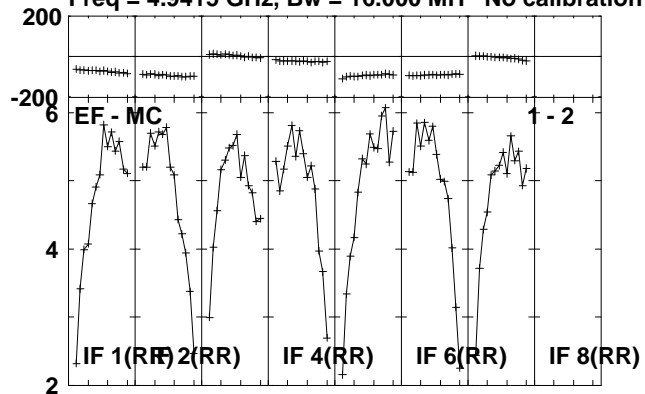

Lower frame: Milli Ampl Jy Top frame: Phas deg
Scalar averaged cross-power spectrum Several baselines displayed
Timerange: 01/00:14:41 to 01/00:16:09

Plot file version 192 created 14-JUL-2010 16:37:18
J1953+35 RR004A.UVDATA.1
Freq = 4.9415 GHz, Bw = 16.000 MH No calibration applied and no bandpass applied

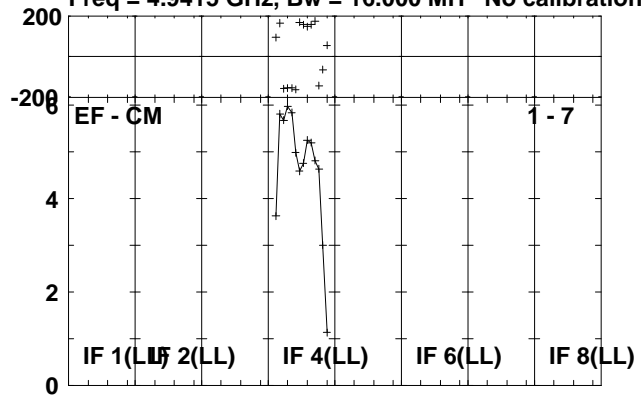

Lower frame: Milli Ampl Jy Top frame: Phas deg
Scalar averaged cross-power spectrum Several baselines displayed
Timerange: 01/00:14:41 to 01/00:16:09

Plot file version 193 created 14-JUL-2010 16:37:18

CYGX-1 RR004A.UVDATA.1

Freq = 4.9415 GHz, Bw = 16.000 MH No calibration applied and no bandpass applied

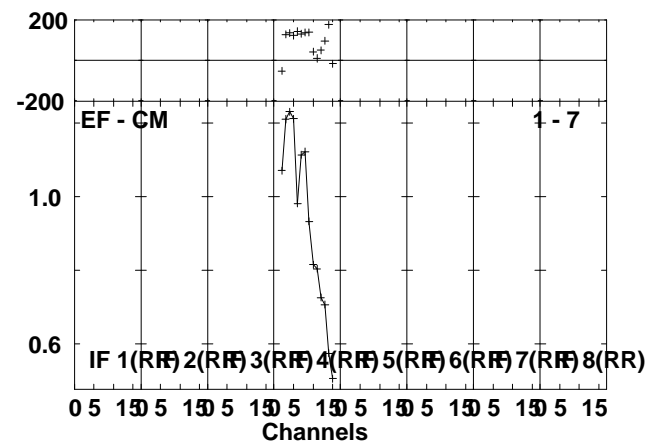
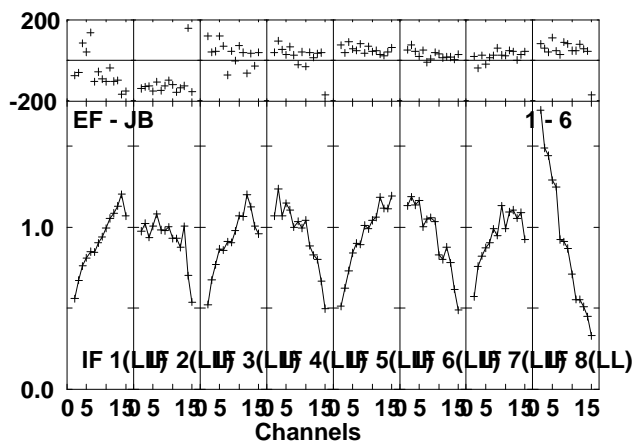
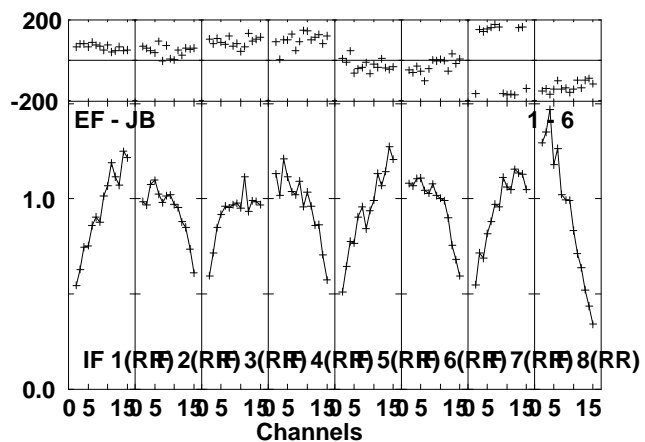
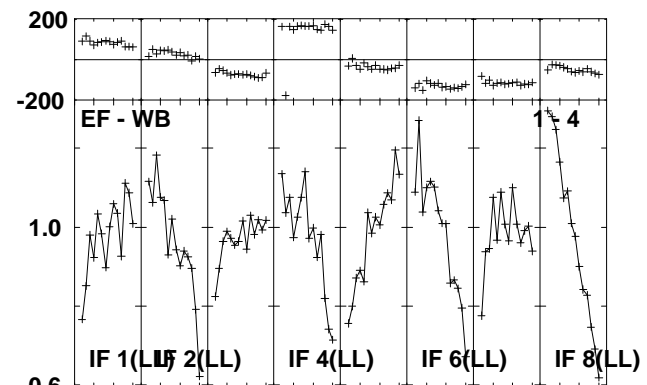
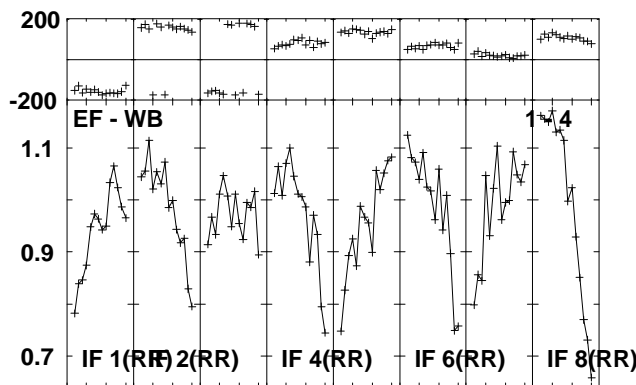
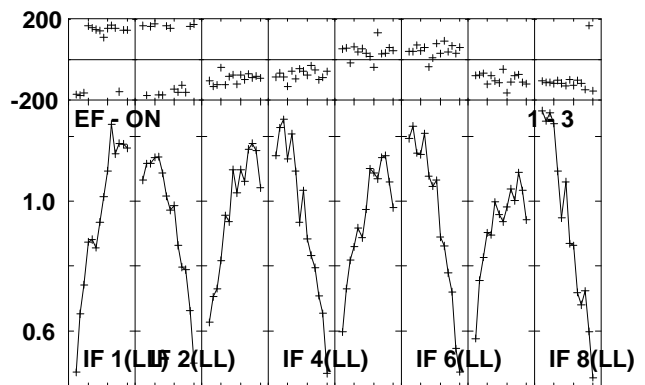
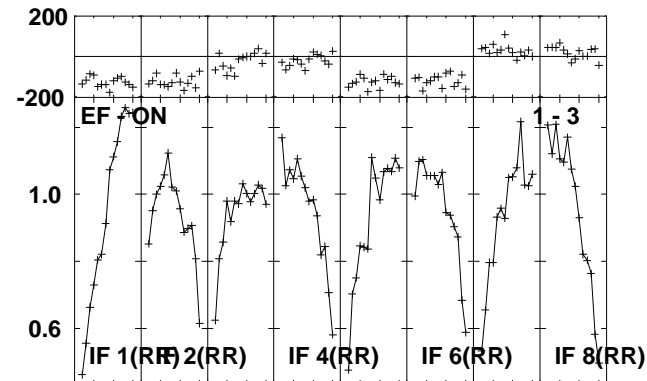
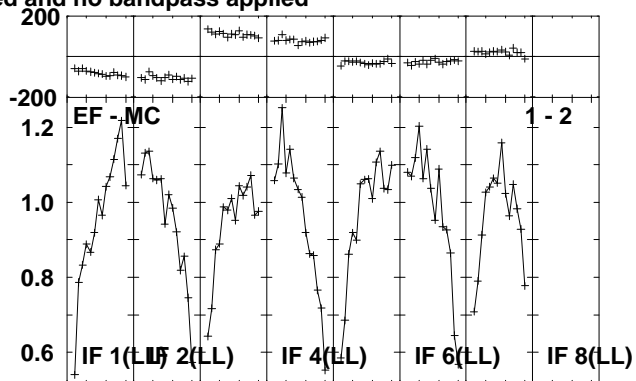
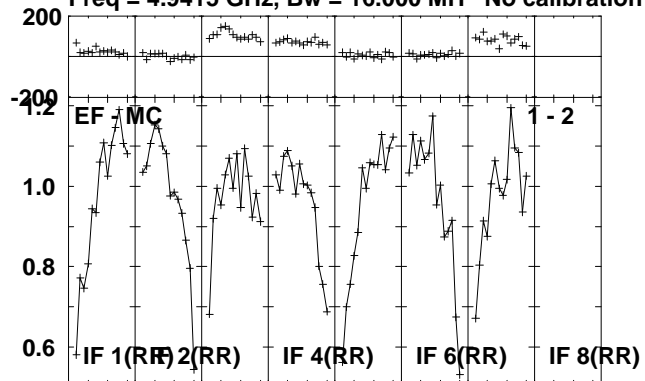

Lower frame: Milli Ampl Jy Top frame: Phas deg
Scalar averaged cross-power spectrum Several baselines displayed
Timerange: 01/00:16:11 to 01/00:21:09

Plot file version 194 created 14-JUL-2010 16:37:19
CYGX-1 RR004A.UVDATA.1
Freq = 4.9415 GHz, Bw = 16.000 MH No calibration applied and no bandpass applied

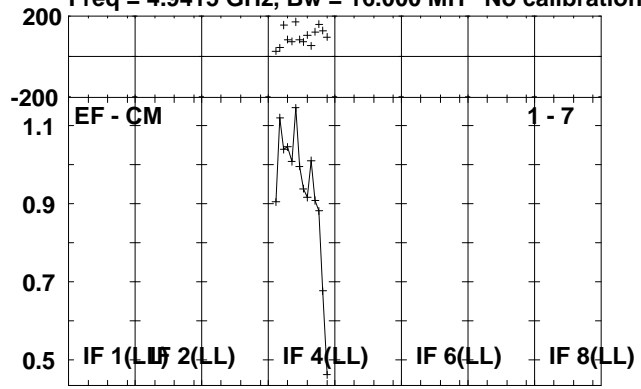

Lower frame: Milli Ampl Jy Top frame: Phas deg
Scalar averaged cross-power spectrum Several baselines displayed
Timerange: 01/00:16:11 to 01/00:21:09

Plot file version 195 created 14-JUL-2010 16:37:20

J1953+35 RR004A.UVDATA.1

Freq = 4.9415 GHz, Bw = 16.000 MH No calibration applied and no bandpass applied

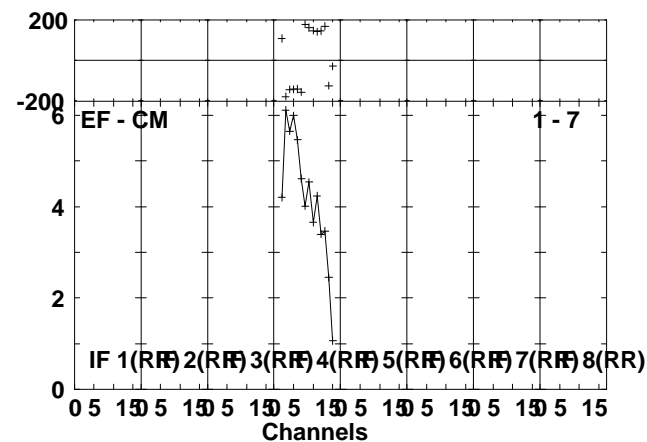
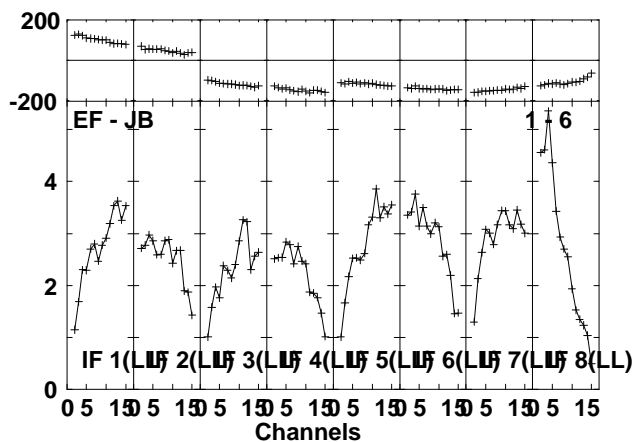
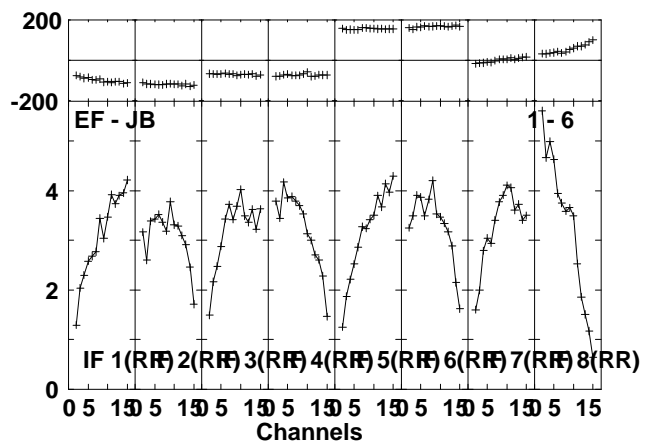
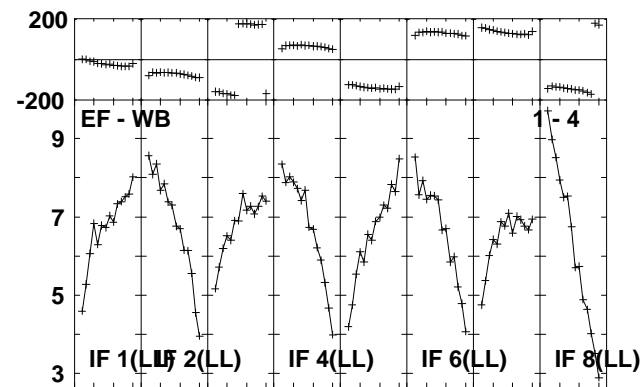
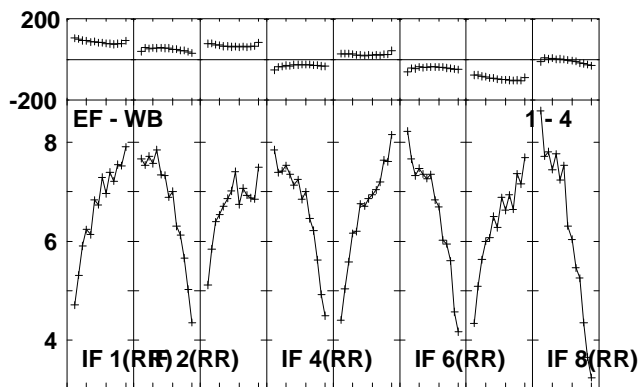
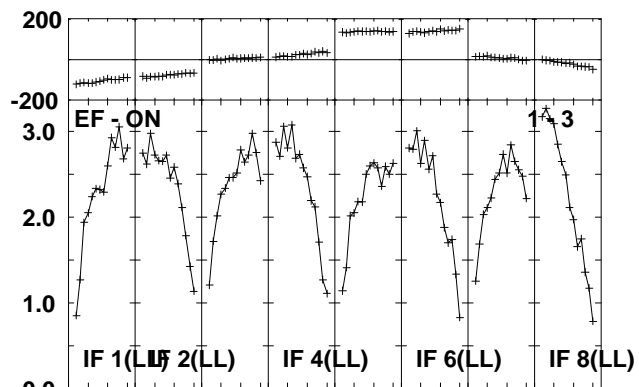
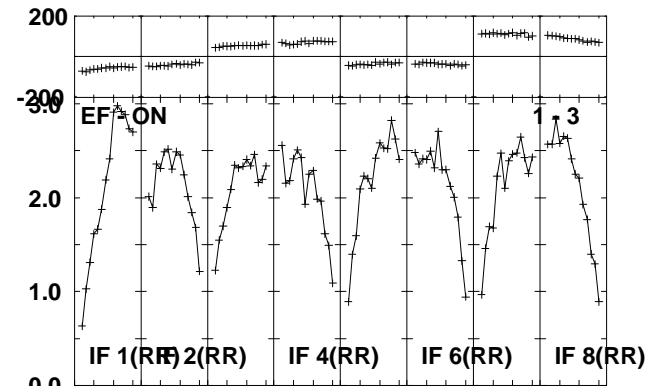
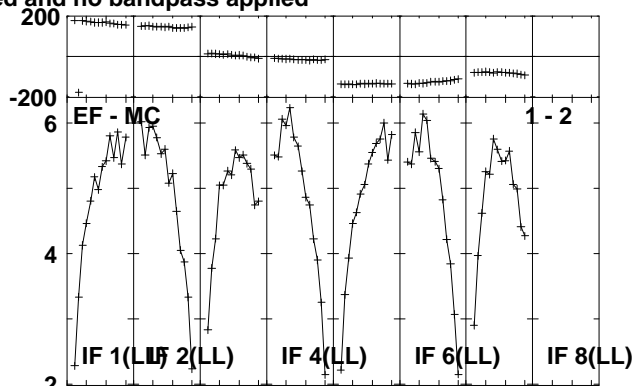
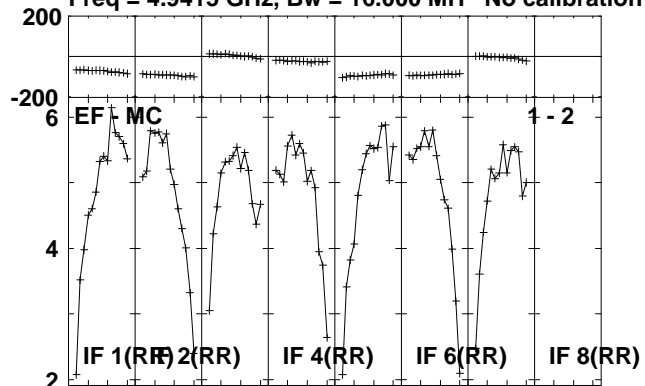

Lower frame: Milli Ampl Jy Top frame: Phas deg
Scalar averaged cross-power spectrum Several baselines displayed
Timerange: 01/00:21:11 to 01/00:23:09

Plot file version 196 created 14-JUL-2010 16:37:20
J1953+35 RR004A.UVDATA.1
Freq = 4.9415 GHz, Bw = 16.000 MH No calibration applied and no bandpass applied

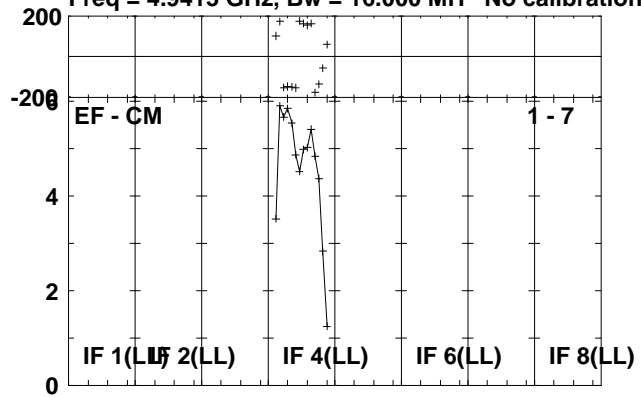

Lower frame: Milli Ampl Jy Top frame: Phas deg
Scalar averaged cross-power spectrum Several baselines displayed
Timerange: 01/00:21:11 to 01/00:23:09

Plot file version 197 created 14-JUL-2010 16:37:21

CYGX-1 RR004A.UVDATA.1

Freq = 4.9415 GHz, Bw = 16.000 MH No calibration applied and no bandpass applied

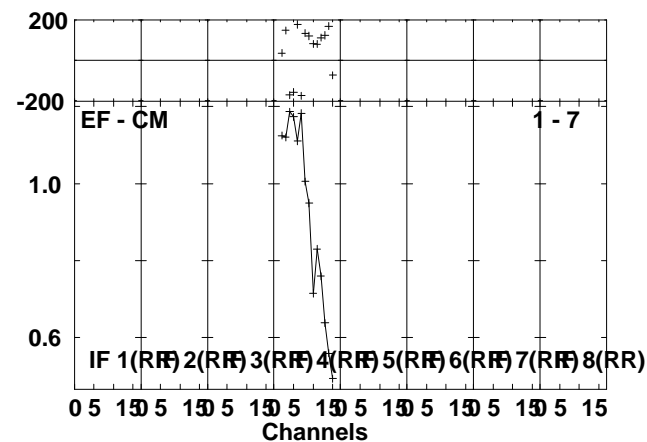
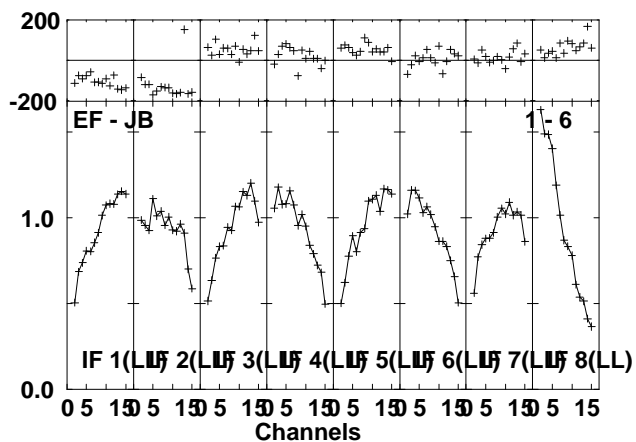
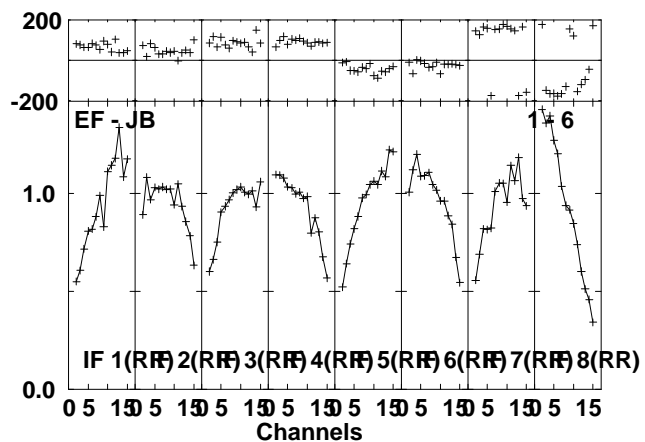
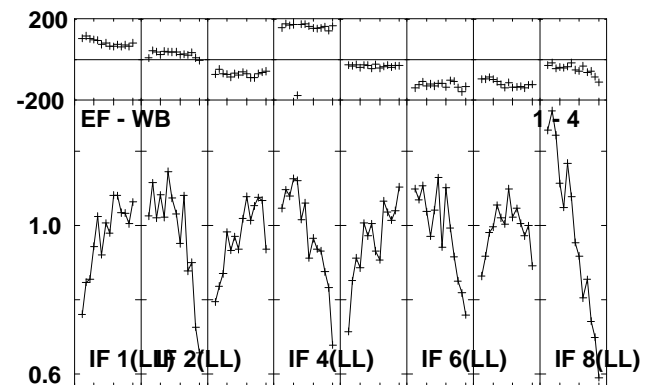
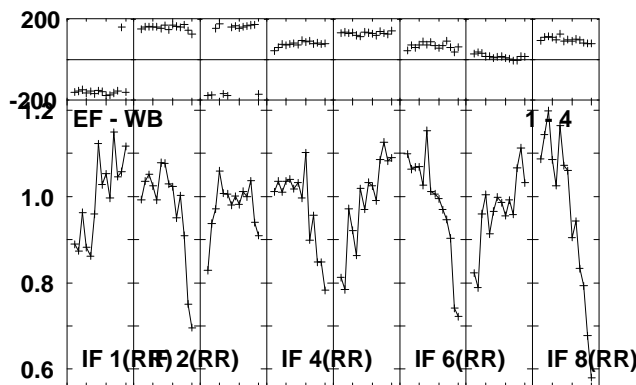
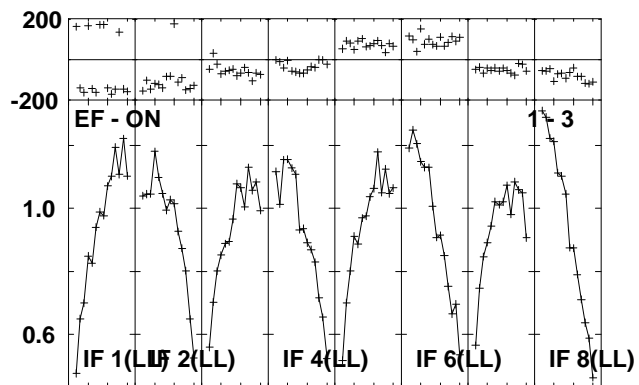
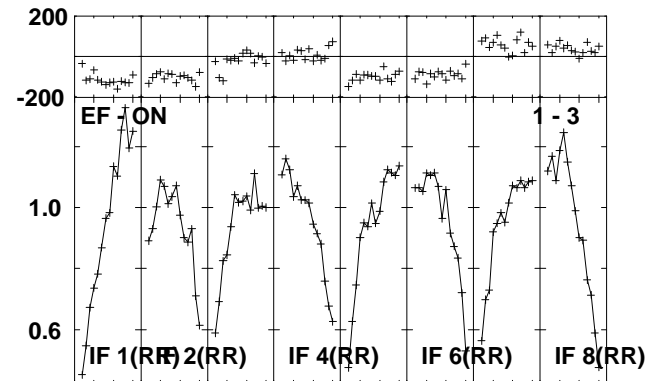
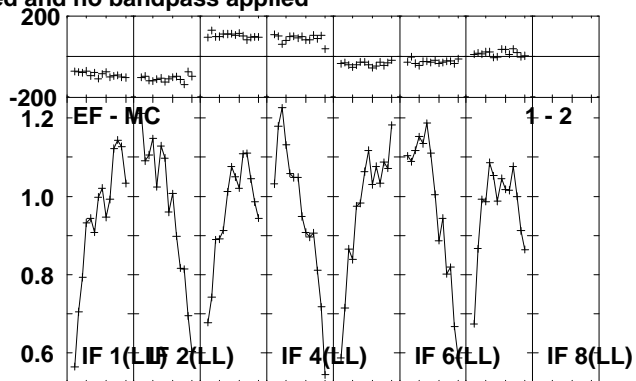
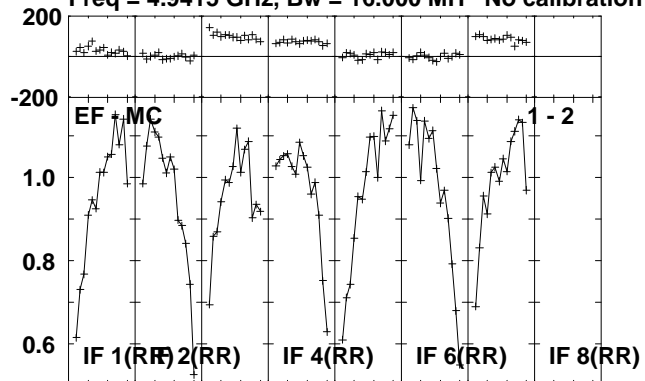

Lower frame: Milli Ampl Jy Top frame: Phas deg
Scalar averaged cross-power spectrum Several baselines displayed
Timerange: 01/00:23:11 to 01/00:28:09

Plot file version 198 created 14-JUL-2010 16:37:22

CYGX-1 RR004A.UVDATA.1

Freq = 4.9415 GHz, Bw = 16.000 MH No calibration applied and no bandpass applied

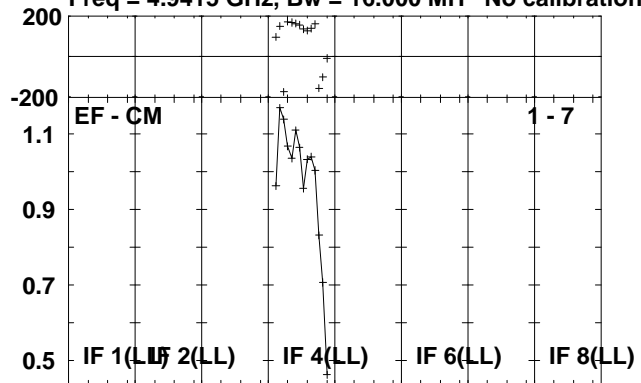

Lower frame: Milli Ampl Jy Top frame: Phas deg
Scalar averaged cross-power spectrum Several baselines displayed
Timerange: 01/00:23:11 to 01/00:28:09

Plot file version 199 created 14-JUL-2010 16:37:22

J1953+35 RR004A.UVDATA.1

Freq = 4.9415 GHz, Bw = 16.000 MH No calibration applied and no bandpass applied

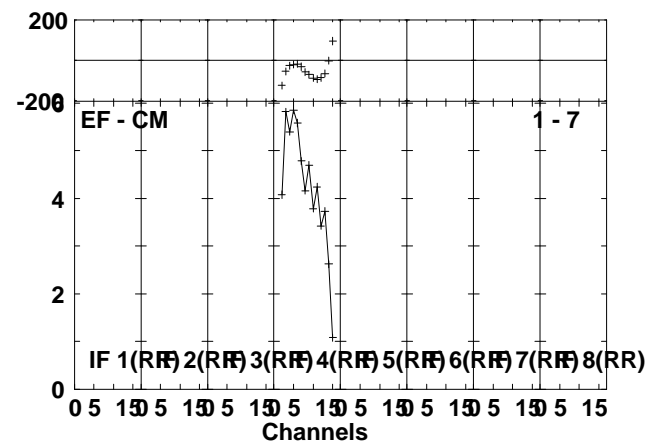
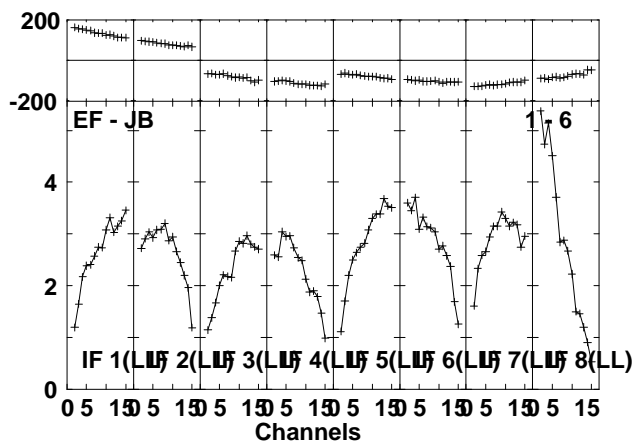
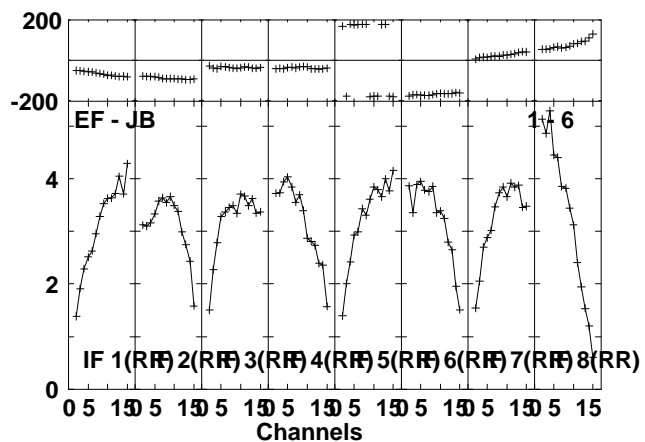
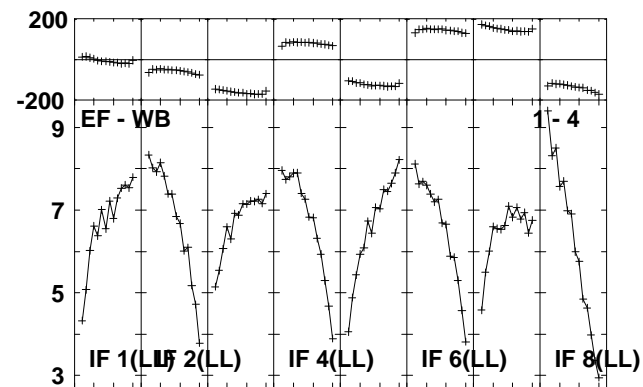
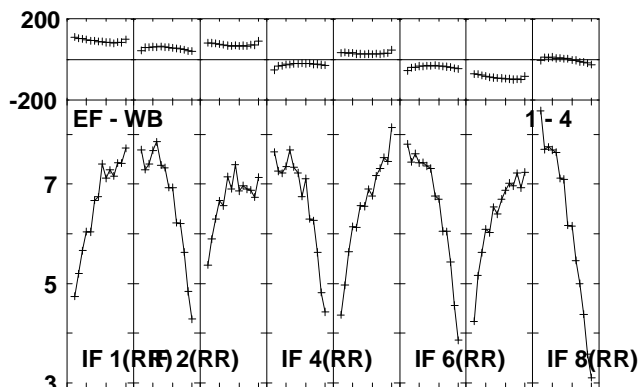
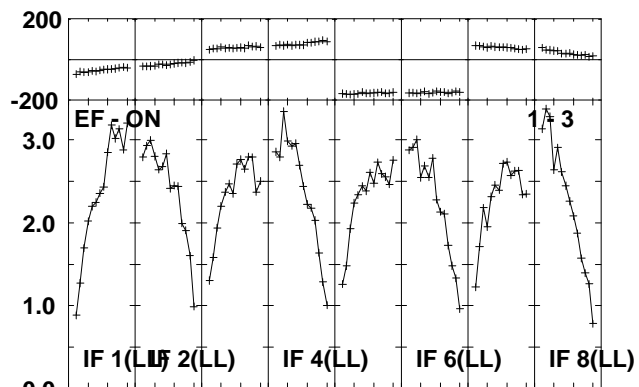
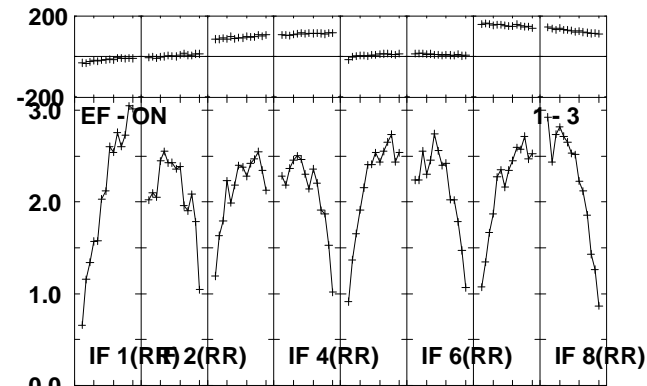
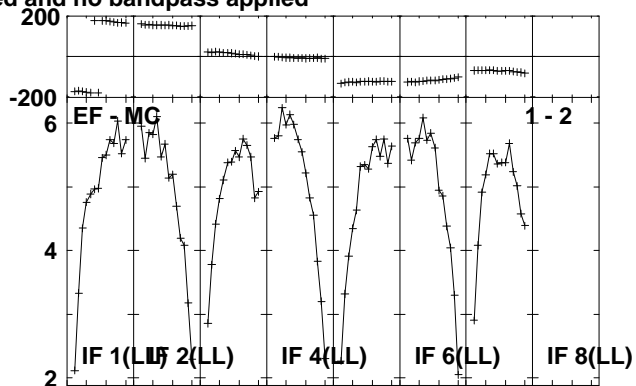
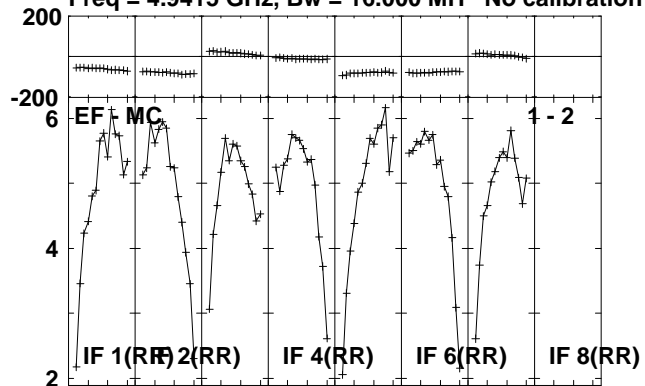

Lower frame: Milli Ampl Jy Top frame: Phas deg
Scalar averaged cross-power spectrum Several baselines displayed
Timerange: 01/00:29:11 to 01/00:30:39

Plot file version 200 created 14-JUL-2010 16:37:23
J1953+35 RR004A.UVDATA.1
Freq = 4.9415 GHz, Bw = 16.000 MH No calibration applied and no bandpass applied

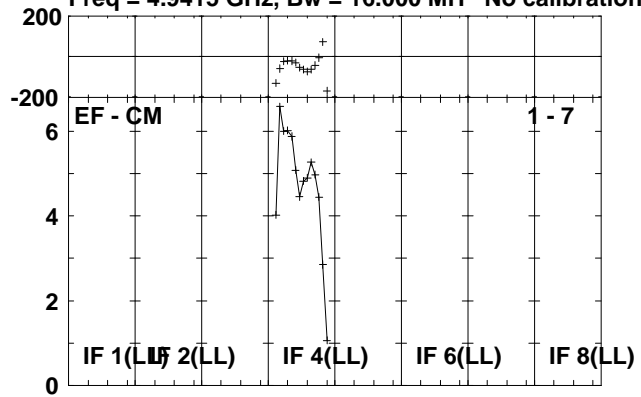

Lower frame: Milli Ampl Jy Top frame: Phas deg
Scalar averaged cross-power spectrum Several baselines displayed
Timerange: 01/00:29:11 to 01/00:30:39

Plot file version 201 created 14-JUL-2010 16:37:23

J2002+47 RR004A.UVDATA.1

Freq = 4.9415 GHz, Bw = 16.000 MH No calibration applied and no bandpass applied

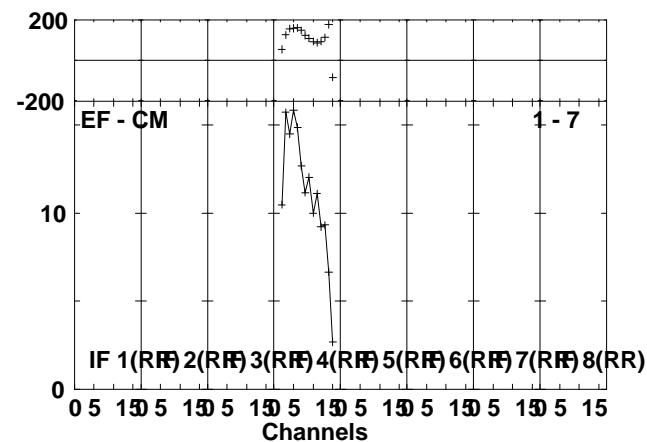
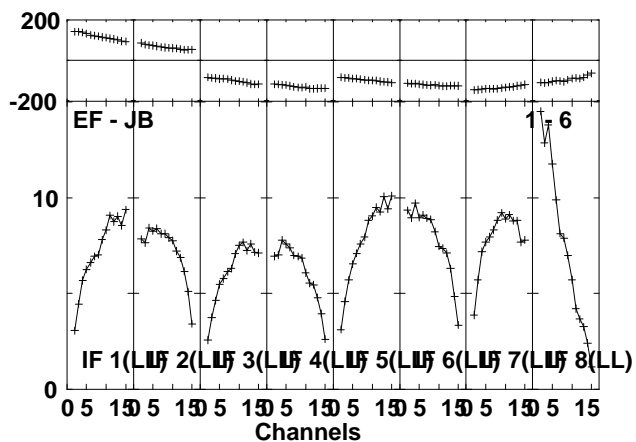
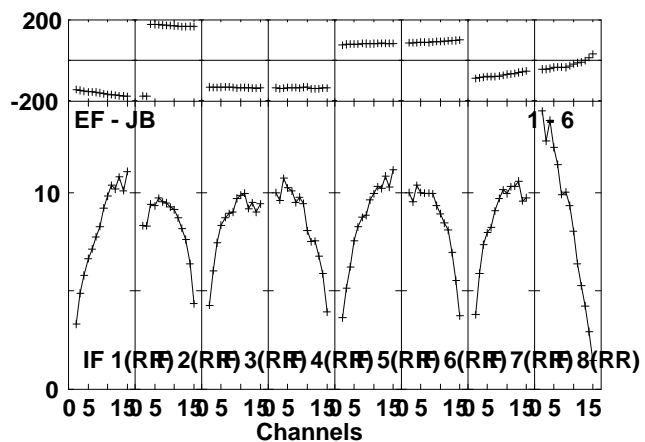
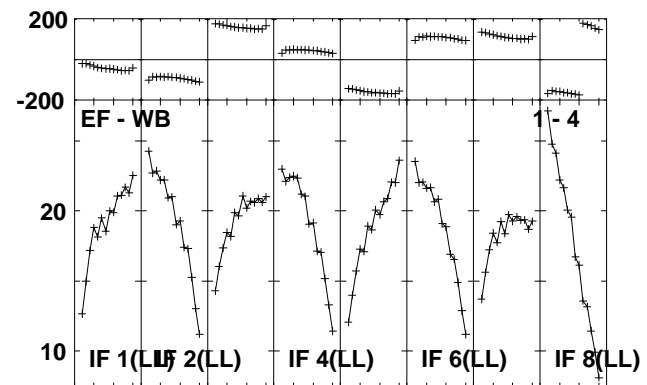
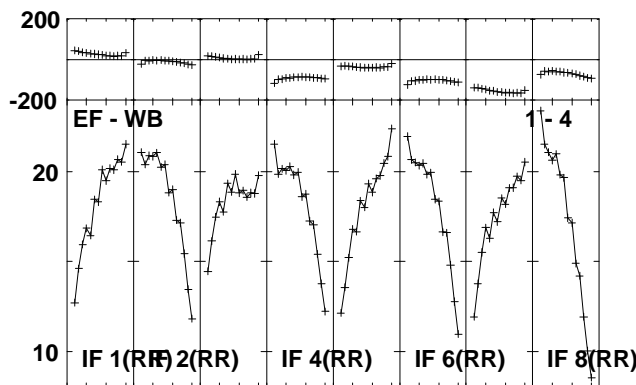
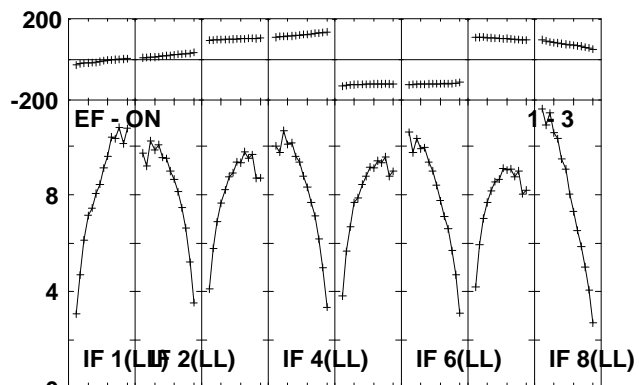
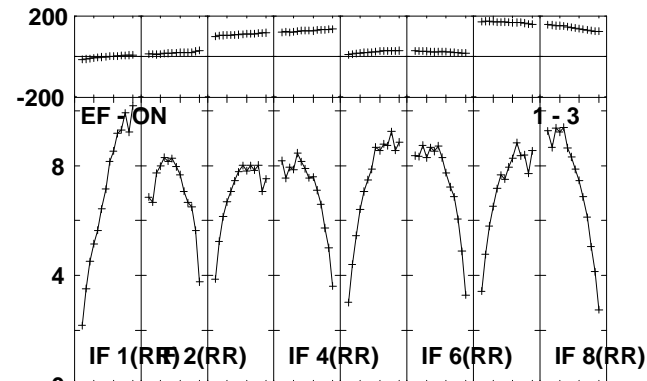
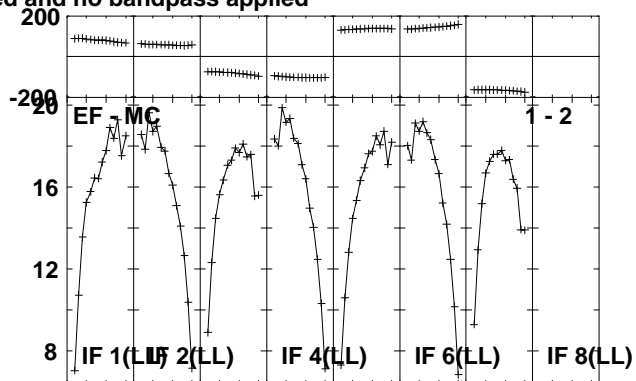
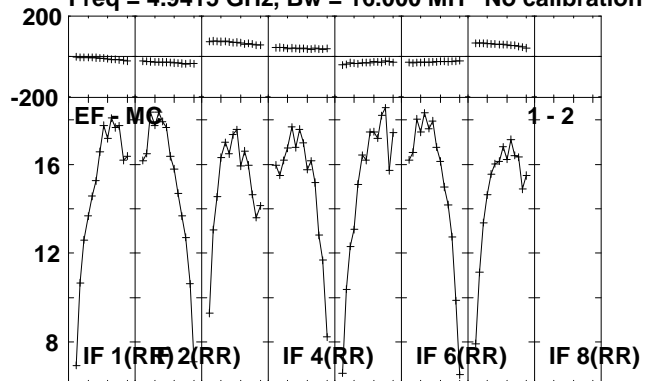

Lower frame: Milli Ampl Jy Top frame: Phas deg
Scalar averaged cross-power spectrum Several baselines displayed
Timerange: 01/00:32:41 to 01/00:37:39

Plot file version 202 created 14-JUL-2010 16:37:24
J2002+47 RR004A.UVDATA.1
Freq = 4.9415 GHz, Bw = 16.000 MH No calibration applied and no bandpass applied

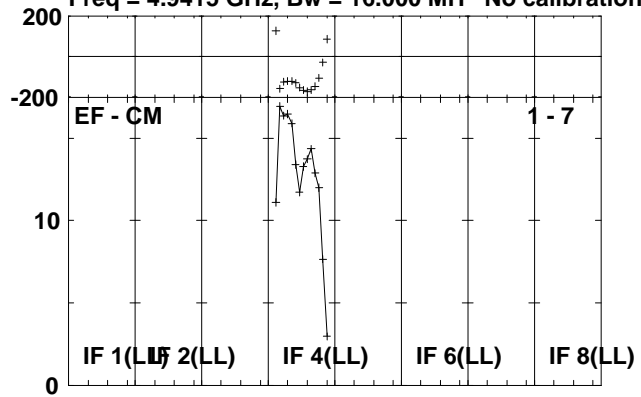

Lower frame: Milli Ampl Jy Top frame: Phas deg
Scalar averaged cross-power spectrum Several baselines displayed
Timerange: 01/00:32:41 to 01/00:37:39

Plot file version 203 created 14-JUL-2010 16:37:25

J1953+35 RR004A.UVDATA.1

Freq = 4.9415 GHz, Bw = 16.000 MH No calibration applied and no bandpass applied

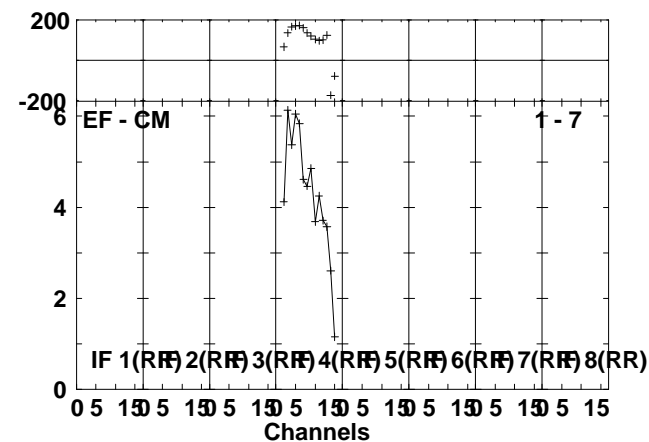
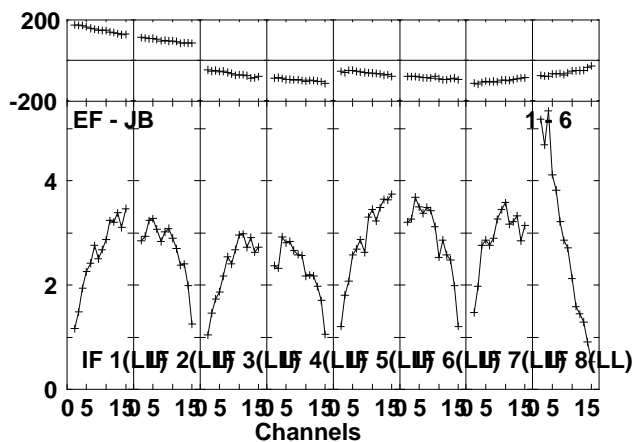
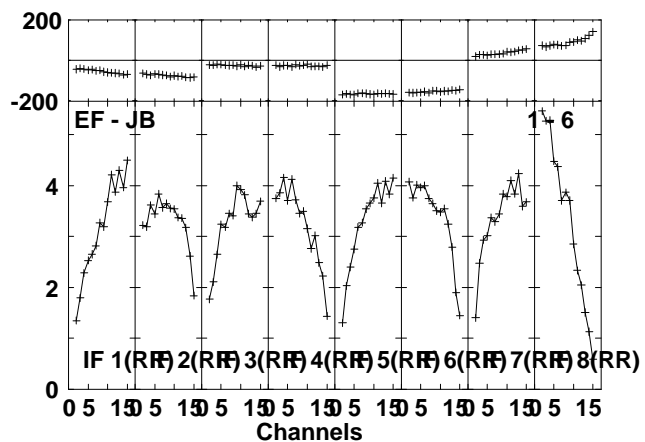
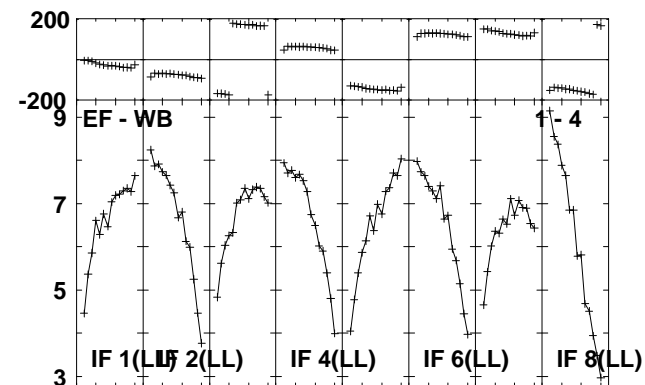
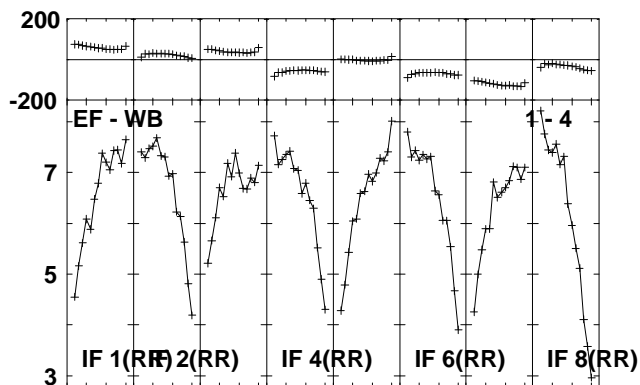
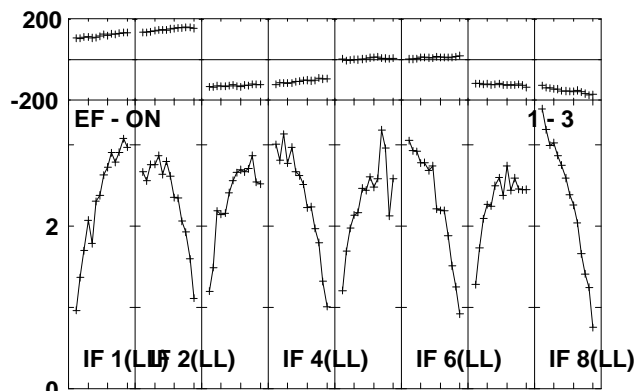
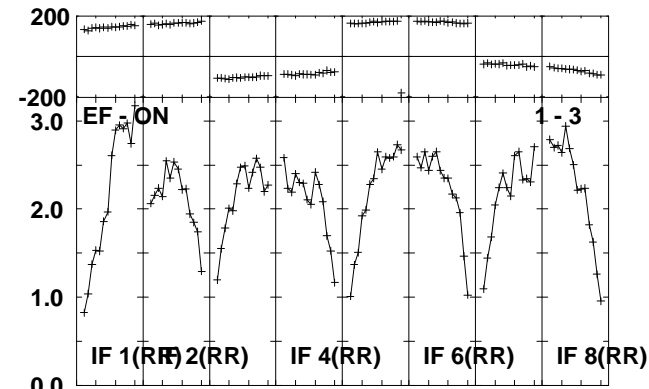
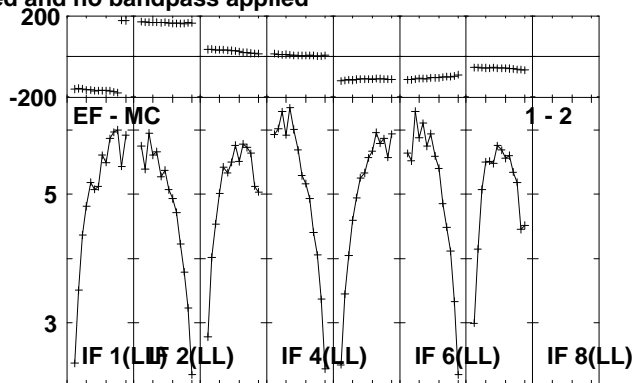
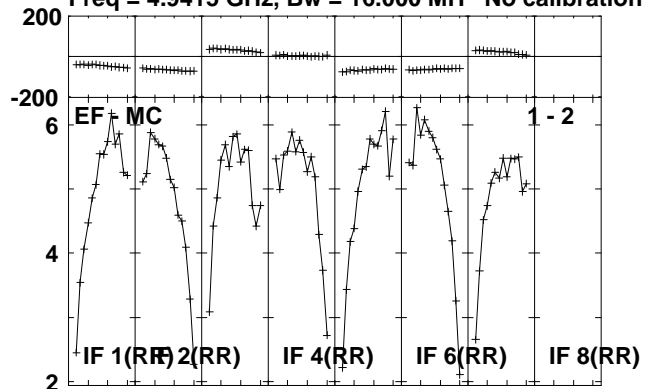

Lower frame: Milli Ampl Jy Top frame: Phas deg
Scalar averaged cross-power spectrum Several baselines displayed
Timerange: 01/00:39:41 to 01/00:41:09

Plot file version 204 created 14-JUL-2010 16:37:25
J1953+35 RR004A.UVDATA.1
Freq = 4.9415 GHz, Bw = 16.000 MH No calibration applied and no bandpass applied

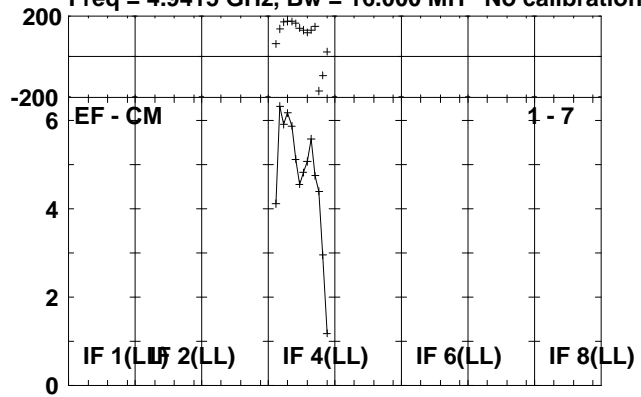

Lower frame: Milli Ampl Jy Top frame: Phas deg
Scalar averaged cross-power spectrum Several baselines displayed
Timerange: 01/00:39:41 to 01/00:41:09

Plot file version 205 created 14-JUL-2010 16:37:26

CYGX-1 RR004A.UVDATA.1

Freq = 4.9415 GHz, Bw = 16.000 MH No calibration applied and no bandpass applied

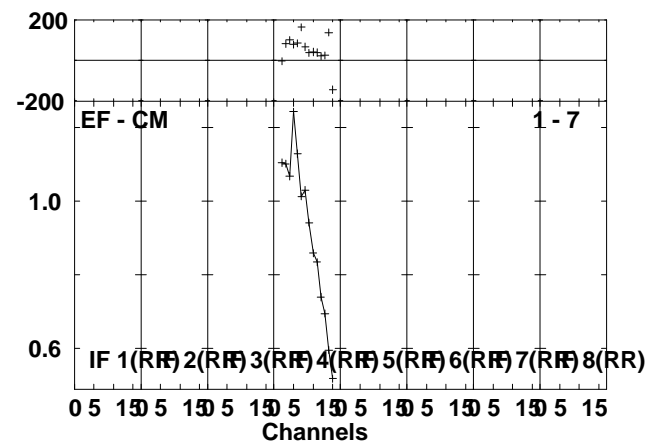
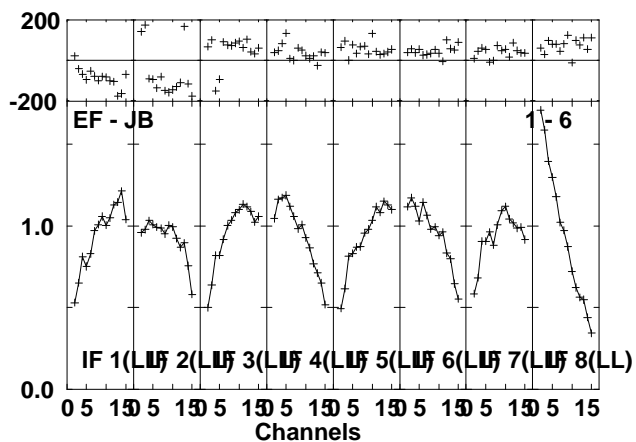
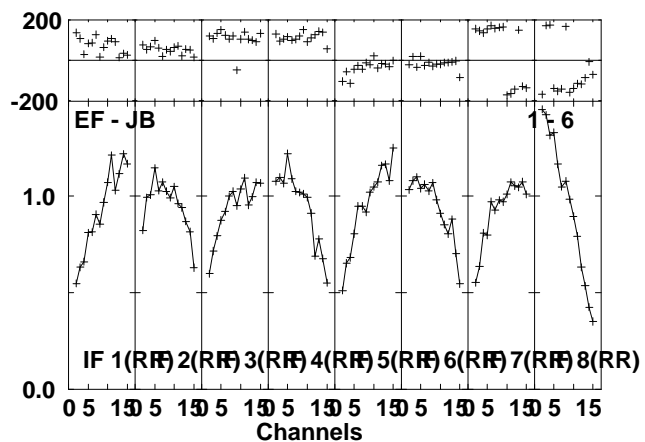
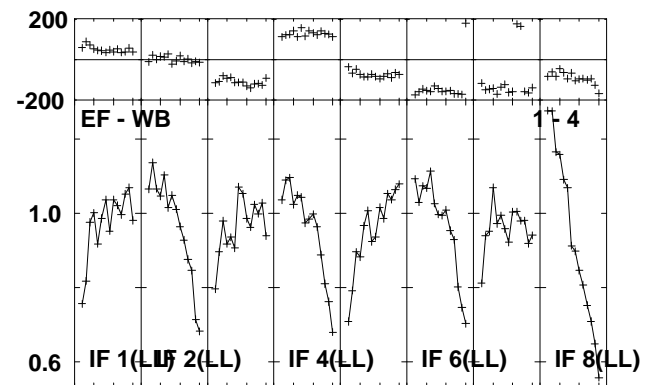
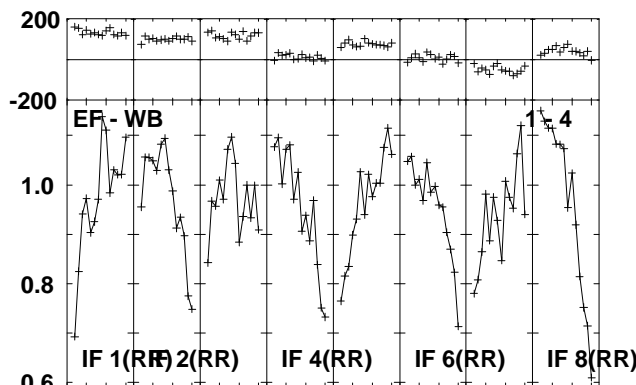
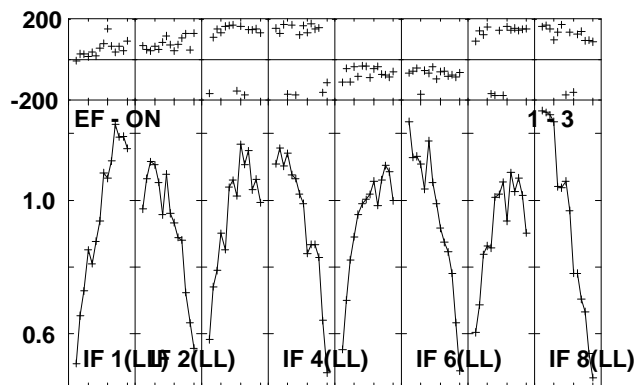
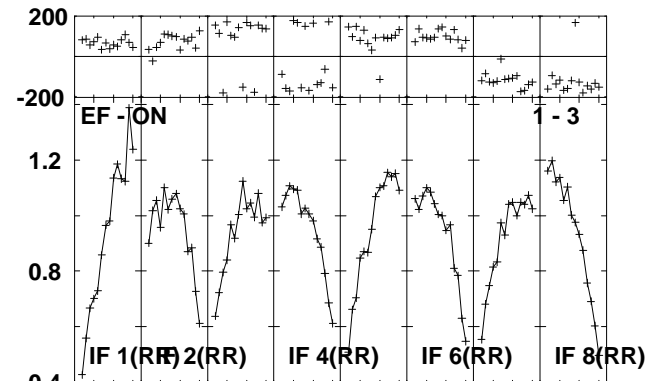
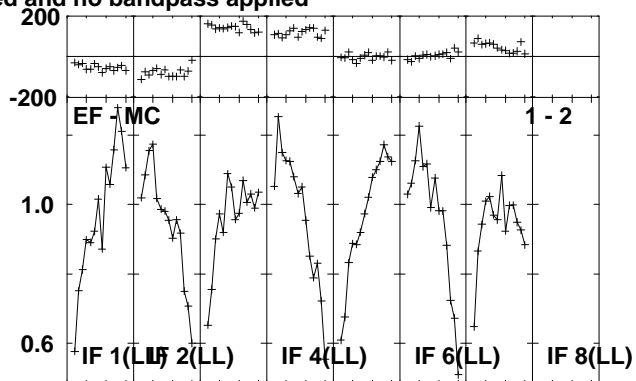
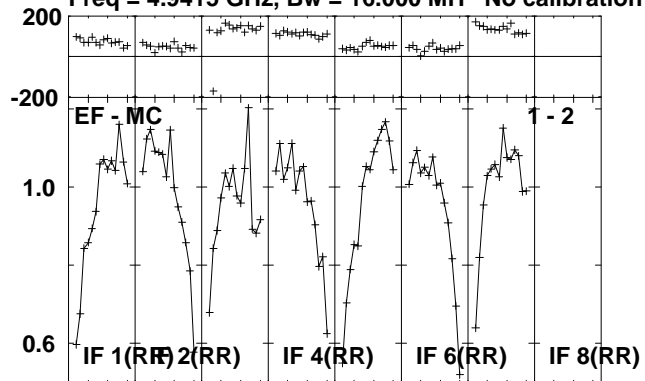

Lower frame: Milli Ampl Jy Top frame: Phas deg
Scalar averaged cross-power spectrum Several baselines displayed
Timerange: 01/00:41:11 to 01/00:46:09

Plot file version 206 created 14-JUL-2010 16:37:27
CYGX-1 RR004A.UVDATA.1
Freq = 4.9415 GHz, Bw = 16.000 MH No calibration applied and no bandpass applied

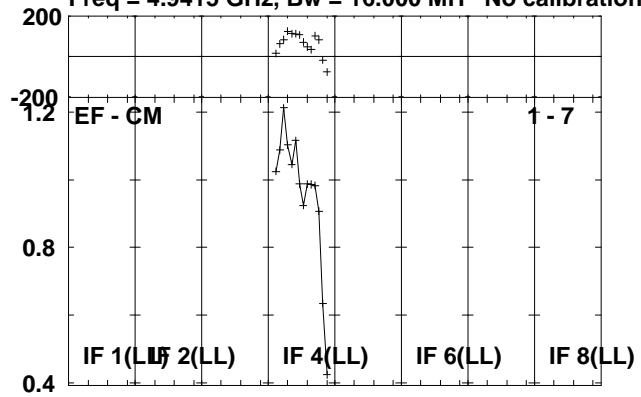

Lower frame: Milli Ampl Jy Top frame: Phas deg
Scalar averaged cross-power spectrum Several baselines displayed
Timerange: 01/00:41:11 to 01/00:46:09

Plot file version 207 created 14-JUL-2010 16:37:27

J1953+35 RR004A.UVDATA.1

Freq = 4.9415 GHz, Bw = 16.000 MH No calibration applied and no bandpass applied

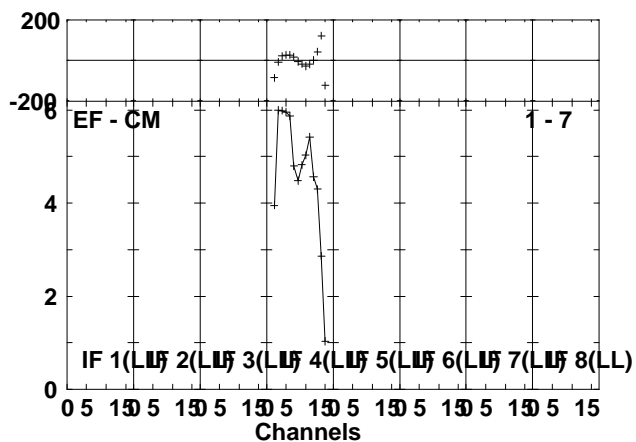
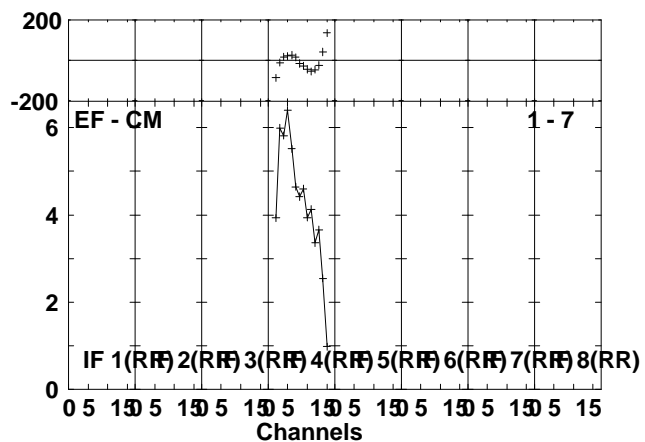
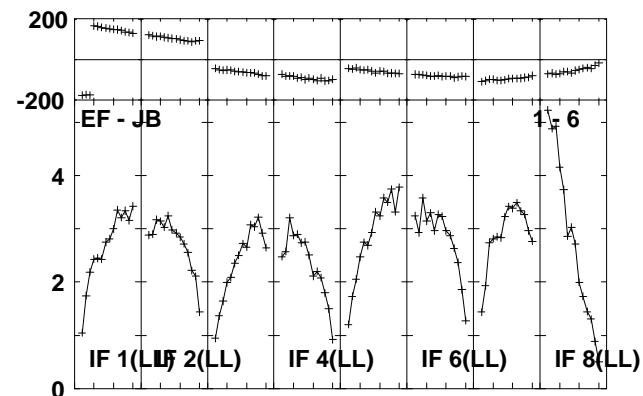
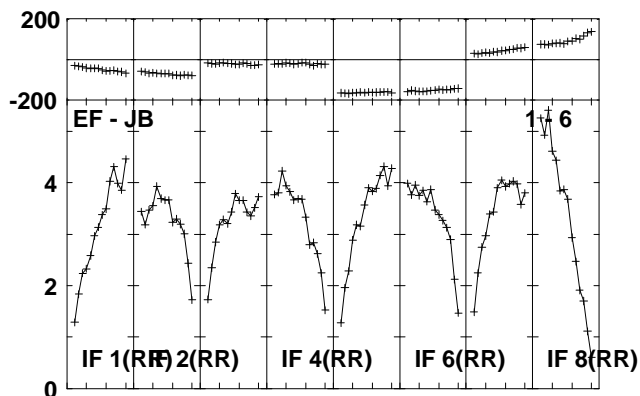
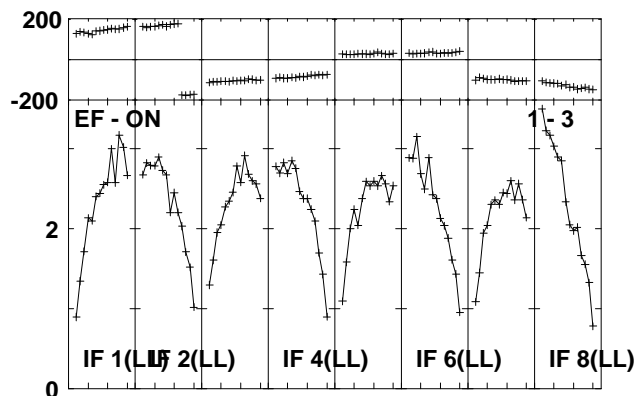
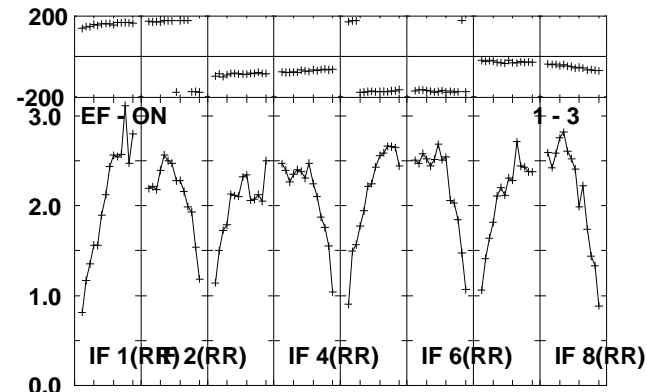
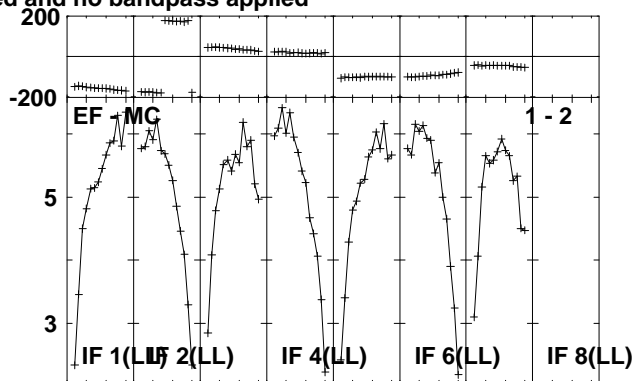
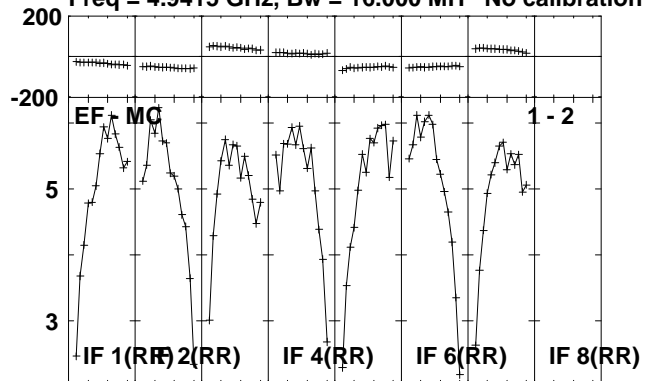

Lower frame: Milli Ampl Jy Top frame: Phas deg
Scalar averaged cross-power spectrum Several baselines displayed
Timerange: 01/00:46:11 to 01/00:48:09

Plot file version 208 created 14-JUL-2010 16:37:28

CYGX-1 RR004A.UVDATA.1

Freq = 4.9415 GHz, Bw = 16.000 MH No calibration applied and no bandpass applied

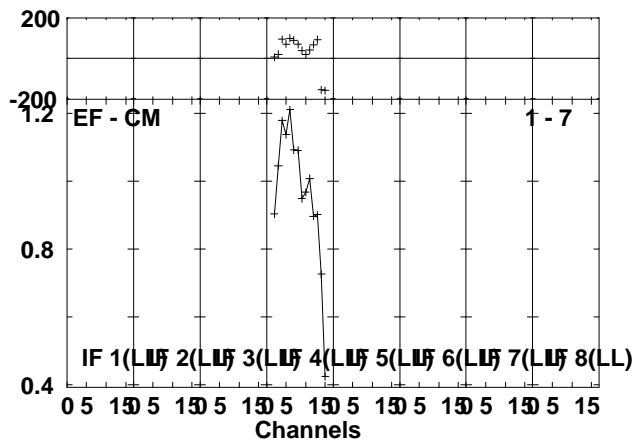
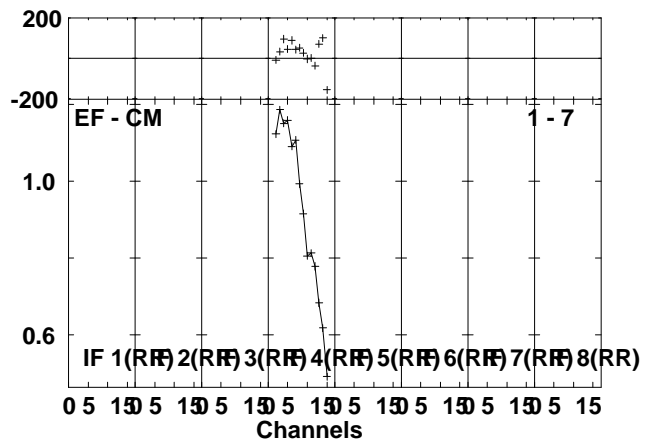
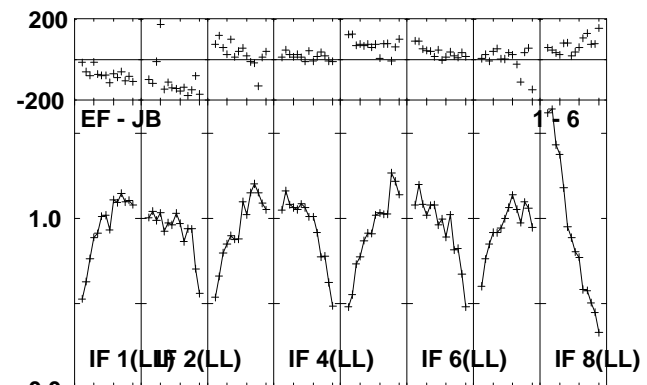
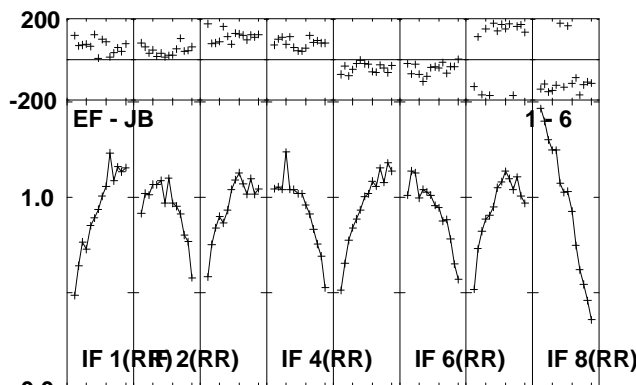
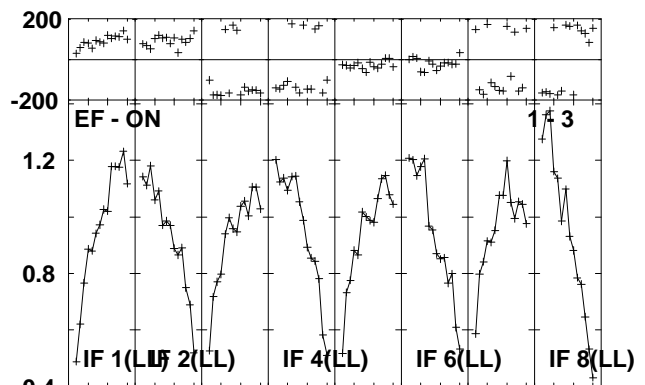
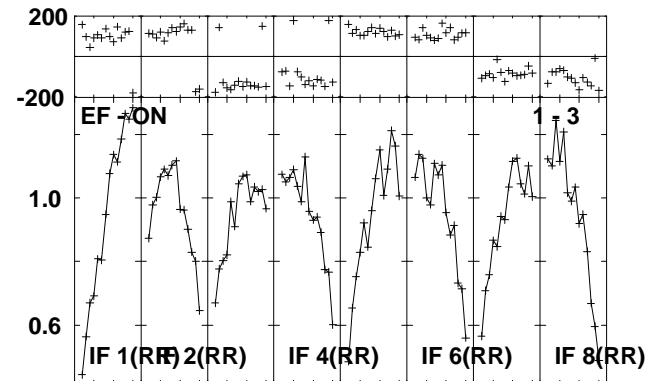
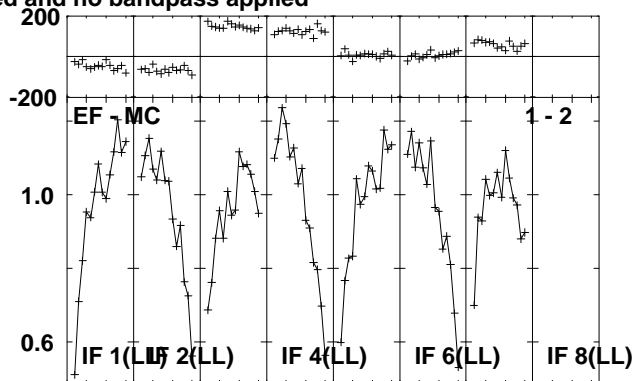
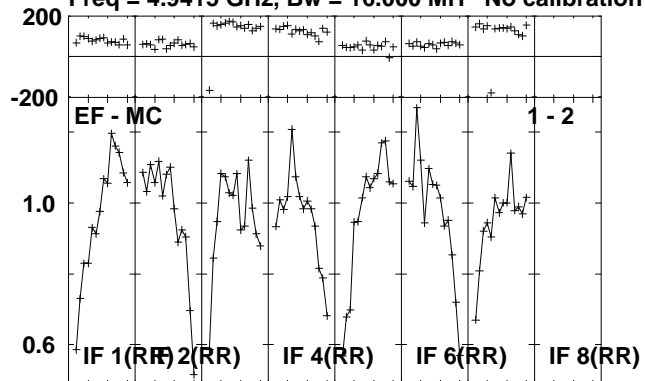

Lower frame: Milli Ampl Jy Top frame: Phas deg
Scalar averaged cross-power spectrum Several baselines displayed
Timerange: 01/00:48:11 to 01/00:53:09

Plot file version 209 created 14-JUL-2010 16:37:29

J1953+35 RR004A.UVDATA.1

Freq = 4.9415 GHz, Bw = 16.000 MH No calibration applied and no bandpass applied

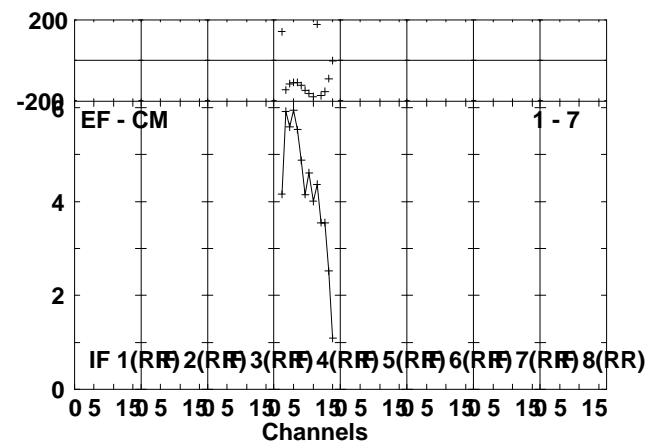
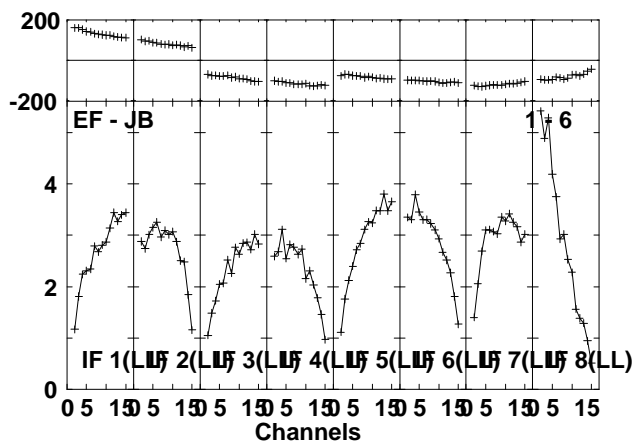
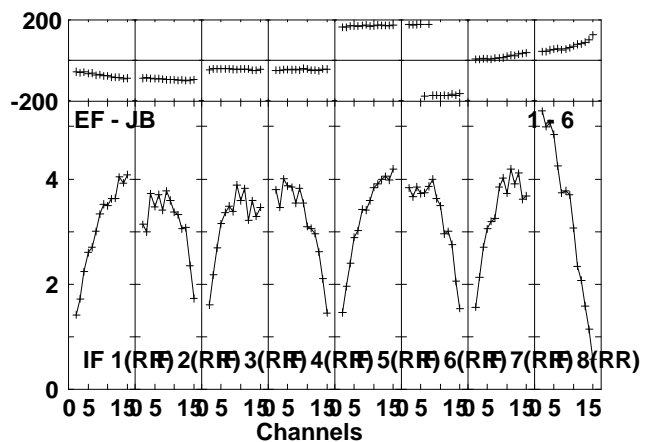
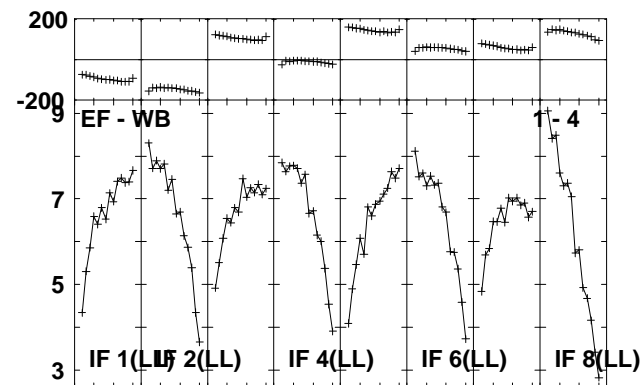
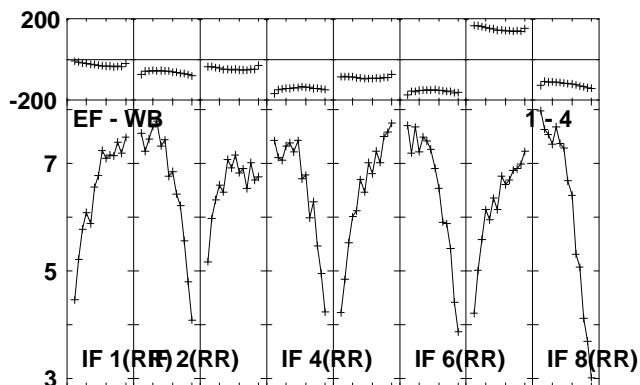
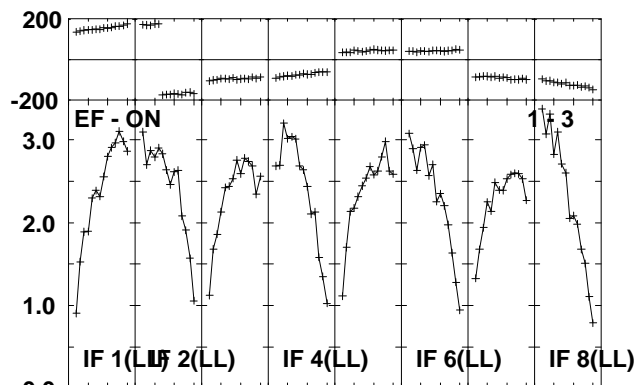
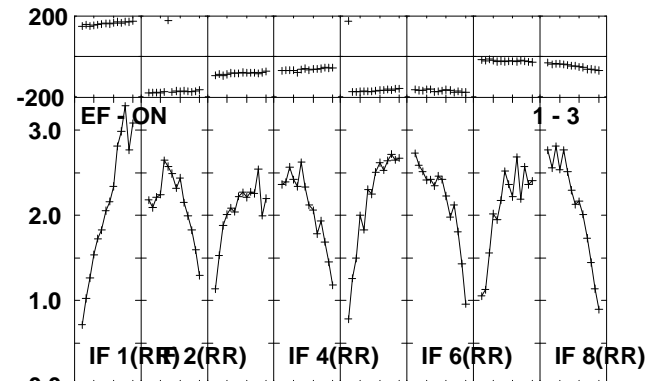
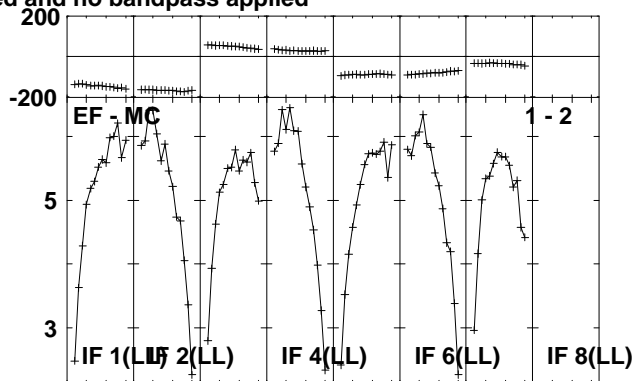
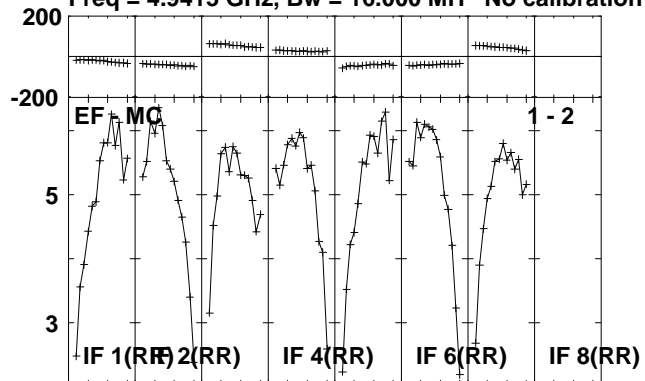

Lower frame: Milli Ampl Jy Top frame: Phas deg
Scalar averaged cross-power spectrum Several baselines displayed
Timerange: 01/00:54:01 to 01/00:55:29

Plot file version 210 created 14-JUL-2010 16:37:30
J1953+35 RR004A.UVDATA.1
Freq = 4.9415 GHz, Bw = 16.000 MH No calibration applied and no bandpass applied

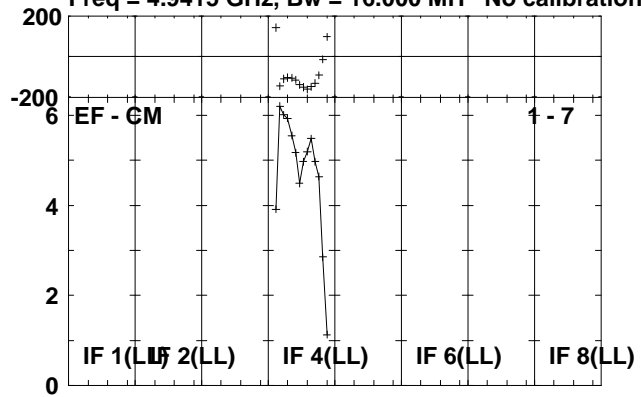

Lower frame: Milli Ampl Jy Top frame: Phas deg
Scalar averaged cross-power spectrum Several baselines displayed
Timerange: 01/00:54:01 to 01/00:55:29

Plot file version 211 created 14-JUL-2010 16:37:30

CYGX-1 RR004A.UVDATA.1

Freq = 4.9415 GHz, Bw = 16.000 MH No calibration applied and no bandpass applied

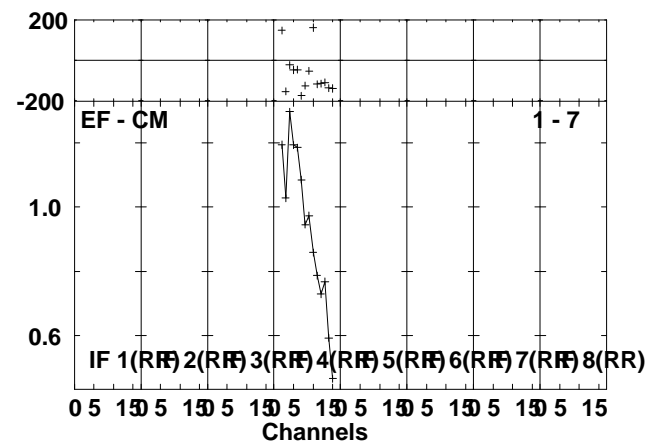
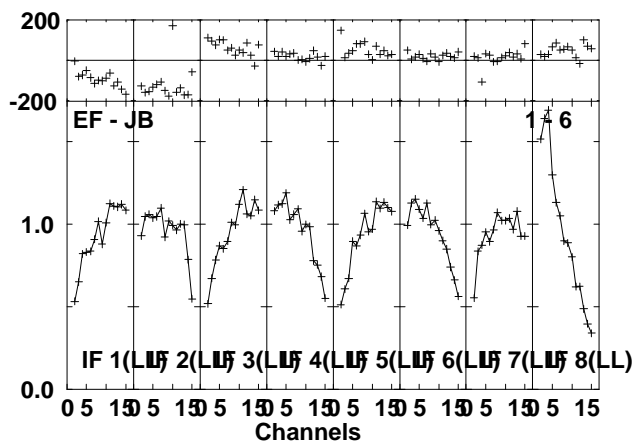
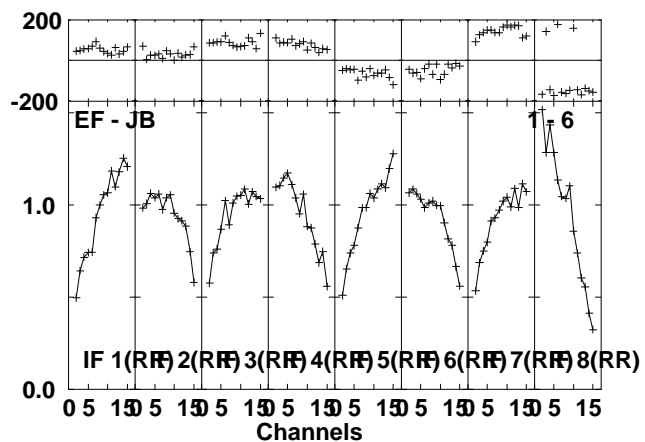
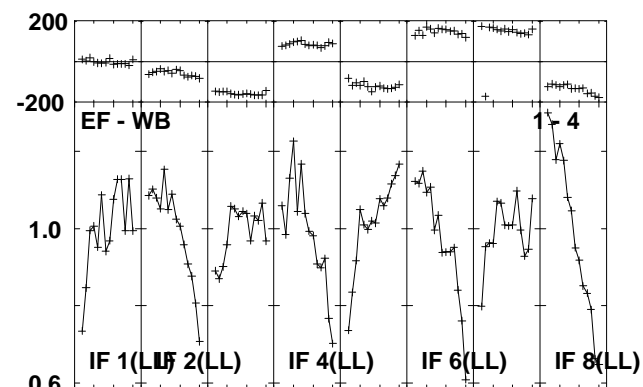
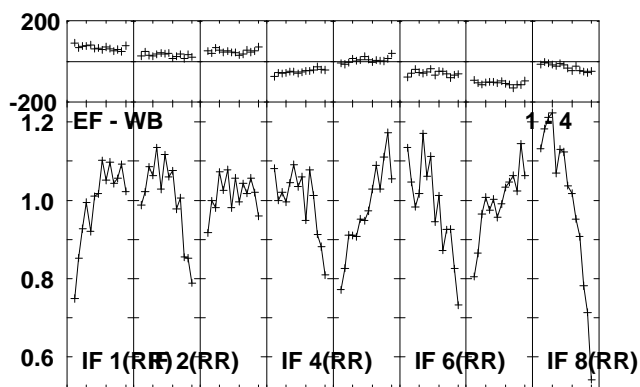
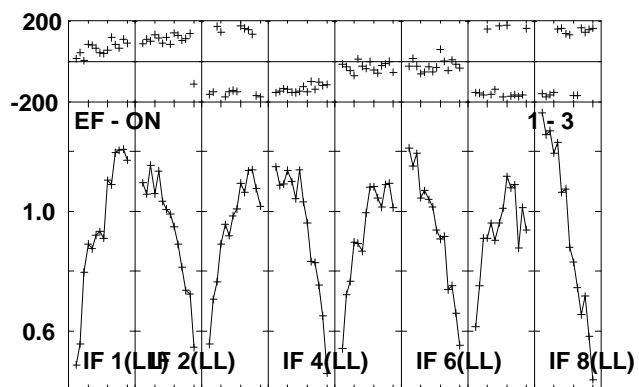
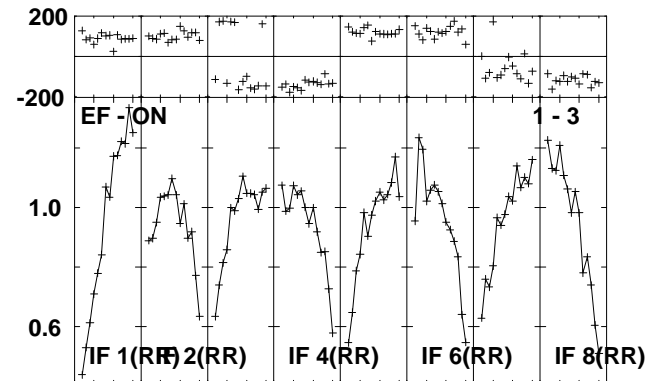
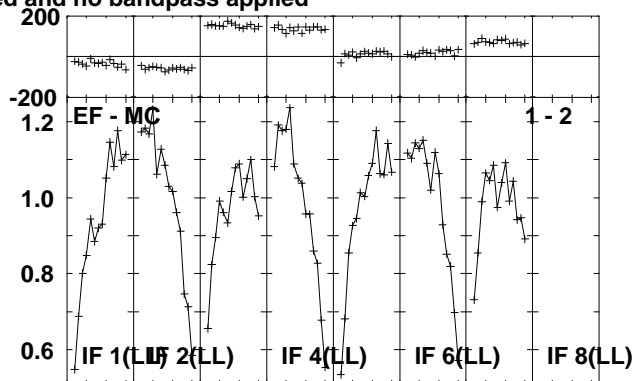
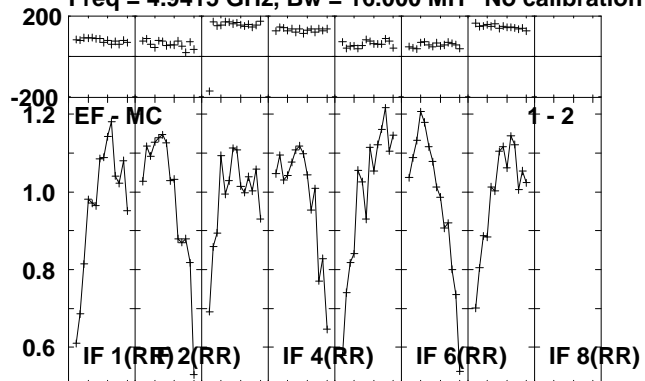

Lower frame: Milli Ampl Jy Top frame: Phas deg
Scalar averaged cross-power spectrum Several baselines displayed
Timerange: 01/00:55:31 to 01/01:00:29

Plot file version 212 created 14-JUL-2010 16:37:31
CYGX-1 RR004A.UVDATA.1
Freq = 4.9415 GHz, Bw = 16.000 MH No calibration applied and no bandpass applied

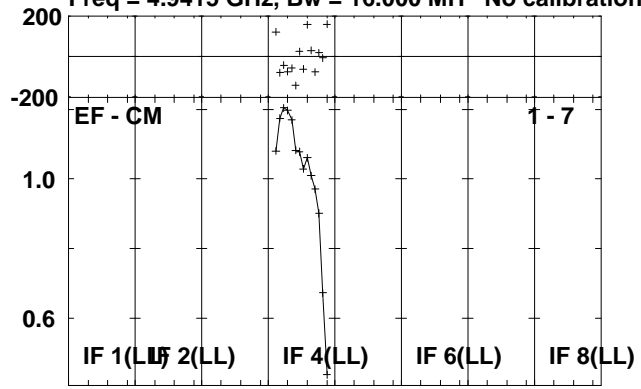

Lower frame: Milli Ampl Jy Top frame: Phas deg
Scalar averaged cross-power spectrum Several baselines displayed
Timerange: 01/00:55:31 to 01/01:00:29

Plot file version 213 created 14-JUL-2010 16:37:32

J1953+35 RR004A.UVDATA.1

Freq = 4.9415 GHz, Bw = 16.000 MH No calibration applied and no bandpass applied

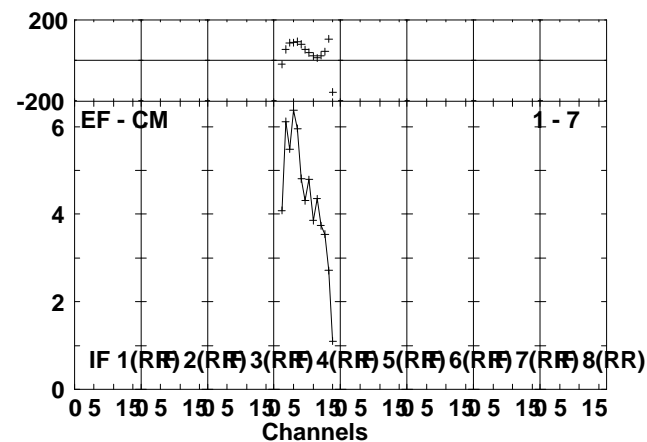
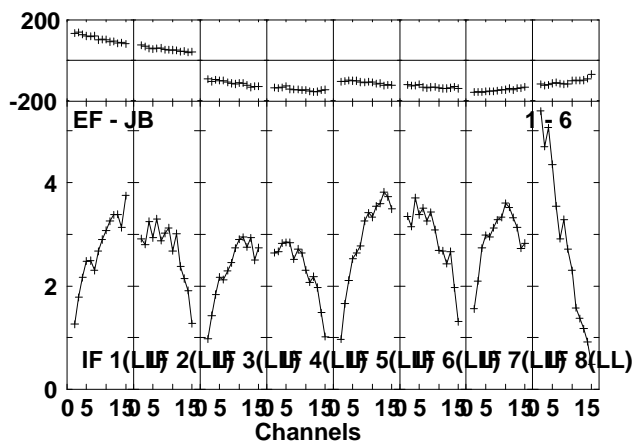
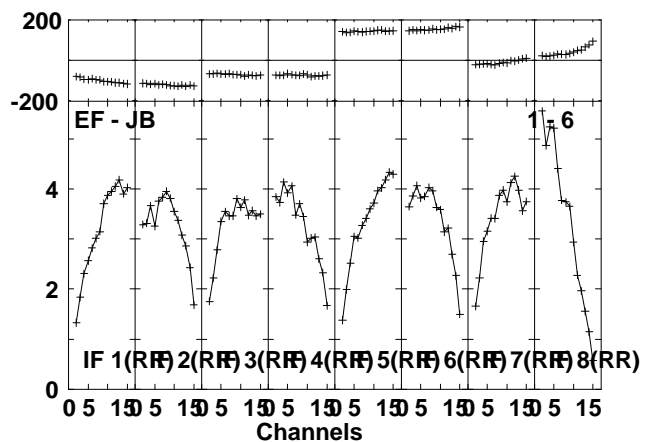
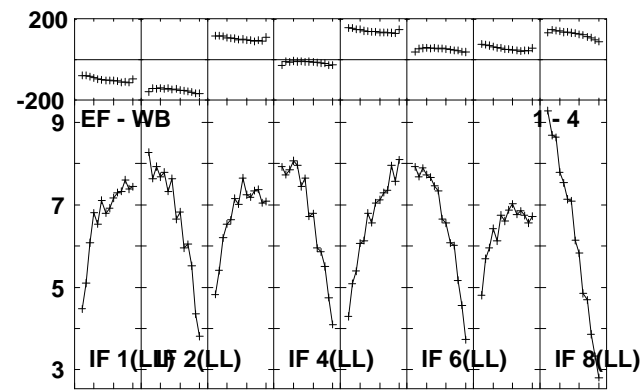
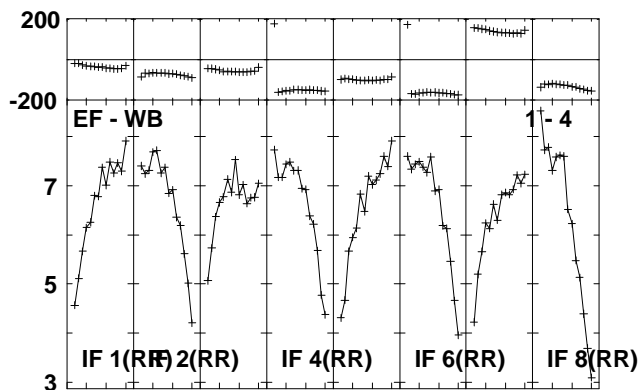
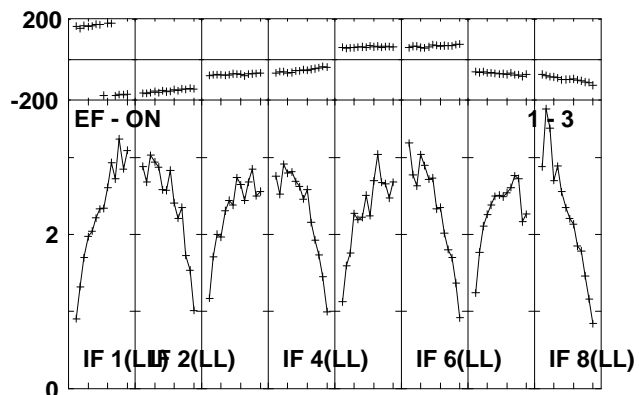
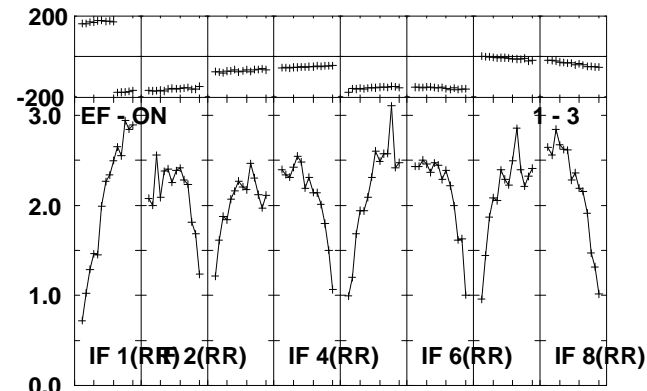
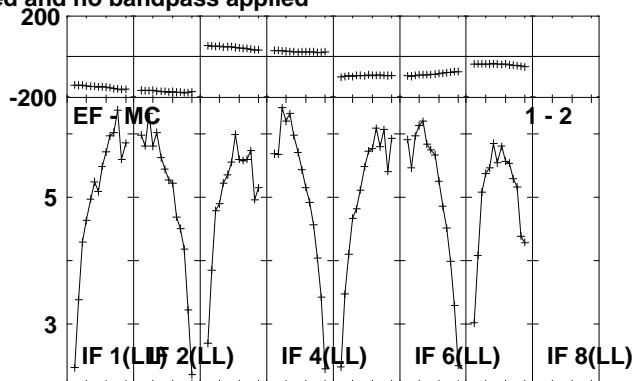
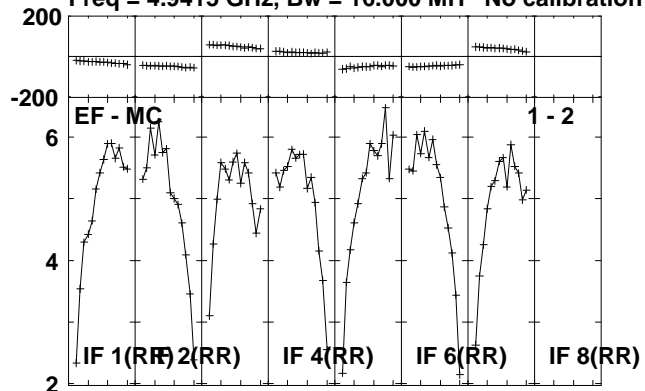

Lower frame: Milli Ampl Jy Top frame: Phas deg
Scalar averaged cross-power spectrum Several baselines displayed
Timerange: 01/01:00:31 to 01/01:02:29

Plot file version 214 created 14-JUL-2010 16:37:32
J1953+35 RR004A.UVDATA.1
Freq = 4.9415 GHz, Bw = 16.000 MH No calibration applied and no bandpass applied

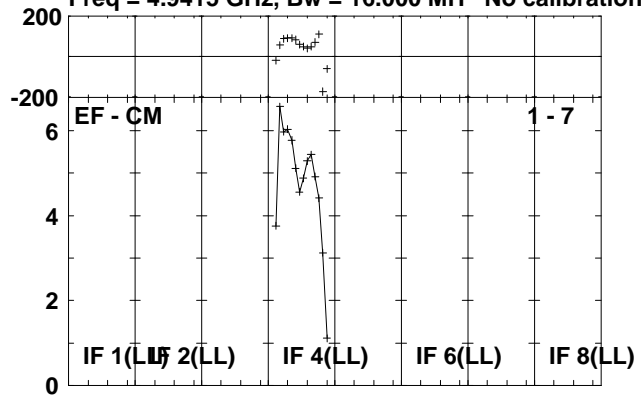

Lower frame: Milli Ampl Jy Top frame: Phas deg
Scalar averaged cross-power spectrum Several baselines displayed
Timerange: 01/01:00:31 to 01/01:02:29

Plot file version 215 created 14-JUL-2010 16:37:33

CYGX-1 RR004A.UVDATA.1

Freq = 4.9415 GHz, Bw = 16.000 MH No calibration applied and no bandpass applied

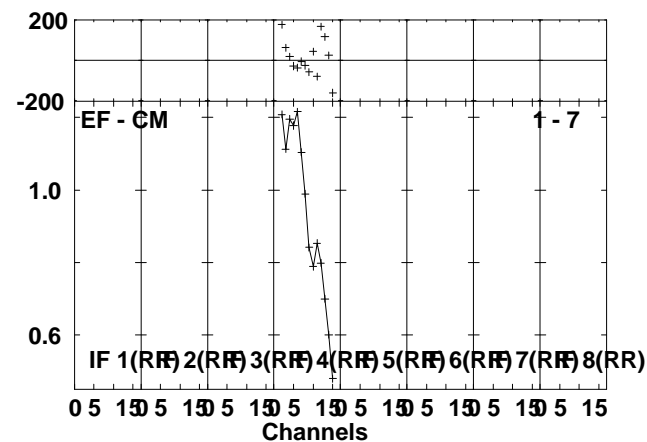
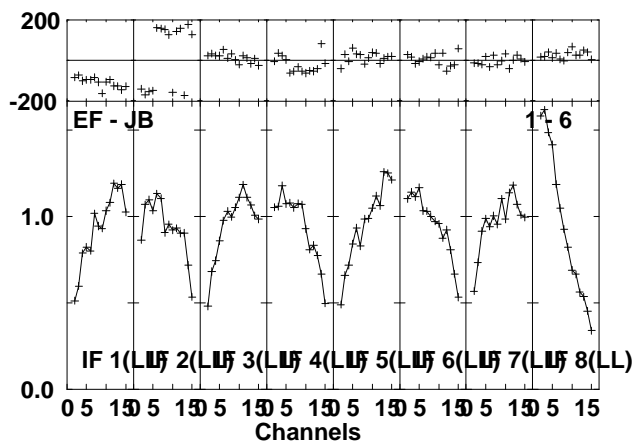
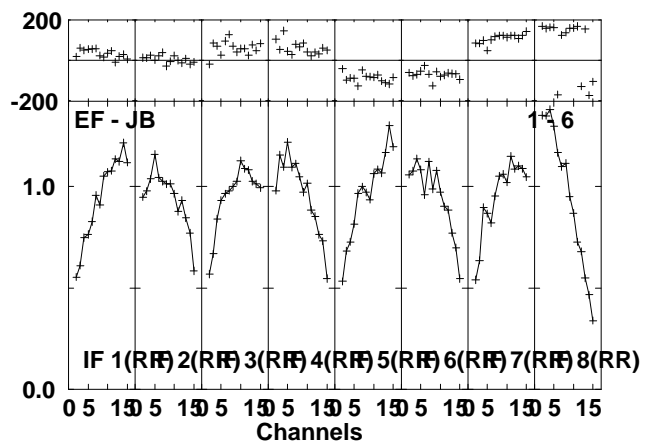
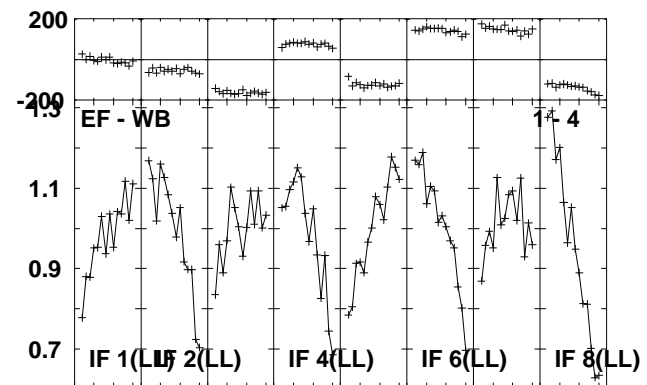
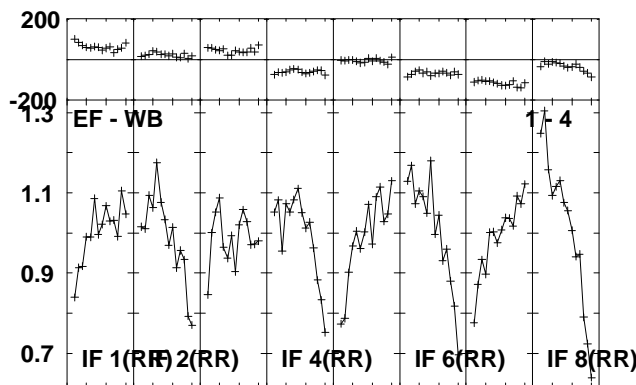
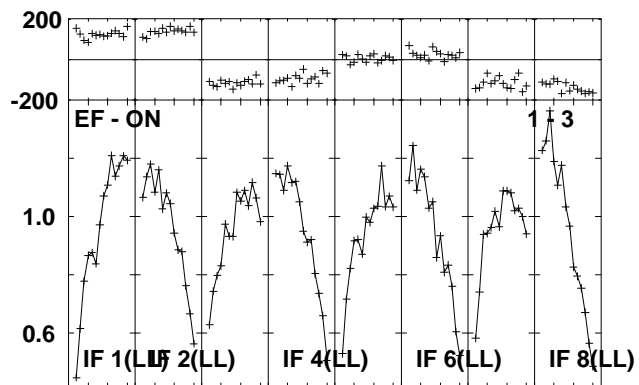
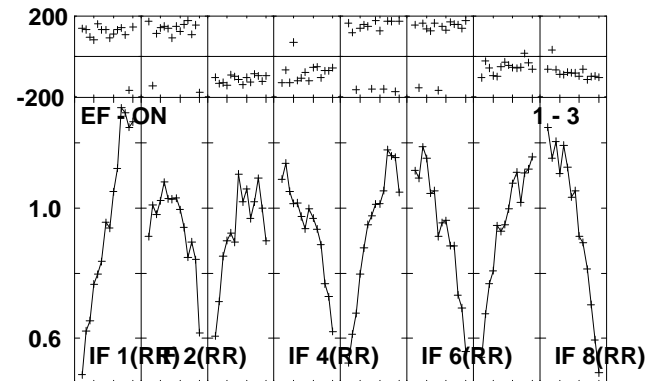
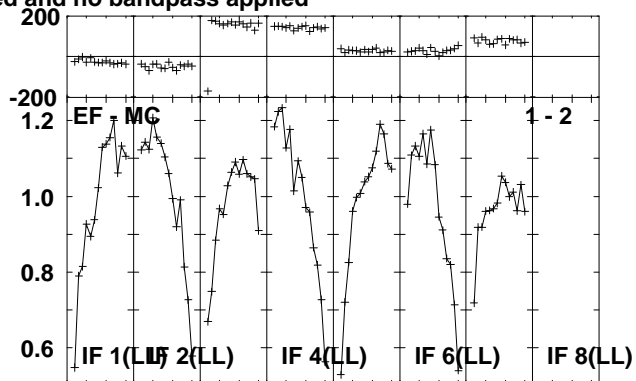
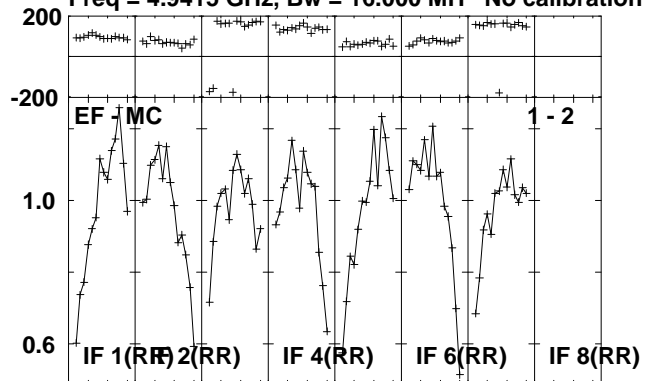

Lower frame: Milli Ampl Jy Top frame: Phas deg
Scalar averaged cross-power spectrum Several baselines displayed
Timerange: 01/01:02:31 to 01/01:07:29

Plot file version 216 created 14-JUL-2010 16:37:34
CYGX-1 RR004A.UVDATA.1
Freq = 4.9415 GHz, Bw = 16.000 MH No calibration applied and no bandpass applied

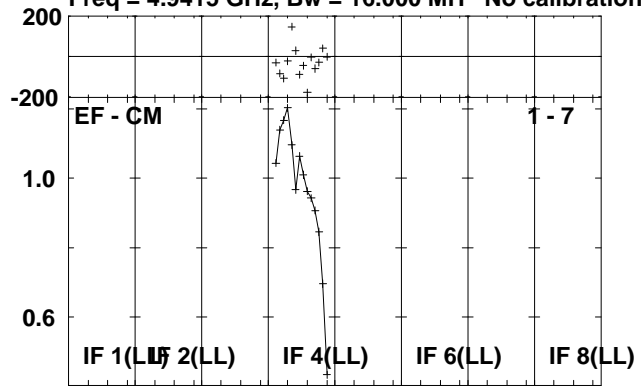

Lower frame: Milli Ampl Jy Top frame: Phas deg
Scalar averaged cross-power spectrum Several baselines displayed
Timerange: 01/01:02:31 to 01/01:07:29

Plot file version 217 created 14-JUL-2010 16:37:35

J1953+35 RR004A.UVDATA.1

Freq = 4.9415 GHz, Bw = 16.000 MH No calibration applied and no bandpass applied

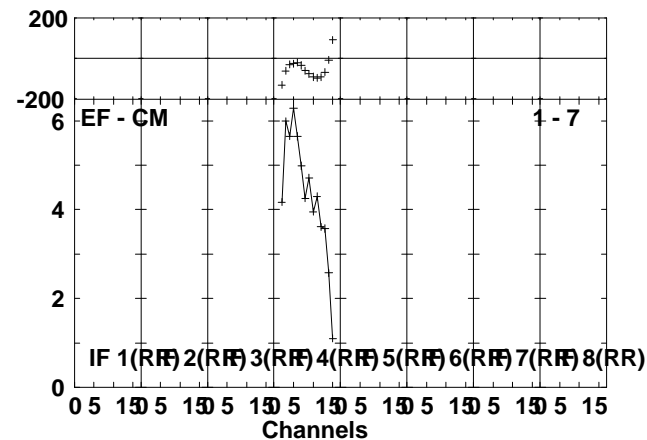
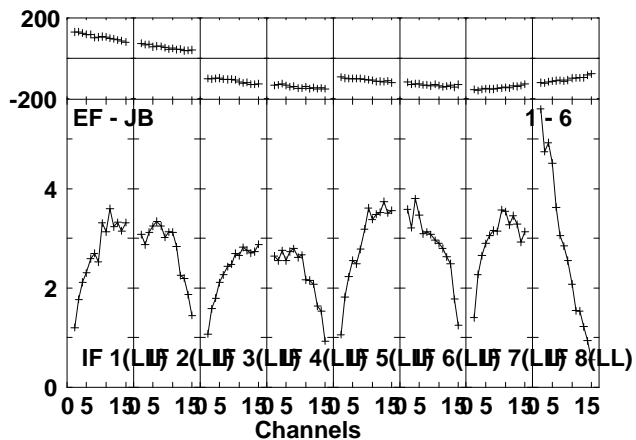
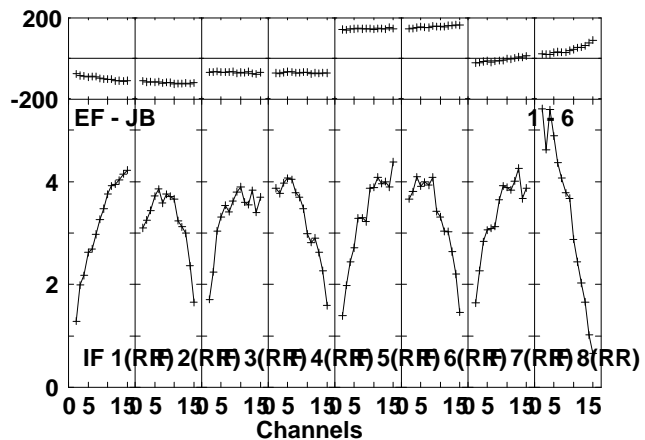
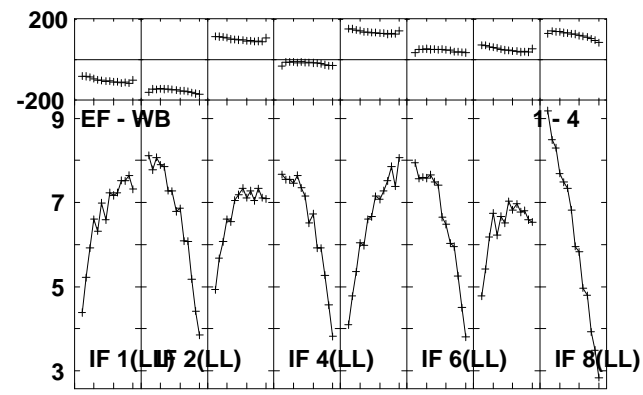
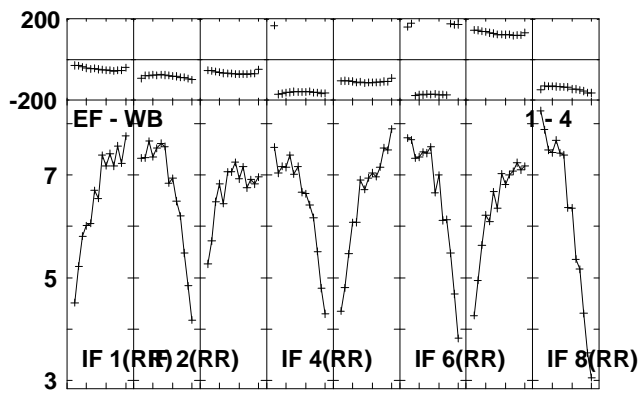
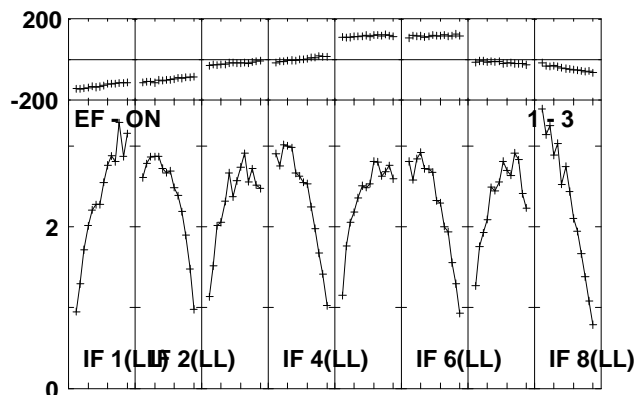
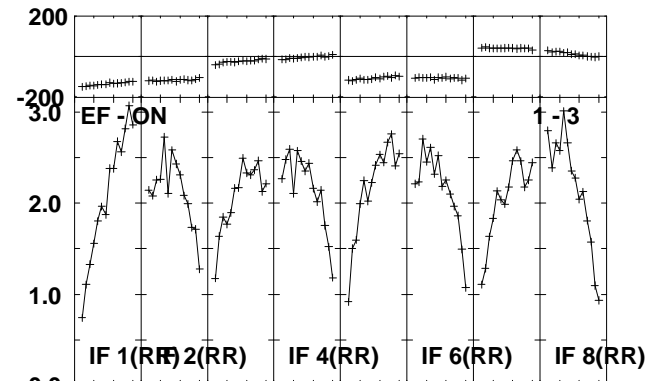
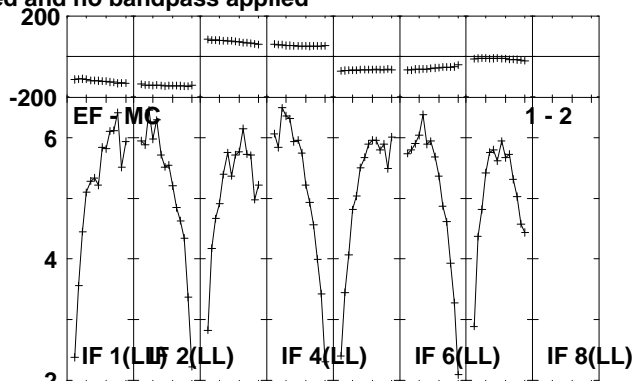
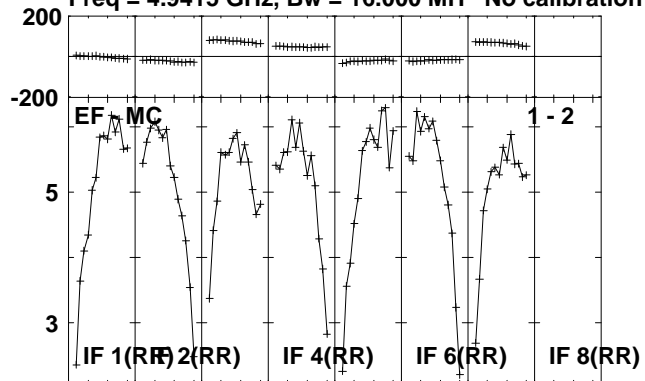

Lower frame: Milli Ampl Jy Top frame: Phas deg
Scalar averaged cross-power spectrum Several baselines displayed
Timerange: 01/01:08:21 to 01/01:09:49

Plot file version 218 created 14-JUL-2010 16:37:35
J1953+35 RR004A.UVDATA.1
Freq = 4.9415 GHz, Bw = 16.000 MH No calibration applied and no bandpass applied

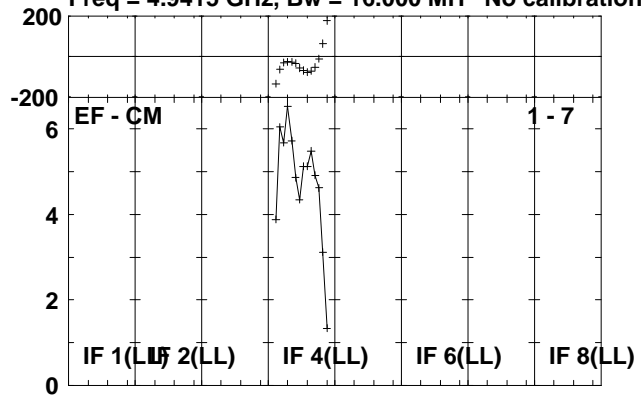

Lower frame: Milli Ampl Jy Top frame: Phas deg
Scalar averaged cross-power spectrum Several baselines displayed
Timerange: 01/01:08:21 to 01/01:09:49

Plot file version 219 created 14-JUL-2010 16:37:35

CYGX-1 RR004A.UVDATA.1

Freq = 4.9415 GHz, Bw = 16.000 MH No calibration applied and no bandpass applied

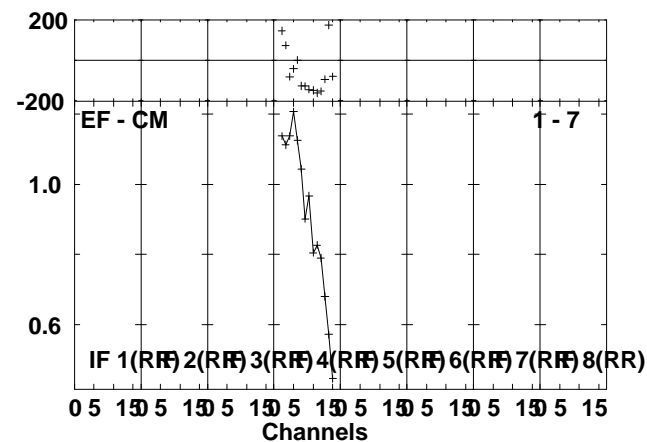
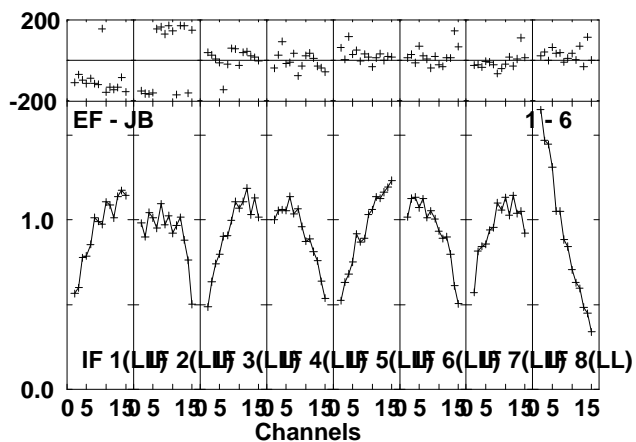
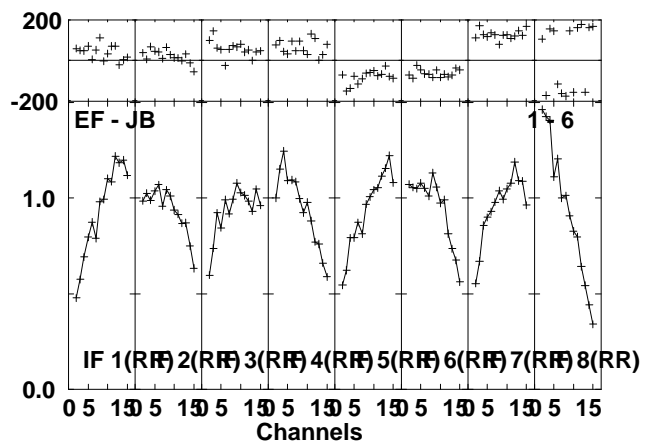
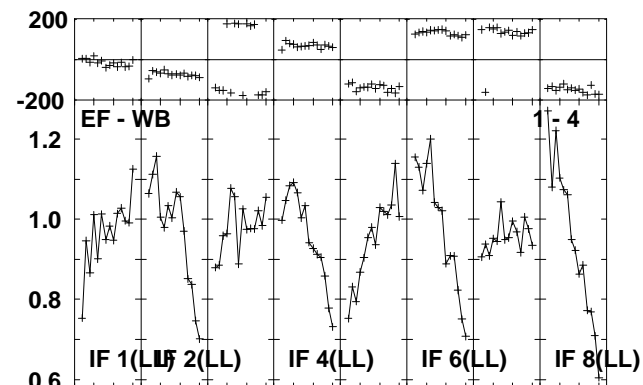
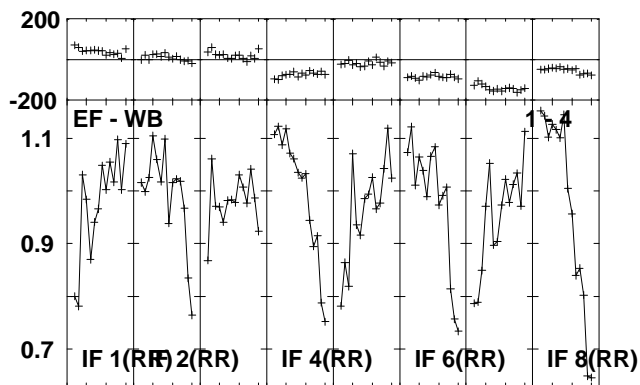
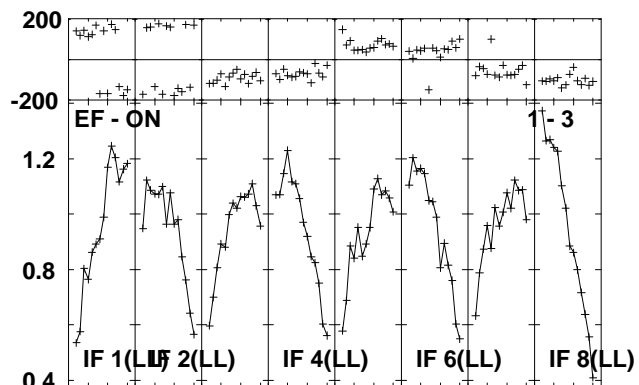
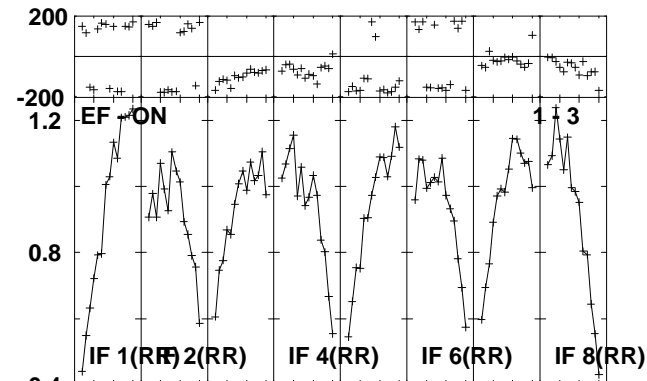
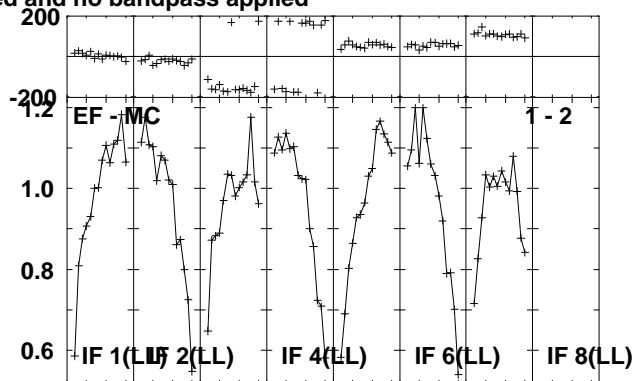
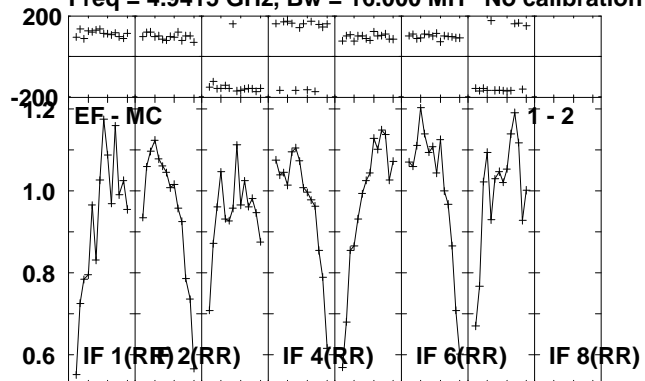

Lower frame: Milli Ampl Jy Top frame: Phas deg
Scalar averaged cross-power spectrum Several baselines displayed
Timerange: 01/01:09:51 to 01/01:14:49

Plot file version 220 created 14-JUL-2010 16:37:37
CYGX-1 RR004A.UVDATA.1
Freq = 4.9415 GHz, Bw = 16.000 MH No calibration applied and no bandpass applied

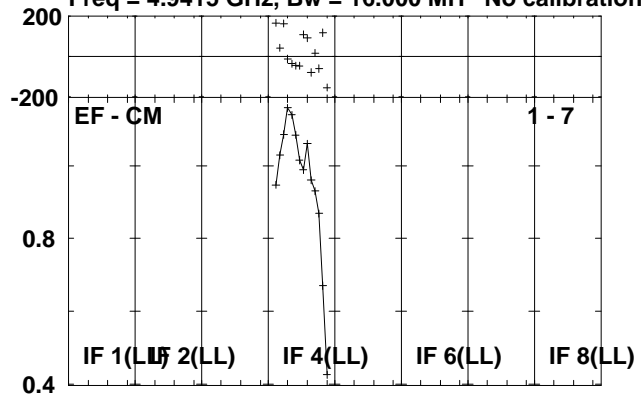

Lower frame: Milli Ampl Jy Top frame: Phas deg
Scalar averaged cross-power spectrum Several baselines displayed
Timerange: 01/01:09:51 to 01/01:14:49

Plot file version 221 created 14-JUL-2010 16:37:37

J1953+35 RR004A.UVDATA.1

Freq = 4.9415 GHz, Bw = 16.000 MH No calibration applied and no bandpass applied

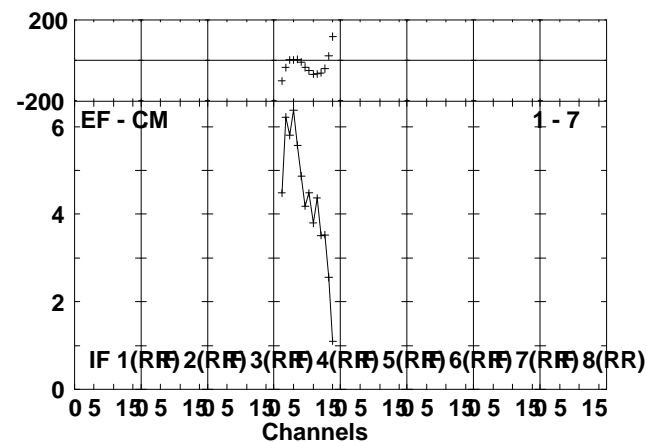
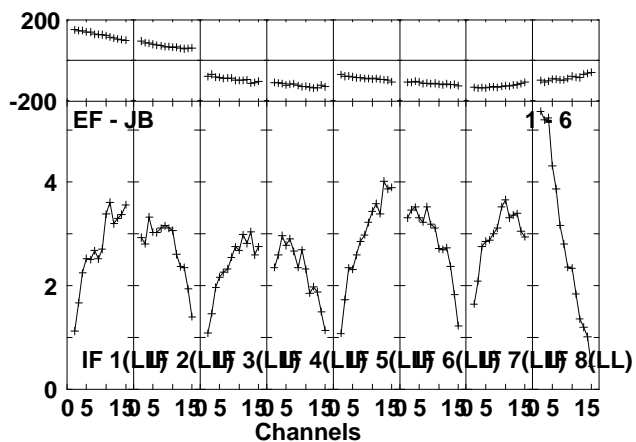
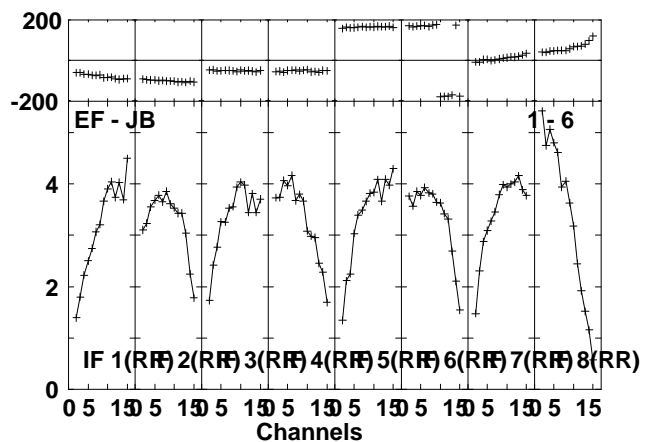
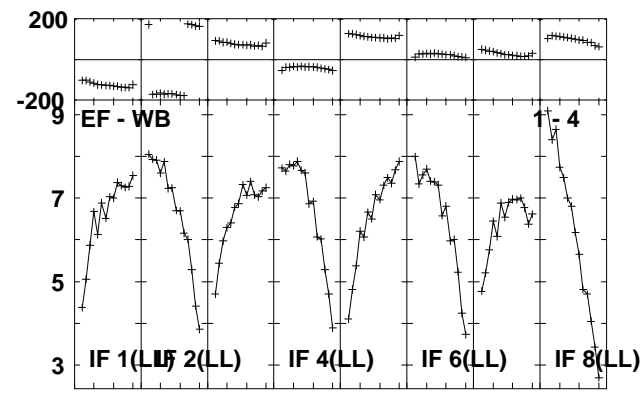
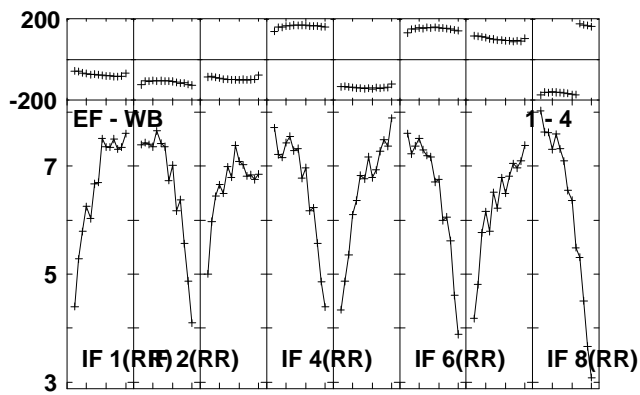
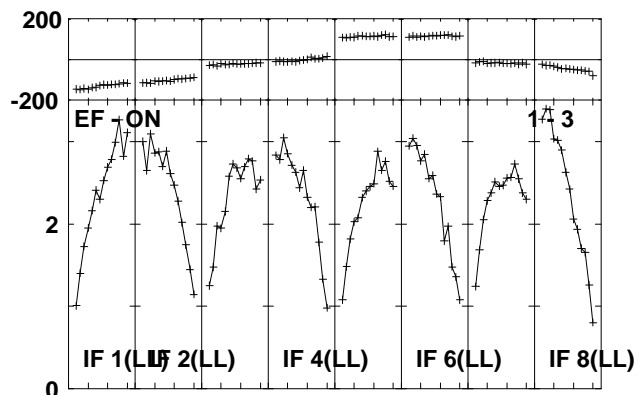
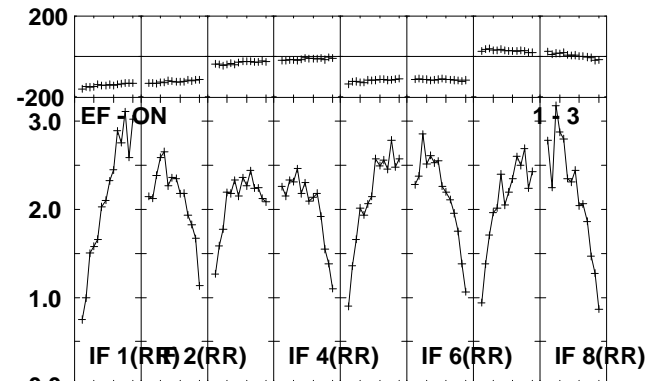
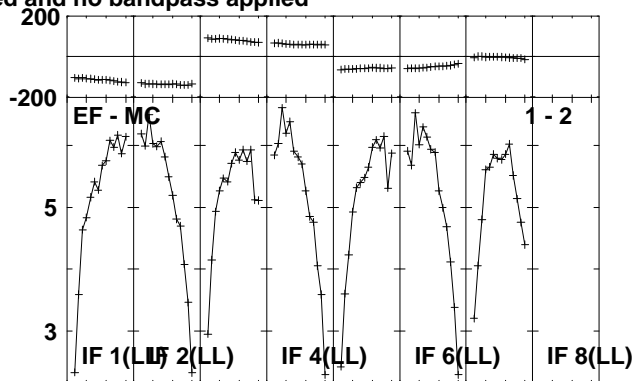
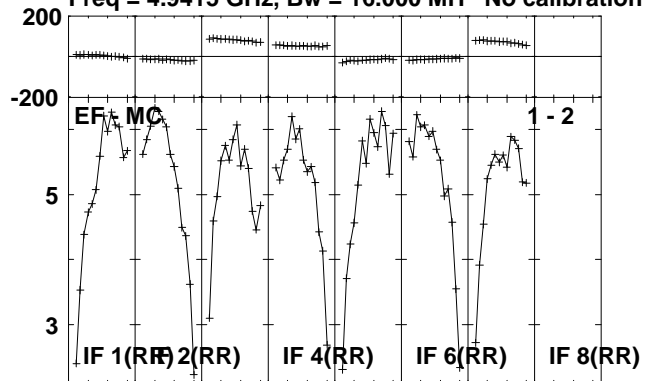

Lower frame: Milli Ampl Jy Top frame: Phas deg
Scalar averaged cross-power spectrum Several baselines displayed
Timerange: 01/01:14:51 to 01/01:16:49

Plot file version 222 created 14-JUL-2010 16:37:38
J1953+35 RR004A.UVDATA.1
Freq = 4.9415 GHz, Bw = 16.000 MH No calibration applied and no bandpass applied

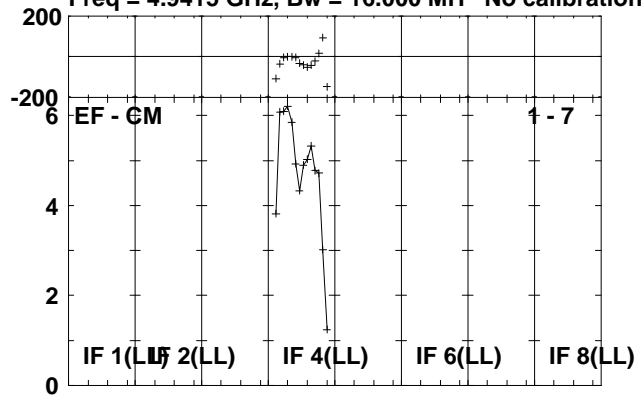

Lower frame: Milli Ampl Jy Top frame: Phas deg
Scalar averaged cross-power spectrum Several baselines displayed
Timerange: 01/01:14:51 to 01/01:16:49

Plot file version 223 created 14-JUL-2010 16:37:38

CYGX-1 RR004A.UVDATA.1

Freq = 4.9415 GHz, Bw = 16.000 MH No calibration applied and no bandpass applied

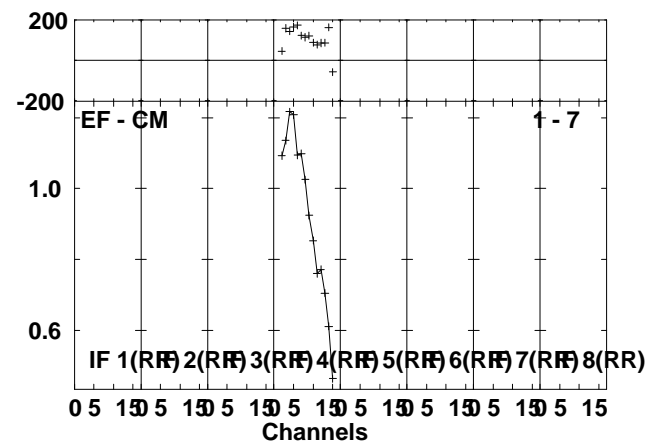
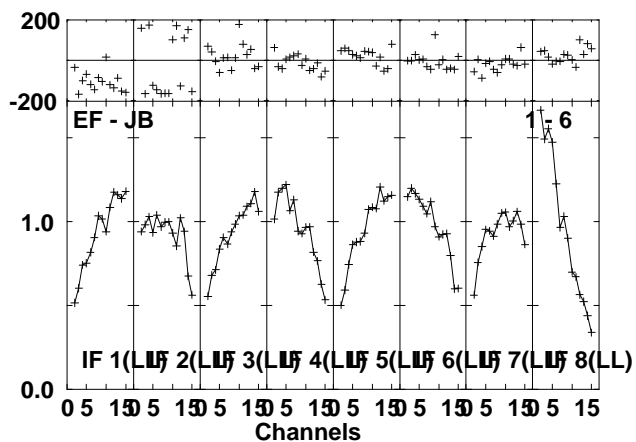
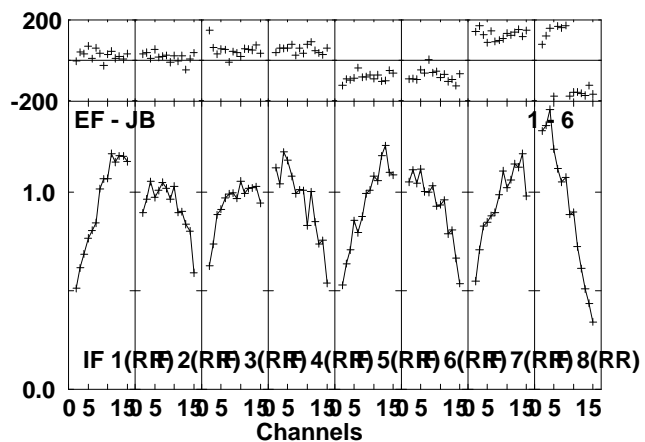
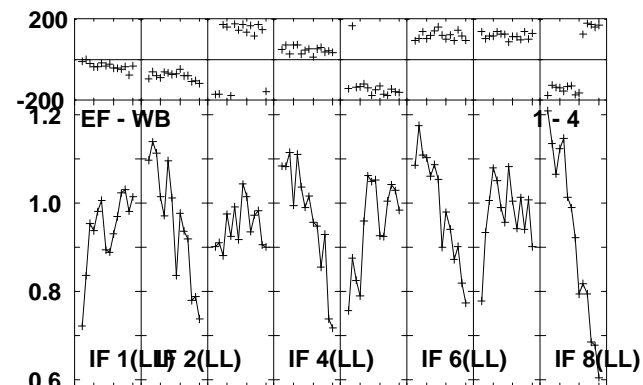
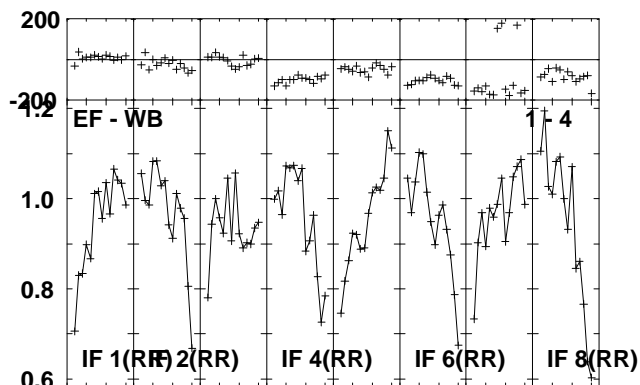
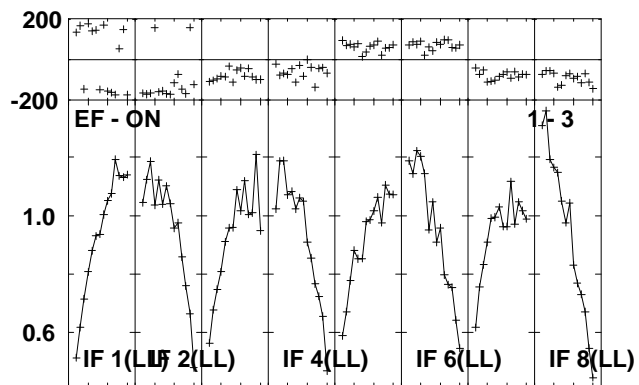
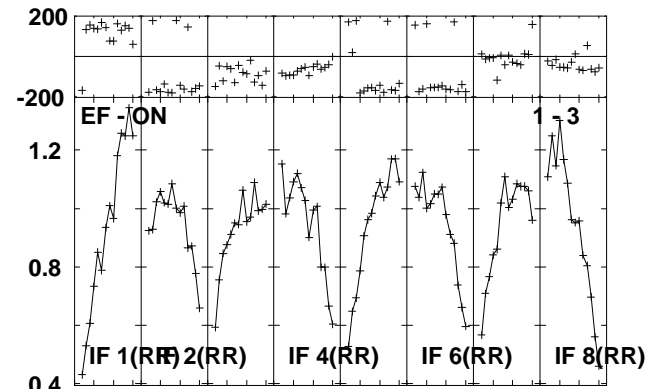
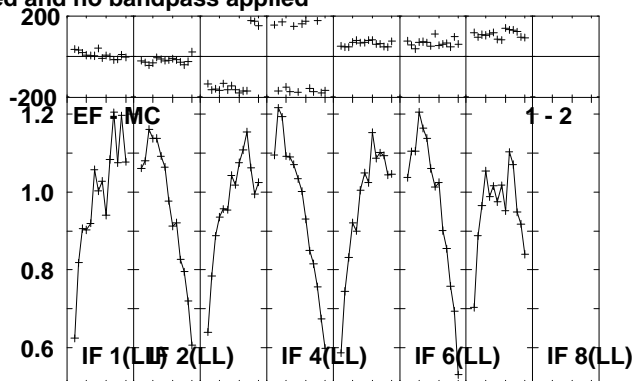
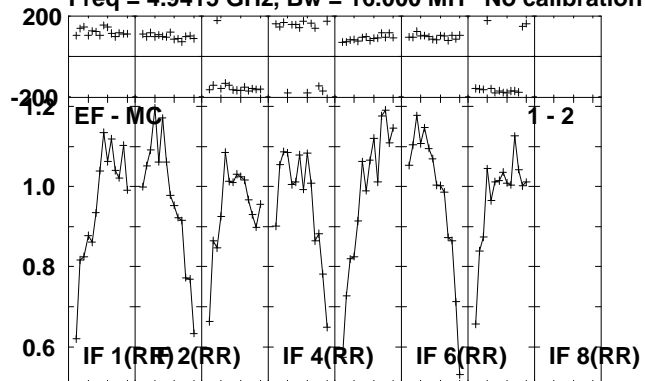

Lower frame: Milli Ampl Jy Top frame: Phas deg
Scalar averaged cross-power spectrum Several baselines displayed
Timerange: 01/01:16:51 to 01/01:21:49

Plot file version 224 created 14-JUL-2010 16:37:39
CYGX-1 RR004A.UVDATA.1
Freq = 4.9415 GHz, Bw = 16.000 MH No calibration applied and no bandpass applied

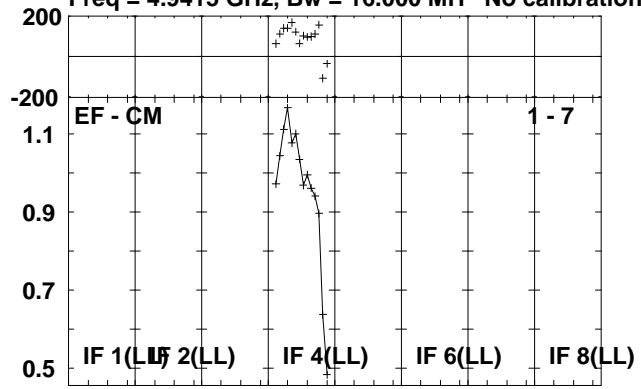

Lower frame: Milli Ampl Jy Top frame: Phas deg
Scalar averaged cross-power spectrum Several baselines displayed
Timerange: 01/01:16:51 to 01/01:21:49

Plot file version 225 created 14-JUL-2010 16:37:40

J1953+35 RR004A.UVDATA.1

Freq = 4.9415 GHz, Bw = 16.000 MH No calibration applied and no bandpass applied

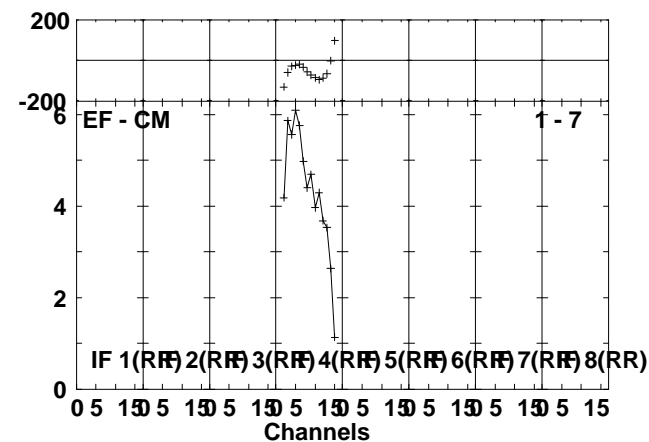
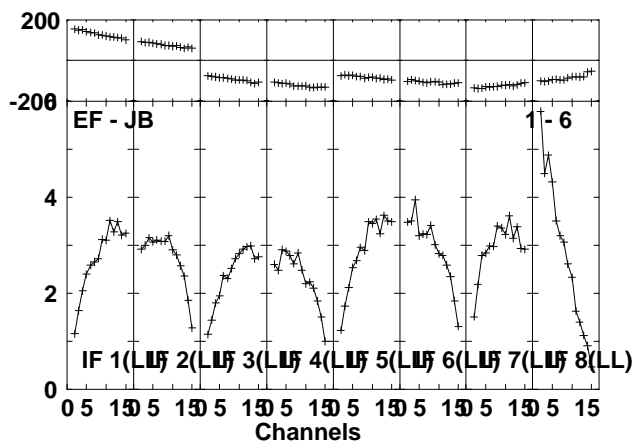
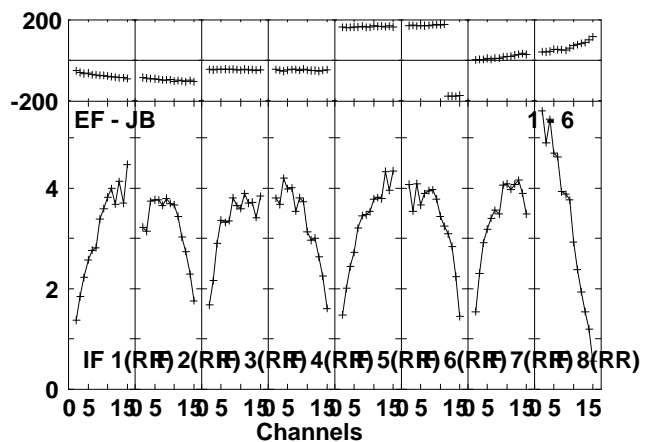
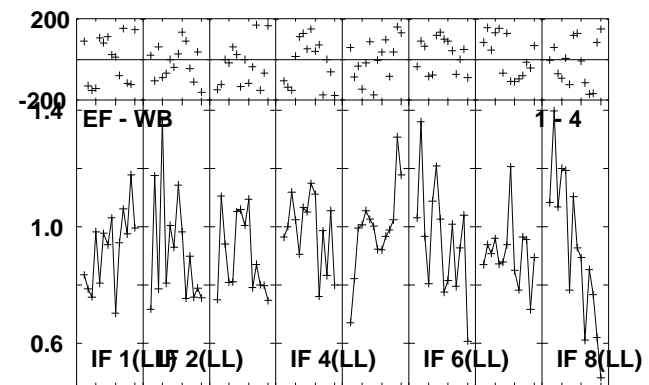
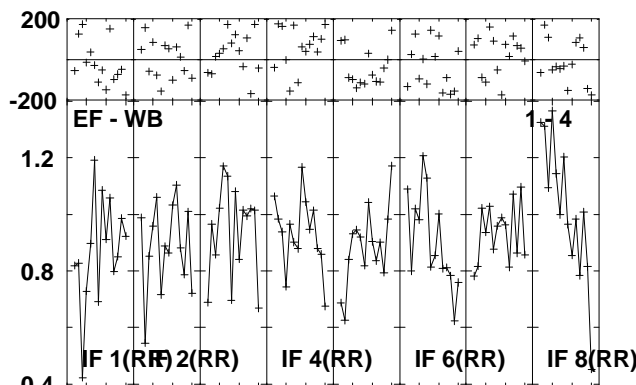
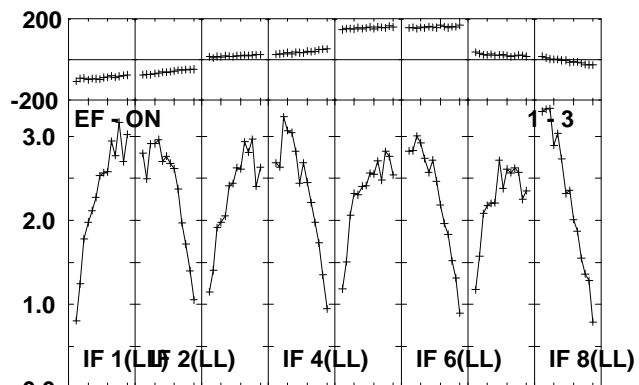
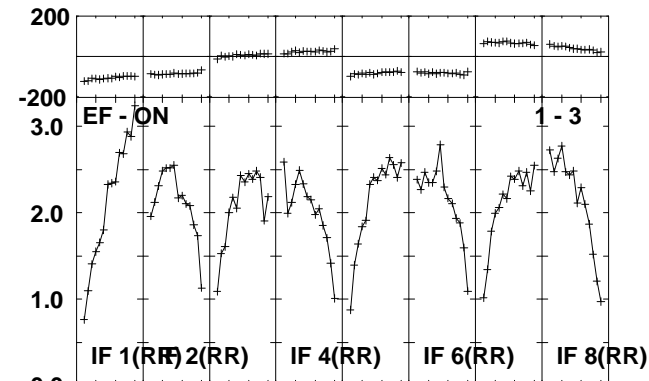
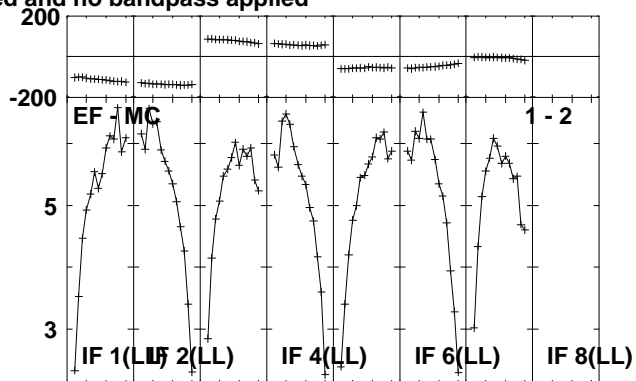
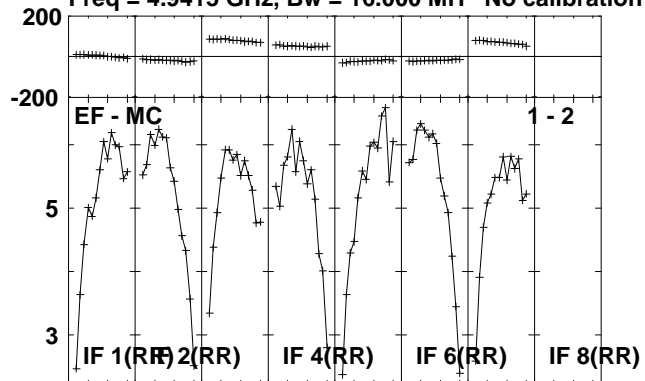

Lower frame: Milli Ampl Jy Top frame: Phas deg
Scalar averaged cross-power spectrum Several baselines displayed
Timerange: 01/01:22:41 to 01/01:24:09

Plot file version 226 created 14-JUL-2010 16:37:40
J1953+35 RR004A.UVDATA.1
Freq = 4.9415 GHz, Bw = 16.000 MH No calibration applied and no bandpass applied

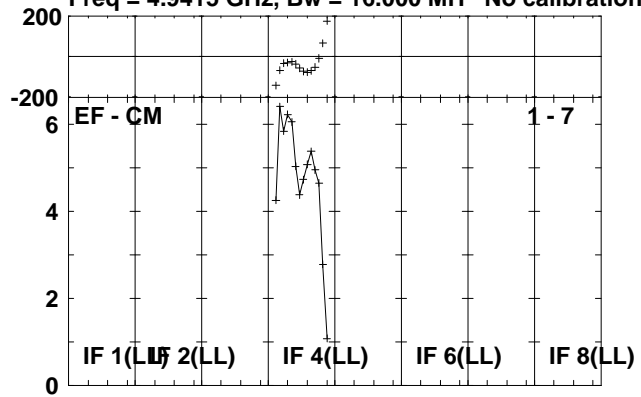

Lower frame: Milli Ampl Jy Top frame: Phas deg
Scalar averaged cross-power spectrum Several baselines displayed
Timerange: 01/01:22:41 to 01/01:24:09

Plot file version 227 created 14-JUL-2010 16:37:40

CYGX-1 RR004A.UVDATA.1

Freq = 4.9415 GHz, Bw = 16.000 MH No calibration applied and no bandpass applied

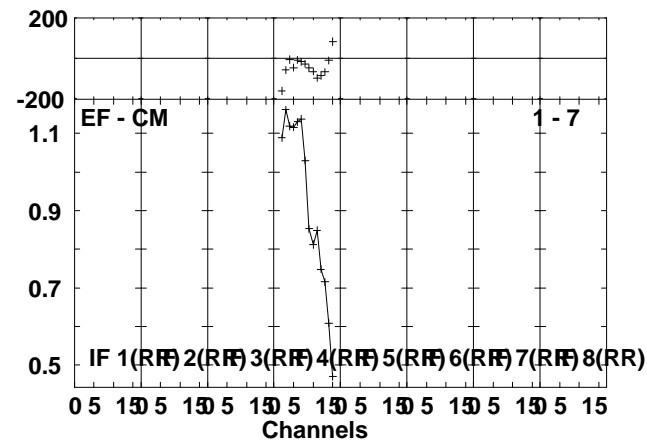
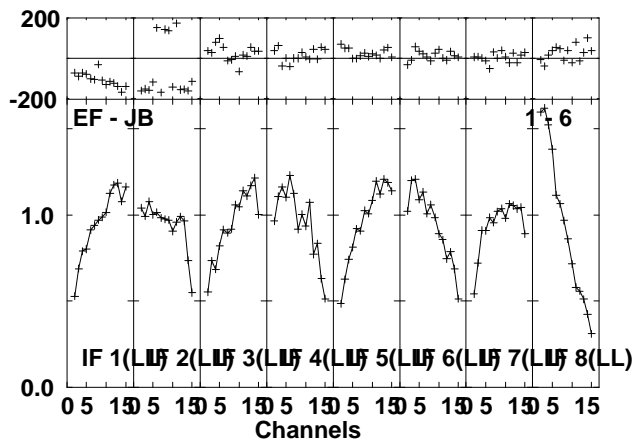
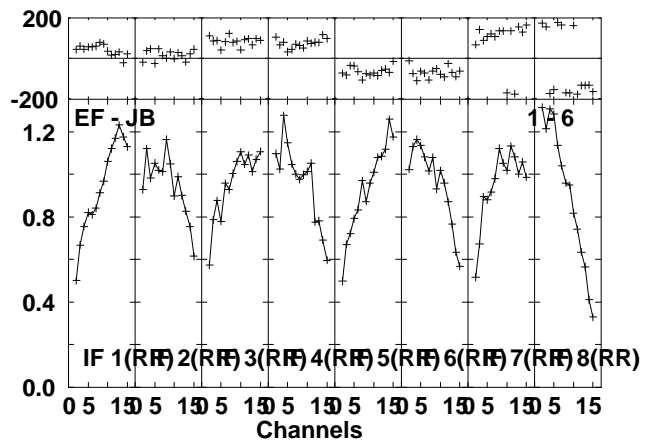
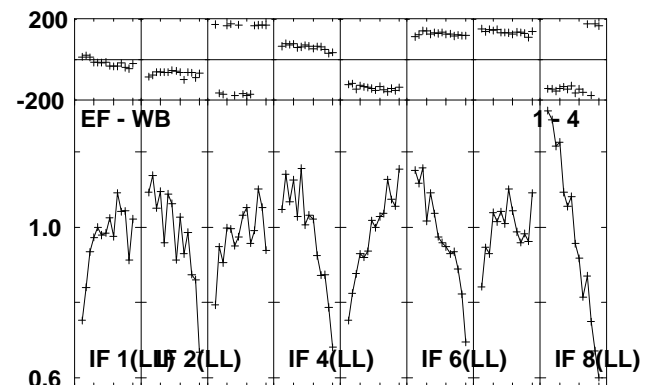
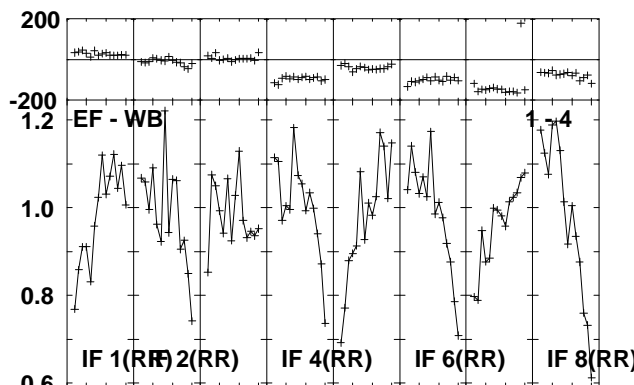
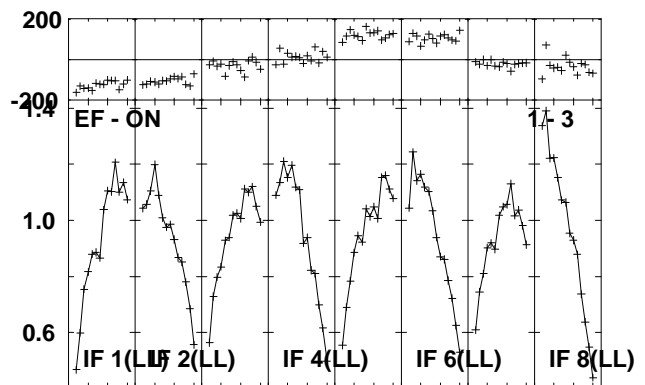
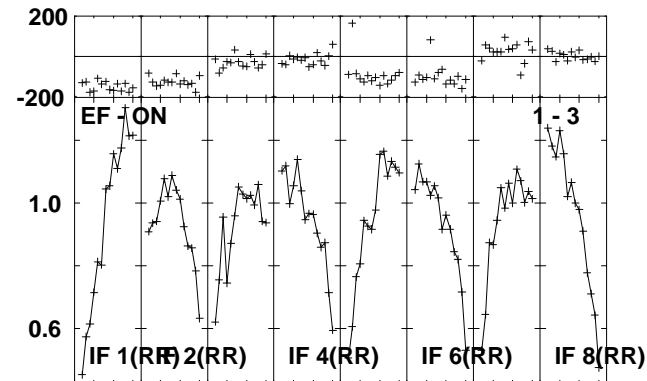
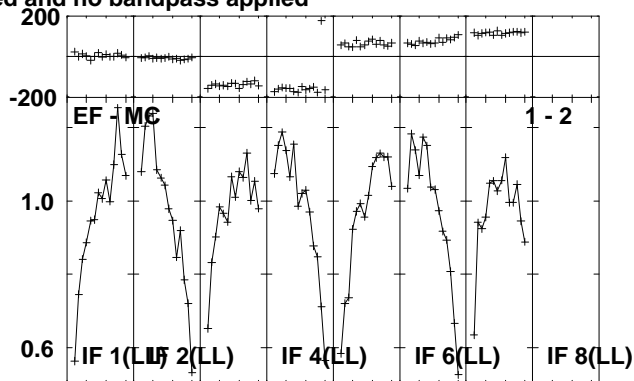
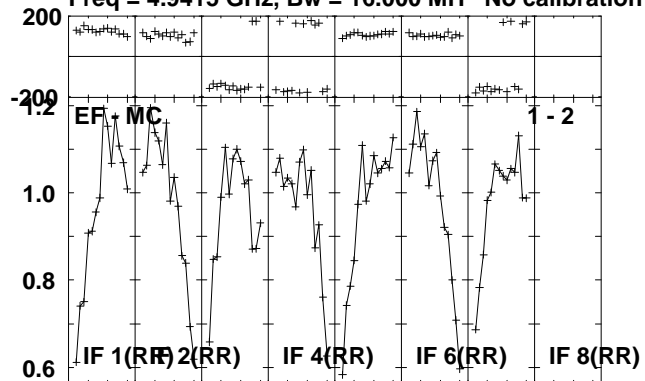

Lower frame: Milli Ampl Jy Top frame: Phas deg
Scalar averaged cross-power spectrum Several baselines displayed
Timerange: 01/01:24:11 to 01/01:29:09

Plot file version 228 created 14-JUL-2010 16:37:42
CYGX-1 RR004A.UVDATA.1
Freq = 4.9415 GHz, Bw = 16.000 MH No calibration applied and no bandpass applied

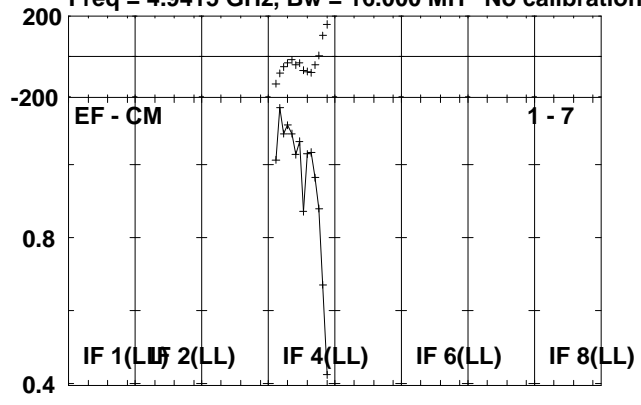

Lower frame: Milli Ampl Jy Top frame: Phas deg
Scalar averaged cross-power spectrum Several baselines displayed
Timerange: 01/01:24:11 to 01/01:29:09

Plot file version 229 created 14-JUL-2010 16:37:42

J1953+35 RR004A.UVDATA.1

Freq = 4.9415 GHz, Bw = 16.000 MH No calibration applied and no bandpass applied

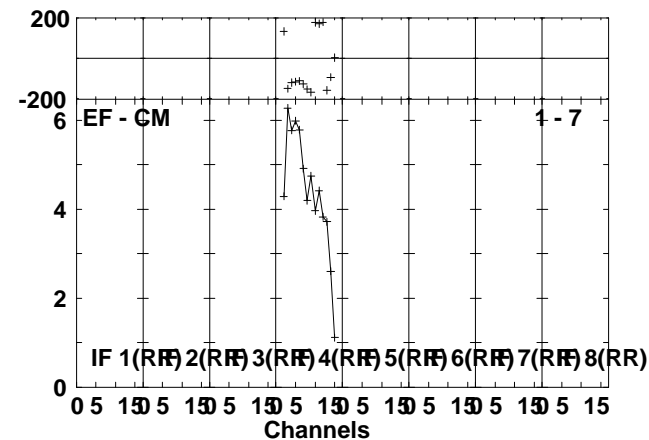
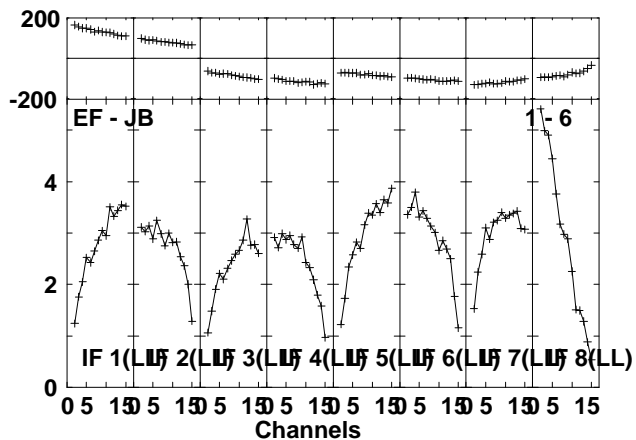
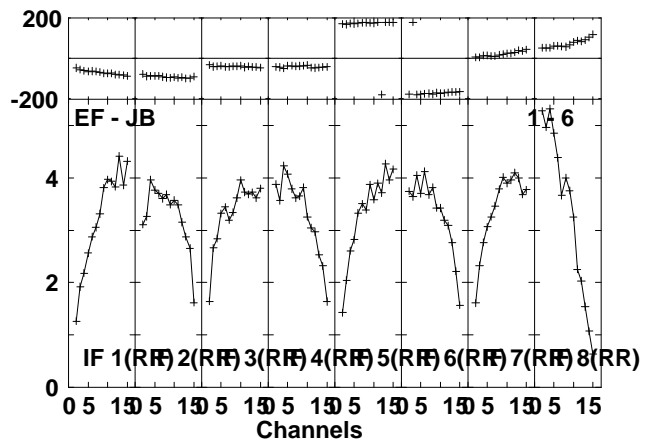
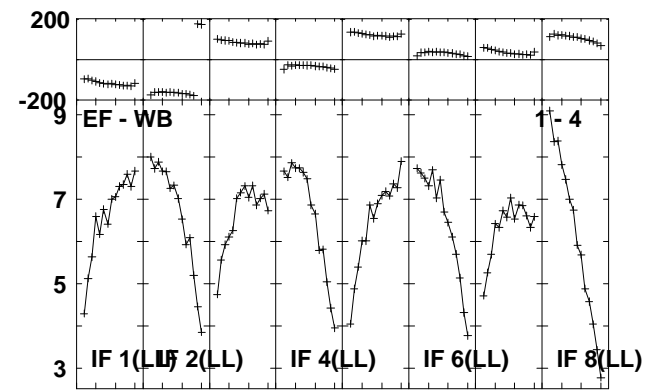
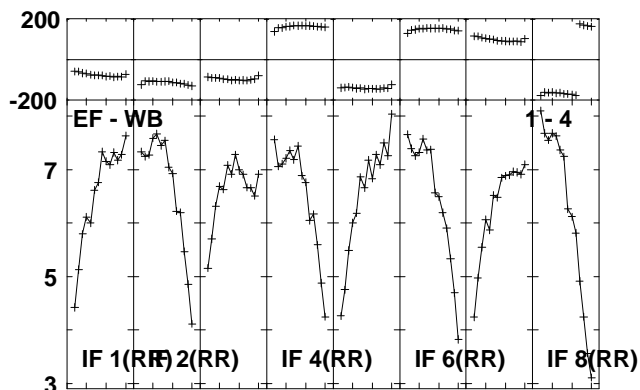
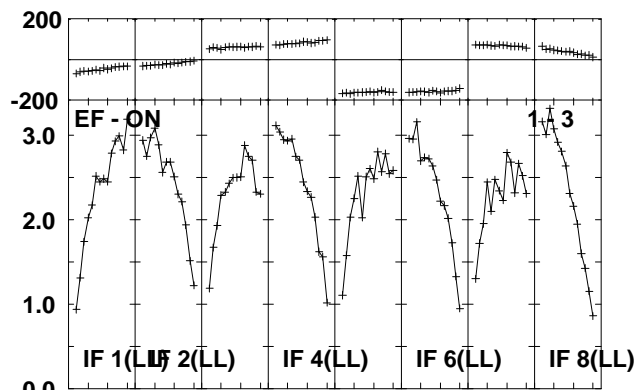
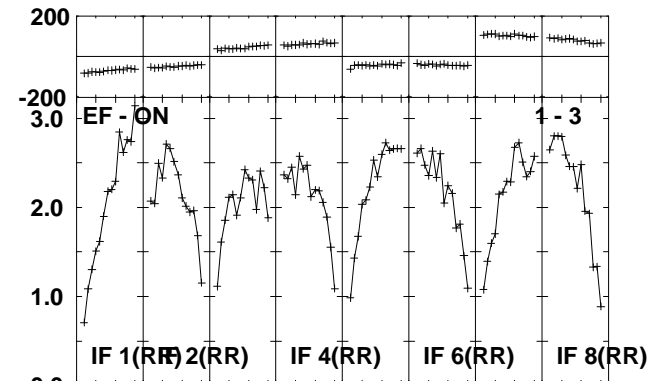
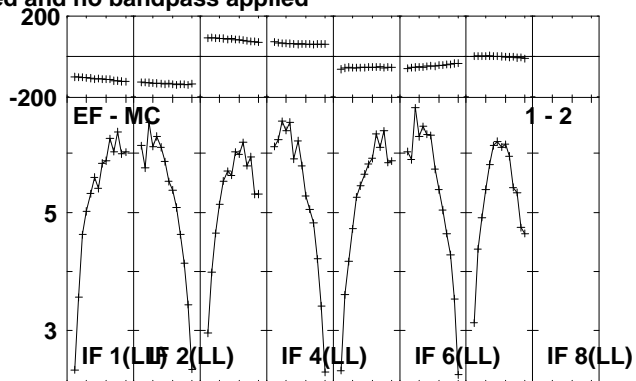
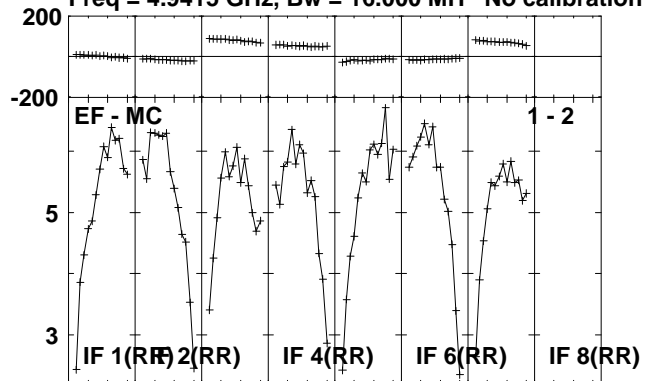

Lower frame: Milli Ampl Jy Top frame: Phas deg
Scalar averaged cross-power spectrum Several baselines displayed
Timerange: 01/01:29:11 to 01/01:31:09

Plot file version 230 created 14-JUL-2010 16:37:43
J1953+35 RR004A.UVDATA.1
Freq = 4.9415 GHz, Bw = 16.000 MH No calibration applied and no bandpass applied

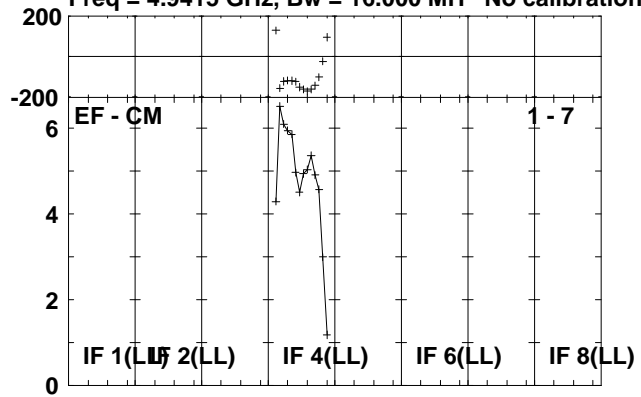

Lower frame: Milli Ampl Jy Top frame: Phas deg
Scalar averaged cross-power spectrum Several baselines displayed
Timerange: 01/01:29:11 to 01/01:31:09

Plot file version 231 created 14-JUL-2010 16:37:44

CYGX-1 RR004A.UVDATA.1

Freq = 4.9415 GHz, Bw = 16.000 MH No calibration applied and no bandpass applied

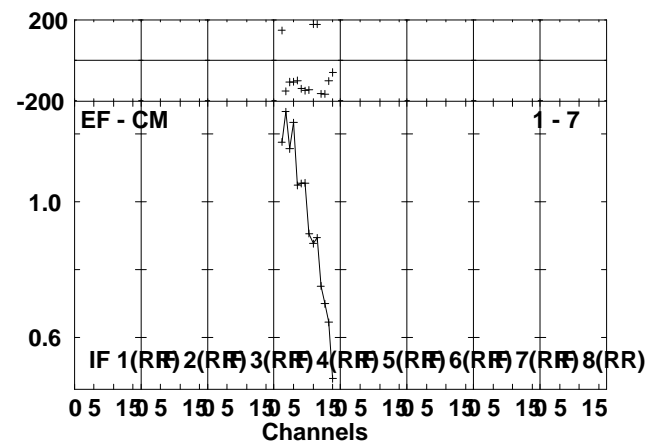
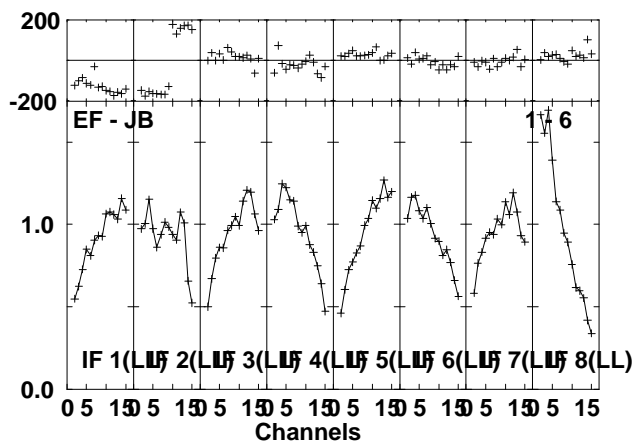
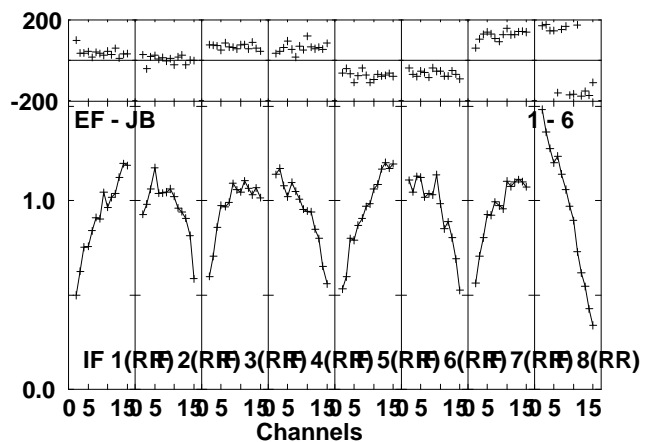
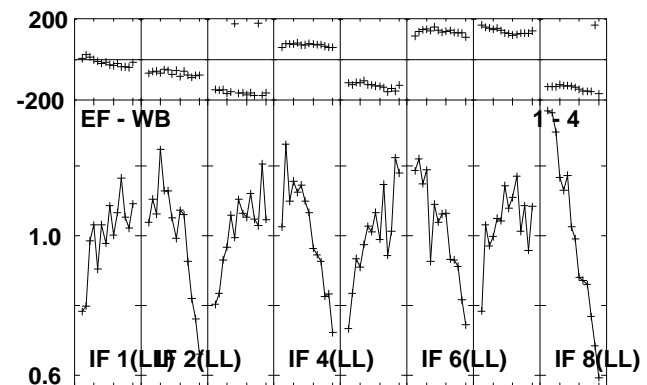
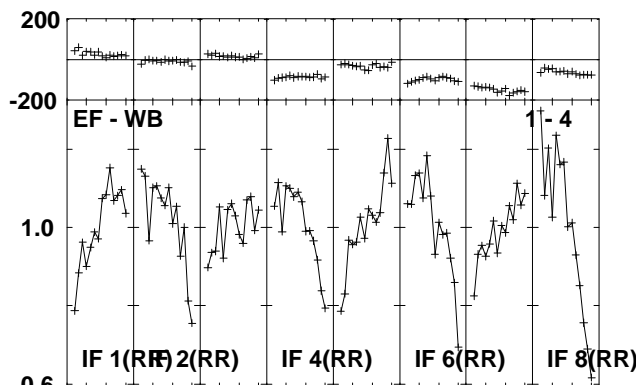
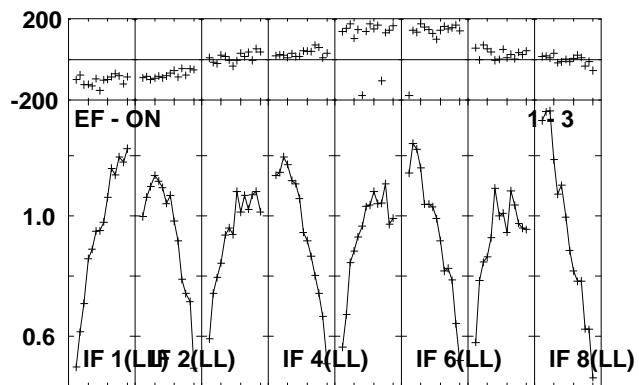
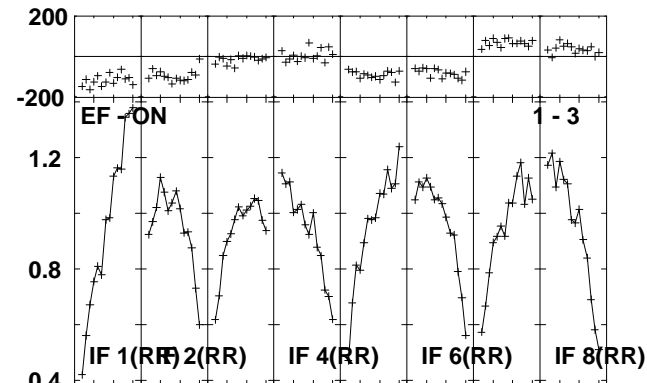
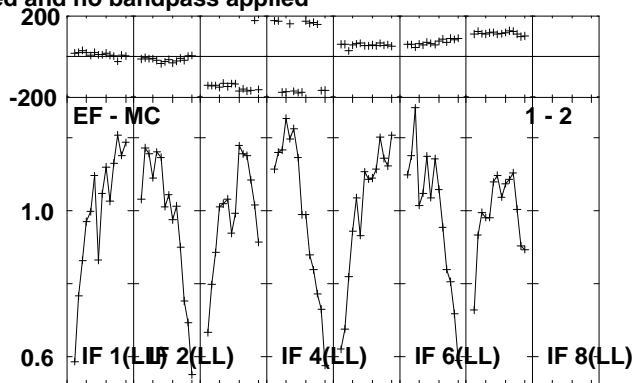
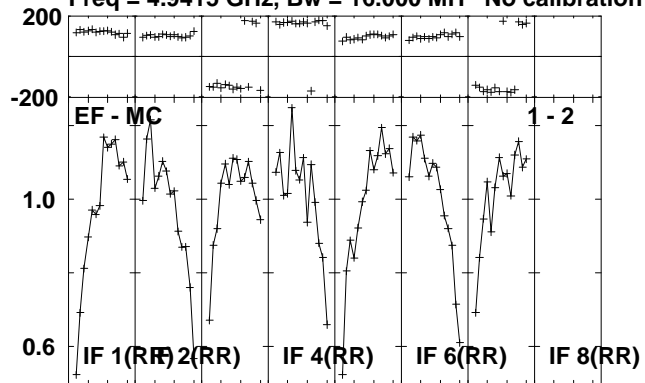

Lower frame: Milli Ampl Jy Top frame: Phas deg
Scalar averaged cross-power spectrum Several baselines displayed
Timerange: 01/01:31:11 to 01/01:36:09

Plot file version 232 created 14-JUL-2010 16:37:50
CYGX-1 RR004A.UVDATA.1
Freq = 4.9415 GHz, Bw = 16.000 MH No calibration applied and no bandpass applied

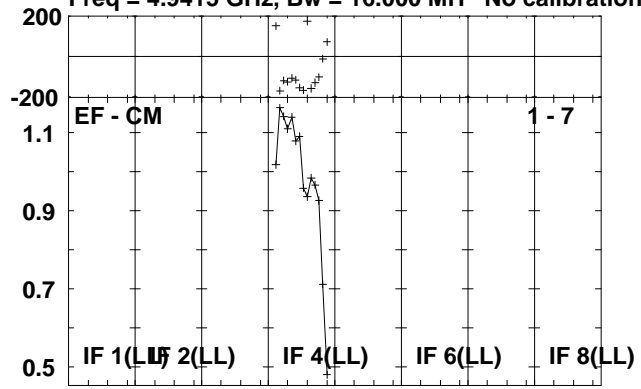

Lower frame: Milli Ampl Jy Top frame: Phas deg
Scalar averaged cross-power spectrum Several baselines displayed
Timerange: 01/01:31:11 to 01/01:36:09

Plot file version 233 created 14-JUL-2010 16:37:50

J1953+35 RR004A.UVDATA.1

Freq = 4.9415 GHz, Bw = 16.000 MH No calibration applied and no bandpass applied

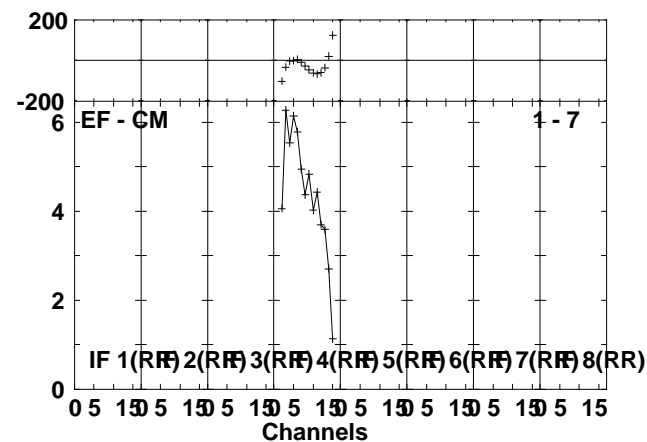
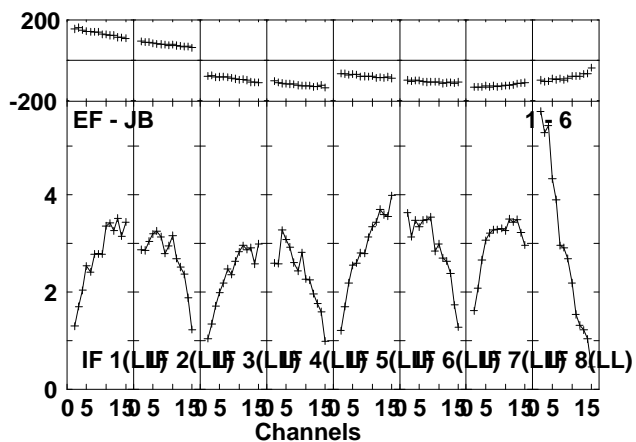
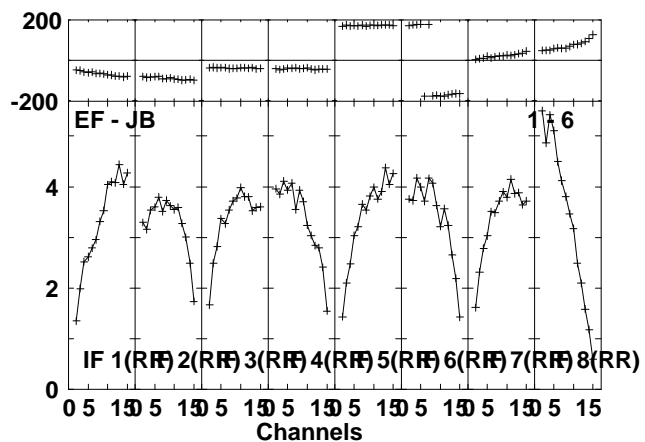
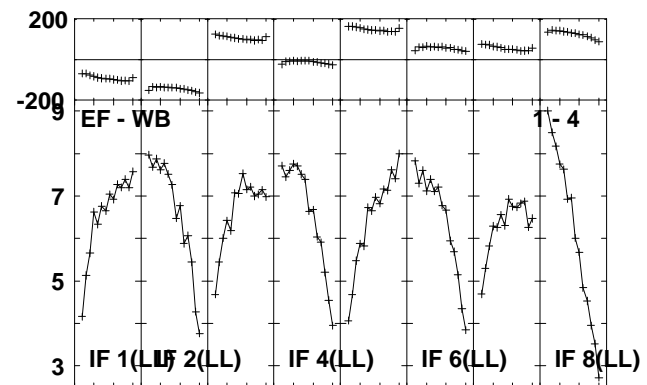
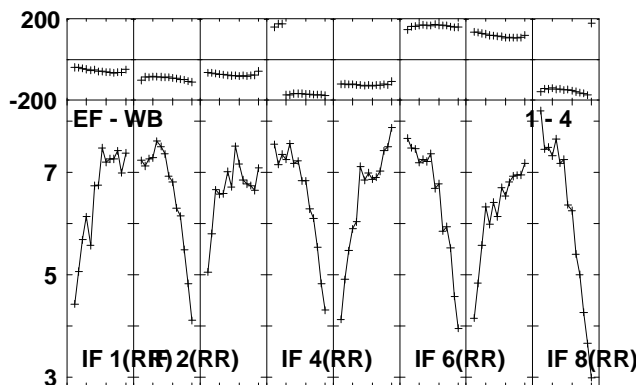
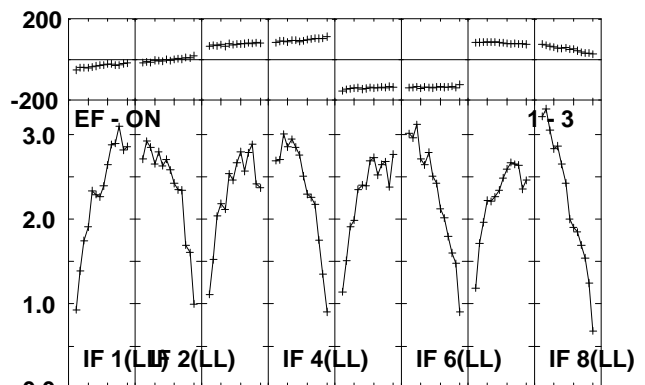
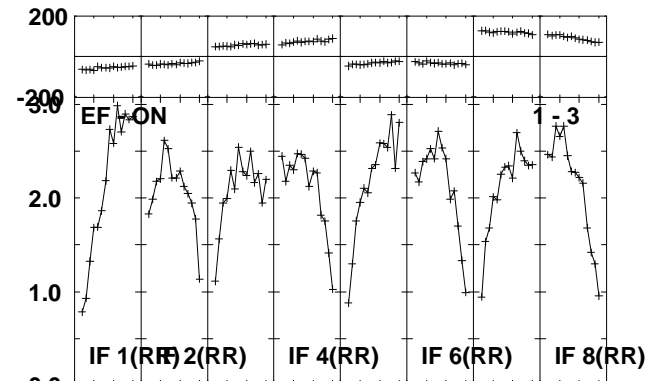
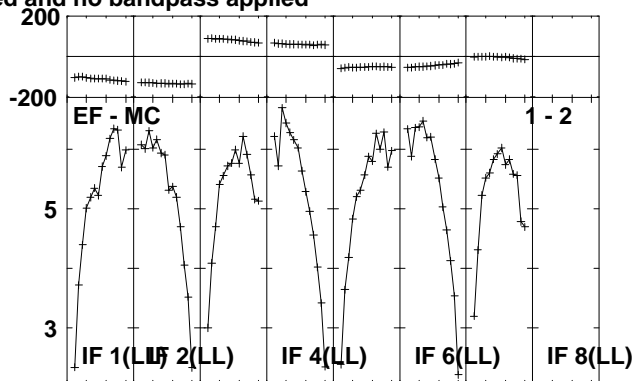
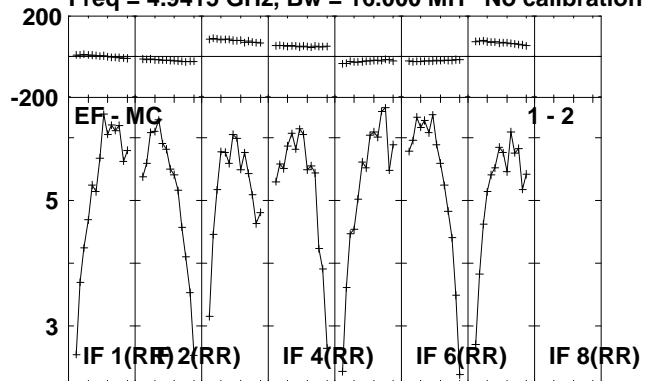

Lower frame: Milli Ampl Jy Top frame: Phas deg
Scalar averaged cross-power spectrum Several baselines displayed
Timerange: 01/01:37:01 to 01/01:38:29

Plot file version 234 created 14-JUL-2010 16:37:51
J1953+35 RR004A.UVDATA.1
Freq = 4.9415 GHz, Bw = 16.000 MH No calibration applied and no bandpass applied

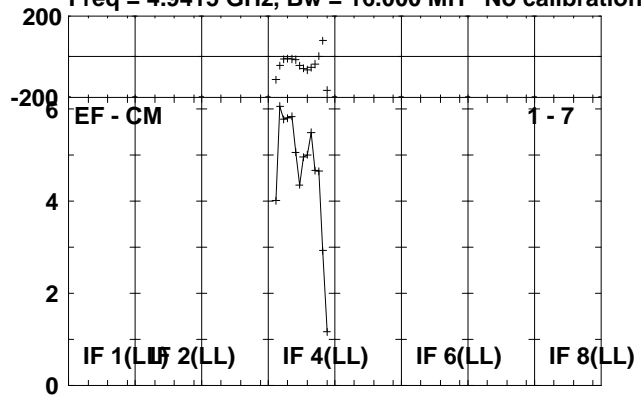

Lower frame: Milli Ampl Jy Top frame: Phas deg
Scalar averaged cross-power spectrum Several baselines displayed
Timerange: 01/01:37:01 to 01/01:38:29

Plot file version 235 created 14-JUL-2010 16:37:51

CYGX-1 RR004A.UVDATA.1

Freq = 4.9415 GHz, Bw = 16.000 MH No calibration applied and no bandpass applied

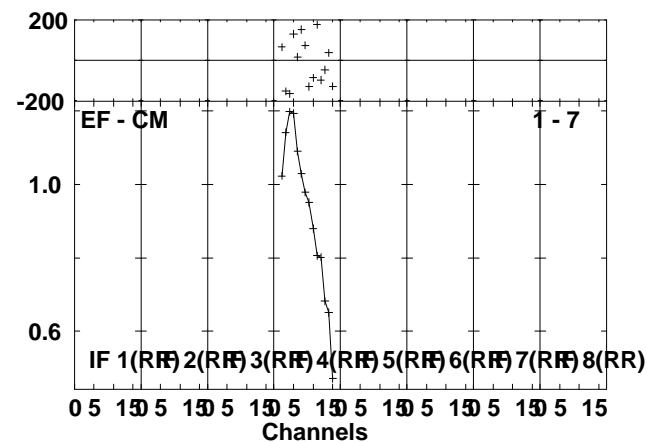
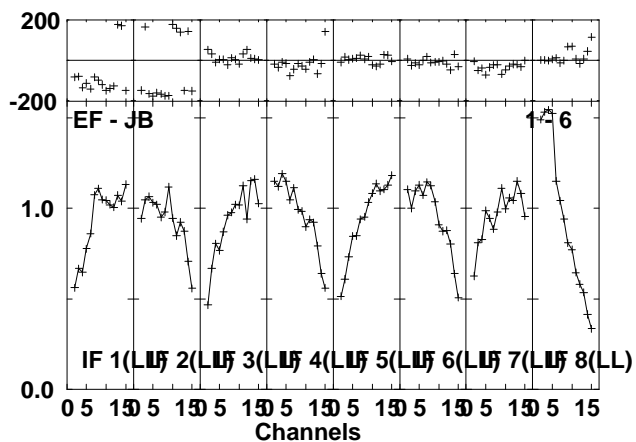
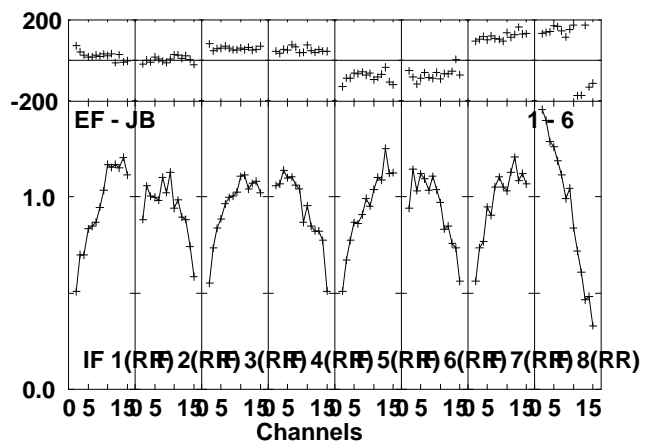
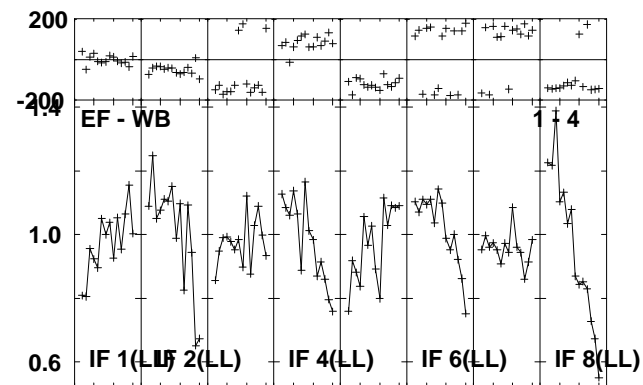
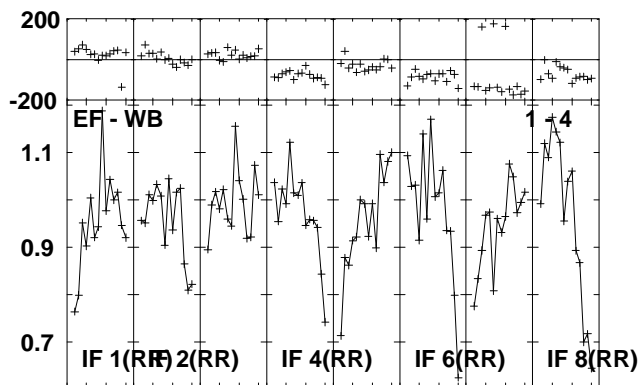
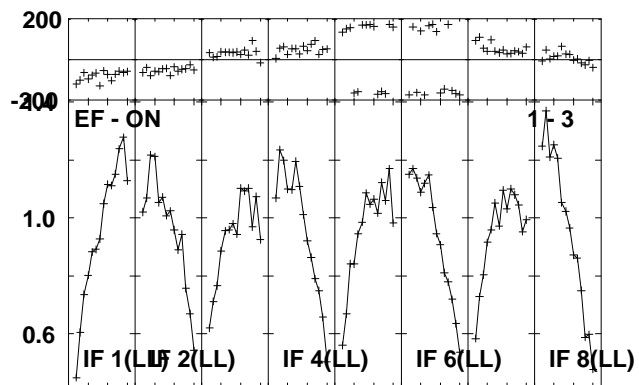
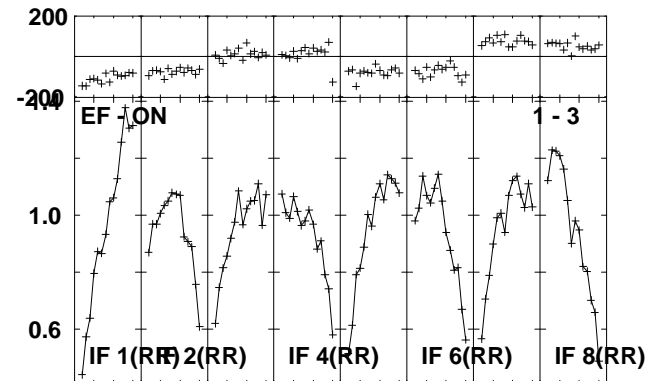
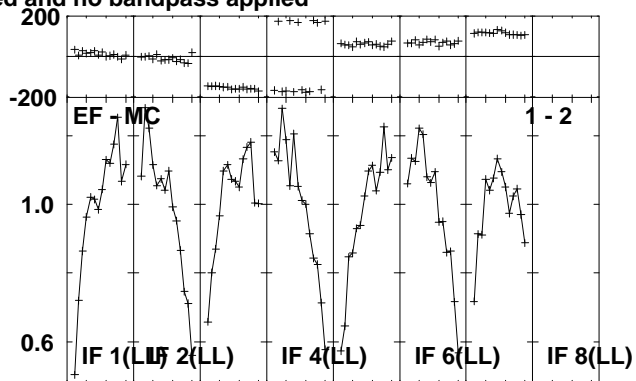
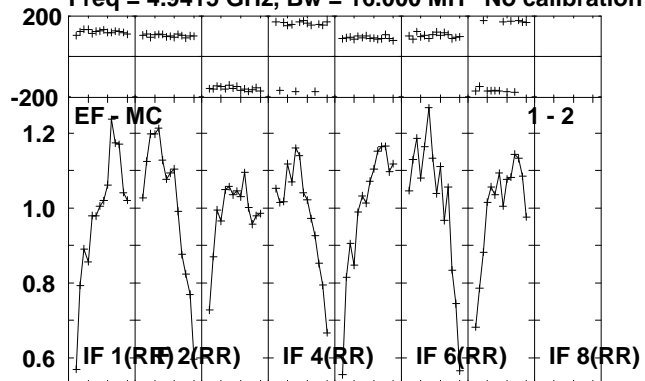

Lower frame: Milli Ampl Jy Top frame: Phas deg
Scalar averaged cross-power spectrum Several baselines displayed
Timerange: 01/01:38:31 to 01/01:43:29

Plot file version 236 created 14-JUL-2010 16:37:52
CYGX-1 RR004A.UVDATA.1
Freq = 4.9415 GHz, Bw = 16.000 MH No calibration applied and no bandpass applied

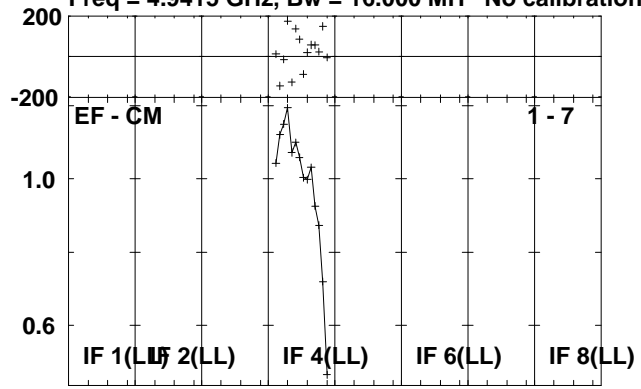

Lower frame: Milli Ampl Jy Top frame: Phas deg
Scalar averaged cross-power spectrum Several baselines displayed
Timerange: 01/01:38:31 to 01/01:43:29

Plot file version 237 created 14-JUL-2010 16:37:52

J1953+35 RR004A.UVDATA.1

Freq = 4.9415 GHz, Bw = 16.000 MH No calibration applied and no bandpass applied

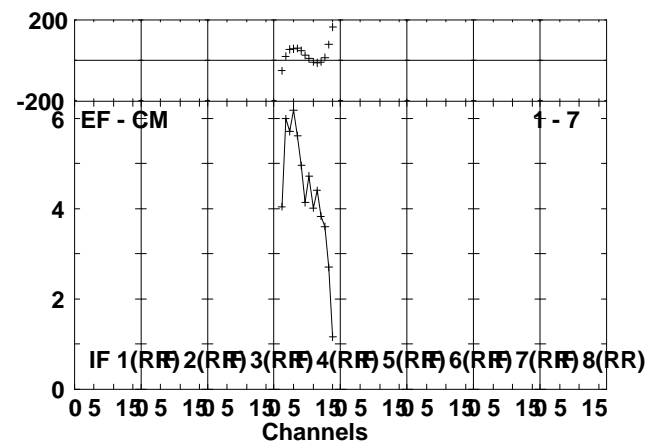
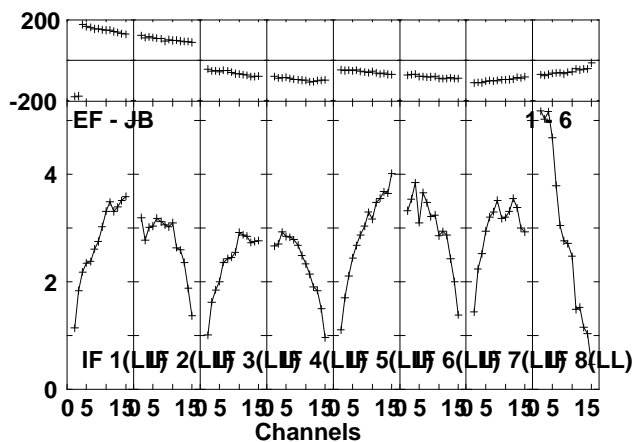
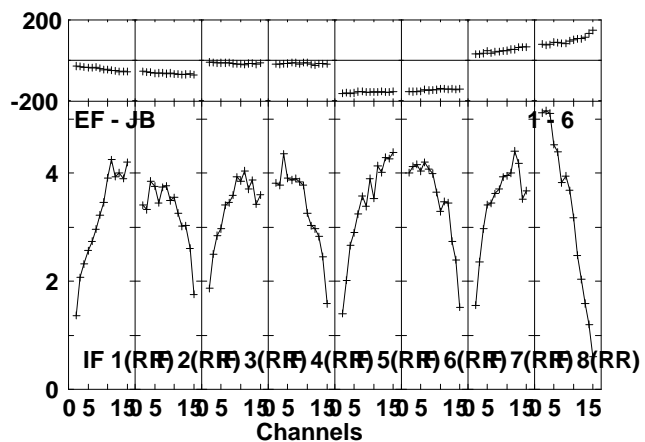
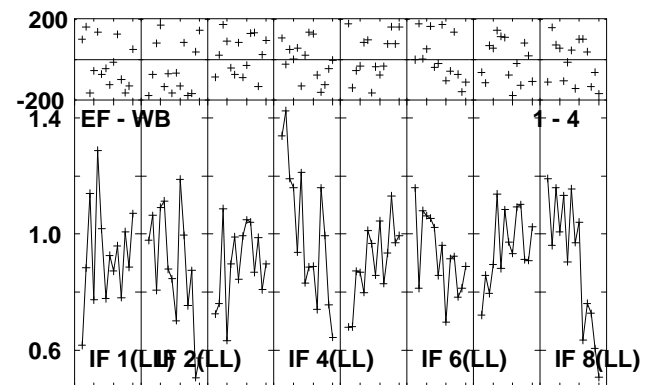
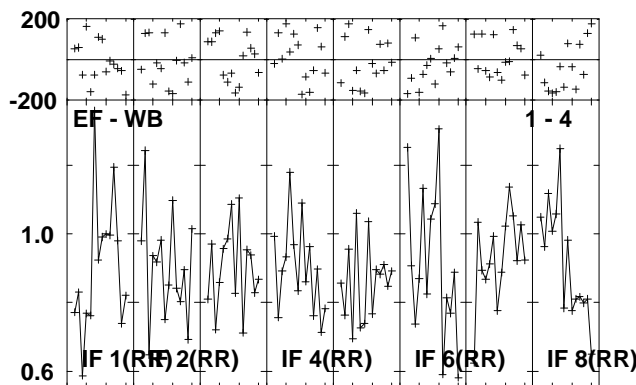
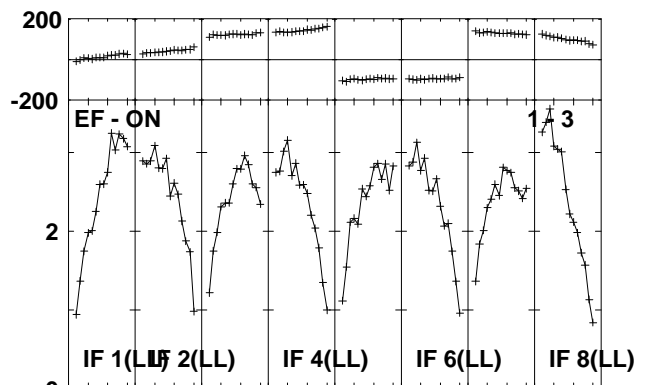
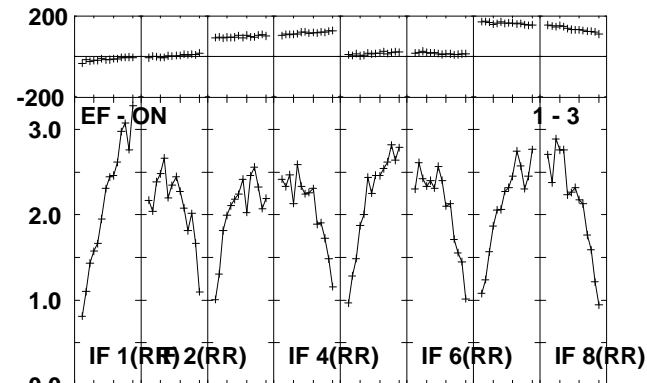
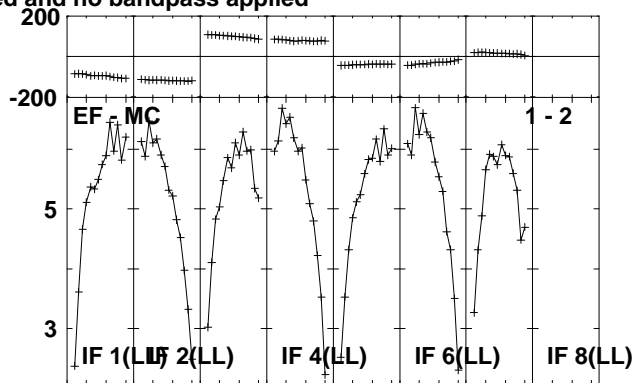
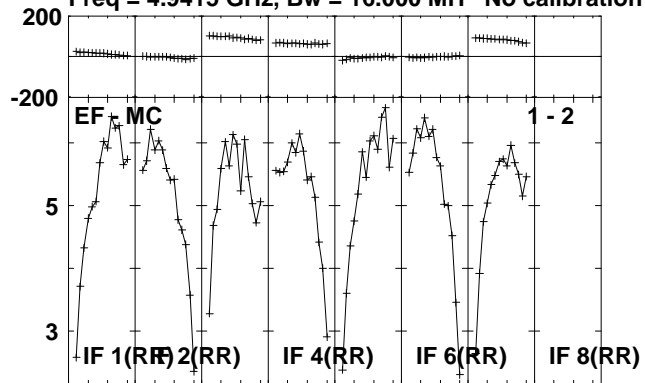

Lower frame: Milli Ampl Jy Top frame: Phas deg
Scalar averaged cross-power spectrum Several baselines displayed
Timerange: 01/01:43:31 to 01/01:45:29

Plot file version 238 created 14-JUL-2010 16:37:53
J1953+35 RR004A.UVDATA.1
Freq = 4.9415 GHz, Bw = 16.000 MH No calibration applied and no bandpass applied

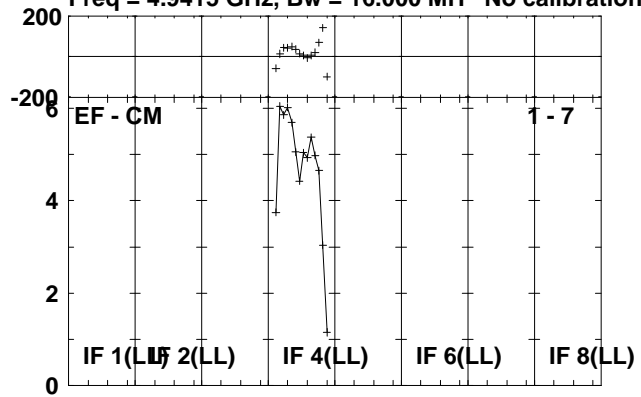

Lower frame: Milli Ampl Jy Top frame: Phas deg
Scalar averaged cross-power spectrum Several baselines displayed
Timerange: 01/01:43:31 to 01/01:45:29

Plot file version 239 created 14-JUL-2010 16:37:53

CYGX-1 RR004A.UVDATA.1

Freq = 4.9415 GHz, Bw = 16.000 MH No calibration applied and no bandpass applied

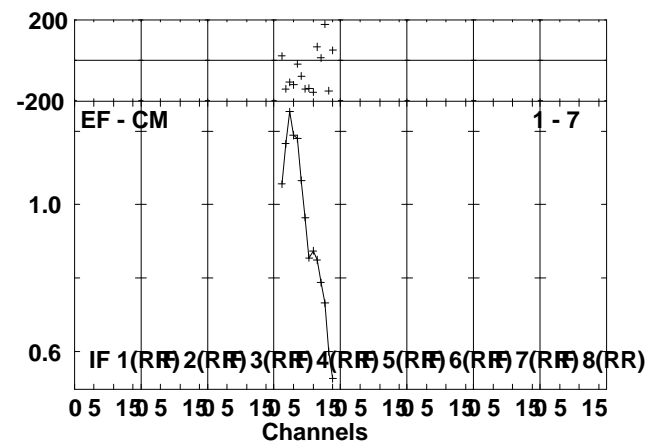
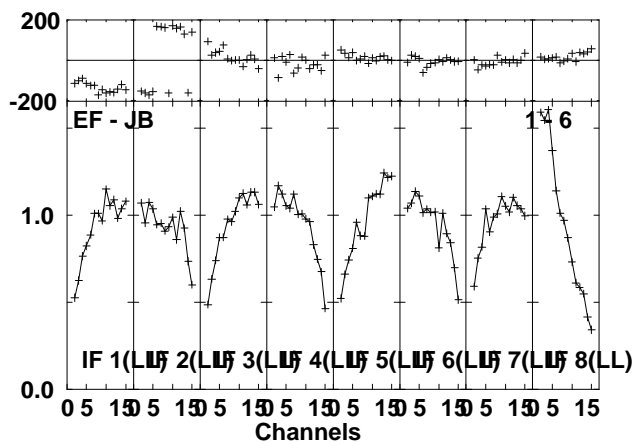
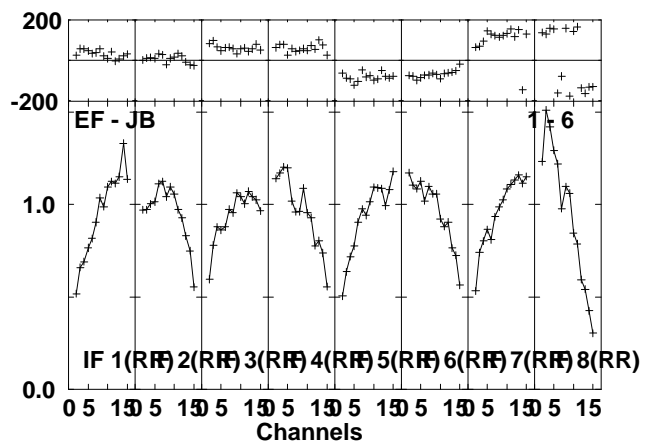
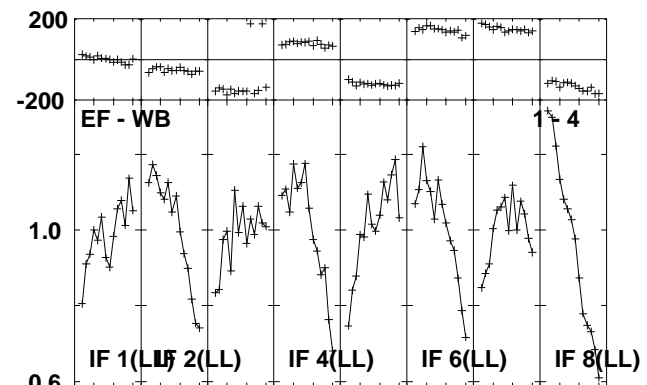
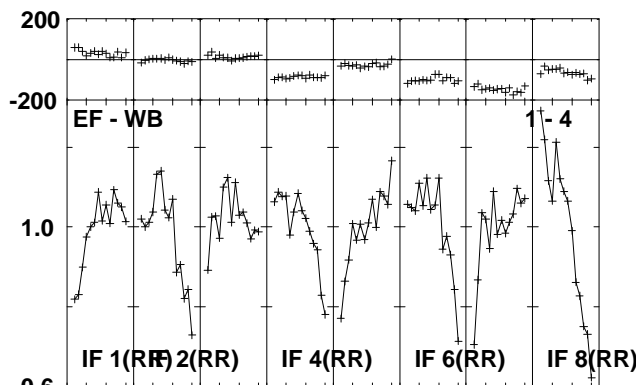
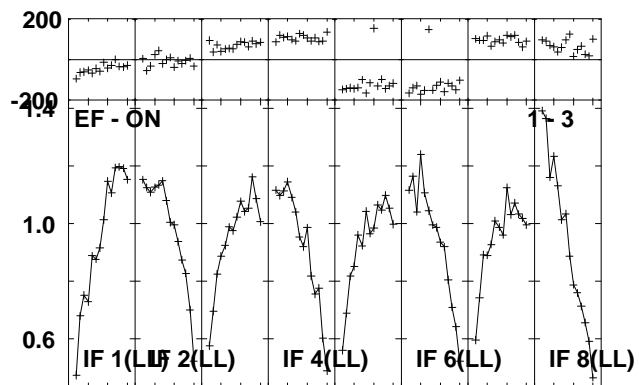
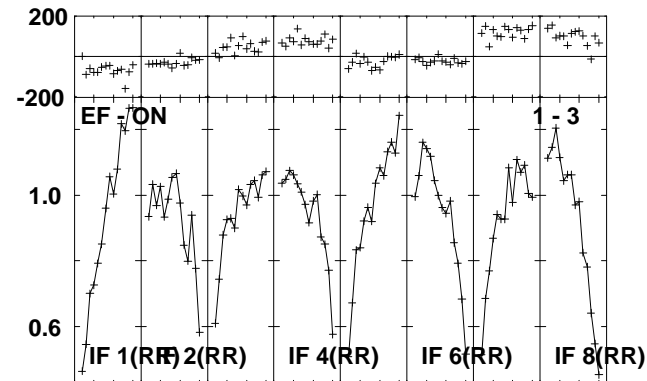
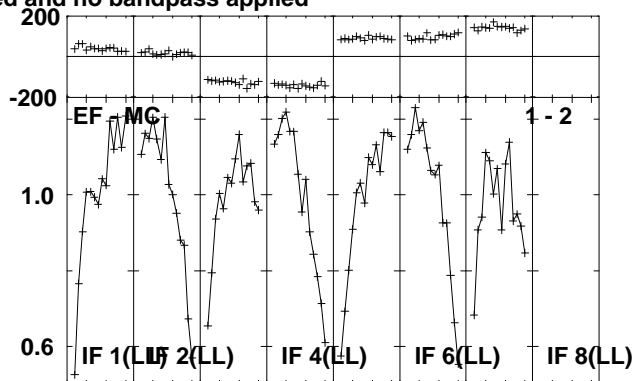
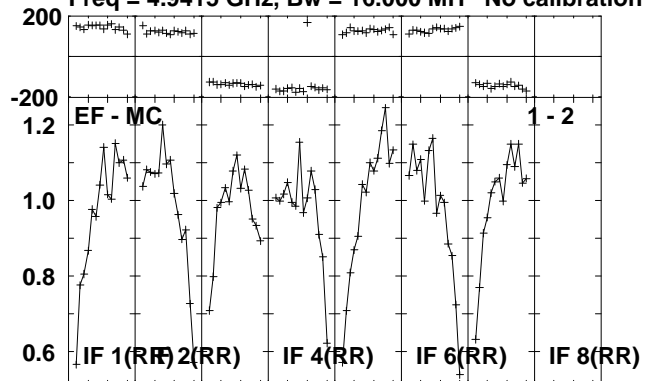

Lower frame: Milli Ampl Jy Top frame: Phas deg
Scalar averaged cross-power spectrum Several baselines displayed
Timerange: 01/01:45:31 to 01/01:50:29

Plot file version 240 created 14-JUL-2010 16:37:54
CYGX-1 RR004A.UVDATA.1
Freq = 4.9415 GHz, Bw = 16.000 MH No calibration applied and no bandpass applied

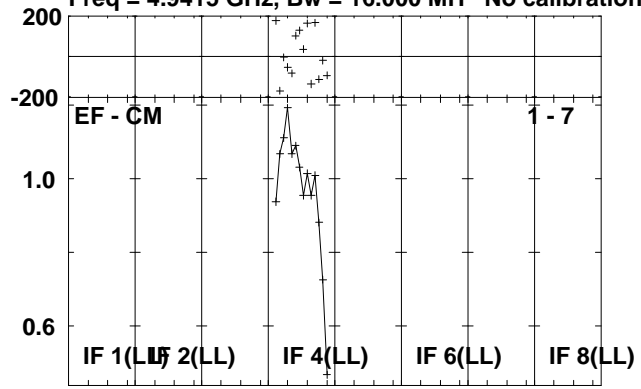

Lower frame: Milli Ampl Jy Top frame: Phas deg
Scalar averaged cross-power spectrum Several baselines displayed
Timerange: 01/01:45:31 to 01/01:50:29

Plot file version 241 created 14-JUL-2010 16:37:55

J1953+35 RR004A.UVDATA.1

Freq = 4.9415 GHz, Bw = 16.000 MH No calibration applied and no bandpass applied

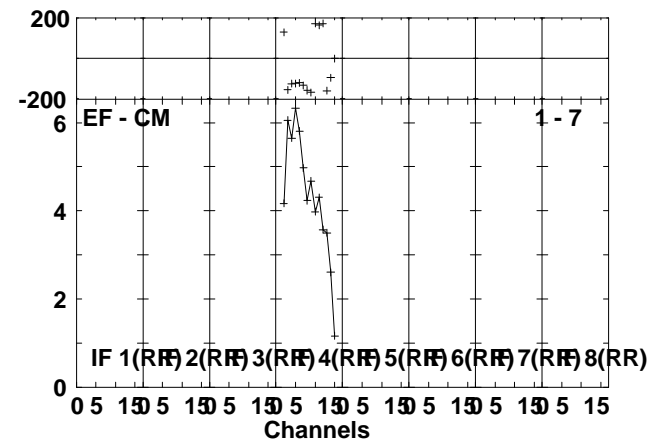
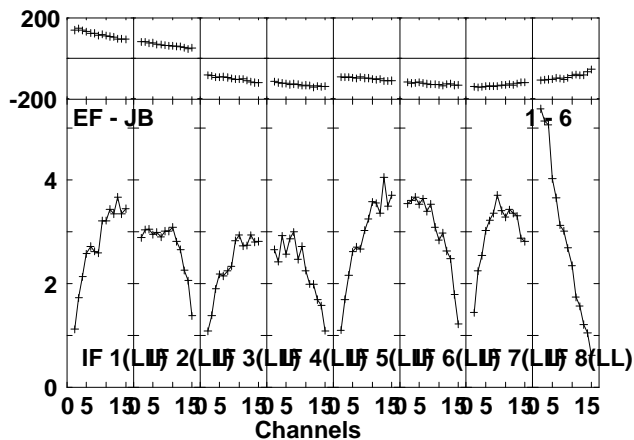
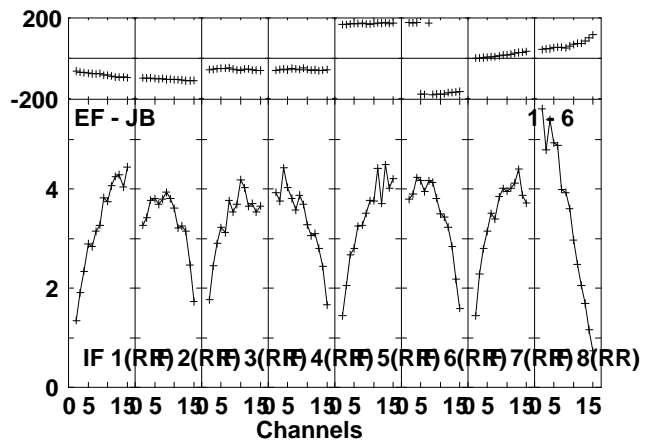
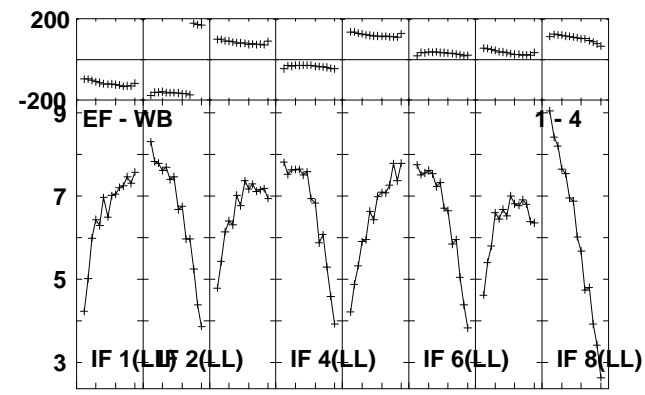
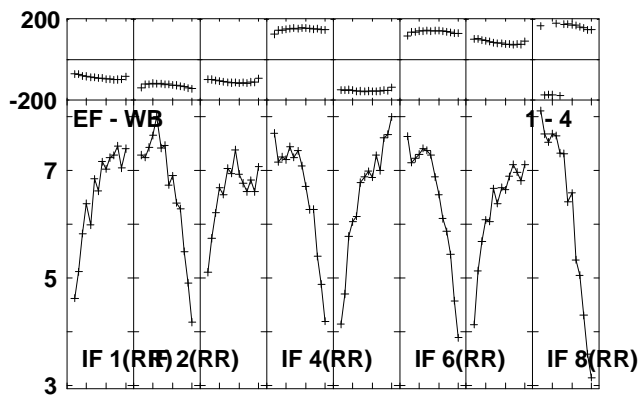
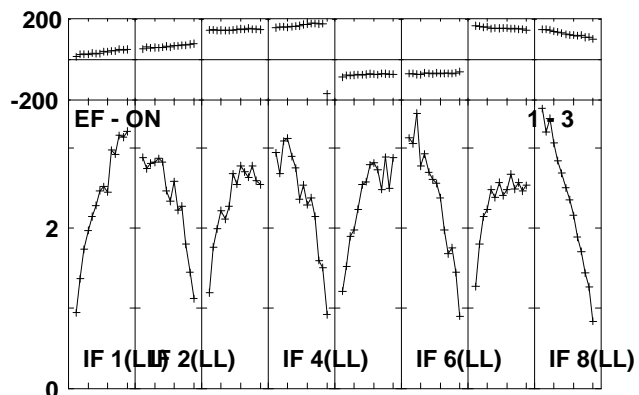
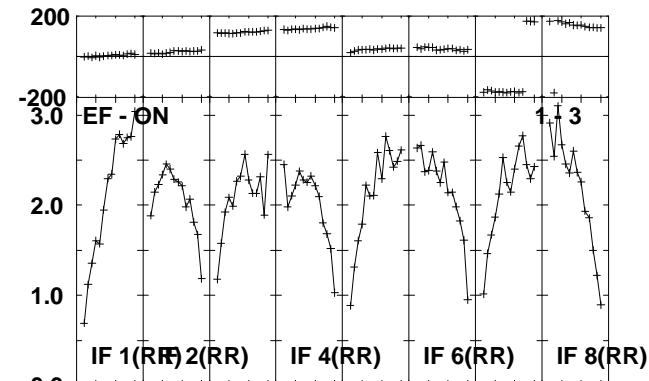
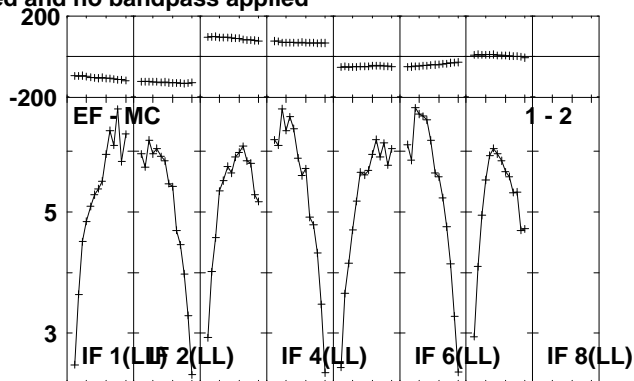
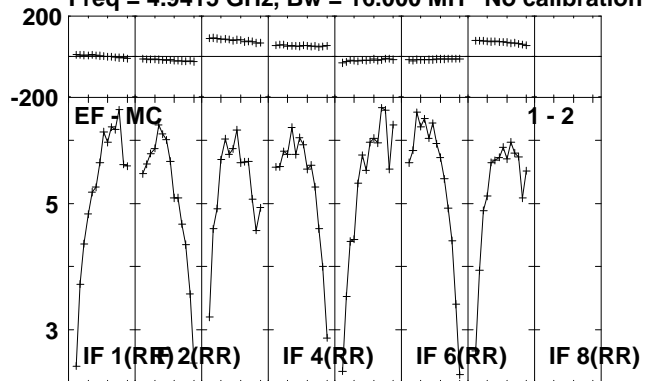

Lower frame: Milli Ampl Jy Top frame: Phas deg
Scalar averaged cross-power spectrum Several baselines displayed
Timerange: 01/01:51:21 to 01/01:52:49

Plot file version 242 created 14-JUL-2010 16:37:55
J1953+35 RR004A.UVDATA.1
Freq = 4.9415 GHz, Bw = 16.000 MH No calibration applied and no bandpass applied

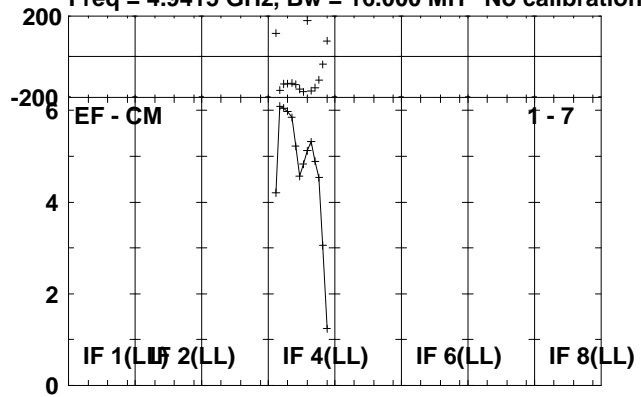

Lower frame: Milli Ampl Jy Top frame: Phas deg
Scalar averaged cross-power spectrum Several baselines displayed
Timerange: 01/01:51:21 to 01/01:52:49

Plot file version 243 created 14-JUL-2010 16:37:56

CYGX-1 RR004A.UVDATA.1

Freq = 4.9415 GHz, Bw = 16.000 MH No calibration applied and no bandpass applied

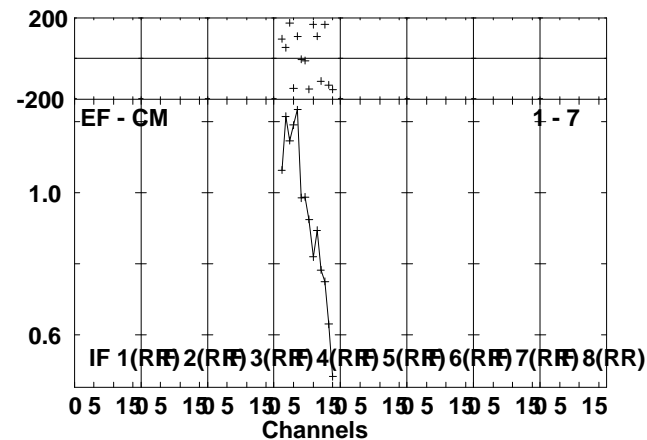
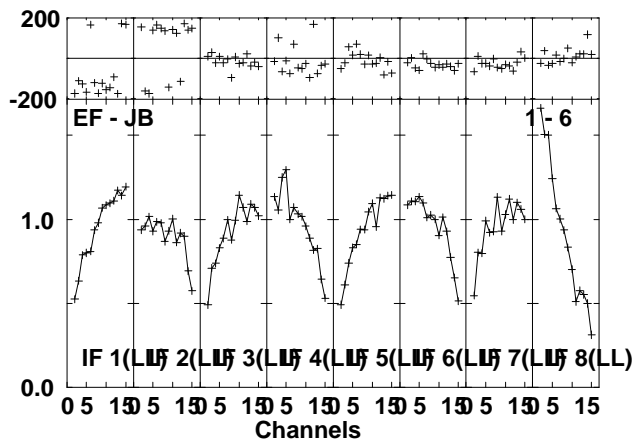
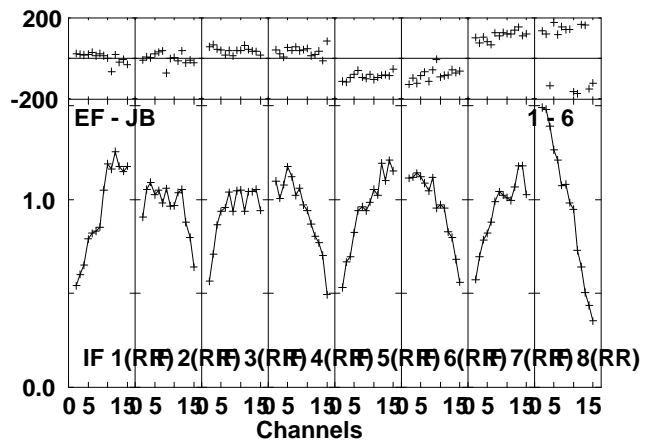
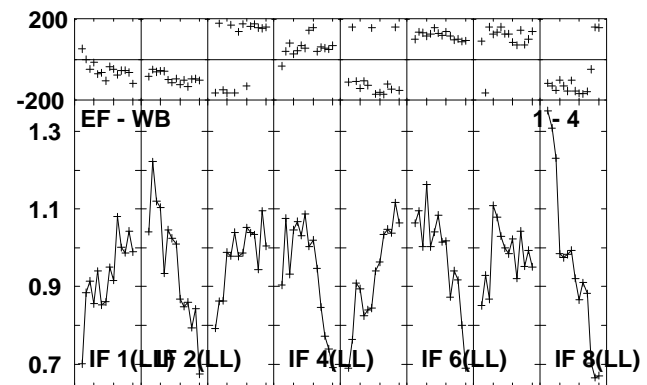
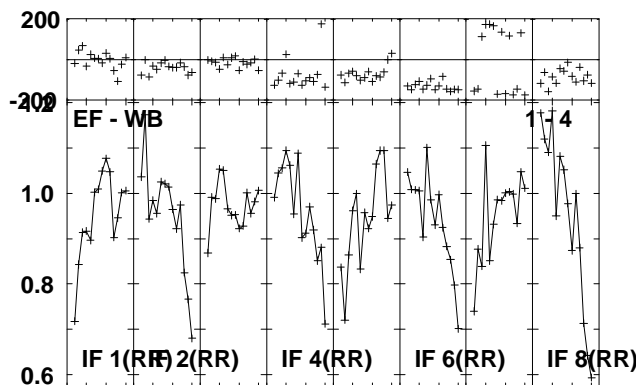
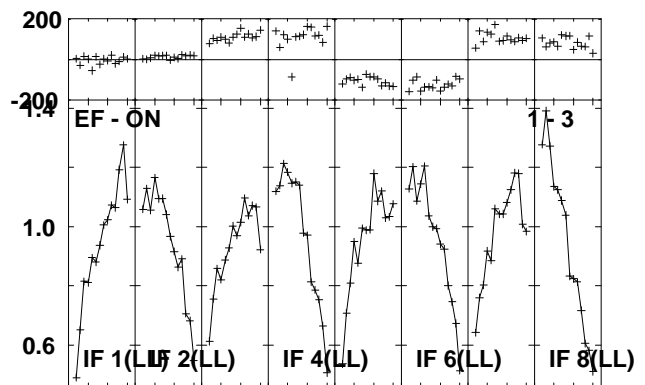
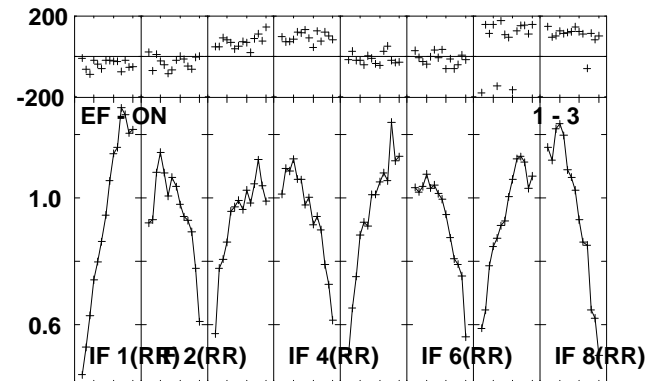
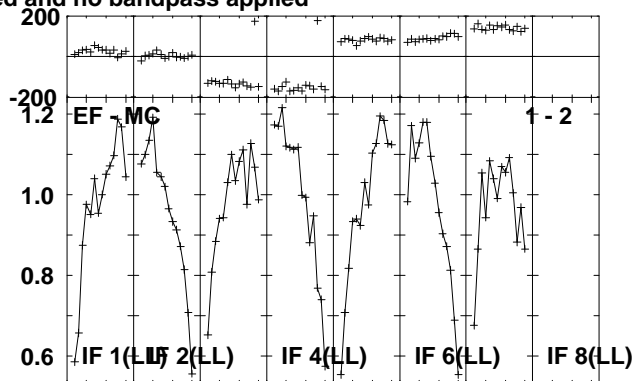
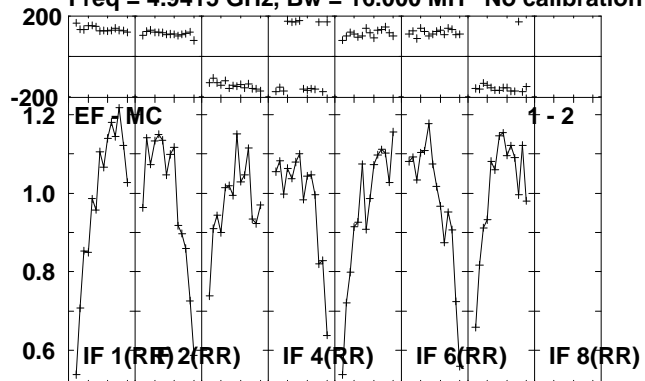

Lower frame: Milli Ampl Jy Top frame: Phas deg
Scalar averaged cross-power spectrum Several baselines displayed
Timerange: 01/01:52:51 to 01/01:57:49

Plot file version 244 created 14-JUL-2010 16:37:57
CYGX-1 RR004A.UVDATA.1
Freq = 4.9415 GHz, Bw = 16.000 MH No calibration applied and no bandpass applied

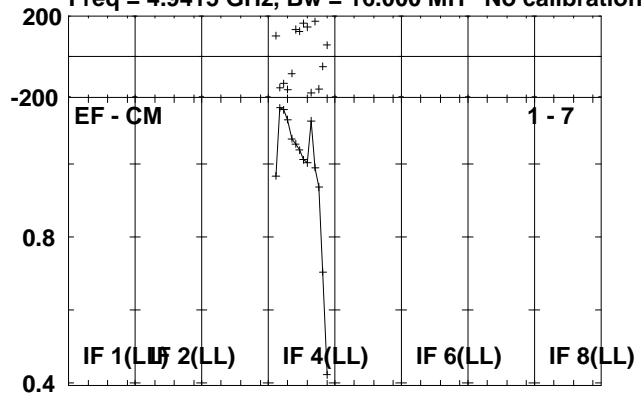

Lower frame: Milli Ampl Jy Top frame: Phas deg
Scalar averaged cross-power spectrum Several baselines displayed
Timerange: 01/01:52:51 to 01/01:57:49

Plot file version 245 created 14-JUL-2010 16:37:57

J1953+35 RR004A.UVDATA.1

Freq = 4.9415 GHz, Bw = 16.000 MH No calibration applied and no bandpass applied

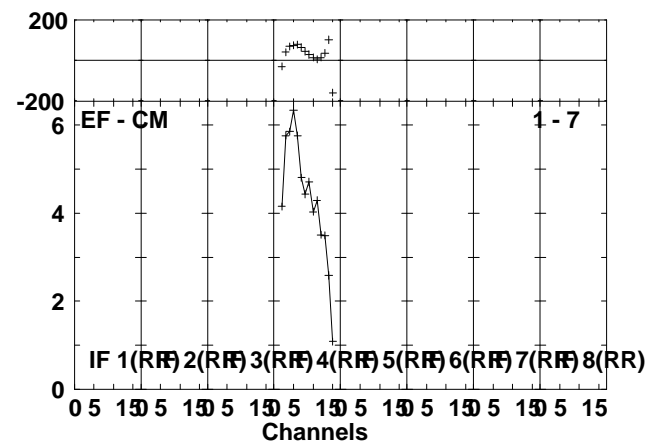
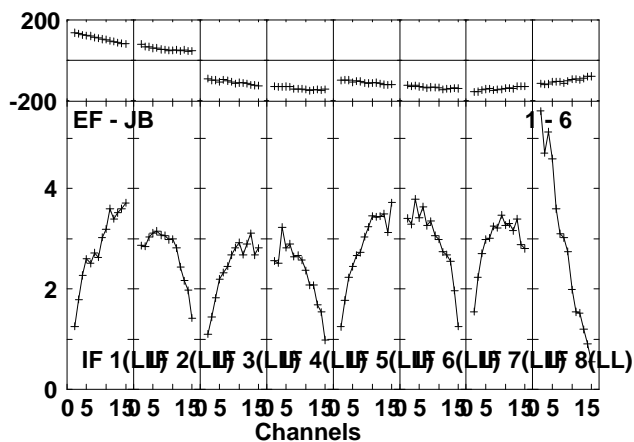
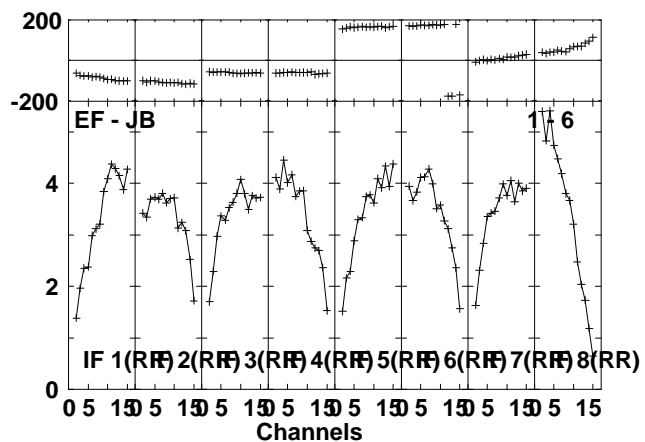
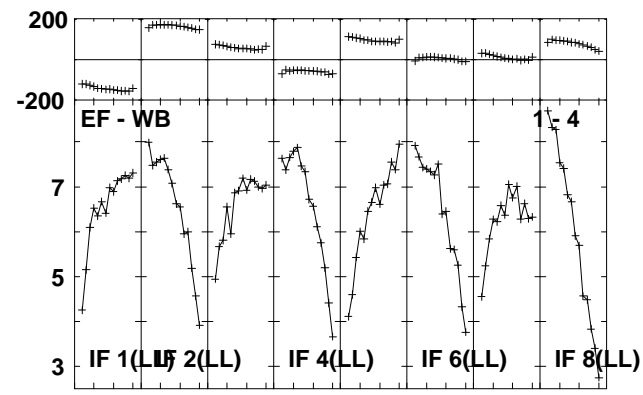
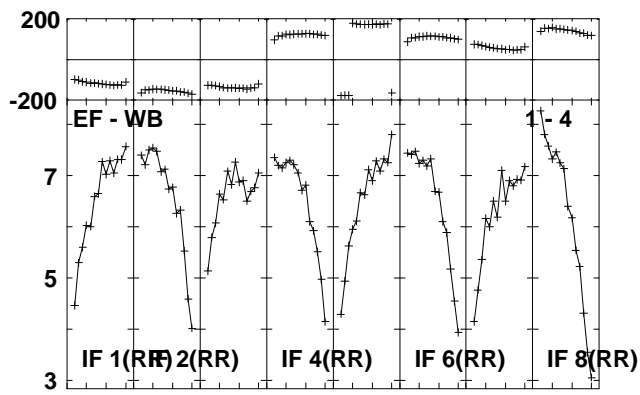
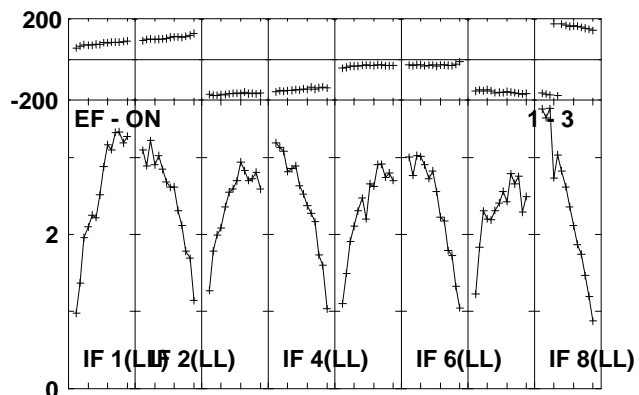
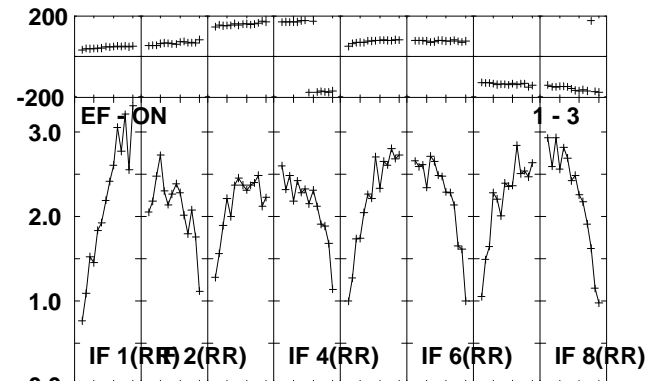
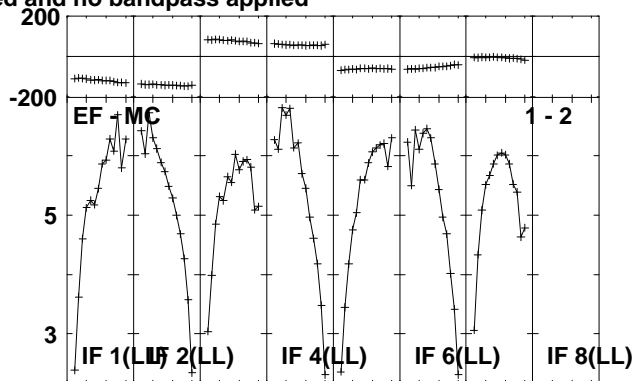
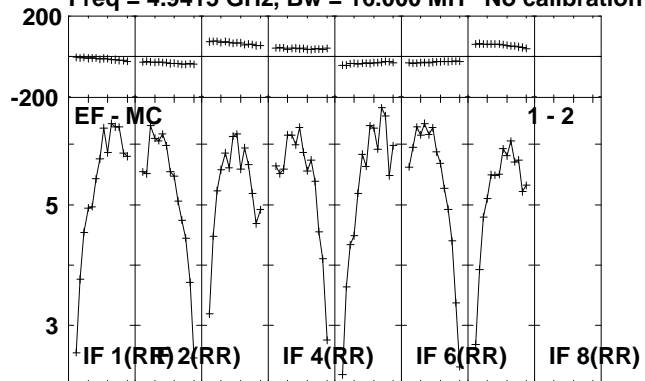

Lower frame: Milli Ampl Jy Top frame: Phas deg
Scalar averaged cross-power spectrum Several baselines displayed
Timerange: 01/01:57:51 to 01/01:59:49

Plot file version 246 created 14-JUL-2010 16:37:58
J1953+35 RR004A.UVDATA.1
Freq = 4.9415 GHz, Bw = 16.000 MH No calibration applied and no bandpass applied

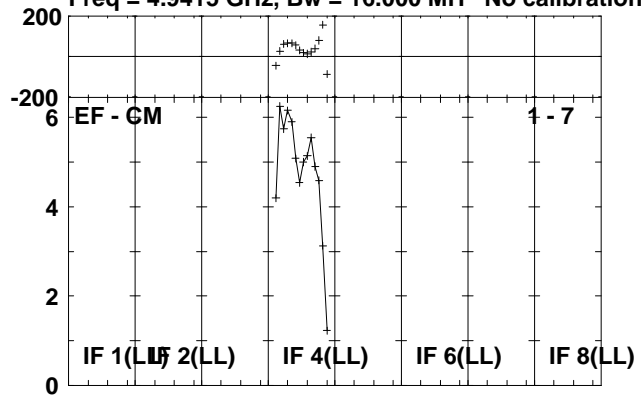

Lower frame: Milli Ampl Jy Top frame: Phas deg
Scalar averaged cross-power spectrum Several baselines displayed
Timerange: 01/01:57:51 to 01/01:59:49

Plot file version 247 created 14-JUL-2010 16:37:58

CYGX-1 RR004A.UVDATA.1

Freq = 4.9415 GHz, Bw = 16.000 MH No calibration applied and no bandpass applied

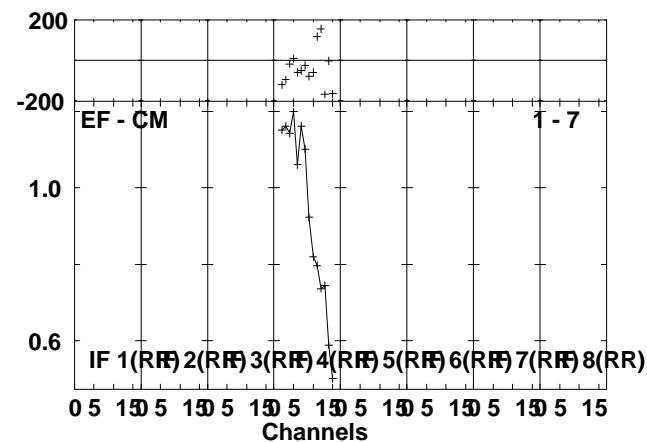
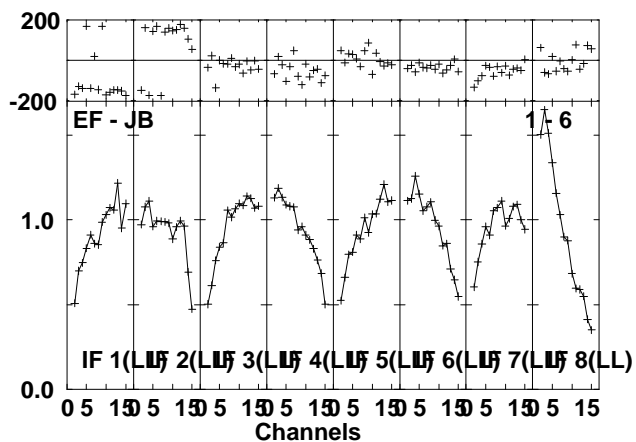
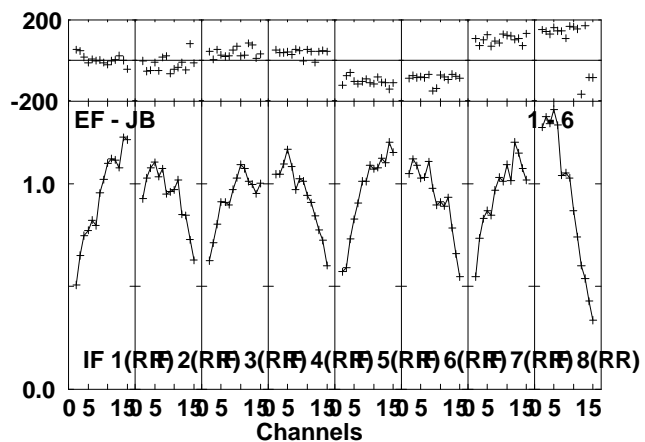
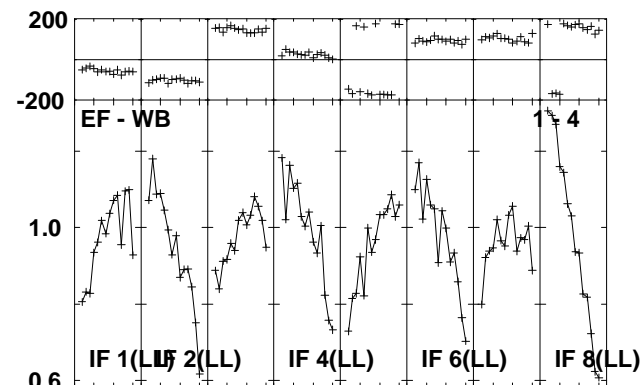
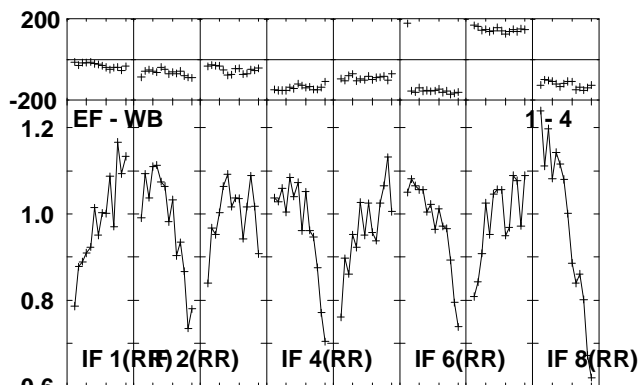
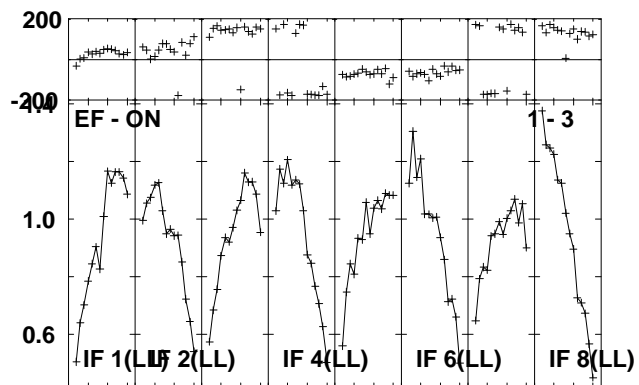
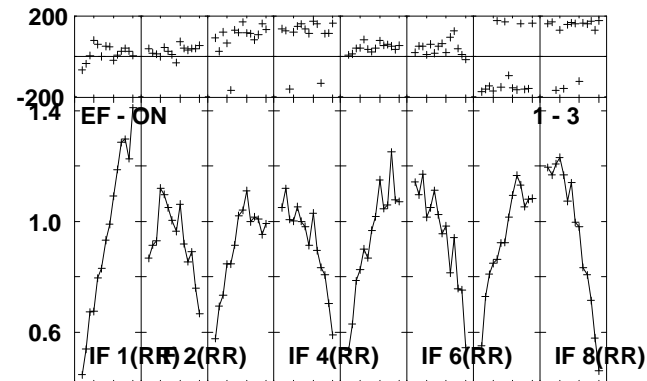
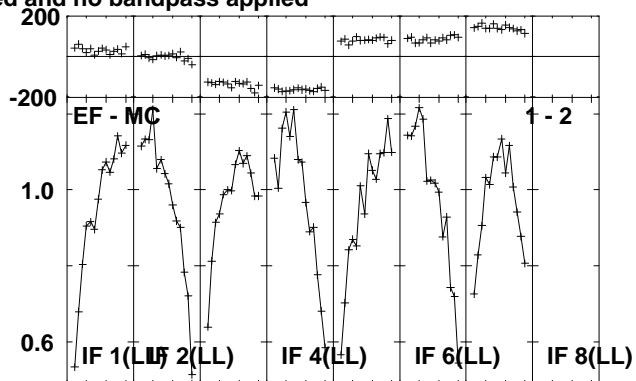
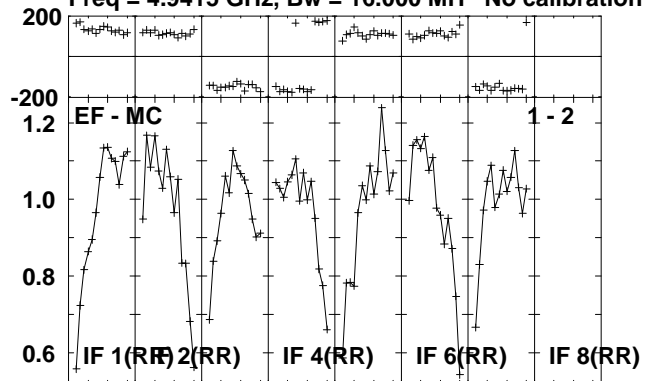

Lower frame: Milli Ampl Jy Top frame: Phas deg
Scalar averaged cross-power spectrum Several baselines displayed
Timerange: 01/01:59:51 to 01/02:04:49

Plot file version 248 created 14-JUL-2010 16:37:59
CYGX-1 RR004A.UVDATA.1
Freq = 4.9415 GHz, Bw = 16.000 MH No calibration applied and no bandpass applied

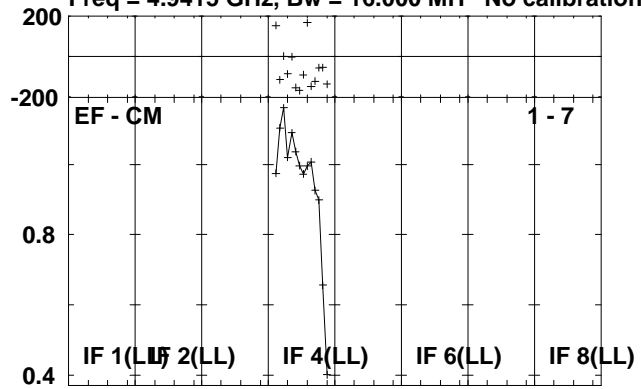

Lower frame: Milli Ampl Jy Top frame: Phas deg
Scalar averaged cross-power spectrum Several baselines displayed
Timerange: 01/01:59:51 to 01/02:04:49

Plot file version 249 created 14-JUL-2010 16:38:00

J1953+35 RR004A.UVDATA.1

Freq = 4.9415 GHz, Bw = 16.000 MH No calibration applied and no bandpass applied

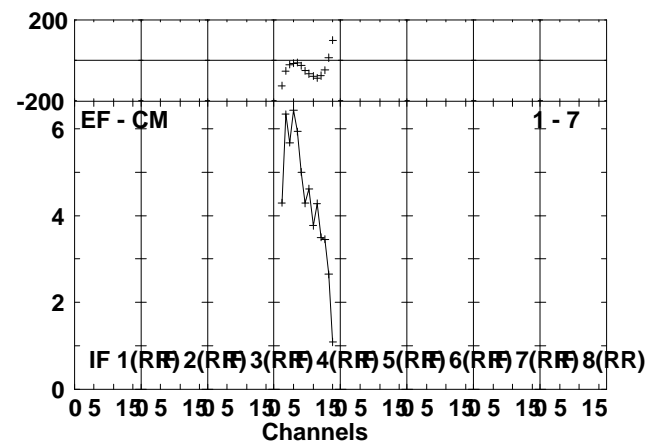
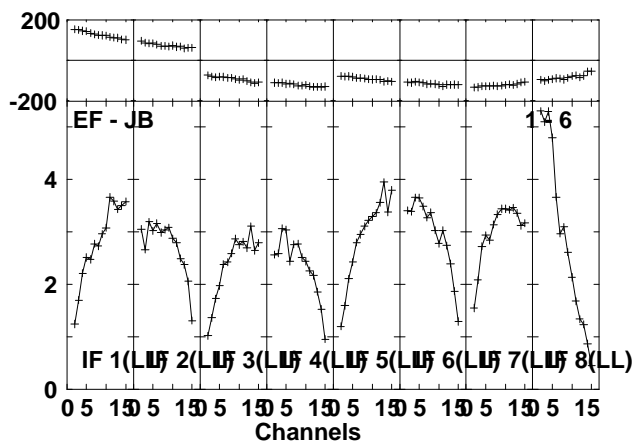
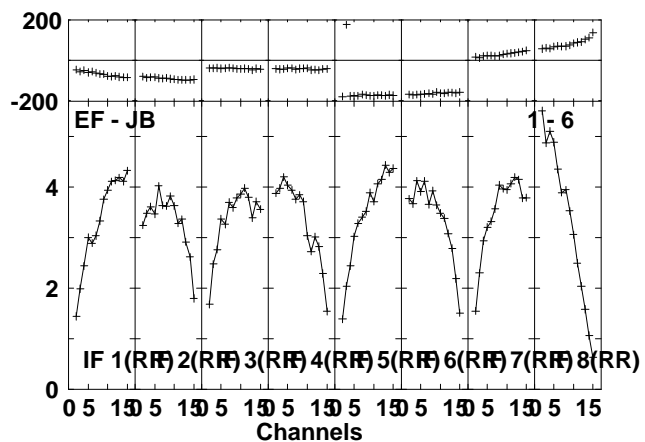
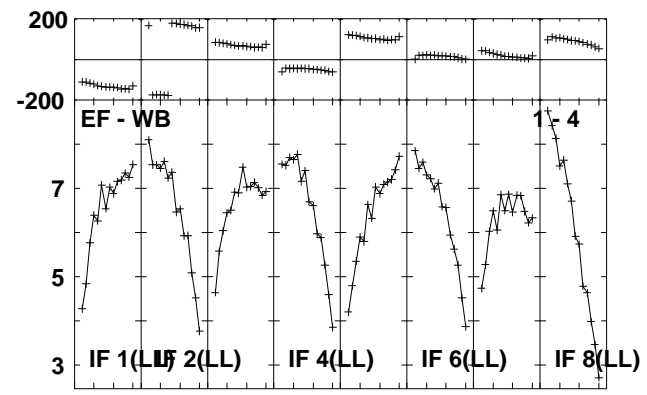
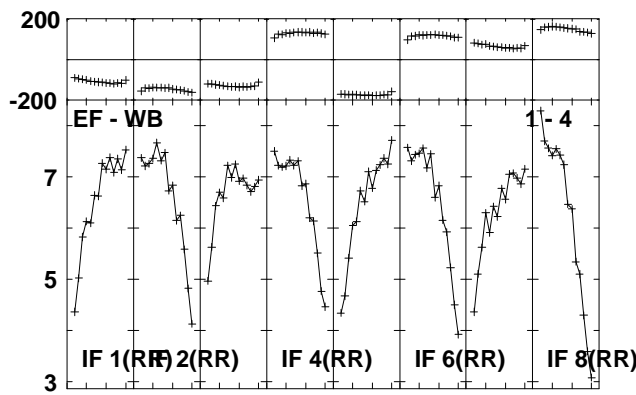
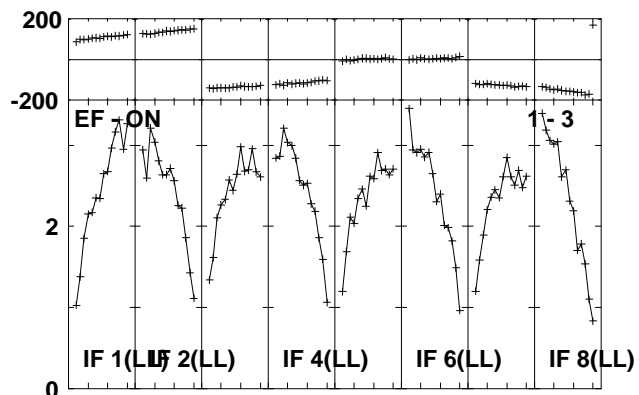
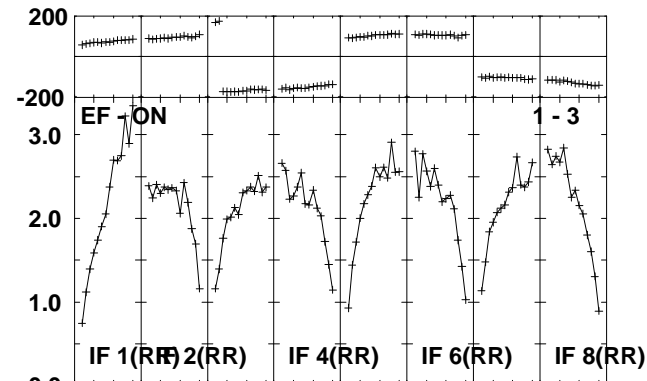
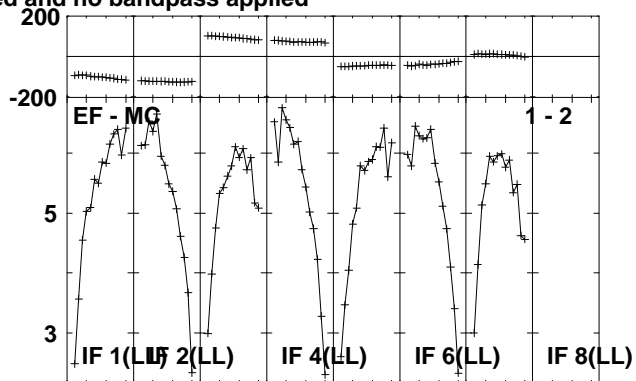
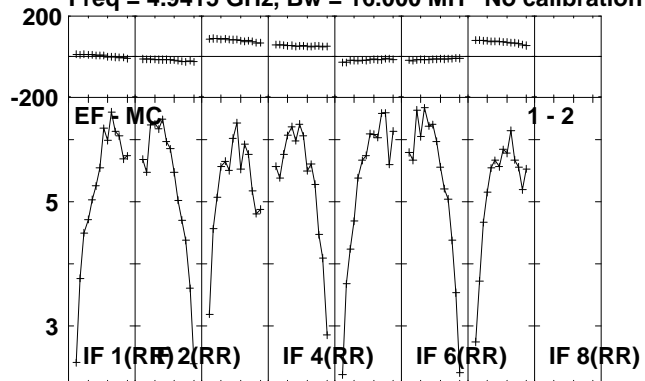

Lower frame: Milli Ampl Jy Top frame: Phas deg
Scalar averaged cross-power spectrum Several baselines displayed
Timerange: 01/02:05:41 to 01/02:07:09

Plot file version 250 created 14-JUL-2010 16:38:00
J1953+35 RR004A.UVDATA.1
Freq = 4.9415 GHz, Bw = 16.000 MH No calibration applied and no bandpass applied

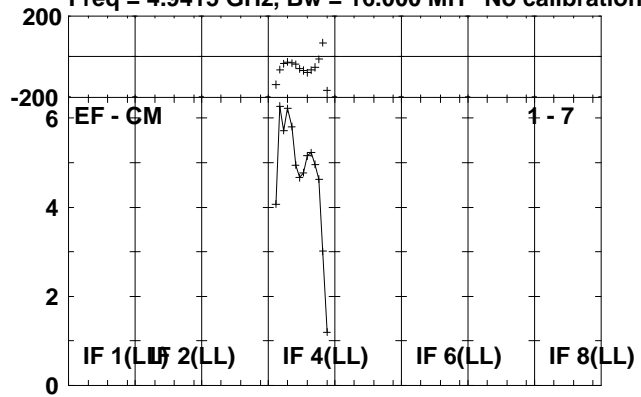

Lower frame: Milli Ampl Jy Top frame: Phas deg
Scalar averaged cross-power spectrum Several baselines displayed
Timerange: 01/02:05:41 to 01/02:07:09

Plot file version 251 created 14-JUL-2010 16:38:01

CYGX-1 RR004A.UVDATA.1

Freq = 4.9415 GHz, Bw = 16.000 MH No calibration applied and no bandpass applied

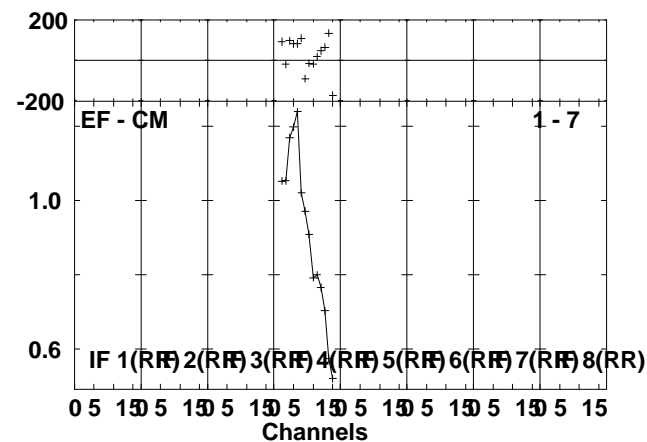
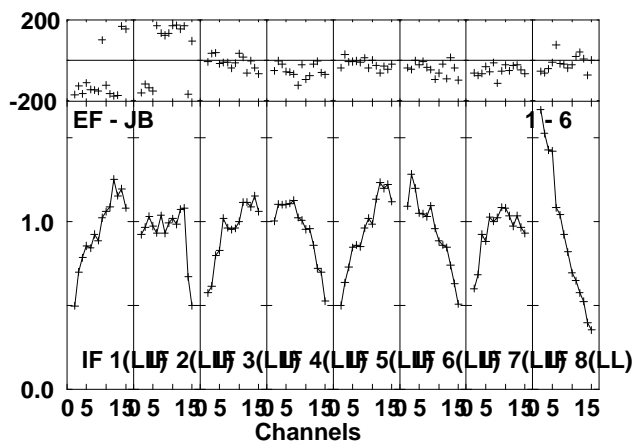
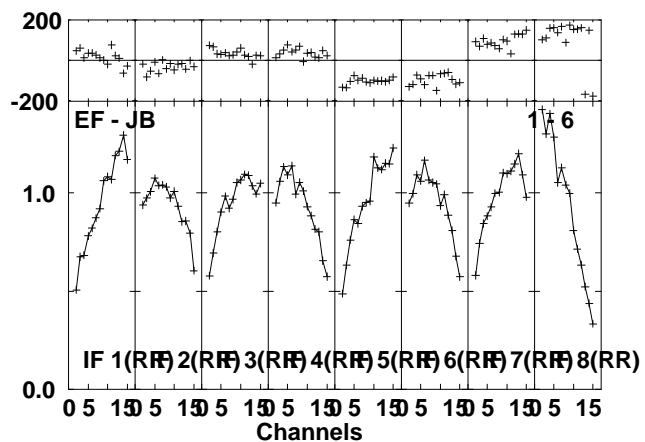
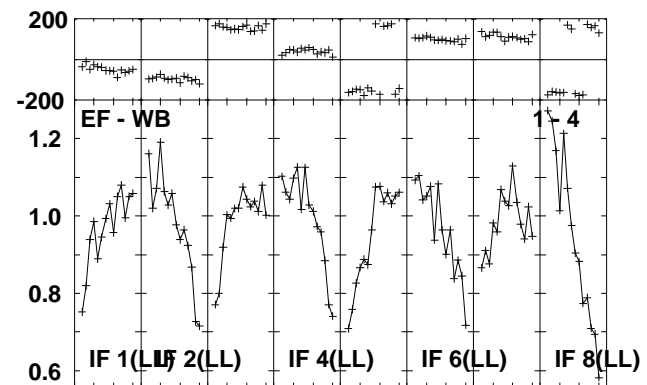
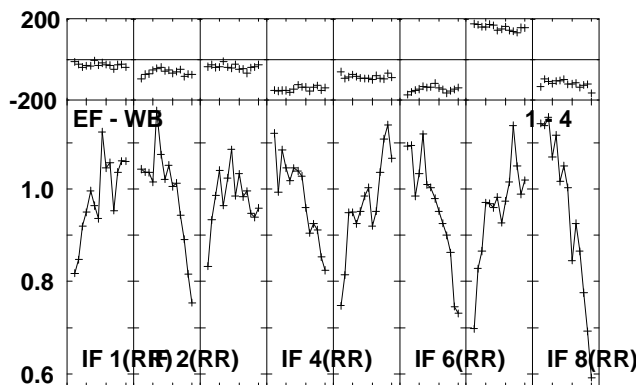
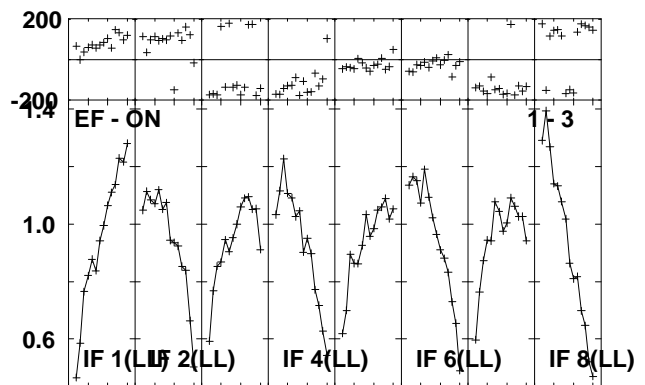
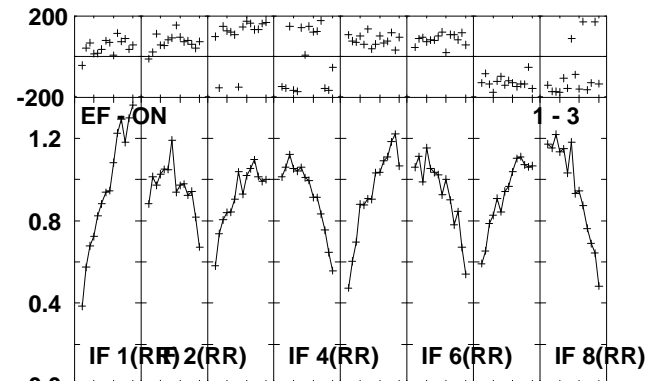
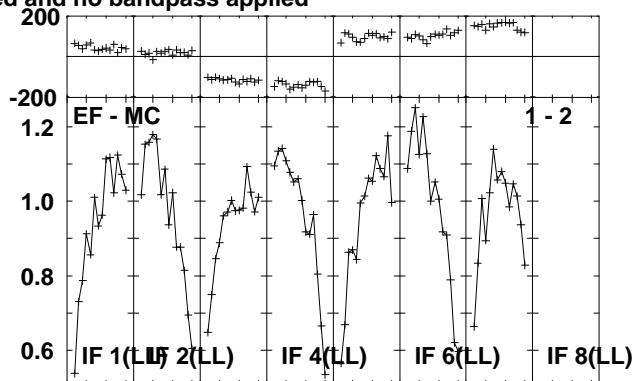
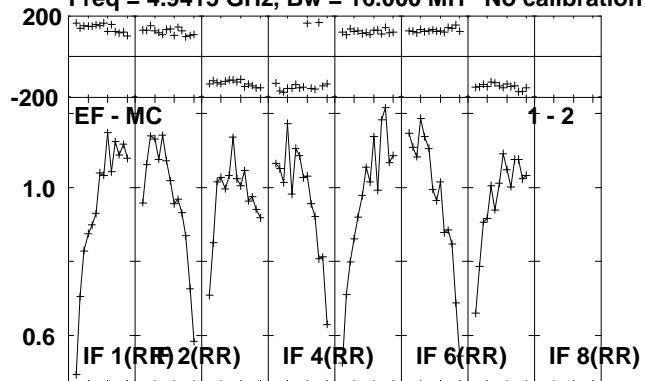

Lower frame: Milli Ampl Jy Top frame: Phas deg
Scalar averaged cross-power spectrum Several baselines displayed
Timerange: 01/02:07:11 to 01/02:12:09

Plot file version 252 created 14-JUL-2010 16:38:02
CYGX-1 RR004A.UVDATA.1
Freq = 4.9415 GHz, Bw = 16.000 MH No calibration applied and no bandpass applied

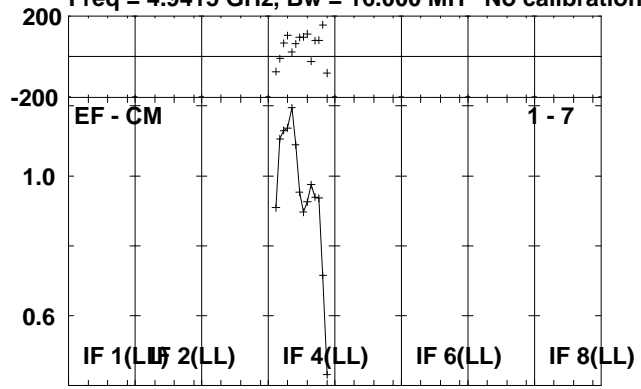

Lower frame: Milli Ampl Jy Top frame: Phas deg
Scalar averaged cross-power spectrum Several baselines displayed
Timerange: 01/02:07:11 to 01/02:12:09

Plot file version 253 created 14-JUL-2010 16:38:03

J1953+35 RR004A.UVDATA.1

Freq = 4.9415 GHz, Bw = 16.000 MH No calibration applied and no bandpass applied

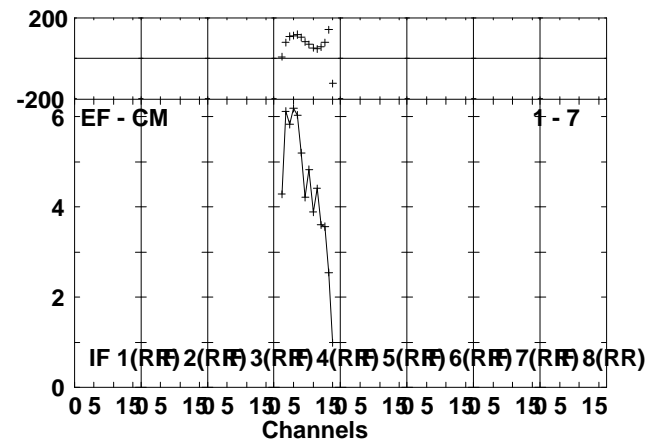
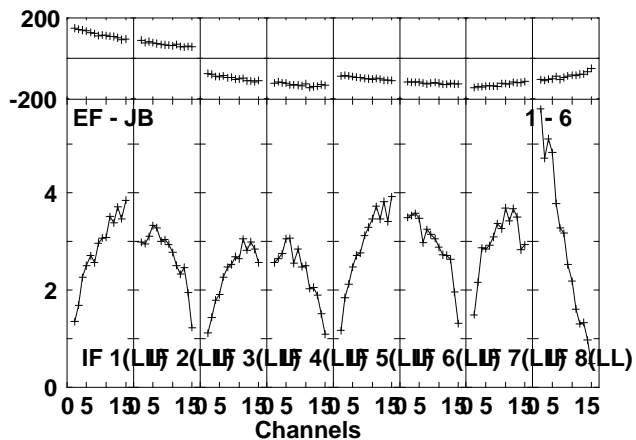
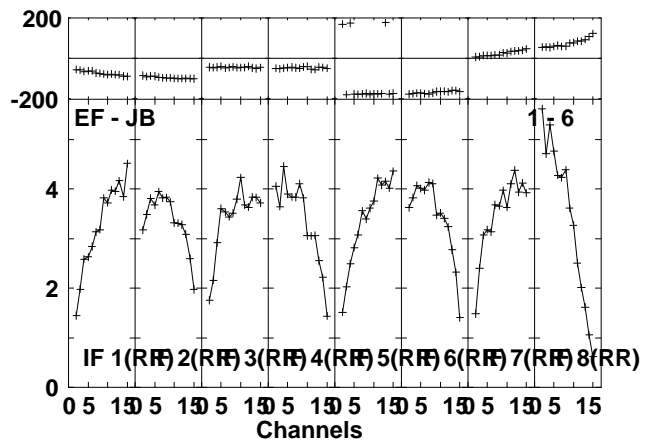
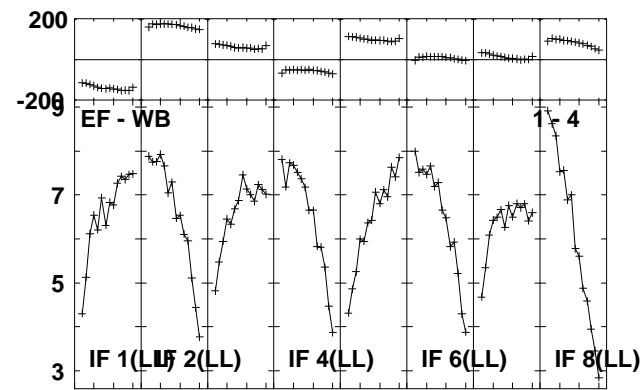
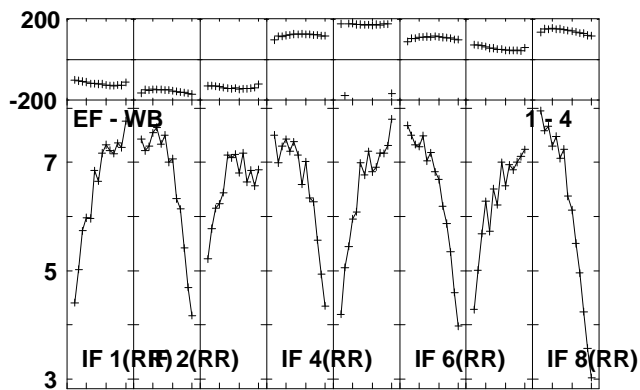
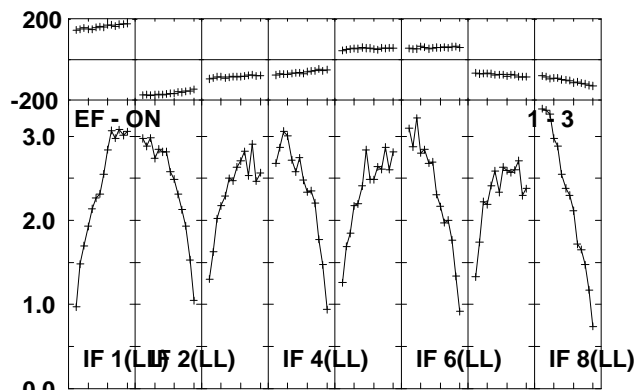
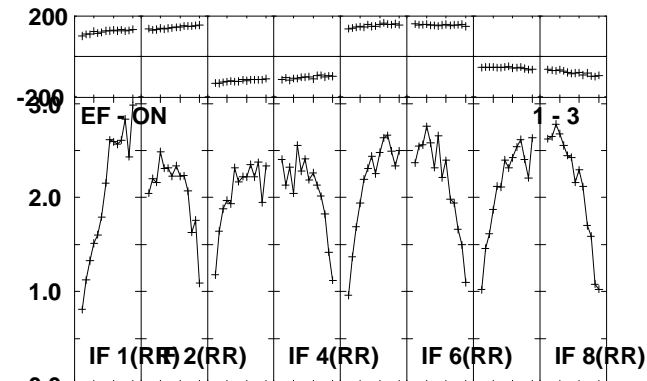
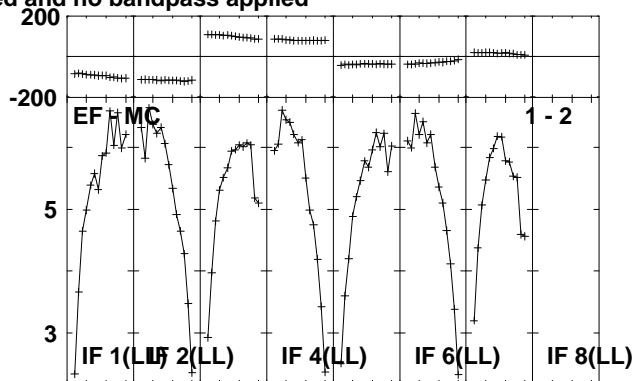
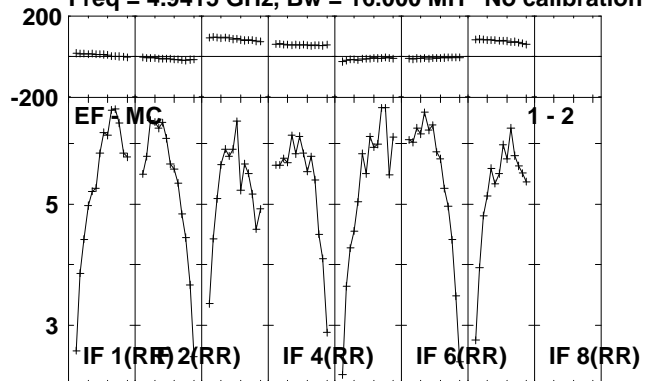

Lower frame: Milli Ampl Jy Top frame: Phas deg
Scalar averaged cross-power spectrum Several baselines displayed
Timerange: 01/02:12:11 to 01/02:14:09

Plot file version 254 created 14-JUL-2010 16:38:03
J1953+35 RR004A.UVDATA.1
Freq = 4.9415 GHz, Bw = 16.000 MH No calibration applied and no bandpass applied

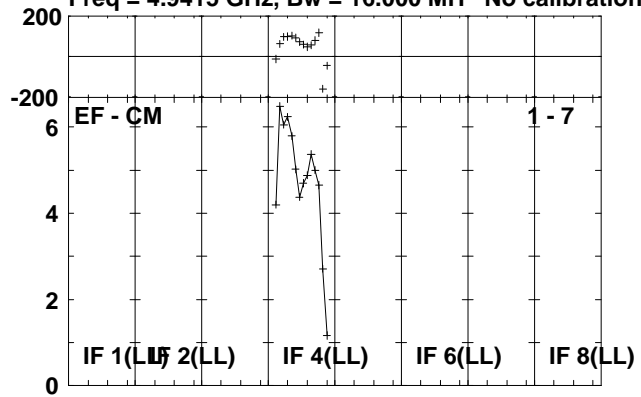

Lower frame: Milli Ampl Jy Top frame: Phas deg
Scalar averaged cross-power spectrum Several baselines displayed
Timerange: 01/02:12:11 to 01/02:14:09

Plot file version 255 created 14-JUL-2010 16:38:03

CYGX-1 RR004A.UVDATA.1

Freq = 4.9415 GHz, Bw = 16.000 MH No calibration applied and no bandpass applied

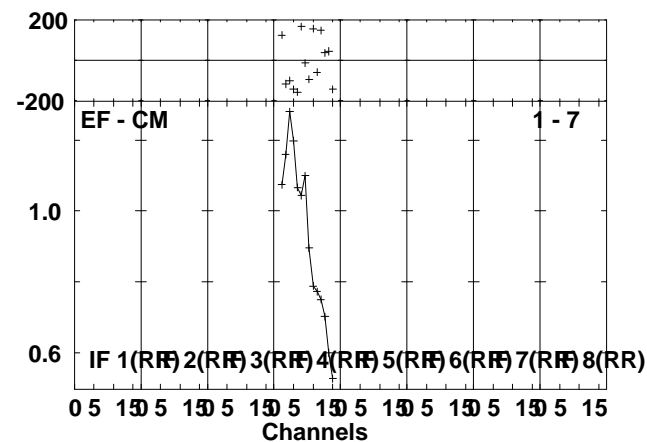
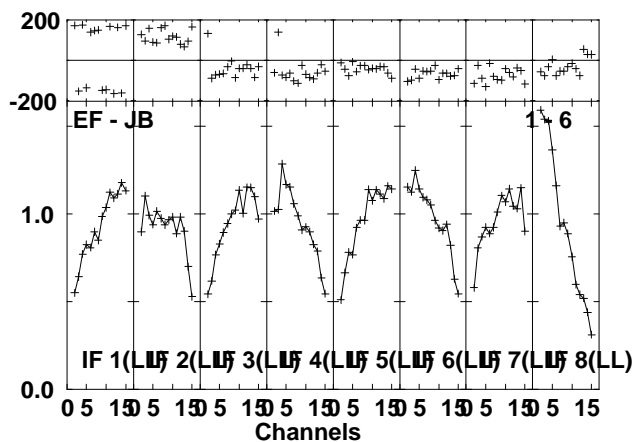
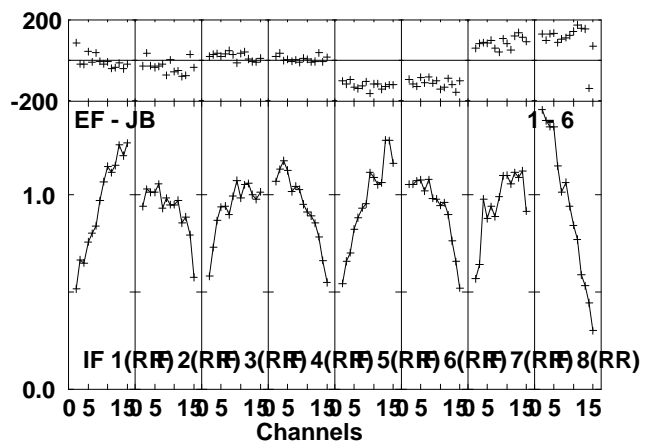
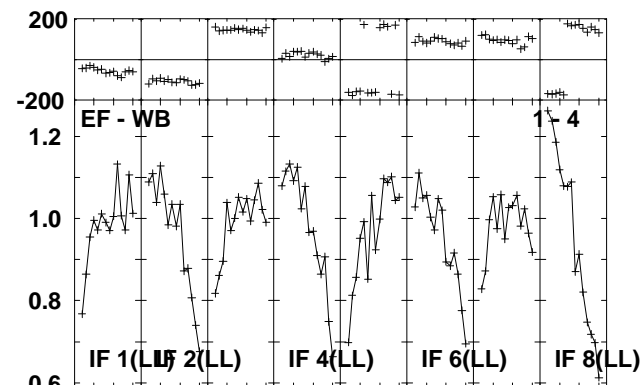
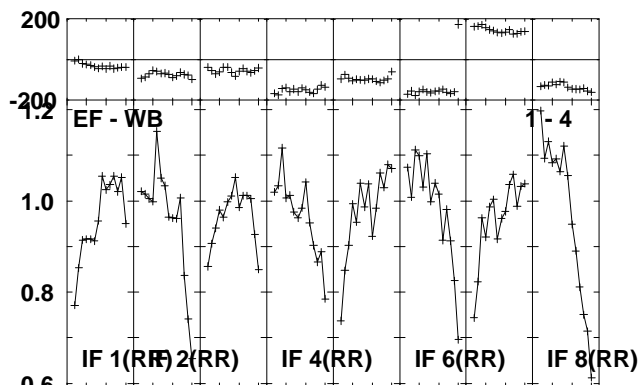
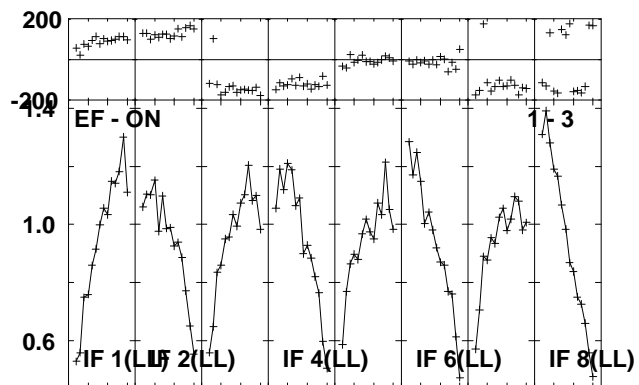
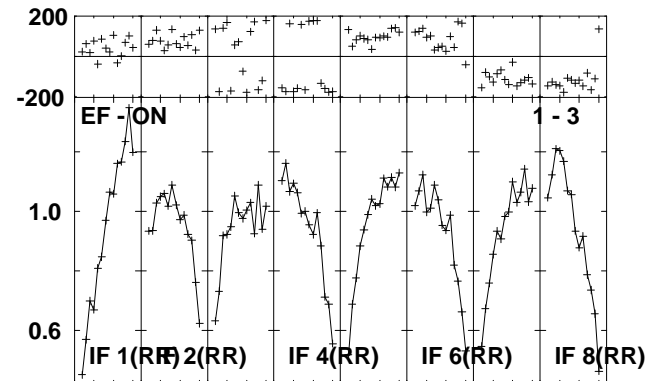
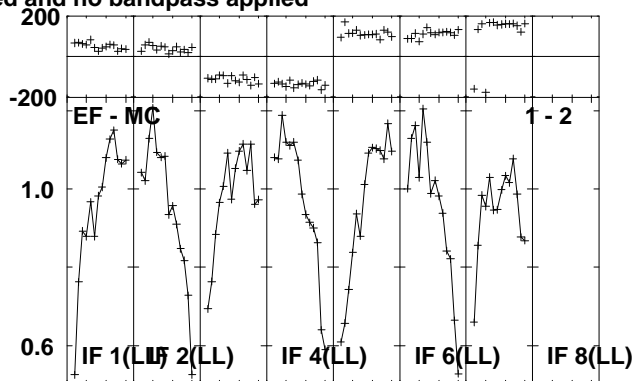
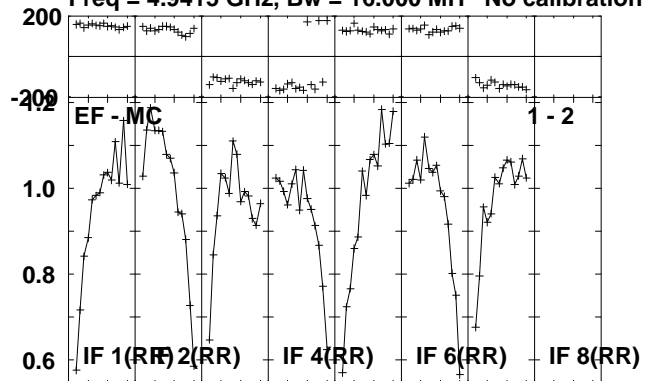

Lower frame: Milli Ampl Jy Top frame: Phas deg
Scalar averaged cross-power spectrum Several baselines displayed
Timerange: 01/02:14:11 to 01/02:19:09

Plot file version 256 created 14-JUL-2010 16:38:05
CYGX-1 RR004A.UVDATA.1
Freq = 4.9415 GHz, Bw = 16.000 MH No calibration applied and no bandpass applied

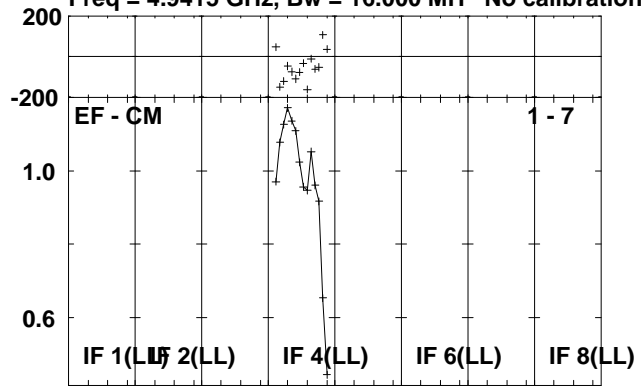

Lower frame: Milli Ampl Jy Top frame: Phas deg
Scalar averaged cross-power spectrum Several baselines displayed
Timerange: 01/02:14:11 to 01/02:19:09

Plot file version 257 created 14-JUL-2010 16:38:05

J1953+35 RR004A.UVDATA.1

Freq = 4.9415 GHz, Bw = 16.000 MH No calibration applied and no bandpass applied

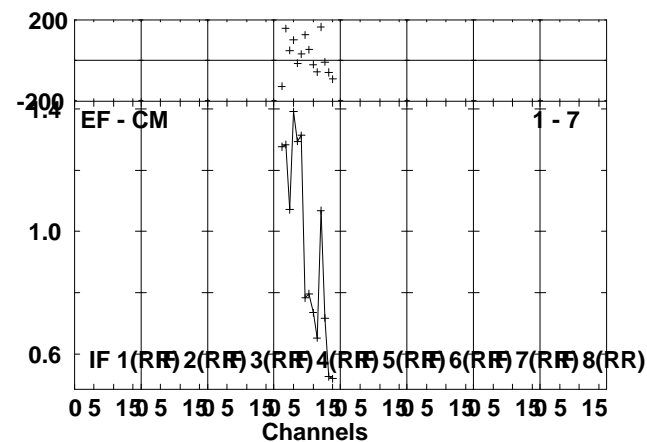
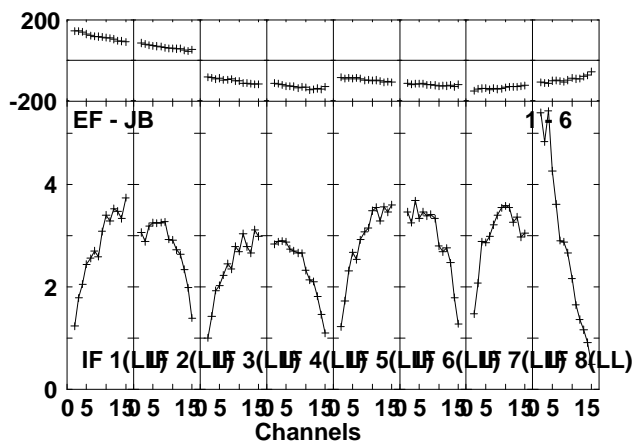
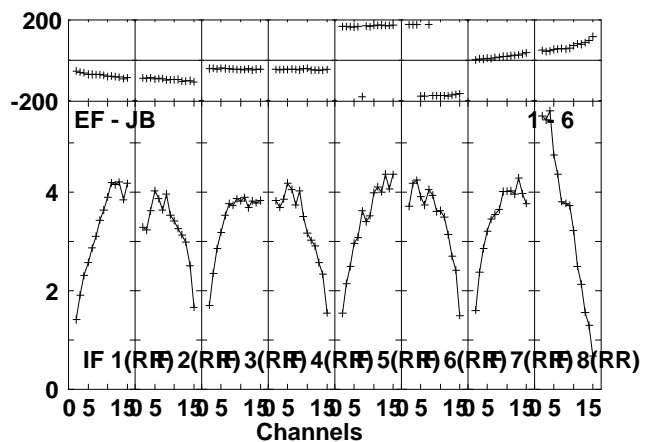
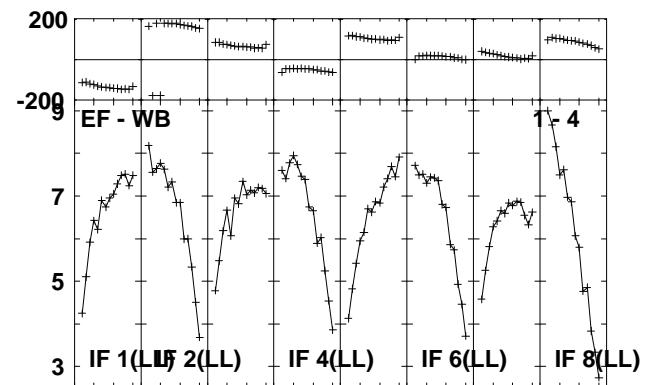
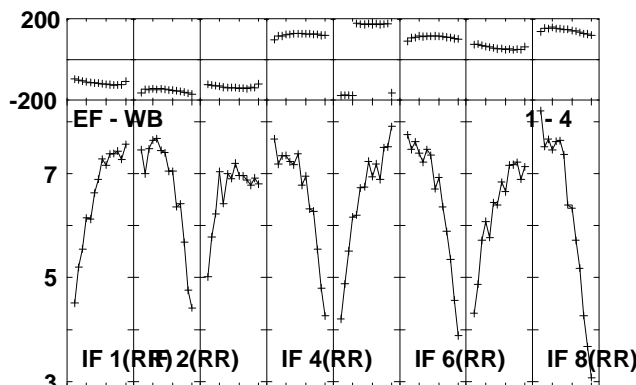
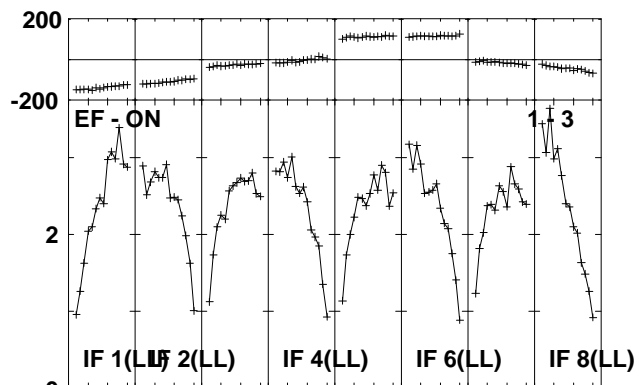
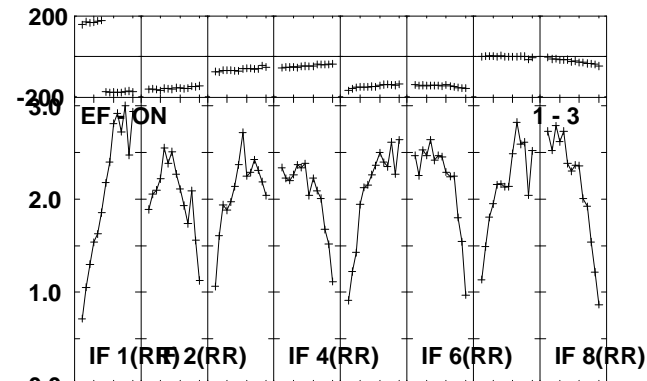
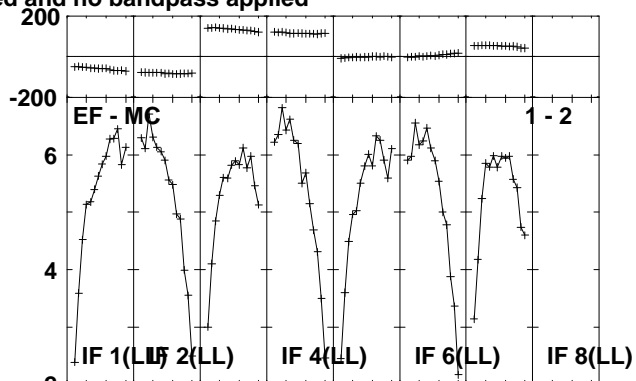
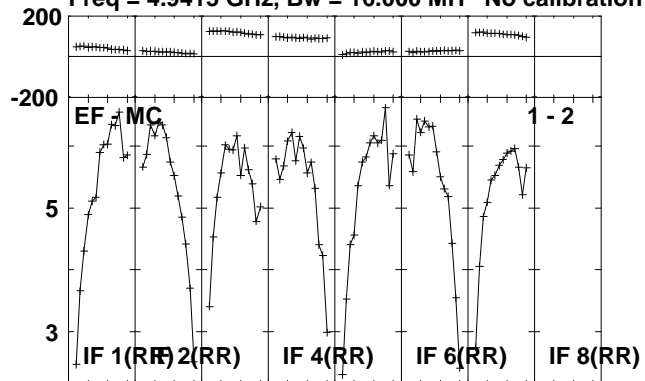

Lower frame: Milli Ampl Jy Top frame: Phas deg
Scalar averaged cross-power spectrum Several baselines displayed
Timerange: 01/02:20:01 to 01/02:21:29

Plot file version 258 created 14-JUL-2010 16:38:06
J1953+35 RR004A.UVDATA.1
Freq = 4.9415 GHz, Bw = 16.000 MH No calibration applied and no bandpass applied

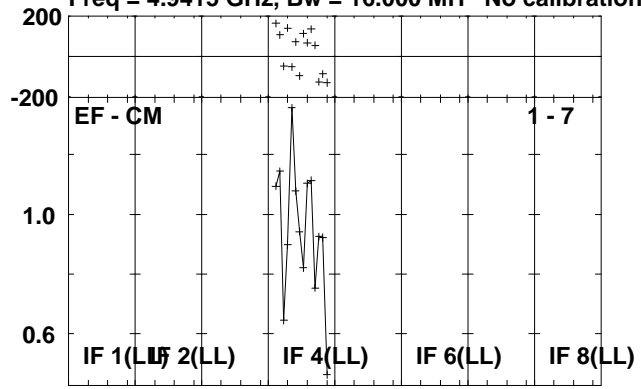

Lower frame: Milli Ampl Jy Top frame: Phas deg
Scalar averaged cross-power spectrum Several baselines displayed
Timerange: 01/02:20:01 to 01/02:21:29

Plot file version 259 created 14-JUL-2010 16:38:06

CYGX-1 RR004A.UVDATA.1

Freq = 4.9415 GHz, Bw = 16.000 MH No calibration applied and no bandpass applied

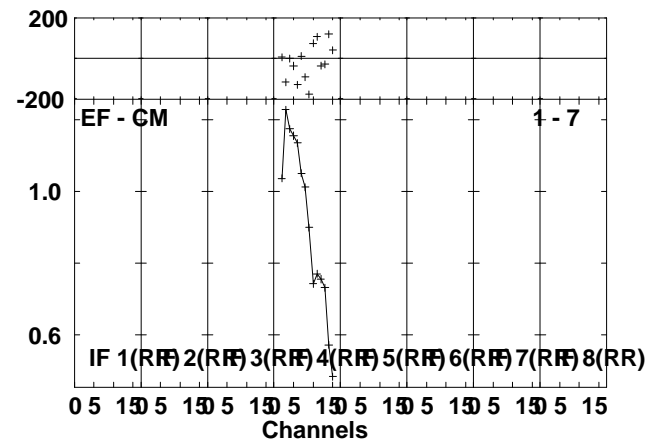
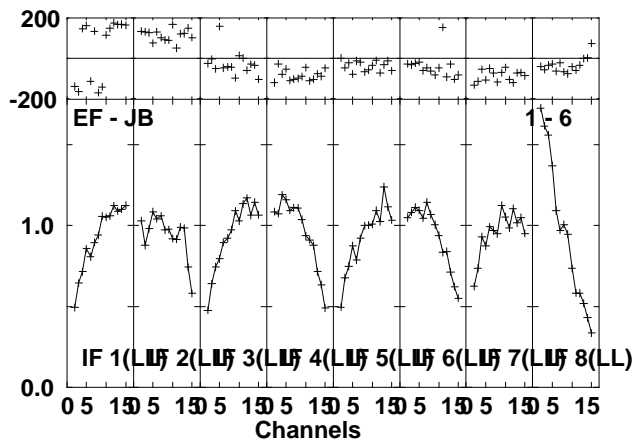
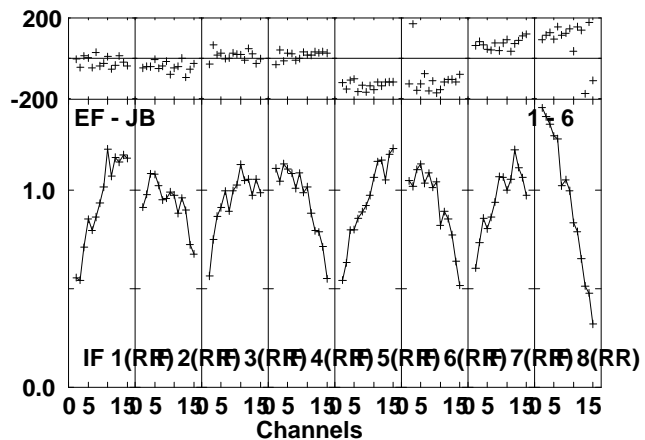
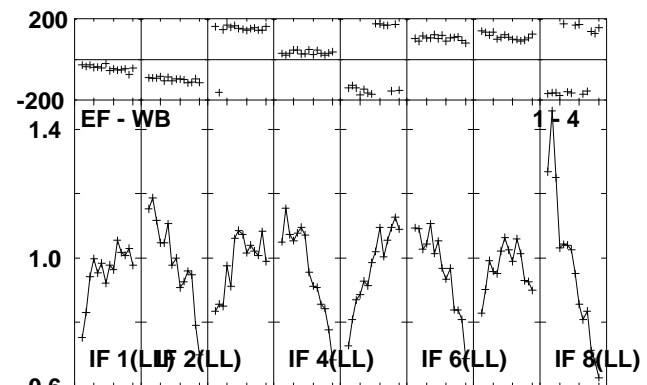
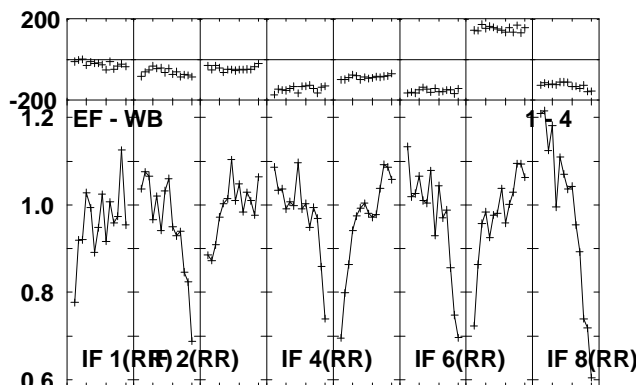
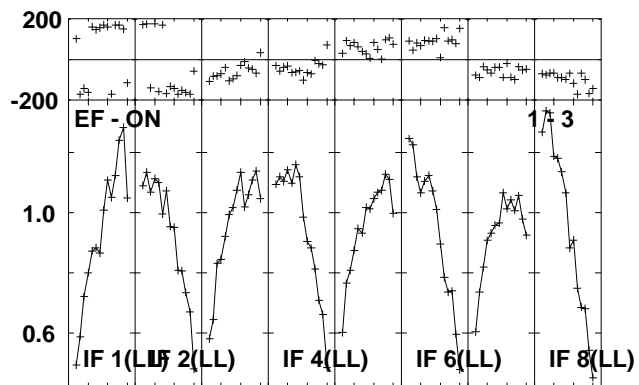
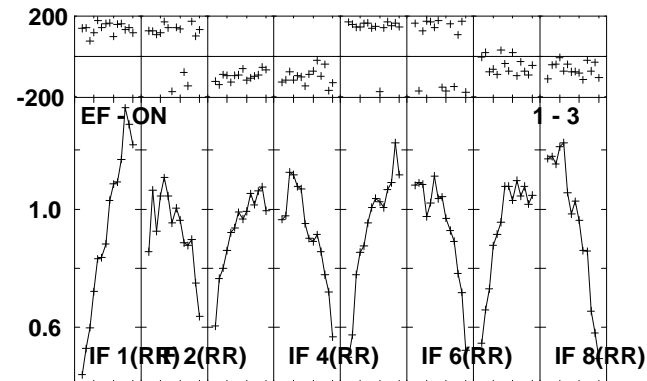
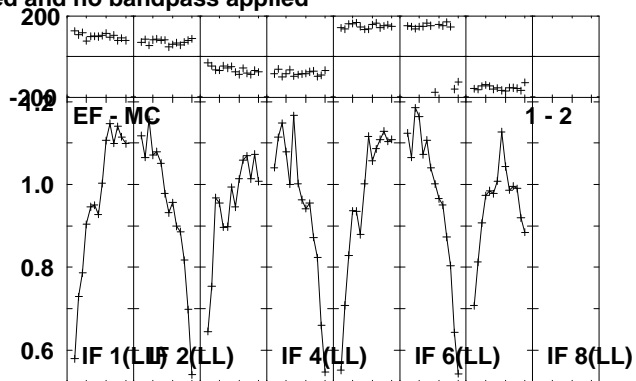
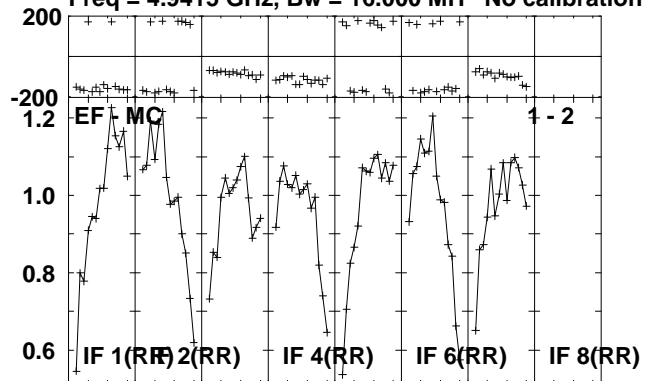

Lower frame: Milli Ampl Jy Top frame: Phas deg
Scalar averaged cross-power spectrum Several baselines displayed
Timerange: 01/02:21:31 to 01/02:26:29

Plot file version 260 created 14-JUL-2010 16:38:07
CYGX-1 RR004A.UVDATA.1
Freq = 4.9415 GHz, Bw = 16.000 MH No calibration applied and no bandpass applied

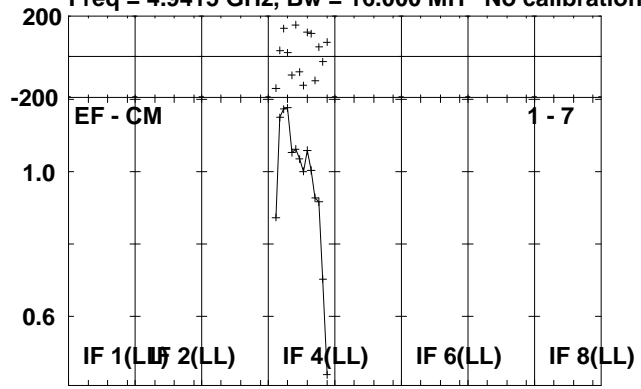

Lower frame: Milli Ampl Jy Top frame: Phas deg
Scalar averaged cross-power spectrum Several baselines displayed
Timerange: 01/02:21:31 to 01/02:26:29

Plot file version 261 created 14-JUL-2010 16:38:08

J1953+35 RR004A.UVDATA.1

Freq = 4.9415 GHz, Bw = 16.000 MH No calibration applied and no bandpass applied

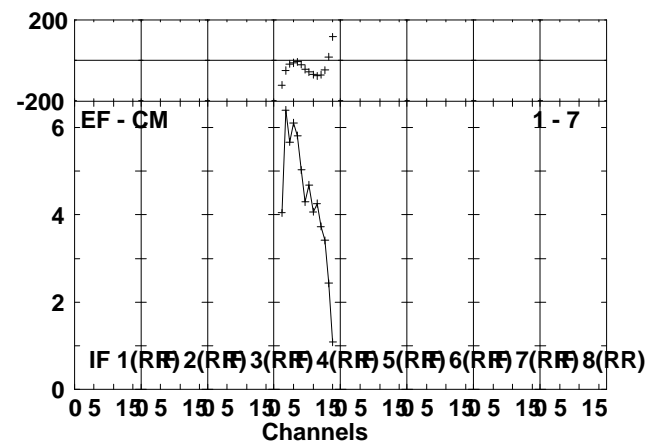
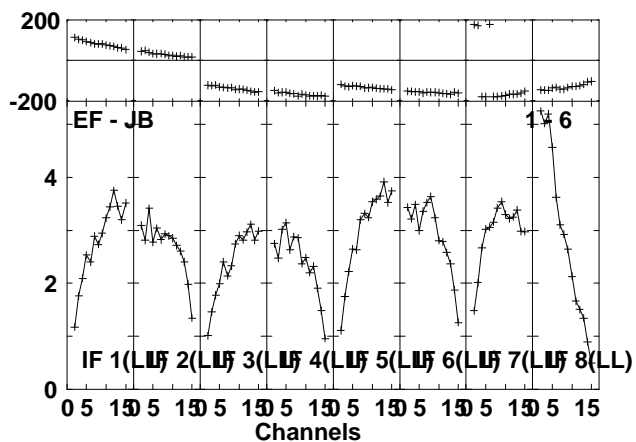
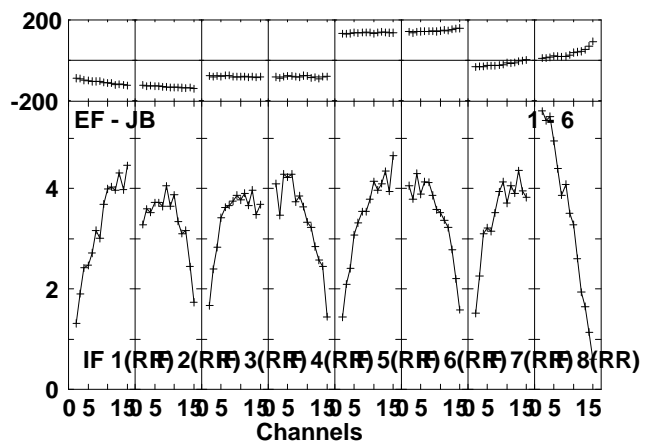
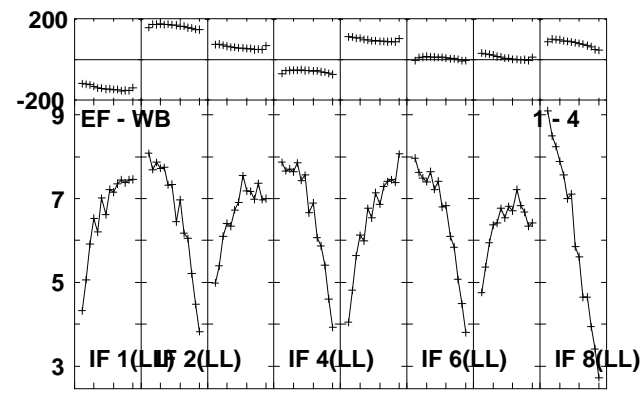
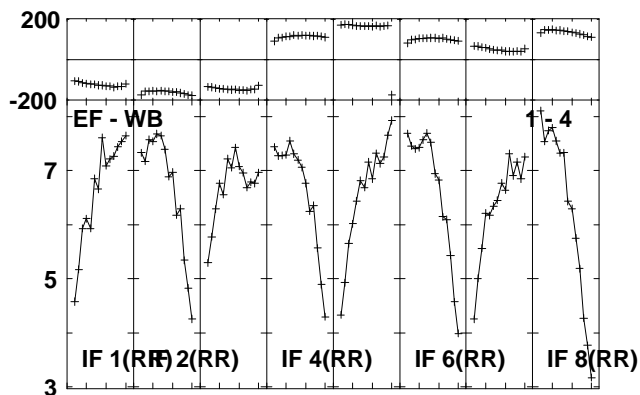
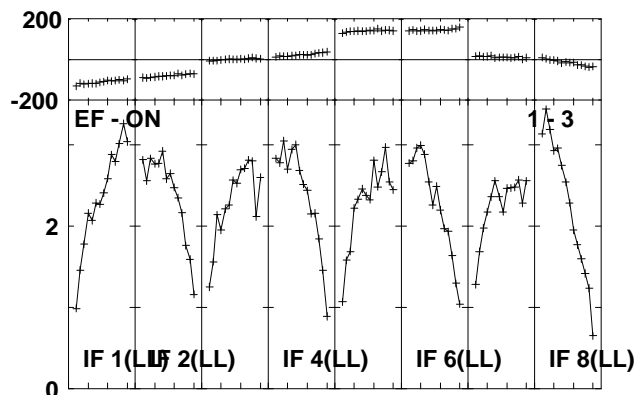
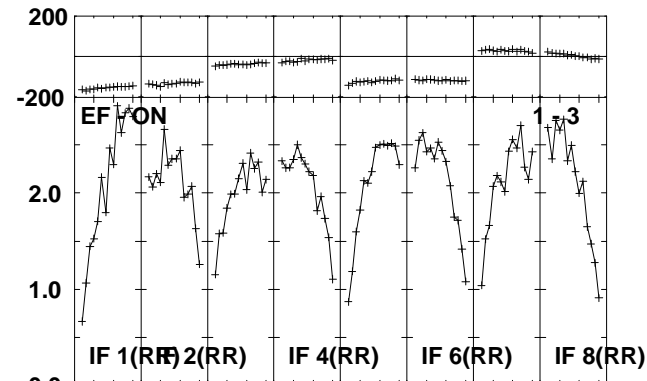
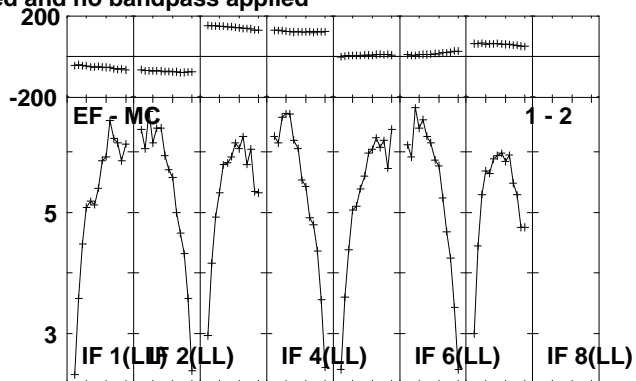
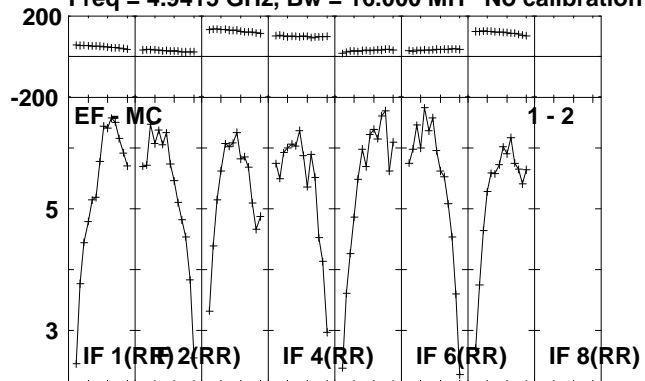

Lower frame: Milli Ampl Jy Top frame: Phas deg
Scalar averaged cross-power spectrum Several baselines displayed
Timerange: 01/02:26:31 to 01/02:28:29

Plot file version 262 created 14-JUL-2010 16:38:08
J1953+35 RR004A.UVDATA.1
Freq = 4.9415 GHz, Bw = 16.000 MH No calibration applied and no bandpass applied

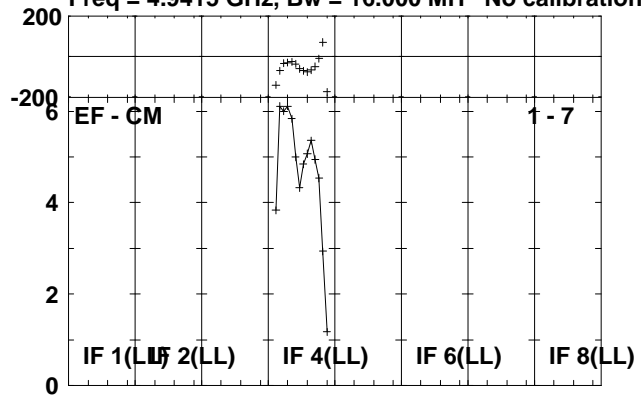

Lower frame: Milli Ampl Jy Top frame: Phas deg
Scalar averaged cross-power spectrum Several baselines displayed
Timerange: 01/02:26:31 to 01/02:28:29

Plot file version 263 created 14-JUL-2010 16:38:09

CYGX-1 RR004A.UVDATA.1

Freq = 4.9415 GHz, Bw = 16.000 MH No calibration applied and no bandpass applied

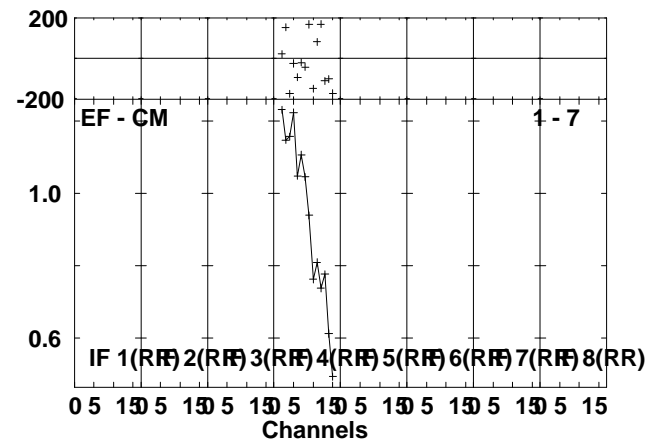
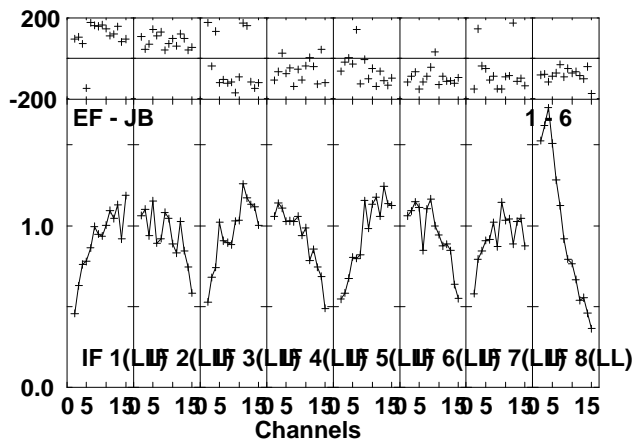
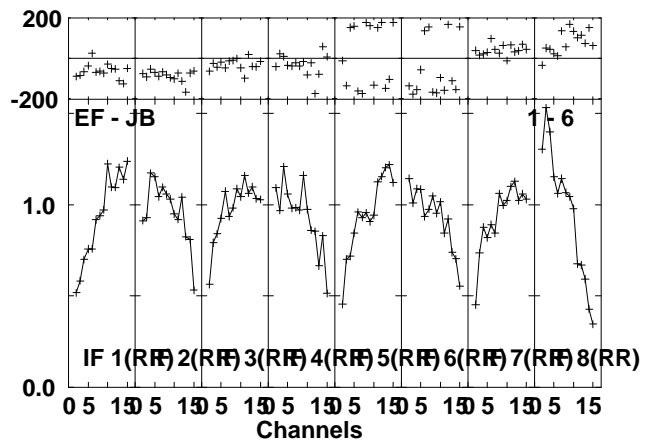
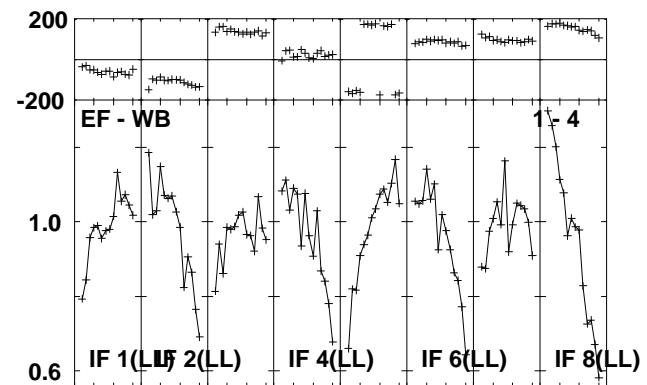
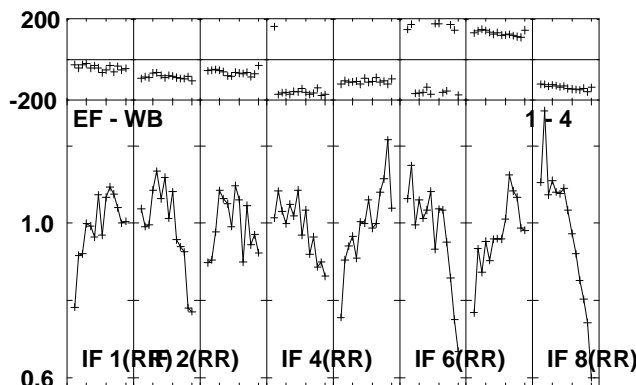
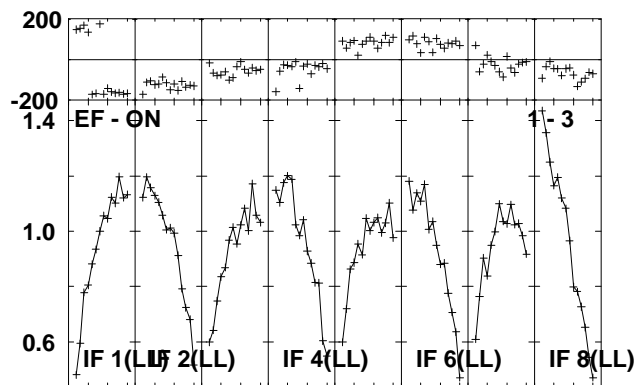
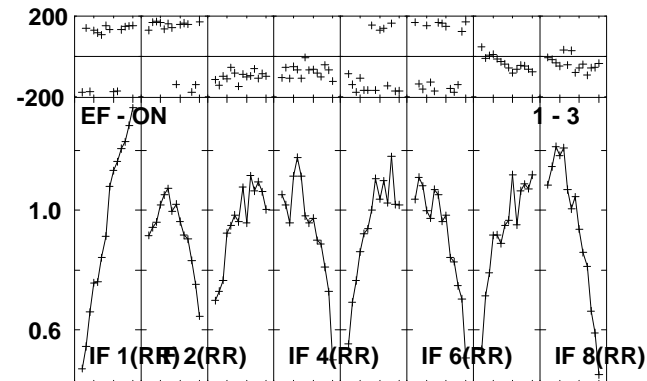
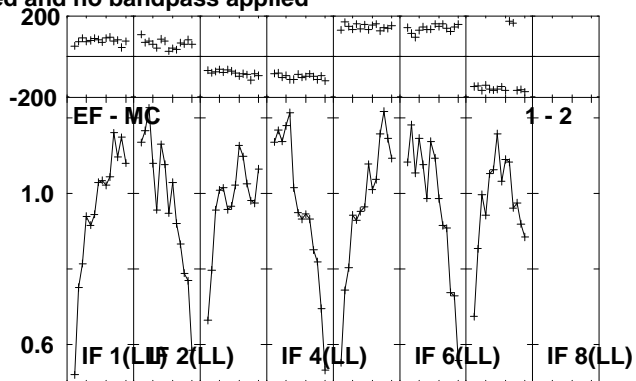
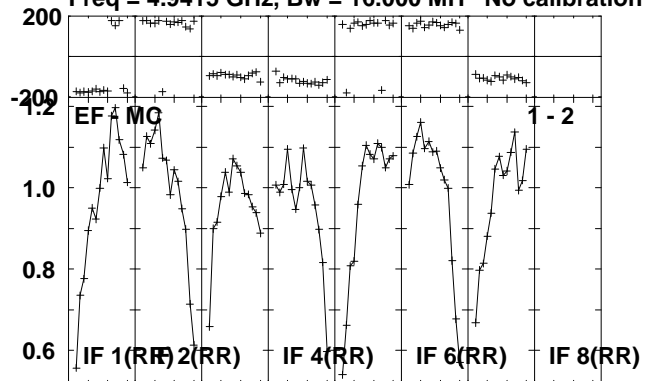

Lower frame: Milli Ampl Jy Top frame: Phas deg
Scalar averaged cross-power spectrum Several baselines displayed
Timerange: 01/02:28:31 to 01/02:33:29

Plot file version 264 created 14-JUL-2010 16:38:10
CYGX-1 RR004A.UVDATA.1
Freq = 4.9415 GHz, Bw = 16.000 MH No calibration applied and no bandpass applied

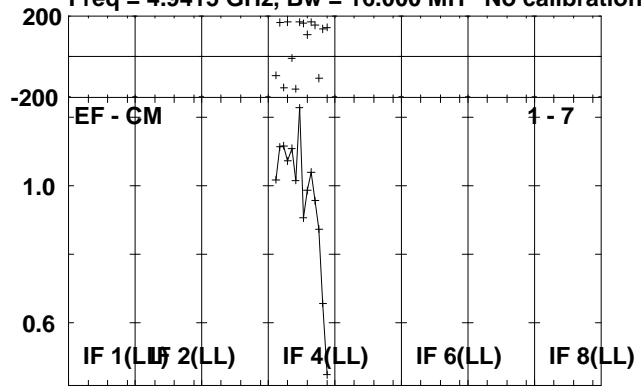

Lower frame: Milli Ampl Jy Top frame: Phas deg
Scalar averaged cross-power spectrum Several baselines displayed
Timerange: 01/02:28:31 to 01/02:33:29

Plot file version 265 created 14-JUL-2010 16:38:10

J1953+35 RR004A.UVDATA.1

Freq = 4.9415 GHz, Bw = 16.000 MH No calibration applied and no bandpass applied

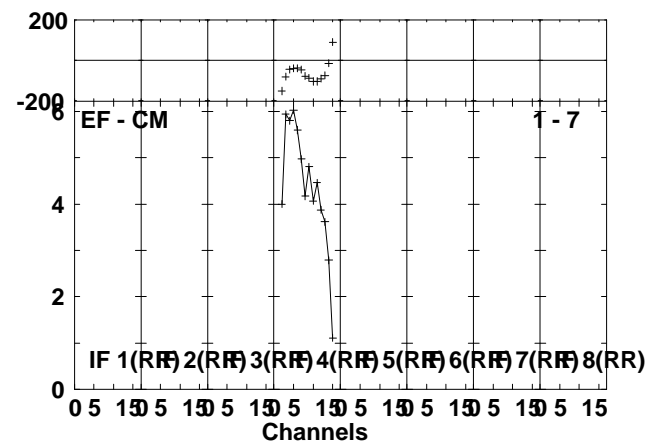
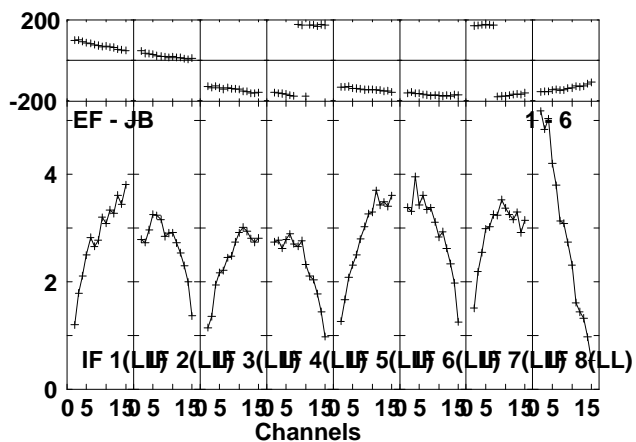
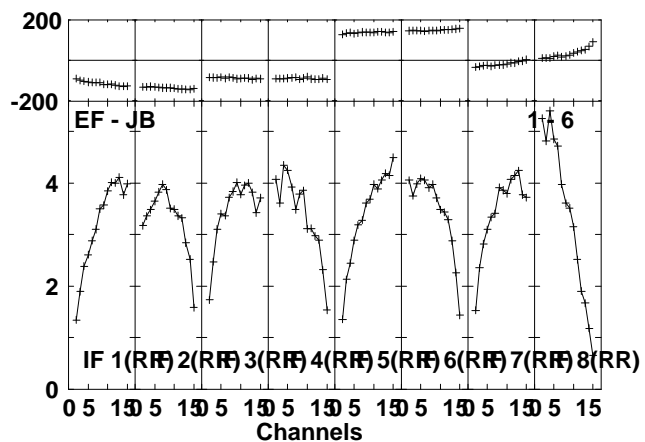
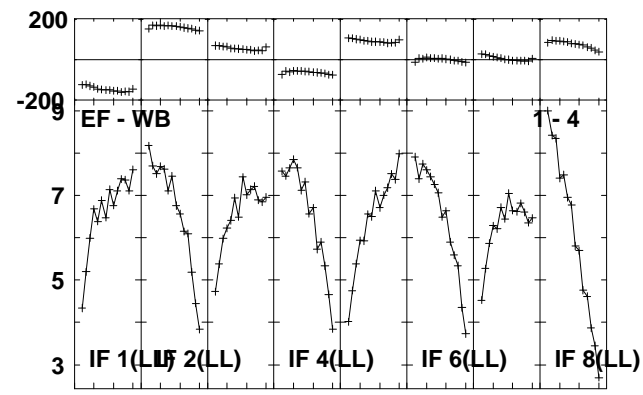
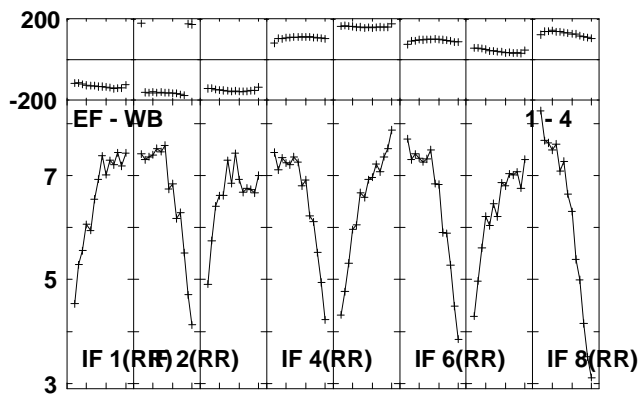
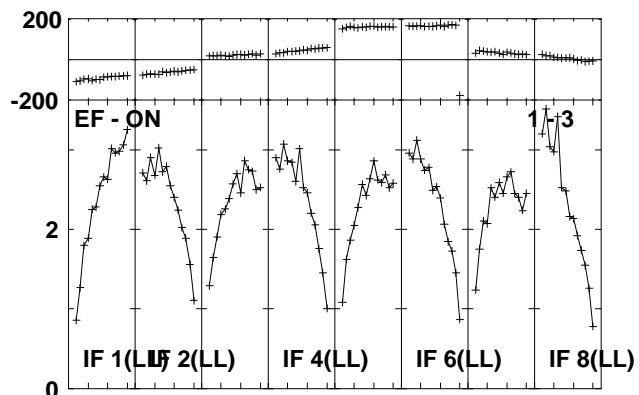
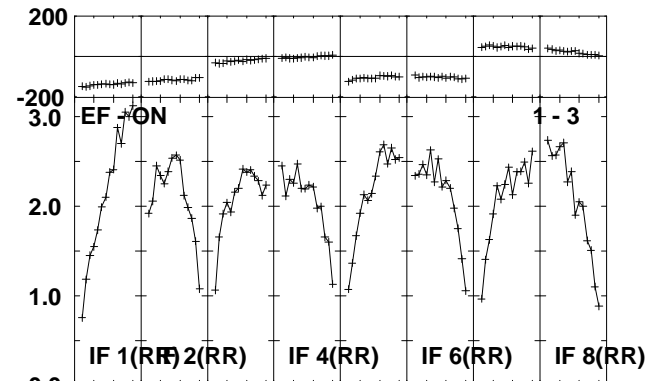
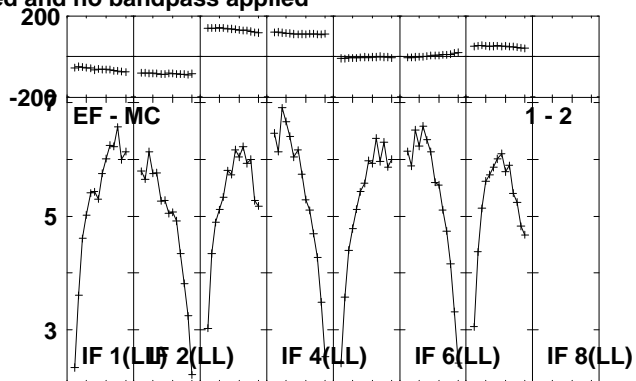
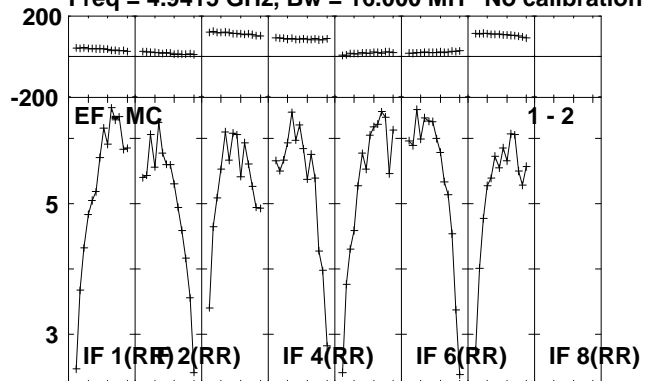

Lower frame: Milli Ampl Jy Top frame: Phas deg
Scalar averaged cross-power spectrum Several baselines displayed
Timerange: 01/02:34:21 to 01/02:35:49

Plot file version 266 created 14-JUL-2010 16:38:10
J1953+35 RR004A.UVDATA.1
Freq = 4.9415 GHz, Bw = 16.000 MH No calibration applied and no bandpass applied

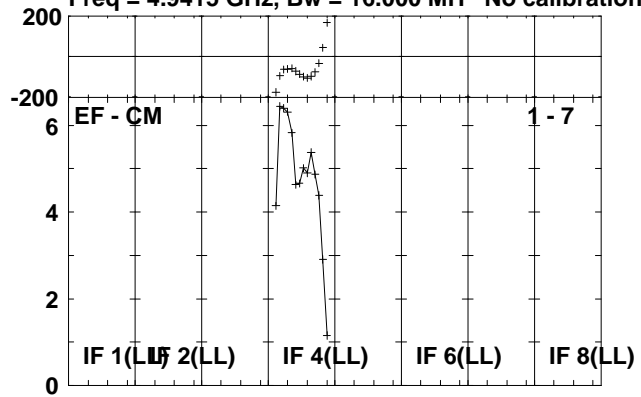

Lower frame: Milli Ampl Jy Top frame: Phas deg
Scalar averaged cross-power spectrum Several baselines displayed
Timerange: 01/02:34:21 to 01/02:35:49

Plot file version 267 created 14-JUL-2010 16:38:11

J2002+47 RR004A.UVDATA.1

Freq = 4.9415 GHz, Bw = 16.000 MH No calibration applied and no bandpass applied

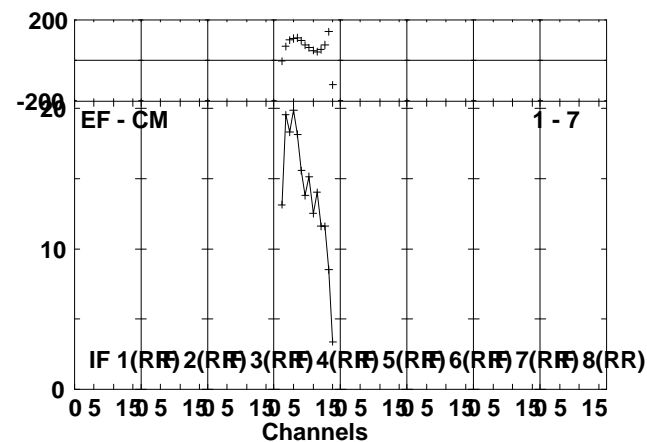
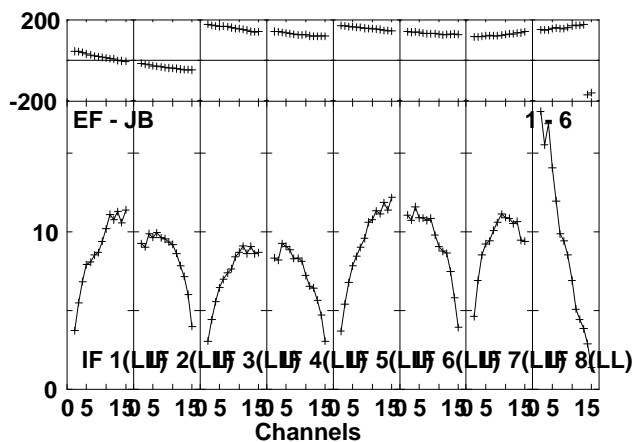
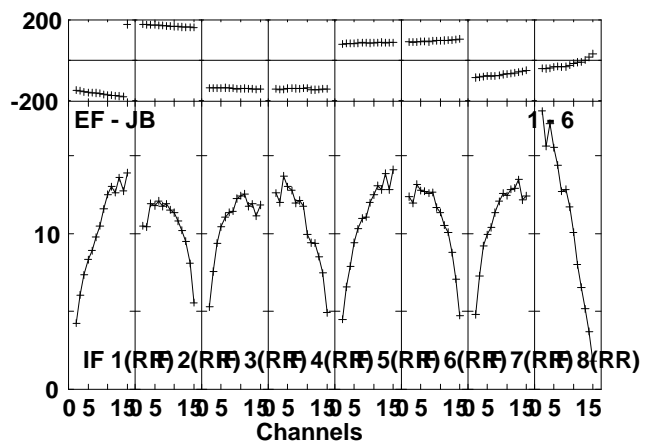
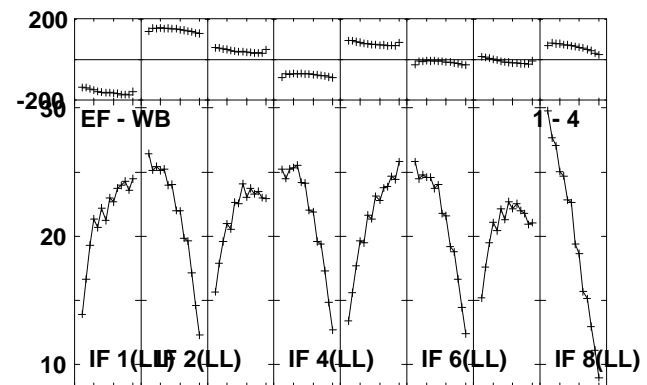
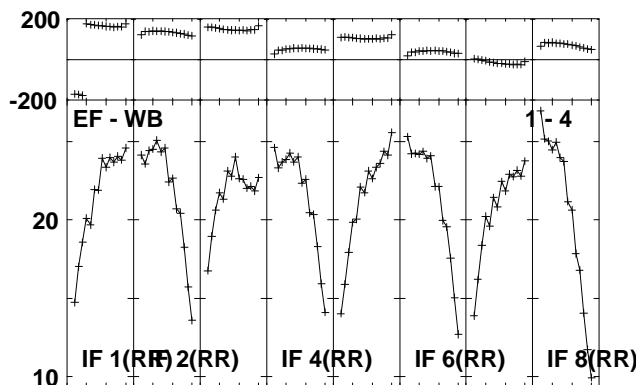
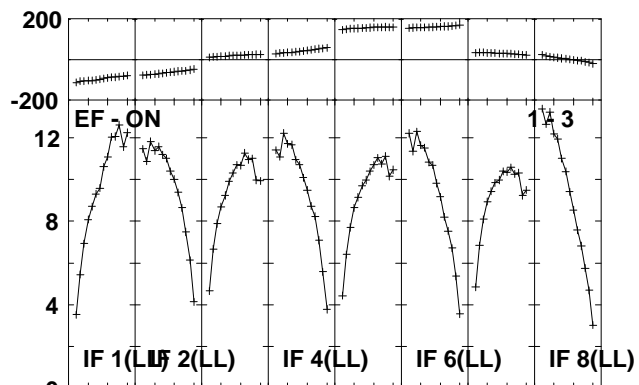
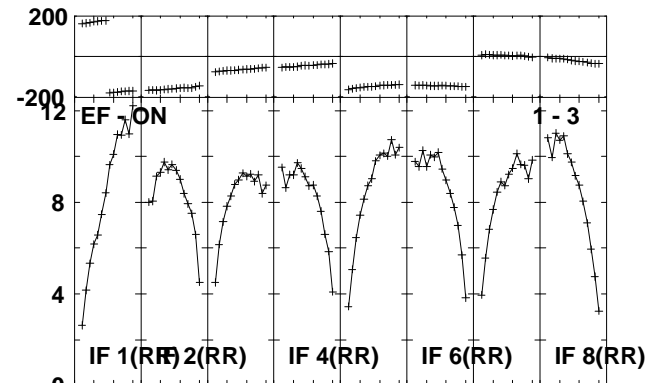
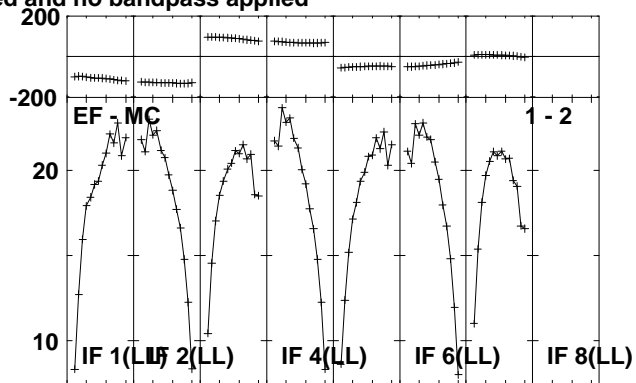
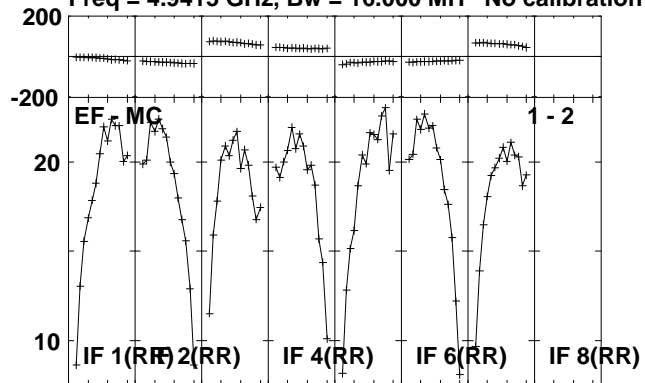

Lower frame: Milli Ampl Jy Top frame: Phas deg
Scalar averaged cross-power spectrum Several baselines displayed
Timerange: 01/02:37:51 to 01/02:42:49

Plot file version 268 created 14-JUL-2010 16:38:12
J2002+47 RR004A.UVDATA.1
Freq = 4.9415 GHz, Bw = 16.000 MH No calibration applied and no bandpass applied

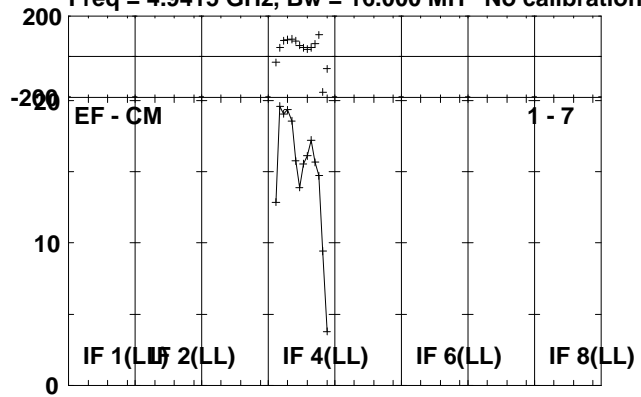

Lower frame: Milli Ampl Jy Top frame: Phas deg
Scalar averaged cross-power spectrum Several baselines displayed
Timerange: 01/02:37:51 to 01/02:42:49

Plot file version 269 created 14-JUL-2010 16:38:12

J1953+35 RR004A.UVDATA.1

Freq = 4.9415 GHz, Bw = 16.000 MH No calibration applied and no bandpass applied

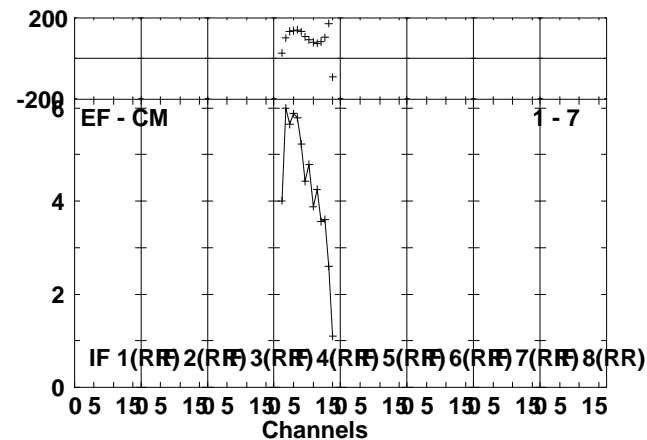
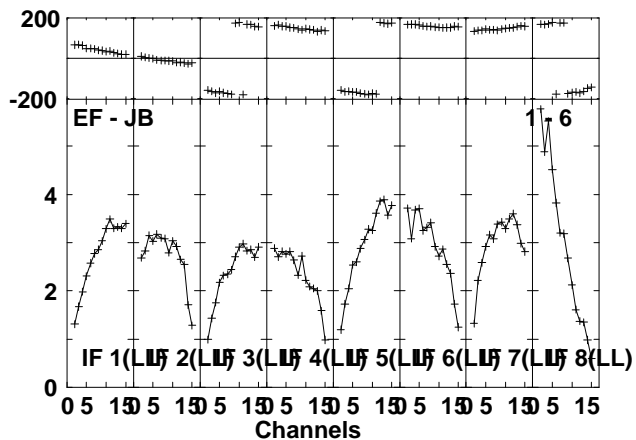
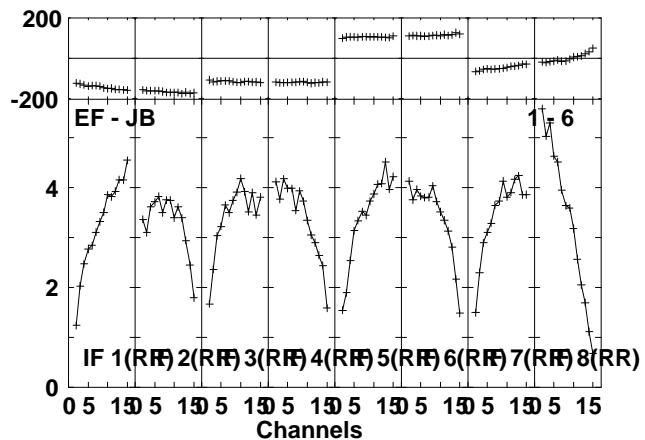
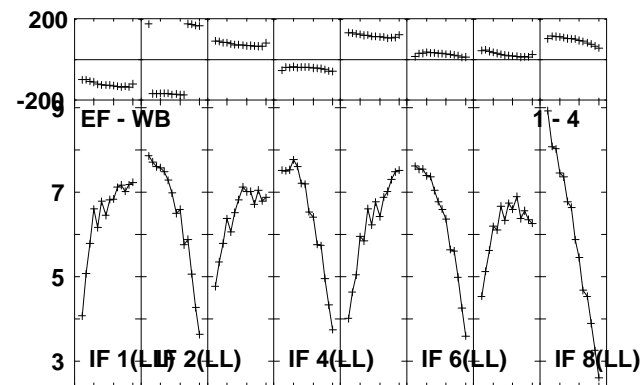
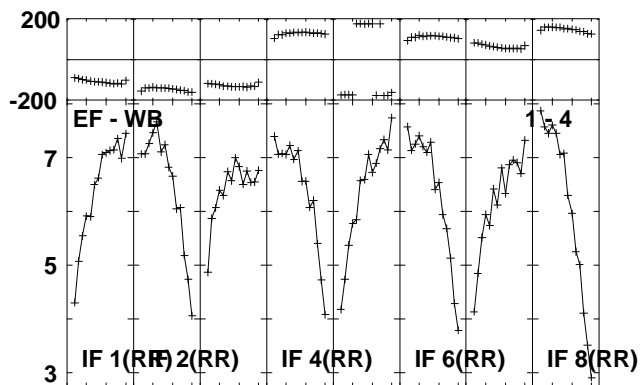
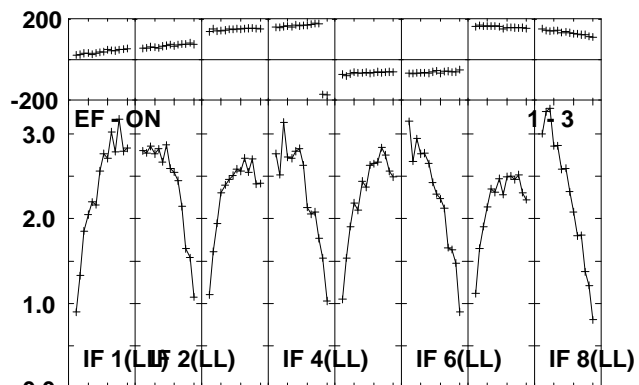
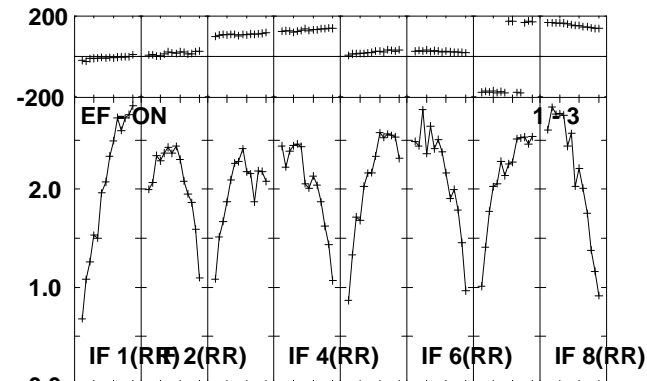
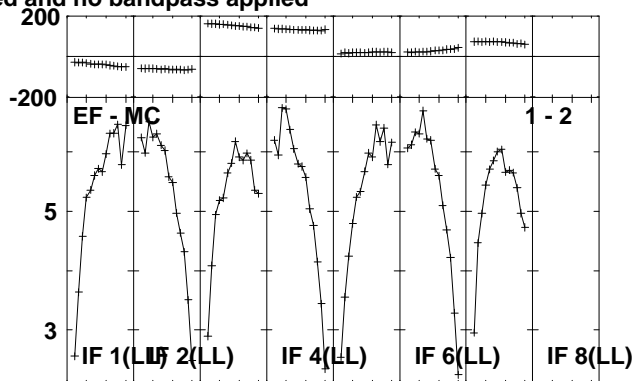
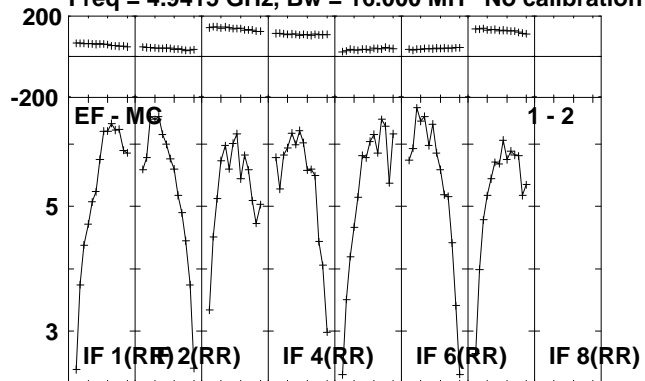

Lower frame: Milli Ampl Jy Top frame: Phas deg
Scalar averaged cross-power spectrum Several baselines displayed
Timerange: 01/02:44:51 to 01/02:46:19

Plot file version 270 created 14-JUL-2010 16:38:13
J1953+35 RR004A.UVDATA.1
Freq = 4.9415 GHz, Bw = 16.000 MH No calibration applied and no bandpass applied

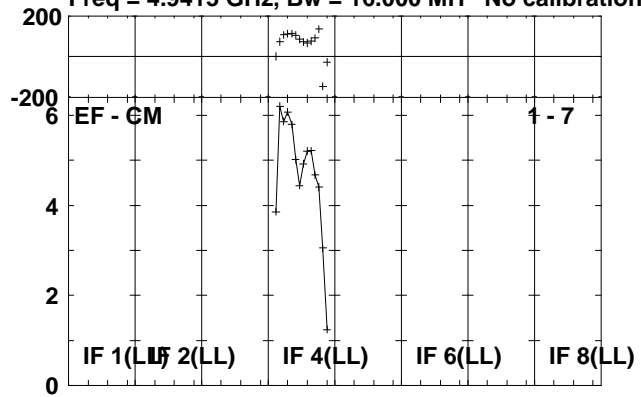

Lower frame: Milli Ampl Jy Top frame: Phas deg
Scalar averaged cross-power spectrum Several baselines displayed
Timerange: 01/02:44:51 to 01/02:46:19

Plot file version 271 created 14-JUL-2010 16:38:13

CYGX-1 RR004A.UVDATA.1

Freq = 4.9415 GHz, Bw = 16.000 MH No calibration applied and no bandpass applied

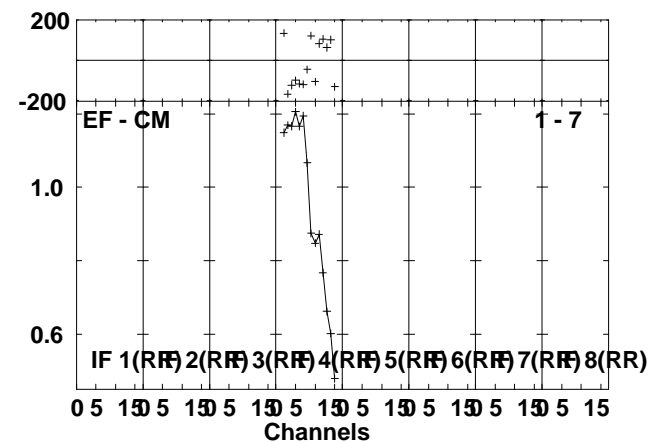
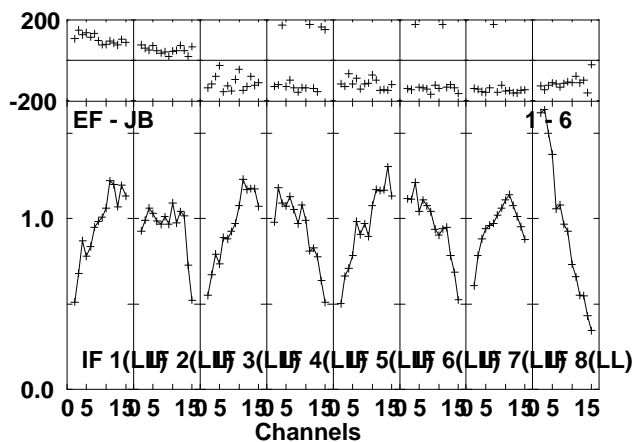
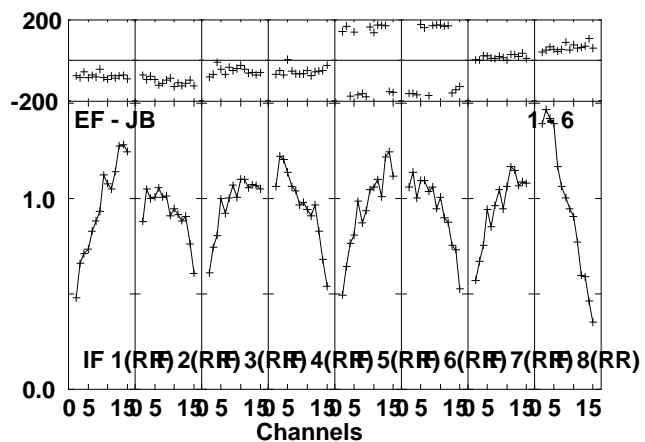
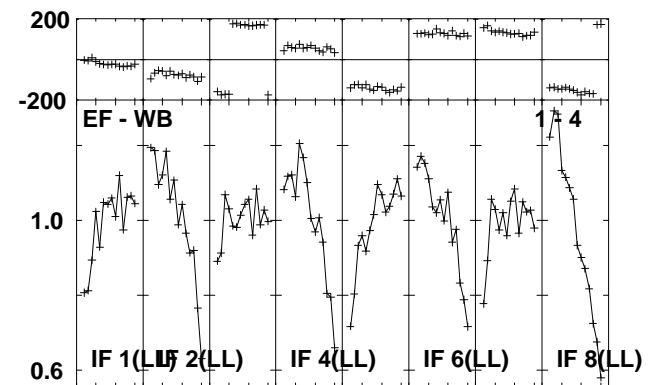
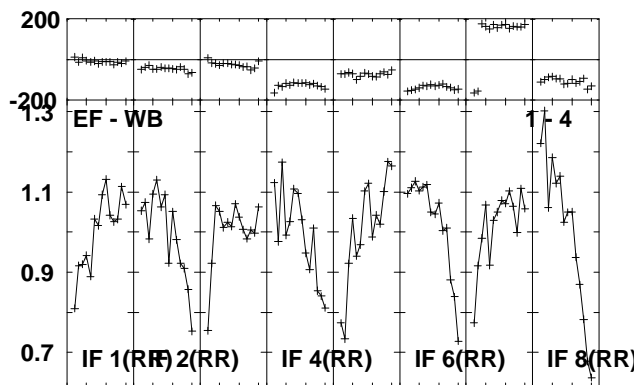
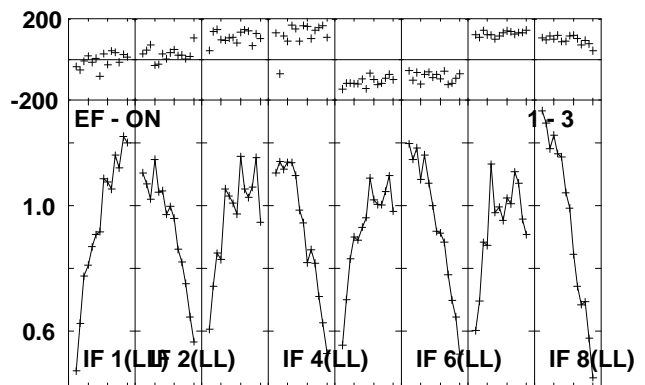
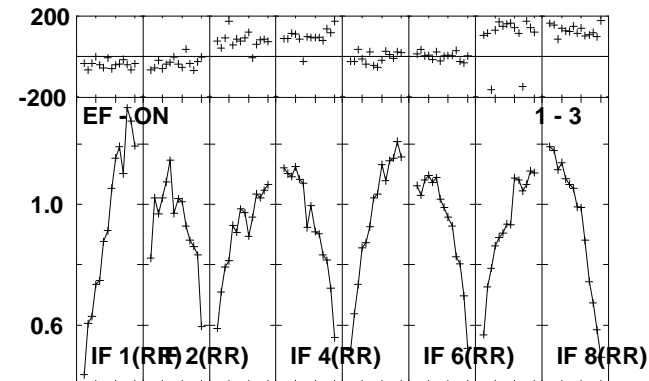
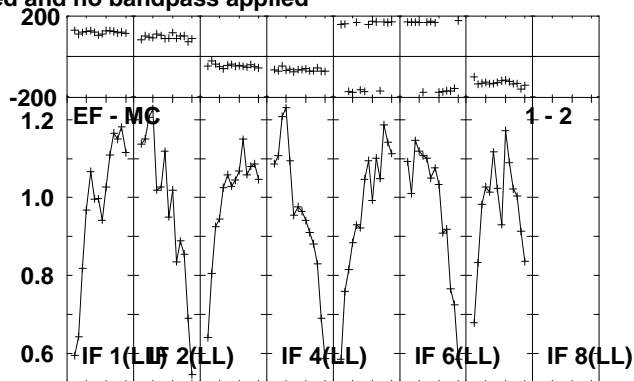
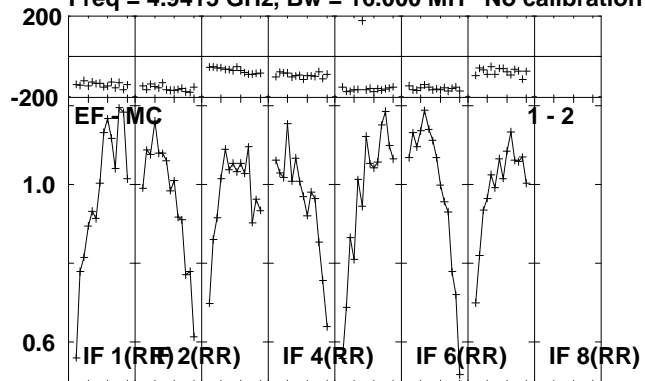

Lower frame: Milli Ampl Jy Top frame: Phas deg
Scalar averaged cross-power spectrum Several baselines displayed
Timerange: 01/02:46:21 to 01/02:51:19

Plot file version 272 created 14-JUL-2010 16:38:14
CYGX-1 RR004A.UVDATA.1
Freq = 4.9415 GHz, Bw = 16.000 MH No calibration applied and no bandpass applied

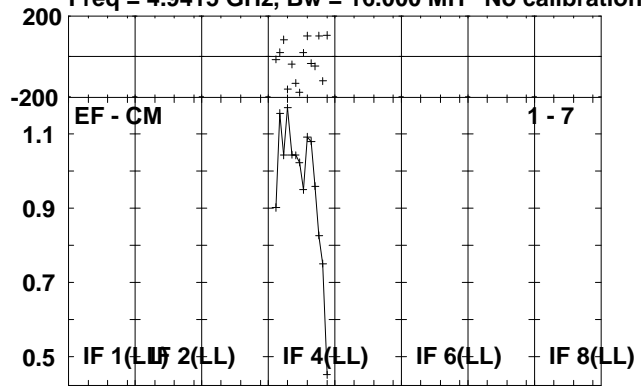

Lower frame: Milli Ampl Jy Top frame: Phas deg
Scalar averaged cross-power spectrum Several baselines displayed
Timerange: 01/02:46:21 to 01/02:51:19

Plot file version 273 created 14-JUL-2010 16:38:15

J1953+35 RR004A.UVDATA.1

Freq = 4.9415 GHz, Bw = 16.000 MH No calibration applied and no bandpass applied

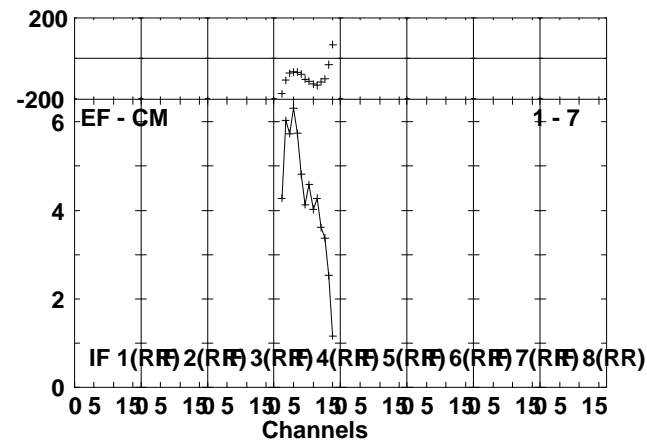
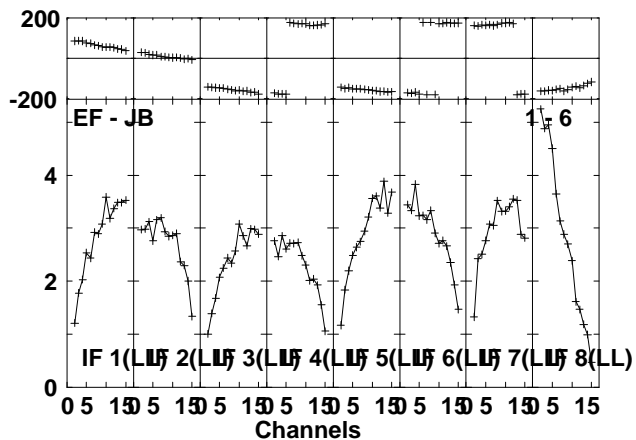
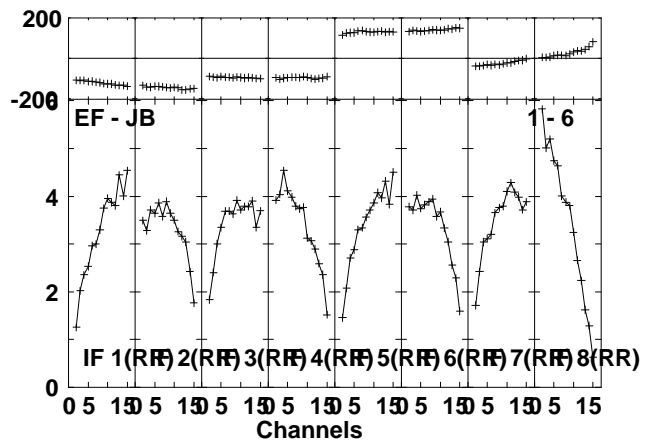
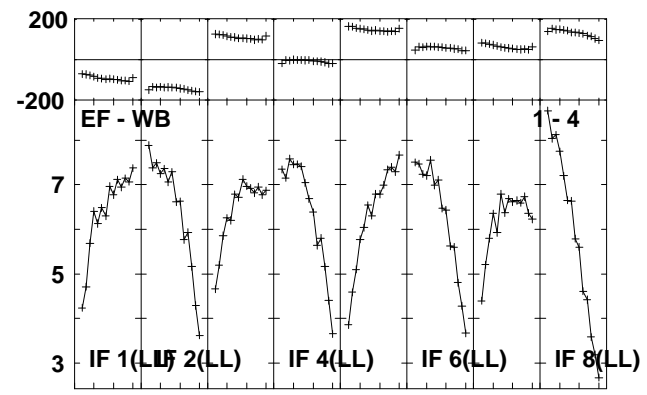
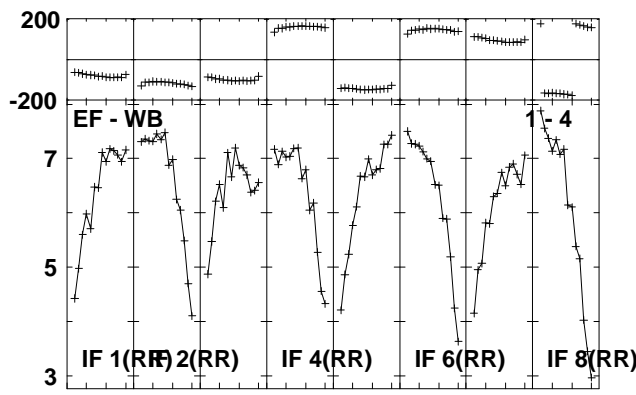
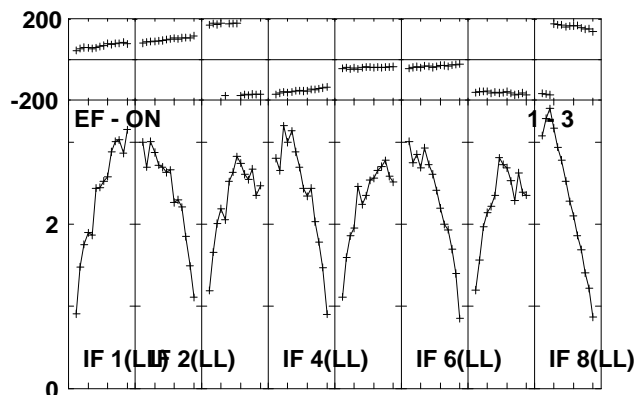
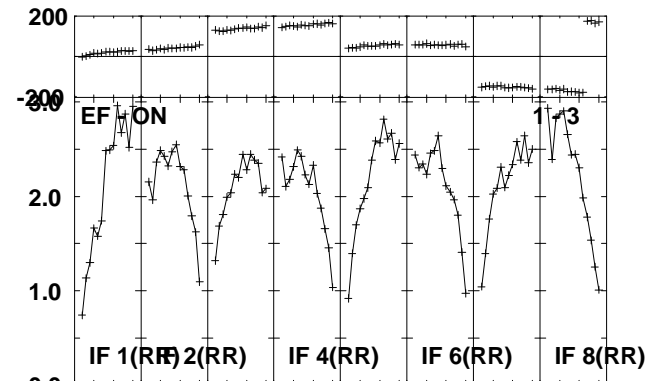
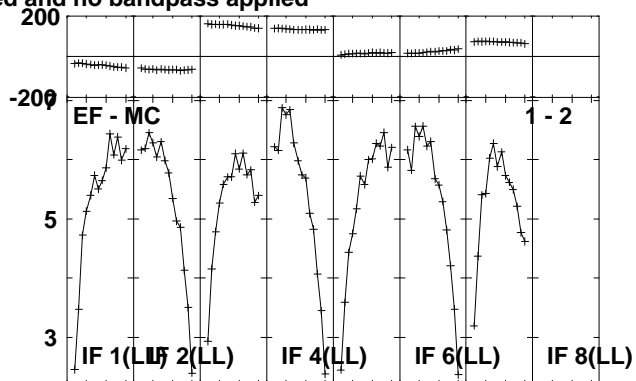
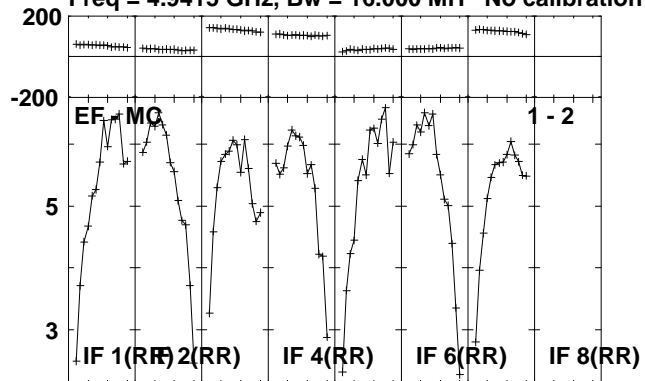

Lower frame: Milli Ampl Jy Top frame: Phas deg
Scalar averaged cross-power spectrum Several baselines displayed
Timerange: 01/02:51:21 to 01/02:53:19

Plot file version 274 created 14-JUL-2010 16:38:16
J1953+35 RR004A.UVDATA.1
Freq = 4.9415 GHz, Bw = 16.000 MH No calibration applied and no bandpass applied

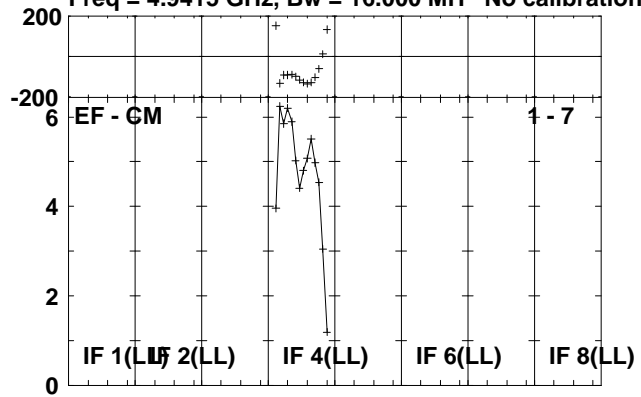

Lower frame: Milli Ampl Jy Top frame: Phas deg
Scalar averaged cross-power spectrum Several baselines displayed
Timerange: 01/02:51:21 to 01/02:53:19

Plot file version 275 created 14-JUL-2010 16:38:16

CYGX-1 RR004A.UVDATA.1

Freq = 4.9415 GHz, Bw = 16.000 MH No calibration applied and no bandpass applied

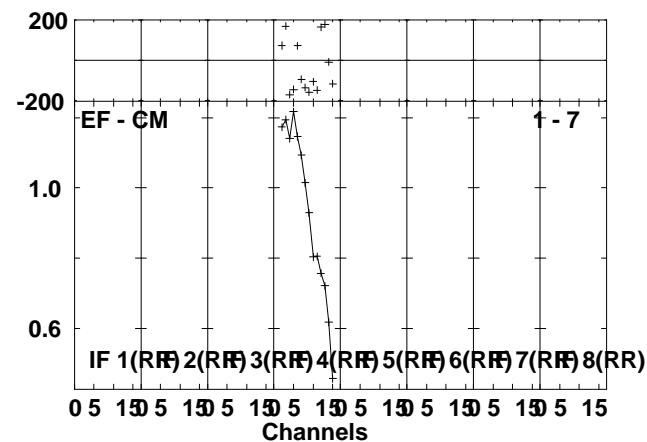
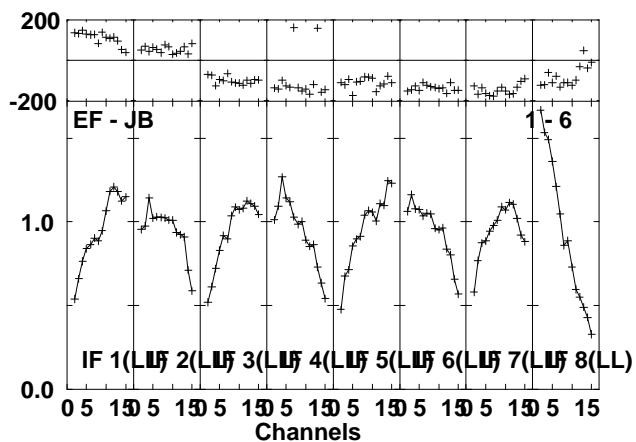
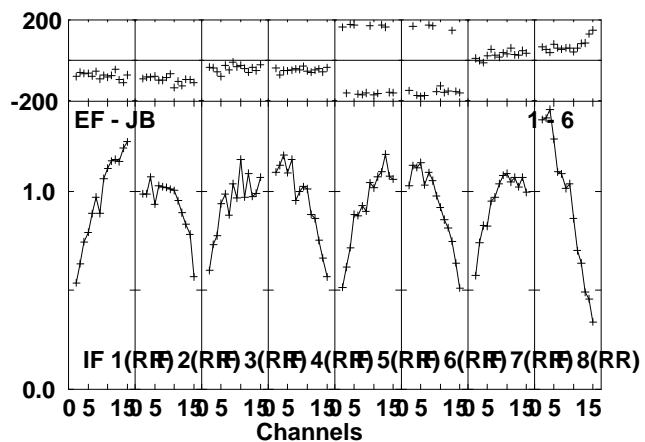
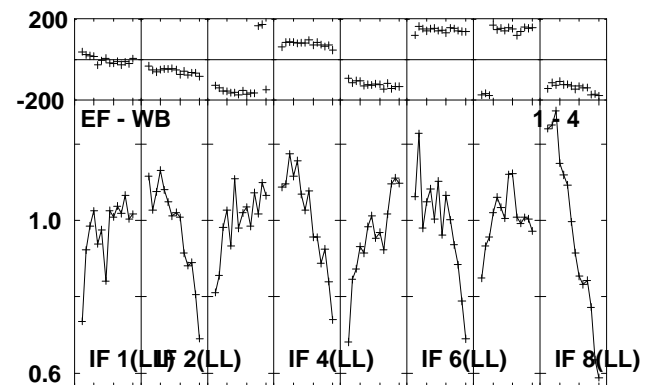
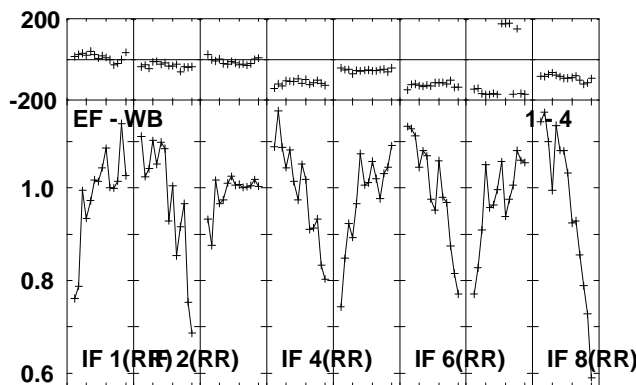
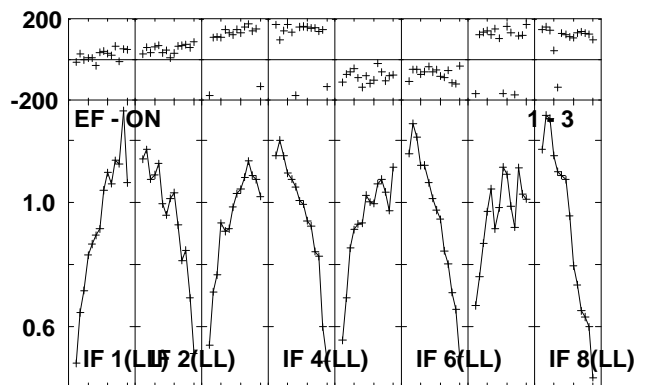
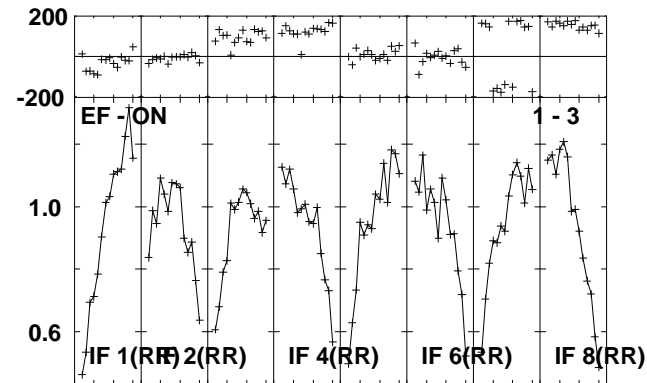
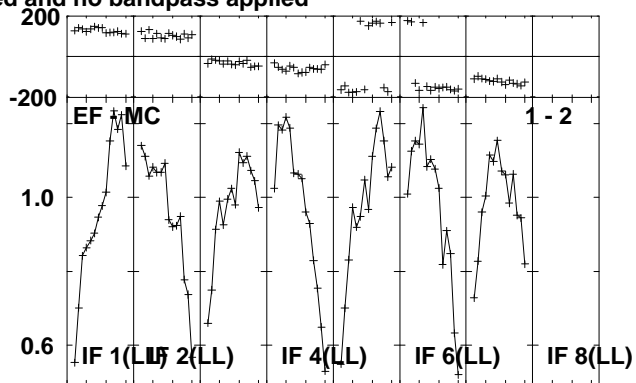
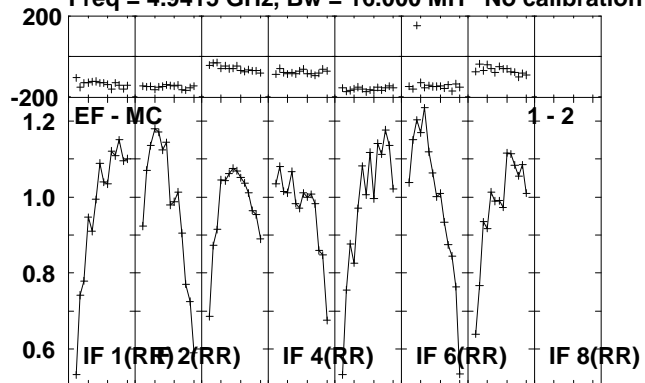

Lower frame: Milli Ampl Jy Top frame: Phas deg
Scalar averaged cross-power spectrum Several baselines displayed
Timerange: 01/02:53:21 to 01/02:58:19

Plot file version 276 created 14-JUL-2010 16:38:17

CYGX-1 RR004A.UVDATA.1

Freq = 4.9415 GHz, Bw = 16.000 MH No calibration applied and no bandpass applied

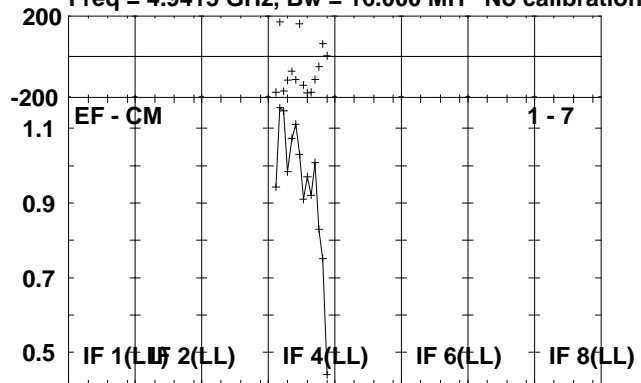

Lower frame: Milli Ampl Jy Top frame: Phas deg
Scalar averaged cross-power spectrum Several baselines displayed
Timerange: 01/02:53:21 to 01/02:58:19

Plot file version 277 created 14-JUL-2010 16:38:17

J1953+35 RR004A.UVDATA.1

Freq = 4.9415 GHz, Bw = 16.000 MH No calibration applied and no bandpass applied

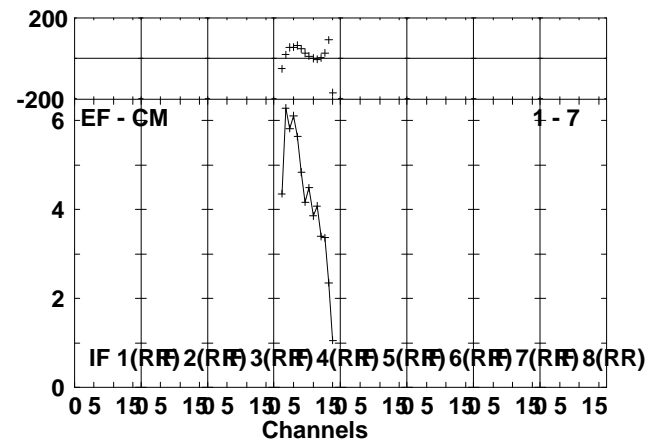
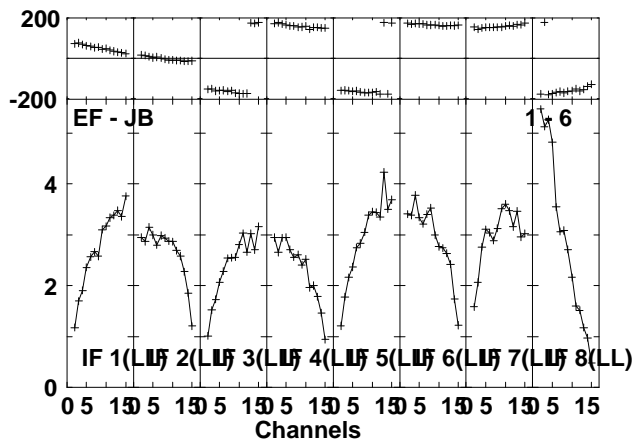
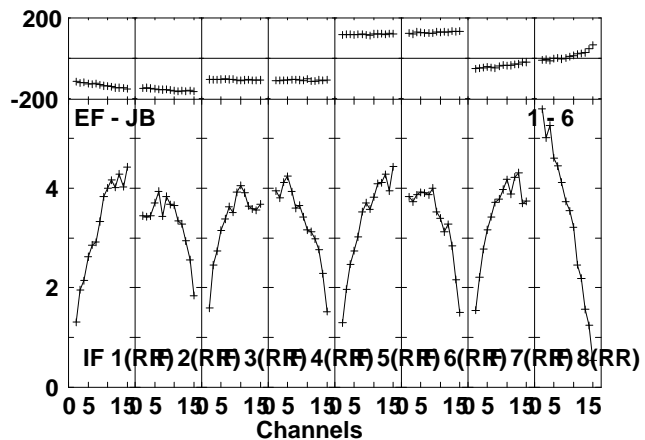
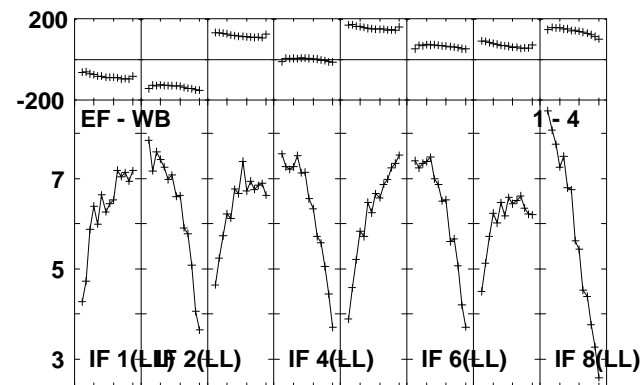
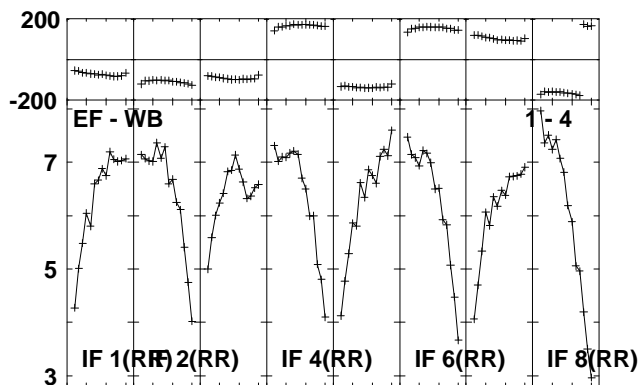
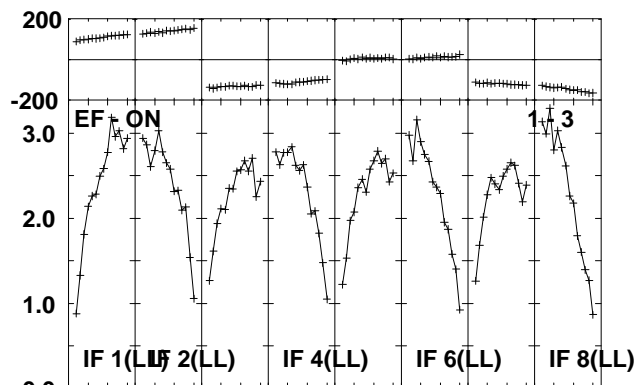
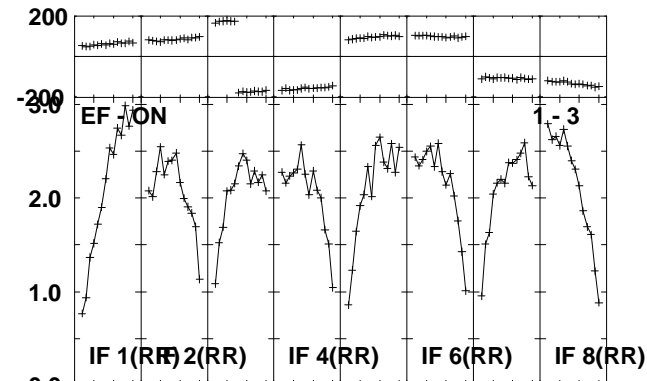
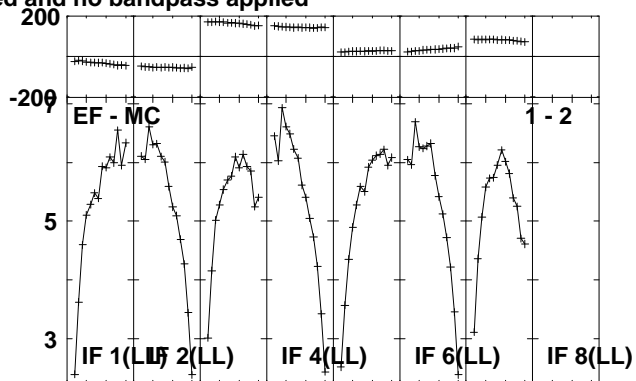
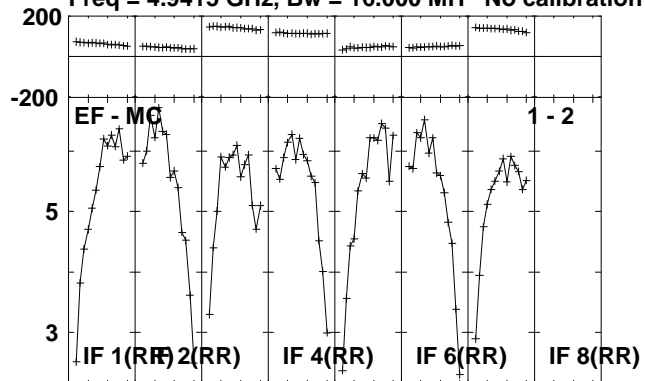

Lower frame: Milli Ampl Jy Top frame: Phas deg
Scalar averaged cross-power spectrum Several baselines displayed
Timerange: 01/02:59:01 to 01/03:00:29

Plot file version 278 created 14-JUL-2010 16:38:18
J1953+35 RR004A.UVDATA.1
Freq = 4.9415 GHz, Bw = 16.000 MH No calibration applied and no bandpass applied

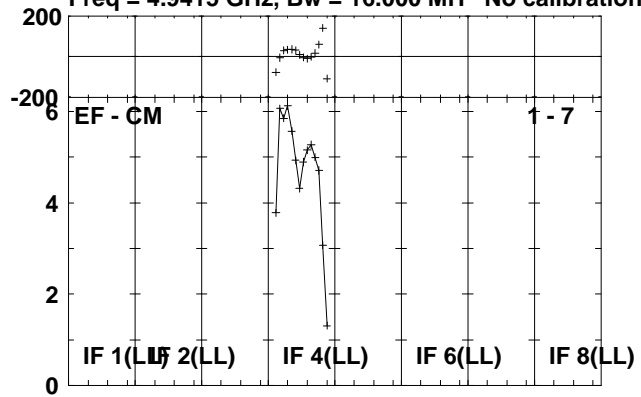

Lower frame: Milli Ampl Jy Top frame: Phas deg
Scalar averaged cross-power spectrum Several baselines displayed
Timerange: 01/02:59:01 to 01/03:00:29

Plot file version 279 created 14-JUL-2010 16:38:18

CYGX-1 RR004A.UVDATA.1

Freq = 4.9415 GHz, Bw = 16.000 MH No calibration applied and no bandpass applied

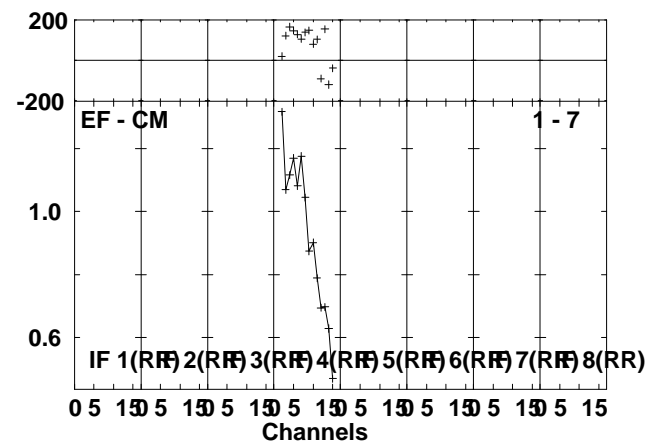
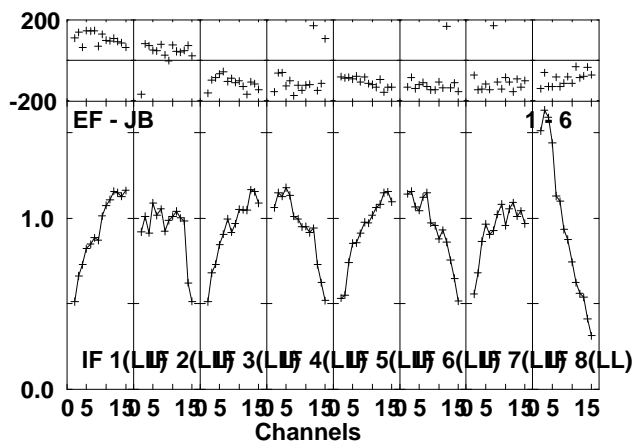
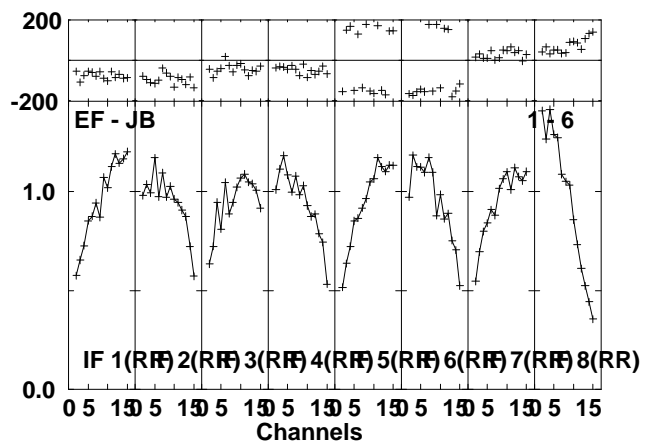
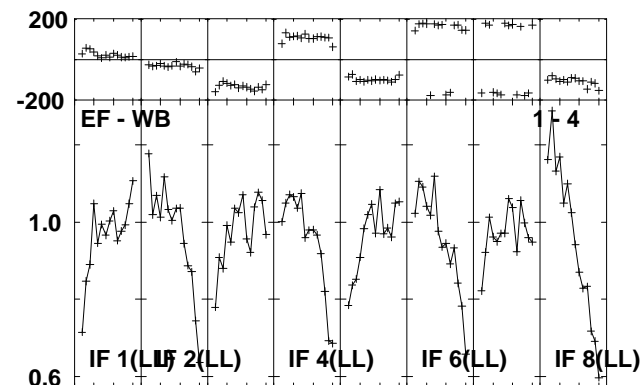
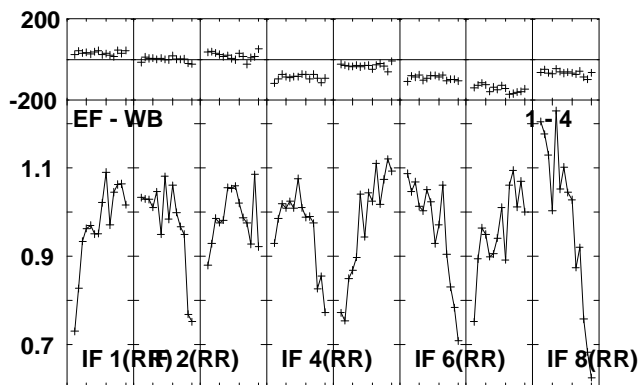
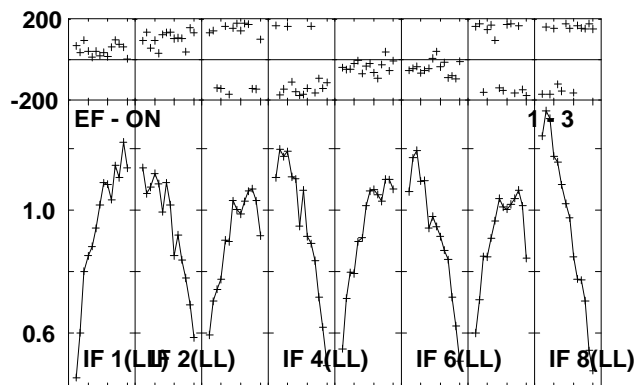
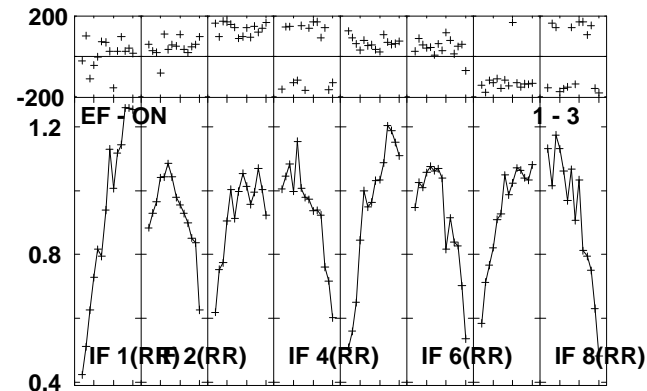
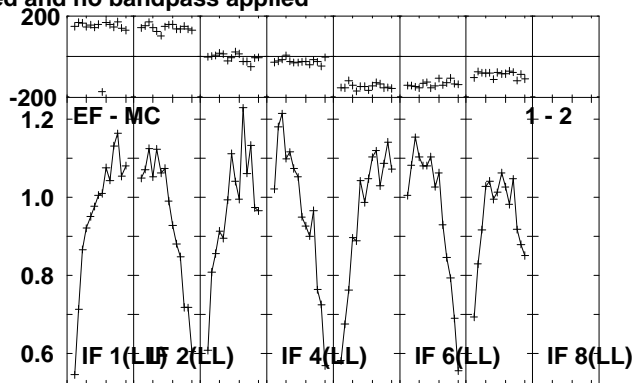
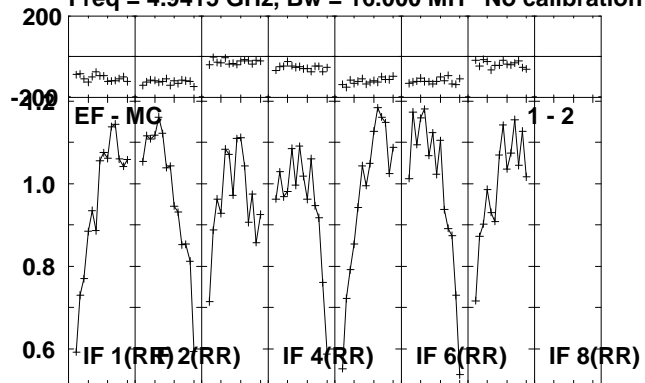

Lower frame: Milli Ampl Jy Top frame: Phas deg
Scalar averaged cross-power spectrum Several baselines displayed
Timerange: 01/03:00:31 to 01/03:05:29

Plot file version 280 created 14-JUL-2010 16:38:19
CYGX-1 RR004A.UVDATA.1
Freq = 4.9415 GHz, Bw = 16.000 MH No calibration applied and no bandpass applied

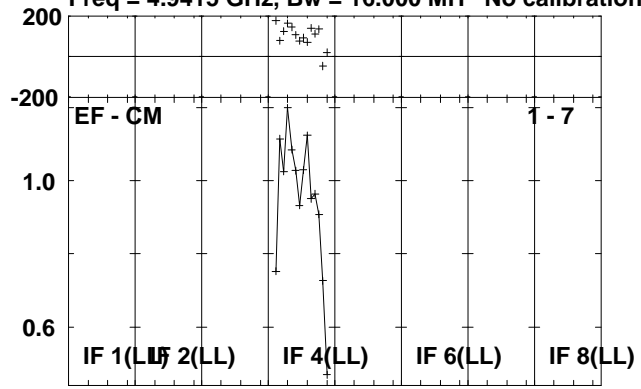

Lower frame: Milli Ampl Jy Top frame: Phas deg
Scalar averaged cross-power spectrum Several baselines displayed
Timerange: 01/03:00:31 to 01/03:05:29

Plot file version 281 created 14-JUL-2010 16:38:19

J1953+35 RR004A.UVDATA.1

Freq = 4.9415 GHz, Bw = 16.000 MH No calibration applied and no bandpass applied

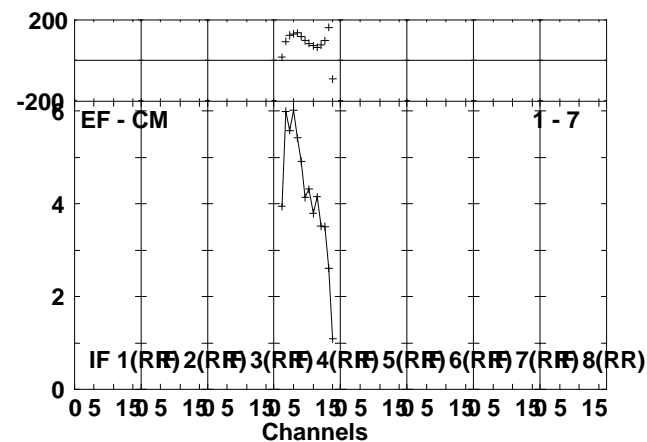
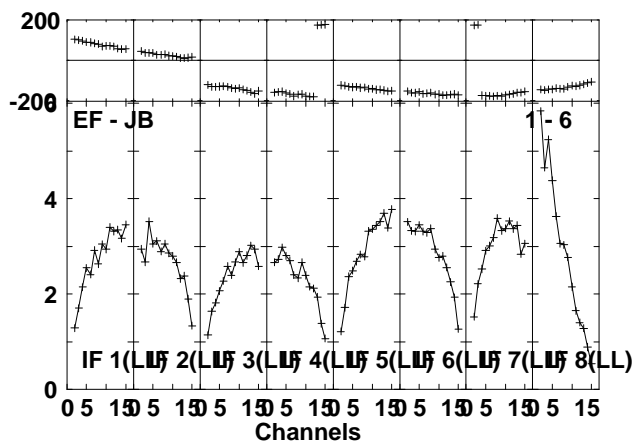
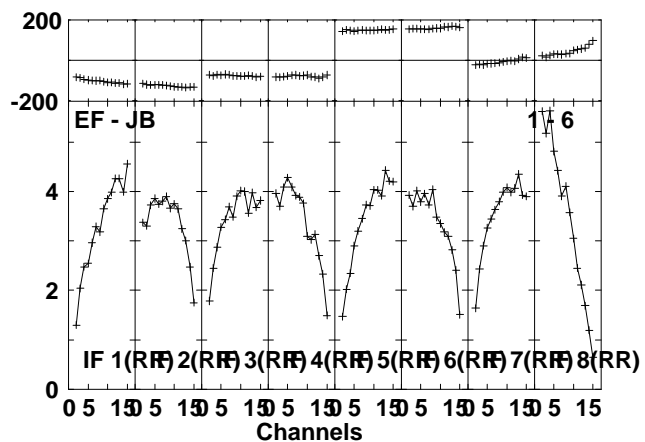
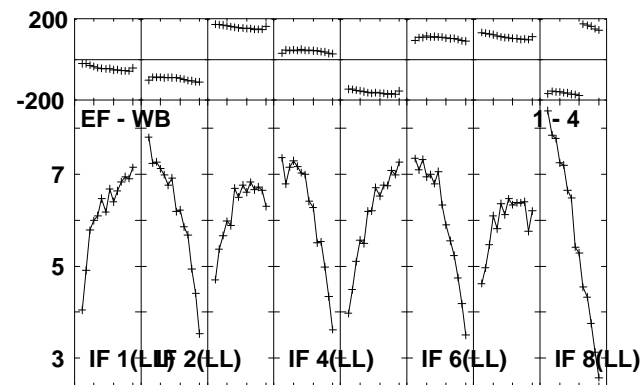
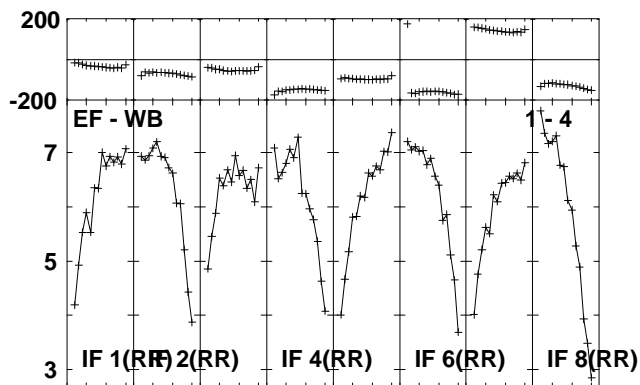
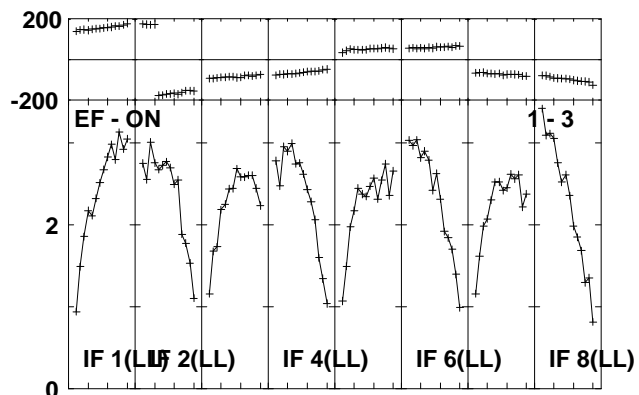
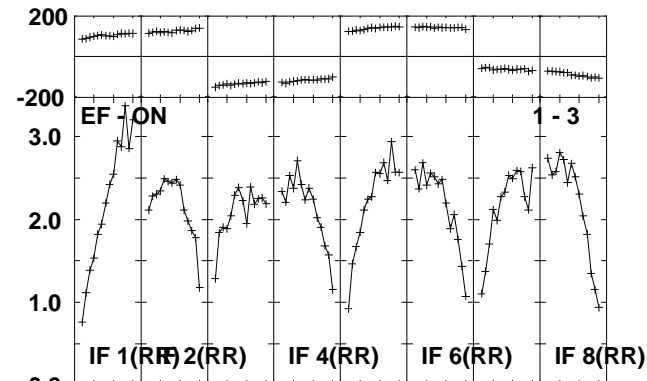
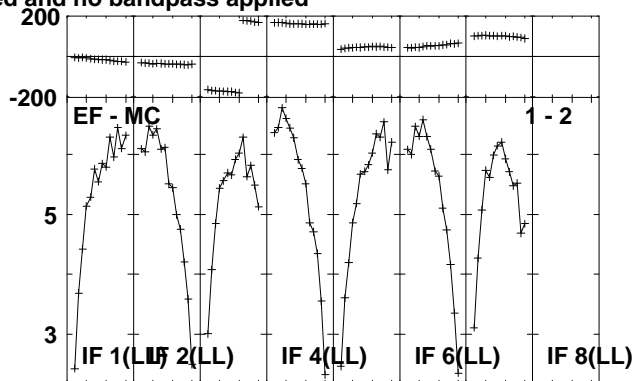
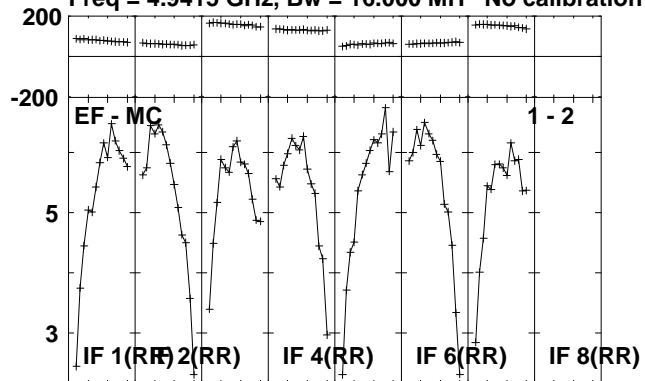

Lower frame: Milli Ampl Jy Top frame: Phas deg
Scalar averaged cross-power spectrum Several baselines displayed
Timerange: 01/03:05:31 to 01/03:07:29

Plot file version 282 created 14-JUL-2010 16:38:20
J1953+35 RR004A.UVDATA.1
Freq = 4.9415 GHz, Bw = 16.000 MH No calibration applied and no bandpass applied

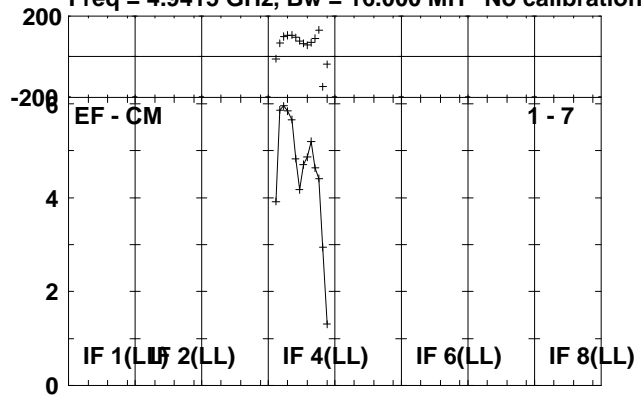

Lower frame: Milli Ampl Jy Top frame: Phas deg
Scalar averaged cross-power spectrum Several baselines displayed
Timerange: 01/03:05:31 to 01/03:07:29

Plot file version 283 created 14-JUL-2010 16:38:20

CYGX-1 RR004A.UVDATA.1

Freq = 4.9415 GHz, Bw = 16.000 MH No calibration applied and no bandpass applied

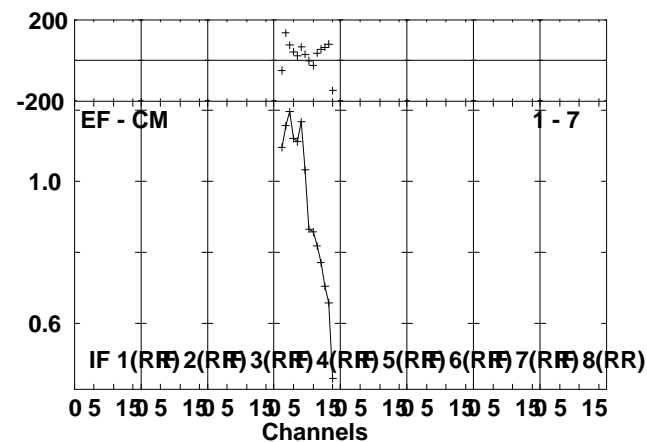
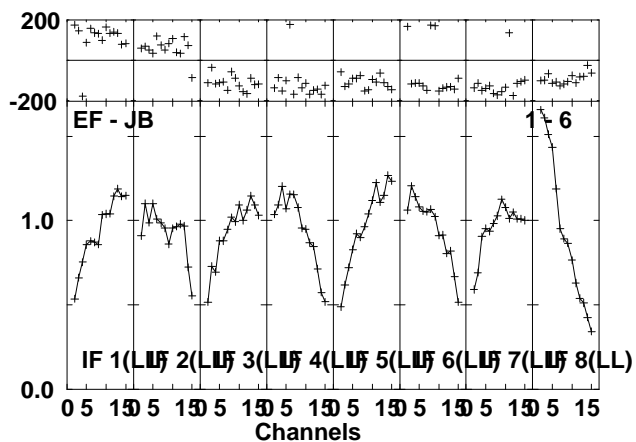
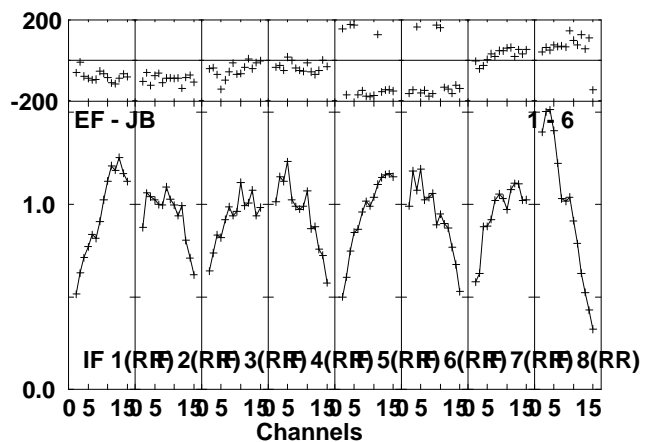
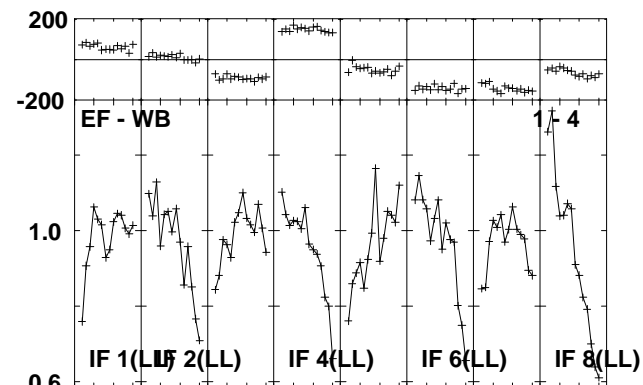
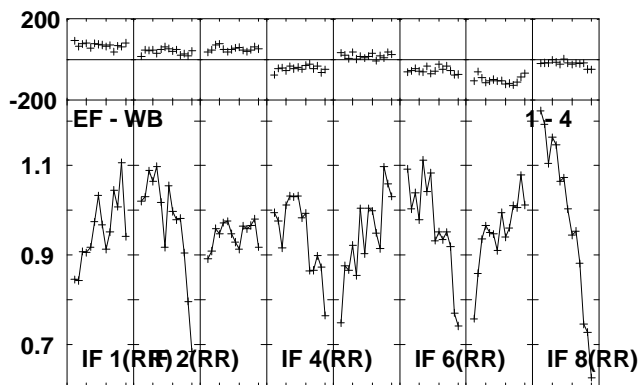
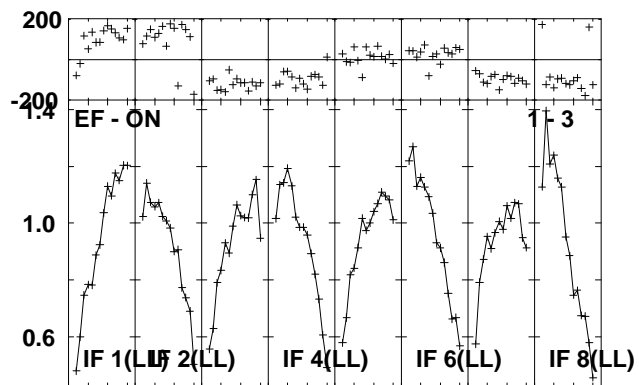
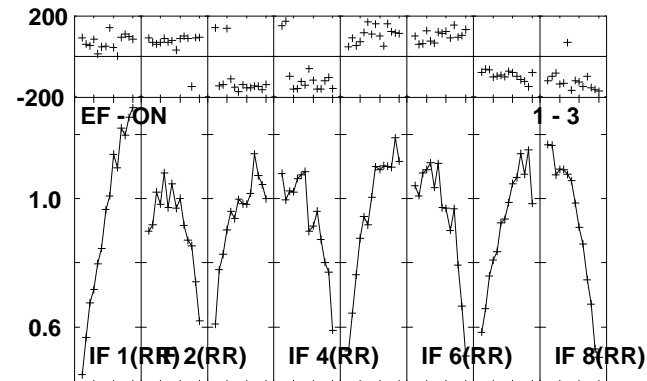
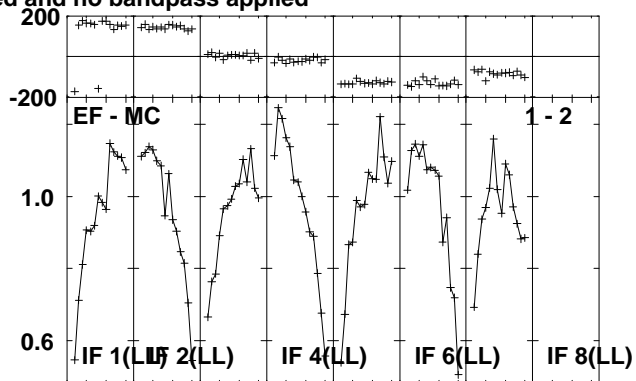
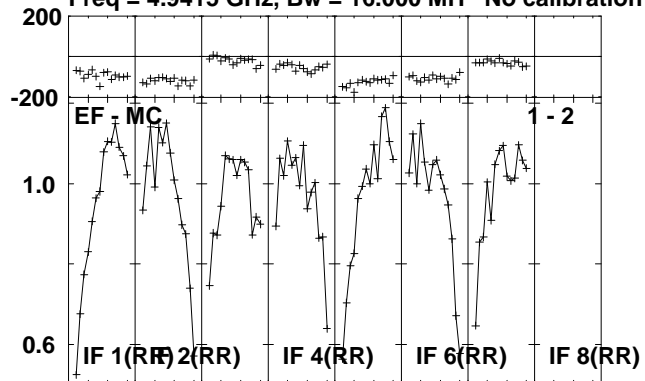

Lower frame: Milli Ampl Jy Top frame: Phas deg
Scalar averaged cross-power spectrum Several baselines displayed
Timerange: 01/03:07:31 to 01/03:12:29

Plot file version 284 created 14-JUL-2010 16:38:22
CYGX-1 RR004A.UVDATA.1
Freq = 4.9415 GHz, Bw = 16.000 MH No calibration applied and no bandpass applied

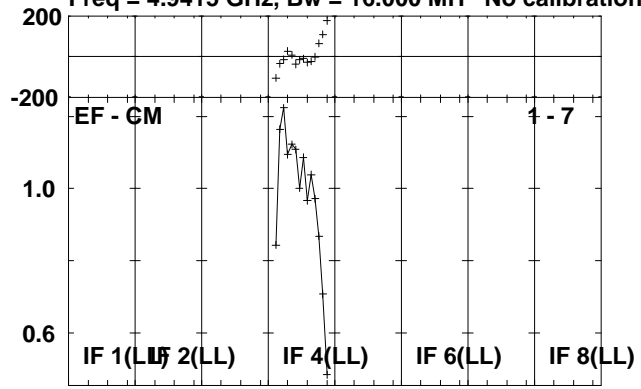

Lower frame: Milli Ampl Jy Top frame: Phas deg
Scalar averaged cross-power spectrum Several baselines displayed
Timerange: 01/03:07:31 to 01/03:12:29

Plot file version 285 created 14-JUL-2010 16:38:22

J1953+35 RR004A.UVDATA.1

Freq = 4.9415 GHz, Bw = 16.000 MH No calibration applied and no bandpass applied

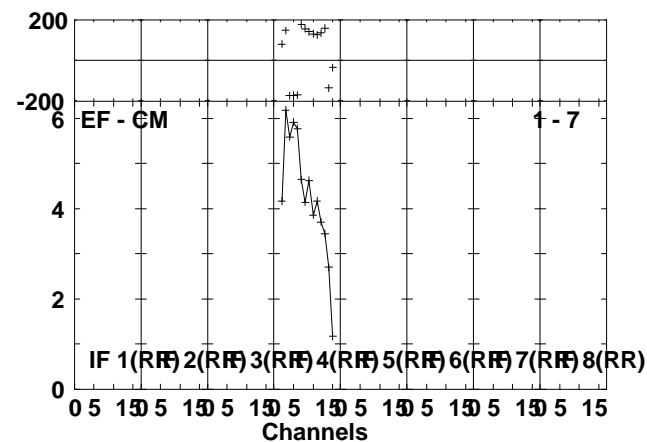
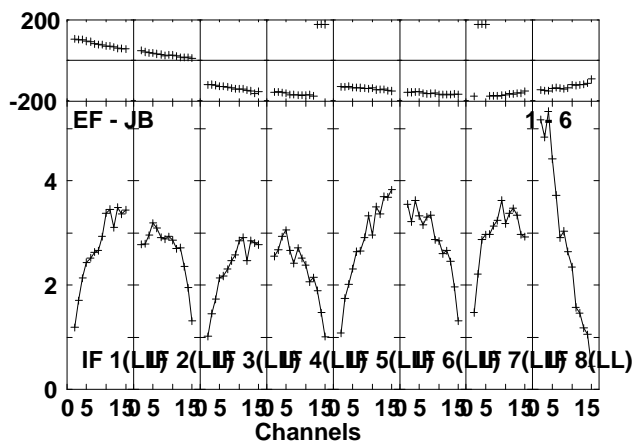
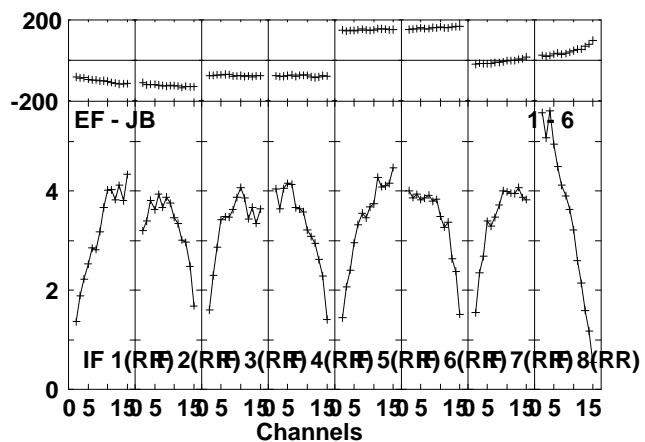
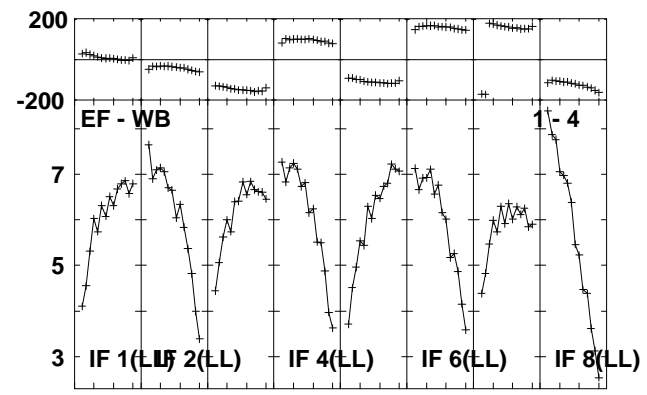
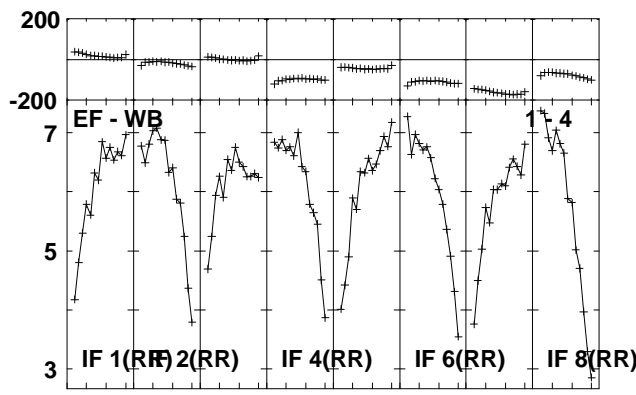
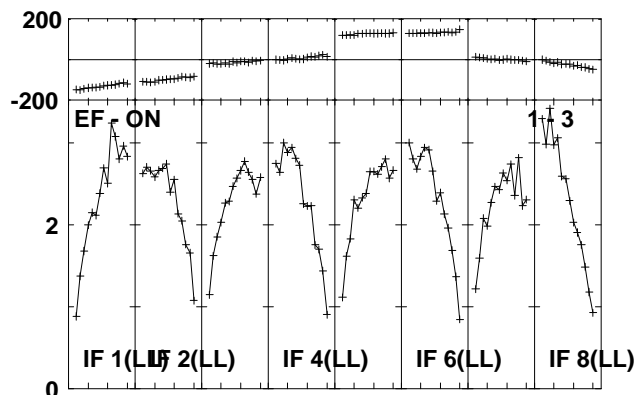
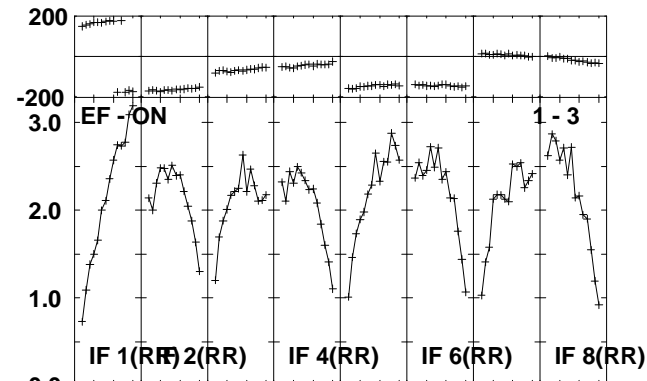
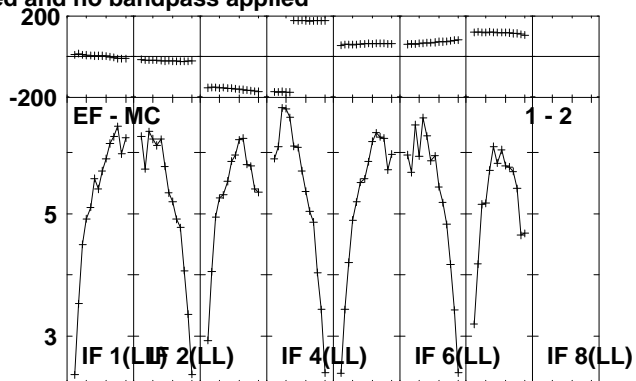
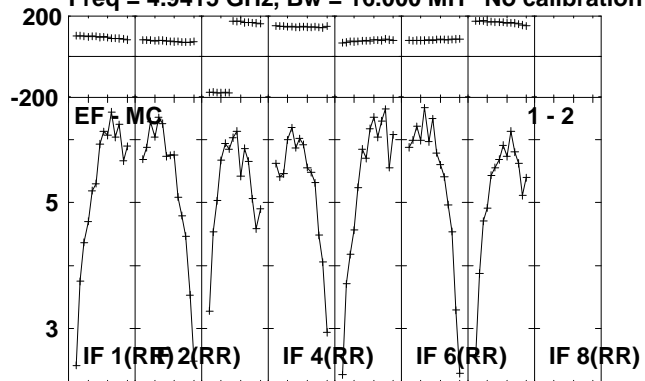

Lower frame: Milli Ampl Jy Top frame: Phas deg
Scalar averaged cross-power spectrum Several baselines displayed
Timerange: 01/03:13:11 to 01/03:14:39

Plot file version 286 created 14-JUL-2010 16:38:22
J1953+35 RR004A.UVDATA.1
Freq = 4.9415 GHz, Bw = 16.000 MH No calibration applied and no bandpass applied

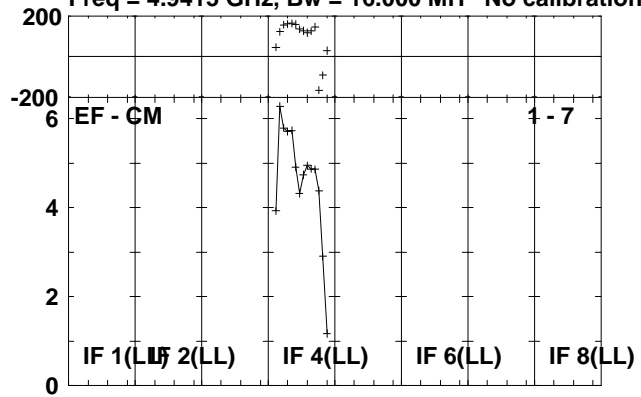

Lower frame: Milli Ampl Jy Top frame: Phas deg
Scalar averaged cross-power spectrum Several baselines displayed
Timerange: 01/03:13:11 to 01/03:14:39

Plot file version 287 created 14-JUL-2010 16:38:23

CYGX-1 RR004A.UVDATA.1

Freq = 4.9415 GHz, Bw = 16.000 MH No calibration applied and no bandpass applied

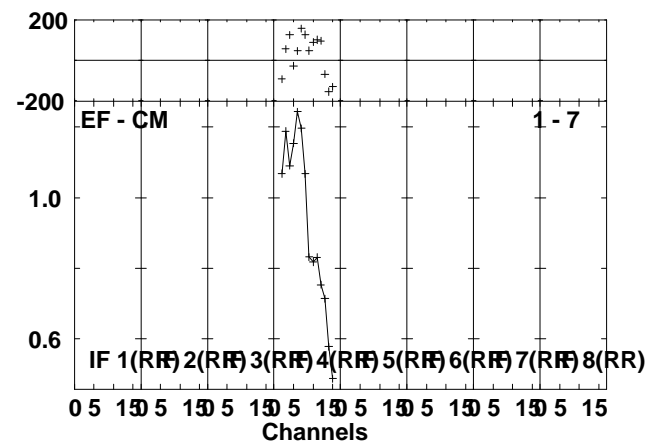
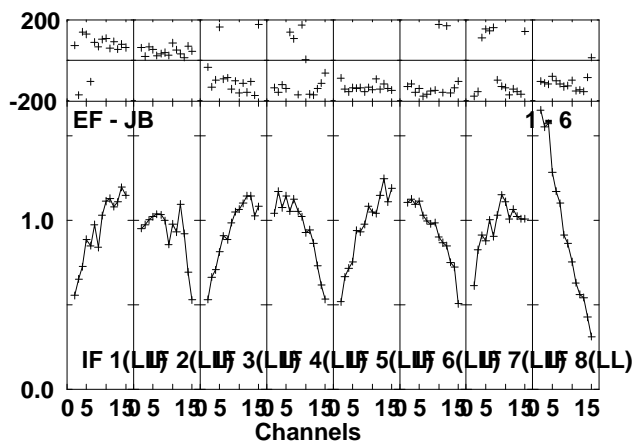
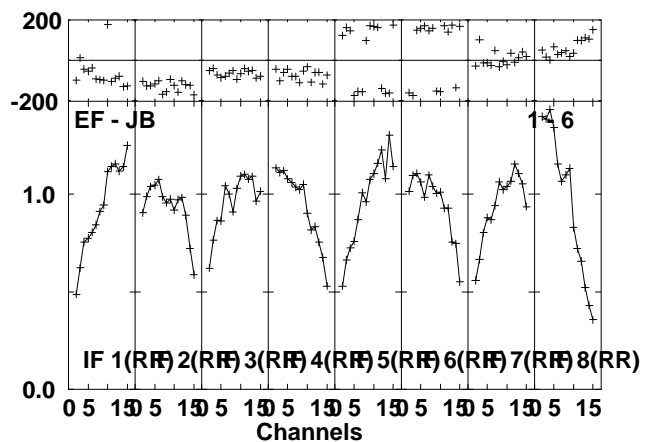
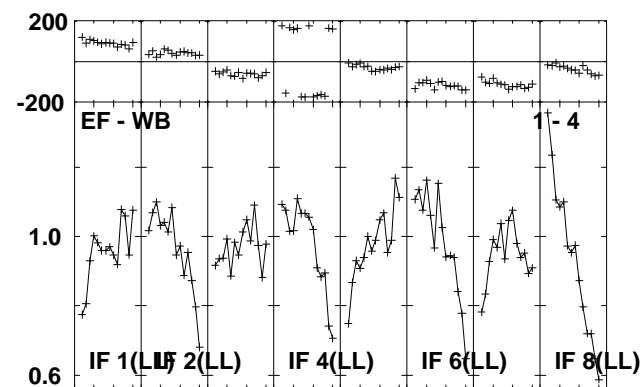
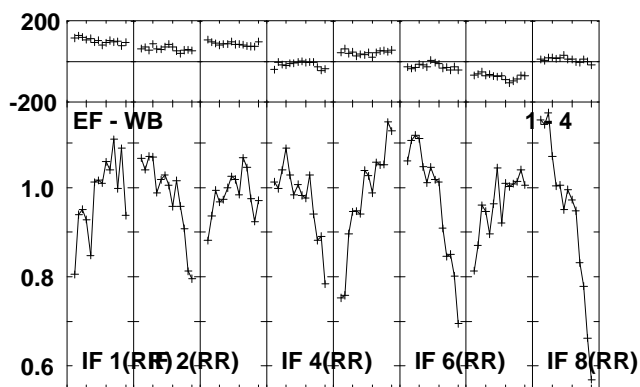
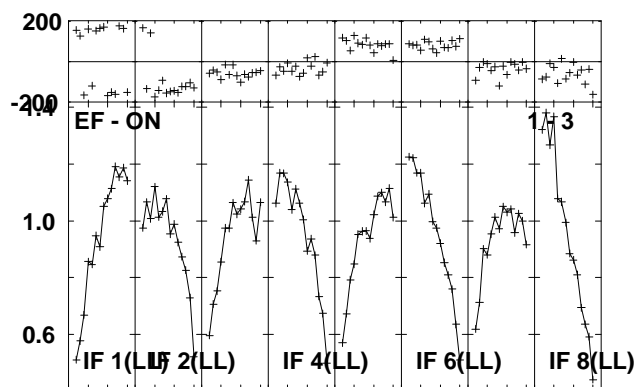
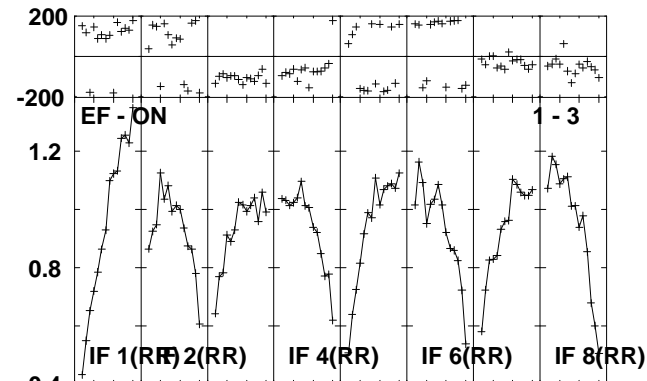
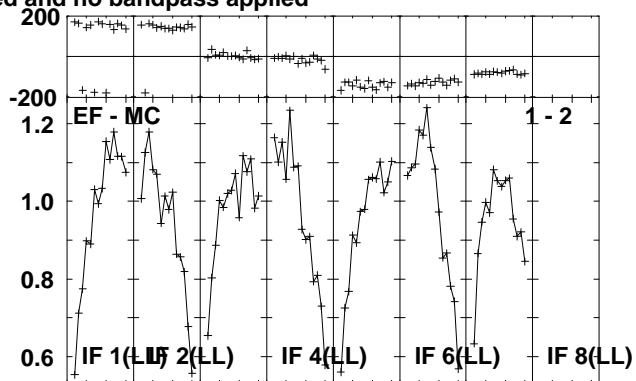
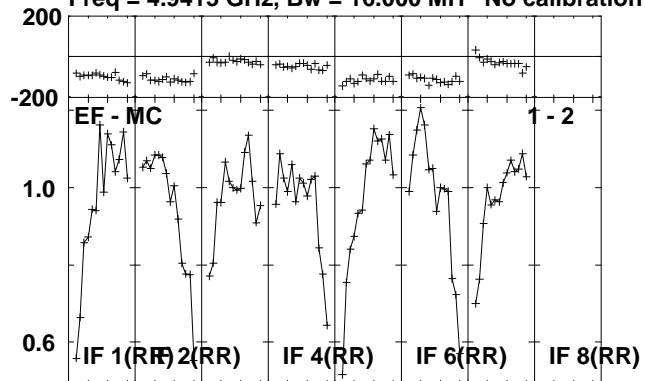

Lower frame: Milli Ampl Jy Top frame: Phas deg
Scalar averaged cross-power spectrum Several baselines displayed
Timerange: 01/03:14:41 to 01/03:19:39

Plot file version 288 created 14-JUL-2010 16:38:24
CYGX-1 RR004A.UVDATA.1
Freq = 4.9415 GHz, Bw = 16.000 MH No calibration applied and no bandpass applied

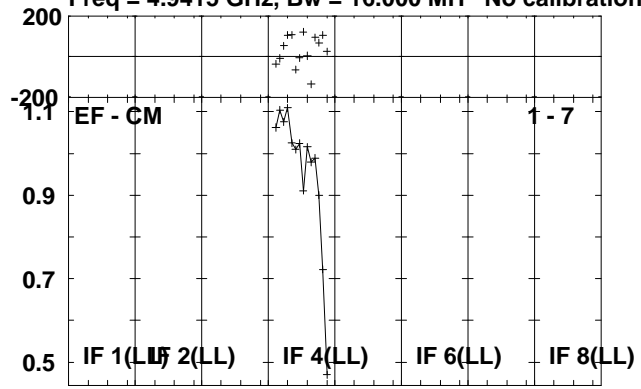

Lower frame: Milli Ampl Jy Top frame: Phas deg
Scalar averaged cross-power spectrum Several baselines displayed
Timerange: 01/03:14:41 to 01/03:19:39

Plot file version 289 created 14-JUL-2010 16:38:25

J1953+35 RR004A.UVDATA.1

Freq = 4.9415 GHz, Bw = 16.000 MH No calibration applied and no bandpass applied

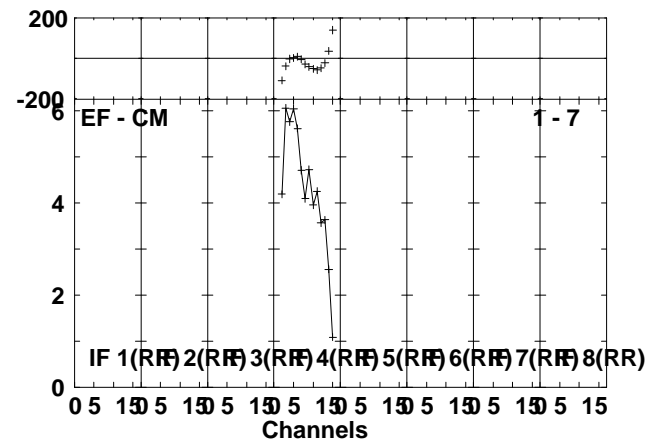
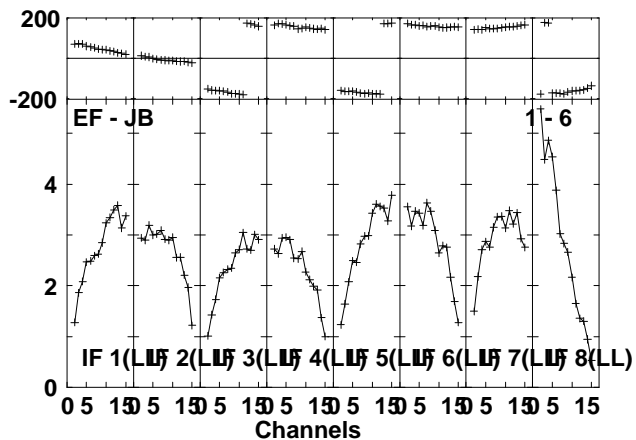
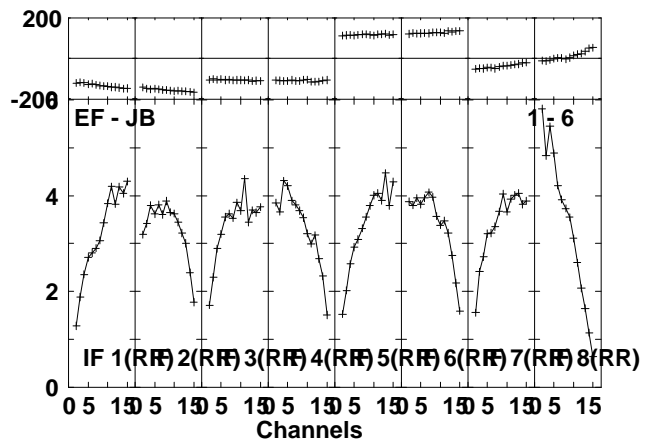
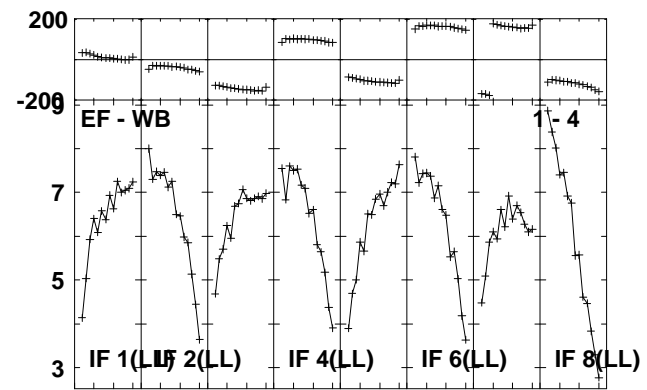
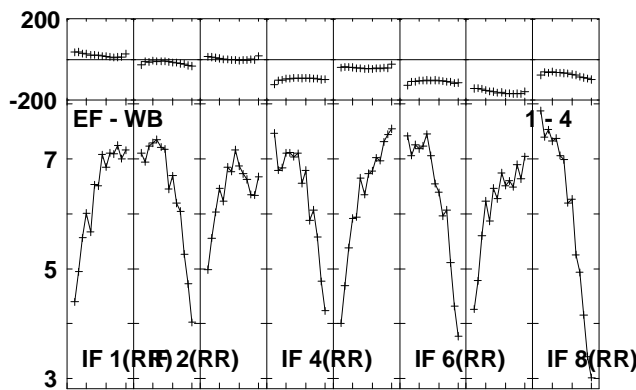
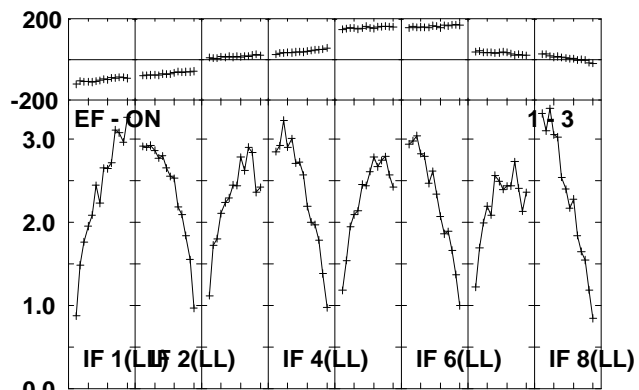
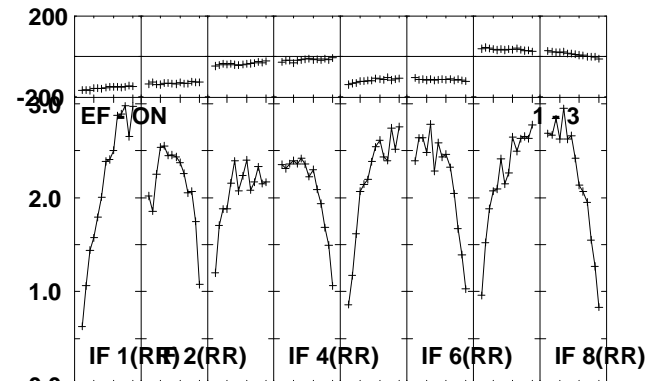
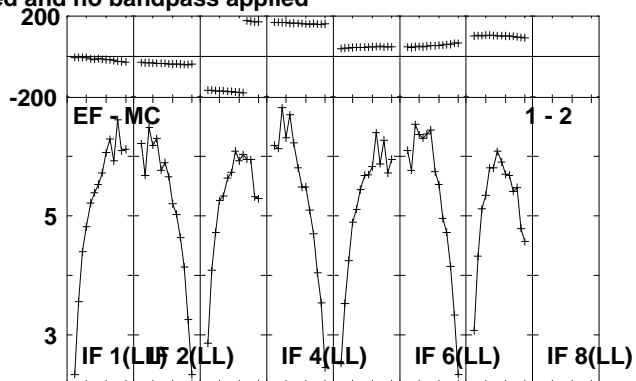
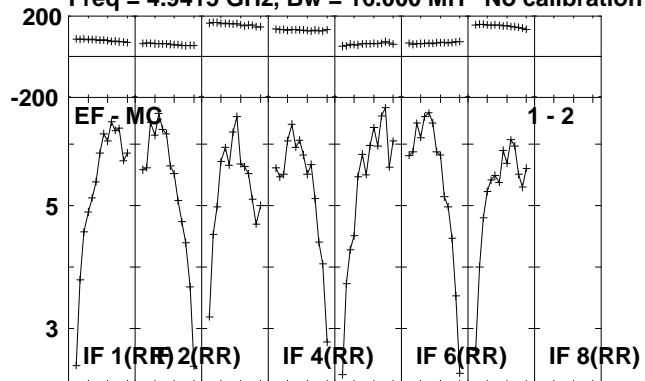

Lower frame: Milli Ampl Jy Top frame: Phas deg
Scalar averaged cross-power spectrum Several baselines displayed
Timerange: 01/03:19:41 to 01/03:21:39

Plot file version 290 created 14-JUL-2010 16:38:25
J1953+35 RR004A.UVDATA.1
Freq = 4.9415 GHz, Bw = 16.000 MH No calibration applied and no bandpass applied

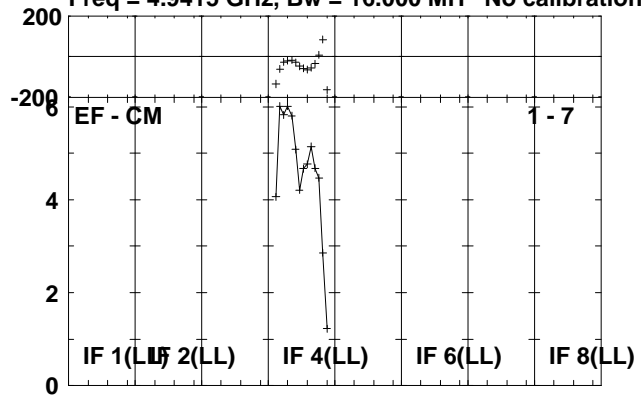

Lower frame: Milli Ampl Jy Top frame: Phas deg
Scalar averaged cross-power spectrum Several baselines displayed
Timerange: 01/03:19:41 to 01/03:21:39

Plot file version 291 created 14-JUL-2010 16:38:26

CYGX-1 RR004A.UVDATA.1

Freq = 4.9415 GHz, Bw = 16.000 MH No calibration applied and no bandpass applied

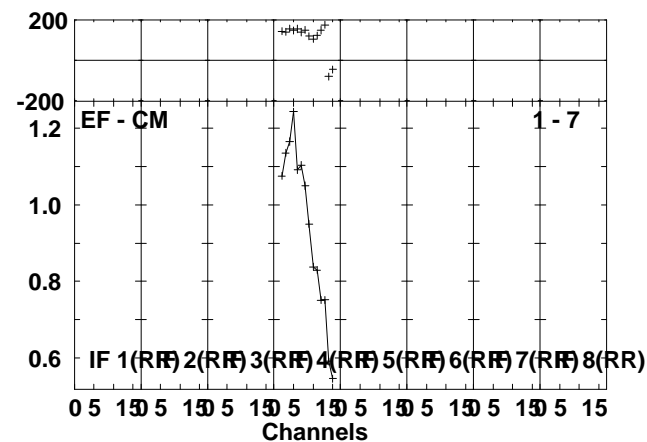
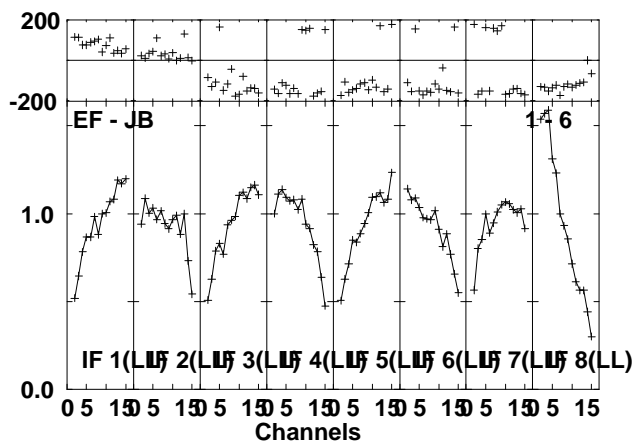
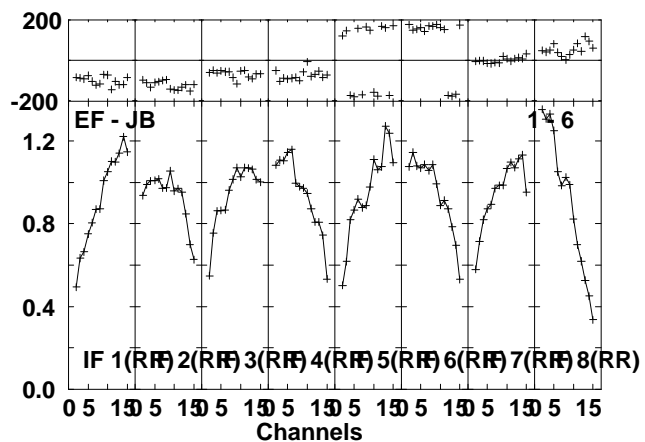
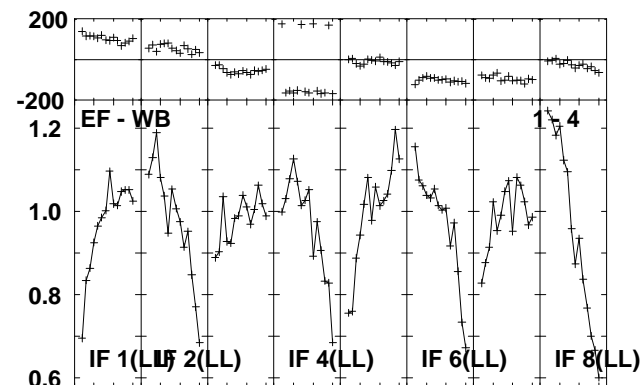
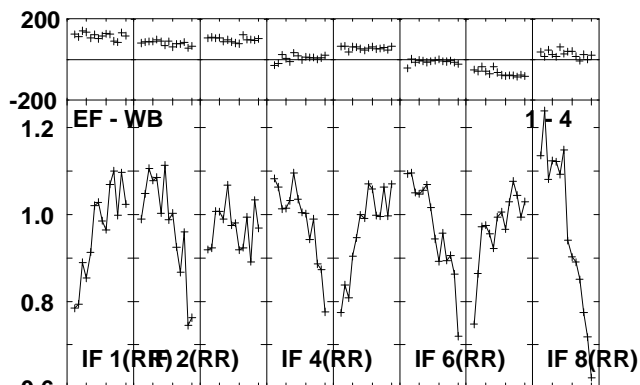
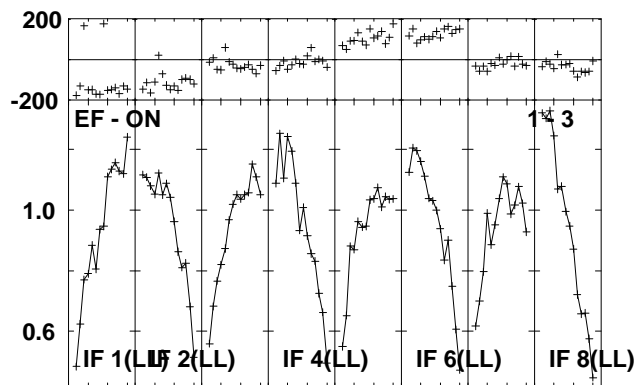
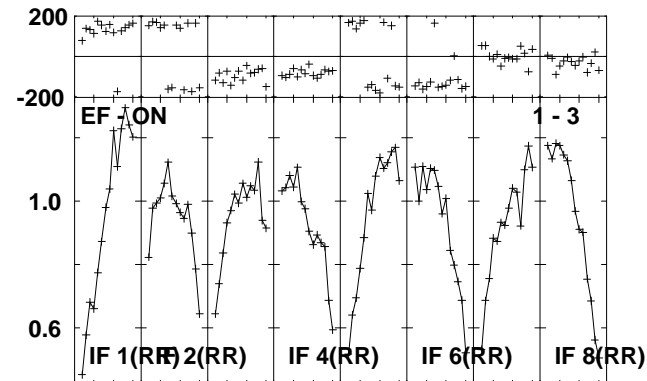
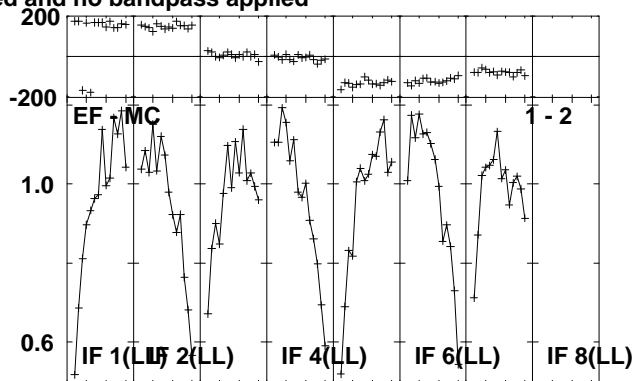
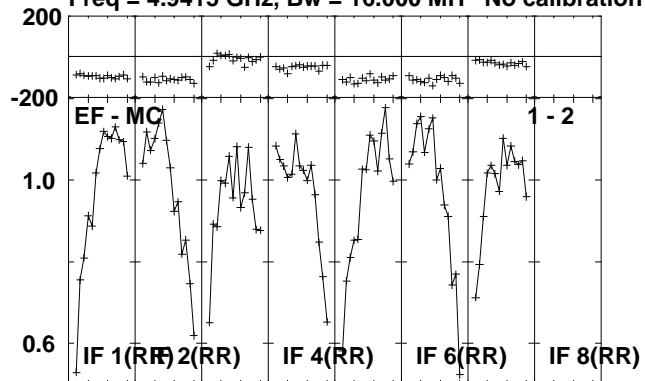

Lower frame: Milli Ampl Jy Top frame: Phas deg
Scalar averaged cross-power spectrum Several baselines displayed
Timerange: 01/03:21:41 to 01/03:26:39

Plot file version 292 created 14-JUL-2010 16:38:27
CYGX-1 RR004A.UVDATA.1
Freq = 4.9415 GHz, Bw = 16.000 MH No calibration applied and no bandpass applied

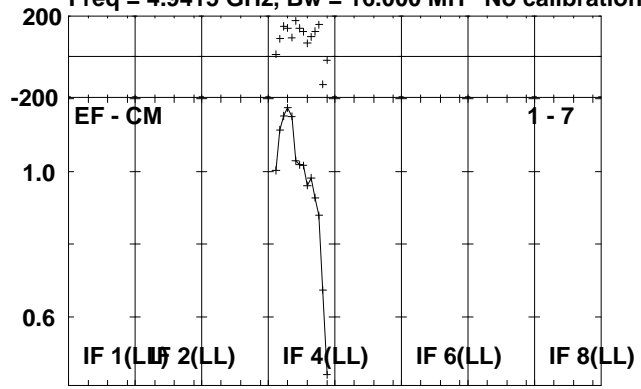

Lower frame: Milli Ampl Jy Top frame: Phas deg
Scalar averaged cross-power spectrum Several baselines displayed
Timerange: 01/03:21:41 to 01/03:26:39

Plot file version 293 created 14-JUL-2010 16:38:27

J1953+35 RR004A.UVDATA.1

Freq = 4.9415 GHz, Bw = 16.000 MH No calibration applied and no bandpass applied

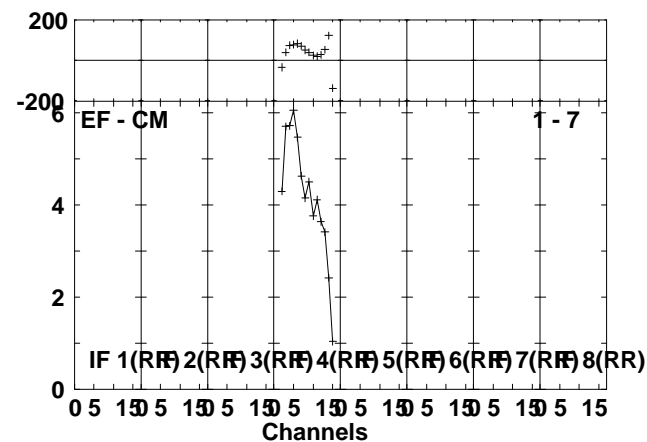
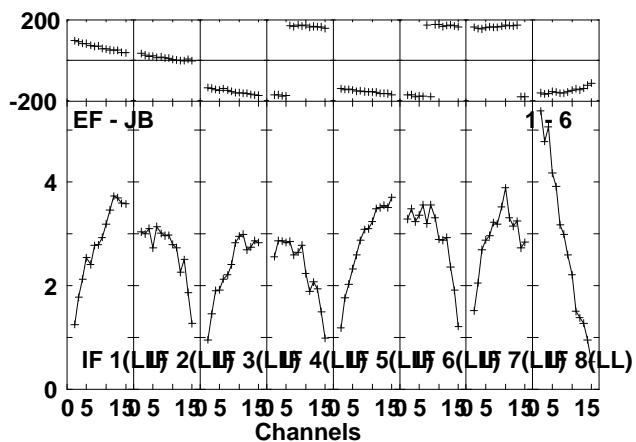
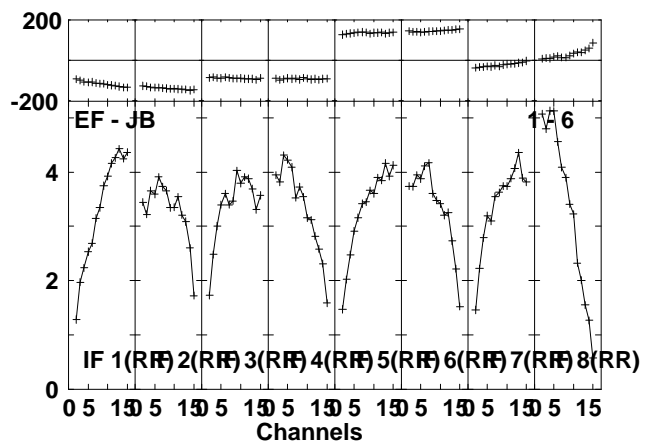
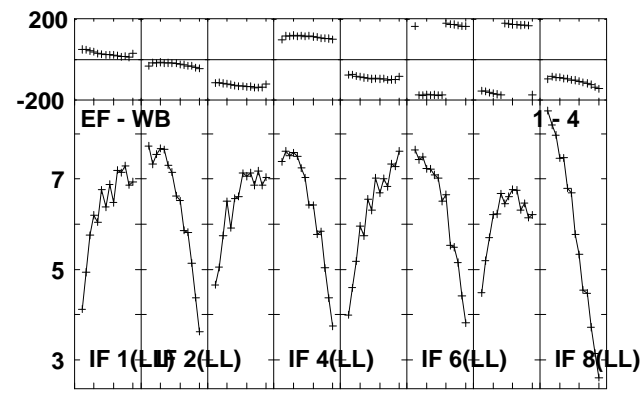
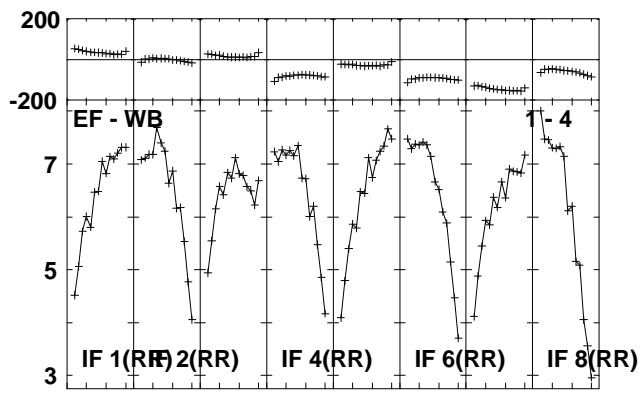
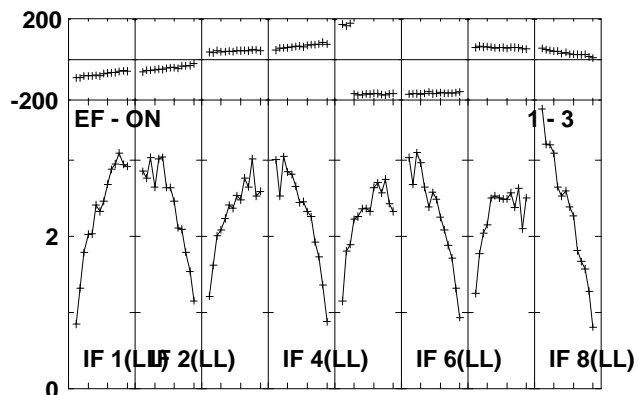
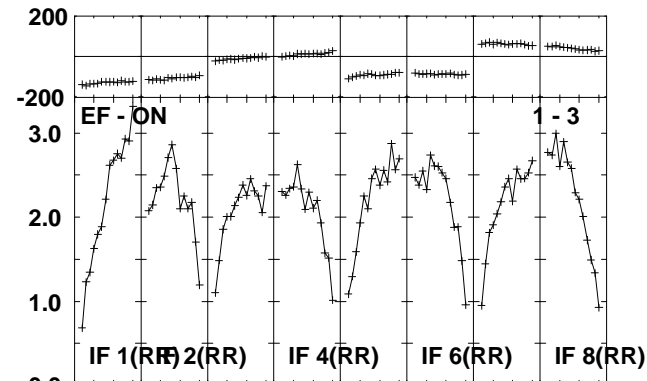
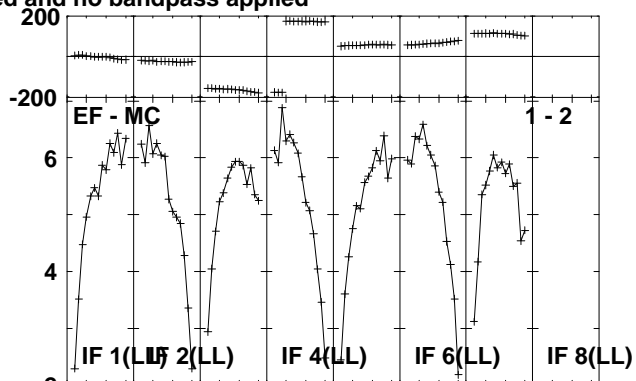
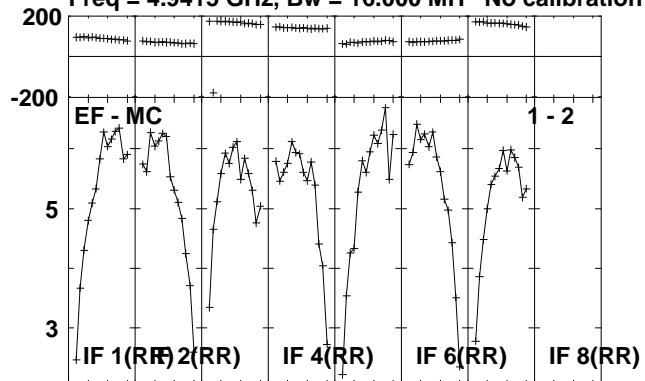

Lower frame: Milli Ampl Jy Top frame: Phas deg
Scalar averaged cross-power spectrum Several baselines displayed
Timerange: 01/03:27:21 to 01/03:28:49

Plot file version 294 created 14-JUL-2010 16:38:28
J1953+35 RR004A.UVDATA.1
Freq = 4.9415 GHz, Bw = 16.000 MH No calibration applied and no bandpass applied

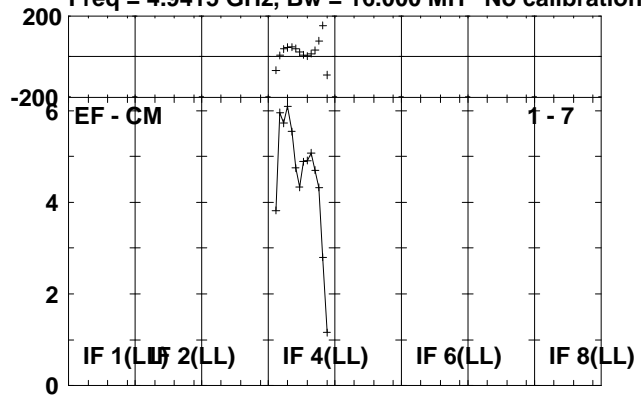

Lower frame: Milli Ampl Jy Top frame: Phas deg
Scalar averaged cross-power spectrum Several baselines displayed
Timerange: 01/03:27:21 to 01/03:28:49

Plot file version 295 created 14-JUL-2010 16:38:28

CYGX-1 RR004A.UVDATA.1

Freq = 4.9415 GHz, Bw = 16.000 MH No calibration applied and no bandpass applied

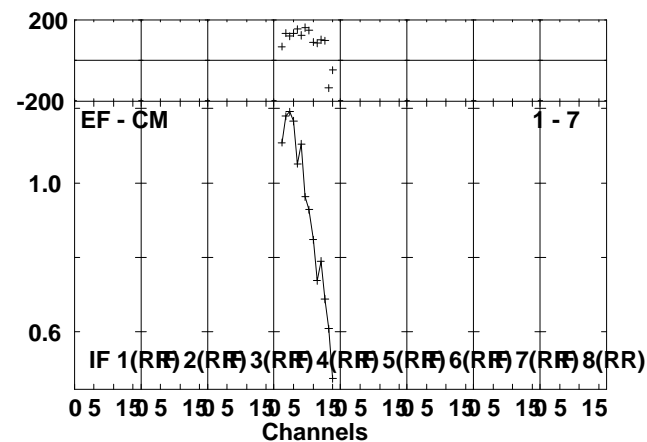
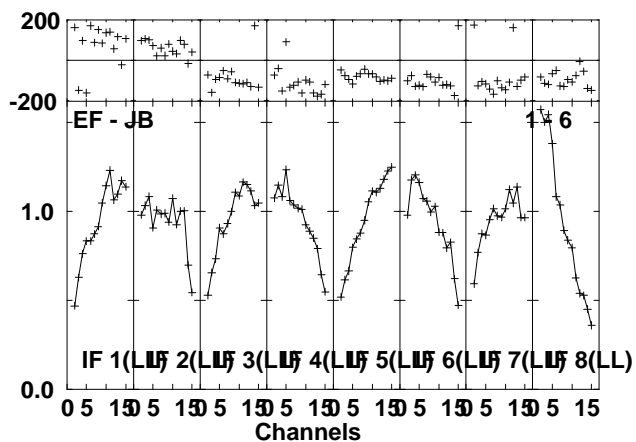
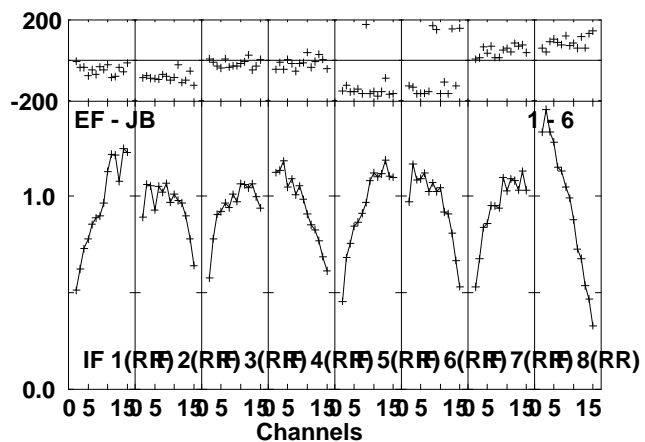
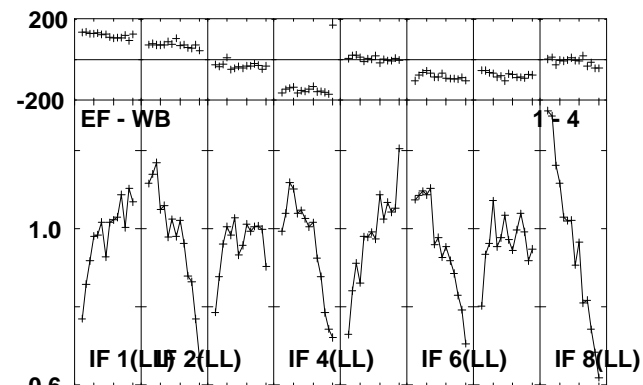
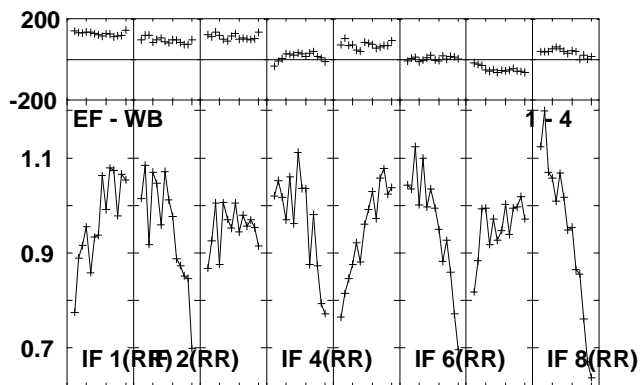
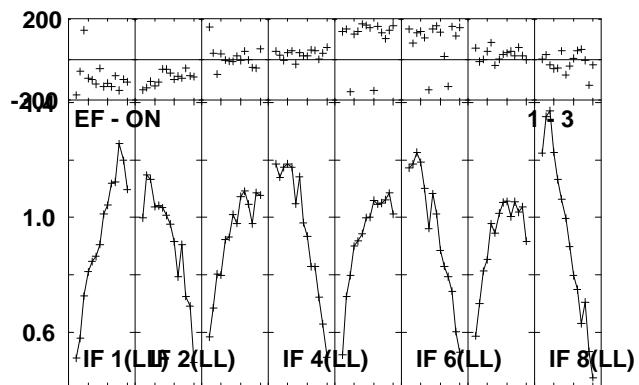
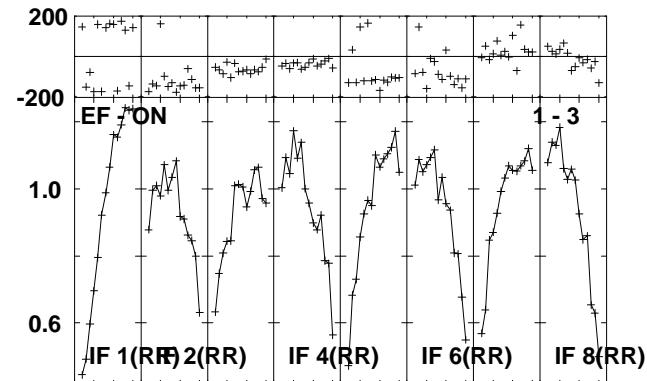
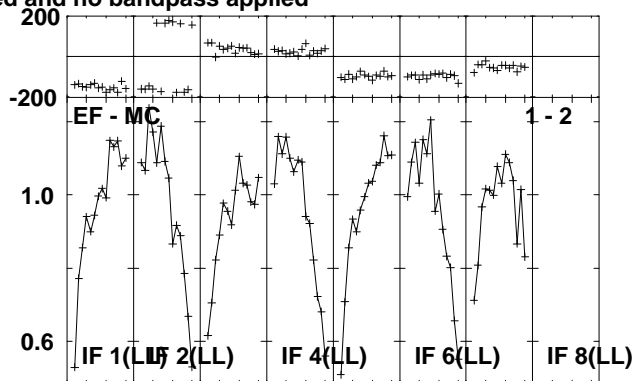
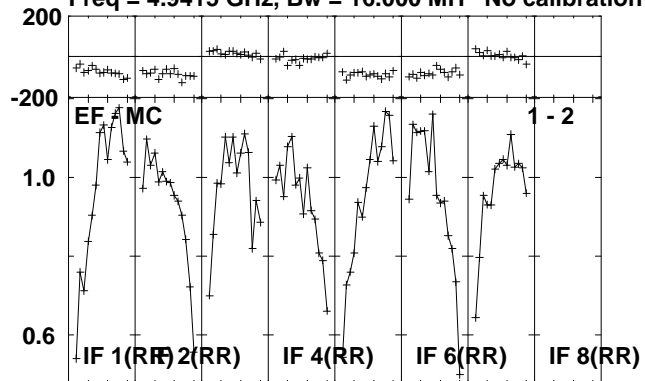

Lower frame: Milli Ampl Jy Top frame: Phas deg
Scalar averaged cross-power spectrum Several baselines displayed
Timerange: 01/03:28:51 to 01/03:33:49

Plot file version 296 created 14-JUL-2010 16:38:29
CYGX-1 RR004A.UVDATA.1
Freq = 4.9415 GHz, Bw = 16.000 MH No calibration applied and no bandpass applied

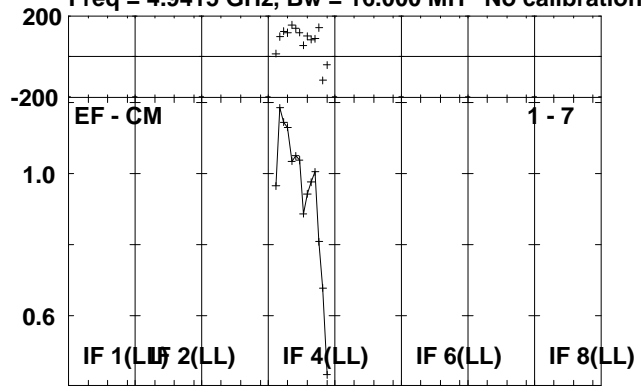

Lower frame: Milli Ampl Jy Top frame: Phas deg
Scalar averaged cross-power spectrum Several baselines displayed
Timerange: 01/03:28:51 to 01/03:33:49

Plot file version 297 created 14-JUL-2010 16:38:30

J1953+35 RR004A.UVDATA.1

Freq = 4.9415 GHz, Bw = 16.000 MH No calibration applied and no bandpass applied

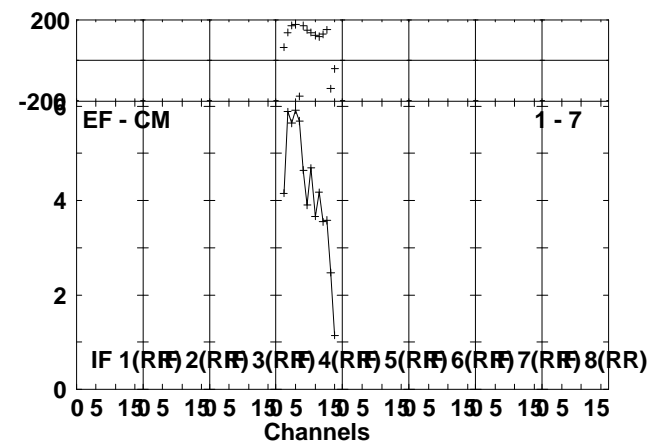
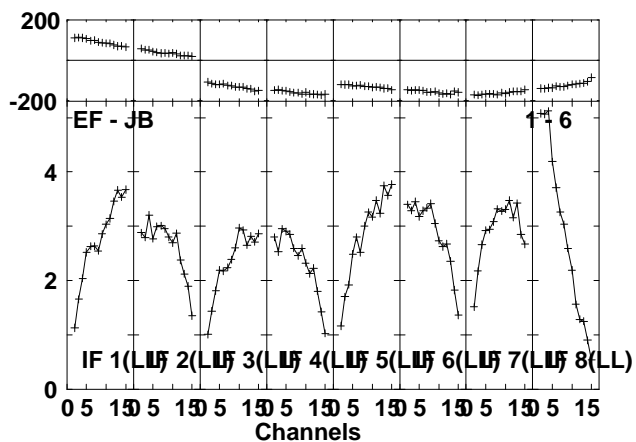
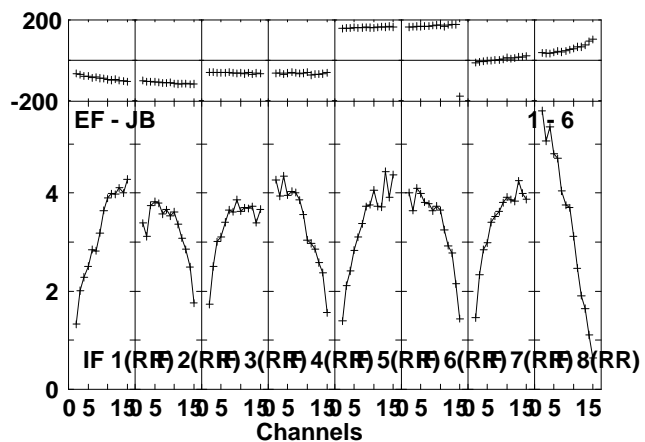
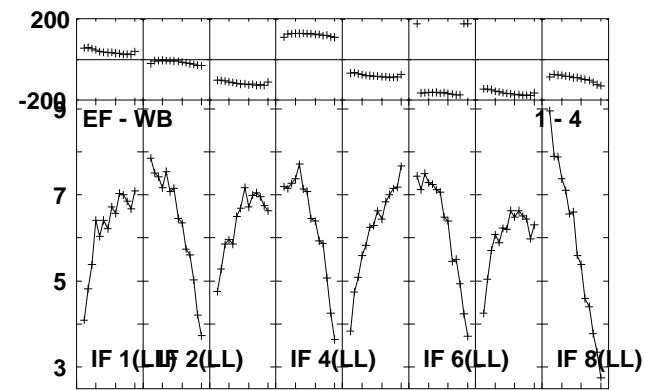
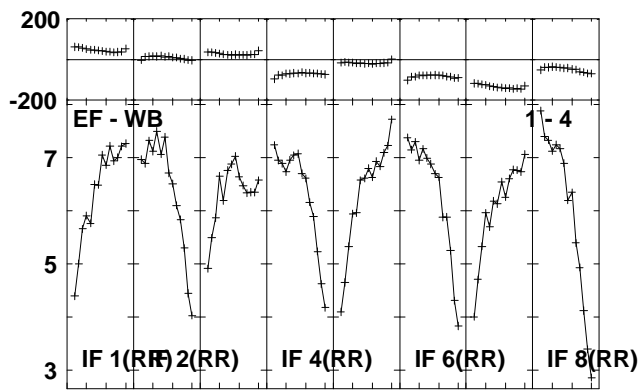
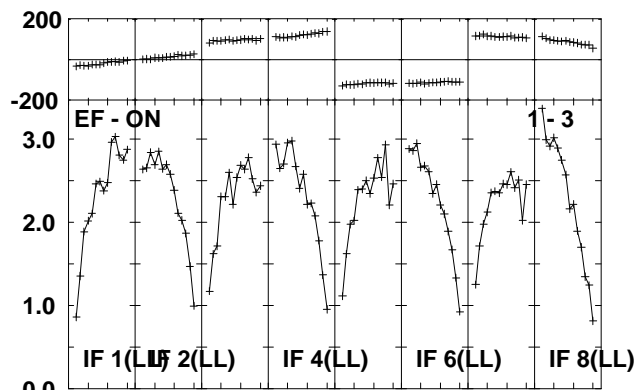
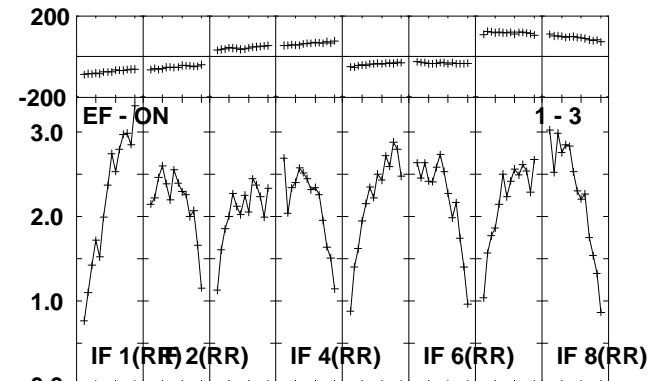
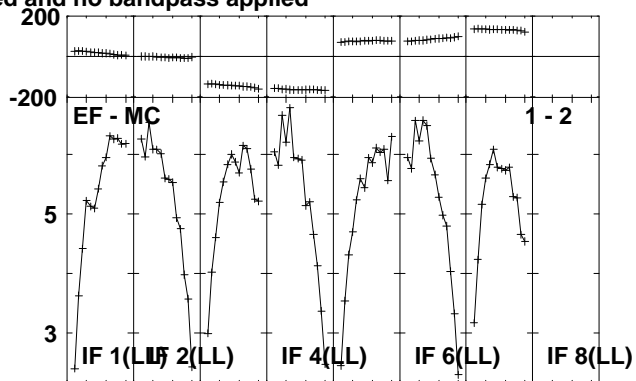
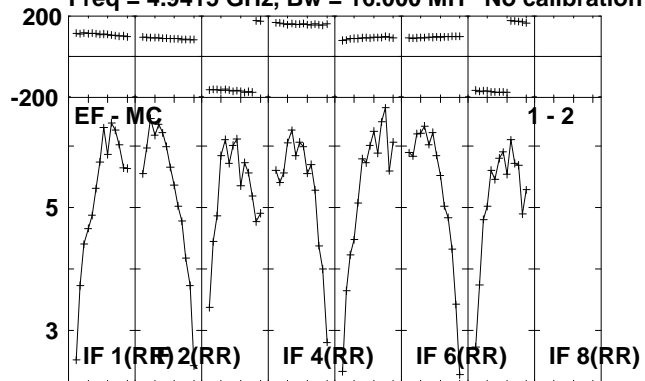

Lower frame: Milli Ampl Jy Top frame: Phas deg
Scalar averaged cross-power spectrum Several baselines displayed
Timerange: 01/03:33:51 to 01/03:35:49

Plot file version 298 created 14-JUL-2010 16:38:30
J1953+35 RR004A.UVDATA.1
Freq = 4.9415 GHz, Bw = 16.000 MH No calibration applied and no bandpass applied

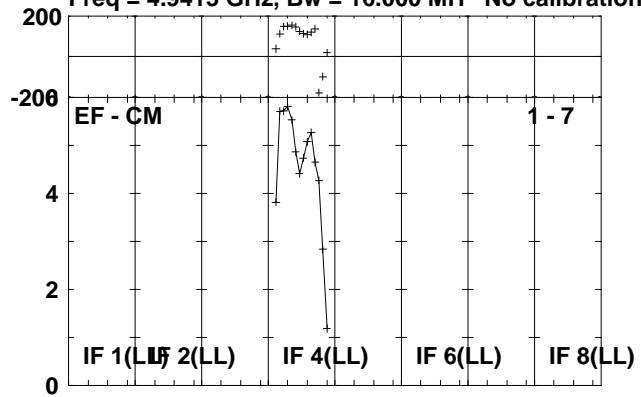

Lower frame: Milli Ampl Jy Top frame: Phas deg
Scalar averaged cross-power spectrum Several baselines displayed
Timerange: 01/03:33:51 to 01/03:35:49

Plot file version 299 created 14-JUL-2010 16:38:31

CYGX-1 RR004A.UVDATA.1

Freq = 4.9415 GHz, Bw = 16.000 MH No calibration applied and no bandpass applied

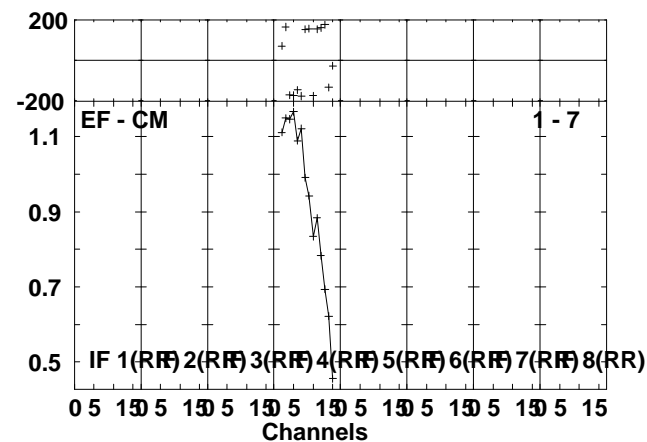
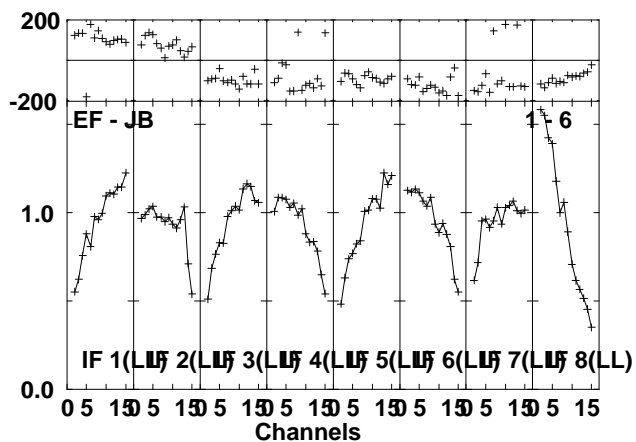
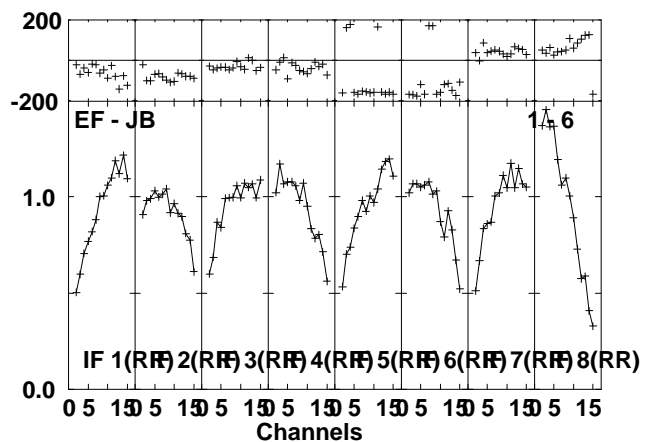
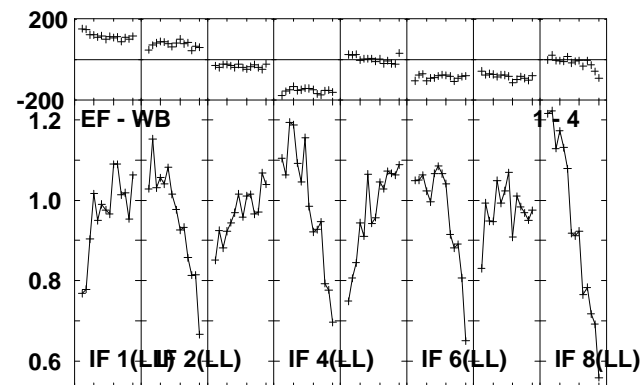
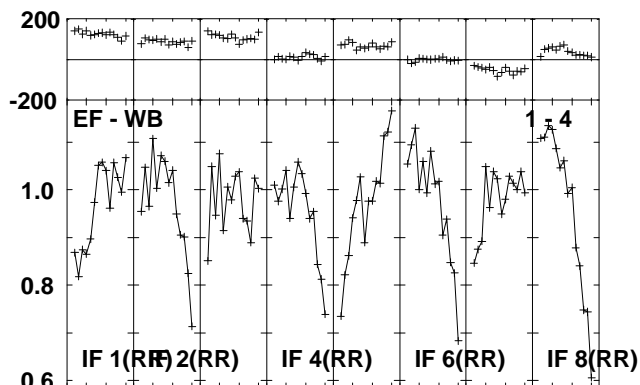
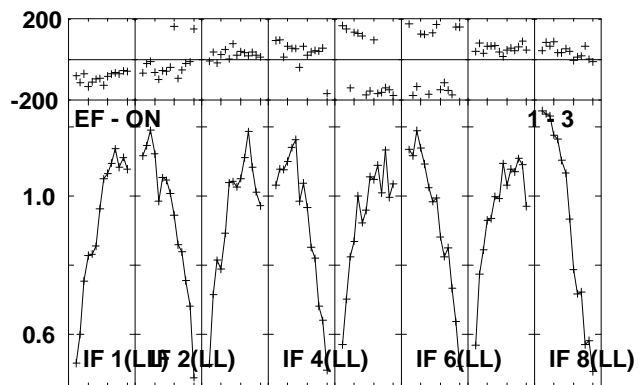
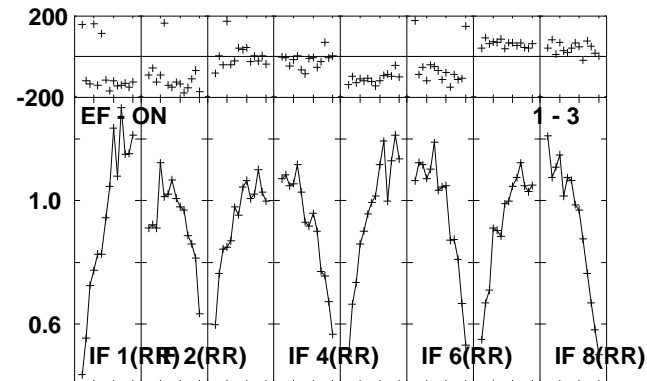
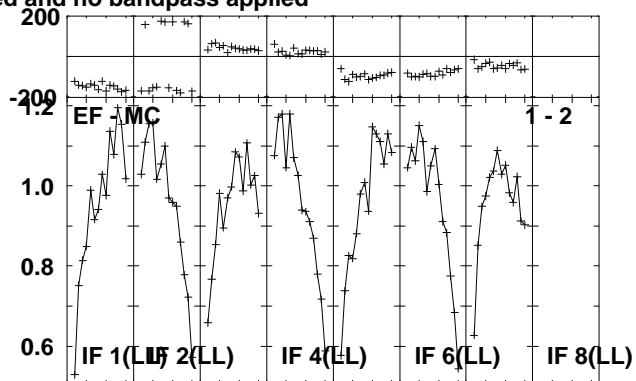
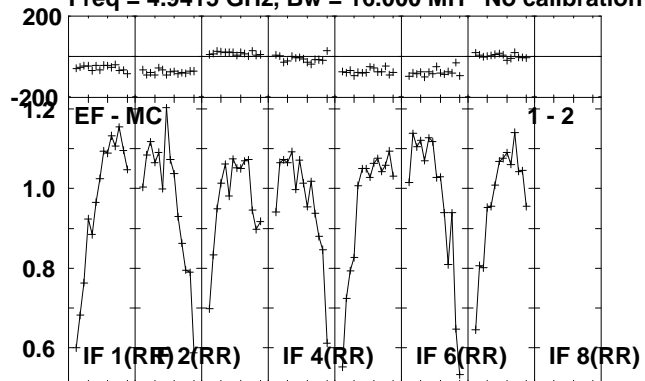

Lower frame: Milli Ampl Jy Top frame: Phas deg
Scalar averaged cross-power spectrum Several baselines displayed
Timerange: 01/03:35:51 to 01/03:40:49

Plot file version 300 created 14-JUL-2010 16:38:32
CYGX-1 RR004A.UVDATA.1
Freq = 4.9415 GHz, Bw = 16.000 MH No calibration applied and no bandpass applied

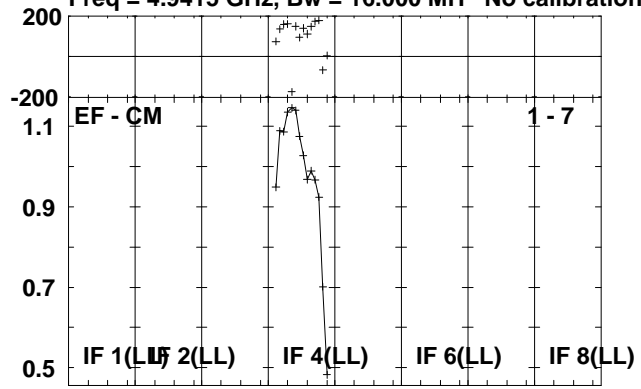

Lower frame: Milli Ampl Jy Top frame: Phas deg
Scalar averaged cross-power spectrum Several baselines displayed
Timerange: 01/03:35:51 to 01/03:40:49

Plot file version 301 created 14-JUL-2010 16:38:32

J1953+35 RR004A.UVDATA.1

Freq = 4.9415 GHz, Bw = 16.000 MH No calibration applied and no bandpass applied

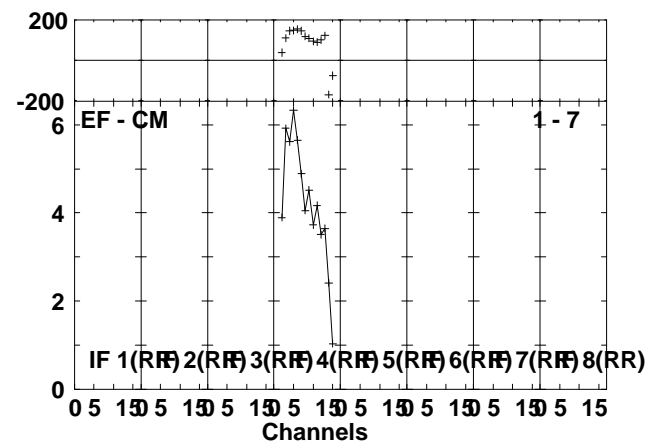
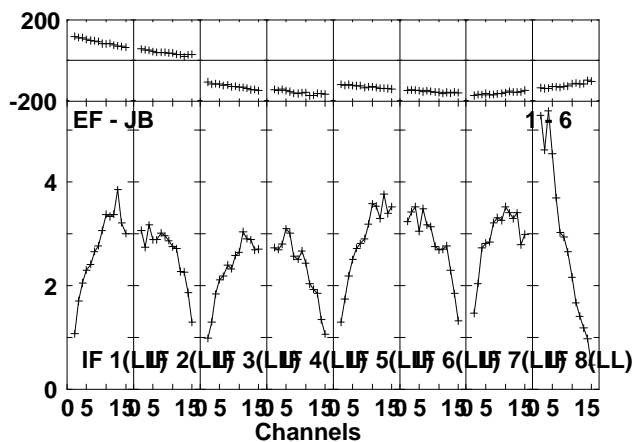
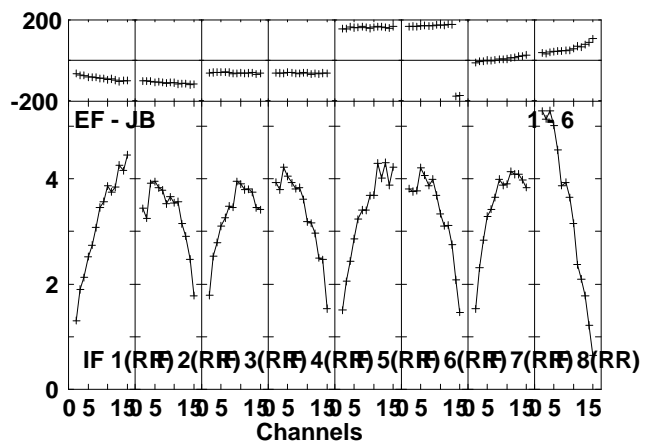
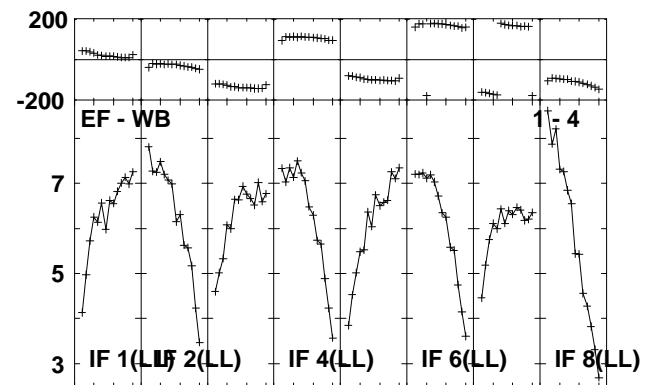
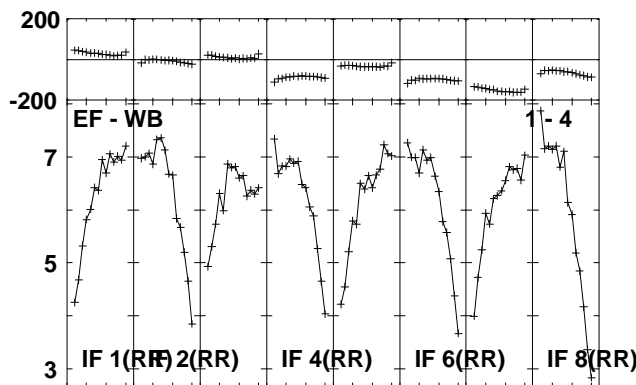
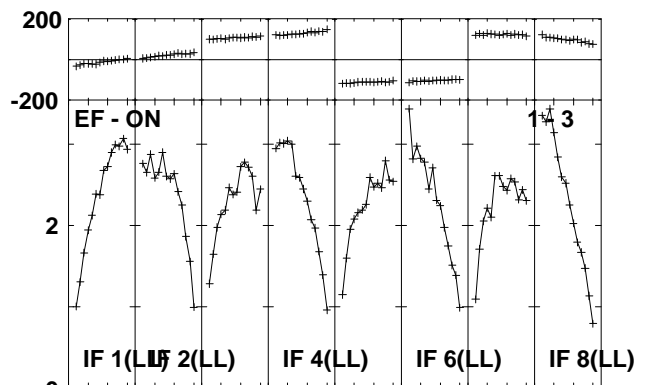
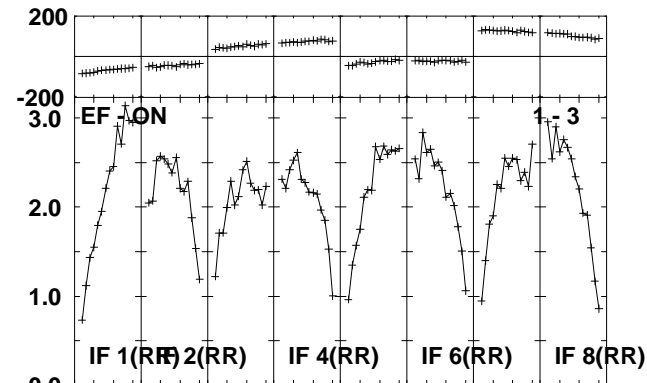
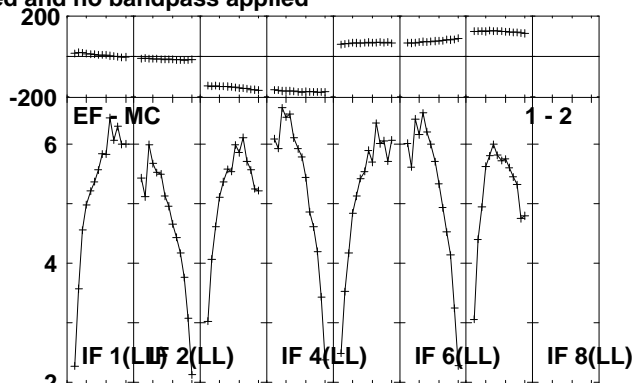
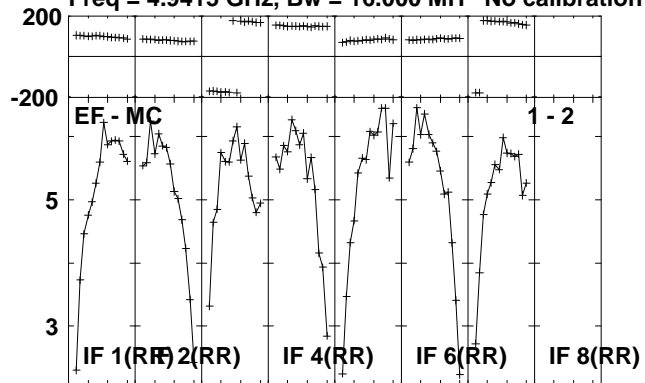

Lower frame: Milli Ampl Jy Top frame: Phas deg
Scalar averaged cross-power spectrum Several baselines displayed
Timerange: 01/03:41:31 to 01/03:42:59

Plot file version 302 created 14-JUL-2010 16:38:33
J1953+35 RR004A.UVDATA.1
Freq = 4.9415 GHz, Bw = 16.000 MH No calibration applied and no bandpass applied

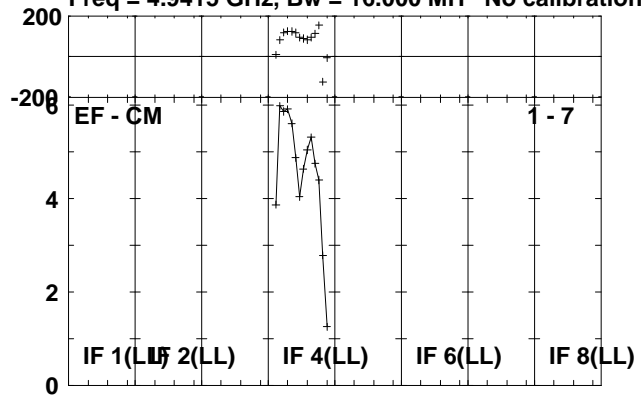

Lower frame: Milli Ampl Jy Top frame: Phas deg
Scalar averaged cross-power spectrum Several baselines displayed
Timerange: 01/03:41:31 to 01/03:42:59

Plot file version 303 created 14-JUL-2010 16:38:33

CYGX-1 RR004A.UVDATA.1

Freq = 4.9415 GHz, Bw = 16.000 MH No calibration applied and no bandpass applied

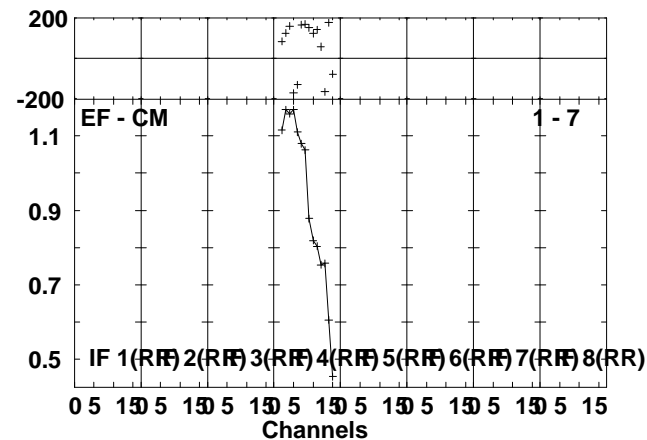
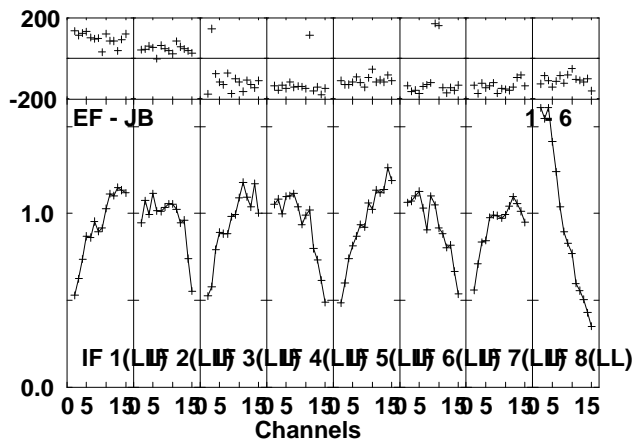
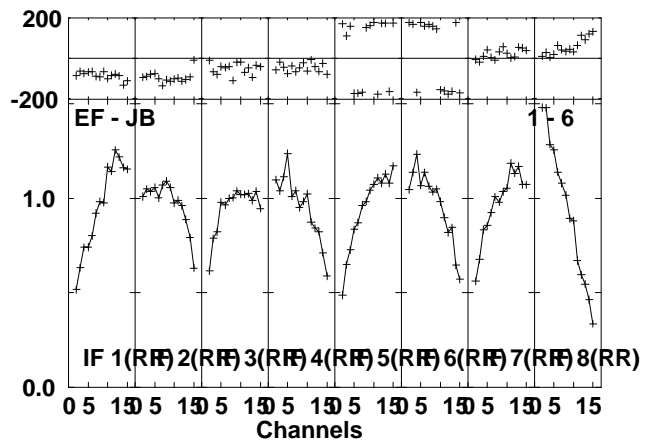
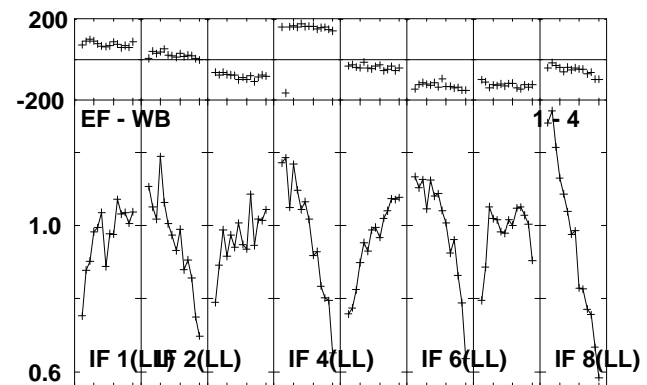
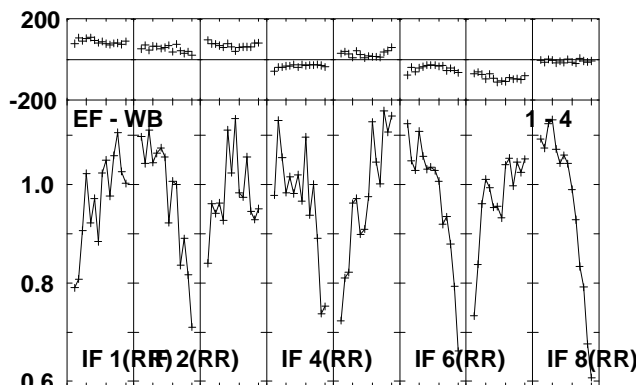
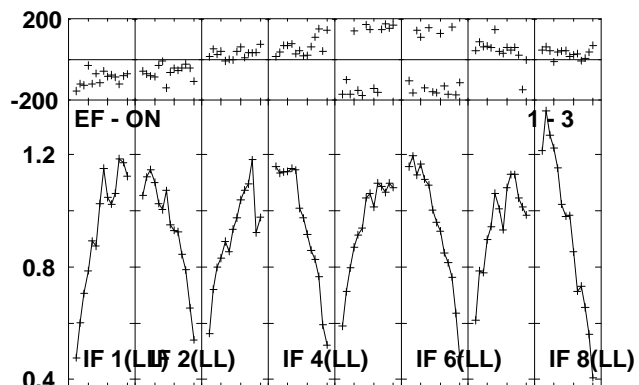
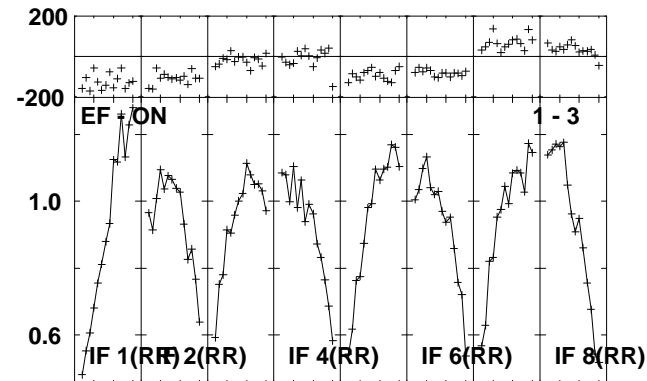
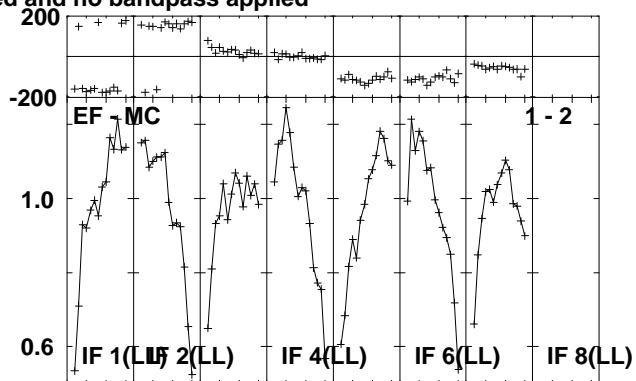
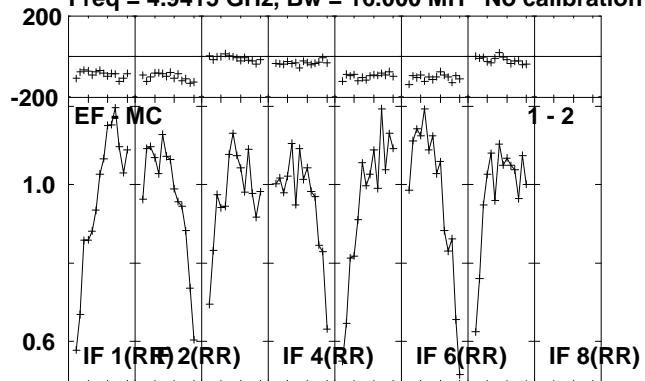

Lower frame: Milli Ampl Jy Top frame: Phas deg
Scalar averaged cross-power spectrum Several baselines displayed
Timerange: 01/03:43:01 to 01/03:47:59

Plot file version 304 created 14-JUL-2010 16:38:34
CYGX-1 RR004A.UVDATA.1
Freq = 4.9415 GHz, Bw = 16.000 MH No calibration applied and no bandpass applied

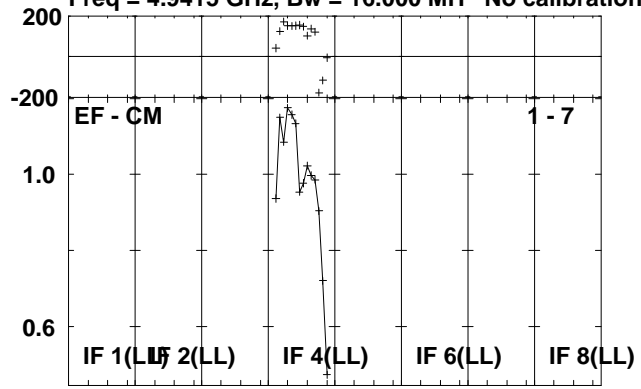

Lower frame: Milli Ampl Jy Top frame: Phas deg
Scalar averaged cross-power spectrum Several baselines displayed
Timerange: 01/03:43:01 to 01/03:47:59

Plot file version 305 created 14-JUL-2010 16:38:35

J1953+35 RR004A.UVDATA.1

Freq = 4.9415 GHz, Bw = 16.000 MH No calibration applied and no bandpass applied

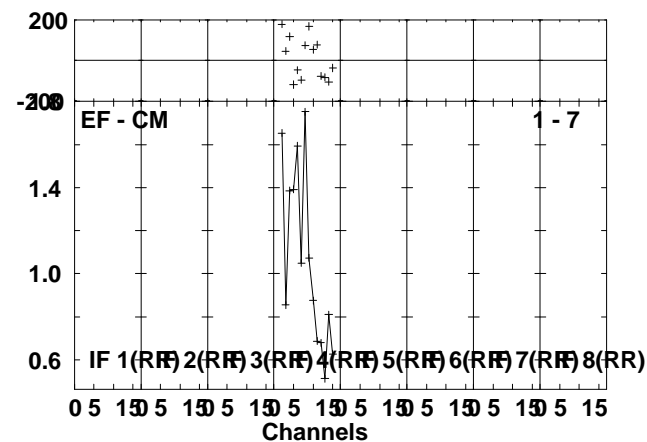
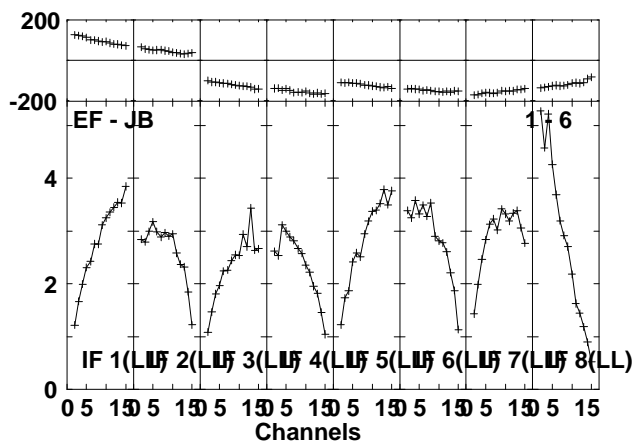
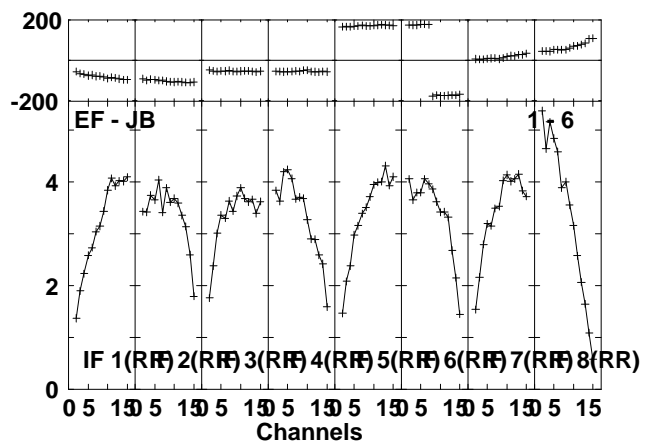
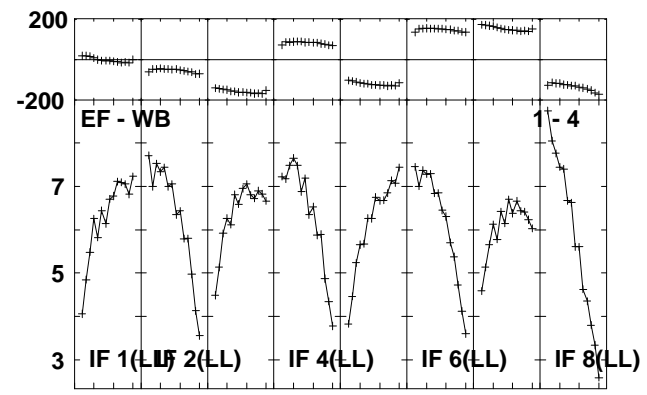
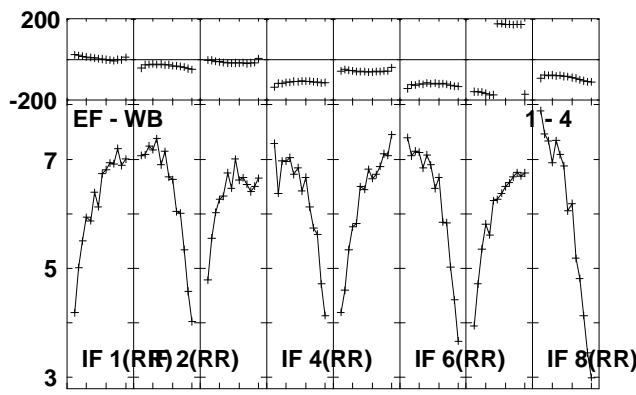
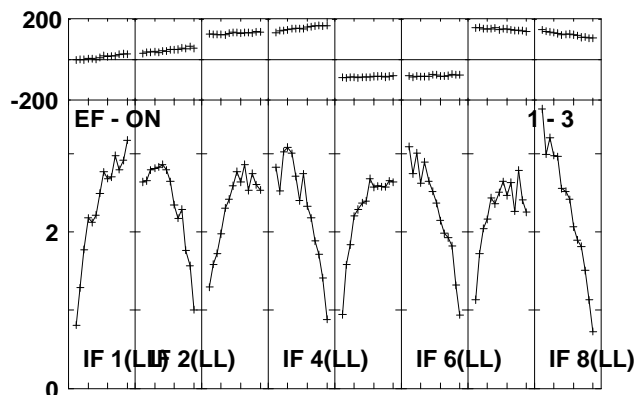
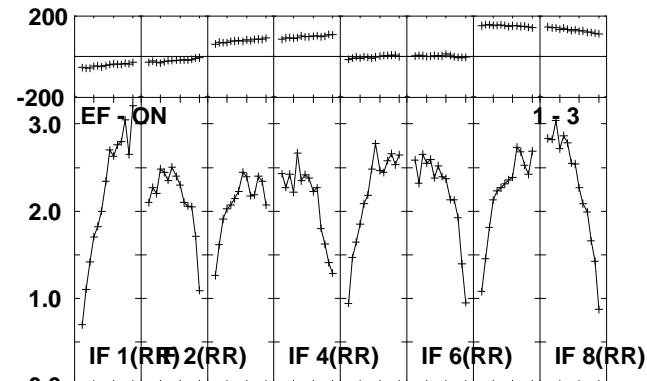
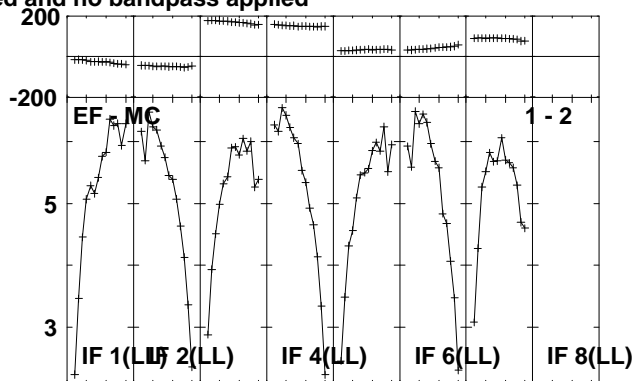
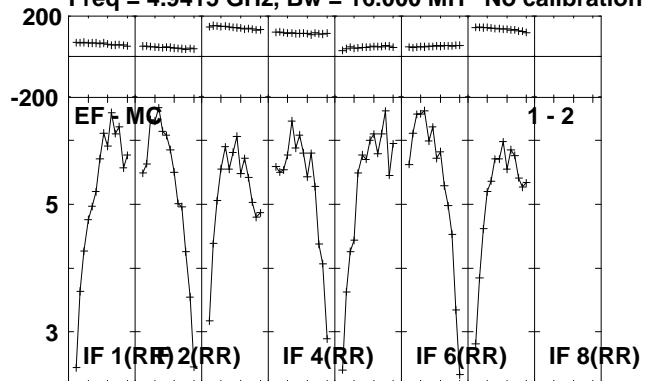

Lower frame: Milli Ampl Jy Top frame: Phas deg
Scalar averaged cross-power spectrum Several baselines displayed
Timerange: 01/03:48:01 to 01/03:49:59

Plot file version 306 created 14-JUL-2010 16:38:35
J1953+35 RR004A.UVDATA.1
Freq = 4.9415 GHz, Bw = 16.000 MH No calibration applied and no bandpass applied

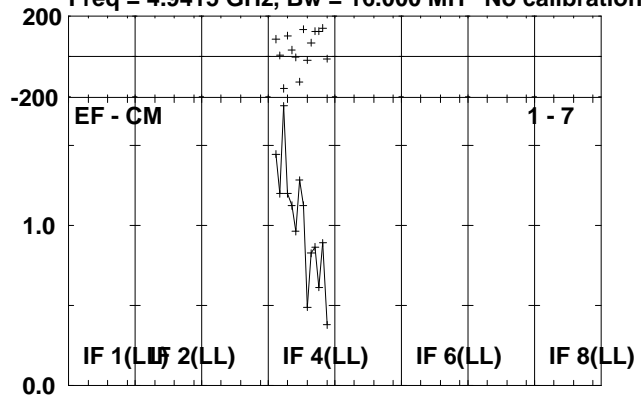

Lower frame: Milli Ampl Jy Top frame: Phas deg
Scalar averaged cross-power spectrum Several baselines displayed
Timerange: 01/03:48:01 to 01/03:49:59

Plot file version 307 created 14-JUL-2010 16:38:36

CYGX-1 RR004A.UVDATA.1

Freq = 4.9415 GHz, Bw = 16.000 MH No calibration applied and no bandpass applied

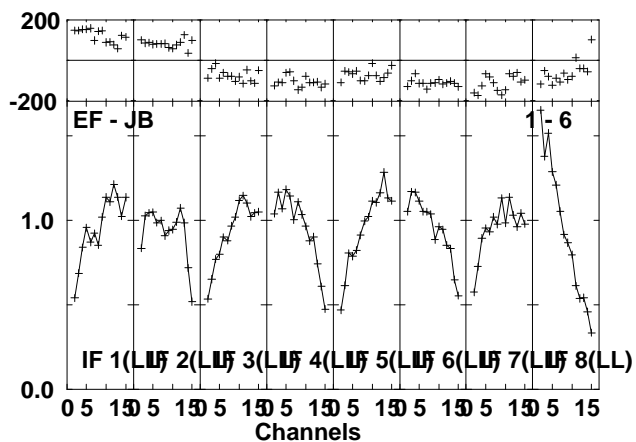
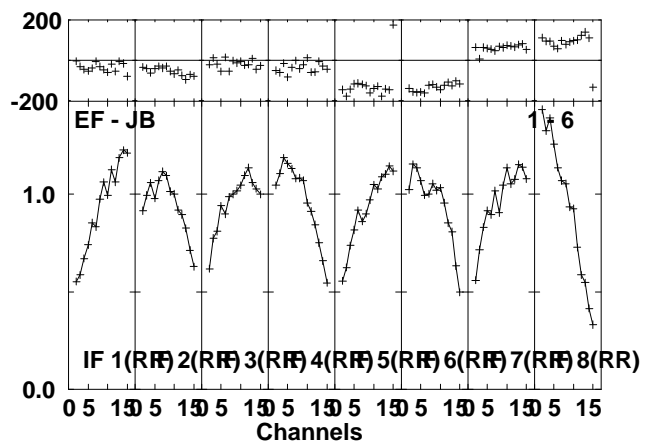
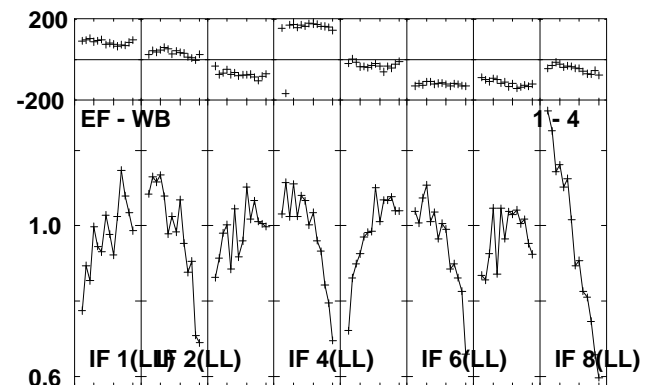
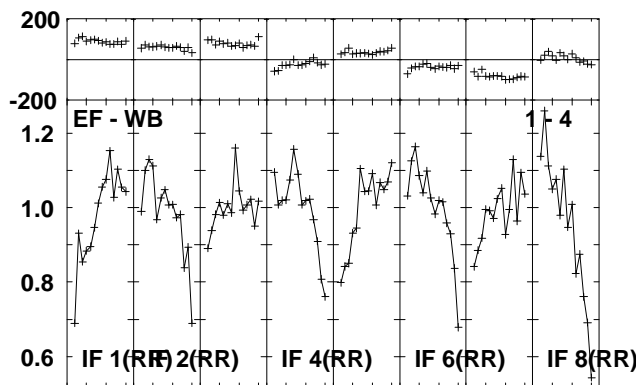
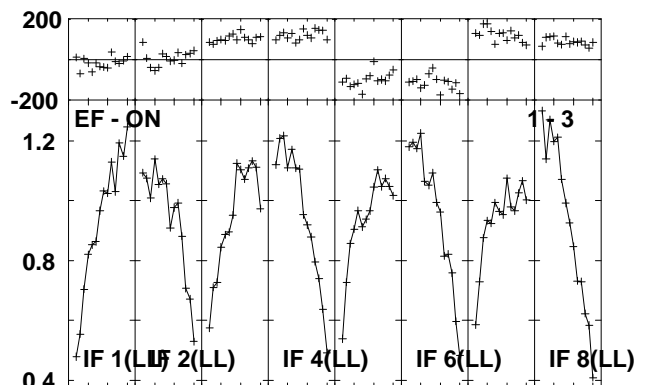
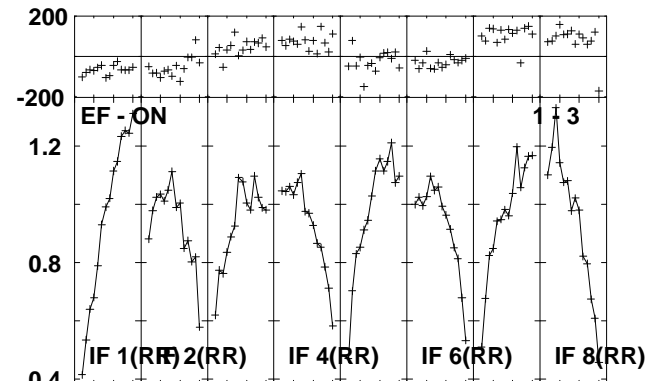
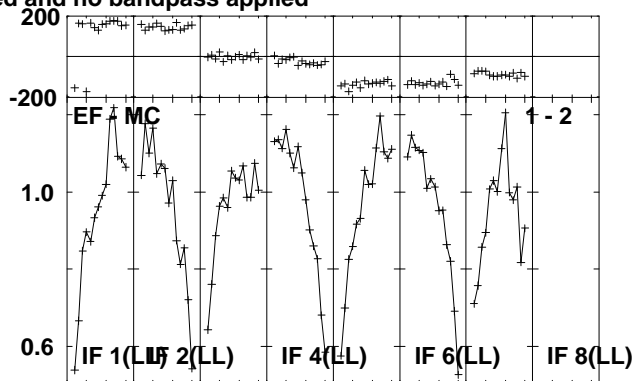
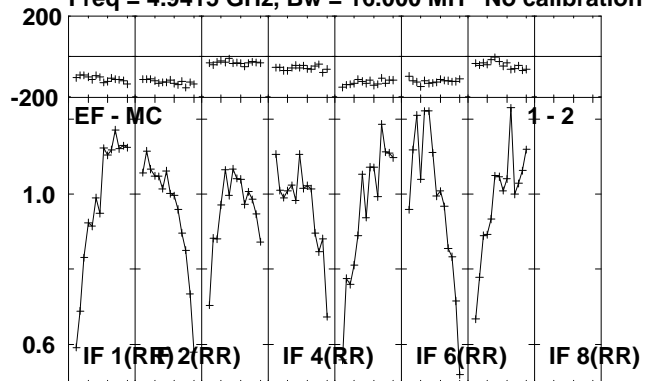

Lower frame: Milli Ampl Jy Top frame: Phas deg
Scalar averaged cross-power spectrum Several baselines displayed
Timerange: 01/03:50:01 to 01/03:54:59

Plot file version 308 created 14-JUL-2010 16:38:37

J1953+35 RR004A.UVDATA.1

Freq = 4.9415 GHz, Bw = 16.000 MH No calibration applied and no bandpass applied

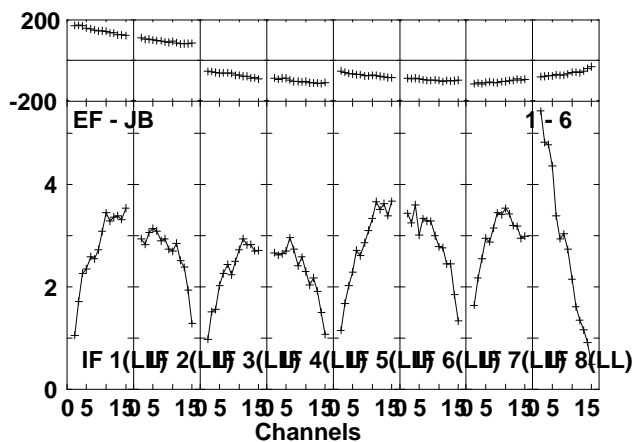
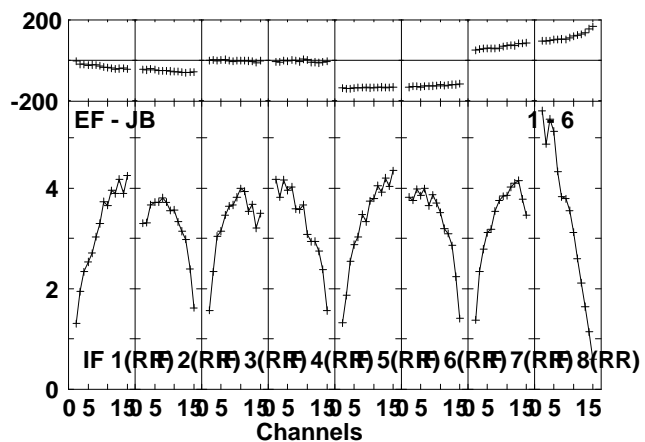
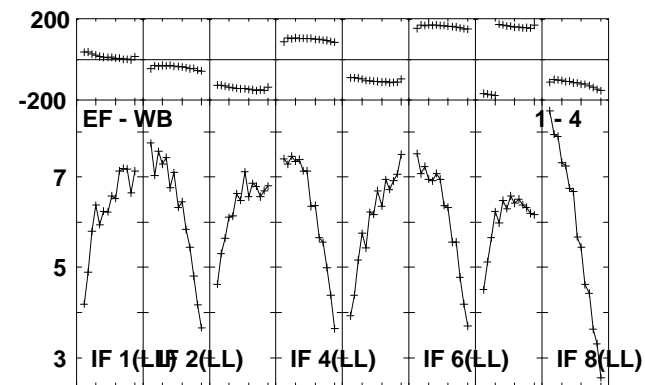
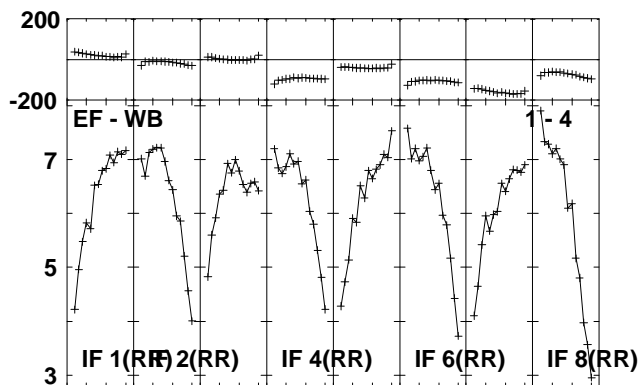
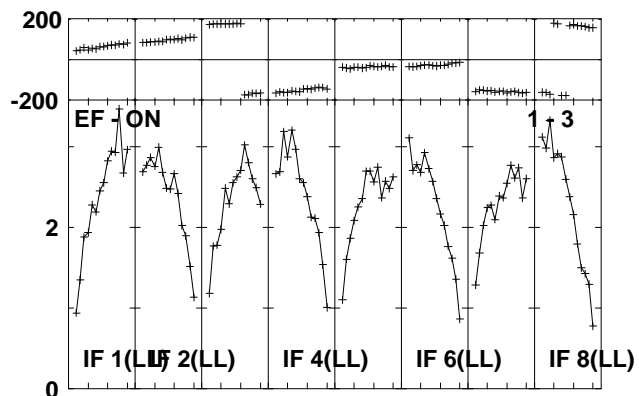
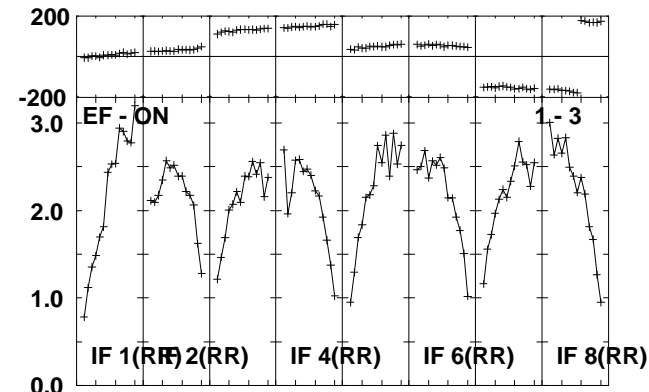
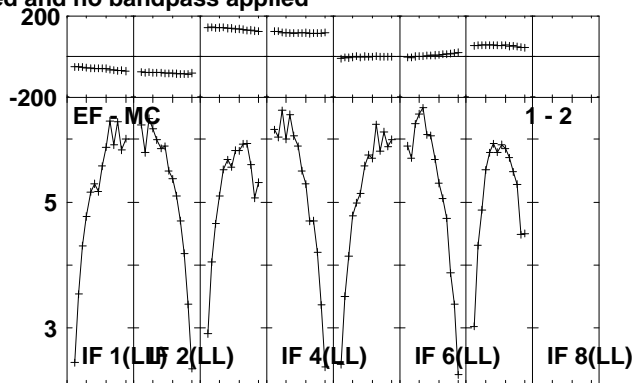
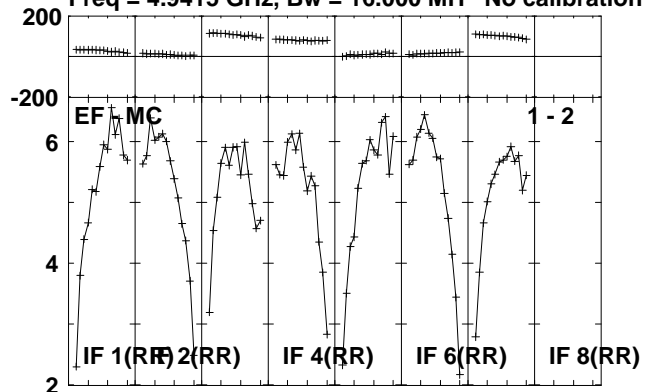

Lower frame: Milli Ampl Jy Top frame: Phas deg
Scalar averaged cross-power spectrum Several baselines displayed
Timerange: 01/03:55:41 to 01/03:57:09

Plot file version 309 created 14-JUL-2010 16:38:37

CYGX-1 RR004A.UVDATA.1

Freq = 4.9415 GHz, Bw = 16.000 MH No calibration applied and no bandpass applied

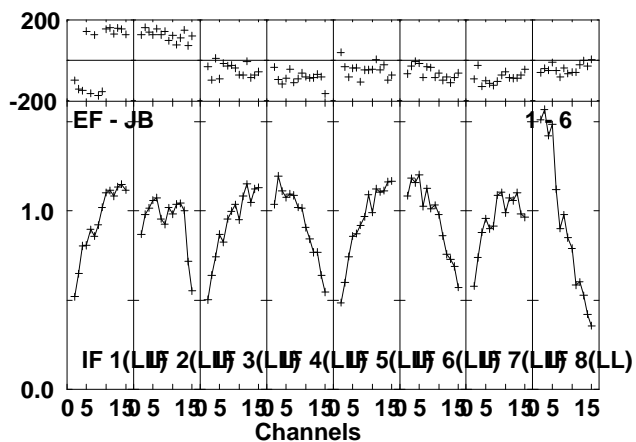
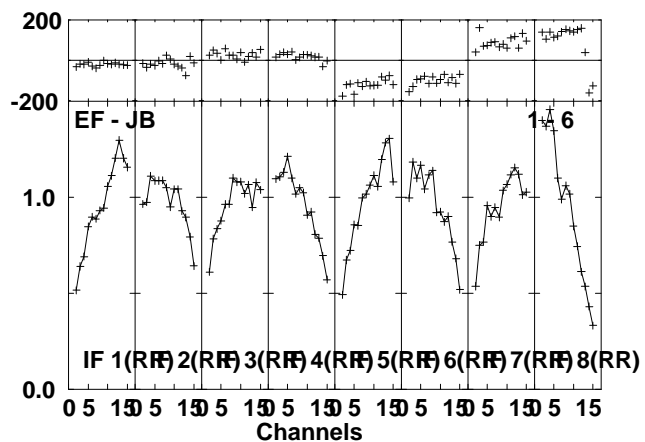
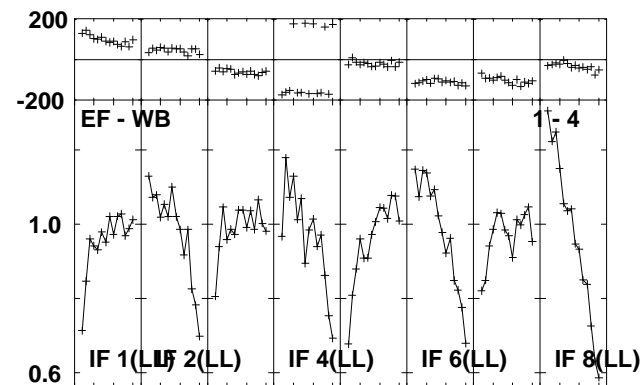
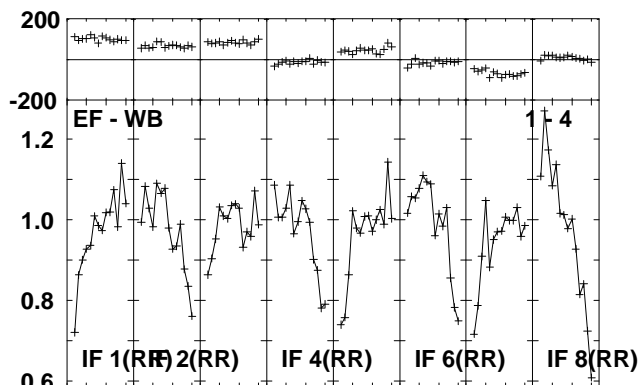
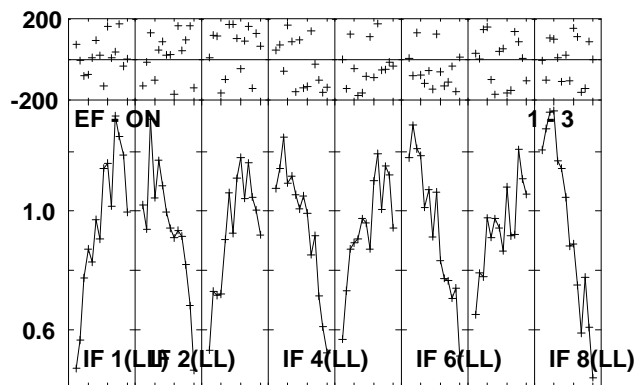
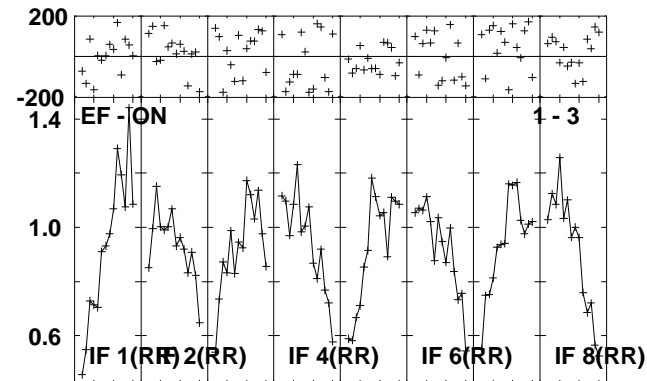
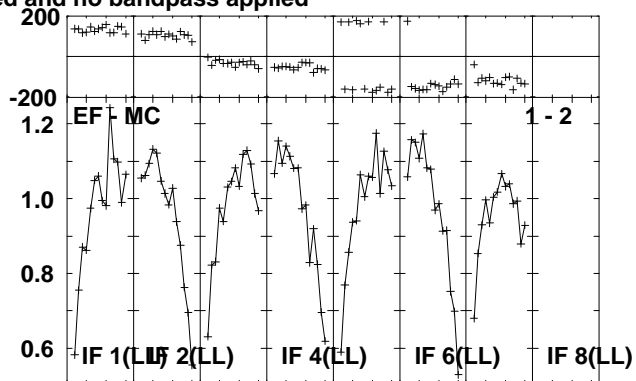
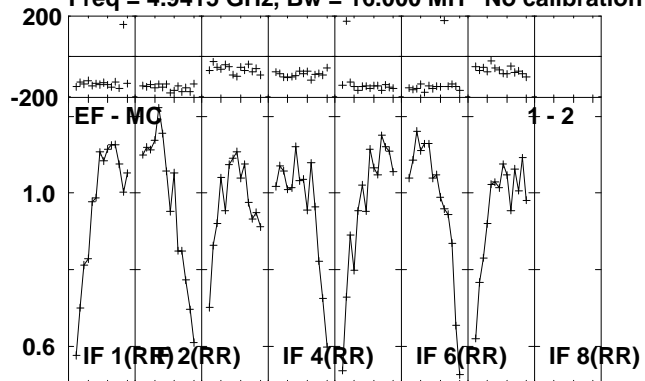

Lower frame: Milli Ampl Jy Top frame: Phas deg
Scalar averaged cross-power spectrum Several baselines displayed
Timerange: 01/03:57:11 to 01/04:02:09

Plot file version 310 created 14-JUL-2010 16:38:38

J1953+35 RR004A.UVDATA.1

Freq = 4.9415 GHz, Bw = 16.000 MH No calibration applied and no bandpass applied

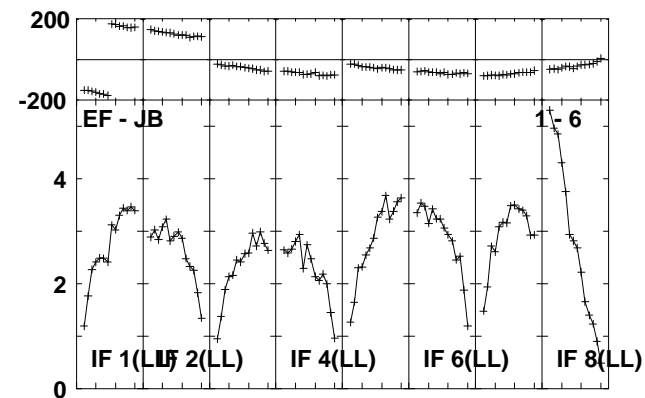
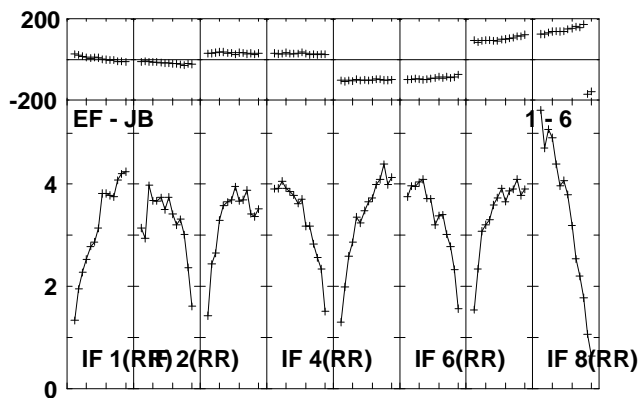
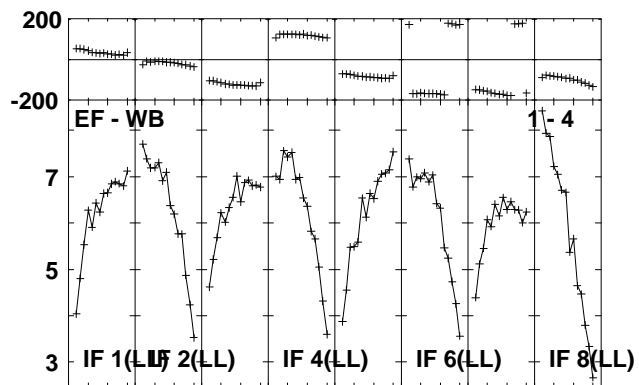
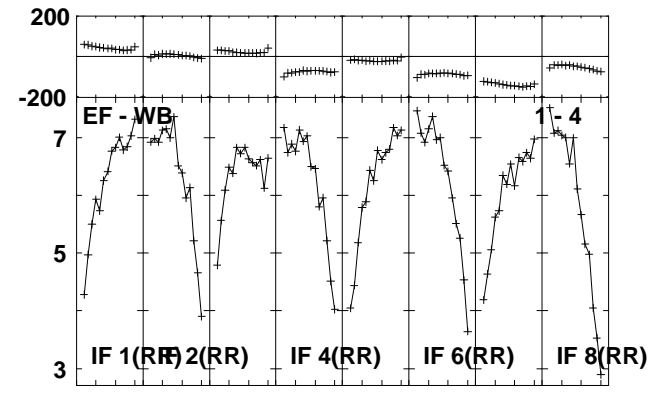
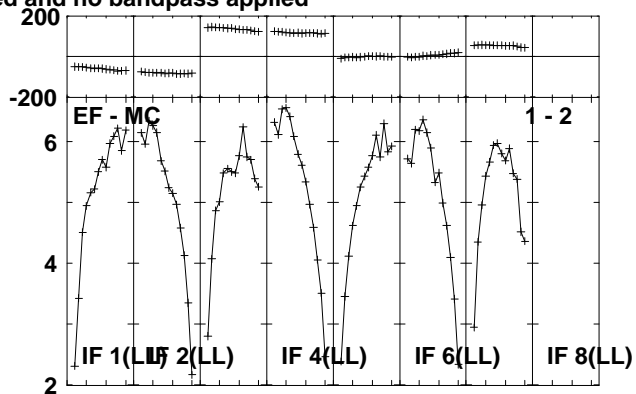
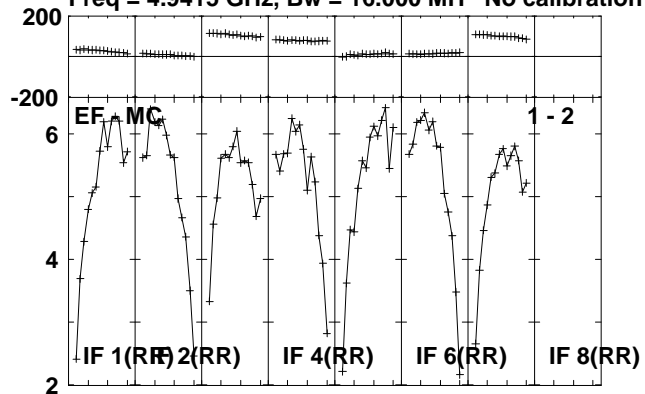

Lower frame: Milli Ampl Jy Top frame: Phas deg
Scalar averaged cross-power spectrum Several baselines displayed
Timerange: 01/04:02:11 to 01/04:04:09

Plot file version 311 created 14-JUL-2010 16:38:39

CYGX-1 RR004A.UVDATA.1

Freq = 4.9415 GHz, Bw = 16.000 MH No calibration applied and no bandpass applied

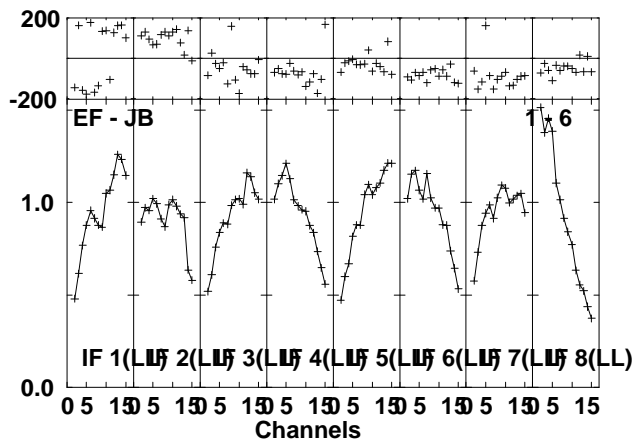
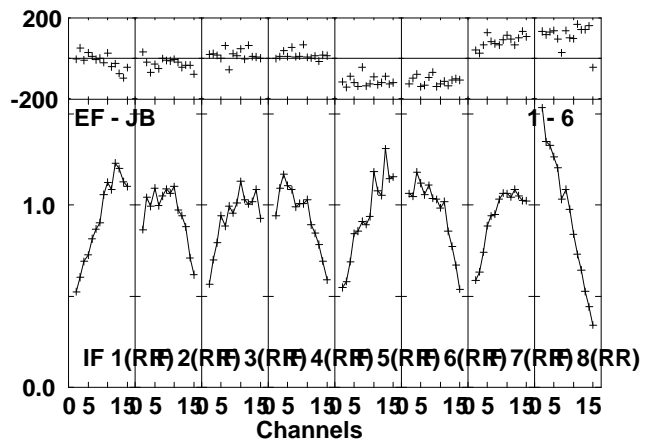
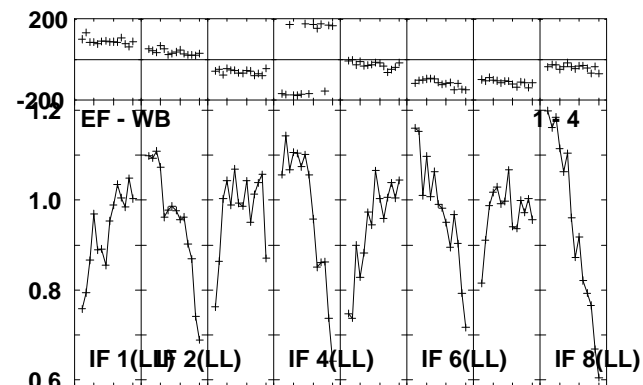
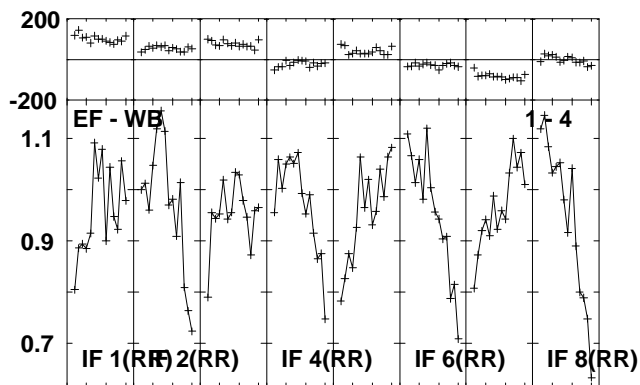
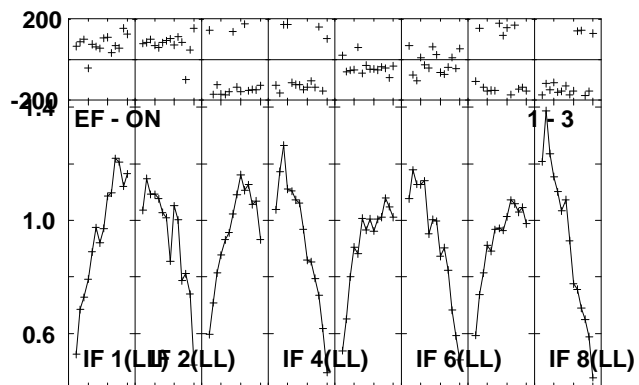
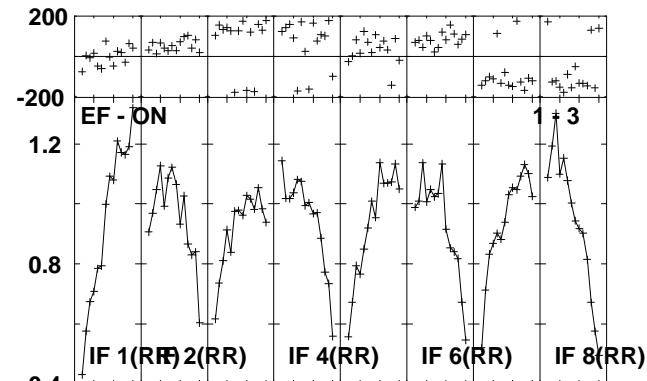
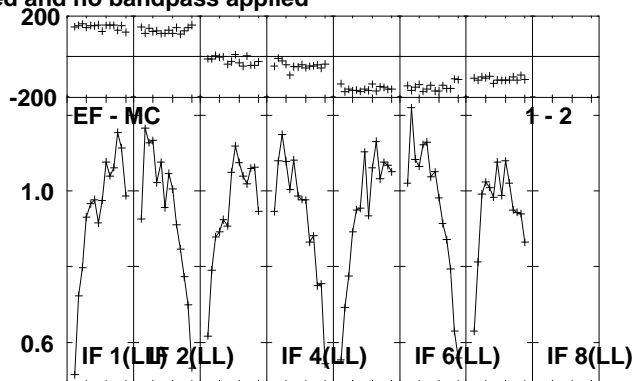
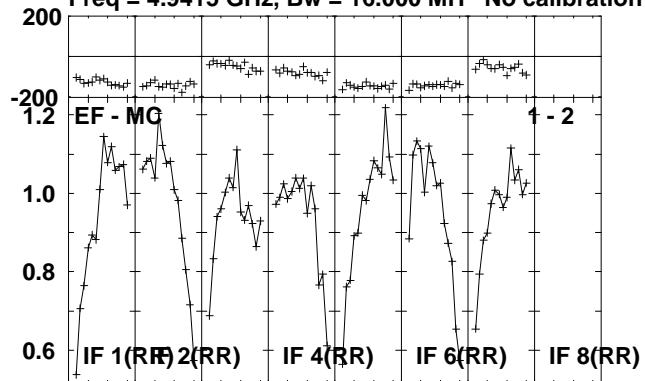

Lower frame: Milli Ampl Jy Top frame: Phas deg
Scalar averaged cross-power spectrum Several baselines displayed
Timerange: 01/04:04:11 to 01/04:09:09

Plot file version 312 created 14-JUL-2010 16:38:40

J1953+35 RR004A.UVDATA.1

Freq = 4.9415 GHz, Bw = 16.000 MH No calibration applied and no bandpass applied

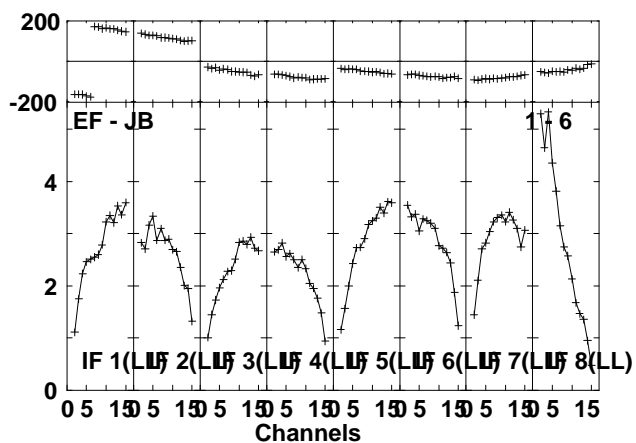
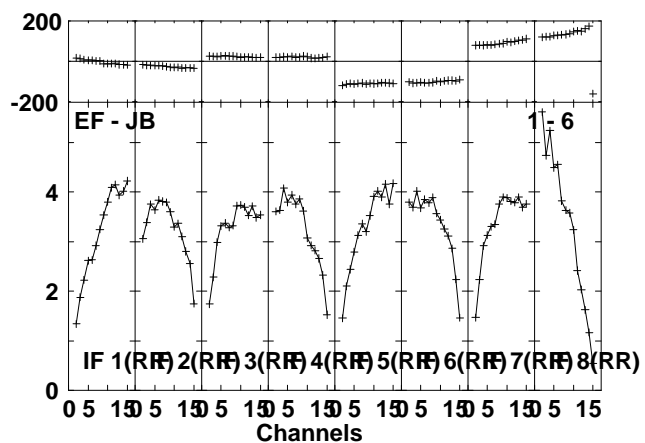
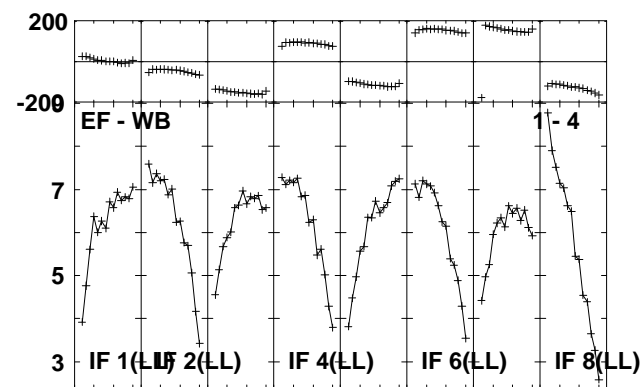
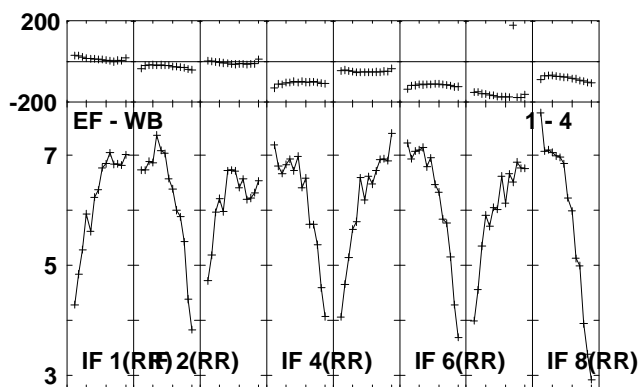
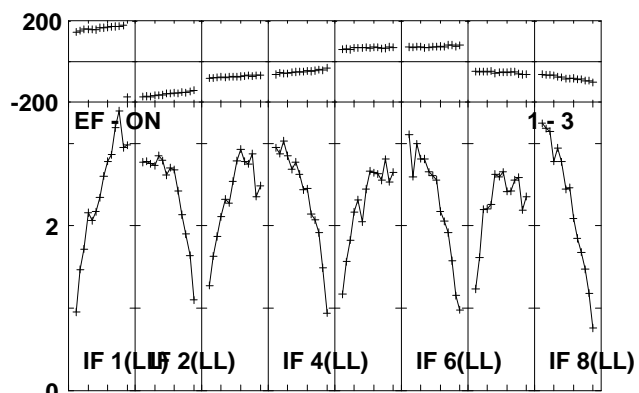
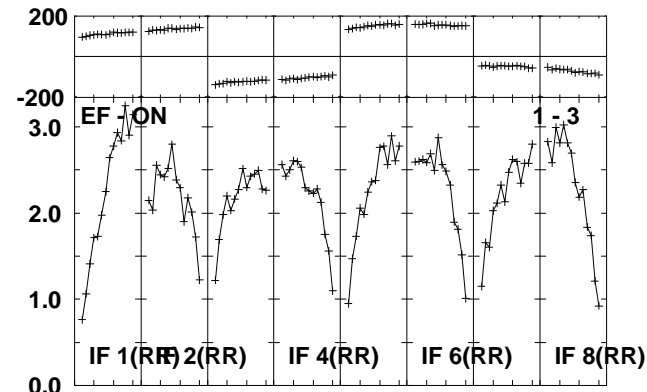
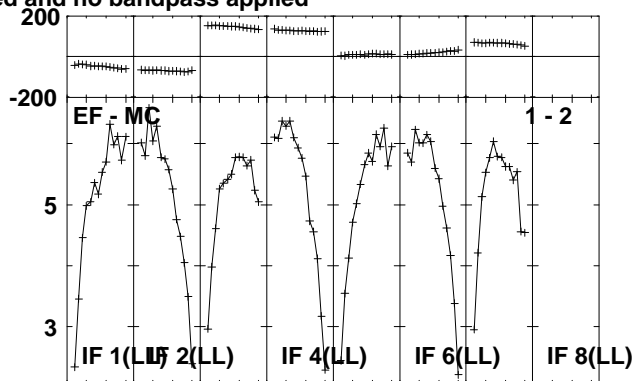
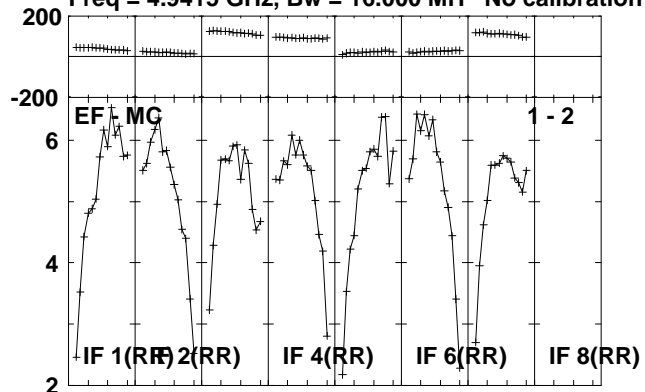

Lower frame: Milli Ampl Jy Top frame: Phas deg
Scalar averaged cross-power spectrum Several baselines displayed
Timerange: 01/04:09:51 to 01/04:11:19

Plot file version 313 created 14-JUL-2010 16:38:40

CYGX-1 RR004A.UVDATA.1

Freq = 4.9415 GHz, Bw = 16.000 MH No calibration applied and no bandpass applied

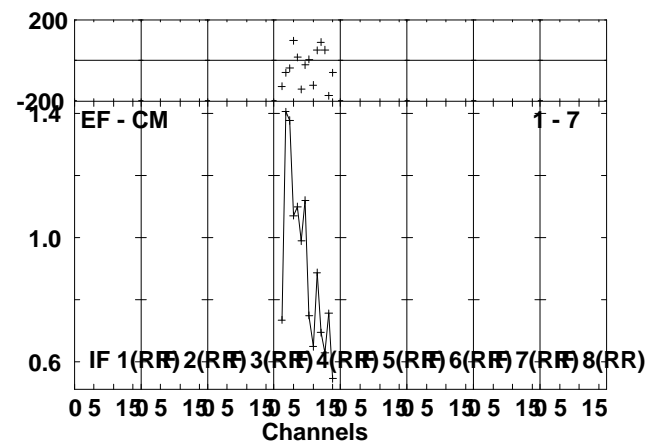
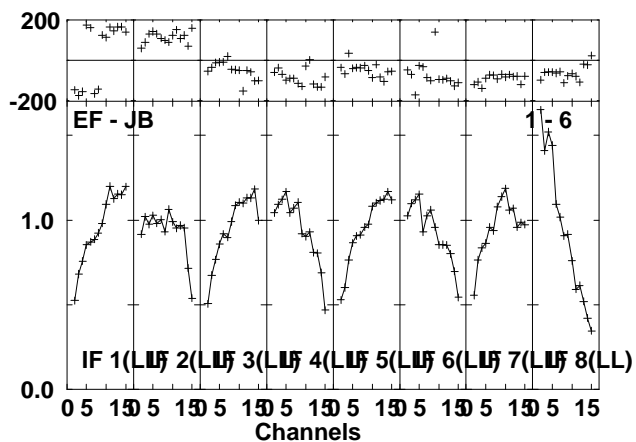
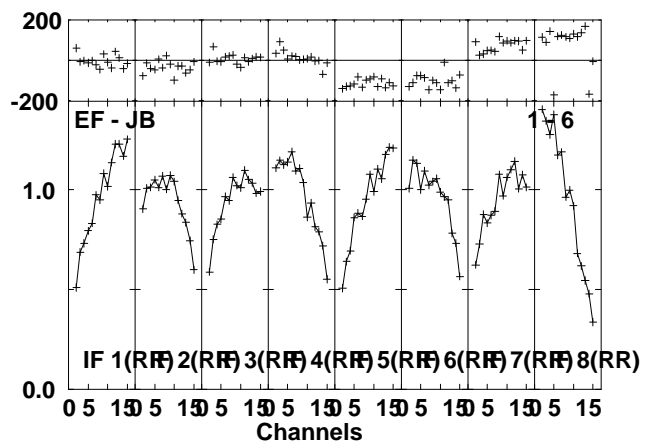
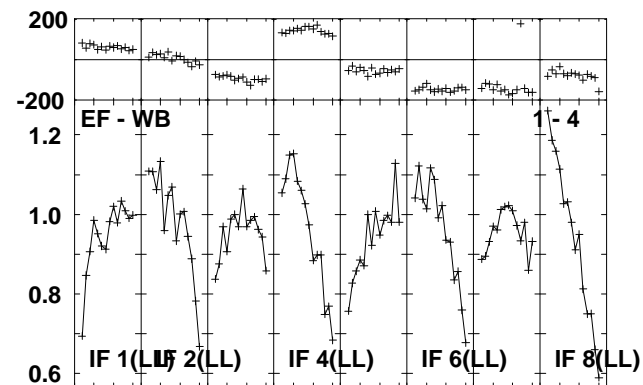
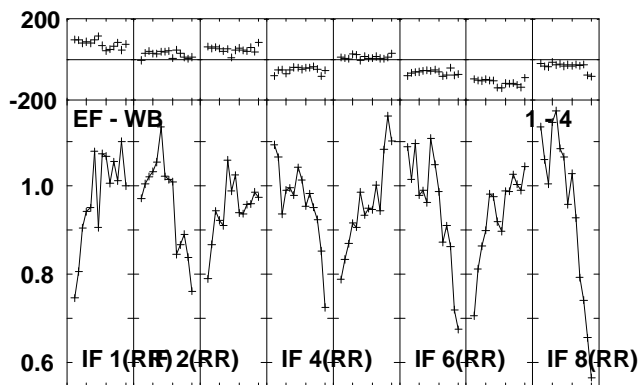
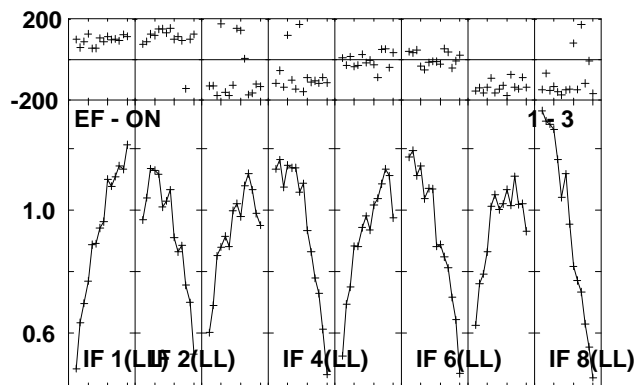
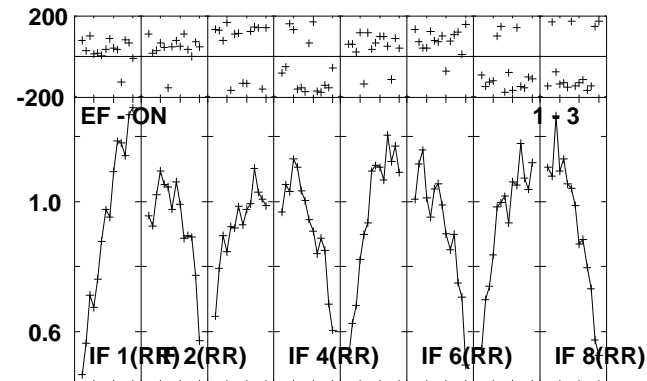
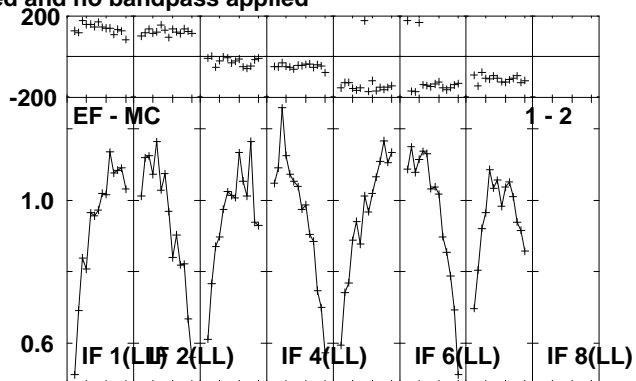
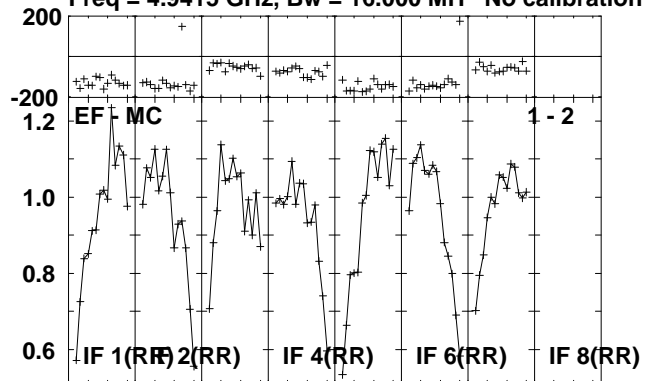

Lower frame: Milli Ampl Jy Top frame: Phas deg
Scalar averaged cross-power spectrum Several baselines displayed
Timerange: 01/04:11:21 to 01/04:16:19

Plot file version 314 created 14-JUL-2010 16:38:41
CYGX-1 RR004A.UVDATA.1
Freq = 4.9415 GHz, Bw = 16.000 MH No calibration applied and no bandpass applied

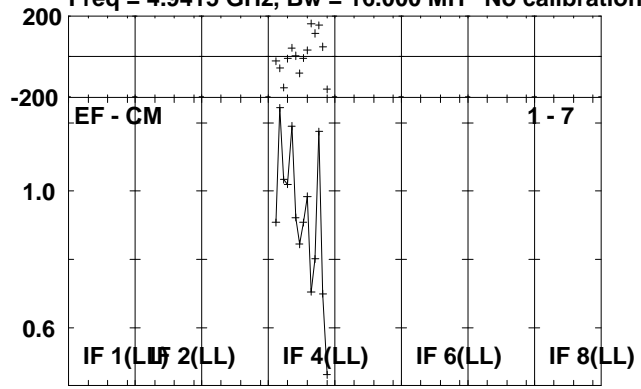

Lower frame: Milli Ampl Jy Top frame: Phas deg
Scalar averaged cross-power spectrum Several baselines displayed
Timerange: 01/04:11:21 to 01/04:16:19

Plot file version 315 created 14-JUL-2010 16:38:42

J1953+35 RR004A.UVDATA.1

Freq = 4.9415 GHz, Bw = 16.000 MH No calibration applied and no bandpass applied

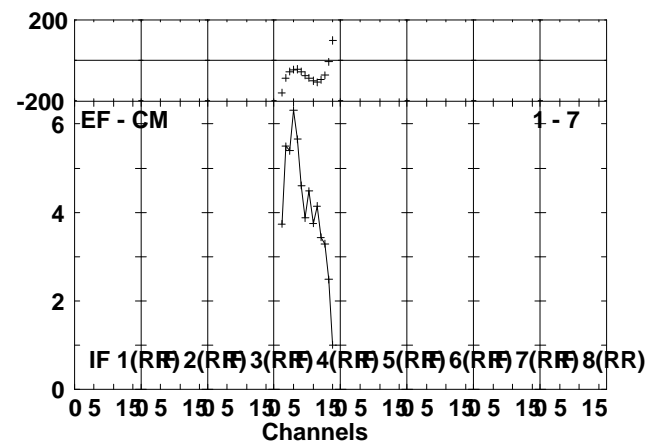
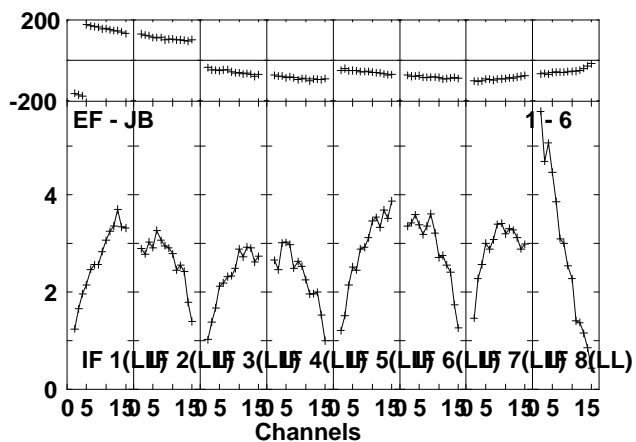
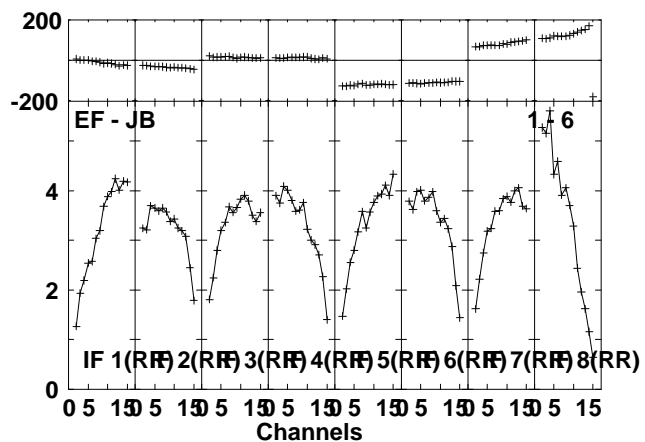
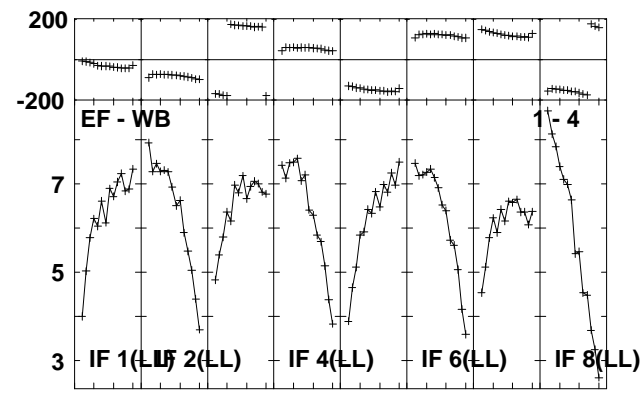
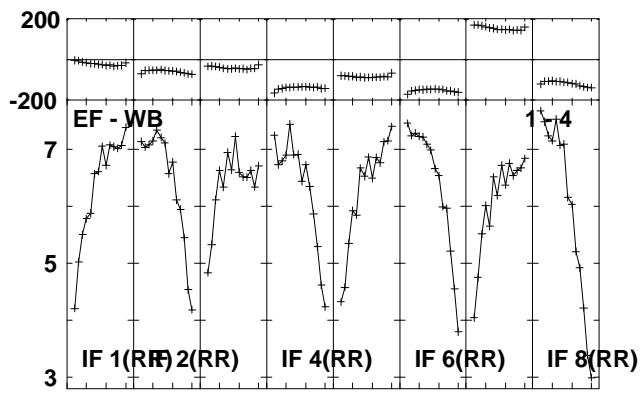
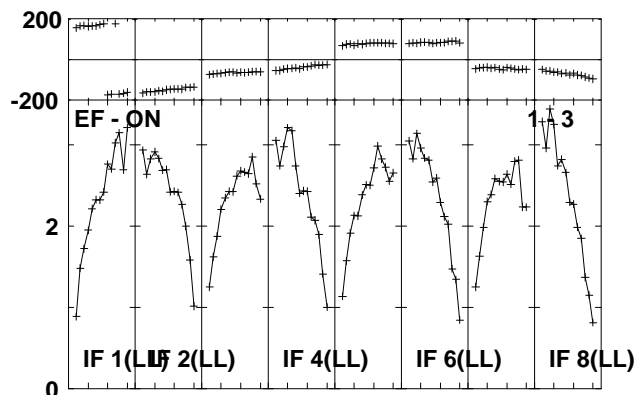
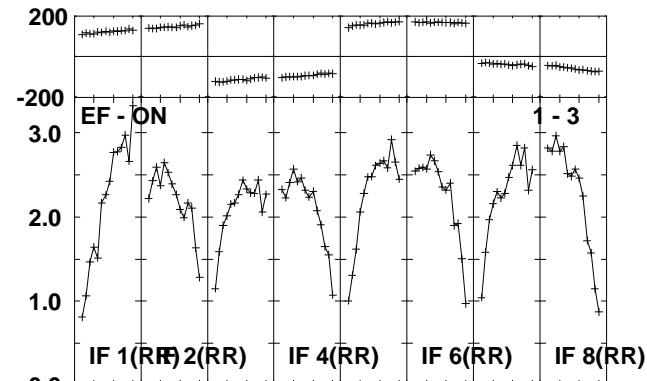
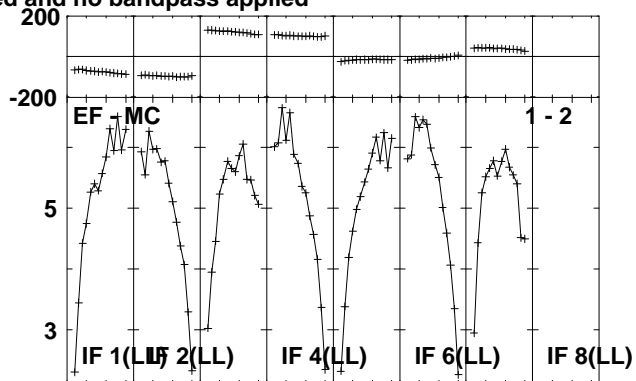
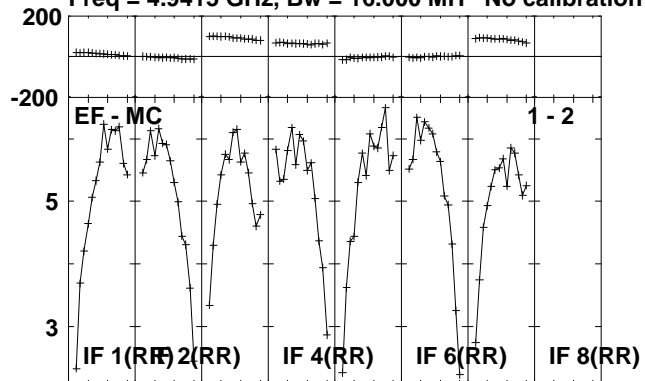

Lower frame: Milli Ampl Jy Top frame: Phas deg
Scalar averaged cross-power spectrum Several baselines displayed
Timerange: 01/04:16:21 to 01/04:18:19

Plot file version 316 created 14-JUL-2010 16:38:42
J1953+35 RR004A.UVDATA.1
Freq = 4.9415 GHz, Bw = 16.000 MH No calibration applied and no bandpass applied

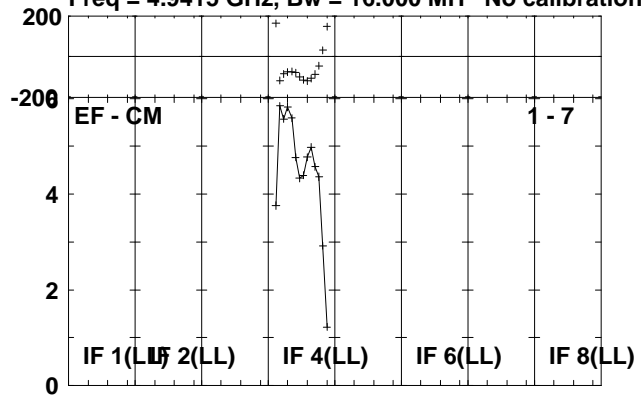

Lower frame: Milli Ampl Jy Top frame: Phas deg
Scalar averaged cross-power spectrum Several baselines displayed
Timerange: 01/04:16:21 to 01/04:18:19

Plot file version 317 created 14-JUL-2010 16:38:43

CYGX-1 RR004A.UVDATA.1

Freq = 4.9415 GHz, Bw = 16.000 MH No calibration applied and no bandpass applied

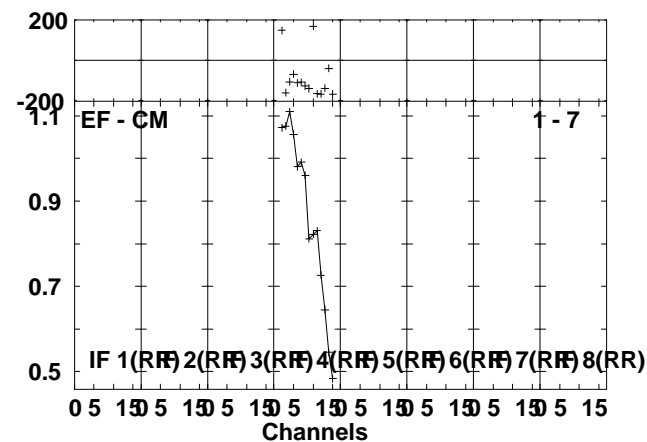
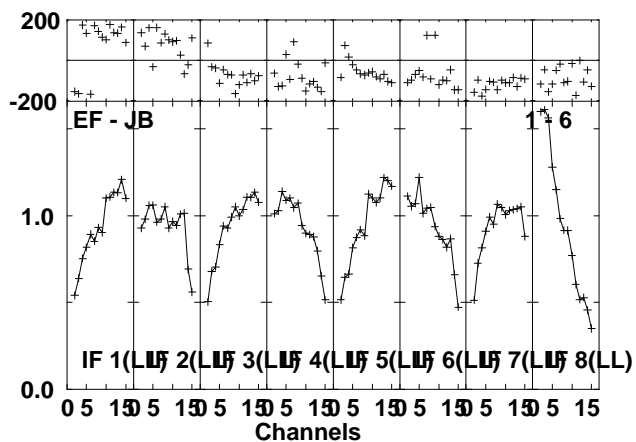
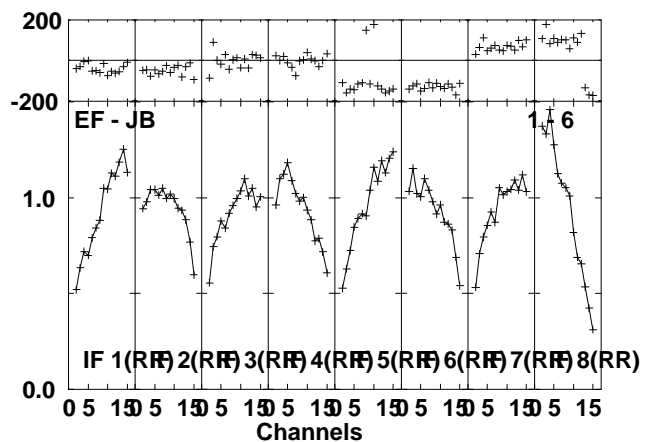
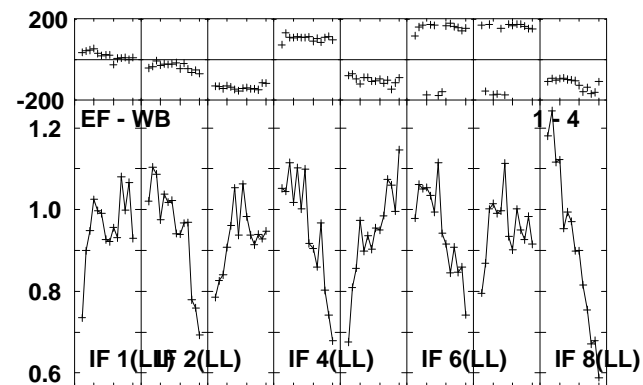
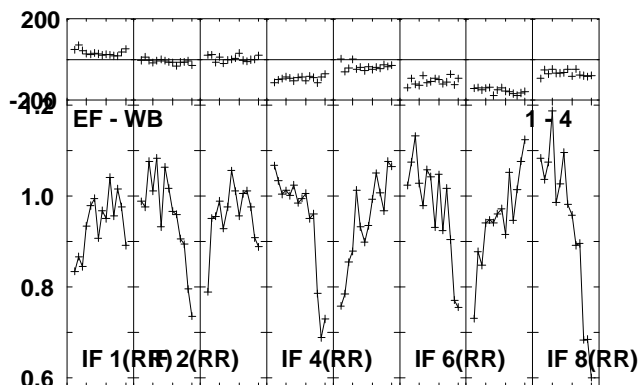
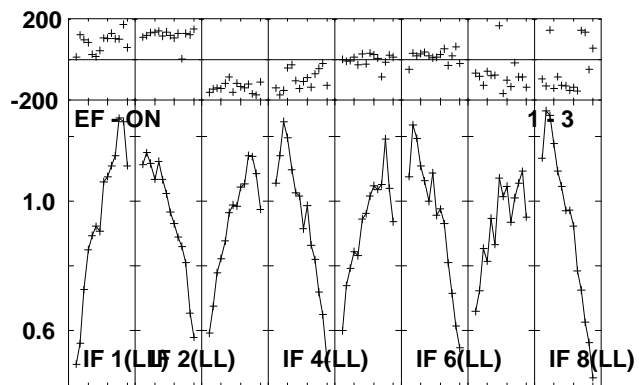
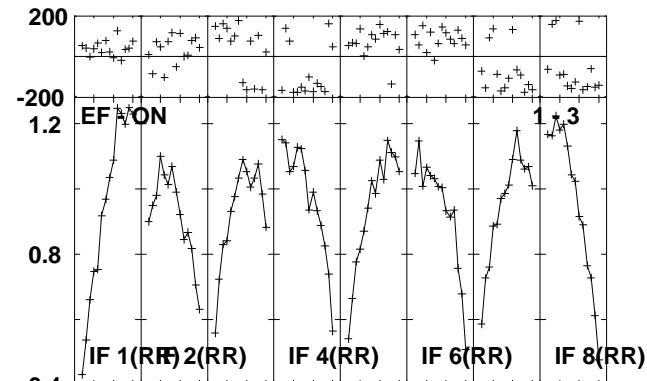
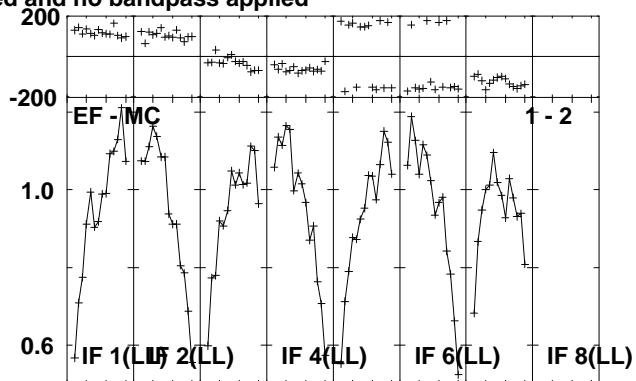
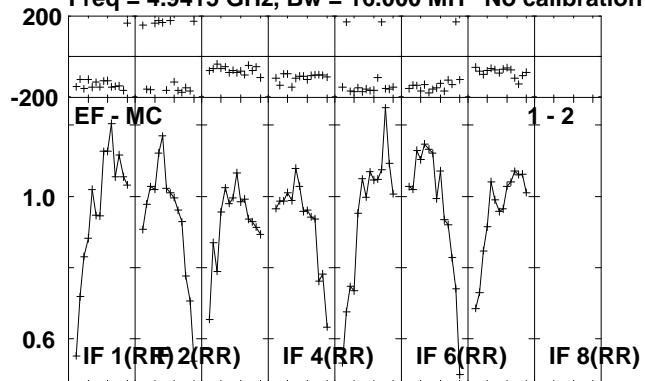

Lower frame: Milli Ampl Jy Top frame: Phas deg
Scalar averaged cross-power spectrum Several baselines displayed
Timerange: 01/04:18:21 to 01/04:23:19

Plot file version 318 created 14-JUL-2010 16:38:44
CYGX-1 RR004A.UVDATA.1
Freq = 4.9415 GHz, Bw = 16.000 MH No calibration applied and no bandpass applied

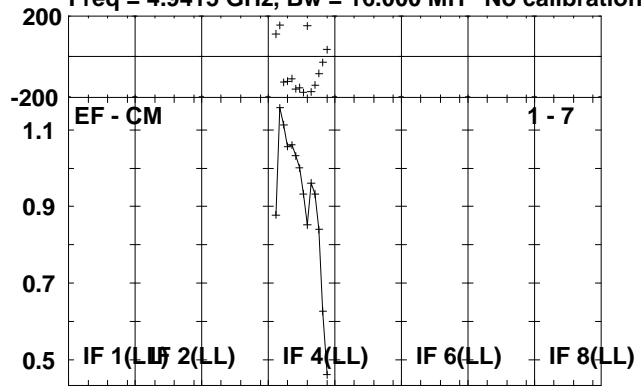

Lower frame: Milli Ampl Jy Top frame: Phas deg
Scalar averaged cross-power spectrum Several baselines displayed
Timerange: 01/04:18:21 to 01/04:23:19

Plot file version 319 created 14-JUL-2010 16:38:44

J1953+35 RR004A.UVDATA.1

Freq = 4.9415 GHz, Bw = 16.000 MH No calibration applied and no bandpass applied

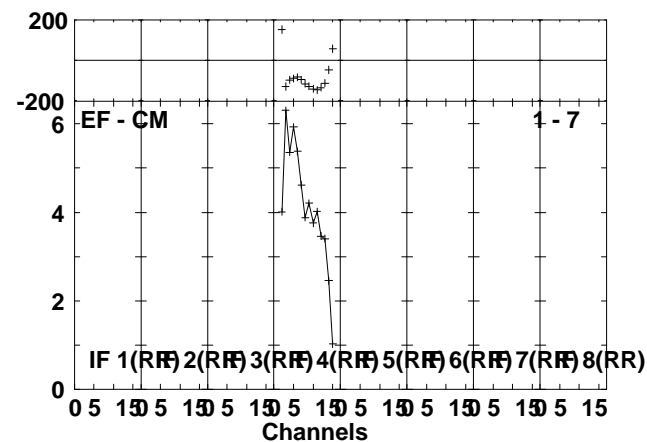
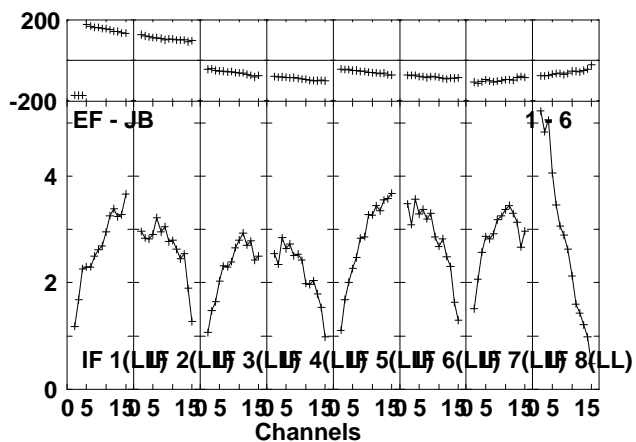
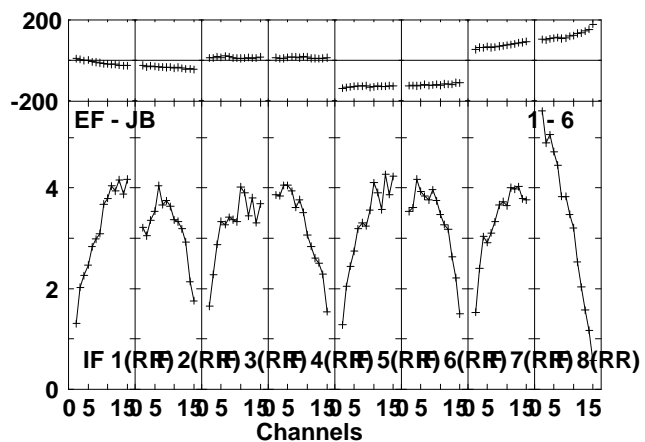
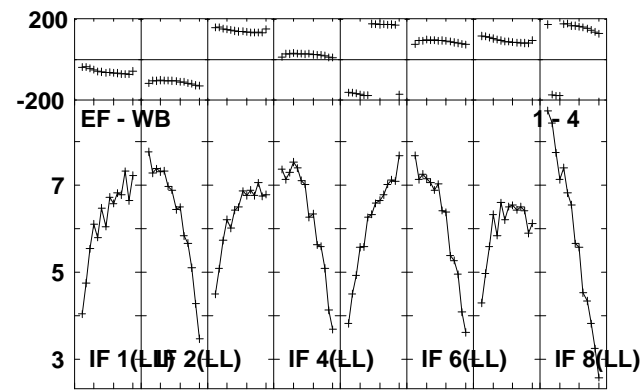
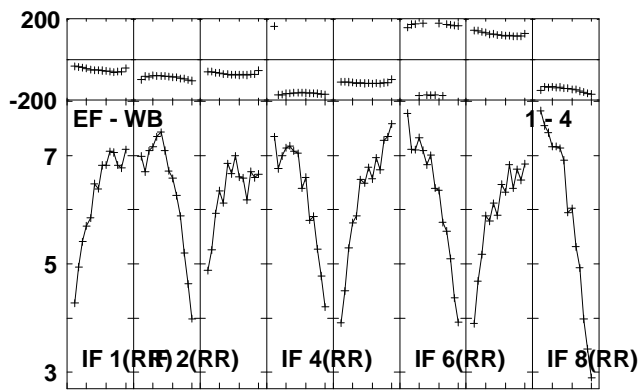
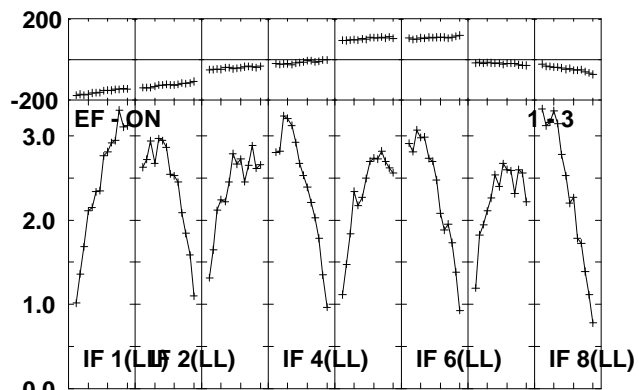
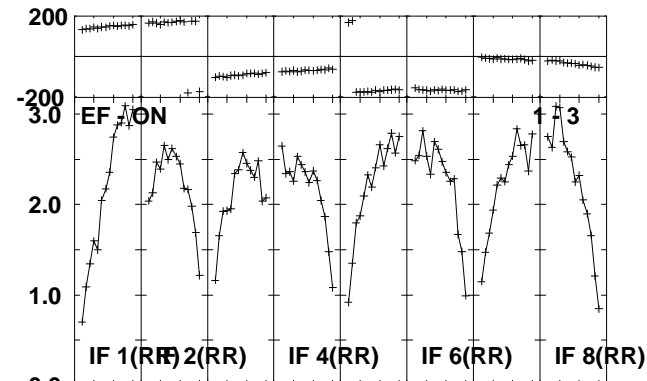
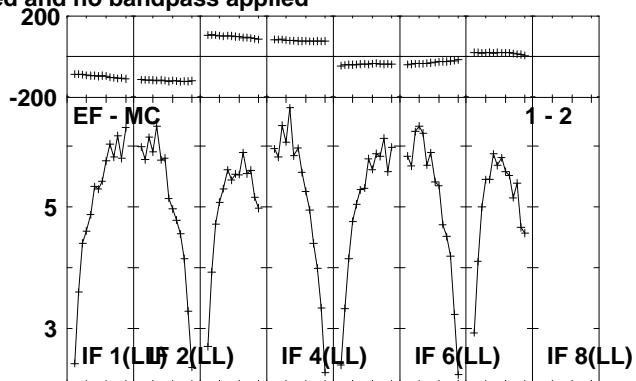
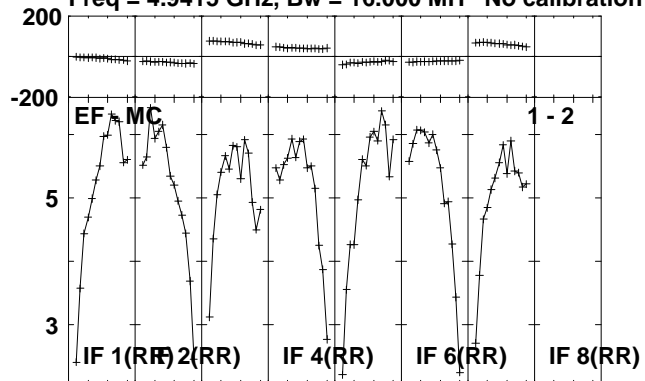

Lower frame: Milli Ampl Jy Top frame: Phas deg
Scalar averaged cross-power spectrum Several baselines displayed
Timerange: 01/04:24:01 to 01/04:25:29

Plot file version 320 created 14-JUL-2010 16:38:45
J1953+35 RR004A.UVDATA.1
Freq = 4.9415 GHz, Bw = 16.000 MH No calibration applied and no bandpass applied

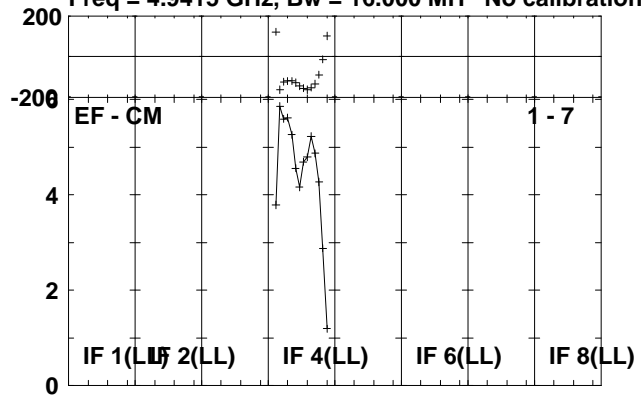

Lower frame: Milli Ampl Jy Top frame: Phas deg
Scalar averaged cross-power spectrum Several baselines displayed
Timerange: 01/04:24:01 to 01/04:25:29

Plot file version 321 created 14-JUL-2010 16:38:45

CYGX-1 RR004A.UVDATA.1

Freq = 4.9415 GHz, Bw = 16.000 MH No calibration applied and no bandpass applied

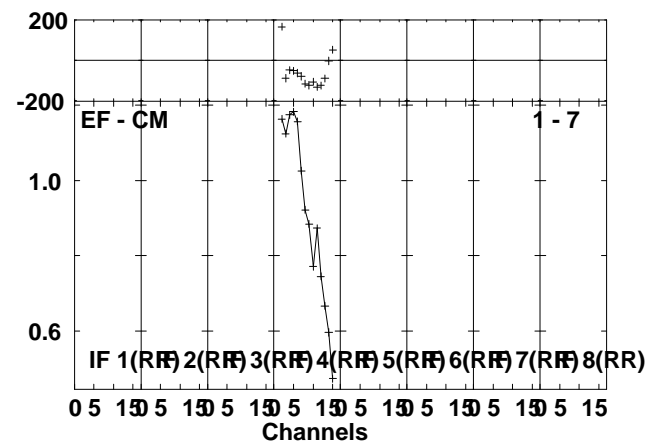
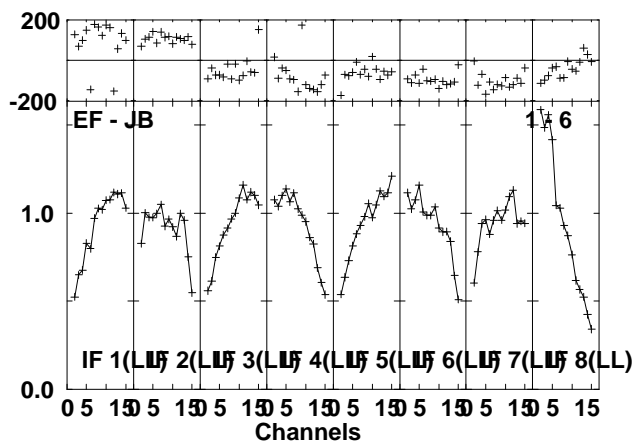
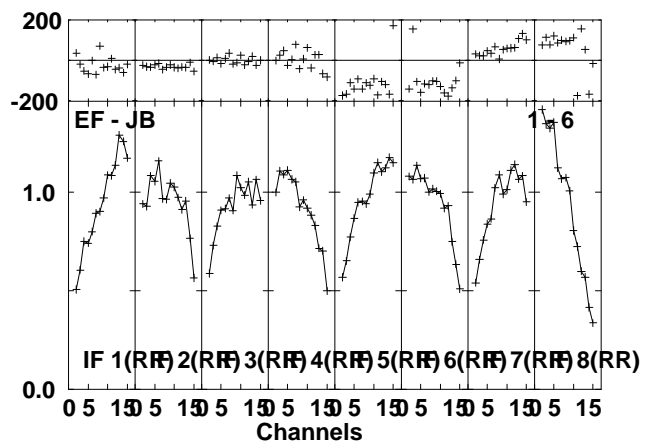
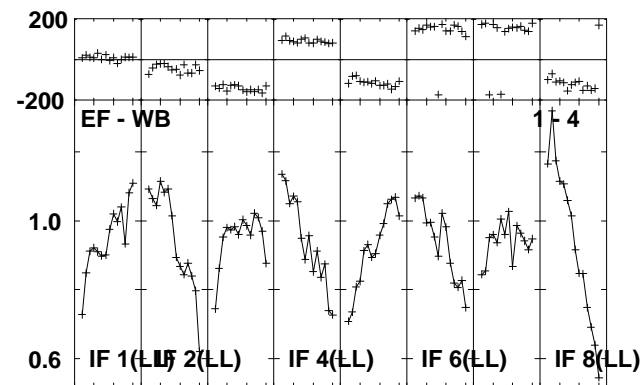
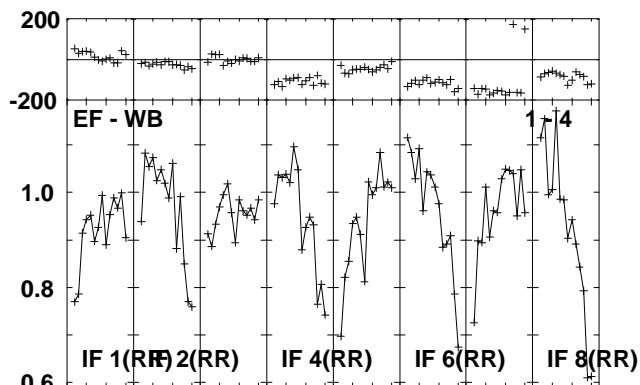
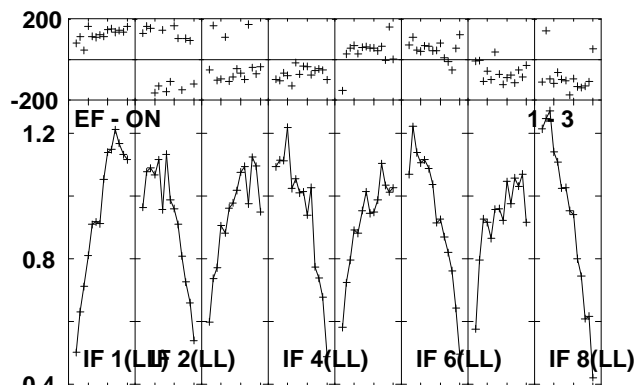
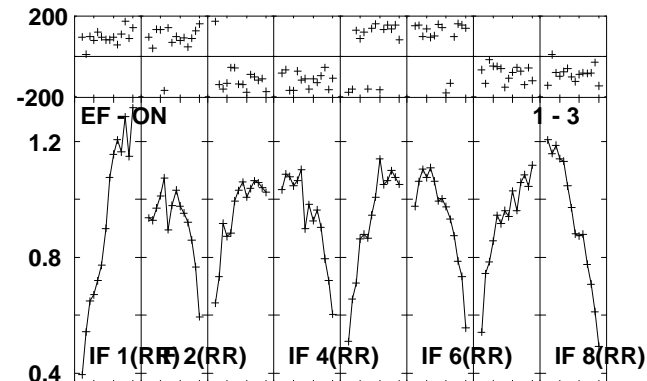
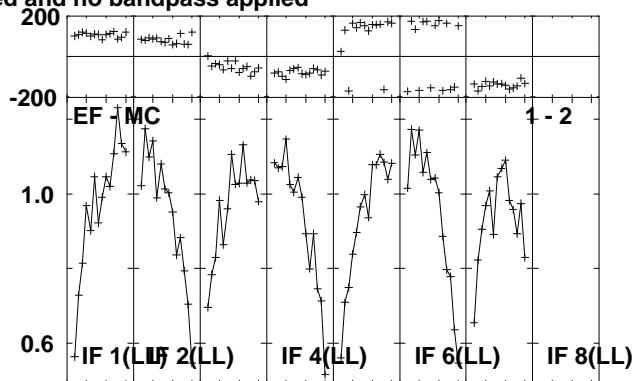
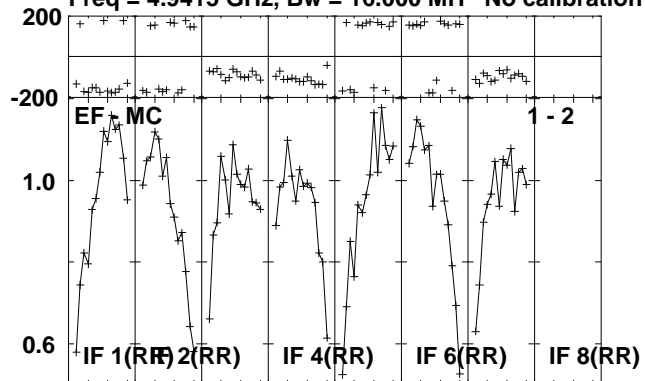

Lower frame: Milli Ampl Jy Top frame: Phas deg
Scalar averaged cross-power spectrum Several baselines displayed
Timerange: 01/04:25:31 to 01/04:30:29

Plot file version 322 created 14-JUL-2010 16:38:46
CYGX-1 RR004A.UVDATA.1
Freq = 4.9415 GHz, Bw = 16.000 MH No calibration applied and no bandpass applied

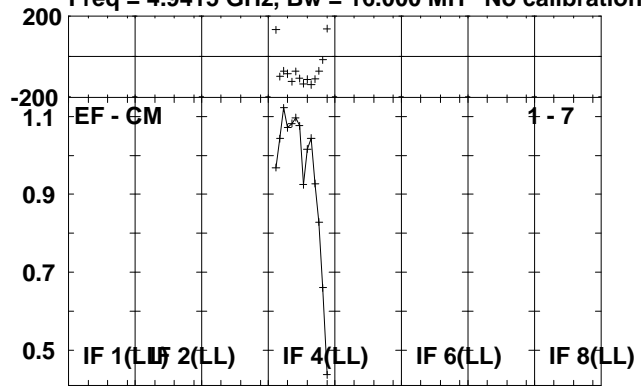

Lower frame: Milli Ampl Jy Top frame: Phas deg
Scalar averaged cross-power spectrum Several baselines displayed
Timerange: 01/04:25:31 to 01/04:30:29

Plot file version 323 created 14-JUL-2010 16:38:47

J1953+35 RR004A.UVDATA.1

Freq = 4.9415 GHz, Bw = 16.000 MH No calibration applied and no bandpass applied

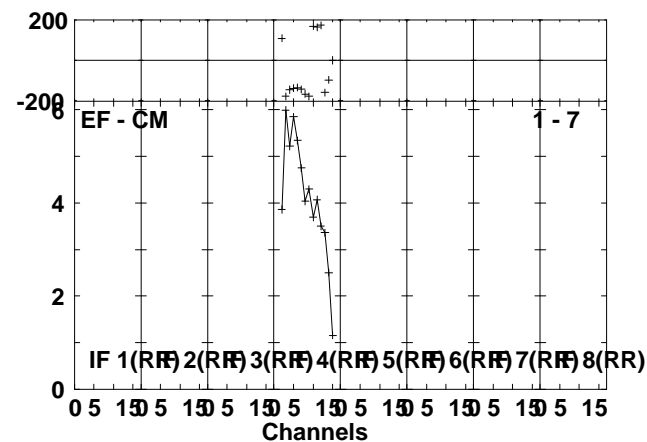
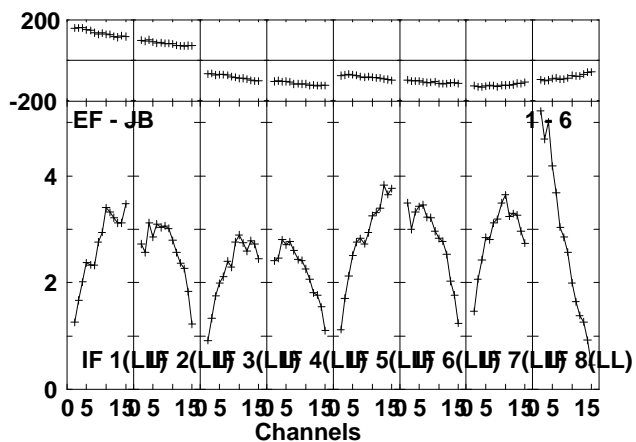
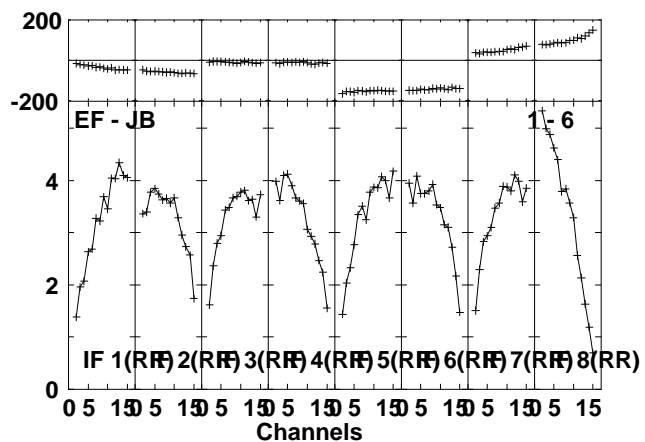
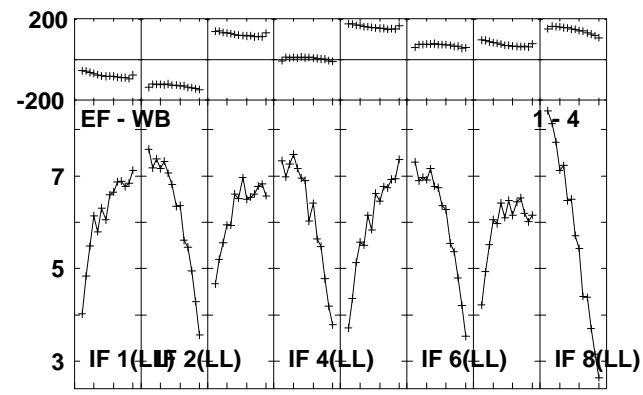
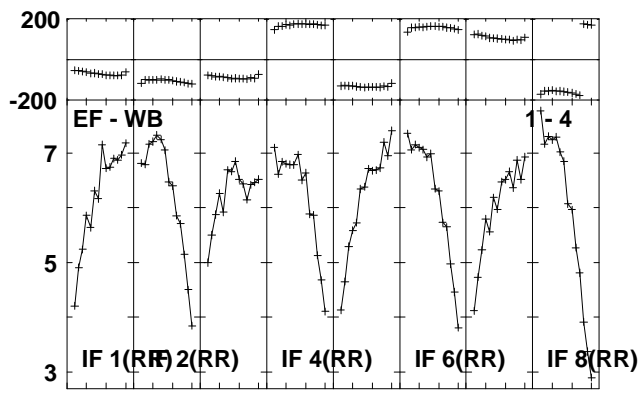
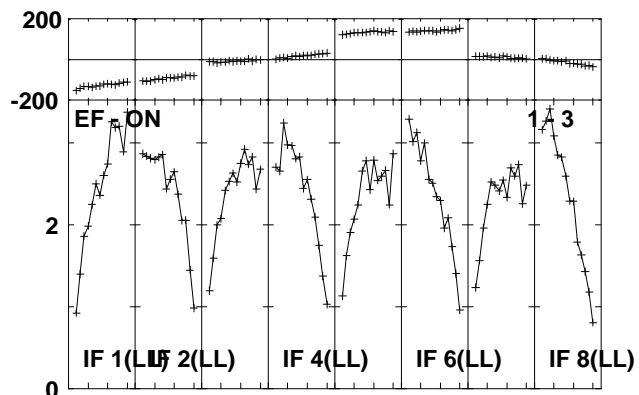
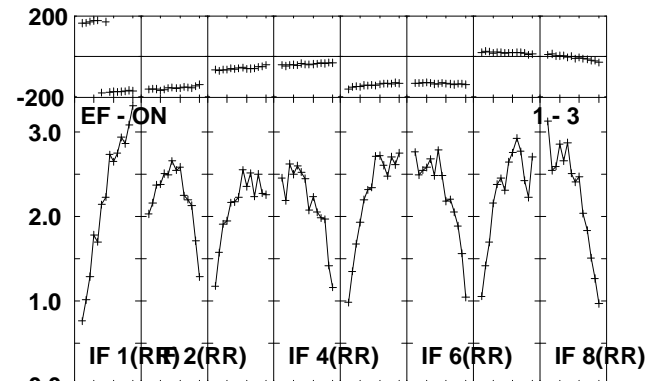
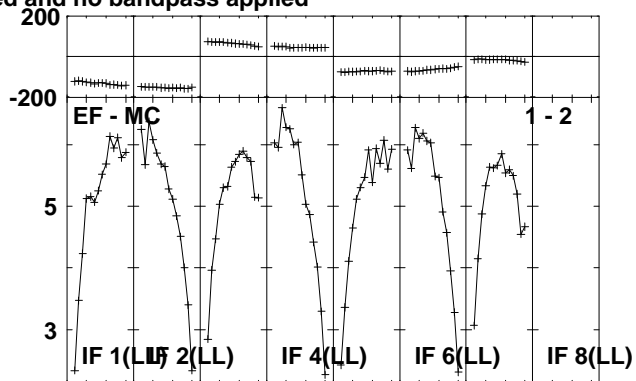
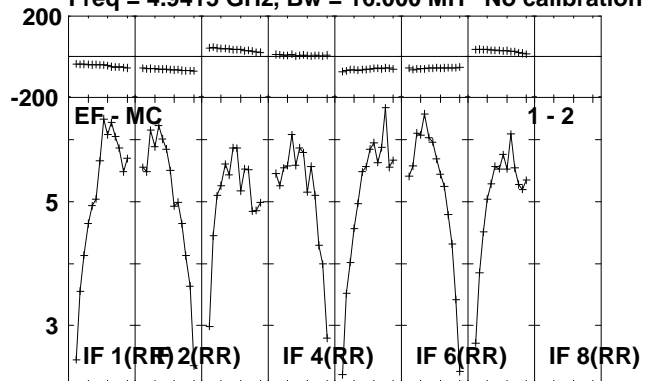

Lower frame: Milli Ampl Jy Top frame: Phas deg
Scalar averaged cross-power spectrum Several baselines displayed
Timerange: 01/04:30:31 to 01/04:32:29

Plot file version 324 created 14-JUL-2010 16:38:47
J1953+35 RR004A.UVDATA.1
Freq = 4.9415 GHz, Bw = 16.000 MH No calibration applied and no bandpass applied

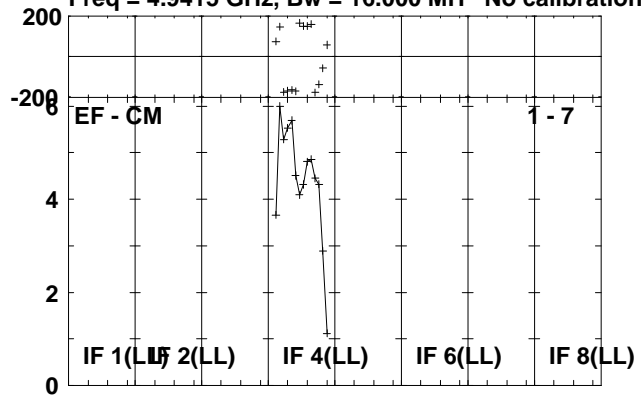

Lower frame: Milli Ampl Jy Top frame: Phas deg
Scalar averaged cross-power spectrum Several baselines displayed
Timerange: 01/04:30:31 to 01/04:32:29

Plot file version 325 created 14-JUL-2010 16:38:48

CYGX-1 RR004A.UVDATA.1

Freq = 4.9415 GHz, Bw = 16.000 MH No calibration applied and no bandpass applied

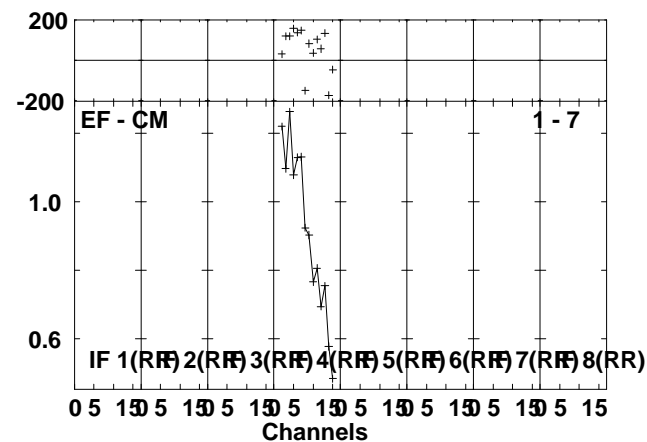
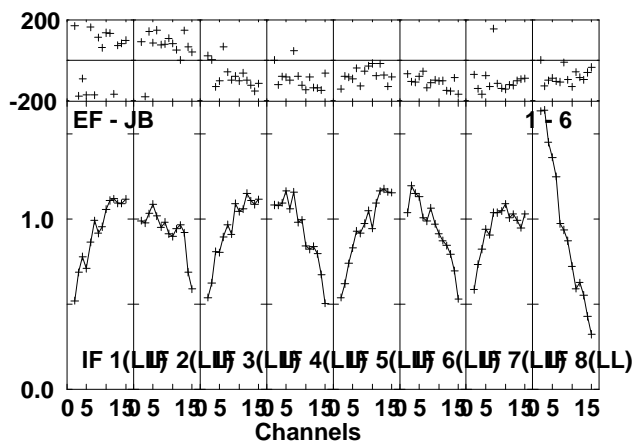
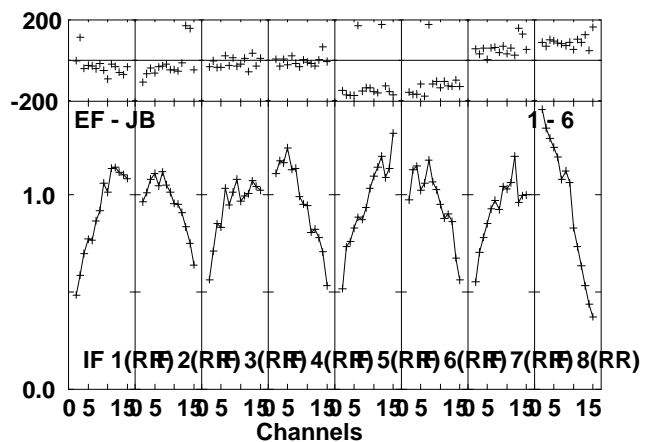
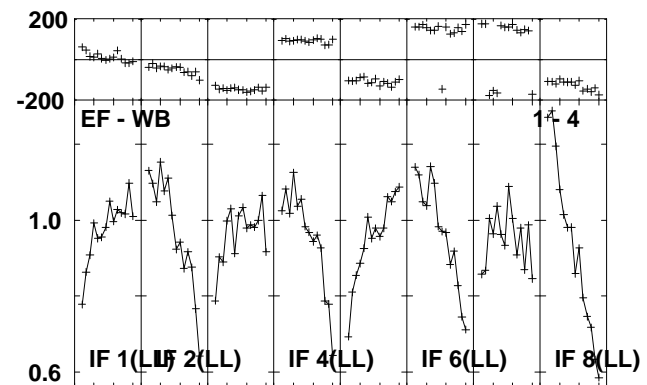
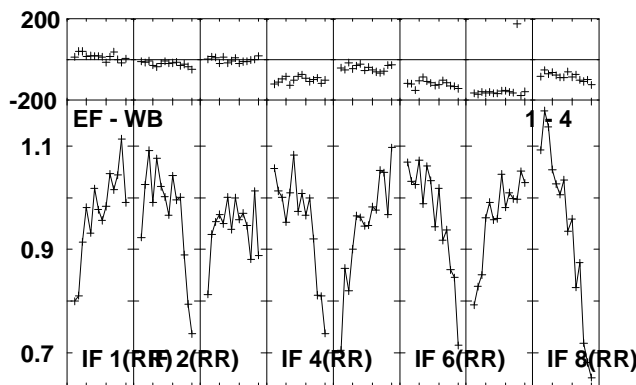
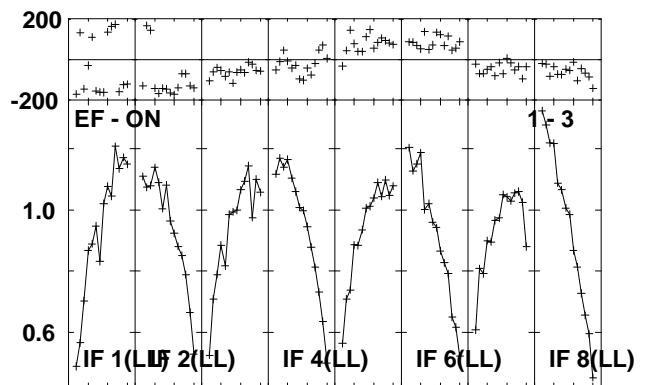
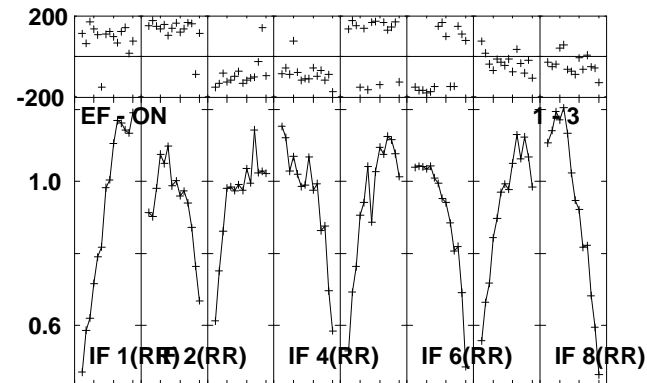
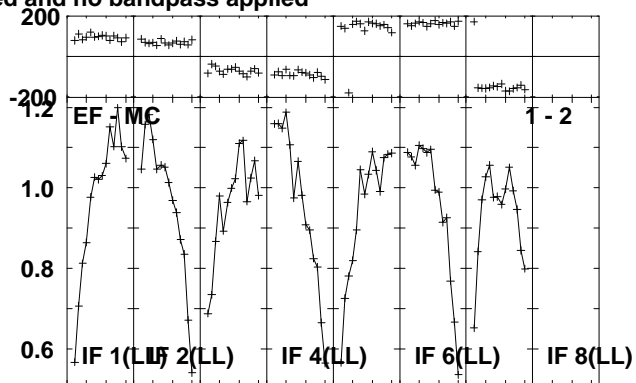
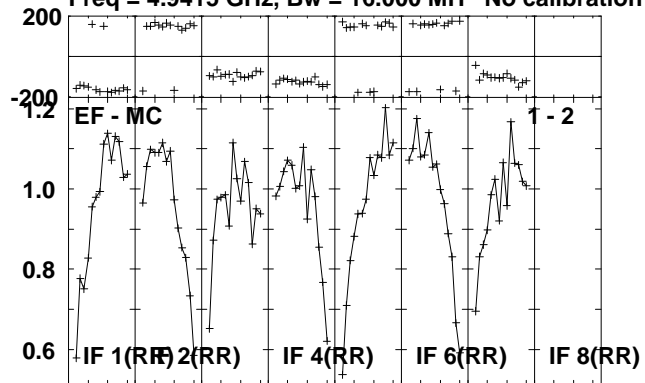

Lower frame: Milli Ampl Jy Top frame: Phas deg
Scalar averaged cross-power spectrum Several baselines displayed
Timerange: 01/04:32:31 to 01/04:37:29

Plot file version 326 created 14-JUL-2010 16:38:49
CYGX-1 RR004A.UVDATA.1
Freq = 4.9415 GHz, Bw = 16.000 MH No calibration applied and no bandpass applied

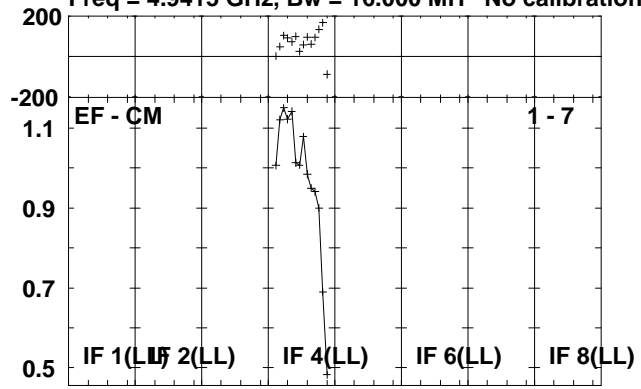

Lower frame: Milli Ampl Jy Top frame: Phas deg
Scalar averaged cross-power spectrum Several baselines displayed
Timerange: 01/04:32:31 to 01/04:37:29

Plot file version 327 created 14-JUL-2010 16:38:50

J1953+35 RR004A.UVDATA.1

Freq = 4.9415 GHz, Bw = 16.000 MH No calibration applied and no bandpass applied

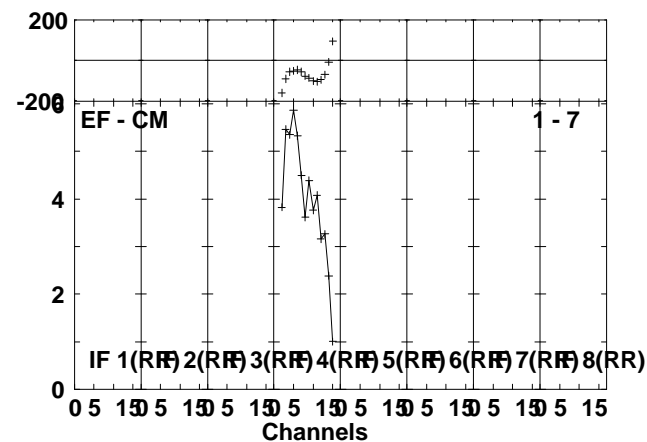
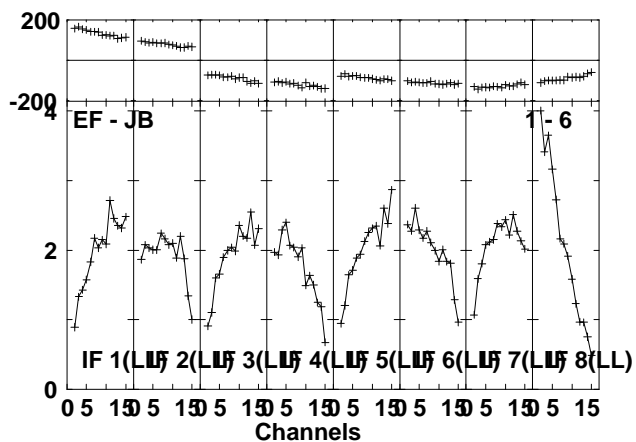
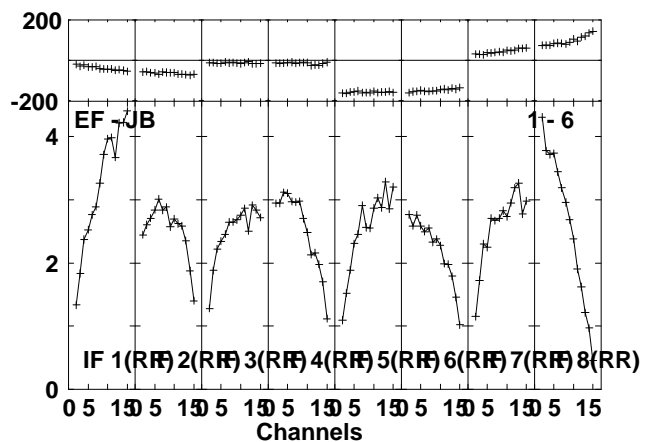
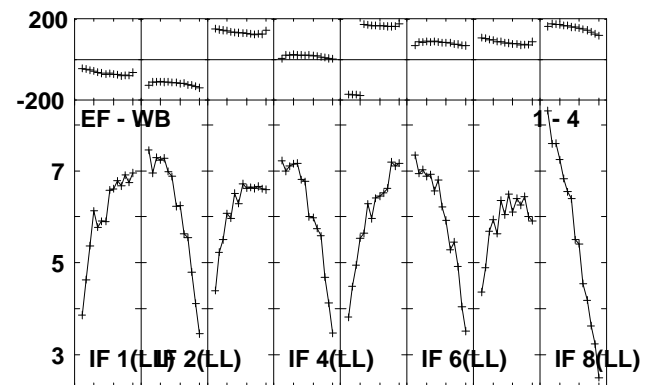
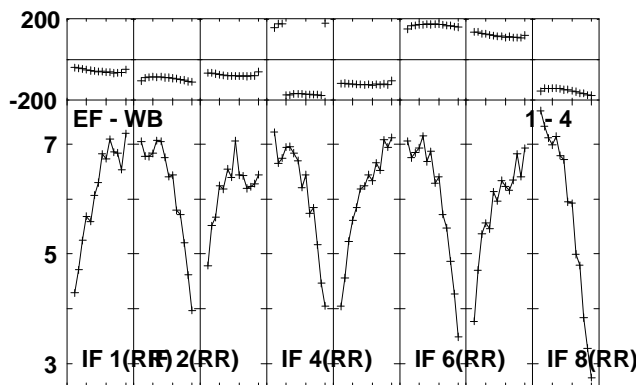
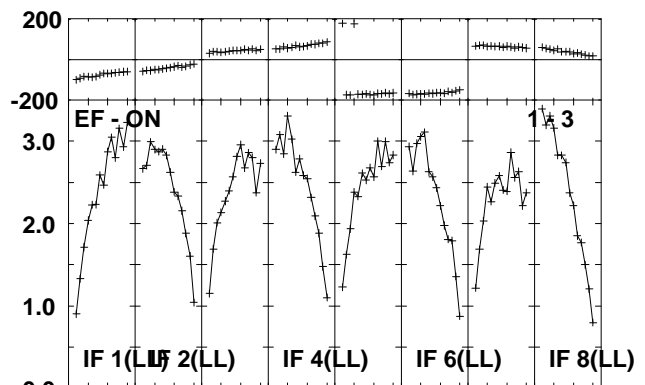
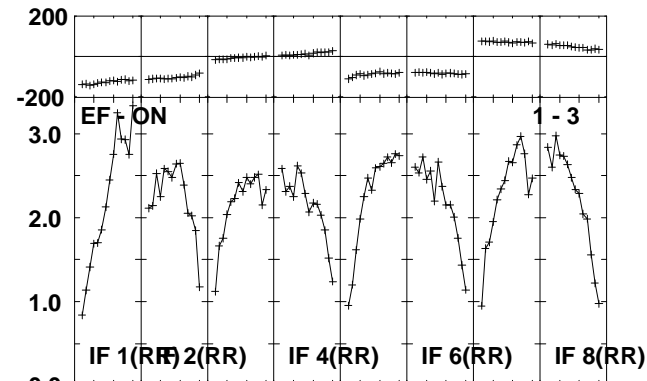
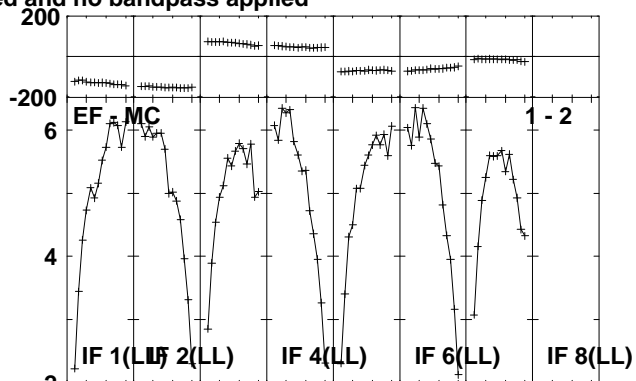
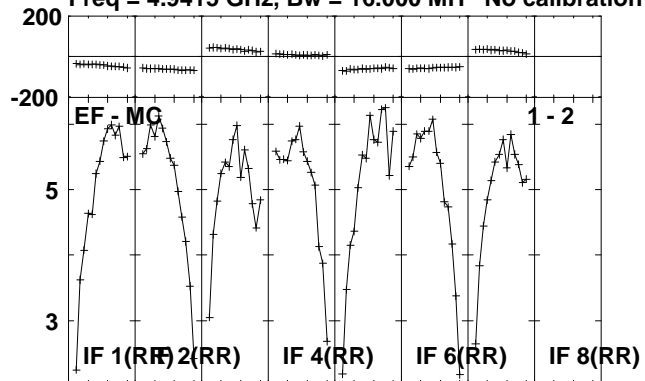

Lower frame: Milli Ampl Jy Top frame: Phas deg
Scalar averaged cross-power spectrum Several baselines displayed
Timerange: 01/04:38:11 to 01/04:39:39

Plot file version 328 created 14-JUL-2010 16:38:50
J1953+35 RR004A.UVDATA.1
Freq = 4.9415 GHz, Bw = 16.000 MH No calibration applied and no bandpass applied

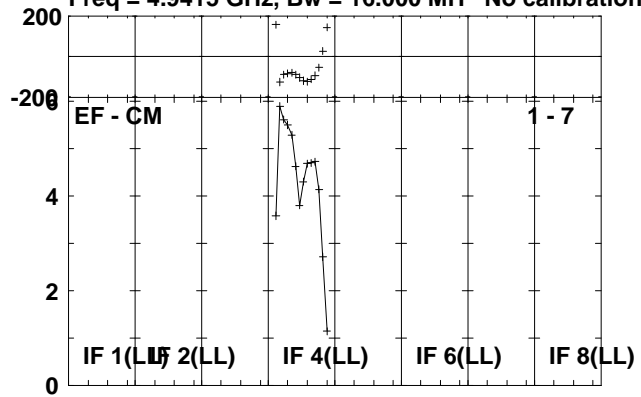

Lower frame: Milli Ampl Jy Top frame: Phas deg
Scalar averaged cross-power spectrum Several baselines displayed
Timerange: 01/04:38:11 to 01/04:39:39

Plot file version 329 created 14-JUL-2010 16:38:50

J2002+47 RR004A.UVDATA.1

Freq = 4.9415 GHz, Bw = 16.000 MH No calibration applied and no bandpass applied

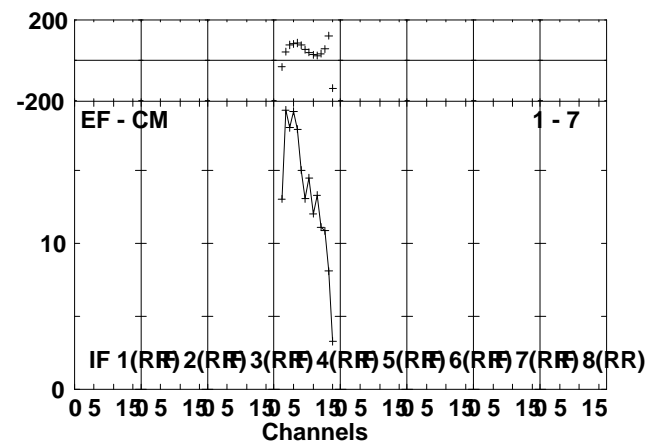
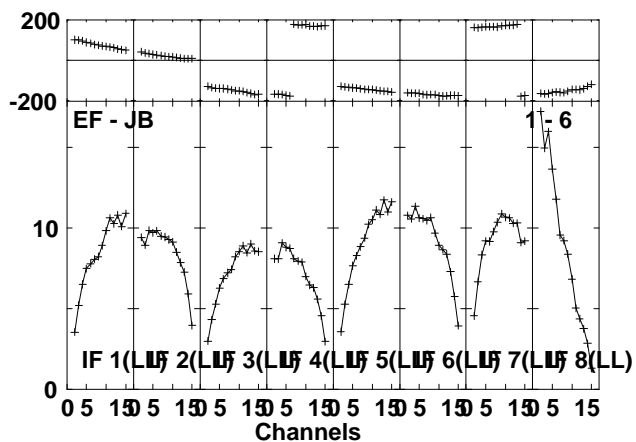
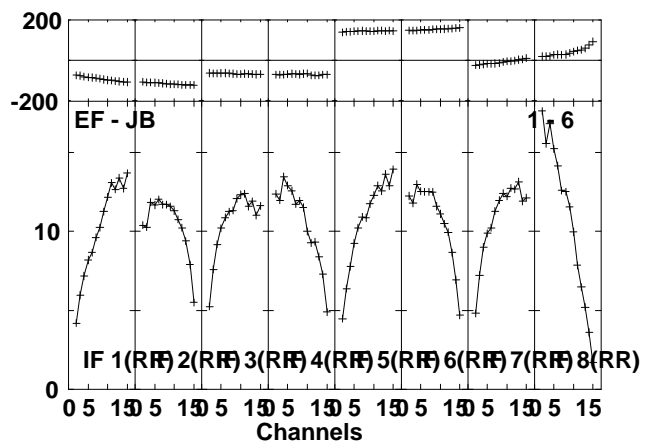
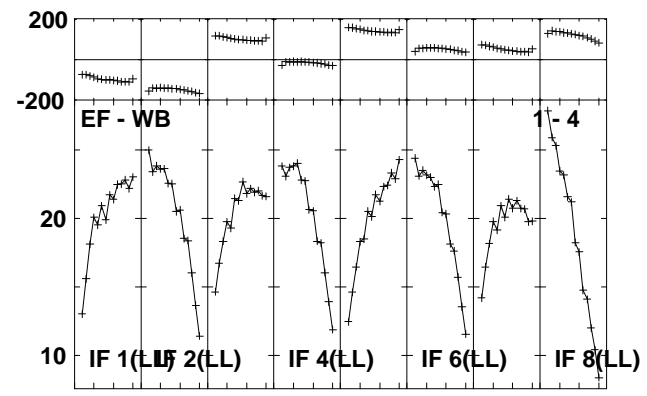
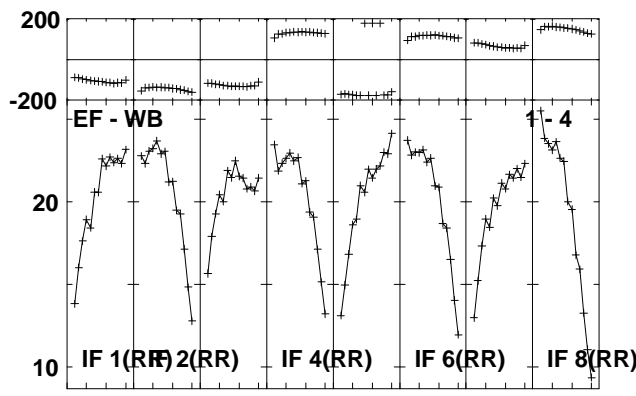
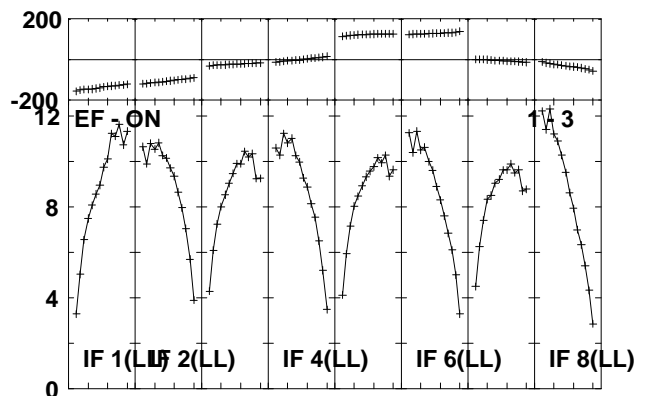
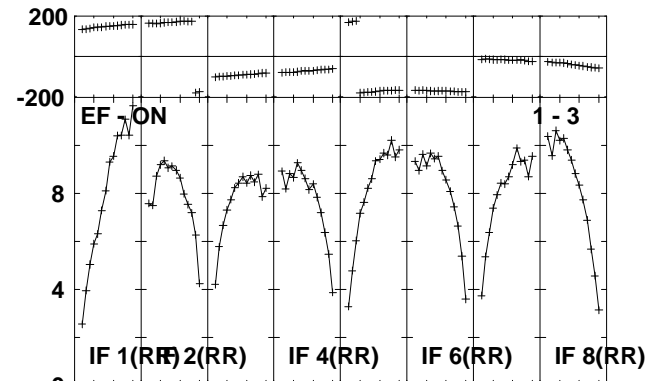
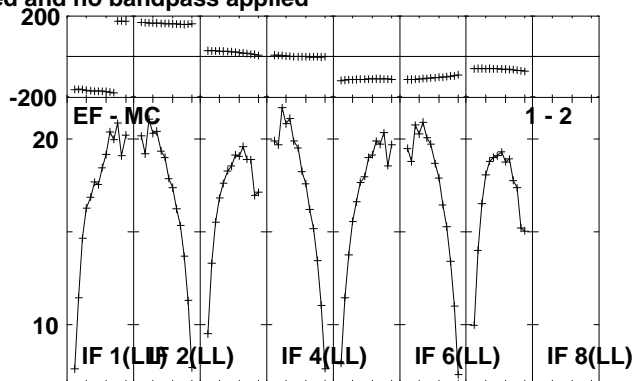
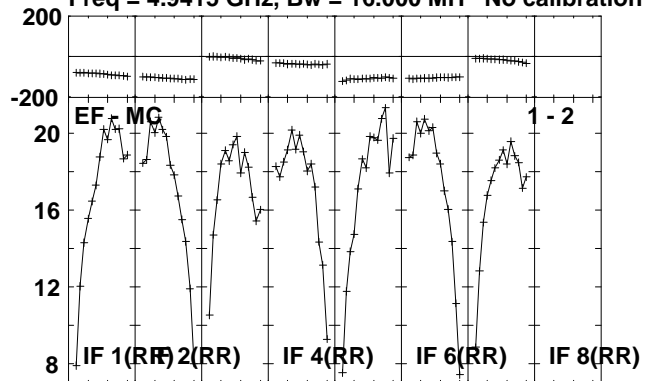

Lower frame: Milli Ampl Jy Top frame: Phas deg
Scalar averaged cross-power spectrum Several baselines displayed
Timerange: 01/04:41:41 to 01/04:46:39

Plot file version 330 created 14-JUL-2010 16:38:51
J2002+47 RR004A.UVDATA.1
Freq = 4.9415 GHz, Bw = 16.000 MH No calibration applied and no bandpass applied

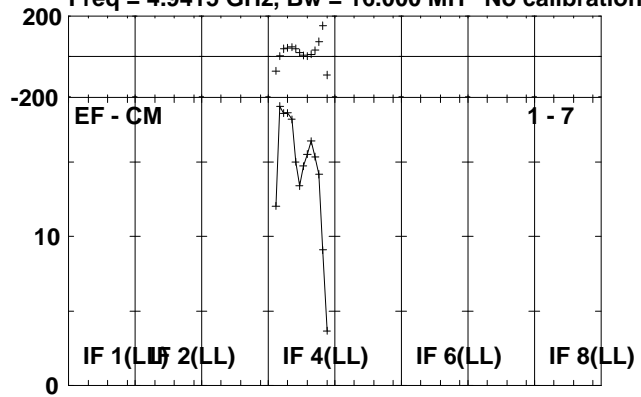

Lower frame: Milli Ampl Jy Top frame: Phas deg
Scalar averaged cross-power spectrum Several baselines displayed
Timerange: 01/04:41:41 to 01/04:46:39

Plot file version 331 created 14-JUL-2010 16:38:52

J1953+35 RR004A.UVDATA.1

Freq = 4.9415 GHz, Bw = 16.000 MH No calibration applied and no bandpass applied

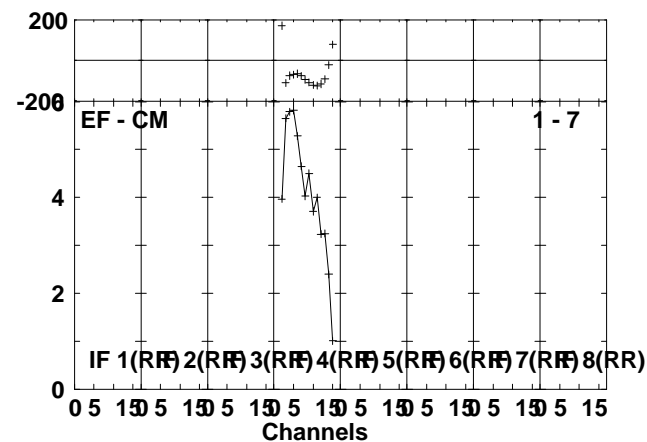
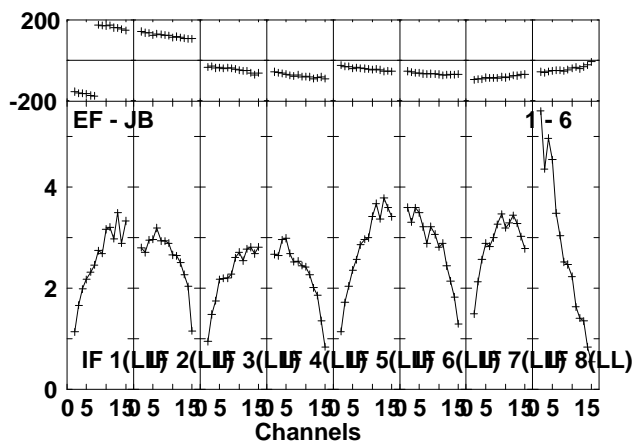
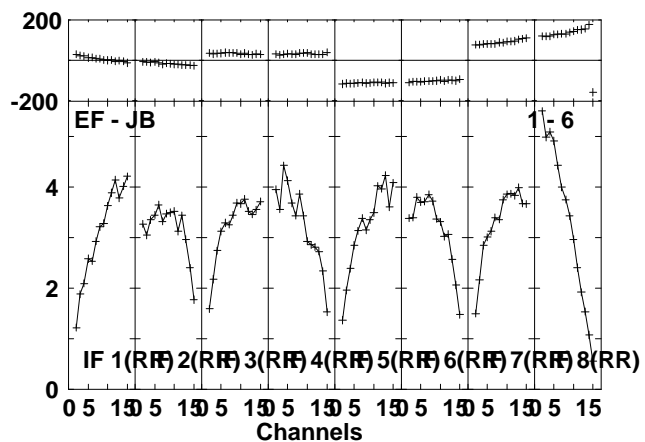
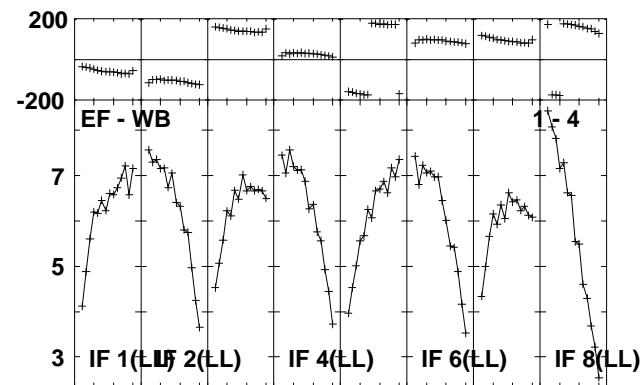
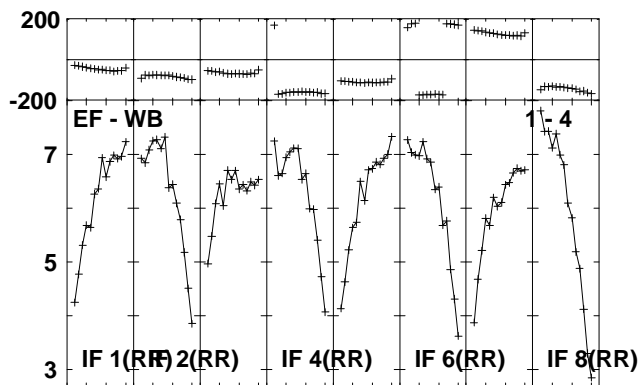
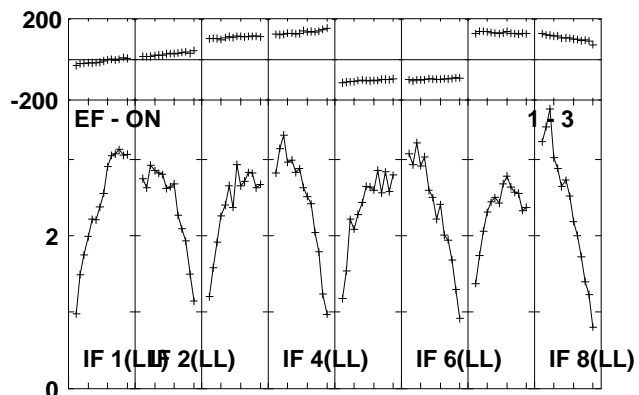
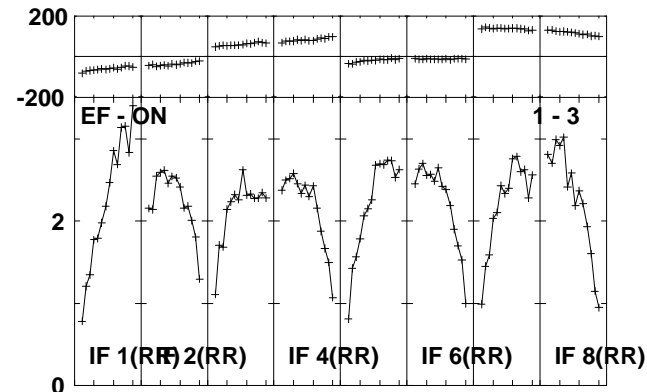
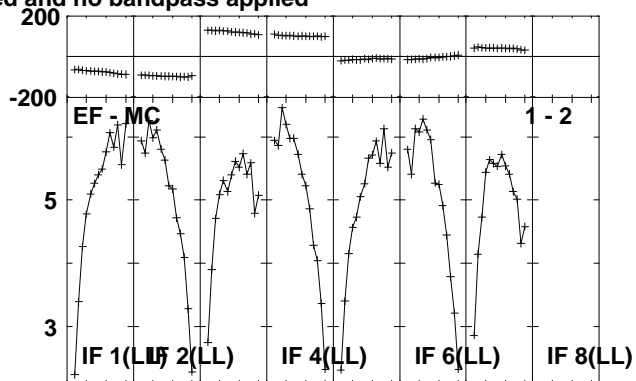
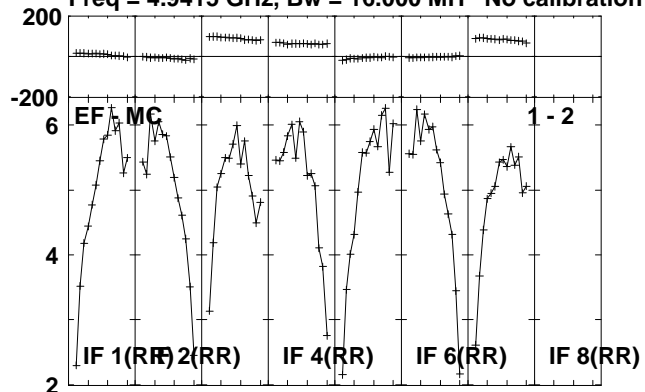

Lower frame: Milli Ampl Jy Top frame: Phas deg
Scalar averaged cross-power spectrum Several baselines displayed
Timerange: 01/04:48:11 to 01/04:49:39

Plot file version 332 created 14-JUL-2010 16:38:52
J1953+35 RR004A.UVDATA.1
Freq = 4.9415 GHz, Bw = 16.000 MH No calibration applied and no bandpass applied

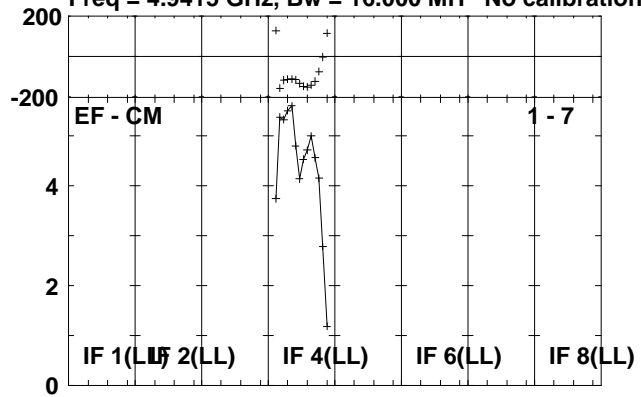

Lower frame: Milli Ampl Jy Top frame: Phas deg
Scalar averaged cross-power spectrum Several baselines displayed
Timerange: 01/04:48:11 to 01/04:49:39

Plot file version 333 created 14-JUL-2010 16:38:53

CYGX-1 RR004A.UVDATA.1

Freq = 4.9415 GHz, Bw = 16.000 MH No calibration applied and no bandpass applied

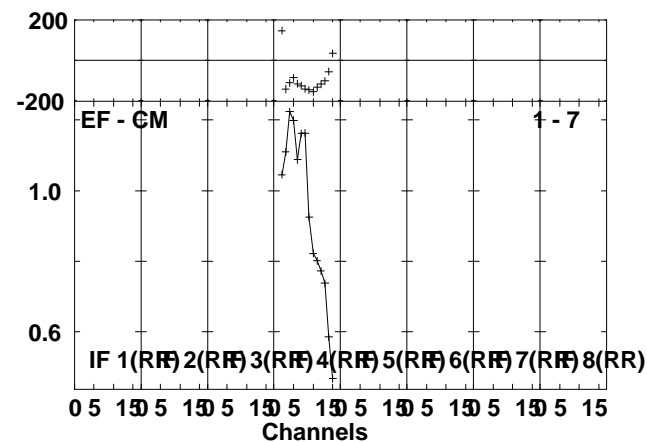
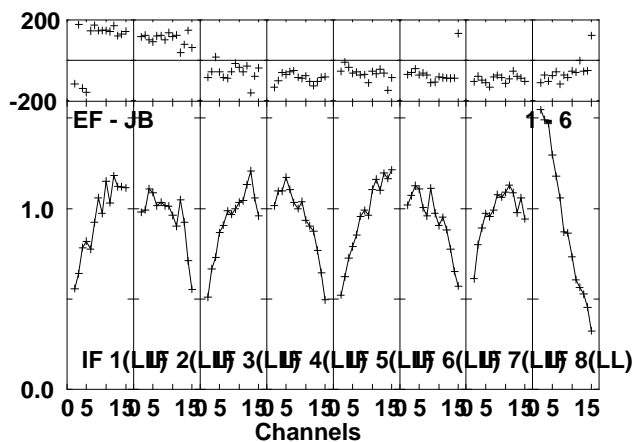
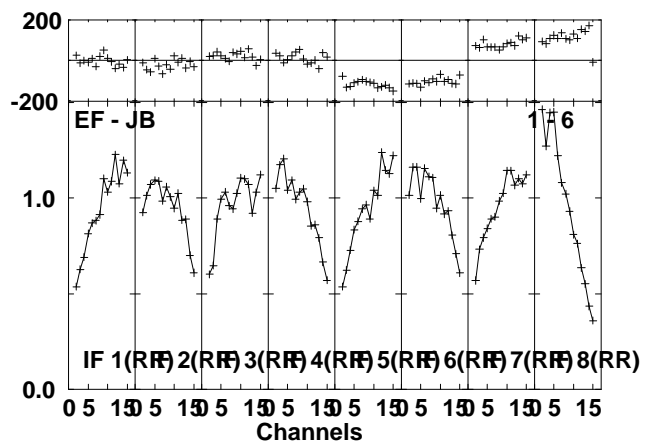
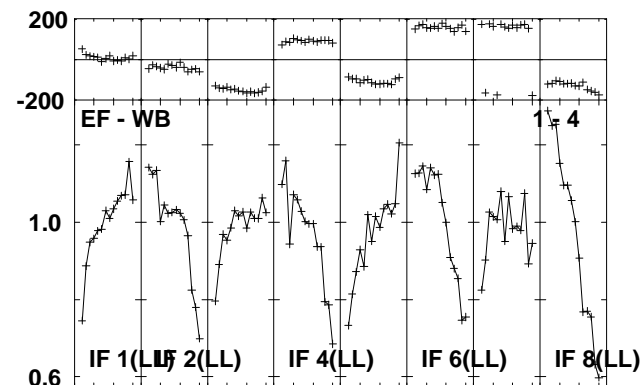
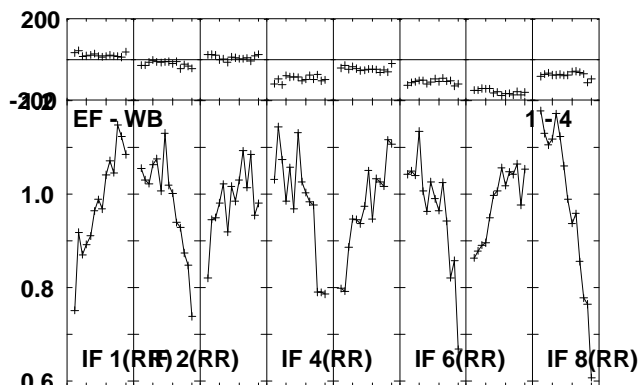
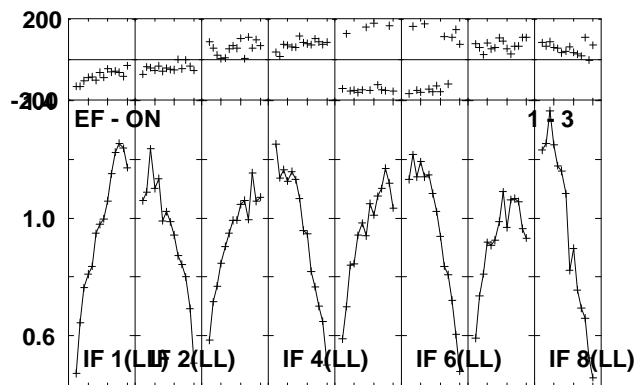
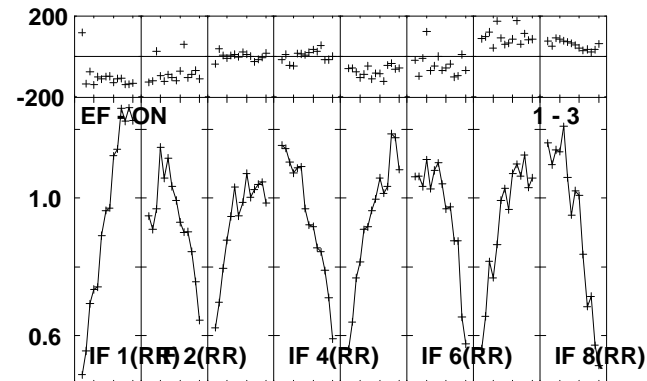
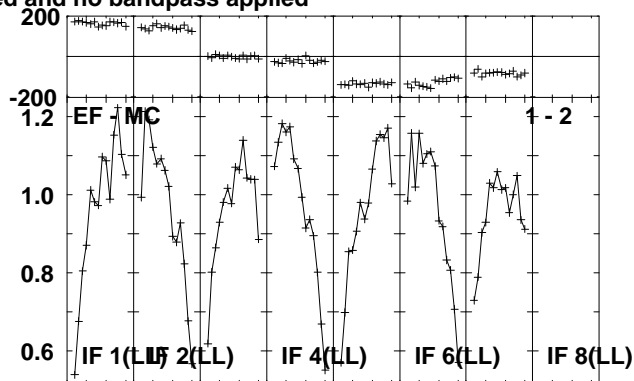
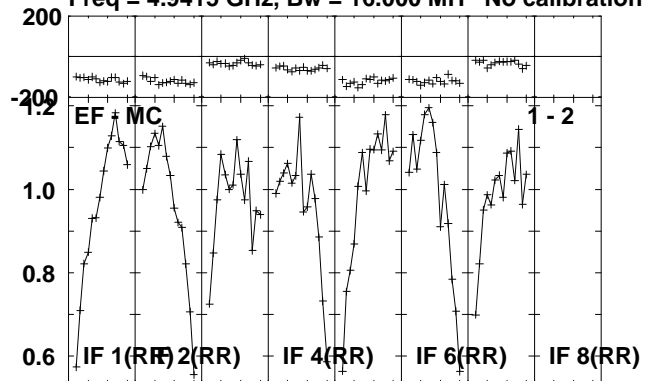

Lower frame: Milli Ampl Jy Top frame: Phas deg
Scalar averaged cross-power spectrum Several baselines displayed
Timerange: 01/04:49:41 to 01/04:54:39

Plot file version 334 created 14-JUL-2010 16:38:54
CYGX-1 RR004A.UVDATA.1
Freq = 4.9415 GHz, Bw = 16.000 MH No calibration applied and no bandpass applied

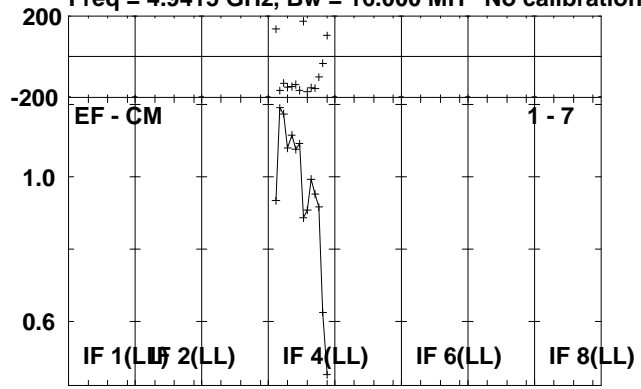

Lower frame: Milli Ampl Jy Top frame: Phas deg
Scalar averaged cross-power spectrum Several baselines displayed
Timerange: 01/04:49:41 to 01/04:54:39

Plot file version 335 created 14-JUL-2010 16:38:55

J1953+35 RR004A.UVDATA.1

Freq = 4.9415 GHz, Bw = 16.000 MH No calibration applied and no bandpass applied

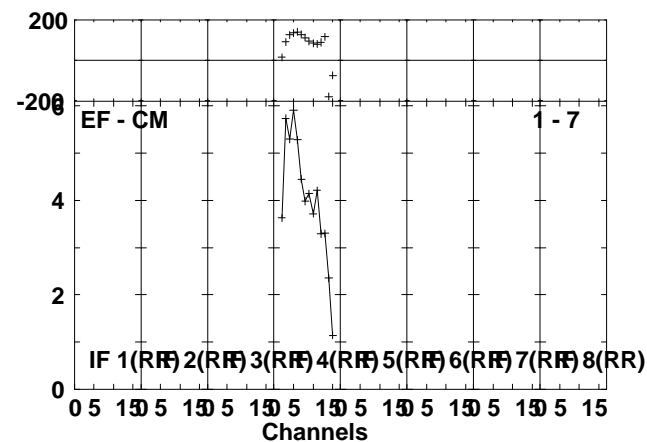
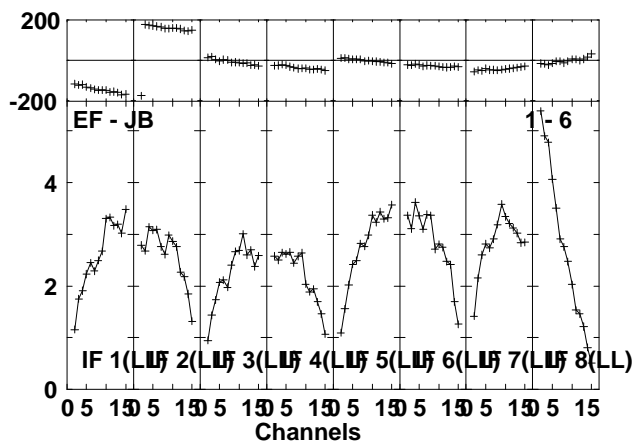
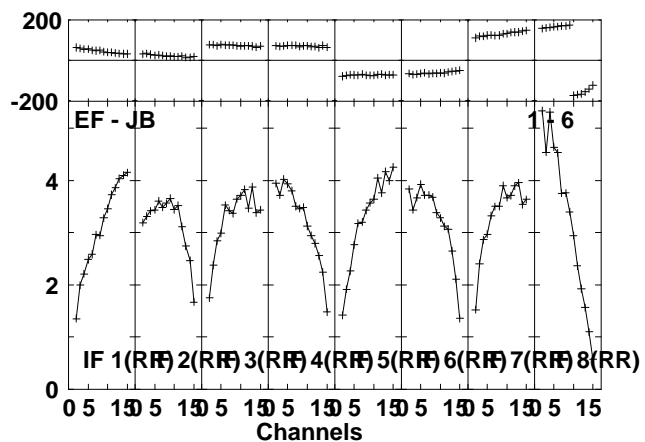
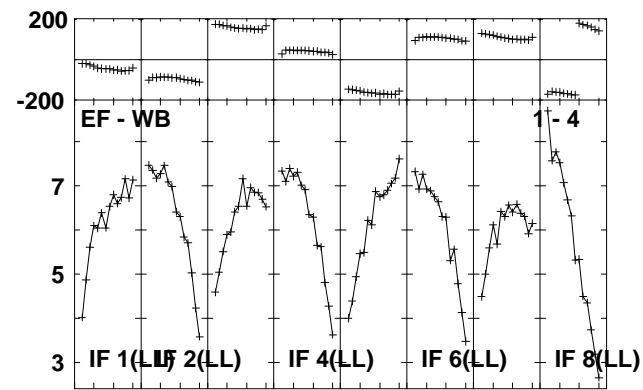
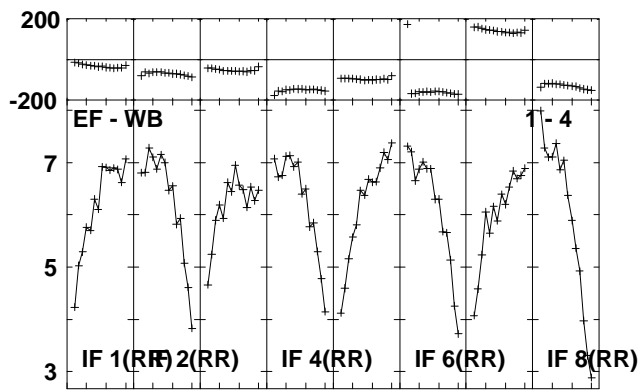
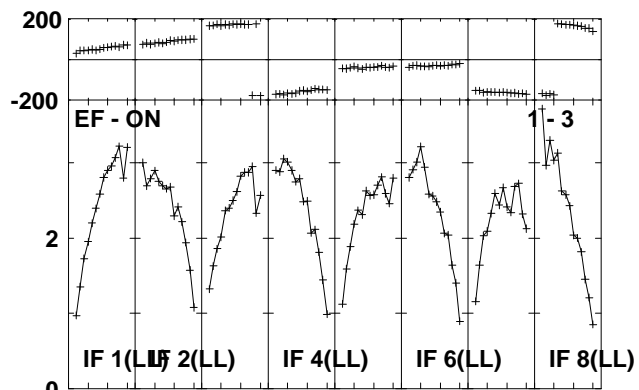
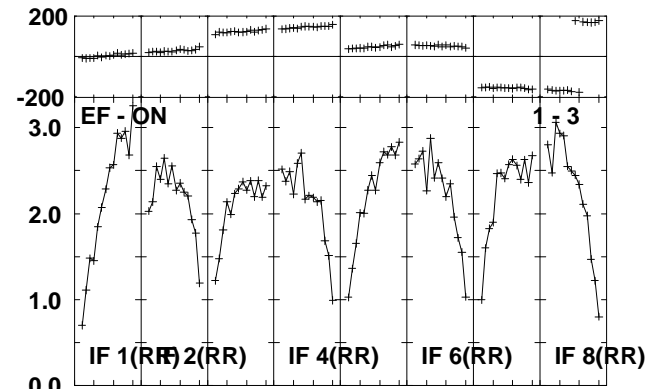
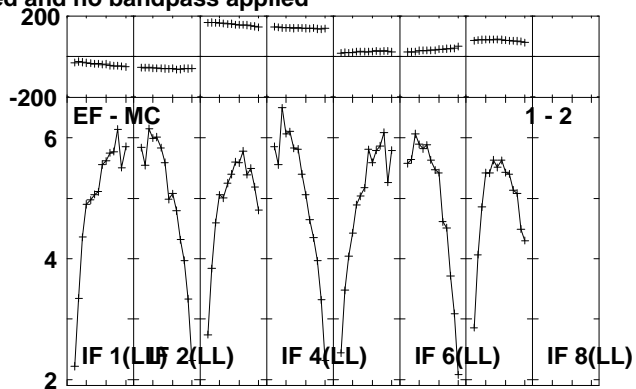
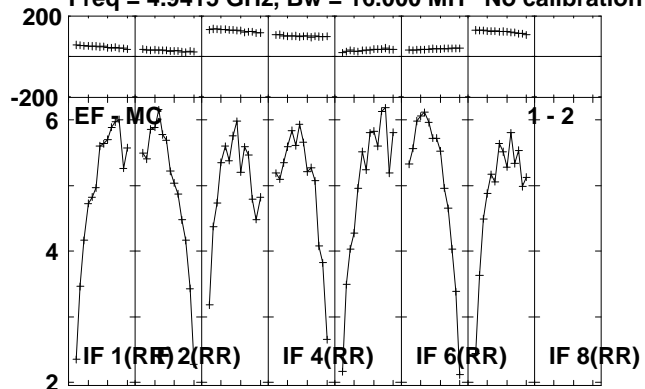

Lower frame: Milli Ampl Jy Top frame: Phas deg
Scalar averaged cross-power spectrum Several baselines displayed
Timerange: 01/04:54:41 to 01/04:56:39

Plot file version 336 created 14-JUL-2010 16:38:55
J1953+35 RR004A.UVDATA.1
Freq = 4.9415 GHz, Bw = 16.000 MH No calibration applied and no bandpass applied

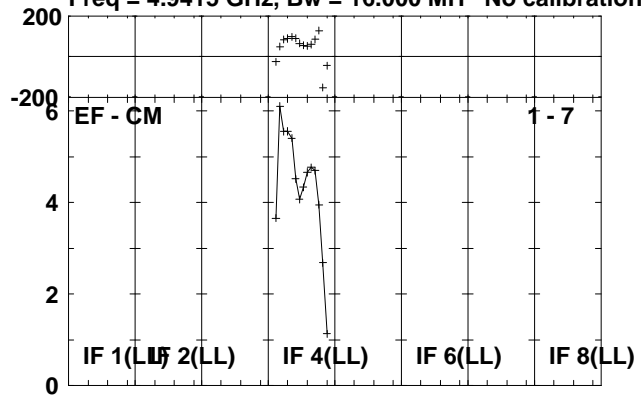

Lower frame: Milli Ampl Jy Top frame: Phas deg
Scalar averaged cross-power spectrum Several baselines displayed
Timerange: 01/04:54:41 to 01/04:56:39

Plot file version 337 created 14-JUL-2010 16:38:55

CYGX-1 RR004A.UVDATA.1

Freq = 4.9415 GHz, Bw = 16.000 MH No calibration applied and no bandpass applied

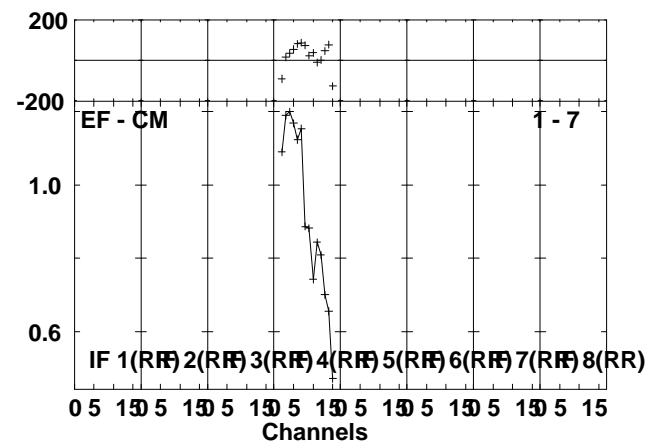
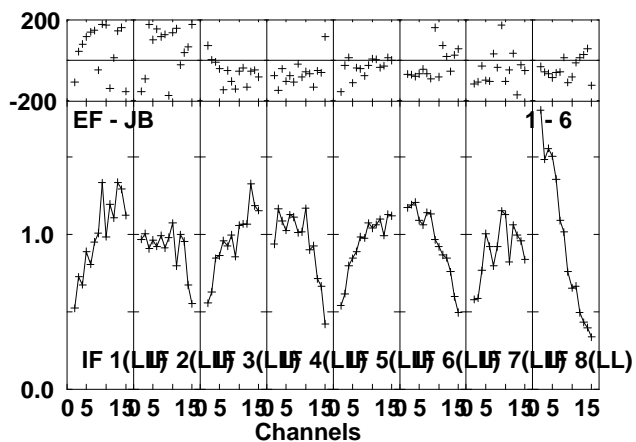
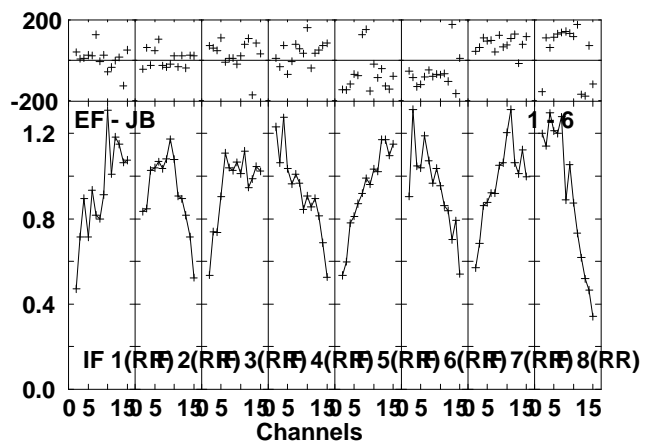
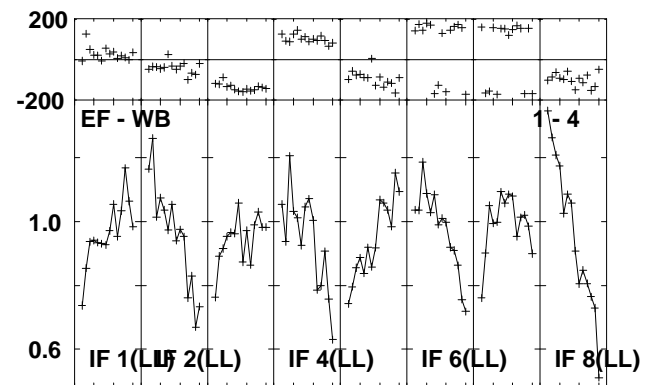
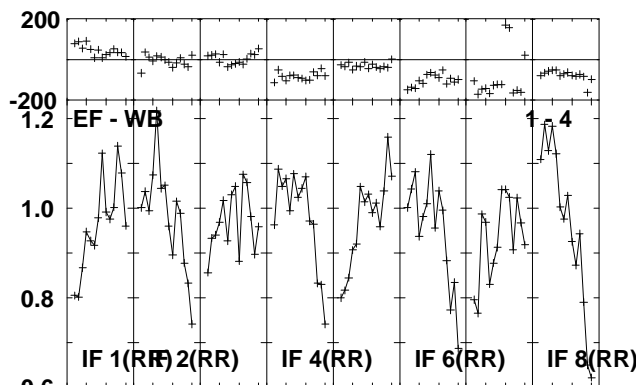
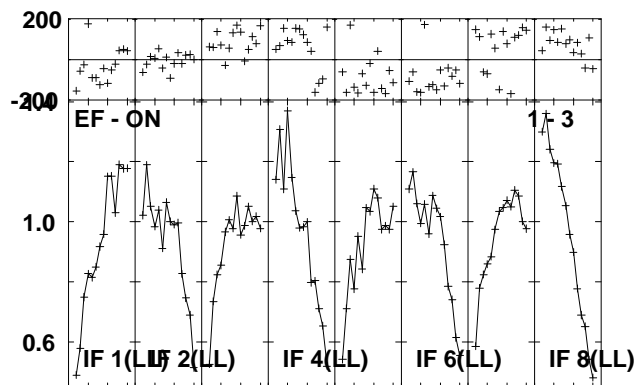
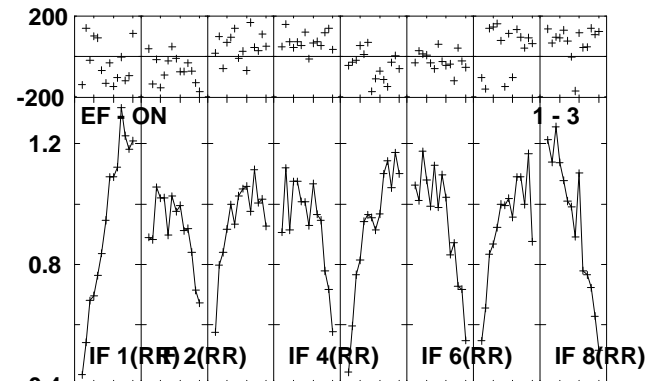
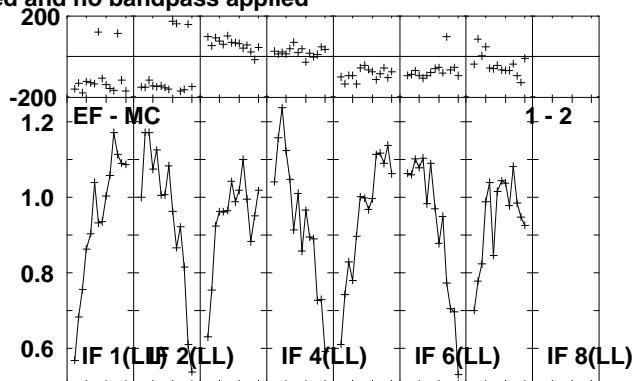
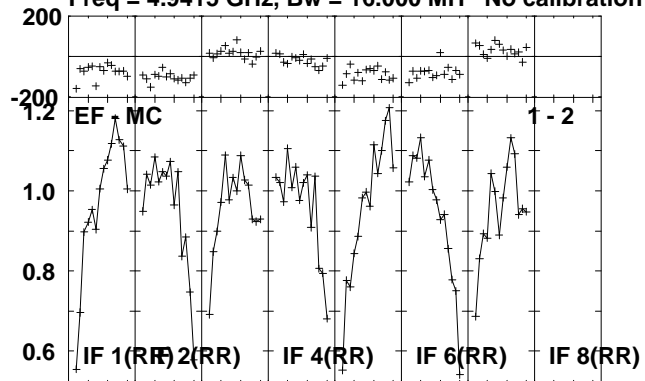

Lower frame: Milli Ampl Jy Top frame: Phas deg
Scalar averaged cross-power spectrum Several baselines displayed
Timerange: 01/04:56:41 to 01/05:01:39

Plot file version 338 created 14-JUL-2010 16:38:56
CYGX-1 RR004A.UVDATA.1
Freq = 4.9415 GHz, Bw = 16.000 MH No calibration applied and no bandpass applied

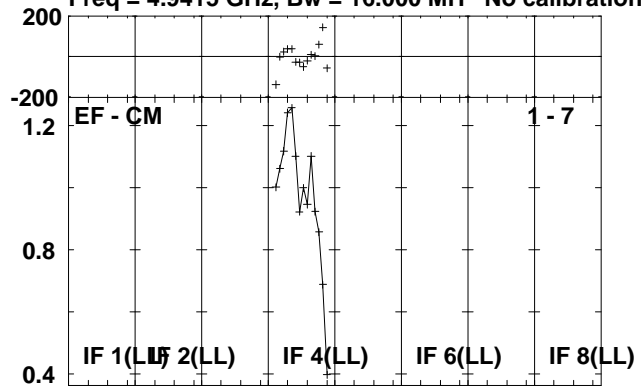

Lower frame: Milli Ampl Jy Top frame: Phas deg
Scalar averaged cross-power spectrum Several baselines displayed
Timerange: 01/04:56:41 to 01/05:01:39

Plot file version 339 created 14-JUL-2010 16:38:57

J1953+35 RR004A.UVDATA.1

Freq = 4.9415 GHz, Bw = 16.000 MH No calibration applied and no bandpass applied

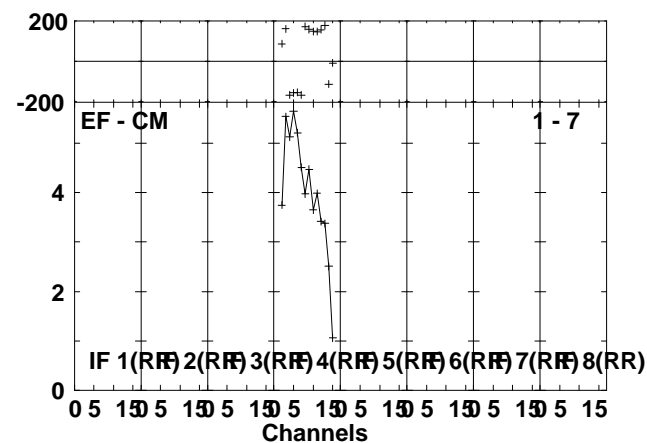
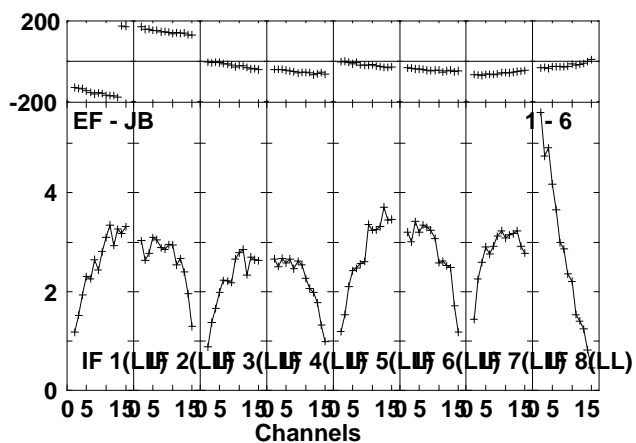
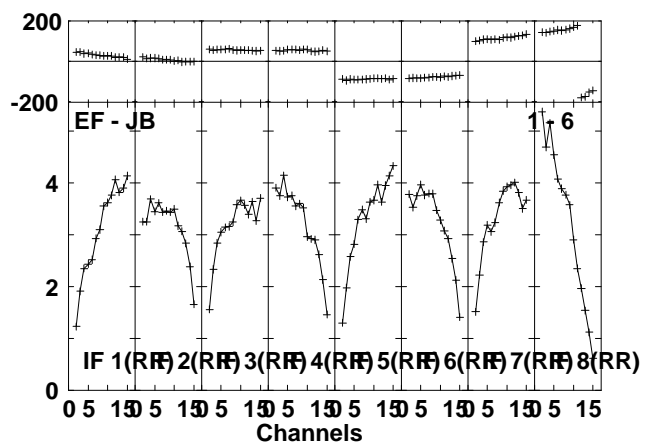
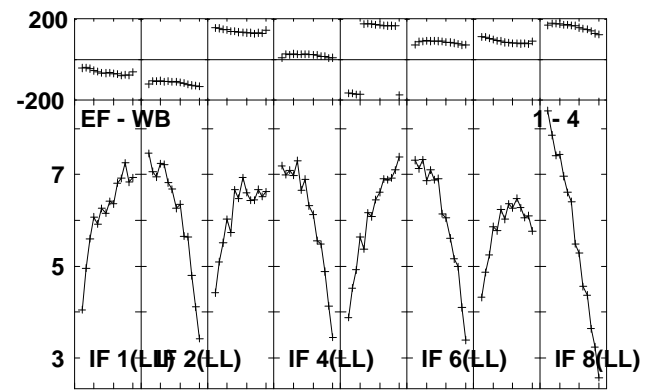
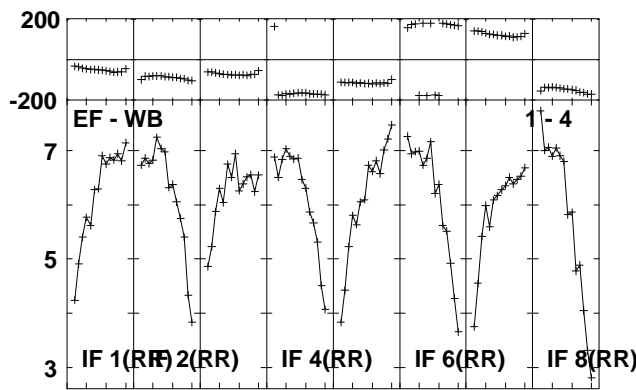
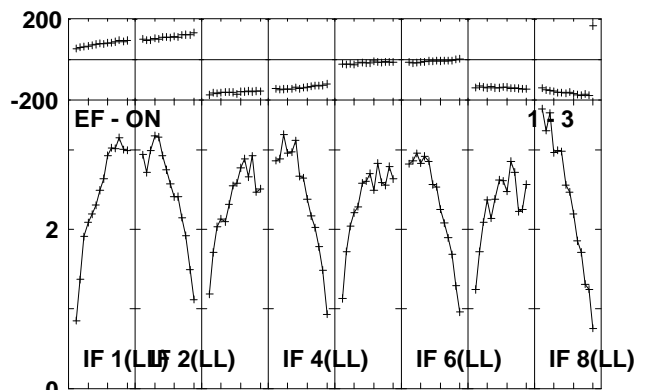
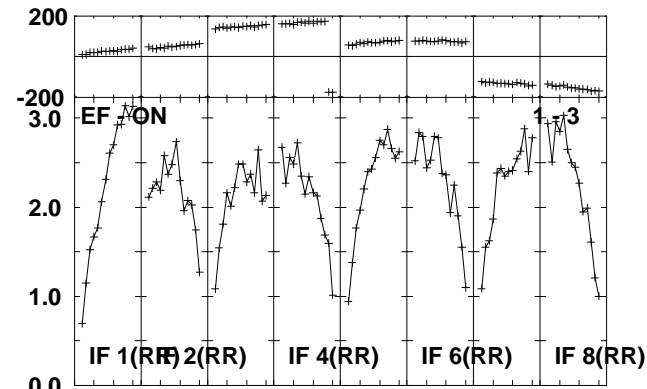
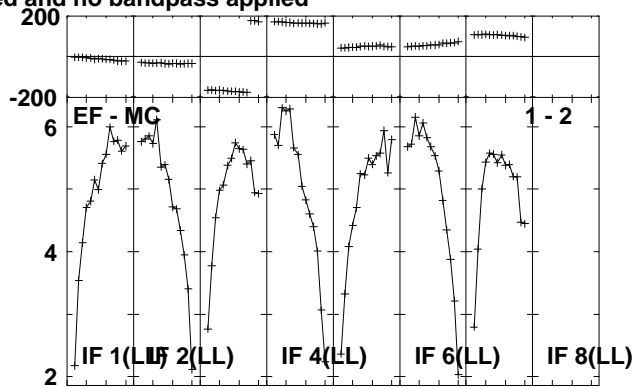
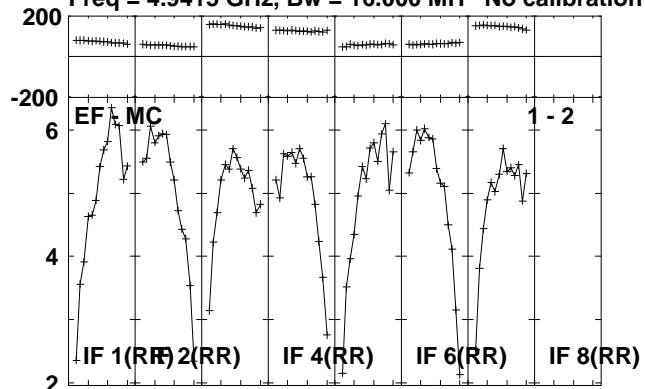

Lower frame: Milli Ampl Jy Top frame: Phas deg
Scalar averaged cross-power spectrum Several baselines displayed
Timerange: 01/05:02:21 to 01/05:03:49

Plot file version 340 created 14-JUL-2010 16:38:57
J1953+35 RR004A.UVDATA.1
Freq = 4.9415 GHz, Bw = 16.000 MH No calibration applied and no bandpass applied

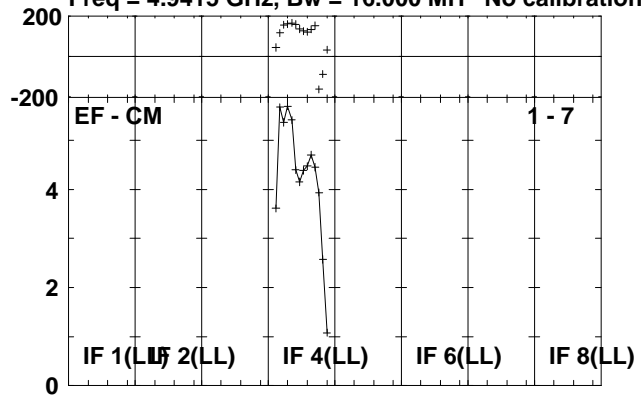

Lower frame: Milli Ampl Jy Top frame: Phas deg
Scalar averaged cross-power spectrum Several baselines displayed
Timerange: 01/05:02:21 to 01/05:03:49

Plot file version 341 created 14-JUL-2010 16:38:58

CYGX-1 RR004A.UVDATA.1

Freq = 4.9415 GHz, Bw = 16.000 MH No calibration applied and no bandpass applied

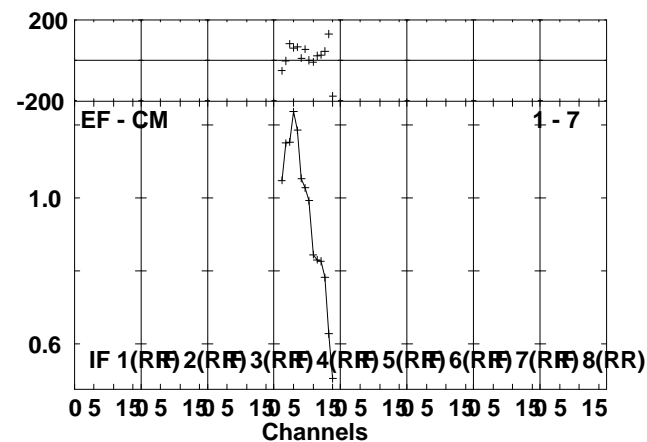
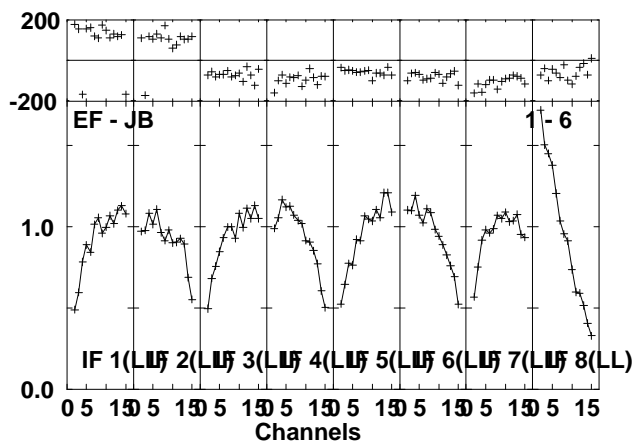
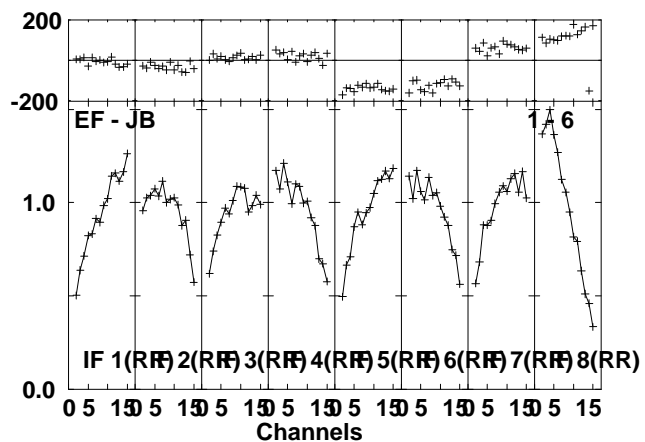
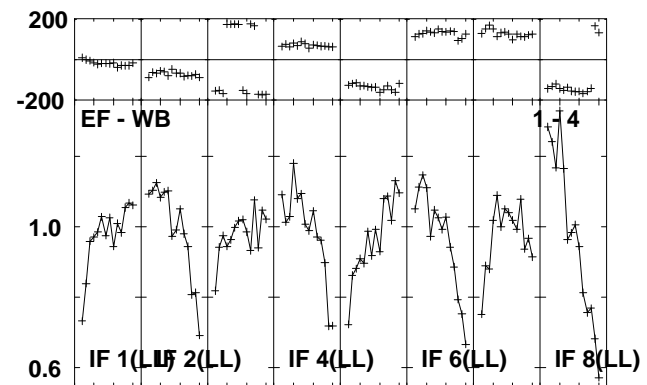
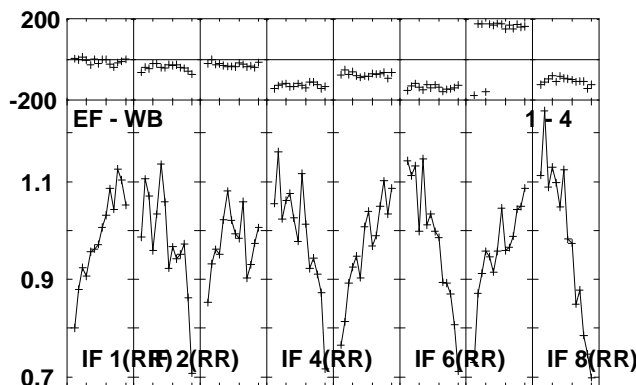
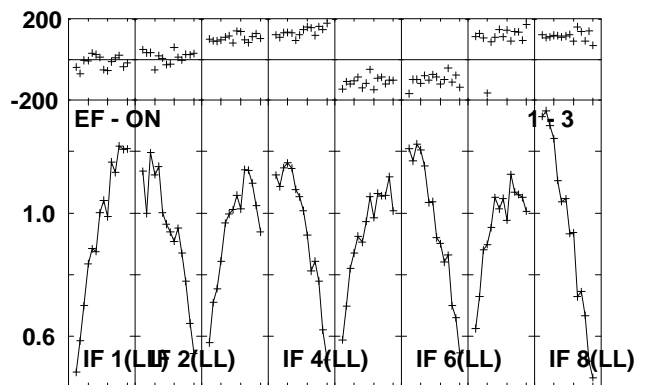
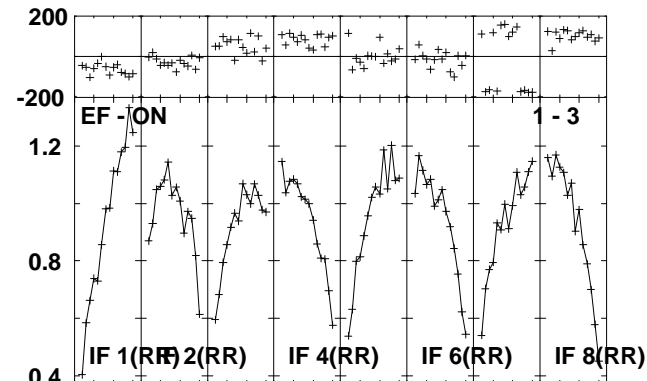
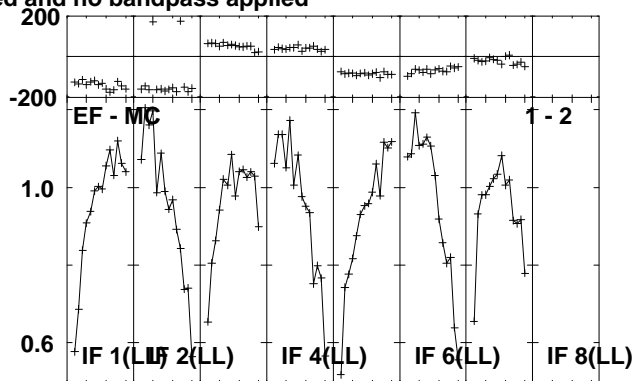
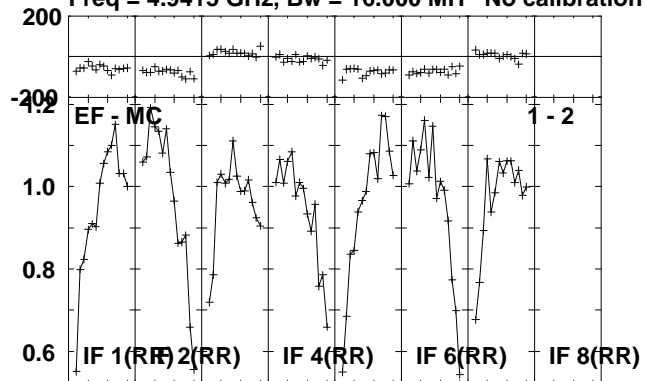

Lower frame: Milli Ampl Jy Top frame: Phas deg
Scalar averaged cross-power spectrum Several baselines displayed
Timerange: 01/05:03:51 to 01/05:08:49

Plot file version 342 created 14-JUL-2010 16:38:59

CYGX-1 RR004A.UVDATA.1

Freq = 4.9415 GHz, Bw = 16.000 MH No calibration applied and no bandpass applied

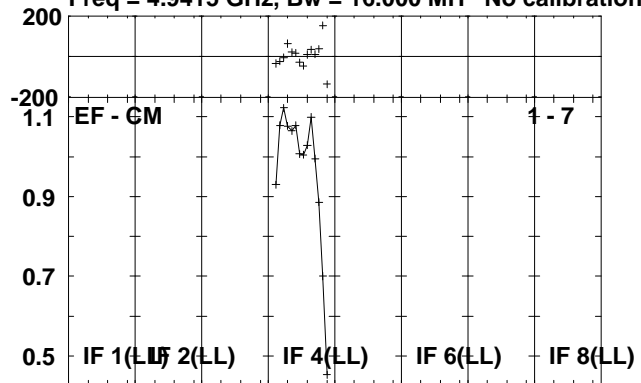

Lower frame: Milli Ampl Jy Top frame: Phas deg
Scalar averaged cross-power spectrum Several baselines displayed
Timerange: 01/05:03:51 to 01/05:08:49

Plot file version 343 created 14-JUL-2010 16:38:59

J1953+35 RR004A.UVDATA.1

Freq = 4.9415 GHz, Bw = 16.000 MH No calibration applied and no bandpass applied

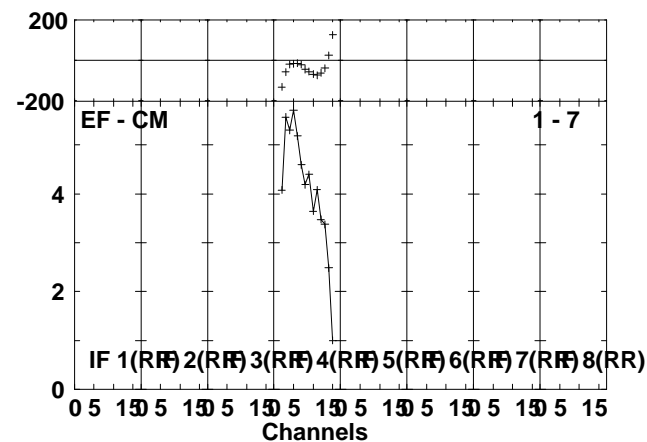
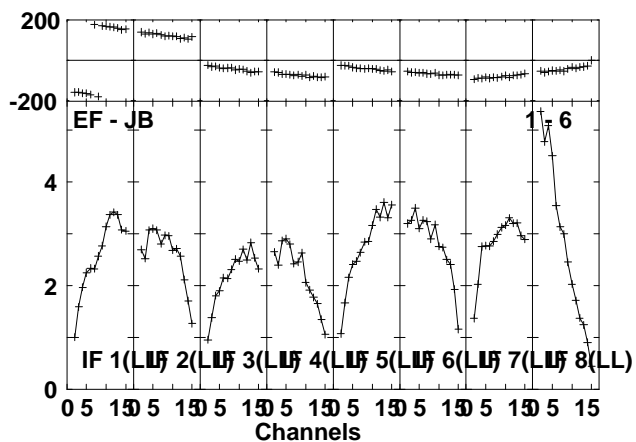
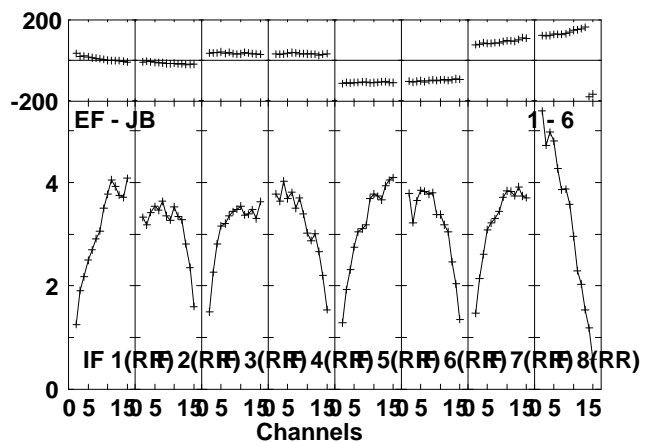
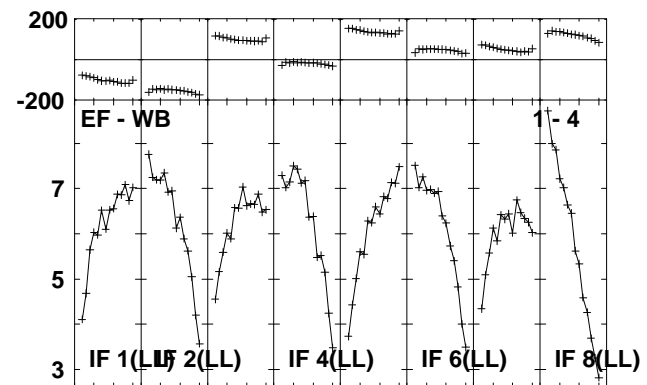
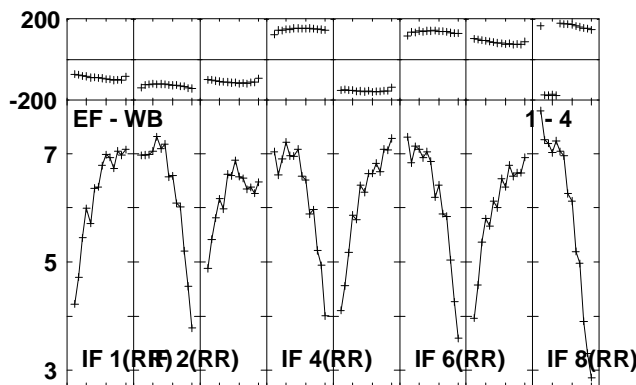
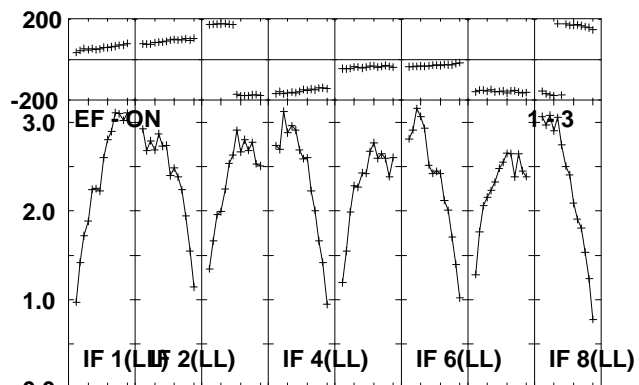
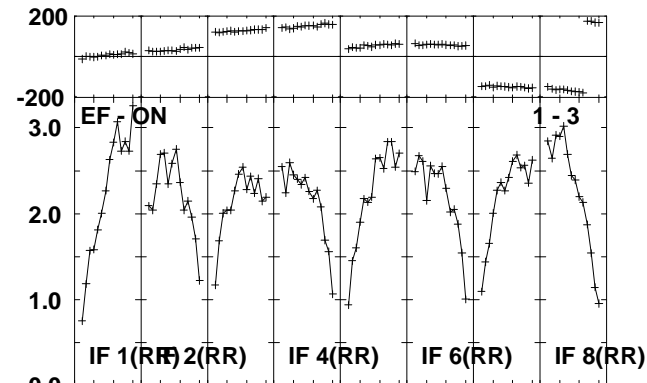
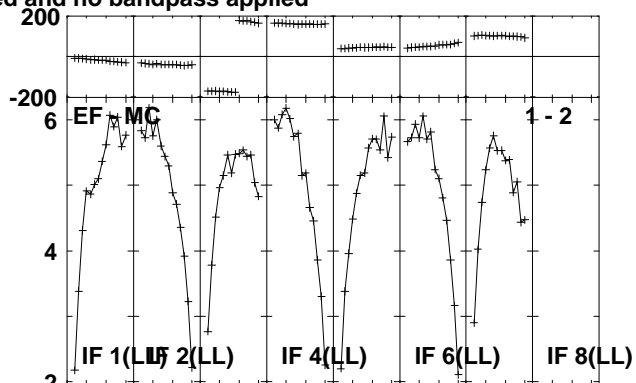
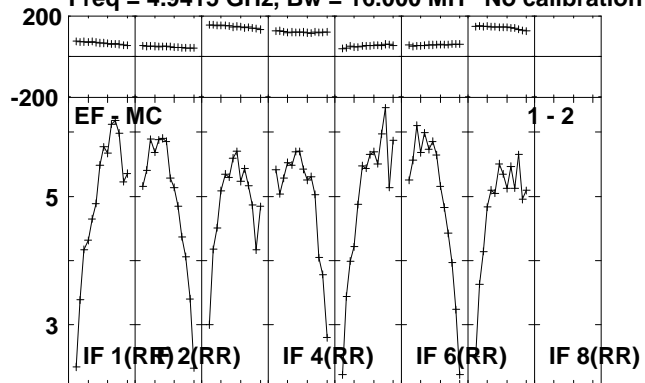

Lower frame: Milli Ampl Jy Top frame: Phas deg
Scalar averaged cross-power spectrum Several baselines displayed
Timerange: 01/05:08:51 to 01/05:10:49

Plot file version 344 created 14-JUL-2010 16:39:00
J1953+35 RR004A.UVDATA.1
Freq = 4.9415 GHz, Bw = 16.000 MH No calibration applied and no bandpass applied

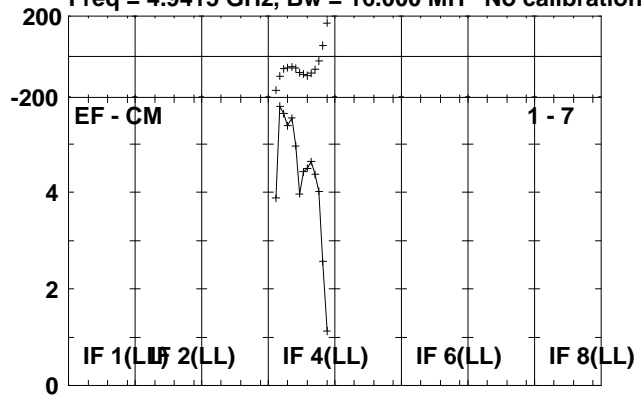

Lower frame: Milli Ampl Jy Top frame: Phas deg
Scalar averaged cross-power spectrum Several baselines displayed
Timerange: 01/05:08:51 to 01/05:10:49

Plot file version 345 created 14-JUL-2010 16:39:00

CYGX-1 RR004A.UVDATA.1

Freq = 4.9415 GHz, Bw = 16.000 MH No calibration applied and no bandpass applied

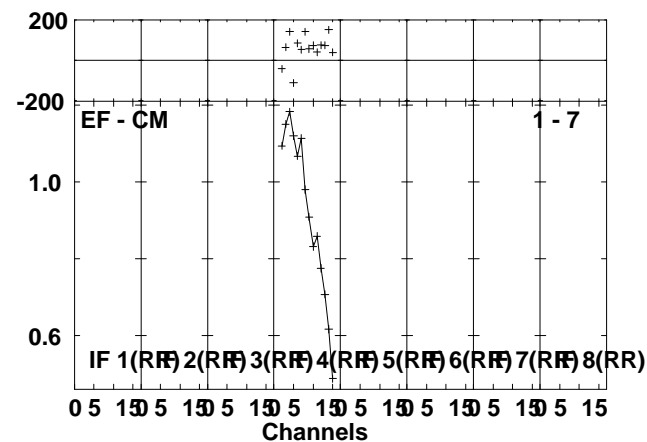
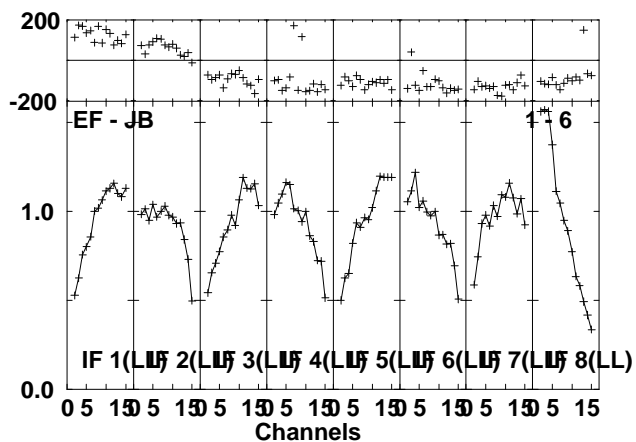
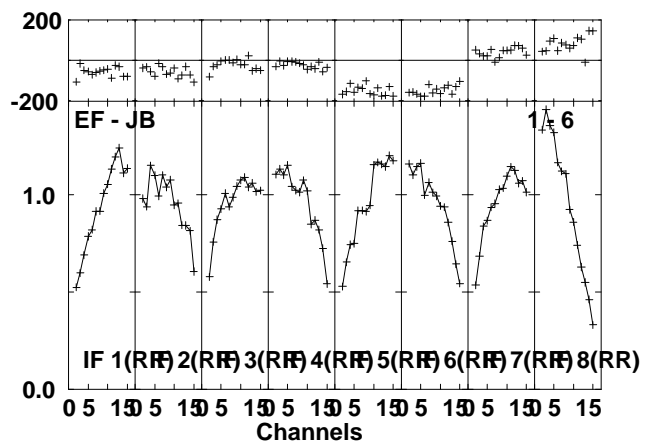
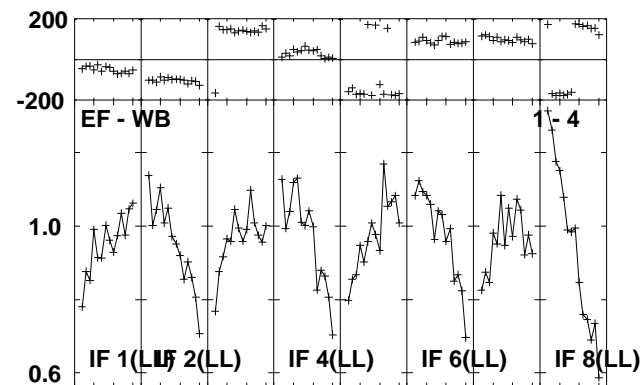
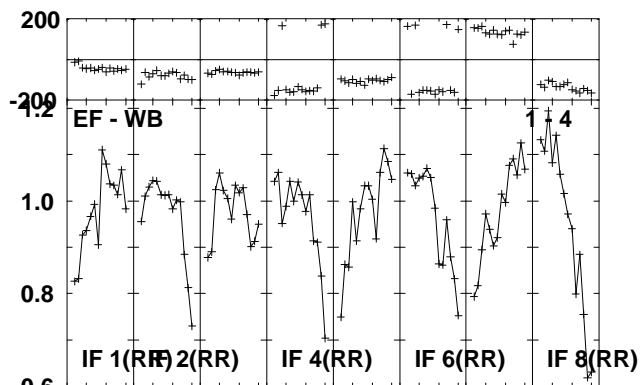
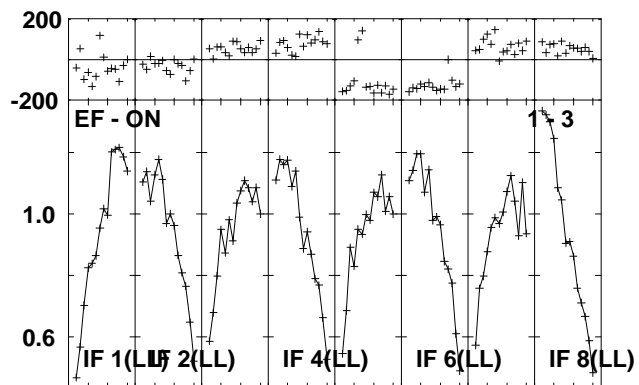
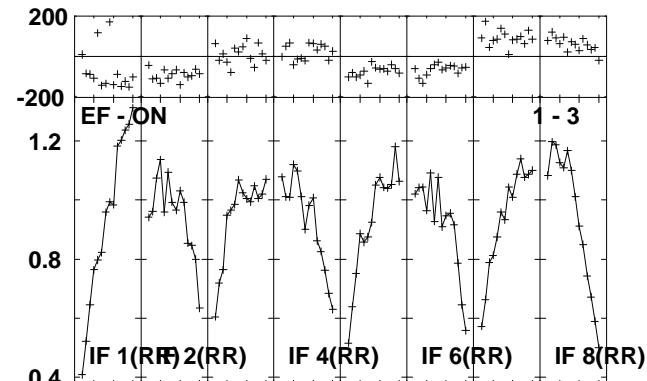
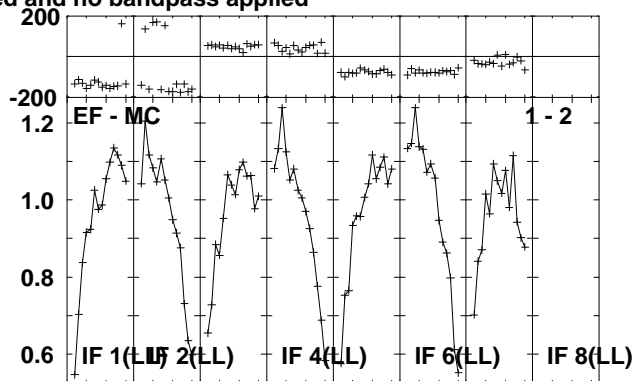
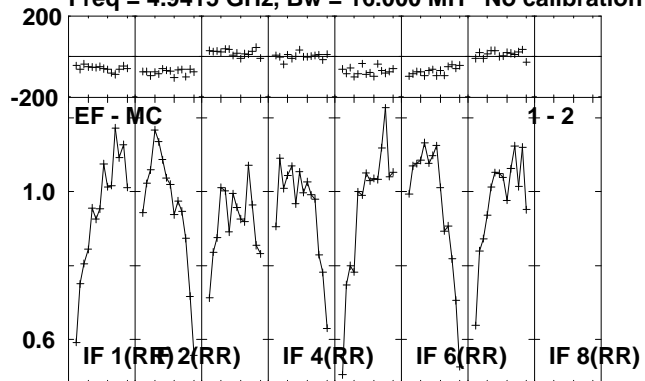

Lower frame: Milli Ampl Jy Top frame: Phas deg
Scalar averaged cross-power spectrum Several baselines displayed
Timerange: 01/05:10:51 to 01/05:15:49

Plot file version 346 created 14-JUL-2010 16:39:02
CYGX-1 RR004A.UVDATA.1
Freq = 4.9415 GHz, Bw = 16.000 MH No calibration applied and no bandpass applied

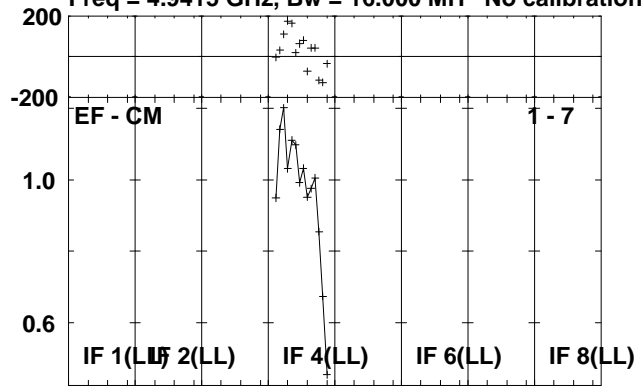

Lower frame: Milli Ampl Jy Top frame: Phas deg
Scalar averaged cross-power spectrum Several baselines displayed
Timerange: 01/05:10:51 to 01/05:15:49

Plot file version 347 created 14-JUL-2010 16:39:02

J1953+35 RR004A.UVDATA.1

Freq = 4.9415 GHz, Bw = 16.000 MH No calibration applied and no bandpass applied

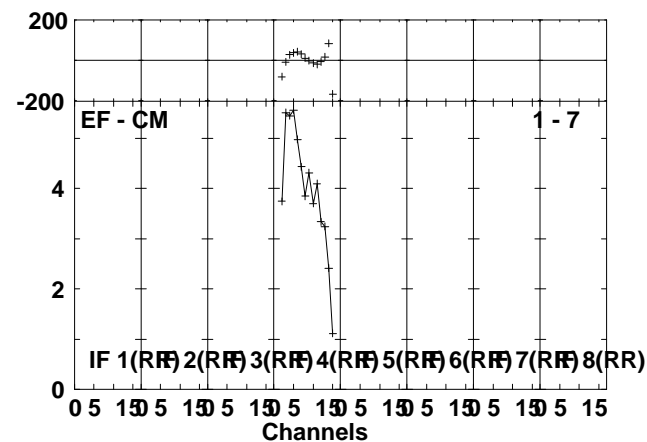
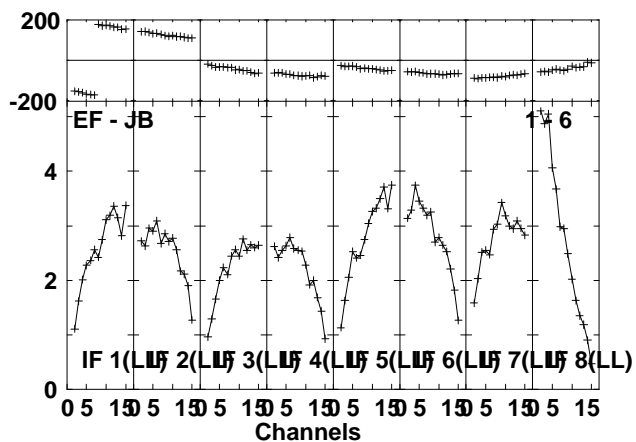
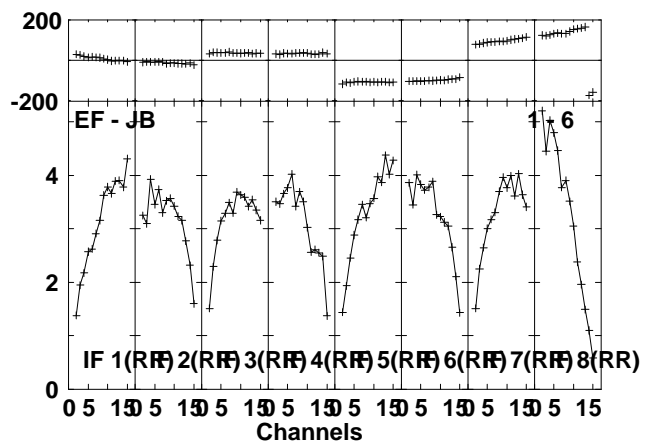
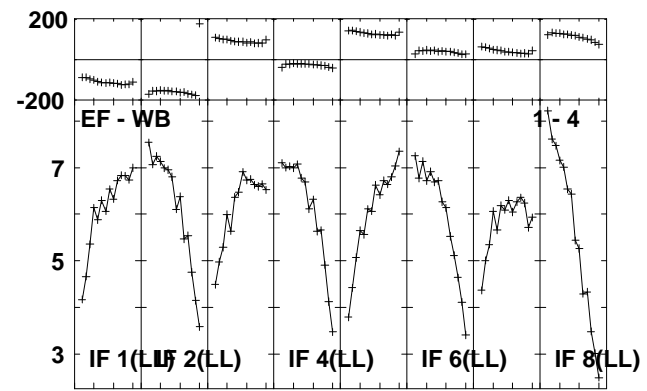
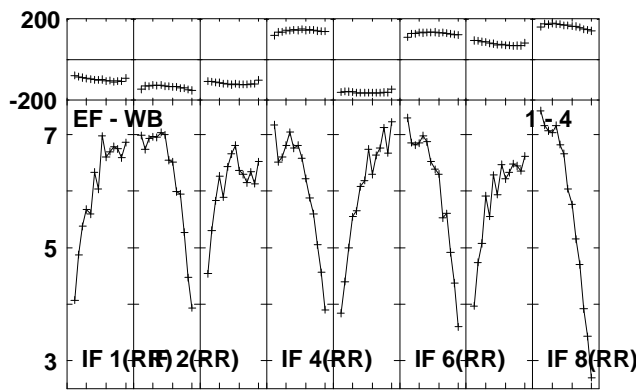
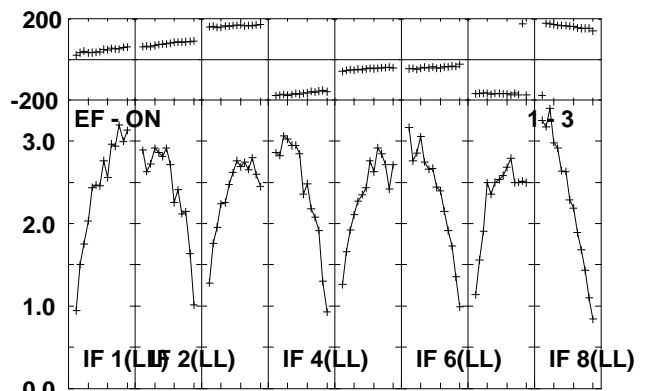
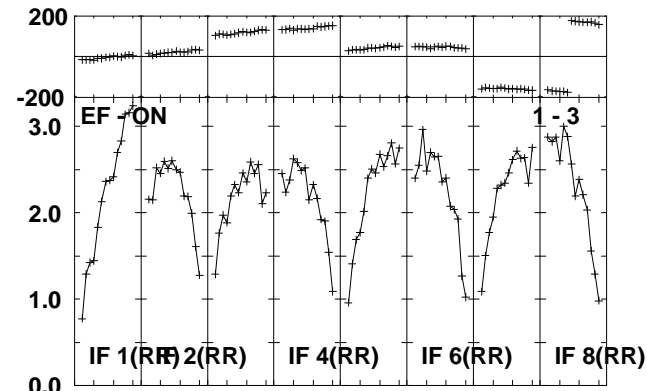
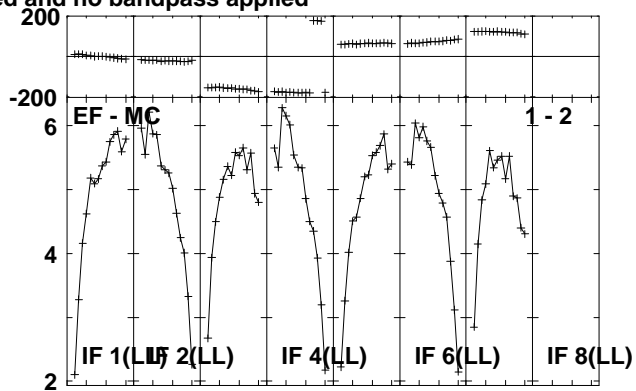
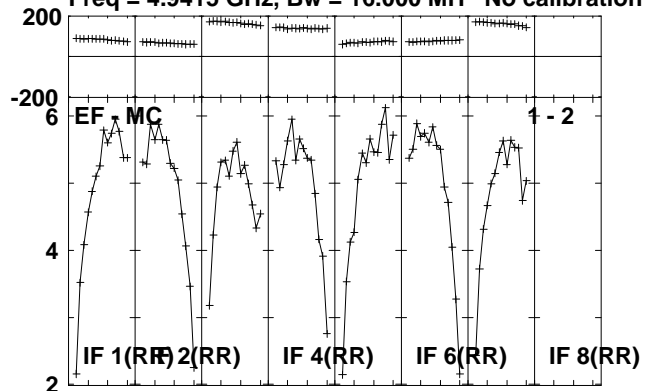

Lower frame: Milli Ampl Jy Top frame: Phas deg
Scalar averaged cross-power spectrum Several baselines displayed
Timerange: 01/05:16:31 to 01/05:17:59

Plot file version 348 created 14-JUL-2010 16:39:03
J1953+35 RR004A.UVDATA.1
Freq = 4.9415 GHz, Bw = 16.000 MH No calibration applied and no bandpass applied

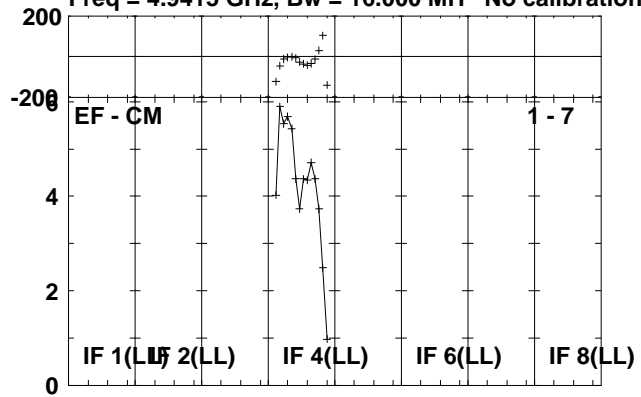

Lower frame: Milli Ampl Jy Top frame: Phas deg
Scalar averaged cross-power spectrum Several baselines displayed
Timerange: 01/05:16:31 to 01/05:17:59

Plot file version 349 created 14-JUL-2010 16:39:03

CYGX-1 RR004A.UVDATA.1

Freq = 4.9415 GHz, Bw = 16.000 MH No calibration applied and no bandpass applied

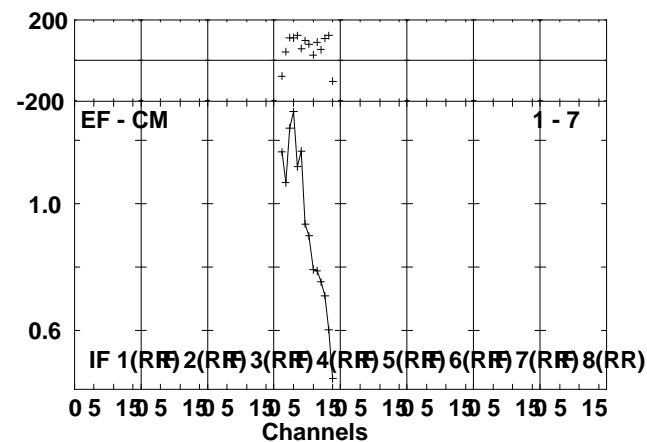
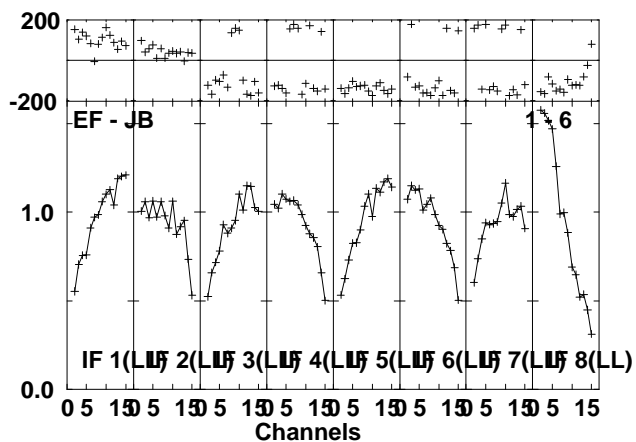
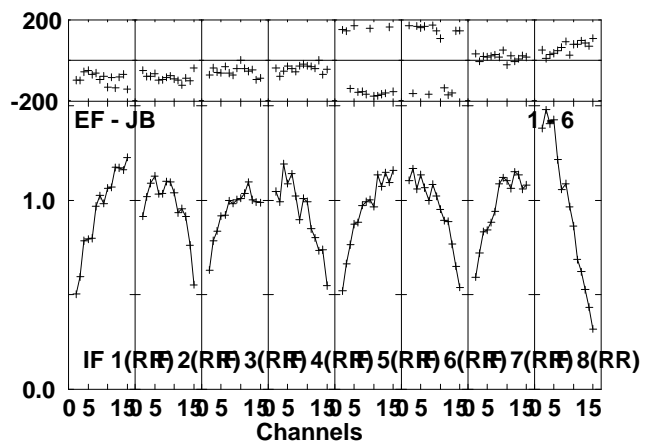
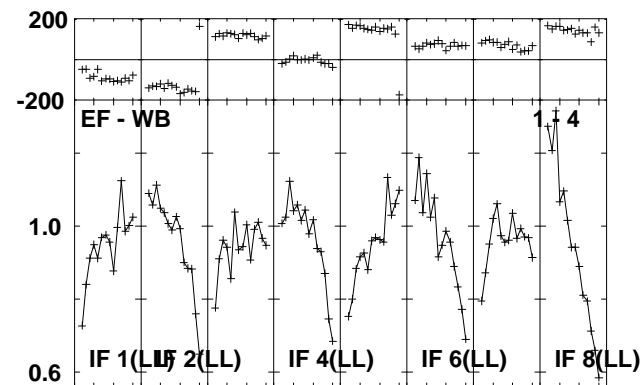
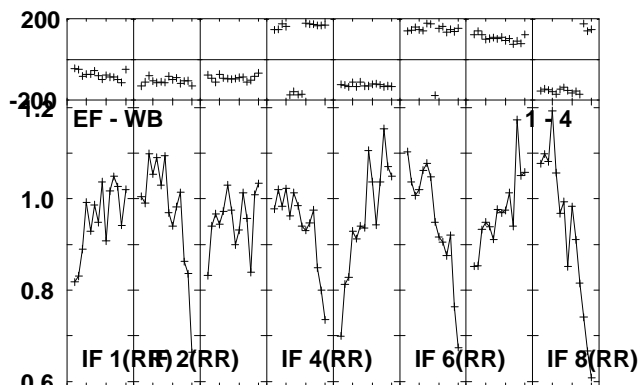
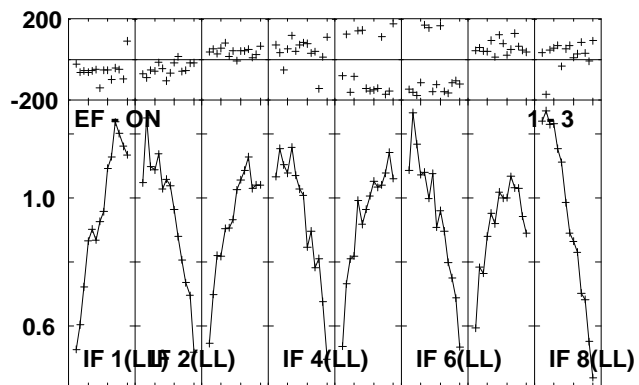
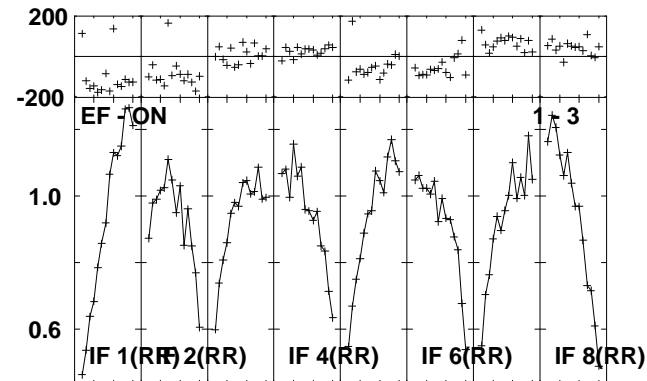
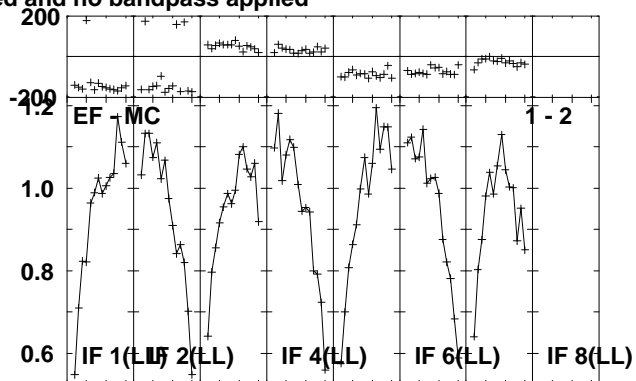
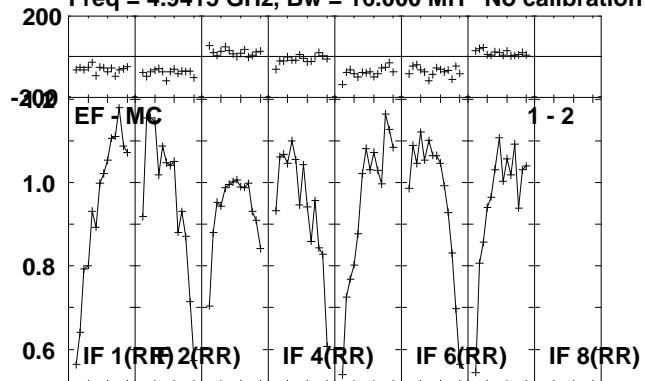

Lower frame: Milli Ampl Jy Top frame: Phas deg
Scalar averaged cross-power spectrum Several baselines displayed
Timerange: 01/05:18:01 to 01/05:22:59

Plot file version 350 created 14-JUL-2010 16:39:04
CYGX-1 RR004A.UVDATA.1
Freq = 4.9415 GHz, Bw = 16.000 MH No calibration applied and no bandpass applied

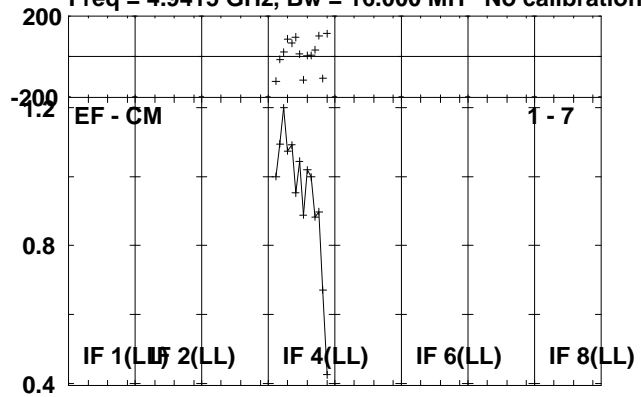

Lower frame: Milli Ampl Jy Top frame: Phas deg
Scalar averaged cross-power spectrum Several baselines displayed
Timerange: 01/05:18:01 to 01/05:22:59

Plot file version 351 created 14-JUL-2010 16:39:05

J1953+35 RR004A.UVDATA.1

Freq = 4.9415 GHz, Bw = 16.000 MH No calibration applied and no bandpass applied

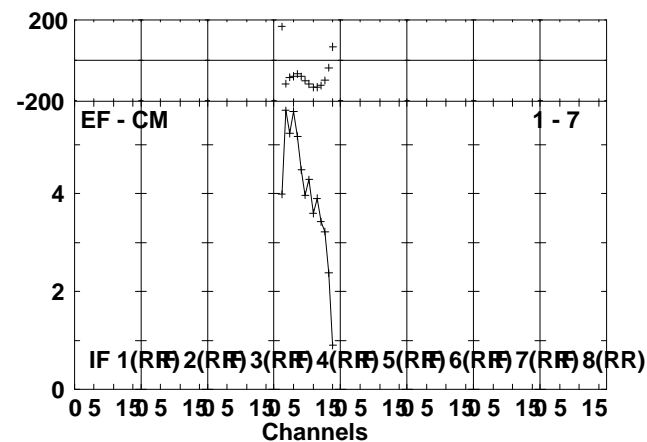
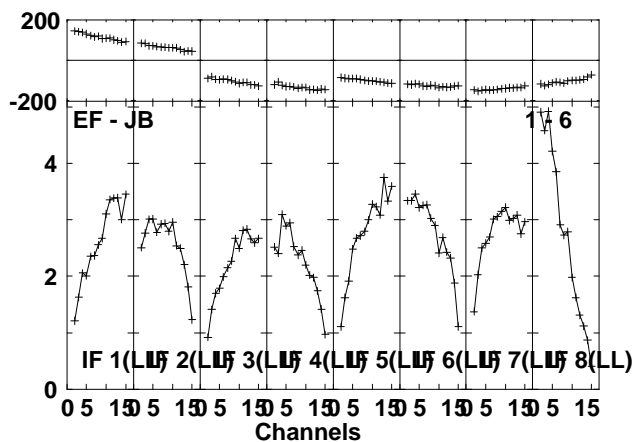
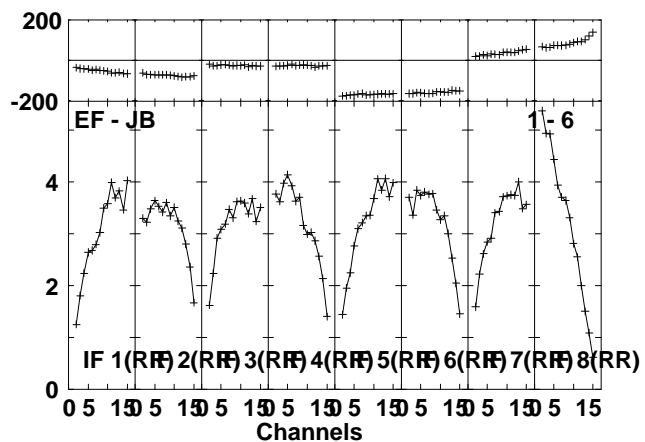
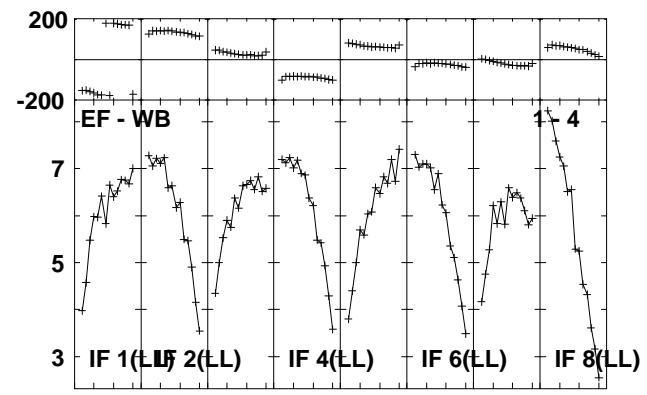
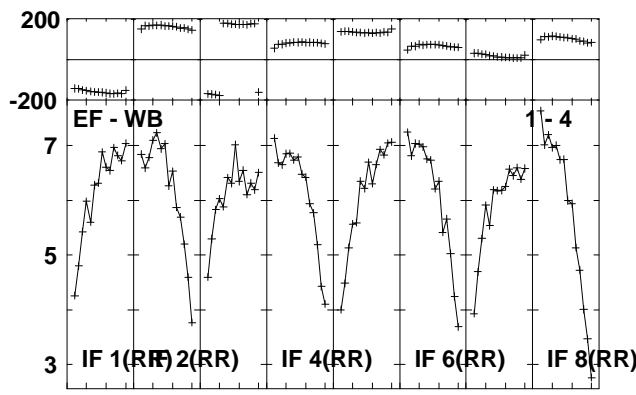
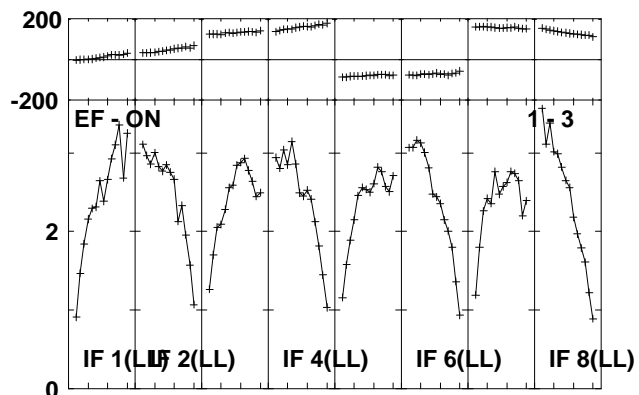
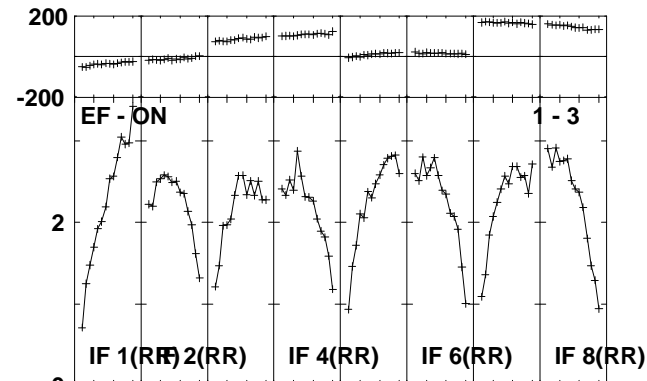
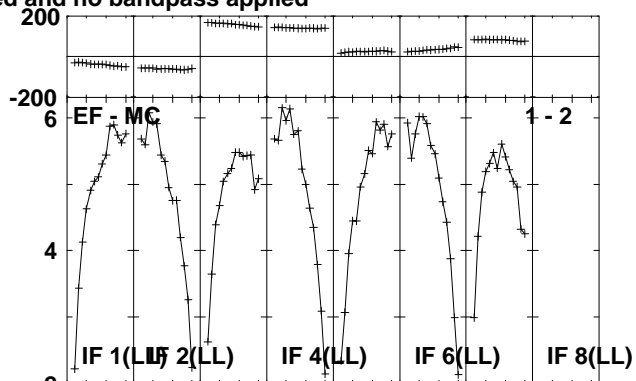
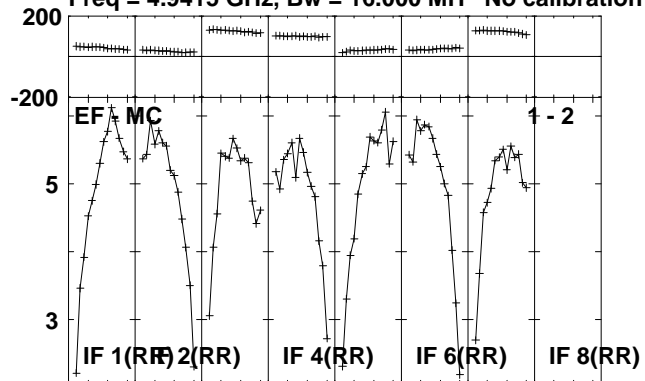

Lower frame: Milli Ampl Jy Top frame: Phas deg
Scalar averaged cross-power spectrum Several baselines displayed
Timerange: 01/05:23:01 to 01/05:24:59

Plot file version 352 created 14-JUL-2010 16:39:05
J1953+35 RR004A.UVDATA.1
Freq = 4.9415 GHz, Bw = 16.000 MH No calibration applied and no bandpass applied

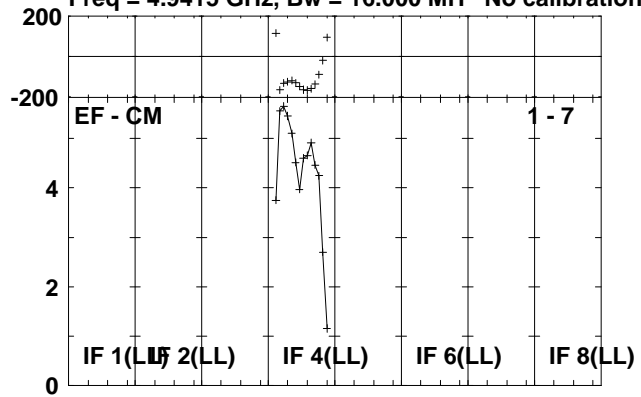

Lower frame: Milli Ampl Jy Top frame: Phas deg
Scalar averaged cross-power spectrum Several baselines displayed
Timerange: 01/05:23:01 to 01/05:24:59

Plot file version 353 created 14-JUL-2010 16:39:06

CYGX-1 RR004A.UVDATA.1

Freq = 4.9415 GHz, Bw = 16.000 MH No calibration applied and no bandpass applied

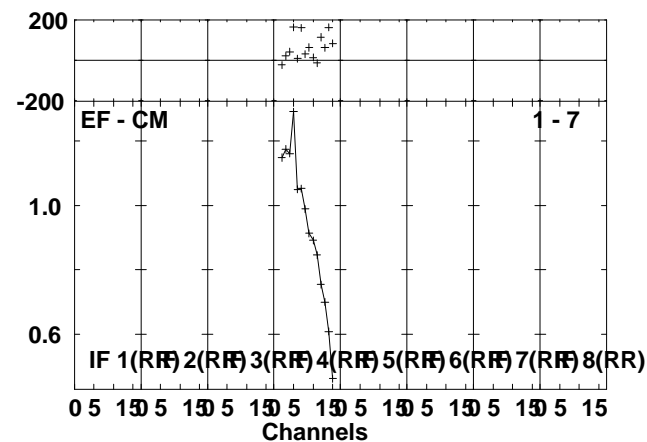
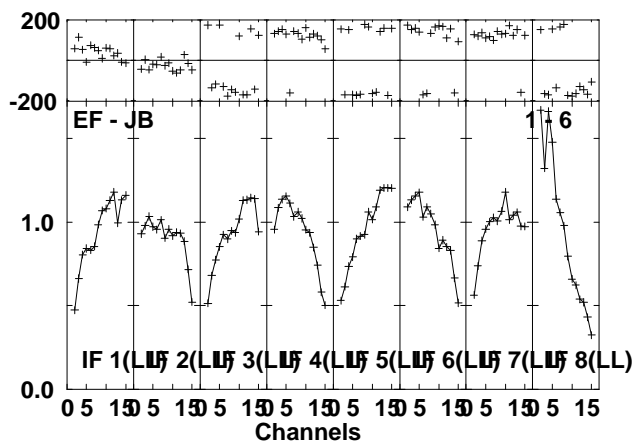
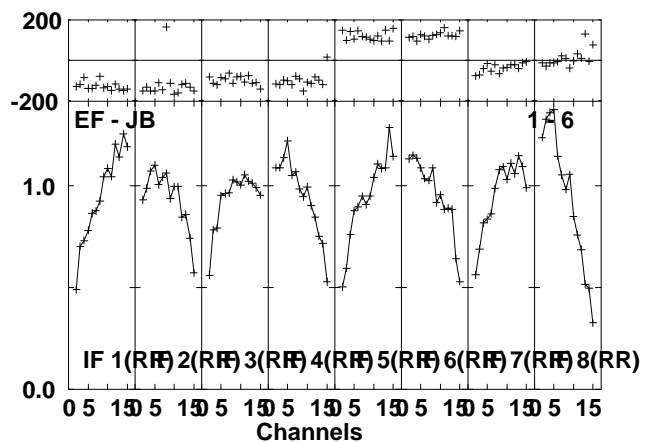
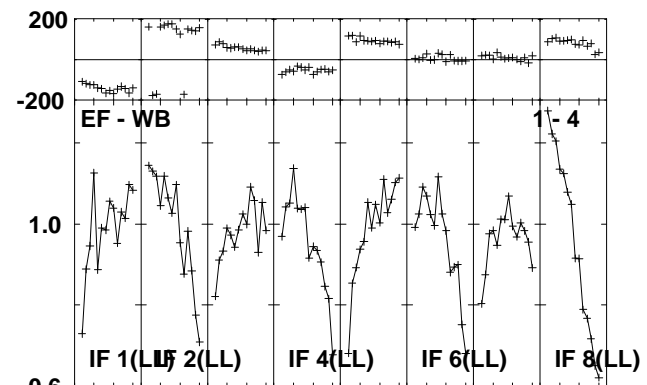
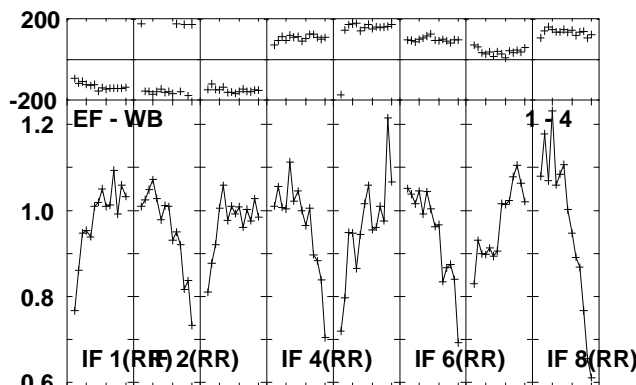
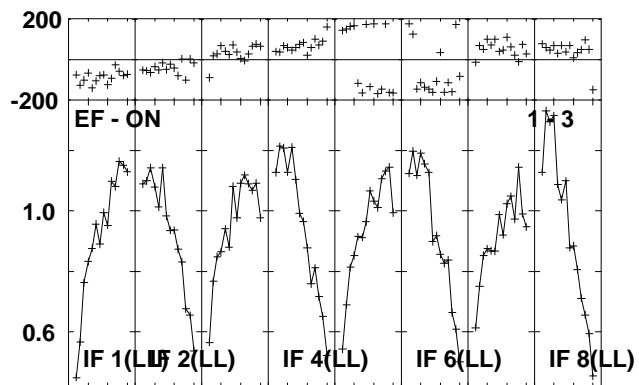
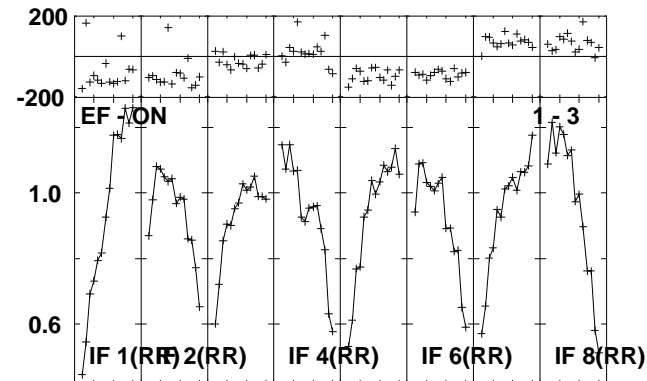
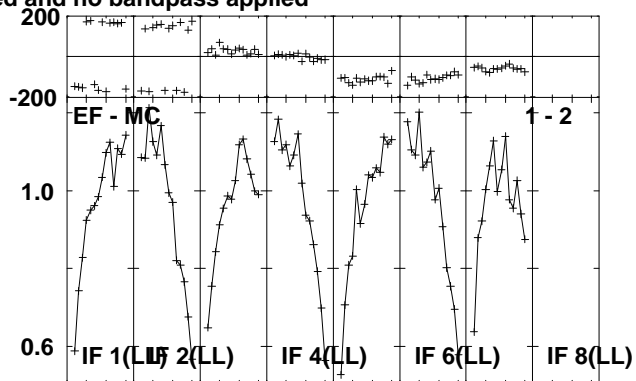
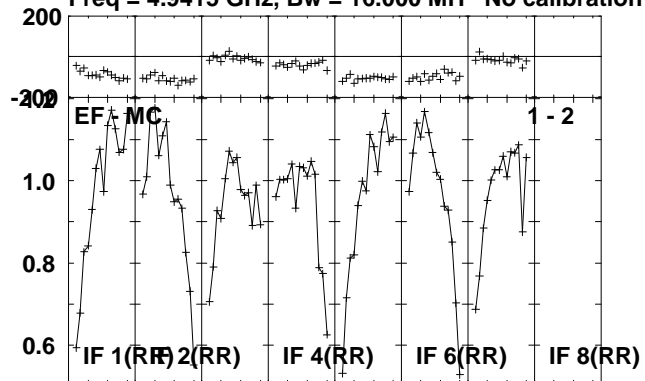

Lower frame: Milli Ampl Jy Top frame: Phas deg
Scalar averaged cross-power spectrum Several baselines displayed
Timerange: 01/05:25:01 to 01/05:29:59

Plot file version 354 created 14-JUL-2010 16:39:07
CYGX-1 RR004A.UVDATA.1
Freq = 4.9415 GHz, Bw = 16.000 MH No calibration applied and no bandpass applied

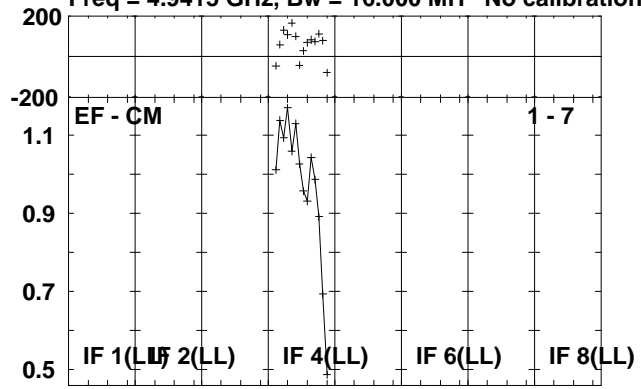

Lower frame: Milli Ampl Jy Top frame: Phas deg
Scalar averaged cross-power spectrum Several baselines displayed
Timerange: 01/05:25:01 to 01/05:29:59

Plot file version 355 created 14-JUL-2010 16:39:07

J1953+35 RR004A.UVDATA.1

Freq = 4.9415 GHz, Bw = 16.000 MH No calibration applied and no bandpass applied

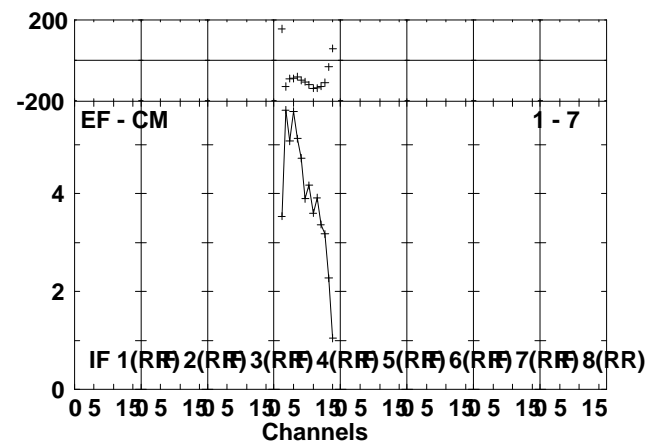
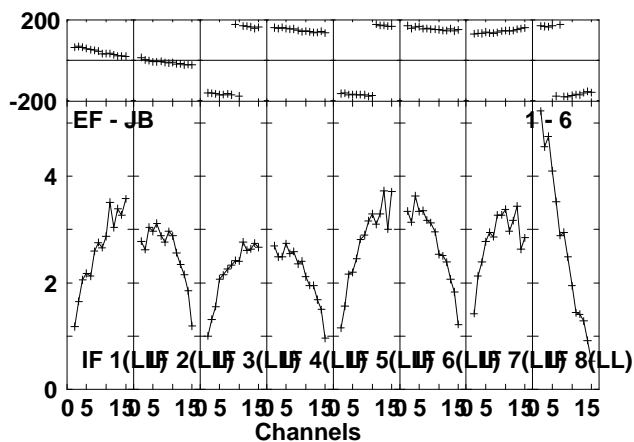
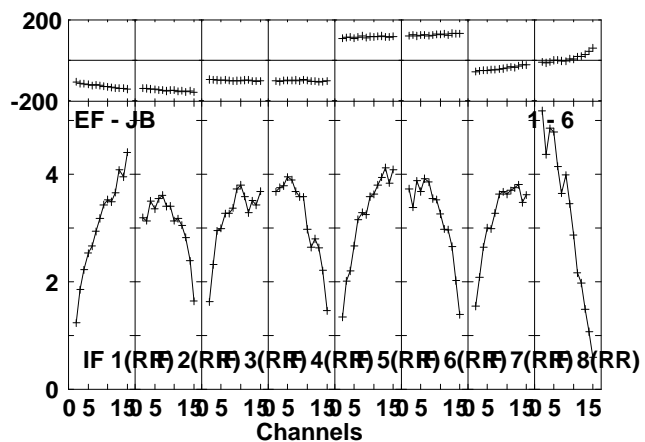
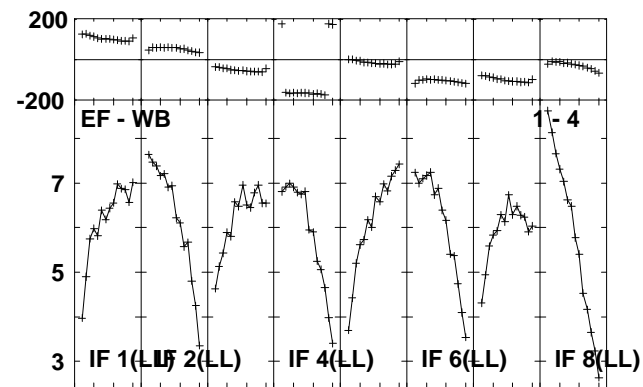
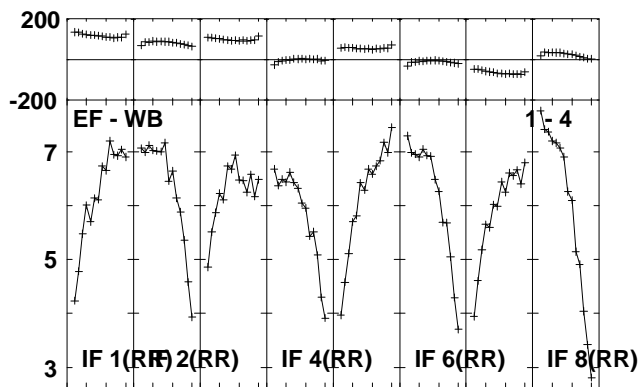
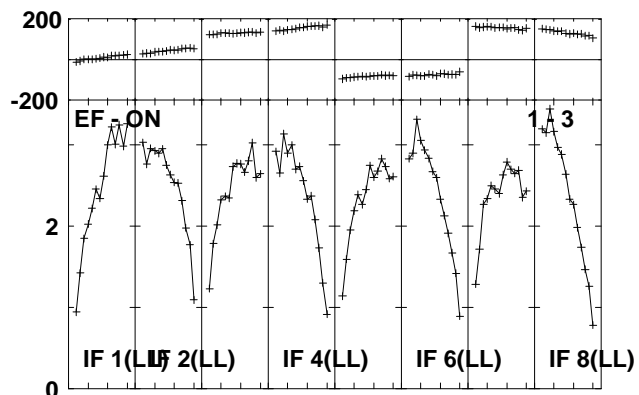
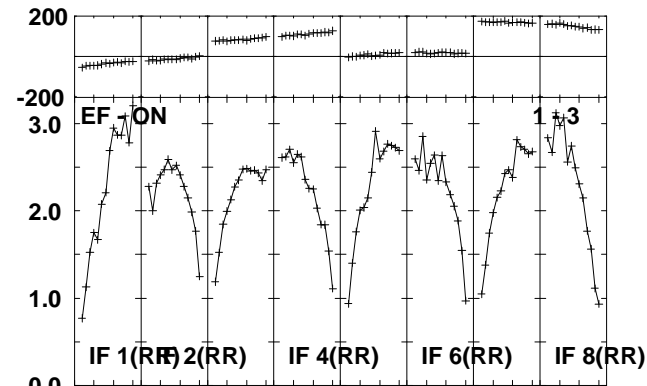
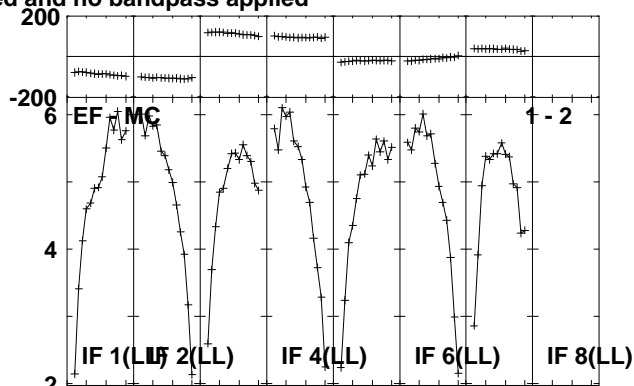
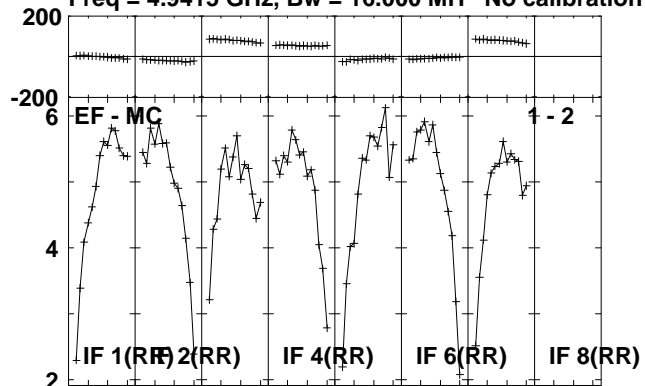

Lower frame: Milli Ampl Jy Top frame: Phas deg
Scalar averaged cross-power spectrum Several baselines displayed
Timerange: 01/05:30:41 to 01/05:32:09

Plot file version 356 created 14-JUL-2010 16:39:08
J1953+35 RR004A.UVDATA.1
Freq = 4.9415 GHz, Bw = 16.000 MH No calibration applied and no bandpass applied

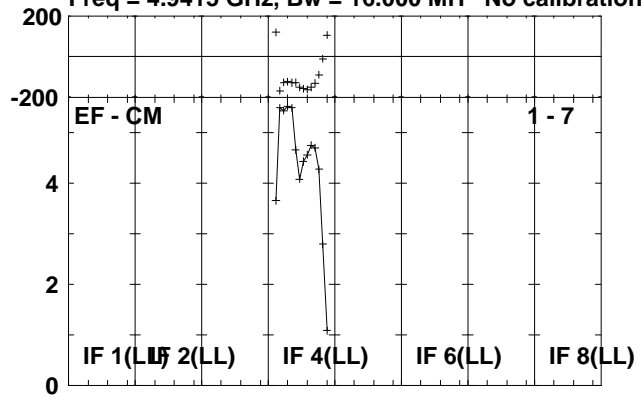

Lower frame: Milli Ampl Jy Top frame: Phas deg
Scalar averaged cross-power spectrum Several baselines displayed
Timerange: 01/05:30:41 to 01/05:32:09

Plot file version 357 created 14-JUL-2010 16:39:08

CYGX-1 RR004A.UVDATA.1

Freq = 4.9415 GHz, Bw = 16.000 MH No calibration applied and no bandpass applied

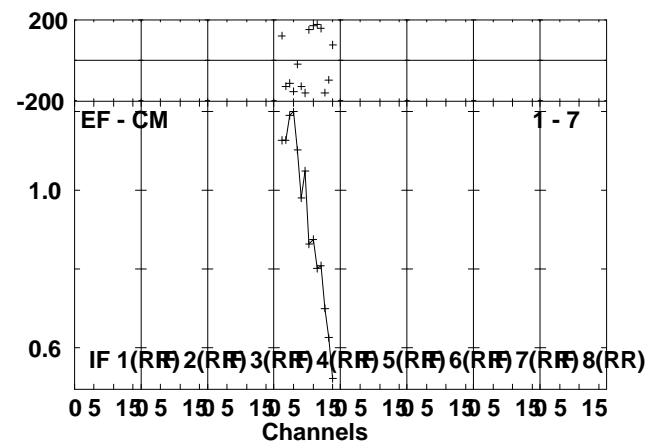
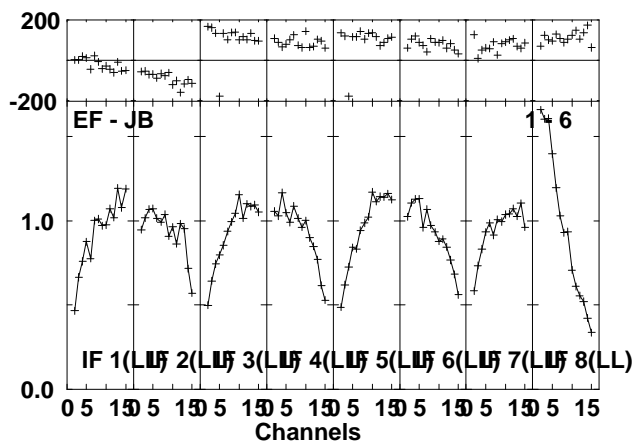
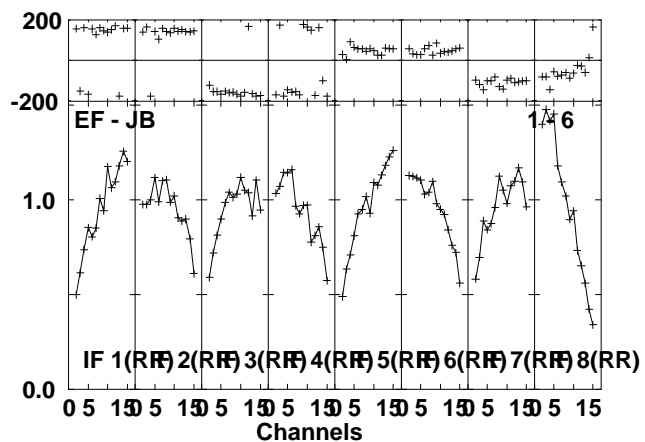
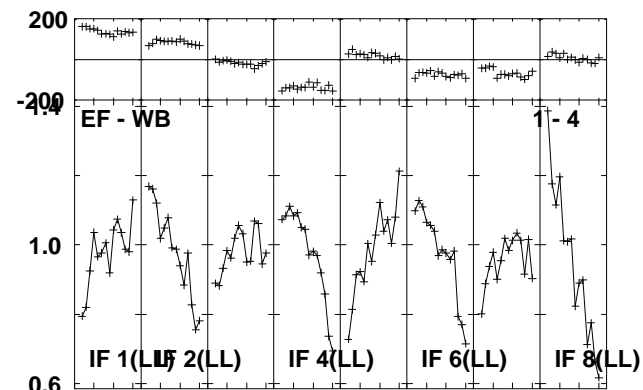
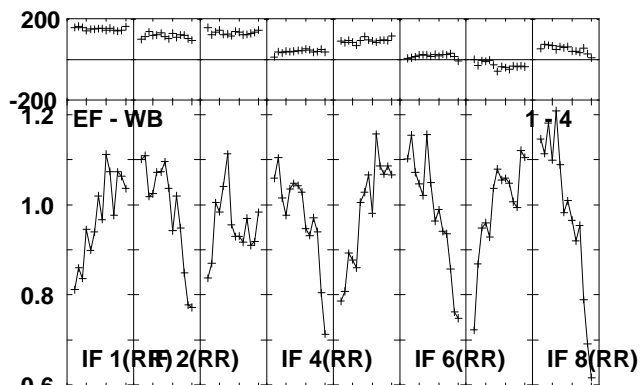
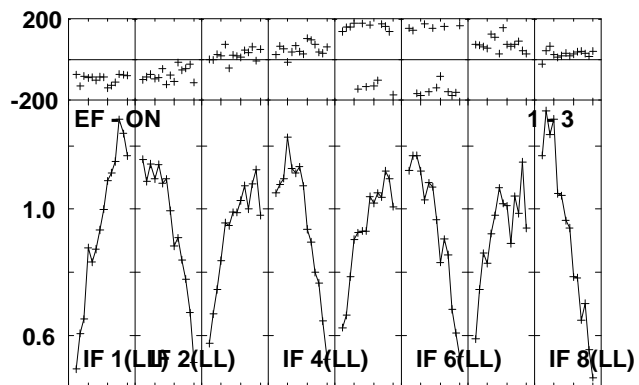
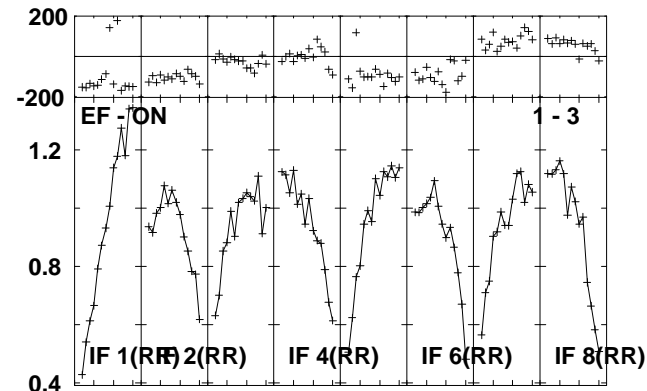
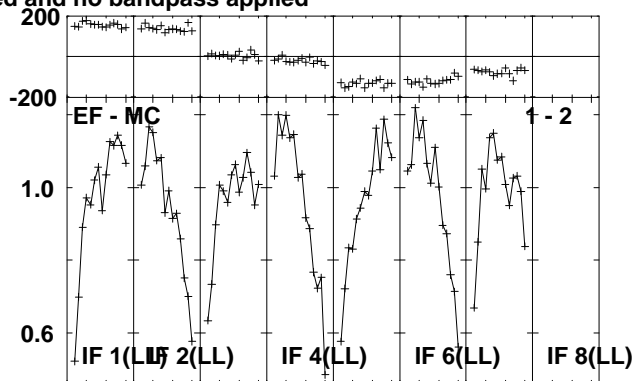
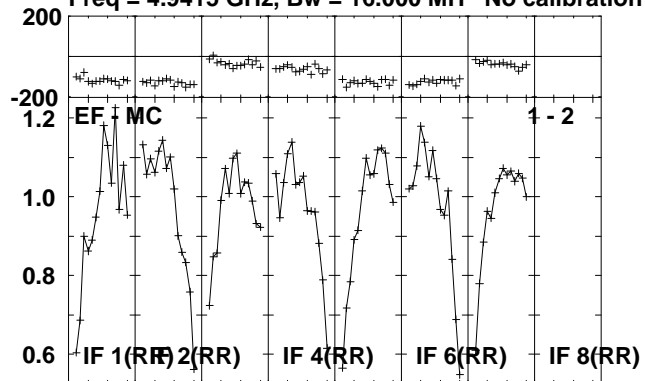

Lower frame: Milli Ampl Jy Top frame: Phas deg
Scalar averaged cross-power spectrum Several baselines displayed
Timerange: 01/05:32:11 to 01/05:37:09

Plot file version 358 created 14-JUL-2010 16:39:09

CYGX-1 RR004A.UVDATA.1

Freq = 4.9415 GHz, Bw = 16.000 MH No calibration applied and no bandpass applied

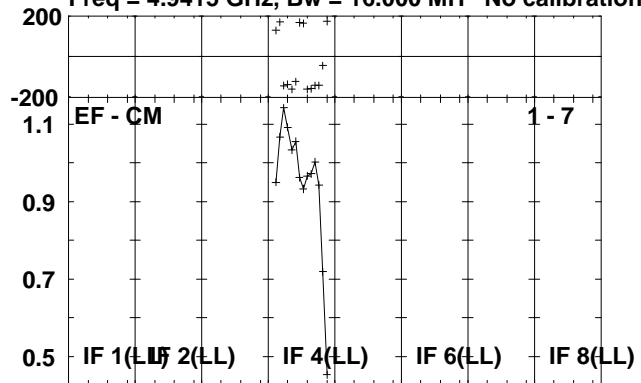

Lower frame: Milli Ampl Jy Top frame: Phas deg
Scalar averaged cross-power spectrum Several baselines displayed
Timerange: 01/05:32:11 to 01/05:37:09

Plot file version 359 created 14-JUL-2010 16:39:10
 J1953+35 RR004A.UVDATA.1

Freq = 4.9415 GHz, Bw = 16.000 MH No calibration applied and no bandpass applied

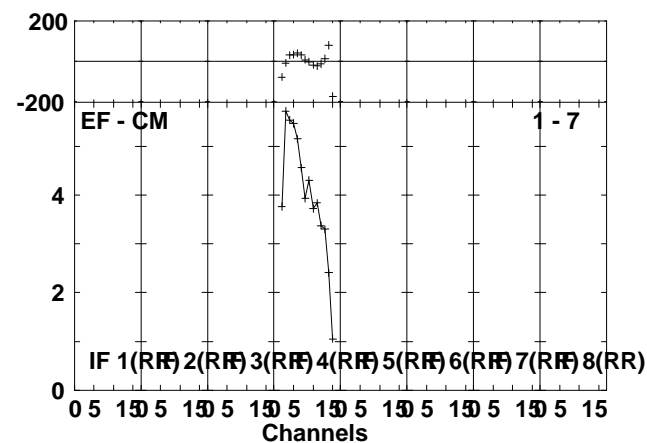
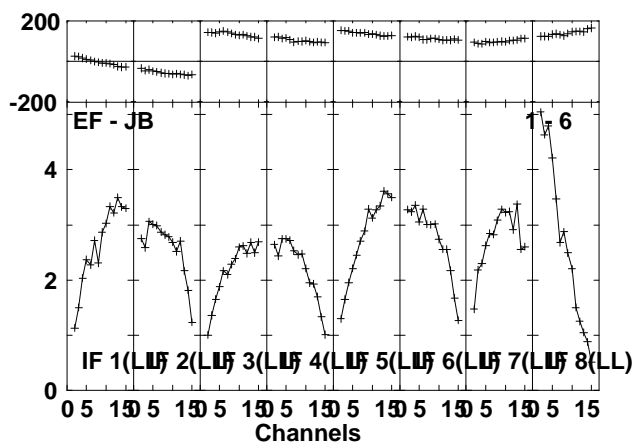
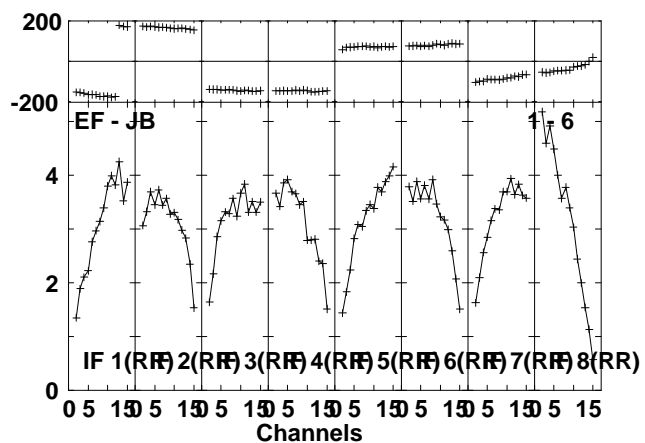
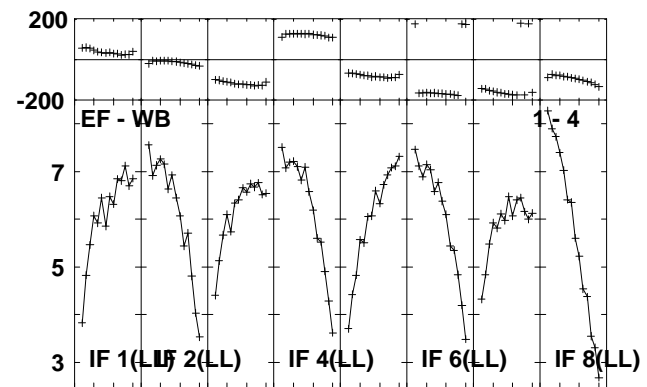
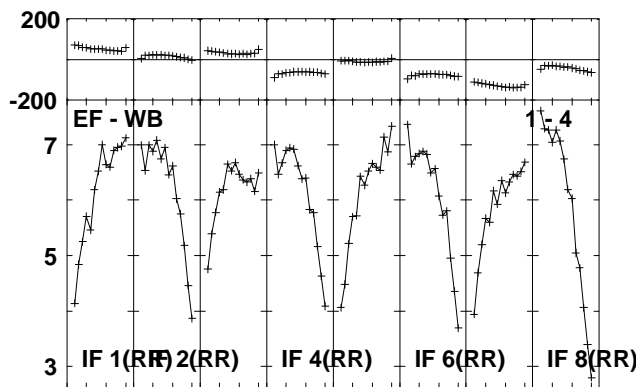
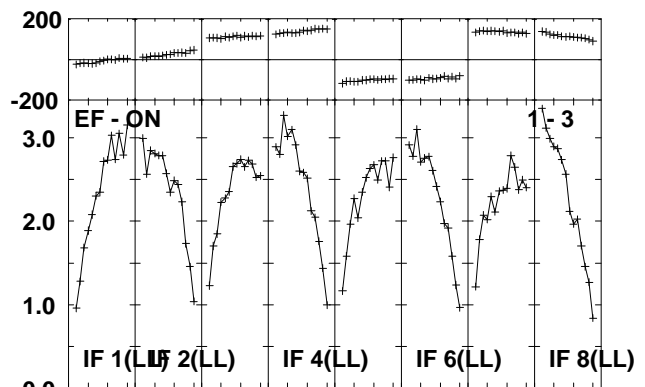
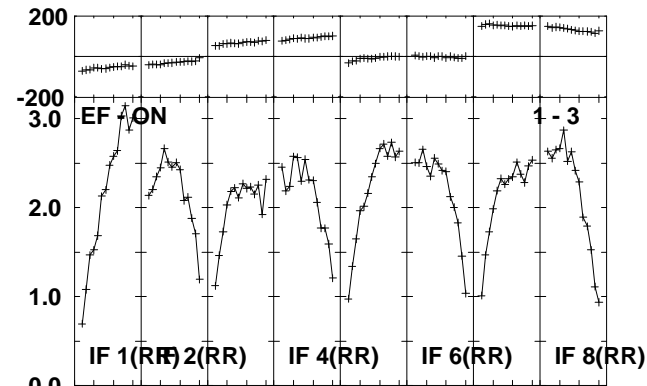
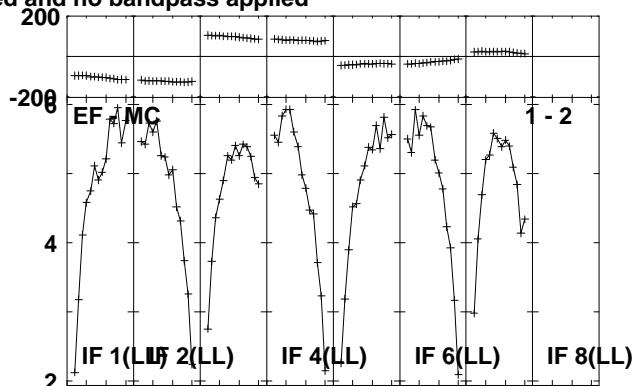
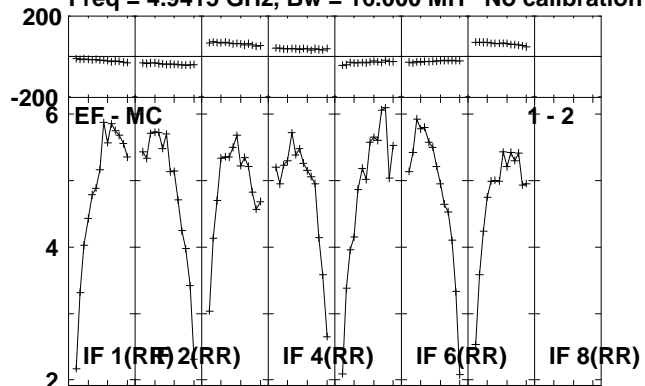

Lower frame: Milli Ampl Jy Top frame: Phas deg
 Scalar averaged cross-power spectrum Several baselines displayed
 Timerange: 01/05:37:11 to 01/05:39:09

Plot file version 360 created 14-JUL-2010 16:39:10
J1953+35 RR004A.UVDATA.1
Freq = 4.9415 GHz, Bw = 16.000 MH No calibration applied and no bandpass applied

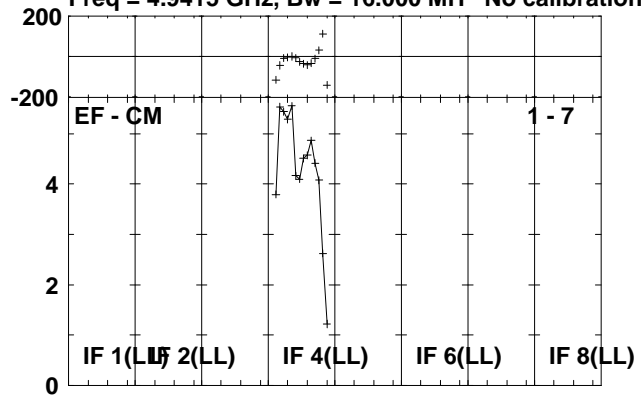

Lower frame: Milli Ampl Jy Top frame: Phas deg
Scalar averaged cross-power spectrum Several baselines displayed
Timerange: 01/05:37:11 to 01/05:39:09

Plot file version 361 created 14-JUL-2010 16:39:11

CYGX-1 RR004A.UVDATA.1

Freq = 4.9415 GHz, Bw = 16.000 MH No calibration applied and no bandpass applied

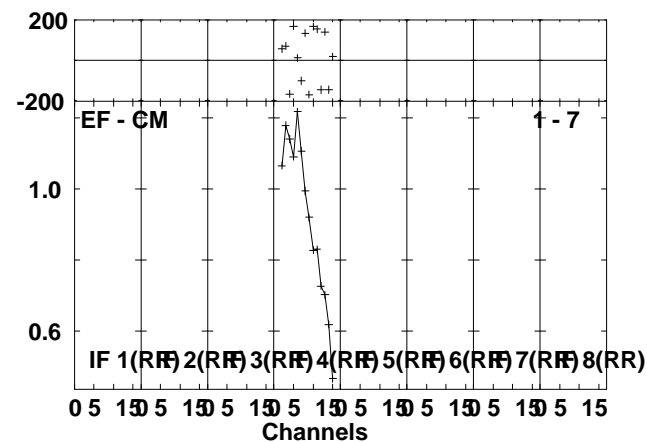
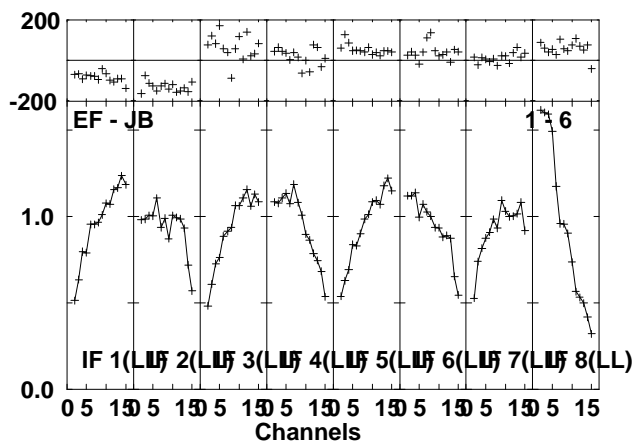
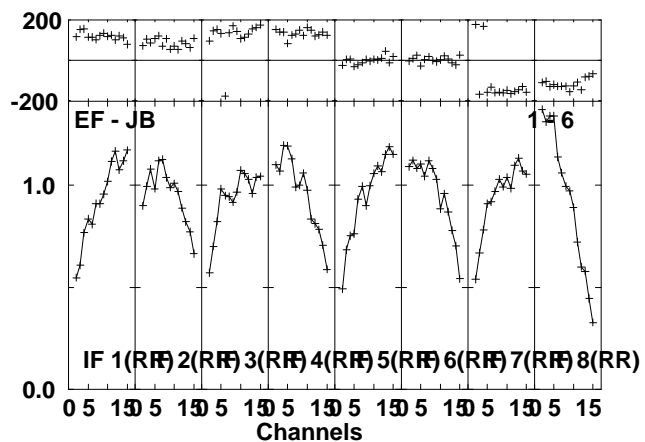
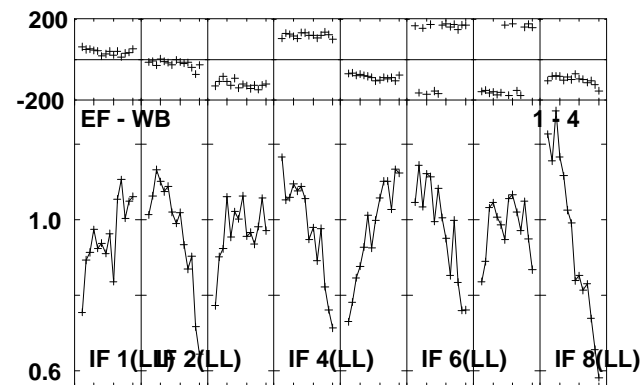
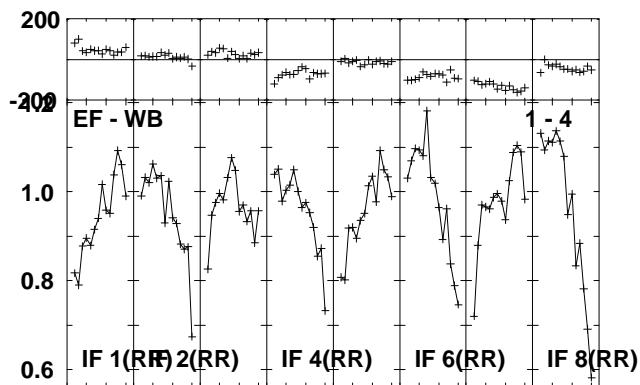
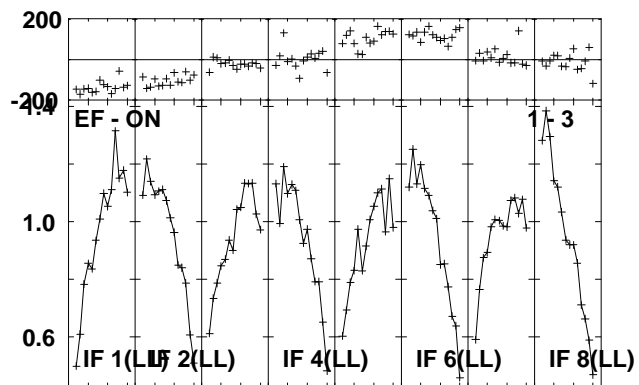
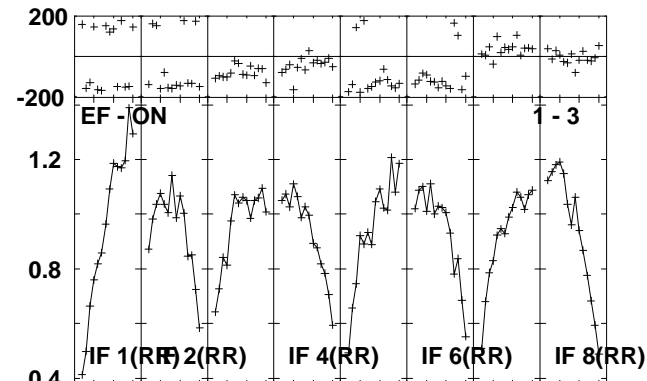
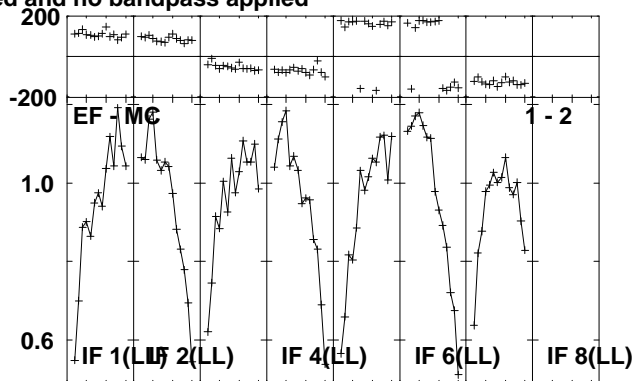
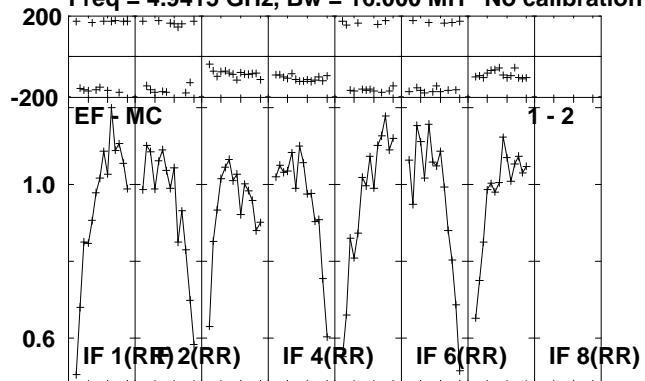

Lower frame: Milli Ampl Jy Top frame: Phas deg
Scalar averaged cross-power spectrum Several baselines displayed
Timerange: 01/05:39:11 to 01/05:44:09

Plot file version 362 created 14-JUL-2010 16:39:12
CYGX-1 RR004A.UVDATA.1
Freq = 4.9415 GHz, Bw = 16.000 MH No calibration applied and no bandpass applied

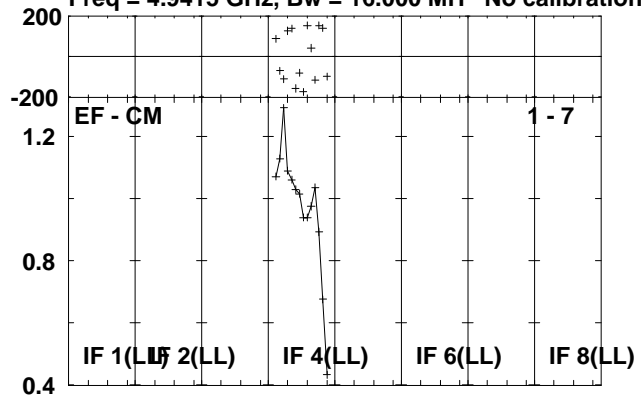

Lower frame: Milli Ampl Jy Top frame: Phas deg
Scalar averaged cross-power spectrum Several baselines displayed
Timerange: 01/05:39:11 to 01/05:44:09

Plot file version 363 created 14-JUL-2010 16:39:18

J1953+35 RR004A.UVDATA.1

Freq = 4.9415 GHz, Bw = 16.000 MH No calibration applied and no bandpass applied

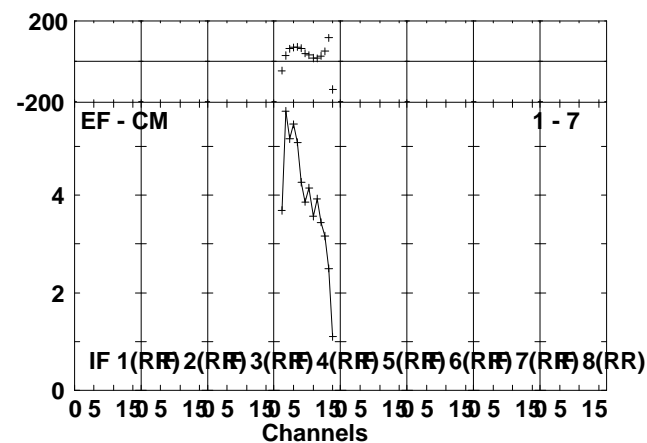
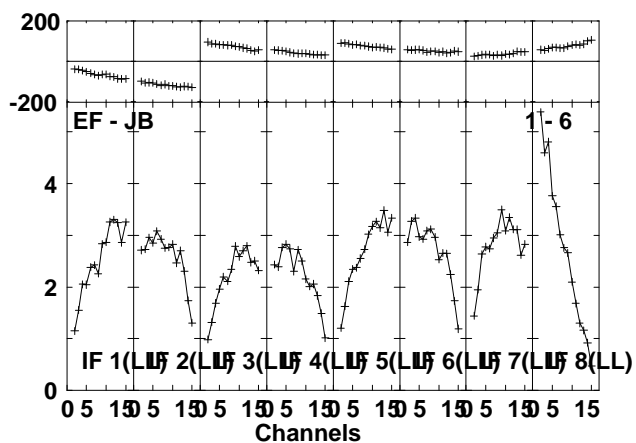
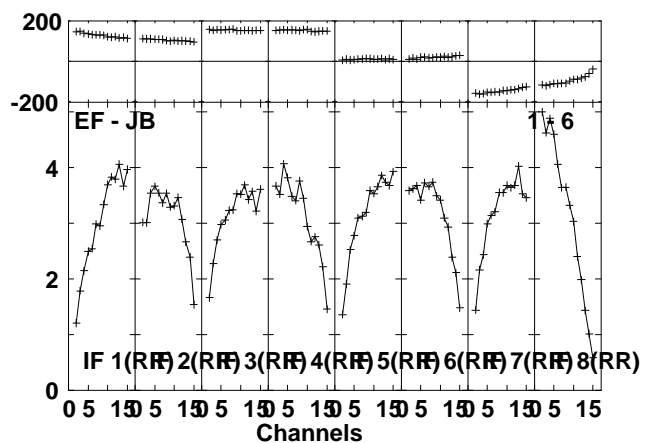
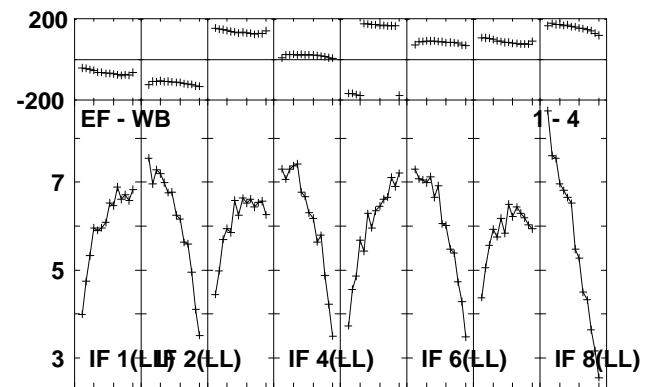
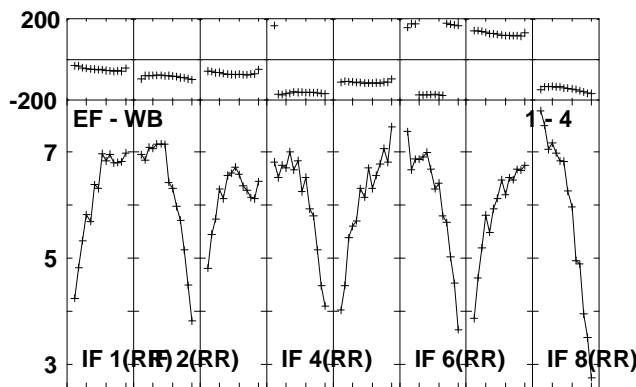
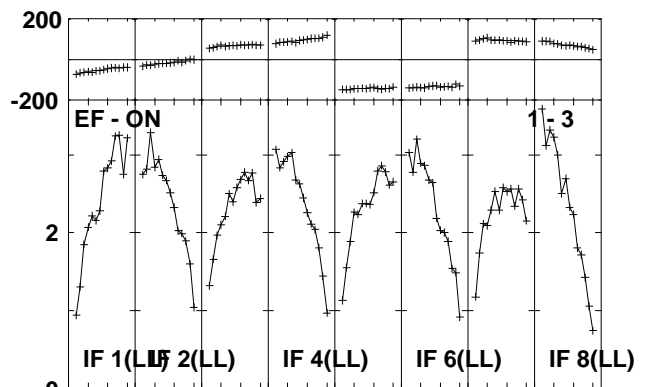
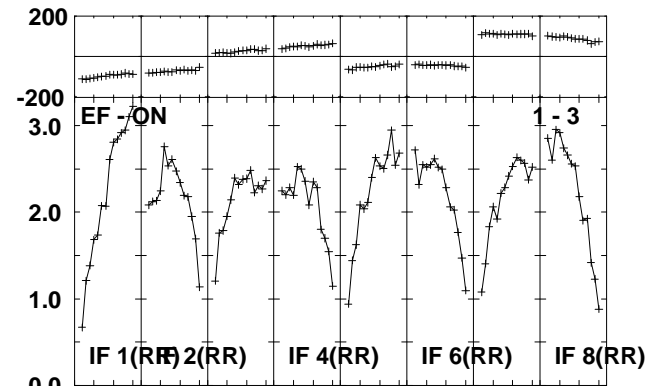
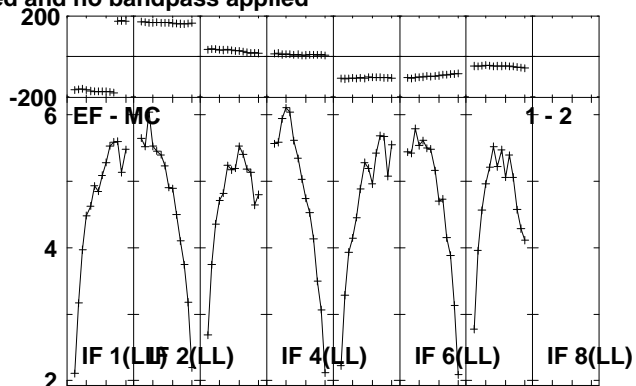
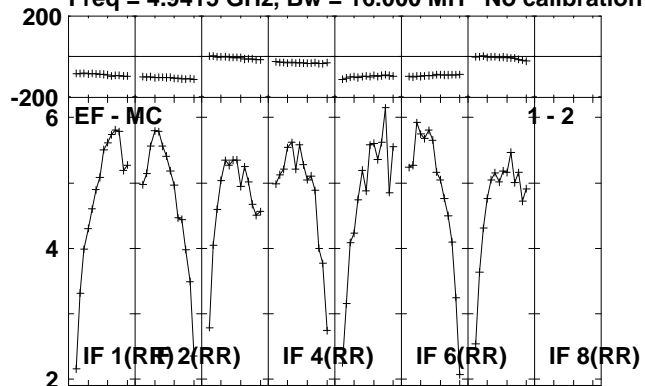

Lower frame: Milli Ampl Jy Top frame: Phas deg
Scalar averaged cross-power spectrum Several baselines displayed
Timerange: 01/05:44:51 to 01/05:46:19

Plot file version 364 created 14-JUL-2010 16:39:18
J1953+35 RR004A.UVDATA.1
Freq = 4.9415 GHz, Bw = 16.000 MH No calibration applied and no bandpass applied

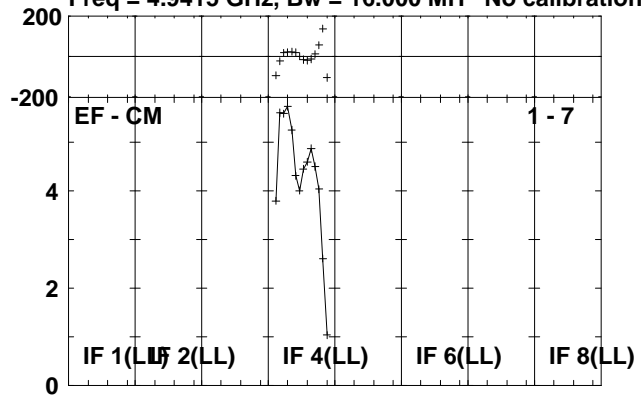

Lower frame: Milli Ampl Jy Top frame: Phas deg
Scalar averaged cross-power spectrum Several baselines displayed
Timerange: 01/05:44:51 to 01/05:46:19