

Plot file version 1 created 15-JUL-2010 10:41:44

3C345 RR004B.UVDATA.1

Freq = 4.9415 GHz, Bw = 16.000 MH No calibration applied and no bandpass applied

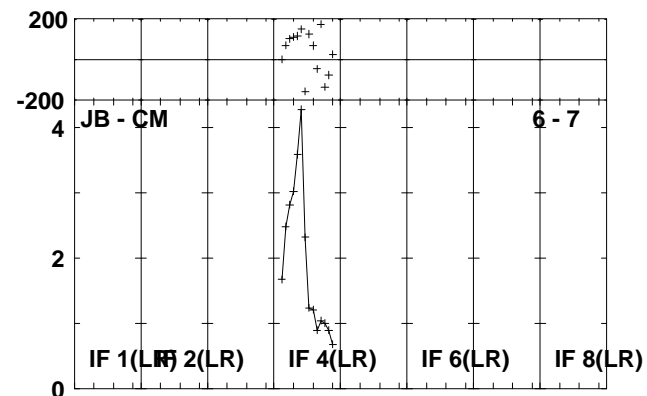
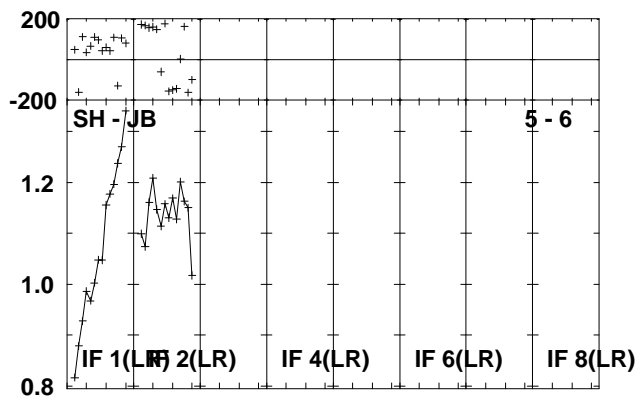
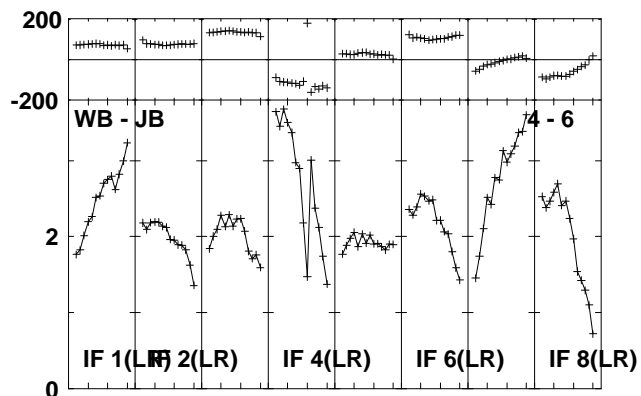
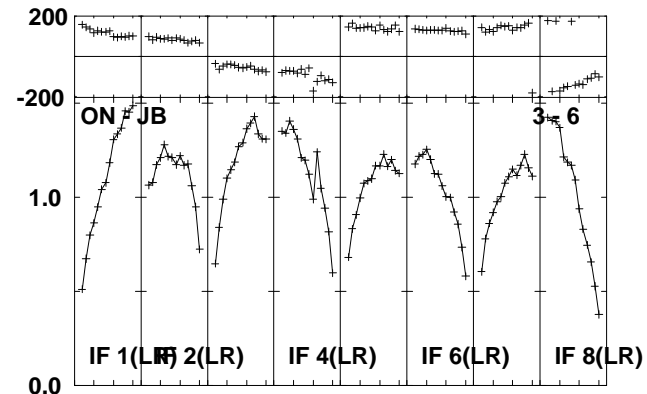
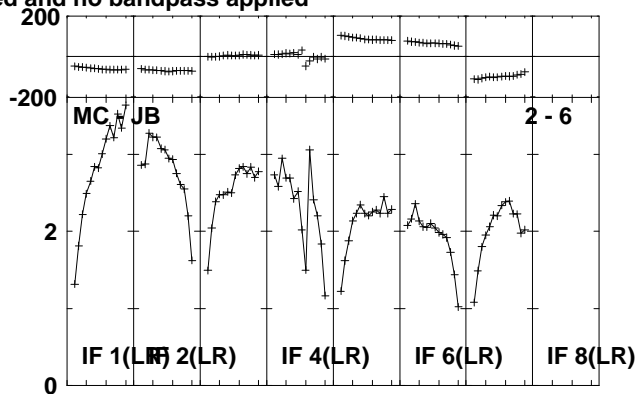
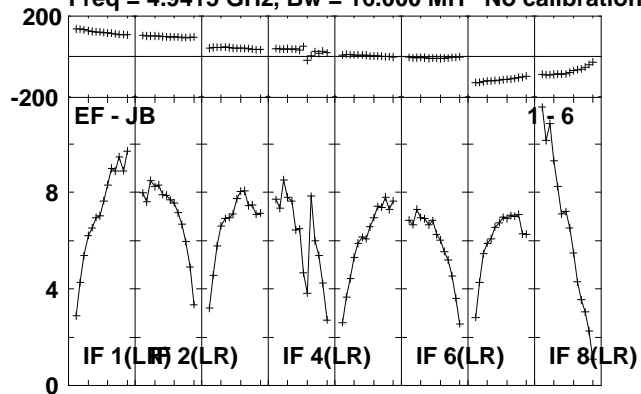

Lower frame: Milli Ampl Jy Top frame: Phas deg
Scalar averaged cross-power spectrum Several baselines displayed
Timerange: 00/17:24:10 to 00/17:46:08

Plot file version 2 created 15-JUL-2010 10:41:53

3C345 RR004B.UVDATA.1

Freq = 4.9415 GHz, Bw = 16.000 MH No calibration applied and no bandpass applied

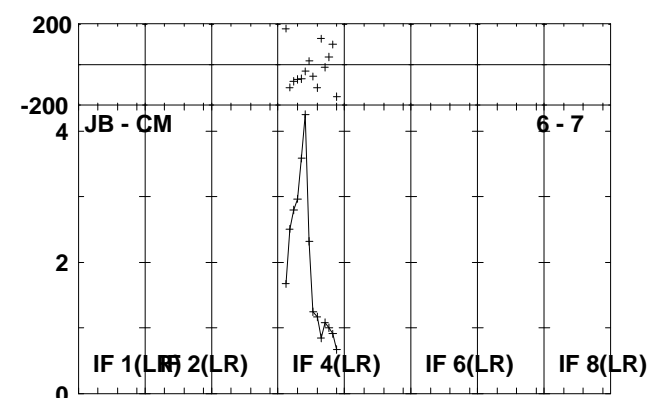
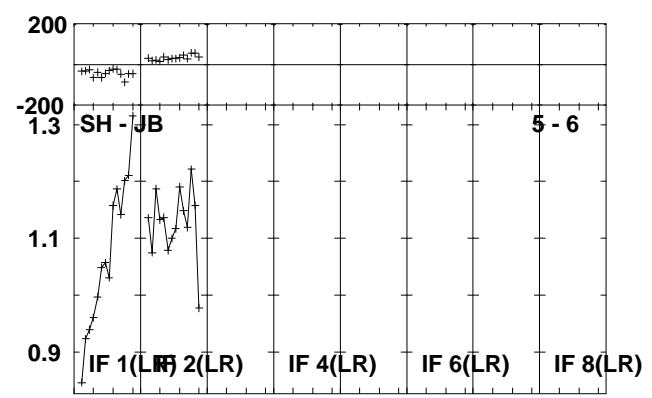
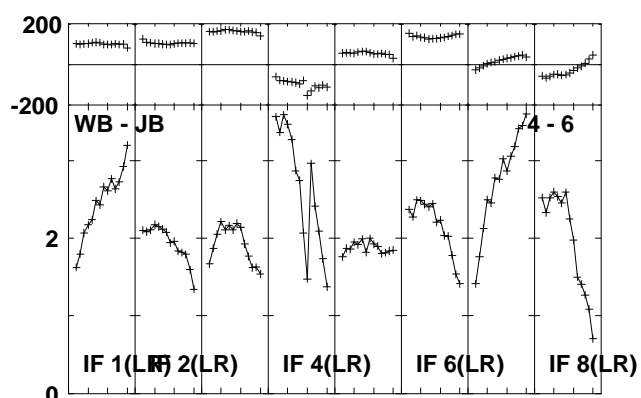
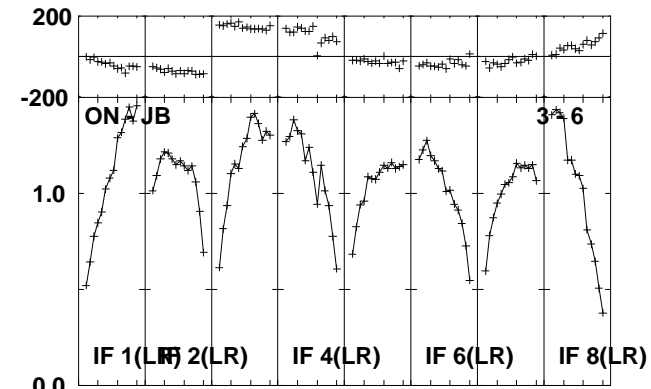
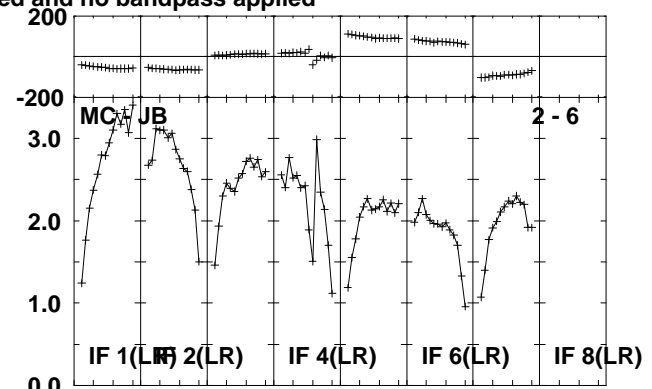
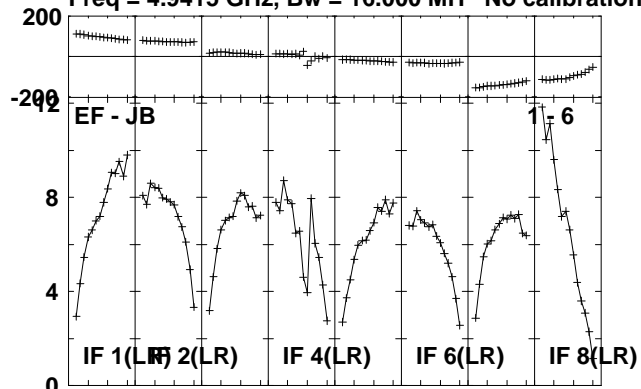

Lower frame: Milli Ampl Jy Top frame: Phas deg
Scalar averaged cross-power spectrum Several baselines displayed
Timerange: 00/17:46:10 to 00/17:59:18

Plot file version 3 created 15-JUL-2010 10:41:59
J2002+47 RR004B.UVDATA.1

Freq = 4.9415 GHz, Bw = 16.000 MH No calibration applied and no bandpass applied

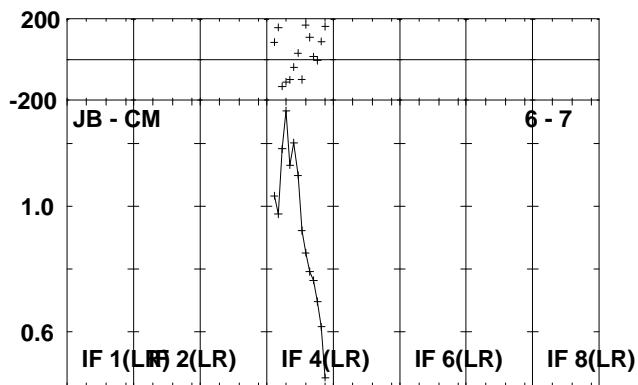
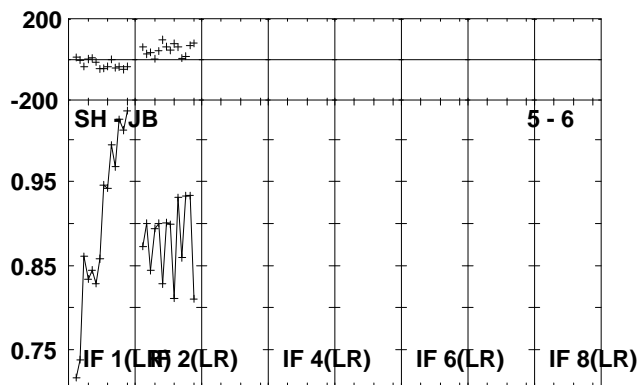
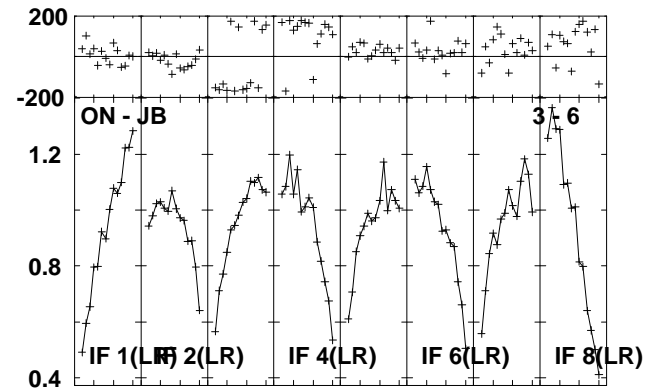
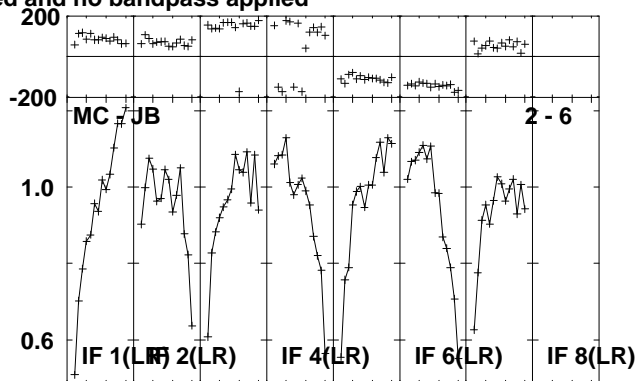
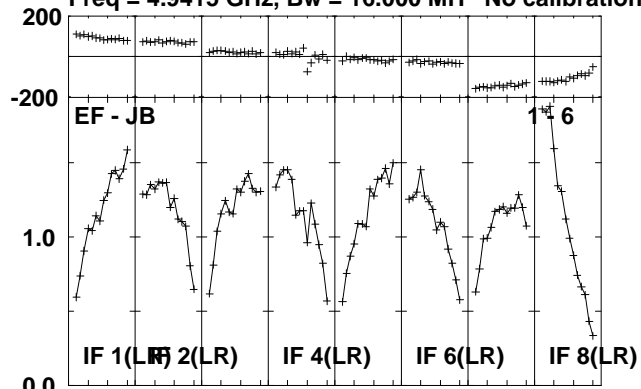

Lower frame: Milli Ampl Jy Top frame: Phas deg
Scalar averaged cross-power spectrum Several baselines displayed
Timerange: 00/18:01:20 to 00/18:09:18

Plot file version 4 created 15-JUL-2010 10:42:03

J1953+35 RR004B.UVDATA.1

Freq = 4.9415 GHz, Bw = 16.000 MH No calibration applied and no bandpass applied

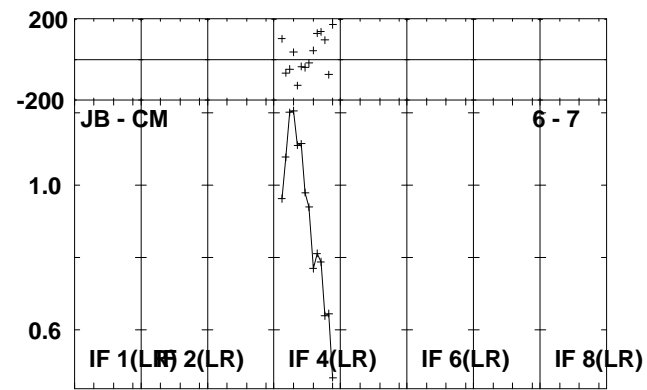
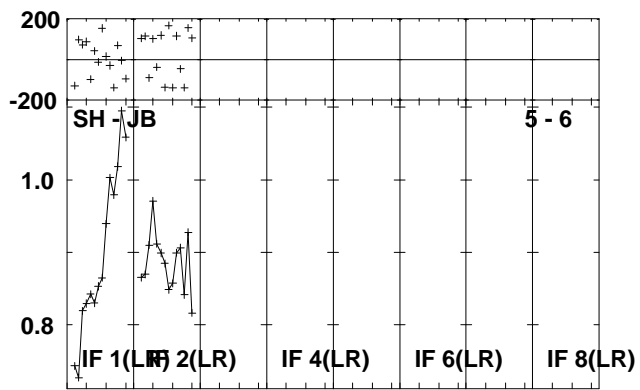
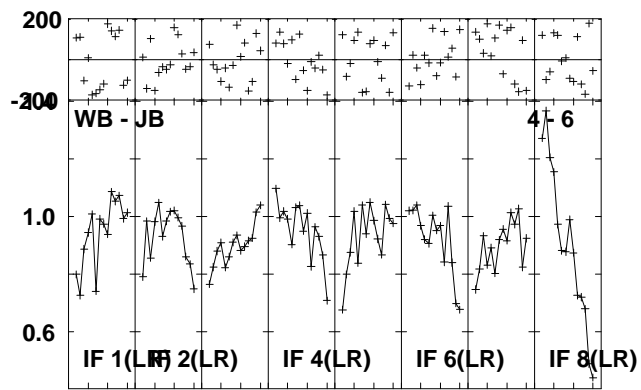
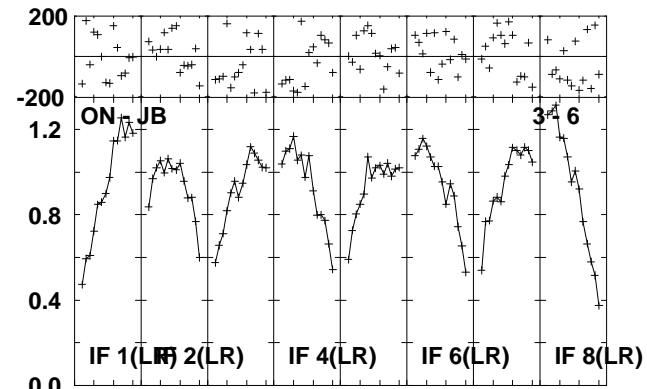
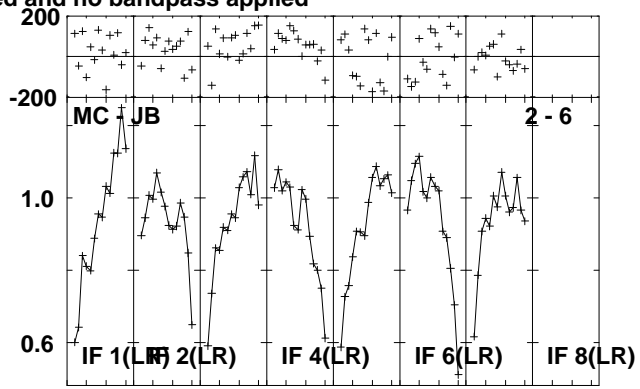
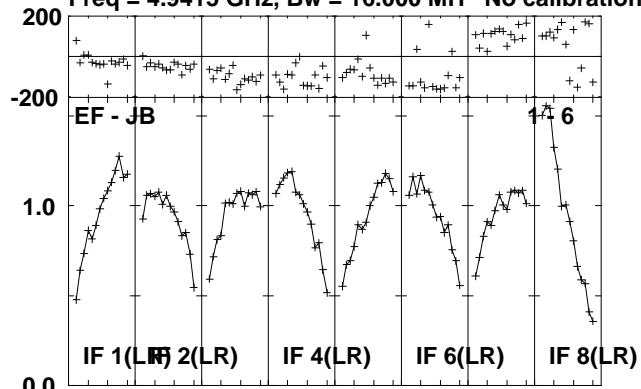

Lower frame: Milli Ampl Jy Top frame: Phas deg
Scalar averaged cross-power spectrum Several baselines displayed
Timerange: 00:18:09:20 to 00:18:16:28

Plot file version 5 created 15-JUL-2010 10:42:06

CYGX-1 RR004B.UVDATA.1

Freq = 4.9415 GHz, Bw = 16.000 MH No calibration applied and no bandpass applied

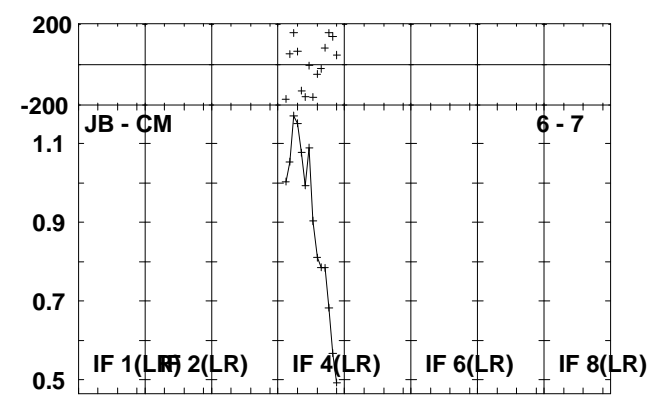
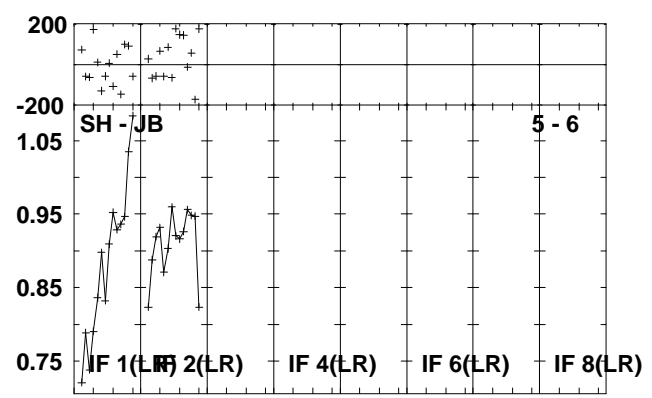
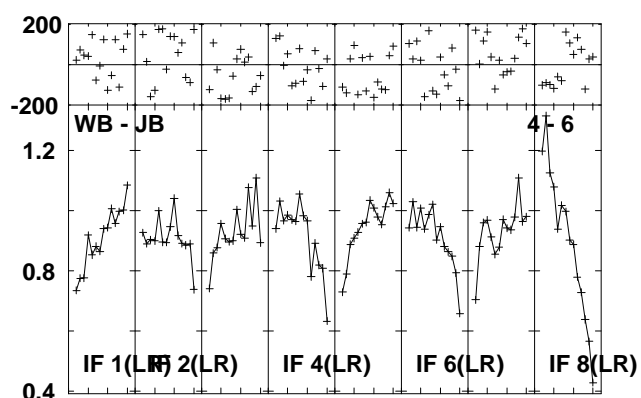
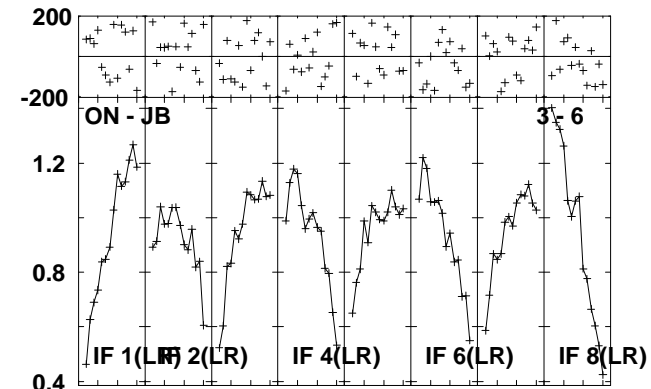
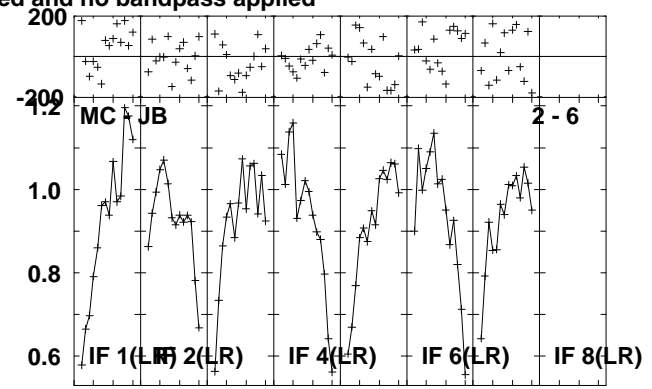
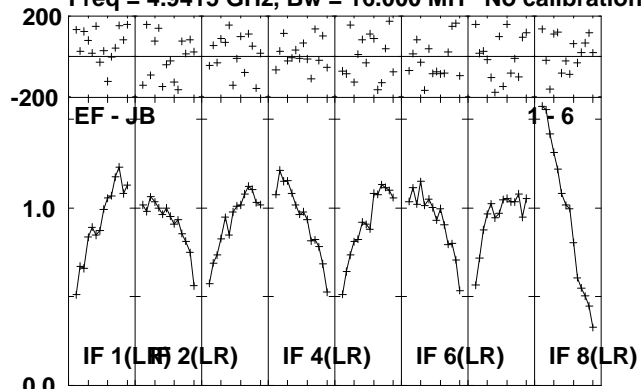

Lower frame: Milli Ampl Jy Top frame: Phas deg
Scalar averaged cross-power spectrum Several baselines displayed
Timerange: 00/18:16:30 to 00/18:21:28

Plot file version 6 created 15-JUL-2010 10:42:09

J1953+35 RR004B.UVDATA.1

Freq = 4.9415 GHz, Bw = 16.000 MH No calibration applied and no bandpass applied

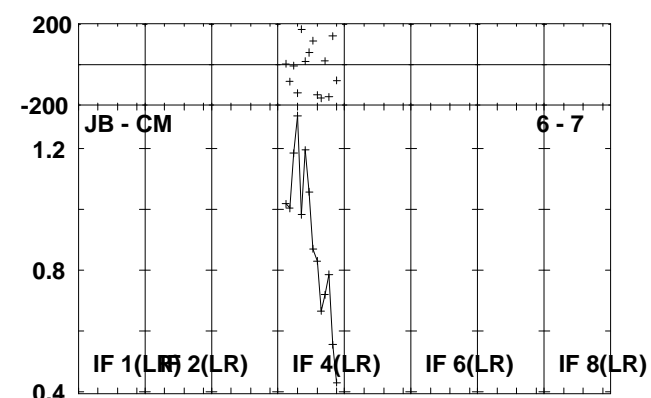
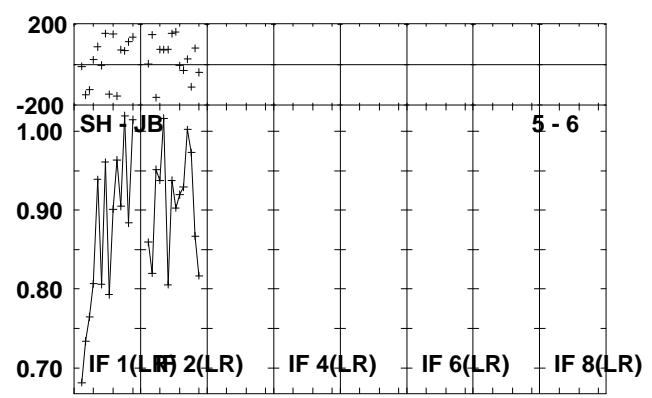
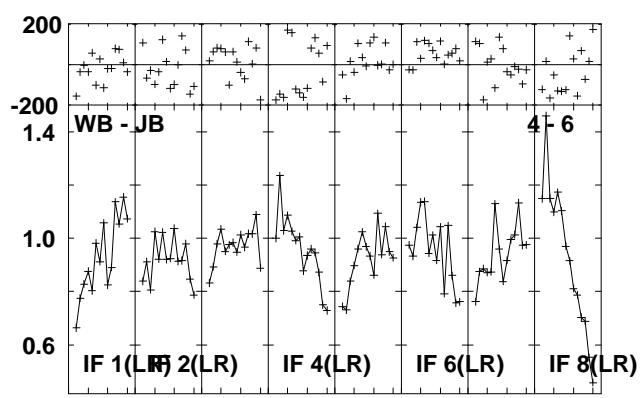
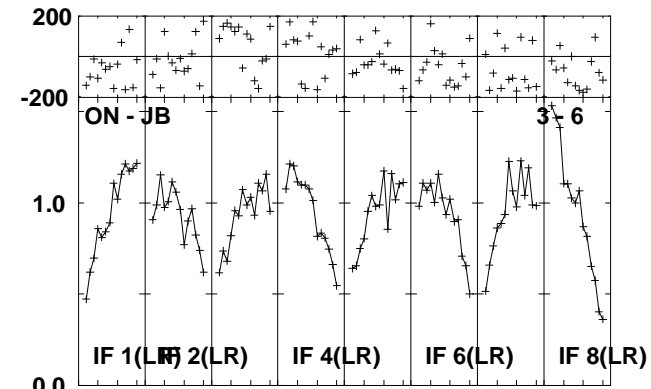
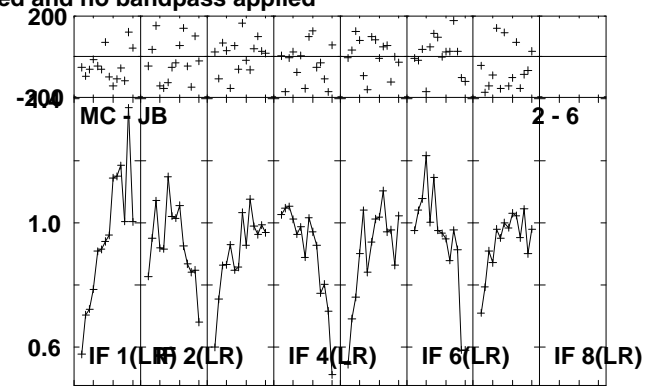
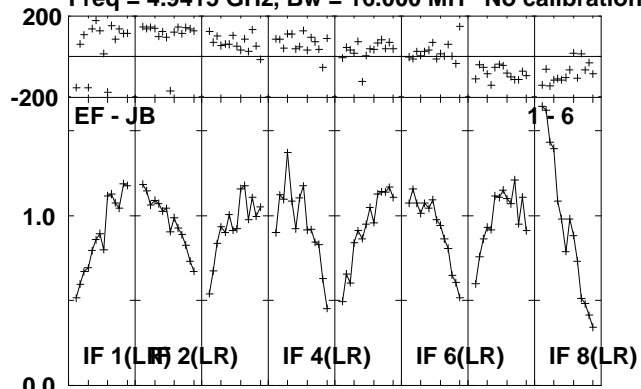

Lower frame: Milli Ampl Jy Top frame: Phas deg
Scalar averaged cross-power spectrum Several baselines displayed
Timerange: 00/18:21:30 to 00/18:23:28

Plot file version 7 created 15-JUL-2010 10:42:10
CYGX-1 RR004B.UVDATA.1

Freq = 4.9415 GHz, Bw = 16.000 MH No calibration applied and no bandpass applied

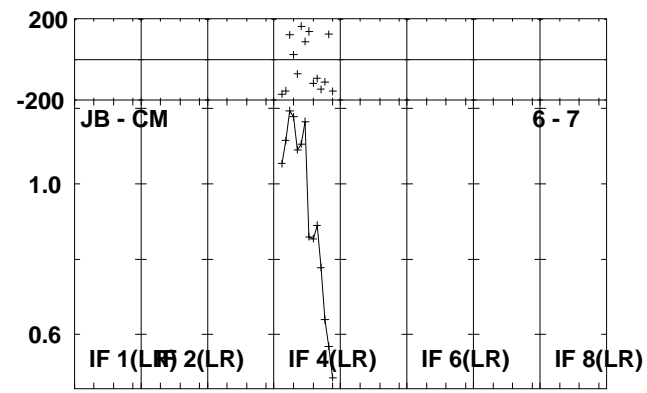
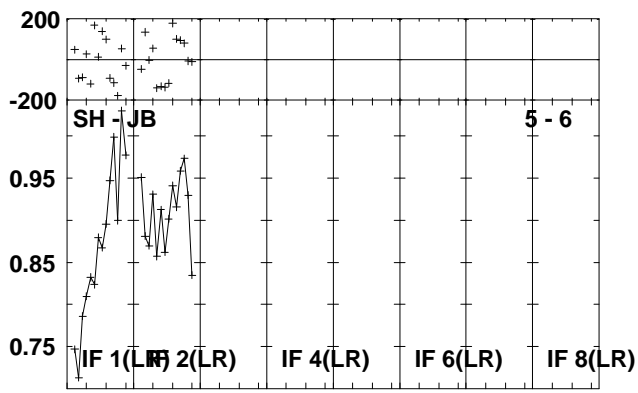
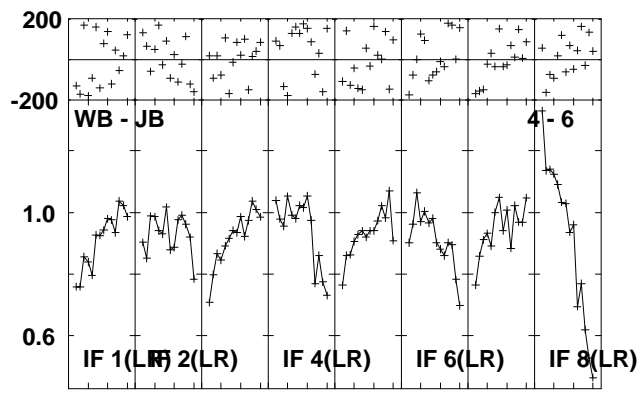
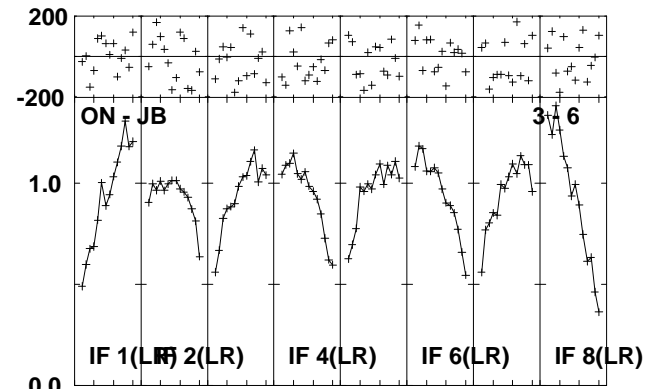
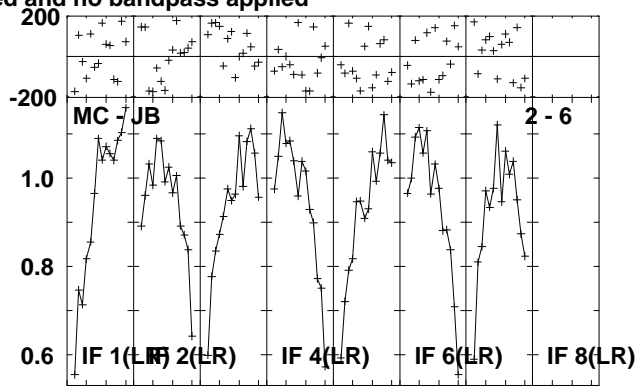
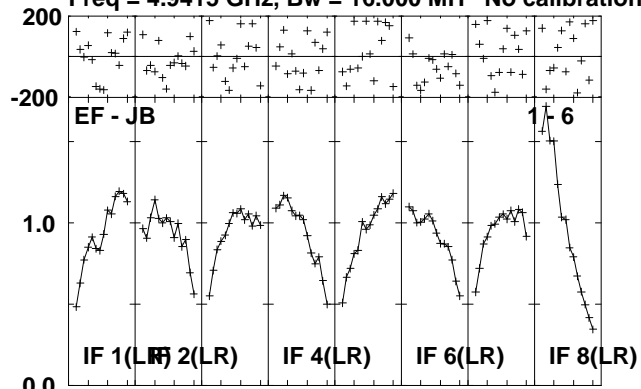

Lower frame: Milli Ampl Jy Top frame: Phas deg
Scalar averaged cross-power spectrum Several baselines displayed
Timerange: 00/18:23:30 to 00/18:28:28

Plot file version 8 created 15-JUL-2010 10:42:13
J1953+35 RR004B.UVDATA.1

Freq = 4.9415 GHz, Bw = 16.000 MH No calibration applied and no bandpass applied

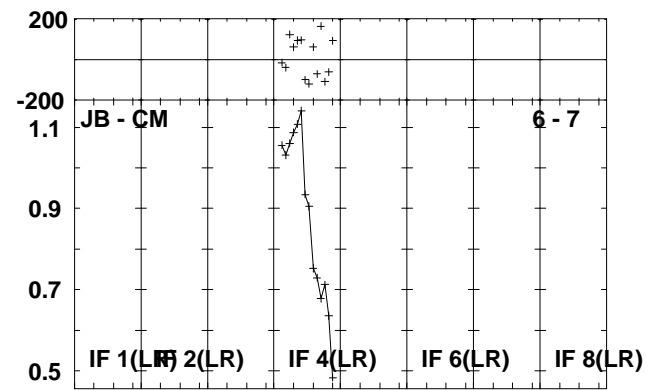
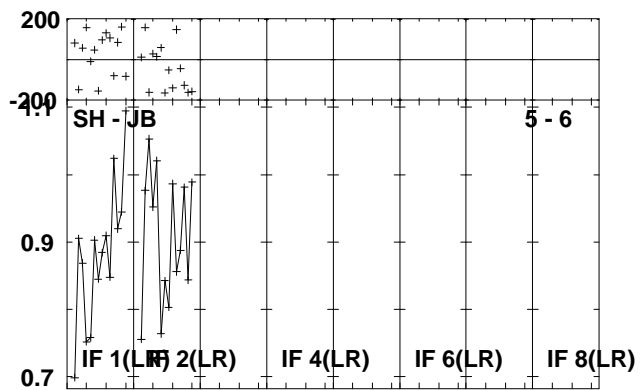
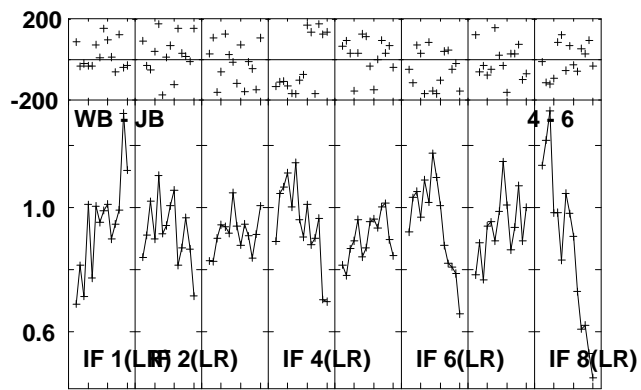
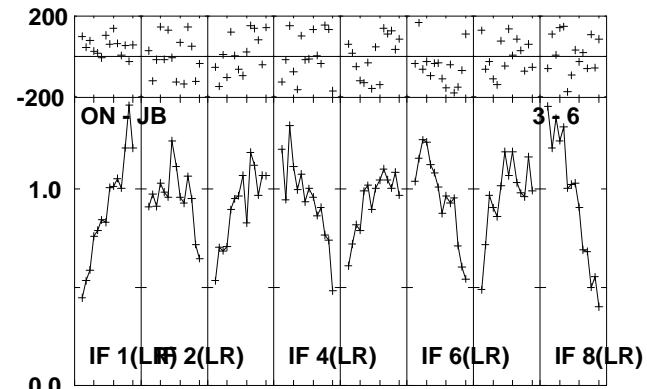
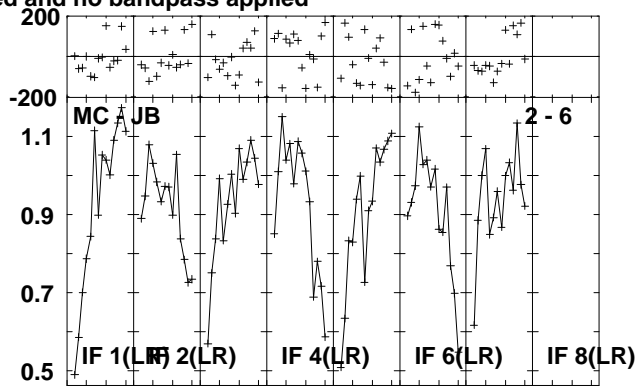
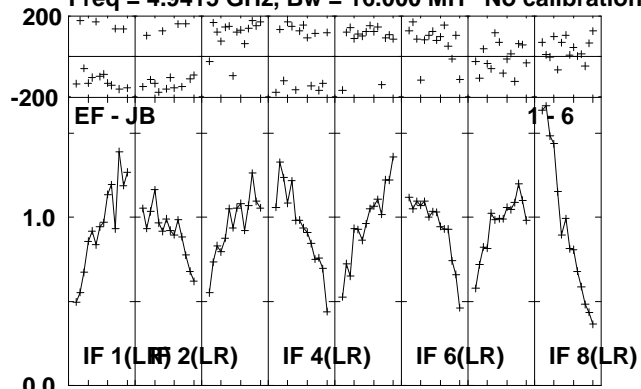

Lower frame: Milli Ampl Jy Top frame: Phas deg
Scalar averaged cross-power spectrum Several baselines displayed
Timerange: 00/18:29:10 to 00/18:30:38

Plot file version 9 created 15-JUL-2010 10:42:14
CYGX-1 RR004B.UVDATA.1

Freq = 4.9415 GHz, Bw = 16.000 MH No calibration applied and no bandpass applied

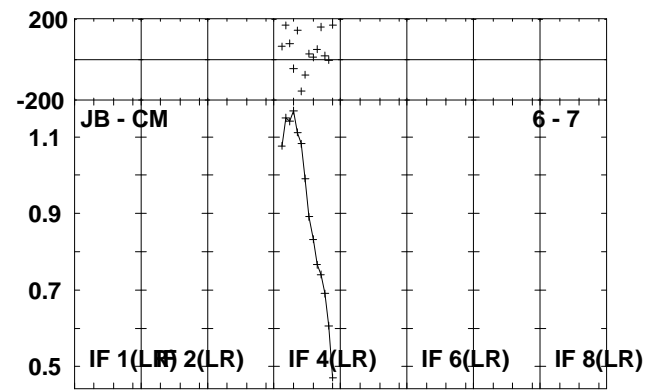
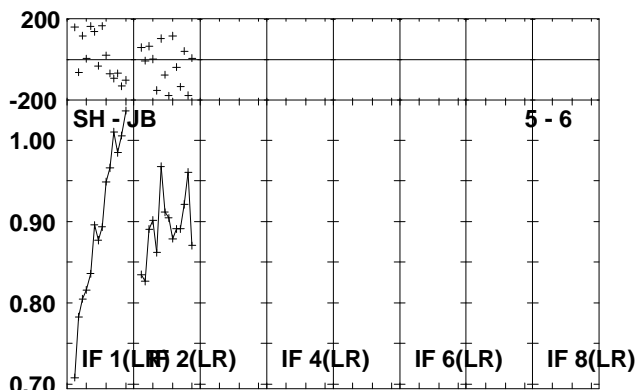
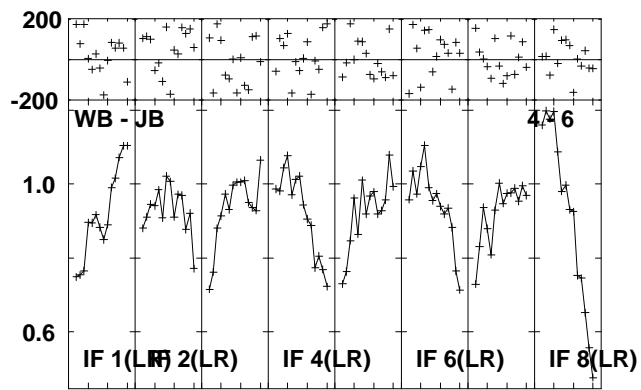
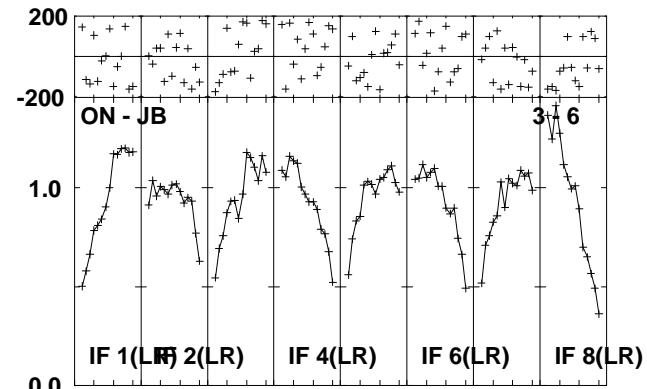
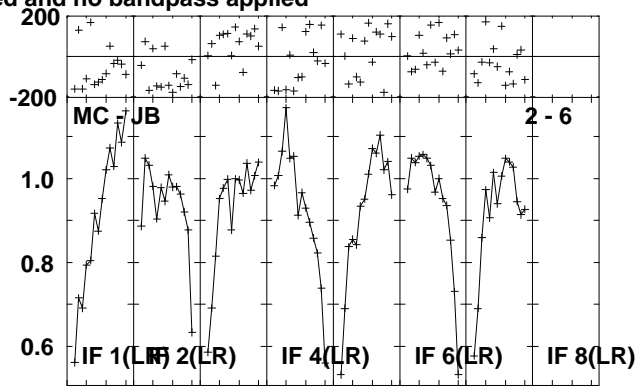
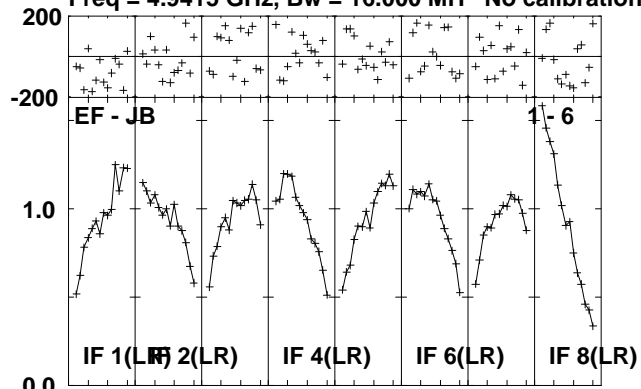

Lower frame: Milli Ampl Jy Top frame: Phas deg
Scalar averaged cross-power spectrum Several baselines displayed
Timerange: 00/18:30:40 to 00/18:35:38

Plot file version 10 created 15-JUL-2010 10:42:16
J1953+35 RR004B.UVDATA.1

Freq = 4.9415 GHz, Bw = 16.000 MH No calibration applied and no bandpass applied

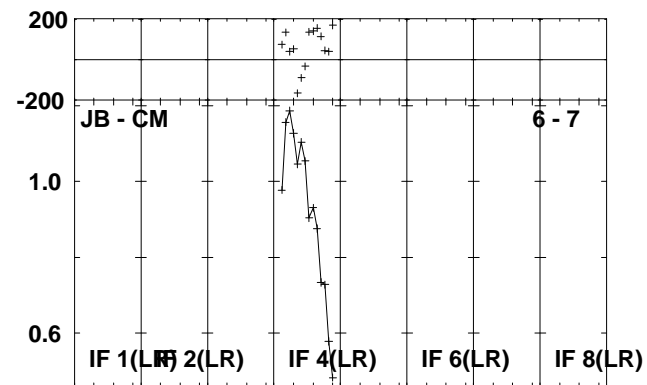
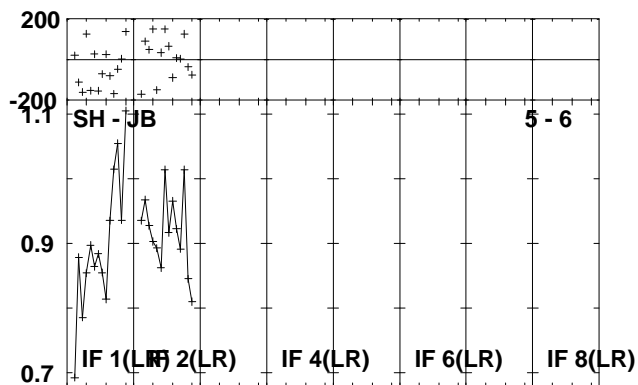
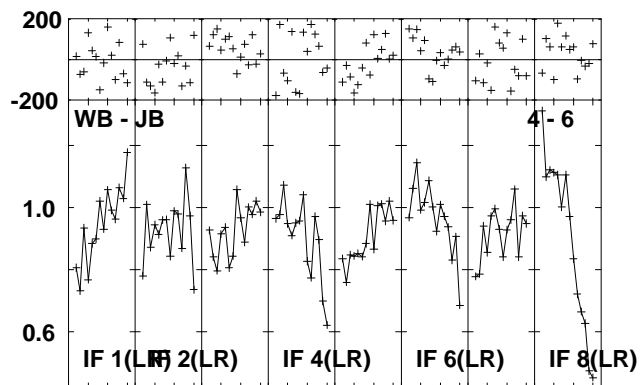
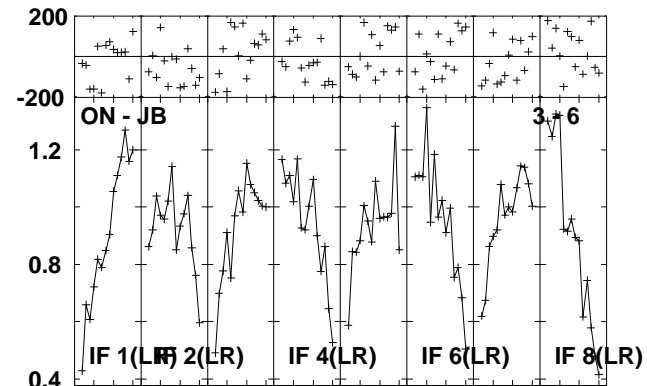
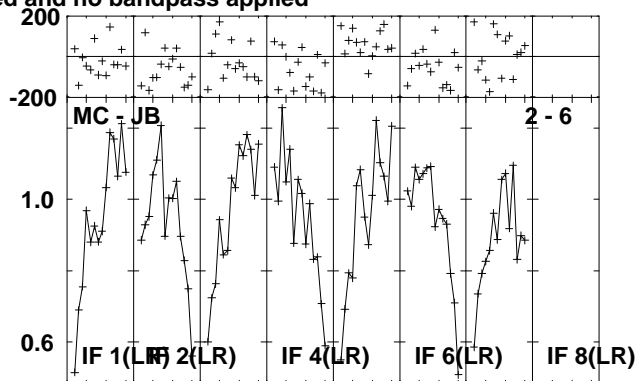
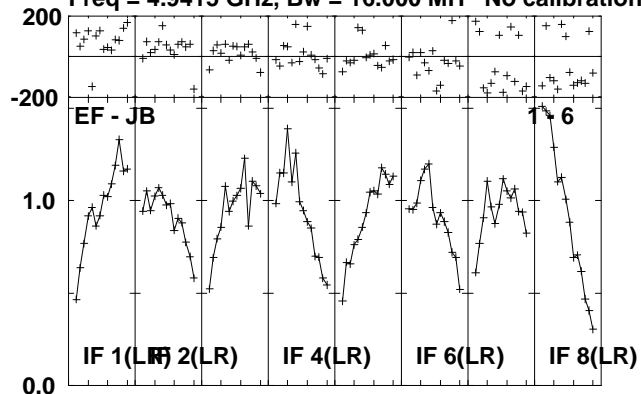

Lower frame: Milli Ampl Jy Top frame: Phas deg
Scalar averaged cross-power spectrum Several baselines displayed
Timerange: 00:18:35:40 to 00:18:37:38

Plot file version 11 created 15-JUL-2010 10:42:17
CYGX-1 RR004B.UVDATA.1

Freq = 4.9415 GHz, Bw = 16.000 MH No calibration applied and no bandpass applied

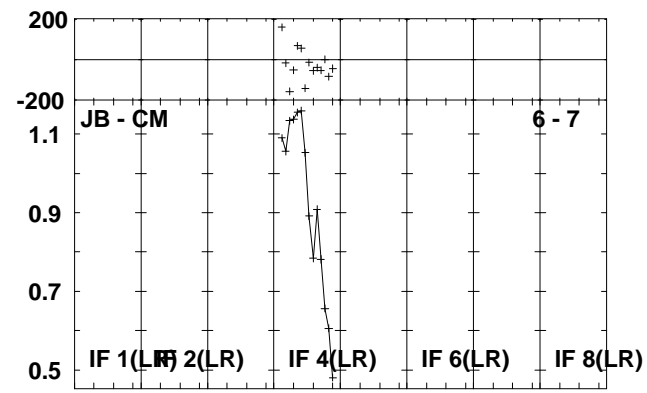
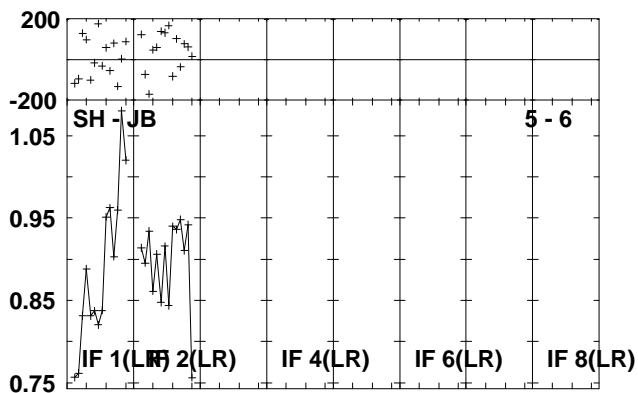
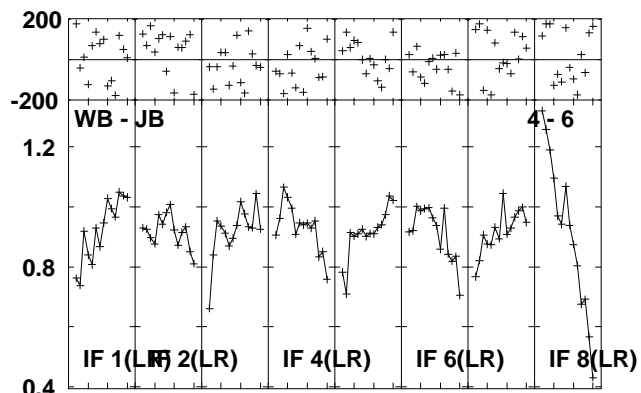
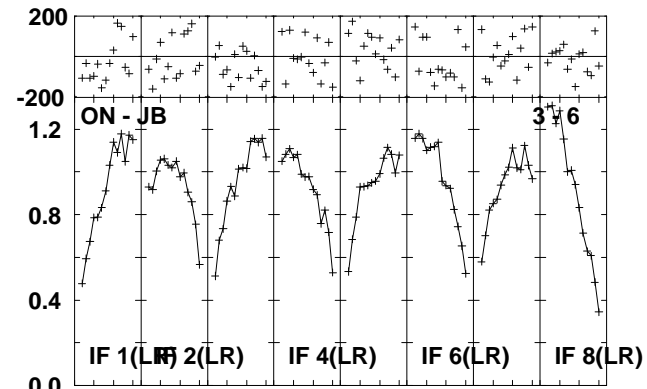
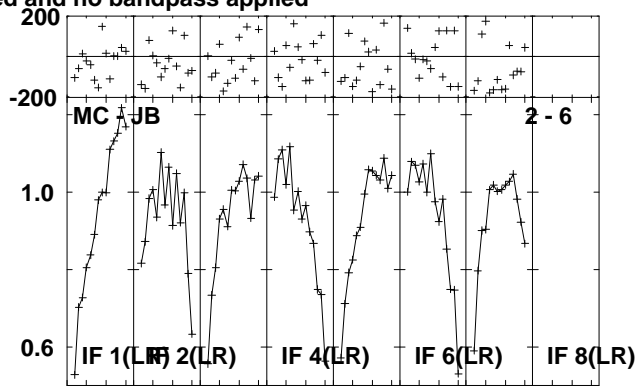
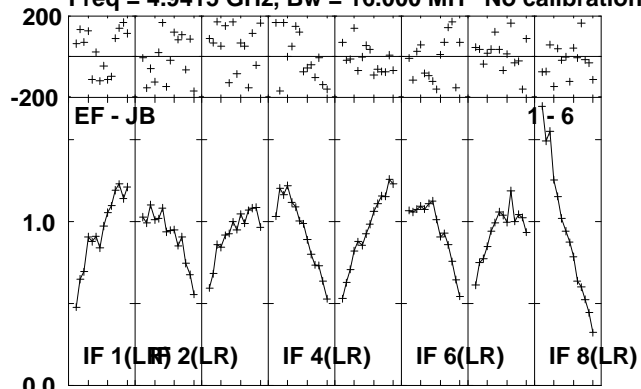

Lower frame: Milli Ampl Jy Top frame: Phas deg
Scalar averaged cross-power spectrum Several baselines displayed
Timerange: 00:18:37:40 to 00:18:42:38

Plot file version 12 created 15-JUL-2010 10:42:20
J1953+35 RR004B.UVDATA.1

Freq = 4.9415 GHz, Bw = 16.000 MH No calibration applied and no bandpass applied

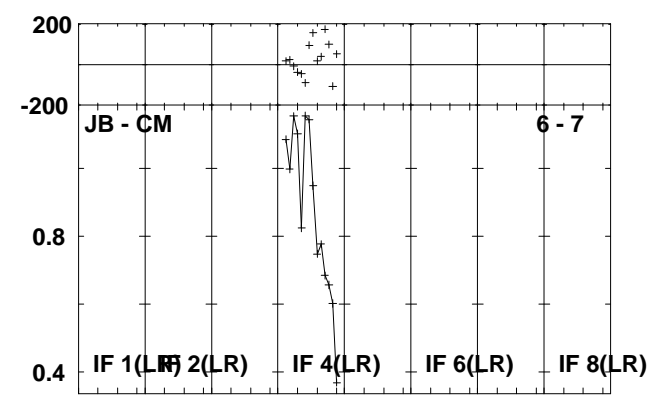
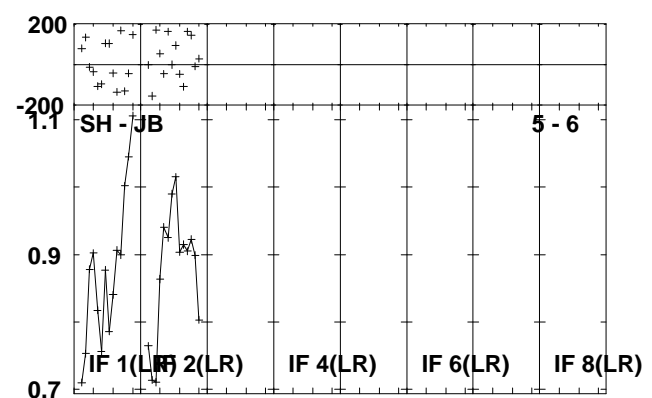
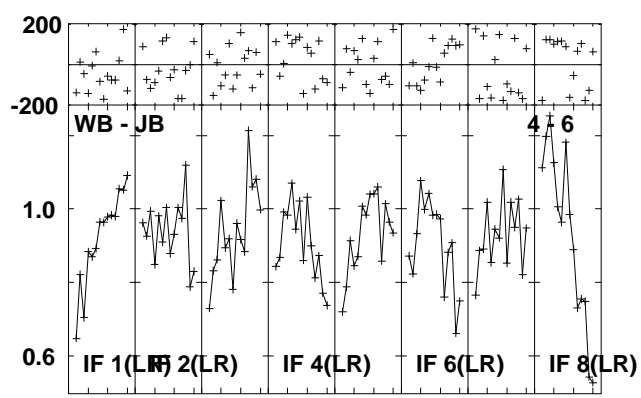
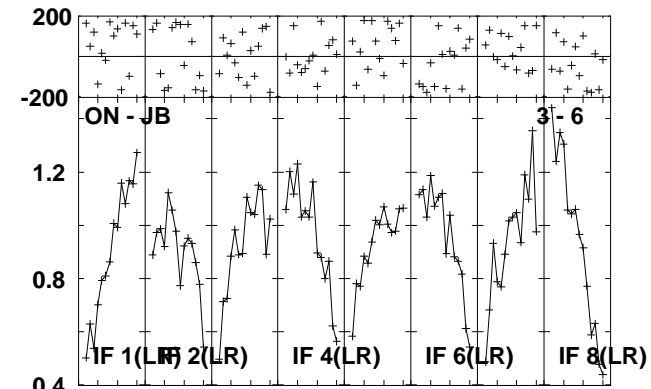
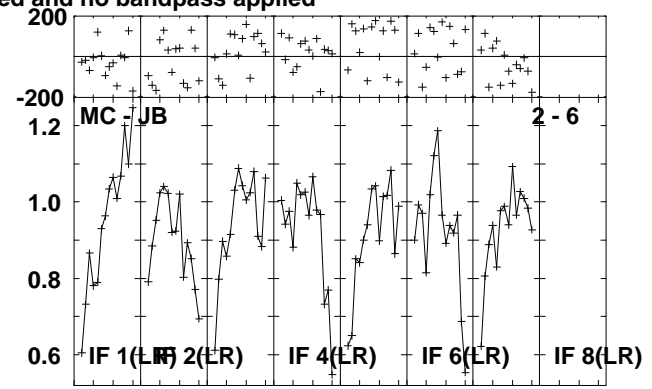
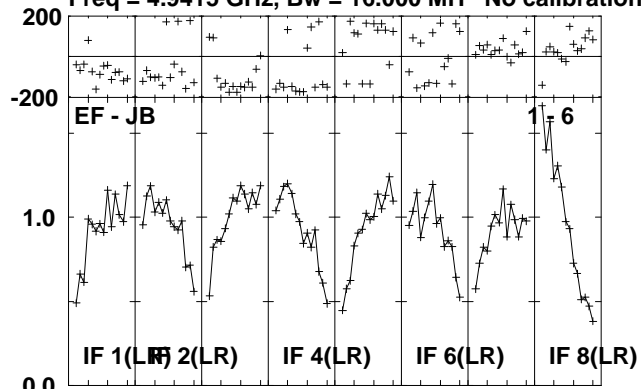

Lower frame: Milli Ampl Jy Top frame: Phas deg
Scalar averaged cross-power spectrum Several baselines displayed
Timerange: 00:18:43:20 to 00:18:44:48

Plot file version 13 created 15-JUL-2010 10:42:21
CYGX-1 RR004B.UVDATA.1

Freq = 4.9415 GHz, Bw = 16.000 MH No calibration applied and no bandpass applied

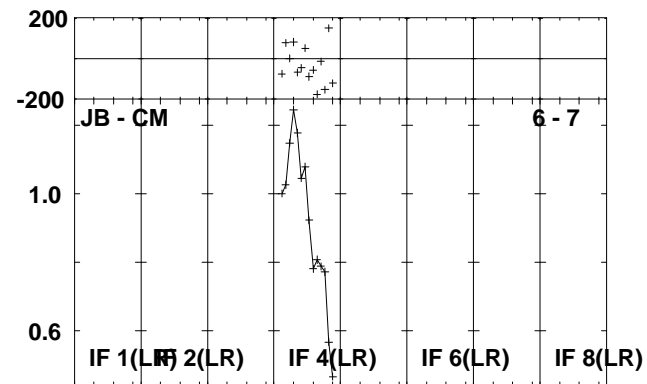
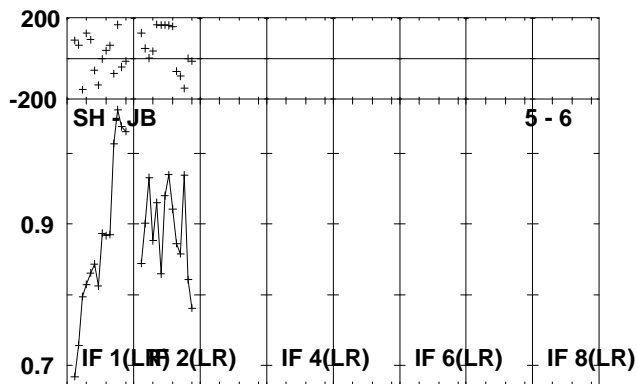
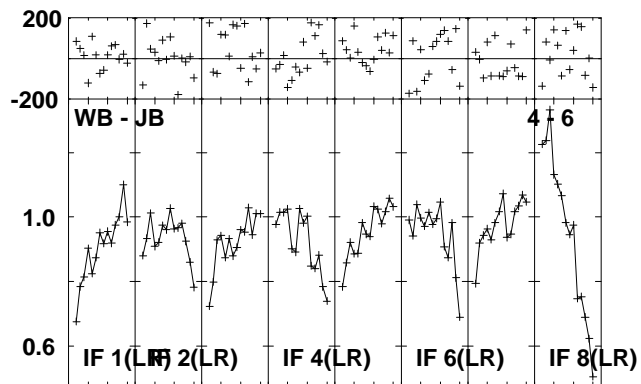
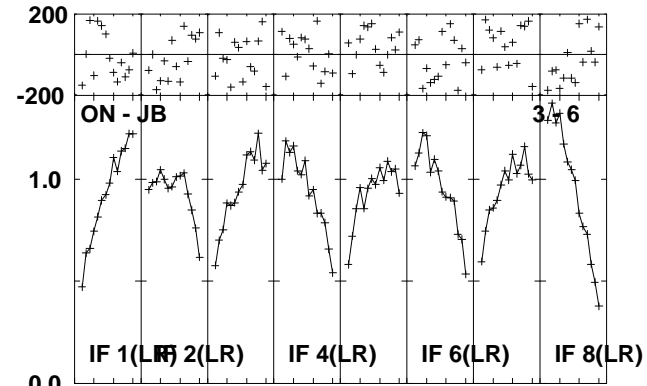
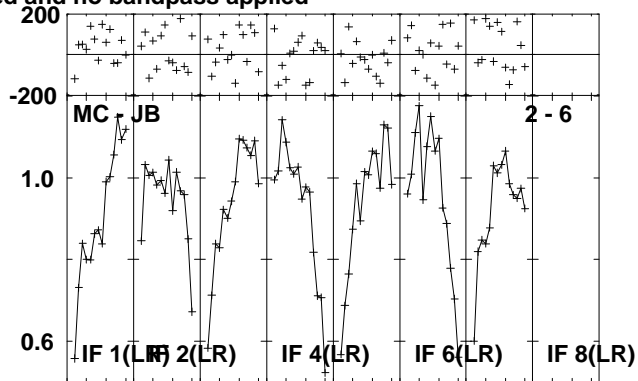
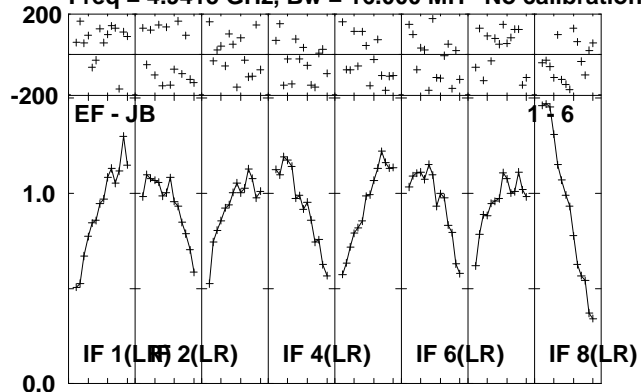

Lower frame: Milli Ampl Jy Top frame: Phas deg
Scalar averaged cross-power spectrum Several baselines displayed
Timerange: 00:18:44:50 to 00:18:49:48

Plot file version 14 created 15-JUL-2010 10:42:23
J1953+35 RR004B.UVDATA.1

Freq = 4.9415 GHz, Bw = 16.000 MH No calibration applied and no bandpass applied

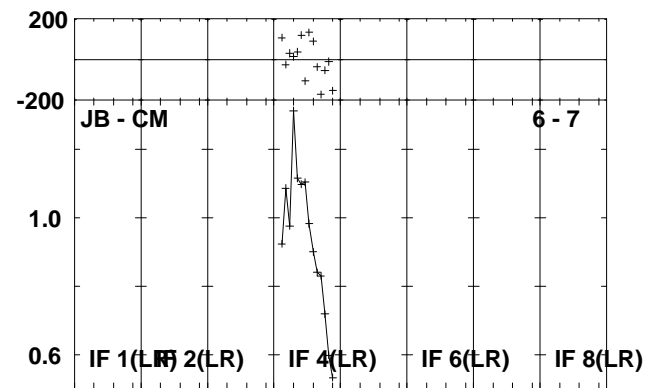
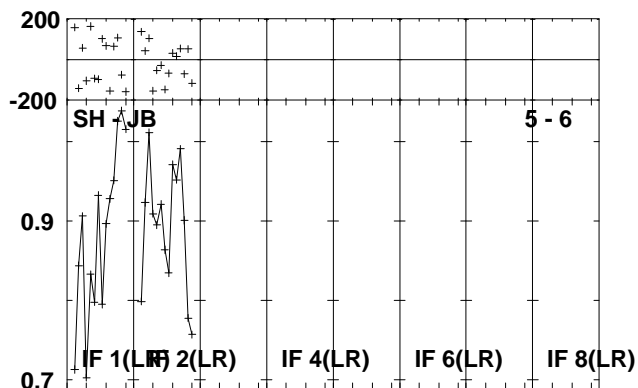
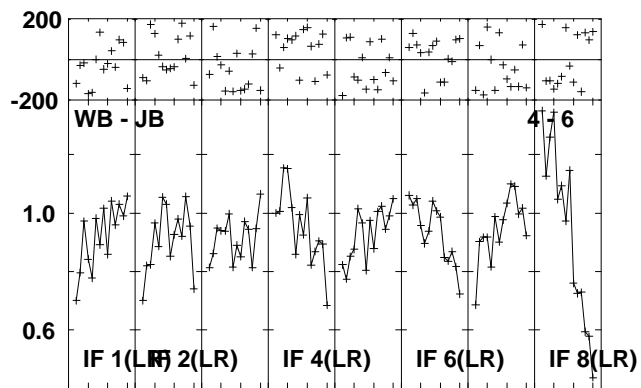
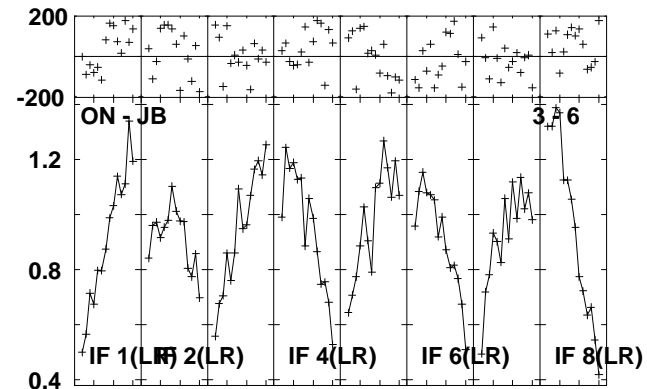
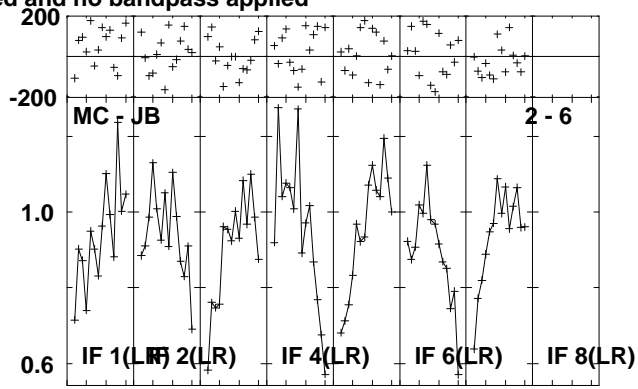
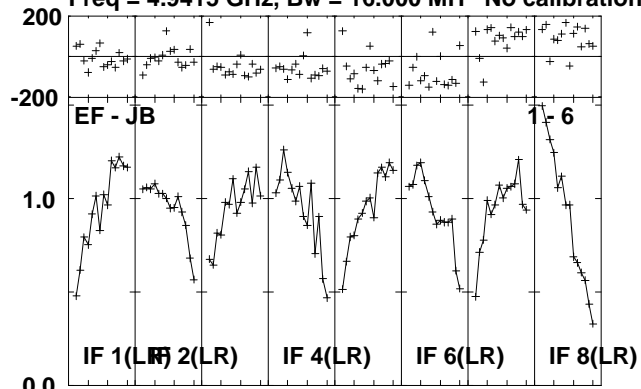

Lower frame: Milli Ampl Jy Top frame: Phas deg
Scalar averaged cross-power spectrum Several baselines displayed
Timerange: 00/18:49:50 to 00/18:51:48

Plot file version 15 created 15-JUL-2010 10:42:25

CYGX-1 RR004B.UVDATA.1

Freq = 4.9415 GHz, Bw = 16.000 MH No calibration applied and no bandpass applied

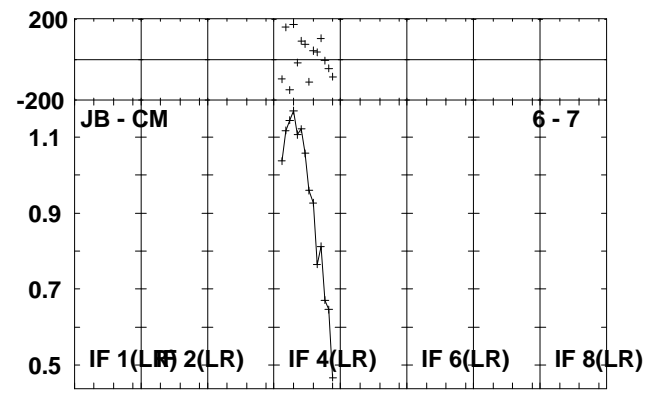
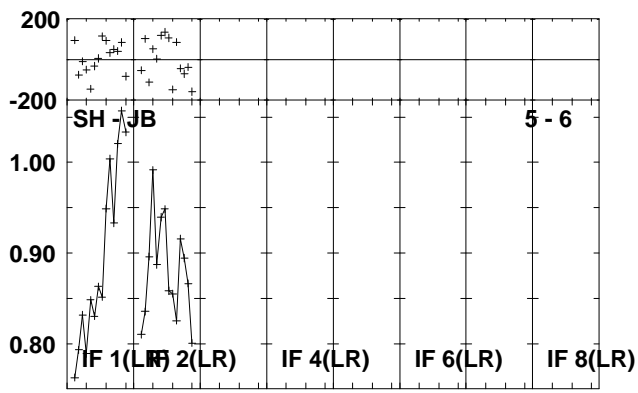
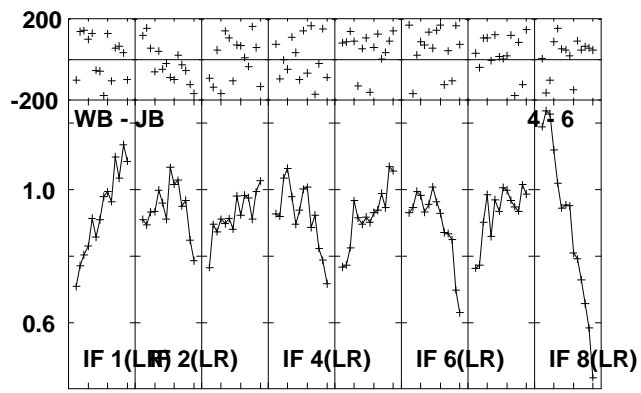
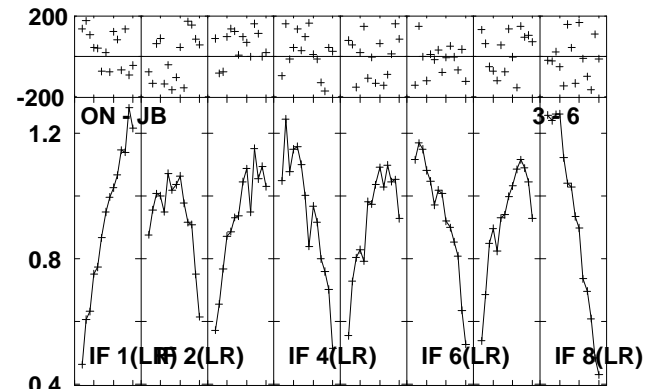
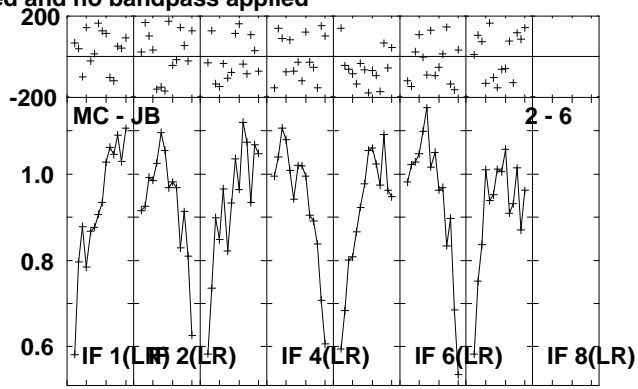
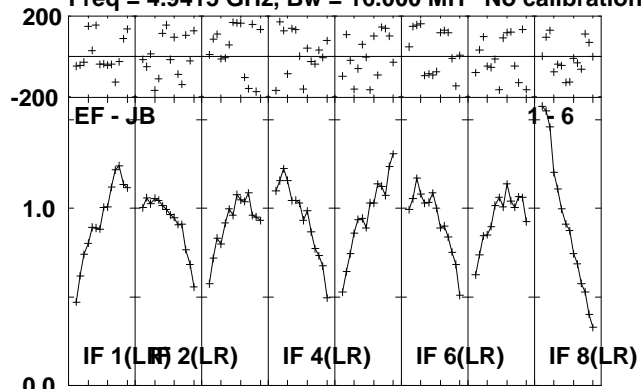

Lower frame: Milli Ampl Jy Top frame: Phas deg
Scalar averaged cross-power spectrum Several baselines displayed
Timerange: 00/18:51:50 to 00/18:56:48

Plot file version 16 created 15-JUL-2010 10:42:27

J1953+35 RR004B.UVDATA.1

Freq = 4.9415 GHz, Bw = 16.000 MH No calibration applied and no bandpass applied

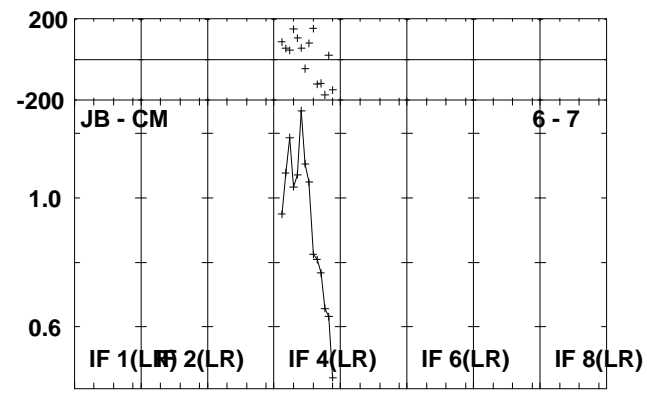
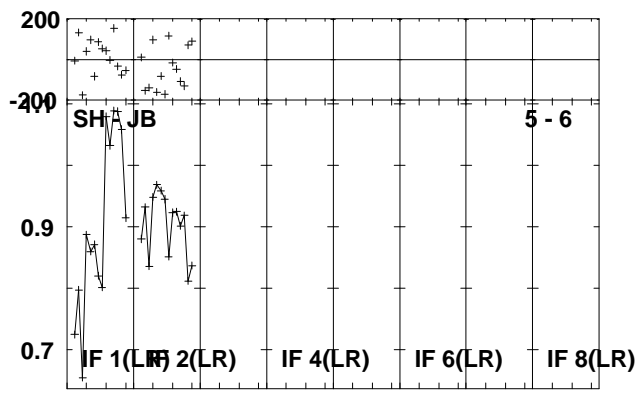
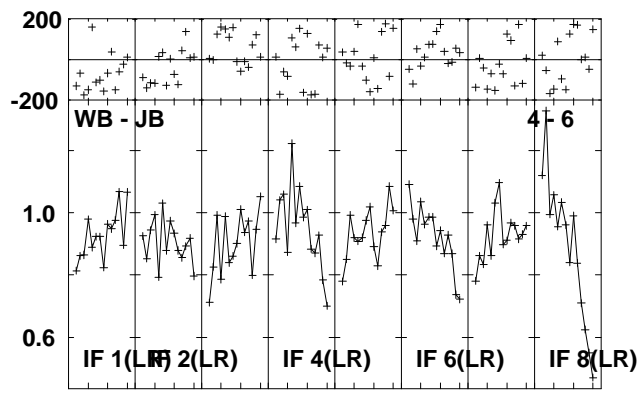
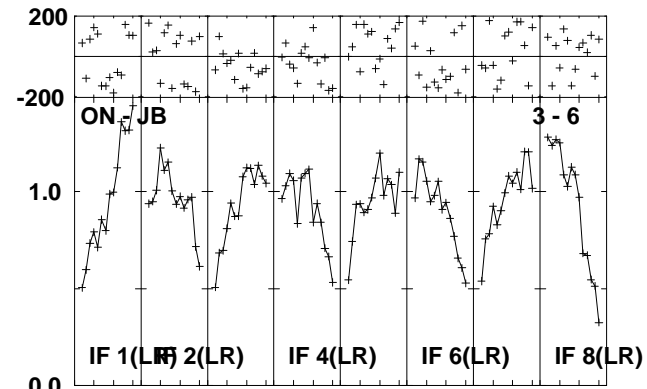
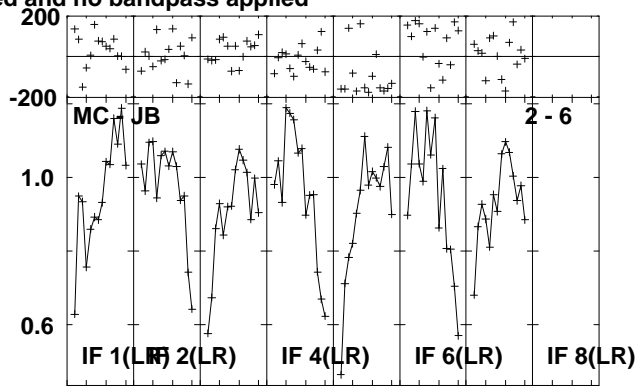
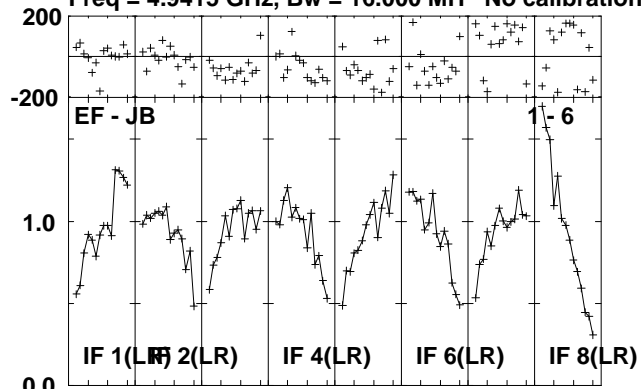

Lower frame: Milli Ampl Jy Top frame: Phas deg
Scalar averaged cross-power spectrum Several baselines displayed
Timerange: 00:18:57:30 to 00:18:58:58

Plot file version 17 created 15-JUL-2010 10:42:28
CYGX-1 RR004B.UVDATA.1

Freq = 4.9415 GHz, Bw = 16.000 MH No calibration applied and no bandpass applied

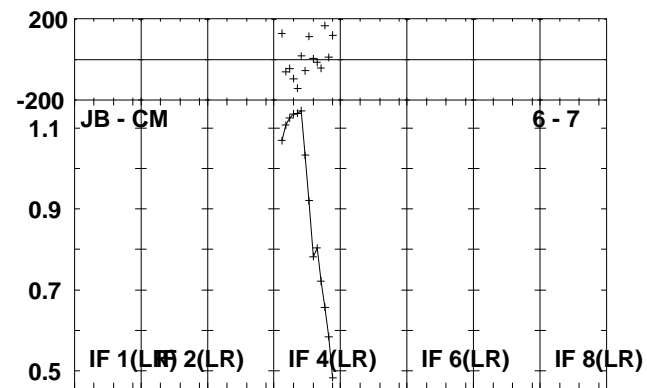
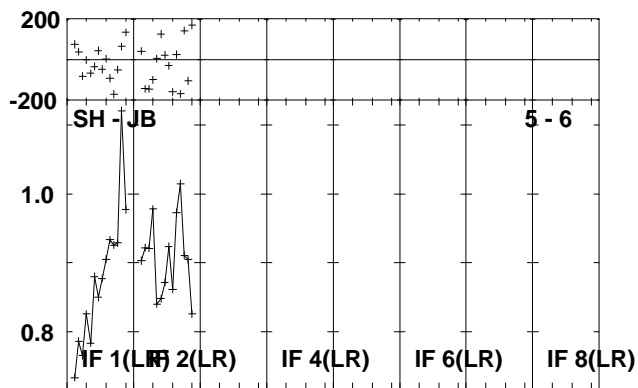
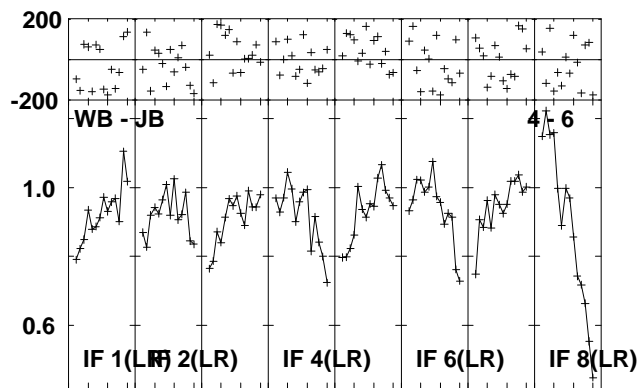
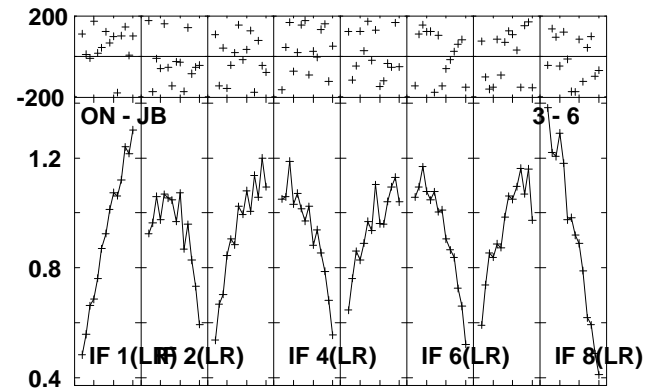
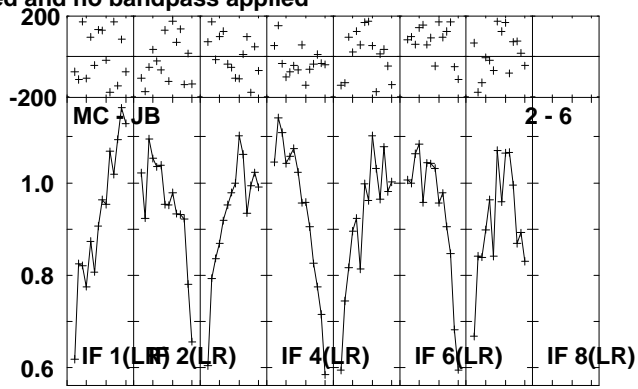
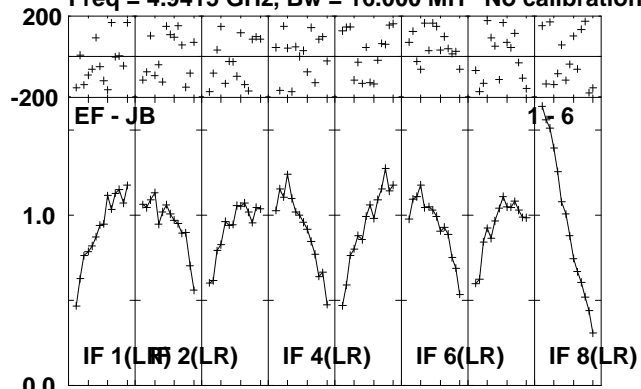

Lower frame: Milli Ampl Jy Top frame: Phas deg
Scalar averaged cross-power spectrum Several baselines displayed
Timerange: 00/18:59:00 to 00/19:03:58

Plot file version 18 created 15-JUL-2010 10:42:30
J1953+35 RR004B.UVDATA.1

Freq = 4.9415 GHz, Bw = 16.000 MH No calibration applied and no bandpass applied

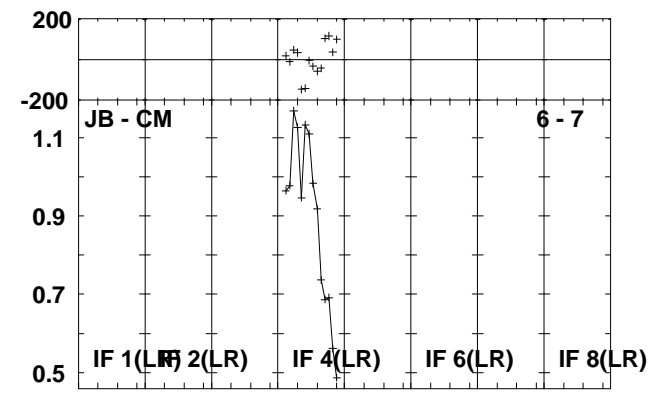
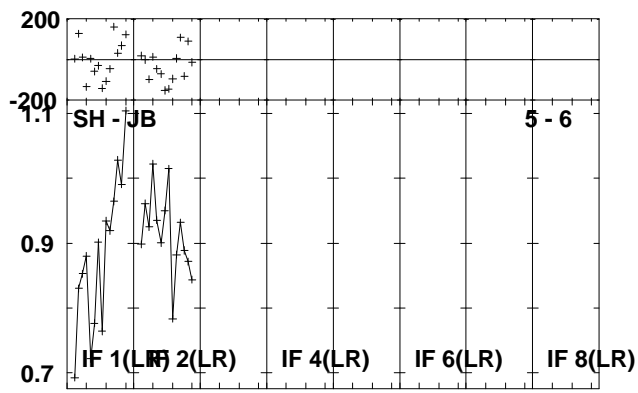
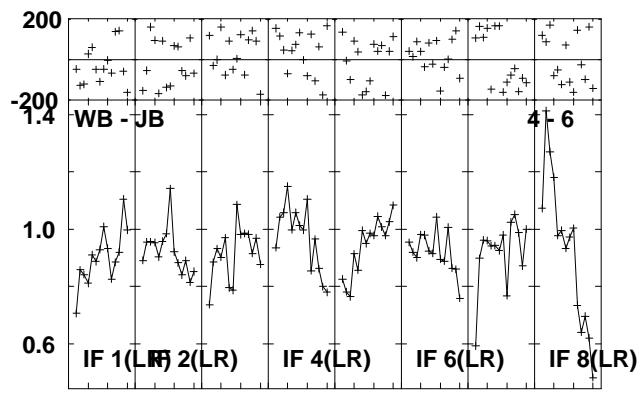
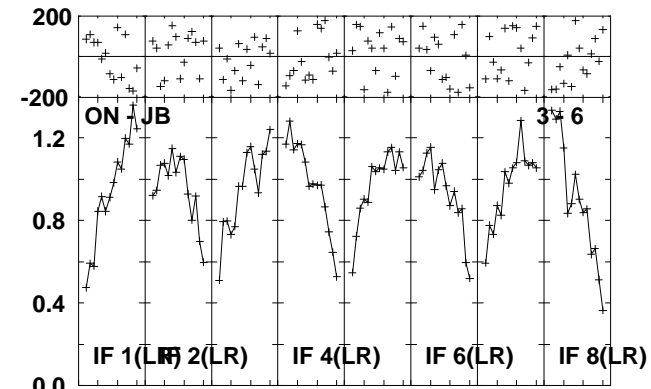
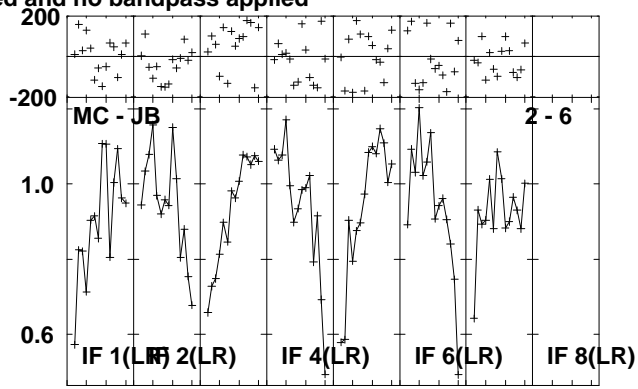
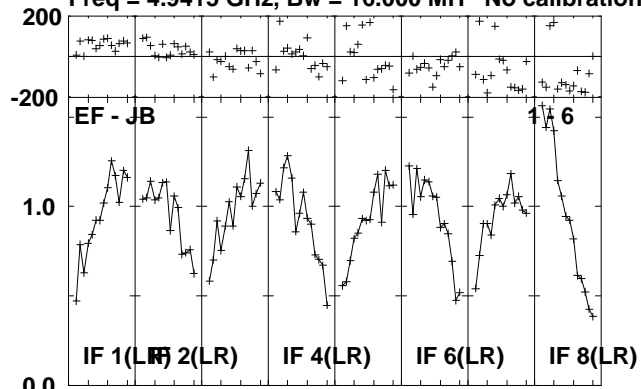

Lower frame: Milli Ampl Jy Top frame: Phas deg
Scalar averaged cross-power spectrum Several baselines displayed
Timerange: 00/19:04:00 to 00/19:05:58

Plot file version 19 created 15-JUL-2010 10:42:32

CYGX-1 RR004B.UVDATA.1

Freq = 4.9415 GHz, Bw = 16.000 MH No calibration applied and no bandpass applied

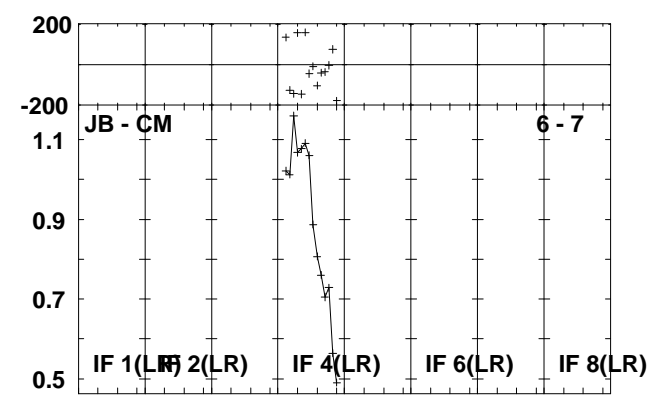
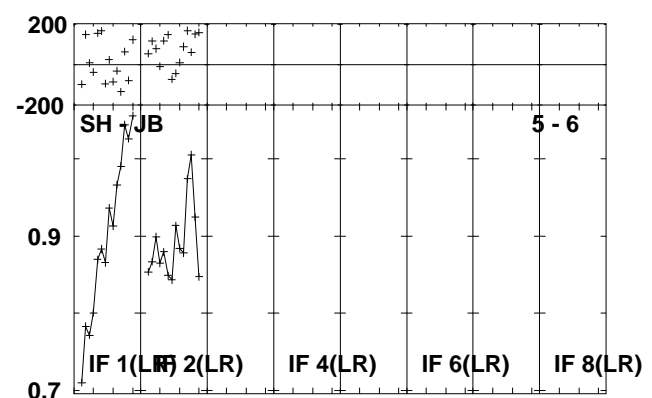
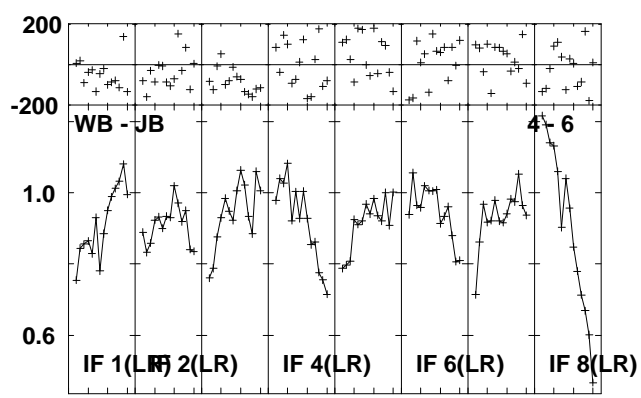
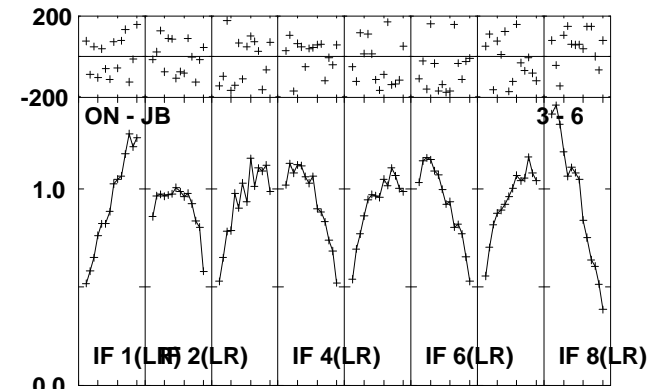
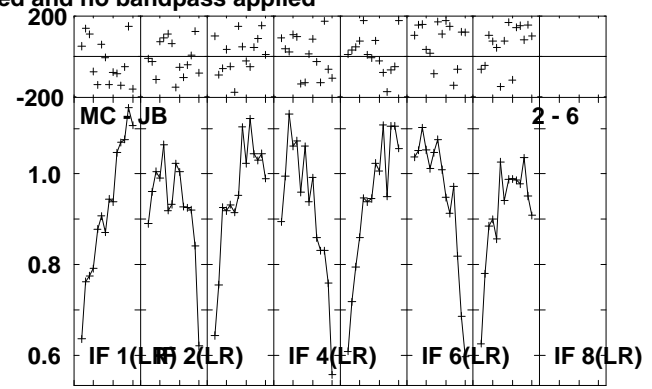
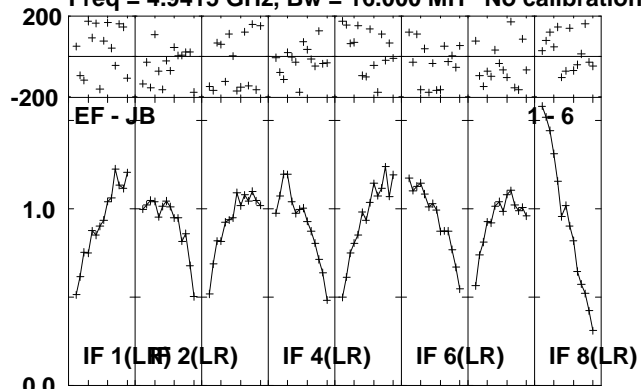

Lower frame: Milli Ampl Jy Top frame: Phas deg
Scalar averaged cross-power spectrum Several baselines displayed
Timerange: 00/19:06:00 to 00/19:10:58

Plot file version 20 created 15-JUL-2010 10:42:34
J2002+47 RR004B.UVDATA.1

Freq = 4.9415 GHz, Bw = 16.000 MH No calibration applied and no bandpass applied

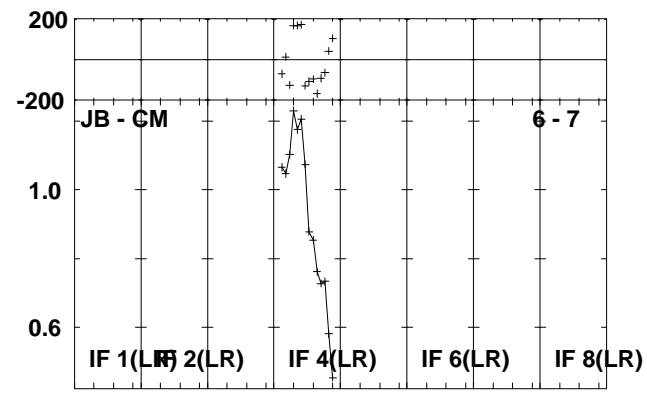
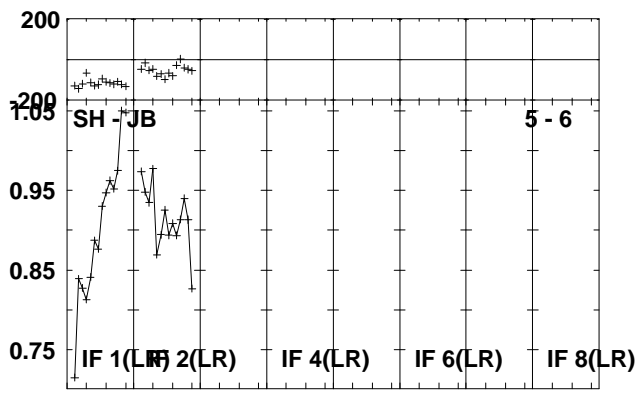
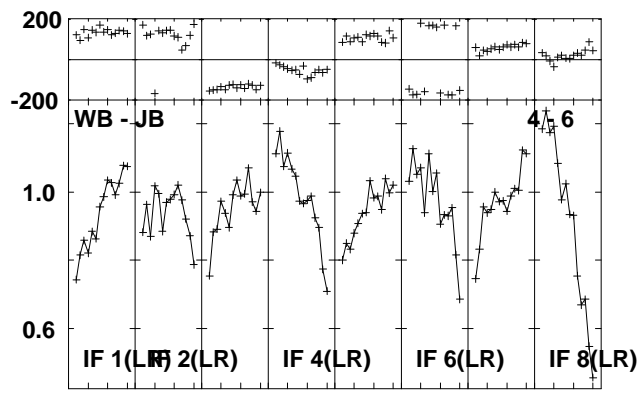
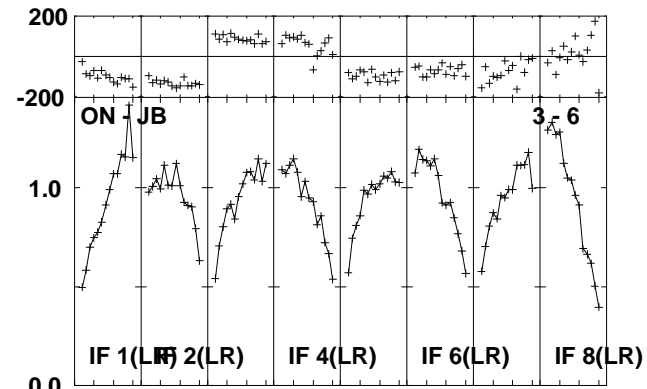
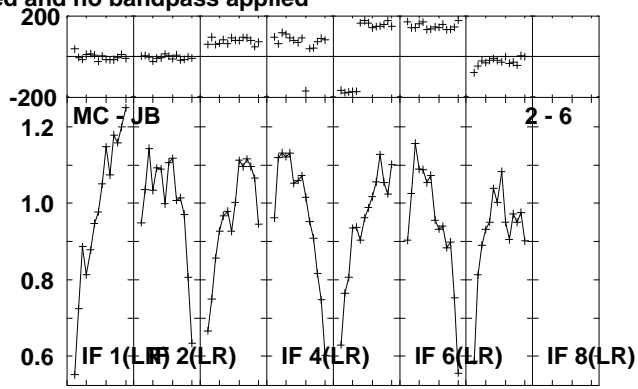
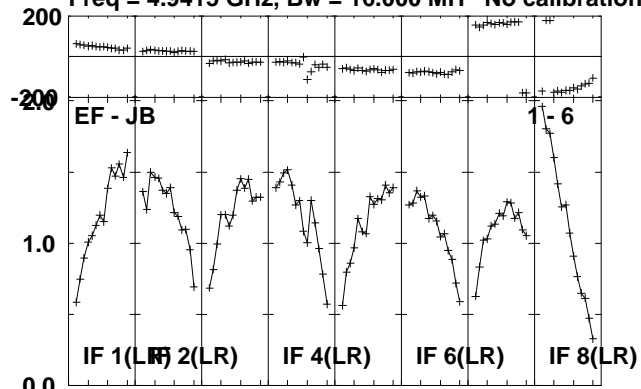

Lower frame: Milli Ampl Jy Top frame: Phas deg
Scalar averaged cross-power spectrum Several baselines displayed
Timerange: 00/19:13:00 to 00/19:17:58

Plot file version 21 created 15-JUL-2010 10:42:37

J1953+35 RR004B.UVDATA.1

Freq = 4.9415 GHz, Bw = 16.000 MH No calibration applied and no bandpass applied

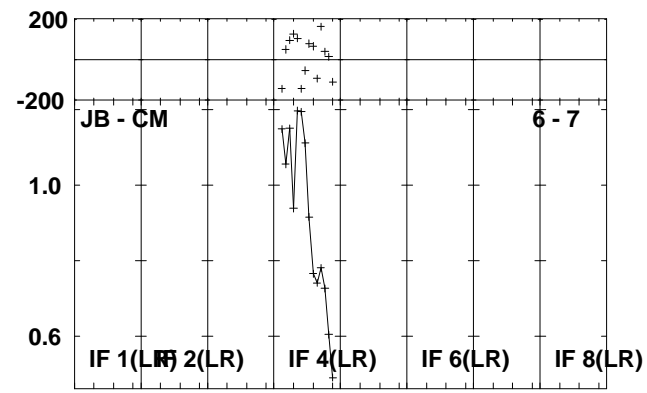
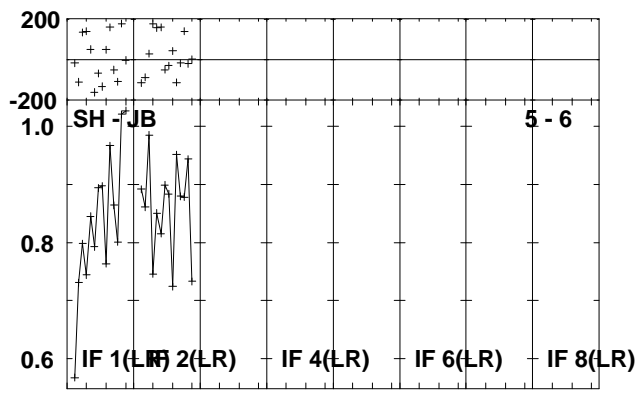
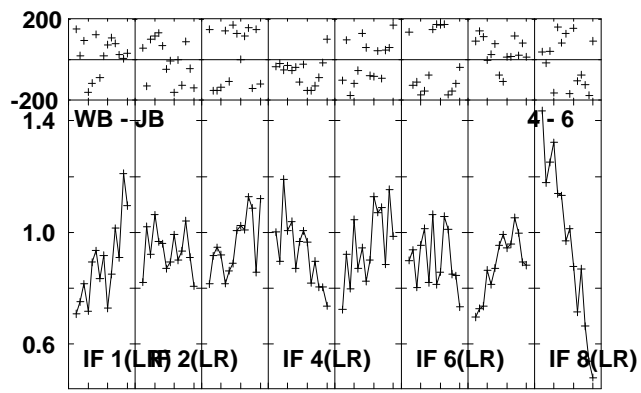
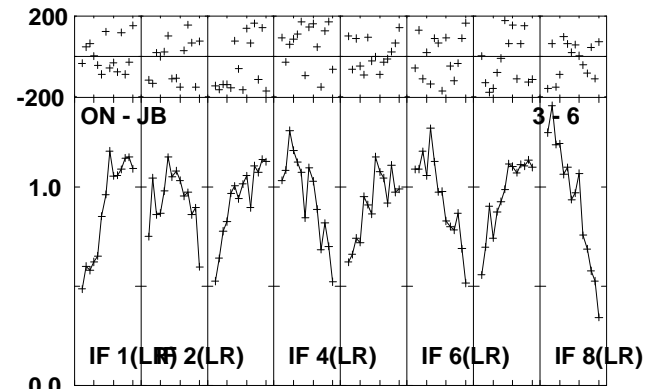
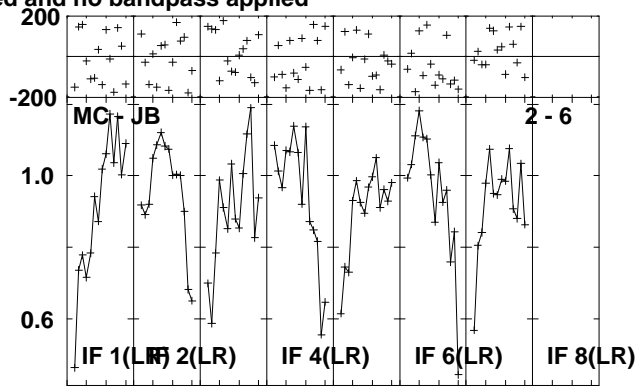
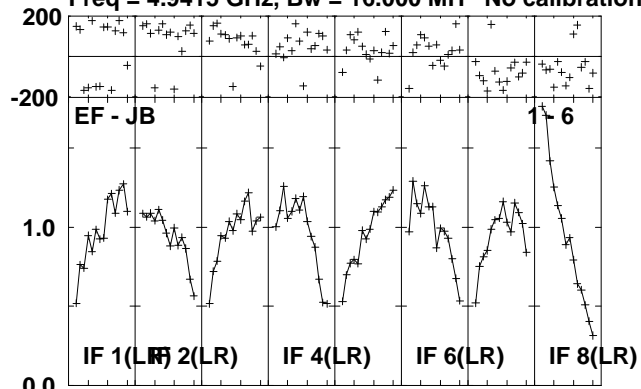

Lower frame: Milli Ampl Jy Top frame: Phas deg
Scalar averaged cross-power spectrum Several baselines displayed
Timerange: 00/19:19:30 to 00/19:20:58

Plot file version 22 created 15-JUL-2010 10:42:38

CYGX-1 RR004B.UVDATA.1

Freq = 4.9415 GHz, Bw = 16.000 MH No calibration applied and no bandpass applied

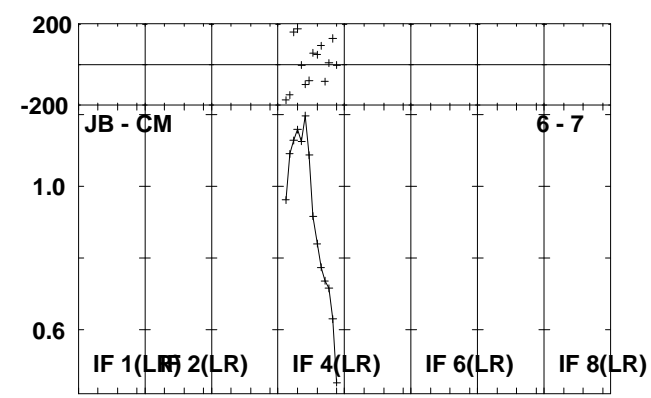
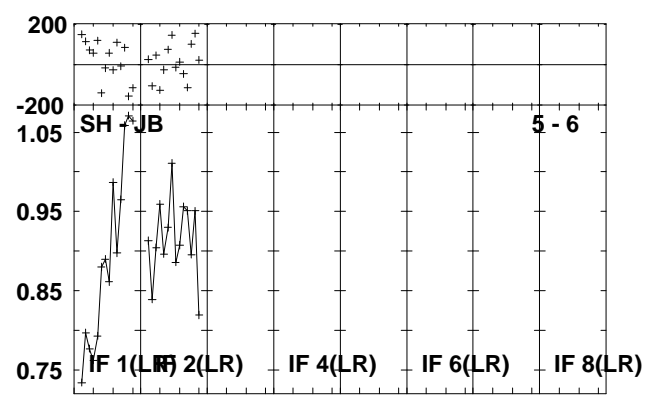
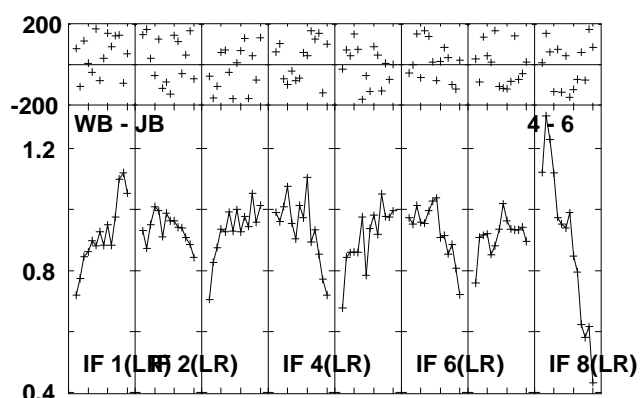
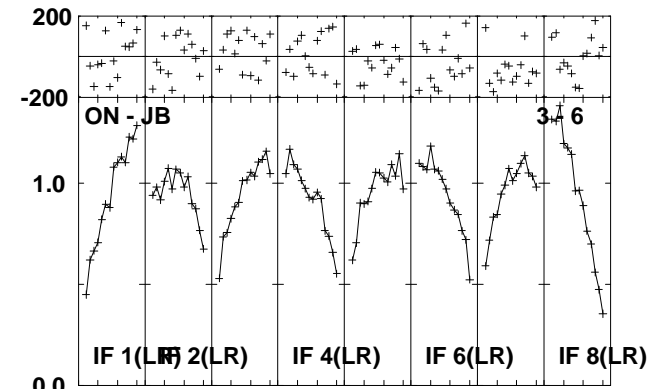
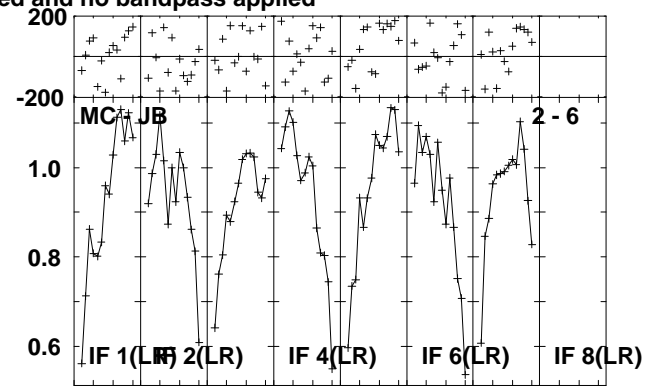
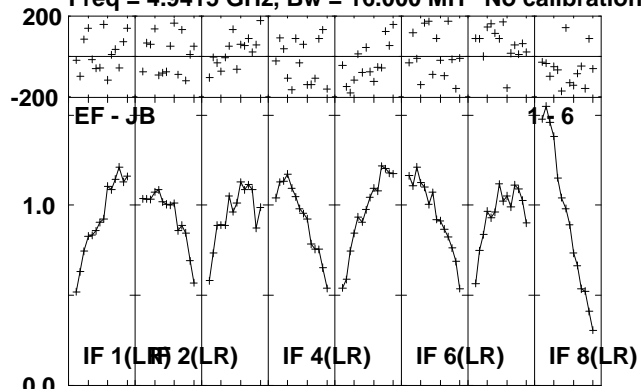

Lower frame: Milli Ampl Jy Top frame: Phas deg
Scalar averaged cross-power spectrum Several baselines displayed
Timerange: 00/19:21:00 to 00/19:25:58

Plot file version 23 created 15-JUL-2010 10:42:40
 J1953+35 RR004B.UVDATA.1

Freq = 4.9415 GHz, Bw = 16.000 MH No calibration applied and no bandpass applied

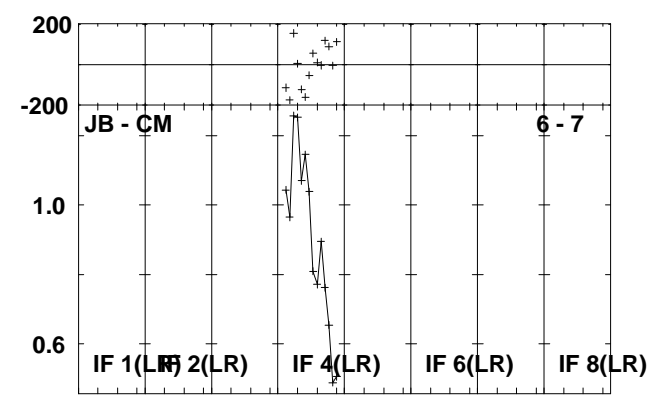
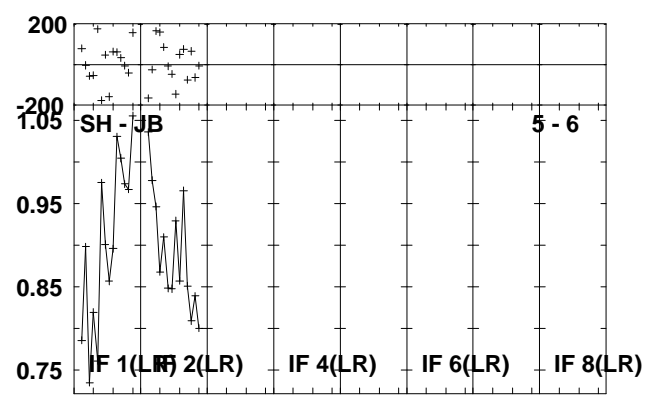
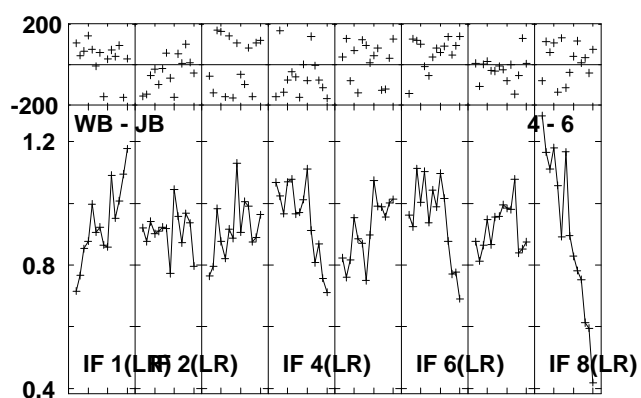
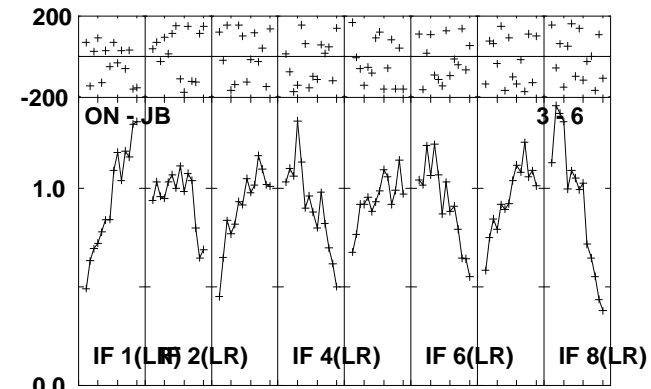
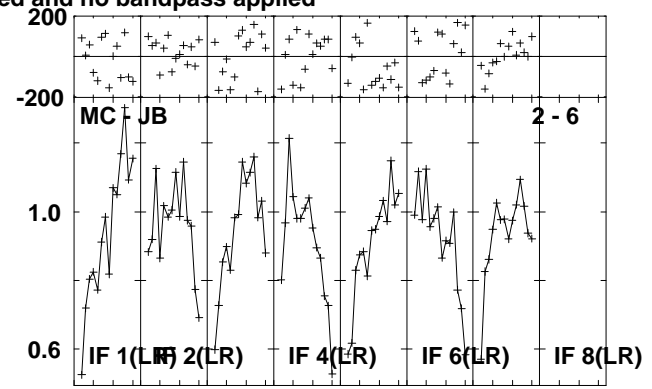
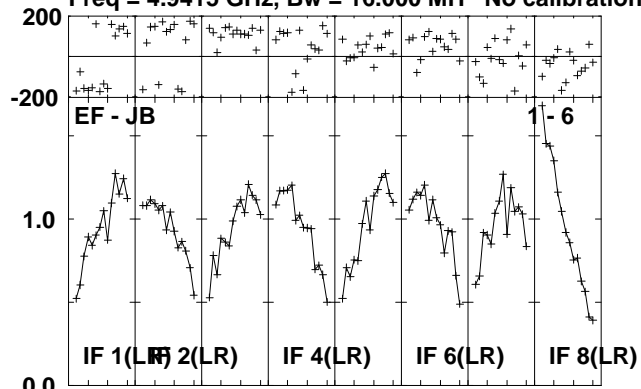

Lower frame: Milli Ampl Jy Top frame: Phas deg
 Scalar averaged cross-power spectrum Several baselines displayed
 Timerange: 00/19:26:00 to 00/19:27:58

Plot file version 24 created 15-JUL-2010 10:42:42

CYGX-1 RR004B.UVDATA.1

Freq = 4.9415 GHz, Bw = 16.000 MH No calibration applied and no bandpass applied

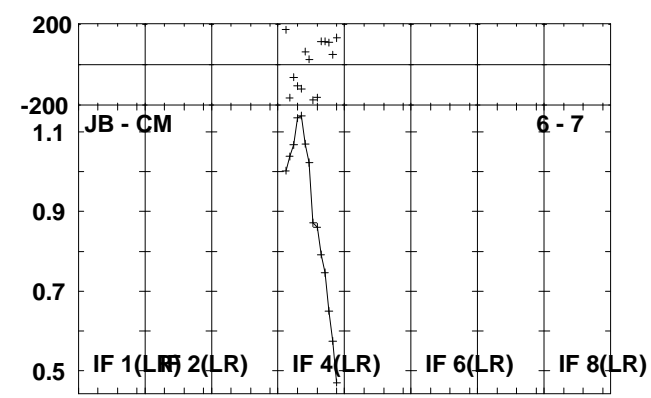
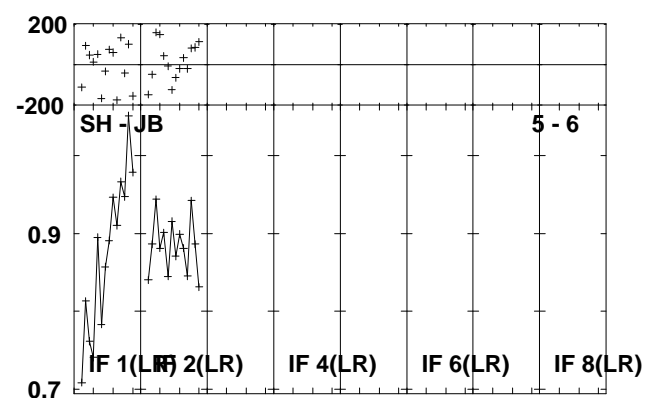
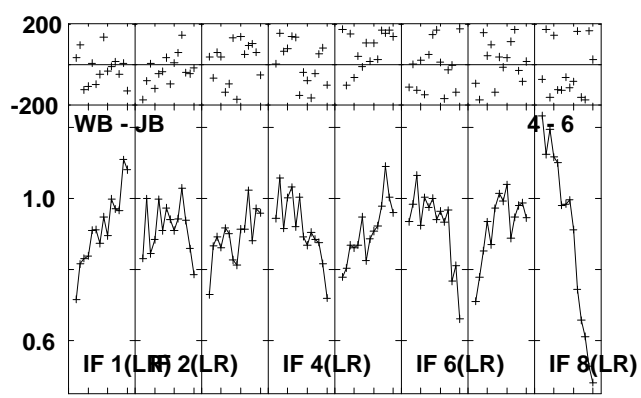
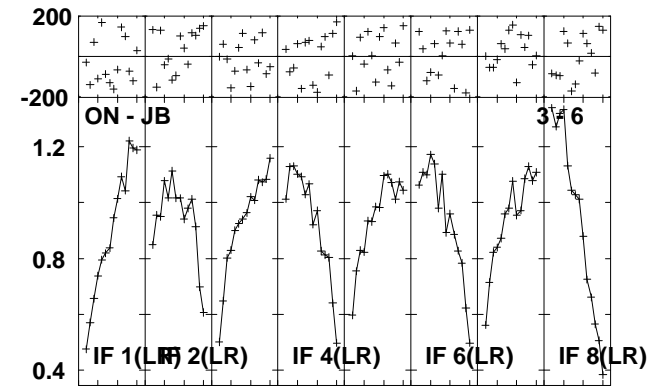
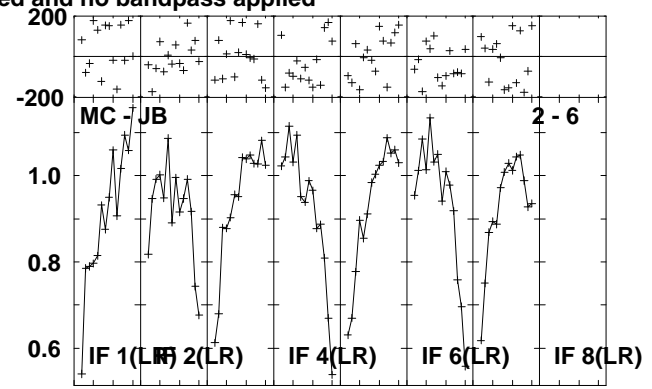
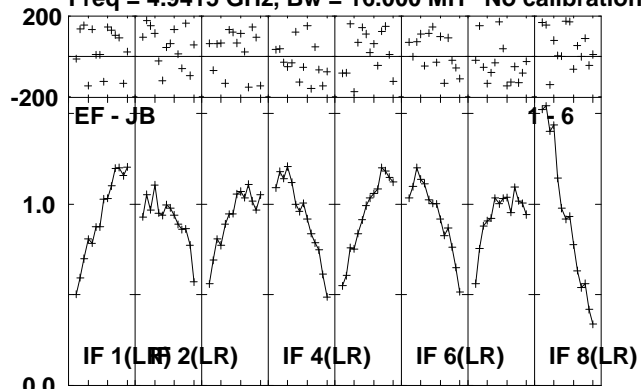

Lower frame: Milli Ampl Jy Top frame: Phas deg
Scalar averaged cross-power spectrum Several baselines displayed
Timerange: 00/19:28:00 to 00/19:32:58

Plot file version 25 created 15-JUL-2010 10:42:44
J1953+35 RR004B.UVDATA.1

Freq = 4.9415 GHz, Bw = 16.000 MH No calibration applied and no bandpass applied

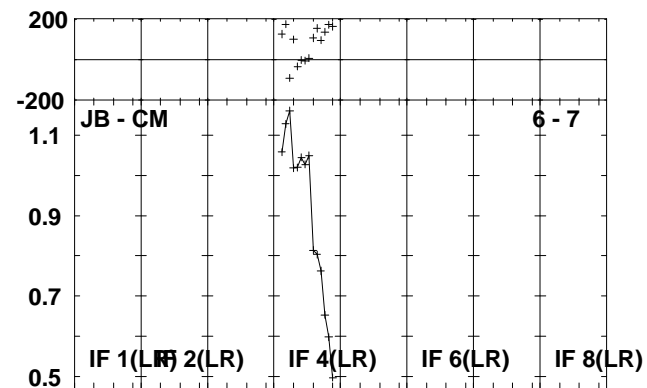
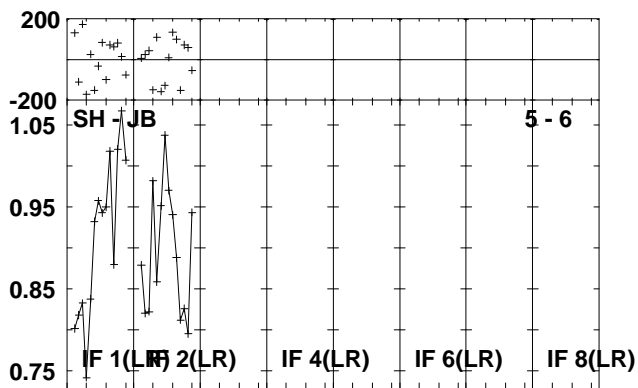
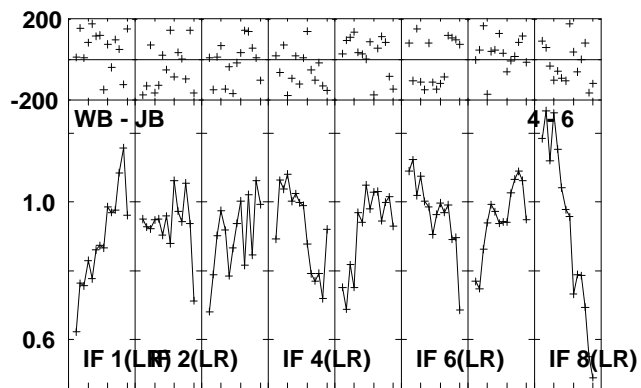
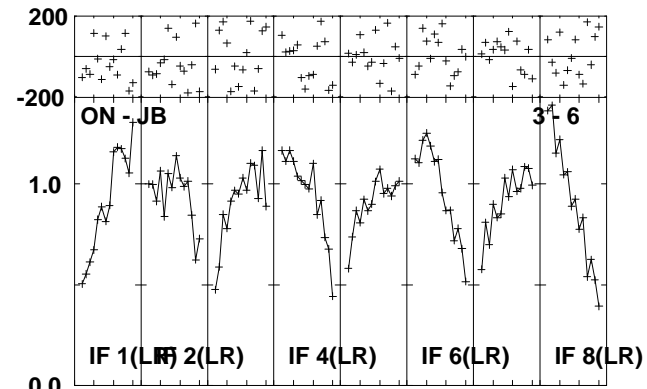
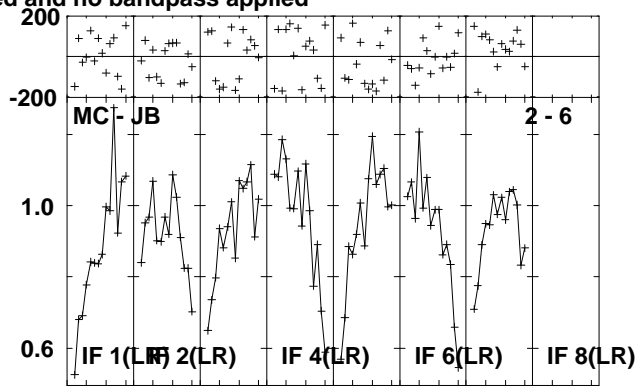
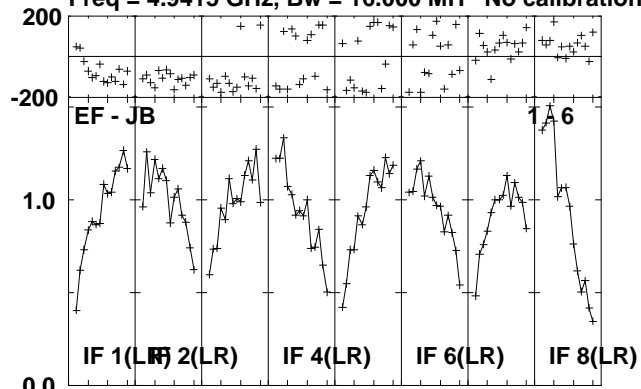

Lower frame: Milli Ampl Jy Top frame: Phas deg
Scalar averaged cross-power spectrum Several baselines displayed
Timerange: 00/19:33:40 to 00/19:35:08

Plot file version 26 created 15-JUL-2010 10:42:45
CYGX-1 RR004B.UVDATA.1

Freq = 4.9415 GHz, Bw = 16.000 MH No calibration applied and no bandpass applied

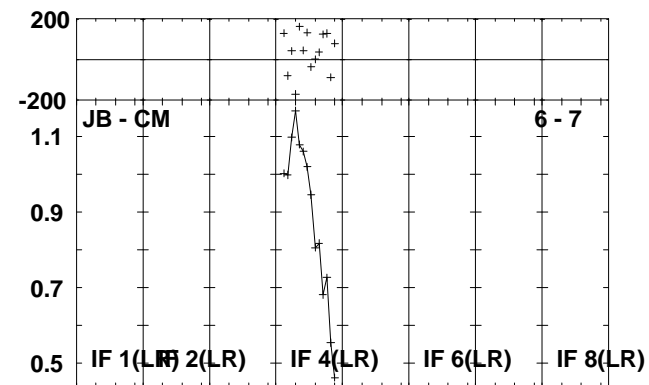
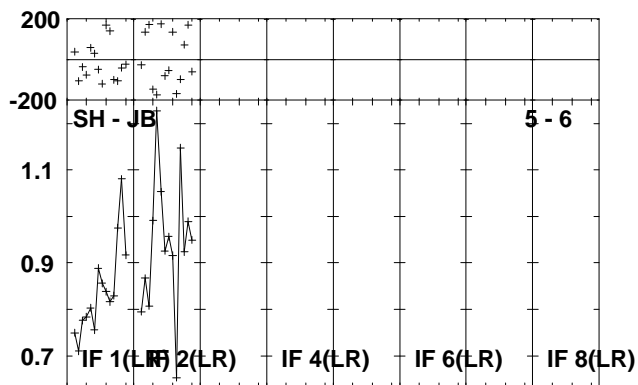
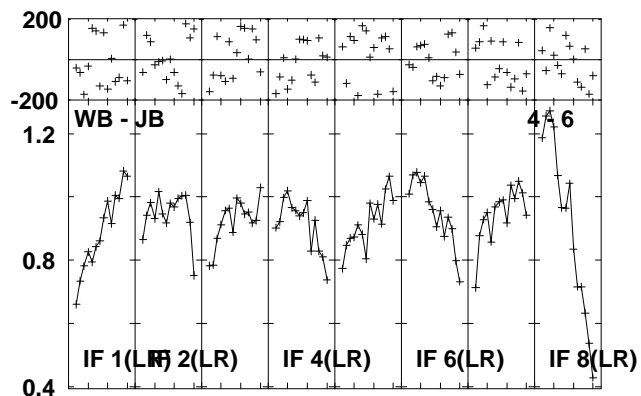
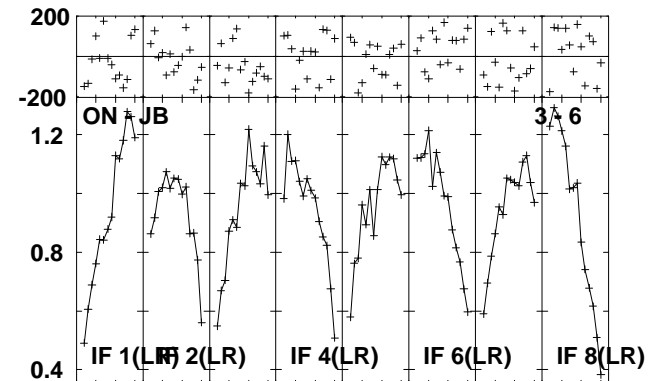
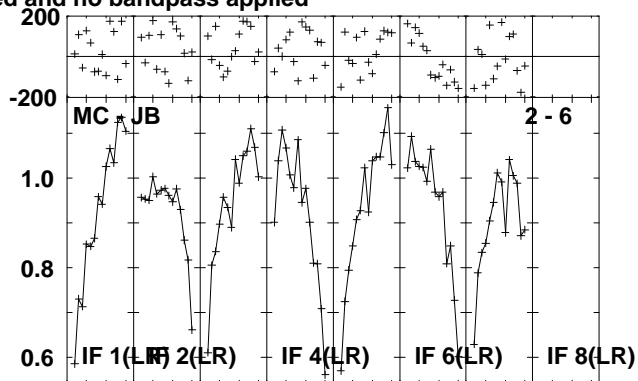
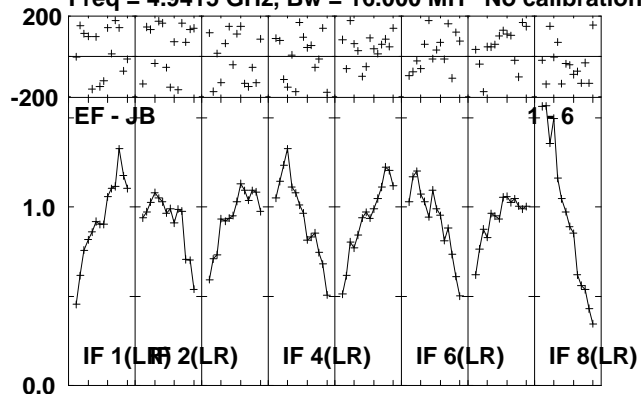

Lower frame: Milli Ampl Jy Top frame: Phas deg
Scalar averaged cross-power spectrum Several baselines displayed
Timerange: 00/19:35:10 to 00/19:40:08

Plot file version 27 created 15-JUL-2010 10:42:47
J1953+35 RR004B.UVDATA.1

Freq = 4.9415 GHz, Bw = 16.000 MH No calibration applied and no bandpass applied

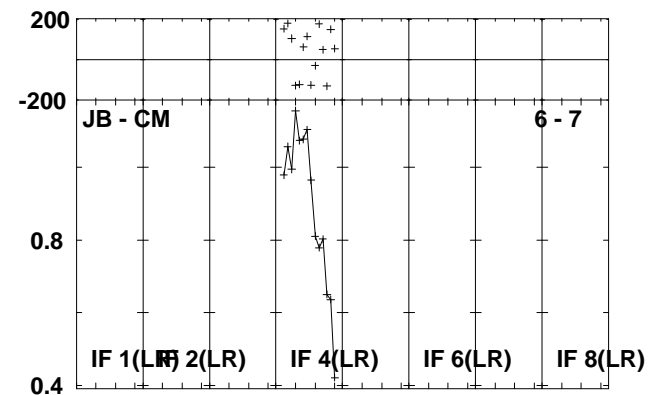
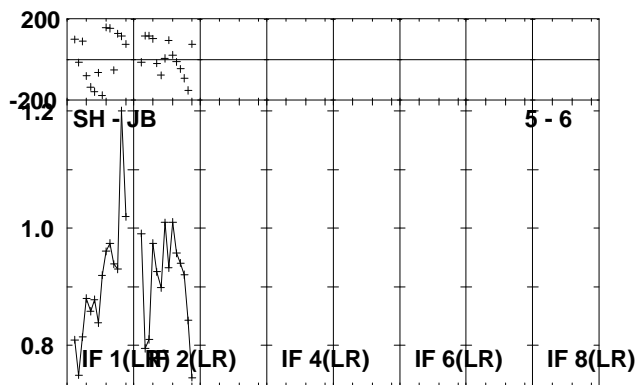
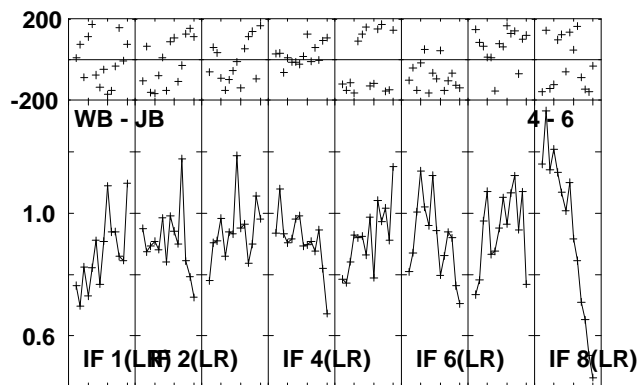
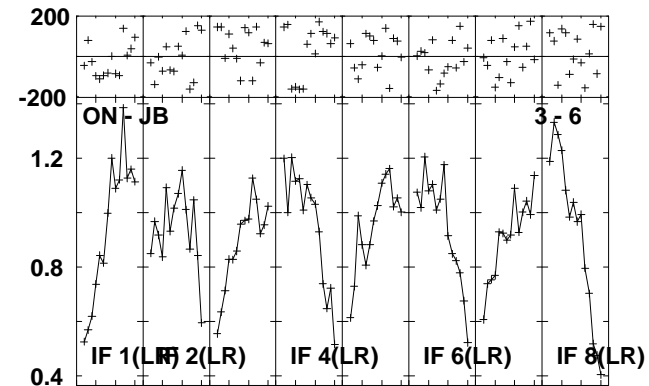
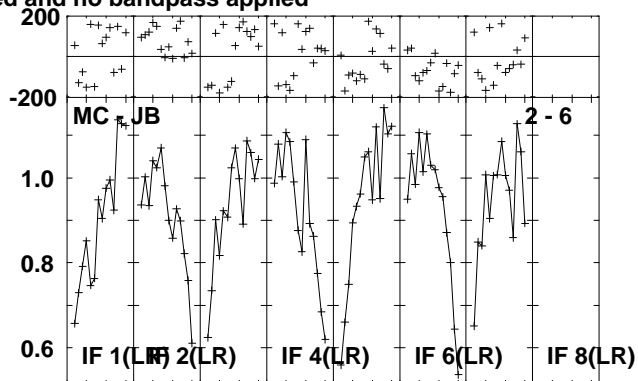
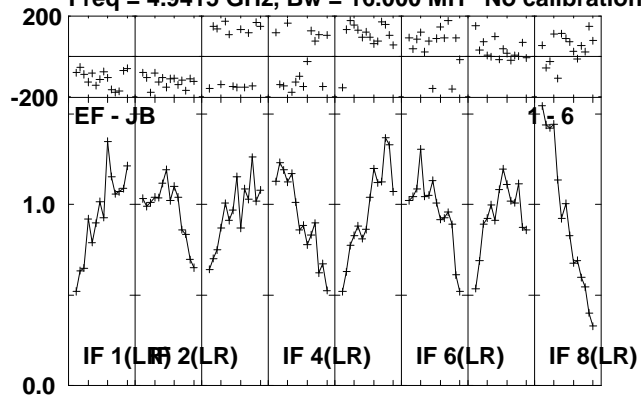

Lower frame: Milli Ampl Jy Top frame: Phas deg
Scalar averaged cross-power spectrum Several baselines displayed
Timerange: 00/19:40:10 to 00/19:42:08

Plot file version 28 created 15-JUL-2010 10:42:48
 CYGX-1 RR004B.UVDATA.1

Freq = 4.9415 GHz, Bw = 16.000 MH No calibration applied and no bandpass applied

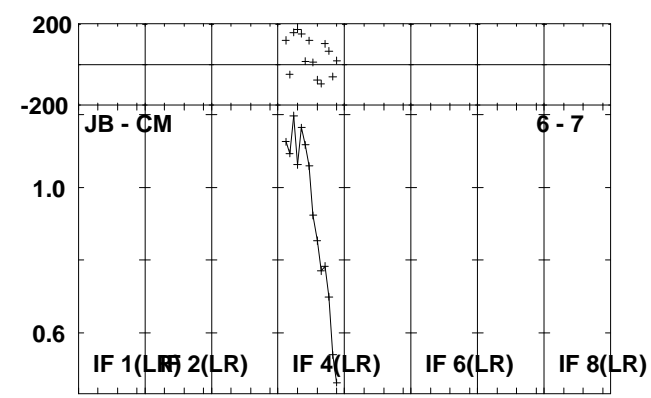
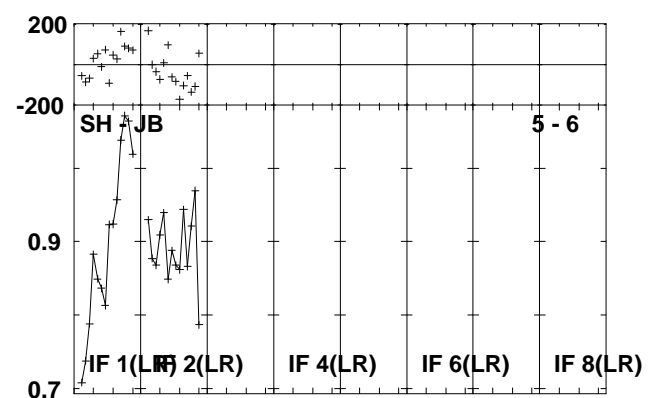
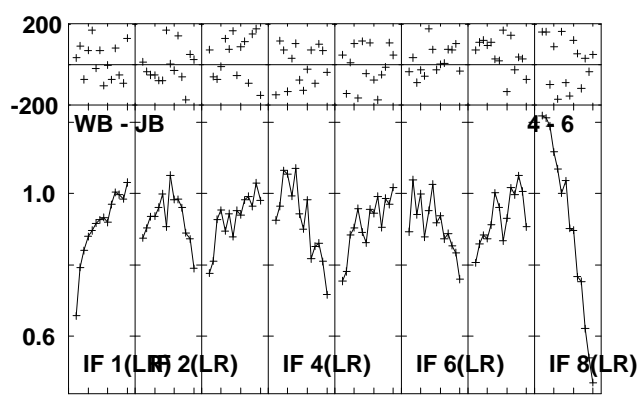
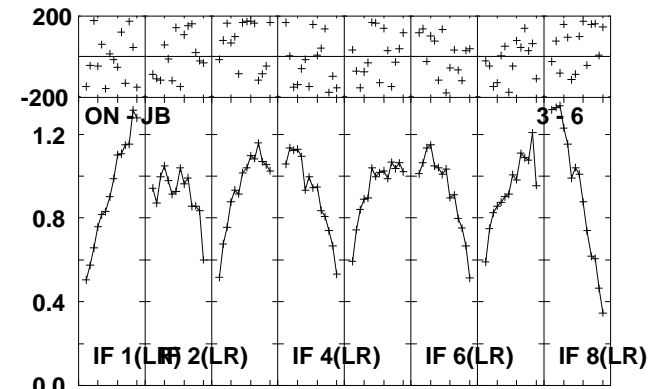
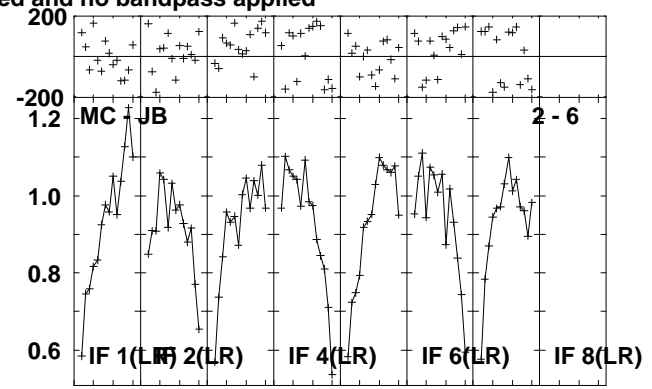
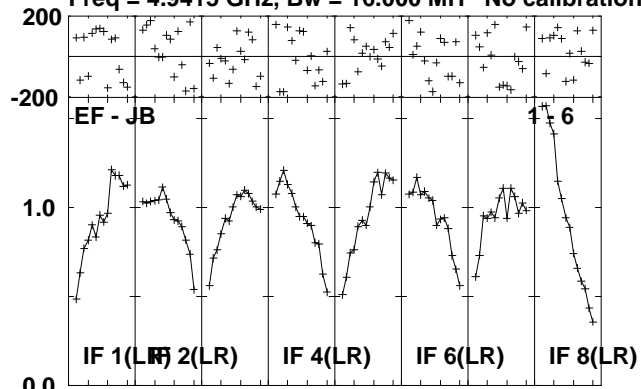

Lower frame: Milli Ampl Jy Top frame: Phas deg
 Scalar averaged cross-power spectrum Several baselines displayed
 Timerange: 00:19:42:10 to 00:19:47:08

Plot file version 29 created 15-JUL-2010 10:42:51
J1953+35 RR004B.UVDATA.1

Freq = 4.9415 GHz, Bw = 16.000 MH No calibration applied and no bandpass applied

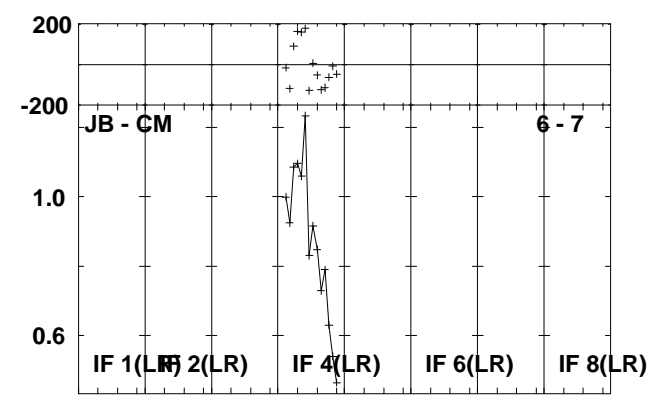
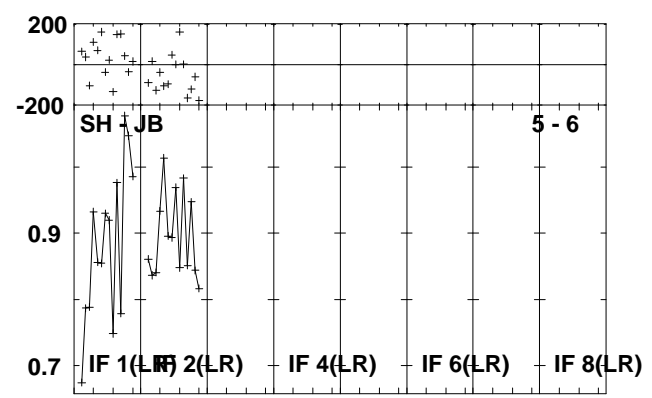
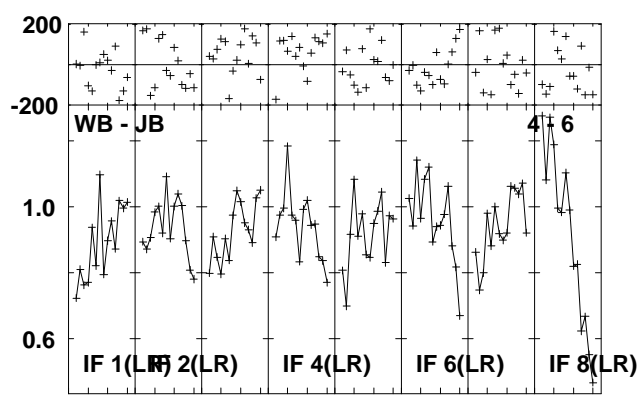
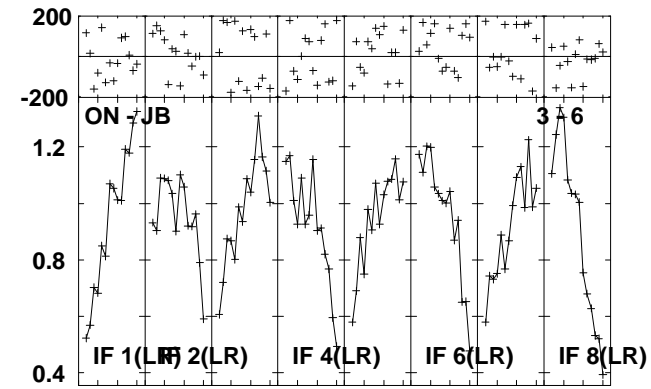
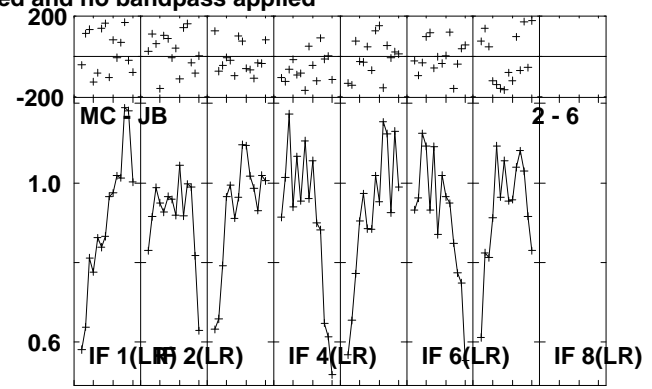
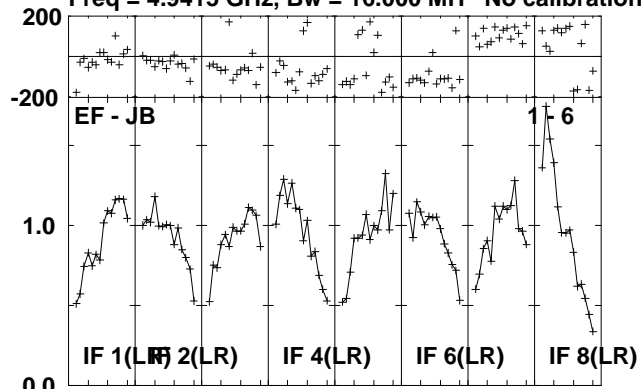

Lower frame: Milli Ampl Jy Top frame: Phas deg
Scalar averaged cross-power spectrum Several baselines displayed
Timerange: 00/19:47:50 to 00/19:49:18

Plot file version 30 created 15-JUL-2010 10:42:52

CYGX-1 RR004B.UVDATA.1

Freq = 4.9415 GHz, Bw = 16.000 MH No calibration applied and no bandpass applied

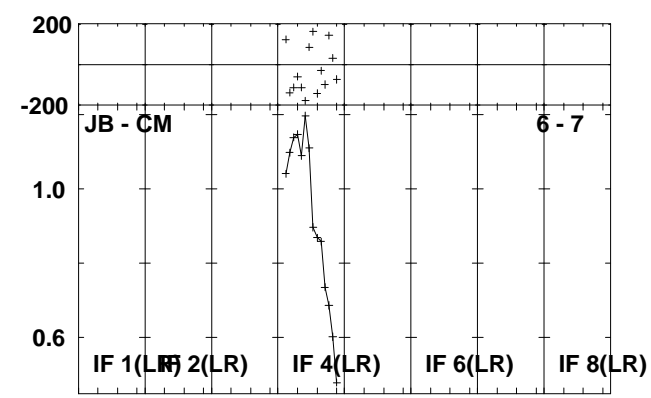
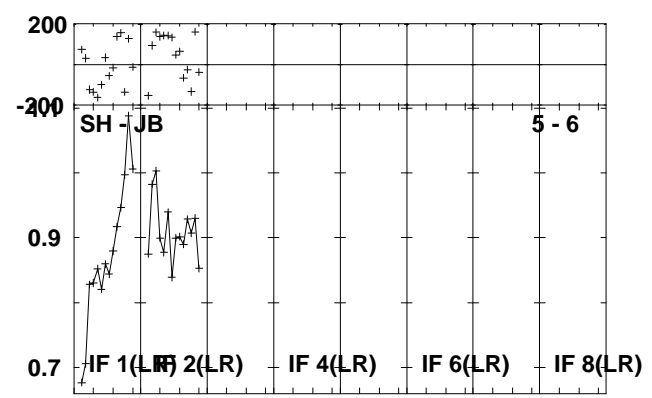
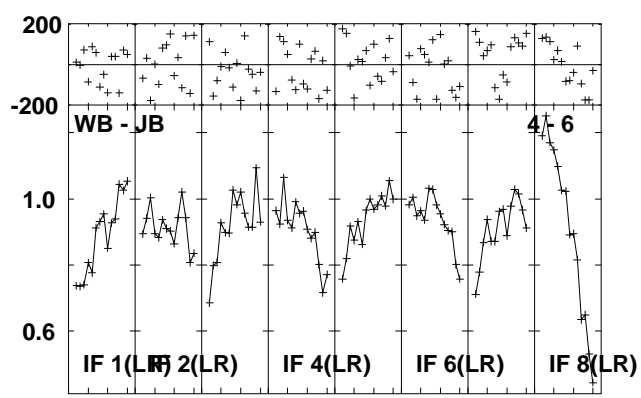
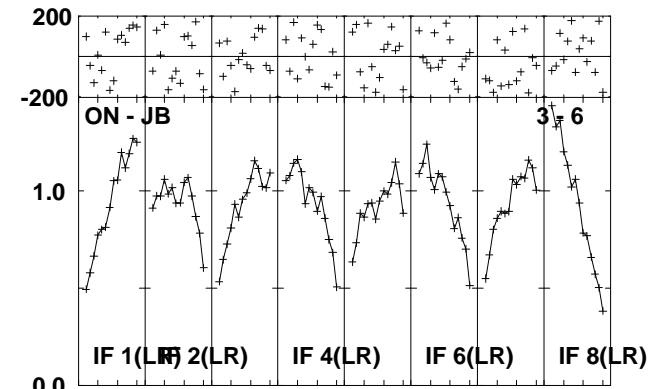
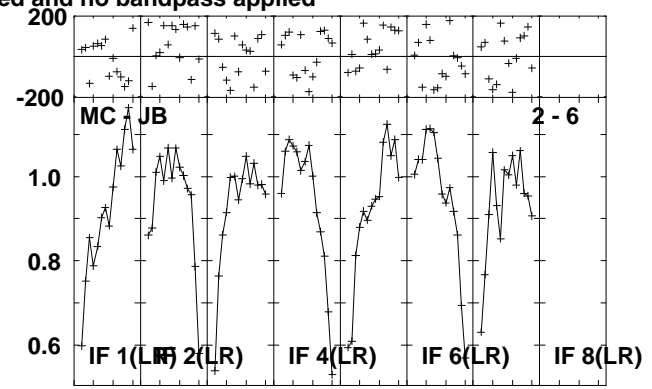
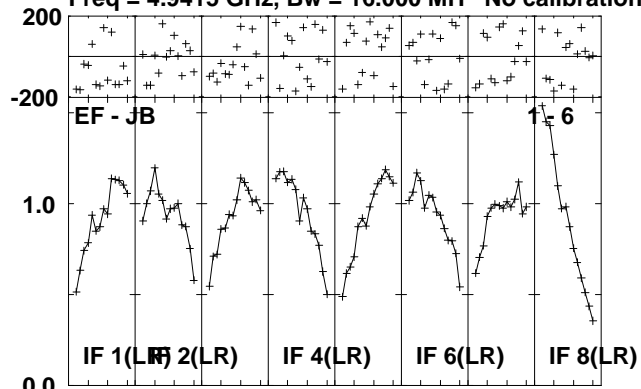

Lower frame: Milli Ampl Jy Top frame: Phas deg
Scalar averaged cross-power spectrum Several baselines displayed
Timerange: 00/19:49:20 to 00/19:54:18

Plot file version 31 created 15-JUL-2010 10:42:54
J1953+35 RR004B.UVDATA.1

Freq = 4.9415 GHz, Bw = 16.000 MH No calibration applied and no bandpass applied

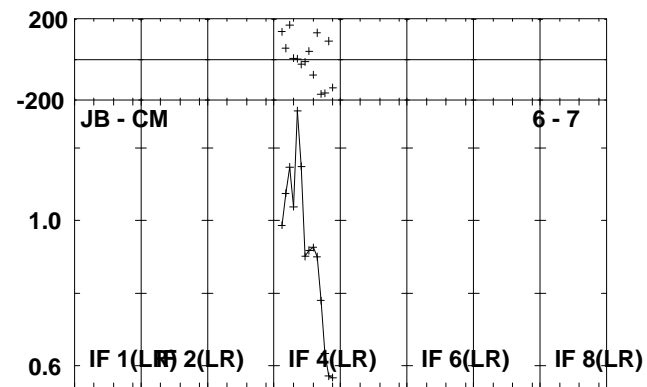
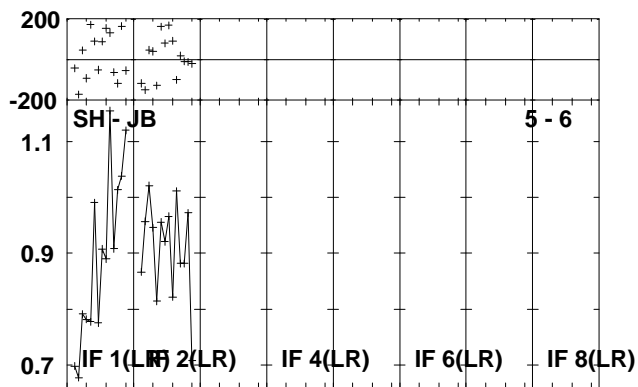
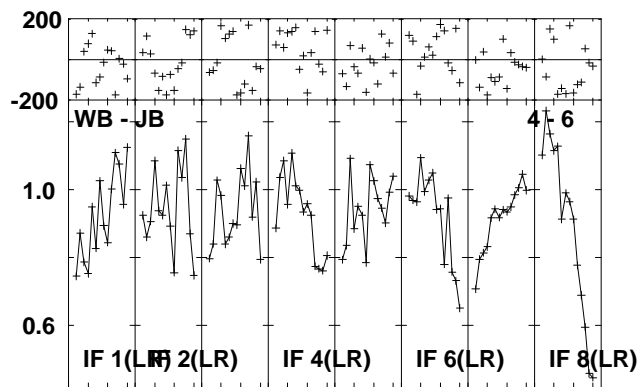
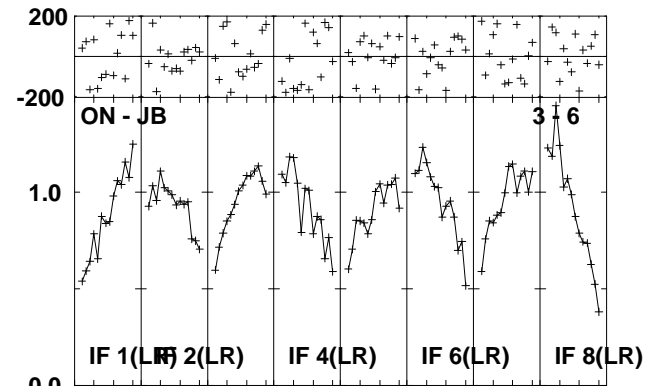
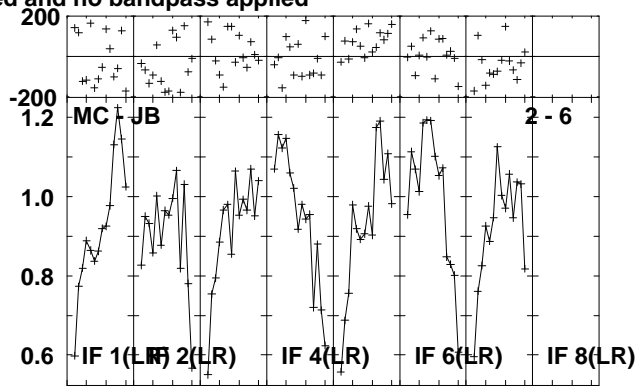
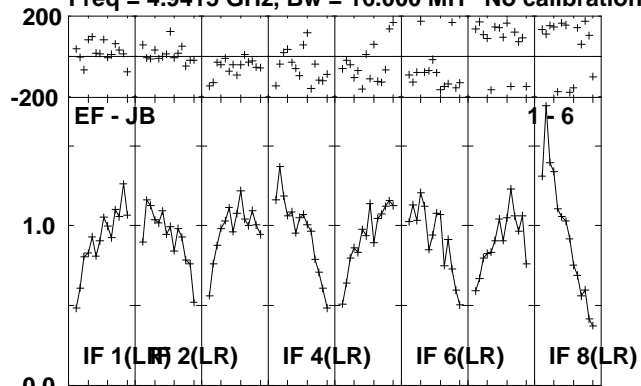

Lower frame: Milli Ampl Jy Top frame: Phas deg
Scalar averaged cross-power spectrum Several baselines displayed
Timerange: 00/19:54:20 to 00/19:56:18

Plot file version 32 created 15-JUL-2010 10:42:55

CYGX-1 RR004B.UVDATA.1

Freq = 4.9415 GHz, Bw = 16.000 MH No calibration applied and no bandpass applied

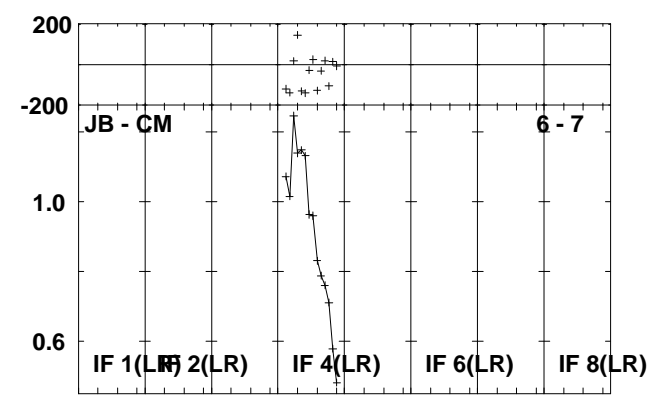
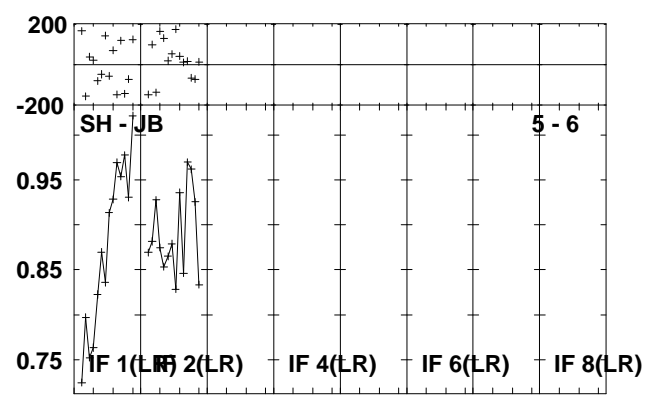
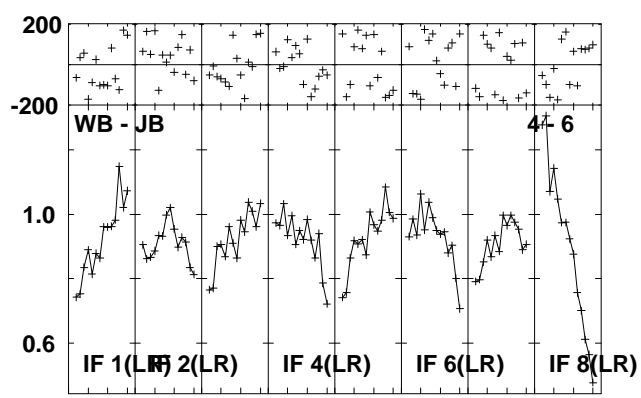
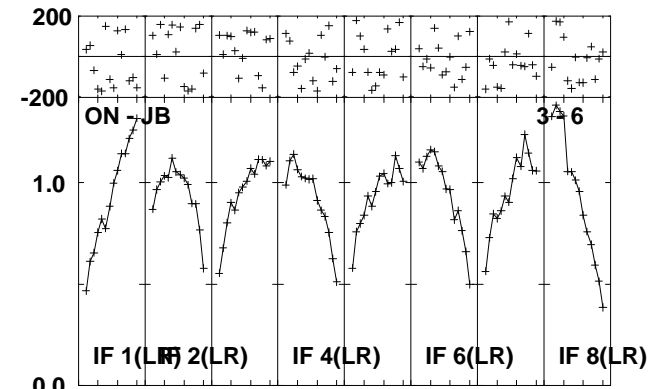
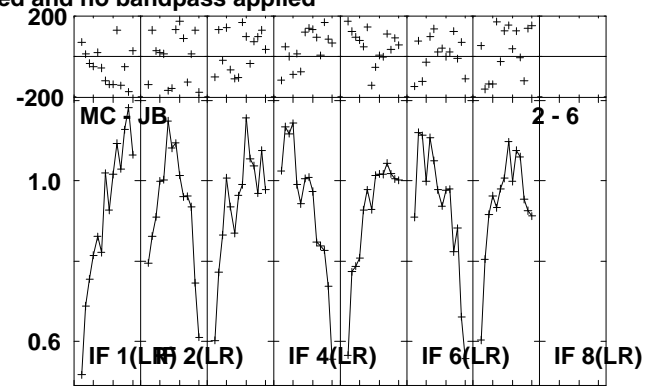
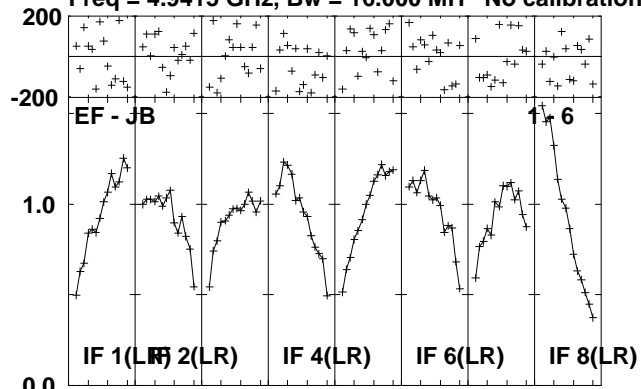

Lower frame: Milli Ampl Jy Top frame: Phas deg
Scalar averaged cross-power spectrum Several baselines displayed
Timerange: 00/19:56:20 to 00/20:01:18

Plot file version 33 created 15-JUL-2010 10:42:58
J1953+35 RR004B.UVDATA.1

Freq = 4.9415 GHz, Bw = 16.000 MH No calibration applied and no bandpass applied

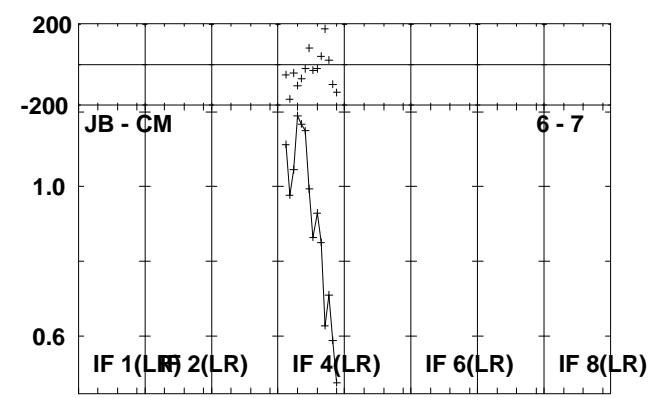
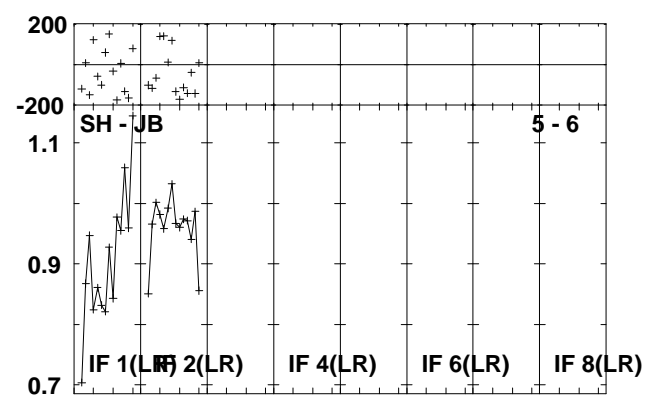
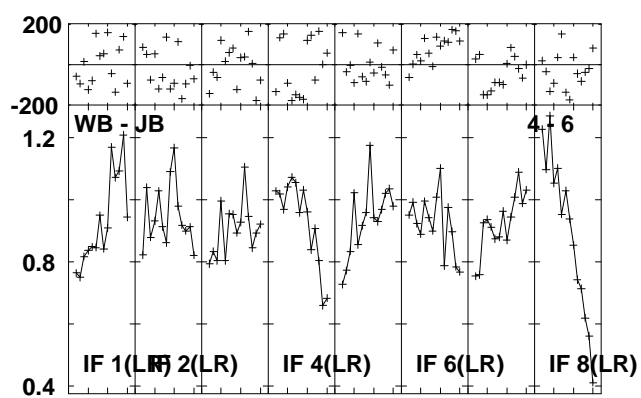
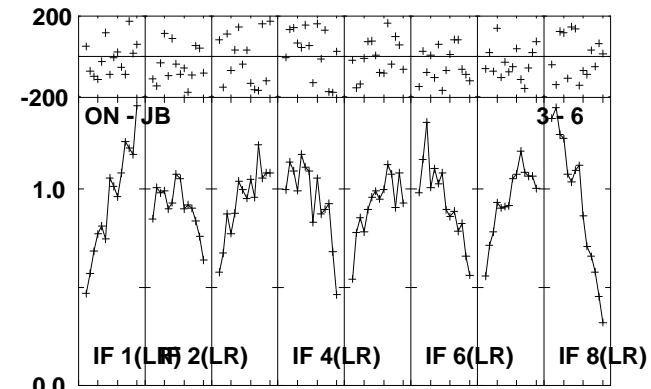
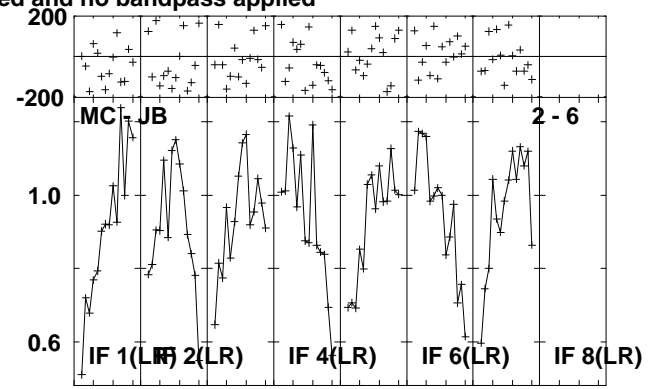
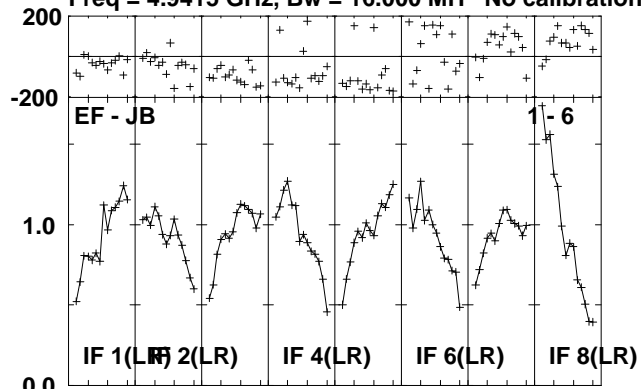

Lower frame: Milli Ampl Jy Top frame: Phas deg
Scalar averaged cross-power spectrum Several baselines displayed
Timerange: 00/20:02:00 to 00/20:03:28

Plot file version 34 created 15-JUL-2010 10:42:59
CYGX-1 RR004B.UVDATA.1

Freq = 4.9415 GHz, Bw = 16.000 MH No calibration applied and no bandpass applied

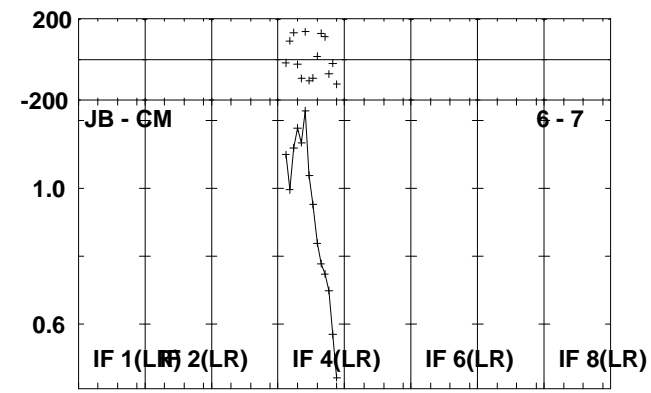
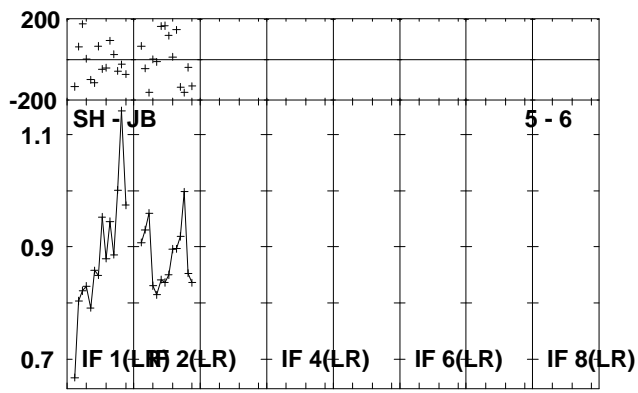
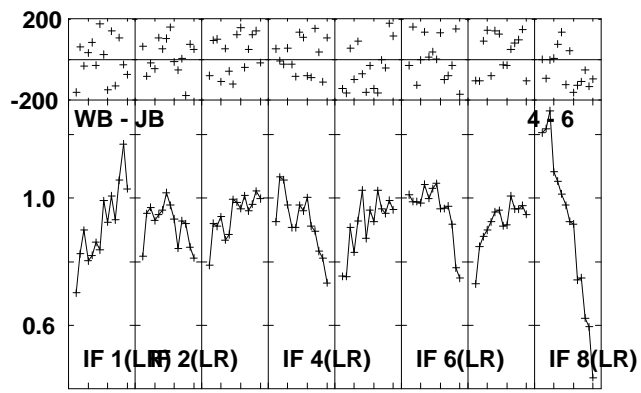
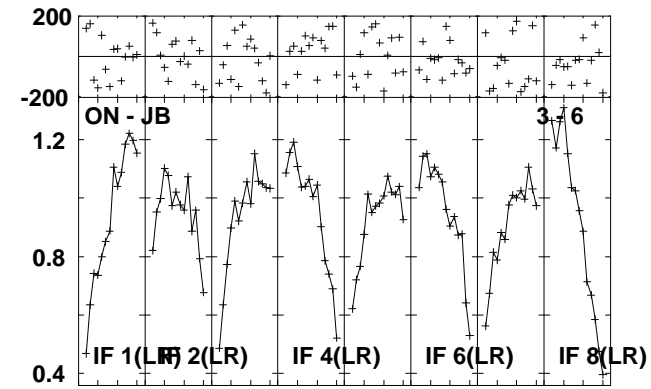
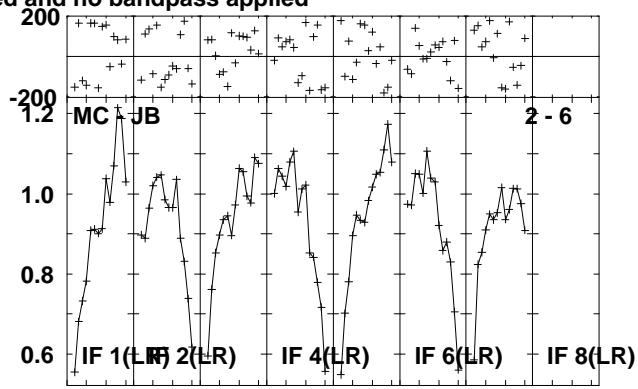
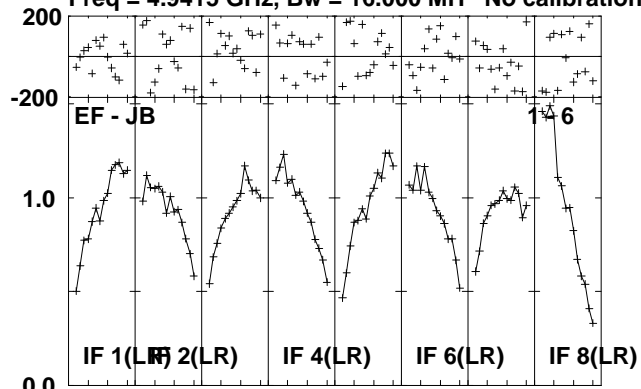

Lower frame: Milli Ampl Jy Top frame: Phas deg
Scalar averaged cross-power spectrum Several baselines displayed
Timerange: 00/20:03:30 to 00/20:08:28

Plot file version 35 created 15-JUL-2010 10:43:02

J1953+35 RR004B.UVDATA.1

Freq = 4.9415 GHz, Bw = 16.000 MH No calibration applied and no bandpass applied

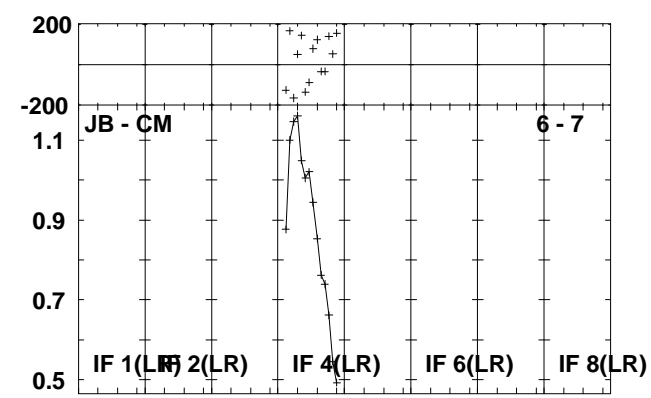
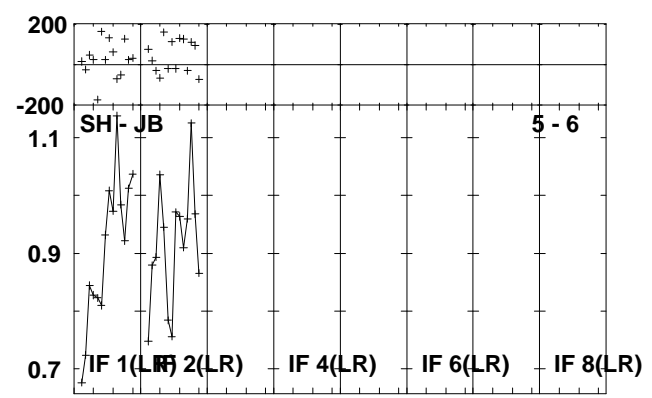
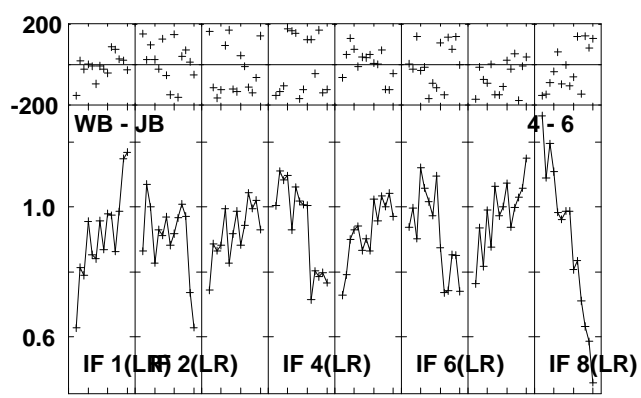
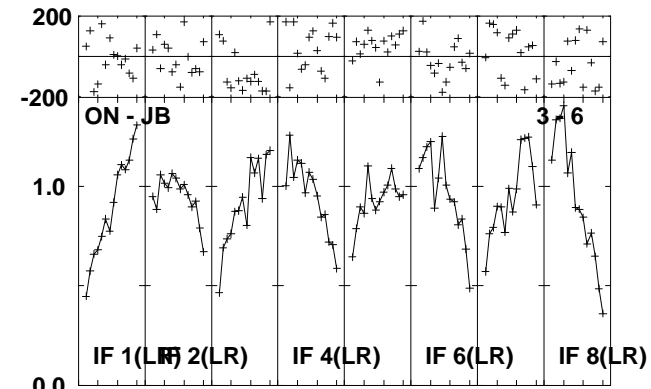
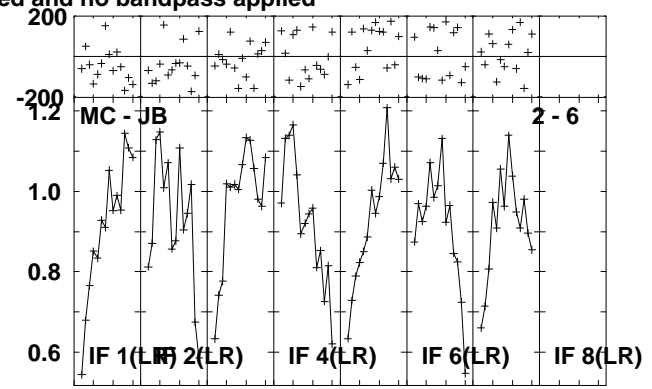
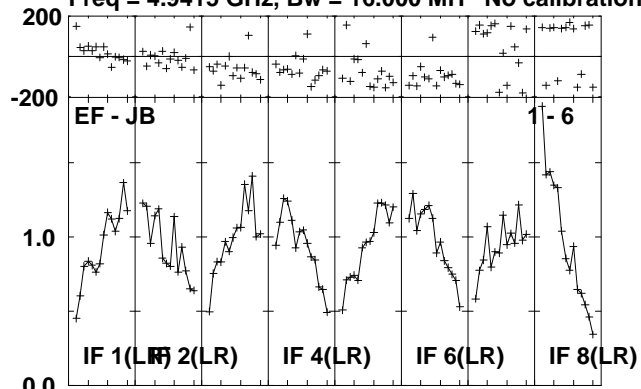

Lower frame: Milli Ampl Jy Top frame: Phas deg
Scalar averaged cross-power spectrum Several baselines displayed
Timerange: 00/20:08:30 to 00/20:10:28

Plot file version 36 created 15-JUL-2010 10:43:03

CYGX-1 RR004B.UVDATA.1

Freq = 4.9415 GHz, Bw = 16.000 MH No calibration applied and no bandpass applied

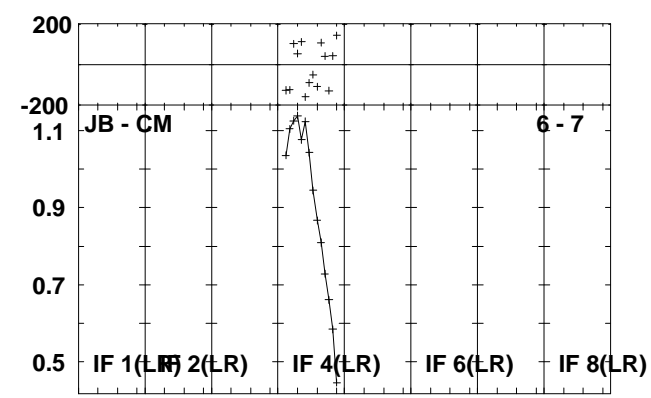
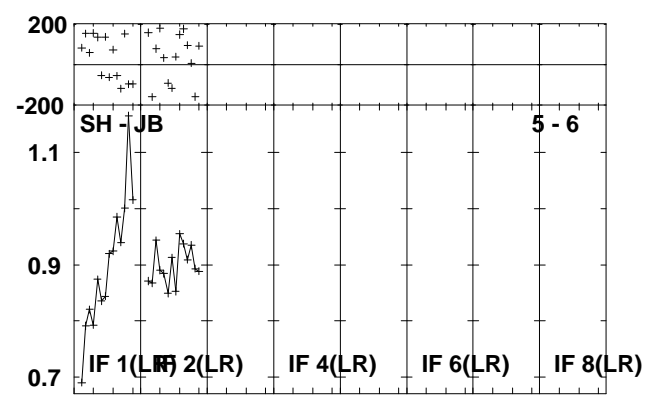
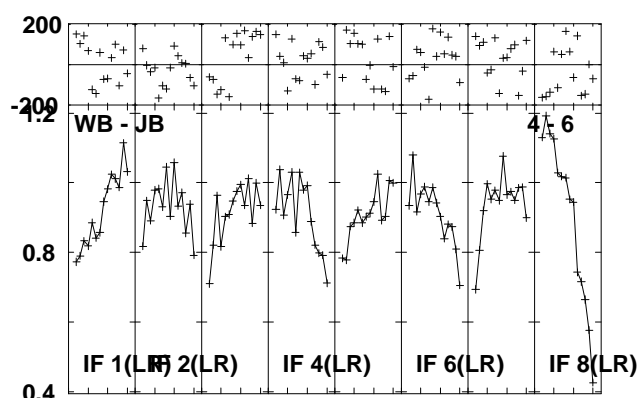
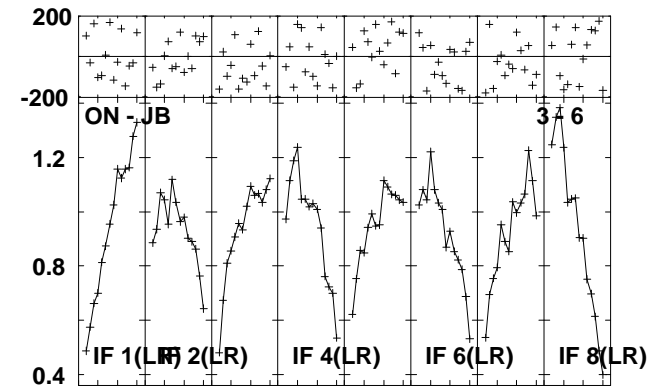
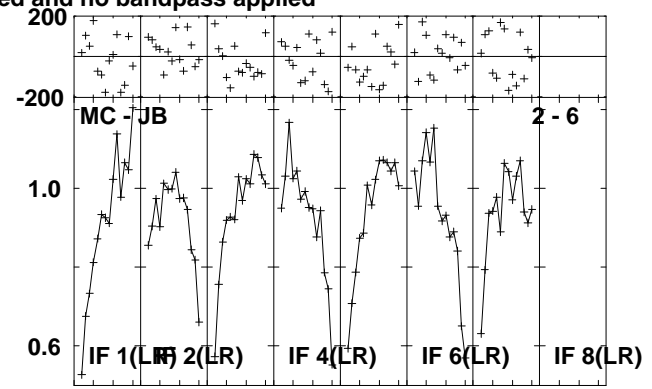
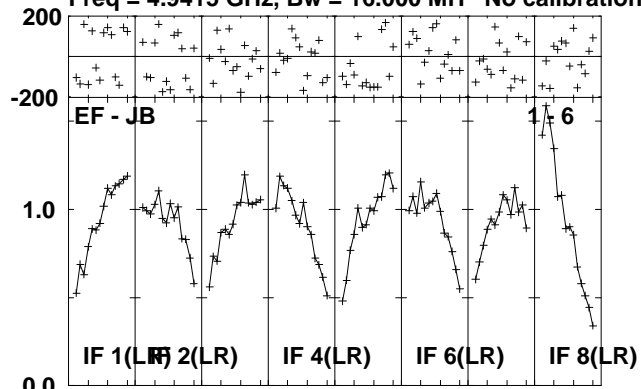

Lower frame: Milli Ampl Jy Top frame: Phas deg
Scalar averaged cross-power spectrum Several baselines displayed
Timerange: 00/20:10:30 to 00/20:15:28

Plot file version 37 created 15-JUL-2010 10:43:05
J1953+35 RR004B.UVDATA.1

Freq = 4.9415 GHz, Bw = 16.000 MH No calibration applied and no bandpass applied

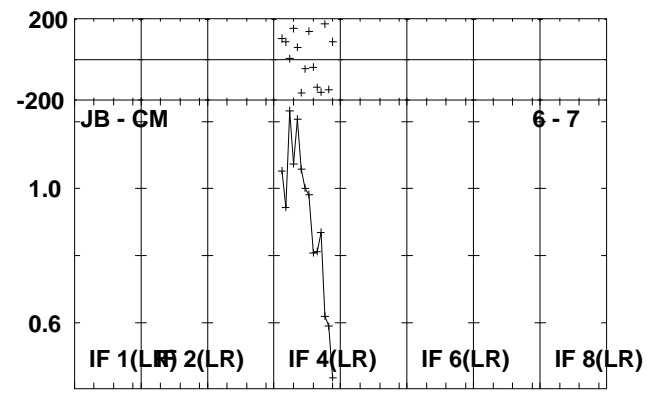
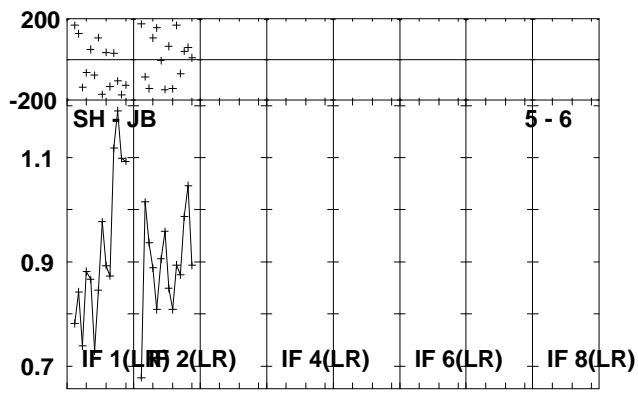
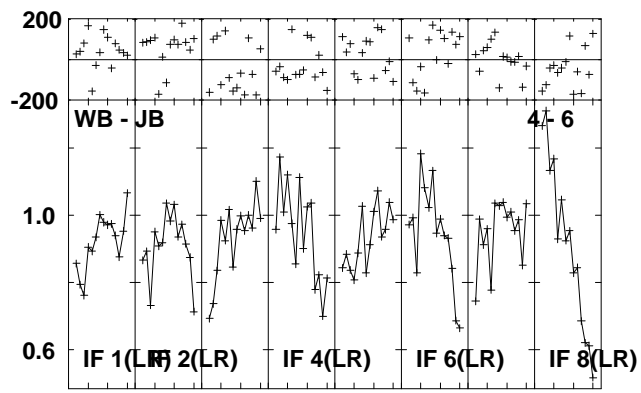
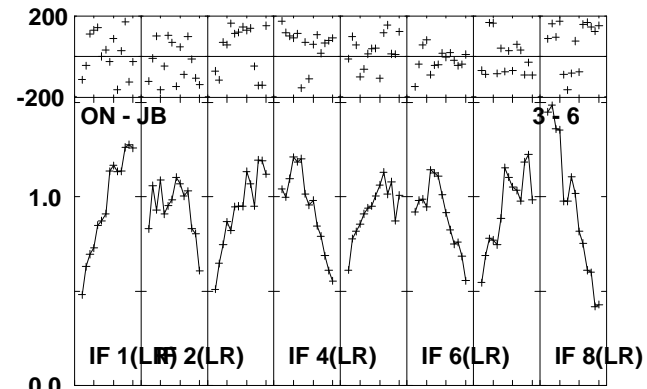
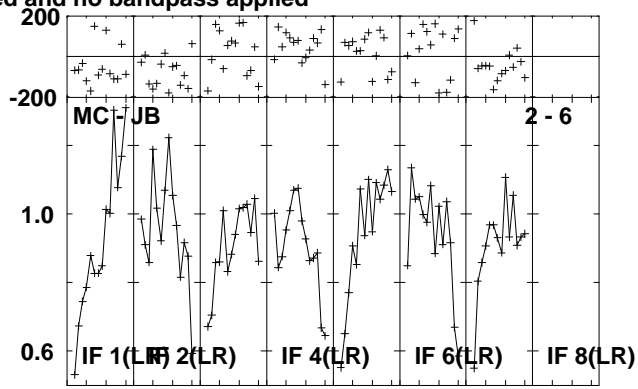
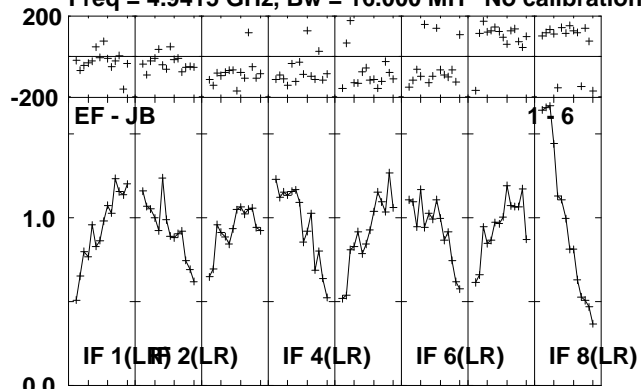

Lower frame: Milli Ampl Jy Top frame: Phas deg
Scalar averaged cross-power spectrum Several baselines displayed
Timerange: 00/20:16:10 to 00/20:17:38

Plot file version 38 created 15-JUL-2010 10:43:06
CYGX-1 RR004B.UVDATA.1

Freq = 4.9415 GHz, Bw = 16.000 MH No calibration applied and no bandpass applied

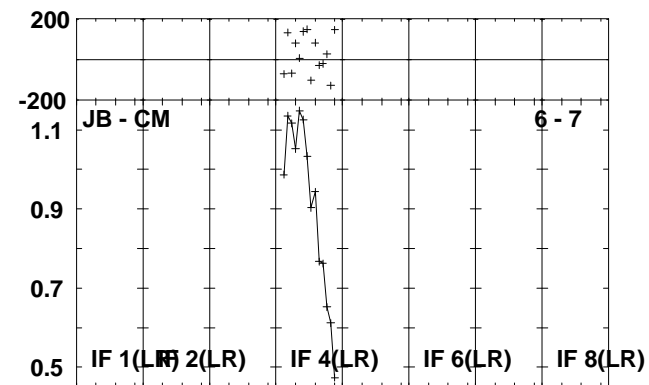
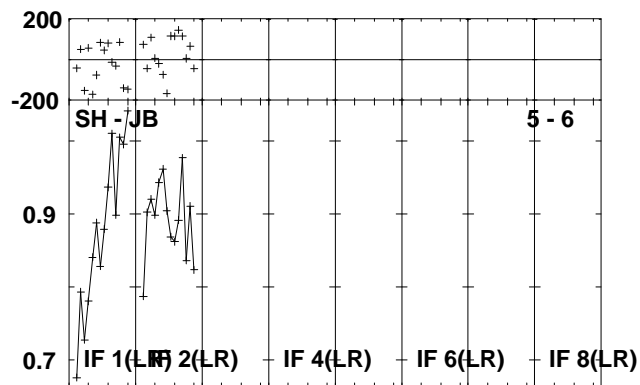
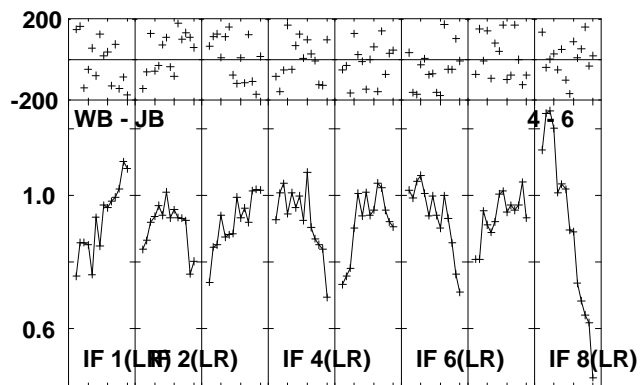
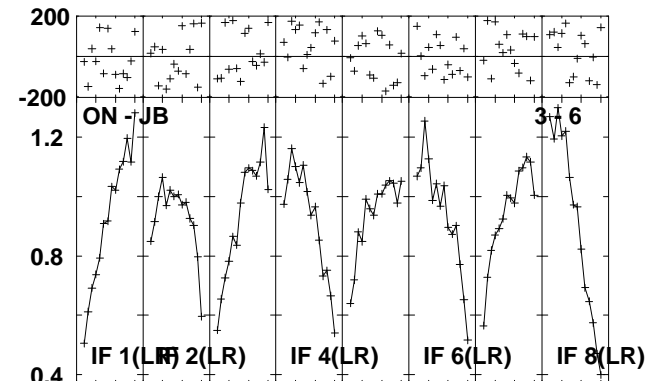
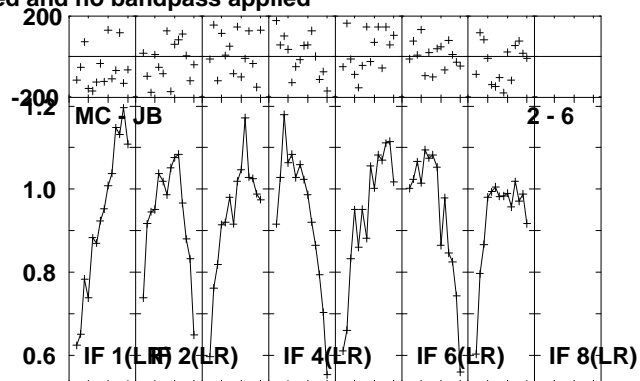
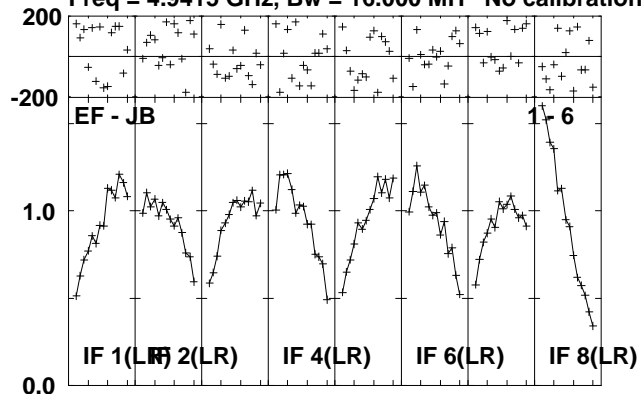

Lower frame: Milli Ampl Jy Top frame: Phas deg
Scalar averaged cross-power spectrum Several baselines displayed
Timerange: 00/20:17:40 to 00/20:22:38

Plot file version 39 created 15-JUL-2010 10:43:09
J1953+35 RR004B.UVDATA.1

Freq = 4.9415 GHz, Bw = 16.000 MH No calibration applied and no bandpass applied

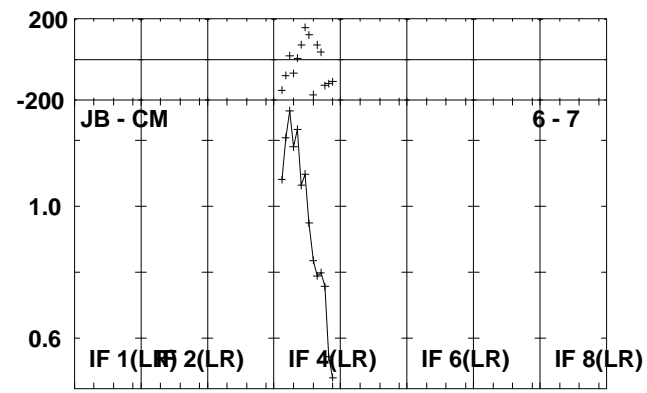
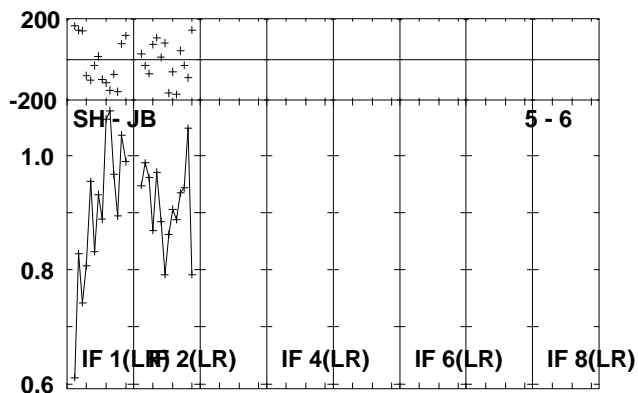
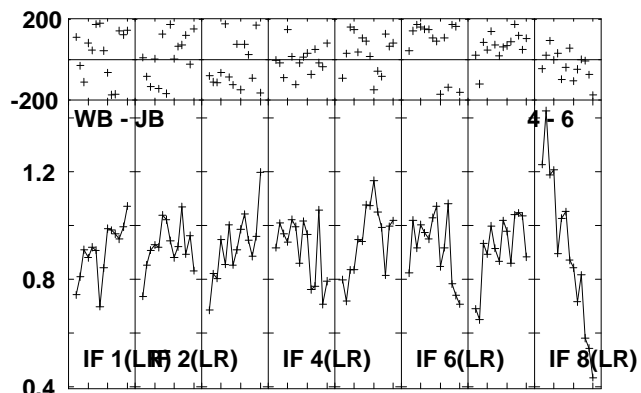
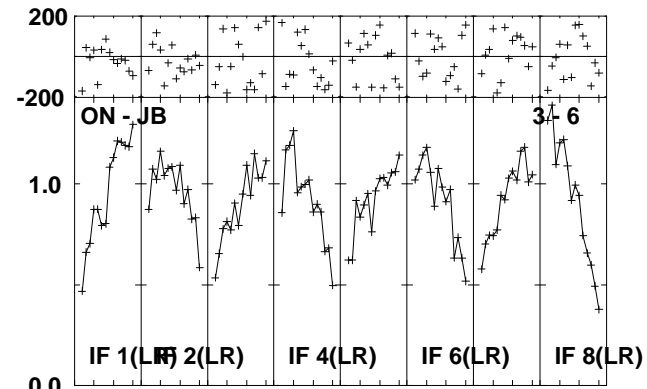
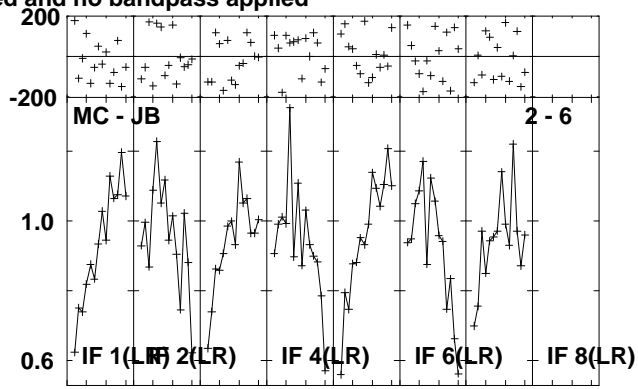
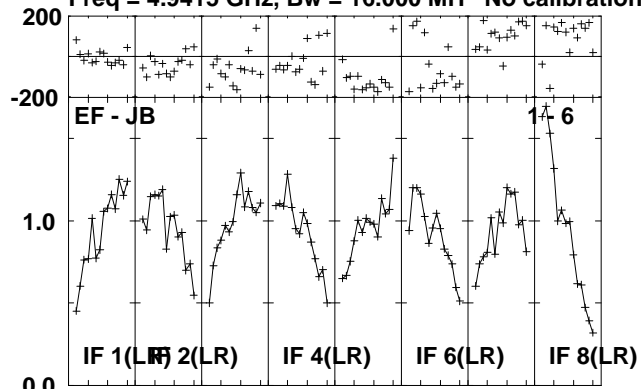

Lower frame: Milli Ampl Jy Top frame: Phas deg
Scalar averaged cross-power spectrum Several baselines displayed
Timerange: 00/20:22:40 to 00/20:24:38

Plot file version 40 created 15-JUL-2010 10:43:10

CYGX-1 RR004B.UVDATA.1

Freq = 4.9415 GHz, Bw = 16.000 MH No calibration applied and no bandpass applied

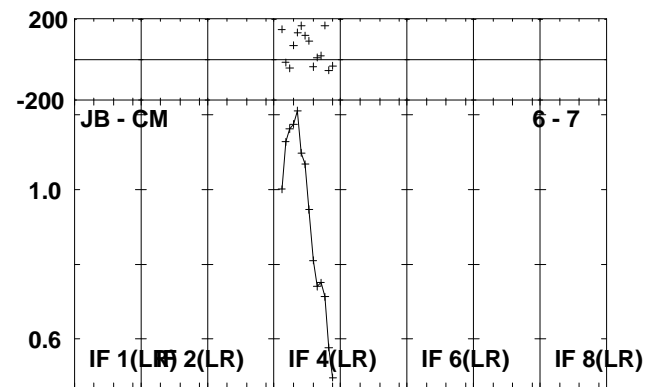
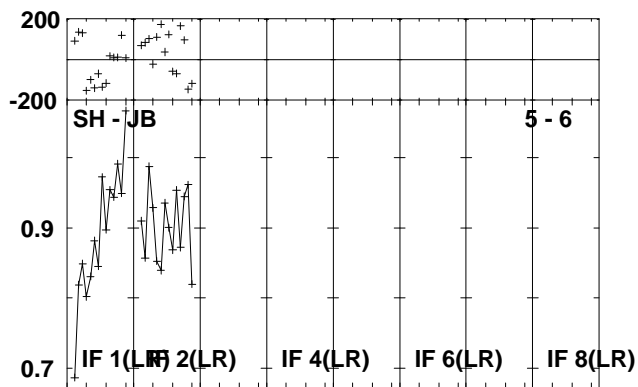
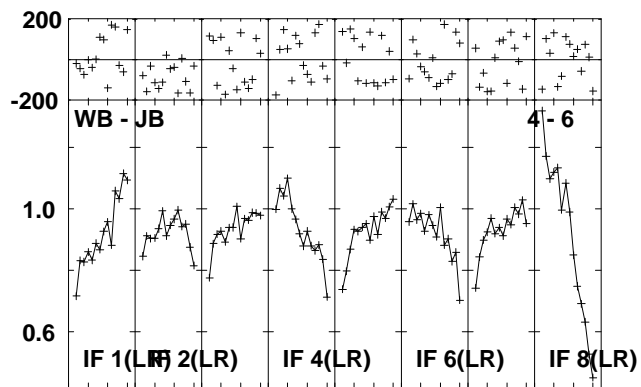
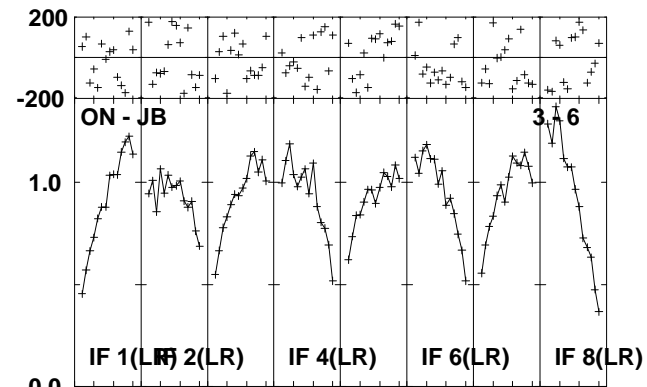
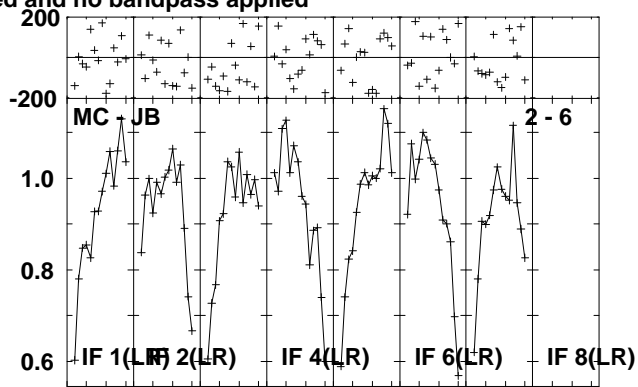
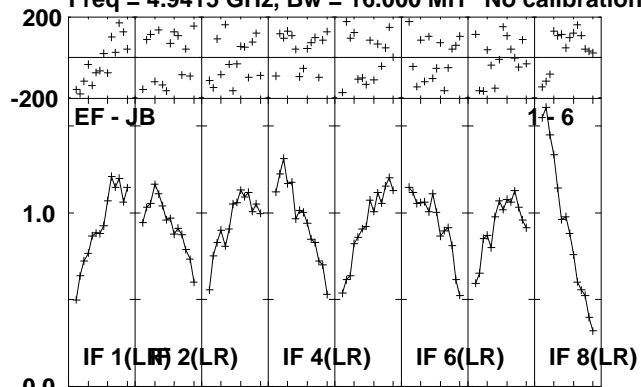

Lower frame: Milli Ampl Jy Top frame: Phas deg
Scalar averaged cross-power spectrum Several baselines displayed
Timerange: 00/20:24:40 to 00/20:29:38

Plot file version 41 created 15-JUL-2010 10:43:13
J1953+35 RR004B.UVDATA.1

Freq = 4.9415 GHz, Bw = 16.000 MH No calibration applied and no bandpass applied

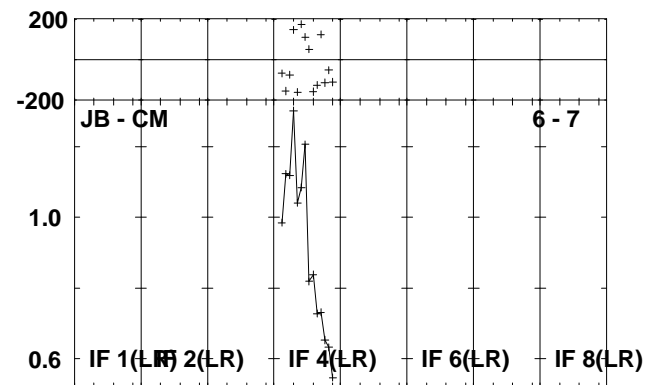
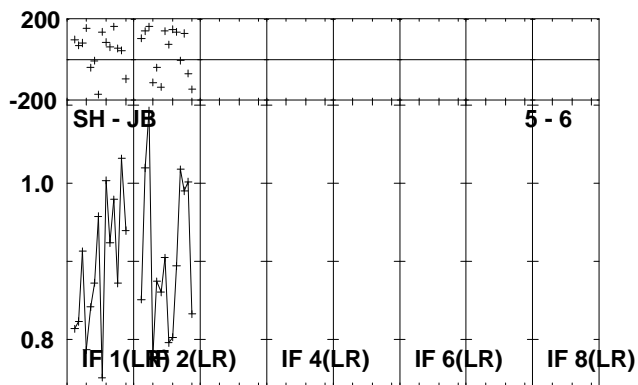
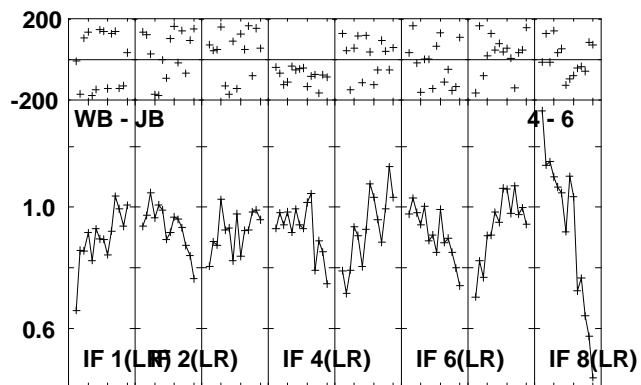
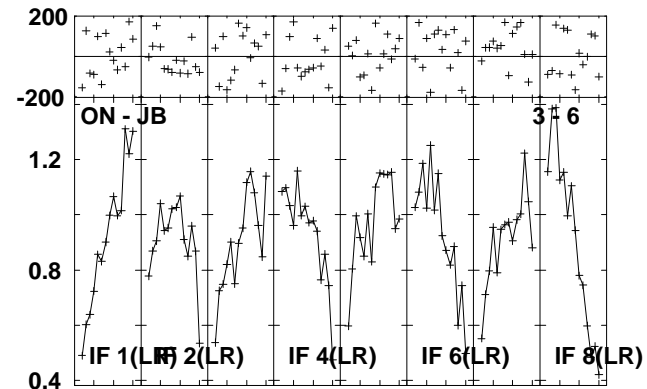
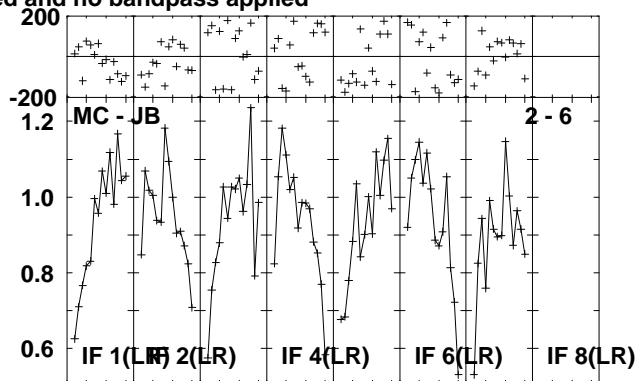
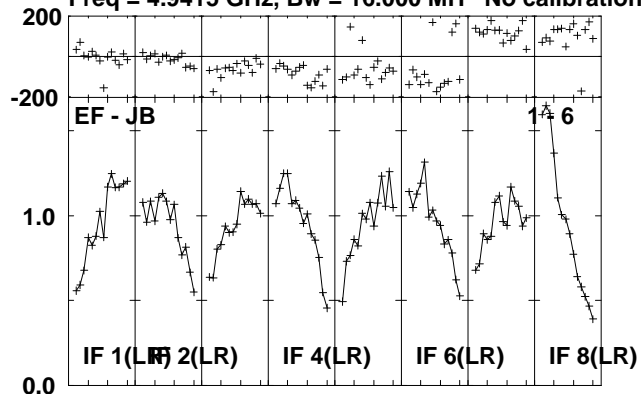

Lower frame: Milli Ampl Jy Top frame: Phas deg
Scalar averaged cross-power spectrum Several baselines displayed
Timerange: 00/20:30:20 to 00/20:31:48

Plot file version 42 created 15-JUL-2010 10:43:14

CYGX-1 RR004B.UVDATA.1

Freq = 4.9415 GHz, Bw = 16.000 MH No calibration applied and no bandpass applied

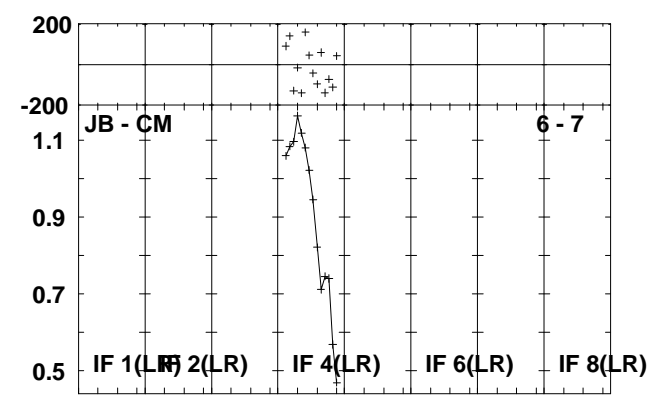
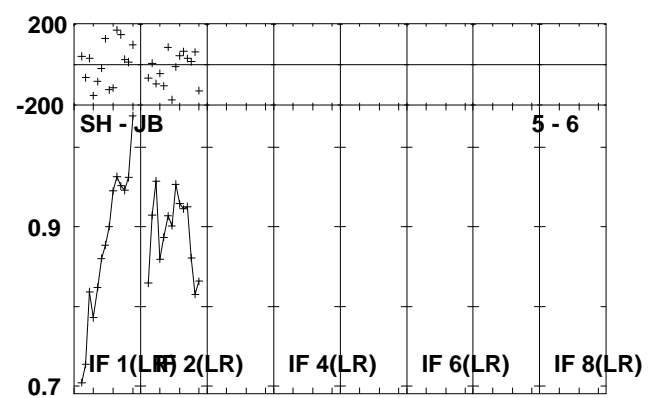
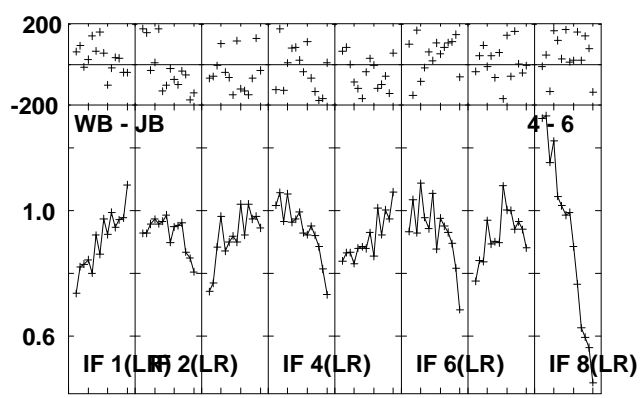
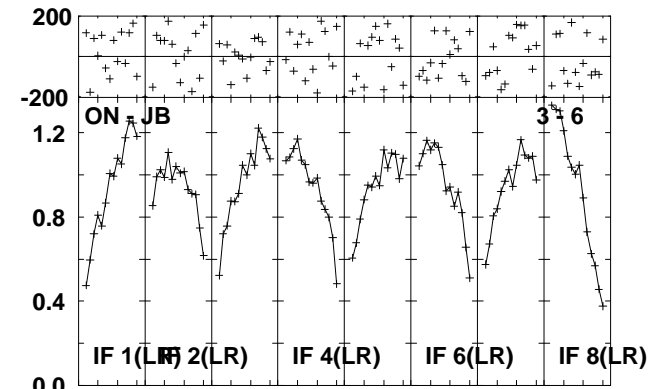
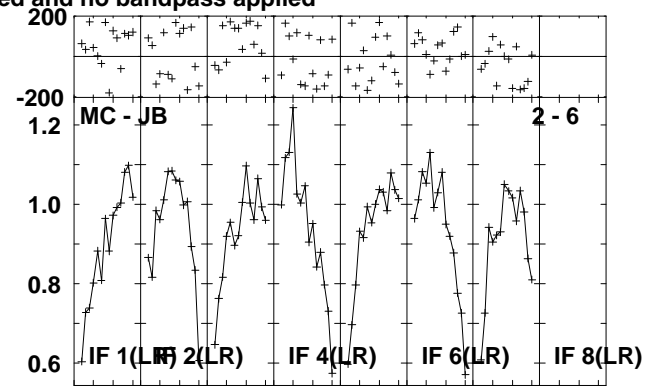
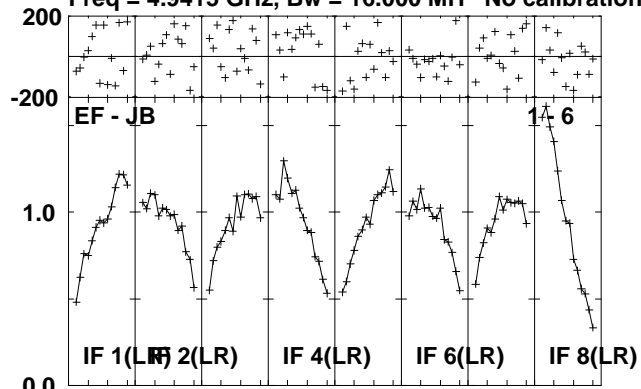

Lower frame: Milli Ampl Jy Top frame: Phas deg
Scalar averaged cross-power spectrum Several baselines displayed
Timerange: 00/20:31:50 to 00/20:36:48

Plot file version 43 created 15-JUL-2010 10:43:22

J1953+35 RR004B.UVDATA.1

Freq = 4.9415 GHz, Bw = 16.000 MH No calibration applied and no bandpass applied

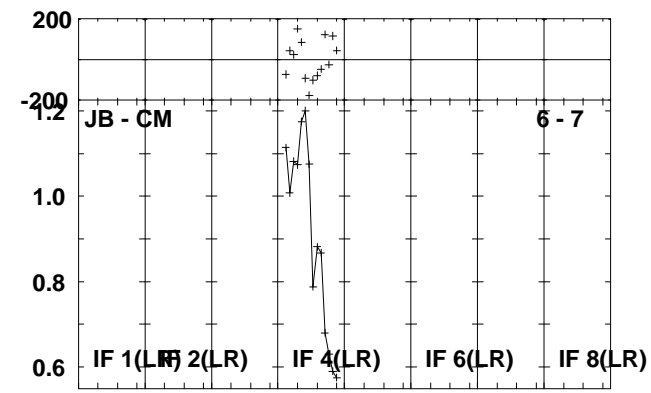
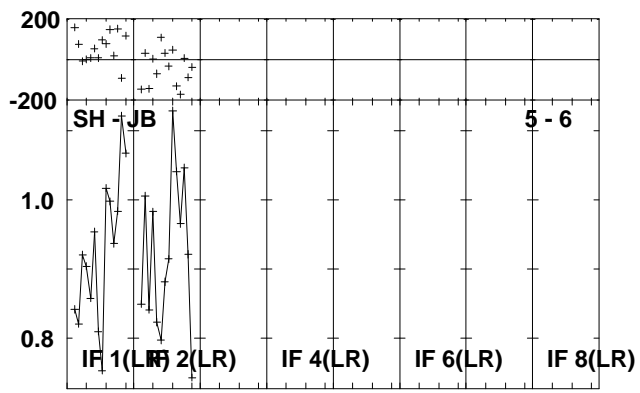
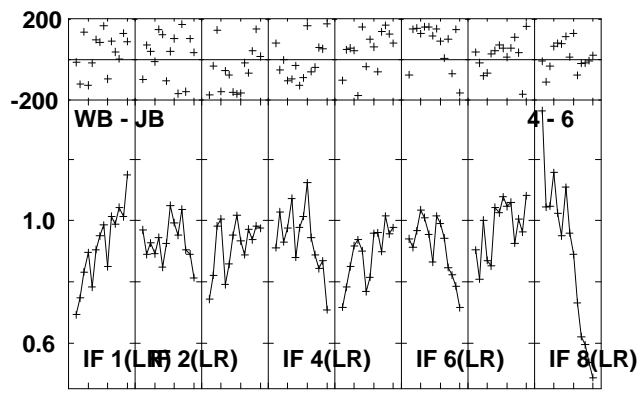
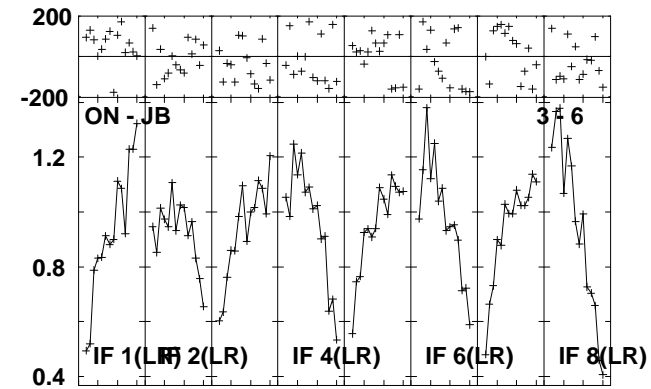
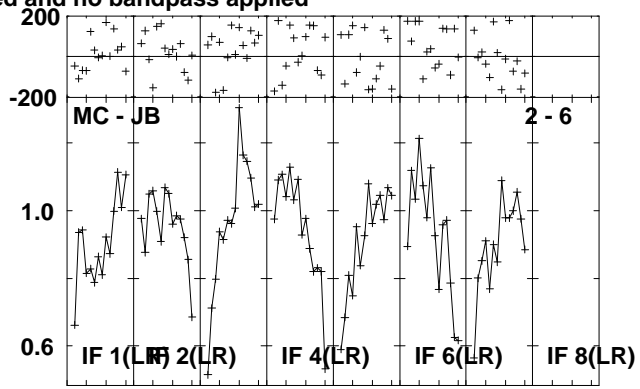
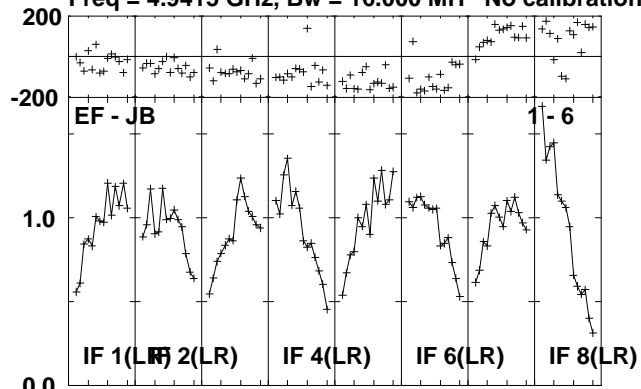

Lower frame: Milli Ampl Jy Top frame: Phas deg
Scalar averaged cross-power spectrum Several baselines displayed
Timerange: 00/20:36:50 to 00/20:38:48

Plot file version 44 created 15-JUL-2010 10:43:23
CYGX-1 RR004B.UVDATA.1

Freq = 4.9415 GHz, Bw = 16.000 MH No calibration applied and no bandpass applied

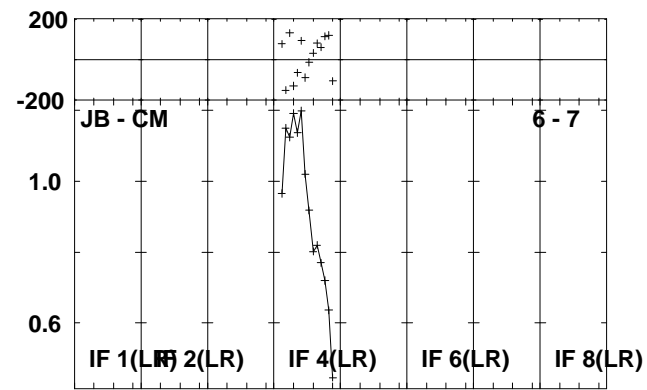
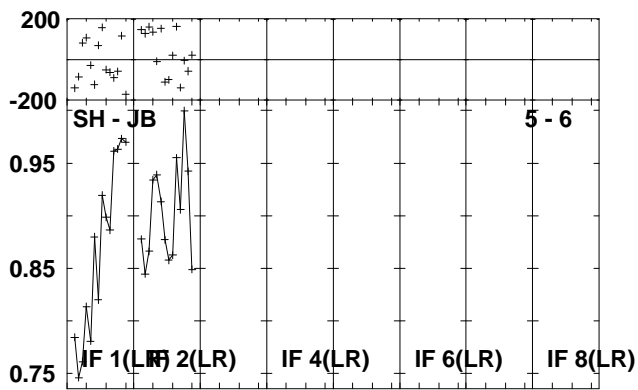
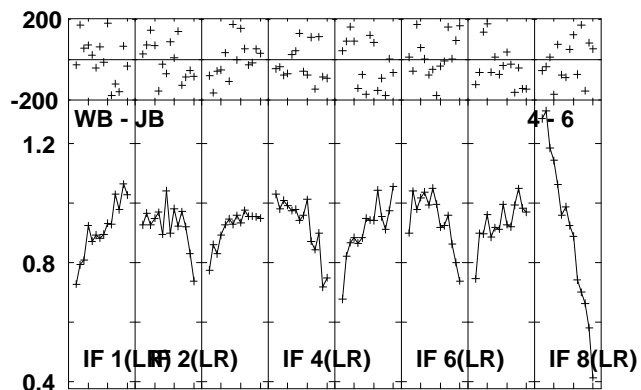
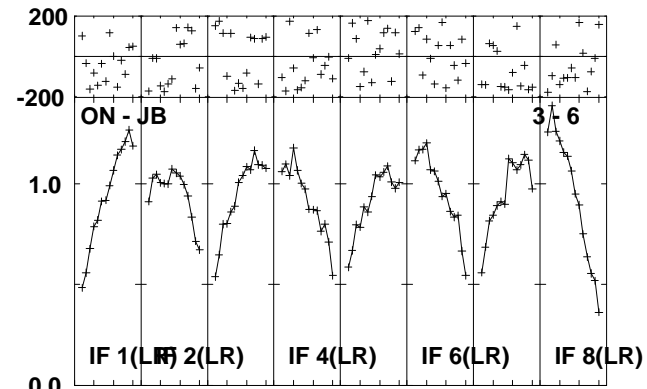
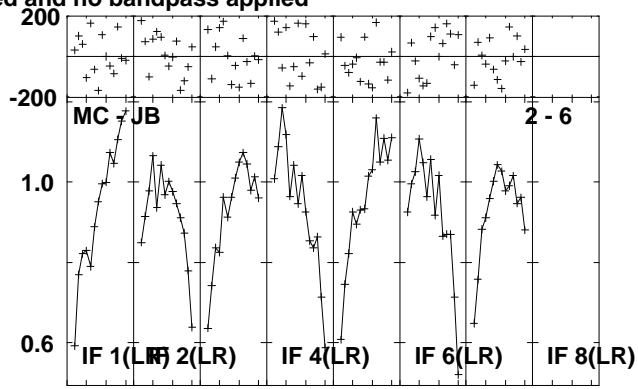
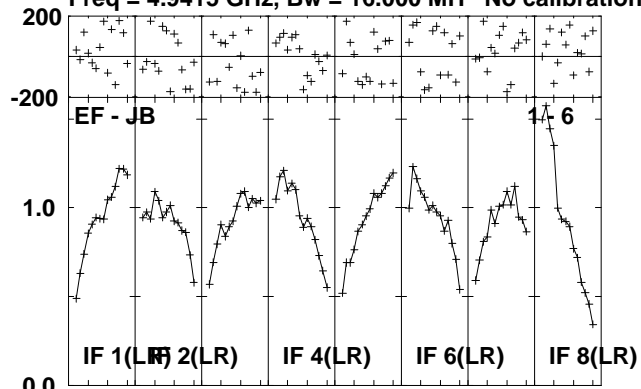

Lower frame: Milli Ampl Jy Top frame: Phas deg
Scalar averaged cross-power spectrum Several baselines displayed
Timerange: 00/20:38:50 to 00/20:43:48

Plot file version 45 created 15-JUL-2010 10:43:25
J1953+35 RR004B.UVDATA.1

Freq = 4.9415 GHz, Bw = 16.000 MH No calibration applied and no bandpass applied

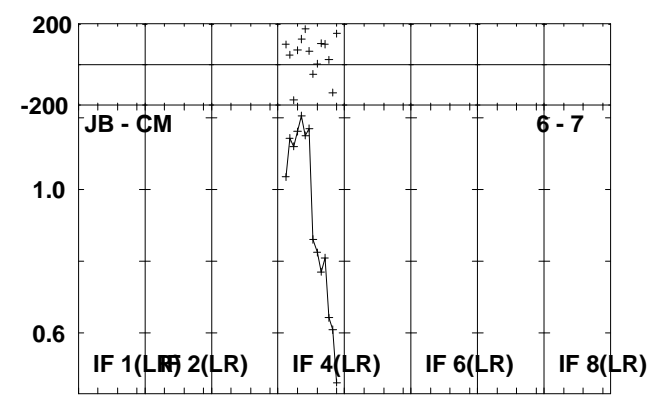
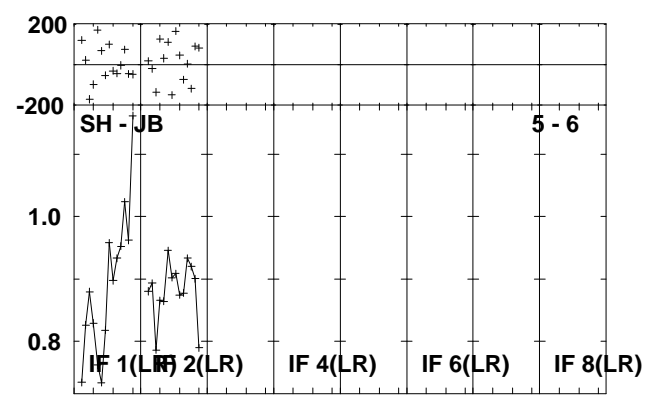
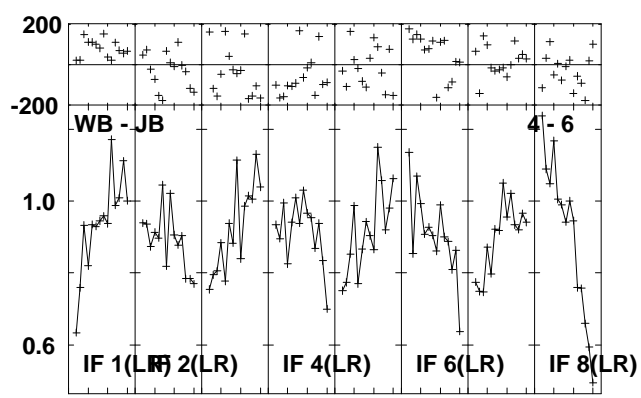
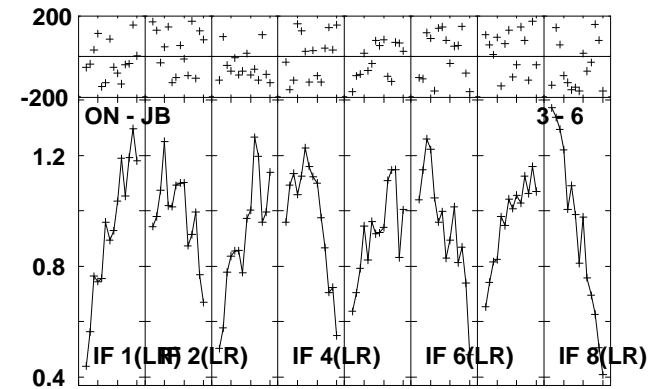
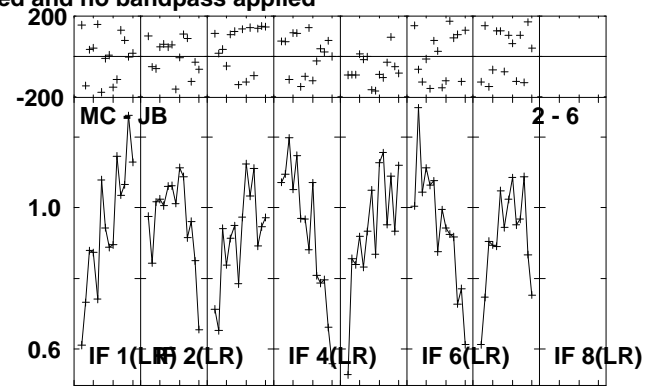
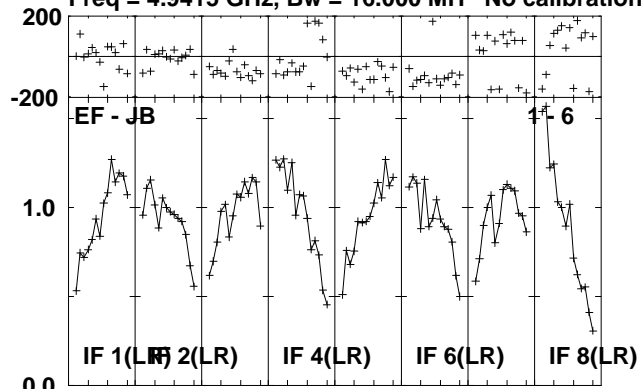

Lower frame: Milli Ampl Jy Top frame: Phas deg
Scalar averaged cross-power spectrum Several baselines displayed
Timerange: 00/20:44:30 to 00/20:45:58

Plot file version 46 created 15-JUL-2010 10:43:27

CYGX-1 RR004B.UVDATA.1

Freq = 4.9415 GHz, Bw = 16.000 MH No calibration applied and no bandpass applied

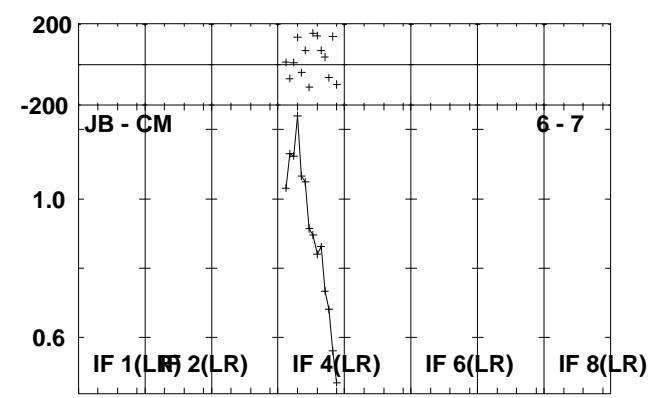
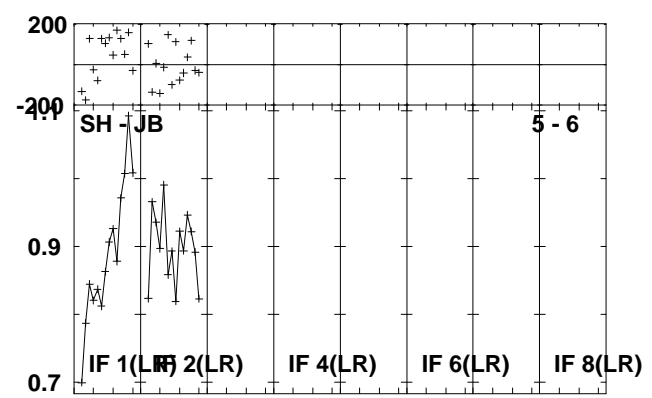
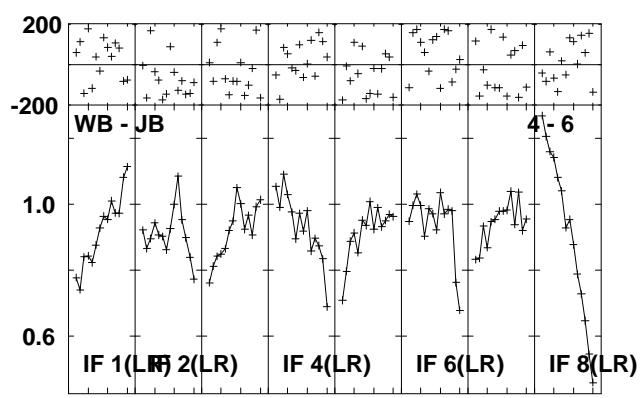
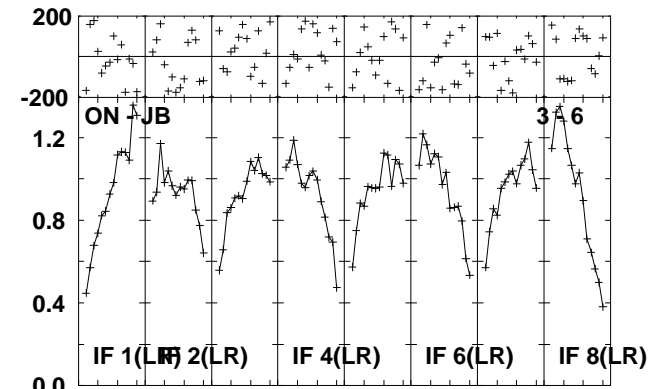
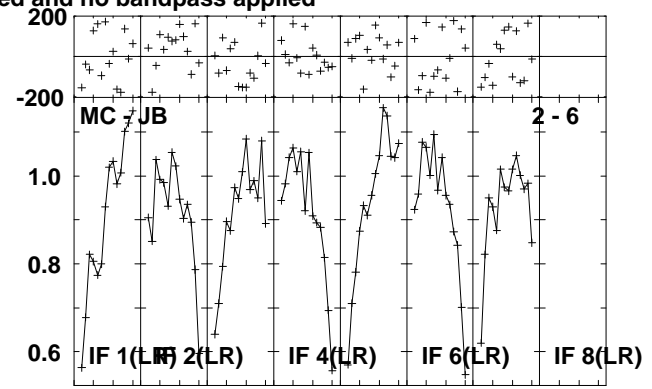
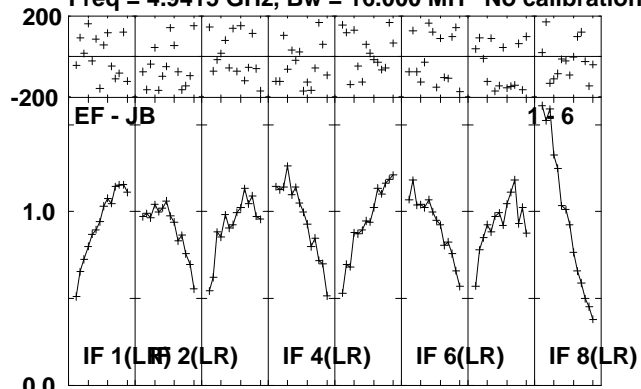

Lower frame: Milli Ampl Jy Top frame: Phas deg
Scalar averaged cross-power spectrum Several baselines displayed
Timerange: 00/20:46:00 to 00/20:50:58

Plot file version 47 created 15-JUL-2010 10:43:29

J1953+35 RR004B.UVDATA.1

Freq = 4.9415 GHz, Bw = 16.000 MH No calibration applied and no bandpass applied

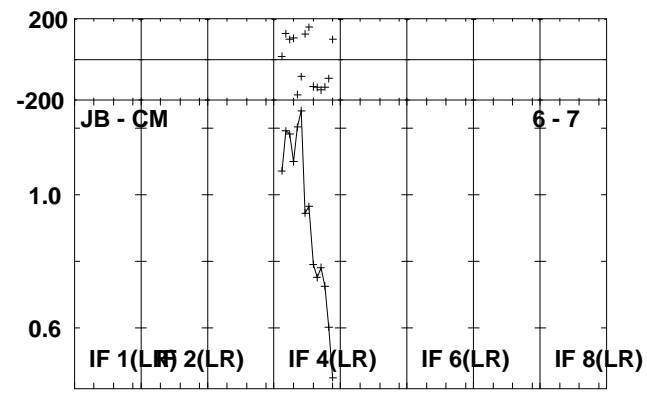
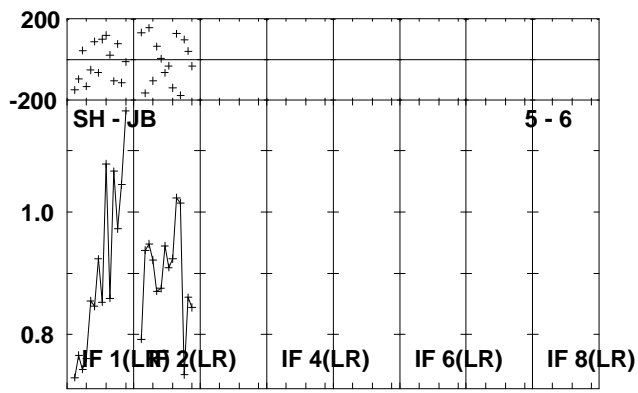
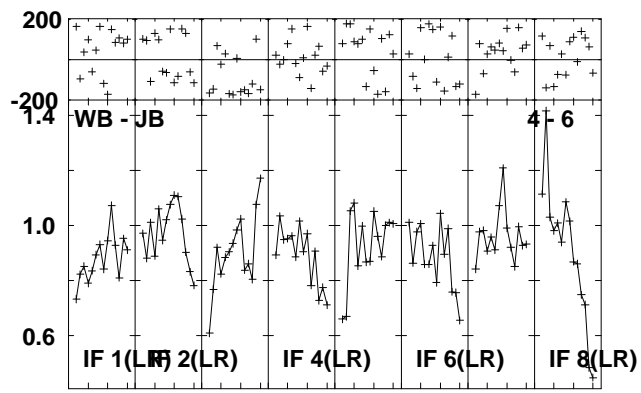
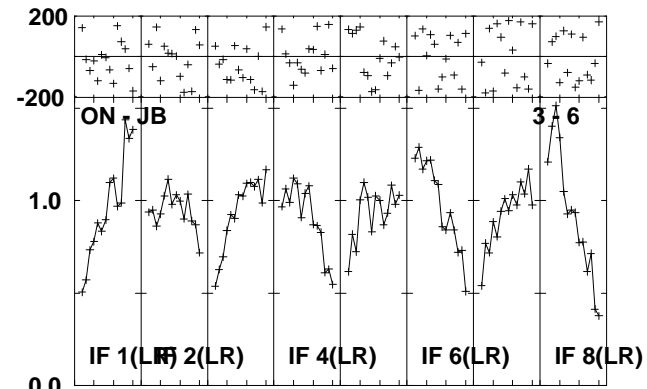
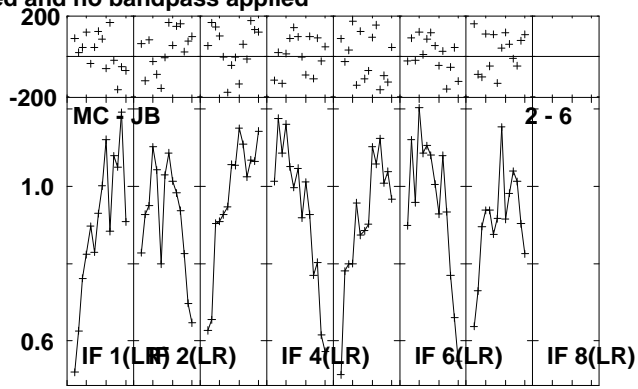
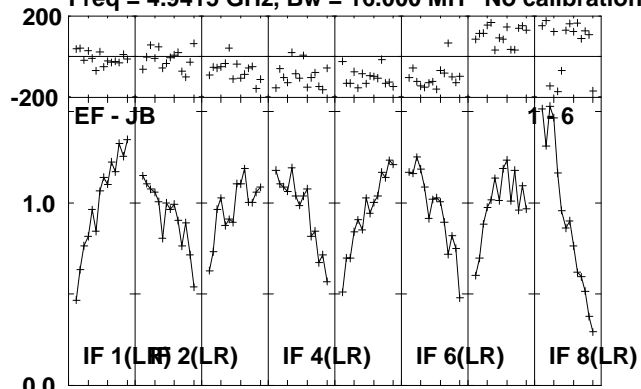

Lower frame: Milli Ampl Jy Top frame: Phas deg
Scalar averaged cross-power spectrum Several baselines displayed
Timerange: 00/20:51:00 to 00/20:52:58

Plot file version 48 created 15-JUL-2010 10:43:30

CYGX-1 RR004B.UVDATA.1

Freq = 4.9415 GHz, Bw = 16.000 MH No calibration applied and no bandpass applied

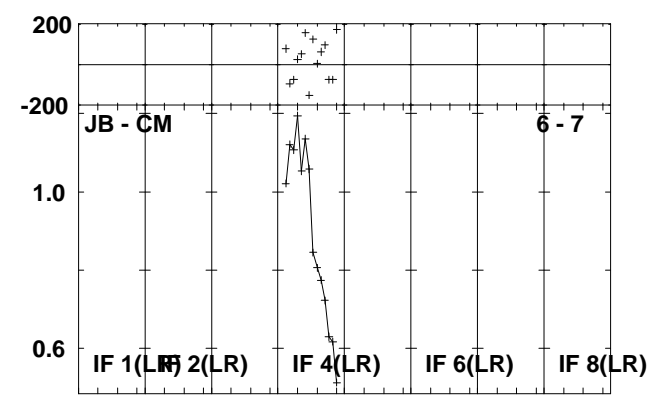
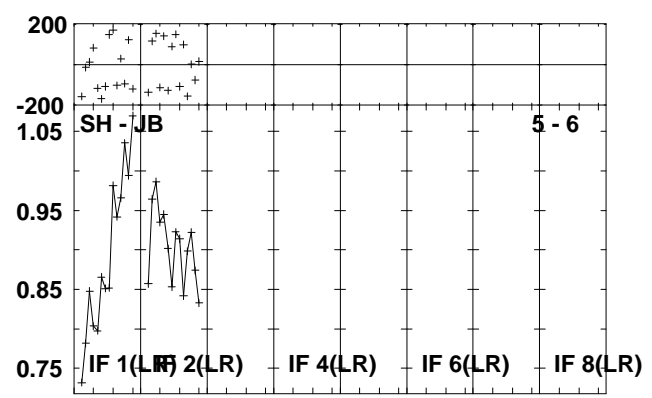
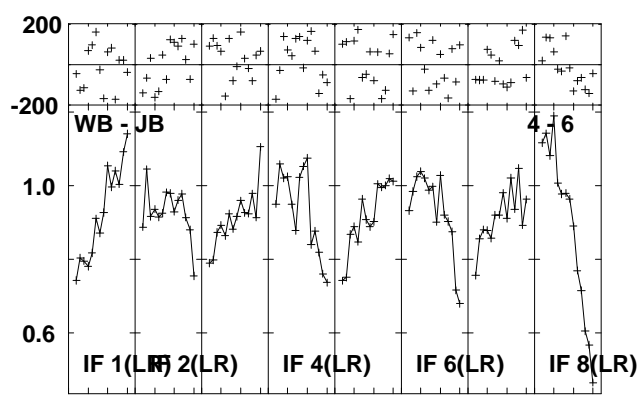
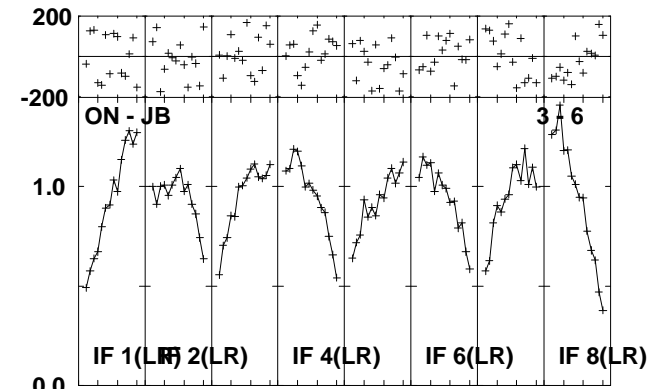
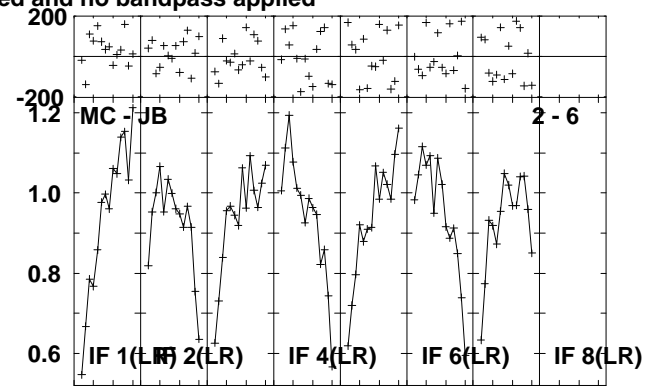
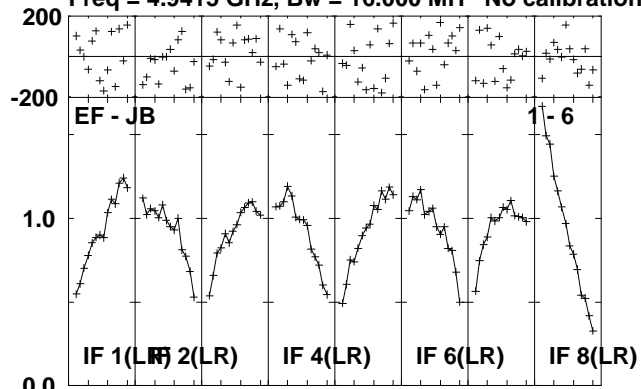

Lower frame: Milli Ampl Jy Top frame: Phas deg
Scalar averaged cross-power spectrum Several baselines displayed
Timerange: 00/20:53:00 to 00/20:57:58

Plot file version 49 created 15-JUL-2010 10:43:33
J1953+35 RR004B.UVDATA.1

Freq = 4.9415 GHz, Bw = 16.000 MH No calibration applied and no bandpass applied

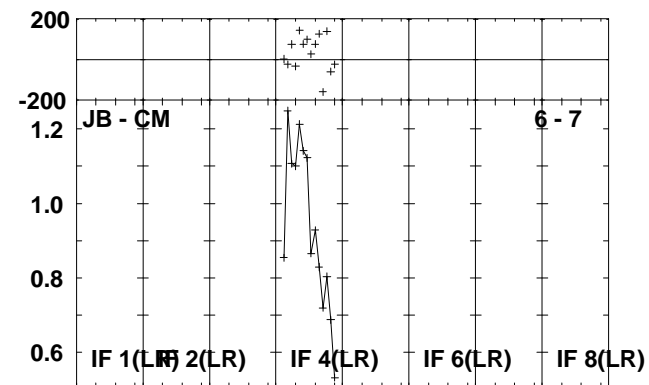
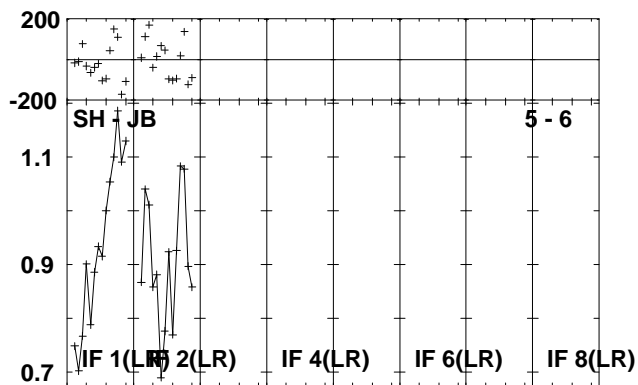
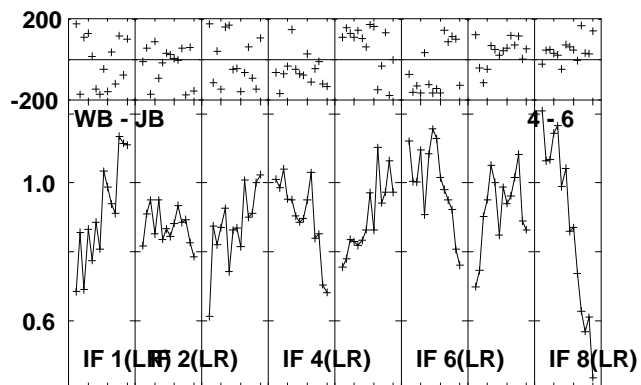
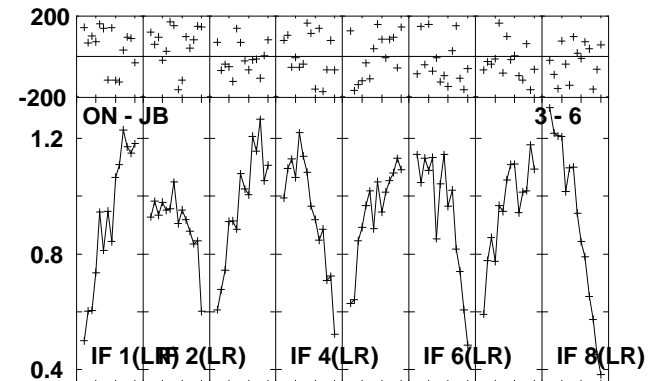
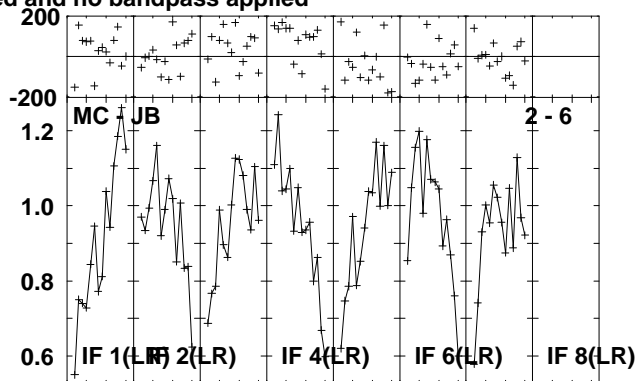
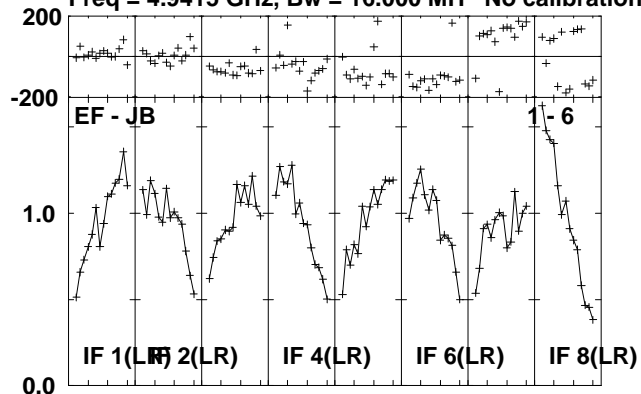

Lower frame: Milli Ampl Jy Top frame: Phas deg
Scalar averaged cross-power spectrum Several baselines displayed
Timerange: 00/20:58:40 to 00/21:00:08

Plot file version 50 created 15-JUL-2010 10:43:34
CYGX-1 RR004B.UVDATA.1

Freq = 4.9415 GHz, Bw = 16.000 MH No calibration applied and no bandpass applied

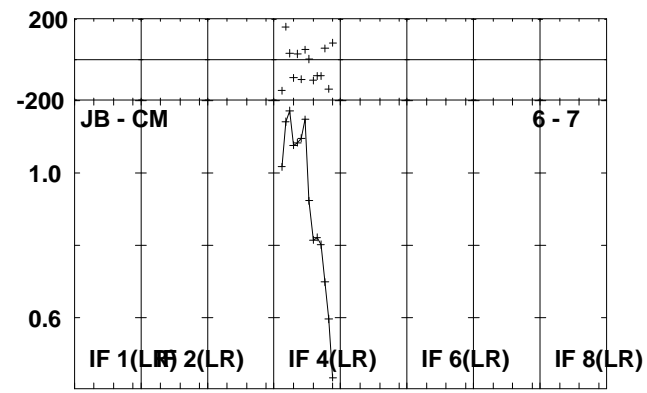
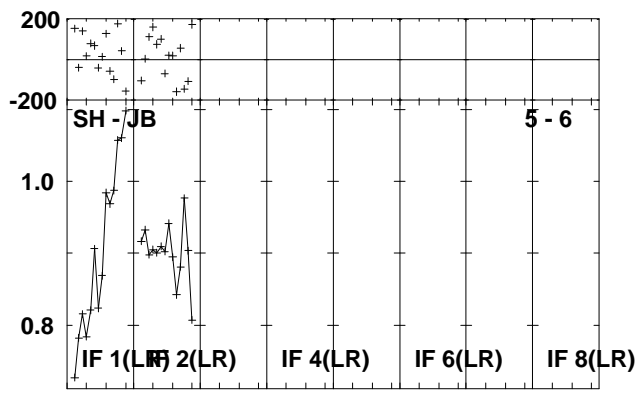
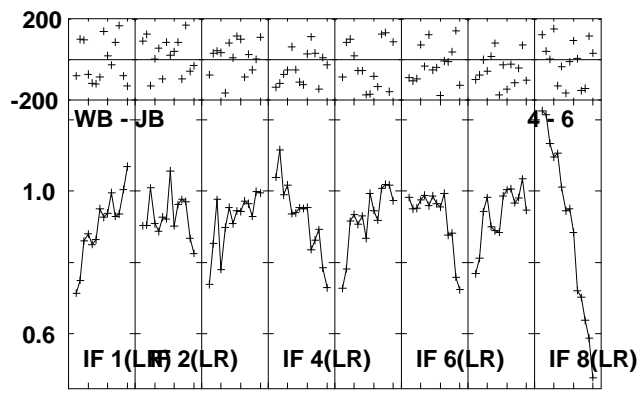
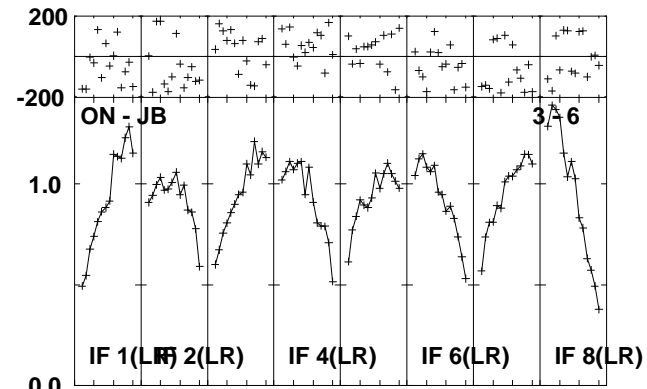
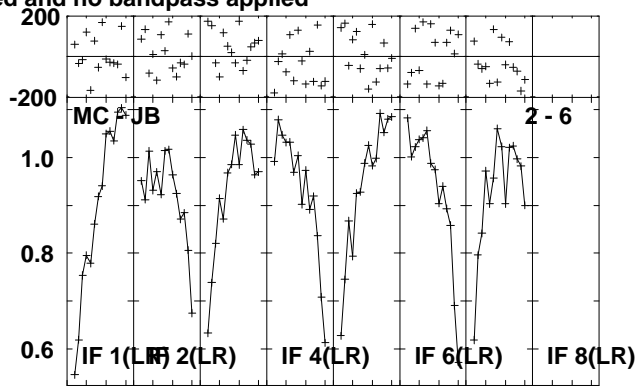
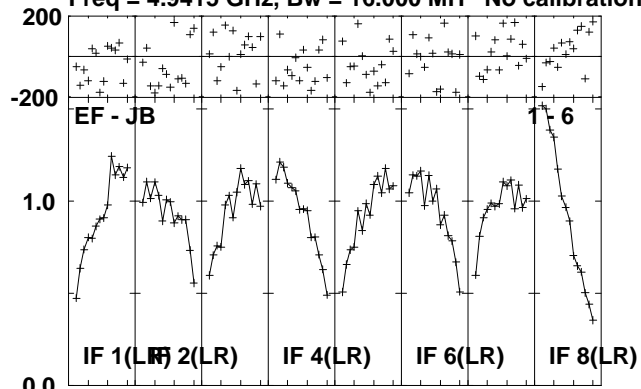

Lower frame: Milli Ampl Jy Top frame: Phas deg
Scalar averaged cross-power spectrum Several baselines displayed
Timerange: 00/21:00:10 to 00/21:05:08

Plot file version 51 created 15-JUL-2010 10:43:36
 J1953+35 RR004B.UVDATA.1

Freq = 4.9415 GHz, Bw = 16.000 MH No calibration applied and no bandpass applied

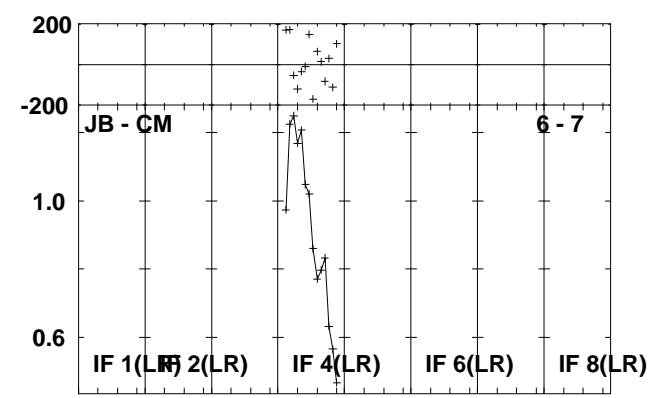
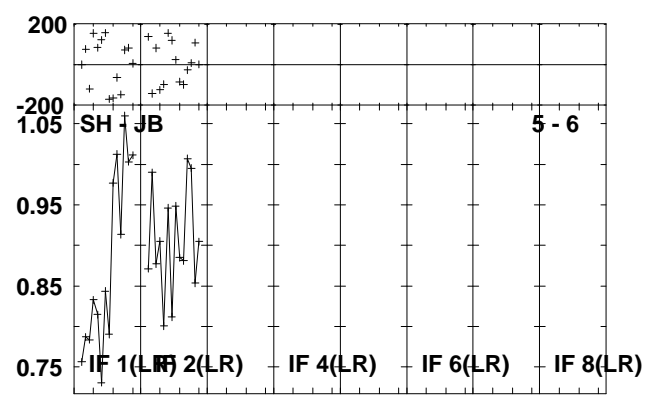
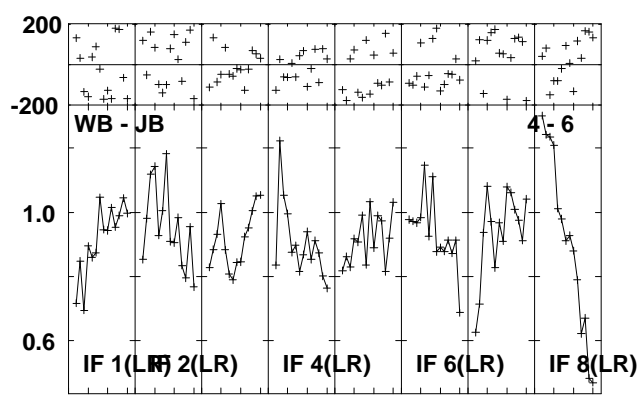
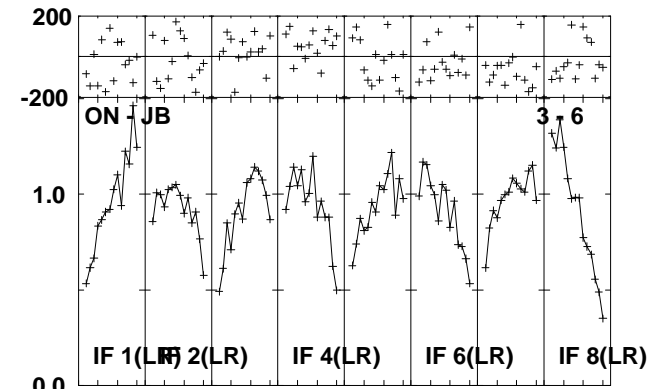
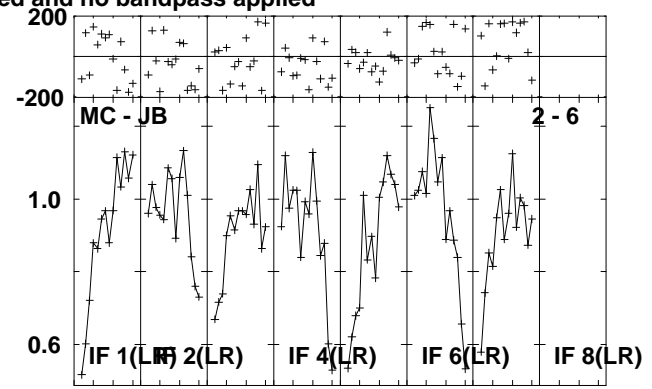
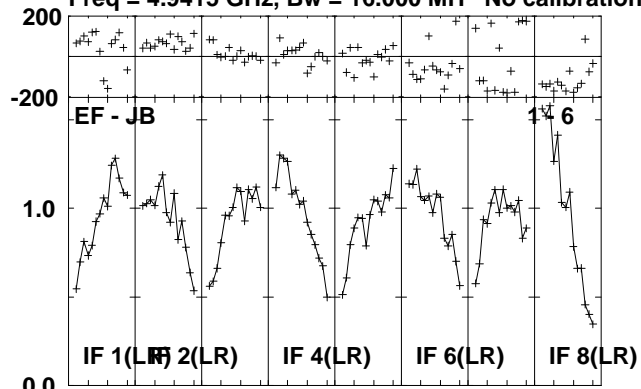

Lower frame: Milli Ampl Jy Top frame: Phas deg
 Scalar averaged cross-power spectrum Several baselines displayed
 Timerange: 00/21:05:10 to 00/21:07:08

Plot file version 52 created 15-JUL-2010 10:43:38
CYGX-1 RR004B.UVDATA.1

Freq = 4.9415 GHz, Bw = 16.000 MH No calibration applied and no bandpass applied

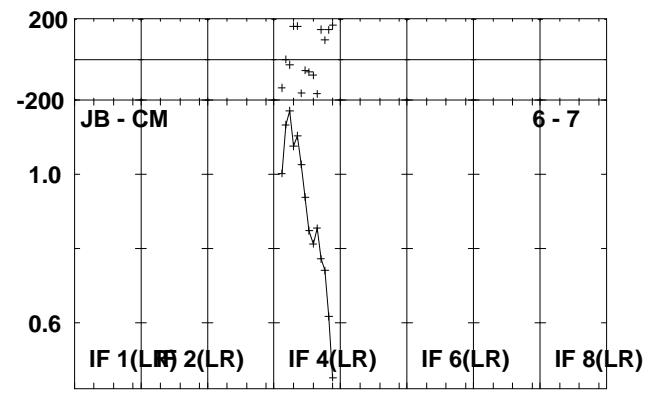
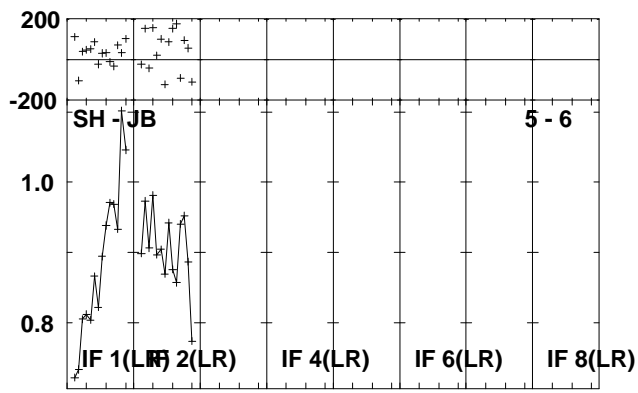
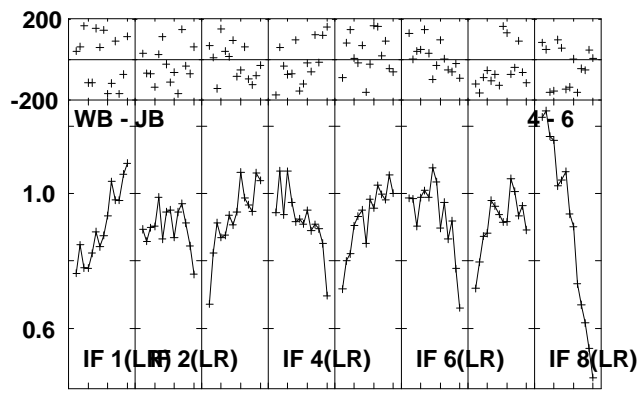
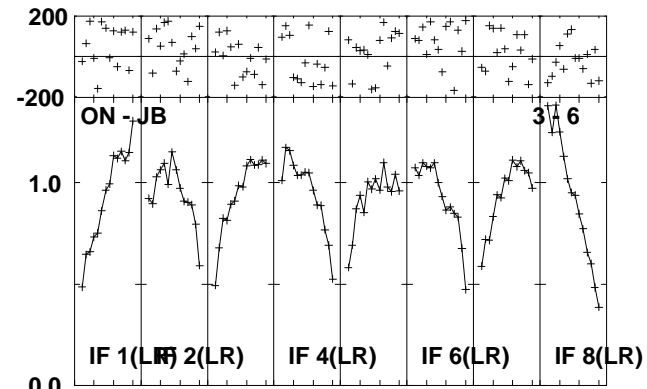
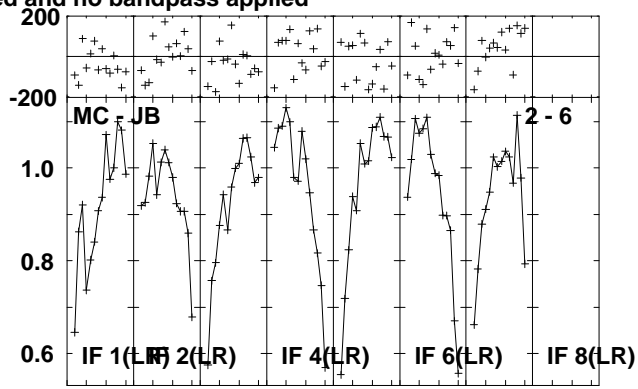
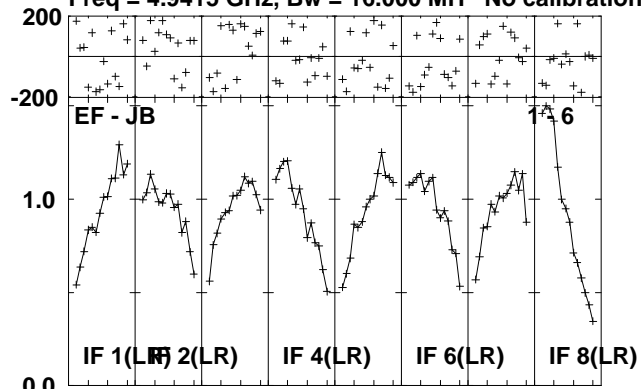

Lower frame: Milli Ampl Jy Top frame: Phas deg
Scalar averaged cross-power spectrum Several baselines displayed
Timerange: 00/21:07:10 to 00/21:12:08

Plot file version 53 created 15-JUL-2010 10:43:40
J1953+35 RR004B.UVDATA.1

Freq = 4.9415 GHz, Bw = 16.000 MH No calibration applied and no bandpass applied

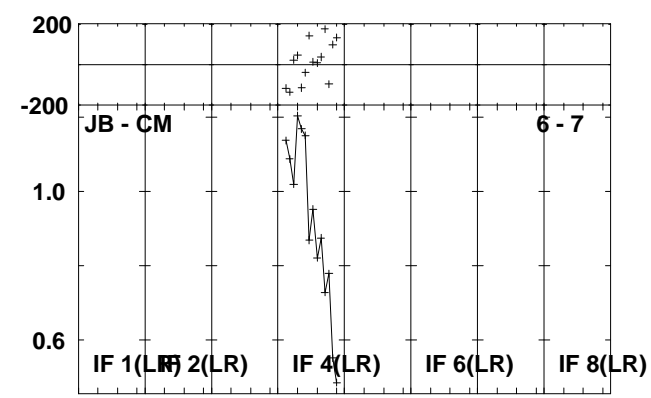
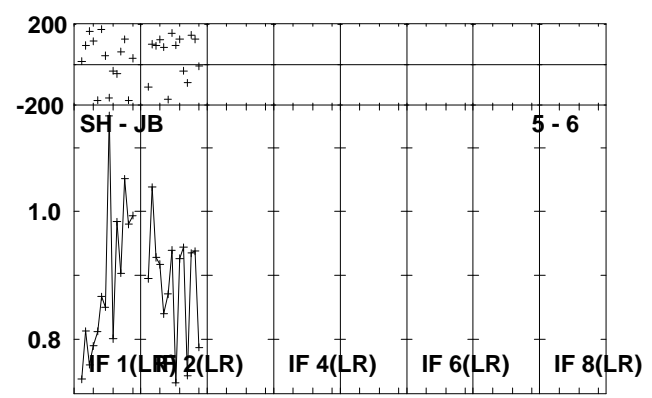
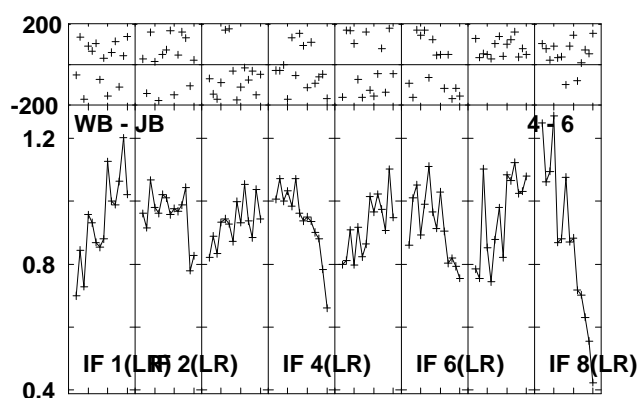
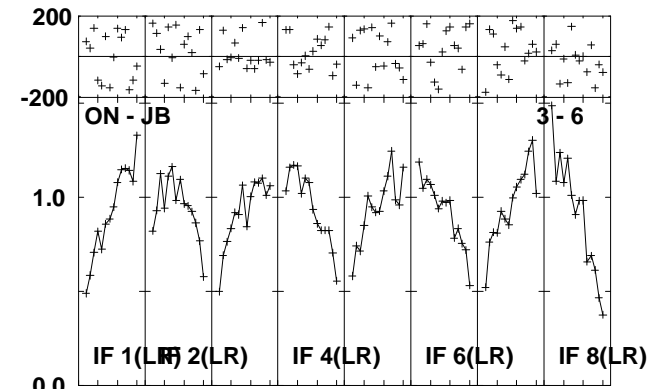
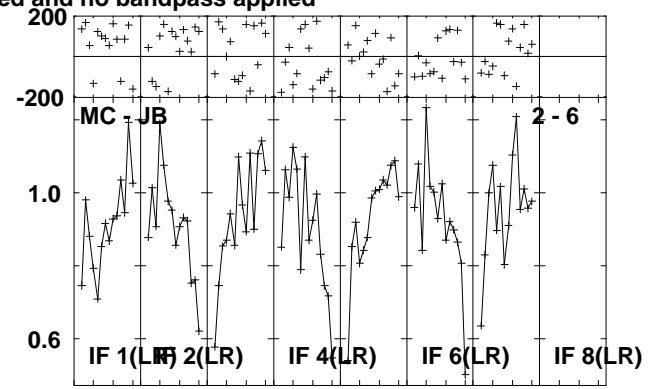
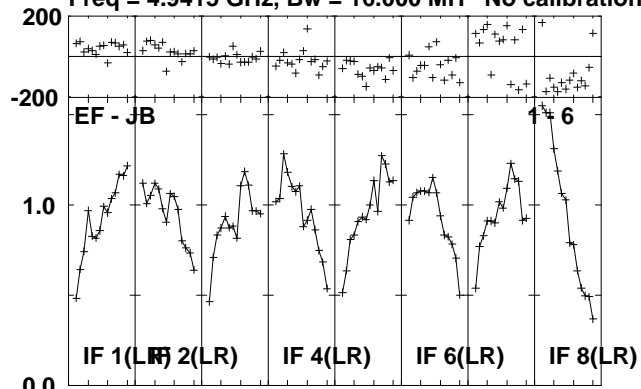

Lower frame: Milli Ampl Jy Top frame: Phas deg
Scalar averaged cross-power spectrum Several baselines displayed
Timerange: 00/21:12:50 to 00/21:14:18

Plot file version 54 created 15-JUL-2010 10:43:41
J2002+47 RR004B.UVDATA.1

Freq = 4.9415 GHz, Bw = 16.000 MH No calibration applied and no bandpass applied

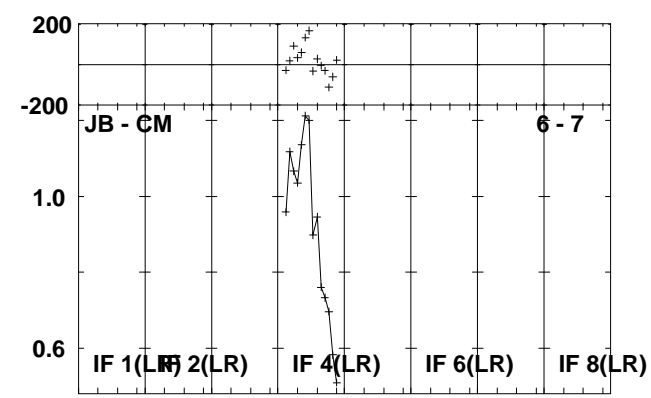
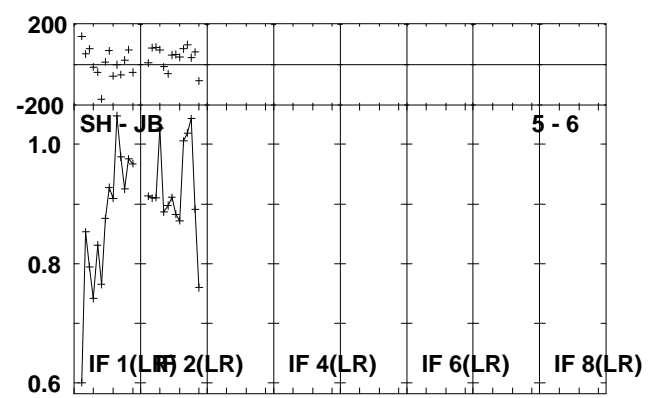
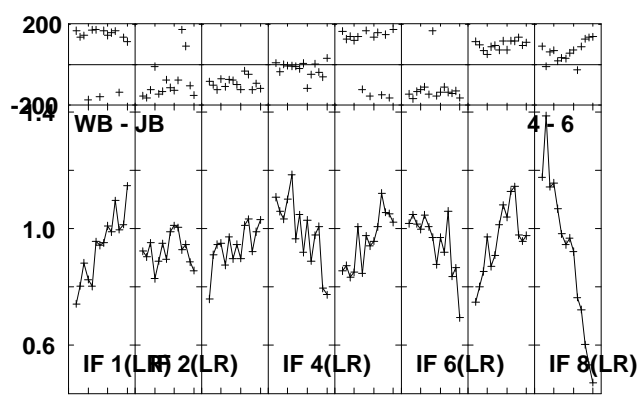
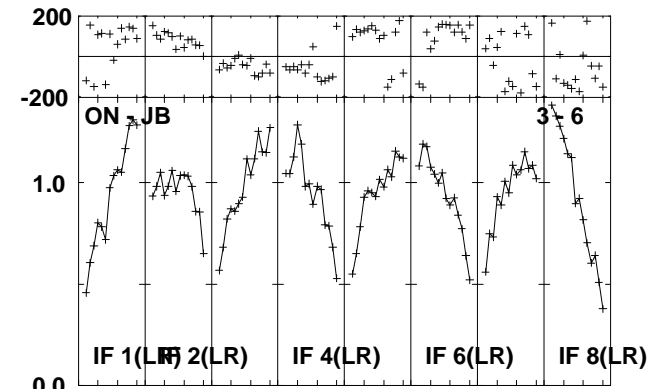
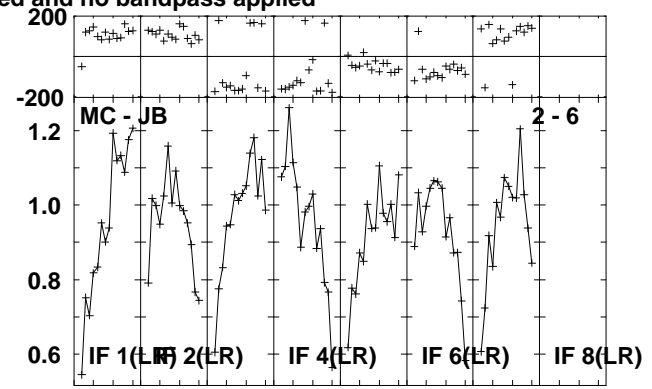
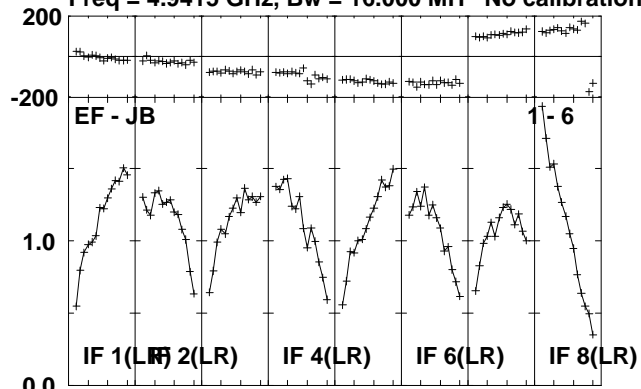

Lower frame: Milli Ampl Jy Top frame: Phas deg
Scalar averaged cross-power spectrum Several baselines displayed
Timerange: 00/21:16:20 to 00/21:21:18

Plot file version 55 created 15-JUL-2010 10:43:43
J1953+35 RR004B.UVDATA.1

Freq = 4.9415 GHz, Bw = 16.000 MH No calibration applied and no bandpass applied

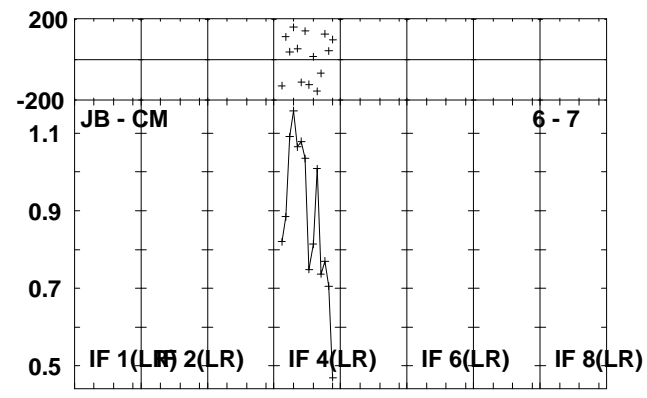
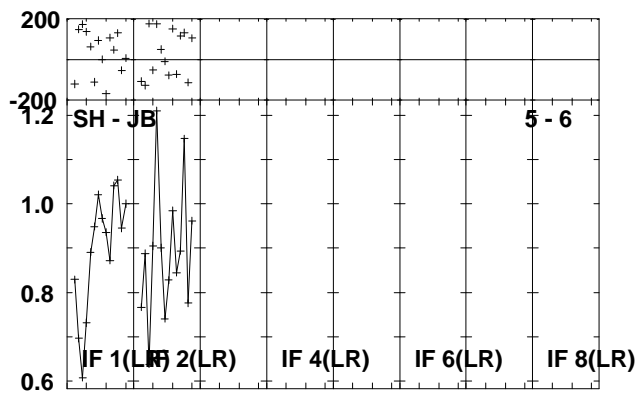
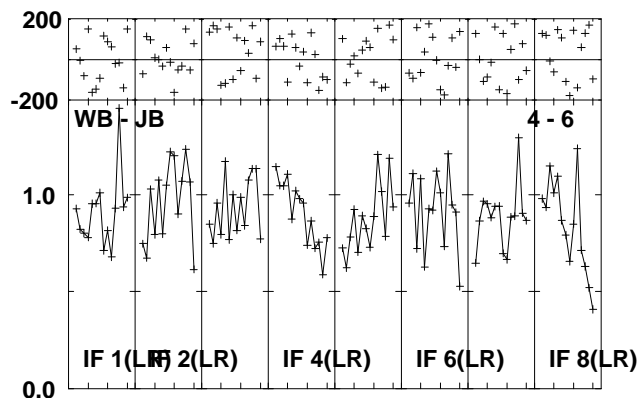
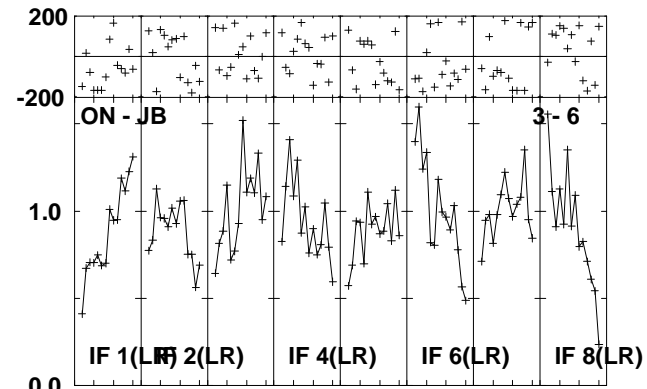
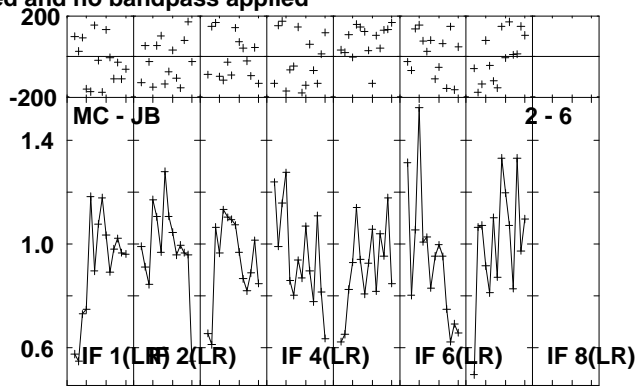
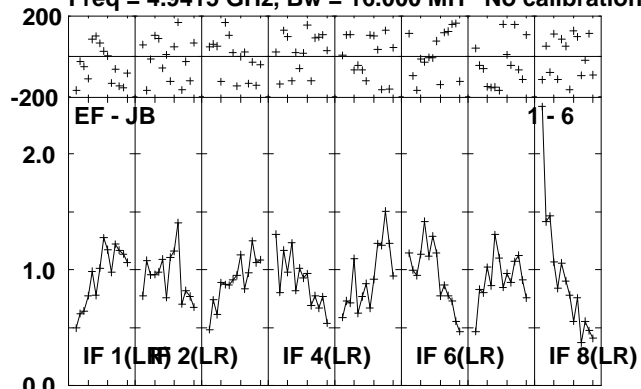

Lower frame: Milli Ampl Jy Top frame: Phas deg
Scalar averaged cross-power spectrum Several baselines displayed
Timerange: 00/21:22:50 to 00/21:24:18

Plot file version 56 created 15-JUL-2010 10:43:44
CYGX-1 RR004B.UVDATA.1

Freq = 4.9415 GHz, Bw = 16.000 MH No calibration applied and no bandpass applied

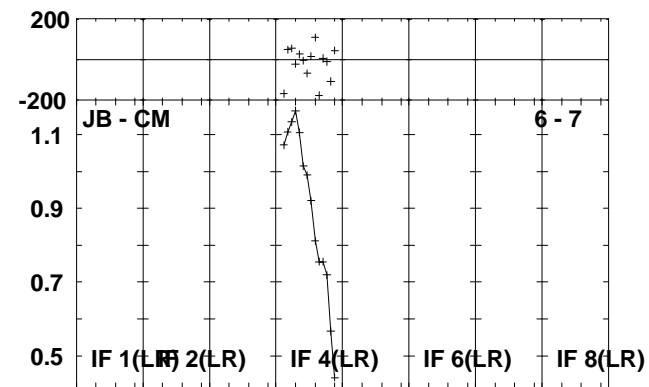
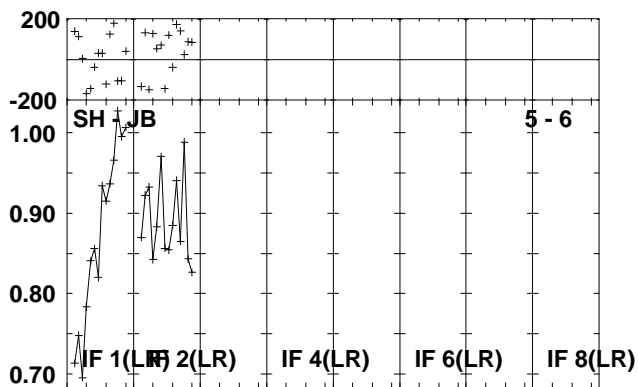
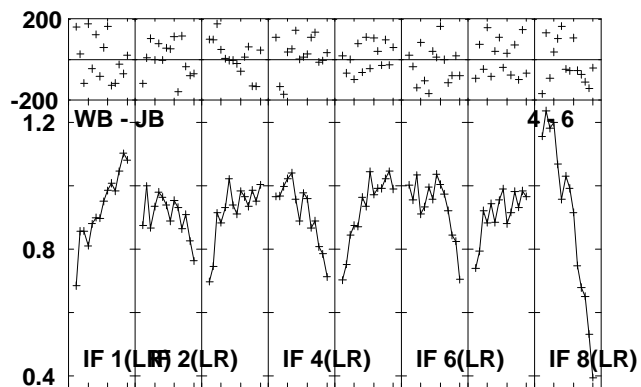
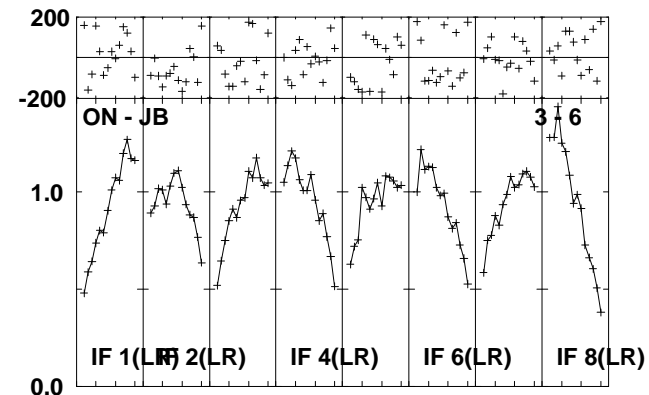
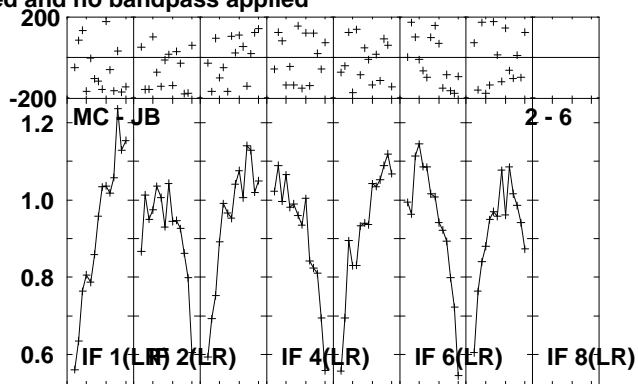
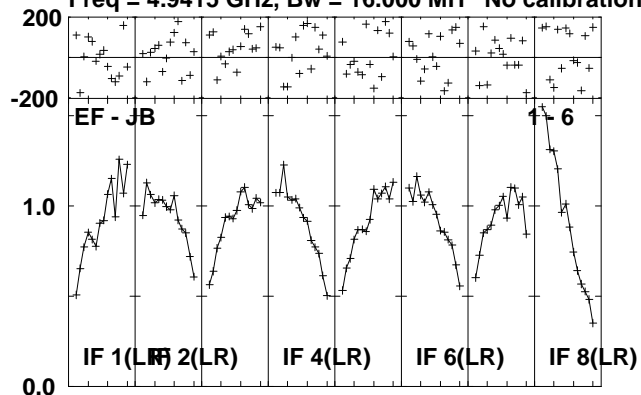

Lower frame: Milli Ampl Jy Top frame: Phas deg
Scalar averaged cross-power spectrum Several baselines displayed
Timerange: 00/21:24:20 to 00/21:29:18

Plot file version 57 created 15-JUL-2010 10:43:47
J1953+35 RR004B.UVDATA.1

Freq = 4.9415 GHz, Bw = 16.000 MH No calibration applied and no bandpass applied

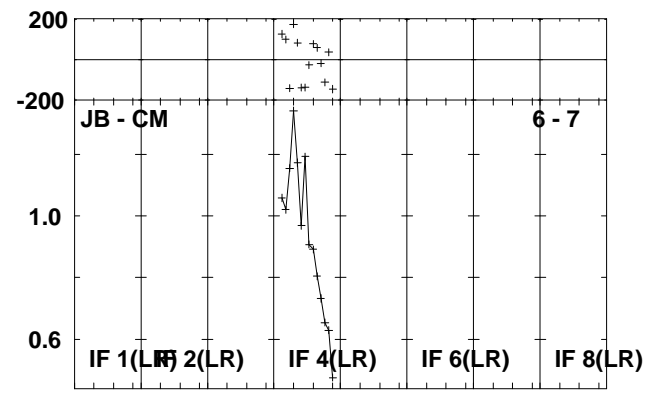
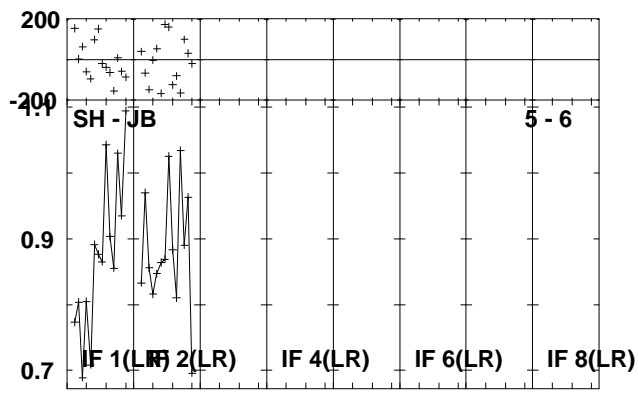
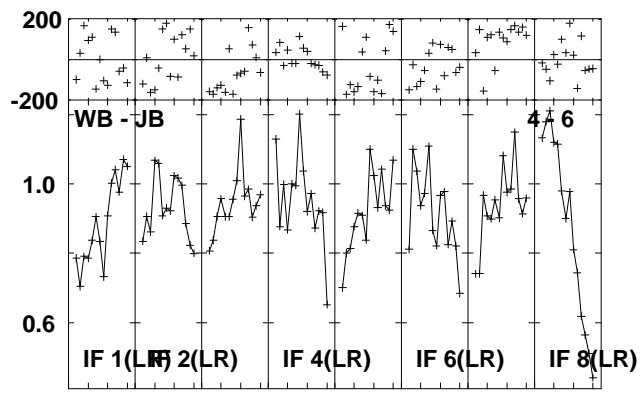
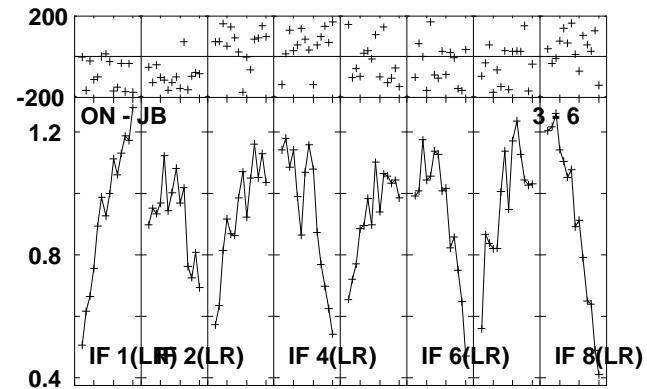
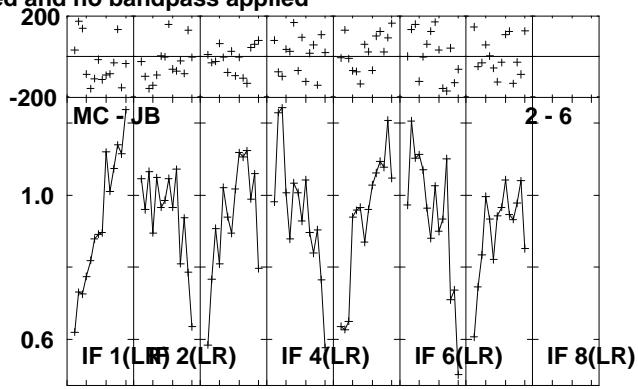
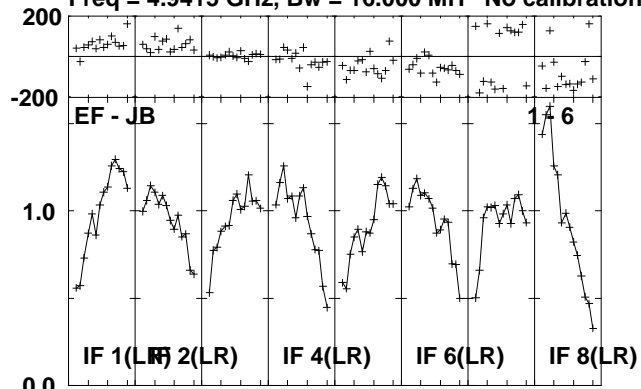

Lower frame: Milli Ampl Jy Top frame: Phas deg
Scalar averaged cross-power spectrum Several baselines displayed
Timerange: 00/21:29:20 to 00/21:31:18

Plot file version 58 created 15-JUL-2010 10:43:48
CYGX-1 RR004B.UVDATA.1

Freq = 4.9415 GHz, Bw = 16.000 MH No calibration applied and no bandpass applied

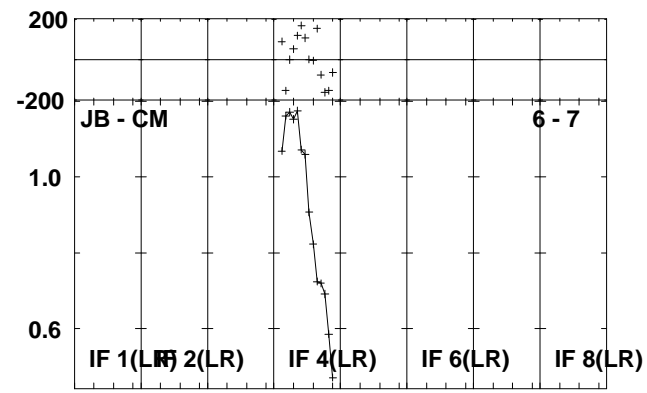
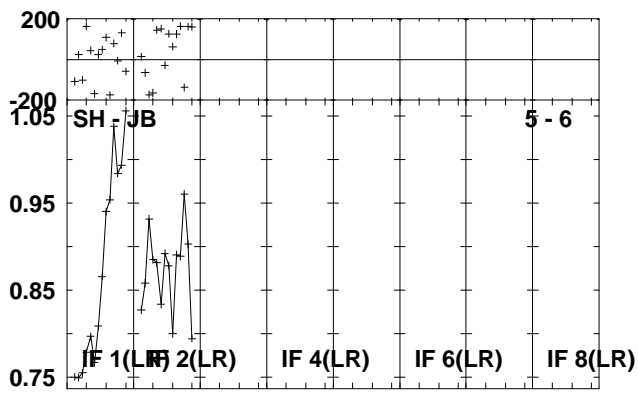
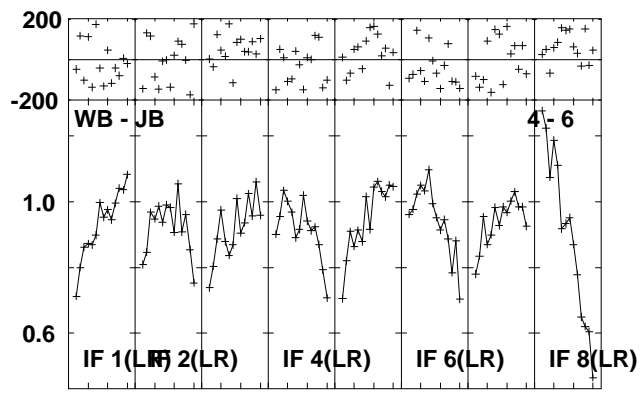
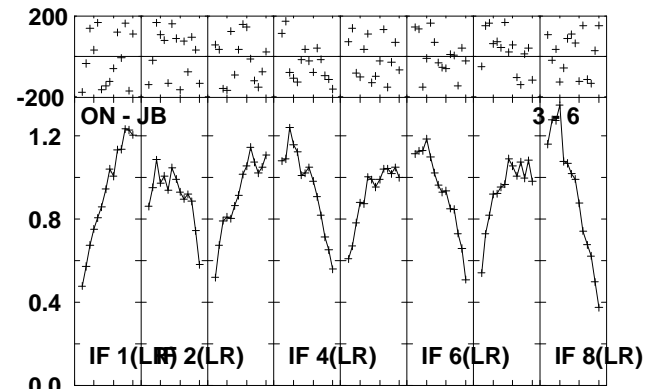
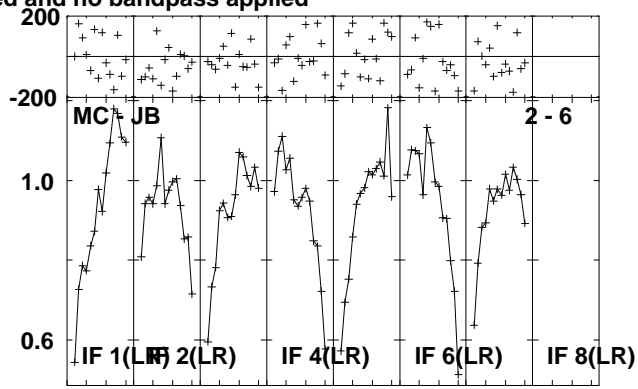
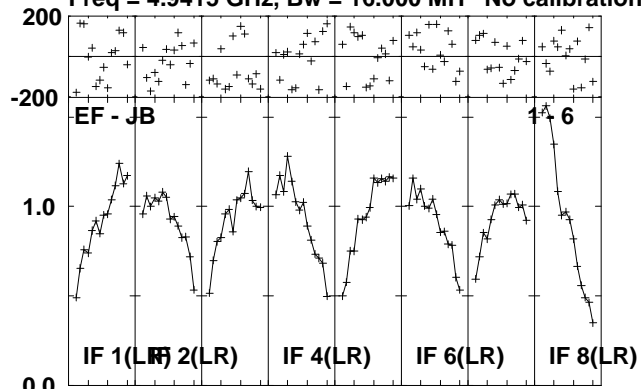

Lower frame: Milli Ampl Jy Top frame: Phas deg
Scalar averaged cross-power spectrum Several baselines displayed
Timerange: 00/21:31:20 to 00/21:36:18

Plot file version 59 created 15-JUL-2010 10:43:51
J1953+35 RR004B.UVDATA.1

Freq = 4.9415 GHz, Bw = 16.000 MH No calibration applied and no bandpass applied

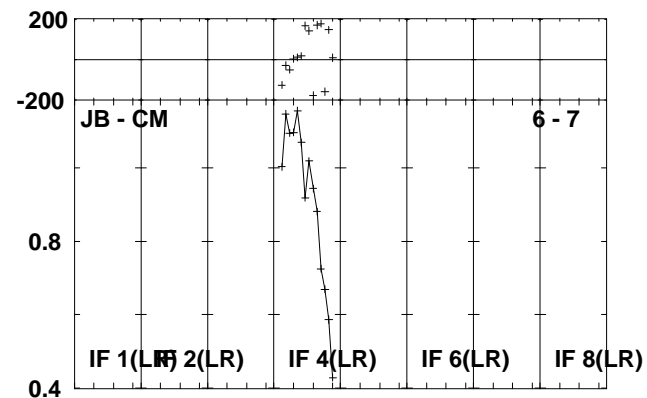
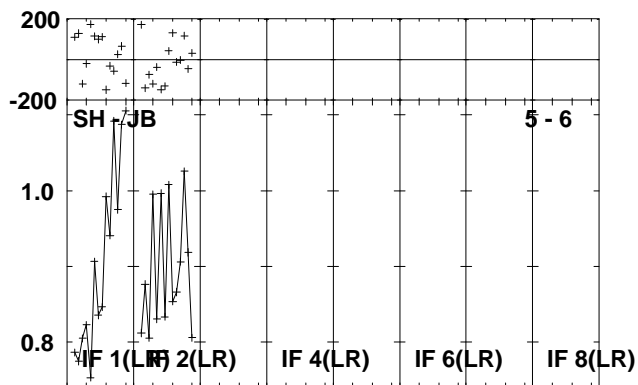
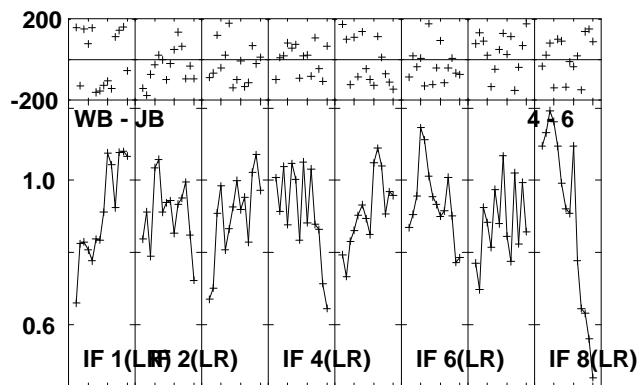
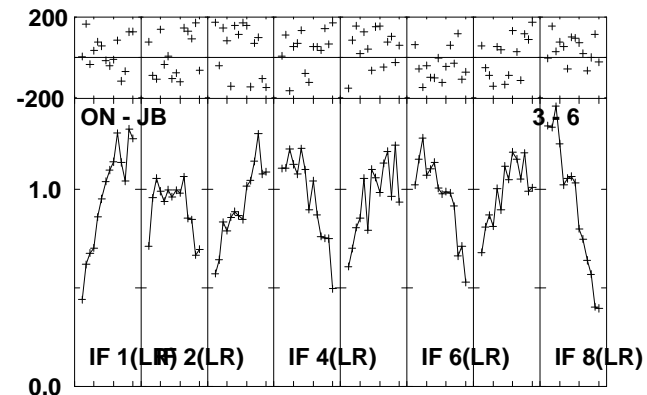
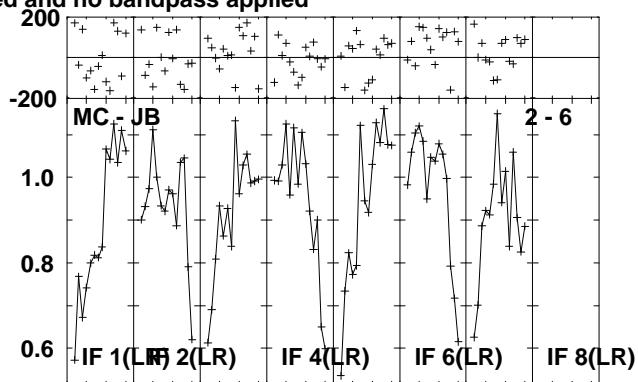
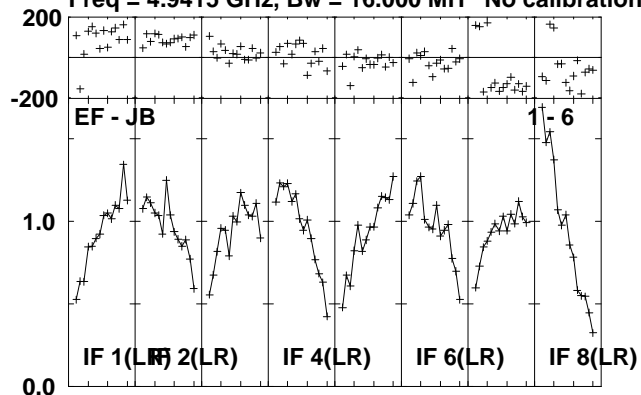

Lower frame: Milli Ampl Jy Top frame: Phas deg
Scalar averaged cross-power spectrum Several baselines displayed
Timerange: 00/21:37:00 to 00/21:38:28

Plot file version 60 created 15-JUL-2010 10:43:52

CYGX-1 RR004B.UVDATA.1

Freq = 4.9415 GHz, Bw = 16.000 MH No calibration applied and no bandpass applied

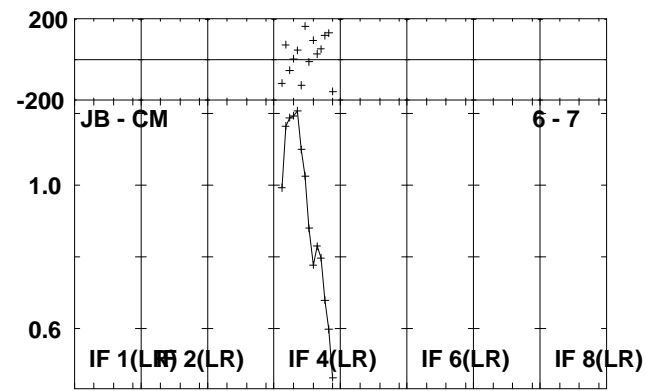
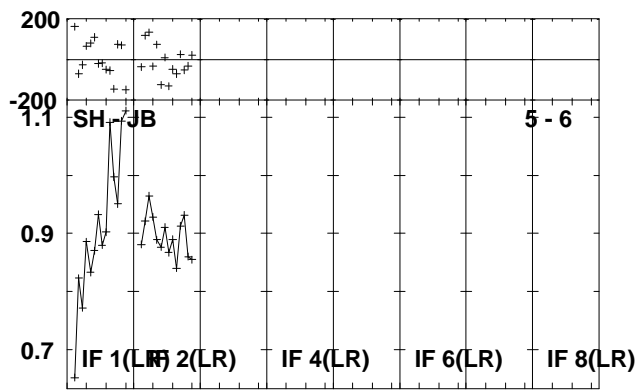
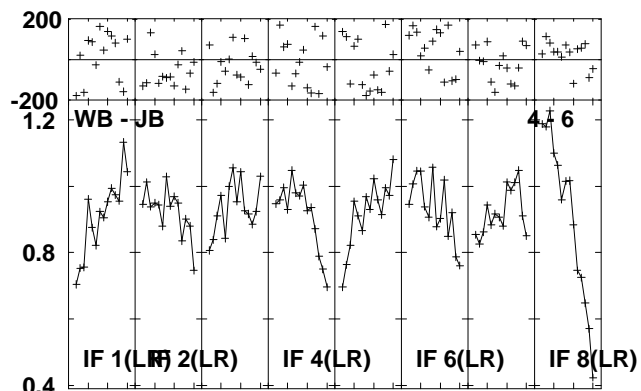
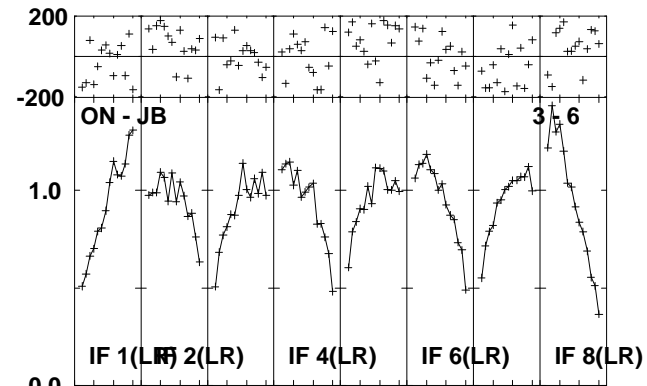
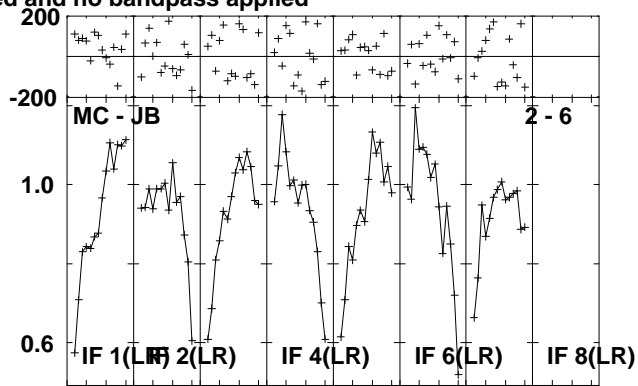
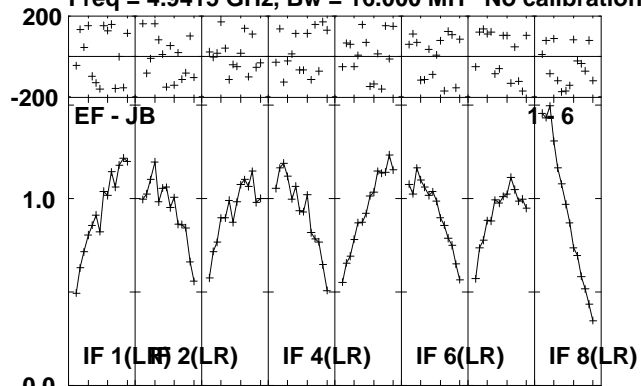

Lower frame: Milli Ampl Jy Top frame: Phas deg
Scalar averaged cross-power spectrum Several baselines displayed
Timerange: 00/21:38:30 to 00/21:43:28

Plot file version 61 created 15-JUL-2010 10:43:54
J1953+35 RR004B.UVDATA.1

Freq = 4.9415 GHz, Bw = 16.000 MH No calibration applied and no bandpass applied

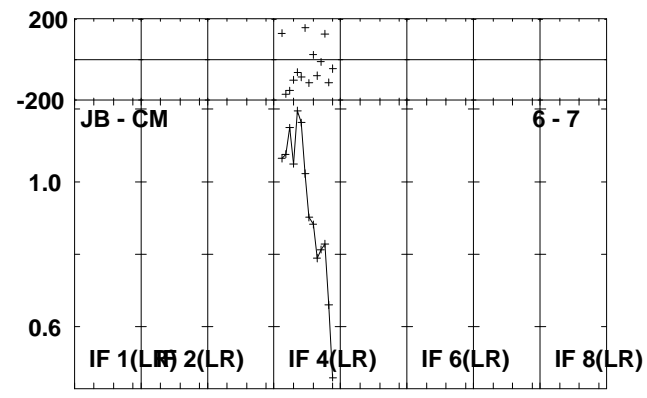
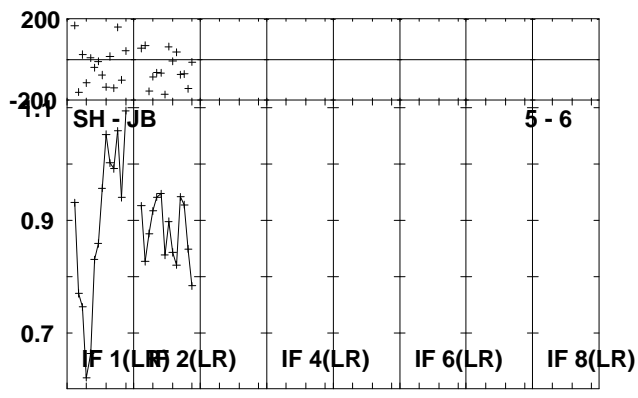
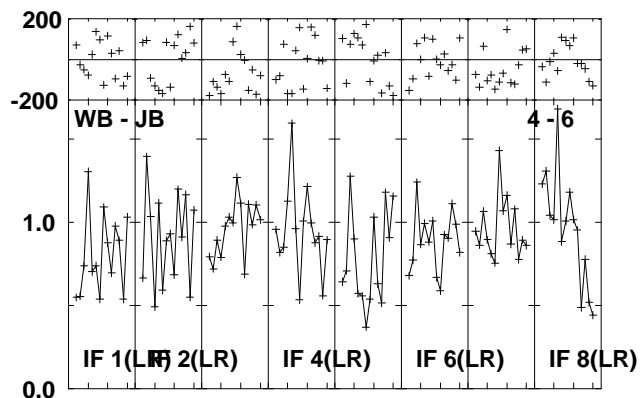
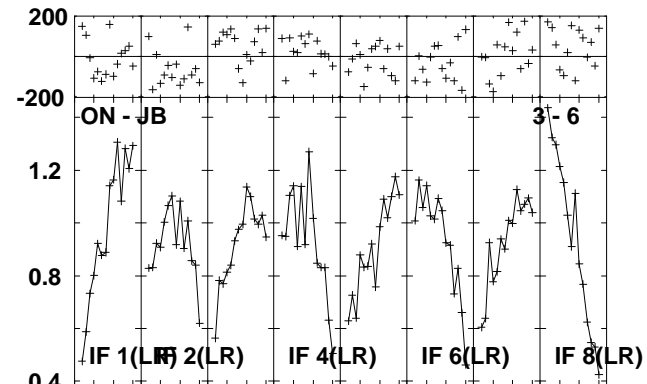
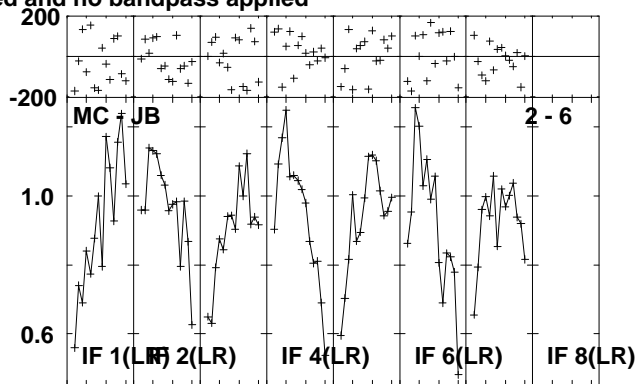
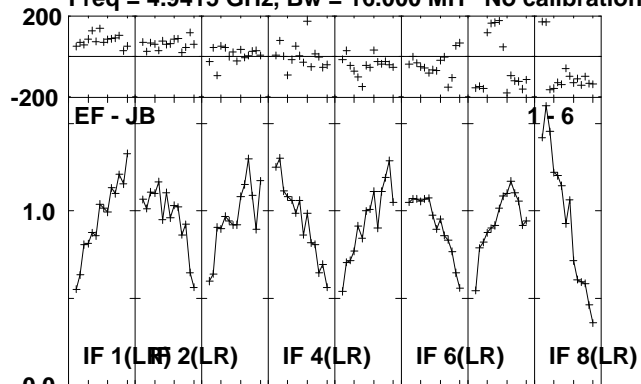

Lower frame: Milli Ampl Jy Top frame: Phas deg
Scalar averaged cross-power spectrum Several baselines displayed
Timerange: 00/21:43:30 to 00/21:45:28

Plot file version 62 created 15-JUL-2010 10:43:55

CYGX-1 RR004B.UVDATA.1

Freq = 4.9415 GHz, Bw = 16.000 MH No calibration applied and no bandpass applied

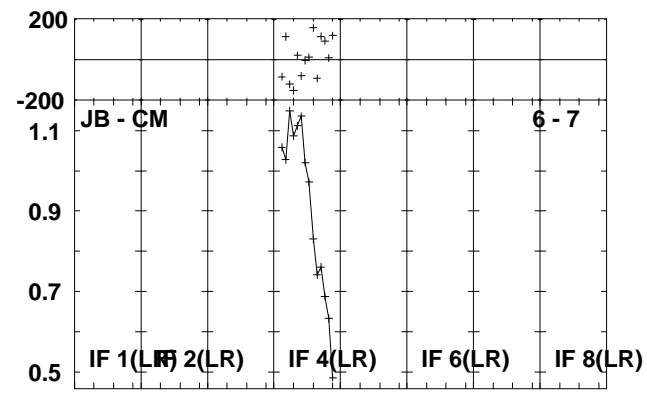
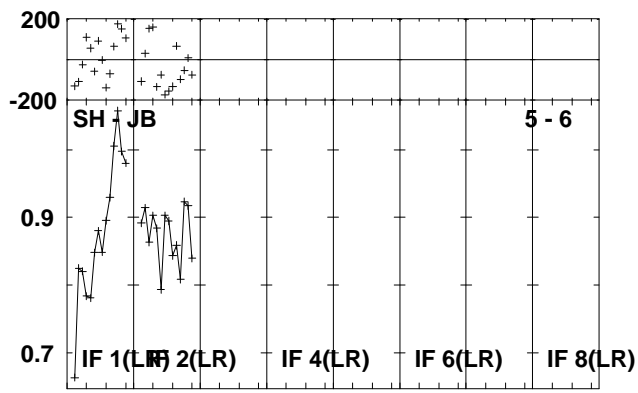
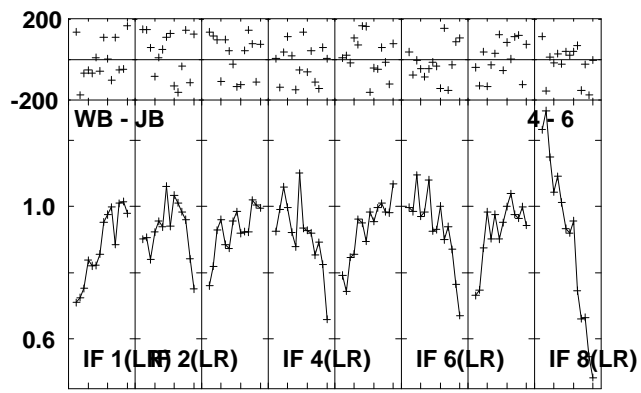
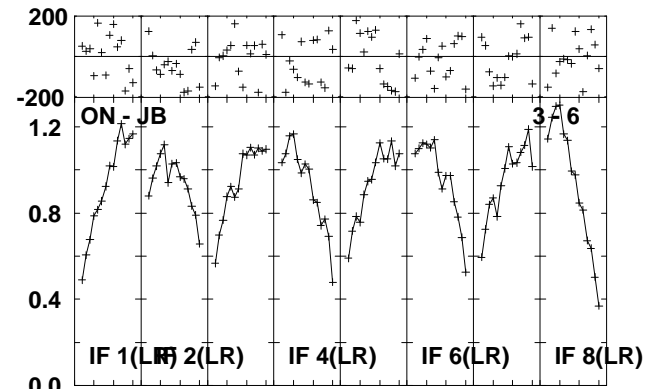
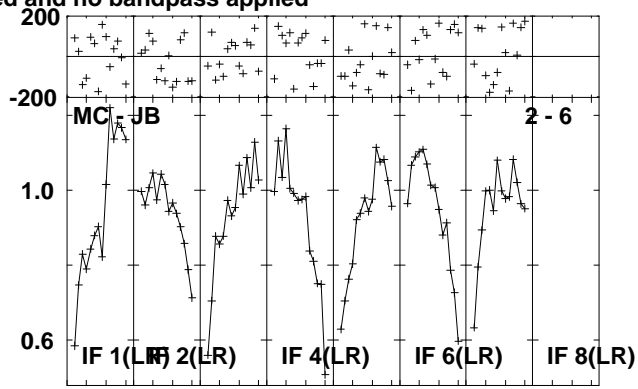
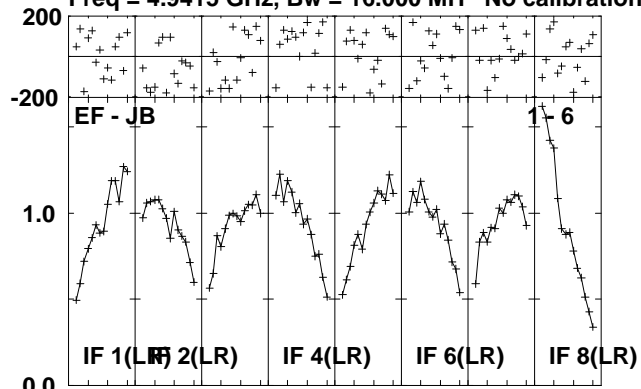

Lower frame: Milli Ampl Jy Top frame: Phas deg
Scalar averaged cross-power spectrum Several baselines displayed
Timerange: 00/21:45:30 to 00/21:50:28

Plot file version 63 created 15-JUL-2010 10:43:57

J1953+35 RR004B.UVDATA.1

Freq = 4.9415 GHz, Bw = 16.000 MH No calibration applied and no bandpass applied

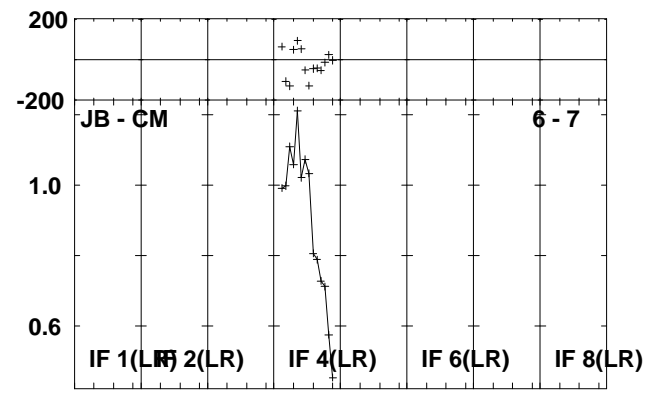
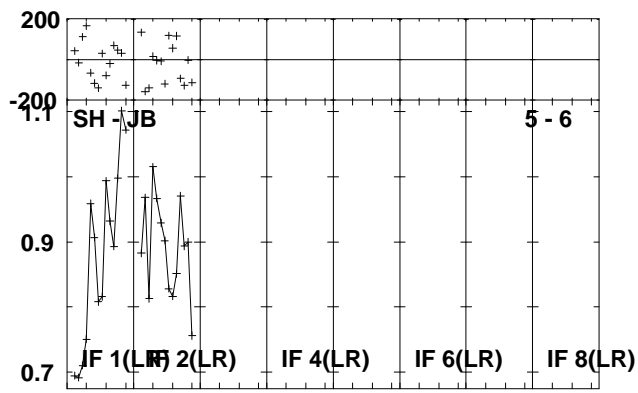
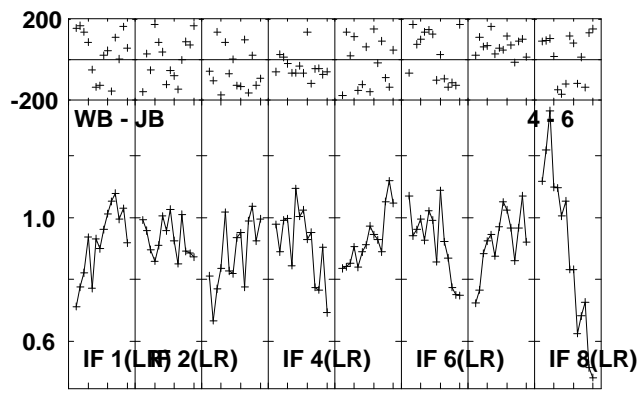
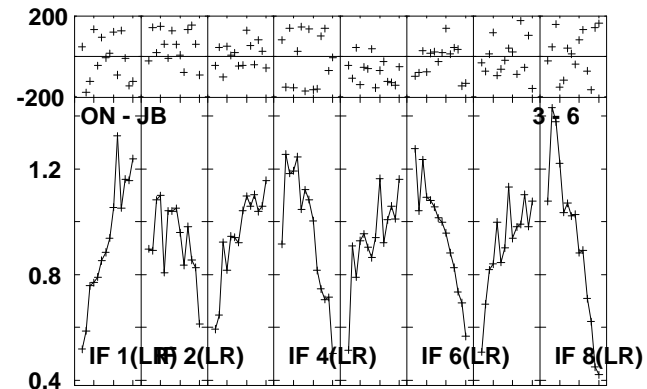
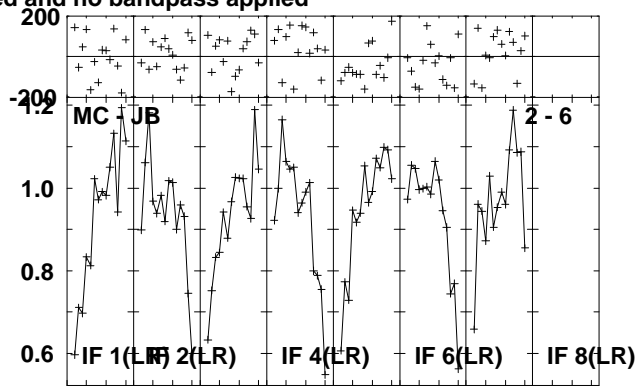
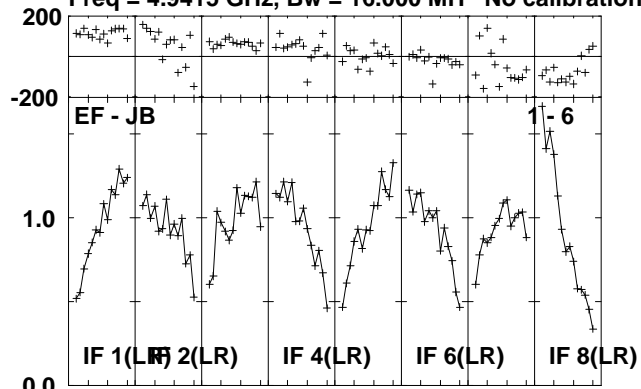

Lower frame: Milli Ampl Jy Top frame: Phas deg
Scalar averaged cross-power spectrum Several baselines displayed
Timerange: 00/21:51:10 to 00/21:52:38

Plot file version 64 created 15-JUL-2010 10:43:59

CYGX-1 RR004B.UVDATA.1

Freq = 4.9415 GHz, Bw = 16.000 MH No calibration applied and no bandpass applied

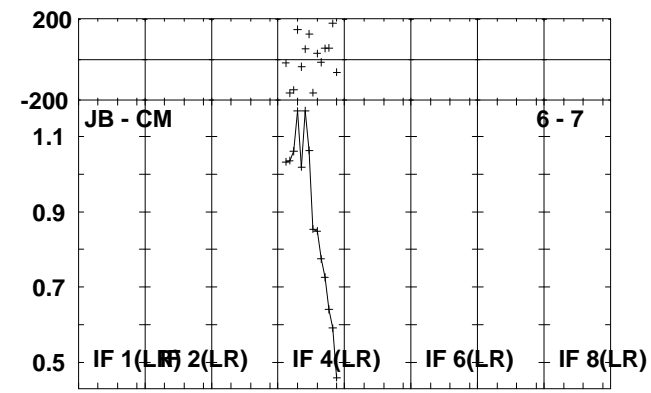
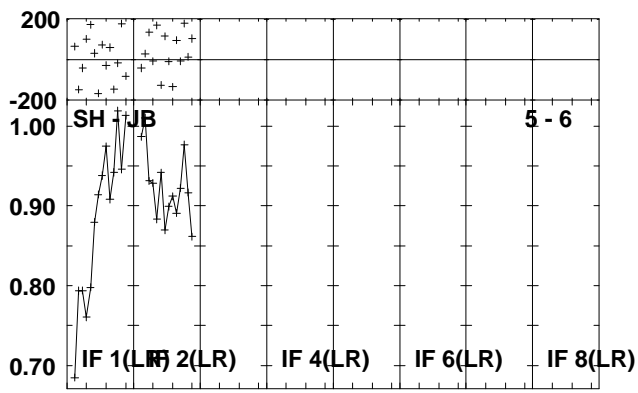
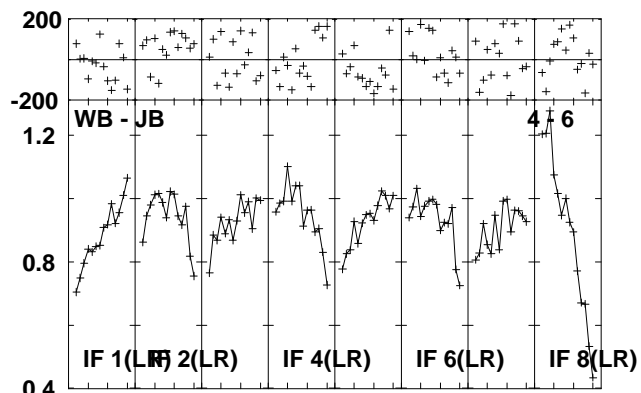
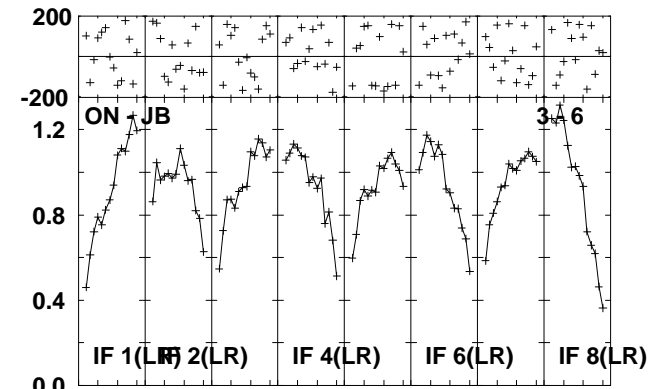
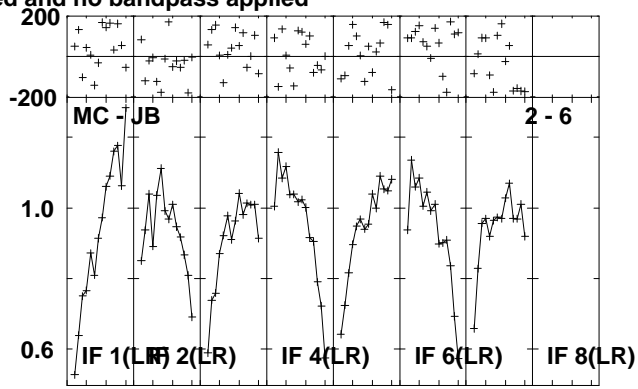
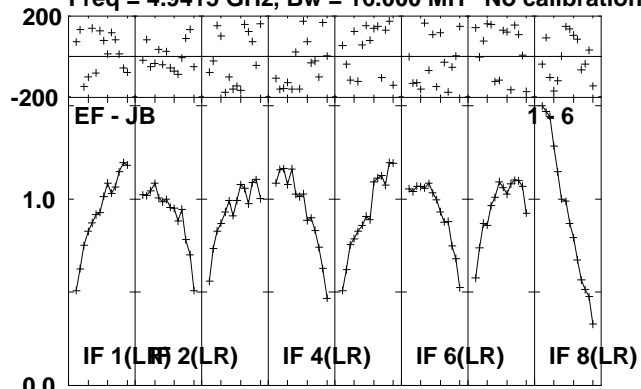

Lower frame: Milli Ampl Jy Top frame: Phas deg
Scalar averaged cross-power spectrum Several baselines displayed
Timerange: 00/21:52:40 to 00/21:57:38

Plot file version 65 created 15-JUL-2010 10:44:01
J1953+35 RR004B.UVDATA.1

Freq = 4.9415 GHz, Bw = 16.000 MH No calibration applied and no bandpass applied

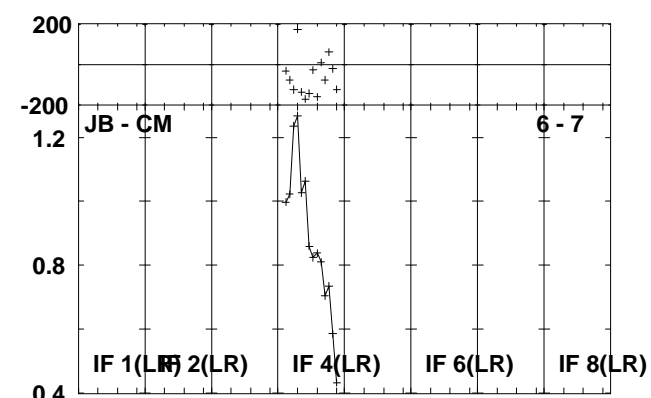
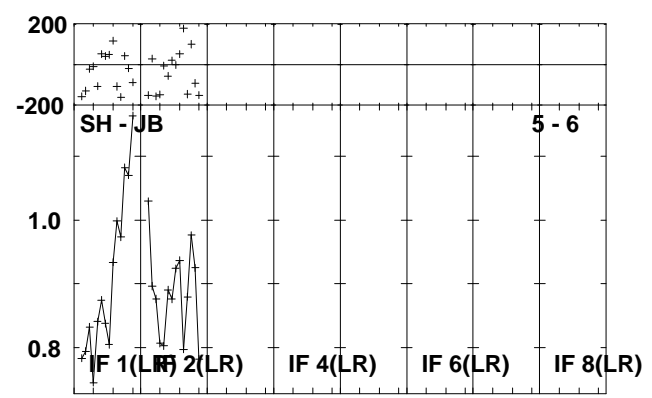
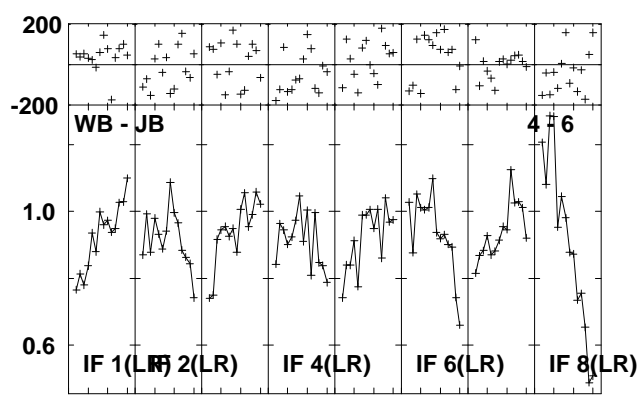
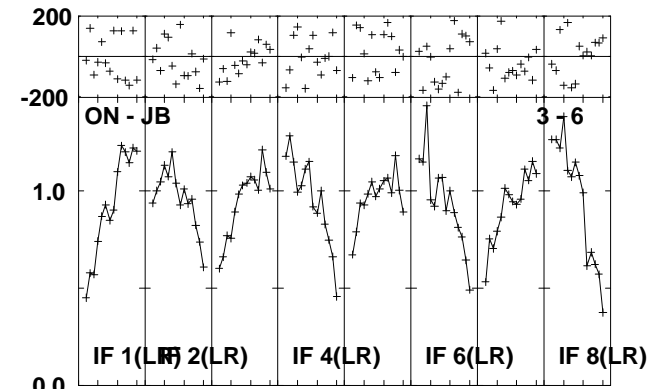
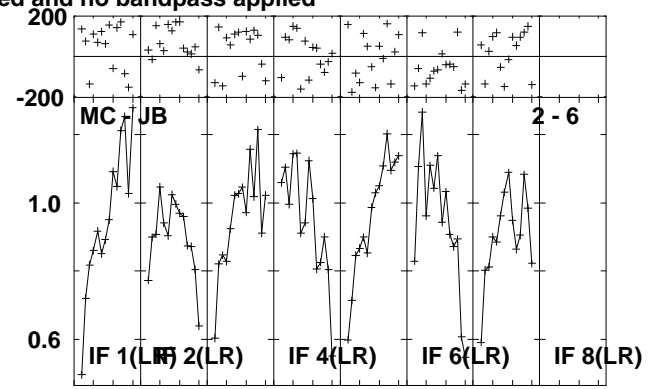
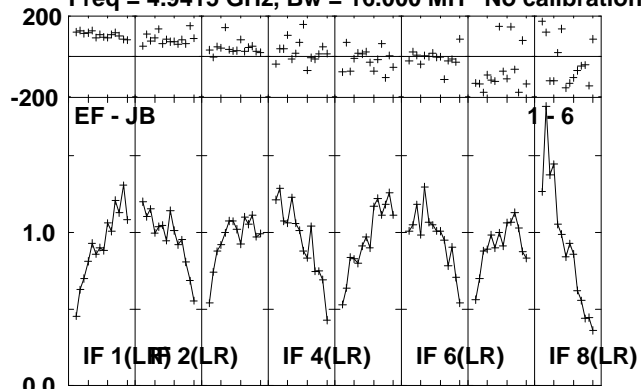

Lower frame: Milli Ampl Jy Top frame: Phas deg
Scalar averaged cross-power spectrum Several baselines displayed
Timerange: 00/21:57:40 to 00/21:59:38

Plot file version 66 created 15-JUL-2010 10:44:03
CYGX-1 RR004B.UVDATA.1

Freq = 4.9415 GHz, Bw = 16.000 MH No calibration applied and no bandpass applied

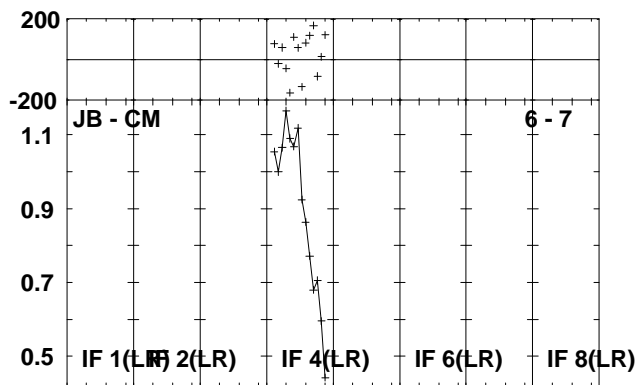
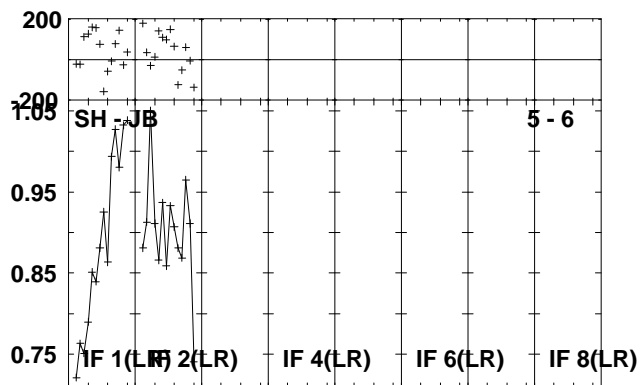
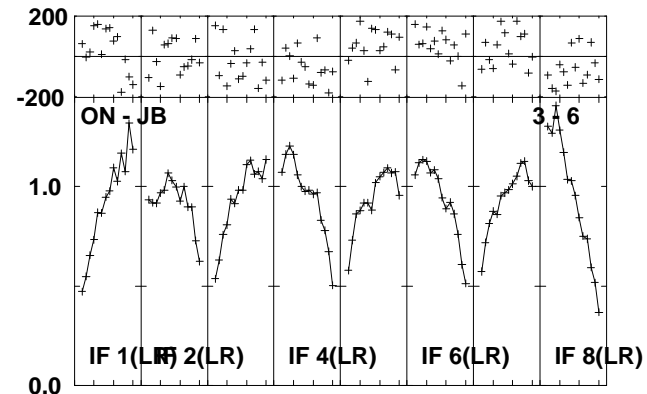
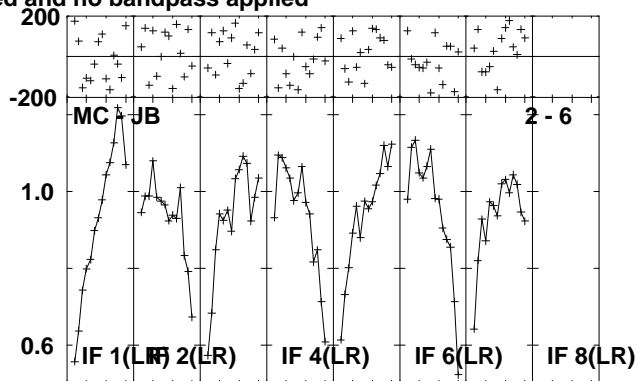
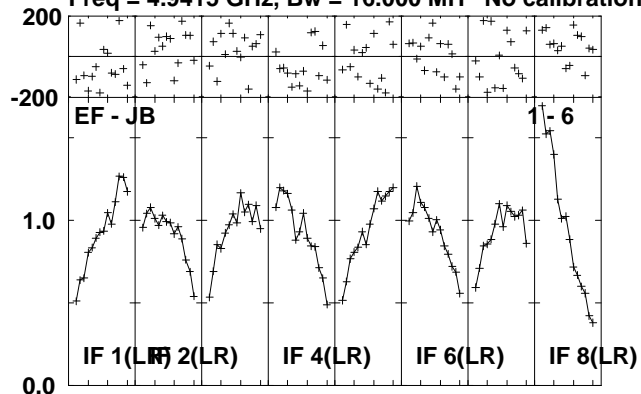

Lower frame: Milli Ampl Jy Top frame: Phas deg
Scalar averaged cross-power spectrum Several baselines displayed
Timerange: 00/21:59:40 to 00/22:04:38

Plot file version 67 created 15-JUL-2010 10:44:05
J1953+35 RR004B.UVDATA.1

Freq = 4.9415 GHz, Bw = 16.000 MH No calibration applied and no bandpass applied

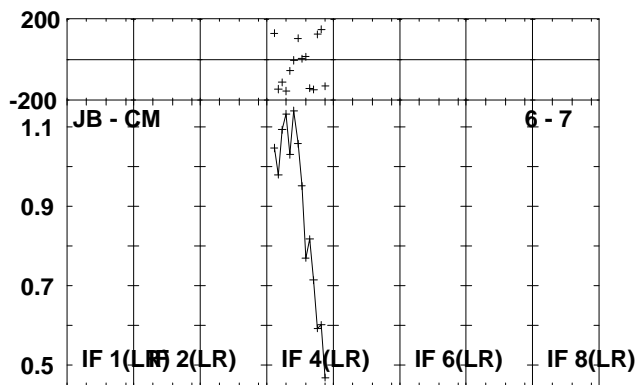
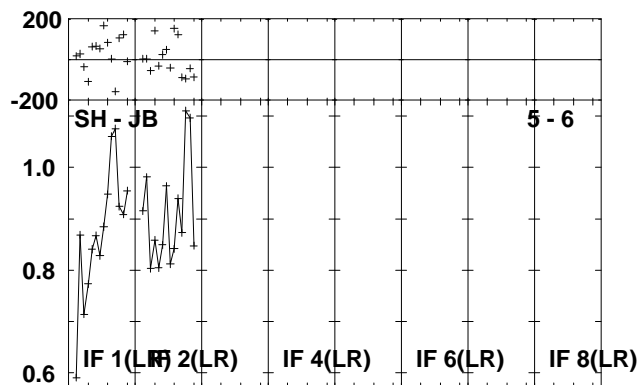
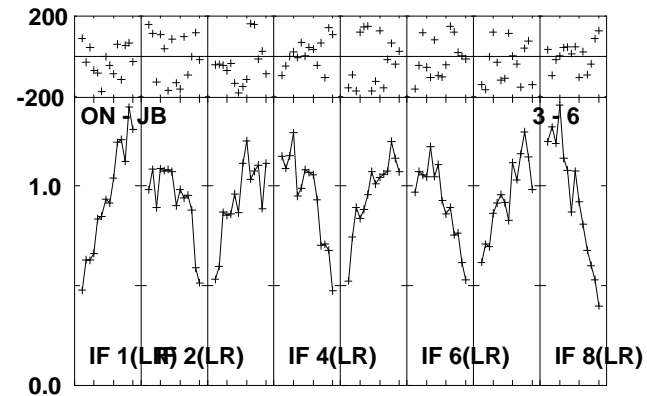
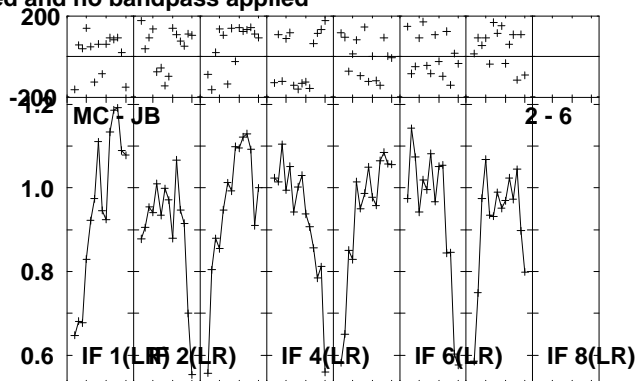
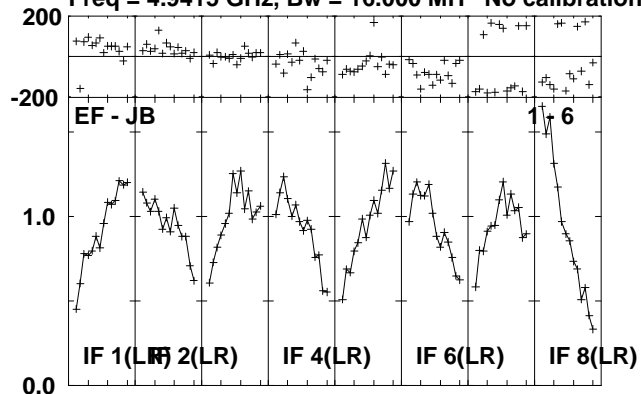

Lower frame: Milli Ampl Jy Top frame: Phas deg
Scalar averaged cross-power spectrum Several baselines displayed
Timerange: 00/22:05:20 to 00/22:06:48

Plot file version 68 created 15-JUL-2010 10:44:06

CYGX-1 RR004B.UVDATA.1

Freq = 4.9415 GHz, Bw = 16.000 MH No calibration applied and no bandpass applied

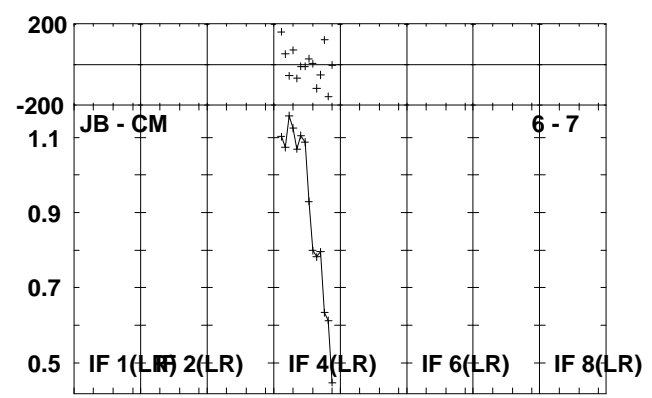
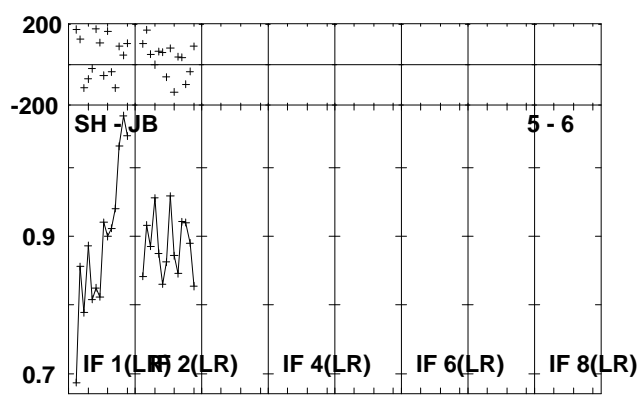
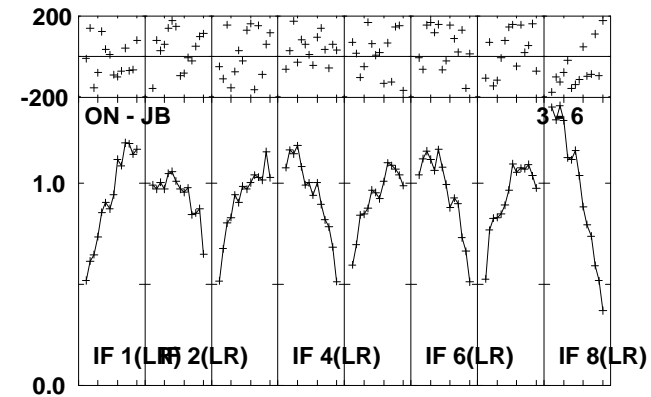
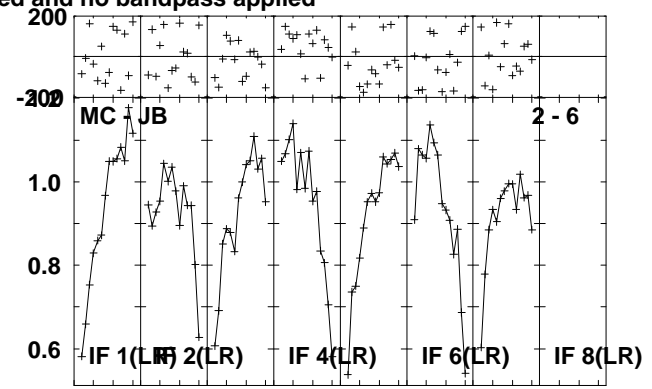
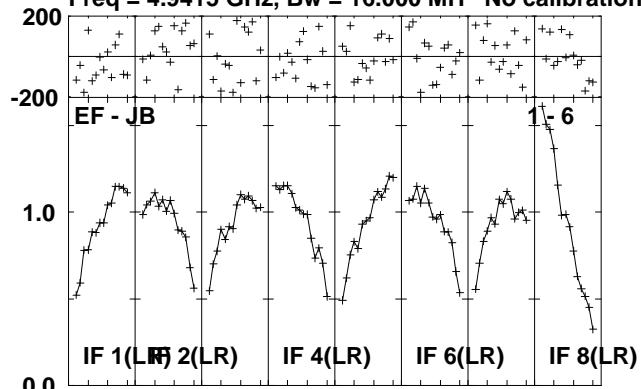

Lower frame: Milli Ampl Jy Top frame: Phas deg
Scalar averaged cross-power spectrum Several baselines displayed
Timerange: 00/22:06:50 to 00/22:11:48

Plot file version 69 created 15-JUL-2010 10:44:09
 J1953+35 RR004B.UVDATA.1

Freq = 4.9415 GHz, Bw = 16.000 MH No calibration applied and no bandpass applied

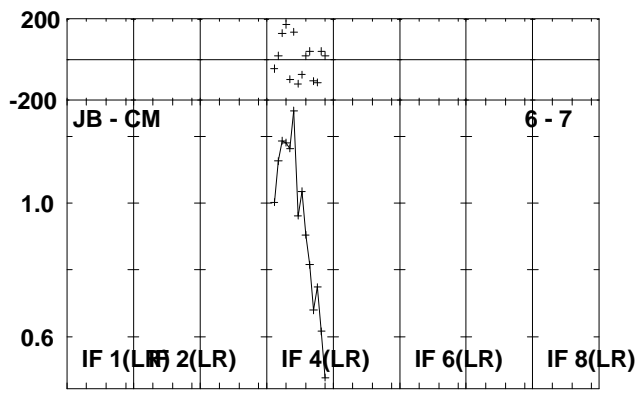
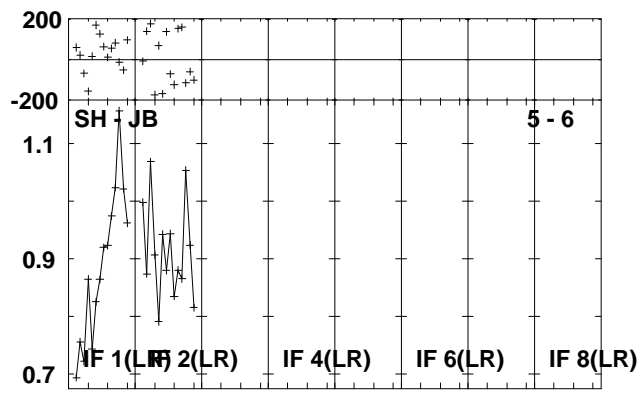
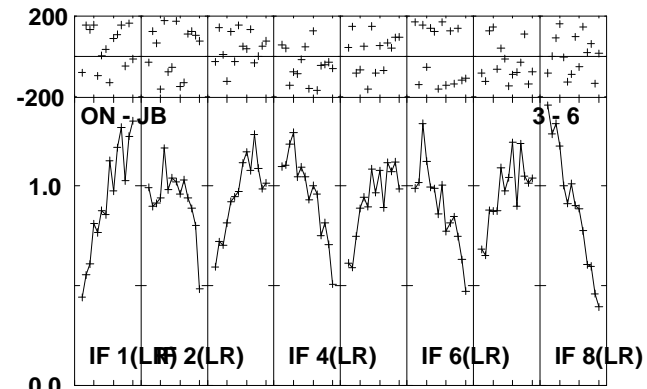
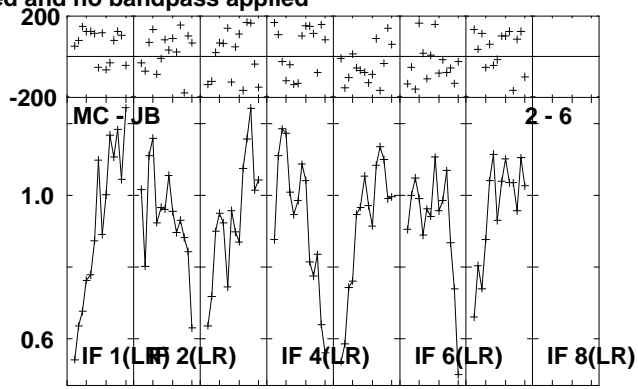
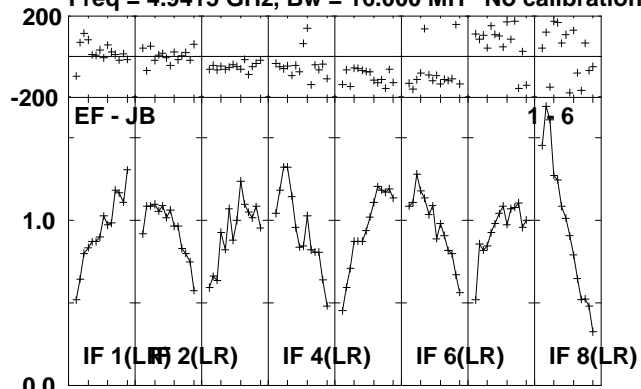

Lower frame: Milli Ampl Jy Top frame: Phas deg
 Scalar averaged cross-power spectrum Several baselines displayed
 Timerange: 00/22:11:50 to 00/22:13:48

Plot file version 70 created 15-JUL-2010 10:44:10

CYGX-1 RR004B.UVDATA.1

Freq = 4.9415 GHz, Bw = 16.000 MH No calibration applied and no bandpass applied

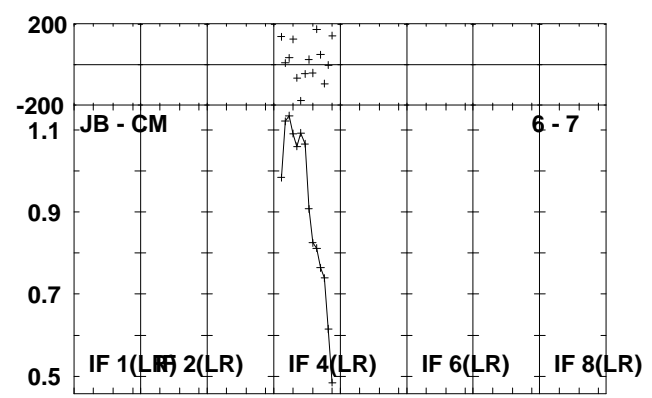
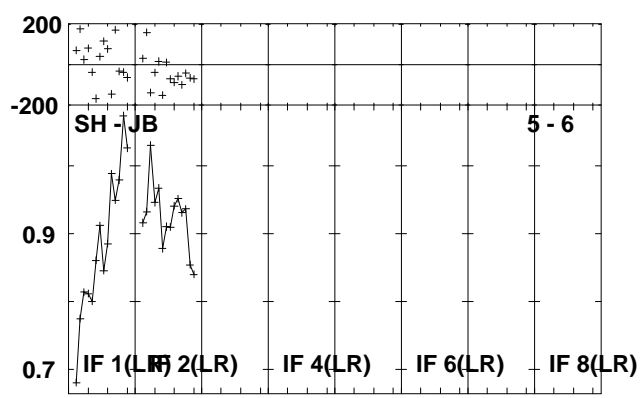
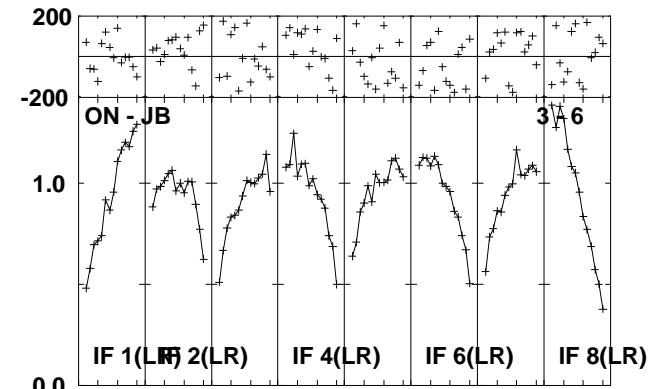
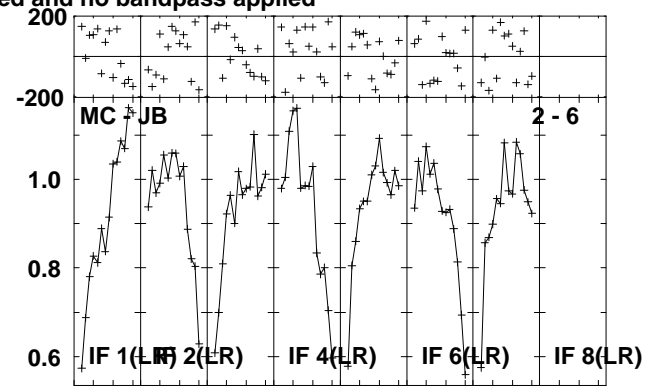
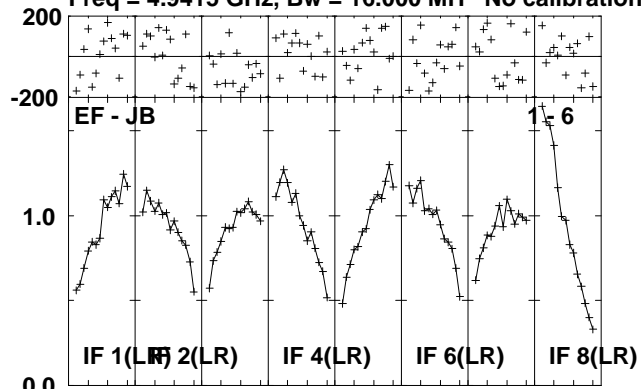

Lower frame: Milli Ampl Jy Top frame: Phas deg
Scalar averaged cross-power spectrum Several baselines displayed
Timerange: 00/22:13:50 to 00/22:18:48

Plot file version 71 created 15-JUL-2010 10:44:12
J1953+35 RR004B.UVDATA.1

Freq = 4.9415 GHz, Bw = 16.000 MH No calibration applied and no bandpass applied

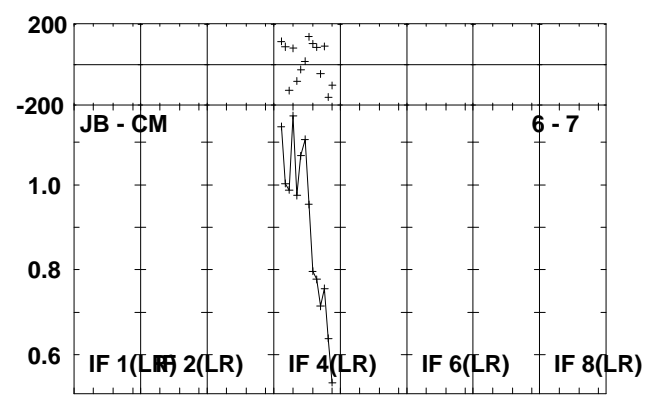
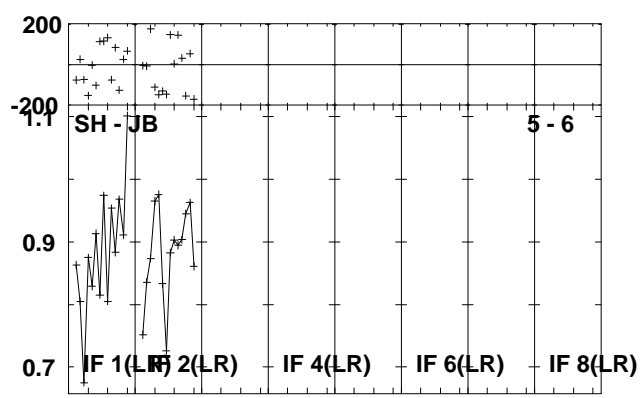
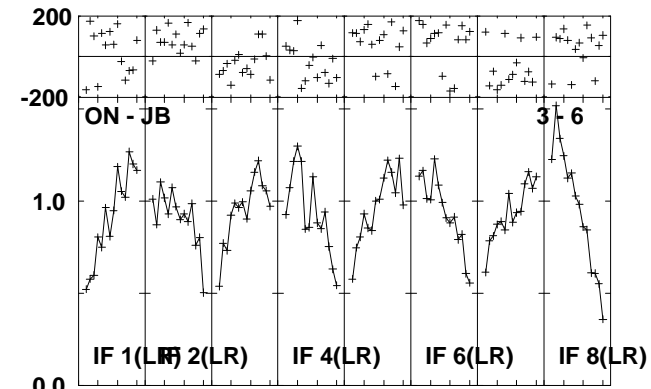
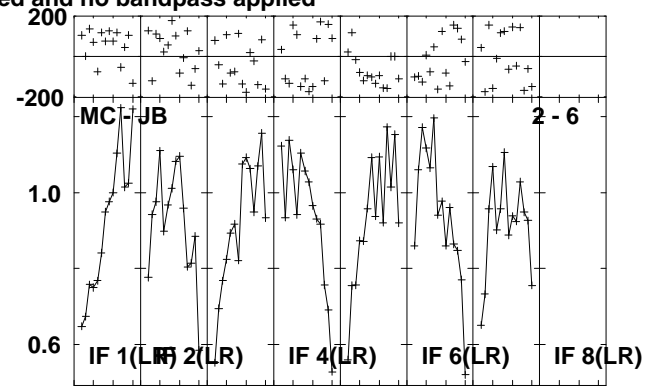
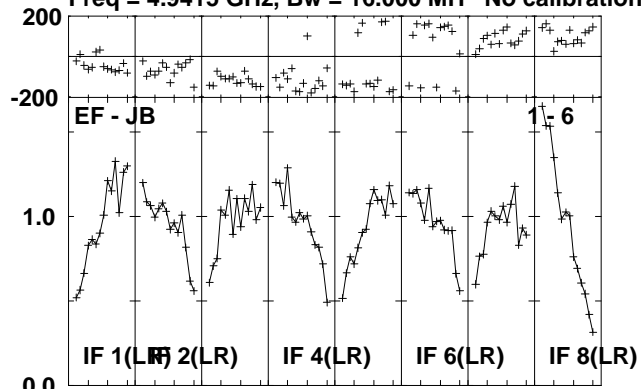

Lower frame: Milli Ampl Jy Top frame: Phas deg
Scalar averaged cross-power spectrum Several baselines displayed
Timerange: 00/22:19:30 to 00/22:20:58

Plot file version 72 created 15-JUL-2010 10:44:13

CYGX-1 RR004B.UVDATA.1

Freq = 4.9415 GHz, Bw = 16.000 MH No calibration applied and no bandpass applied

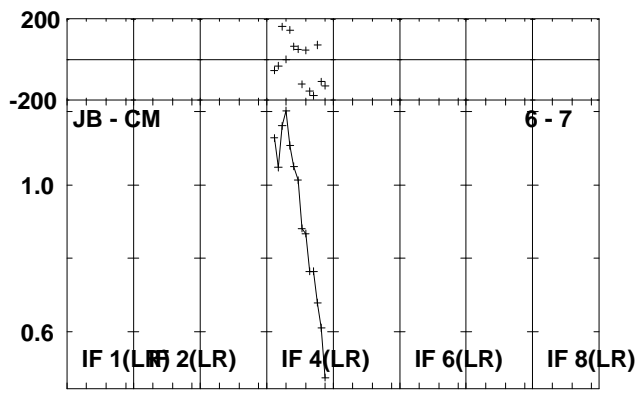
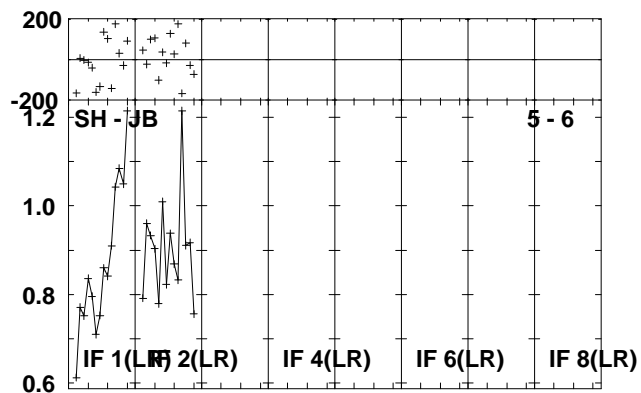
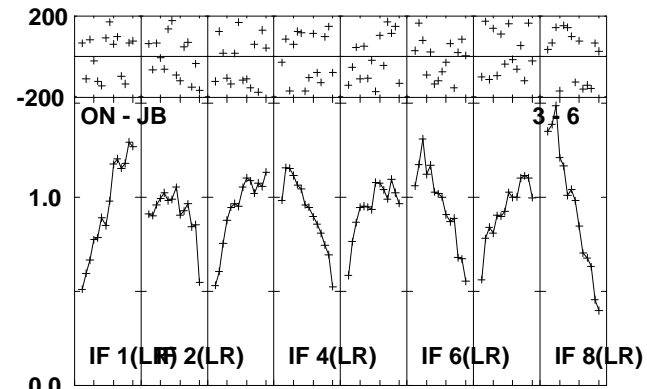
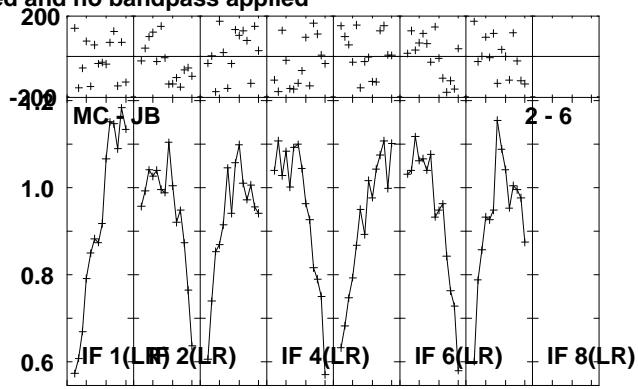
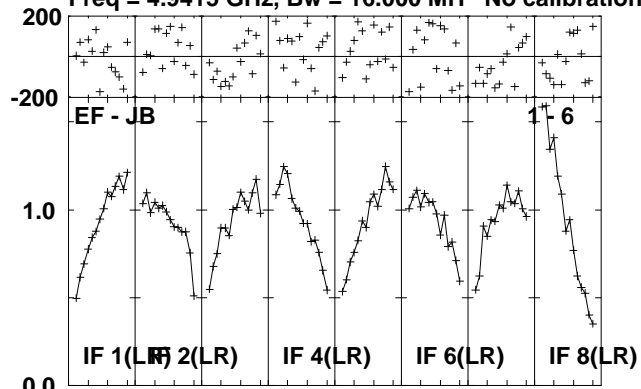

Lower frame: Milli Ampl Jy Top frame: Phas deg
Scalar averaged cross-power spectrum Several baselines displayed
Timerange: 00/22:21:00 to 00/22:25:58

Plot file version 73 created 15-JUL-2010 10:44:15
J1953+35 RR004B.UVDATA.1

Freq = 4.9415 GHz, Bw = 16.000 MH No calibration applied and no bandpass applied

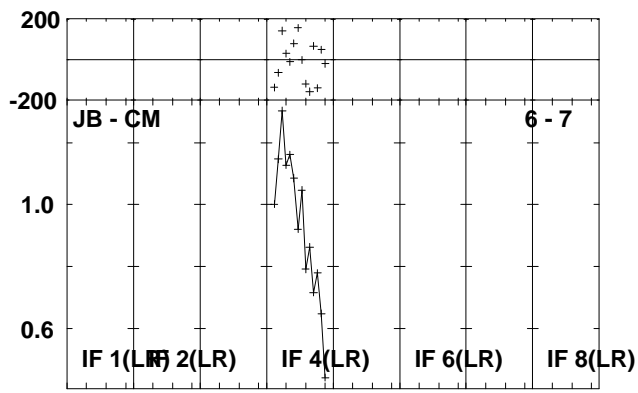
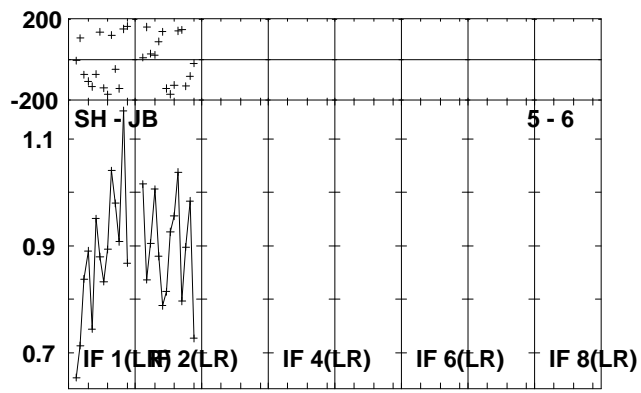
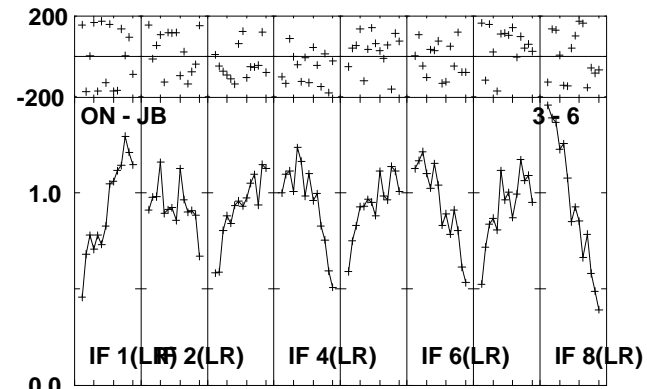
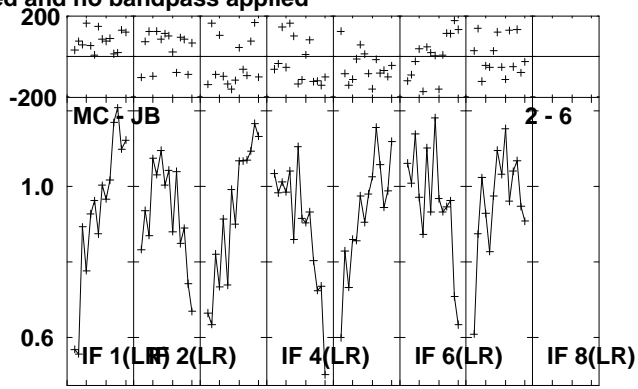
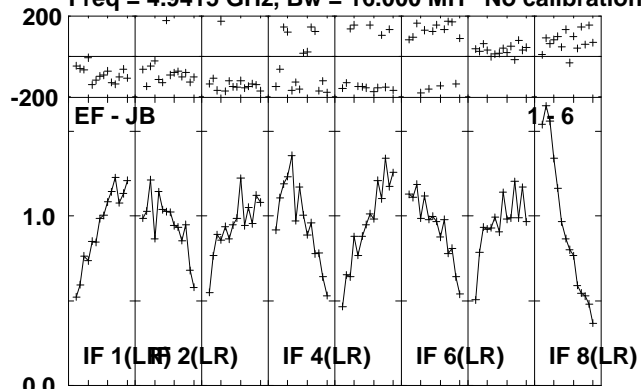

Lower frame: Milli Ampl Jy Top frame: Phas deg
Scalar averaged cross-power spectrum Several baselines displayed
Timerange: 00/22:26:00 to 00/22:27:58

Plot file version 74 created 15-JUL-2010 10:44:17
CYGX-1 RR004B.UVDATA.1

Freq = 4.9415 GHz, Bw = 16.000 MH No calibration applied and no bandpass applied

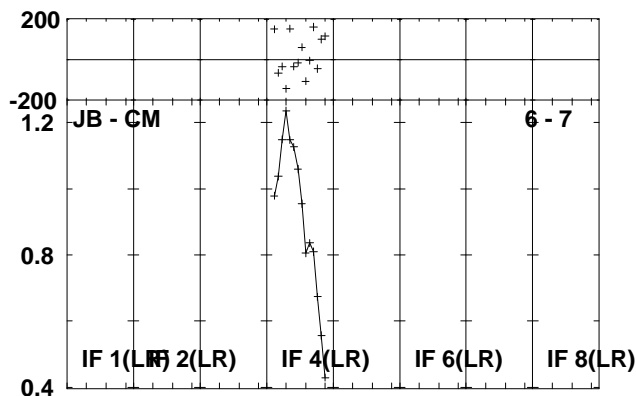
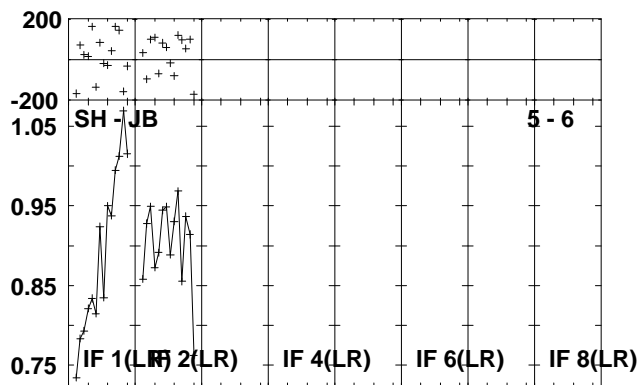
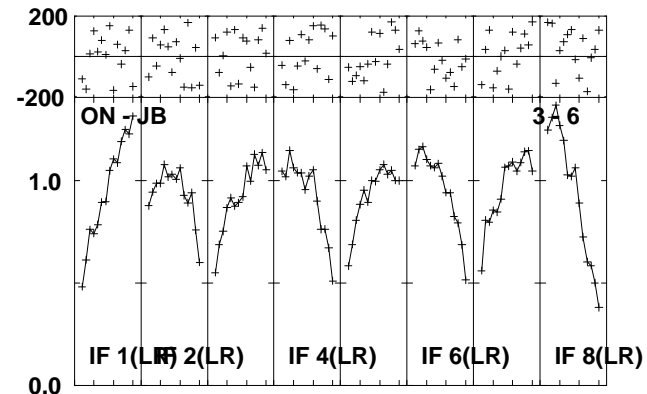
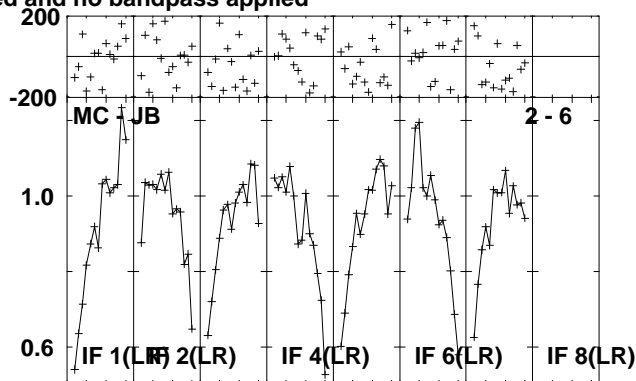
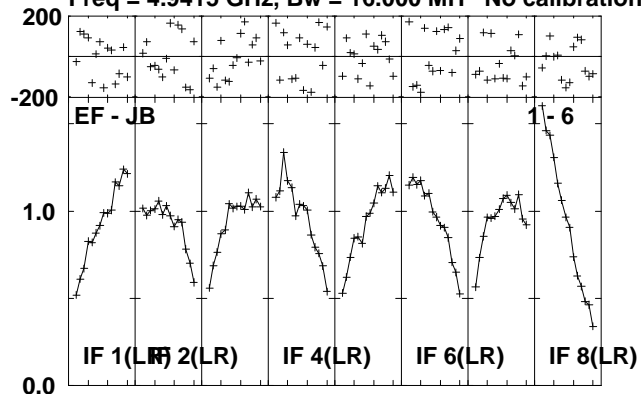

Lower frame: Milli Ampl Jy Top frame: Phas deg
Scalar averaged cross-power spectrum Several baselines displayed
Timerange: 00/22:28:00 to 00/22:32:58

Plot file version 75 created 15-JUL-2010 10:44:19
J1953+35 RR004B.UVDATA.1

Freq = 4.9415 GHz, Bw = 16.000 MH No calibration applied and no bandpass applied

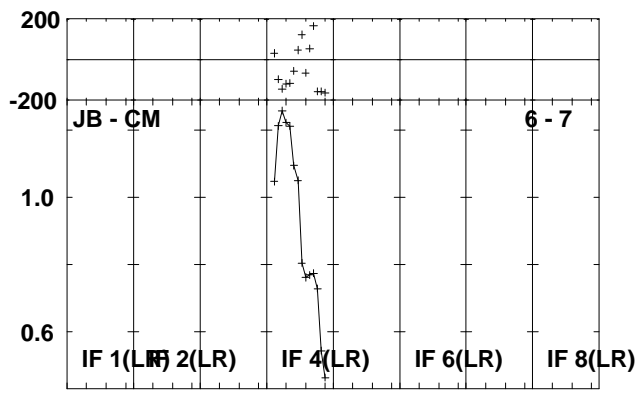
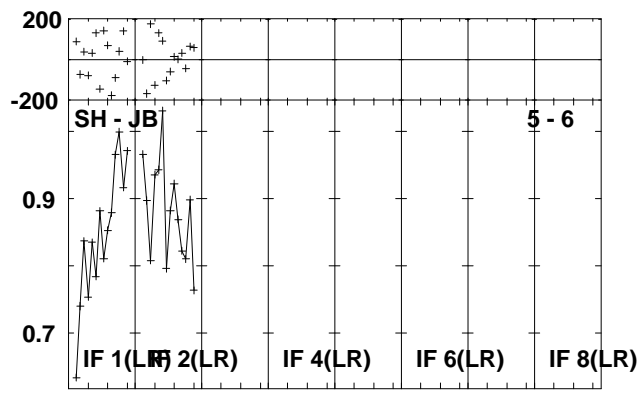
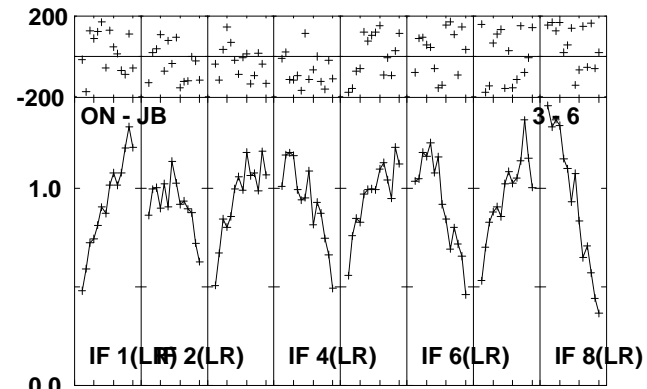
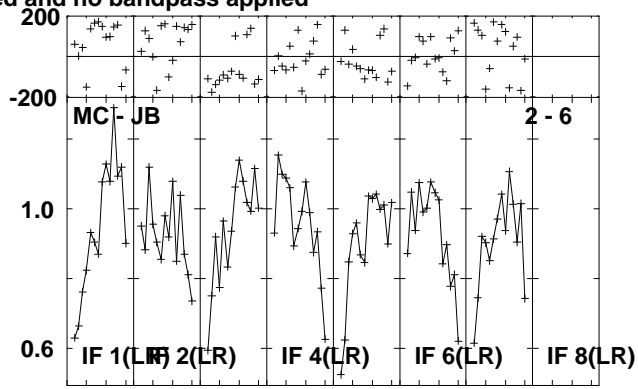
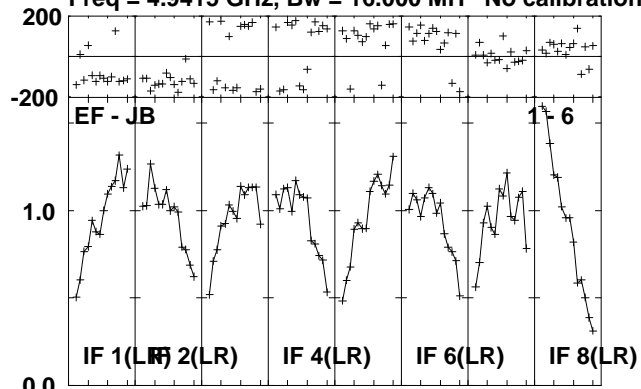

Lower frame: Milli Ampl Jy Top frame: Phas deg
Scalar averaged cross-power spectrum Several baselines displayed
Timerange: 00/22:33:40 to 00/22:35:08

Plot file version 76 created 15-JUL-2010 10:44:20
CYGX-1 RR004B.UVDATA.1

Freq = 4.9415 GHz, Bw = 16.000 MH No calibration applied and no bandpass applied

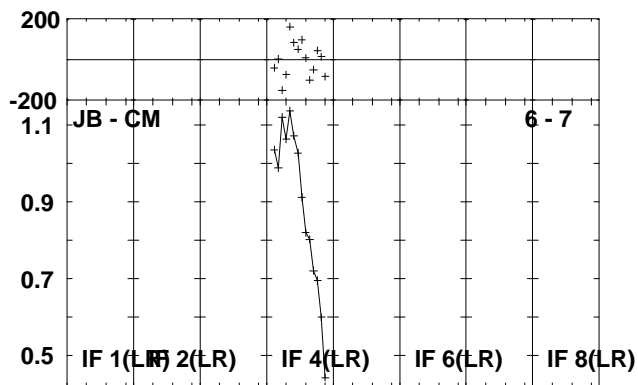
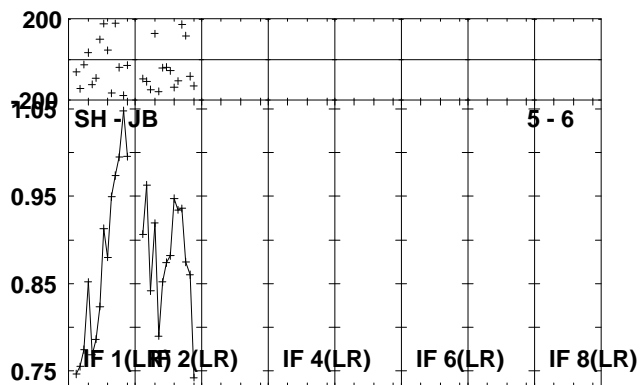
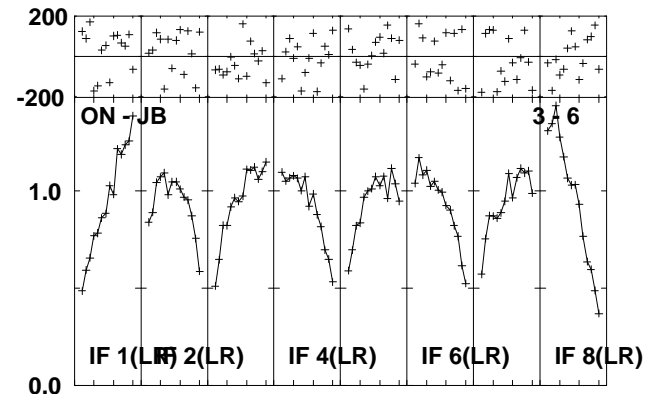
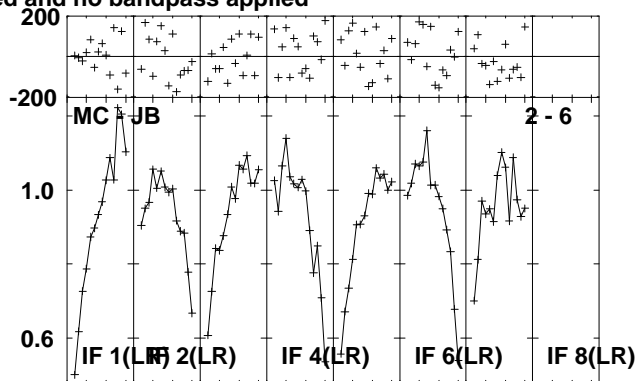
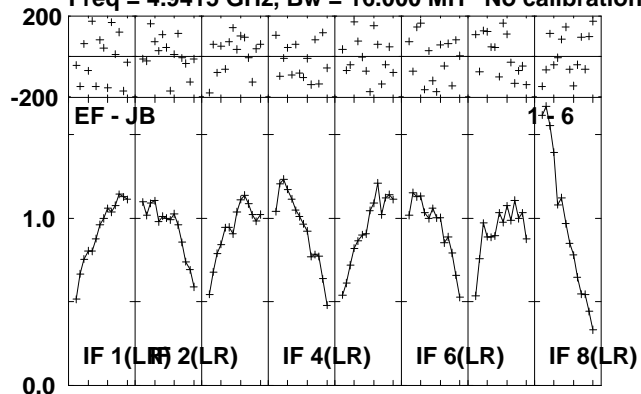

Lower frame: Milli Ampl Jy Top frame: Phas deg
Scalar averaged cross-power spectrum Several baselines displayed
Timerange: 00/22:35:10 to 00/22:40:08

Plot file version 77 created 15-JUL-2010 10:44:23
J1953+35 RR004B.UVDATA.1

Freq = 4.9415 GHz, Bw = 16.000 MH No calibration applied and no bandpass applied

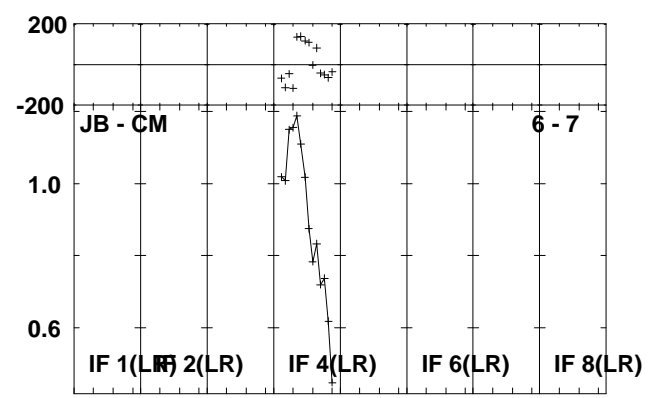
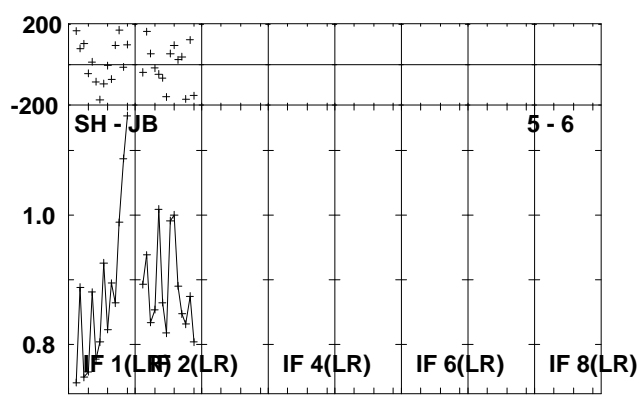
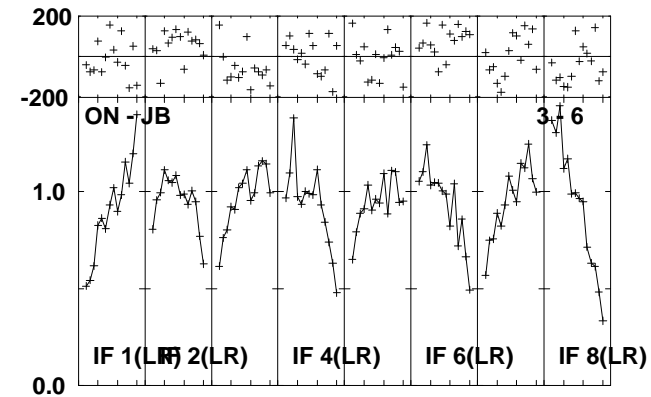
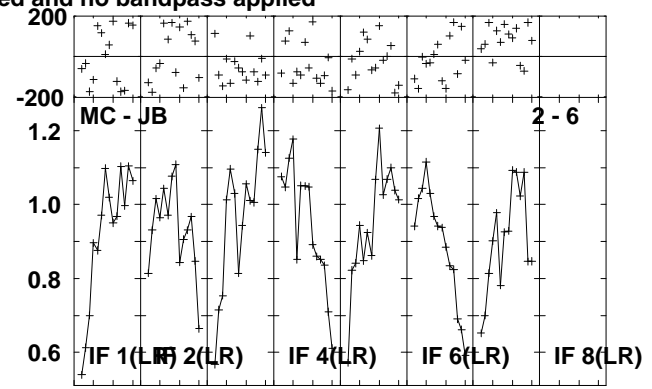
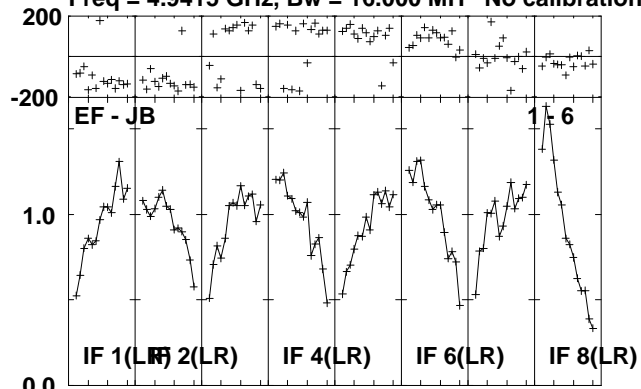

Lower frame: Milli Ampl Jy Top frame: Phas deg
Scalar averaged cross-power spectrum Several baselines displayed
Timerange: 00/22:40:10 to 00/22:42:08

Plot file version 78 created 15-JUL-2010 10:44:24
CYGX-1 RR004B.UVDATA.1

Freq = 4.9415 GHz, Bw = 16.000 MH No calibration applied and no bandpass applied

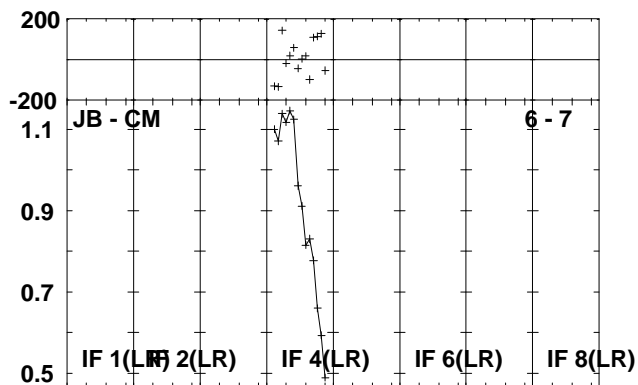
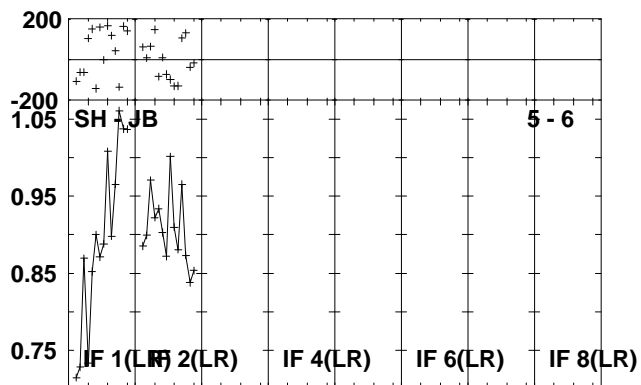
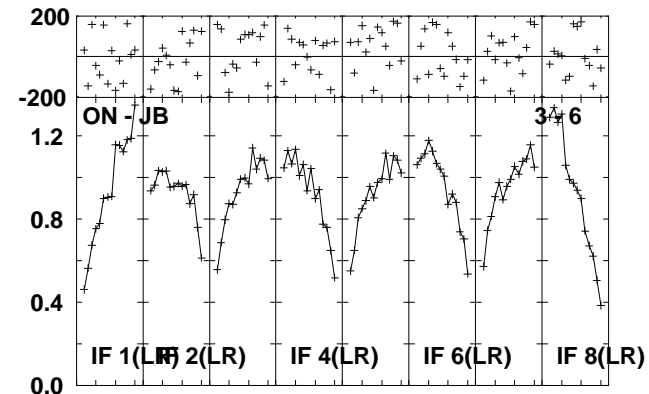
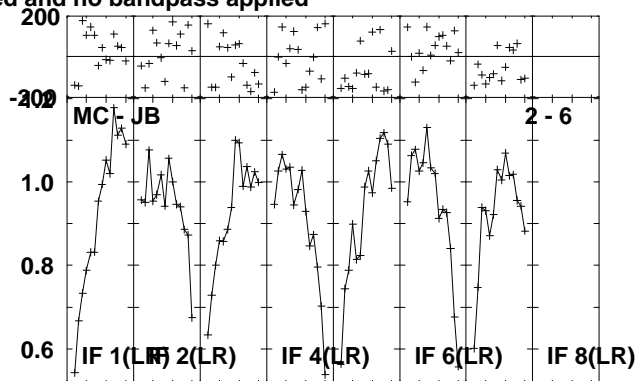
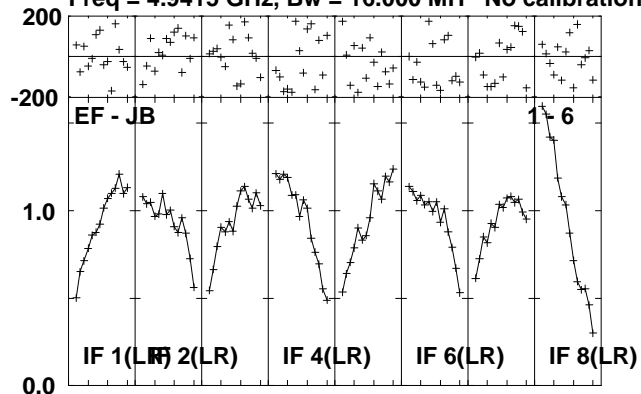

Lower frame: Milli Ampl Jy Top frame: Phas deg
Scalar averaged cross-power spectrum Several baselines displayed
Timerange: 00/22:42:10 to 00/22:47:08

Plot file version 79 created 15-JUL-2010 10:44:26
J1953+35 RR004B.UVDATA.1

Freq = 4.9415 GHz, Bw = 16.000 MH No calibration applied and no bandpass applied

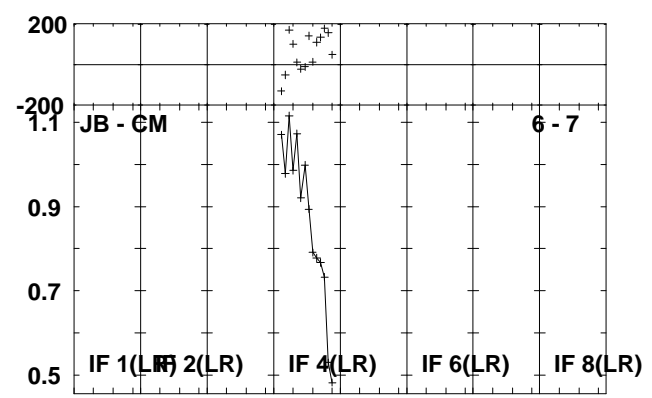
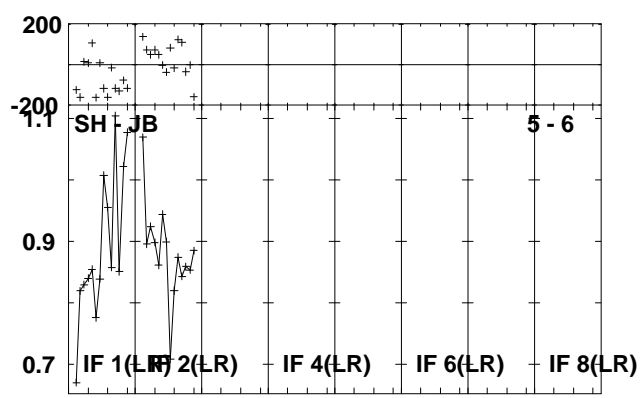
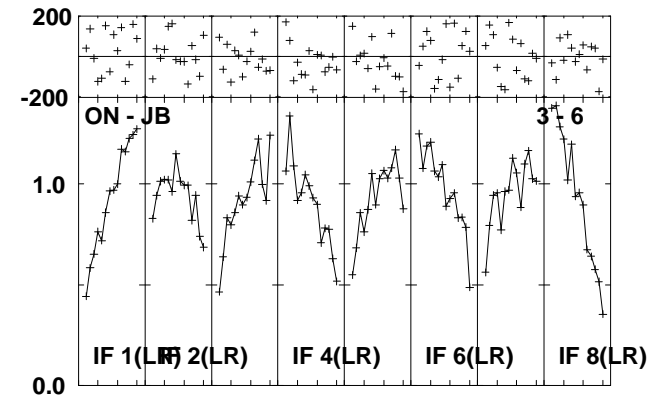
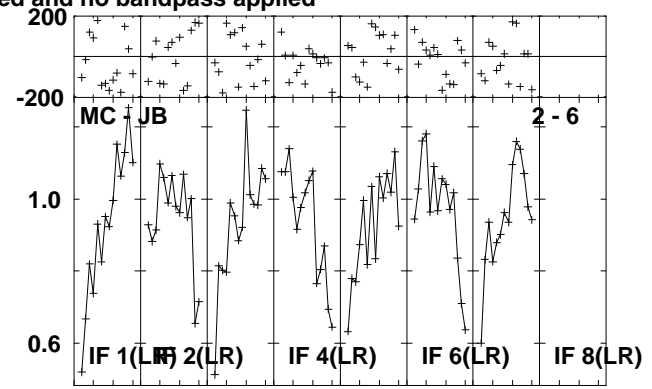
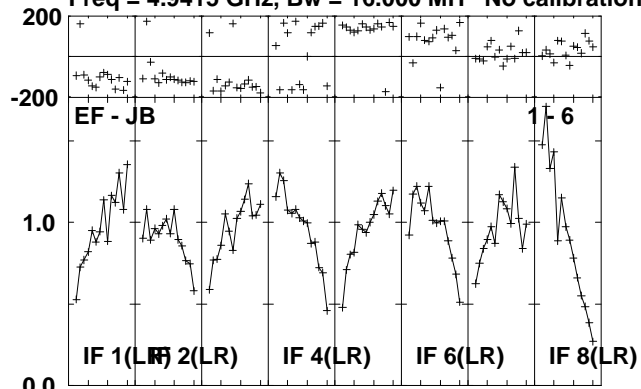

Lower frame: Milli Ampl Jy Top frame: Phas deg
Scalar averaged cross-power spectrum Several baselines displayed
Timerange: 00/22:47:50 to 00/22:49:18

Plot file version 80 created 15-JUL-2010 10:44:27

CYGX-1 RR004B.UVDATA.1

Freq = 4.9415 GHz, Bw = 16.000 MH No calibration applied and no bandpass applied

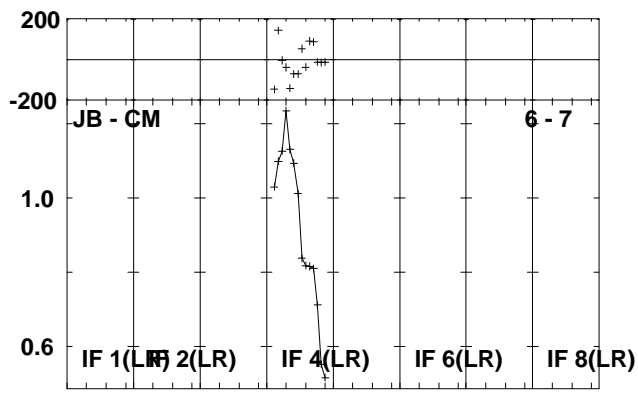
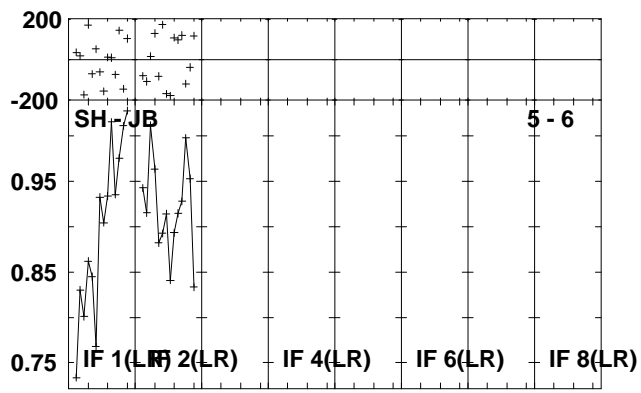
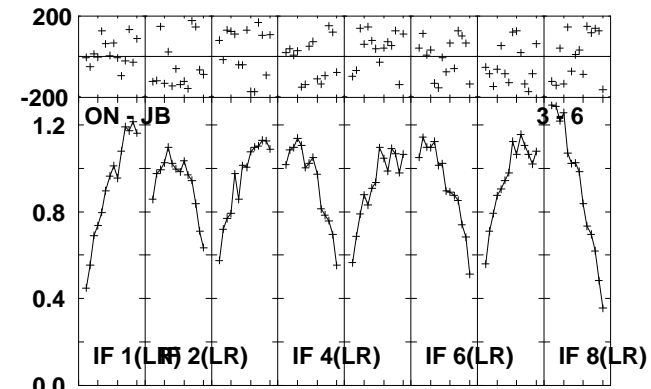
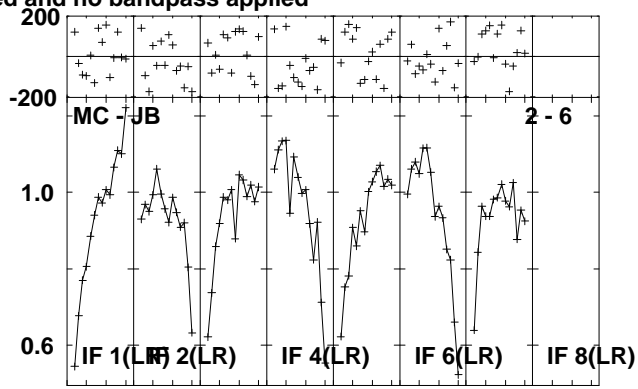
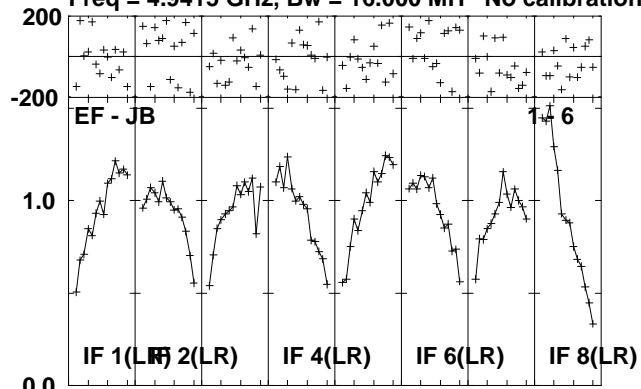

Lower frame: Milli Ampl Jy Top frame: Phas deg
Scalar averaged cross-power spectrum Several baselines displayed
Timerange: 00/22:49:20 to 00/22:54:18

Plot file version 81 created 15-JUL-2010 10:44:30
J1953+35 RR004B.UVDATA.1

Freq = 4.9415 GHz, Bw = 16.000 MH No calibration applied and no bandpass applied

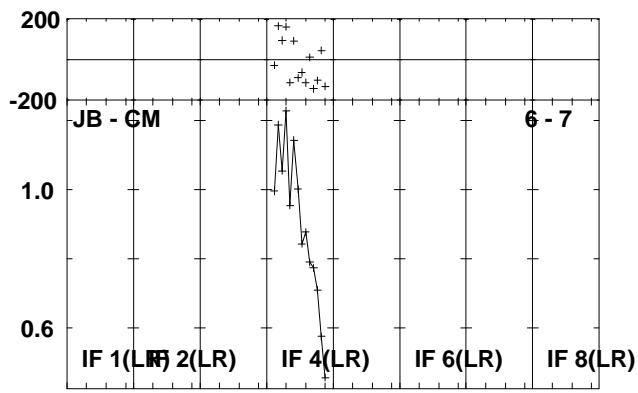
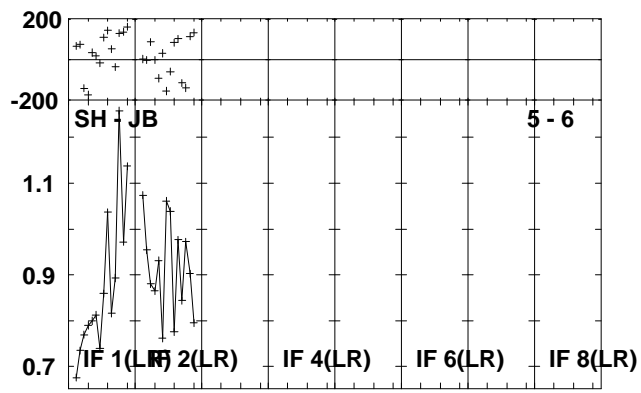
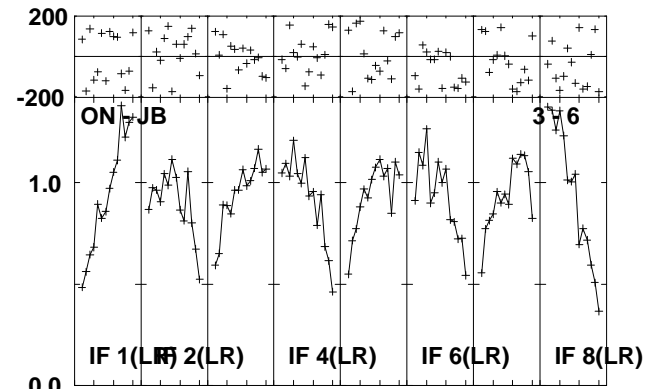
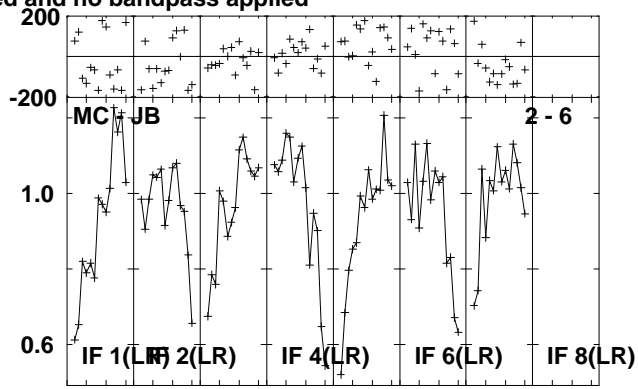
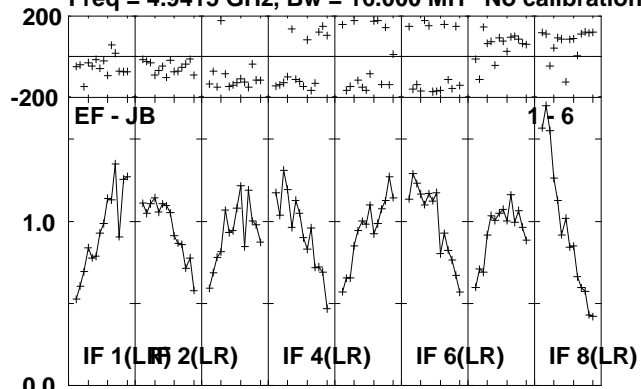

Lower frame: Milli Ampl Jy Top frame: Phas deg
Scalar averaged cross-power spectrum Several baselines displayed
Timerange: 00/22:54:20 to 00/22:56:18

Plot file version 82 created 15-JUL-2010 10:44:31
CYGX-1 RR004B.UVDATA.1

Freq = 4.9415 GHz, Bw = 16.000 MH No calibration applied and no bandpass applied

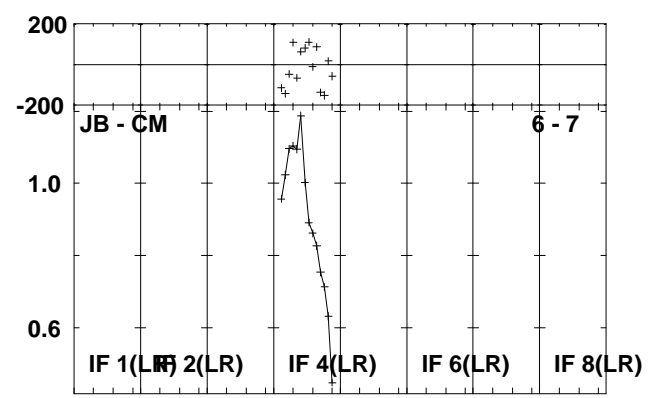
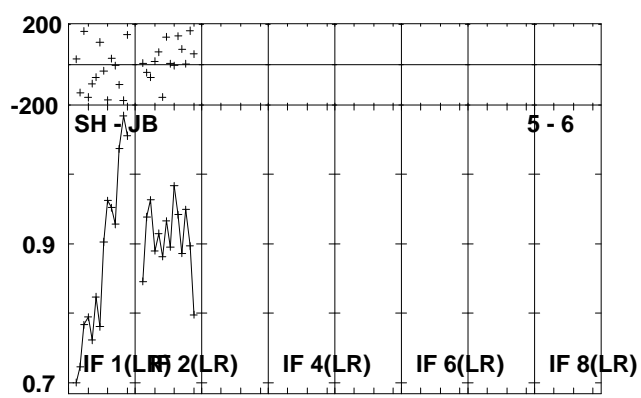
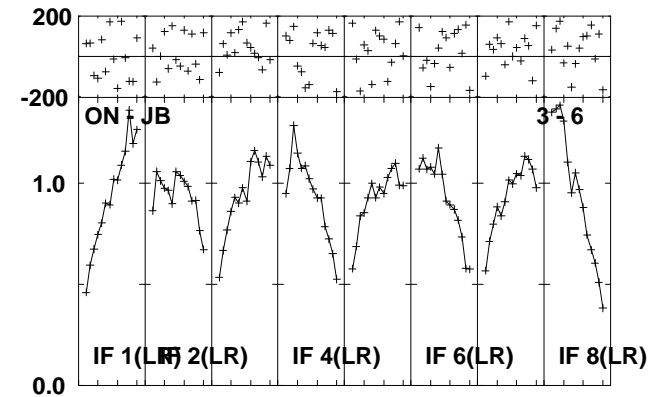
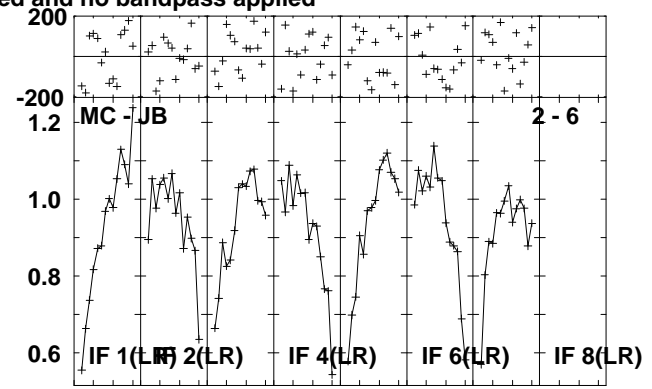
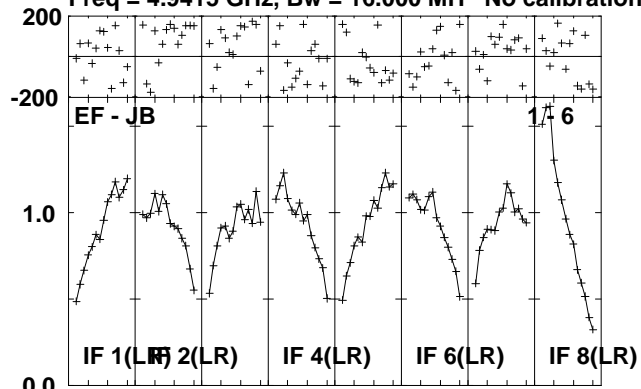

Lower frame: Milli Ampl Jy Top frame: Phas deg
Scalar averaged cross-power spectrum Several baselines displayed
Timerange: 00/22:56:20 to 00/23:01:18

Plot file version 83 created 15-JUL-2010 10:44:34
J1953+35 RR004B.UVDATA.1

Freq = 4.9415 GHz, Bw = 16.000 MH No calibration applied and no bandpass applied

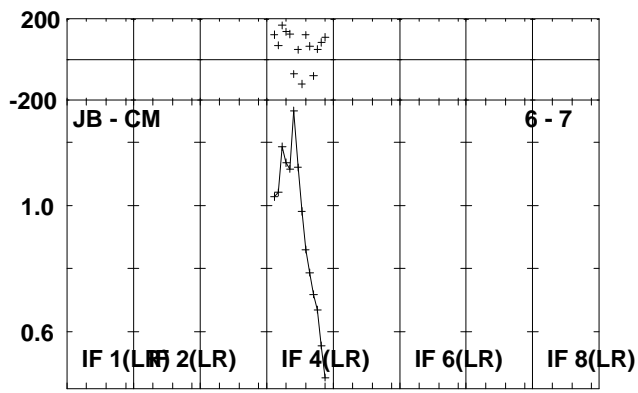
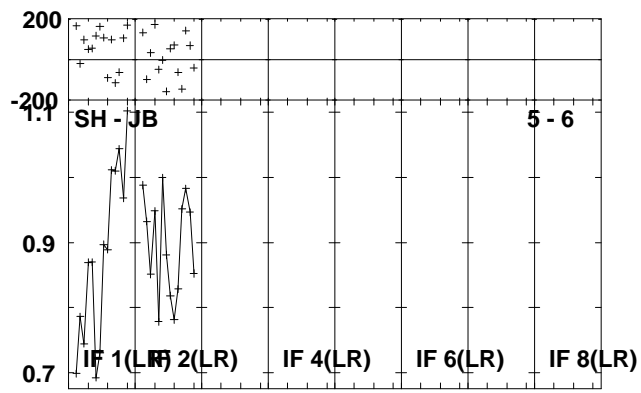
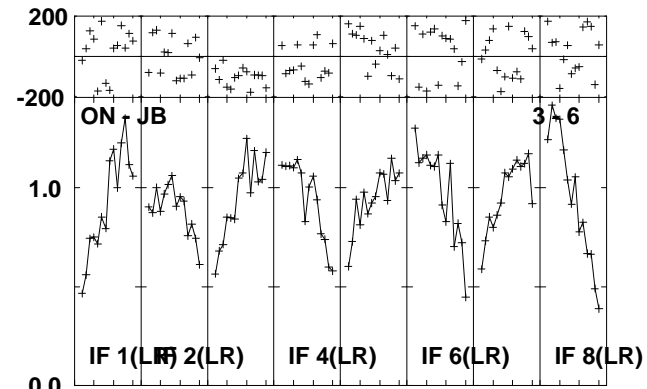
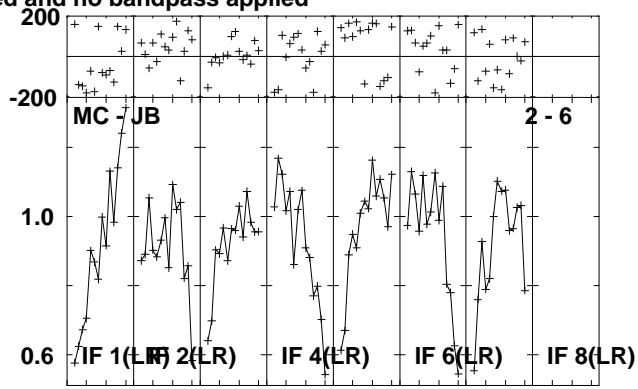
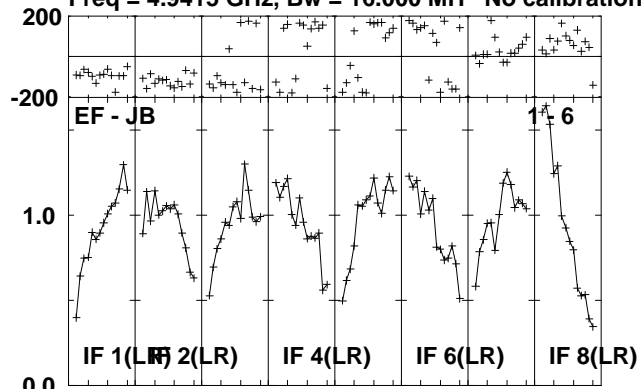

Lower frame: Milli Ampl Jy Top frame: Phas deg
Scalar averaged cross-power spectrum Several baselines displayed
Timerange: 00/23:02:00 to 00/23:03:28

Plot file version 84 created 15-JUL-2010 10:44:34
CYGX-1 RR004B.UVDATA.1

Freq = 4.9415 GHz, Bw = 16.000 MH No calibration applied and no bandpass applied

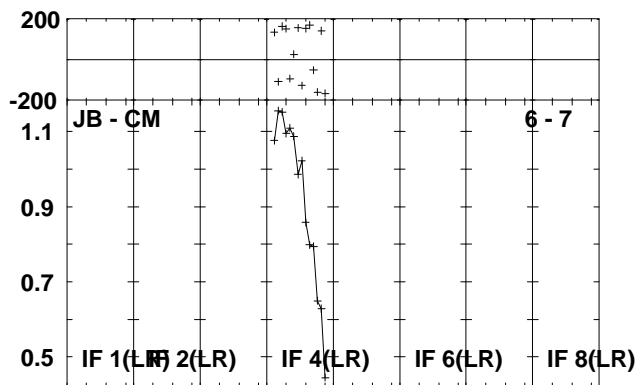
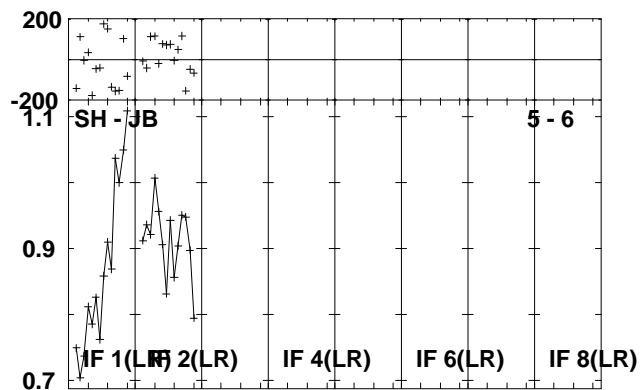
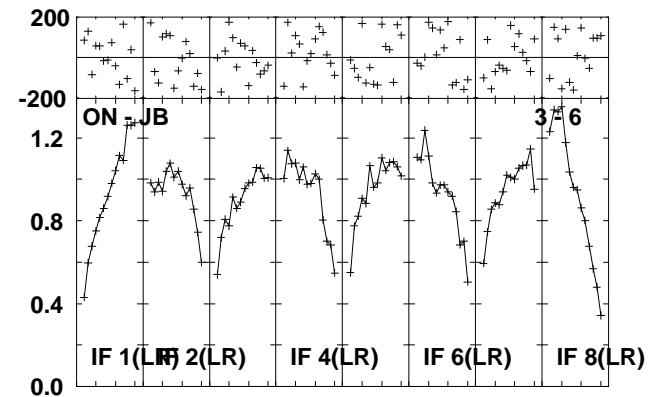
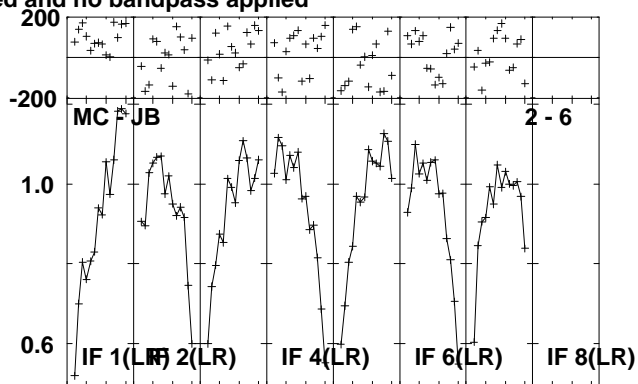
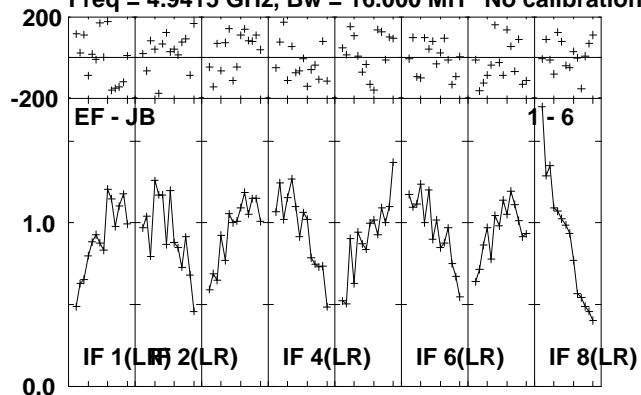

Lower frame: Milli Ampl Jy Top frame: Phas deg
Scalar averaged cross-power spectrum Several baselines displayed
Timerange: 00/23:03:30 to 00/23:08:28

Plot file version 85 created 15-JUL-2010 10:44:37
J1953+35 RR004B.UVDATA.1

Freq = 4.9415 GHz, Bw = 16.000 MH No calibration applied and no bandpass applied

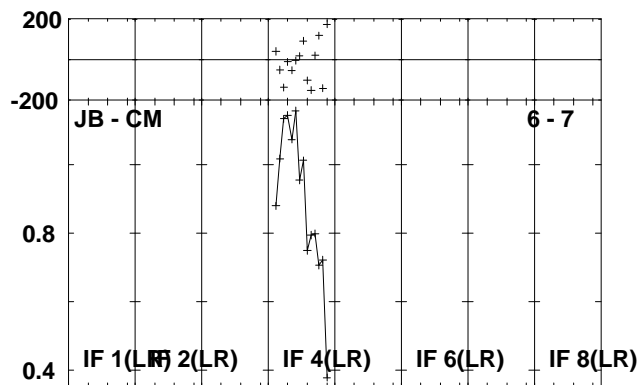
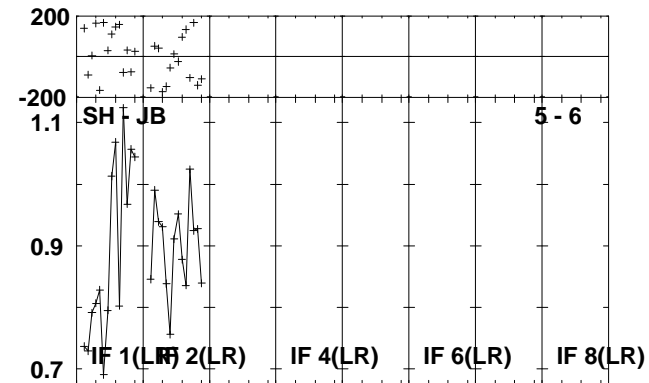
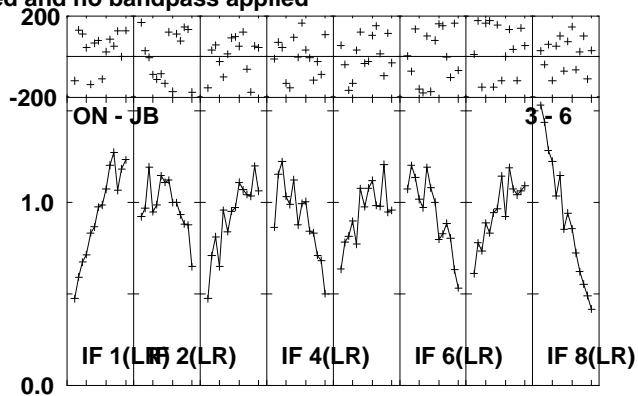
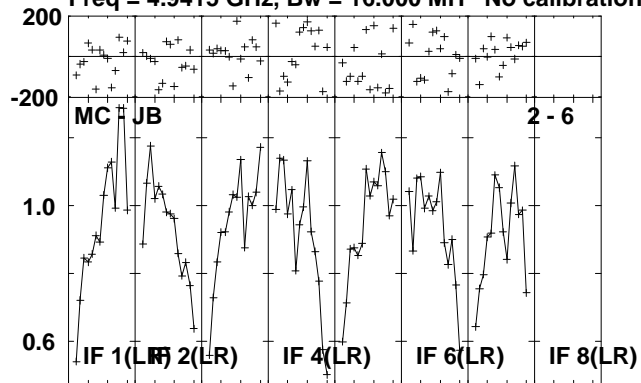

Lower frame: Milli Ampl Jy Top frame: Phas deg
Scalar averaged cross-power spectrum Several baselines displayed
Timerange: 00/23:08:30 to 00/23:10:28

Plot file version 86 created 15-JUL-2010 10:44:38
CYGX-1 RR004B.UVDATA.1

Freq = 4.9415 GHz, Bw = 16.000 MH No calibration applied and no bandpass applied

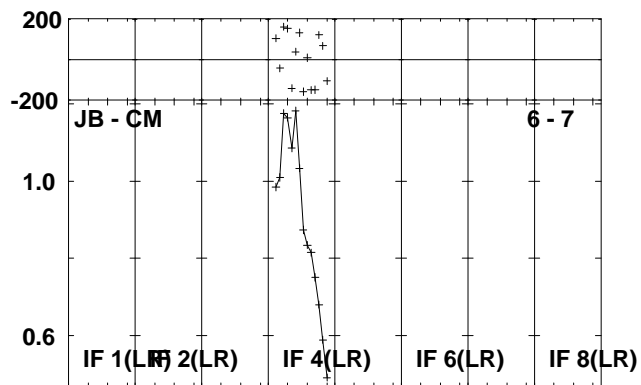
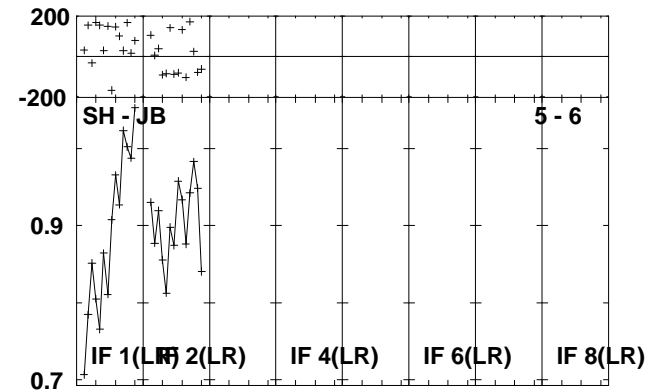
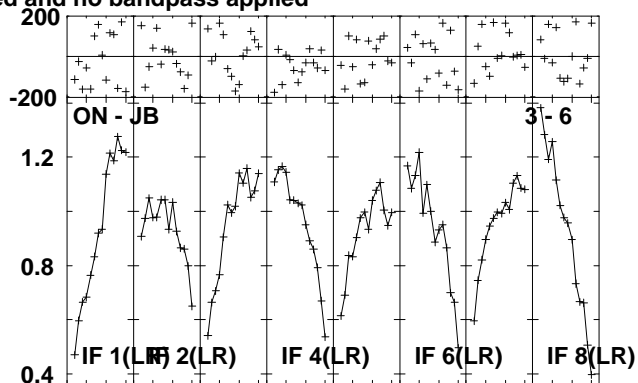
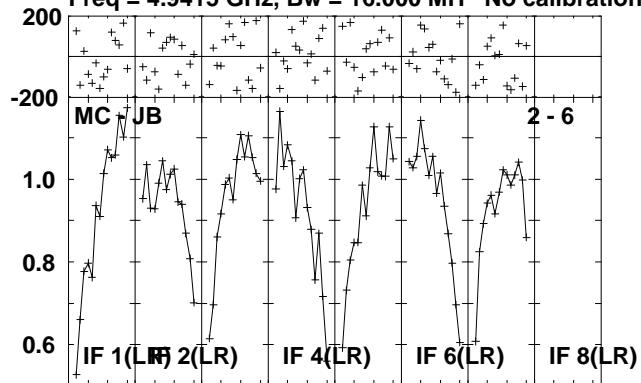

Lower frame: Milli Ampl Jy Top frame: Phas deg
Scalar averaged cross-power spectrum Several baselines displayed
Timerange: 00/23:10:30 to 00/23:15:28

Plot file version 87 created 15-JUL-2010 10:44:40
J1953+35 RR004B.UVDATA.1

Freq = 4.9415 GHz, Bw = 16.000 MH No calibration applied and no bandpass applied

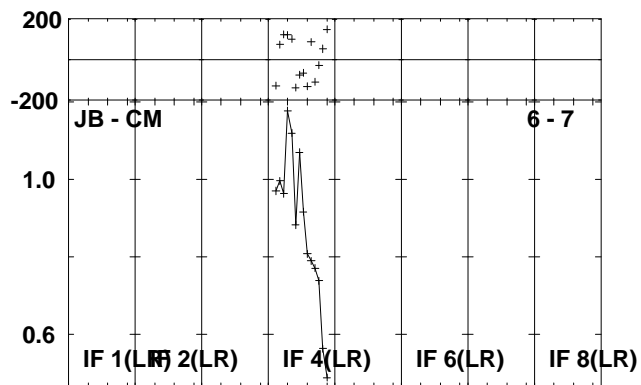
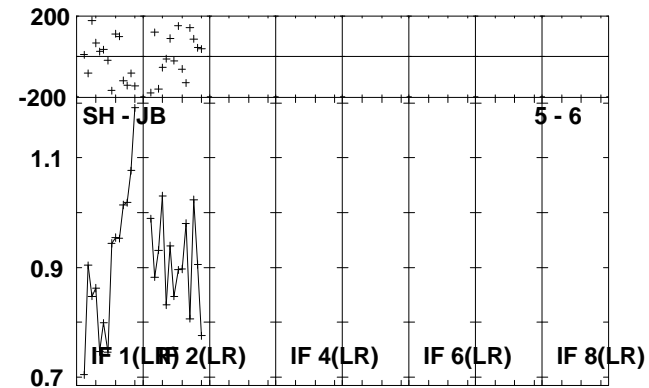
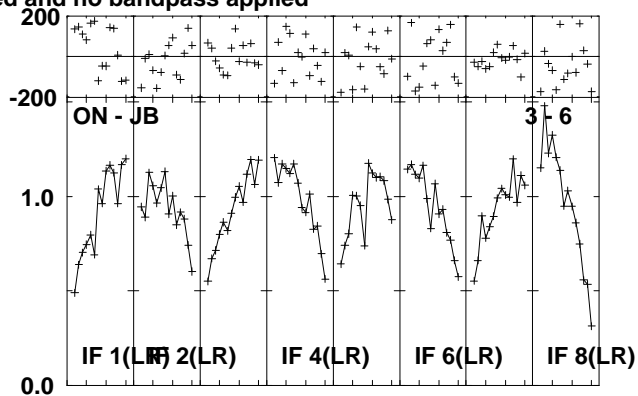
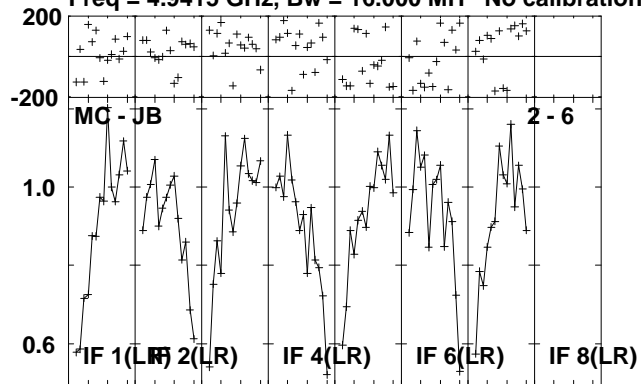

Lower frame: Milli Ampl Jy Top frame: Phas deg
Scalar averaged cross-power spectrum Several baselines displayed
Timerange: 00/23:16:10 to 00/23:17:38

Plot file version 88 created 15-JUL-2010 10:44:41
CYGX-1 RR004B.UVDATA.1

Freq = 4.9415 GHz, Bw = 16.000 MH No calibration applied and no bandpass applied

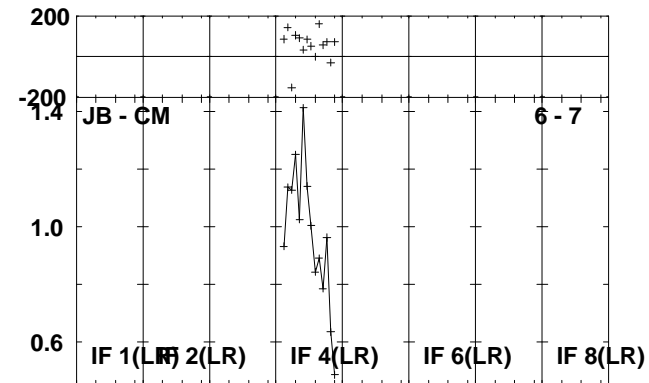
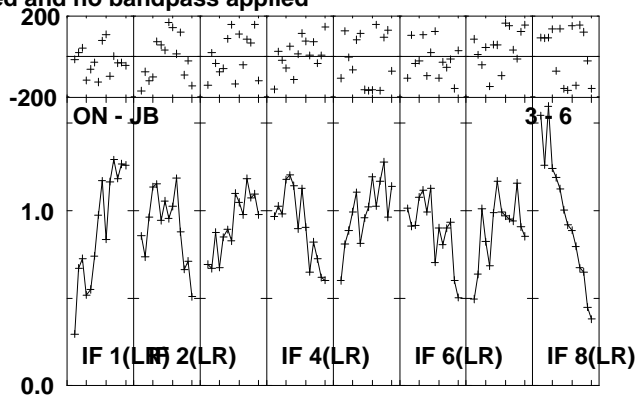
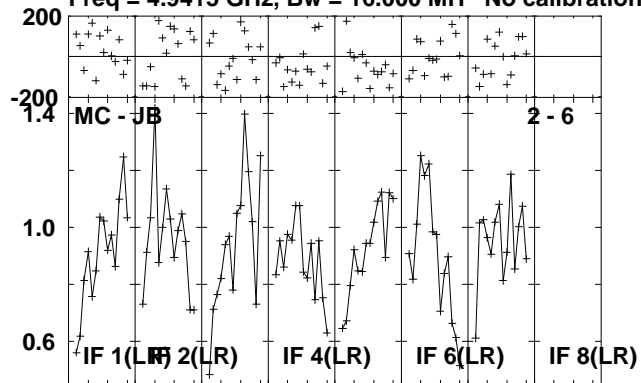

Lower frame: Milli Ampl Jy Top frame: Phas deg
Scalar averaged cross-power spectrum Several baselines displayed
Timerange: 00/23:29:04 to 00/23:29:38

Plot file version 89 created 15-JUL-2010 10:44:41

J1953+35 RR004B.UVDATA.1

Freq = 4.9415 GHz, Bw = 16.000 MH No calibration applied and no bandpass applied

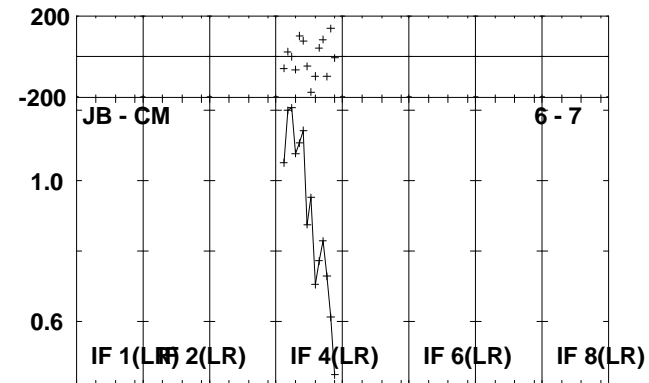
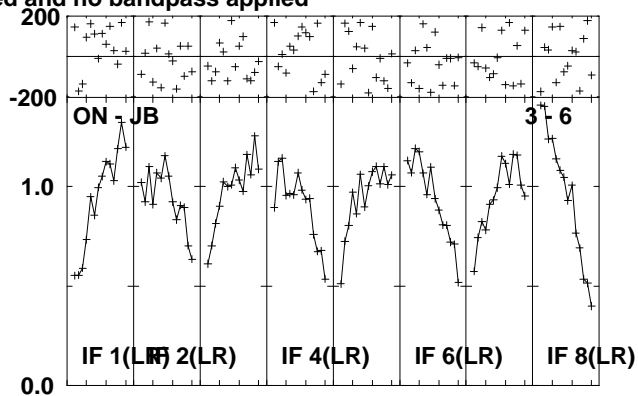
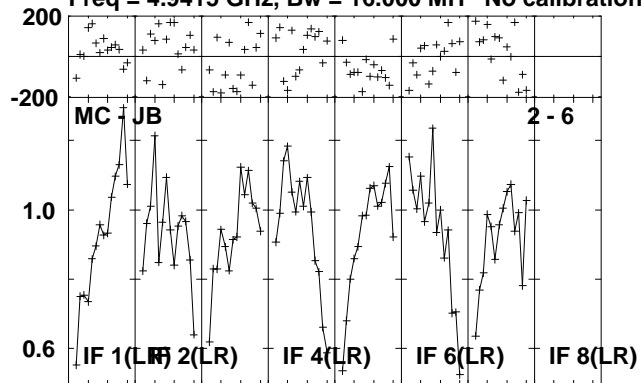

Lower frame: Milli Ampl Jy Top frame: Phas deg
Scalar averaged cross-power spectrum Several baselines displayed
Timerange: 00/23:30:40 to 00/23:32:08

Plot file version 90 created 15-JUL-2010 10:44:43

CYGX-1 RR004B.UVDATA.1

Freq = 4.9415 GHz, Bw = 16.000 MH No calibration applied and no bandpass applied

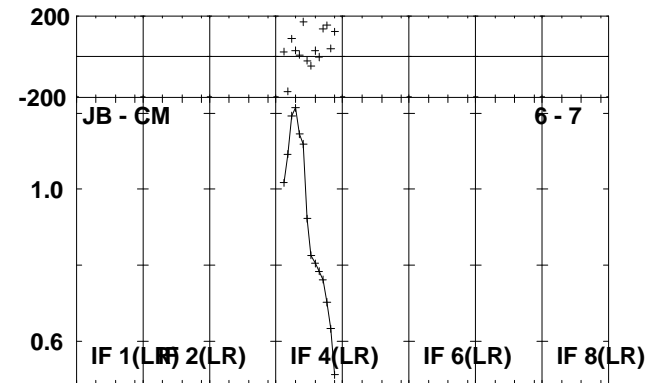
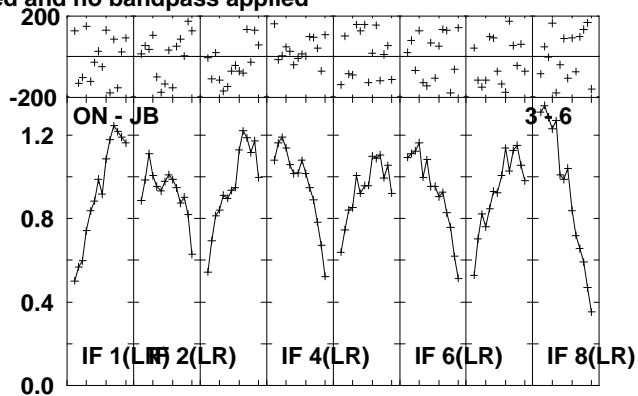
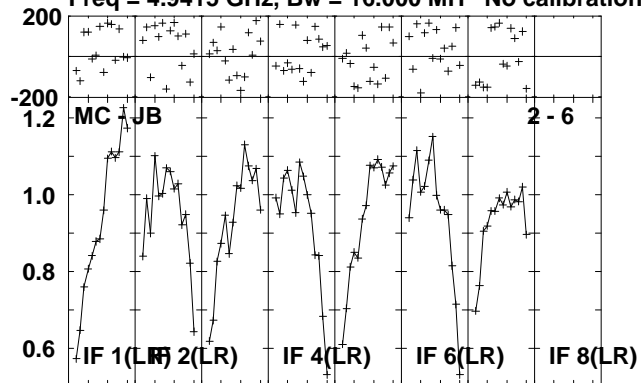

Lower frame: Milli Ampl Jy Top frame: Phas deg
Scalar averaged cross-power spectrum Several baselines displayed
Timerange: 00/23:32:10 to 00/23:37:08

Plot file version 91 created 15-JUL-2010 10:44:44

J1953+35 RR004B.UVDATA.1

Freq = 4.9415 GHz, Bw = 16.000 MH No calibration applied and no bandpass applied

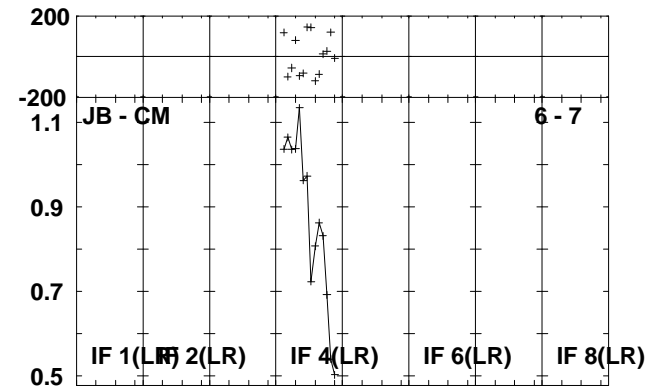
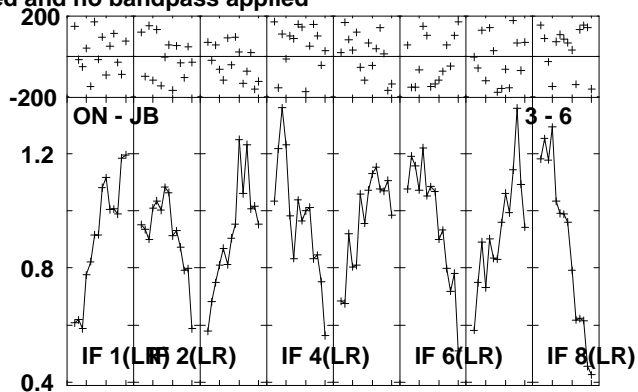
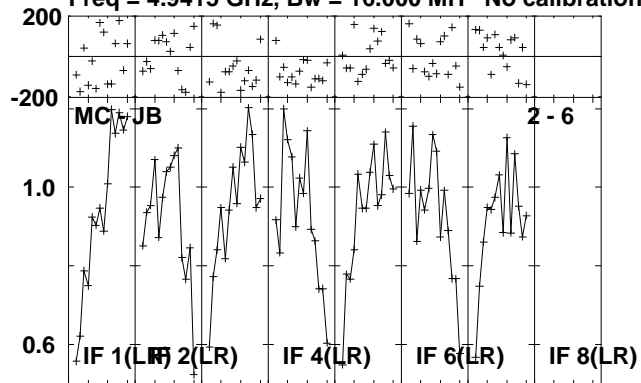

Lower frame: Milli Ampl Jy Top frame: Phas deg
Scalar averaged cross-power spectrum Several baselines displayed
Timerange: 00/23:37:10 to 00/23:39:08

Plot file version 92 created 15-JUL-2010 10:44:45

CYGX-1 RR004B.UVDATA.1

Freq = 4.9415 GHz, Bw = 16.000 MH No calibration applied and no bandpass applied

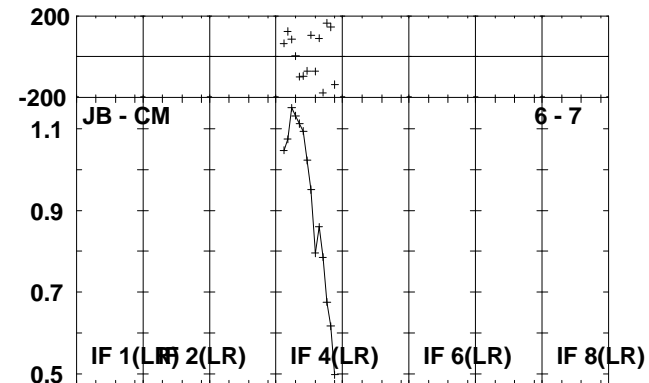
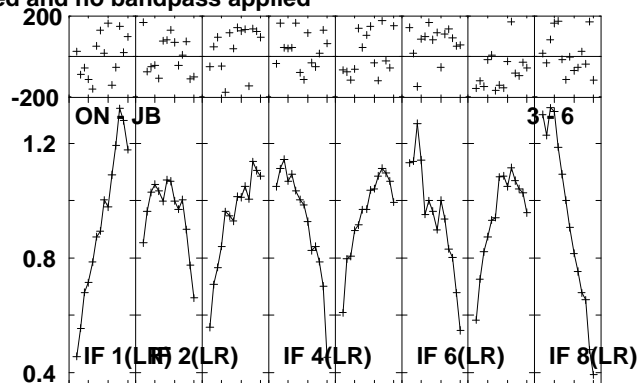
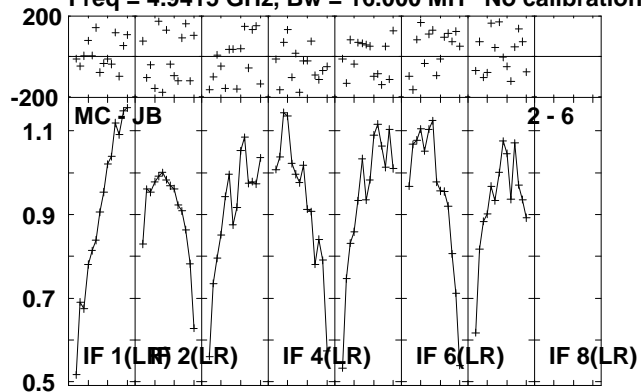

Lower frame: Milli Ampl Jy Top frame: Phas deg
Scalar averaged cross-power spectrum Several baselines displayed
Timerange: 00/23:39:10 to 00/23:44:08

Plot file version 93 created 15-JUL-2010 10:44:47
J1953+35 RR004B.UVDATA.1

Freq = 4.9415 GHz, Bw = 16.000 MH No calibration applied and no bandpass applied

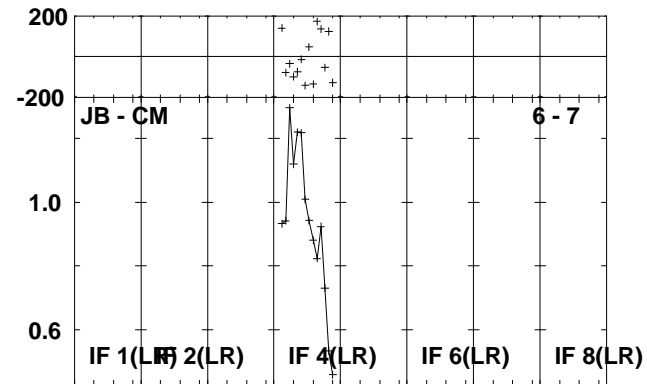
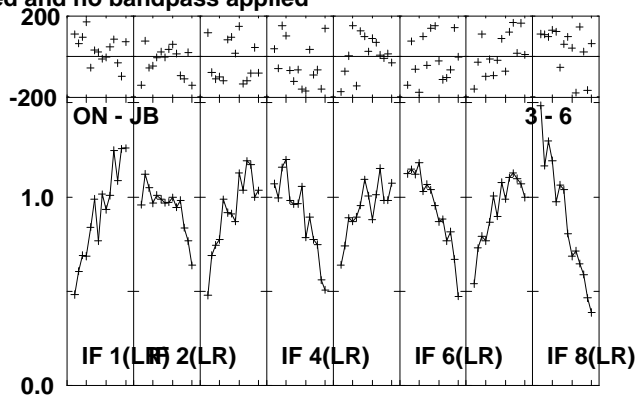
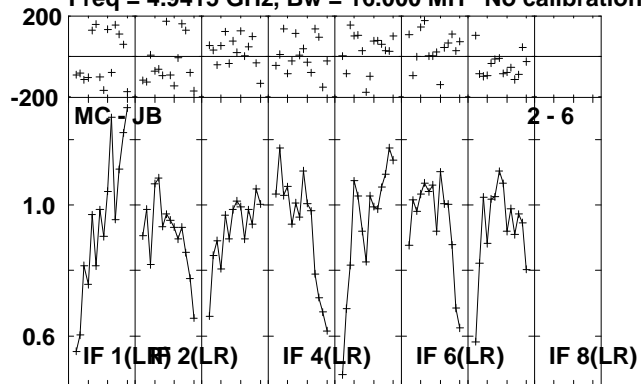

Lower frame: Milli Ampl Jy Top frame: Phas deg
Scalar averaged cross-power spectrum Several baselines displayed
Timerange: 00/23:45:10 to 00/23:46:38

Plot file version 94 created 15-JUL-2010 10:44:48
CYGX-1 RR004B.UVDATA.1

Freq = 4.9415 GHz, Bw = 16.000 MH No calibration applied and no bandpass applied

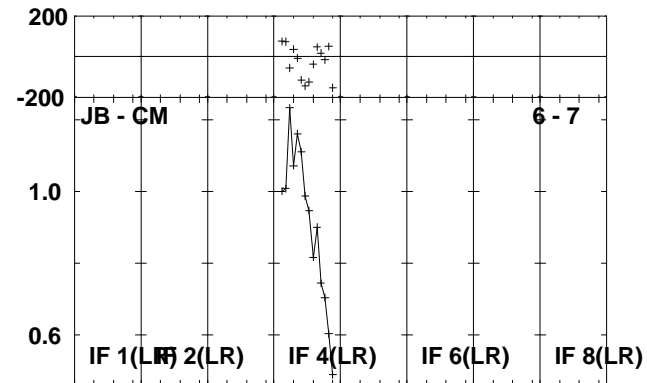
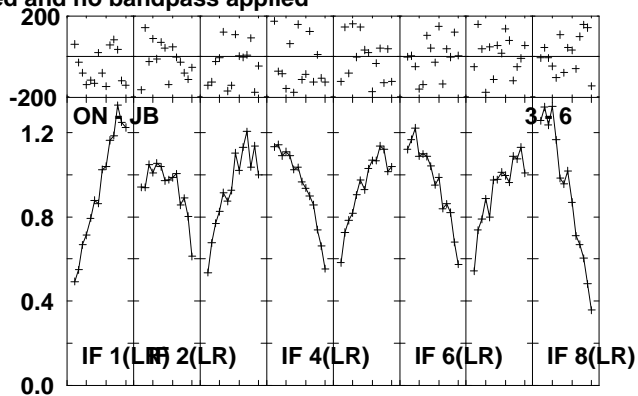
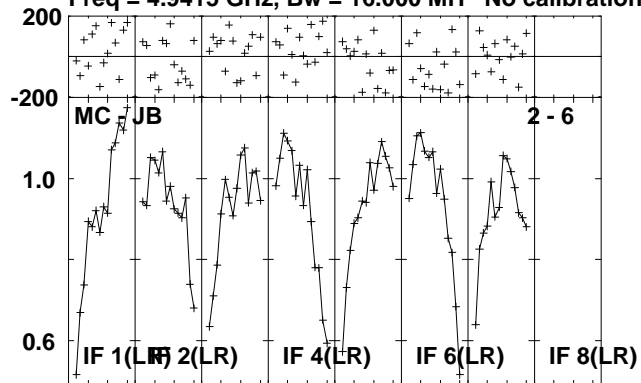

Lower frame: Milli Ampl Jy Top frame: Phas deg
Scalar averaged cross-power spectrum Several baselines displayed
Timerange: 00/23:46:40 to 00/23:51:38

Plot file version 95 created 15-JUL-2010 10:44:49

J1953+35 RR004B.UVDATA.1

Freq = 4.9415 GHz, Bw = 16.000 MH No calibration applied and no bandpass applied

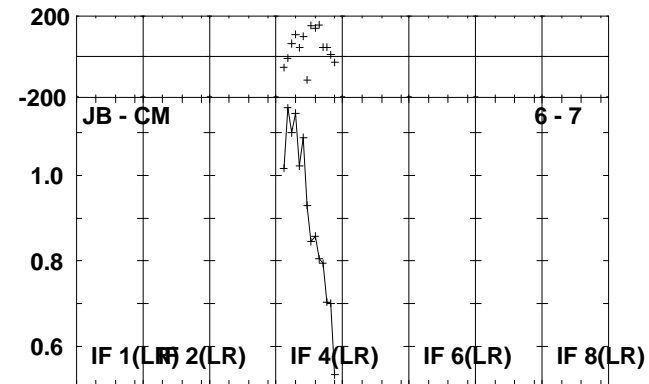
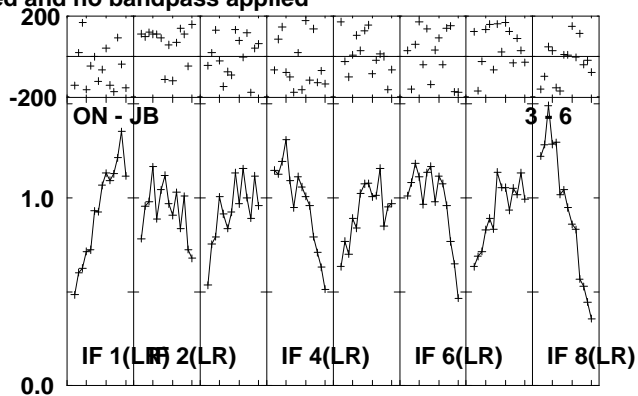
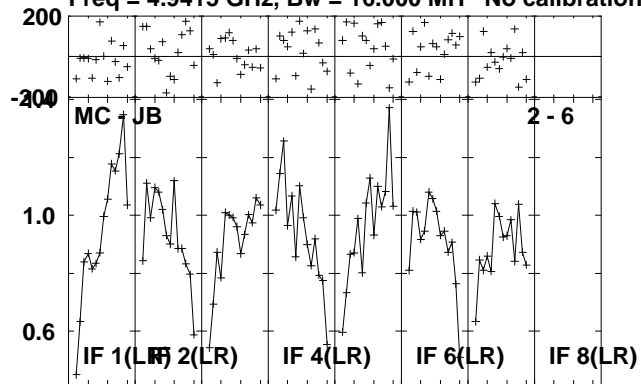

Lower frame: Milli Ampl Jy Top frame: Phas deg
Scalar averaged cross-power spectrum Several baselines displayed
Timerange: 00/23:51:40 to 00/23:53:38

Plot file version 96 created 15-JUL-2010 10:44:50

CYGX-1 RR004B.UVDATA.1

Freq = 4.9415 GHz, Bw = 16.000 MH No calibration applied and no bandpass applied

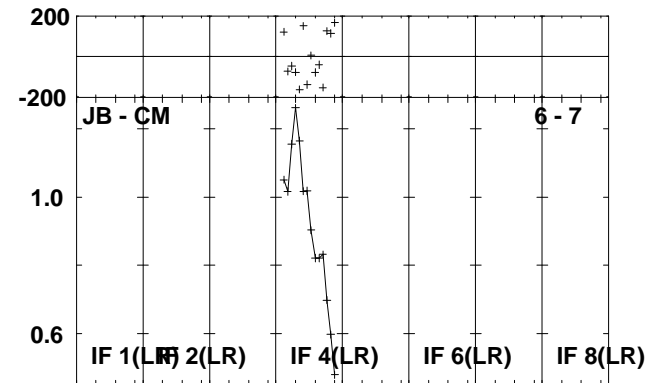
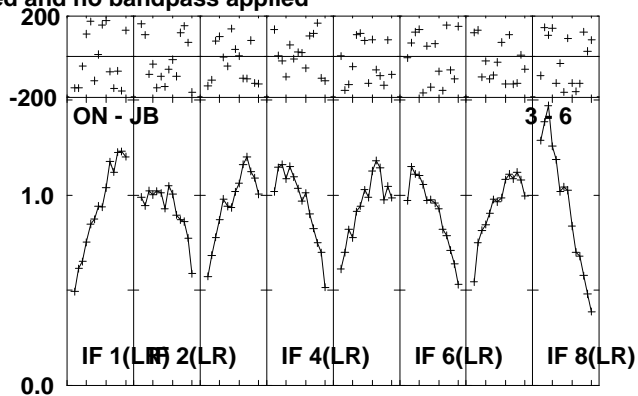
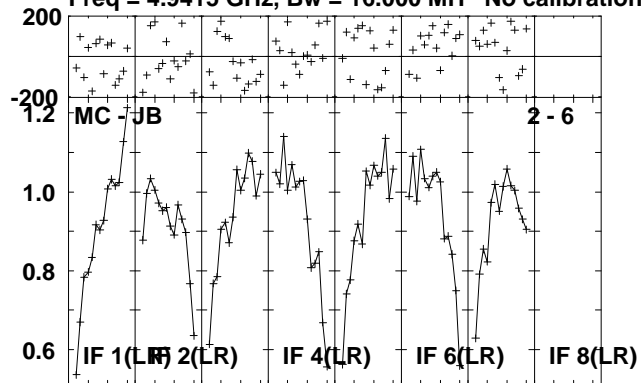

Lower frame: Milli Ampl Jy Top frame: Phas deg
Scalar averaged cross-power spectrum Several baselines displayed
Timerange: 00/23:53:40 to 00/23:58:38

Plot file version 97 created 15-JUL-2010 10:44:52

J1953+35 RR004B.UVDATA.1

Freq = 4.9415 GHz, Bw = 16.000 MH No calibration applied and no bandpass applied

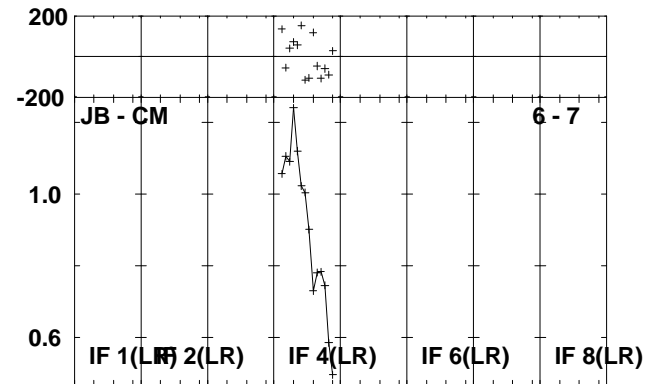
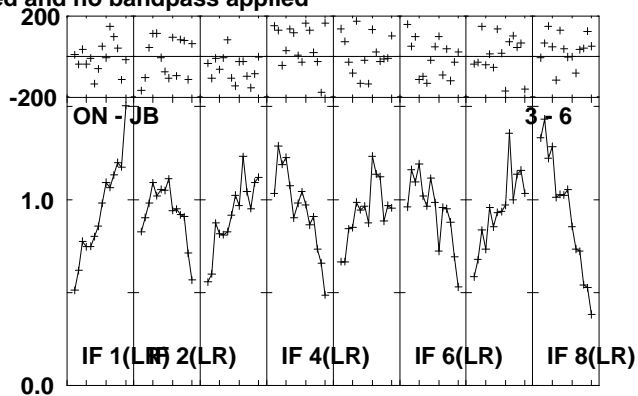
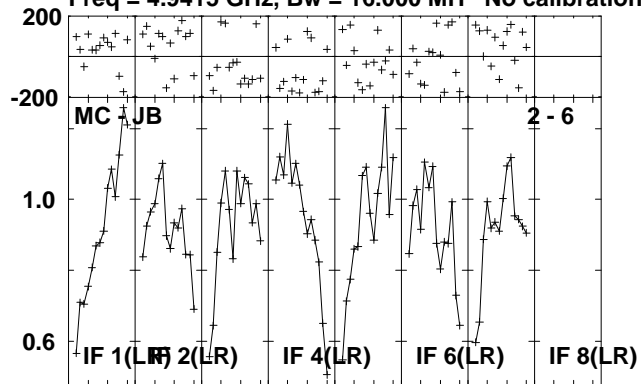

Lower frame: Milli Ampl Jy Top frame: Phas deg
Scalar averaged cross-power spectrum Several baselines displayed
Timerange: 00/23:59:40 to 01/00:01:08

Plot file version 98 created 15-JUL-2010 10:44:53

CYGX-1 RR004B.UVDATA.1

Freq = 4.9415 GHz, Bw = 16.000 MH No calibration applied and no bandpass applied

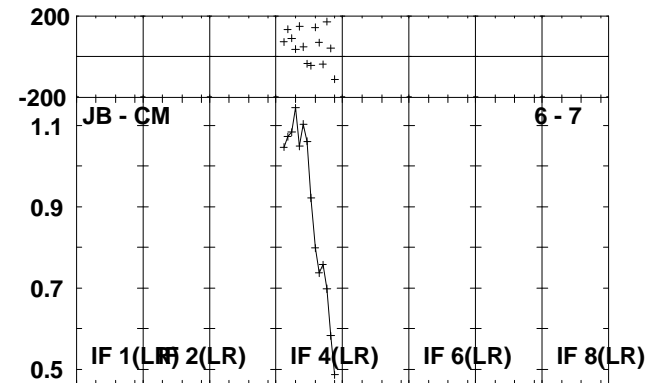
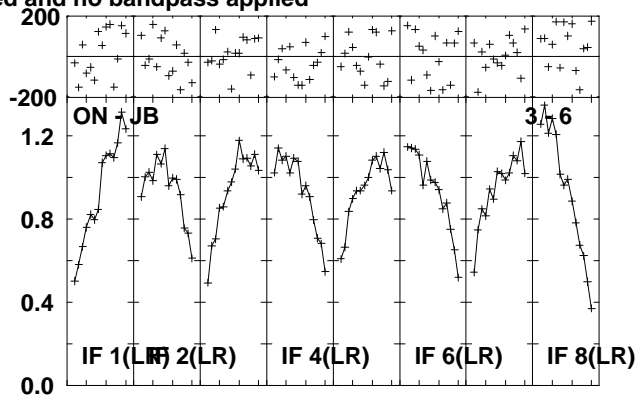
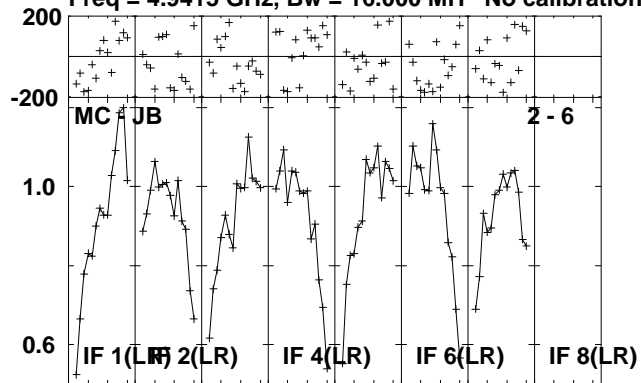

Lower frame: Milli Ampl Jy Top frame: Phas deg
Scalar averaged cross-power spectrum Several baselines displayed
Timerange: 01/00:01:10 to 01/00:06:08

Plot file version 99 created 15-JUL-2010 10:44:55
J1953+35 RR004B.UVDATA.1

Freq = 4.9415 GHz, Bw = 16.000 MH No calibration applied and no bandpass applied

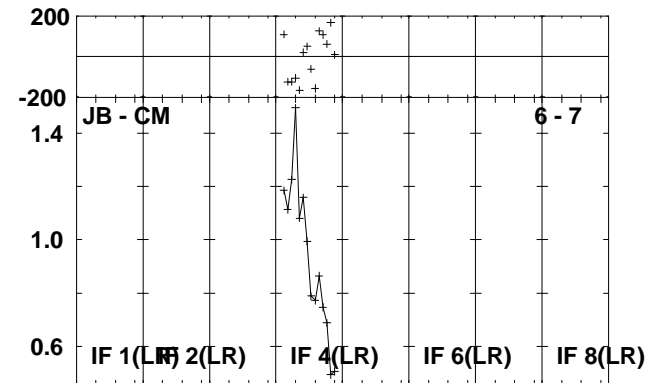
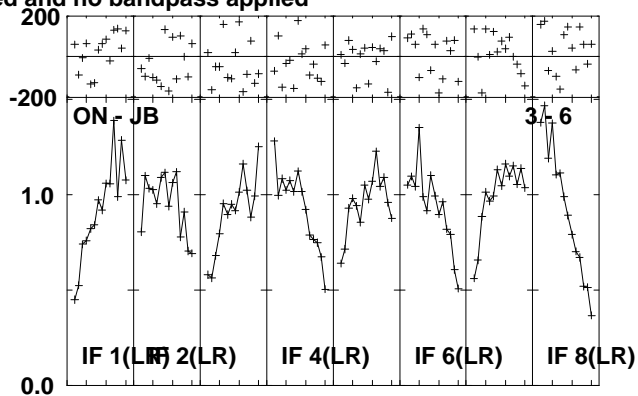
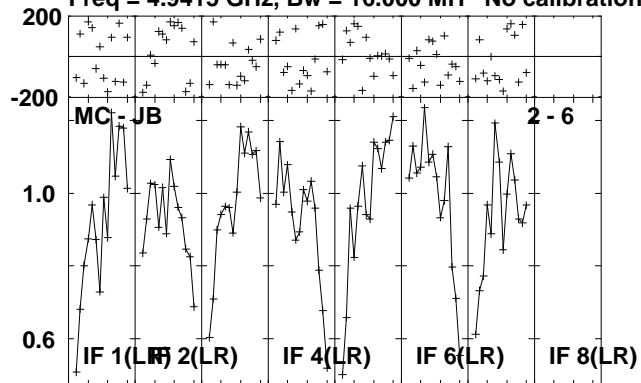

Lower frame: Milli Ampl Jy Top frame: Phas deg
Scalar averaged cross-power spectrum Several baselines displayed
Timerange: 01/00:06:10 to 01/00:08:08

Plot file version 100 created 15-JUL-2010 10:44:56

CYGX-1 RR004B.UVDATA.1

Freq = 4.9415 GHz, Bw = 16.000 MH No calibration applied and no bandpass applied

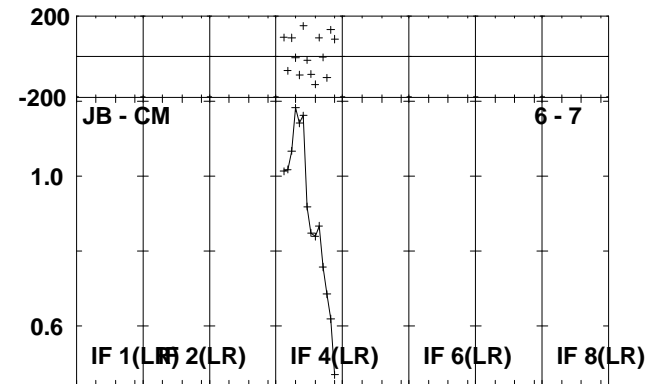
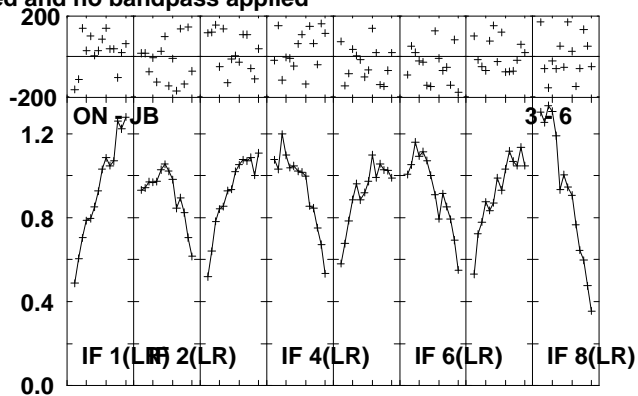
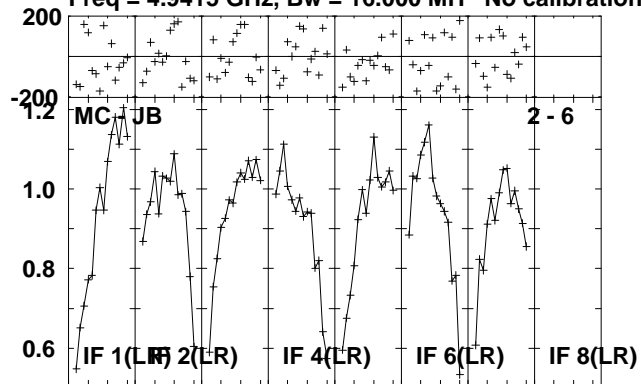

Lower frame: Milli Ampl Jy Top frame: Phas deg
Scalar averaged cross-power spectrum Several baselines displayed
Timerange: 01/00:08:10 to 01/00:13:08

Plot file version 101 created 15-JUL-2010 10:44:57

J1953+35 RR004B.UVDATA.1

Freq = 4.9415 GHz, Bw = 16.000 MH No calibration applied and no bandpass applied

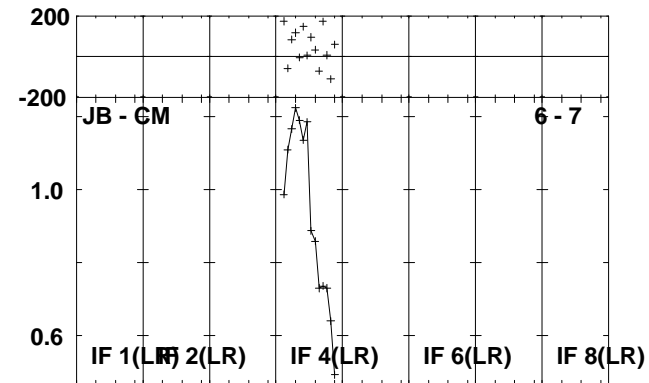
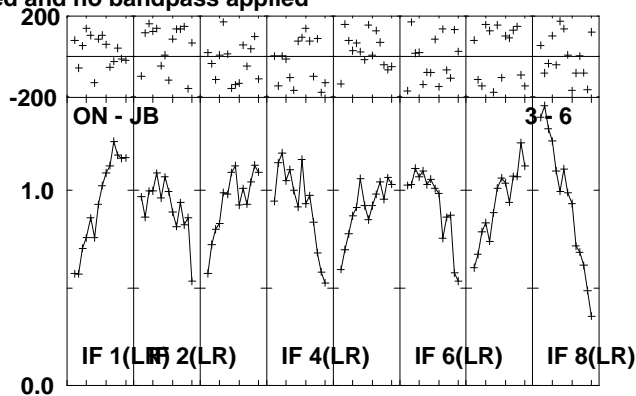
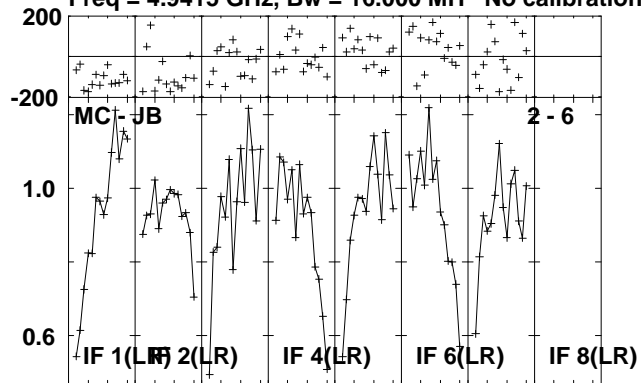

Lower frame: Milli Ampl Jy Top frame: Phas deg
Scalar averaged cross-power spectrum Several baselines displayed
Timerange: 01/00:14:10 to 01/00:15:38

Plot file version 102 created 15-JUL-2010 10:44:58

J2002+47 RR004B.UVDATA.1

Freq = 4.9415 GHz, Bw = 16.000 MH No calibration applied and no bandpass applied

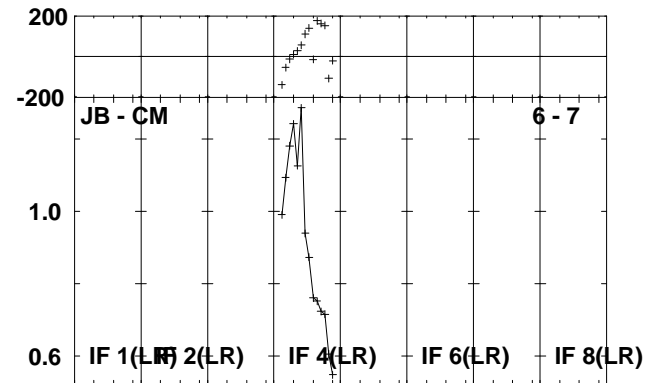
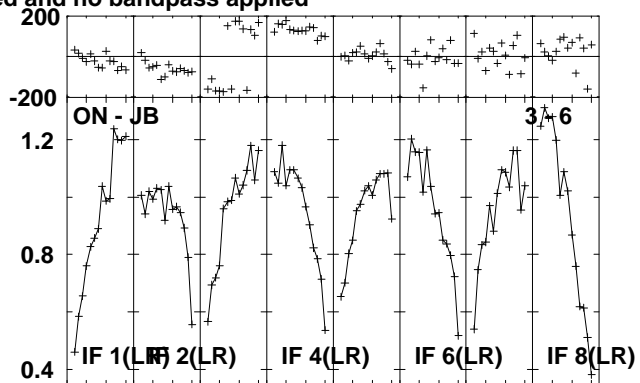
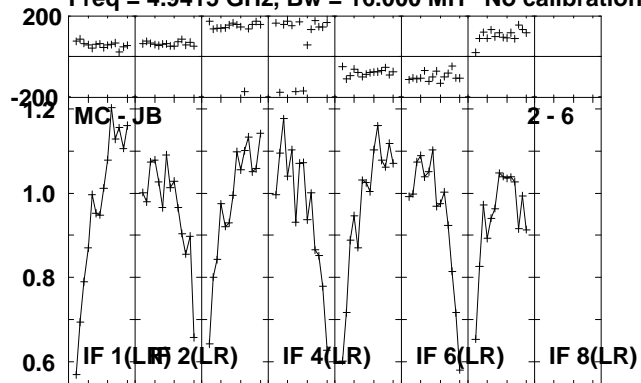

Lower frame: Milli Ampl Jy Top frame: Phas deg
Scalar averaged cross-power spectrum Several baselines displayed
Timerange: 01/00:17:40 to 01/00:22:38

Plot file version 103 created 15-JUL-2010 10:45:00
J1953+35 RR004B.UVDATA.1

Freq = 4.9415 GHz, Bw = 16.000 MH No calibration applied and no bandpass applied

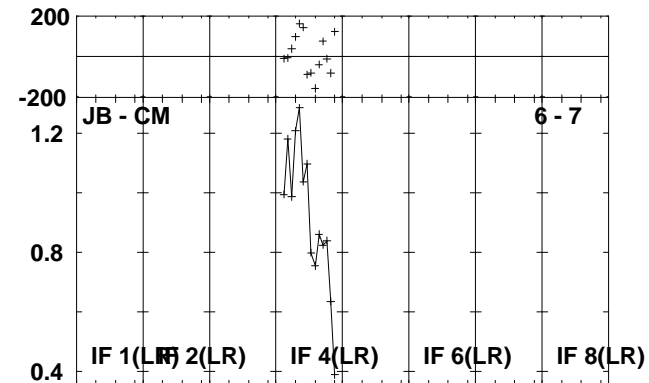
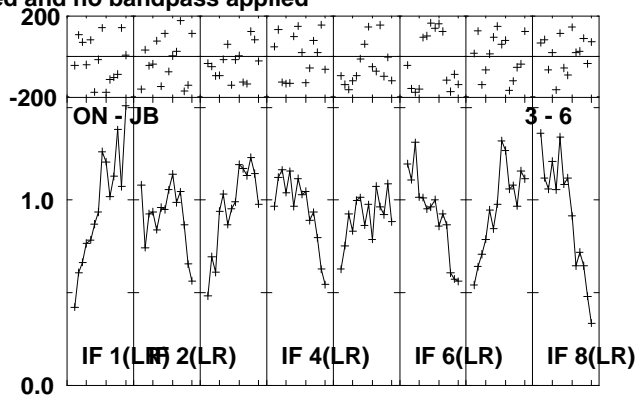
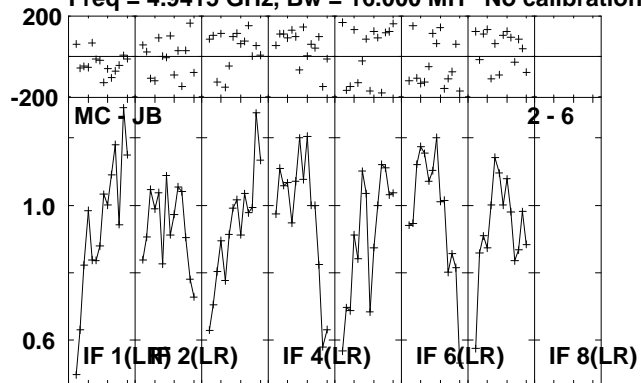

Lower frame: Milli Ampl Jy Top frame: Phas deg
Scalar averaged cross-power spectrum Several baselines displayed
Timerange: 01/00:24:40 to 01/00:26:08

Plot file version 104 created 15-JUL-2010 10:45:01

CYGX-1 RR004B.UVDATA.1

Freq = 4.9415 GHz, Bw = 16.000 MH No calibration applied and no bandpass applied

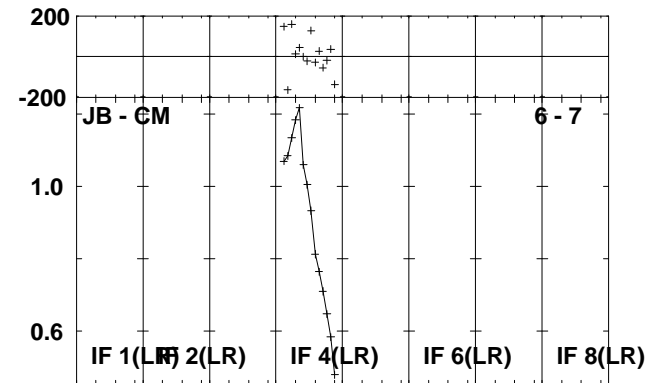
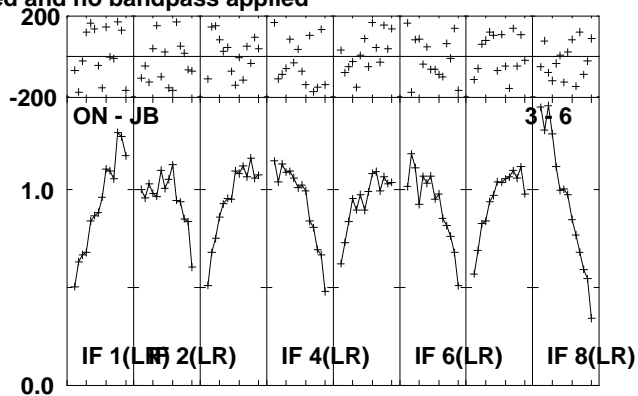
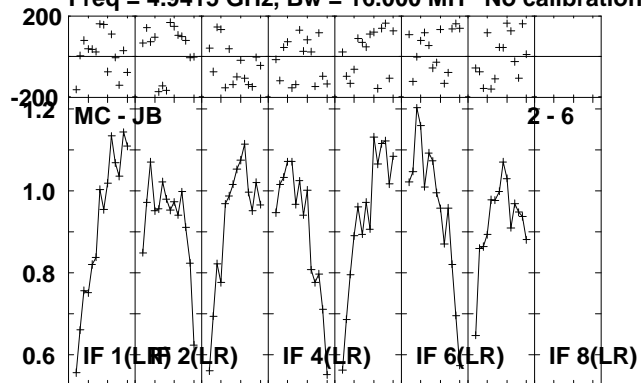

Lower frame: Milli Ampl Jy Top frame: Phas deg
Scalar averaged cross-power spectrum Several baselines displayed
Timerange: 01/00:26:10 to 01/00:31:08

Plot file version 105 created 15-JUL-2010 10:45:08

J1953+35 RR004B.UVDATA.1

Freq = 4.9415 GHz, Bw = 16.000 MH No calibration applied and no bandpass applied

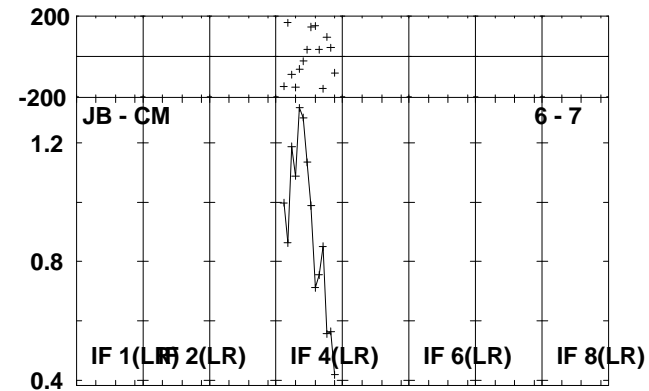
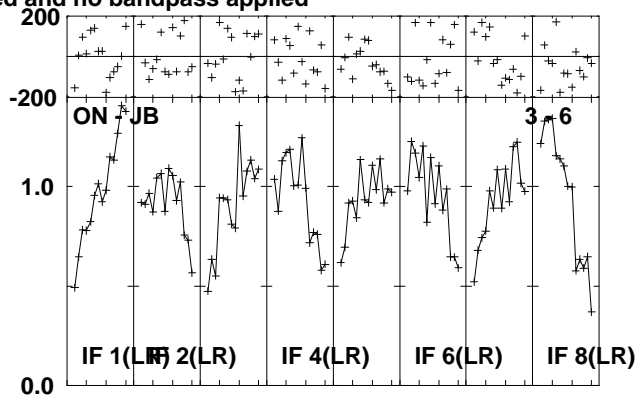
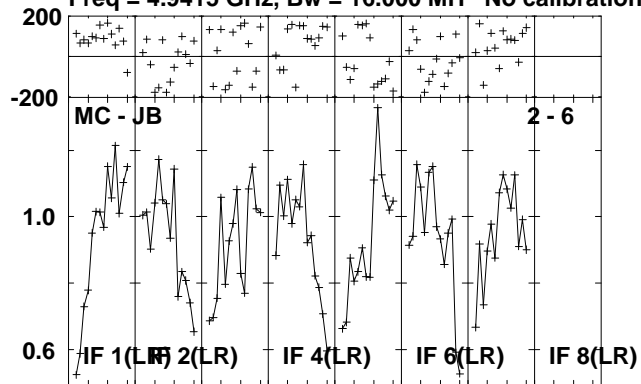

Lower frame: Milli Ampl Jy Top frame: Phas deg
Scalar averaged cross-power spectrum Several baselines displayed
Timerange: 01/00:31:10 to 01/00:33:08

Plot file version 106 created 15-JUL-2010 10:45:09

CYGX-1 RR004B.UVDATA.1

Freq = 4.9415 GHz, Bw = 16.000 MH No calibration applied and no bandpass applied

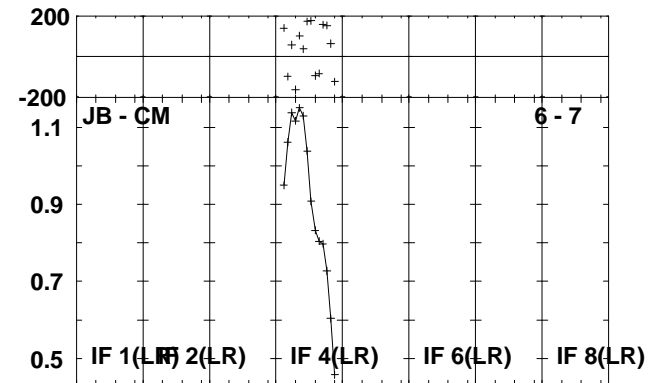
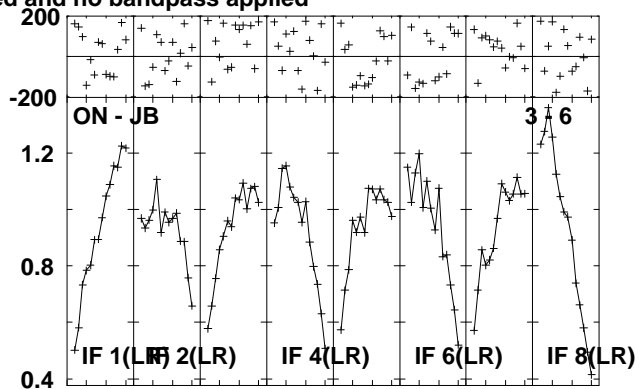
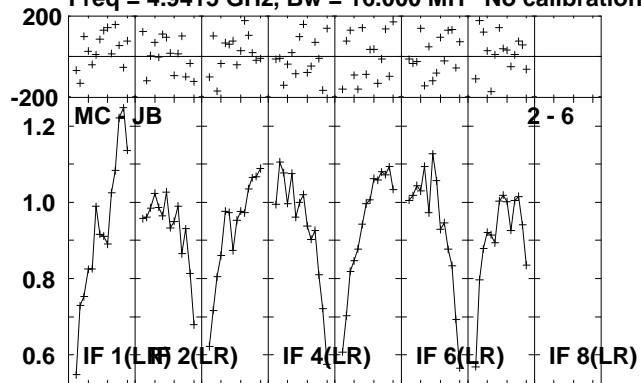

Lower frame: Milli Ampl Jy Top frame: Phas deg
Scalar averaged cross-power spectrum Several baselines displayed
Timerange: 01/00:33:10 to 01/00:38:08

Plot file version 107 created 15-JUL-2010 10:45:11

J1953+35 RR004B.UVDATA.1

Freq = 4.9415 GHz, Bw = 16.000 MH No calibration applied and no bandpass applied

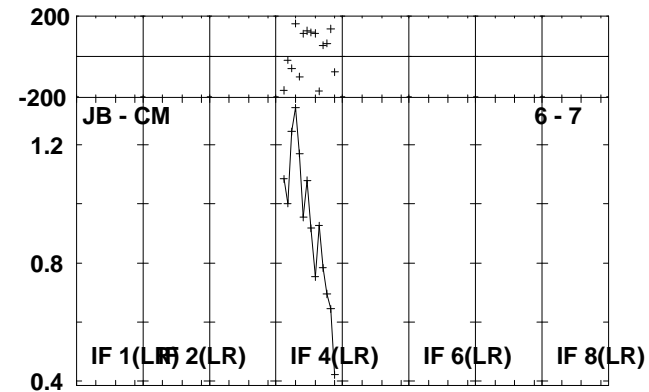
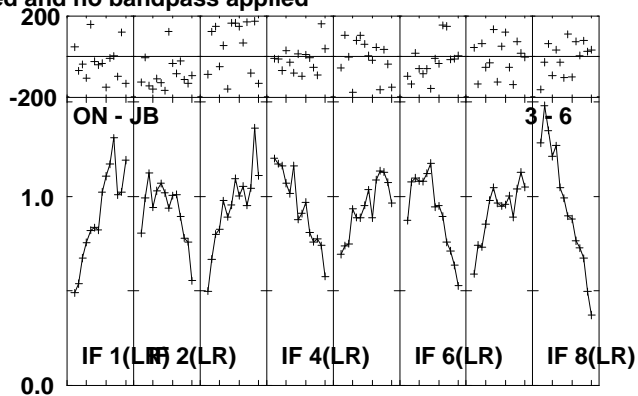
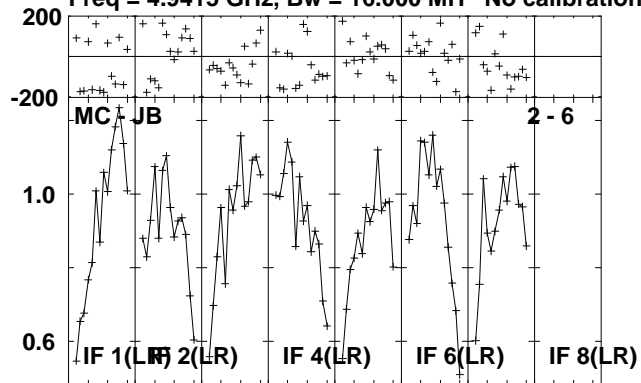

Lower frame: Milli Ampl Jy Top frame: Phas deg
Scalar averaged cross-power spectrum Several baselines displayed
Timerange: 01/00:39:00 to 01/00:40:28

Plot file version 108 created 15-JUL-2010 10:45:11

CYGX-1 RR004B.UVDATA.1

Freq = 4.9415 GHz, Bw = 16.000 MH No calibration applied and no bandpass applied

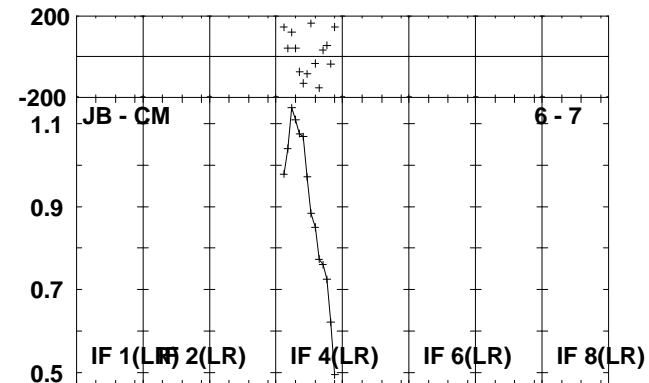
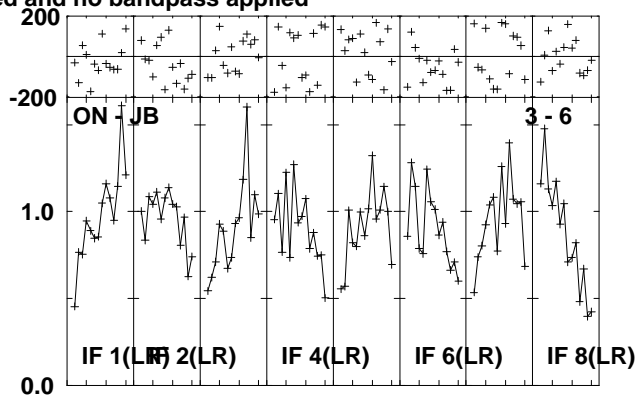
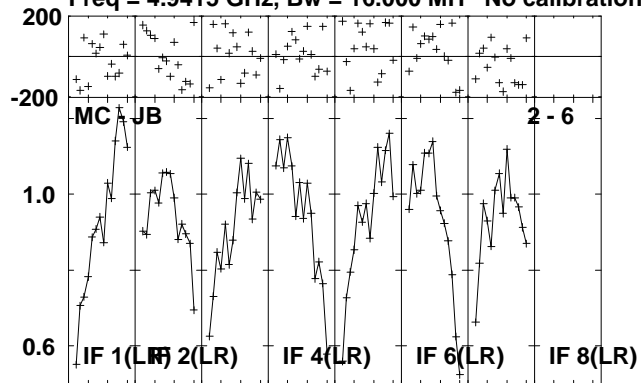

Lower frame: Milli Ampl Jy Top frame: Phas deg
Scalar averaged cross-power spectrum Several baselines displayed
Timerange: 01/00:40:30 to 01/00:45:28

Plot file version 109 created 15-JUL-2010 10:45:13

J1953+35 RR004B.UVDATA.1

Freq = 4.9415 GHz, Bw = 16.000 MH No calibration applied and no bandpass applied

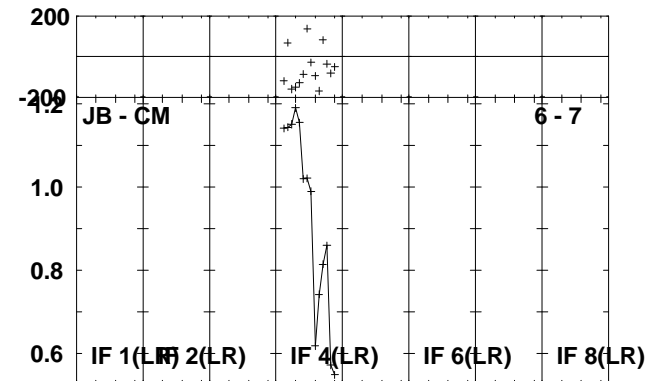
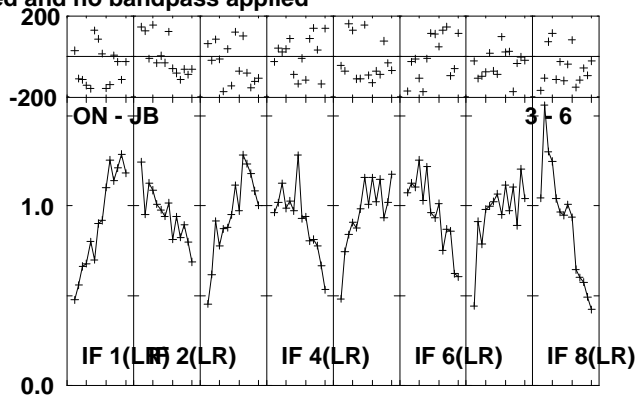
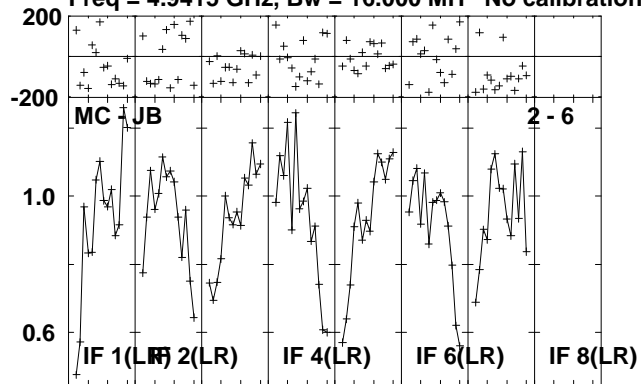

Lower frame: Milli Ampl Jy Top frame: Phas deg
Scalar averaged cross-power spectrum Several baselines displayed
Timerange: 01/00:45:30 to 01/00:47:28

Plot file version 110 created 15-JUL-2010 10:45:14

CYGX-1 RR004B.UVDATA.1

Freq = 4.9415 GHz, Bw = 16.000 MH No calibration applied and no bandpass applied

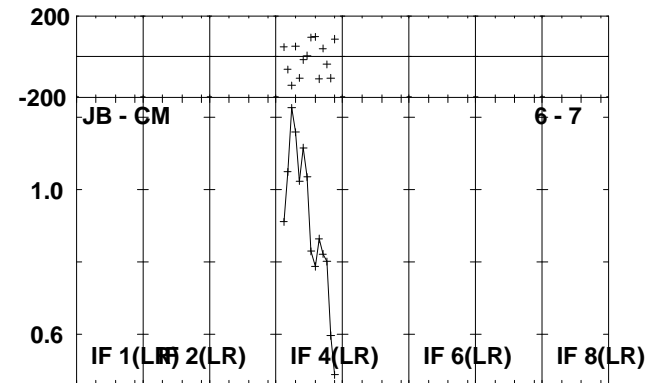
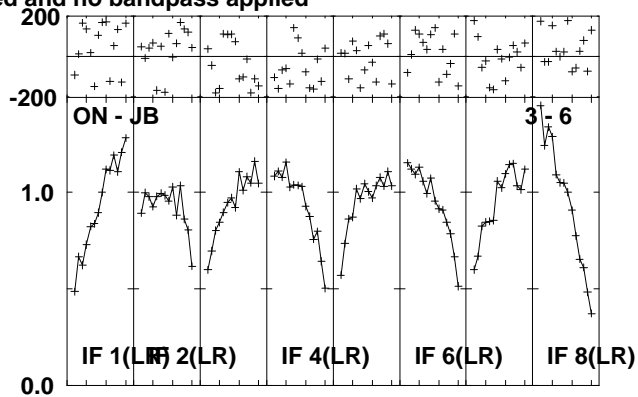
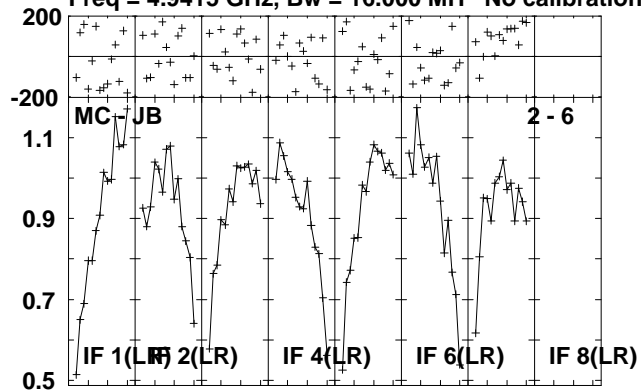

Lower frame: Milli Ampl Jy Top frame: Phas deg
Scalar averaged cross-power spectrum Several baselines displayed
Timerange: 01/00:47:30 to 01/00:52:28

Plot file version 111 created 15-JUL-2010 10:45:15

J1953+35 RR004B.UVDATA.1

Freq = 4.9415 GHz, Bw = 16.000 MH No calibration applied and no bandpass applied

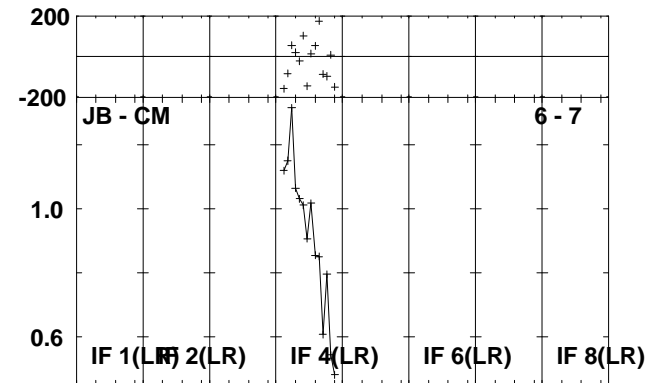
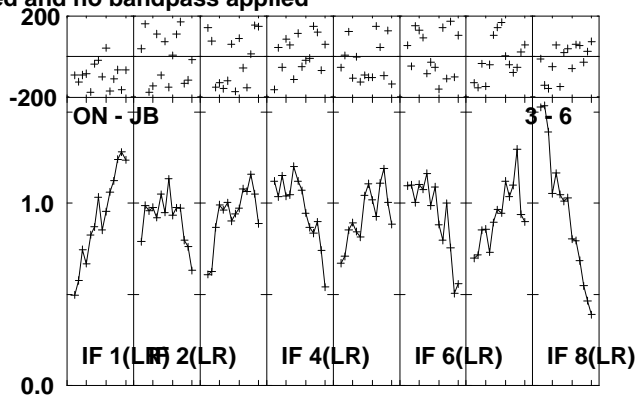
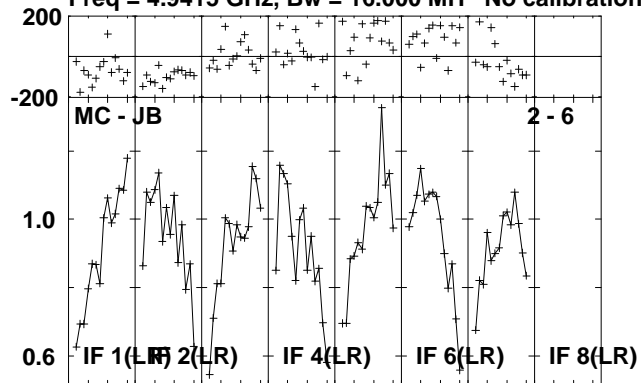

Lower frame: Milli Ampl Jy Top frame: Phas deg
Scalar averaged cross-power spectrum Several baselines displayed
Timerange: 01/00:53:20 to 01/00:54:48

Plot file version 112 created 15-JUL-2010 10:45:16

CYGX-1 RR004B.UVDATA.1

Freq = 4.9415 GHz, Bw = 16.000 MH No calibration applied and no bandpass applied

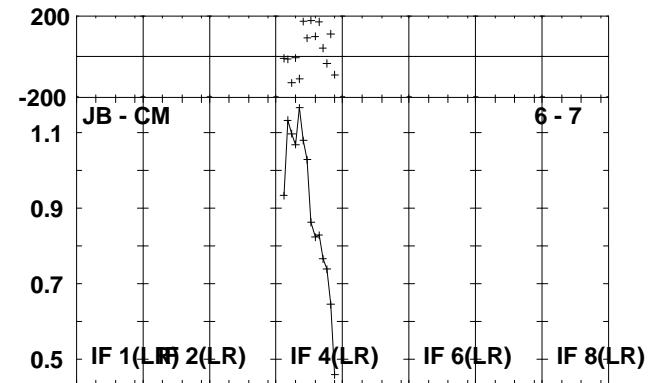
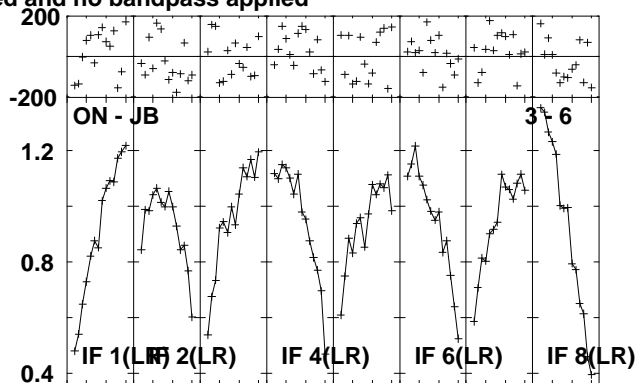
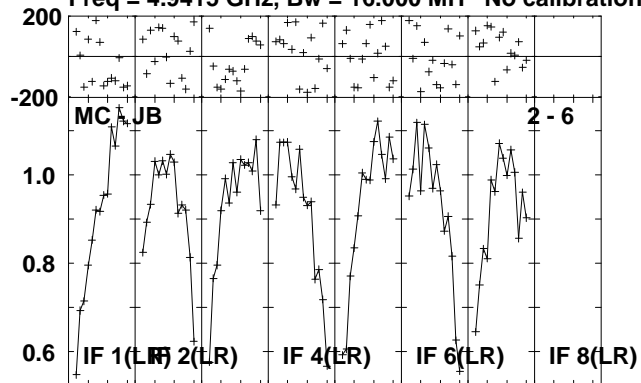

Lower frame: Milli Ampl Jy Top frame: Phas deg
Scalar averaged cross-power spectrum Several baselines displayed
Timerange: 01/00:54:50 to 01/00:59:48

Plot file version 113 created 15-JUL-2010 10:45:18

J1953+35 RR004B.UVDATA.1

Freq = 4.9415 GHz, Bw = 16.000 MH No calibration applied and no bandpass applied

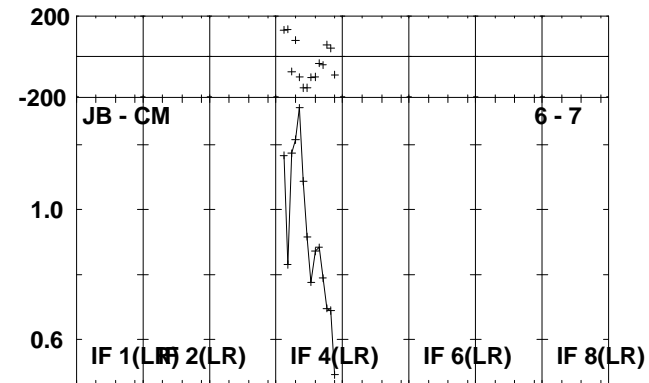
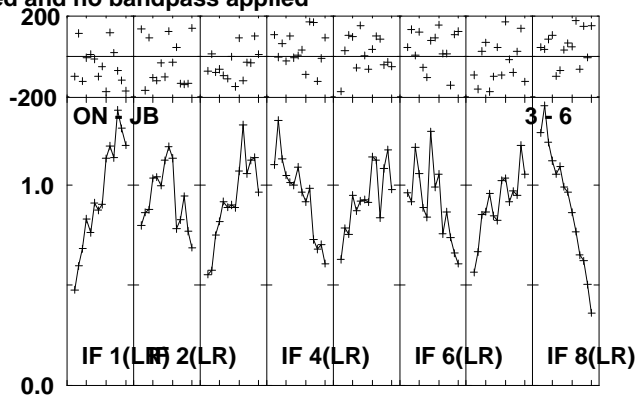
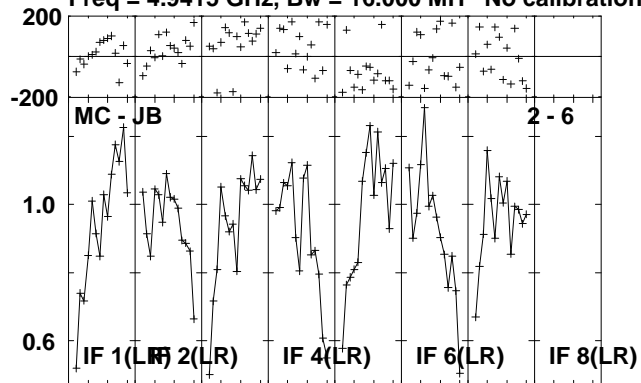

Lower frame: Milli Ampl Jy Top frame: Phas deg
Scalar averaged cross-power spectrum Several baselines displayed
Timerange: 01/00:59:50 to 01/01:01:48

Plot file version 114 created 15-JUL-2010 10:45:19

CYGX-1 RR004B.UVDATA.1

Freq = 4.9415 GHz, Bw = 16.000 MH No calibration applied and no bandpass applied

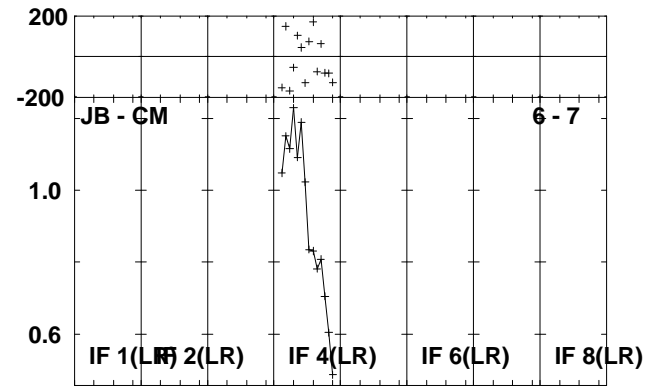
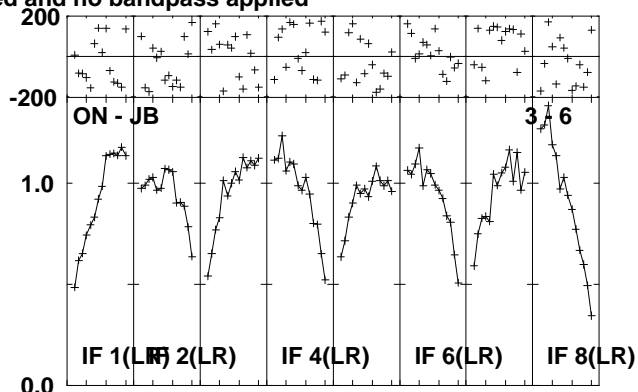
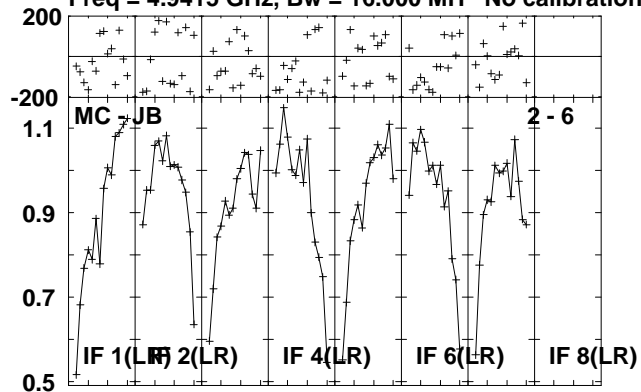

Lower frame: Milli Ampl Jy Top frame: Phas deg
Scalar averaged cross-power spectrum Several baselines displayed
Timerange: 01/01:01:50 to 01/01:06:48

Plot file version 115 created 15-JUL-2010 10:45:21

J1953+35 RR004B.UVDATA.1

Freq = 4.9415 GHz, Bw = 16.000 MH No calibration applied and no bandpass applied

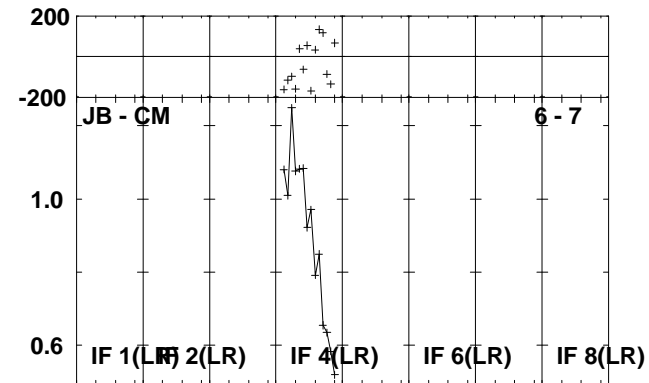
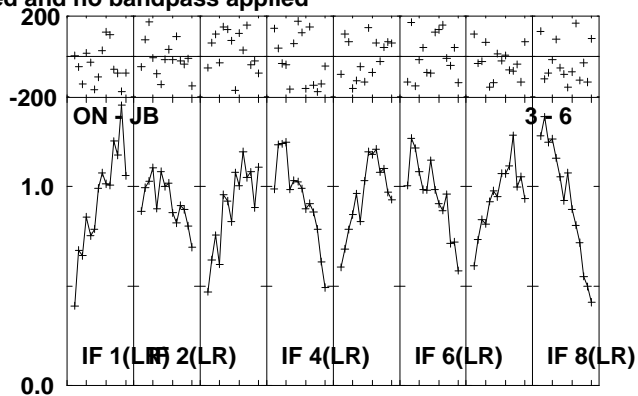
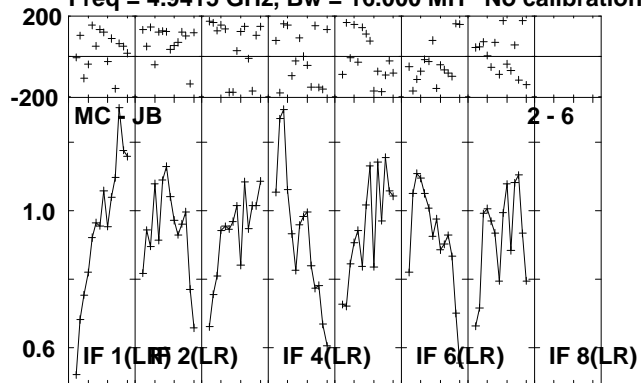

Lower frame: Milli Ampl Jy Top frame: Phas deg
Scalar averaged cross-power spectrum Several baselines displayed
Timerange: 01/01:07:40 to 01/01:09:08

Plot file version 116 created 15-JUL-2010 10:45:22

CYGX-1 RR004B.UVDATA.1

Freq = 4.9415 GHz, Bw = 16.000 MH No calibration applied and no bandpass applied

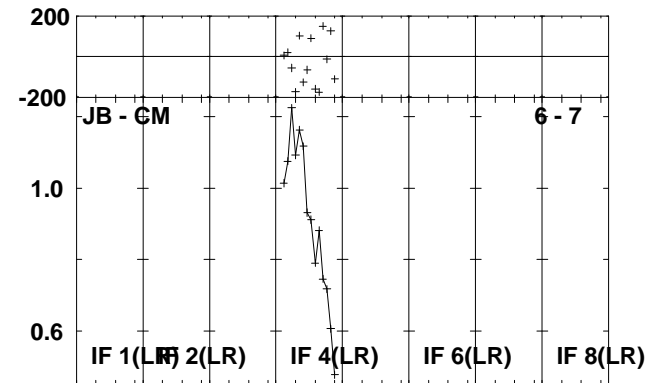
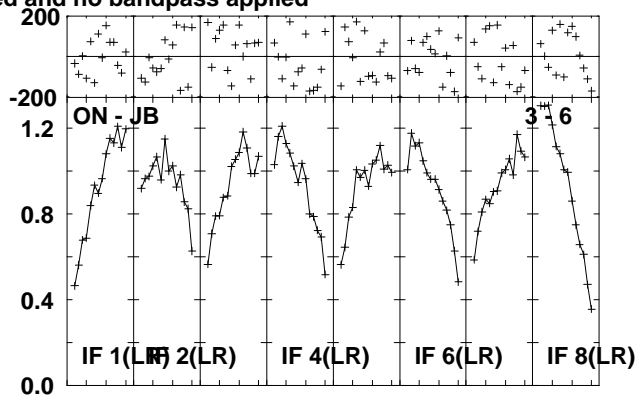
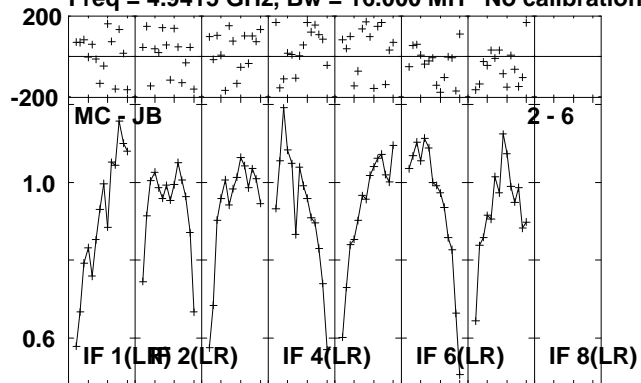

Lower frame: Milli Ampl Jy Top frame: Phas deg
Scalar averaged cross-power spectrum Several baselines displayed
Timerange: 01/01:09:10 to 01/01:14:08

Plot file version 117 created 15-JUL-2010 10:45:23

J1953+35 RR004B.UVDATA.1

Freq = 4.9415 GHz, Bw = 16.000 MH No calibration applied and no bandpass applied

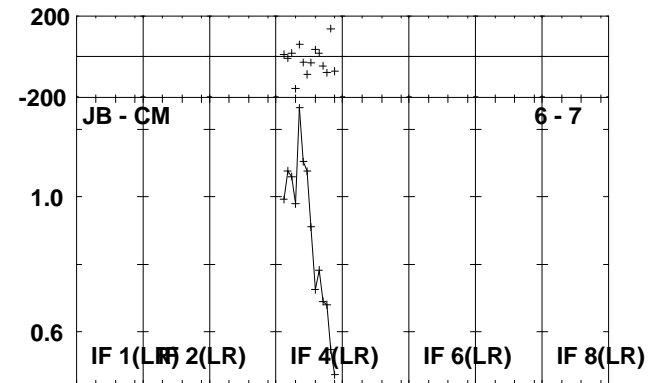
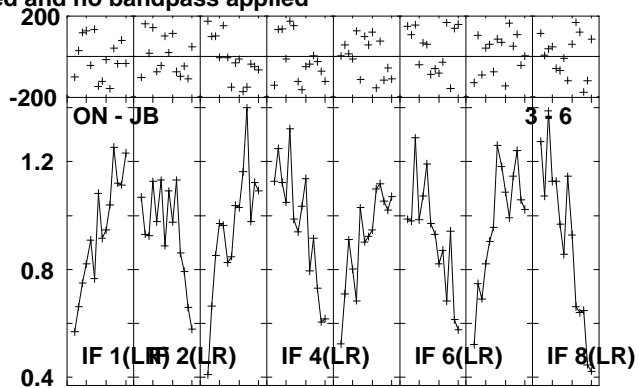
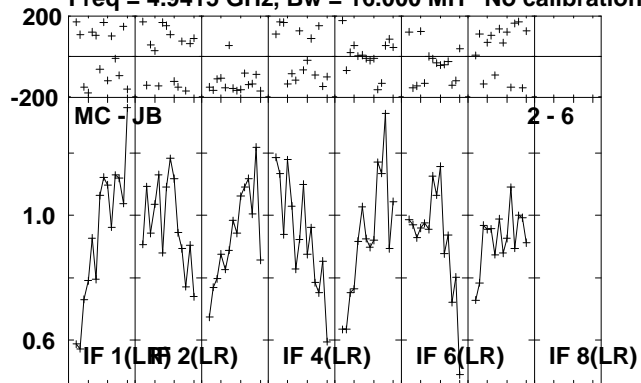

Lower frame: Milli Ampl Jy Top frame: Phas deg
Scalar averaged cross-power spectrum Several baselines displayed
Timerange: 01/01:14:10 to 01/01:16:08

Plot file version 118 created 15-JUL-2010 10:45:25

CYGX-1 RR004B.UVDATA.1

Freq = 4.9415 GHz, Bw = 16.000 MH No calibration applied and no bandpass applied

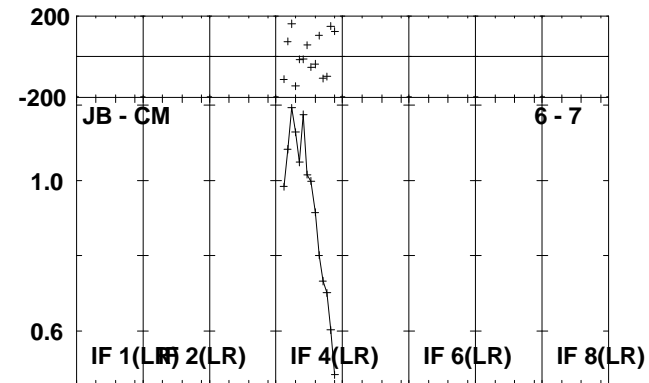
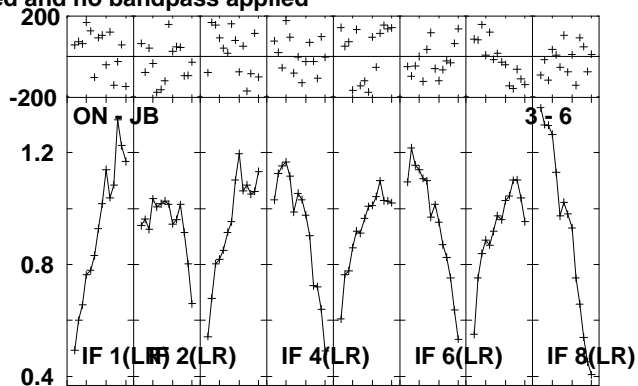
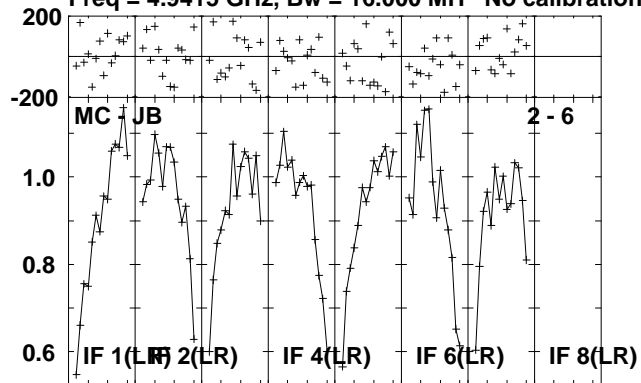

Lower frame: Milli Ampl Jy Top frame: Phas deg
Scalar averaged cross-power spectrum Several baselines displayed
Timerange: 01/01:16:10 to 01/01:21:08

Plot file version 119 created 15-JUL-2010 10:45:26

J1953+35 RR004B.UVDATA.1

Freq = 4.9415 GHz, Bw = 16.000 MH No calibration applied and no bandpass applied

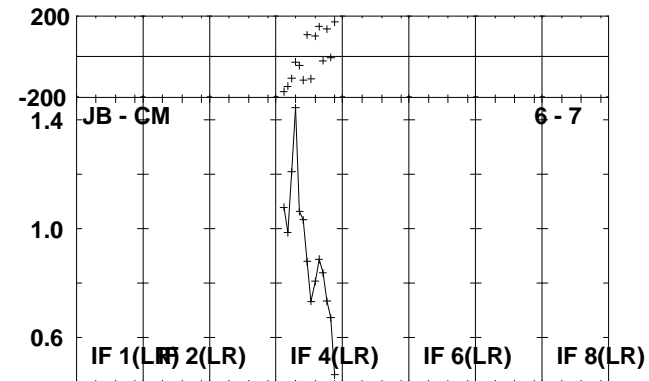
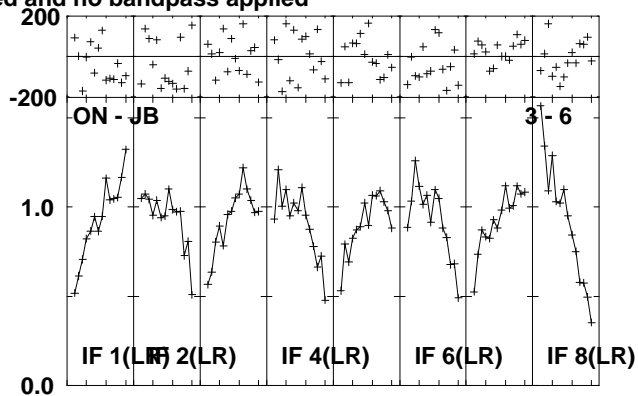
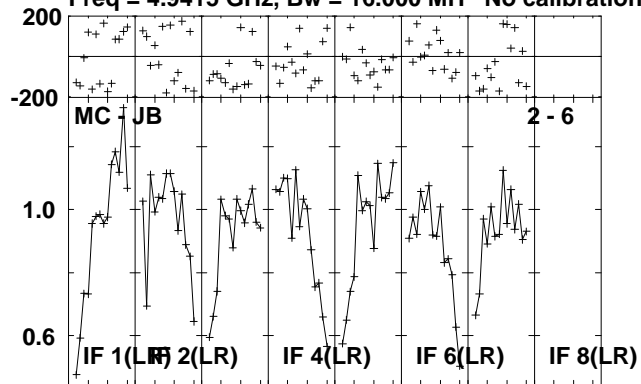

Lower frame: Milli Ampl Jy Top frame: Phas deg
Scalar averaged cross-power spectrum Several baselines displayed
Timerange: 01/01:22:00 to 01/01:23:28

Plot file version 120 created 15-JUL-2010 10:45:27

CYGX-1 RR004B.UVDATA.1

Freq = 4.9415 GHz, Bw = 16.000 MH No calibration applied and no bandpass applied

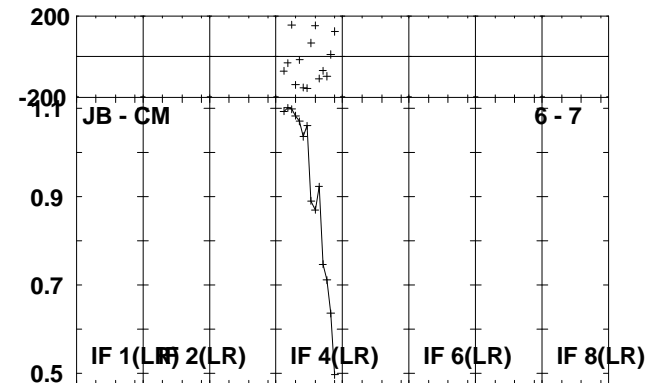
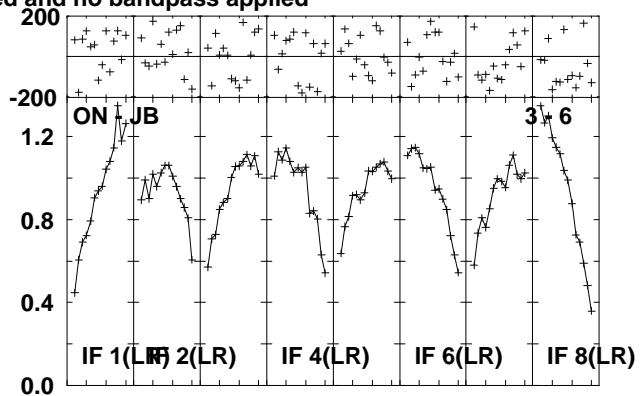
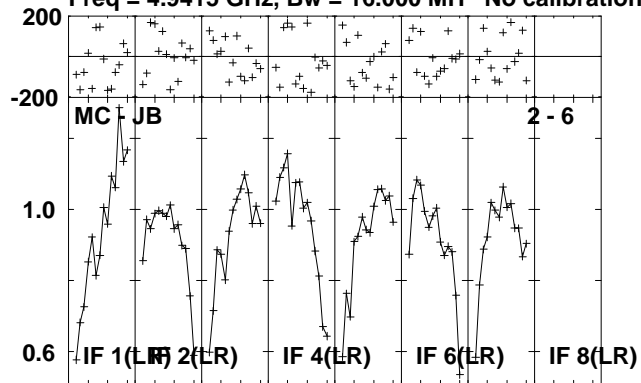

Lower frame: Milli Ampl Jy Top frame: Phas deg
Scalar averaged cross-power spectrum Several baselines displayed
Timerange: 01/01:23:30 to 01/01:28:28

Plot file version 121 created 15-JUL-2010 10:45:29
J1953+35 RR004B.UVDATA.1

Freq = 4.9415 GHz, Bw = 16.000 MH No calibration applied and no bandpass applied

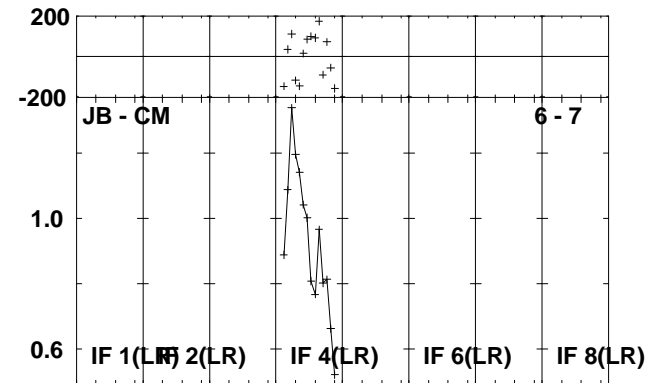
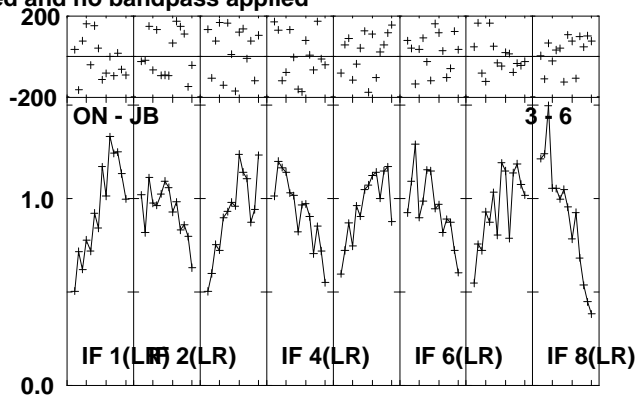
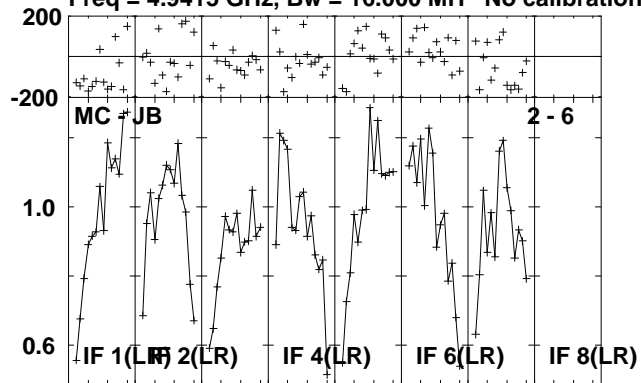

Lower frame: Milli Ampl Jy Top frame: Phas deg
Scalar averaged cross-power spectrum Several baselines displayed
Timerange: 01/01:28:30 to 01/01:30:28

Plot file version 122 created 15-JUL-2010 10:45:30

CYGX-1 RR004B.UVDATA.1

Freq = 4.9415 GHz, Bw = 16.000 MH No calibration applied and no bandpass applied

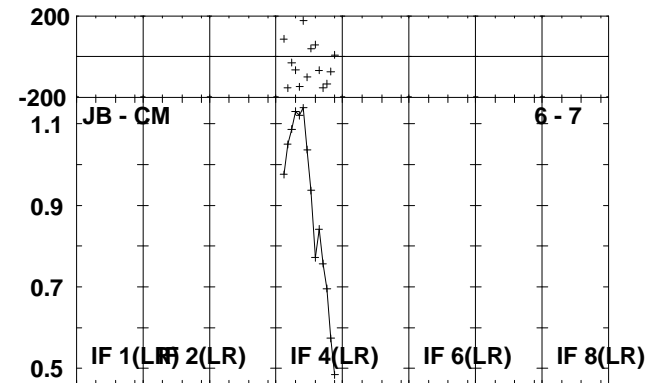
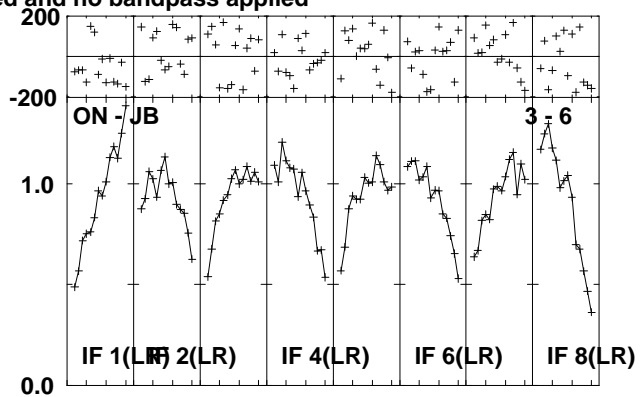
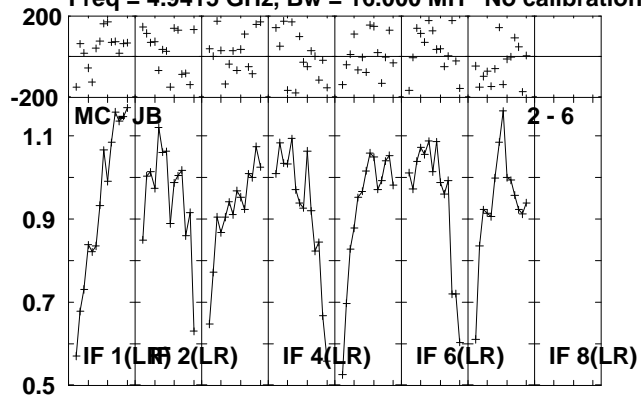

Lower frame: Milli Ampl Jy Top frame: Phas deg
Scalar averaged cross-power spectrum Several baselines displayed
Timerange: 01/01:30:30 to 01/01:35:28

Plot file version 123 created 15-JUL-2010 10:45:31

J1953+35 RR004B.UVDATA.1

Freq = 4.9415 GHz, Bw = 16.000 MH No calibration applied and no bandpass applied

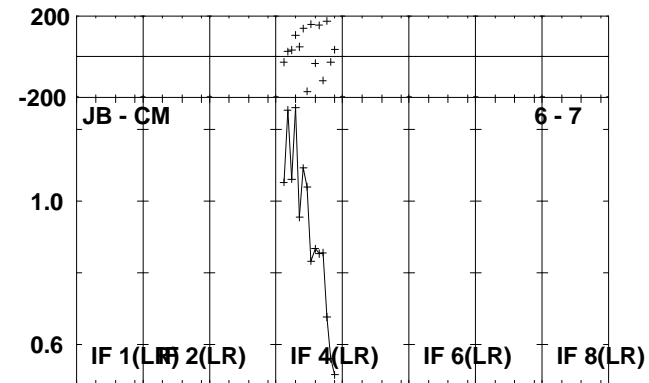
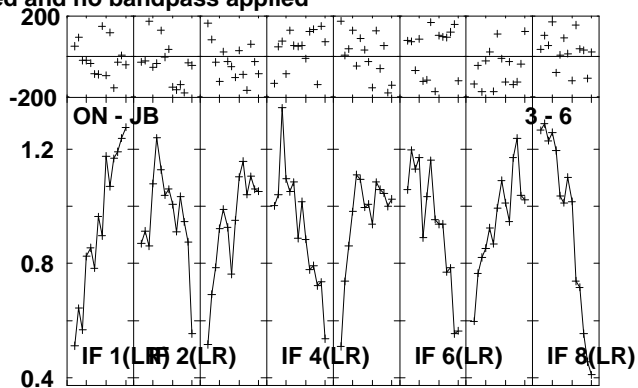
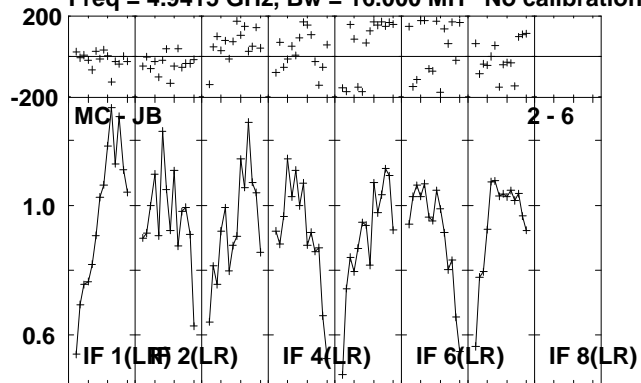

Lower frame: Milli Ampl Jy Top frame: Phas deg
Scalar averaged cross-power spectrum Several baselines displayed
Timerange: 01/01:36:20 to 01/01:37:48

Plot file version 124 created 15-JUL-2010 10:45:32

CYGX-1 RR004B.UVDATA.1

Freq = 4.9415 GHz, Bw = 16.000 MH No calibration applied and no bandpass applied

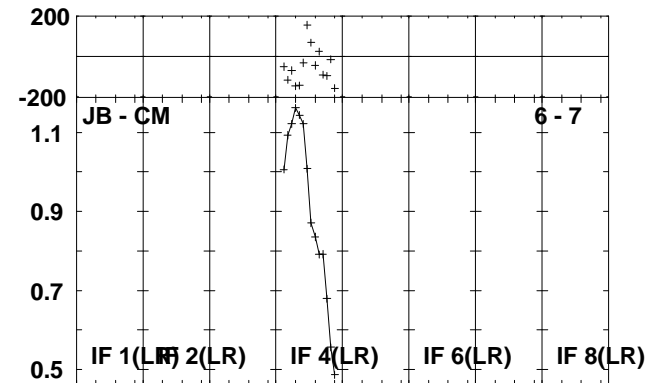
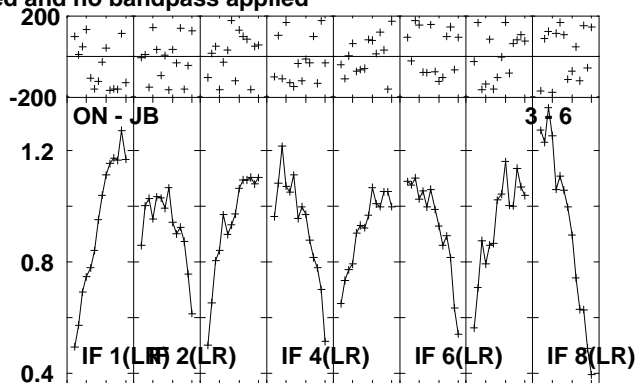
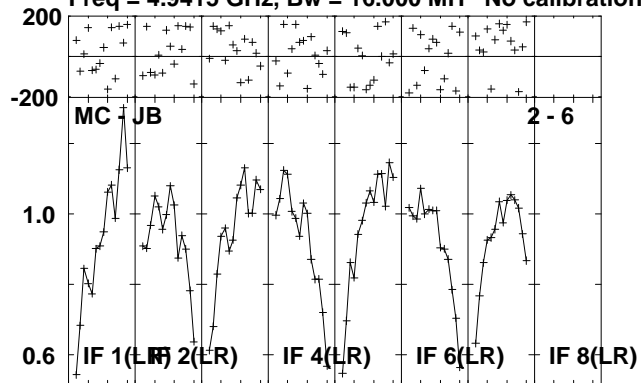

Lower frame: Milli Ampl Jy Top frame: Phas deg
Scalar averaged cross-power spectrum Several baselines displayed
Timerange: 01/01:37:50 to 01/01:42:48

Plot file version 125 created 15-JUL-2010 10:45:33

J1953+35 RR004B.UVDATA.1

Freq = 4.9415 GHz, Bw = 16.000 MH No calibration applied and no bandpass applied

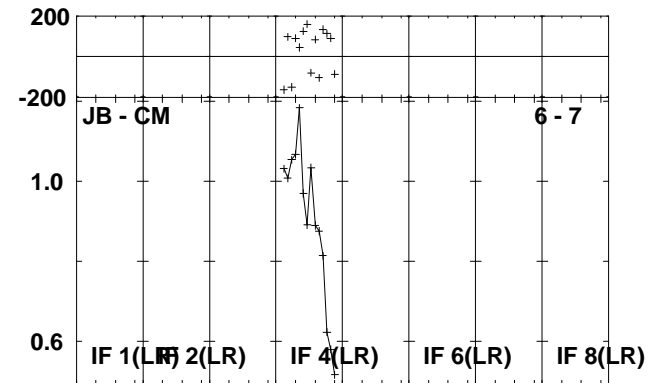
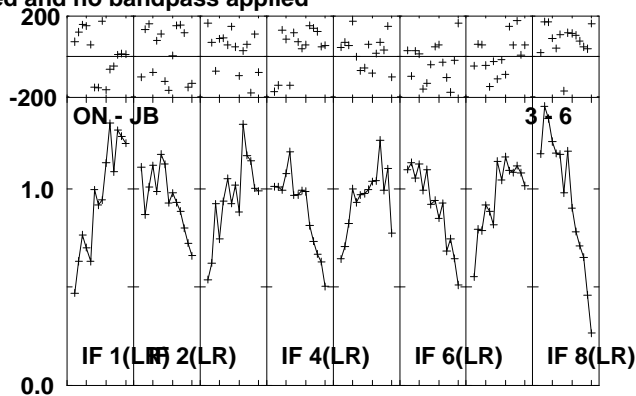
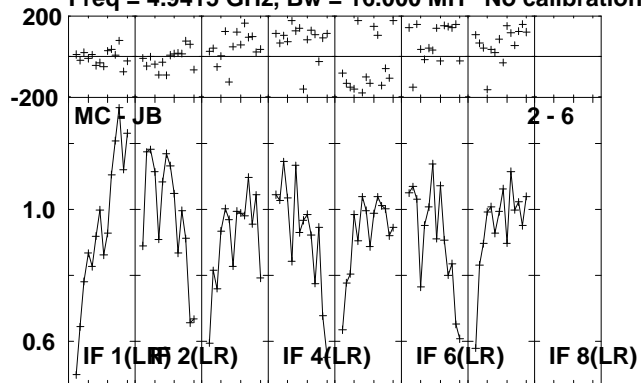

Lower frame: Milli Ampl Jy Top frame: Phas deg
Scalar averaged cross-power spectrum Several baselines displayed
Timerange: 01/01:42:50 to 01/01:44:48

Plot file version 126 created 15-JUL-2010 10:45:34

CYGX-1 RR004B.UVDATA.1

Freq = 4.9415 GHz, Bw = 16.000 MH No calibration applied and no bandpass applied

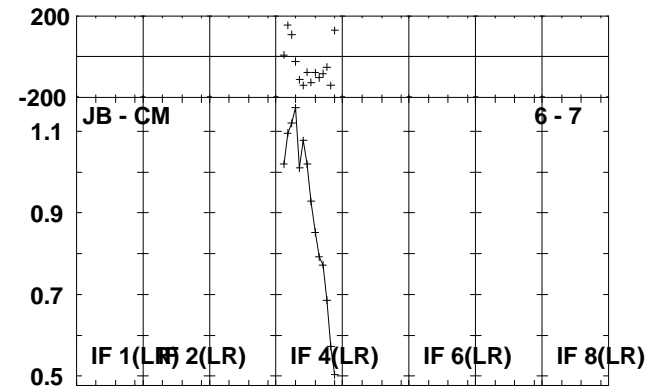
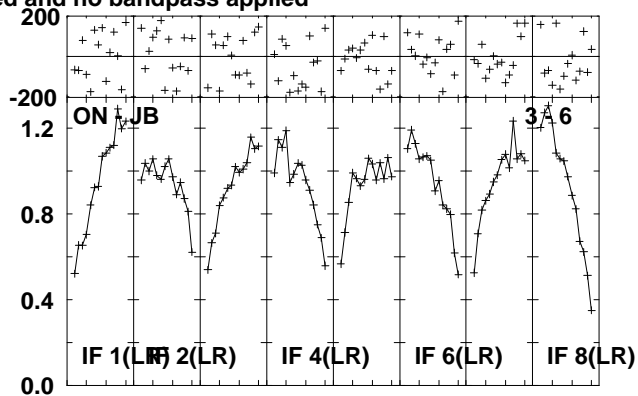
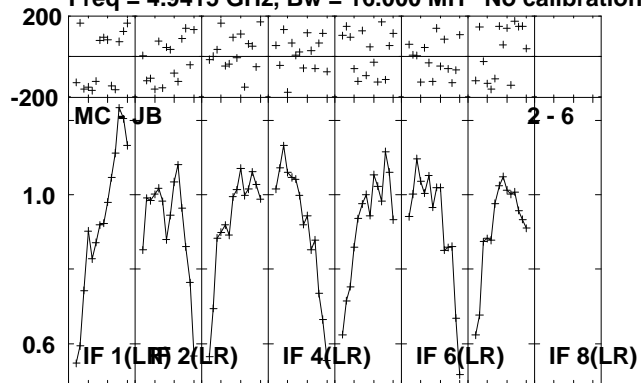

Lower frame: Milli Ampl Jy Top frame: Phas deg
Scalar averaged cross-power spectrum Several baselines displayed
Timerange: 01/01:44:50 to 01/01:49:48

Plot file version 127 created 15-JUL-2010 10:45:36

J1953+35 RR004B.UVDATA.1

Freq = 4.9415 GHz, Bw = 16.000 MH No calibration applied and no bandpass applied

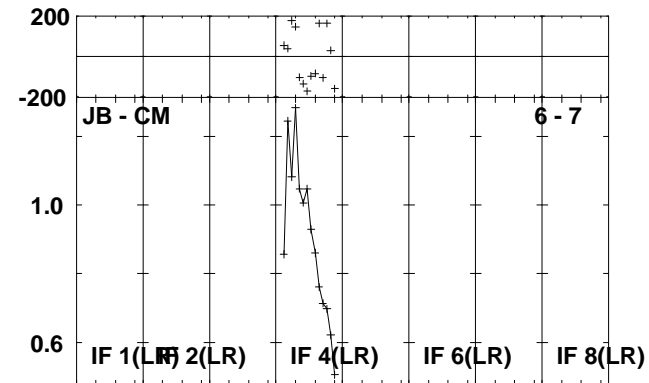
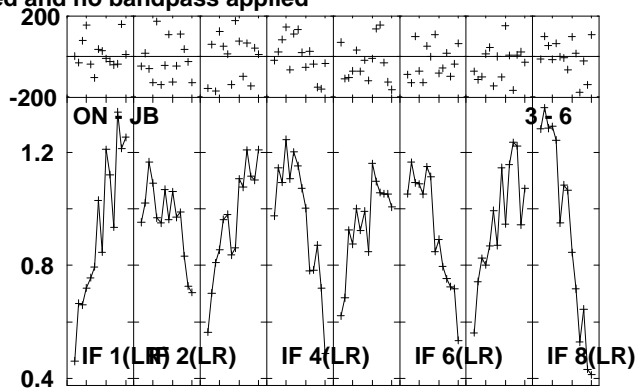
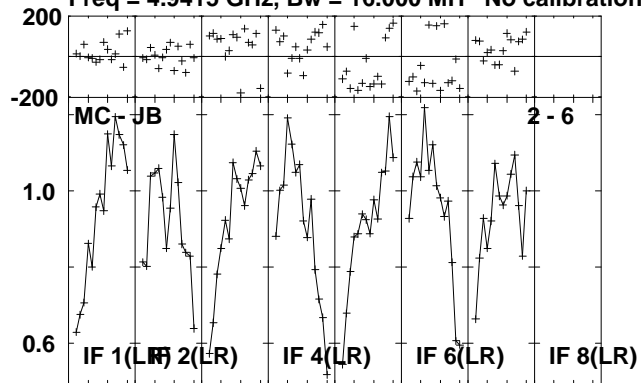

Lower frame: Milli Ampl Jy Top frame: Phas deg
Scalar averaged cross-power spectrum Several baselines displayed
Timerange: 01/01:50:40 to 01/01:52:08

Plot file version 128 created 15-JUL-2010 10:45:37

CYGX-1 RR004B.UVDATA.1

Freq = 4.9415 GHz, Bw = 16.000 MH No calibration applied and no bandpass applied

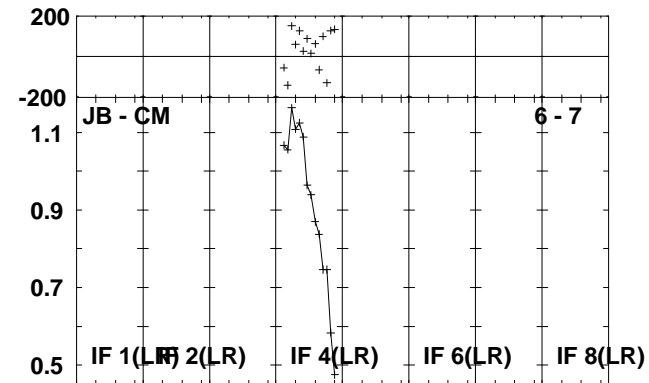
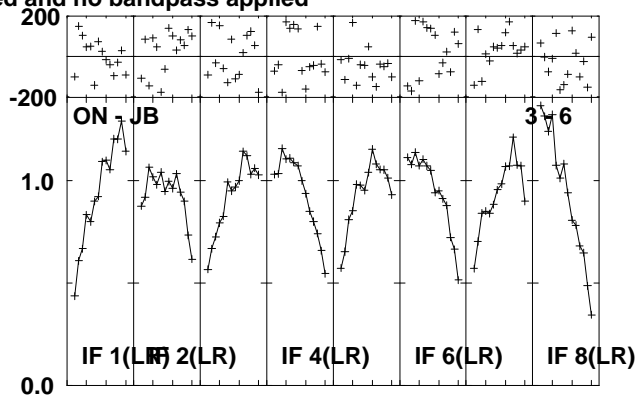
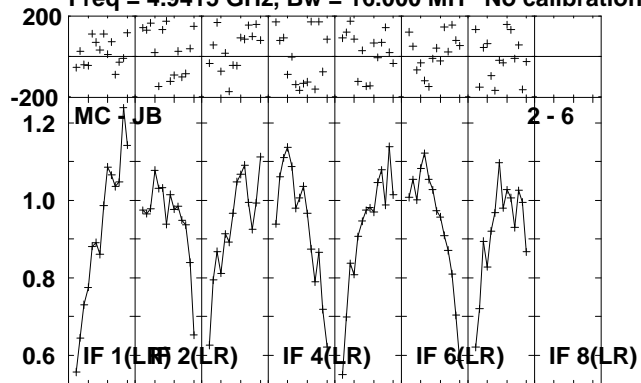

Lower frame: Milli Ampl Jy Top frame: Phas deg
Scalar averaged cross-power spectrum Several baselines displayed
Timerange: 01/01:52:10 to 01/01:57:08

Plot file version 129 created 15-JUL-2010 10:45:39
J1953+35 RR004B.UVDATA.1

Freq = 4.9415 GHz, Bw = 16.000 MH No calibration applied and no bandpass applied

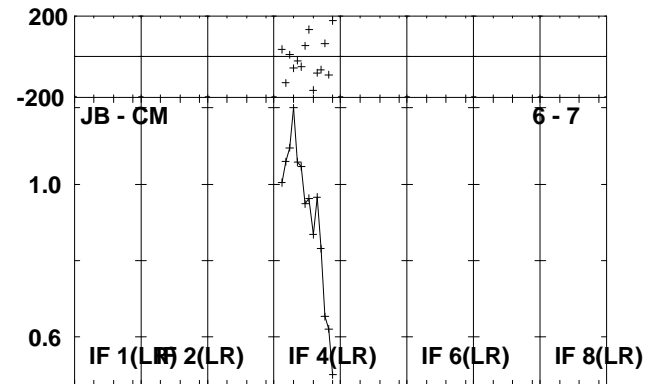
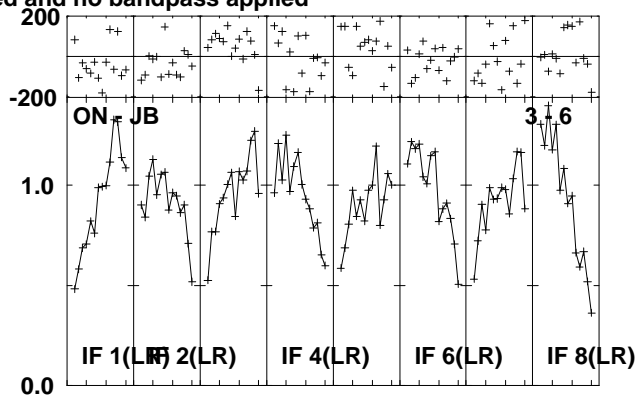
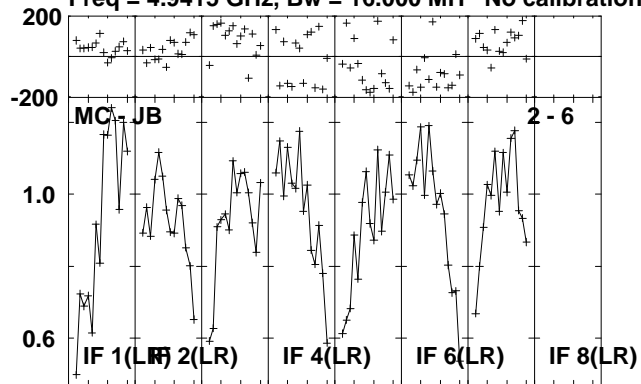

Lower frame: Milli Ampl Jy Top frame: Phas deg
Scalar averaged cross-power spectrum Several baselines displayed
Timerange: 01/01:57:10 to 01/01:59:08

Plot file version 130 created 15-JUL-2010 10:45:40

CYGX-1 RR004B.UVDATA.1

Freq = 4.9415 GHz, Bw = 16.000 MH No calibration applied and no bandpass applied

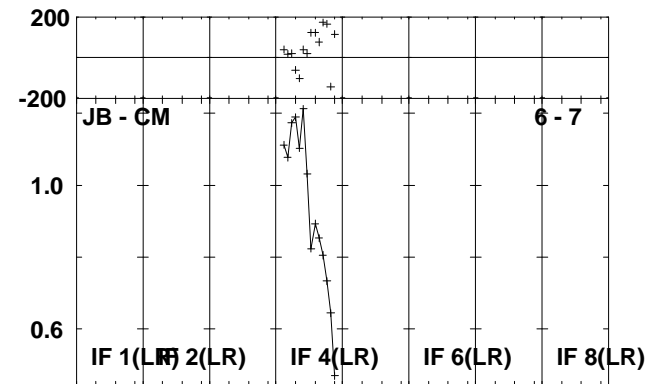
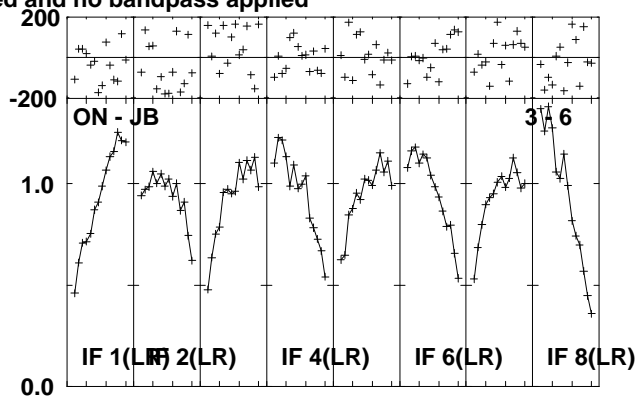
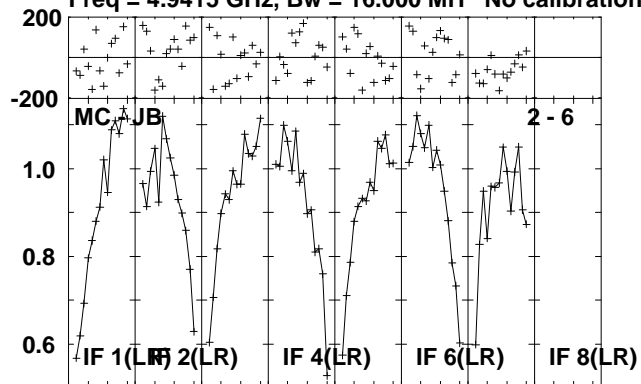

Lower frame: Milli Ampl Jy Top frame: Phas deg
Scalar averaged cross-power spectrum Several baselines displayed
Timerange: 01/01:59:10 to 01/02:04:08

Plot file version 131 created 15-JUL-2010 10:45:41

J1953+35 RR004B.UVDATA.1

Freq = 4.9415 GHz, Bw = 16.000 MH No calibration applied and no bandpass applied

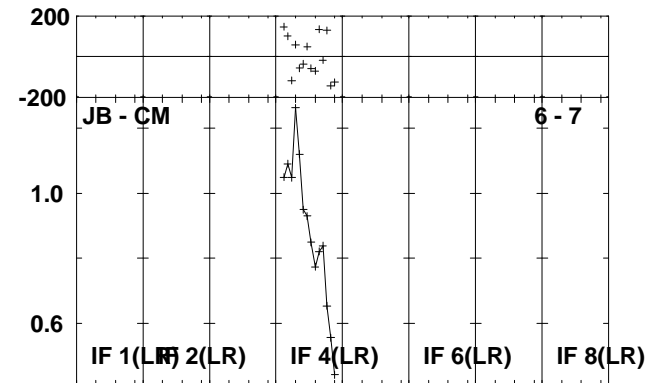
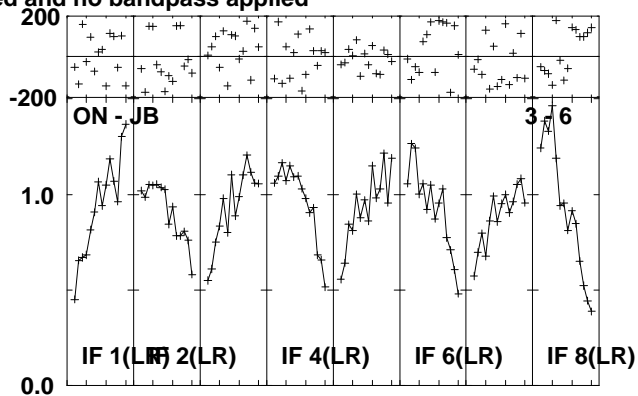
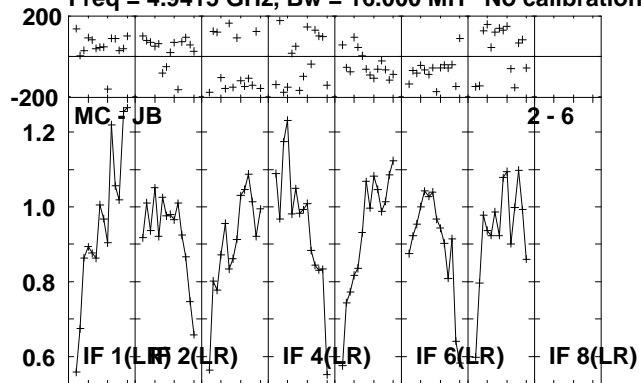

Lower frame: Milli Ampl Jy Top frame: Phas deg
Scalar averaged cross-power spectrum Several baselines displayed
Timerange: 01/02:05:00 to 01/02:06:28

Plot file version 132 created 15-JUL-2010 10:45:42

CYGX-1 RR004B.UVDATA.1

Freq = 4.9415 GHz, Bw = 16.000 MH No calibration applied and no bandpass applied

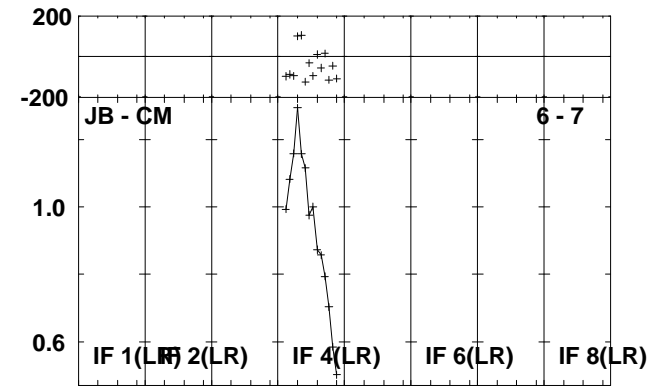
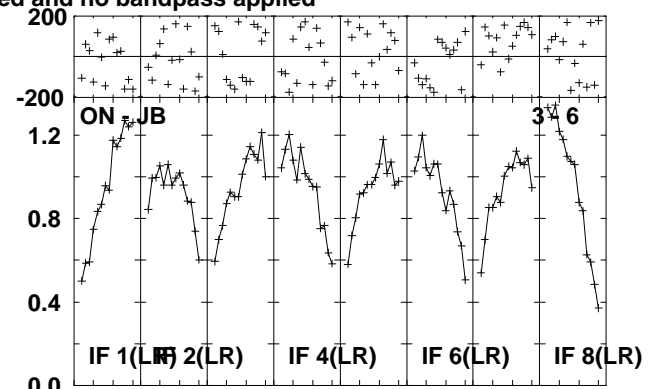
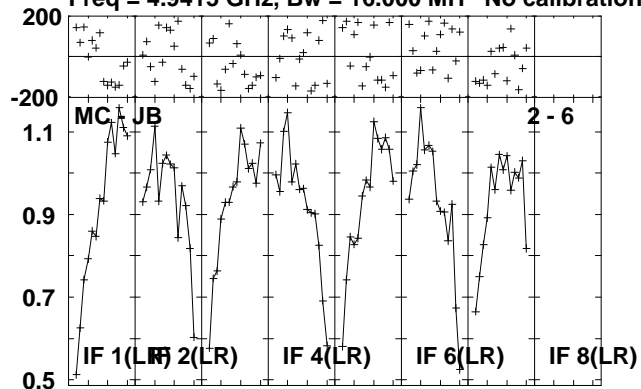

Lower frame: Milli Ampl Jy Top frame: Phas deg
Scalar averaged cross-power spectrum Several baselines displayed
Timerange: 01/02:06:30 to 01/02:11:28

Plot file version 133 created 15-JUL-2010 10:45:44
J1953+35 RR004B.UVDATA.1

Freq = 4.9415 GHz, Bw = 16.000 MH No calibration applied and no bandpass applied

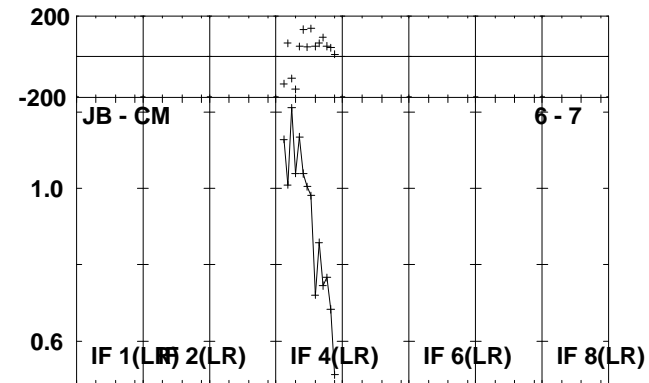
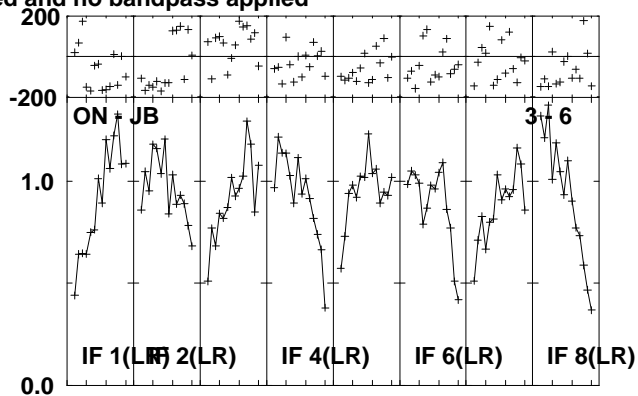
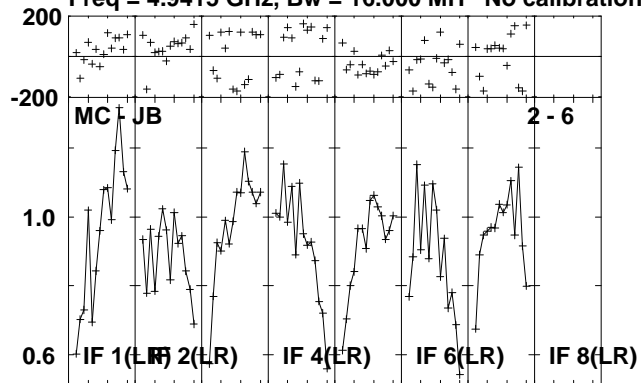

Lower frame: Milli Ampl Jy Top frame: Phas deg
Scalar averaged cross-power spectrum Several baselines displayed
Timerange: 01/02:11:30 to 01/02:13:28

Plot file version 134 created 15-JUL-2010 10:45:45

CYGX-1 RR004B.UVDATA.1

Freq = 4.9415 GHz, Bw = 16.000 MH No calibration applied and no bandpass applied

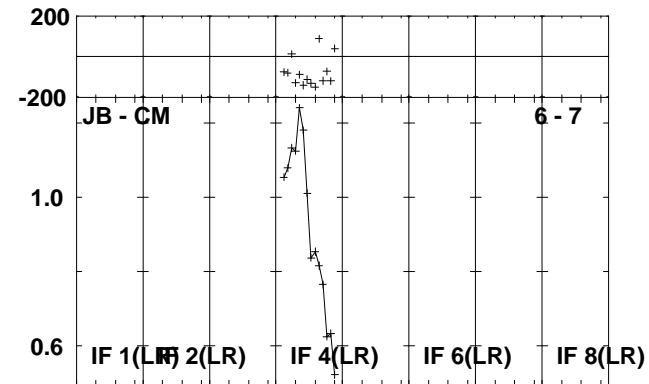
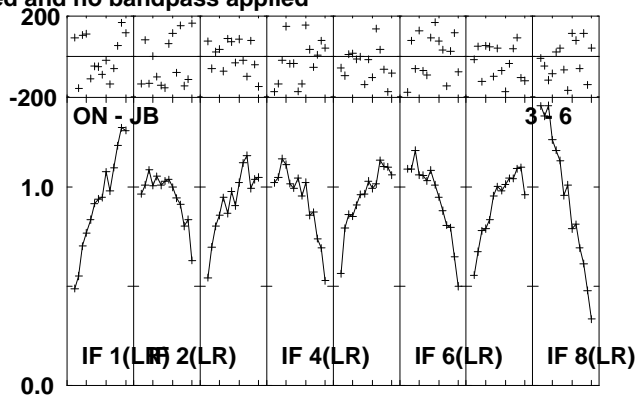
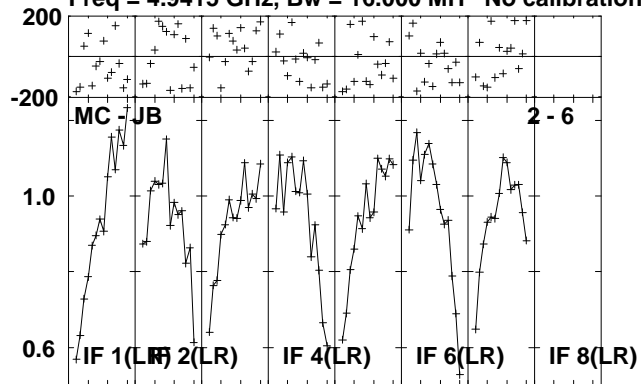

Lower frame: Milli Ampl Jy Top frame: Phas deg
Scalar averaged cross-power spectrum Several baselines displayed
Timerange: 01/02:13:30 to 01/02:18:28

Plot file version 135 created 15-JUL-2010 10:45:47

J1953+35 RR004B.UVDATA.1

Freq = 4.9415 GHz, Bw = 16.000 MH No calibration applied and no bandpass applied

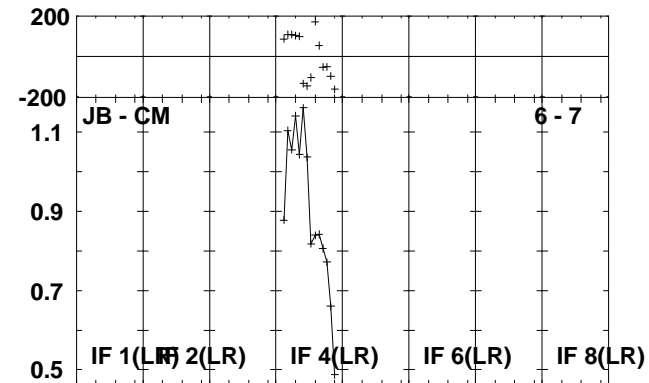
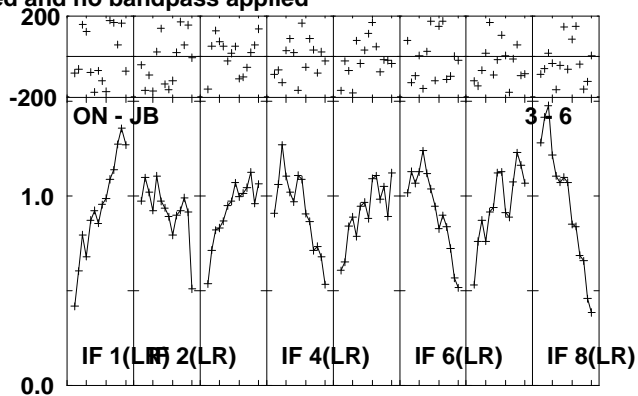
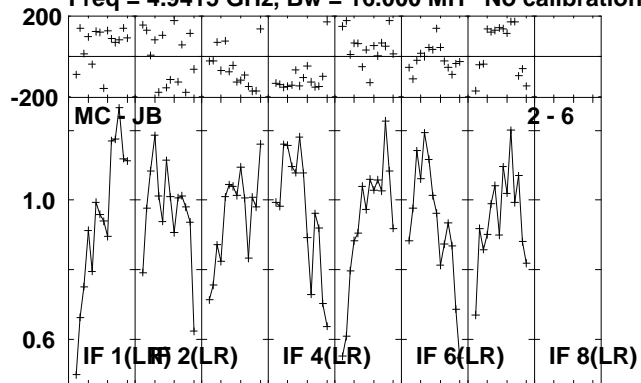

Lower frame: Milli Ampl Jy Top frame: Phas deg
Scalar averaged cross-power spectrum Several baselines displayed
Timerange: 01/02:19:20 to 01/02:20:48

Plot file version 136 created 15-JUL-2010 10:45:48
J2002+47 RR004B.UVDATA.1

Freq = 4.9415 GHz, Bw = 16.000 MH No calibration applied and no bandpass applied

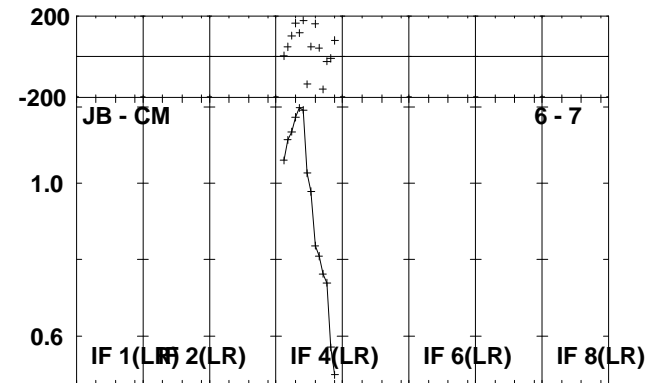
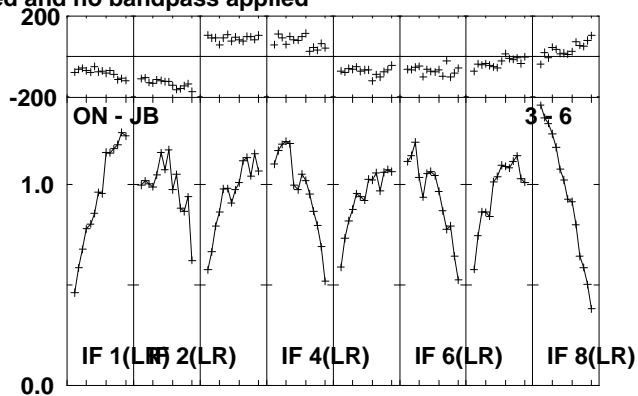
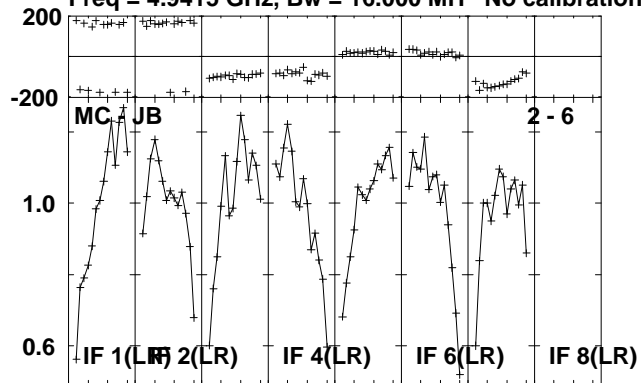

Lower frame: Milli Ampl Jy Top frame: Phas deg
Scalar averaged cross-power spectrum Several baselines displayed
Timerange: 01/02:22:50 to 01/02:27:48

Plot file version 137 created 15-JUL-2010 10:45:49

J1953+35 RR004B.UVDATA.1

Freq = 4.9415 GHz, Bw = 16.000 MH No calibration applied and no bandpass applied

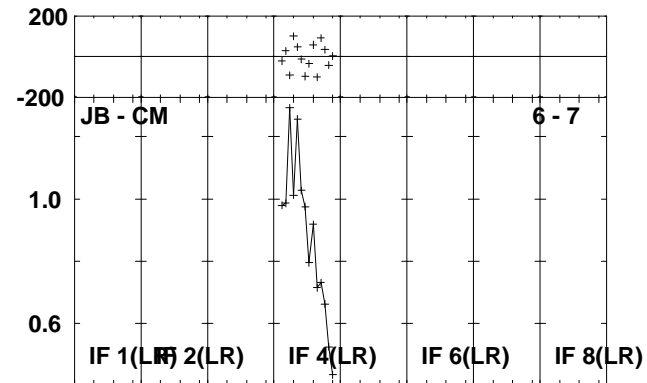
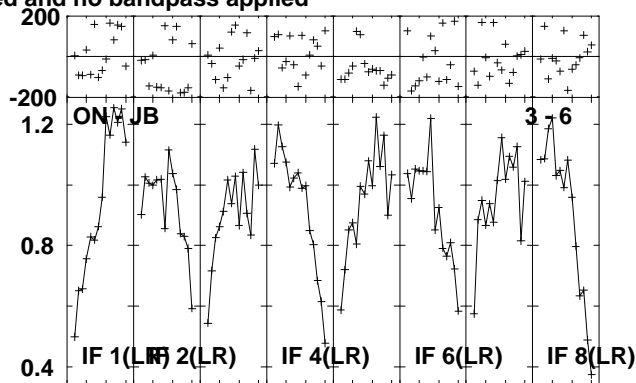
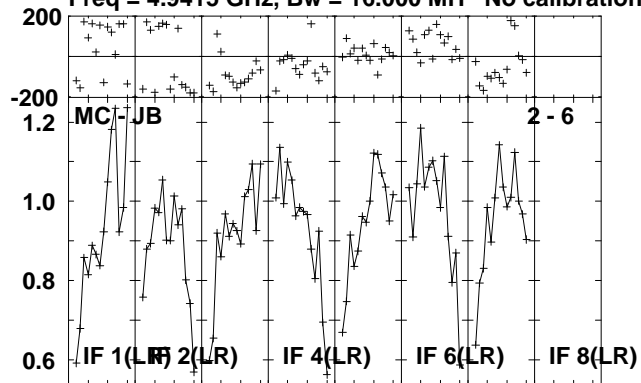

Lower frame: Milli Ampl Jy Top frame: Phas deg
Scalar averaged cross-power spectrum Several baselines displayed
Timerange: 01/02:29:50 to 01/02:31:18

Plot file version 138 created 15-JUL-2010 10:45:50

CYGX-1 RR004B.UVDATA.1

Freq = 4.9415 GHz, Bw = 16.000 MH No calibration applied and no bandpass applied

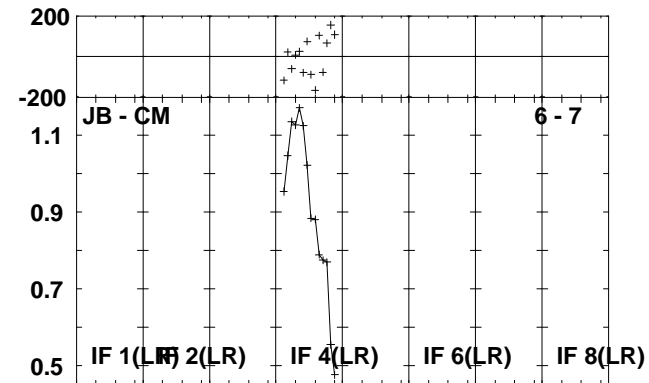
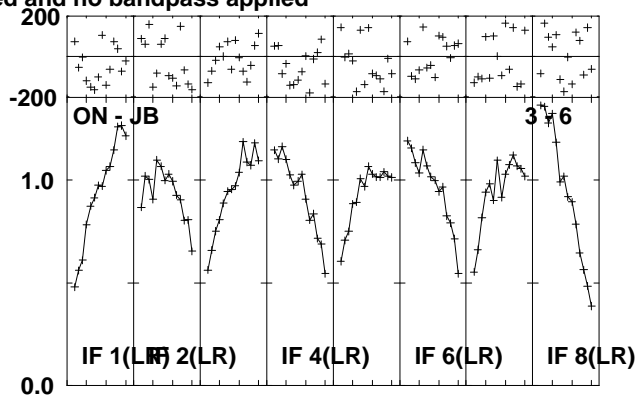
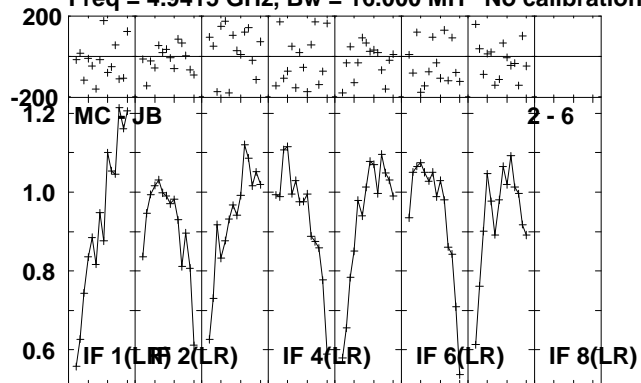

Lower frame: Milli Ampl Jy Top frame: Phas deg
Scalar averaged cross-power spectrum Several baselines displayed
Timerange: 01/02:31:20 to 01/02:36:18

Plot file version 139 created 15-JUL-2010 10:45:52

J1953+35 RR004B.UVDATA.1

Freq = 4.9415 GHz, Bw = 16.000 MH No calibration applied and no bandpass applied

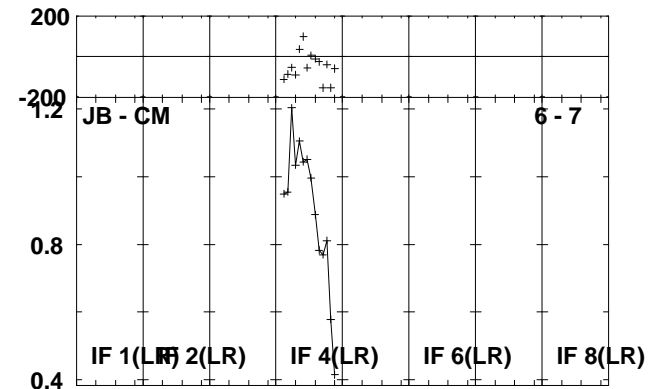
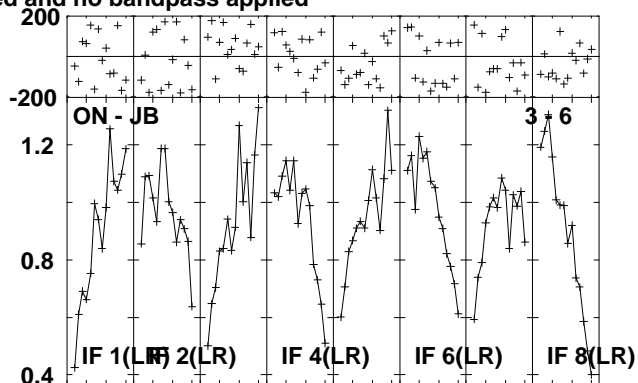
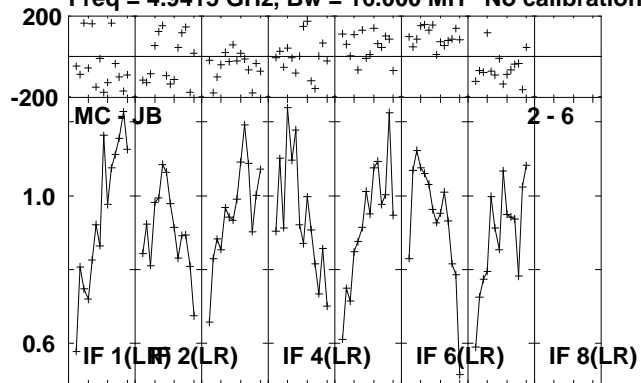

Lower frame: Milli Ampl Jy Top frame: Phas deg
Scalar averaged cross-power spectrum Several baselines displayed
Timerange: 01/02:36:20 to 01/02:38:18

Plot file version 140 created 15-JUL-2010 10:45:53

CYGX-1 RR004B.UVDATA.1

Freq = 4.9415 GHz, Bw = 16.000 MH No calibration applied and no bandpass applied

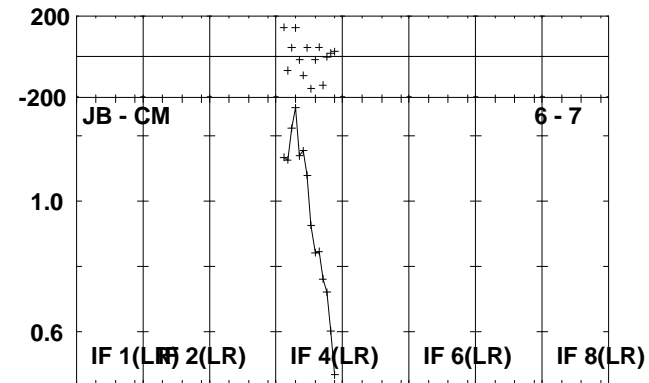
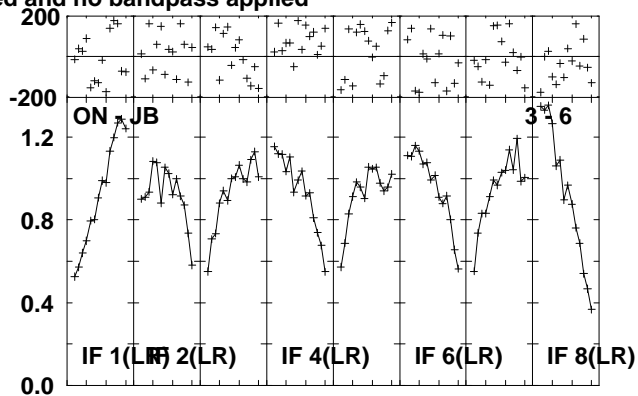
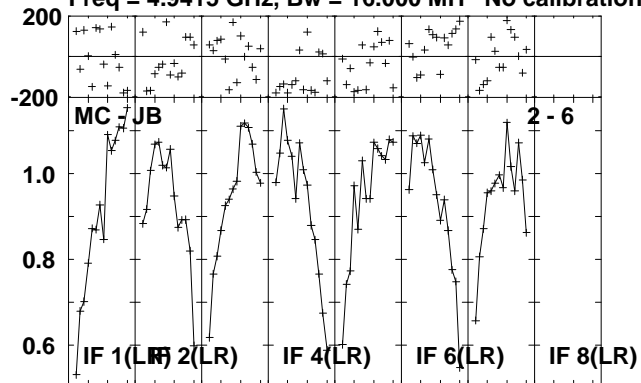

Lower frame: Milli Ampl Jy Top frame: Phas deg
Scalar averaged cross-power spectrum Several baselines displayed
Timerange: 01/02:38:20 to 01/02:43:18

Plot file version 141 created 15-JUL-2010 10:45:54

J1953+35 RR004B.UVDATA.1

Freq = 4.9415 GHz, Bw = 16.000 MH No calibration applied and no bandpass applied

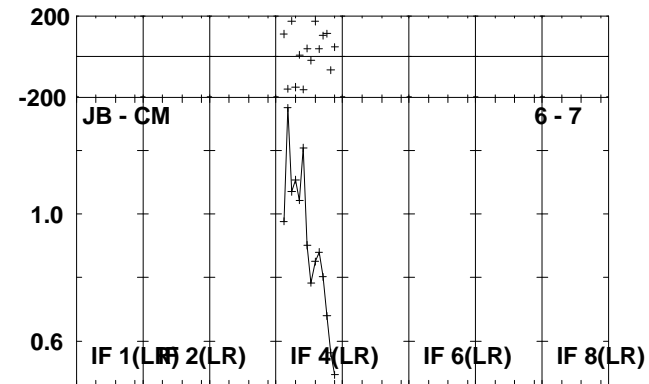
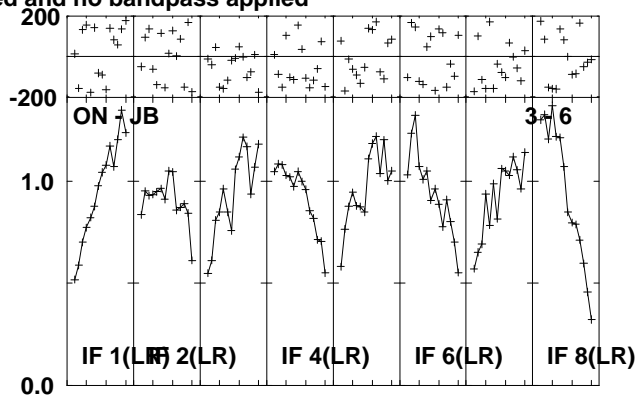
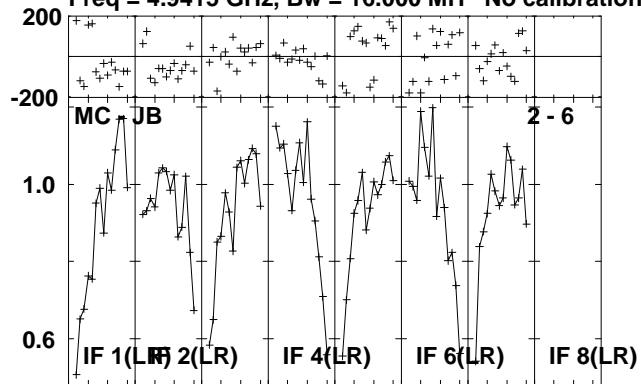

Lower frame: Milli Ampl Jy Top frame: Phas deg
Scalar averaged cross-power spectrum Several baselines displayed
Timerange: 01/02:44:00 to 01/02:45:28

Plot file version 142 created 15-JUL-2010 10:45:55

CYGX-1 RR004B.UVDATA.1

Freq = 4.9415 GHz, Bw = 16.000 MH No calibration applied and no bandpass applied

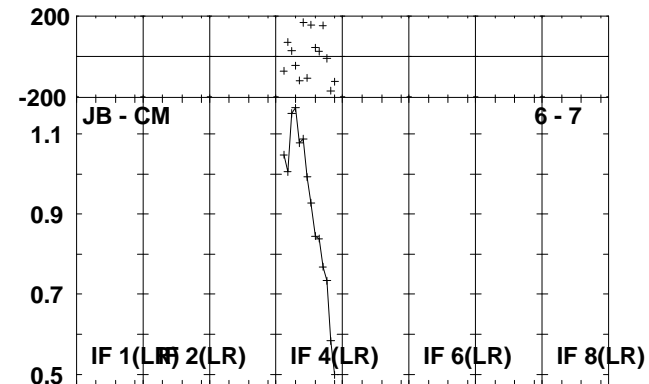
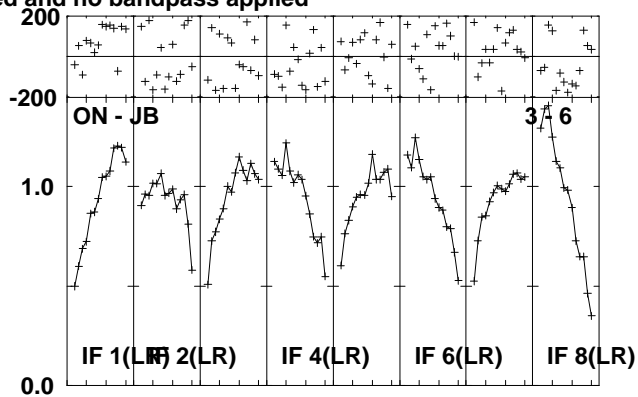
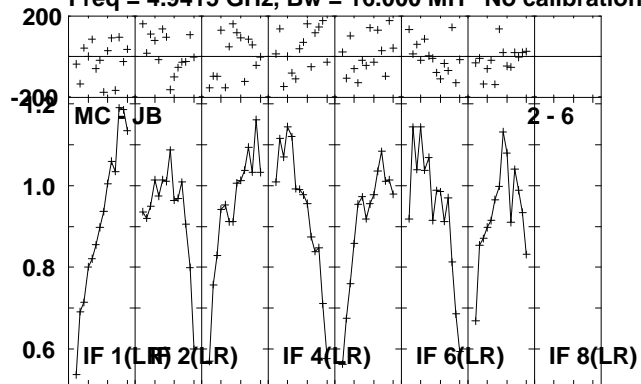

Lower frame: Milli Ampl Jy Top frame: Phas deg
Scalar averaged cross-power spectrum Several baselines displayed
Timerange: 01/02:45:30 to 01/02:50:28

Plot file version 143 created 15-JUL-2010 10:45:57

J1953+35 RR004B.UVDATA.1

Freq = 4.9415 GHz, Bw = 16.000 MH No calibration applied and no bandpass applied

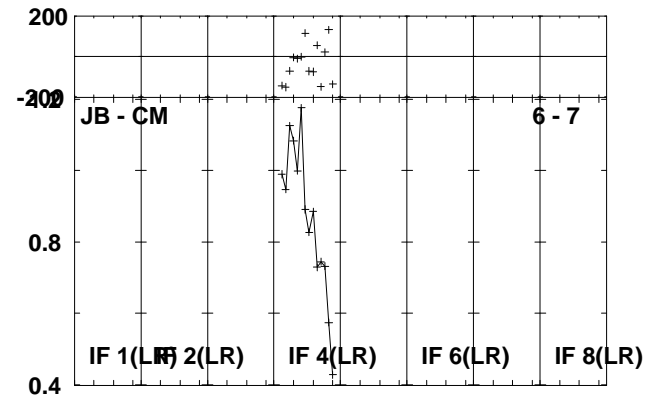
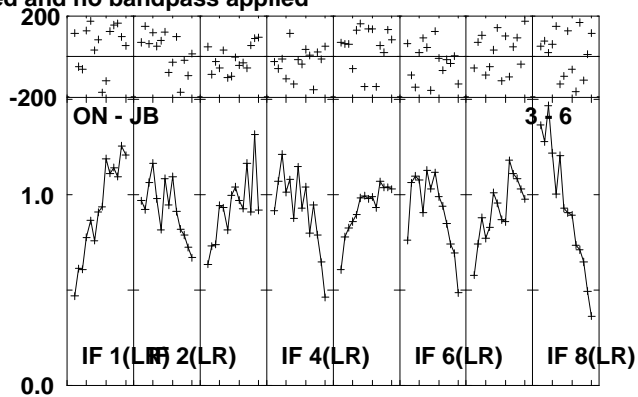
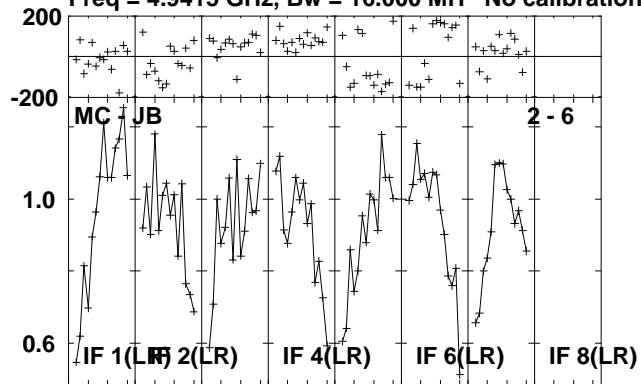

Lower frame: Milli Ampl Jy Top frame: Phas deg
Scalar averaged cross-power spectrum Several baselines displayed
Timerange: 01/02:50:30 to 01/02:52:28

Plot file version 144 created 15-JUL-2010 10:45:58

CYGX-1 RR004B.UVDATA.1

Freq = 4.9415 GHz, Bw = 16.000 MH No calibration applied and no bandpass applied

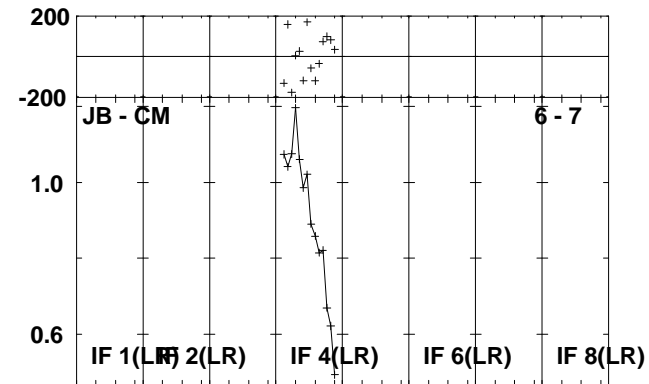
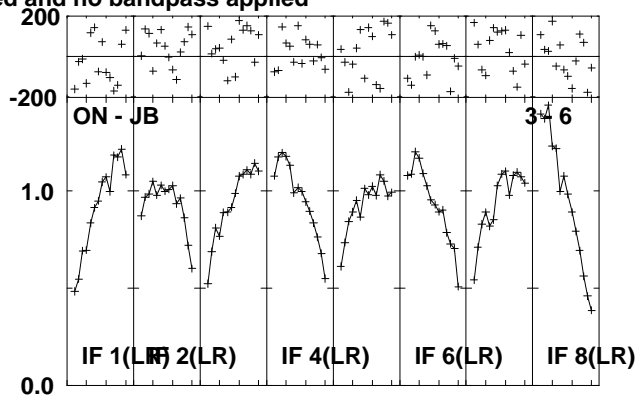
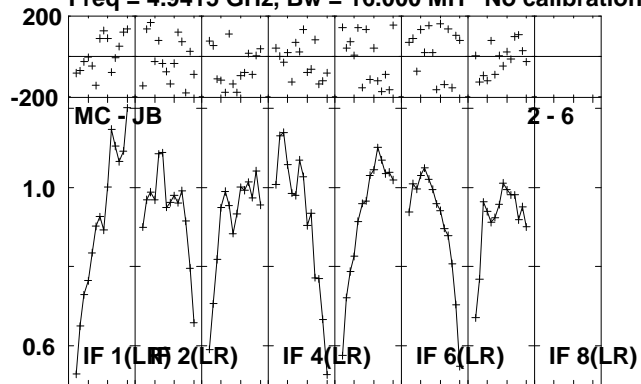

Lower frame: Milli Ampl Jy Top frame: Phas deg
Scalar averaged cross-power spectrum Several baselines displayed
Timerange: 01/02:52:30 to 01/02:57:28

Plot file version 145 created 15-JUL-2010 10:46:00

J1953+35 RR004B.UVDATA.1

Freq = 4.9415 GHz, Bw = 16.000 MH No calibration applied and no bandpass applied

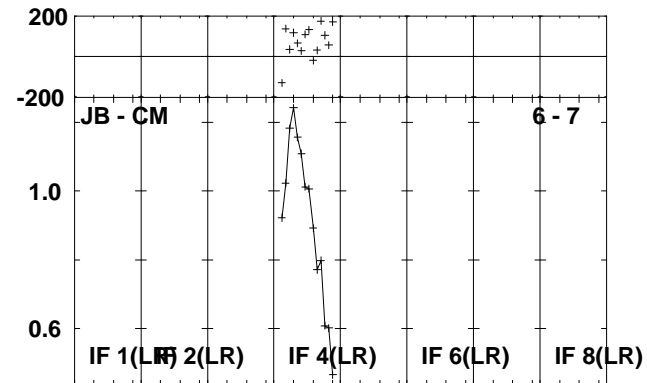
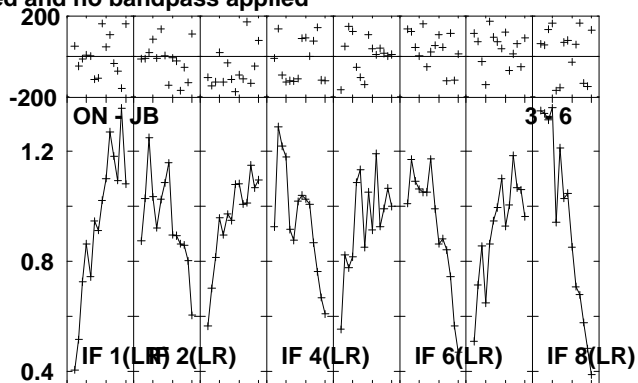
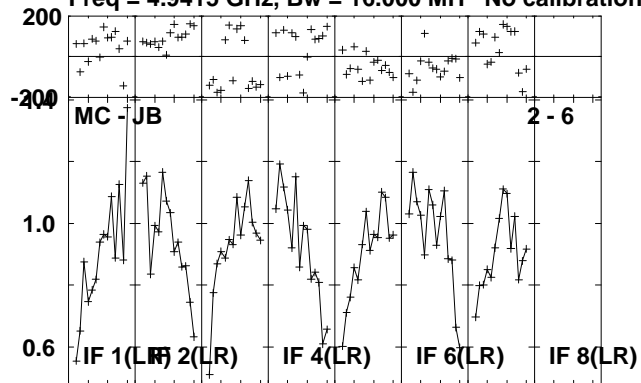

Lower frame: Milli Ampl Jy Top frame: Phas deg
Scalar averaged cross-power spectrum Several baselines displayed
Timerange: 01/02:58:10 to 01/02:59:38

Plot file version 146 created 15-JUL-2010 10:46:01

CYGX-1 RR004B.UVDATA.1

Freq = 4.9415 GHz, Bw = 16.000 MH No calibration applied and no bandpass applied

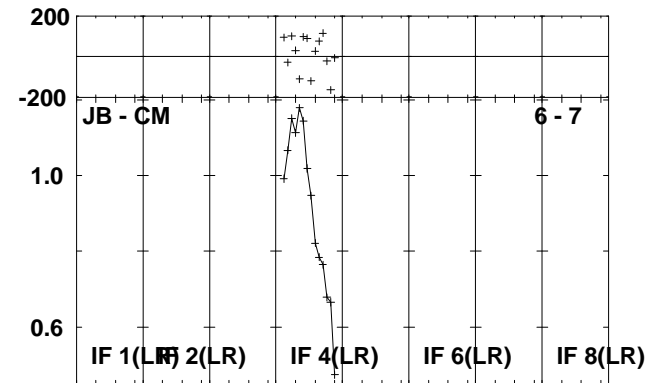
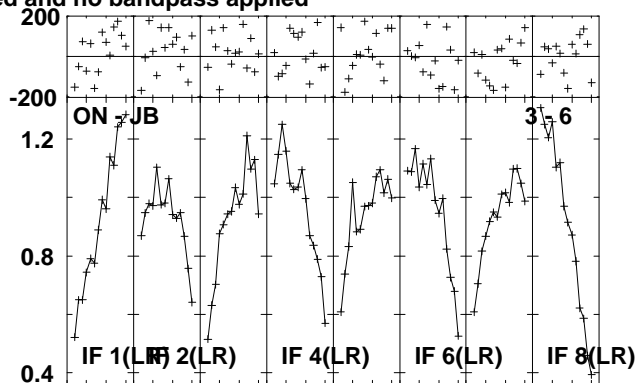
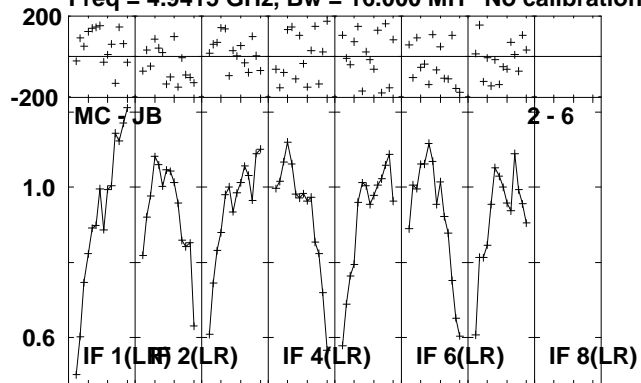

Lower frame: Milli Ampl Jy Top frame: Phas deg
Scalar averaged cross-power spectrum Several baselines displayed
Timerange: 01/02:59:40 to 01/03:04:38

Plot file version 147 created 15-JUL-2010 10:46:02

J1953+35 RR004B.UVDATA.1

Freq = 4.9415 GHz, Bw = 16.000 MH No calibration applied and no bandpass applied

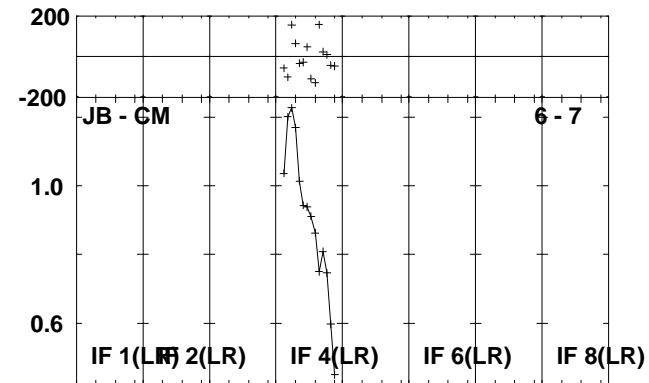
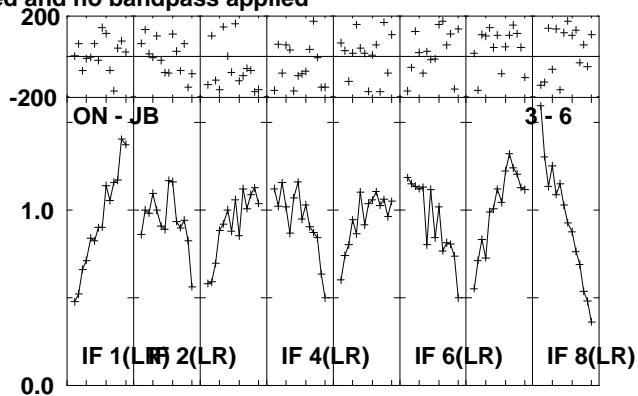
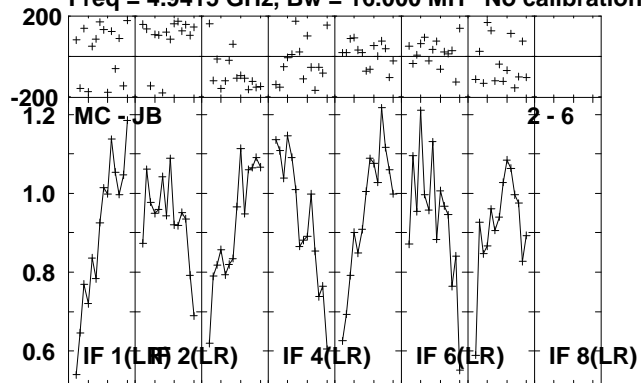

Lower frame: Milli Ampl Jy Top frame: Phas deg
Scalar averaged cross-power spectrum Several baselines displayed
Timerange: 01/03:04:40 to 01/03:06:38

Plot file version 148 created 15-JUL-2010 10:46:04

CYGX-1 RR004B.UVDATA.1

Freq = 4.9415 GHz, Bw = 16.000 MH No calibration applied and no bandpass applied

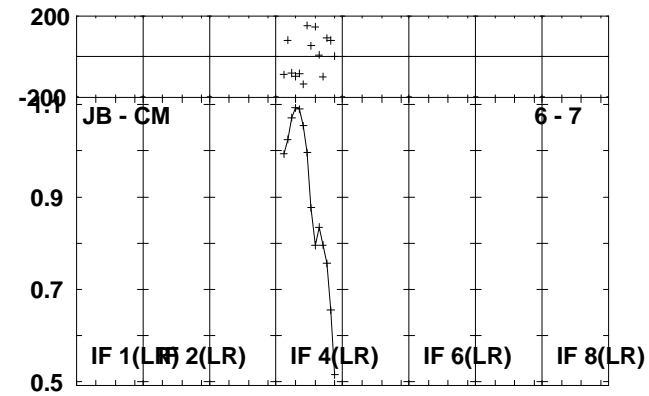
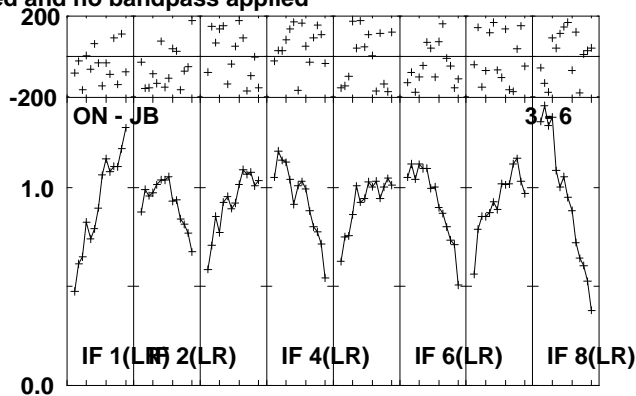
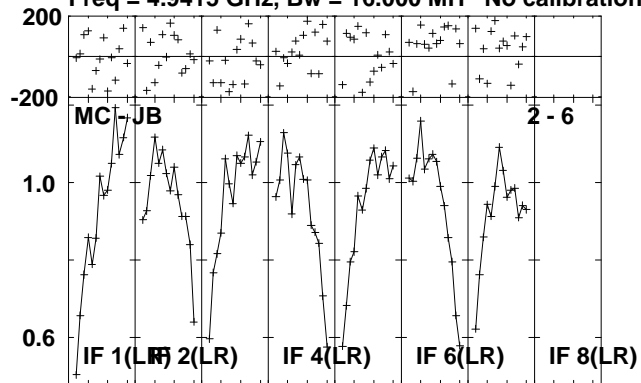

Lower frame: Milli Ampl Jy Top frame: Phas deg
Scalar averaged cross-power spectrum Several baselines displayed
Timerange: 01/03:06:40 to 01/03:11:38

Plot file version 149 created 15-JUL-2010 10:46:05

J1953+35 RR004B.UVDATA.1

Freq = 4.9415 GHz, Bw = 16.000 MH No calibration applied and no bandpass applied

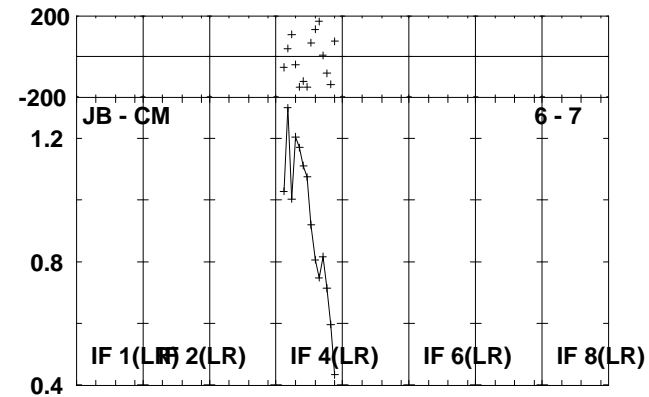
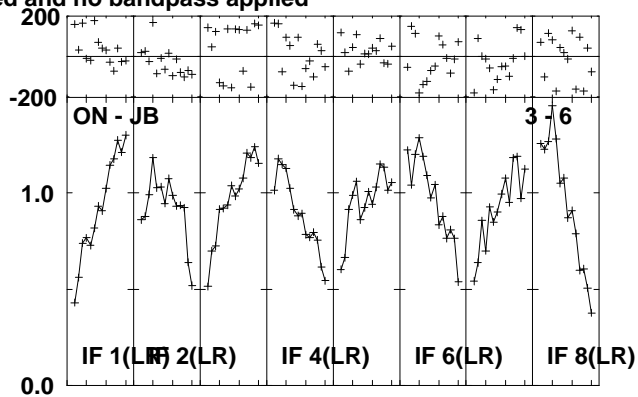
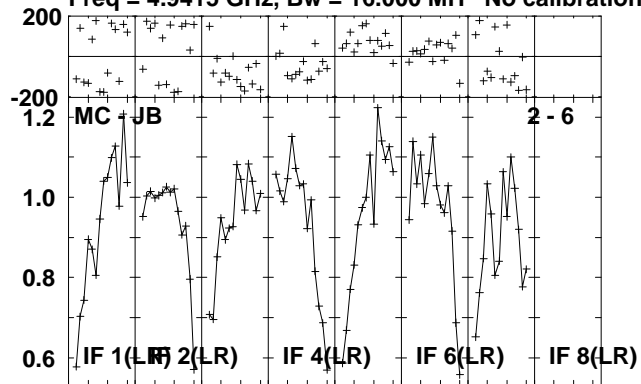

Lower frame: Milli Ampl Jy Top frame: Phas deg
Scalar averaged cross-power spectrum Several baselines displayed
Timerange: 01/03:12:20 to 01/03:13:48

Plot file version 150 created 15-JUL-2010 10:46:06

CYGX-1 RR004B.UVDATA.1

Freq = 4.9415 GHz, Bw = 16.000 MH No calibration applied and no bandpass applied

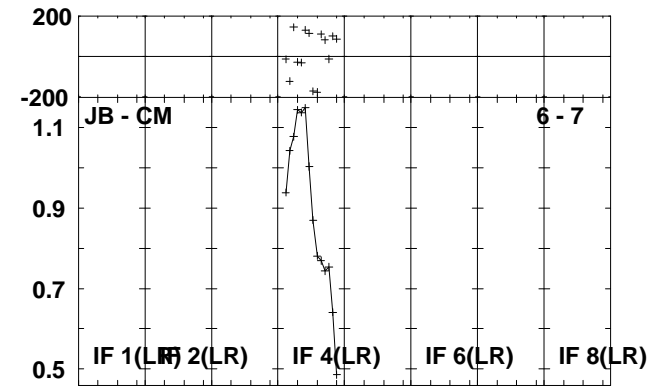
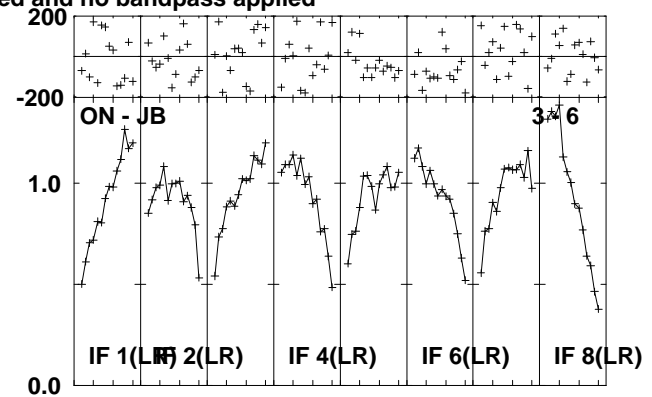
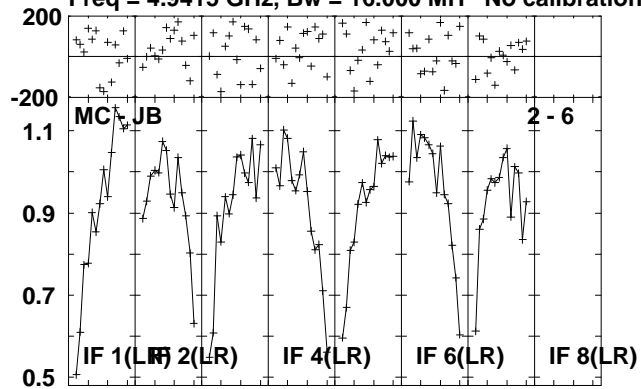

Lower frame: Milli Ampl Jy Top frame: Phas deg
Scalar averaged cross-power spectrum Several baselines displayed
Timerange: 01/03:13:50 to 01/03:18:48

Plot file version 151 created 15-JUL-2010 10:46:08

J1953+35 RR004B.UVDATA.1

Freq = 4.9415 GHz, Bw = 16.000 MH No calibration applied and no bandpass applied

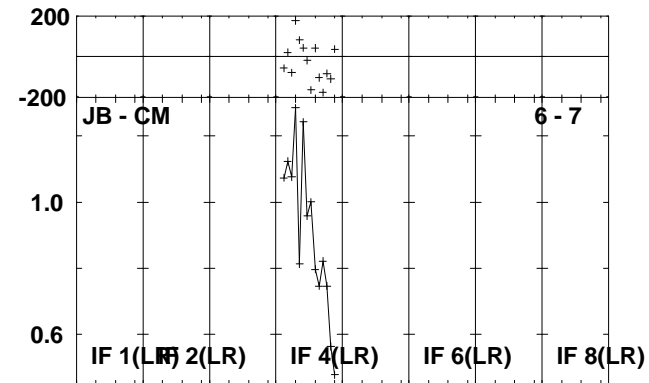
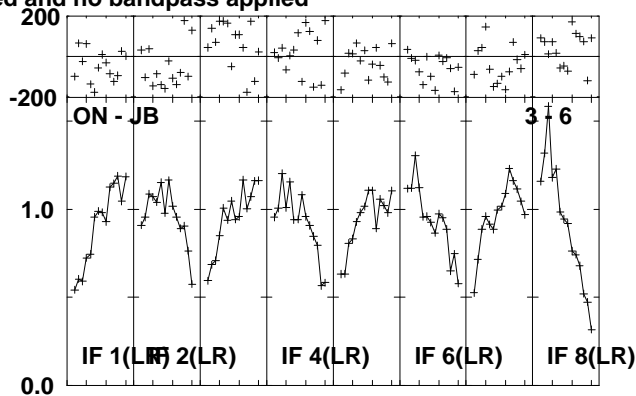
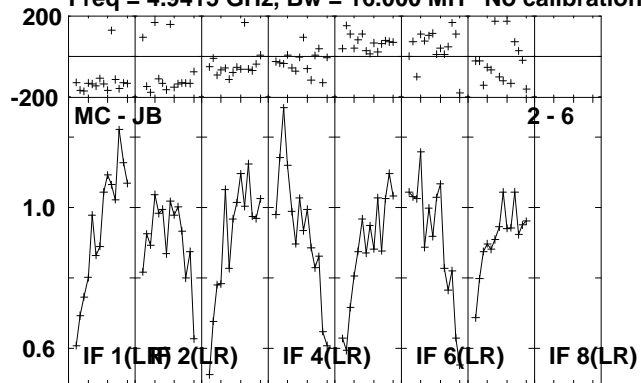

Lower frame: Milli Ampl Jy Top frame: Phas deg
Scalar averaged cross-power spectrum Several baselines displayed
Timerange: 01/03:18:50 to 01/03:20:48

Plot file version 152 created 15-JUL-2010 10:46:09

CYGX-1 RR004B.UVDATA.1

Freq = 4.9415 GHz, Bw = 16.000 MH No calibration applied and no bandpass applied

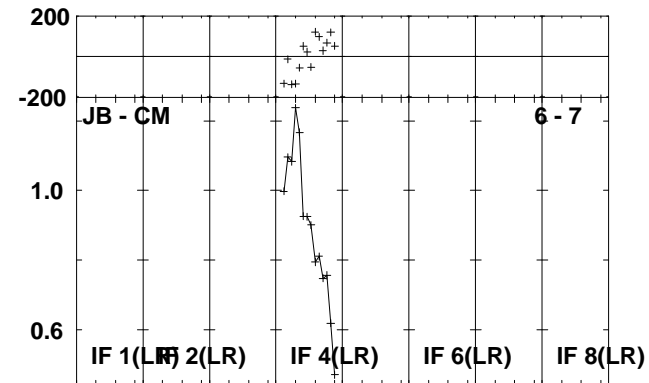
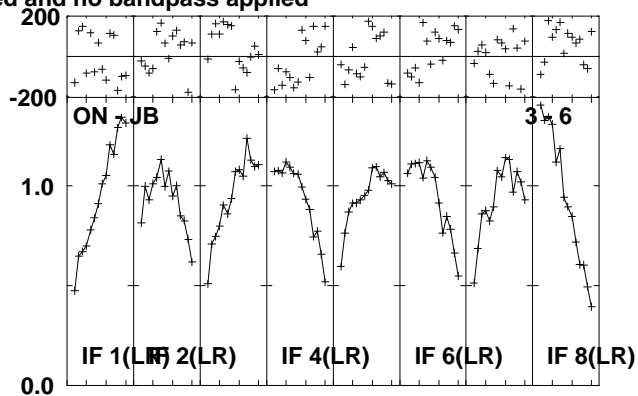
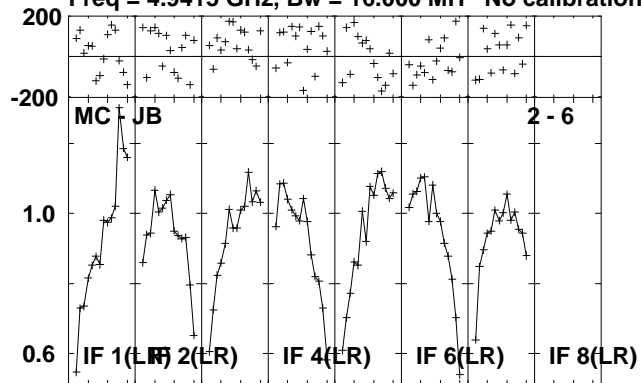

Lower frame: Milli Ampl Jy Top frame: Phas deg
Scalar averaged cross-power spectrum Several baselines displayed
Timerange: 01/03:20:50 to 01/03:25:48

Plot file version 153 created 15-JUL-2010 10:46:10
J1953+35 RR004B.UVDATA.1

Freq = 4.9415 GHz, Bw = 16.000 MH No calibration applied and no bandpass applied

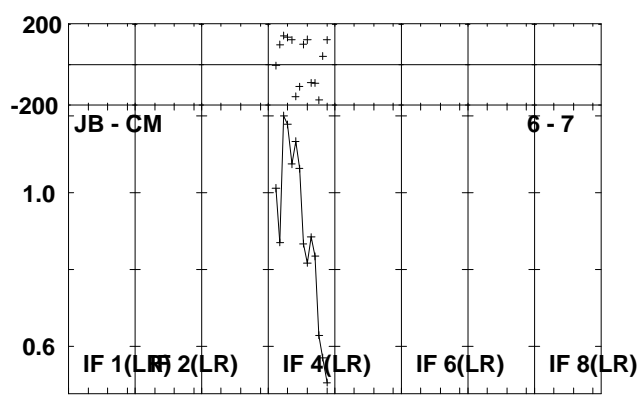
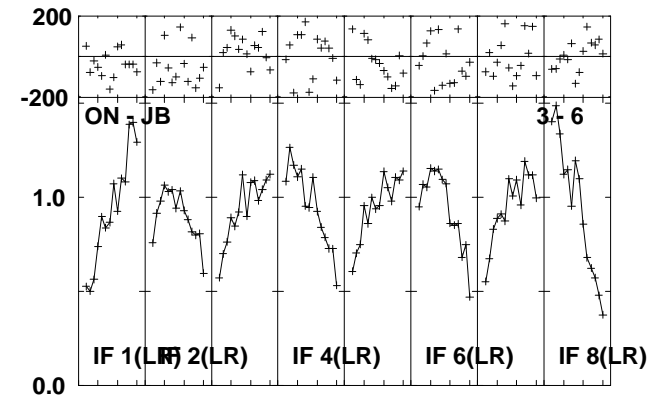
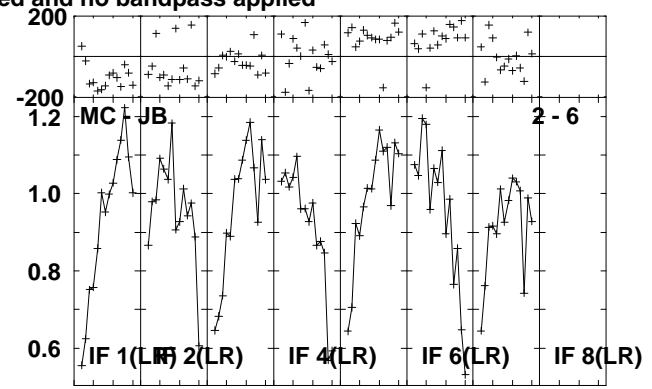
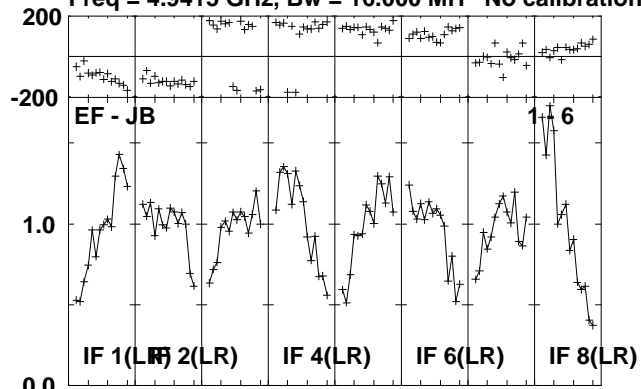

Lower frame: Milli Ampl Jy Top frame: Phas deg
Scalar averaged cross-power spectrum Several baselines displayed
Timerange: 01/03:26:30 to 01/03:27:58

Plot file version 154 created 15-JUL-2010 10:46:11

CYGX-1 RR004B.UVDATA.1

Freq = 4.9415 GHz, Bw = 16.000 MH No calibration applied and no bandpass applied

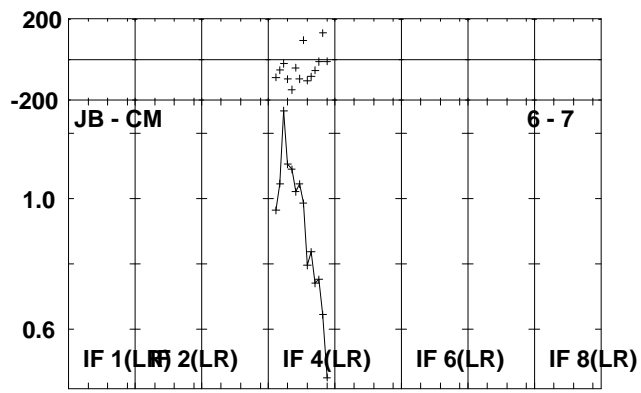
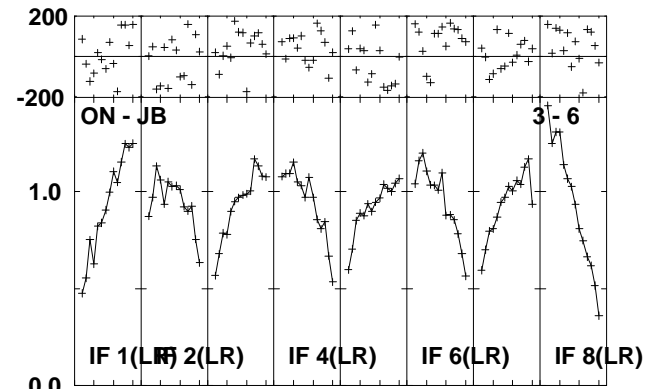
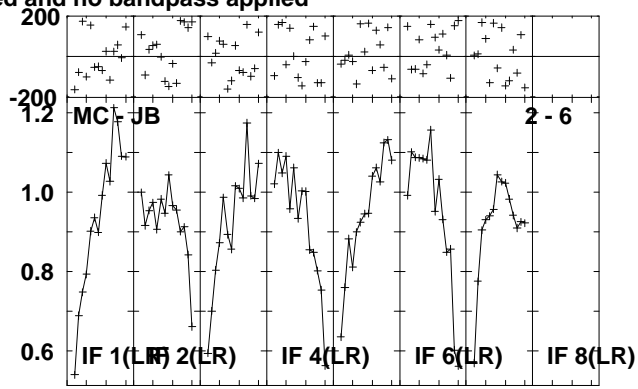
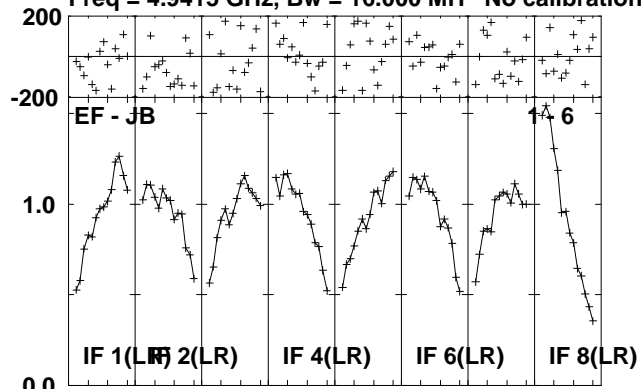

Lower frame: Milli Ampl Jy Top frame: Phas deg
Scalar averaged cross-power spectrum Several baselines displayed
Timerange: 01/03:28:00 to 01/03:32:58

Plot file version 155 created 15-JUL-2010 10:46:13

J1953+35 RR004B.UVDATA.1

Freq = 4.9415 GHz, Bw = 16.000 MH No calibration applied and no bandpass applied

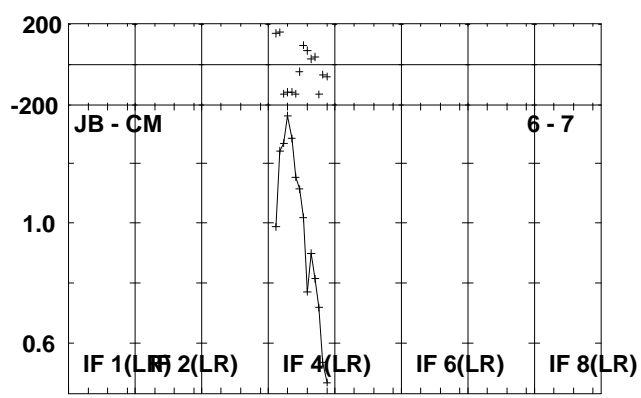
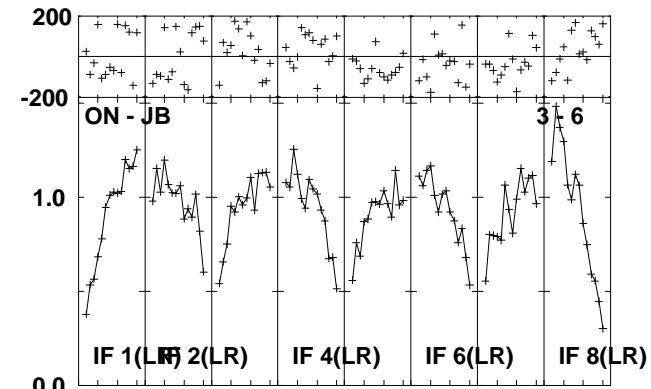
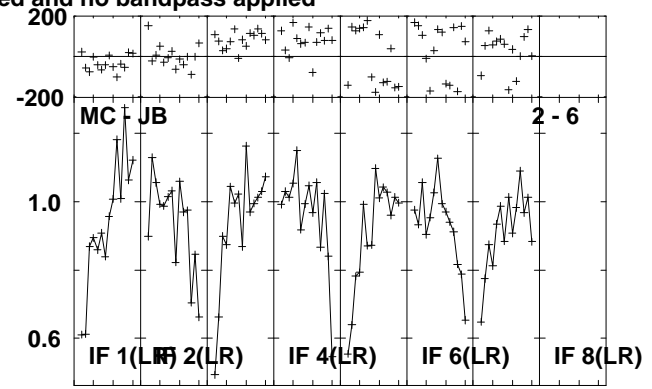
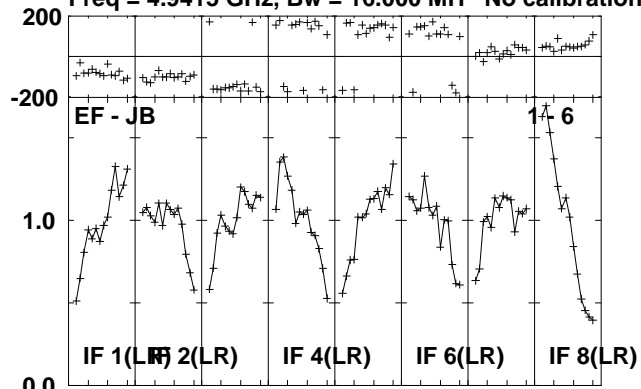

Lower frame: Milli Ampl Jy Top frame: Phas deg
Scalar averaged cross-power spectrum Several baselines displayed
Timerange: 01/03:33:00 to 01/03:34:58

Plot file version 156 created 15-JUL-2010 10:46:14

CYGX-1 RR004B.UVDATA.1

Freq = 4.9415 GHz, Bw = 16.000 MH No calibration applied and no bandpass applied

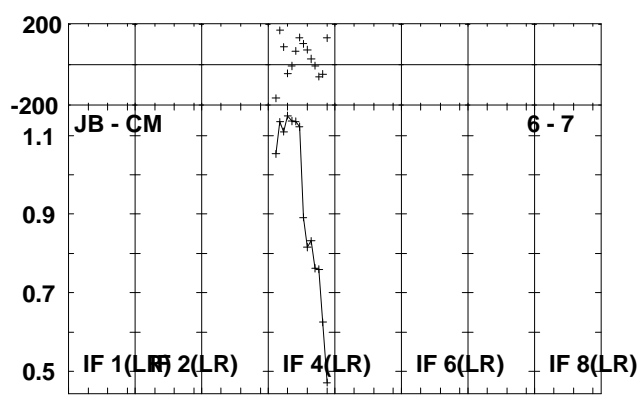
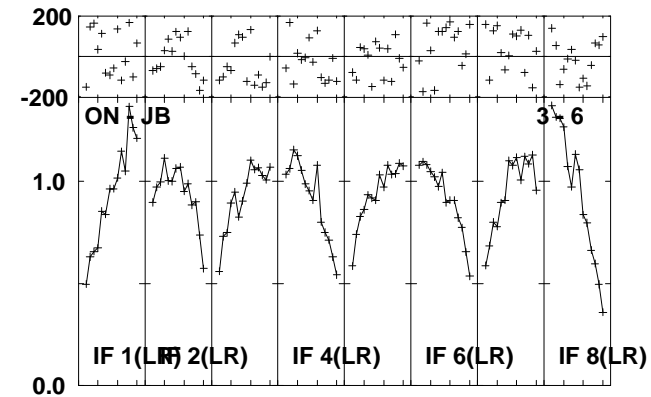
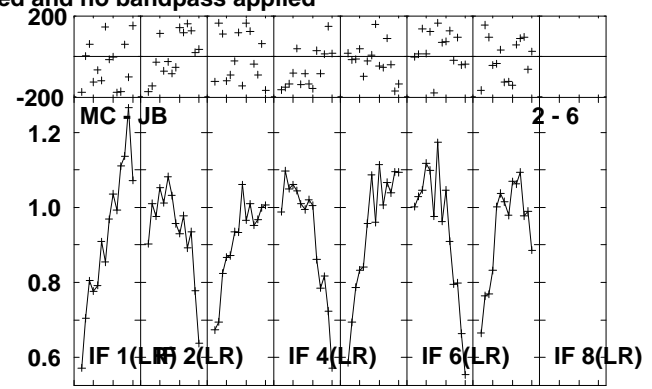
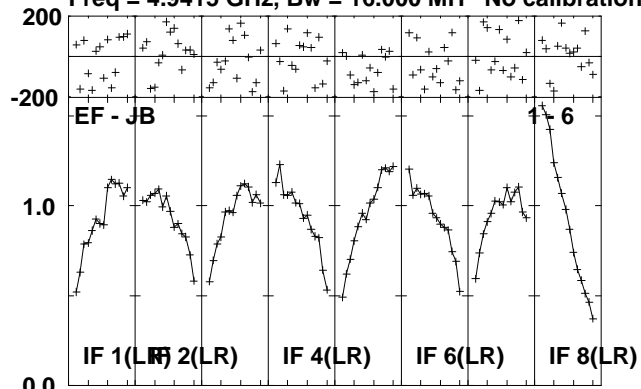

Lower frame: Milli Ampl Jy Top frame: Phas deg
Scalar averaged cross-power spectrum Several baselines displayed
Timerange: 01/03:35:00 to 01/03:39:58

Plot file version 157 created 15-JUL-2010 10:46:16

CYGX-1 RR004B.UVDATA.1

Freq = 4.9415 GHz, Bw = 16.000 MH No calibration applied and no bandpass applied

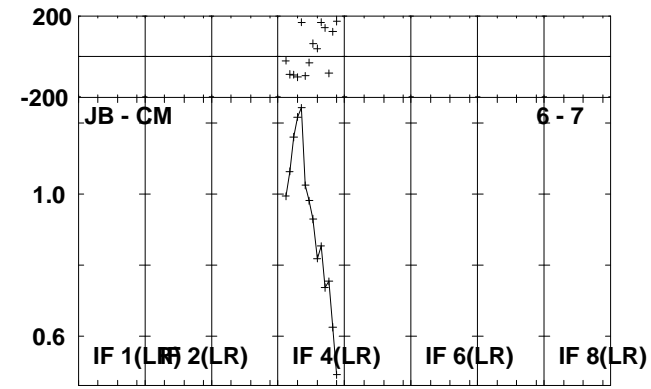
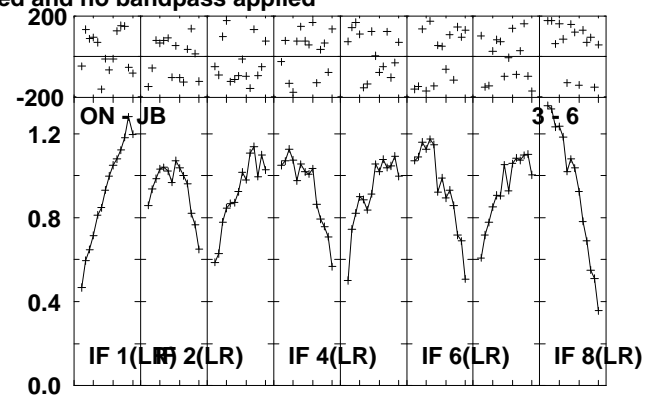
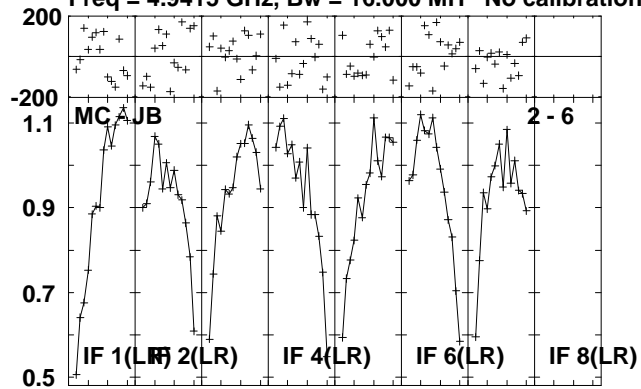

Lower frame: Milli Ampl Jy Top frame: Phas deg
Scalar averaged cross-power spectrum Several baselines displayed
Timerange: 01/03:42:10 to 01/03:47:08

Plot file version 158 created 15-JUL-2010 10:46:18

J1953+35 RR004B.UVDATA.1

Freq = 4.9415 GHz, Bw = 16.000 MH No calibration applied and no bandpass applied

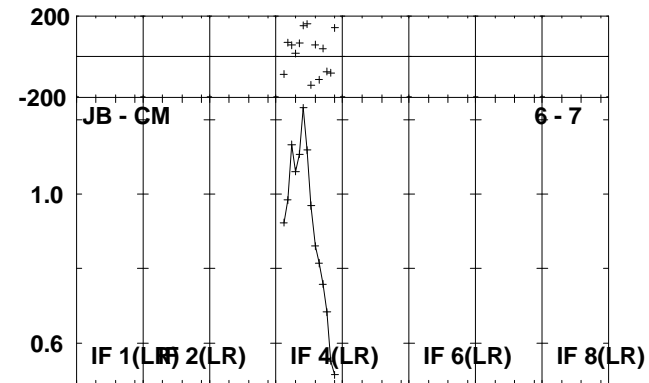
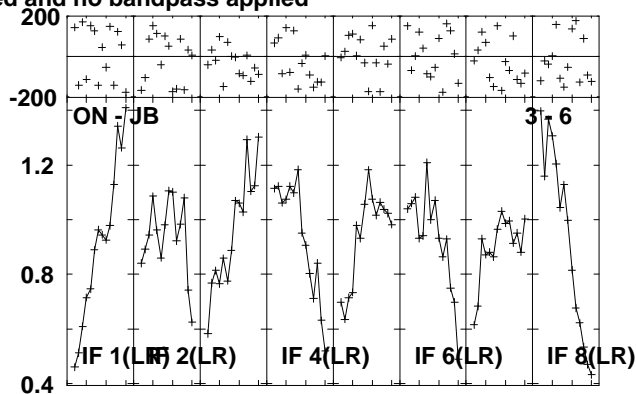
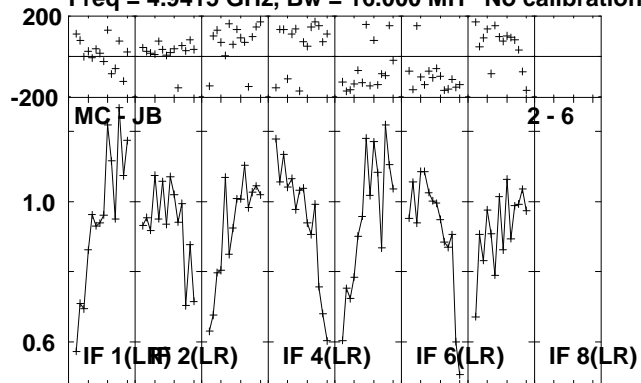

Lower frame: Milli Ampl Jy Top frame: Phas deg
Scalar averaged cross-power spectrum Several baselines displayed
Timerange: 01/03:47:10 to 01/03:49:08

Plot file version 159 created 15-JUL-2010 10:46:19

CYGX-1 RR004B.UVDATA.1

Freq = 4.9415 GHz, Bw = 16.000 MH No calibration applied and no bandpass applied

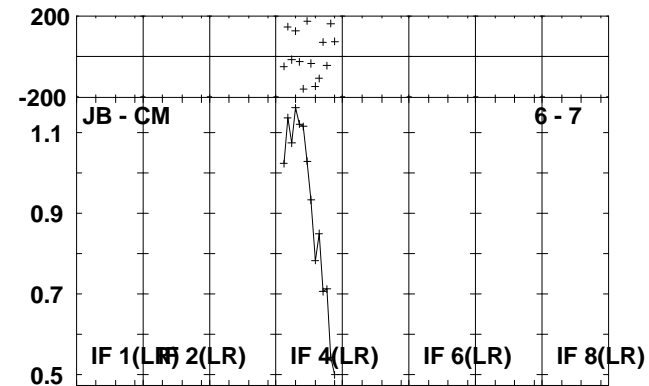
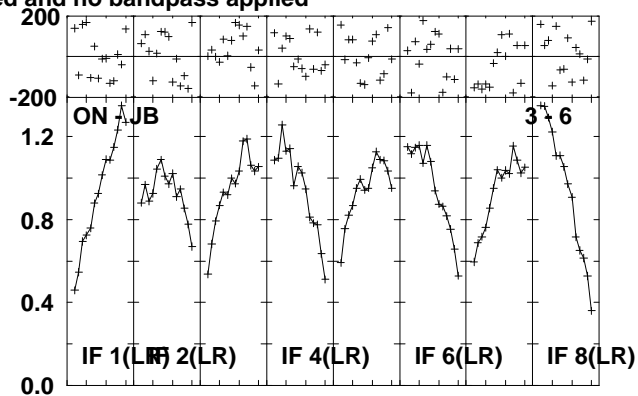
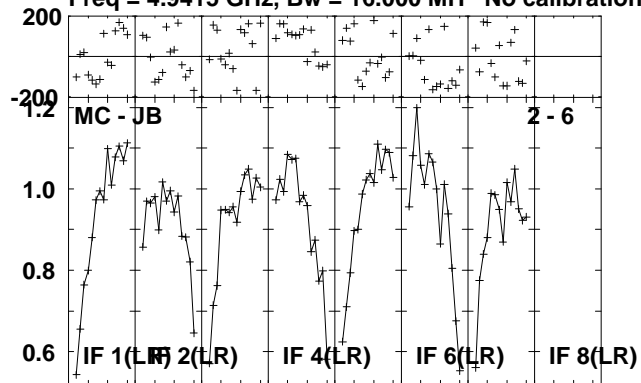

Lower frame: Milli Ampl Jy Top frame: Phas deg
Scalar averaged cross-power spectrum Several baselines displayed
Timerange: 01/03:49:10 to 01/03:54:08

Plot file version 160 created 15-JUL-2010 10:46:20

J1953+35 RR004B.UVDATA.1

Freq = 4.9415 GHz, Bw = 16.000 MH No calibration applied and no bandpass applied

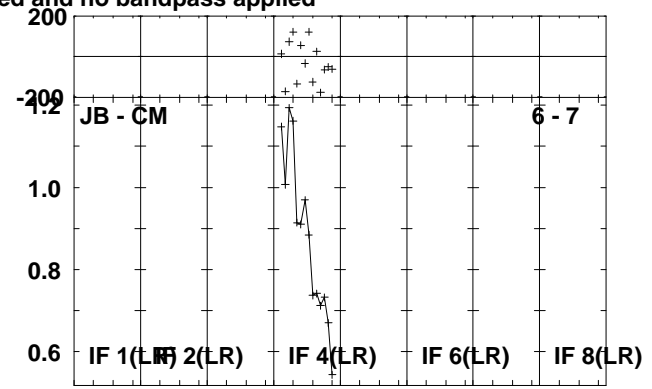
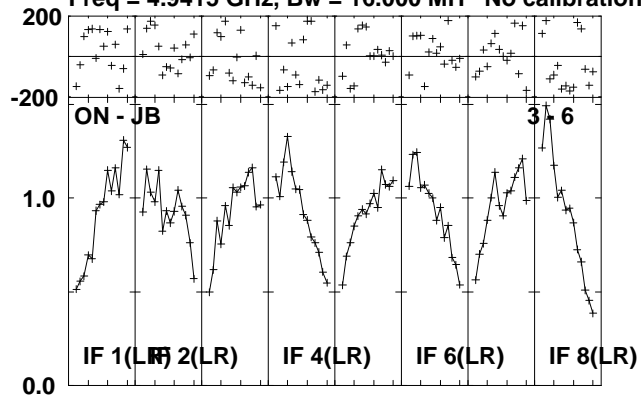

Lower frame: Milli Ampl Jy Top frame: Phas deg
Scalar averaged cross-power spectrum Several baselines displayed
Timerange: 01/03:54:50 to 01/03:56:18

Plot file version 161 created 15-JUL-2010 10:46:21

CYGX-1 RR004B.UVDATA.1

Freq = 4.9415 GHz, Bw = 16.000 MH No calibration applied and no bandpass applied

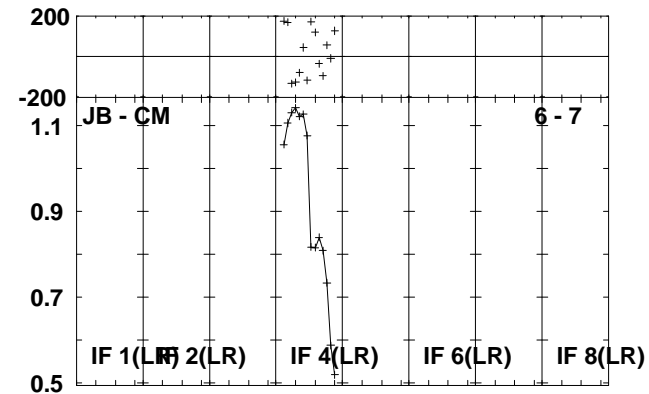
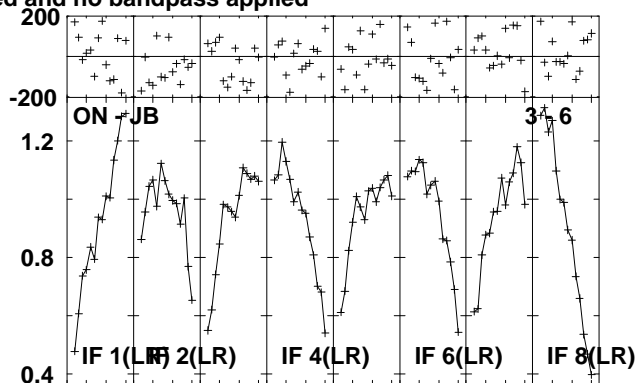
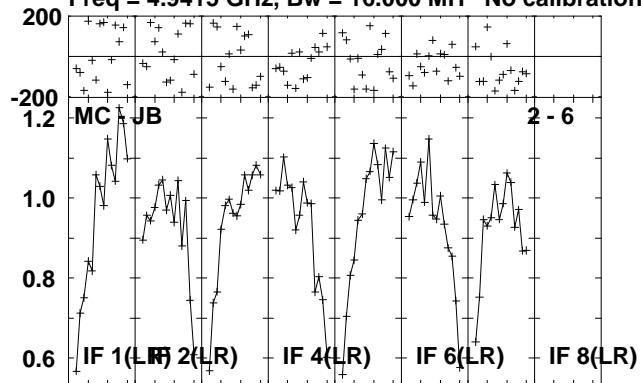

Lower frame: Milli Ampl Jy Top frame: Phas deg
Scalar averaged cross-power spectrum Several baselines displayed
Timerange: 01/03:56:20 to 01/04:01:18

Plot file version 162 created 15-JUL-2010 10:46:22

J1953+35 RR004B.UVDATA.1

Freq = 4.9415 GHz, Bw = 16.000 MH No calibration applied and no bandpass applied

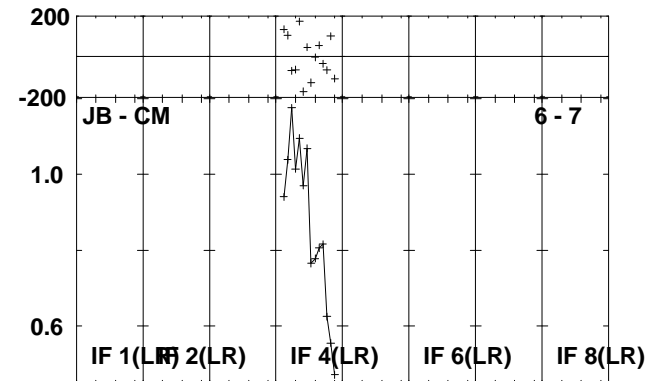
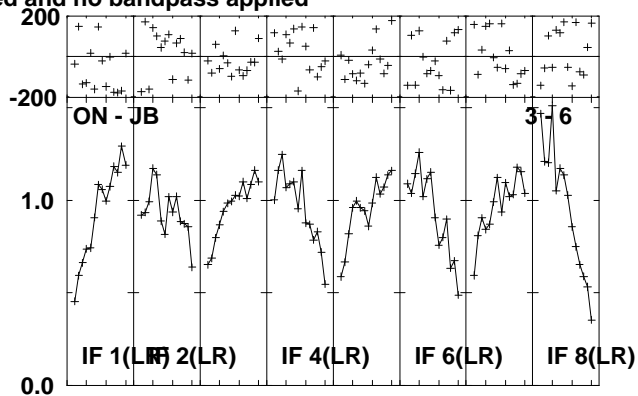
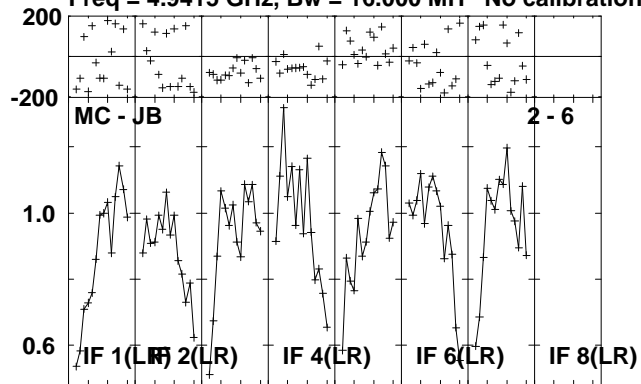

Lower frame: Milli Ampl Jy Top frame: Phas deg
Scalar averaged cross-power spectrum Several baselines displayed
Timerange: 01/04:01:20 to 01/04:03:18

Plot file version 163 created 15-JUL-2010 10:46:23

CYGX-1 RR004B.UVDATA.1

Freq = 4.9415 GHz, Bw = 16.000 MH No calibration applied and no bandpass applied

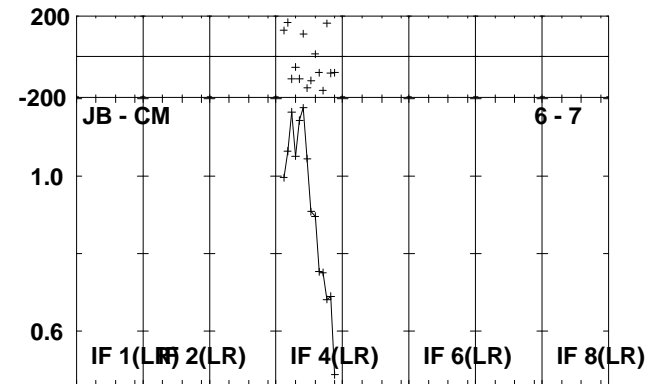
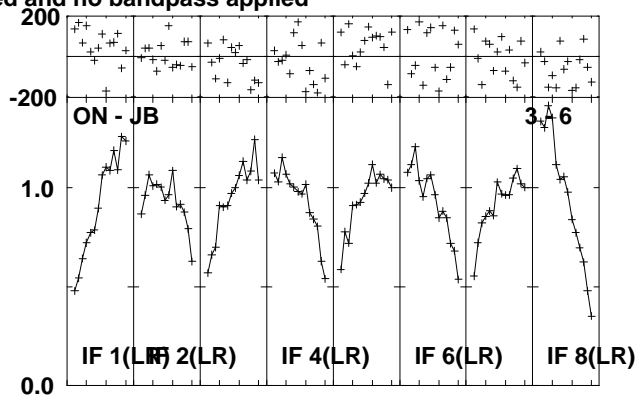
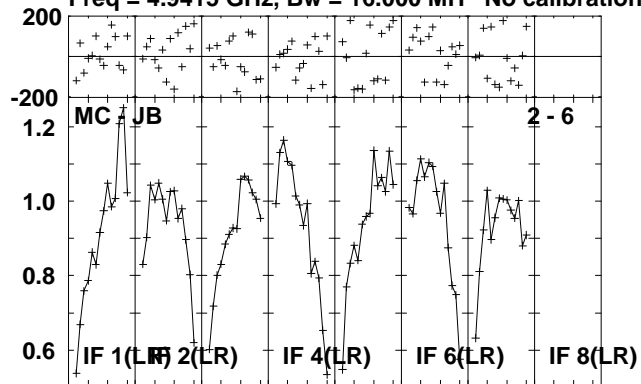

Lower frame: Milli Ampl Jy Top frame: Phas deg
Scalar averaged cross-power spectrum Several baselines displayed
Timerange: 01/04:03:20 to 01/04:08:18

Plot file version 164 created 15-JUL-2010 10:46:24
J1953+35 RR004B.UVDATA.1

Freq = 4.9415 GHz, Bw = 16.000 MH No calibration applied and no bandpass applied

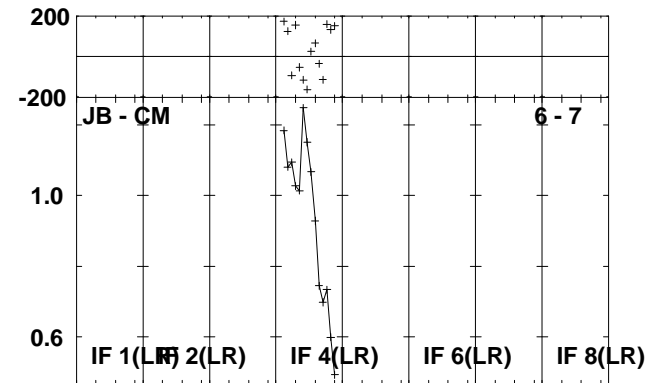
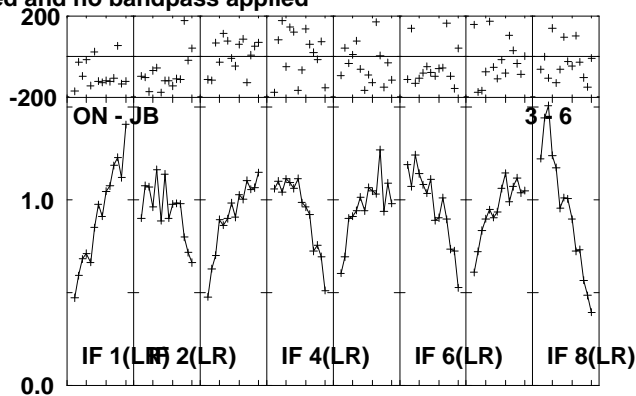
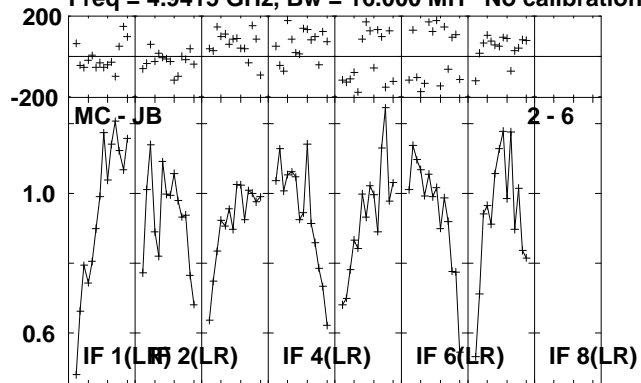

Lower frame: Milli Ampl Jy Top frame: Phas deg
Scalar averaged cross-power spectrum Several baselines displayed
Timerange: 01/04:09:00 to 01/04:10:28

Plot file version 165 created 15-JUL-2010 10:46:25

CYGX-1 RR004B.UVDATA.1

Freq = 4.9415 GHz, Bw = 16.000 MH No calibration applied and no bandpass applied

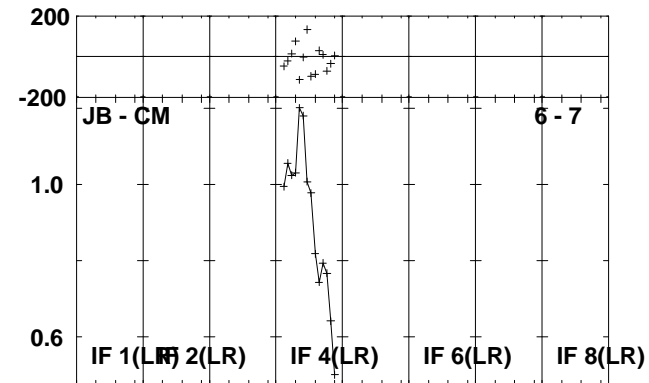
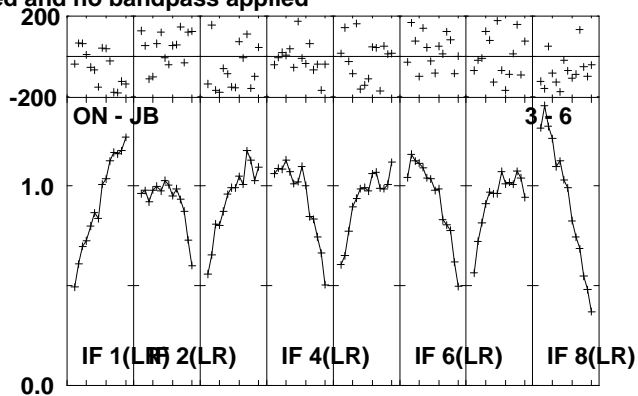
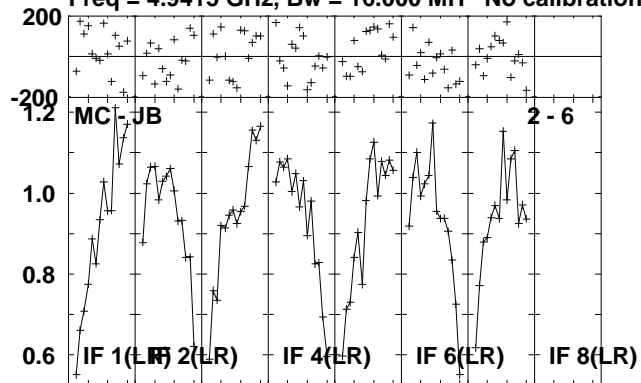

Lower frame: Milli Ampl Jy Top frame: Phas deg
Scalar averaged cross-power spectrum Several baselines displayed
Timerange: 01/04:10:30 to 01/04:15:28

Plot file version 166 created 15-JUL-2010 10:46:26

J1953+35 RR004B.UVDATA.1

Freq = 4.9415 GHz, Bw = 16.000 MH No calibration applied and no bandpass applied

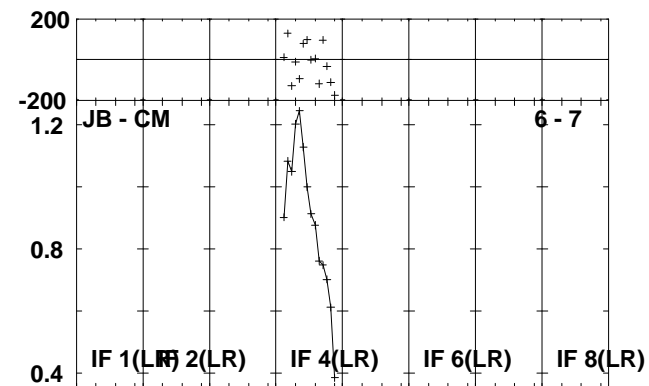
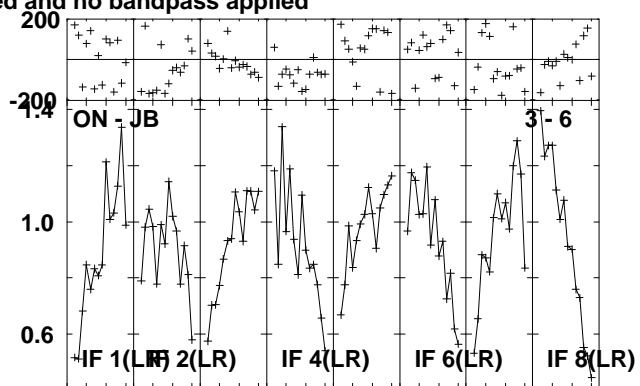
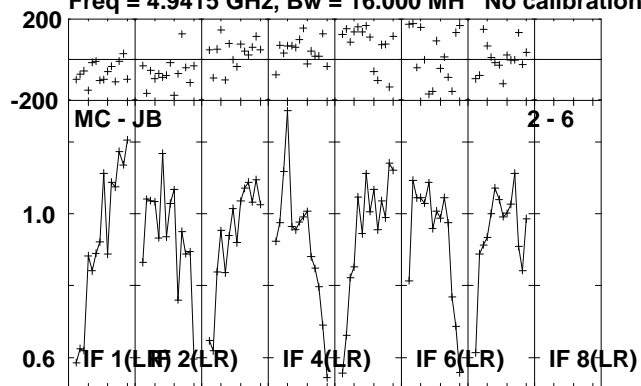

Lower frame: Milli Ampl Jy Top frame: Phas deg
Scalar averaged cross-power spectrum Several baselines displayed
Timerange: 01/04:15:30 to 01/04:17:28

Plot file version 167 created 15-JUL-2010 10:46:26

CYGX-1 RR004B.UVDATA.1

Freq = 4.9415 GHz, Bw = 16.000 MH No calibration applied and no bandpass applied

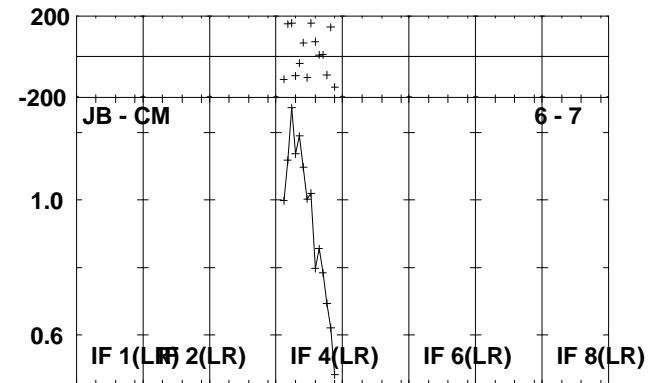
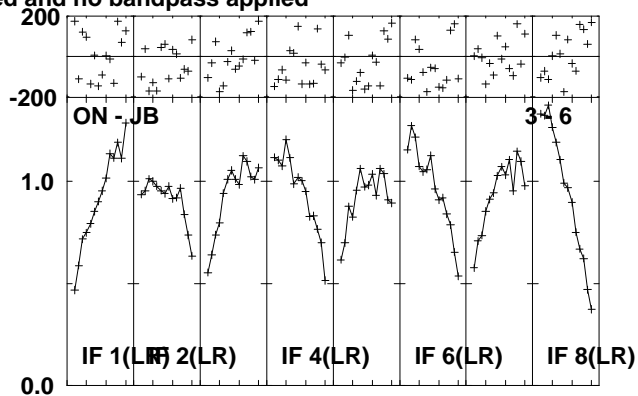
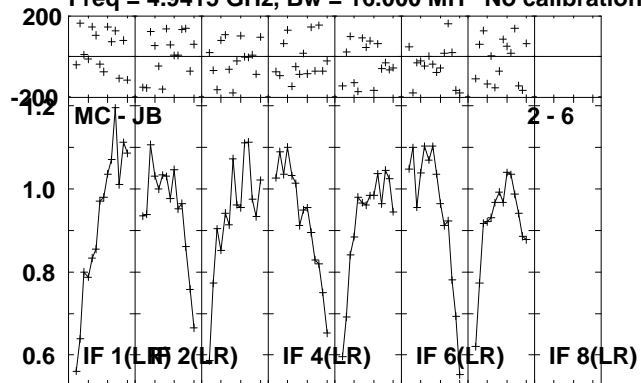

Lower frame: Milli Ampl Jy Top frame: Phas deg
Scalar averaged cross-power spectrum Several baselines displayed
Timerange: 01/04:17:30 to 01/04:22:28

Plot file version 168 created 15-JUL-2010 10:46:27

J1953+35 RR004B.UVDATA.1

Freq = 4.9415 GHz, Bw = 16.000 MH No calibration applied and no bandpass applied

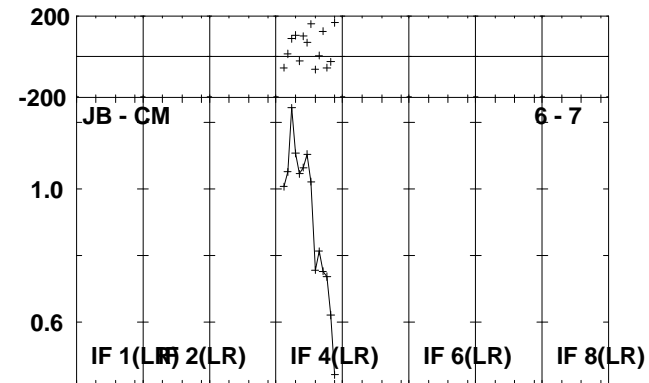
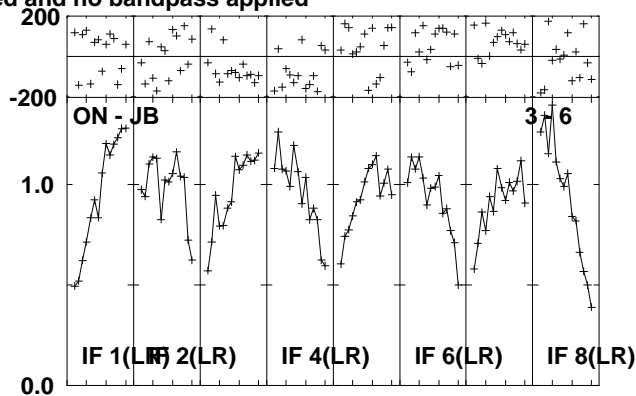
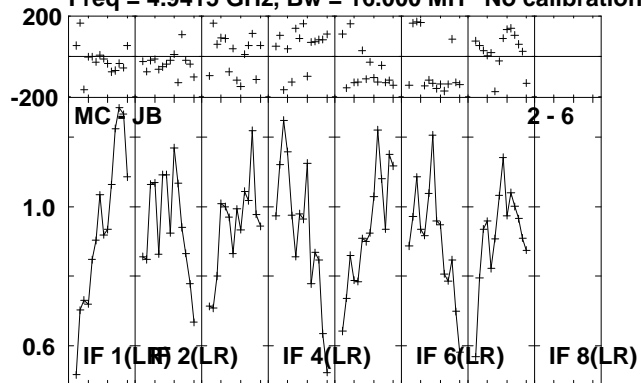

Lower frame: Milli Ampl Jy Top frame: Phas deg
Scalar averaged cross-power spectrum Several baselines displayed
Timerange: 01/04:23:10 to 01/04:24:38

Plot file version 169 created 15-JUL-2010 10:46:28

J2002+47 RR004B.UVDATA.1

Freq = 4.9415 GHz, Bw = 16.000 MH No calibration applied and no bandpass applied

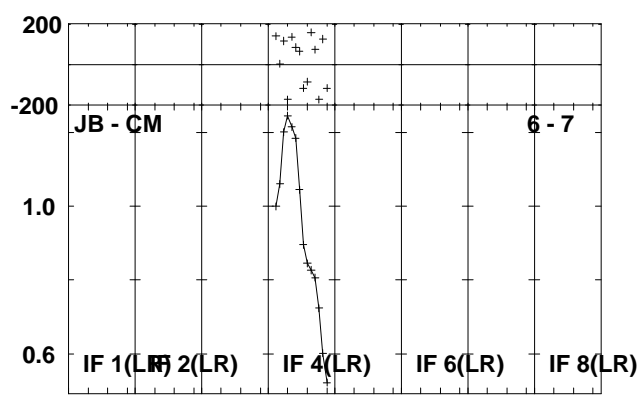
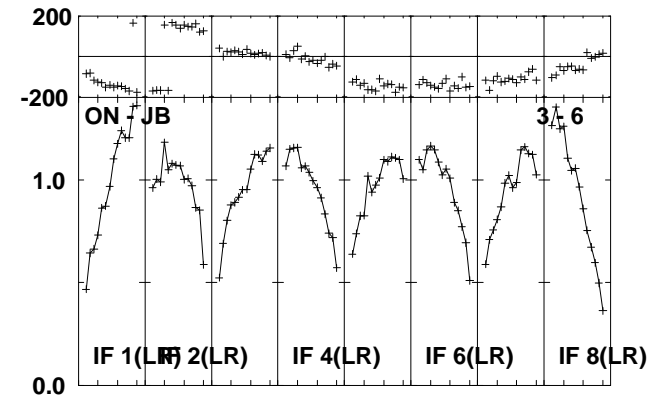
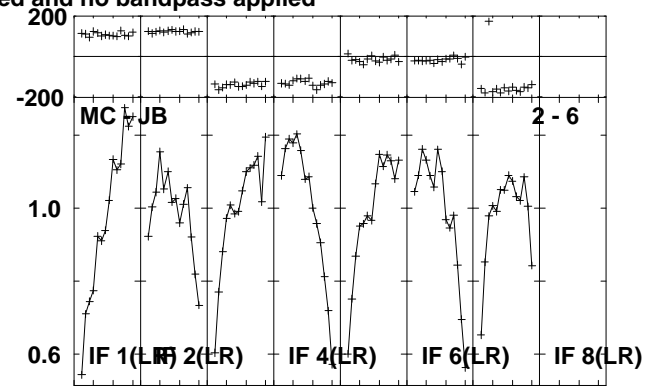
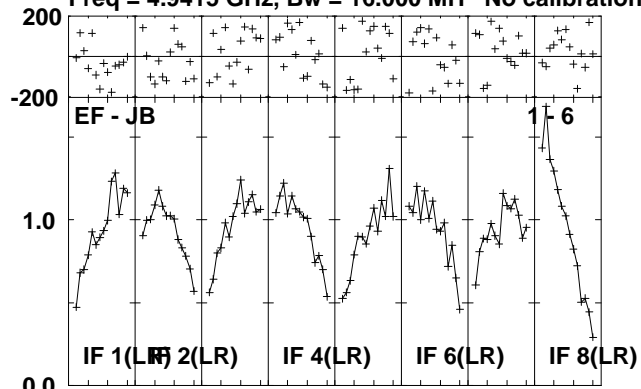

Lower frame: Milli Ampl Jy Top frame: Phas deg
Scalar averaged cross-power spectrum Several baselines displayed
Timerange: 01/04:26:40 to 01/04:31:38

Plot file version 170 created 15-JUL-2010 10:46:30

J1953+35 RR004B.UVDATA.1

Freq = 4.9415 GHz, Bw = 16.000 MH No calibration applied and no bandpass applied

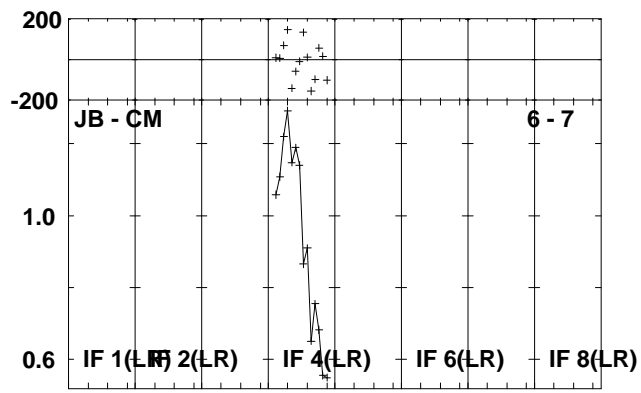
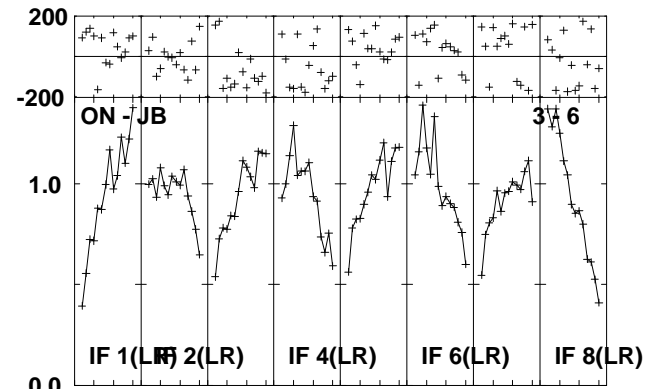
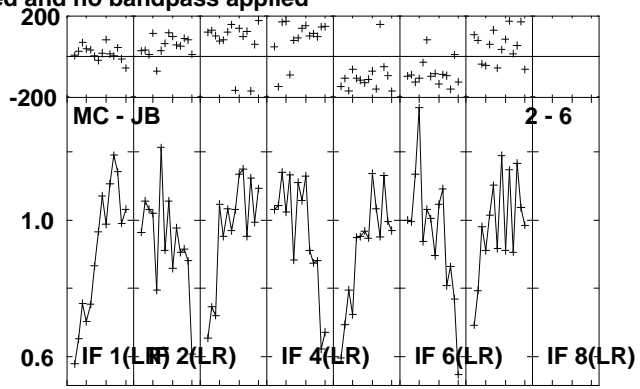
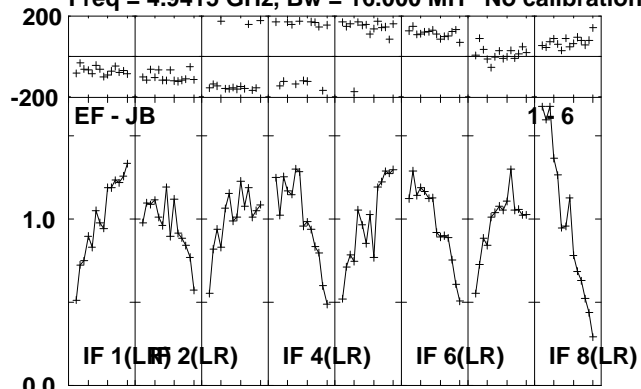

Lower frame: Milli Ampl Jy Top frame: Phas deg
Scalar averaged cross-power spectrum Several baselines displayed
Timerange: 01/04:33:10 to 01/04:34:38

Plot file version 171 created 15-JUL-2010 10:46:31

CYGX-1 RR004B.UVDATA.1

Freq = 4.9415 GHz, Bw = 16.000 MH No calibration applied and no bandpass applied

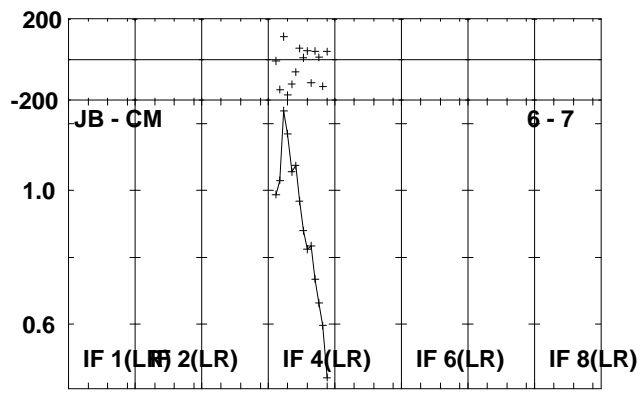
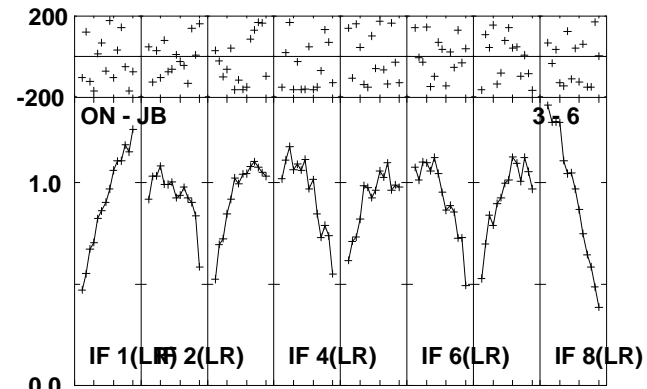
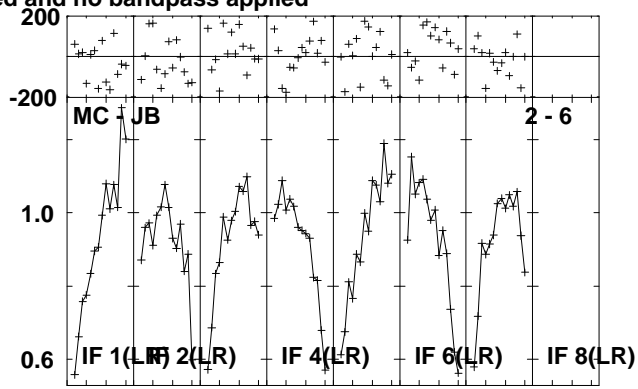
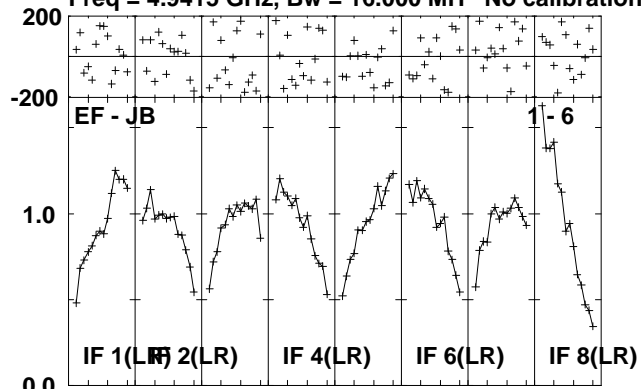

Lower frame: Milli Ampl Jy Top frame: Phas deg
Scalar averaged cross-power spectrum Several baselines displayed
Timerange: 01/04:34:40 to 01/04:39:38

Plot file version 172 created 15-JUL-2010 10:46:32

J1953+35 RR004B.UVDATA.1

Freq = 4.9415 GHz, Bw = 16.000 MH No calibration applied and no bandpass applied

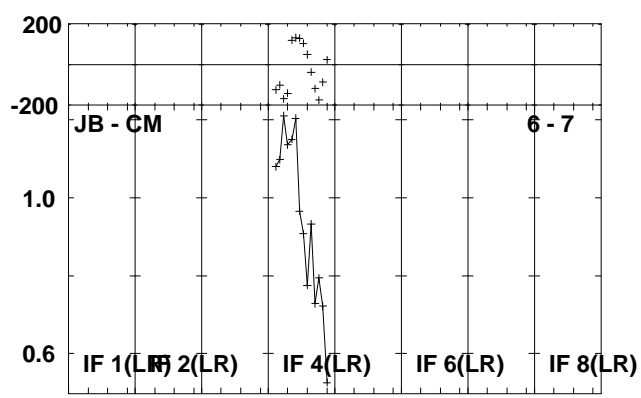
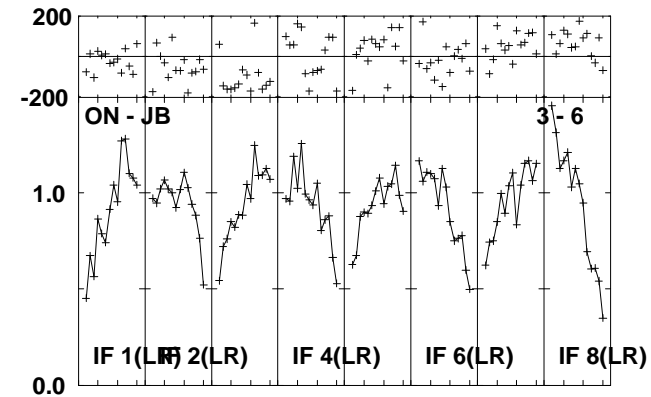
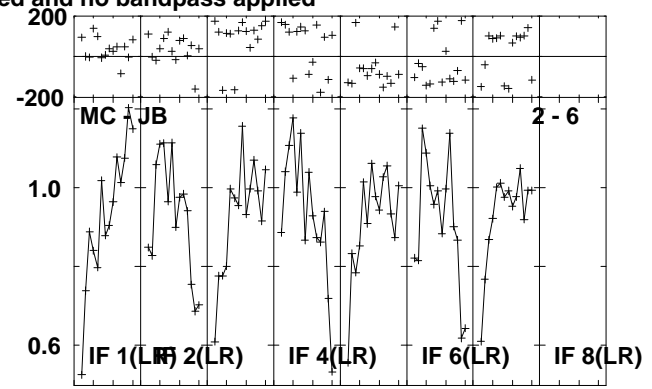
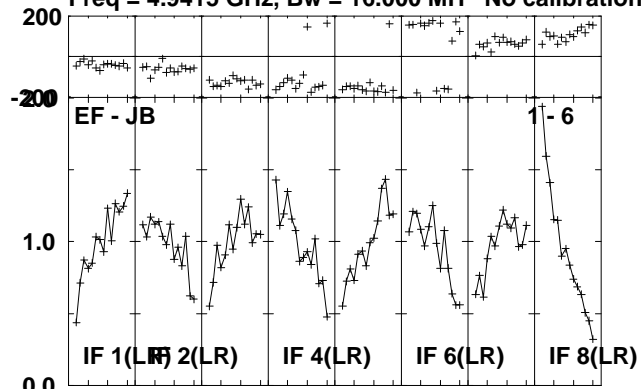

Lower frame: Milli Ampl Jy Top frame: Phas deg
Scalar averaged cross-power spectrum Several baselines displayed
Timerange: 01/04:39:40 to 01/04:41:38

Plot file version 173 created 15-JUL-2010 10:46:33
CYGX-1 RR004B.UVDATA.1

Freq = 4.9415 GHz, Bw = 16.000 MH No calibration applied and no bandpass applied

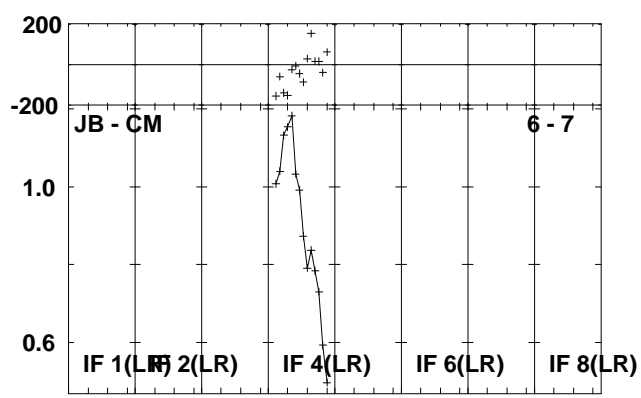
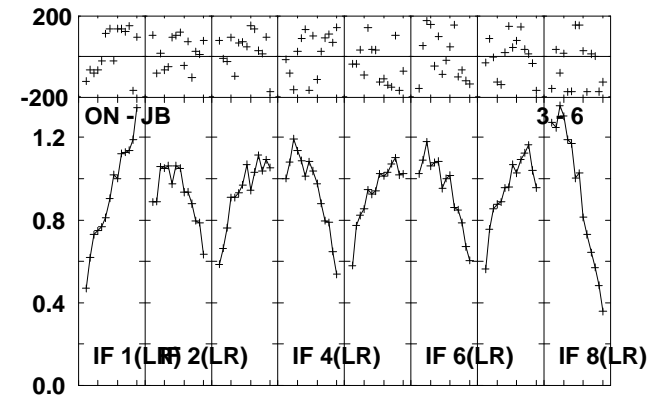
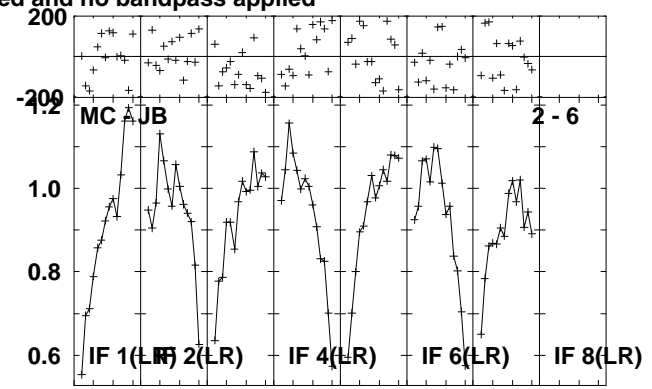
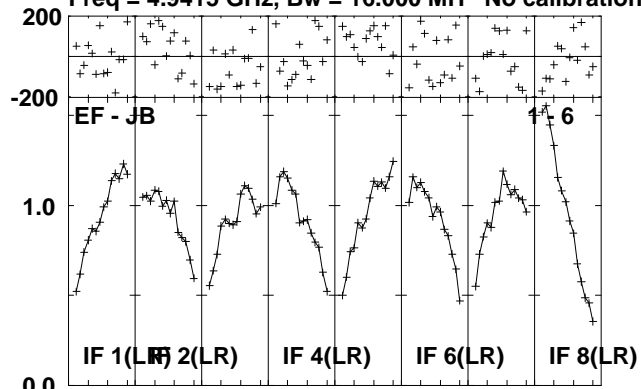

Lower frame: Milli Ampl Jy Top frame: Phas deg
Scalar averaged cross-power spectrum Several baselines displayed
Timerange: 01/04:41:40 to 01/04:46:38

Plot file version 174 created 15-JUL-2010 10:46:35

J1953+35 RR004B.UVDATA.1

Freq = 4.9415 GHz, Bw = 16.000 MH No calibration applied and no bandpass applied

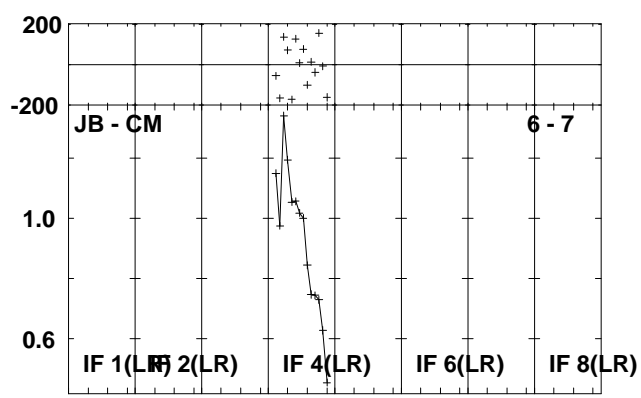
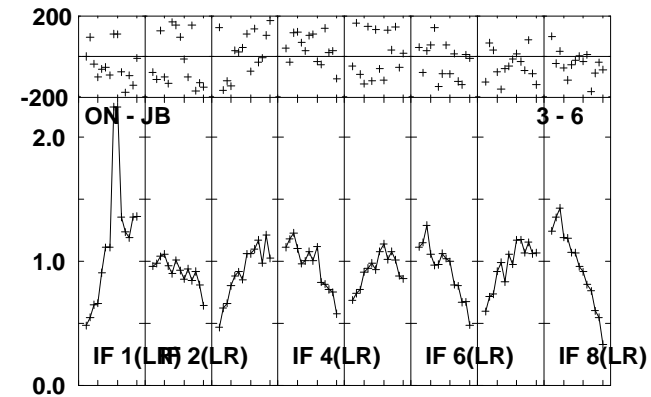
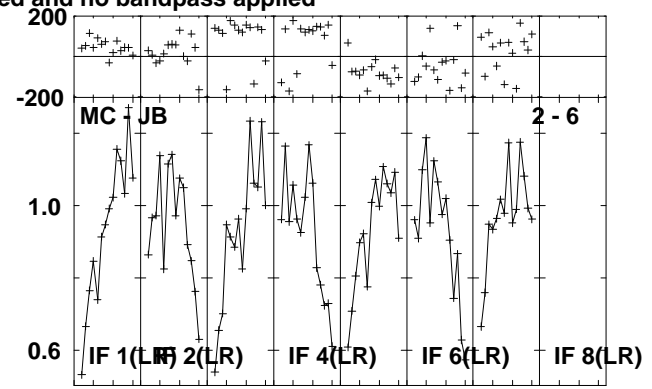
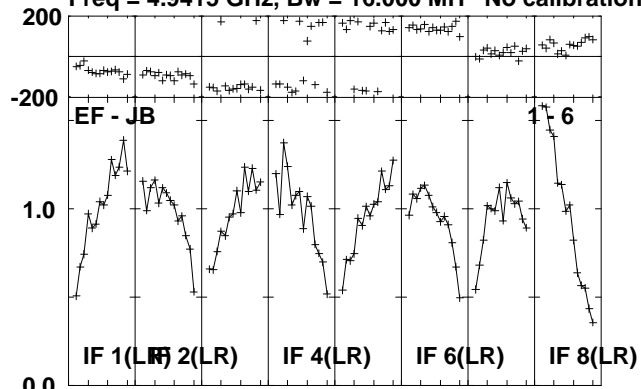

Lower frame: Milli Ampl Jy Top frame: Phas deg
Scalar averaged cross-power spectrum Several baselines displayed
Timerange: 01/04:47:20 to 01/04:48:48

Plot file version 175 created 15-JUL-2010 10:46:36

CYGX-1 RR004B.UVDATA.1

Freq = 4.9415 GHz, Bw = 16.000 MH No calibration applied and no bandpass applied

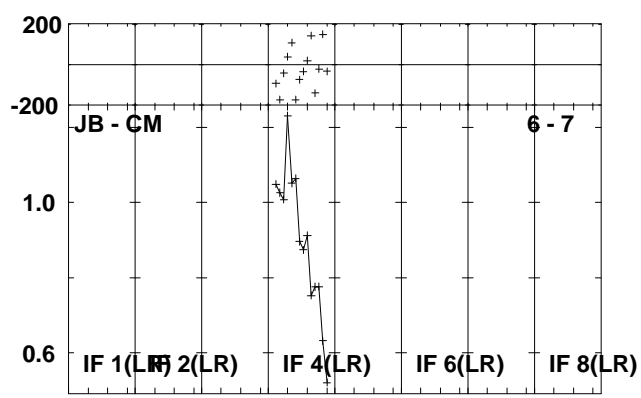
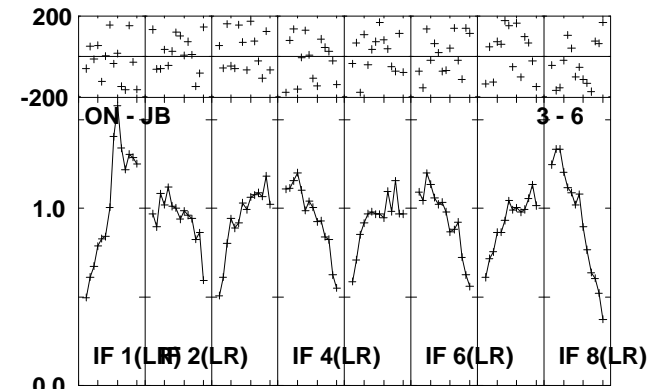
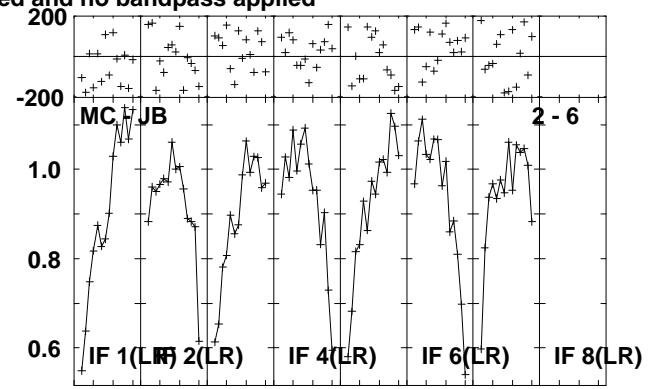
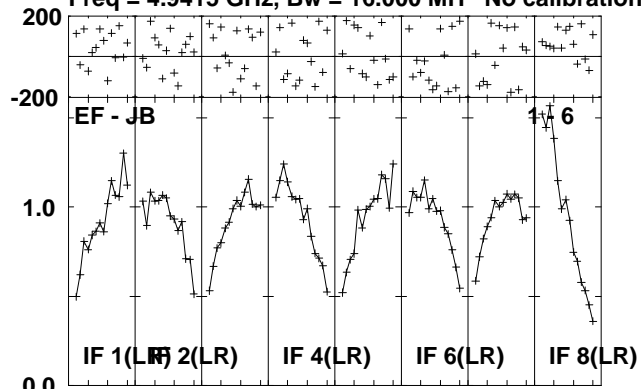

Lower frame: Milli Ampl Jy Top frame: Phas deg
Scalar averaged cross-power spectrum Several baselines displayed
Timerange: 01/04:48:50 to 01/04:53:48

Plot file version 176 created 15-JUL-2010 10:46:37
J1953+35 RR004B.UVDATA.1

Freq = 4.9415 GHz, Bw = 16.000 MH No calibration applied and no bandpass applied

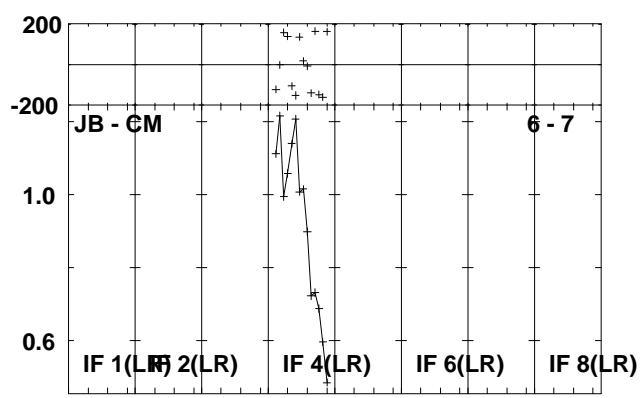
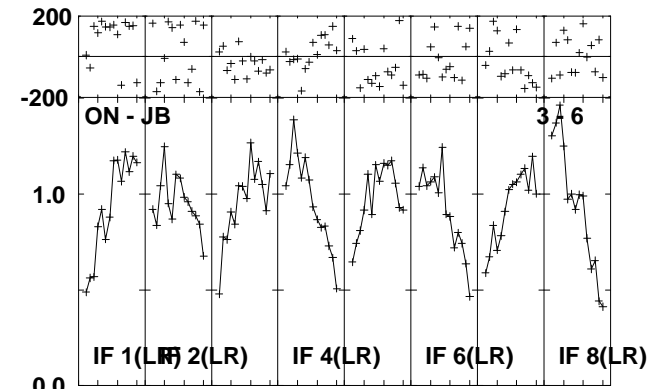
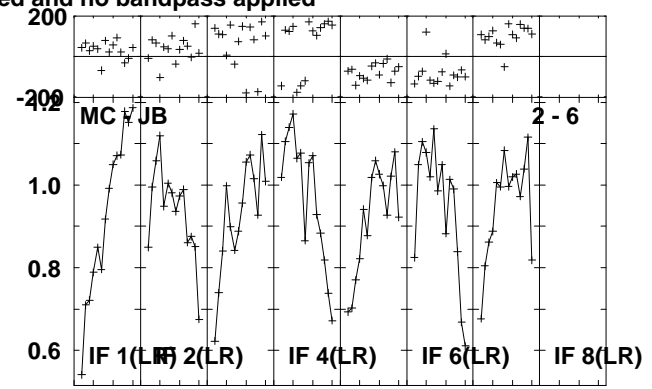
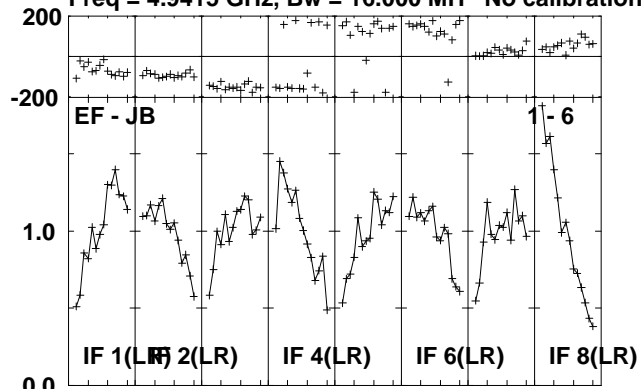

Lower frame: Milli Ampl Jy Top frame: Phas deg
Scalar averaged cross-power spectrum Several baselines displayed
Timerange: 01/04:53:50 to 01/04:55:48

Plot file version 177 created 15-JUL-2010 10:46:38

CYGX-1 RR004B.UVDATA.1

Freq = 4.9415 GHz, Bw = 16.000 MH No calibration applied and no bandpass applied

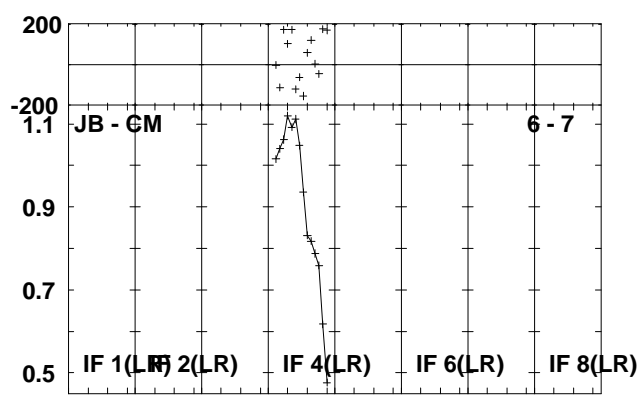
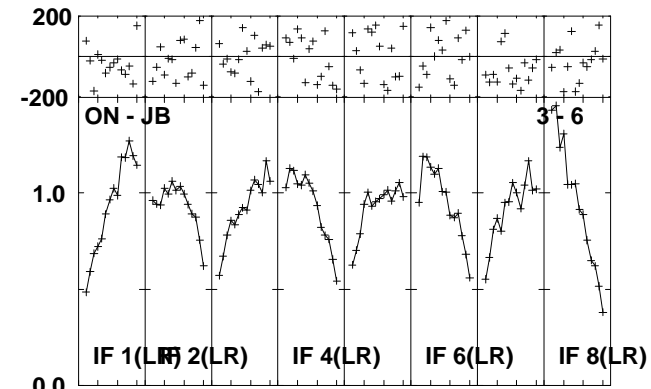
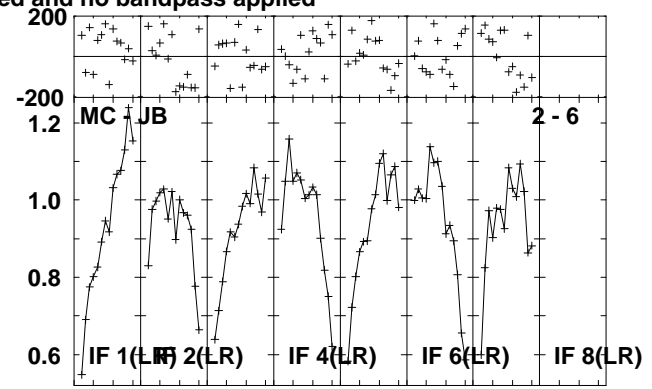
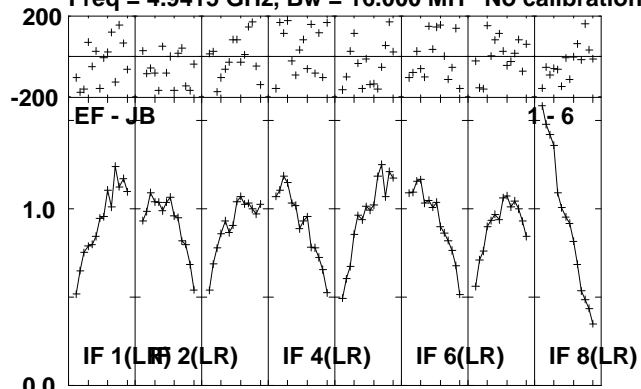

Lower frame: Milli Ampl Jy Top frame: Phas deg
Scalar averaged cross-power spectrum Several baselines displayed
Timerange: 01/04:55:50 to 01/05:00:48

Plot file version 178 created 15-JUL-2010 10:46:40
J1953+35 RR004B.UVDATA.1

Freq = 4.9415 GHz, Bw = 16.000 MH No calibration applied and no bandpass applied

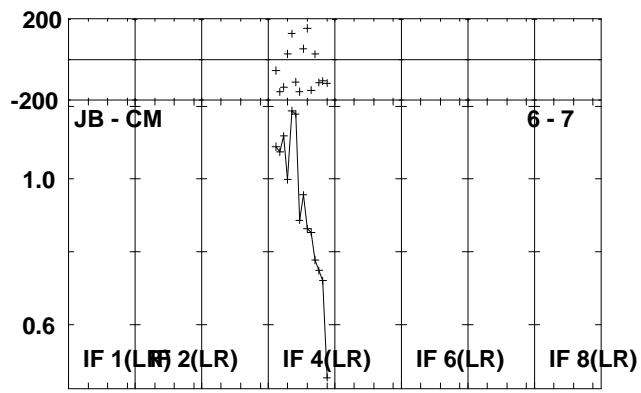
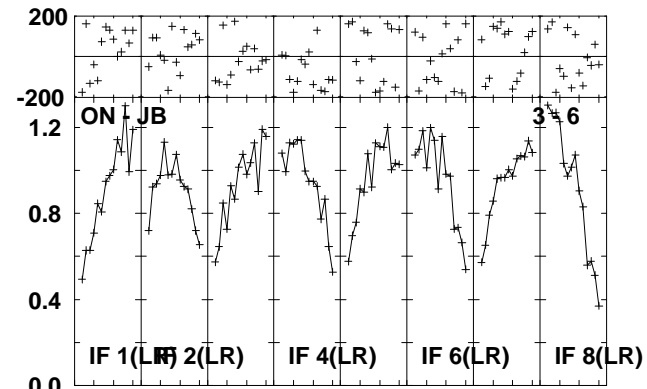
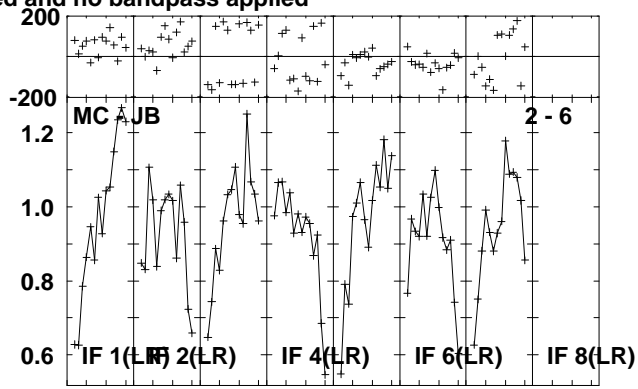
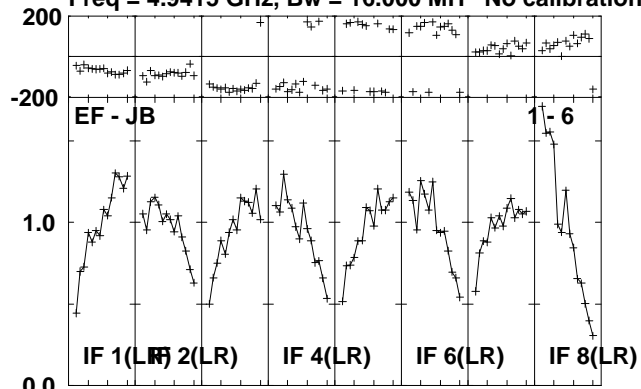

Lower frame: Milli Ampl Jy Top frame: Phas deg
Scalar averaged cross-power spectrum Several baselines displayed
Timerange: 01/05:01:30 to 01/05:02:58

Plot file version 179 created 15-JUL-2010 10:46:41
CYGX-1 RR004B.UVDATA.1

Freq = 4.9415 GHz, Bw = 16.000 MH No calibration applied and no bandpass applied

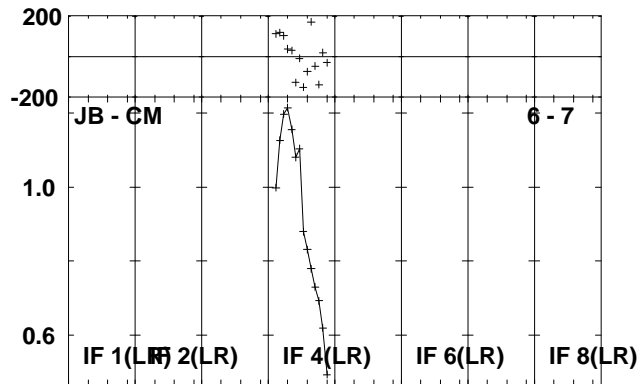
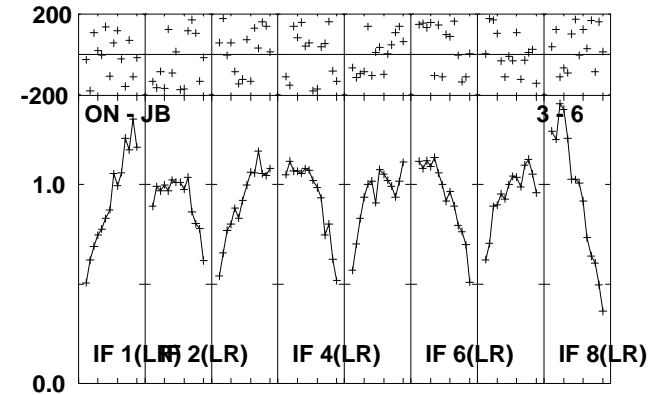
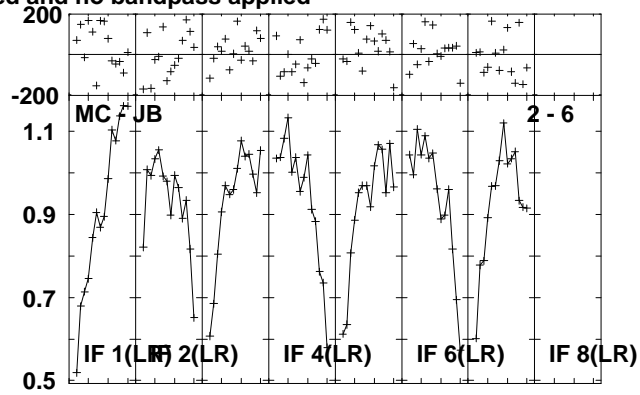
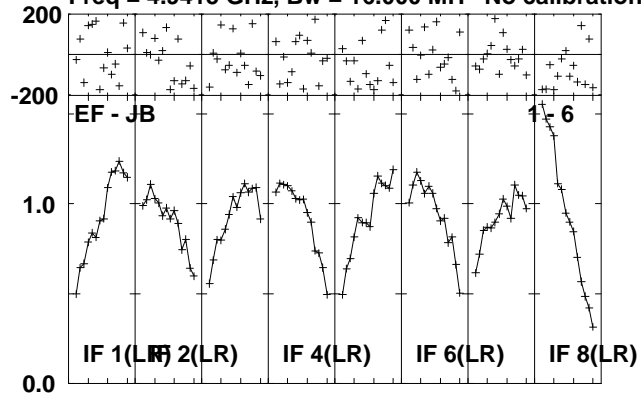

Lower frame: Milli Ampl Jy Top frame: Phas deg
Scalar averaged cross-power spectrum Several baselines displayed
Timerange: 01/05:03:00 to 01/05:07:58

Plot file version 180 created 15-JUL-2010 10:46:43
J1953+35 RR004B.UVDATA.1

Freq = 4.9415 GHz, Bw = 16.000 MH No calibration applied and no bandpass applied

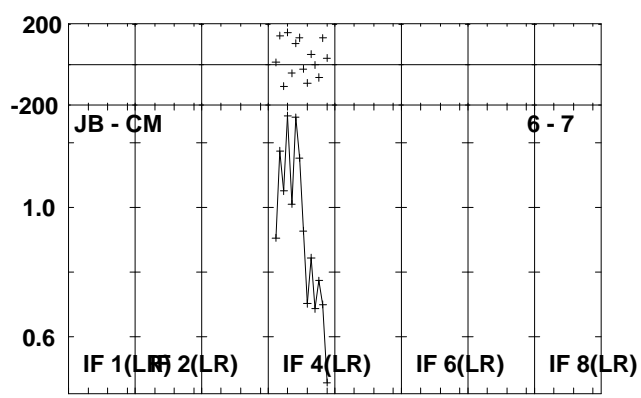
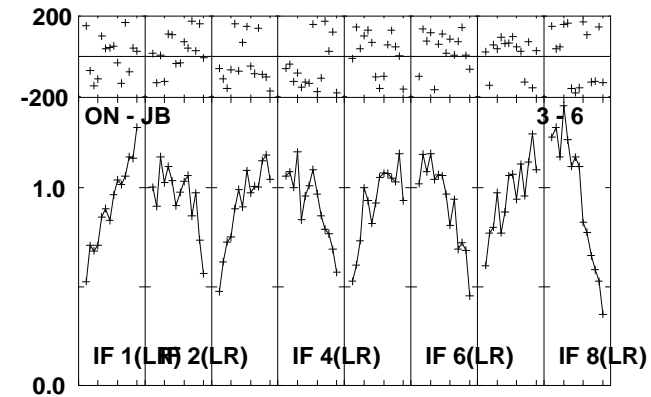
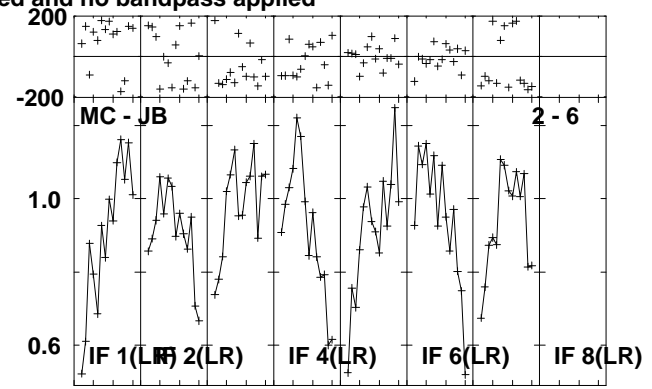
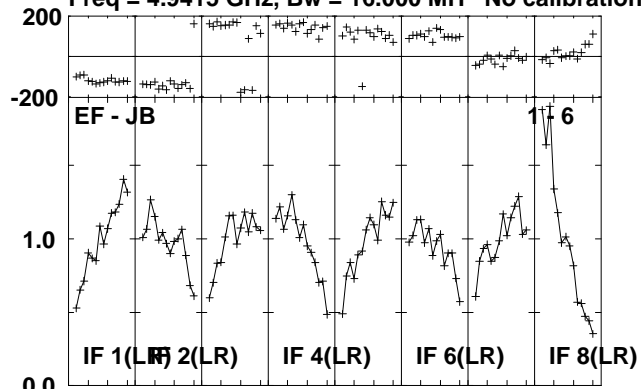

Lower frame: Milli Ampl Jy Top frame: Phas deg
Scalar averaged cross-power spectrum Several baselines displayed
Timerange: 01/05:08:00 to 01/05:09:58

Plot file version 181 created 15-JUL-2010 10:46:44

CYGX-1 RR004B.UVDATA.1

Freq = 4.9415 GHz, Bw = 16.000 MH No calibration applied and no bandpass applied

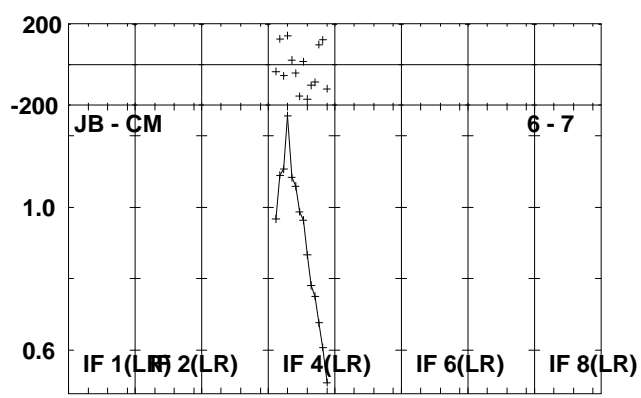
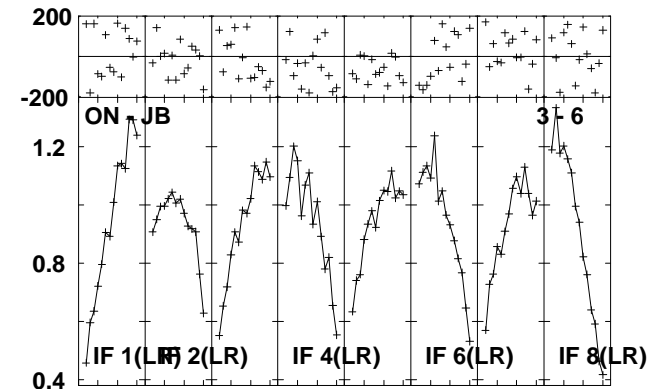
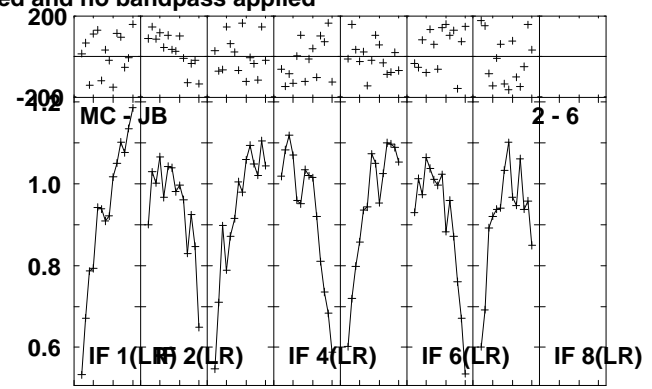
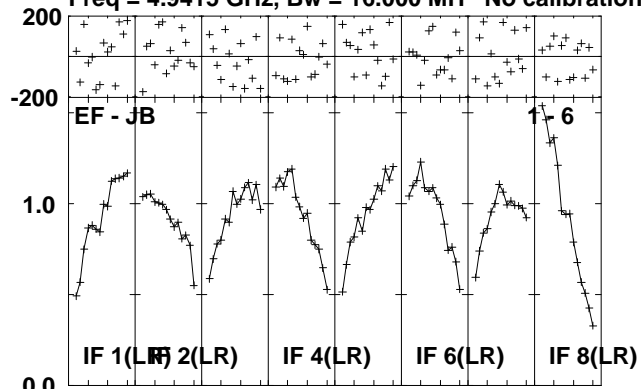

Lower frame: Milli Ampl Jy Top frame: Phas deg
Scalar averaged cross-power spectrum Several baselines displayed
Timerange: 01/05:10:00 to 01/05:14:58

Plot file version 182 created 15-JUL-2010 10:46:45

J1953+35 RR004B.UVDATA.1

Freq = 4.9415 GHz, Bw = 16.000 MH No calibration applied and no bandpass applied

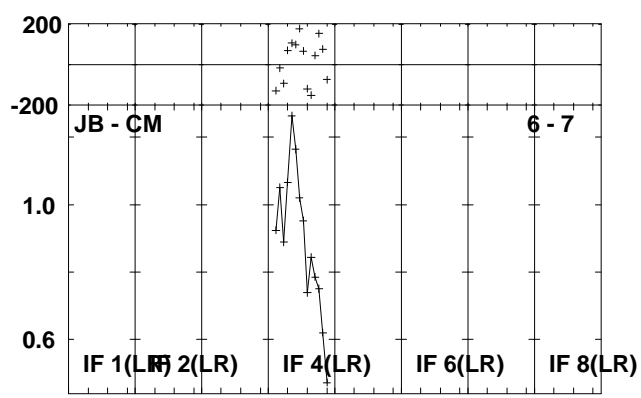
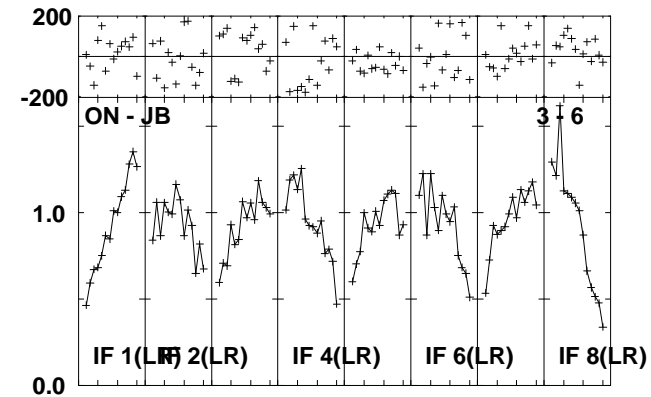
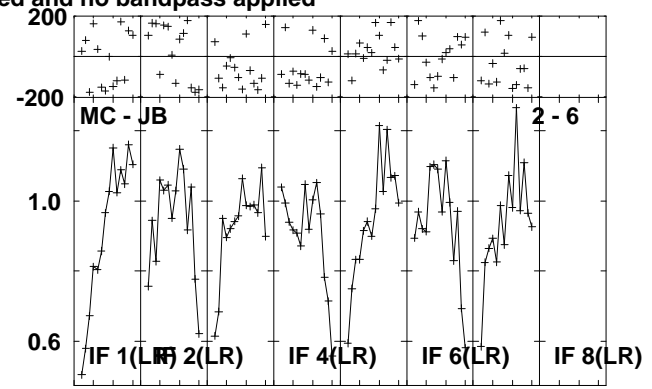
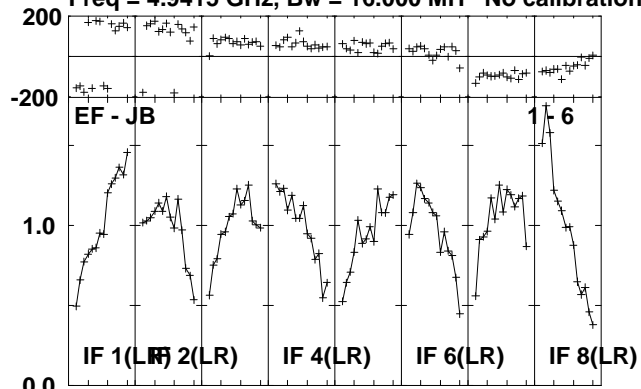

Lower frame: Milli Ampl Jy Top frame: Phas deg
Scalar averaged cross-power spectrum Several baselines displayed
Timerange: 01/05:15:40 to 01/05:17:08

Plot file version 183 created 15-JUL-2010 10:46:46

CYGX-1 RR004B.UVDATA.1

Freq = 4.9415 GHz, Bw = 16.000 MH No calibration applied and no bandpass applied

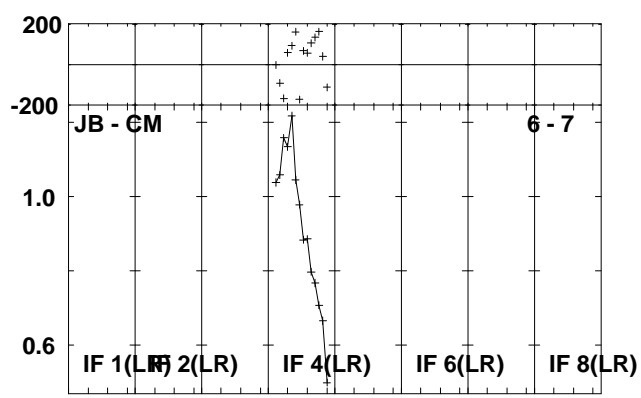
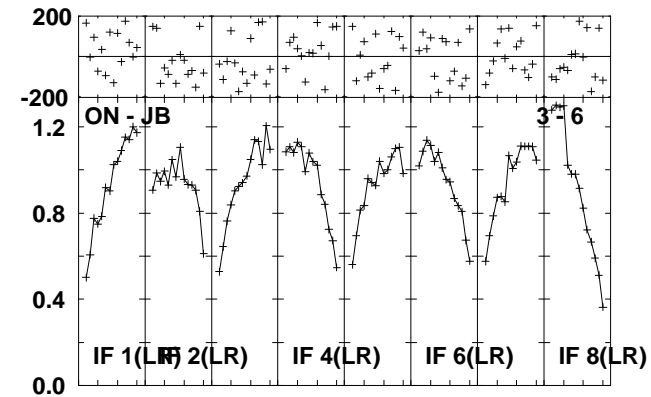
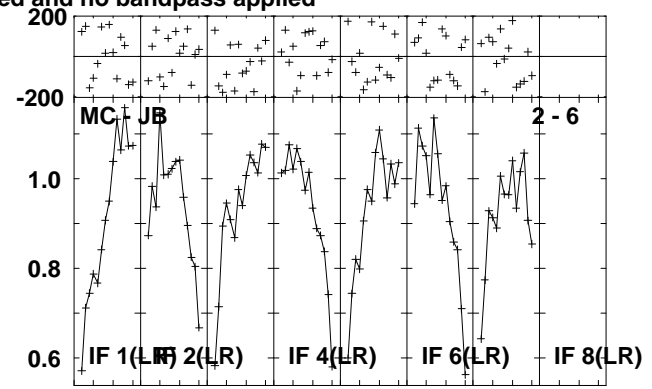
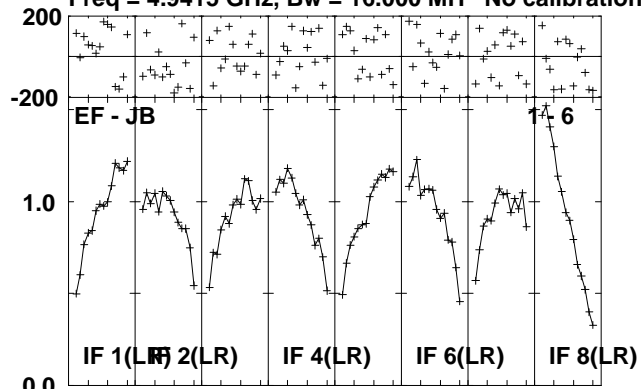

Lower frame: Milli Ampl Jy Top frame: Phas deg
Scalar averaged cross-power spectrum Several baselines displayed
Timerange: 01/05:17:10 to 01/05:22:08

Plot file version 184 created 15-JUL-2010 10:46:48

J1953+35 RR004B.UVDATA.1

Freq = 4.9415 GHz, Bw = 16.000 MH No calibration applied and no bandpass applied

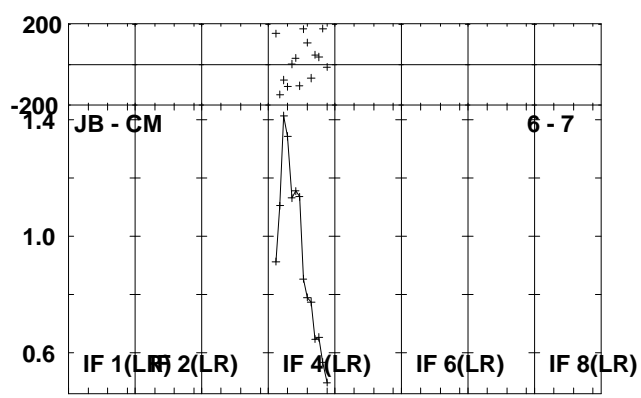
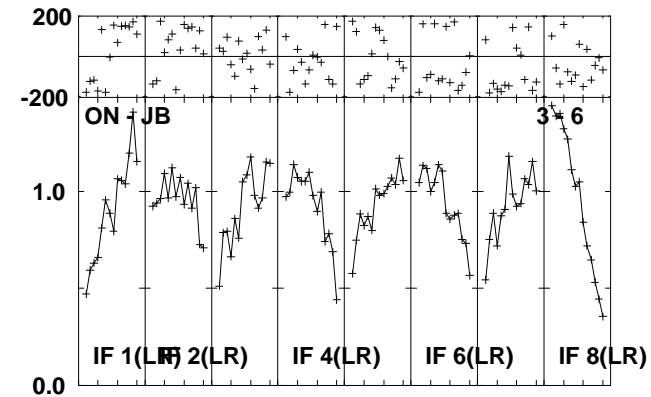
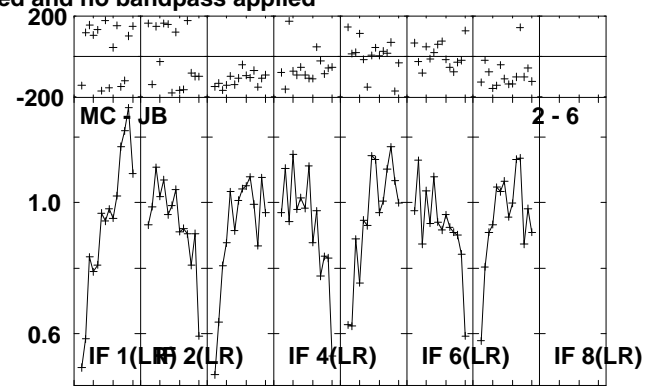
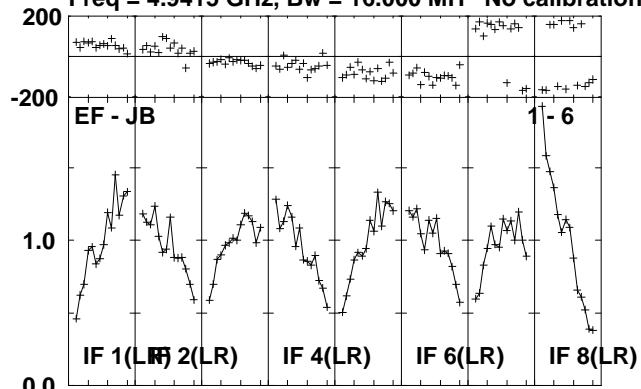

Lower frame: Milli Ampl Jy Top frame: Phas deg
Scalar averaged cross-power spectrum Several baselines displayed
Timerange: 01/05:22:10 to 01/05:24:08

Plot file version 185 created 15-JUL-2010 10:46:49

CYGX-1 RR004B.UVDATA.1

Freq = 4.9415 GHz, Bw = 16.000 MH No calibration applied and no bandpass applied

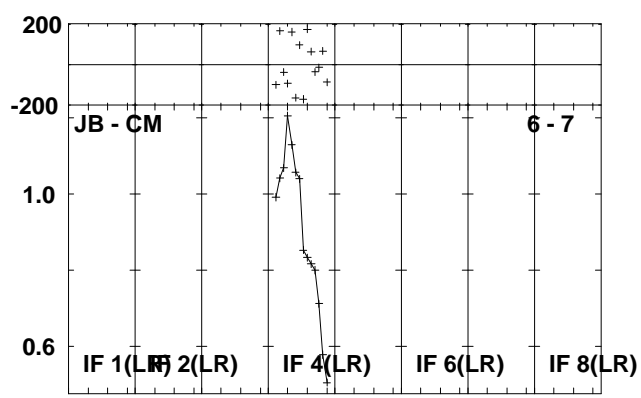
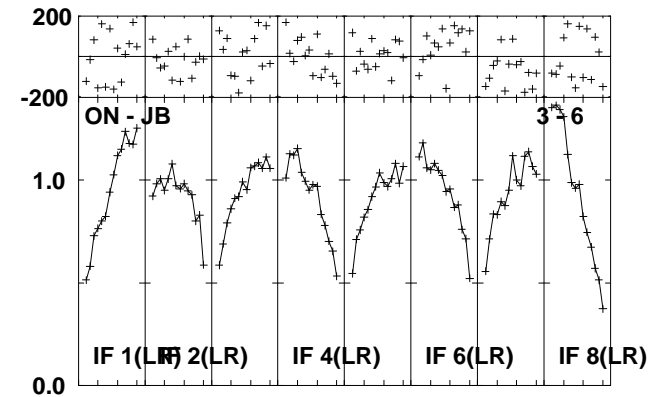
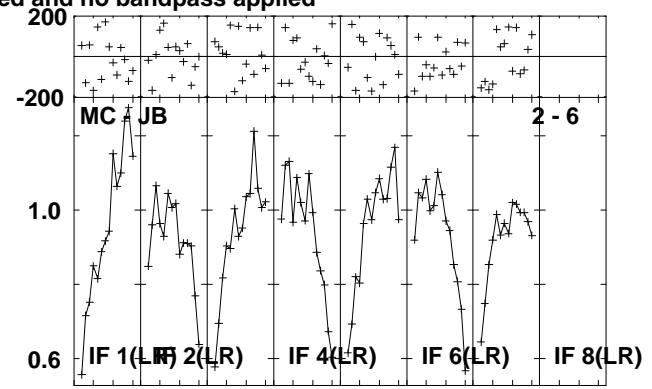
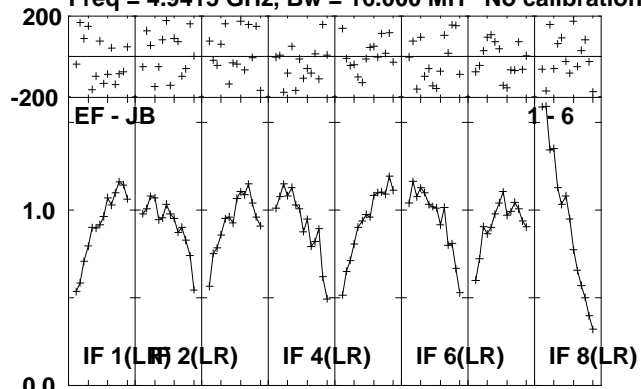

Lower frame: Milli Ampl Jy Top frame: Phas deg
Scalar averaged cross-power spectrum Several baselines displayed
Timerange: 01/05:24:10 to 01/05:29:08

Plot file version 186 created 15-JUL-2010 10:46:56
J1953+35 RR004B.UVDATA.1

Freq = 4.9415 GHz, Bw = 16.000 MH No calibration applied and no bandpass applied

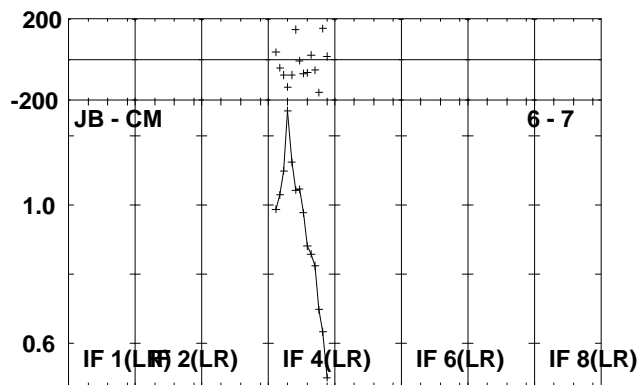
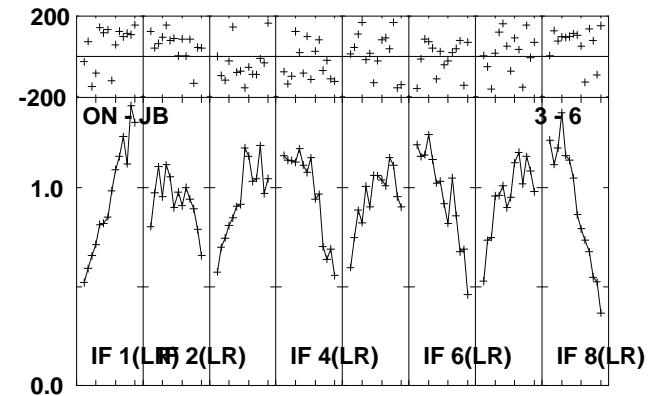
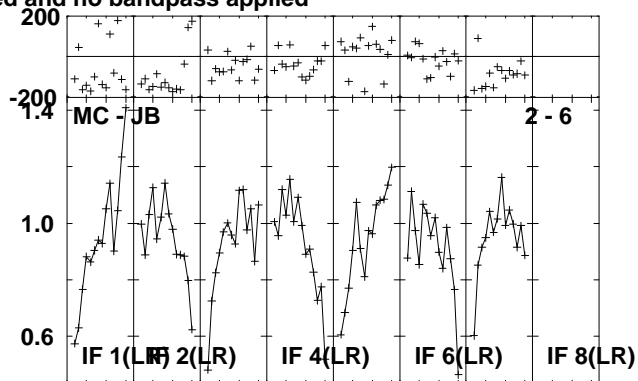
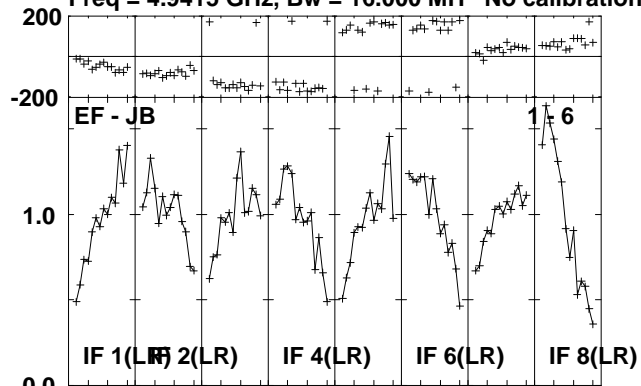

Lower frame: Milli Ampl Jy Top frame: Phas deg
Scalar averaged cross-power spectrum Several baselines displayed
Timerange: 01/05:29:50 to 01/05:31:18

Plot file version 187 created 15-JUL-2010 10:46:57

3C48 RR004B.UVDATA.1

Freq = 4.9415 GHz, Bw = 16.000 MH No calibration applied and no bandpass applied

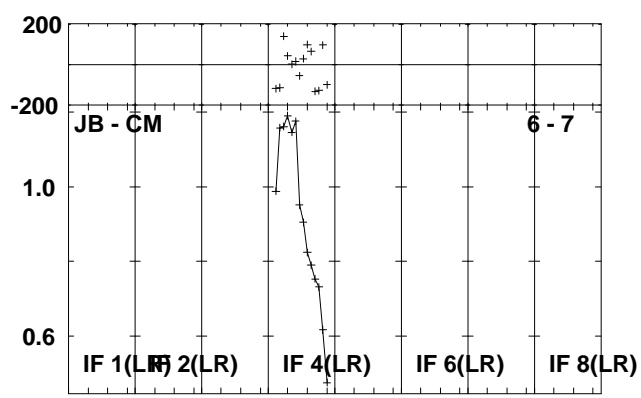
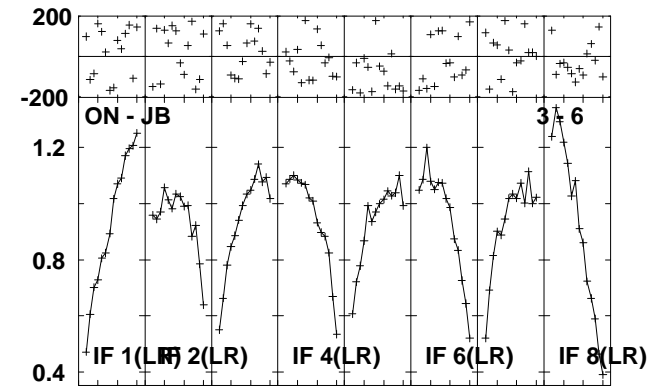
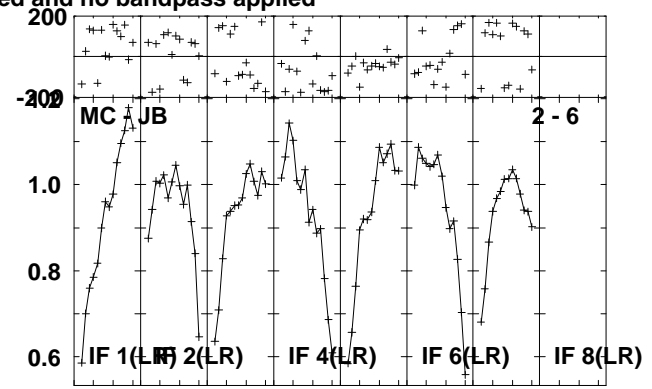
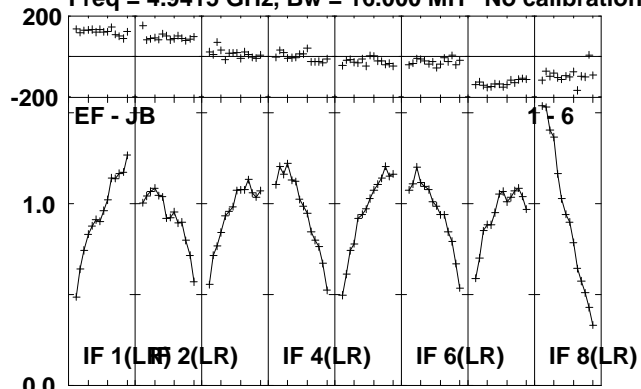

Lower frame: Milli Ampl Jy Top frame: Phas deg
Scalar averaged cross-power spectrum Several baselines displayed
Timerange: 01/05:33:20 to 01/05:48:18

Plot file version 188 created 15-JUL-2010 10:47:03
3C84 RR004B.UVDATA.1

Freq = 4.9415 GHz, Bw = 16.000 MH No calibration applied and no bandpass applied

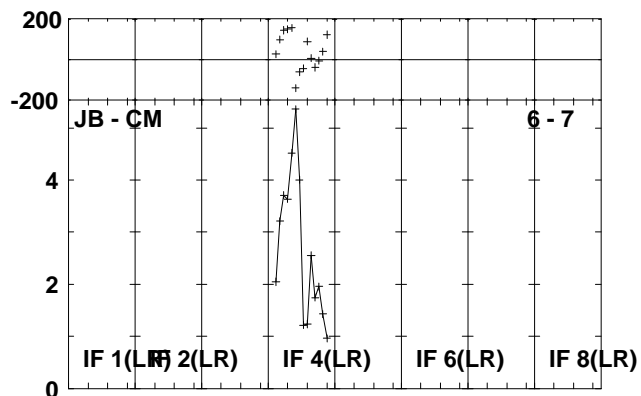
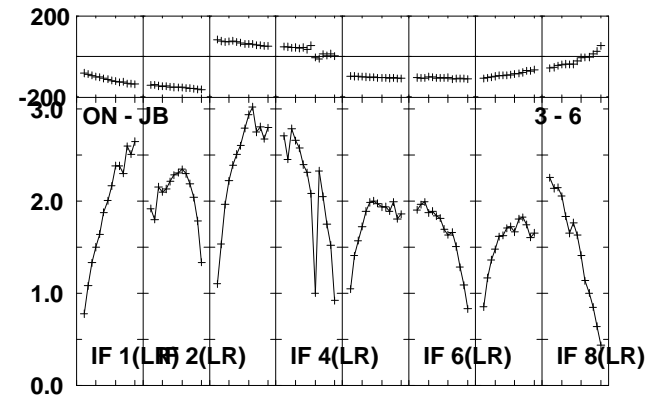
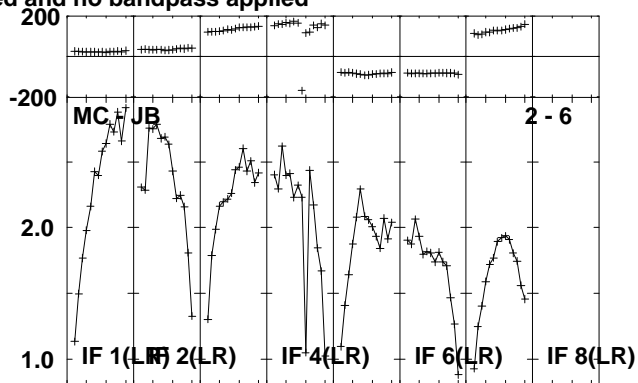
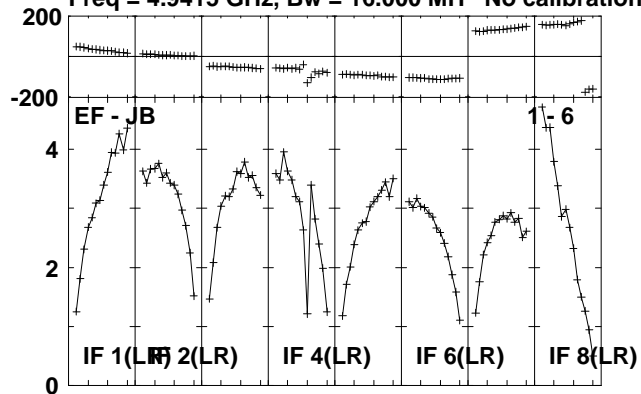

Lower frame: Milli Ampl Jy Top frame: Phas deg
Scalar averaged cross-power spectrum Several baselines displayed
Timerange: 01/05:50:20 to 01/06:01:18

Plot file version 189 created 15-JUL-2010 10:47:07

3C138 RR004B.UVDATA.1

Freq = 4.9415 GHz, Bw = 16.000 MH No calibration applied and no bandpass applied

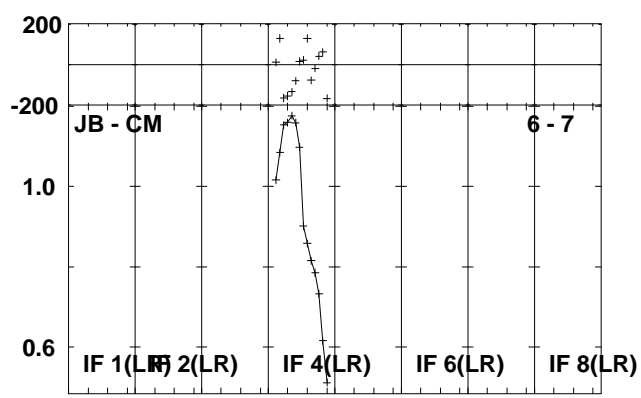
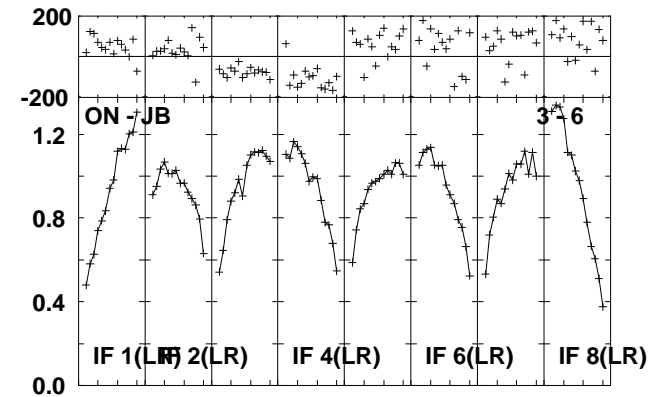
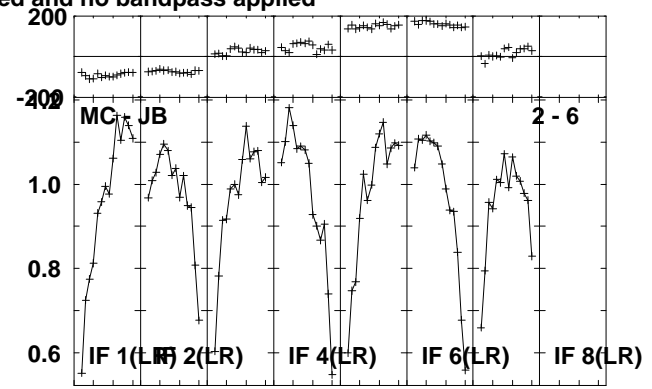
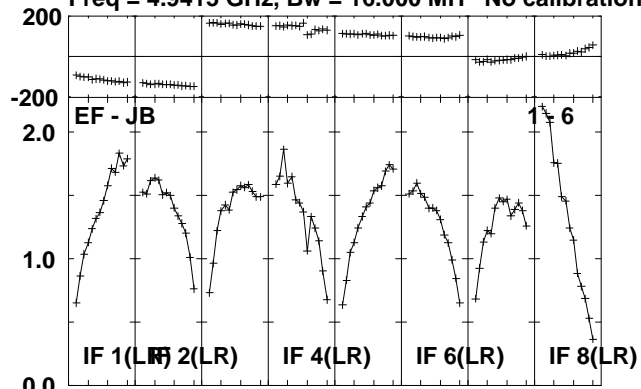

Lower frame: Milli Ampl Jy Top frame: Phas deg
Scalar averaged cross-power spectrum Several baselines displayed
Timerange: 01/06:03:20 to 01/06:14:16