

Plot file version 1 created 21-MAY-2010 15:43:37
 4C39.25 RSD03.UVDATA.1
 Freq = 4.9415 GHz, Bw = 16.000 MH Calibrated with CL # 3 and BP # 1 (BP mode 1)

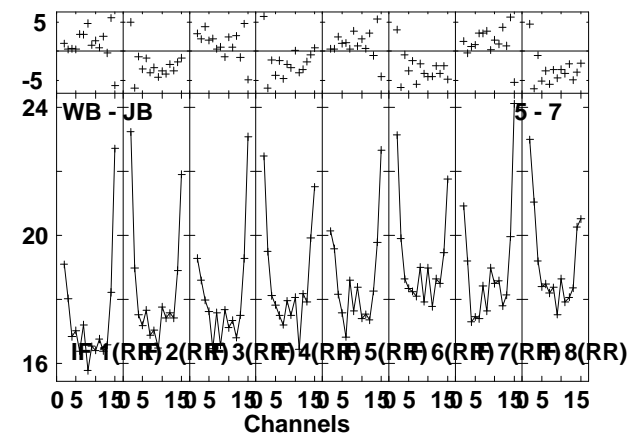
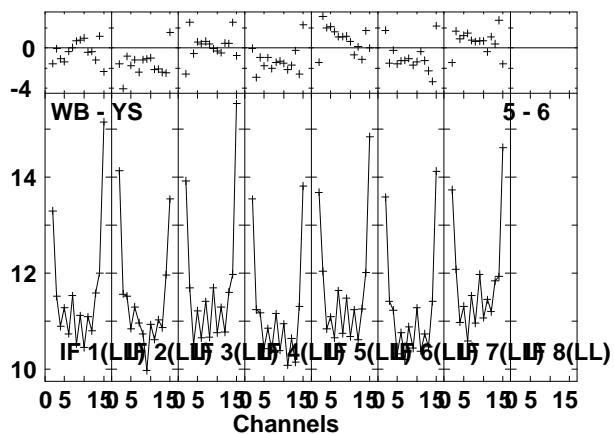
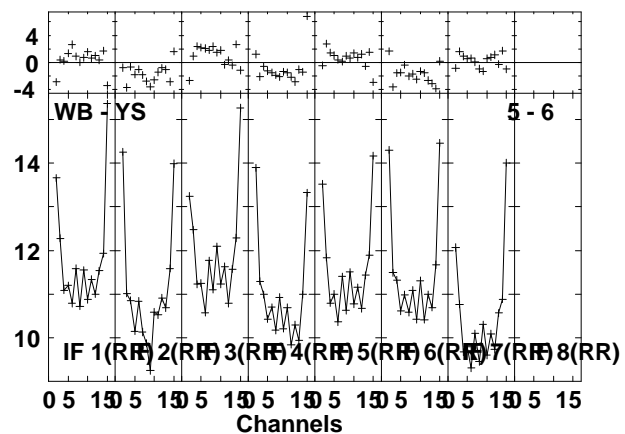
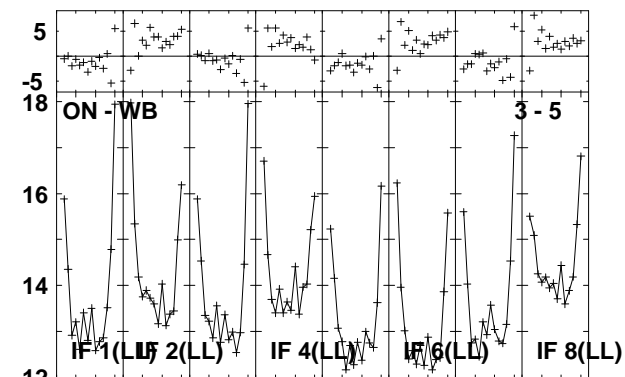
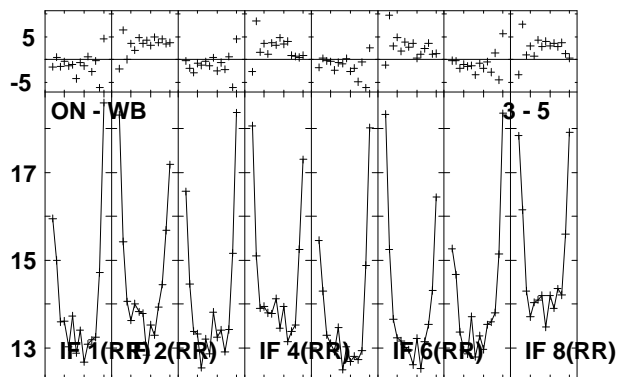
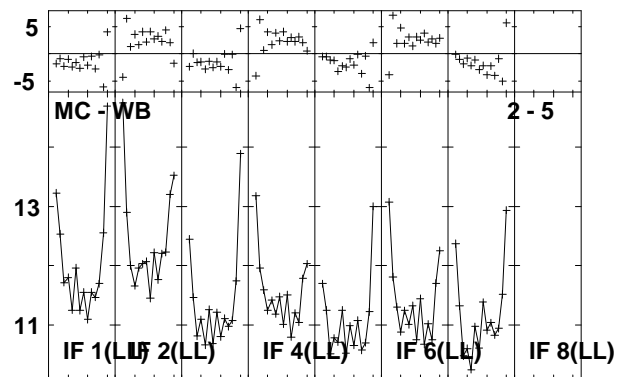
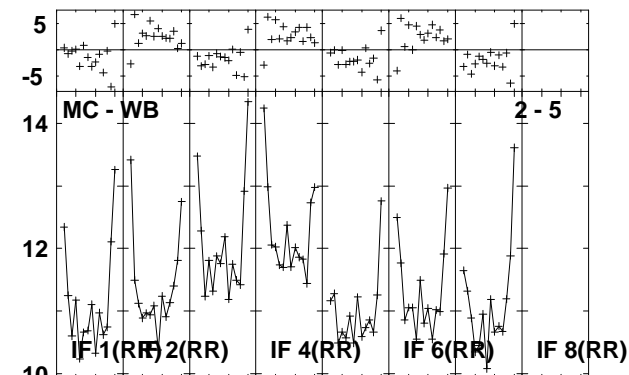
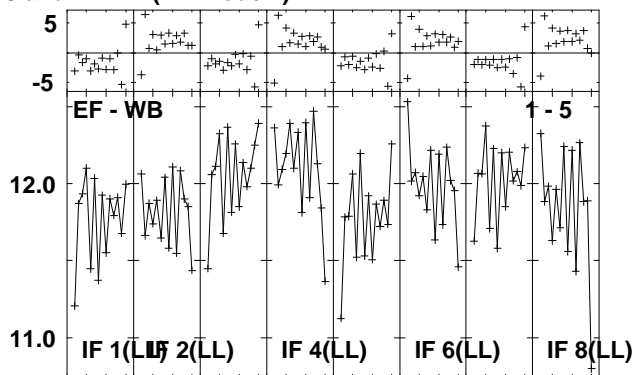
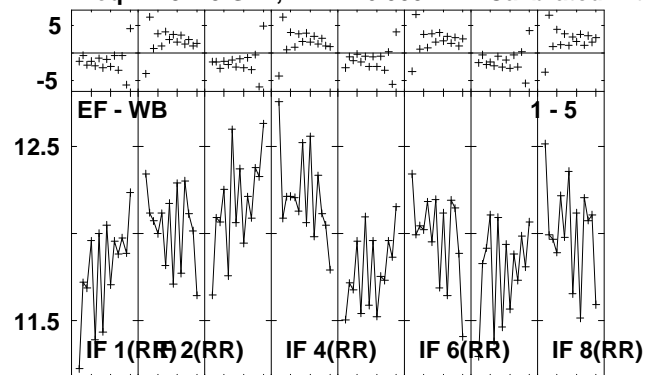

Lower frame: Ampl Jy Top frame: Phas deg
 Vector averaged cross-power spectrum Several baselines displayed
 Timerange: 00/12:30:01 to 00/12:44:19

Plot file version 2 created 21-MAY-2010 15:43:50

4C39.25 RSD03.UVDATA.1

Freq = 4.9415 GHz, Bw = 16.000 MH Calibrated with CL # 3 and BP # 1 (BP mode 1)

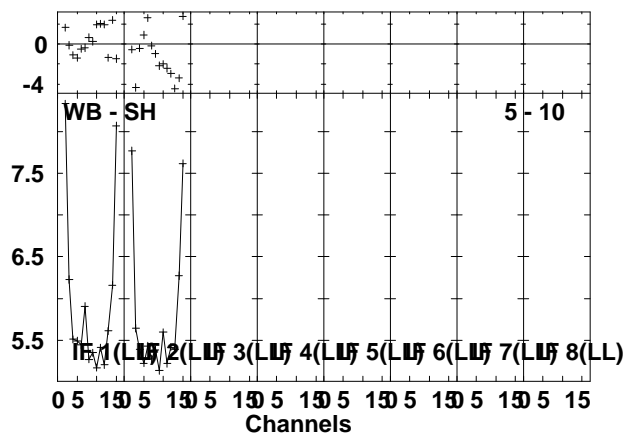
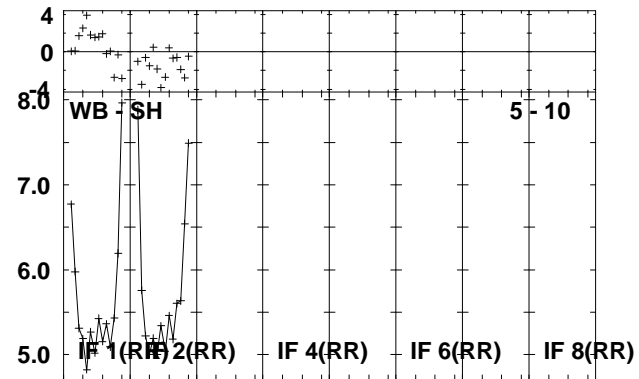
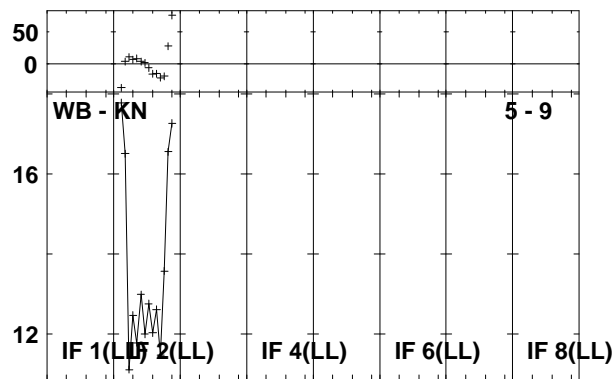
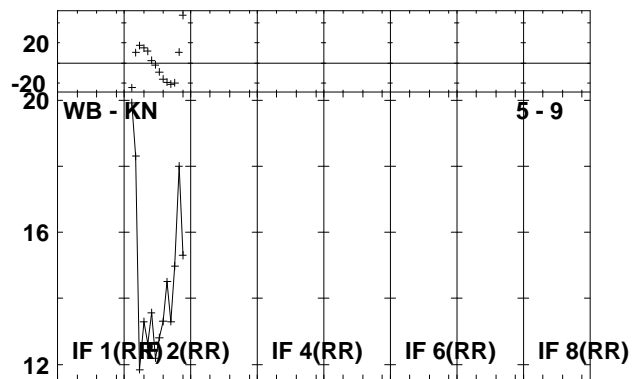
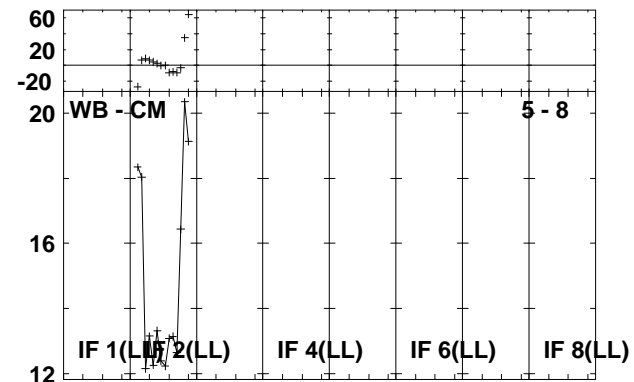
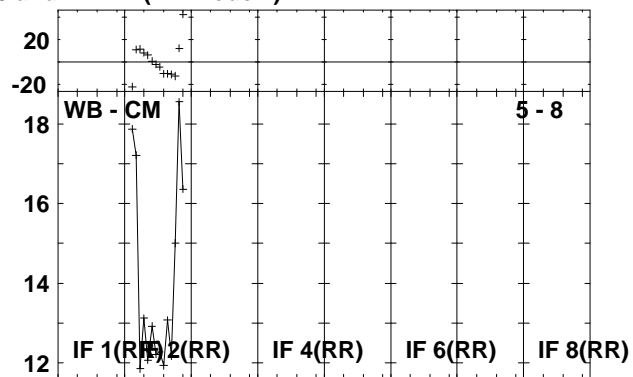
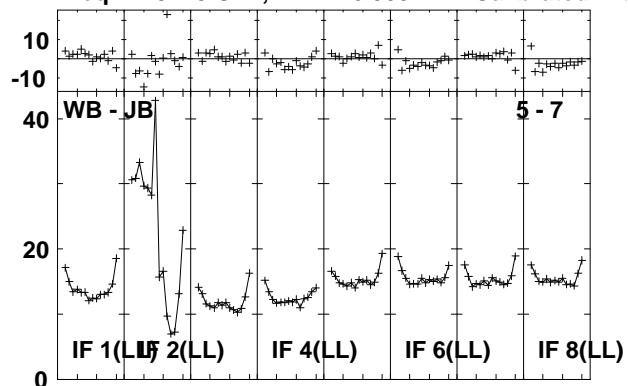

Lower frame: Ampl Jy Top frame: Phas deg
Vector averaged cross-power spectrum Several baselines displayed
Timerange: 00/12:30:01 to 00/12:44:19

Plot file version 3 created 21-MAY-2010 15:44:02

J0909+02 RSD03.UVDATA.1

Freq = 4.9415 GHz, Bw = 16.000 MH Calibrated with CL # 3 and BP # 1 (BP mode 1)

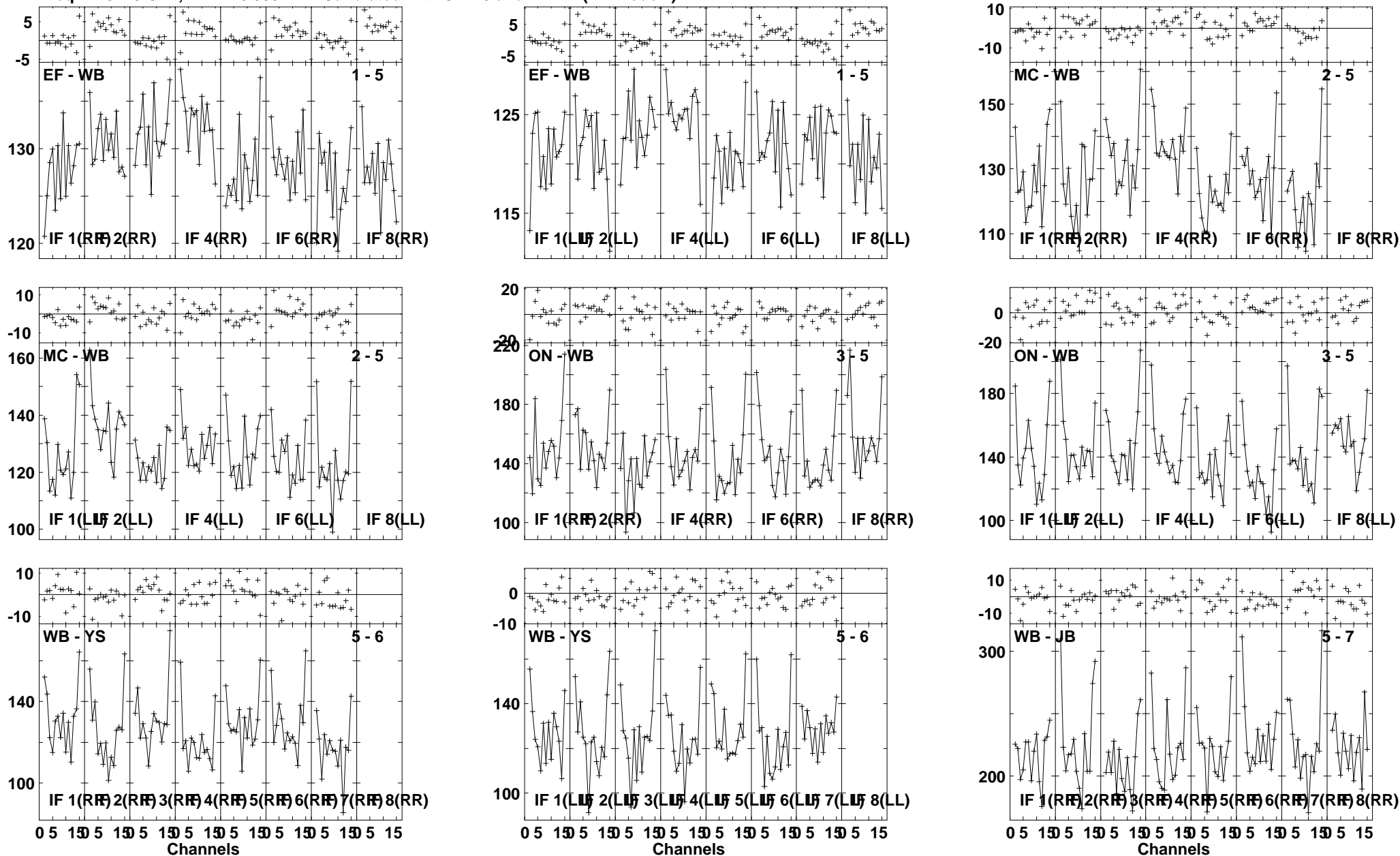

Lower frame: Milli Ampl Jy Top frame: Phas deg
Vector averaged cross-power spectrum Several baselines displayed
Timerange: 00/12:45:01 to 00/12:59:19

Plot file version 4 created 21-MAY-2010 15:44:14

J0909+02 RSD03.UVDATA.1

Freq = 4.9415 GHz, Bw = 16.000 MH Calibrated with CL # 3 and BP # 1 (BP mode 1)

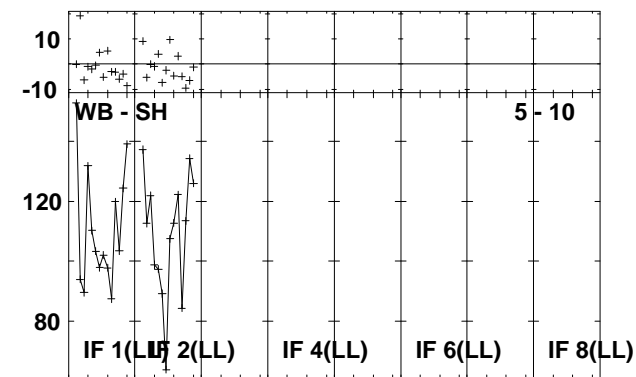
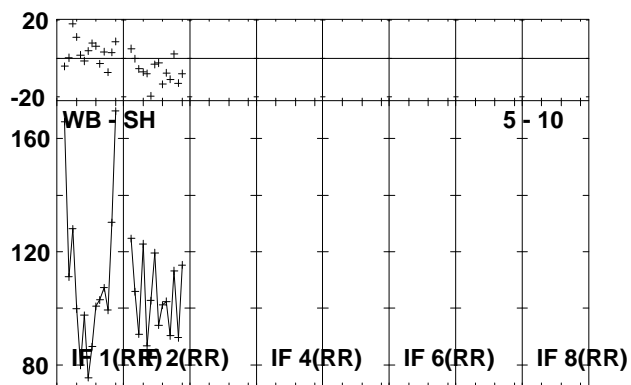
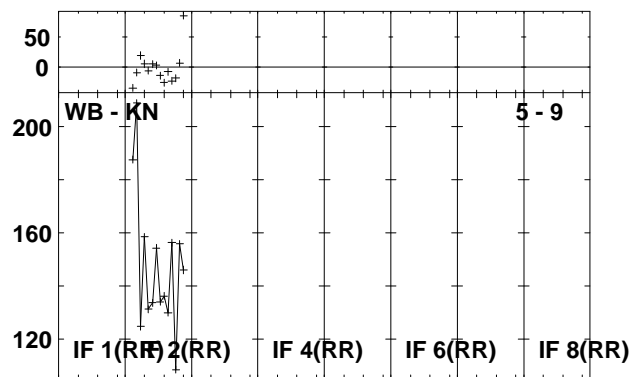
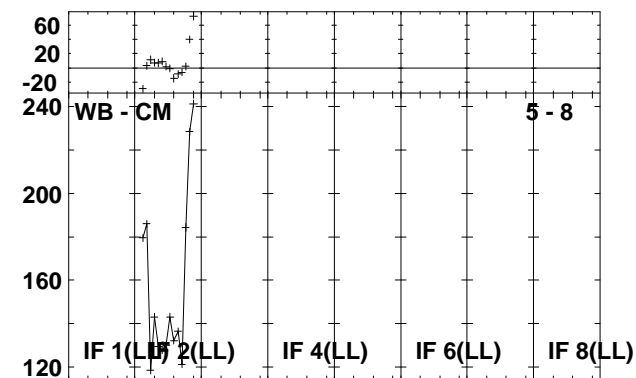
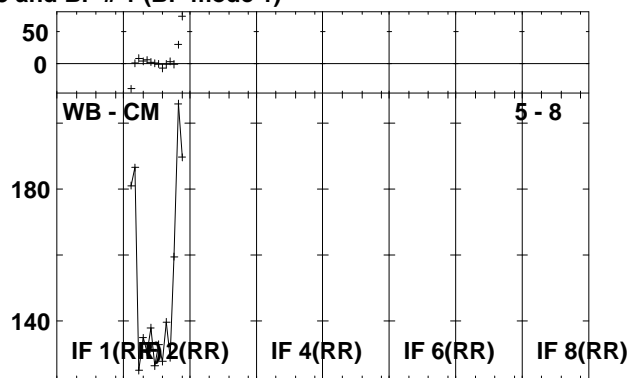
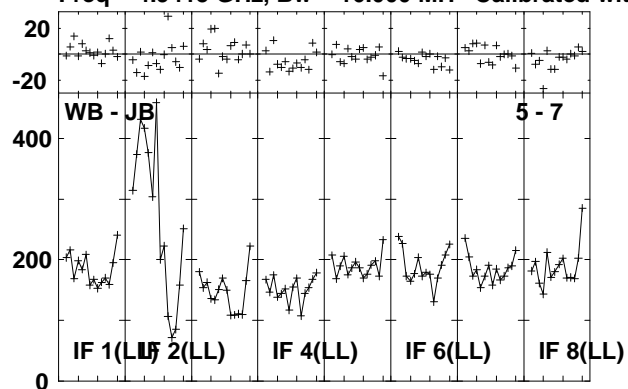

Lower frame: Milli Ampl Jy Top frame: Phas deg
Vector averaged cross-power spectrum Several baselines displayed
Timerange: 00:12:45:01 to 00:12:59:19

Plot file version 5 created 21-MAY-2010 15:44:24

CALA RSD03.UVDATA.1

Freq = 4.9415 GHz, Bw = 16.000 MH Calibrated with CL # 3 and BP # 1 (BP mode 1)

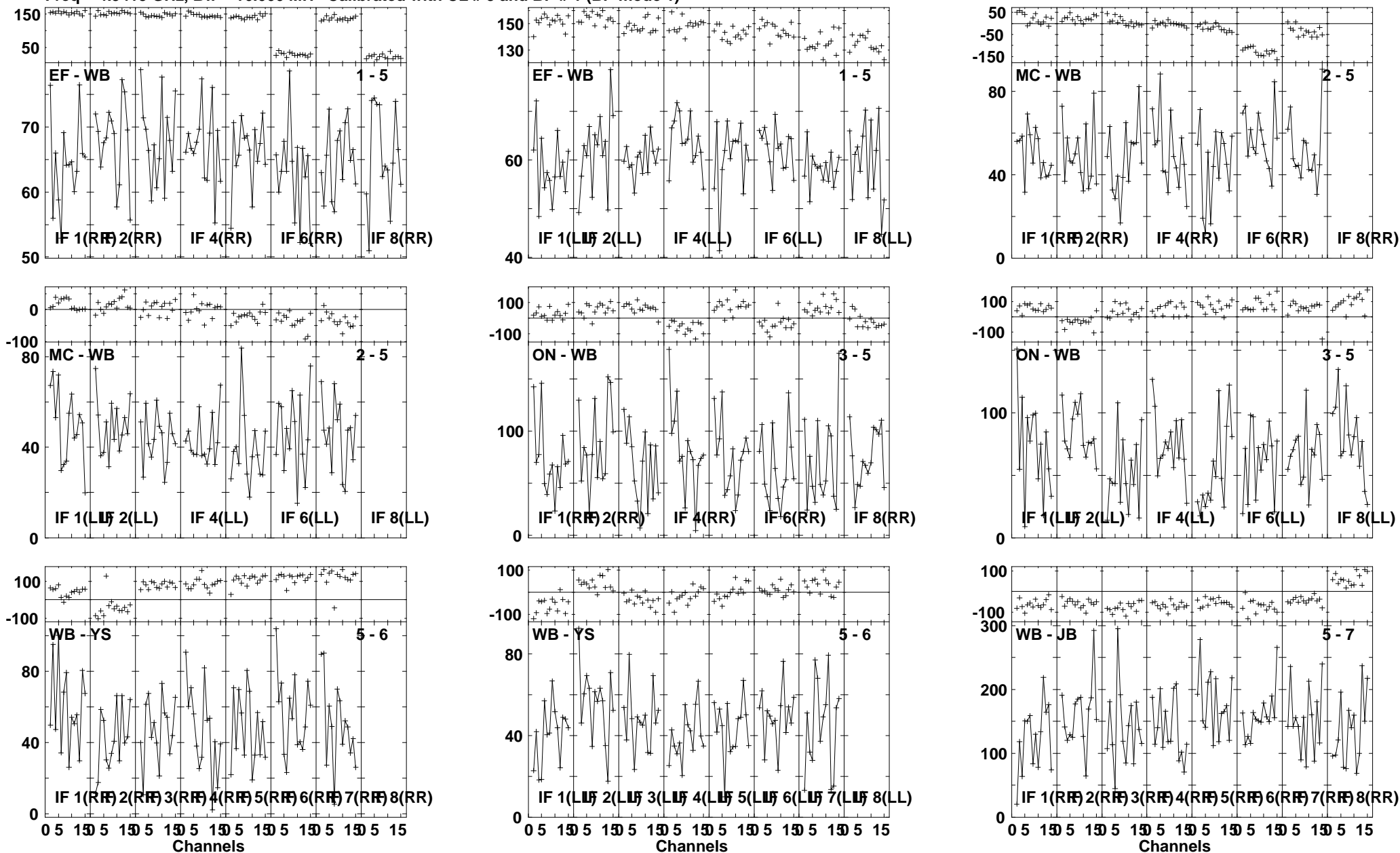

Lower frame: Milli Ampl Jy Top frame: Phas deg
Vector averaged cross-power spectrum Several baselines displayed
Timerange: 00/12:59:21 to 00/13:01:49

Plot file version 6 created 21-MAY-2010 15:44:27

CALA RSD03.UVDATA.1

Freq = 4.9415 GHz, Bw = 16.000 MH Calibrated with CL # 3 and BP # 1 (BP mode 1)

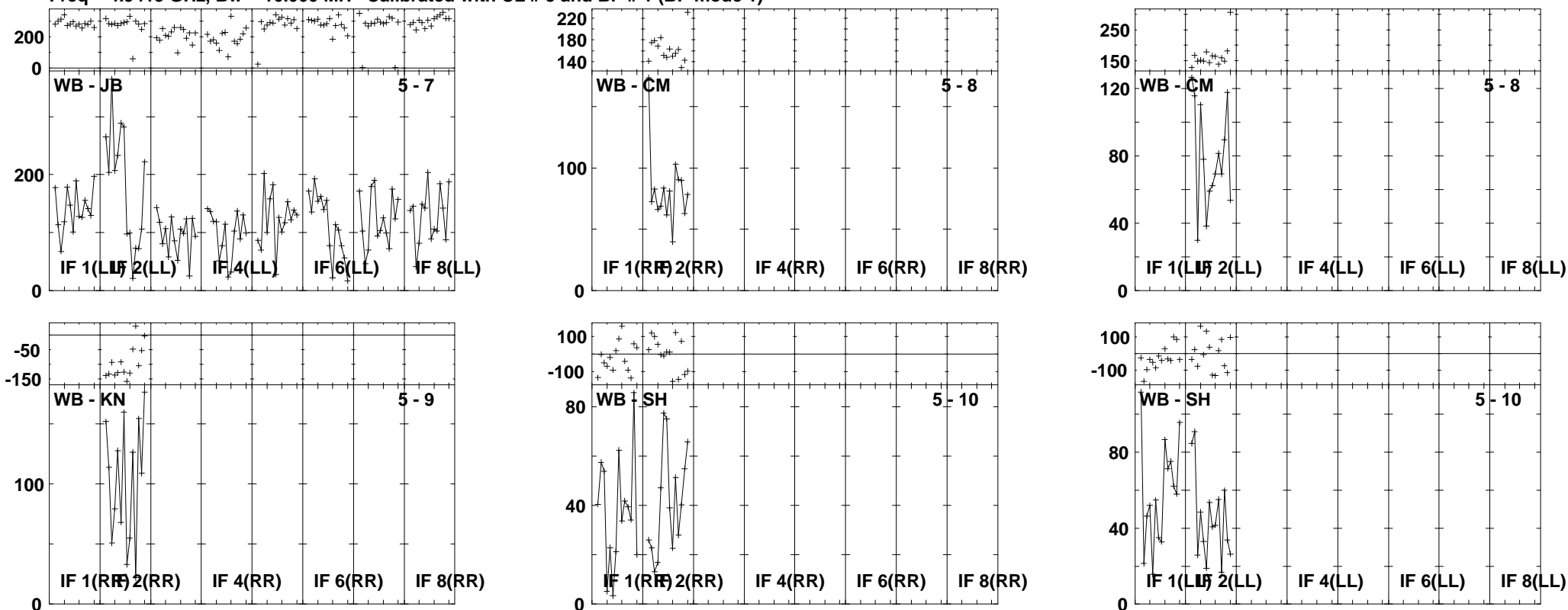

Lower frame: Milli Ampl Jy Top frame: Phas deg
Vector averaged cross-power spectrum Several baselines displayed
Timerange: 00/12:59:21 to 00/13:01:49

Plot file version 7 created 21-MAY-2010 15:44:29

CALK RSD03.UVDATA.1

Freq = 4.9415 GHz, Bw = 16.000 MH Calibrated with CL # 3 and BP # 1 (BP mode 1)

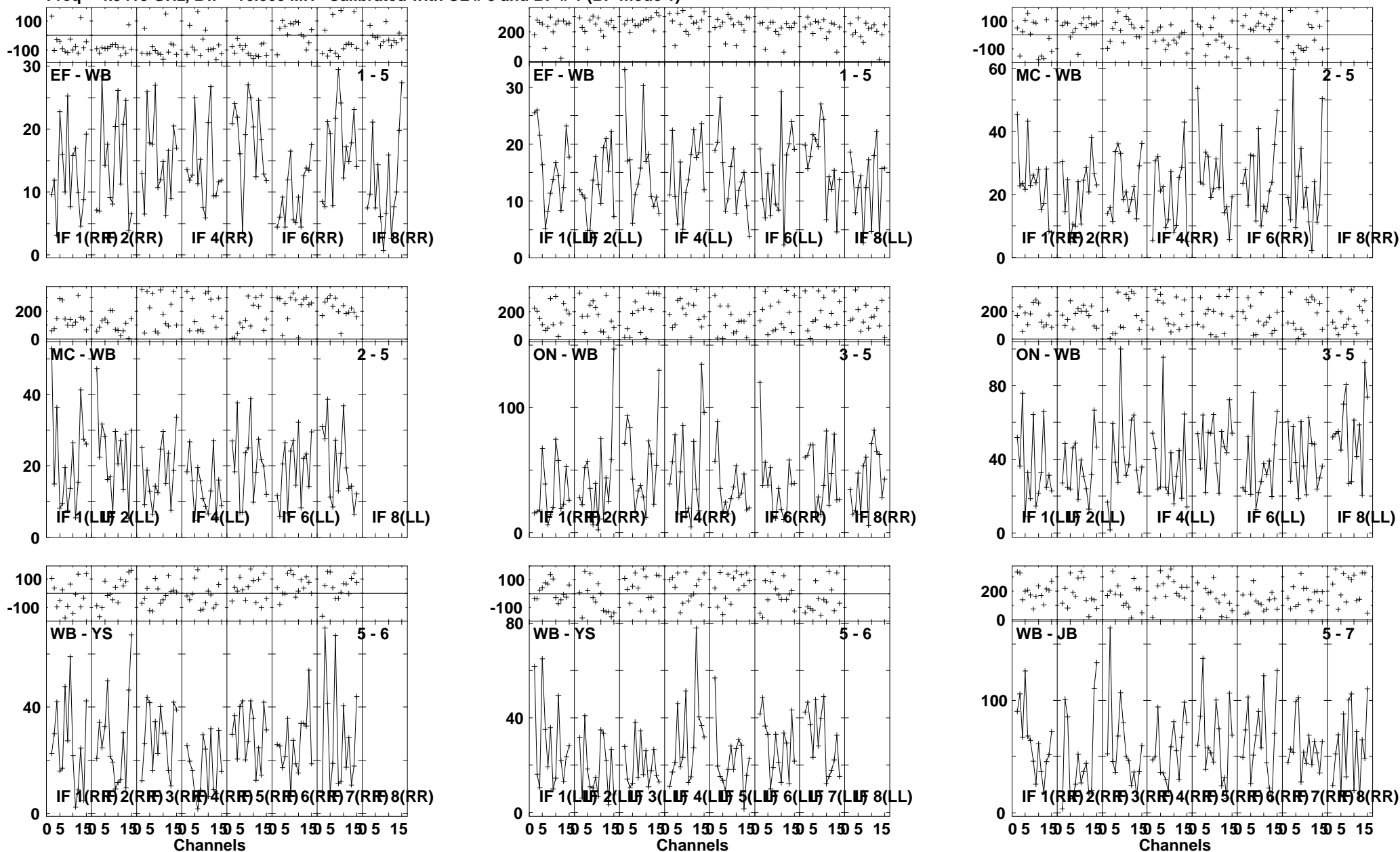

Lower frame: Milli Ampl Jy Top frame: Phas deg
Vector averaged cross-power spectrum Several baselines displayed
Timerange: 00/13:01:51 to 00/13:04:19

Plot file version 8 created 21-MAY-2010 15:44:31

CALK RSD03.UVDATA.1

Freq = 4.9415 GHz, Bw = 16.000 MH Calibrated with CL # 3 and BP # 1 (BP mode 1)

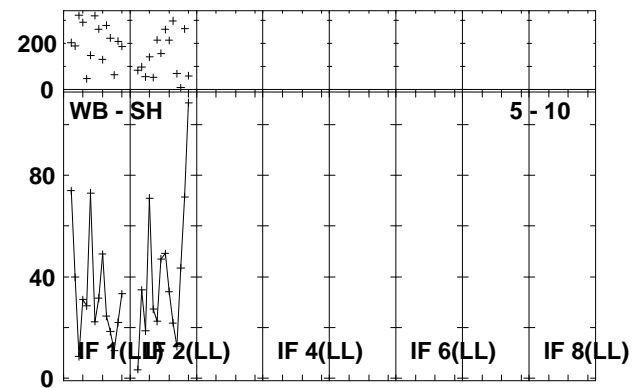
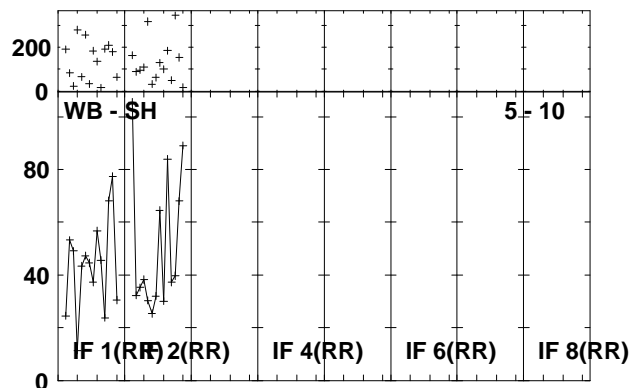
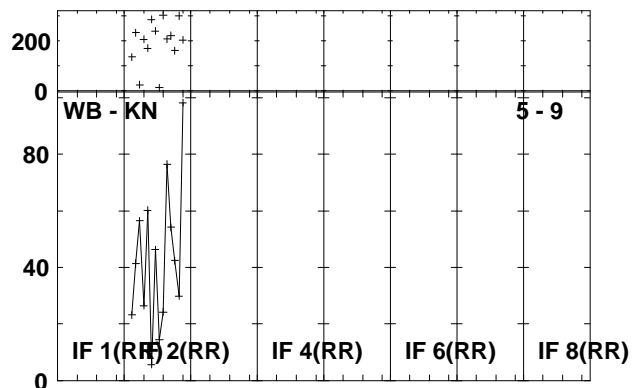
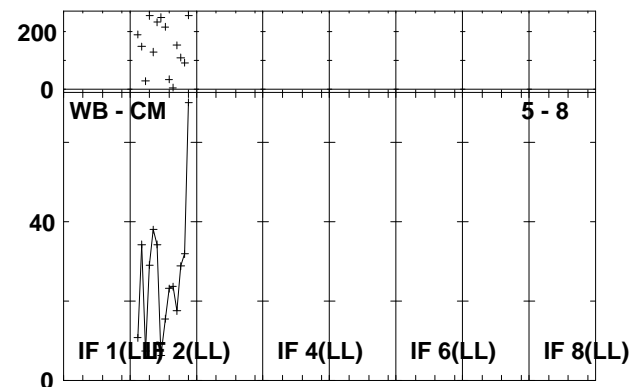
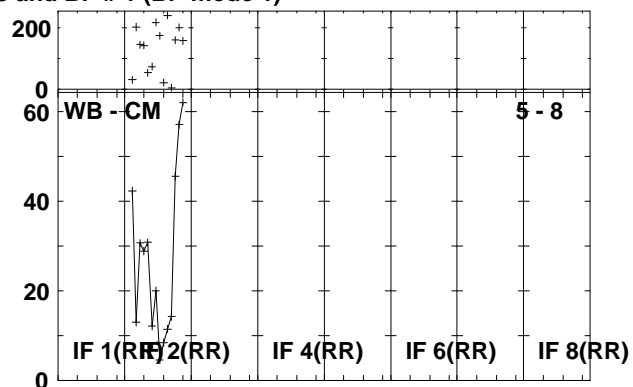
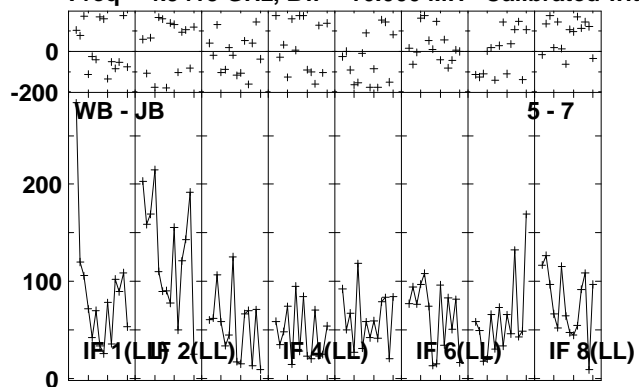

Lower frame: Milli Ampl Jy Top frame: Phas deg
Vector averaged cross-power spectrum Several baselines displayed
Timerange: 00/13:01:51 to 00/13:04:19

Plot file version 9 created 21-MAY-2010 15:44:33

J0909+02 RSD03.UVDATA.1

Freq = 4.9415 GHz, Bw = 16.000 MH Calibrated with CL # 3 and BP # 1 (BP mode 1)

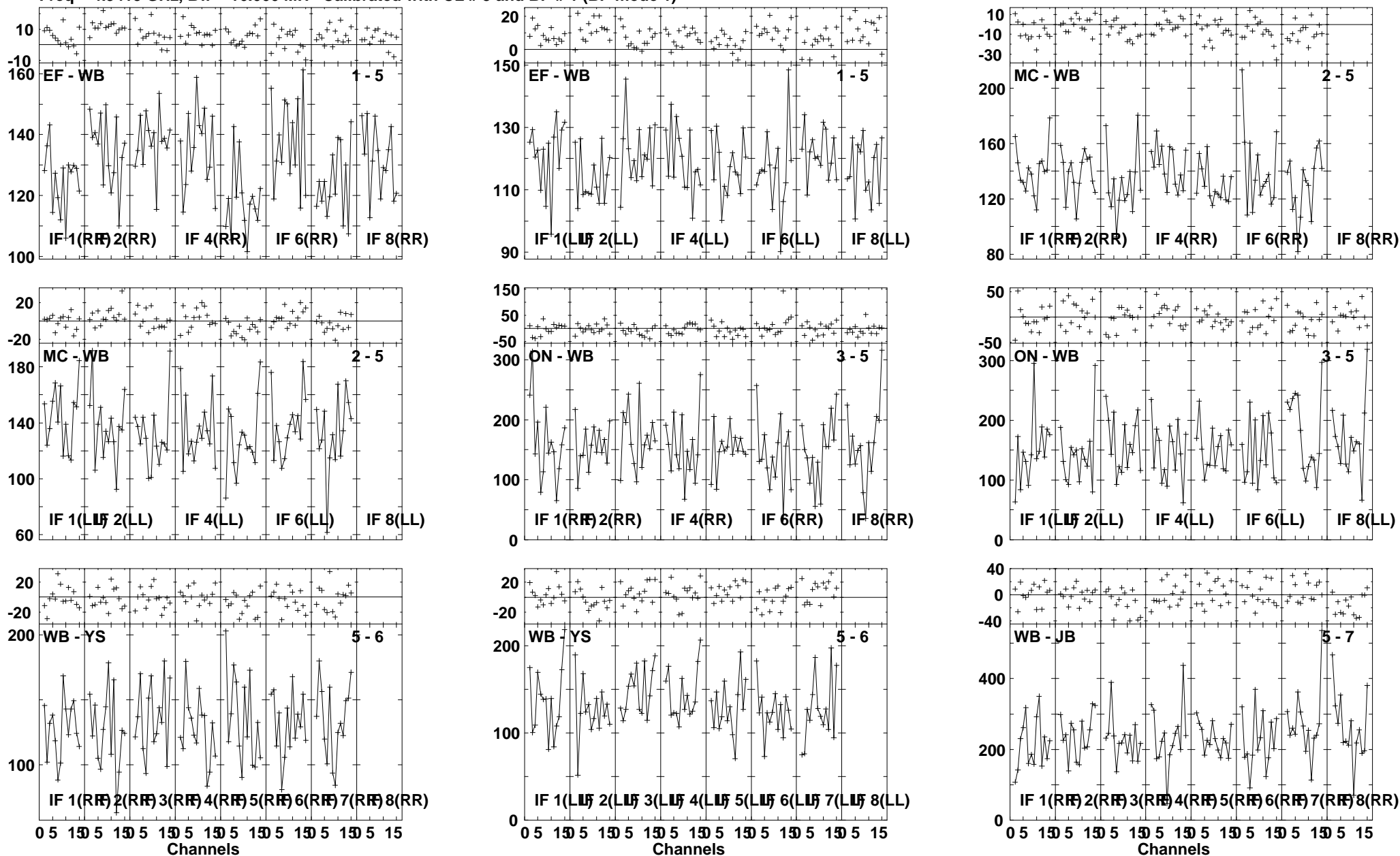

Lower frame: Milli Ampl Jy Top frame: Phas deg
Vector averaged cross-power spectrum Several baselines displayed
Timerange: 00/13:05:01 to 00/13:05:59

Plot file version 10 created 21-MAY-2010 15:44:34

J0909+02 RSD03.UVDATA.1

Freq = 4.9415 GHz, Bw = 16.000 MH Calibrated with CL # 3 and BP # 1 (BP mode 1)

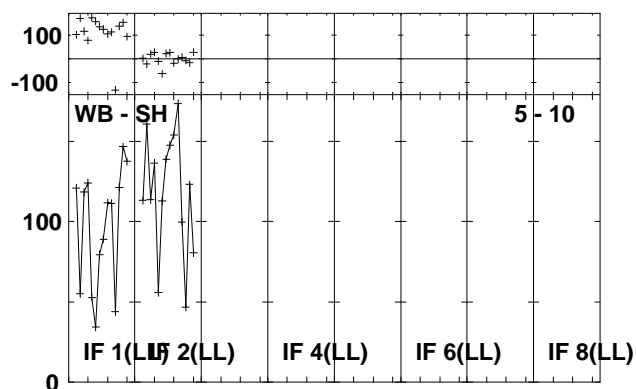
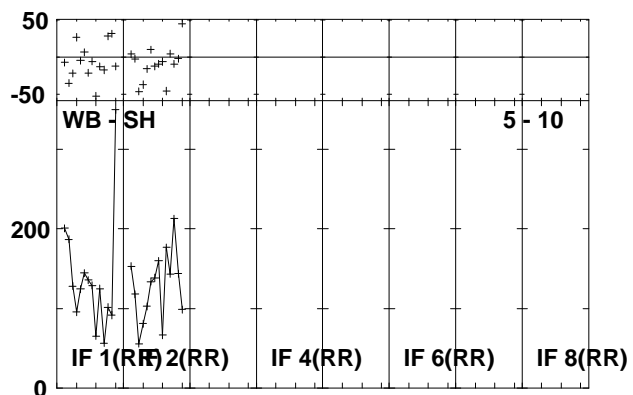
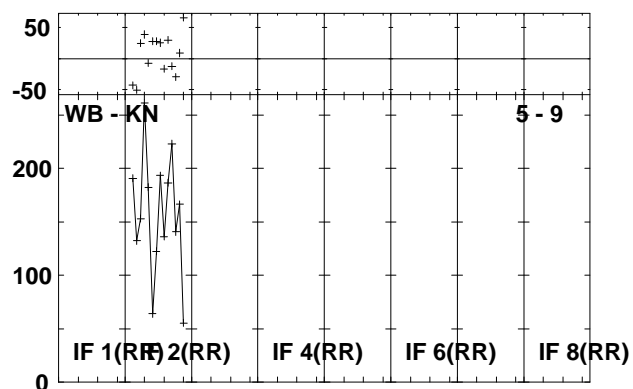
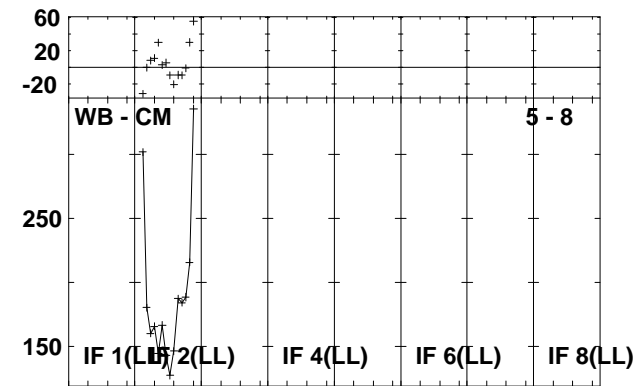
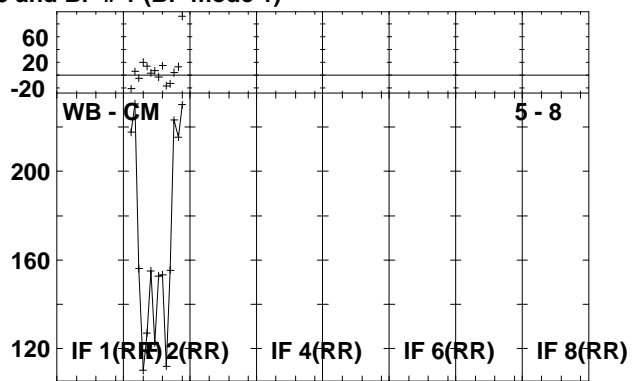
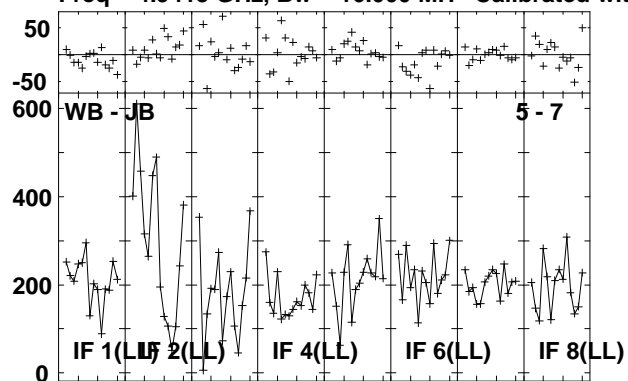

Lower frame: Milli Ampl Jy Top frame: Phas deg
Vector averaged cross-power spectrum Several baselines displayed
Timerange: 00/13:05:01 to 00/13:05:59

Plot file version 11 created 21-MAY-2010 15:44:35

CALB RSD03.UVDATA.1

Freq = 4.9415 GHz, Bw = 16.000 MH Calibrated with CL # 3 and BP # 1 (BP mode 1)

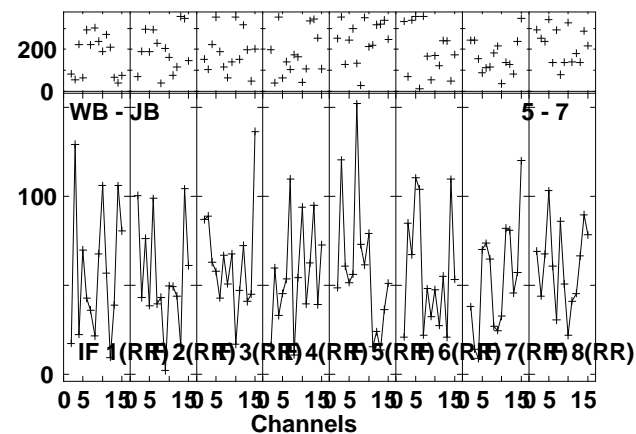
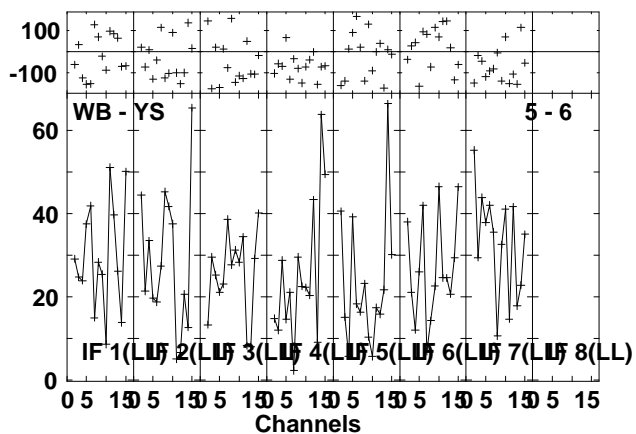
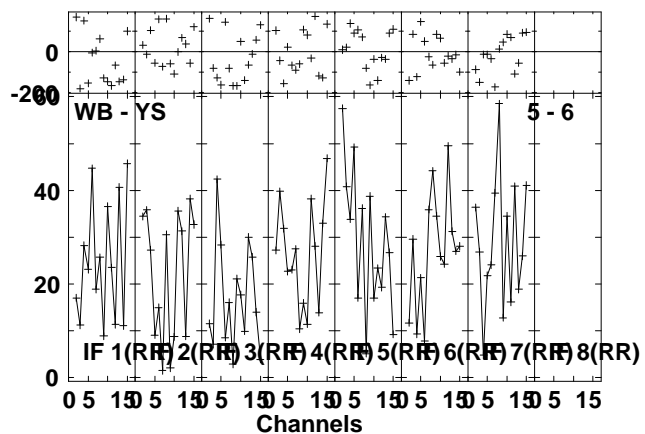
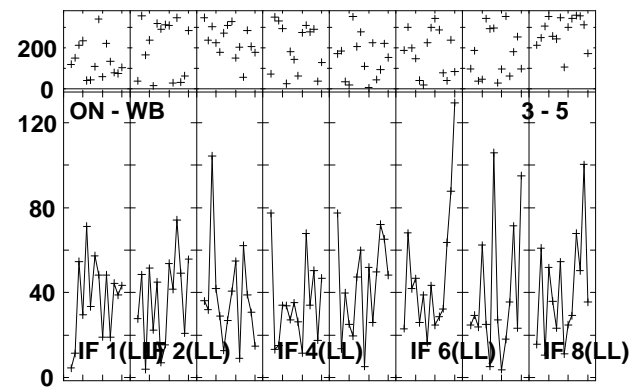
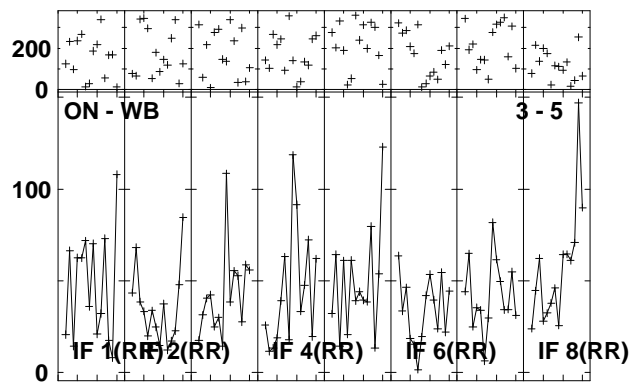
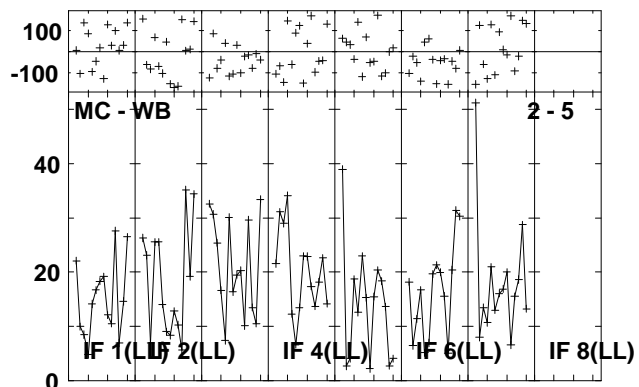
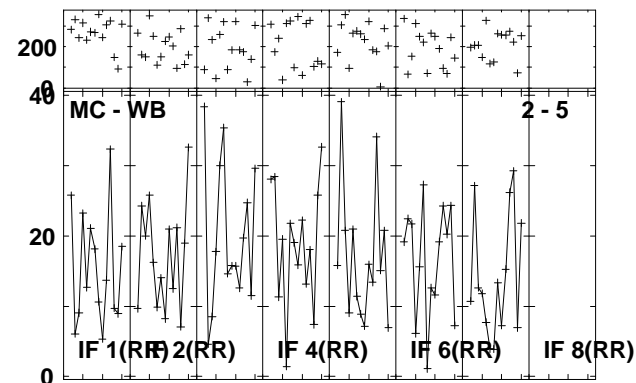
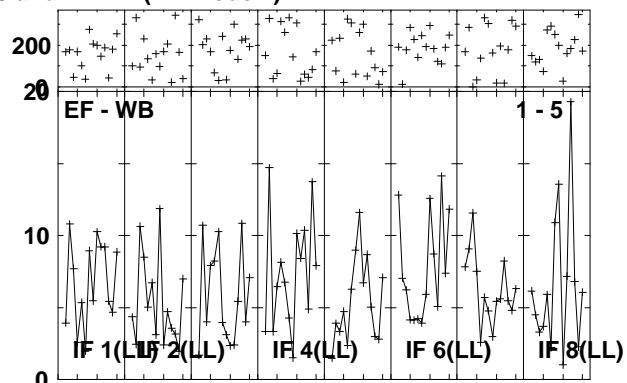
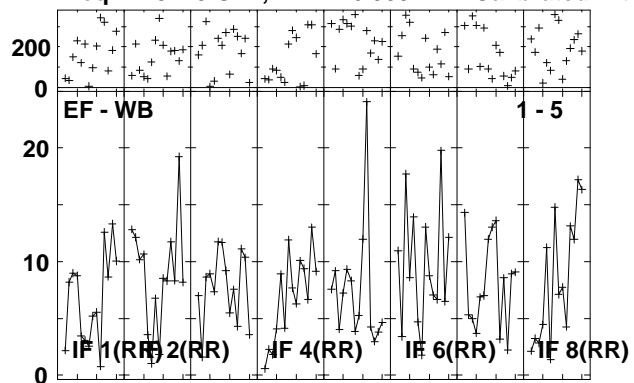

Lower frame: Milli Ampl Jy Top frame: Phas deg
Vector averaged cross-power spectrum Several baselines displayed
Timerange: 00/13:06:01 to 00/13:08:29

Plot file version 12 created 21-MAY-2010 15:44:37

CALB RSD03.UVDATA.1

Freq = 4.9415 GHz, Bw = 16.000 MH Calibrated with CL # 3 and BP # 1 (BP mode 1)

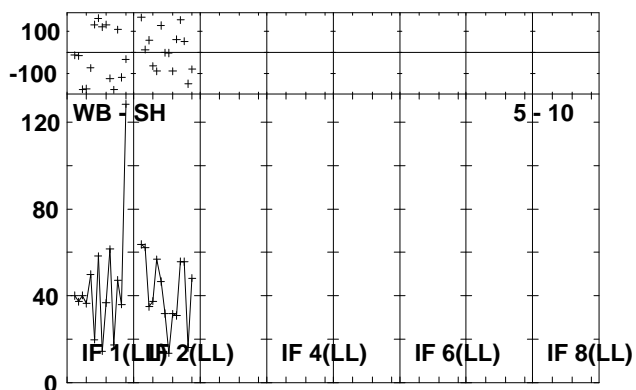
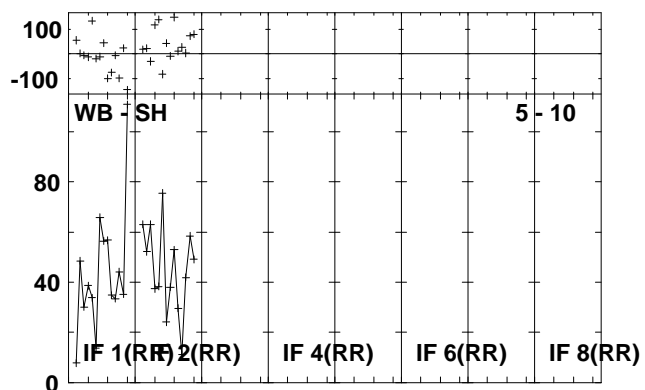
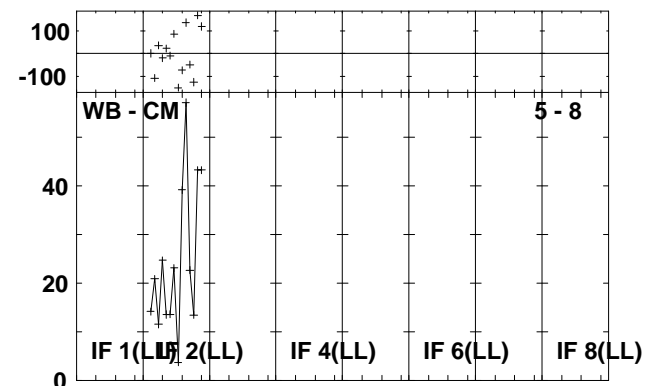
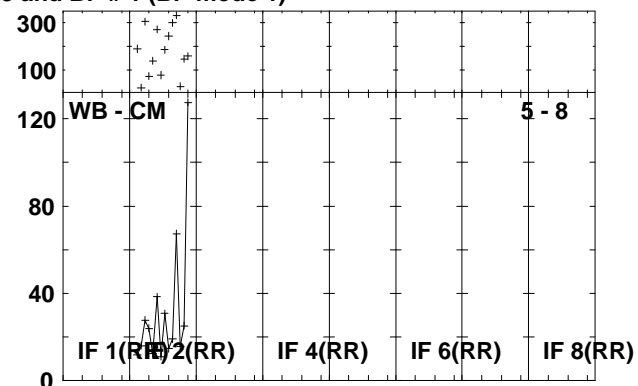
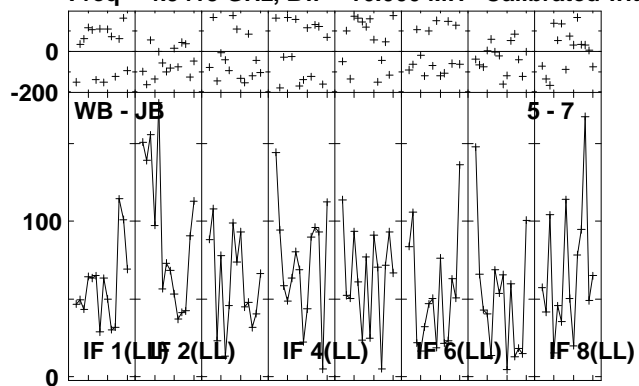

Lower frame: Milli Ampl Jy Top frame: Phas deg
Vector averaged cross-power spectrum Several baselines displayed
Timerange: 00/13:06:01 to 00/13:08:29

Plot file version 13 created 21-MAY-2010 15:44:40

CALC RSD03.UVDATA.1

Freq = 4.9415 GHz, Bw = 16.000 MH Calibrated with CL # 3 and BP # 1 (BP mode 1)

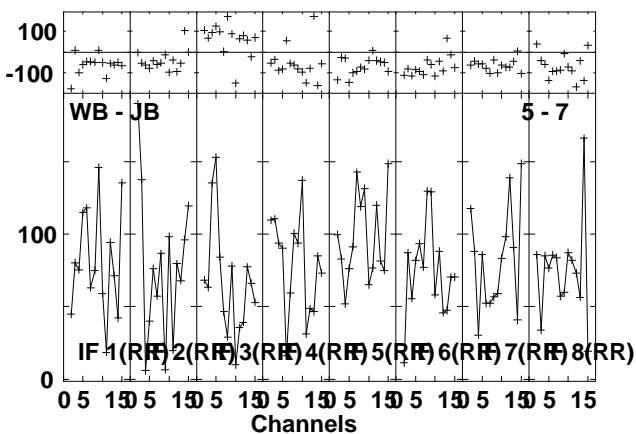
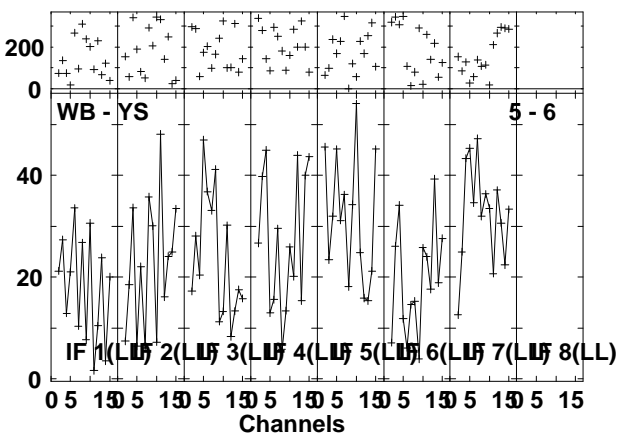
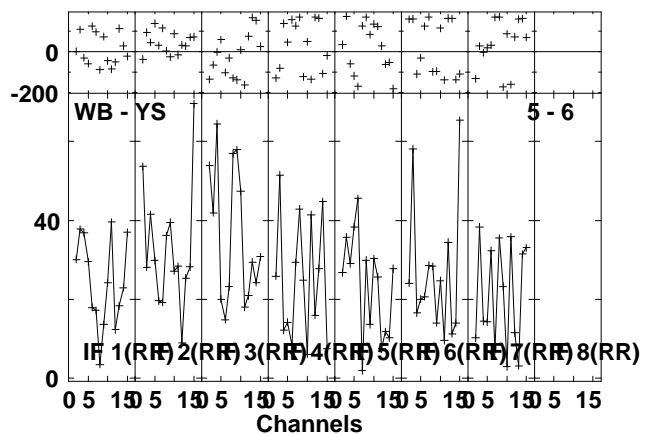
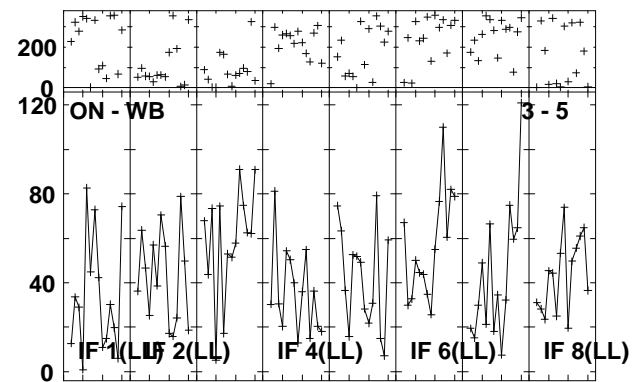
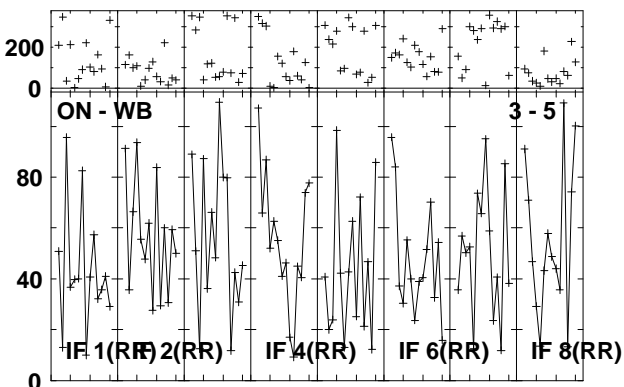
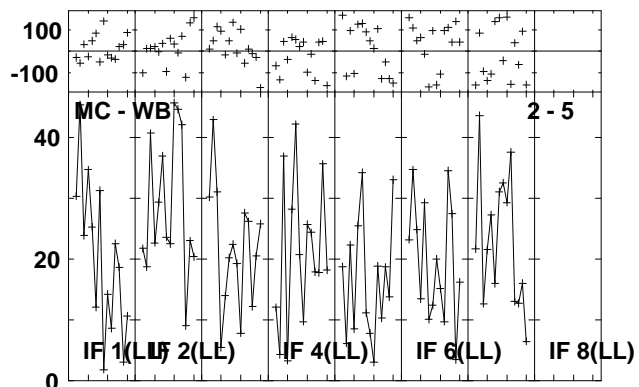
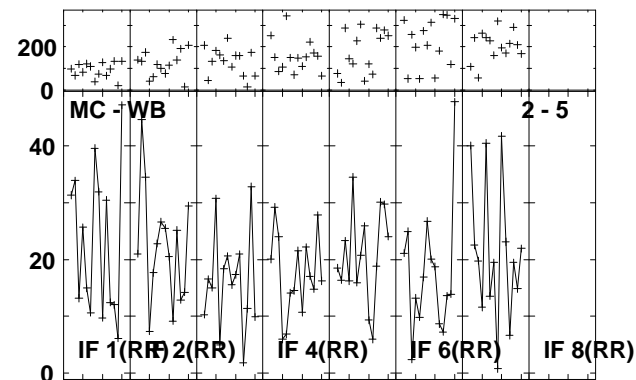
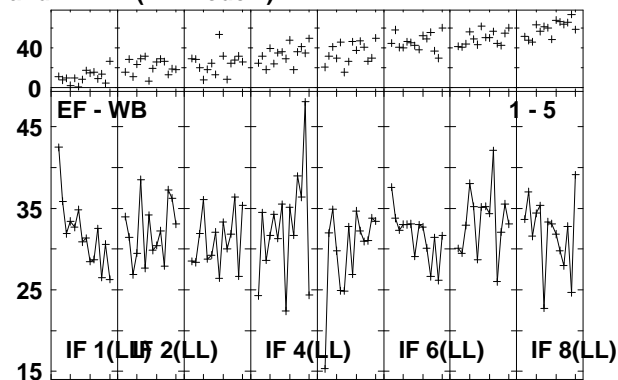
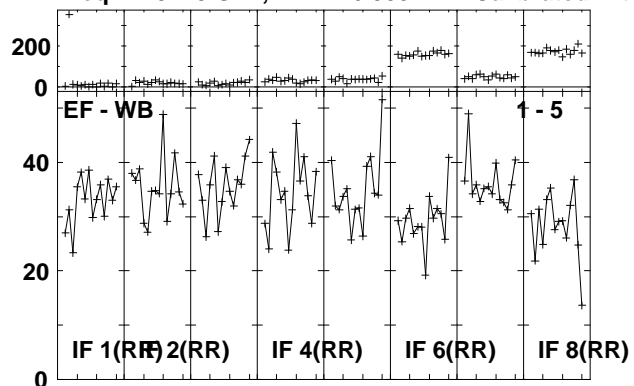

Lower frame: Milli Ampl Jy Top frame: Phas deg
Vector averaged cross-power spectrum Several baselines displayed
Timerange: 00/13:08:31 to 00/13:10:59

Plot file version 14 created 21-MAY-2010 15:44:42

CALC RSD03.UVDATA.1

Freq = 4.9415 GHz, Bw = 16.000 MH Calibrated with CL # 3 and BP # 1 (BP mode 1)

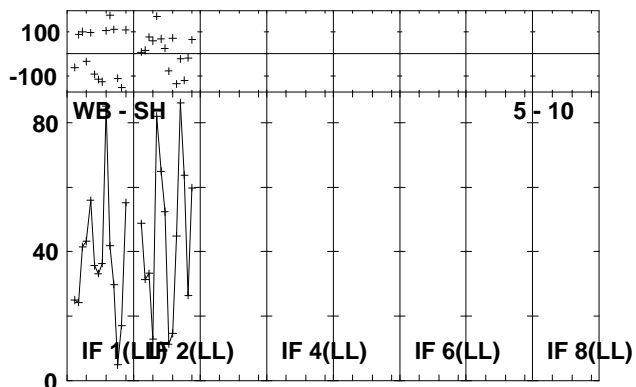
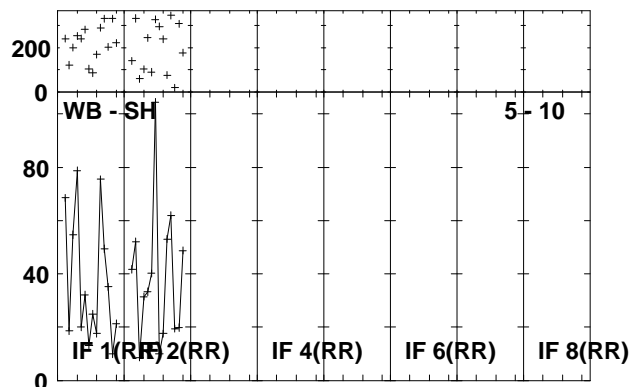
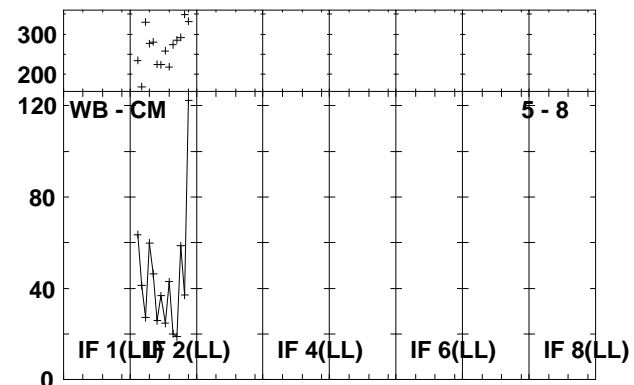
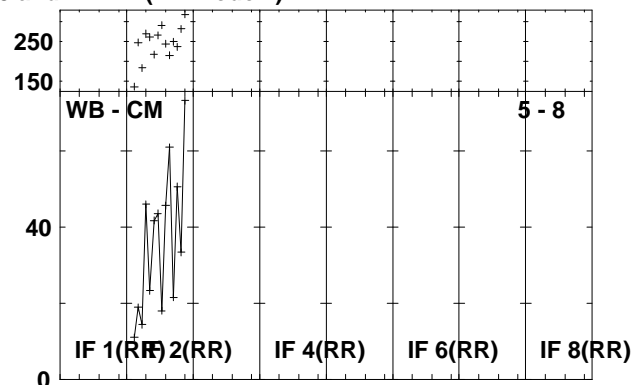
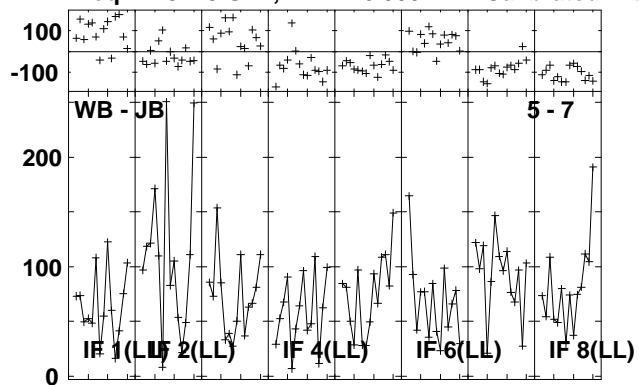

Lower frame: Milli Ampl Jy Top frame: Phas deg
Vector averaged cross-power spectrum Several baselines displayed
Timerange: 00/13:08:31 to 00/13:10:59

Plot file version 15 created 21-MAY-2010 15:44:44

J0909+02 RSD03.UVDATA.1

Freq = 4.9415 GHz, Bw = 16.000 MH Calibrated with CL # 3 and BP # 1 (BP mode 1)

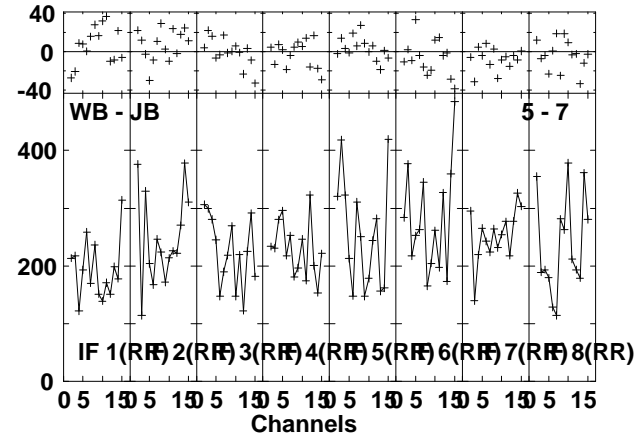
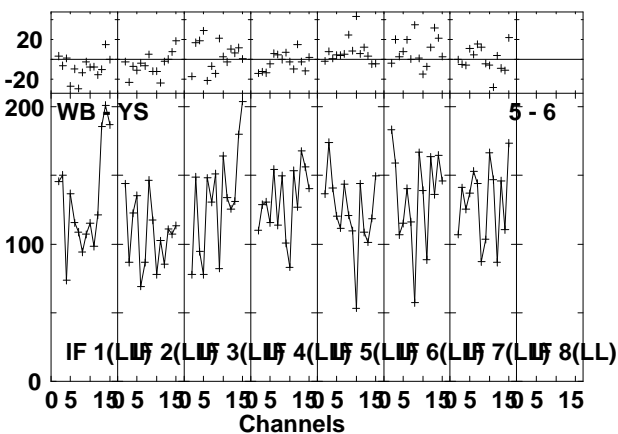
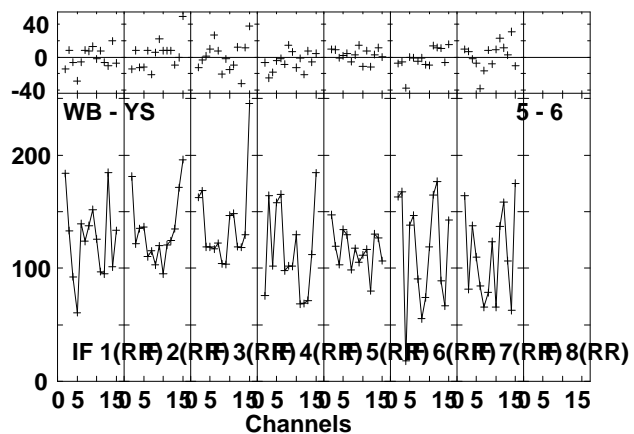
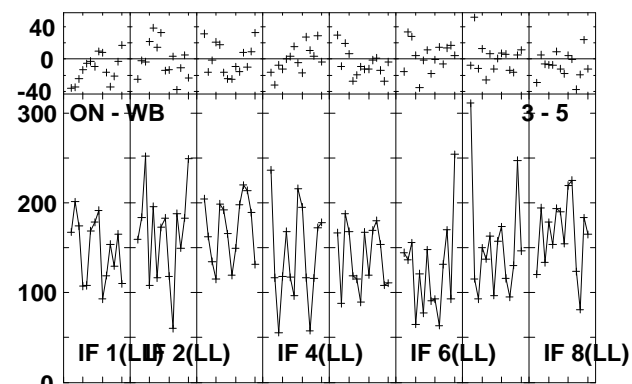
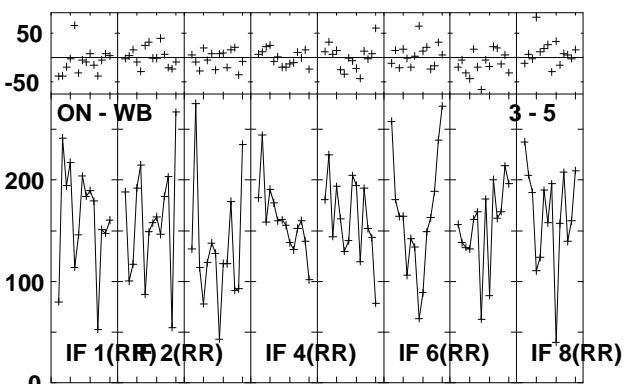
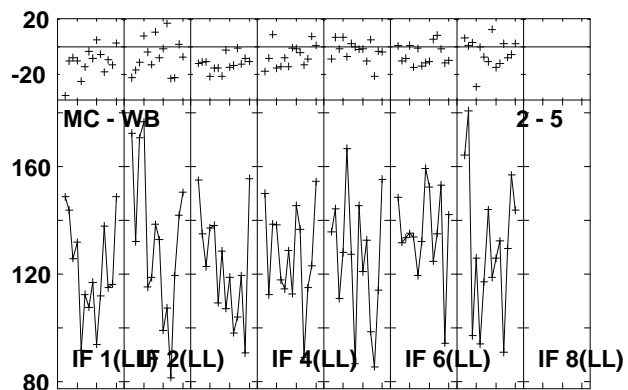
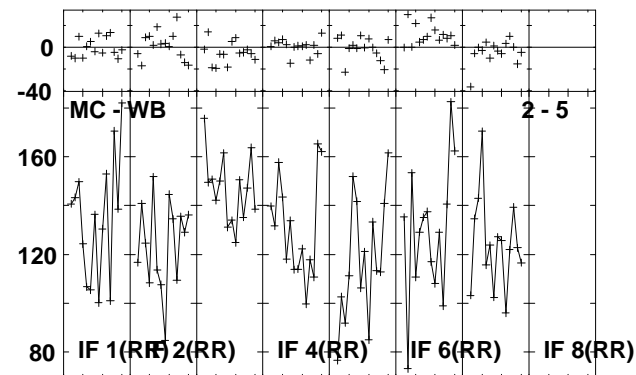
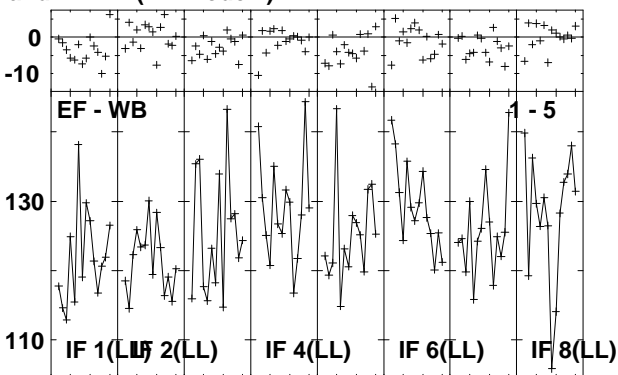
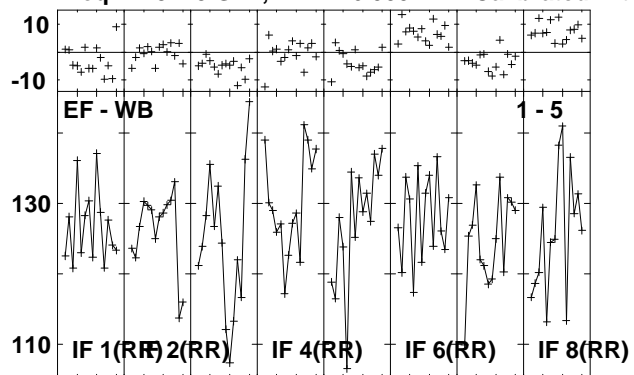

Lower frame: Milli Ampl Jy Top frame: Phas deg
Vector averaged cross-power spectrum Several baselines displayed
Timerange: 00/13:11:41 to 00/13:12:39

Plot file version 16 created 21-MAY-2010 15:44:45

J0909+02 RSD03.UVDATA.1

Freq = 4.9415 GHz, Bw = 16.000 MH Calibrated with CL # 3 and BP # 1 (BP mode 1)

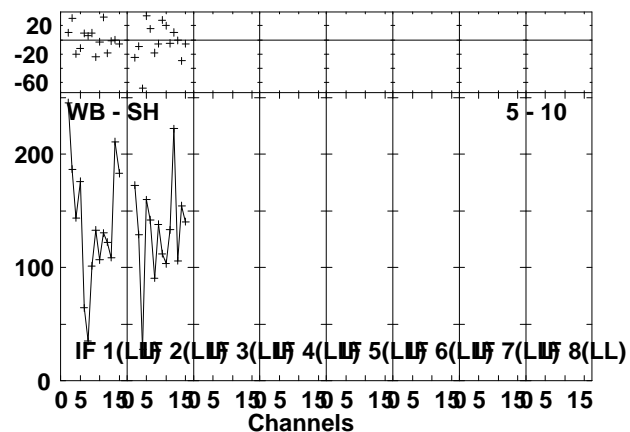
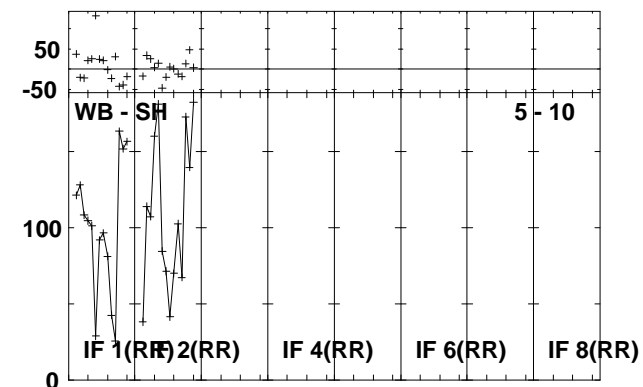
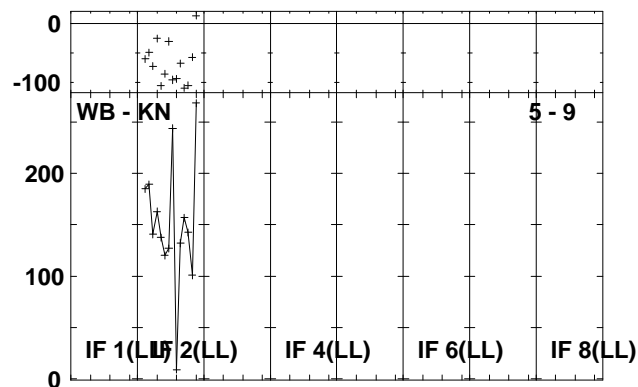
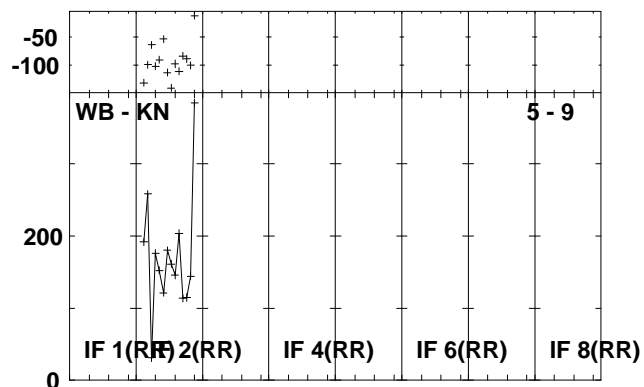
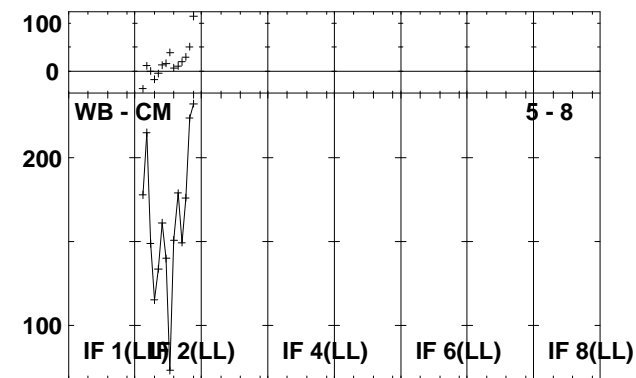
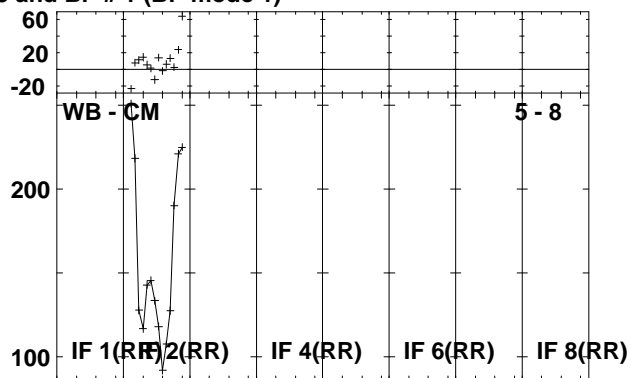
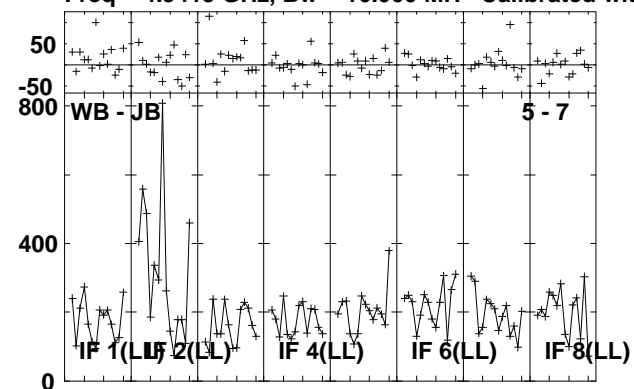

Lower frame: Milli Ampl Jy Top frame: Phas deg

Vector averaged cross-power spectrum Several baselines displayed

Timerange: 00/13:11:41 to 00/13:12:39

Plot file version 17 created 21-MAY-2010 15:44:46

CALD RSD03.UVDATA.1

Freq = 4.9415 GHz, Bw = 16.000 MH Calibrated with CL # 3 and BP # 1 (BP mode 1)

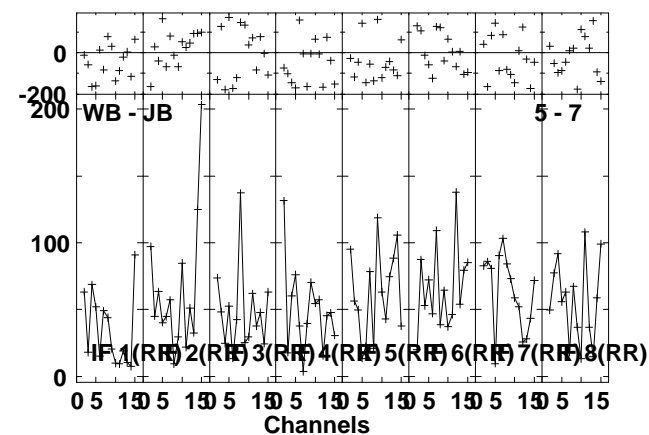
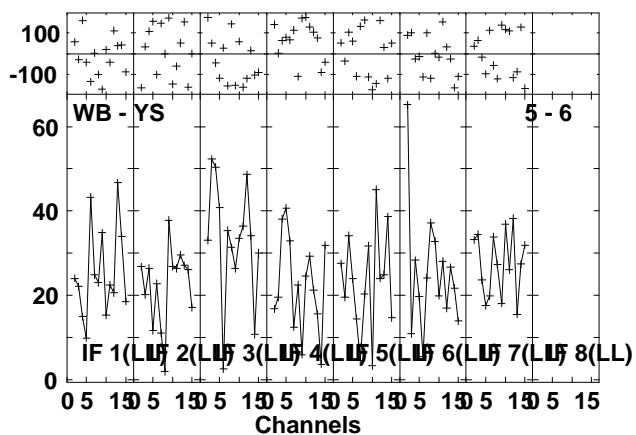
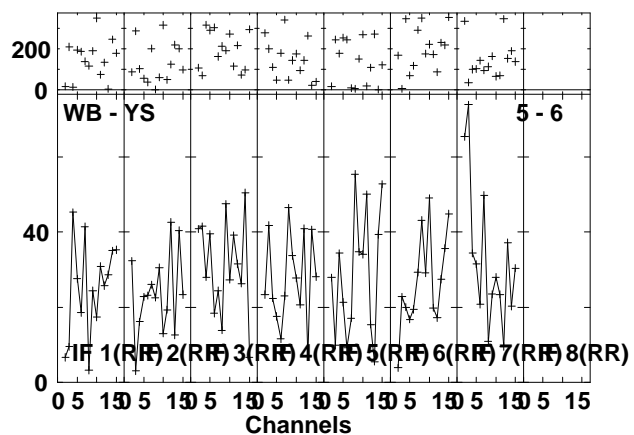
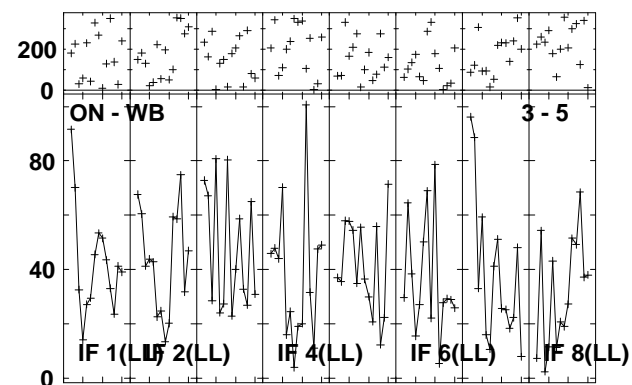
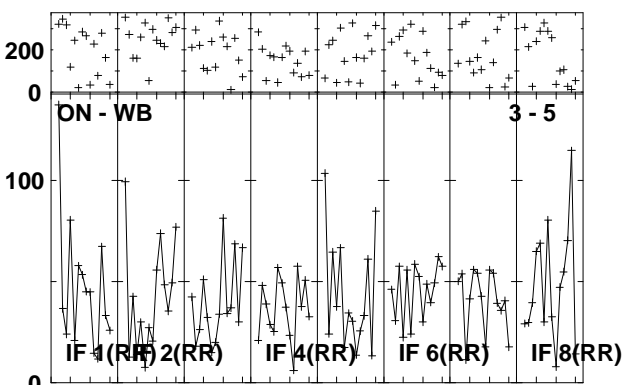
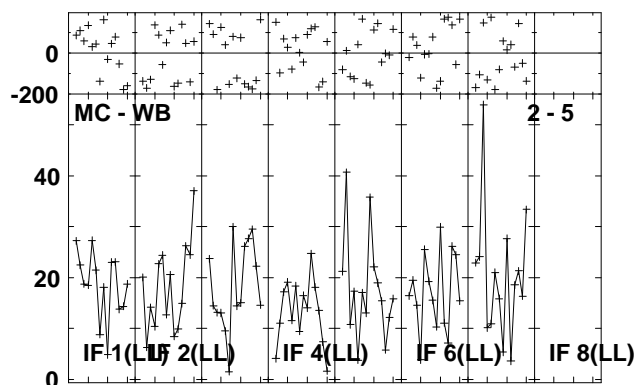
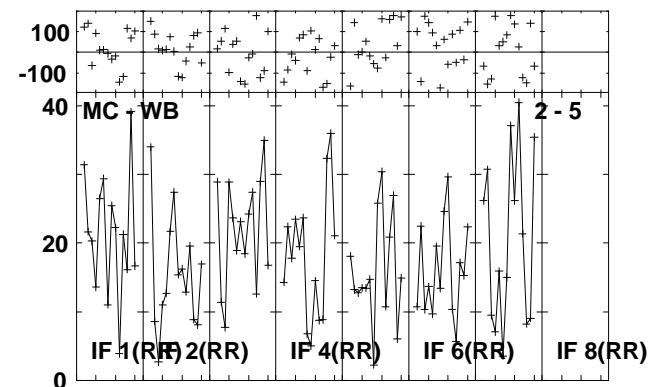
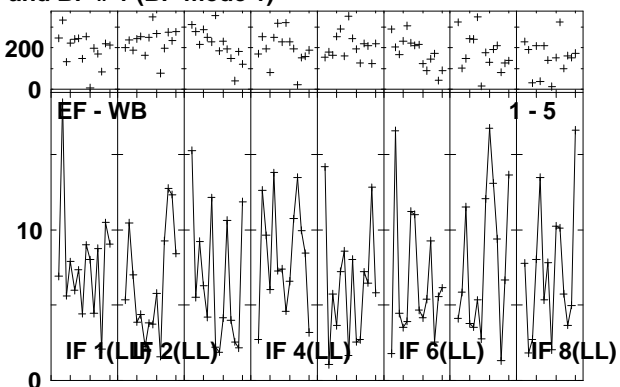
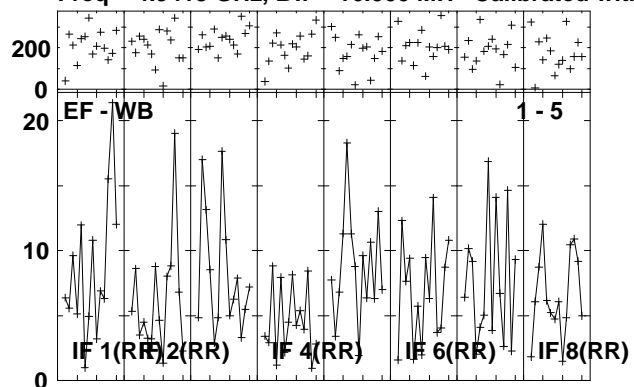

Lower frame: Milli Ampl Jy Top frame: Phas deg
Vector averaged cross-power spectrum Several baselines displayed
Timerange: 00/13:12:41 to 00/13:15:09

Plot file version 18 created 21-MAY-2010 15:44:49

CALD RSD03.UVDATA.1

Freq = 4.9415 GHz, Bw = 16.000 MH Calibrated with CL # 3 and BP # 1 (BP mode 1)

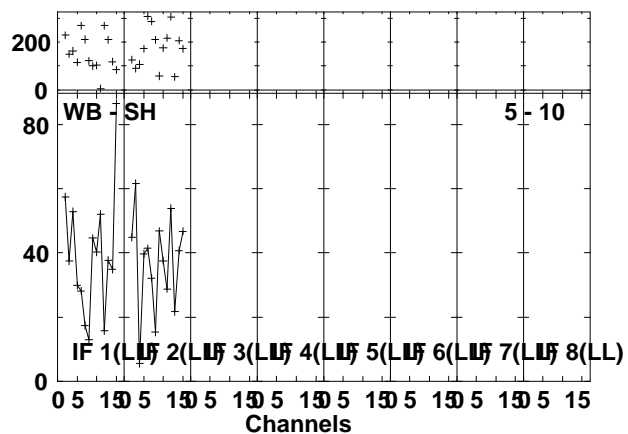
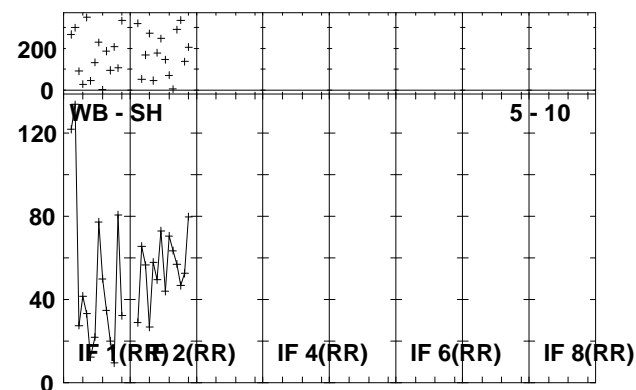
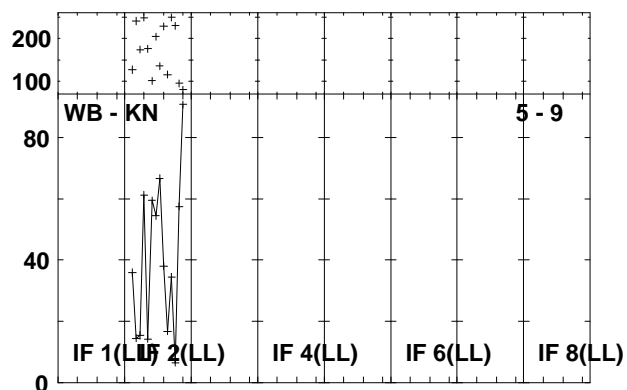
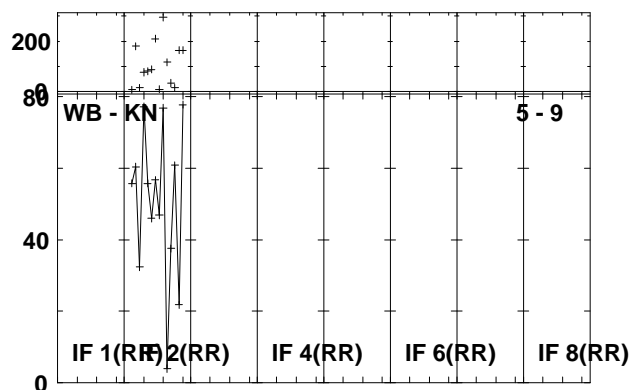
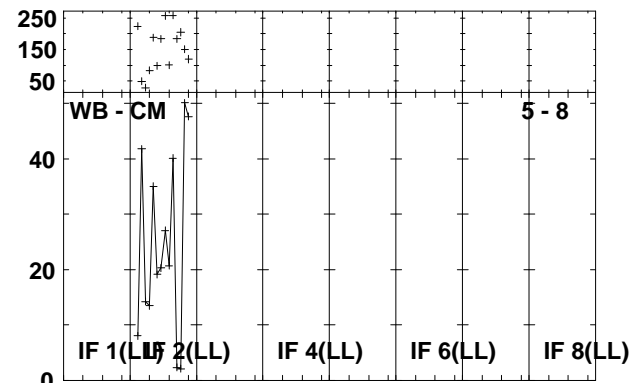
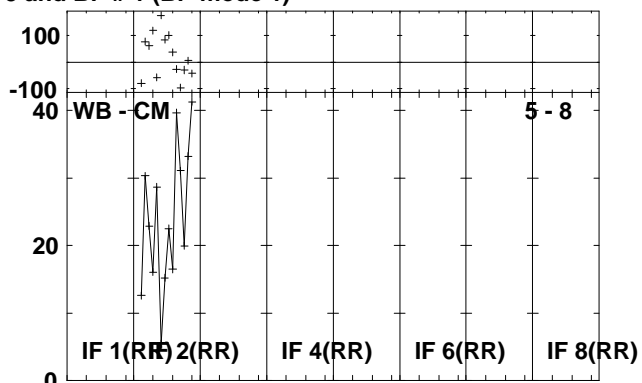
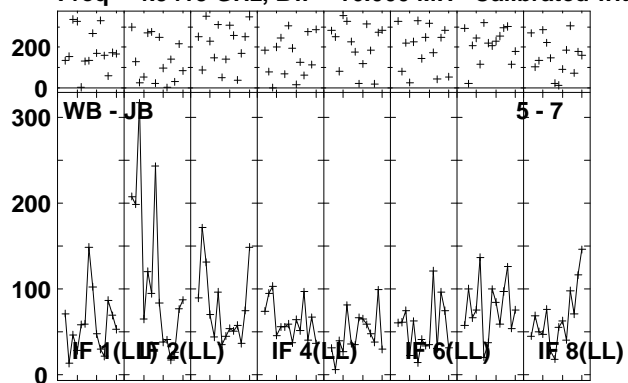

Lower frame: Milli Ampl Jy Top frame: Phas deg
Vector averaged cross-power spectrum Several baselines displayed
Timerange: 00/13:12:41 to 00/13:15:09

Plot file version 19 created 21-MAY-2010 15:44:51

CALF RSD03.UVDATA.1

Freq = 4.9415 GHz, Bw = 16.000 MH Calibrated with CL # 3 and BP # 1 (BP mode 1)

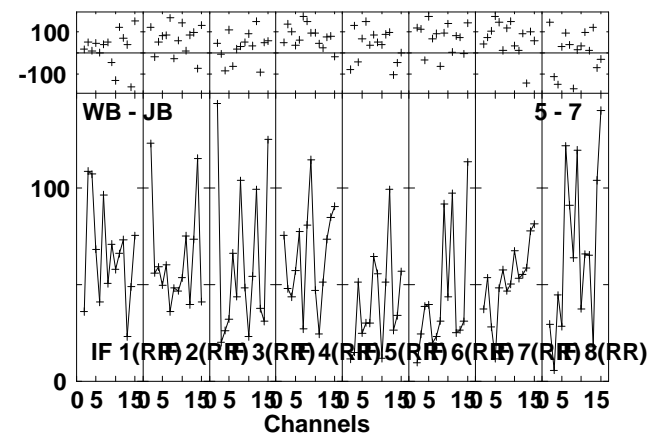
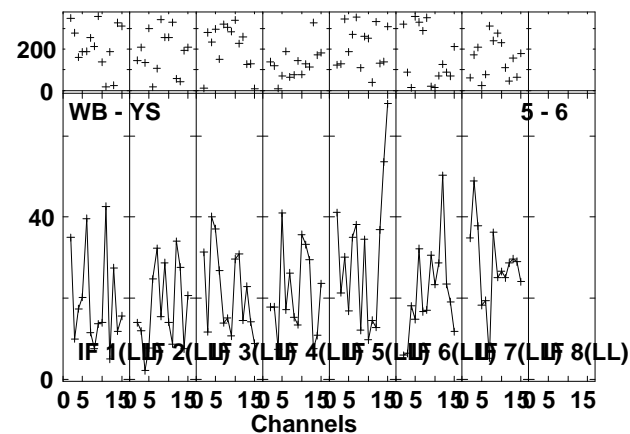
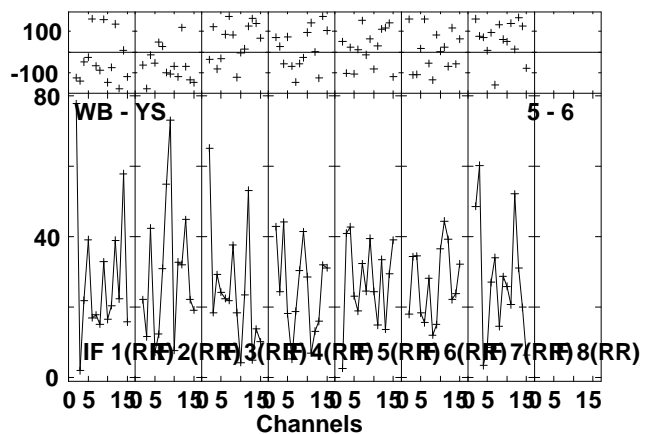
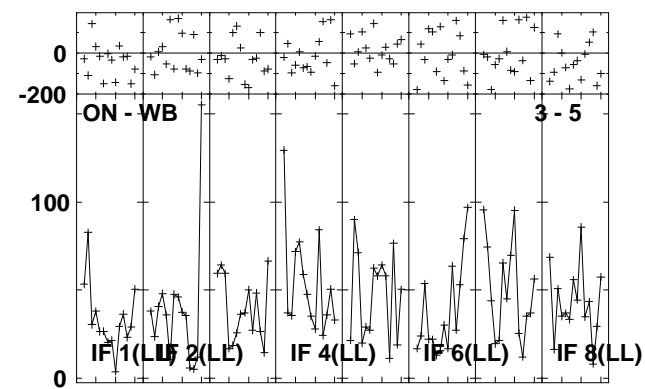
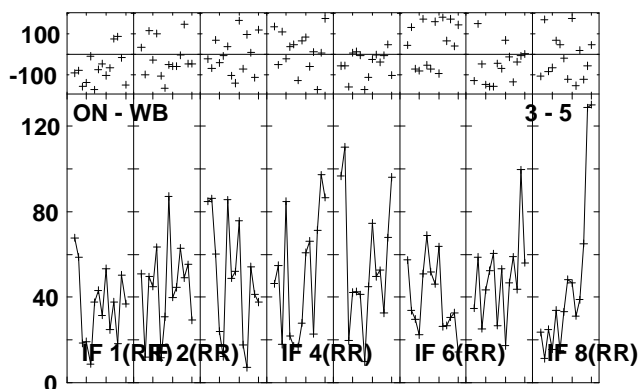
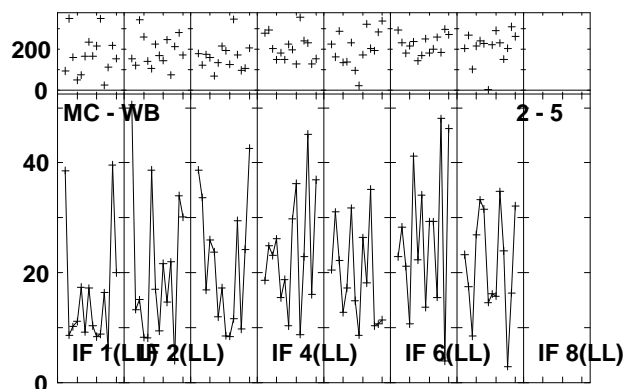
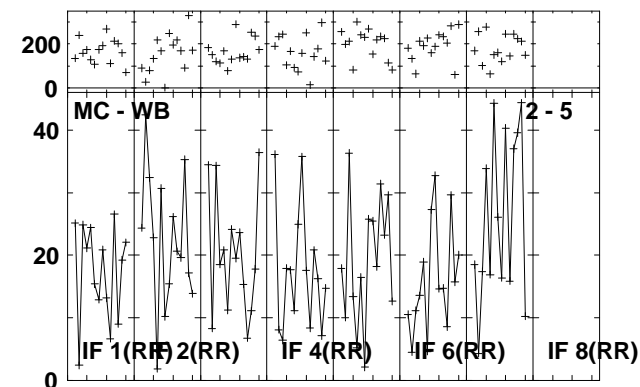
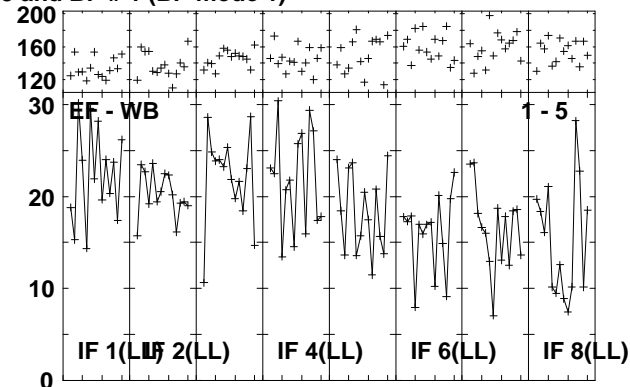
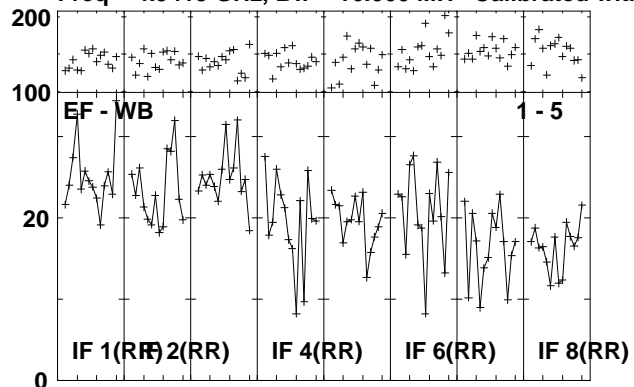

Lower frame: Milli Ampl Jy Top frame: Phas deg
Vector averaged cross-power spectrum Several baselines displayed
Timerange: 00/13:15:11 to 00/13:17:39

Plot file version 20 created 21-MAY-2010 15:44:53

CALF RSD03.UVDATA.1

Freq = 4.9415 GHz, Bw = 16.000 MH Calibrated with CL # 3 and BP # 1 (BP mode 1)

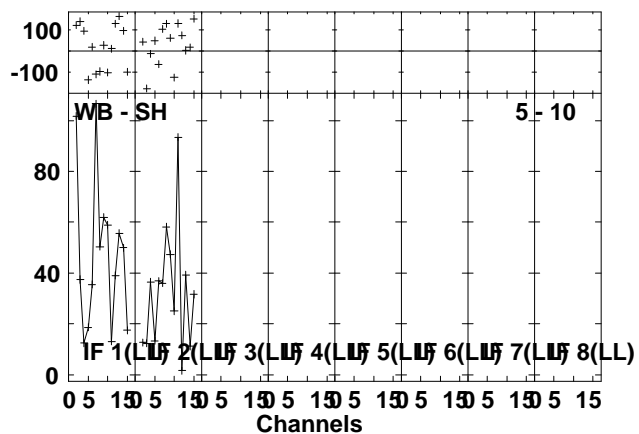
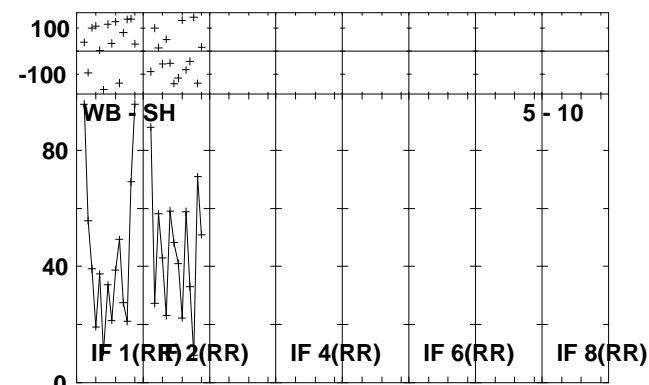
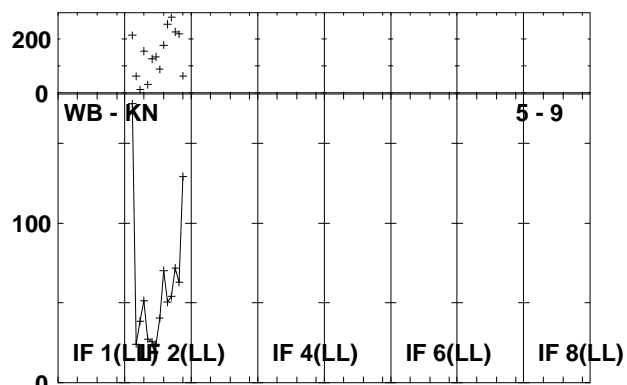
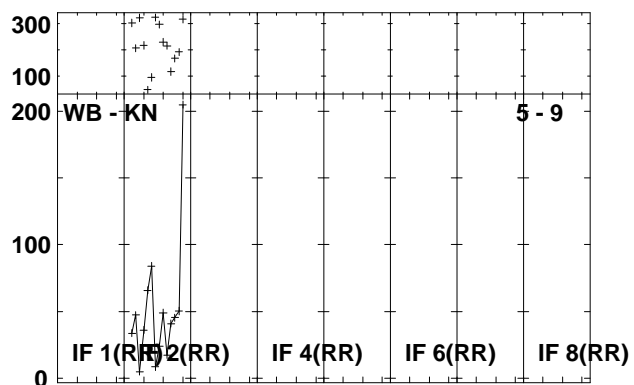
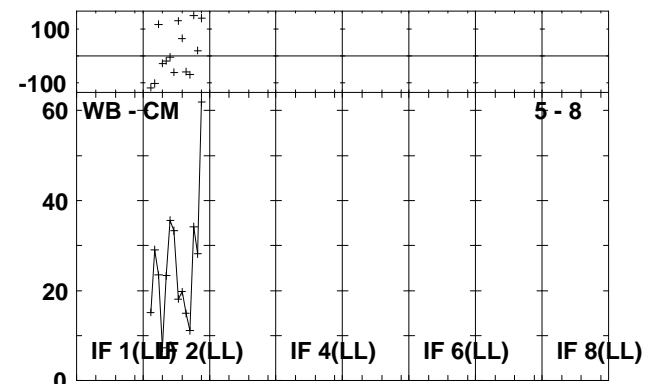
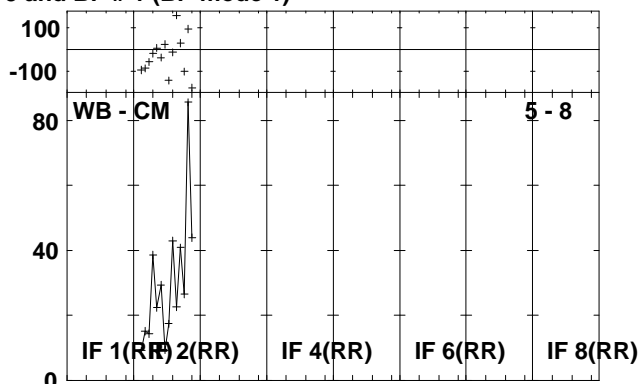
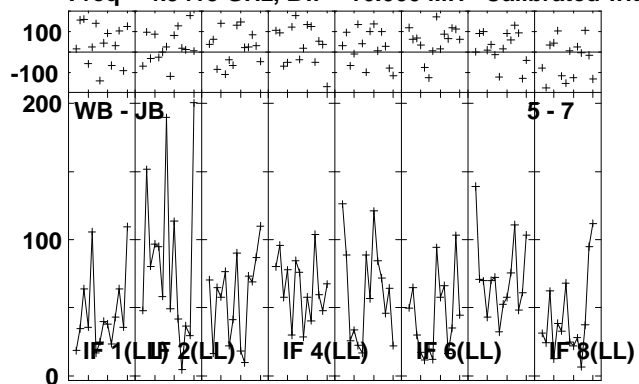

Lower frame: Milli Ampl Jy Top frame: Phas deg
Vector averaged cross-power spectrum Several baselines displayed
Timerange: 00/13:15:11 to 00/13:17:39

Plot file version 21 created 21-MAY-2010 15:44:55
 J0909+02 RSD03.UVDATA.1
 Freq = 4.9415 GHz, Bw = 16.000 MH Calibrated with CL # 3 and BP # 1 (BP mode 1)

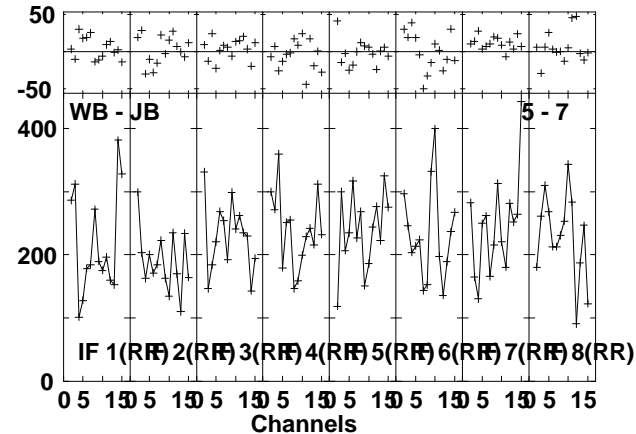
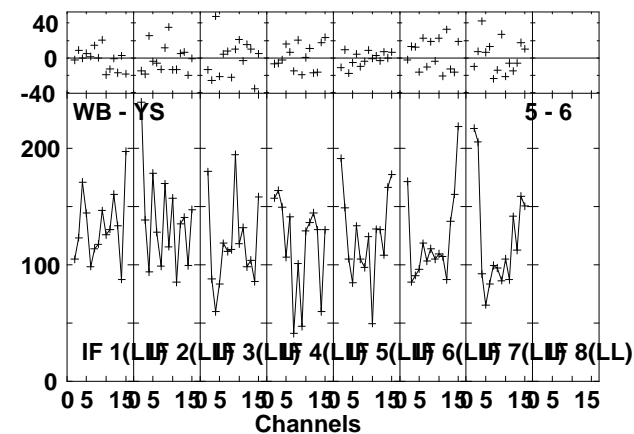
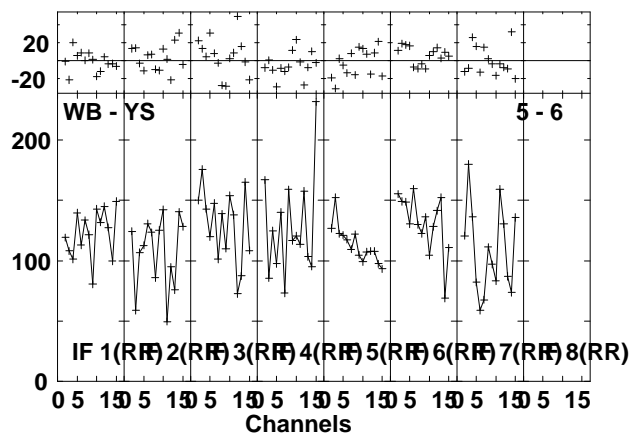
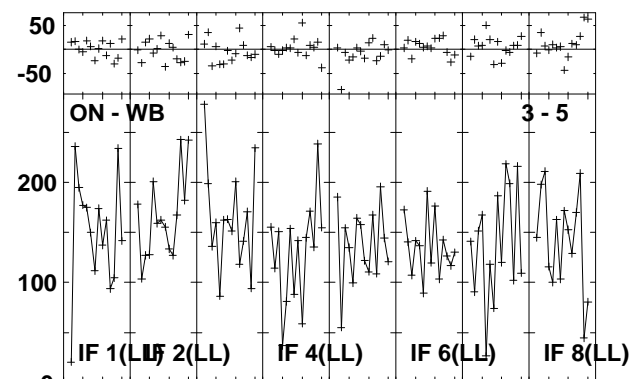
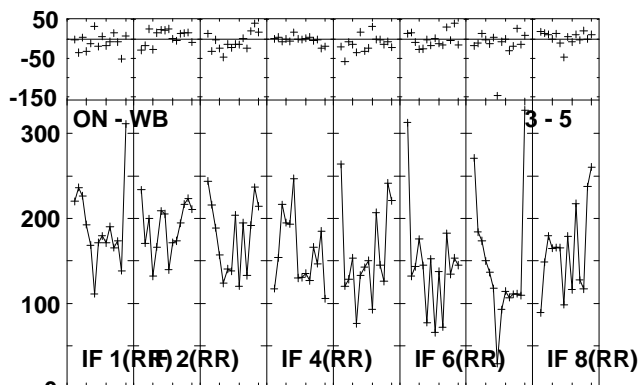
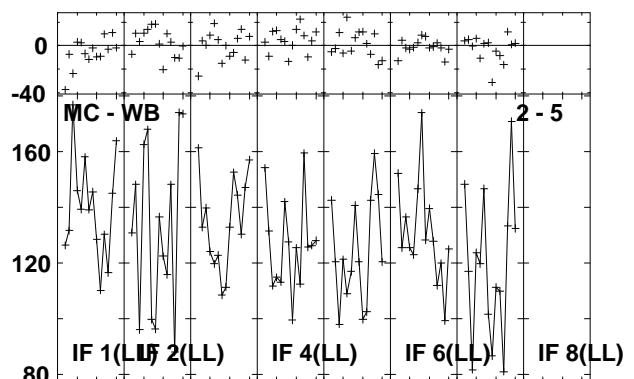
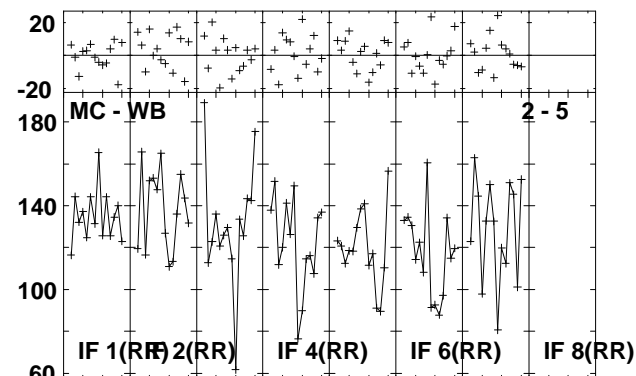
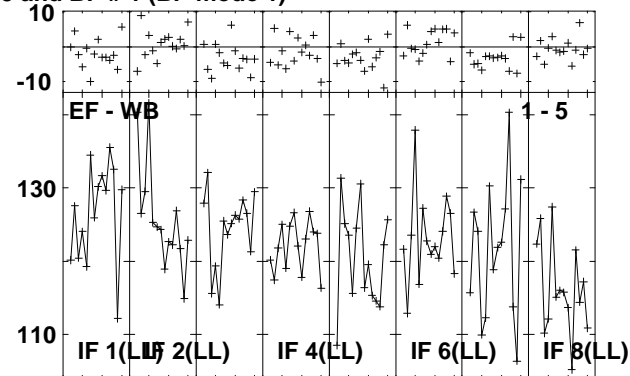
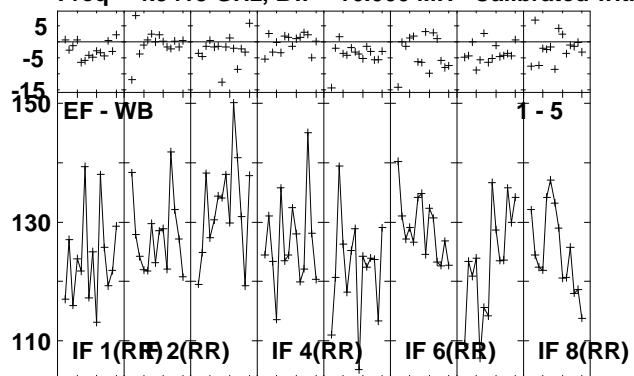

Lower frame: Milli Ampl Jy Top frame: Phas deg
 Vector averaged cross-power spectrum Several baselines displayed
 Timerange: 00/13:18:21 to 00/13:19:19

Plot file version 22 created 21-MAY-2010 15:44:56

J0909+02 RSD03.UVDATA.1

Freq = 4.9415 GHz, Bw = 16.000 MH Calibrated with CL # 3 and BP # 1 (BP mode 1)

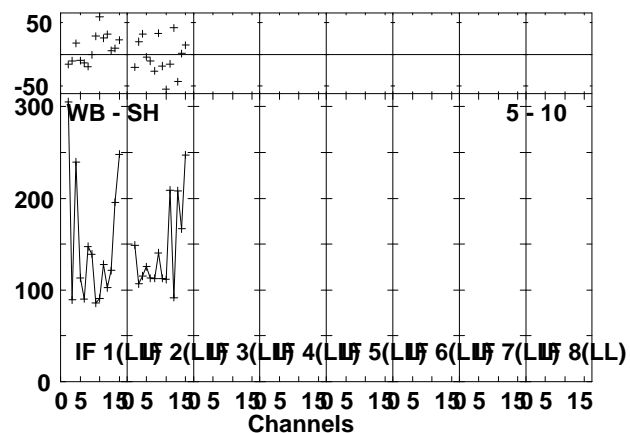
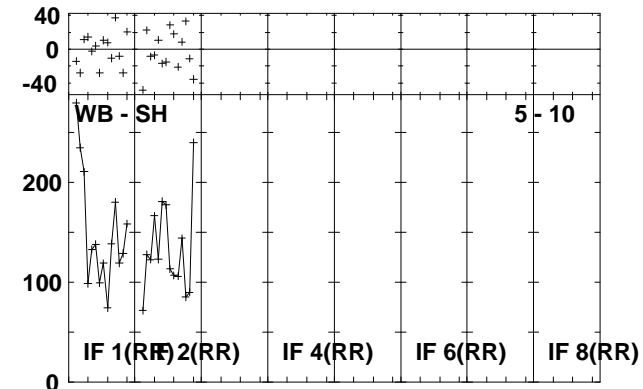
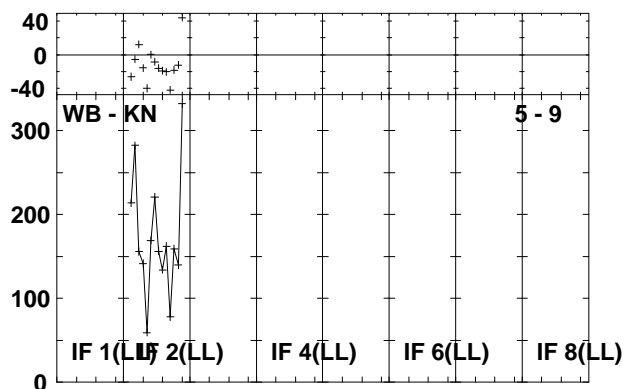
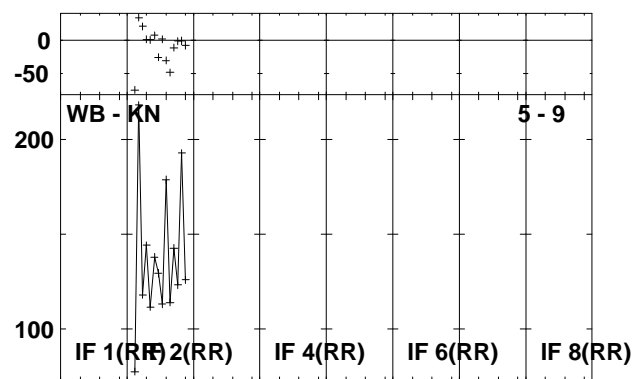
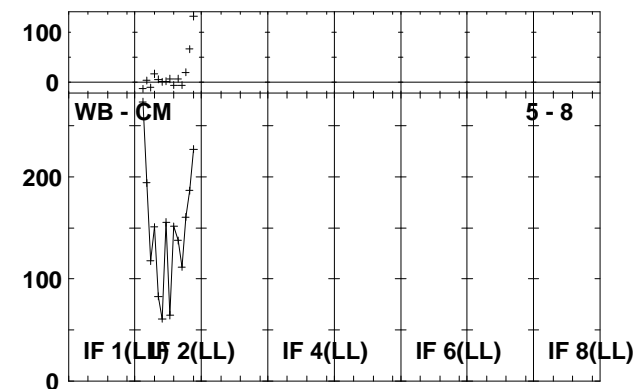
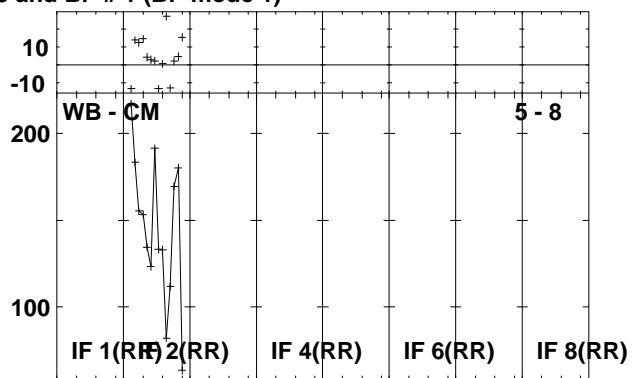
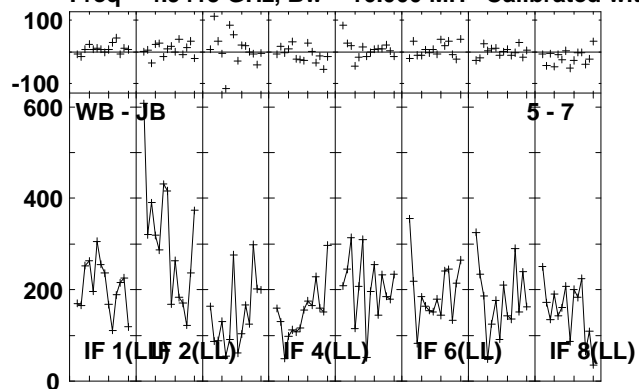

Lower frame: Milli Ampl Jy Top frame: Phas deg

Vector averaged cross-power spectrum Several baselines displayed

Timerange: 00/13:18:21 to 00/13:19:19

Plot file version 23 created 21-MAY-2010 15:44:57

CALG RSD03.UVDATA.1

Freq = 4.9415 GHz, Bw = 16.000 MH Calibrated with CL # 3 and BP # 1 (BP mode 1)

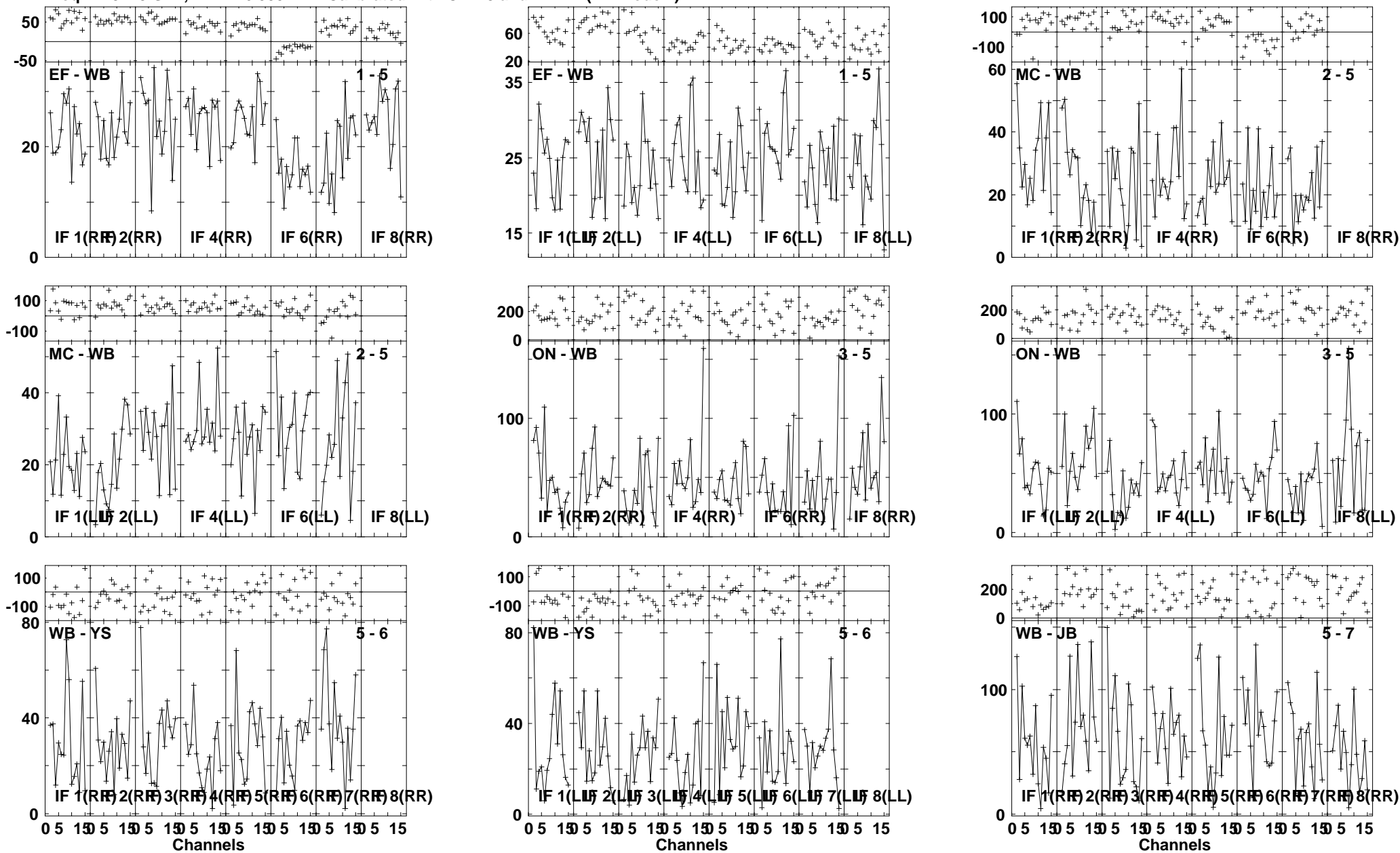

Lower frame: Milli Ampl Jy Top frame: Phas deg
Vector averaged cross-power spectrum Several baselines displayed
Timerange: 00/13:19:21 to 00/13:21:49

Plot file version 24 created 21-MAY-2010 15:44:59

CALG RSD03.UVDATA.1

Freq = 4.9415 GHz, Bw = 16.000 MH Calibrated with CL # 3 and BP # 1 (BP mode 1)

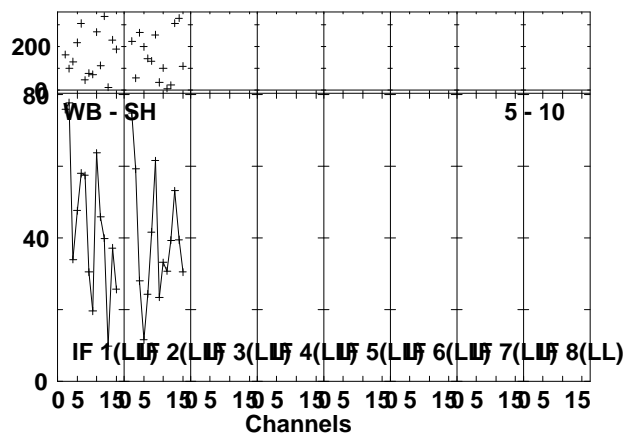
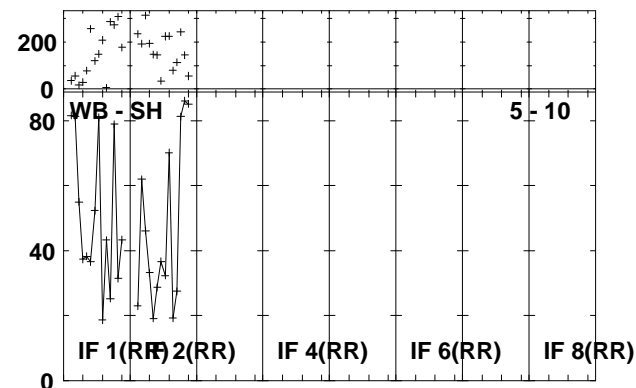
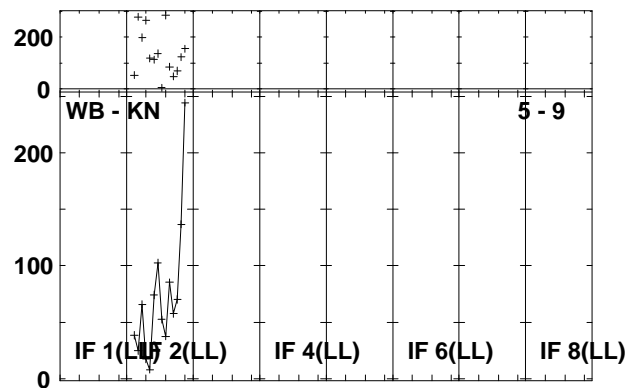
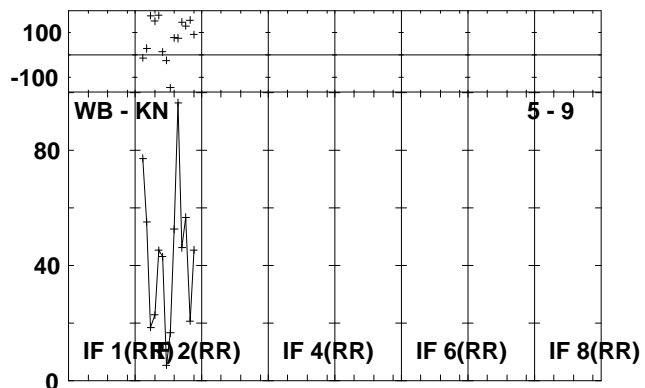
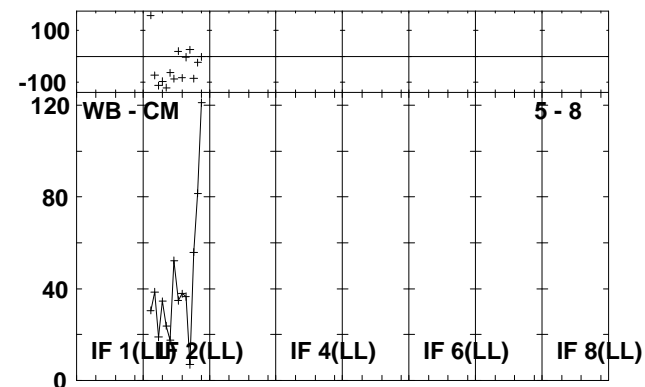
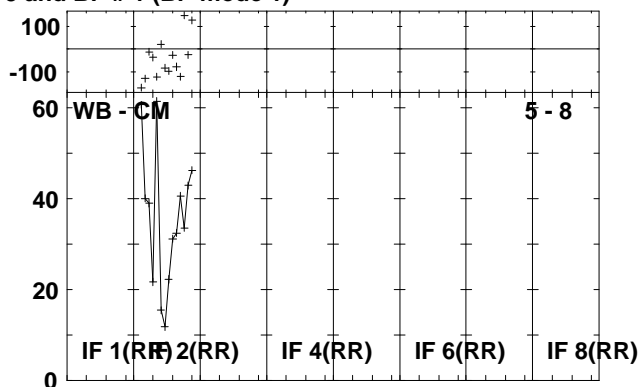
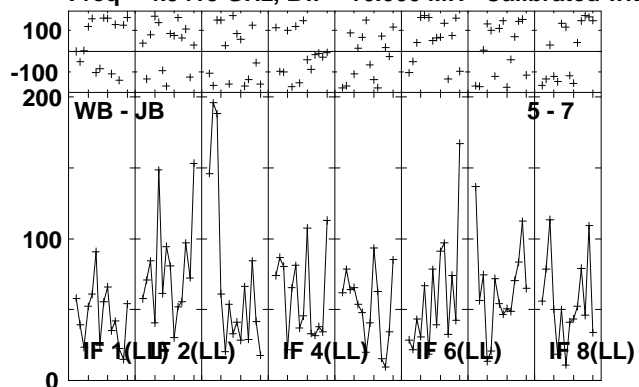

Lower frame: Milli Ampl Jy Top frame: Phas deg
Vector averaged cross-power spectrum Several baselines displayed
Timerange: 00/13:19:21 to 00/13:21:49

Plot file version 25 created 21-MAY-2010 15:45:02

CALE RSD03.UVDATA.1

Freq = 4.9415 GHz, Bw = 16.000 MH Calibrated with CL # 3 and BP # 1 (BP mode 1)

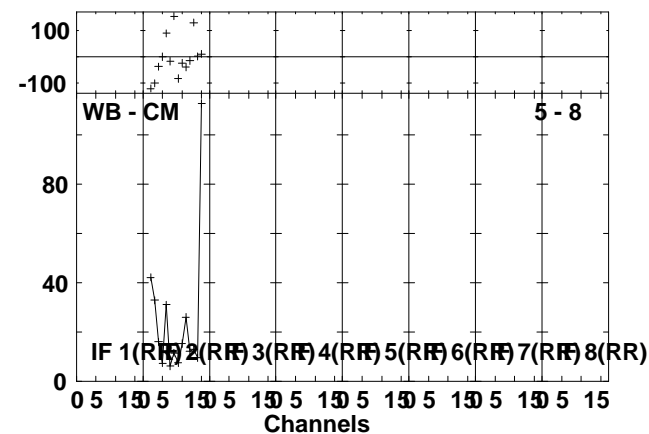
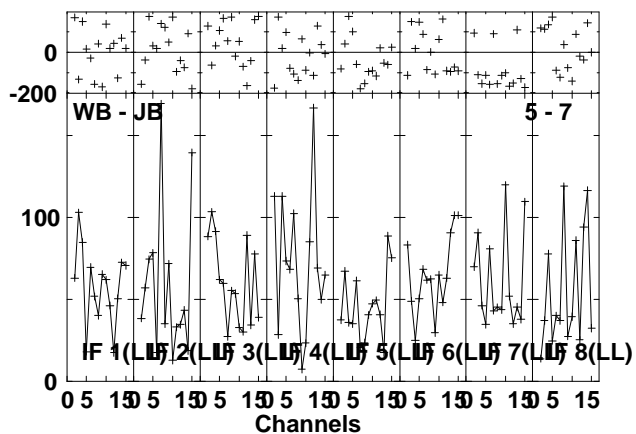
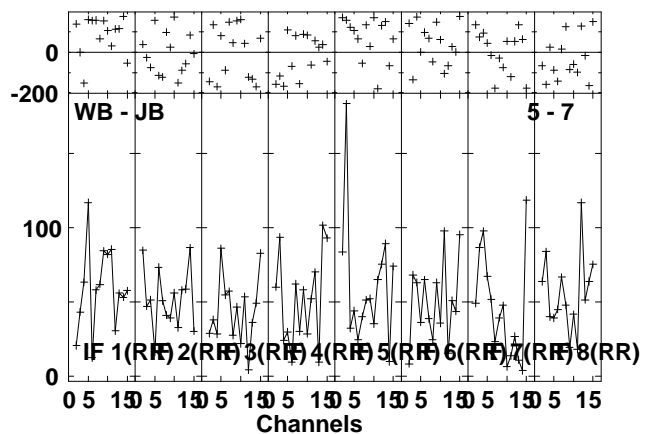
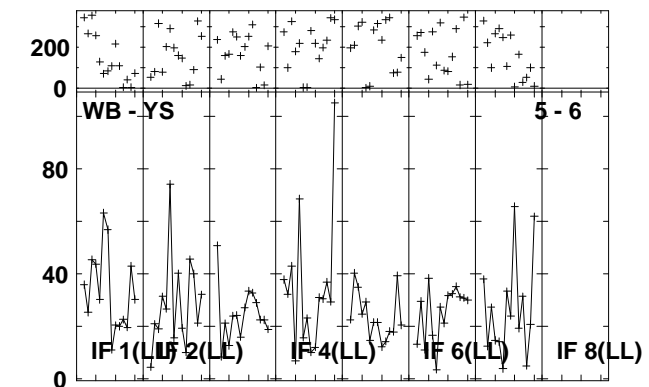
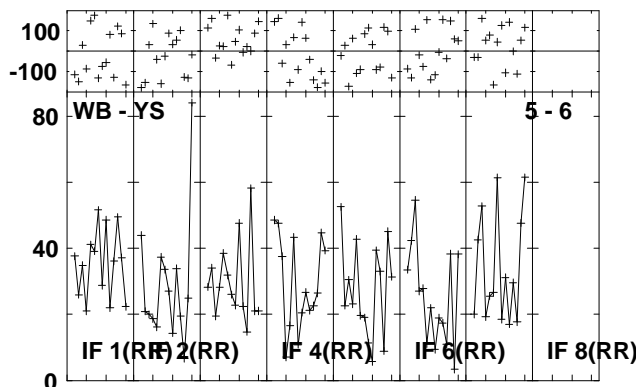
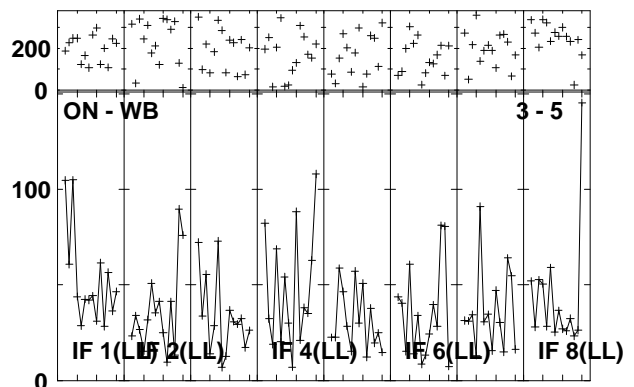
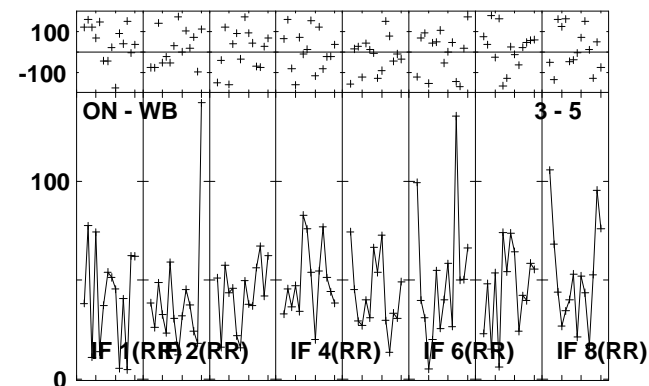
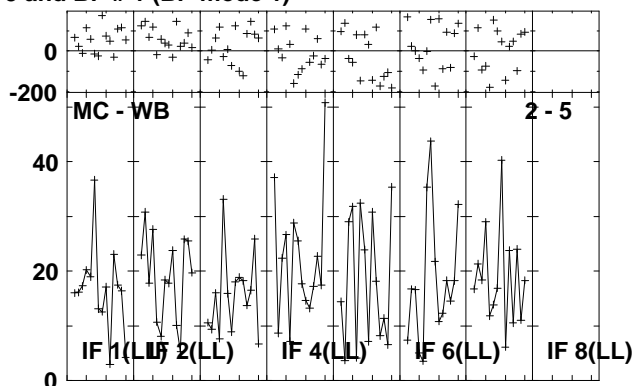
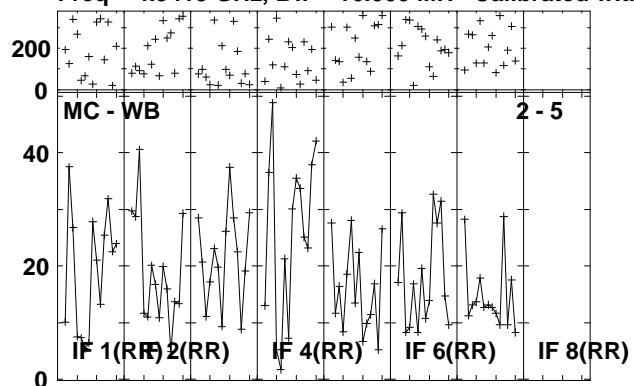

Lower frame: Milli Ampl Jy Top frame: Phas deg
Vector averaged cross-power spectrum Several baselines displayed
Timerange: 00/13:21:51 to 00/13:24:19

Plot file version 26 created 21-MAY-2010 15:45:04

CALE RSD03.UVDATA.1

Freq = 4.9415 GHz, Bw = 16.000 MH Calibrated with CL # 3 and BP # 1 (BP mode 1)

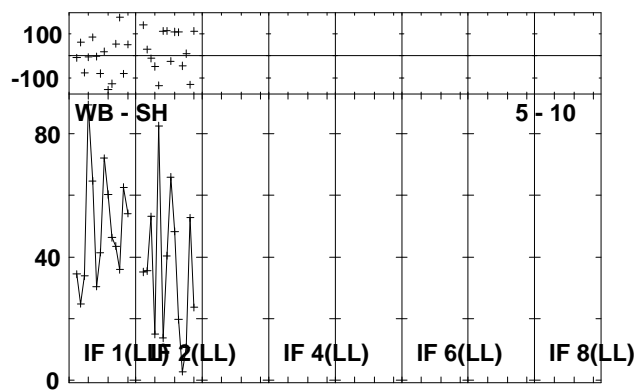
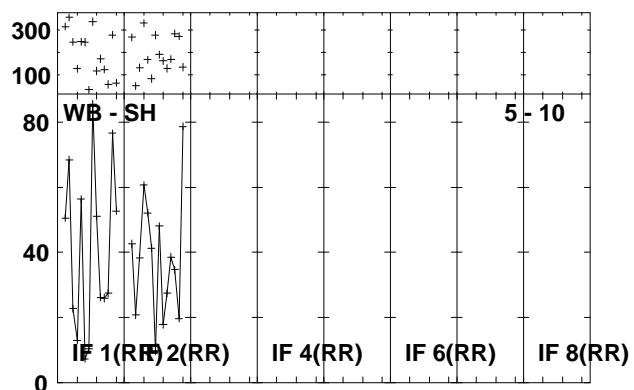
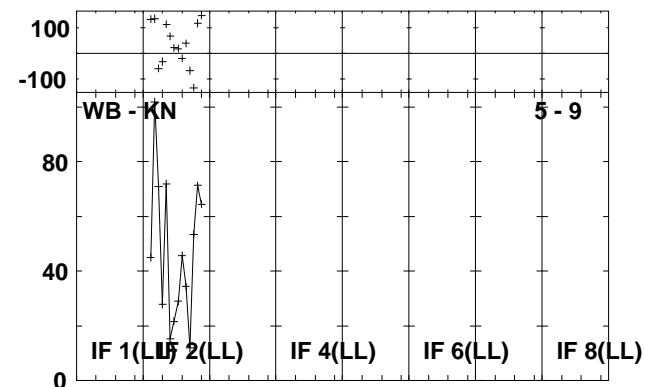
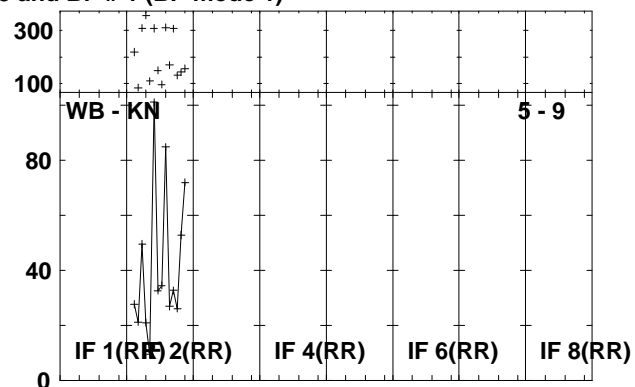
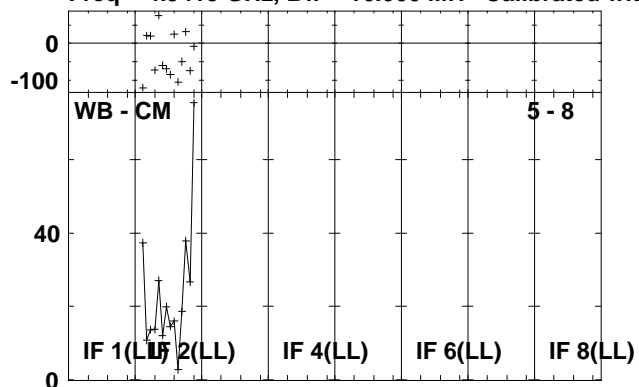

Lower frame: Milli Ampl Jy Top frame: Phas deg
Vector averaged cross-power spectrum Several baselines displayed
Timerange: 00/13:21:51 to 00/13:24:19

Plot file version 27 created 21-MAY-2010 15:45:06

J0909+02 RSD03.UVDATA.1

Freq = 4.9415 GHz, Bw = 16.000 MH Calibrated with CL # 3 and BP # 1 (BP mode 1)

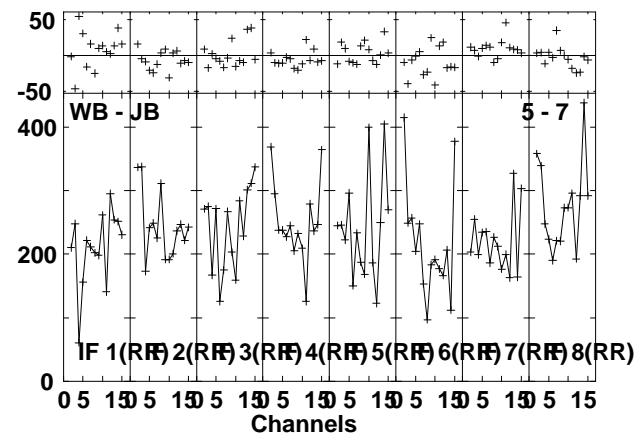
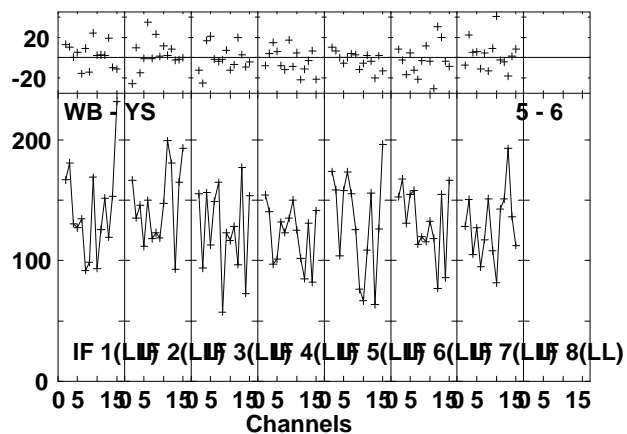
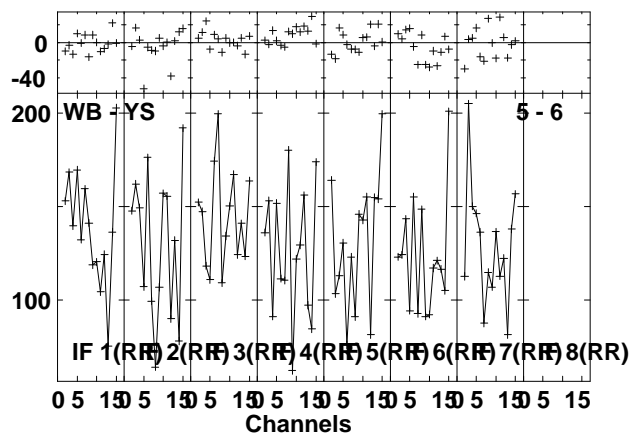
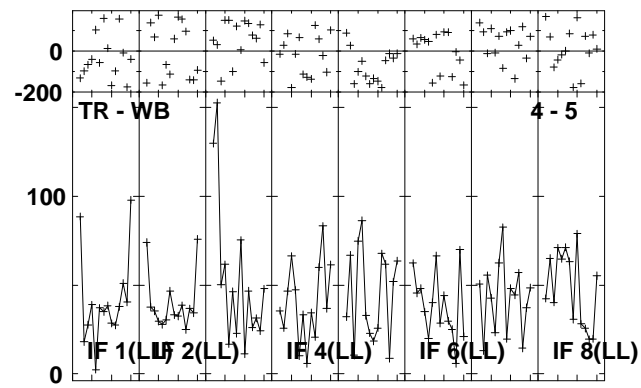
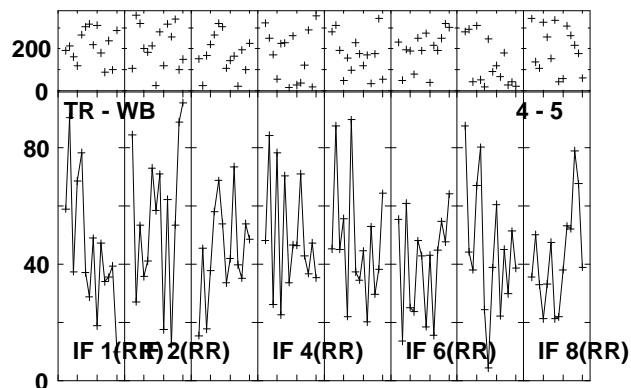
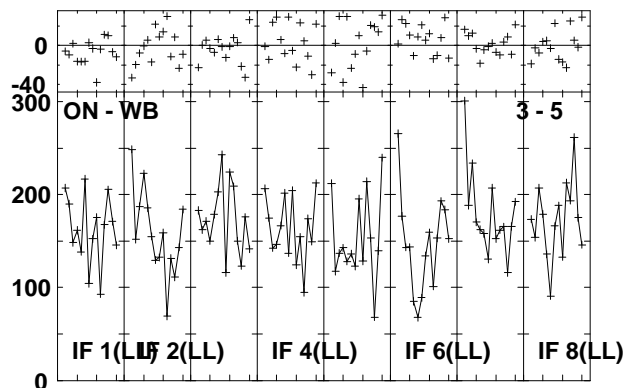
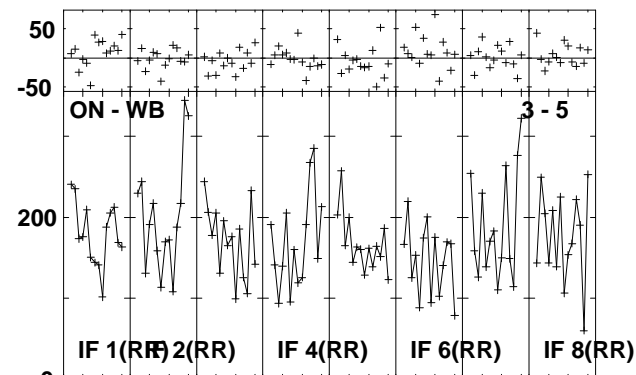
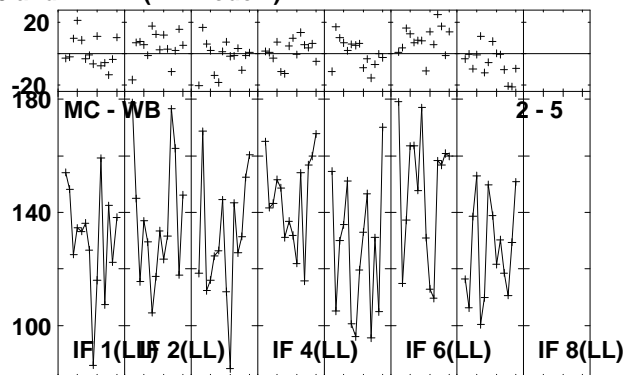
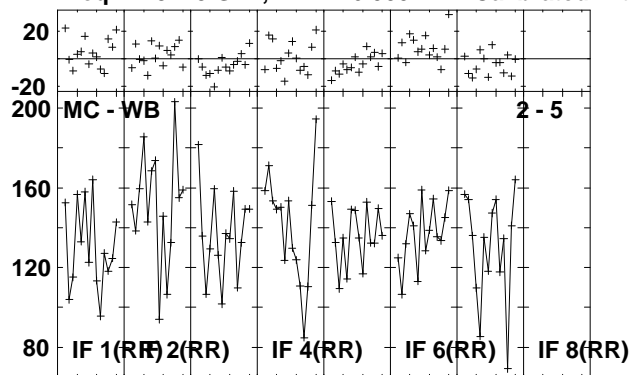

Lower frame: Milli Ampl Jy Top frame: Phas deg
Vector averaged cross-power spectrum Several baselines displayed
Timerange: 00/13:25:01 to 00/13:25:59

Plot file version 28 created 21-MAY-2010 15:45:06

J0909+02 RSD03.UVDATA.1

Freq = 4.9415 GHz, Bw = 16.000 MH Calibrated with CL # 3 and BP # 1 (BP mode 1)

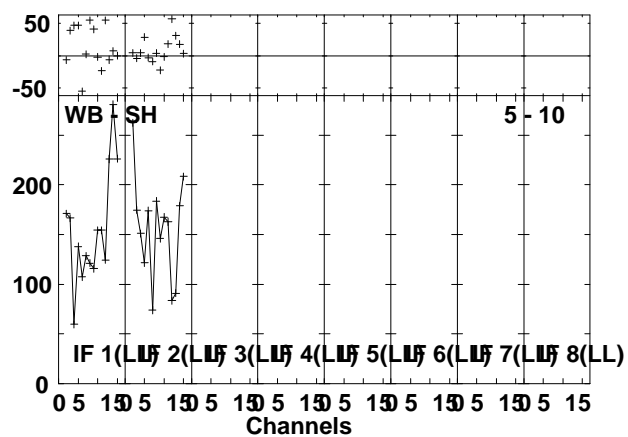
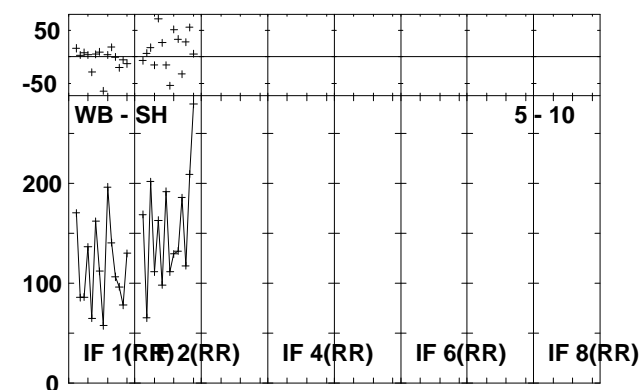
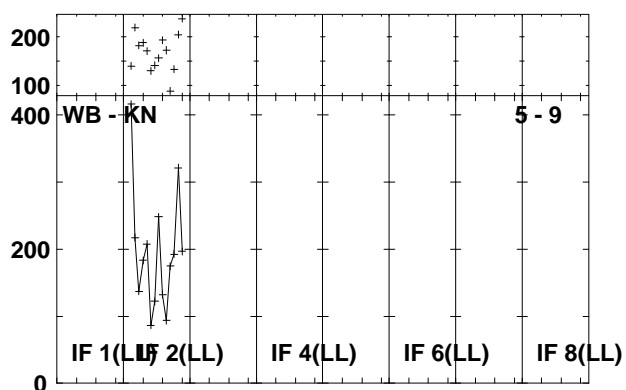
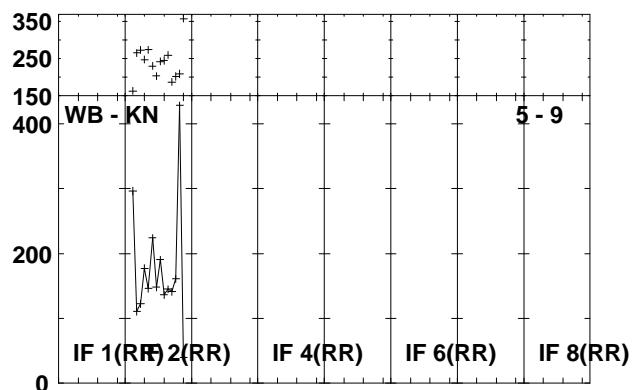
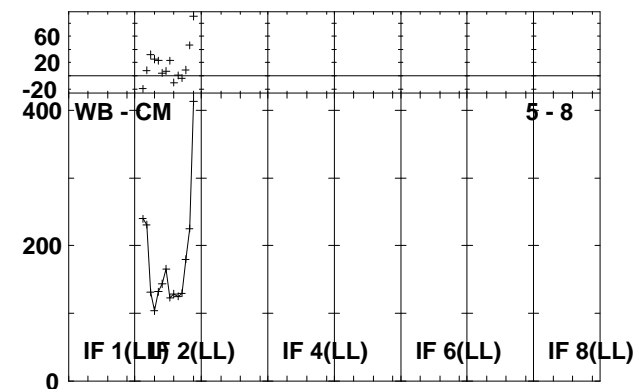
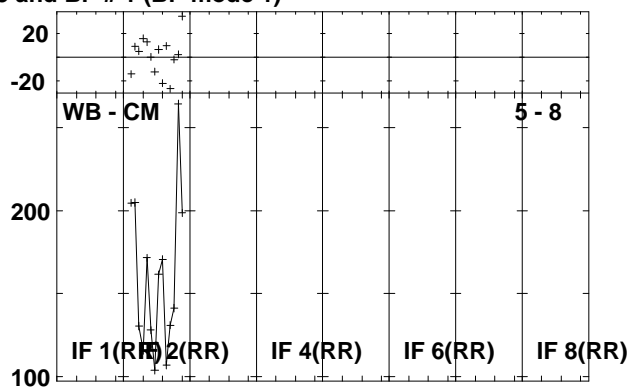
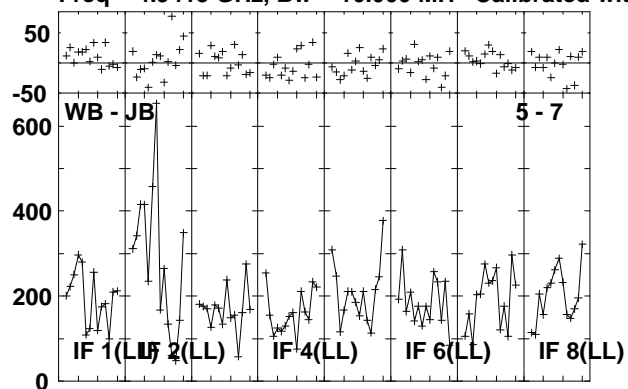

Lower frame: Milli Ampl Jy Top frame: Phas deg
Vector averaged cross-power spectrum Several baselines displayed
Timerange: 00/13:25:01 to 00/13:25:59

Plot file version 29 created 21-MAY-2010 15:45:08

CALI RSD03.UVDATA.1

Freq = 4.9415 GHz, Bw = 16.000 MH Calibrated with CL # 3 and BP # 1 (BP mode 1)

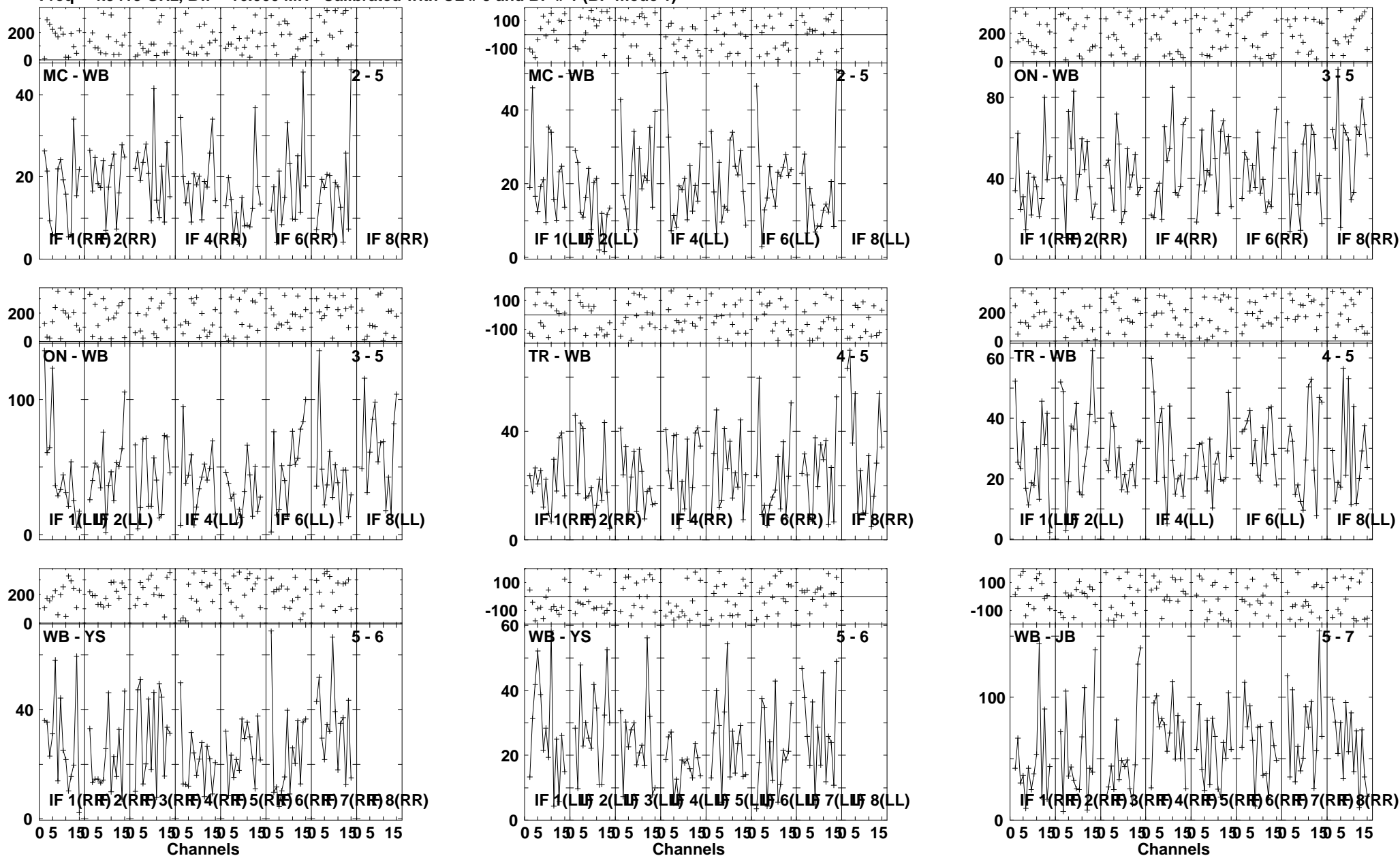

Lower frame: Milli Ampl Jy Top frame: Phas deg
Vector averaged cross-power spectrum Several baselines displayed
Timerange: 00/13:26:01 to 00/13:28:29

Plot file version 30 created 21-MAY-2010 15:45:10

CALI RSD03.UVDATA.1

Freq = 4.9415 GHz, Bw = 16.000 MH Calibrated with CL # 3 and BP # 1 (BP mode 1)

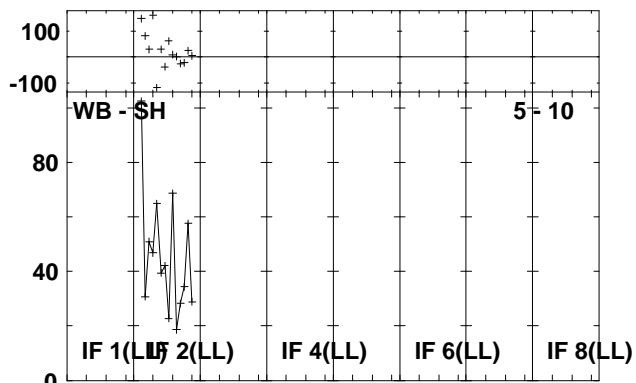
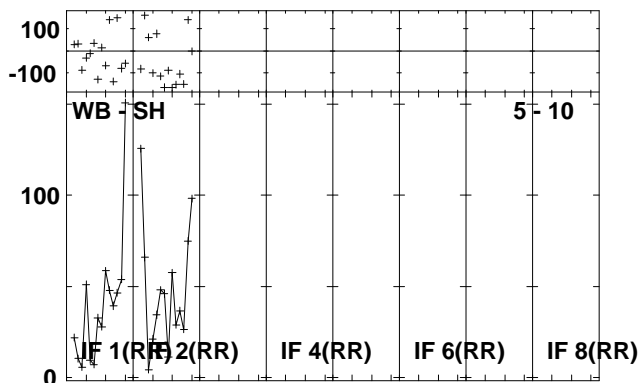
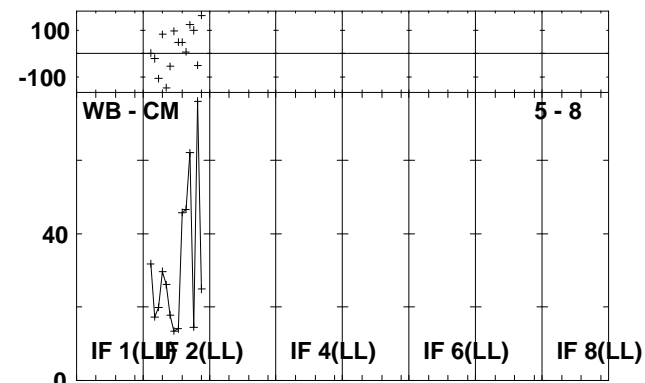
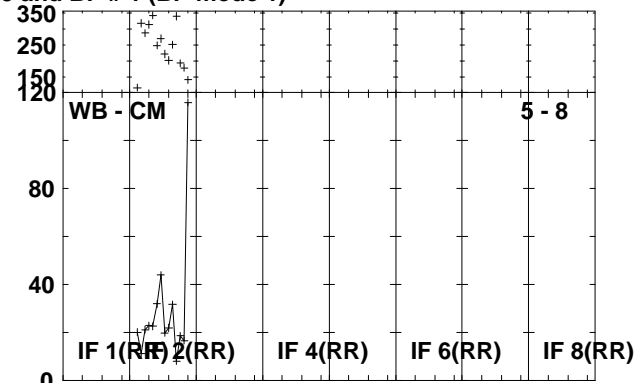
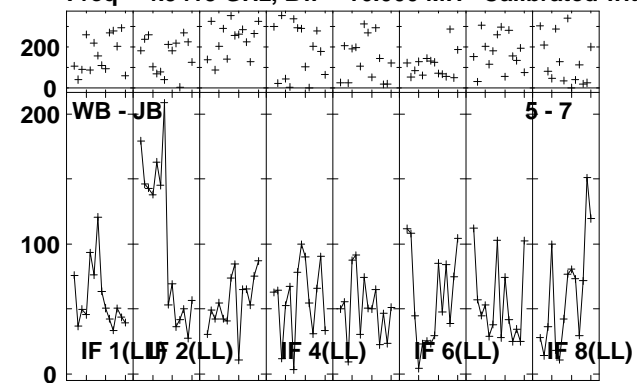

Lower frame: Milli Ampl Jy Top frame: Phas deg
Vector averaged cross-power spectrum Several baselines displayed
Timerange: 00/13:26:01 to 00/13:28:29

Plot file version 31 created 21-MAY-2010 15:45:13

CALH RSD03.UVDATA.1

Freq = 4.9415 GHz, Bw = 16.000 MH Calibrated with CL # 3 and BP # 1 (BP mode 1)

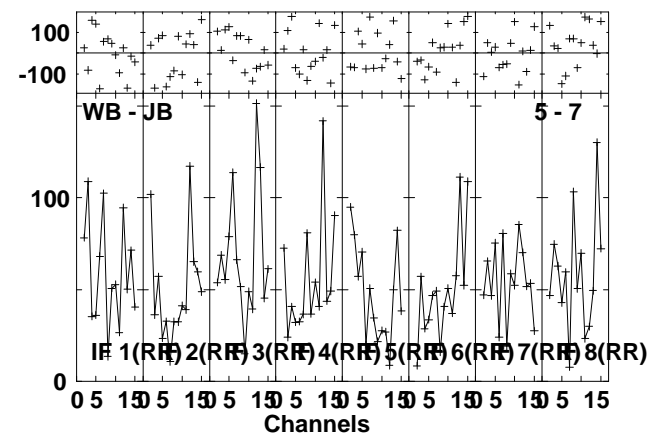
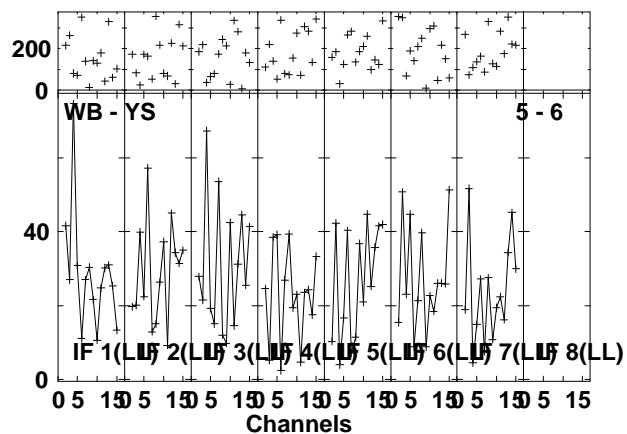
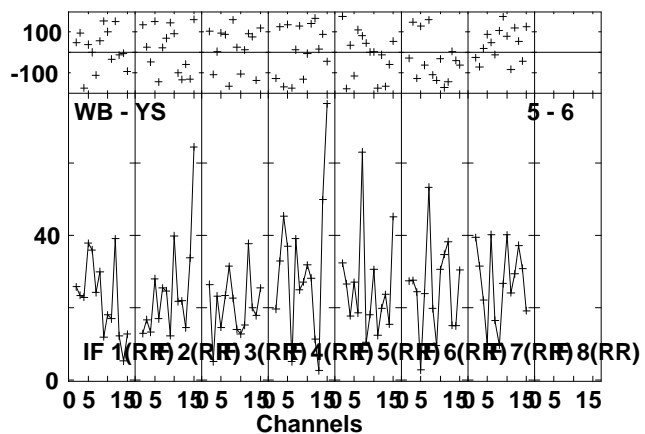
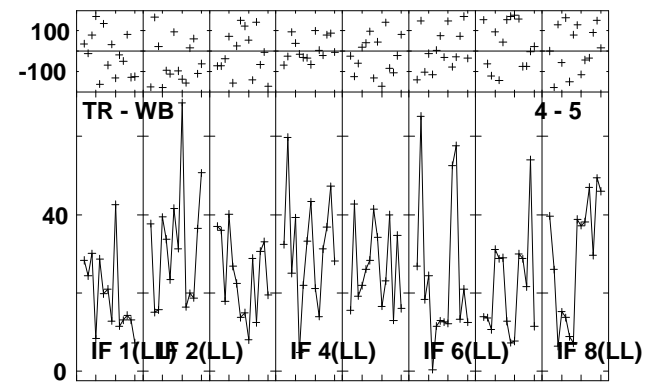
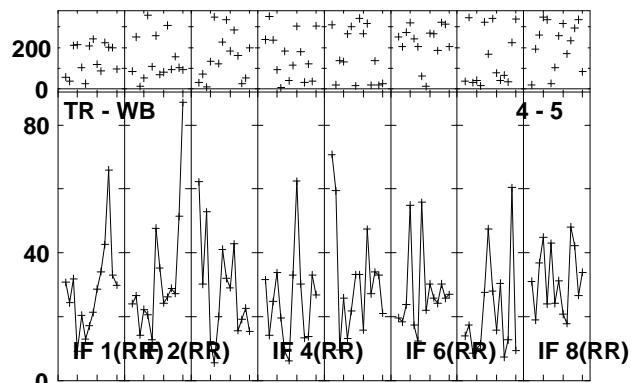
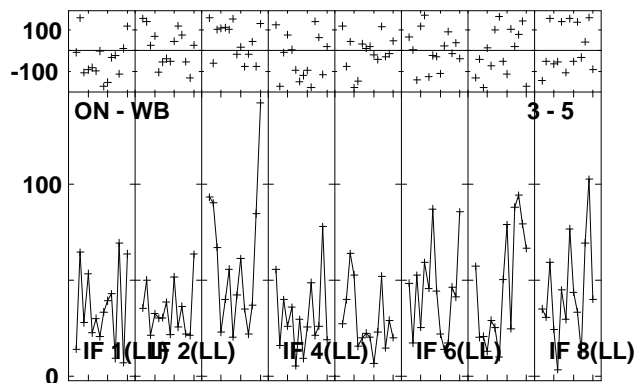
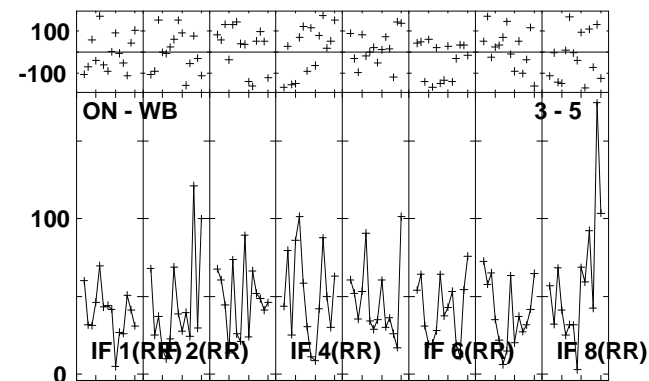
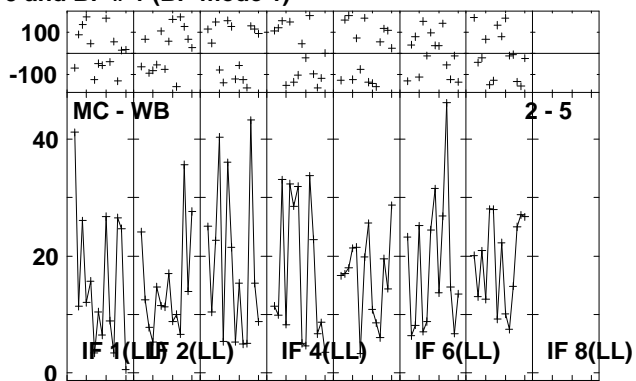
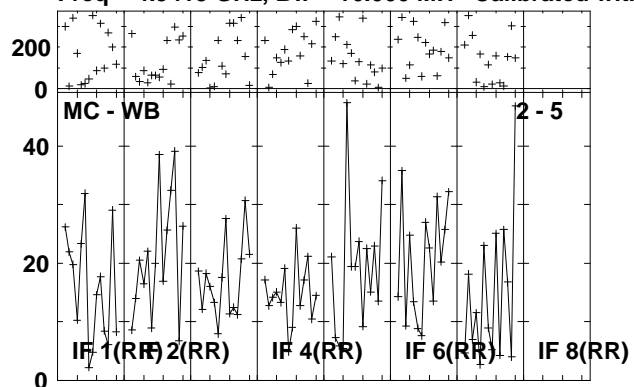

Lower frame: Milli Ampl Jy Top frame: Phas deg
Vector averaged cross-power spectrum Several baselines displayed
Timerange: 00/13:28:31 to 00/13:30:59

Plot file version 32 created 21-MAY-2010 15:45:15

CALH RSD03.UVDATA.1

Freq = 4.9415 GHz, Bw = 16.000 MH Calibrated with CL # 3 and BP # 1 (BP mode 1)

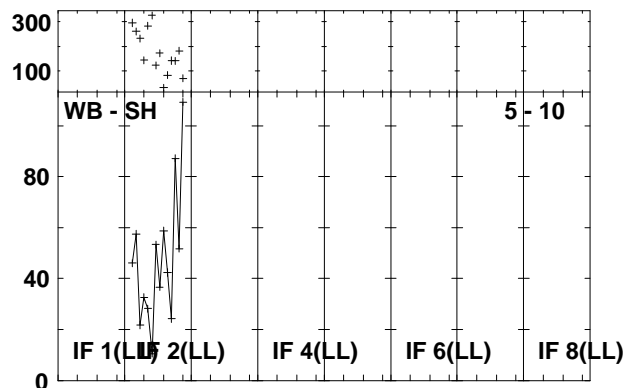
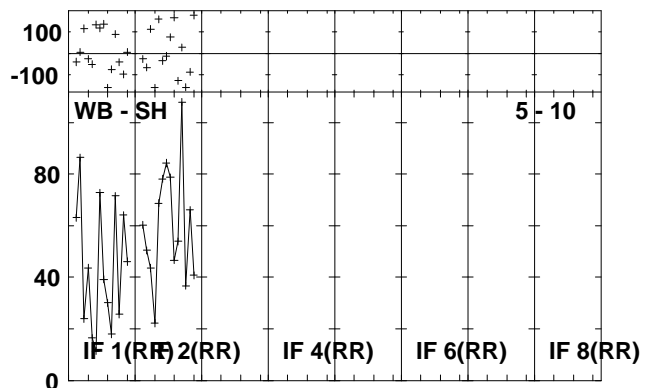
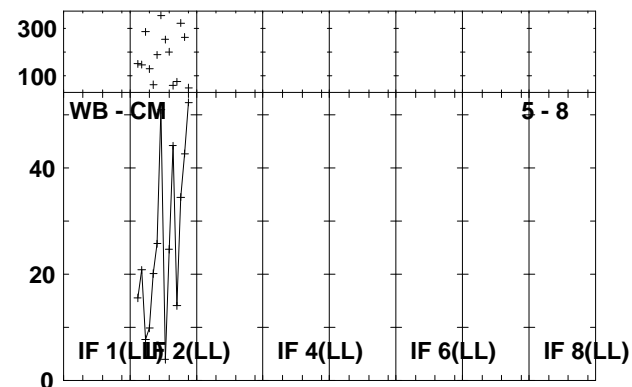
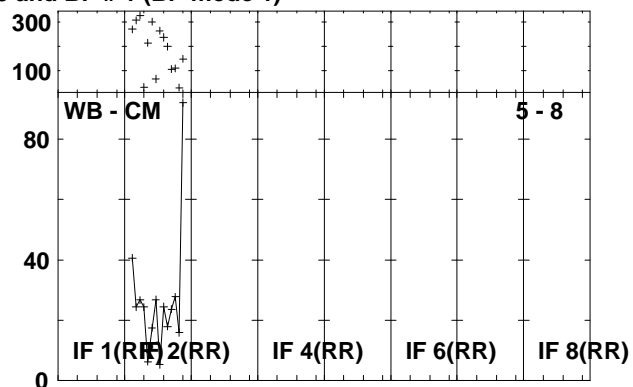
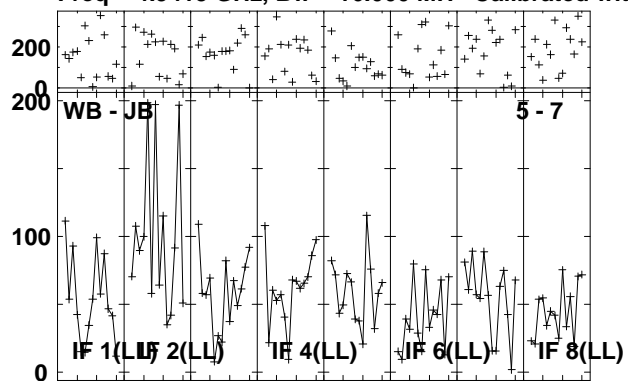

Lower frame: Milli Ampl Jy Top frame: Phas deg
Vector averaged cross-power spectrum Several baselines displayed
Timerange: 00/13:28:31 to 00/13:30:59

Plot file version 33 created 21-MAY-2010 15:45:17

CALJ RSD03.UVDATA.1

Freq = 4.9415 GHz, Bw = 16.000 MH Calibrated with CL # 3 and BP # 1 (BP mode 1)

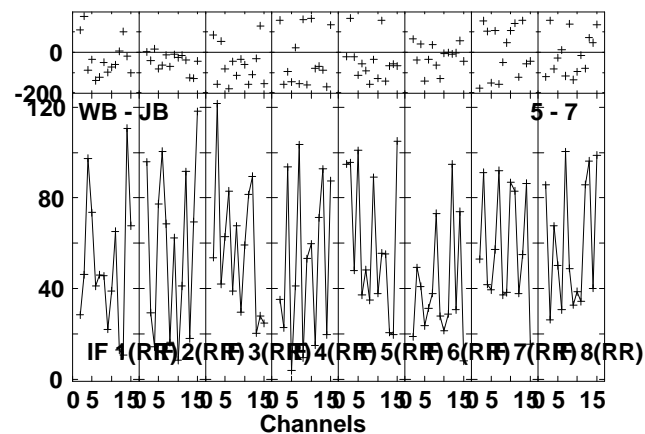
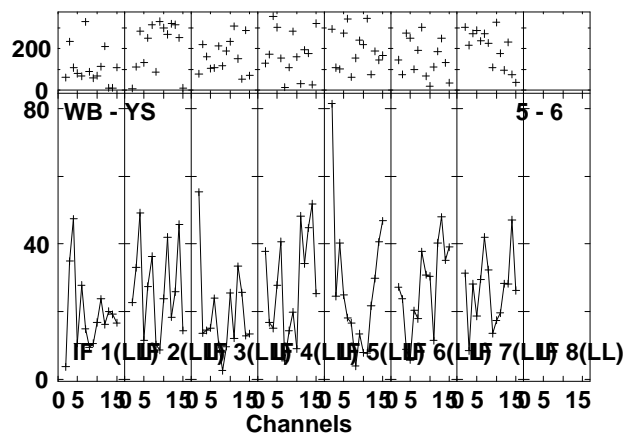
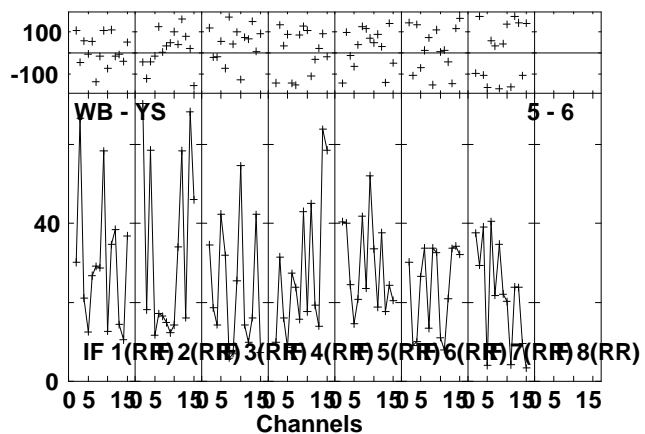
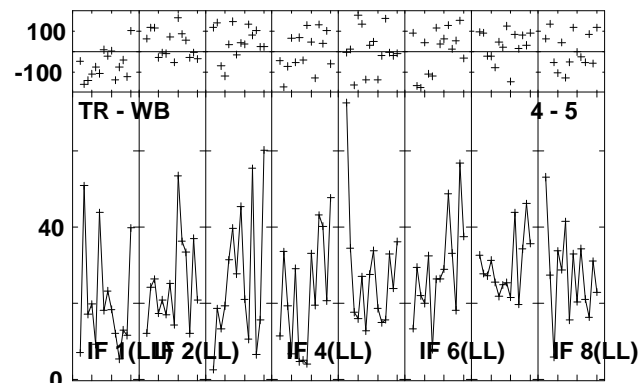
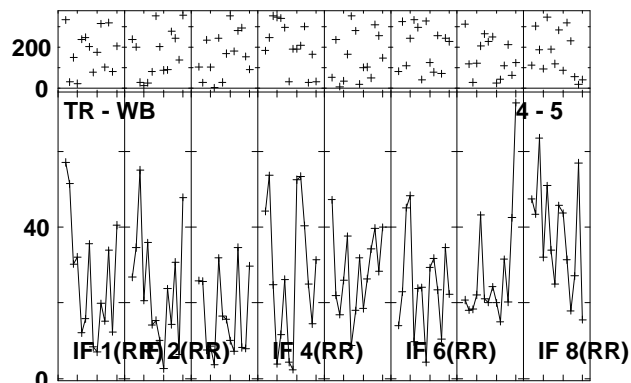
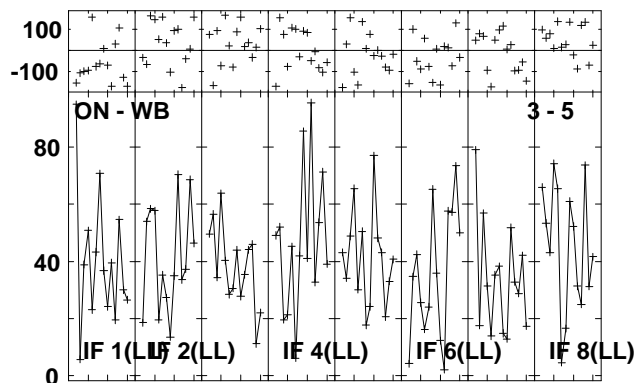
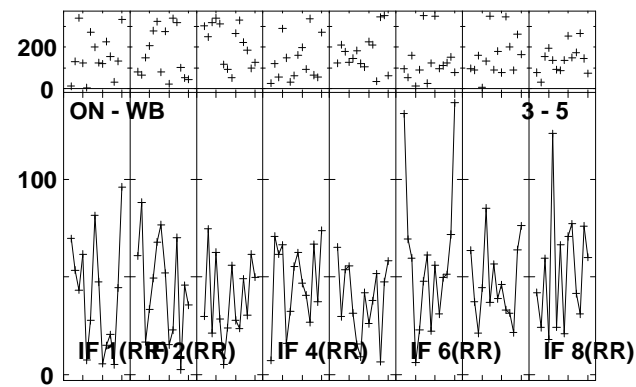
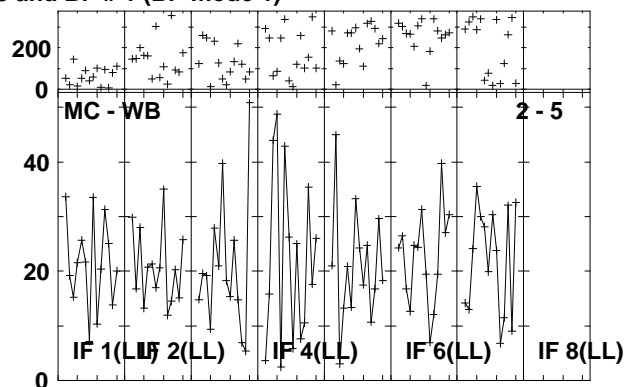
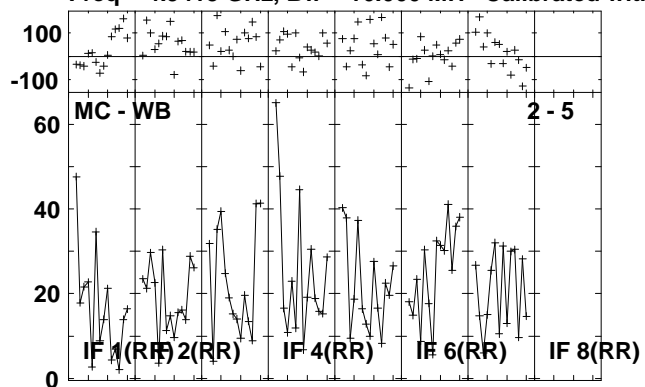

Lower frame: Milli Ampl Jy Top frame: Phas deg
Vector averaged cross-power spectrum Several baselines displayed
Timerange: 00/13:31:01 to 00/13:33:29

Plot file version 34 created 21-MAY-2010 15:45:19

CALJ RSD03.UVDATA.1

Freq = 4.9415 GHz, Bw = 16.000 MH Calibrated with CL # 3 and BP # 1 (BP mode 1)

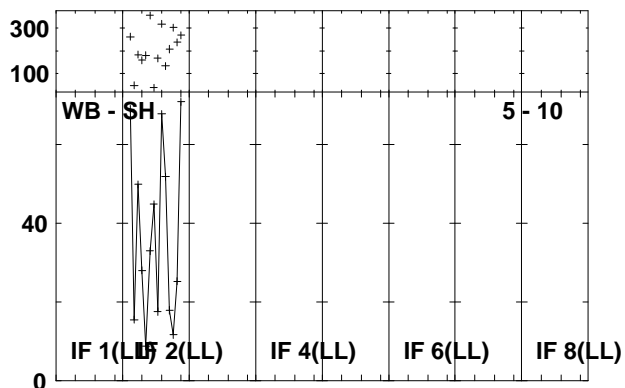
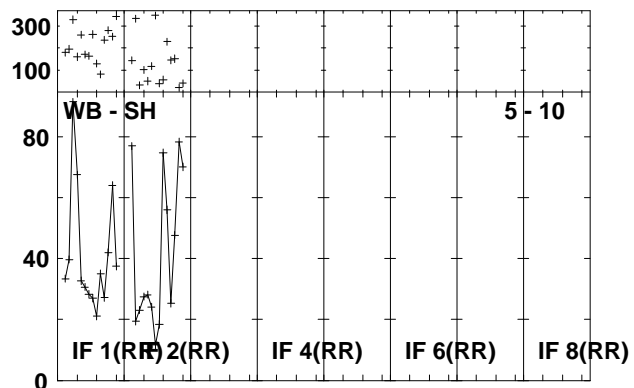
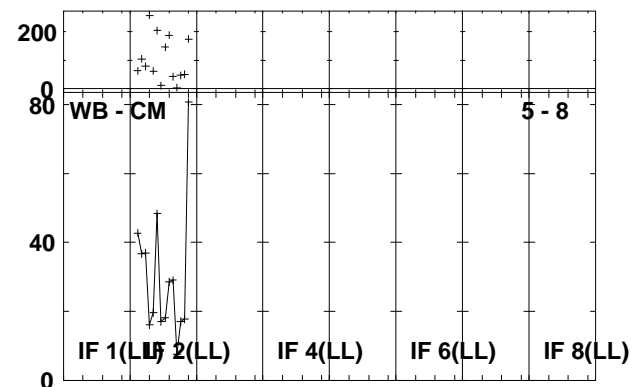
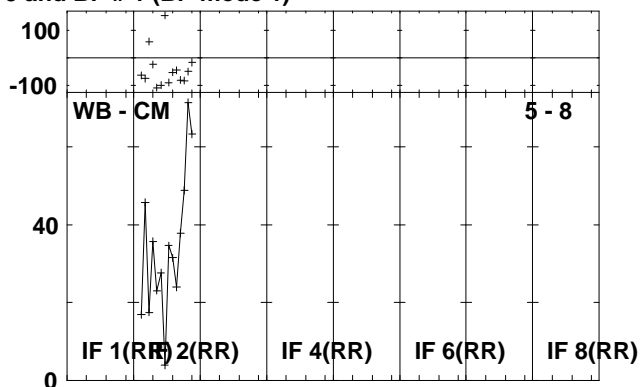
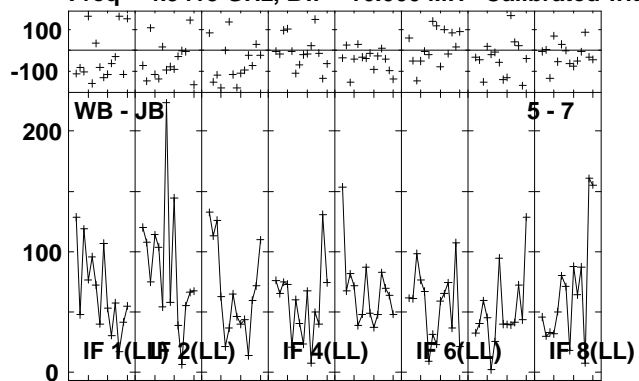

Lower frame: Milli Ampl Jy Top frame: Phas deg
Vector averaged cross-power spectrum Several baselines displayed
Timerange: 00/13:31:01 to 00/13:33:29

Plot file version 35 created 21-MAY-2010 15:45:21

J0909+02 RSD03.UVDATA.1

Freq = 4.9415 GHz, Bw = 16.000 MH Calibrated with CL # 3 and BP # 1 (BP mode 1)

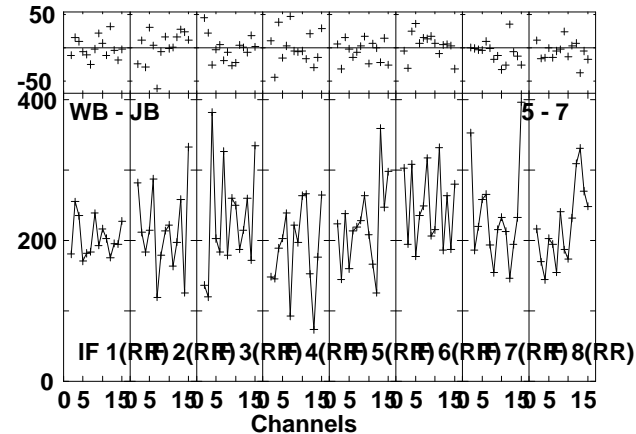
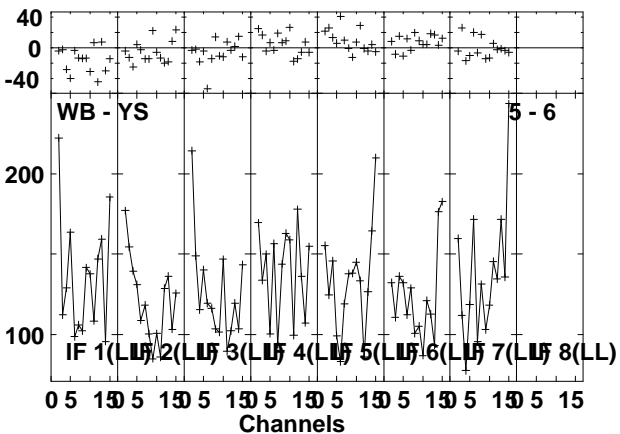
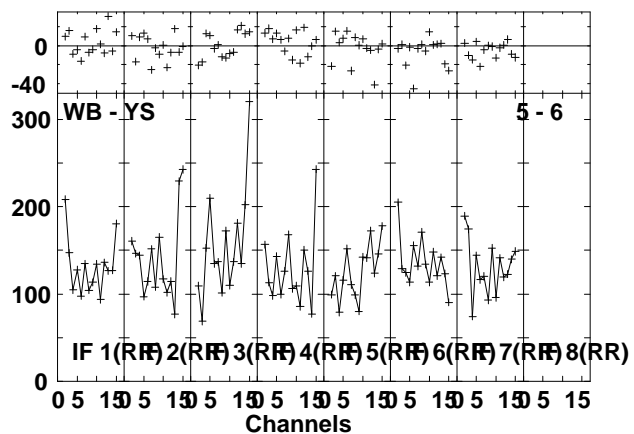
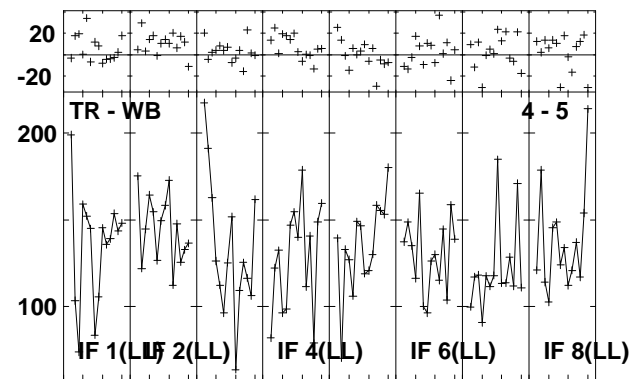
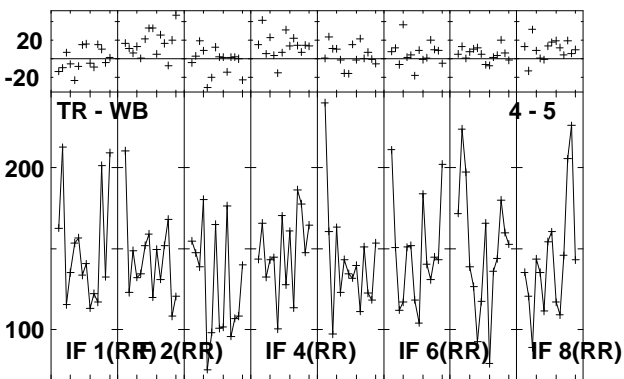
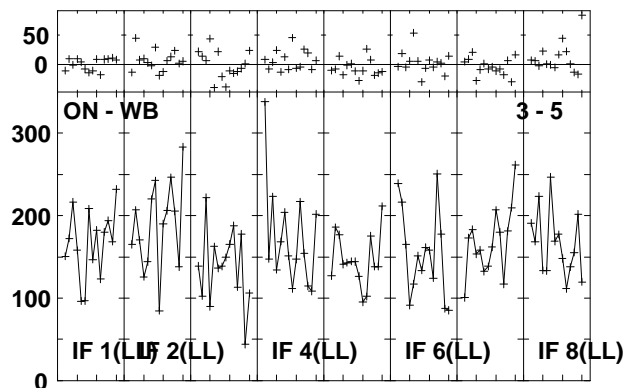
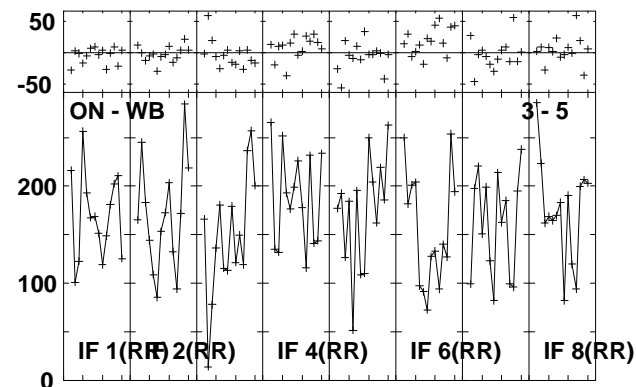
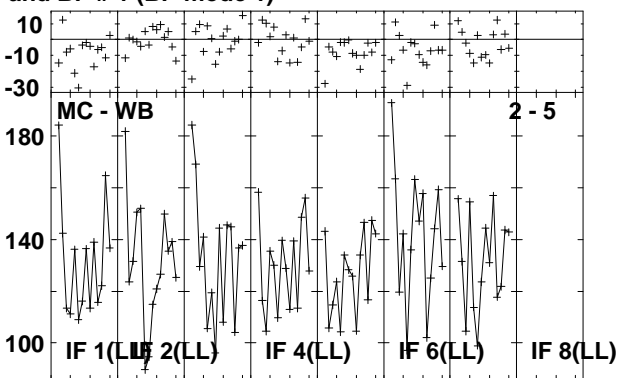
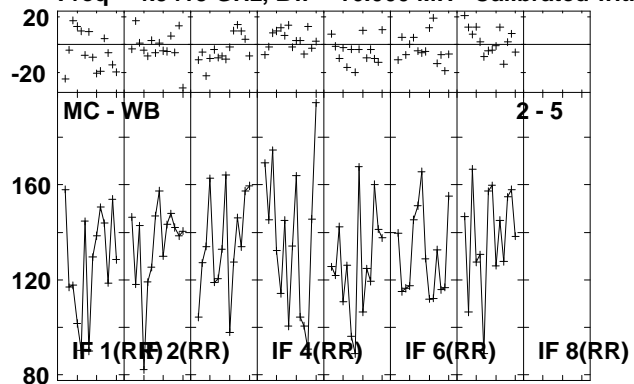

Lower frame: Milli Ampl Jy Top frame: Phas deg
Vector averaged cross-power spectrum Several baselines displayed
Timerange: 00/13:34:11 to 00/13:35:09

Plot file version 36 created 21-MAY-2010 15:45:22

J0909+02 RSD03.UVDATA.1

Freq = 4.9415 GHz, Bw = 16.000 MH Calibrated with CL # 3 and BP # 1 (BP mode 1)

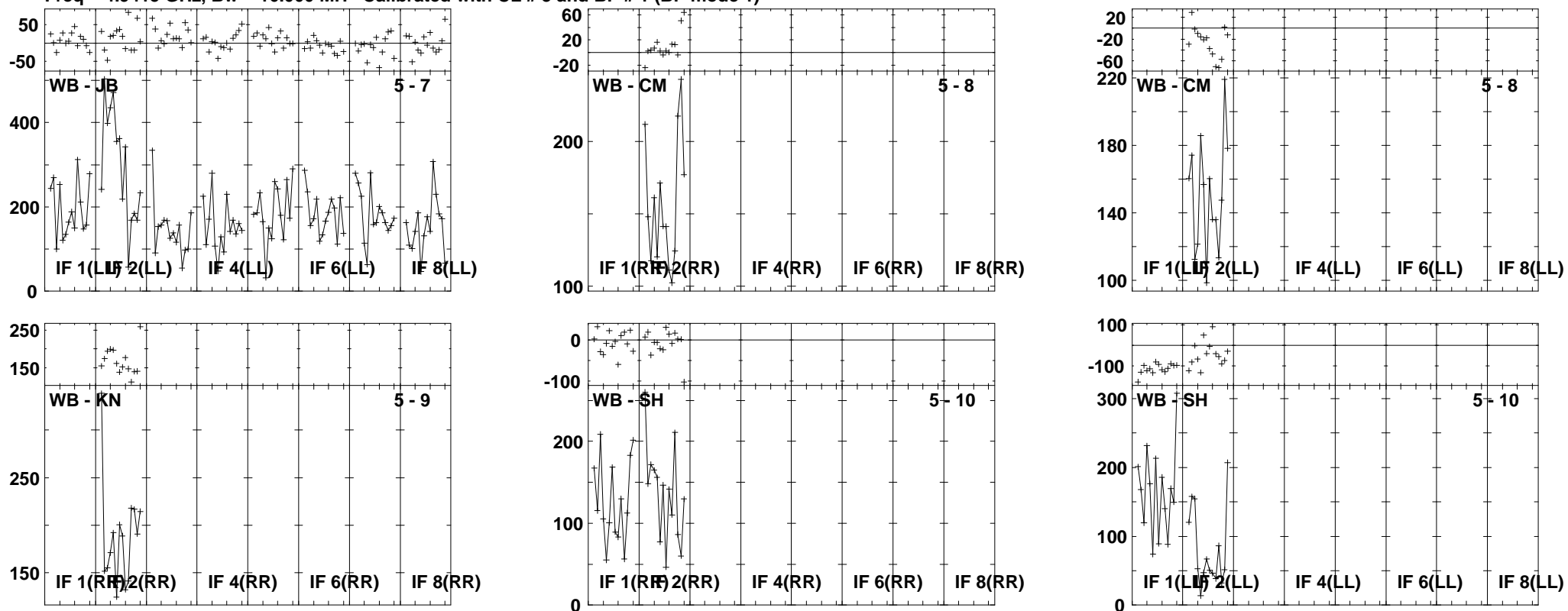

Lower frame: Milli Ampl Jy Top frame: Phas deg
Vector averaged cross-power spectrum Several baselines displayed
Timerange: 00/13:34:11 to 00/13:35:09

Plot file version 37 created 21-MAY-2010 15:45:24

CALA RSD03.UVDATA.1

Freq = 4.9415 GHz, Bw = 16.000 MH Calibrated with CL # 3 and BP # 1 (BP mode 1)

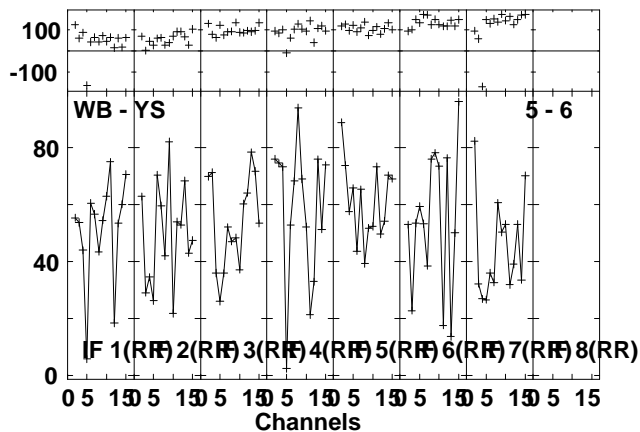
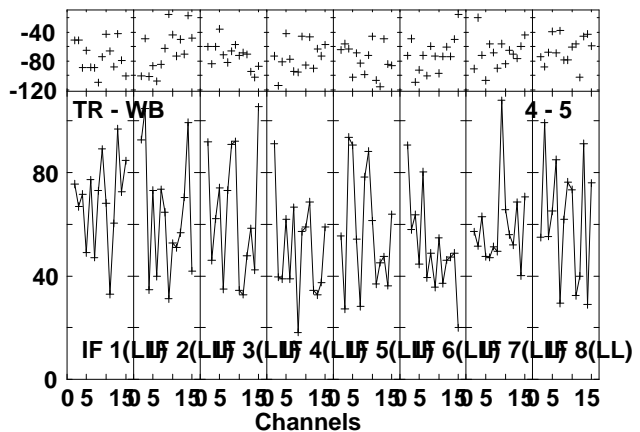
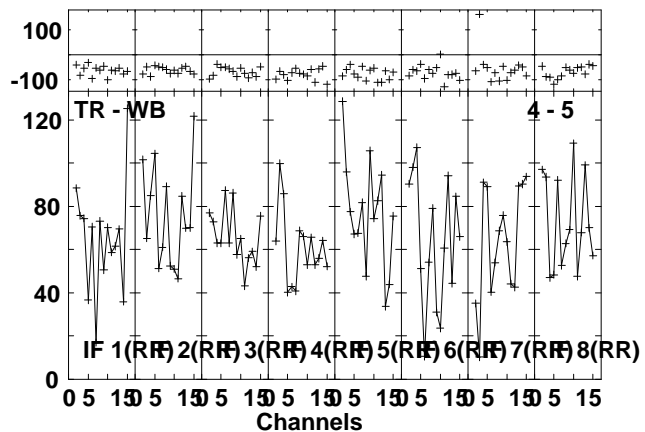
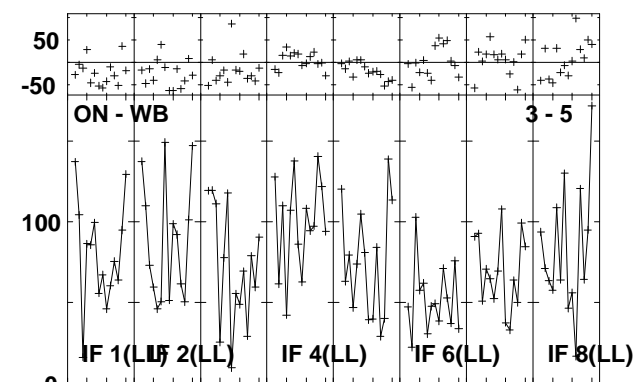
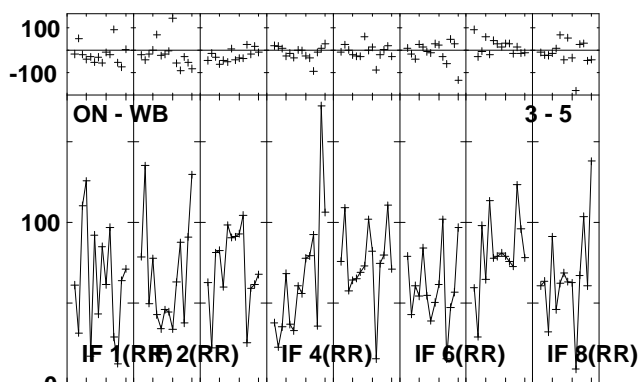
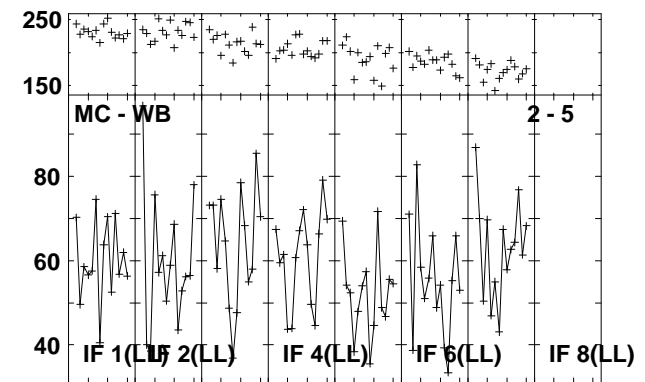
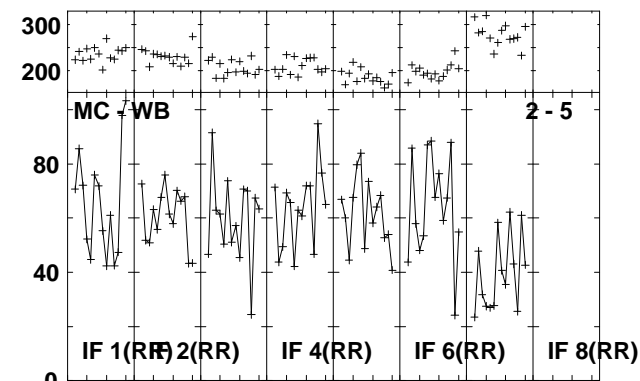
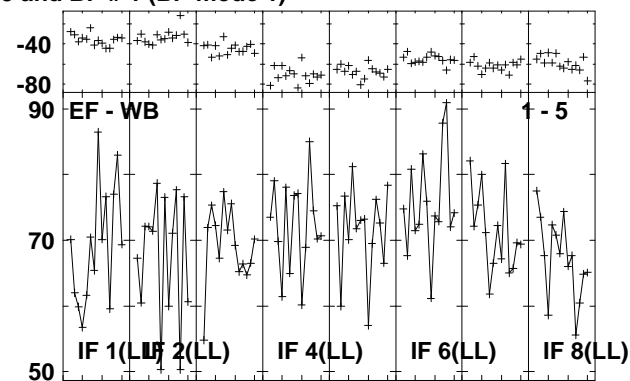
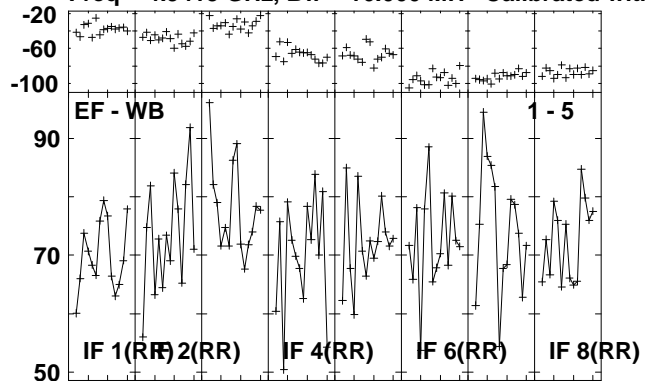

Lower frame: Milli Ampl Jy Top frame: Phas deg
Vector averaged cross-power spectrum Several baselines displayed
Timerange: 00/13:35:11 to 00/13:37:39

Plot file version 38 created 21-MAY-2010 15:45:26

CALA RSD03.UVDATA.1

Freq = 4.9415 GHz, Bw = 16.000 MH Calibrated with CL # 3 and BP # 1 (BP mode 1)

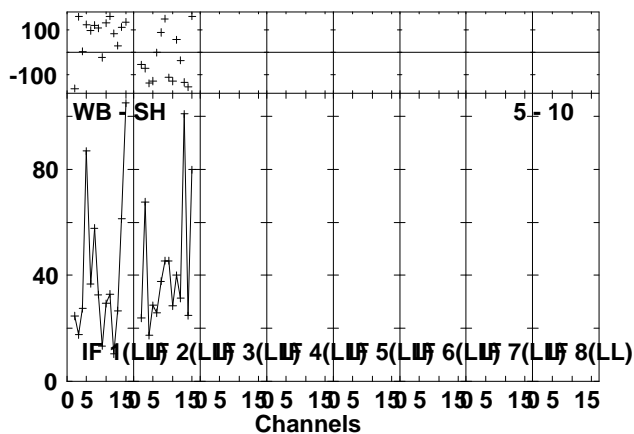
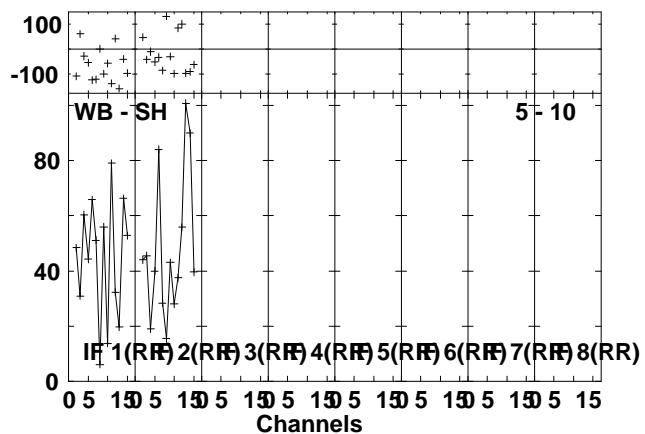
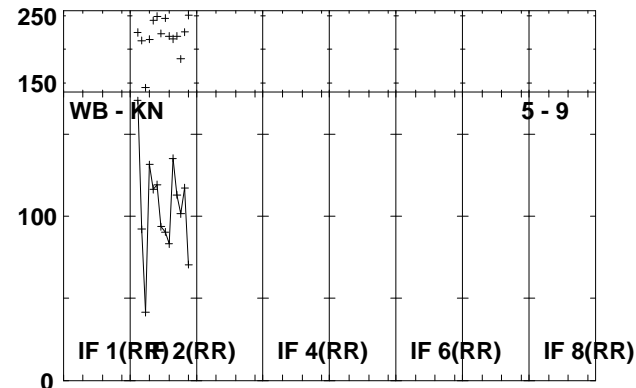
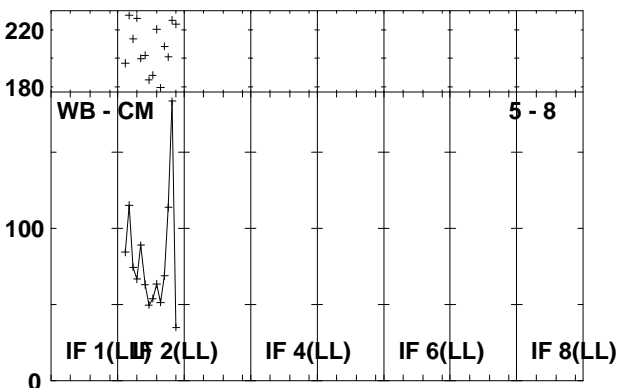
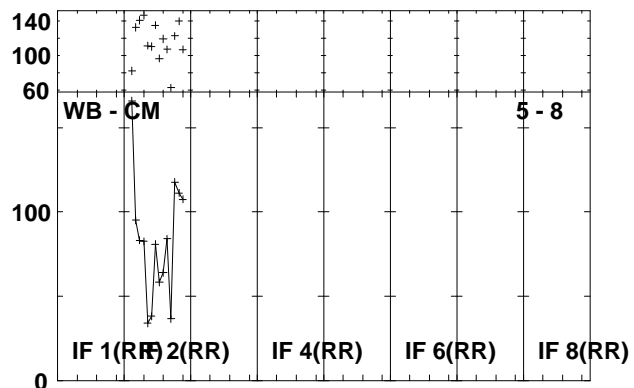
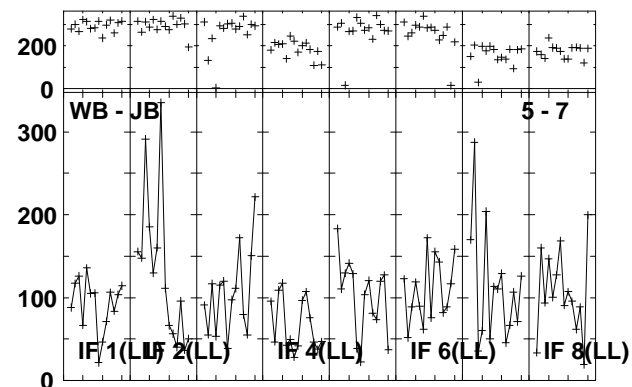
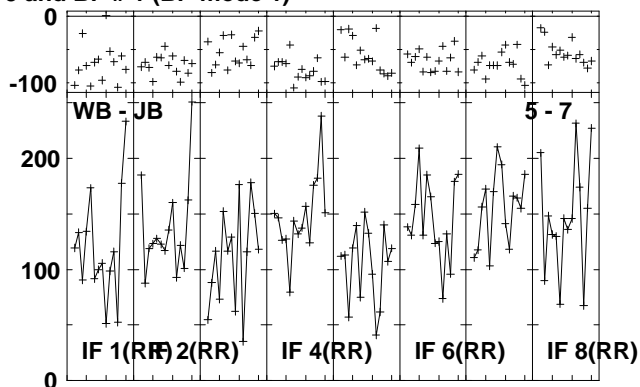
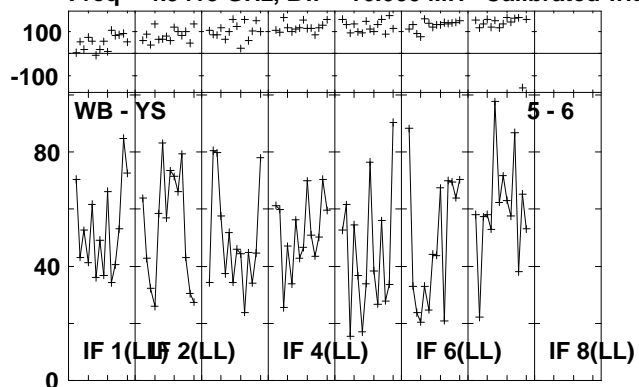

Lower frame: Milli Ampl Jy Top frame: Phas deg
Vector averaged cross-power spectrum Several baselines displayed
Timerange: 00/13:35:11 to 00/13:37:39

Plot file version 39 created 21-MAY-2010 15:45:28

CALK RSD03.UVDATA.1

Freq = 4.9415 GHz, Bw = 16.000 MH Calibrated with CL # 3 and BP # 1 (BP mode 1)

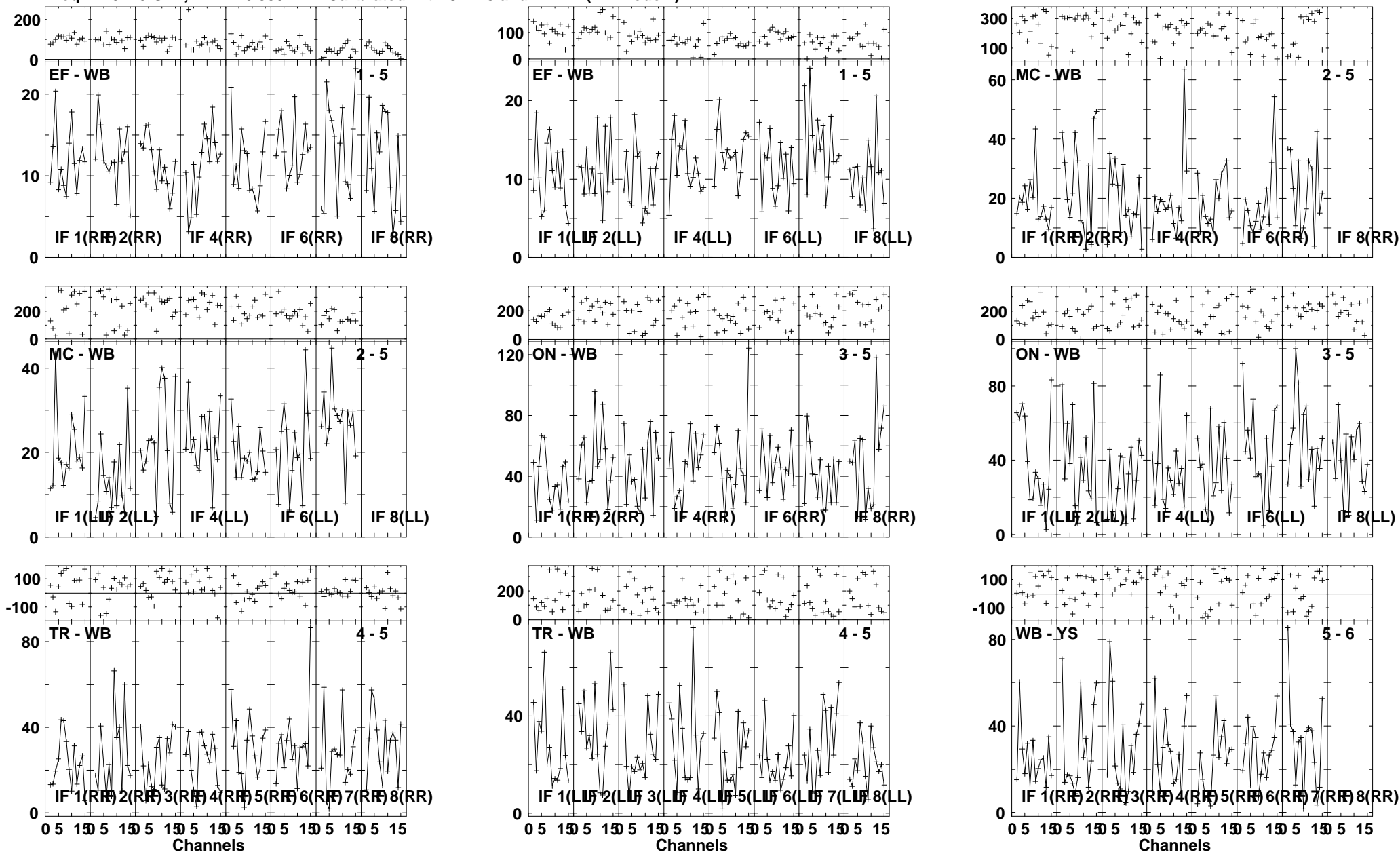

Lower frame: Milli Ampl Jy Top frame: Phas deg
Vector averaged cross-power spectrum Several baselines displayed
Timerange: 00/13:37:41 to 00/13:40:09

Plot file version 40 created 21-MAY-2010 15:45:30

CALK RSD03.UVDATA.1

Freq = 4.9415 GHz, Bw = 16.000 MH Calibrated with CL # 3 and BP # 1 (BP mode 1)

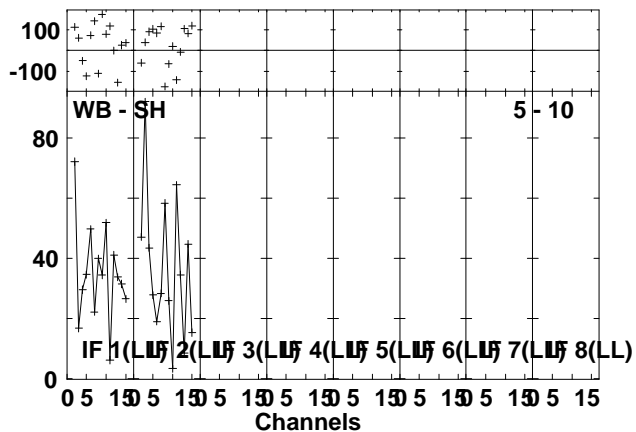
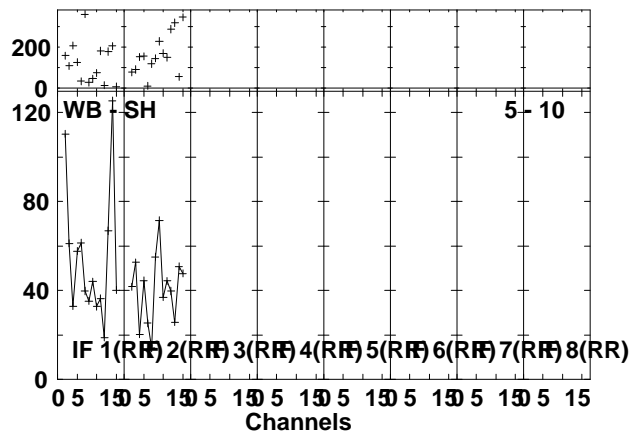
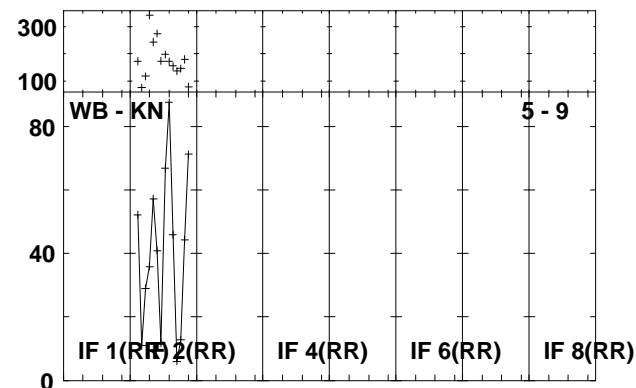
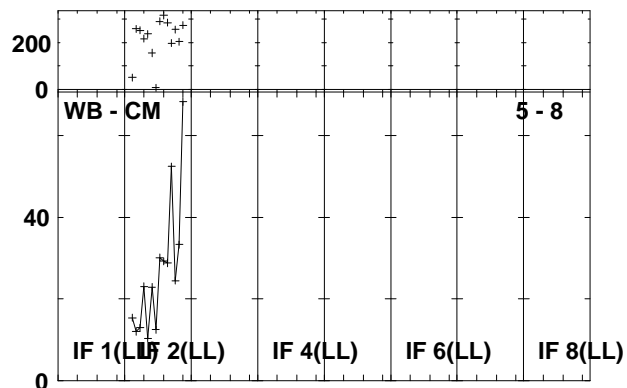
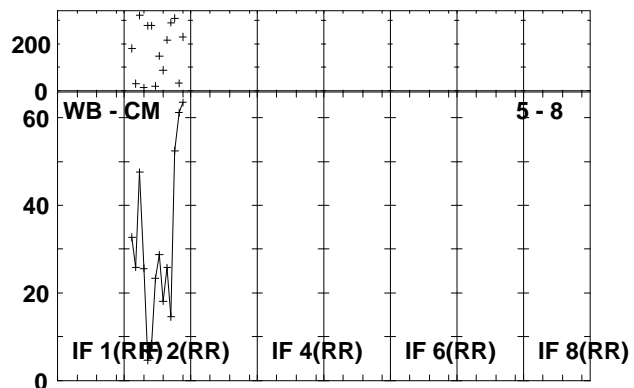
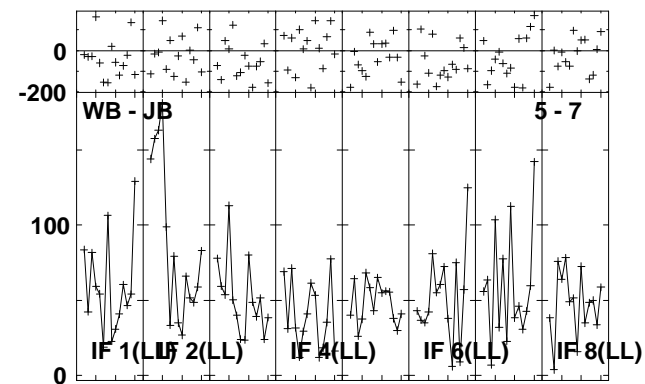
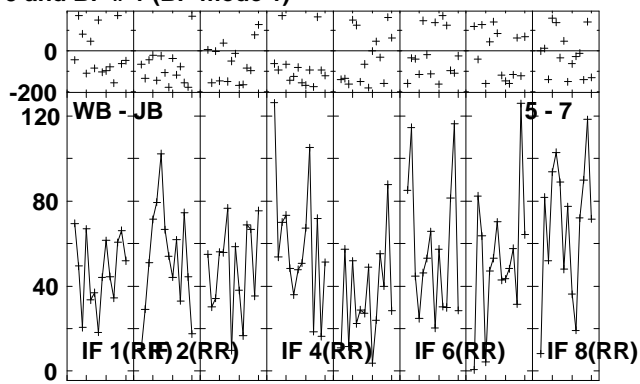
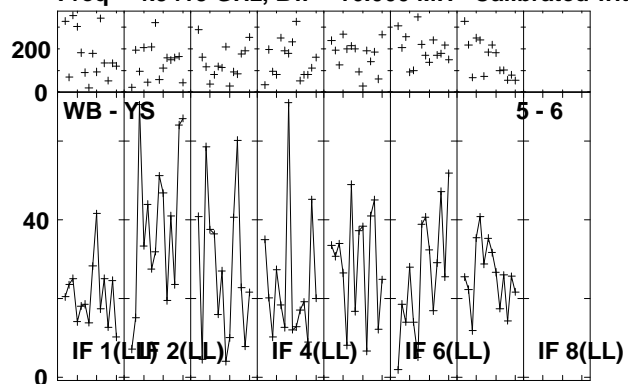

Lower frame: Milli Ampl Jy Top frame: Phas deg
Vector averaged cross-power spectrum Several baselines displayed
Timerange: 00/13:37:41 to 00/13:40:09

Plot file version 41 created 21-MAY-2010 15:45:33

J0909+02 RSD03.UVDATA.1

Freq = 4.9415 GHz, Bw = 16.000 MH Calibrated with CL # 3 and BP # 1 (BP mode 1)

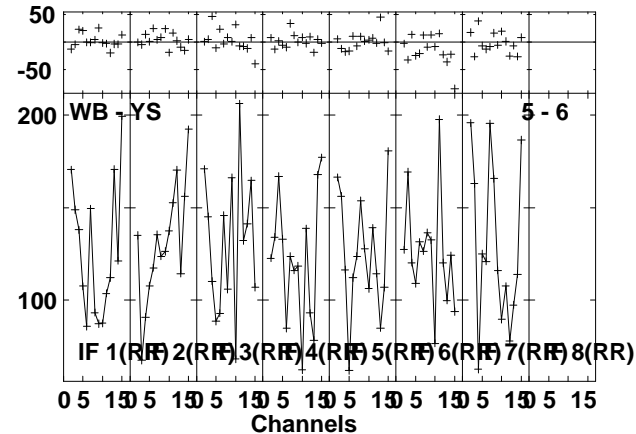
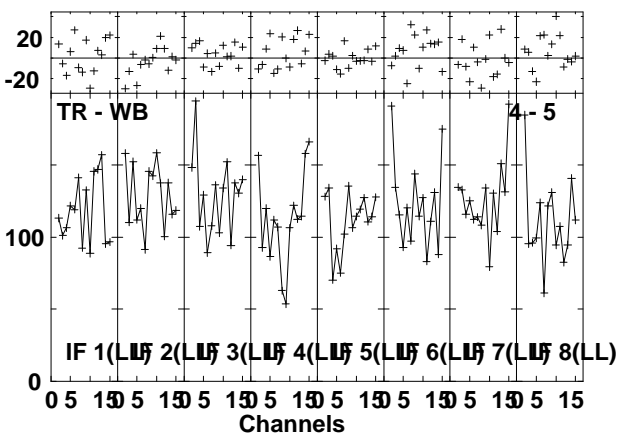
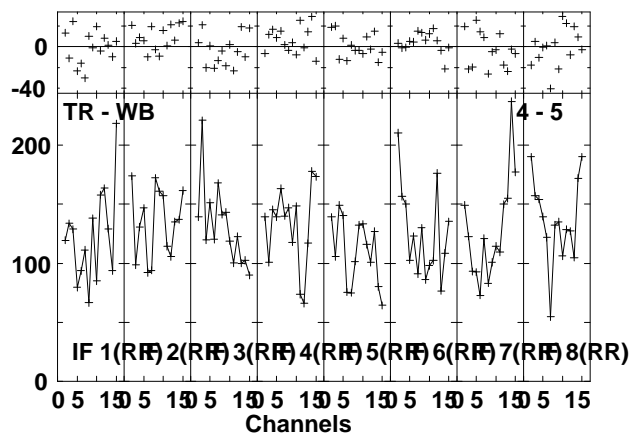
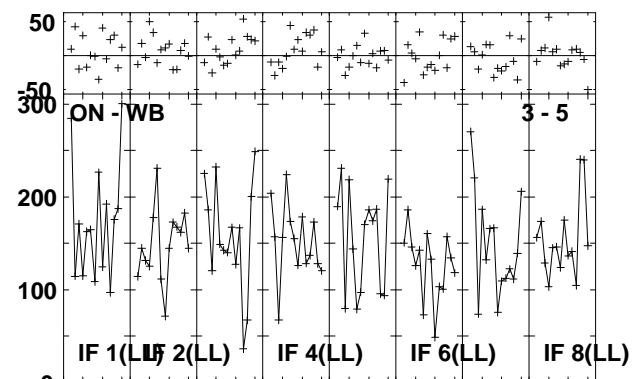
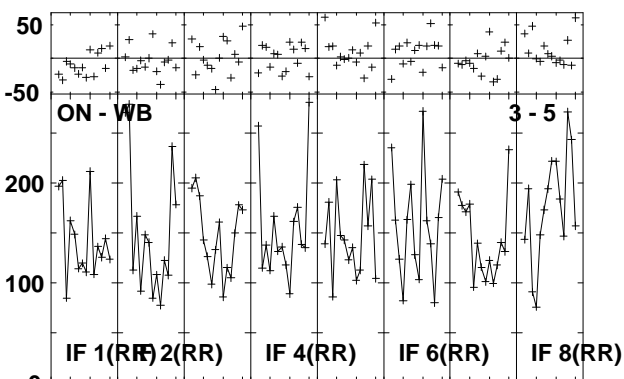
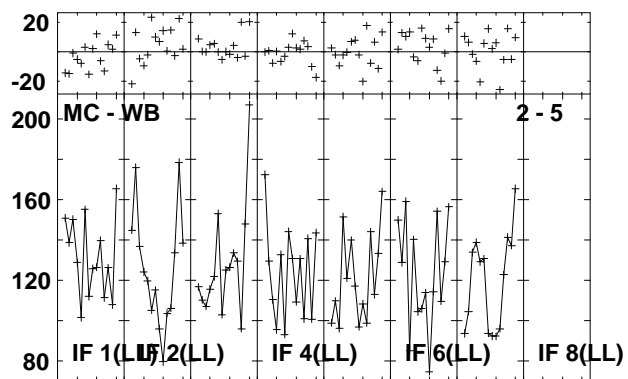
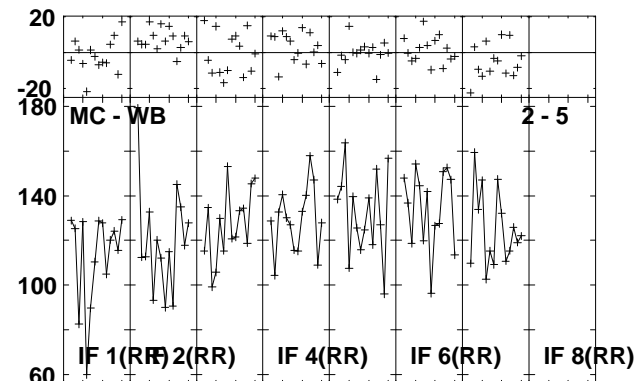
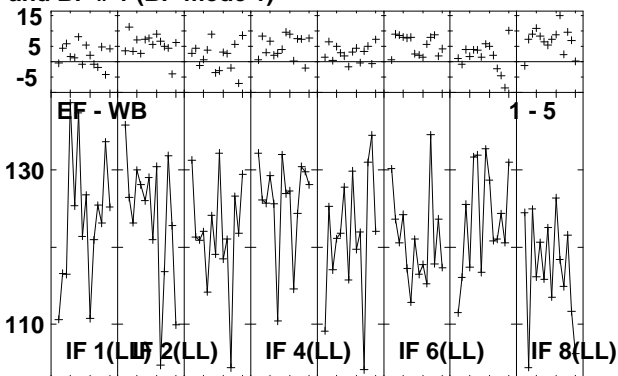
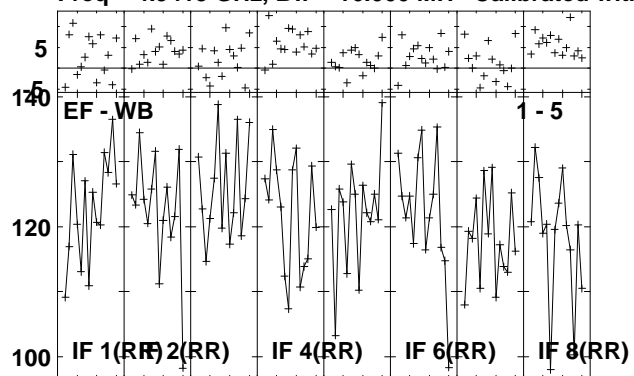

Lower frame: Milli Ampl Jy Top frame: Phas deg
Vector averaged cross-power spectrum Several baselines displayed
Timerange: 00/13:40:51 to 00/13:41:49

Plot file version 42 created 21-MAY-2010 15:45:34

J0909+02 RSD03.UVDATA.1

Freq = 4.9415 GHz, Bw = 16.000 MH Calibrated with CL # 3 and BP # 1 (BP mode 1)

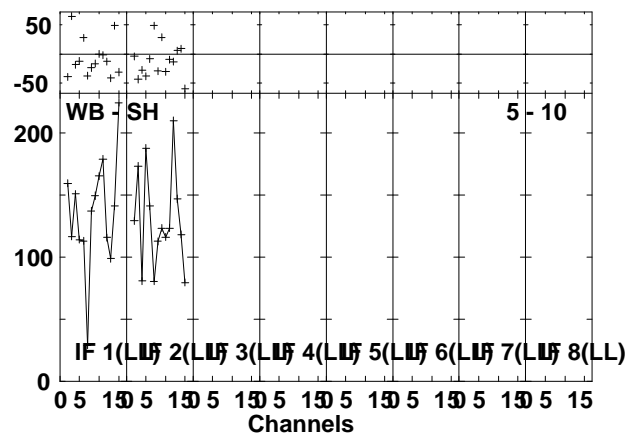
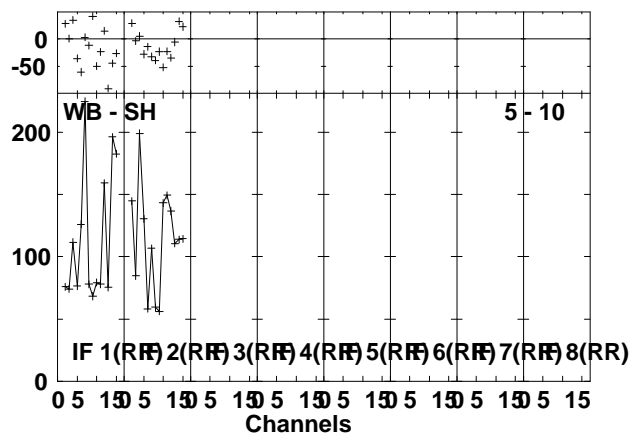
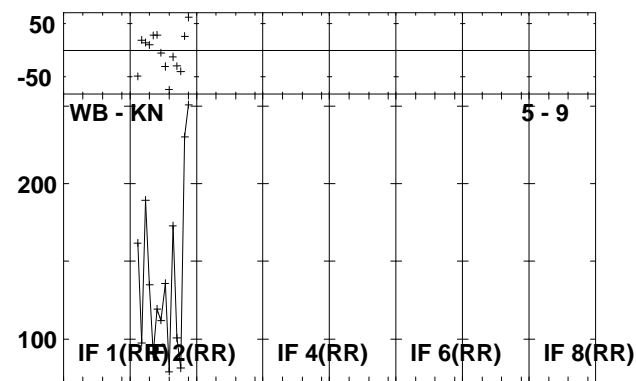
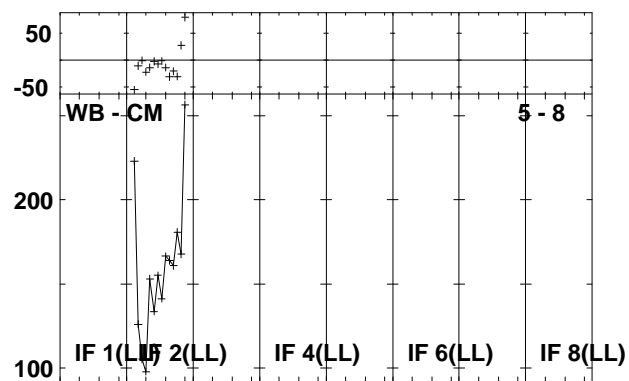
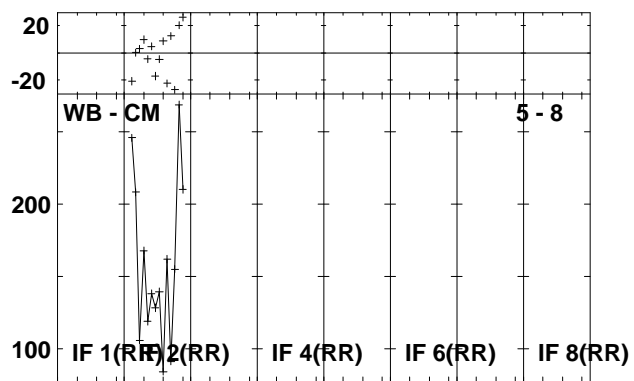
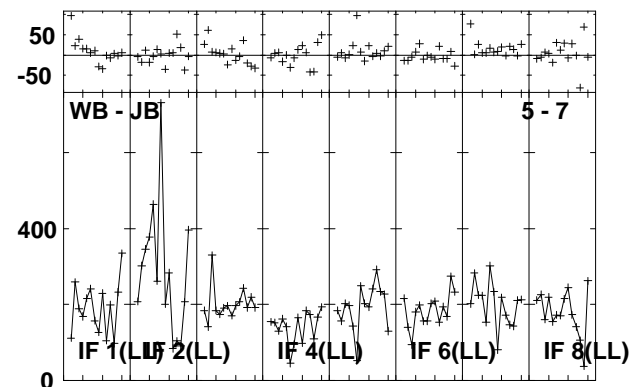
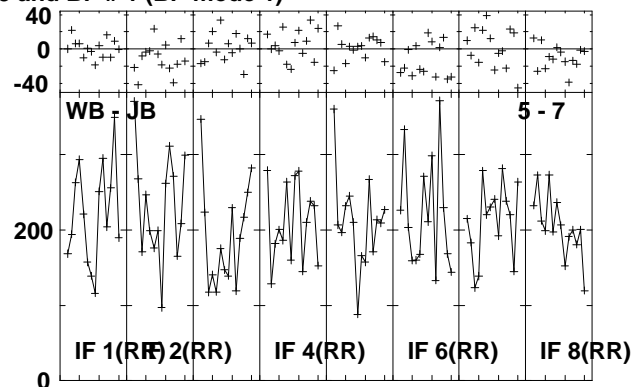
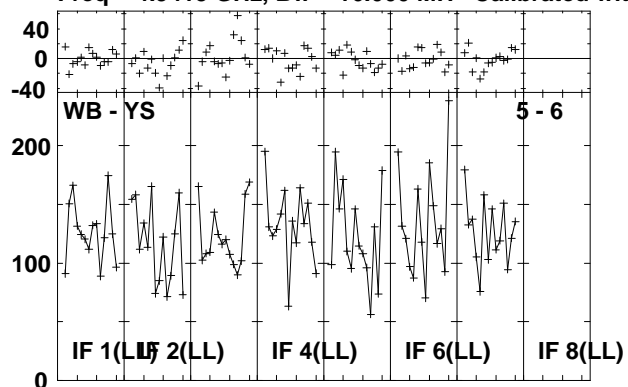

Lower frame: Milli Ampl Jy Top frame: Phas deg
Vector averaged cross-power spectrum Several baselines displayed
Timerange: 00/13:40:51 to 00/13:41:49

Plot file version 43 created 21-MAY-2010 15:45:36

CALB RSD03.UVDATA.1

Freq = 4.9415 GHz, Bw = 16.000 MH Calibrated with CL # 3 and BP # 1 (BP mode 1)

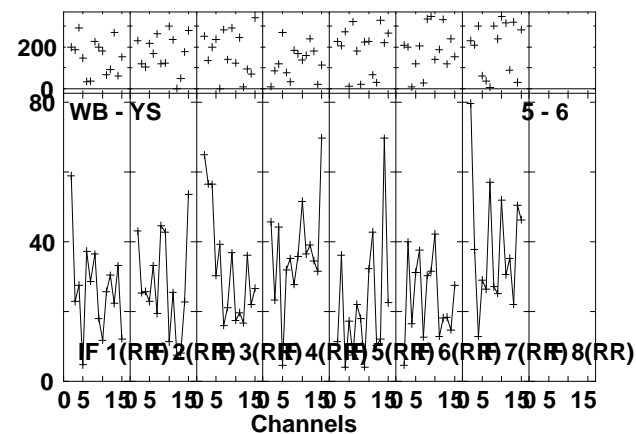
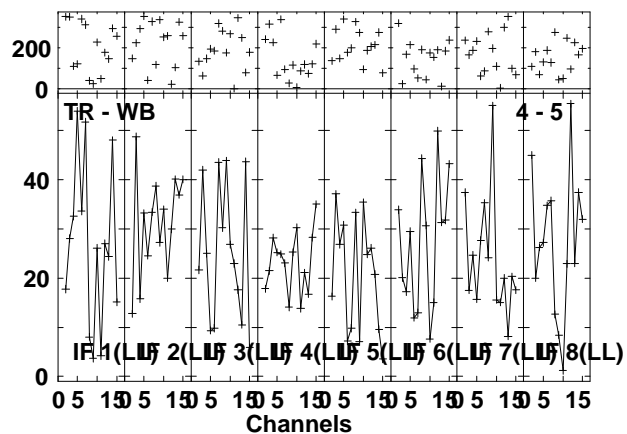
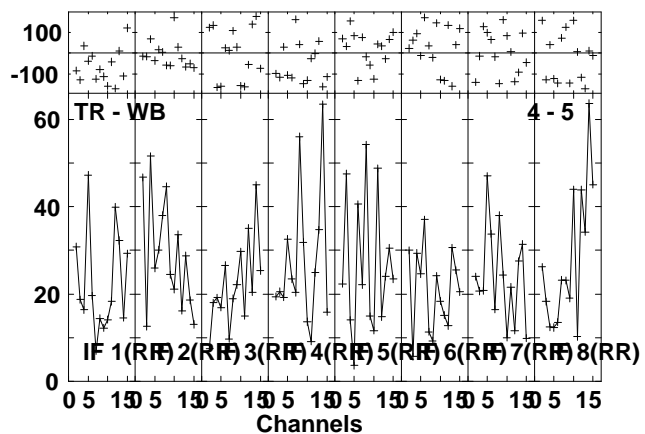
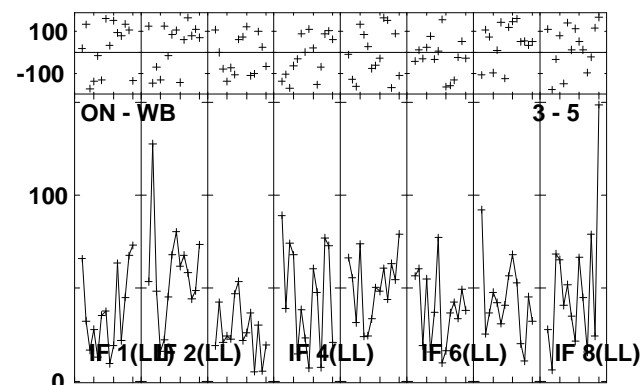
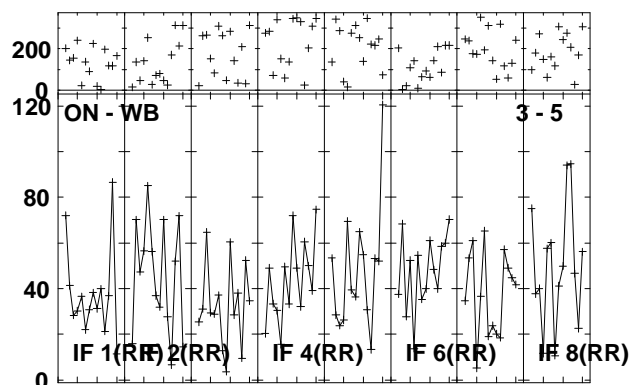
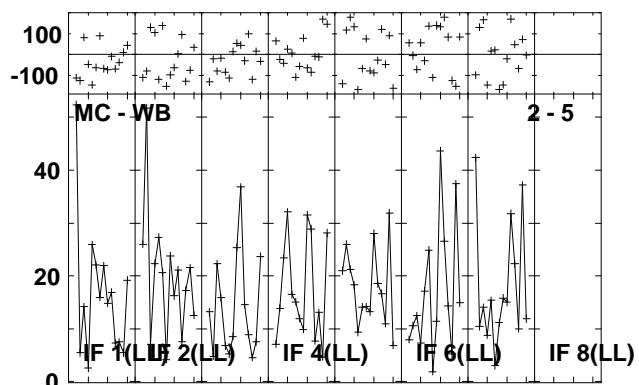
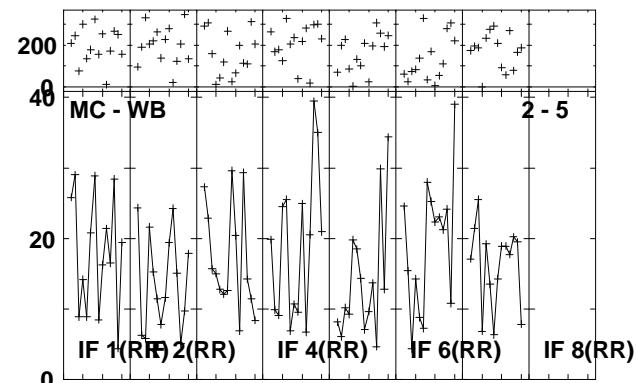
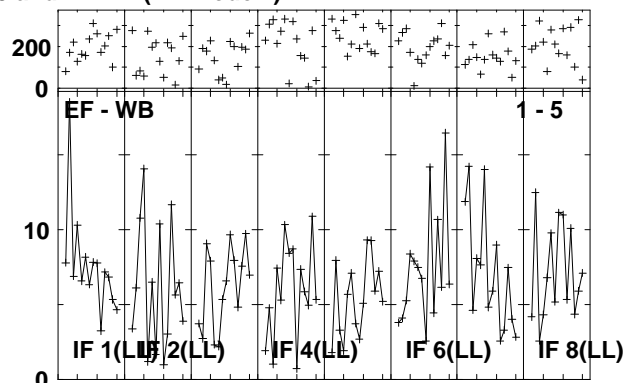
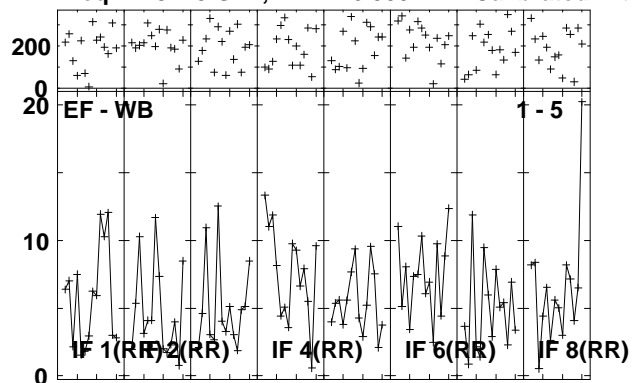

Lower frame: Milli Ampl Jy Top frame: Phas deg
Vector averaged cross-power spectrum Several baselines displayed
Timerange: 00/13:41:51 to 00/13:44:19

Plot file version 44 created 21-MAY-2010 15:45:38

CALB RSD03.UVDATA.1

Freq = 4.9415 GHz, Bw = 16.000 MH Calibrated with CL # 3 and BP # 1 (BP mode 1)

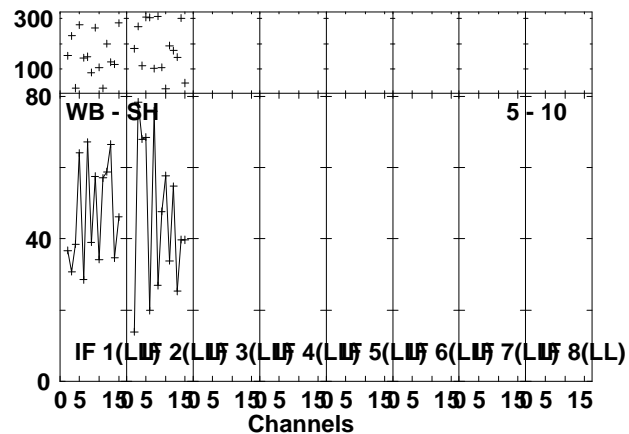
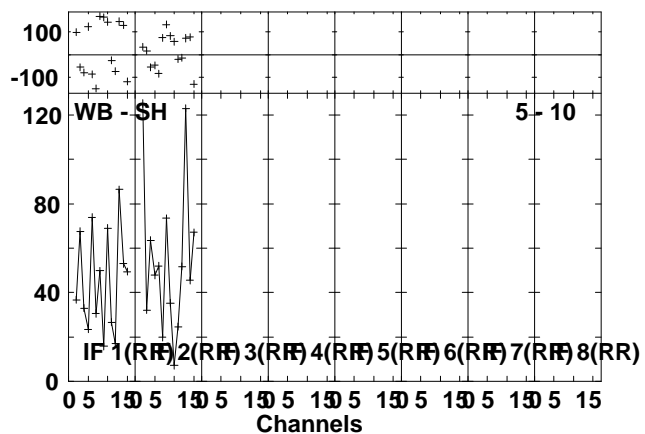
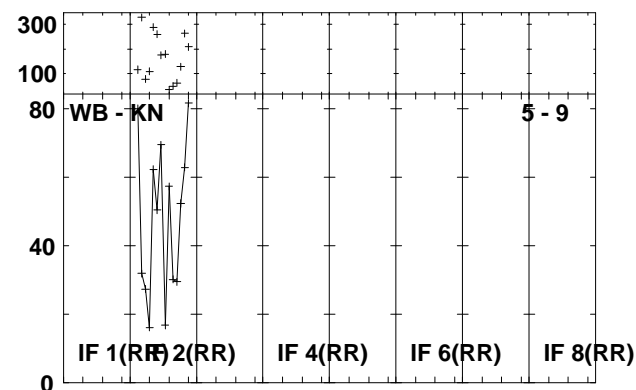
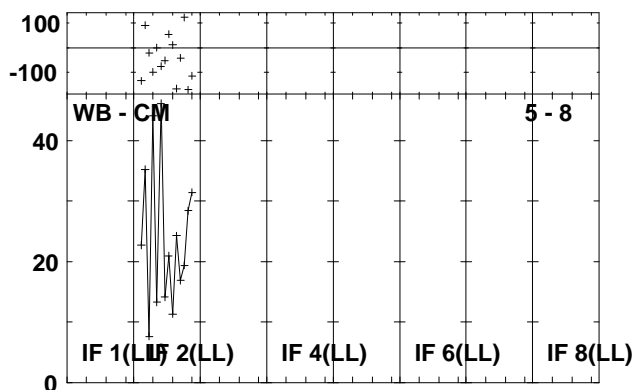
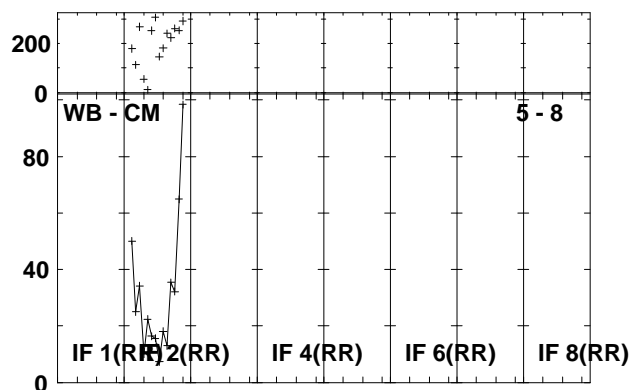
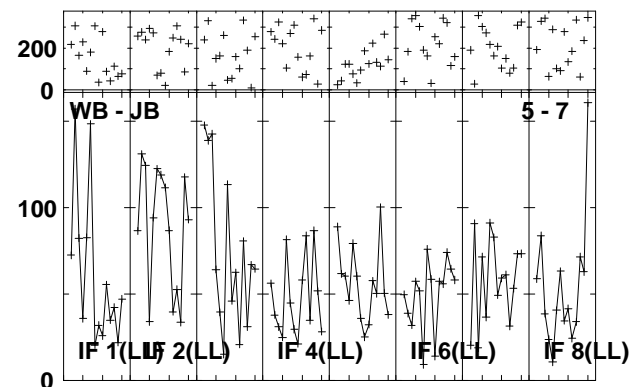
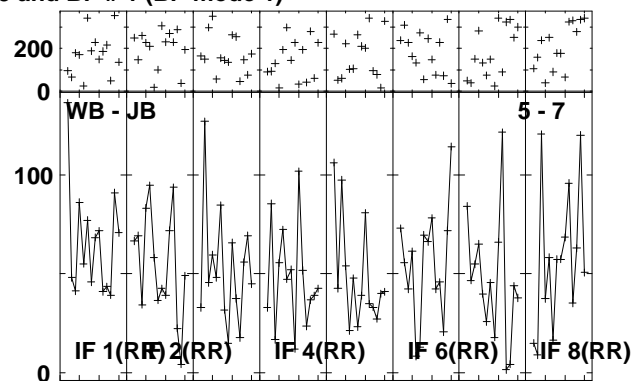
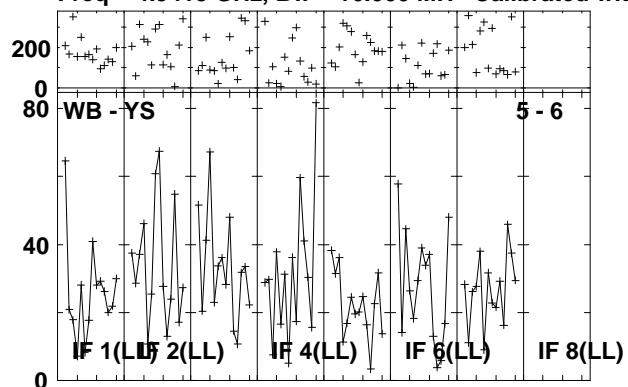

Lower frame: Milli Ampl Jy Top frame: Phas deg
Vector averaged cross-power spectrum Several baselines displayed
Timerange: 00/13:41:51 to 00/13:44:19

Plot file version 45 created 21-MAY-2010 15:45:40
 CALC RSD03.UVDATA.1
 Freq = 4.9415 GHz, Bw = 16.000 MH Calibrated with CL # 3 and BP # 1 (BP mode 1)

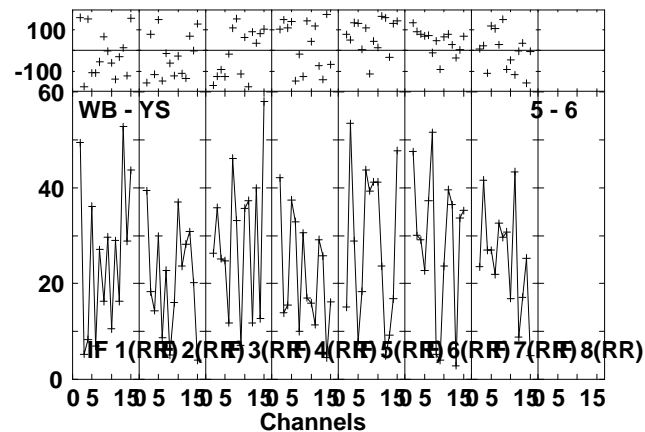
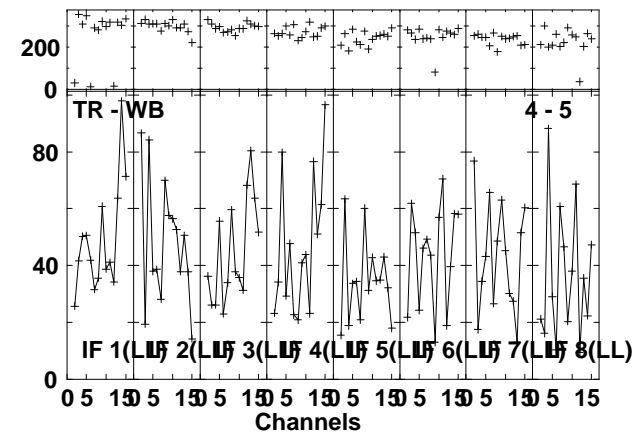
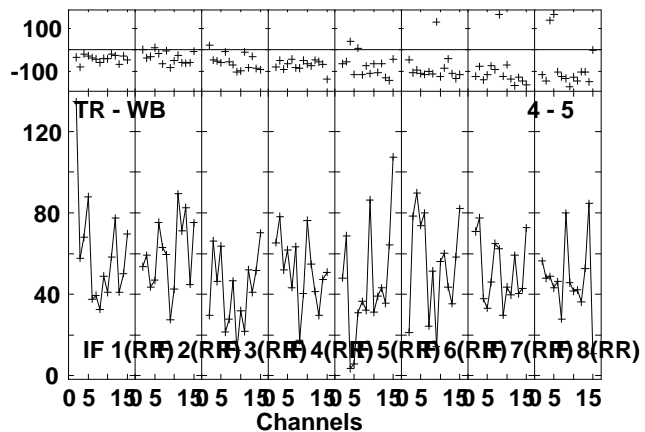
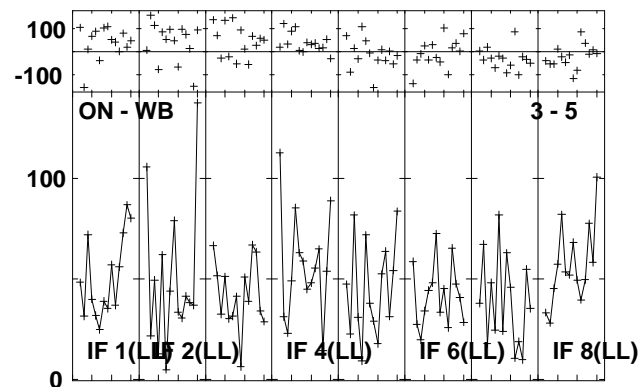
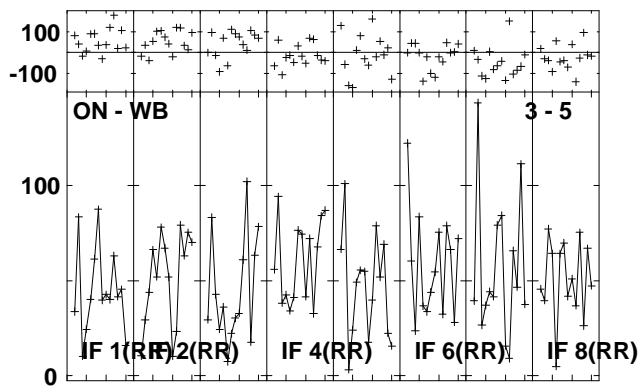
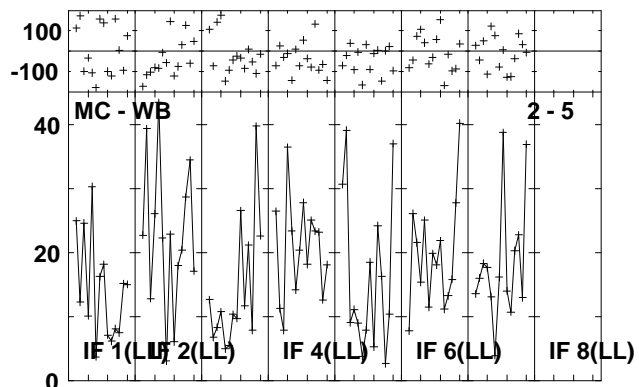
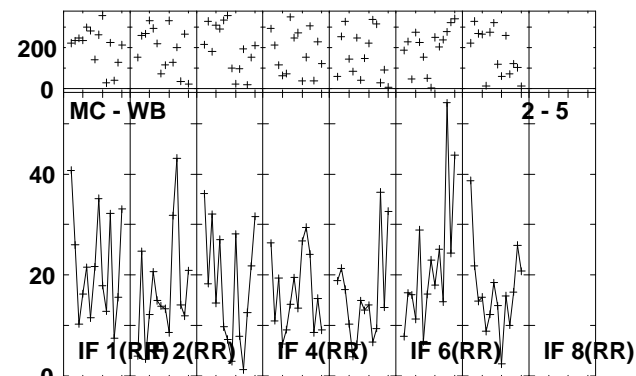
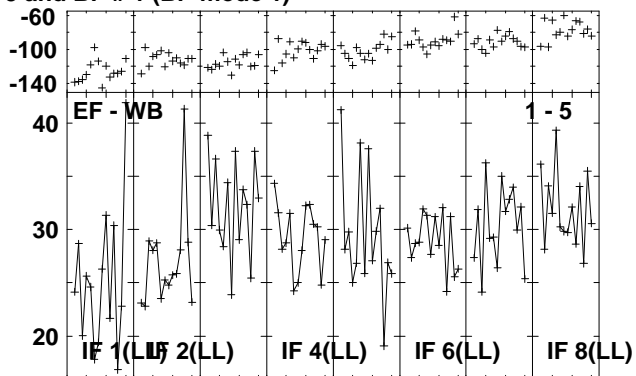
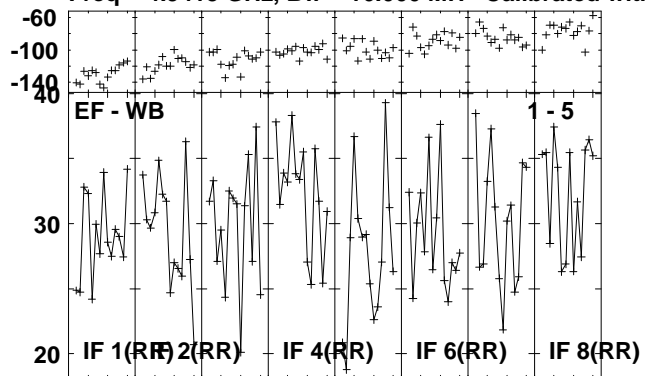

Lower frame: Milli Ampl Jy Top frame: Phas deg
 Vector averaged cross-power spectrum Several baselines displayed
 Timerange: 00/13:44:21 to 00/13:46:49

Plot file version 46 created 21-MAY-2010 15:45:42

CALC RSD03.UVDATA.1

Freq = 4.9415 GHz, Bw = 16.000 MH Calibrated with CL # 3 and BP # 1 (BP mode 1)

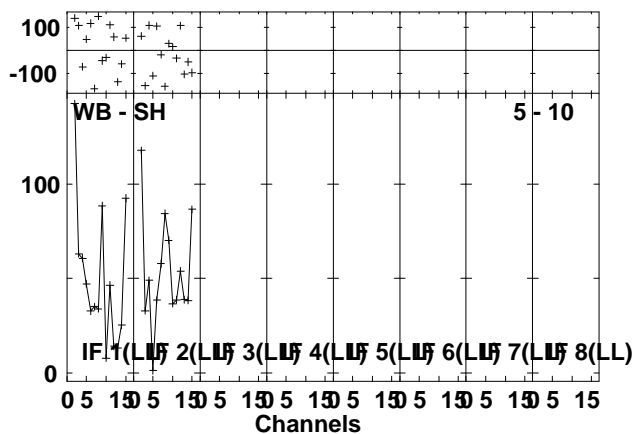
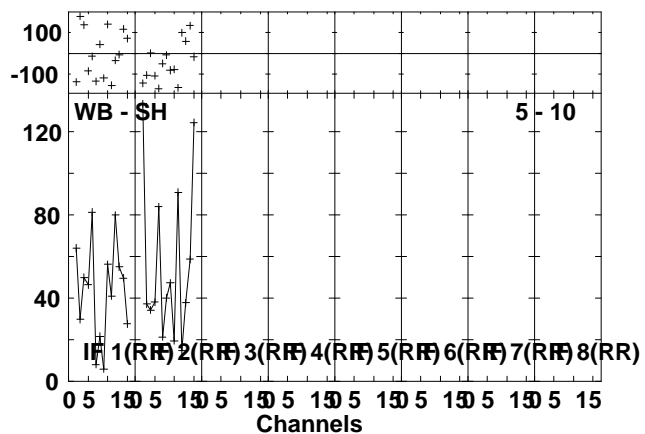
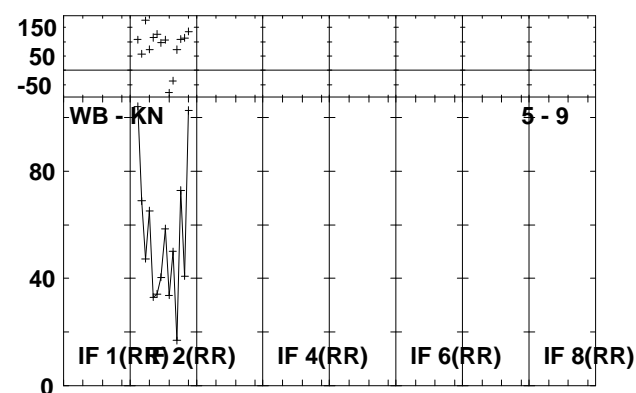
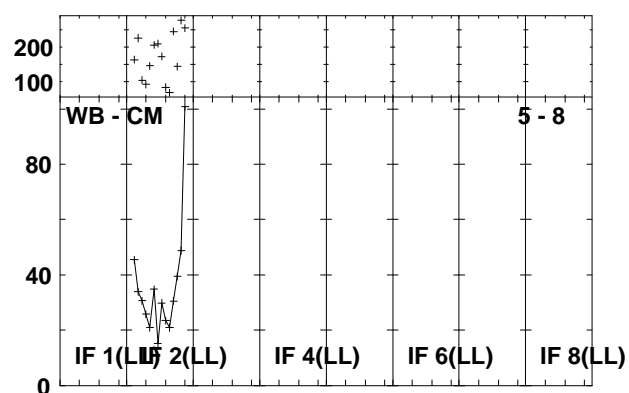
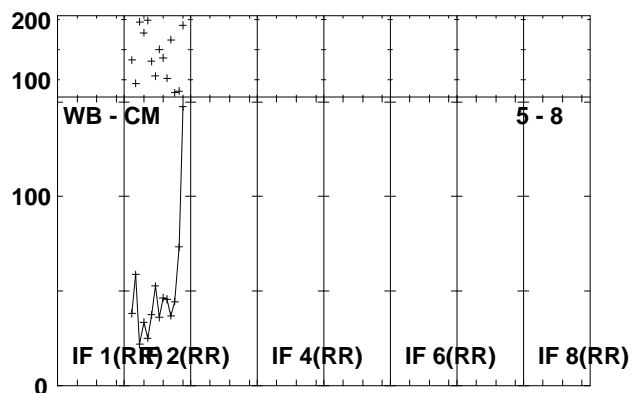
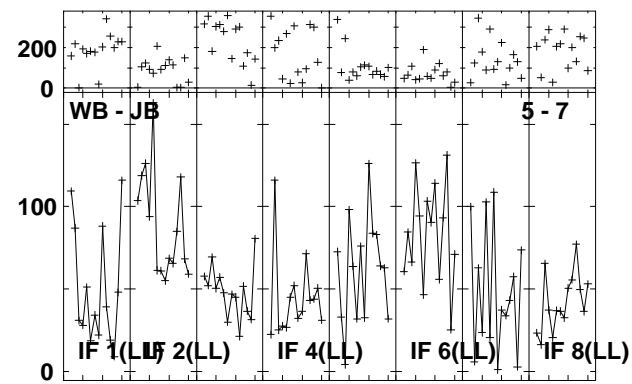
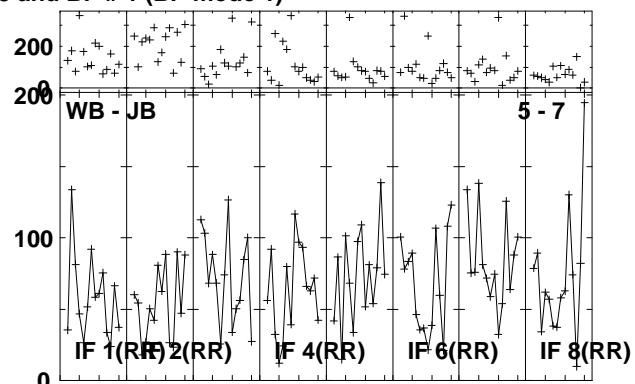
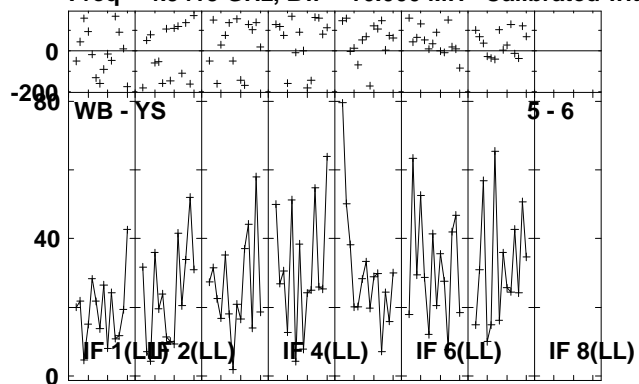

Lower frame: Milli Ampl Jy Top frame: Phas deg
Vector averaged cross-power spectrum Several baselines displayed
Timerange: 00/13:44:21 to 00/13:46:49

Plot file version 47 created 21-MAY-2010 15:45:45
 J0909+02 RSD03.UVDATA.1
 Freq = 4.9415 GHz, Bw = 16.000 MH Calibrated with CL # 3 and BP # 1 (BP mode 1)

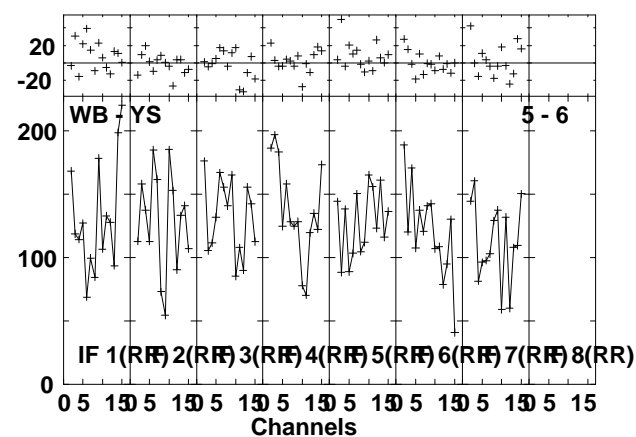
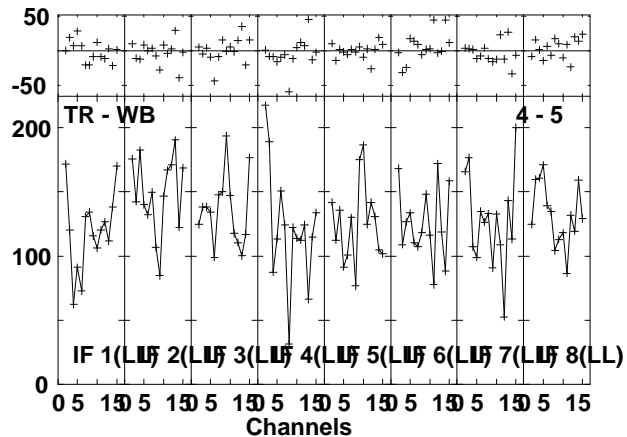
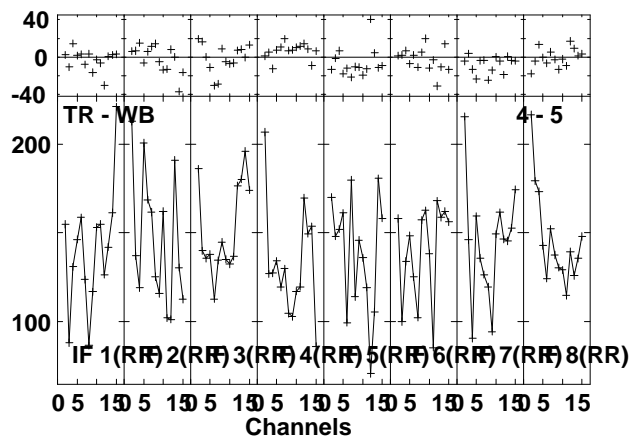
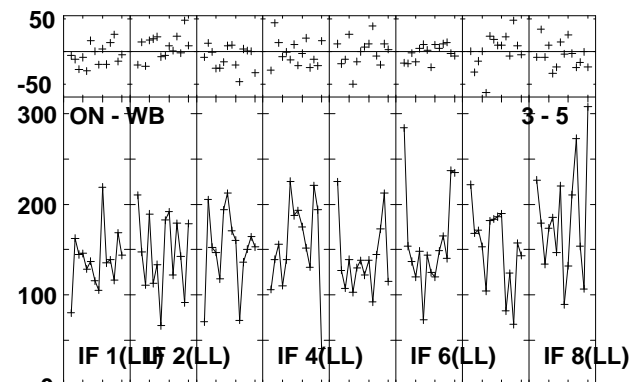
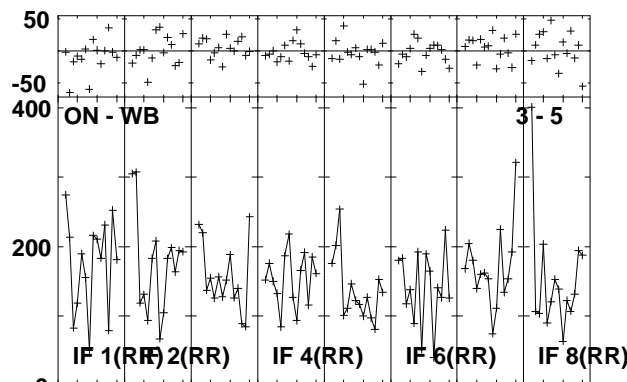
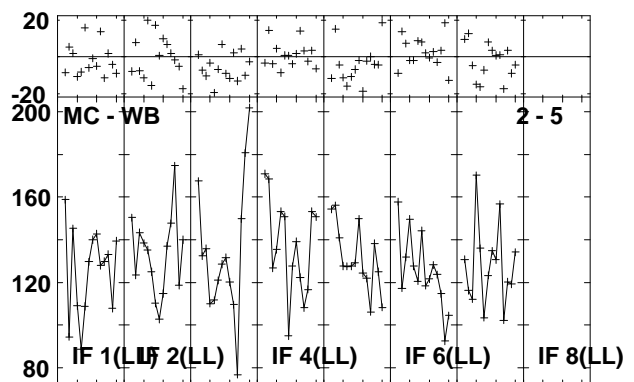
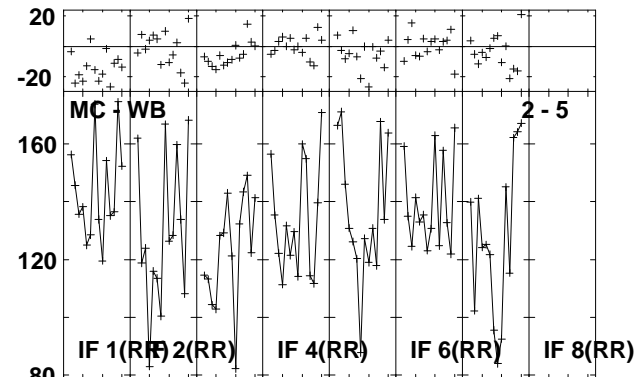
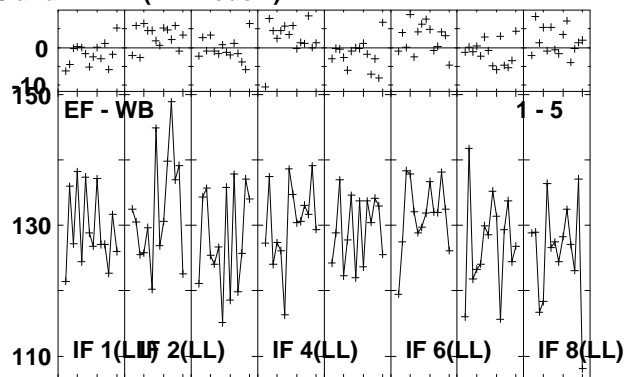
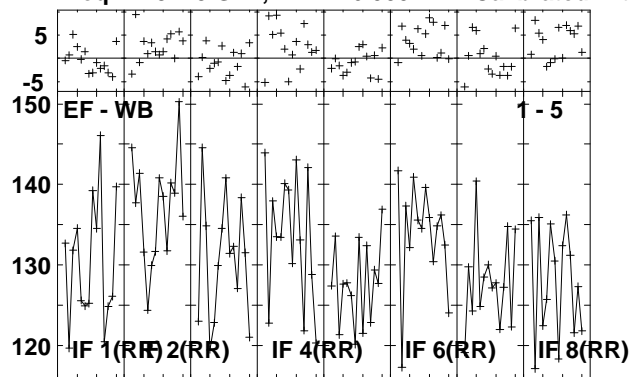

Lower frame: Milli Ampl Jy Top frame: Phas deg
 Vector averaged cross-power spectrum Several baselines displayed
 Timerange: 00/13:47:31 to 00/13:48:29

Plot file version 48 created 21-MAY-2010 15:45:46

J0909+02 RSD03.UVDATA.1

Freq = 4.9415 GHz, Bw = 16.000 MH Calibrated with CL # 3 and BP # 1 (BP mode 1)

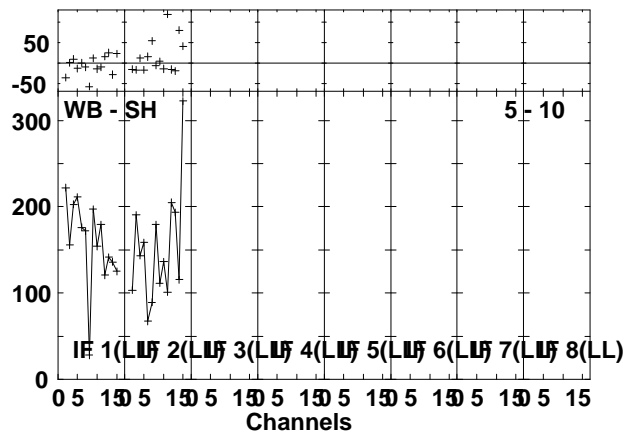
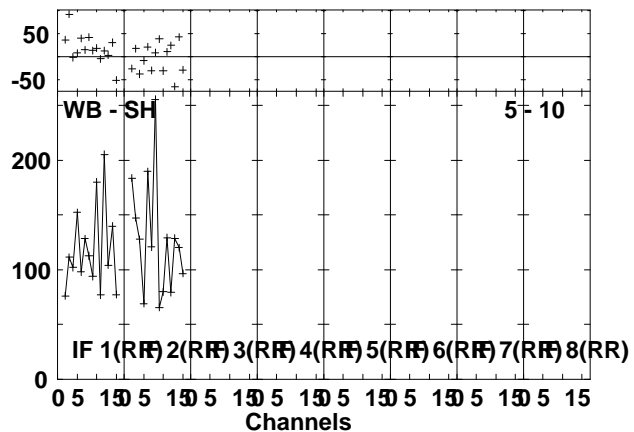
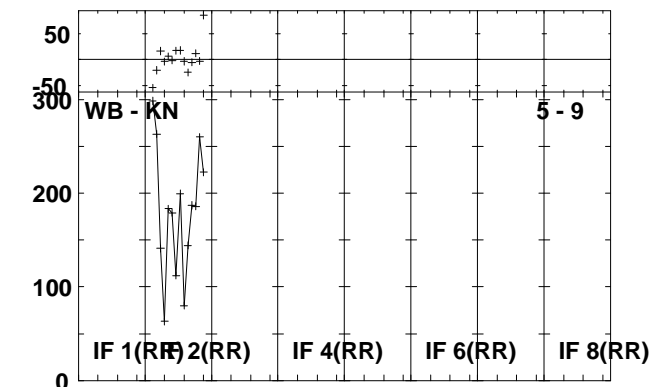
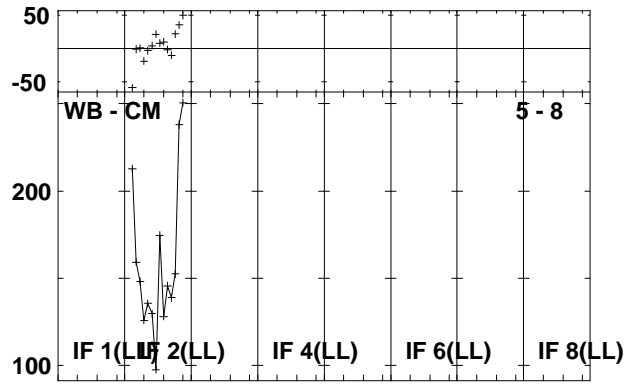
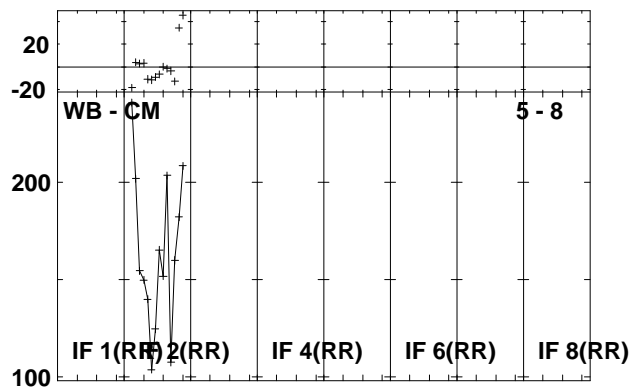
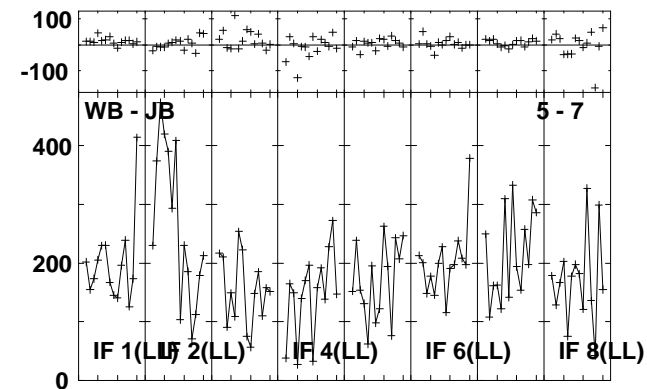
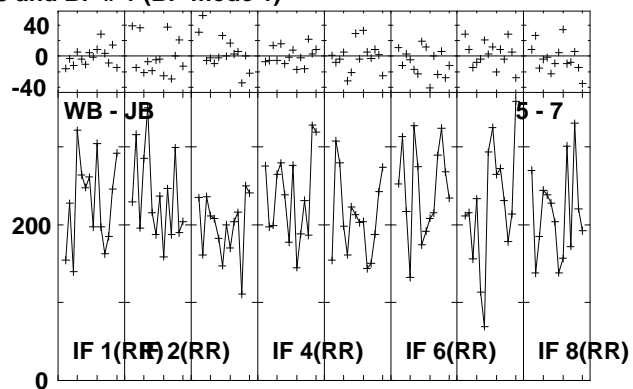
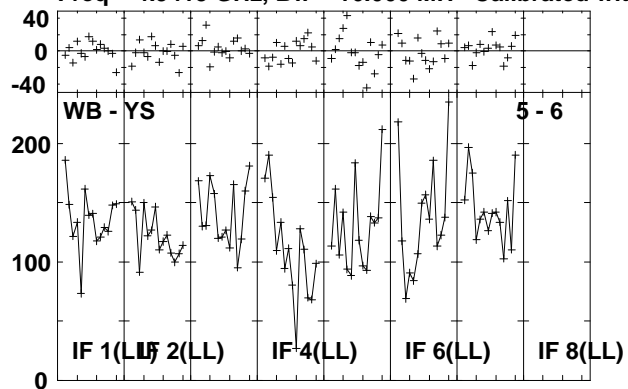

Lower frame: Milli Ampl Jy Top frame: Phas deg
Vector averaged cross-power spectrum Several baselines displayed
Timerange: 00/13:47:31 to 00/13:48:29

Plot file version 49 created 21-MAY-2010 15:45:48

CALD RSD03.UVDATA.1

Freq = 4.9415 GHz, Bw = 16.000 MH Calibrated with CL # 3 and BP # 1 (BP mode 1)

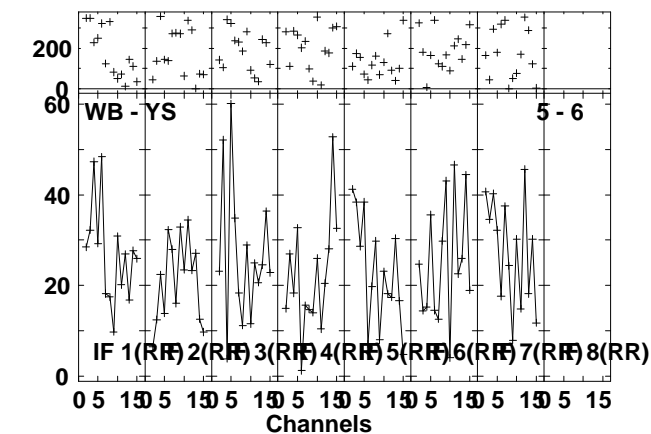
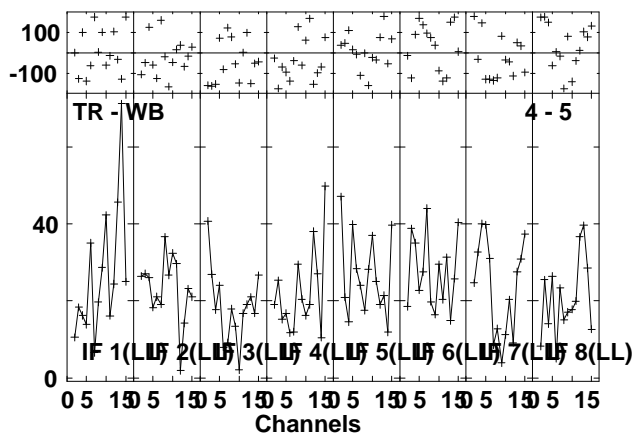
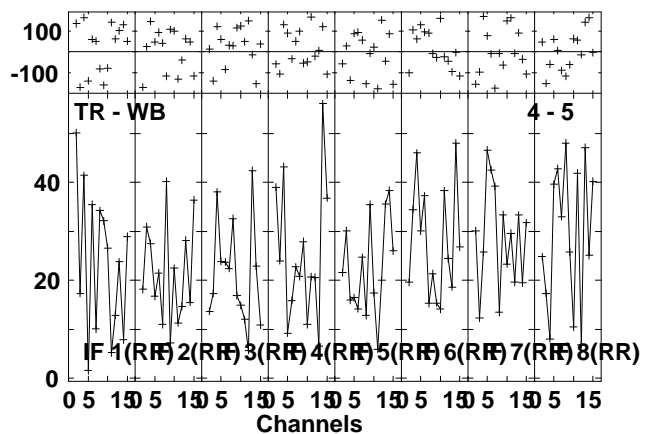
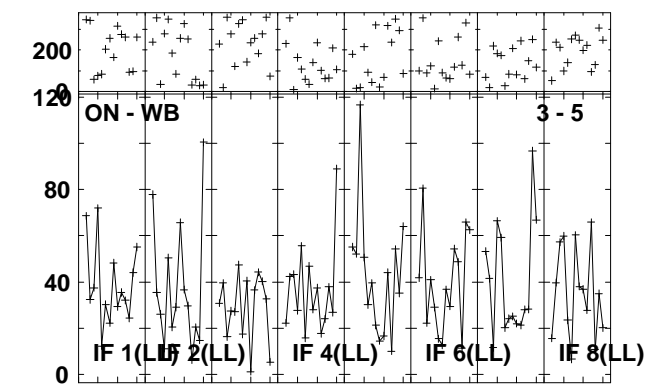
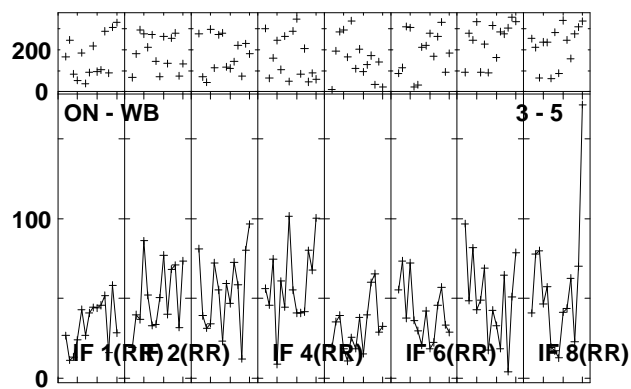
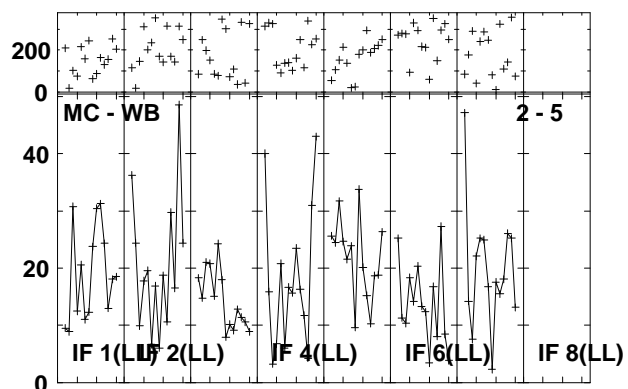
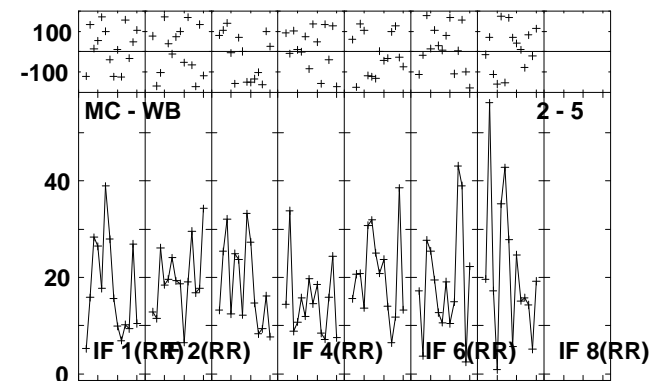
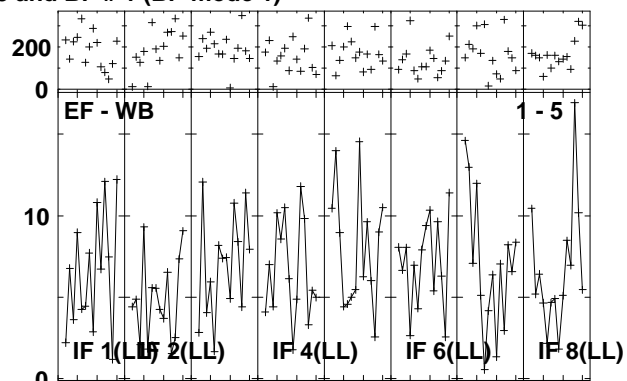
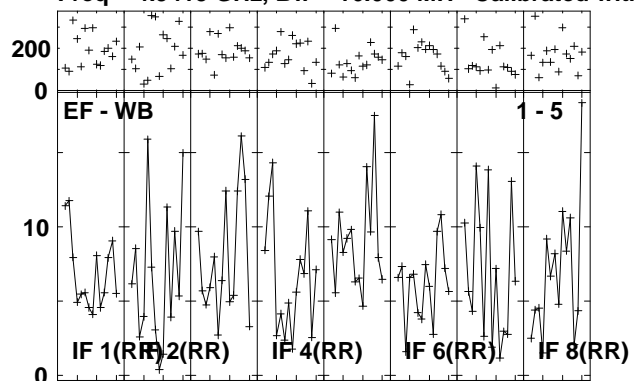

Lower frame: Milli Ampl Jy Top frame: Phas deg
Vector averaged cross-power spectrum Several baselines displayed
Timerange: 00/13:48:31 to 00/13:50:59

Plot file version 50 created 21-MAY-2010 15:45:50

CALD RSD03.UVDATA.1

Freq = 4.9415 GHz, Bw = 16.000 MH Calibrated with CL # 3 and BP # 1 (BP mode 1)

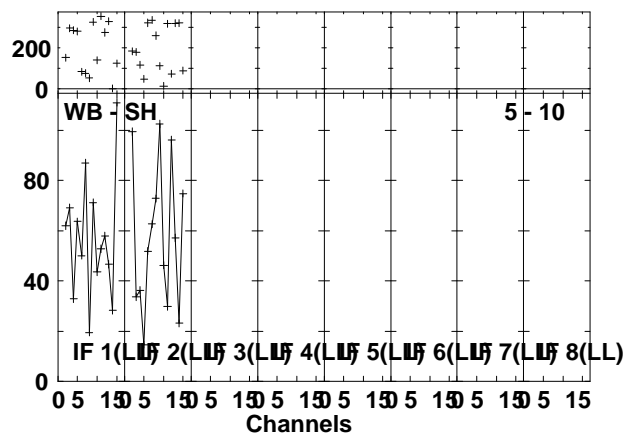
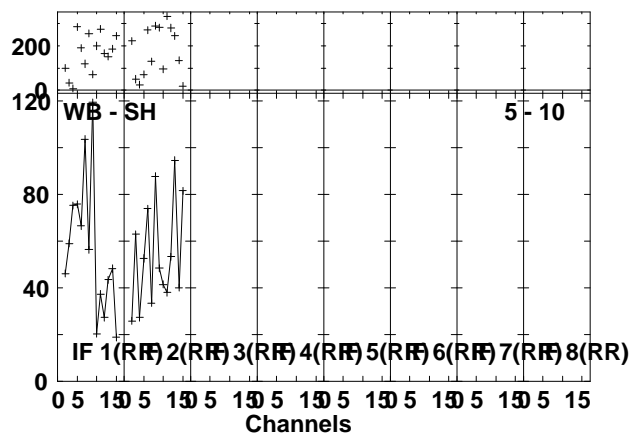
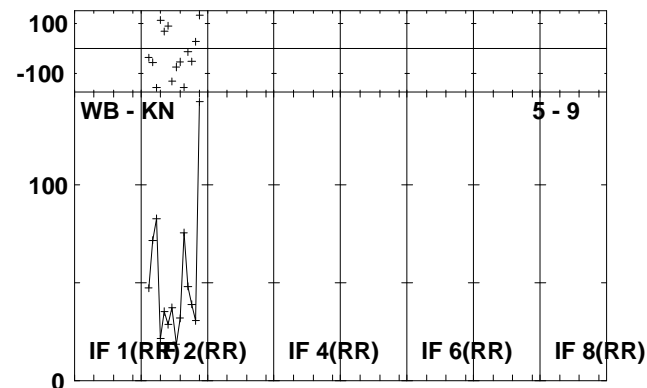
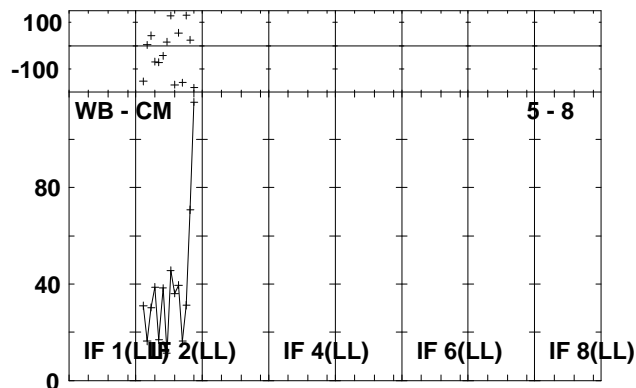
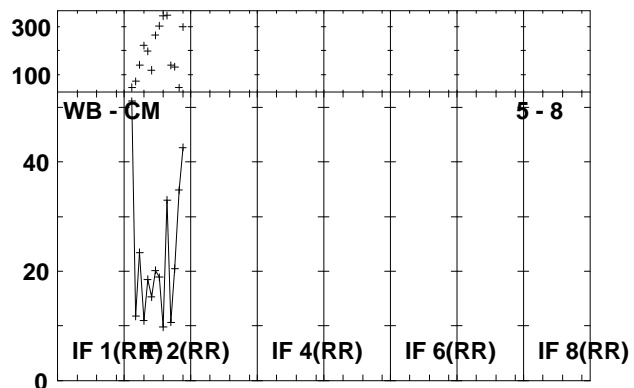
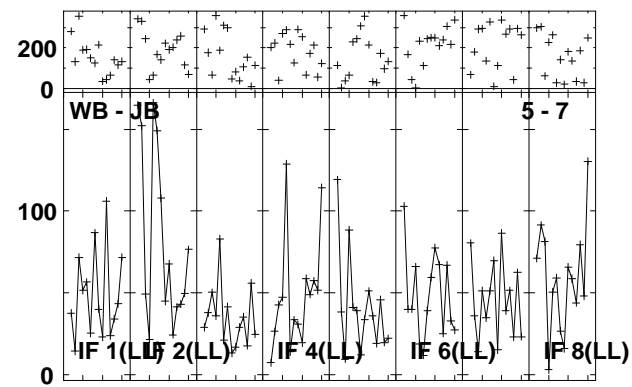
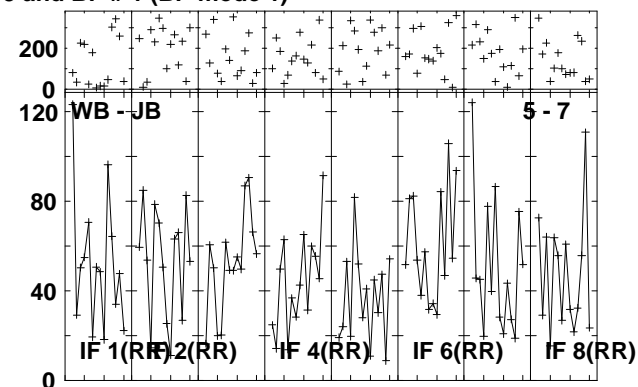
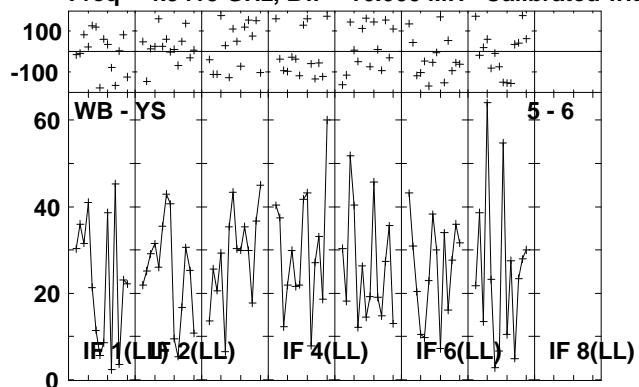

Lower frame: Milli Ampl Jy Top frame: Phas deg
Vector averaged cross-power spectrum Several baselines displayed
Timerange: 00/13:48:31 to 00/13:50:59

Plot file version 51 created 21-MAY-2010 15:45:53

CALF RSD03.UVDATA.1

Freq = 4.9415 GHz, Bw = 16.000 MH Calibrated with CL # 3 and BP # 1 (BP mode 1)

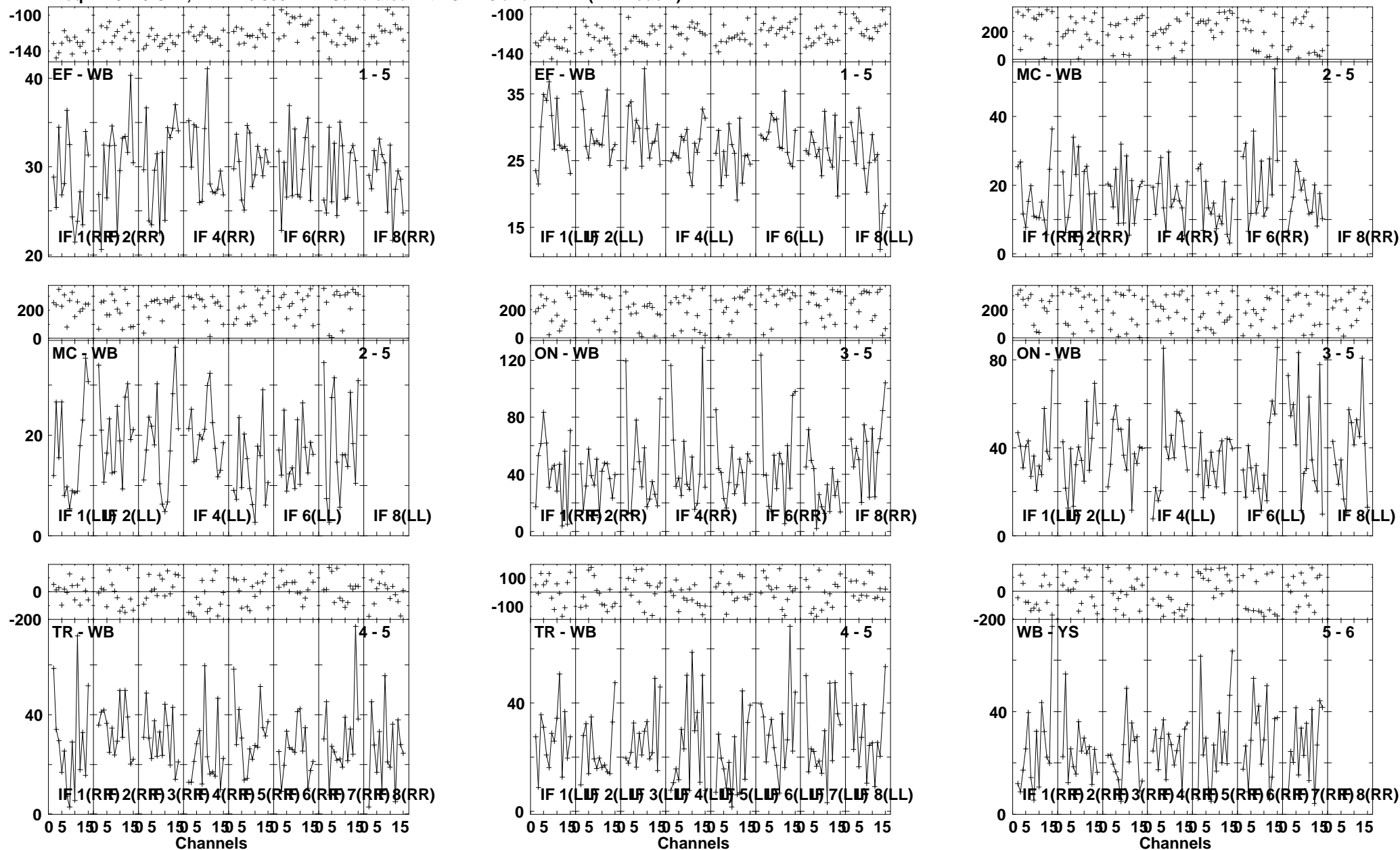

Lower frame: Milli Ampl Jy Top frame: Phas deg
Vector averaged cross-power spectrum Several baselines displayed
Timerange: 00/13:51:01 to 00/13:53:29

Plot file version 52 created 21-MAY-2010 15:45:55

CALF RSD03.UVDATA.1

Freq = 4.9415 GHz, Bw = 16.000 MH Calibrated with CL # 3 and BP # 1 (BP mode 1)

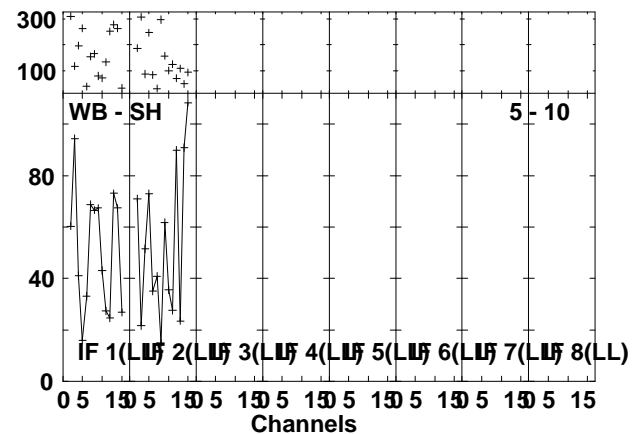
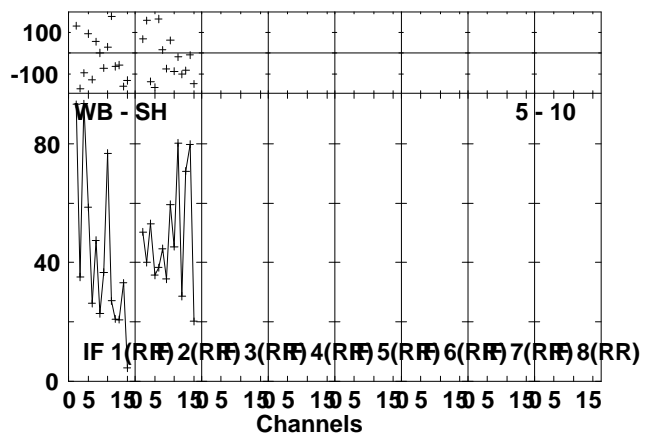
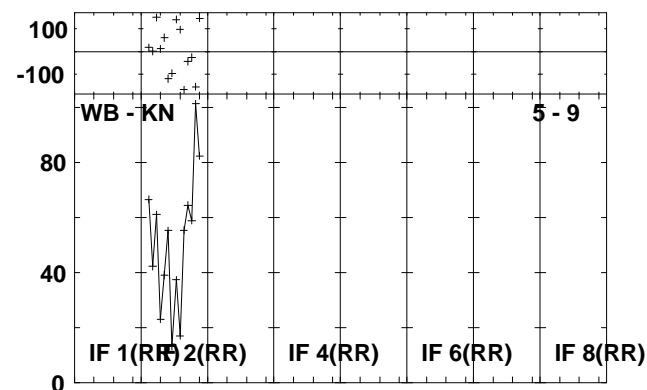
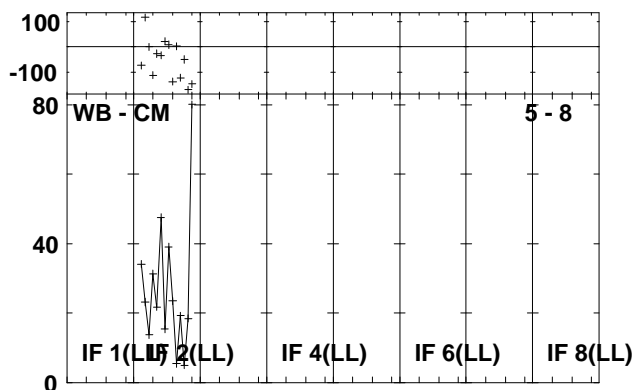
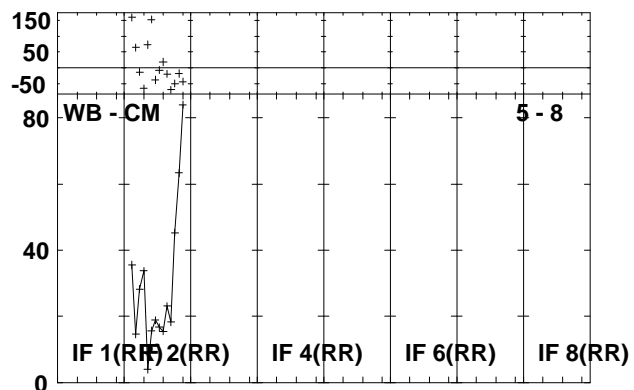
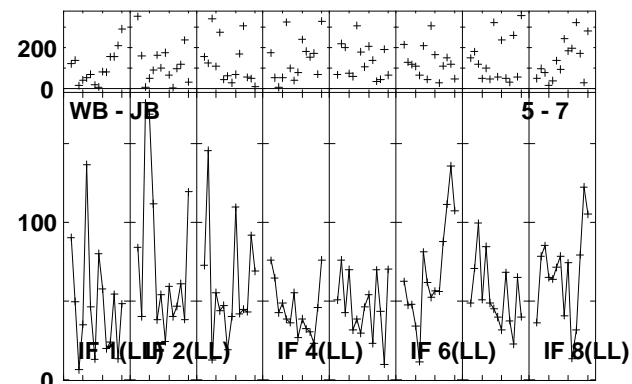
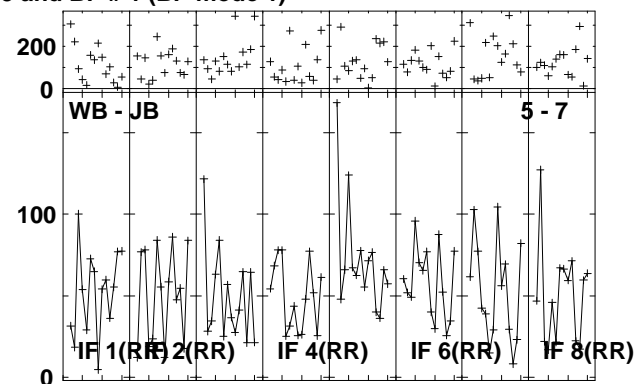
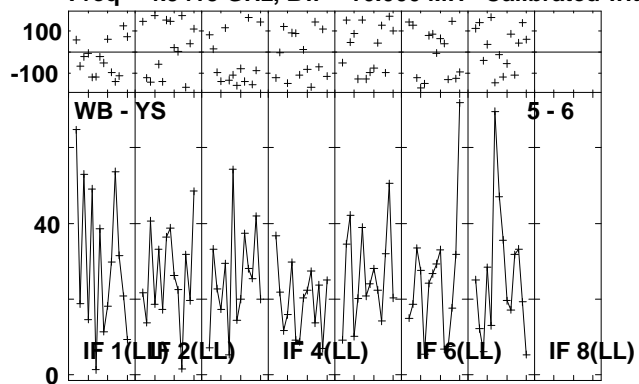

Lower frame: Milli Ampl Jy Top frame: Phas deg
Vector averaged cross-power spectrum Several baselines displayed
Timerange: 00/13:51:01 to 00/13:53:29

Plot file version 53 created 21-MAY-2010 15:45:58

J0909+02 RSD03.UVDATA.1

Freq = 4.9415 GHz, Bw = 16.000 MH Calibrated with CL # 3 and BP # 1 (BP mode 1)

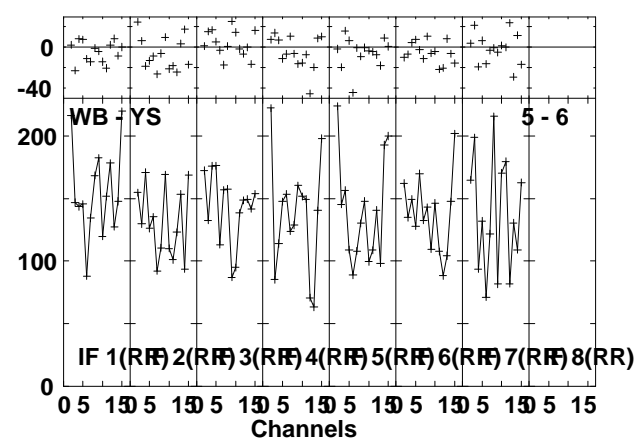
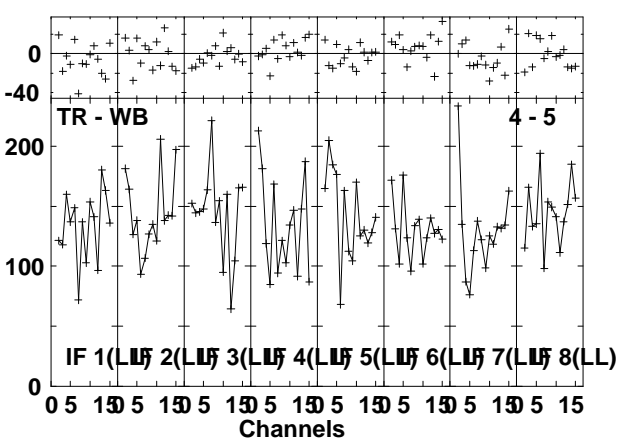
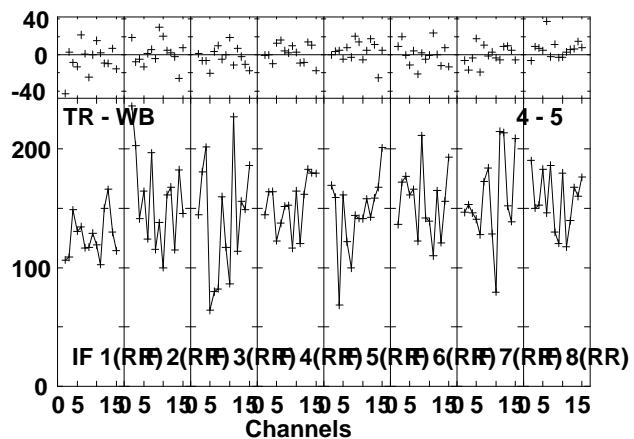
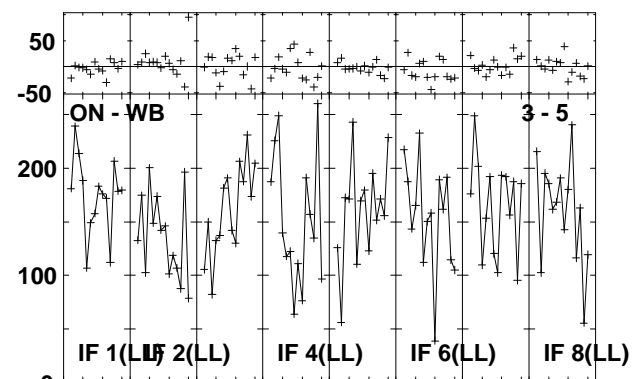
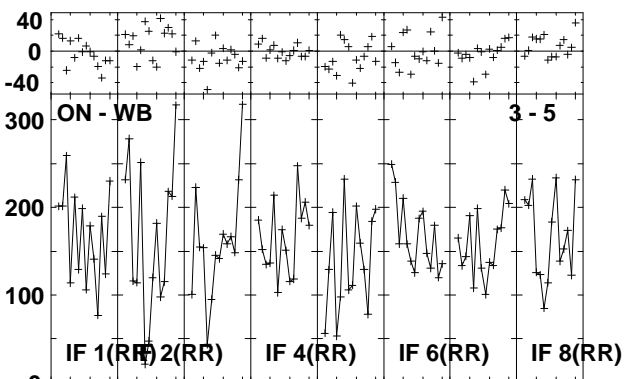
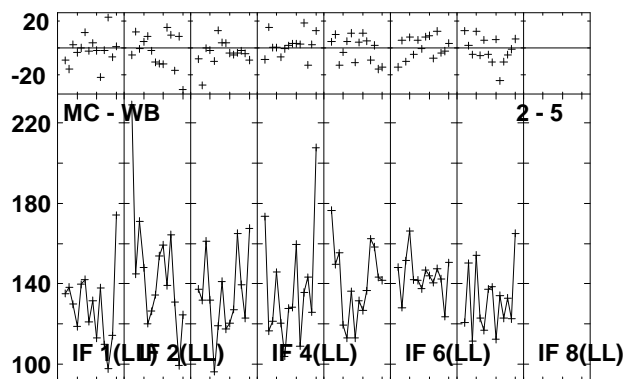
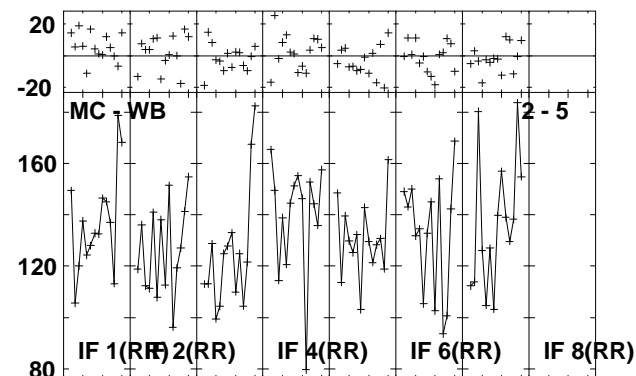
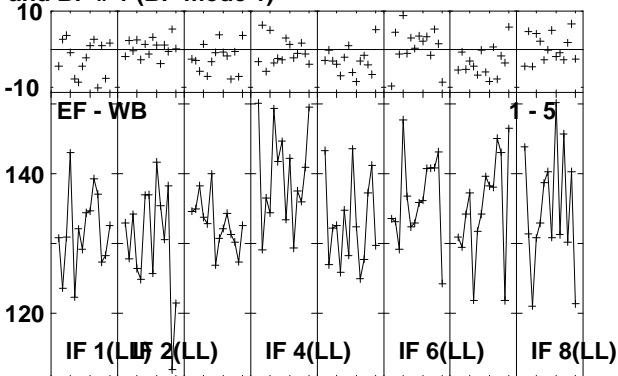
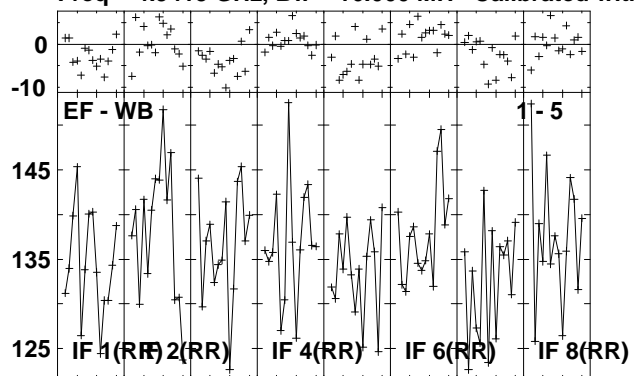

Lower frame: Milli Ampl Jy Top frame: Phas deg
Vector averaged cross-power spectrum Several baselines displayed
Timerange: 00/13:54:11 to 00/13:55:09

Plot file version 54 created 21-MAY-2010 15:45:59

J0909+02 RSD03.UVDATA.1

Freq = 4.9415 GHz, Bw = 16.000 MH Calibrated with CL # 3 and BP # 1 (BP mode 1)

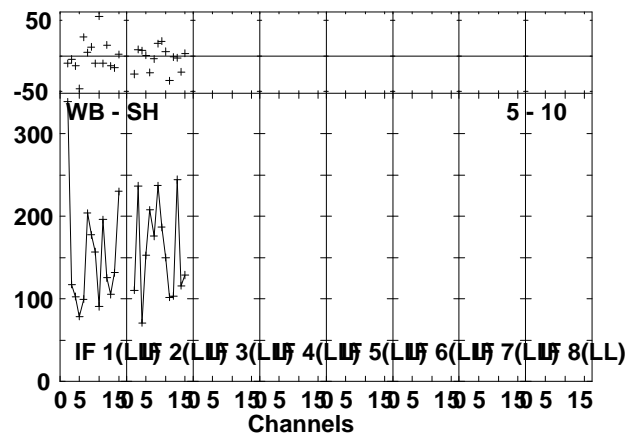
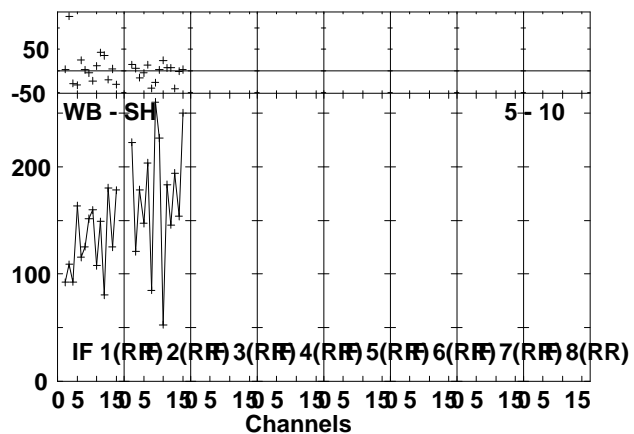
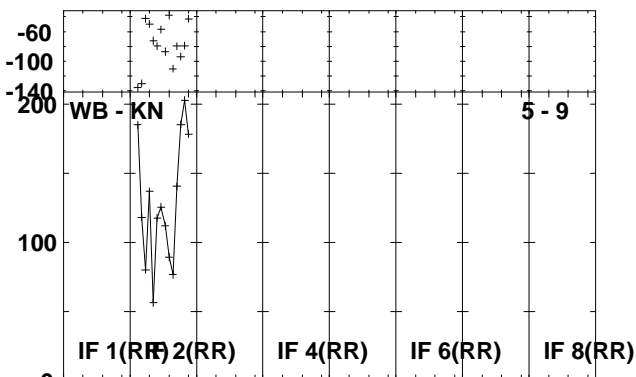
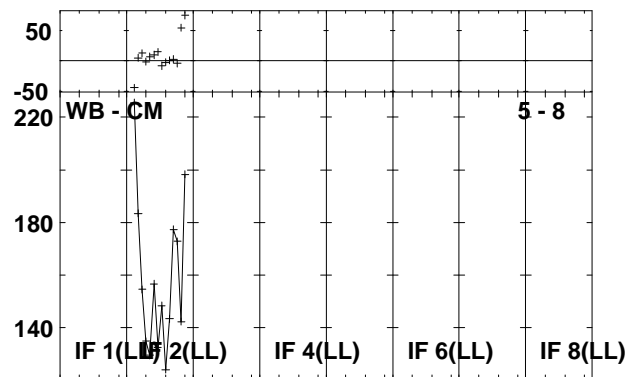
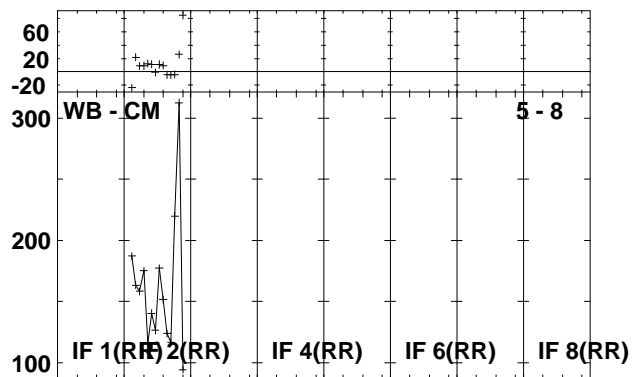
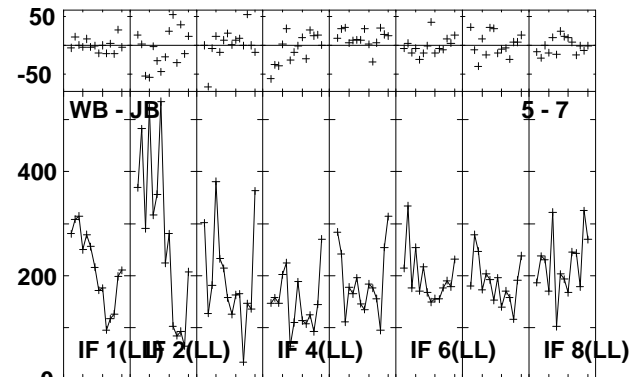
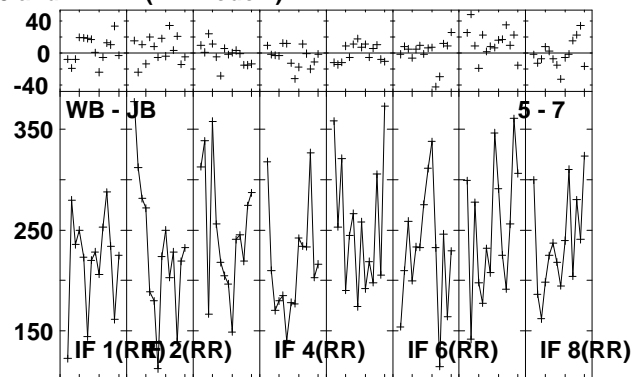
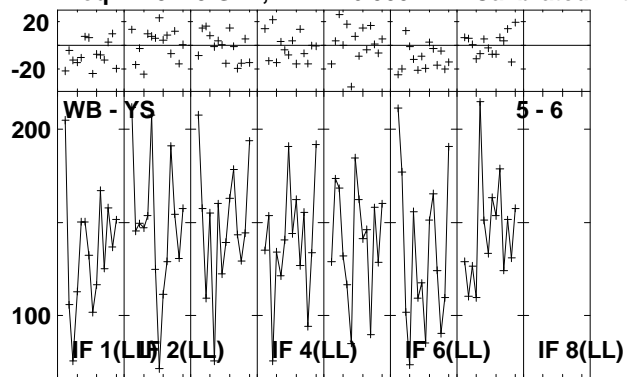

Lower frame: Milli Ampl Jy Top frame: Phas deg
Vector averaged cross-power spectrum Several baselines displayed
Timerange: 00/13:54:11 to 00/13:55:09

Plot file version 55 created 21-MAY-2010 15:46:00

CALG RSD03.UVDATA.1

Freq = 4.9415 GHz, Bw = 16.000 MH Calibrated with CL # 3 and BP # 1 (BP mode 1)

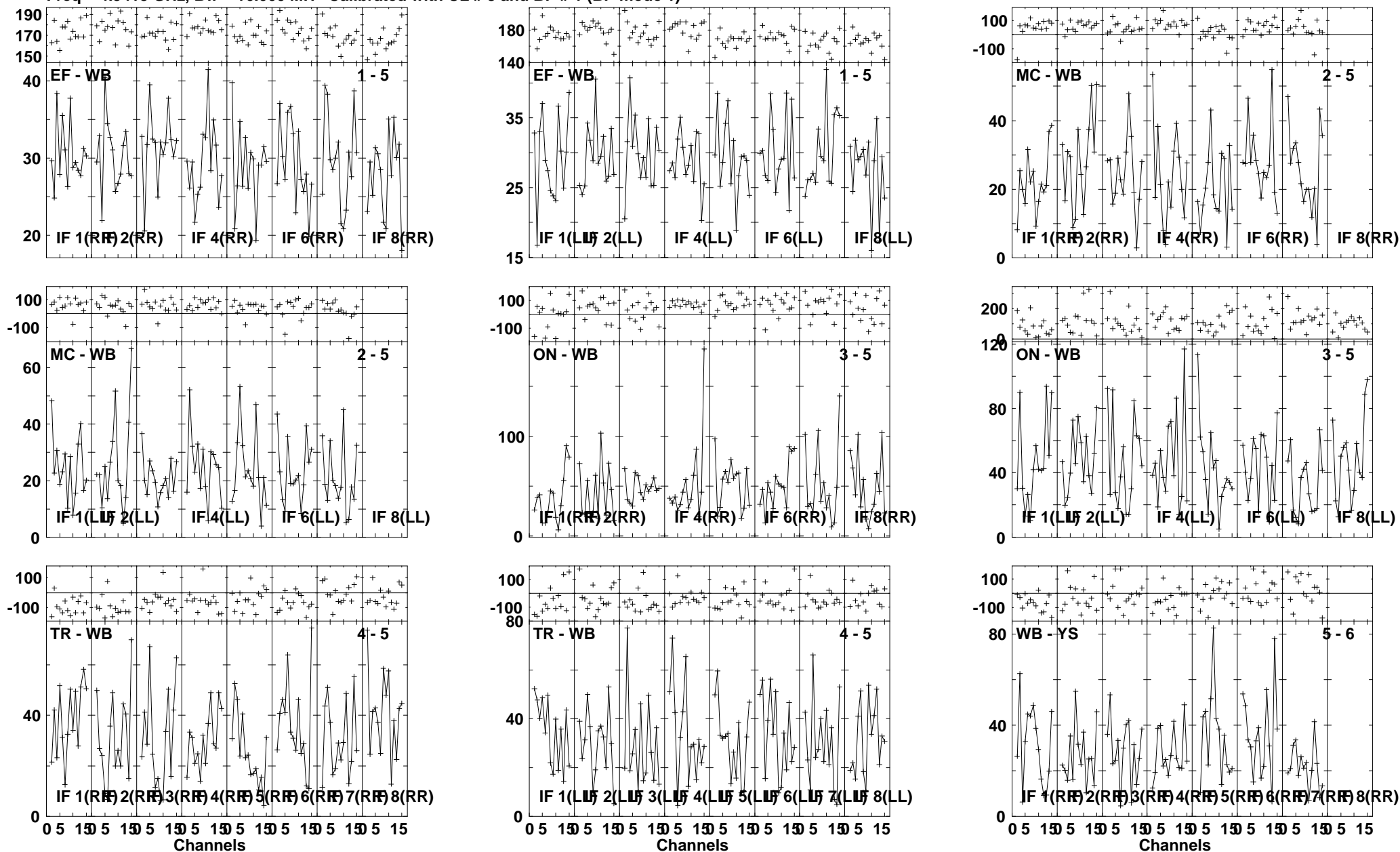

Lower frame: Milli Ampl Jy Top frame: Phas deg
Vector averaged cross-power spectrum Several baselines displayed
Timerange: 00/13:55:11 to 00/13:57:39

Plot file version 56 created 21-MAY-2010 15:46:02

CALG RSD03.UVDATA.1

Freq = 4.9415 GHz, Bw = 16.000 MH Calibrated with CL # 3 and BP # 1 (BP mode 1)

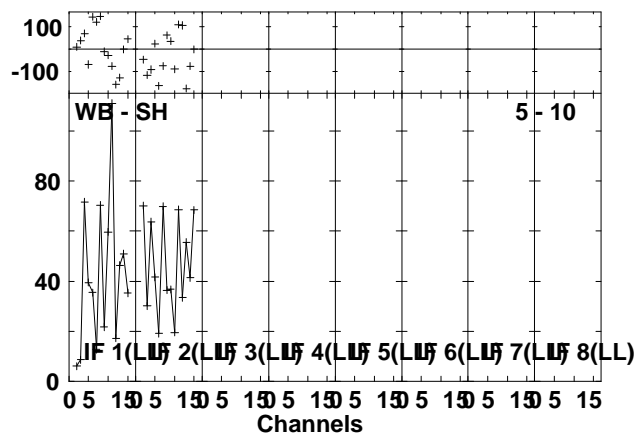
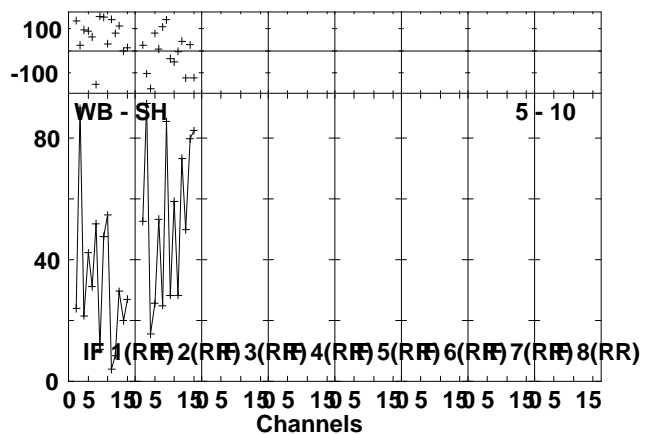
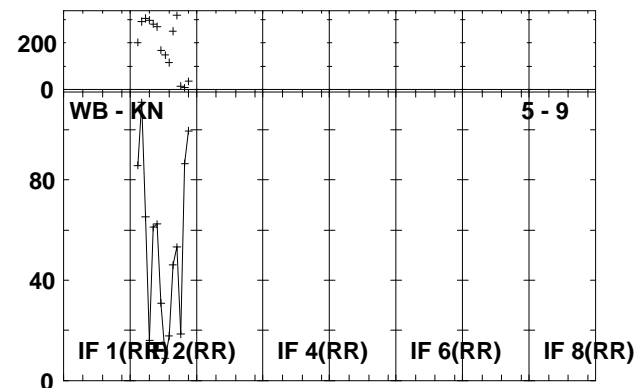
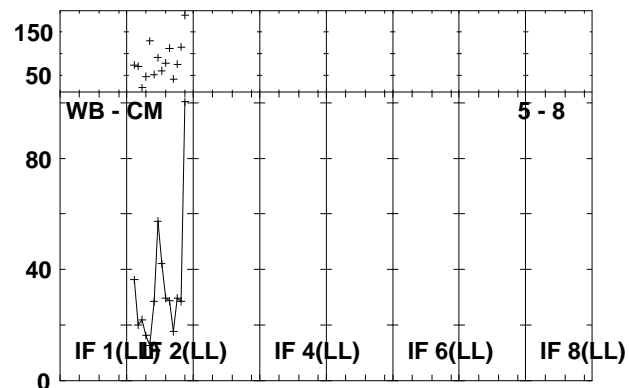
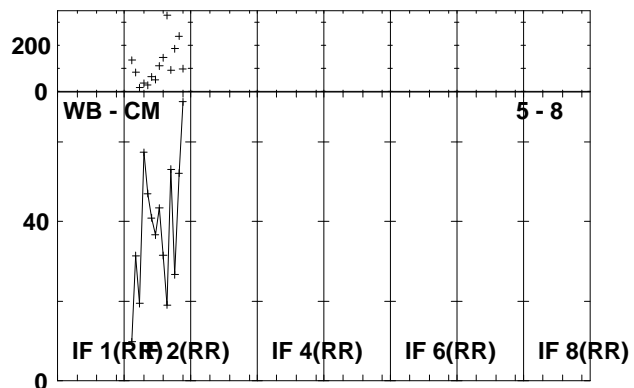
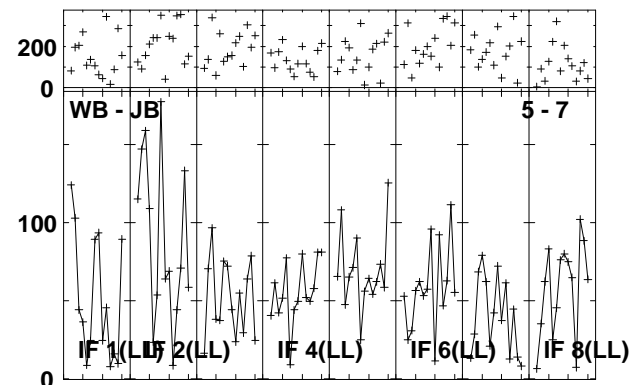
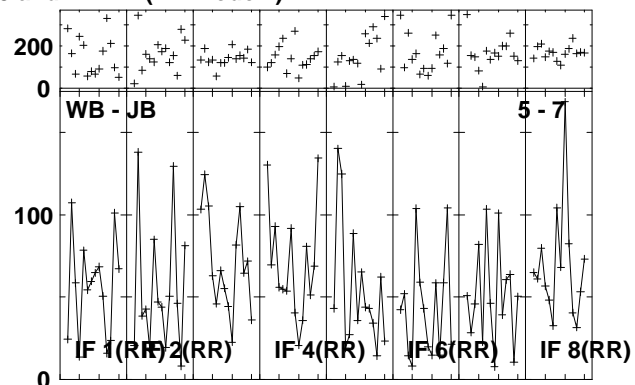
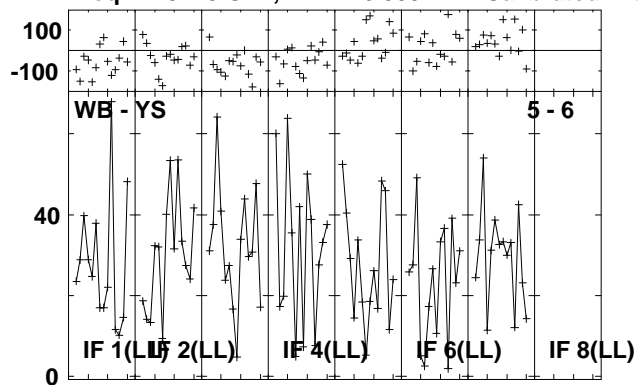

Lower frame: Milli Ampl Jy Top frame: Phas deg
Vector averaged cross-power spectrum Several baselines displayed
Timerange: 00/13:55:11 to 00/13:57:39

Plot file version 57 created 21-MAY-2010 15:46:05

CALE RSD03.UVDATA.1

Freq = 4.9415 GHz, Bw = 16.000 MH Calibrated with CL # 3 and BP # 1 (BP mode 1)

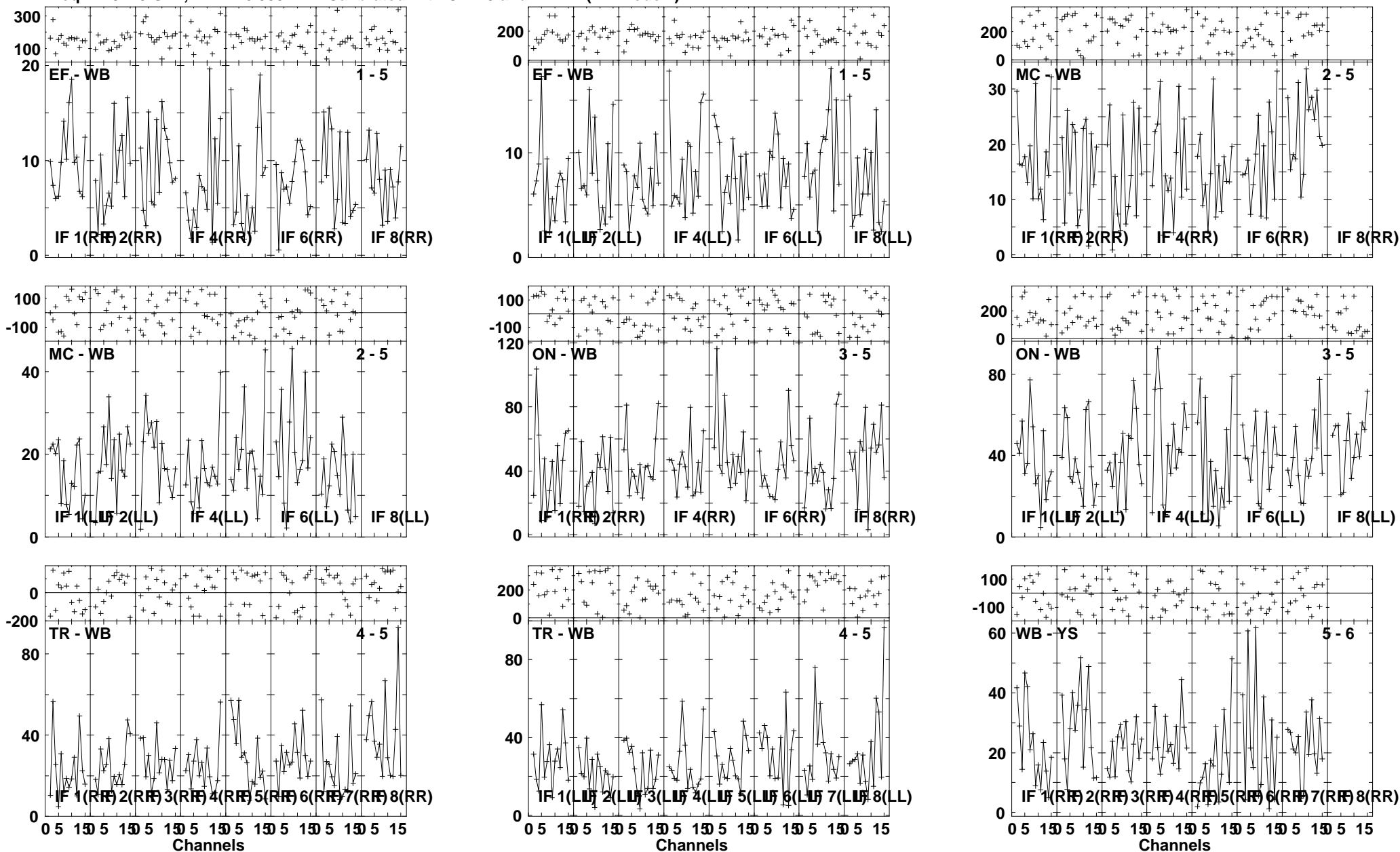

Lower frame: Milli Ampl Jy Top frame: Phas deg
Vector averaged cross-power spectrum Several baselines displayed
Timerange: 00/13:57:41 to 00/14:00:09

Plot file version 58 created 21-MAY-2010 15:46:07

CALE RSD03.UVDATA.1

Freq = 4.9415 GHz, Bw = 16.000 MH Calibrated with CL # 3 and BP # 1 (BP mode 1)

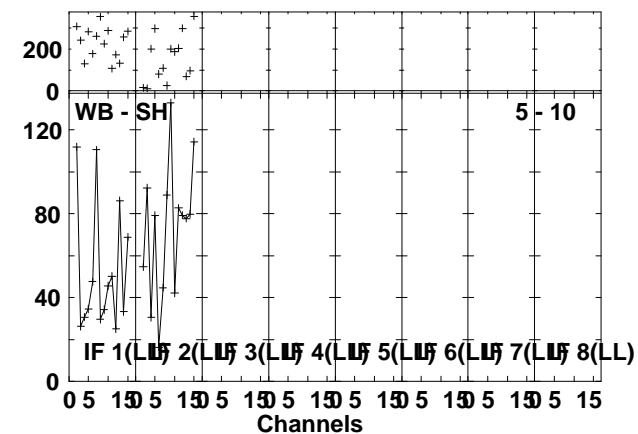
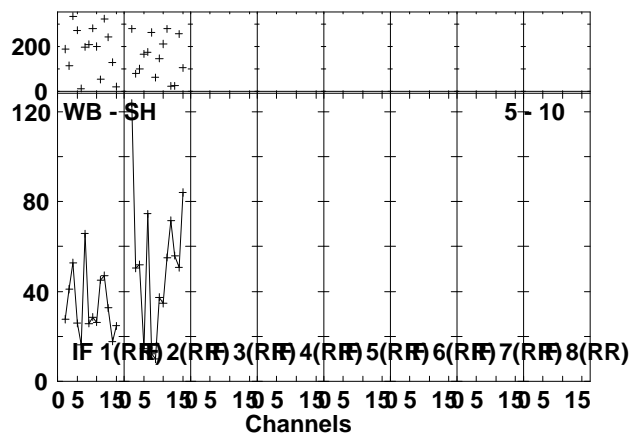
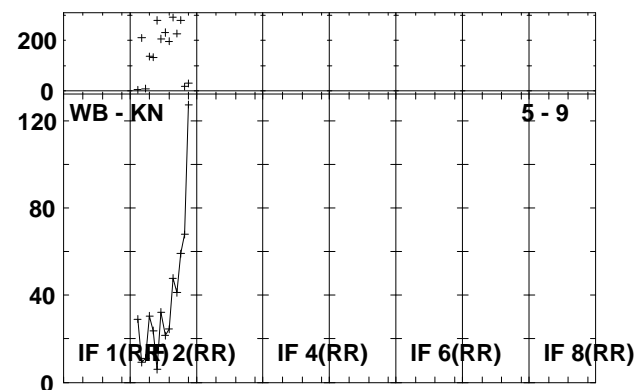
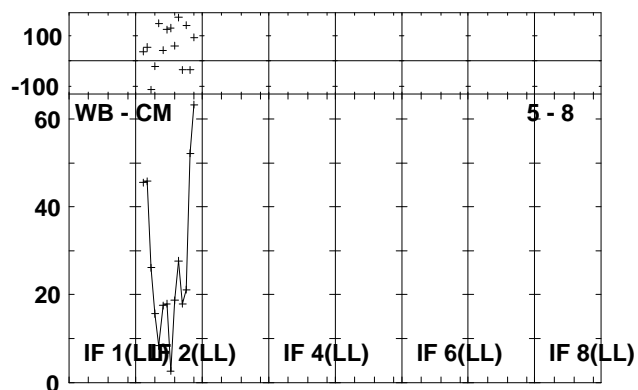
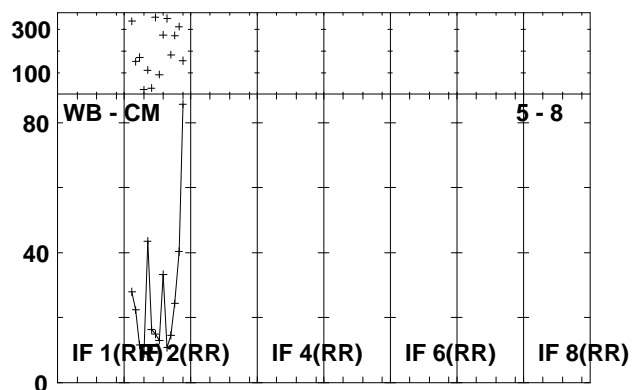
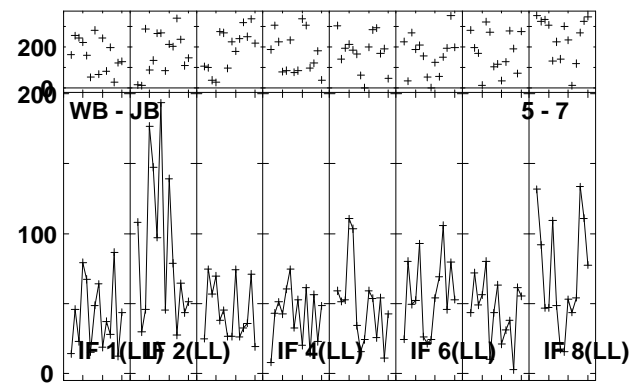
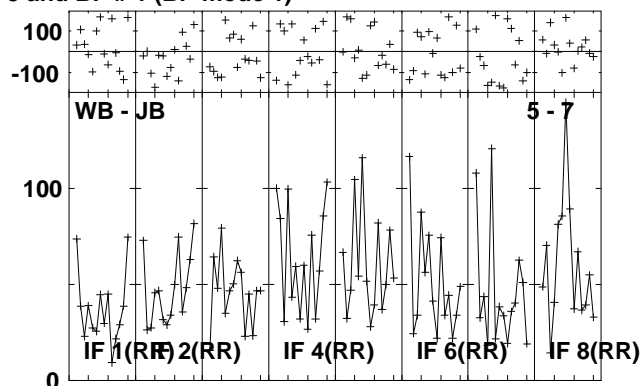
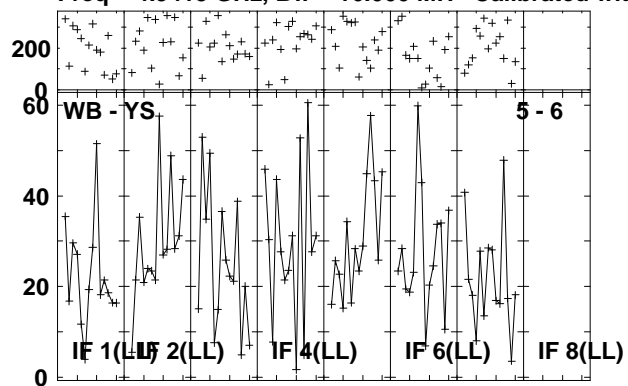

Lower frame: Milli Ampl Jy Top frame: Phas deg
Vector averaged cross-power spectrum Several baselines displayed
Timerange: 00/13:57:41 to 00/14:00:09

Plot file version 59 created 21-MAY-2010 15:46:10

J0909+02 RSD03.UVDATA.1

Freq = 4.9415 GHz, Bw = 16.000 MH Calibrated with CL # 3 and BP # 1 (BP mode 1)

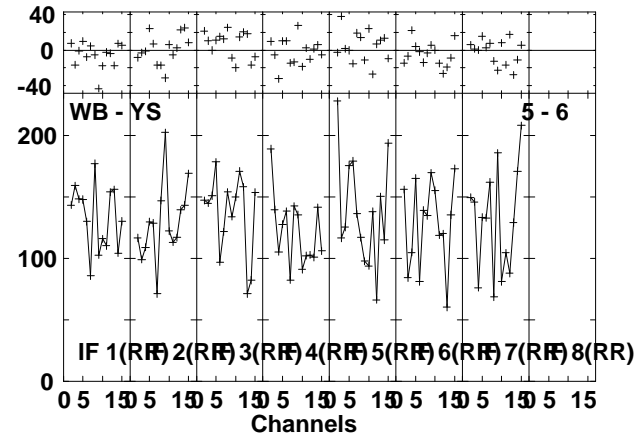
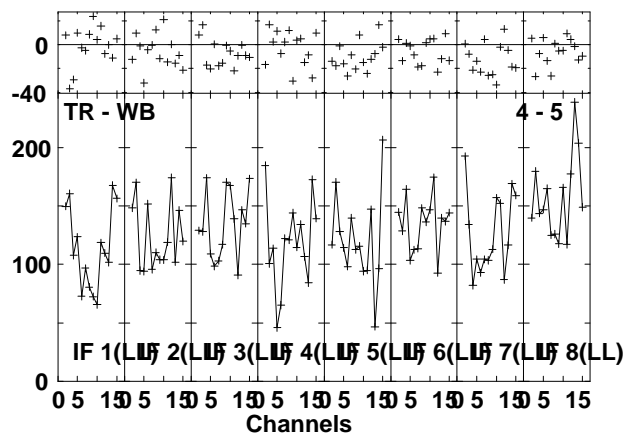
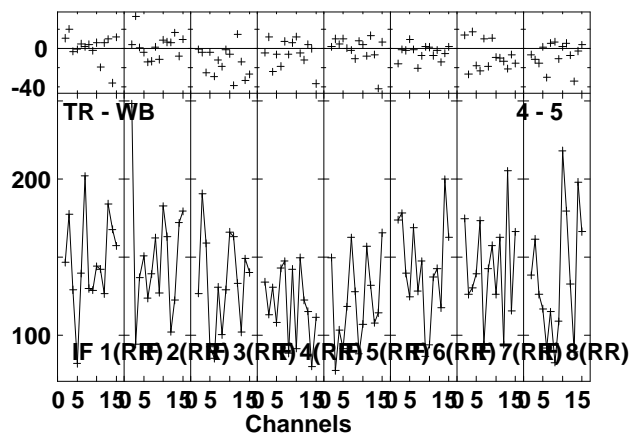
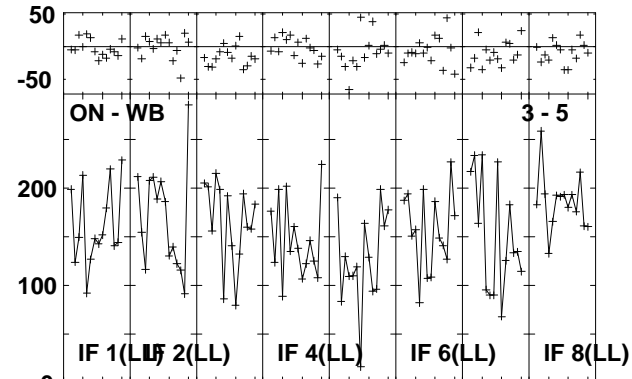
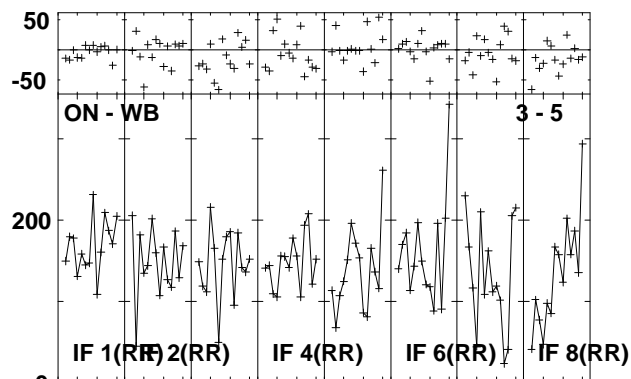
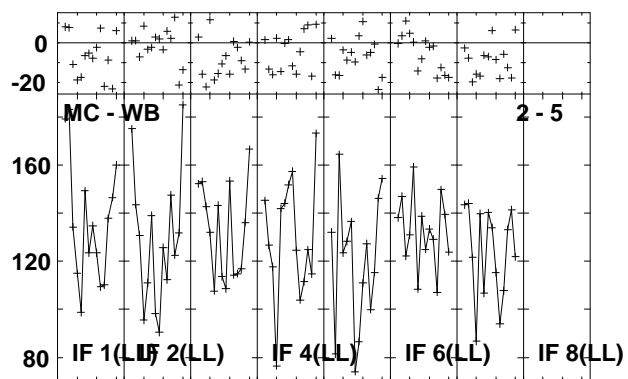
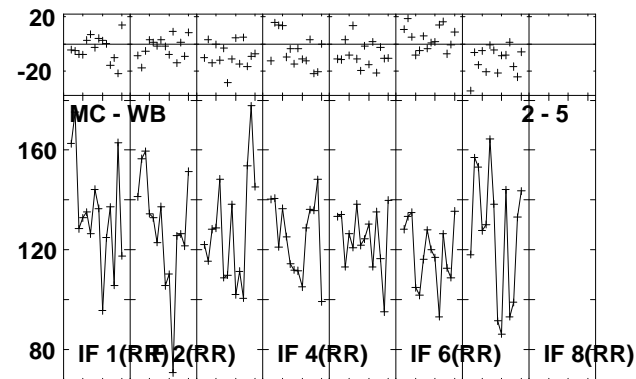
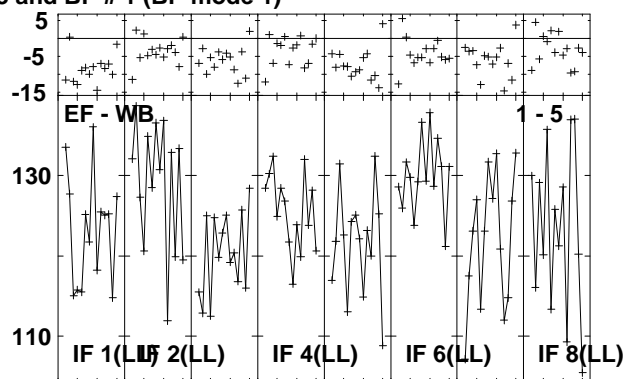
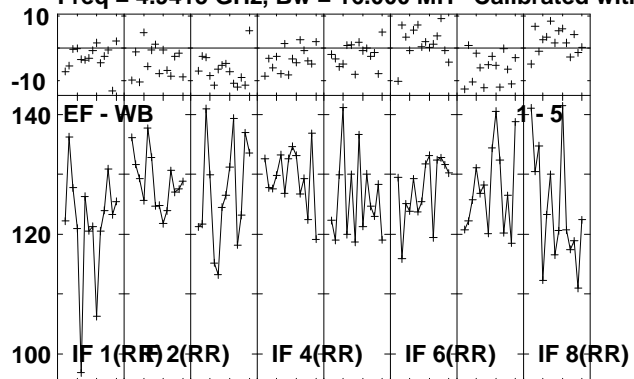

Lower frame: Milli Ampl Jy Top frame: Phas deg
Vector averaged cross-power spectrum Several baselines displayed
Timerange: 00/14:00:51 to 00/14:01:49

Plot file version 60 created 21-MAY-2010 15:46:11

J0909+02 RSD03.UVDATA.1

Freq = 4.9415 GHz, Bw = 16.000 MH Calibrated with CL # 3 and BP # 1 (BP mode 1)

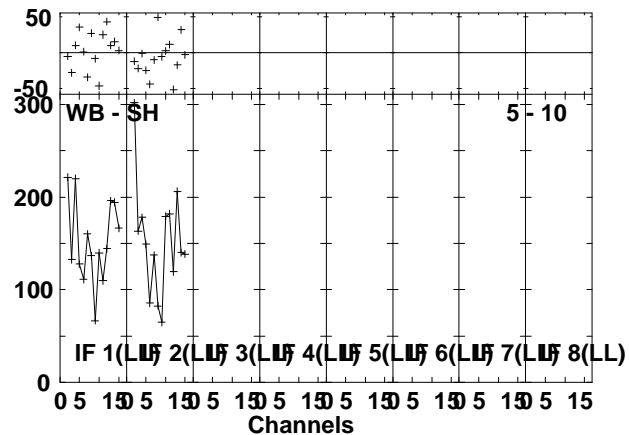
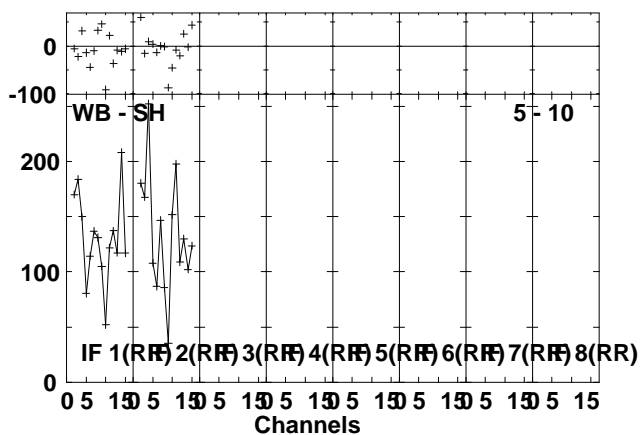
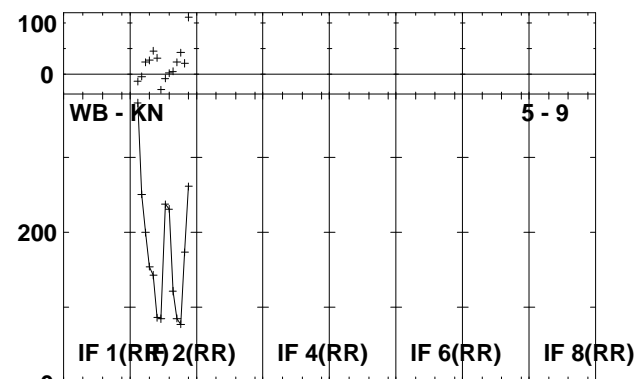
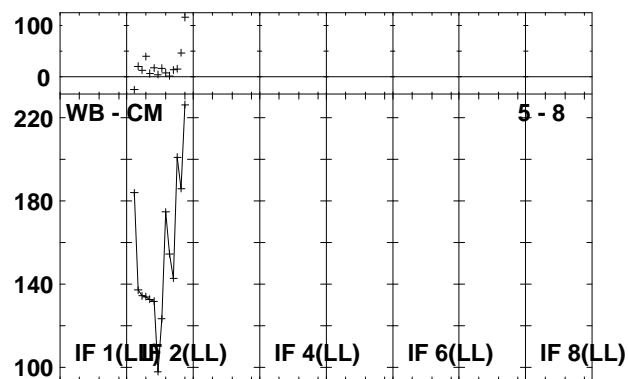
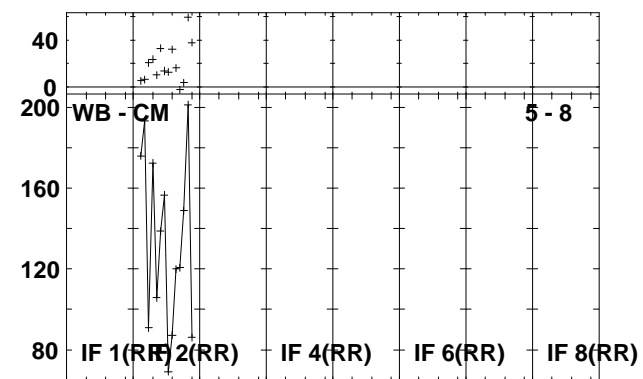
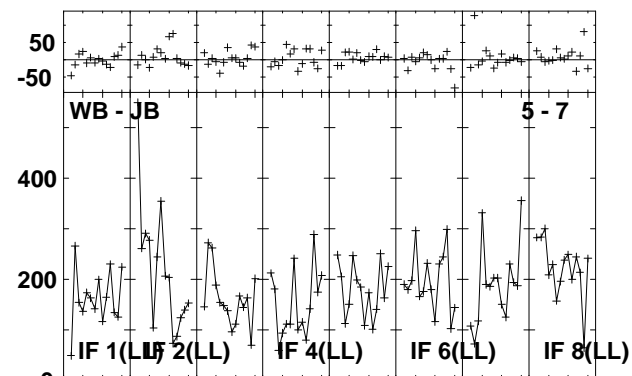
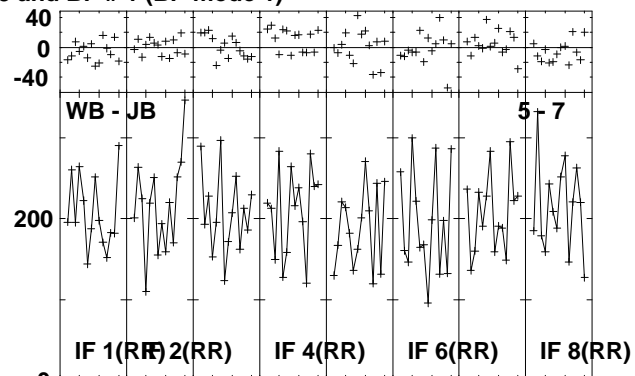
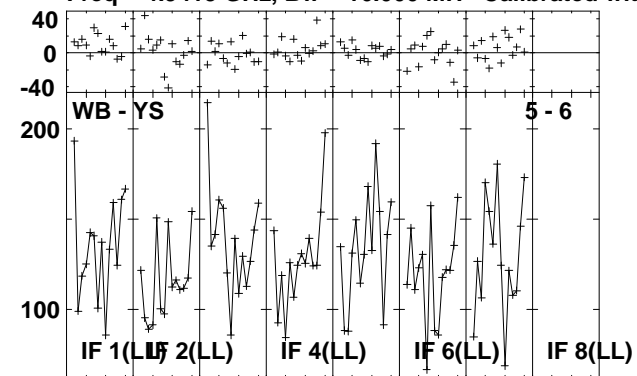

Lower frame: Milli Ampl Jy Top frame: Phas deg
Vector averaged cross-power spectrum Several baselines displayed
Timerange: 00/14:00:51 to 00/14:01:49

Plot file version 61 created 21-MAY-2010 15:46:12

CALI RSD03.UVDATA.1

Freq = 4.9415 GHz, Bw = 16.000 MH Calibrated with CL # 3 and BP # 1 (BP mode 1)

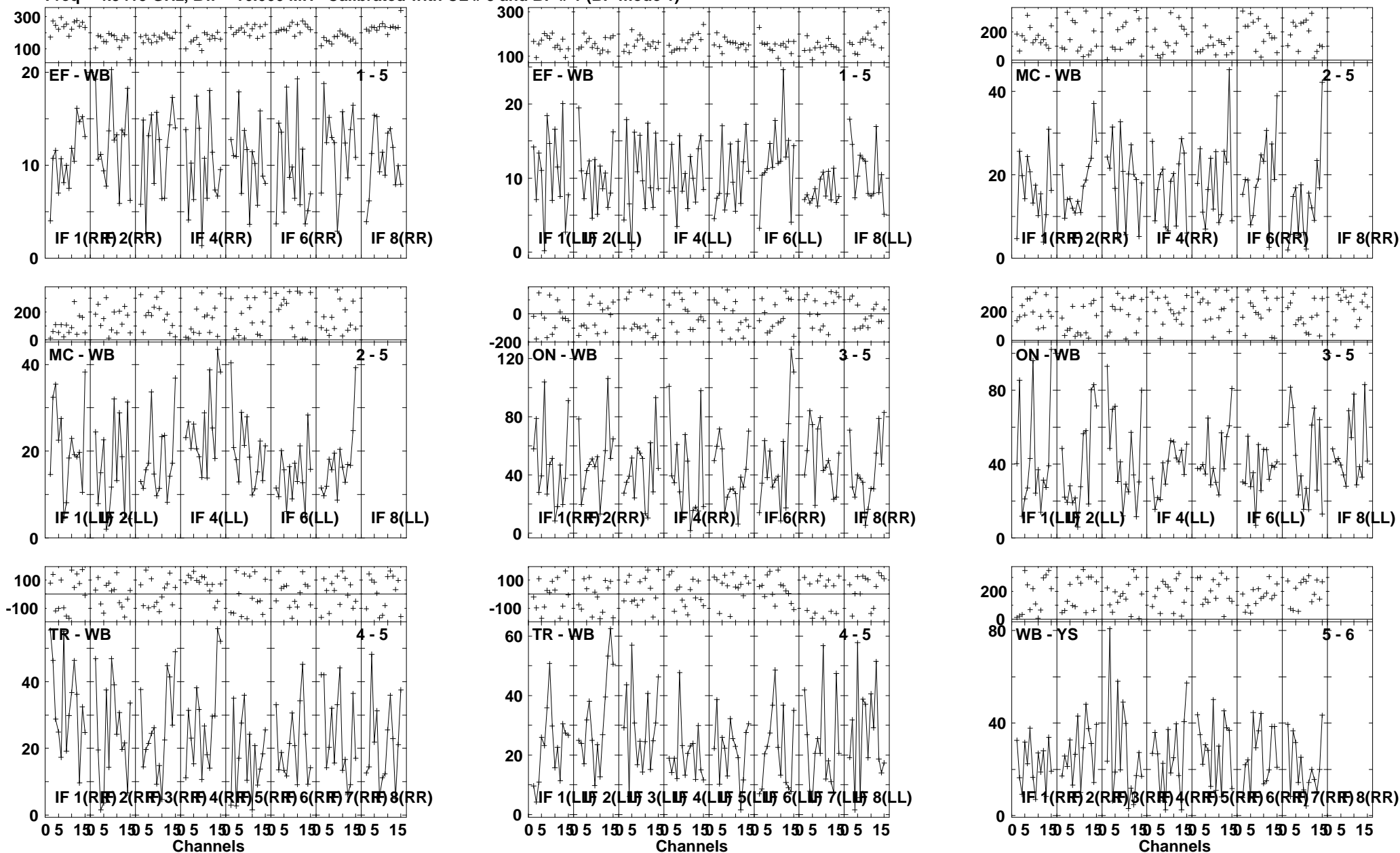

Lower frame: Milli Ampl Jy Top frame: Phas deg
Vector averaged cross-power spectrum Several baselines displayed
Timerange: 00/14:01:51 to 00/14:04:19

Plot file version 62 created 21-MAY-2010 15:46:14

CALI RSD03.UVDATA.1

Freq = 4.9415 GHz, Bw = 16.000 MH Calibrated with CL # 3 and BP # 1 (BP mode 1)

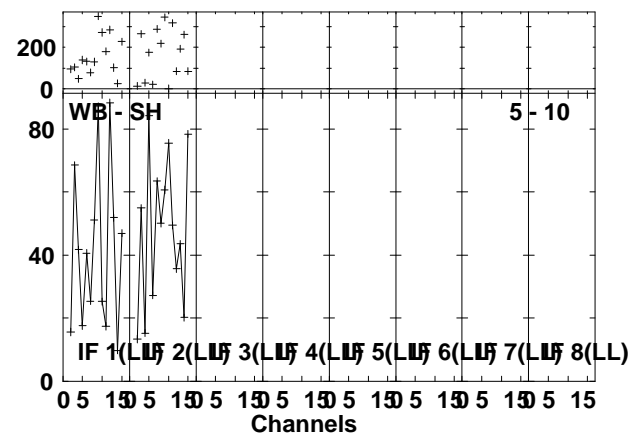
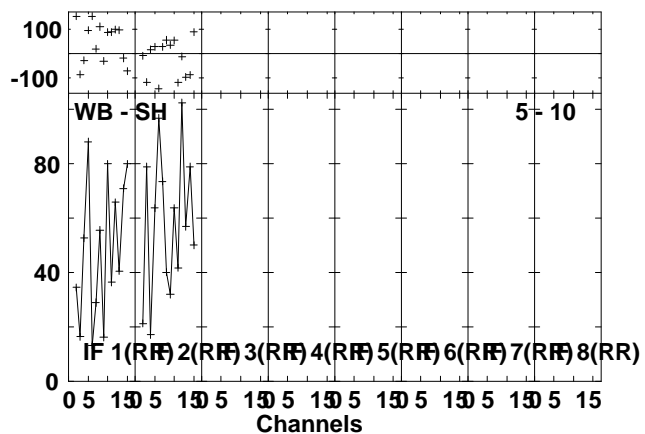
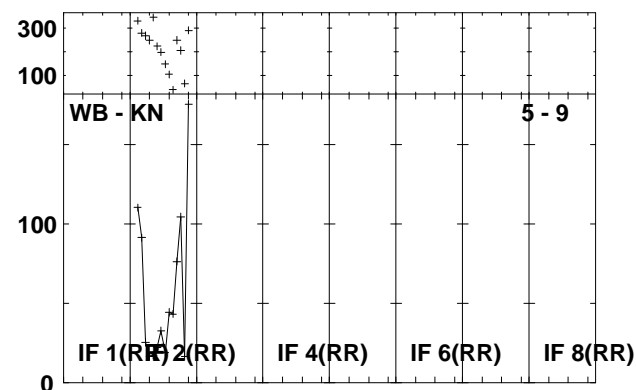
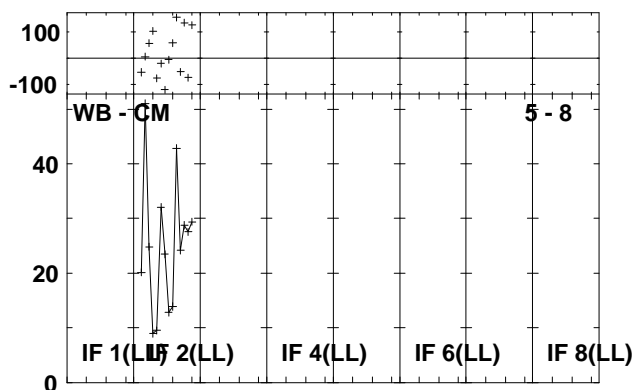
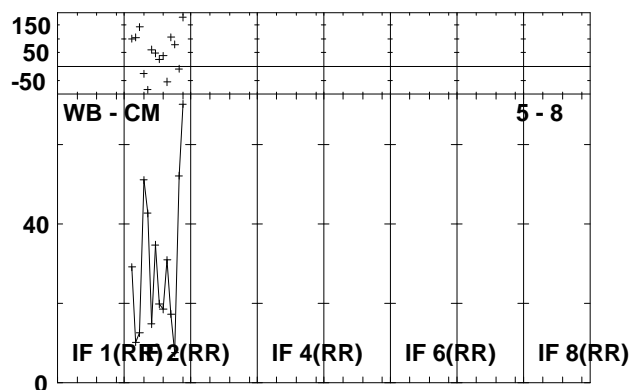
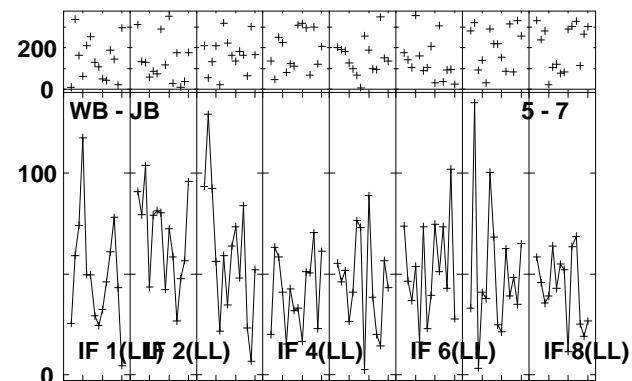
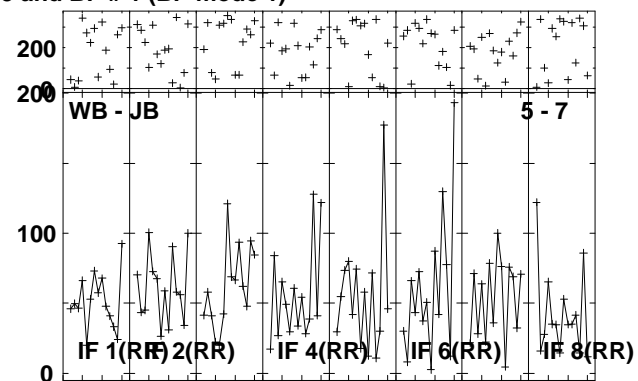
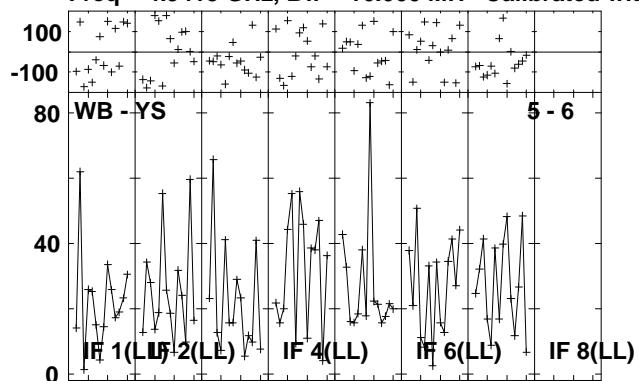

Lower frame: Milli Ampl Jy Top frame: Phas deg
Vector averaged cross-power spectrum Several baselines displayed
Timerange: 00/14:01:51 to 00/14:04:19

Plot file version 63 created 21-MAY-2010 15:46:17

CALH RSD03.UVDATA.1

Freq = 4.9415 GHz, Bw = 16.000 MH Calibrated with CL # 3 and BP # 1 (BP mode 1)

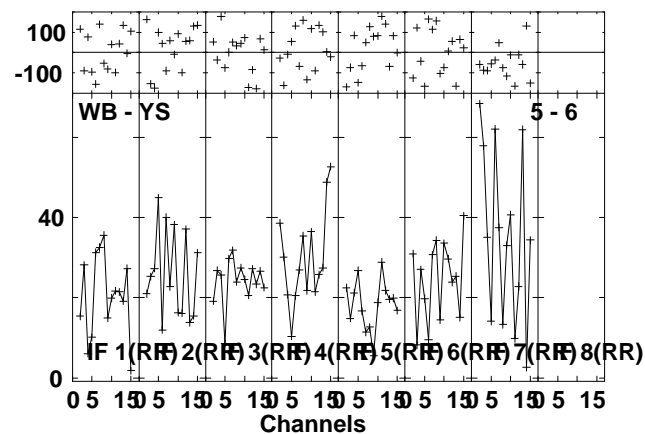
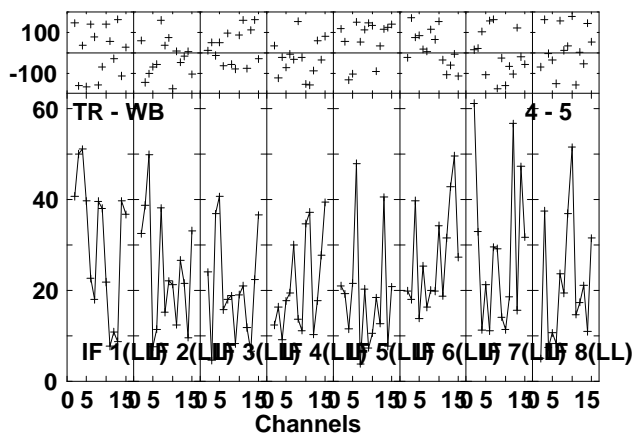
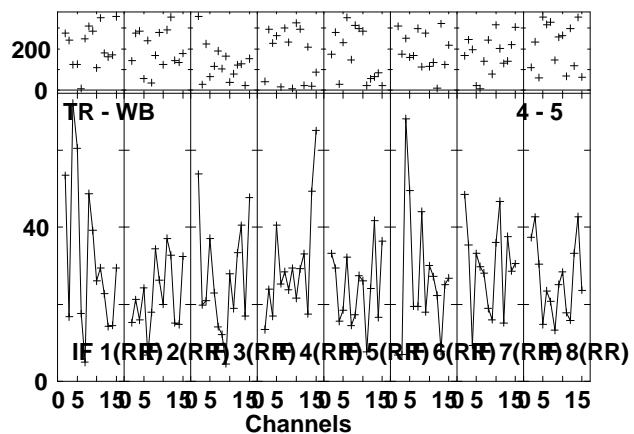
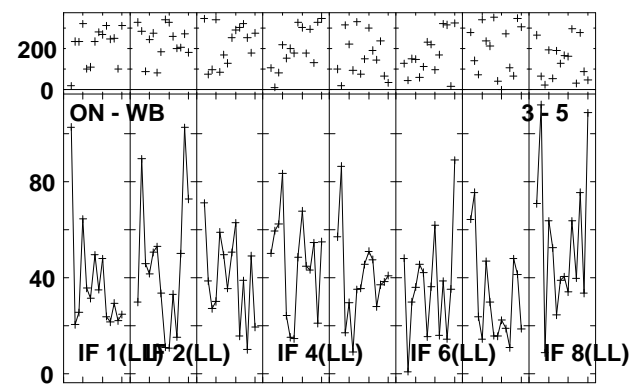
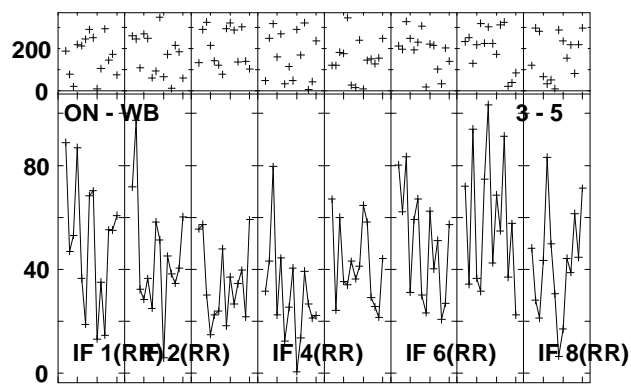
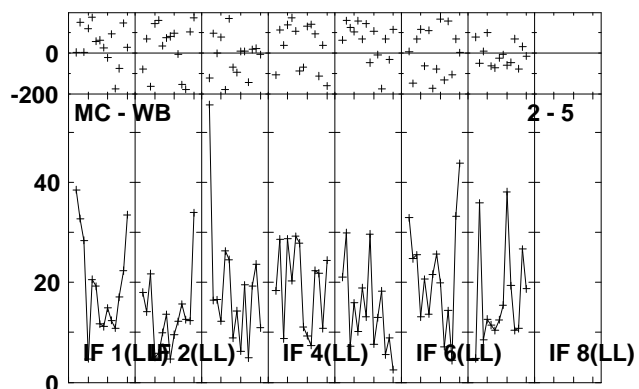
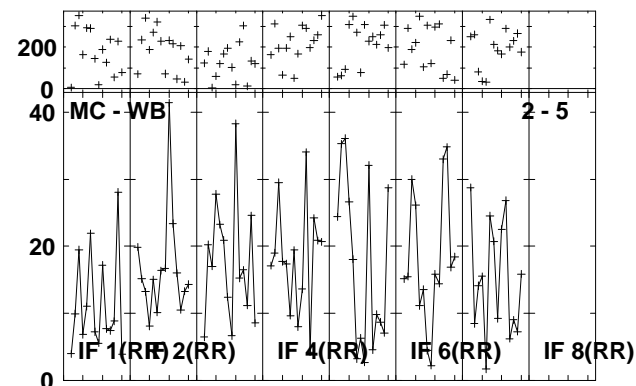
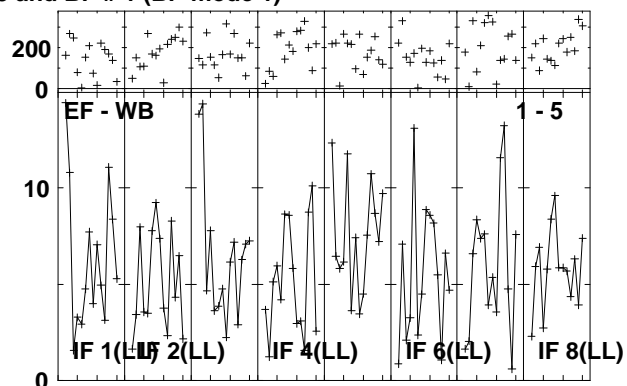
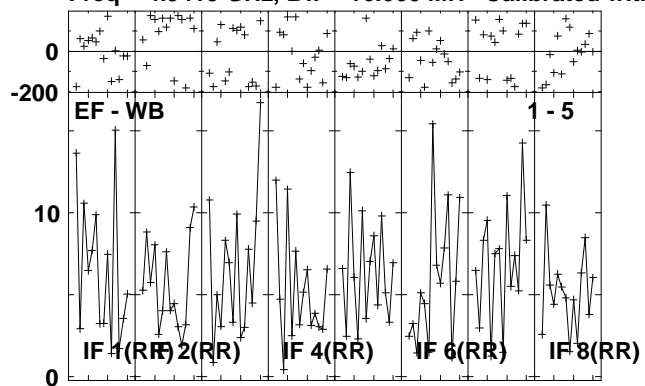

Lower frame: Milli Ampl Jy Top frame: Phas deg
Vector averaged cross-power spectrum Several baselines displayed
Timerange: 00/14:04:21 to 00/14:06:49

Plot file version 64 created 21-MAY-2010 15:46:19

CALH RSD03.UVDATA.1

Freq = 4.9415 GHz, Bw = 16.000 MH Calibrated with CL # 3 and BP # 1 (BP mode 1)

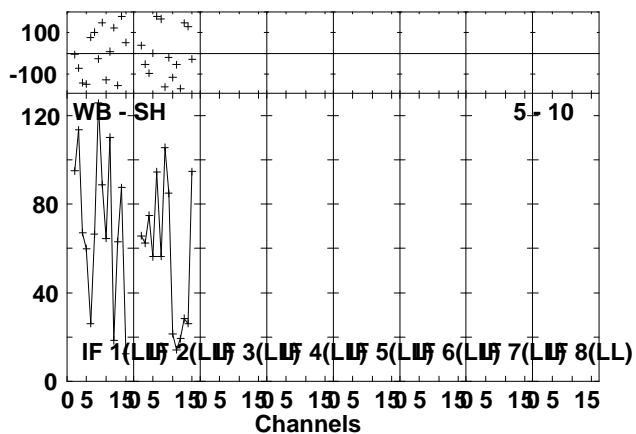
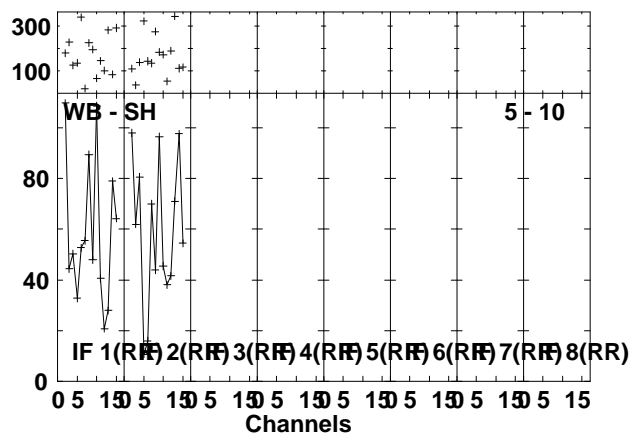
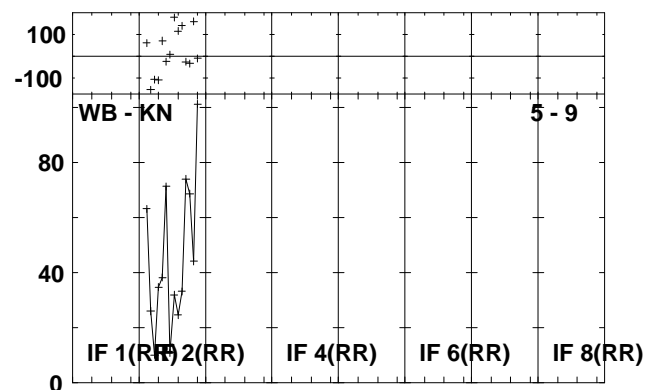
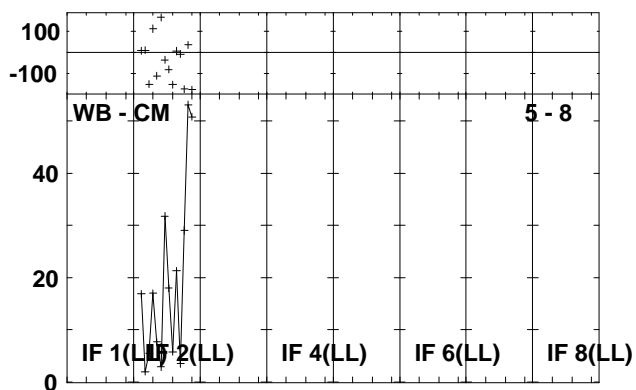
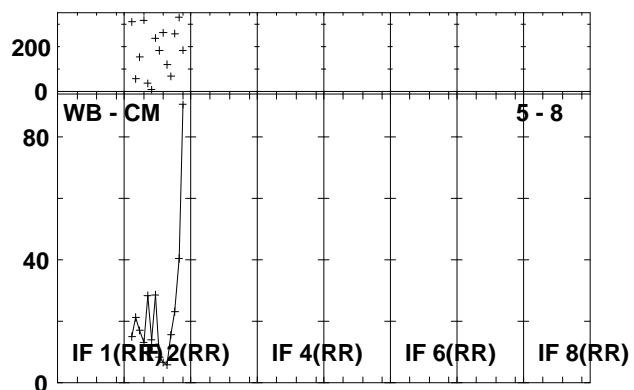
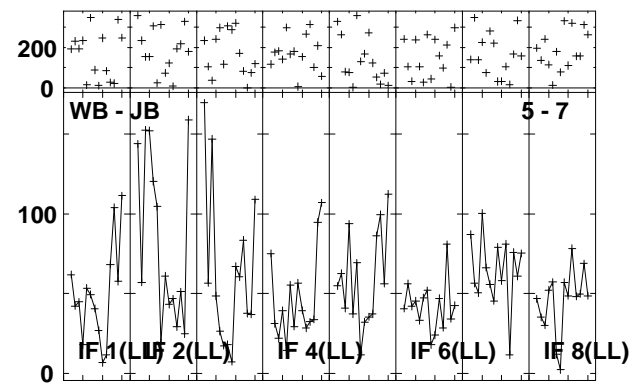
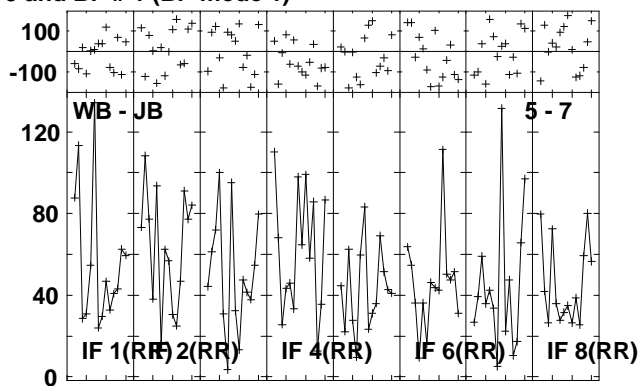
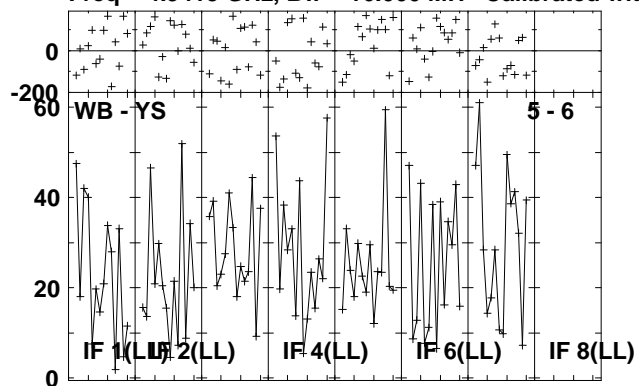

Lower frame: Milli Ampl Jy Top frame: Phas deg
Vector averaged cross-power spectrum Several baselines displayed
Timerange: 00/14:04:21 to 00/14:06:49

Plot file version 65 created 21-MAY-2010 15:46:22

CALJ RSD03.UVDATA.1

Freq = 4.9415 GHz, Bw = 16.000 MH Calibrated with CL # 3 and BP # 1 (BP mode 1)

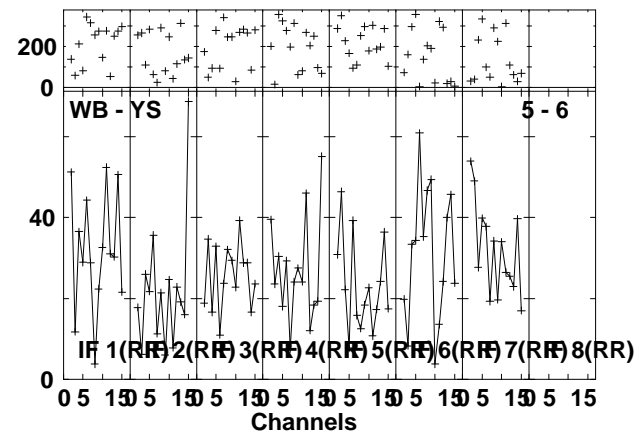
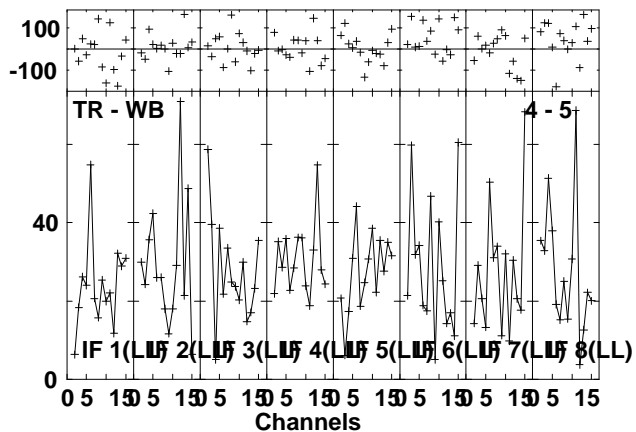
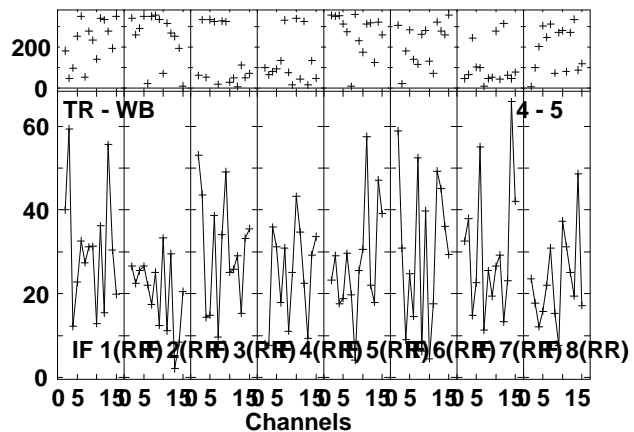
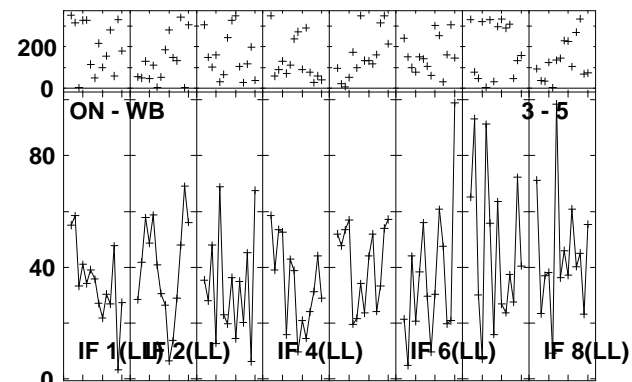
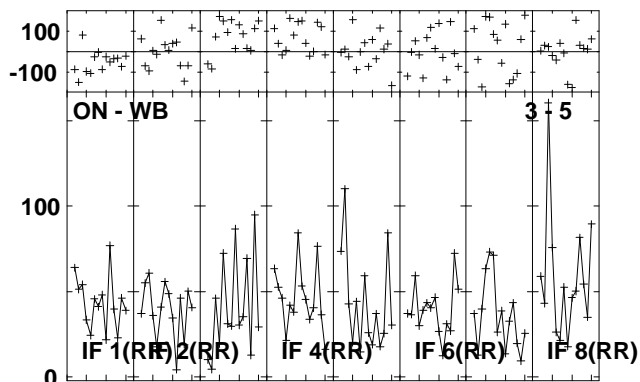
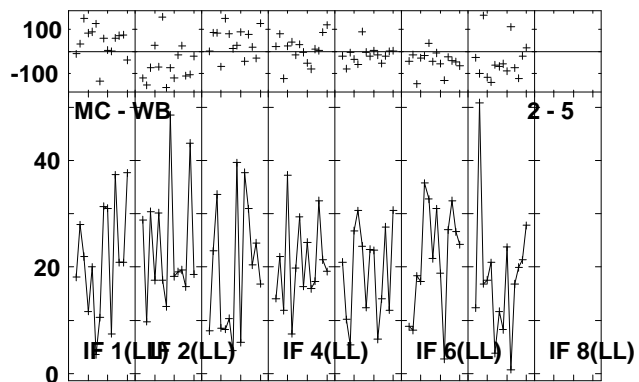
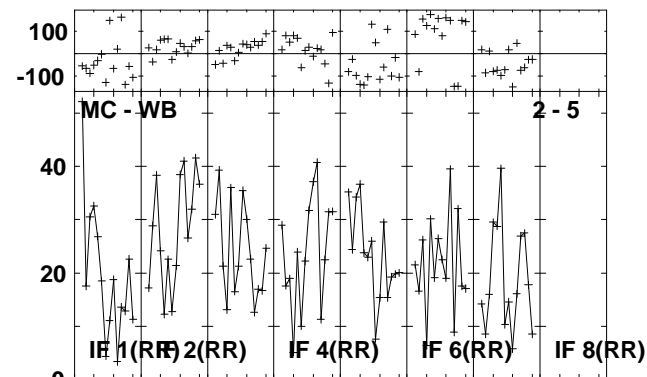
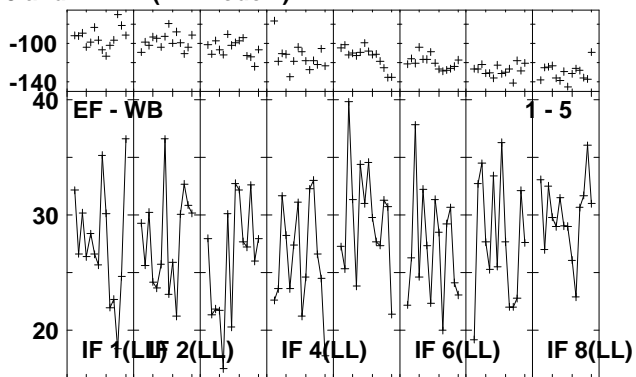
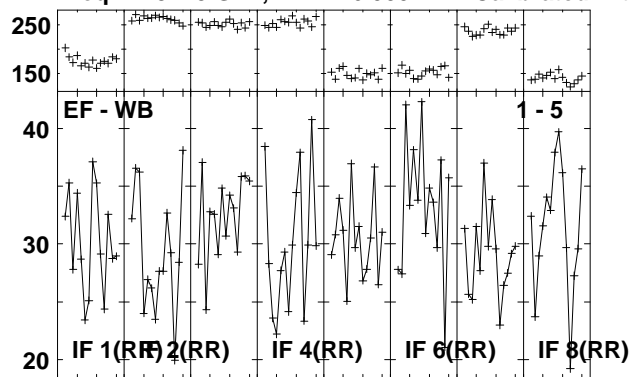

Lower frame: Milli Ampl Jy Top frame: Phas deg
Vector averaged cross-power spectrum Several baselines displayed
Timerange: 00/14:06:51 to 00/14:09:19

Plot file version 66 created 21-MAY-2010 15:46:24

CALJ RSD03.UVDATA.1

Freq = 4.9415 GHz, Bw = 16.000 MH Calibrated with CL # 3 and BP # 1 (BP mode 1)

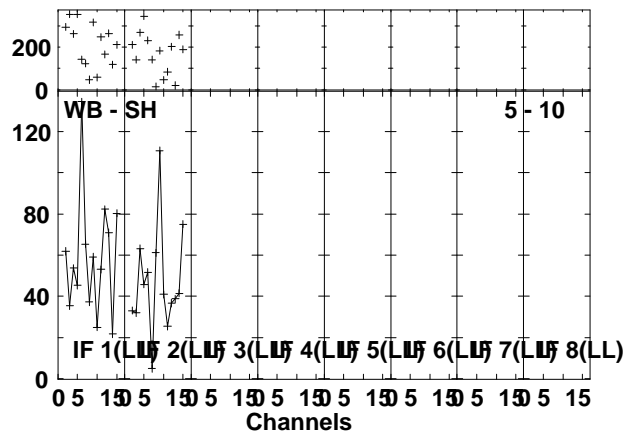
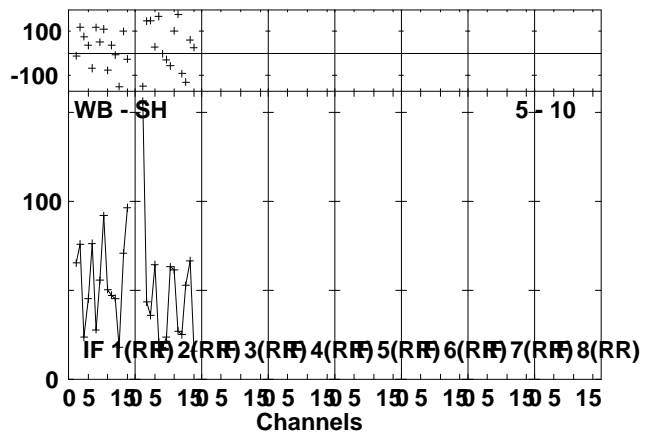
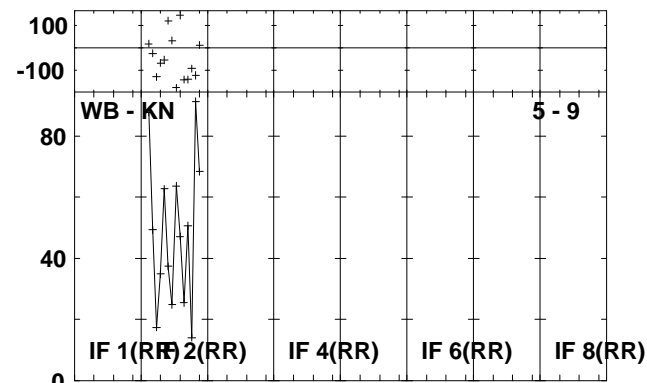
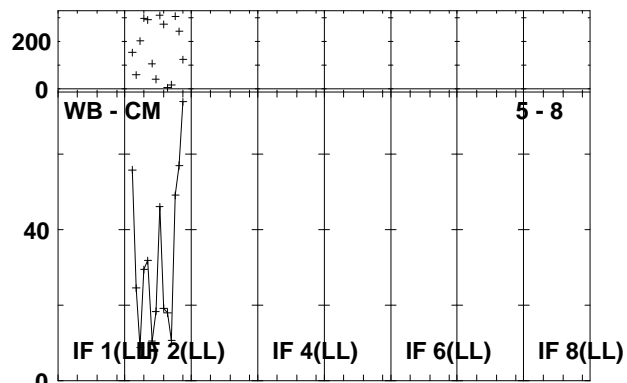
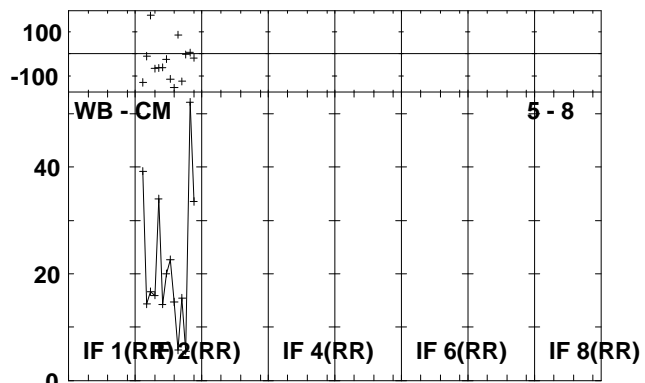
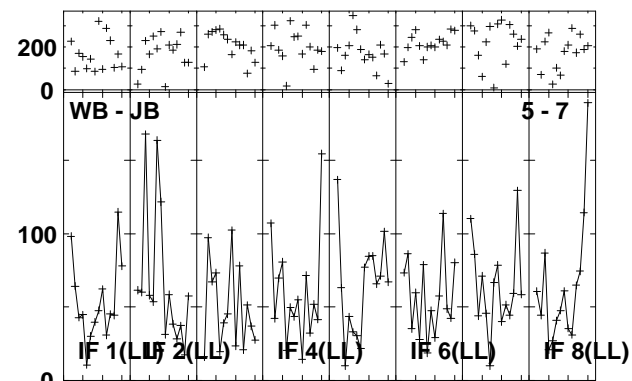
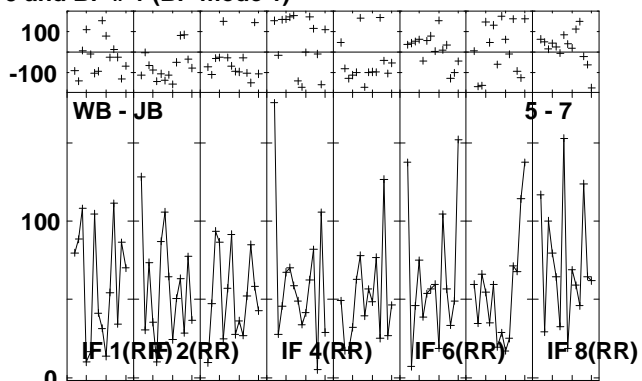
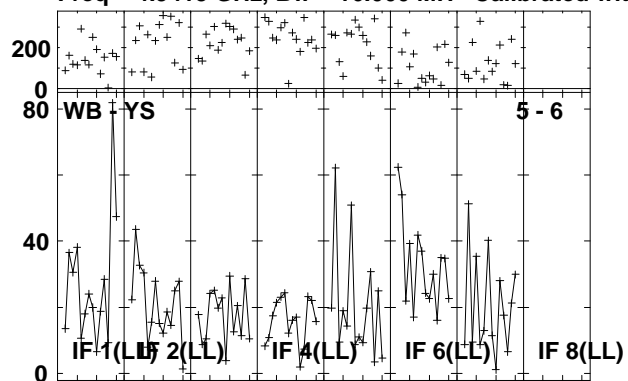

Lower frame: Milli Ampl Jy Top frame: Phas deg
Vector averaged cross-power spectrum Several baselines displayed
Timerange: 00/14:06:51 to 00/14:09:19

Plot file version 67 created 21-MAY-2010 15:46:27

J0909+02 RSD03.UVDATA.1

Freq = 4.9415 GHz, Bw = 16.000 MH Calibrated with CL # 3 and BP # 1 (BP mode 1)

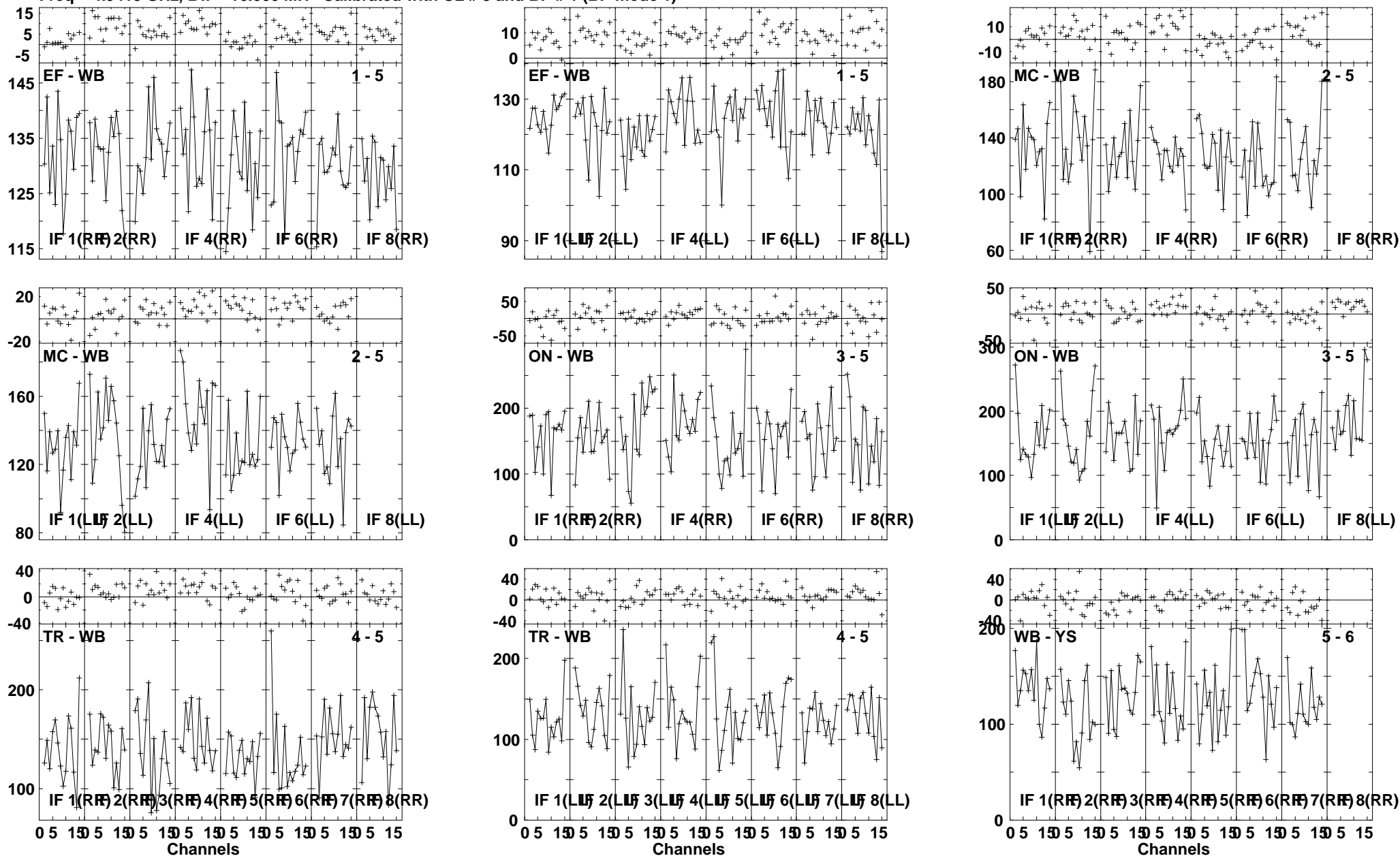

Lower frame: Milli Ampl Jy Top frame: Phas deg
Vector averaged cross-power spectrum Several baselines displayed
Timerange: 00/14:10:01 to 00/14:10:59

Plot file version 68 created 21-MAY-2010 15:46:28

J0909+02 RSD03.UVDATA.1

Freq = 4.9415 GHz, Bw = 16.000 MH Calibrated with CL # 3 and BP # 1 (BP mode 1)

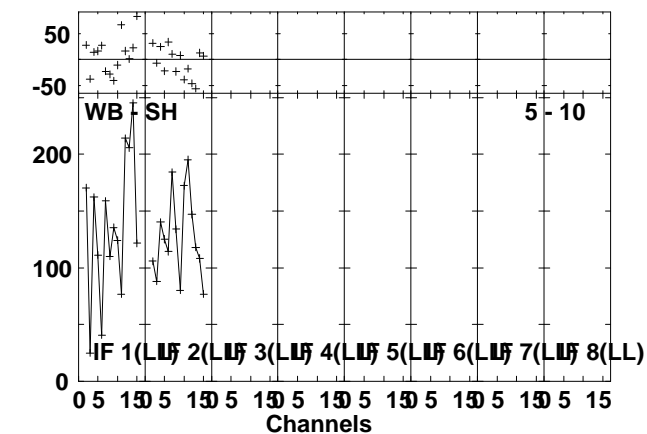
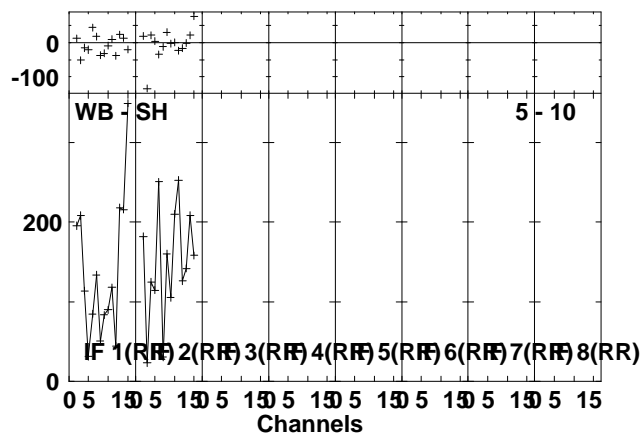
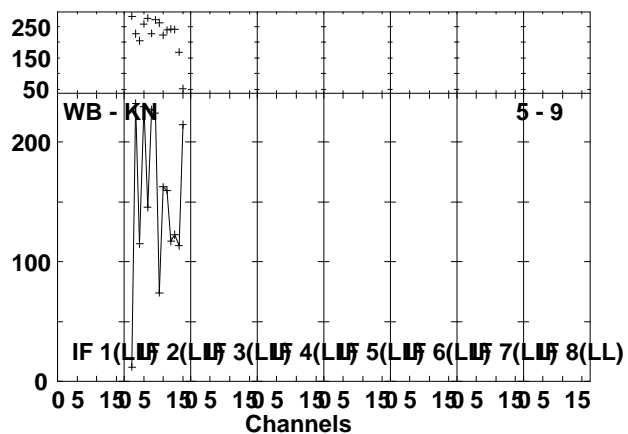
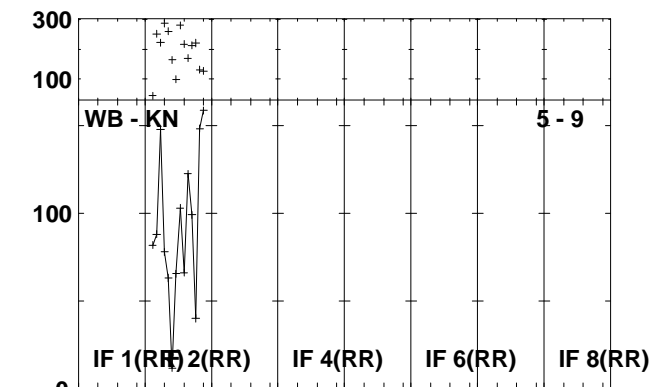
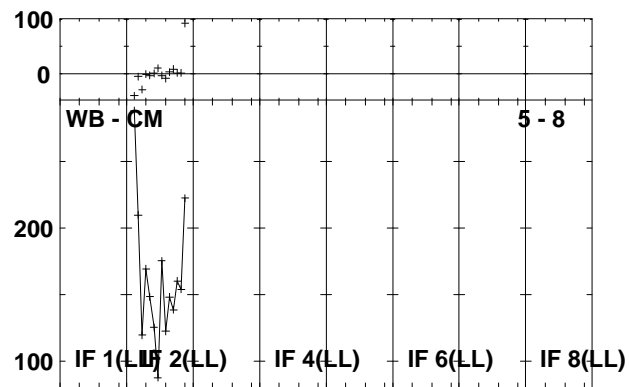
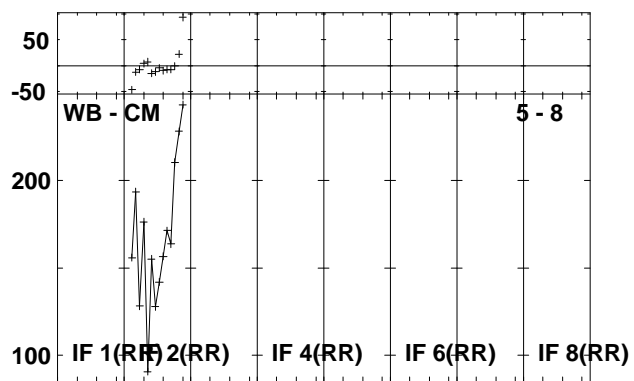
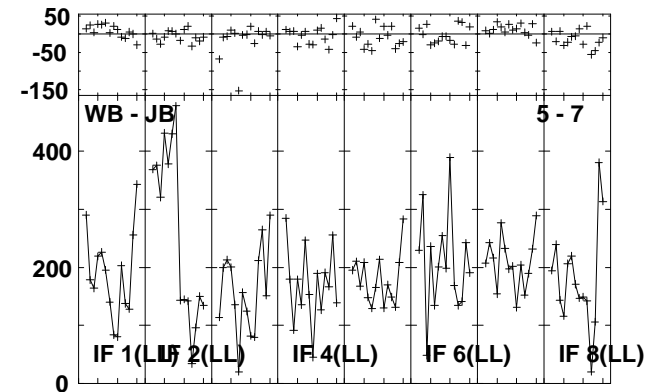
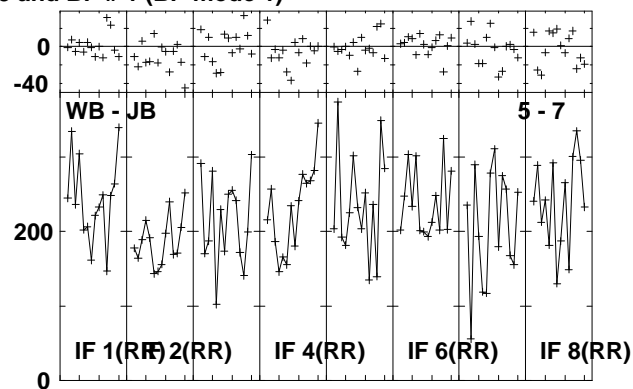
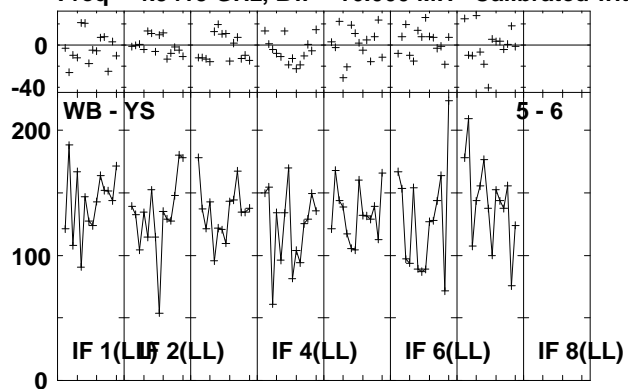

Lower frame: Milli Ampl Jy Top frame: Phas deg
Vector averaged cross-power spectrum Several baselines displayed
Timerange: 00/14:10:01 to 00/14:10:59

Plot file version 69 created 21-MAY-2010 15:46:30

CALA RSD03.UVDATA.1

Freq = 4.9415 GHz, Bw = 16.000 MH Calibrated with CL # 3 and BP # 1 (BP mode 1)

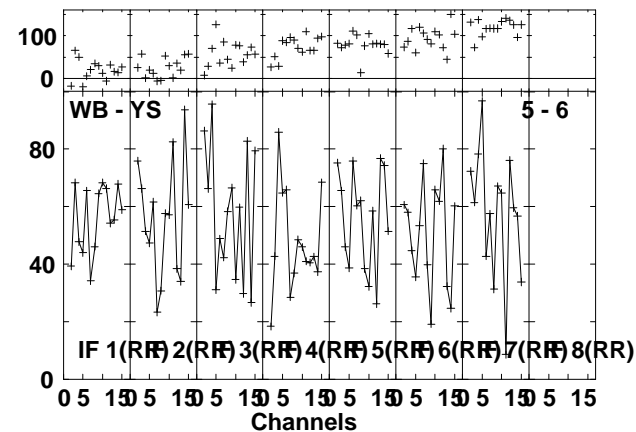
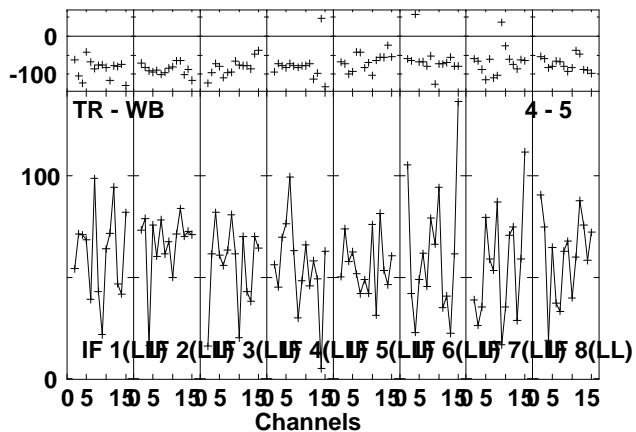
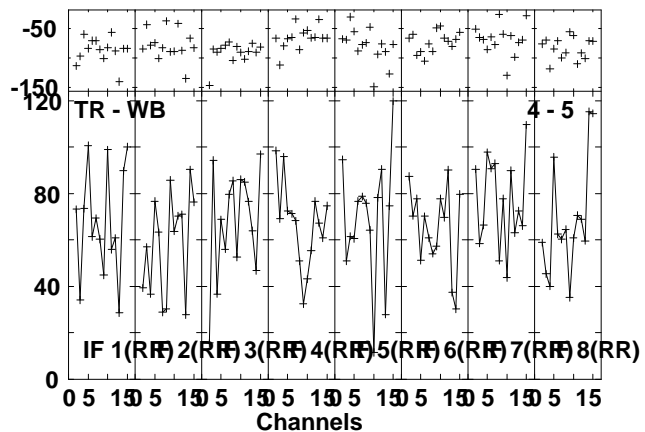
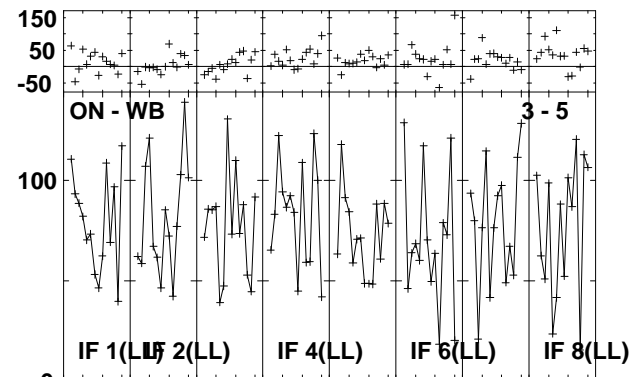
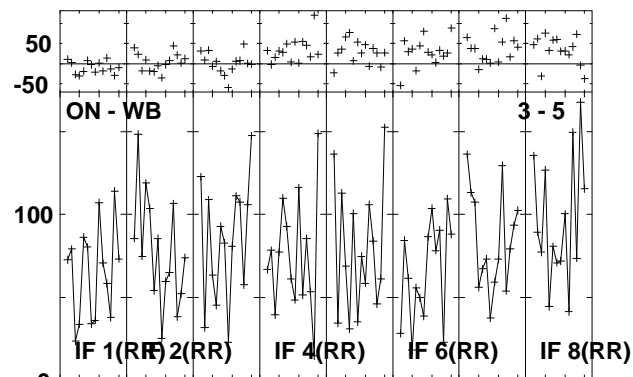
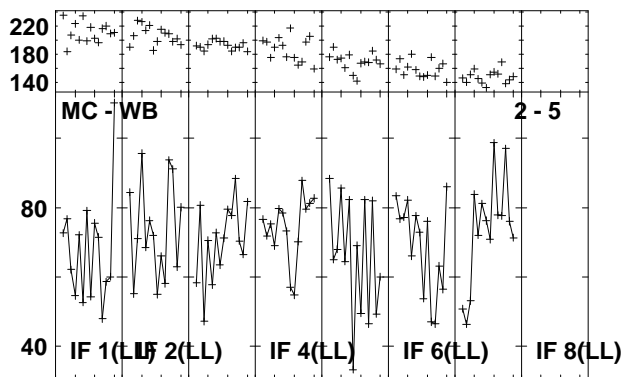
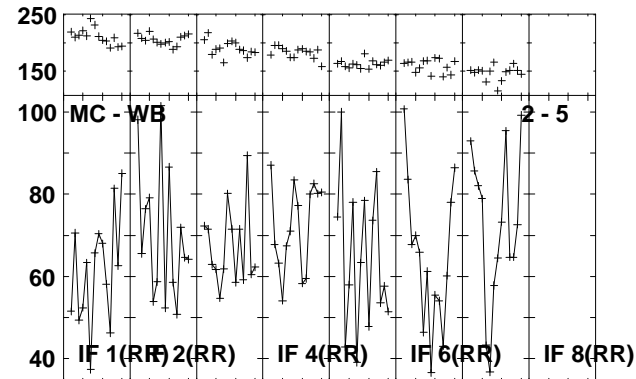
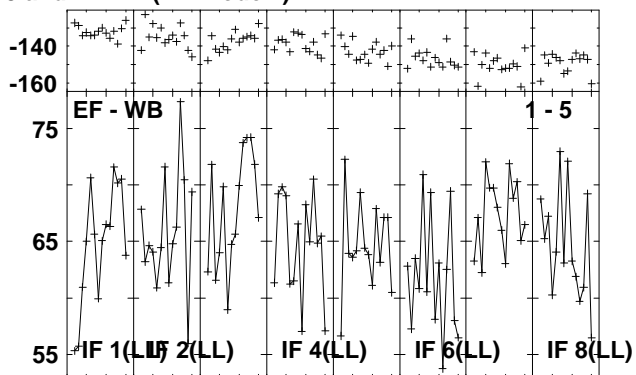
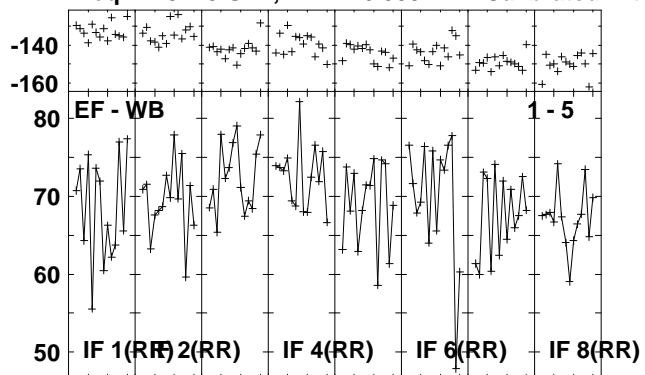

Lower frame: Milli Ampl Jy Top frame: Phas deg
Vector averaged cross-power spectrum Several baselines displayed
Timerange: 00/14:11:01 to 00/14:13:29

Plot file version 70 created 21-MAY-2010 15:46:32

CALA RSD03.UVDATA.1

Freq = 4.9415 GHz, Bw = 16.000 MH Calibrated with CL # 3 and BP # 1 (BP mode 1)

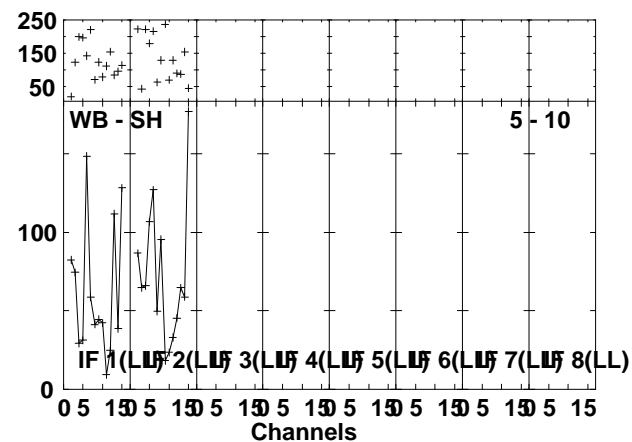
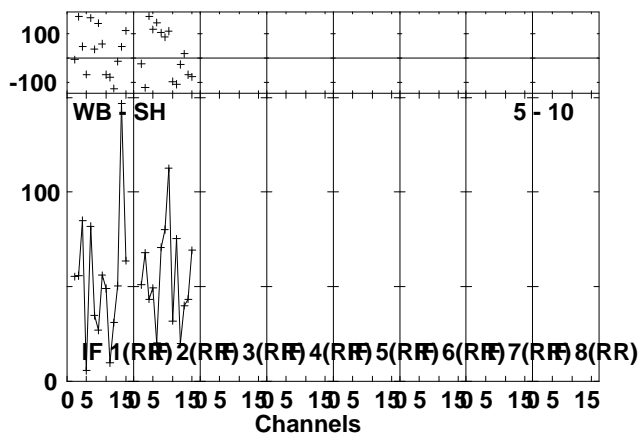
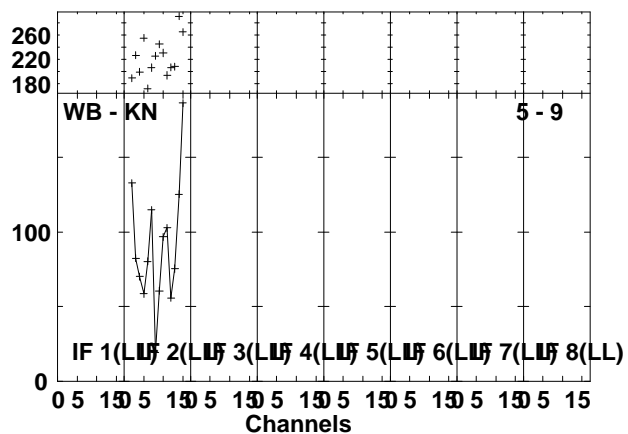
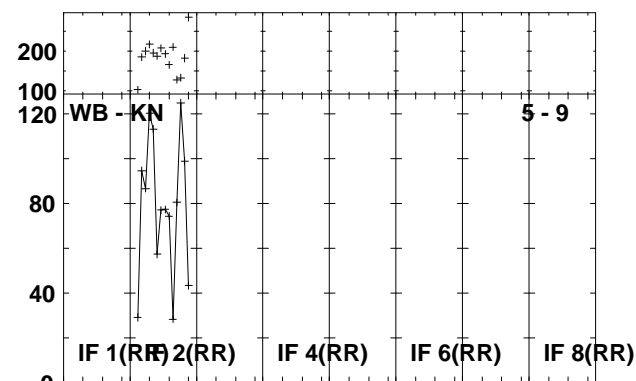
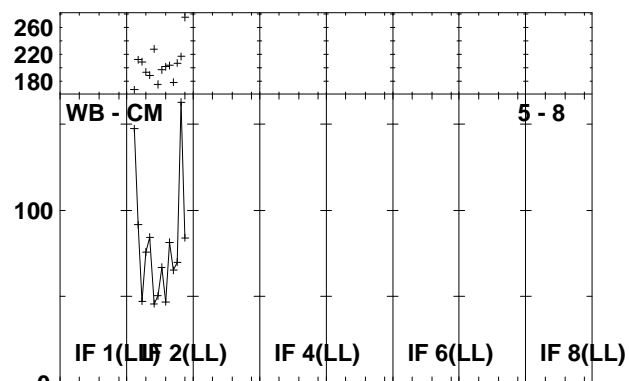
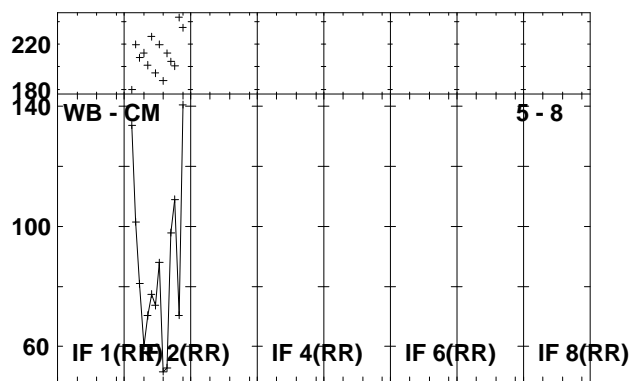
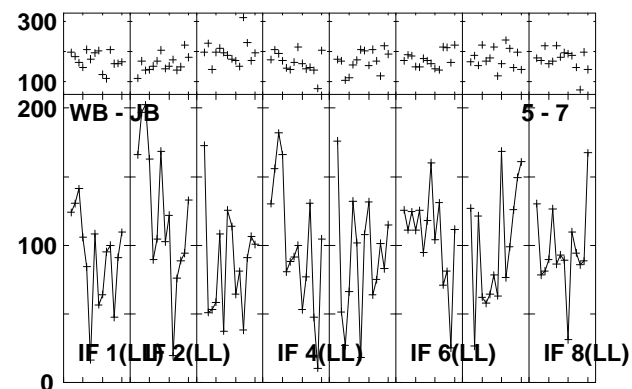
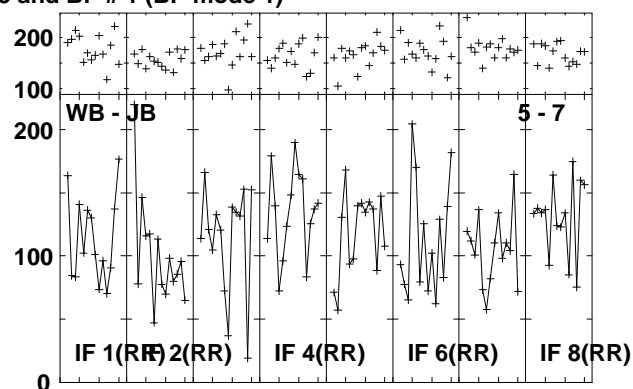
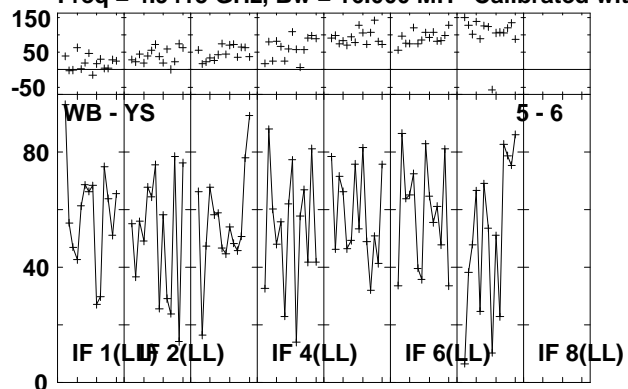

Lower frame: Milli Ampl Jy Top frame: Phas deg
Vector averaged cross-power spectrum Several baselines displayed
Timerange: 00/14:11:01 to 00/14:13:29

Plot file version 71 created 21-MAY-2010 15:46:34

CALK RSD03.UVDATA.1

Freq = 4.9415 GHz, Bw = 16.000 MH Calibrated with CL # 3 and BP # 1 (BP mode 1)

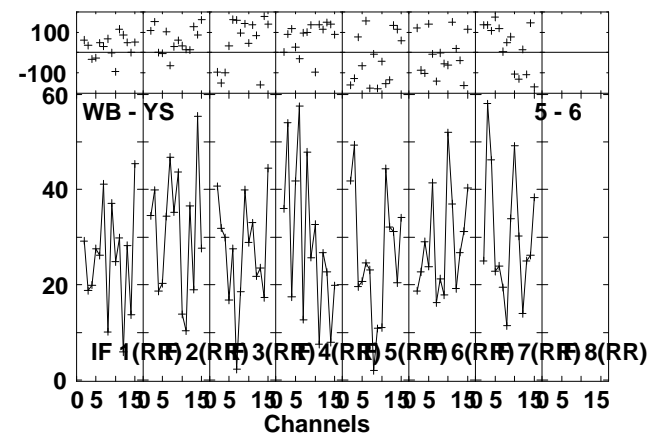
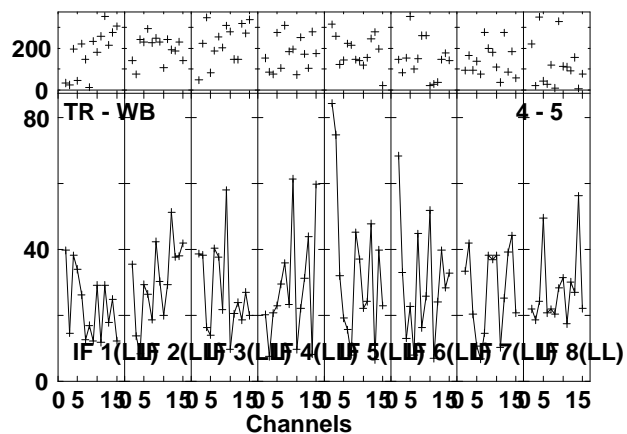
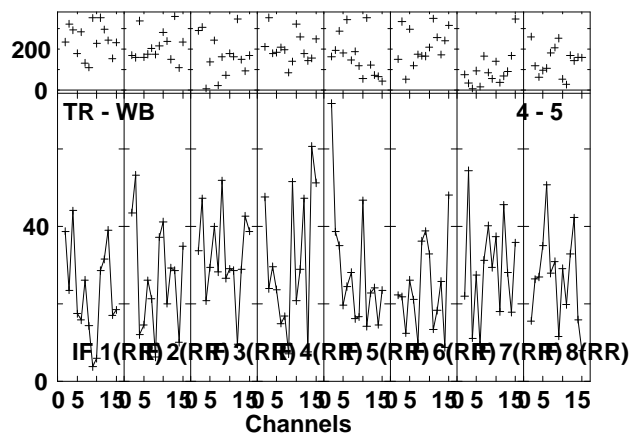
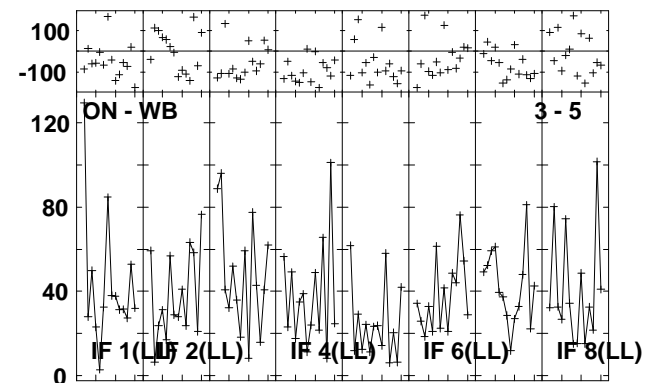
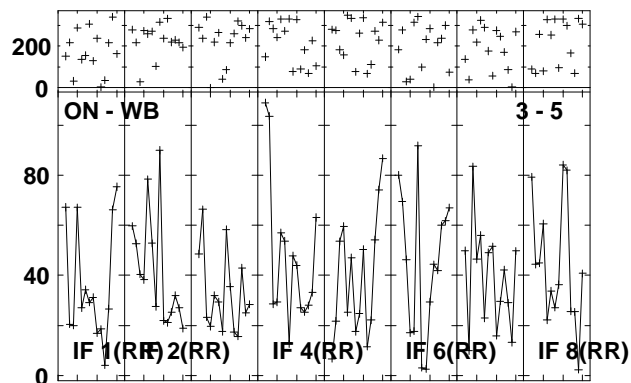
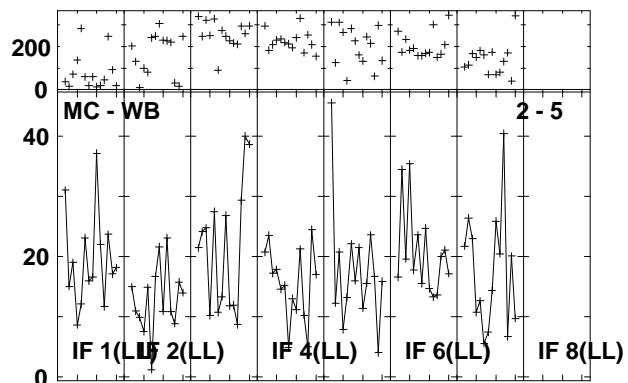
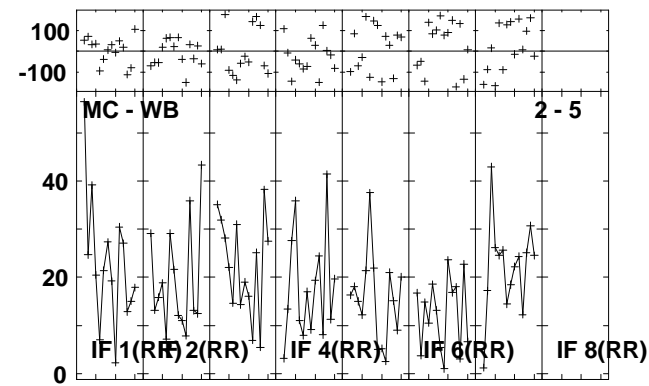
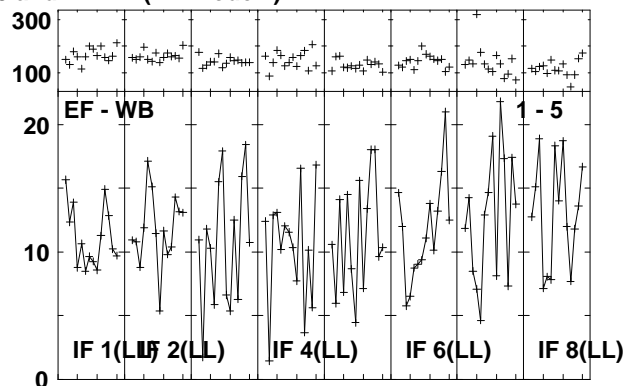
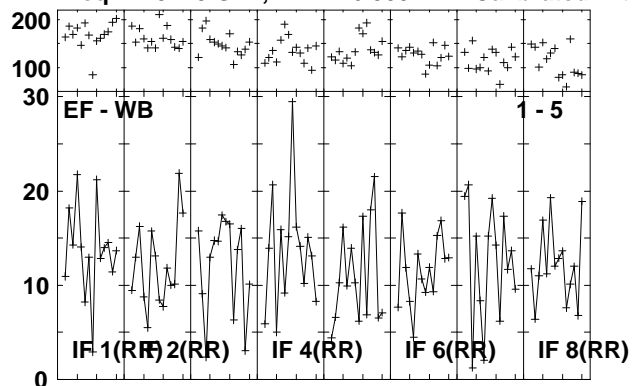

Lower frame: Milli Ampl Jy Top frame: Phas deg
Vector averaged cross-power spectrum Several baselines displayed
Timerange: 00/14:13:31 to 00/14:15:59

Plot file version 72 created 21-MAY-2010 15:46:36

CALK RSD03.UVDATA.1

Freq = 4.9415 GHz, Bw = 16.000 MH Calibrated with CL # 3 and BP # 1 (BP mode 1)

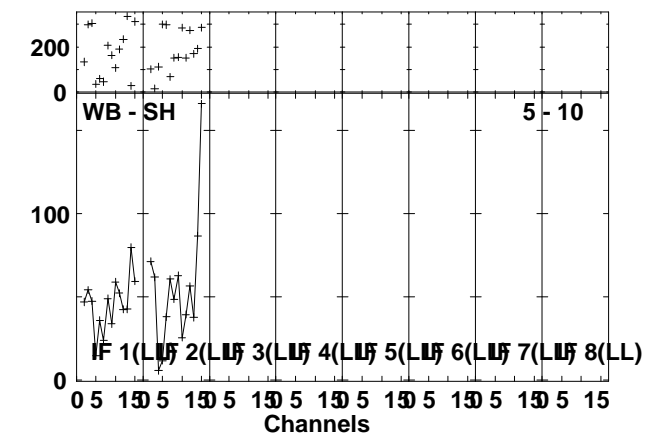
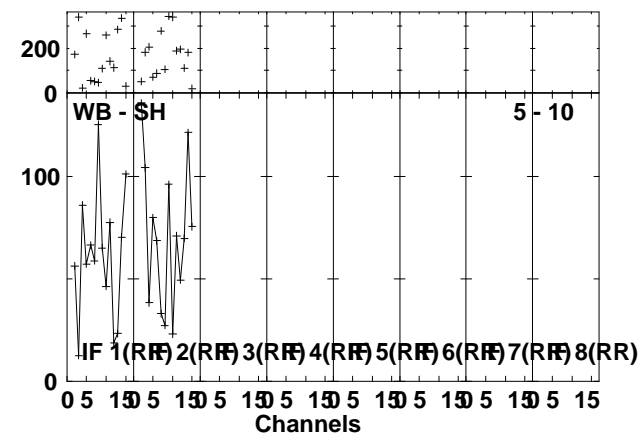
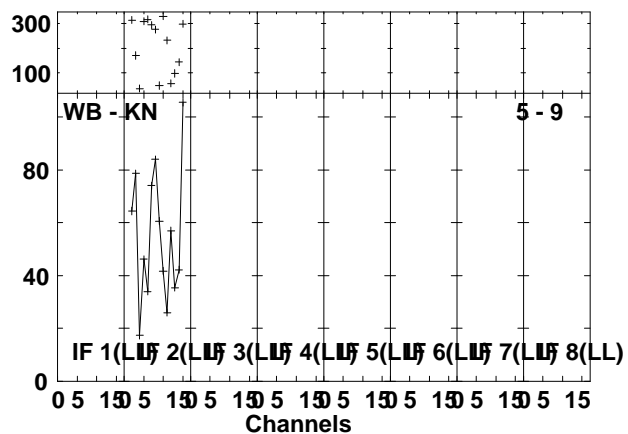
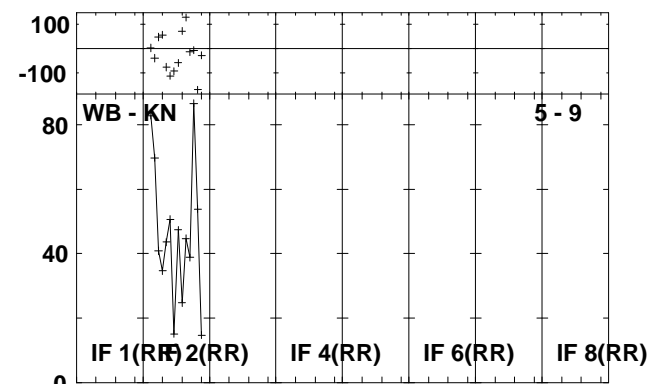
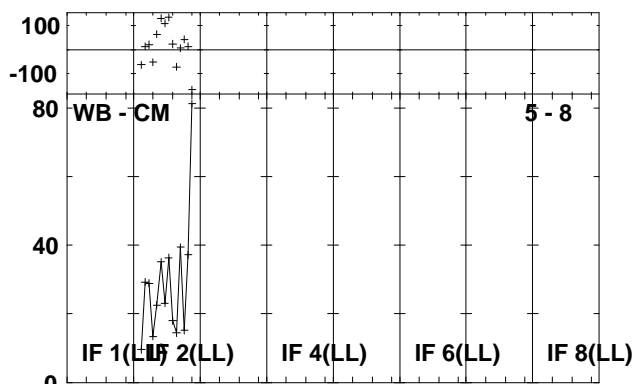
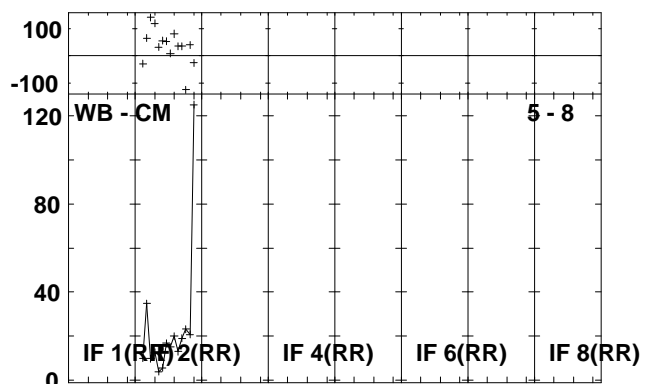
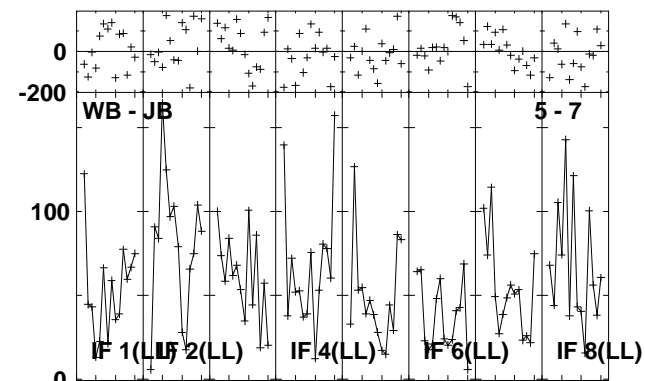
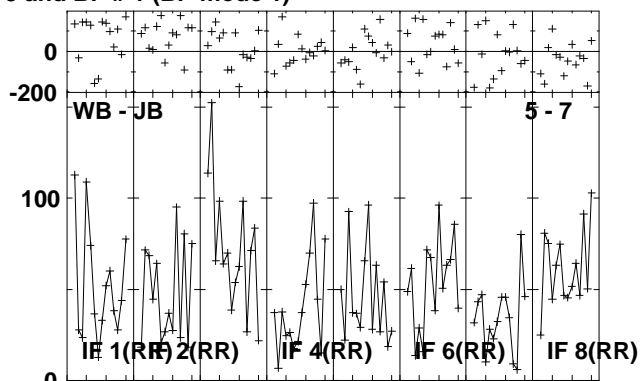
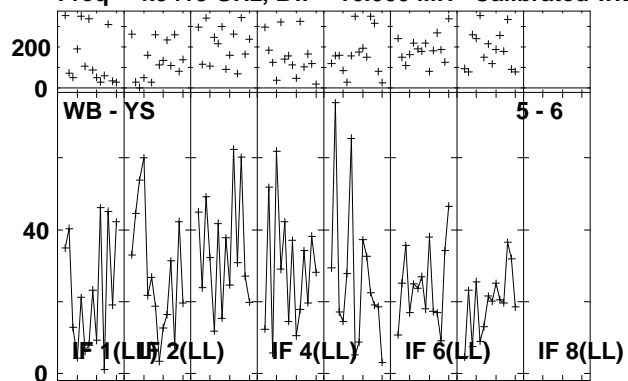

Lower frame: Milli Ampl Jy Top frame: Phas deg
Vector averaged cross-power spectrum Several baselines displayed
Timerange: 00/14:13:31 to 00/14:15:59

Plot file version 73 created 21-MAY-2010 15:46:39

J0909+02 RSD03.UVDATA.1

Freq = 4.9415 GHz, Bw = 16.000 MH Calibrated with CL # 3 and BP # 1 (BP mode 1)

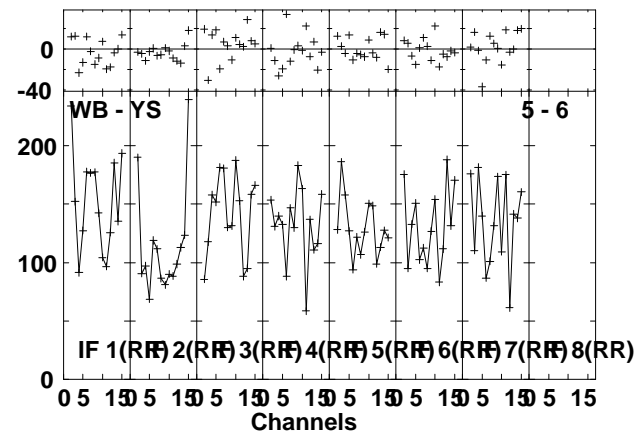
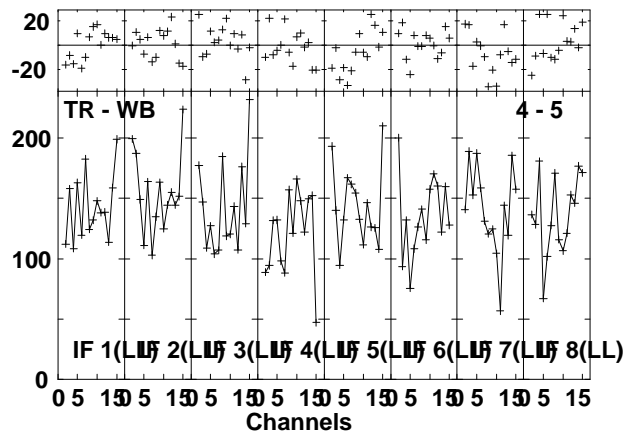
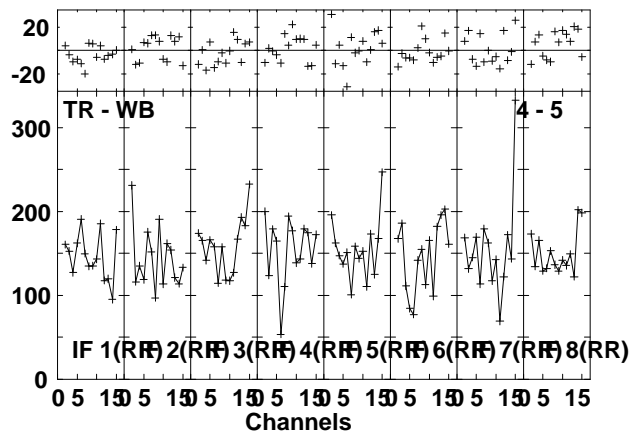
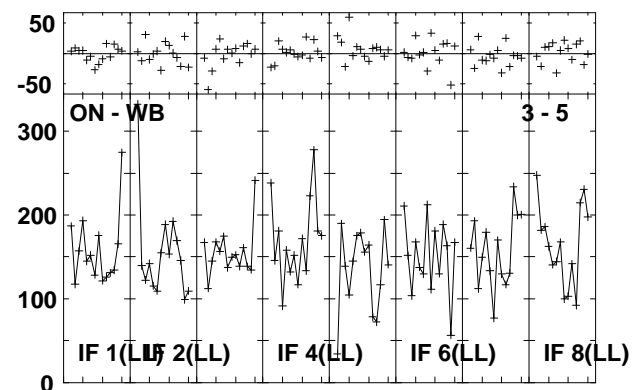
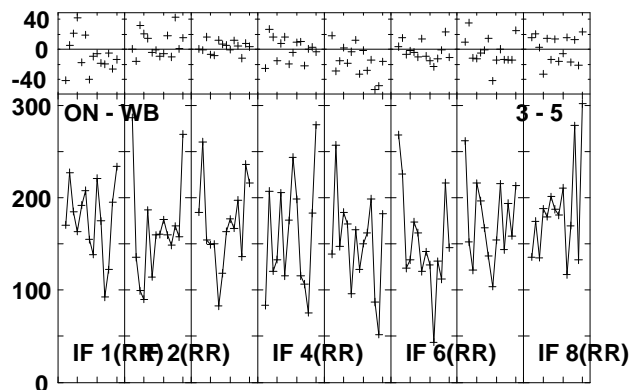
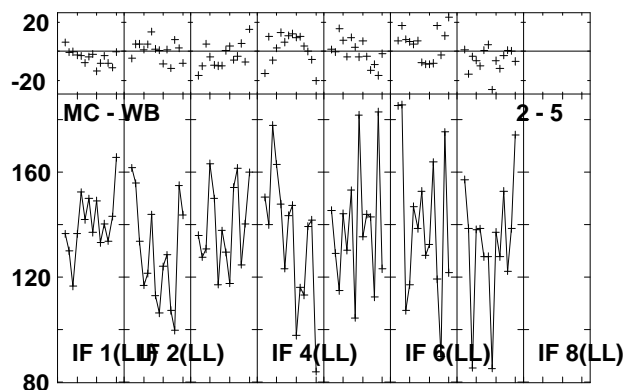
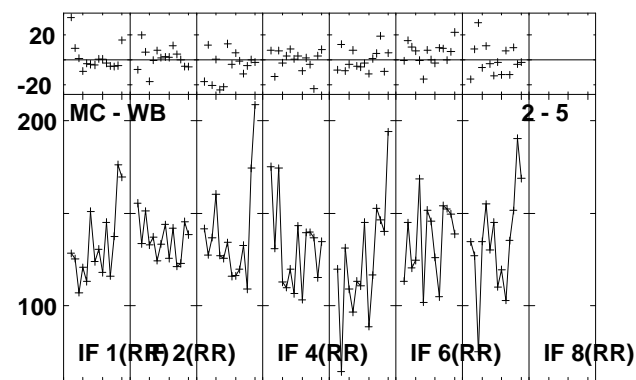
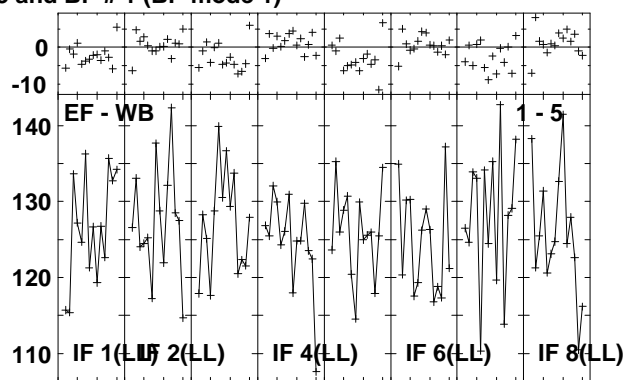
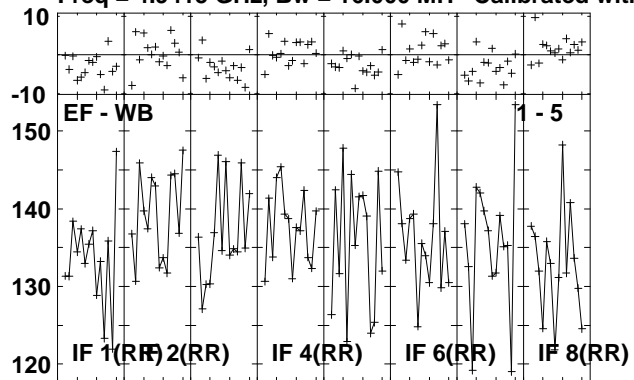

Lower frame: Milli Ampl Jy Top frame: Phas deg
Vector averaged cross-power spectrum Several baselines displayed
Timerange: 00/14:16:41 to 00/14:17:39

Plot file version 74 created 21-MAY-2010 15:46:40

J0909+02 RSD03.UVDATA.1

Freq = 4.9415 GHz, Bw = 16.000 MH Calibrated with CL # 3 and BP # 1 (BP mode 1)

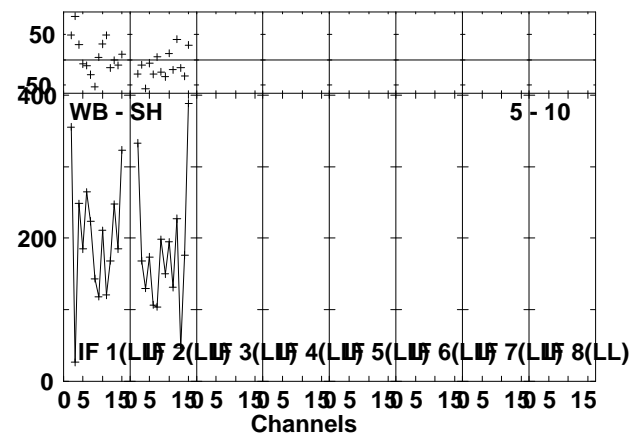
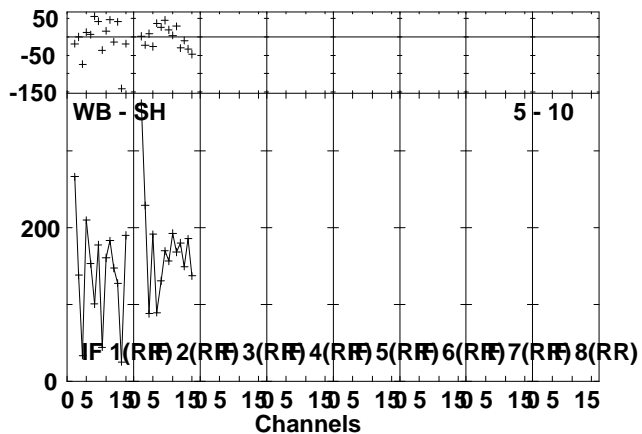
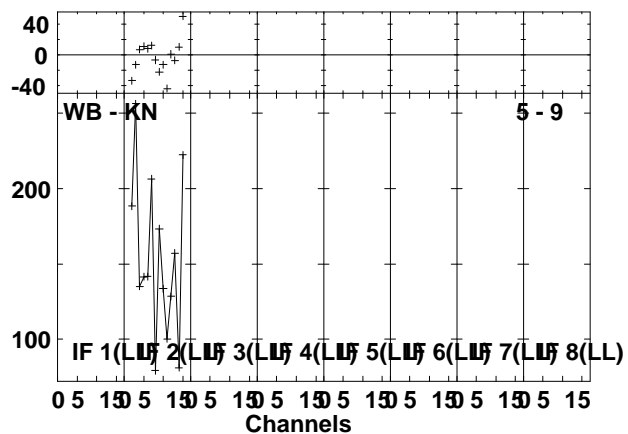
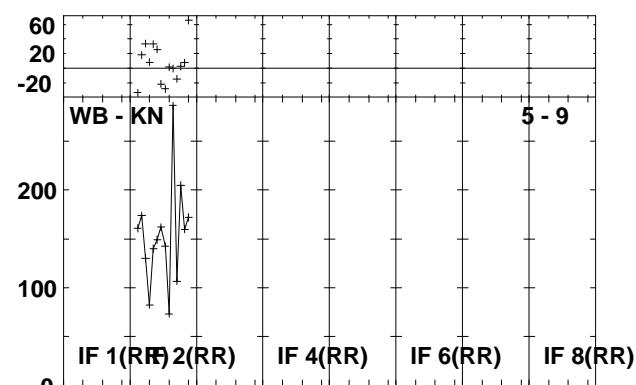
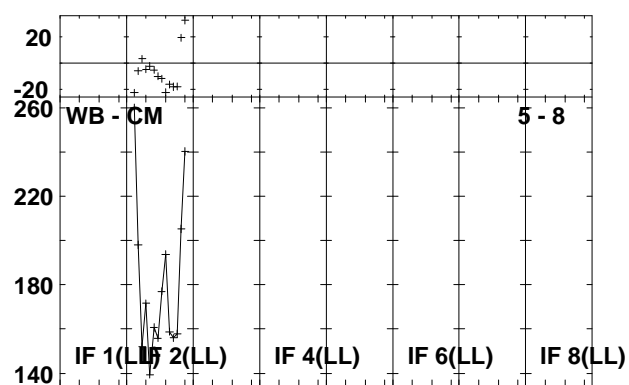
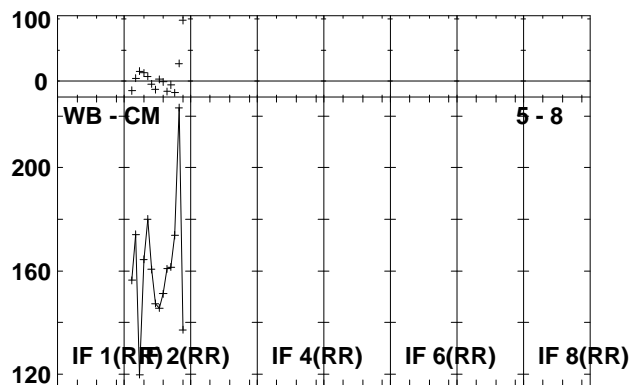
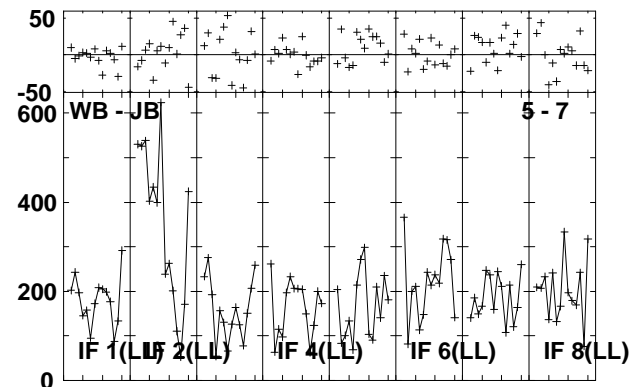
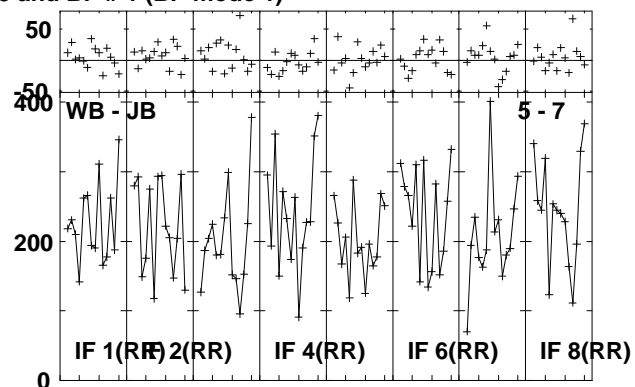
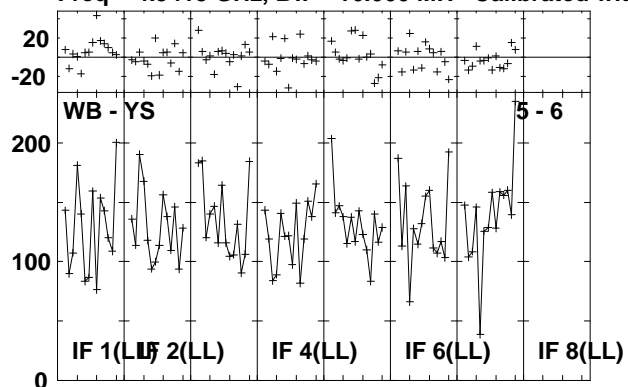

Lower frame: Milli Ampl Jy Top frame: Phas deg
Vector averaged cross-power spectrum Several baselines displayed
Timerange: 00/14:16:41 to 00/14:17:39

Plot file version 75 created 21-MAY-2010 15:46:42

CALB RSD03.UVDATA.1

Freq = 4.9415 GHz, Bw = 16.000 MH Calibrated with CL # 3 and BP # 1 (BP mode 1)

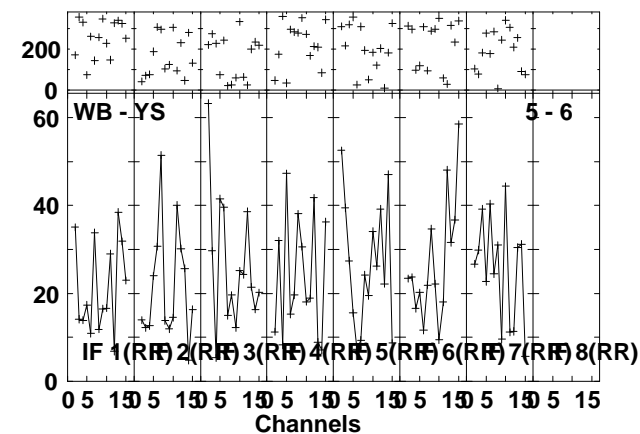
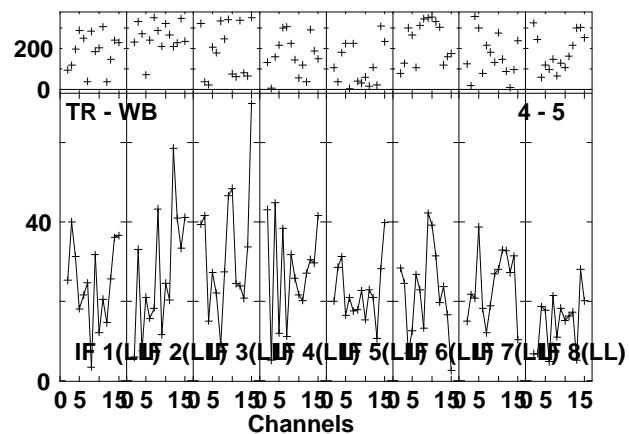
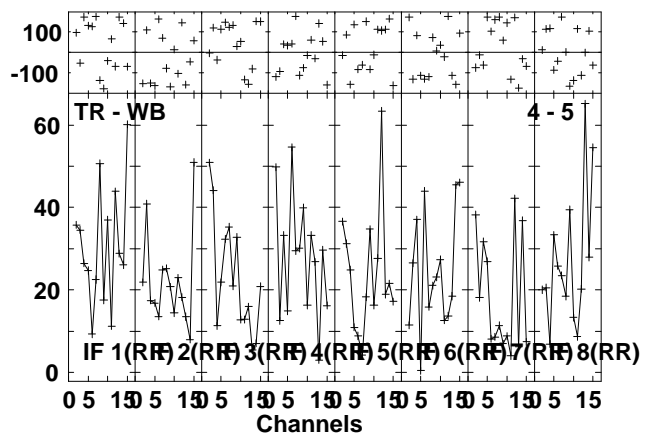
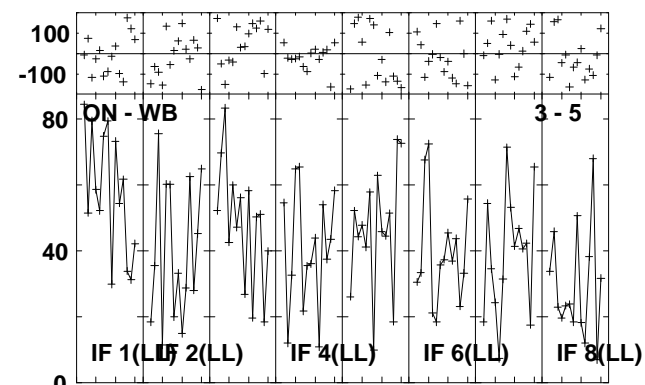
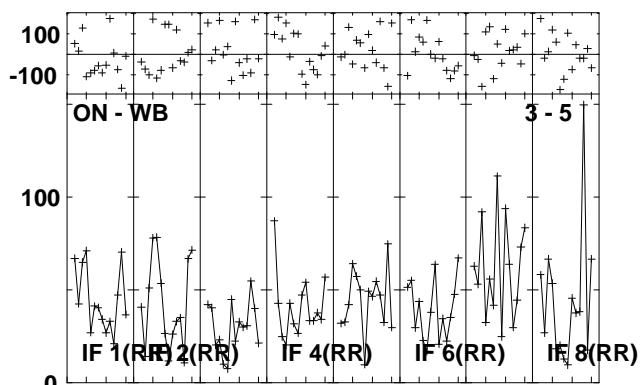
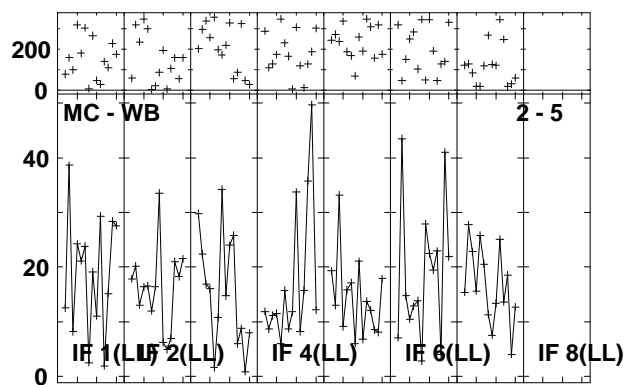
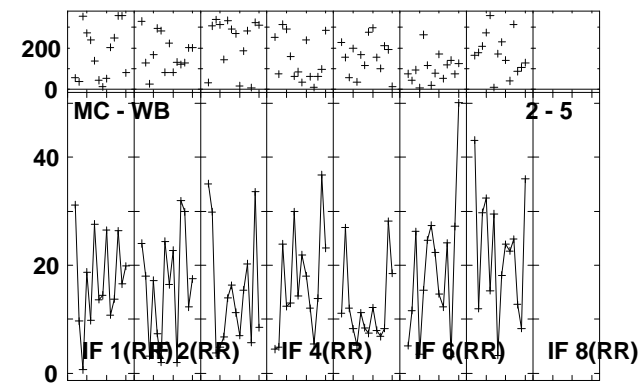
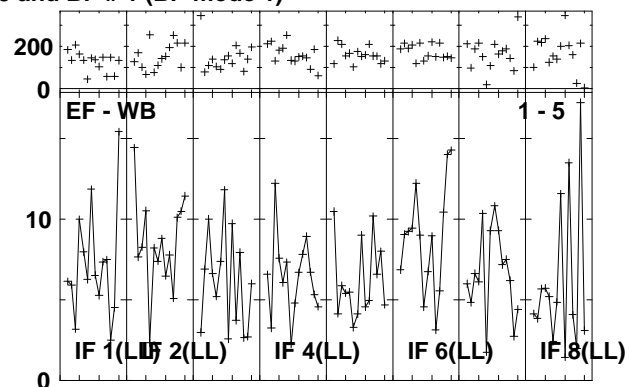
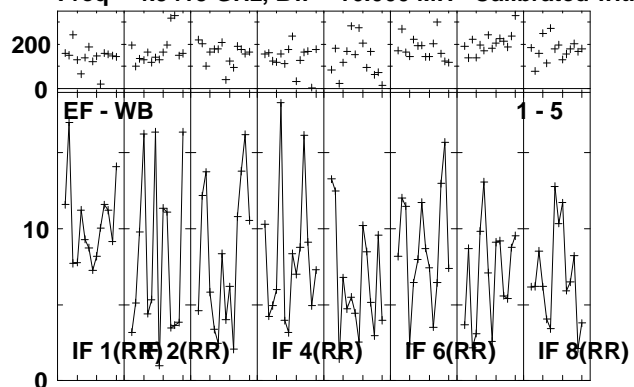

Lower frame: Milli Ampl Jy Top frame: Phas deg
Vector averaged cross-power spectrum Several baselines displayed
Timerange: 00/14:17:41 to 00/14:20:09

Plot file version 76 created 21-MAY-2010 15:46:44

CALB RSD03.UVDATA.1

Freq = 4.9415 GHz, Bw = 16.000 MH Calibrated with CL # 3 and BP # 1 (BP mode 1)

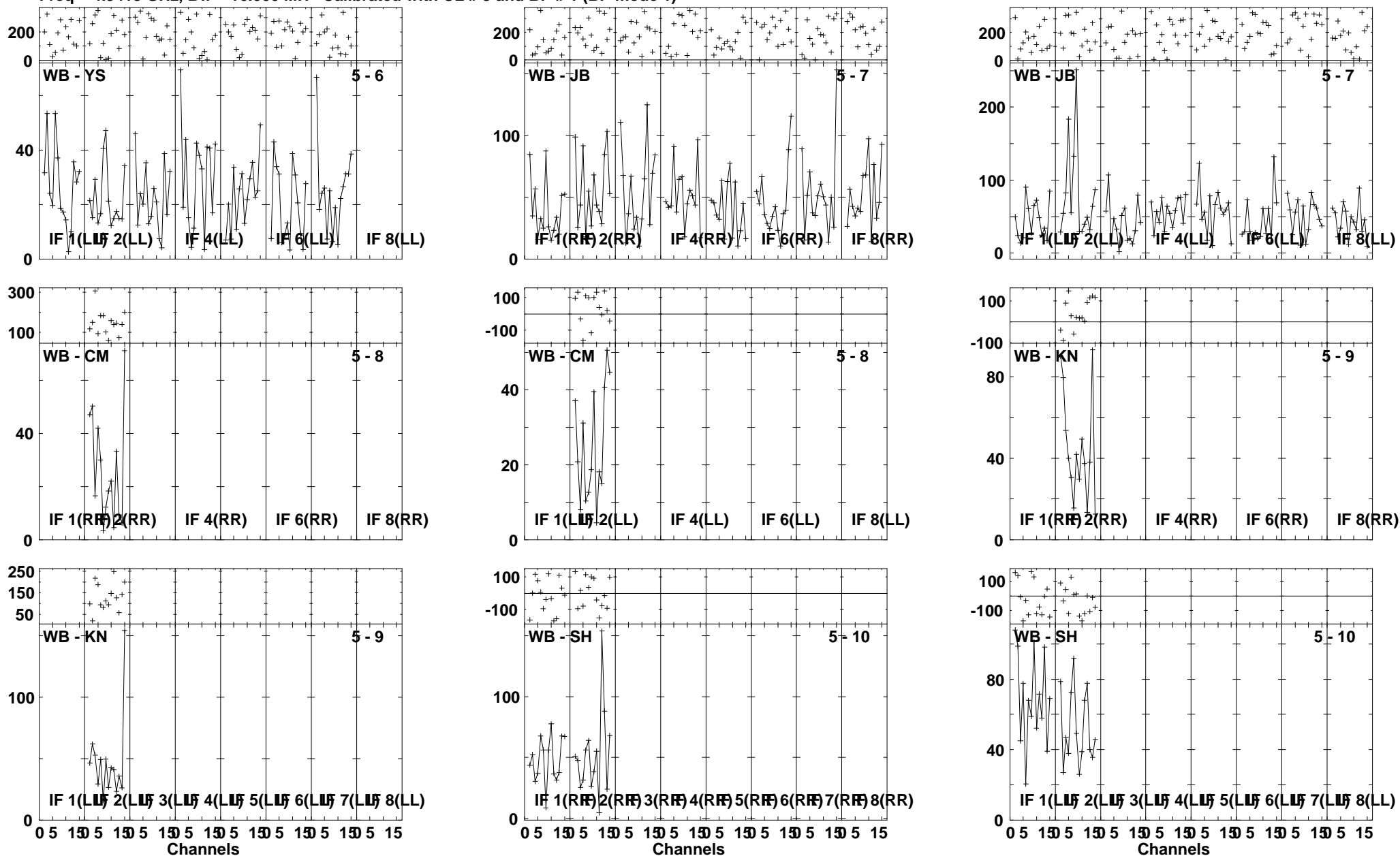

Lower frame: Milli Ampl Jy Top frame: Phas deg
Vector averaged cross-power spectrum Several baselines displayed
Timerange: 00/14:17:41 to 00/14:20:09

Plot file version 77 created 21-MAY-2010 15:46:47

CALC RSD03.UVDATA.1

Freq = 4.9415 GHz, Bw = 16.000 MH Calibrated with CL # 3 and BP # 1 (BP mode 1)

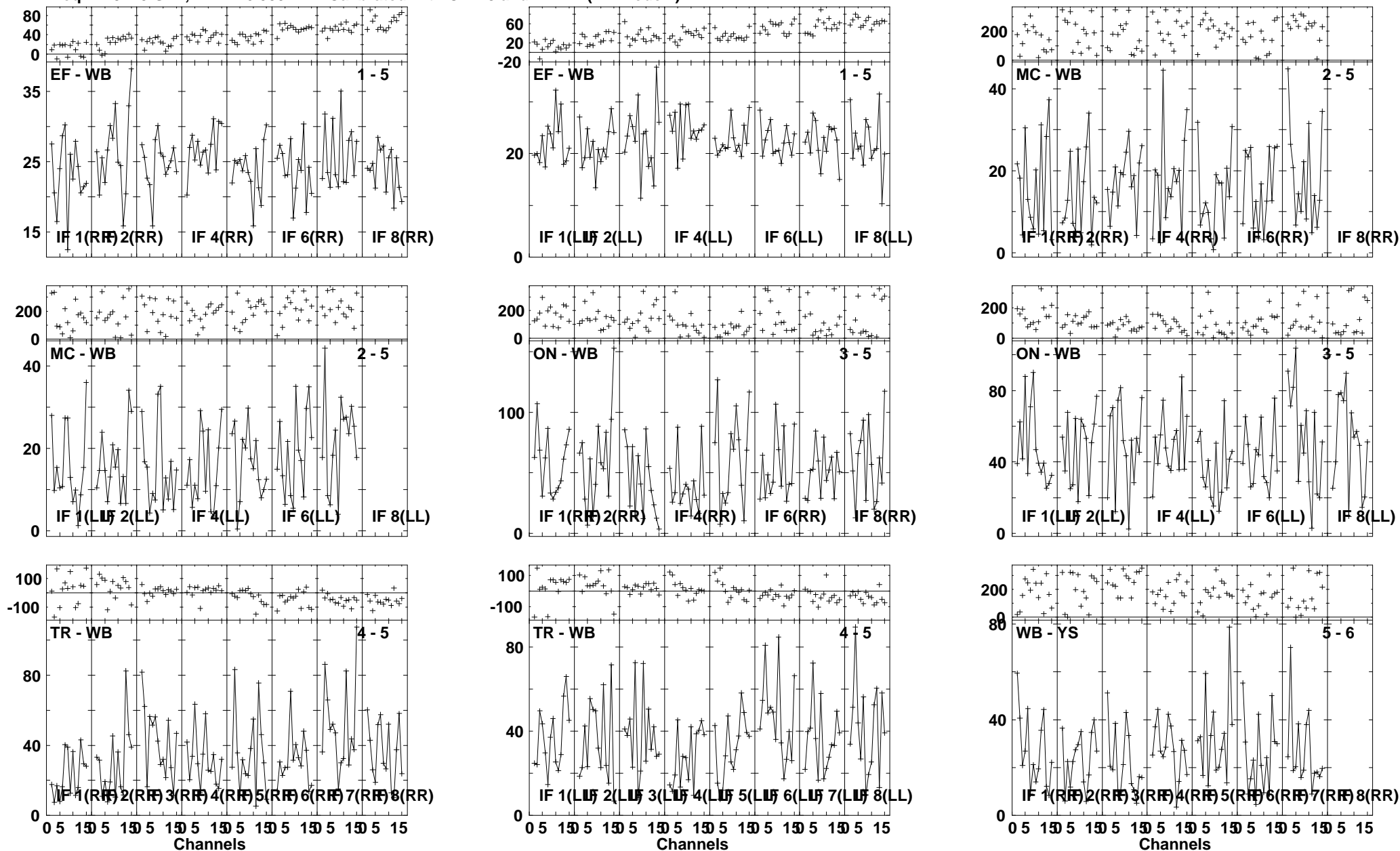

Lower frame: Milli Ampl Jy Top frame: Phas deg
Vector averaged cross-power spectrum Several baselines displayed
Timerange: 00/14:20:11 to 00/14:22:39

Plot file version 78 created 21-MAY-2010 15:46:49

CALC RSD03.UVDATA.1

Freq = 4.9415 GHz, Bw = 16.000 MH Calibrated with CL # 3 and BP # 1 (BP mode 1)

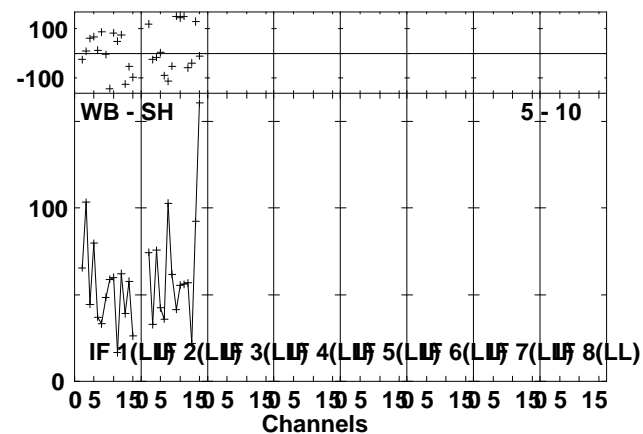
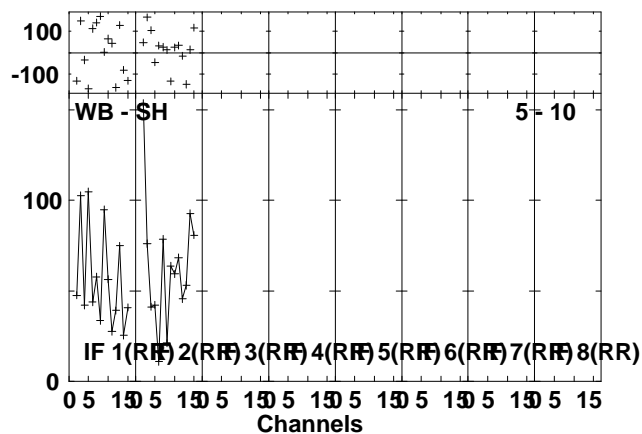
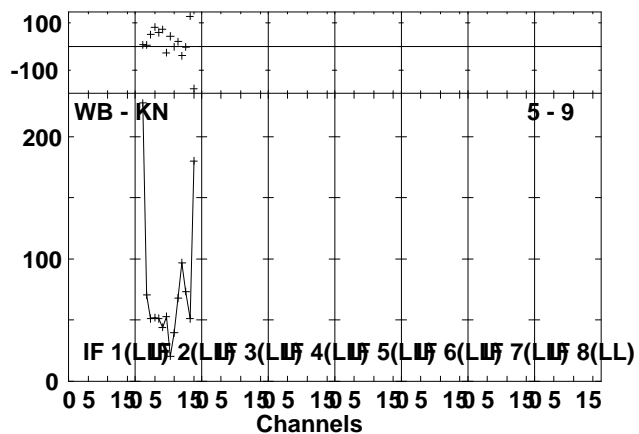
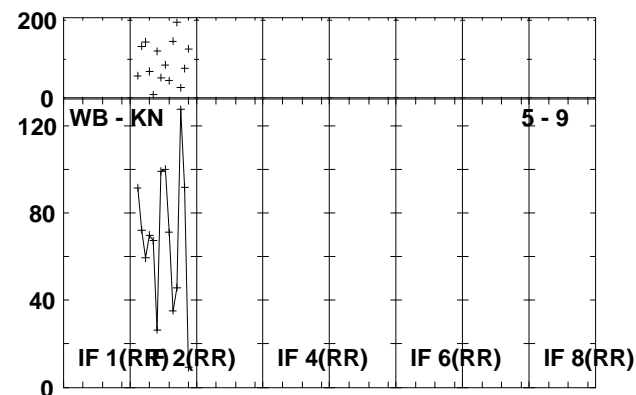
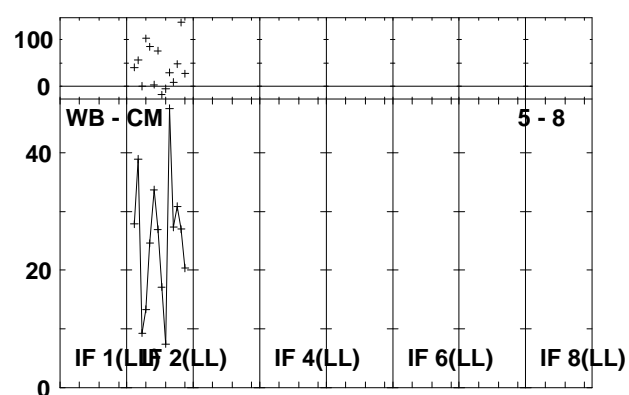
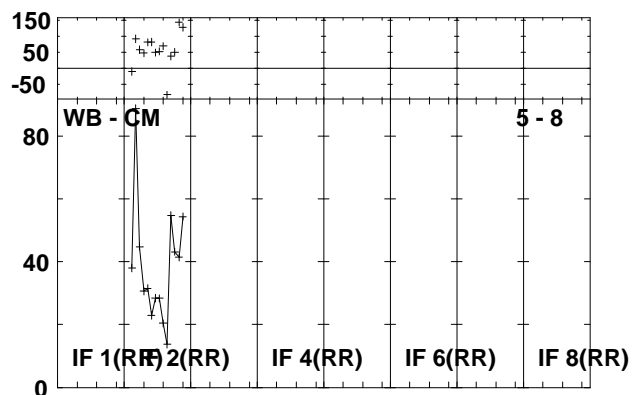
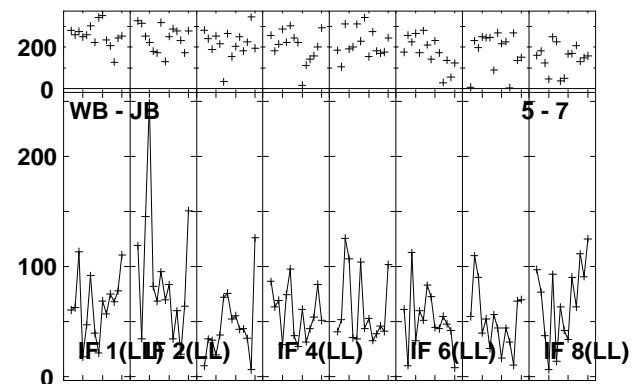
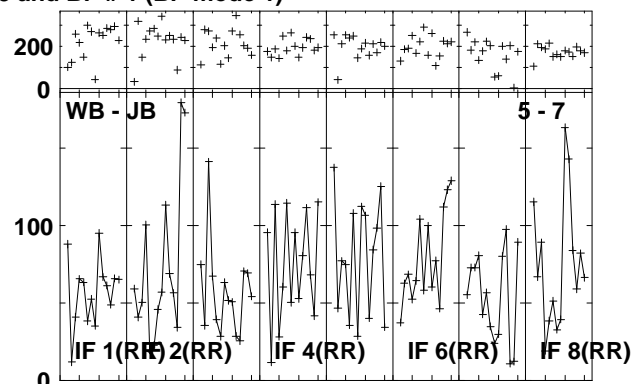
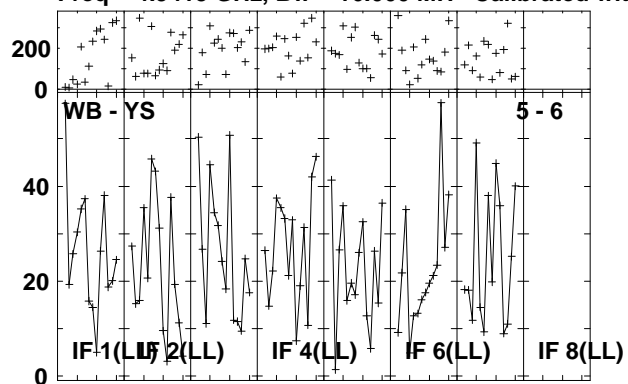

Lower frame: Milli Ampl Jy Top frame: Phas deg
Vector averaged cross-power spectrum Several baselines displayed
Timerange: 00/14:20:11 to 00/14:22:39

Plot file version 79 created 21-MAY-2010 15:46:52

J0909+02 RSD03.UVDATA.1

Freq = 4.9415 GHz, Bw = 16.000 MH Calibrated with CL # 3 and BP # 1 (BP mode 1)

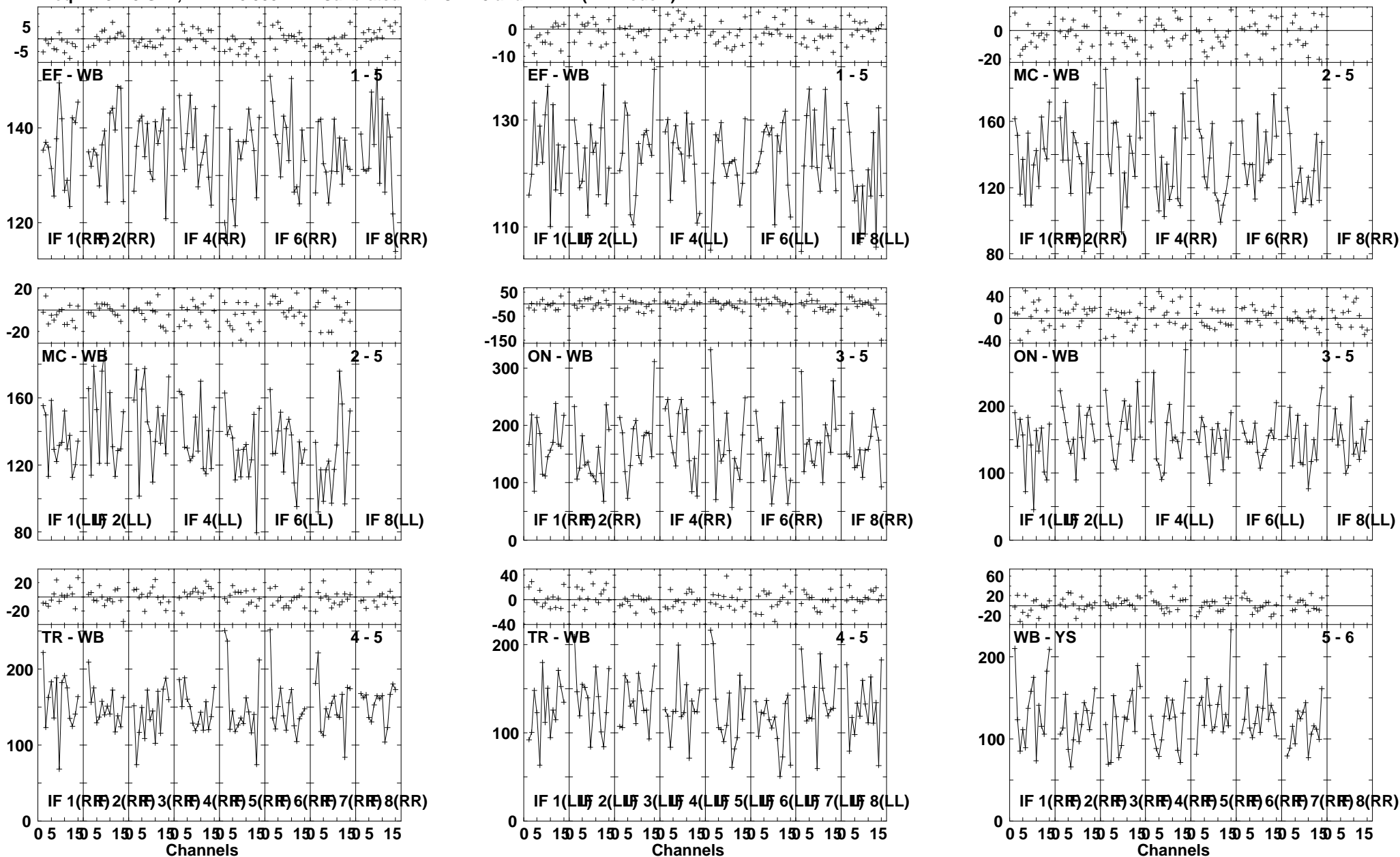

Lower frame: Milli Ampl Jy Top frame: Phas deg
Vector averaged cross-power spectrum Several baselines displayed
Timerange: 00/14:23:21 to 00/14:24:19

Plot file version 80 created 21-MAY-2010 15:46:53

J0909+02 RSD03.UVDATA.1

Freq = 4.9415 GHz, Bw = 16.000 MH Calibrated with CL # 3 and BP # 1 (BP mode 1)

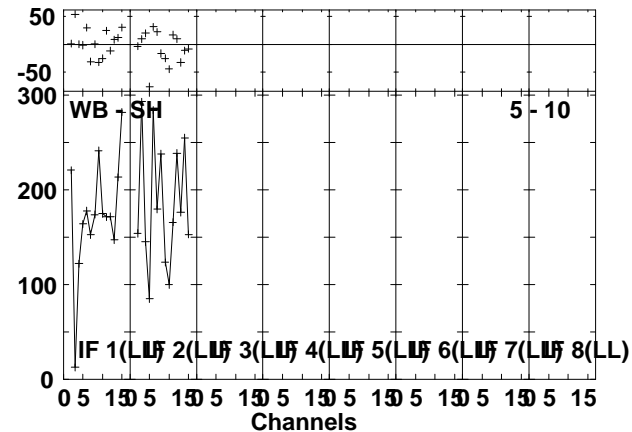
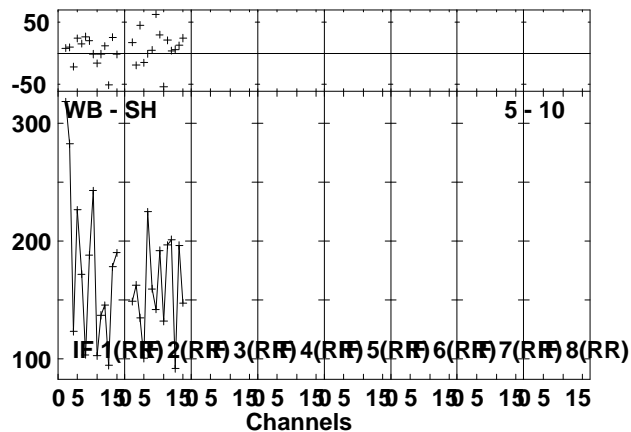
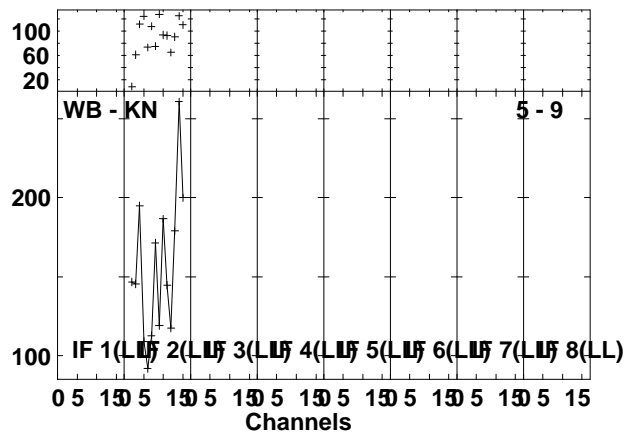
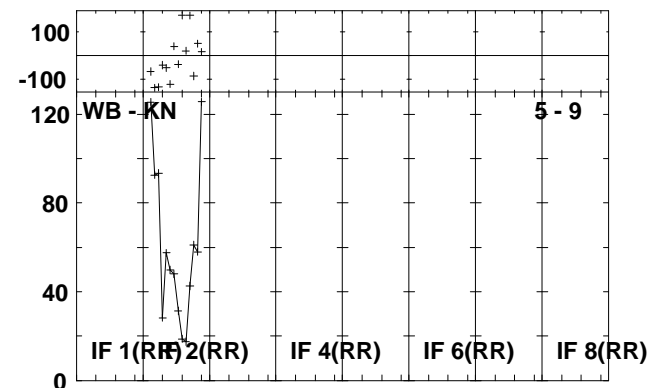
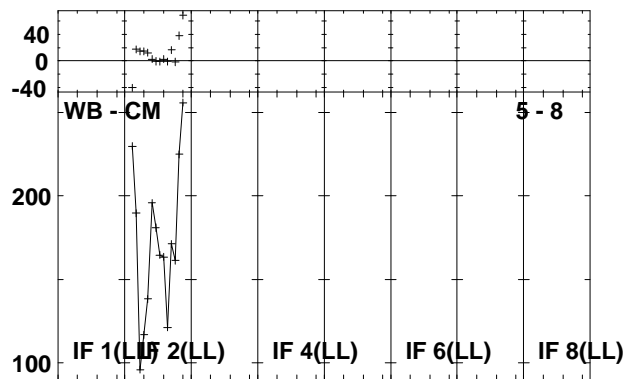
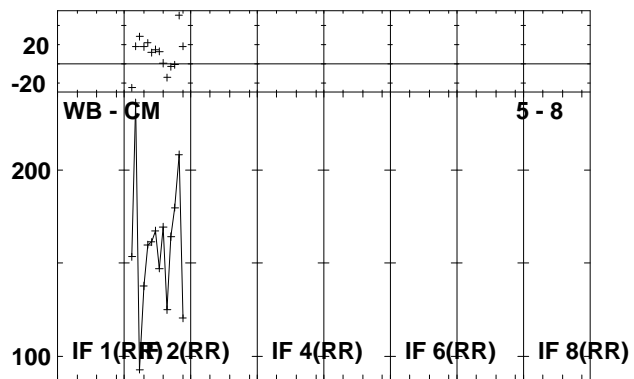
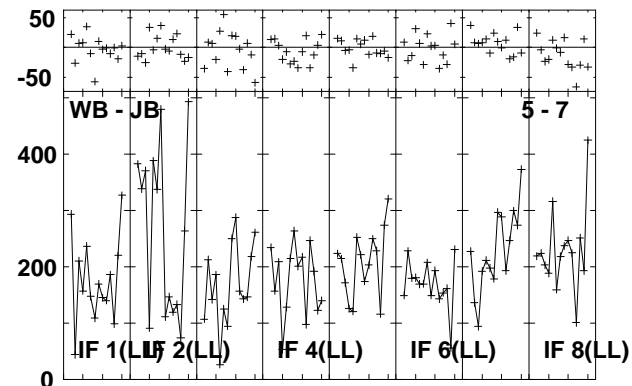
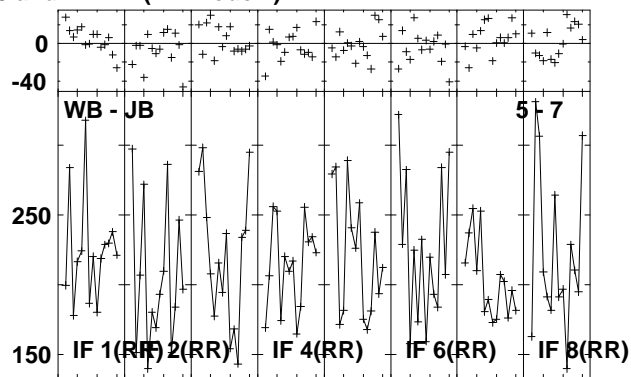
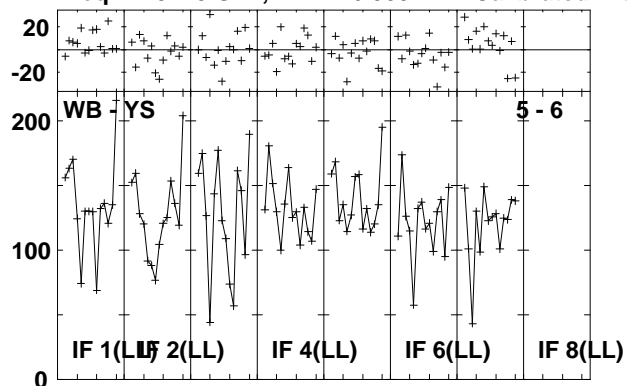

Lower frame: Milli Ampl Jy Top frame: Phas deg
Vector averaged cross-power spectrum Several baselines displayed
Timerange: 00/14:23:21 to 00/14:24:19

Plot file version 81 created 21-MAY-2010 15:46:54

CALD RSD03.UVDATA.1

Freq = 4.9415 GHz, Bw = 16.000 MH Calibrated with CL # 3 and BP # 1 (BP mode 1)

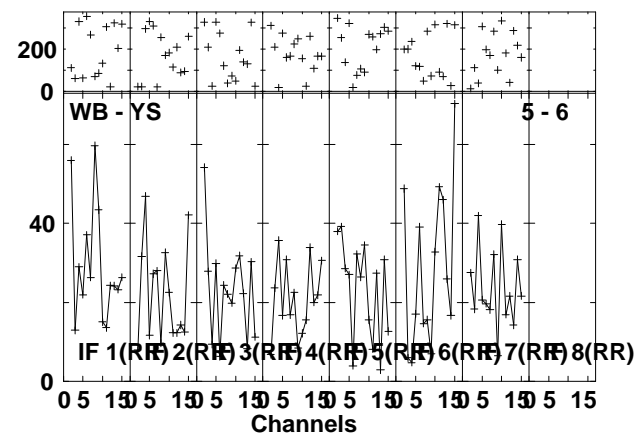
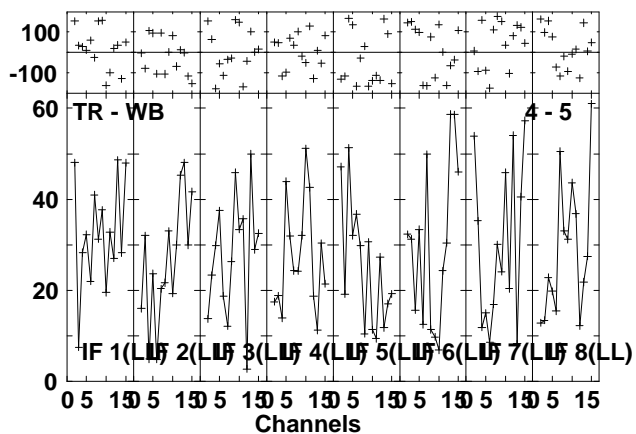
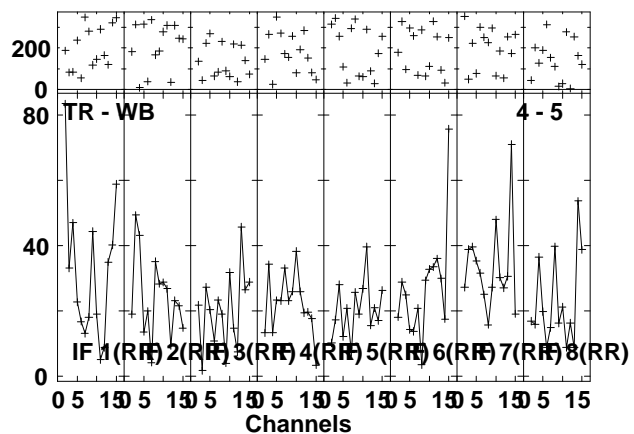
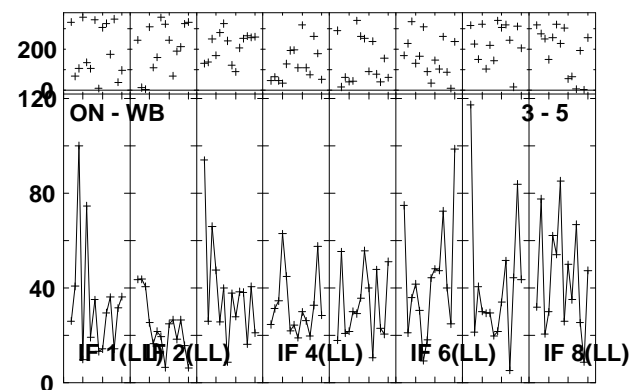
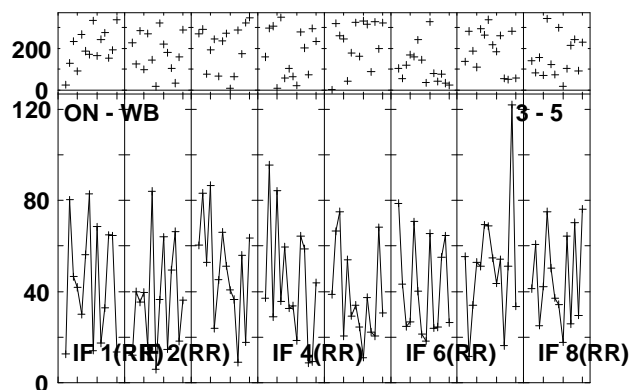
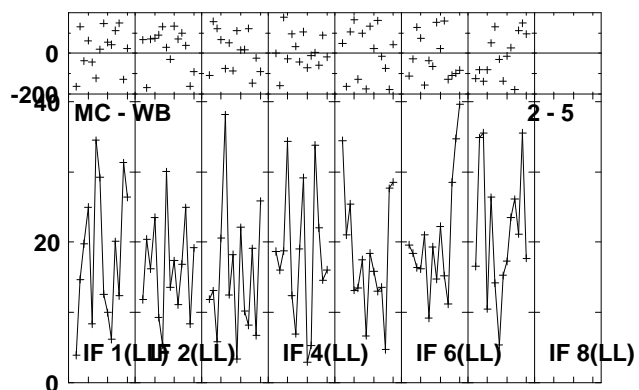
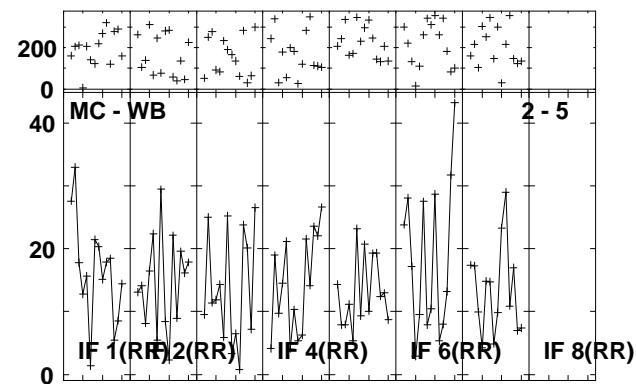
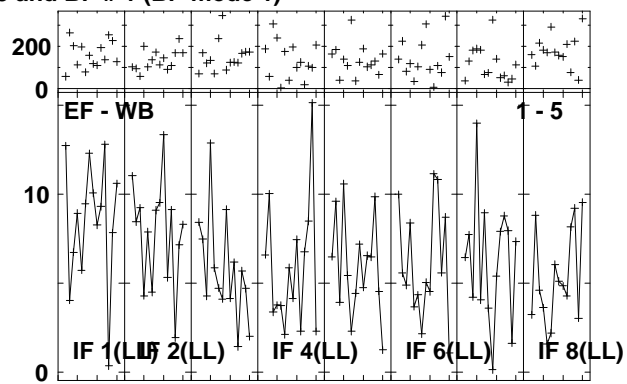
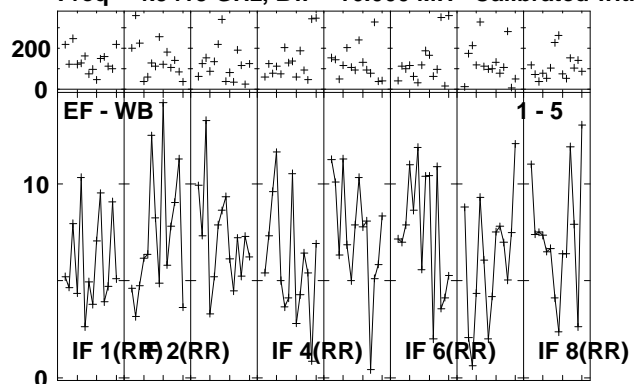

Lower frame: Milli Ampl Jy Top frame: Phas deg
Vector averaged cross-power spectrum Several baselines displayed
Timerange: 00/14:24:21 to 00/14:26:49

Plot file version 82 created 21-MAY-2010 15:46:56

CALD RSD03.UVDATA.1

Freq = 4.9415 GHz, Bw = 16.000 MH Calibrated with CL # 3 and BP # 1 (BP mode 1)

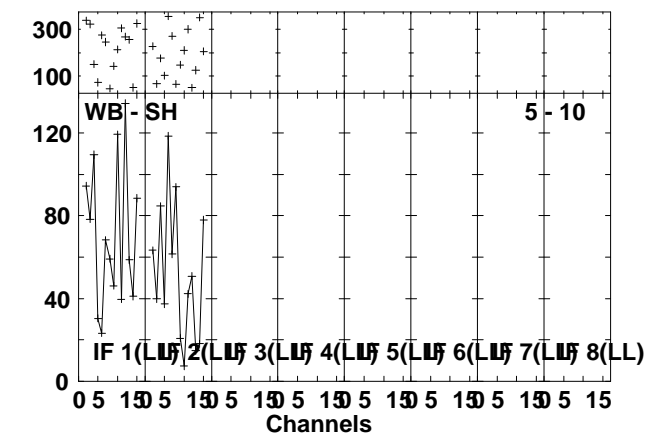
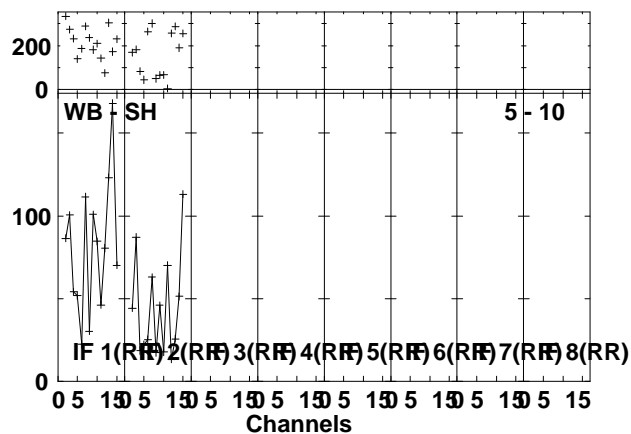
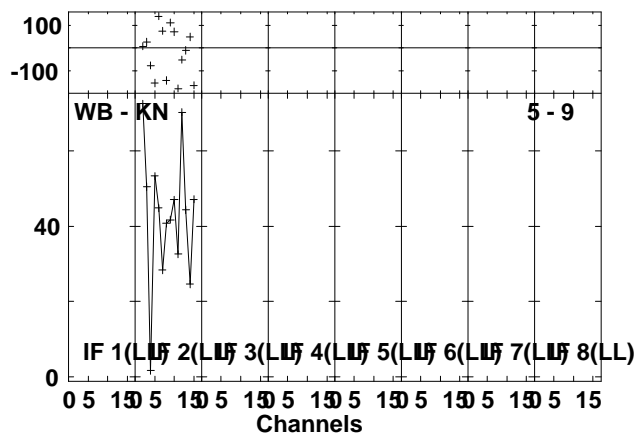
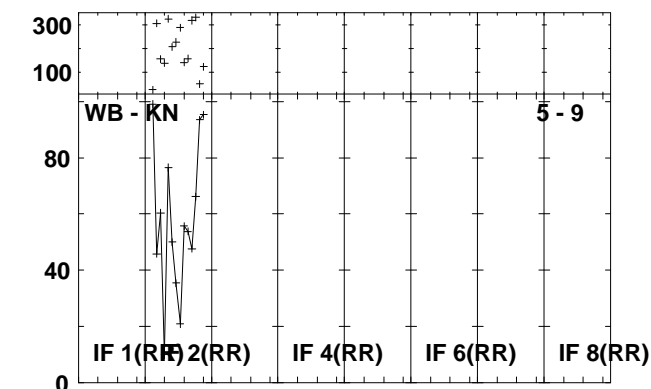
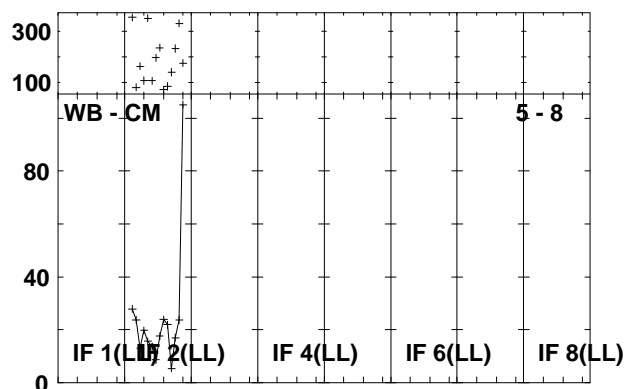
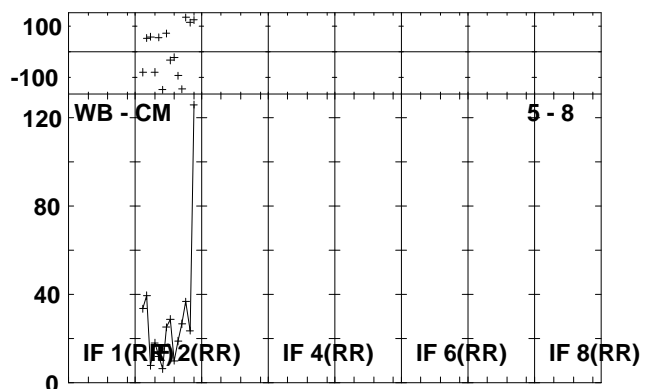
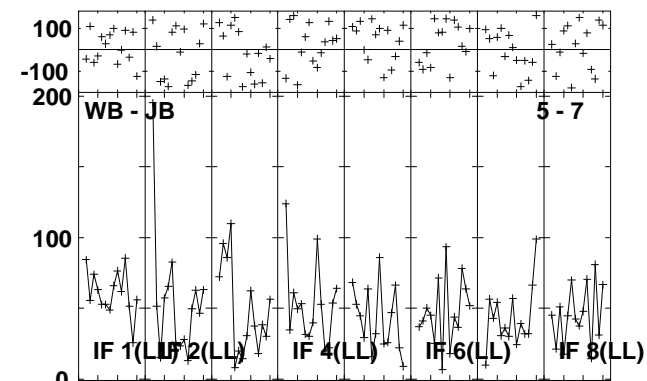
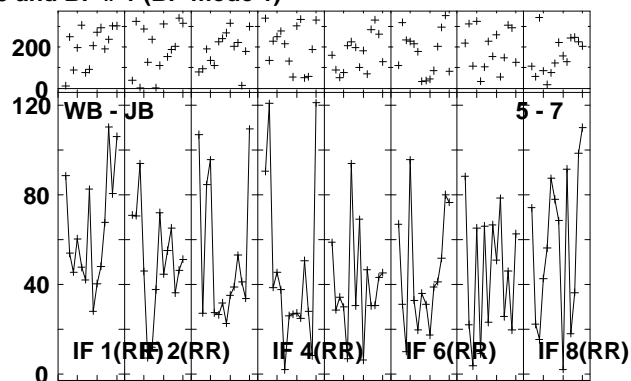
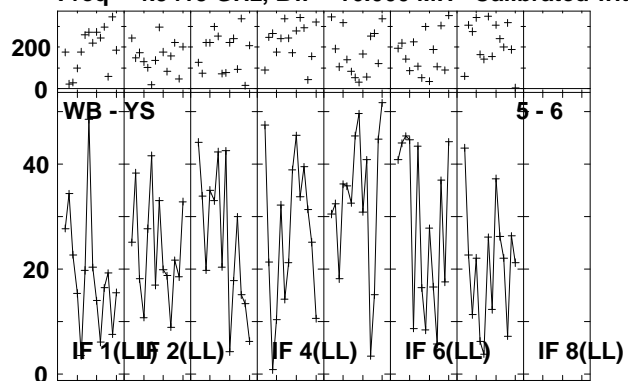

Lower frame: Milli Ampl Jy Top frame: Phas deg
Vector averaged cross-power spectrum Several baselines displayed
Timerange: 00/14:24:21 to 00/14:26:49

Plot file version 83 created 21-MAY-2010 15:46:59

CALF RSD03.UVDATA.1

Freq = 4.9415 GHz, Bw = 16.000 MH Calibrated with CL # 3 and BP # 1 (BP mode 1)

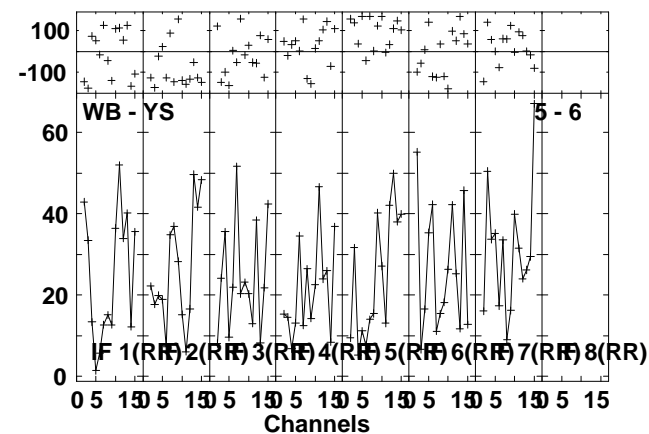
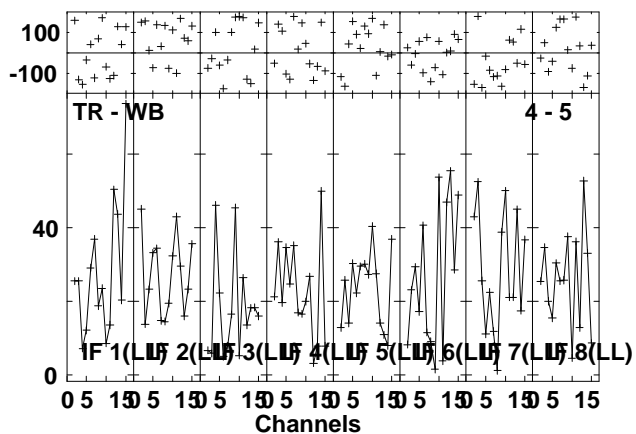
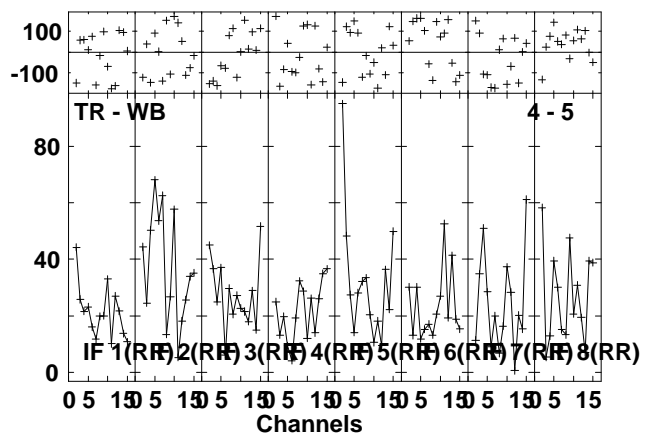
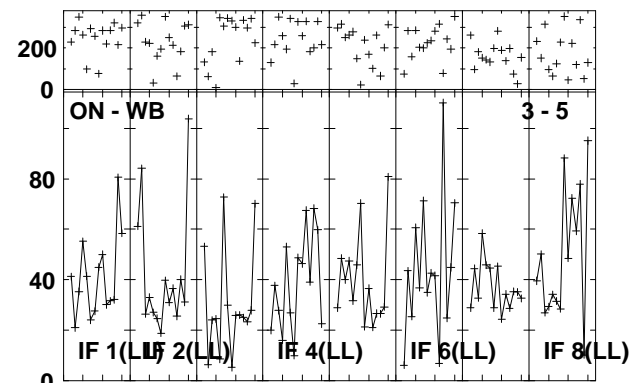
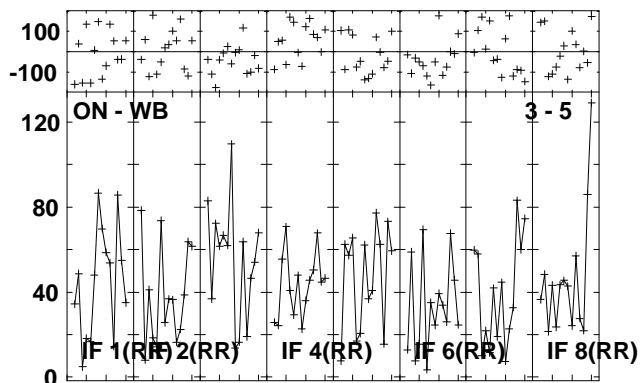
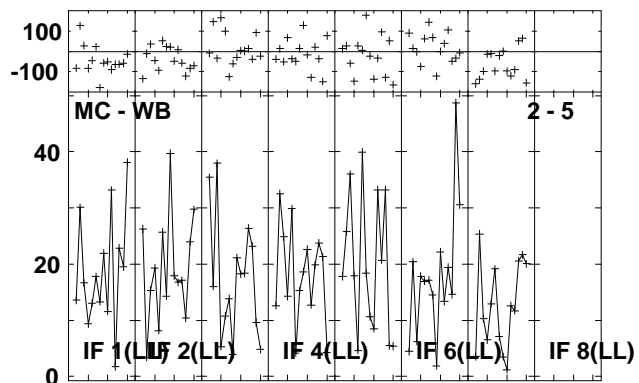
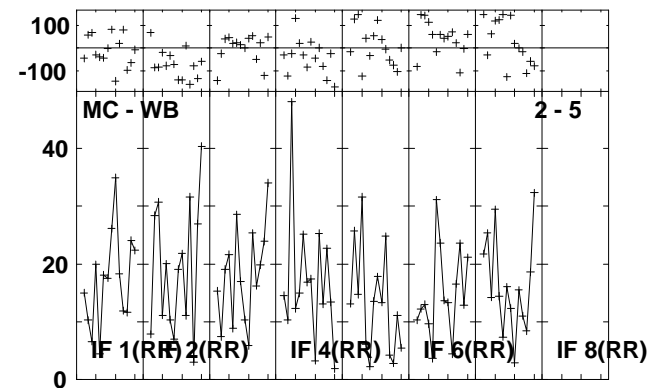
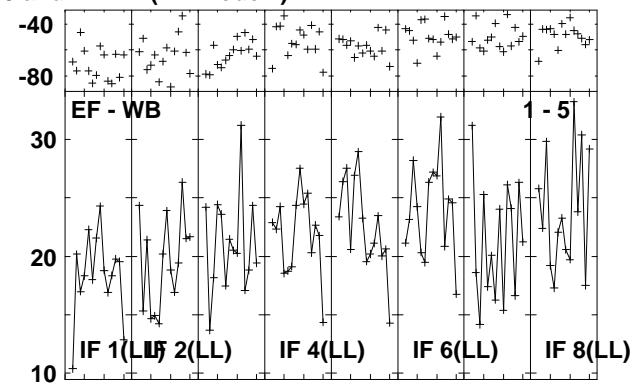
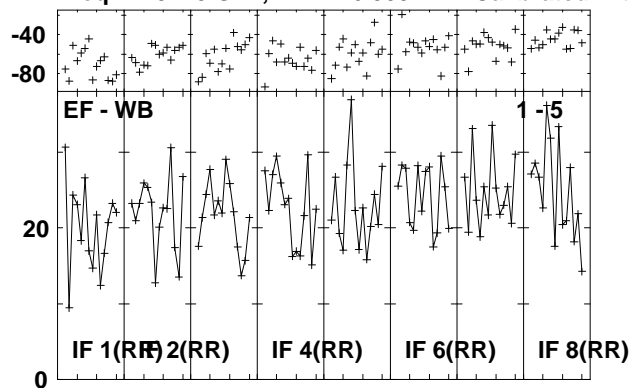

Lower frame: Milli Ampl Jy Top frame: Phas deg
Vector averaged cross-power spectrum Several baselines displayed
Timerange: 00/14:26:51 to 00/14:29:19

Plot file version 84 created 21-MAY-2010 15:47:01

CALF RSD03.UVDATA.1

Freq = 4.9415 GHz, Bw = 16.000 MH Calibrated with CL # 3 and BP # 1 (BP mode 1)

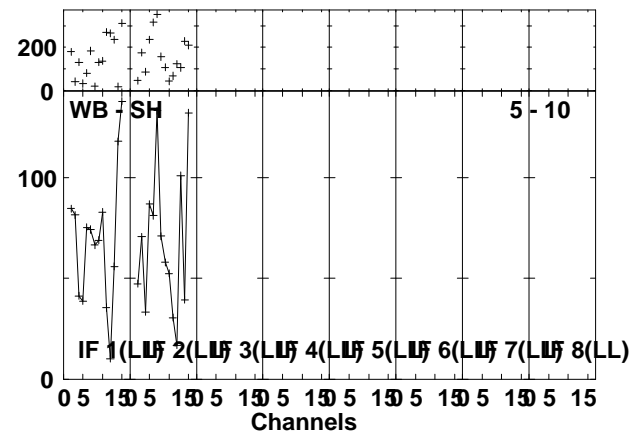
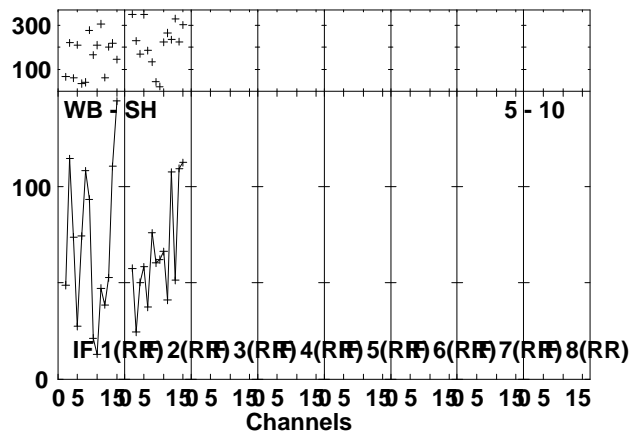
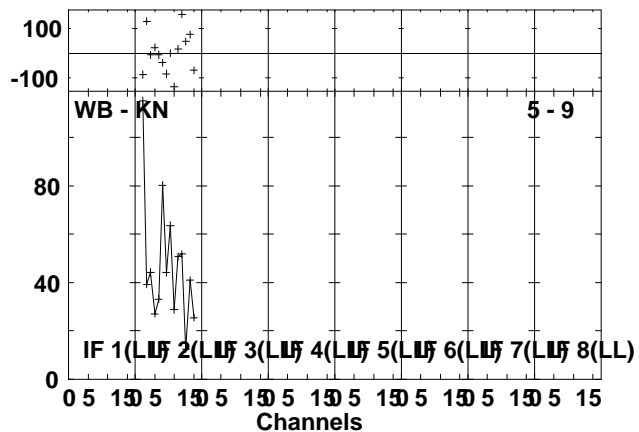
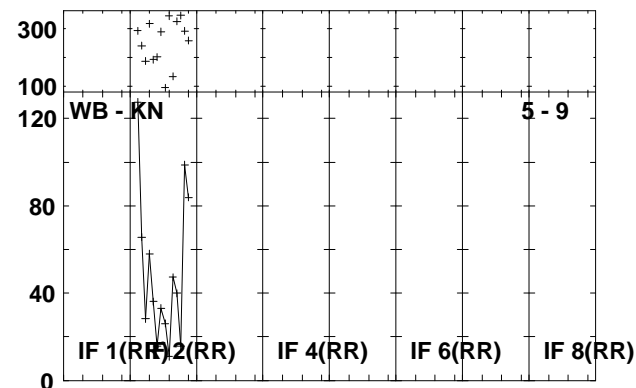
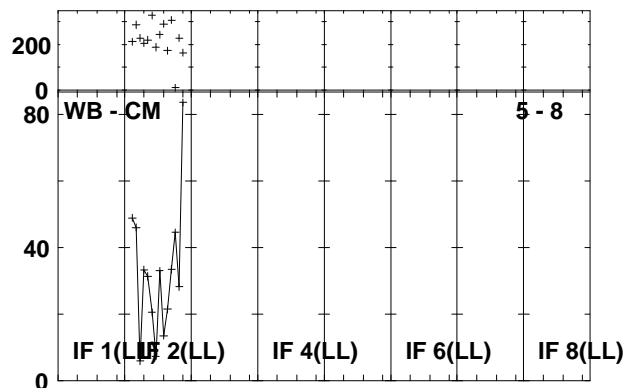
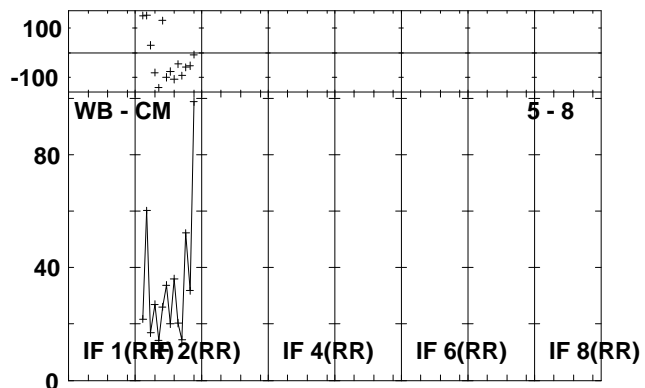
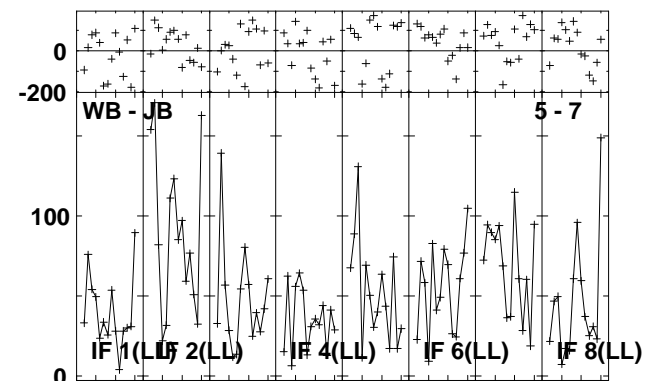
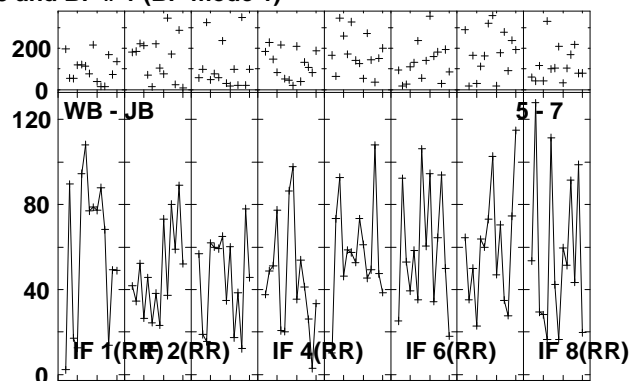
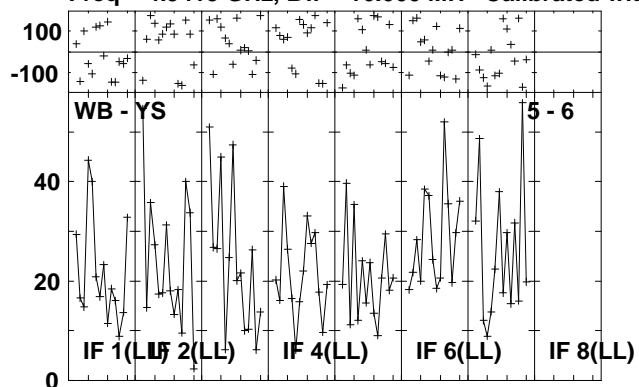

Lower frame: Milli Ampl Jy Top frame: Phas deg
Vector averaged cross-power spectrum Several baselines displayed
Timerange: 00/14:26:51 to 00/14:29:19

Plot file version 85 created 21-MAY-2010 15:47:04

J0909+02 RSD03.UVDATA.1

Freq = 4.9415 GHz, Bw = 16.000 MH Calibrated with CL # 3 and BP # 1 (BP mode 1)

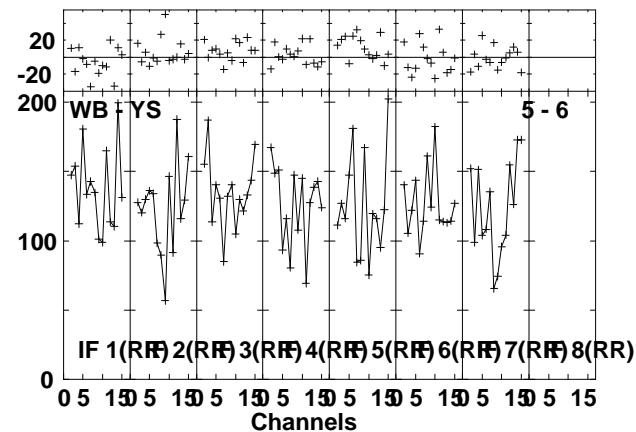
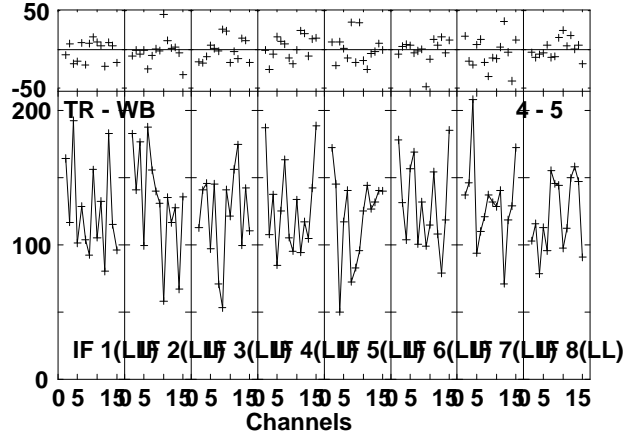
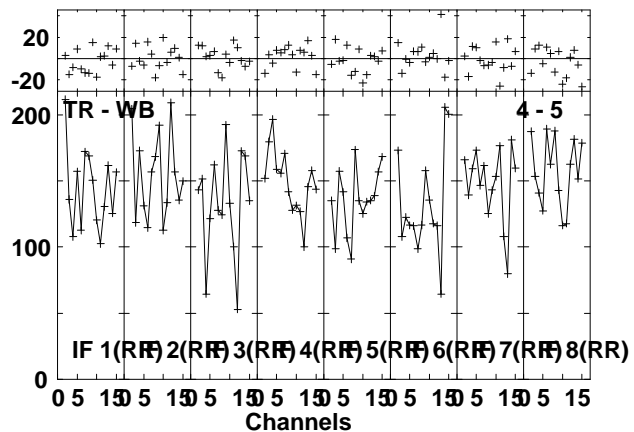
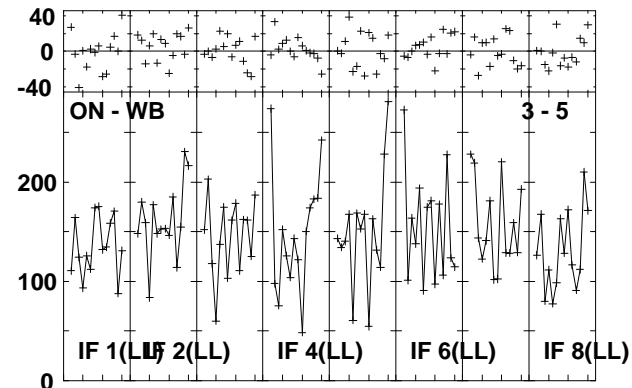
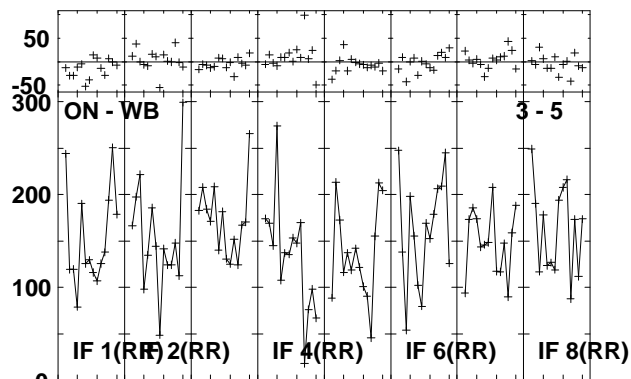
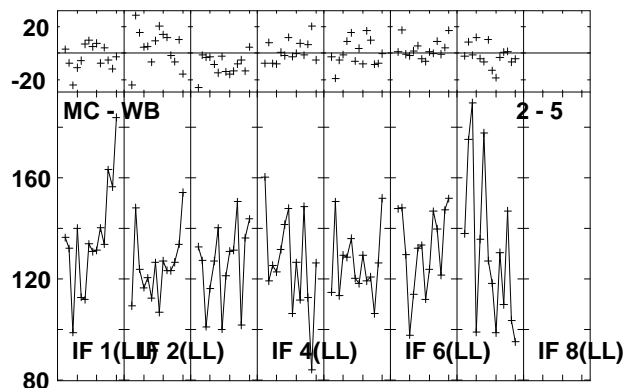
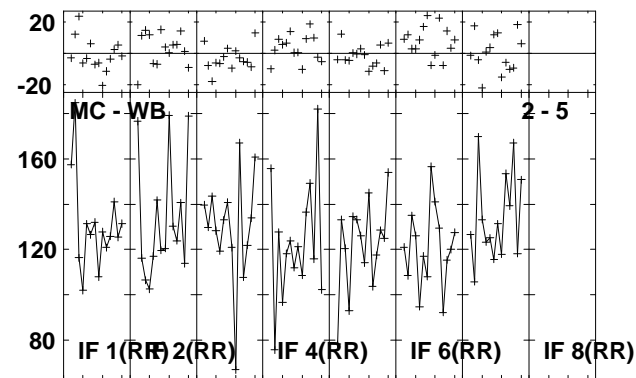
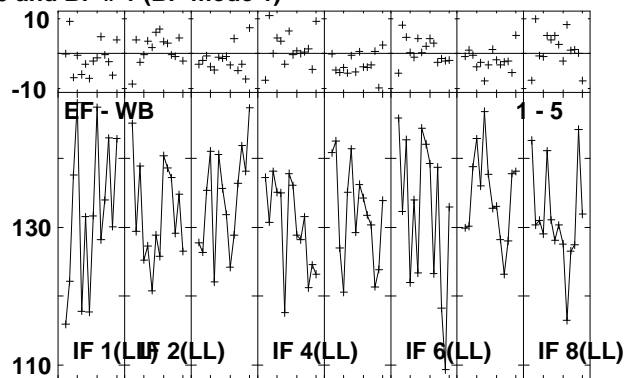
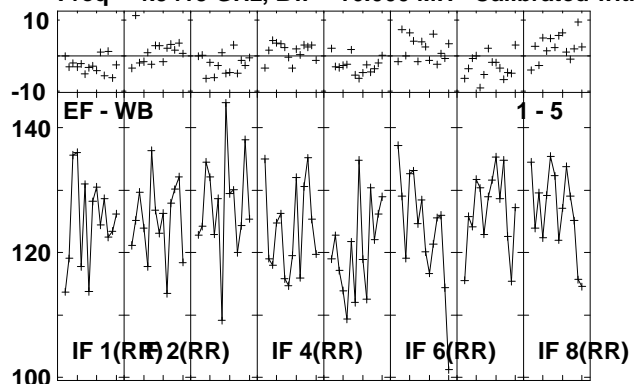

Lower frame: Milli Ampl Jy Top frame: Phas deg
Vector averaged cross-power spectrum Several baselines displayed
Timerange: 00/14:30:01 to 00/14:30:59

Plot file version 86 created 21-MAY-2010 15:47:05

J0909+02 RSD03.UVDATA.1

Freq = 4.9415 GHz, Bw = 16.000 MH Calibrated with CL # 3 and BP # 1 (BP mode 1)

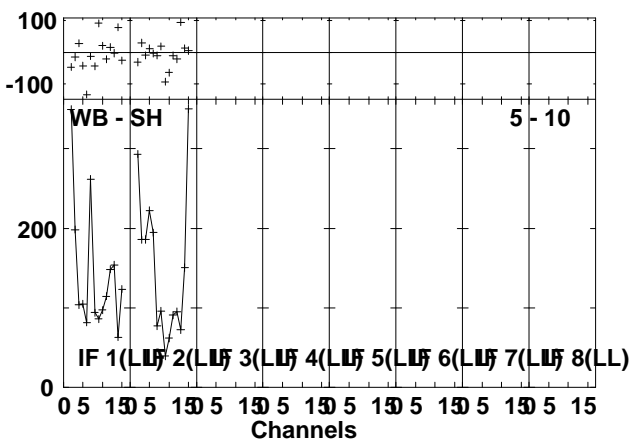
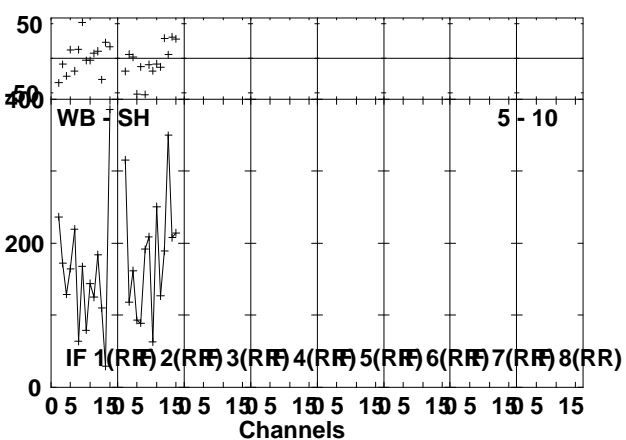
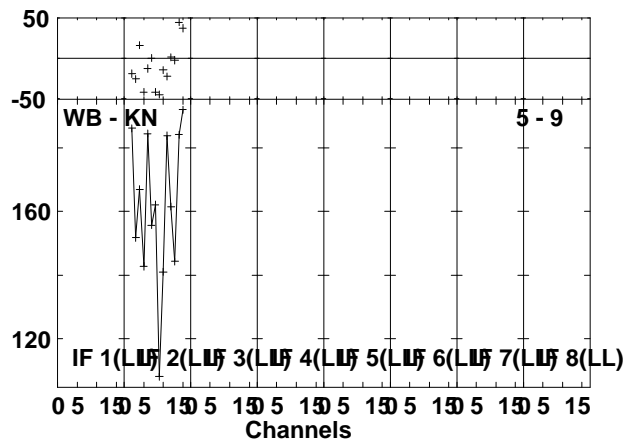
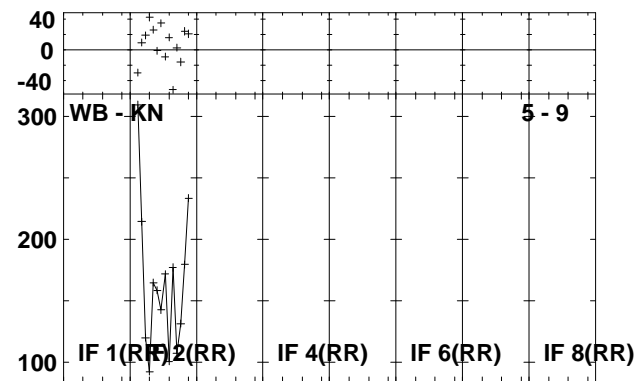
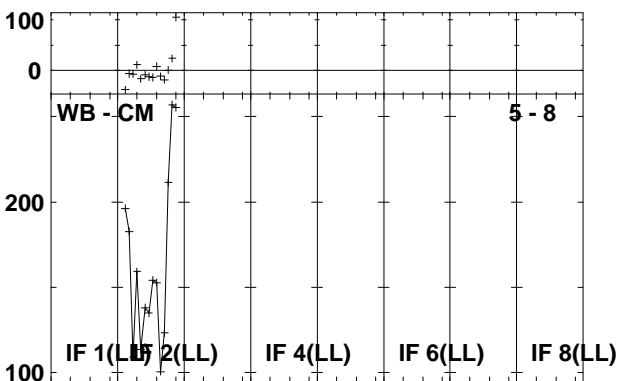
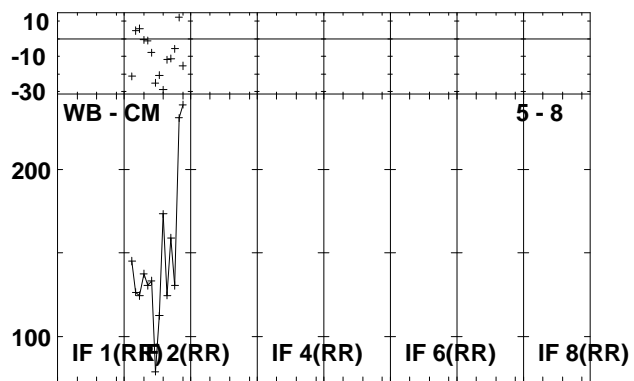
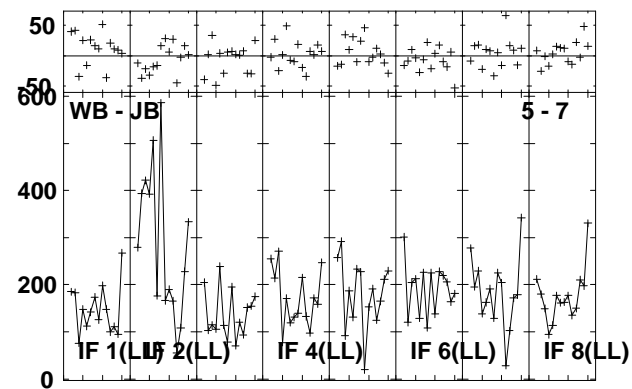
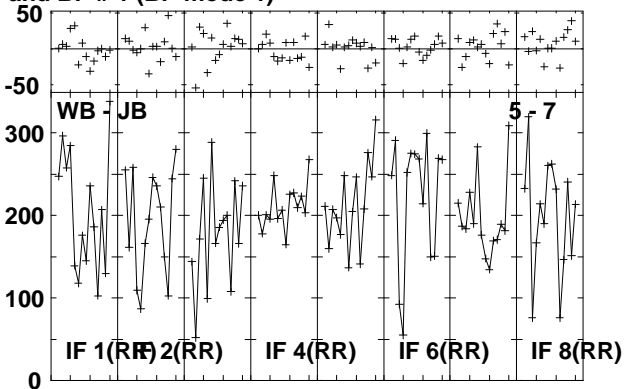
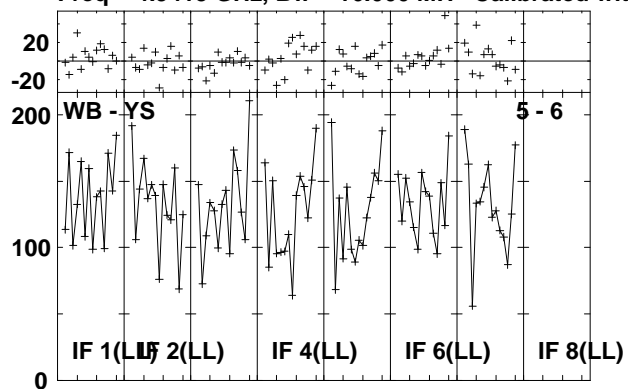

Lower frame: Milli Ampl Jy Top frame: Phas deg
Vector averaged cross-power spectrum Several baselines displayed
Timerange: 00/14:30:01 to 00/14:30:59

Plot file version 87 created 21-MAY-2010 15:47:07

CALG RSD03.UVDATA.1

Freq = 4.9415 GHz, Bw = 16.000 MH Calibrated with CL # 3 and BP # 1 (BP mode 1)

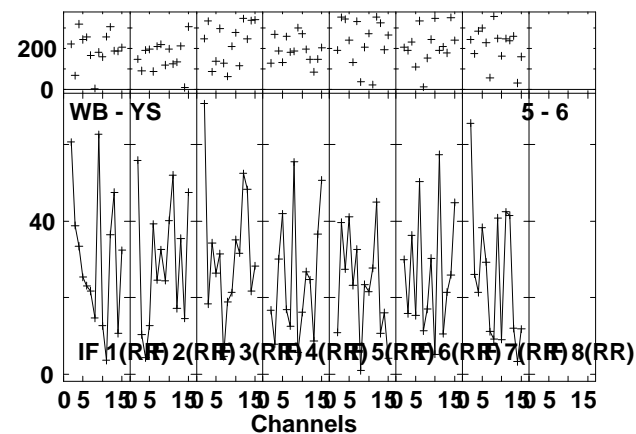
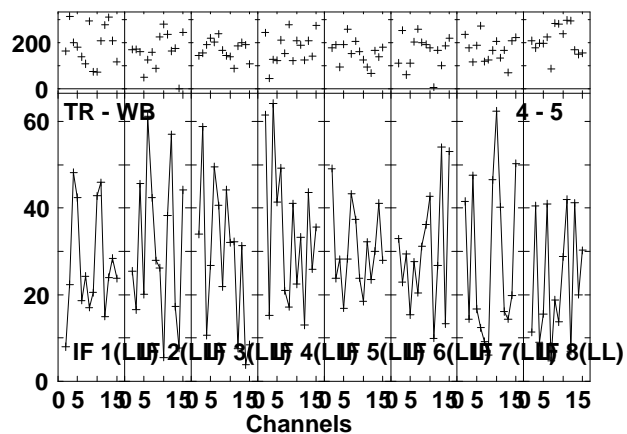
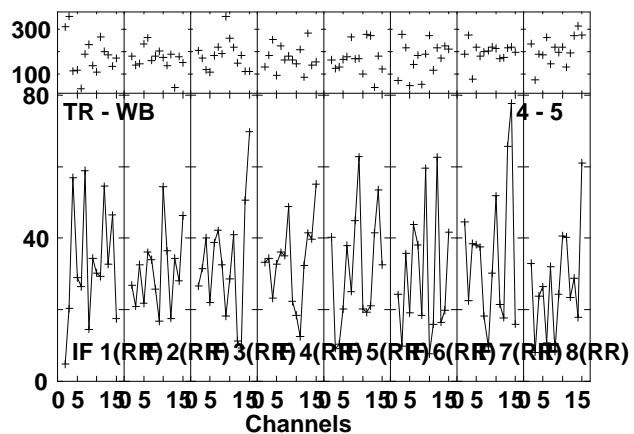
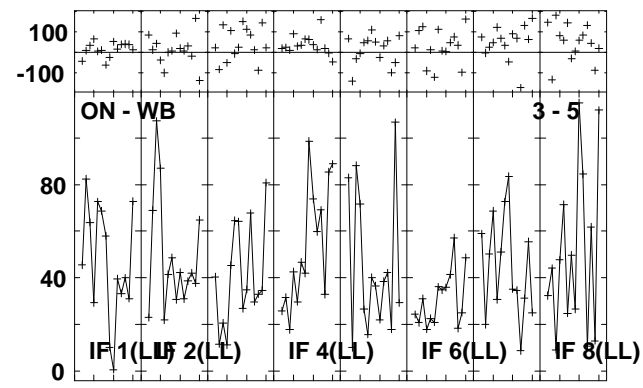
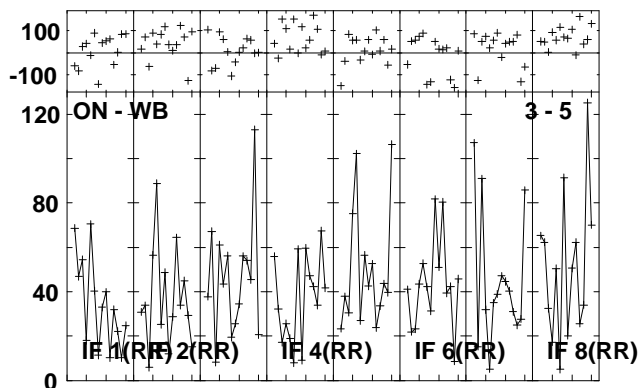
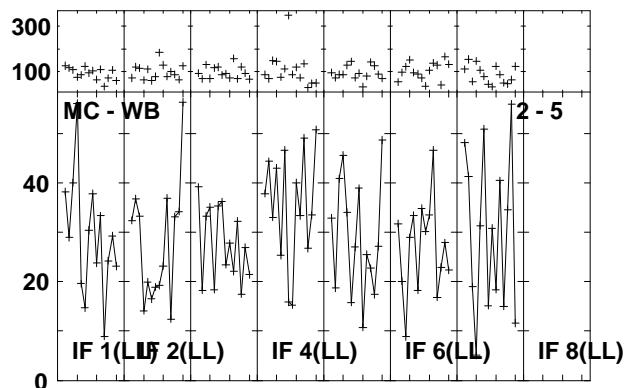
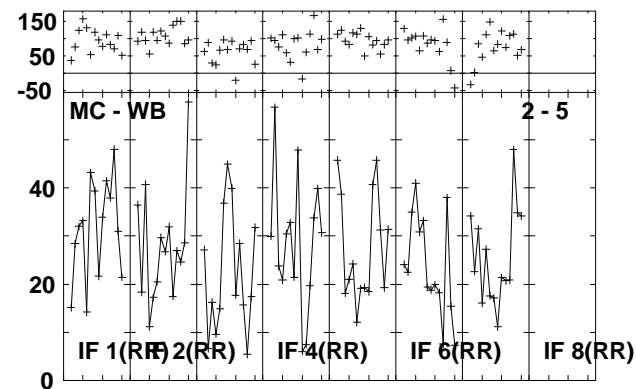
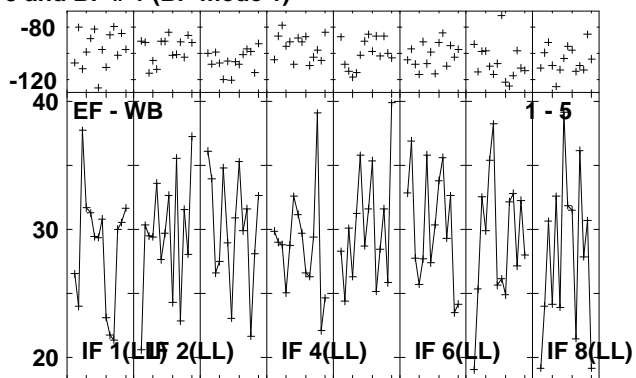
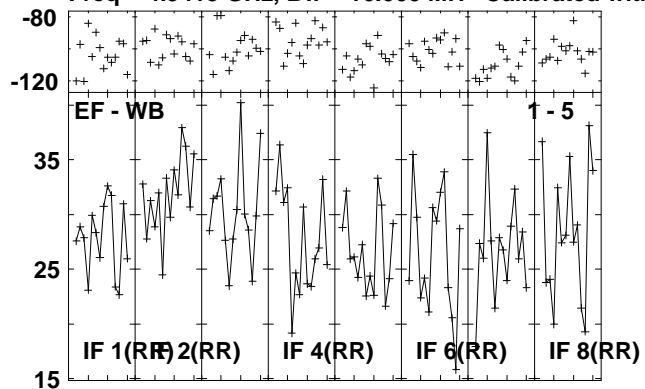

Lower frame: Milli Ampl Jy Top frame: Phas deg
Vector averaged cross-power spectrum Several baselines displayed
Timerange: 00/14:31:01 to 00/14:33:29

Plot file version 88 created 21-MAY-2010 15:47:09

CALG RSD03.UVDATA.1

Freq = 4.9415 GHz, Bw = 16.000 MH Calibrated with CL # 3 and BP # 1 (BP mode 1)

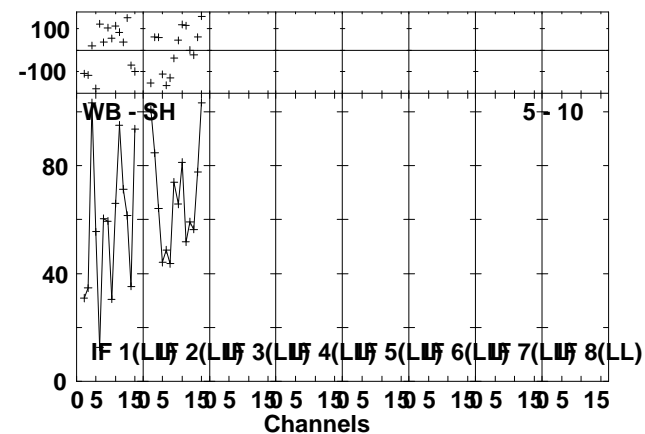
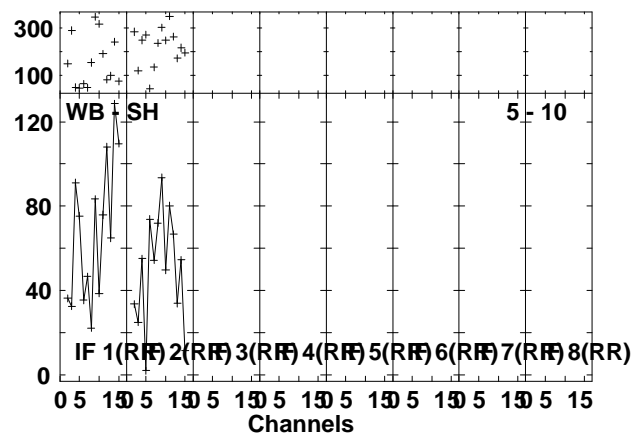
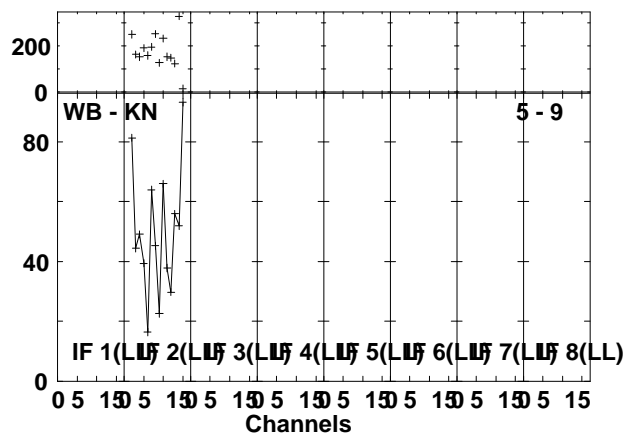
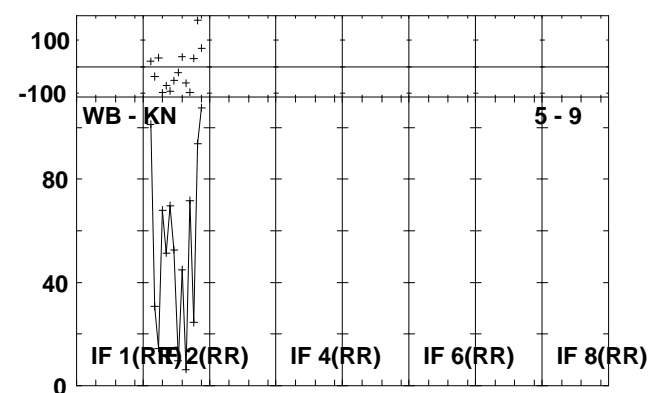
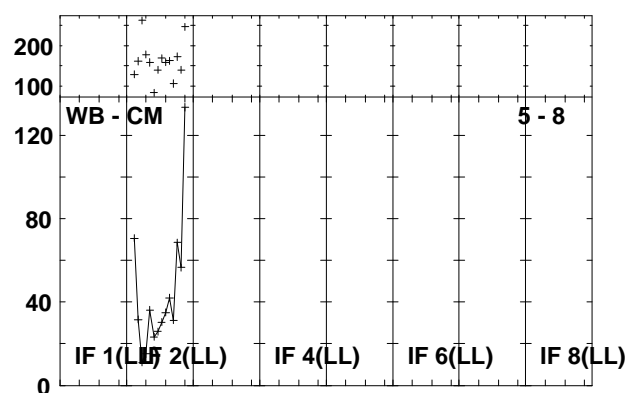
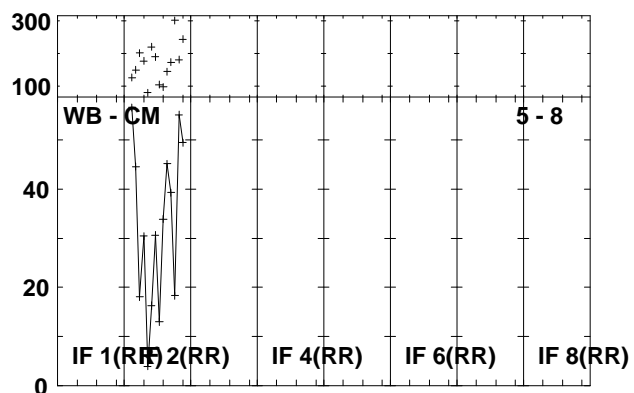
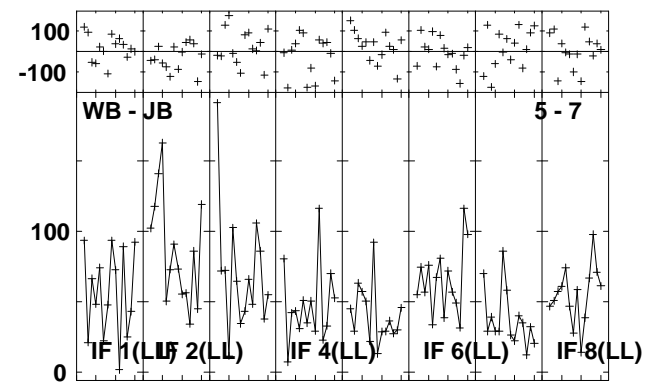
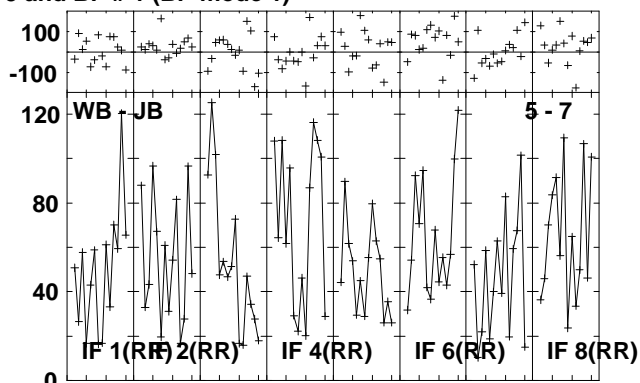
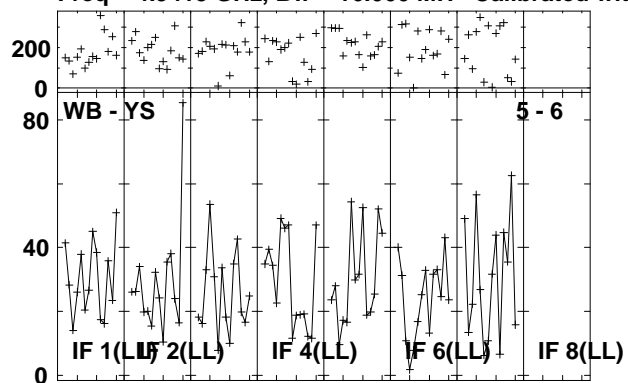

Lower frame: Milli Ampl Jy Top frame: Phas deg
Vector averaged cross-power spectrum Several baselines displayed
Timerange: 00/14:31:01 to 00/14:33:29

Plot file version 89 created 21-MAY-2010 15:47:12

CALE RSD03.UVDATA.1

Freq = 4.9415 GHz, Bw = 16.000 MH Calibrated with CL # 3 and BP # 1 (BP mode 1)

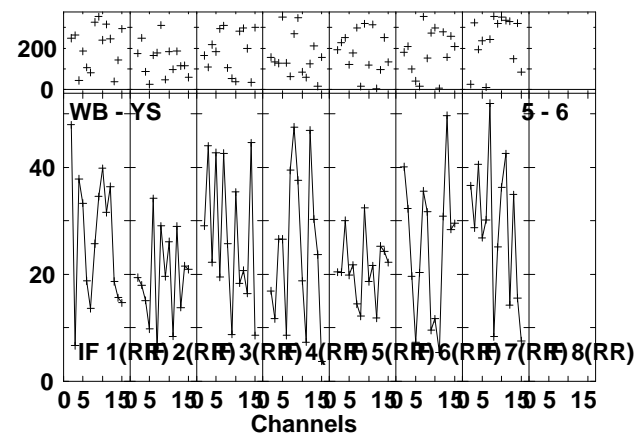
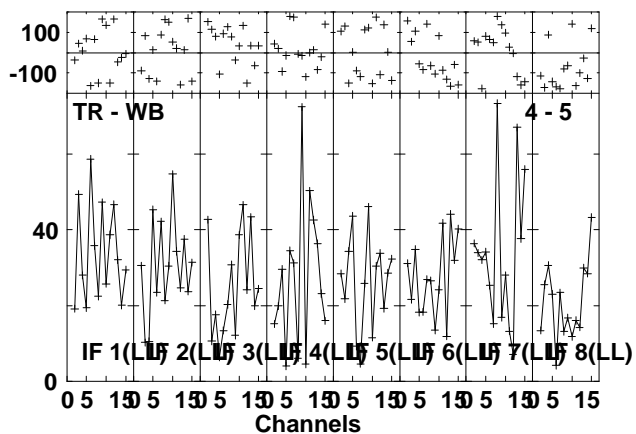
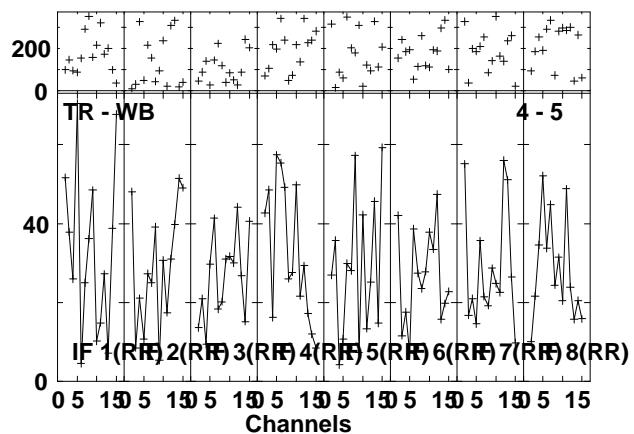
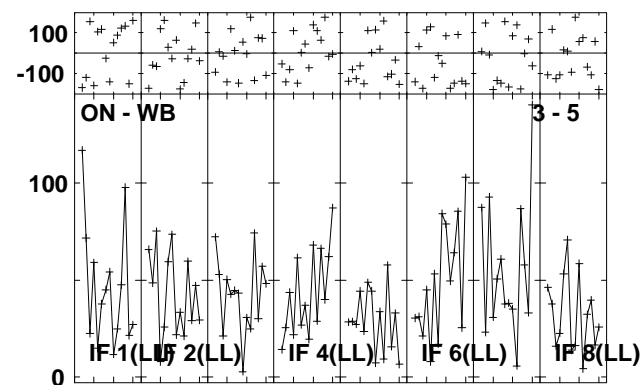
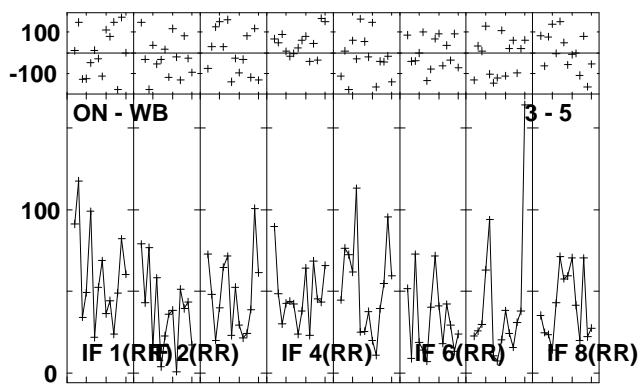
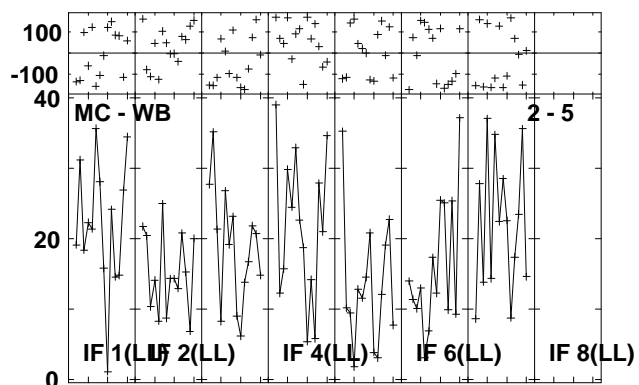
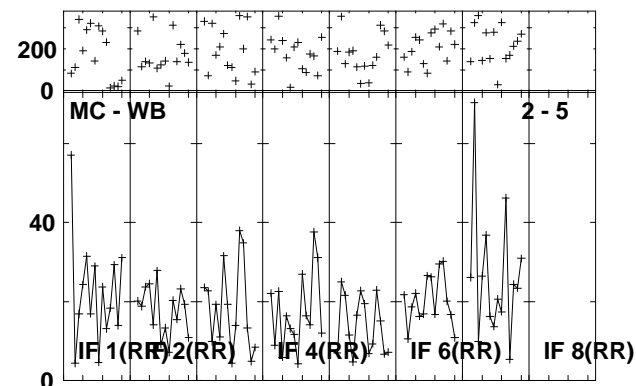
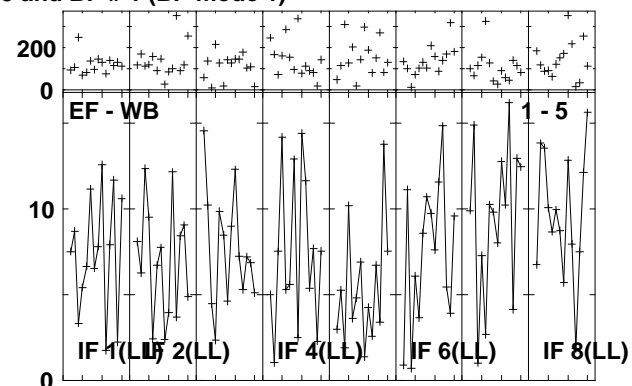
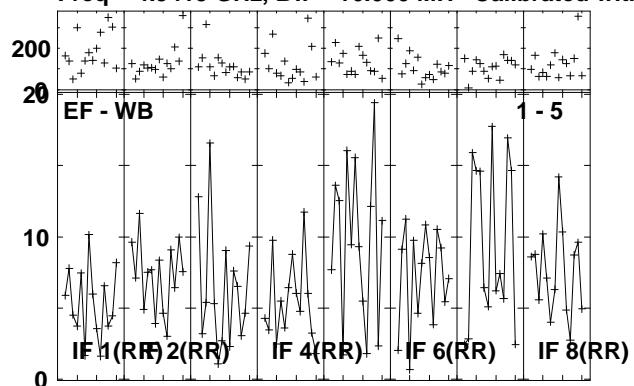

Lower frame: Milli Ampl Jy Top frame: Phas deg
Vector averaged cross-power spectrum Several baselines displayed
Timerange: 00/14:33:31 to 00/14:35:59

Plot file version 90 created 21-MAY-2010 15:47:14

CALE RSD03.UVDATA.1

Freq = 4.9415 GHz, Bw = 16.000 MH Calibrated with CL # 3 and BP # 1 (BP mode 1)

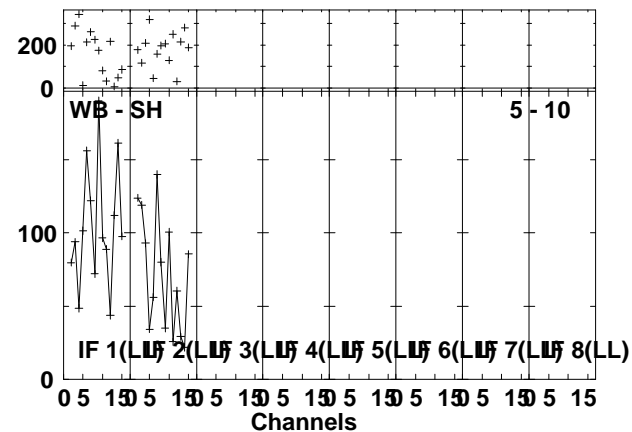
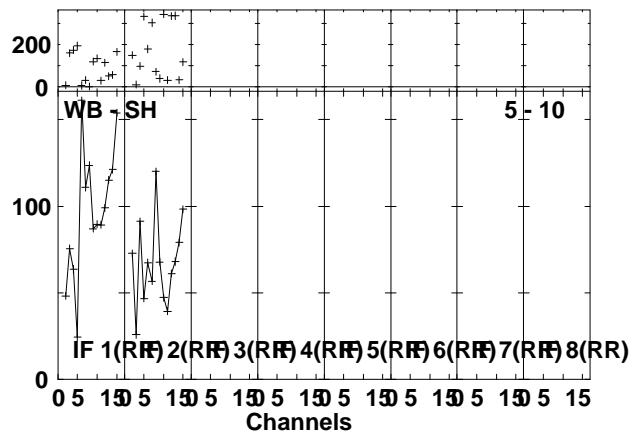
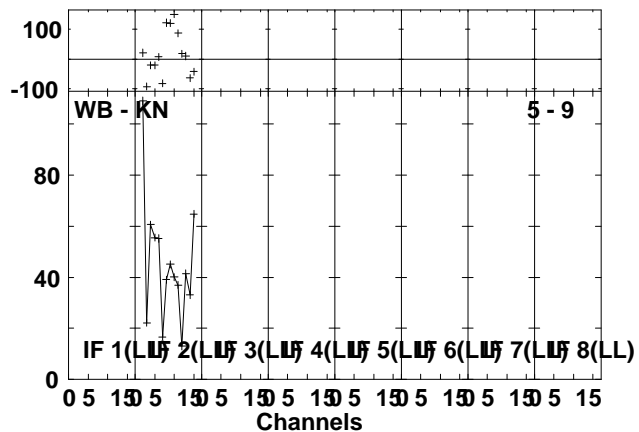
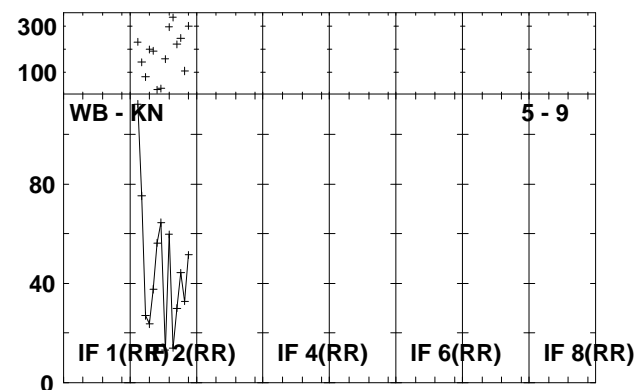
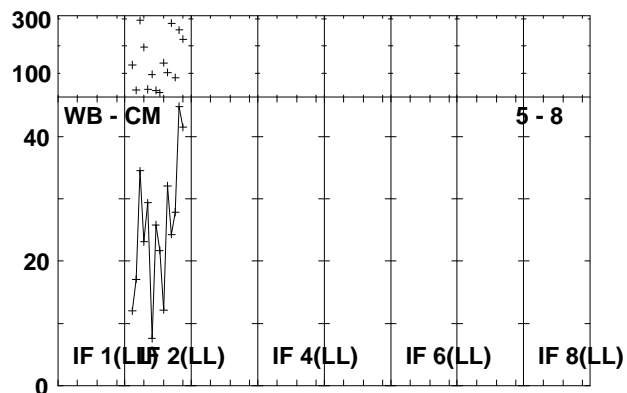
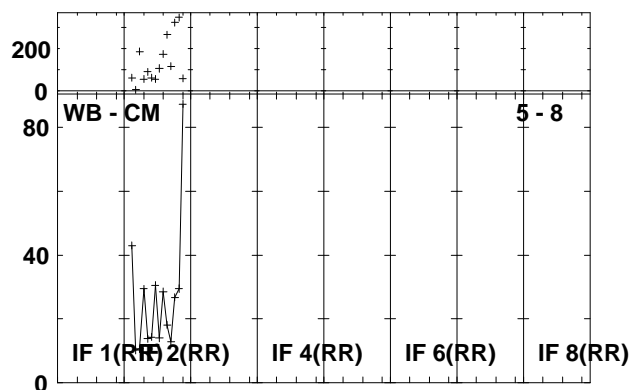
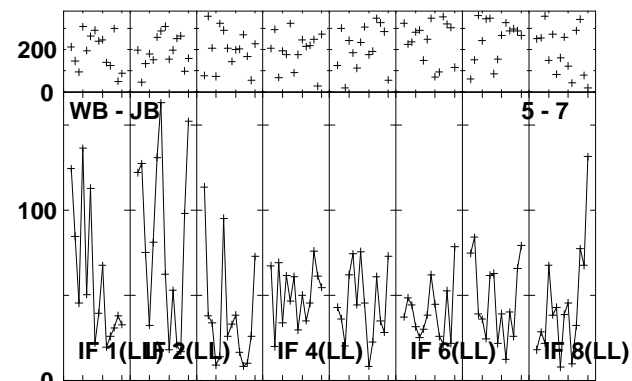
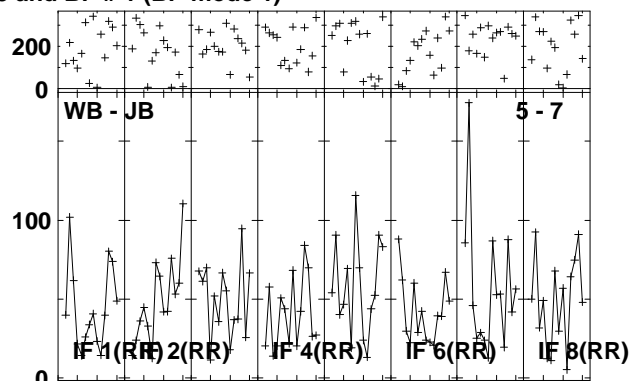
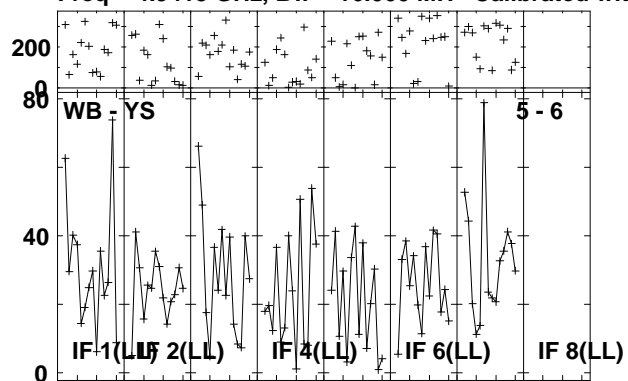

Lower frame: Milli Ampl Jy Top frame: Phas deg
Vector averaged cross-power spectrum Several baselines displayed
Timerange: 00/14:33:31 to 00/14:35:59

Plot file version 91 created 21-MAY-2010 15:47:16

J0909+02 RSD03.UVDATA.1

Freq = 4.9415 GHz, Bw = 16.000 MH Calibrated with CL # 3 and BP # 1 (BP mode 1)

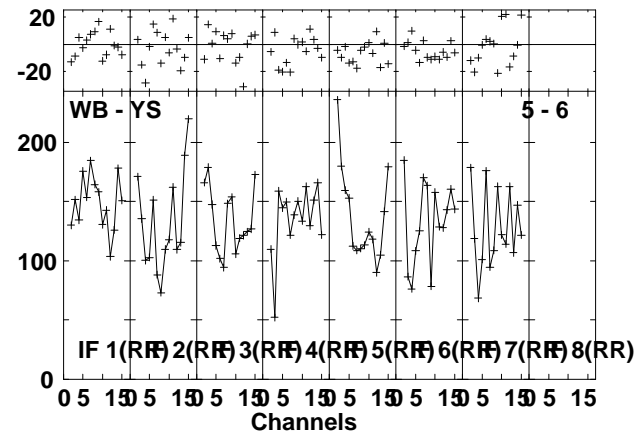
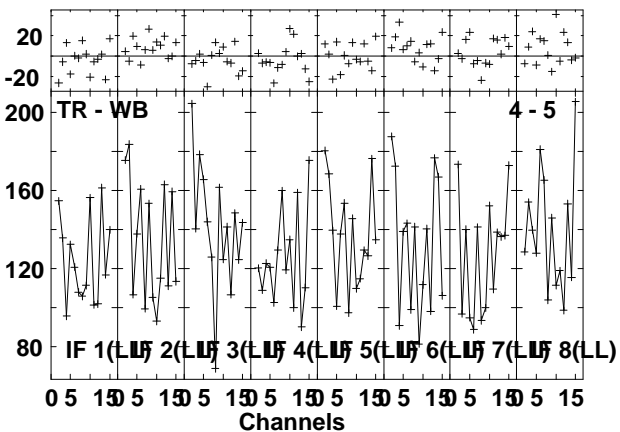
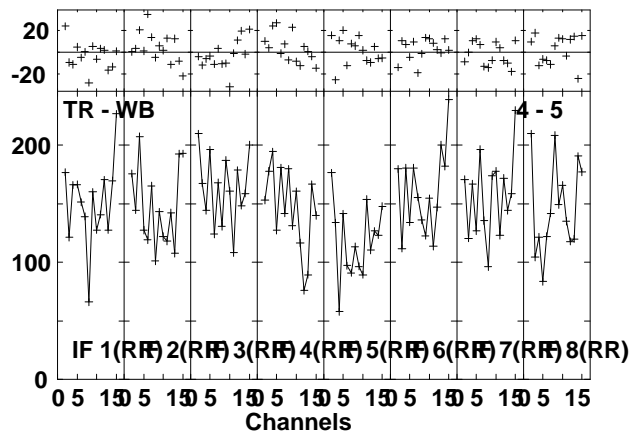
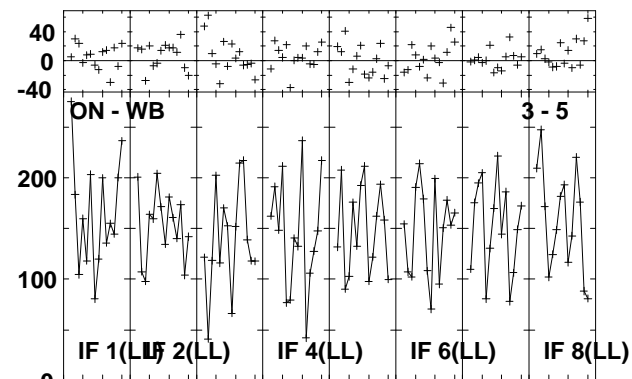
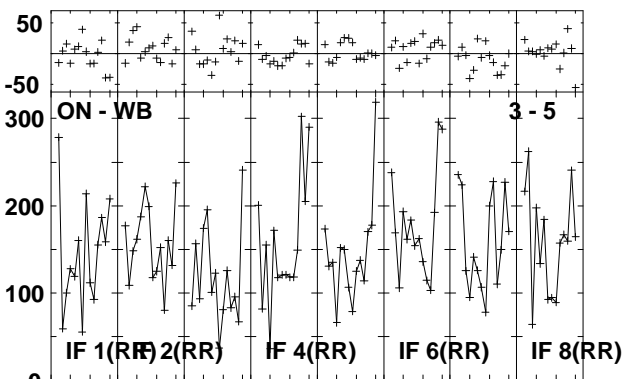
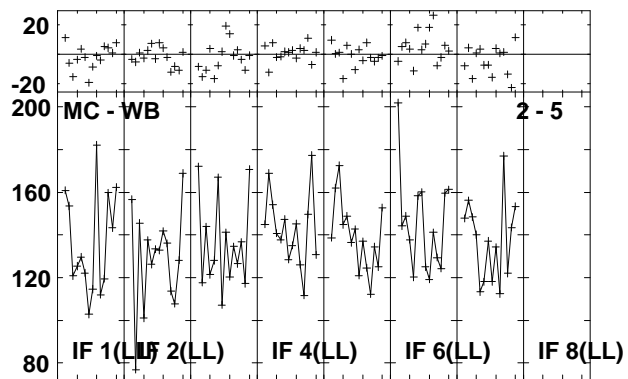
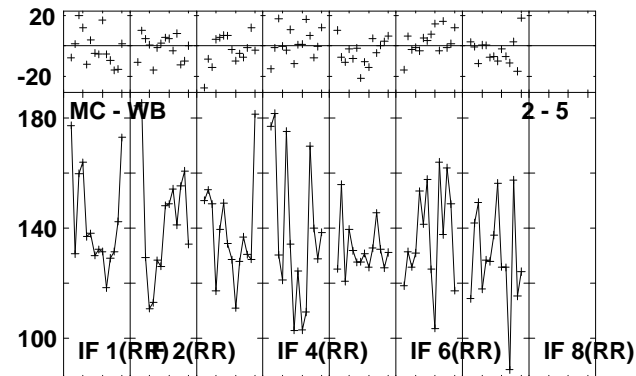
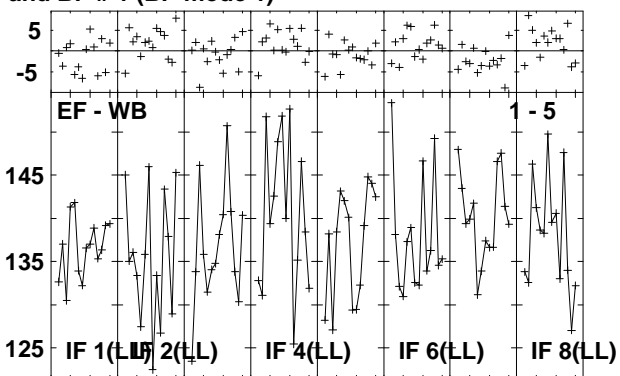
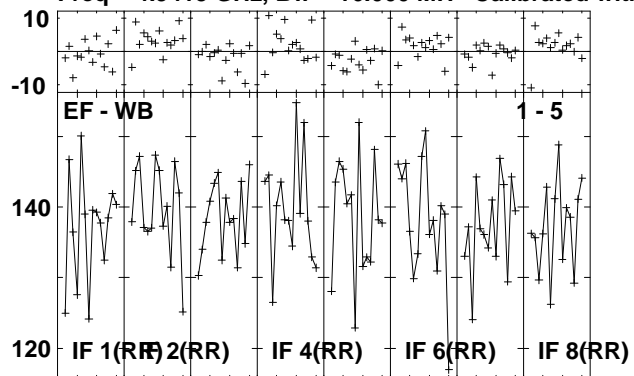

Lower frame: Milli Ampl Jy Top frame: Phas deg
Vector averaged cross-power spectrum Several baselines displayed
Timerange: 00/14:36:41 to 00/14:37:39

Plot file version 92 created 21-MAY-2010 15:47:17

J0909+02 RSD03.UVDATA.1

Freq = 4.9415 GHz, Bw = 16.000 MH Calibrated with CL # 3 and BP # 1 (BP mode 1)

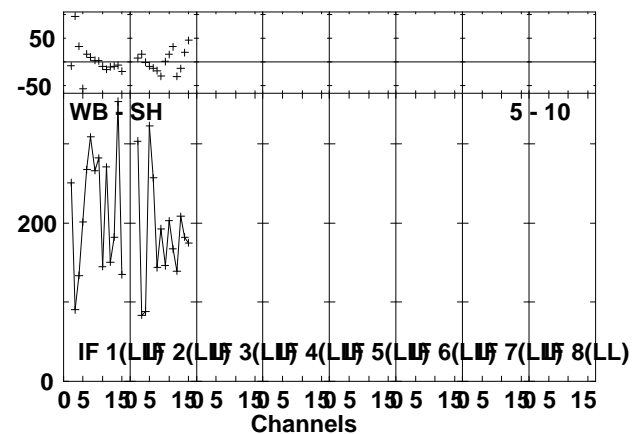
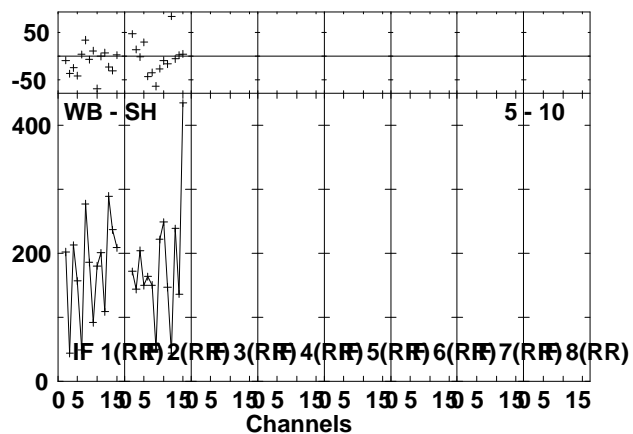
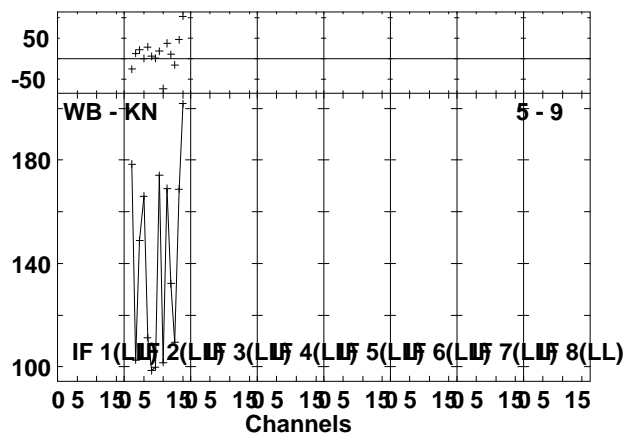
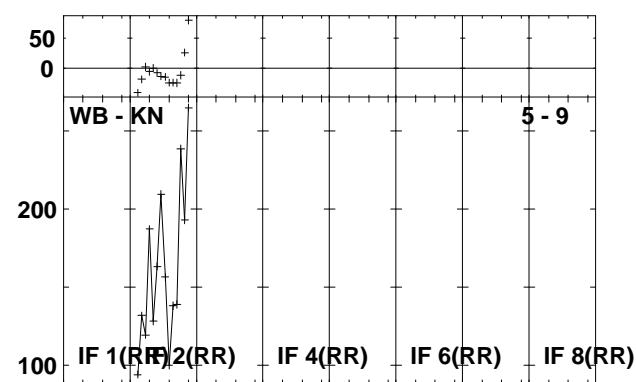
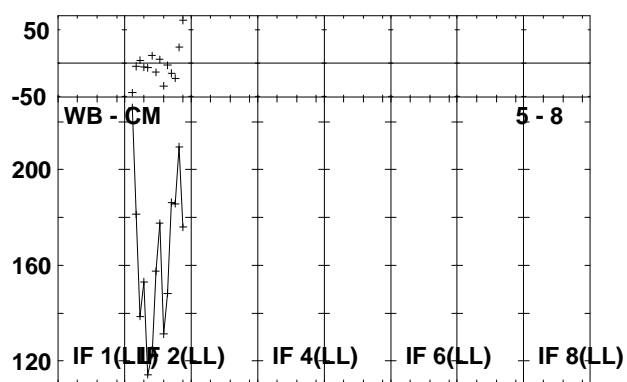
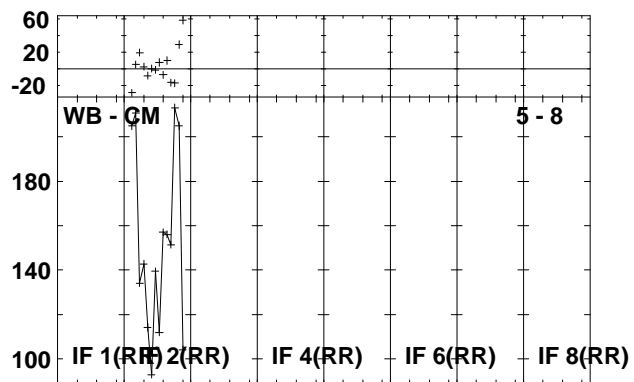
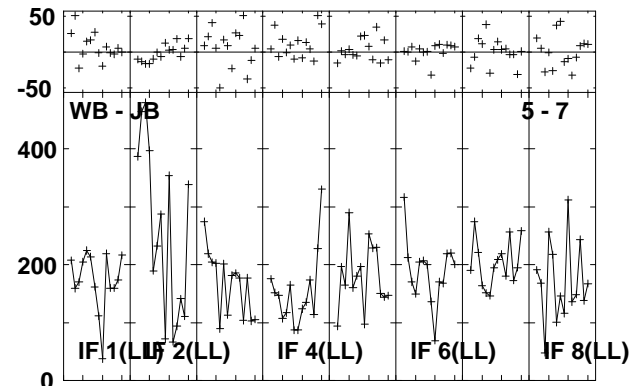
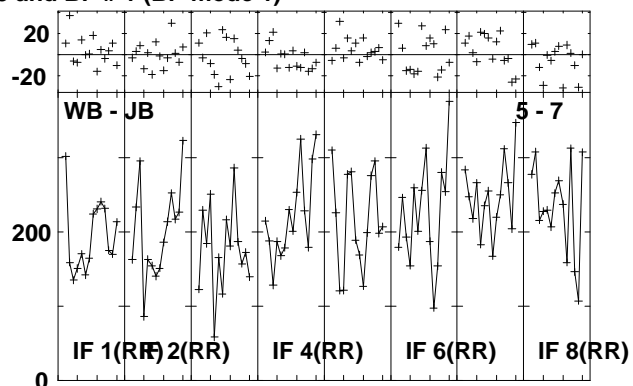
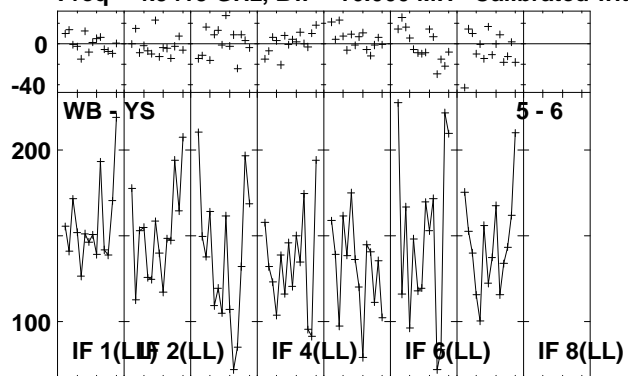

Lower frame: Milli Ampl Jy Top frame: Phas deg
Vector averaged cross-power spectrum Several baselines displayed
Timerange: 00/14:36:41 to 00/14:37:39

Plot file version 93 created 21-MAY-2010 15:47:19

CALI RSD03.UVDATA.1

Freq = 4.9415 GHz, Bw = 16.000 MH Calibrated with CL # 3 and BP # 1 (BP mode 1)

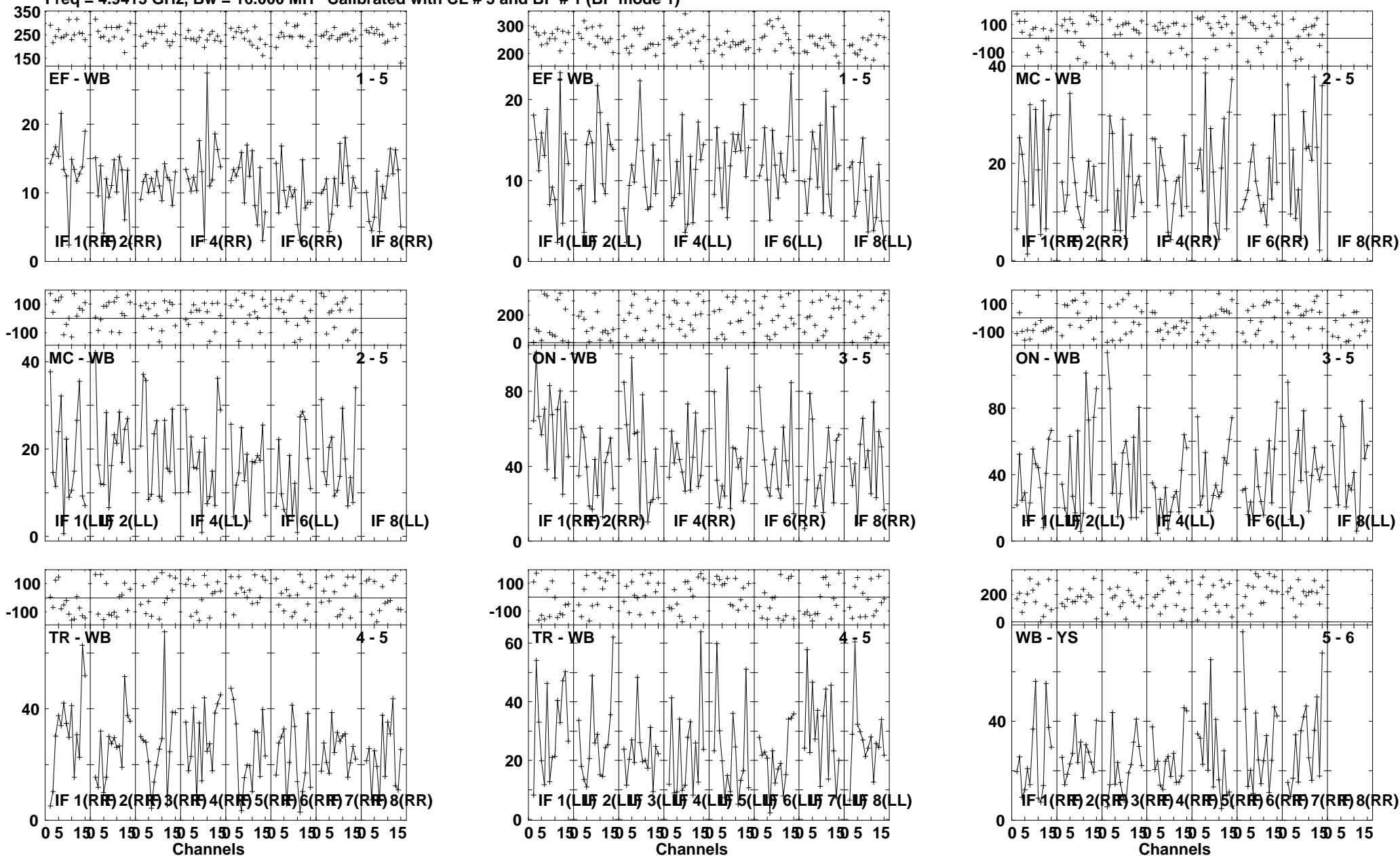

Lower frame: Milli Ampl Jy Top frame: Phas deg
Vector averaged cross-power spectrum Several baselines displayed
Timerange: 00/14:37:41 to 00/14:40:09

Plot file version 94 created 21-MAY-2010 15:47:21

CALI RSD03.UVDATA.1

Freq = 4.9415 GHz, Bw = 16.000 MH Calibrated with CL # 3 and BP # 1 (BP mode 1)

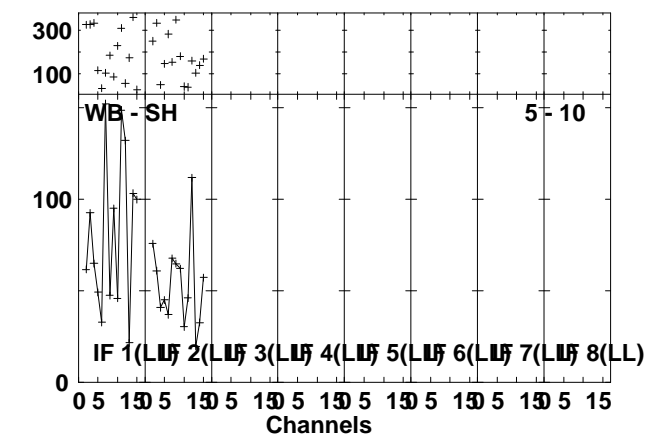
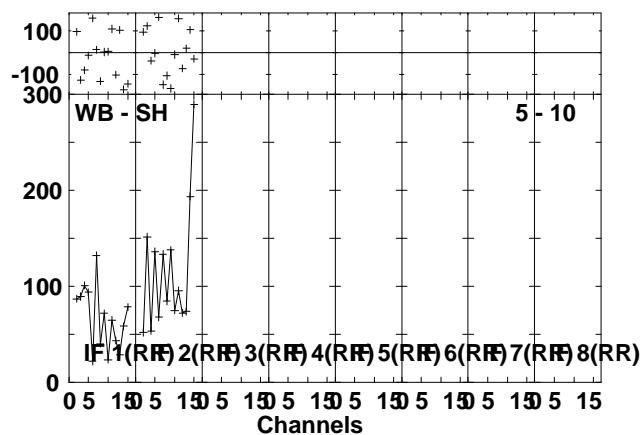
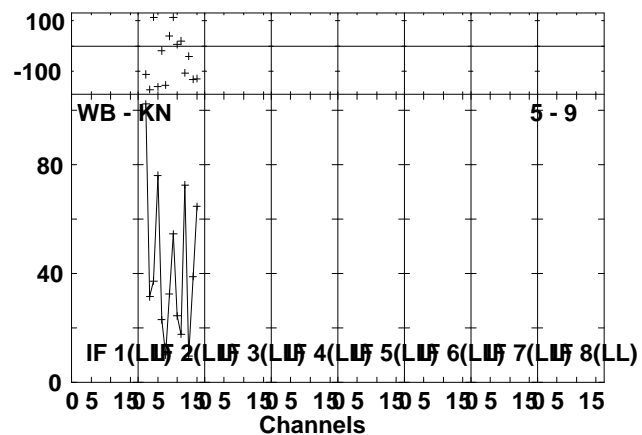
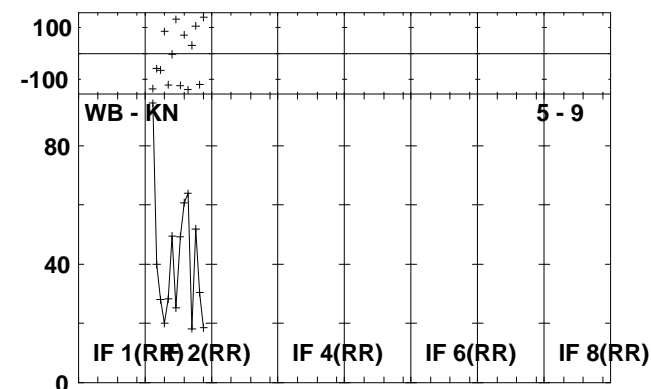
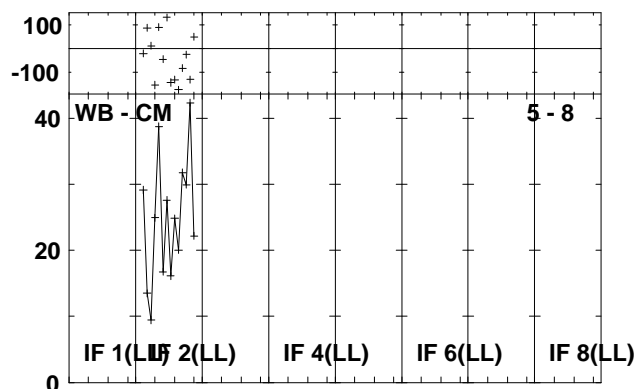
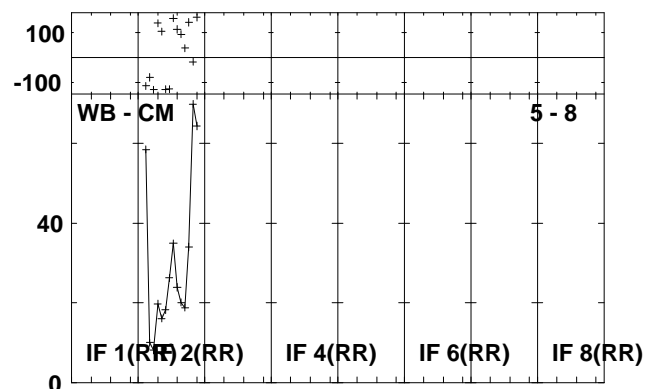
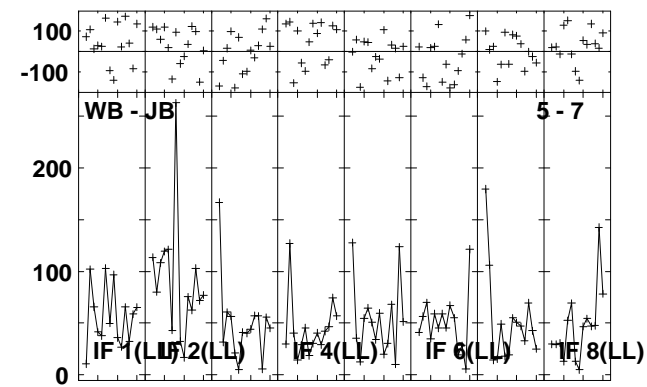
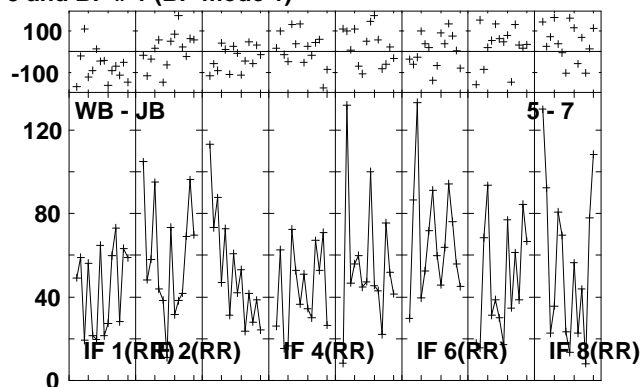
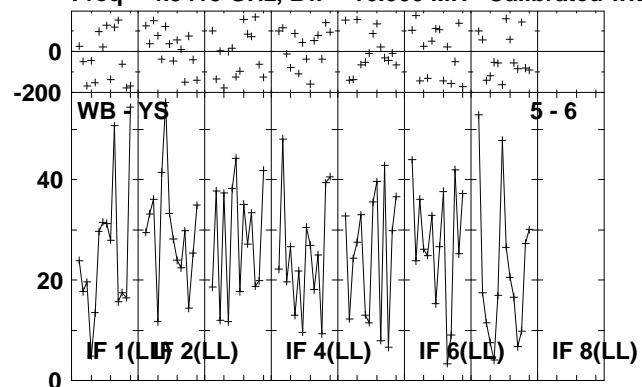

Lower frame: Milli Ampl Jy Top frame: Phas deg
Vector averaged cross-power spectrum Several baselines displayed
Timerange: 00/14:37:41 to 00/14:40:09

Plot file version 95 created 21-MAY-2010 15:47:24

CALH RSD03.UVDATA.1

Freq = 4.9415 GHz, Bw = 16.000 MH Calibrated with CL # 3 and BP # 1 (BP mode 1)

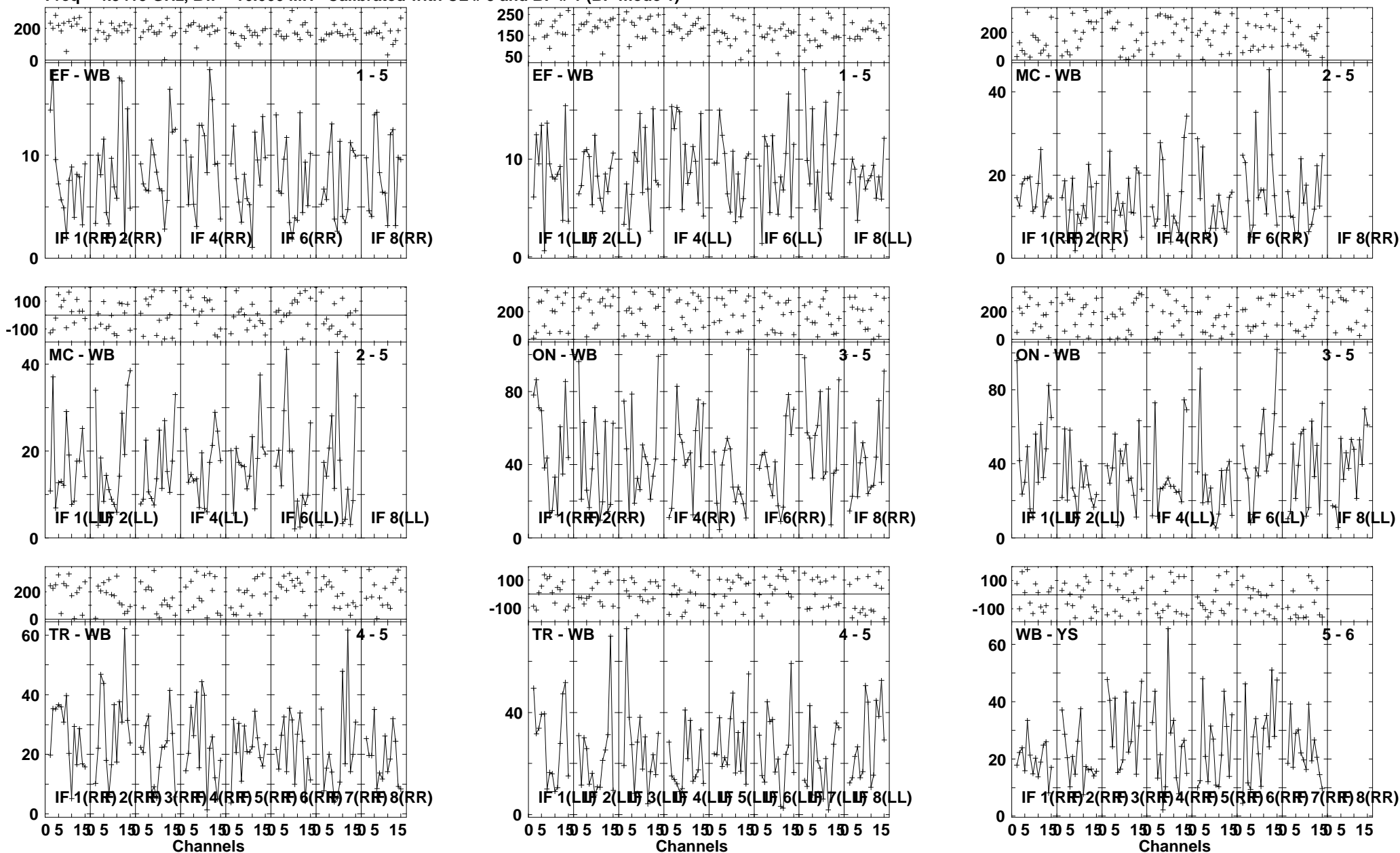

Lower frame: Milli Ampl Jy Top frame: Phas deg
Vector averaged cross-power spectrum Several baselines displayed
Timerange: 00/14:40:11 to 00/14:42:39

Plot file version 96 created 21-MAY-2010 15:47:26

CALH RSD03.UVDATA.1

Freq = 4.9415 GHz, Bw = 16.000 MH Calibrated with CL # 3 and BP # 1 (BP mode 1)

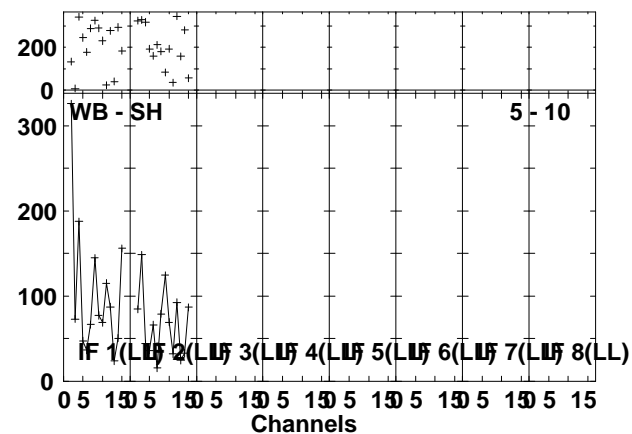
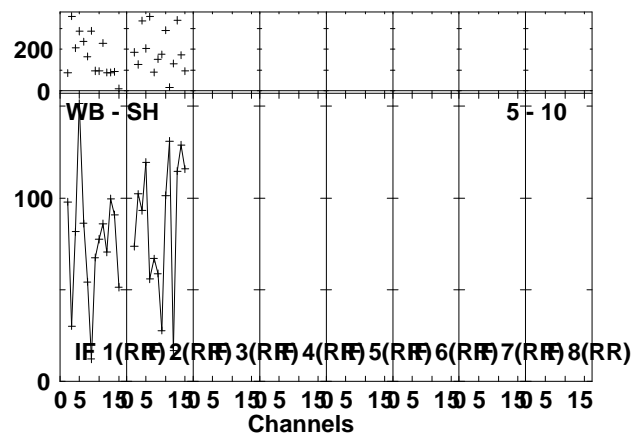
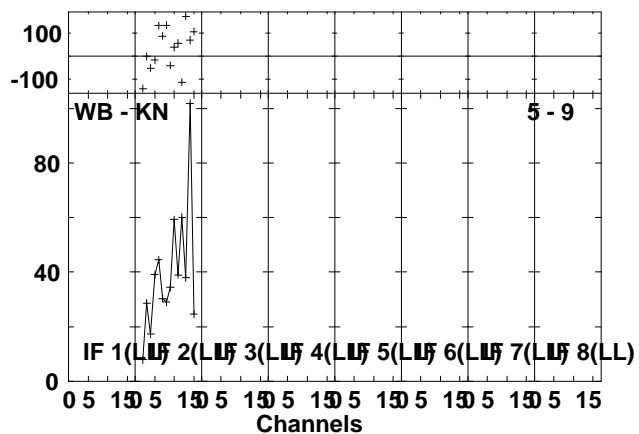
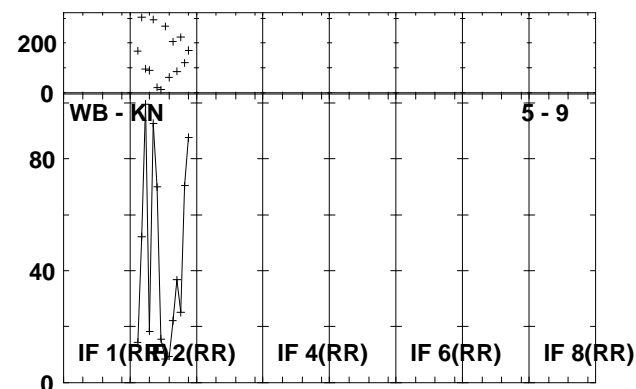
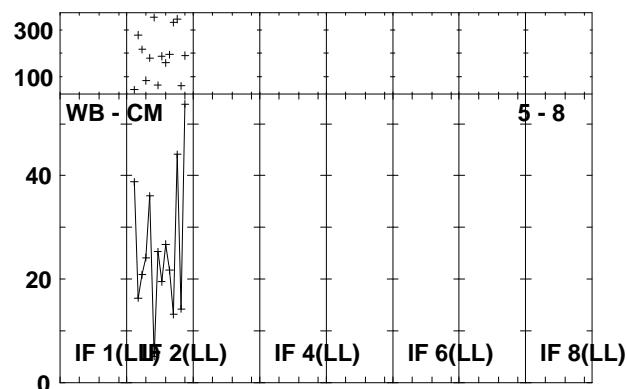
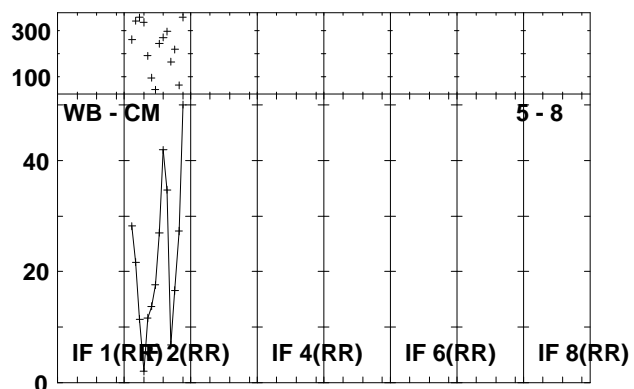
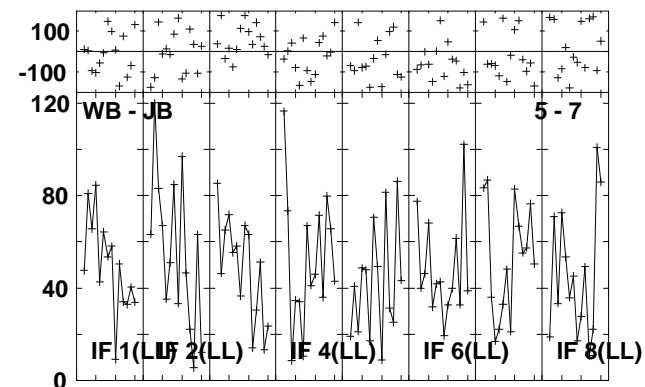
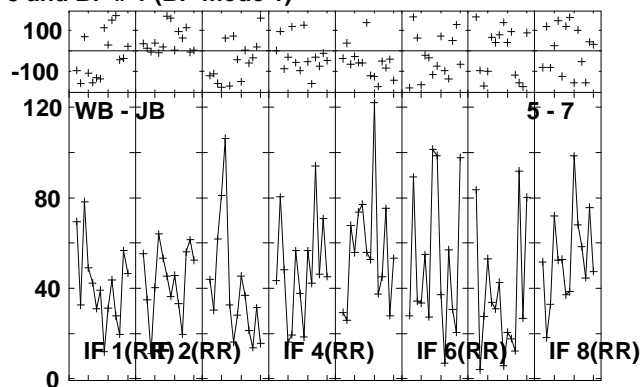
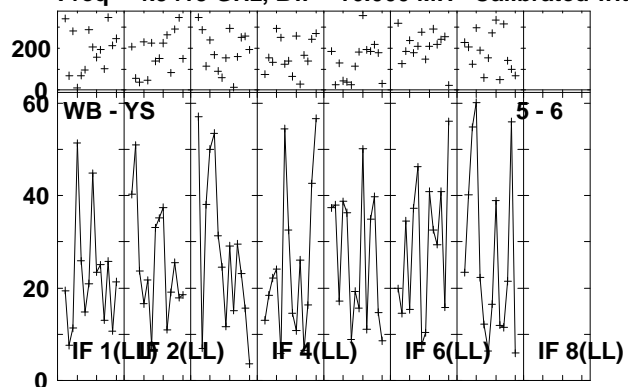

Lower frame: Milli Ampl Jy Top frame: Phas deg
Vector averaged cross-power spectrum Several baselines displayed
Timerange: 00/14:40:11 to 00/14:42:39

Plot file version 97 created 21-MAY-2010 15:47:29

CALJ RSD03.UVDATA.1

Freq = 4.9415 GHz, Bw = 16.000 MH Calibrated with CL # 3 and BP # 1 (BP mode 1)

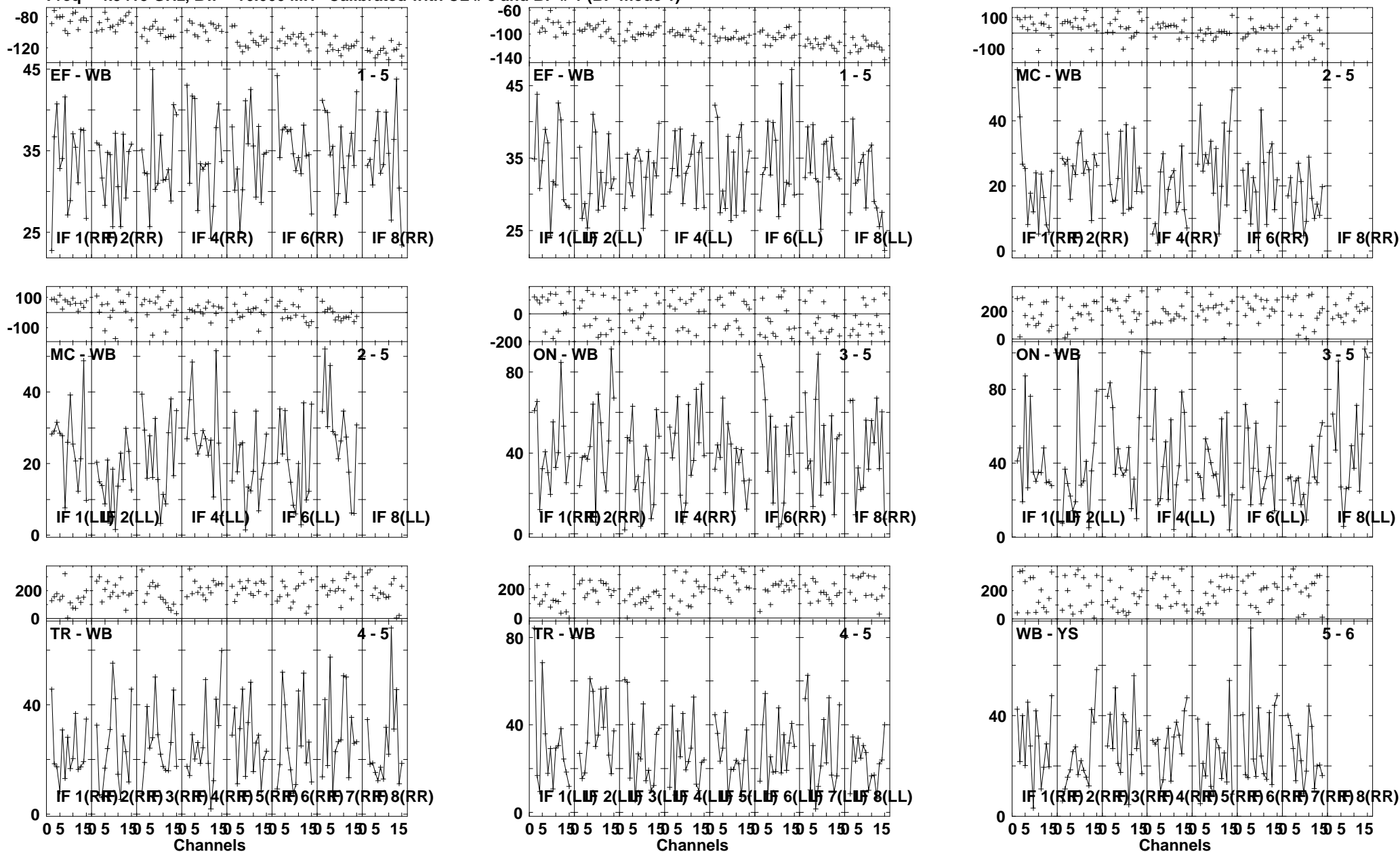

Lower frame: Milli Ampl Jy Top frame: Phas deg
Vector averaged cross-power spectrum Several baselines displayed
Timerange: 00/14:42:41 to 00/14:45:09

Plot file version 98 created 21-MAY-2010 15:47:31

CALJ RSD03.UVDATA.1

Freq = 4.9415 GHz, Bw = 16.000 MH Calibrated with CL # 3 and BP # 1 (BP mode 1)

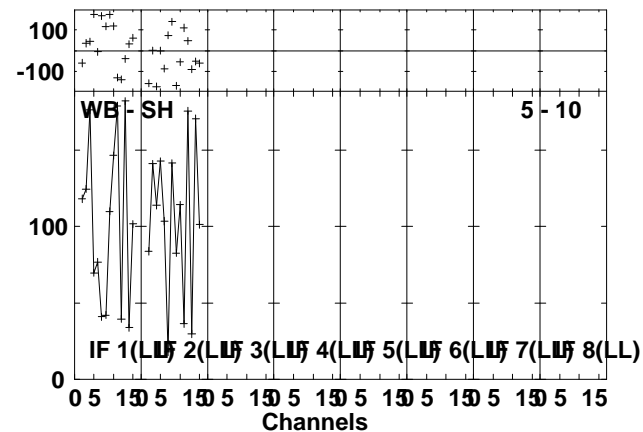
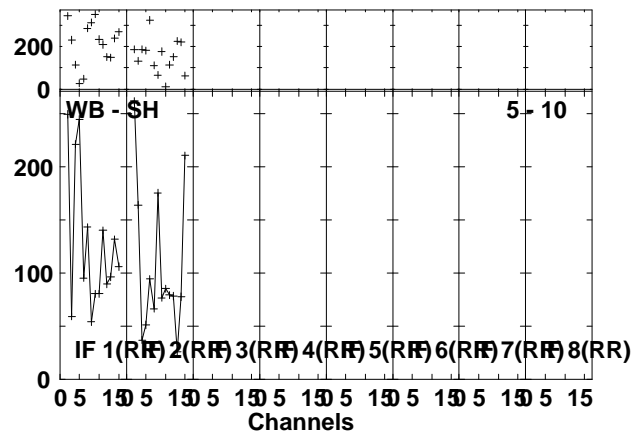
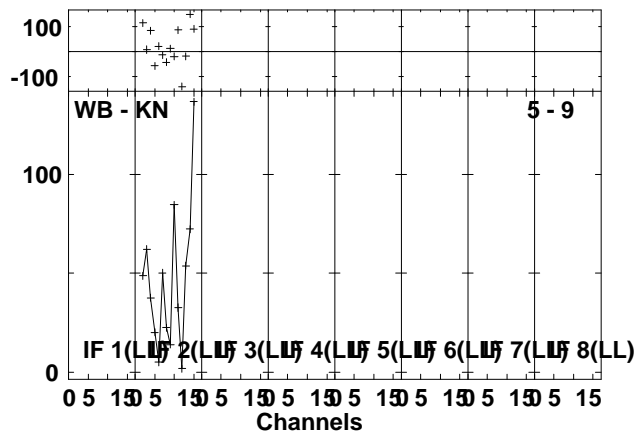
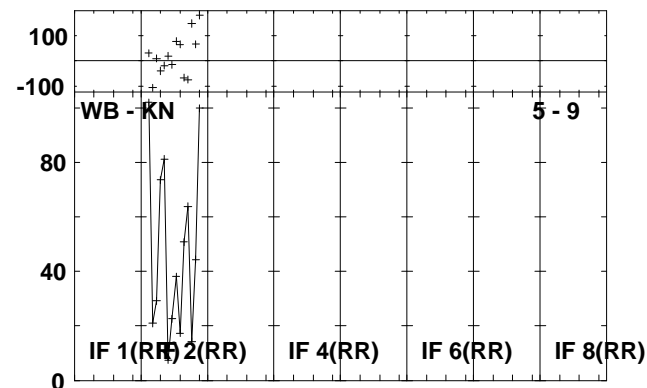
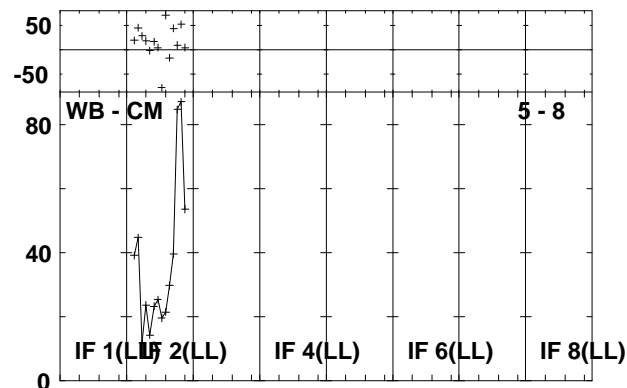
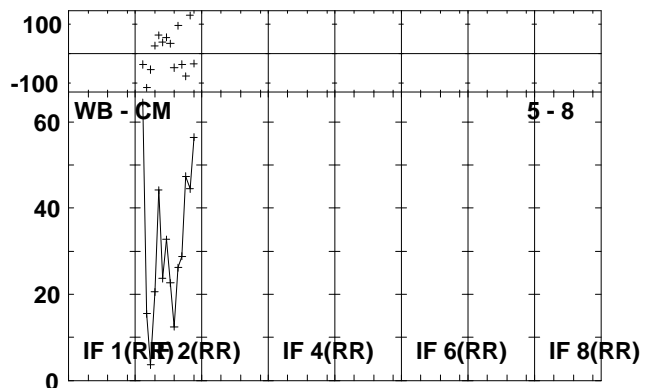
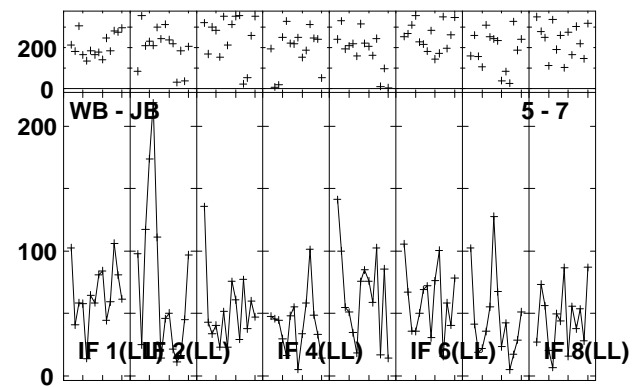
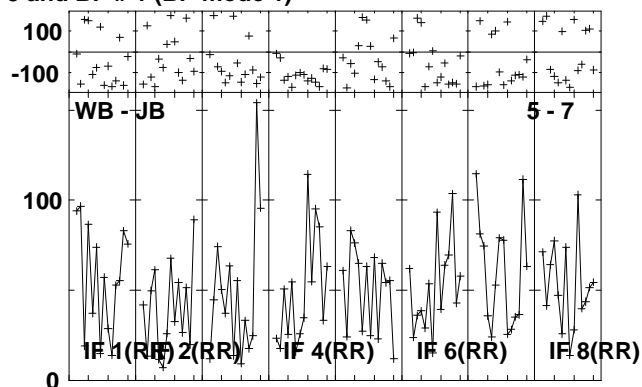
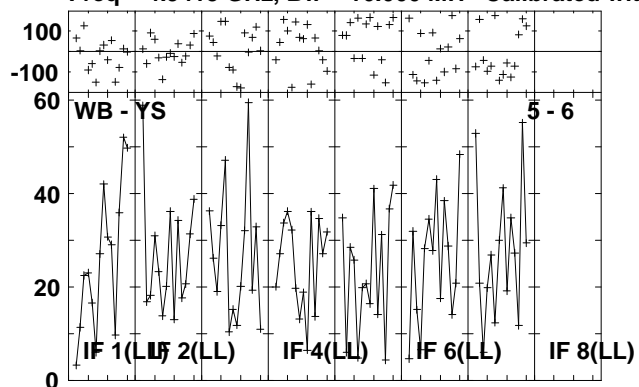

Lower frame: Milli Ampl Jy Top frame: Phas deg
Vector averaged cross-power spectrum Several baselines displayed
Timerange: 00/14:42:41 to 00/14:45:09

Plot file version 99 created 21-MAY-2010 15:47:34

J0909+02 RSD03.UVDATA.1

Freq = 4.9415 GHz, Bw = 16.000 MH Calibrated with CL # 3 and BP # 1 (BP mode 1)

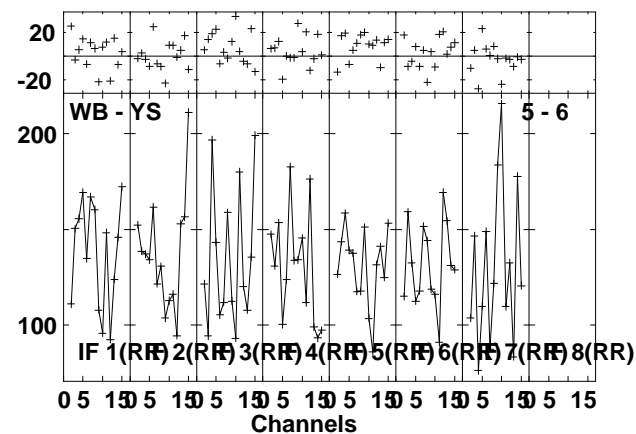
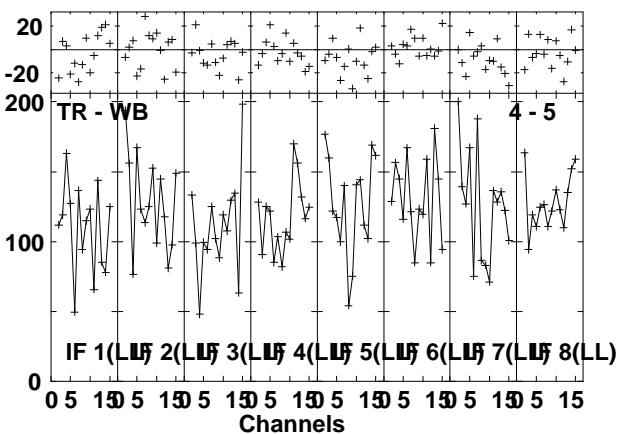
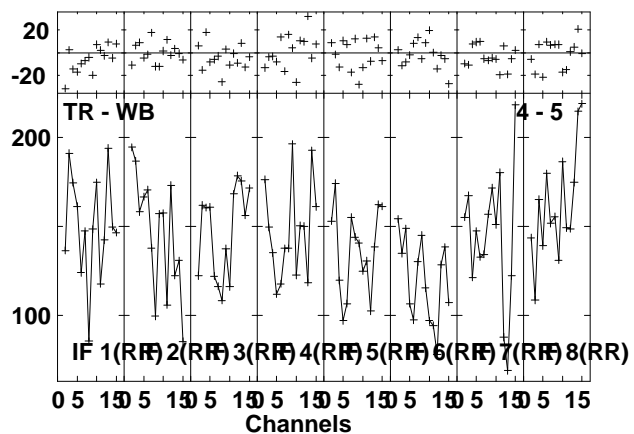
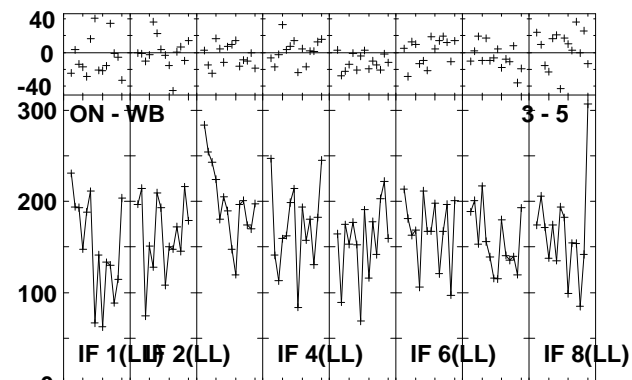
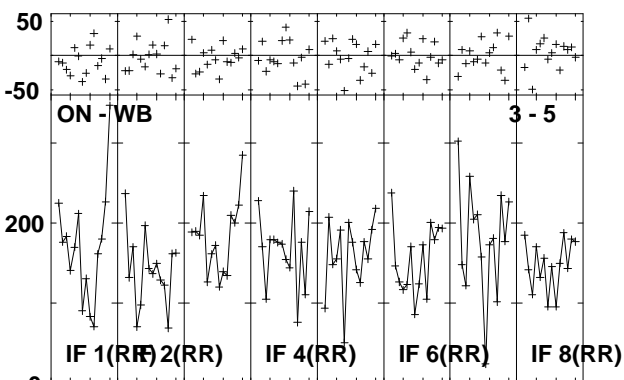
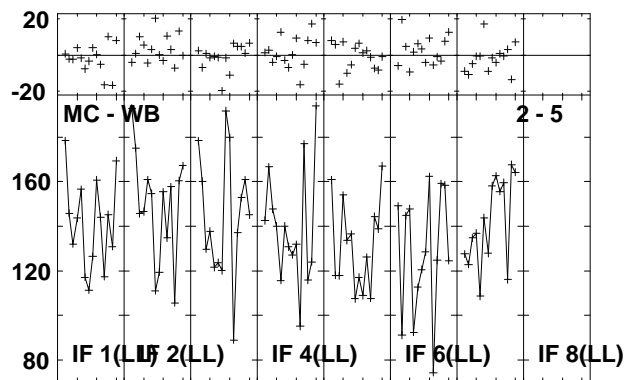
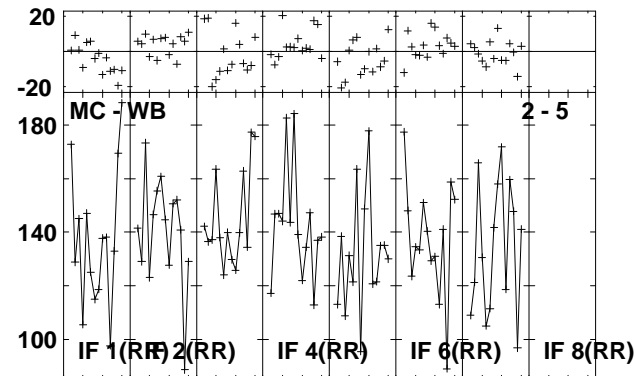
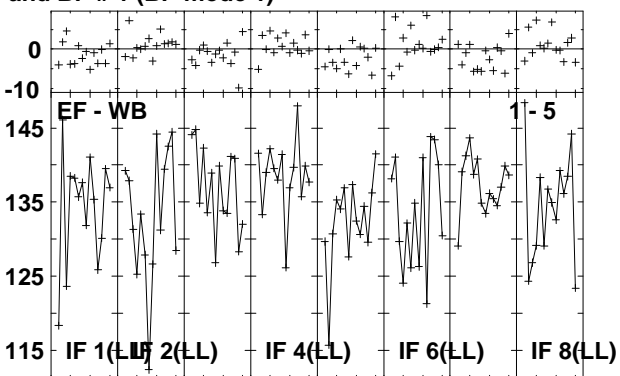
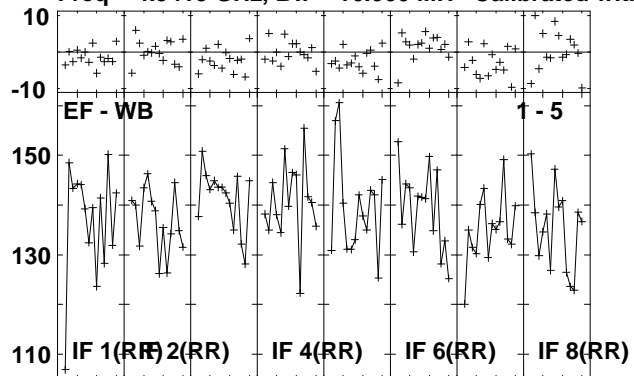

Lower frame: Milli Ampl Jy Top frame: Phas deg
Vector averaged cross-power spectrum Several baselines displayed
Timerange: 00/14:45:51 to 00/14:46:49

Plot file version 100 created 21-MAY-2010 15:47:35

J0909+02 RSD03.UVDATA.1

Freq = 4.9415 GHz, Bw = 16.000 MH Calibrated with CL # 3 and BP # 1 (BP mode 1)

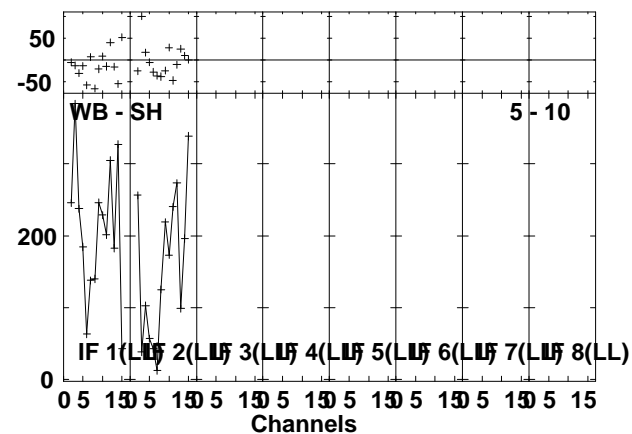
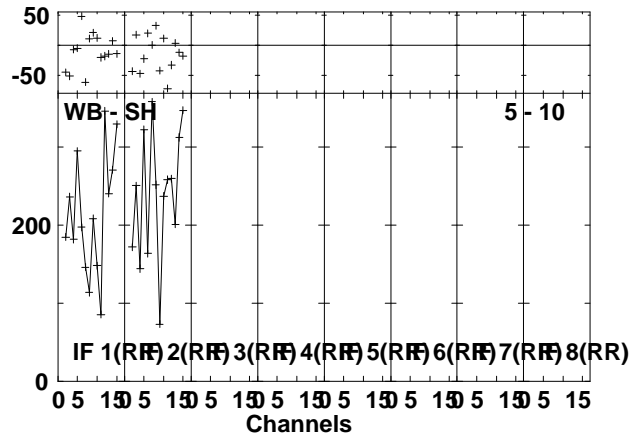
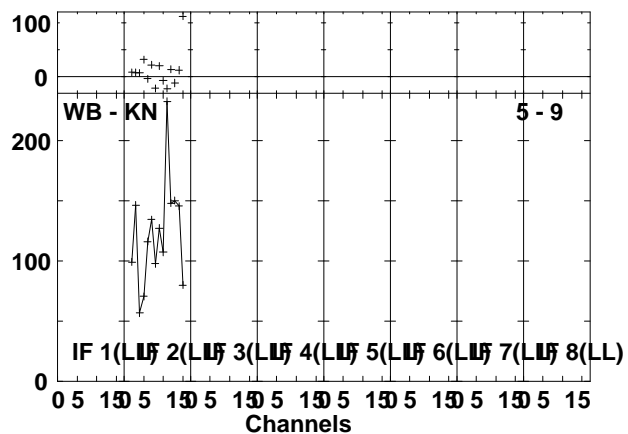
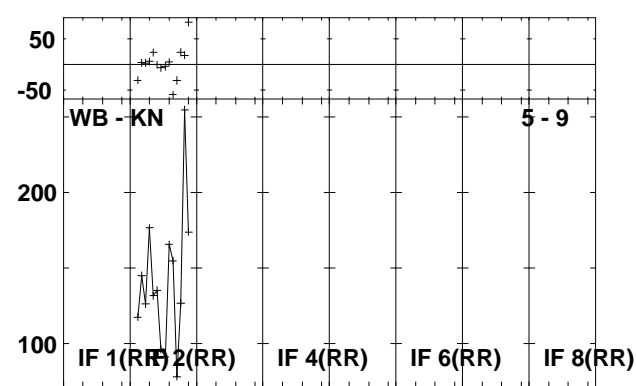
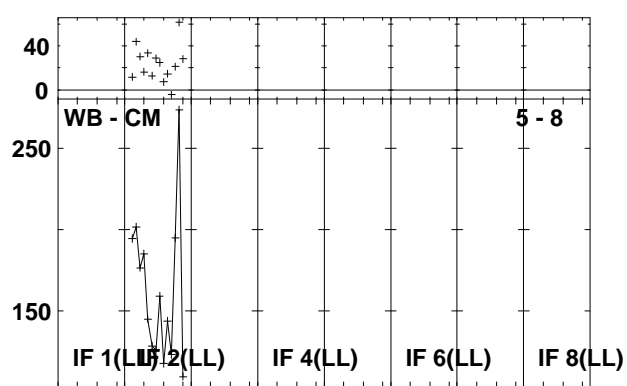
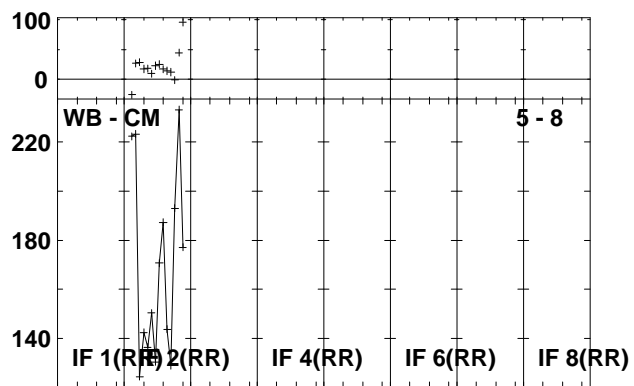
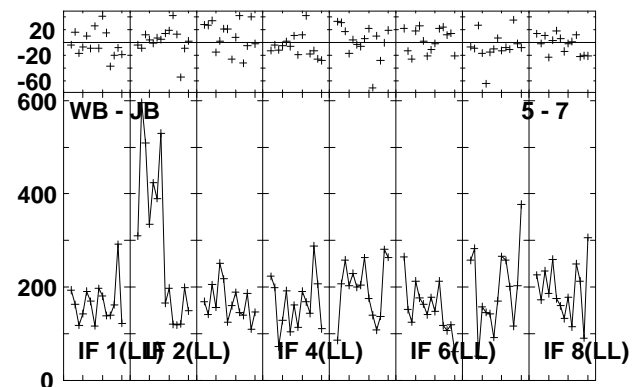
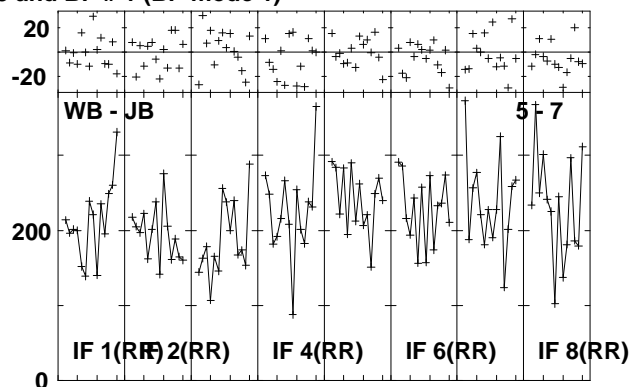
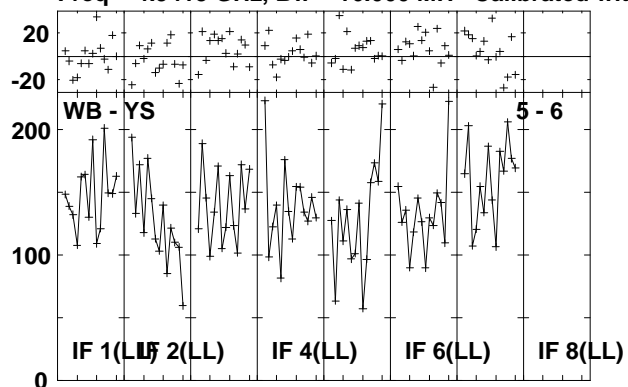

Lower frame: Milli Ampl Jy Top frame: Phas deg
Vector averaged cross-power spectrum Several baselines displayed
Timerange: 00/14:45:51 to 00/14:46:49

Plot file version 101 created 21-MAY-2010 15:47:37

CALA RSD03.UVDATA.1

Freq = 4.9415 GHz, Bw = 16.000 MH Calibrated with CL # 3 and BP # 1 (BP mode 1)

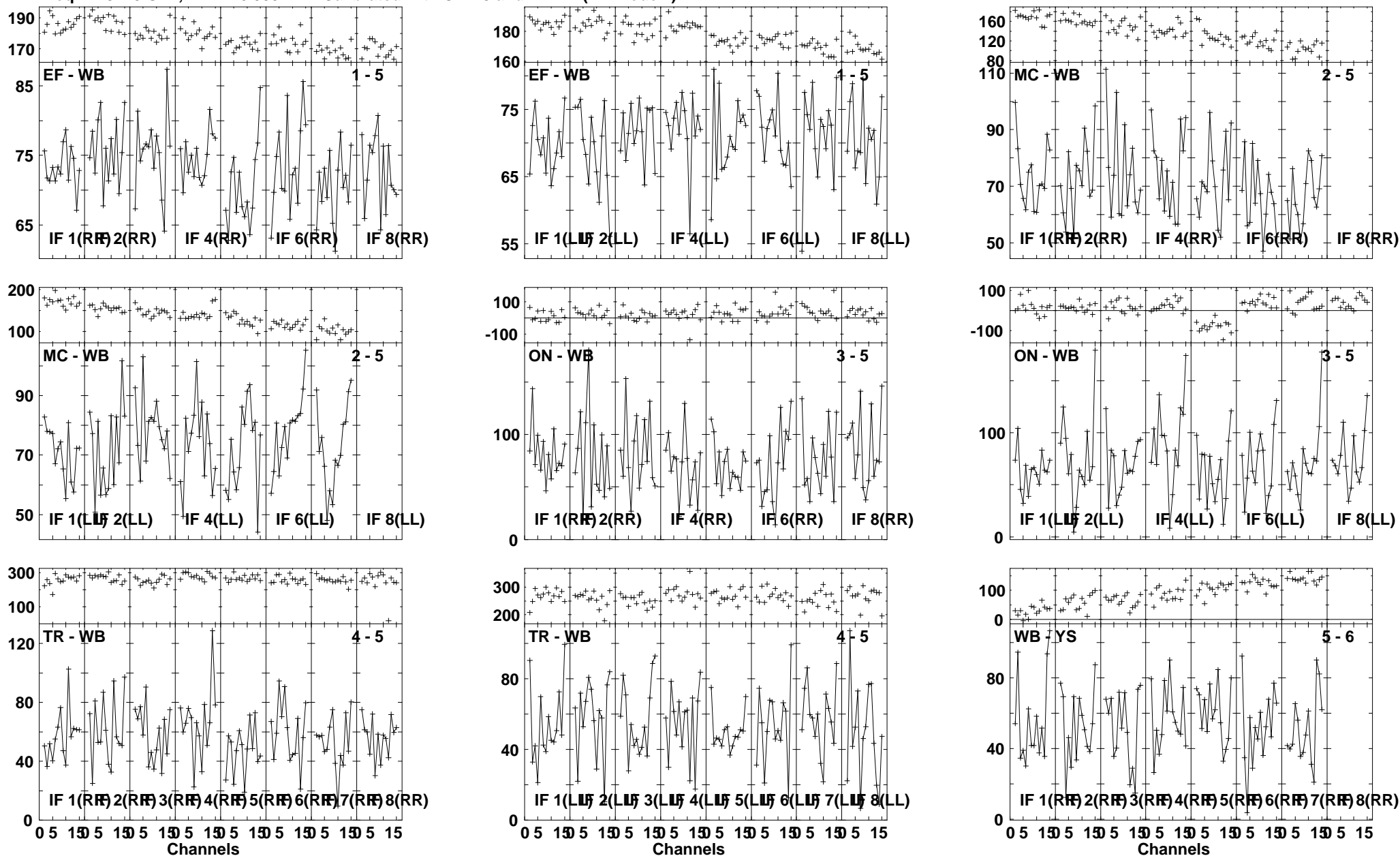

Lower frame: Milli Ampl Jy Top frame: Phas deg
Vector averaged cross-power spectrum Several baselines displayed
Timerange: 00/14:46:51 to 00/14:49:19

Plot file version 102 created 21-MAY-2010 15:47:39

CALA RSD03.UVDATA.1

Freq = 4.9415 GHz, Bw = 16.000 MH Calibrated with CL # 3 and BP # 1 (BP mode 1)

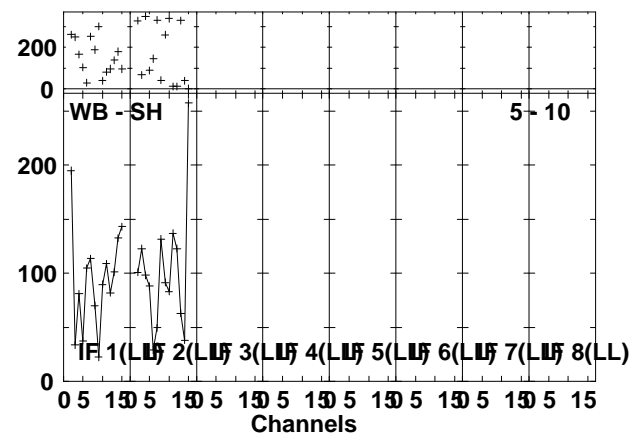
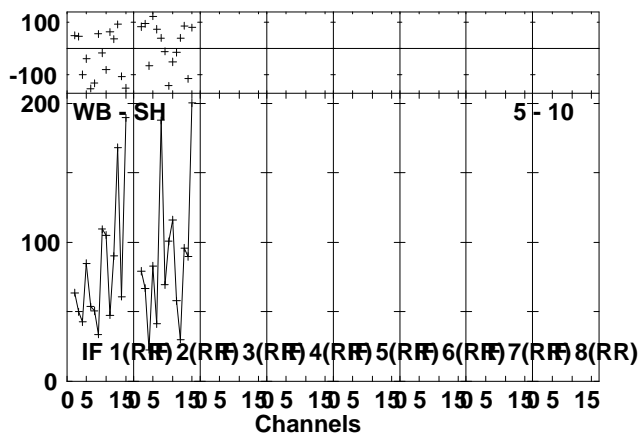
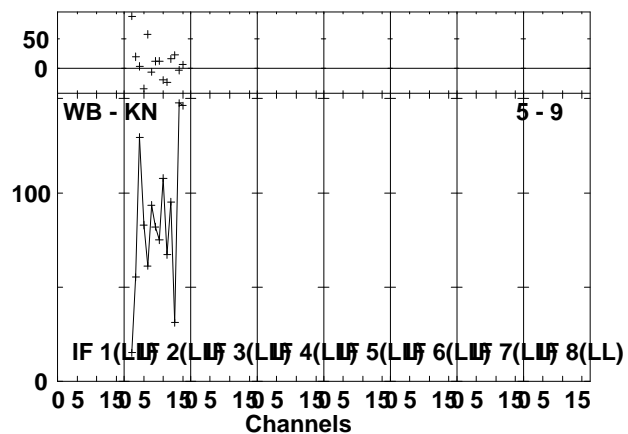
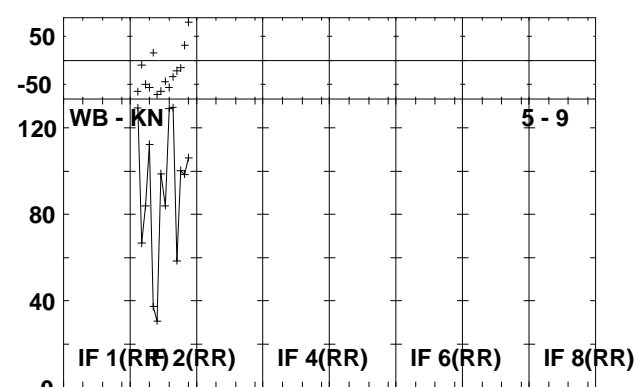
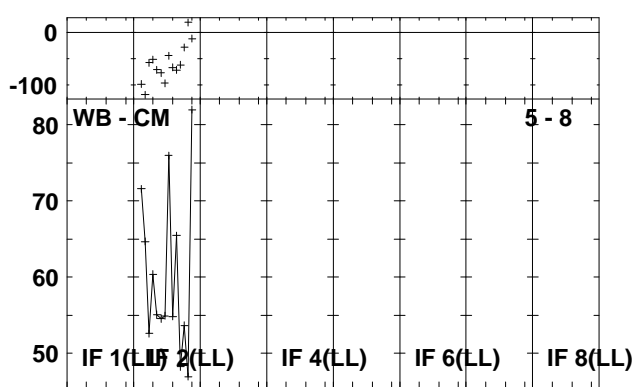
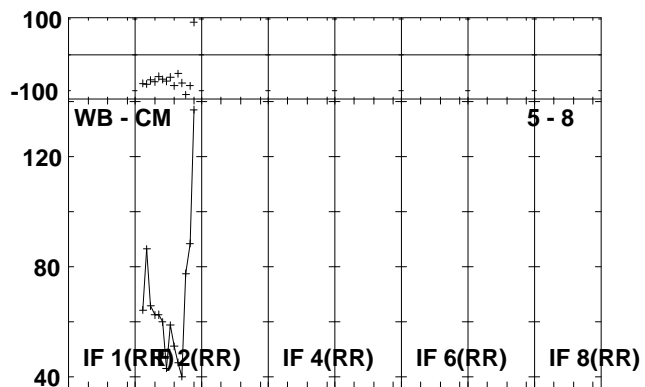
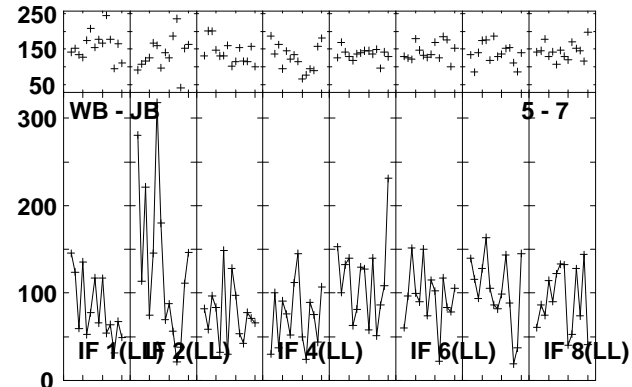
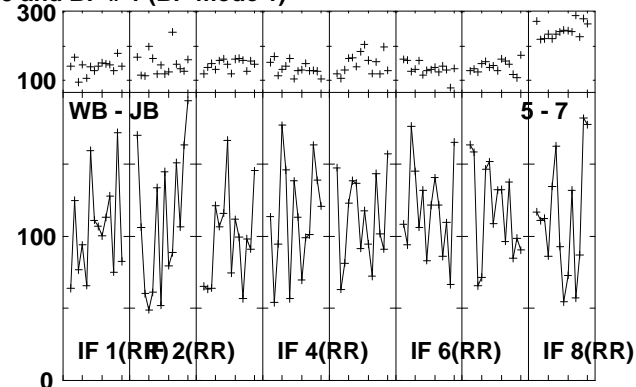
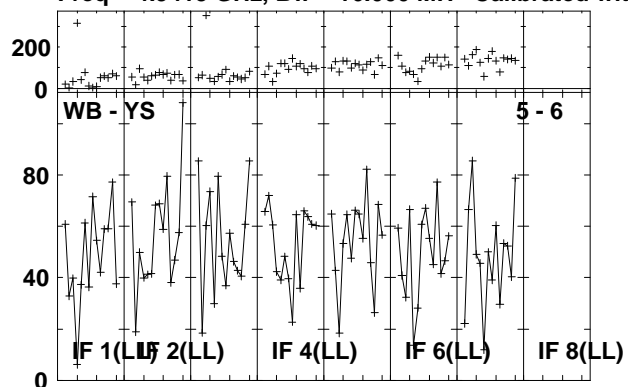

Lower frame: Milli Ampl Jy Top frame: Phas deg
Vector averaged cross-power spectrum Several baselines displayed
Timerange: 00/14:46:51 to 00/14:49:19

Plot file version 103 created 21-MAY-2010 15:47:42

CALK RSD03.UVDATA.1

Freq = 4.9415 GHz, Bw = 16.000 MH Calibrated with CL # 3 and BP # 1 (BP mode 1)

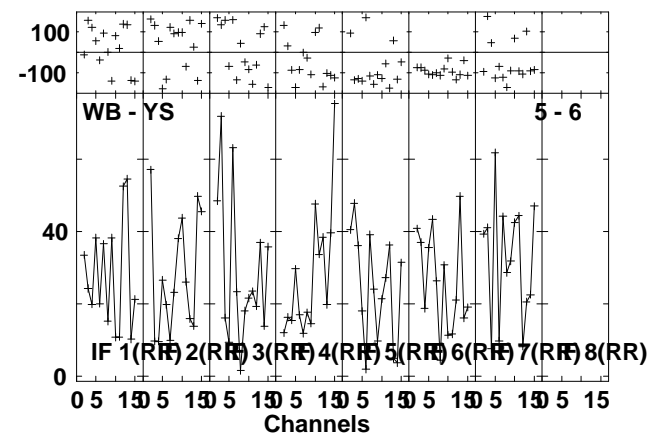
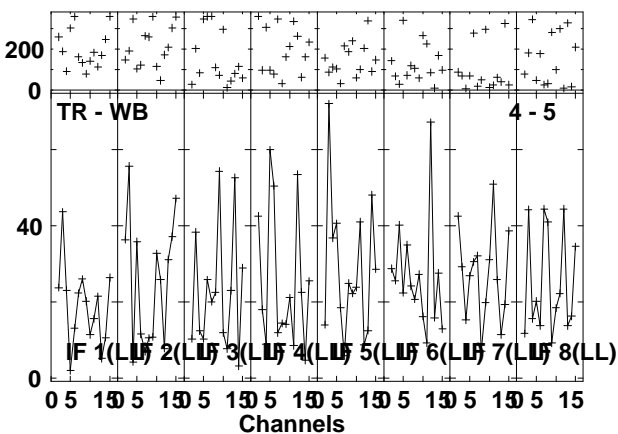
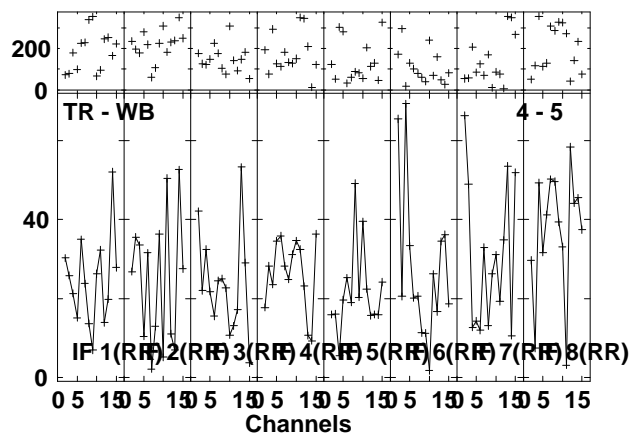
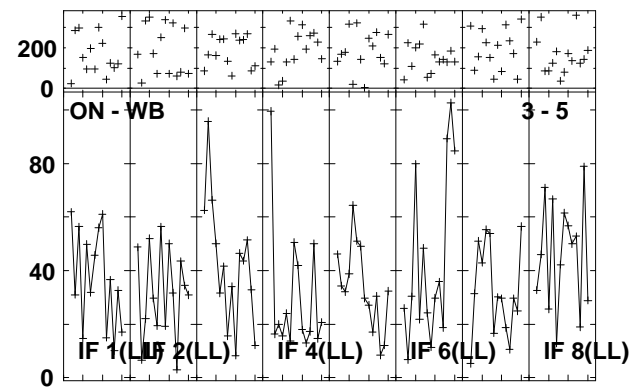
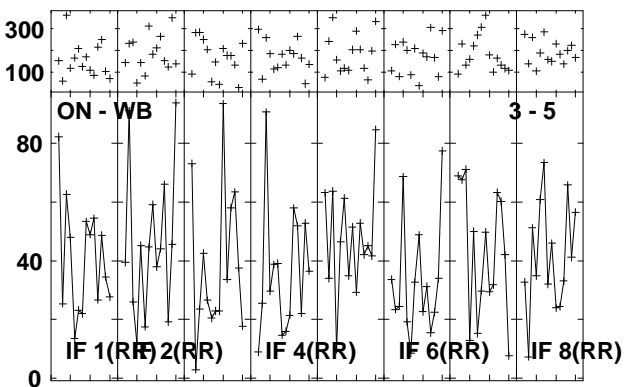
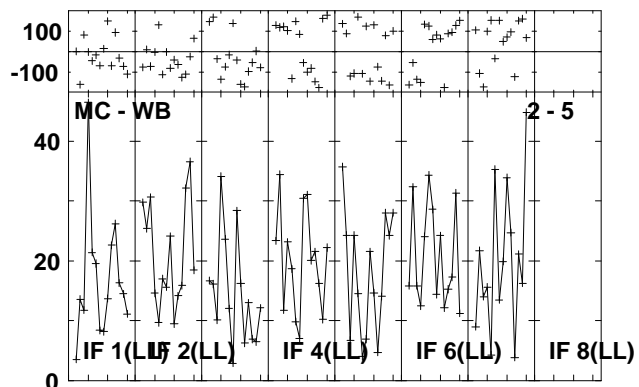
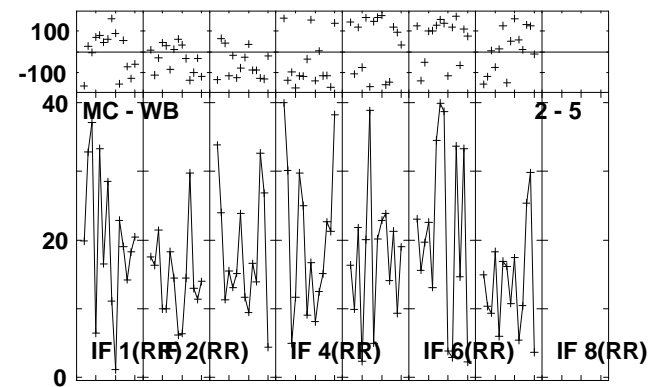
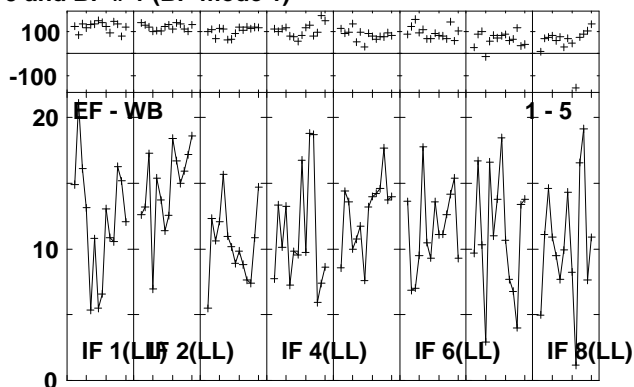
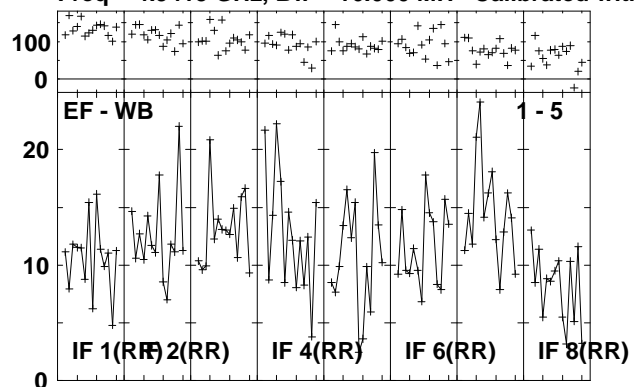

Lower frame: Milli Ampl Jy Top frame: Phas deg
Vector averaged cross-power spectrum Several baselines displayed
Timerange: 00/14:49:21 to 00/14:51:49

Plot file version 104 created 21-MAY-2010 15:47:44

CALK RSD03.UVDATA.1

Freq = 4.9415 GHz, Bw = 16.000 MH Calibrated with CL # 3 and BP # 1 (BP mode 1)

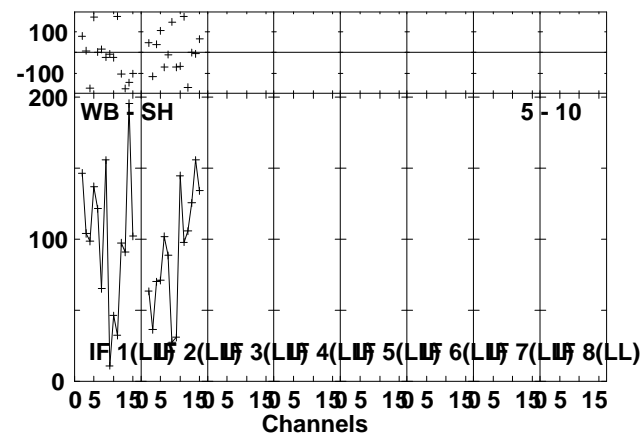
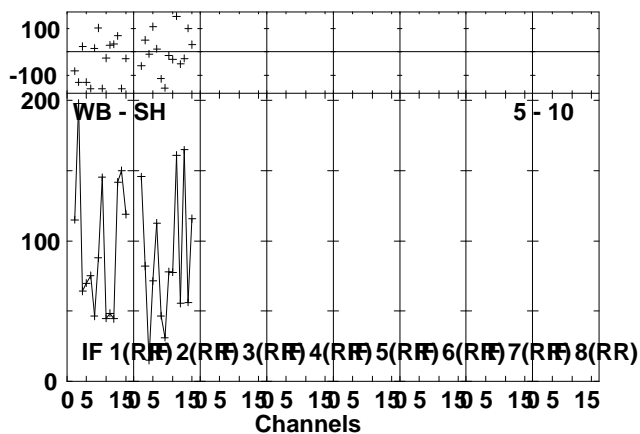
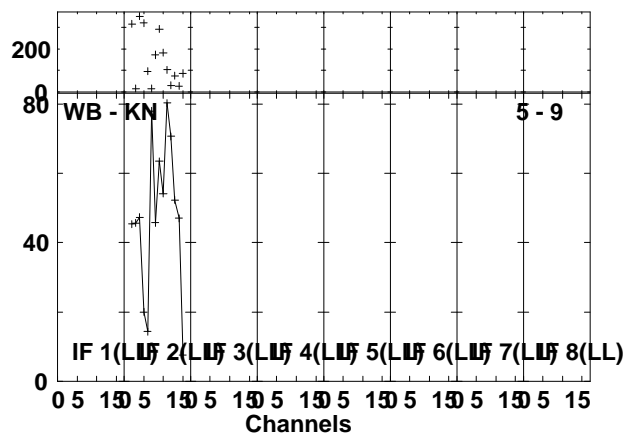
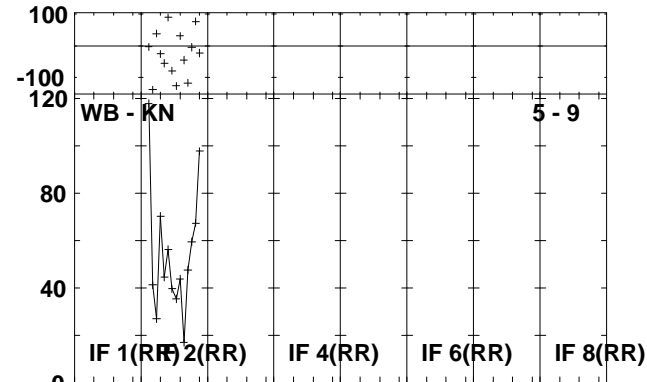
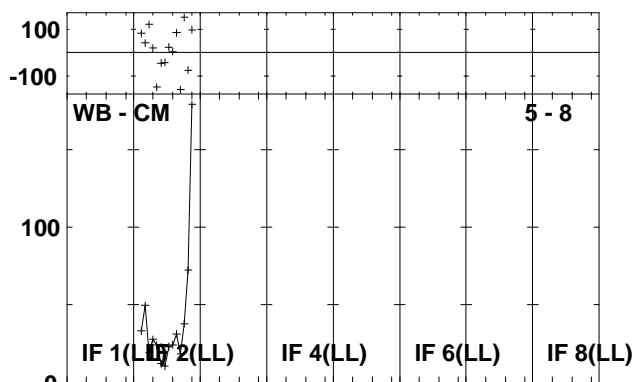
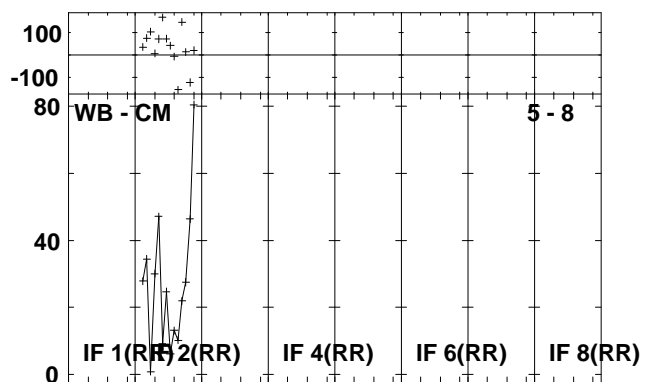
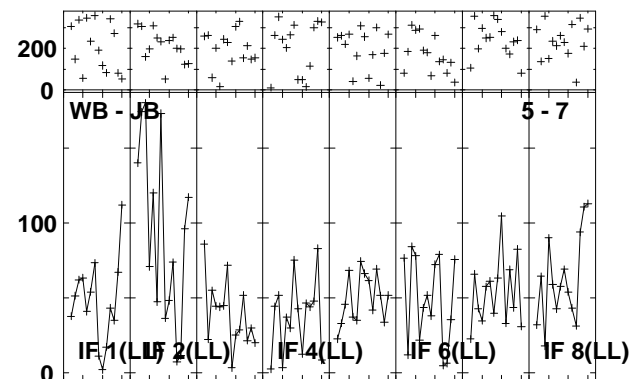
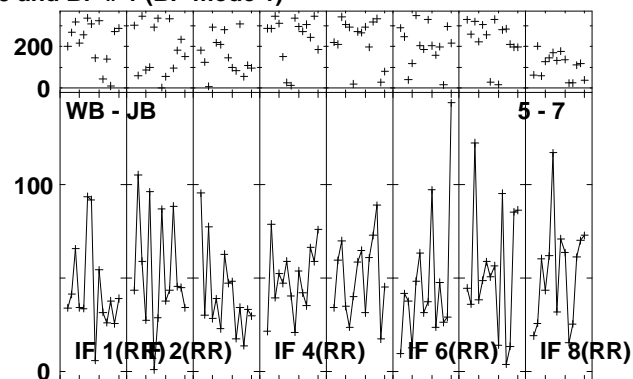
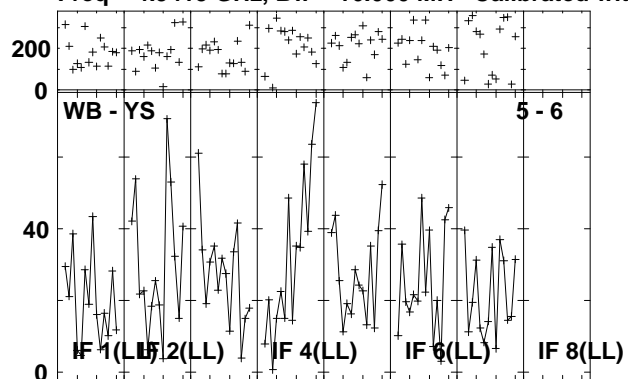

Lower frame: Milli Ampl Jy Top frame: Phas deg
Vector averaged cross-power spectrum Several baselines displayed
Timerange: 00/14:49:21 to 00/14:51:49

Plot file version 105 created 21-MAY-2010 15:47:47

J0909+02 RSD03.UVDATA.1

Freq = 4.9415 GHz, Bw = 16.000 MH Calibrated with CL # 3 and BP # 1 (BP mode 1)

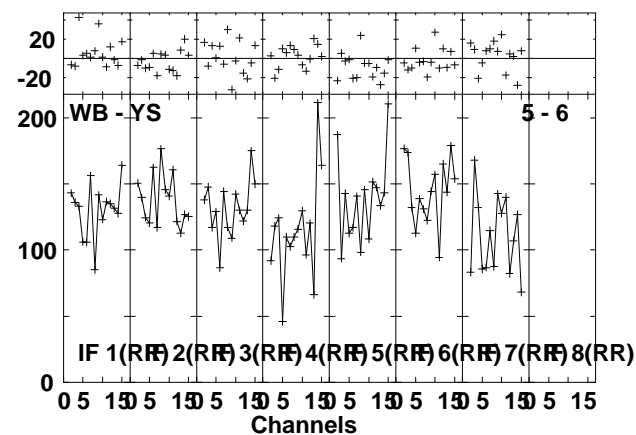
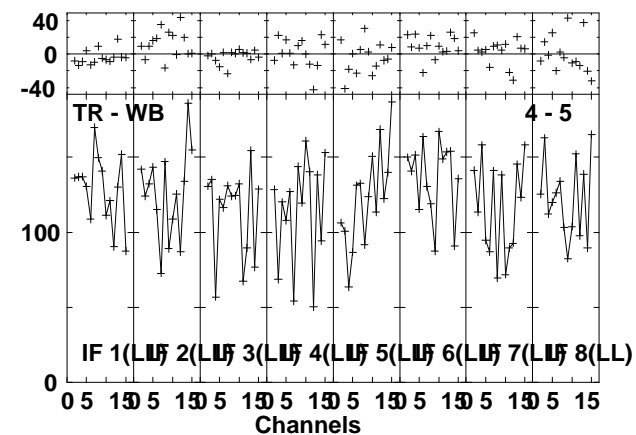
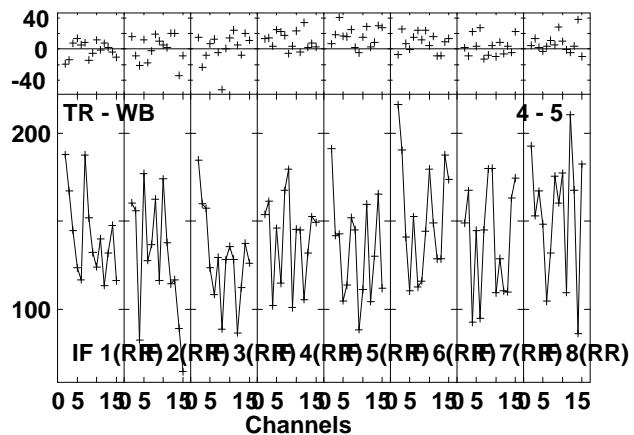
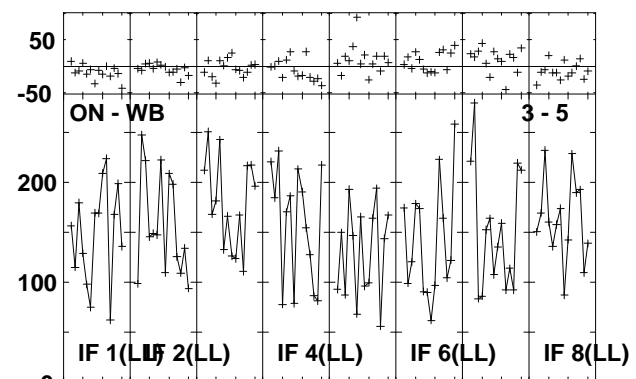
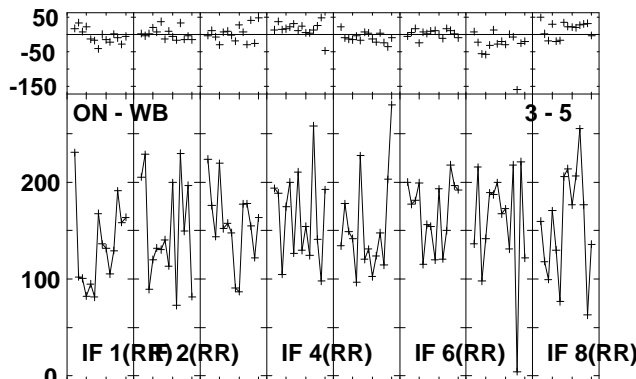
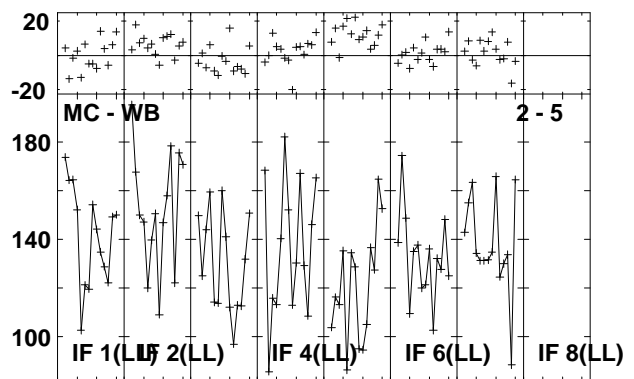
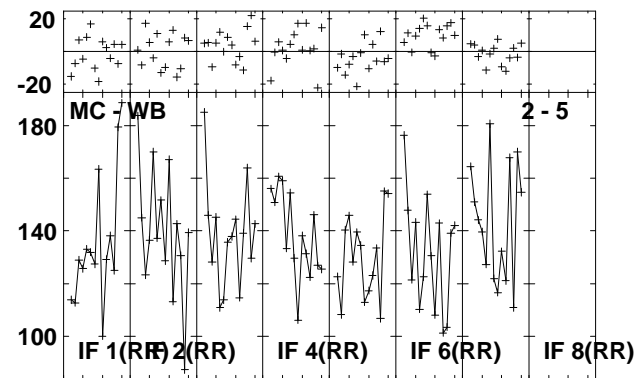
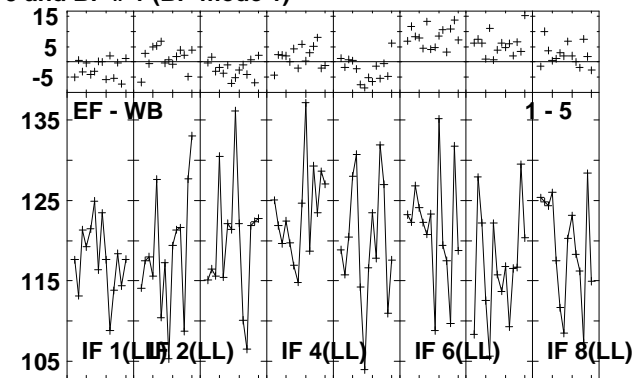
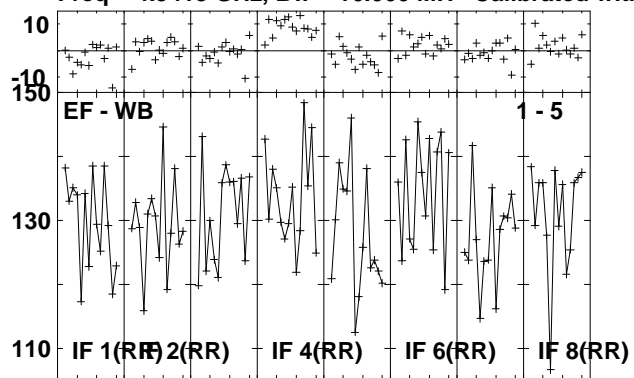

Lower frame: Milli Ampl Jy Top frame: Phas deg
Vector averaged cross-power spectrum Several baselines displayed
Timerange: 00/14:52:31 to 00/14:53:29

Plot file version 106 created 21-MAY-2010 15:47:48

J0909+02 RSD03.UVDATA.1

Freq = 4.9415 GHz, Bw = 16.000 MH Calibrated with CL # 3 and BP # 1 (BP mode 1)

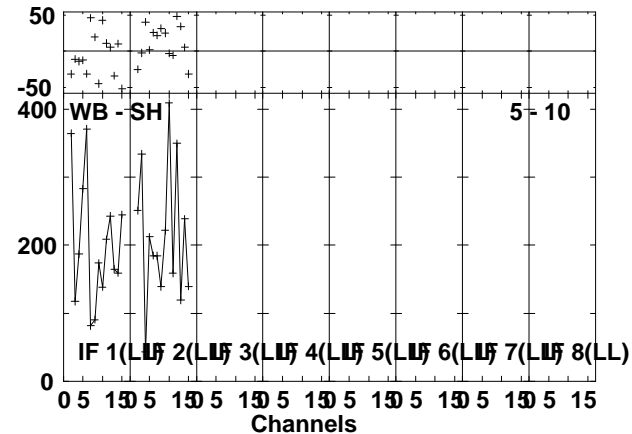
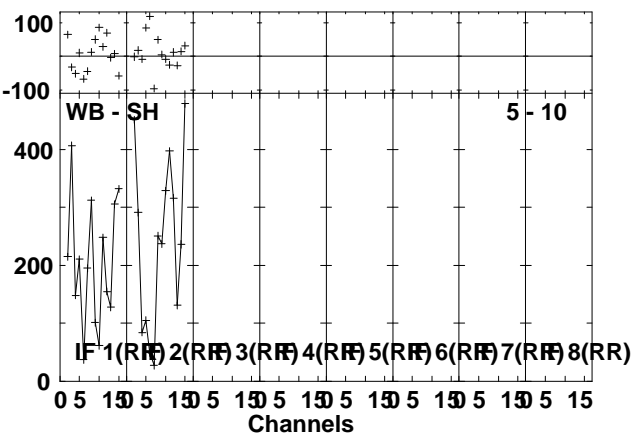
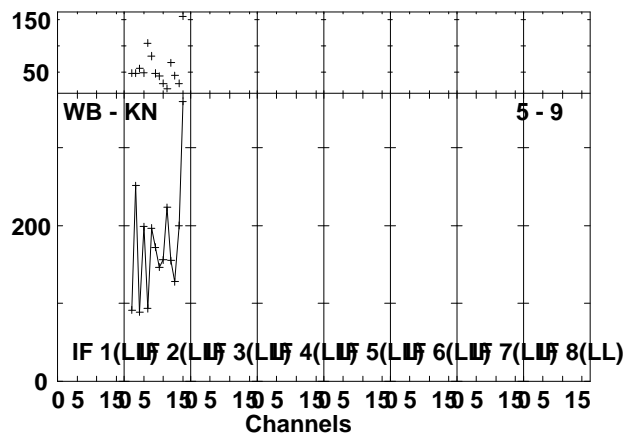
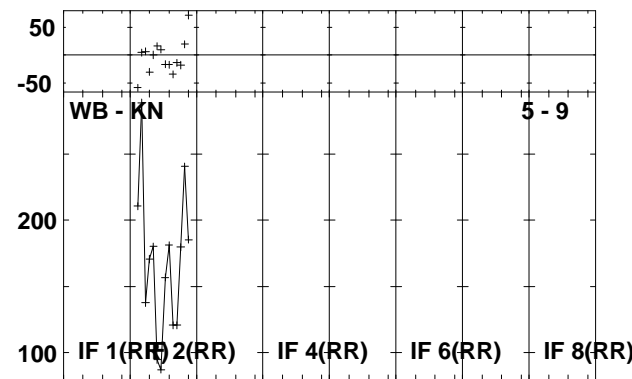
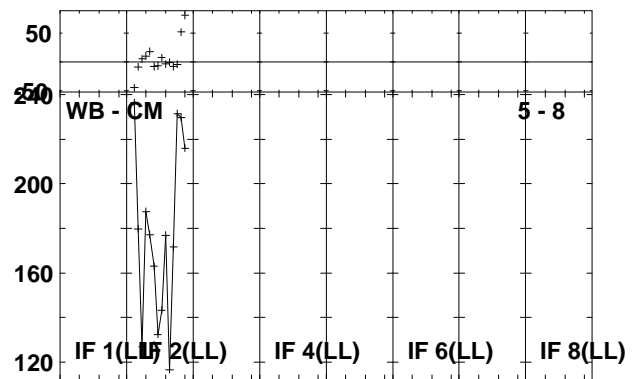
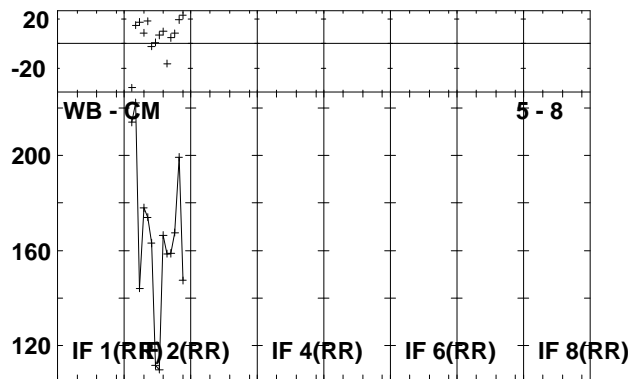
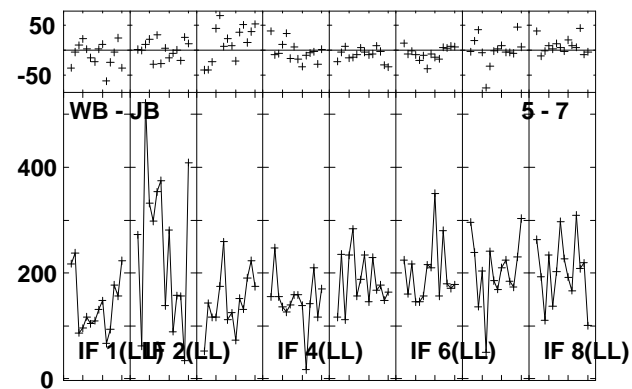
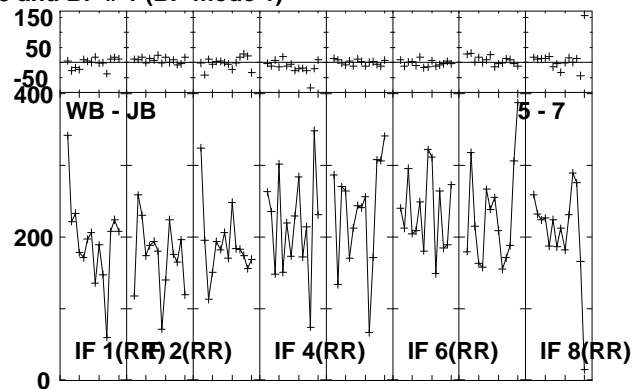
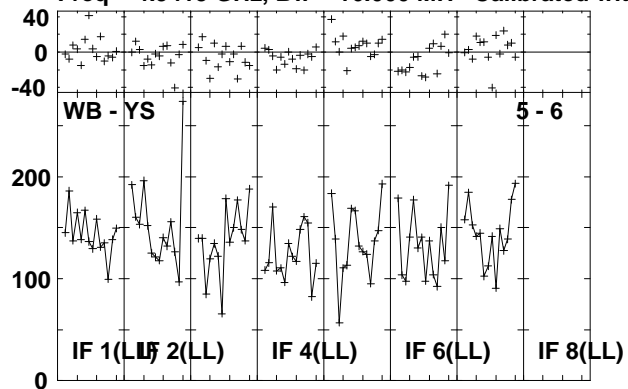

Lower frame: Milli Ampl Jy Top frame: Phas deg
Vector averaged cross-power spectrum Several baselines displayed
Timerange: 00/14:52:31 to 00/14:53:29

Plot file version 107 created 21-MAY-2010 15:47:49

CALB RSD03.UVDATA.1

Freq = 4.9415 GHz, Bw = 16.000 MH Calibrated with CL # 3 and BP # 1 (BP mode 1)

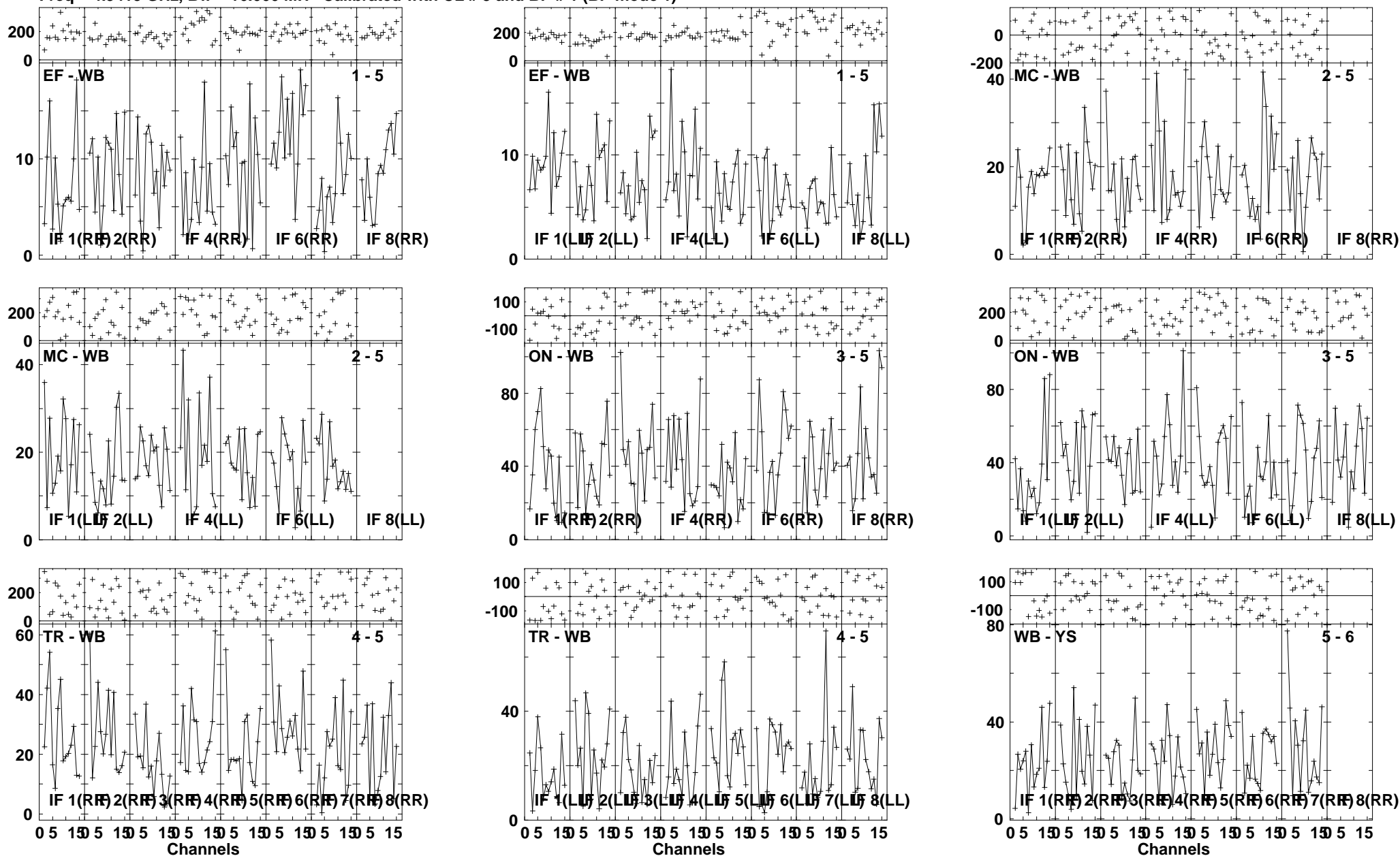

Lower frame: Milli Ampl Jy Top frame: Phas deg
Vector averaged cross-power spectrum Several baselines displayed
Timerange: 00/14:53:31 to 00/14:55:59

Plot file version 108 created 21-MAY-2010 15:47:51

CALB RSD03.UVDATA.1

Freq = 4.9415 GHz, Bw = 16.000 MH Calibrated with CL # 3 and BP # 1 (BP mode 1)

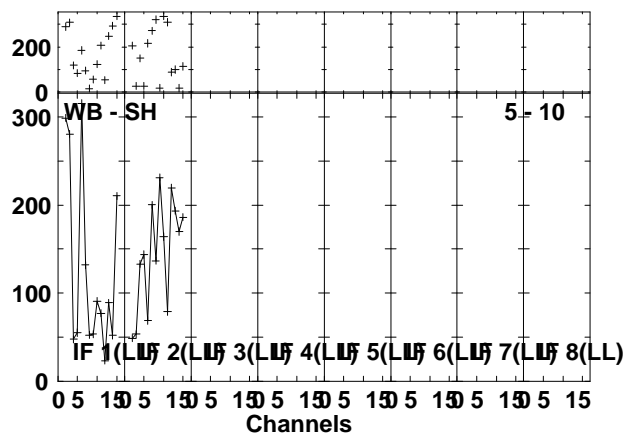
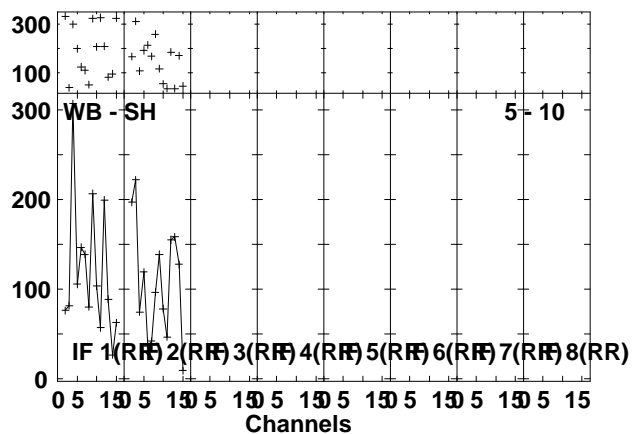
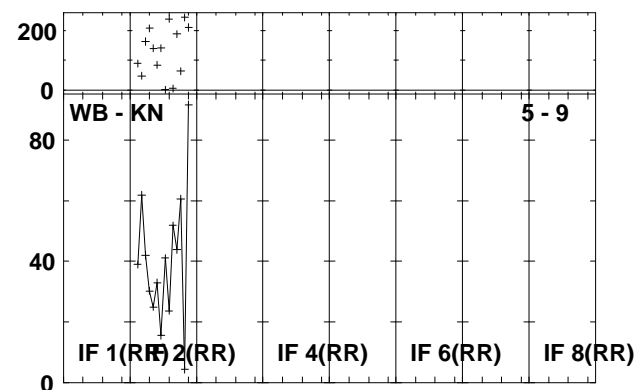
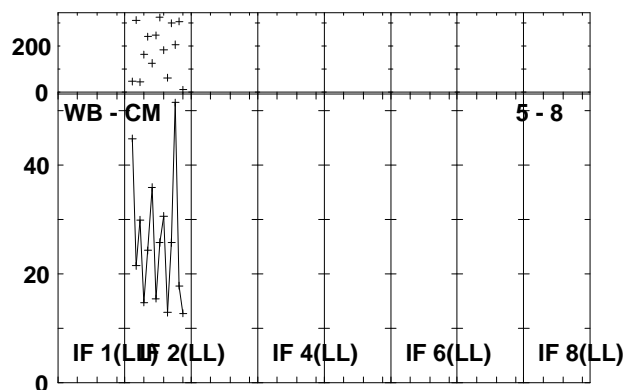
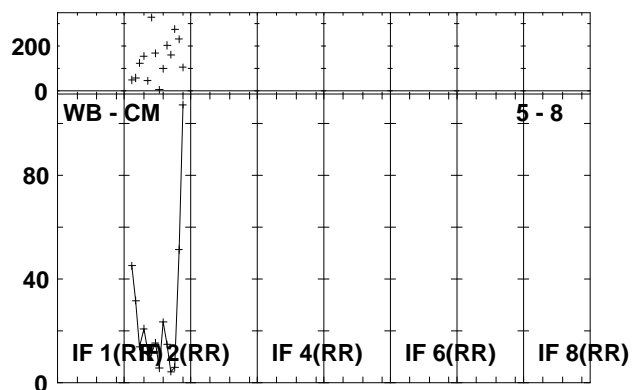
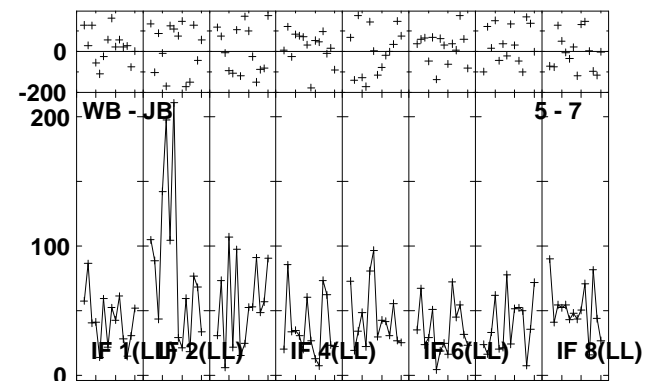
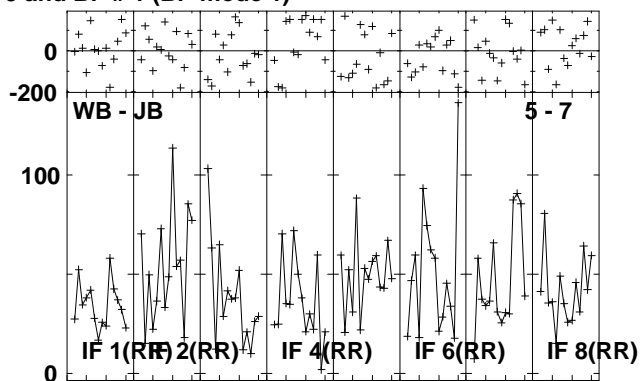
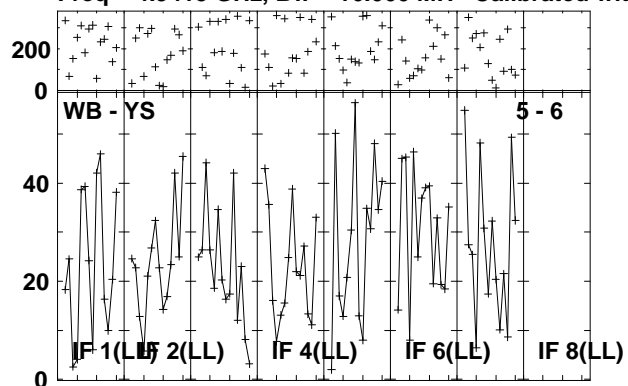

Lower frame: Milli Ampl Jy Top frame: Phas deg
Vector averaged cross-power spectrum Several baselines displayed
Timerange: 00/14:53:31 to 00/14:55:59

Plot file version 109 created 21-MAY-2010 15:47:54

CALC RSD03.UVDATA.1

Freq = 4.9415 GHz, Bw = 16.000 MH Calibrated with CL # 3 and BP # 1 (BP mode 1)

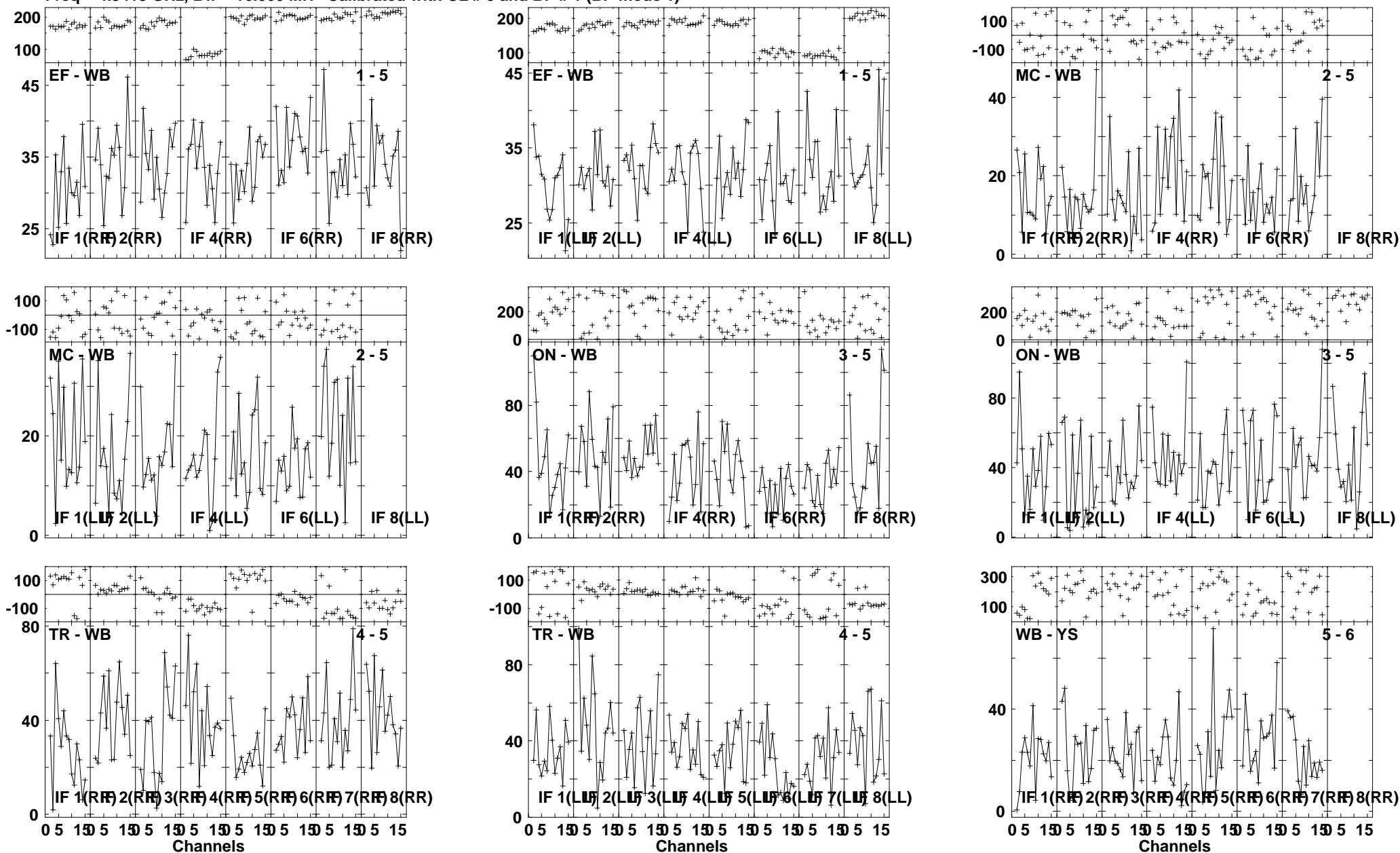

Lower frame: Milli Ampl Jy Top frame: Phas deg
Vector averaged cross-power spectrum Several baselines displayed
Timerange: 00/14:56:01 to 00/14:58:29

Plot file version 110 created 21-MAY-2010 15:47:56

CALC RSD03.UVDATA.1

Freq = 4.9415 GHz, Bw = 16.000 MH Calibrated with CL # 3 and BP # 1 (BP mode 1)

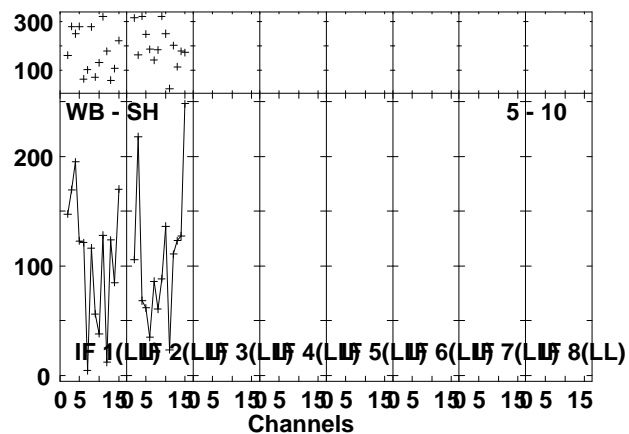
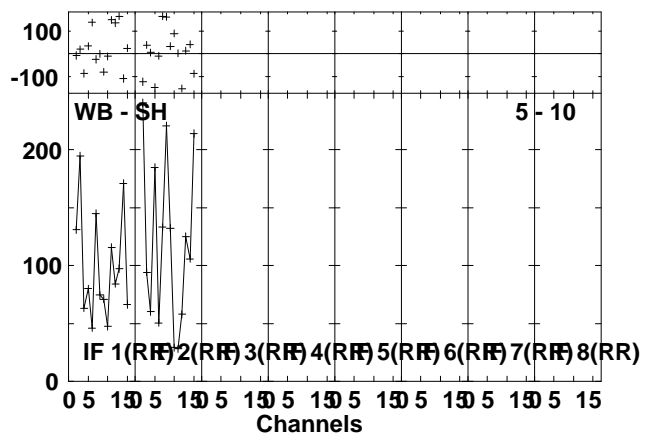
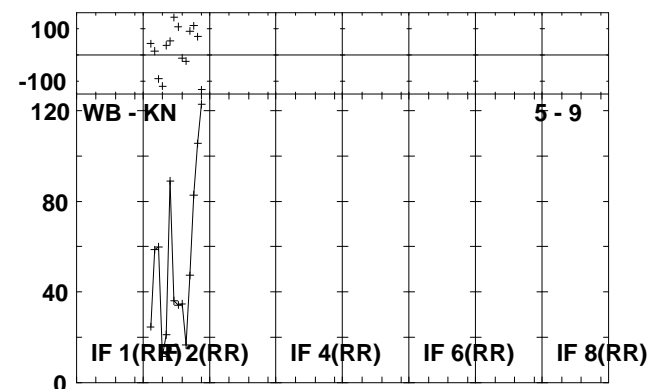
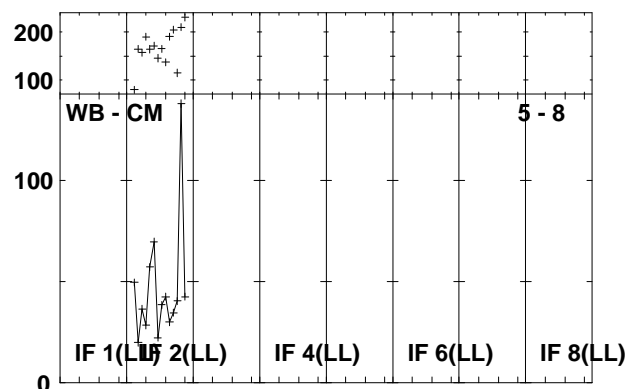
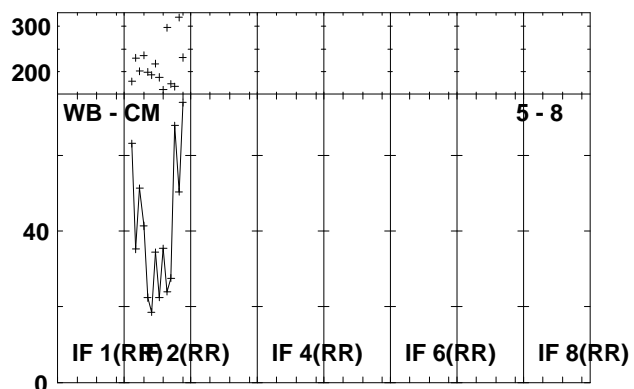
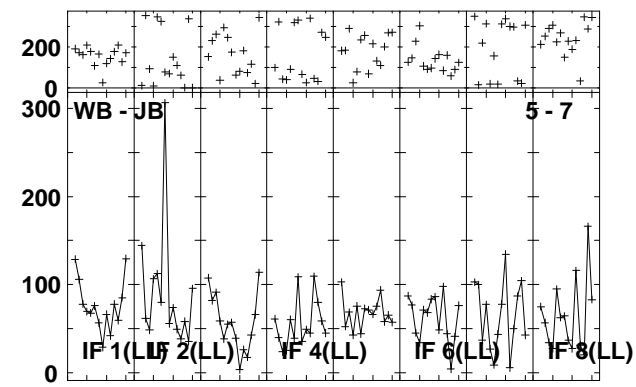
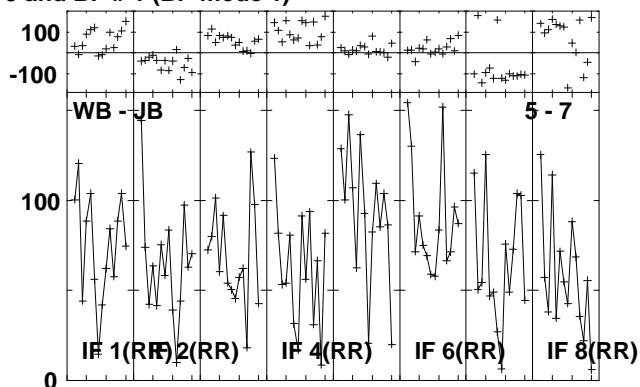
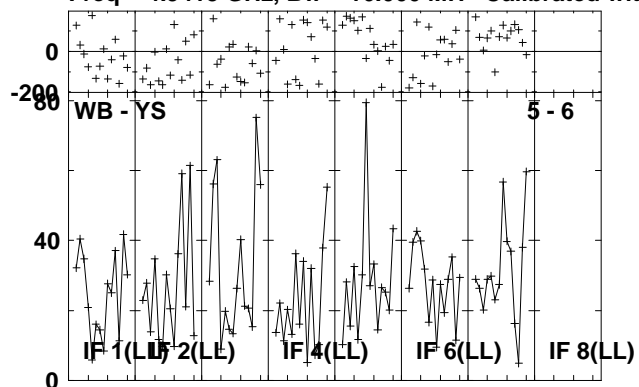

Lower frame: Milli Ampl Jy Top frame: Phas deg
Vector averaged cross-power spectrum Several baselines displayed
Timerange: 00/14:56:01 to 00/14:58:29

Plot file version 111 created 21-MAY-2010 15:47:59

J0909+02 RSD03.UVDATA.1

Freq = 4.9415 GHz, Bw = 16.000 MH Calibrated with CL # 3 and BP # 1 (BP mode 1)

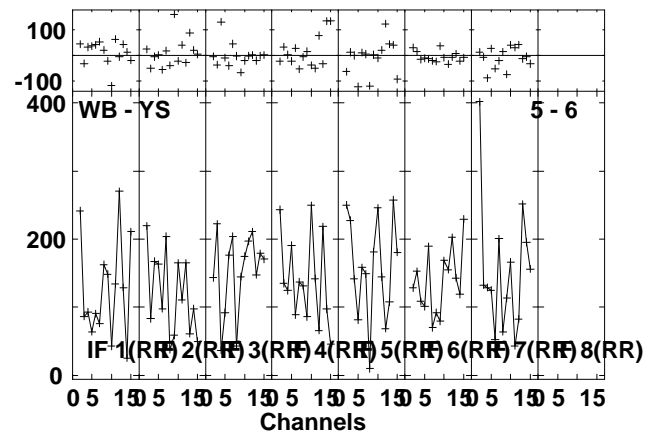
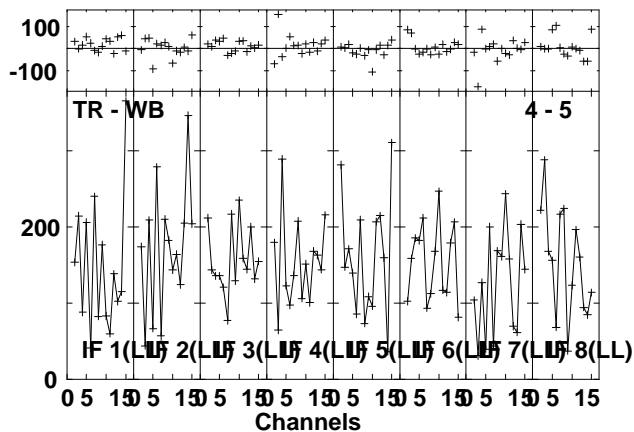
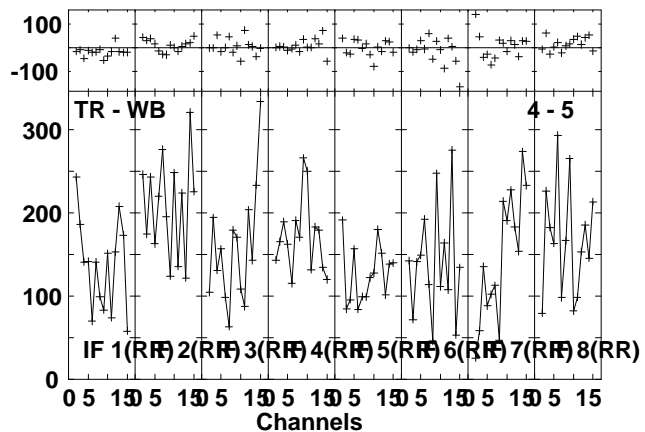
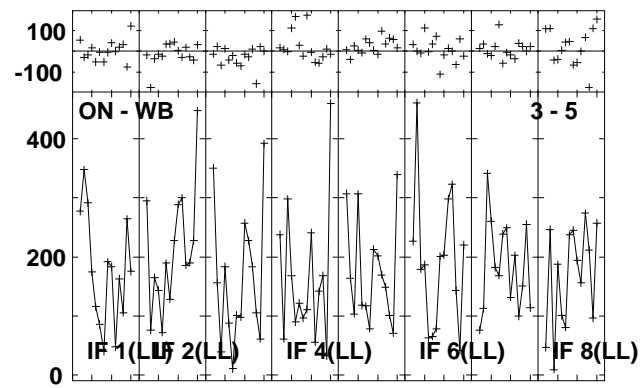
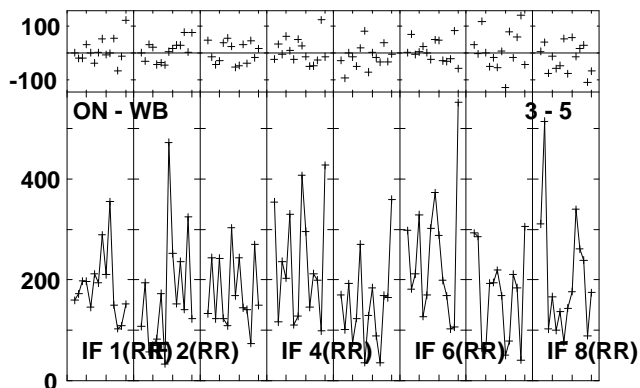
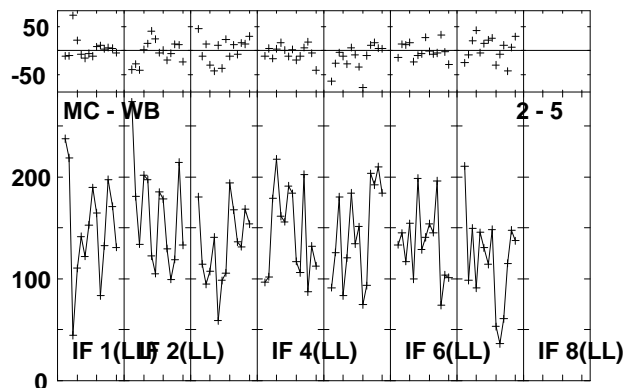
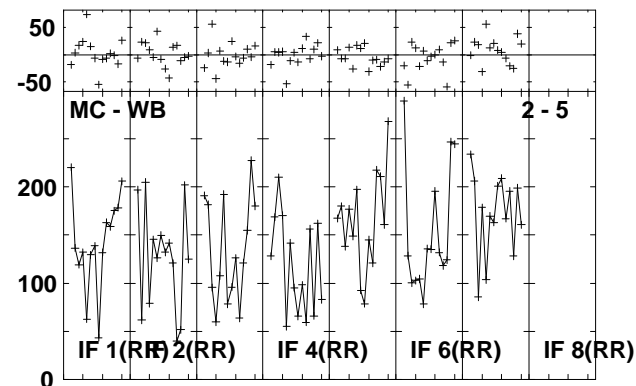
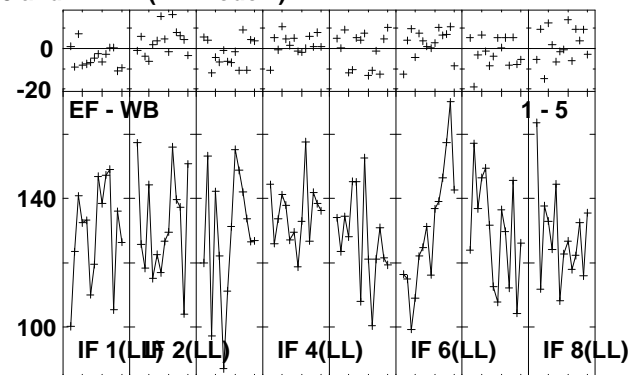
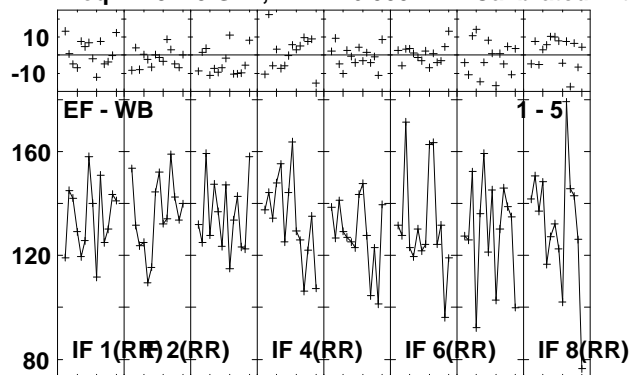

Lower frame: Milli Ampl Jy Top frame: Phas deg
Vector averaged cross-power spectrum Several baselines displayed
Timerange: 00/14:59:11 to 00/14:59:19

Plot file version 112 created 21-MAY-2010 15:47:59

J0909+02 RSD03.UVDATA.1

Freq = 4.9415 GHz, Bw = 16.000 MH Calibrated with CL # 3 and BP # 1 (BP mode 1)

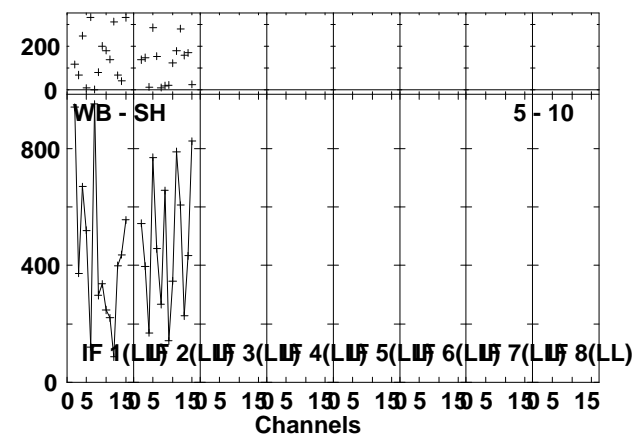
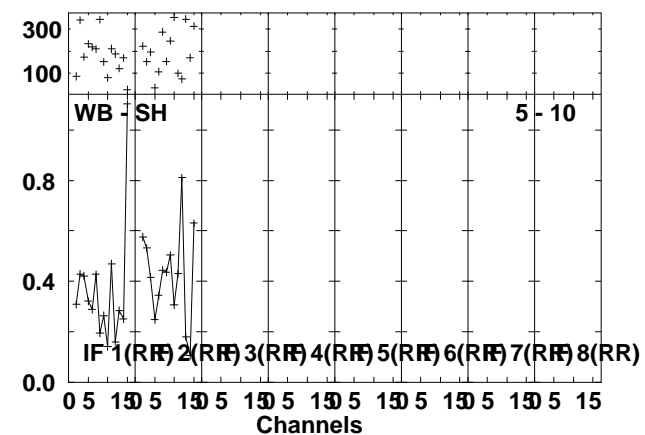
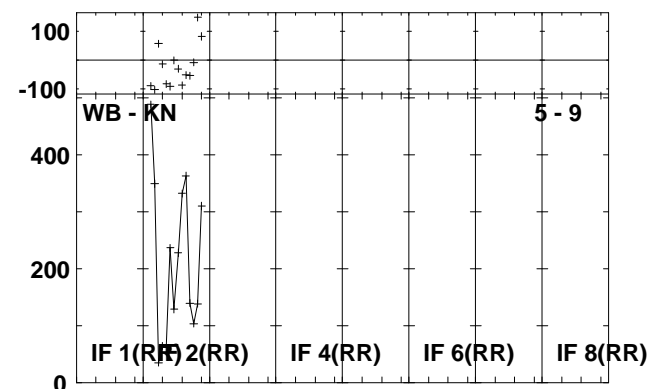
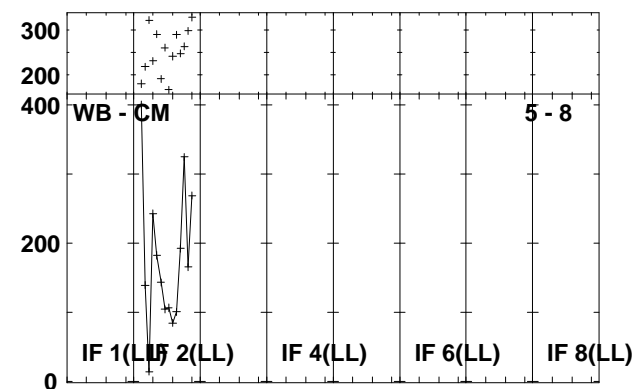
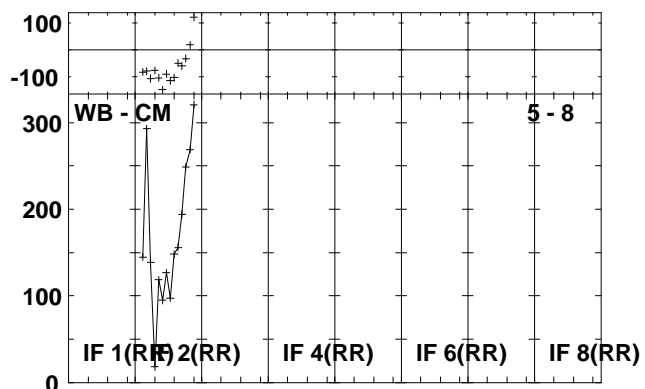
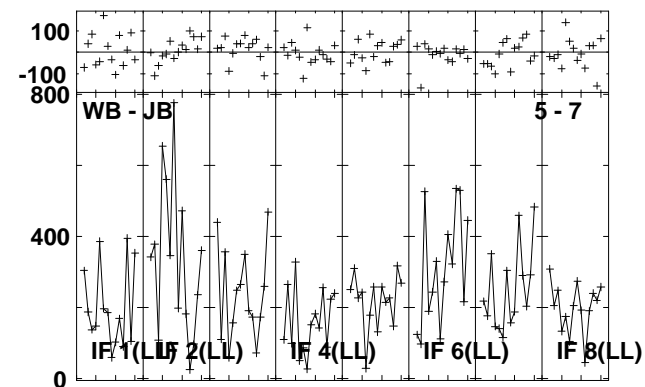
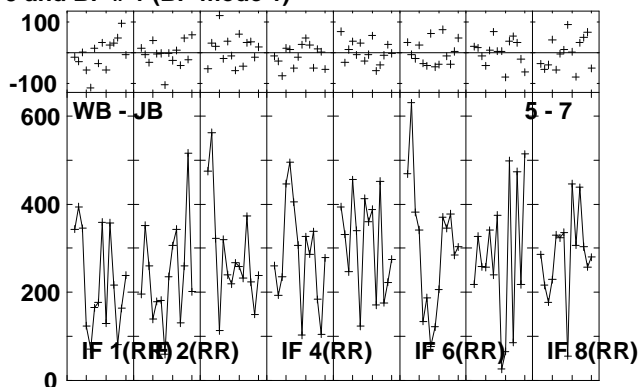
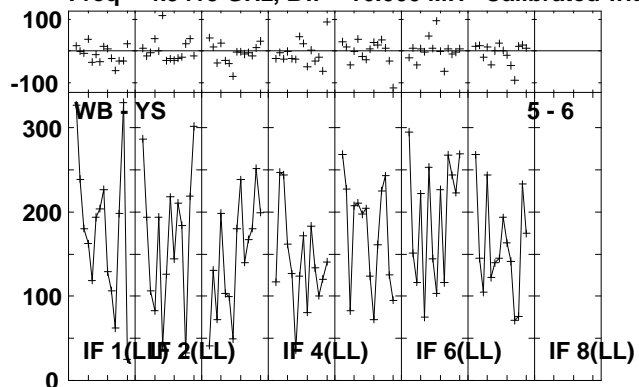

Lower frame: Milli Ampl Jy Top frame: Phas deg
Vector averaged cross-power spectrum Several baselines displayed
Timerange: 00/14:59:11 to 00/14:59:19