

Plot file version 1 created 16-FEB-2009 12:45:42  
 OQ208 RSF02.UVDATA.1  
 Freq = 1.6267 GHz, Bw = 8.000 MH No calibration applied and no bandpass applied

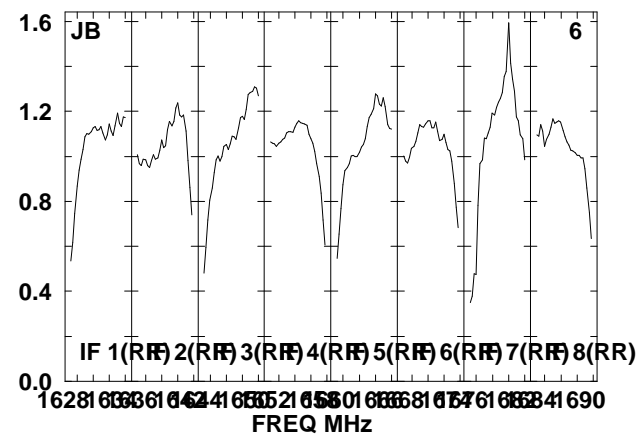
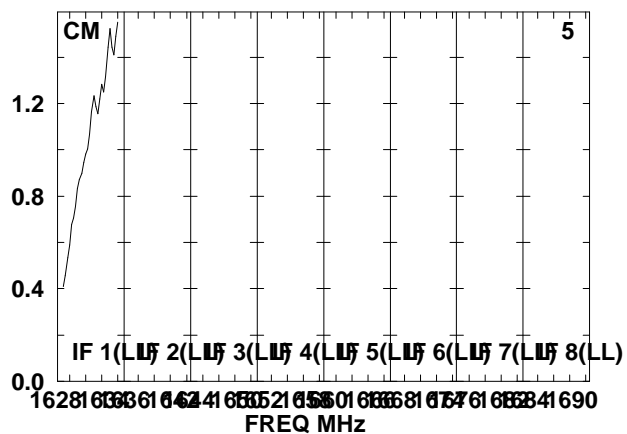
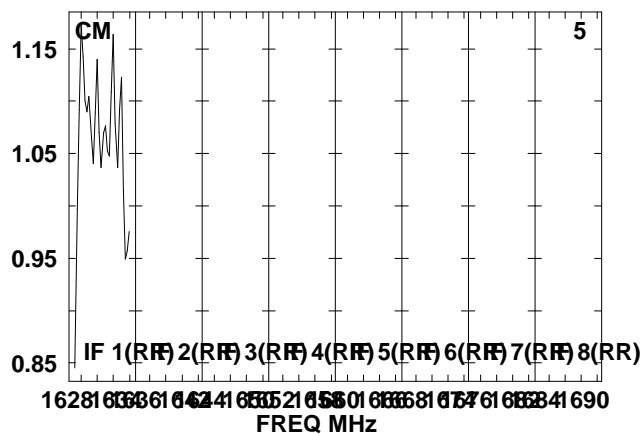
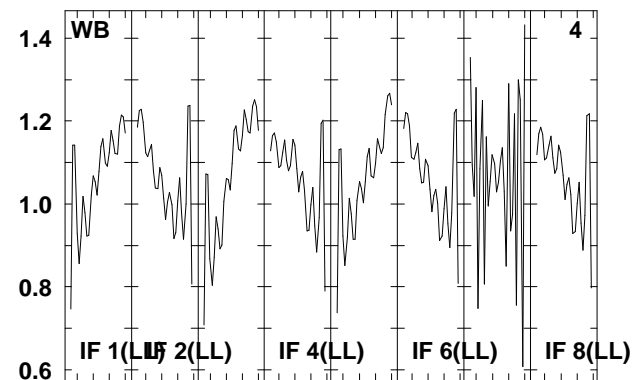
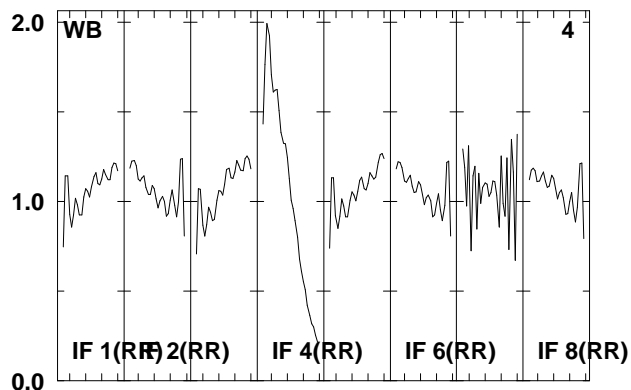
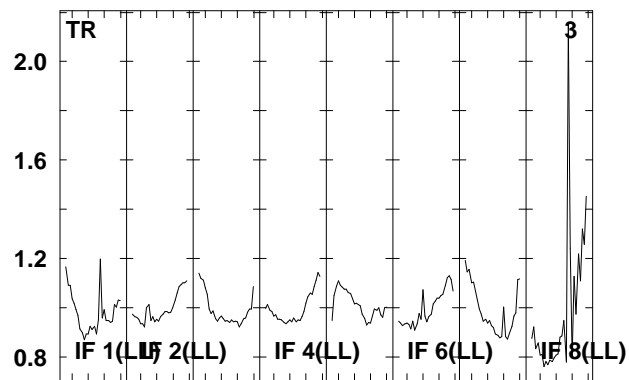
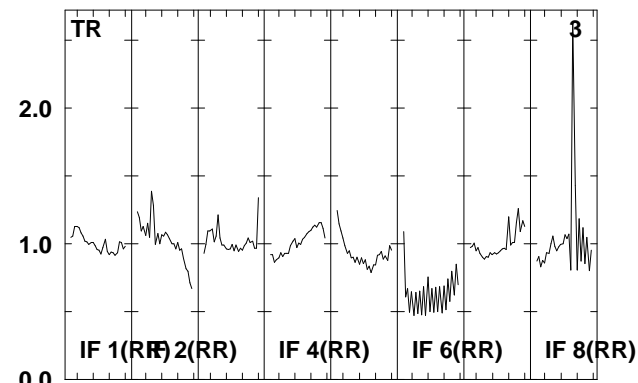
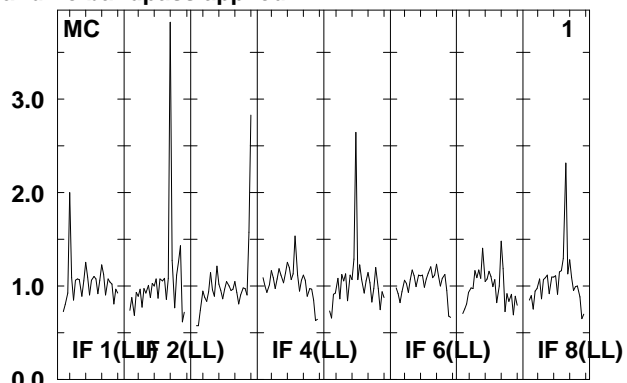
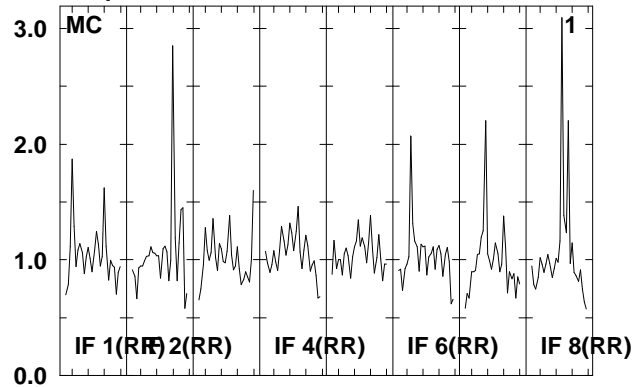

Lower frame: Real Jy  
 Total-power spectrum Antenna: \*  
 Timerange: 00/05:28:19 to 00/05:39:59

Plot file version 2 created 16-FEB-2009 12:45:44

OQ208 RSF02.UVDATA.1

Freq = 1.6267 GHz, Bw = 8.000 MH No calibration applied and no bandpass applied

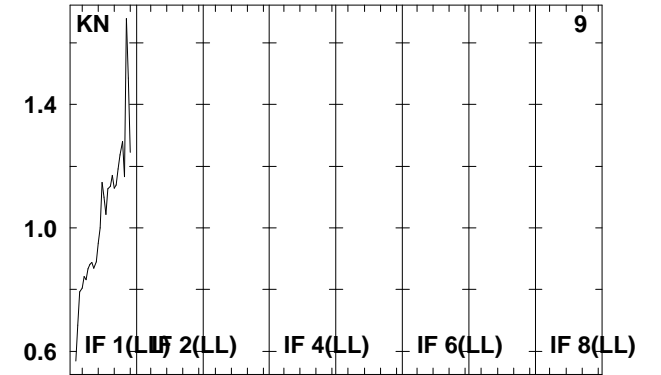
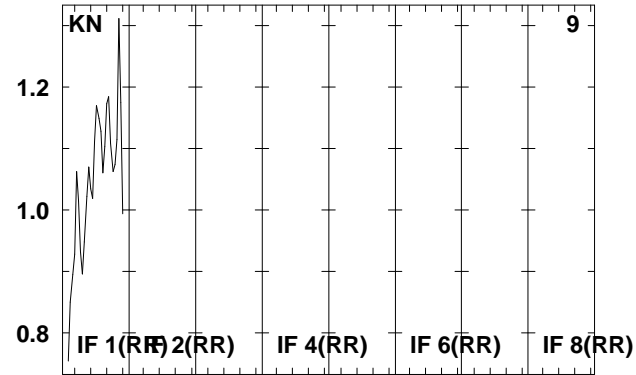
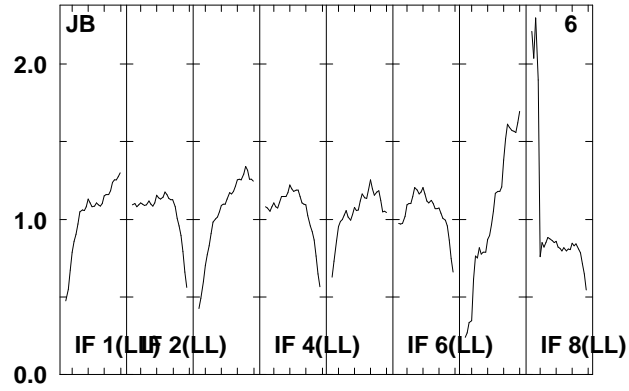

Lower frame: Real Jy  
Total-power spectrum Antenna: \*  
Timerange: 00/05:28:19 to 00/05:39:59

Plot file version 3 created 16-FEB-2009 12:45:48

J1217+30 RSF02.UVDATA.1

Freq = 1.6267 GHz, Bw = 8.000 MH No calibration applied and no bandpass applied

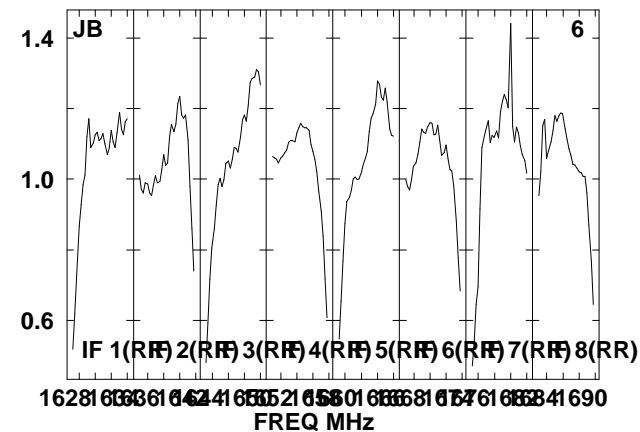
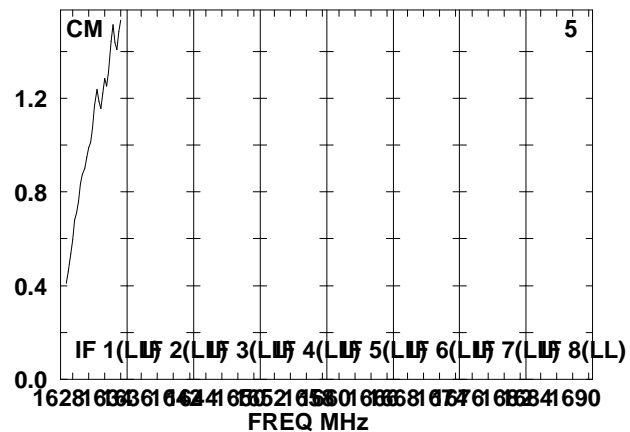
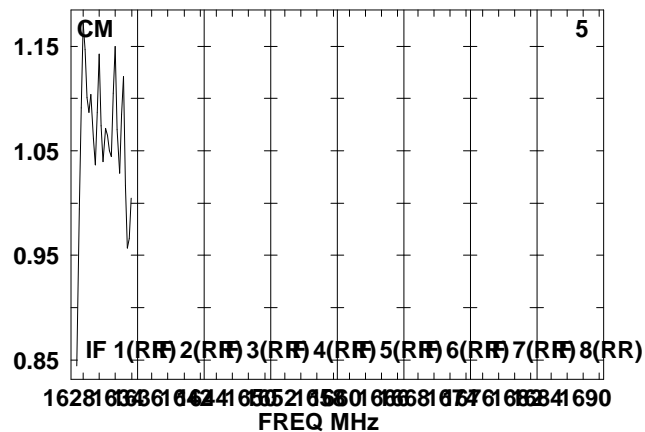
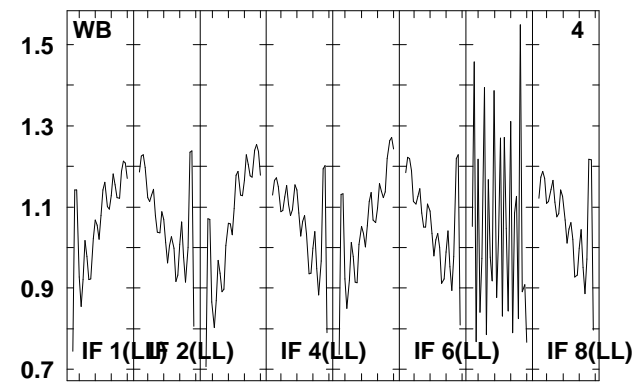
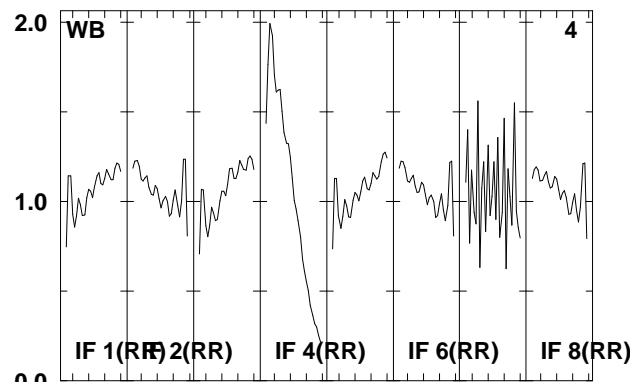
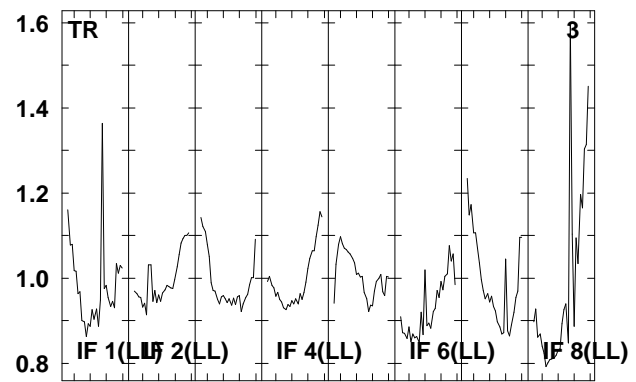
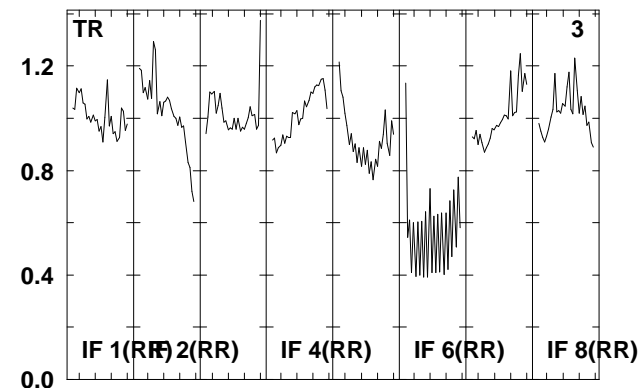
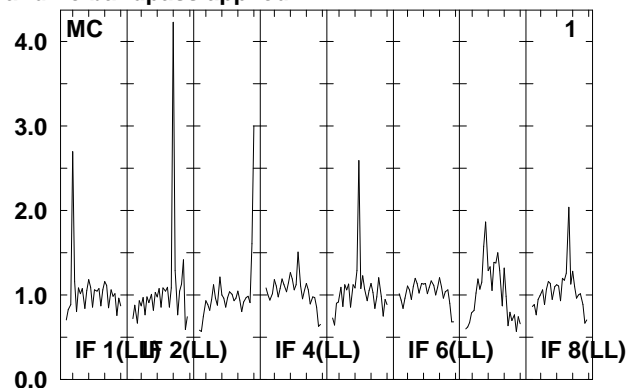
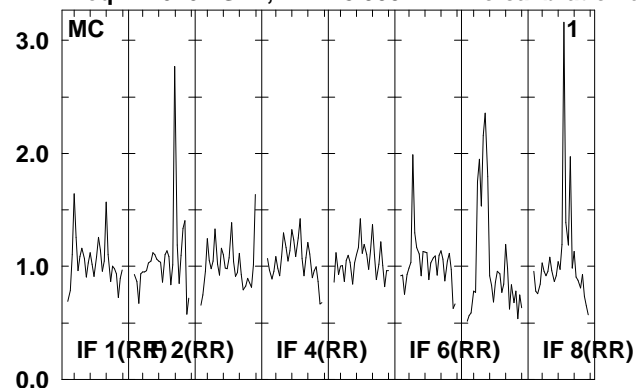

Lower frame: Real Jy  
Total-power spectrum Antenna: \*  
Timerange: 00/05:43:01 to 00/05:44:59

Plot file version 4 created 16-FEB-2009 12:45:48  
J1217+30 RSF02.UVDATA.1  
Freq = 1.6267 GHz, Bw = 8.000 MH No calibration applied and no bandpass applied

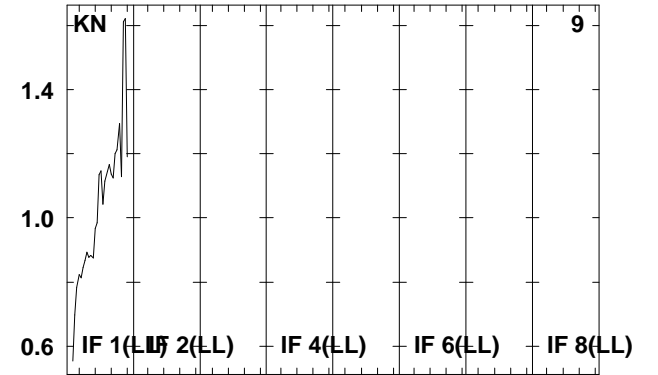
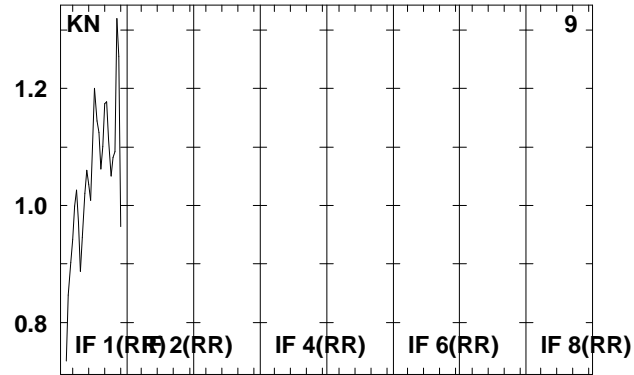
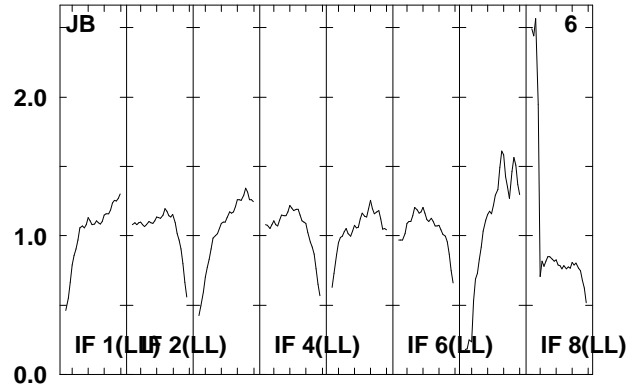

Lower frame: Real Jy  
Total-power spectrum Antenna: \*  
Timerange: 00/05:43:01 to 00/05:44:59

Plot file version 5 created 16-FEB-2009 12:45:49

J121839. RSF02.UVDATA.1

Freq = 1.6267 GHz, Bw = 8.000 MH No calibration applied and no bandpass applied

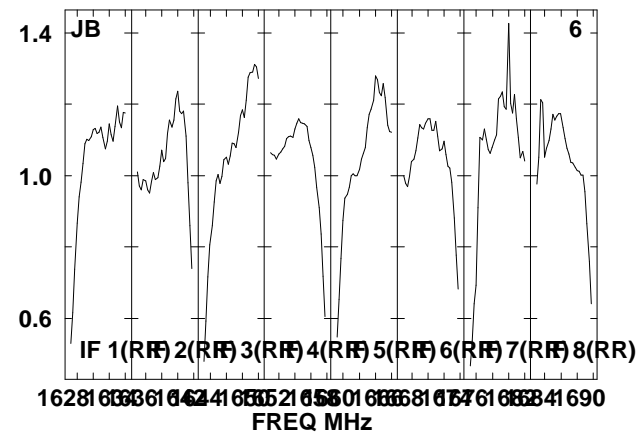
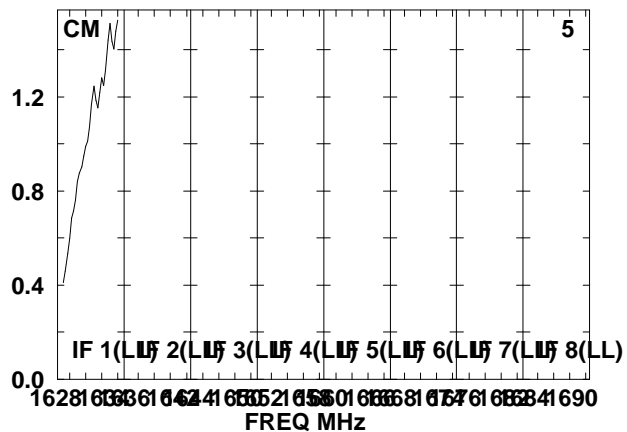
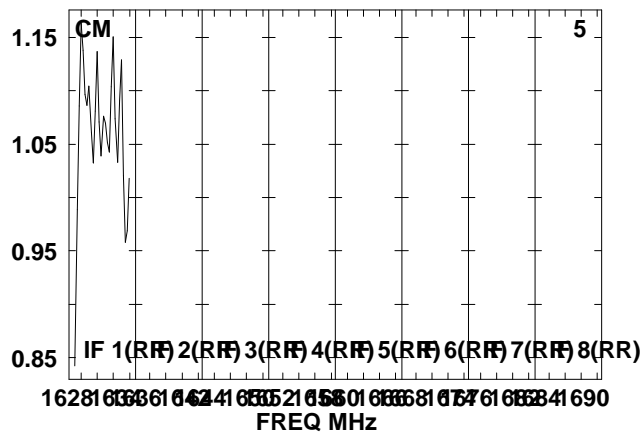
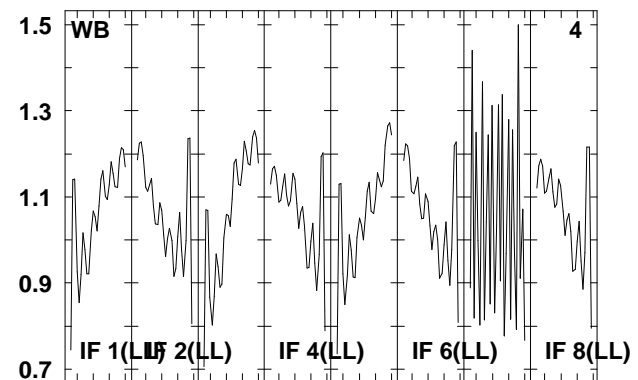
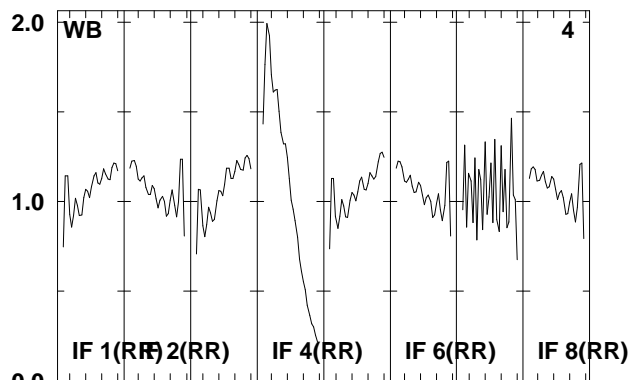
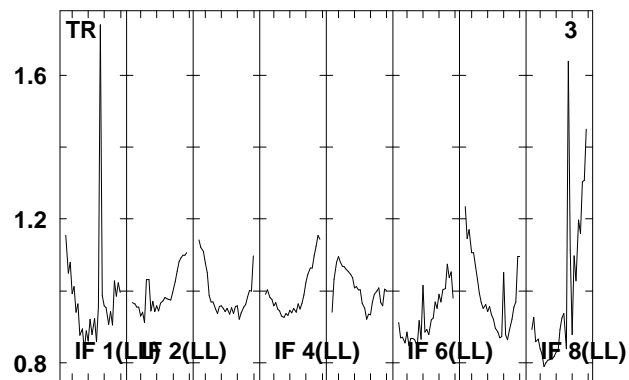
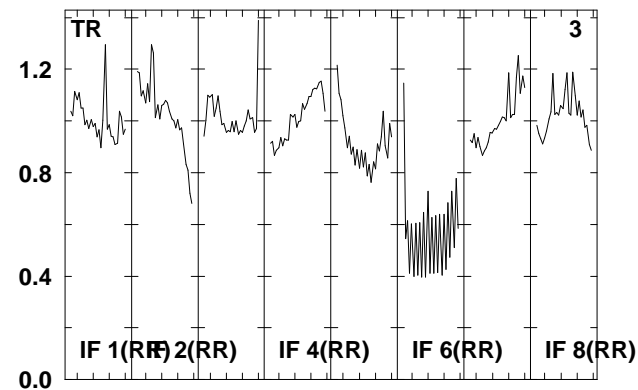
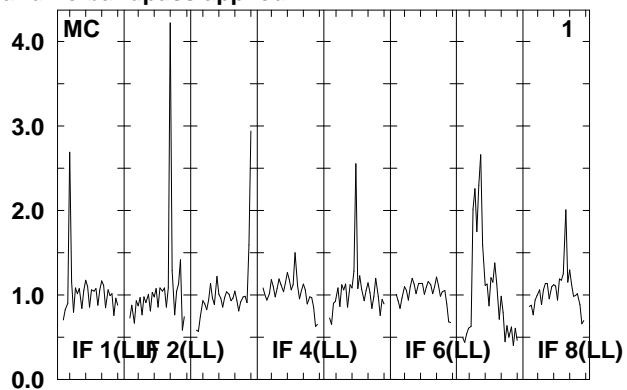
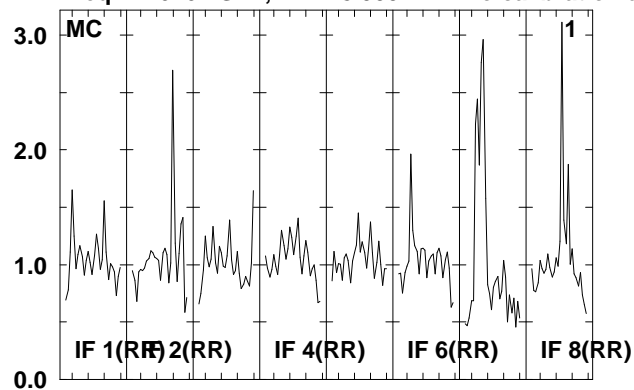

Lower frame: Real Jy  
Total-power spectrum Antenna: \*  
Timerange: 00/05:45:01 to 00/05:48:29

Plot file version 6 created 16-FEB-2009 12:45:50

J121839. RSF02.UVDATA.1

Freq = 1.6267 GHz, Bw = 8.000 MH No calibration applied and no bandpass applied

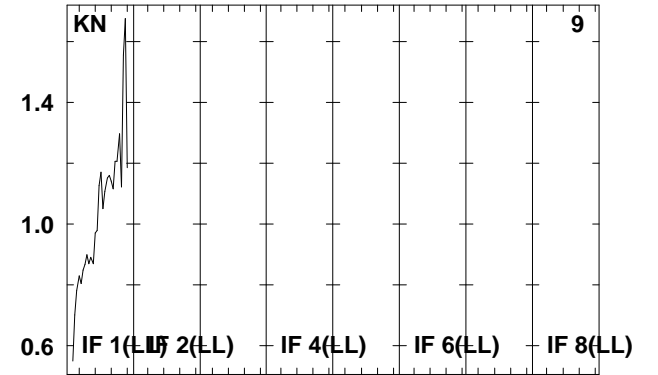
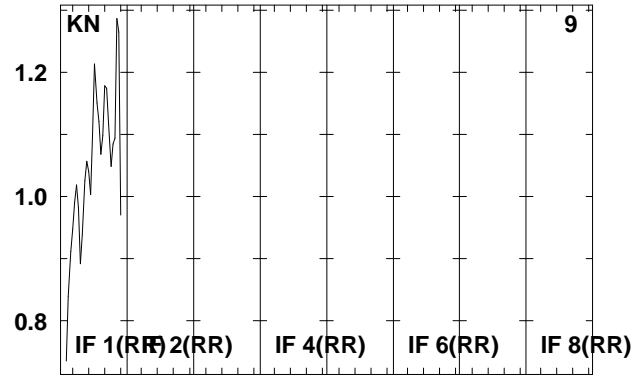
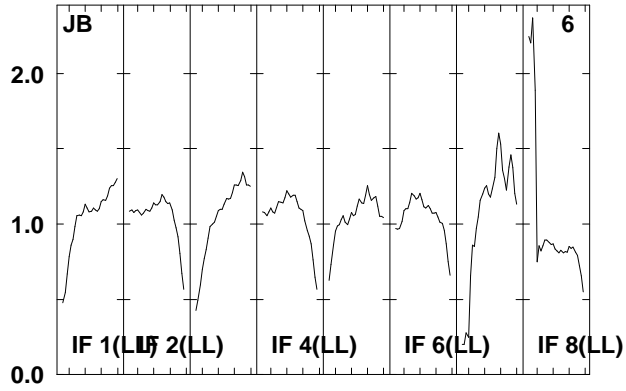

Lower frame: Real Jy  
Total-power spectrum Antenna: \*  
Timerange: 00/05:45:01 to 00/05:48:29

Plot file version 7 created 16-FEB-2009 12:45:51

J1217+30 RSF02.UVDATA.1

Freq = 1.6267 GHz, Bw = 8.000 MH No calibration applied and no bandpass applied

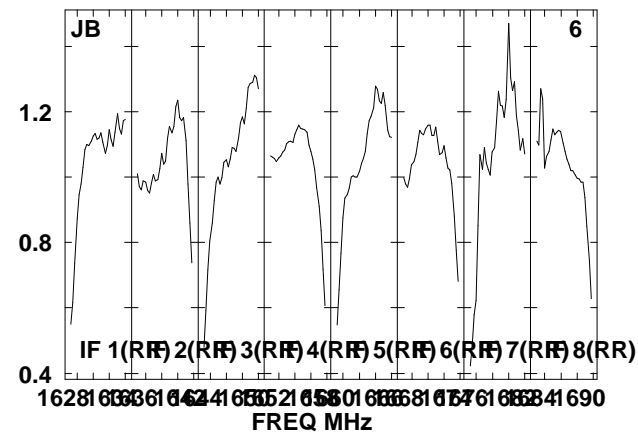
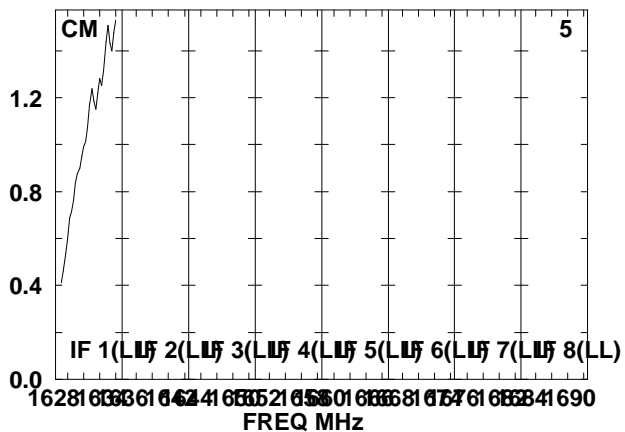
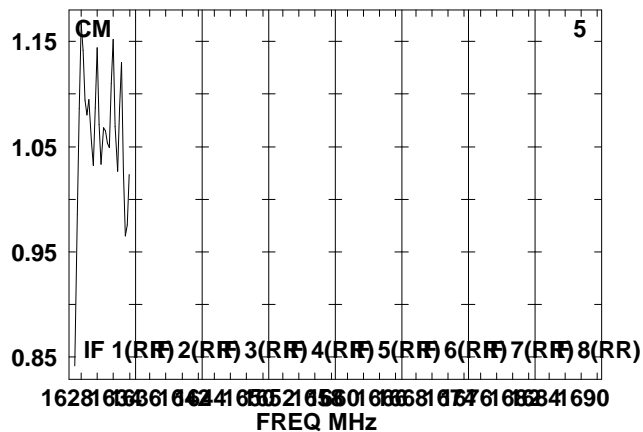
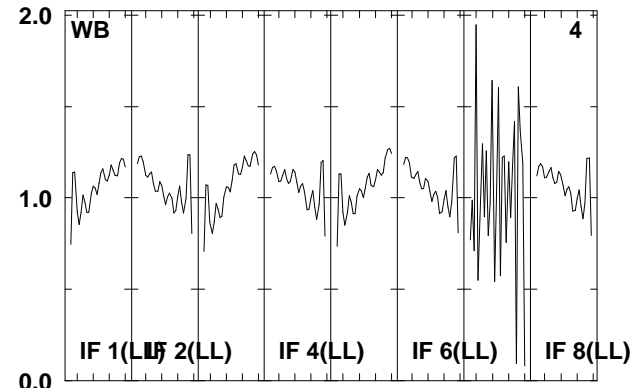
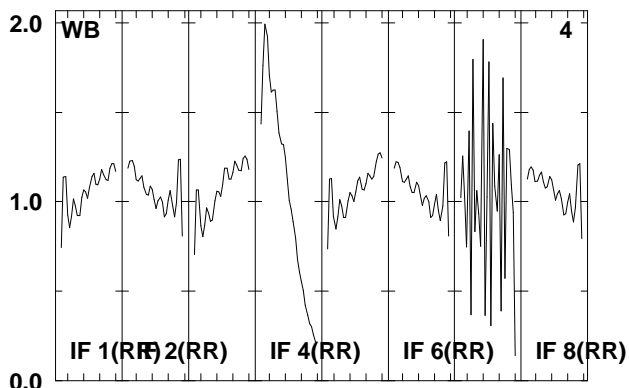
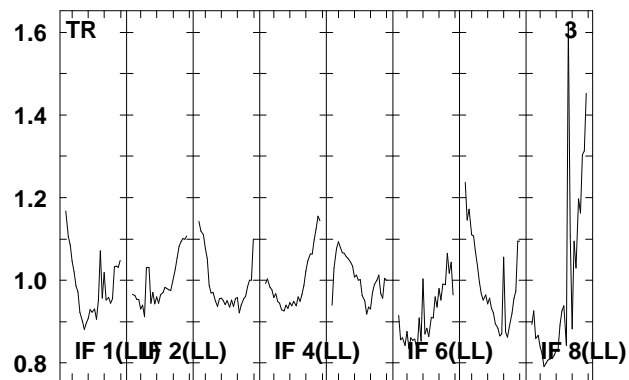
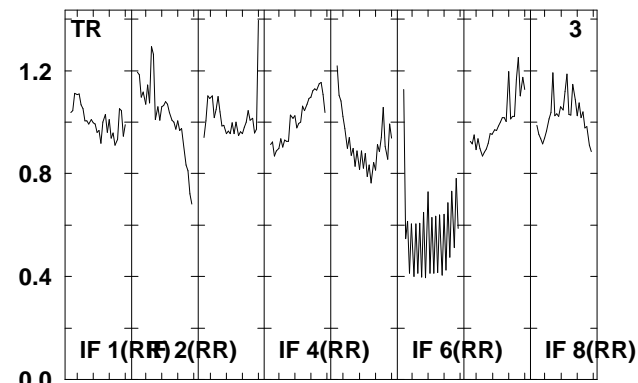
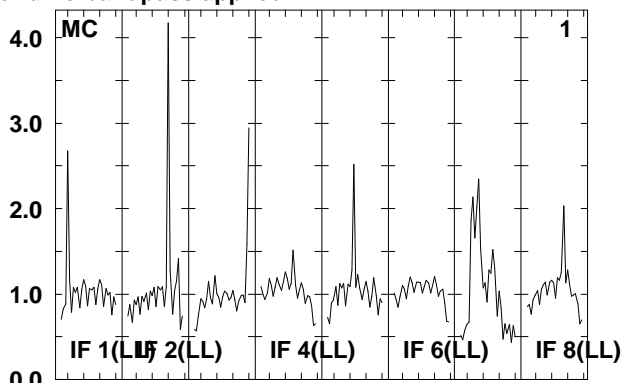
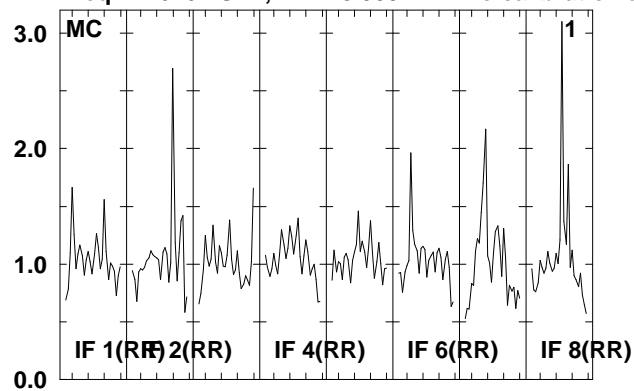

Lower frame: Real Jy  
Total-power spectrum Antenna: \*  
Timerange: 00/05:48:31 to 00/05:49:51

Plot file version 8 created 16-FEB-2009 12:45:51

J1217+30 RSF02.UVDATA.1

Freq = 1.6267 GHz, Bw = 8.000 MH No calibration applied and no bandpass applied

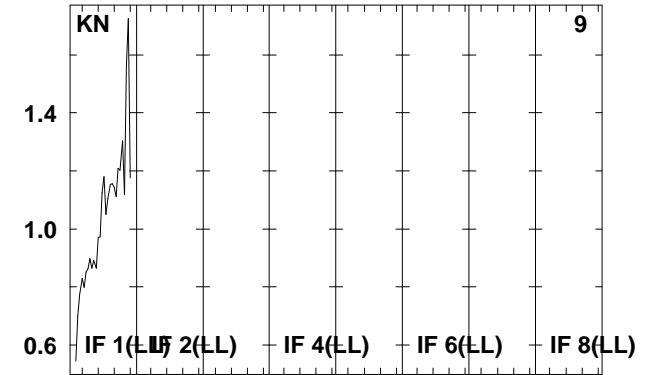
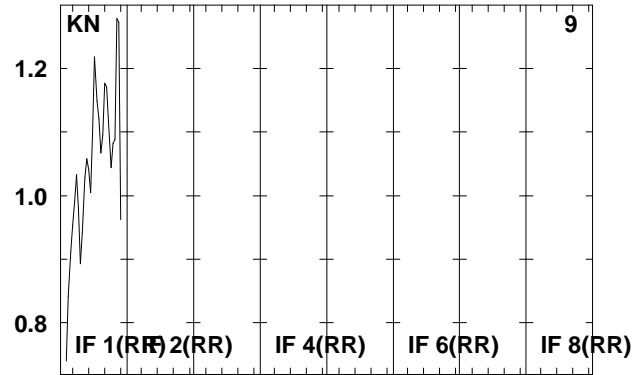
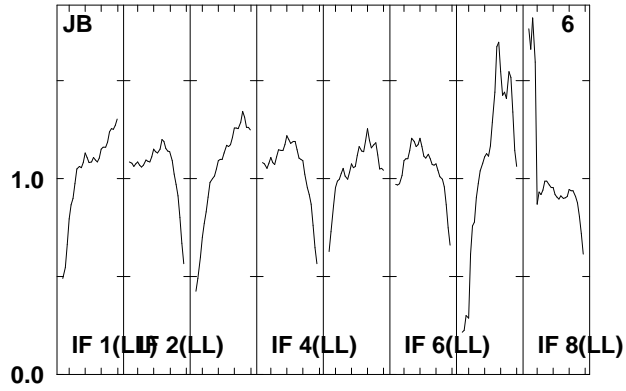

Lower frame: Real Jy  
Total-power spectrum Antenna: \*  
Timerange: 00/05:48:31 to 00/05:49:51



Plot file version 9 created 16-FEB-2009 12:45:52  
 J121839. RSF02.UVDATA.1  
 Freq = 1.6267 GHz, Bw = 8.000 MH No calibration applied and no bandpass applied

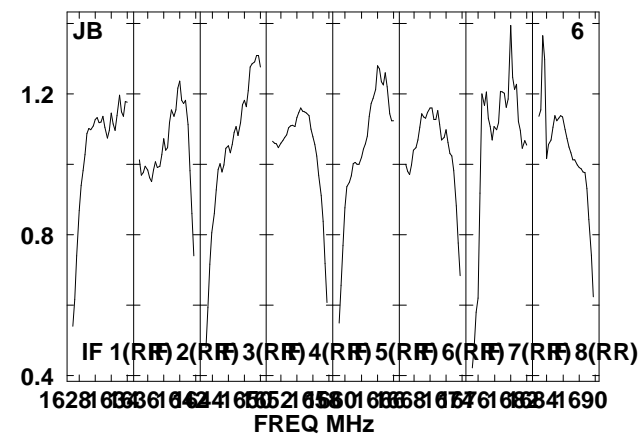
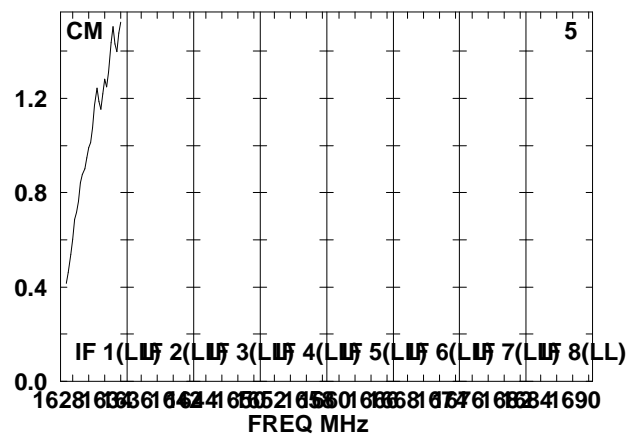
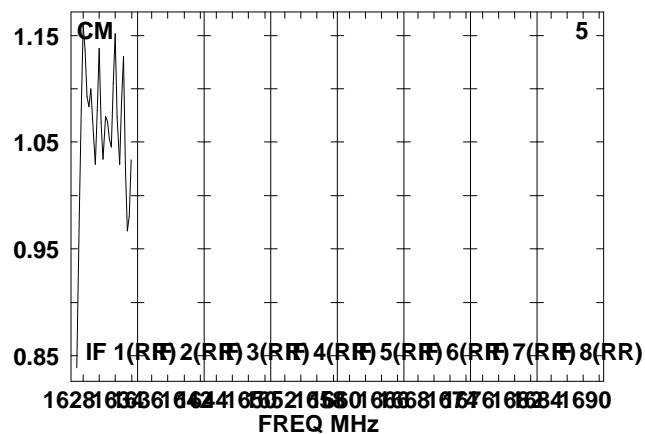
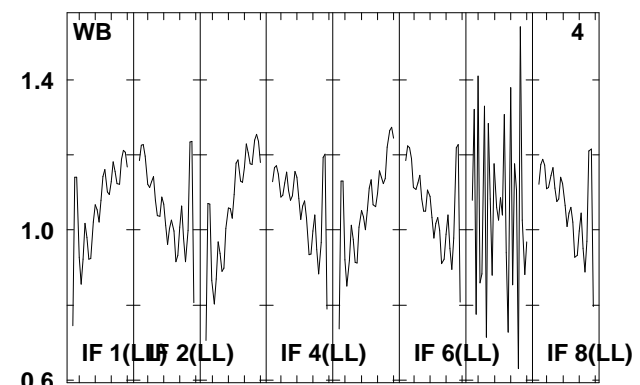
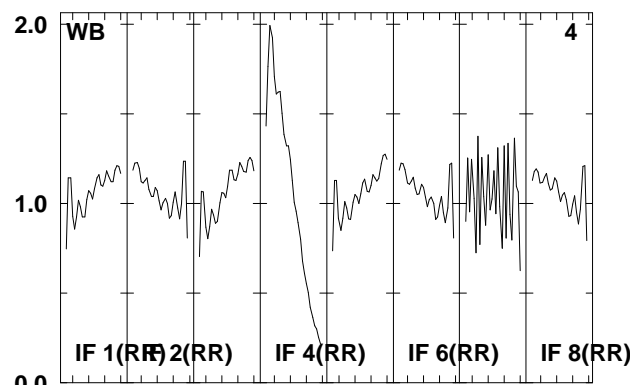
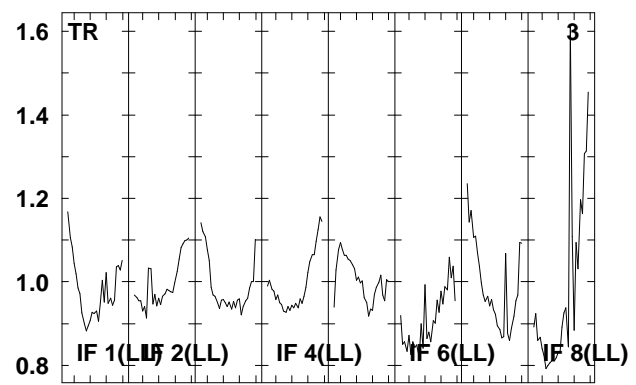
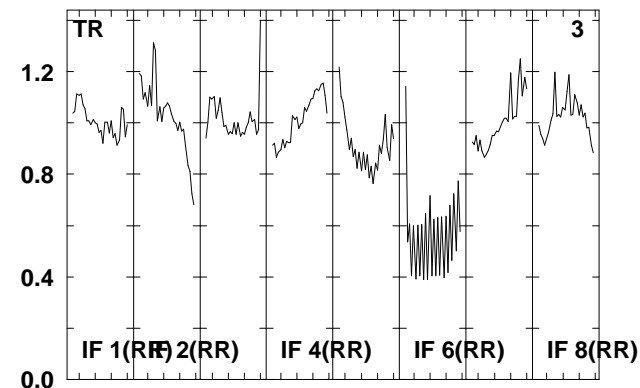
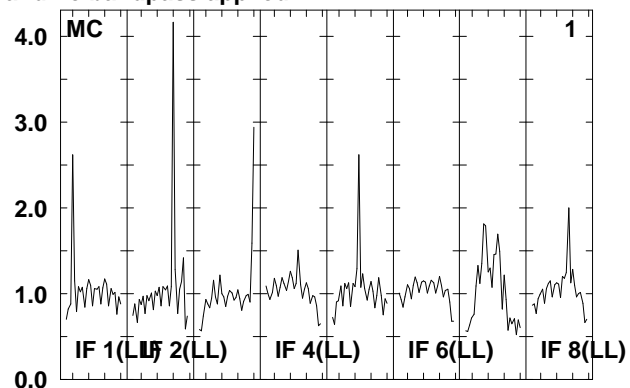
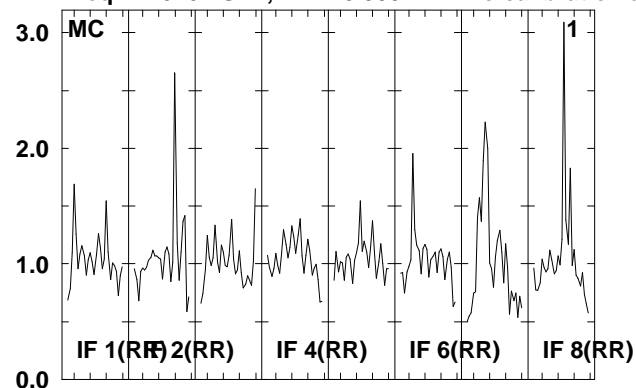

Lower frame: Real Jy  
 Total-power spectrum Antenna: \*  
 Timerange: 00/05:49:53 to 00/05:53:19

Plot file version 10 created 16-FEB-2009 12:45:52

J121839. RSF02.UVDATA.1

Freq = 1.6267 GHz, Bw = 8.000 MH No calibration applied and no bandpass applied

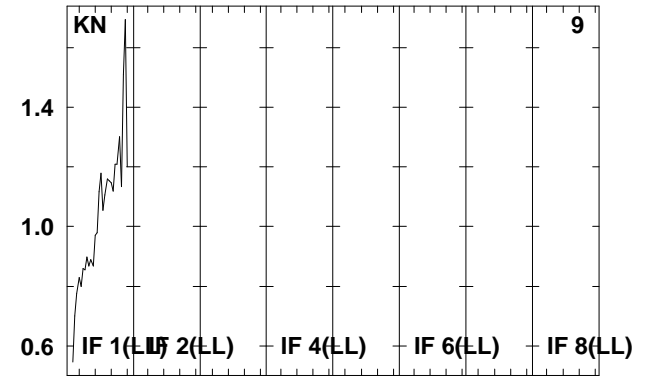
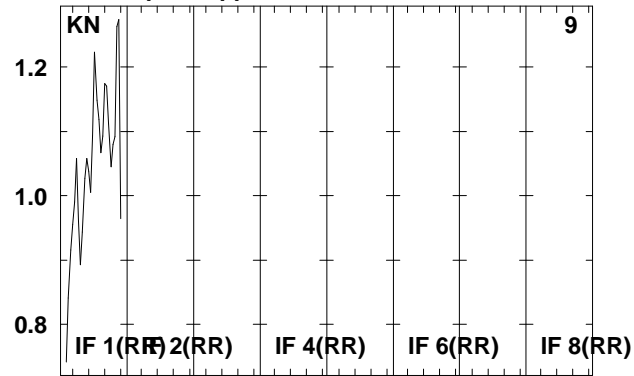
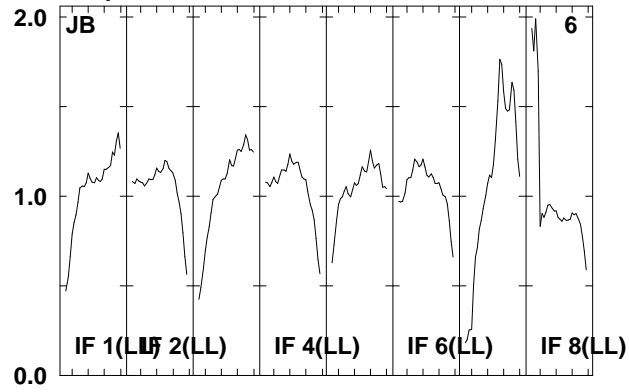

Lower frame: Real Jy  
Total-power spectrum Antenna: \*  
Timerange: 00/05:49:53 to 00/05:53:19

Plot file version 11 created 16-FEB-2009 12:45:53

J1217+30 RSF02.UVDATA.1

Freq = 1.6267 GHz, Bw = 8.000 MH No calibration applied and no bandpass applied

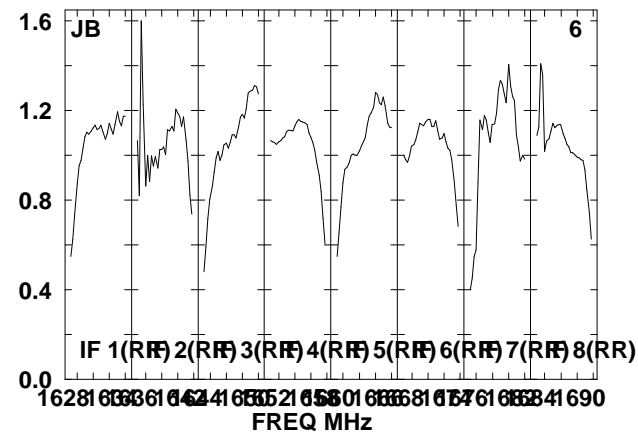
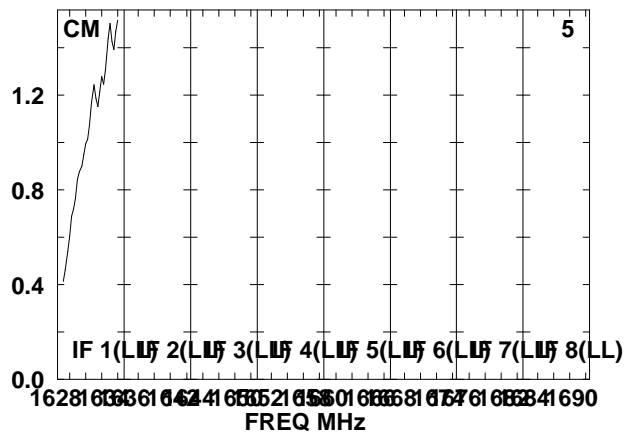
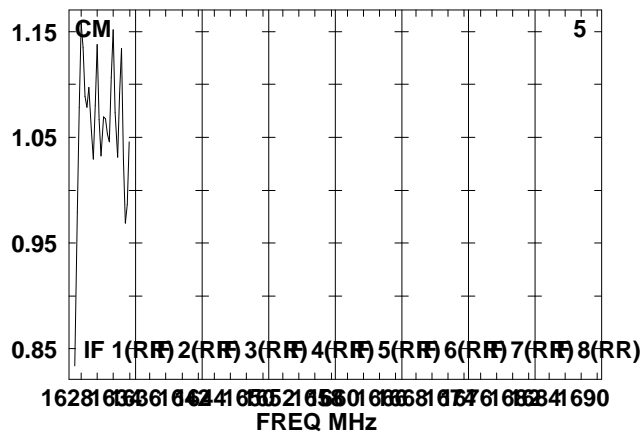
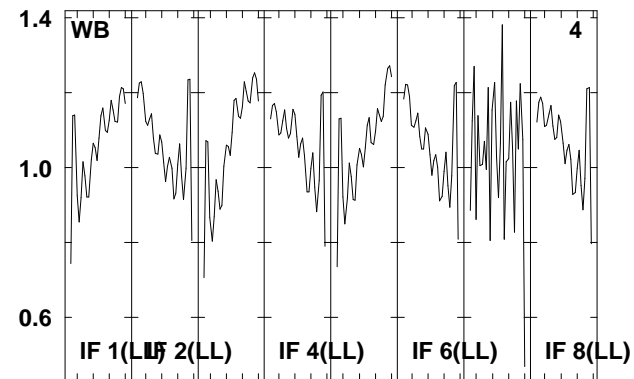
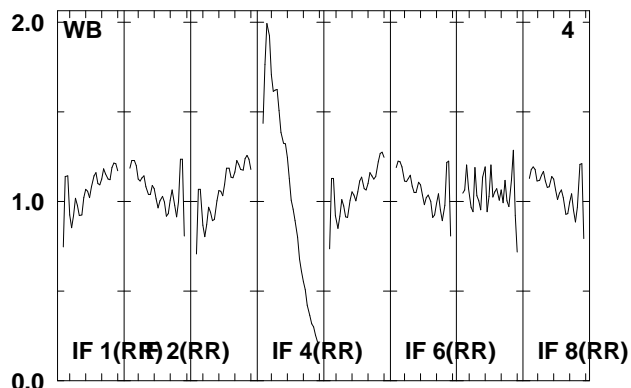
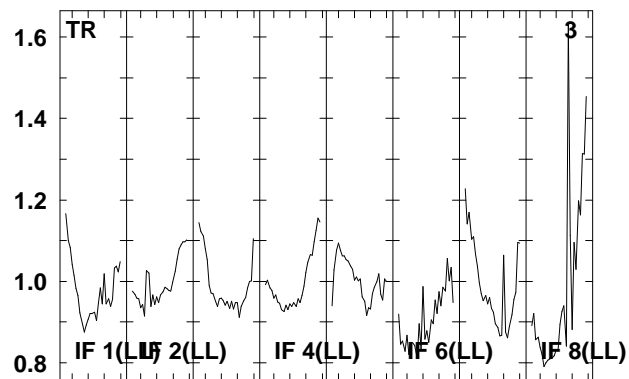
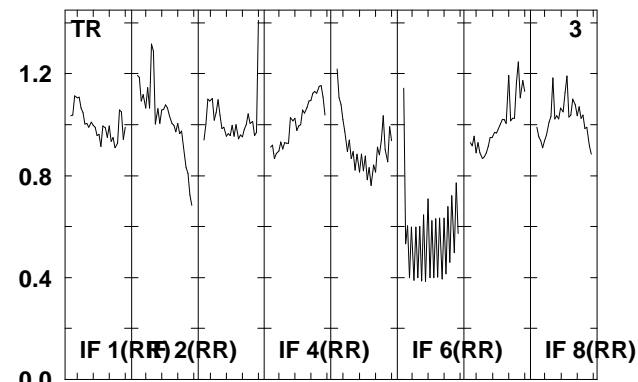
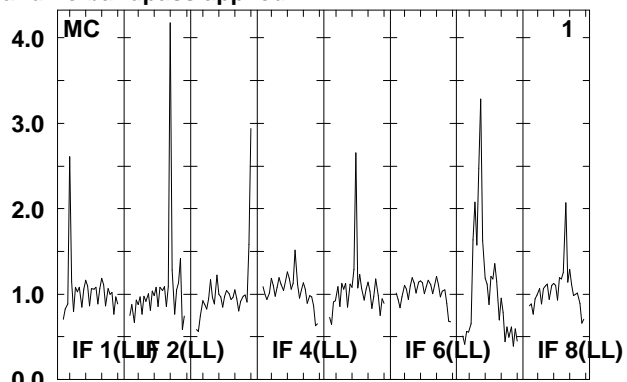
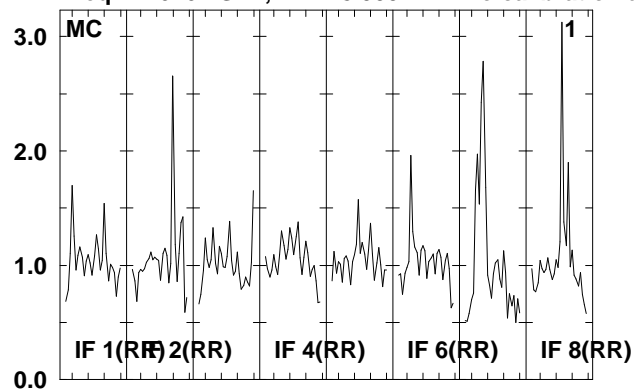

Lower frame: Real Jy  
Total-power spectrum Antenna: \*  
Timerange: 00/05:54:01 to 00/05:54:59

Plot file version 12 created 16-FEB-2009 12:45:54  
J1217+30 RSF02.UVDATA.1  
Freq = 1.6267 GHz, Bw = 8.000 MH No calibration applied and no bandpass applied

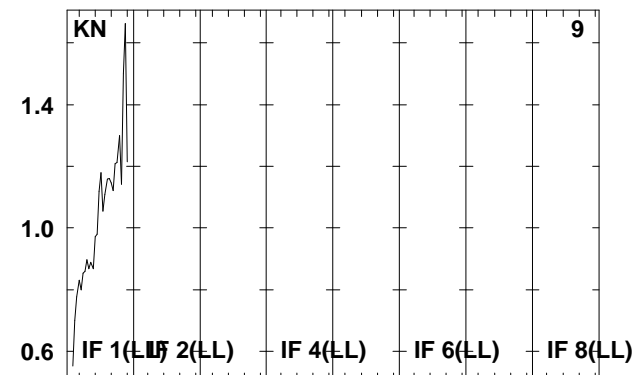
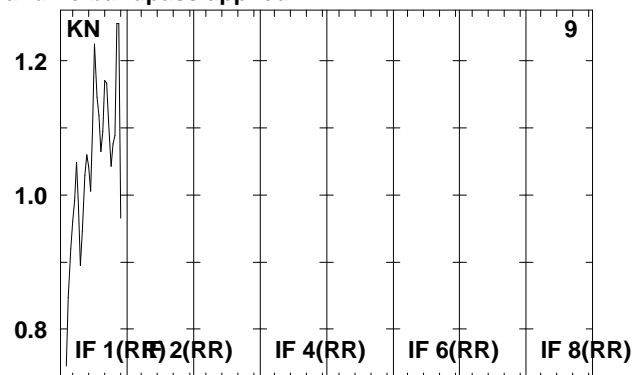
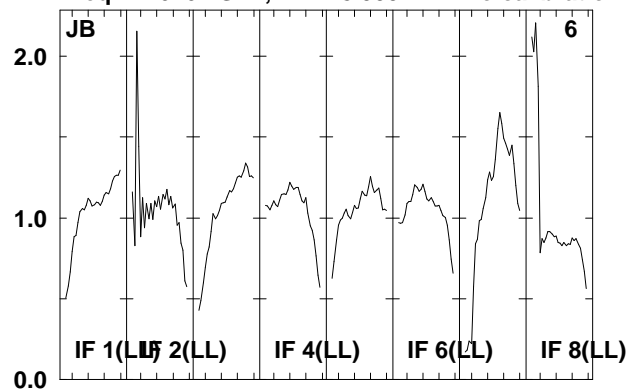

Lower frame: Real Jy  
Total-power spectrum Antenna: \*  
Timerange: 00/05:54:01 to 00/05:54:59

Plot file version 13 created 16-FEB-2009 12:45:54

J121839. RSF02.UVDATA.1

Freq = 1.6267 GHz, Bw = 8.000 MH No calibration applied and no bandpass applied

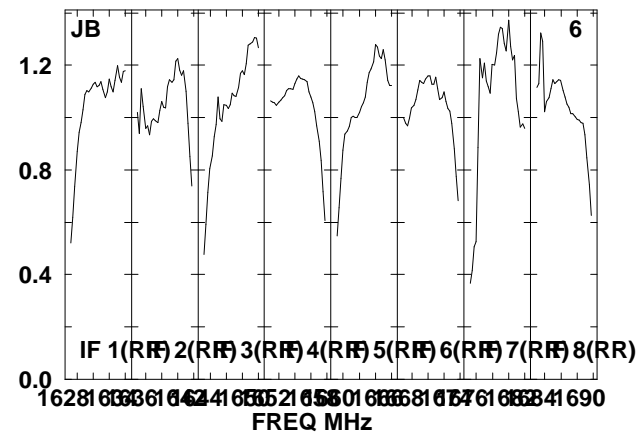
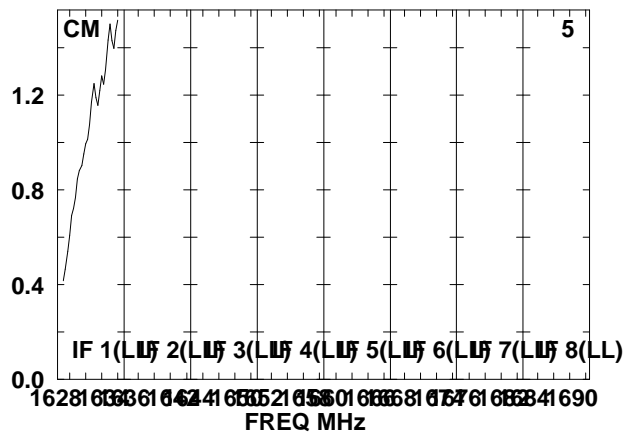
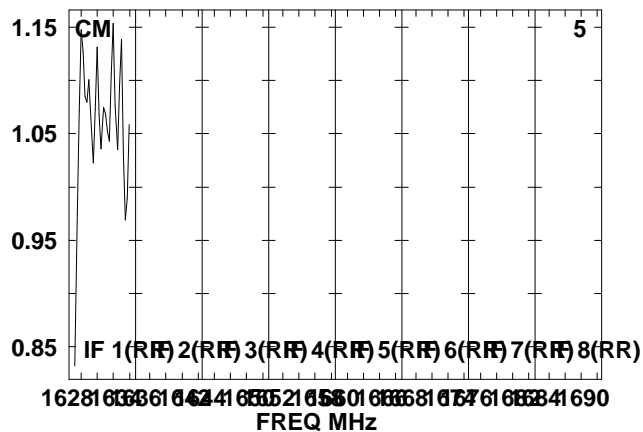
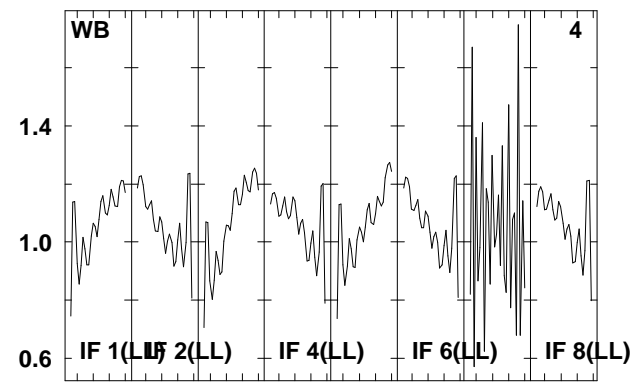
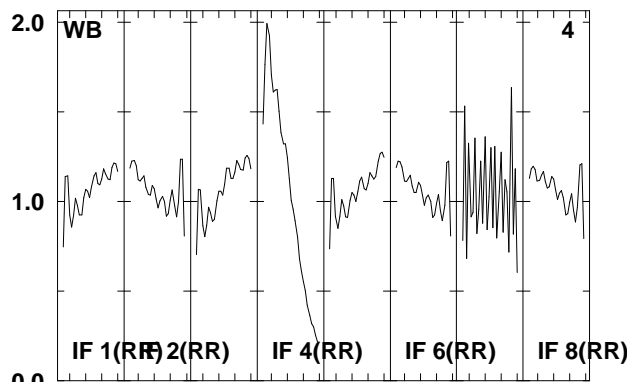
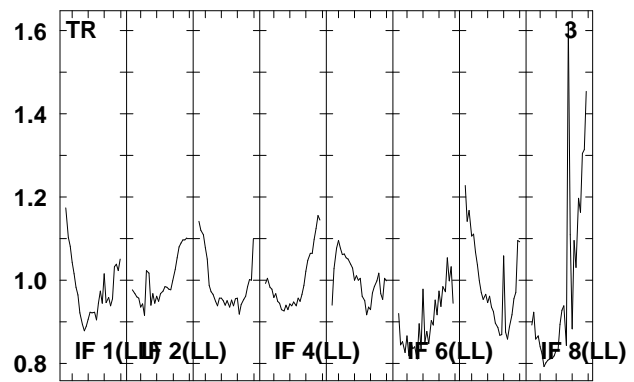
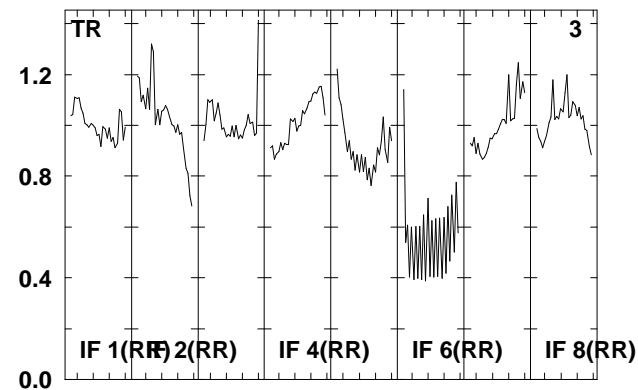
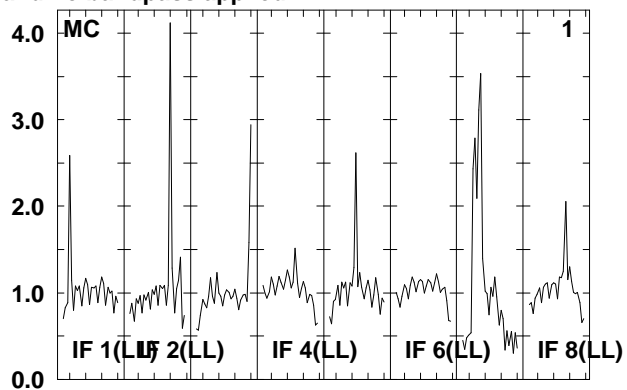
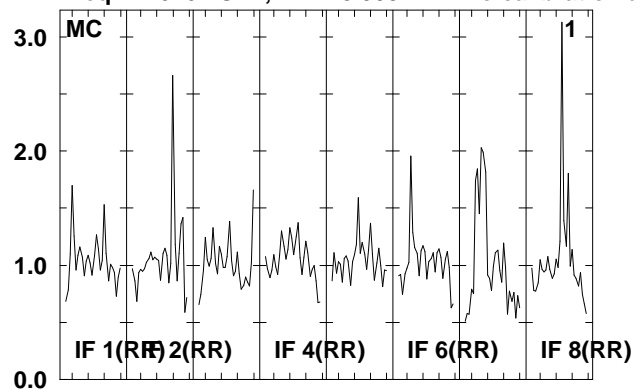

Lower frame: Real Jy  
Total-power spectrum Antenna: \*  
Timerange: 00/05:55:01 to 00/05:58:31

Plot file version 14 created 16-FEB-2009 12:45:55

J121839. RSF02.UVDATA.1

Freq = 1.6267 GHz, Bw = 8.000 MH No calibration applied and no bandpass applied

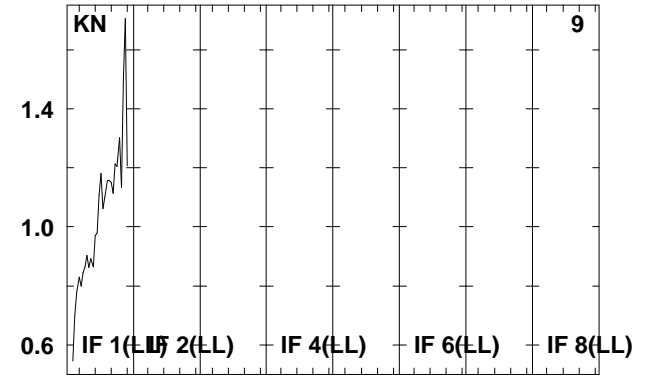
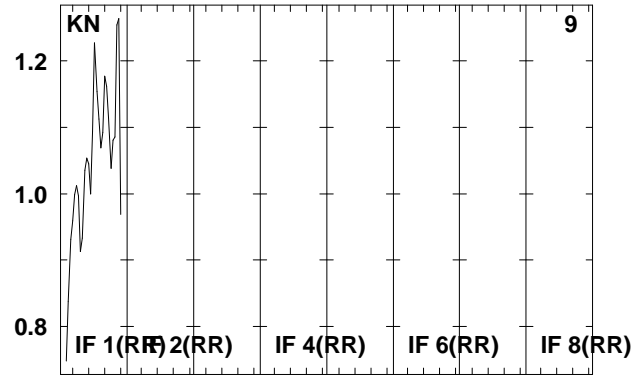
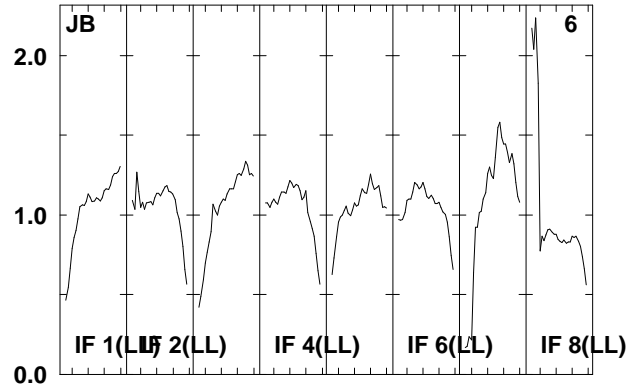

Lower frame: Real Jy  
Total-power spectrum Antenna: \*  
Timerange: 00/05:55:01 to 00/05:58:31

Plot file version 15 created 16-FEB-2009 12:45:56

J1217+30 RSF02.UVDATA.1

Freq = 1.6267 GHz, Bw = 8.000 MH No calibration applied and no bandpass applied

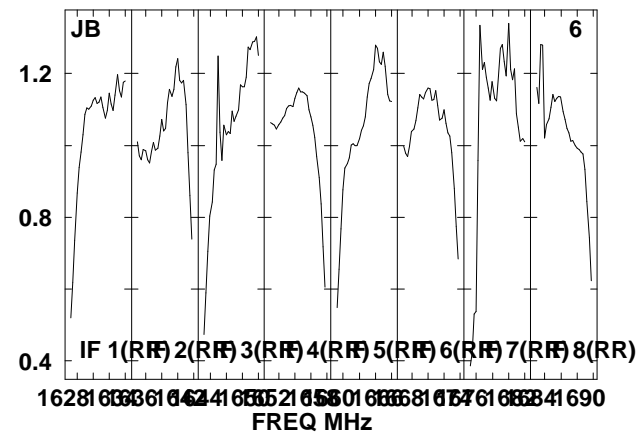
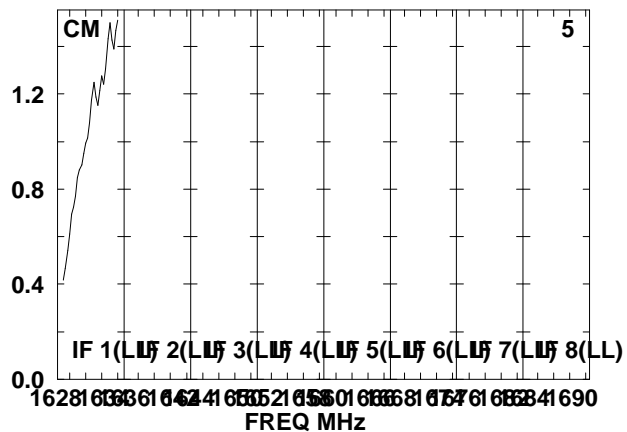
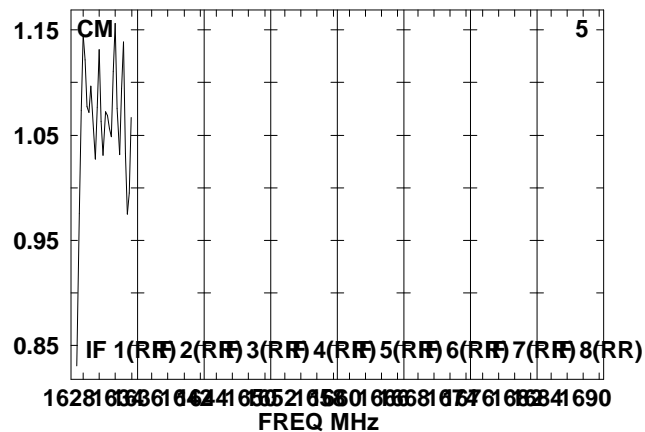
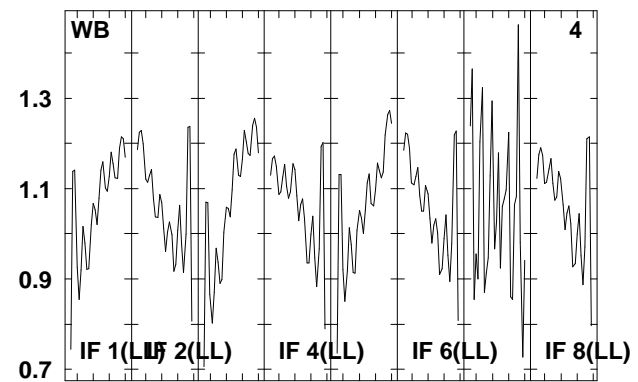
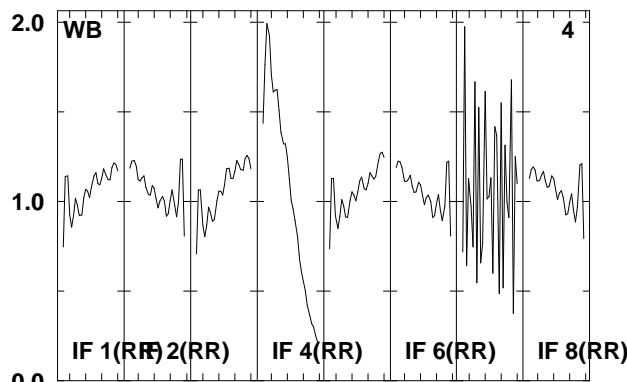
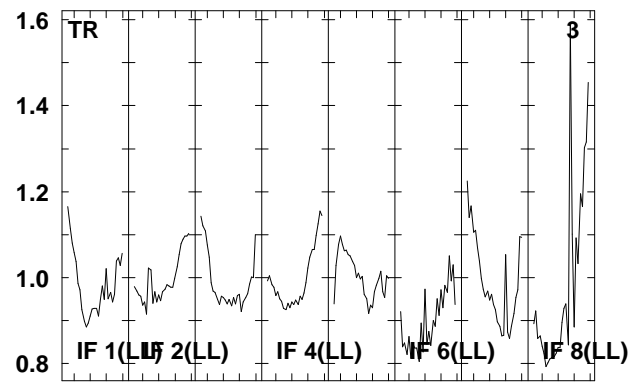
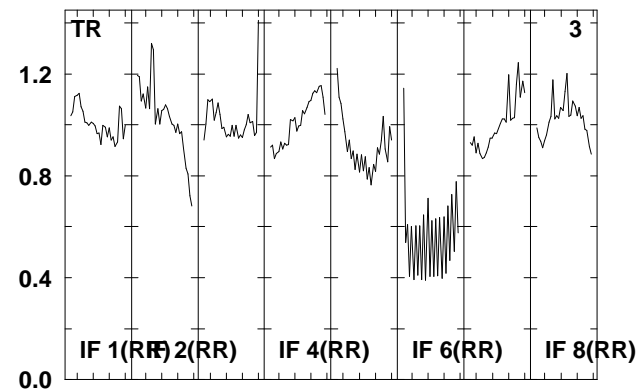
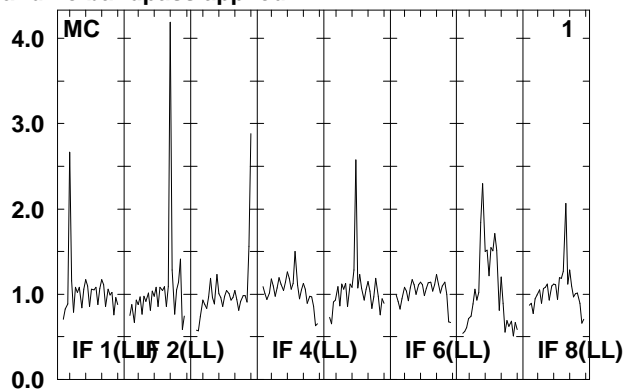
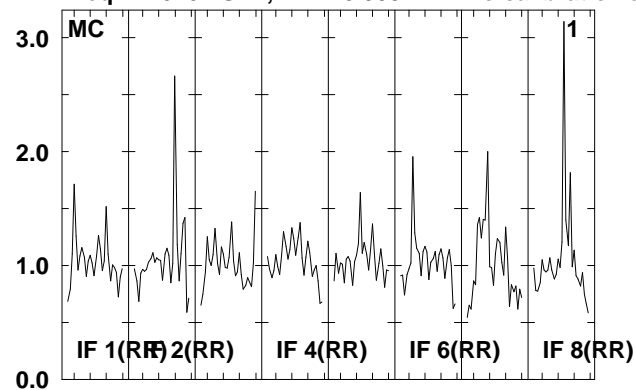

Lower frame: Real Jy  
Total-power spectrum Antenna: \*  
Timerange: 00/05:58:33 to 00/05:59:49

Plot file version 16 created 16-FEB-2009 12:45:56

J1217+30 RSF02.UVDATA.1

Freq = 1.6267 GHz, Bw = 8.000 MH No calibration applied and no bandpass applied

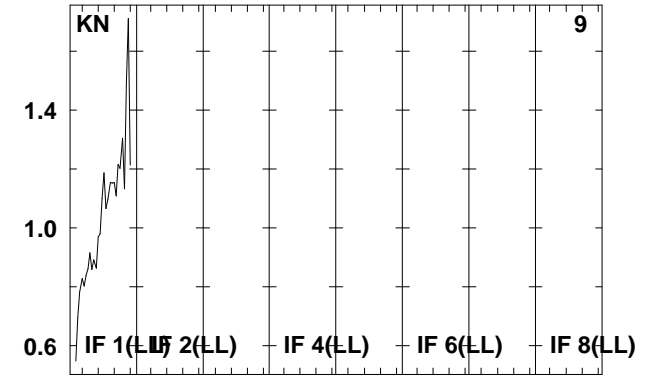
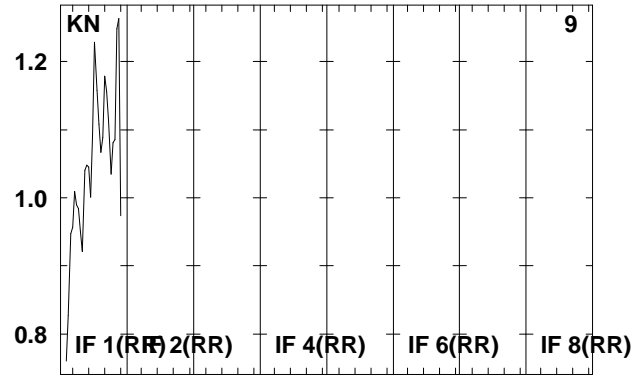
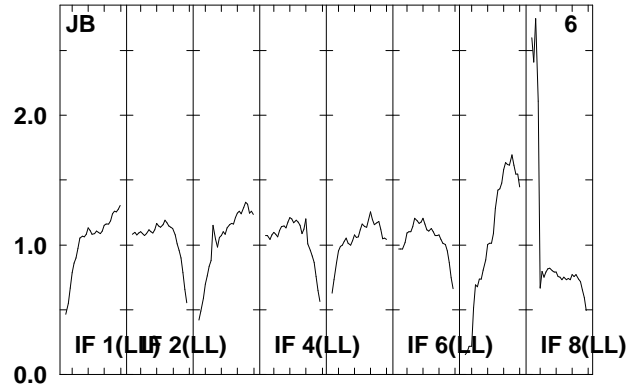

Lower frame: Real Jy  
Total-power spectrum Antenna: \*  
Timerange: 00/05:58:33 to 00/05:59:49



Plot file version 17 created 16-FEB-2009 12:45:57  
 J121839. RSF02.UVDATA.1  
 Freq = 1.6267 GHz, Bw = 8.000 MH No calibration applied and no bandpass applied

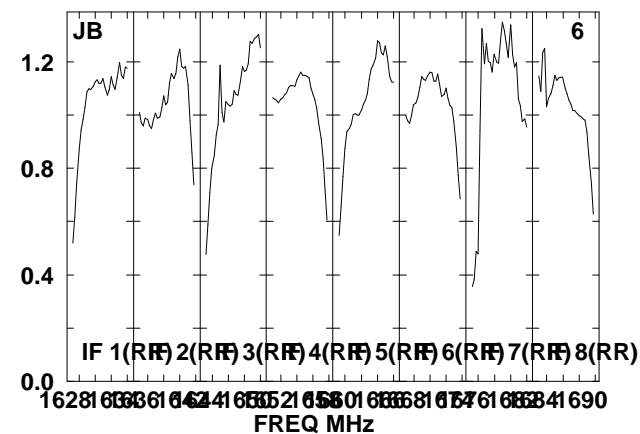
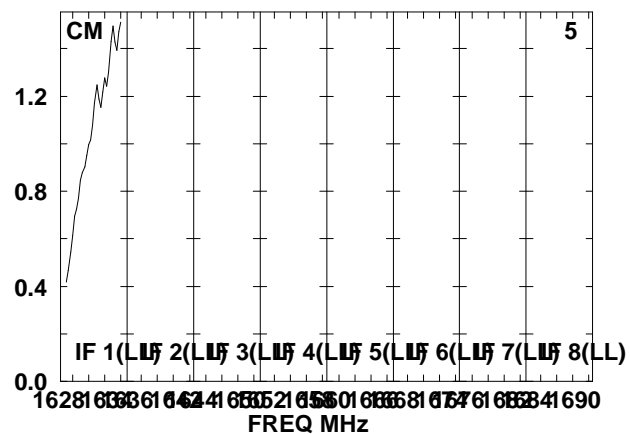
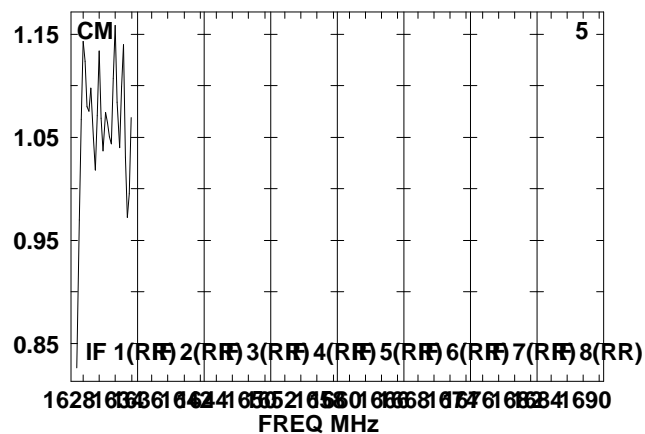
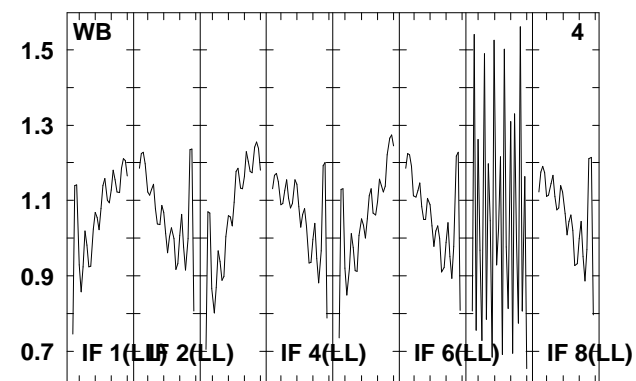
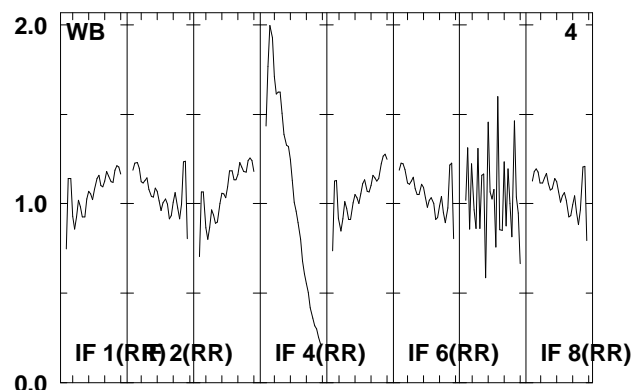
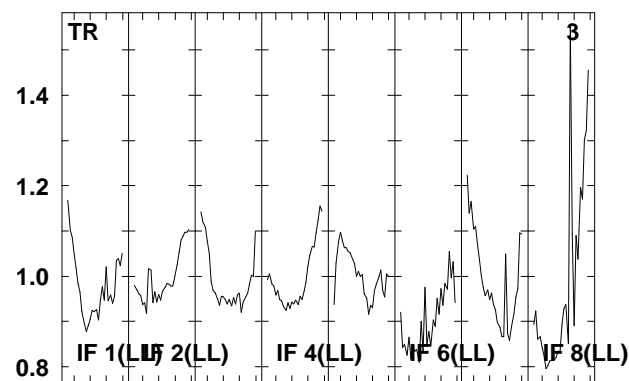
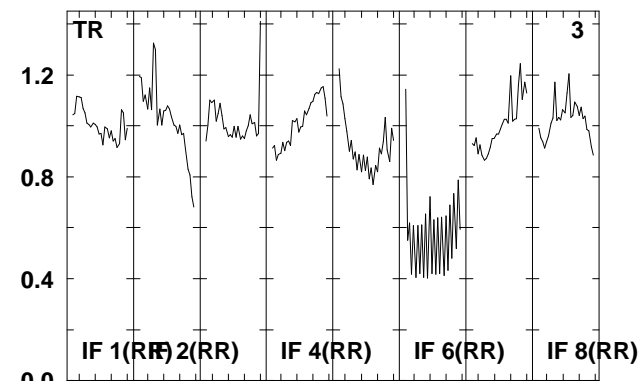
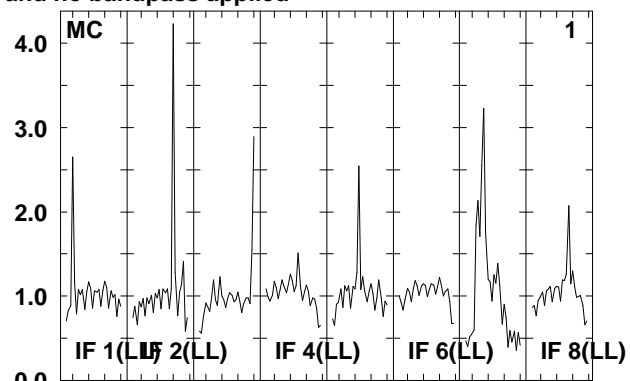
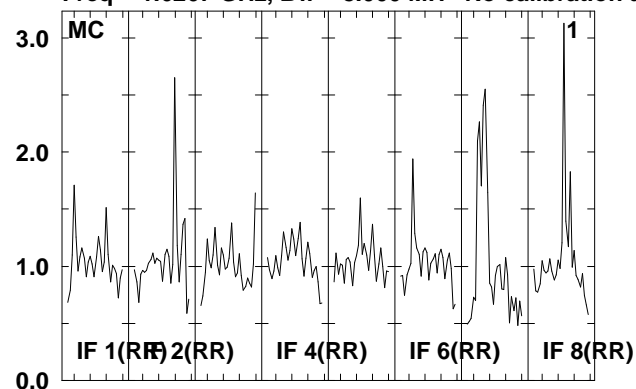

Lower frame: Real Jy  
 Total-power spectrum Antenna: \*  
 Timerange: 00/05:59:51 to 00/06:03:19

Plot file version 18 created 16-FEB-2009 12:45:58

J121839. RSF02.UVDATA.1

Freq = 1.6267 GHz, Bw = 8.000 MH No calibration applied and no bandpass applied

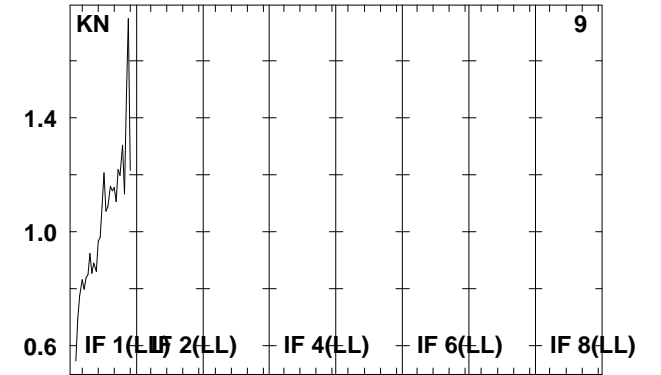
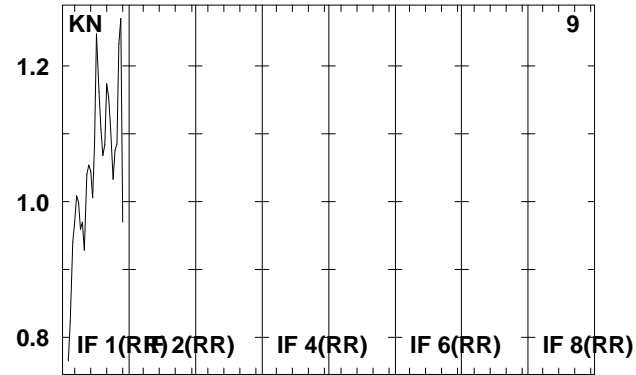
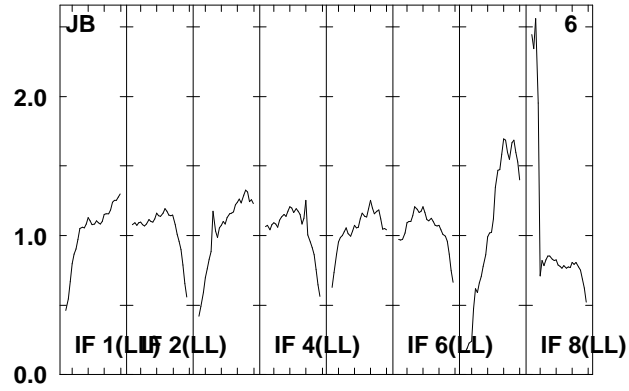

Lower frame: Real Jy  
Total-power spectrum Antenna: \*  
Timerange: 00/05:59:51 to 00/06:03:19

Plot file version 19 created 16-FEB-2009 12:45:59  
 J1217+30 RSF02.UVDATA.1  
 Freq = 1.6267 GHz, Bw = 8.000 MH No calibration applied and no bandpass applied

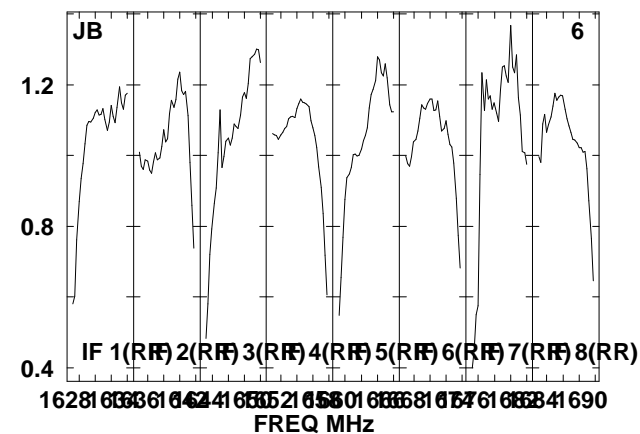
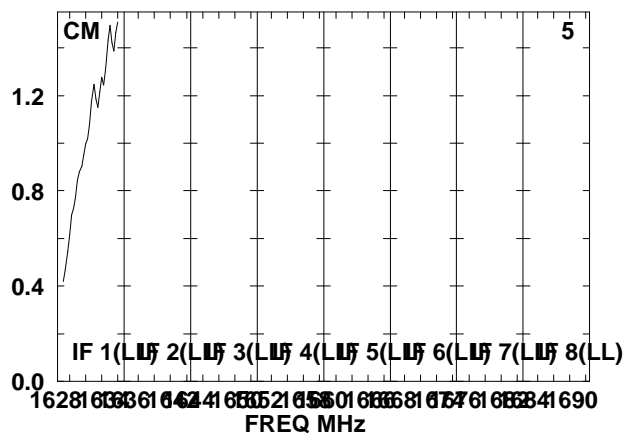
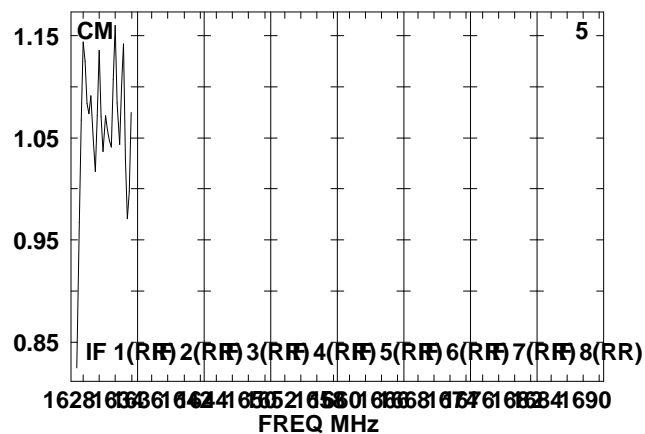
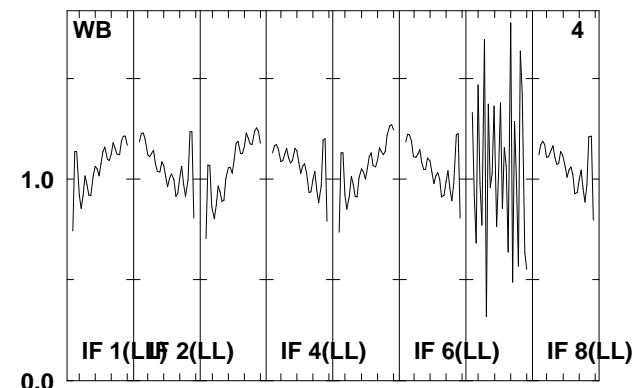
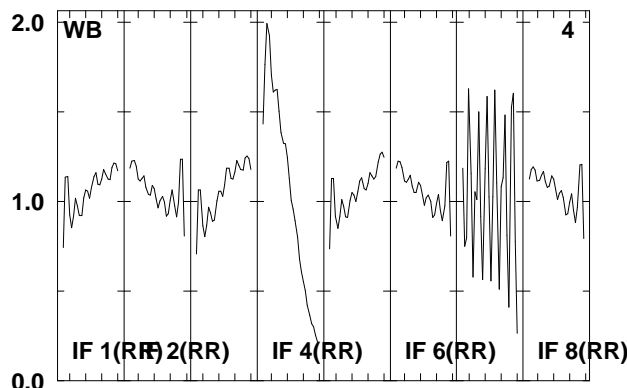
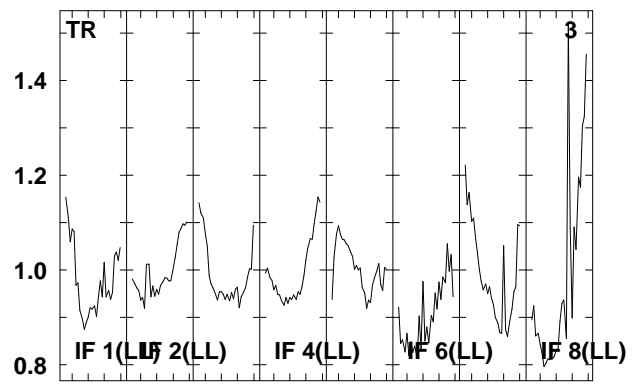
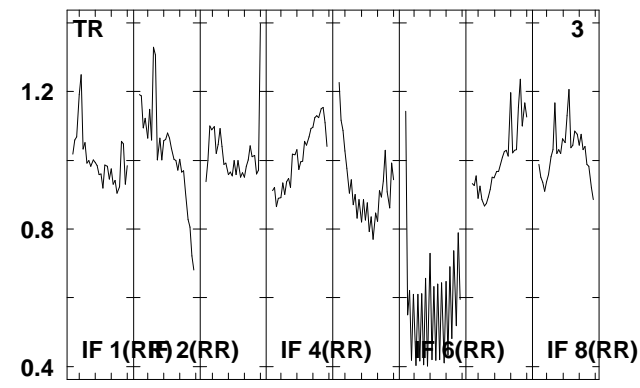
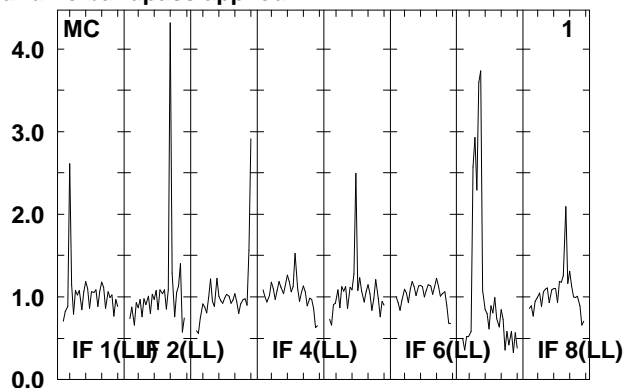
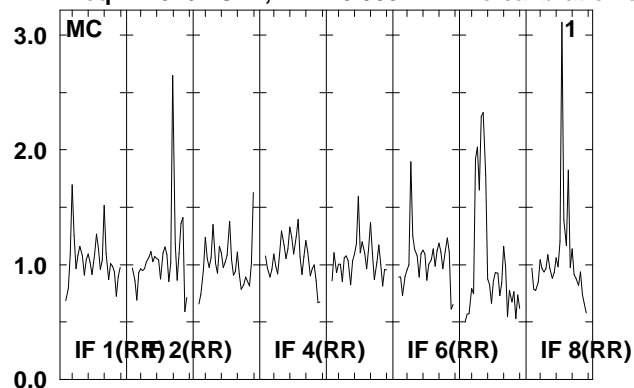

Lower frame: Real Jy  
 Total-power spectrum Antenna: \*  
 Timerange: 00/06:04:01 to 00/06:05:01

Plot file version 20 created 16-FEB-2009 12:45:59

J1217+30 RSF02.UVDATA.1

Freq = 1.6267 GHz, Bw = 8.000 MH No calibration applied and no bandpass applied

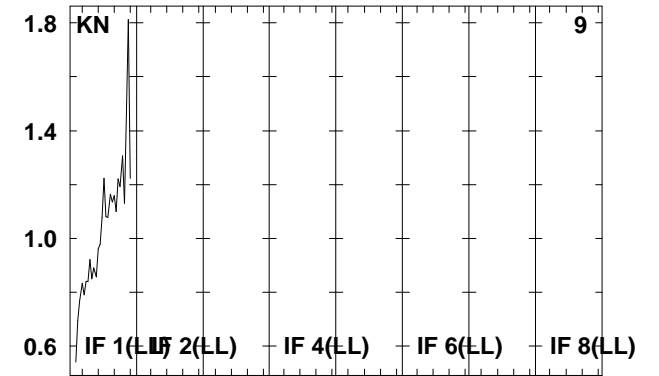
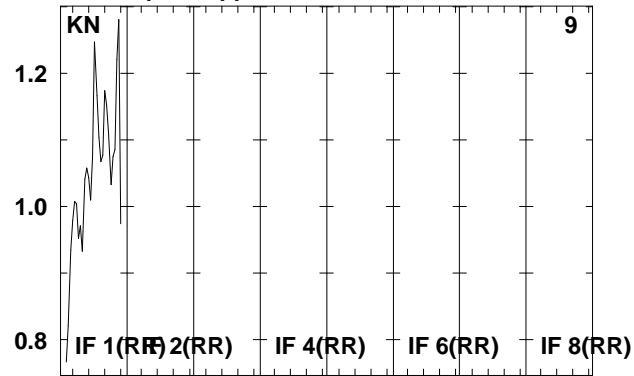
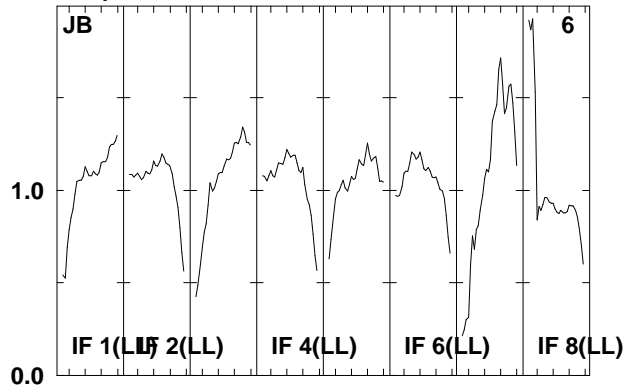

Lower frame: Real Jy  
Total-power spectrum Antenna: \*  
Timerange: 00/06:04:01 to 00/06:05:01

Plot file version 21 created 16-FEB-2009 12:46:00

J121839. RSF02.UVDATA.1

Freq = 1.6267 GHz, Bw = 8.000 MH No calibration applied and no bandpass applied

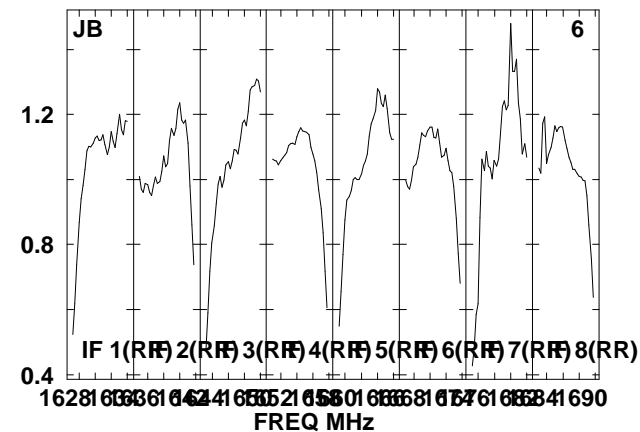
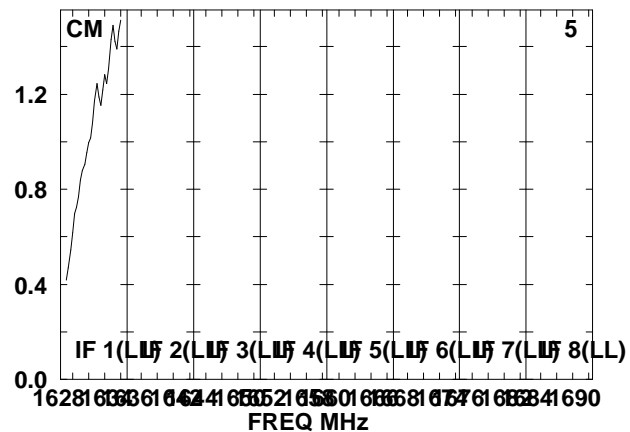
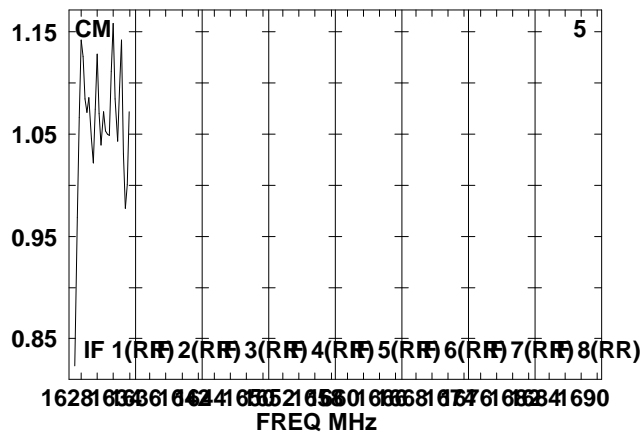
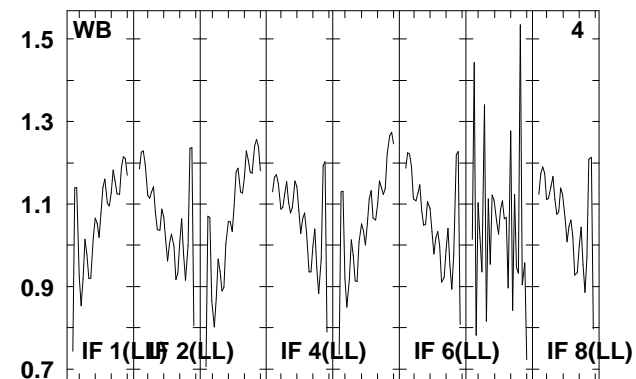
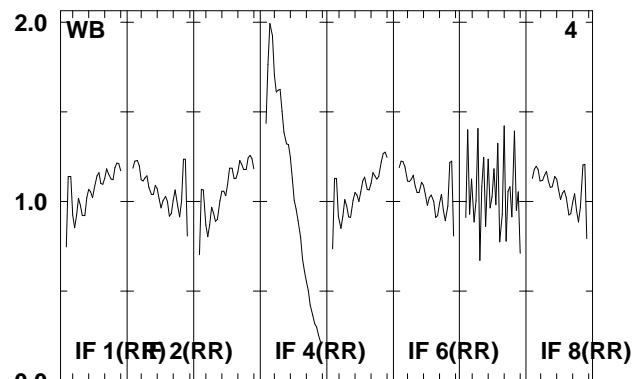
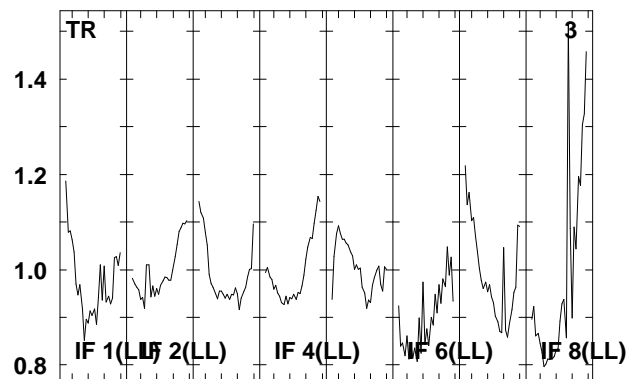
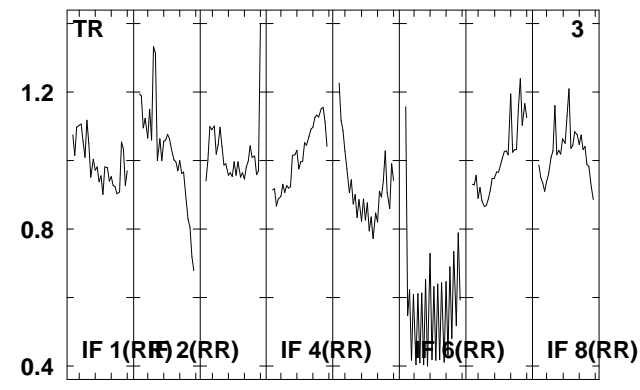
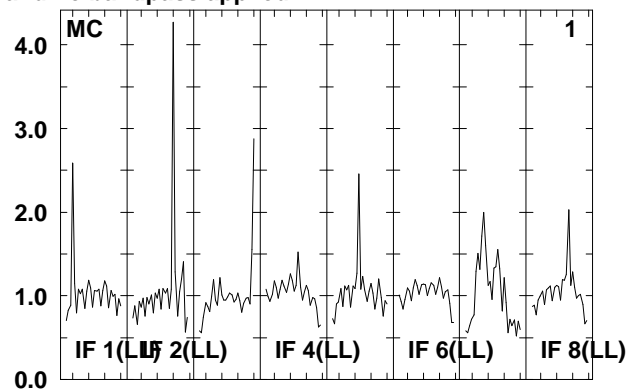
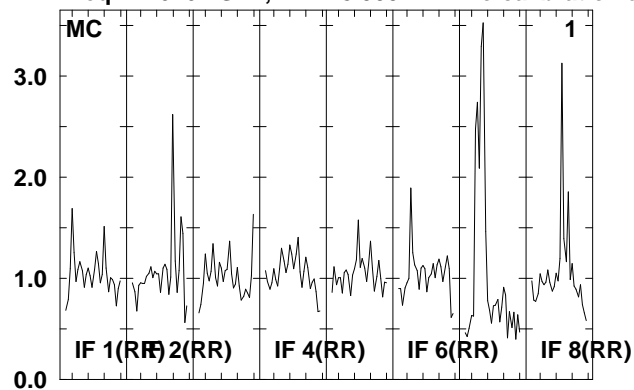

Lower frame: Real Jy  
Total-power spectrum Antenna: \*  
Timerange: 00/06:05:03 to 00/06:08:29

Plot file version 22 created 16-FEB-2009 12:46:00

J121839. RSF02.UVDATA.1

Freq = 1.6267 GHz, Bw = 8.000 MH No calibration applied and no bandpass applied

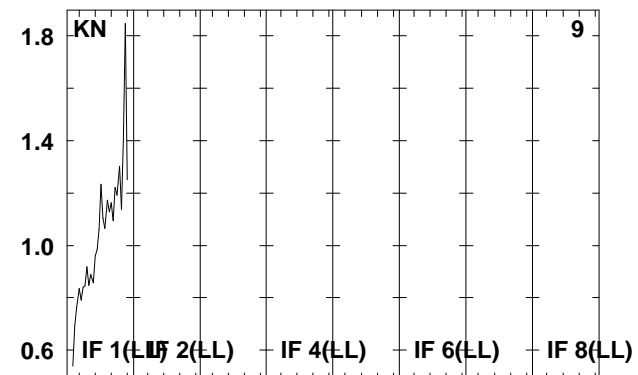
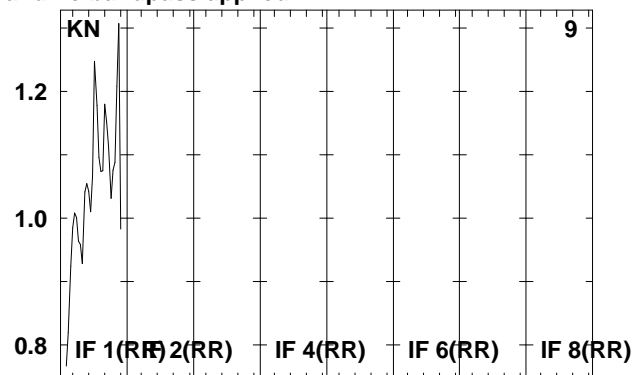
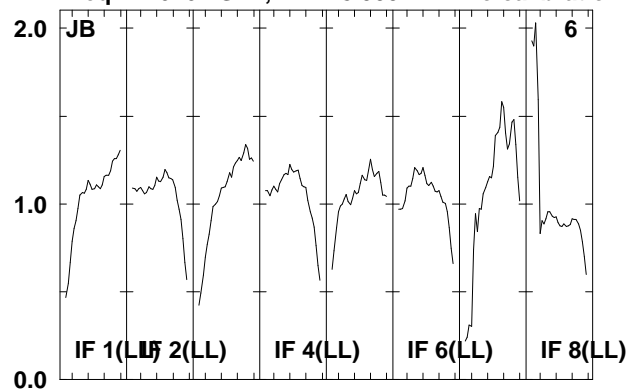

Lower frame: Real Jy  
Total-power spectrum Antenna: \*  
Timerange: 00/06:05:03 to 00/06:08:29

Plot file version 23 created 16-FEB-2009 12:46:01

J1217+30 RSF02.UVDATA.1

Freq = 1.6267 GHz, Bw = 8.000 MH No calibration applied and no bandpass applied

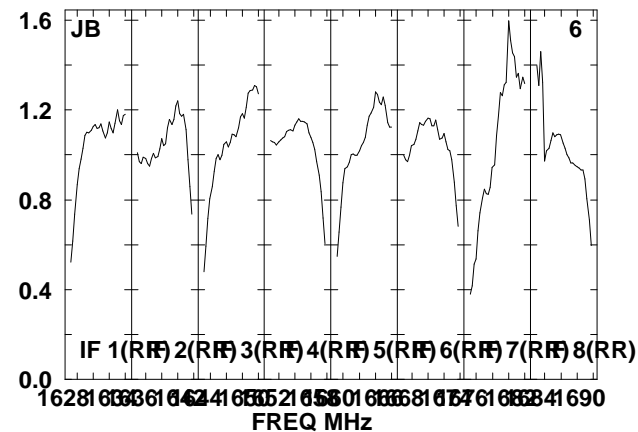
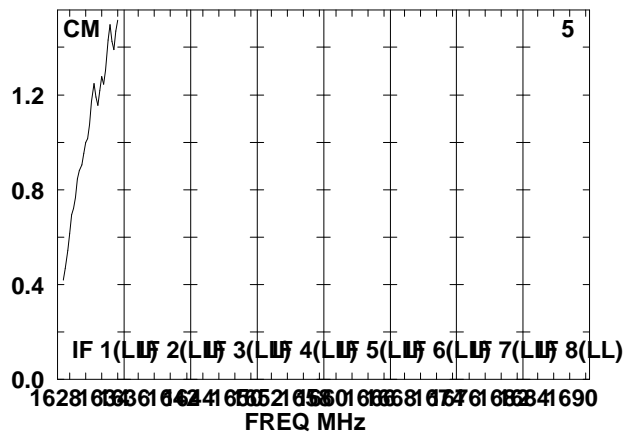
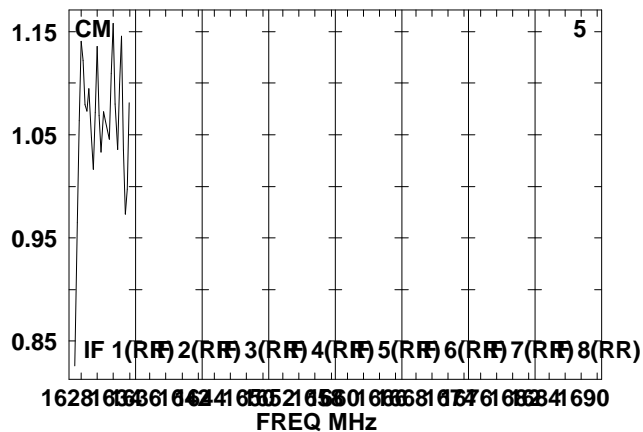
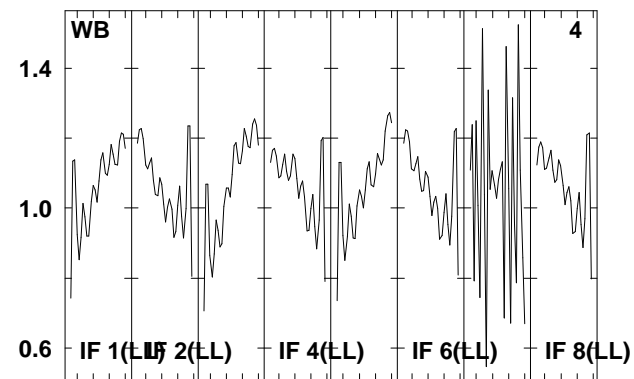
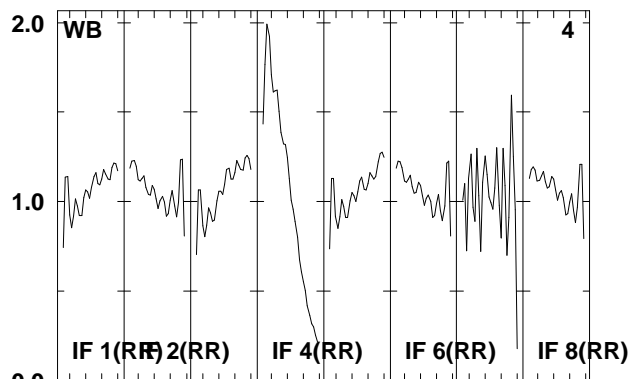
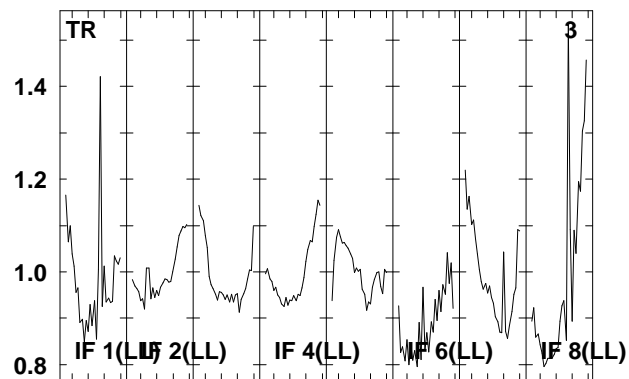
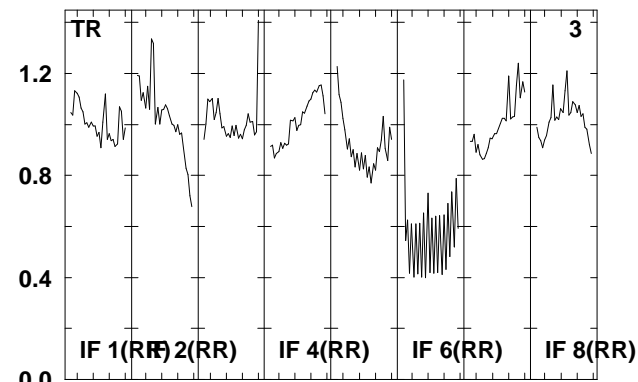
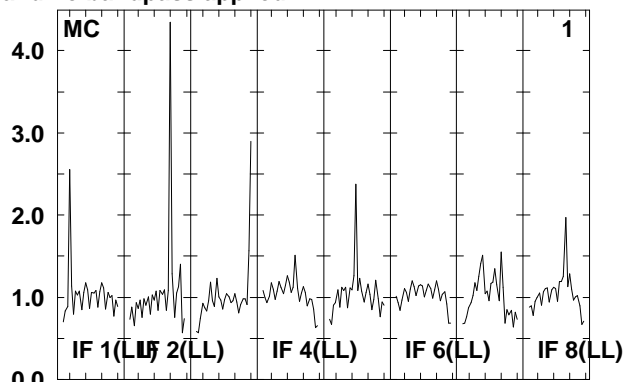
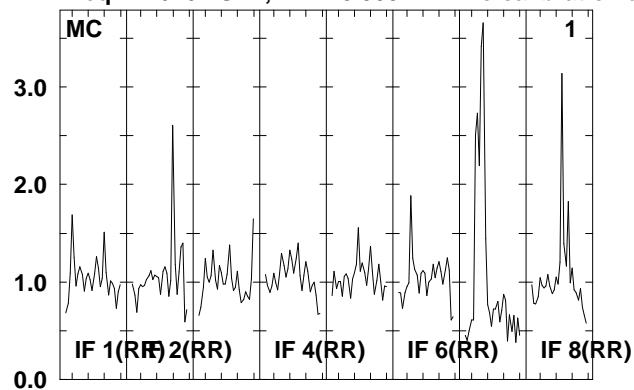

Lower frame: Real Jy  
Total-power spectrum Antenna: \*  
Timerange: 00/06:08:31 to 00/06:09:49

Plot file version 24 created 16-FEB-2009 12:46:02  
J1217+30 RSF02.UVDATA.1  
Freq = 1.6267 GHz, Bw = 8.000 MH No calibration applied and no bandpass applied

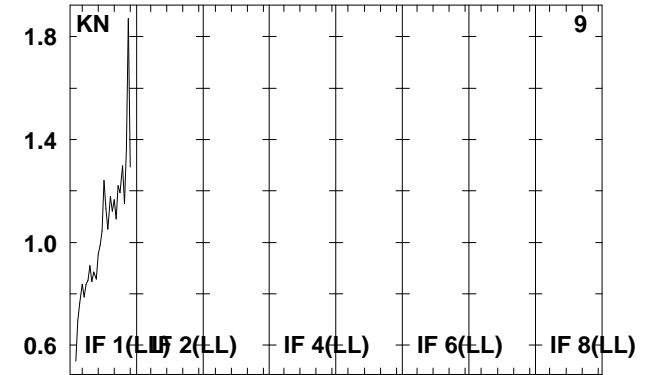
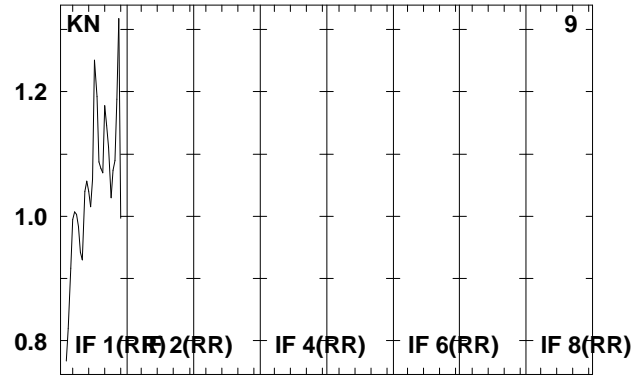
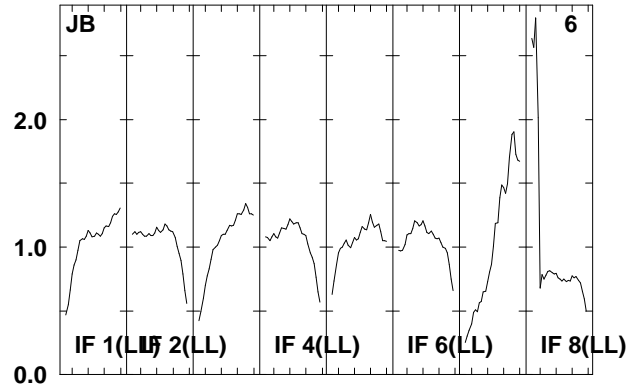

Lower frame: Real Jy  
Total-power spectrum Antenna: \*  
Timerange: 00/06:08:31 to 00/06:09:49



Plot file version 25 created 16-FEB-2009 12:46:03

J121839. RSF02.UVDATA.1

Freq = 1.6267 GHz, Bw = 8.000 MH No calibration applied and no bandpass applied

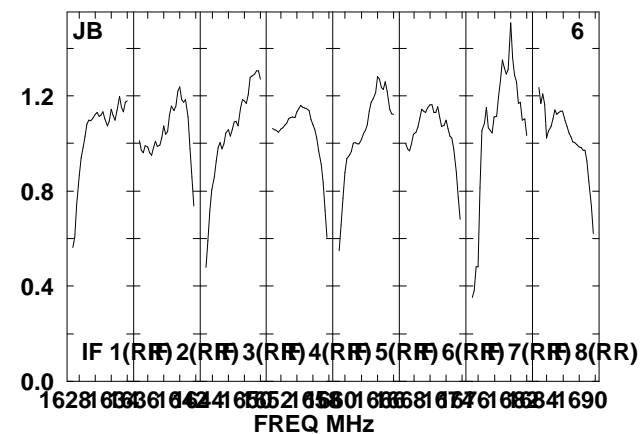
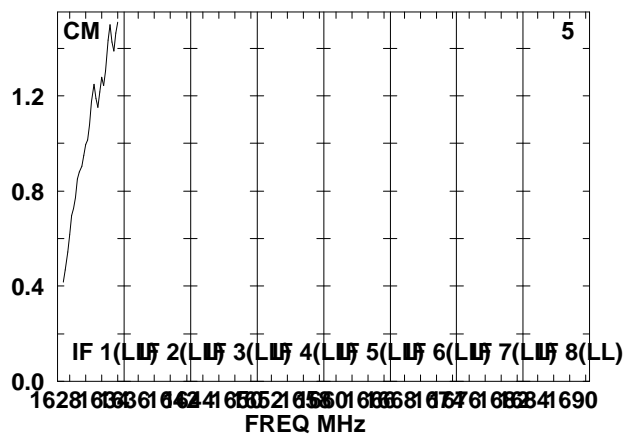
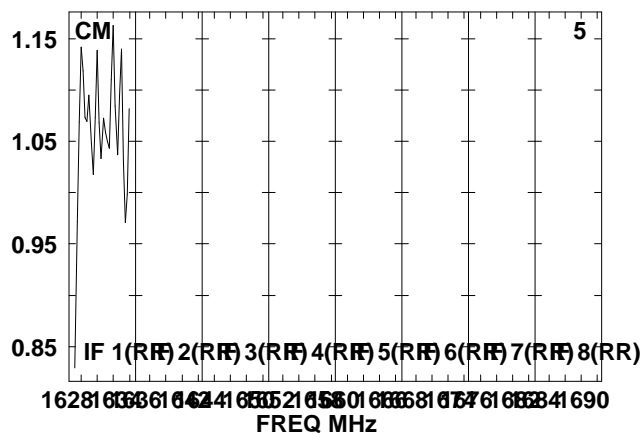
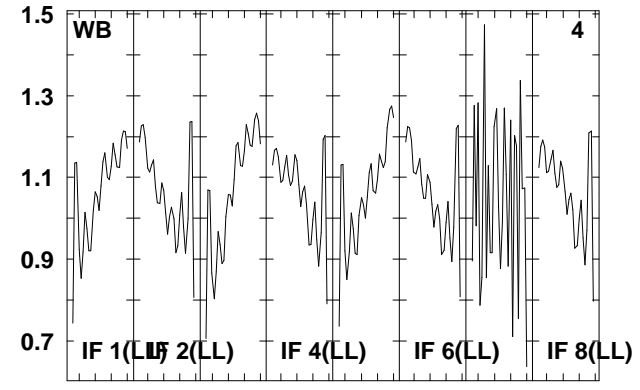
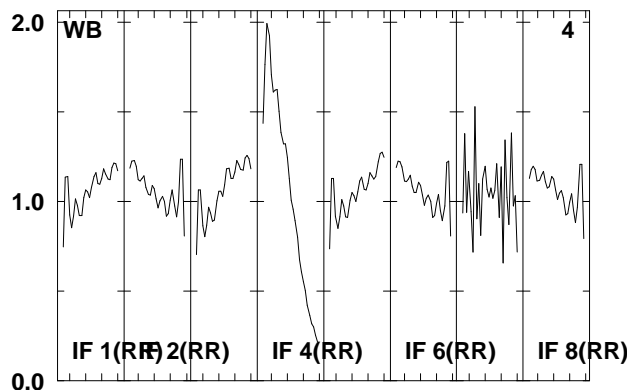
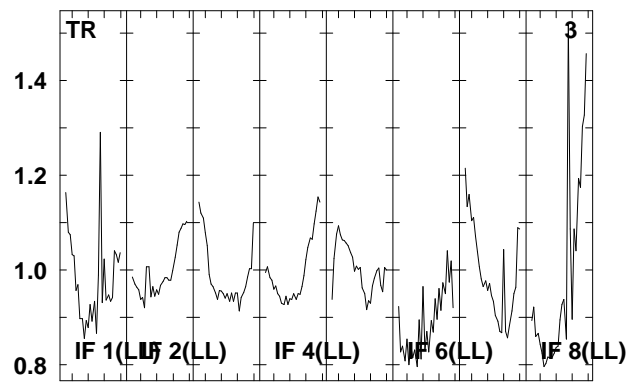
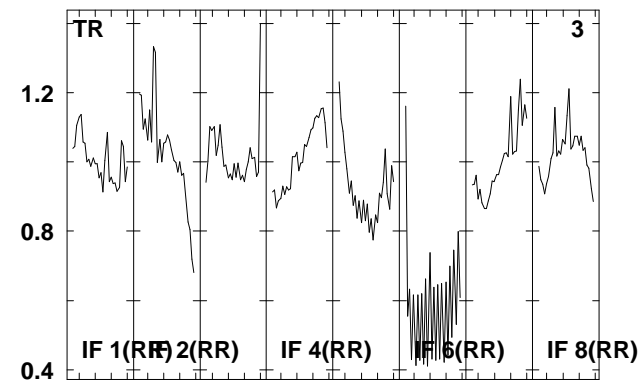
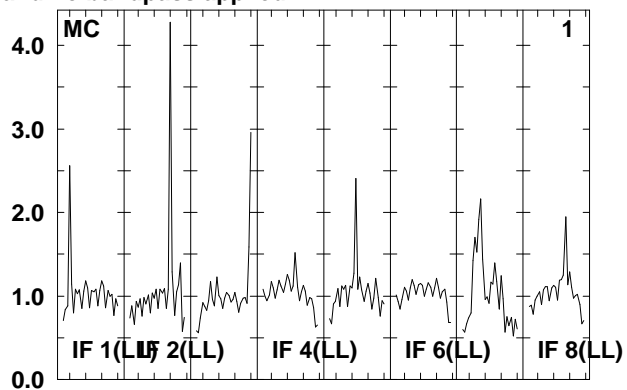
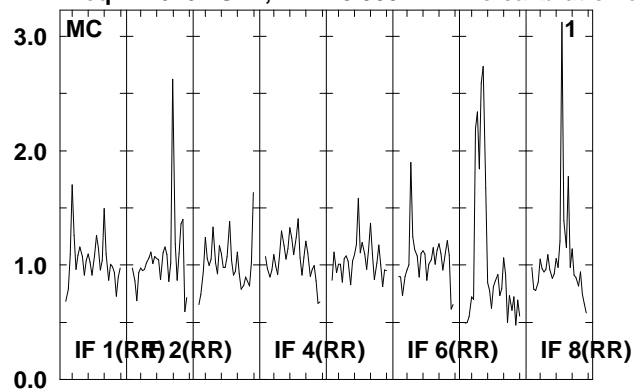

Lower frame: Real Jy  
Total-power spectrum Antenna: \*  
Timerange: 00/06:09:51 to 00/06:13:19

Plot file version 26 created 16-FEB-2009 12:46:03

J121839. RSF02.UVDATA.1

Freq = 1.6267 GHz, Bw = 8.000 MH No calibration applied and no bandpass applied

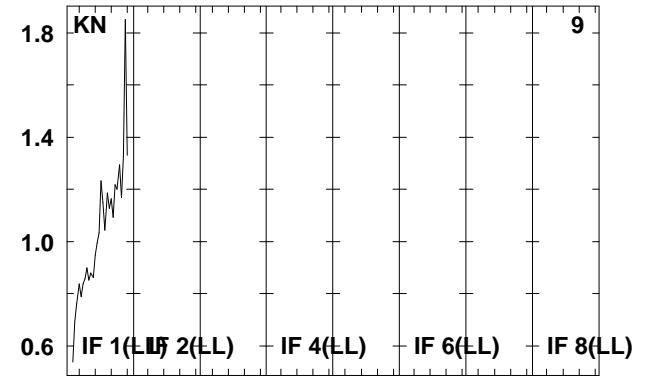
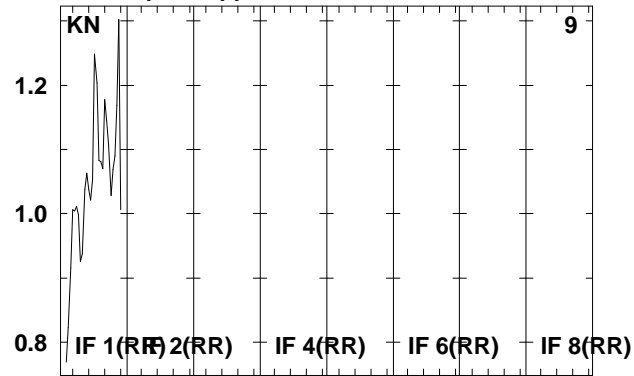
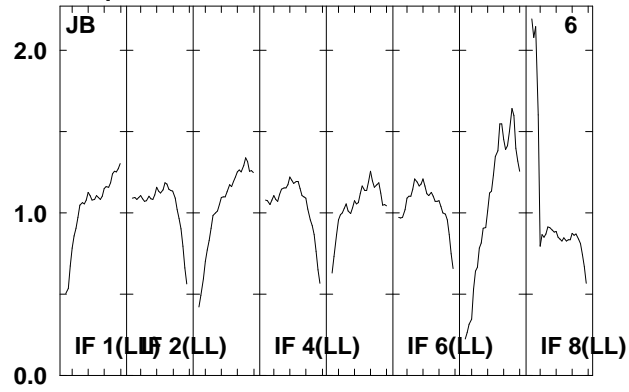

Lower frame: Real Jy  
Total-power spectrum Antenna: \*  
Timerange: 00/06:09:51 to 00/06:13:19

Plot file version 27 created 16-FEB-2009 12:46:04

J1217+30 RSF02.UVDATA.1

Freq = 1.6267 GHz, Bw = 8.000 MH No calibration applied and no bandpass applied

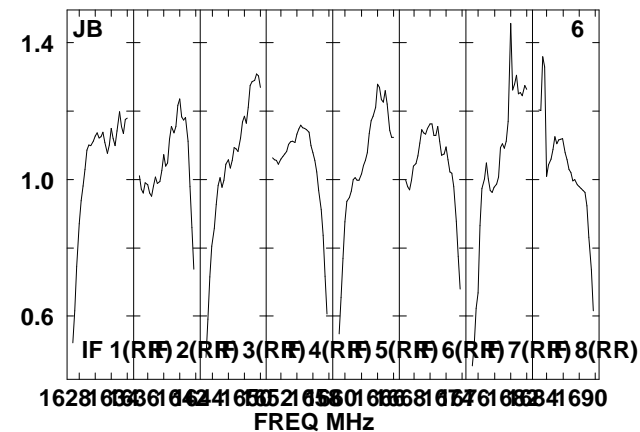
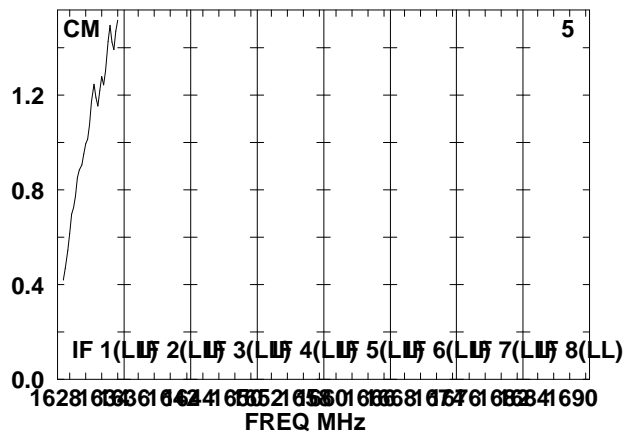
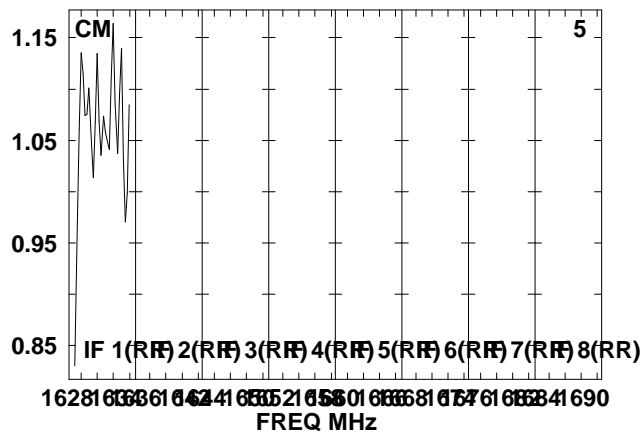
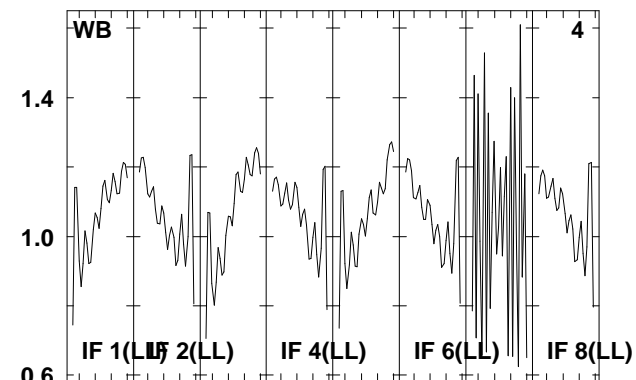
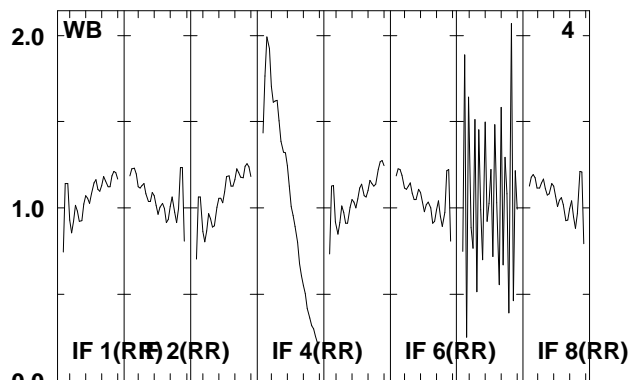
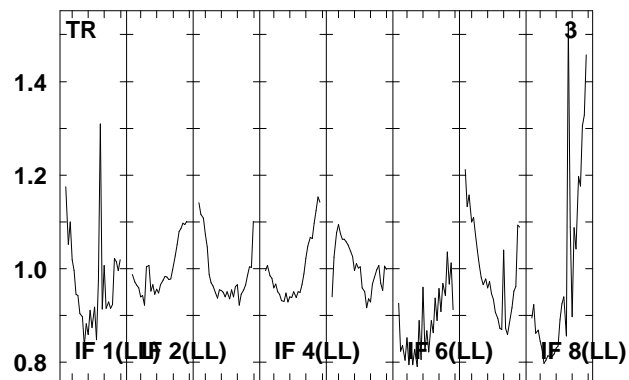
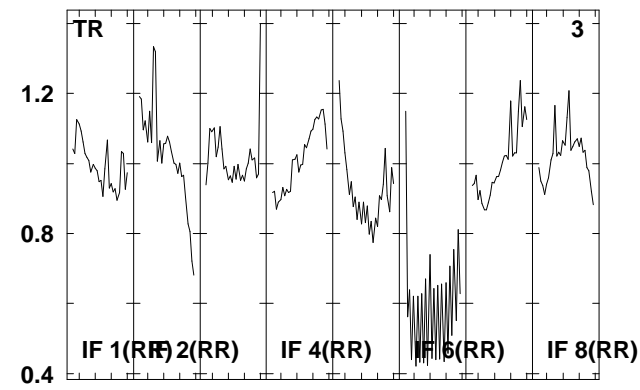
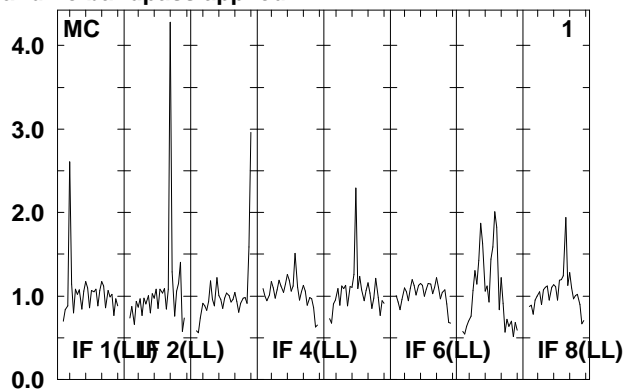
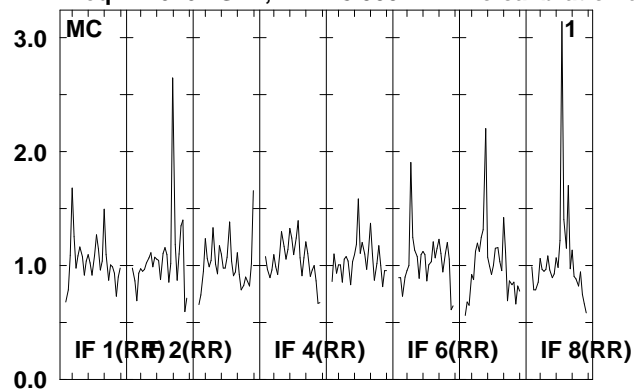

Lower frame: Real Jy  
Total-power spectrum Antenna: \*  
Timerange: 00/06:14:01 to 00/06:15:01

Plot file version 28 created 16-FEB-2009 12:46:05  
J1217+30 RSF02.UVDATA.1  
Freq = 1.6267 GHz, Bw = 8.000 MH No calibration applied and no bandpass applied

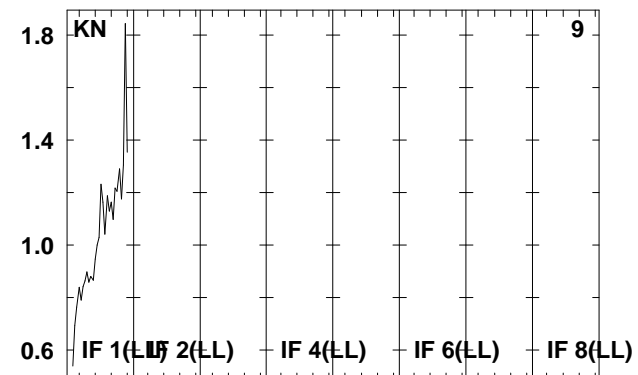
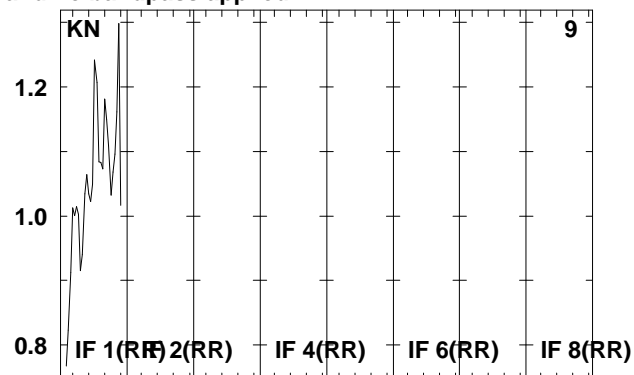
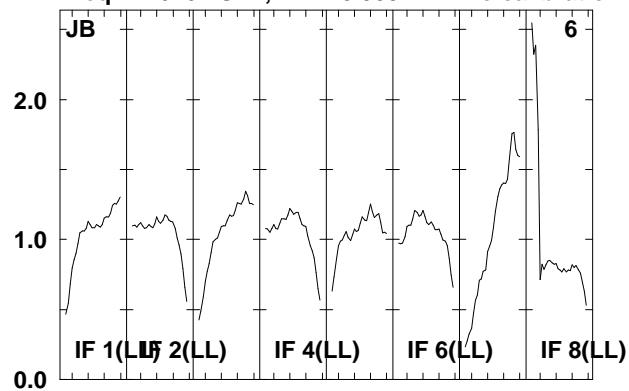

Lower frame: Real Jy  
Total-power spectrum Antenna: \*  
Timerange: 00/06:14:01 to 00/06:15:01

Plot file version 29 created 16-FEB-2009 12:46:05

J121839. RSF02.UVDATA.1

Freq = 1.6267 GHz, Bw = 8.000 MH No calibration applied and no bandpass applied

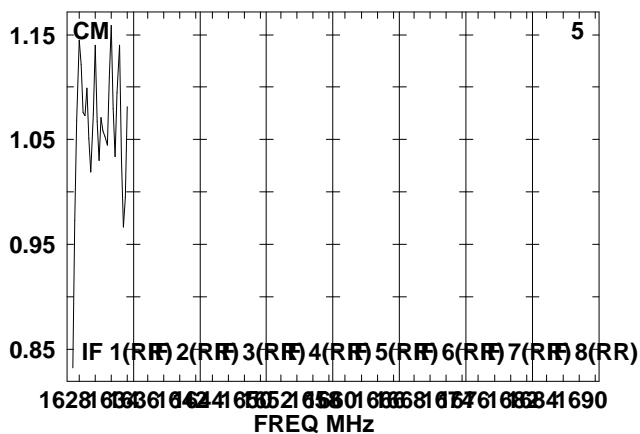
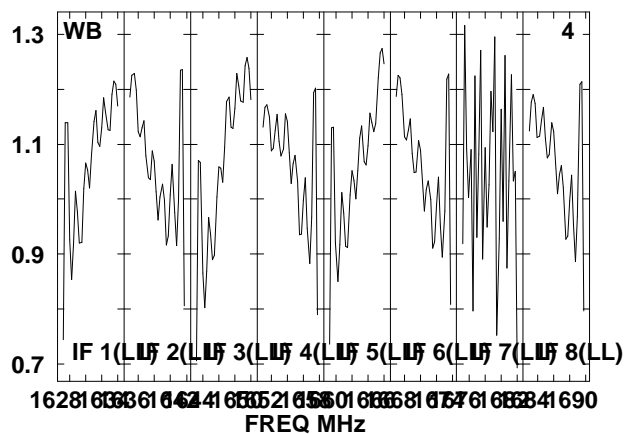
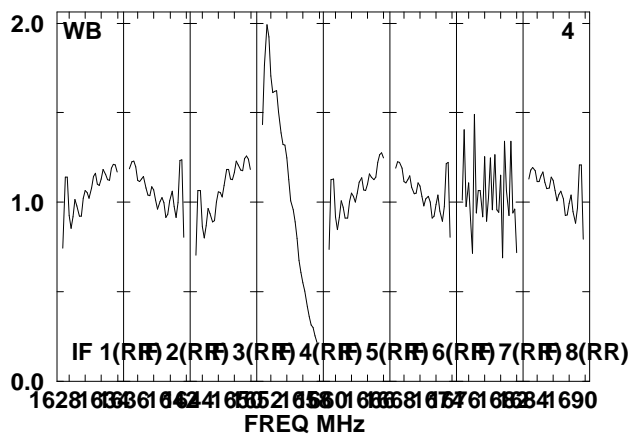
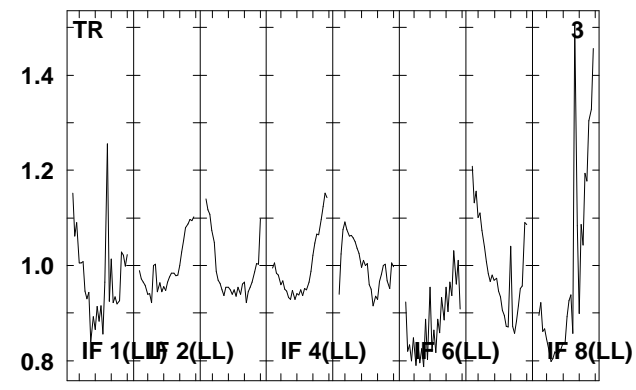
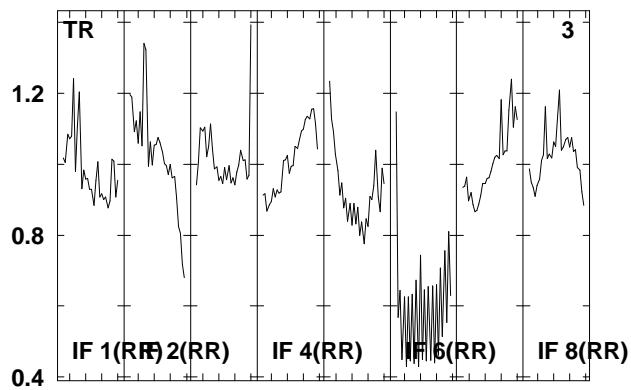
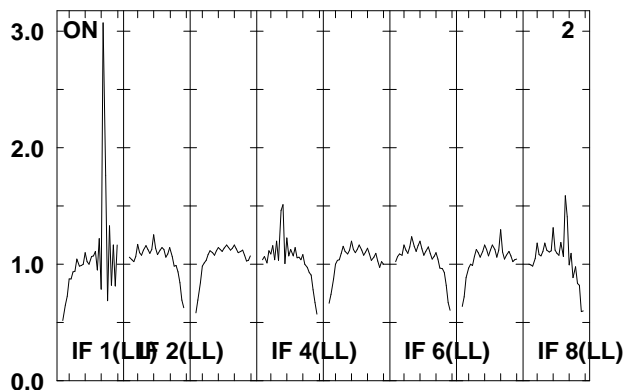
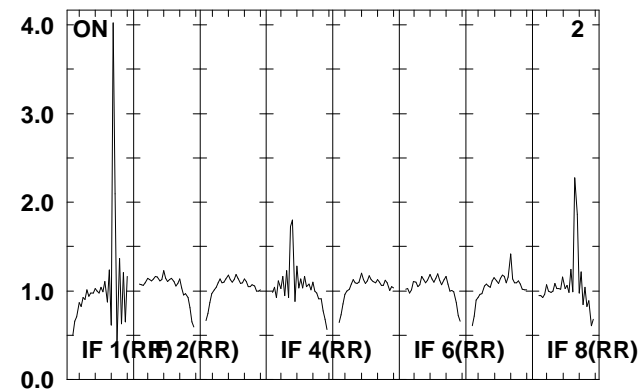
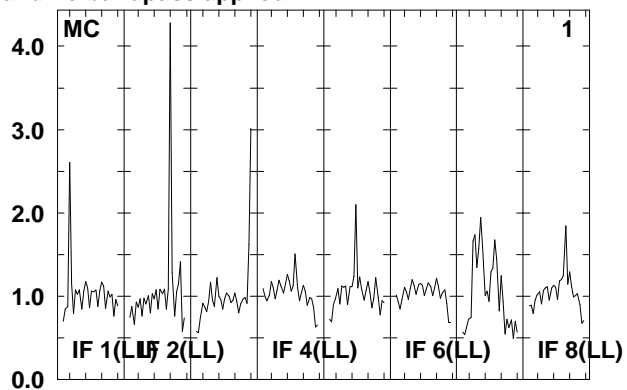
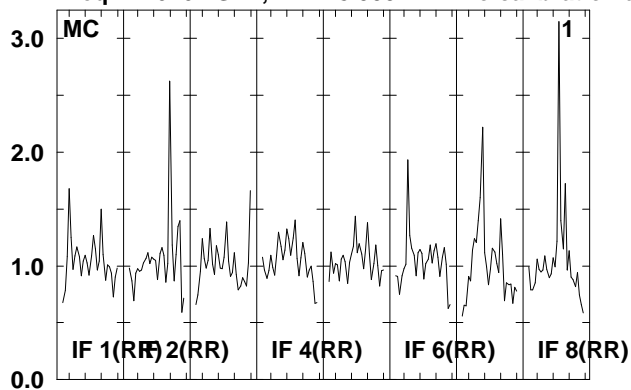

Lower frame: Real Jy  
Total-power spectrum Antenna: \*  
Timerange: 00/06:15:03 to 00/06:18:29

Plot file version 30 created 16-FEB-2009 12:46:06

J121839. RSF02.UVDATA.1

Freq = 1.6267 GHz, Bw = 8.000 MH No calibration applied and no bandpass applied

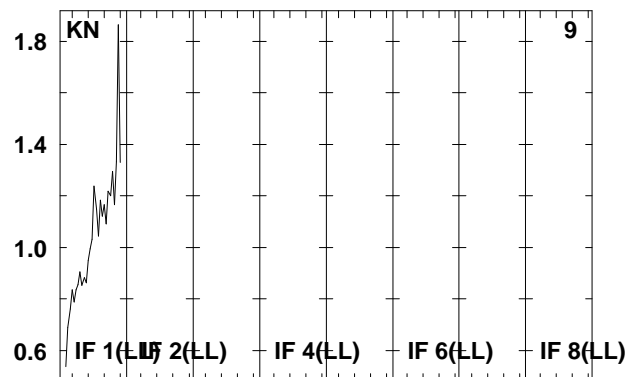
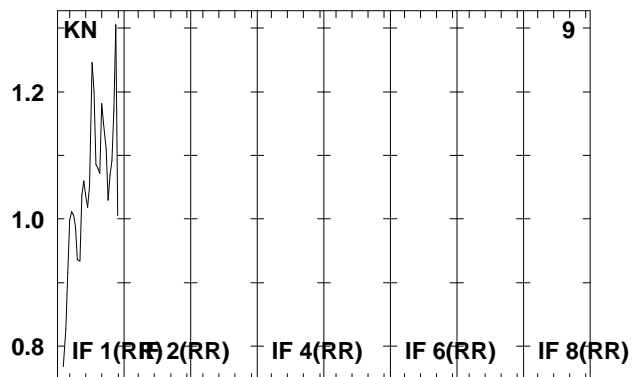
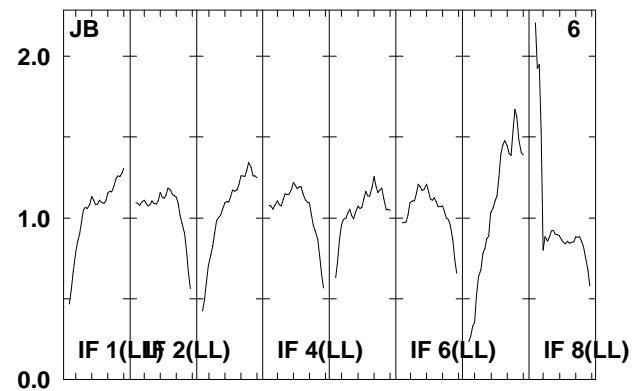
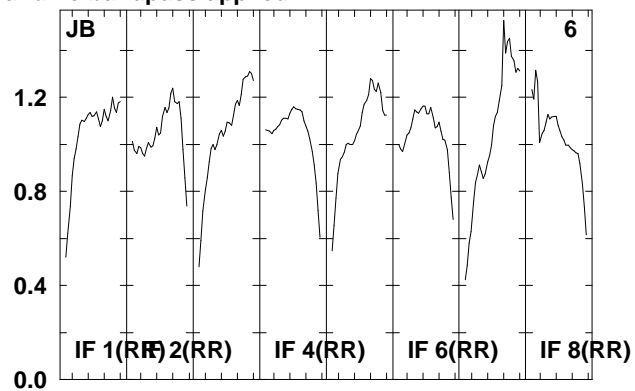
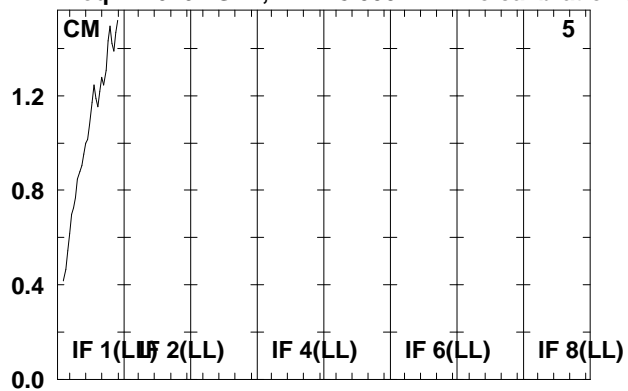

Lower frame: Real Jy  
Total-power spectrum Antenna: \*  
Timerange: 00/06:15:03 to 00/06:18:29

Plot file version 31 created 16-FEB-2009 12:46:07

J1217+30 RSF02.UVDATA.1

Freq = 1.6267 GHz, Bw = 8.000 MH No calibration applied and no bandpass applied

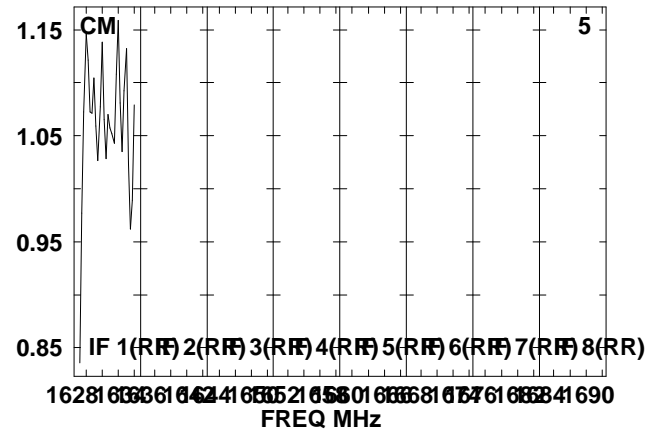
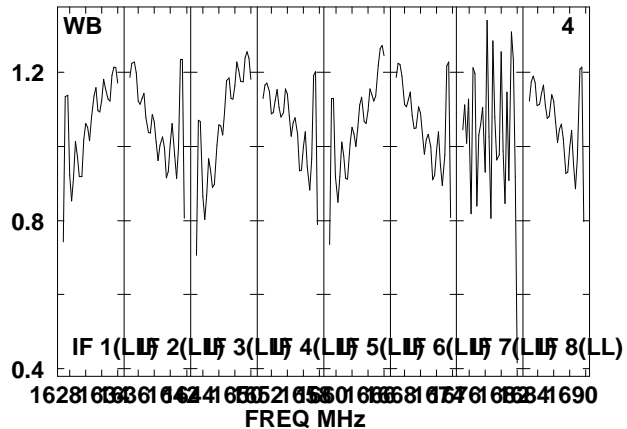
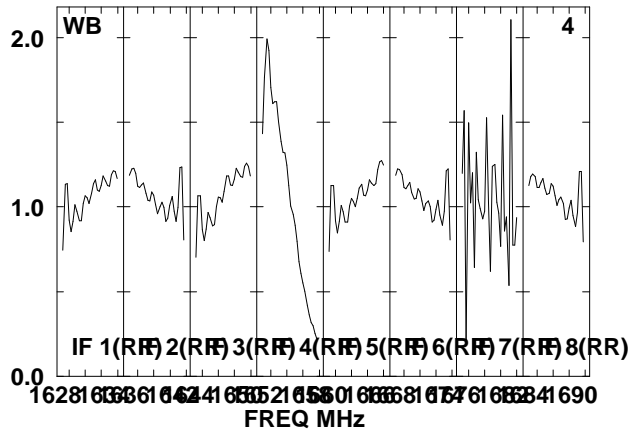
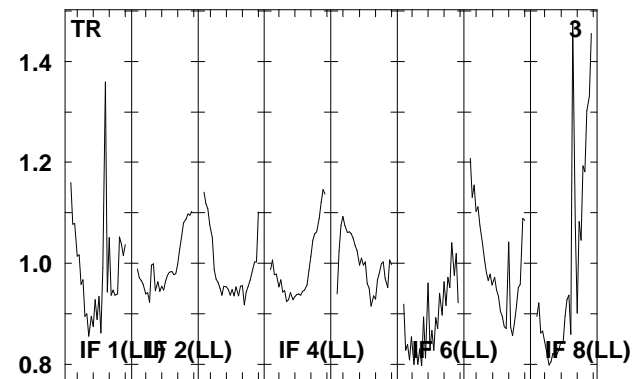
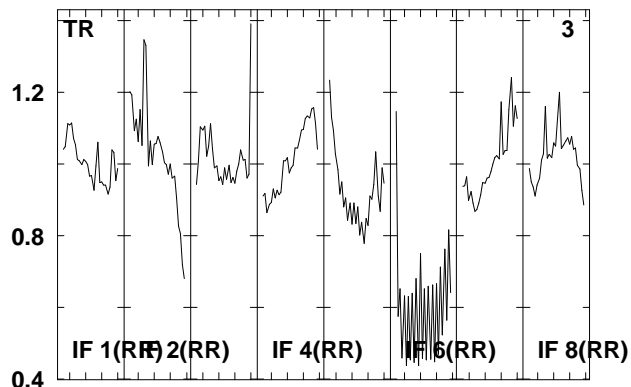
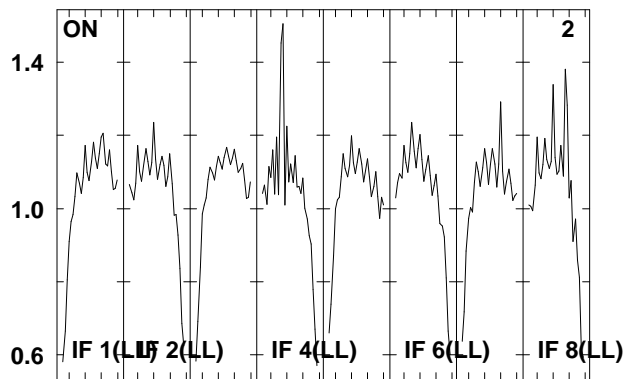
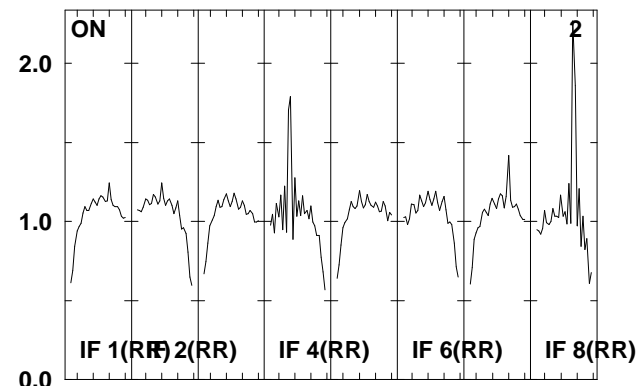
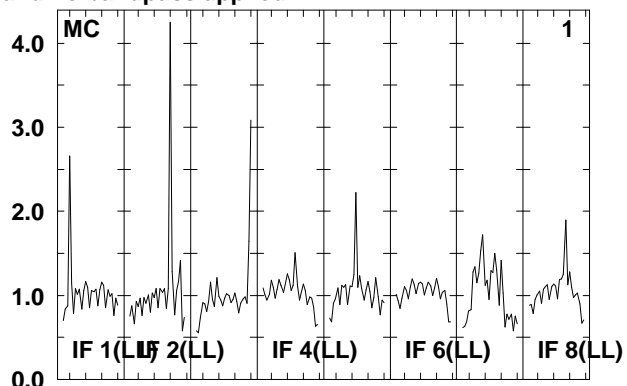
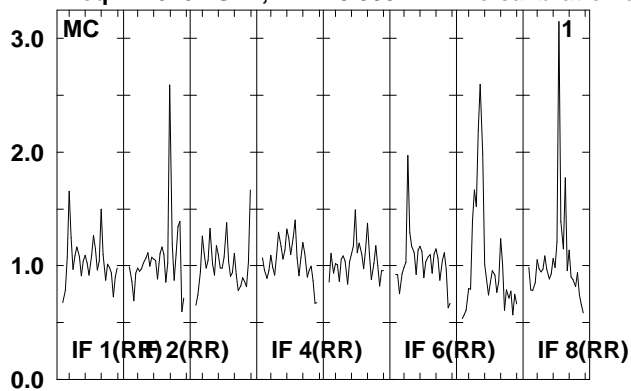

Lower frame: Real Jy  
Total-power spectrum Antenna: \*  
Timerange: 00/06:18:31 to 00/06:19:49

Plot file version 32 created 16-FEB-2009 12:46:07

J1217+30 RSF02.UVDATA.1

Freq = 1.6267 GHz, Bw = 8.000 MH No calibration applied and no bandpass applied

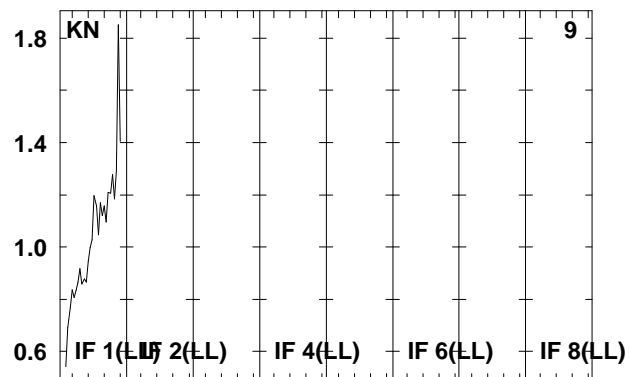
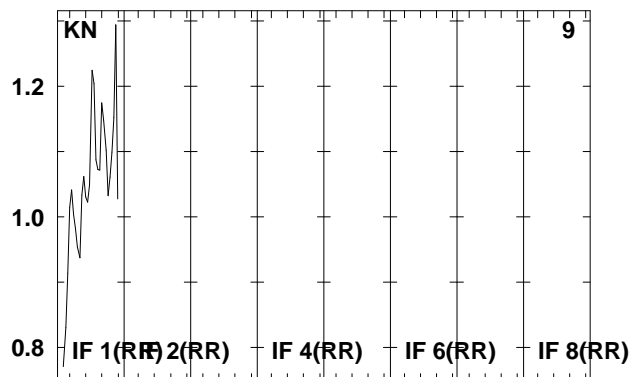
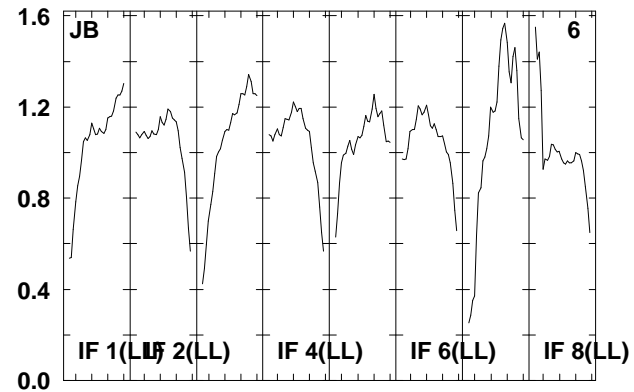
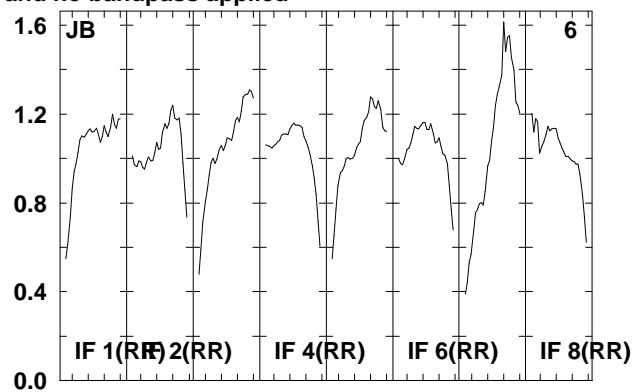
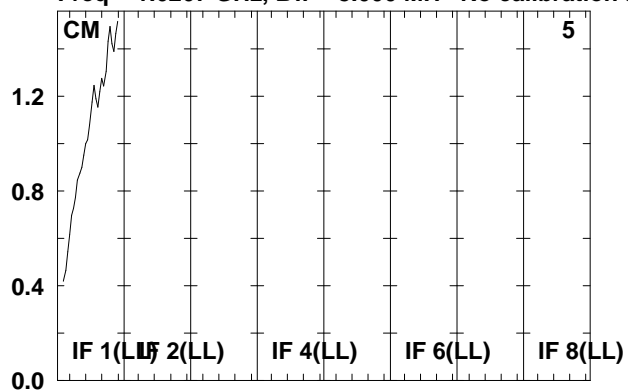

Lower frame: Real Jy  
Total-power spectrum Antenna: \*  
Timerange: 00/06:18:31 to 00/06:19:49



Plot file version 33 created 16-FEB-2009 12:46:08

J121839. RSF02.UVDATA.1

Freq = 1.6267 GHz, Bw = 8.000 MH No calibration applied and no bandpass applied

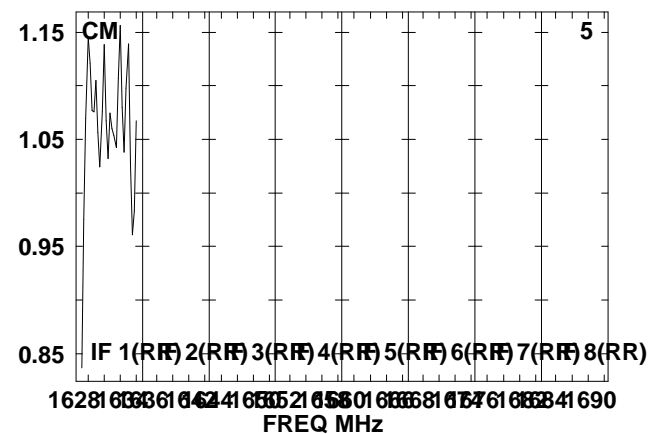
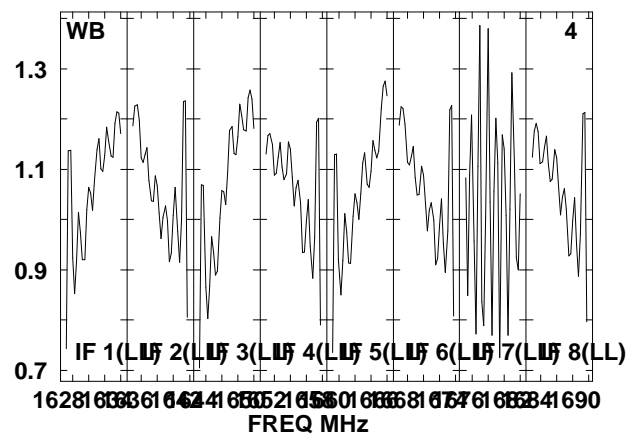
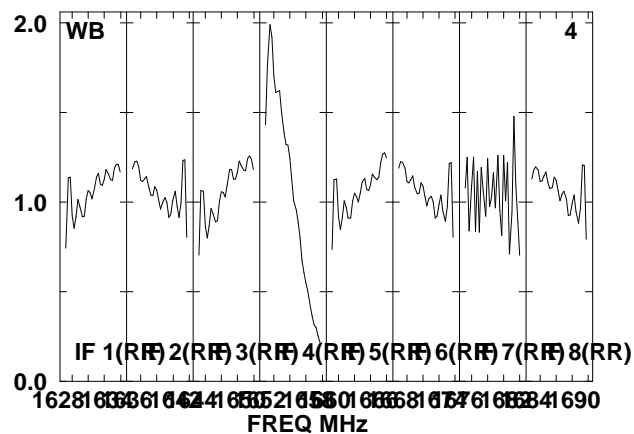
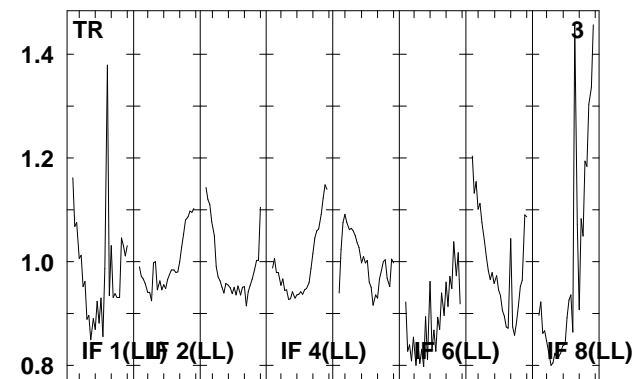
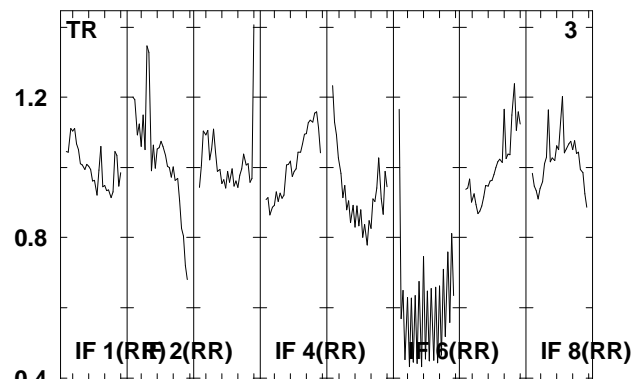
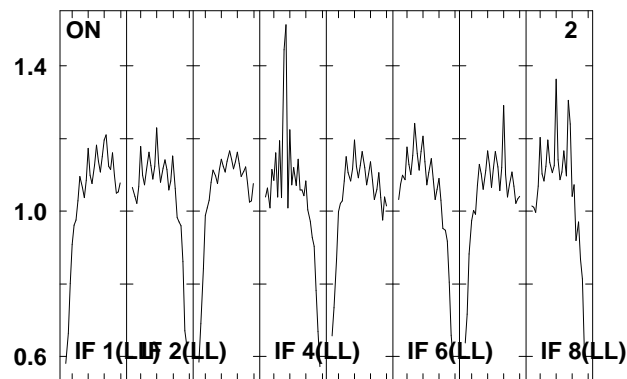
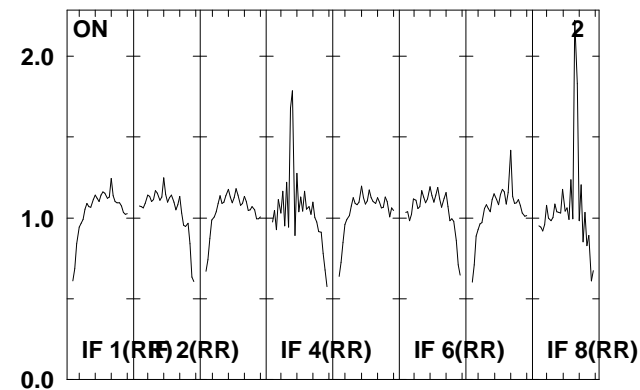
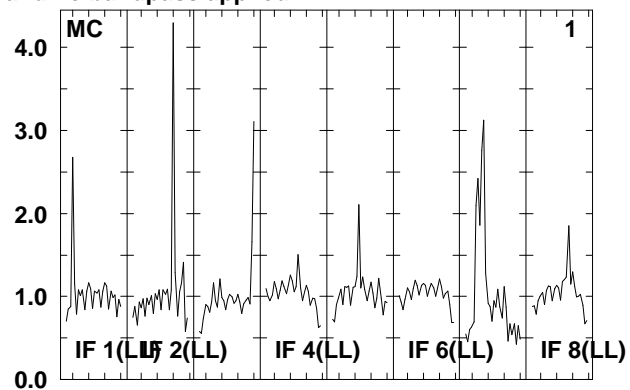
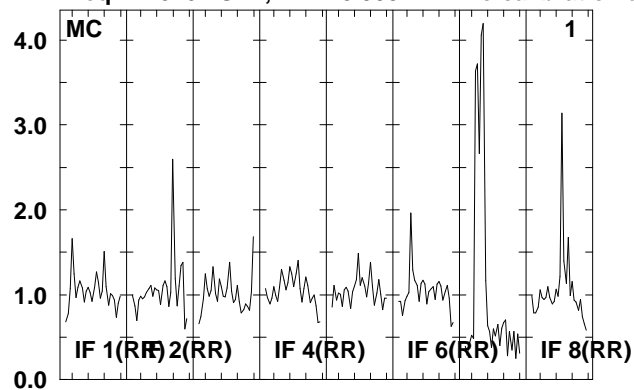

Lower frame: Real Jy  
Total-power spectrum Antenna: \*  
Timerange: 00/06:19:51 to 00/06:23:19

Plot file version 34 created 16-FEB-2009 12:46:09

J121839. RSF02.UVDATA.1

Freq = 1.6267 GHz, Bw = 8.000 MH No calibration applied and no bandpass applied

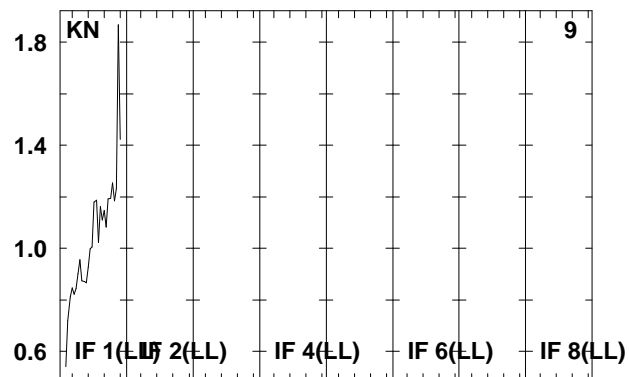
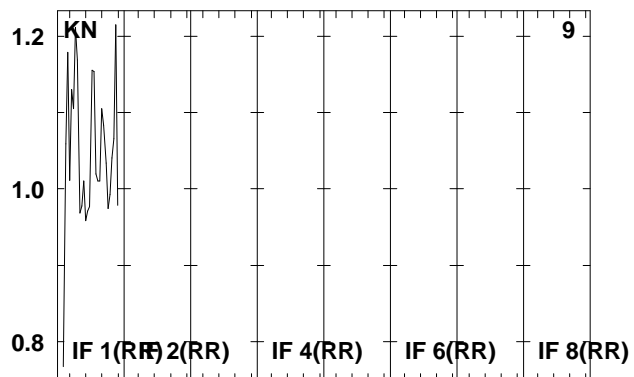
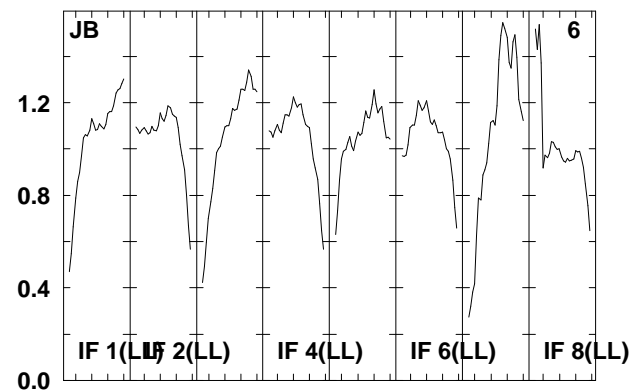
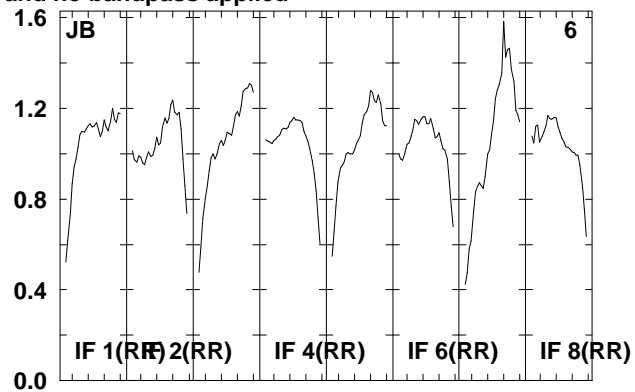
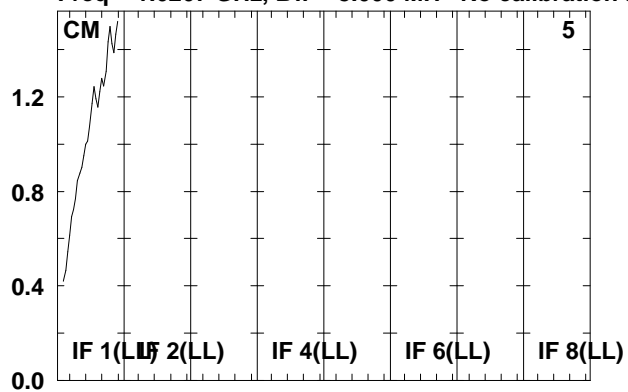

Lower frame: Real Jy  
Total-power spectrum Antenna: \*  
Timerange: 00/06:19:51 to 00/06:23:19

Plot file version 35 created 16-FEB-2009 12:46:10

J1217+30 RSF02.UVDATA.1

Freq = 1.6267 GHz, Bw = 8.000 MH No calibration applied and no bandpass applied

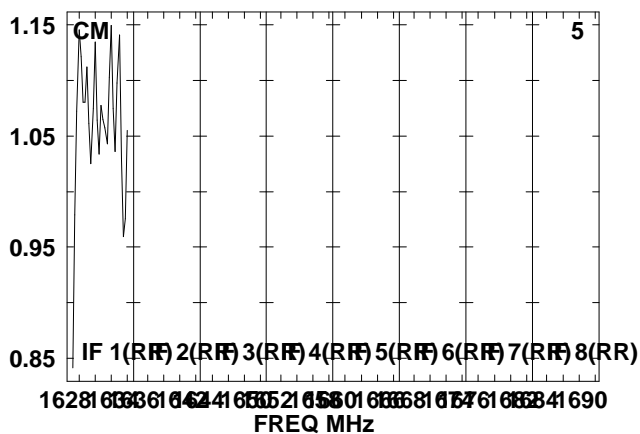
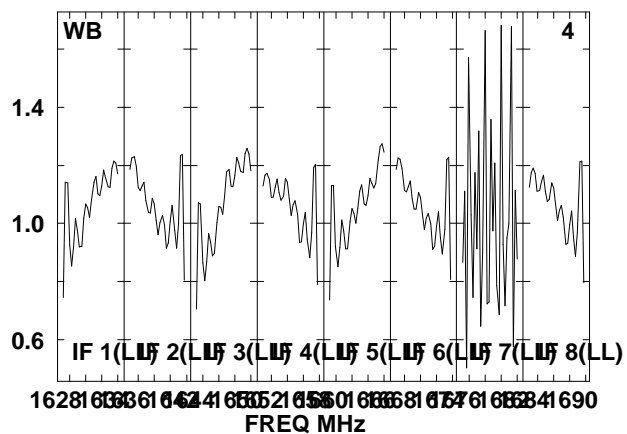
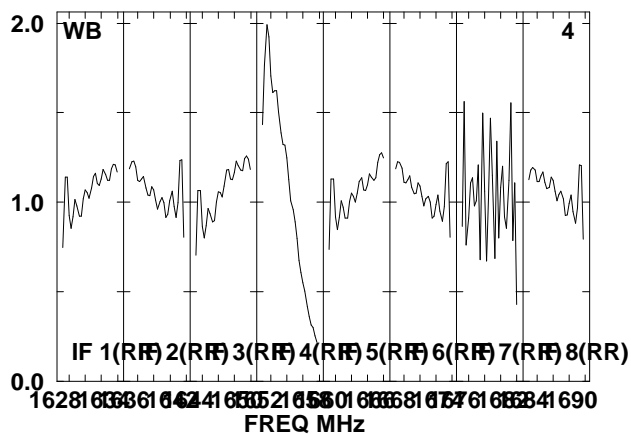
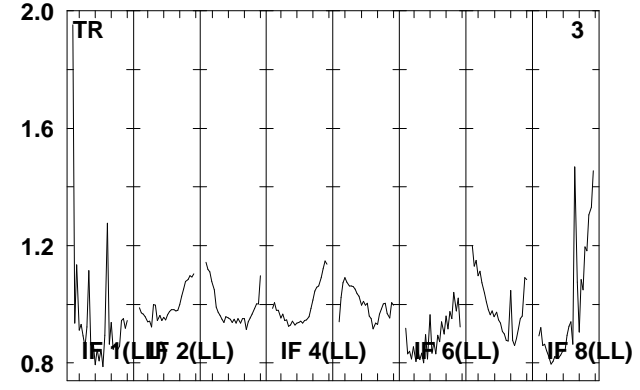
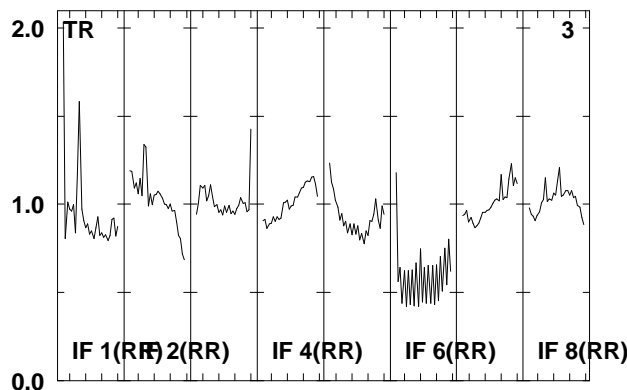
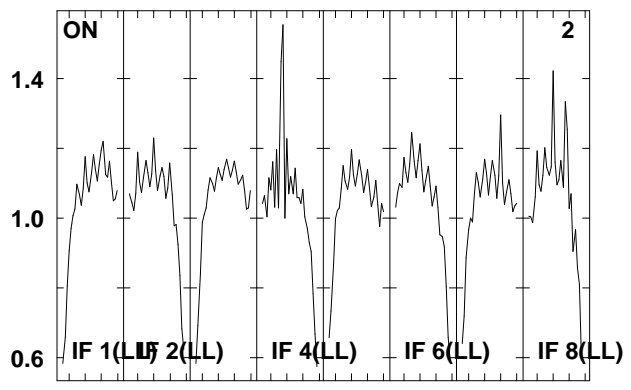
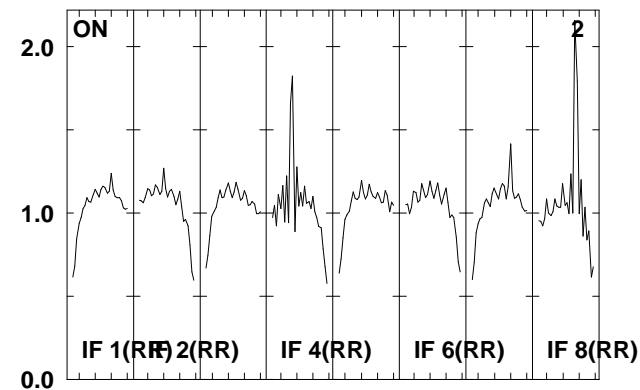
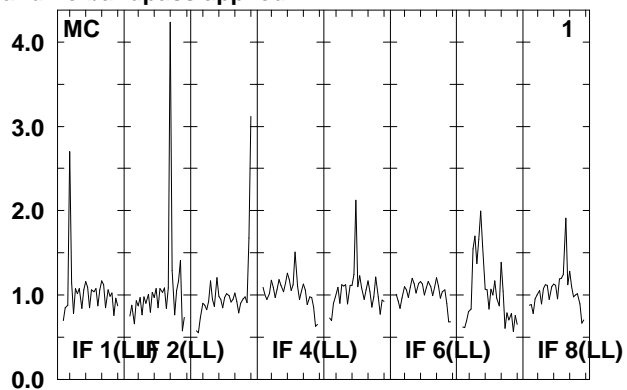
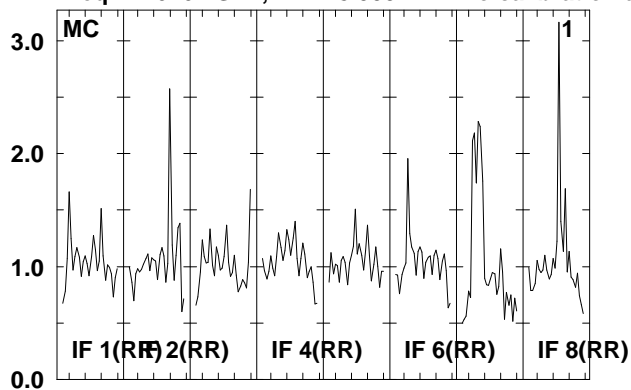

Lower frame: Real Jy

Total-power spectrum Antenna: \*

Timerange: 00/06:24:01 to 00/06:25:01

Plot file version 36 created 16-FEB-2009 12:46:10

J1217+30 RSF02.UVDATA.1

Freq = 1.6267 GHz, Bw = 8.000 MH No calibration applied and no bandpass applied

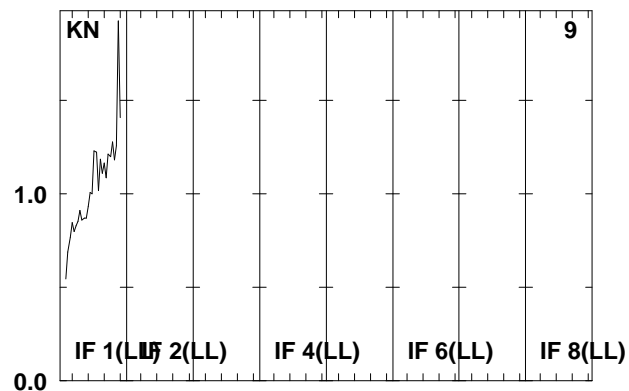
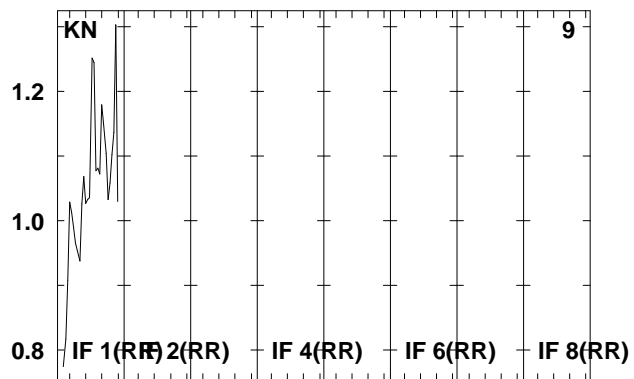
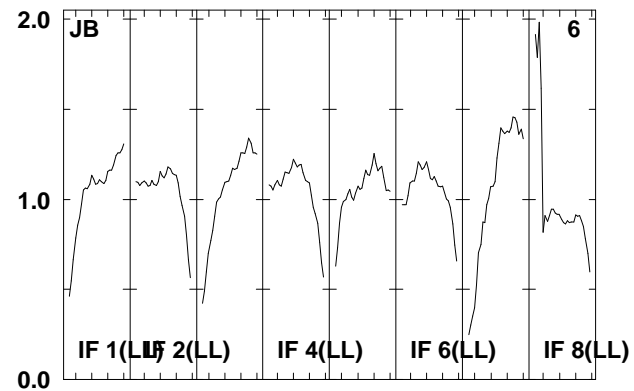
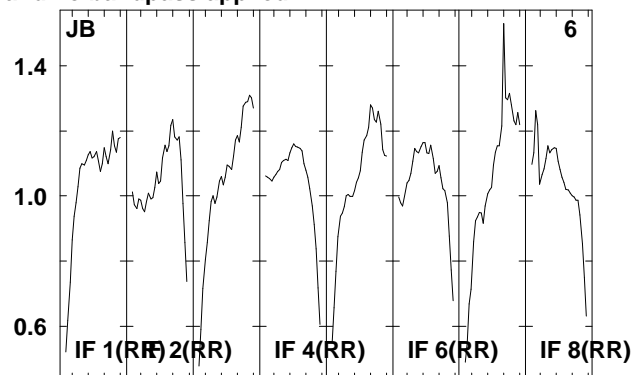
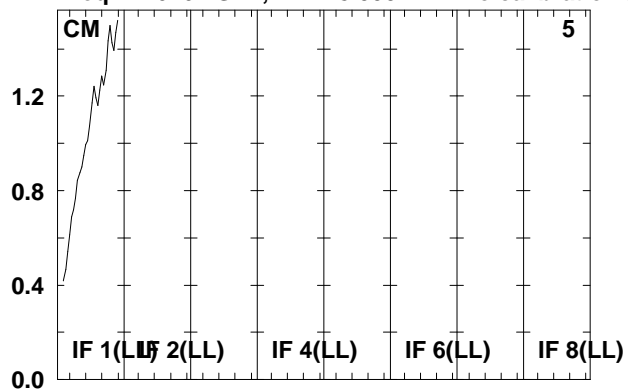

Lower frame: Real Jy  
Total-power spectrum Antenna: \*  
Timerange: 00/06:24:01 to 00/06:25:01

Plot file version 37 created 16-FEB-2009 12:46:11

J121839. RSF02.UVDATA.1

Freq = 1.6267 GHz, Bw = 8.000 MH No calibration applied and no bandpass applied

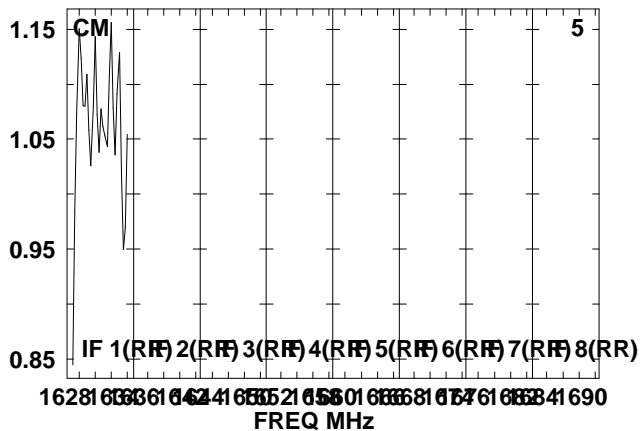
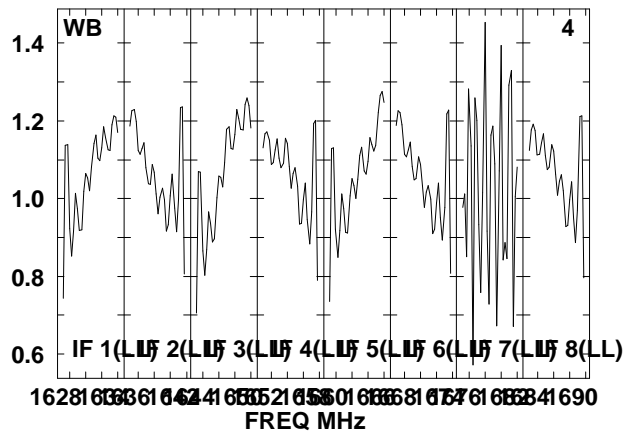
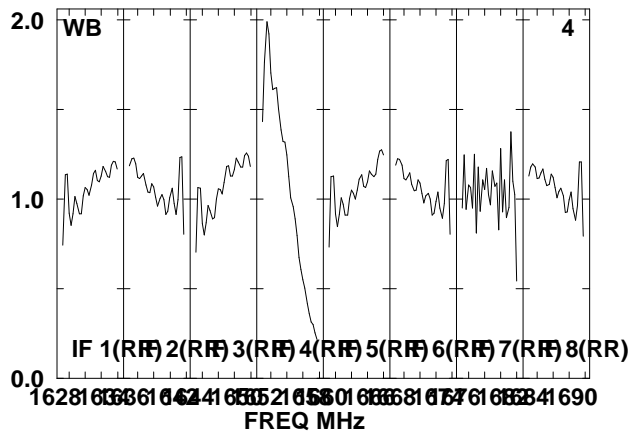
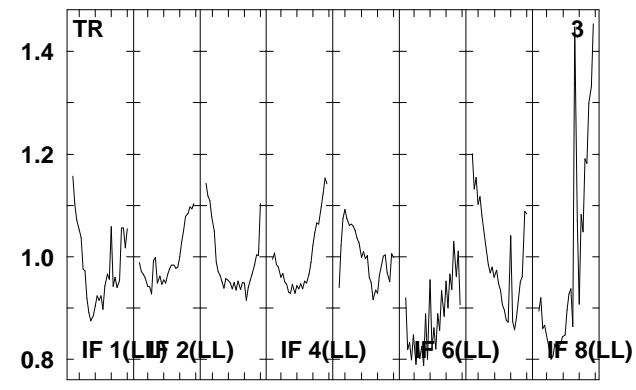
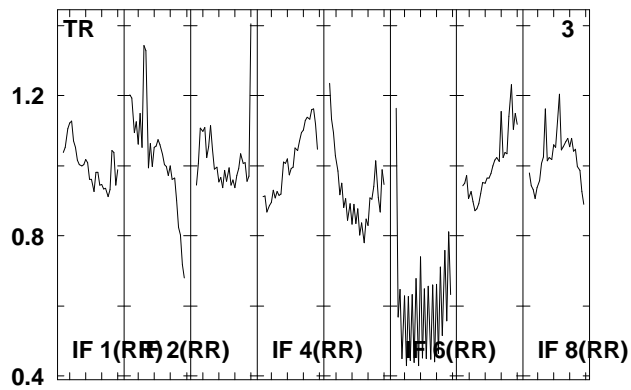
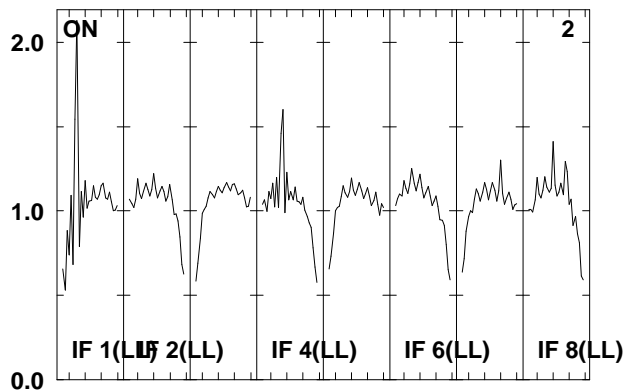
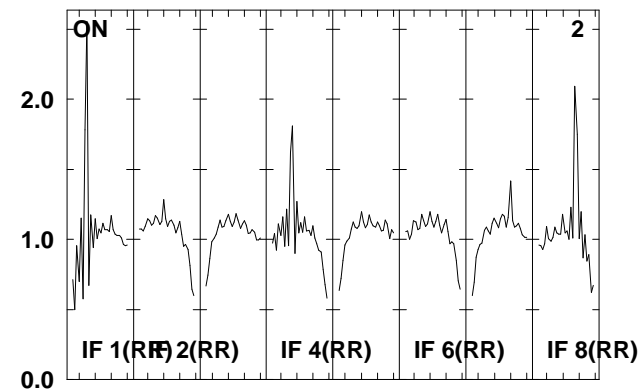
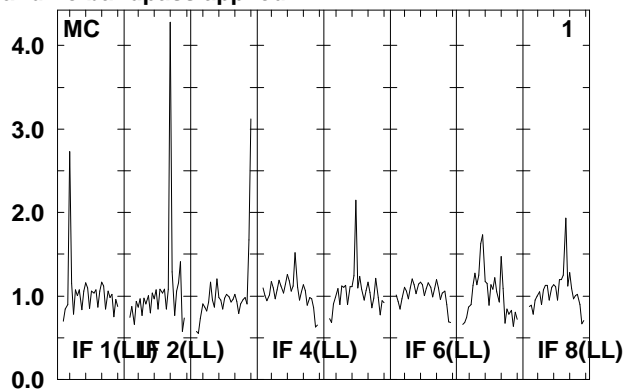
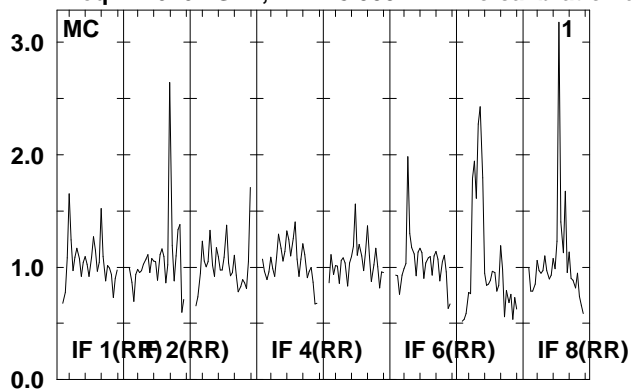

Lower frame: Real Jy

Total-power spectrum Antenna: \*

Timerange: 00/06:25:03 to 00/06:28:29

Plot file version 38 created 16-FEB-2009 12:46:11

J121839. RSF02.UVDATA.1

Freq = 1.6267 GHz, Bw = 8.000 MH No calibration applied and no bandpass applied

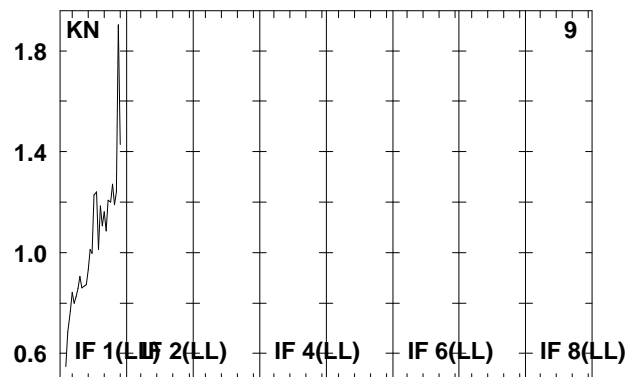
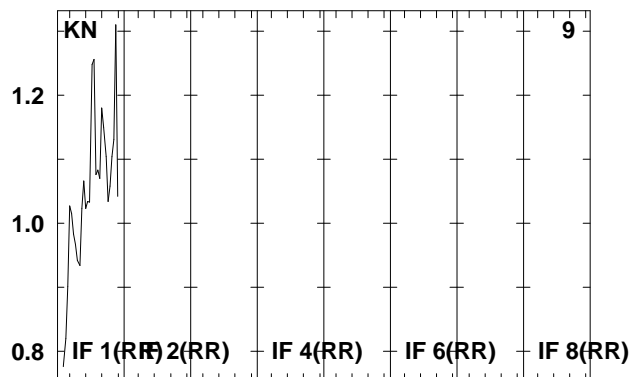
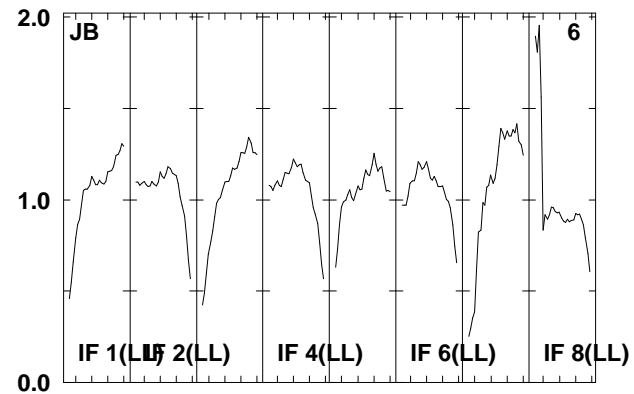
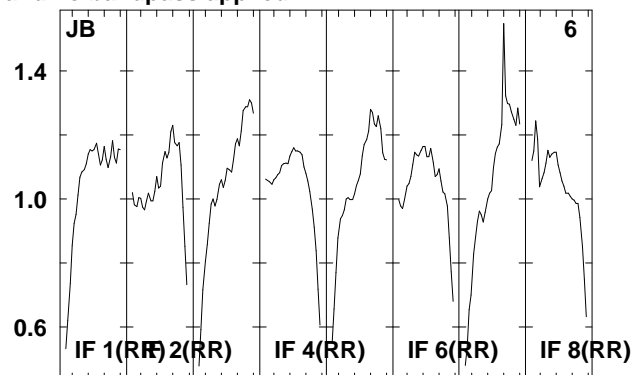
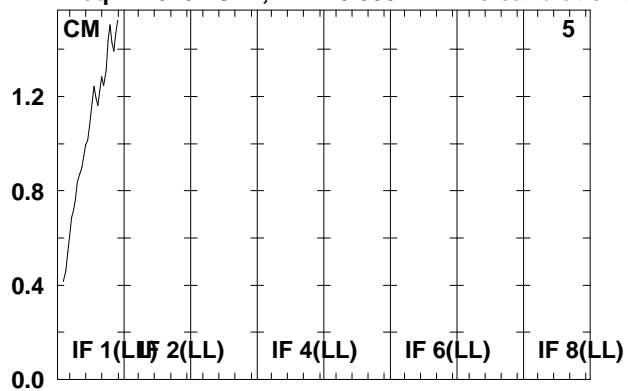

Lower frame: Real Jy  
Total-power spectrum Antenna: \*  
Timerange: 00/06:25:03 to 00/06:28:29

Plot file version 39 created 16-FEB-2009 12:46:13

J1217+30 RSF02.UVDATA.1

Freq = 1.6267 GHz, Bw = 8.000 MH No calibration applied and no bandpass applied

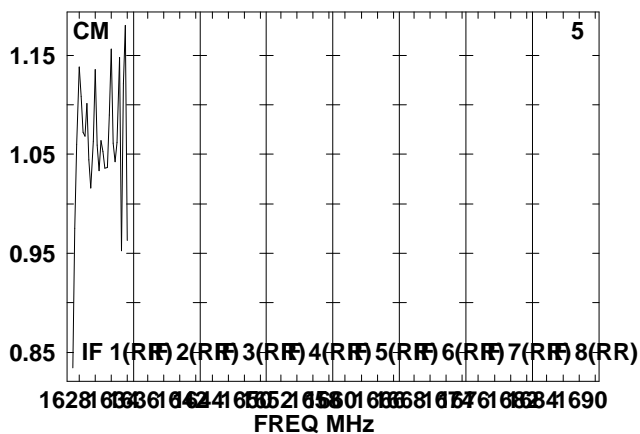
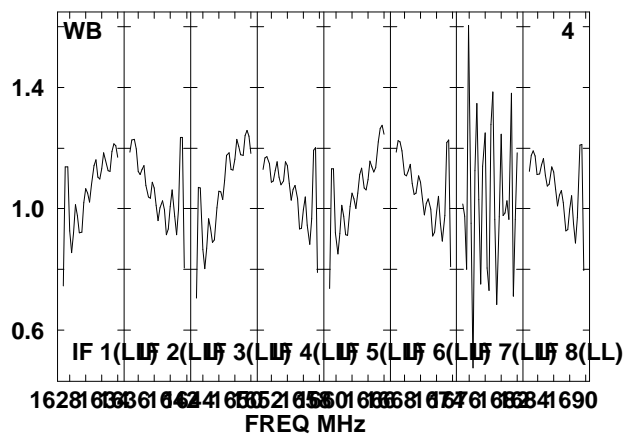
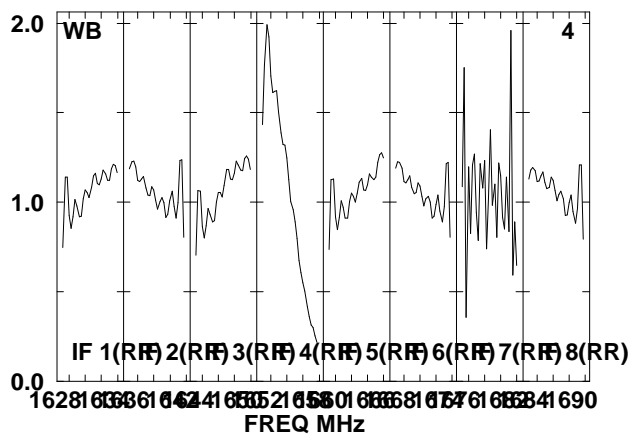
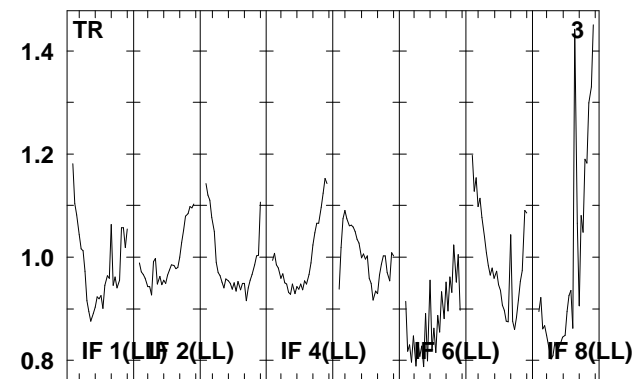
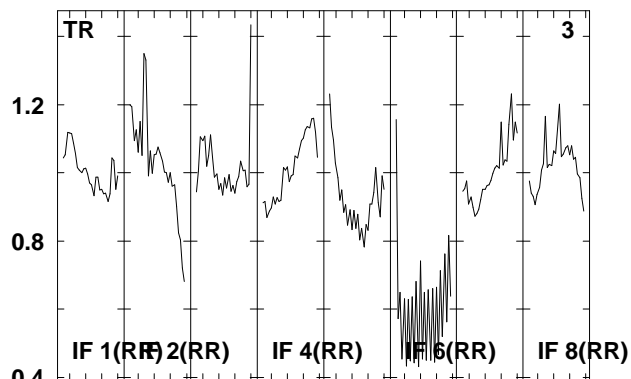
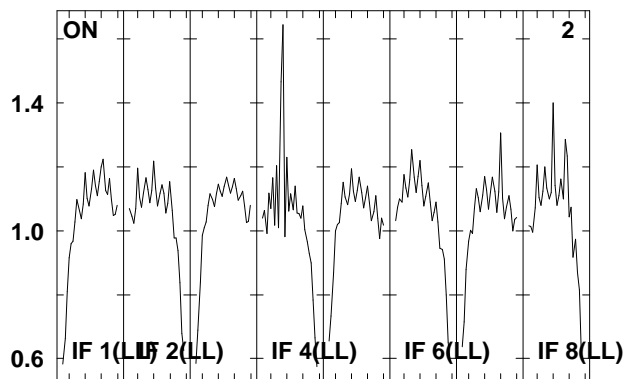
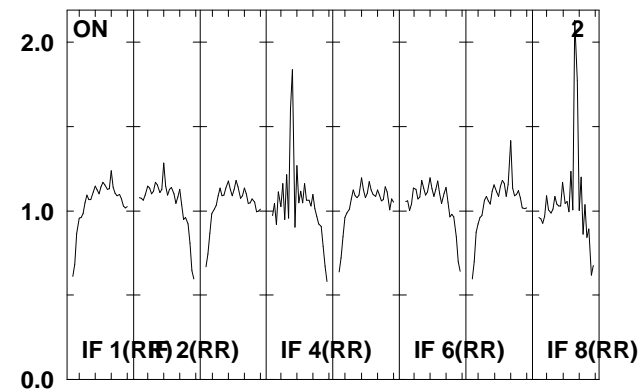
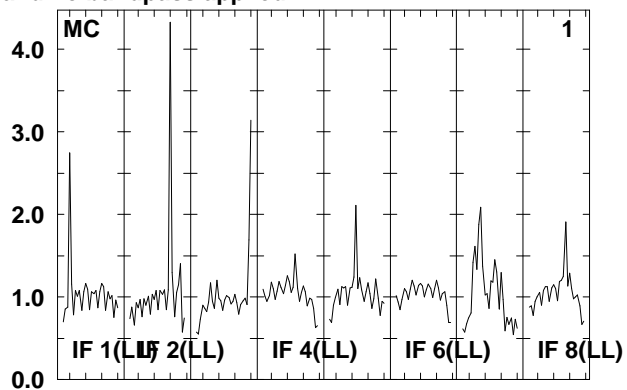
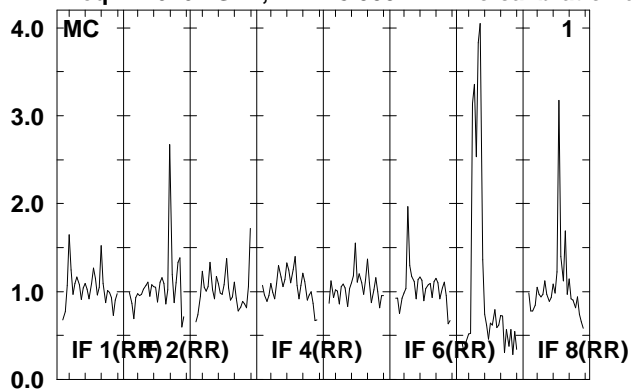

Lower frame: Real Jy  
Total-power spectrum Antenna: \*  
Timerange: 00/06:28:31 to 00/06:29:51

Plot file version 40 created 16-FEB-2009 12:46:13

J1217+30 RSF02.UVDATA.1

Freq = 1.6267 GHz, Bw = 8.000 MH No calibration applied and no bandpass applied

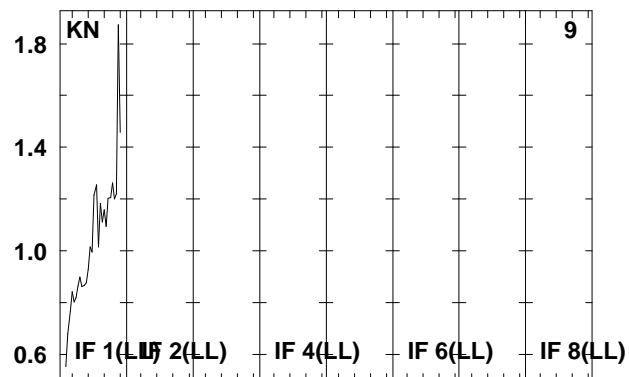
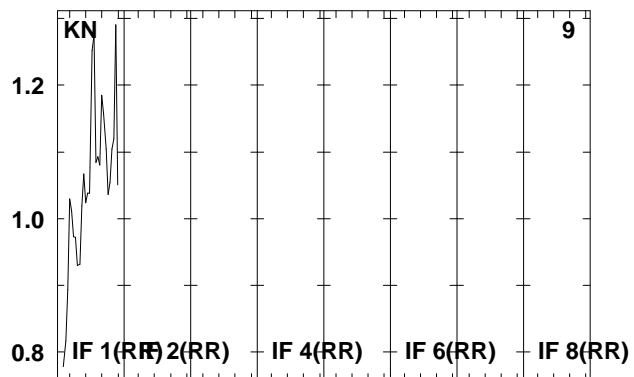
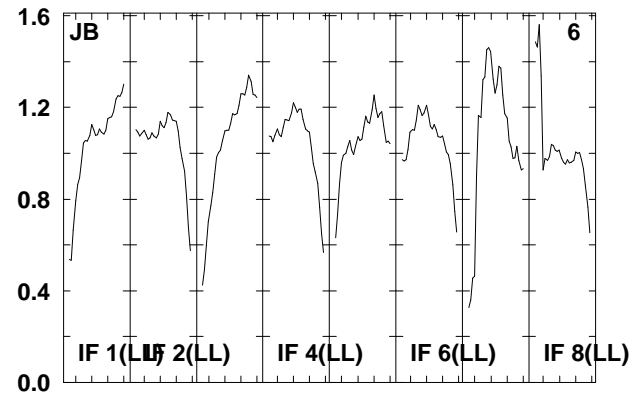
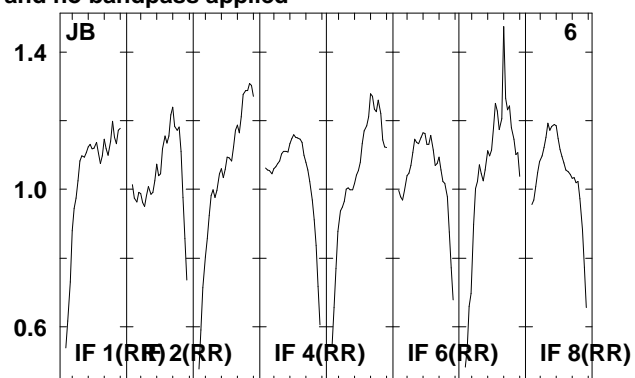
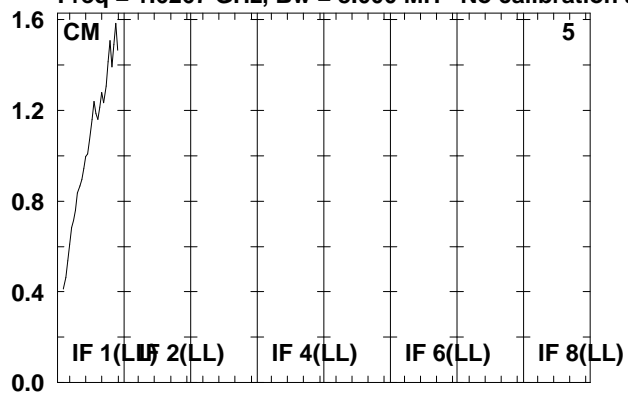

Lower frame: Real Jy  
Total-power spectrum Antenna: \*  
Timerange: 00/06:28:31 to 00/06:29:51



Plot file version 41 created 16-FEB-2009 12:46:13

J121839. RSF02.UVDATA.1

Freq = 1.6267 GHz, Bw = 8.000 MH No calibration applied and no bandpass applied

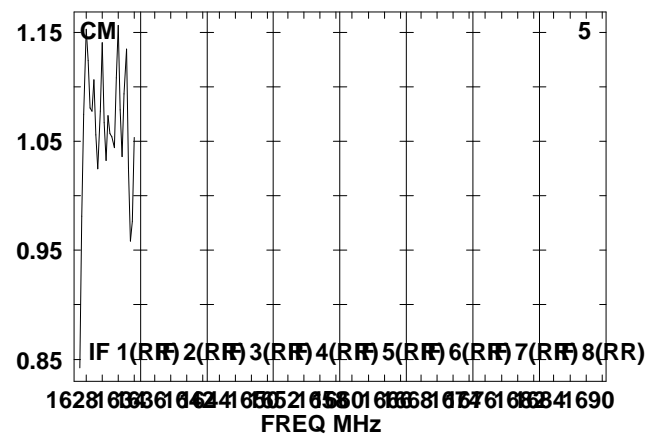
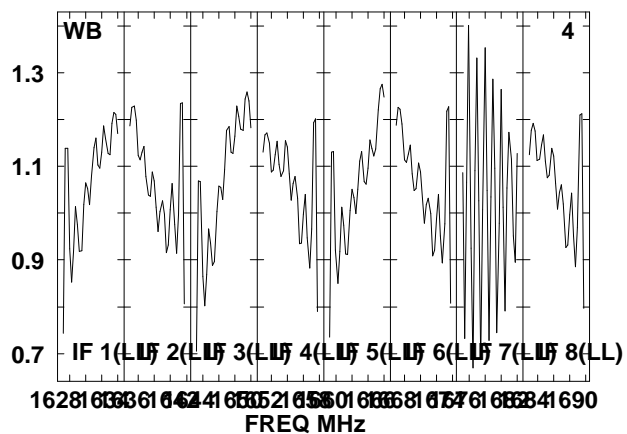
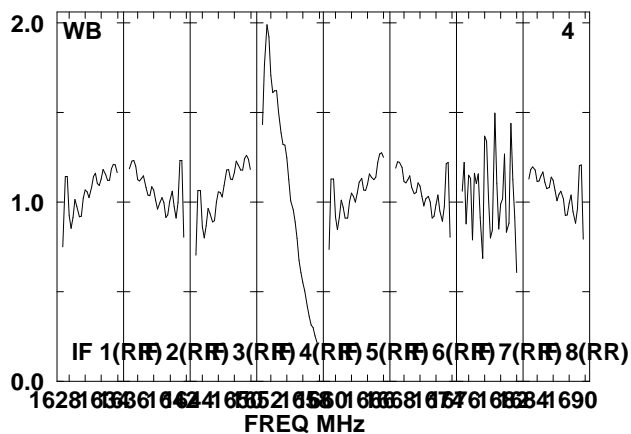
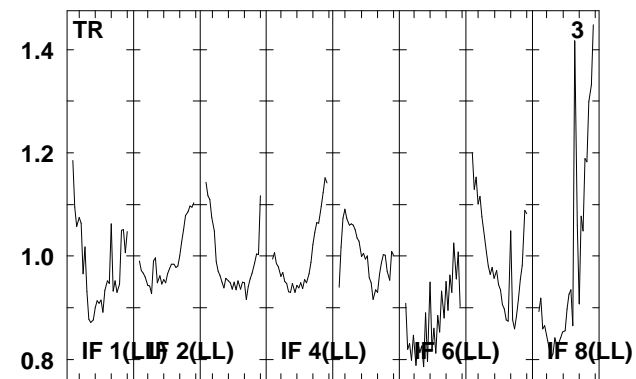
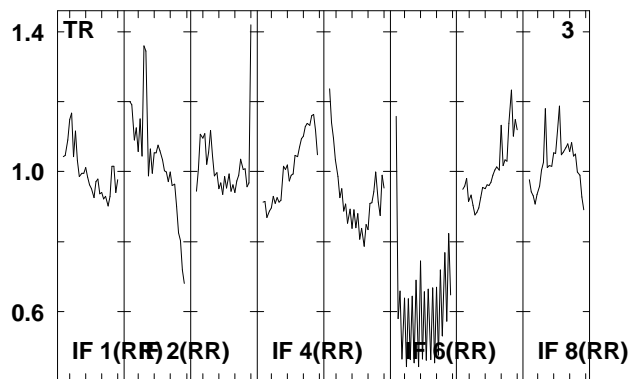
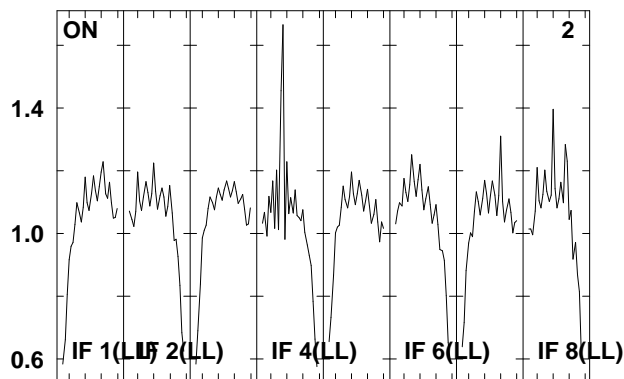
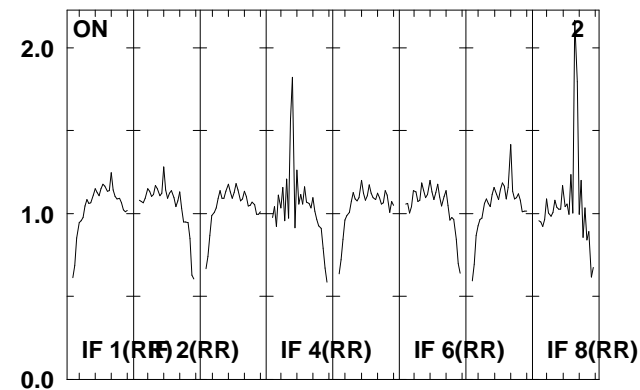
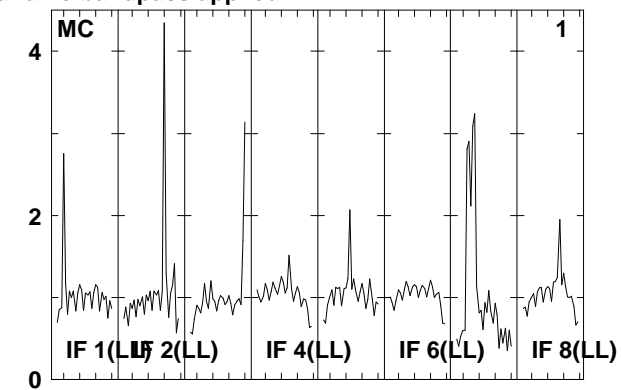
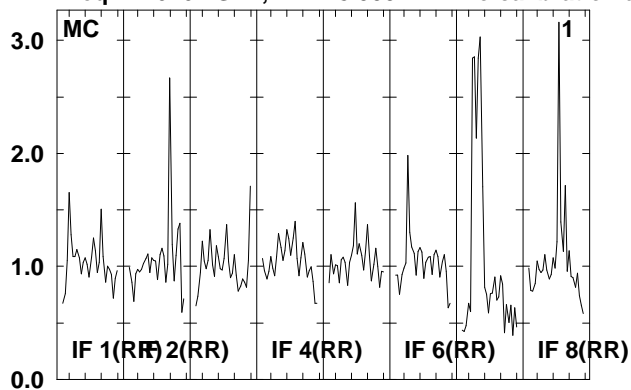

Lower frame: Real Jy

Total-power spectrum Antenna: \*

Timerange: 00/06:29:53 to 00/06:33:19

Plot file version 42 created 16-FEB-2009 12:46:14

J121839. RSF02.UVDATA.1

Freq = 1.6267 GHz, Bw = 8.000 MH No calibration applied and no bandpass applied

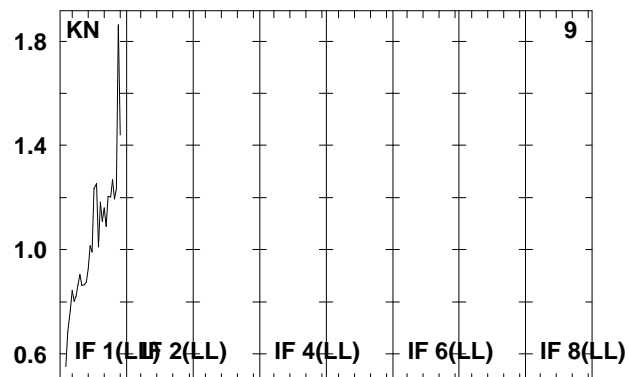
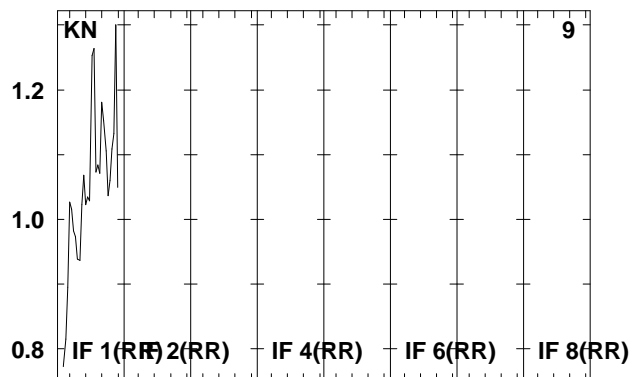
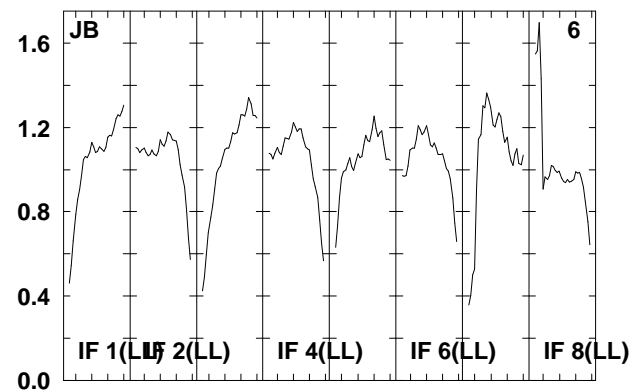
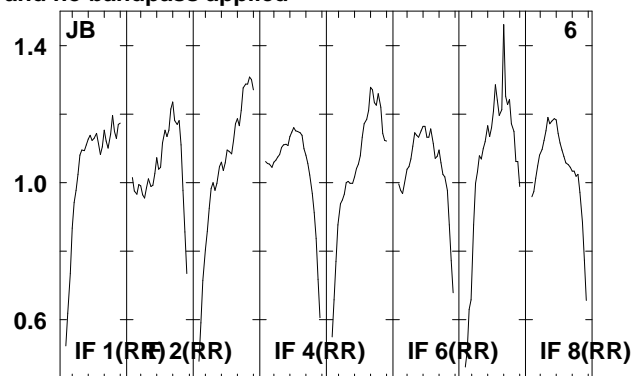
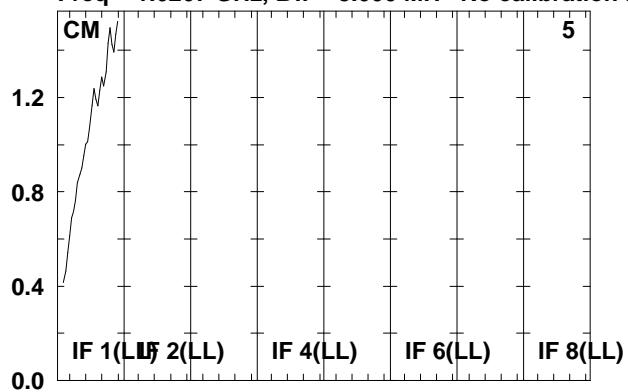

Lower frame: Real Jy  
Total-power spectrum Antenna: \*  
Timerange: 00/06:29:53 to 00/06:33:19

Plot file version 43 created 16-FEB-2009 12:46:15

J1217+30 RSF02.UVDATA.1

Freq = 1.6267 GHz, Bw = 8.000 MH No calibration applied and no bandpass applied

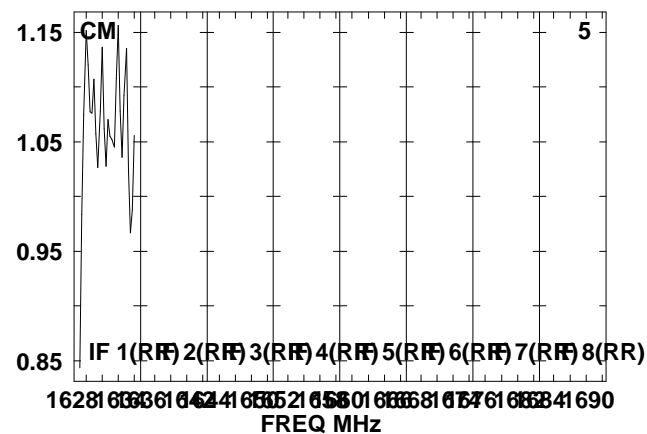
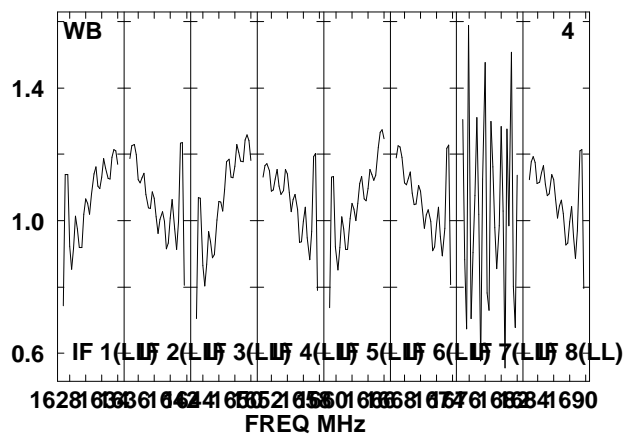
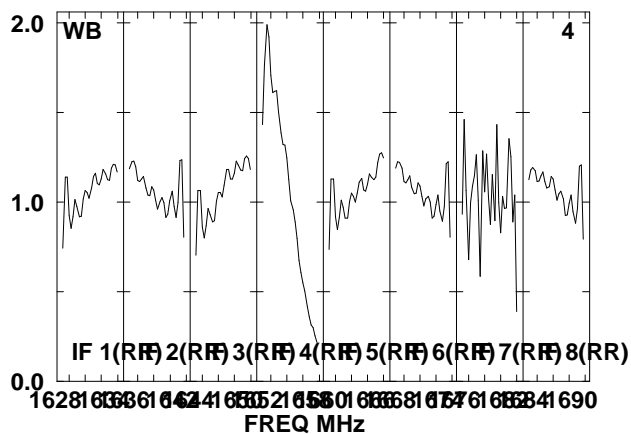
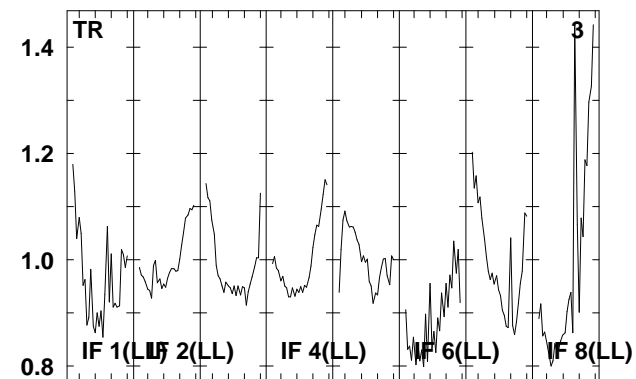
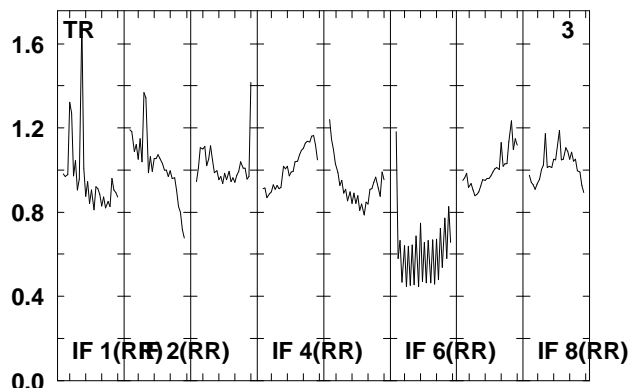
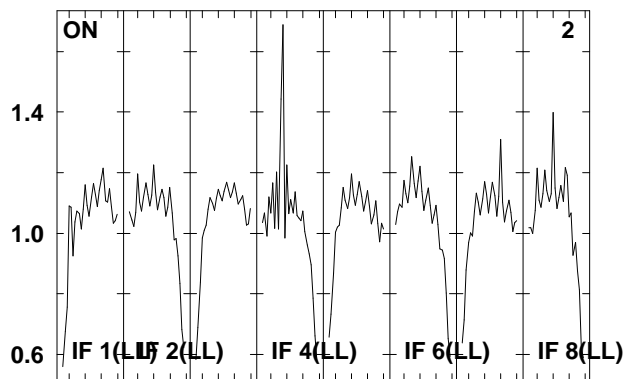
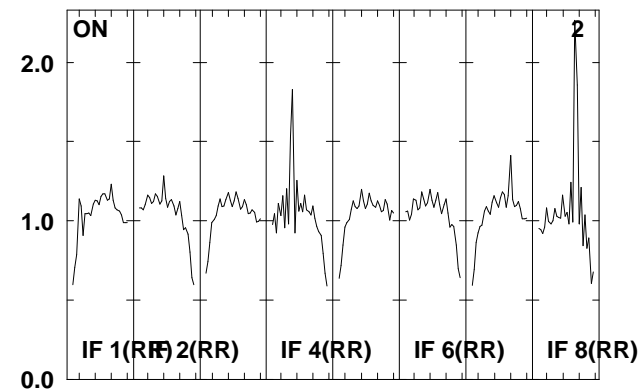
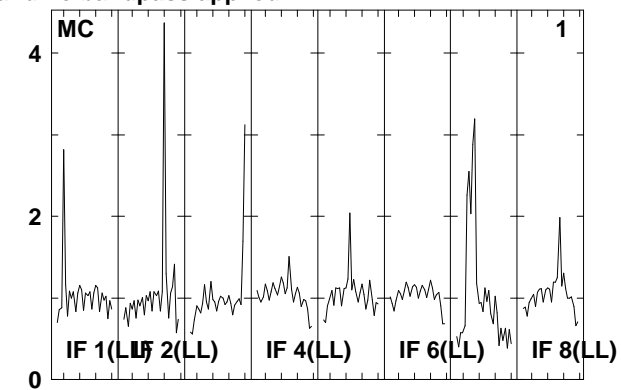
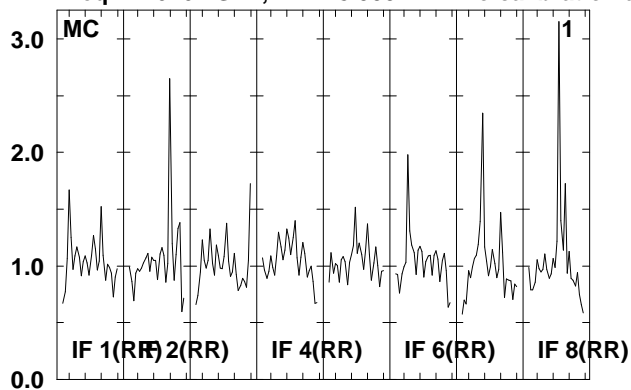

Lower frame: Real Jy

Total-power spectrum Antenna: \*

Timerange: 00/06:34:01 to 00/06:34:59

Plot file version 44 created 16-FEB-2009 12:46:15

J1217+30 RSF02.UVDATA.1

Freq = 1.6267 GHz, Bw = 8.000 MH No calibration applied and no bandpass applied

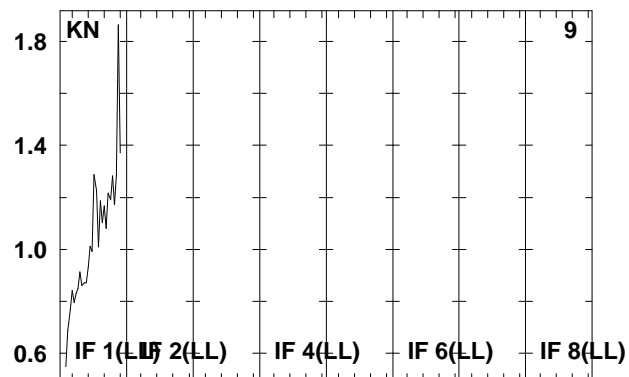
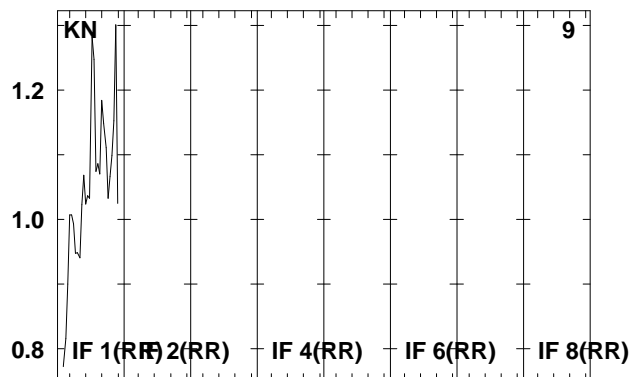
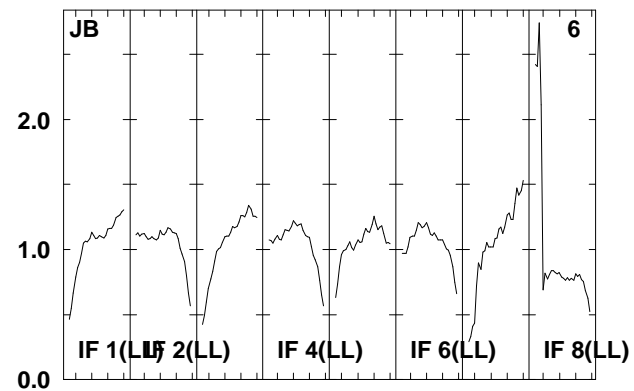
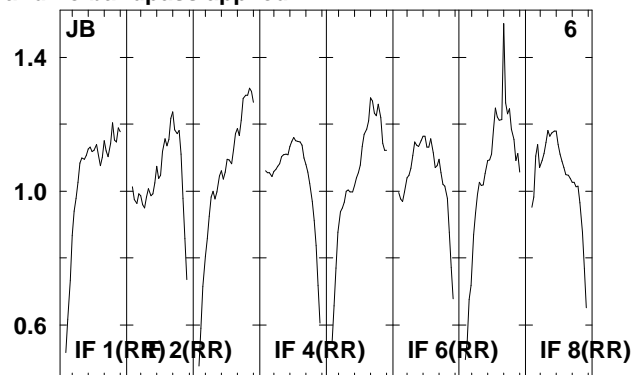
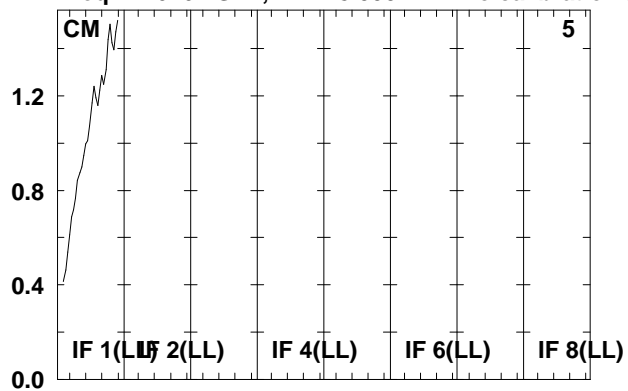

Lower frame: Real Jy  
Total-power spectrum Antenna: \*  
Timerange: 00/06:34:01 to 00/06:34:59

Plot file version 45 created 16-FEB-2009 12:46:16  
 J121839. RSF02.UVDATA.1  
 Freq = 1.6267 GHz, Bw = 8.000 MH No calibration applied and no bandpass applied

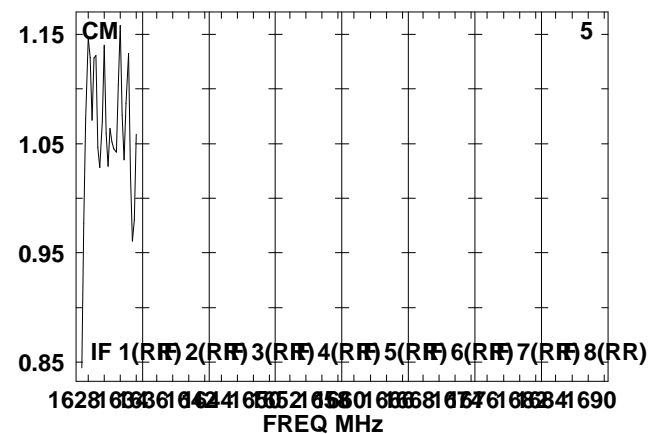
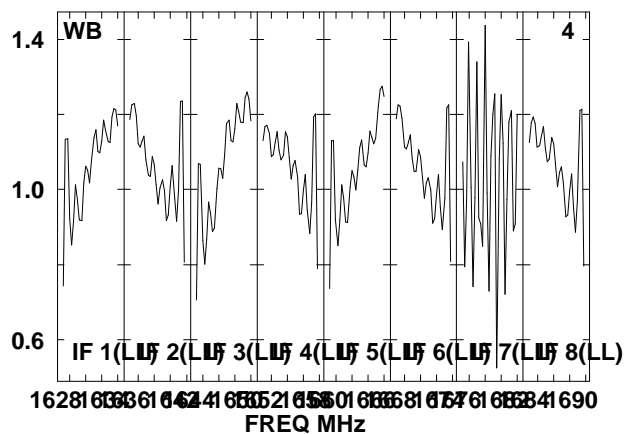
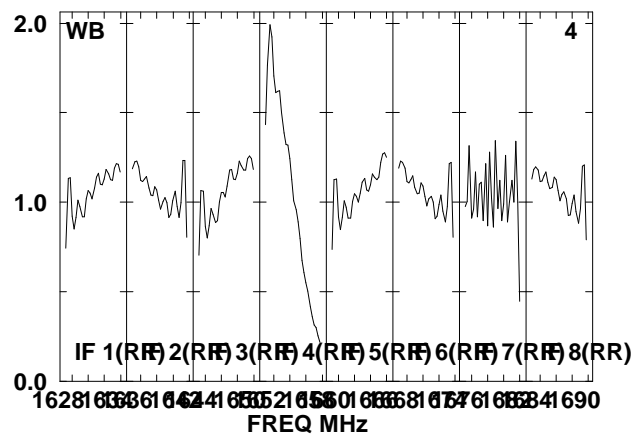
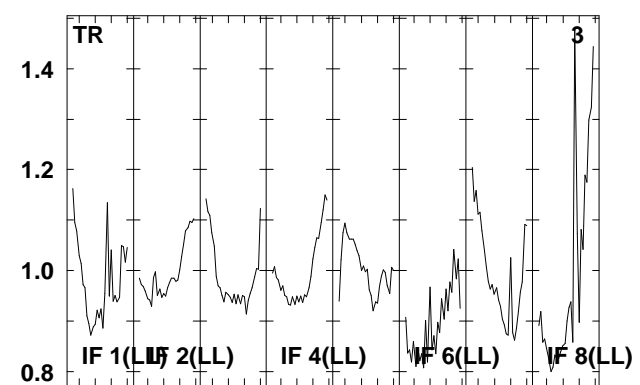
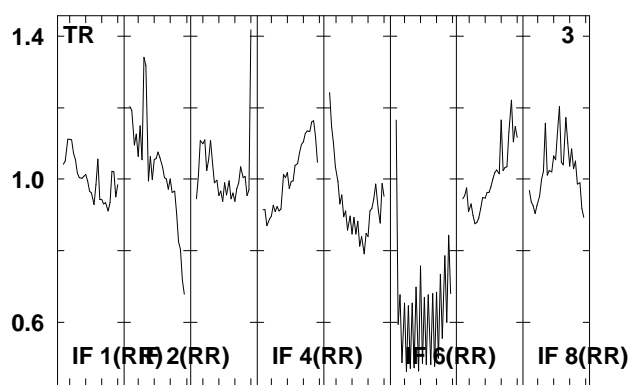
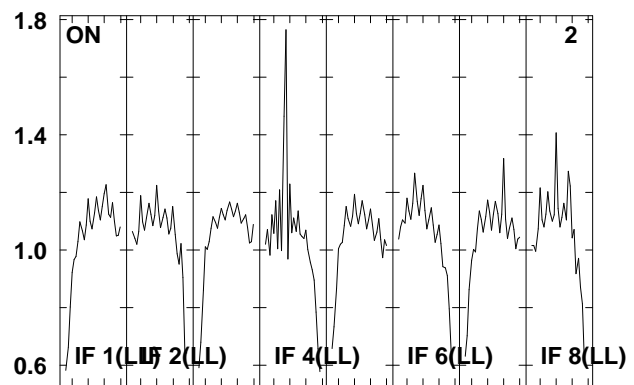
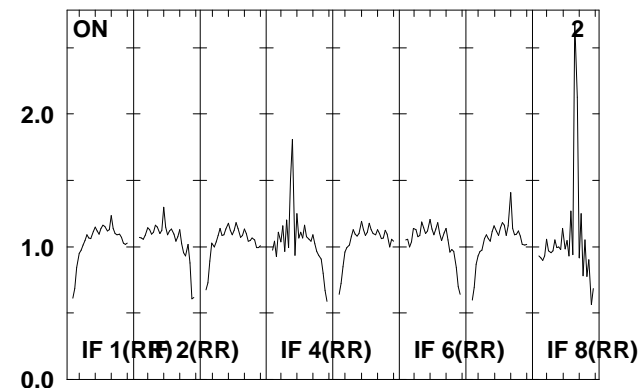
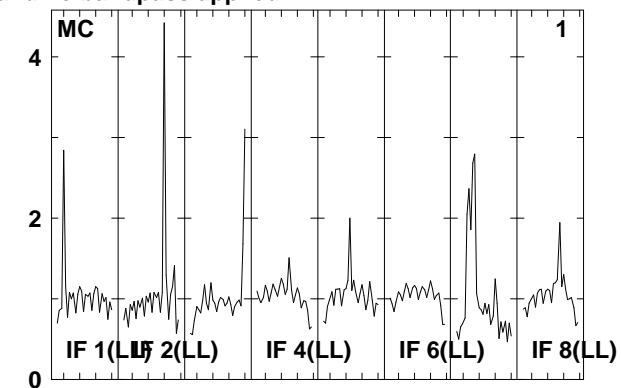
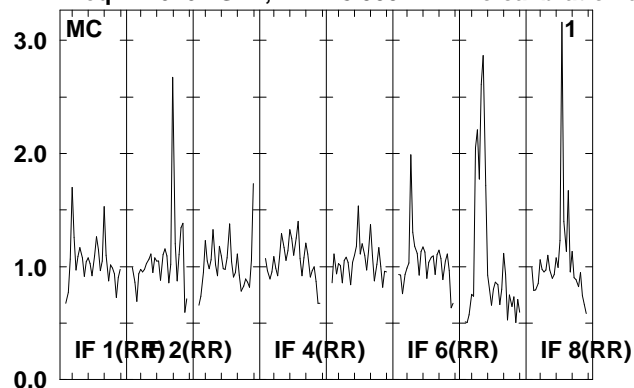

Lower frame: Real Jy  
 Total-power spectrum Antenna: \*  
 Timerange: 00/06:35:01 to 00/06:38:29

Plot file version 46 created 16-FEB-2009 12:46:17

J121839. RSF02.UVDATA.1

Freq = 1.6267 GHz, Bw = 8.000 MH No calibration applied and no bandpass applied

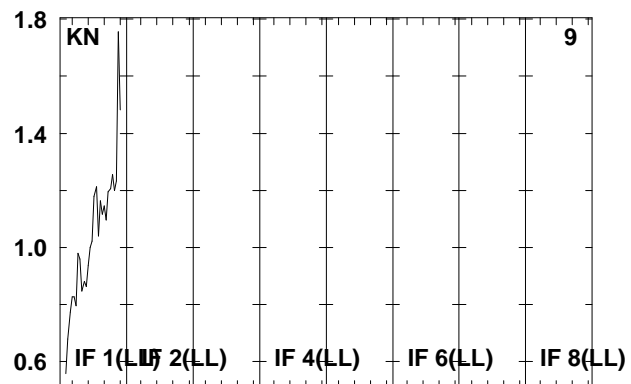
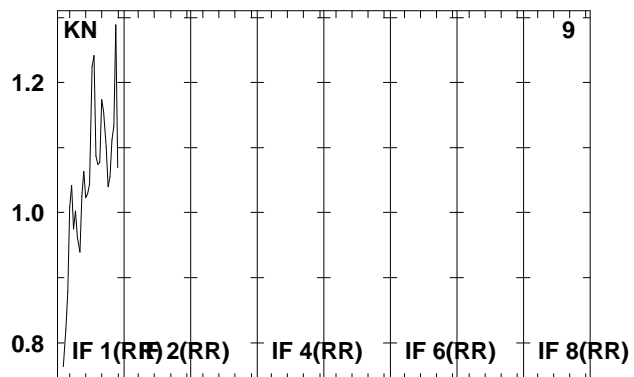
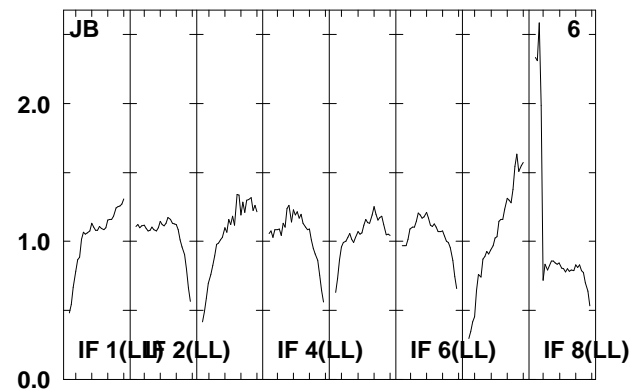
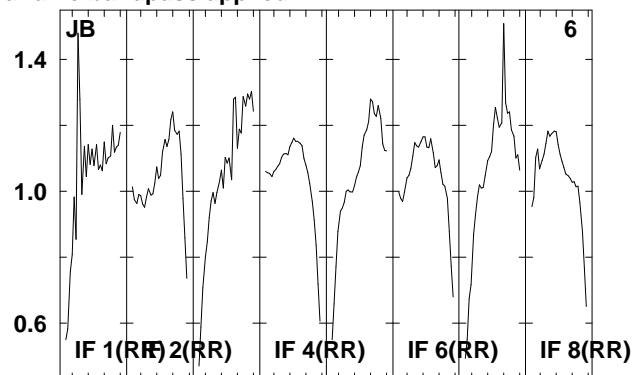
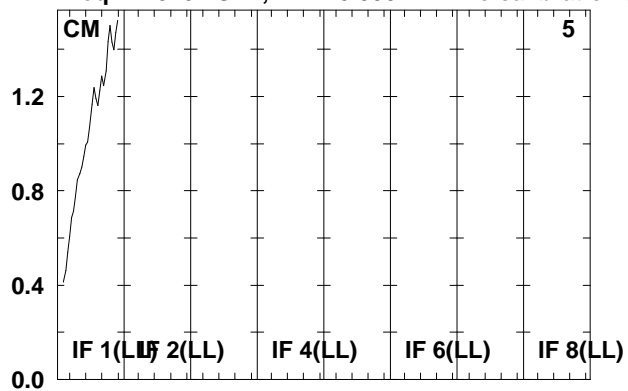

Lower frame: Real Jy  
Total-power spectrum Antenna: \*  
Timerange: 00/06:35:01 to 00/06:38:29

Plot file version 47 created 16-FEB-2009 12:46:18

J1217+30 RSF02.UVDATA.1

Freq = 1.6267 GHz, Bw = 8.000 MH No calibration applied and no bandpass applied

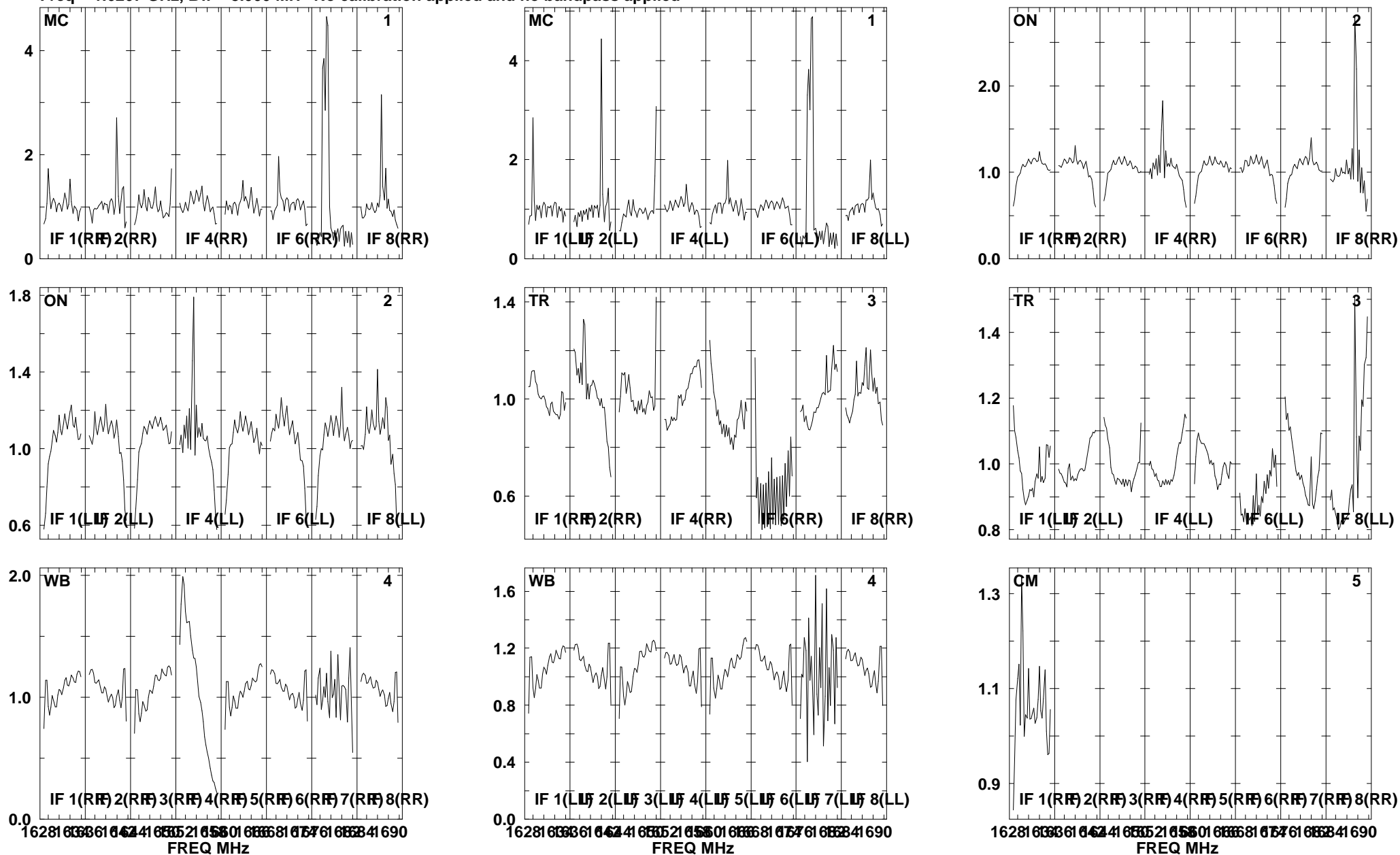

Lower frame: Real Jy  
Total-power spectrum Antenna: \*  
Timerange: 00/06:38:31 to 00/06:39:51

Plot file version 48 created 16-FEB-2009 12:46:18

J1217+30 RSF02.UVDATA.1

Freq = 1.6267 GHz, Bw = 8.000 MH No calibration applied and no bandpass applied

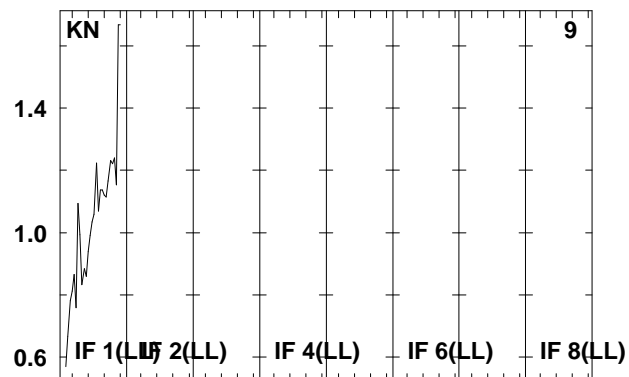
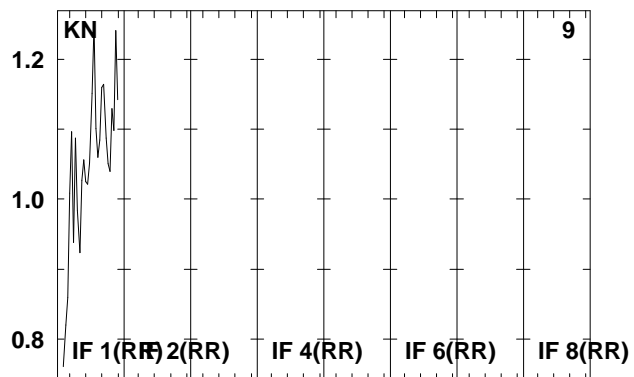
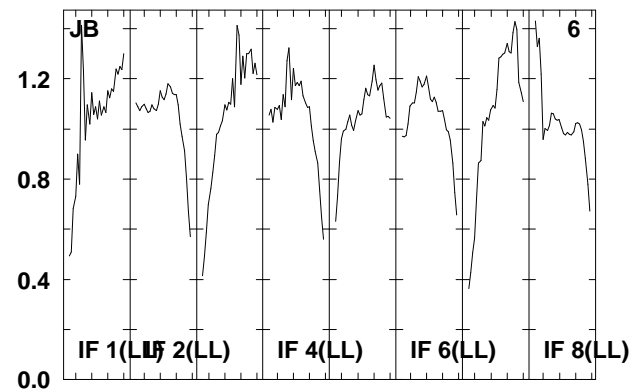
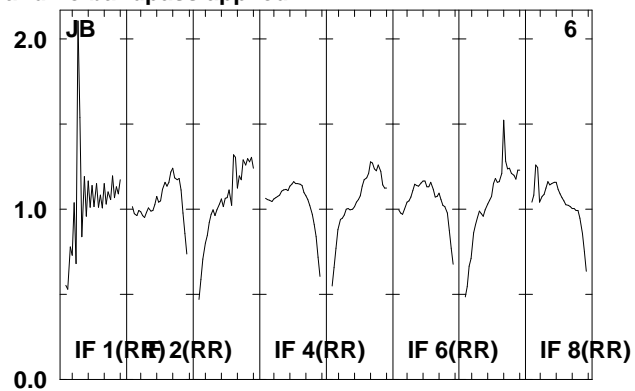
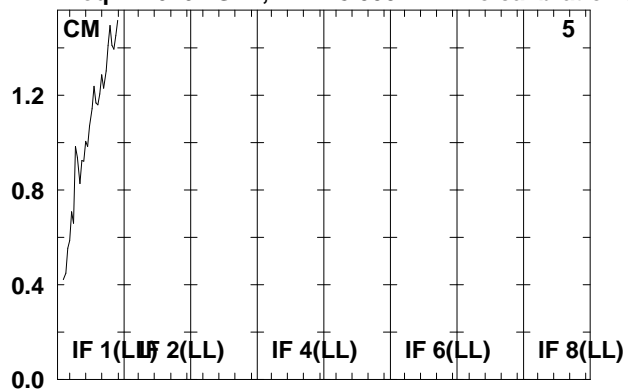

Lower frame: Real Jy  
Total-power spectrum Antenna: \*  
Timerange: 00/06:38:31 to 00/06:39:51



Plot file version 49 created 16-FEB-2009 12:46:19  
 J121839. RSF02.UVDATA.1  
 Freq = 1.6267 GHz, Bw = 8.000 MH No calibration applied and no bandpass applied

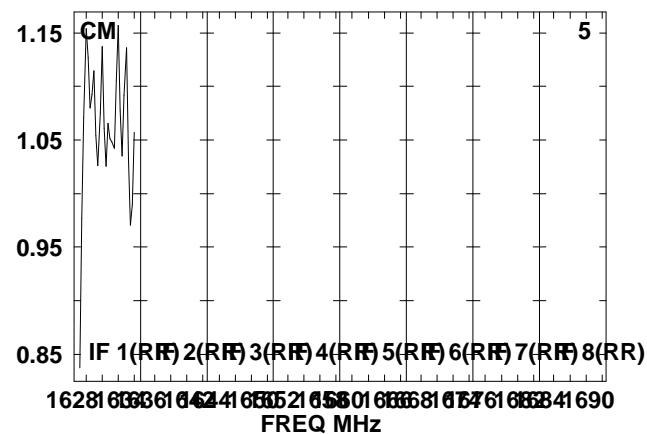
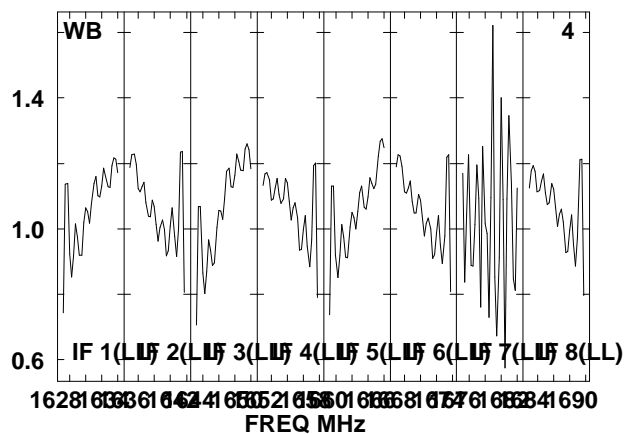
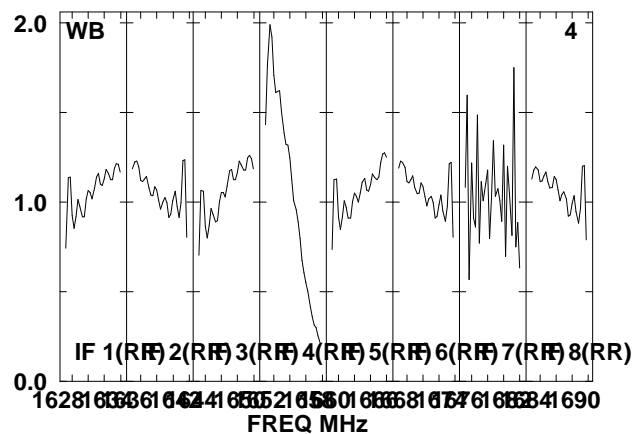
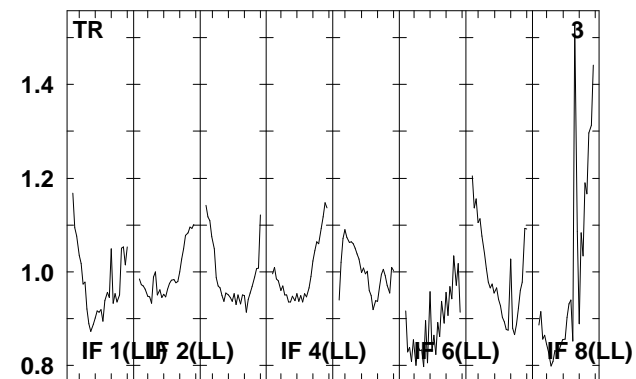
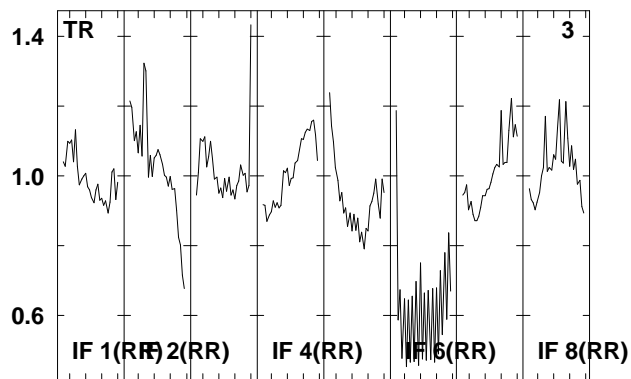
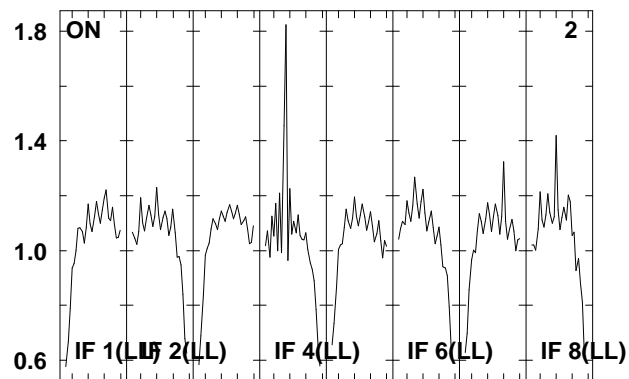
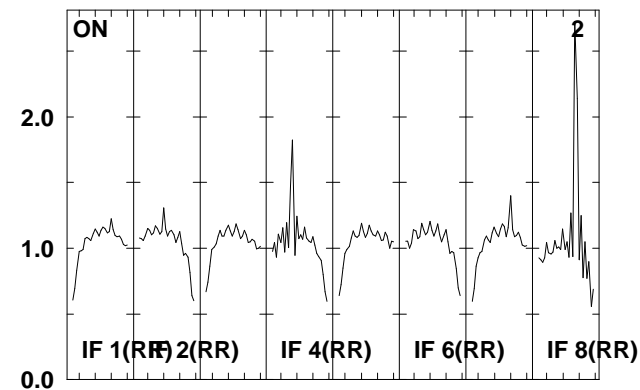
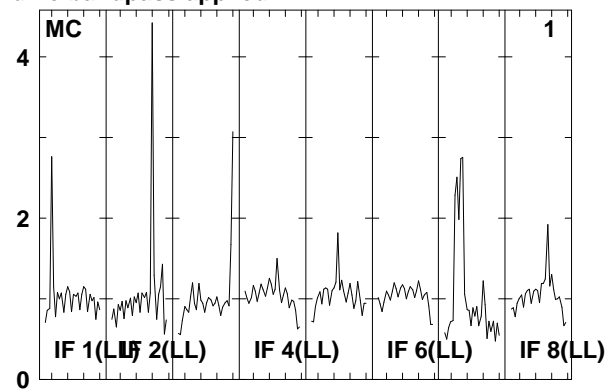
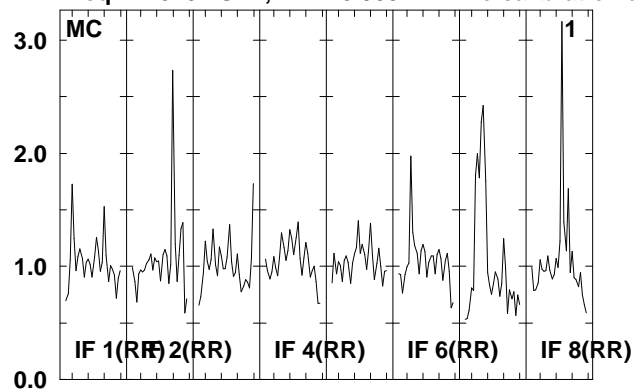

Lower frame: Real Jy  
 Total-power spectrum Antenna: \*  
 Timerange: 00/06:39:53 to 00/06:43:19

Plot file version 50 created 16-FEB-2009 12:46:19

J121839. RSF02.UVDATA.1

Freq = 1.6267 GHz, Bw = 8.000 MH No calibration applied and no bandpass applied

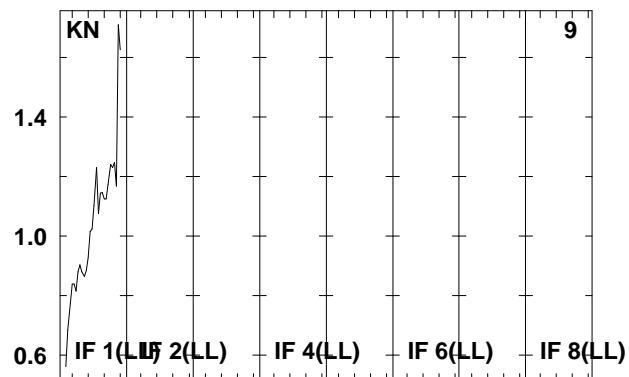
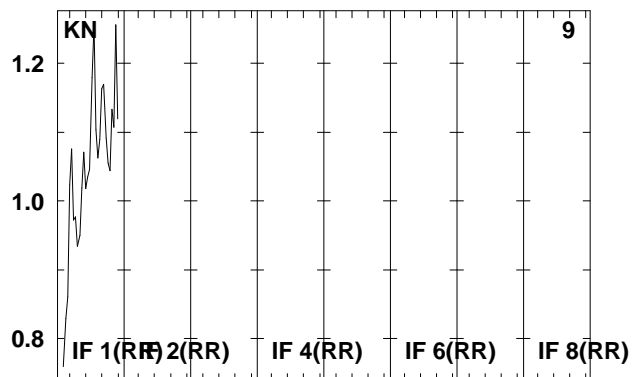
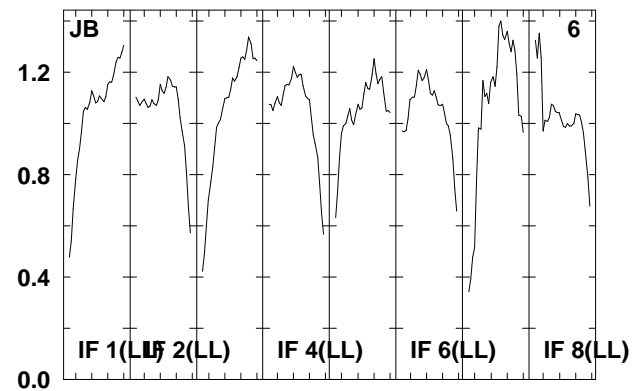
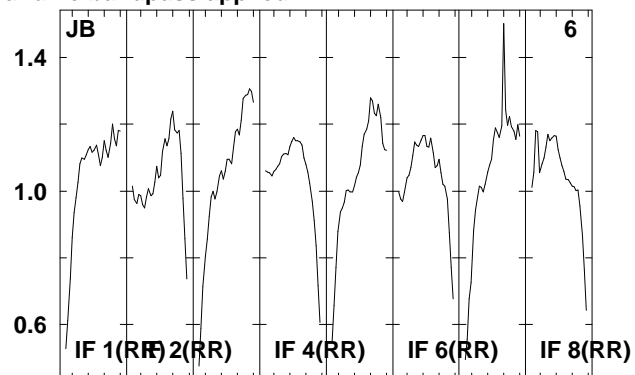
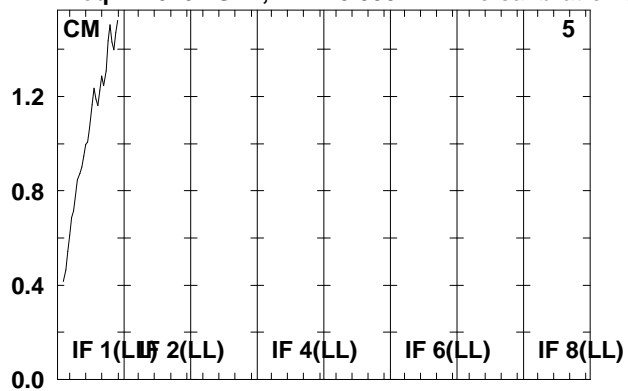

Lower frame: Real Jy  
Total-power spectrum Antenna: \*  
Timerange: 00/06:39:53 to 00/06:43:19

Plot file version 51 created 16-FEB-2009 12:46:21  
 J1217+30 RSF02.UVDATA.1  
 Freq = 1.6267 GHz, Bw = 8.000 MH No calibration applied and no bandpass applied

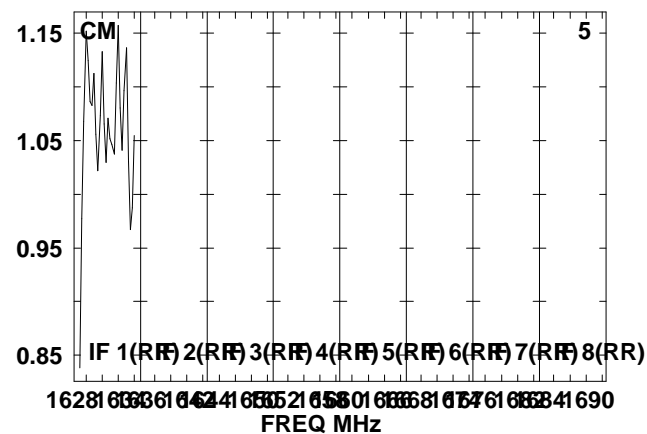
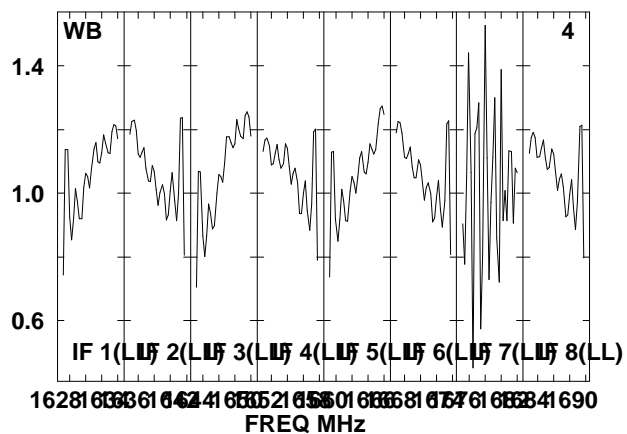
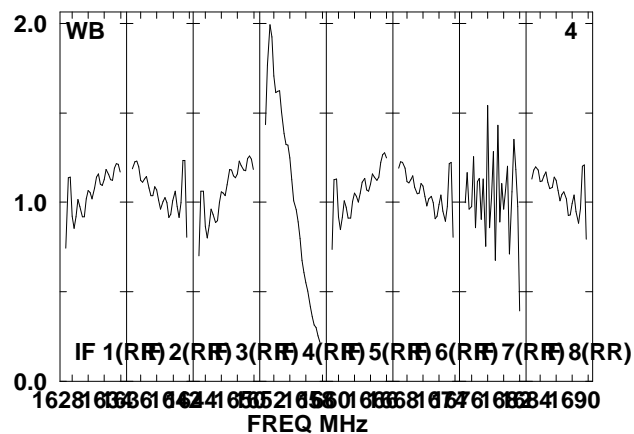
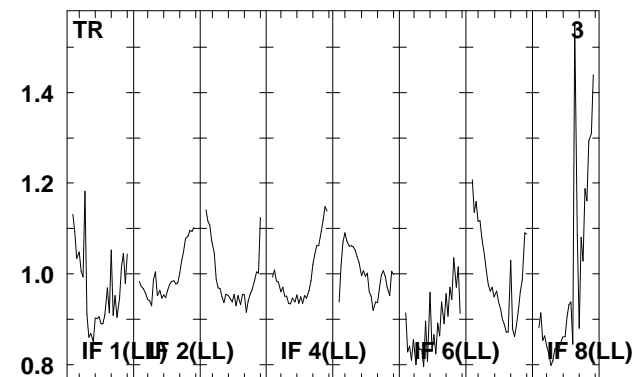
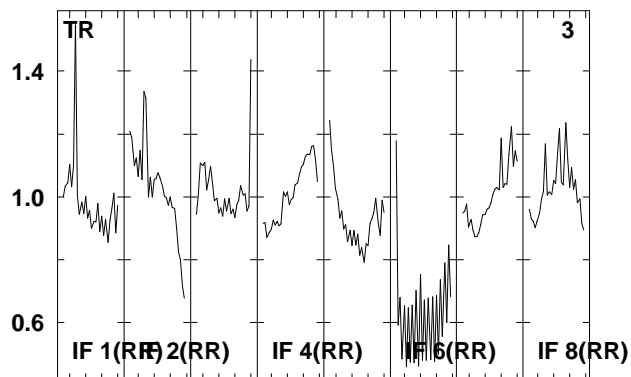
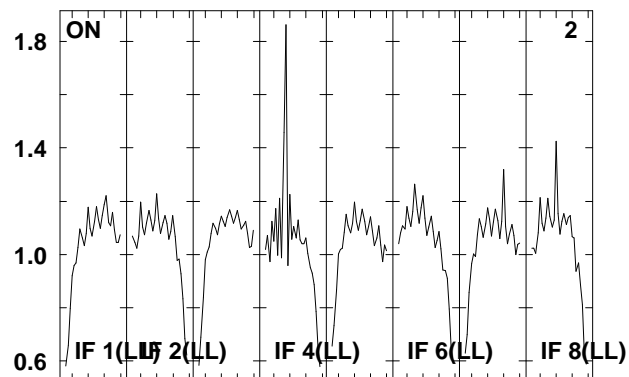
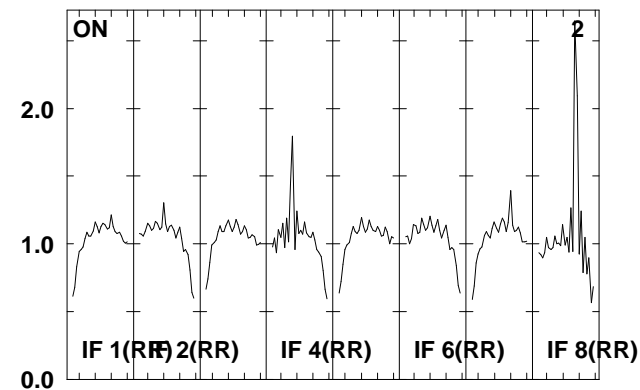
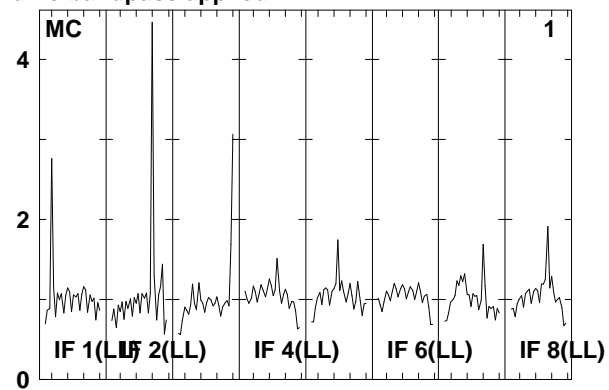
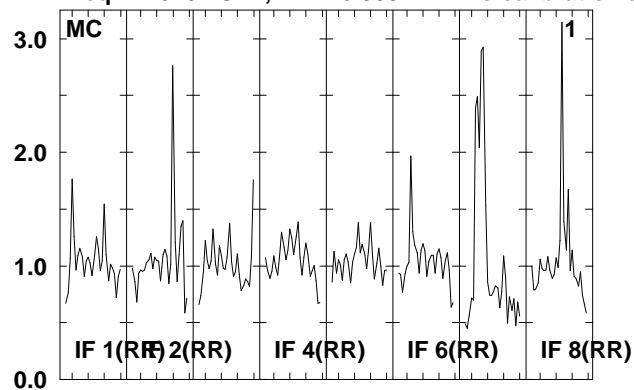

Lower frame: Real Jy  
 Total-power spectrum Antenna: \*  
 Timerange: 00/06:44:01 to 00/06:44:59

Plot file version 52 created 16-FEB-2009 12:46:21

J1217+30 RSF02.UVDATA.1

Freq = 1.6267 GHz, Bw = 8.000 MH No calibration applied and no bandpass applied

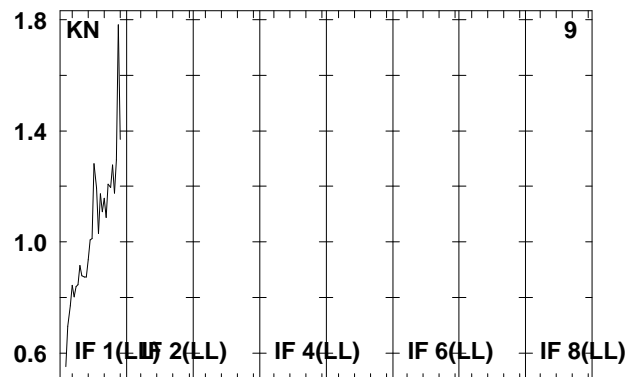
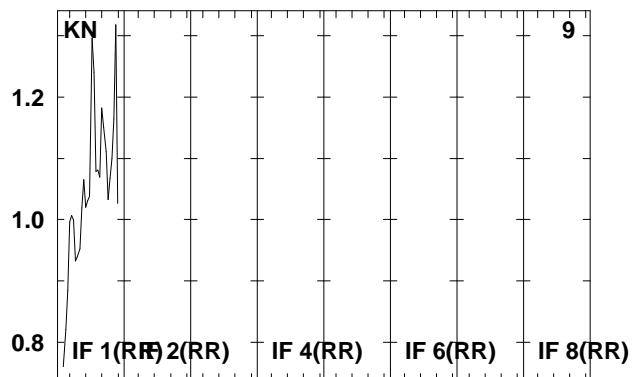
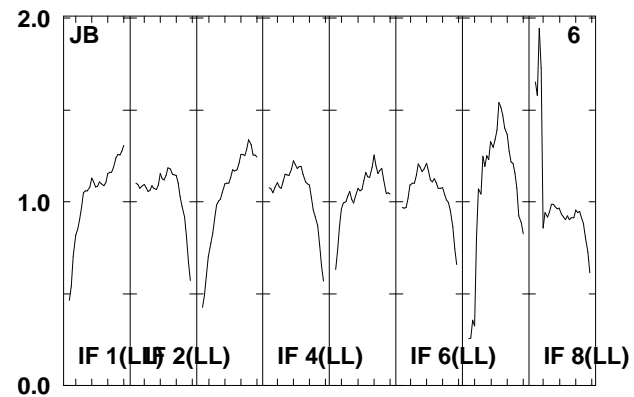
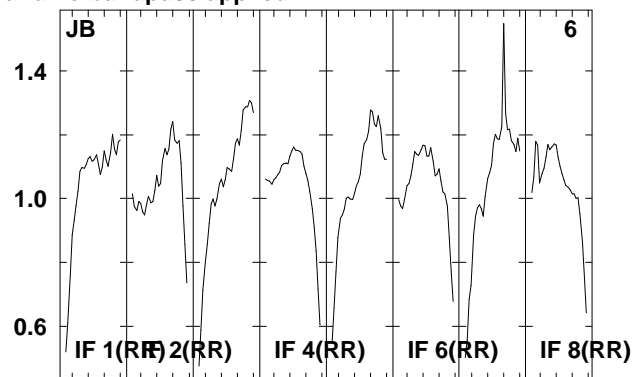
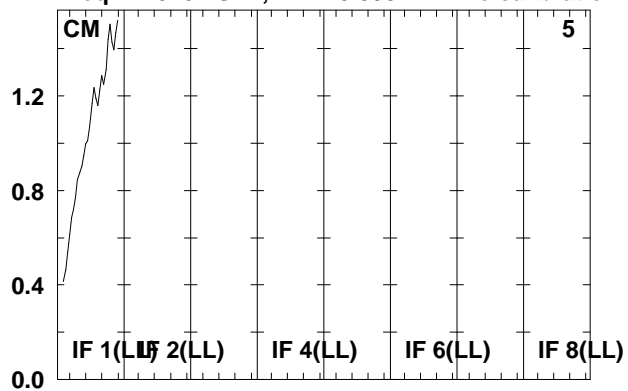

Lower frame: Real Jy  
Total-power spectrum Antenna: \*  
Timerange: 00/06:44:01 to 00/06:44:59

Plot file version 53 created 16-FEB-2009 12:46:21

J121839. RSF02.UVDATA.1

Freq = 1.6267 GHz, Bw = 8.000 MH No calibration applied and no bandpass applied

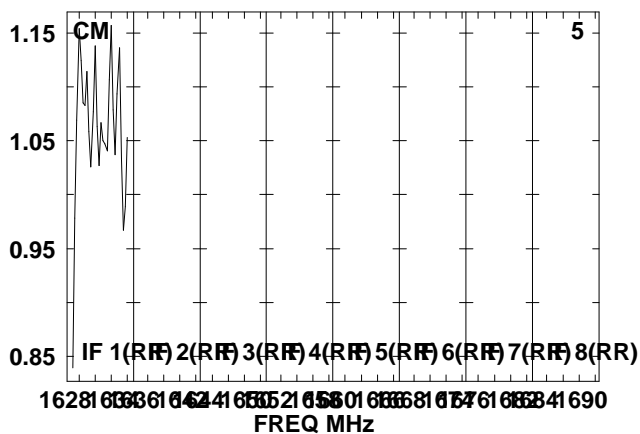
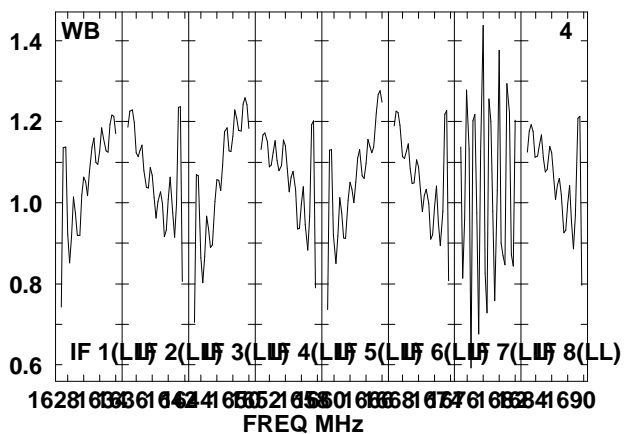
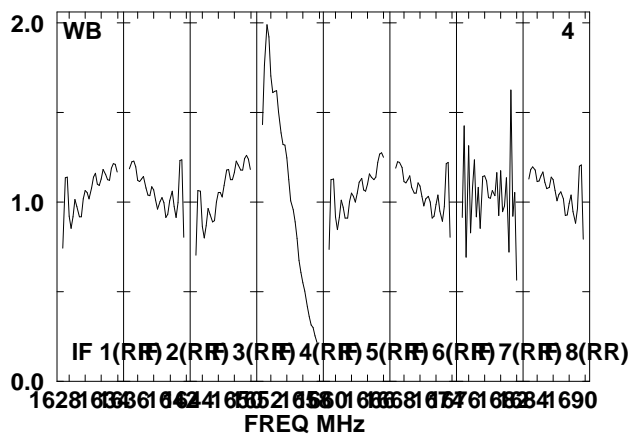
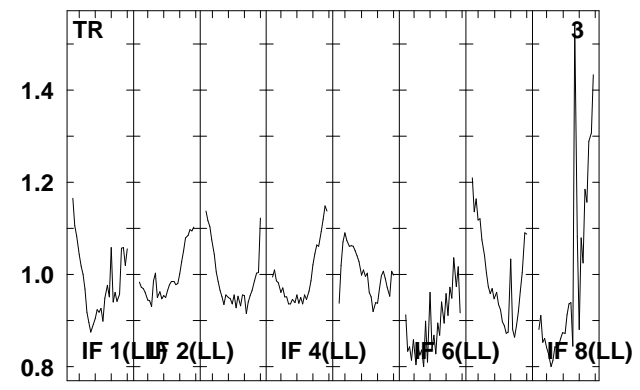
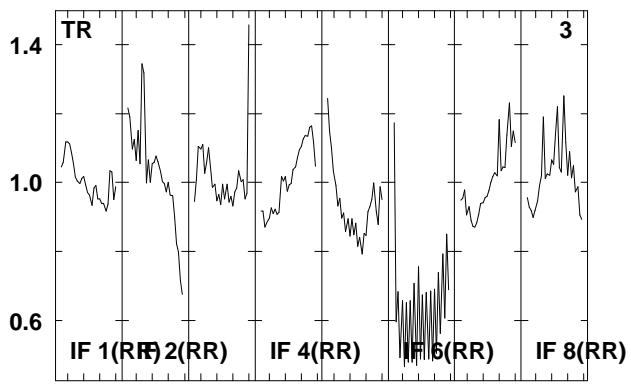
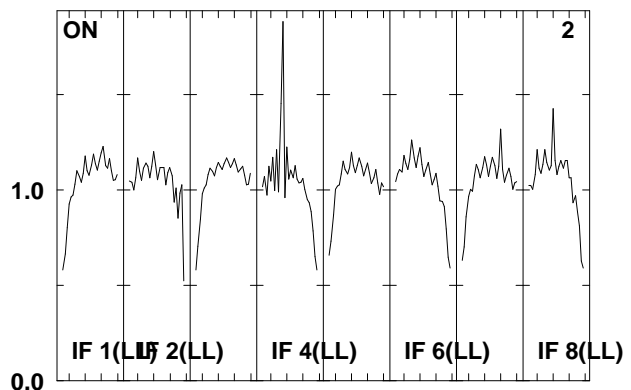
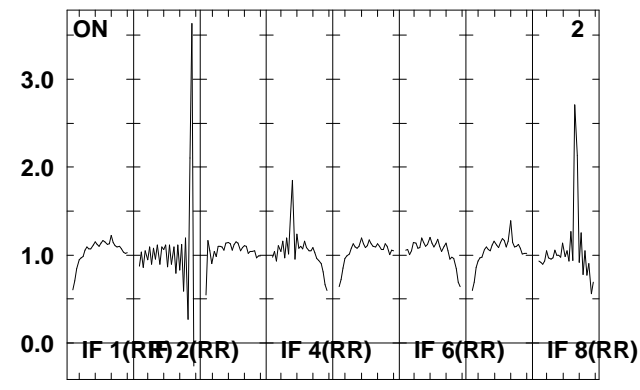
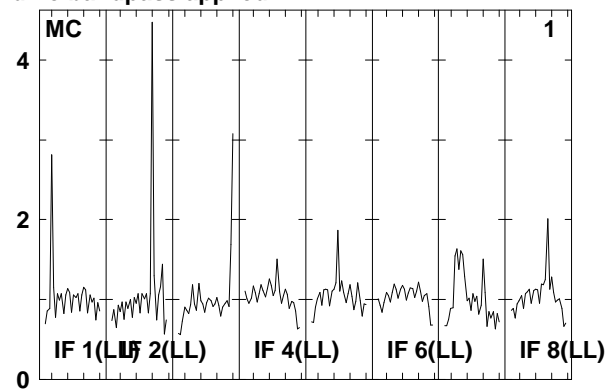
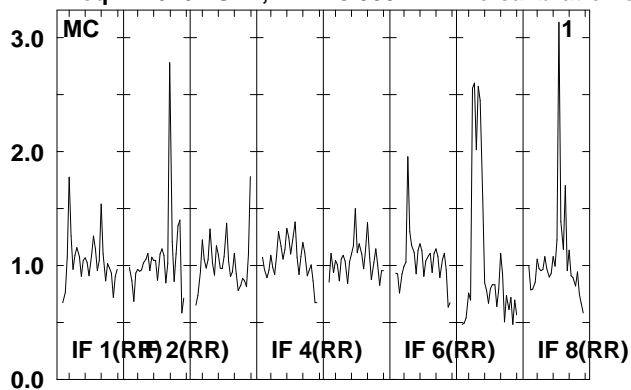

Lower frame: Real Jy  
Total-power spectrum Antenna: \*  
Timerange: 00/06:45:01 to 00/06:48:29

Plot file version 54 created 16-FEB-2009 12:46:22

J121839. RSF02.UVDATA.1

Freq = 1.6267 GHz, Bw = 8.000 MH No calibration applied and no bandpass applied

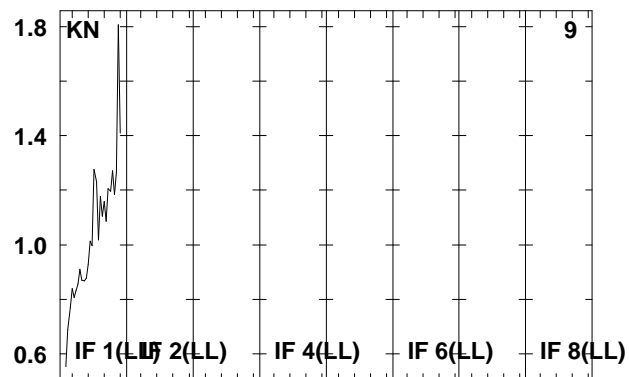
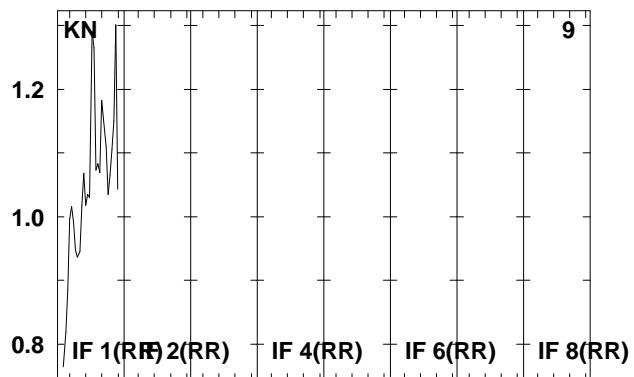
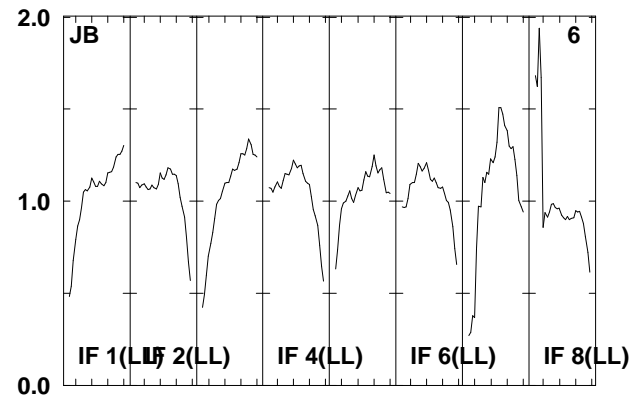
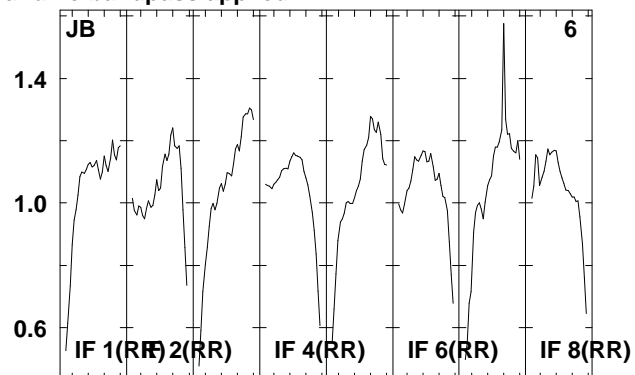
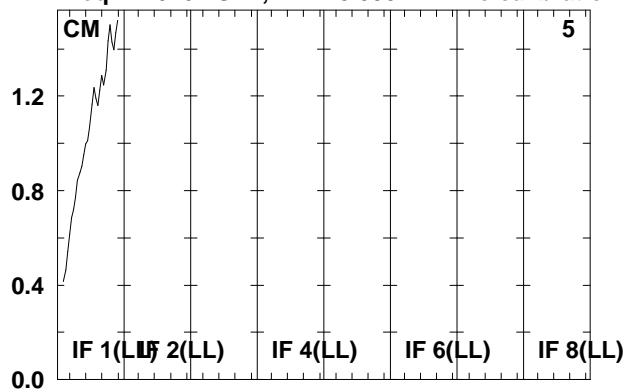

Lower frame: Real Jy  
Total-power spectrum Antenna: \*  
Timerange: 00/06:45:01 to 00/06:48:29

Plot file version 55 created 16-FEB-2009 12:46:23

J1217+30 RSF02.UVDATA.1

Freq = 1.6267 GHz, Bw = 8.000 MH No calibration applied and no bandpass applied

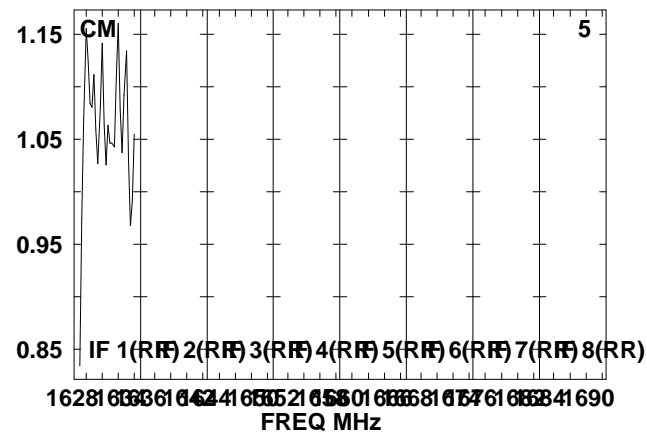
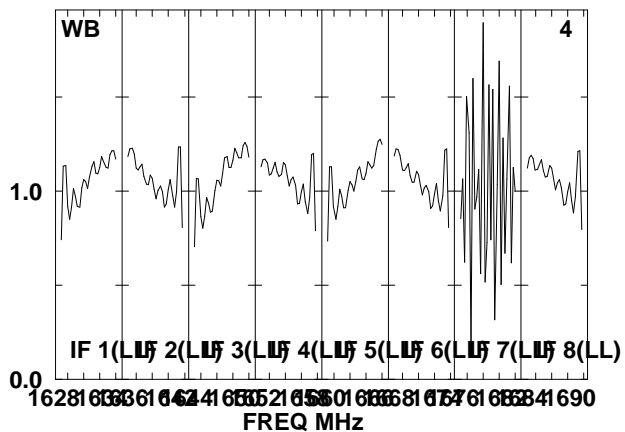
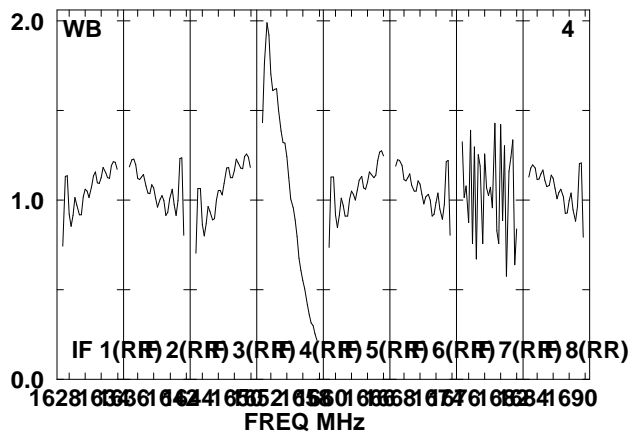
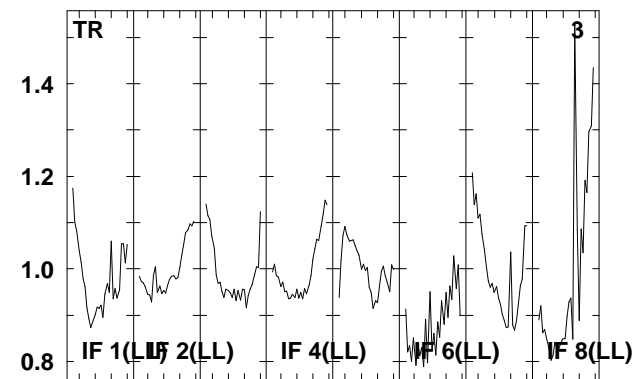
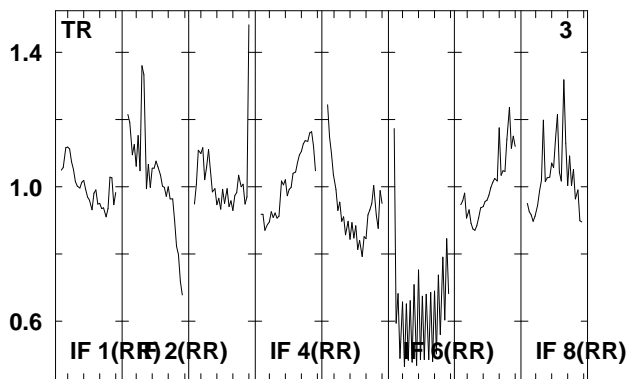
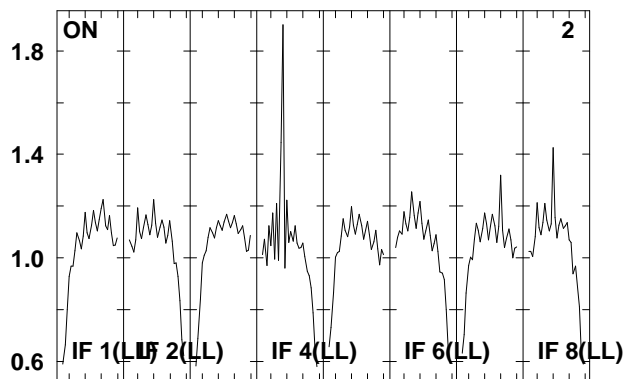
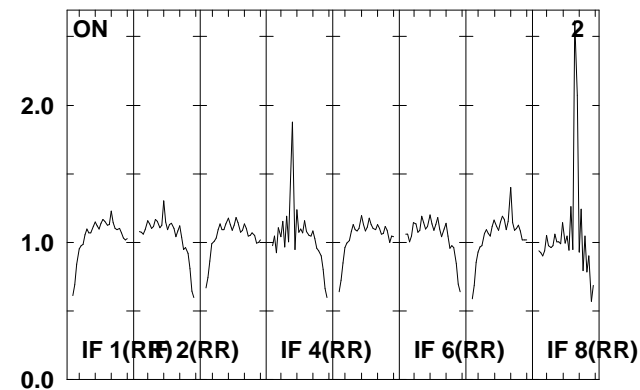
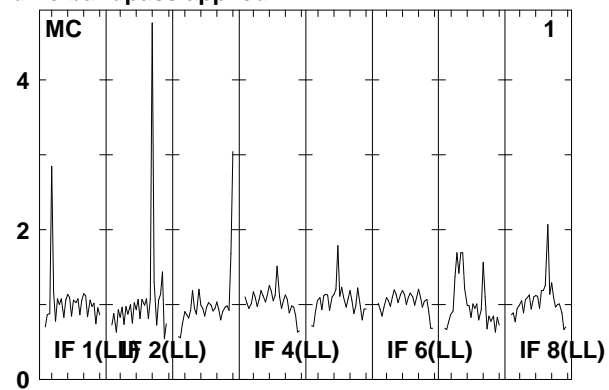
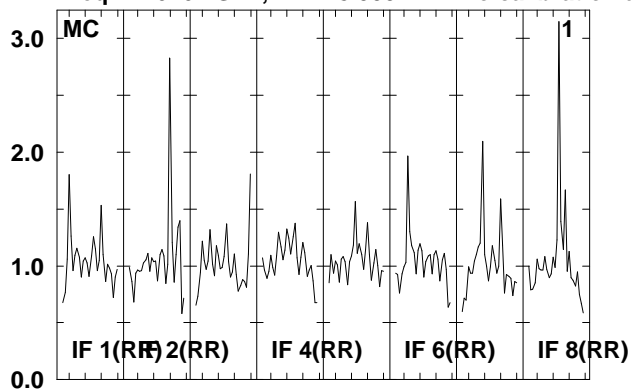

Lower frame: Real Jy  
Total-power spectrum Antenna: \*  
Timerange: 00/06:48:31 to 00/06:49:51

Plot file version 56 created 16-FEB-2009 12:46:23

J1217+30 RSF02.UVDATA.1

Freq = 1.6267 GHz, Bw = 8.000 MH No calibration applied and no bandpass applied

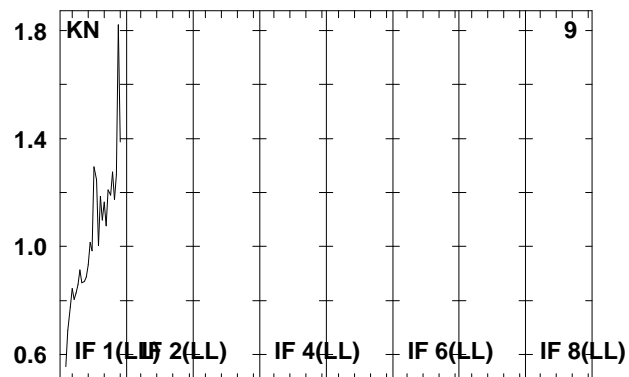
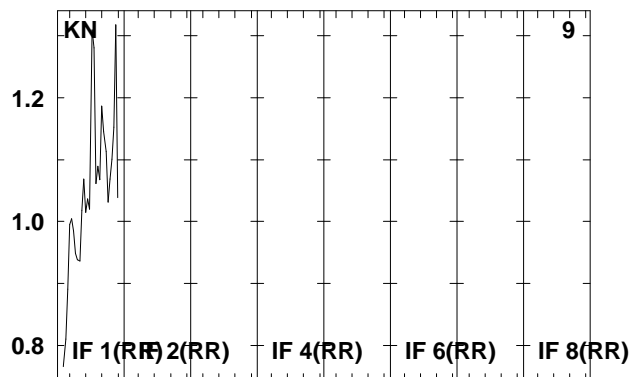
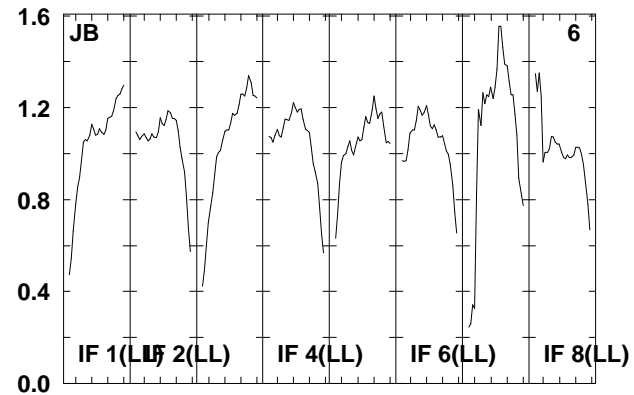
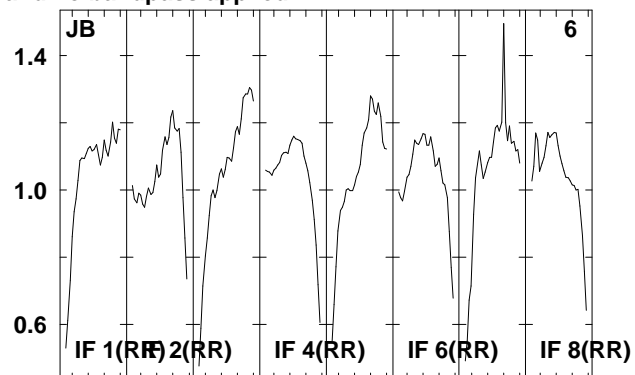
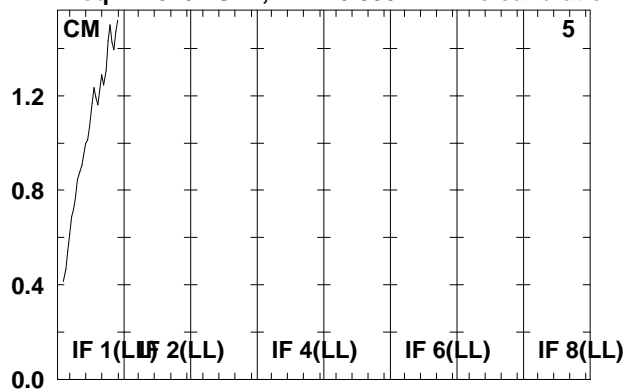

Lower frame: Real Jy  
Total-power spectrum Antenna: \*  
Timerange: 00/06:48:31 to 00/06:49:51



Plot file version 57 created 16-FEB-2009 12:46:24  
 J121839. RSF02.UVDATA.1  
 Freq = 1.6267 GHz, Bw = 8.000 MH No calibration applied and no bandpass applied

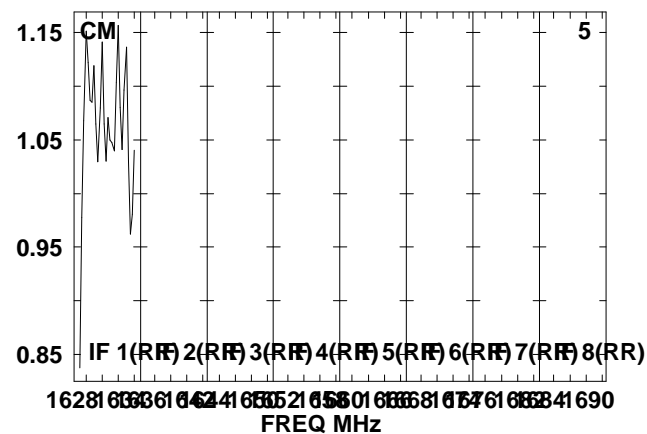
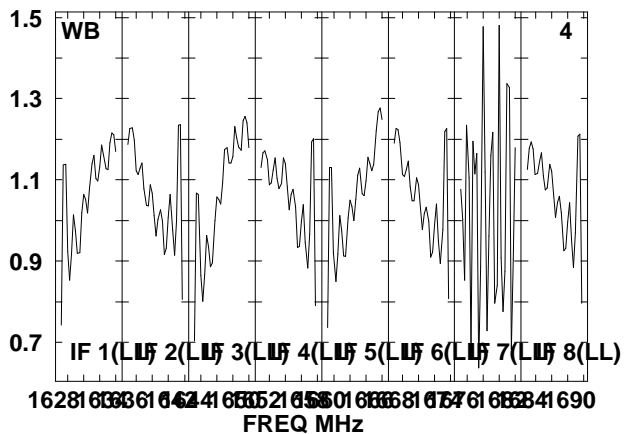
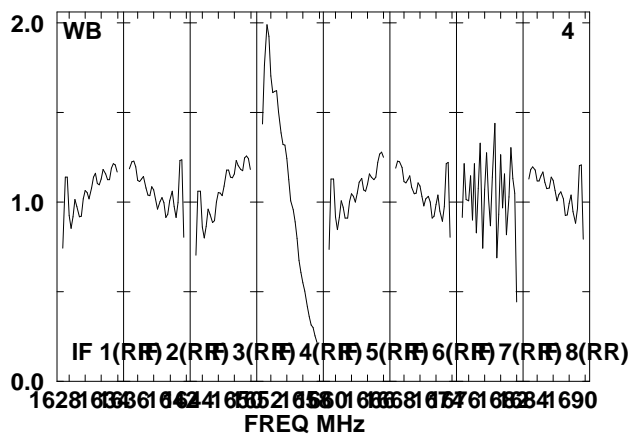
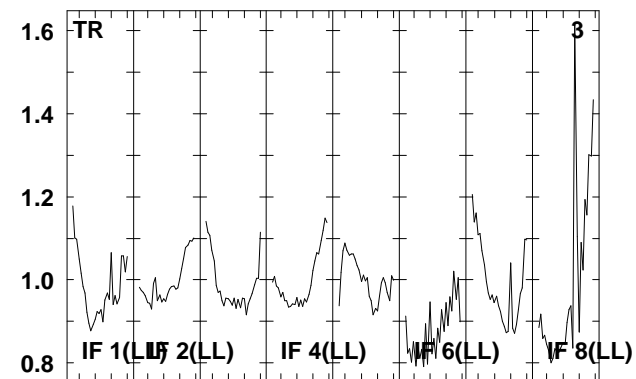
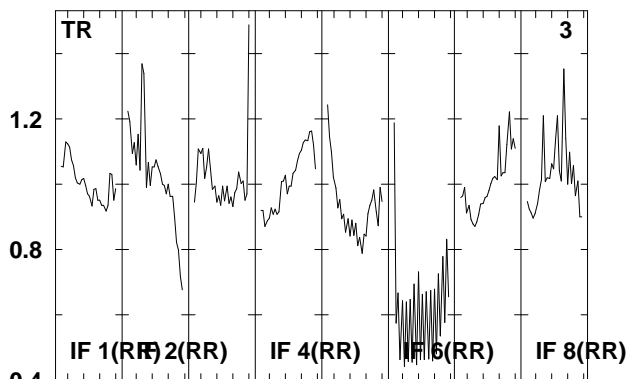
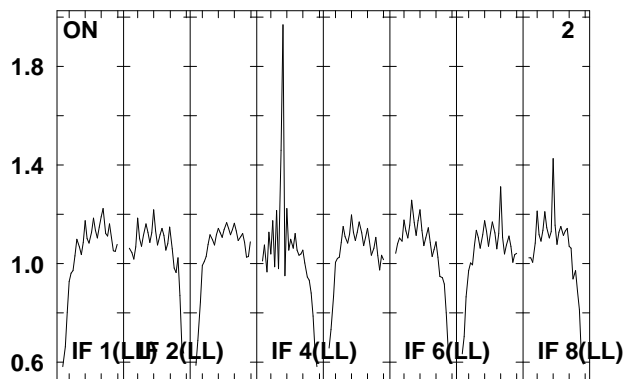
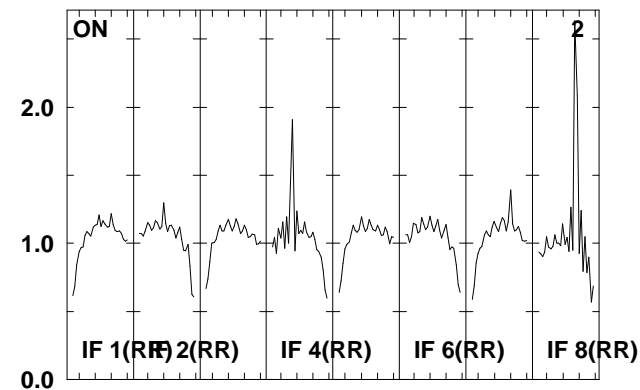
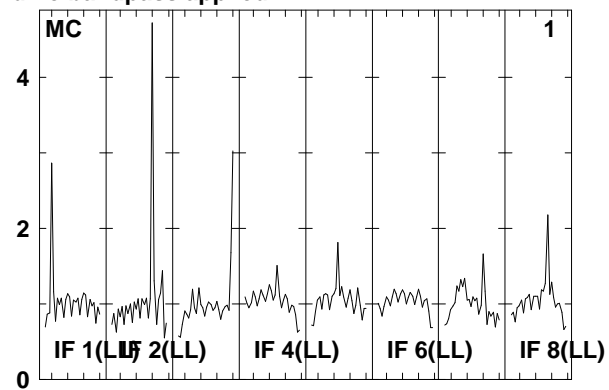
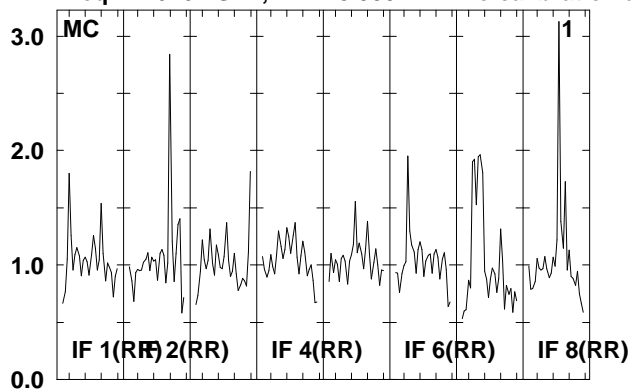

Lower frame: Real Jy  
 Total-power spectrum Antenna: \*  
 Timerange: 00/06:49:53 to 00/06:53:19

Plot file version 58 created 16-FEB-2009 12:46:25

J121839. RSF02.UVDATA.1

Freq = 1.6267 GHz, Bw = 8.000 MH No calibration applied and no bandpass applied

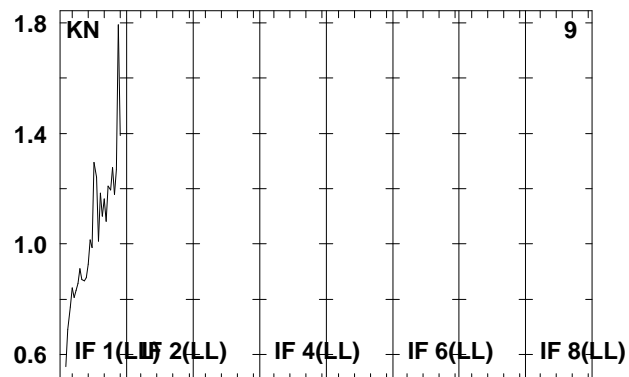
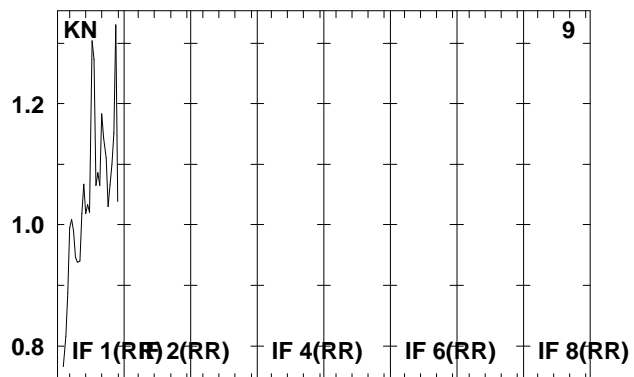
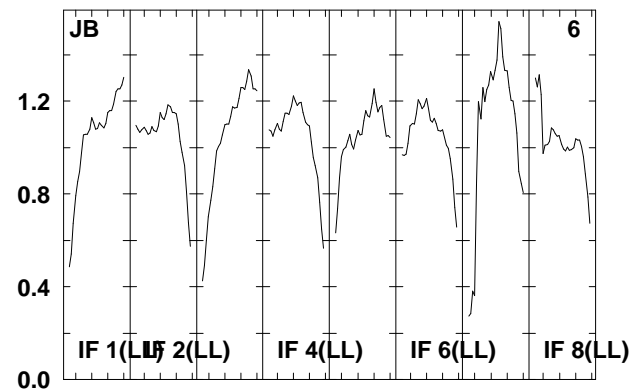
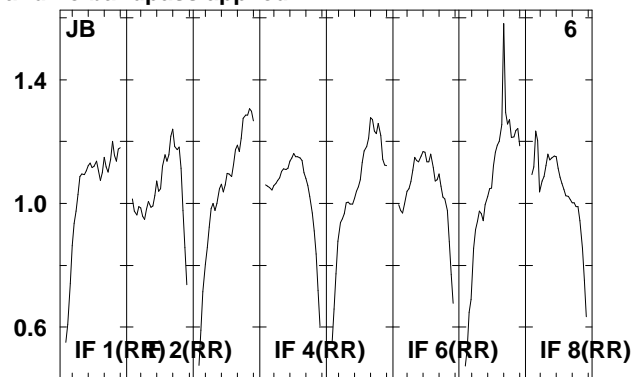
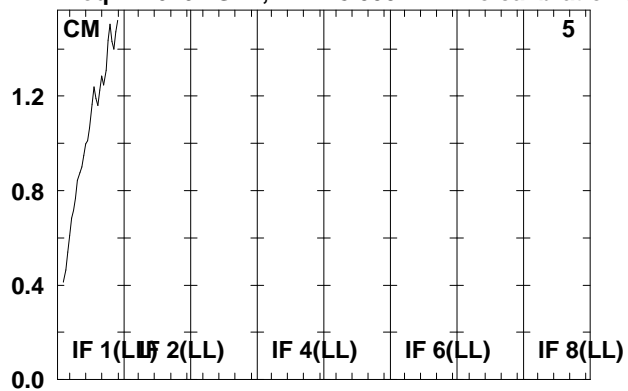

Lower frame: Real Jy  
Total-power spectrum Antenna: \*  
Timerange: 00/06:49:53 to 00/06:53:19

Plot file version 59 created 16-FEB-2009 12:46:26

J1217+30 RSF02.UVDATA.1

Freq = 1.6267 GHz, Bw = 8.000 MH No calibration applied and no bandpass applied

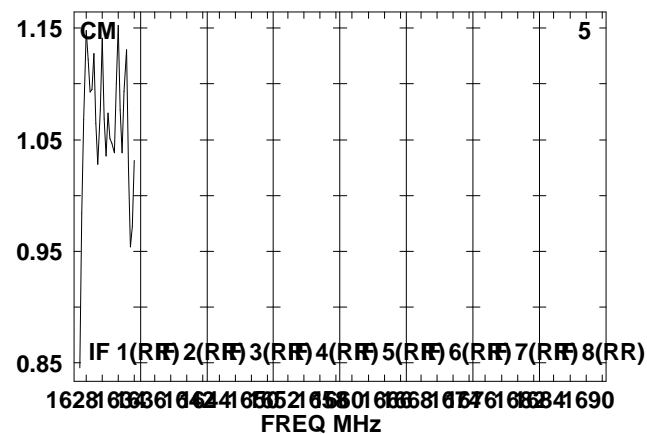
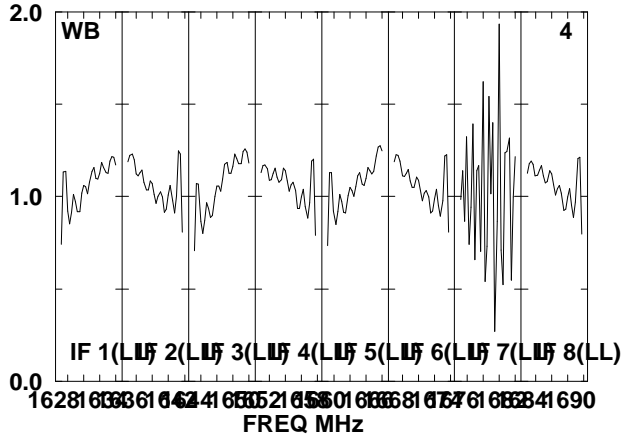
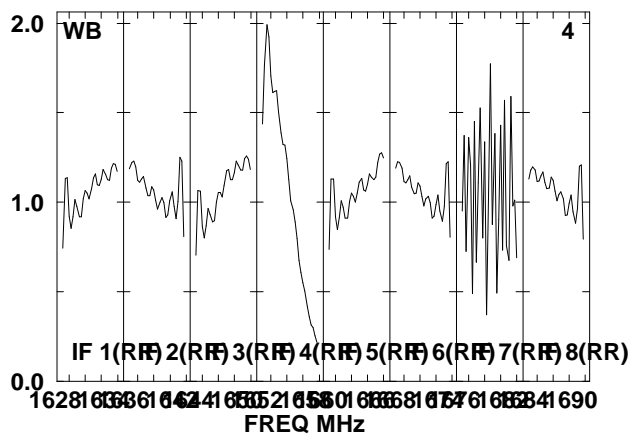
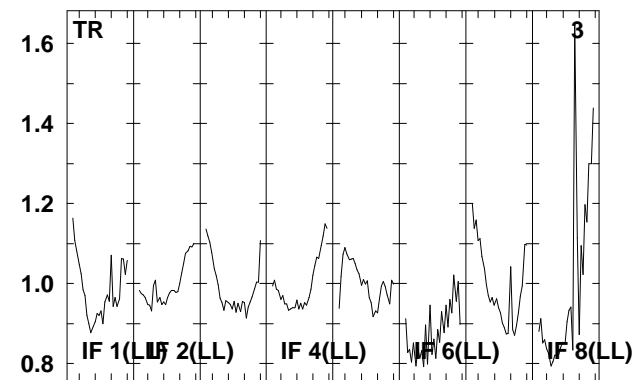
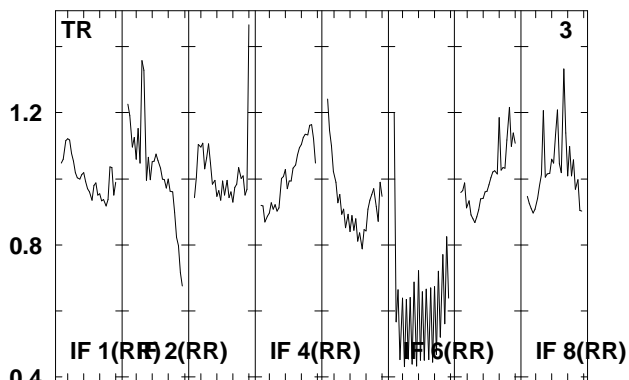
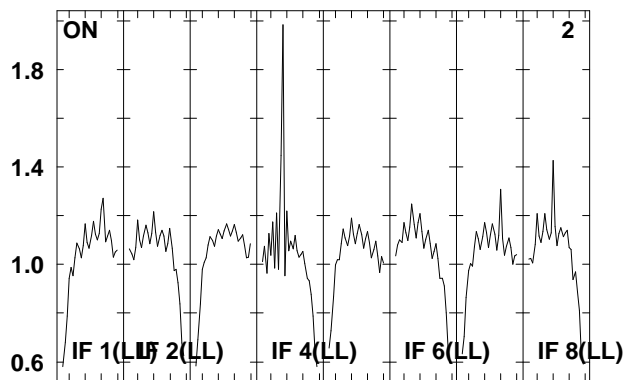
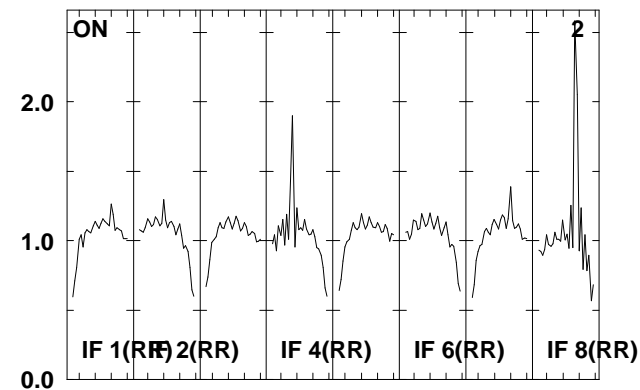
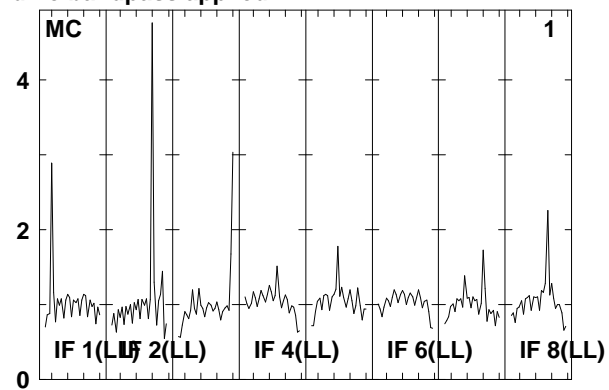
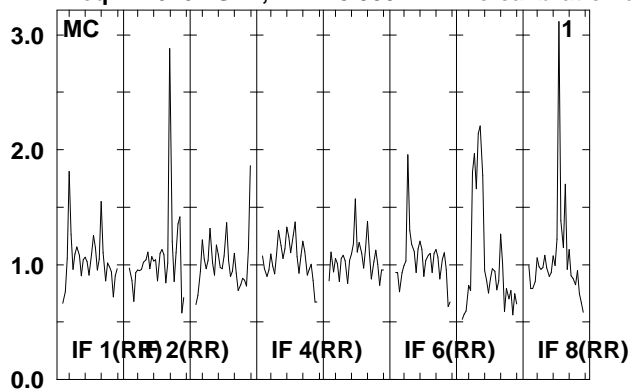

Lower frame: Real Jy  
Total-power spectrum Antenna: \*  
Timerange: 00/06:54:01 to 00/06:54:59

Plot file version 60 created 16-FEB-2009 12:46:26

J1217+30 RSF02.UVDATA.1

Freq = 1.6267 GHz, Bw = 8.000 MH No calibration applied and no bandpass applied

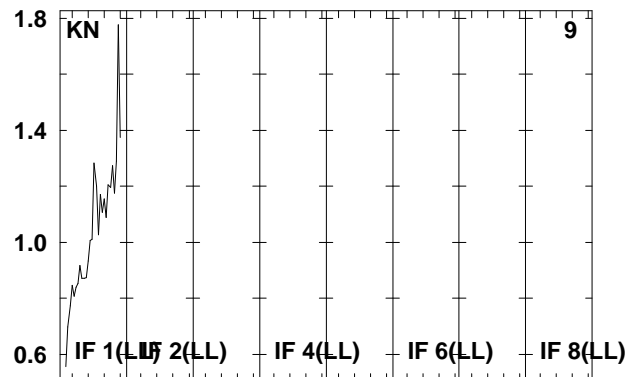
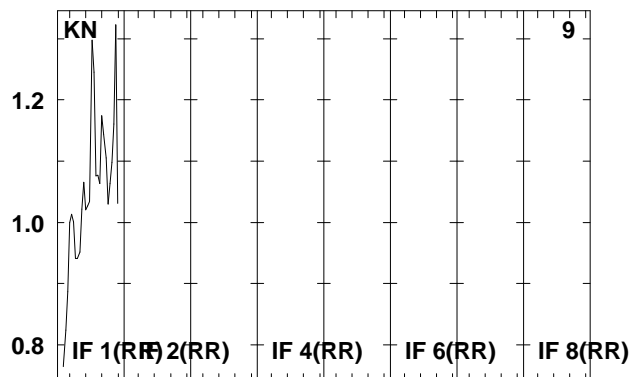
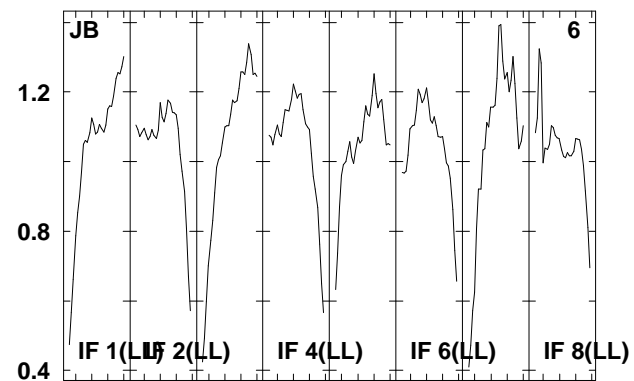
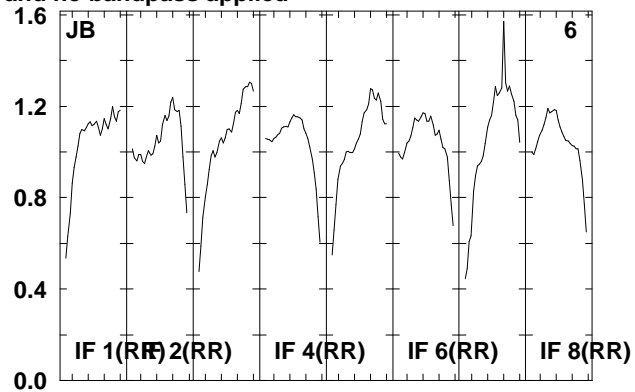
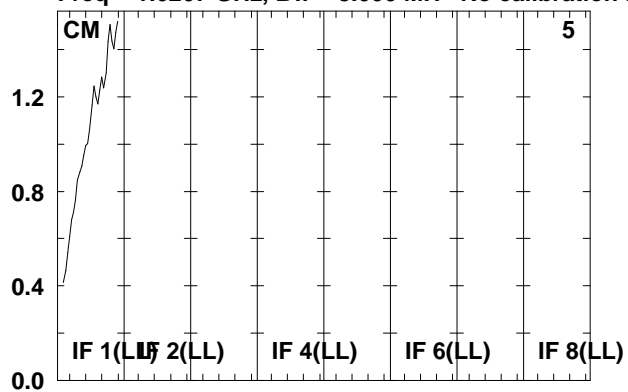

Lower frame: Real Jy  
Total-power spectrum Antenna: \*  
Timerange: 00/06:54:01 to 00/06:54:59

Plot file version 61 created 16-FEB-2009 12:46:27

J121839. RSF02.UVDATA.1

Freq = 1.6267 GHz, Bw = 8.000 MH No calibration applied and no bandpass applied

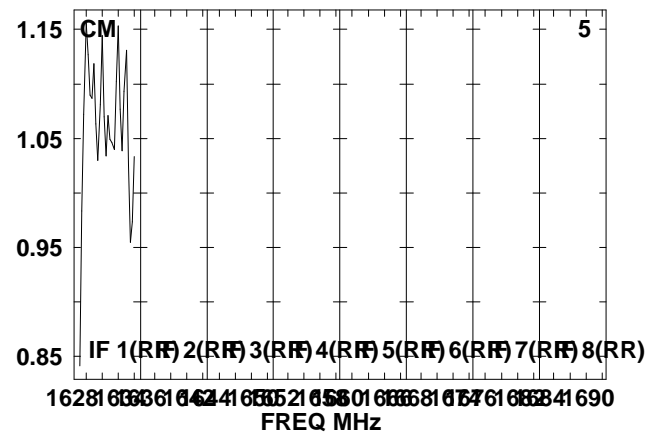
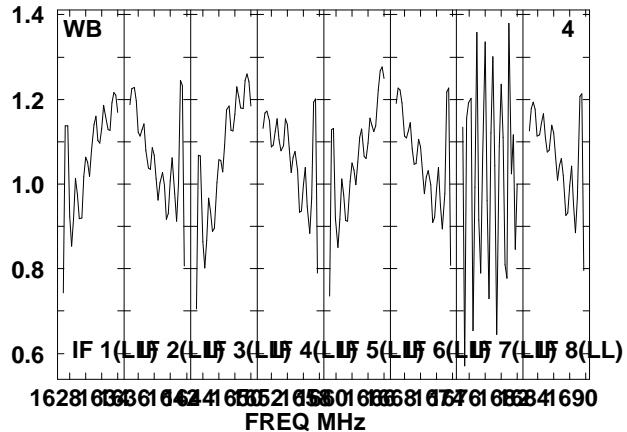
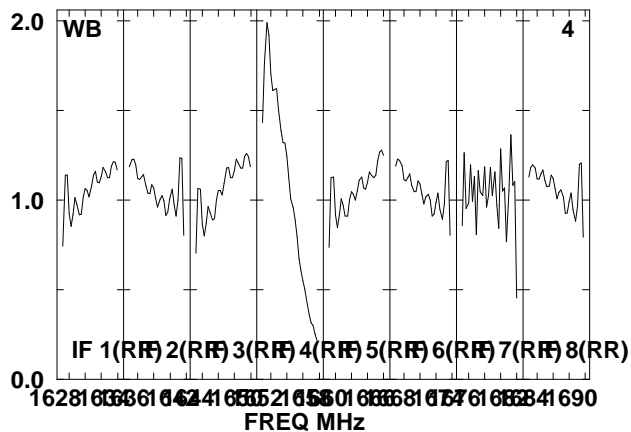
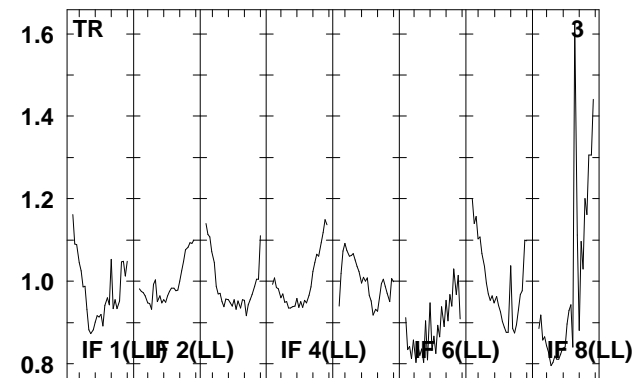
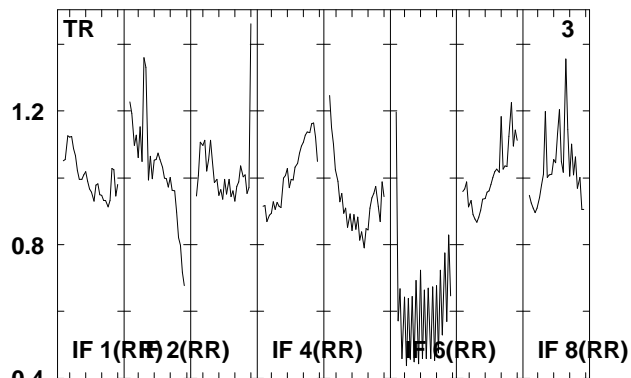
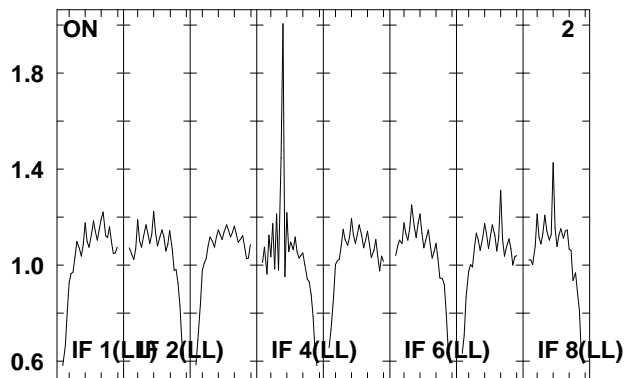
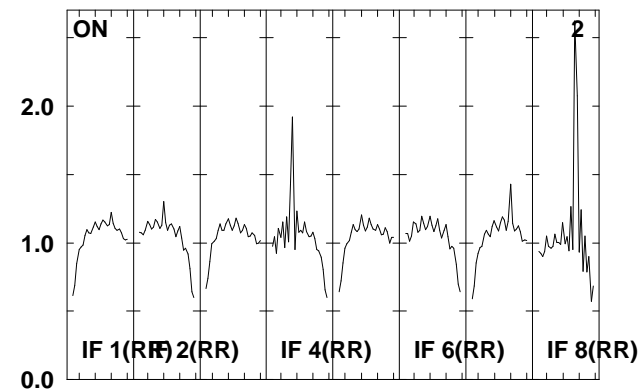
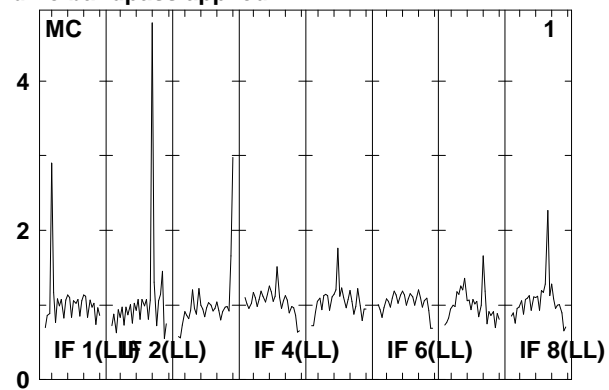
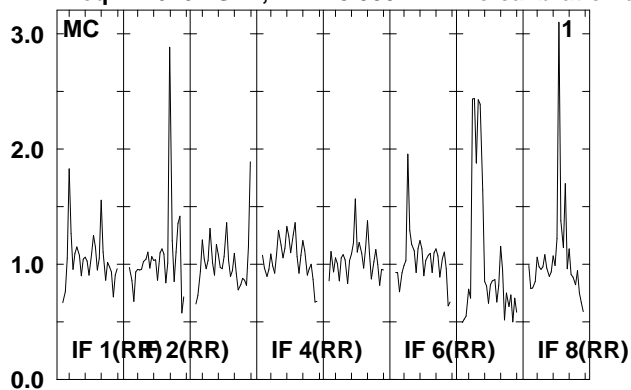

Lower frame: Real Jy  
Total-power spectrum Antenna: \*  
Timerange: 00/06:55:01 to 00/06:58:29

Plot file version 62 created 16-FEB-2009 12:46:27

J121839. RSF02.UVDATA.1

Freq = 1.6267 GHz, Bw = 8.000 MH No calibration applied and no bandpass applied

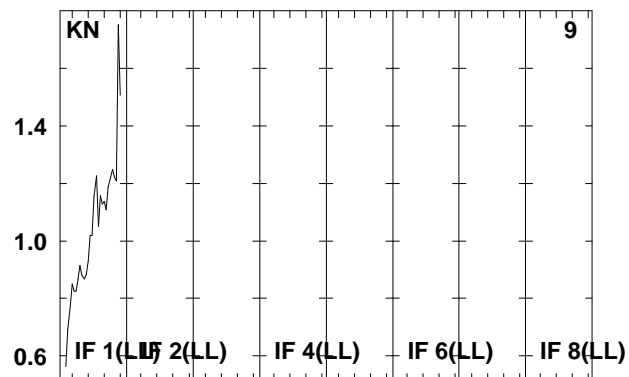
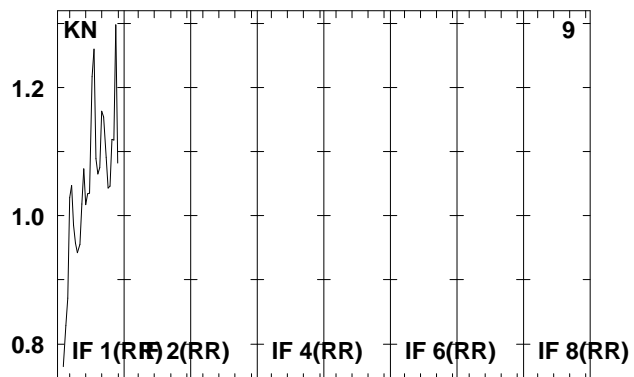
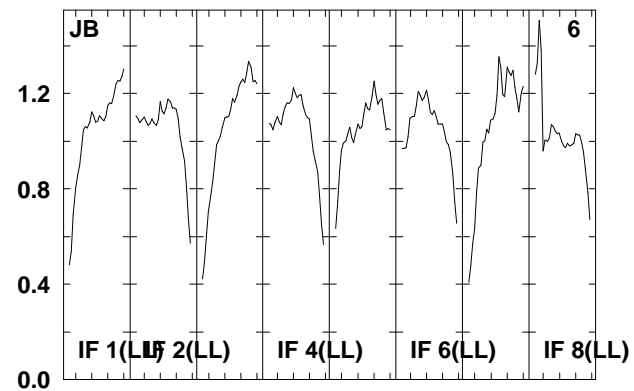
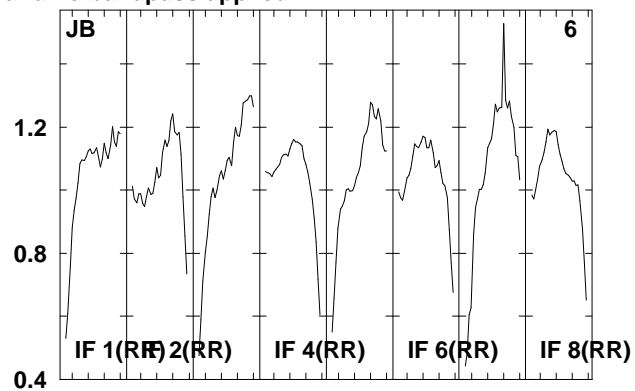
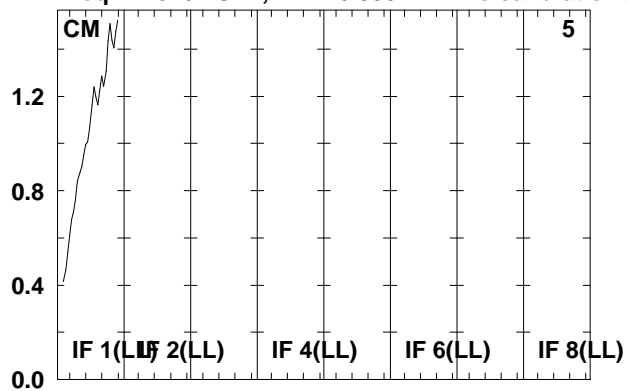

Lower frame: Real Jy  
Total-power spectrum Antenna: \*  
Timerange: 00/06:55:01 to 00/06:58:29

Plot file version 63 created 16-FEB-2009 12:46:29

J1217+30 RSF02.UVDATA.1

Freq = 1.6267 GHz, Bw = 8.000 MH No calibration applied and no bandpass applied

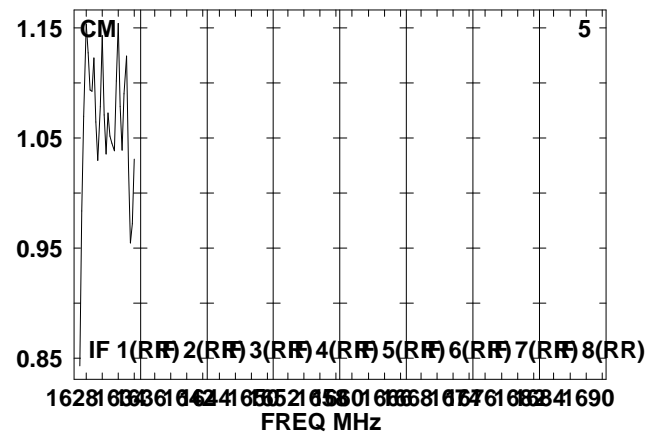
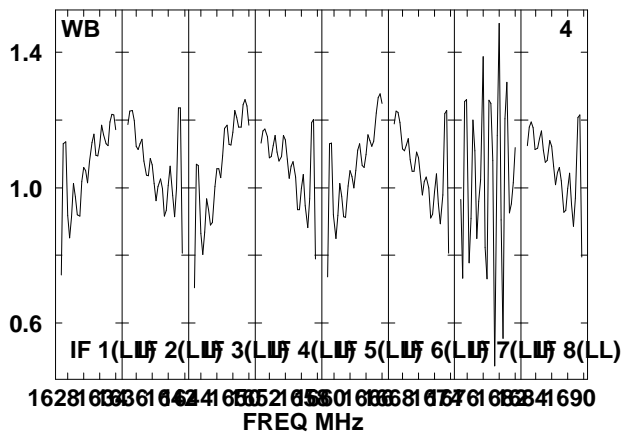
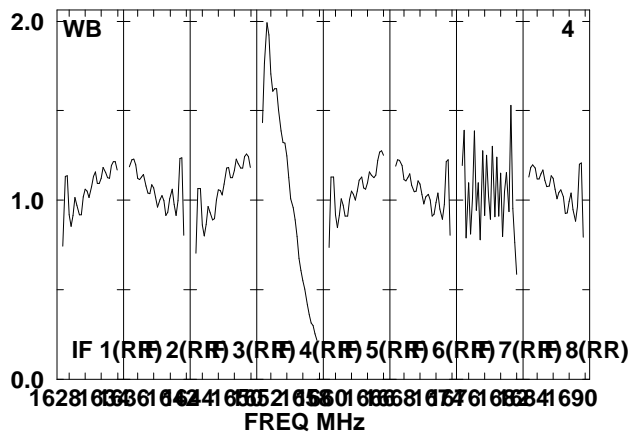
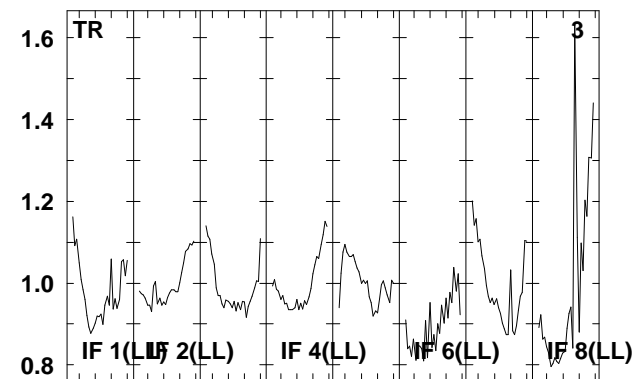
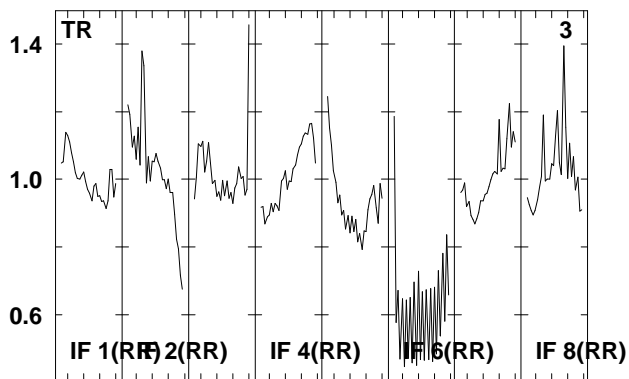
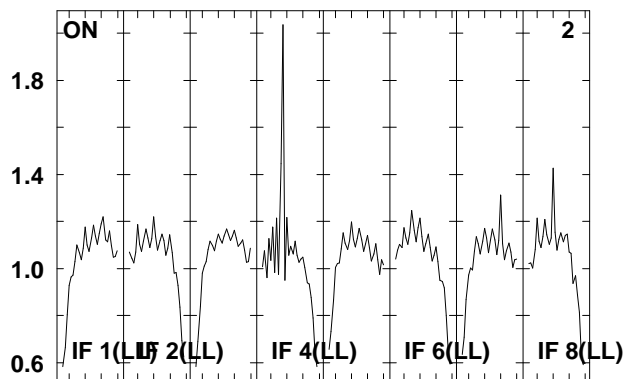
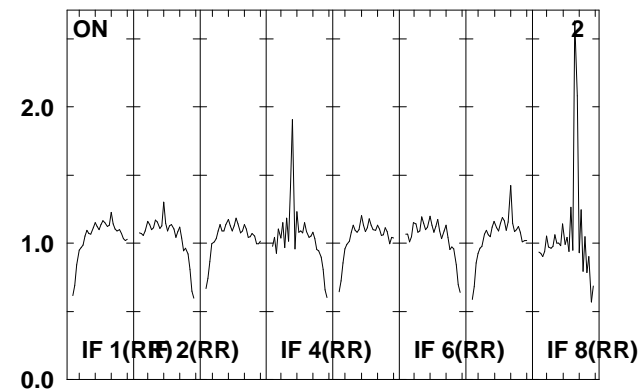
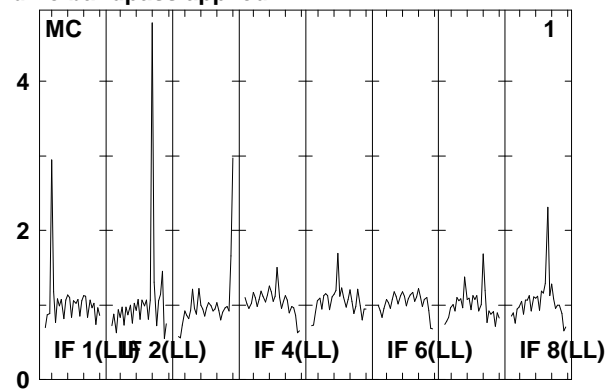
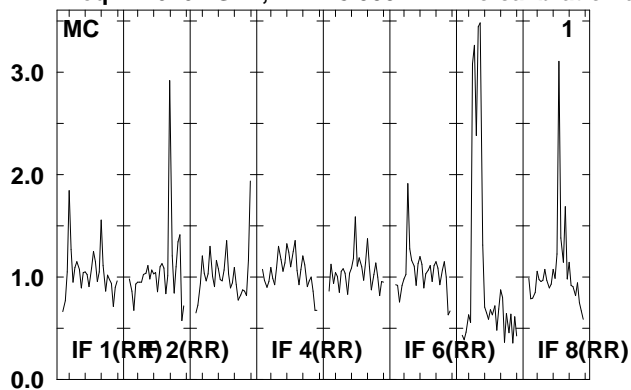

Lower frame: Real Jy  
Total-power spectrum Antenna: \*  
Timerange: 00/06:58:31 to 00/06:59:51

Plot file version 64 created 16-FEB-2009 12:46:29

J1217+30 RSF02.UVDATA.1

Freq = 1.6267 GHz, Bw = 8.000 MH No calibration applied and no bandpass applied

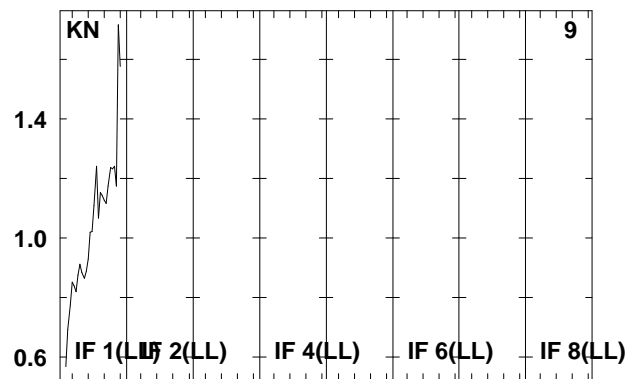
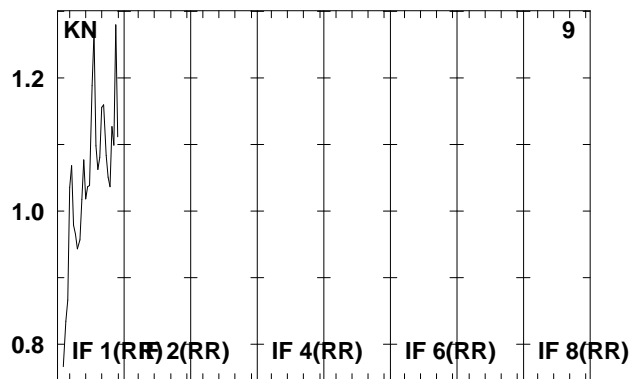
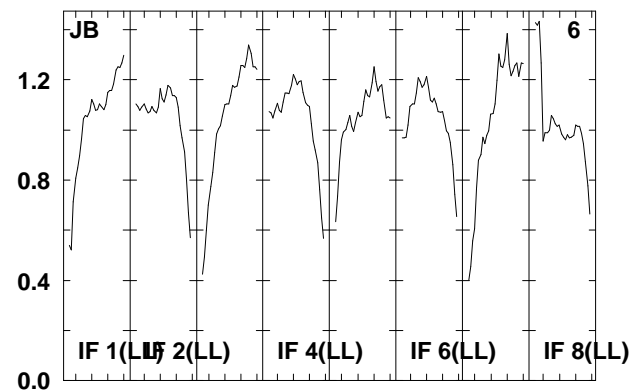
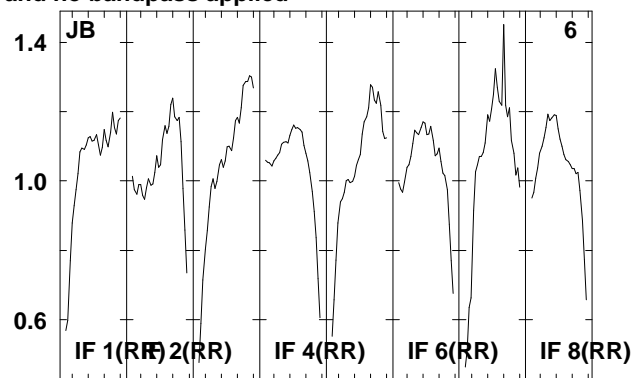
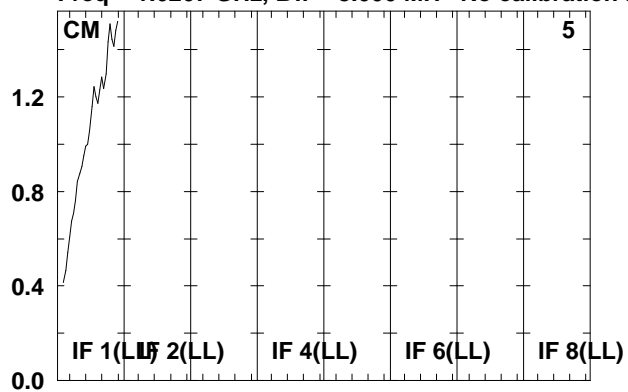

Lower frame: Real Jy  
Total-power spectrum Antenna: \*  
Timerange: 00/06:58:31 to 00/06:59:51



Plot file version 65 created 16-FEB-2009 12:46:30  
 J121839. RSF02.UVDATA.1  
 Freq = 1.6267 GHz, Bw = 8.000 MH No calibration applied and no bandpass applied

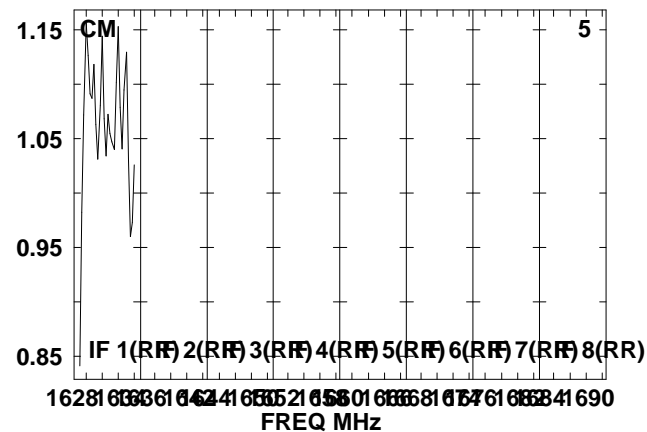
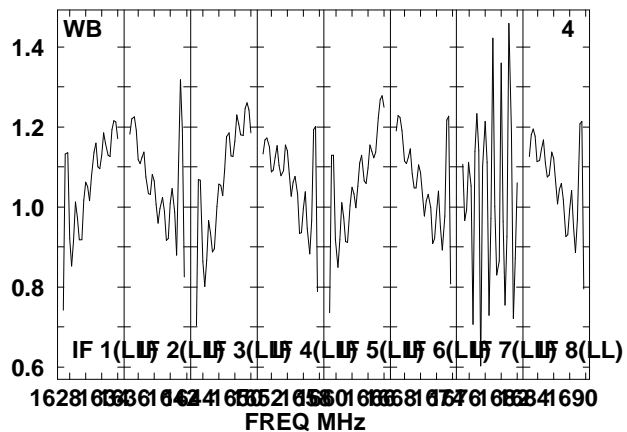
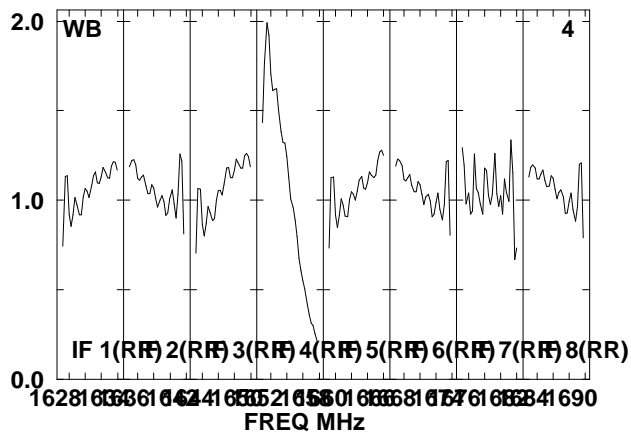
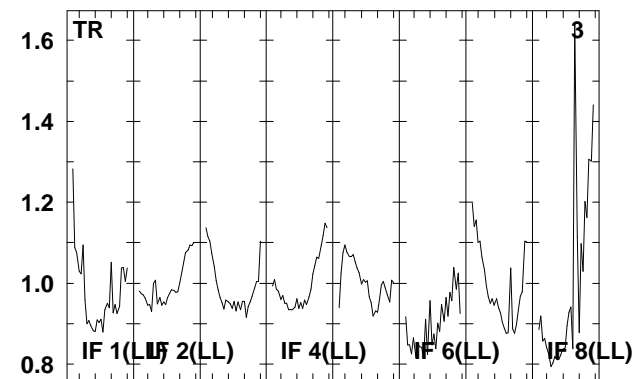
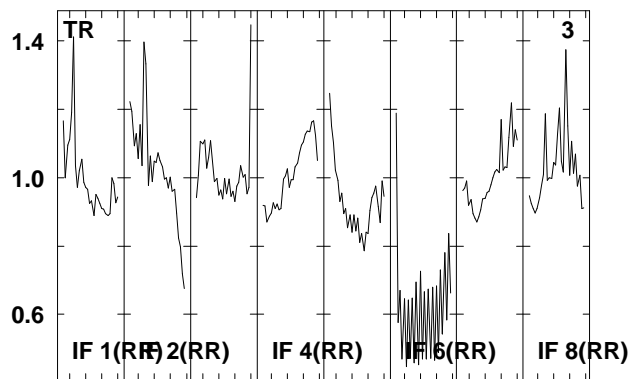
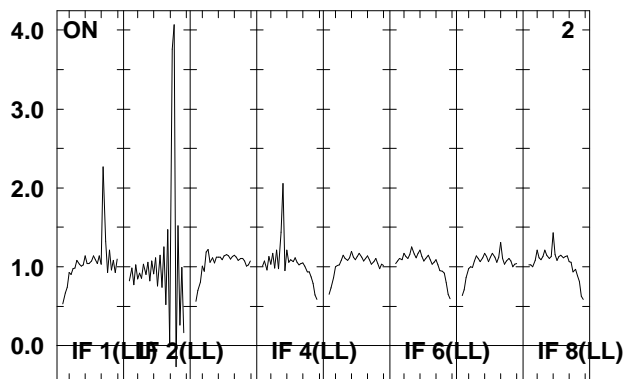
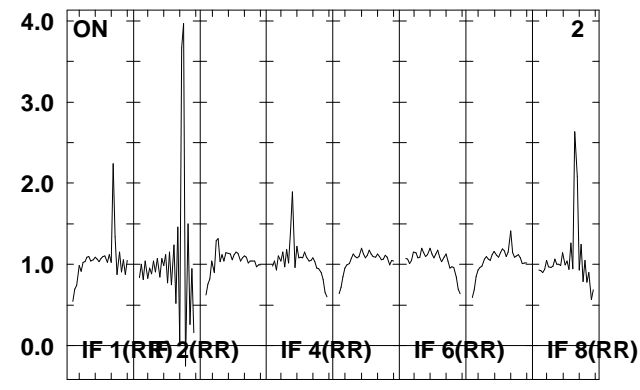
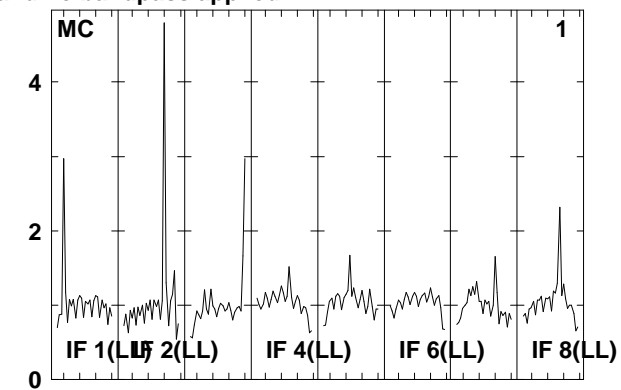
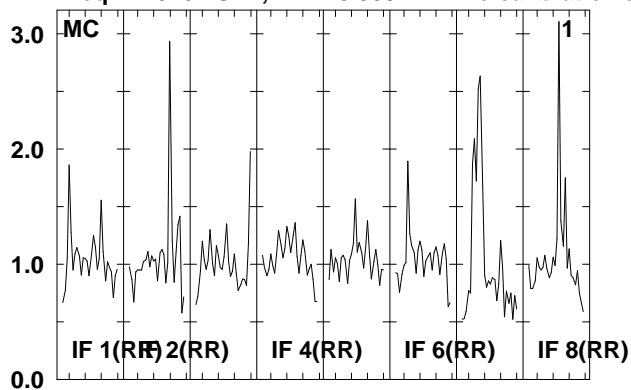

Lower frame: Real Jy  
 Total-power spectrum Antenna: \*  
 Timerange: 00/06:59:53 to 00/07:03:19

Plot file version 66 created 16-FEB-2009 12:46:30

J121839. RSF02.UVDATA.1

Freq = 1.6267 GHz, Bw = 8.000 MH No calibration applied and no bandpass applied

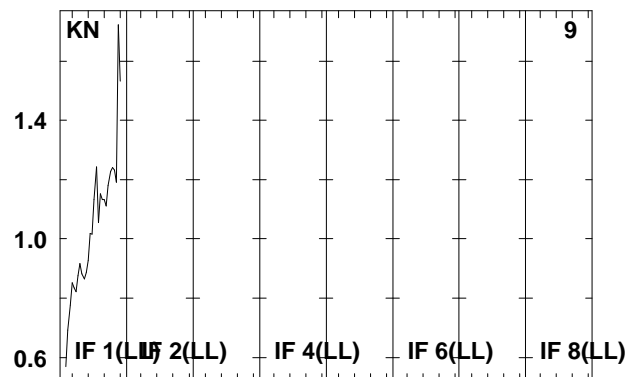
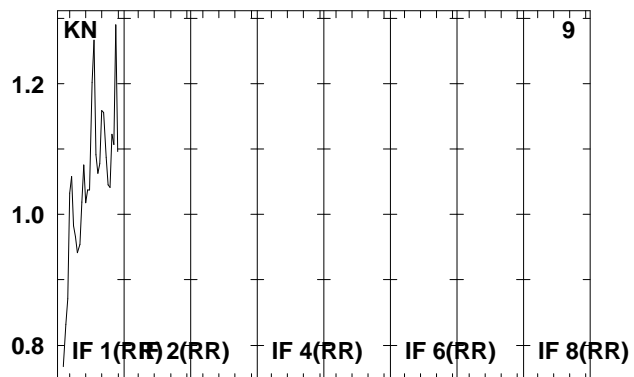
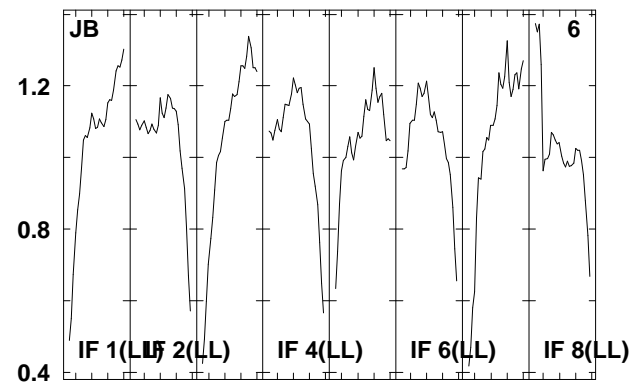
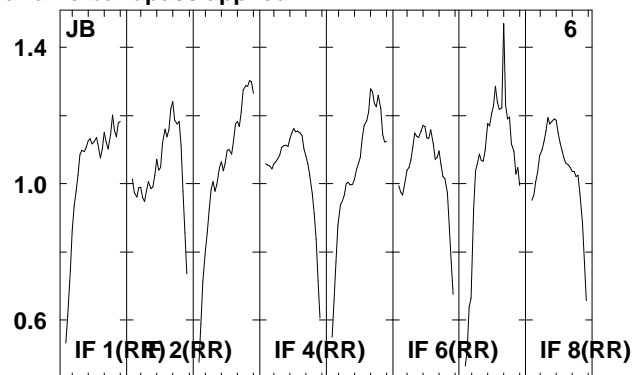
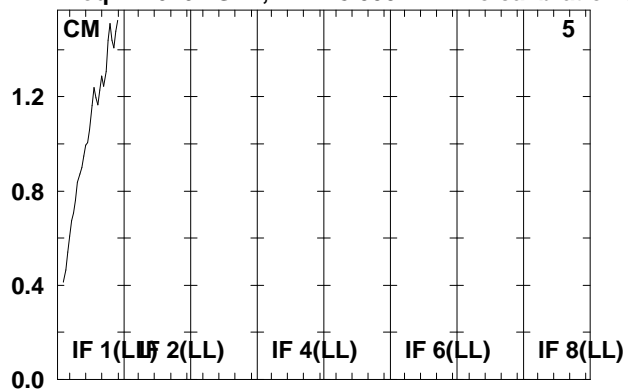

Lower frame: Real Jy  
Total-power spectrum Antenna: \*  
Timerange: 00/06:59:53 to 00/07:03:19

Plot file version 67 created 16-FEB-2009 12:46:32

J1217+30 RSF02.UVDATA.1

Freq = 1.6267 GHz, Bw = 8.000 MH No calibration applied and no bandpass applied

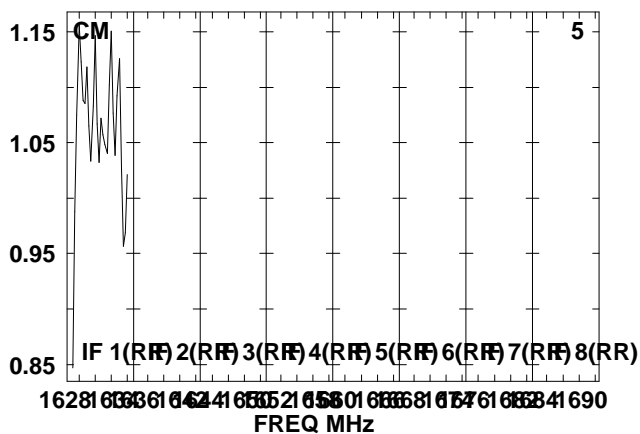
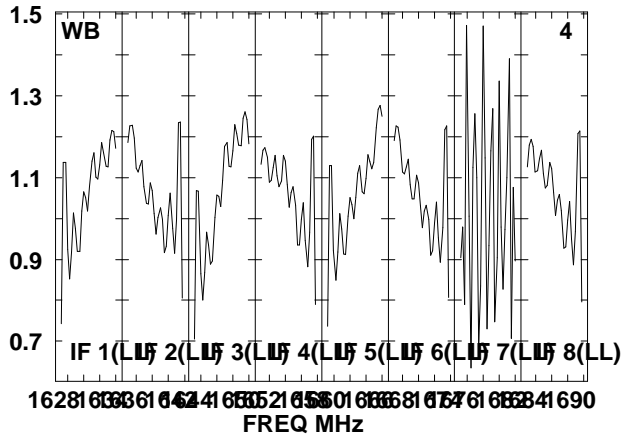
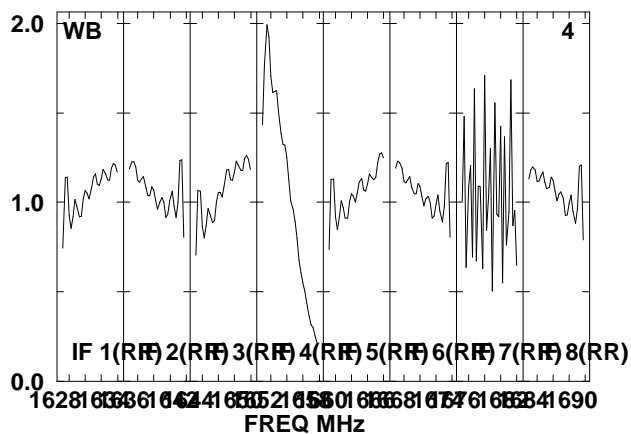
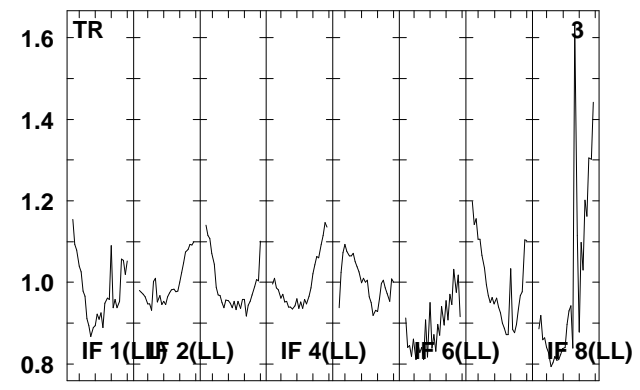
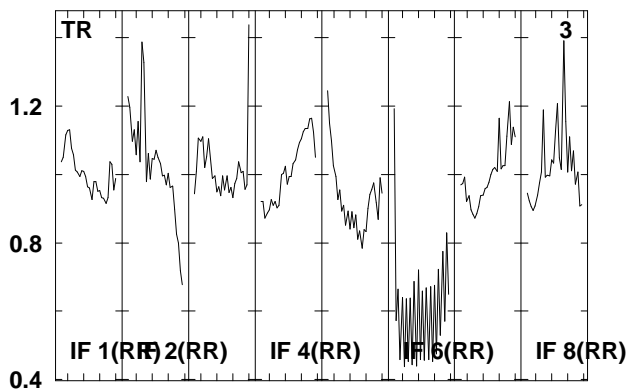
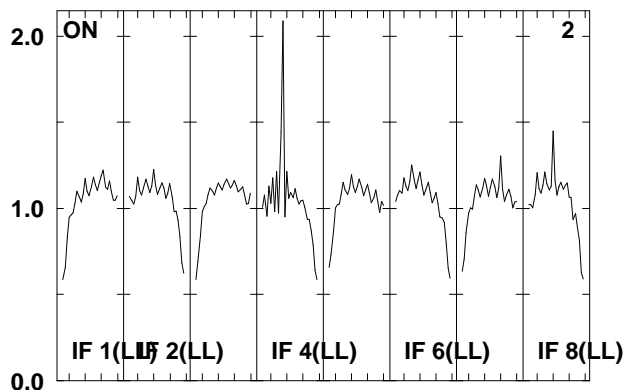
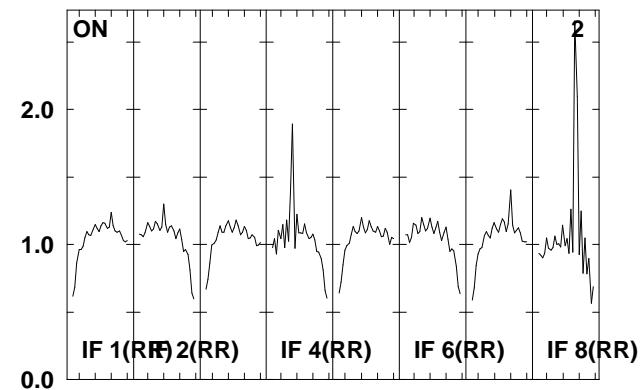
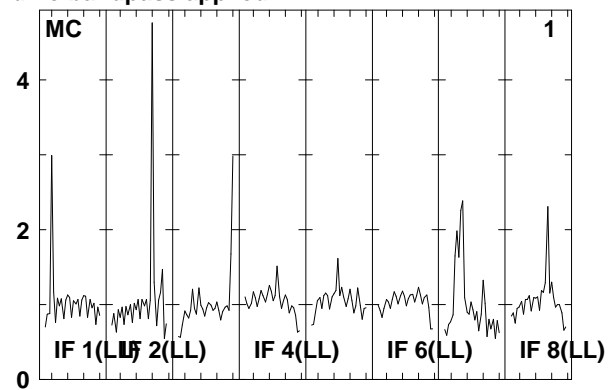
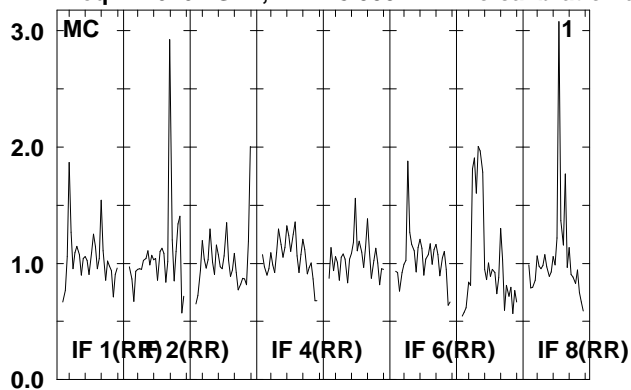

Lower frame: Real Jy  
Total-power spectrum Antenna: \*  
Timerange: 00/07:04:01 to 00/07:04:59

Plot file version 68 created 16-FEB-2009 12:46:32

J1217+30 RSF02.UVDATA.1

Freq = 1.6267 GHz, Bw = 8.000 MH No calibration applied and no bandpass applied

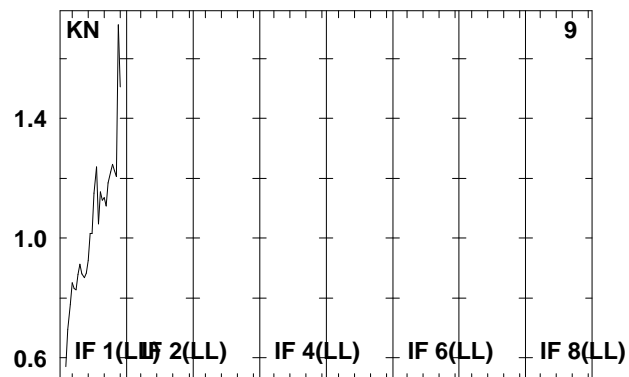
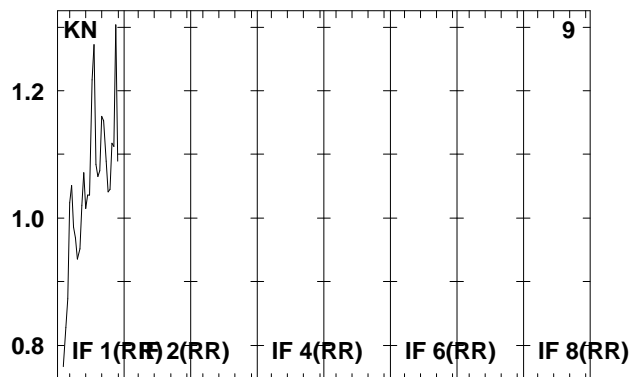
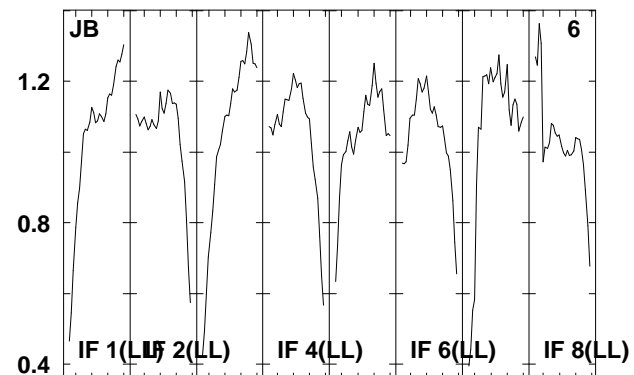
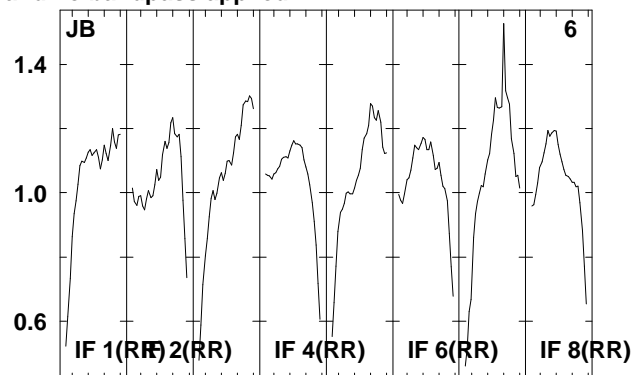
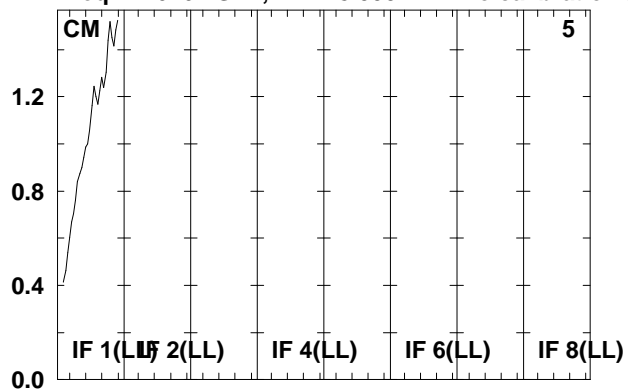

Lower frame: Real Jy  
Total-power spectrum Antenna: \*  
Timerange: 00/07:04:01 to 00/07:04:59

Plot file version 69 created 16-FEB-2009 12:46:32  
 J121839. RSF02.UVDATA.1  
 Freq = 1.6267 GHz, Bw = 8.000 MH No calibration applied and no bandpass applied

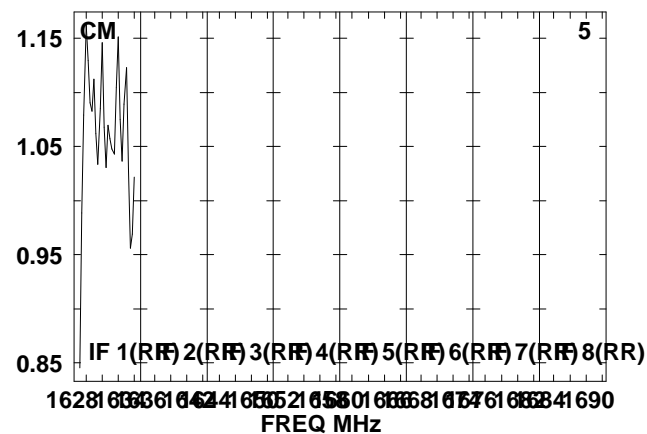
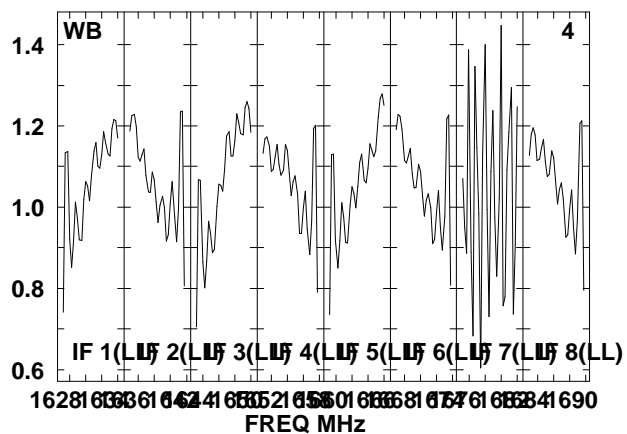
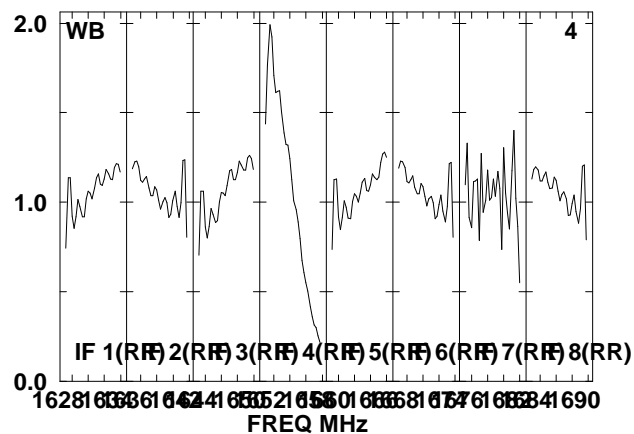
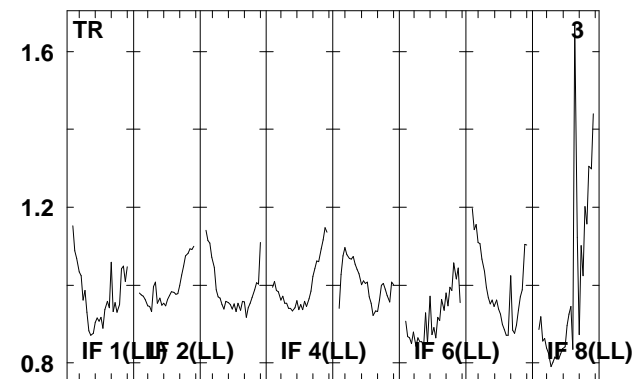
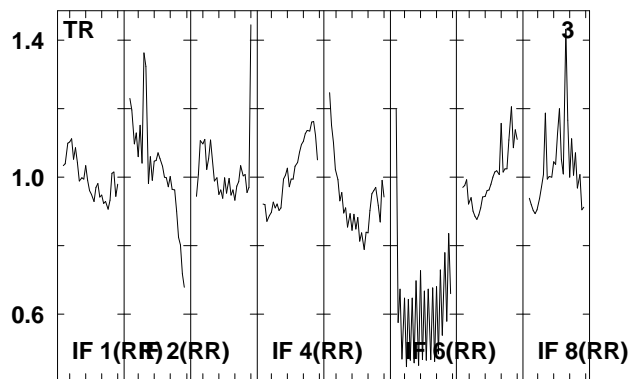
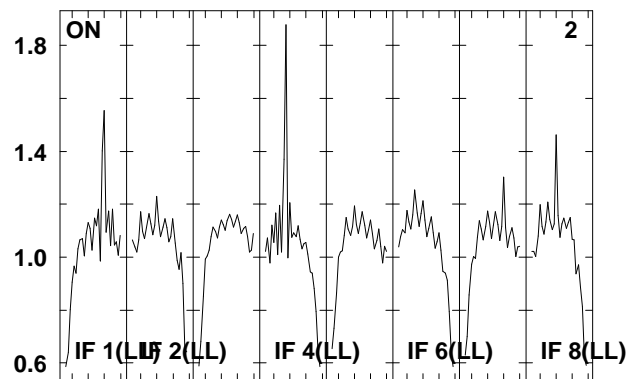
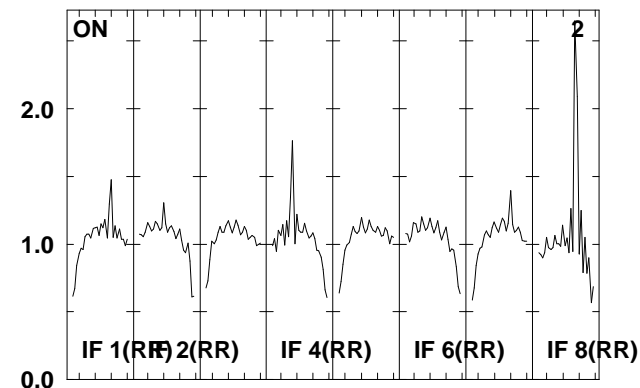
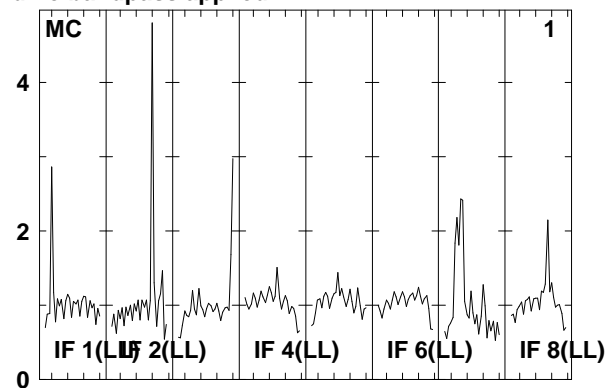
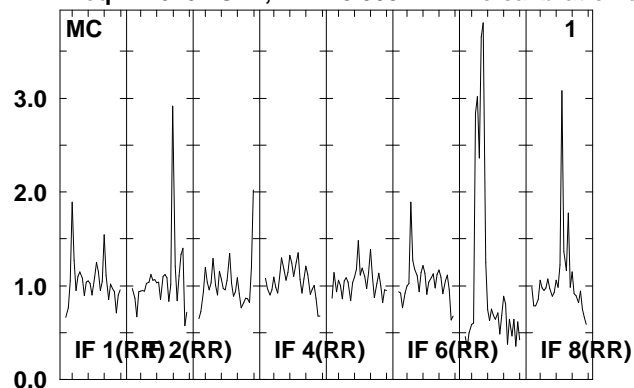

Lower frame: Real Jy  
 Total-power spectrum Antenna: \*  
 Timerange: 00/07:05:01 to 00/07:08:29

Plot file version 70 created 16-FEB-2009 12:46:33

J121839. RSF02.UVDATA.1

Freq = 1.6267 GHz, Bw = 8.000 MH No calibration applied and no bandpass applied

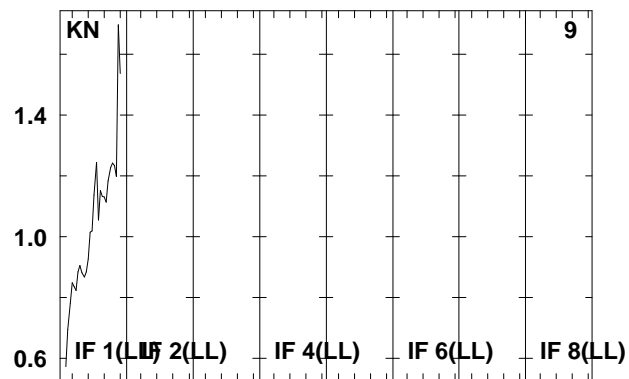
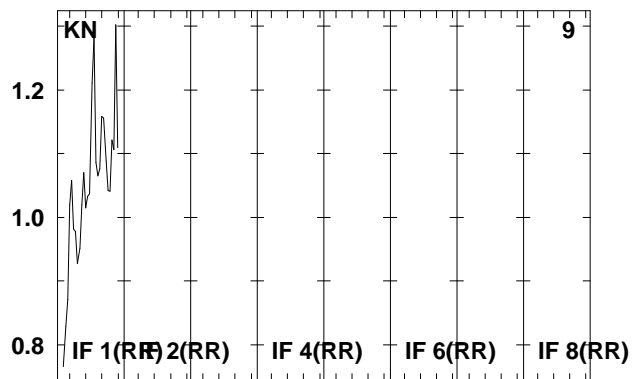
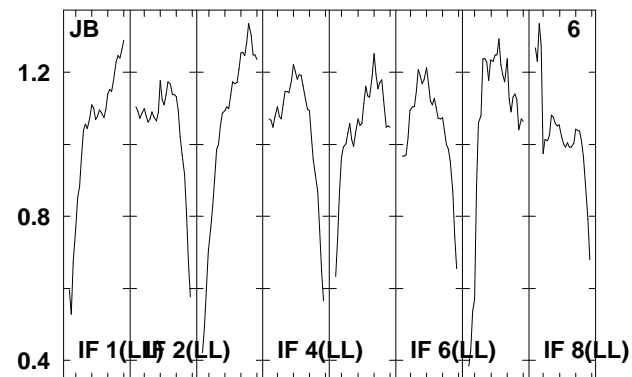
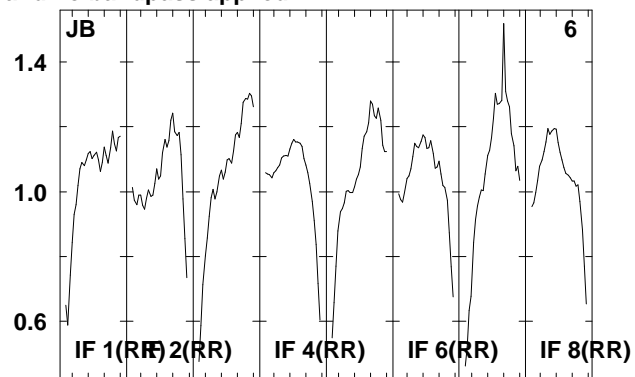
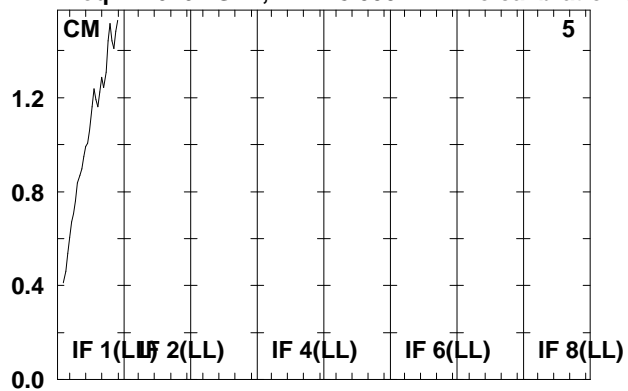

Lower frame: Real Jy  
Total-power spectrum Antenna: \*  
Timerange: 00/07:05:01 to 00/07:08:29

Plot file version 71 created 16-FEB-2009 12:46:34

J1217+30 RSF02.UVDATA.1

Freq = 1.6267 GHz, Bw = 8.000 MH No calibration applied and no bandpass applied

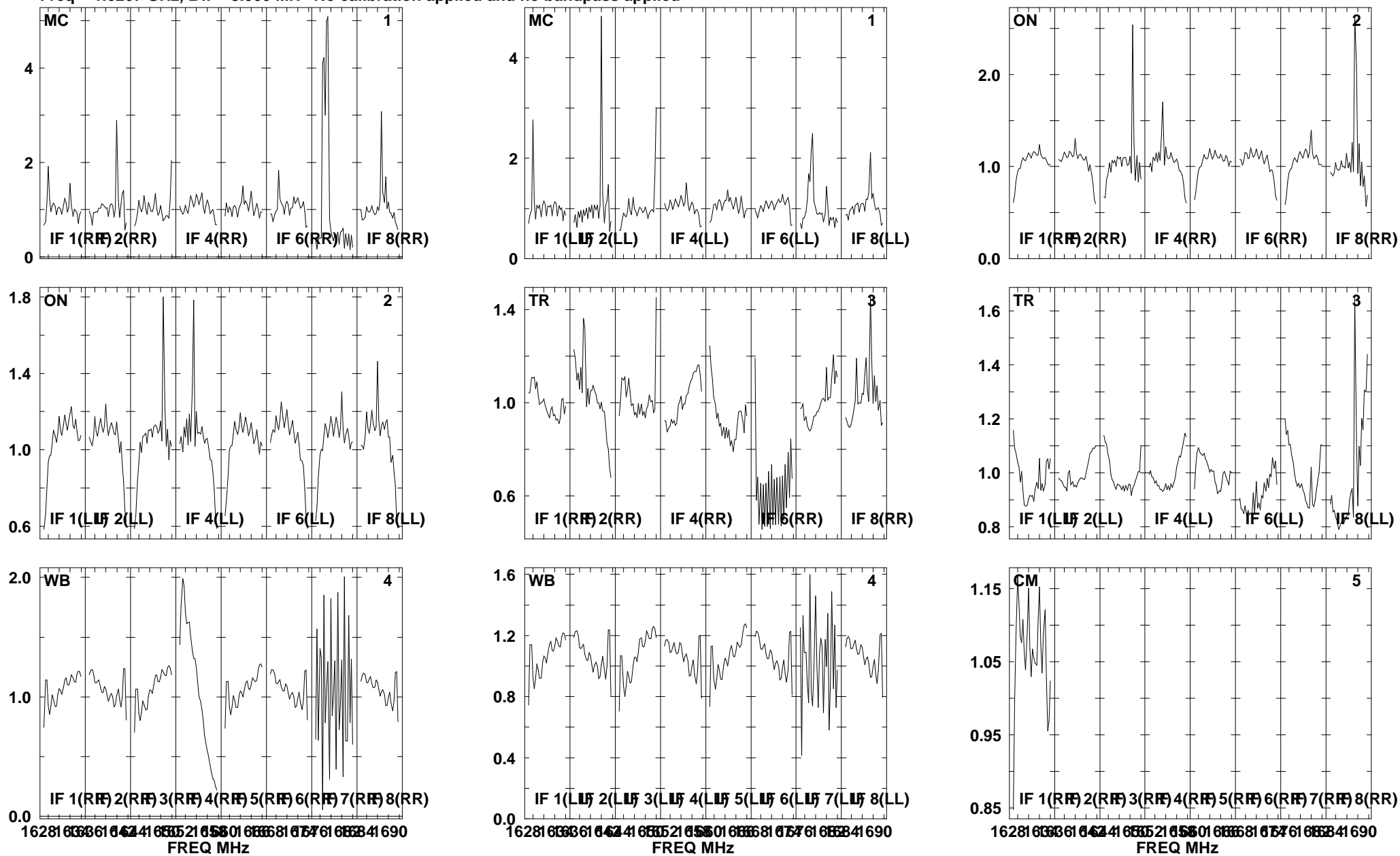

Lower frame: Real Jy  
Total-power spectrum Antenna: \*  
Timerange: 00:07:08:31 to 00:07:09:51

Plot file version 72 created 16-FEB-2009 12:46:34

J1217+30 RSF02.UVDATA.1

Freq = 1.6267 GHz, Bw = 8.000 MH No calibration applied and no bandpass applied

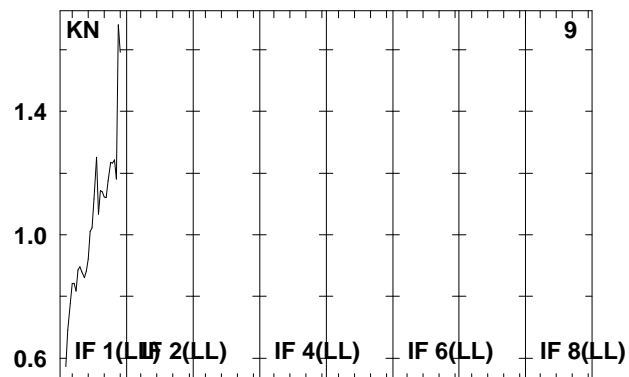
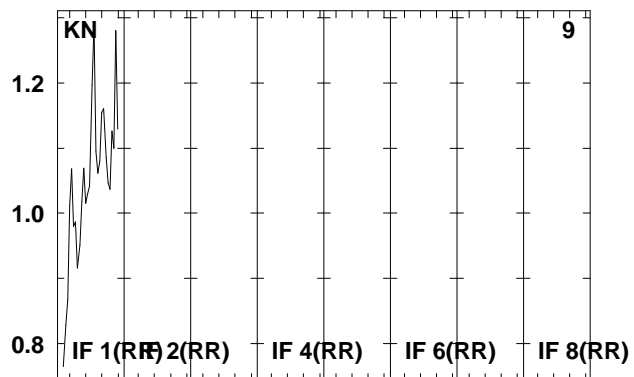
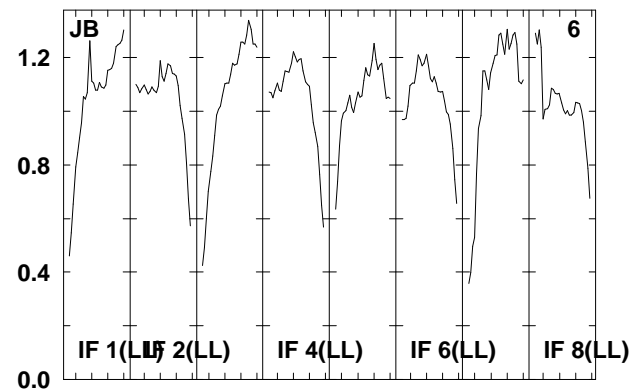
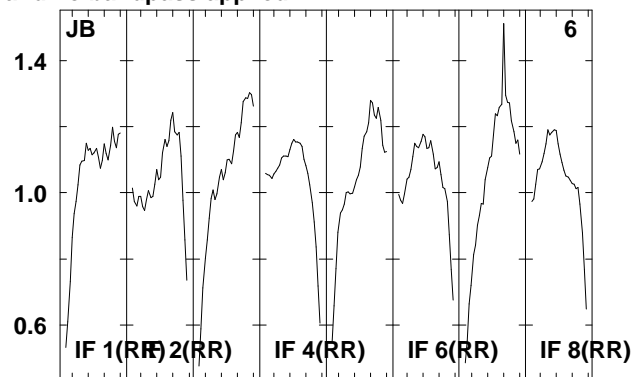
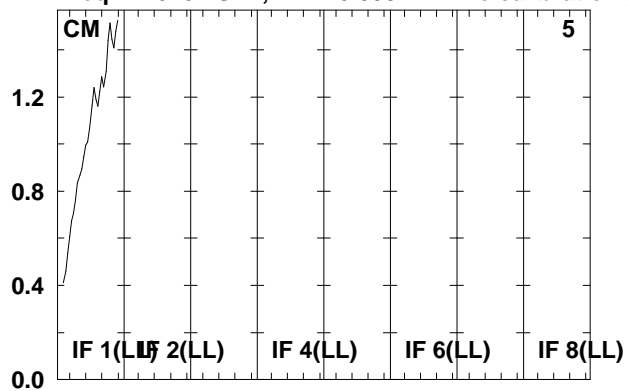

Lower frame: Real Jy  
Total-power spectrum Antenna: \*  
Timerange: 00/07:08:31 to 00/07:09:51



Plot file version 73 created 16-FEB-2009 12:46:35  
 J121839. RSF02.UVDATA.1  
 Freq = 1.6267 GHz, Bw = 8.000 MH No calibration applied and no bandpass applied

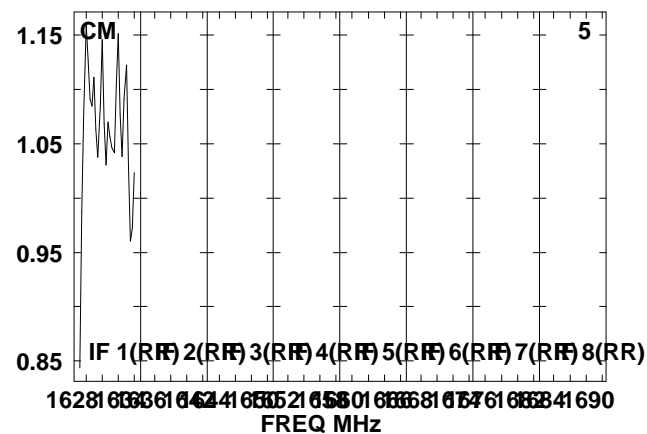
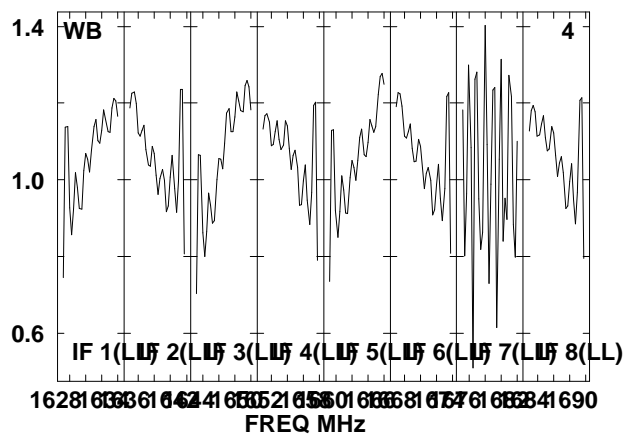
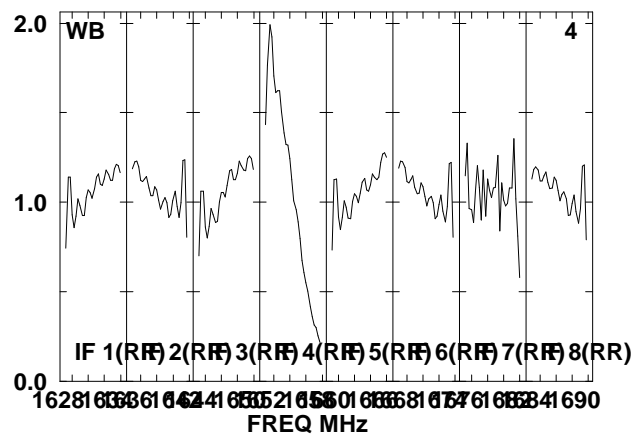
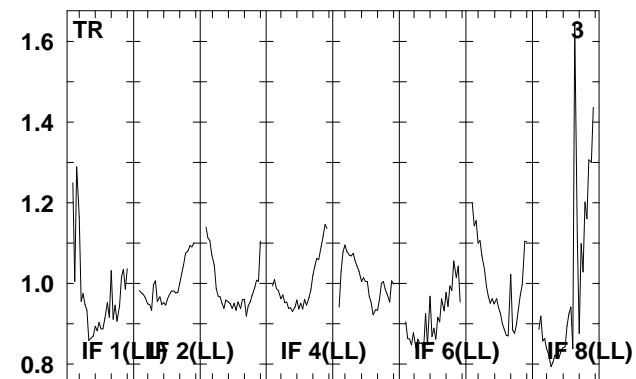
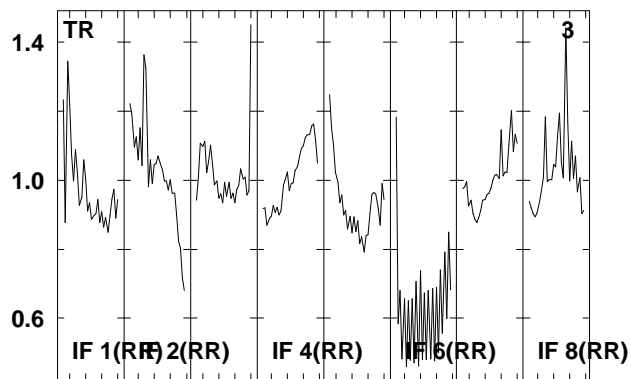
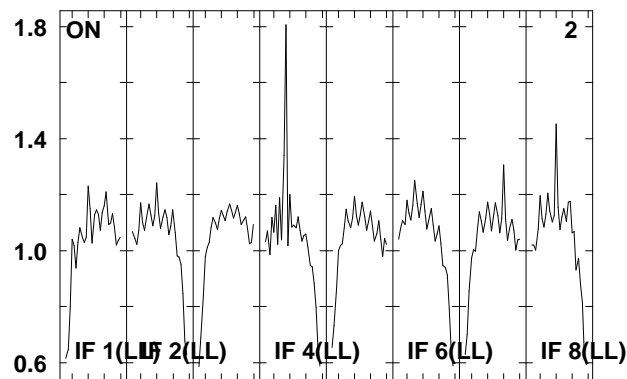
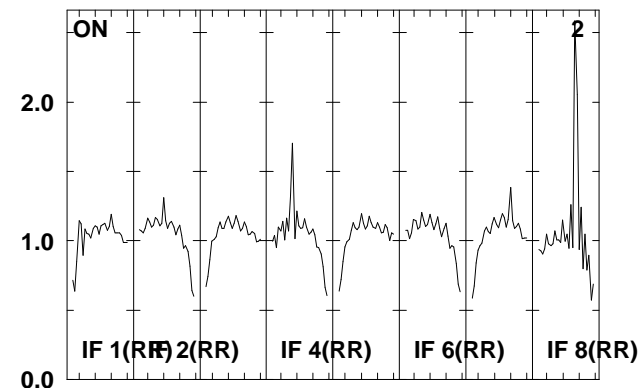
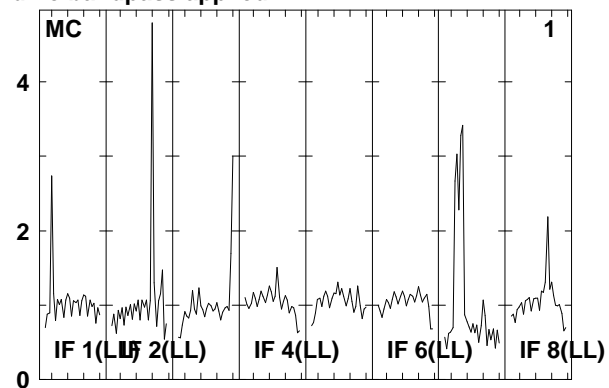
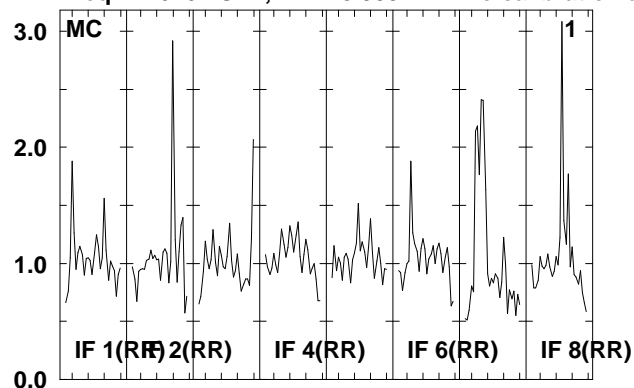

Lower frame: Real Jy  
 Total-power spectrum Antenna: \*  
 Timerange: 00/07:09:53 to 00/07:13:19

Plot file version 74 created 16-FEB-2009 12:46:36

J121839. RSF02.UVDATA.1

Freq = 1.6267 GHz, Bw = 8.000 MH No calibration applied and no bandpass applied

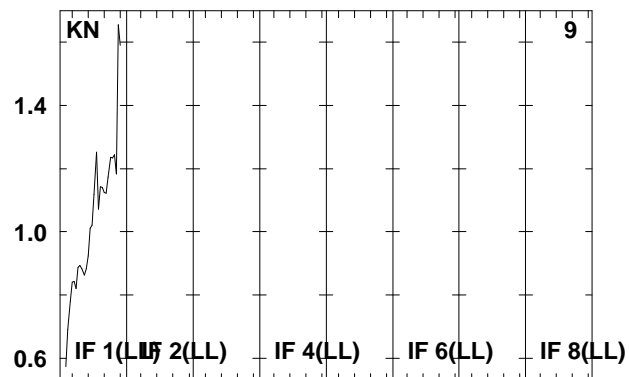
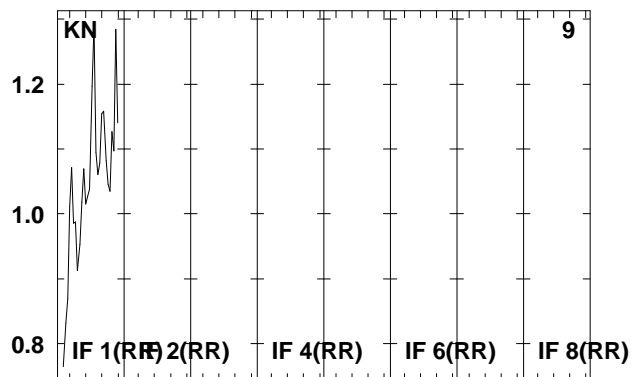
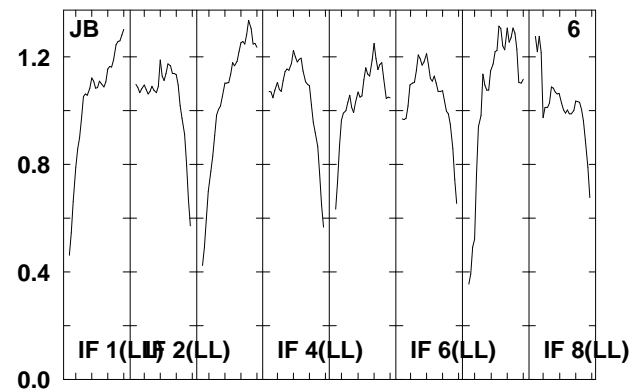
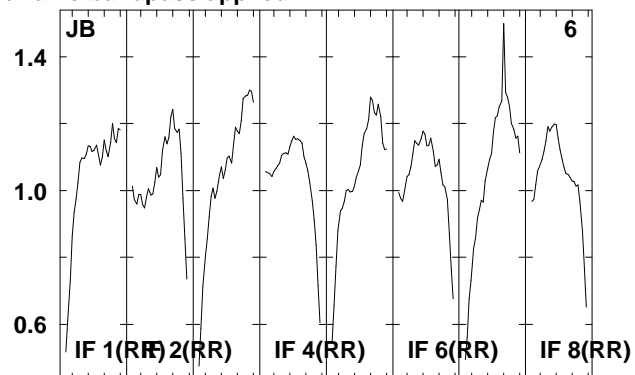
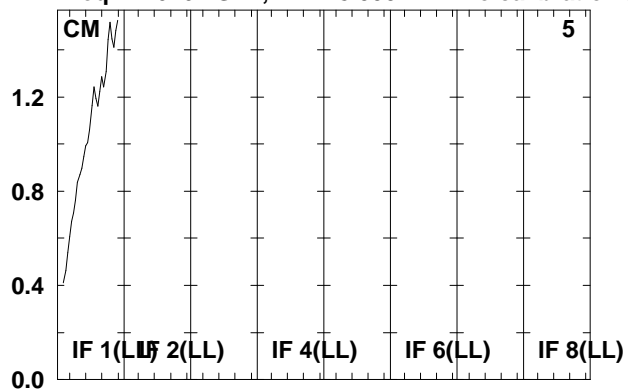

Lower frame: Real Jy  
Total-power spectrum Antenna: \*  
Timerange: 00/07:09:53 to 00/07:13:19

Plot file version 75 created 16-FEB-2009 12:46:37  
 J1217+30 RSF02.UVDATA.1  
 Freq = 1.6267 GHz, Bw = 8.000 MH No calibration applied and no bandpass applied

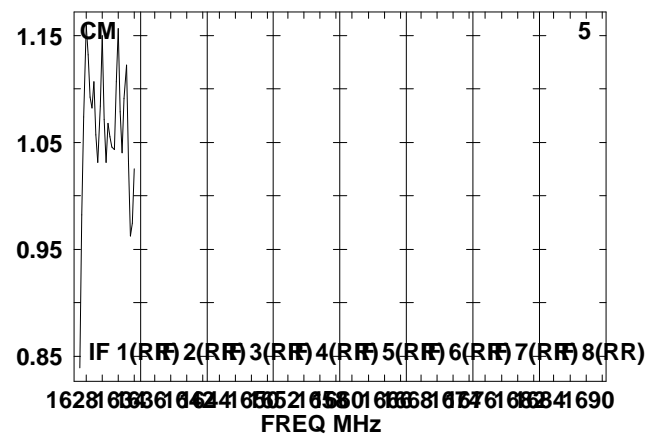
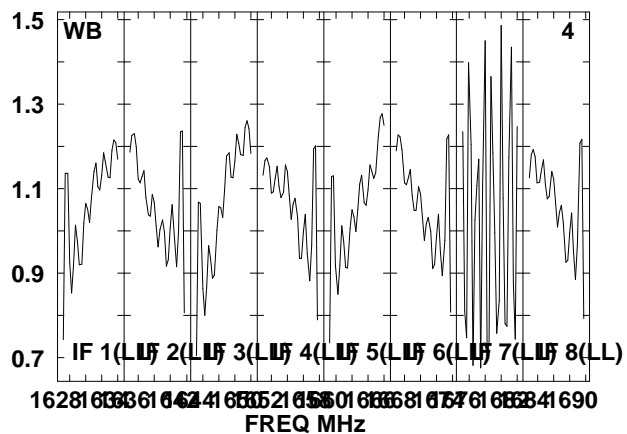
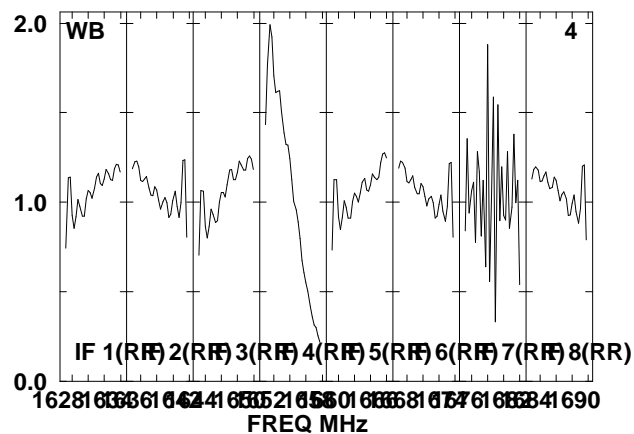
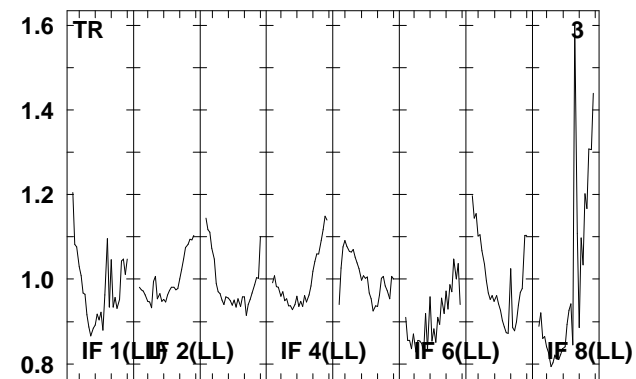
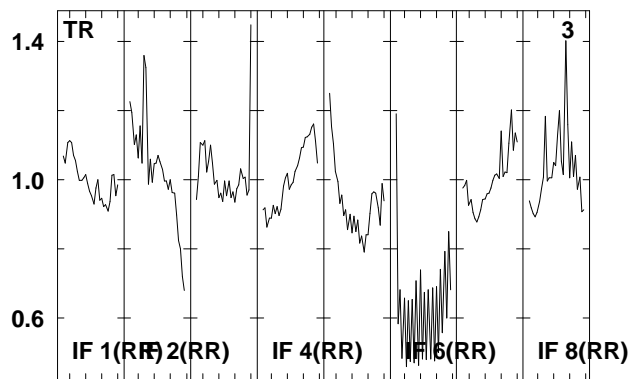
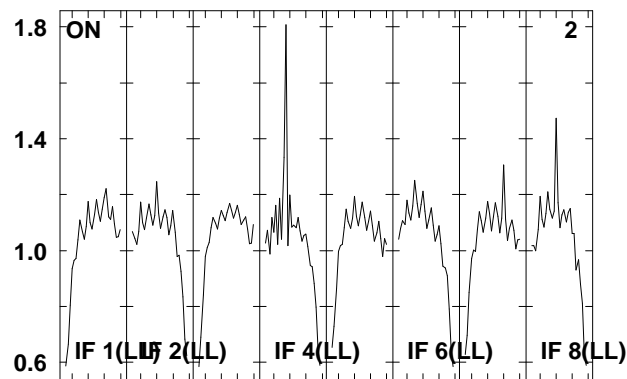
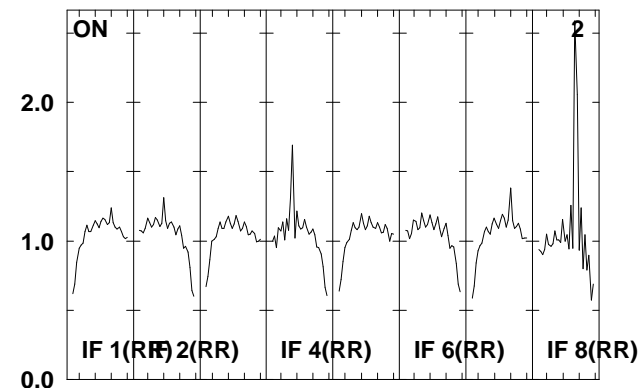
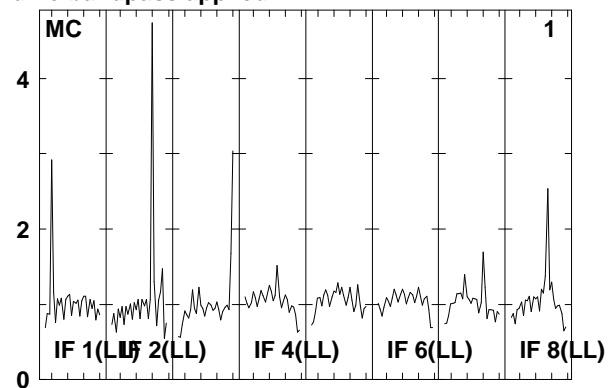
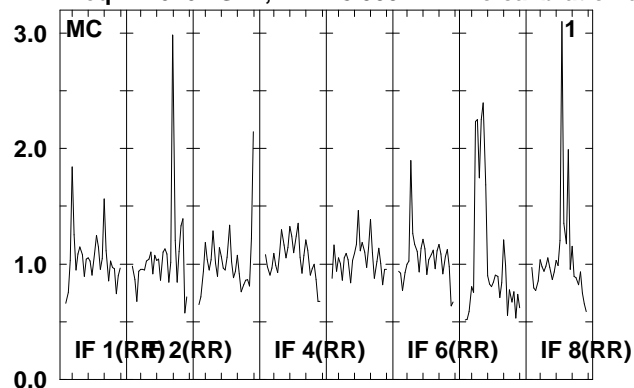

Lower frame: Real Jy  
 Total-power spectrum Antenna: \*  
 Timerange: 00/07:14:01 to 00/07:14:59

Plot file version 76 created 16-FEB-2009 12:46:37

J1217+30 RSF02.UVDATA.1

Freq = 1.6267 GHz, Bw = 8.000 MH No calibration applied and no bandpass applied

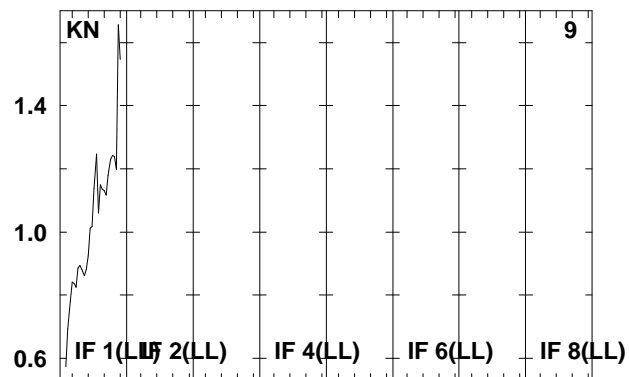
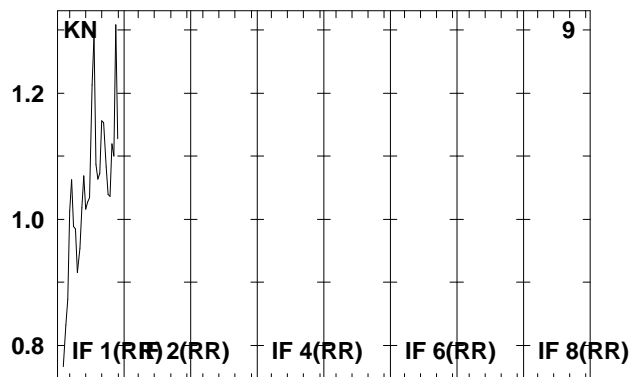
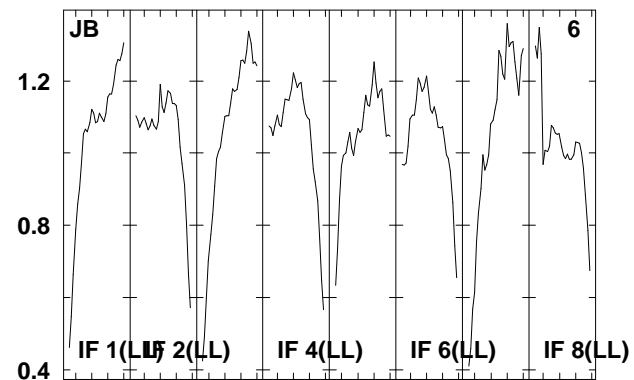
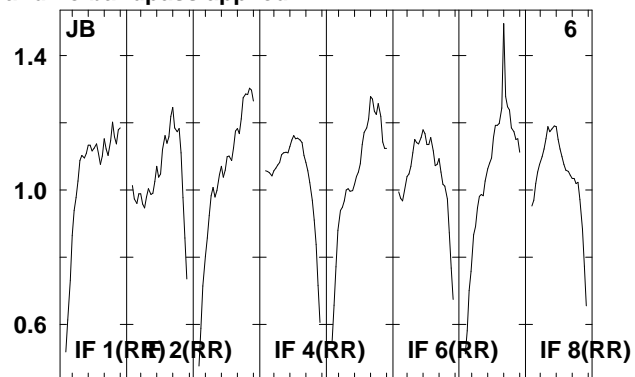
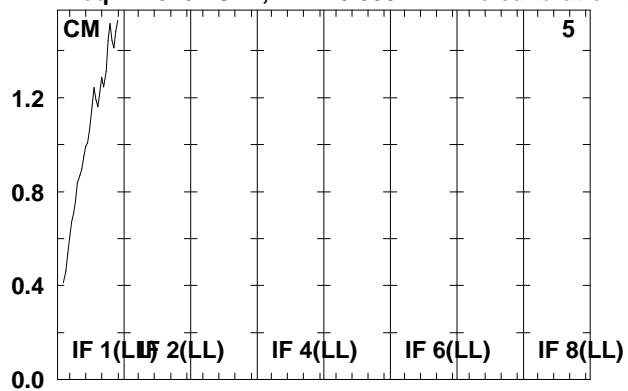

Lower frame: Real Jy  
Total-power spectrum Antenna: \*  
Timerange: 00/07:14:01 to 00/07:14:59

Plot file version 77 created 16-FEB-2009 12:46:38  
 J121839. RSF02.UVDATA.1  
 Freq = 1.6267 GHz, Bw = 8.000 MH No calibration applied and no bandpass applied

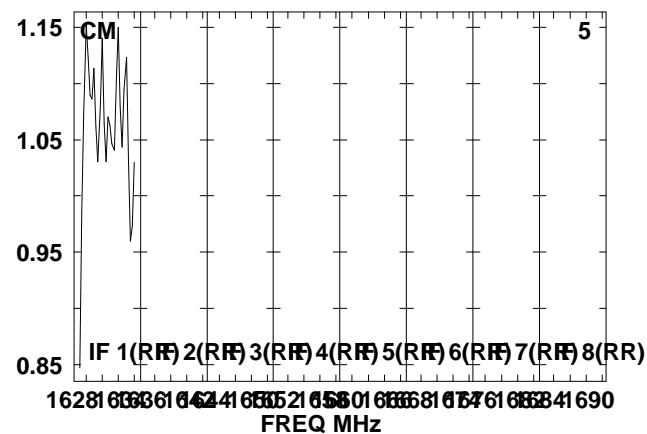
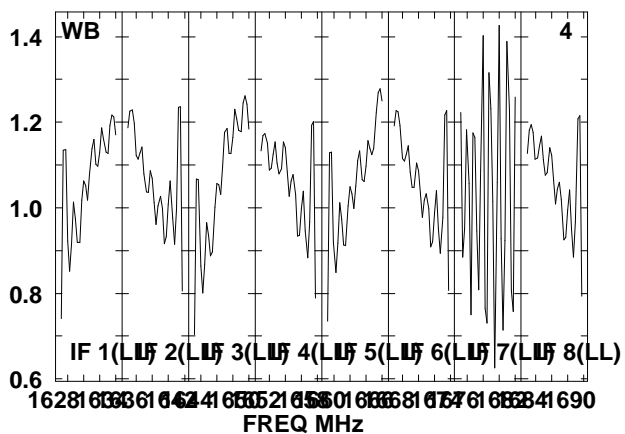
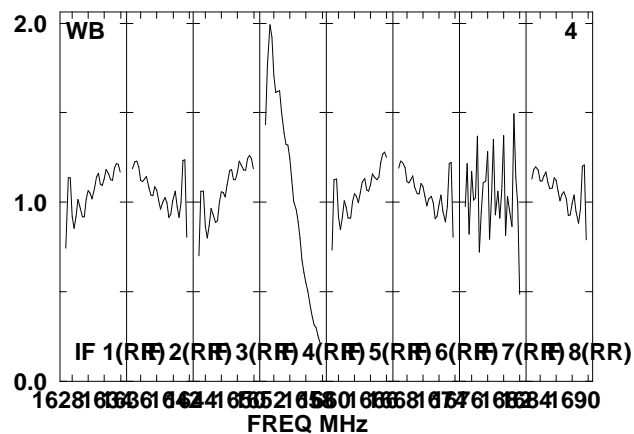
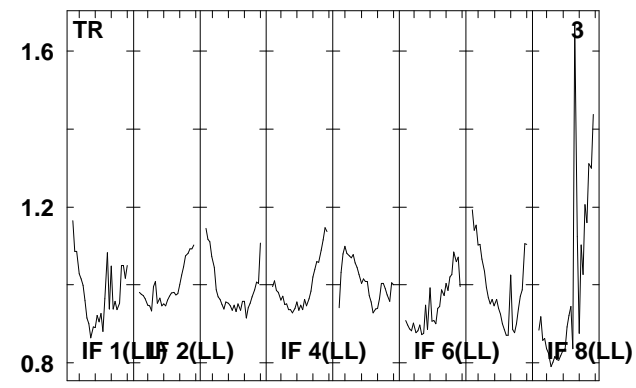
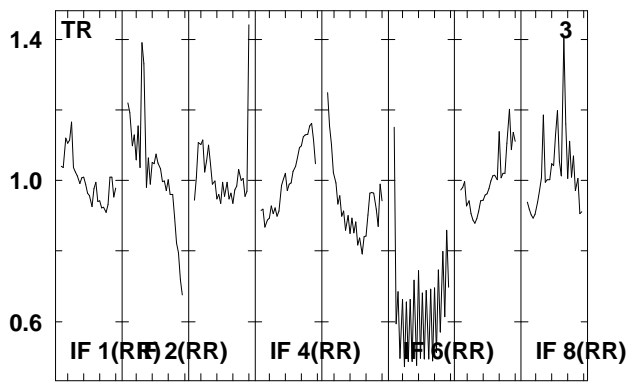
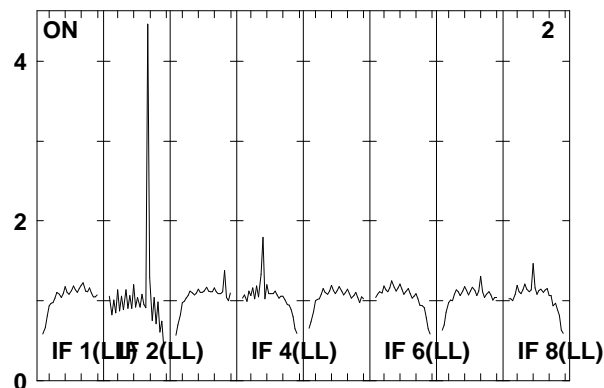
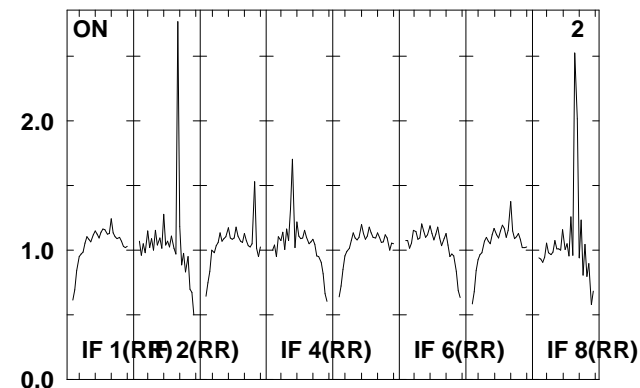
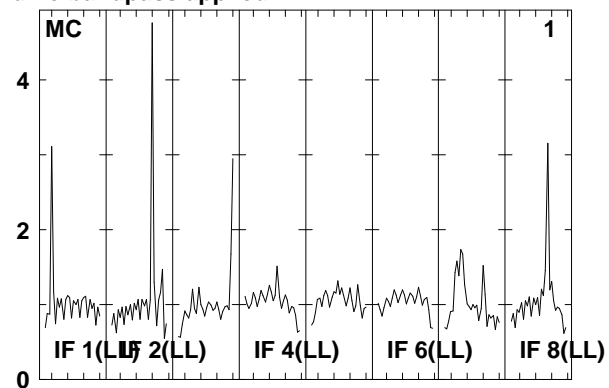
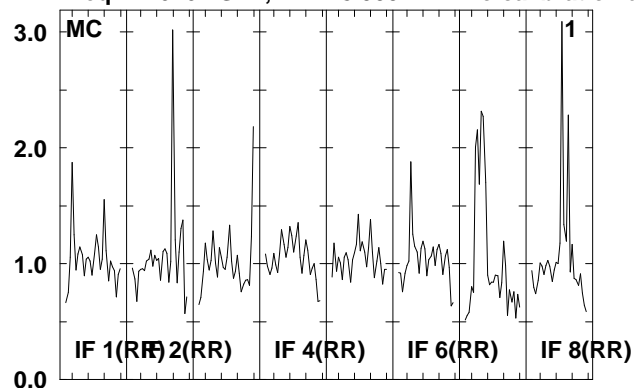

Lower frame: Real Jy  
 Total-power spectrum Antenna: \*  
 Timerange: 00/07:15:01 to 00/07:18:29

Plot file version 78 created 16-FEB-2009 12:46:38

J121839. RSF02.UVDATA.1

Freq = 1.6267 GHz, Bw = 8.000 MH No calibration applied and no bandpass applied

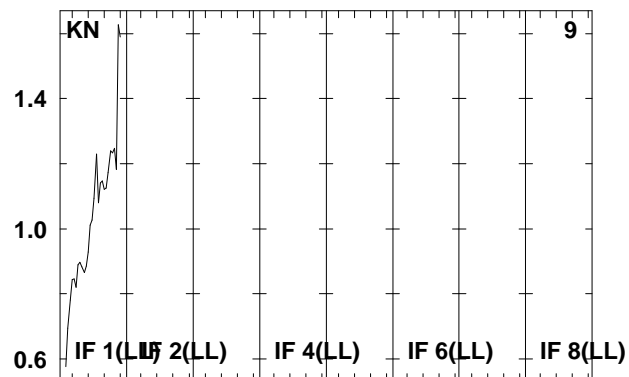
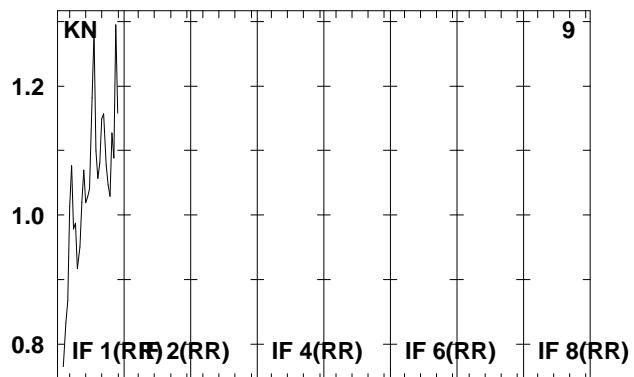
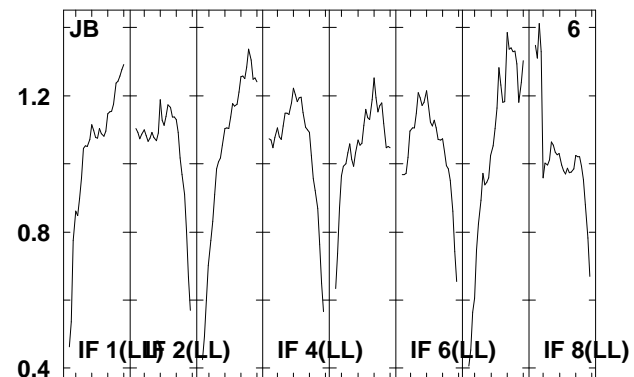
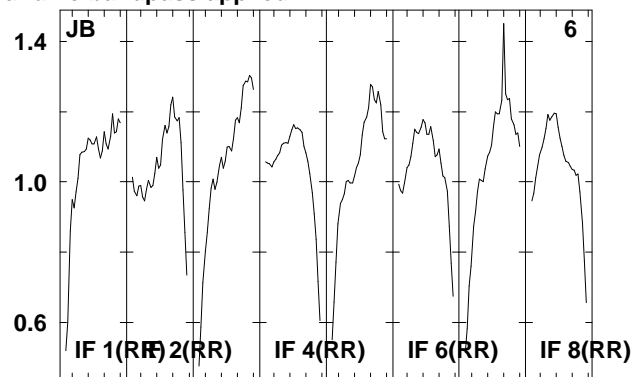
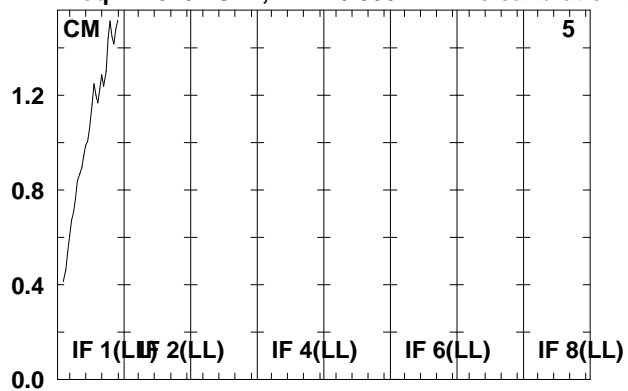

Lower frame: Real Jy  
Total-power spectrum Antenna: \*  
Timerange: 00/07:15:01 to 00/07:18:29

Plot file version 79 created 16-FEB-2009 12:46:39

J1217+30 RSF02.UVDATA.1

Freq = 1.6267 GHz, Bw = 8.000 MH No calibration applied and no bandpass applied

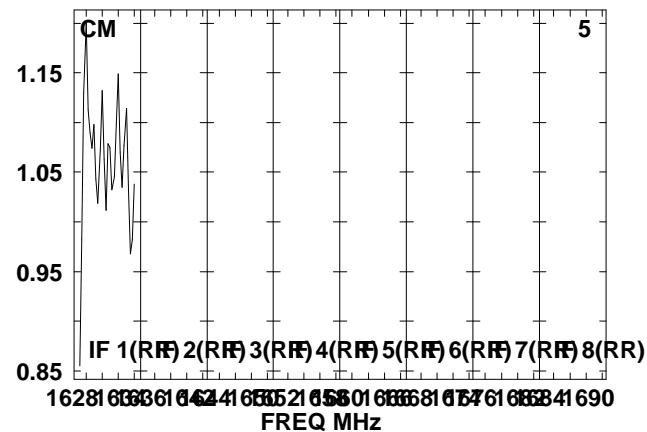
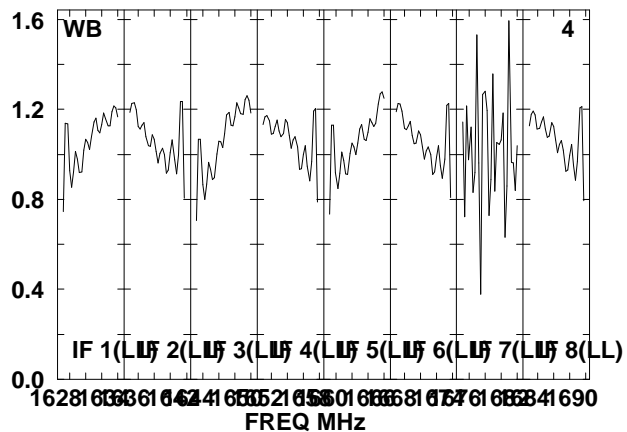
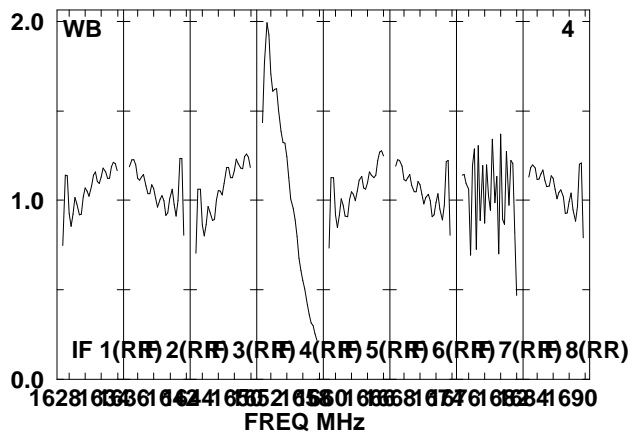
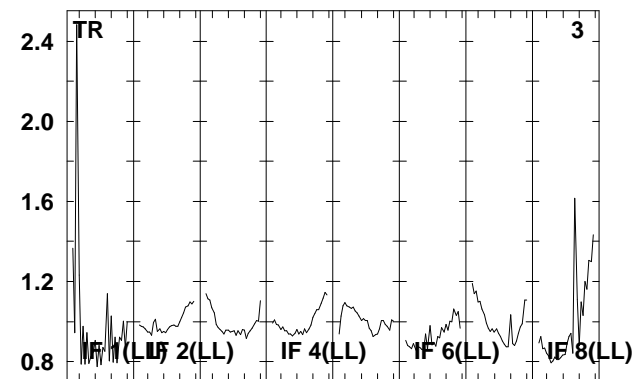
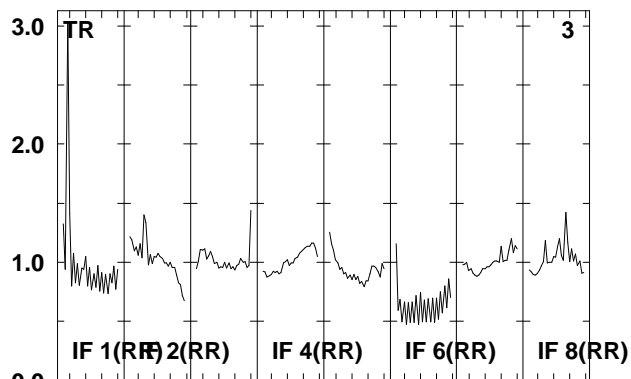
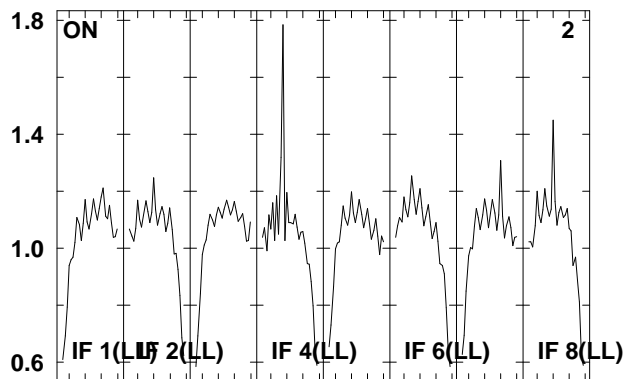
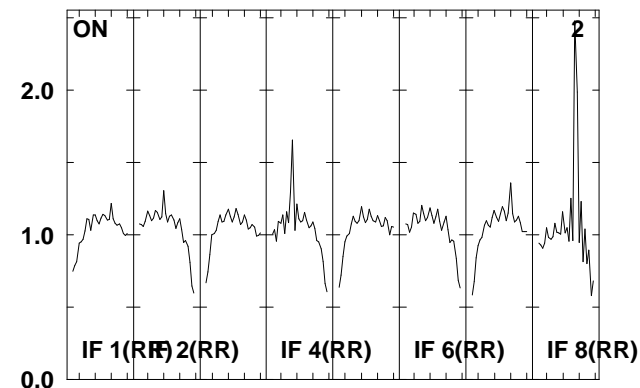
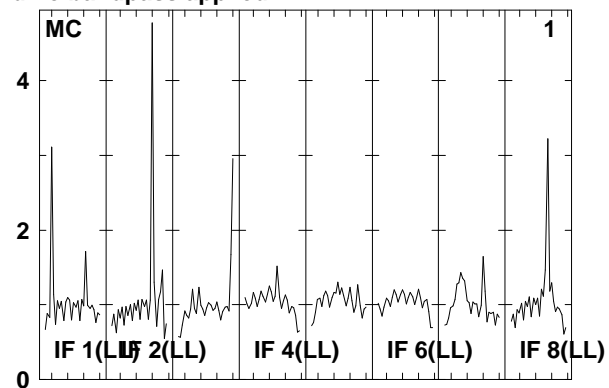
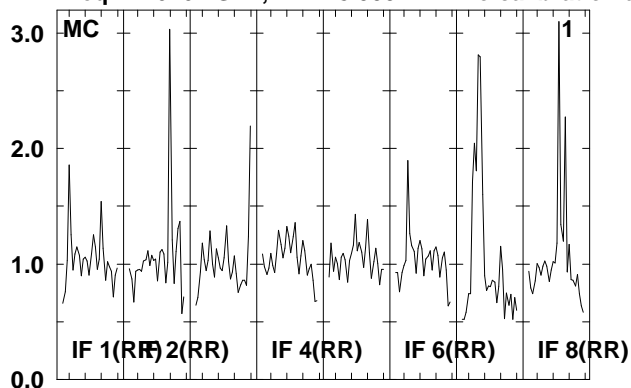

Lower frame: Real Jy

Total-power spectrum Antenna: \*

Timerange: 00/07:18:31 to 00/07:19:51

Plot file version 80 created 16-FEB-2009 12:46:40  
J1217+30 RSF02.UVDATA.1  
Freq = 1.6267 GHz, Bw = 8.000 MH No calibration applied and no bandpass applied

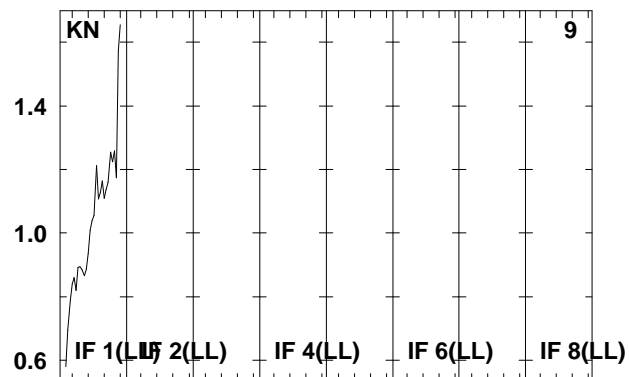
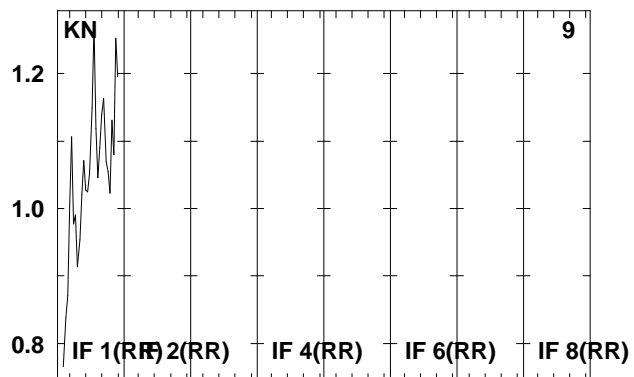
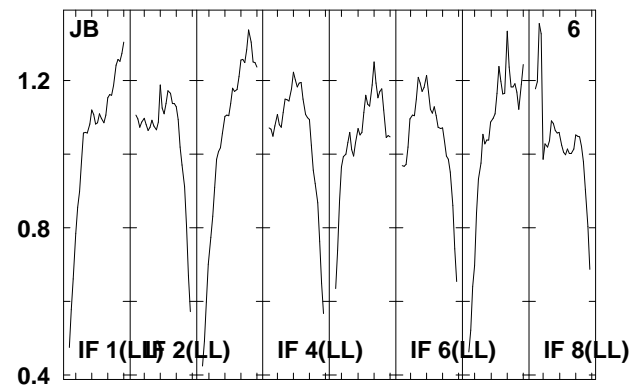
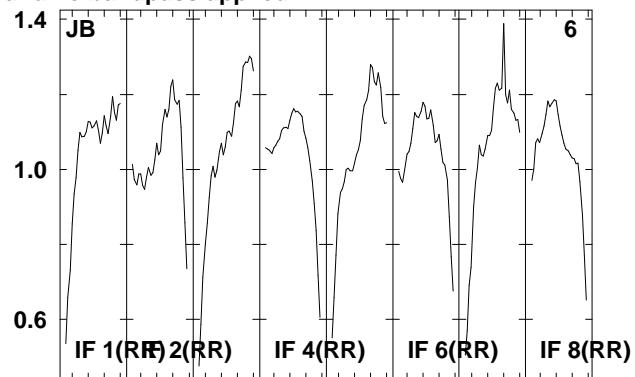
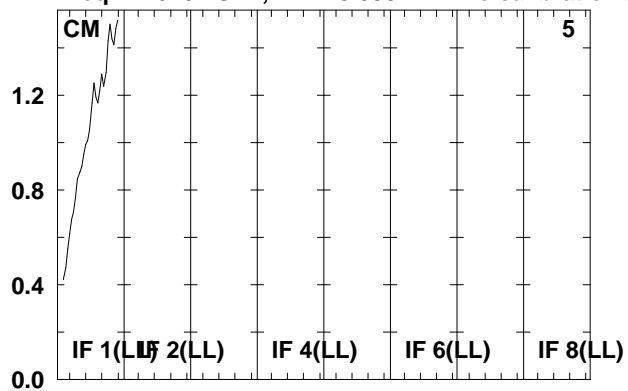

Lower frame: Real Jy  
Total-power spectrum Antenna: \*  
Timerange: 00/07:18:31 to 00/07:19:51



Plot file version 81 created 16-FEB-2009 12:46:40  
 J121839. RSF02.UVDATA.1  
 Freq = 1.6267 GHz, Bw = 8.000 MH No calibration applied and no bandpass applied

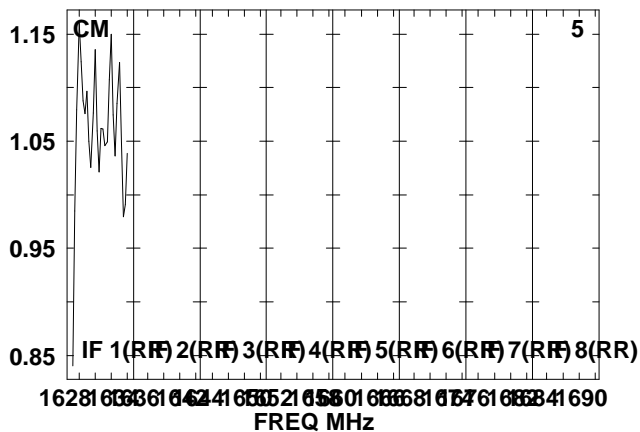
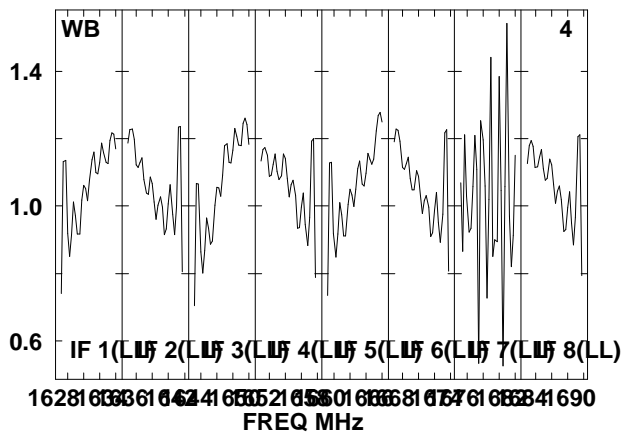
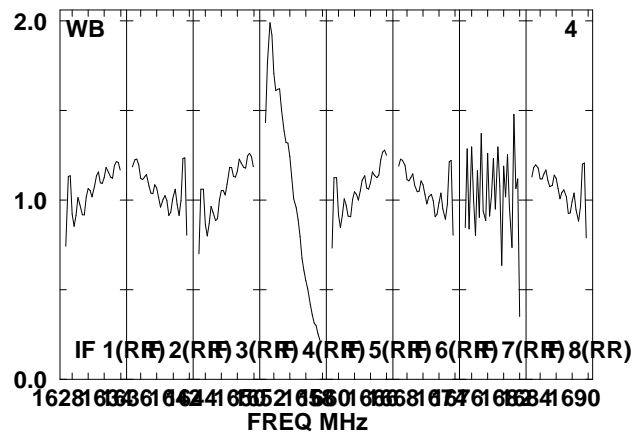
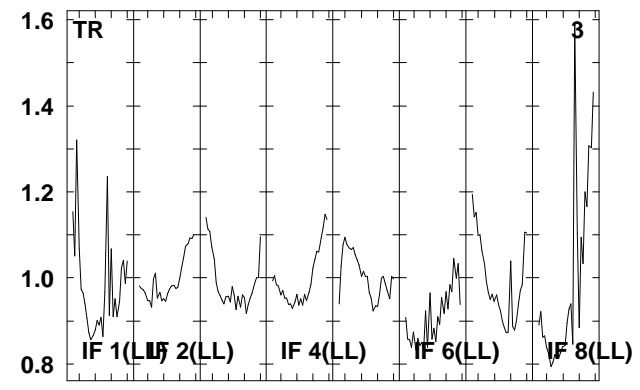
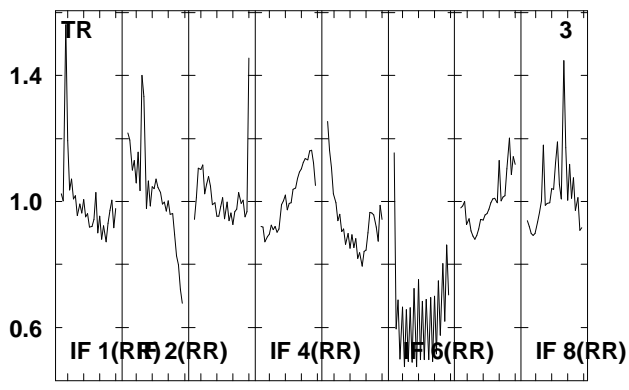
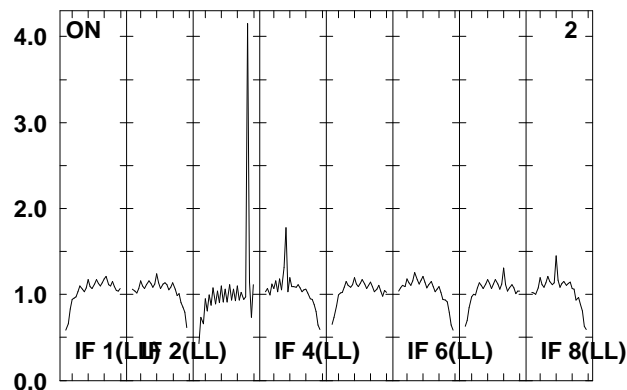
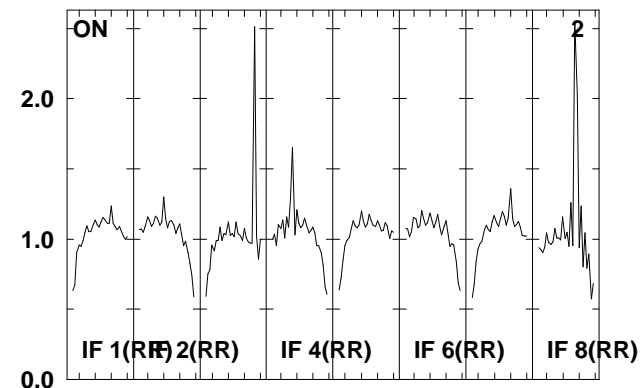
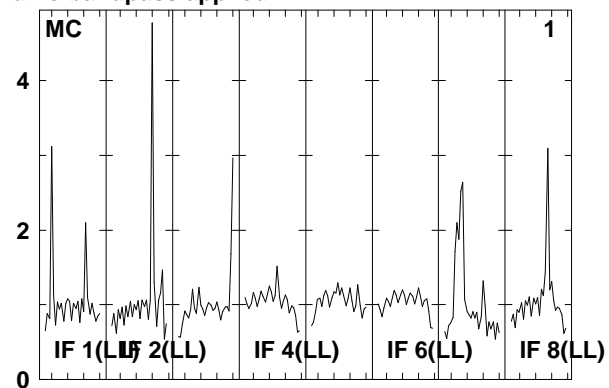
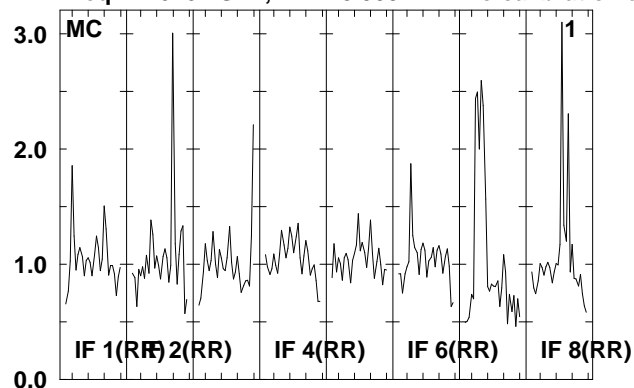

Lower frame: Real Jy  
 Total-power spectrum Antenna: \*  
 Timerange: 00/07:19:53 to 00/07:23:19

Plot file version 82 created 16-FEB-2009 12:46:41  
J121839. RSF02.UVDATA.1

Freq = 1.6267 GHz, Bw = 8.000 MH No calibration applied and no bandpass applied

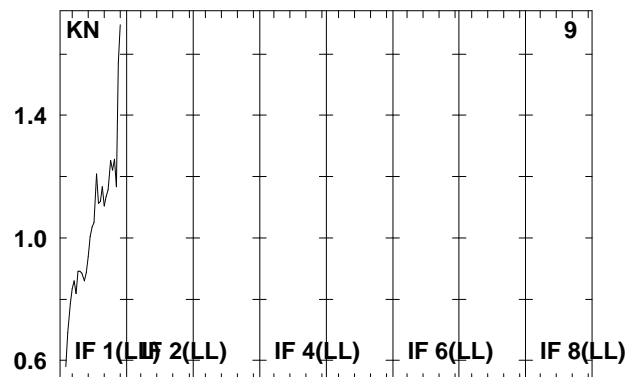
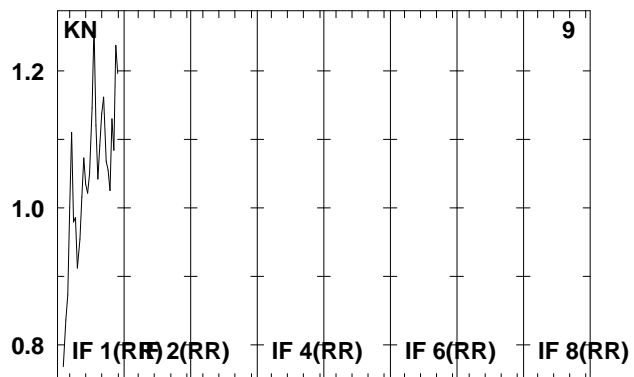
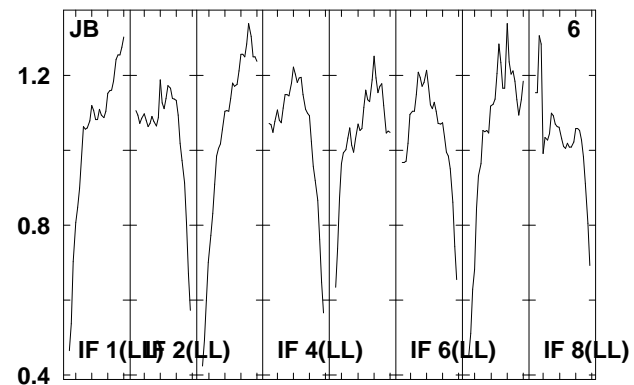
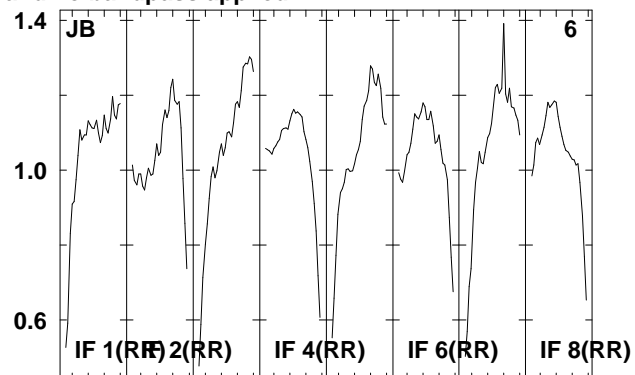
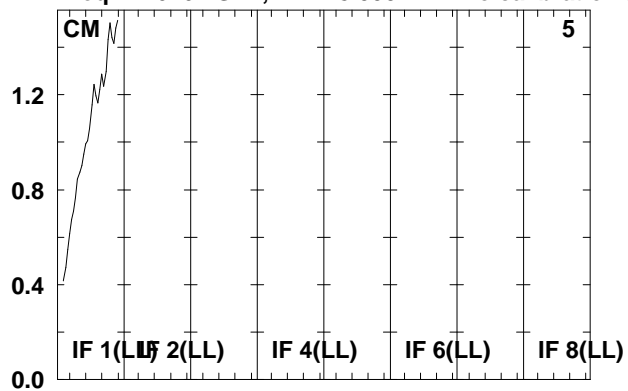

Lower frame: Real Jy  
Total-power spectrum Antenna: \*  
Timerange: 00/07:19:53 to 00/07:23:19

Plot file version 83 created 16-FEB-2009 12:46:42  
 J1217+30 RSF02.UVDATA.1  
 Freq = 1.6267 GHz, Bw = 8.000 MH No calibration applied and no bandpass applied

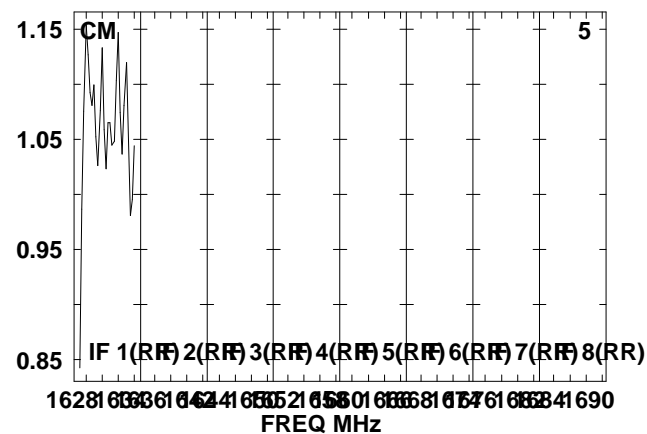
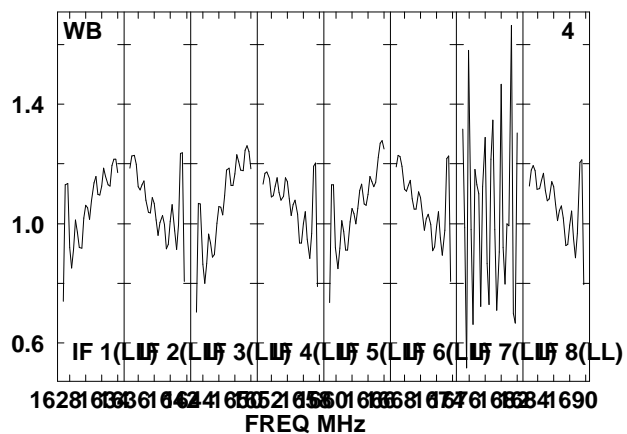
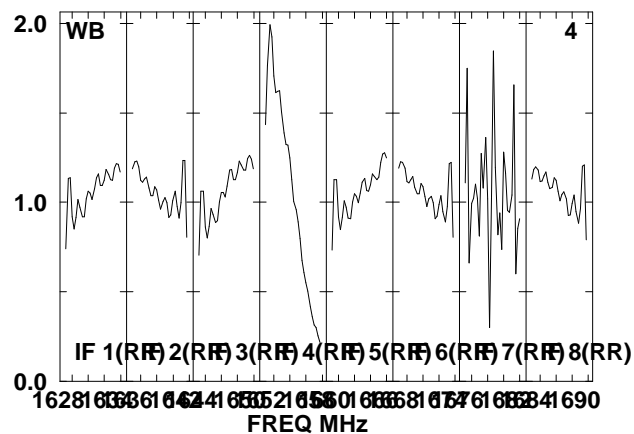
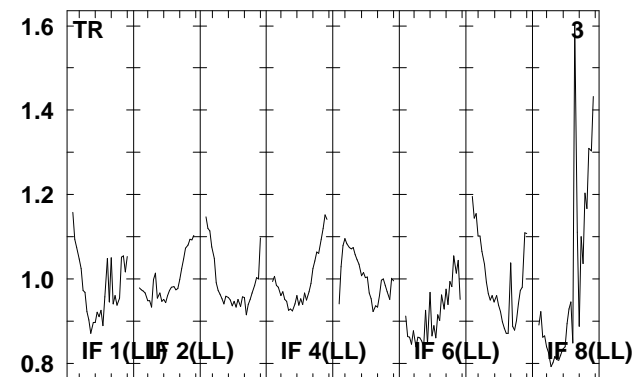
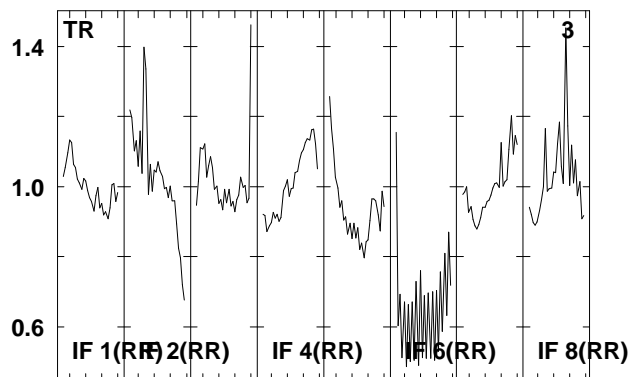
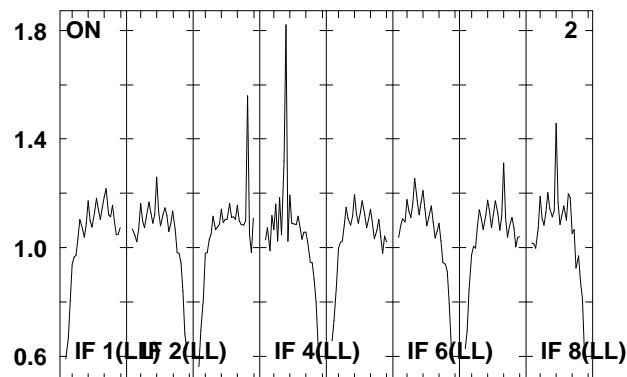
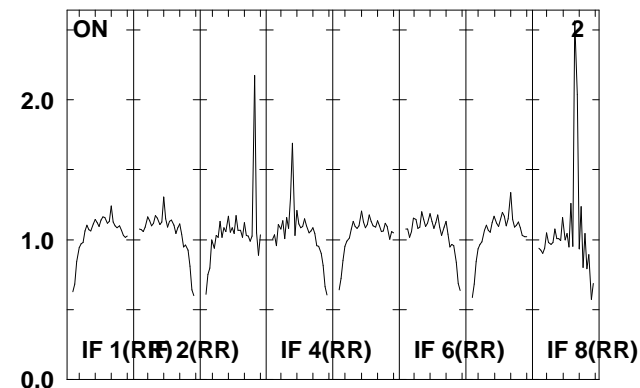
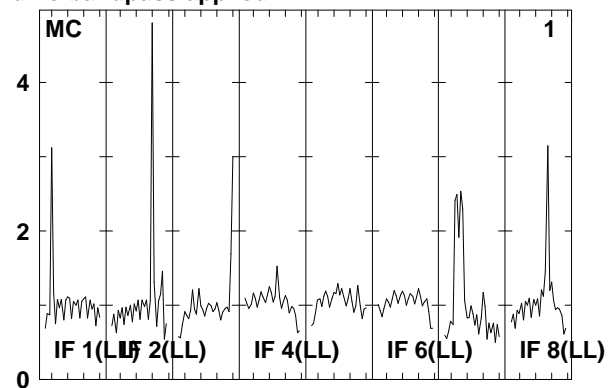
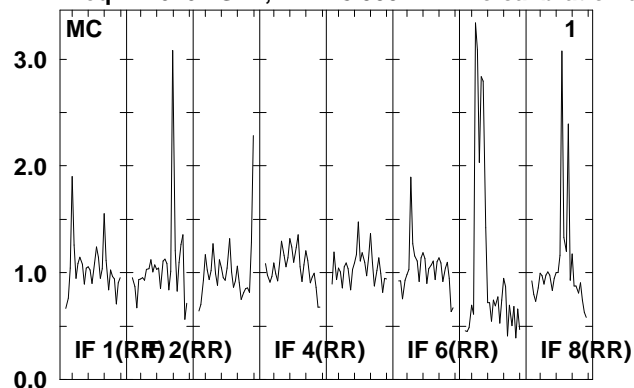

Lower frame: Real Jy  
 Total-power spectrum Antenna: \*  
 Timerange: 00/07:24:01 to 00/07:24:59

Plot file version 84 created 16-FEB-2009 12:46:43

J1217+30 RSF02.UVDATA.1

Freq = 1.6267 GHz, Bw = 8.000 MH No calibration applied and no bandpass applied

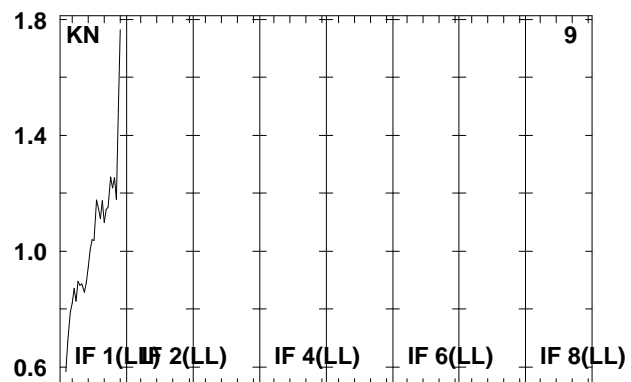
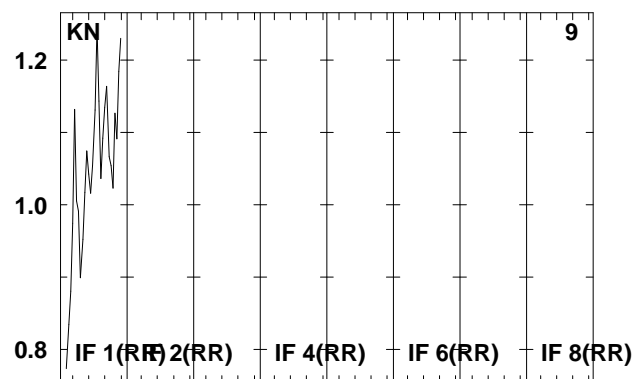
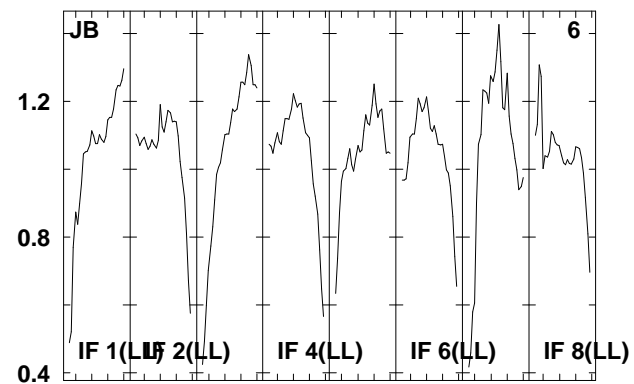
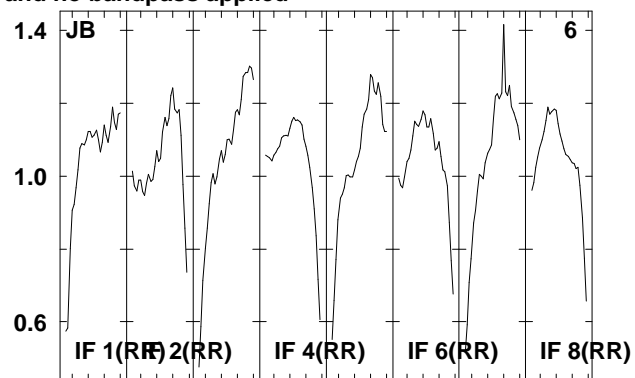
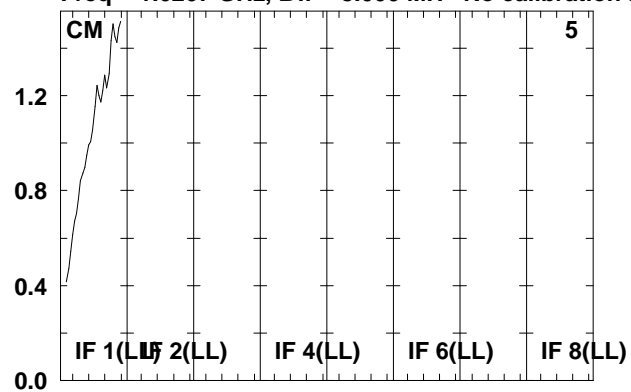

Lower frame: Real Jy  
Total-power spectrum Antenna: \*  
Timerange: 00/07:24:01 to 00/07:24:59

Plot file version 85 created 16-FEB-2009 12:46:44  
 OQ208 RSF02.UVDATA.1  
 Freq = 1.6267 GHz, Bw = 8.000 MH No calibration applied and no bandpass applied

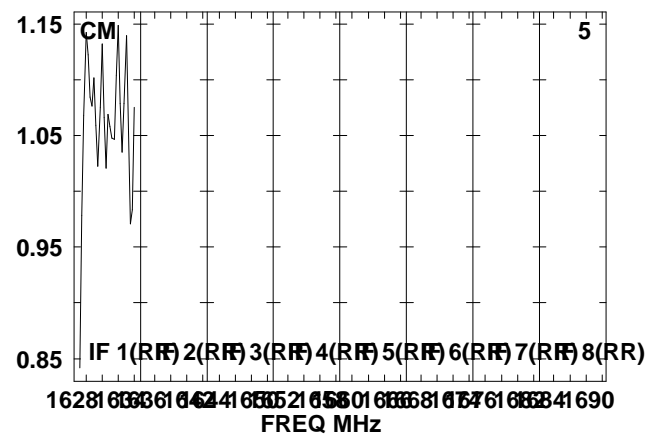
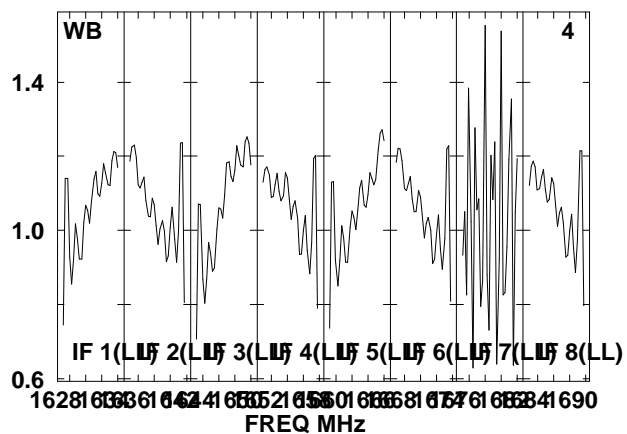
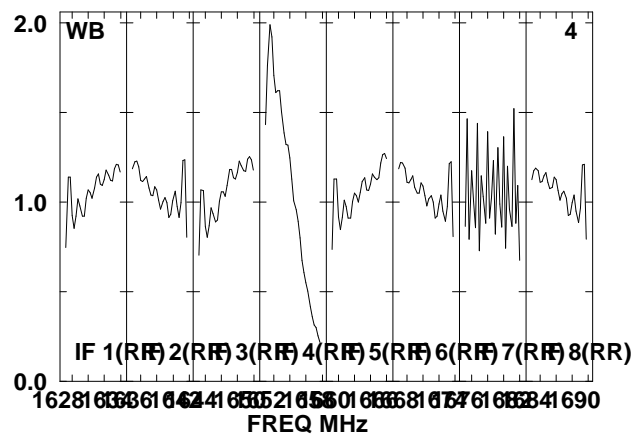
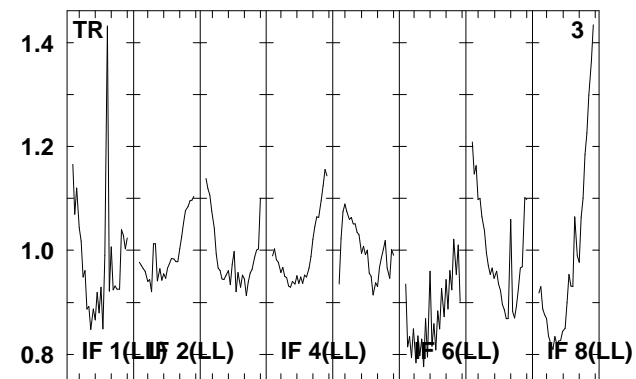
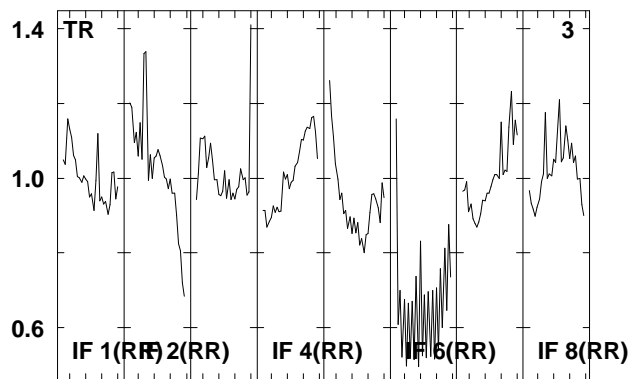
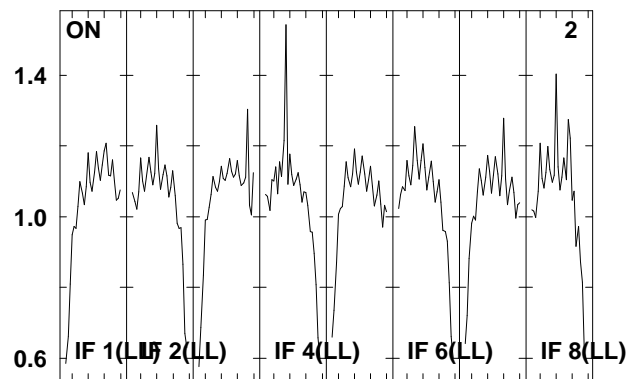
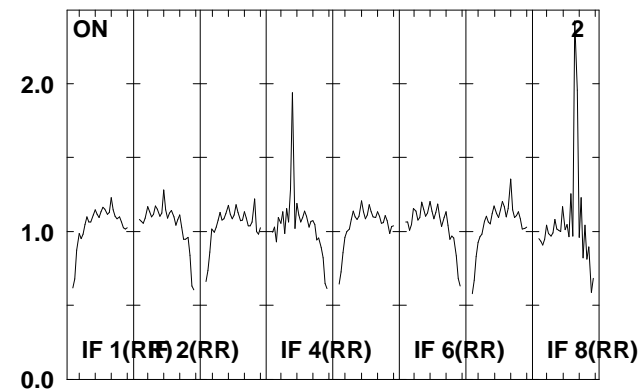
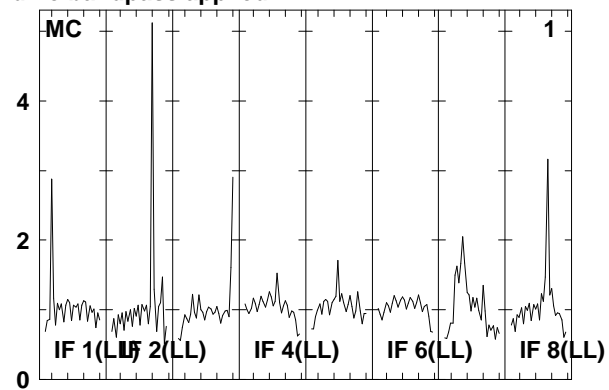
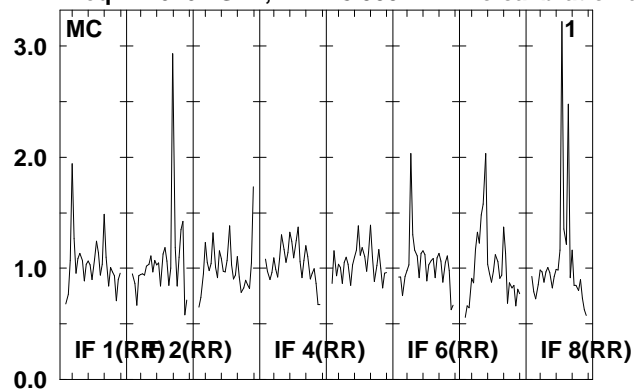

Lower frame: Real Jy  
 Total-power spectrum Antenna: \*  
 Timerange: 00/07:28:01 to 00/07:39:59

Plot file version 86 created 16-FEB-2009 12:46:46

OQ208 RSF02.UVDATA.1

Freq = 1.6267 GHz, Bw = 8.000 MH No calibration applied and no bandpass applied

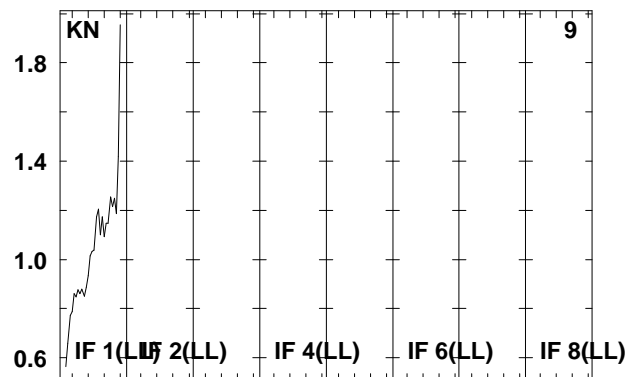
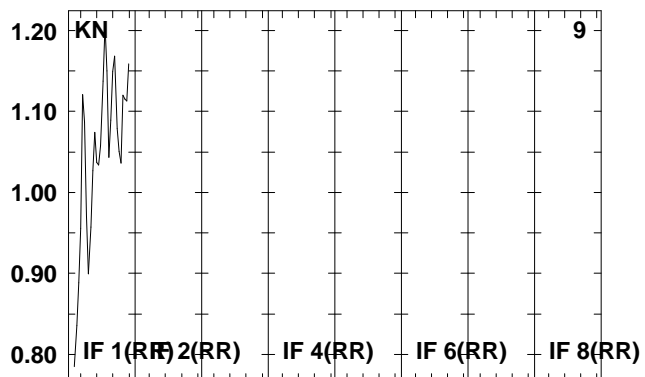
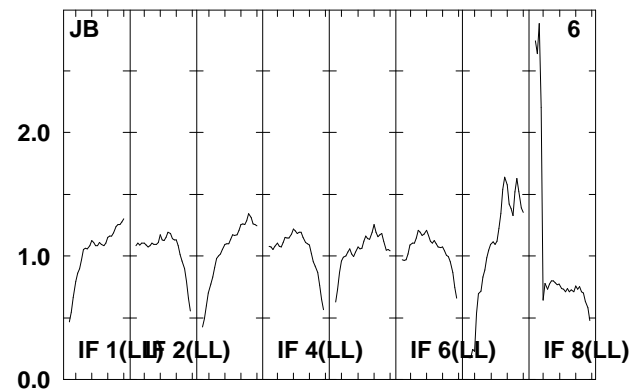
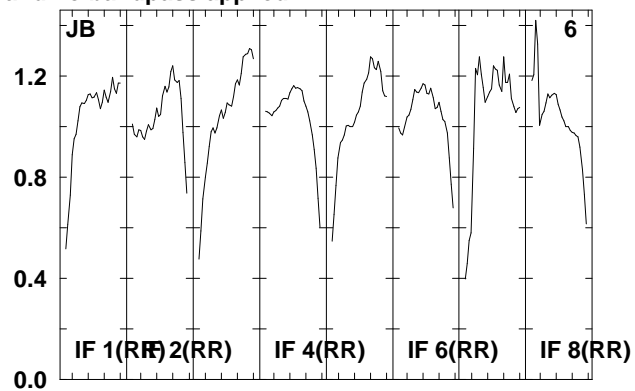
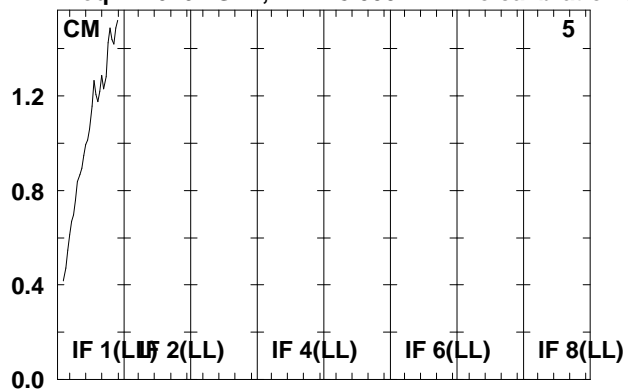

Lower frame: Real Jy  
Total-power spectrum Antenna: \*  
Timerange: 00/07:28:01 to 00/07:39:59