

Plot file version 1 created 23-NOV-2017 14:36:01

J0844+4628 RSM01.UVDATA.1

Freq = 4.7990 GHz, Bw = 32.000 MH No calibration applied and no bandpass applied

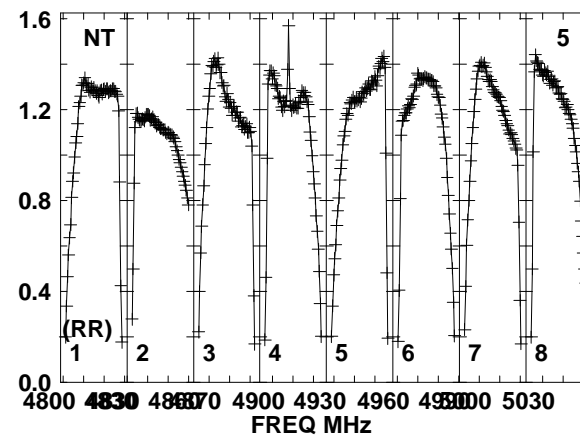
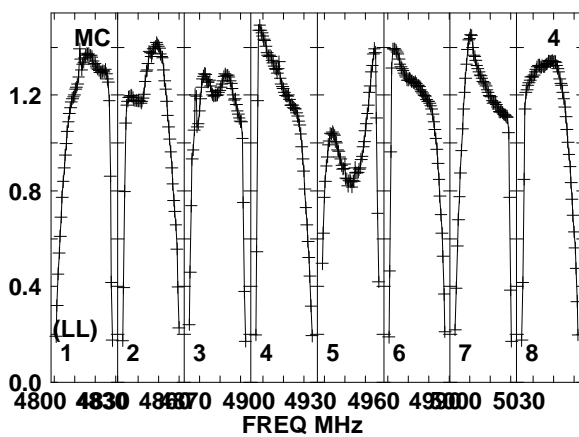
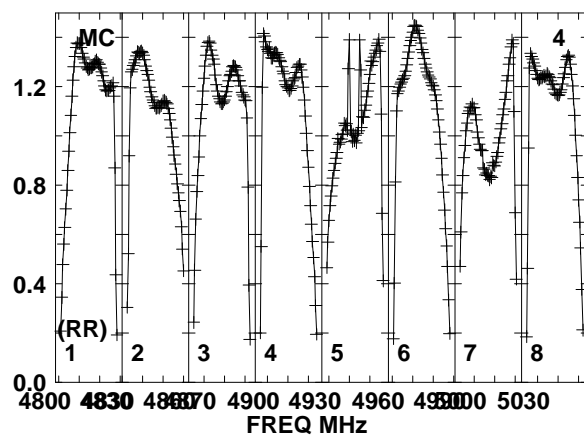
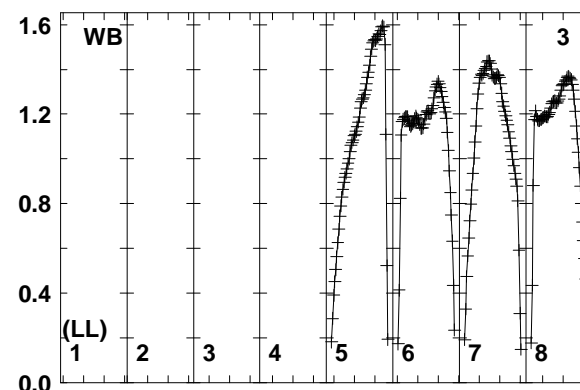
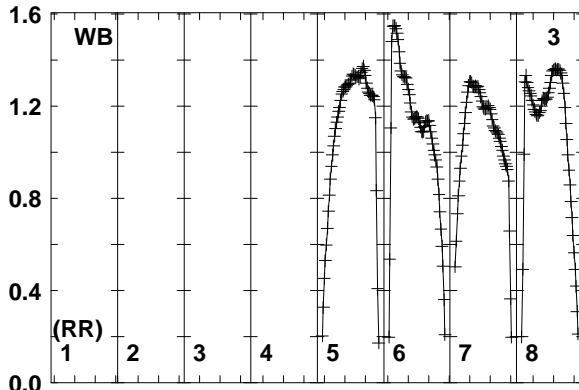
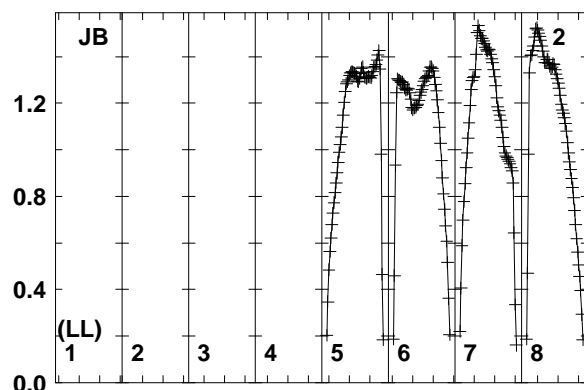
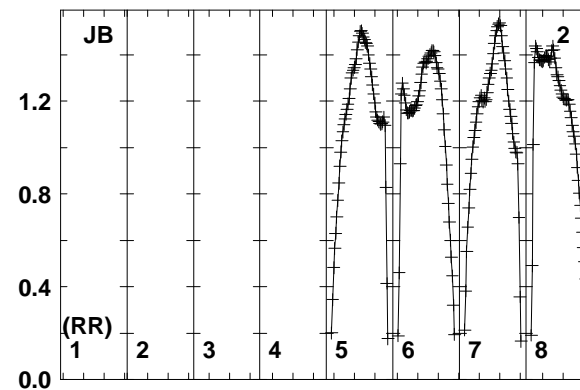
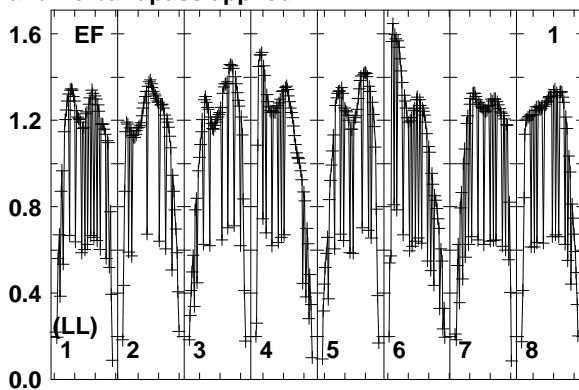
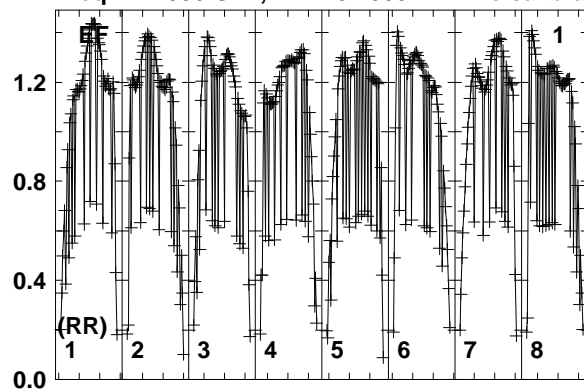

Lower frame: Real Jy
Total-power spectrum Antenna: EF (01)
Timerange: 00/22:43:26 to 00/22:43:33

Plot file version 2 created 23-NOV-2017 14:36:01

J0844+4628 RSM01.UVDATA.1

Freq = 4.7990 GHz, Bw = 32.000 MH No calibration applied and no bandpass applied

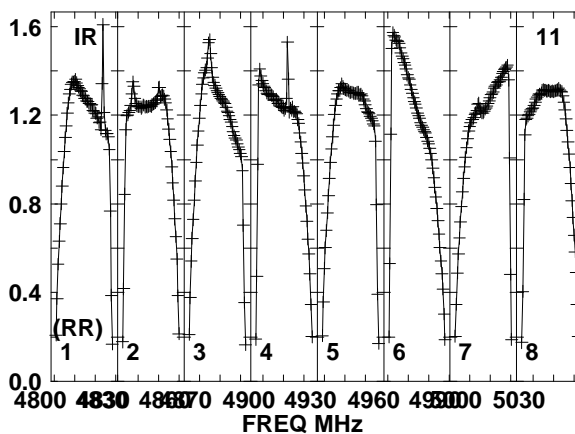
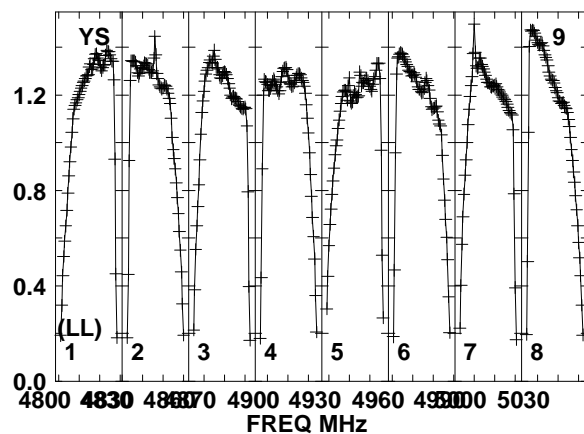
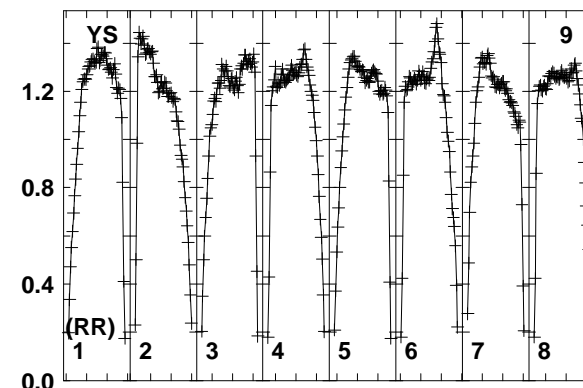
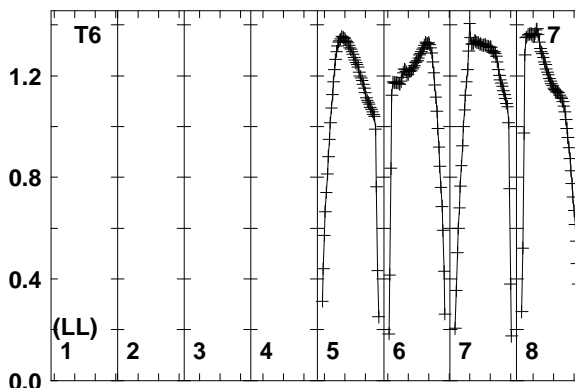
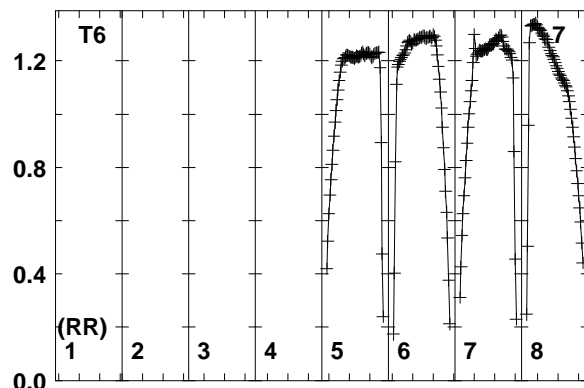
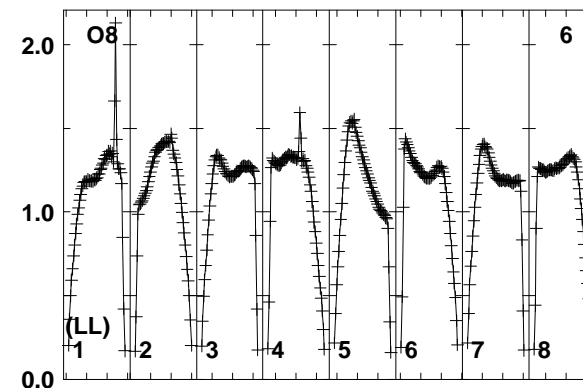
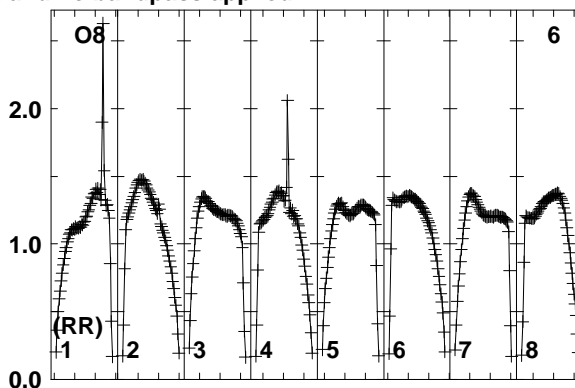
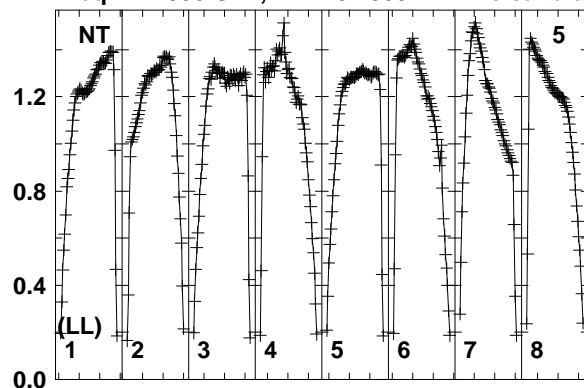

Lower frame: Real Jy
Total-power spectrum Antenna: NT (05)
Timerange: 00/22:43:26 to 00/22:43:33

Plot file version 3 created 23-NOV-2017 14:36:01

J0844+4628 RSM01.UVDATA.1

Freq = 4.7990 GHz, Bw = 32.000 MH No calibration applied and no bandpass applied

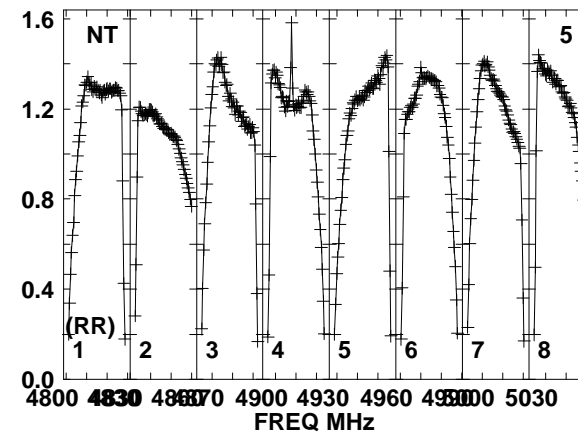
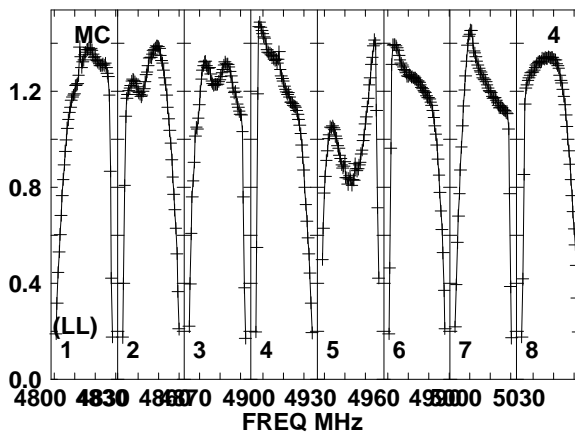
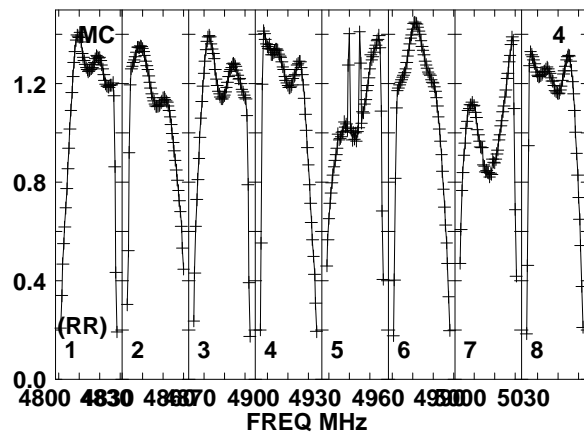
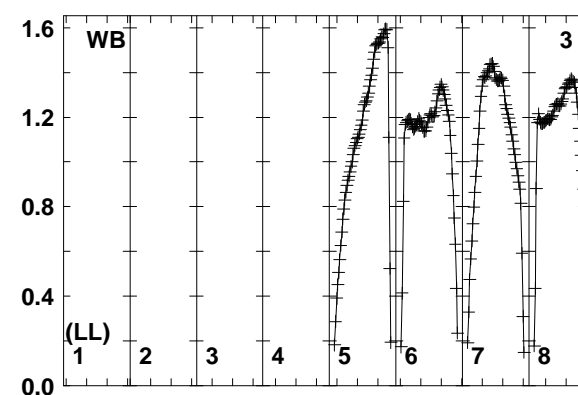
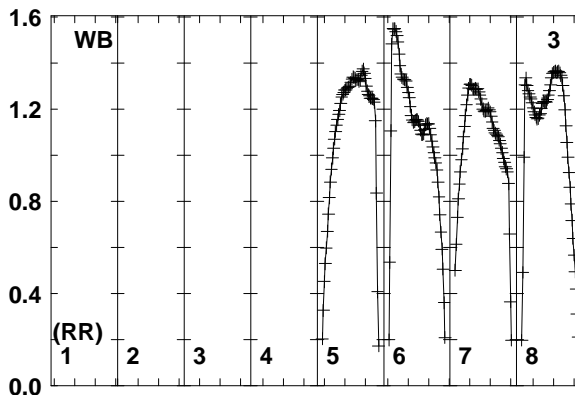
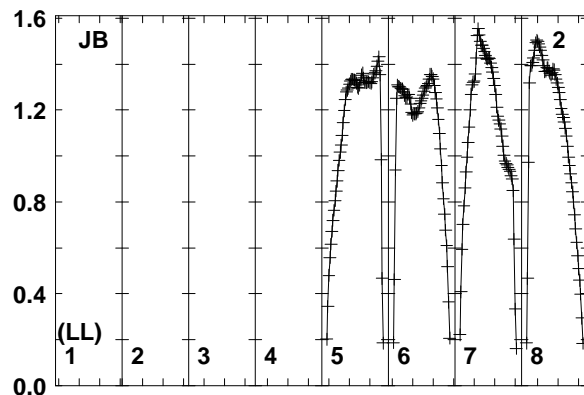
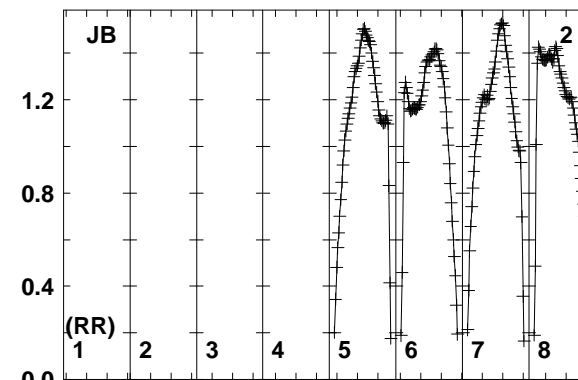
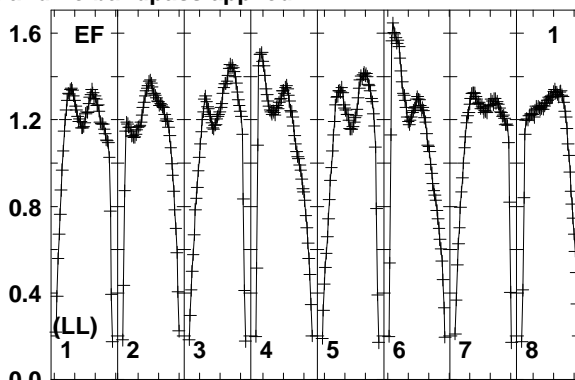
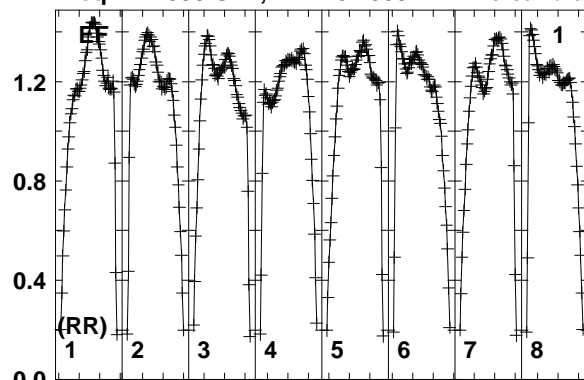

Lower frame: Real Jy
Total-power spectrum Antenna: EF (01)
Timerange: 00/22:55:13 to 00/22:56:39

Plot file version 4 created 23-NOV-2017 14:36:01

J0844+4628 RSM01.UVDATA.1

Freq = 4.7990 GHz, Bw = 32.000 MH No calibration applied and no bandpass applied

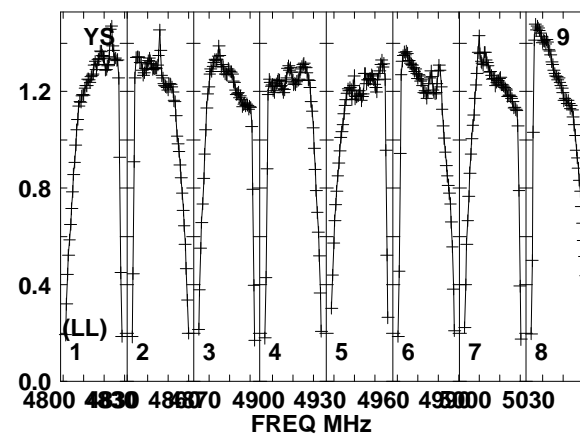
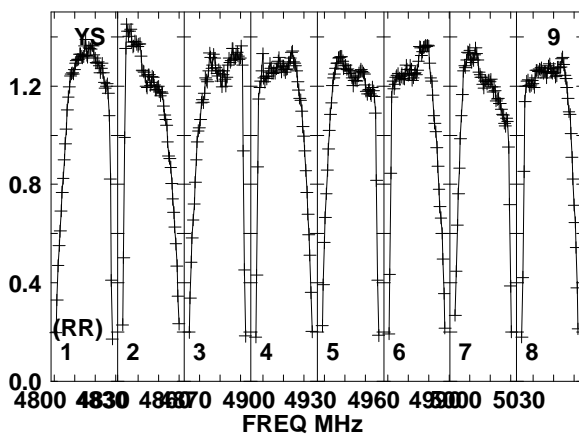
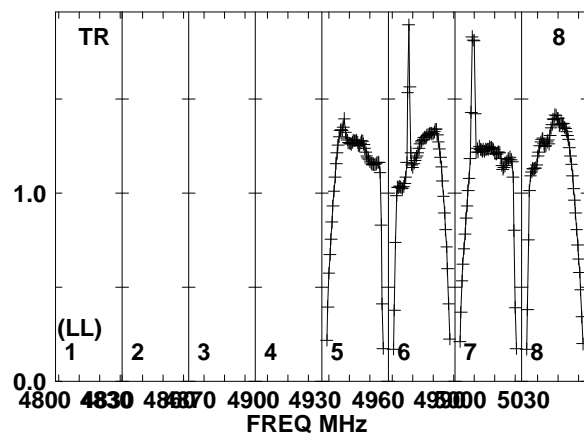
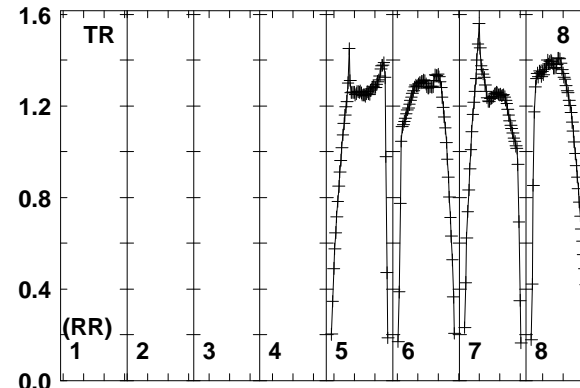
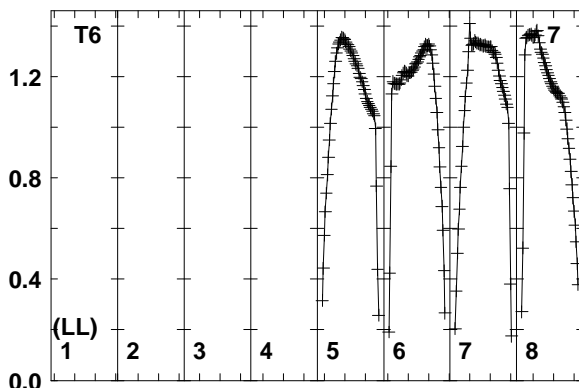
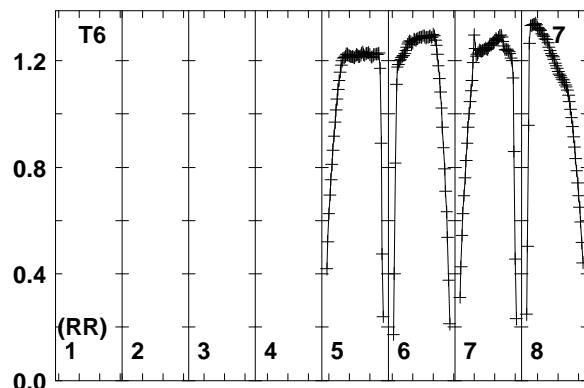
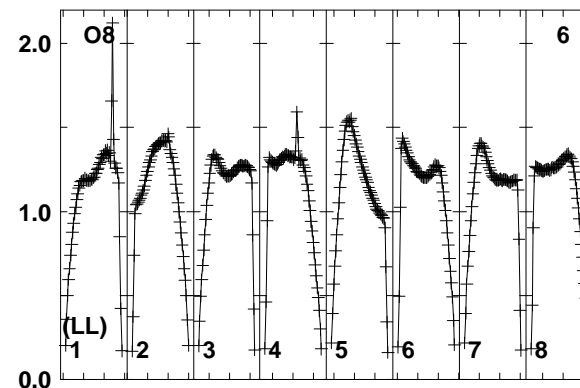
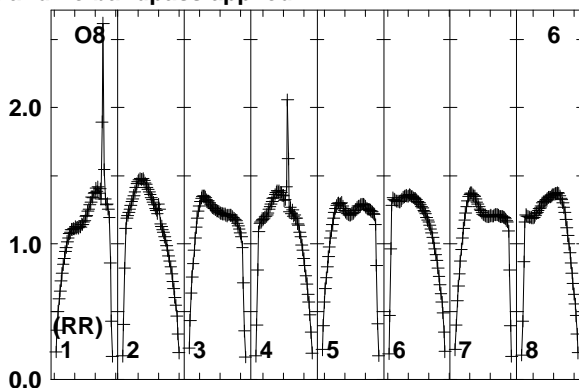
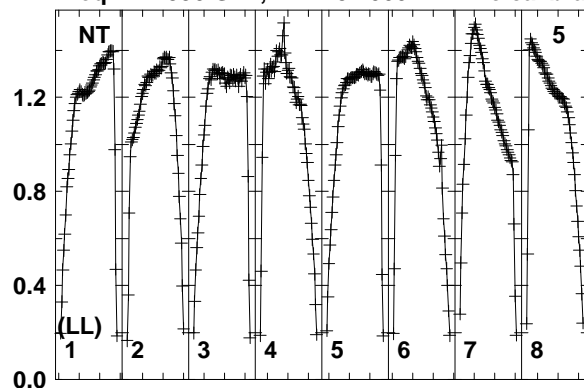

Lower frame: Real Jy
Total-power spectrum Antenna: NT (05)
Timerange: 00/22:55:13 to 00/22:56:39

Plot file version 5 created 23-NOV-2017 14:36:01
J0844+4628 RSM01.UVDATA.1
Freq = 4.7990 GHz, Bw = 32.000 MH No calibration applied and no bandpass applied

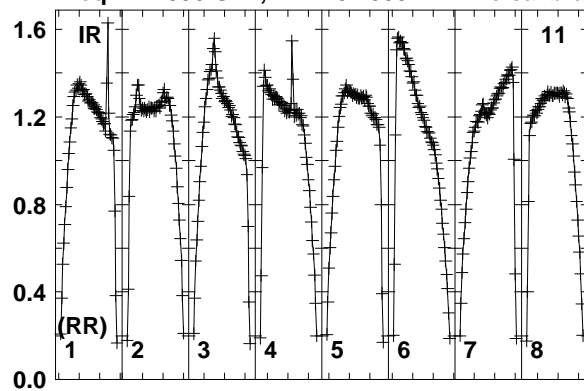

Lower frame: Real Jy
Total-power spectrum Antenna: IR (11)
Timerange: 00/22:55:13 to 00/22:56:39

Plot file version 6 created 23-NOV-2017 14:36:01

J0847+4609 RSM01.UVDATA.1

Freq = 4.7990 GHz, Bw = 32.000 MH No calibration applied and no bandpass applied

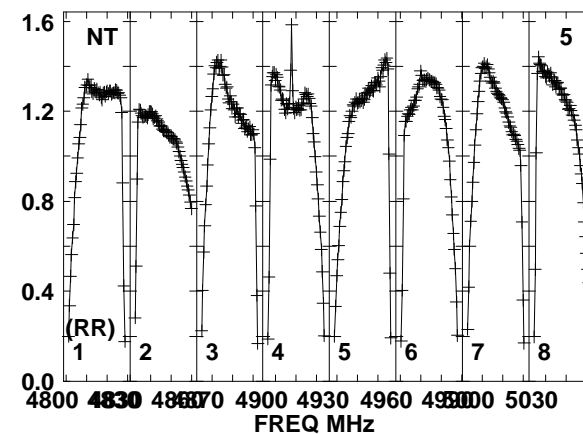
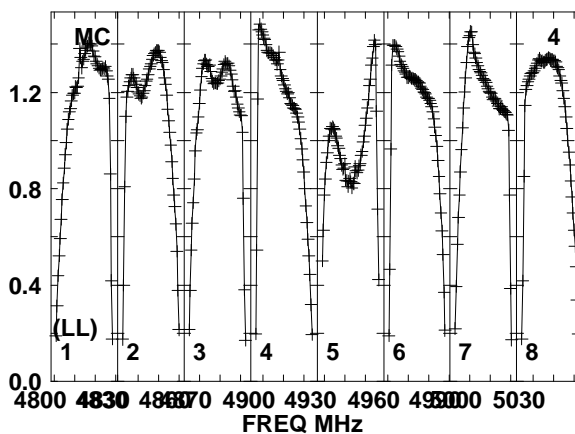
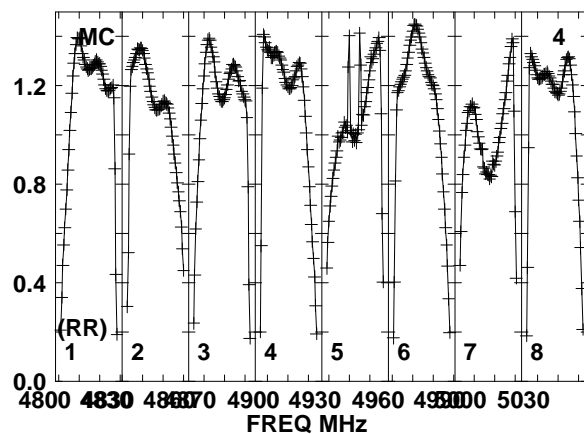
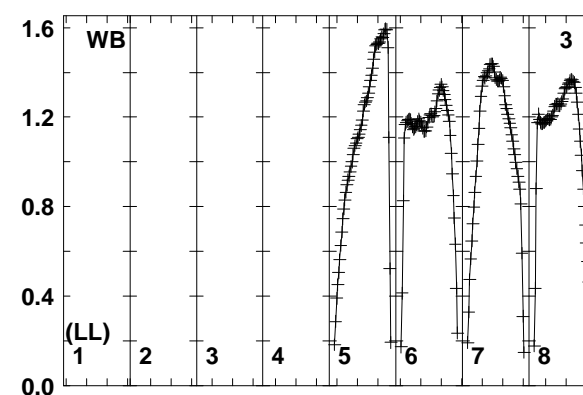
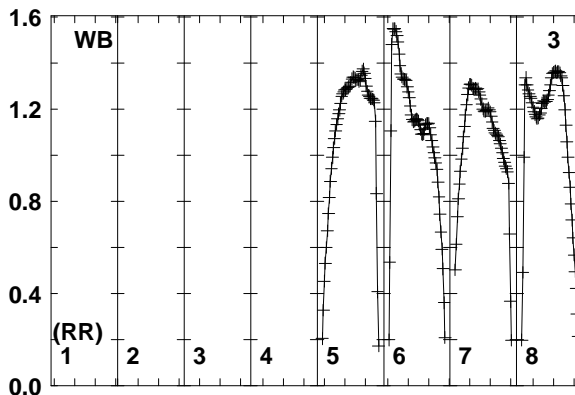
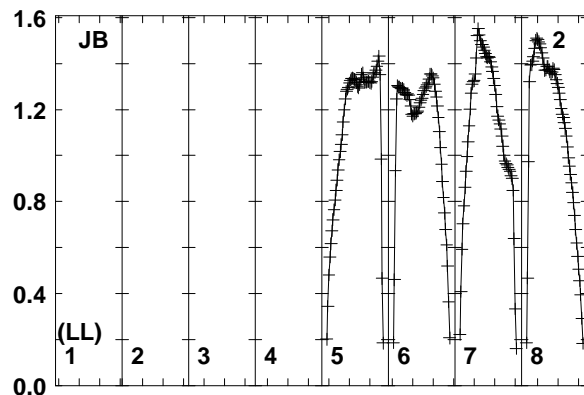
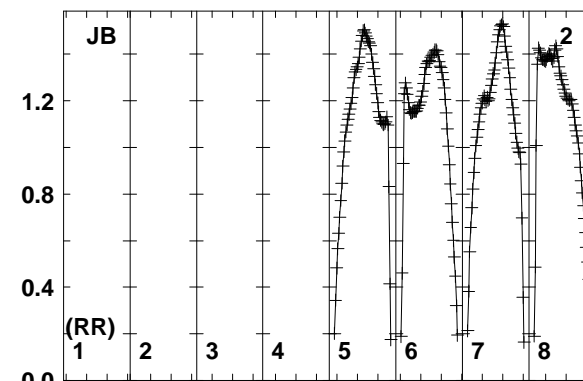
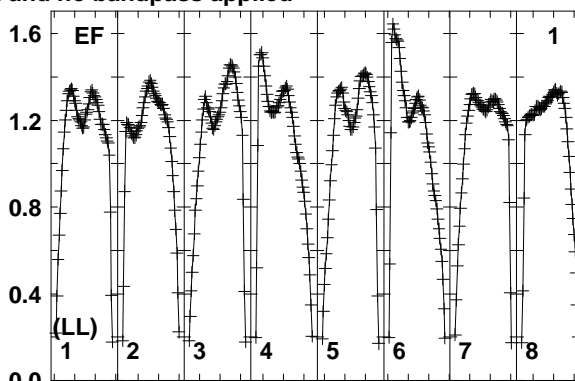
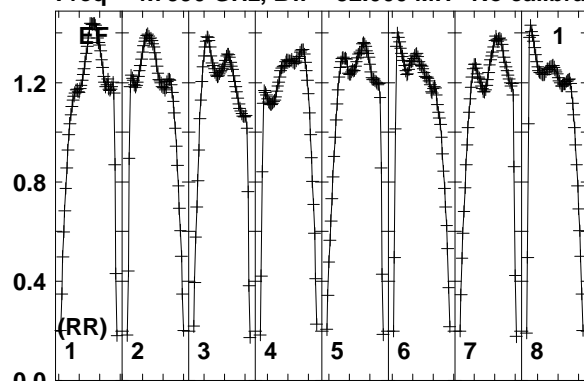

Lower frame: Real Jy
Total-power spectrum Antenna: EF (01)
Timerange: 00/22:57:21 to 00/22:58:20

Plot file version 7 created 23-NOV-2017 14:36:01

J0847+4609 RSM01.UVDATA.1

Freq = 4.7990 GHz, Bw = 32.000 MH No calibration applied and no bandpass applied

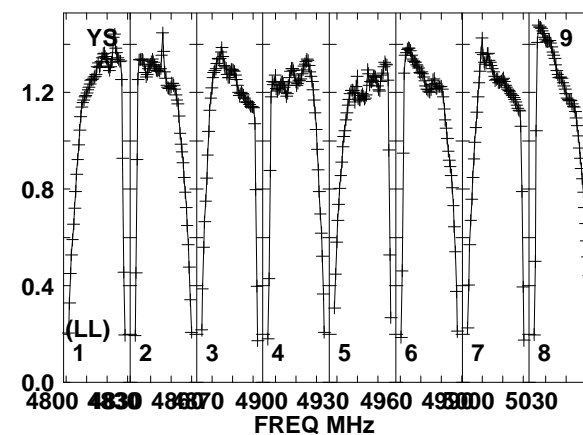
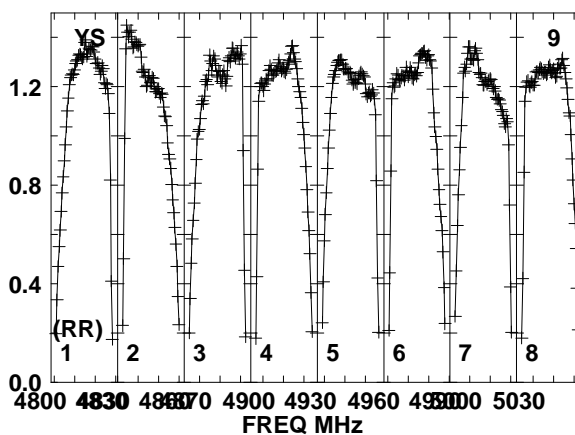
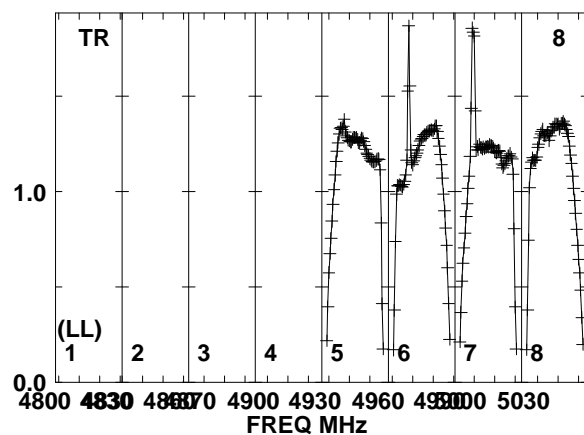
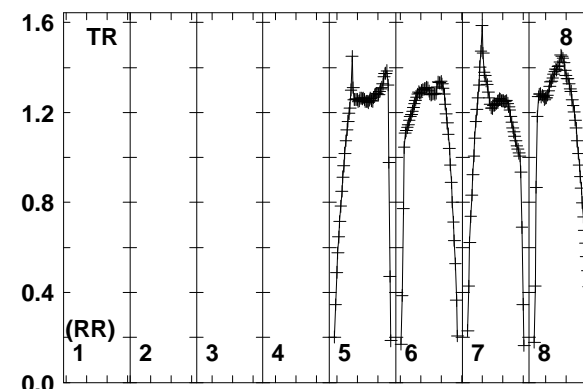
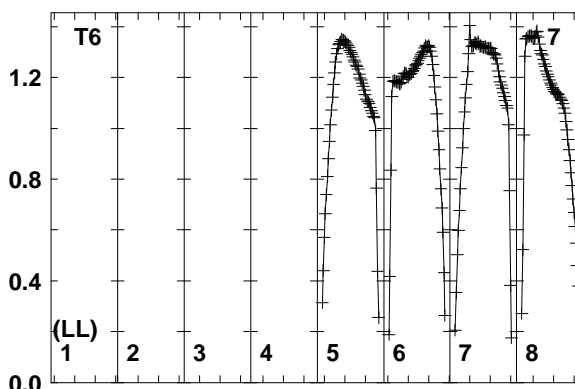
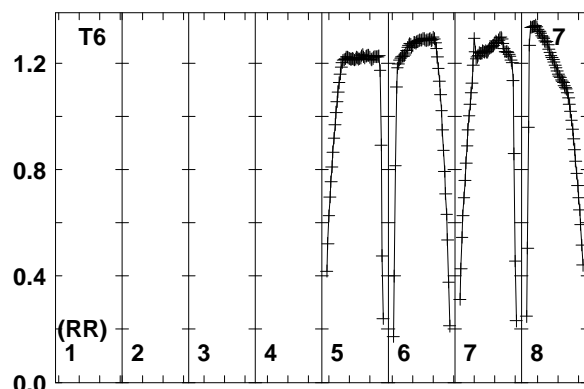
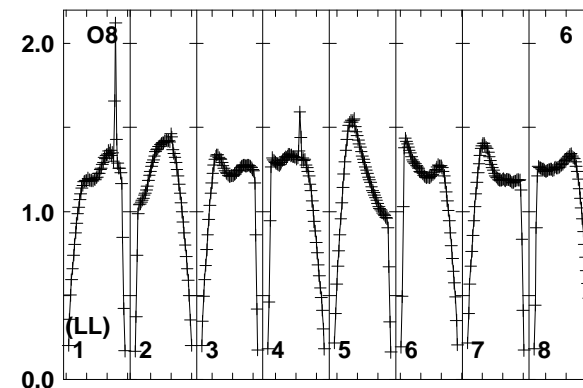
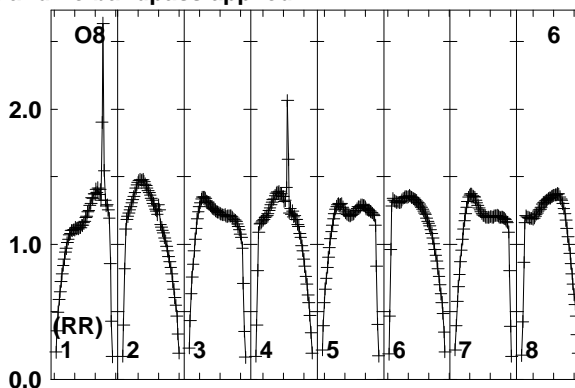
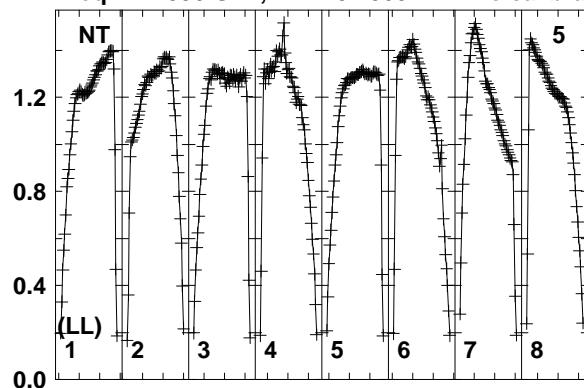

Lower frame: Real Jy
Total-power spectrum Antenna: NT (05)
Timerange: 00/22:57:21 to 00/22:58:20

Plot file version 8 created 23-NOV-2017 14:36:02
J0847+4609 RSM01.UVDATA.1
Freq = 4.7990 GHz, Bw = 32.000 MH No calibration applied and no bandpass applied

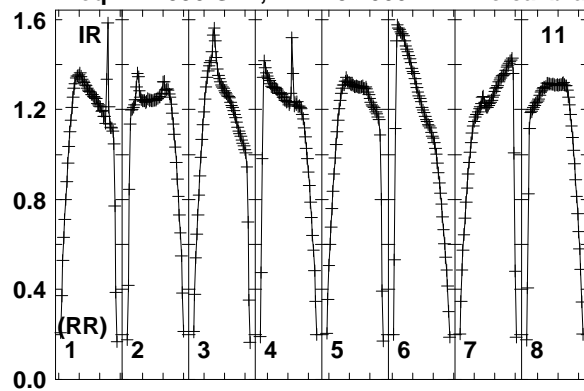

Lower frame: Real Jy
Total-power spectrum Antenna: IR (11)
Timerange: 00/22:57:21 to 00/22:58:20

Plot file version 9 created 23-NOV-2017 14:36:02

J0844+4628 RSM01.UVDATA.1

Freq = 4.7990 GHz, Bw = 32.000 MH No calibration applied and no bandpass applied

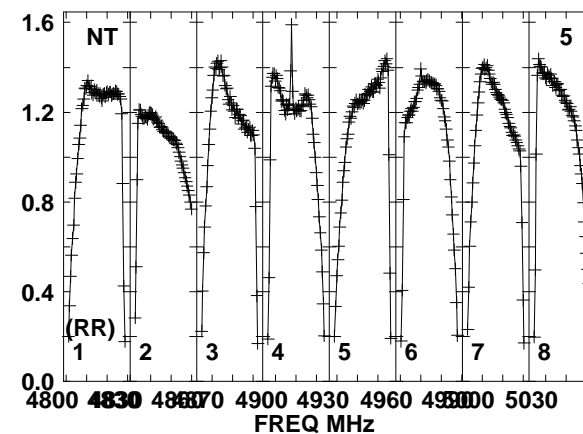
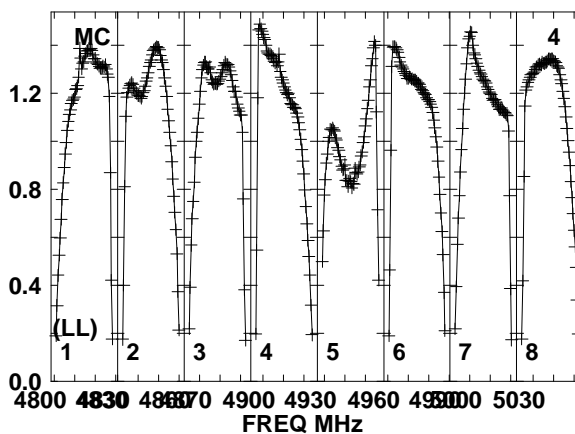
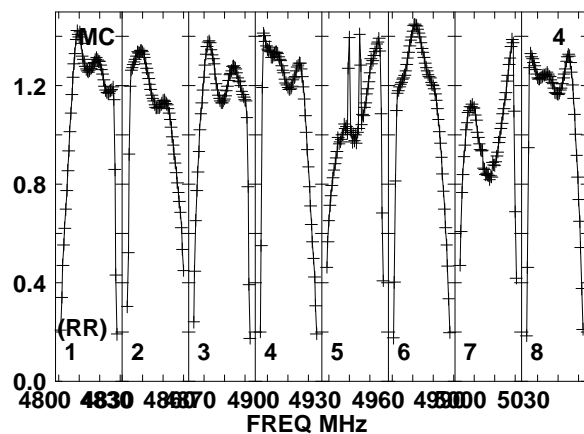
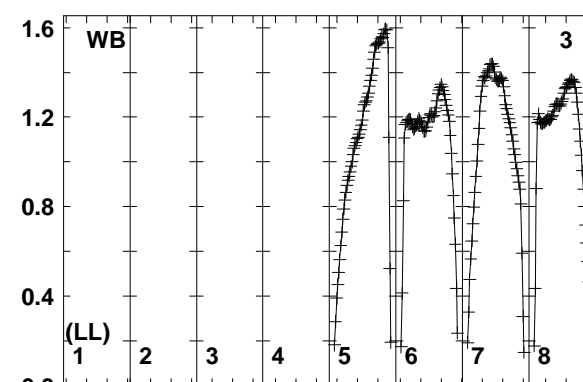
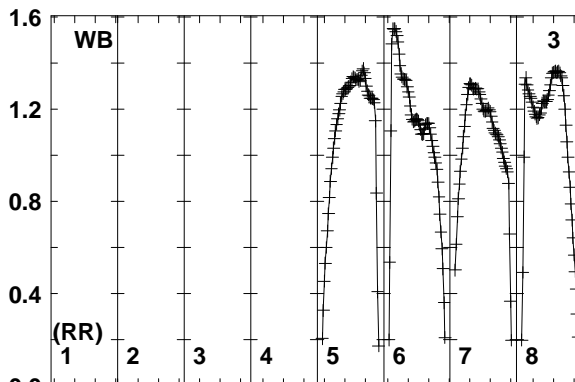
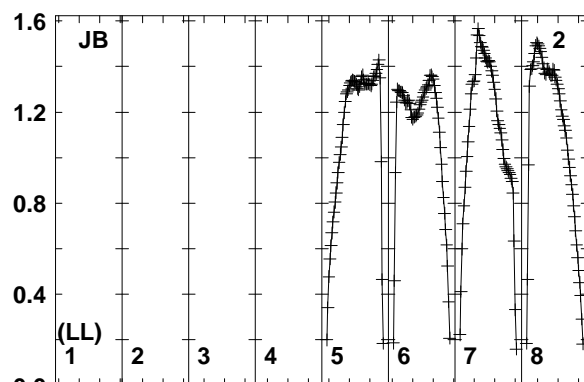
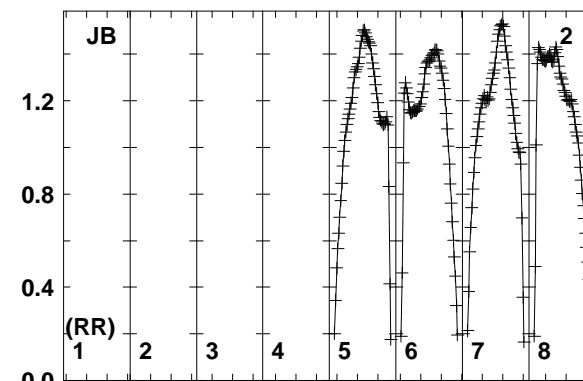
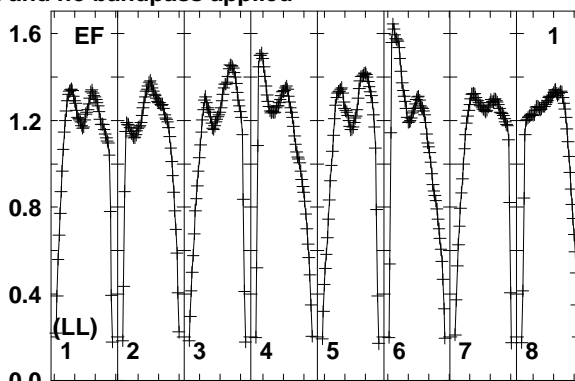
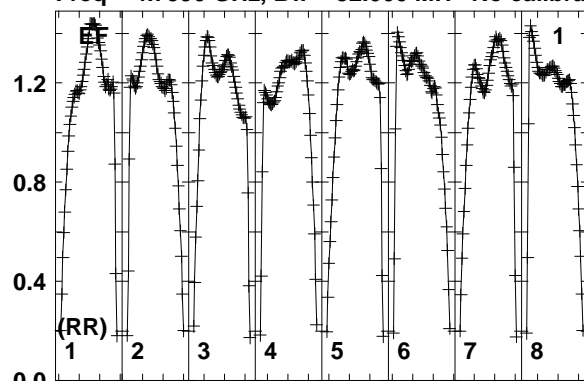

Lower frame: Real Jy
Total-power spectrum Antenna: EF (01)
Timerange: 00/22:58:20 to 00/23:01:49

Plot file version 10 created 23-NOV-2017 14:36:02

J0844+4628 RSM01.UVDATA.1

Freq = 4.7990 GHz, Bw = 32.000 MH No calibration applied and no bandpass applied

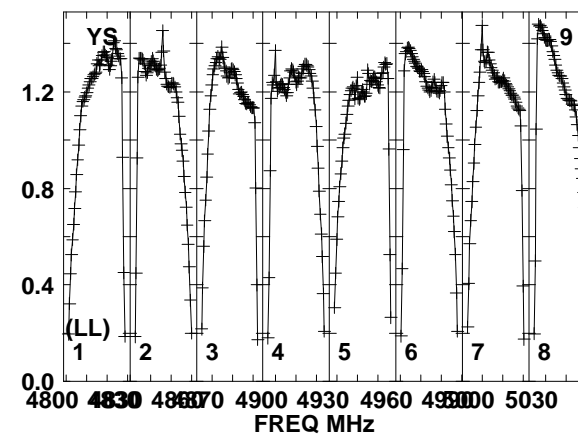
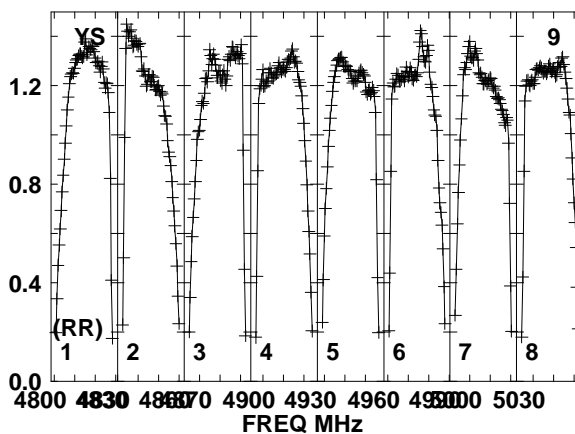
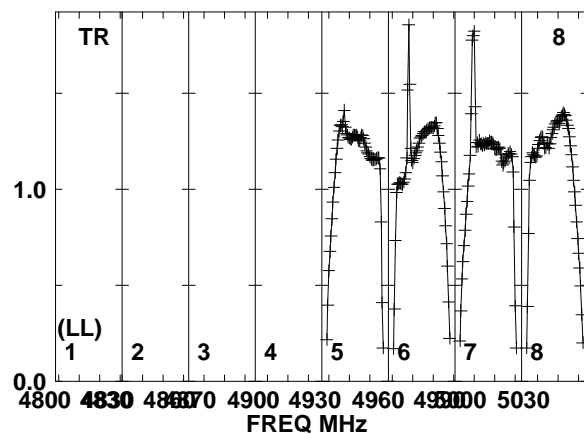
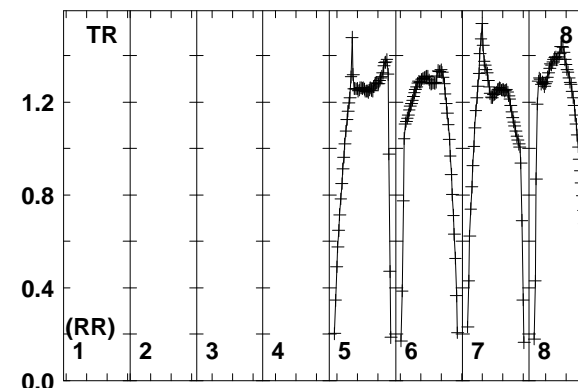
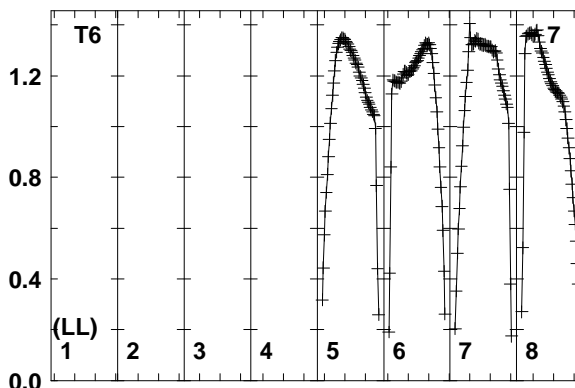
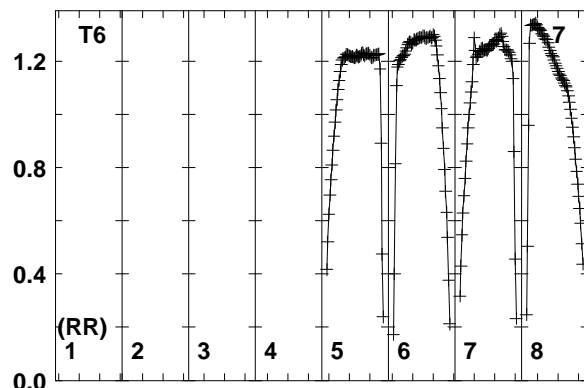
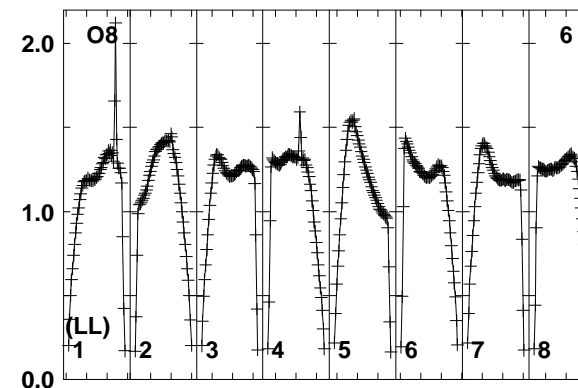
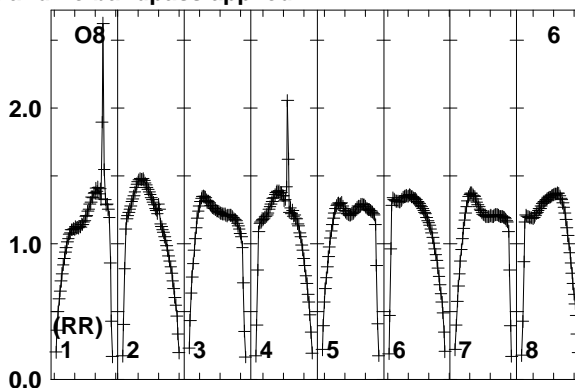
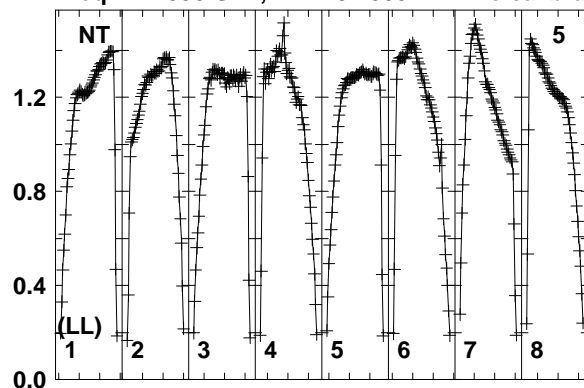

Lower frame: Real Jy
Total-power spectrum Antenna: NT (05)
Timerange: 00/22:58:20 to 00/23:01:49

Plot file version 11 created 23-NOV-2017 14:36:02

J0844+4628 RSM01.UVDATA.1

Freq = 4.7990 GHz, Bw = 32.000 MH No calibration applied and no bandpass applied

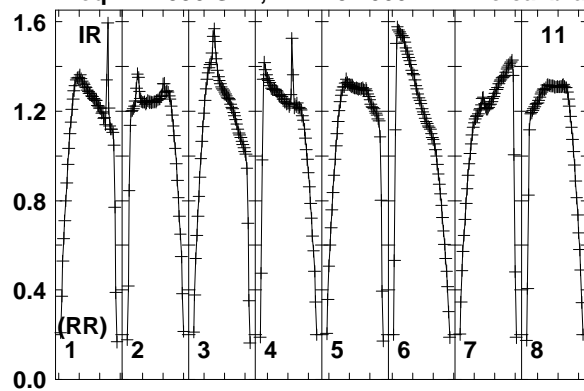

Lower frame: Real Jy
Total-power spectrum Antenna: IR (11)
Timerange: 00/22:58:20 to 00/23:01:49

Plot file version 12 created 23-NOV-2017 14:36:03

J0847+4609 RSM01.UVDATA.1

Freq = 4.7990 GHz, Bw = 32.000 MH No calibration applied and no bandpass applied

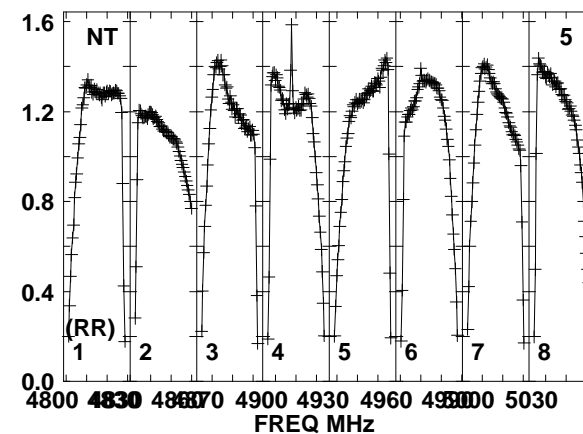
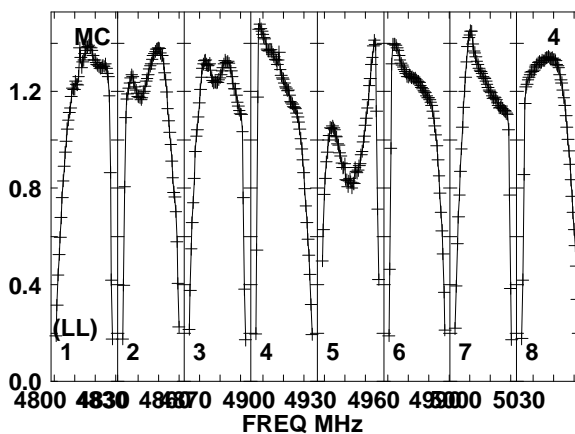
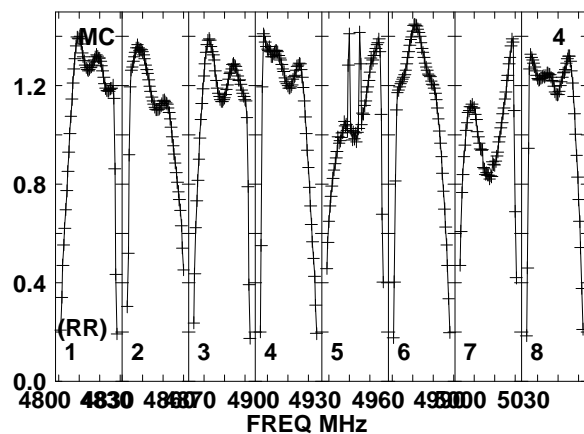
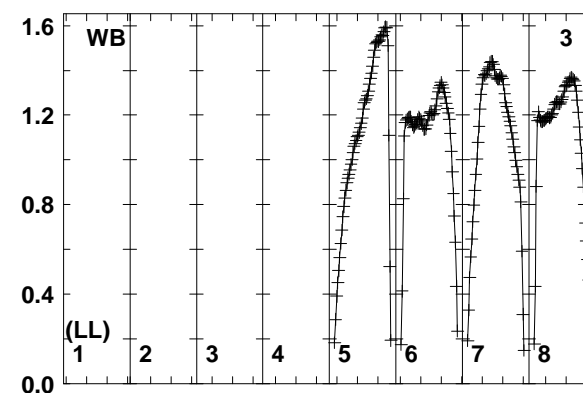
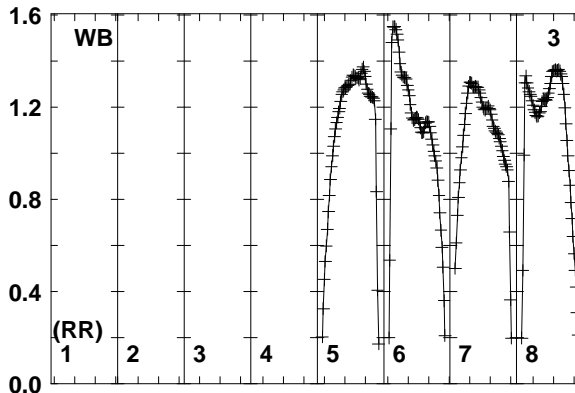
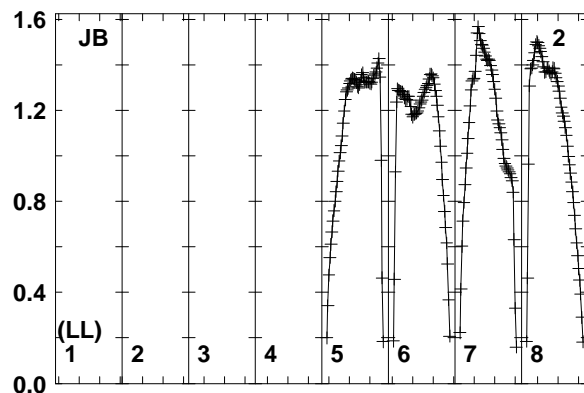
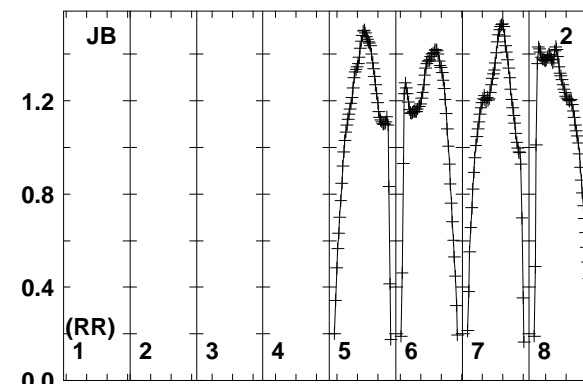
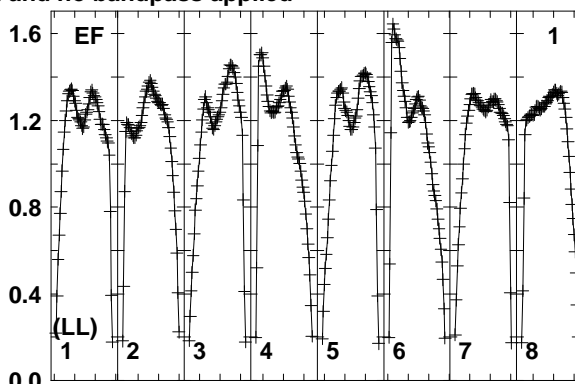
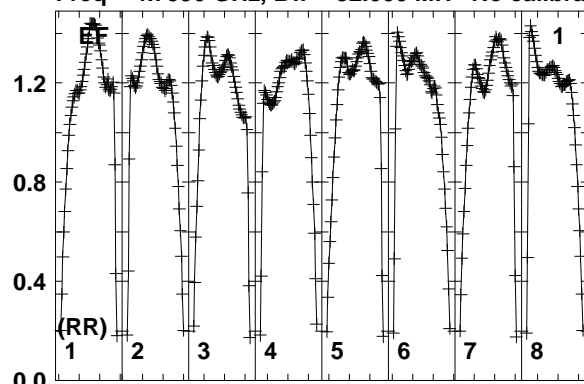

Lower frame: Real Jy
Total-power spectrum Antenna: EF (01)
Timerange: 00/23:01:50 to 00/23:03:19

Plot file version 13 created 23-NOV-2017 14:36:03

J0847+4609 RSM01.UVDATA.1

Freq = 4.7990 GHz, Bw = 32.000 MH No calibration applied and no bandpass applied

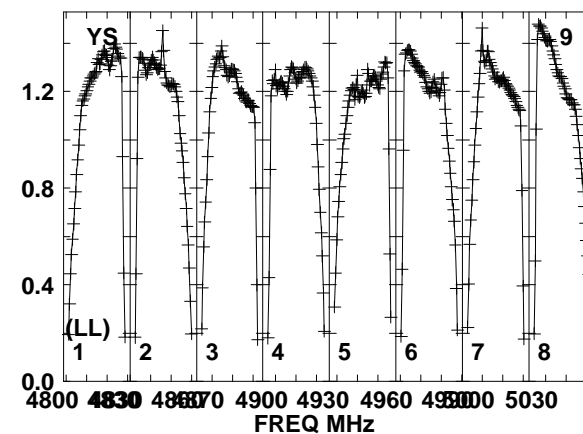
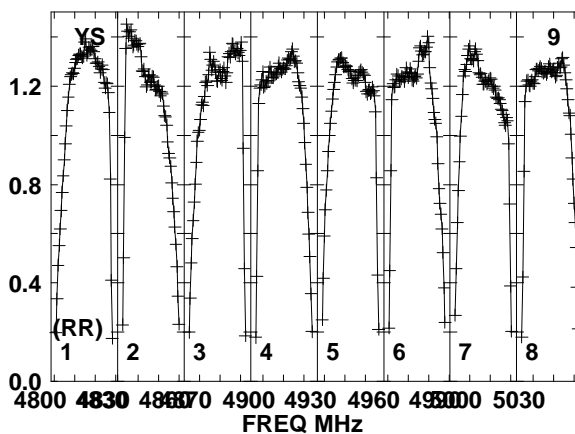
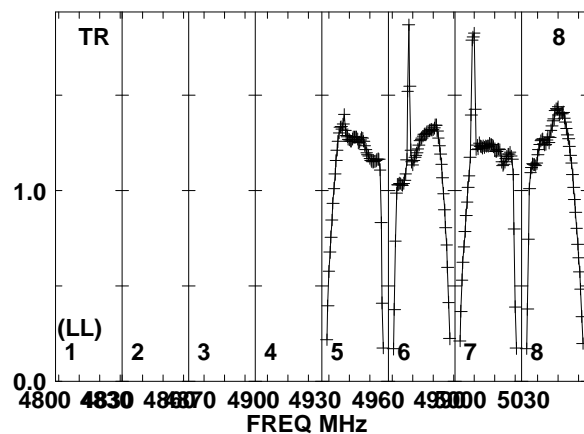
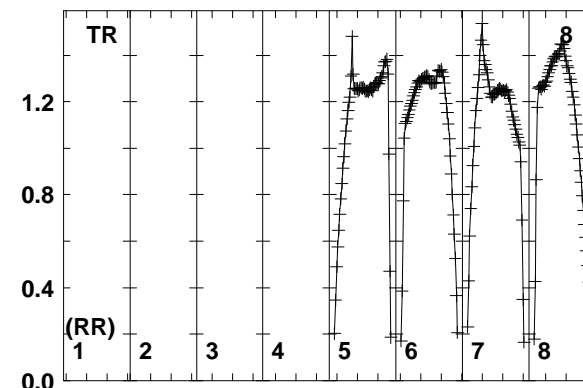
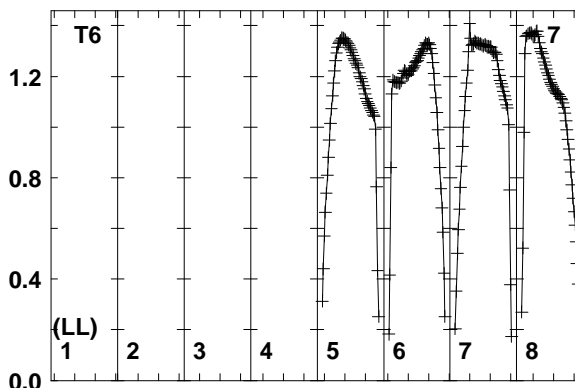
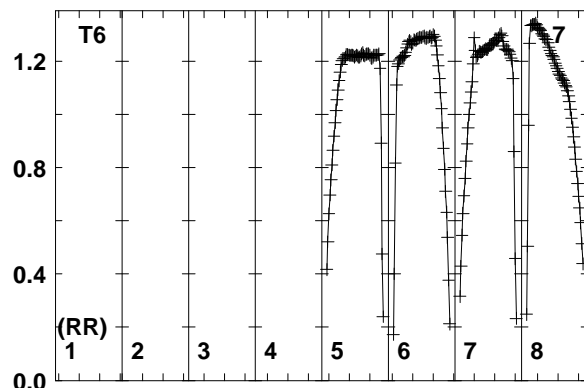
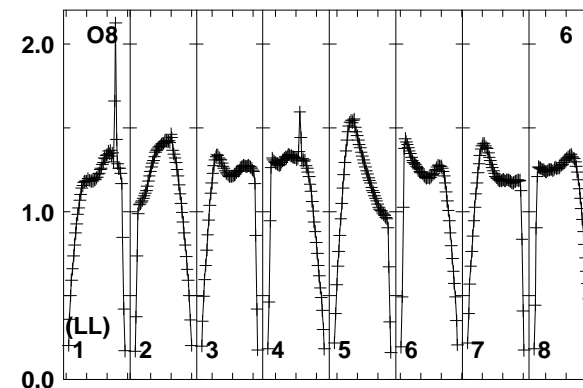
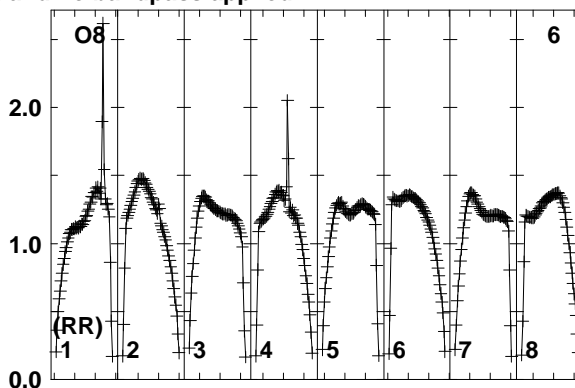
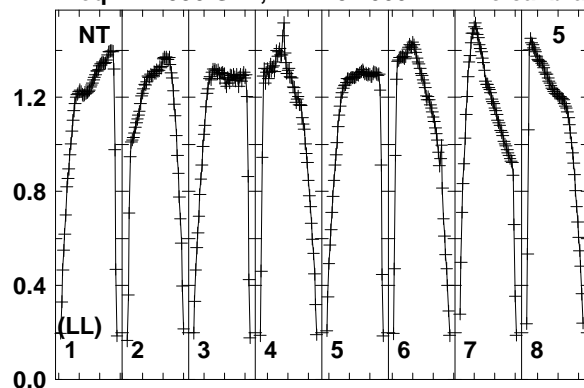

Lower frame: Real Jy
Total-power spectrum Antenna: NT (05)
Timerange: 00/23:01:50 to 00/23:03:19

Plot file version 14 created 23-NOV-2017 14:36:03

J0847+4609 RSM01.UVDATA.1

Freq = 4.7990 GHz, Bw = 32.000 MH No calibration applied and no bandpass applied

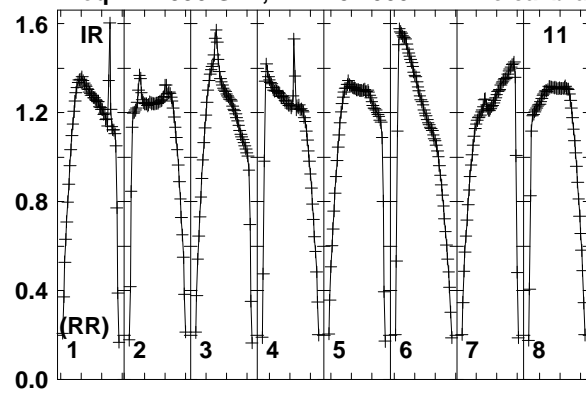

Lower frame: Real Jy
Total-power spectrum Antenna: IR (11)
Timerange: 00/23:01:50 to 00/23:03:19

Plot file version 15 created 23-NOV-2017 14:36:03

J0844+4628 RSM01.UVDATA.1

Freq = 4.7990 GHz, Bw = 32.000 MH No calibration applied and no bandpass applied

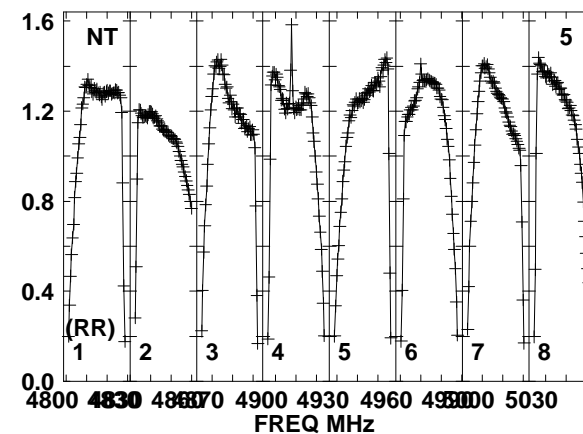
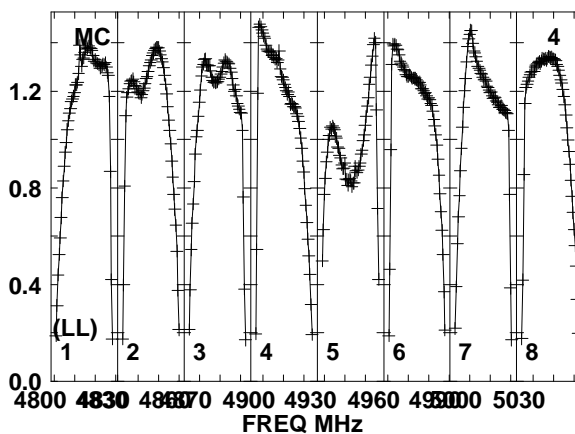
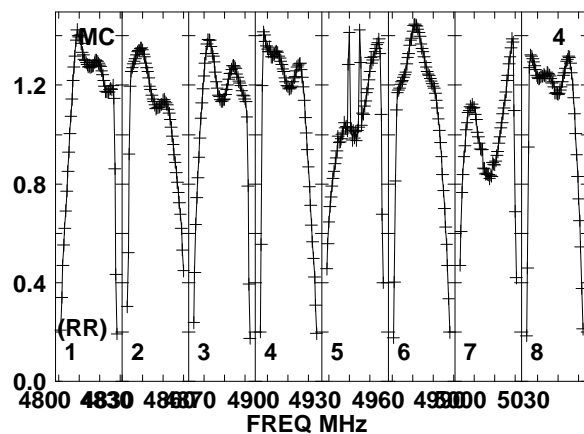
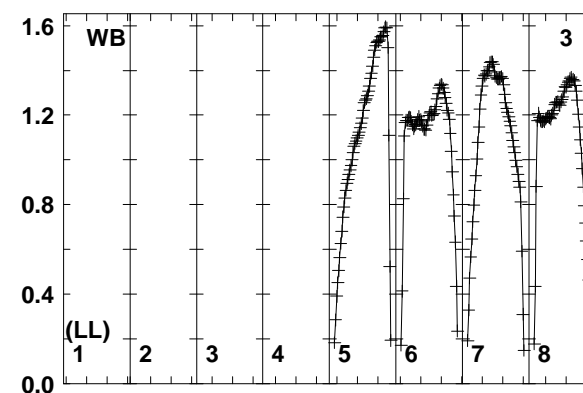
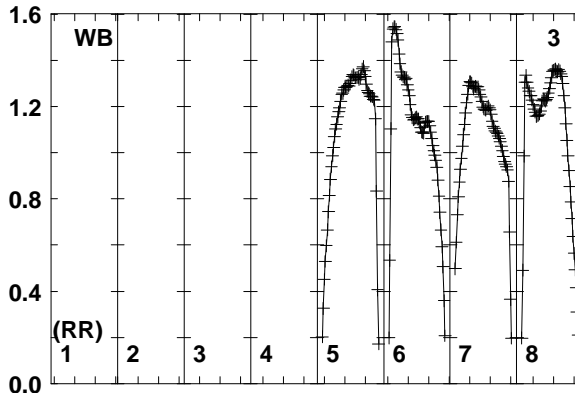
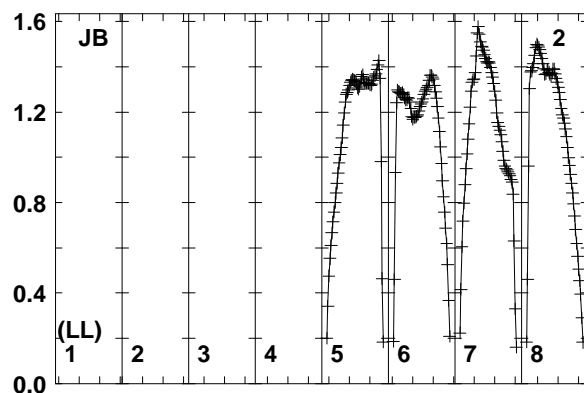
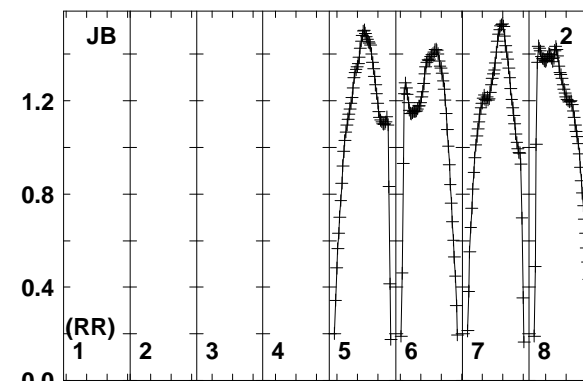
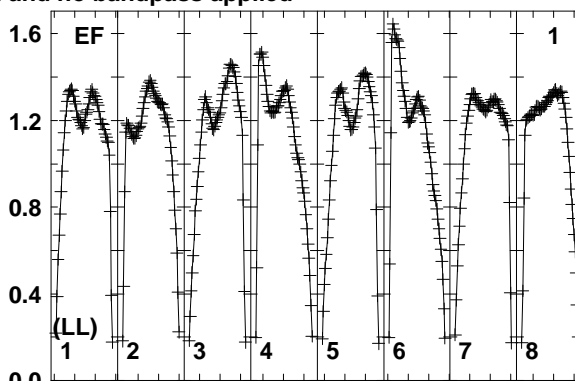
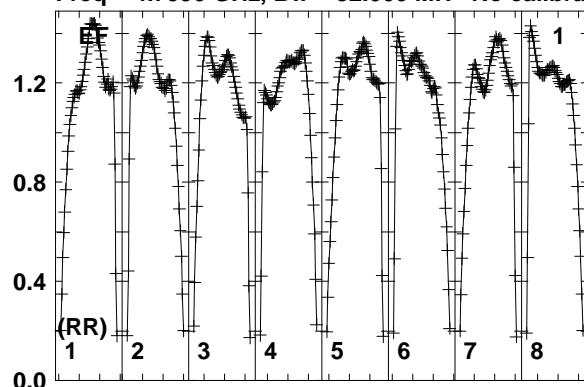

Lower frame: Real Jy
Total-power spectrum Antenna: EF (01)
Timerange: 00/23:03:21 to 00/23:06:50

Plot file version 16 created 23-NOV-2017 14:36:03

J0844+4628 RSM01.UVDATA.1

Freq = 4.7990 GHz, Bw = 32.000 MH No calibration applied and no bandpass applied

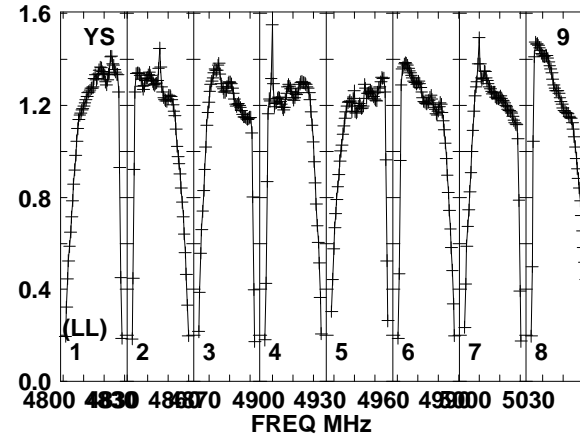
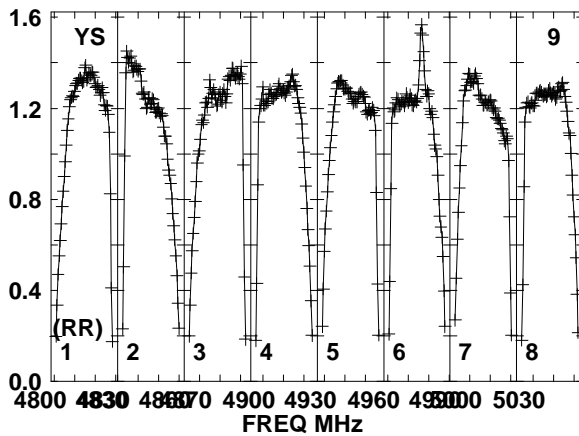
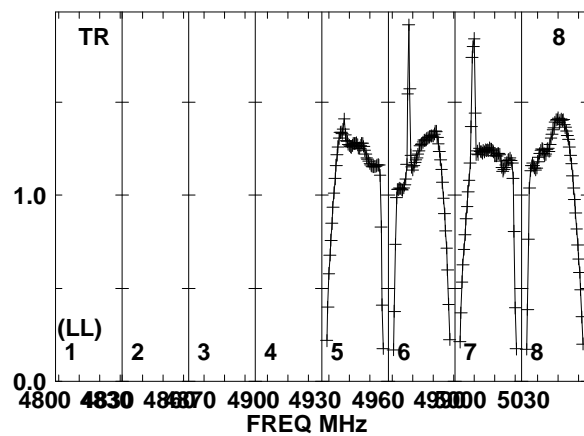
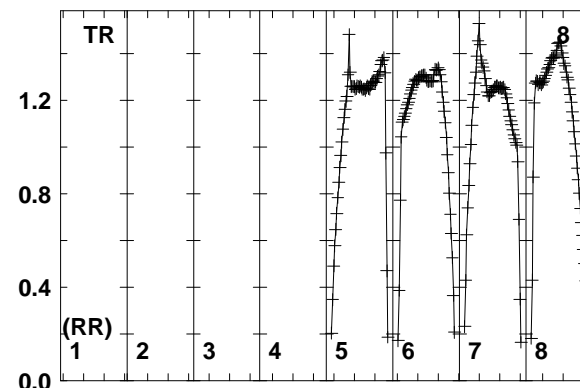
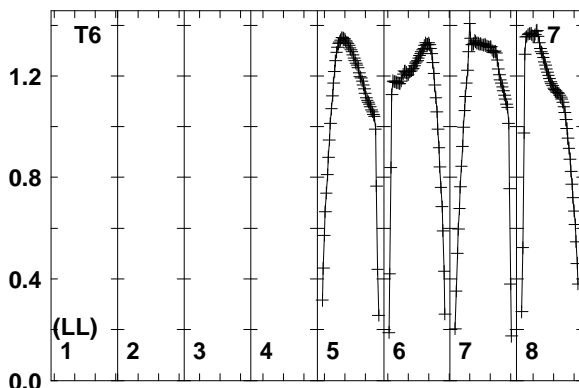
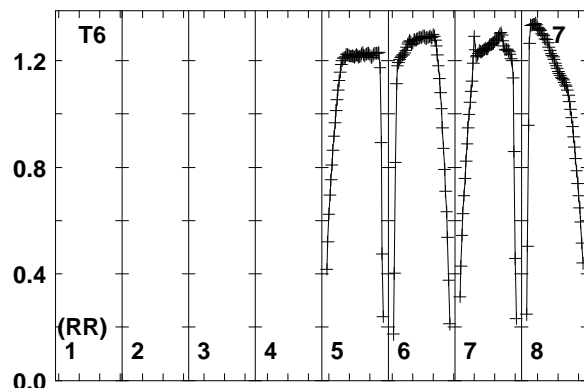
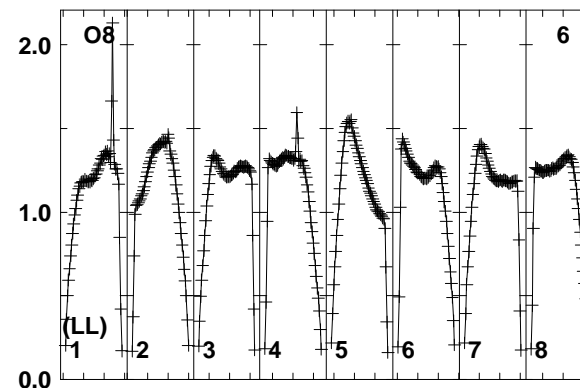
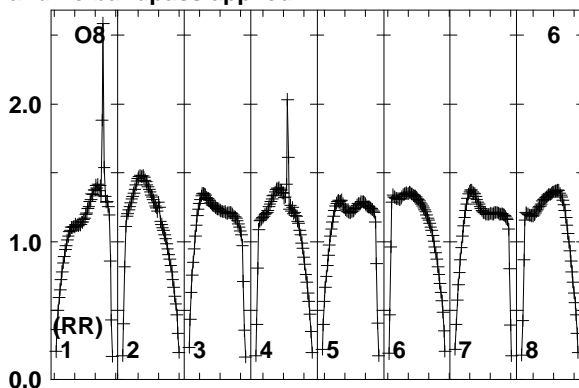
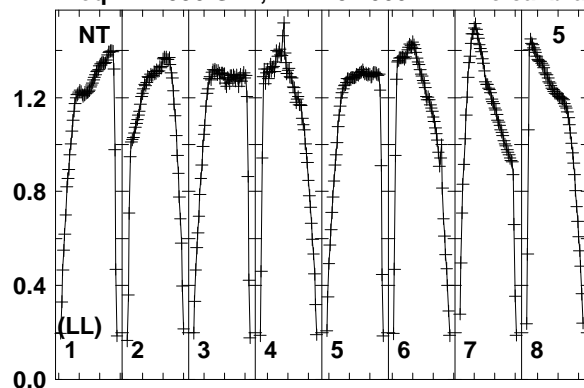

Lower frame: Real Jy
Total-power spectrum Antenna: NT (05)
Timerange: 00/23:03:21 to 00/23:06:50

Plot file version 17 created 23-NOV-2017 14:36:04
J0844+4628 RSM01.UVDATA.1
Freq = 4.7990 GHz, Bw = 32.000 MH No calibration applied and no bandpass applied

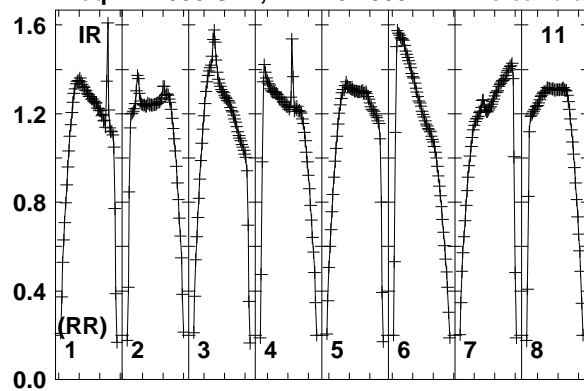

Lower frame: Real Jy
Total-power spectrum Antenna: IR (11)
Timerange: 00/23:03:21 to 00/23:06:50

Plot file version 18 created 23-NOV-2017 14:36:04

J0847+4609 RSM01.UVDATA.1

Freq = 4.7990 GHz, Bw = 32.000 MH No calibration applied and no bandpass applied

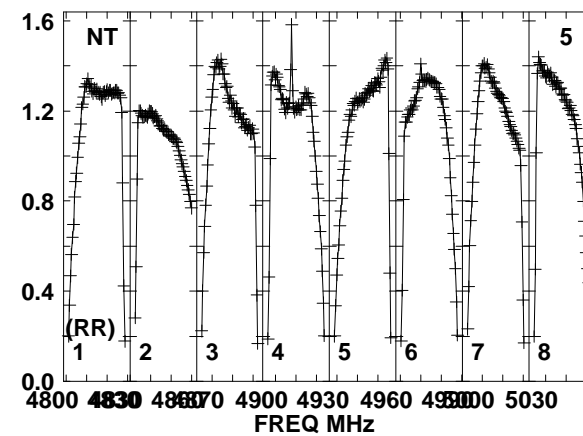
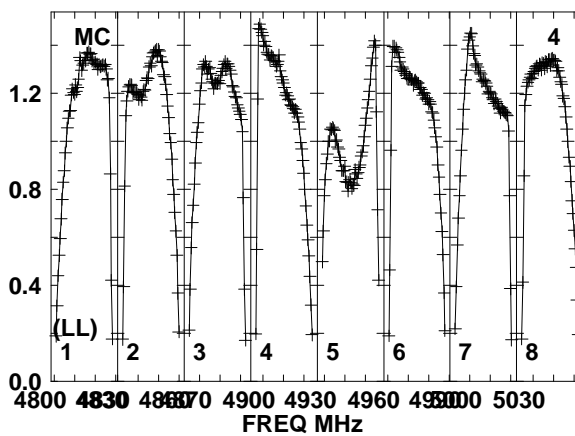
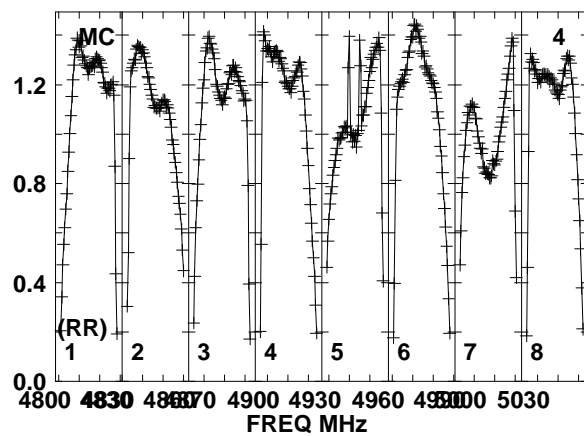
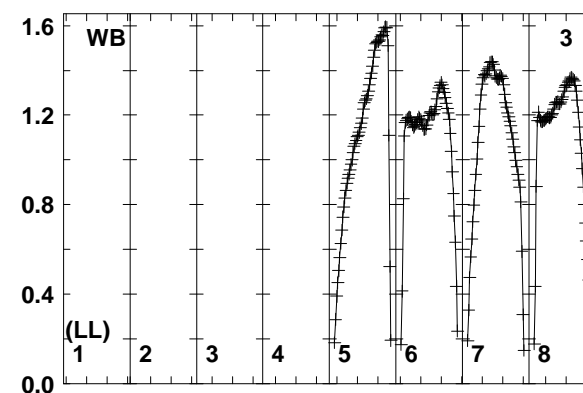
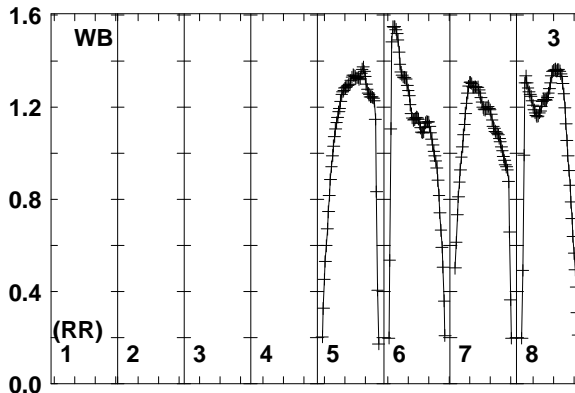
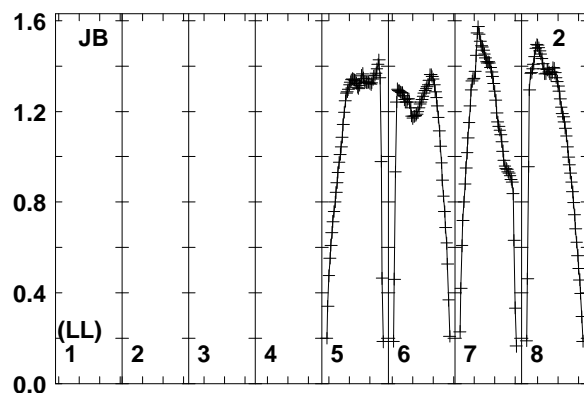
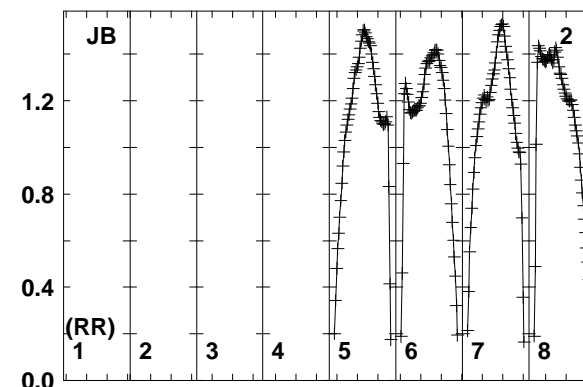
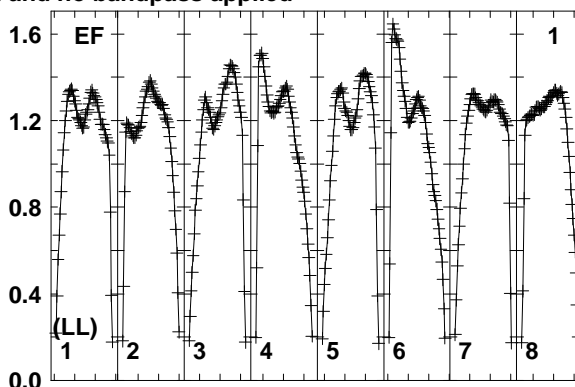
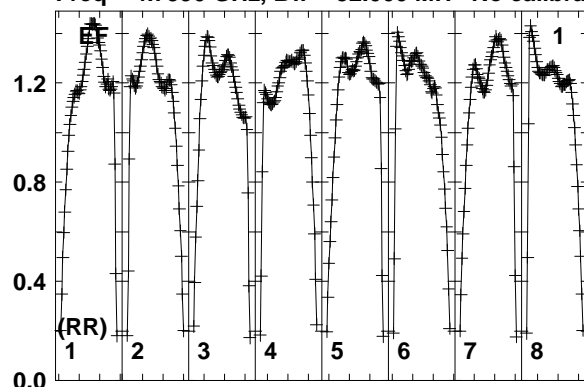

Lower frame: Real Jy
Total-power spectrum Antenna: EF (01)
Timerange: 00/23:07:31 to 00/23:08:29

Plot file version 19 created 23-NOV-2017 14:36:04

J0847+4609 RSM01.UVDATA.1

Freq = 4.7990 GHz, Bw = 32.000 MH No calibration applied and no bandpass applied

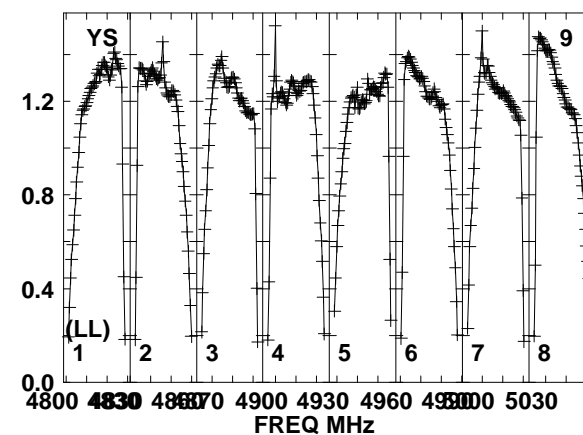
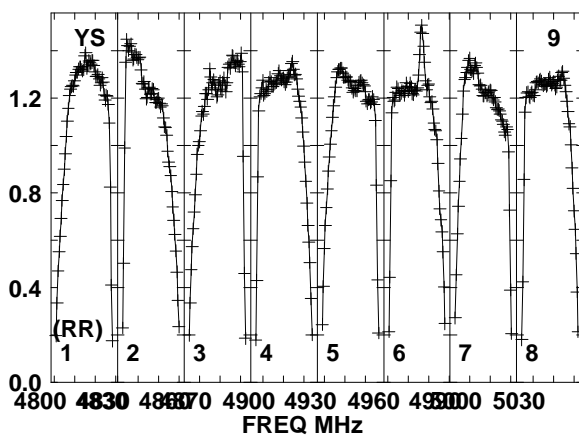
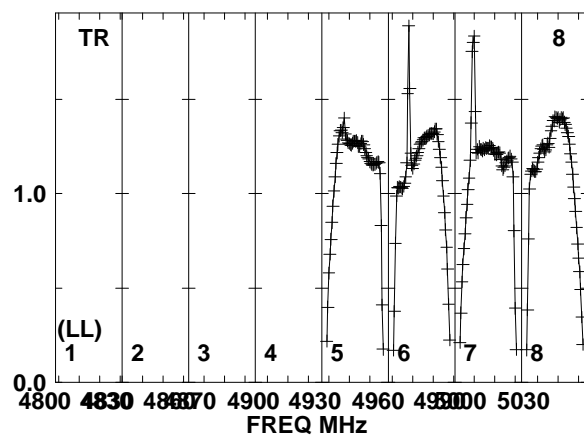
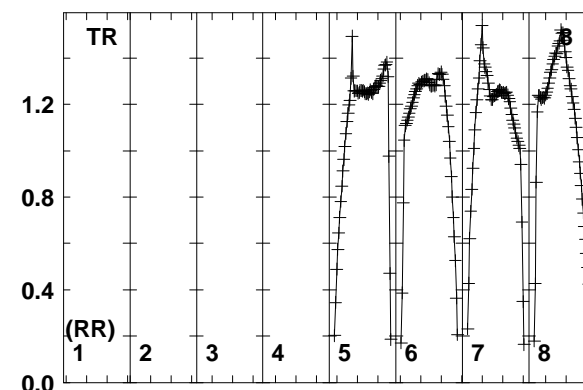
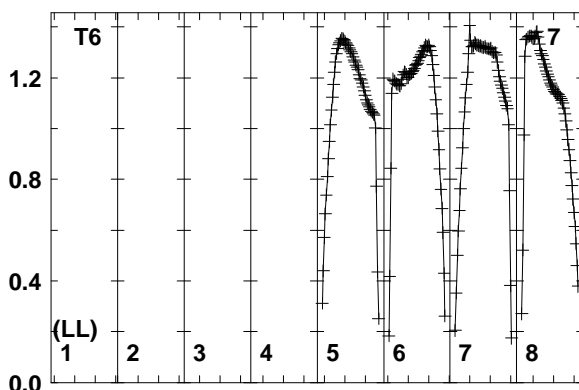
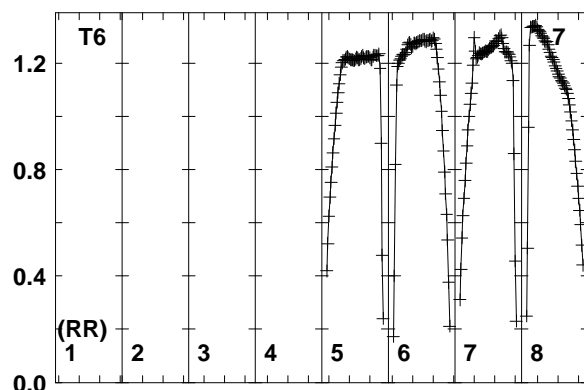
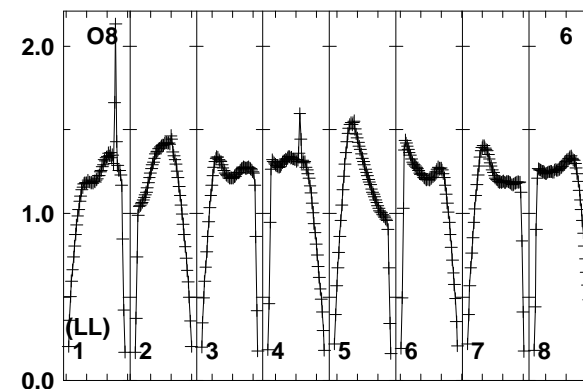
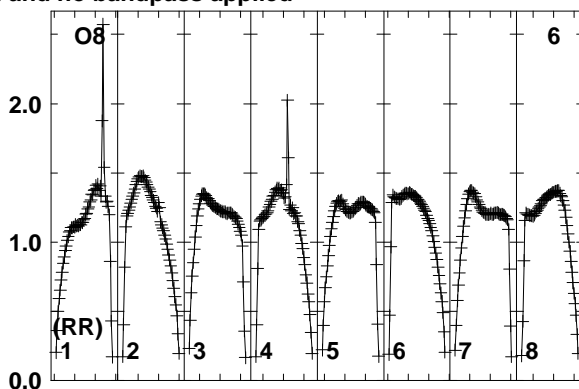
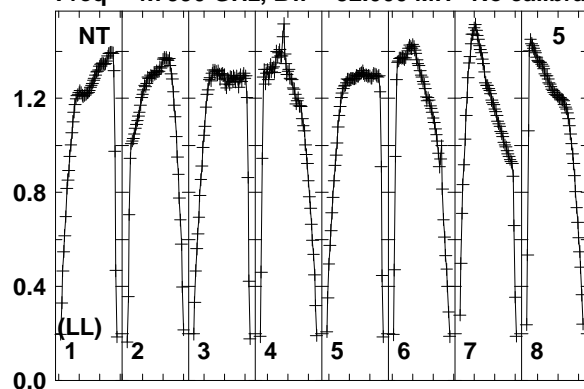

Lower frame: Real Jy
Total-power spectrum Antenna: NT (05)
Timerange: 00/23:07:31 to 00/23:08:29

Plot file version 20 created 23-NOV-2017 14:36:04

J0847+4609 RSM01.UVDATA.1

Freq = 4.7990 GHz, Bw = 32.000 MH No calibration applied and no bandpass applied

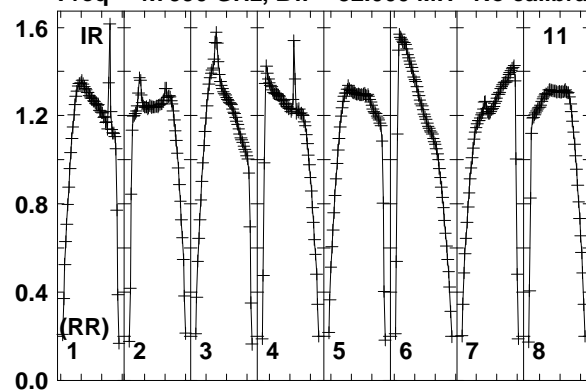

Lower frame: Real Jy
Total-power spectrum Antenna: IR (11)
Timerange: 00/23:07:31 to 00/23:08:29

Plot file version 21 created 23-NOV-2017 14:36:04

J0844+4628 RSM01.UVDATA.1

Freq = 4.7990 GHz, Bw = 32.000 MH No calibration applied and no bandpass applied

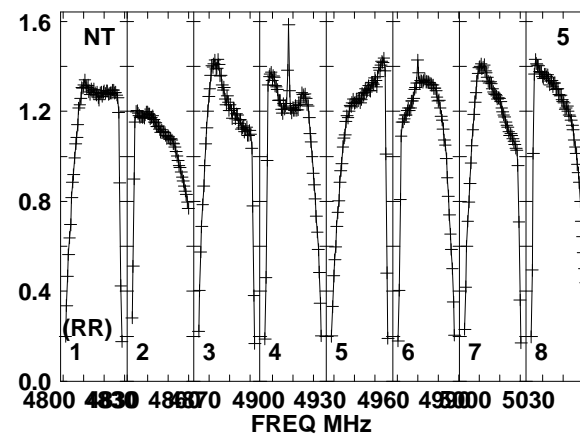
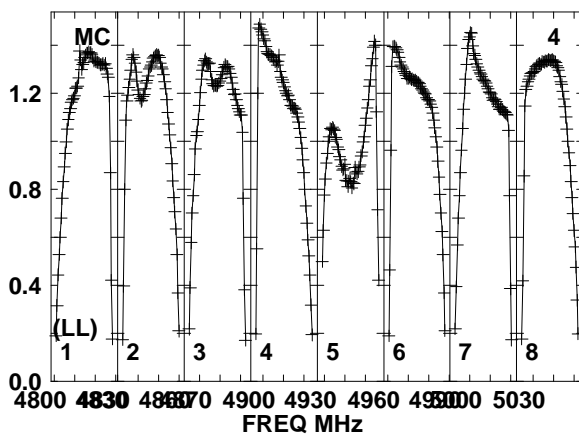
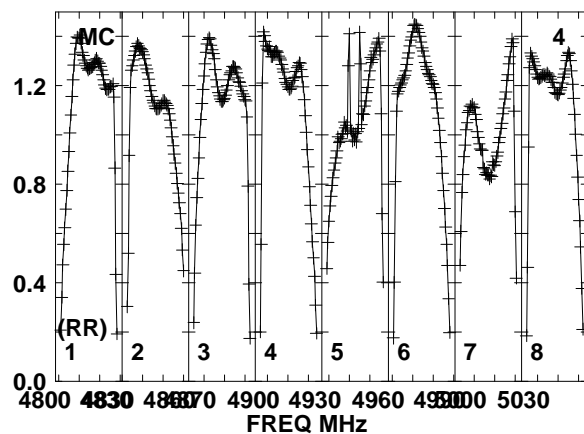
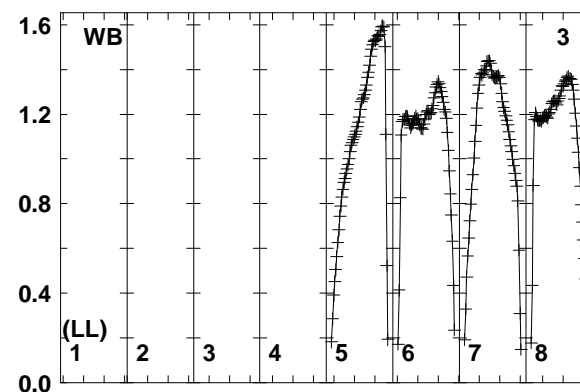
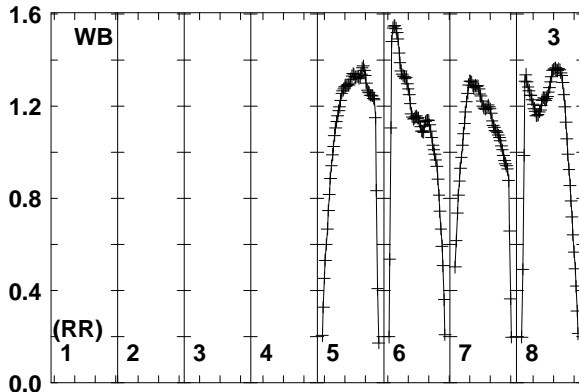
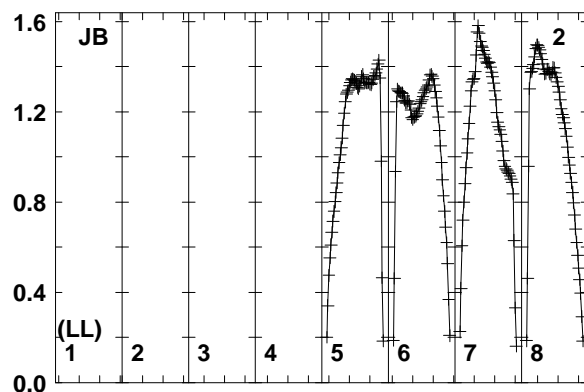
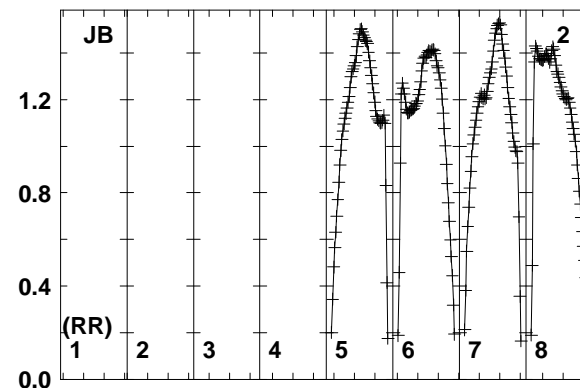
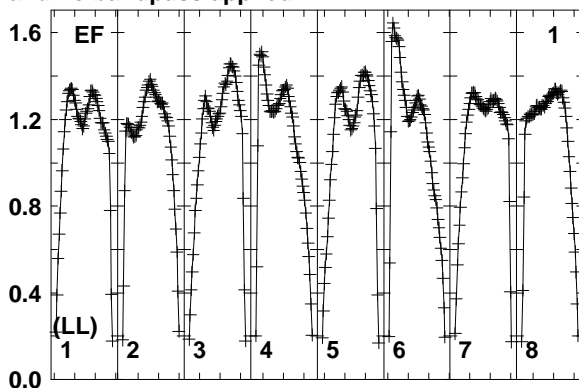
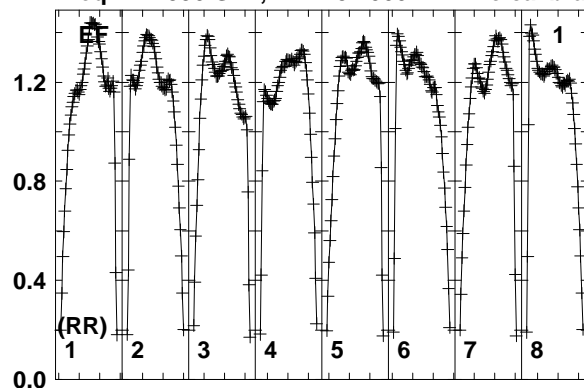

Lower frame: Real Jy
Total-power spectrum Antenna: EF (01)
Timerange: 00/23:08:30 to 00/23:11:59

Plot file version 22 created 23-NOV-2017 14:36:05

J0844+4628 RSM01.UVDATA.1

Freq = 4.7990 GHz, Bw = 32.000 MH No calibration applied and no bandpass applied

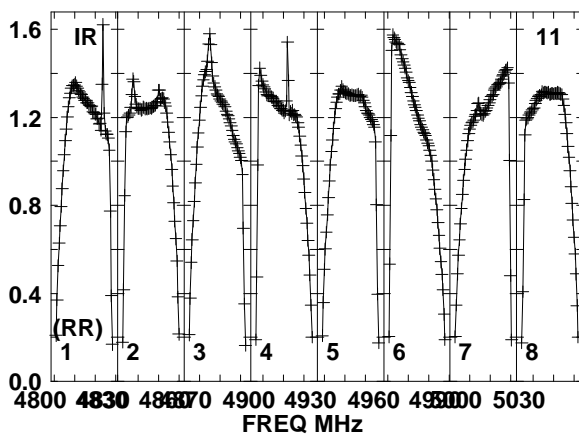
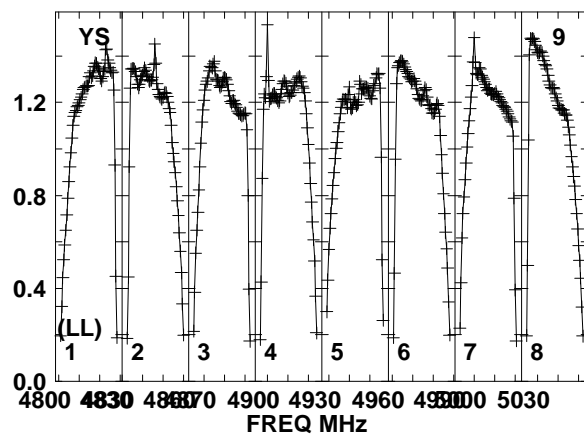
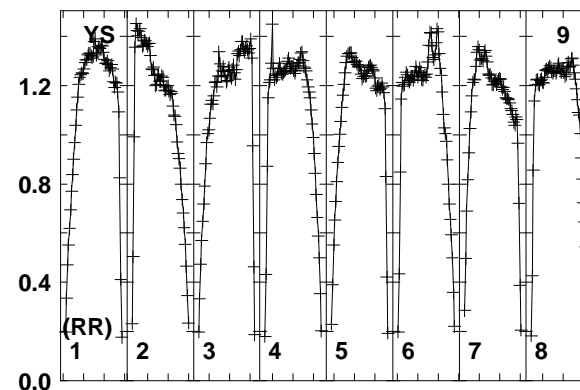
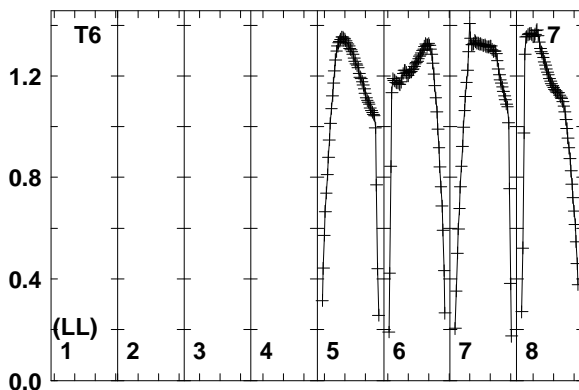
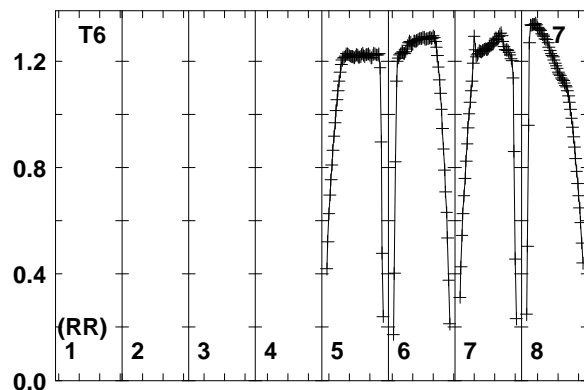
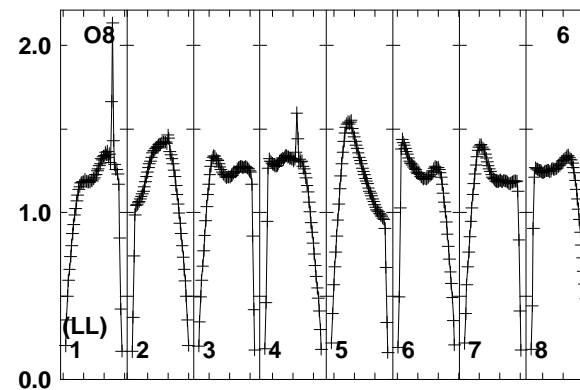
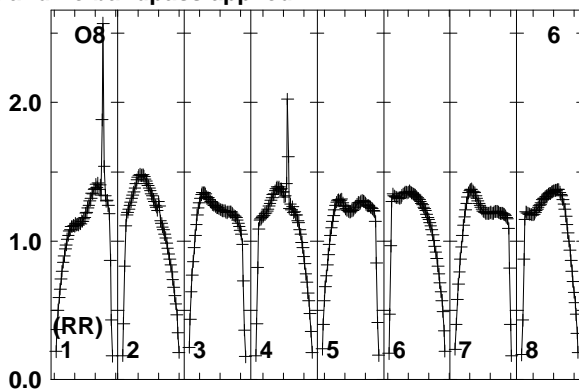
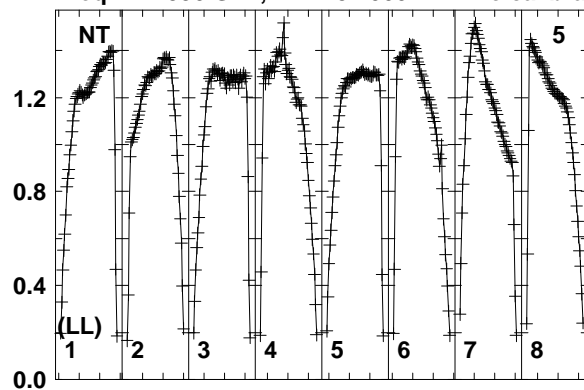

Lower frame: Real Jy
Total-power spectrum Antenna: NT (05)
Timerange: 00/23:08:30 to 00/23:11:59

Plot file version 23 created 23-NOV-2017 14:36:05

J0847+4609 RSM01.UVDATA.1

Freq = 4.7990 GHz, Bw = 32.000 MH No calibration applied and no bandpass applied

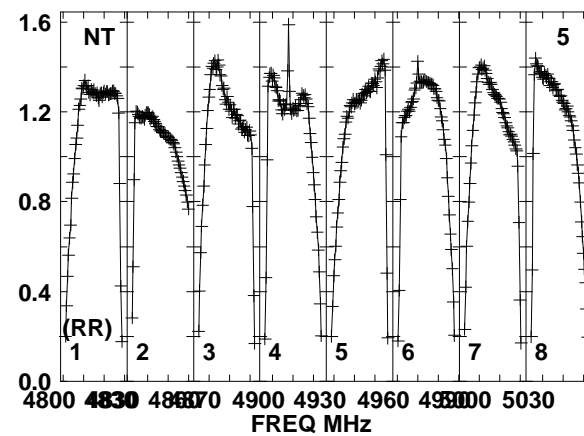
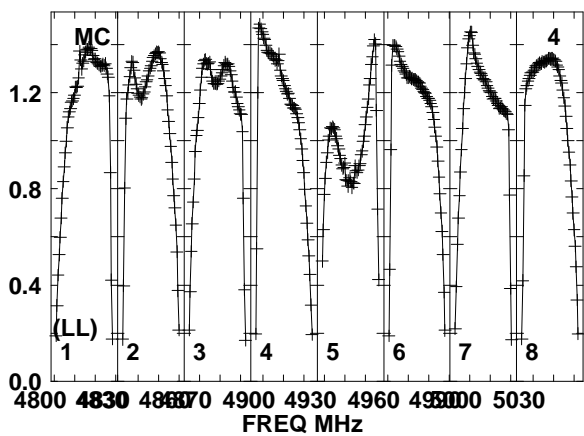
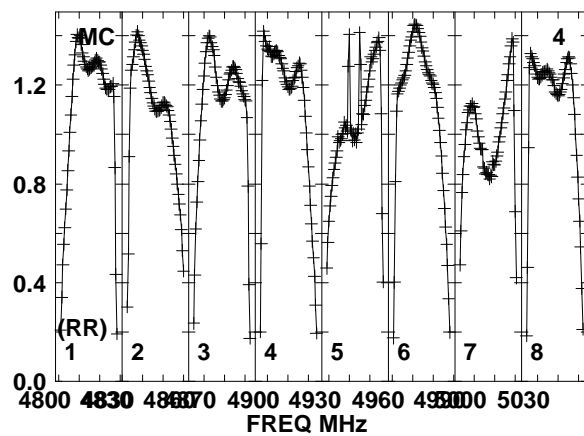
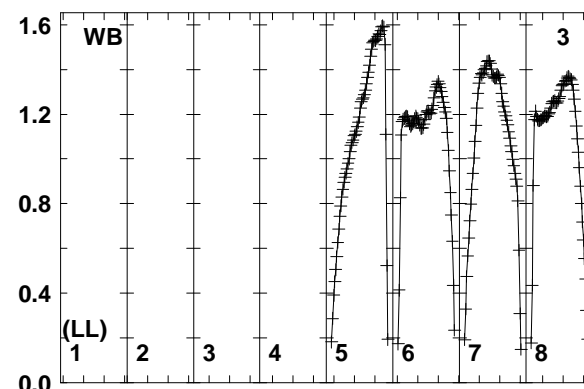
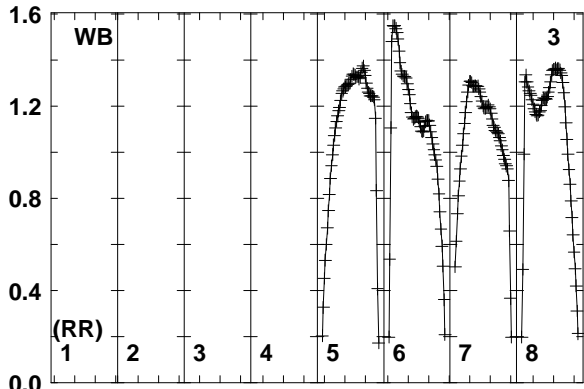
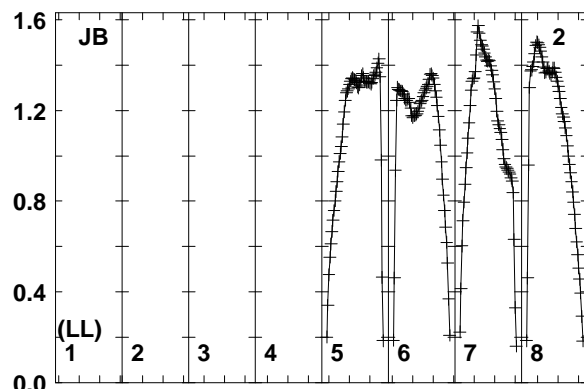
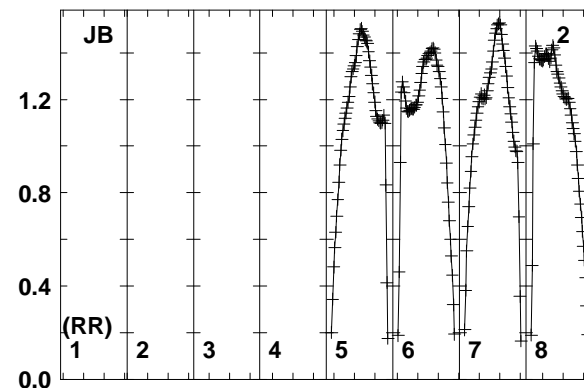
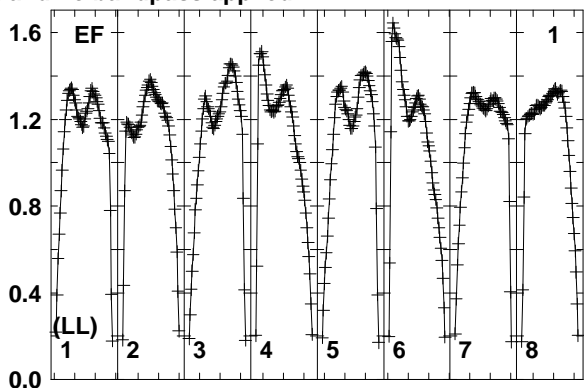
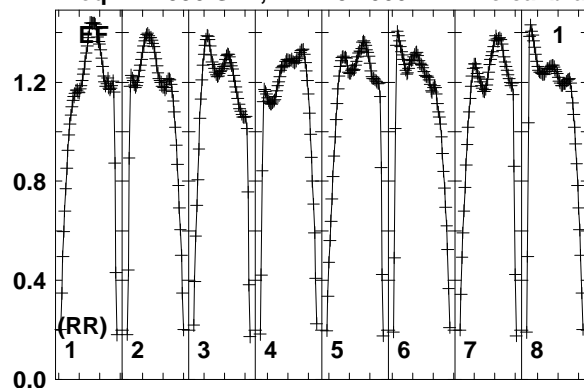

Lower frame: Real Jy
Total-power spectrum Antenna: EF (01)
Timerange: 00/23:12:01 to 00/23:13:30

Plot file version 24 created 23-NOV-2017 14:36:05

J0847+4609 RSM01.UVDATA.1

Freq = 4.7990 GHz, Bw = 32.000 MH No calibration applied and no bandpass applied

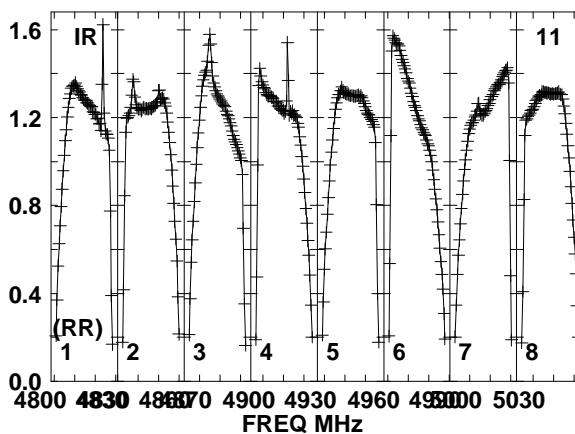
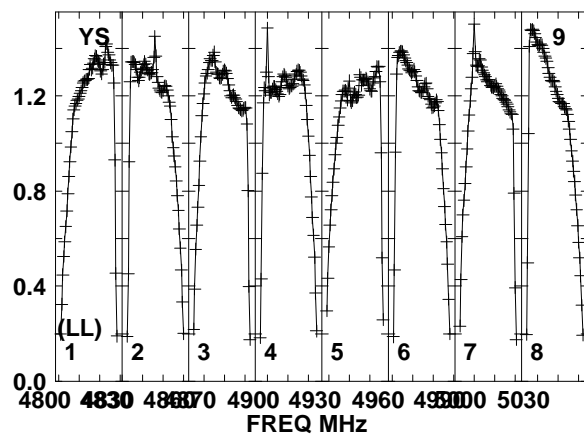
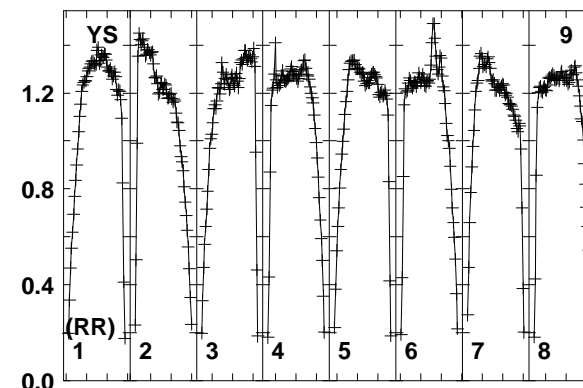
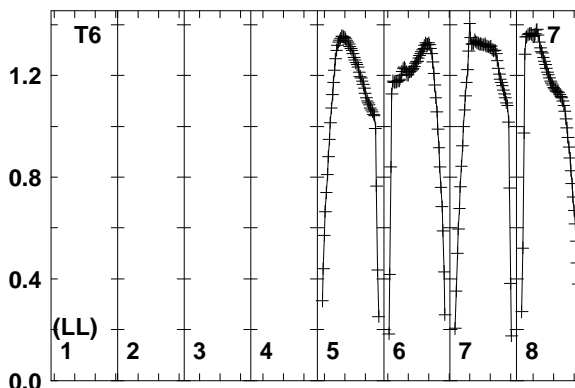
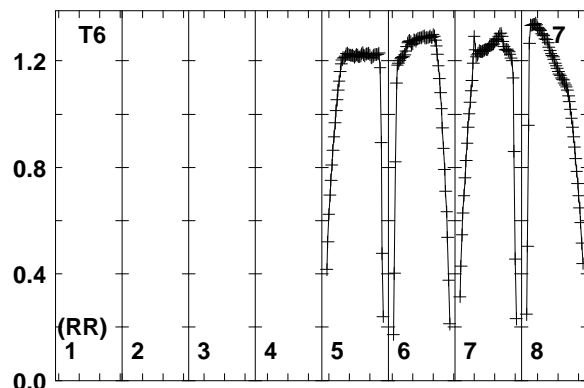
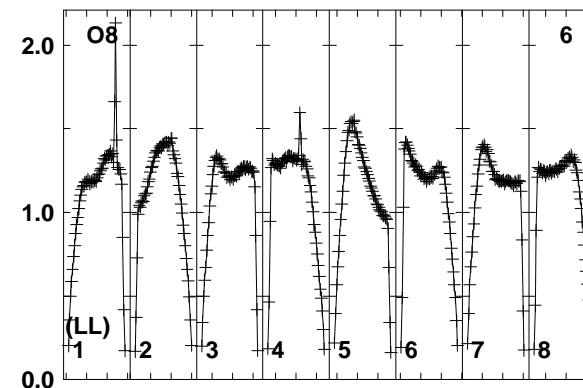
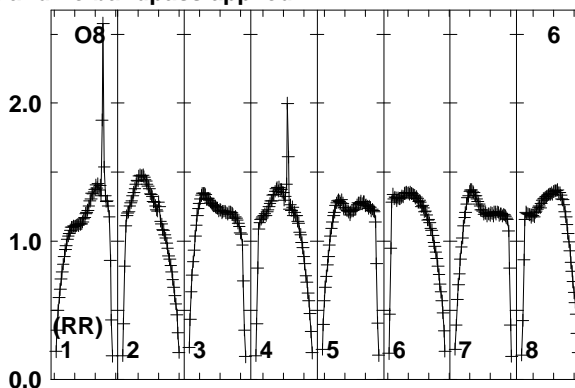
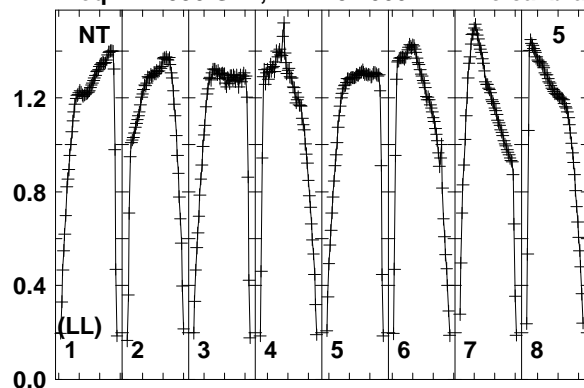

Lower frame: Real Jy
Total-power spectrum Antenna: NT (05)
Timerange: 00/23:12:01 to 00/23:13:30

Plot file version 25 created 23-NOV-2017 14:36:06

J0844+4628 RSM01.UVDATA.1

Freq = 4.7990 GHz, Bw = 32.000 MH No calibration applied and no bandpass applied

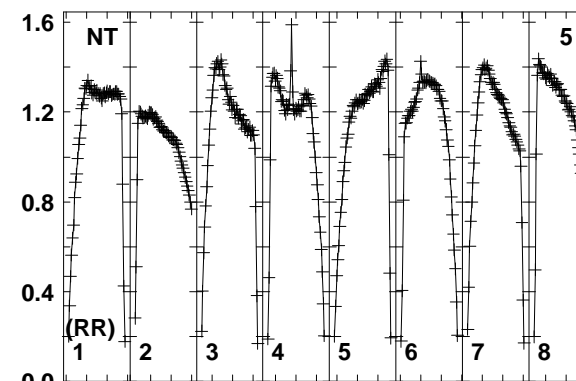
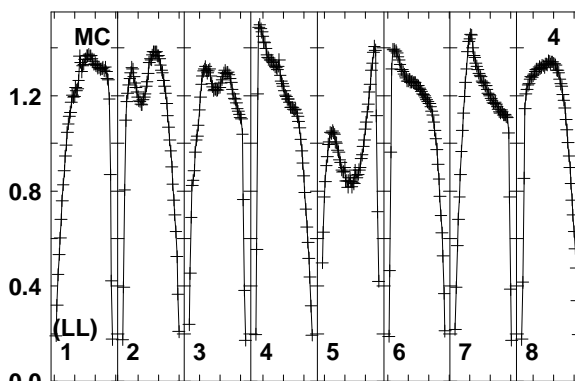
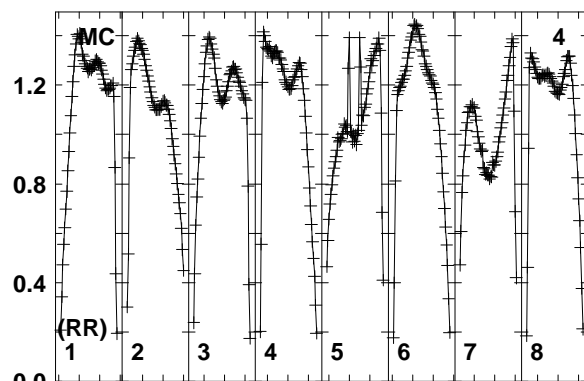
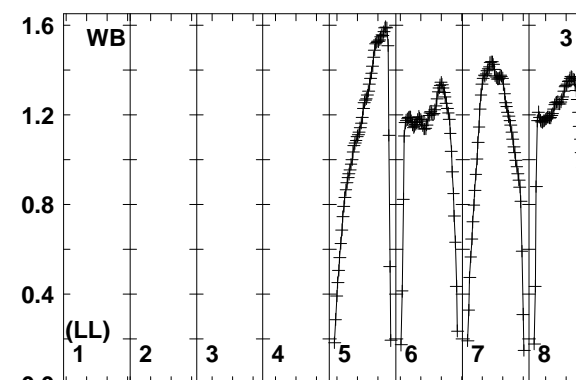
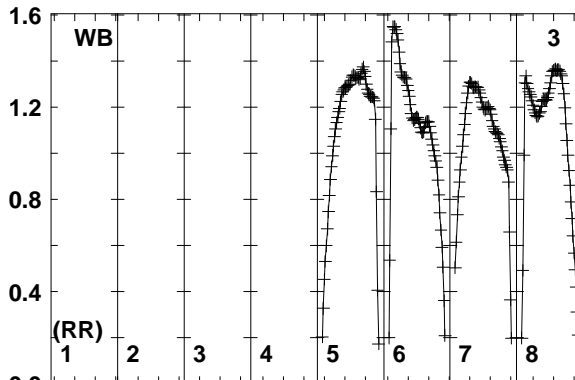
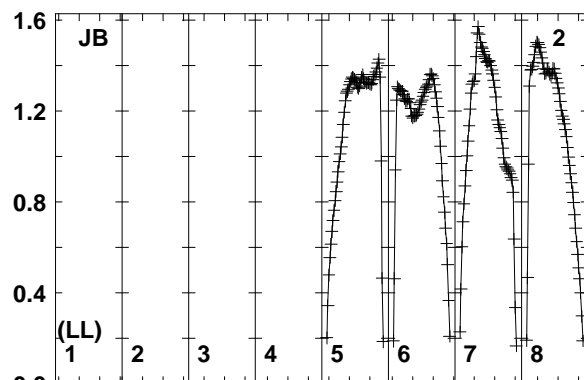
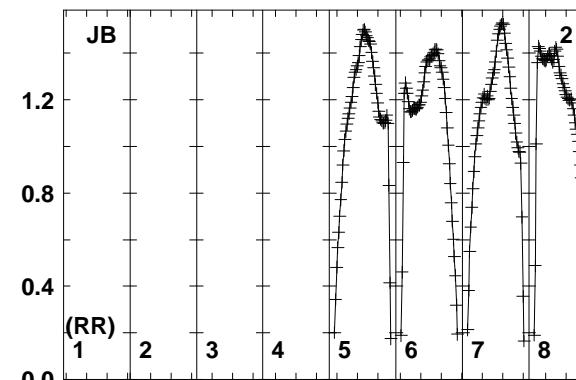
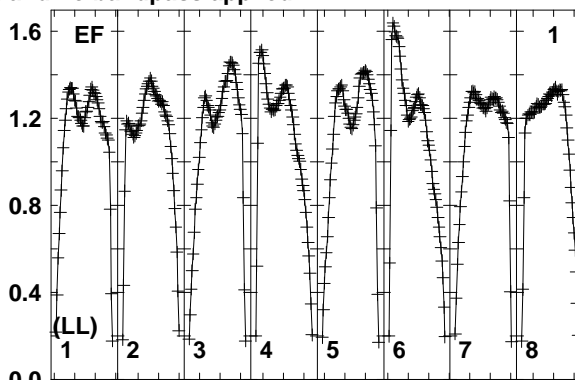
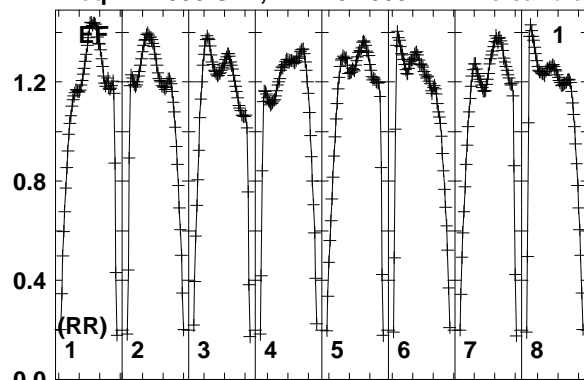

4800 4830 4860 4890 4900 4930 4960 4990 5000 5030
FREQ MHz

4800 4830 4860 4890 4900 4930 4960 4990 5000 5030
FREQ MHz

4800 4830 4860 4890 4900 4930 4960 4990 5000 5030
FREQ MHz

Lower frame: Real Jy
Total-power spectrum Antenna: EF (01)
Timerange: 00/23:13:31 to 00/23:17:00

Plot file version 26 created 23-NOV-2017 14:36:06

J0844+4628 RSM01.UVDATA.1

Freq = 4.7990 GHz, Bw = 32.000 MH No calibration applied and no bandpass applied

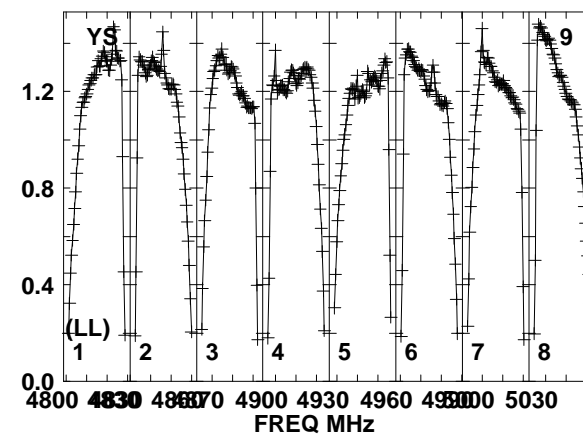
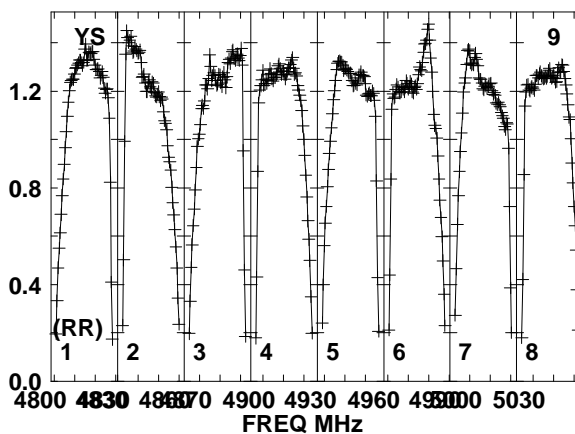
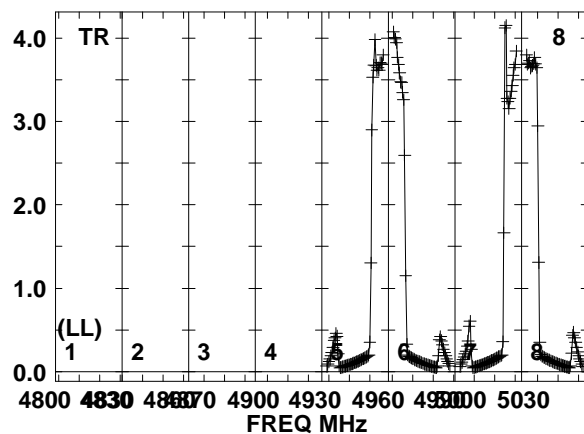
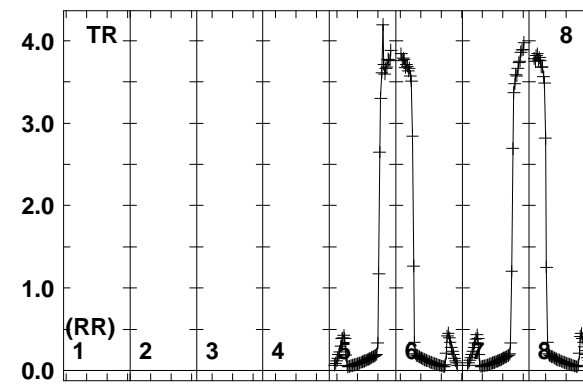
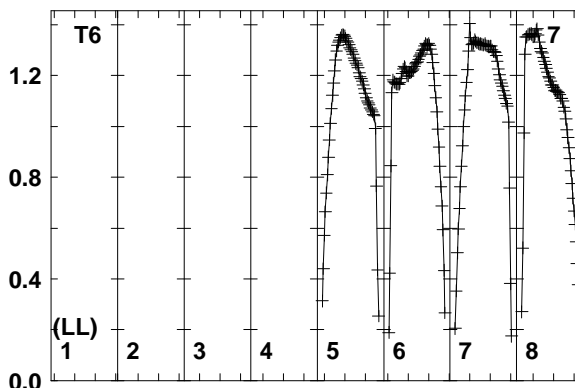
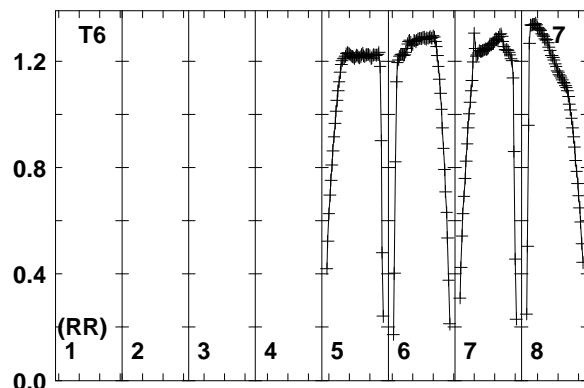
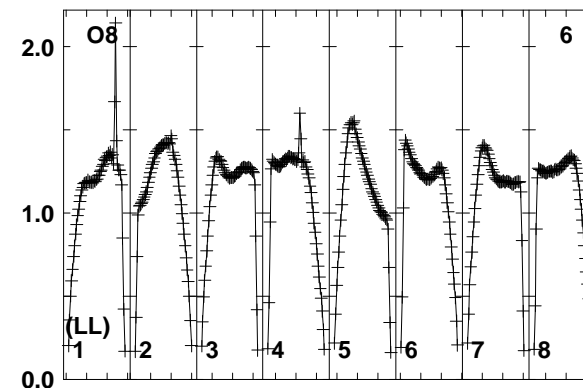
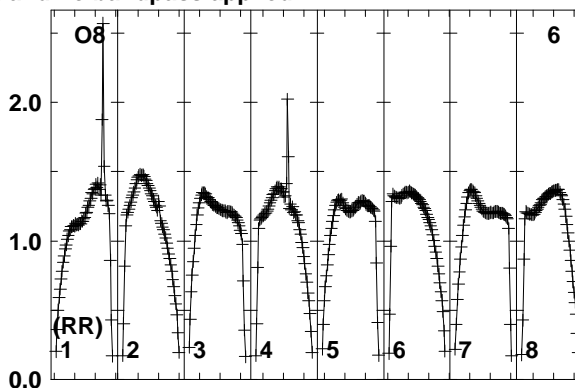
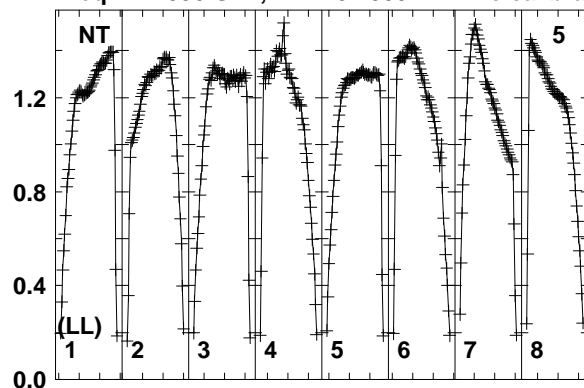

Lower frame: Real Jy
Total-power spectrum Antenna: NT (05)
Timerange: 00/23:13:31 to 00/23:17:00

Plot file version 27 created 23-NOV-2017 14:36:06
J0844+4628 RSM01.UVDATA.1
Freq = 4.7990 GHz, Bw = 32.000 MH No calibration applied and no bandpass applied

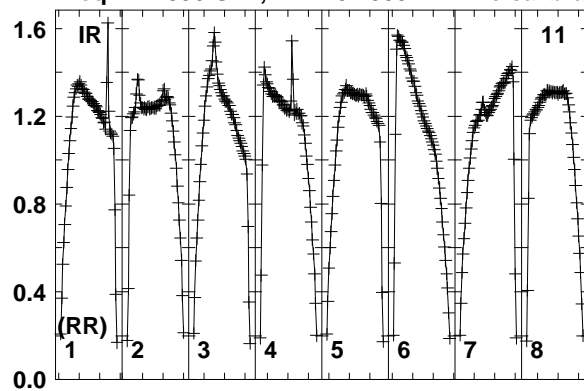

Lower frame: Real Jy
Total-power spectrum Antenna: IR (11)
Timerange: 00/23:13:31 to 00/23:17:00

Plot file version 28 created 23-NOV-2017 14:36:07

J0847+4609 RSM01.UVDATA.1

Freq = 4.7990 GHz, Bw = 32.000 MH No calibration applied and no bandpass applied

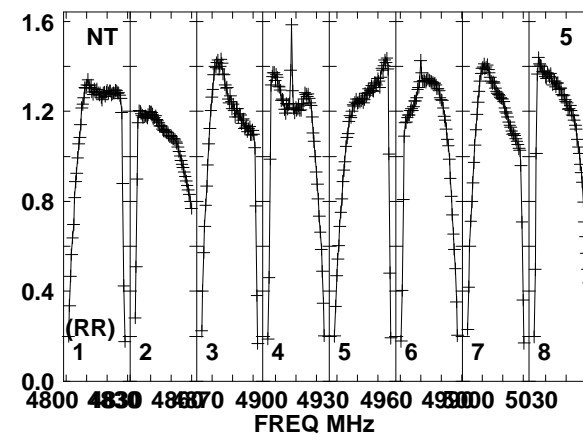
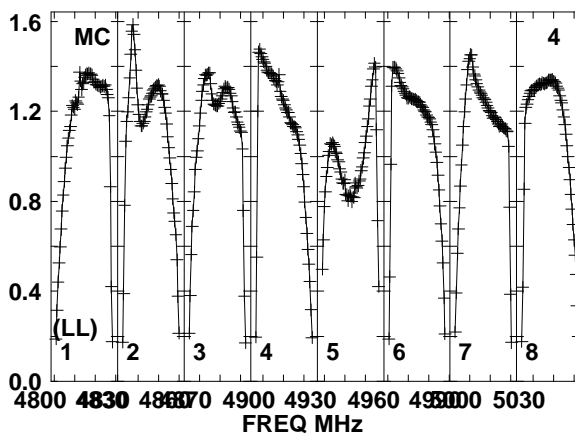
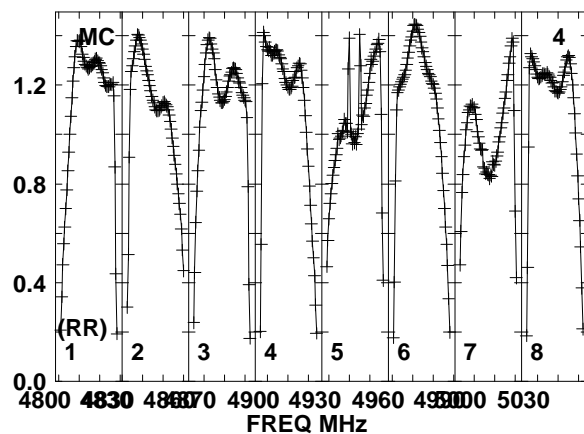
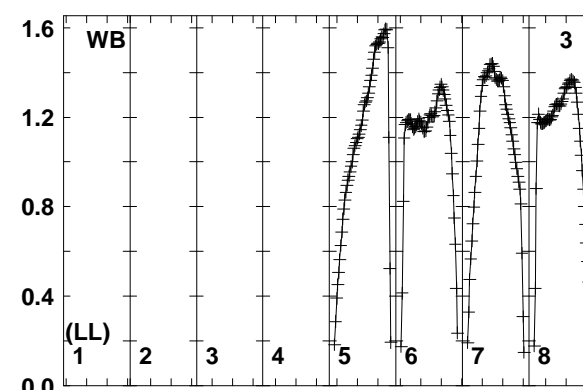
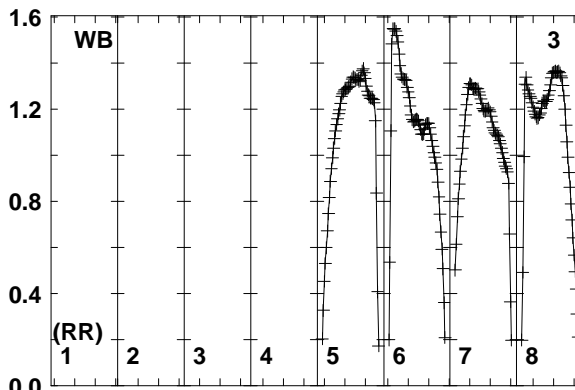
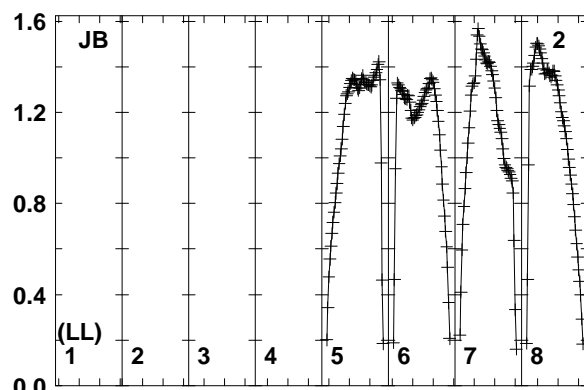
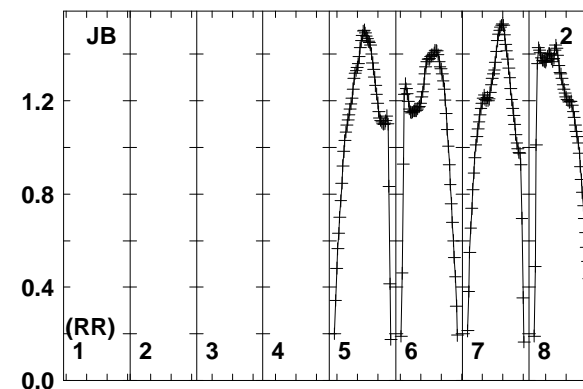
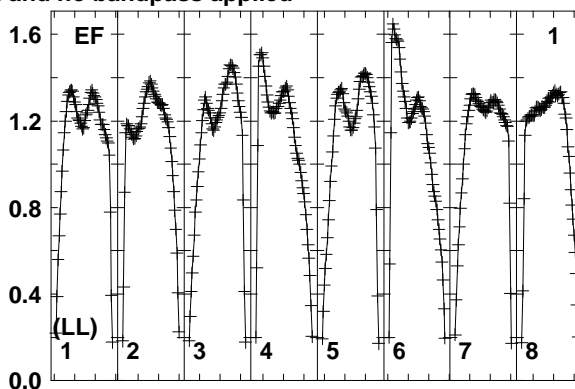
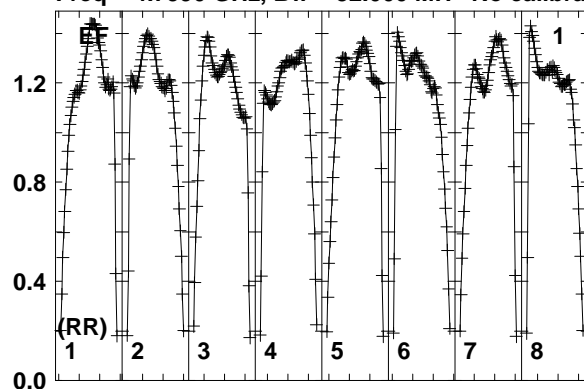

Lower frame: Real Jy
Total-power spectrum Antenna: EF (01)
Timerange: 00/23:17:40 to 00/23:18:39

Plot file version 29 created 23-NOV-2017 14:36:07

J0847+4609 RSM01.UVDATA.1

Freq = 4.7990 GHz, Bw = 32.000 MH No calibration applied and no bandpass applied

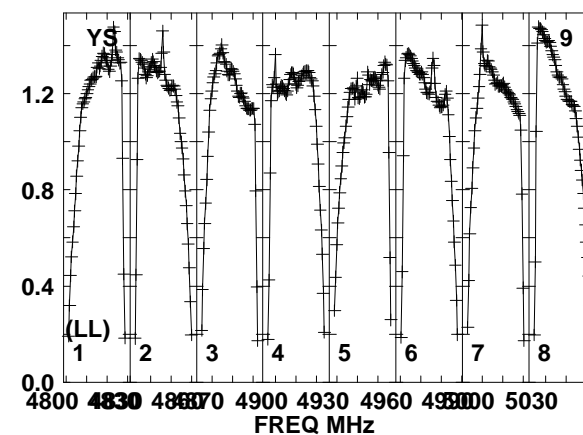
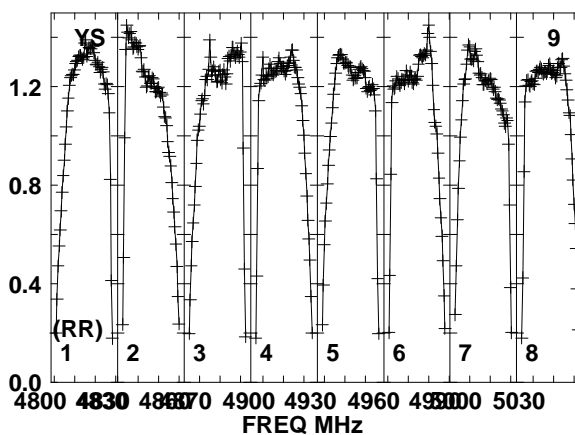
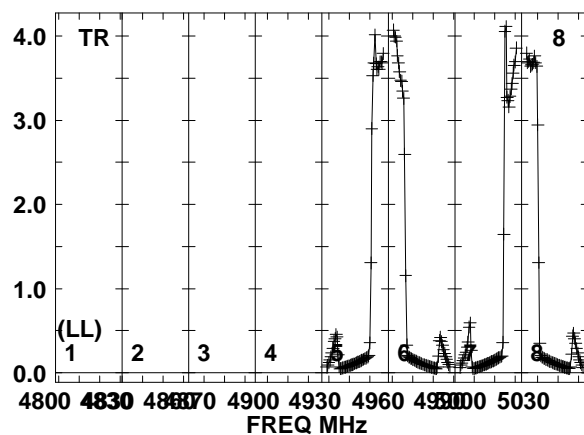
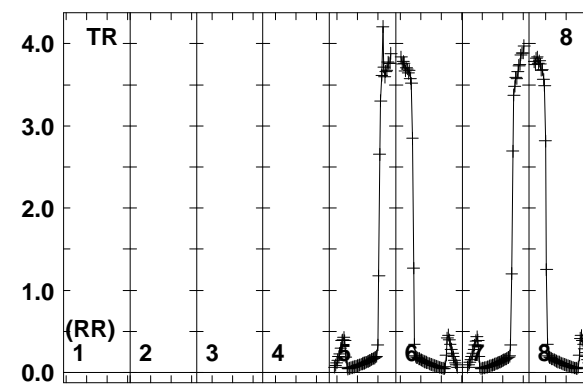
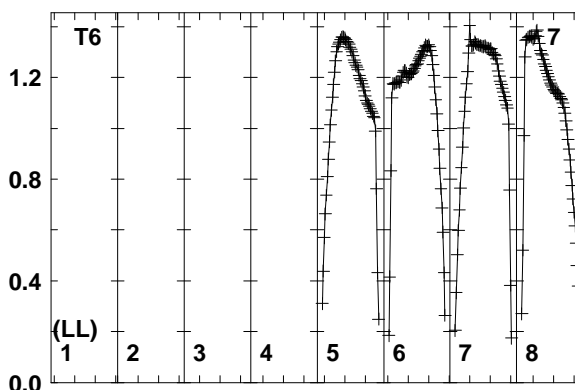
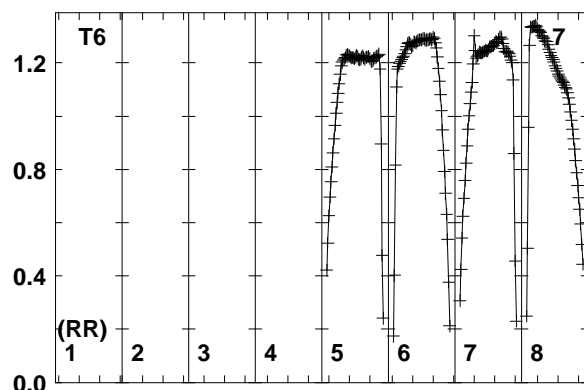
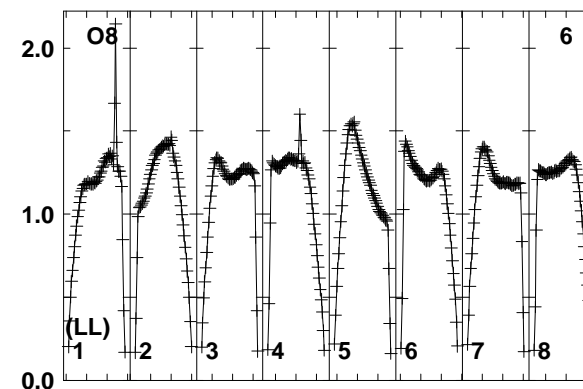
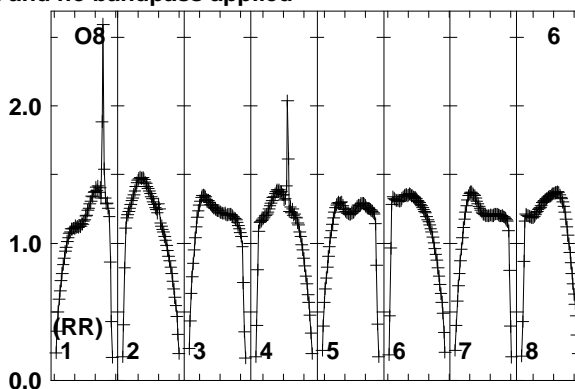
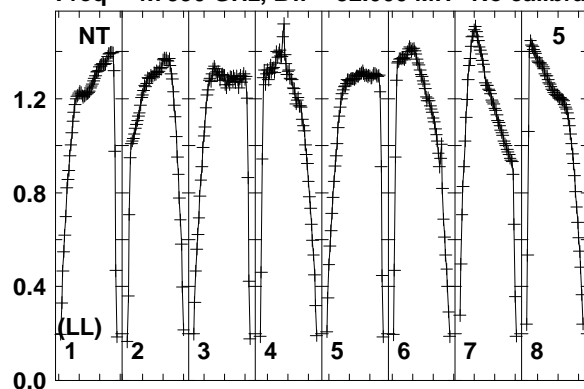

Lower frame: Real Jy
Total-power spectrum Antenna: NT (05)
Timerange: 00/23:17:40 to 00/23:18:39

Plot file version 30 created 23-NOV-2017 14:36:07
J0847+4609 RSM01.UVDATA.1
Freq = 4.7990 GHz, Bw = 32.000 MH No calibration applied and no bandpass applied

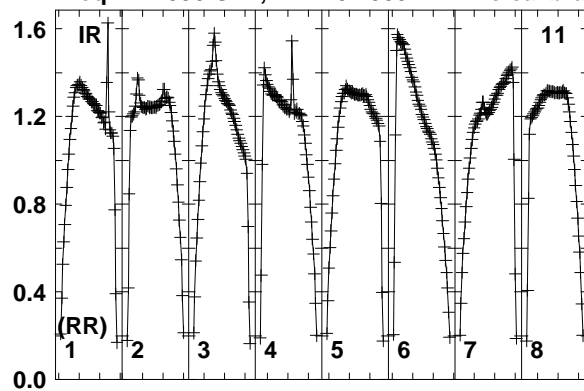

Lower frame: Real Jy
Total-power spectrum Antenna: IR (11)
Timerange: 00/23:17:40 to 00/23:18:39

Plot file version 31 created 23-NOV-2017 14:36:07

J0844+4628 RSM01.UVDATA.1

Freq = 4.7990 GHz, Bw = 32.000 MH No calibration applied and no bandpass applied

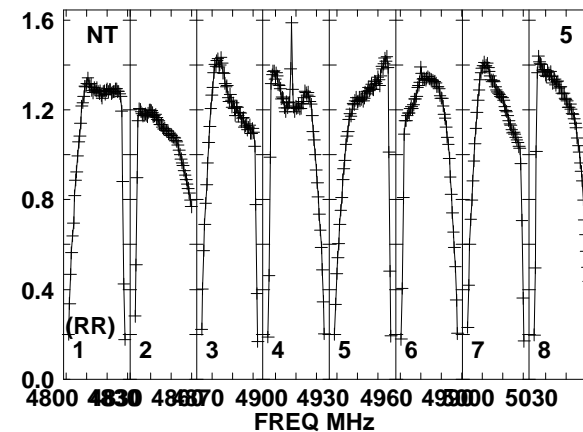
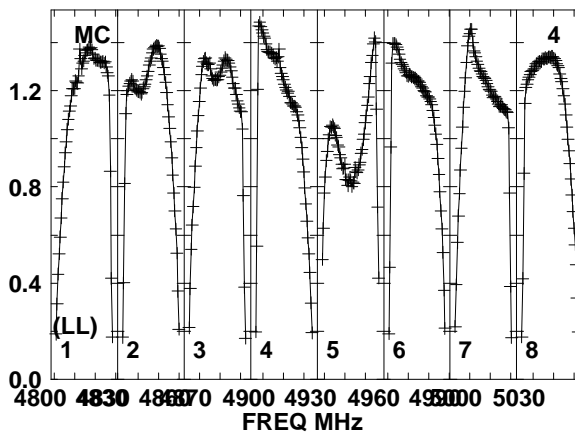
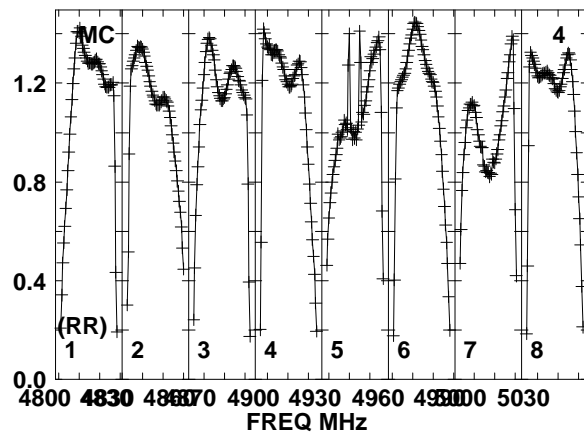
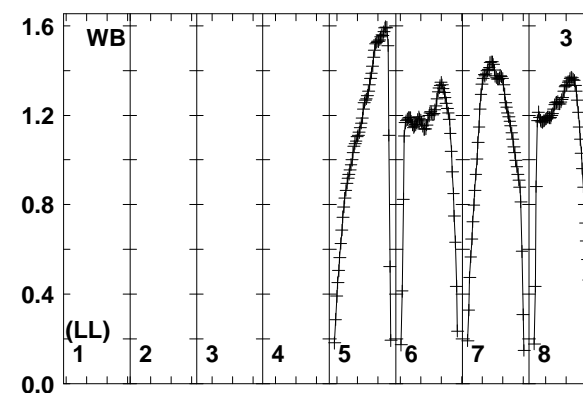
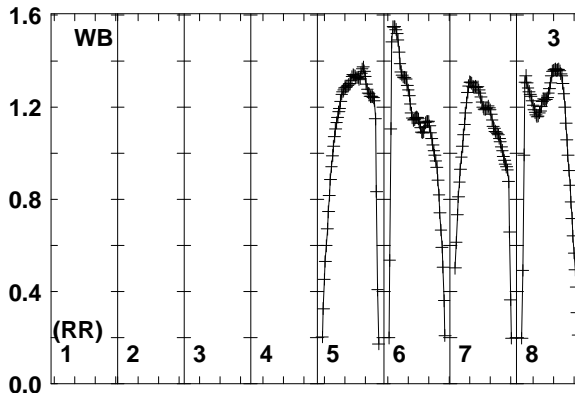
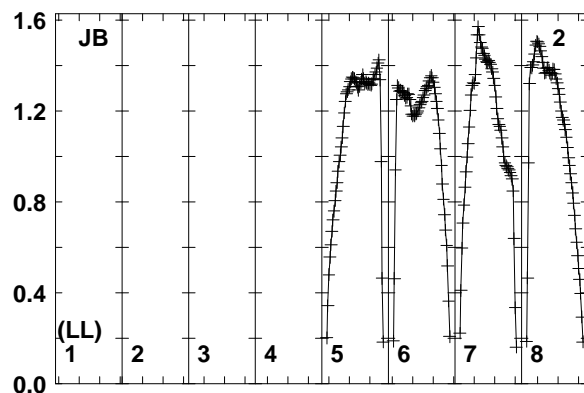
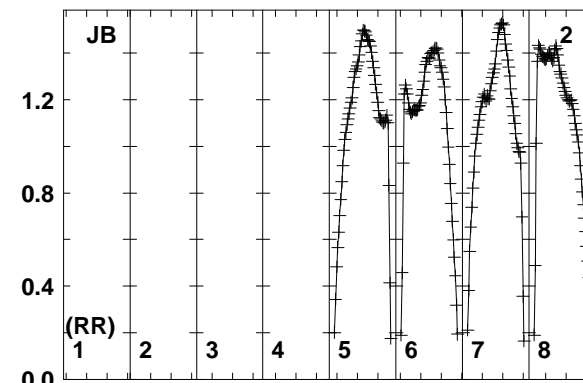
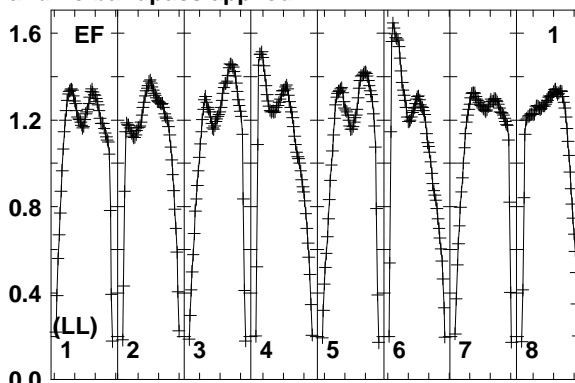
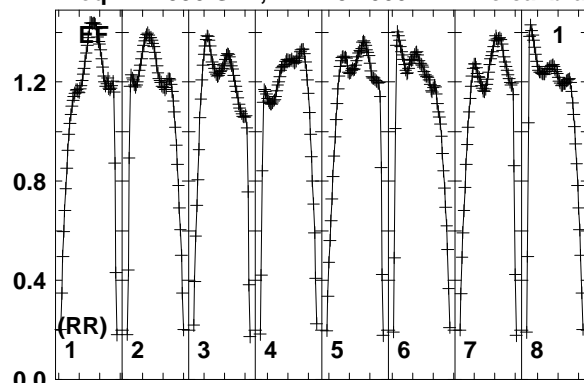

Lower frame: Real Jy
Total-power spectrum Antenna: EF (01)
Timerange: 00/23:18:41 to 00/23:22:10

Plot file version 32 created 23-NOV-2017 14:36:07

J0844+4628 RSM01.UVDATA.1

Freq = 4.7990 GHz, Bw = 32.000 MH No calibration applied and no bandpass applied

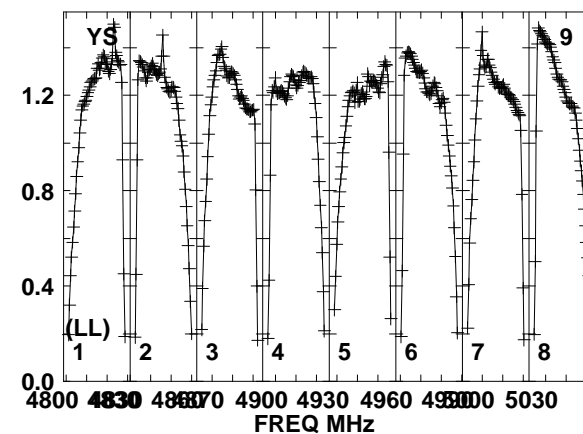
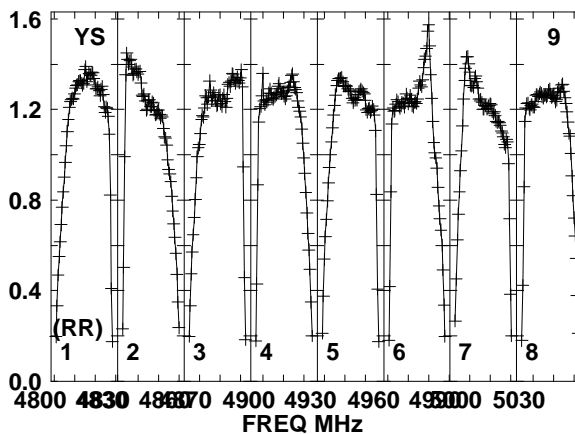
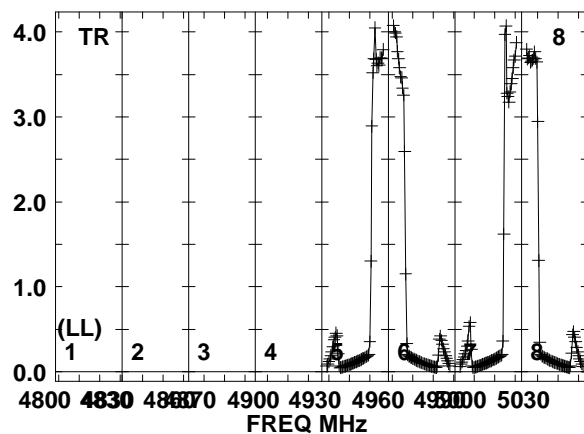
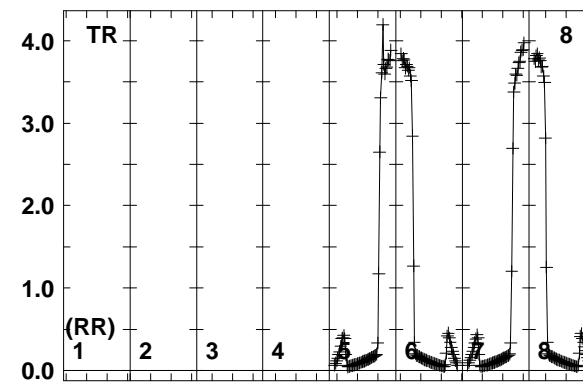
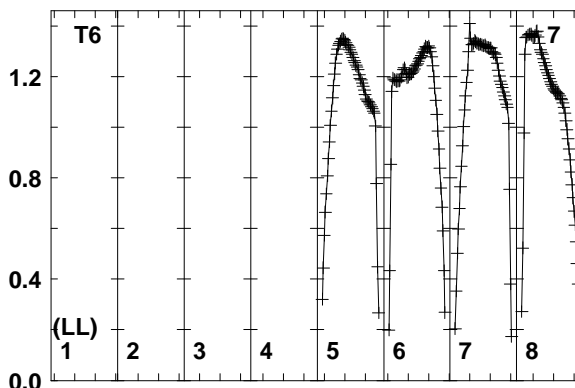
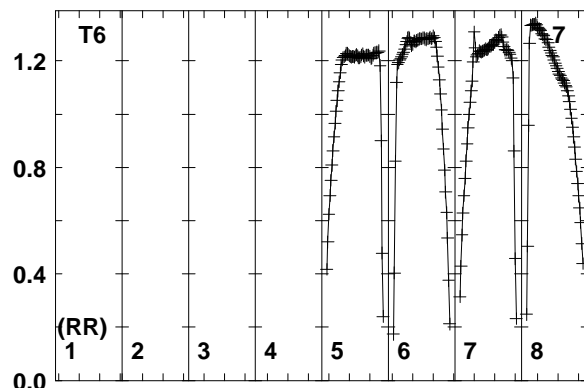
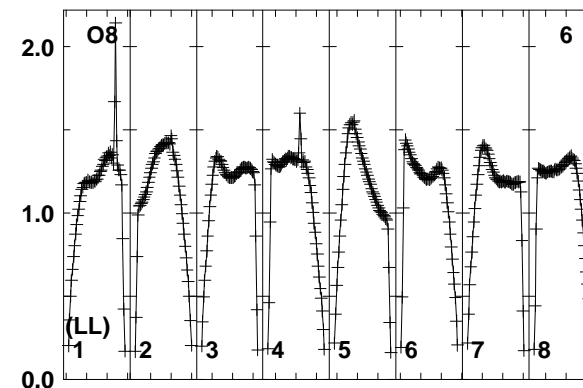
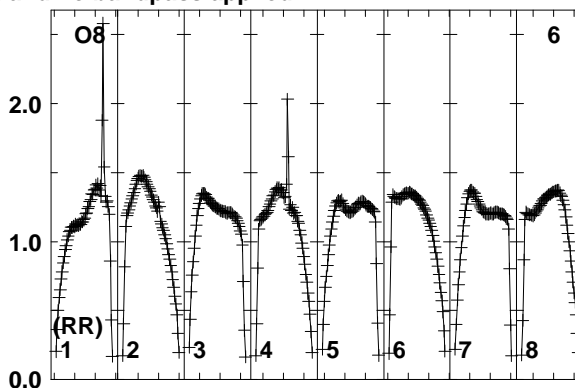
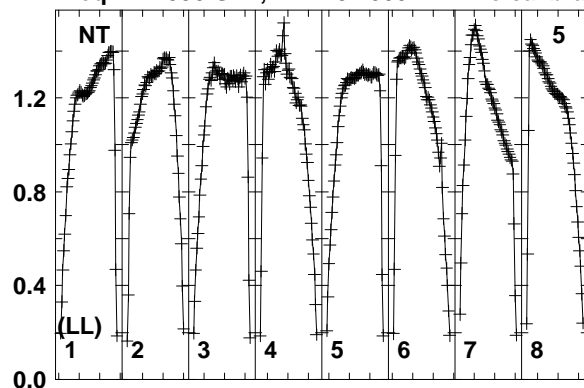

Lower frame: Real Jy
Total-power spectrum Antenna: NT (05)
Timerange: 00/23:18:41 to 00/23:22:10

Plot file version 33 created 23-NOV-2017 14:36:08
J0844+4628 RSM01.UVDATA.1
Freq = 4.7990 GHz, Bw = 32.000 MH No calibration applied and no bandpass applied

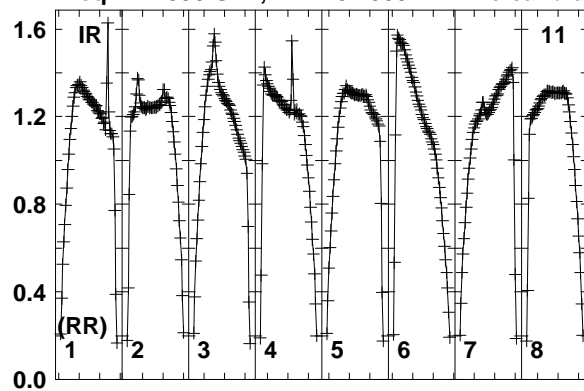

Lower frame: Real Jy
Total-power spectrum Antenna: IR (11)
Timerange: 00/23:18:41 to 00/23:22:10

Plot file version 34 created 23-NOV-2017 14:36:08

J0847+4609 RSM01.UVDATA.1

Freq = 4.7990 GHz, Bw = 32.000 MH No calibration applied and no bandpass applied

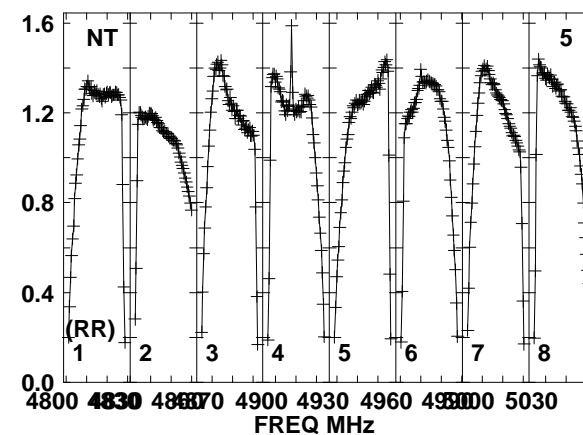
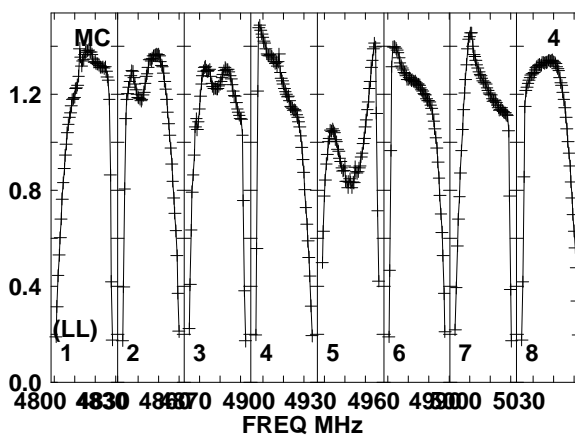
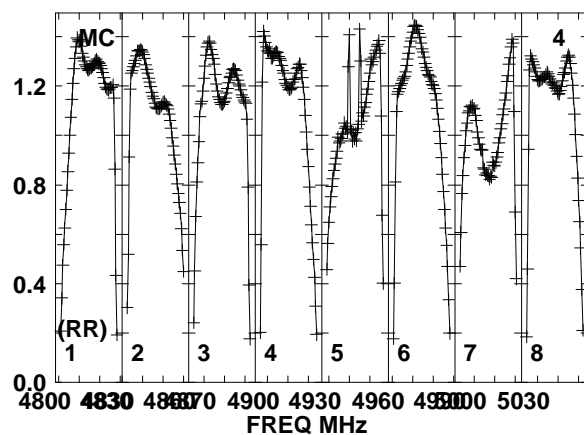
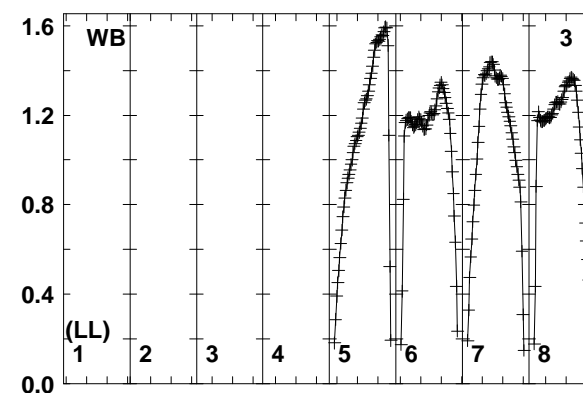
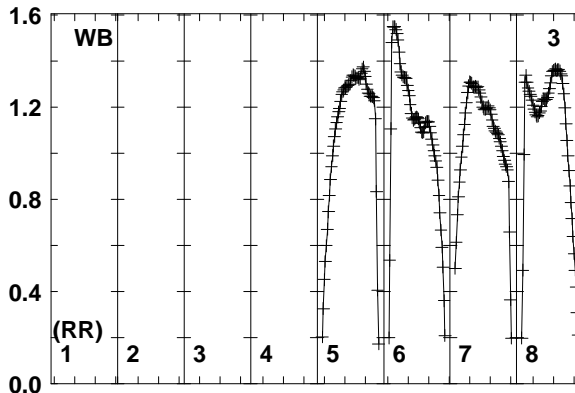
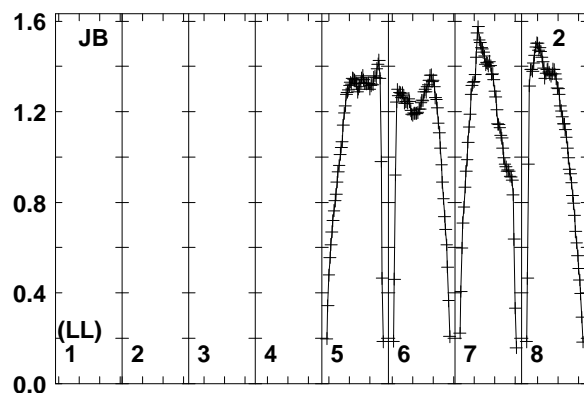
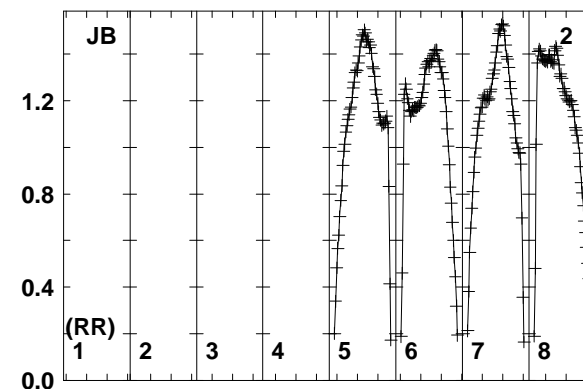
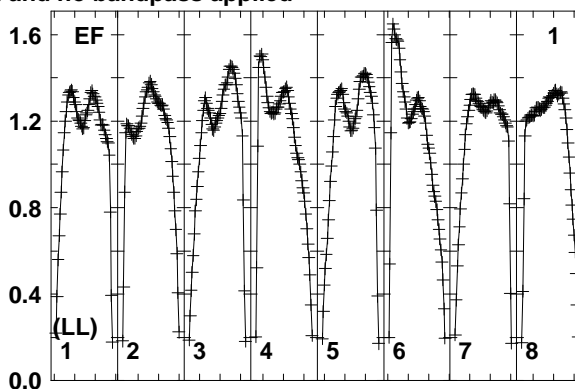
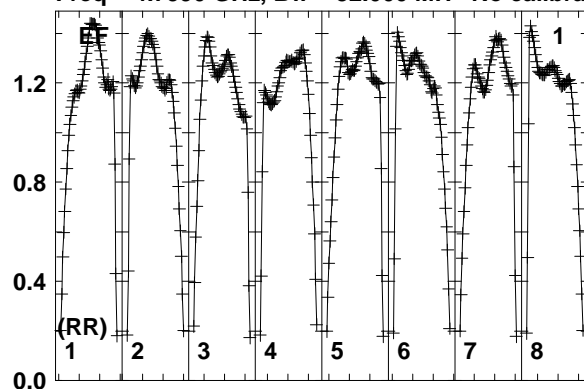

Lower frame: Real Jy
Total-power spectrum Antenna: EF (01)
Timerange: 00/23:22:10 to 00/23:23:40

Plot file version 35 created 23-NOV-2017 14:36:08

J0847+4609 RSM01.UVDATA.1

Freq = 4.7990 GHz, Bw = 32.000 MH No calibration applied and no bandpass applied

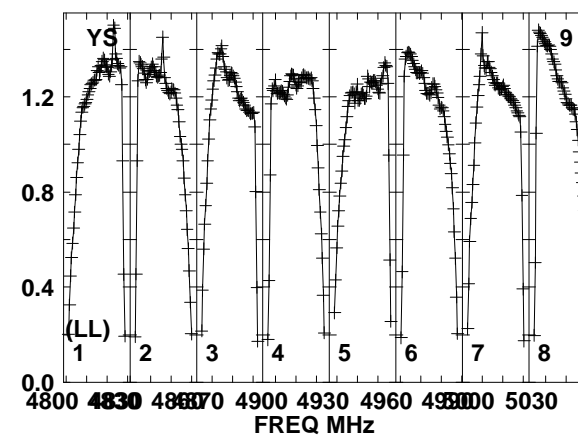
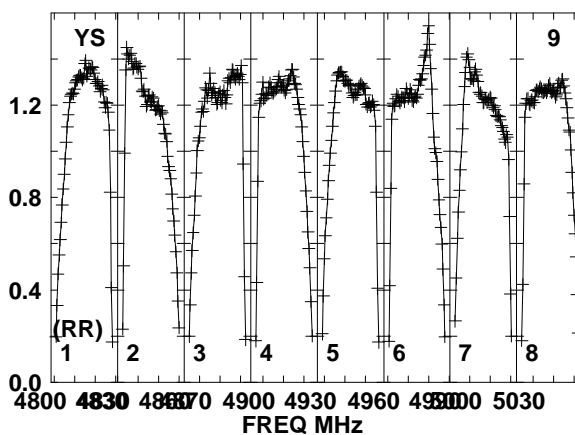
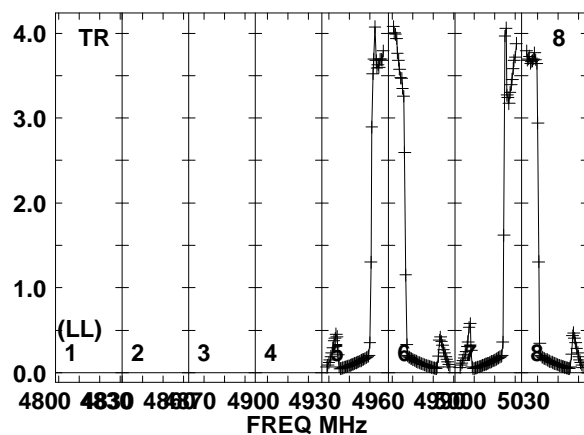
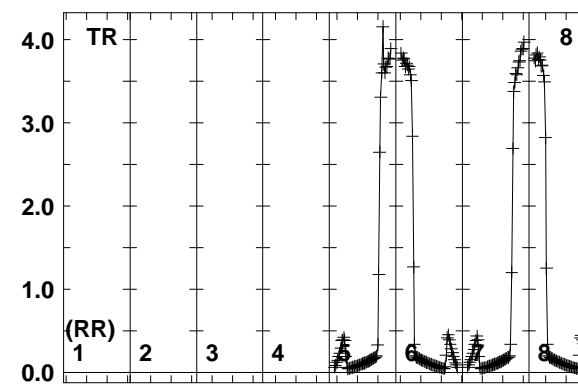
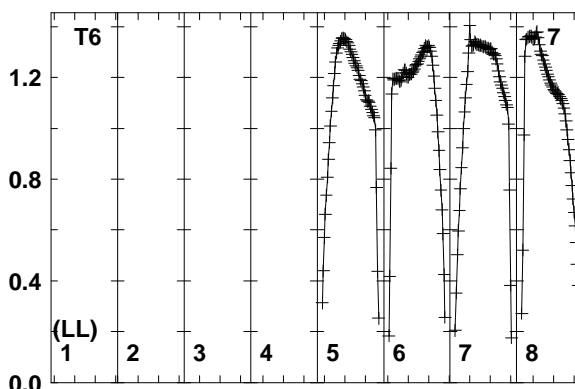
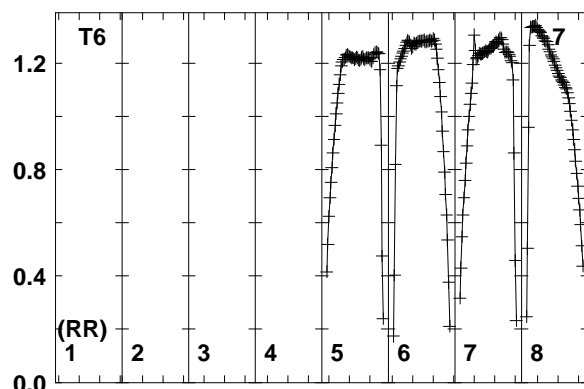
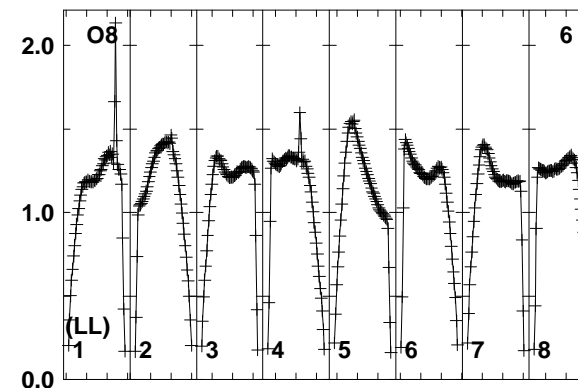
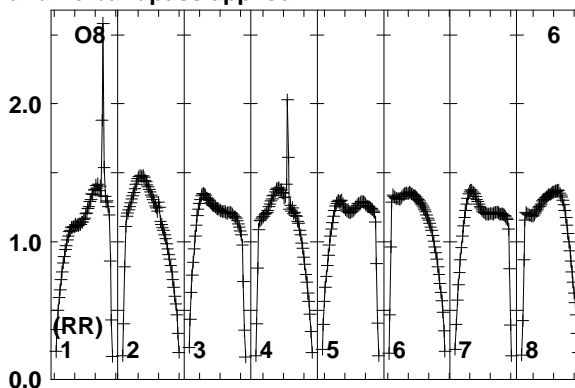
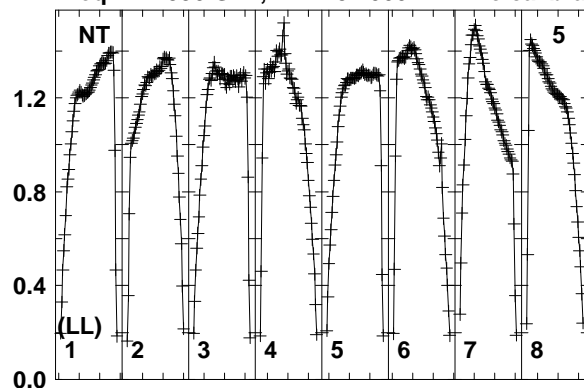

Lower frame: Real Jy
Total-power spectrum Antenna: NT (05)
Timerange: 00/23:22:10 to 00/23:23:40

Plot file version 36 created 23-NOV-2017 14:36:08
J0847+4609 RSM01.UVDATA.1
Freq = 4.7990 GHz, Bw = 32.000 MH No calibration applied and no bandpass applied

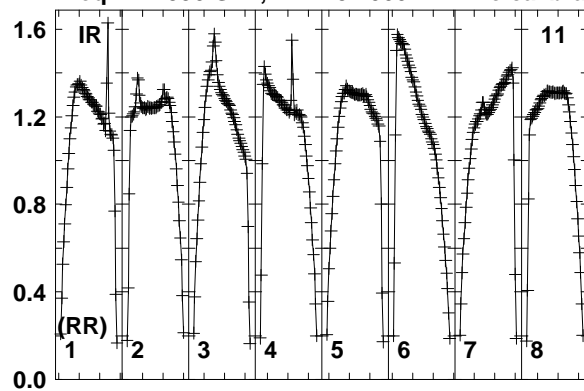

Lower frame: Real Jy
Total-power spectrum Antenna: IR (11)
Timerange: 00/23:22:10 to 00/23:23:40

Plot file version 37 created 23-NOV-2017 14:36:08

J0844+4628 RSM01.UVDATA.1

Freq = 4.7990 GHz, Bw = 32.000 MH No calibration applied and no bandpass applied

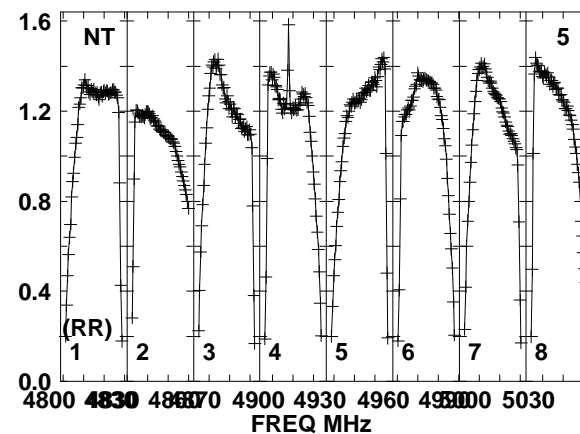
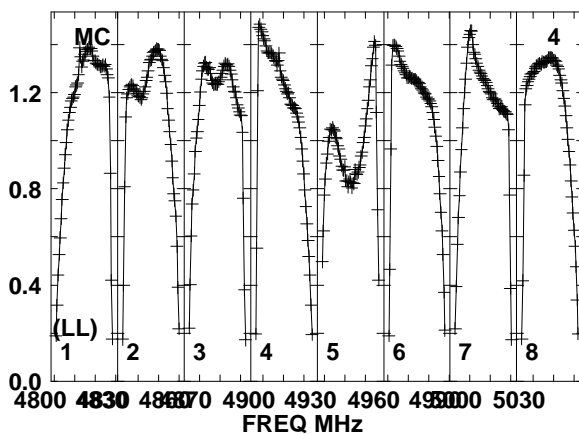
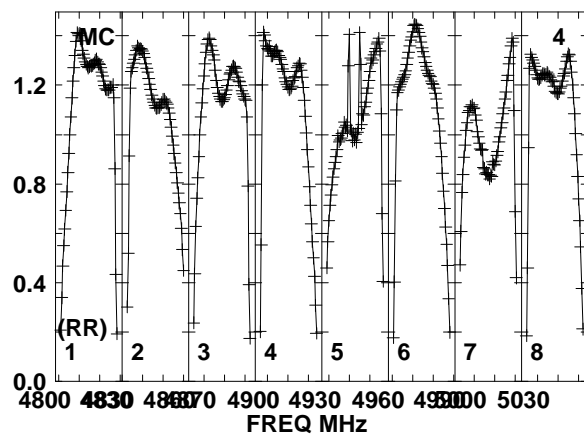
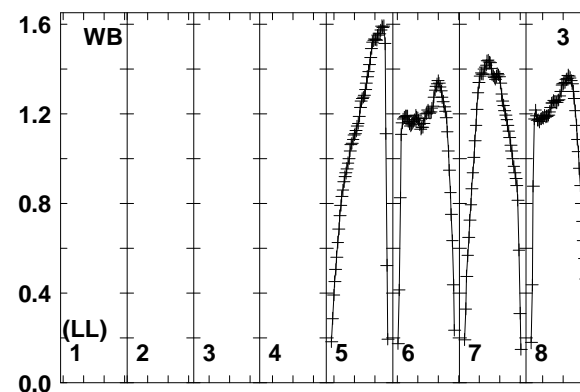
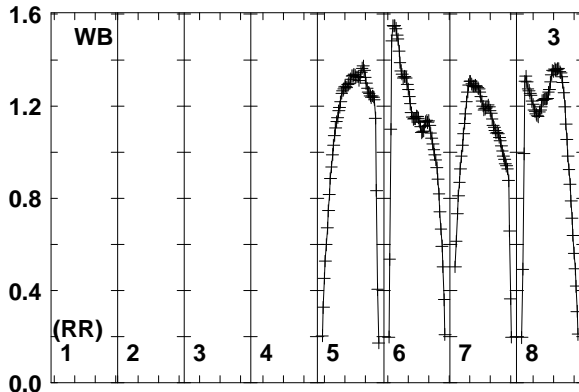
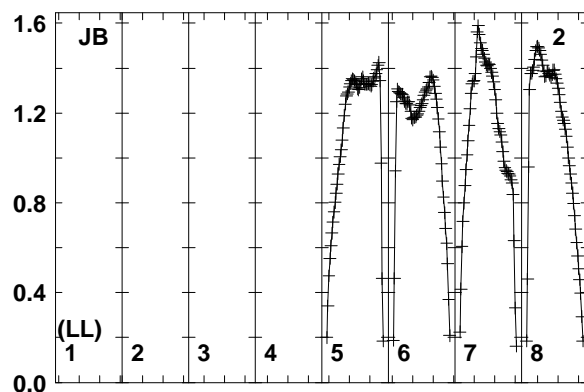
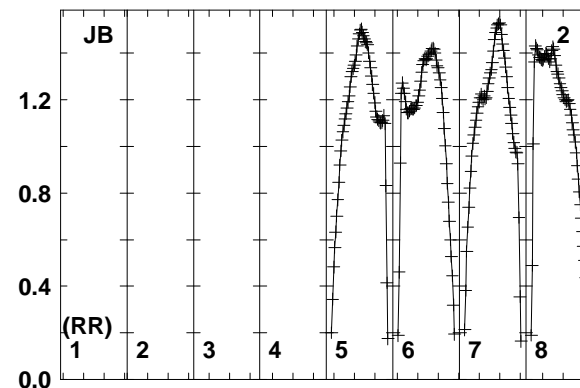
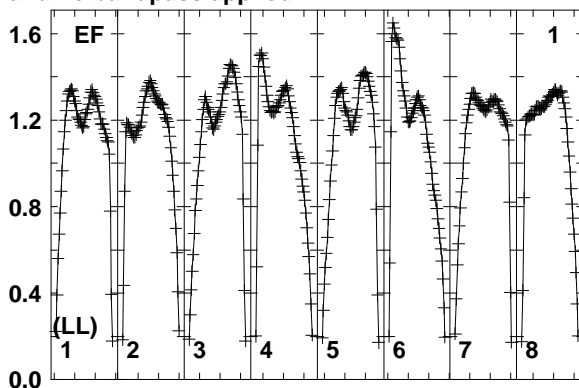
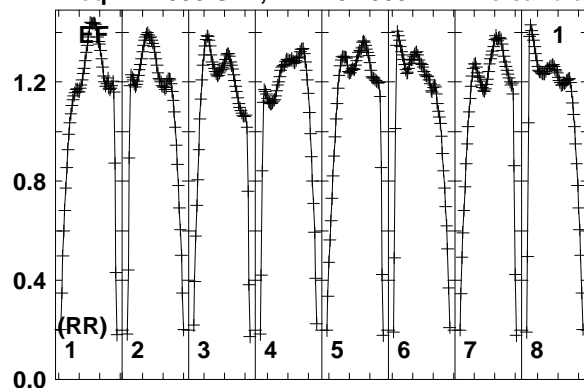

Lower frame: Real Jy
Total-power spectrum Antenna: EF (01)
Timerange: 00/23:23:40 to 00/23:27:09

Plot file version 38 created 23-NOV-2017 14:36:09

J0844+4628 RSM01.UVDATA.1

Freq = 4.7990 GHz, Bw = 32.000 MH No calibration applied and no bandpass applied

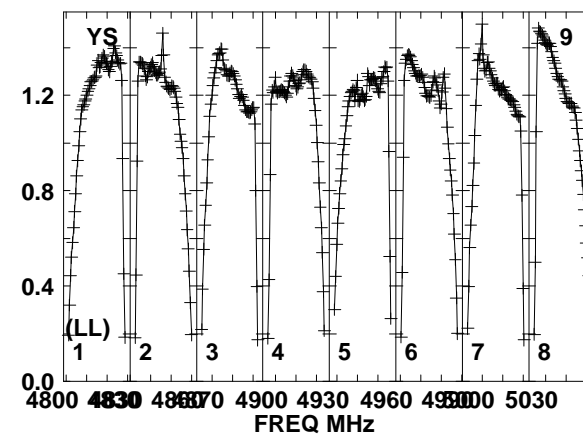
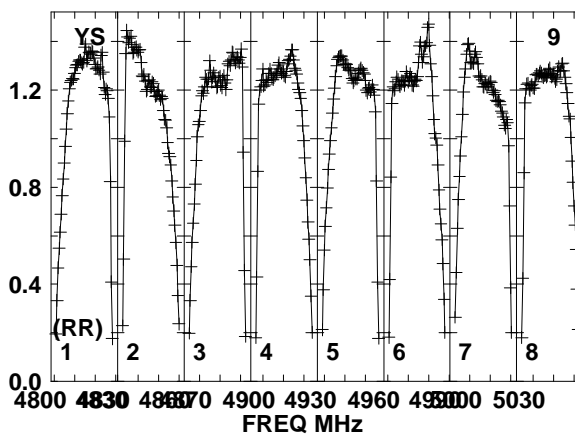
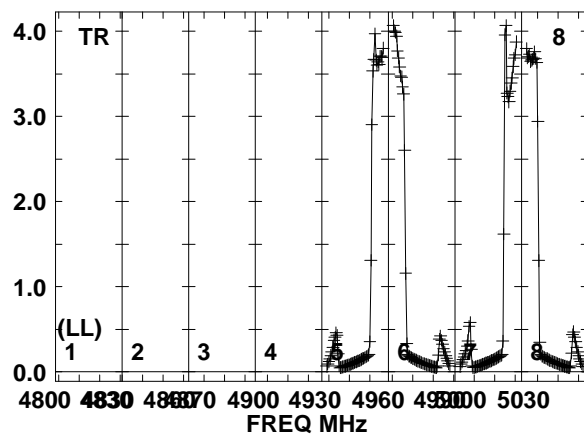
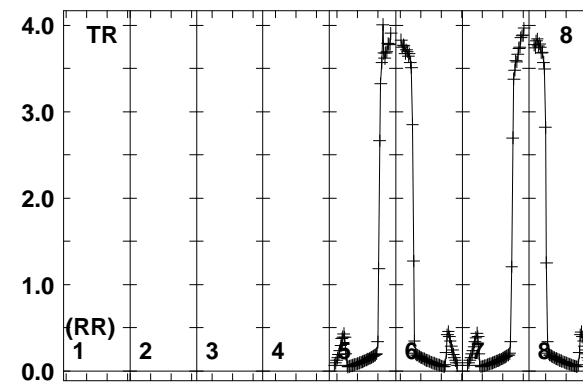
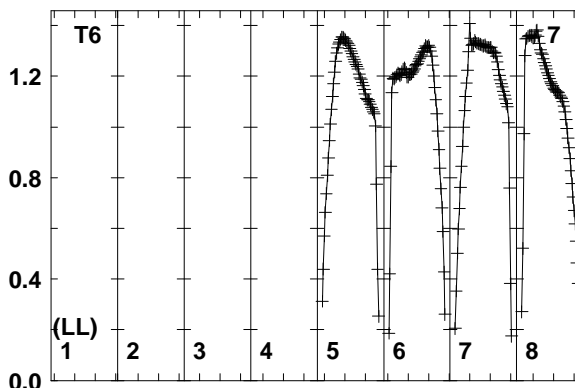
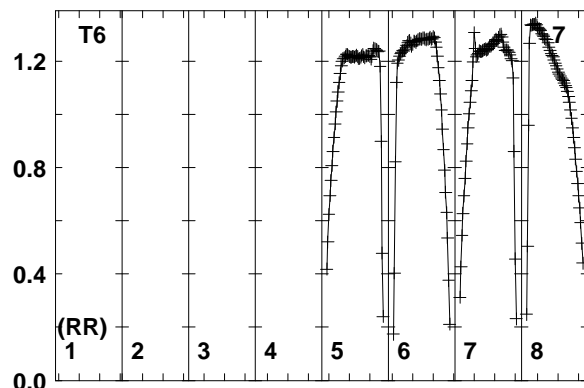
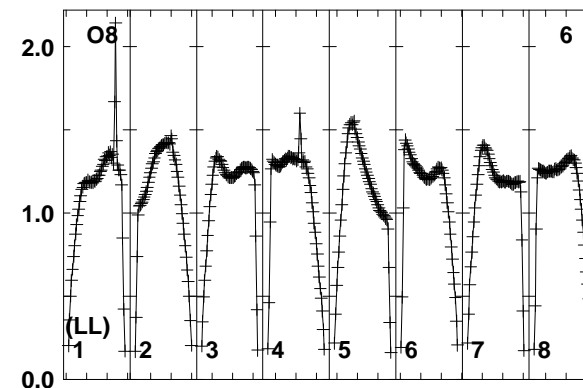
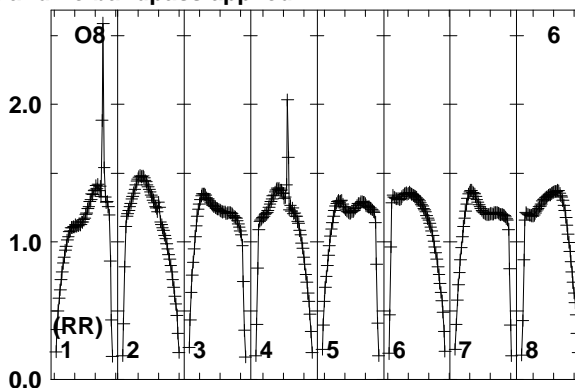
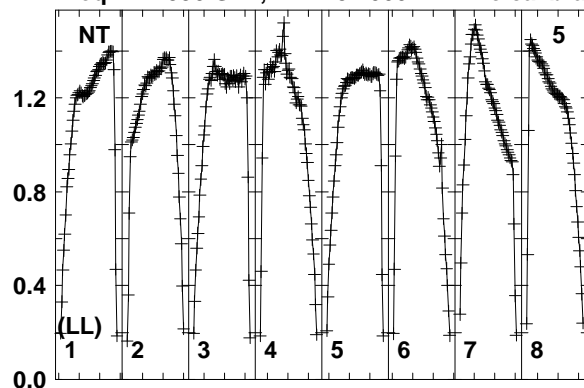

Lower frame: Real Jy
Total-power spectrum Antenna: NT (05)
Timerange: 00/23:23:40 to 00/23:27:09

Plot file version 39 created 23-NOV-2017 14:36:09
J0844+4628 RSM01.UVDATA.1
Freq = 4.7990 GHz, Bw = 32.000 MH No calibration applied and no bandpass applied

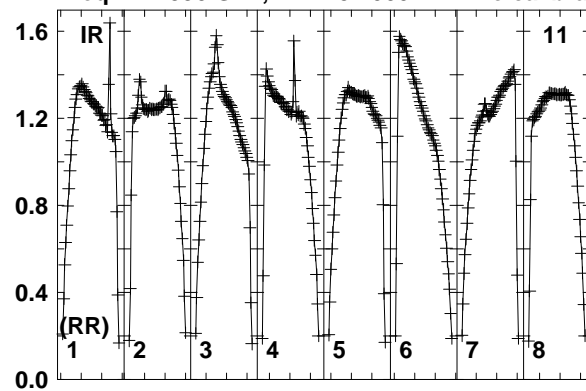

Lower frame: Real Jy
Total-power spectrum Antenna: IR (11)
Timerange: 00/23:23:40 to 00/23:27:09

Plot file version 40 created 23-NOV-2017 14:36:09

J0847+4609 RSM01.UVDATA.1

Freq = 4.7990 GHz, Bw = 32.000 MH No calibration applied and no bandpass applied

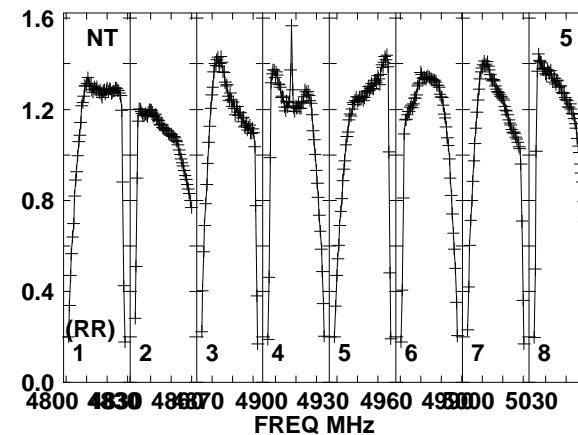
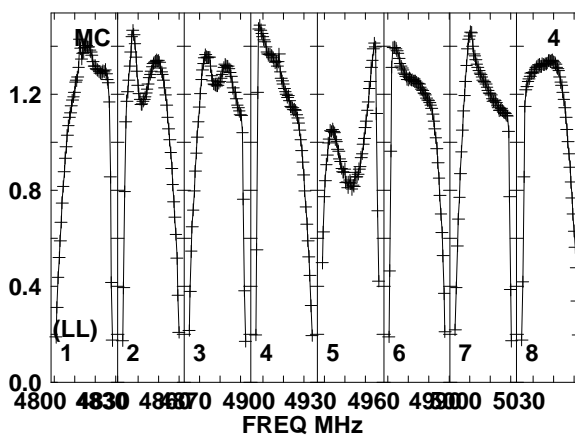
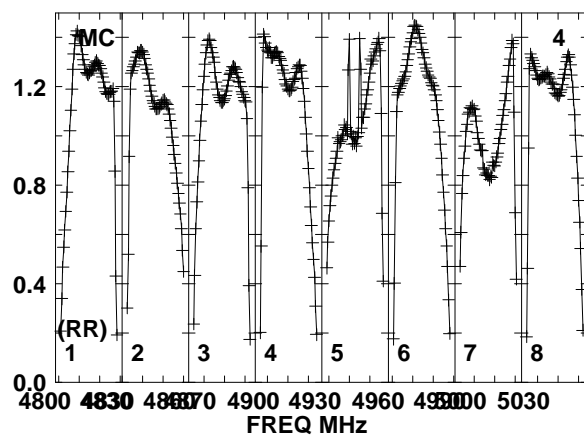
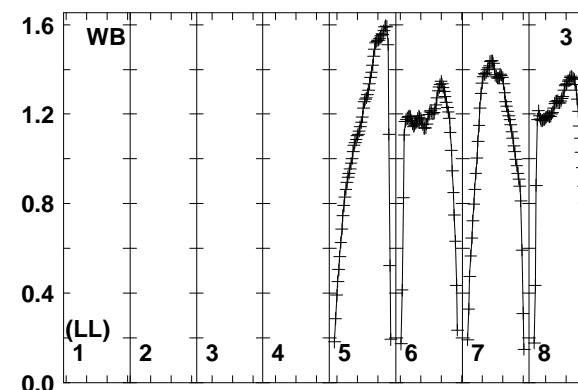
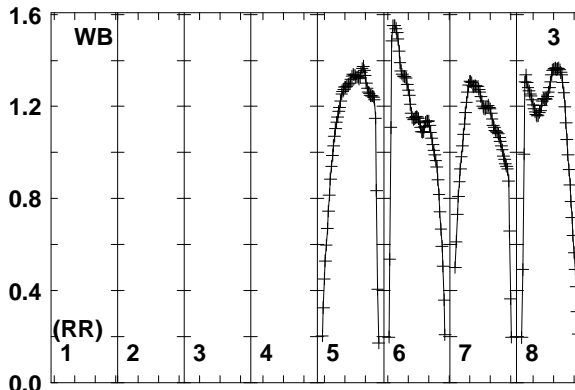
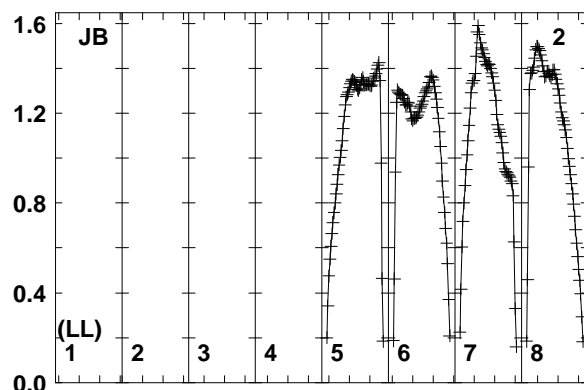
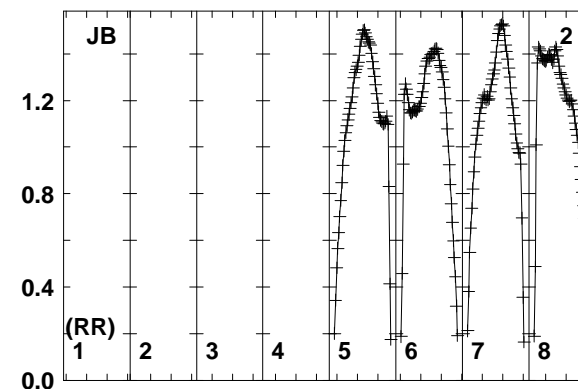
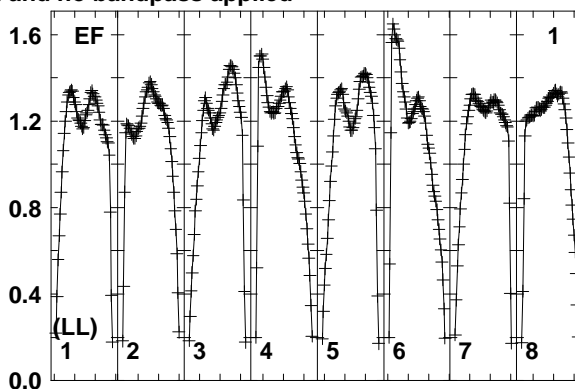
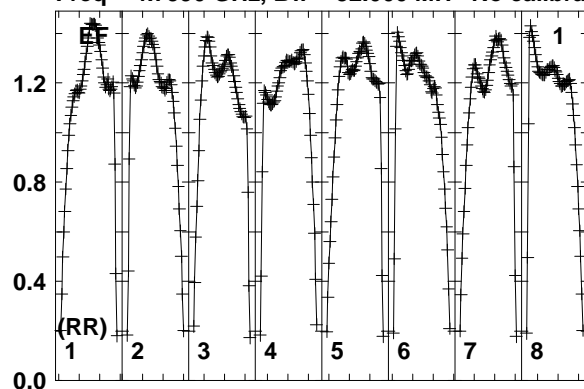

Lower frame: Real Jy
Total-power spectrum Antenna: EF (01)
Timerange: 00/23:27:50 to 00/23:28:49

Plot file version 41 created 23-NOV-2017 14:36:09

J0847+4609 RSM01.UVDATA.1

Freq = 4.7990 GHz, Bw = 32.000 MH No calibration applied and no bandpass applied

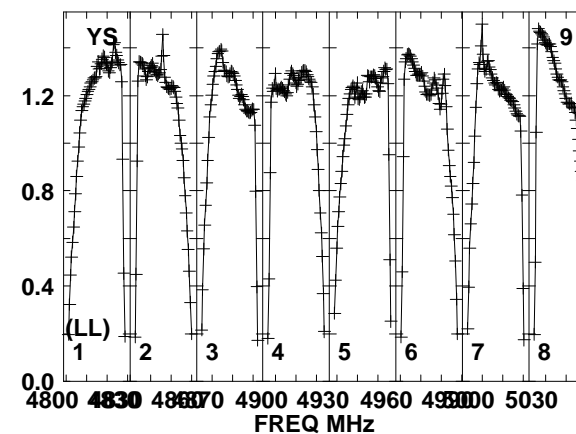
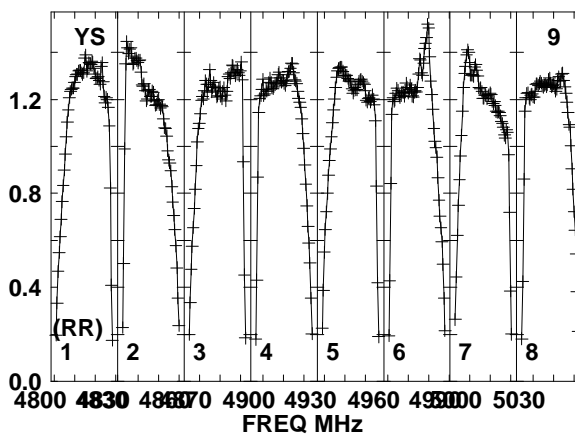
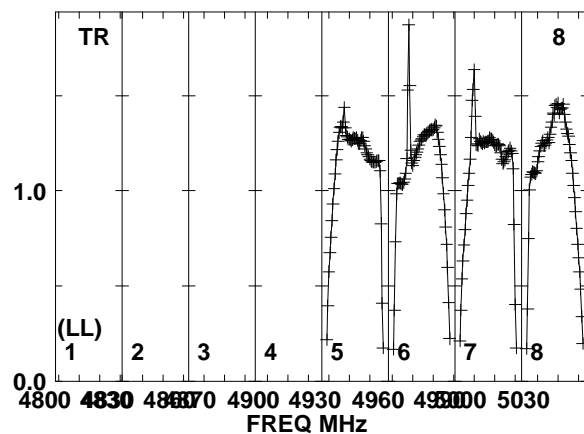
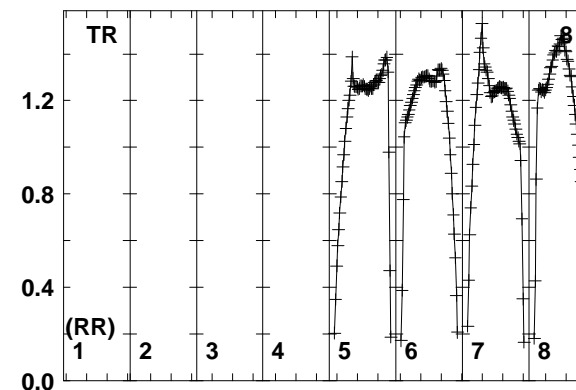
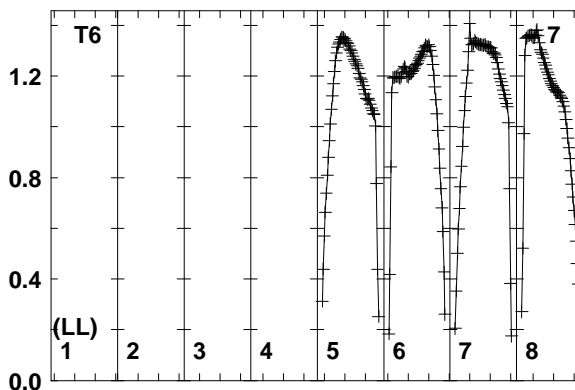
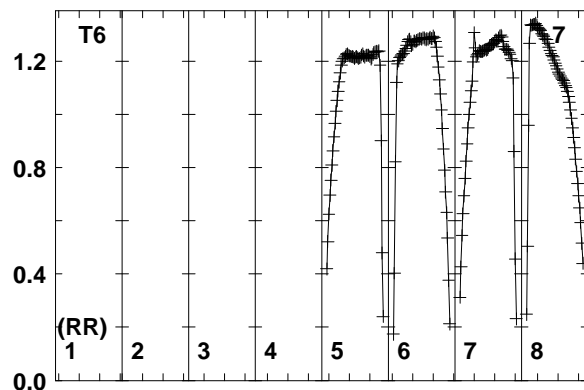
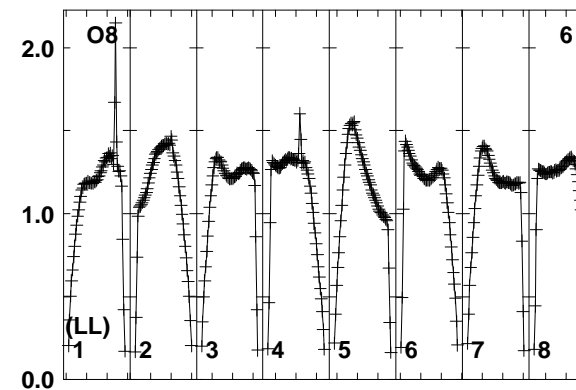
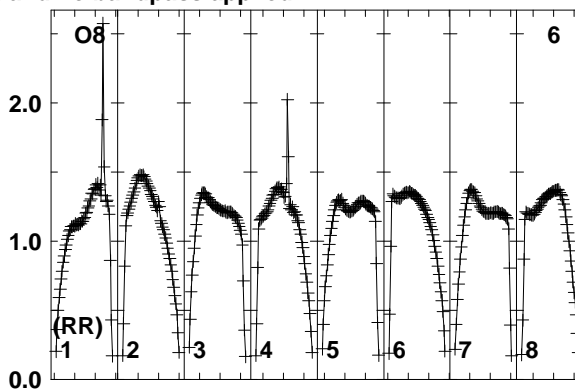
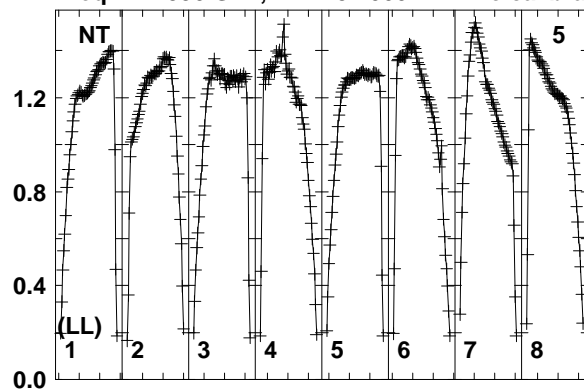

Lower frame: Real Jy
Total-power spectrum Antenna: NT (05)
Timerange: 00/23:27:50 to 00/23:28:49

Plot file version 42 created 23-NOV-2017 14:36:10
J0847+4609 RSM01.UVDATA.1
Freq = 4.7990 GHz, Bw = 32.000 MH No calibration applied and no bandpass applied

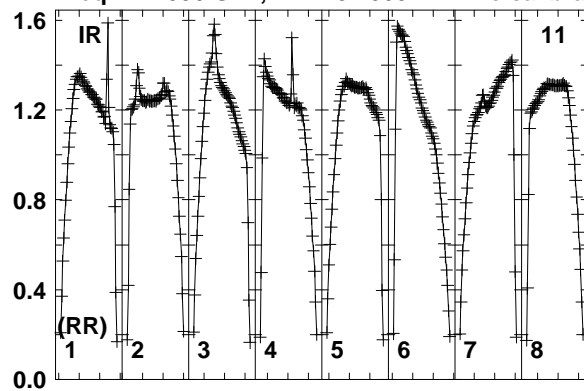

Lower frame: Real Jy
Total-power spectrum Antenna: IR (11)
Timerange: 00/23:27:50 to 00/23:28:49

Plot file version 43 created 23-NOV-2017 14:36:10

J0844+4628 RSM01.UVDATA.1

Freq = 4.7990 GHz, Bw = 32.000 MH No calibration applied and no bandpass applied

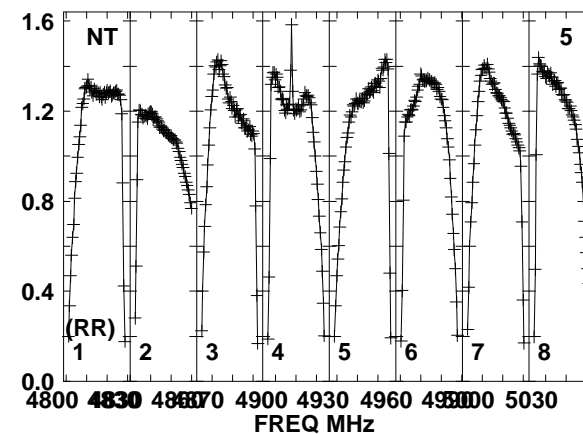
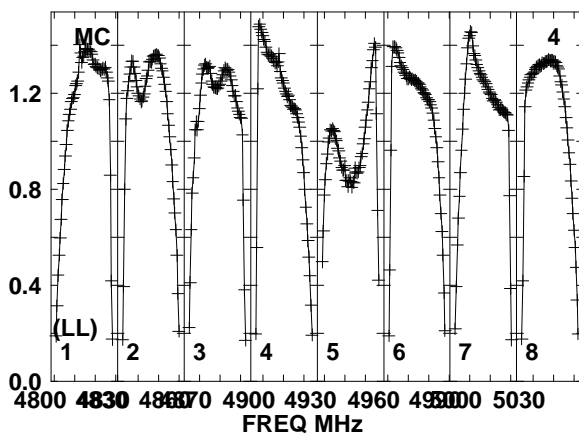
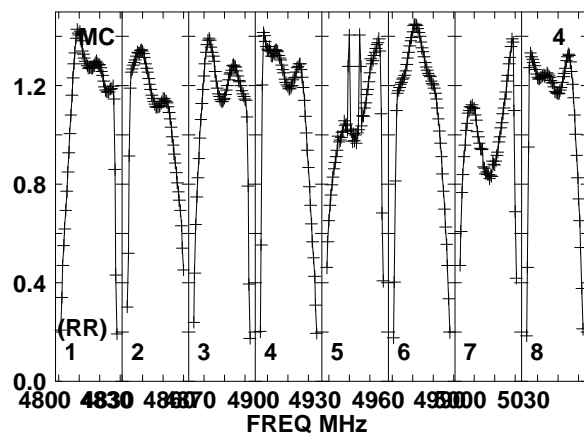
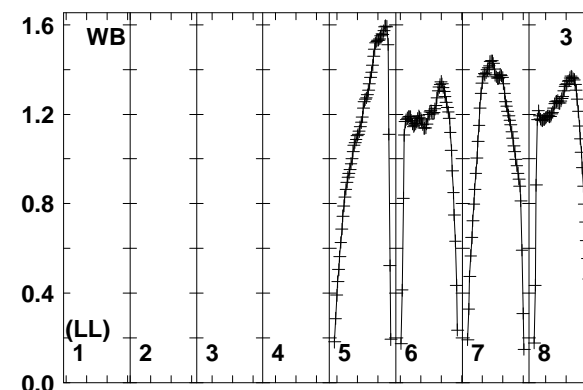
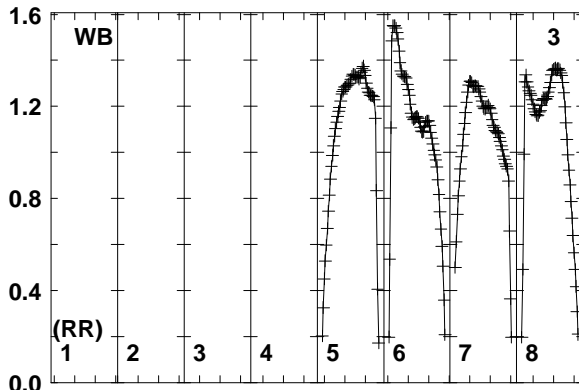
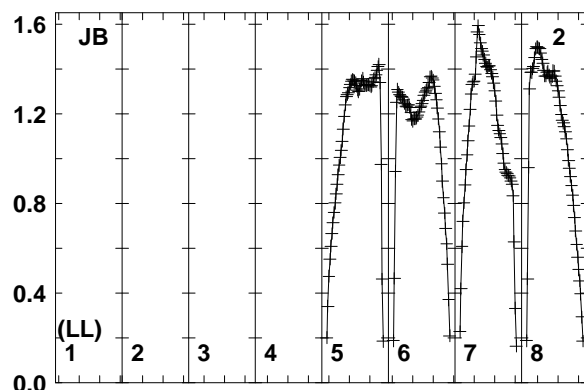
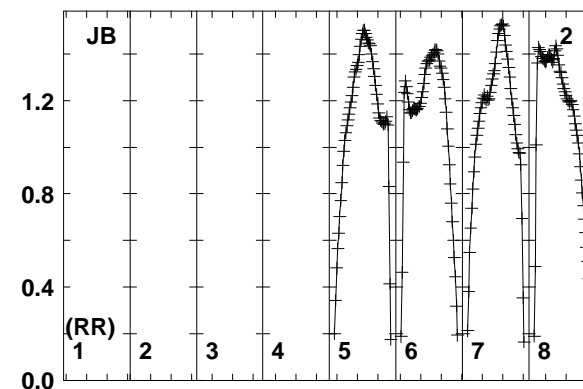
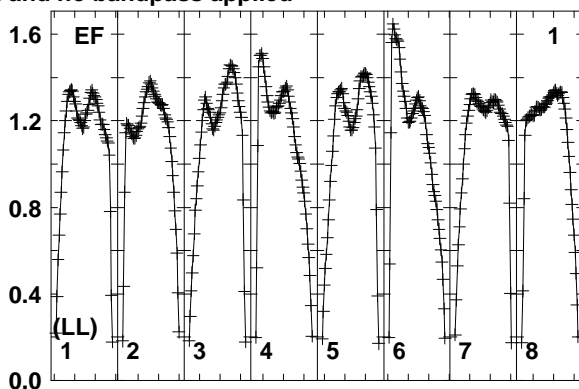
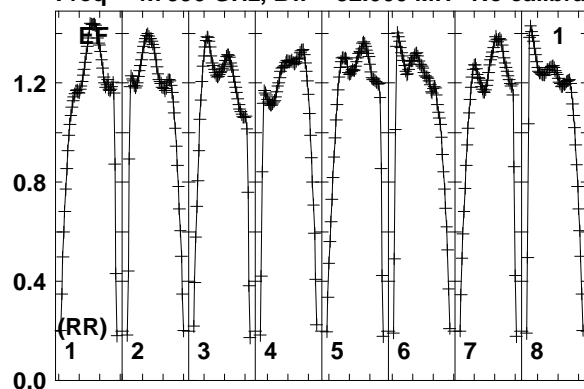

Lower frame: Real Jy
Total-power spectrum Antenna: EF (01)
Timerange: 00/23:28:50 to 00/23:32:19

Plot file version 44 created 23-NOV-2017 14:36:10

J0844+4628 RSM01.UVDATA.1

Freq = 4.7990 GHz, Bw = 32.000 MH No calibration applied and no bandpass applied

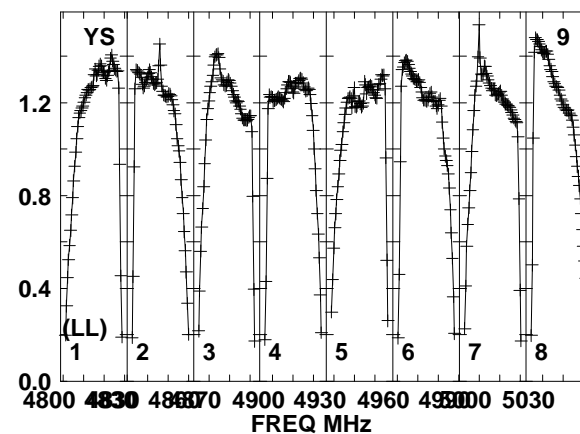
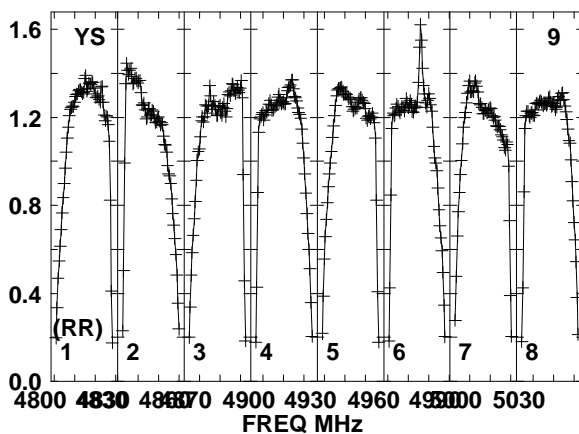
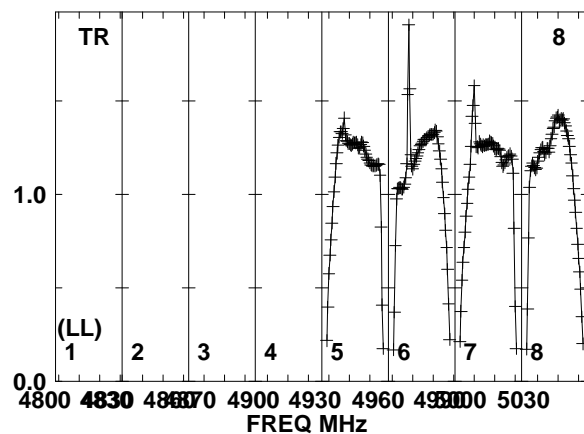
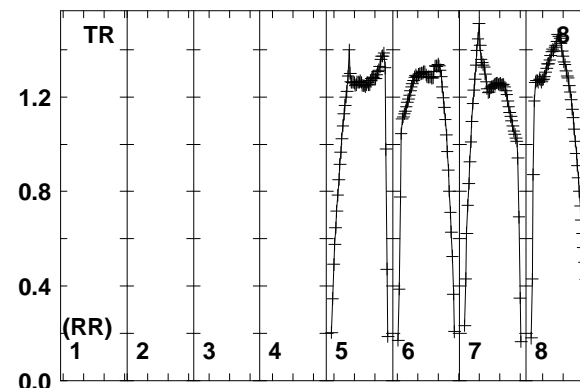
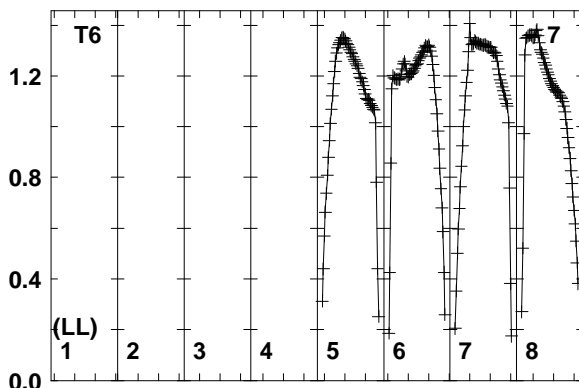
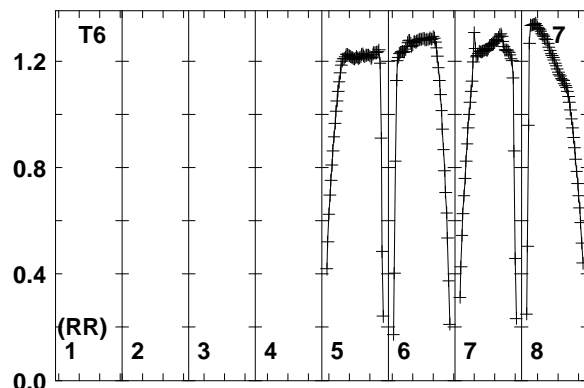
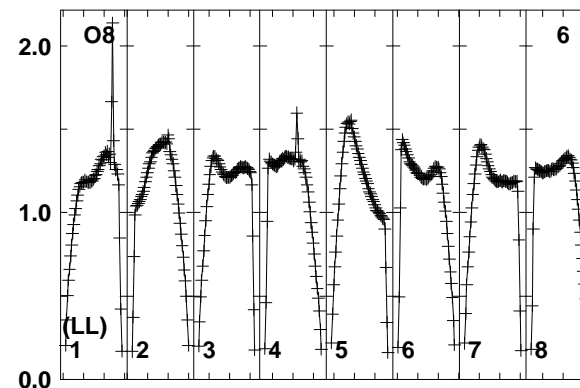
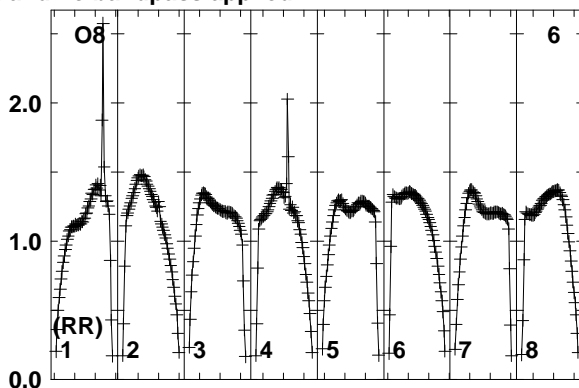
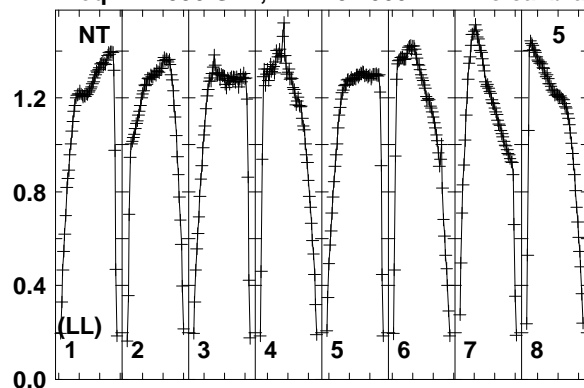

Lower frame: Real Jy
Total-power spectrum Antenna: NT (05)
Timerange: 00/23:28:50 to 00/23:32:19

Plot file version 45 created 23-NOV-2017 14:36:10
J0844+4628 RSM01.UVDATA.1
Freq = 4.7990 GHz, Bw = 32.000 MH No calibration applied and no bandpass applied

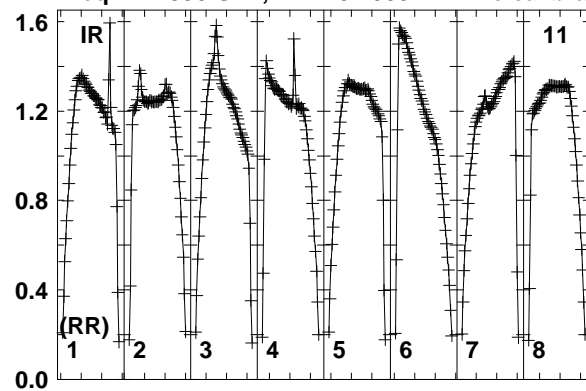

Lower frame: Real Jy
Total-power spectrum Antenna: IR (11)
Timerange: 00/23:28:50 to 00/23:32:19

Plot file version 46 created 23-NOV-2017 14:36:10

J0847+4609 RSM01.UVDATA.1

Freq = 4.7990 GHz, Bw = 32.000 MH No calibration applied and no bandpass applied

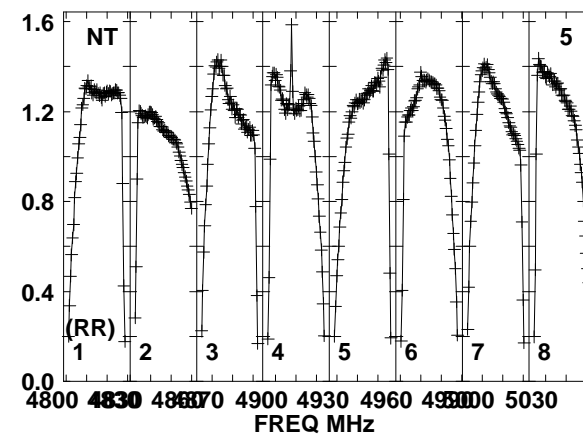
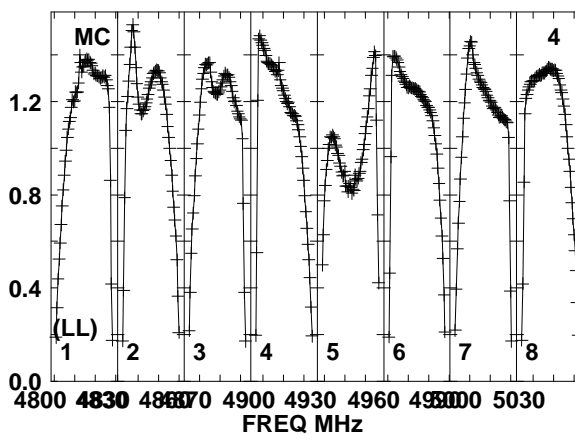
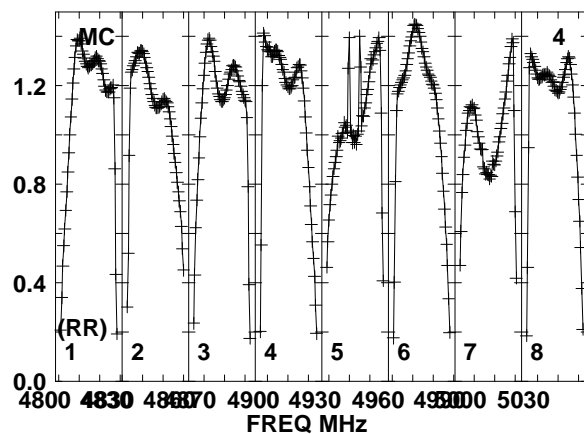
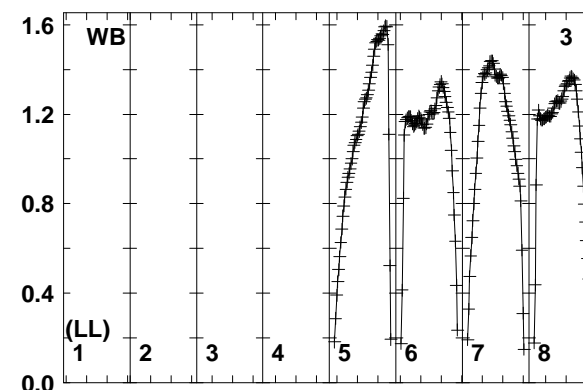
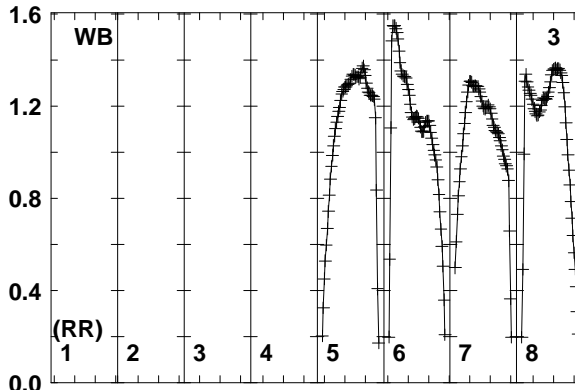
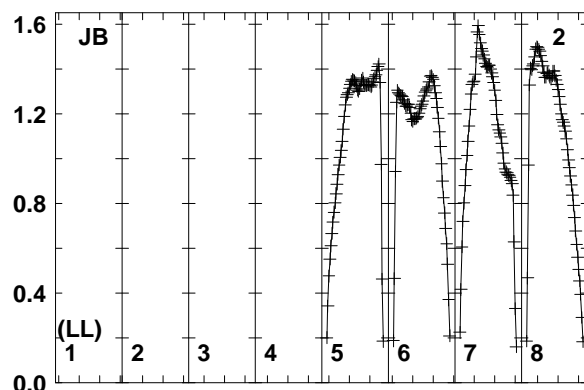
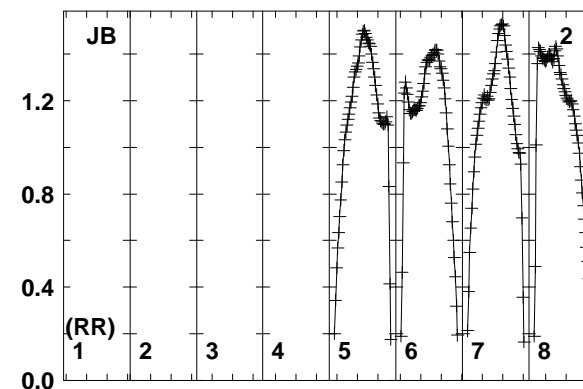
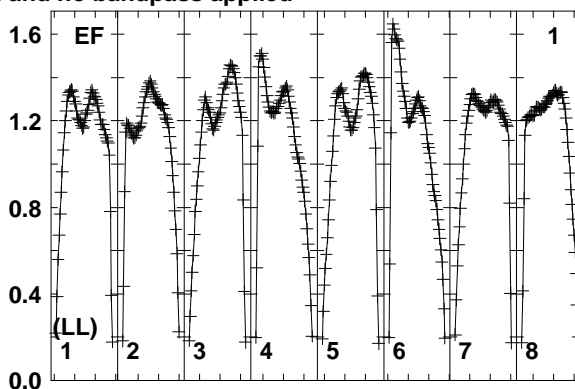
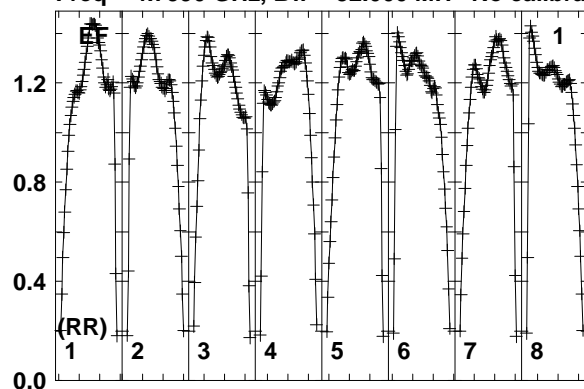

Lower frame: Real Jy
Total-power spectrum Antenna: EF (01)
Timerange: 00/23:32:21 to 00/23:33:49

Plot file version 47 created 23-NOV-2017 14:36:11

J0847+4609 RSM01.UVDATA.1

Freq = 4.7990 GHz, Bw = 32.000 MH No calibration applied and no bandpass applied

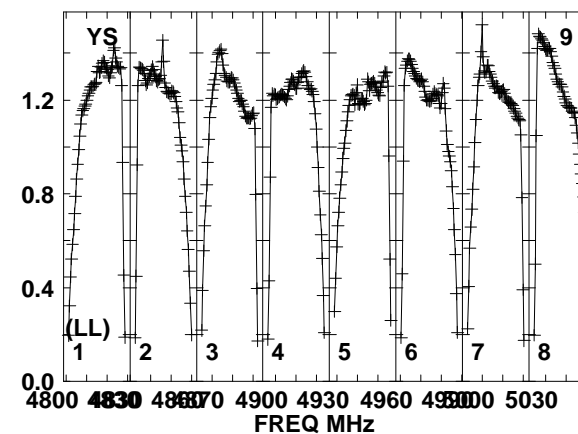
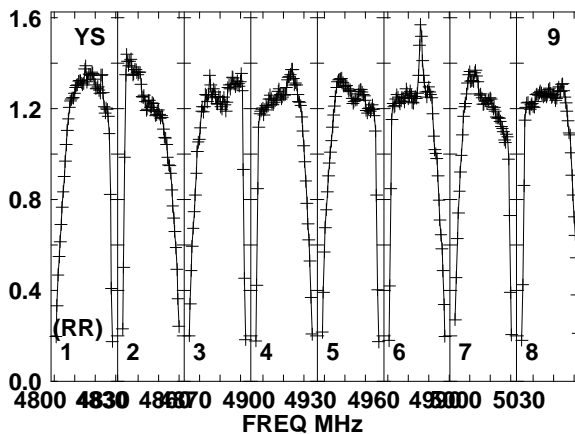
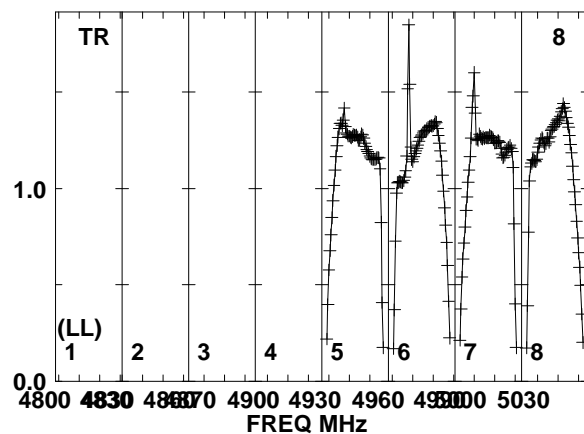
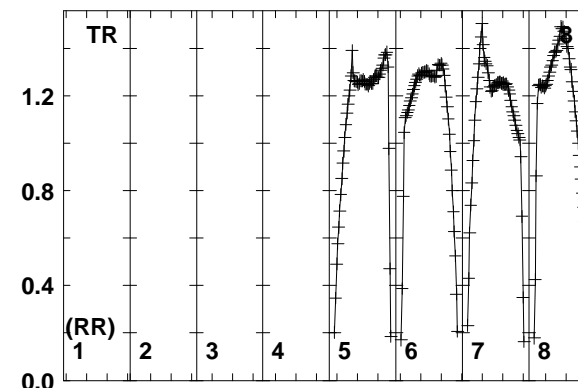
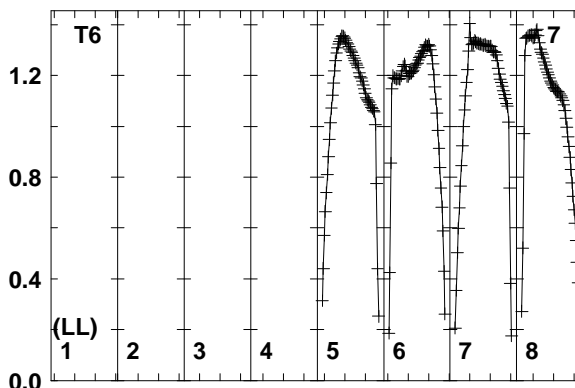
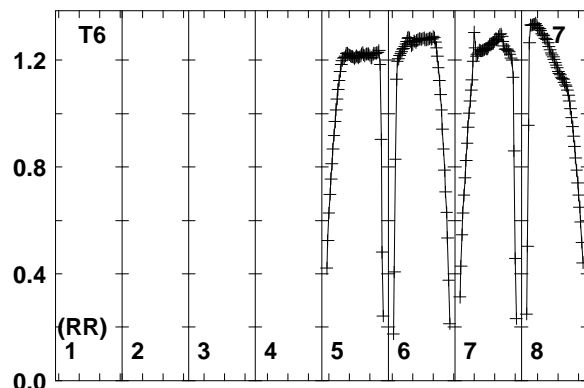
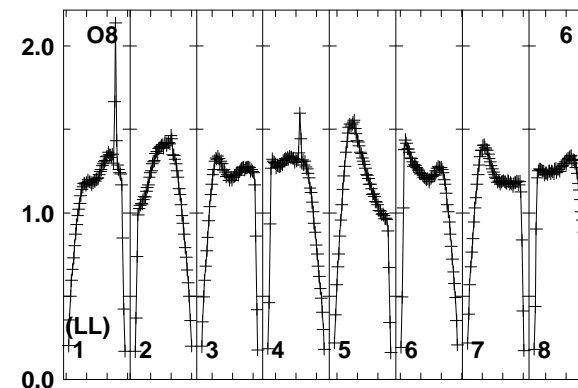
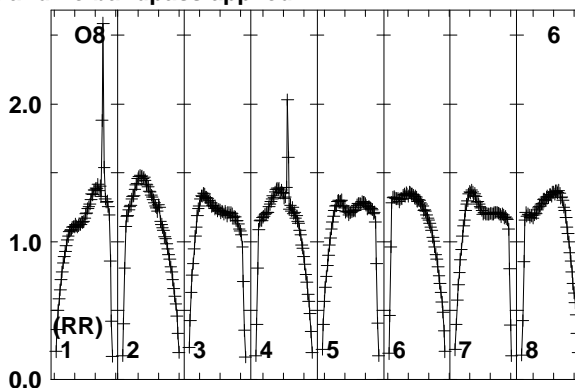
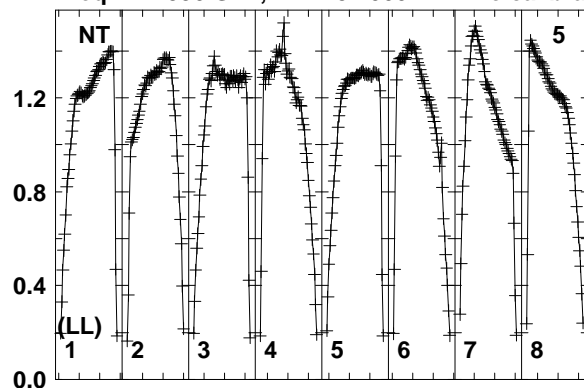

Lower frame: Real Jy
Total-power spectrum Antenna: NT (05)
Timerange: 00/23:32:21 to 00/23:33:49

Plot file version 48 created 23-NOV-2017 14:36:11

J0847+4609 RSM01.UVDATA.1

Freq = 4.7990 GHz, Bw = 32.000 MH No calibration applied and no bandpass applied

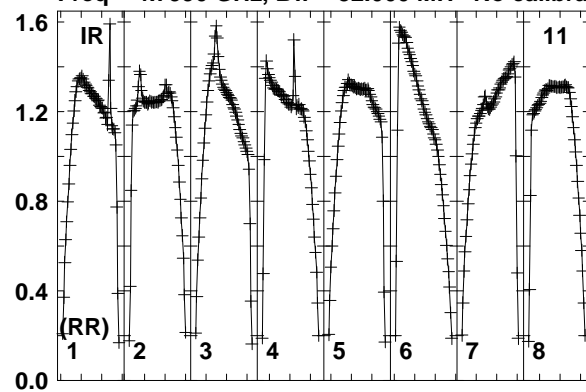

Lower frame: Real Jy
Total-power spectrum Antenna: IR (11)
Timerange: 00/23:32:21 to 00/23:33:49

Plot file version 49 created 23-NOV-2017 14:36:11

J0844+4628 RSM01.UVDATA.1

Freq = 4.7990 GHz, Bw = 32.000 MH No calibration applied and no bandpass applied

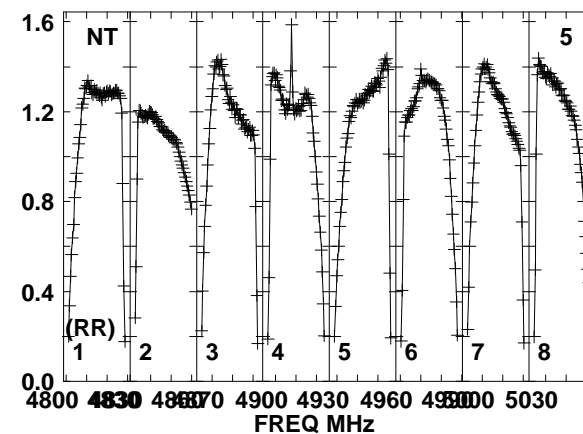
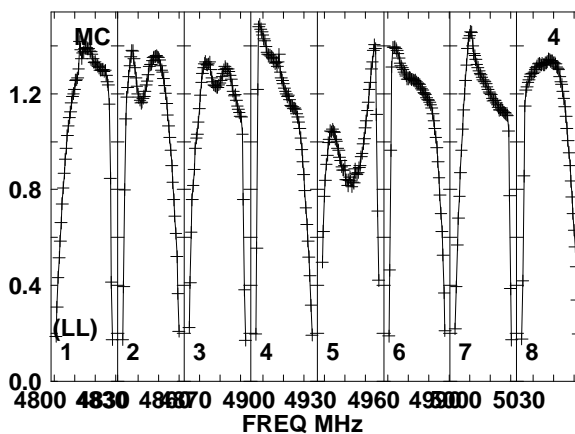
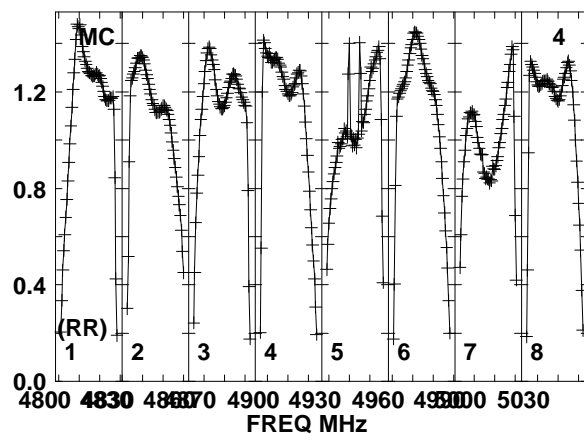
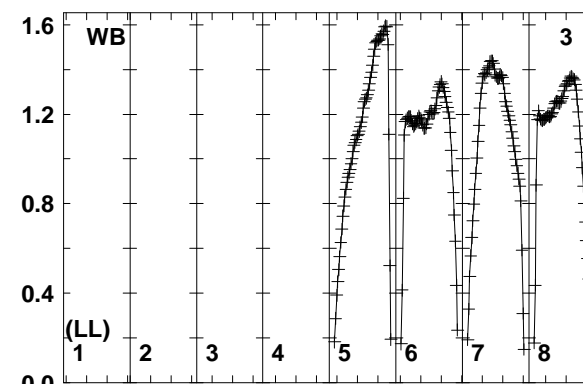
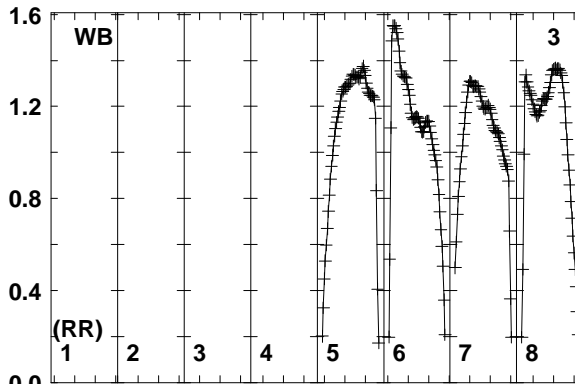
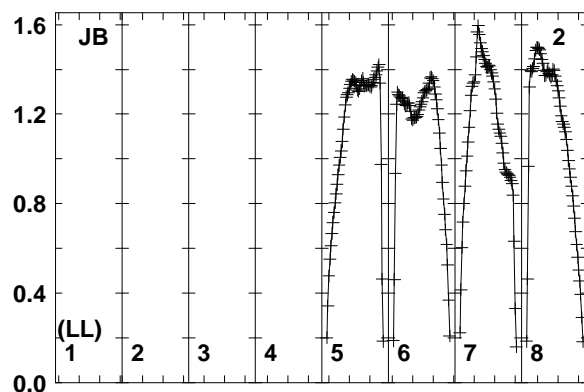
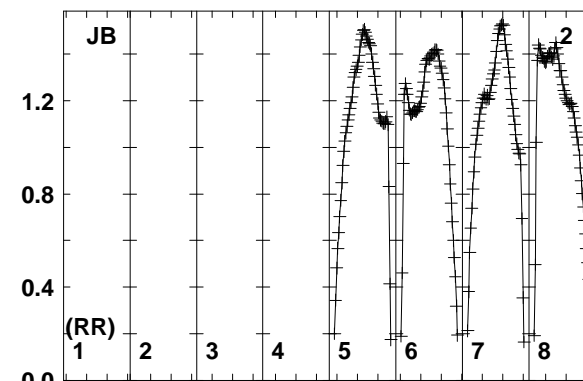
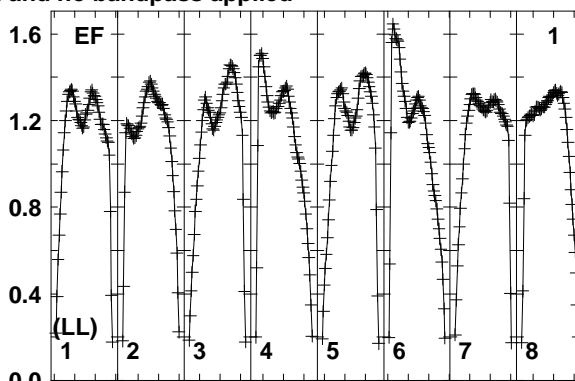
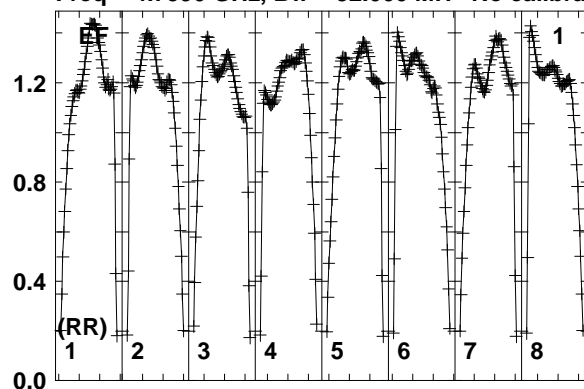

Lower frame: Real Jy
Total-power spectrum Antenna: EF (01)
Timerange: 00/23:33:51 to 00/23:37:20

Plot file version 50 created 23-NOV-2017 14:36:11

J0844+4628 RSM01.UVDATA.1

Freq = 4.7990 GHz, Bw = 32.000 MH No calibration applied and no bandpass applied

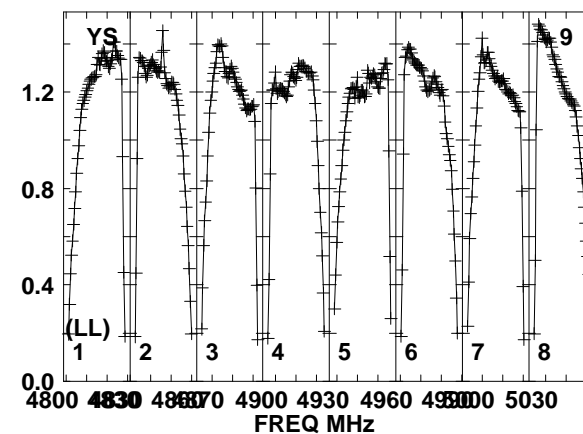
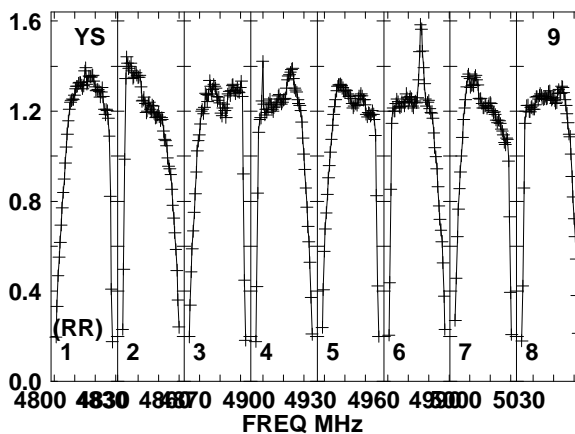
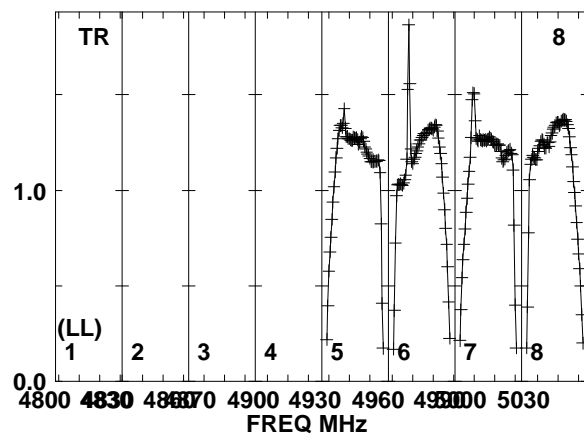
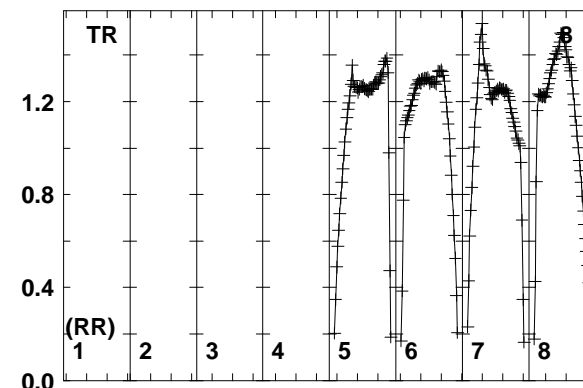
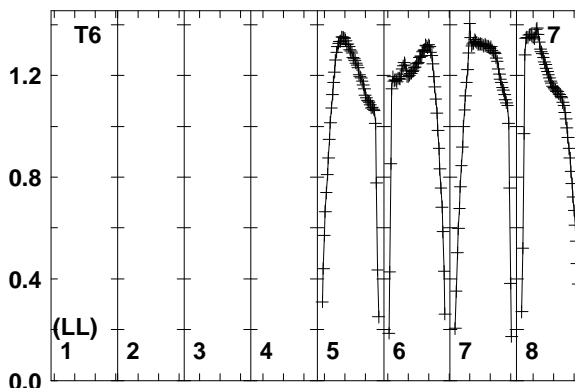
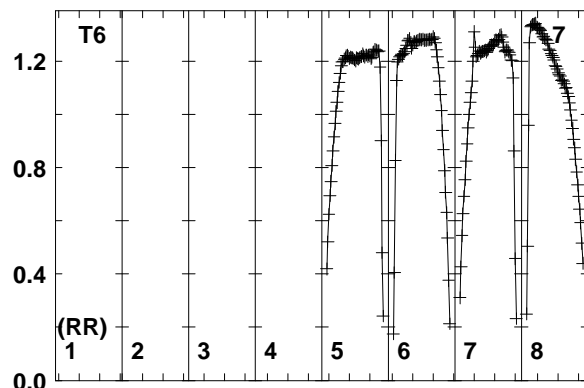
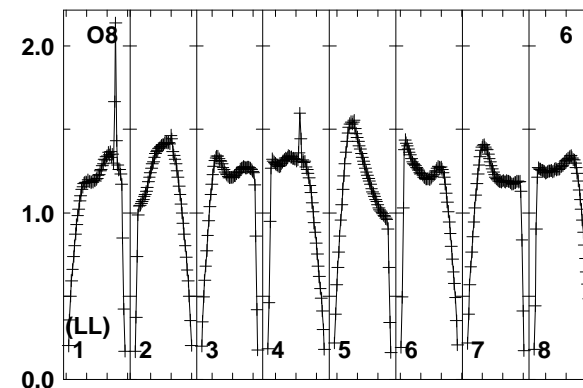
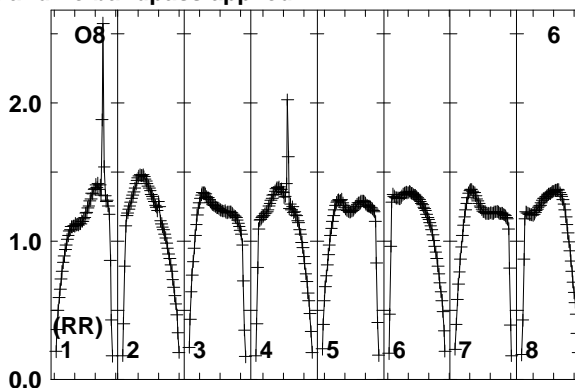
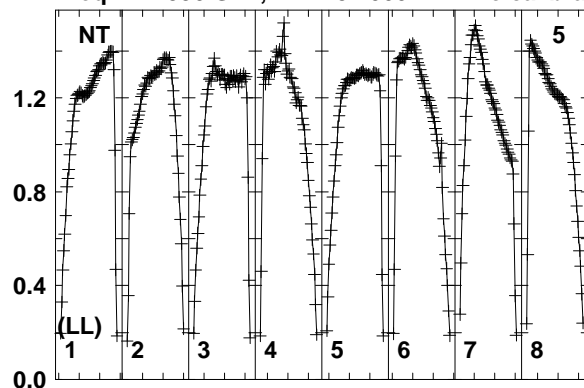

Lower frame: Real Jy
Total-power spectrum Antenna: NT (05)
Timerange: 00/23:33:51 to 00/23:37:20

Plot file version 51 created 23-NOV-2017 14:36:12
J0844+4628 RSM01.UVDATA.1
Freq = 4.7990 GHz, Bw = 32.000 MH No calibration applied and no bandpass applied

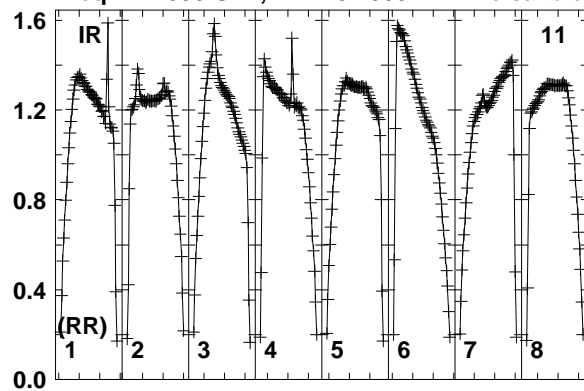

Lower frame: Real Jy
Total-power spectrum Antenna: IR (11)
Timerange: 00/23:33:51 to 00/23:37:20

Plot file version 52 created 23-NOV-2017 14:36:12

J0847+4609 RSM01.UVDATA.1

Freq = 4.7990 GHz, Bw = 32.000 MH No calibration applied and no bandpass applied

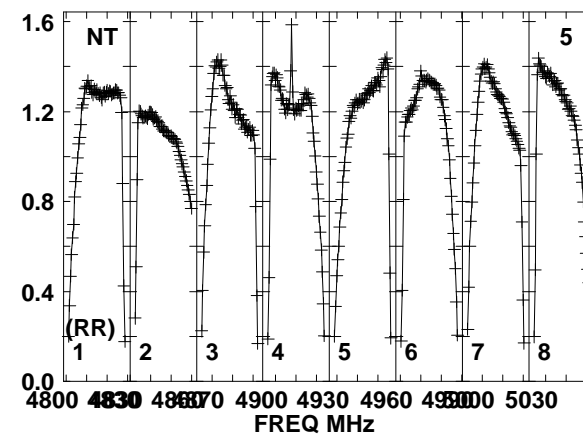
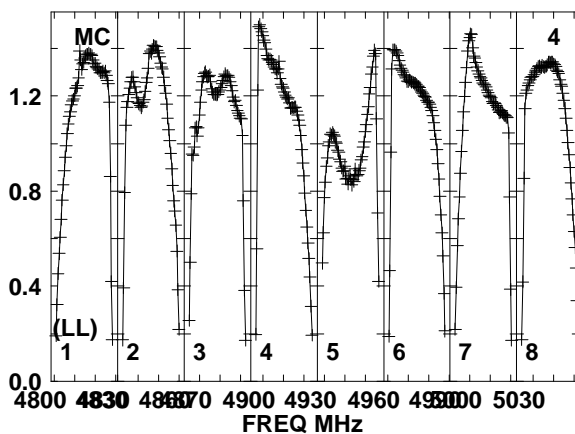
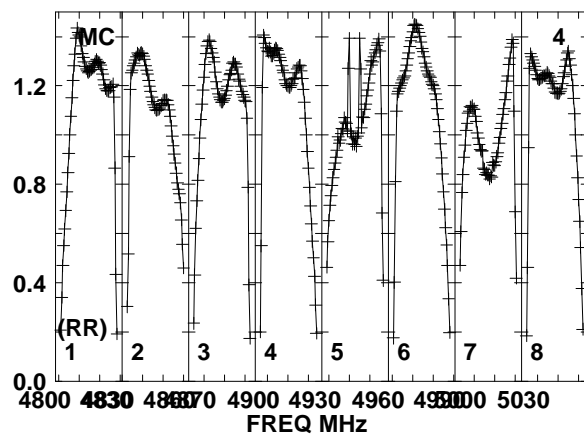
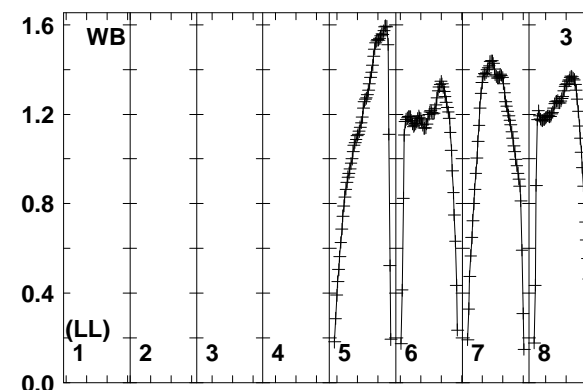
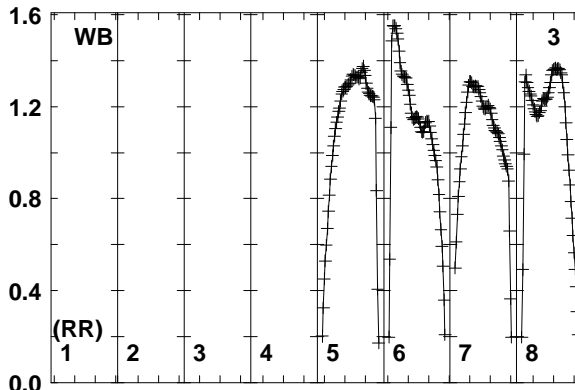
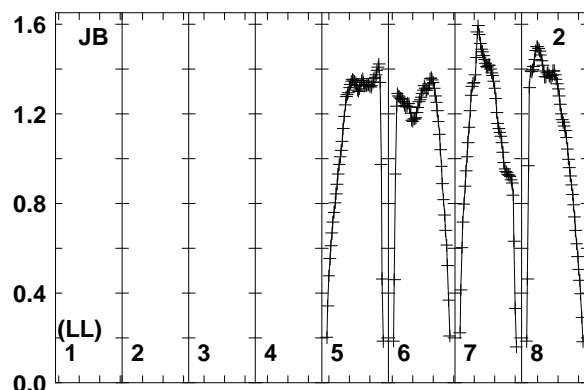
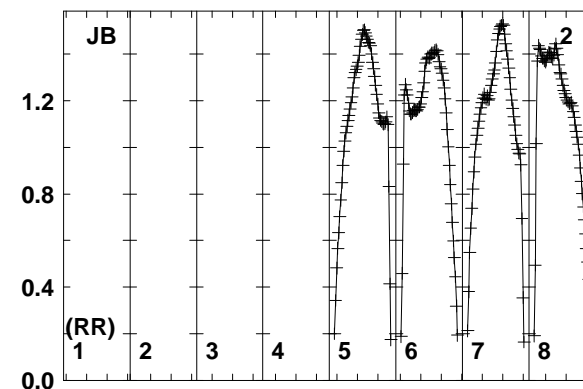
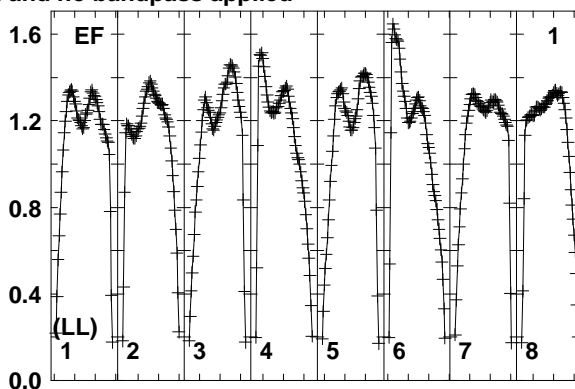
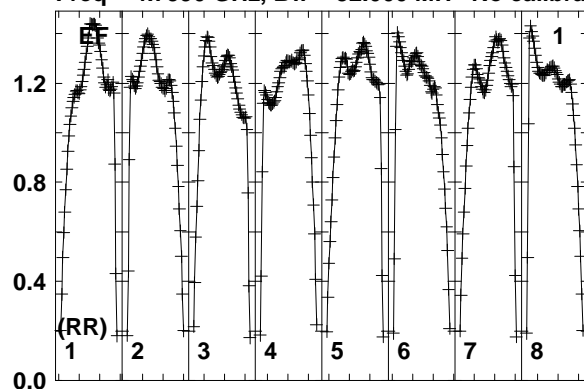

Lower frame: Real Jy
Total-power spectrum Antenna: EF (01)
Timerange: 00/23:38:01 to 00/23:38:59

Plot file version 53 created 23-NOV-2017 14:36:12

J0847+4609 RSM01.UVDATA.1

Freq = 4.7990 GHz, Bw = 32.000 MH No calibration applied and no bandpass applied

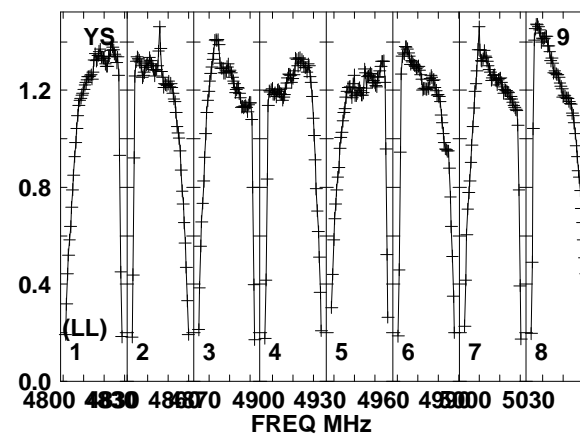
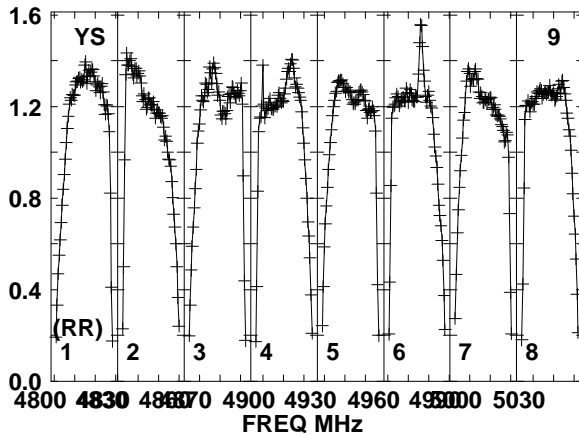
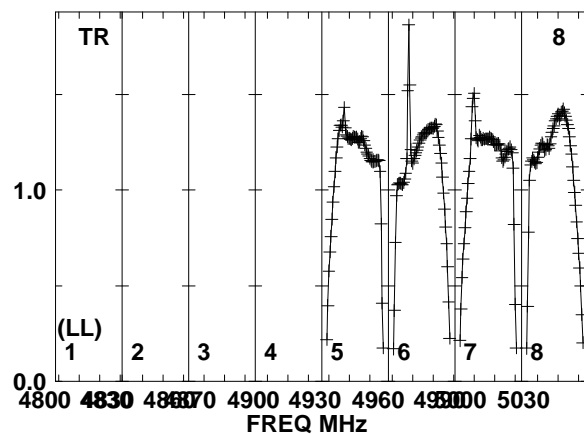
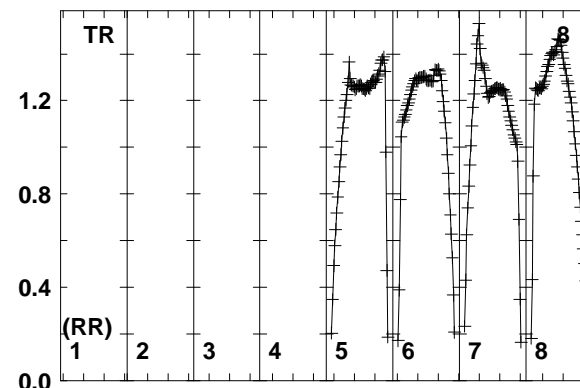
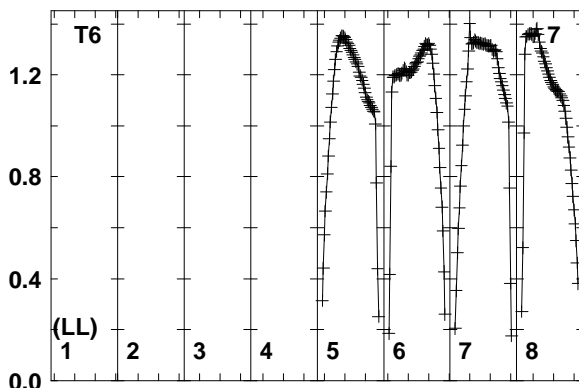
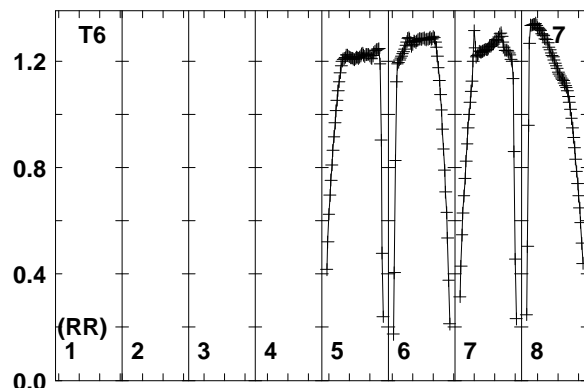
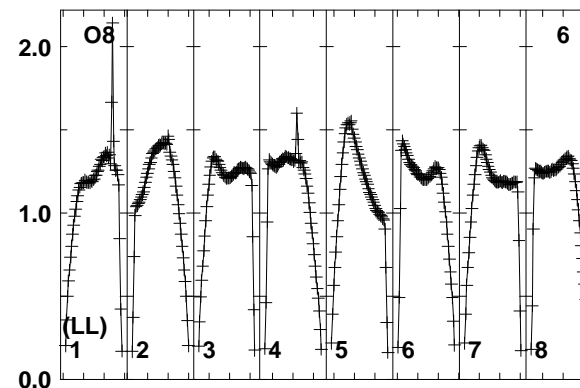
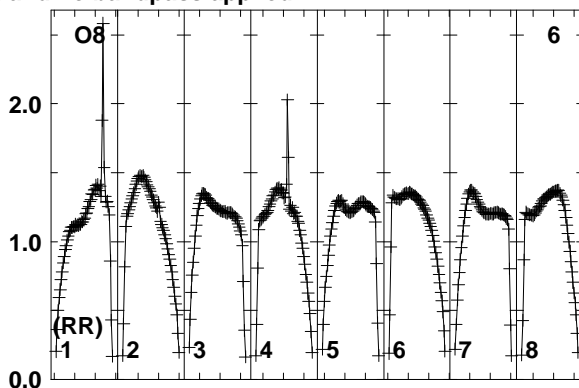
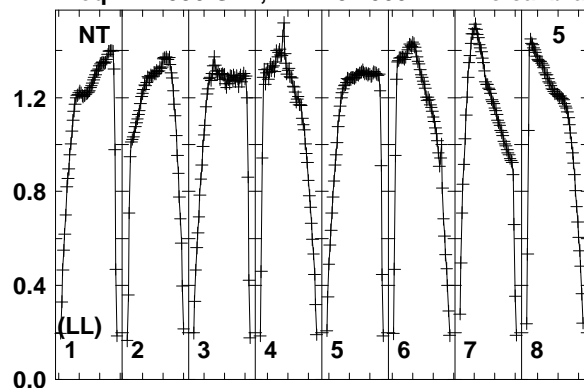

Lower frame: Real Jy
Total-power spectrum Antenna: NT (05)
Timerange: 00/23:38:01 to 00/23:38:59

Plot file version 54 created 23-NOV-2017 14:36:12

J0847+4609 RSM01.UVDATA.1

Freq = 4.7990 GHz, Bw = 32.000 MH No calibration applied and no bandpass applied

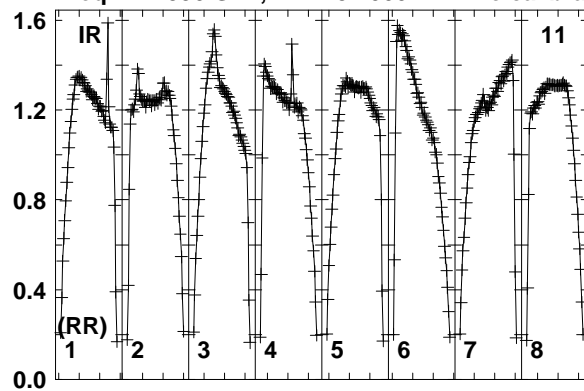

Lower frame: Real Jy
Total-power spectrum Antenna: IR (11)
Timerange: 00/23:38:01 to 00/23:38:59

Plot file version 55 created 23-NOV-2017 14:36:13

J0927+3902 RSM01.UVDATA.1

Freq = 4.7990 GHz, Bw = 32.000 MH No calibration applied and no bandpass applied

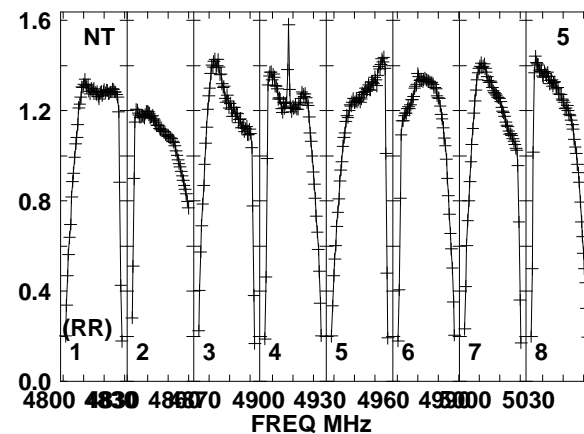
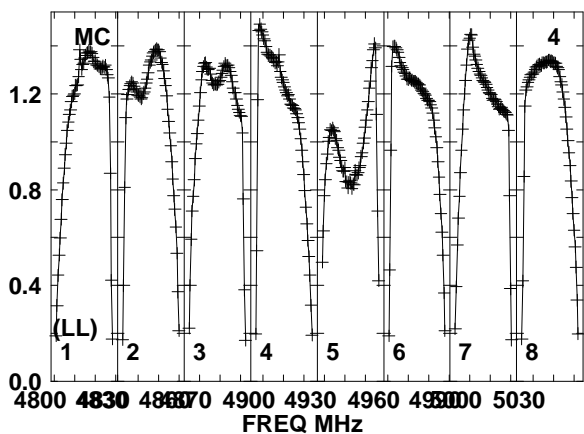
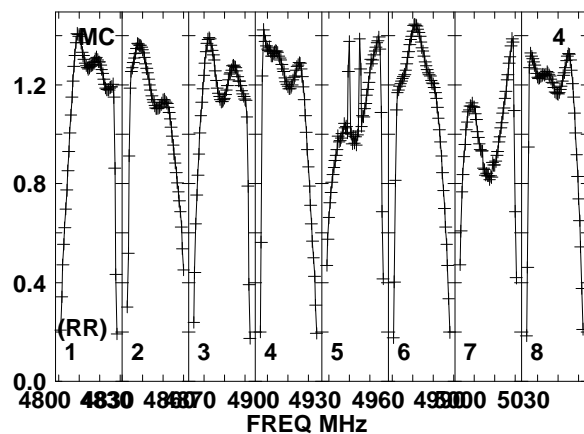
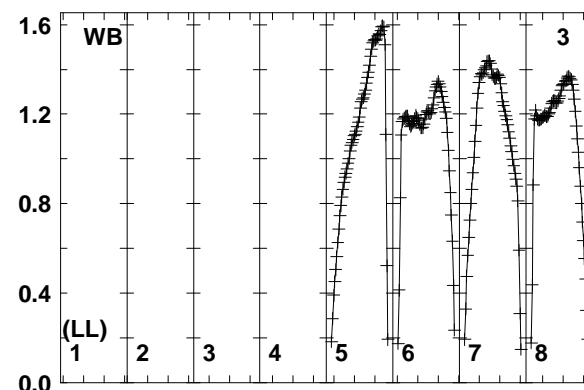
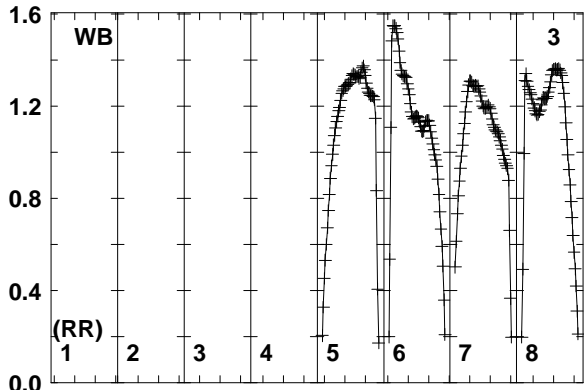
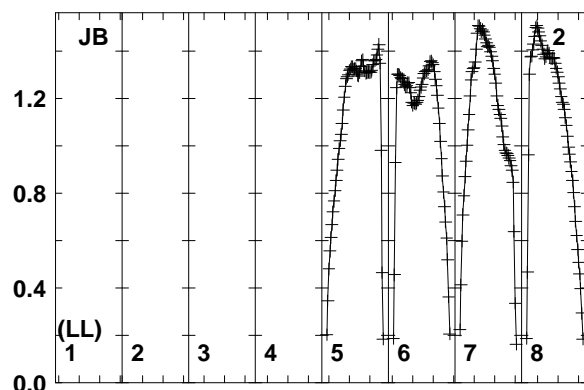
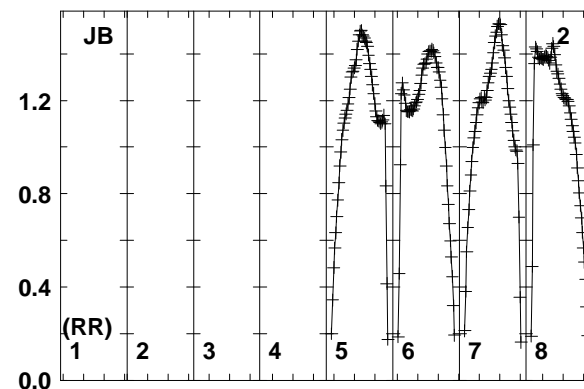
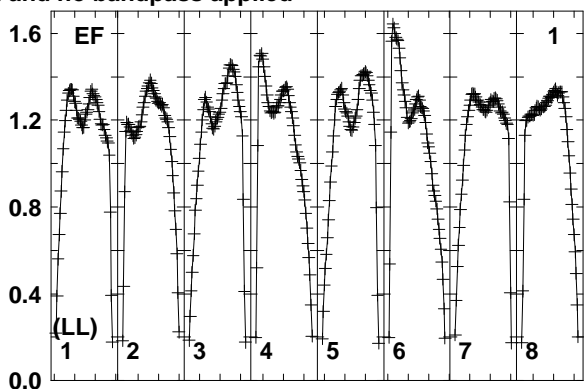
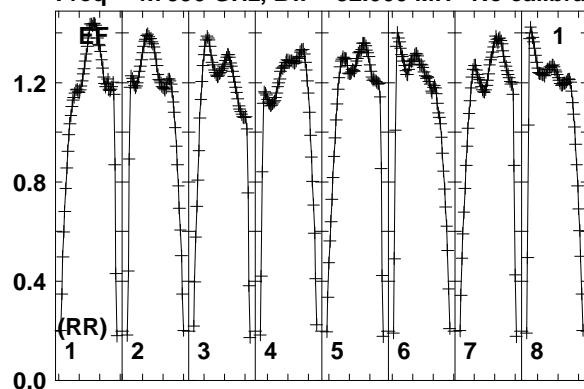

Lower frame: Real Jy
Total-power spectrum Antenna: EF (01)
Timerange: 00/23:40:21 to 00/23:45:20

Plot file version 56 created 23-NOV-2017 14:36:13

J0927+3902 RSM01.UVDATA.1

Freq = 4.7990 GHz, Bw = 32.000 MH No calibration applied and no bandpass applied

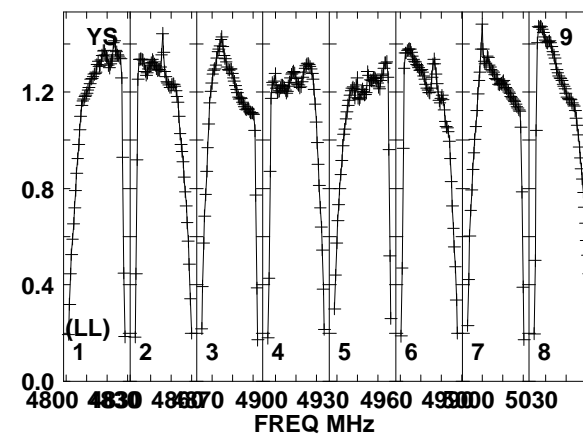
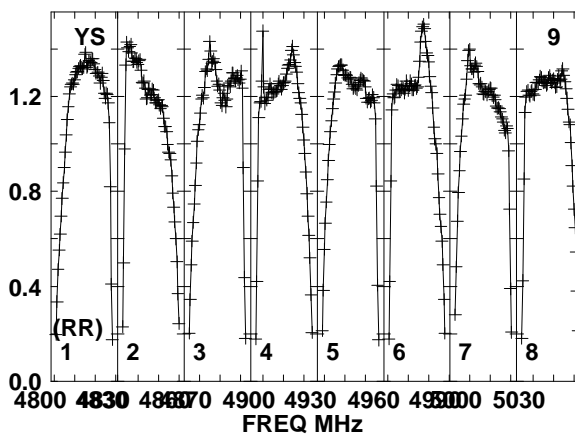
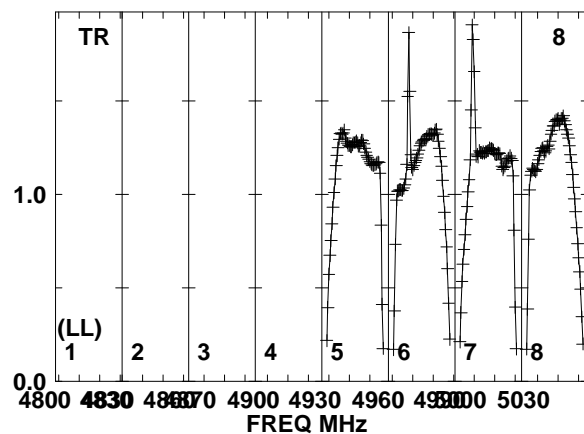
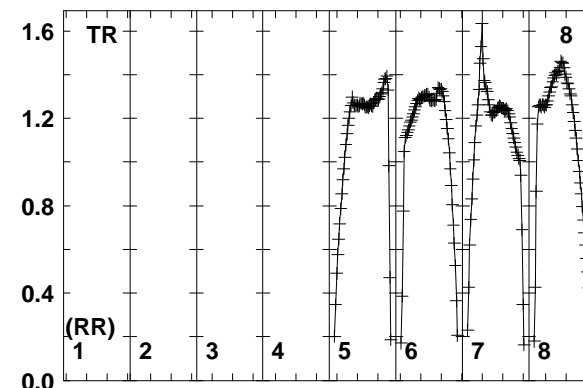
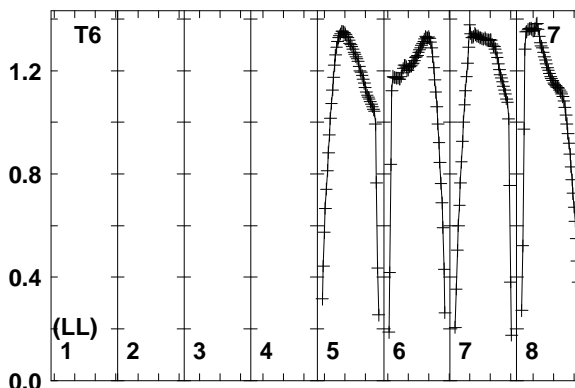
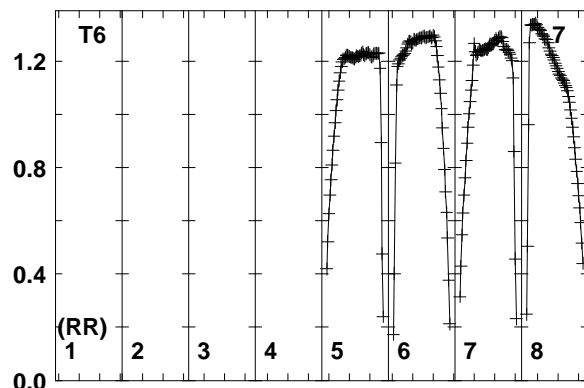
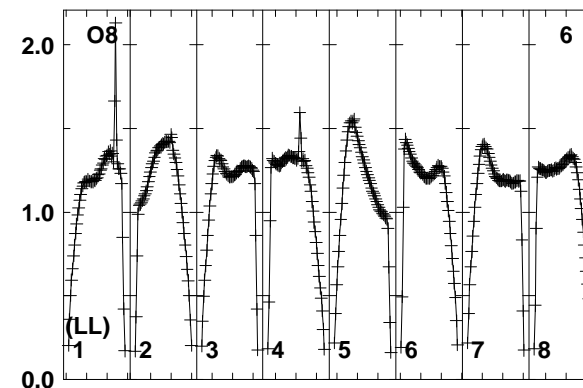
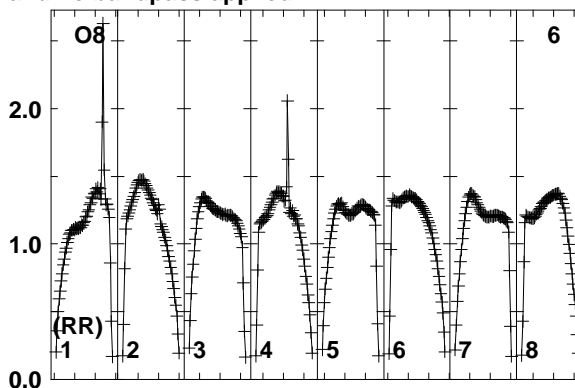
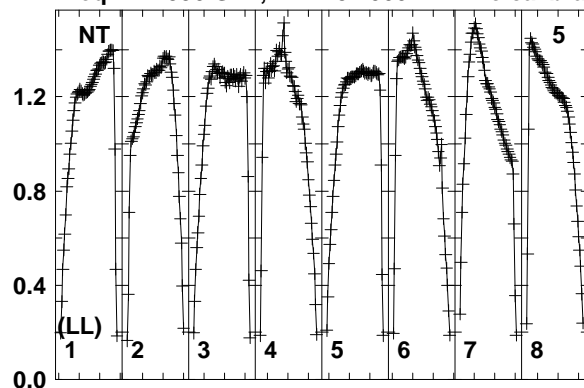

Lower frame: Real Jy
Total-power spectrum Antenna: NT (05)
Timerange: 00/23:40:21 to 00/23:45:20

Plot file version 57 created 23-NOV-2017 14:36:14
J0927+3902 RSM01.UVDATA.1
Freq = 4.7990 GHz, Bw = 32.000 MH No calibration applied and no bandpass applied

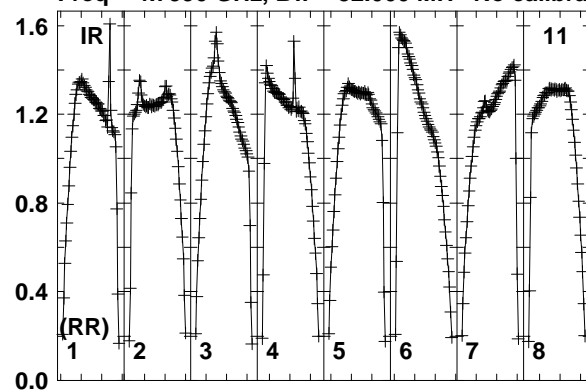

Lower frame: Real Jy
Total-power spectrum Antenna: IR (11)
Timerange: 00/23:40:21 to 00/23:45:20

Plot file version 58 created 23-NOV-2017 14:36:14

J0847+4609 RSM01.UVDATA.1

Freq = 4.7990 GHz, Bw = 32.000 MH No calibration applied and no bandpass applied

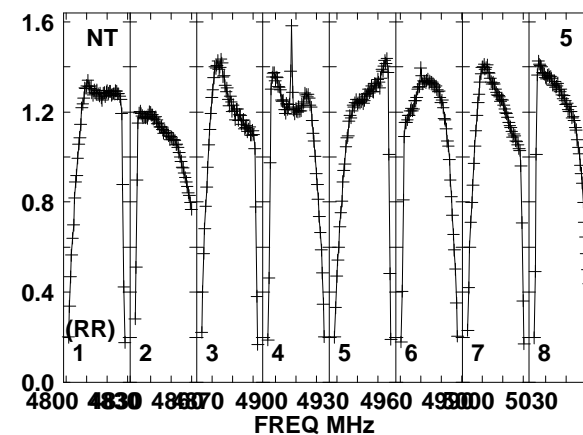
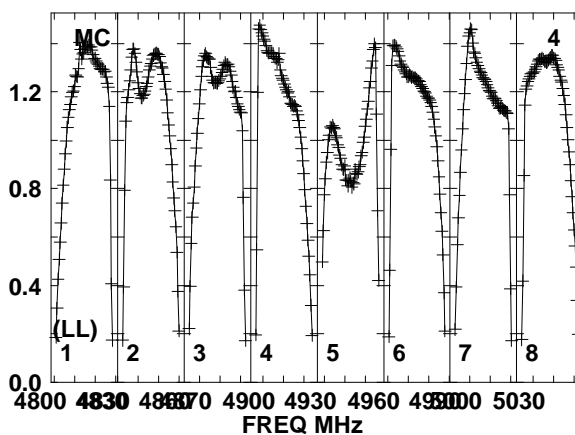
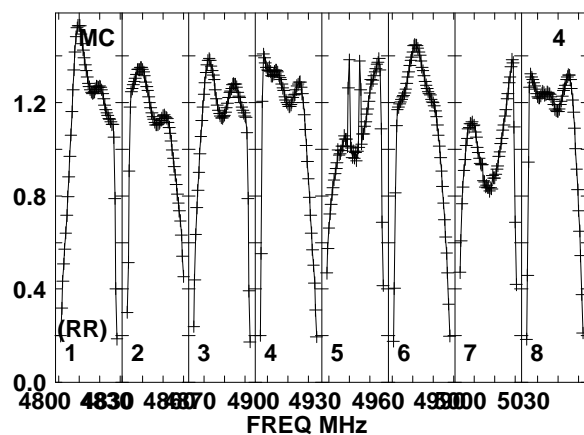
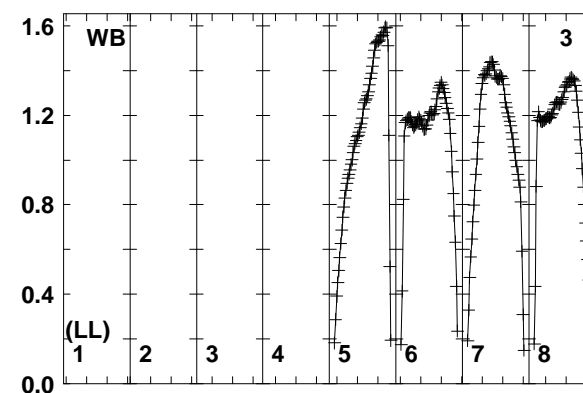
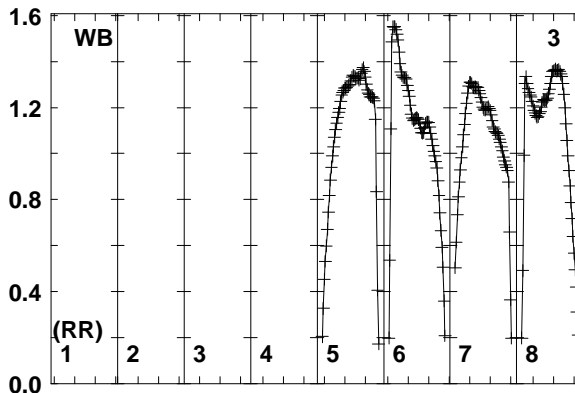
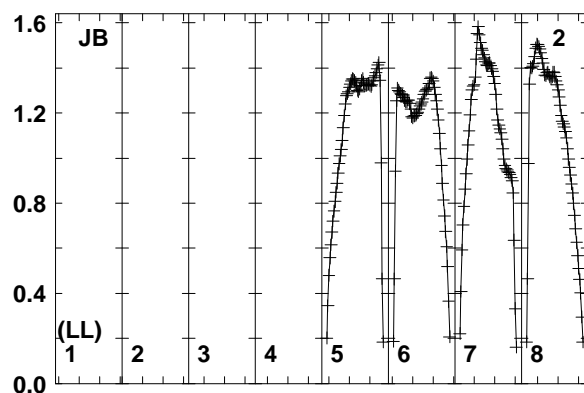
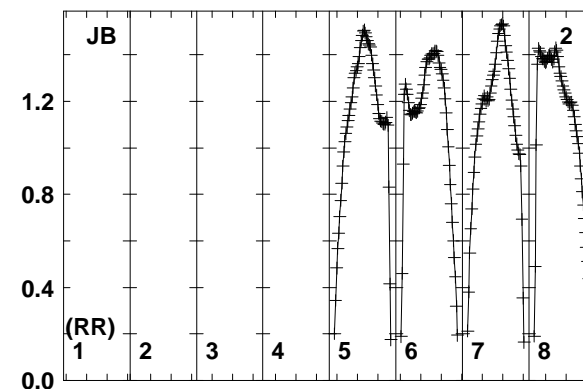
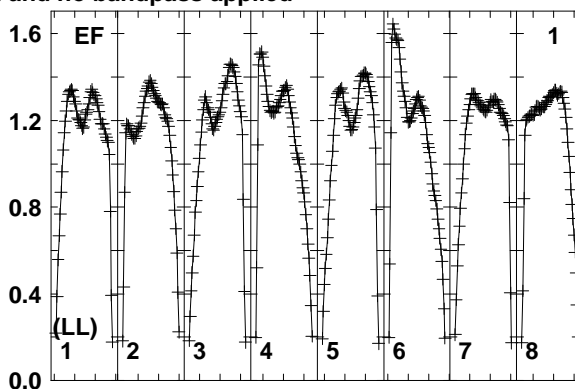
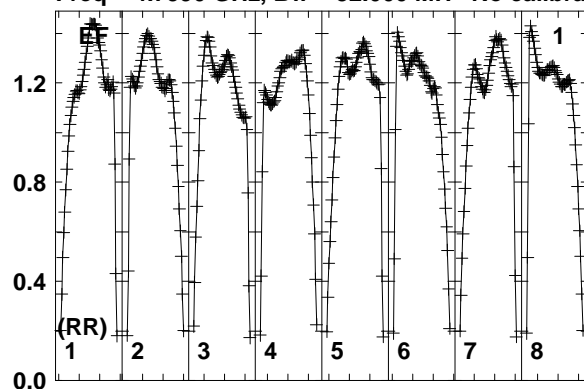

Lower frame: Real Jy
Total-power spectrum Antenna: EF (01)
Timerange: 00/23:46:40 to 00/23:48:39

Plot file version 59 created 23-NOV-2017 14:36:14

J0847+4609 RSM01.UVDATA.1

Freq = 4.7990 GHz, Bw = 32.000 MH No calibration applied and no bandpass applied

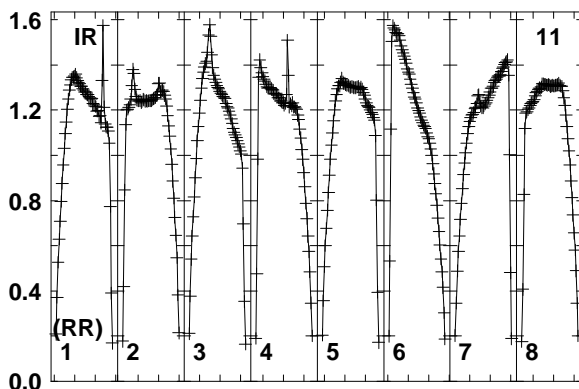
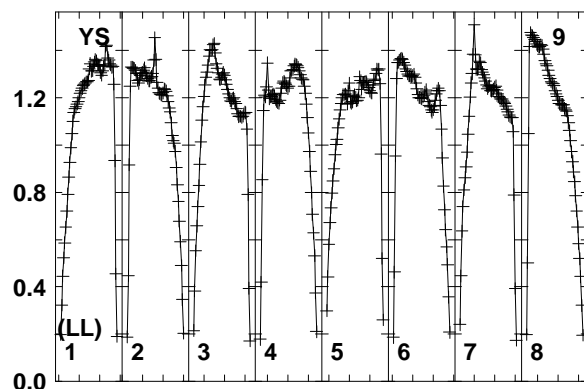
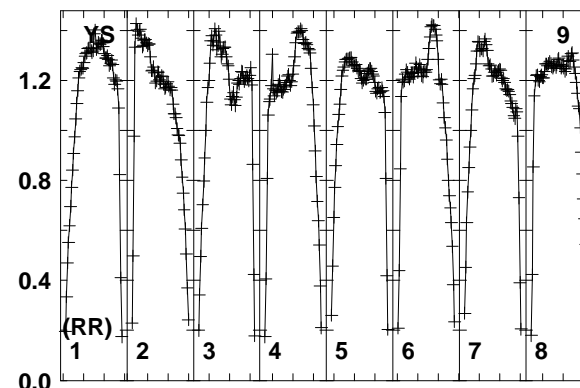
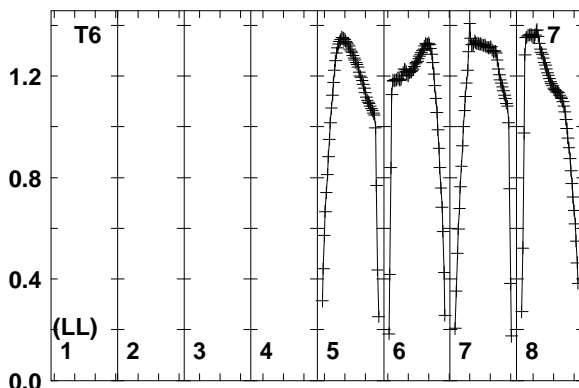
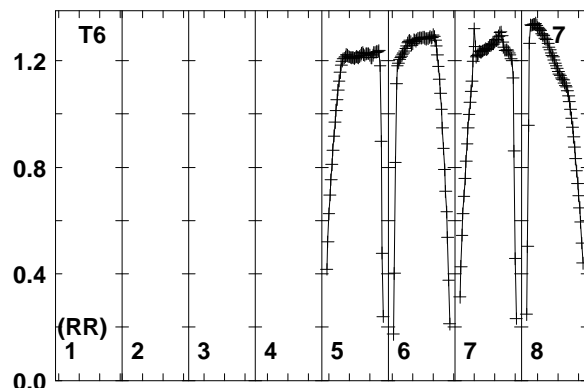
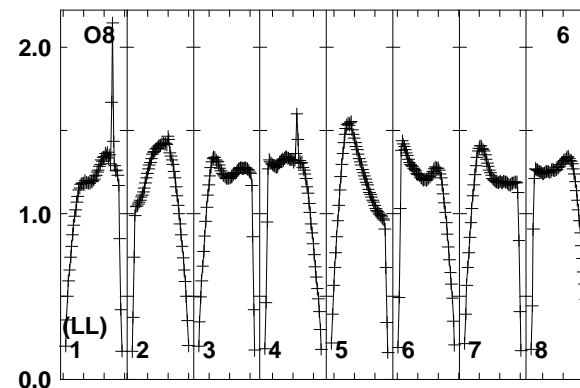
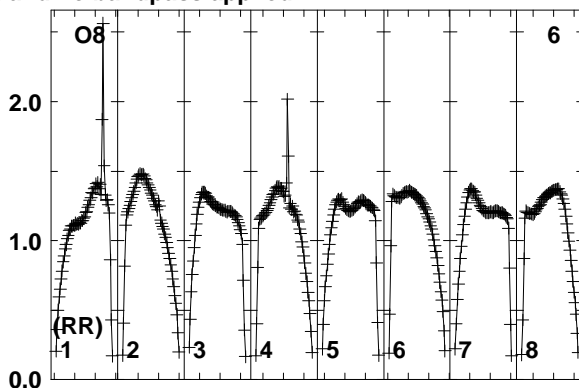
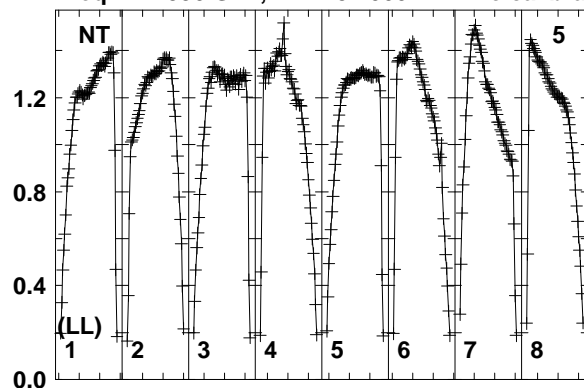

4800 4830 4860 4890 4920 4950 4980 5010 5030
FREQ MHz
Lower frame: Real Jy
Total-power spectrum Antenna: NT (05)
Timerange: 00/23:46:40 to 00/23:48:39

4800 4830 4860 4890 4920 4950 4980 5010 5030
FREQ MHz

Plot file version 60 created 23-NOV-2017 14:36:14

J0844+4628 RSM01.UVDATA.1

Freq = 4.7990 GHz, Bw = 32.000 MH No calibration applied and no bandpass applied

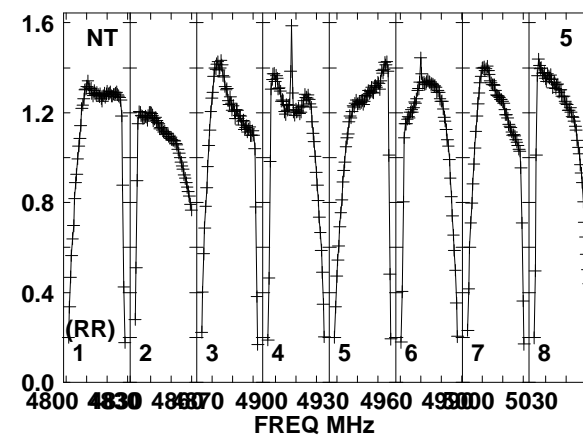
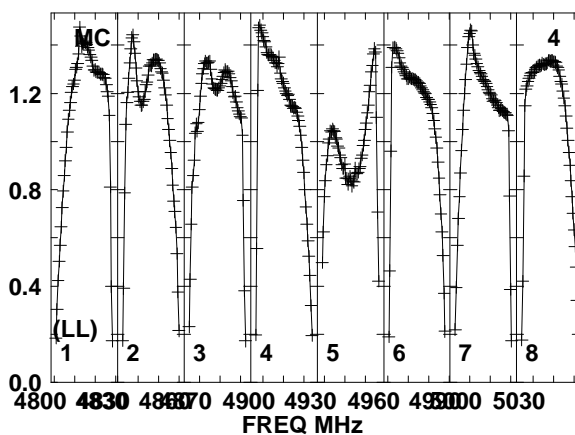
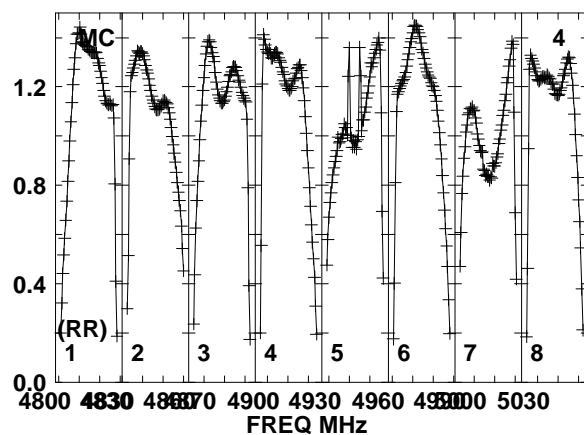
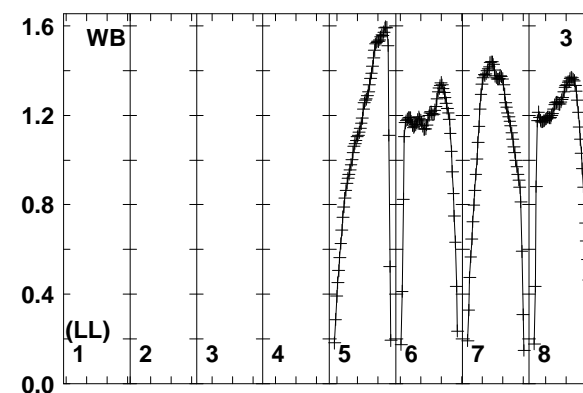
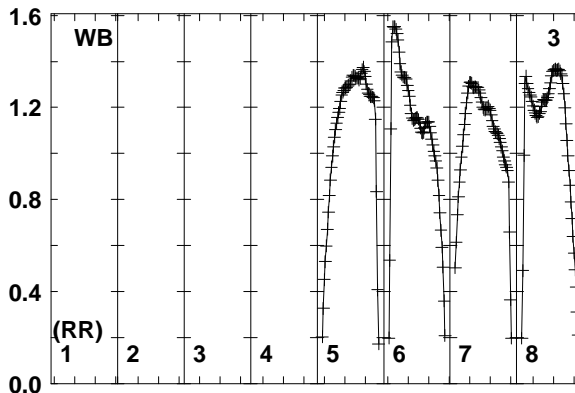
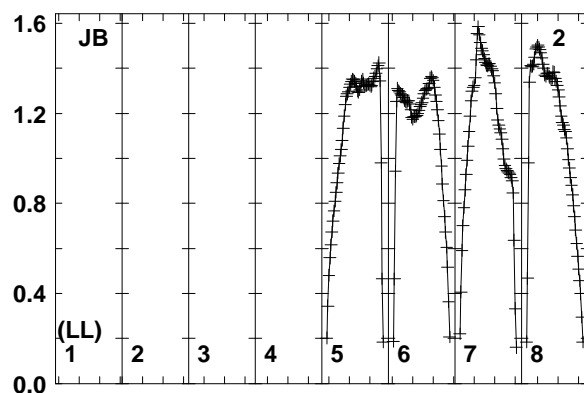
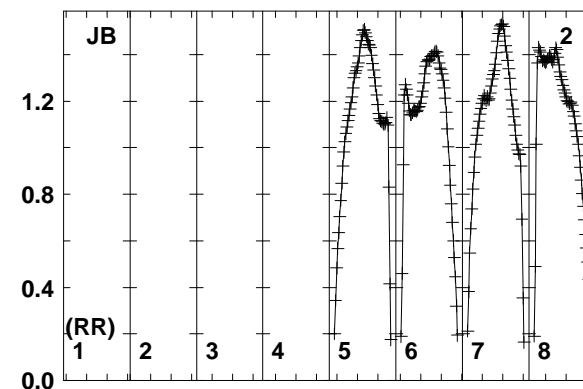
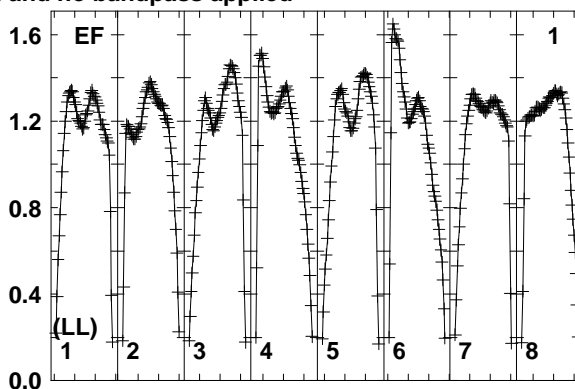
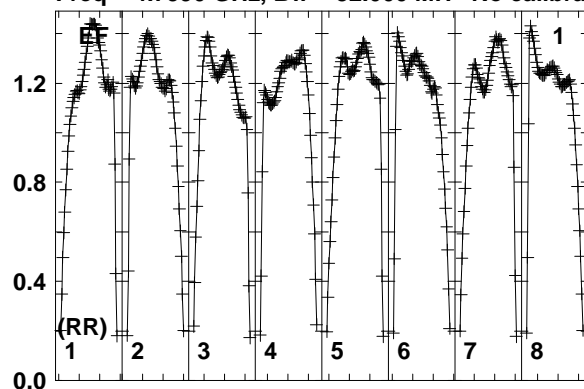

Lower frame: Real Jy
Total-power spectrum Antenna: EF (01)
Timerange: 00/23:48:40 to 00/23:52:09

Plot file version 61 created 23-NOV-2017 14:36:14

J0844+4628 RSM01.UVDATA.1

Freq = 4.7990 GHz, Bw = 32.000 MH No calibration applied and no bandpass applied

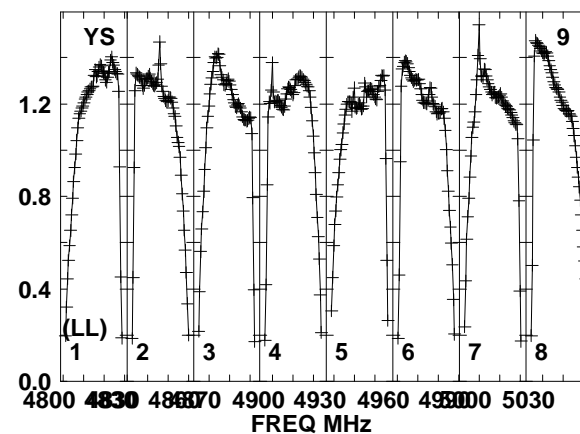
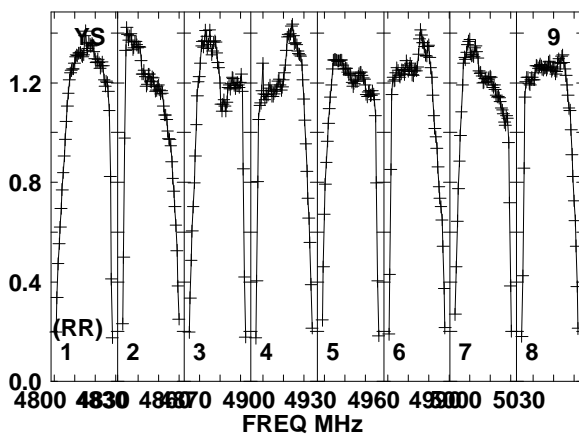
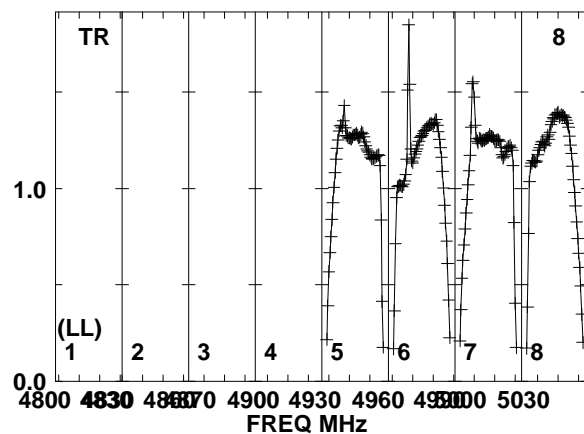
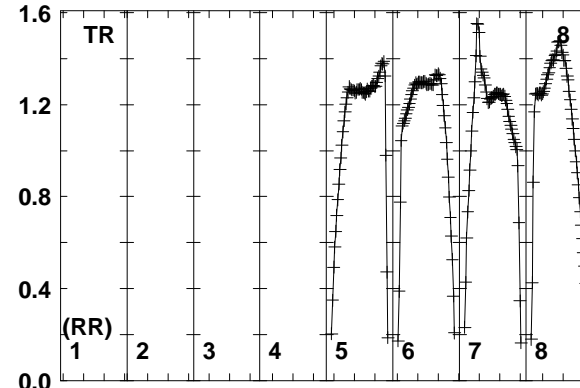
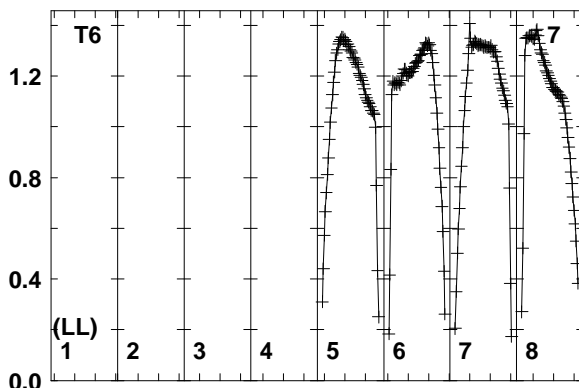
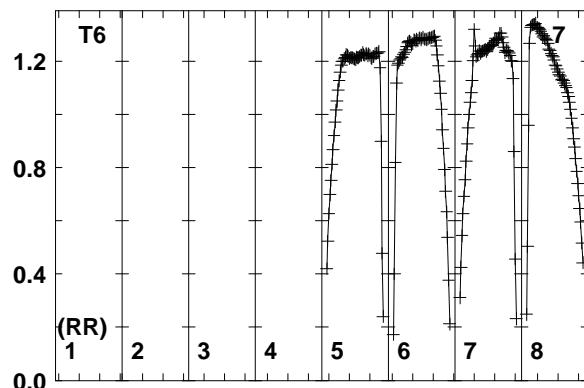
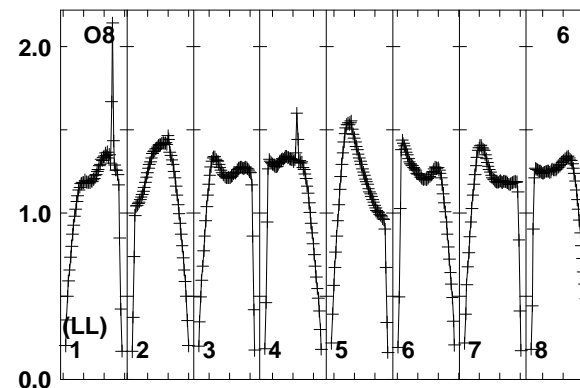
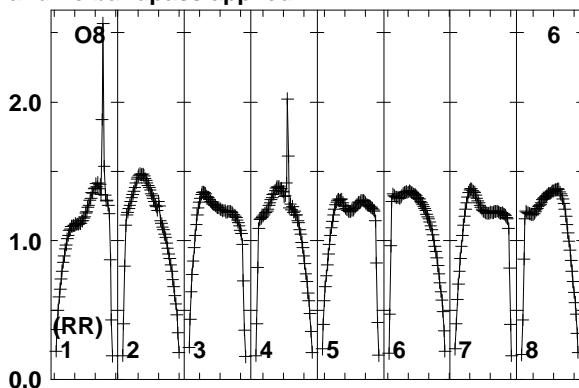
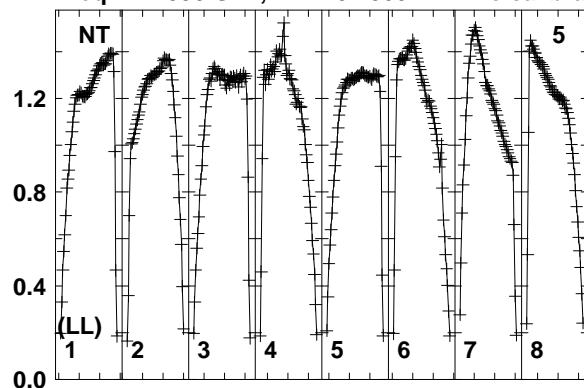

Lower frame: Real Jy
Total-power spectrum Antenna: NT (05)
Timerange: 00/23:48:40 to 00/23:52:09

Plot file version 62 created 23-NOV-2017 14:36:15
J0844+4628 RSM01.UVDATA.1
Freq = 4.7990 GHz, Bw = 32.000 MH No calibration applied and no bandpass applied

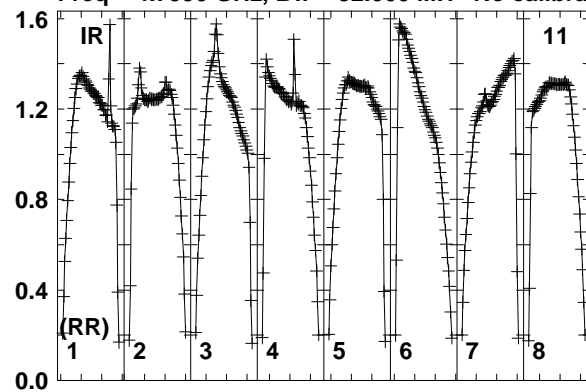

Lower frame: Real Jy
Total-power spectrum Antenna: IR (11)
Timerange: 00/23:48:40 to 00/23:52:09

Plot file version 63 created 23-NOV-2017 14:36:15

J0847+4609 RSM01.UVDATA.1

Freq = 4.7990 GHz, Bw = 32.000 MH No calibration applied and no bandpass applied

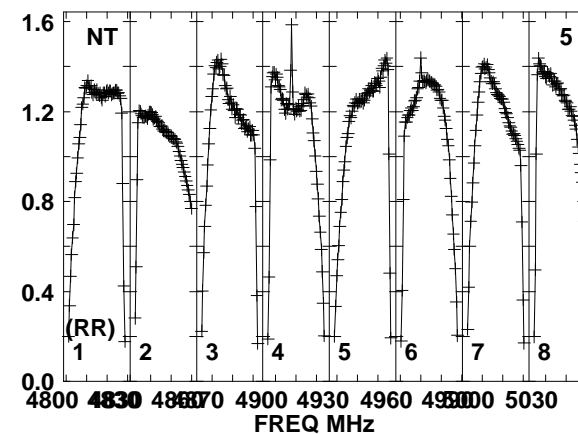
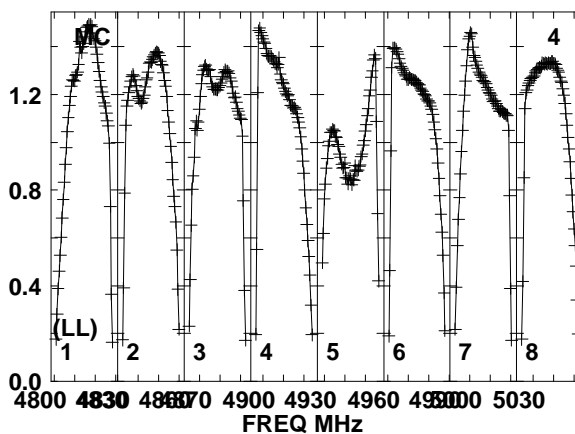
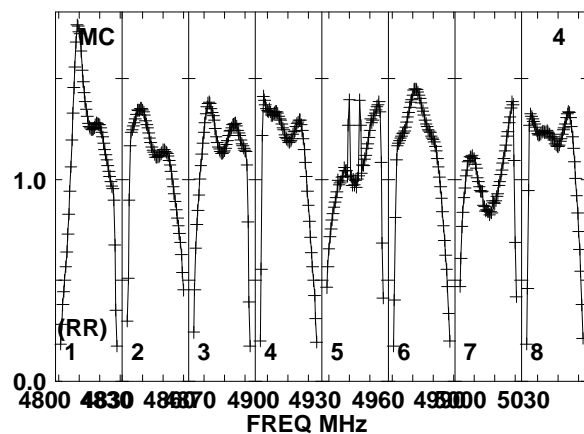
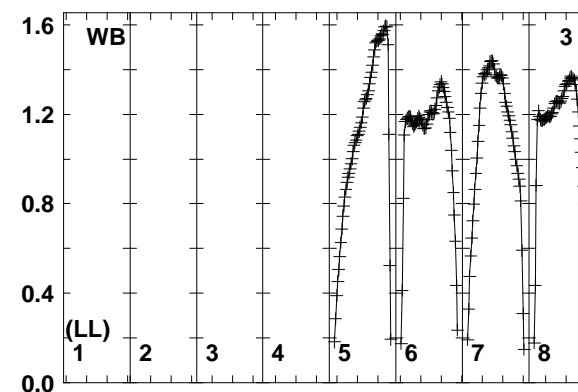
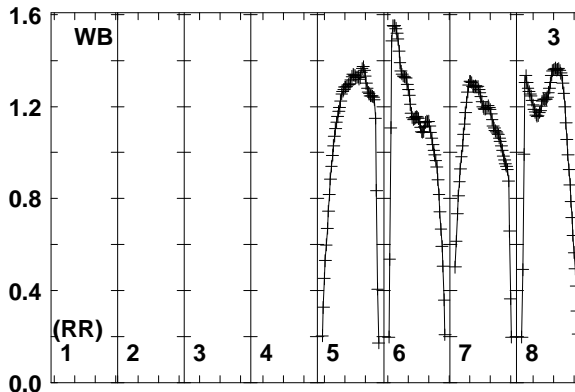
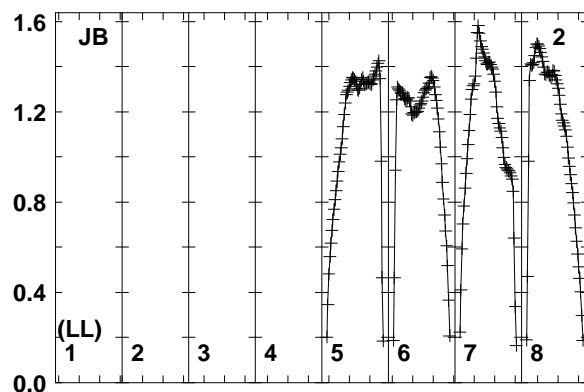
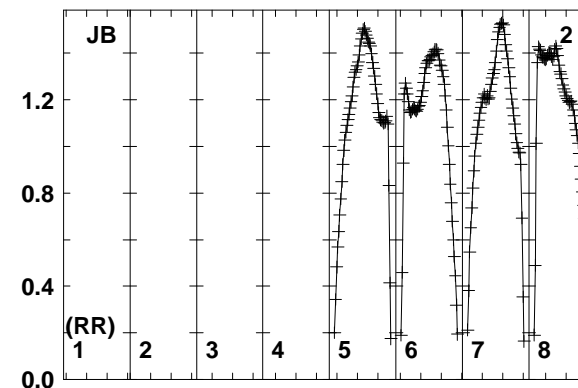
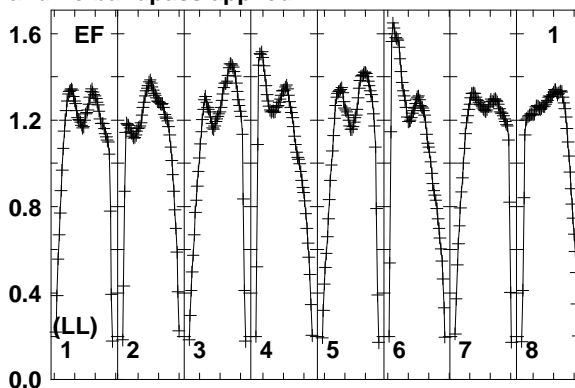
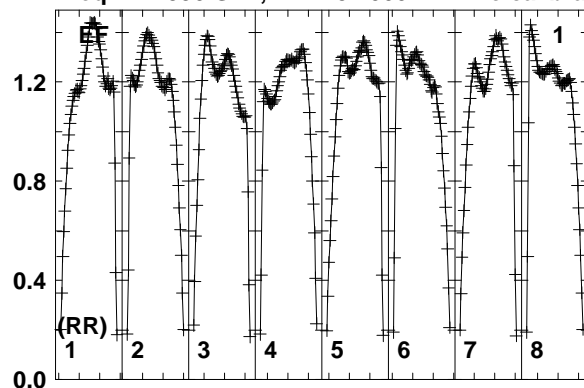

Lower frame: Real Jy
Total-power spectrum Antenna: EF (01)
Timerange: 00/23:52:10 to 00/23:53:40

Plot file version 64 created 23-NOV-2017 14:36:15

J0847+4609 RSM01.UVDATA.1

Freq = 4.7990 GHz, Bw = 32.000 MH No calibration applied and no bandpass applied

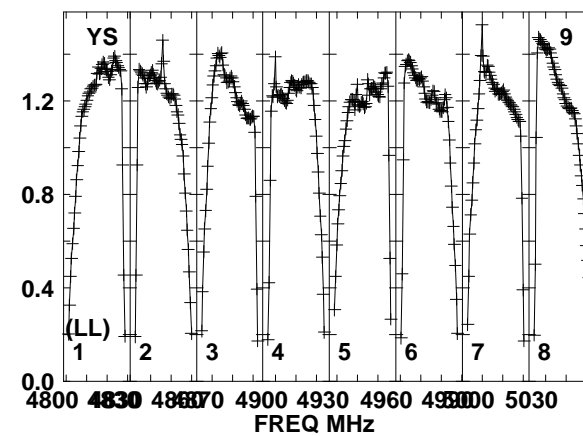
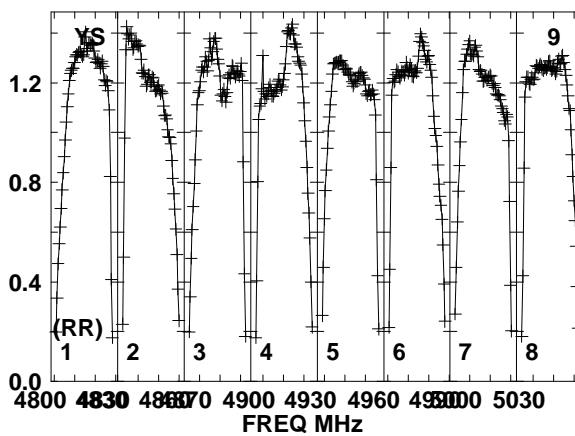
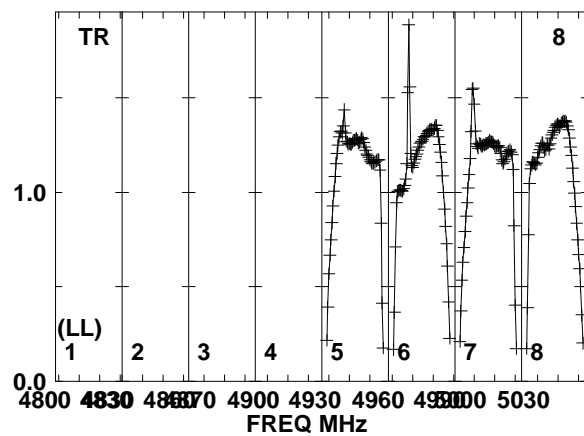
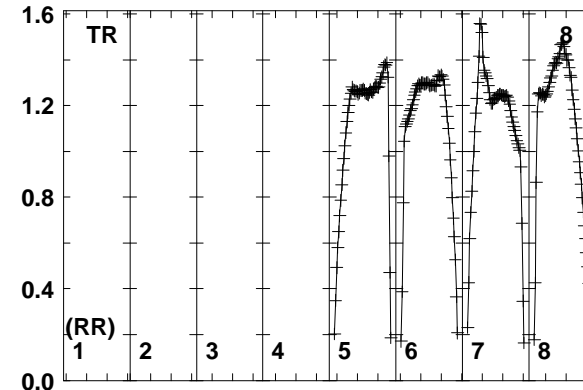
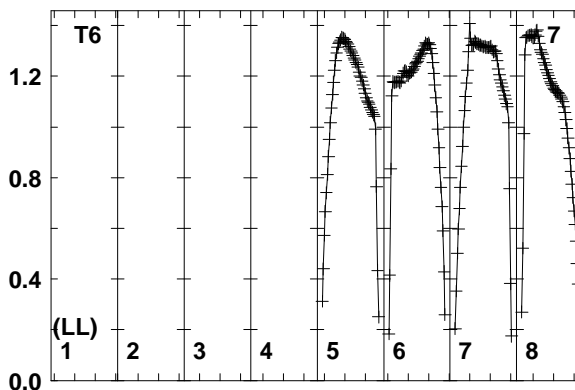
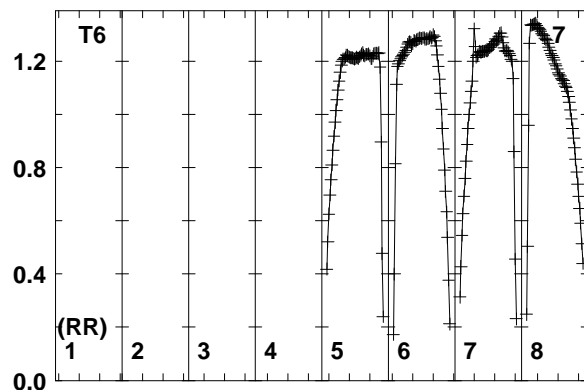
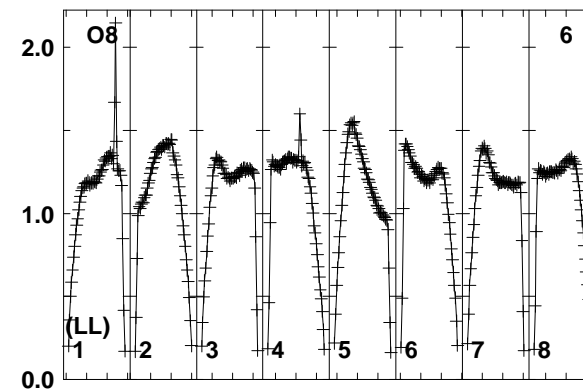
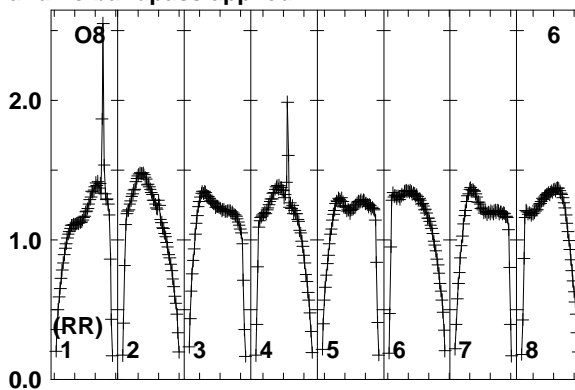
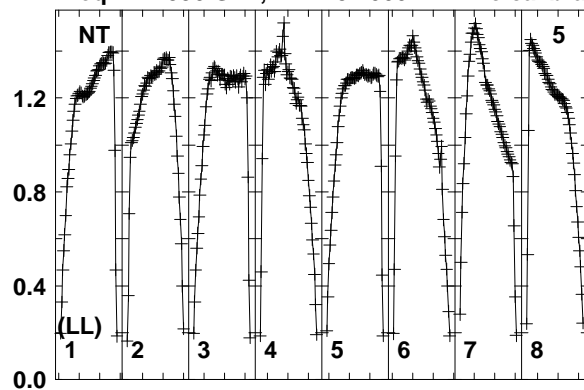

Lower frame: Real Jy
Total-power spectrum Antenna: NT (05)
Timerange: 00/23:52:10 to 00/23:53:40

Plot file version 65 created 23-NOV-2017 14:36:15
J0847+4609 RSM01.UVDATA.1
Freq = 4.7990 GHz, Bw = 32.000 MH No calibration applied and no bandpass applied

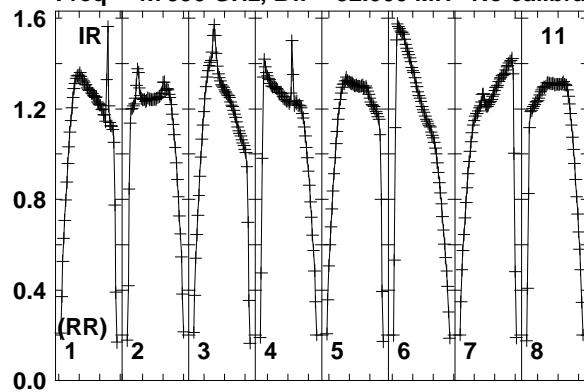

Lower frame: Real Jy
Total-power spectrum Antenna: IR (11)
Timerange: 00/23:52:10 to 00/23:53:40

Plot file version 66 created 23-NOV-2017 14:36:16

J0844+4628 RSM01.UVDATA.1

Freq = 4.7990 GHz, Bw = 32.000 MH No calibration applied and no bandpass applied

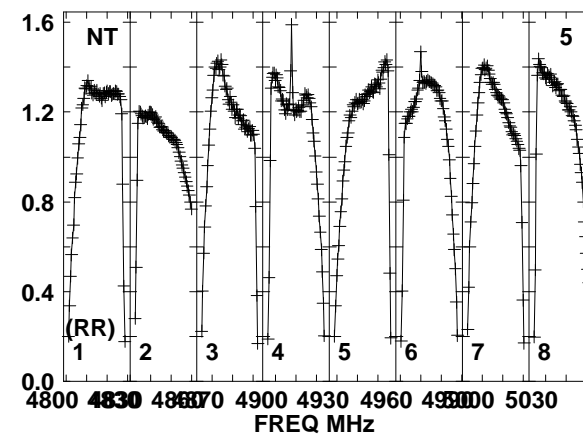
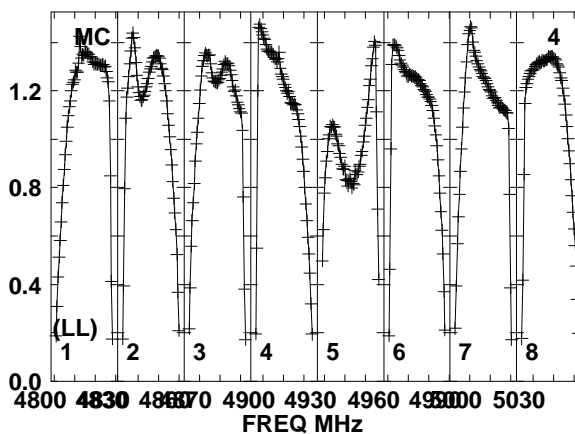
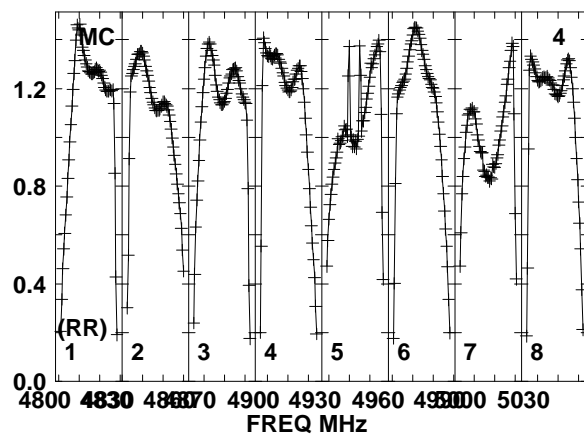
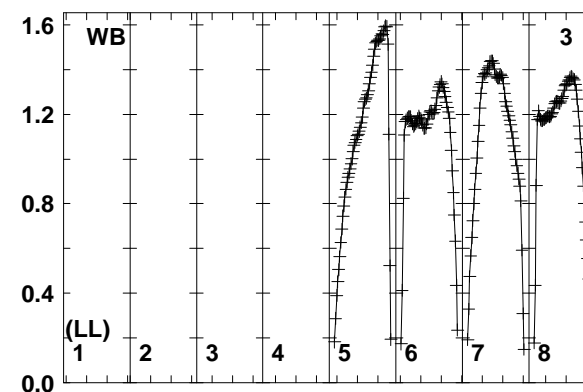
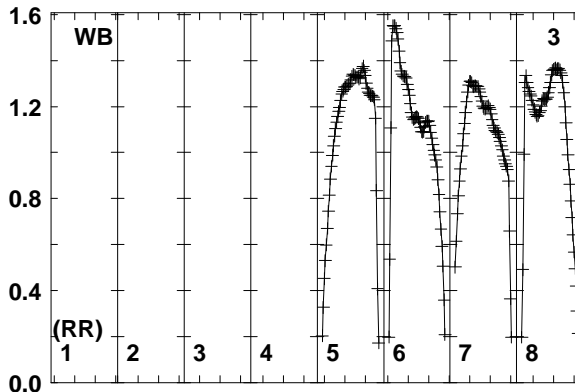
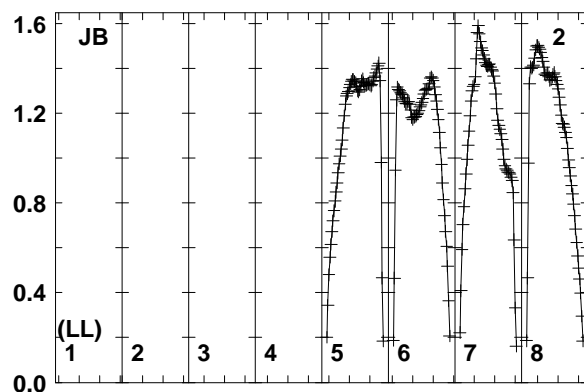
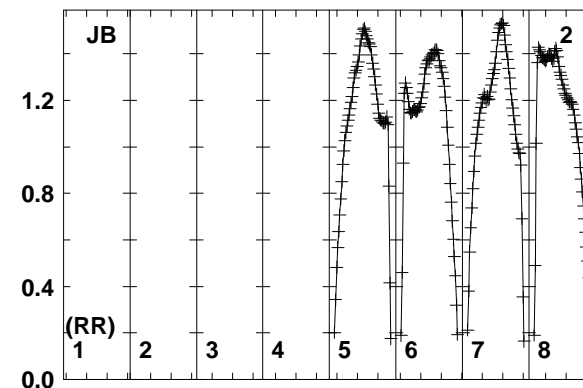
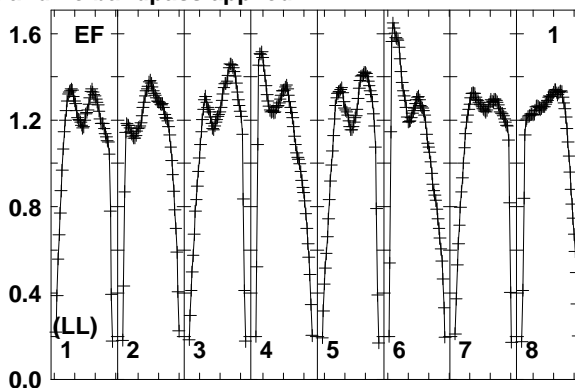
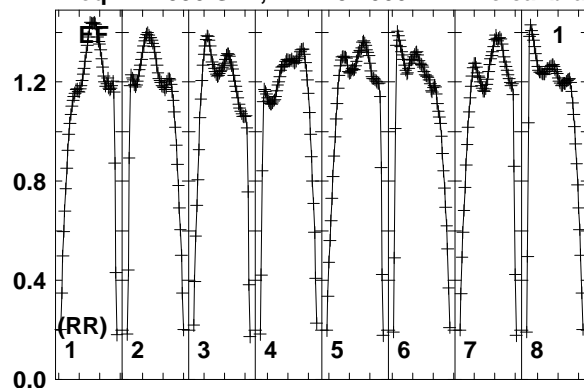

Lower frame: Real Jy
Total-power spectrum Antenna: EF (01)
Timerange: 00/23:53:40 to 00/23:57:09

Plot file version 67 created 23-NOV-2017 14:36:16

J0844+4628 RSM01.UVDATA.1

Freq = 4.7990 GHz, Bw = 32.000 MH No calibration applied and no bandpass applied

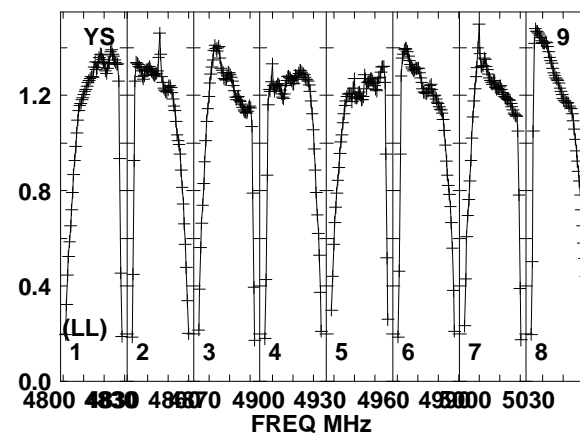
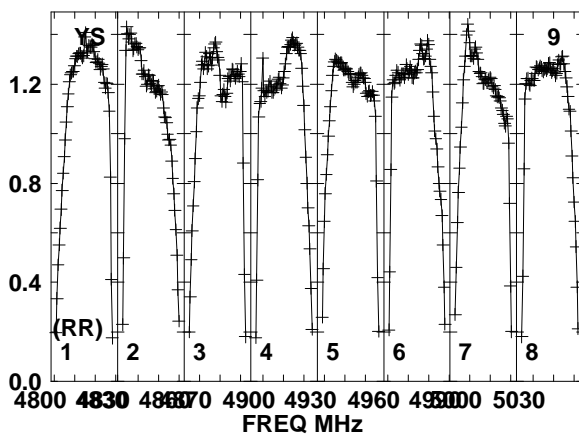
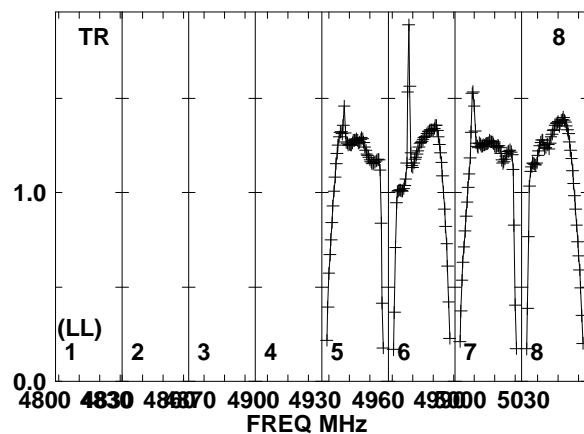
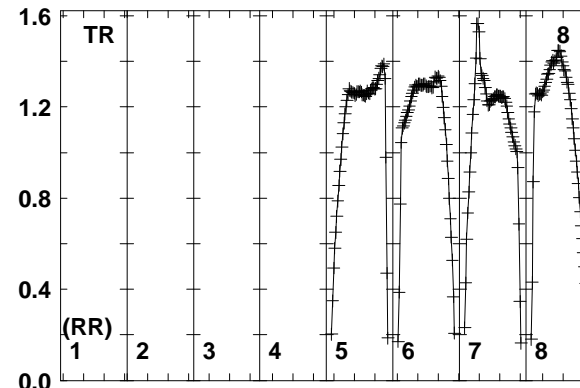
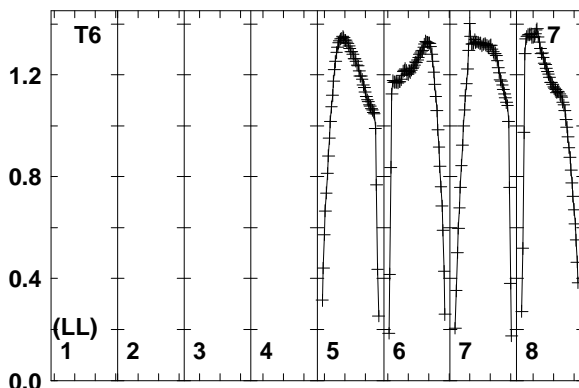
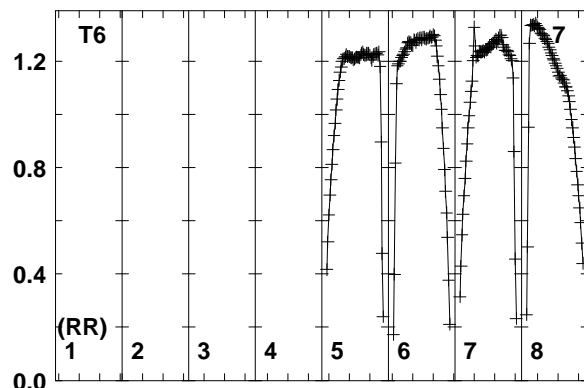
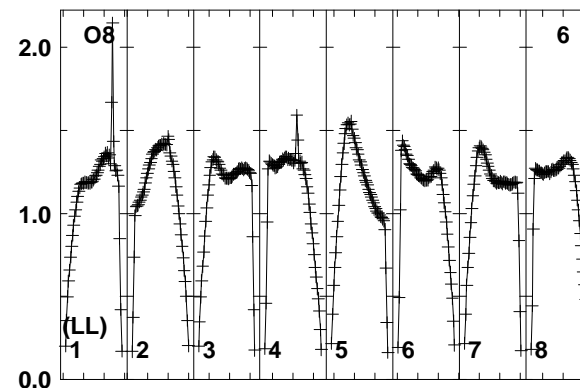
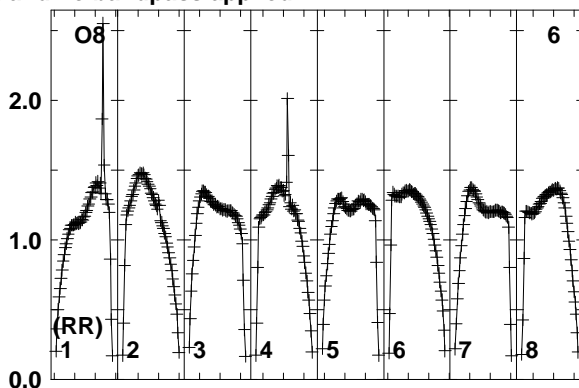
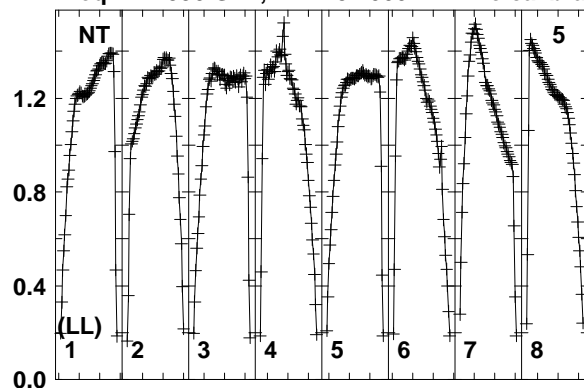

Lower frame: Real Jy
Total-power spectrum Antenna: NT (05)
Timerange: 00/23:53:40 to 00/23:57:09

Plot file version 68 created 23-NOV-2017 14:36:16
J0844+4628 RSM01.UVDATA.1
Freq = 4.7990 GHz, Bw = 32.000 MH No calibration applied and no bandpass applied

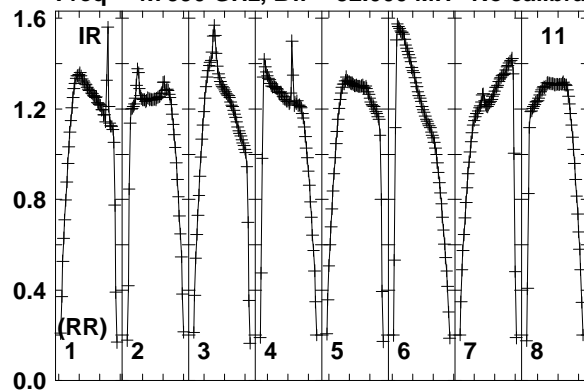

Lower frame: Real Jy
Total-power spectrum Antenna: IR (11)
Timerange: 00/23:53:40 to 00/23:57:09

Plot file version 69 created 23-NOV-2017 14:36:16

J0847+4609 RSM01.UVDATA.1

Freq = 4.7990 GHz, Bw = 32.000 MH No calibration applied and no bandpass applied

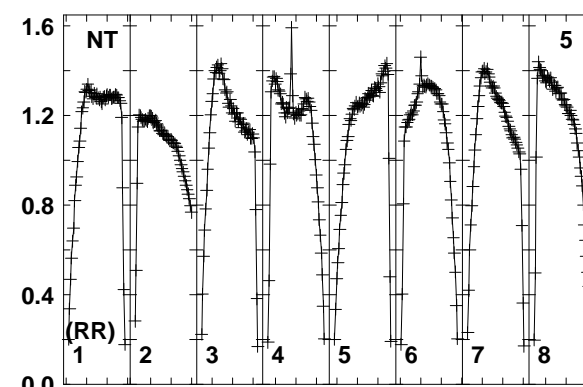
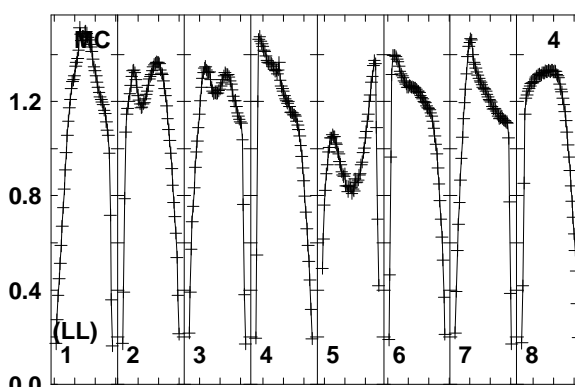
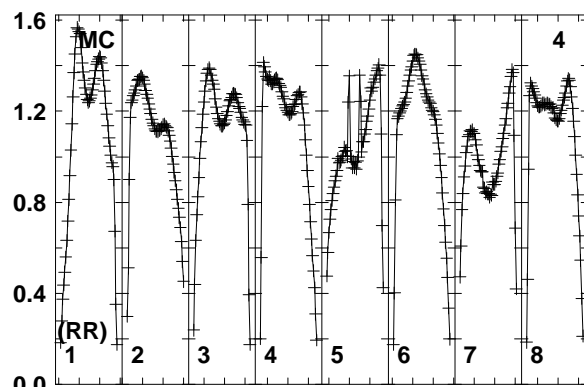
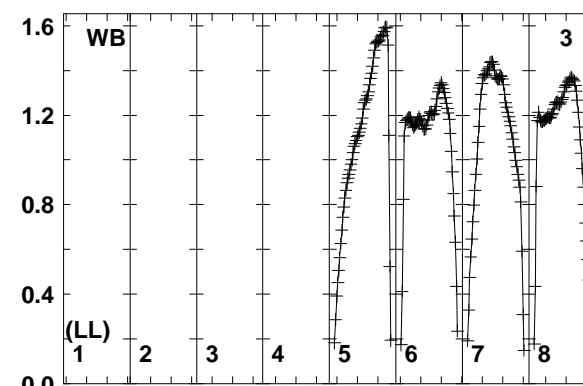
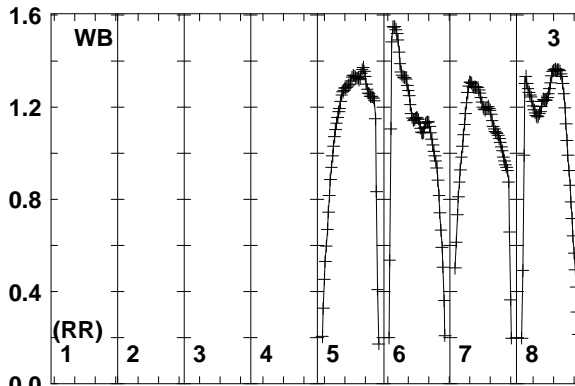
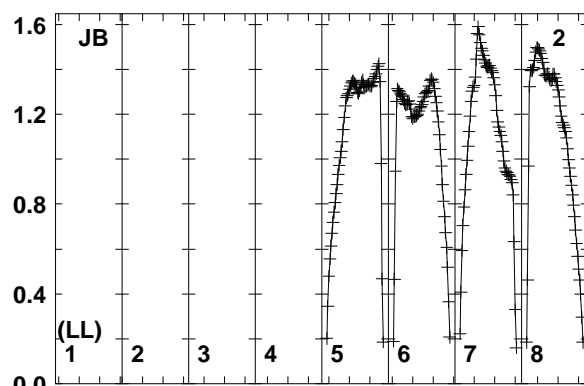
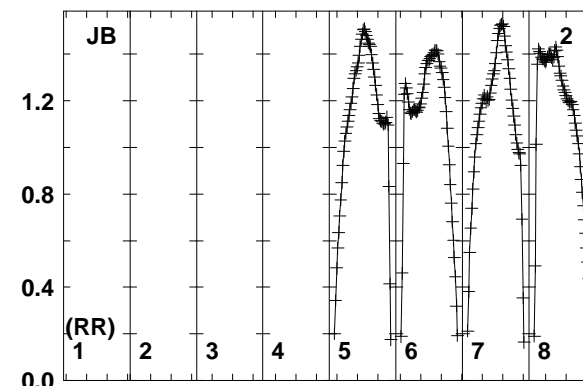
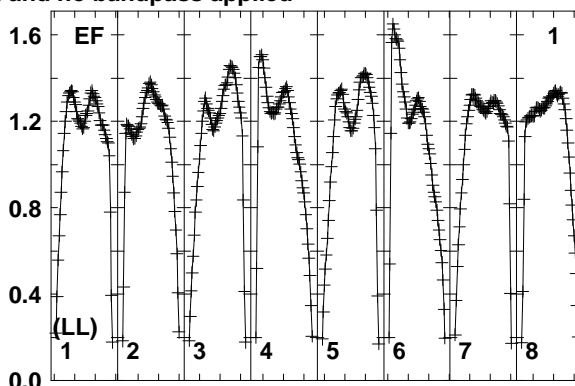
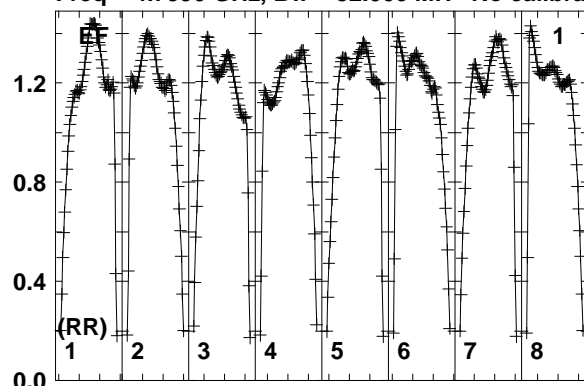

4800 4830 4860 4890 4900 4930 4960 4990 5000 5030
FREQ MHz
Lower frame: Real Jy
Total-power spectrum Antenna: EF (01)
Timerange: 00/23:57:50 to 00/23:58:49

4800 4830 4860 4890 4900 4930 4960 4990 5000 5030
FREQ MHz

4800 4830 4860 4890 4900 4930 4960 4990 5000 5030
FREQ MHz

Plot file version 70 created 23-NOV-2017 14:36:16

J0847+4609 RSM01.UVDATA.1

Freq = 4.7990 GHz, Bw = 32.000 MH No calibration applied and no bandpass applied

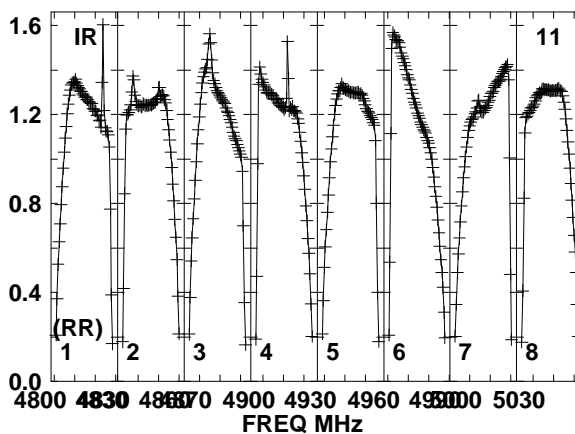
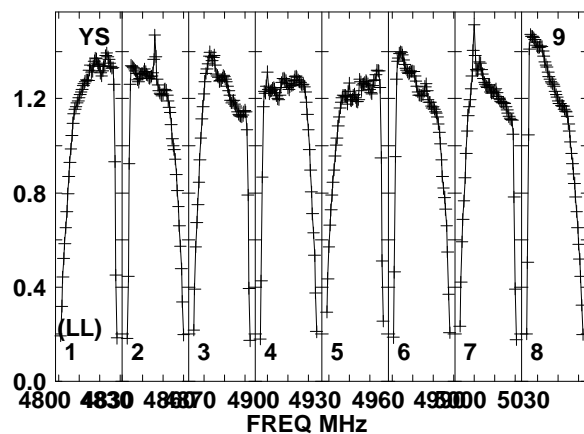
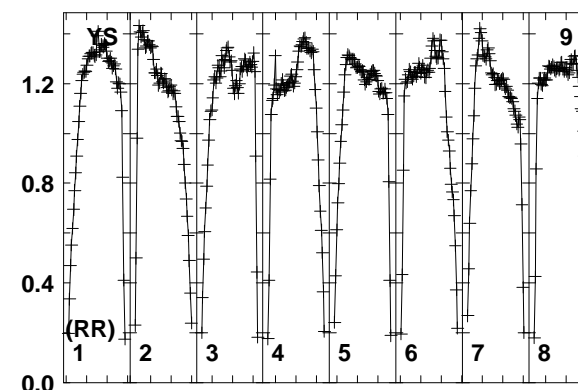
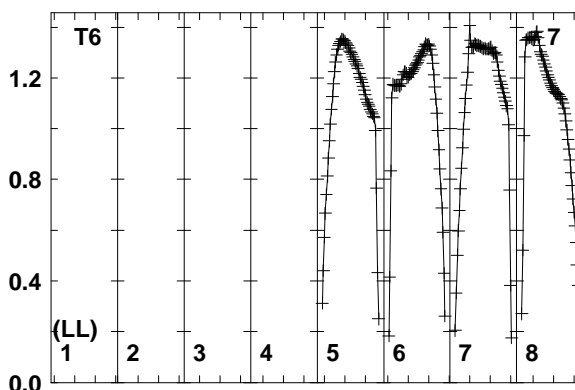
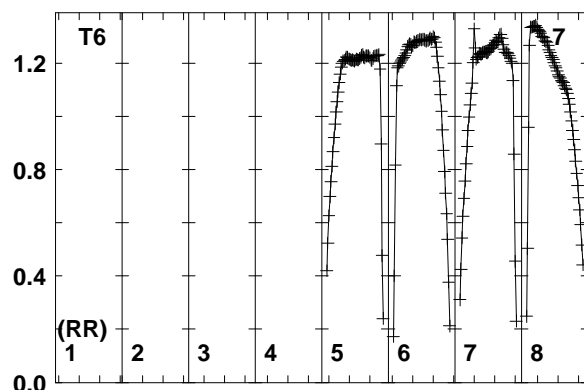
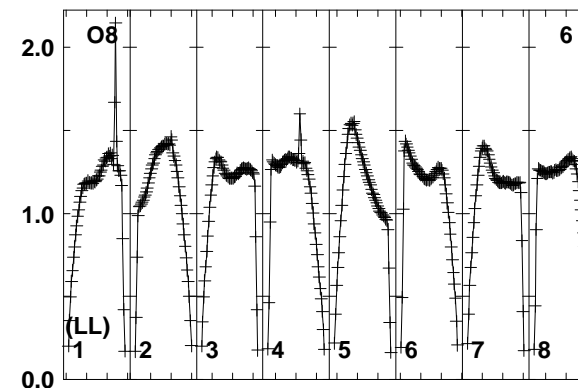
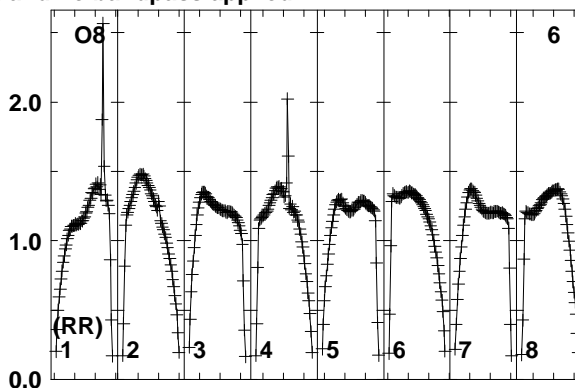
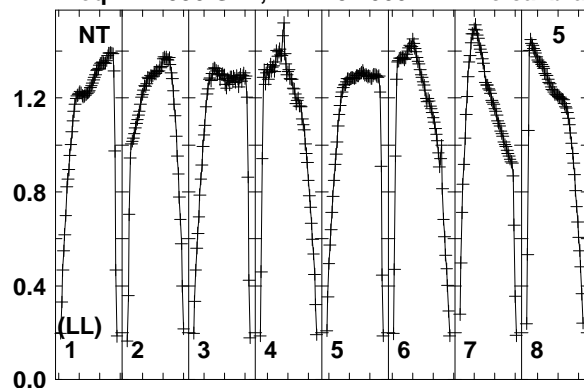

Lower frame: Real Jy
Total-power spectrum Antenna: NT (05)
Timerange: 00/23:57:50 to 00/23:58:49

Plot file version 71 created 23-NOV-2017 14:36:17

J0844+4628 RSM01.UVDATA.1

Freq = 4.7990 GHz, Bw = 32.000 MH No calibration applied and no bandpass applied

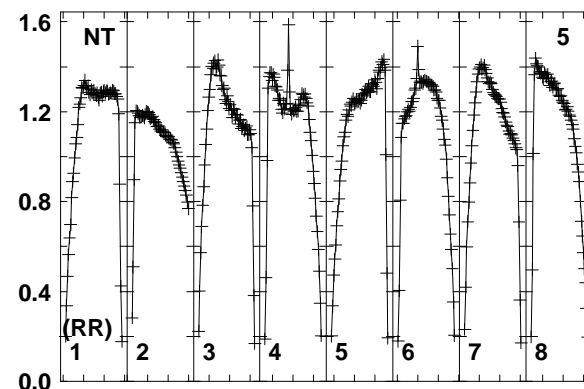
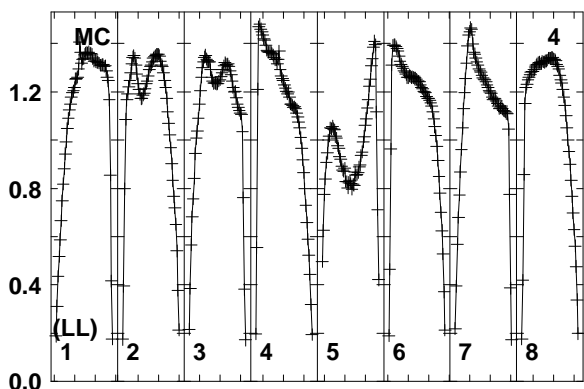
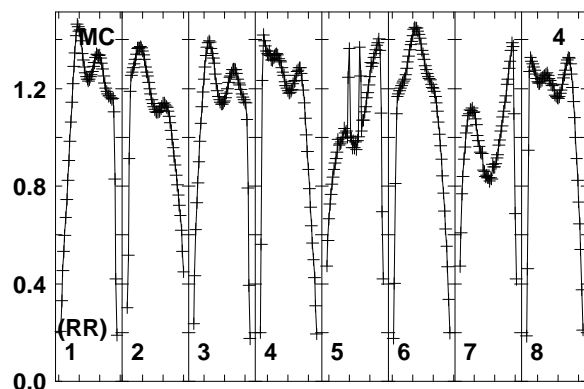
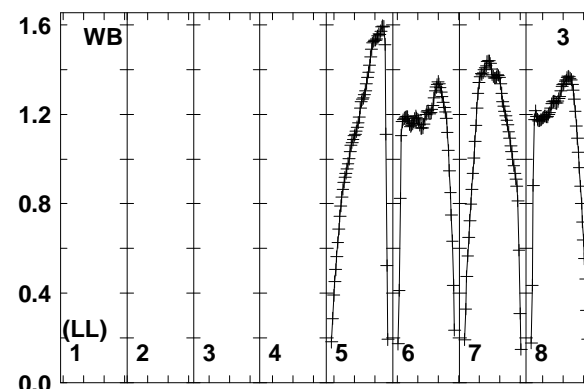
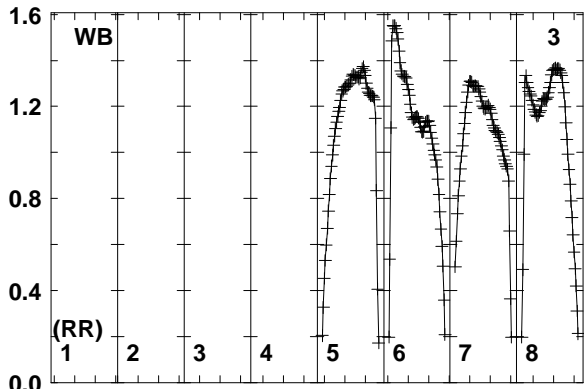
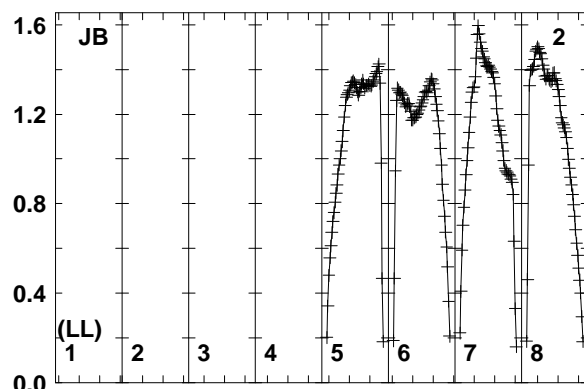
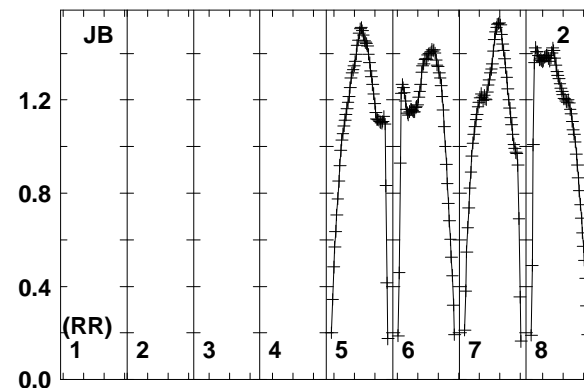
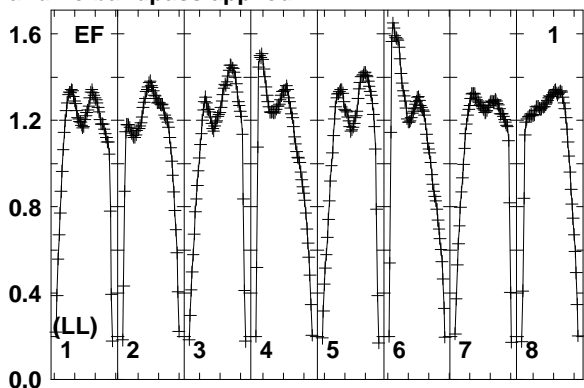
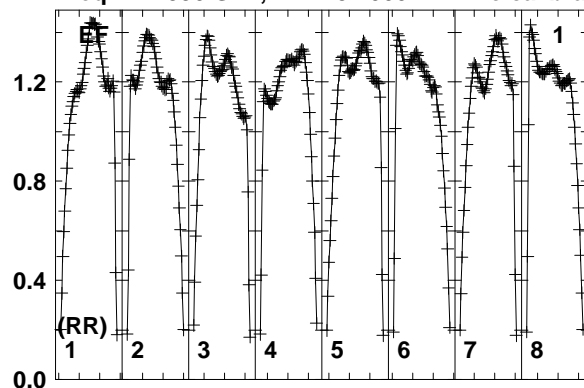

4800 4830 4860 4890 4900 4930 4960 4990 5000 5030
FREQ MHz
Lower frame: Real Jy
Total-power spectrum Antenna: EF (01)
Timerange: 00/23:58:50 to 01/00:02:19

4800 4830 4860 4890 4900 4930 4960 4990 5000 5030
FREQ MHz

4800 4830 4860 4890 4900 4930 4960 4990 5000 5030
FREQ MHz

Plot file version 72 created 23-NOV-2017 14:36:17

J0844+4628 RSM01.UVDATA.1

Freq = 4.7990 GHz, Bw = 32.000 MH No calibration applied and no bandpass applied

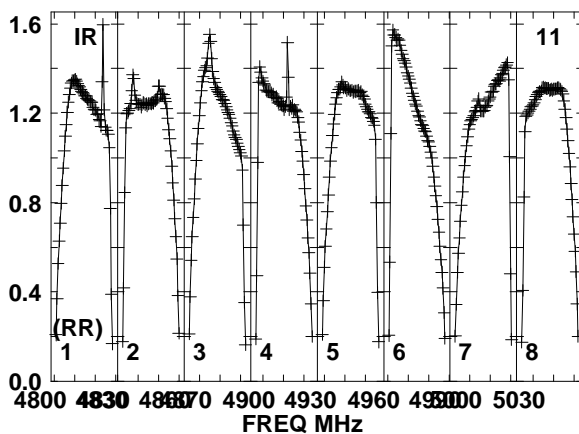
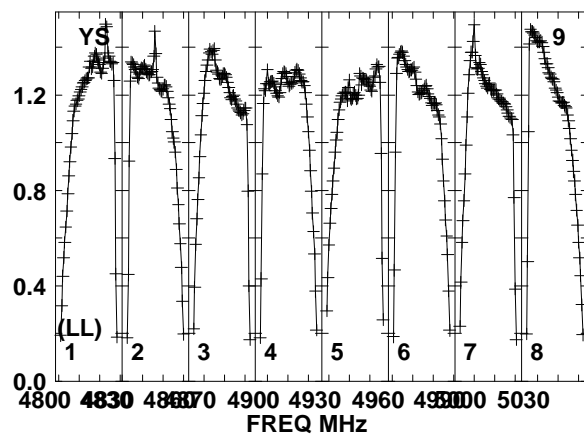
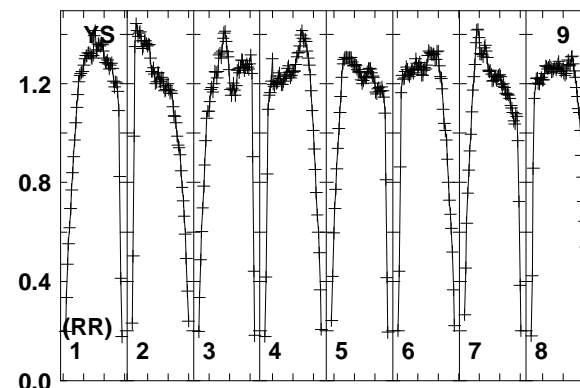
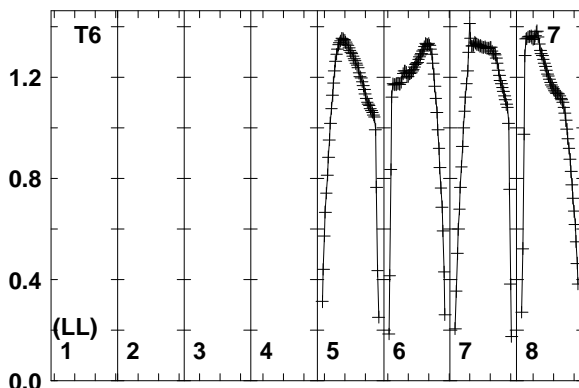
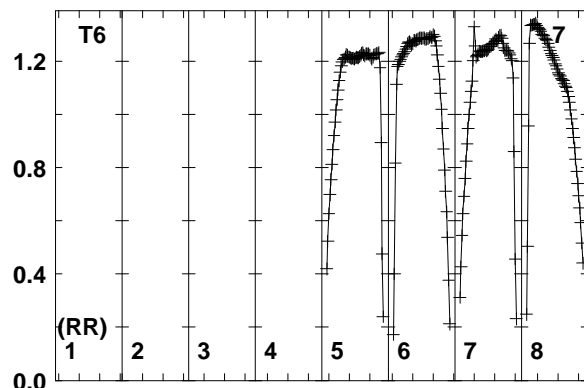
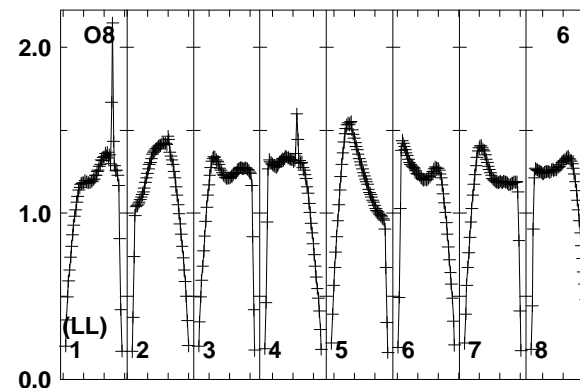
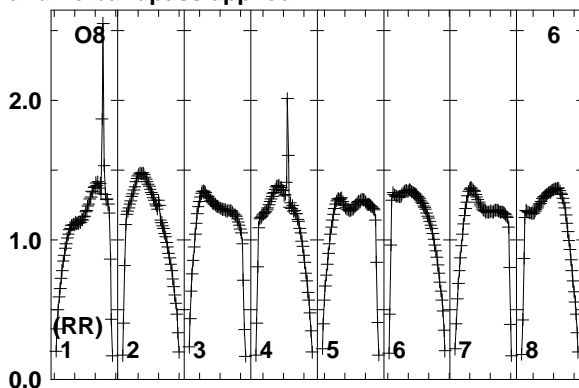
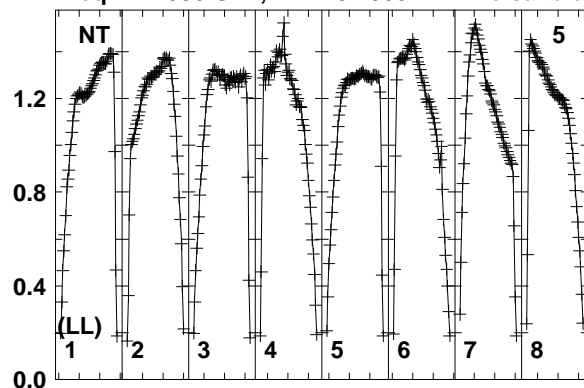

Lower frame: Real Jy
Total-power spectrum Antenna: NT (05)
Timerange: 00/23:58:50 to 01/00:02:19

Plot file version 73 created 23-NOV-2017 14:36:18

J0847+4609 RSM01.UVDATA.1

Freq = 4.7990 GHz, Bw = 32.000 MH No calibration applied and no bandpass applied

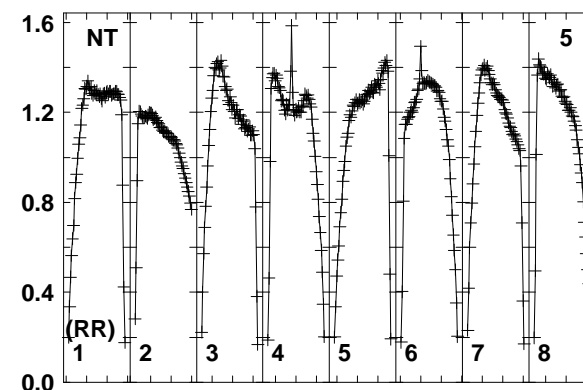
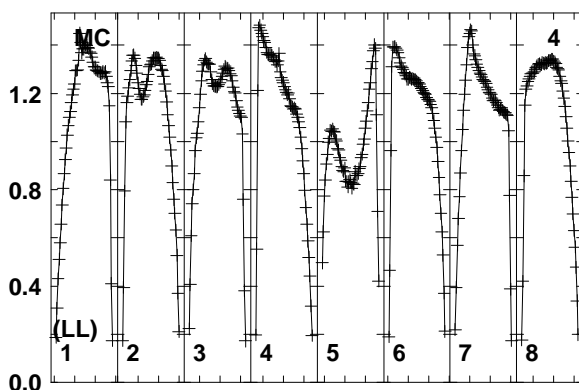
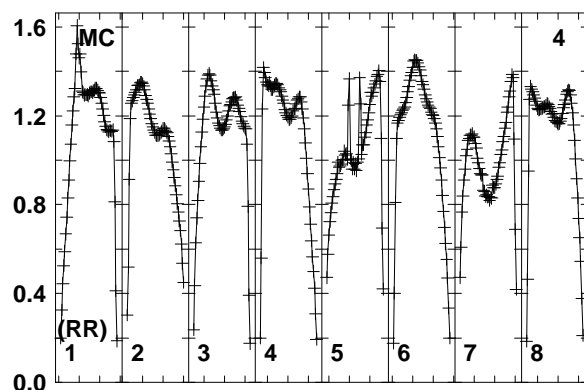
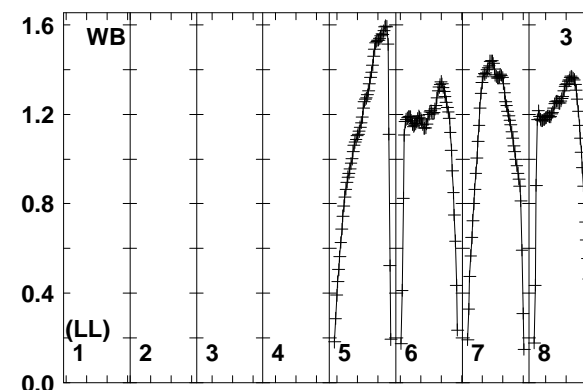
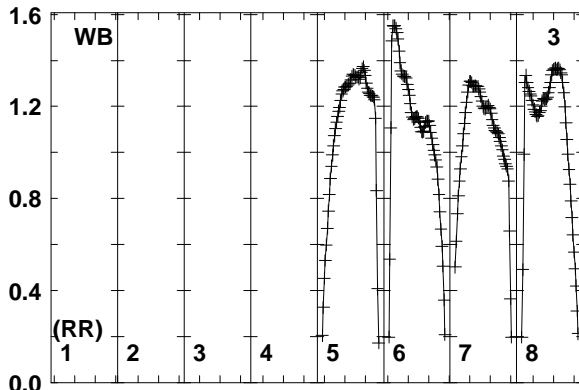
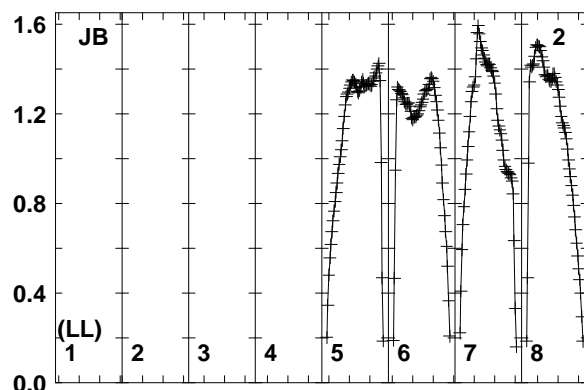
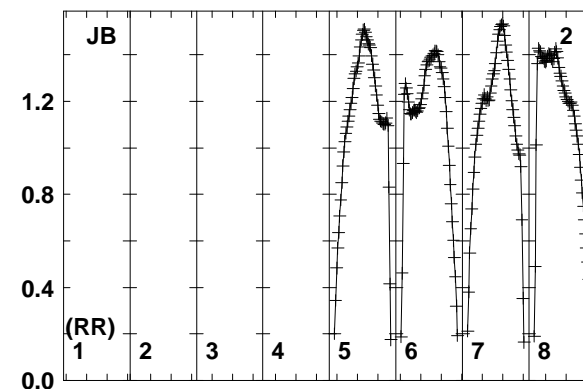
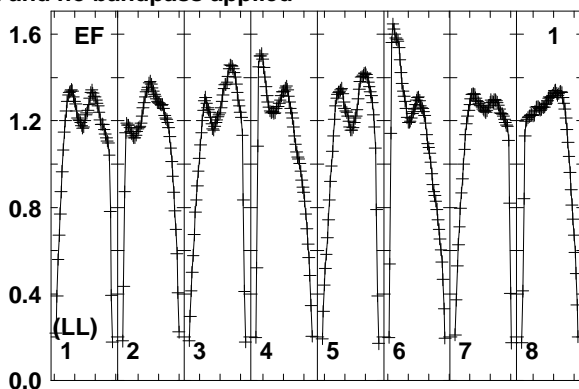
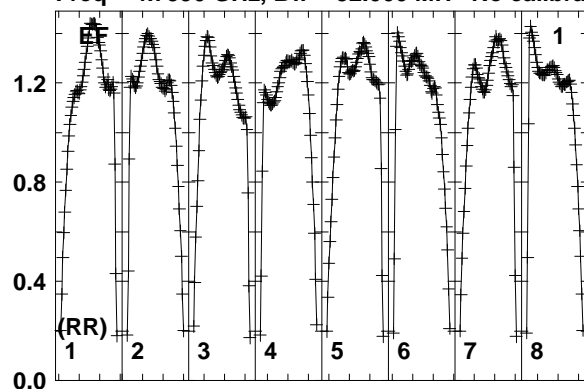

4800 4830 4860 4900 4930 4960 4990 5030
FREQ MHz

4800 4830 4860 4900 4930 4960 4990 5030
FREQ MHz

4800 4830 4860 4900 4930 4960 4990 5030
FREQ MHz

Lower frame: Real Jy
Total-power spectrum Antenna: EF (01)
Timerange: 01/00:02:21 to 01/00:03:49

Plot file version 74 created 23-NOV-2017 14:36:18

J0847+4609 RSM01.UVDATA.1

Freq = 4.7990 GHz, Bw = 32.000 MH No calibration applied and no bandpass applied

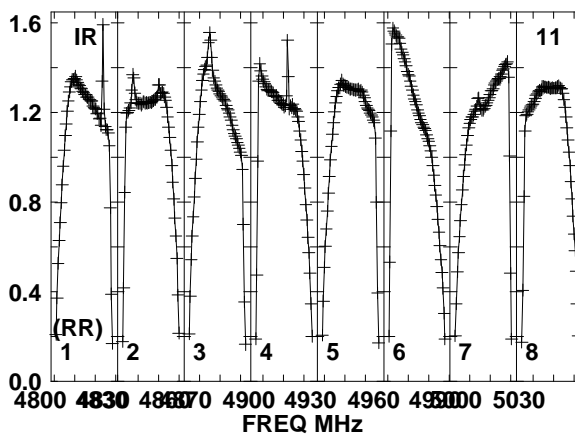
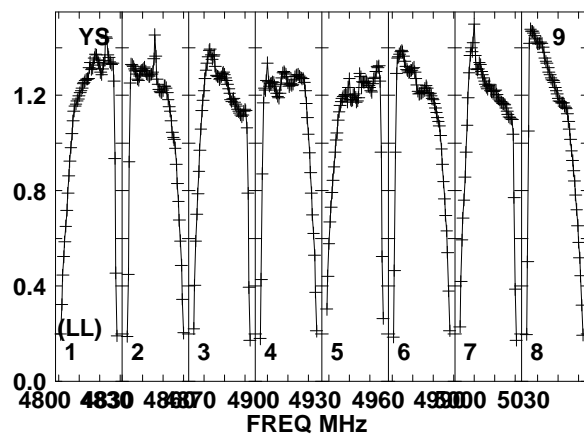
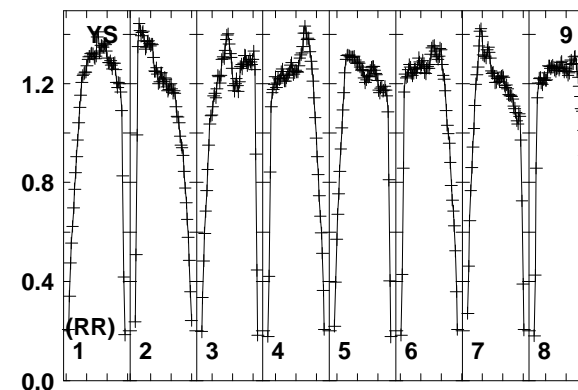
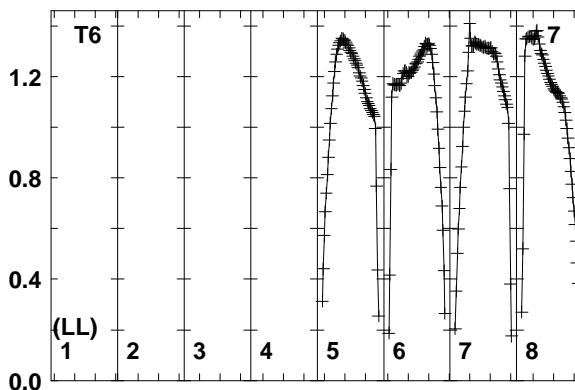
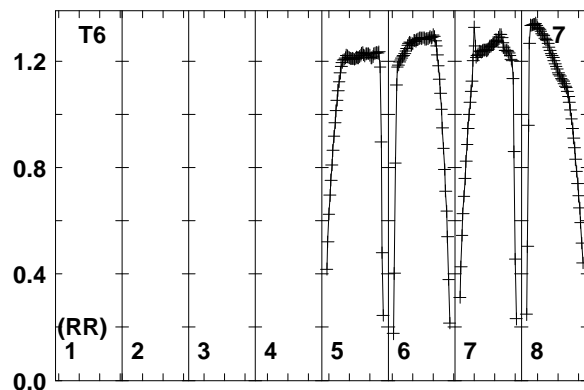
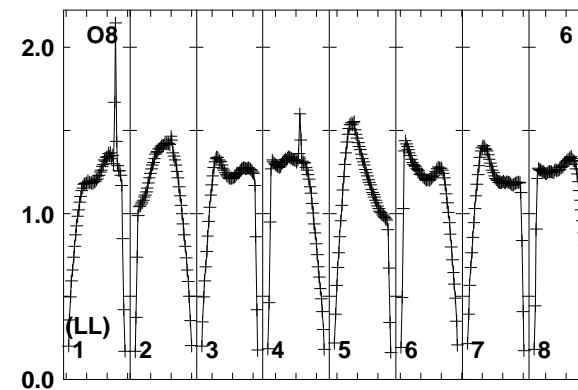
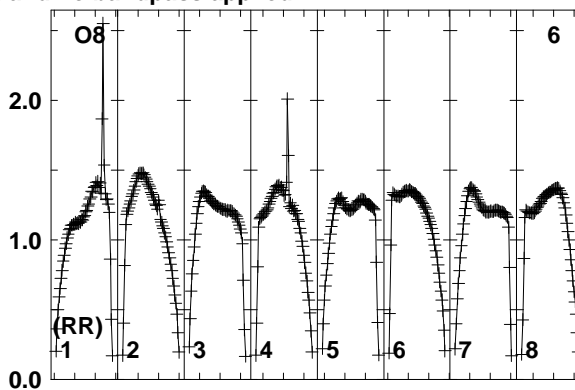
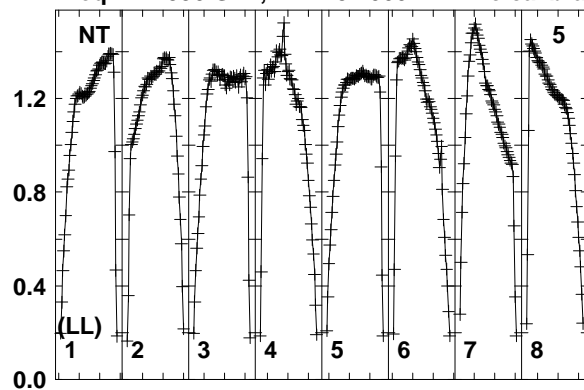

Lower frame: Real Jy
Total-power spectrum Antenna: NT (05)
Timerange: 01/00:02:21 to 01/00:03:49

Plot file version 75 created 23-NOV-2017 14:36:18

J0844+4628 RSM01.UVDATA.1

Freq = 4.7990 GHz, Bw = 32.000 MH No calibration applied and no bandpass applied

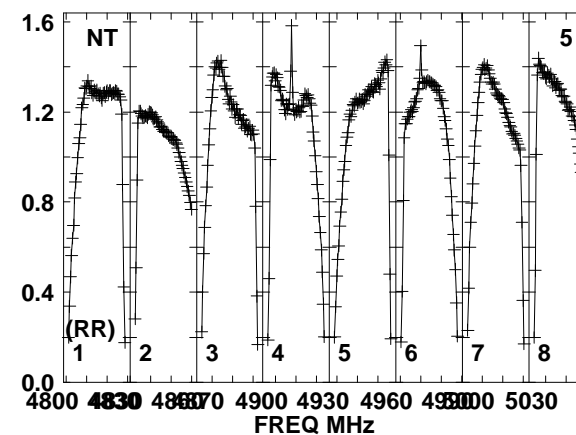
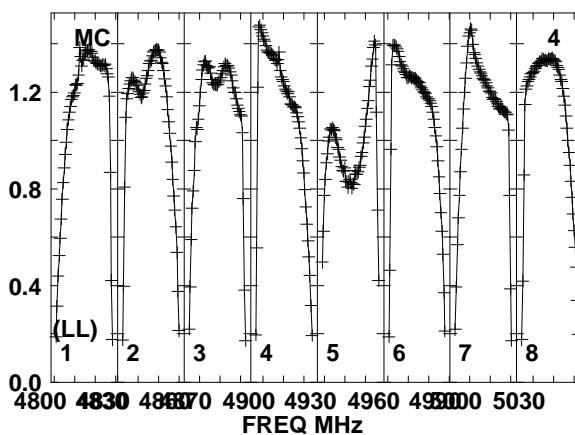
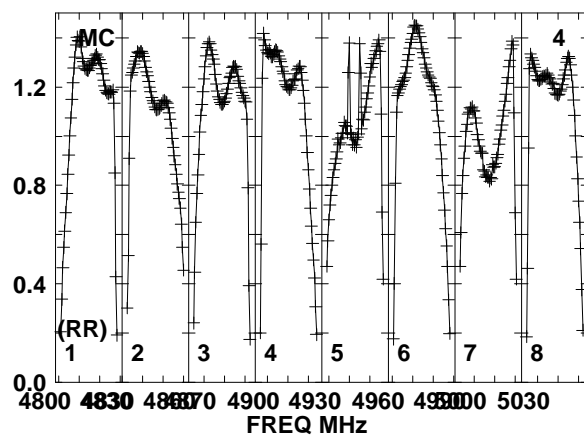
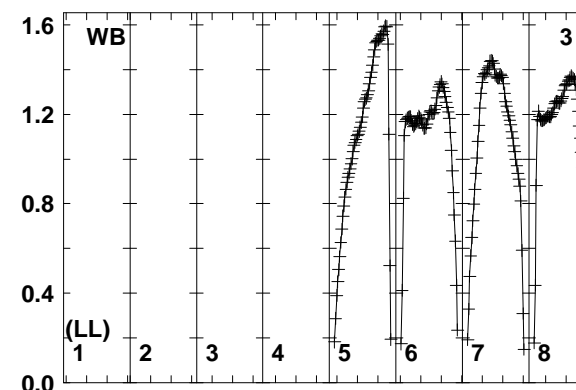
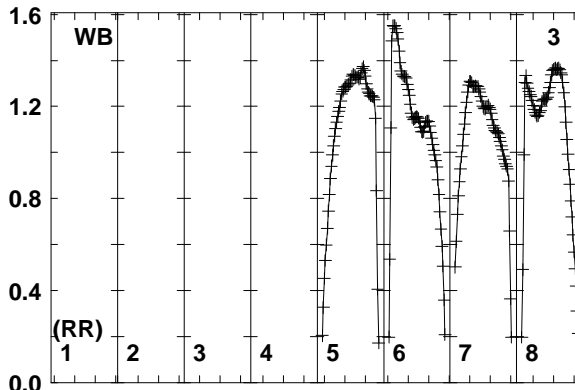
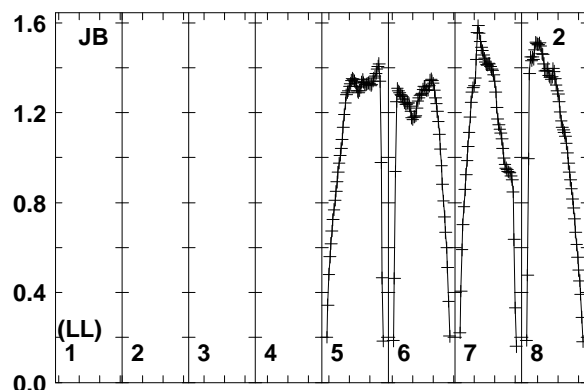
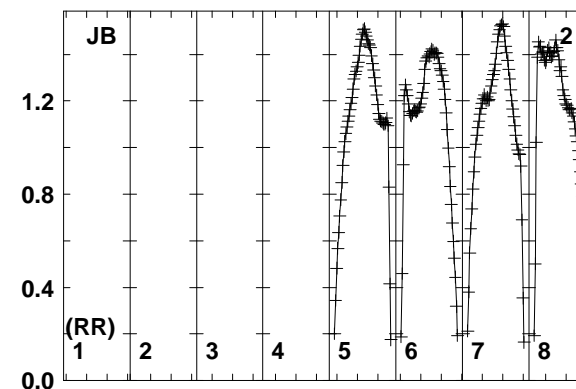
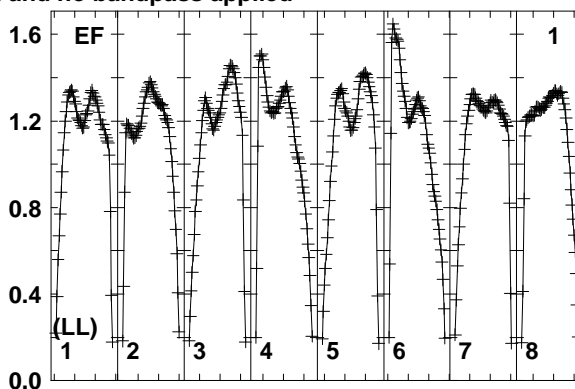
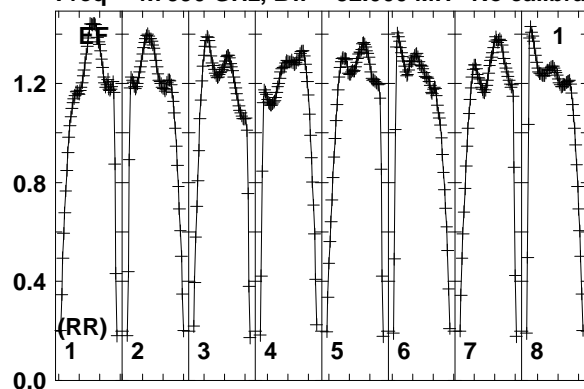

Lower frame: Real Jy
Total-power spectrum Antenna: EF (01)
Timerange: 01/00:03:50 to 01/00:07:19

Plot file version 76 created 23-NOV-2017 14:36:18

J0844+4628 RSM01.UVDATA.1

Freq = 4.7990 GHz, Bw = 32.000 MH No calibration applied and no bandpass applied

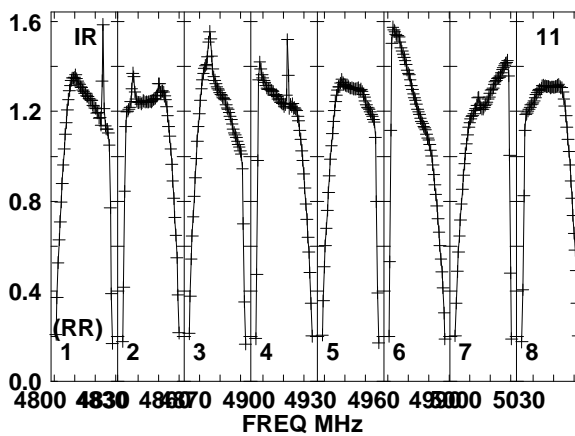
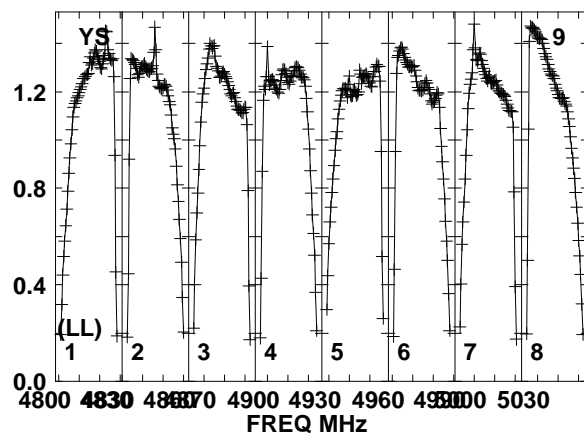
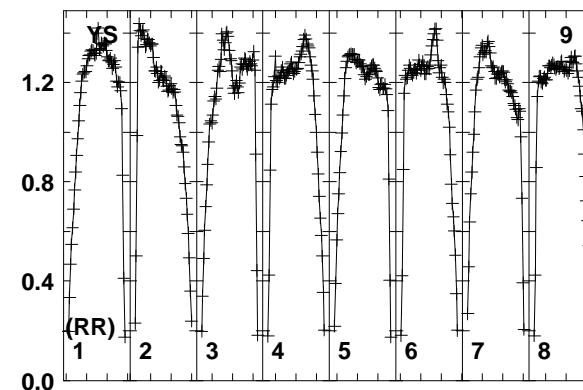
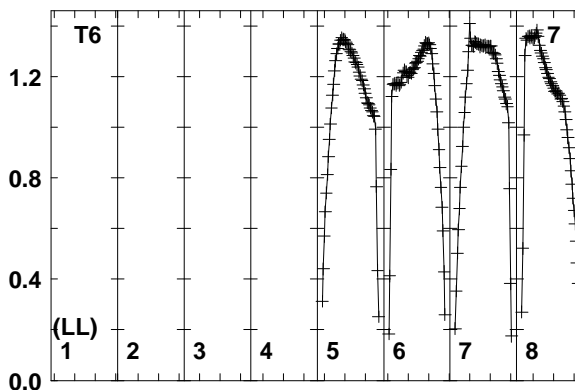
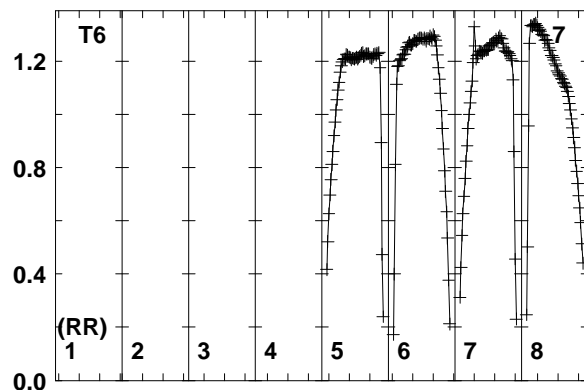
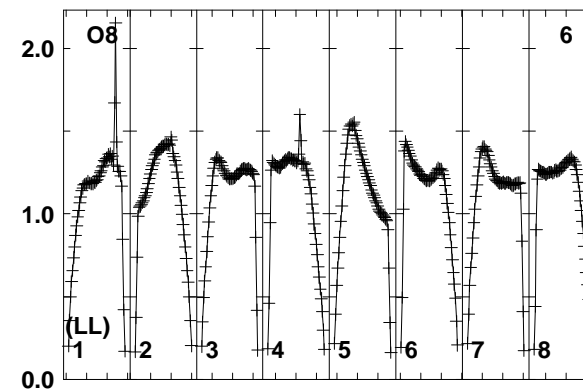
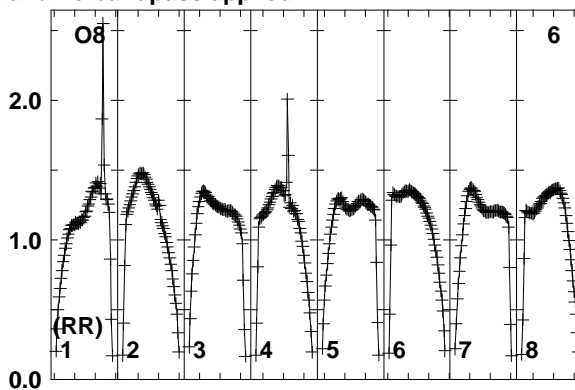
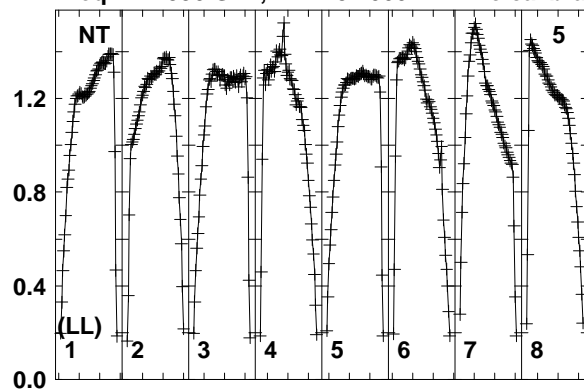

Lower frame: Real Jy
Total-power spectrum Antenna: NT (05)
Timerange: 01/00:03:50 to 01/00:07:19

Plot file version 77 created 23-NOV-2017 14:36:19

J0847+4609 RSM01.UVDATA.1

Freq = 4.7990 GHz, Bw = 32.000 MH No calibration applied and no bandpass applied

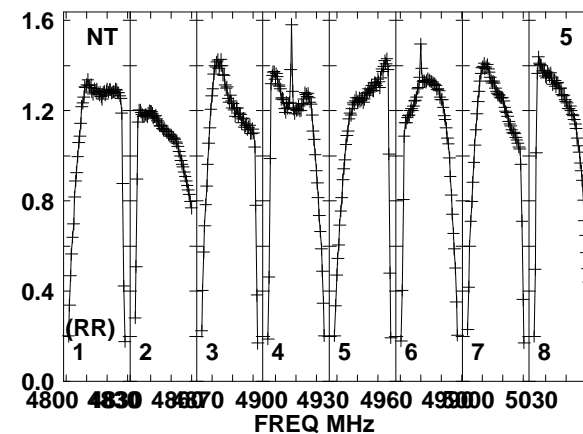
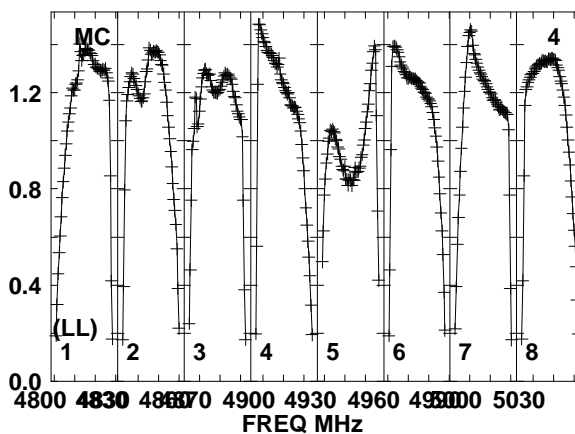
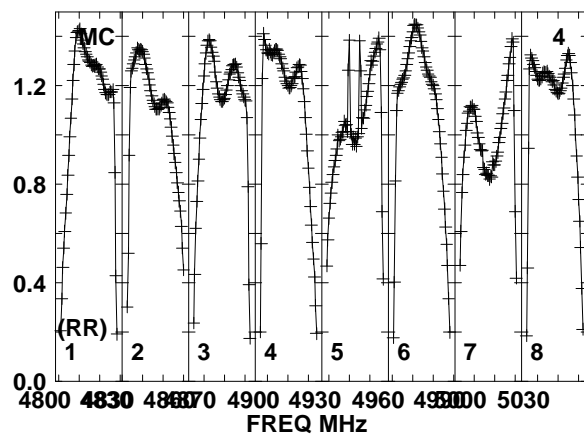
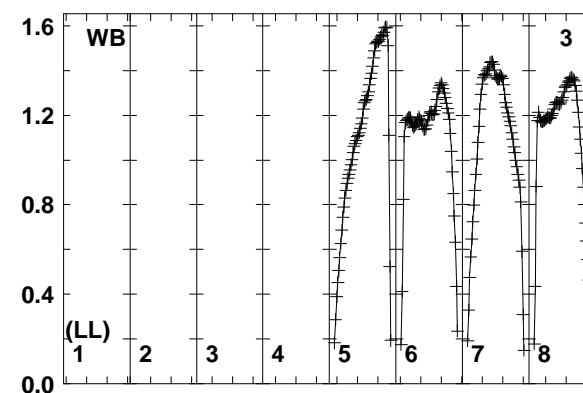
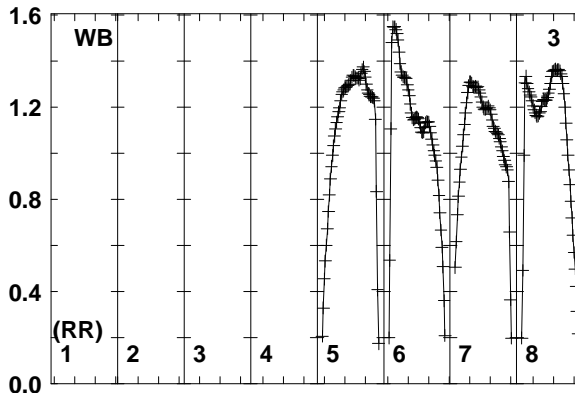
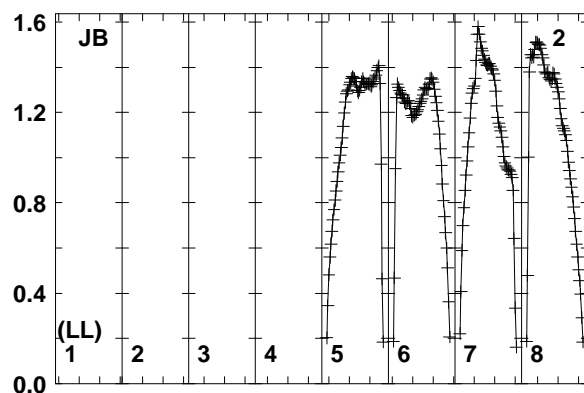
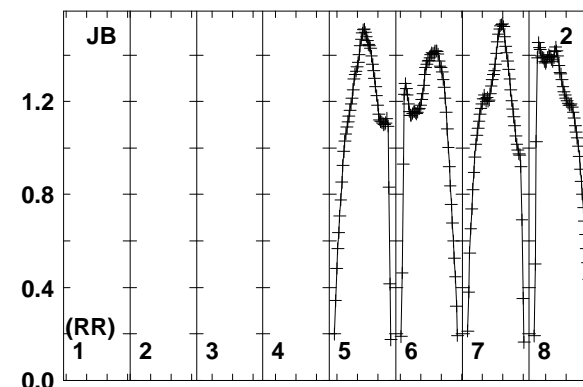
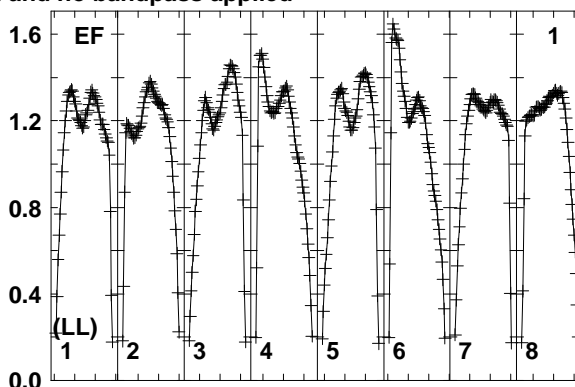
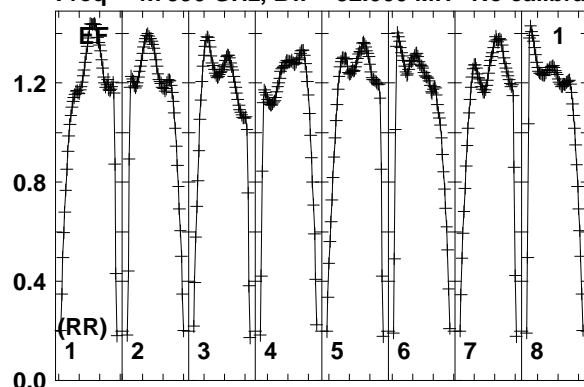

Lower frame: Real Jy
Total-power spectrum Antenna: EF (01)
Timerange: 01/00:08:01 to 01/00:08:59

Plot file version 78 created 23-NOV-2017 14:36:19

J0847+4609 RSM01.UVDATA.1

Freq = 4.7990 GHz, Bw = 32.000 MH No calibration applied and no bandpass applied

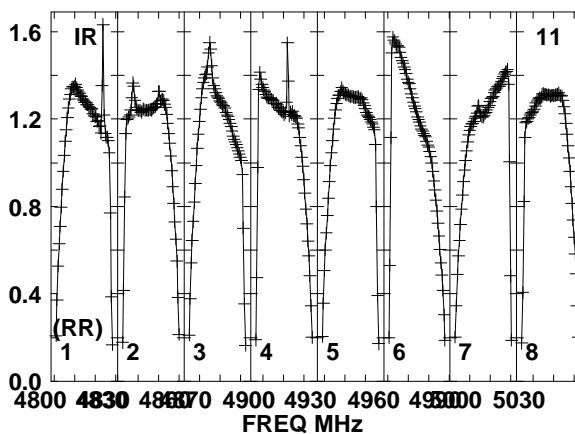
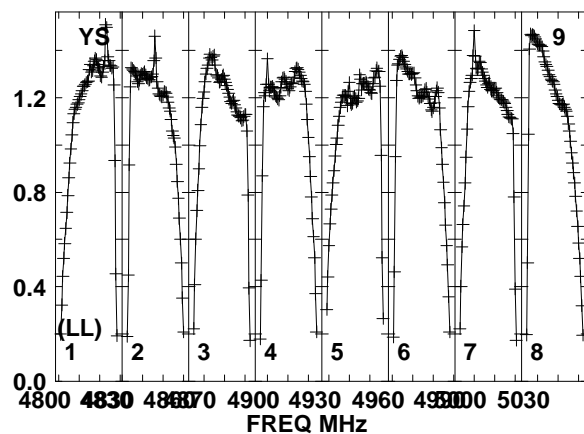
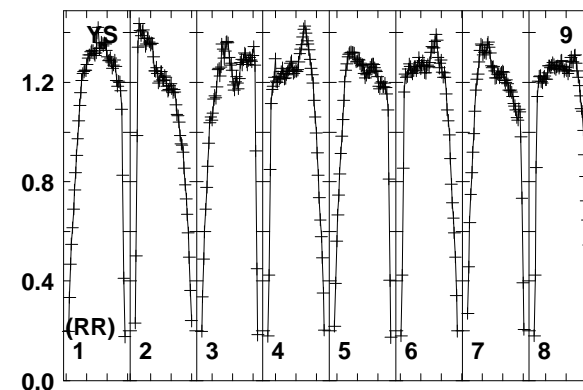
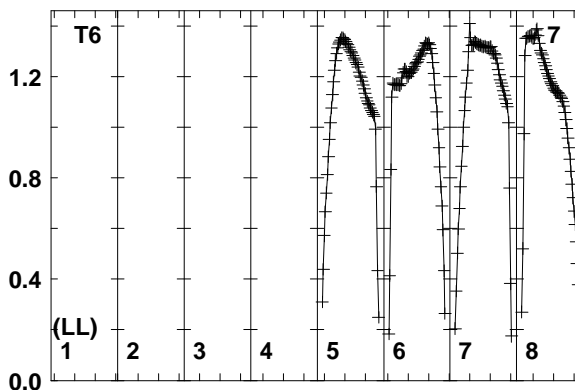
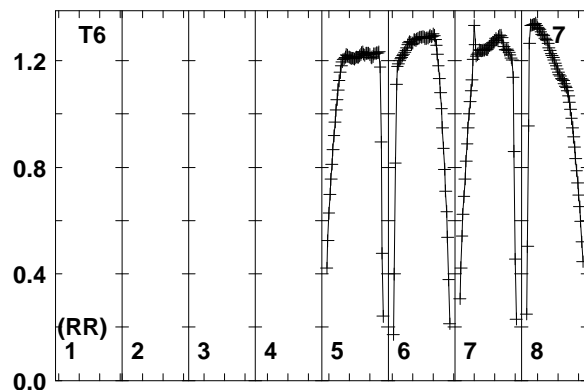
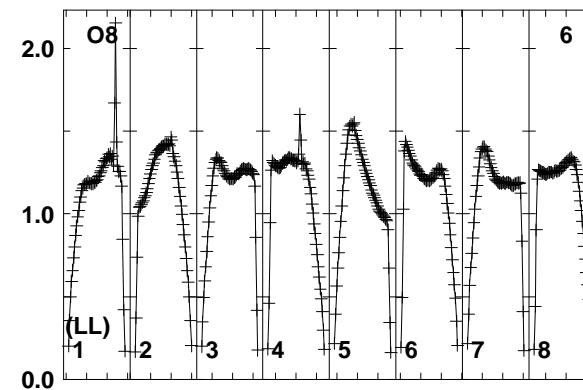
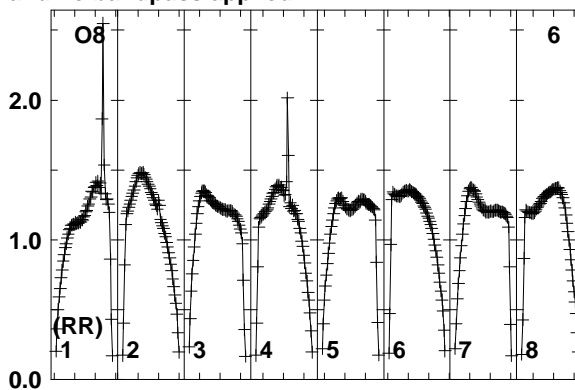
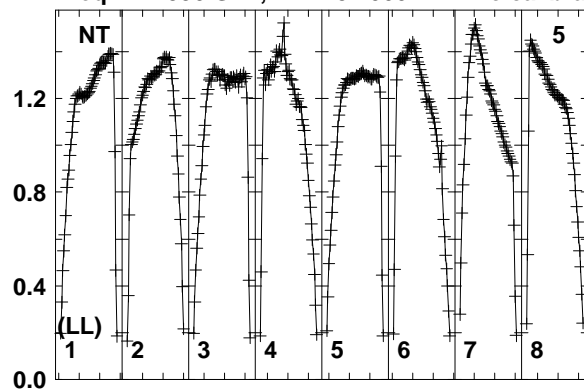

Lower frame: Real Jy
Total-power spectrum Antenna: NT (05)
Timerange: 01/00:08:01 to 01/00:08:59

Plot file version 79 created 23-NOV-2017 14:36:19

J0844+4628 RSM01.UVDATA.1

Freq = 4.7990 GHz, Bw = 32.000 MH No calibration applied and no bandpass applied

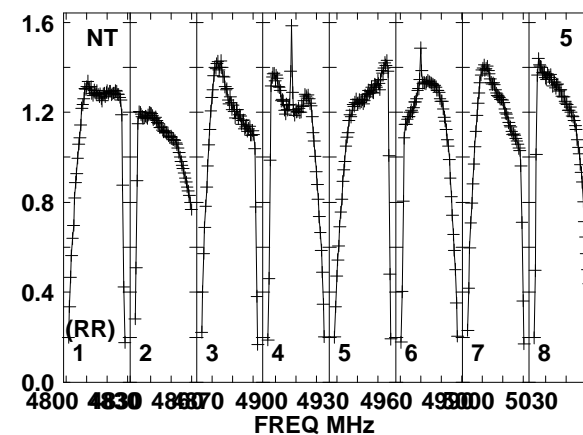
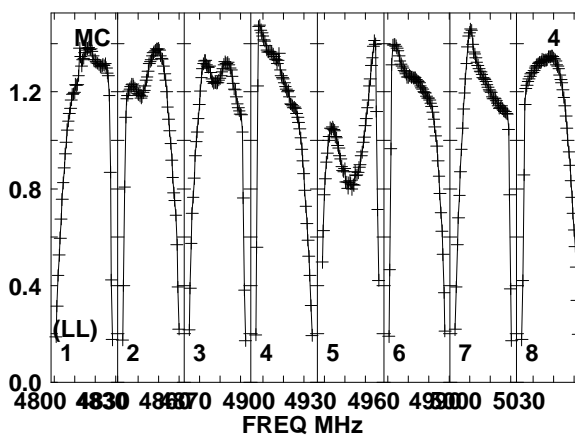
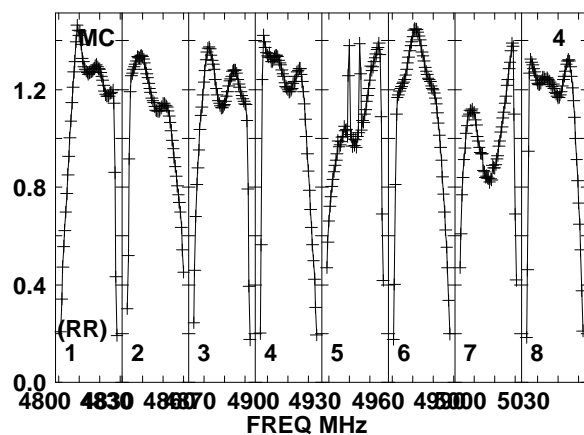
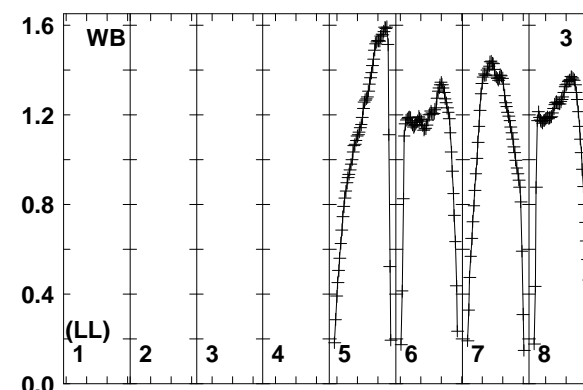
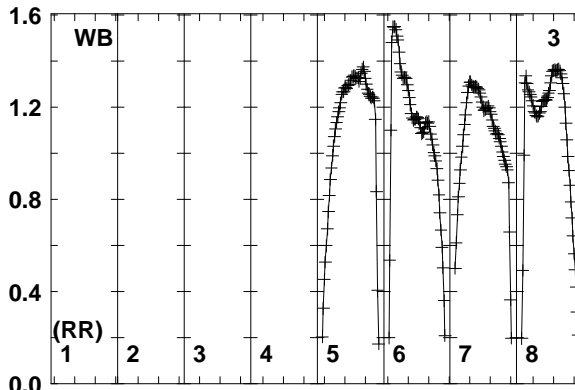
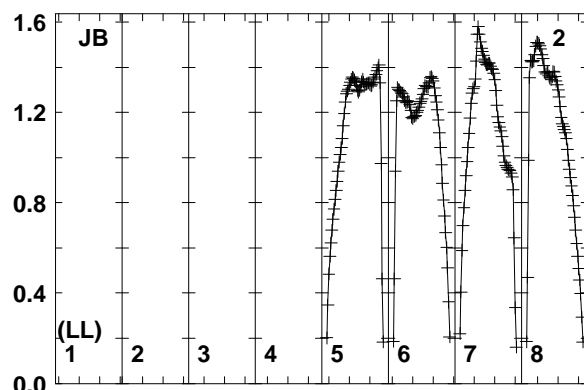
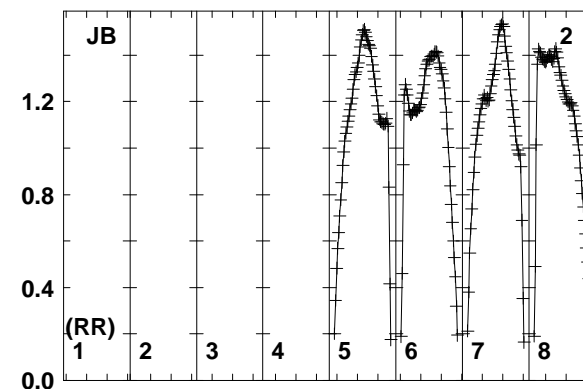
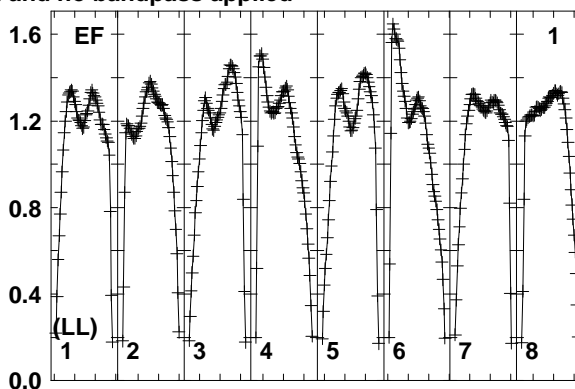
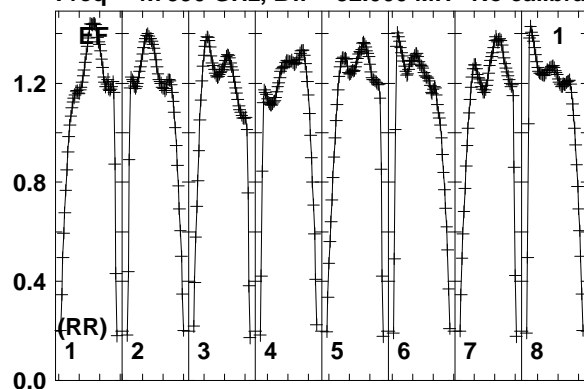

Lower frame: Real Jy
Total-power spectrum Antenna: EF (01)
Timerange: 01/00:09:00 to 01/00:12:29

Plot file version 80 created 23-NOV-2017 14:36:19

J0844+4628 RSM01.UVDATA.1

Freq = 4.7990 GHz, Bw = 32.000 MH No calibration applied and no bandpass applied

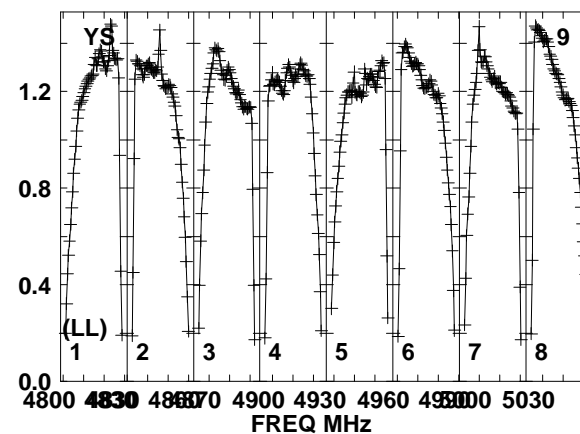
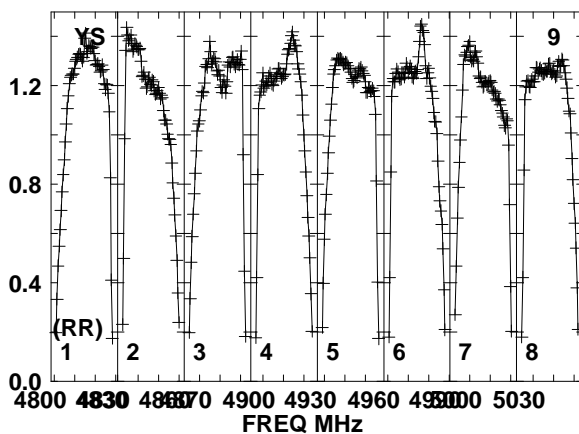
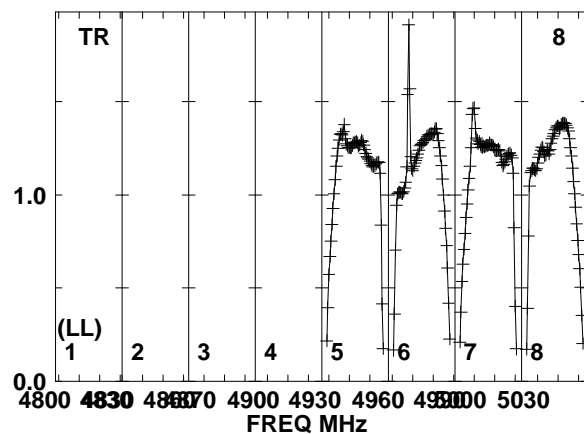
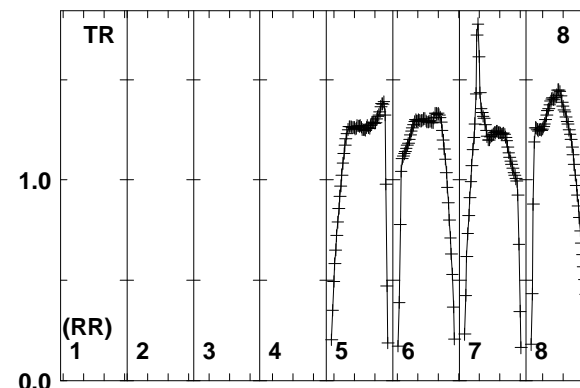
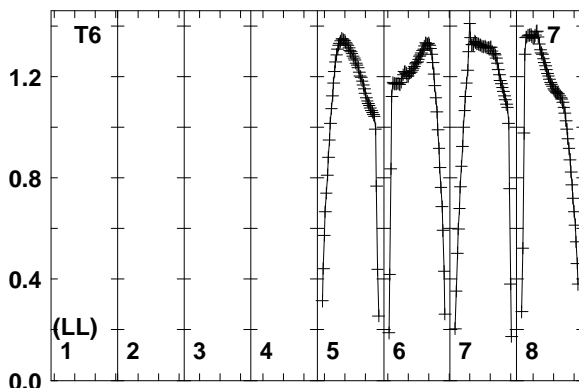
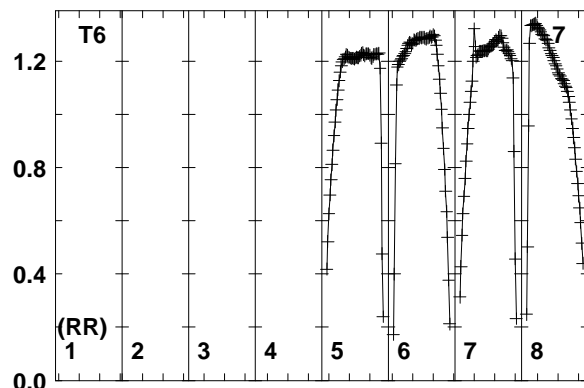
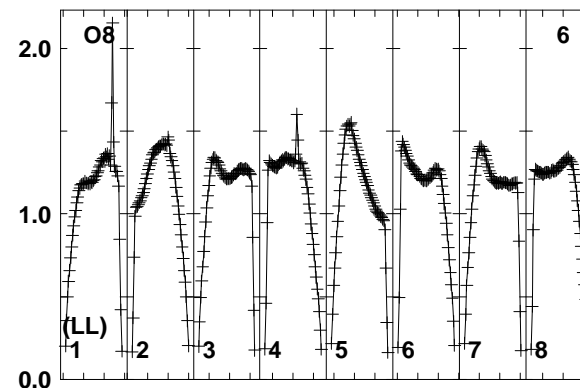
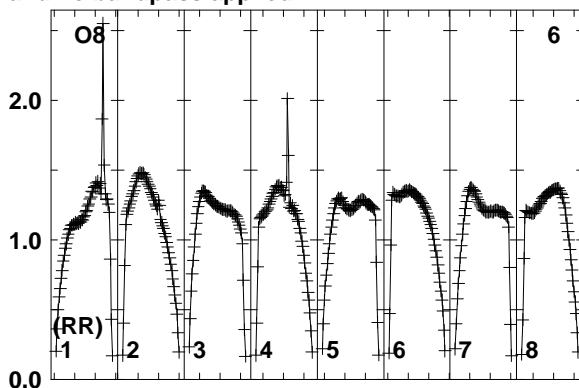
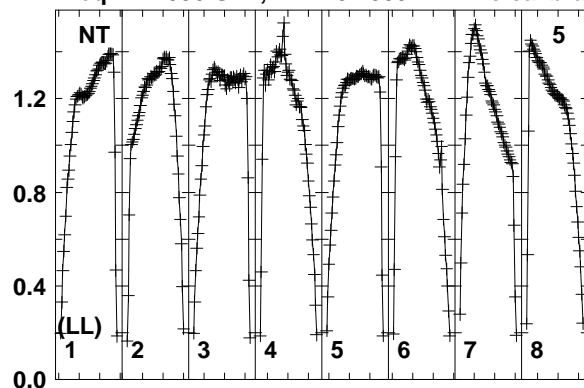

Lower frame: Real Jy
Total-power spectrum Antenna: NT (05)
Timerange: 01/00:09:00 to 01/00:12:29

Plot file version 81 created 23-NOV-2017 14:36:20

J0844+4628 RSM01.UVDATA.1

Freq = 4.7990 GHz, Bw = 32.000 MH No calibration applied and no bandpass applied

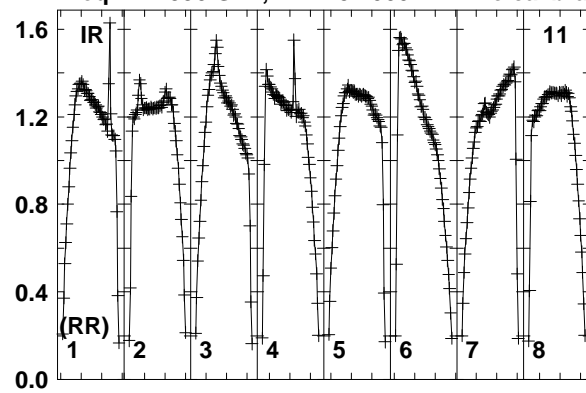

Lower frame: Real Jy

Total-power spectrum Antenna: IR (11)

Timerange: 01/00:09:00 to 01/00:12:29

Plot file version 82 created 23-NOV-2017 14:36:20

J0847+4609 RSM01.UVDATA.1

Freq = 4.7990 GHz, Bw = 32.000 MH No calibration applied and no bandpass applied

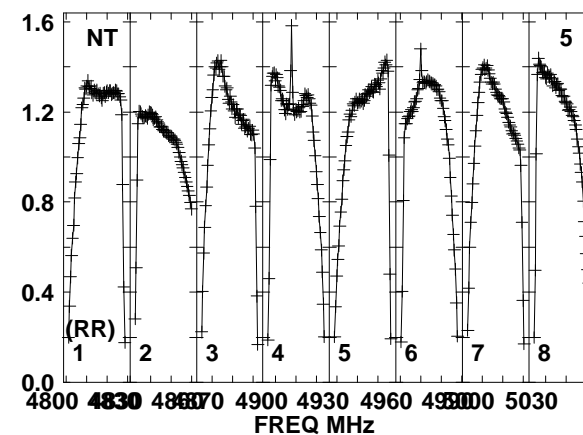
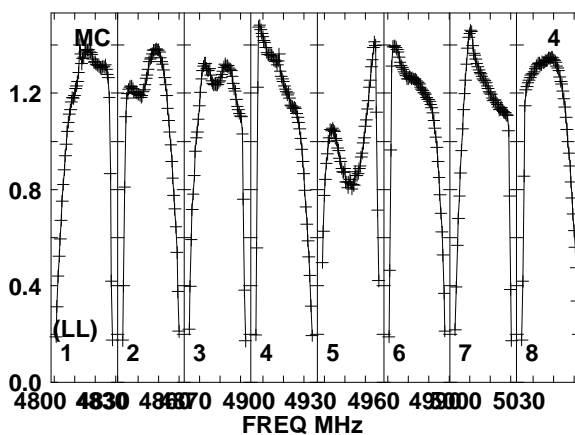
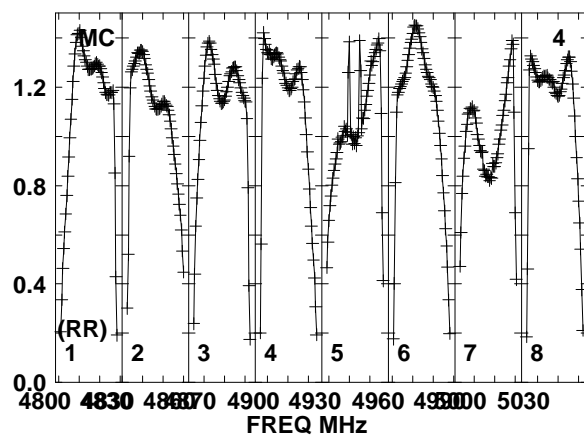
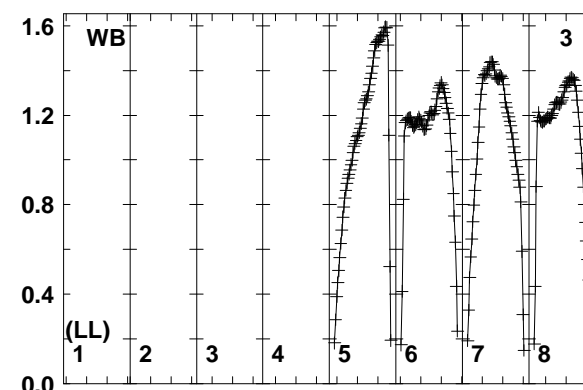
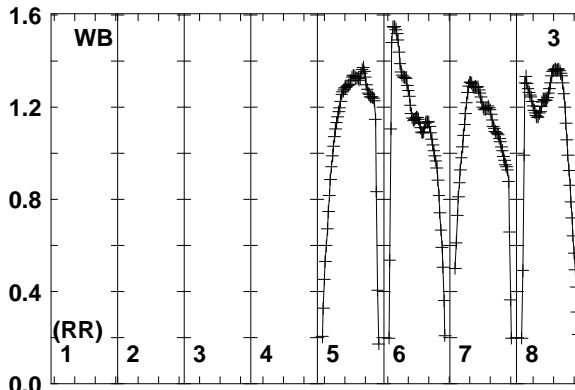
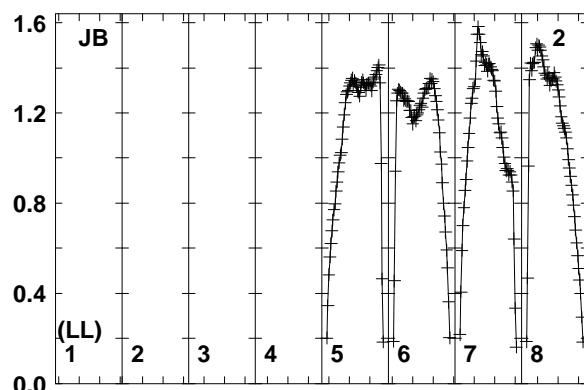
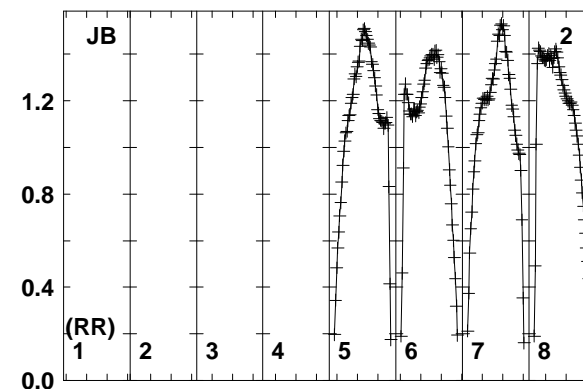
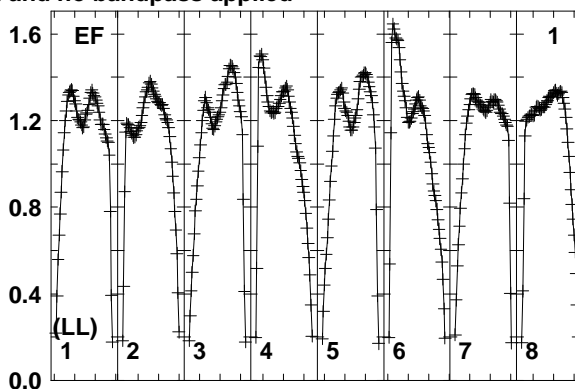
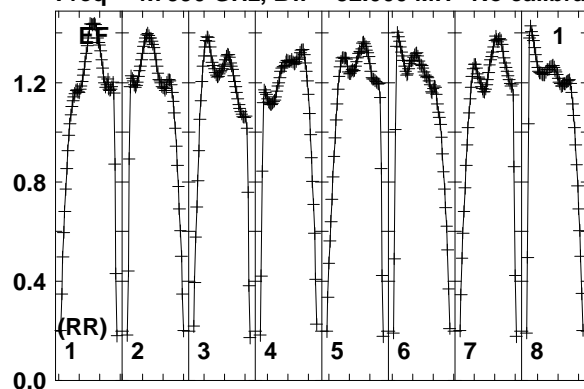

Lower frame: Real Jy
Total-power spectrum Antenna: EF (01)
Timerange: 01/00:12:30 to 01/00:13:59

Plot file version 83 created 23-NOV-2017 14:36:20

J0847+4609 RSM01.UVDATA.1

Freq = 4.7990 GHz, Bw = 32.000 MH No calibration applied and no bandpass applied

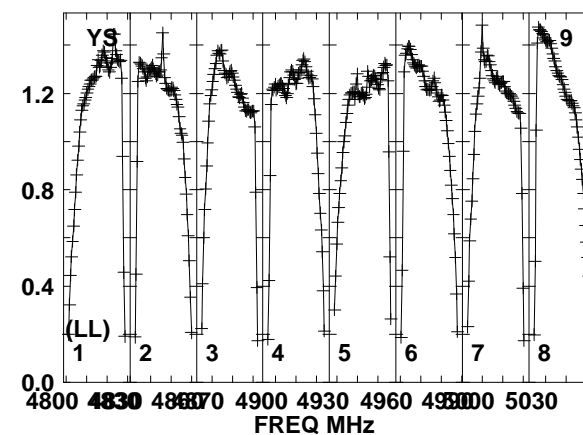
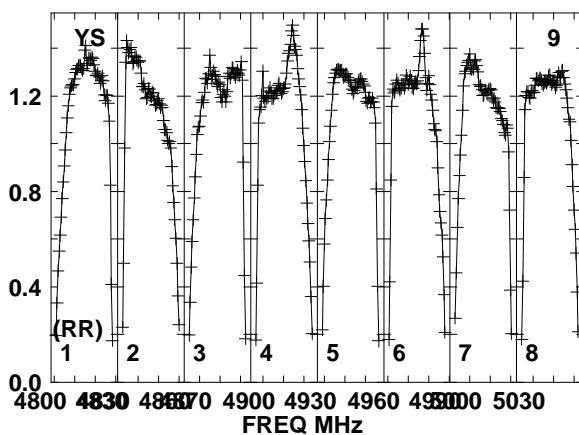
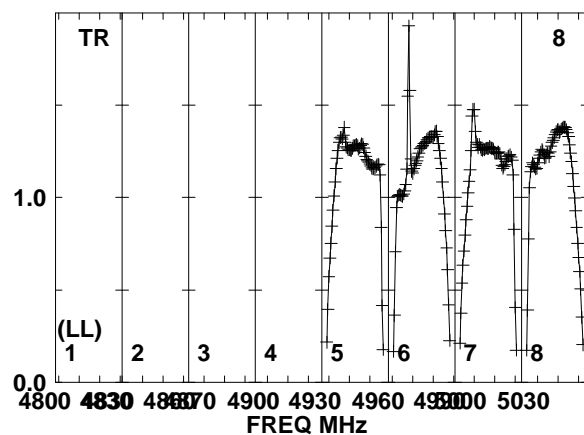
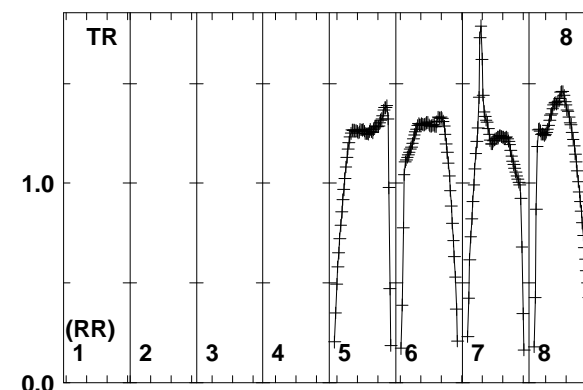
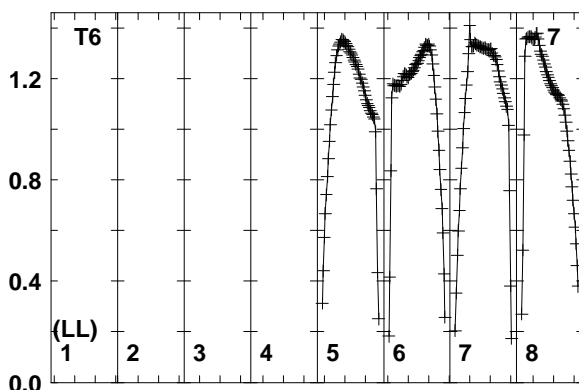
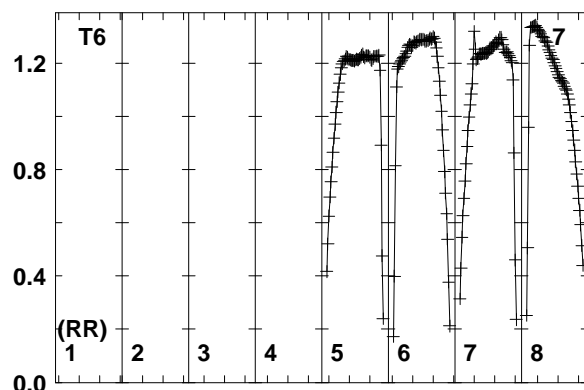
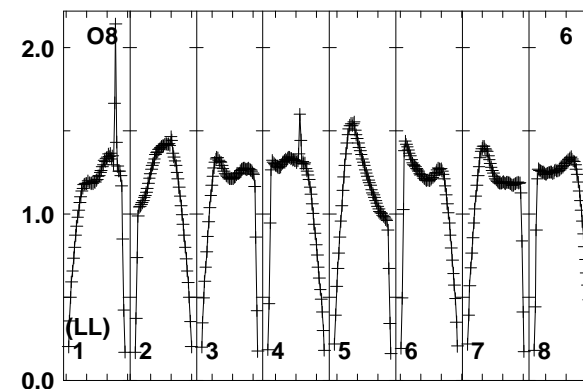
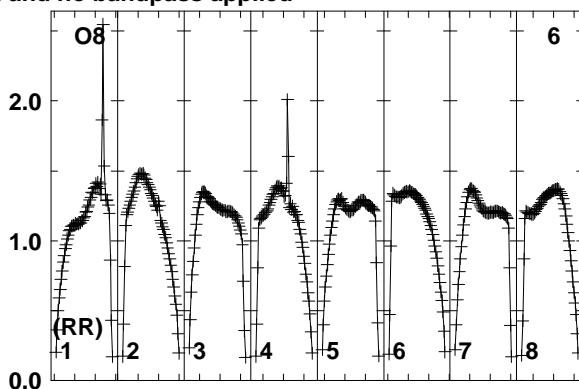
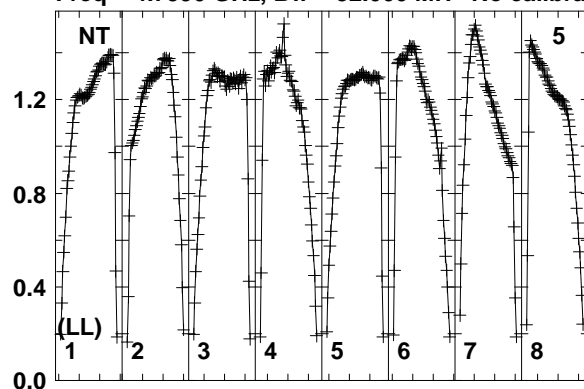

Lower frame: Real Jy
Total-power spectrum Antenna: NT (05)
Timerange: 01/00:12:30 to 01/00:13:59

Plot file version 84 created 23-NOV-2017 14:36:20
J0847+4609 RSM01.UVDATA.1
Freq = 4.7990 GHz, Bw = 32.000 MH No calibration applied and no bandpass applied

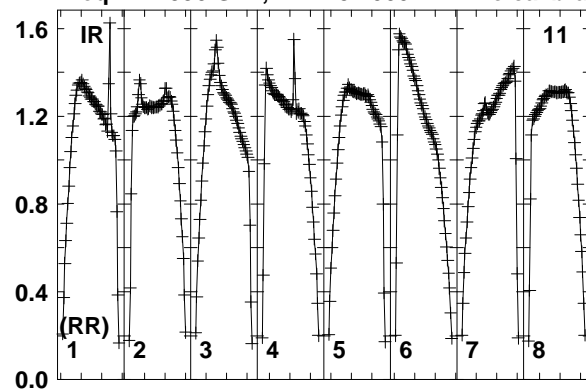

Lower frame: Real Jy
Total-power spectrum Antenna: IR (11)
Timerange: 01/00:12:30 to 01/00:13:59

Plot file version 85 created 23-NOV-2017 14:36:20

J0844+4628 RSM01.UVDATA.1

Freq = 4.7990 GHz, Bw = 32.000 MH No calibration applied and no bandpass applied

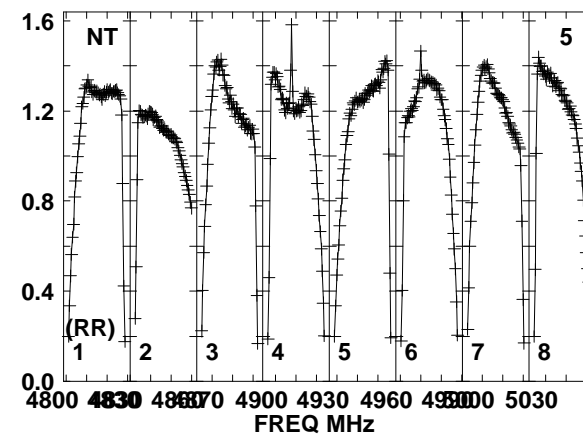
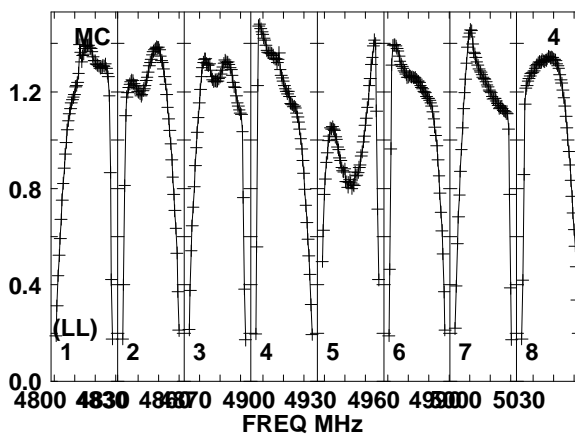
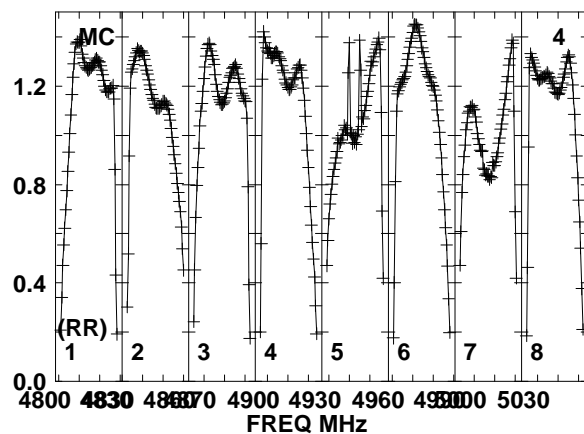
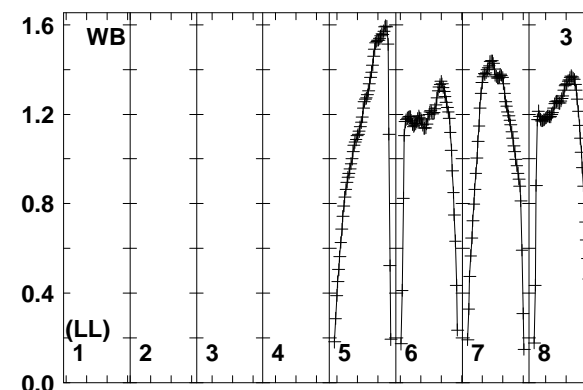
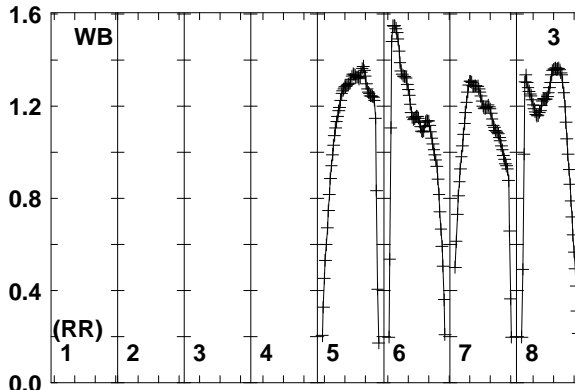
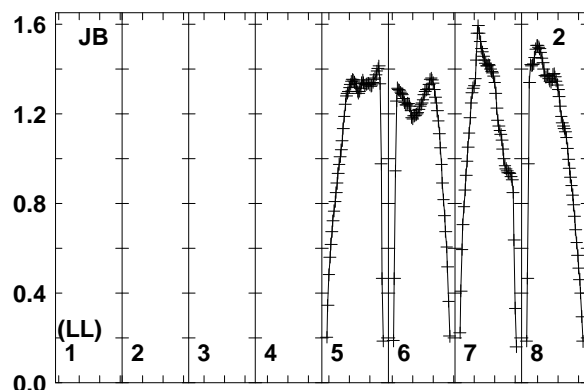
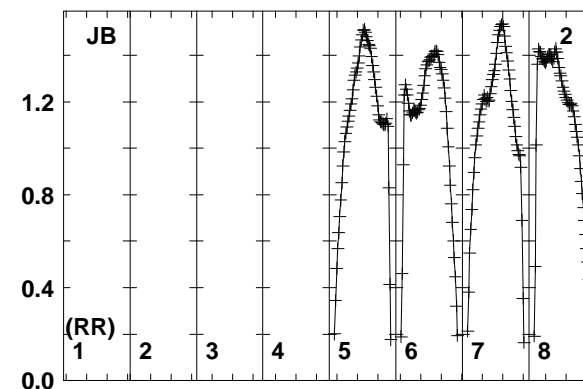
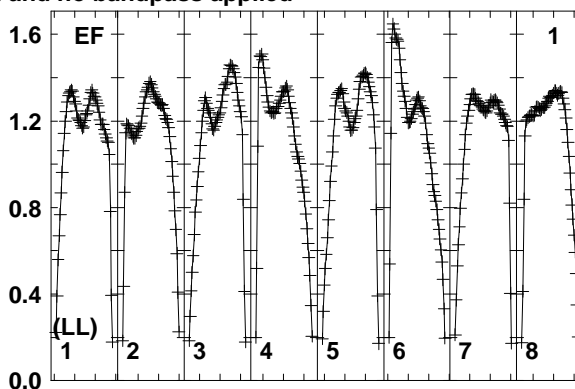
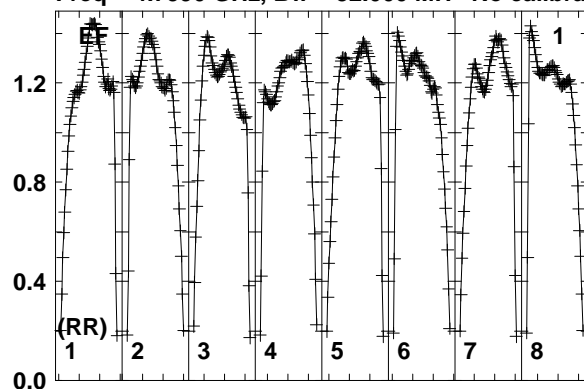

Lower frame: Real Jy
Total-power spectrum Antenna: EF (01)
Timerange: 01/00:14:00 to 01/00:17:29

Plot file version 86 created 23-NOV-2017 14:36:21

J0844+4628 RSM01.UVDATA.1

Freq = 4.7990 GHz, Bw = 32.000 MH No calibration applied and no bandpass applied

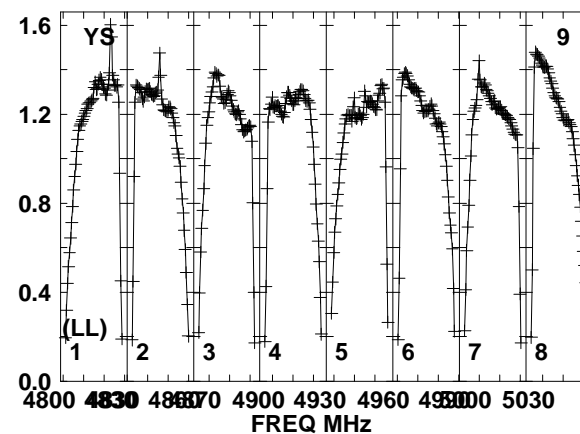
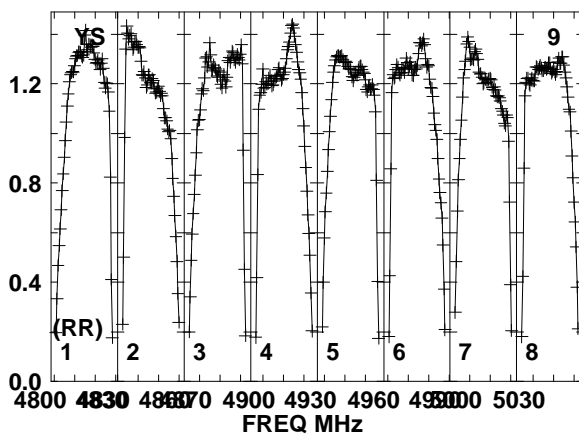
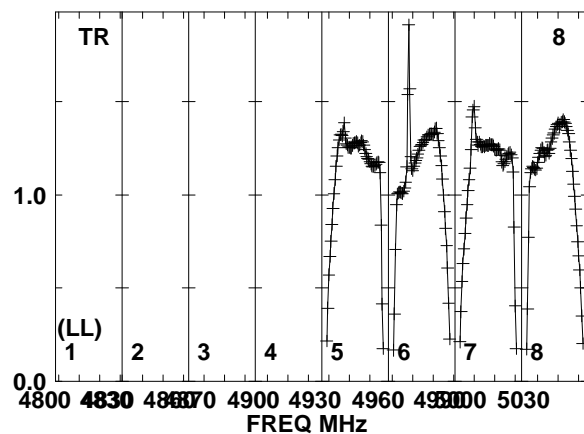
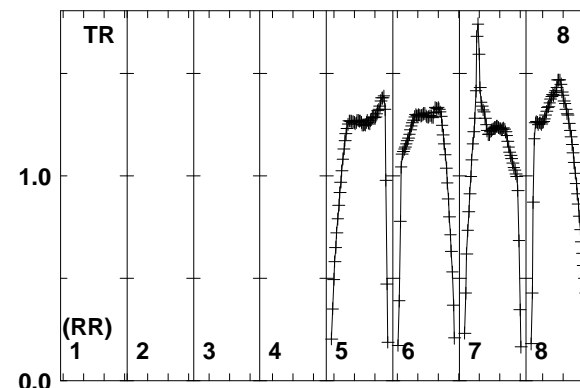
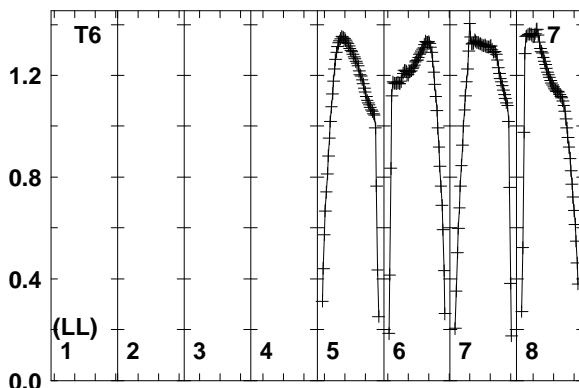
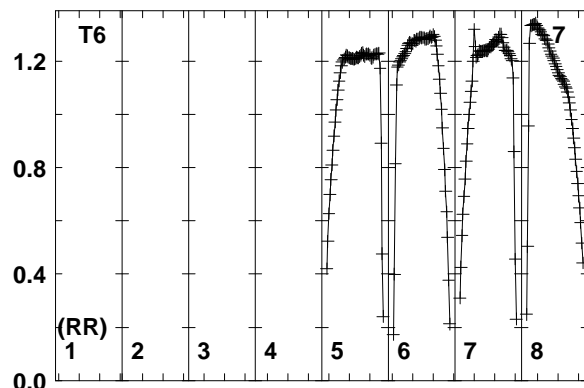
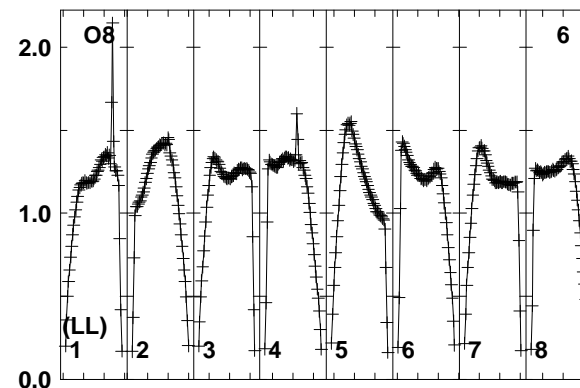
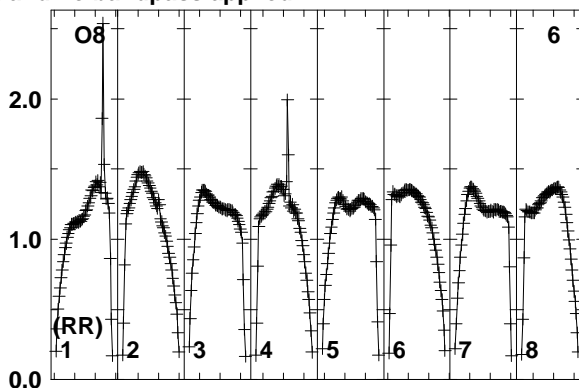
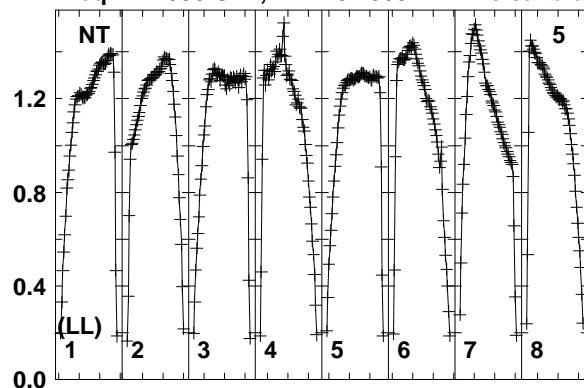

Lower frame: Real Jy
Total-power spectrum Antenna: NT (05)
Timerange: 01/00:14:00 to 01/00:17:29

Plot file version 87 created 23-NOV-2017 14:36:21
J0844+4628 RSM01.UVDATA.1
Freq = 4.7990 GHz, Bw = 32.000 MH No calibration applied and no bandpass applied

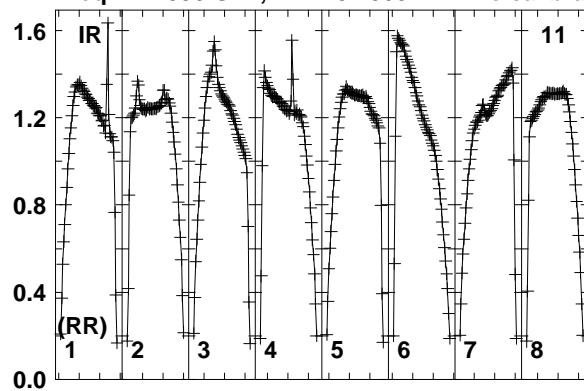

Lower frame: Real Jy
Total-power spectrum Antenna: IR (11)
Timerange: 01/00:14:00 to 01/00:17:29

Plot file version 88 created 23-NOV-2017 14:36:21

J0847+4609 RSM01.UVDATA.1

Freq = 4.7990 GHz, Bw = 32.000 MH No calibration applied and no bandpass applied

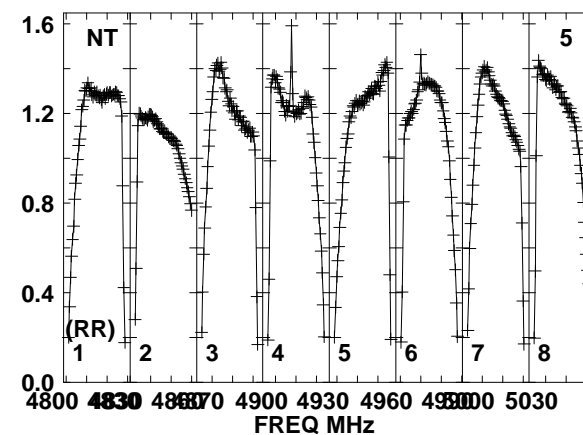
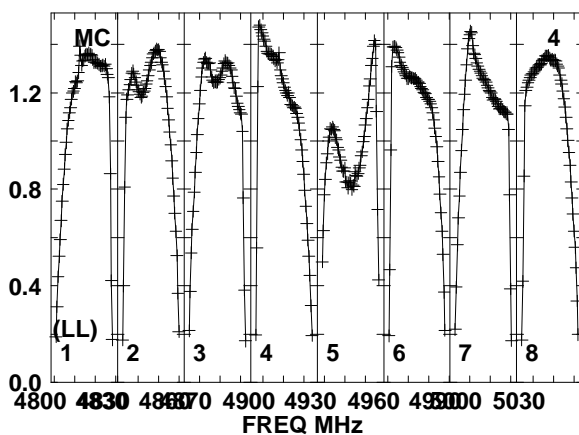
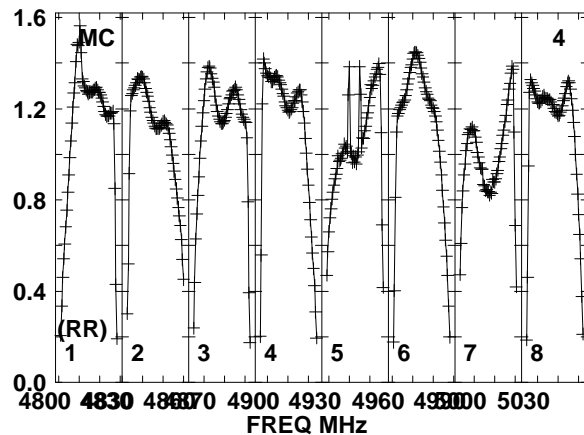
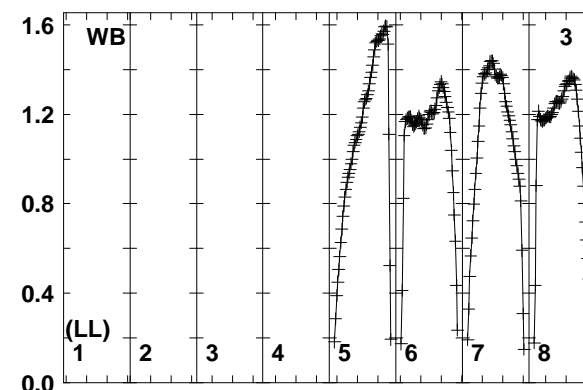
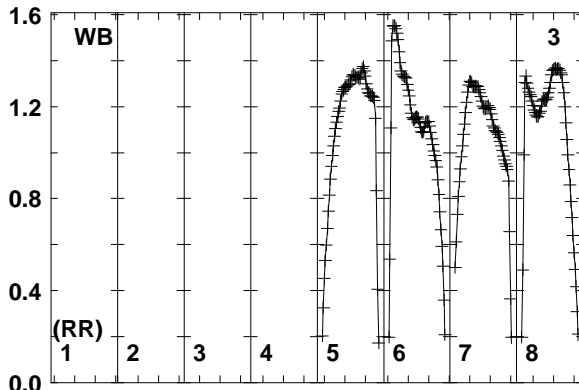
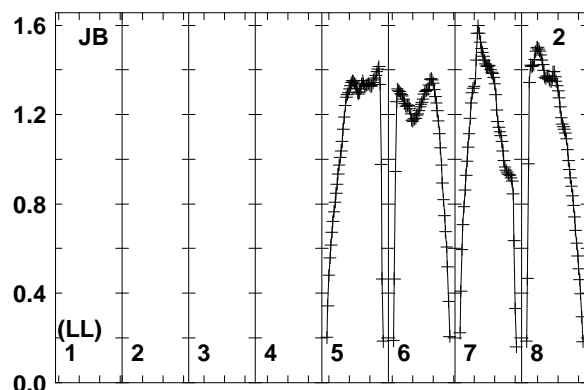
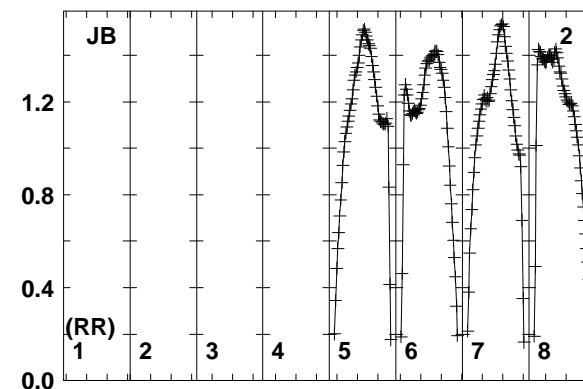
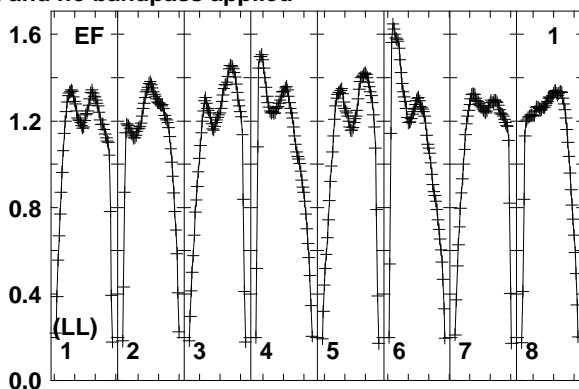
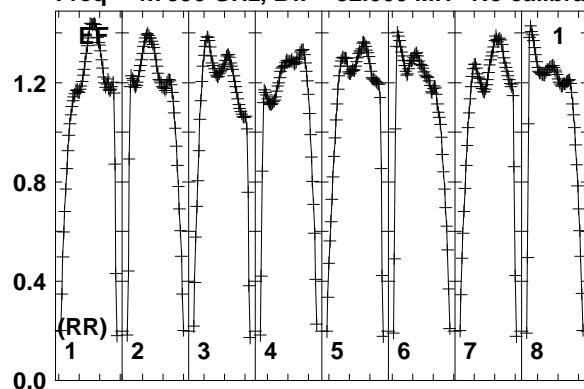

Lower frame: Real Jy
Total-power spectrum Antenna: EF (01)
Timerange: 01/00:18:10 to 01/00:19:09

Plot file version 89 created 23-NOV-2017 14:36:21

J0847+4609 RSM01.UVDATA.1

Freq = 4.7990 GHz, Bw = 32.000 MH No calibration applied and no bandpass applied

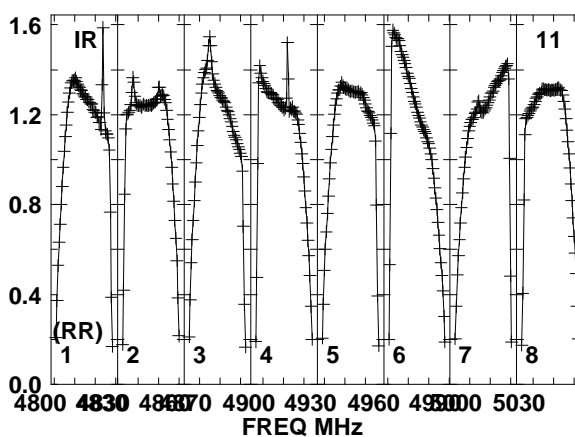
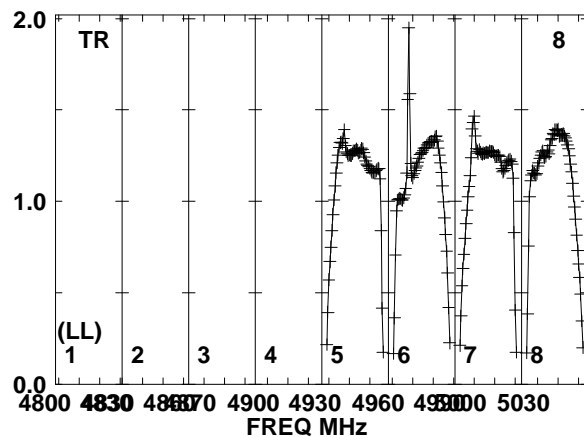
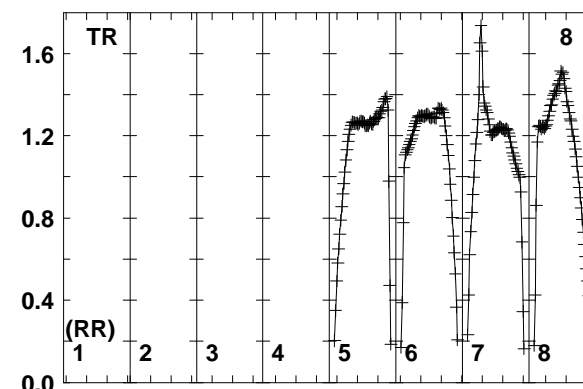
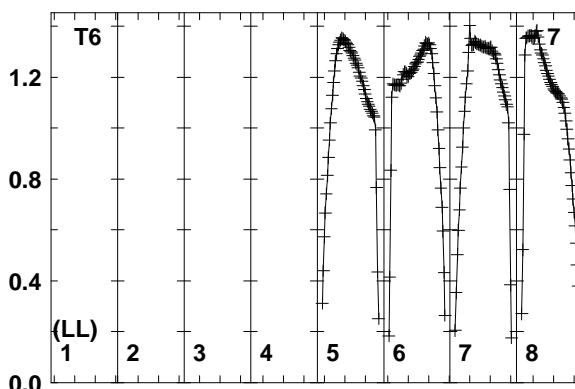
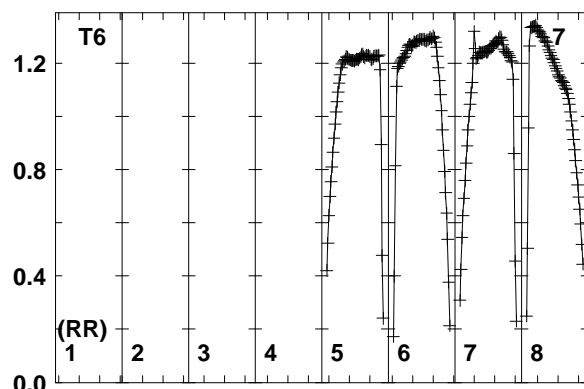
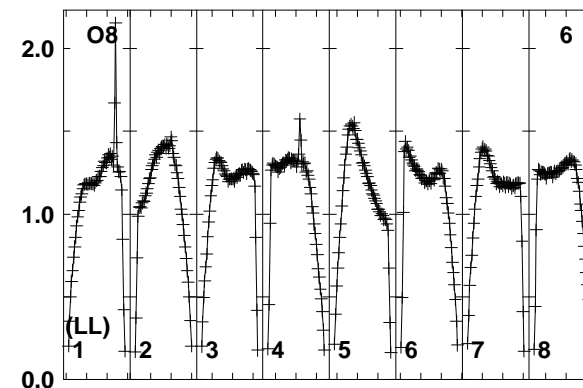
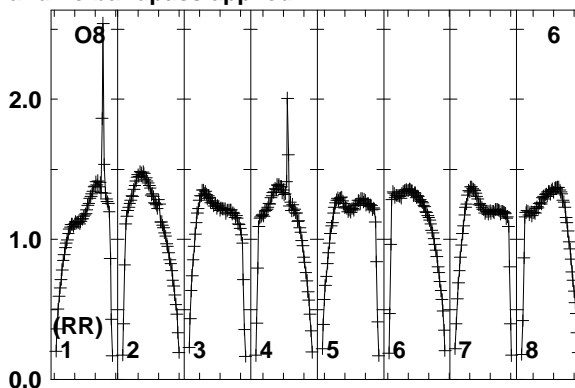
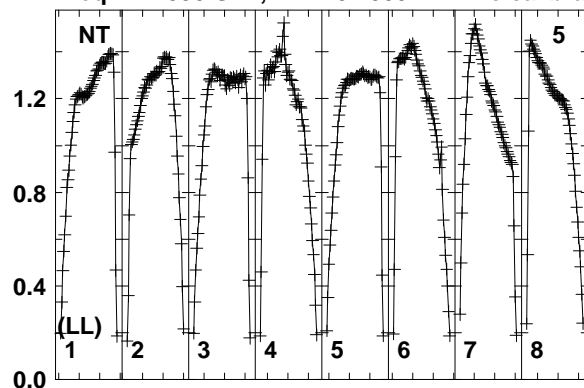

Lower frame: Real Jy
Total-power spectrum Antenna: NT (05)
Timerange: 01/00:18:10 to 01/00:19:09

Plot file version 90 created 23-NOV-2017 14:36:22

J0844+4628 RSM01.UVDATA.1

Freq = 4.7990 GHz, Bw = 32.000 MH No calibration applied and no bandpass applied

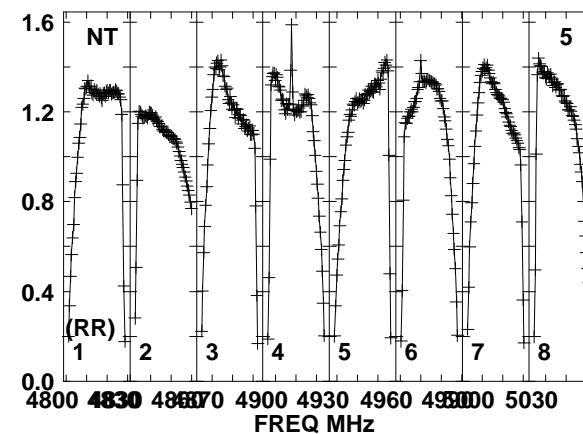
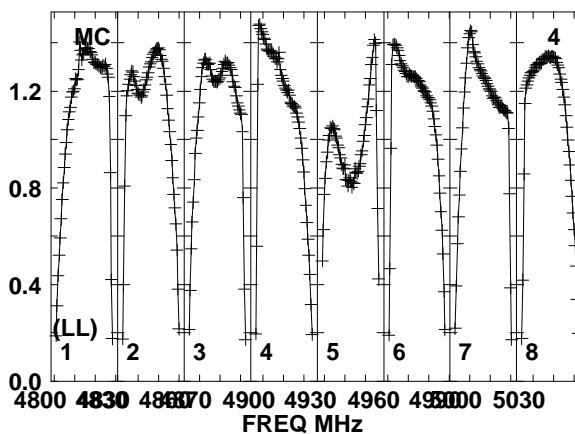
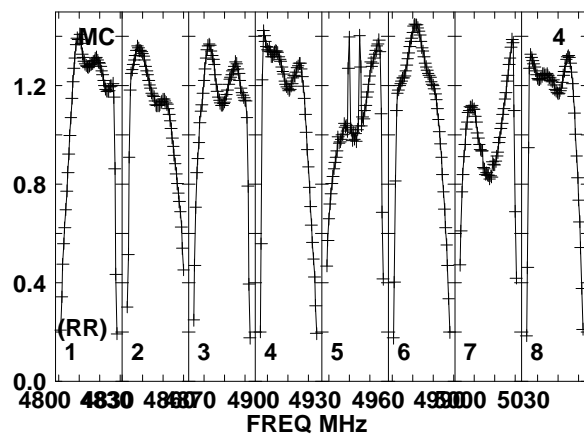
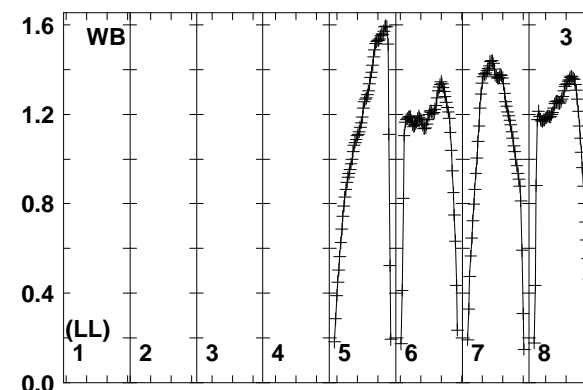
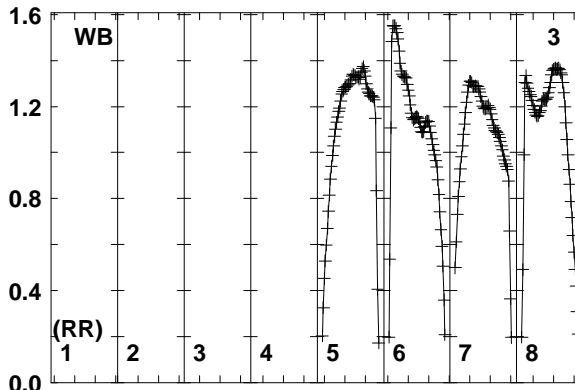
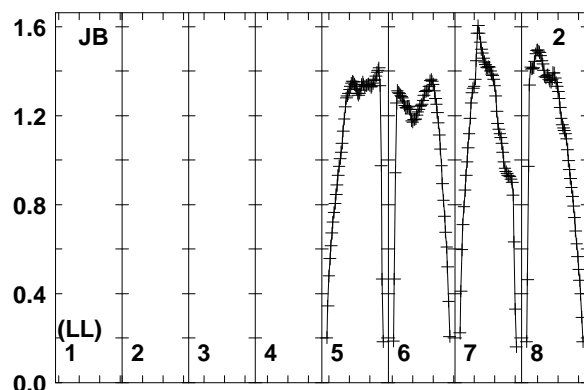
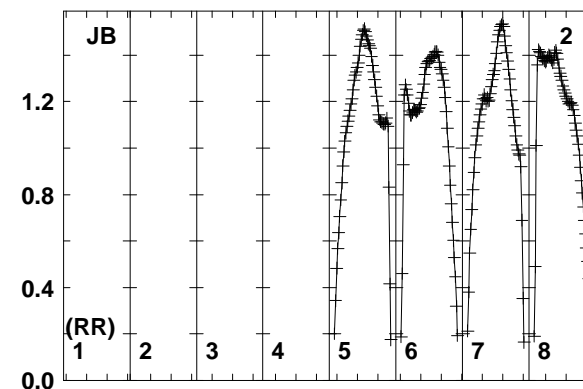
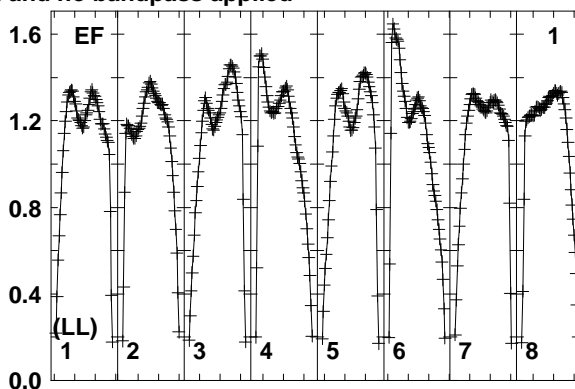
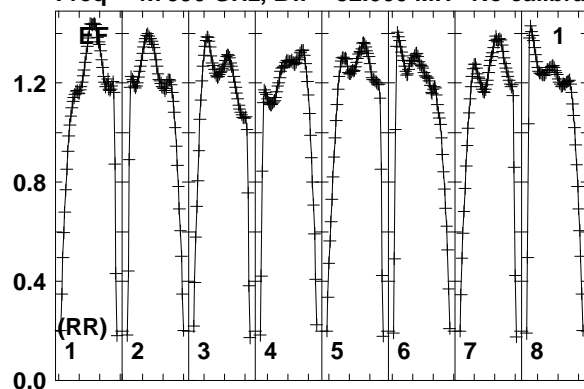

Lower frame: Real Jy
Total-power spectrum Antenna: EF (01)
Timerange: 01/00:19:10 to 01/00:22:39

Plot file version 91 created 23-NOV-2017 14:36:22

J0844+4628 RSM01.UVDATA.1

Freq = 4.7990 GHz, Bw = 32.000 MH No calibration applied and no bandpass applied

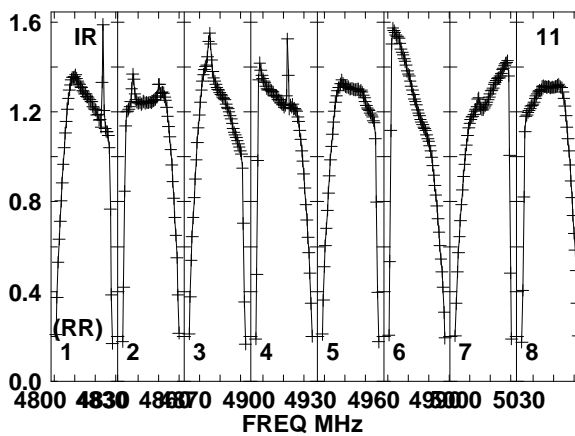
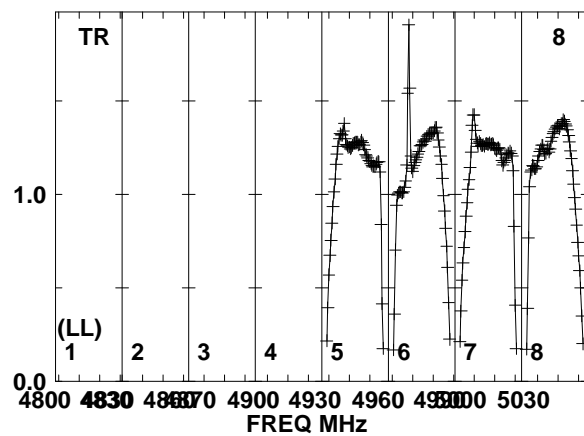
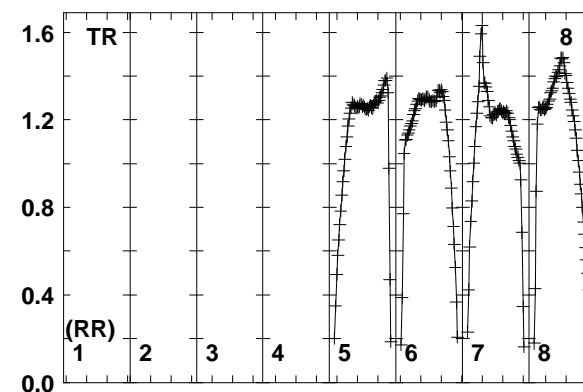
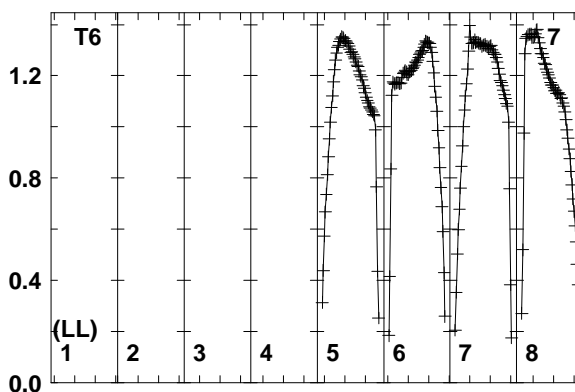
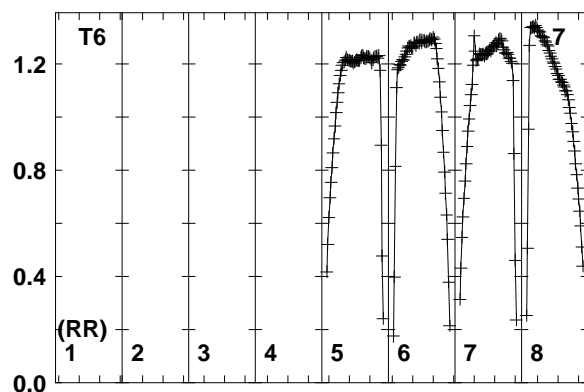
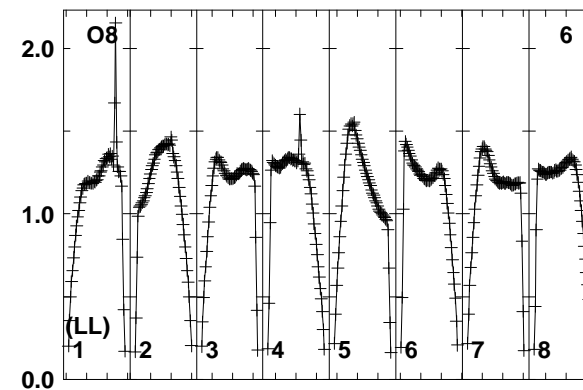
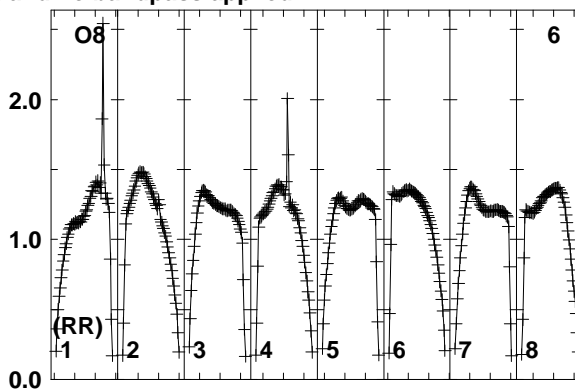
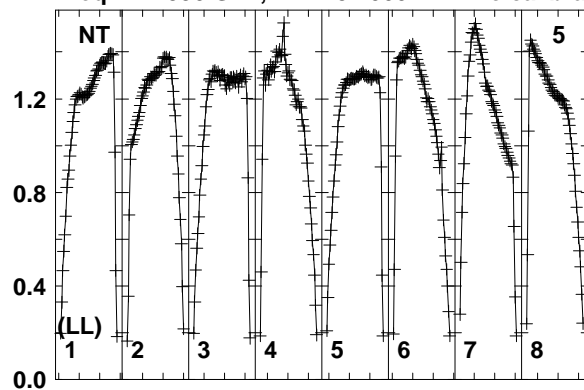

Lower frame: Real Jy
Total-power spectrum Antenna: NT (05)
Timerange: 01/00:19:10 to 01/00:22:39

Plot file version 92 created 23-NOV-2017 14:36:23

J0847+4609 RSM01.UVDATA.1

Freq = 4.7990 GHz, Bw = 32.000 MH No calibration applied and no bandpass applied

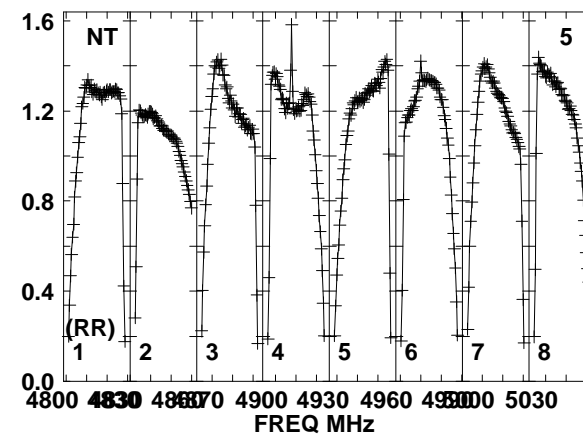
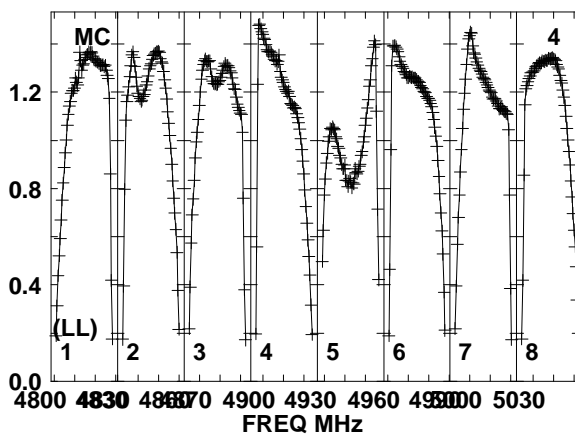
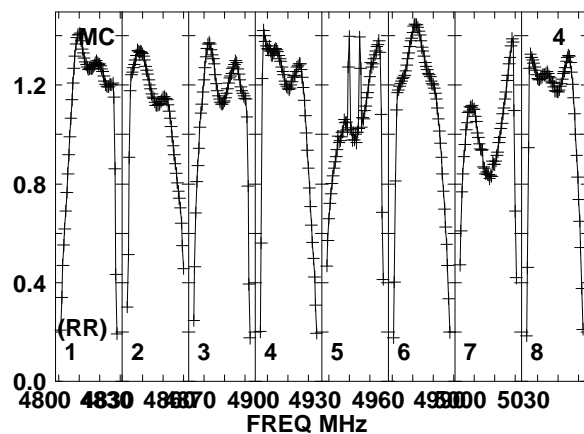
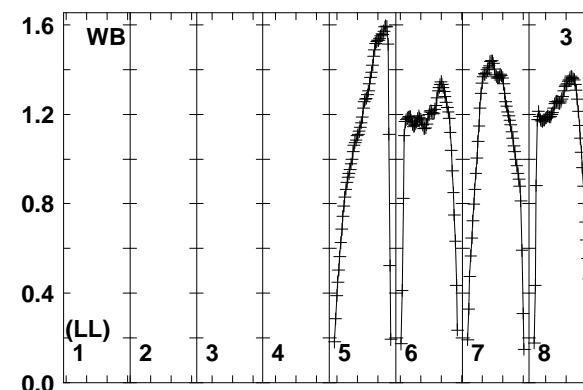
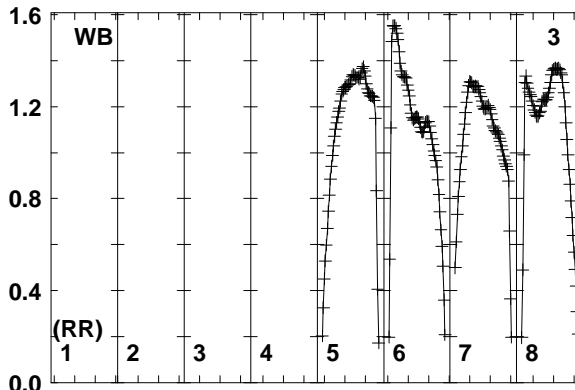
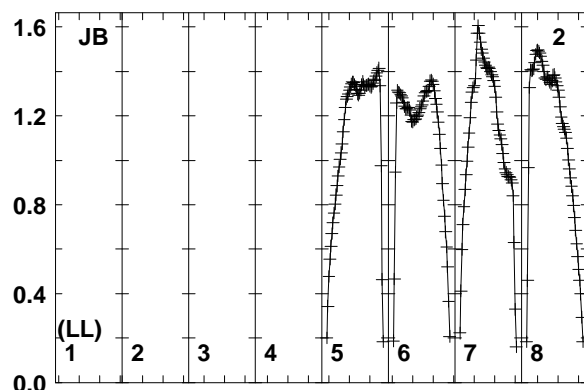
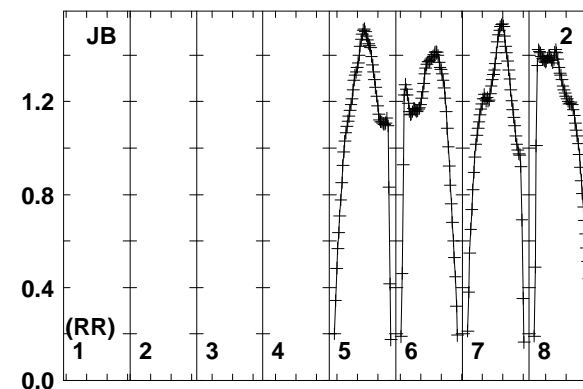
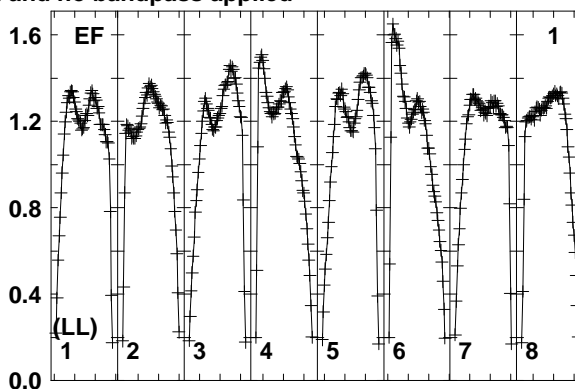
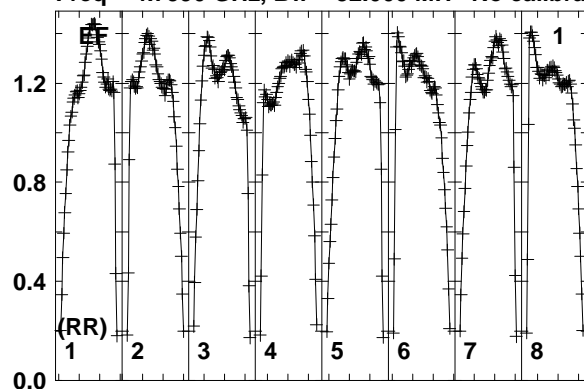

Lower frame: Real Jy
Total-power spectrum Antenna: EF (01)
Timerange: 01/00:22:41 to 01/00:24:09

Plot file version 93 created 23-NOV-2017 14:36:23

J0847+4609 RSM01.UVDATA.1

Freq = 4.7990 GHz, Bw = 32.000 MH No calibration applied and no bandpass applied

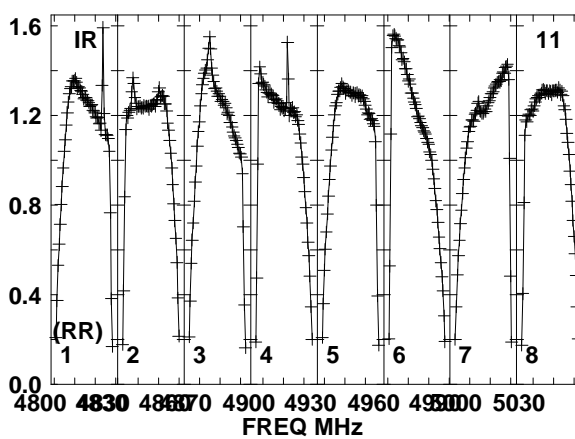
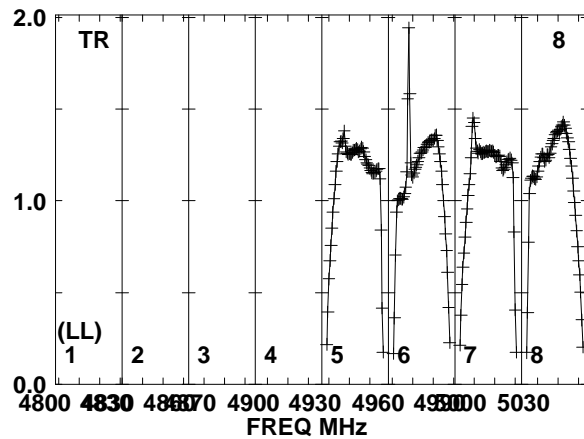
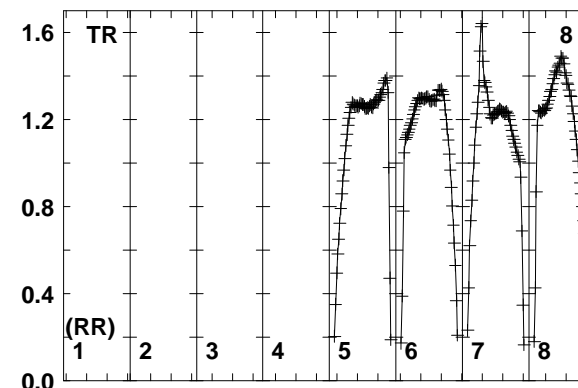
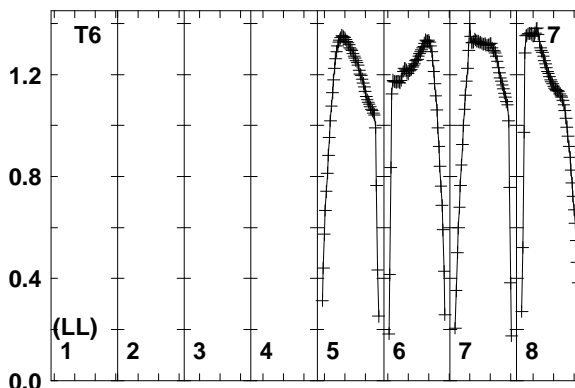
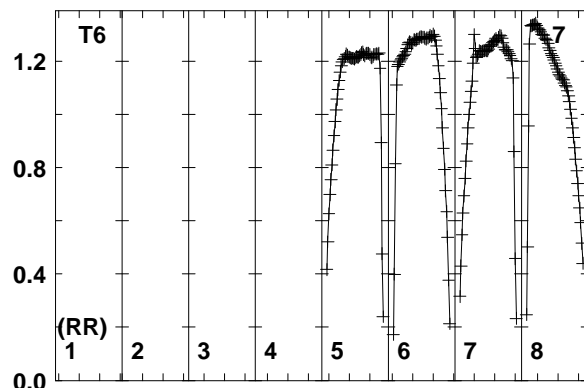
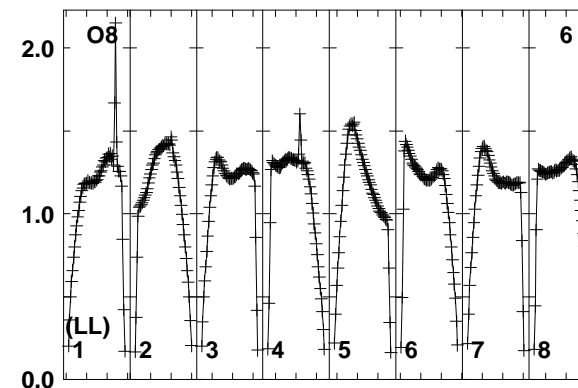
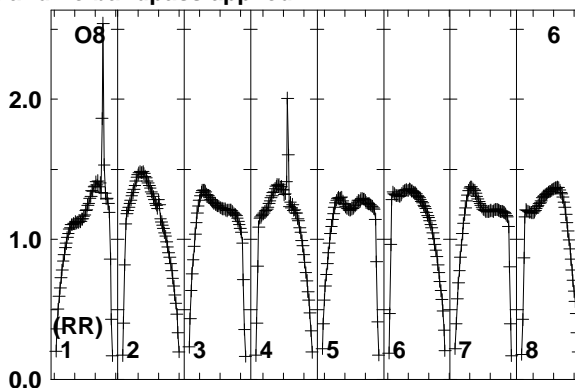
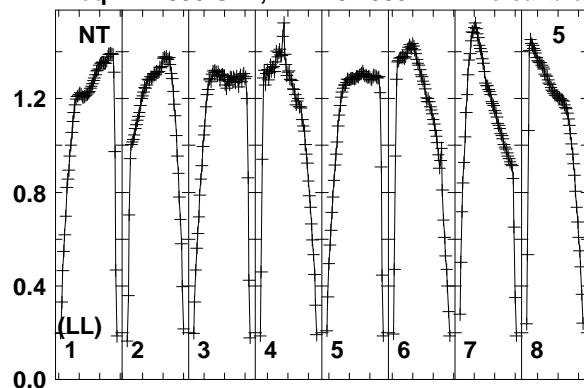

Lower frame: Real Jy
Total-power spectrum Antenna: NT (05)
Timerange: 01/00:22:41 to 01/00:24:09

Plot file version 94 created 23-NOV-2017 14:36:23

J0844+4628 RSM01.UVDATA.1

Freq = 4.7990 GHz, Bw = 32.000 MH No calibration applied and no bandpass applied

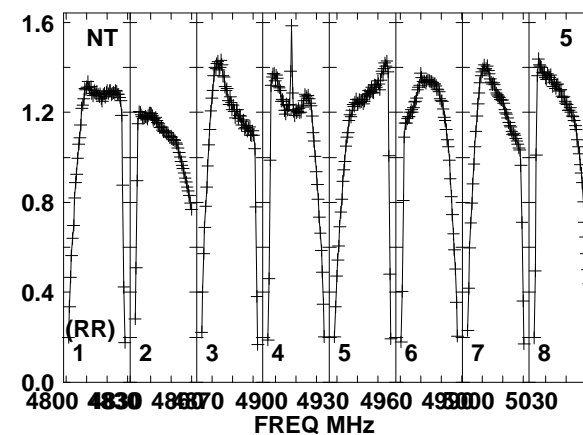
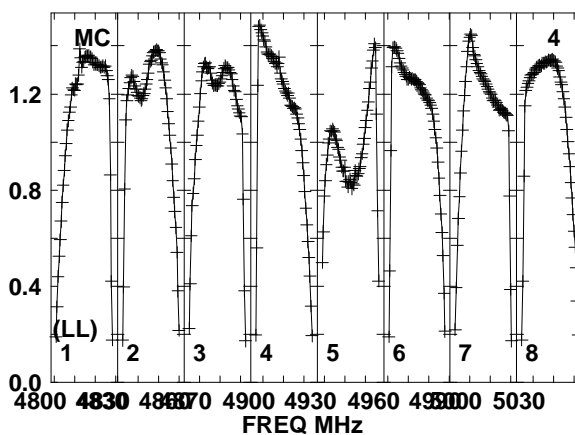
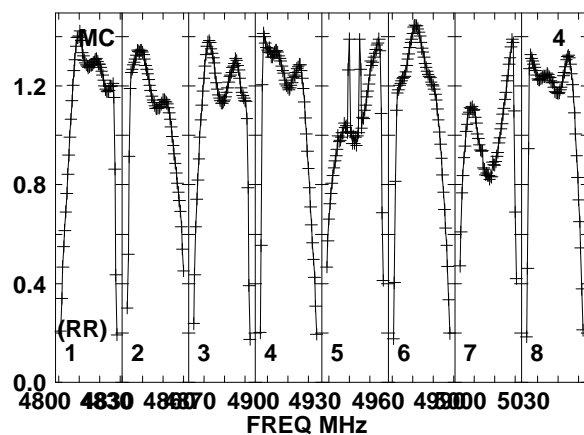
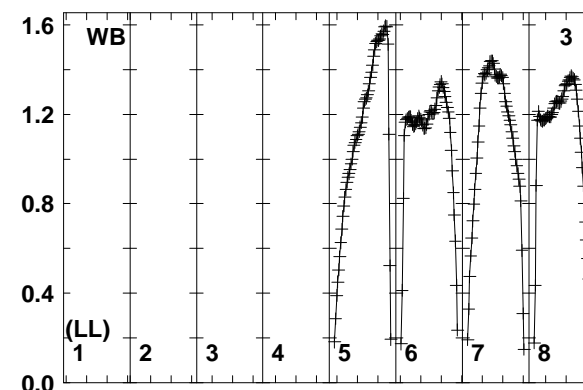
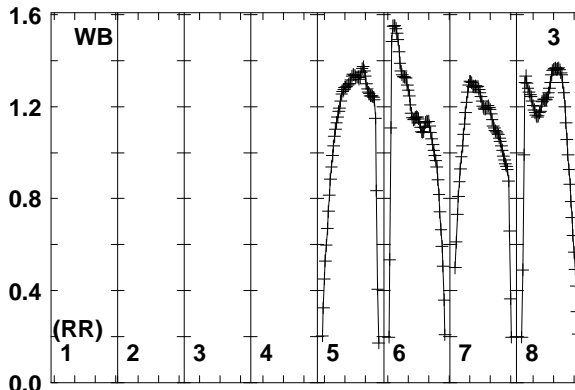
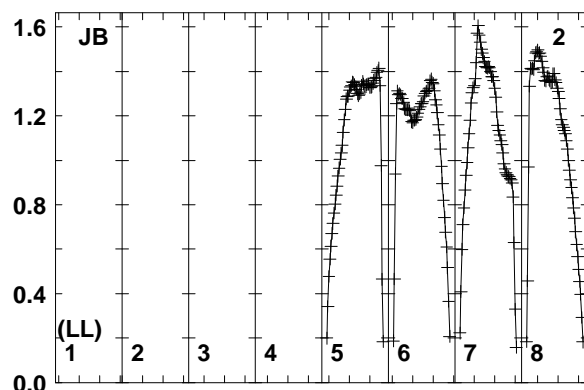
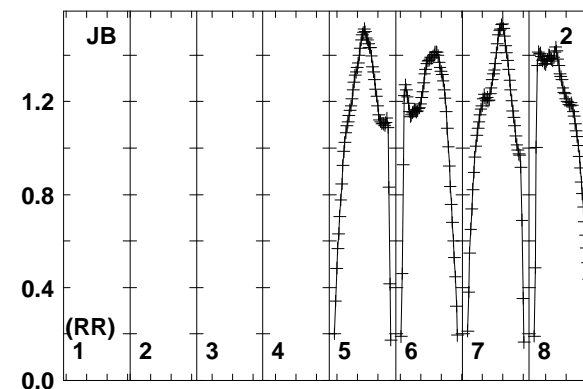
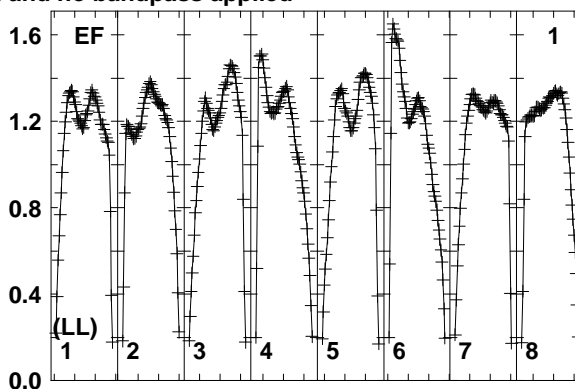
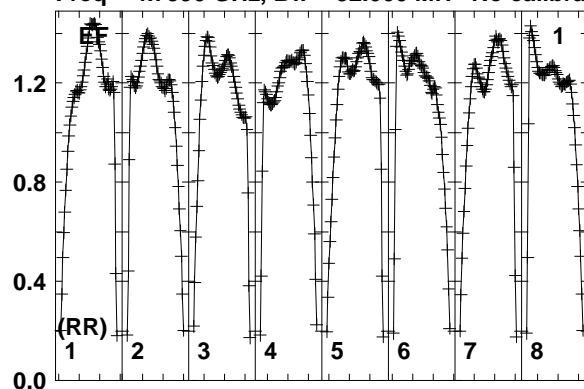

Lower frame: Real Jy
Total-power spectrum Antenna: EF (01)
Timerange: 01/00:24:11 to 01/00:27:40

Plot file version 95 created 23-NOV-2017 14:36:23

J0844+4628 RSM01.UVDATA.1

Freq = 4.7990 GHz, Bw = 32.000 MH No calibration applied and no bandpass applied

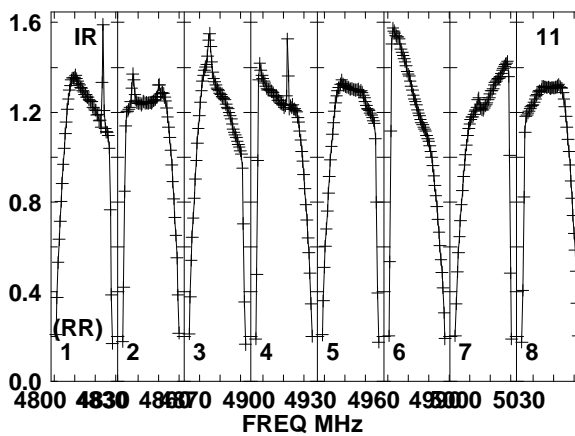
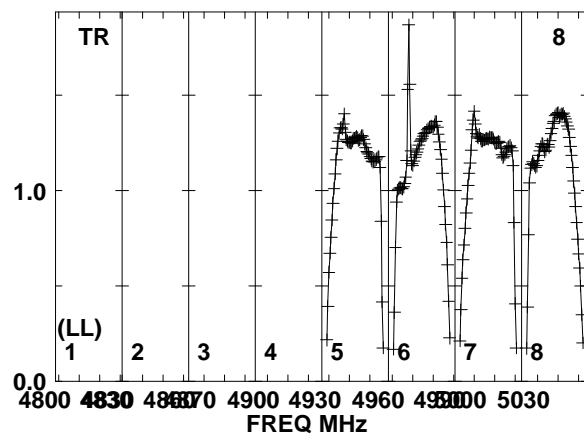
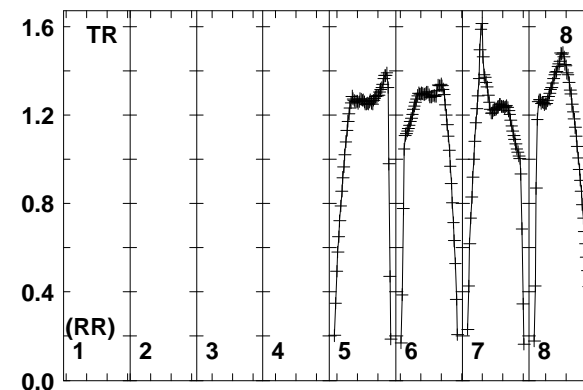
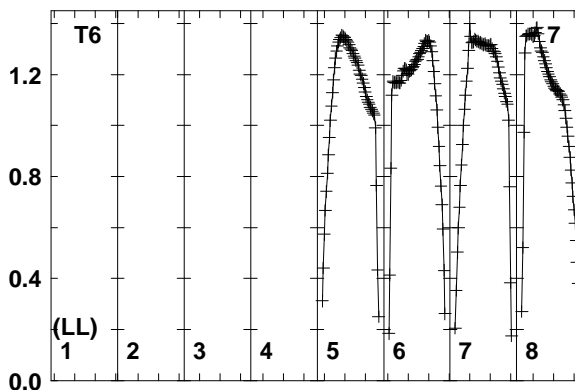
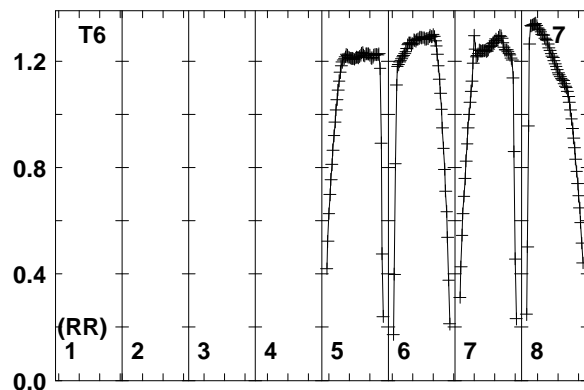
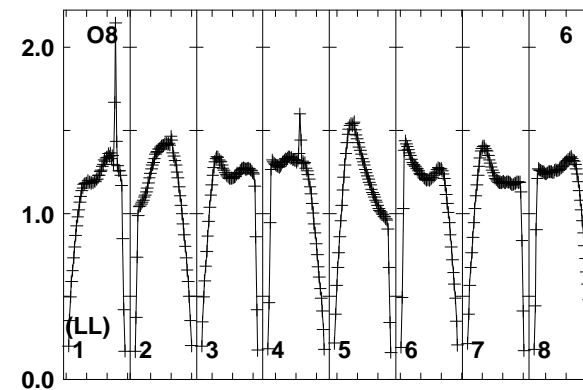
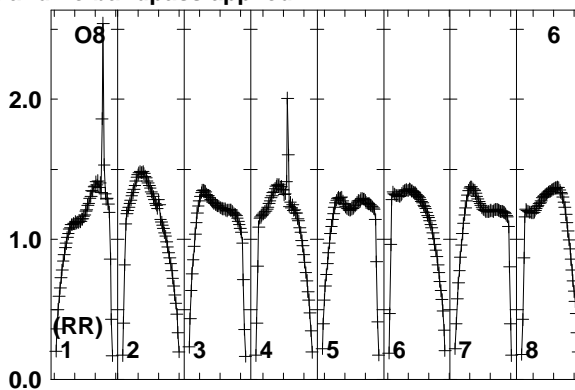
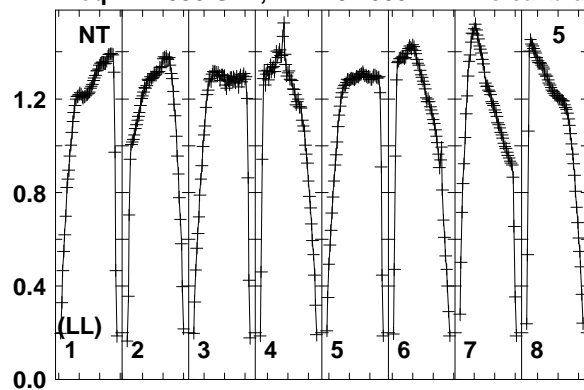

Lower frame: Real Jy
Total-power spectrum Antenna: NT (05)
Timerange: 01/00:24:11 to 01/00:27:40

Plot file version 96 created 23-NOV-2017 14:36:24

J0847+4609 RSM01.UVDATA.1

Freq = 4.7990 GHz, Bw = 32.000 MH No calibration applied and no bandpass applied

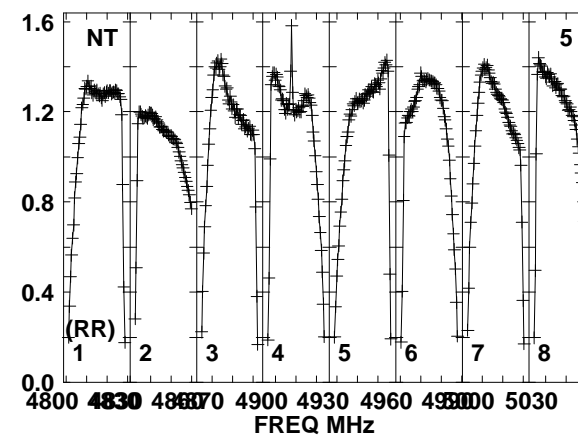
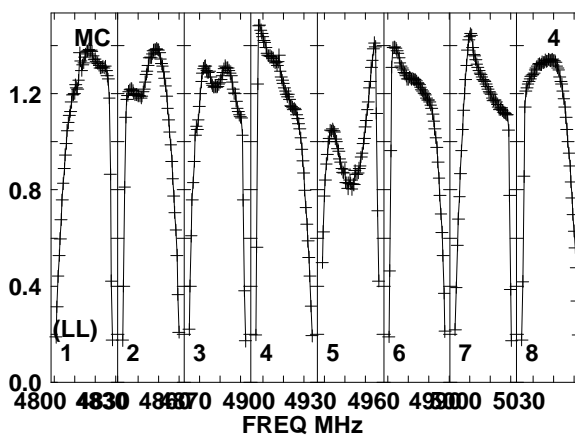
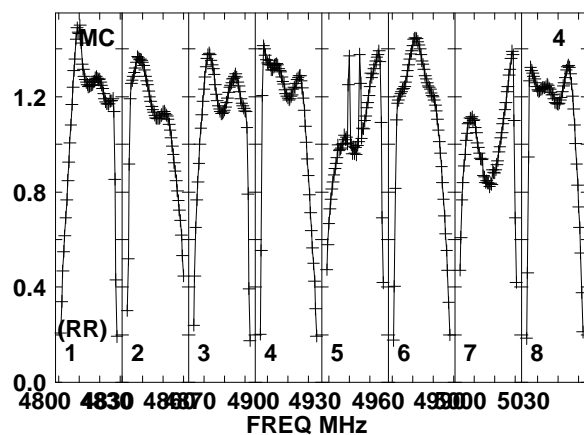
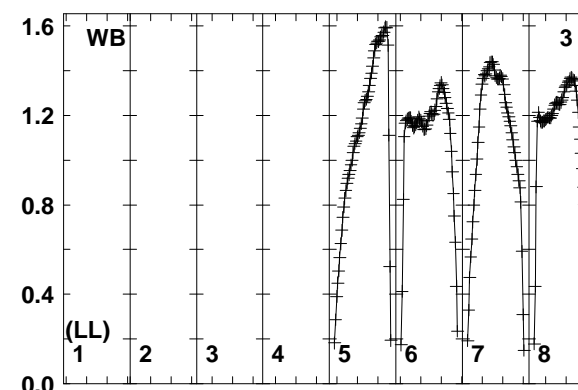
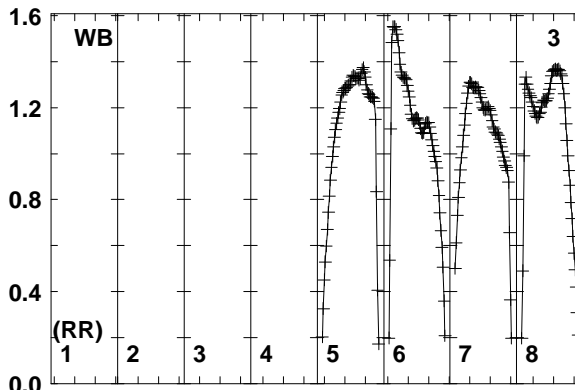
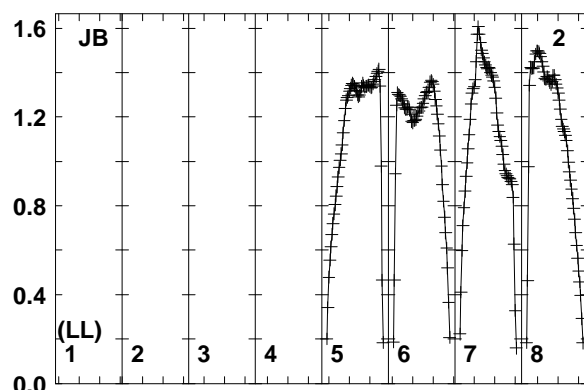
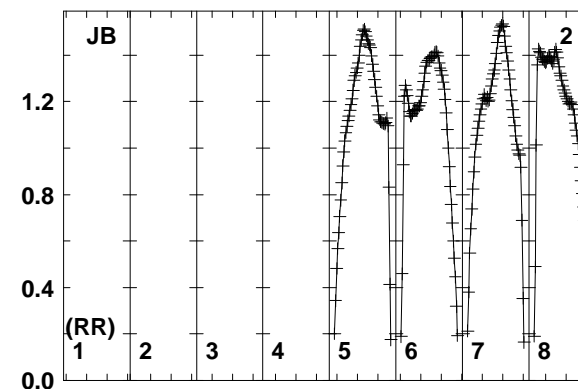
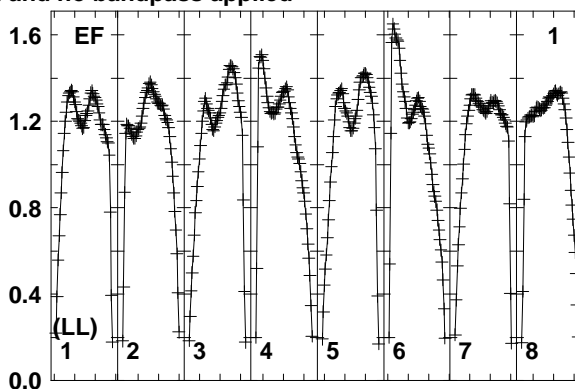
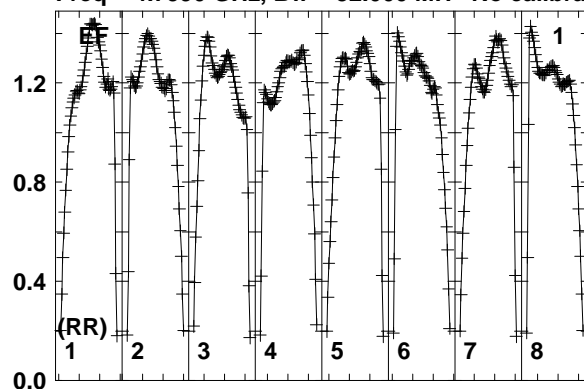

Lower frame: Real Jy
Total-power spectrum Antenna: EF (01)
Timerange: 01/00:28:20 to 01/00:29:19

Plot file version 97 created 23-NOV-2017 14:36:24

J0847+4609 RSM01.UVDATA.1

Freq = 4.7990 GHz, Bw = 32.000 MH No calibration applied and no bandpass applied

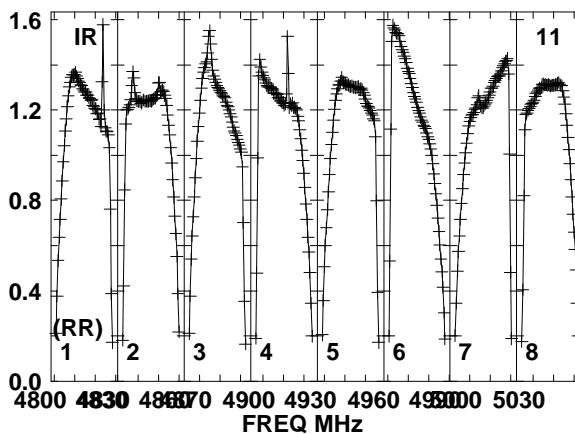
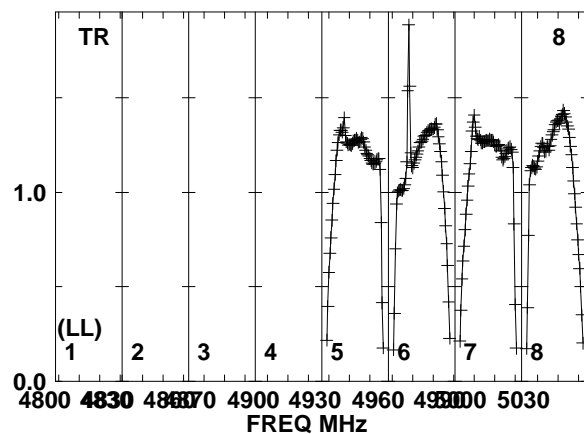
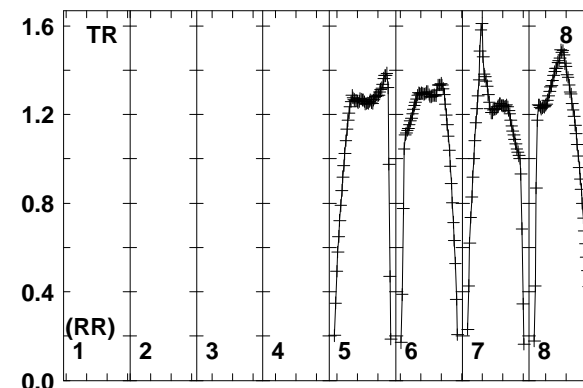
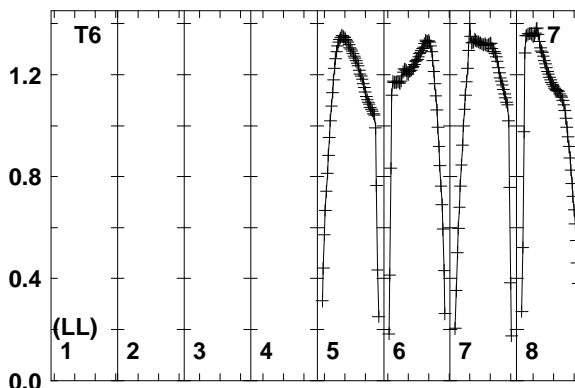
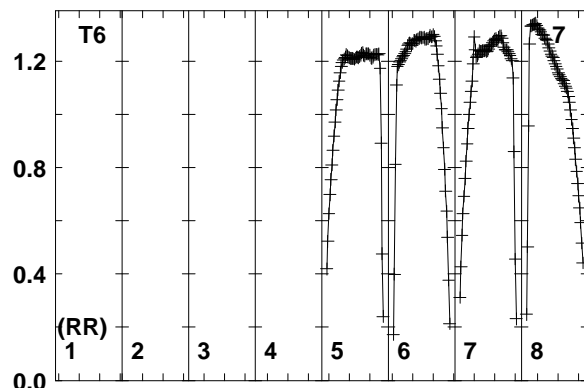
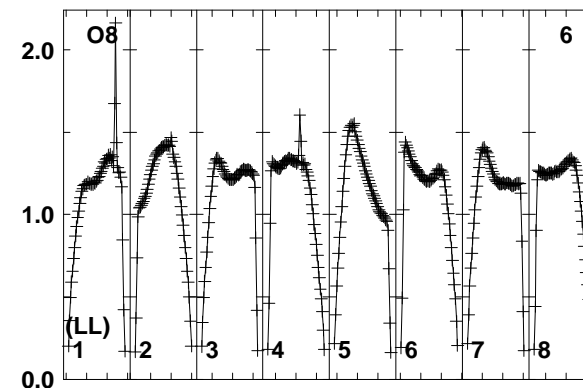
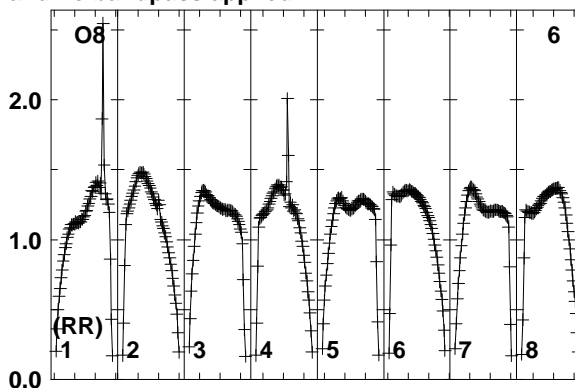
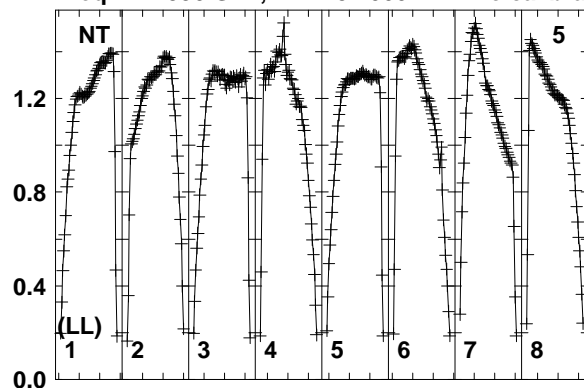

Lower frame: Real Jy
Total-power spectrum Antenna: NT (05)
Timerange: 01/00:28:20 to 01/00:29:19

Plot file version 98 created 23-NOV-2017 14:36:24

J0844+4628 RSM01.UVDATA.1

Freq = 4.7990 GHz, Bw = 32.000 MH No calibration applied and no bandpass applied

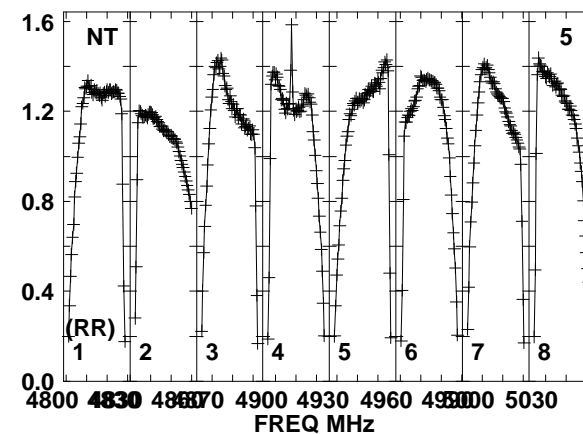
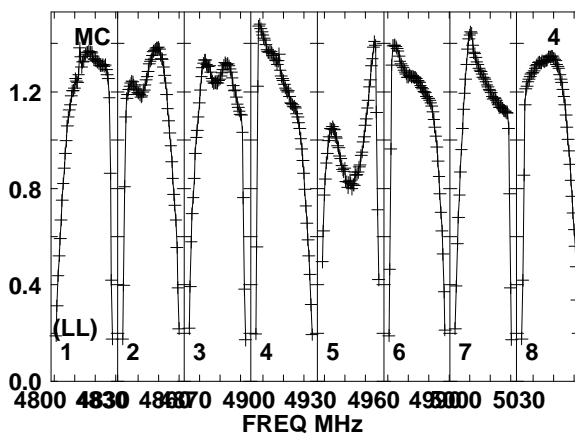
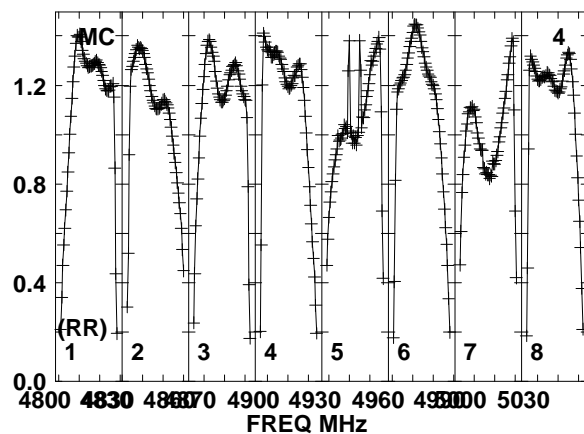
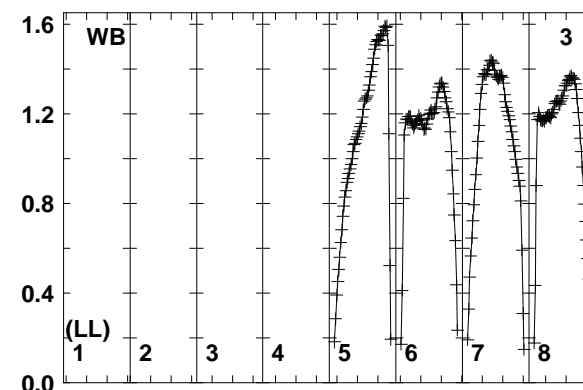
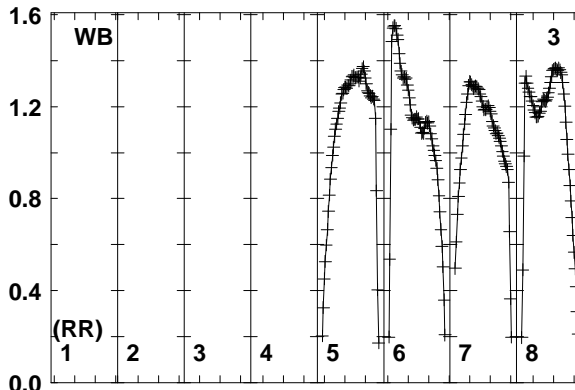
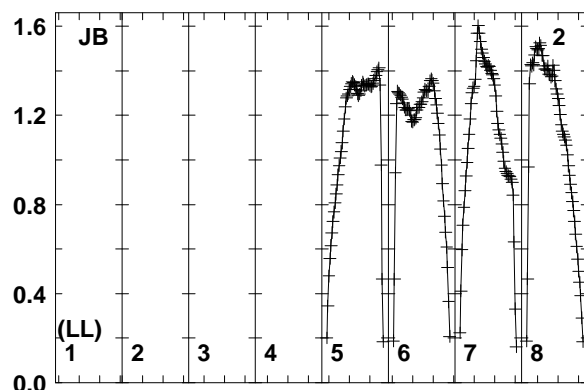
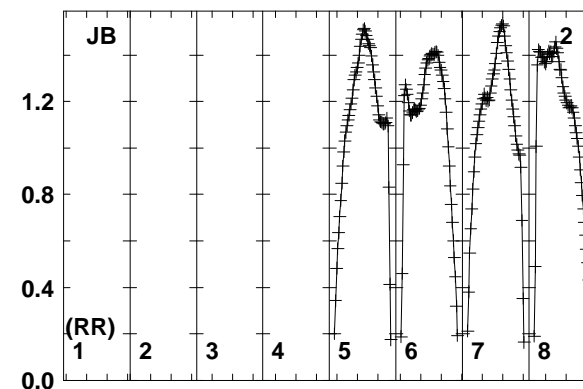
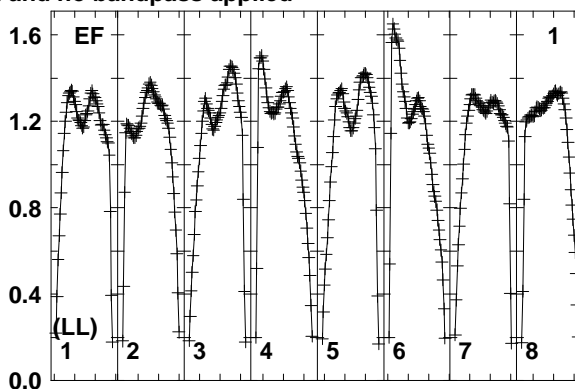
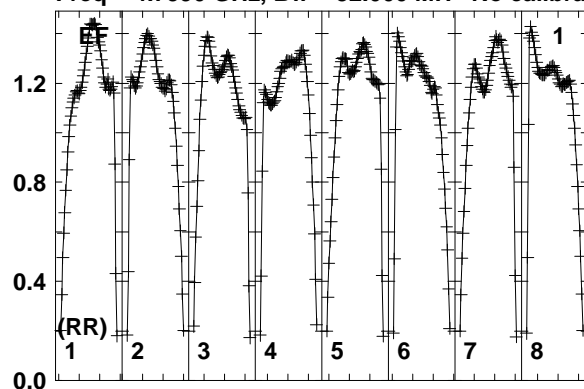

Lower frame: Real Jy
Total-power spectrum Antenna: EF (01)
Timerange: 01/00:29:21 to 01/00:32:50

Plot file version 99 created 23-NOV-2017 14:36:25

J0844+4628 RSM01.UVDATA.1

Freq = 4.7990 GHz, Bw = 32.000 MH No calibration applied and no bandpass applied

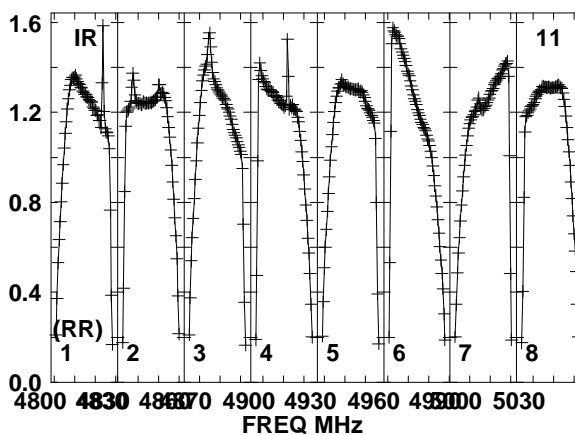
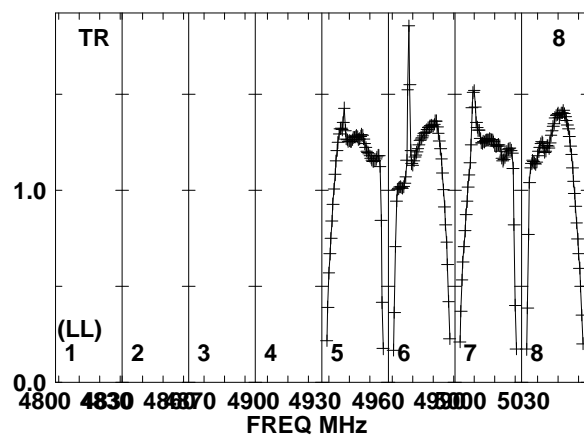
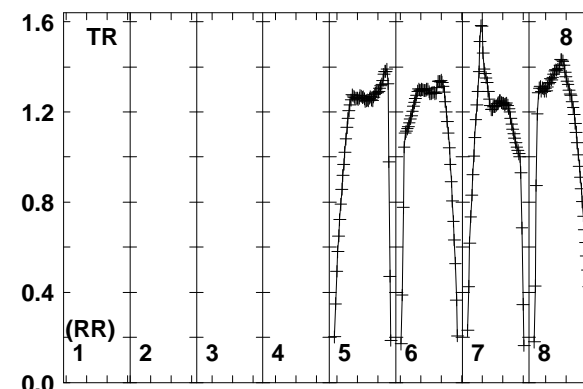
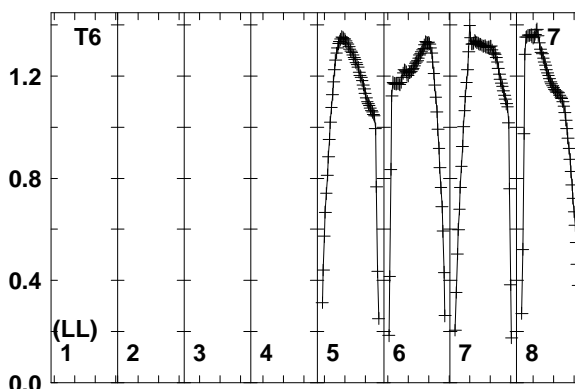
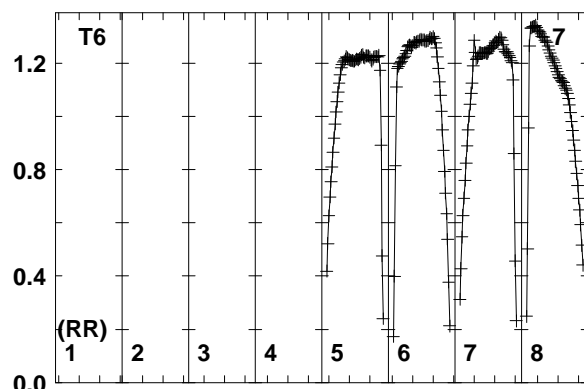
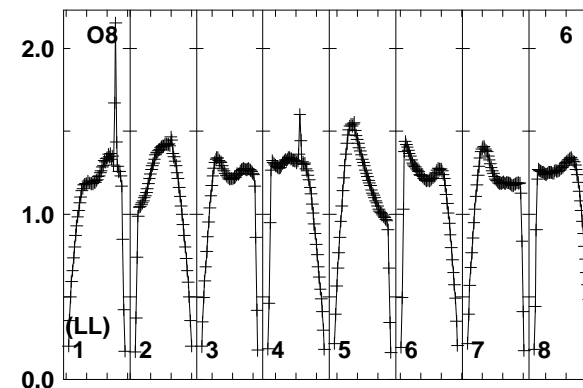
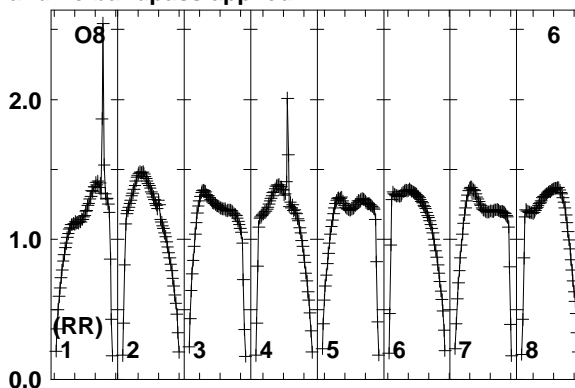
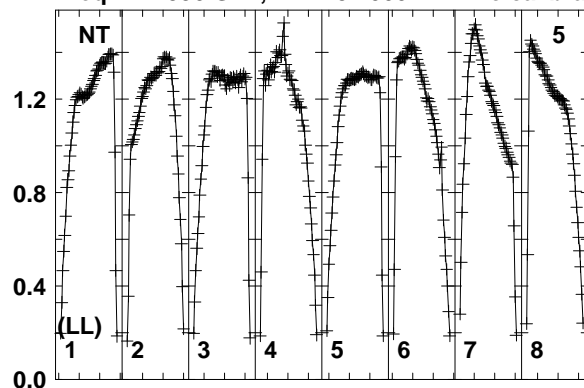

Lower frame: Real Jy
Total-power spectrum Antenna: NT (05)
Timerange: 01/00:29:21 to 01/00:32:50

Plot file version 100 created 23-NOV-2017 14:36:25

J0847+4609 RSM01.UVDATA.1

Freq = 4.7990 GHz, Bw = 32.000 MH No calibration applied and no bandpass applied

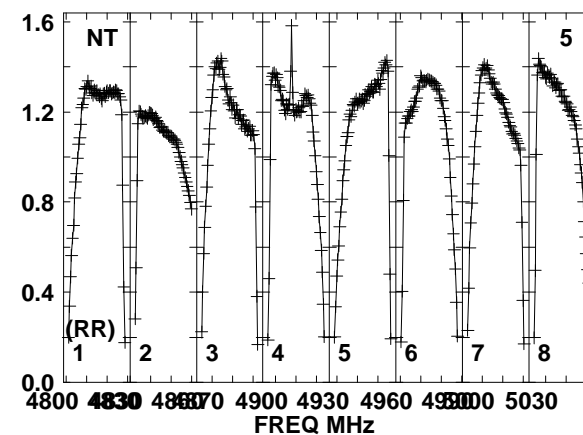
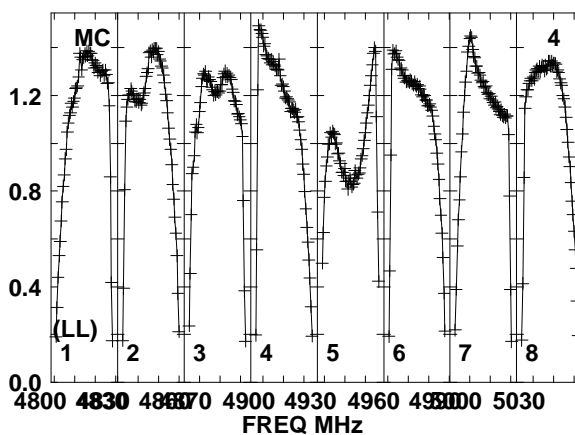
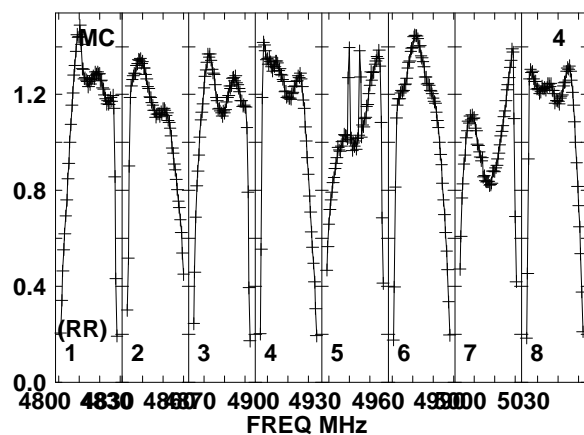
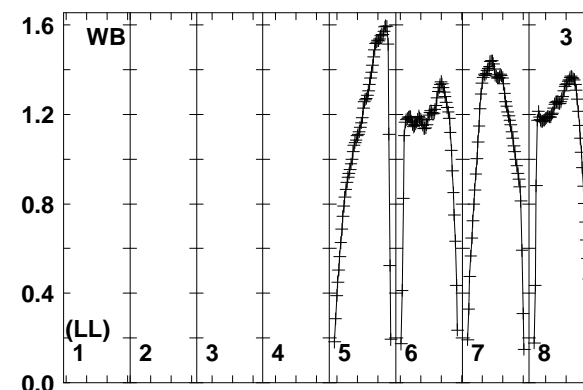
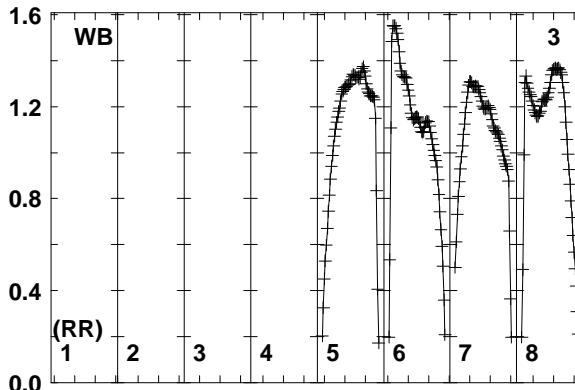
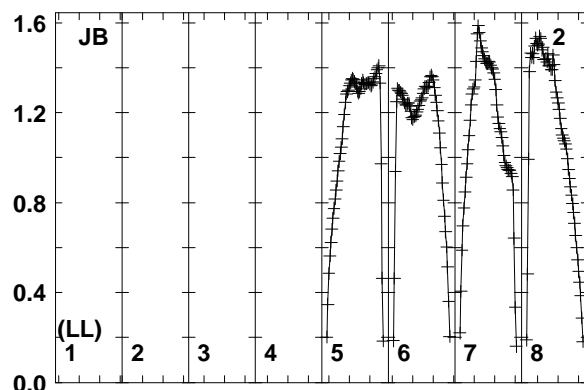
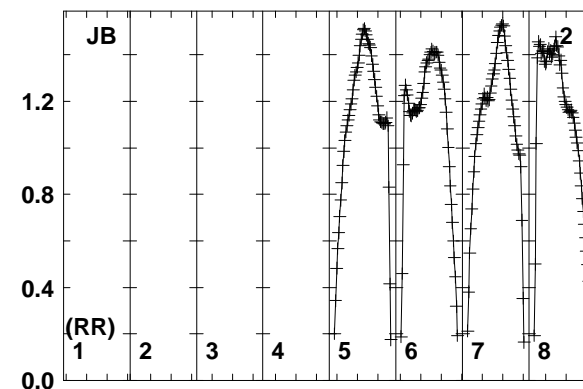
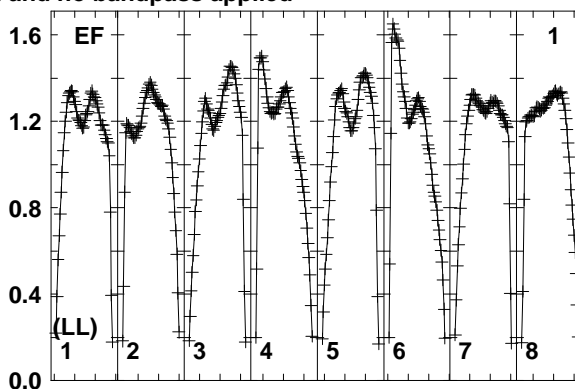
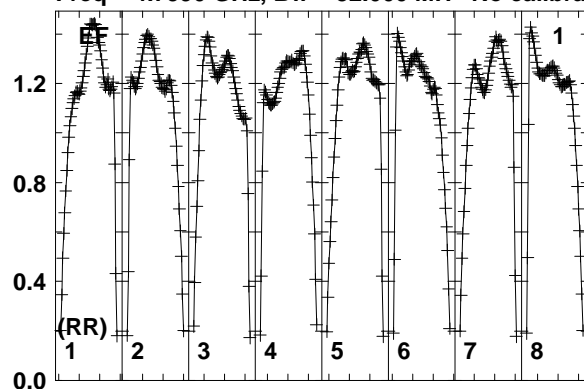

Lower frame: Real Jy
Total-power spectrum Antenna: EF (01)
Timerange: 01/00:32:51 to 01/00:34:20

Plot file version 101 created 23-NOV-2017 14:36:26

J0847+4609 RSM01.UVDATA.1

Freq = 4.7990 GHz, Bw = 32.000 MH No calibration applied and no bandpass applied

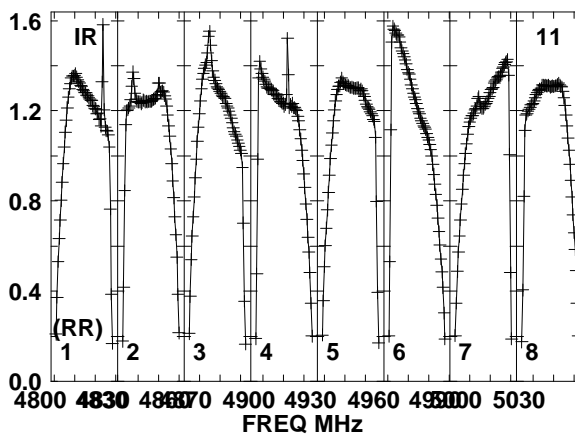
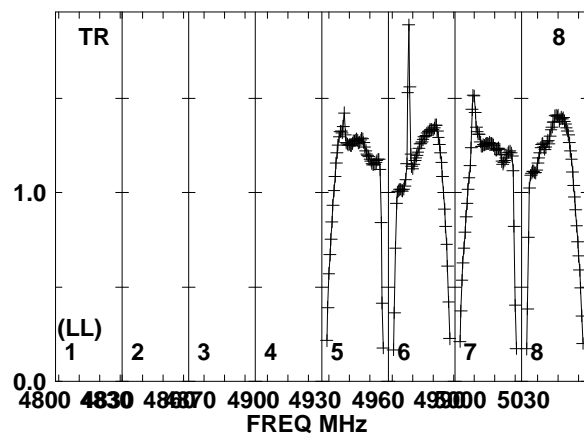
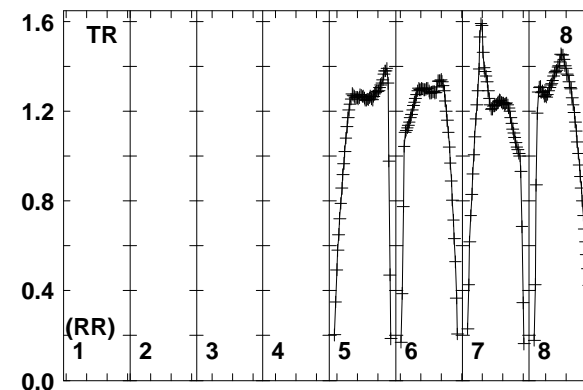
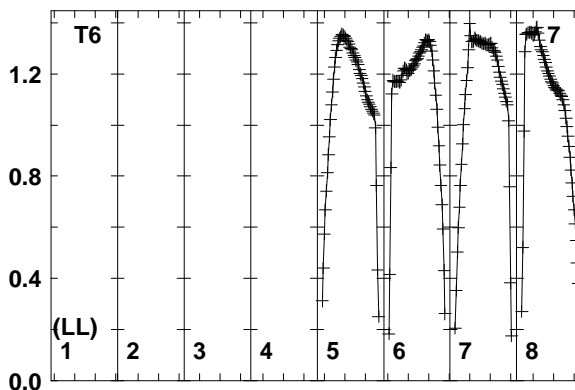
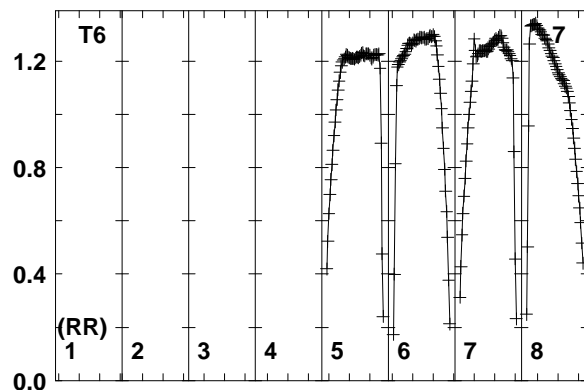
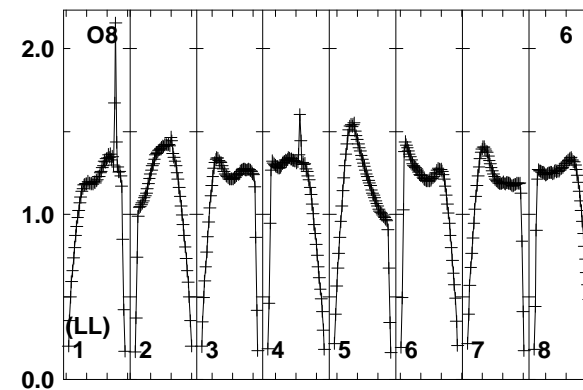
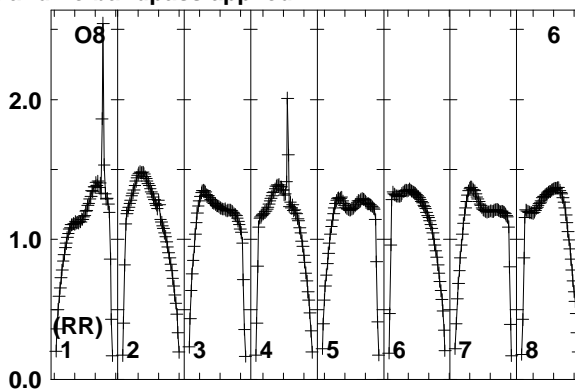
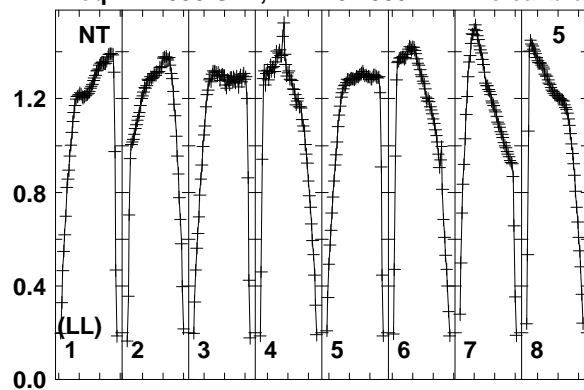

Lower frame: Real Jy
Total-power spectrum Antenna: NT (05)
Timerange: 01/00:32:51 to 01/00:34:20

Plot file version 102 created 23-NOV-2017 14:36:26

J0844+4628 RSM01.UVDATA.1

Freq = 4.7990 GHz, Bw = 32.000 MH No calibration applied and no bandpass applied

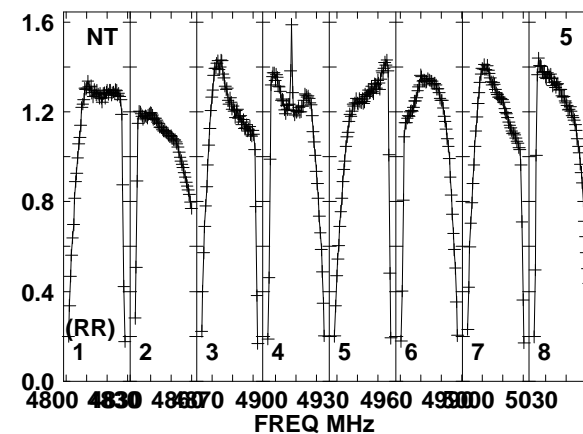
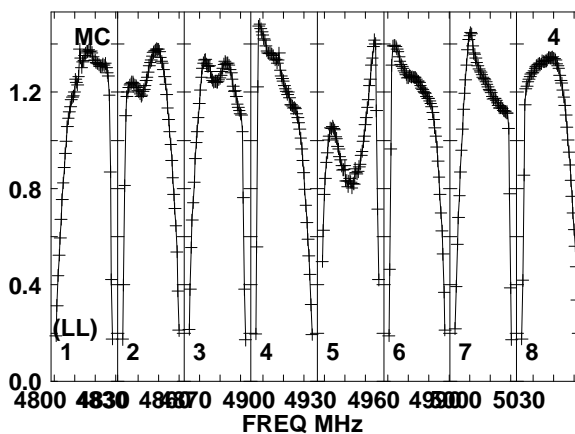
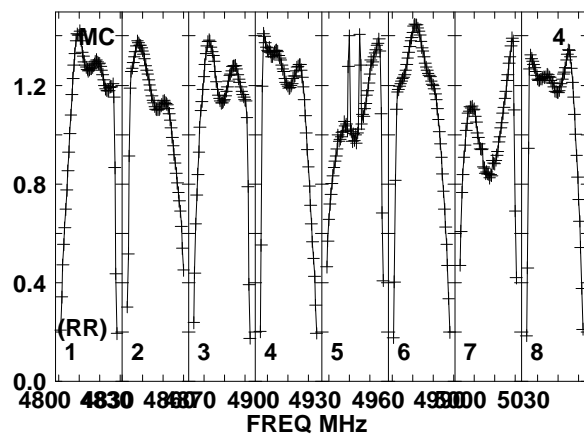
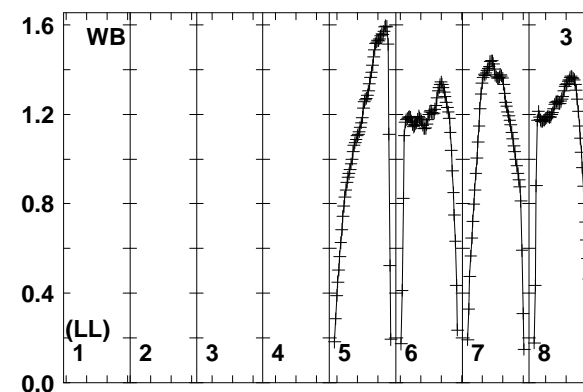
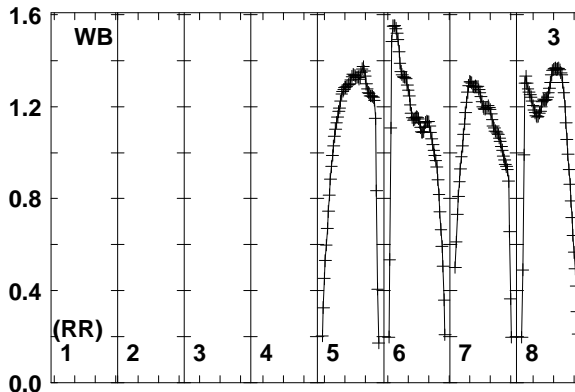
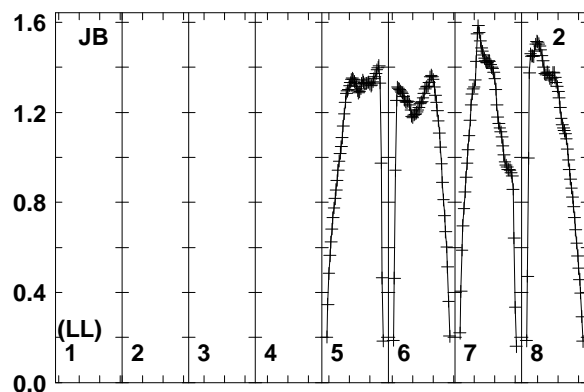
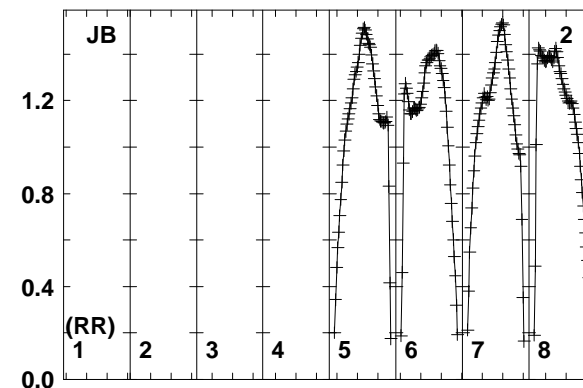
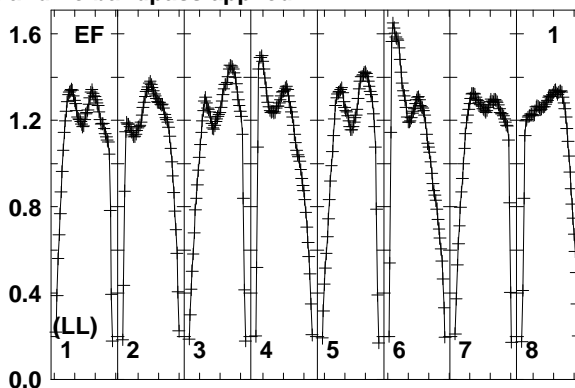
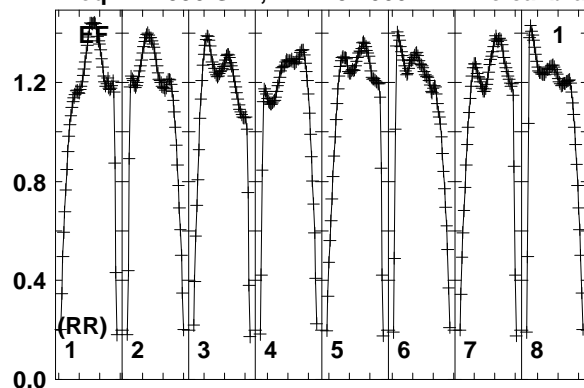

Lower frame: Real Jy
Total-power spectrum Antenna: EF (01)
Timerange: 01/00:34:21 to 01/00:37:50

Plot file version 103 created 23-NOV-2017 14:36:26

J0844+4628 RSM01.UVDATA.1

Freq = 4.7990 GHz, Bw = 32.000 MH No calibration applied and no bandpass applied

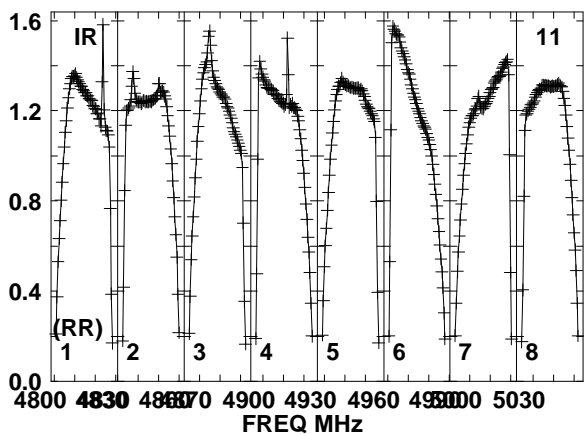
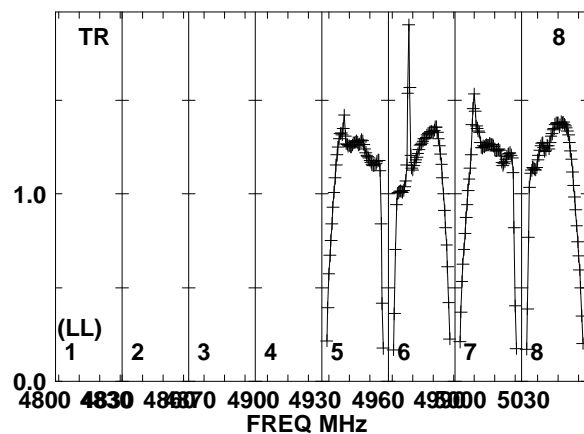
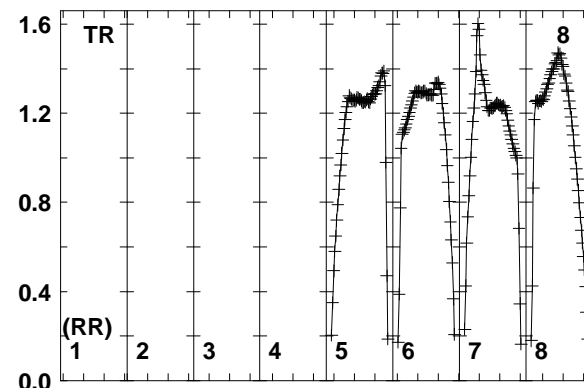
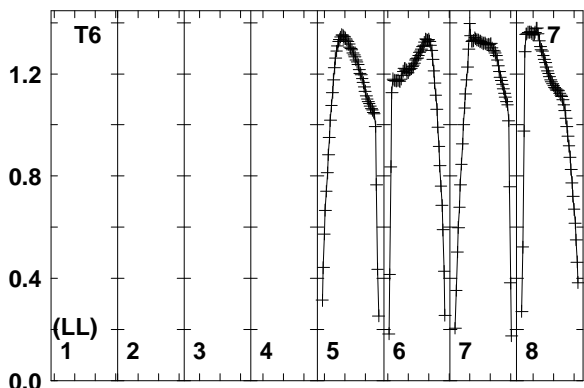
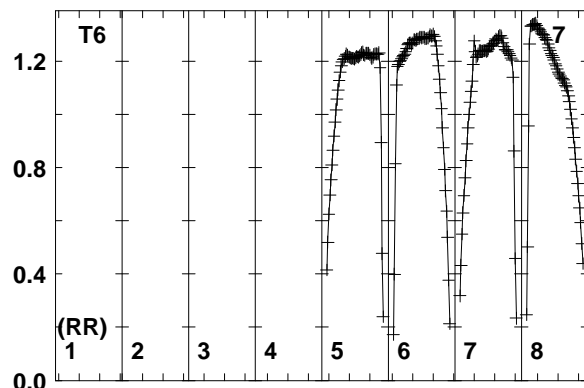
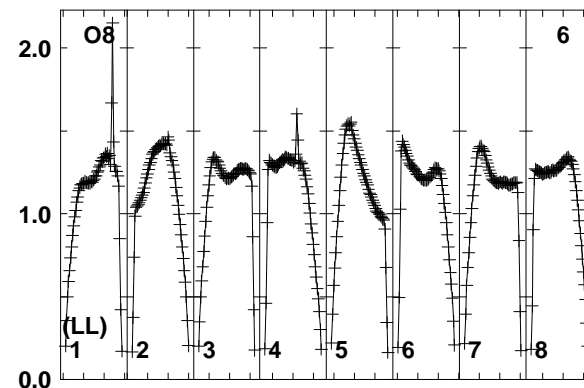
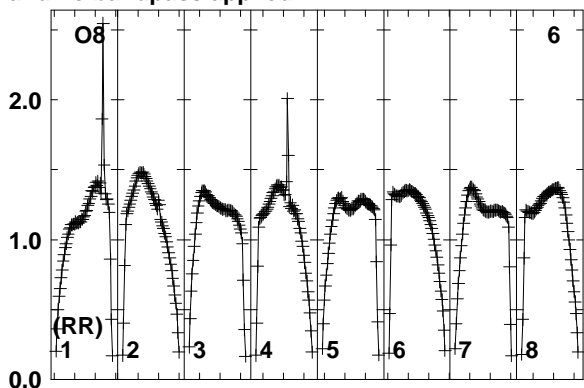
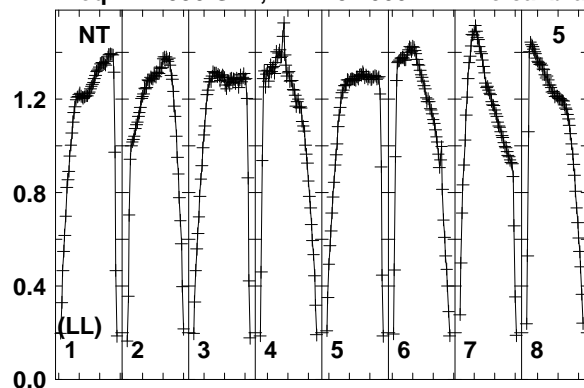

Lower frame: Real Jy
Total-power spectrum Antenna: NT (05)
Timerange: 01/00:34:21 to 01/00:37:50

Plot file version 104 created 23-NOV-2017 14:36:27

J0847+4609 RSM01.UVDATA.1

Freq = 4.7990 GHz, Bw = 32.000 MH No calibration applied and no bandpass applied

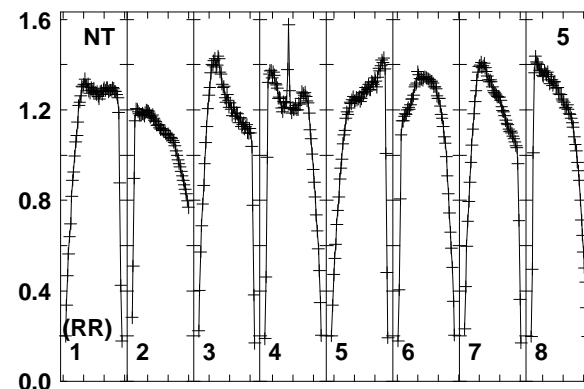
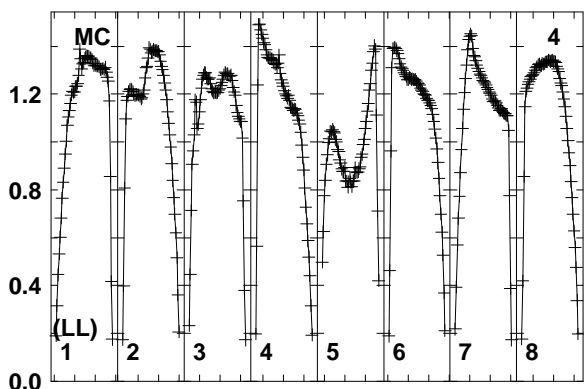
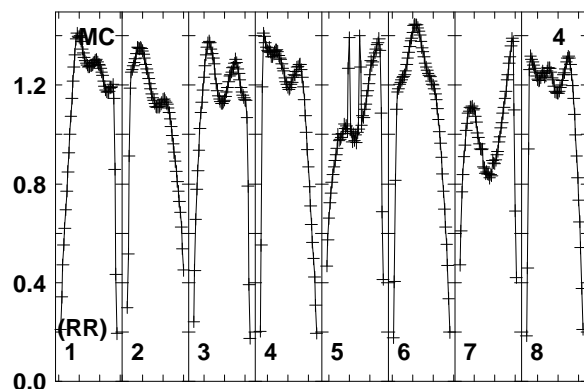
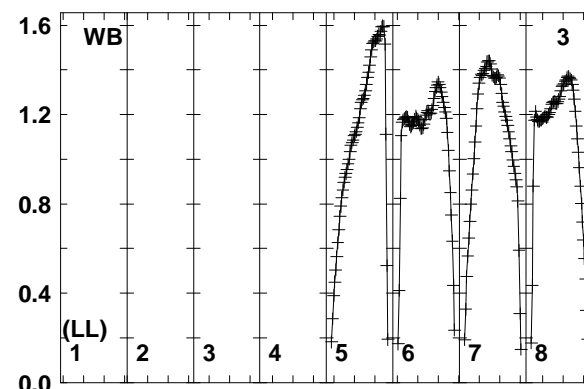
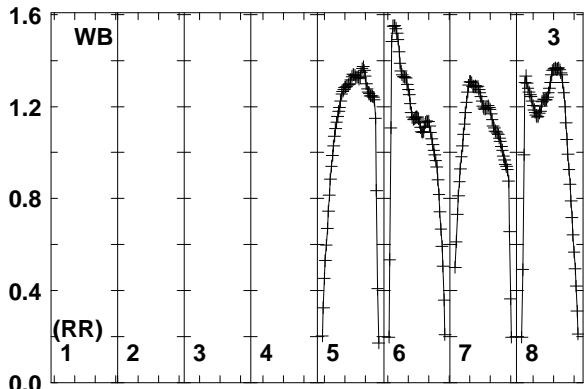
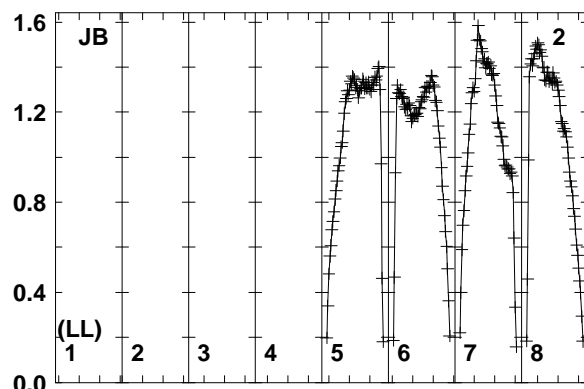
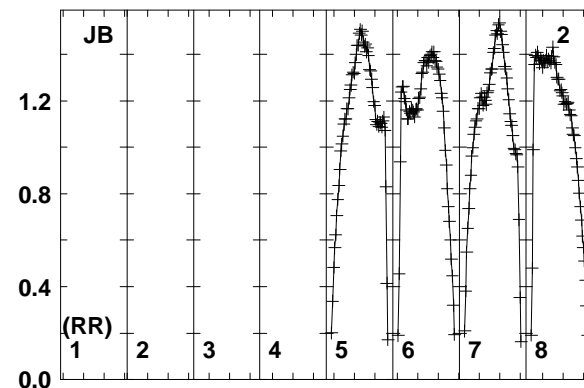
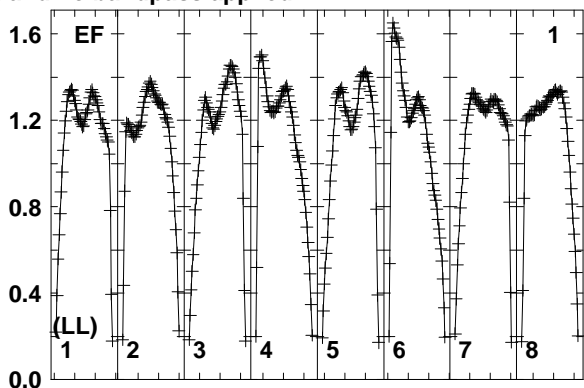
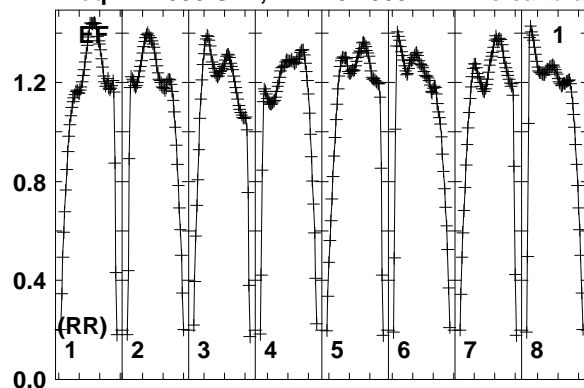

4800 4830 4860 4900 4930 4960 4990 5030
FREQ MHz
Lower frame: Real Jy
Total-power spectrum Antenna: EF (01)
Timerange: 01/00:38:31 to 01/00:39:30

4800 4830 4860 4900 4930 4960 4990 5030
FREQ MHz

4800 4830 4860 4900 4930 4960 4990 5030
FREQ MHz

Plot file version 105 created 23-NOV-2017 14:36:27

J0847+4609 RSM01.UVDATA.1

Freq = 4.7990 GHz, Bw = 32.000 MH No calibration applied and no bandpass applied

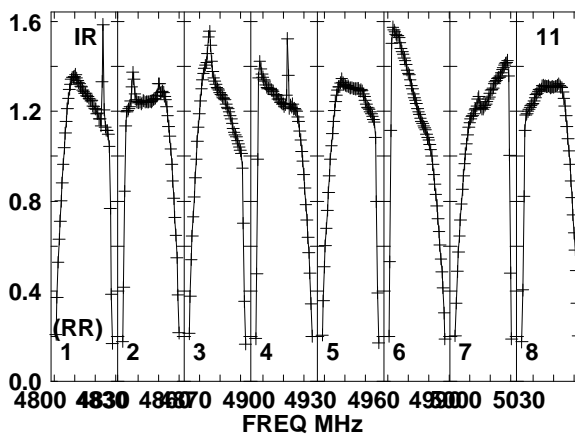
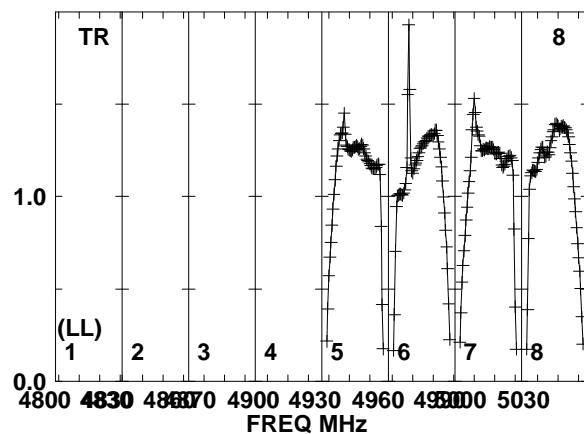
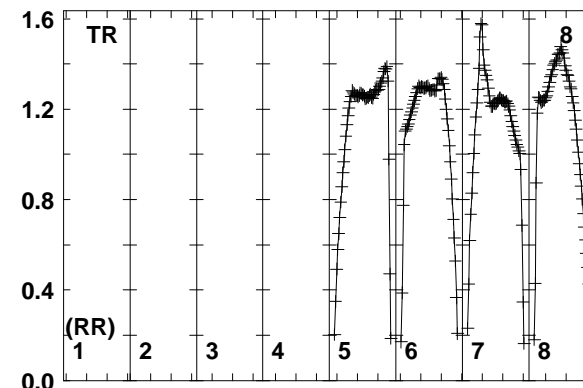
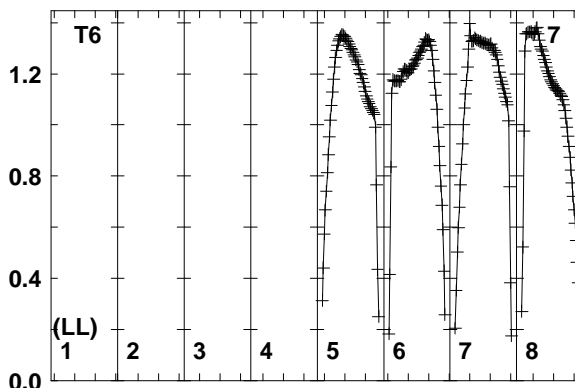
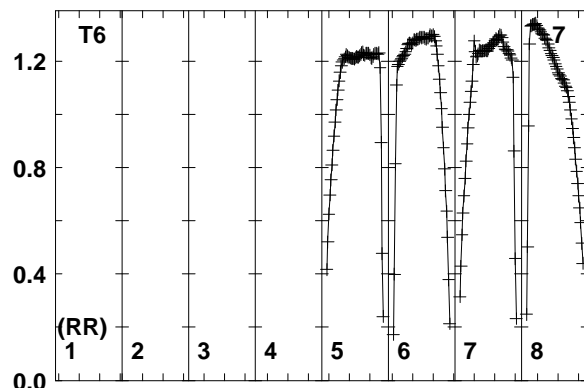
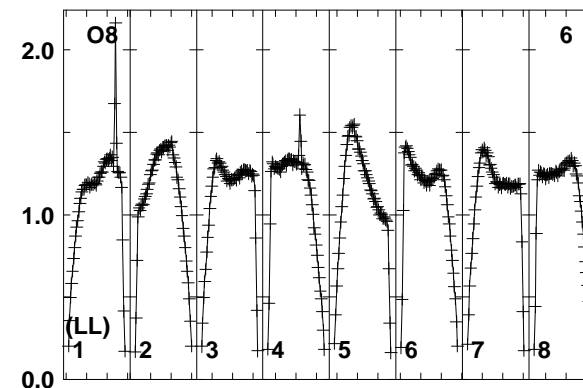
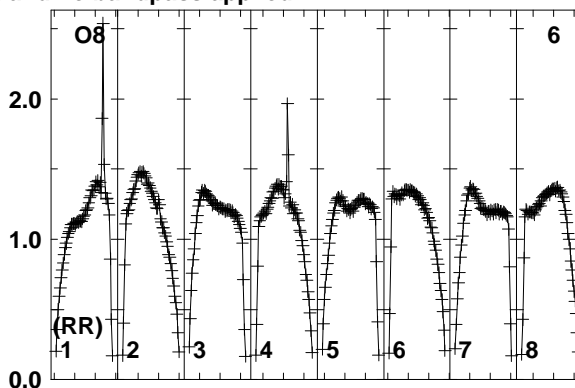
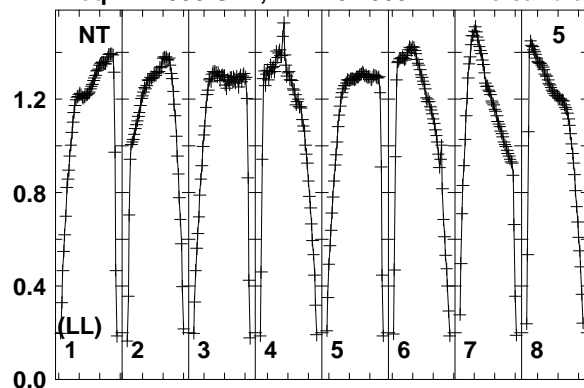

Lower frame: Real Jy
Total-power spectrum Antenna: NT (05)
Timerange: 01/00:38:31 to 01/00:39:30

Plot file version 106 created 23-NOV-2017 14:36:27

J0844+4628 RSM01.UVDATA.1

Freq = 4.7990 GHz, Bw = 32.000 MH No calibration applied and no bandpass applied

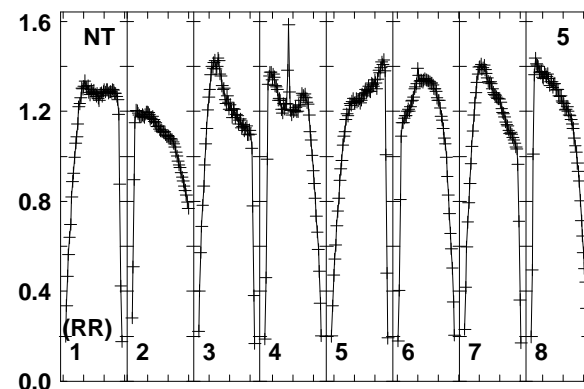
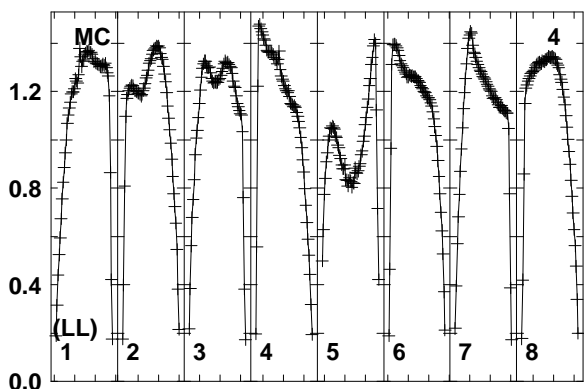
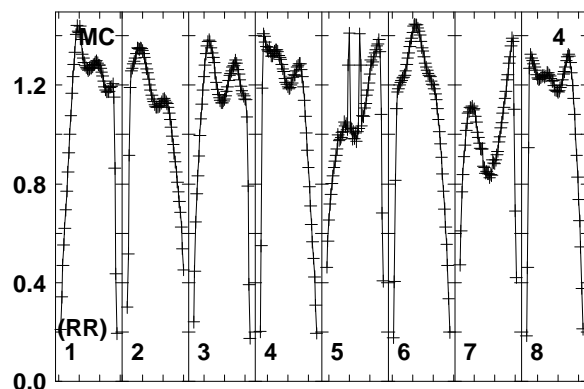
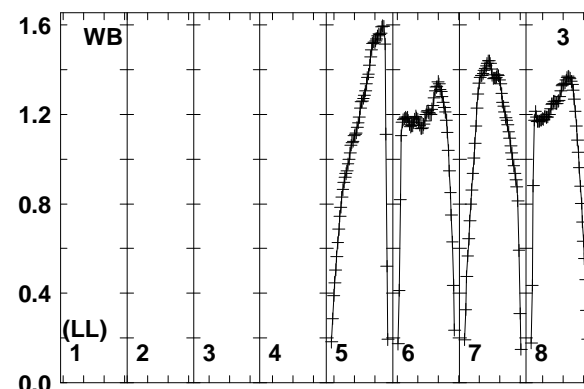
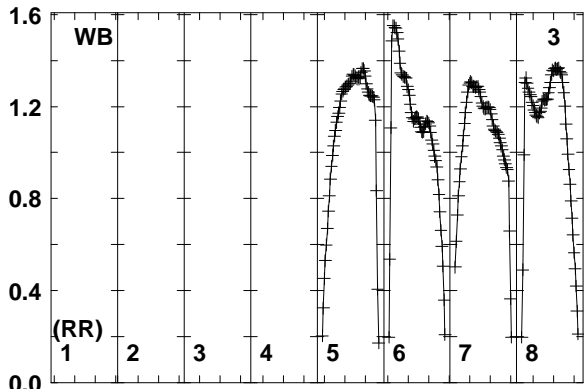
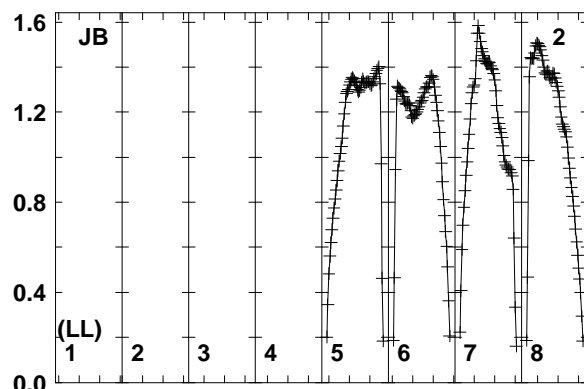
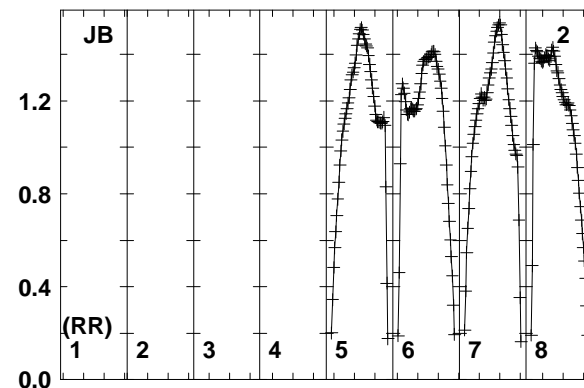
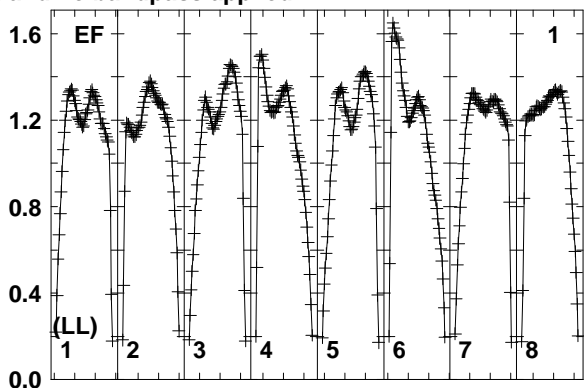
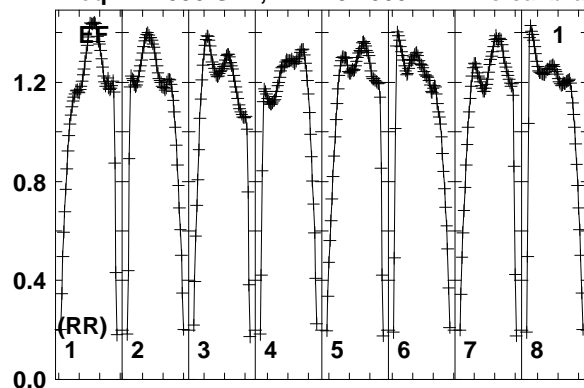

4800 4830 4860 4900 4930 4960 4990 5030
FREQ MHz
Lower frame: Real Jy
Total-power spectrum Antenna: EF (01)
Timerange: 01/00:39:31 to 01/00:43:00

4800 4830 4860 4900 4930 4960 4990 5030
FREQ MHz

4800 4830 4860 4900 4930 4960 4990 5030
FREQ MHz

Plot file version 107 created 23-NOV-2017 14:36:28

J0844+4628 RSM01.UVDATA.1

Freq = 4.7990 GHz, Bw = 32.000 MH No calibration applied and no bandpass applied

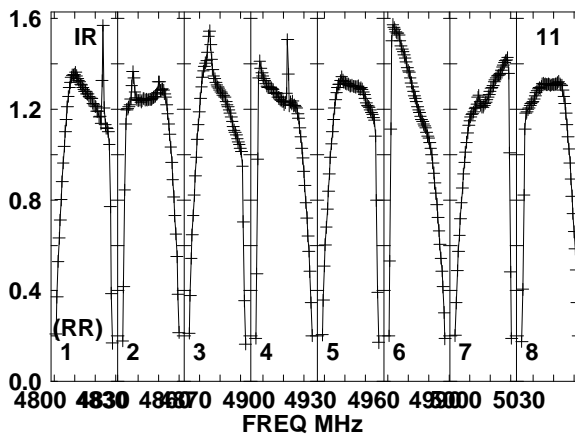
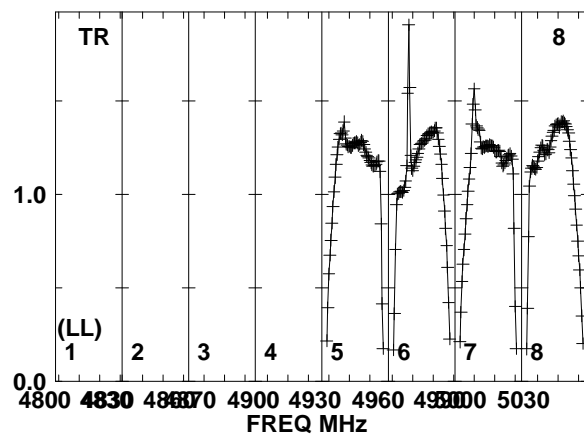
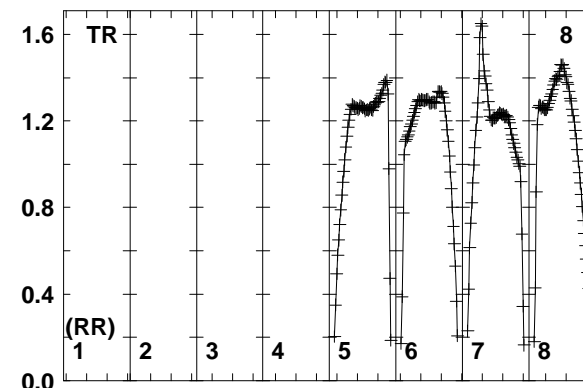
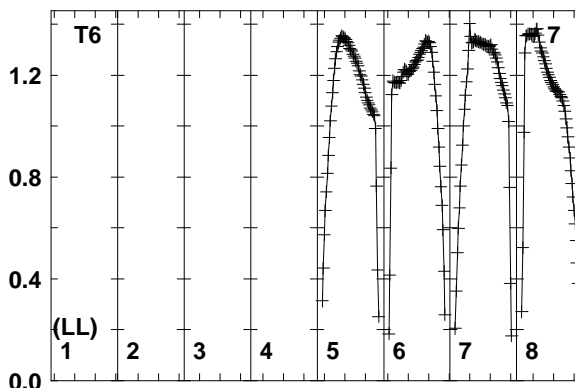
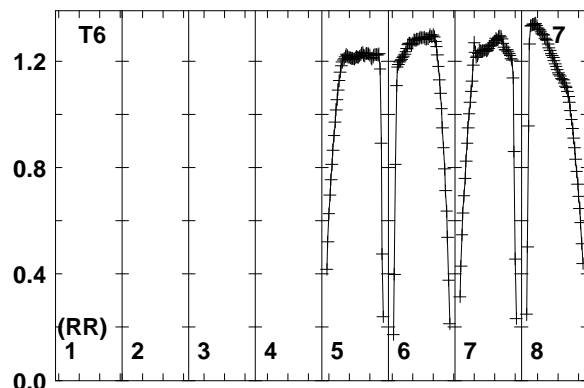
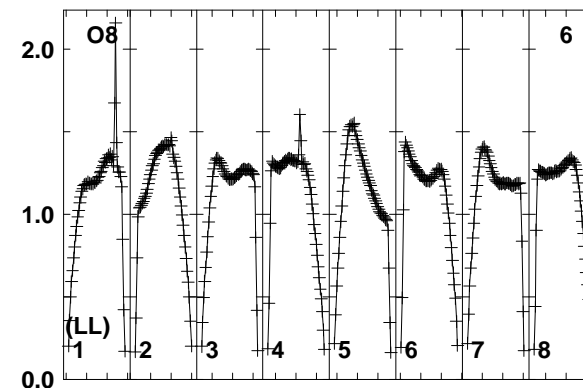
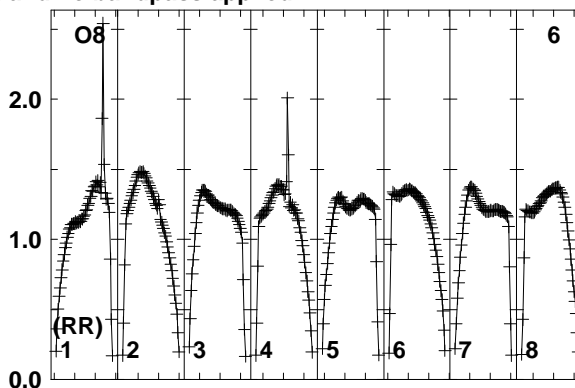
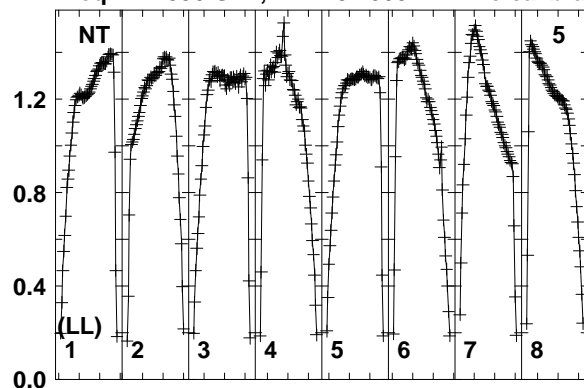

Lower frame: Real Jy
Total-power spectrum Antenna: NT (05)
Timerange: 01/00:39:31 to 01/00:43:00

Plot file version 108 created 23-NOV-2017 14:36:28

J0847+4609 RSM01.UVDATA.1

Freq = 4.7990 GHz, Bw = 32.000 MH No calibration applied and no bandpass applied

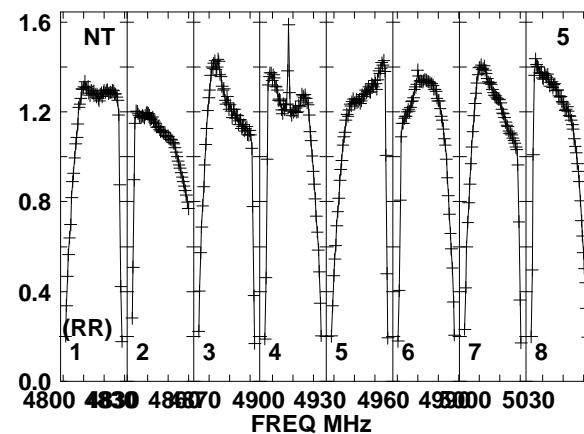
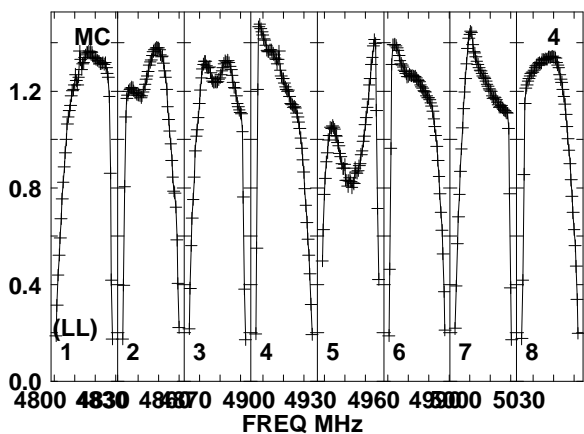
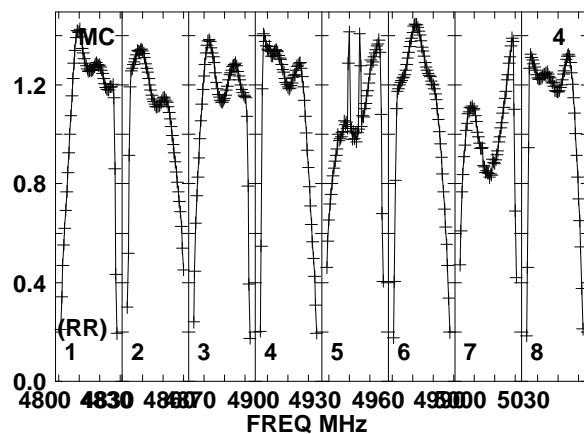
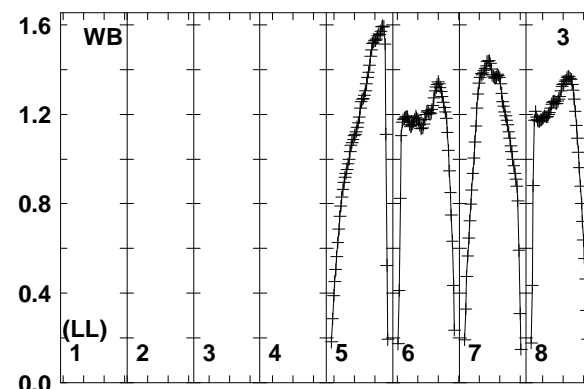
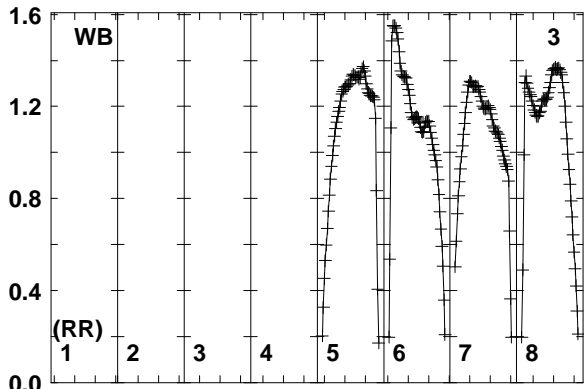
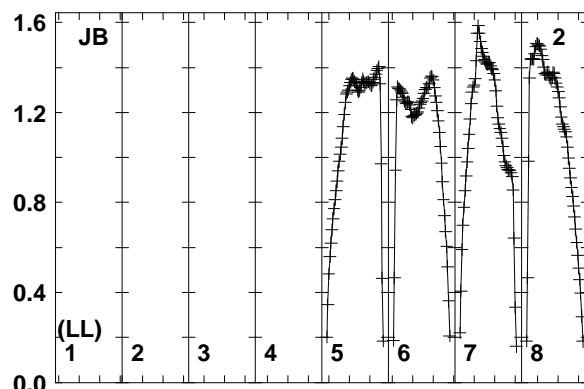
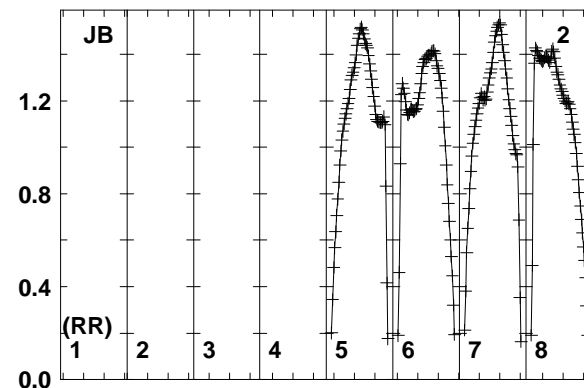
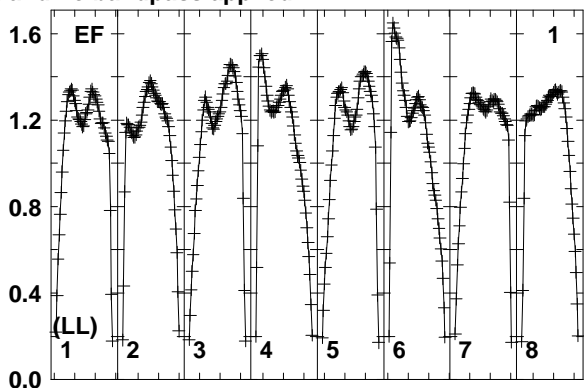
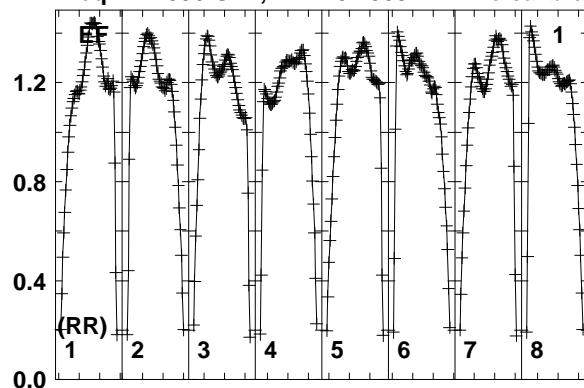

Lower frame: Real Jy
Total-power spectrum Antenna: EF (01)
Timerange: 01/00:43:01 to 01/00:44:29

Plot file version 109 created 23-NOV-2017 14:36:28

J0847+4609 RSM01.UVDATA.1

Freq = 4.7990 GHz, Bw = 32.000 MH No calibration applied and no bandpass applied

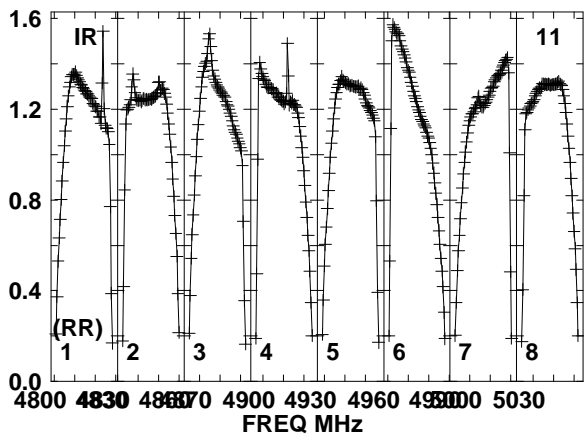
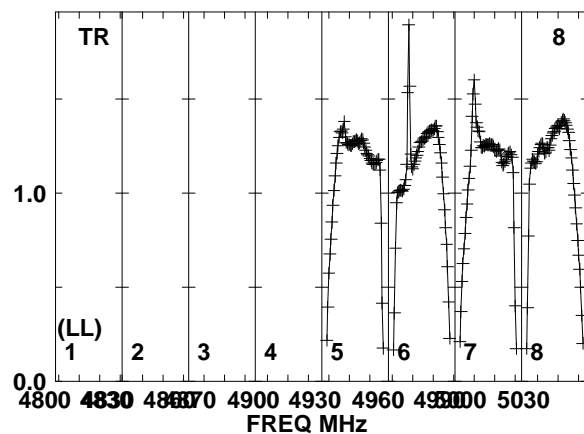
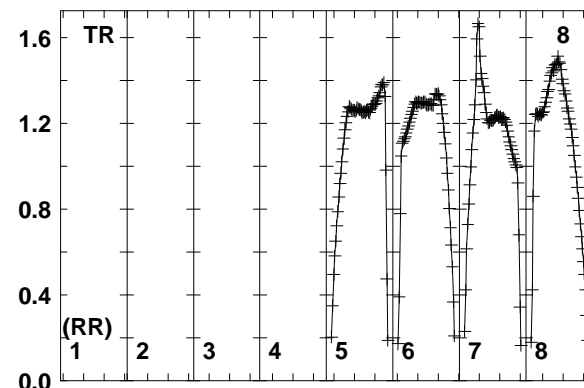
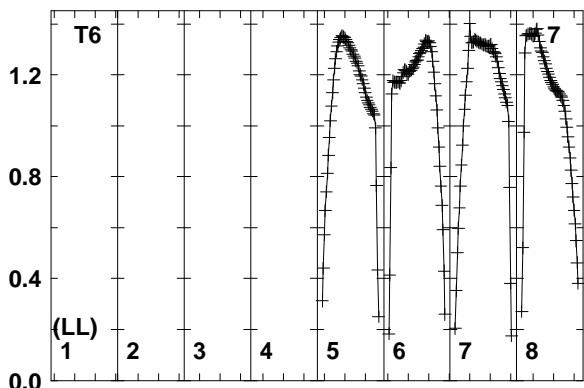
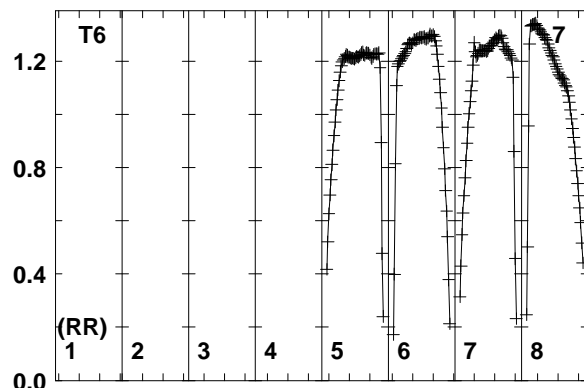
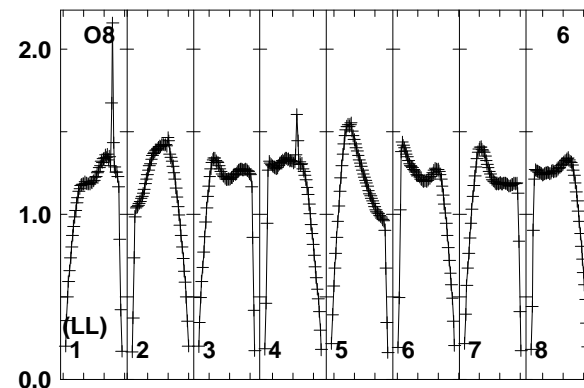
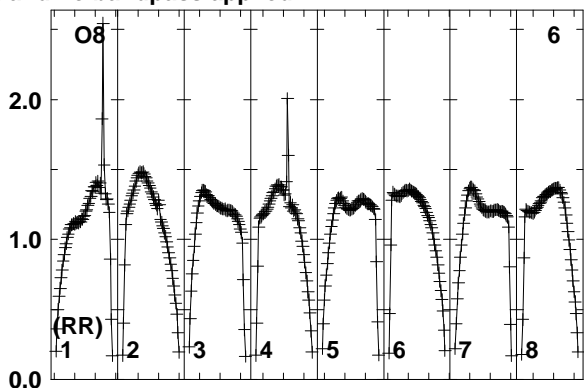
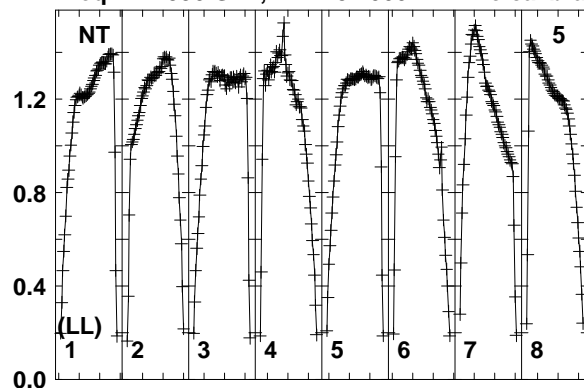

Lower frame: Real Jy
Total-power spectrum Antenna: NT (05)
Timerange: 01/00:43:01 to 01/00:44:29

Plot file version 110 created 23-NOV-2017 14:36:29

J0844+4628 RSM01.UVDATA.1

Freq = 4.7990 GHz, Bw = 32.000 MH No calibration applied and no bandpass applied

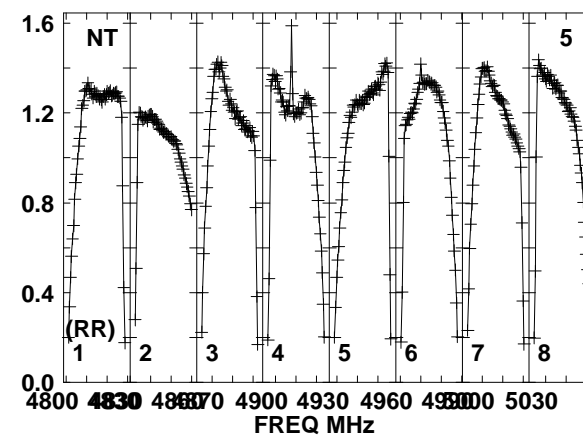
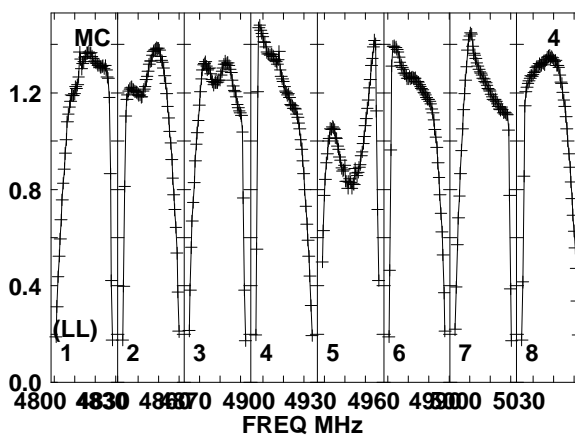
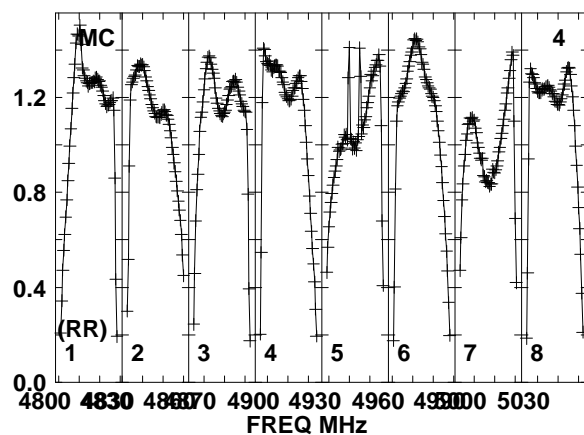
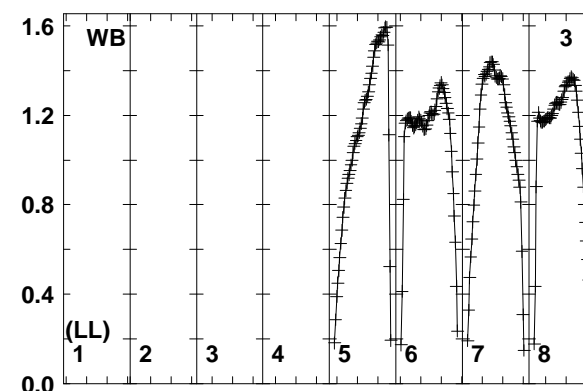
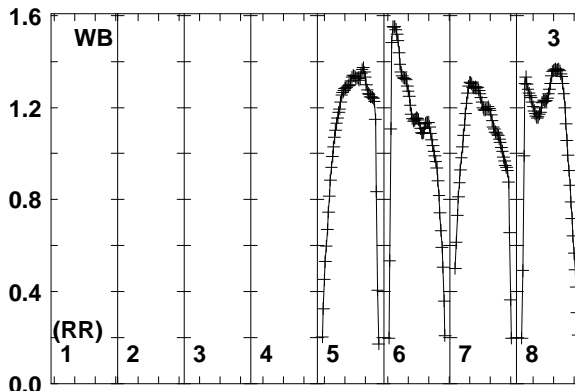
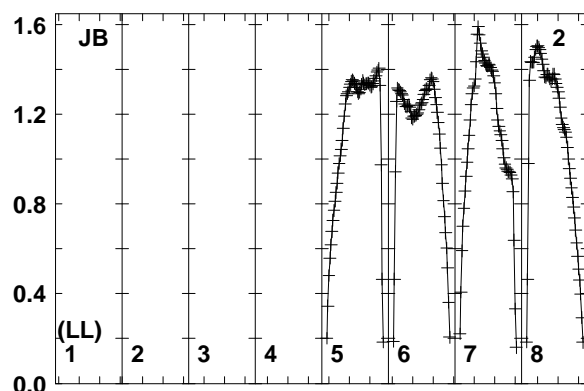
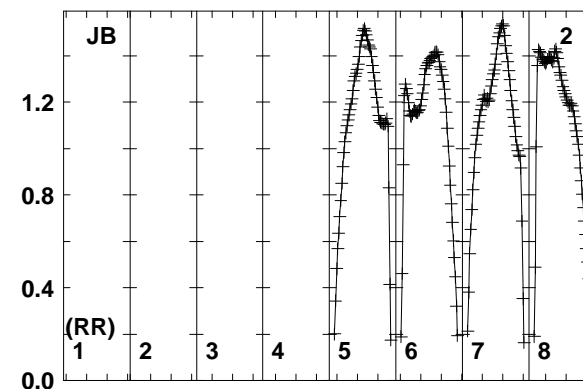
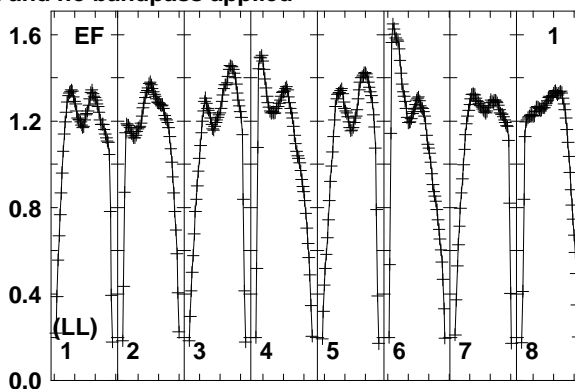
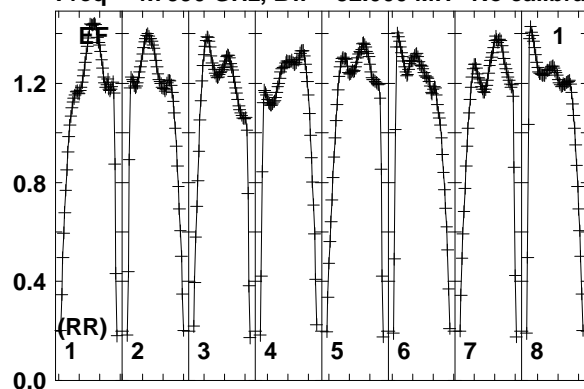

Lower frame: Real Jy
Total-power spectrum Antenna: EF (01)
Timerange: 01/00:44:31 to 01/00:48:00

Plot file version 111 created 23-NOV-2017 14:36:29

J0844+4628 RSM01.UVDATA.1

Freq = 4.7990 GHz, Bw = 32.000 MH No calibration applied and no bandpass applied

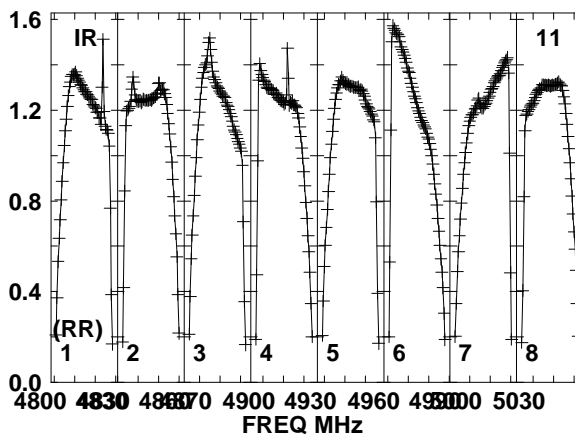
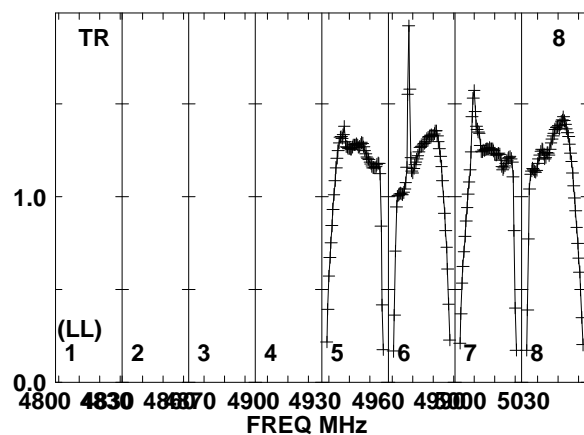
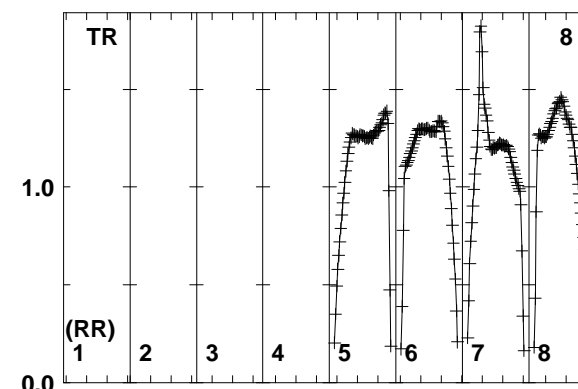
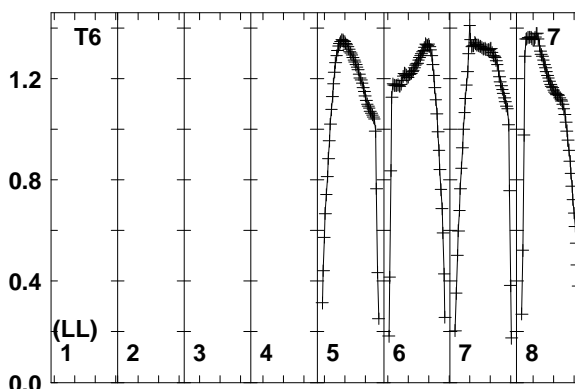
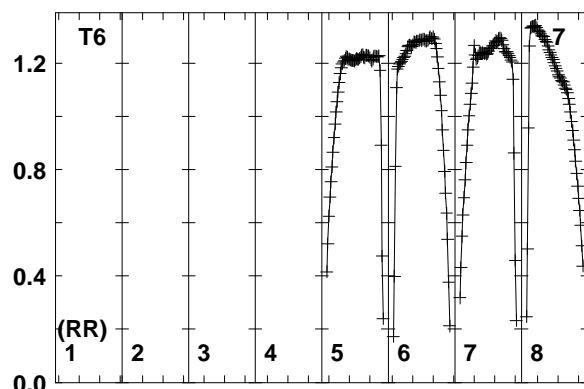
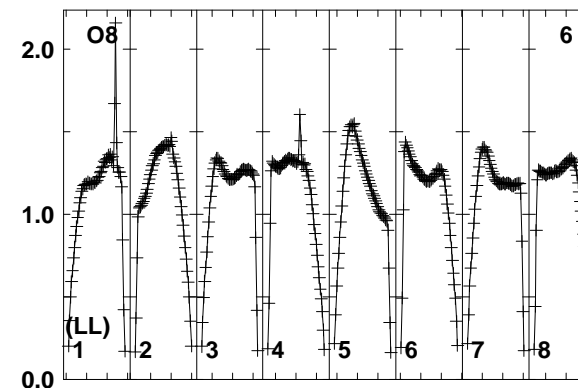
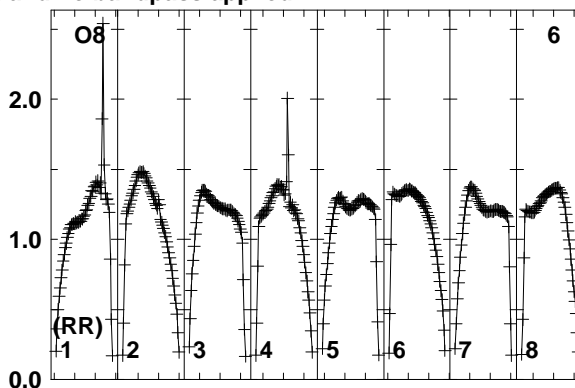
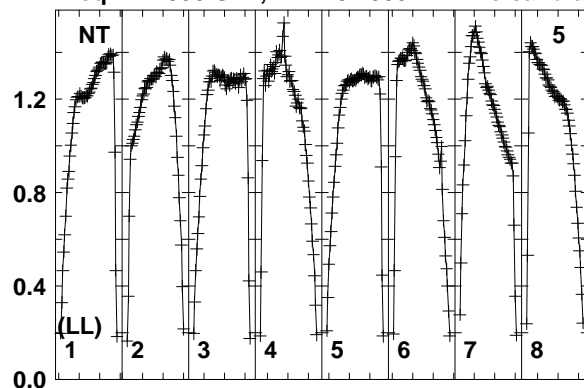

Lower frame: Real Jy
Total-power spectrum Antenna: NT (05)
Timerange: 01/00:44:31 to 01/00:48:00

Plot file version 112 created 23-NOV-2017 14:36:29

J0847+4609 RSM01.UVDATA.1

Freq = 4.7990 GHz, Bw = 32.000 MH No calibration applied and no bandpass applied

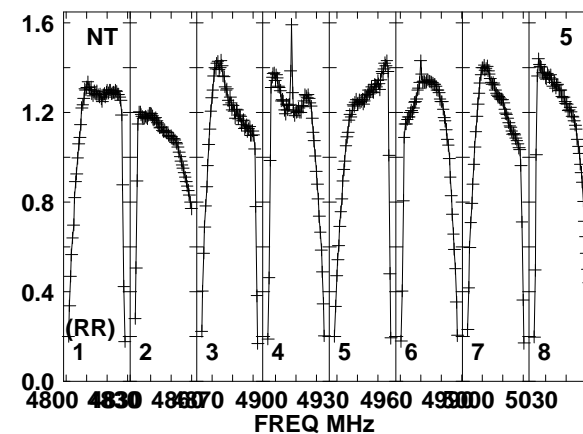
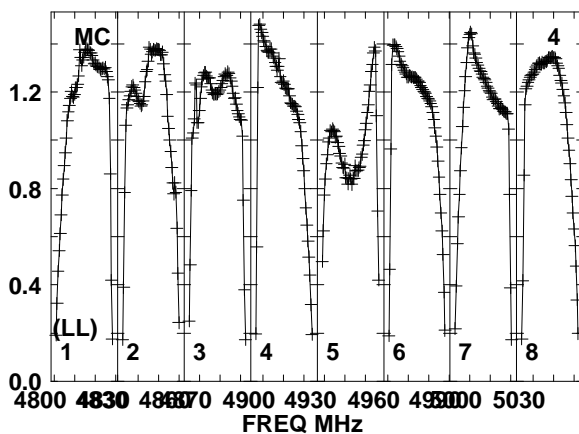
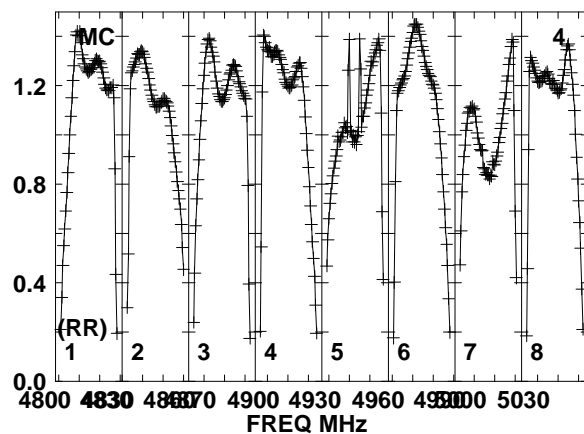
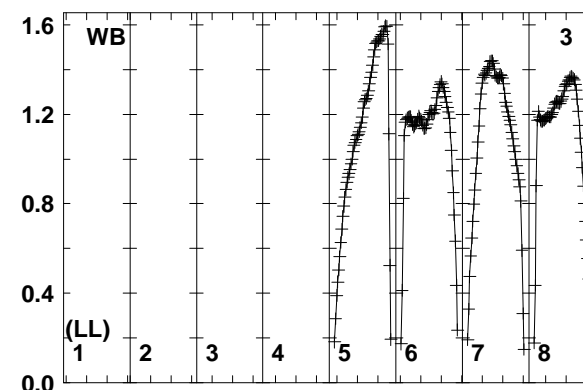
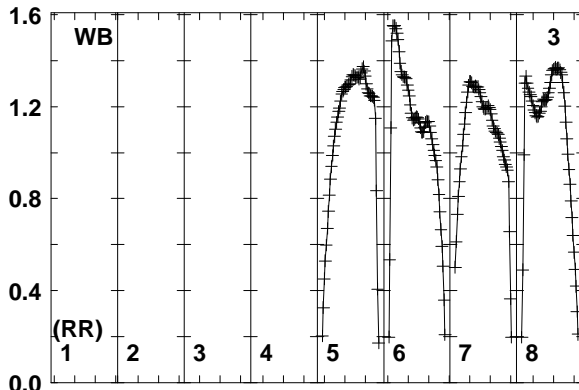
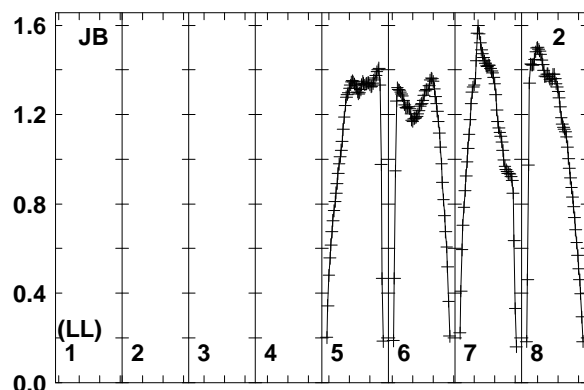
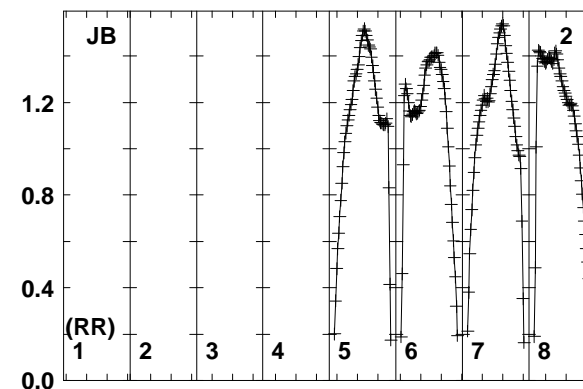
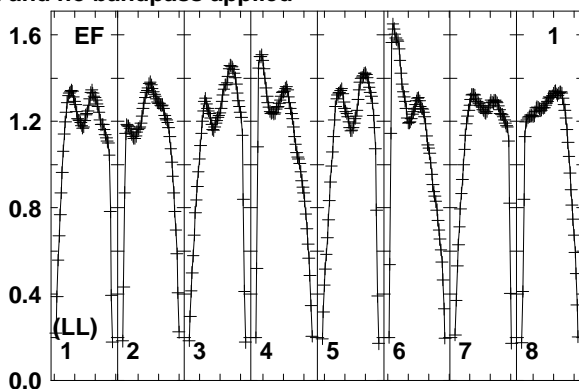
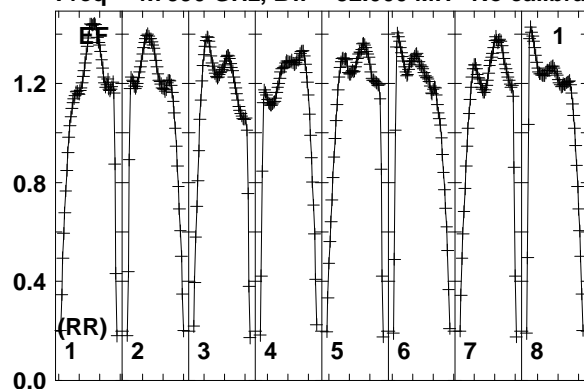

Lower frame: Real Jy
Total-power spectrum Antenna: EF (01)
Timerange: 01/00:48:40 to 01/00:49:39

Plot file version 113 created 23-NOV-2017 14:36:30

J0847+4609 RSM01.UVDATA.1

Freq = 4.7990 GHz, Bw = 32.000 MH No calibration applied and no bandpass applied

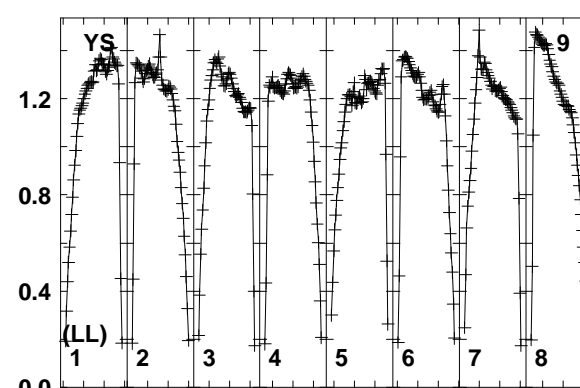
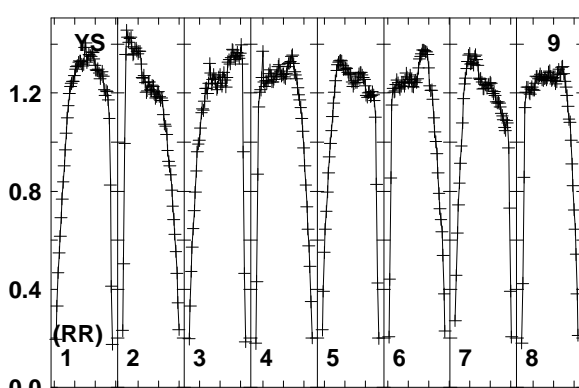
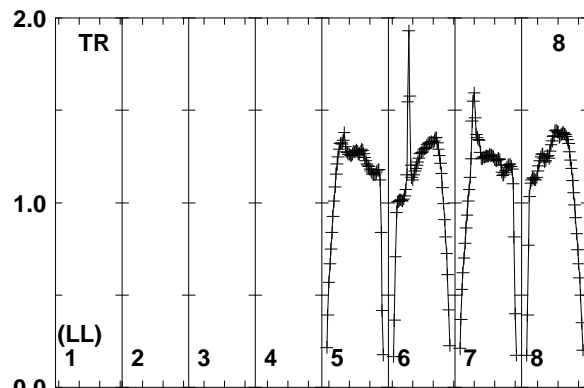
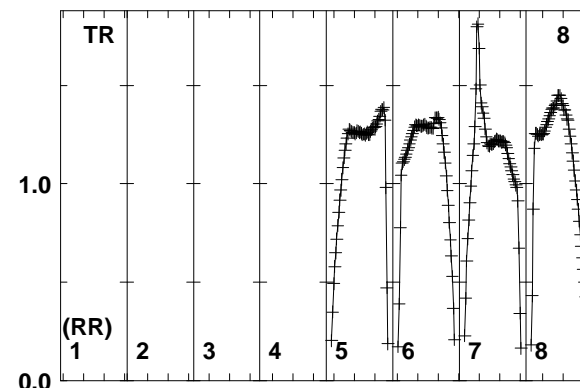
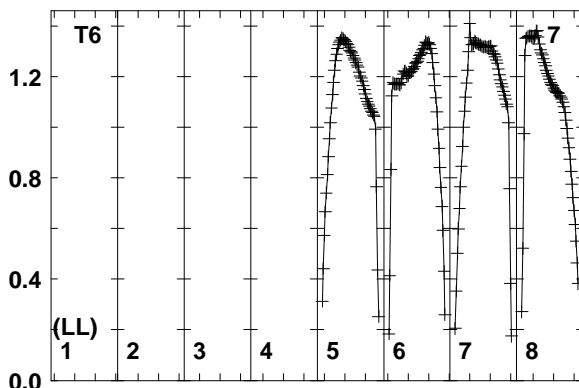
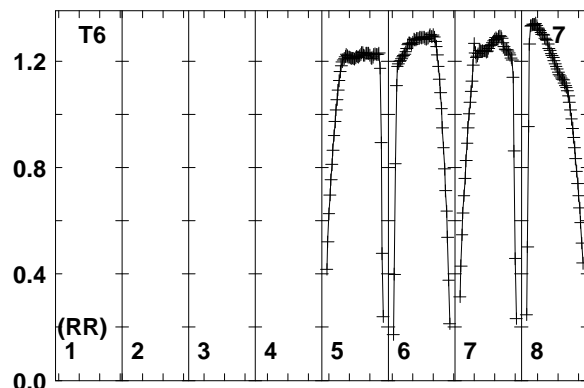
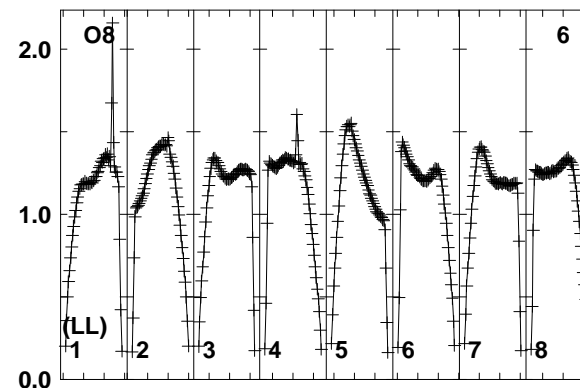
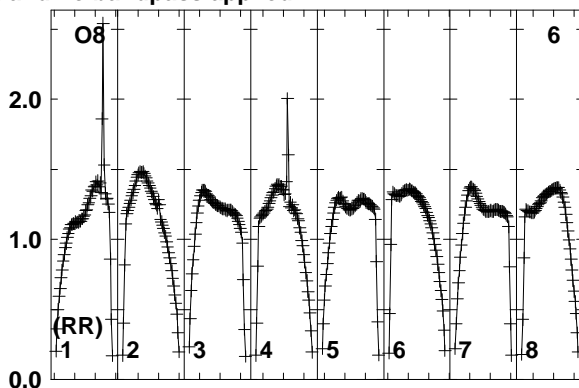
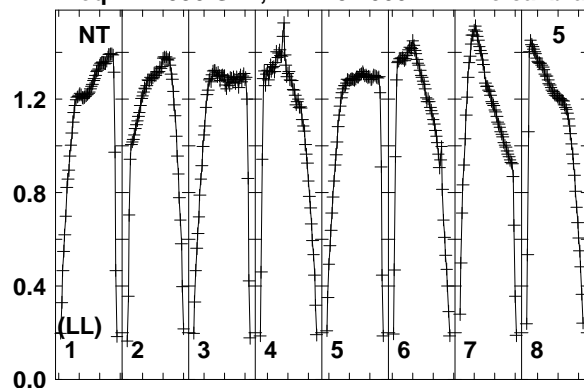

4800 4830 4860 4900 4930 4960 4990 5030
FREQ MHz
Lower frame: Real Jy
Total-power spectrum Antenna: NT (05)
Timerange: 01/00:48:40 to 01/00:49:39

4800 4830 4860 4900 4930 4960 4990 5030
FREQ MHz

4800 4830 4860 4900 4930 4960 4990 5030
FREQ MHz

Plot file version 114 created 23-NOV-2017 14:36:30

J0847+4609 RSM01.UVDATA.1

Freq = 4.7990 GHz, Bw = 32.000 MH No calibration applied and no bandpass applied

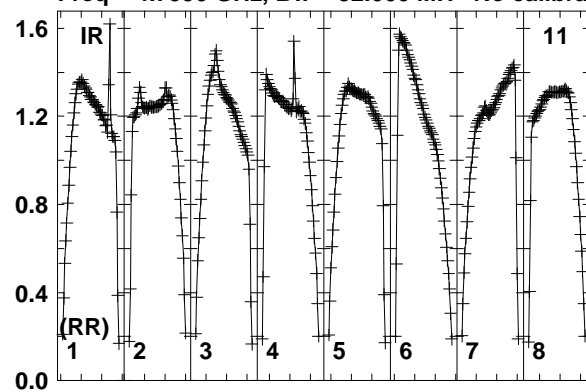

Lower frame: Real Jy
Total-power spectrum Antenna: IR (11)
Timerange: 01/00:48:40 to 01/00:49:39

Plot file version 115 created 23-NOV-2017 14:36:30

J0927+3902 RSM01.UVDATA.1

Freq = 4.7990 GHz, Bw = 32.000 MH No calibration applied and no bandpass applied

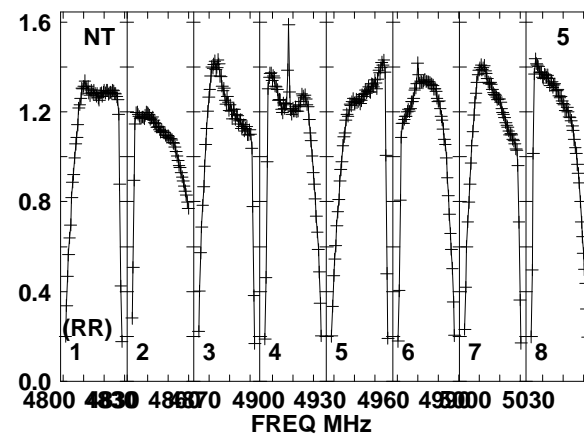
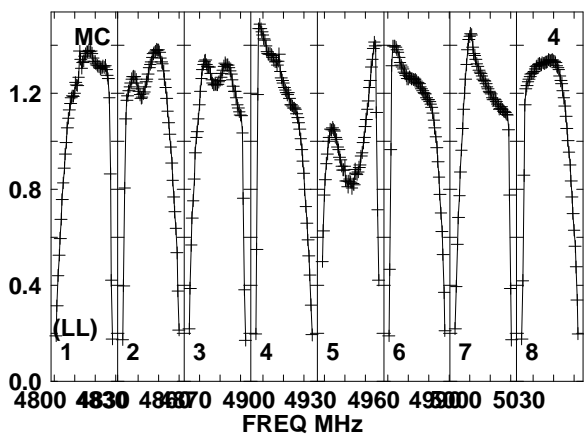
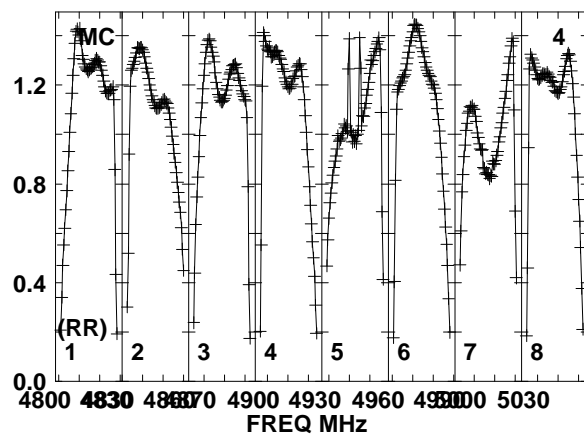
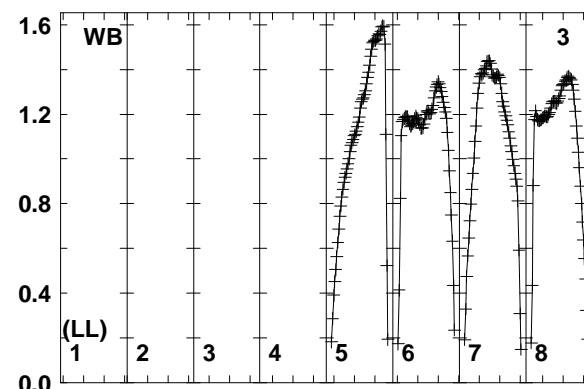
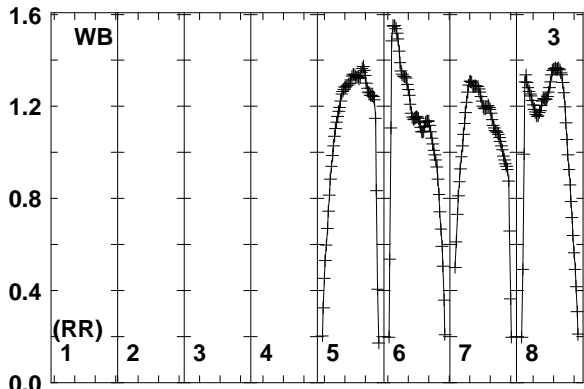
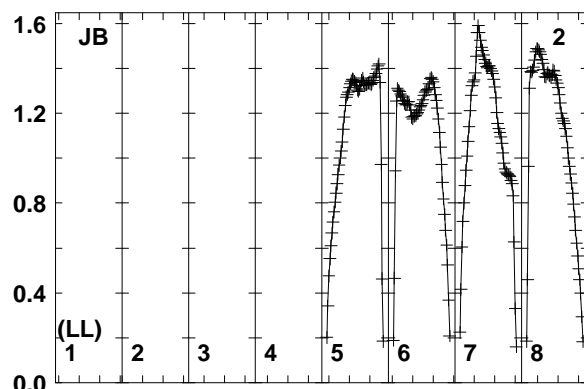
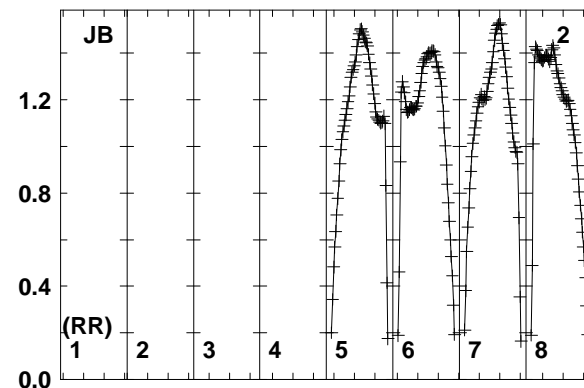
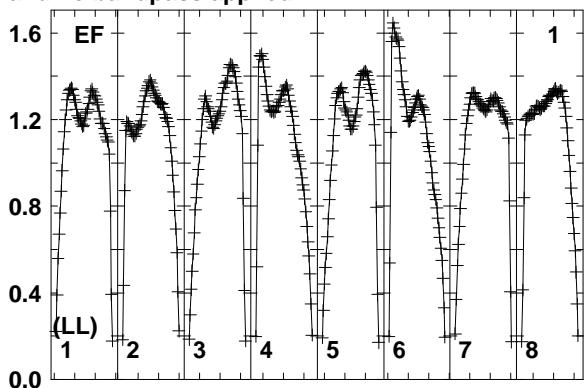
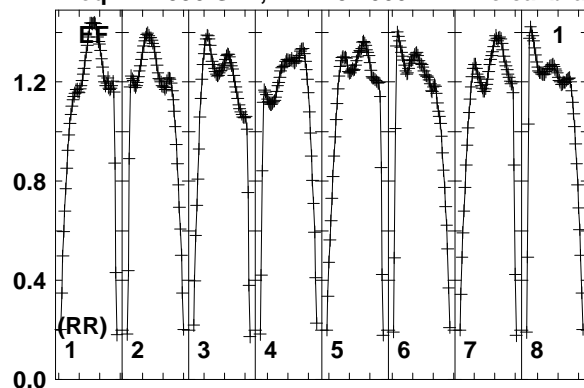

Lower frame: Real Jy
Total-power spectrum Antenna: EF (01)
Timerange: 01/00:50:40 to 01/00:55:29

Plot file version 116 created 23-NOV-2017 14:36:30

J0927+3902 RSM01.UVDATA.1

Freq = 4.7990 GHz, Bw = 32.000 MH No calibration applied and no bandpass applied

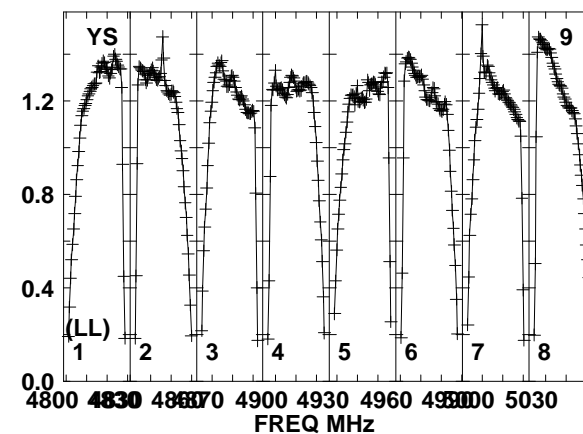
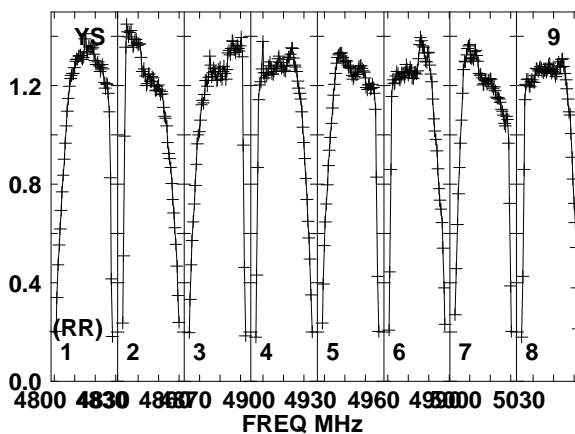
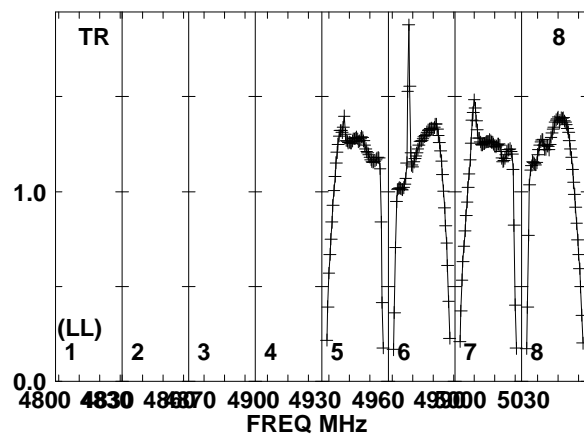
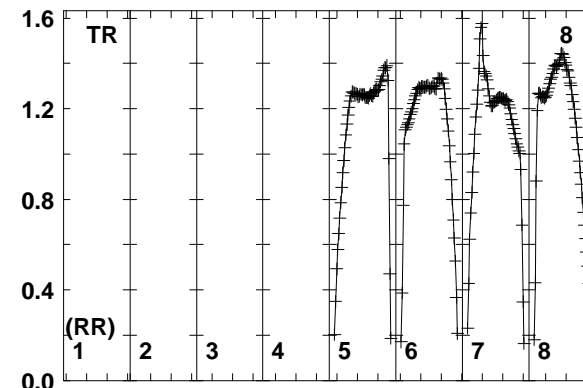
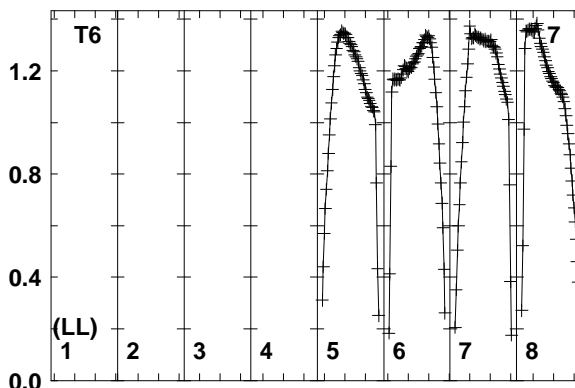
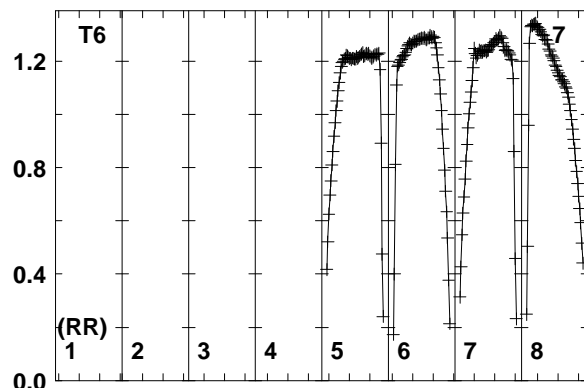
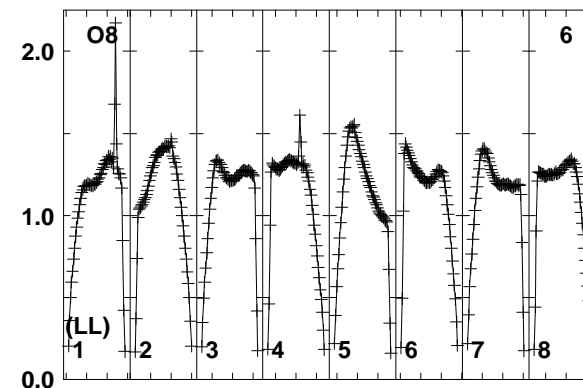
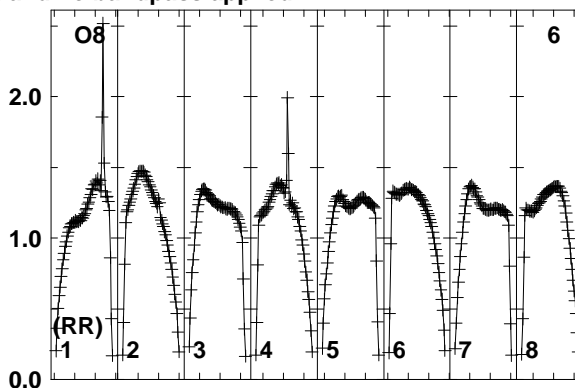
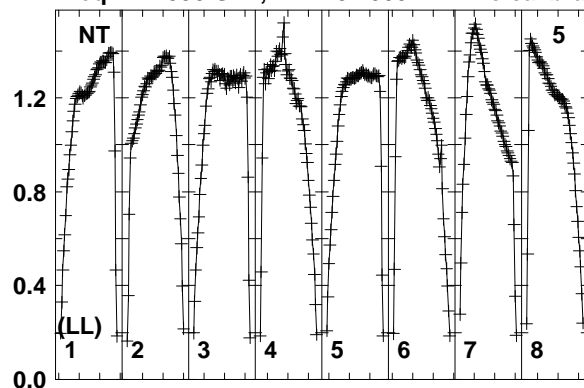

Lower frame: Real Jy
Total-power spectrum Antenna: NT (05)
Timerange: 01/00:50:40 to 01/00:55:29

Plot file version 117 created 23-NOV-2017 14:36:31
J0927+3902 RSM01.UVDATA.1
Freq = 4.7990 GHz, Bw = 32.000 MH No calibration applied and no bandpass applied

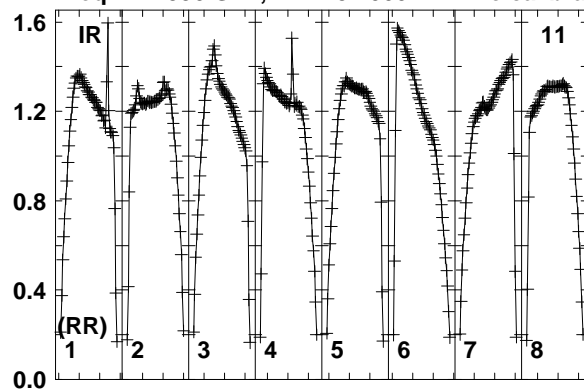

Lower frame: Real Jy
Total-power spectrum Antenna: IR (11)
Timerange: 01/00:50:40 to 01/00:55:29