

Plot file version 1 created 20-APR-2018 17:20:37

J1427+2632 RSM02.UVDATA.1

Freq = 4.7995 GHz, Bw = 32.000 MH No calibration applied and no bandpass applied

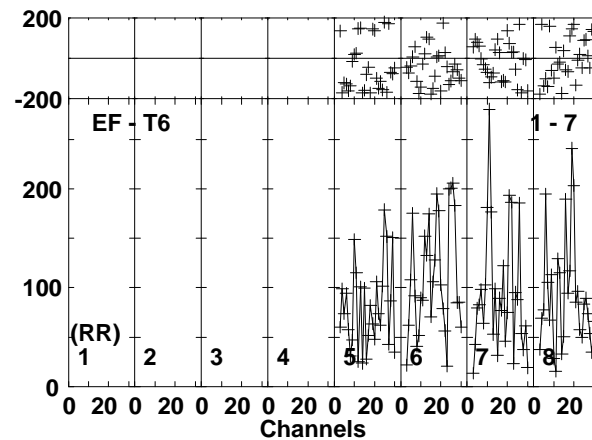
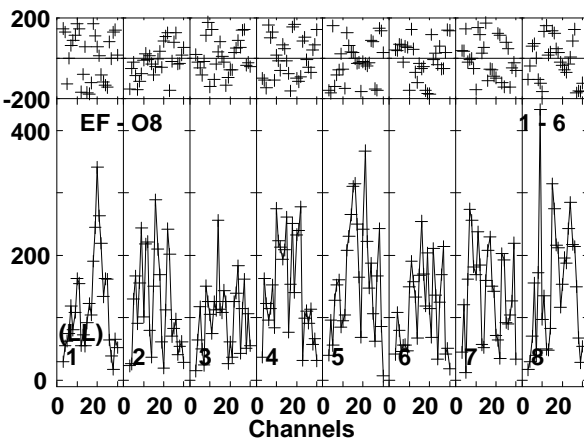
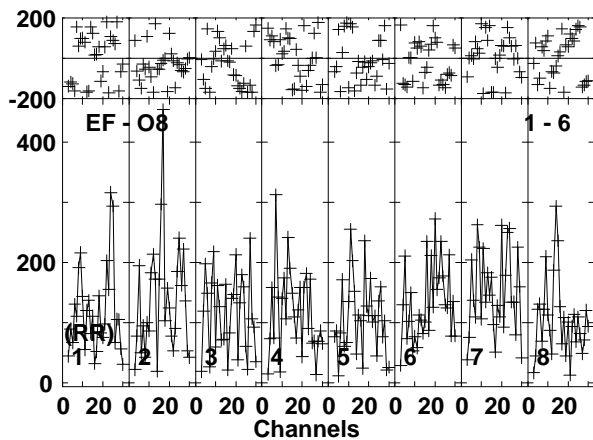
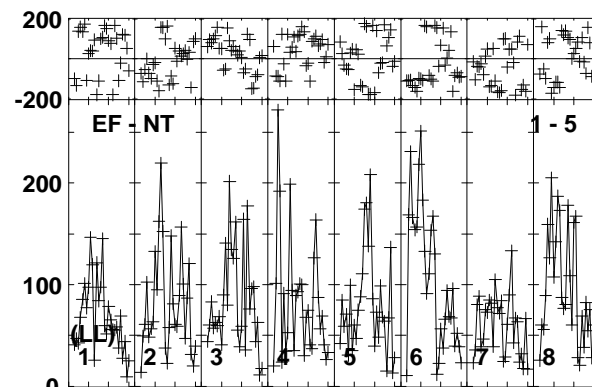
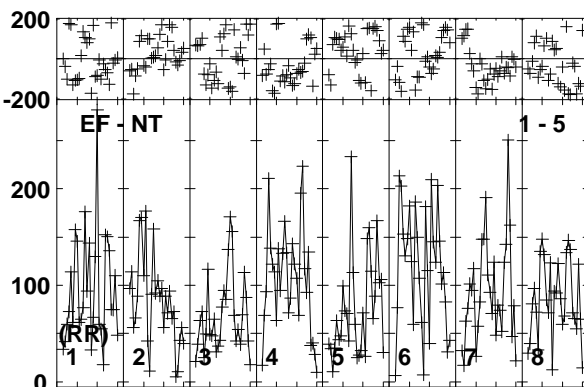
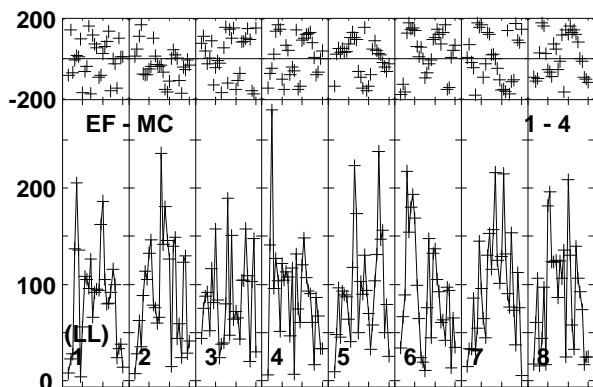
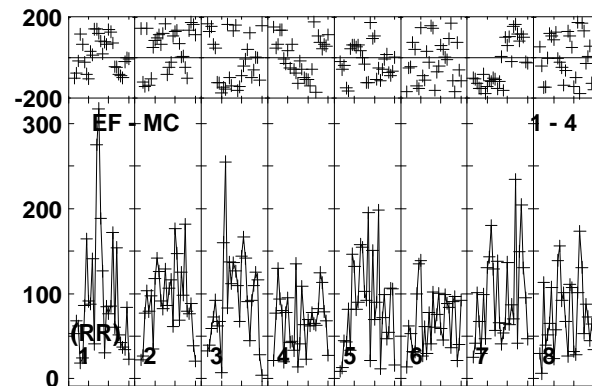
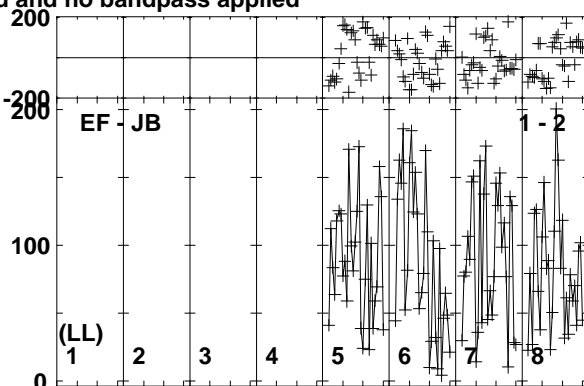
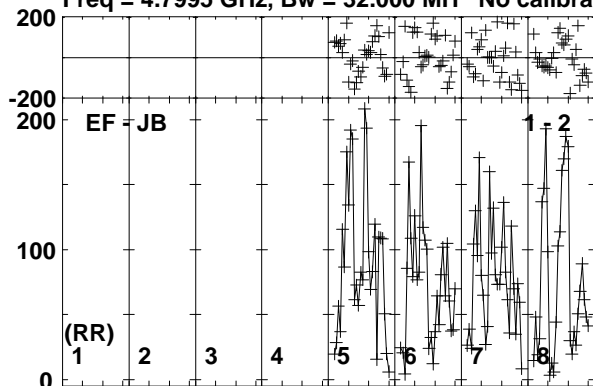

Lower frame: Micro Ampl Jy Top frame: Phas deg
Vector averaged cross-power spectrum Baseline: EF (01) - JB (02)
Timerange: 00:18:31:22 to 00:18:34:48

Plot file version 2 created 20-APR-2018 17:20:38

J1427+2632 RSM02.UVDATA.1

Freq = 4.7995 GHz, Bw = 32.000 MH No calibration applied and no bandpass applied

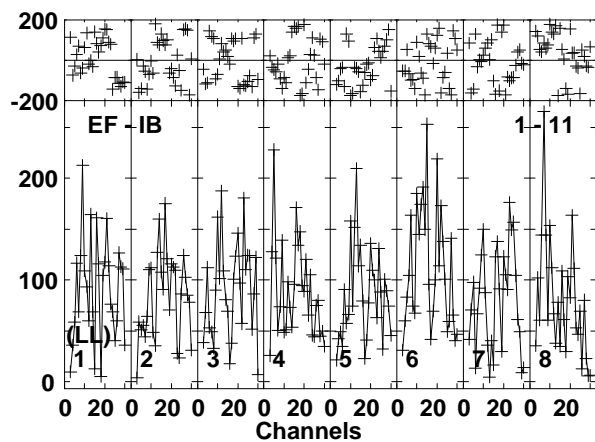
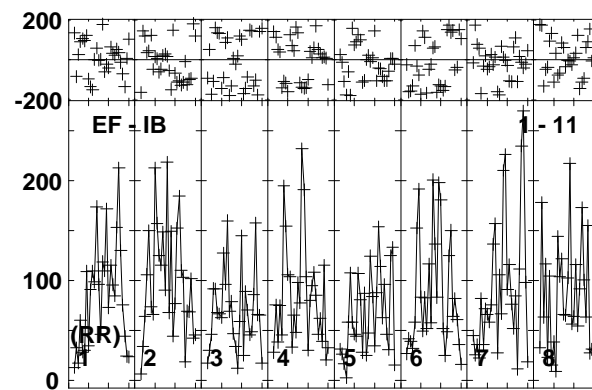
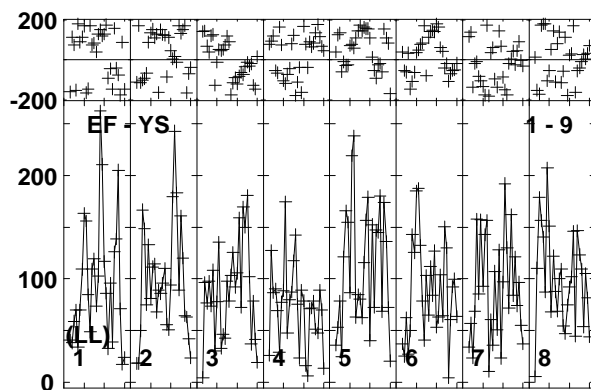
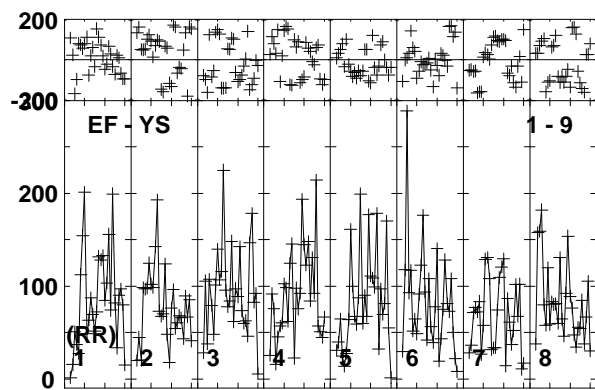
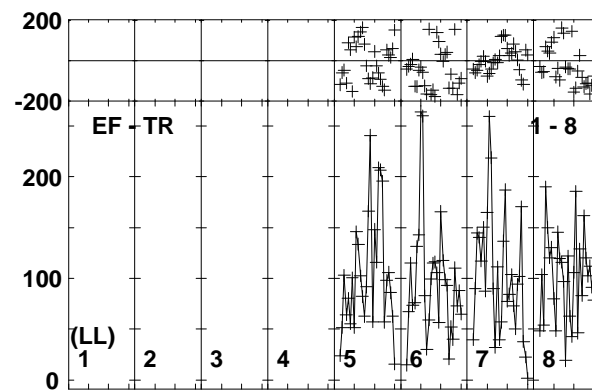
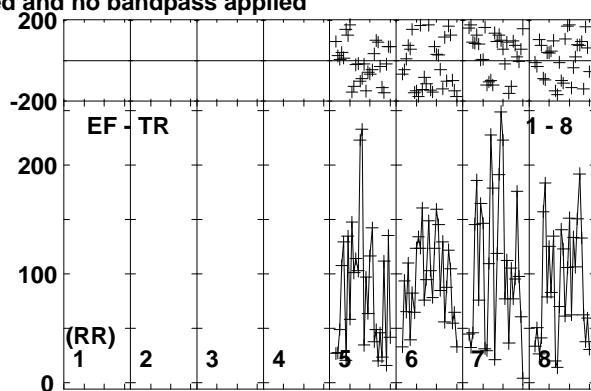
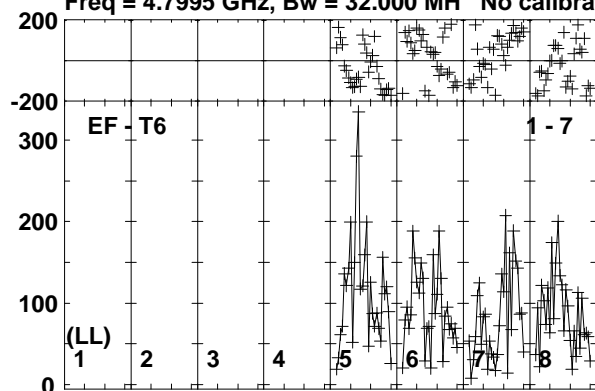

Lower frame: Micro Ampl Jy Top frame: Phas deg
Vector averaged cross-power spectrum Baseline: EF (01) - T6 (07)
Timerange: 00/18:31:22 to 00/18:34:48

Plot file version 3 created 20-APR-2018 17:20:38

J1419+2706 RSM02.UVDATA.1

Freq = 4.7995 GHz, Bw = 32.000 MH No calibration applied and no bandpass applied

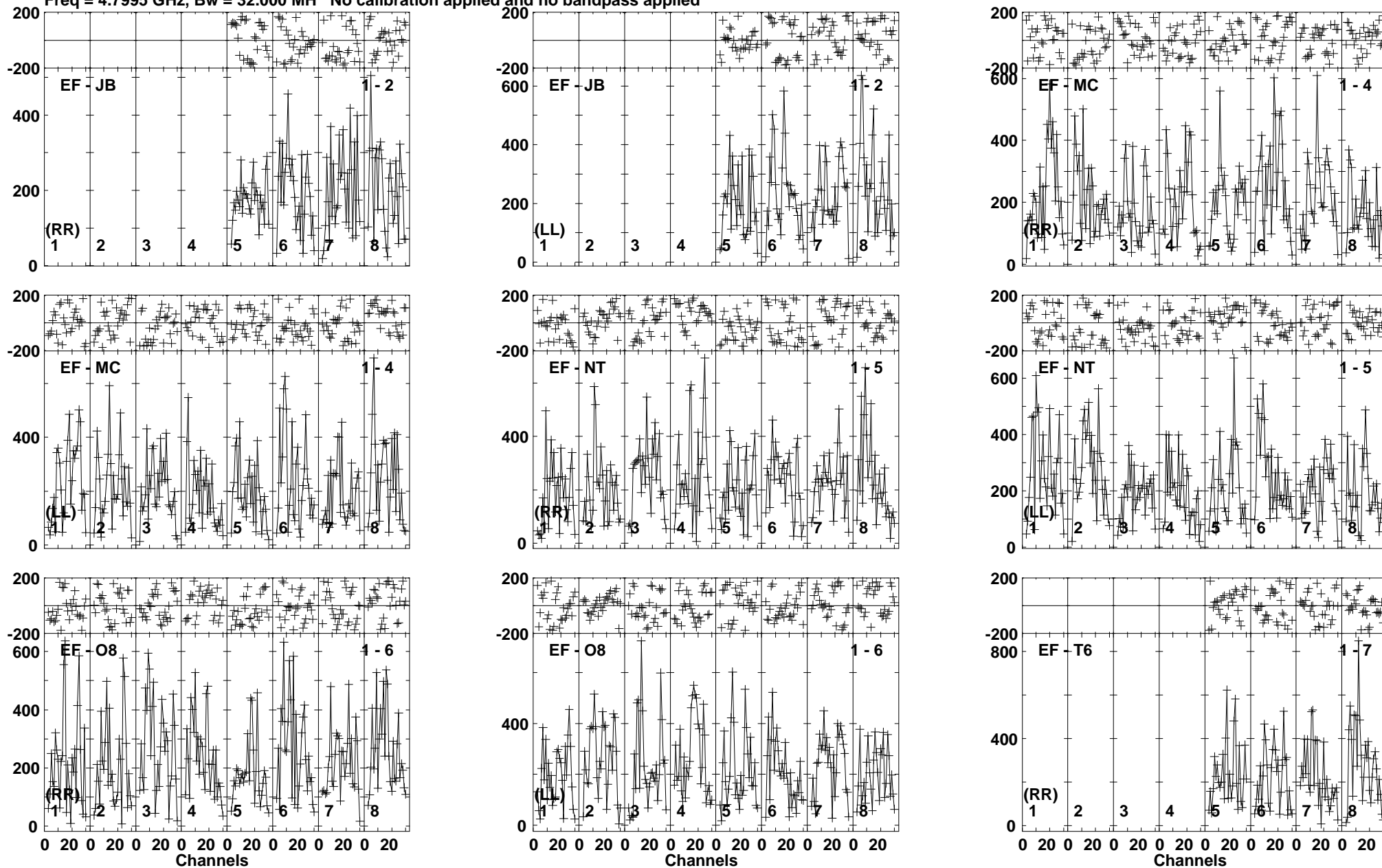

Lower frame: Micro Ampl Jy Top frame: Phas deg
Vector averaged cross-power spectrum Baseline: EF (01) - JB (02)
Timerange: 00:18:35:32 to 00:18:36:28

Plot file version 4 created 20-APR-2018 17:20:38

J1419+2706 RSM02.UVDATA.1

Freq = 4.7995 GHz, Bw = 32.000 MH No calibration applied and no bandpass applied

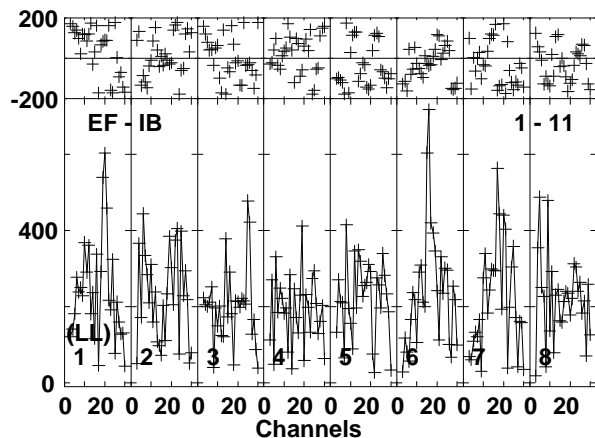
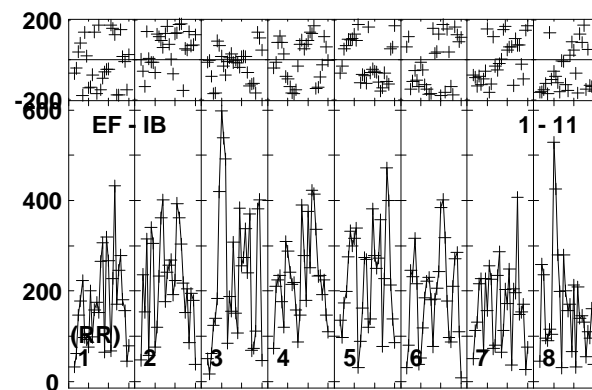
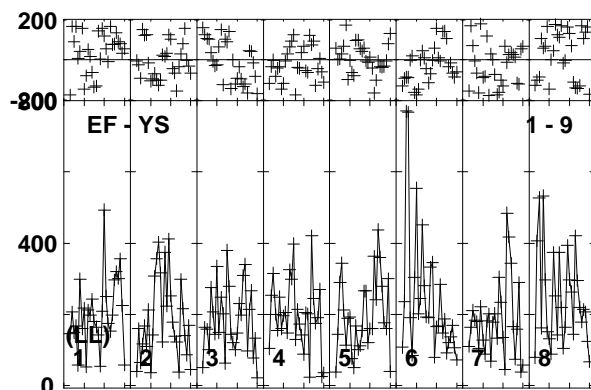
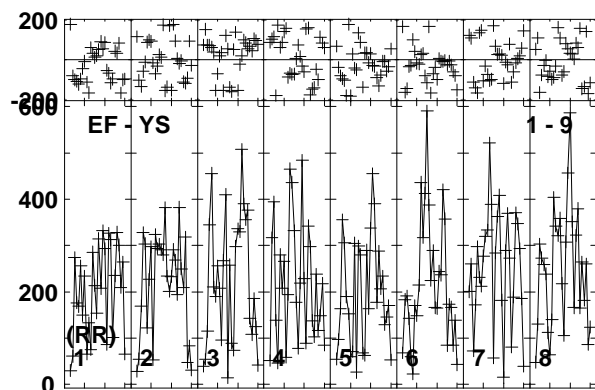
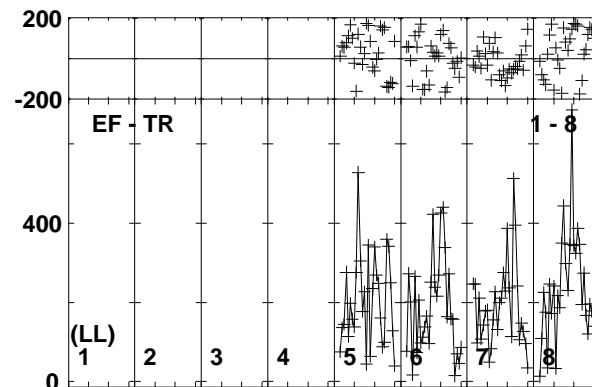
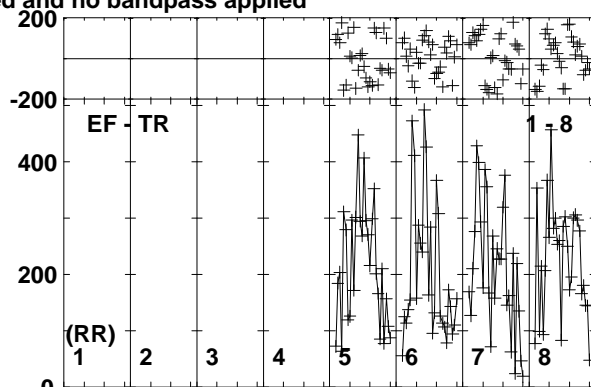
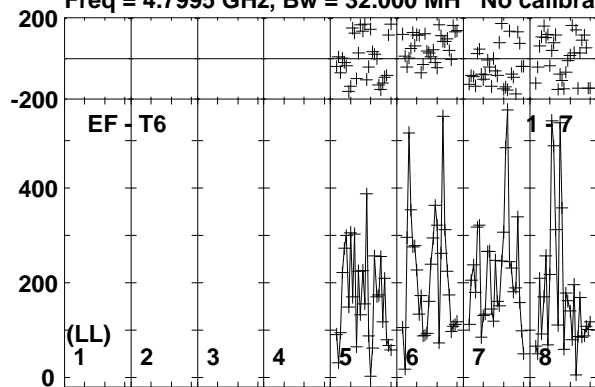

Lower frame: Micro Ampl Jy Top frame: Phas deg
Vector averaged cross-power spectrum Baseline: EF (01) - T6 (07)
Timerange: 00/18:35:32 to 00/18:36:28

Plot file version 5 created 20-APR-2018 17:20:38

J1427+2632 RSM02.UVDATA.1

Freq = 4.7995 GHz, Bw = 32.000 MH No calibration applied and no bandpass applied

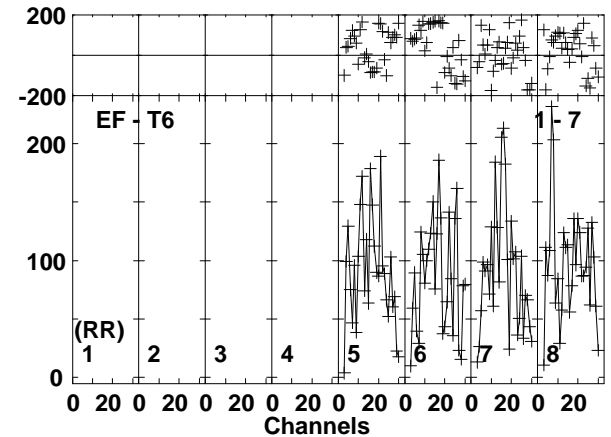
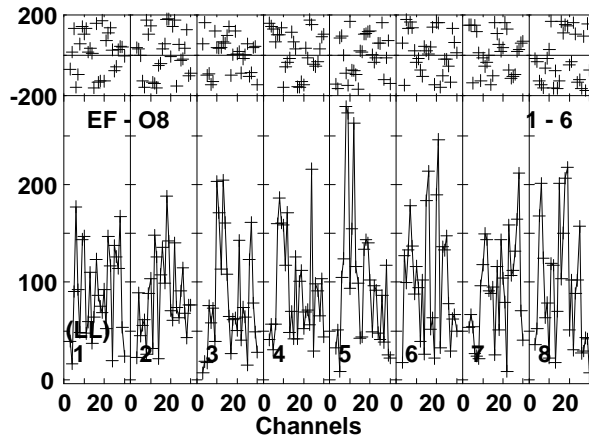
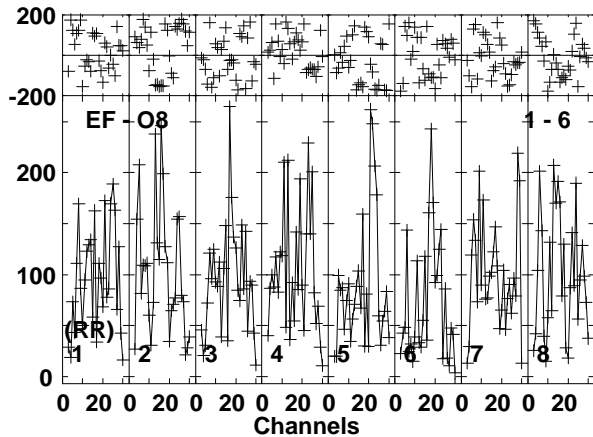
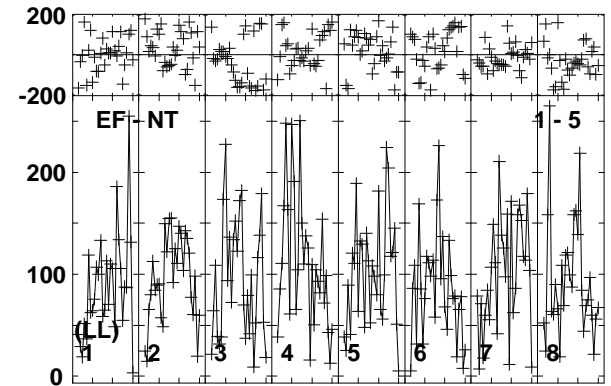
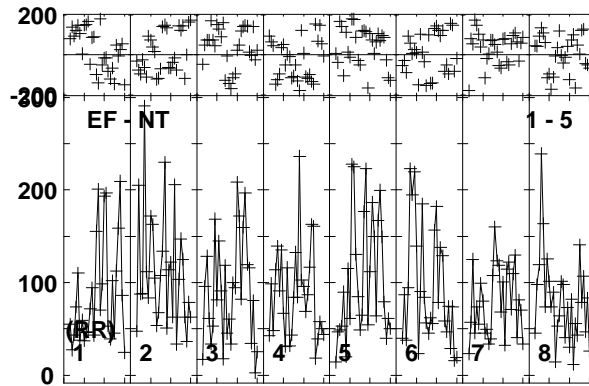
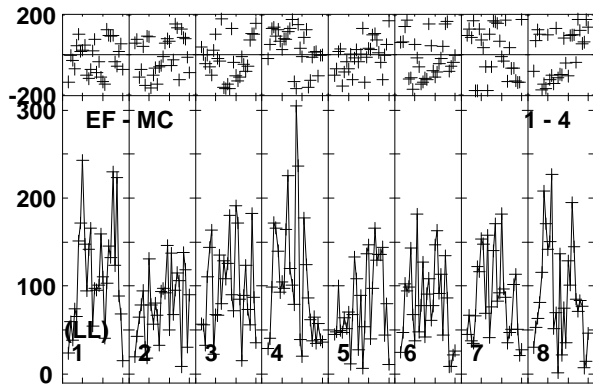
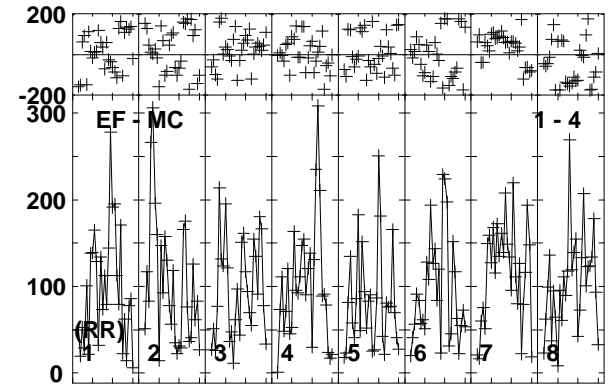
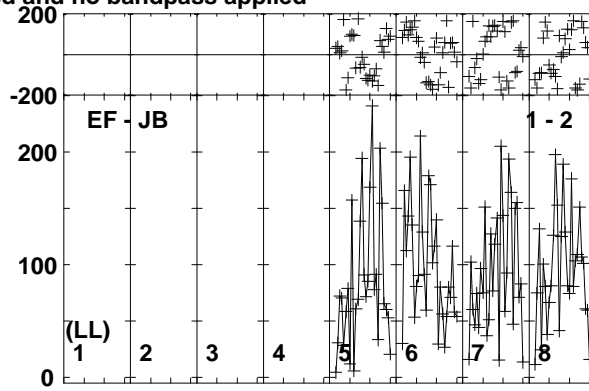
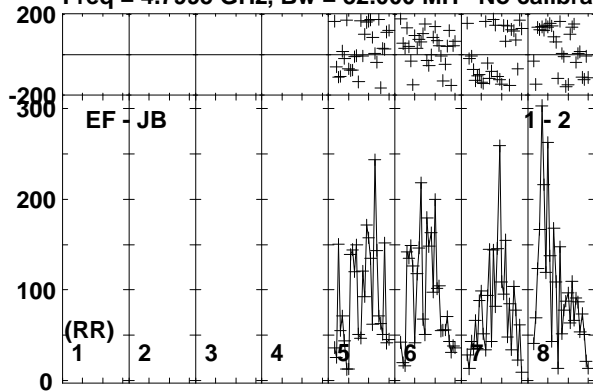

Lower frame: Micro Ampl Jy Top frame: Phas deg
Vector averaged cross-power spectrum Baseline: EF (01) - JB (02)
Timerange: 00/18:36:32 to 00/18:39:58

Plot file version 6 created 20-APR-2018 17:20:38

J1427+2632 RSM02.UVDATA.1

Freq = 4.7995 GHz, Bw = 32.000 MH No calibration applied and no bandpass applied

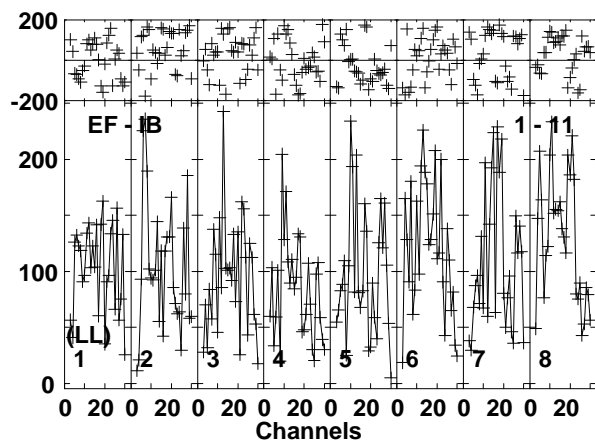
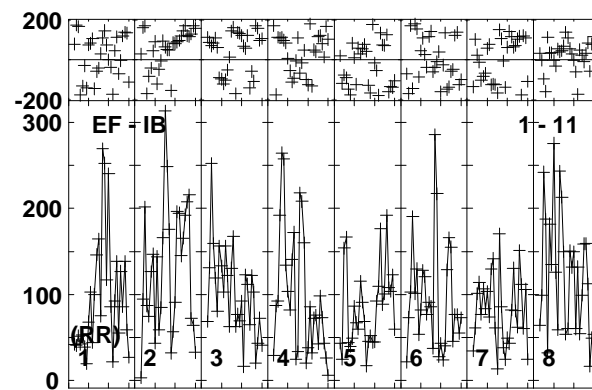
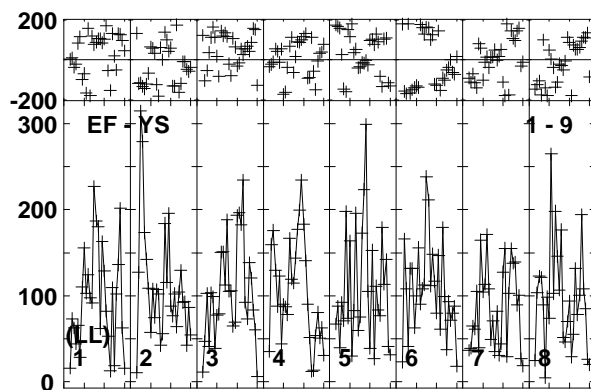
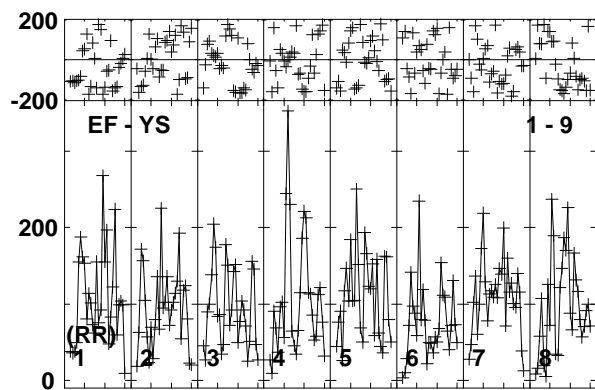
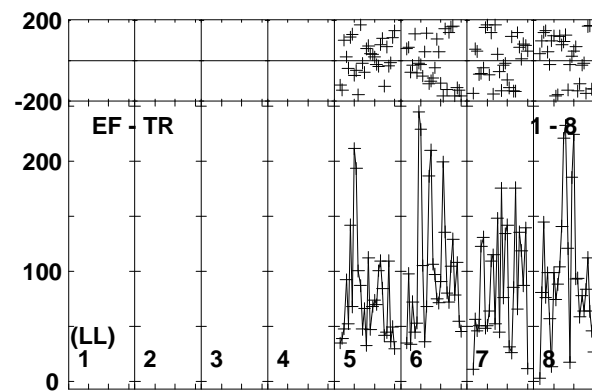
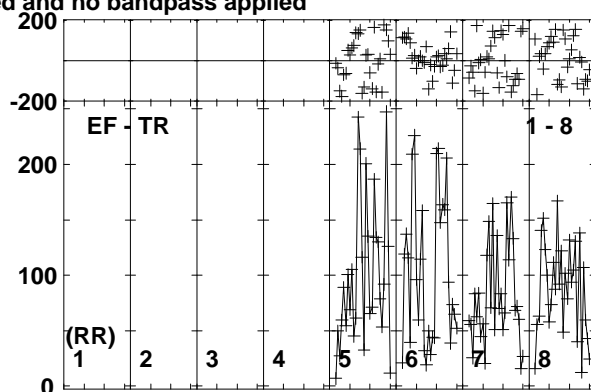
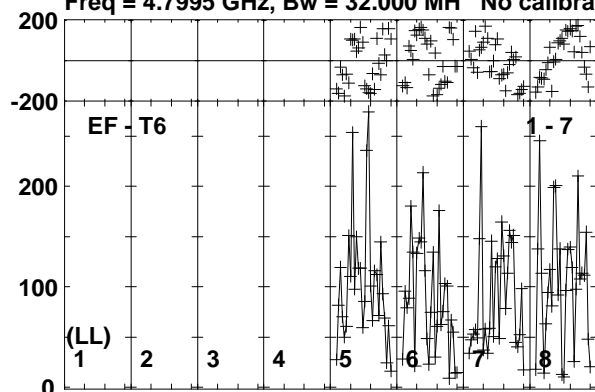

Lower frame: Micro Ampl Jy Top frame: Phas deg
Vector averaged cross-power spectrum Baseline: EF (01) - T6 (07)
Timerange: 00/18:36:32 to 00/18:39:58

Plot file version 7 created 20-APR-2018 17:20:38

J1427+2632 RSM02.UVDATA.1

Freq = 4.7995 GHz, Bw = 32.000 MH No calibration applied and no bandpass applied

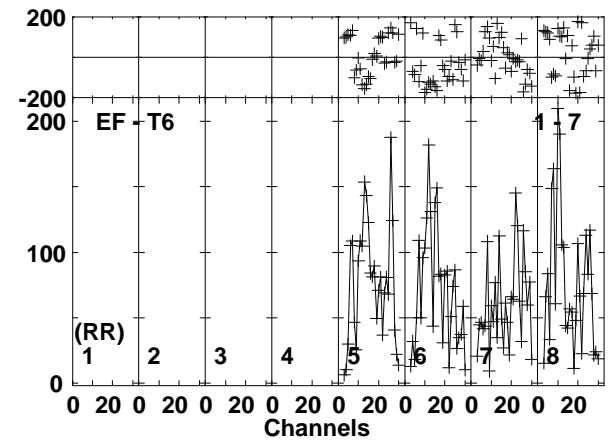
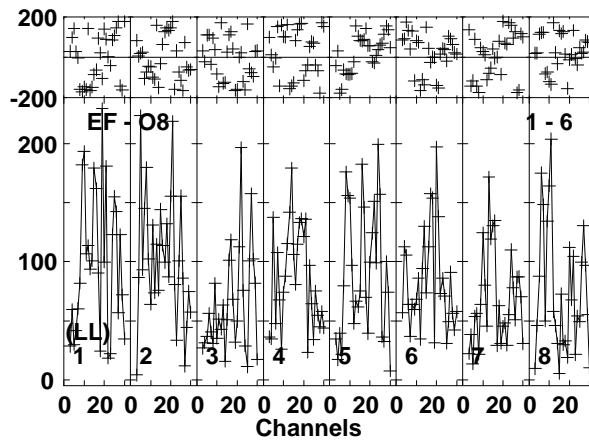
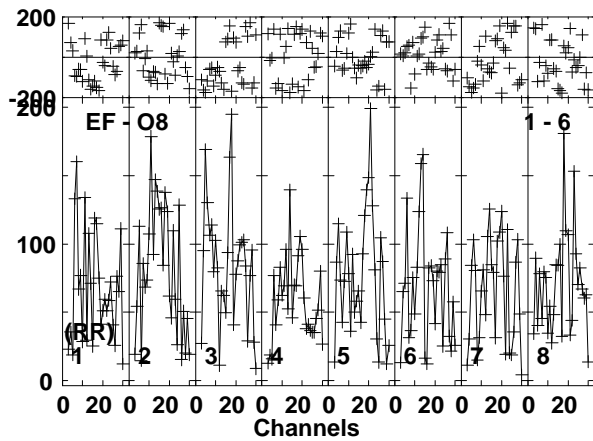
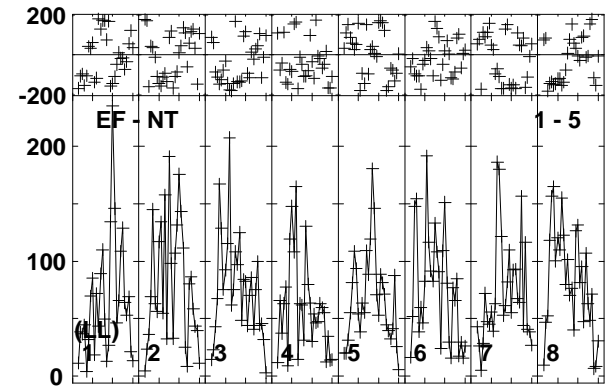
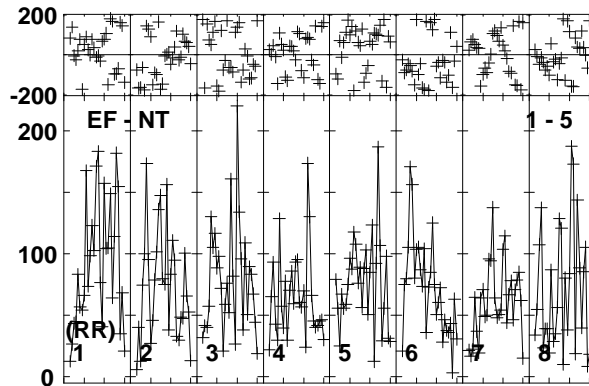
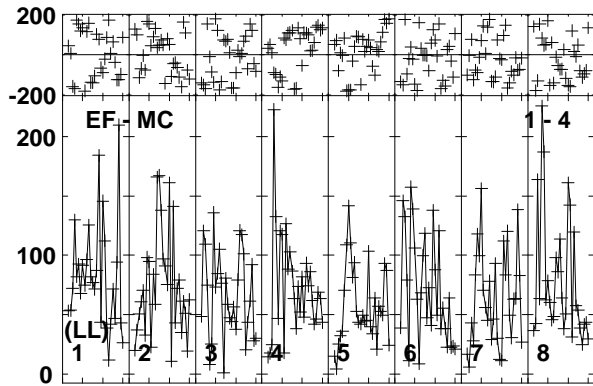
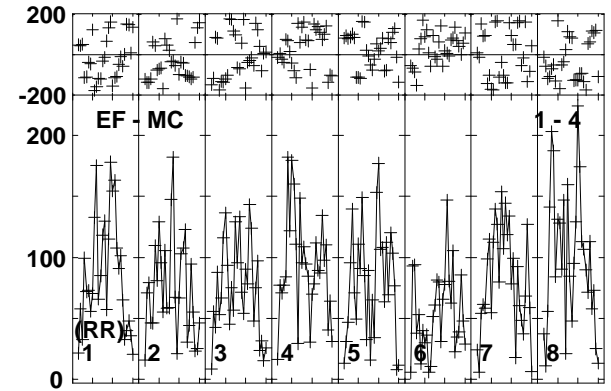
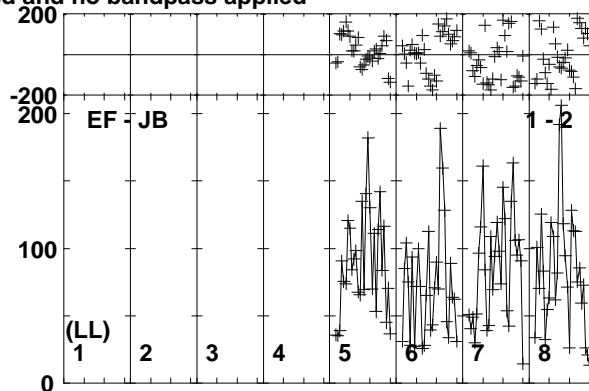
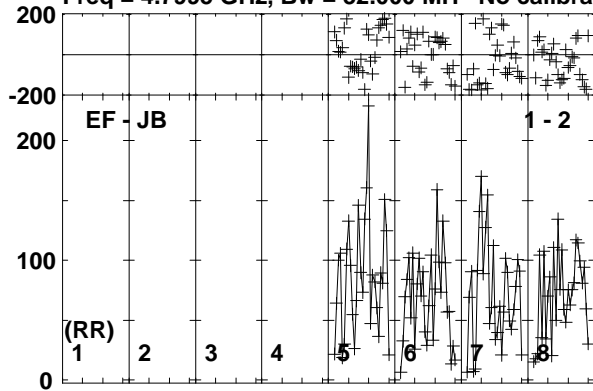

Lower frame: Micro Ampl Jy Top frame: Phas deg
Vector averaged cross-power spectrum Baseline: EF (01) - JB (02)
Timerange: 00/18:41:32 to 00/18:44:58

Plot file version 8 created 20-APR-2018 17:20:38

J1427+2632 RSM02.UVDATA.1

Freq = 4.7995 GHz, Bw = 32.000 MH No calibration applied and no bandpass applied

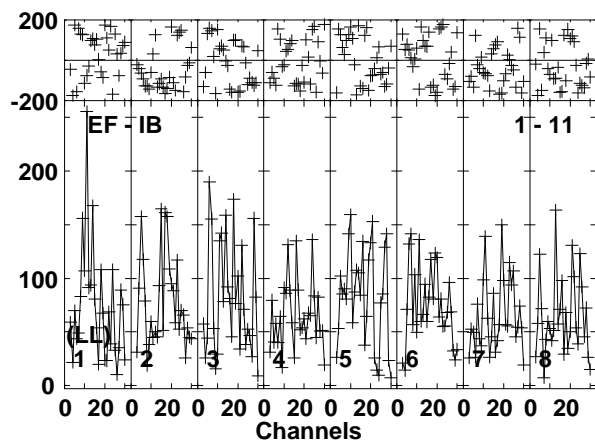
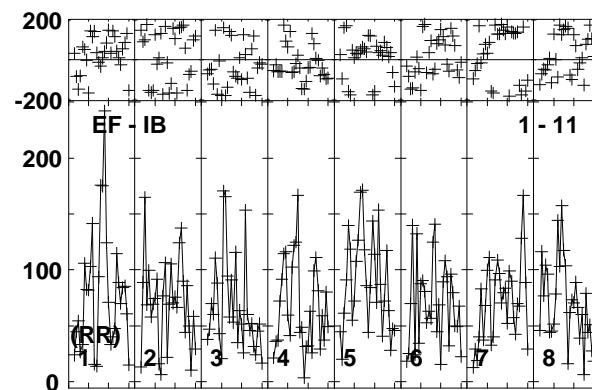
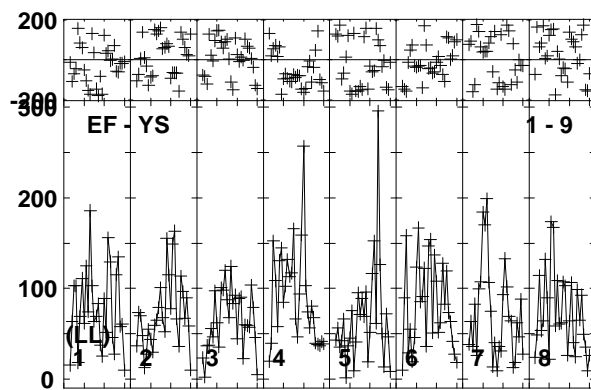
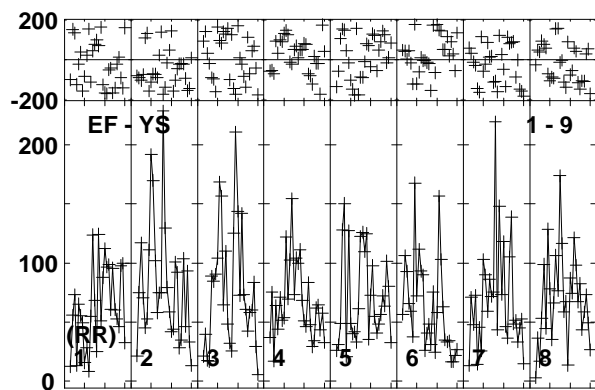
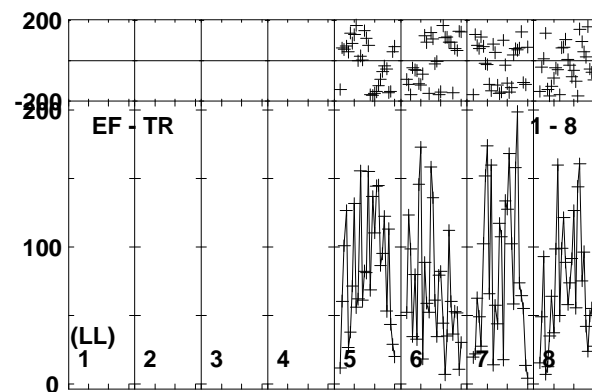
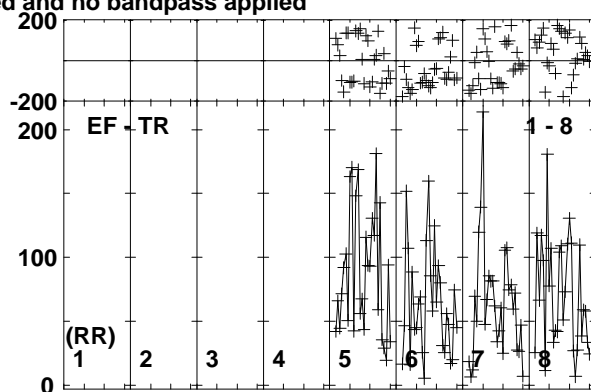
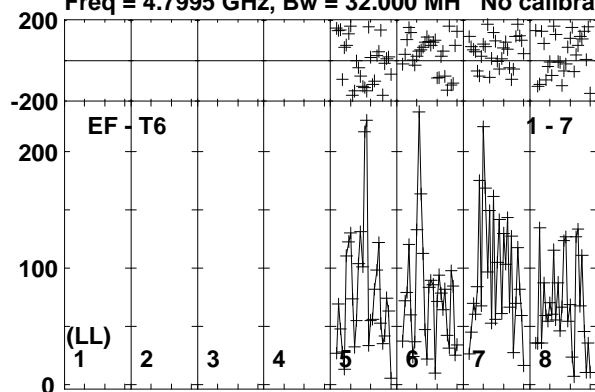

Lower frame: Micro Ampl Jy Top frame: Phas deg
Vector averaged cross-power spectrum Baseline: EF (01) - T6 (07)
Timerange: 00/18:41:32 to 00/18:44:58

Plot file version 9 created 20-APR-2018 17:20:38

J1419+2706 RSM02.UVDATA.1

Freq = 4.7995 GHz, Bw = 32.000 MH No calibration applied and no bandpass applied

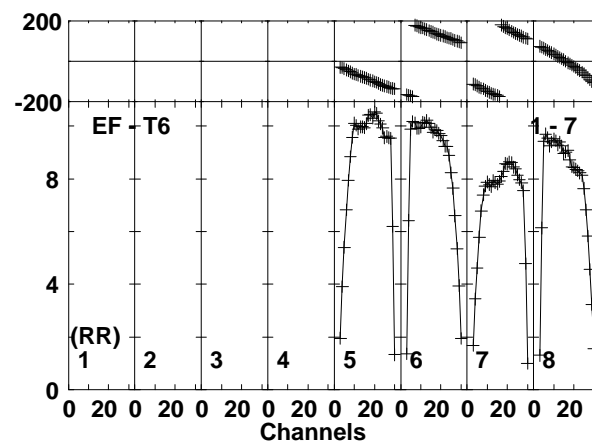
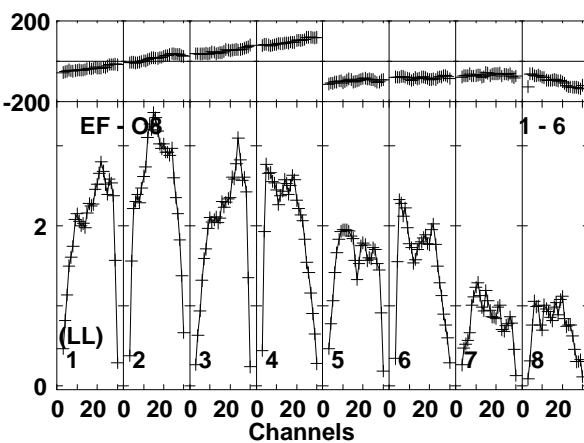
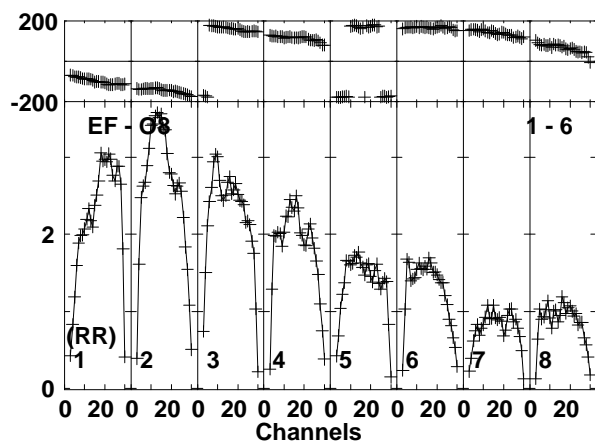
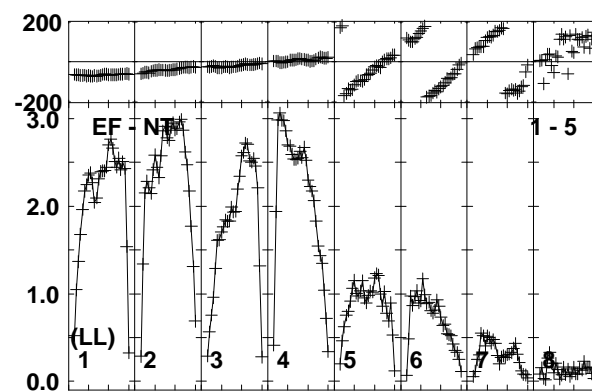
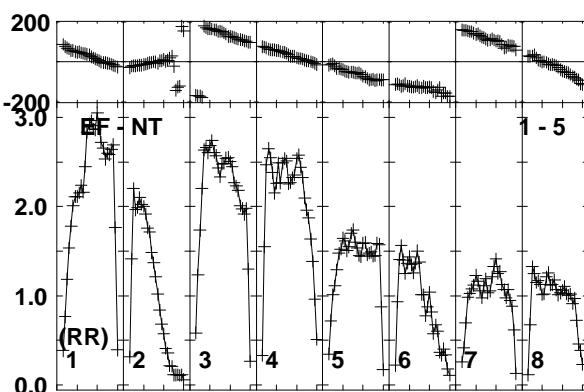
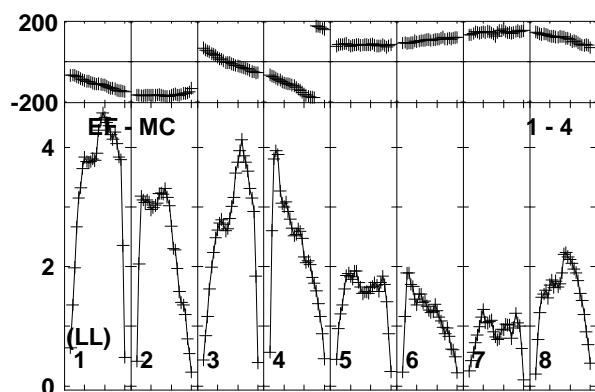
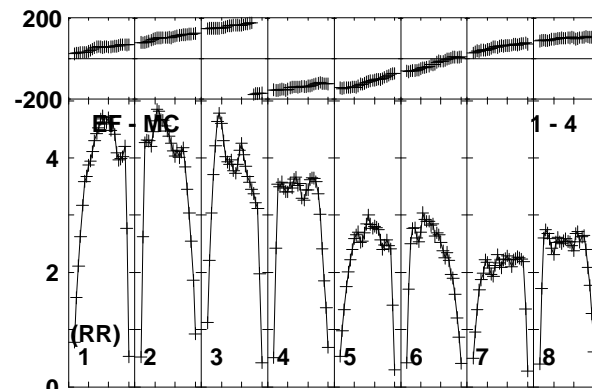
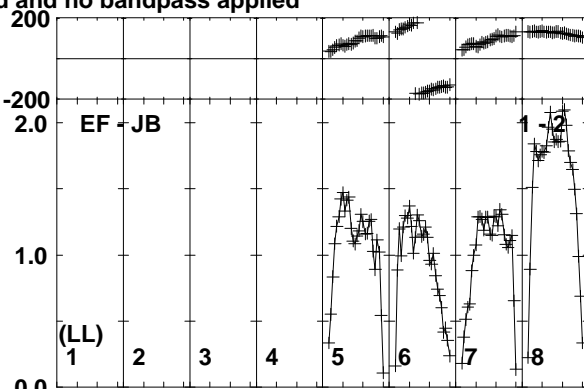
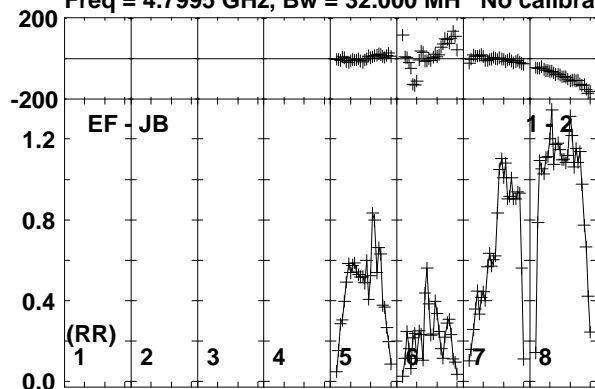

Lower frame: Milli Ampl Jy Top frame: Phas deg
Vector averaged cross-power spectrum Baseline: EF (01) - JB (02)
Timerange: 00/18:45:02 to 00/18:46:28

Plot file version 10 created 20-APR-2018 17:20:38

J1419+2706 RSM02.UVDATA.1

Freq = 4.7995 GHz, Bw = 32.000 MH No calibration applied and no bandpass applied

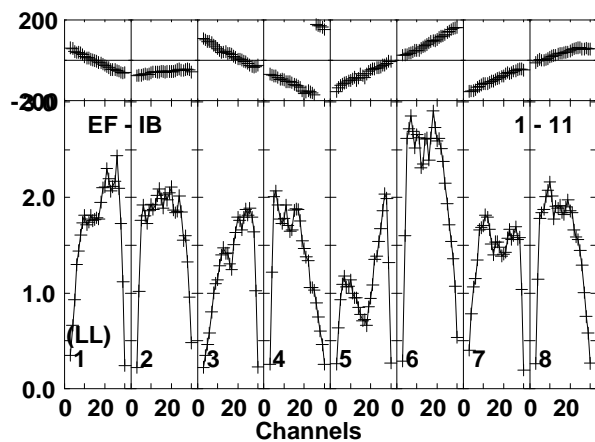
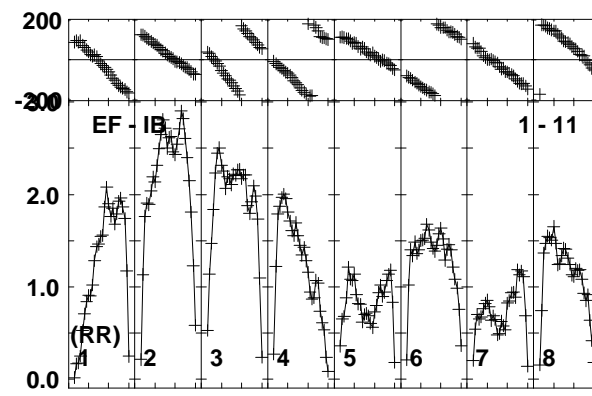
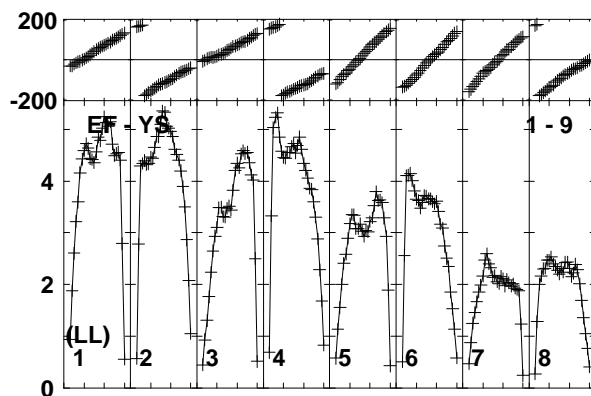
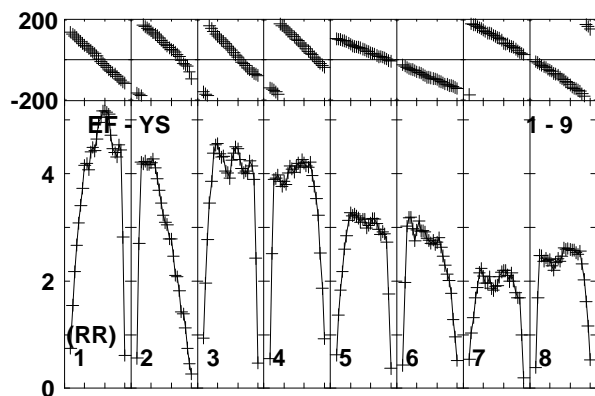
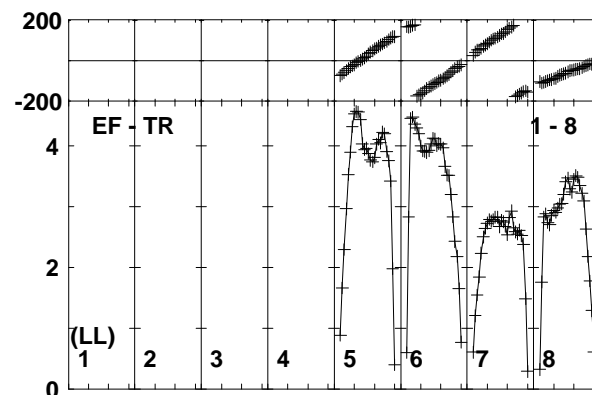
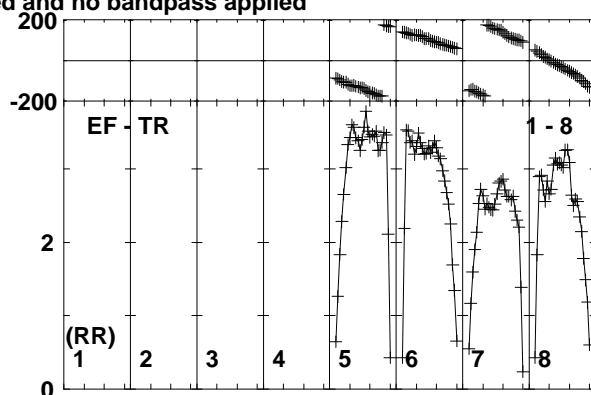
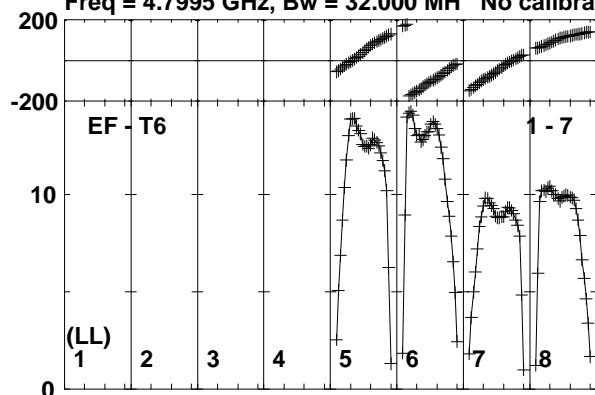

Lower frame: Milli Ampl Jy Top frame: Phas deg
Vector averaged cross-power spectrum Baseline: EF (01) - T6 (07)
Timerange: 00:18:45:02 to 00:18:46:28

Plot file version 11 created 20-APR-2018 17:20:38

J1427+2632 RSM02.UVDATA.1

Freq = 4.7995 GHz, Bw = 32.000 MH No calibration applied and no bandpass applied

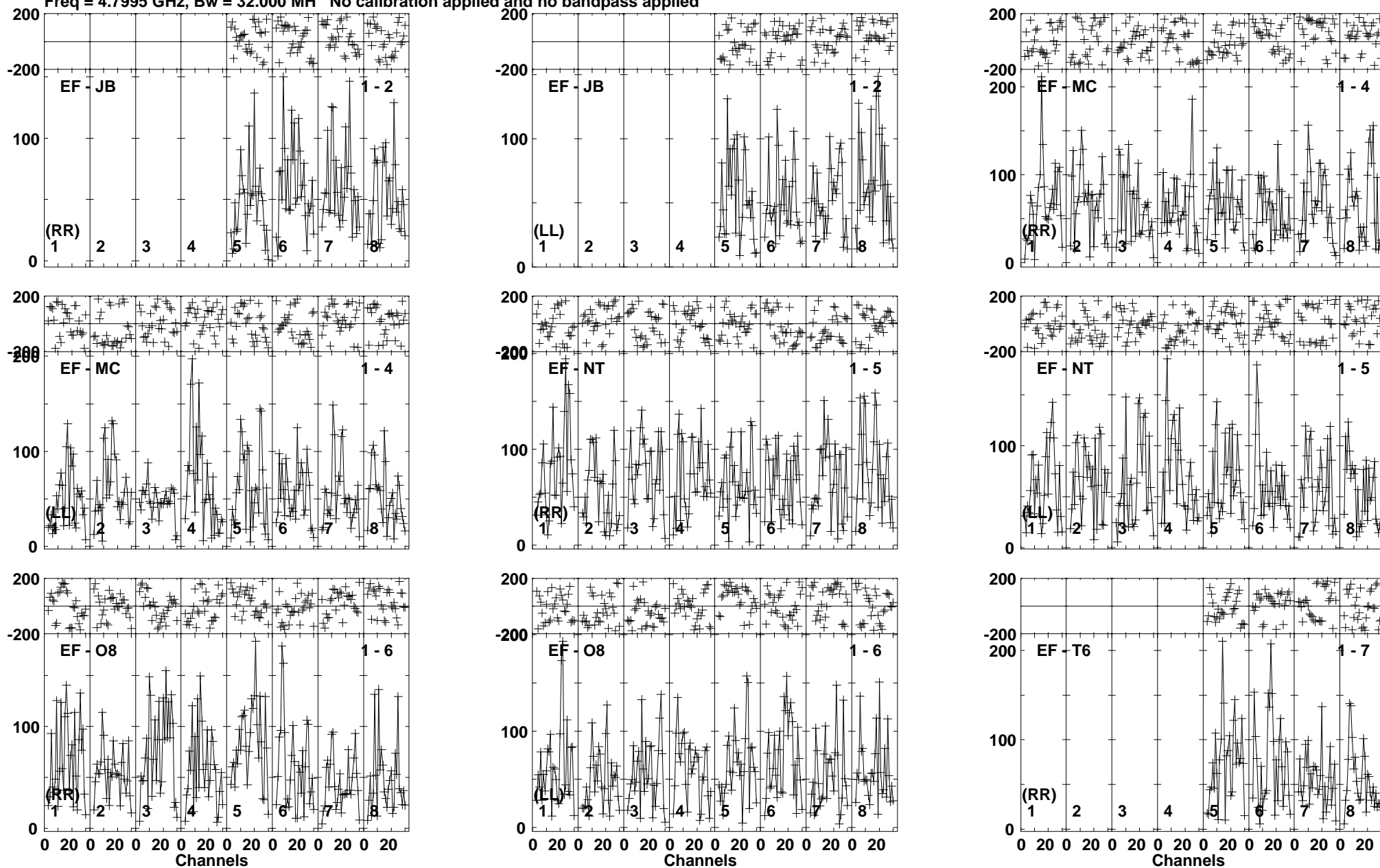

Lower frame: Micro Ampl Jy Top frame: Phas deg
Vector averaged cross-power spectrum Baseline: EF (01) - JB (02)
Timerange: 00:18:46:32 to 00:18:49:58

Plot file version 12 created 20-APR-2018 17:20:39

J1427+2632 RSM02.UVDATA.1

Freq = 4.7995 GHz, Bw = 32.000 MH No calibration applied and no bandpass applied

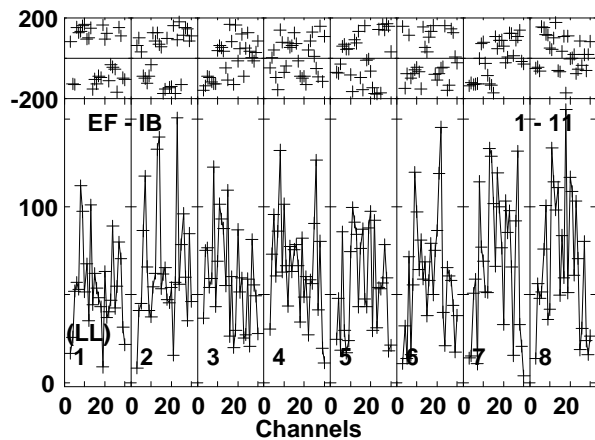
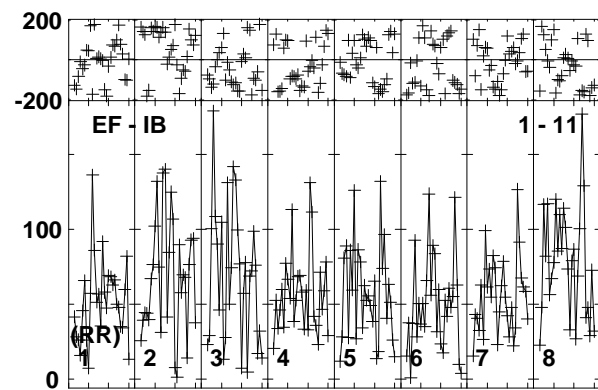
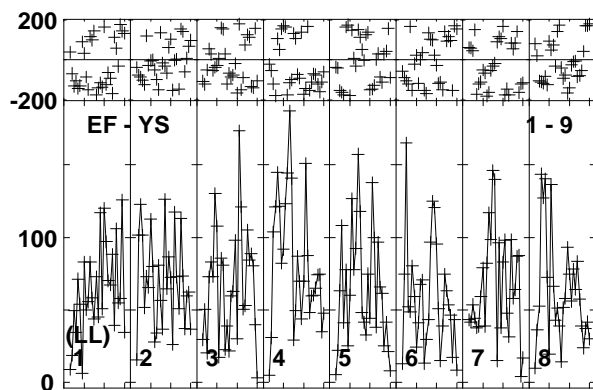
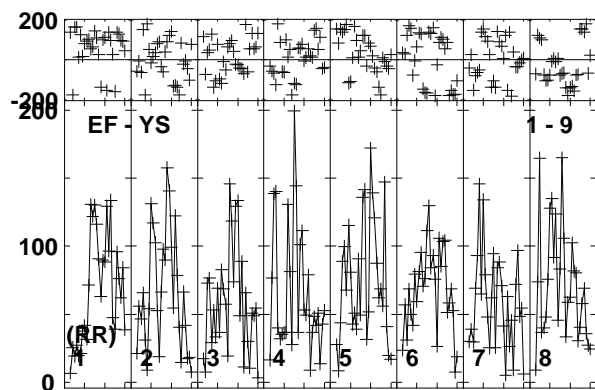
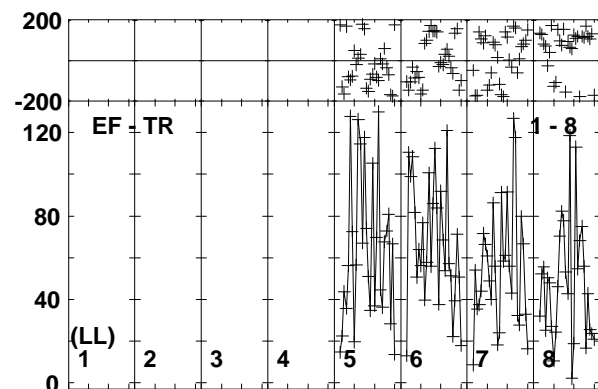
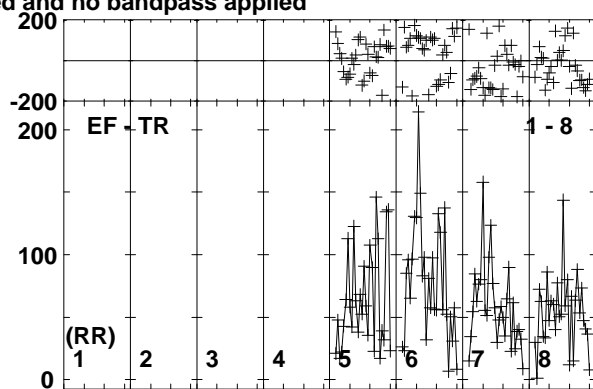
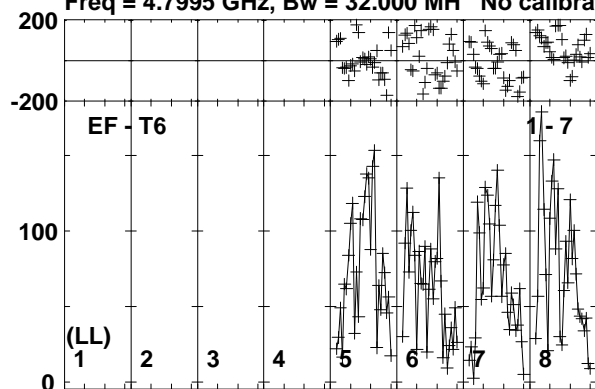

Lower frame: Micro Ampl Jy Top frame: Phas deg
Vector averaged cross-power spectrum Baseline: EF (01) - T6 (07)
Timerange: 00/18:46:32 to 00/18:49:58

Plot file version 13 created 20-APR-2018 17:20:39

J1419+2706 RSM02.UVDATA.1

Freq = 4.7995 GHz, Bw = 32.000 MH No calibration applied and no bandpass applied

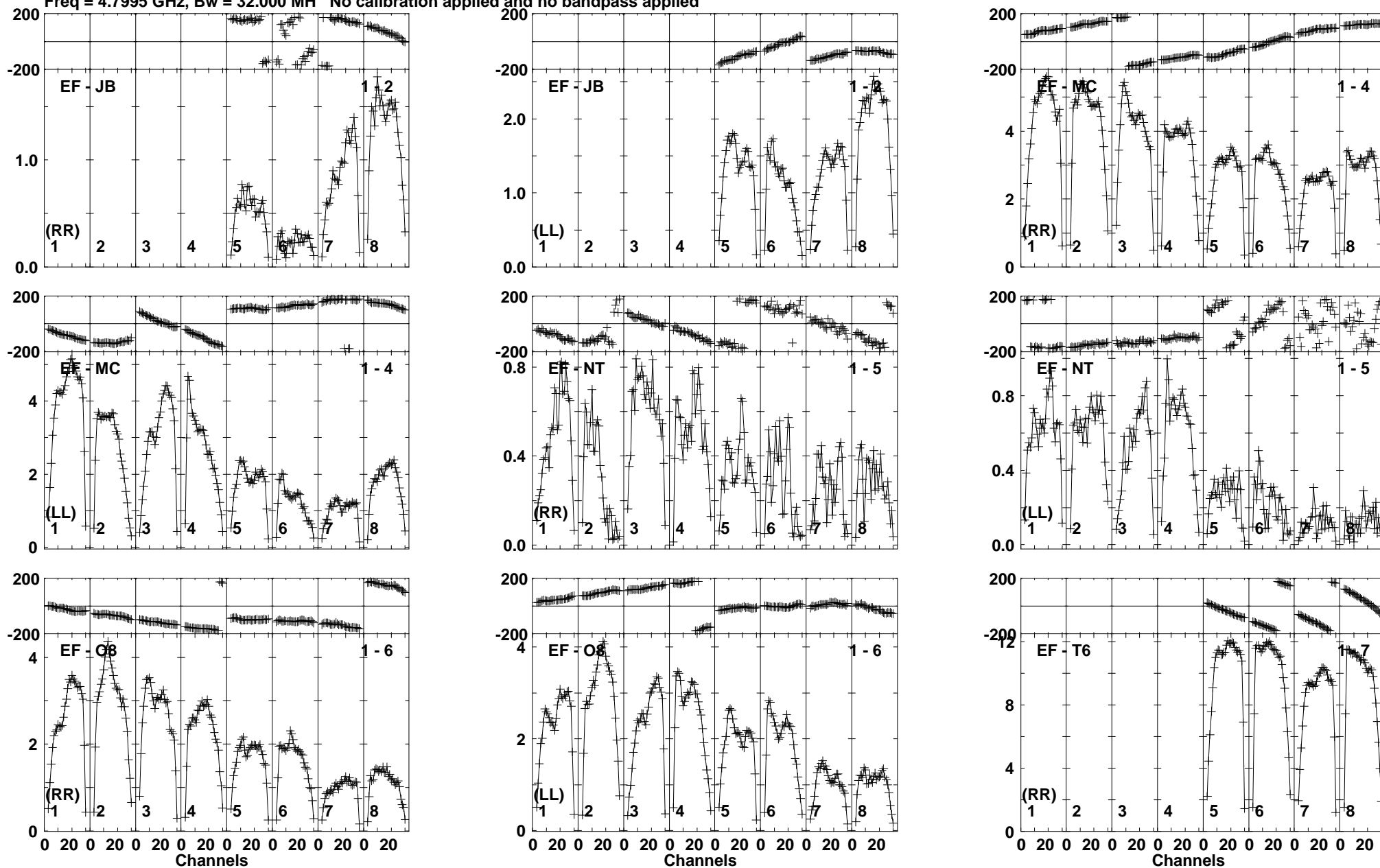

Lower frame: Milli Ampl Jy Top frame: Phas deg
Vector averaged cross-power spectrum Baseline: EF (01) - JB (02)
Timerange: 00:18:50:42 to 00:18:51:38

Plot file version 14 created 20-APR-2018 17:20:39

J1419+2706 RSM02.UVDATA.1

Freq = 4.7995 GHz, Bw = 32.000 MH No calibration applied and no bandpass applied

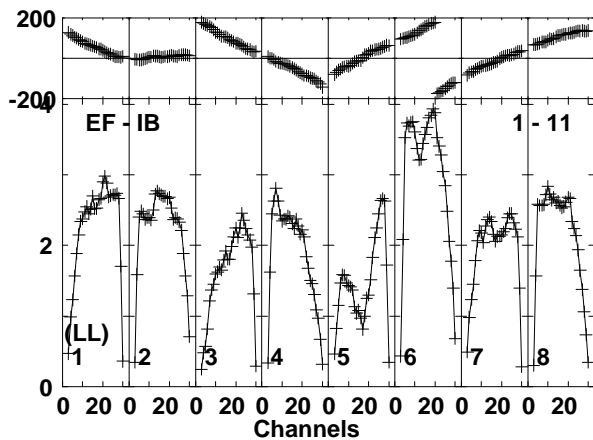
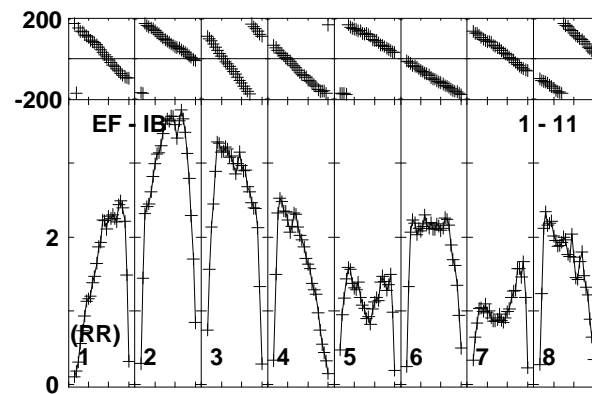
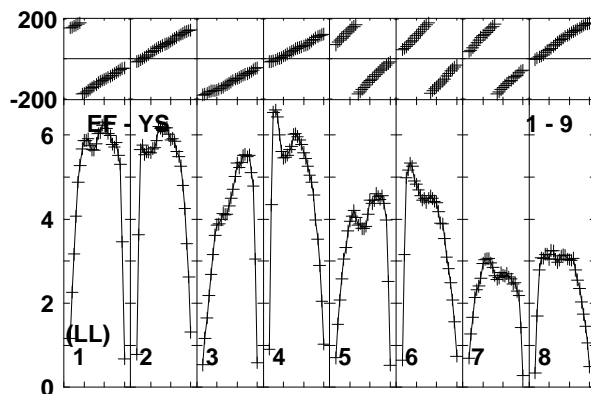
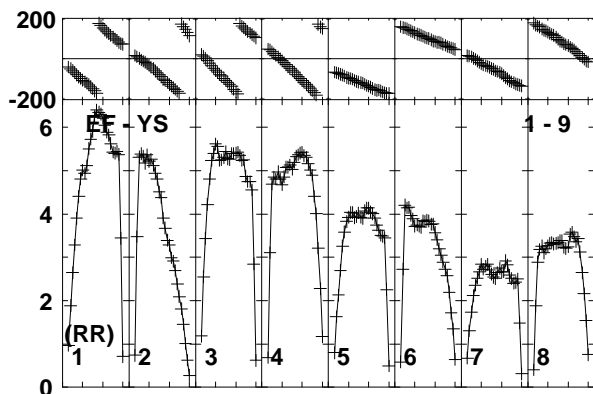
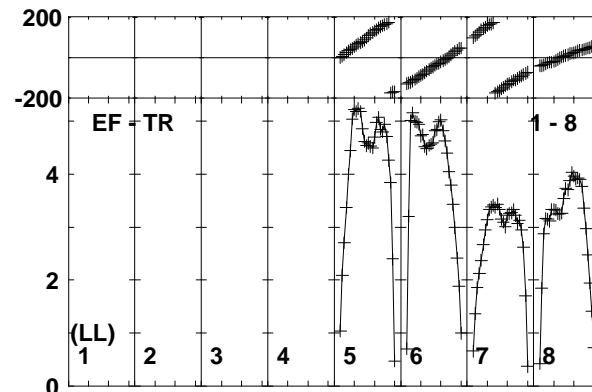
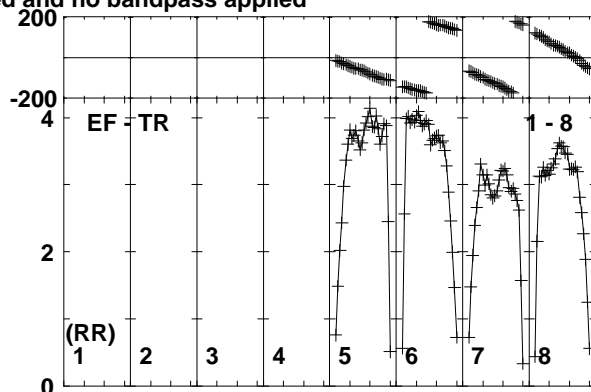
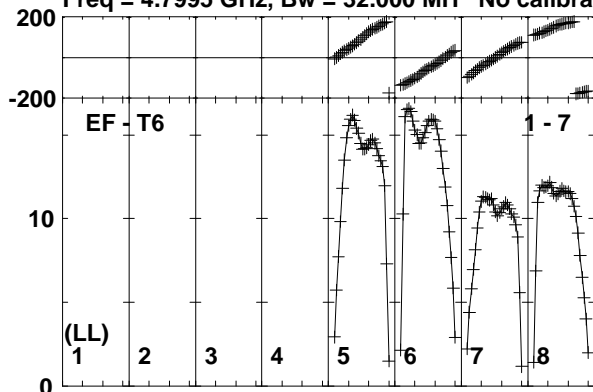

Lower frame: Milli Ampl Jy Top frame: Phas deg
Vector averaged cross-power spectrum Baseline: EF (01) - T6 (07)
Timerange: 00/18:50:42 to 00/18:51:38

Plot file version 15 created 20-APR-2018 17:20:39

J1427+2632 RSM02.UVDATA.1

Freq = 4.7995 GHz, Bw = 32.000 MH No calibration applied and no bandpass applied

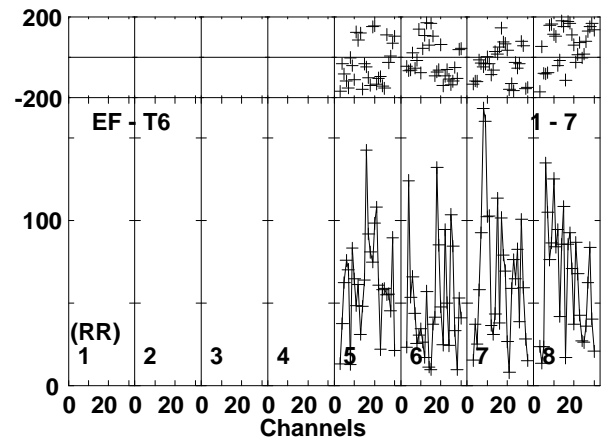
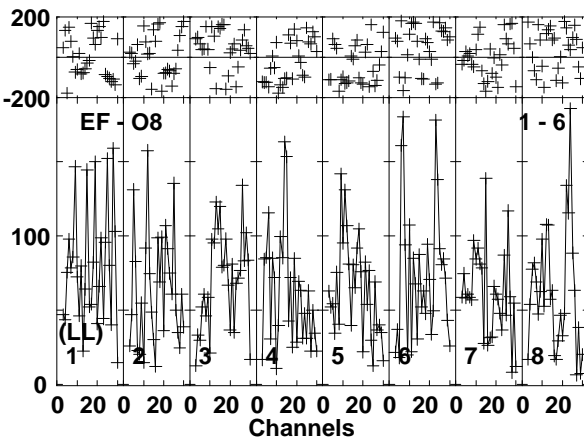
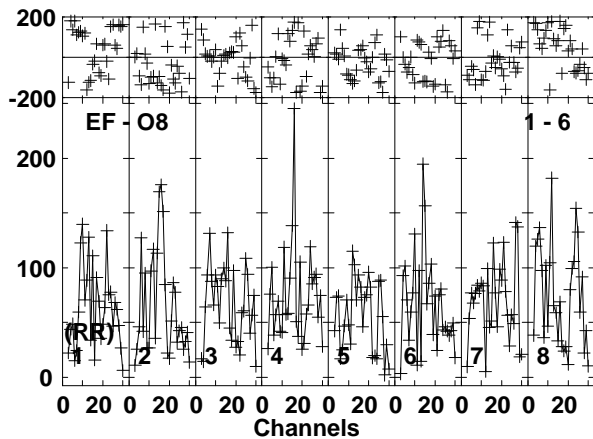
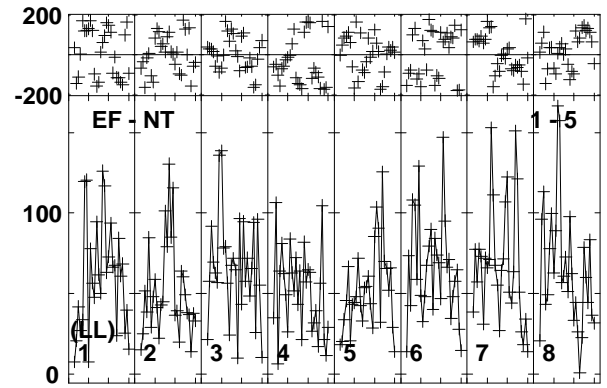
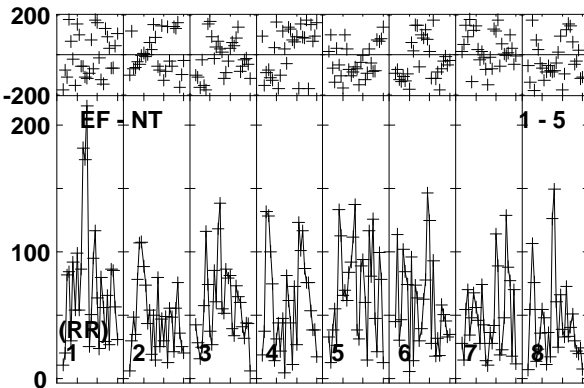
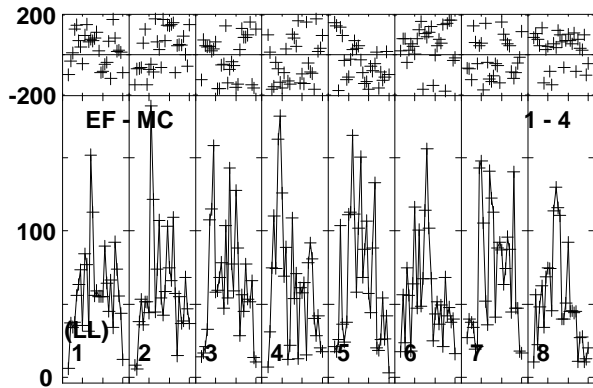
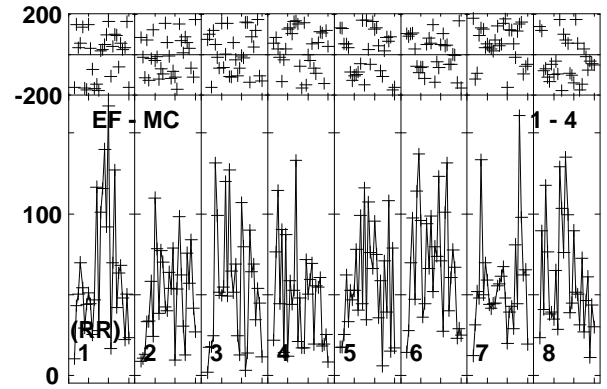
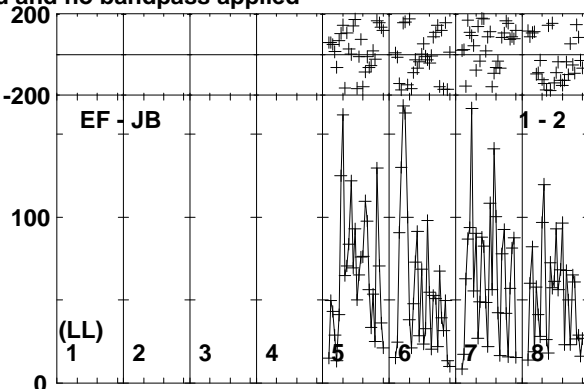
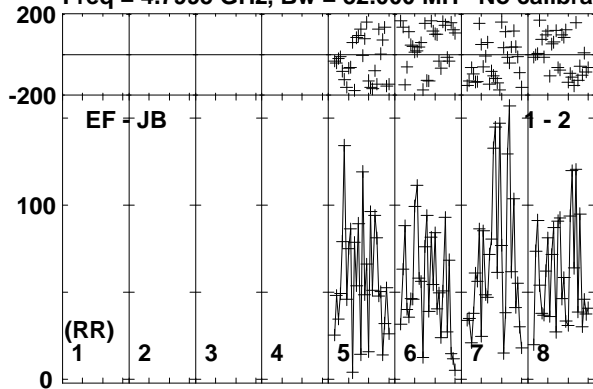

Lower frame: Micro Ampl Jy Top frame: Phas deg
Vector averaged cross-power spectrum Baseline: EF (01) - JB (02)
Timerange: 00/18:51:42 to 00/18:55:08

Plot file version 16 created 20-APR-2018 17:20:39

J1427+2632 RSM02.UVDATA.1

Freq = 4.7995 GHz, Bw = 32.000 MH No calibration applied and no bandpass applied

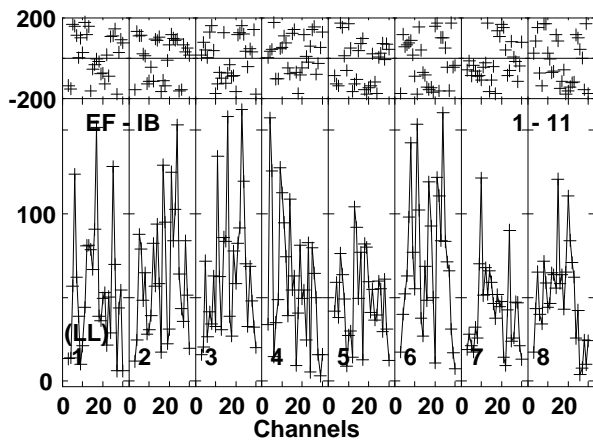
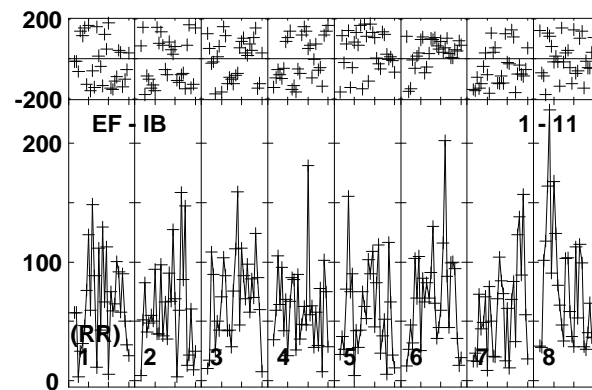
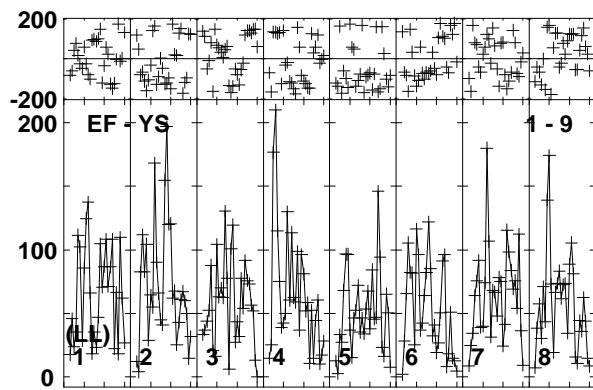
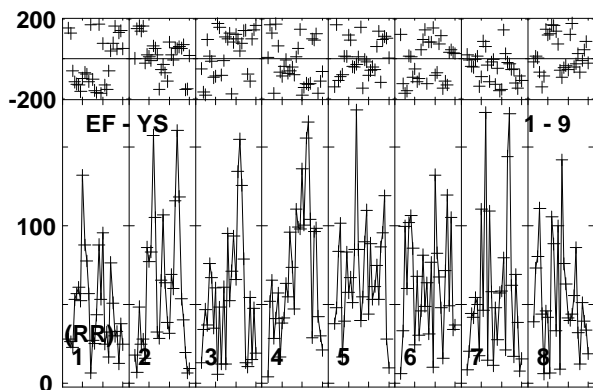
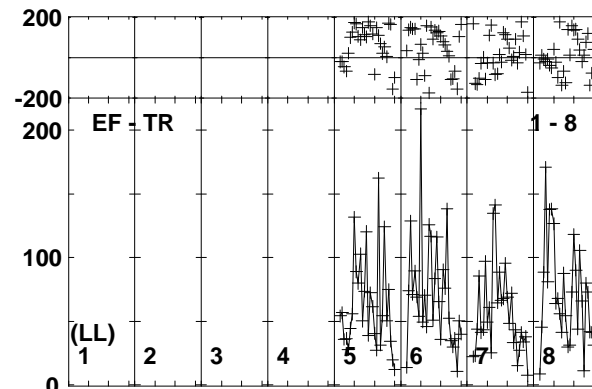
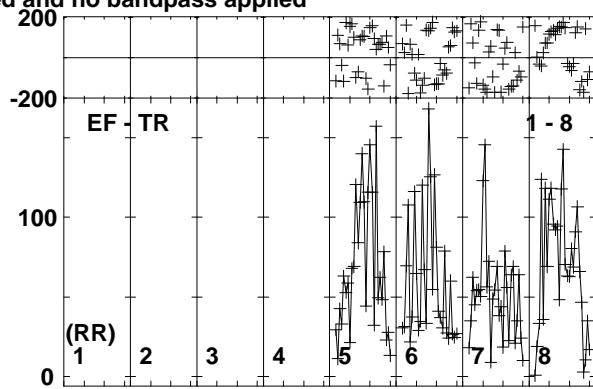
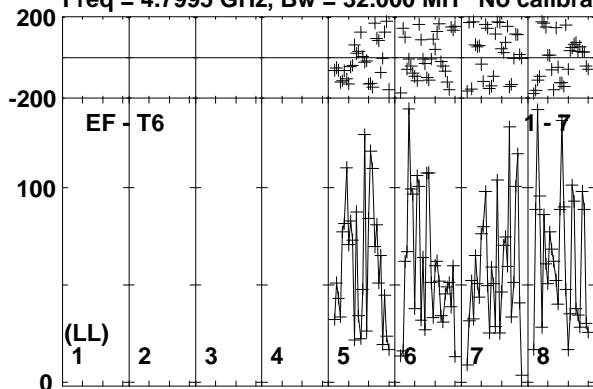

Lower frame: Micro Ampl Jy Top frame: Phas deg
Vector averaged cross-power spectrum Baseline: EF (01) - T6 (07)
Timerange: 00/18:51:42 to 00/18:55:08

Plot file version 17 created 20-APR-2018 17:20:39

J1419+2706 RSM02.UVDATA.1

Freq = 4.7995 GHz, Bw = 32.000 MH No calibration applied and no bandpass applied

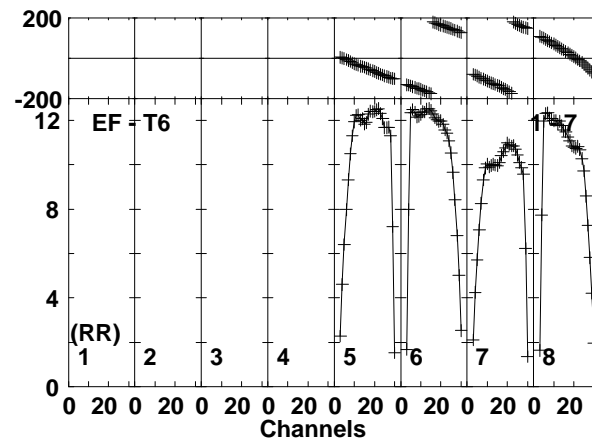
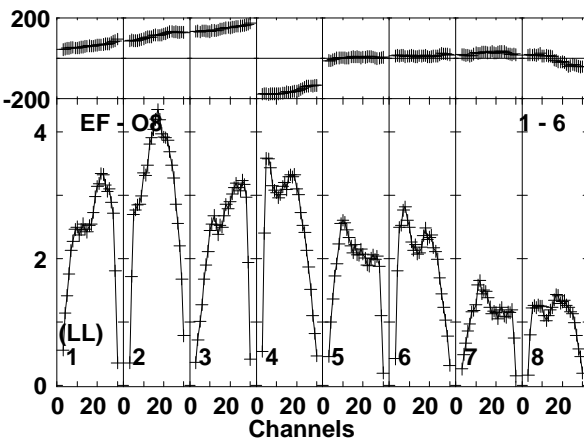
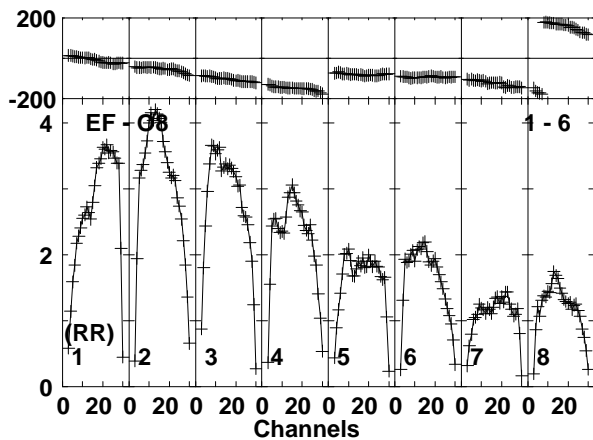
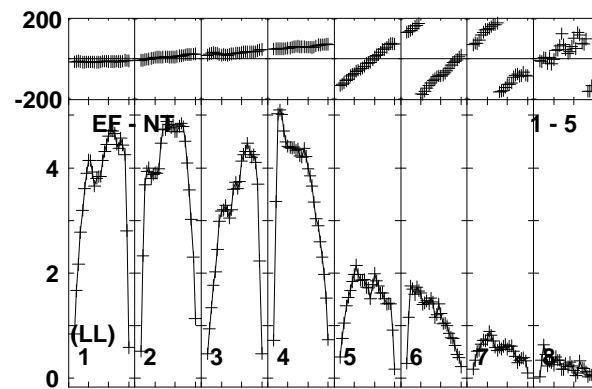
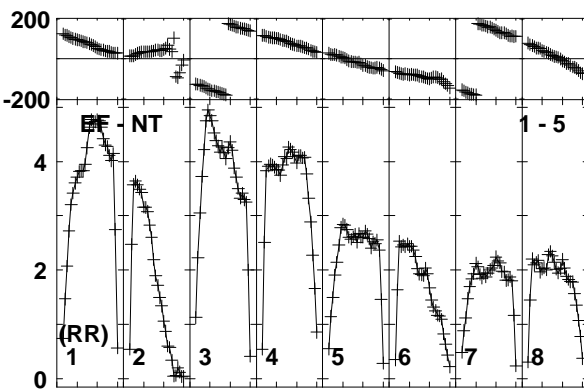
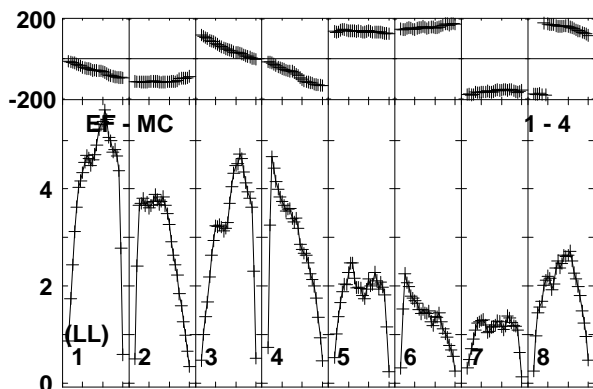
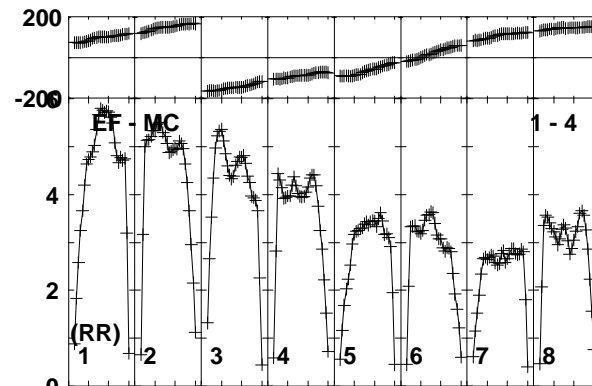
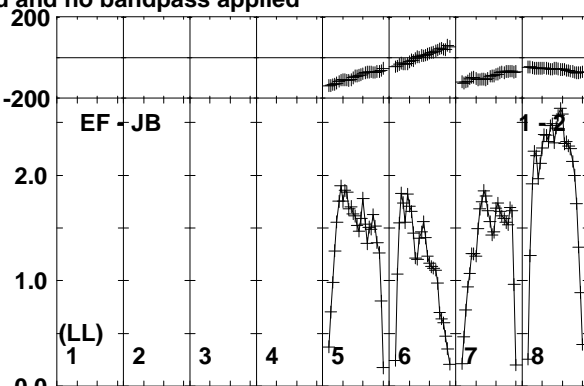
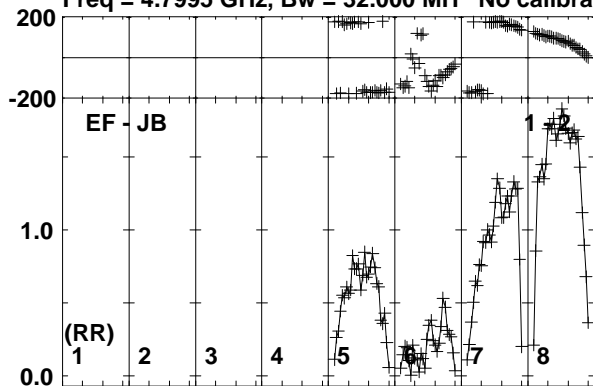

Lower frame: Milli Ampl Jy Top frame: Phas deg
Vector averaged cross-power spectrum Baseline: EF (01) - JB (02)
Timerange: 00:18:55:12 to 00:18:56:38

Plot file version 18 created 20-APR-2018 17:20:39

J1419+2706 RSM02.UVDATA.1

Freq = 4.7995 GHz, Bw = 32.000 MH No calibration applied and no bandpass applied

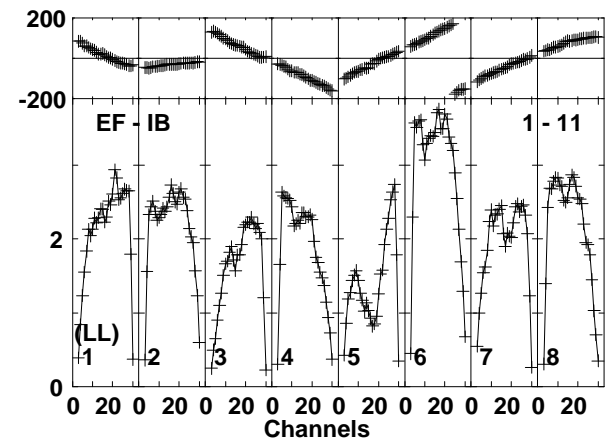
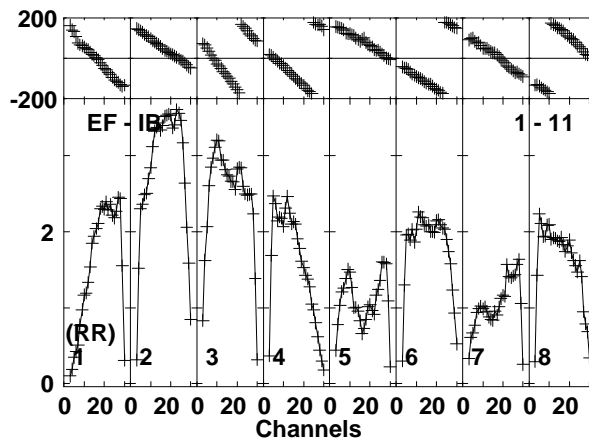
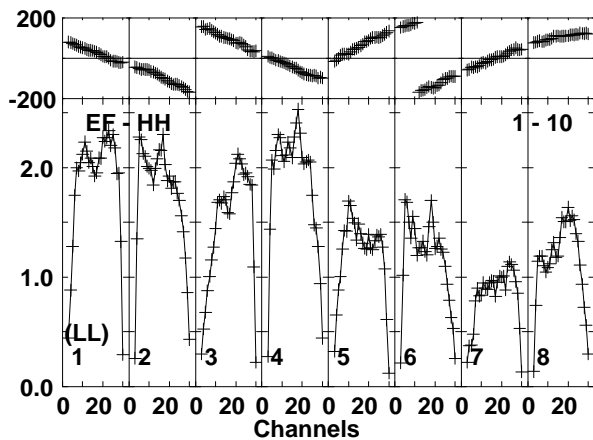
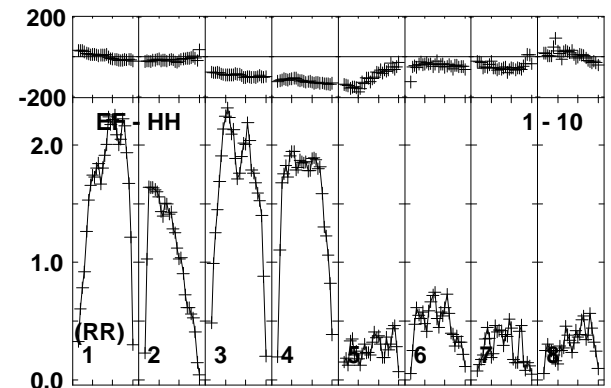
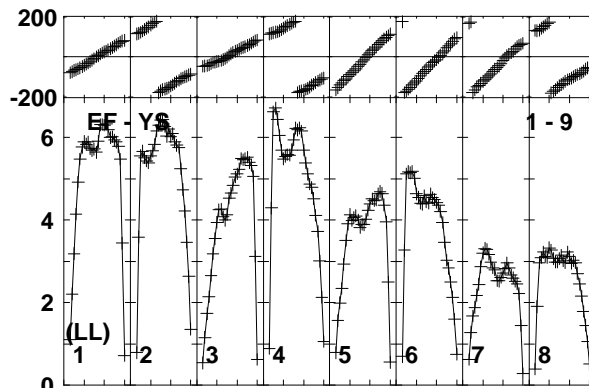
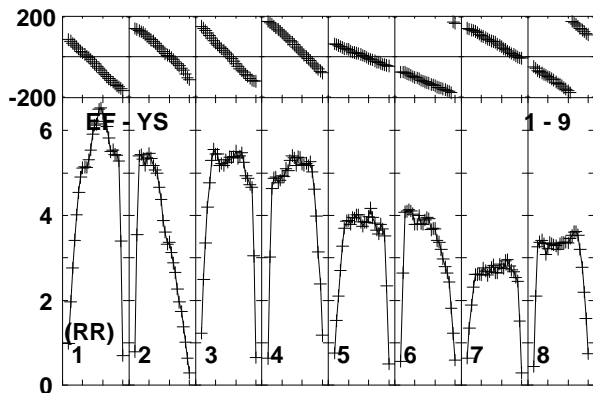
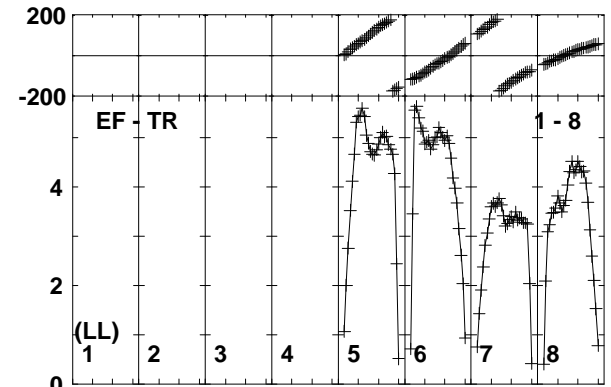
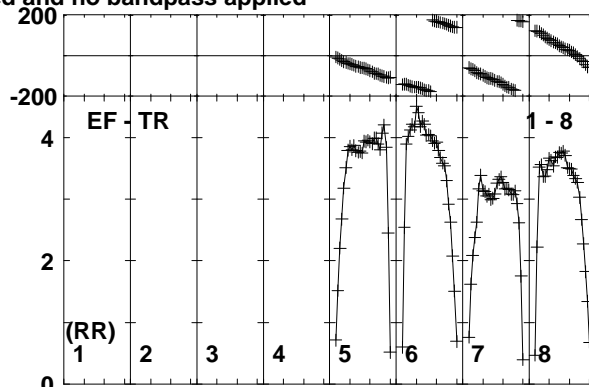
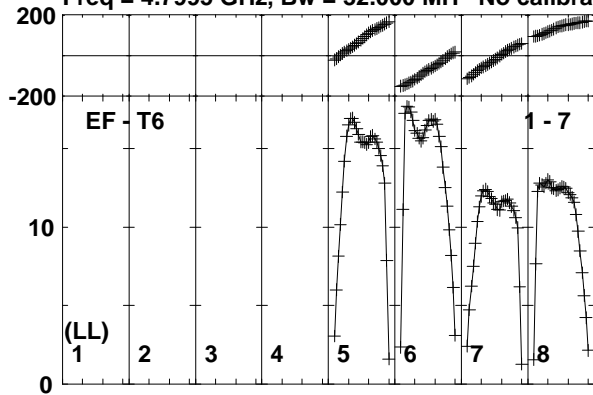

Lower frame: Milli Ampl Jy Top frame: Phas deg
Vector averaged cross-power spectrum Baseline: EF (01) - T6 (07)
Timerange: 00/18:55:12 to 00/18:56:38

Plot file version 19 created 20-APR-2018 17:20:39

J1427+2632 RSM02.UVDATA.1

Freq = 4.7995 GHz, Bw = 32.000 MH No calibration applied and no bandpass applied

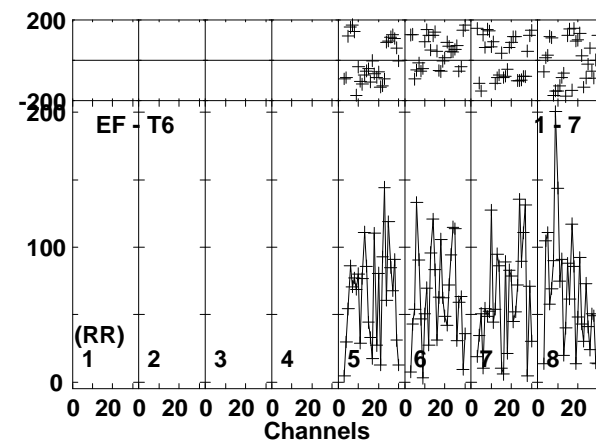
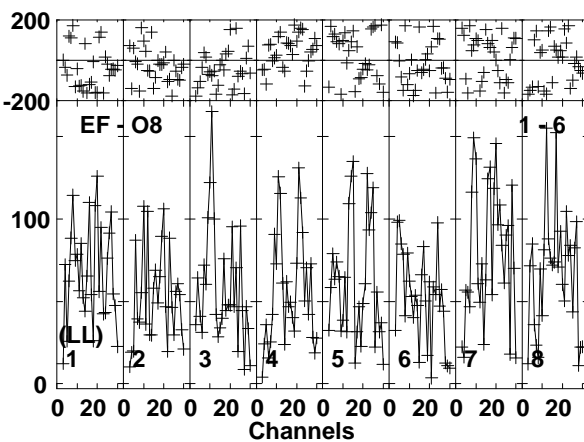
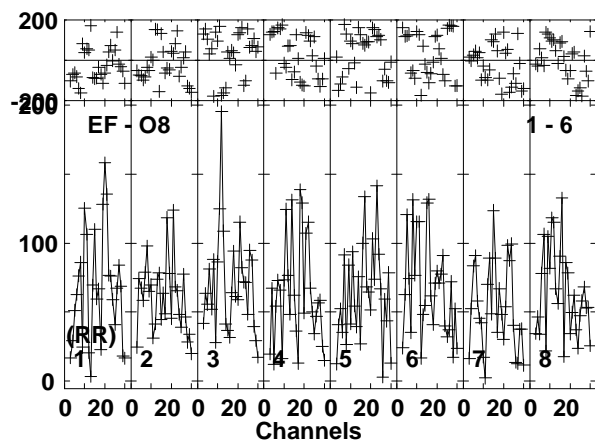
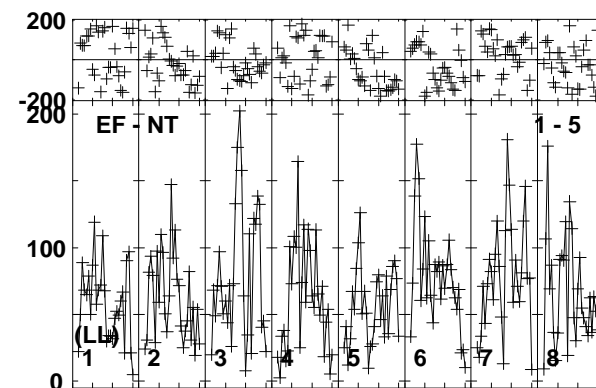
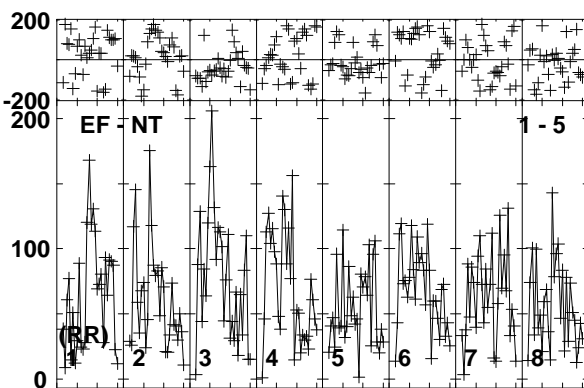
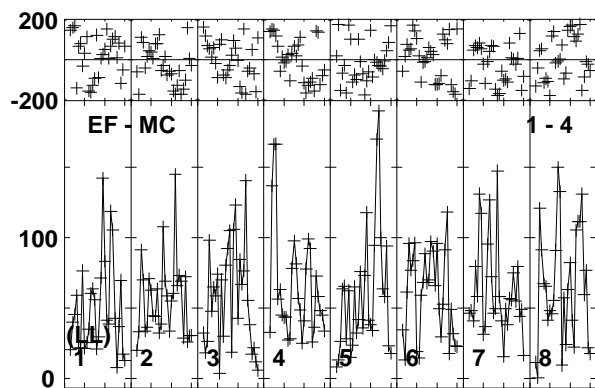
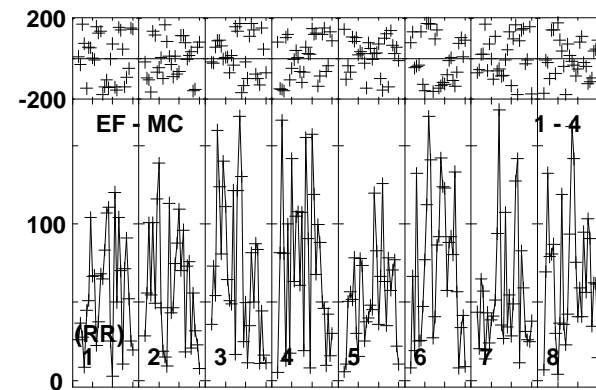
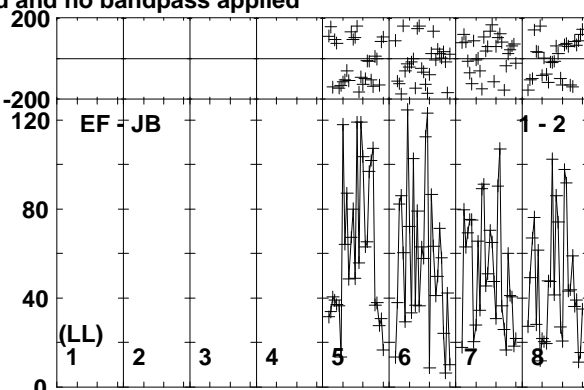
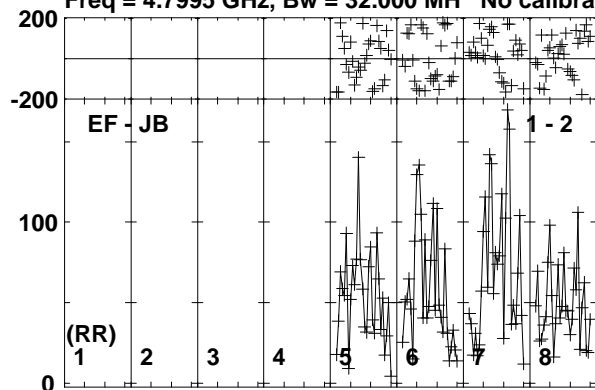

Lower frame: Micro Ampl Jy Top frame: Phas deg
Vector averaged cross-power spectrum Baseline: EF (01) - JB (02)
Timerange: 00/18:56:42 to 00/19:00:08

Plot file version 20 created 20-APR-2018 17:20:39

J1427+2632 RSM02.UVDATA.1

Freq = 4.7995 GHz, Bw = 32.000 MH No calibration applied and no bandpass applied

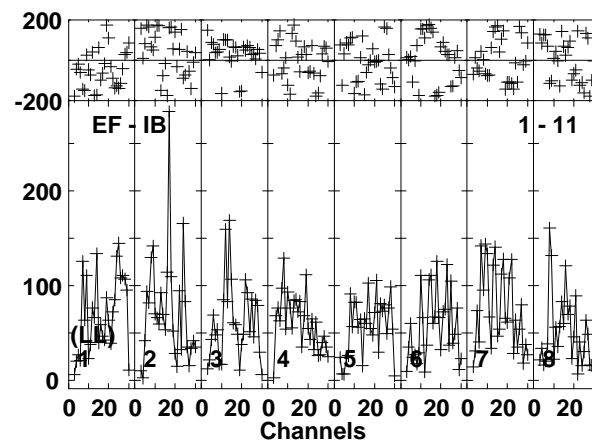
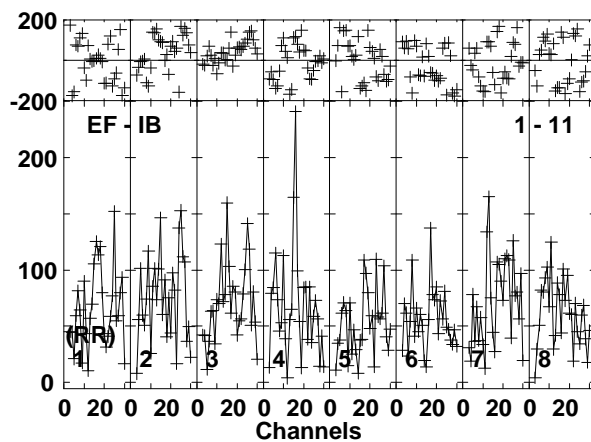
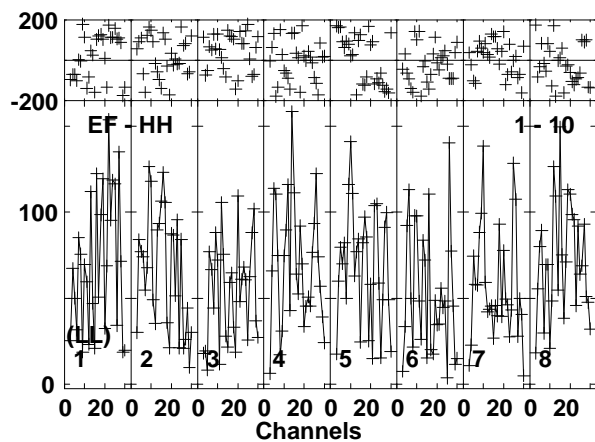
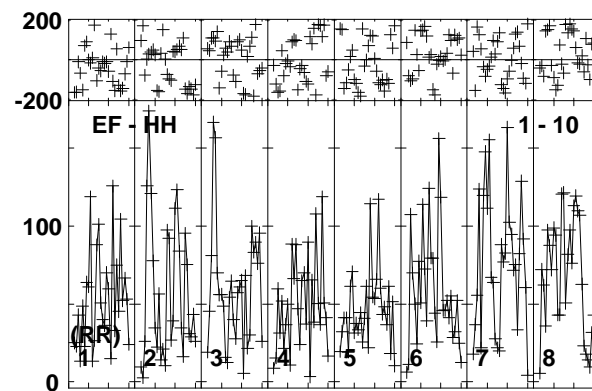
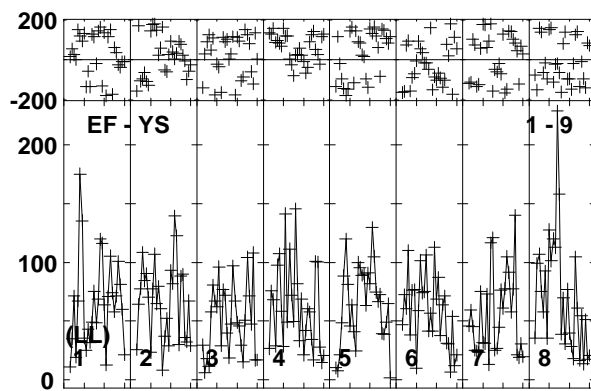
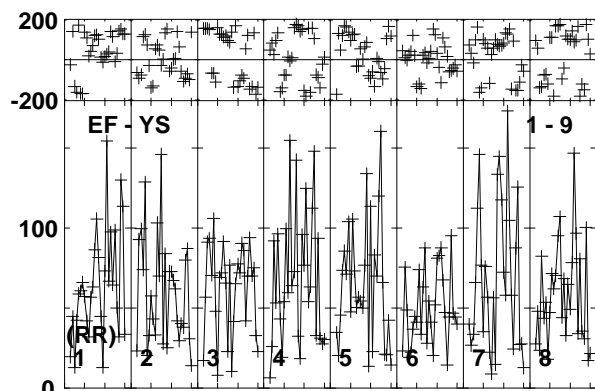
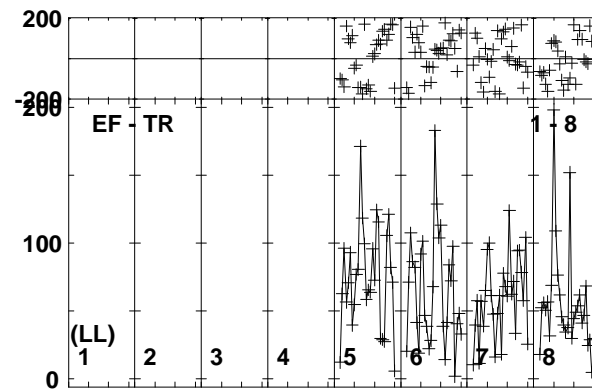
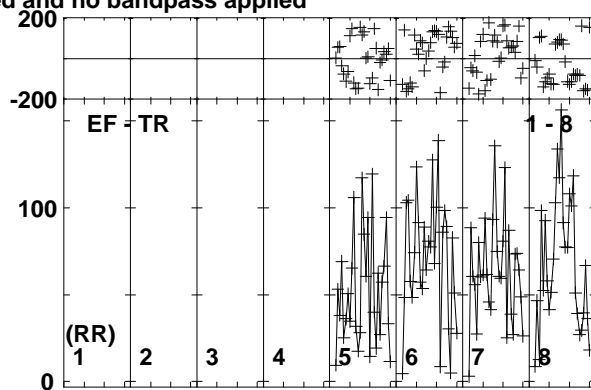
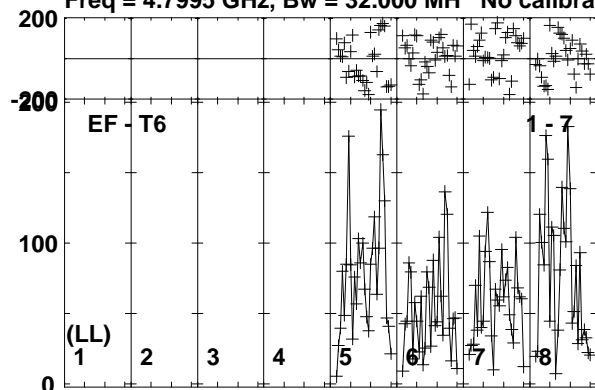

Lower frame: Micro Ampl Jy Top frame: Phas deg
Vector averaged cross-power spectrum Baseline: EF (01) - T6 (07)
Timerange: 00:18:56:42 to 00:19:00:08

Plot file version 21 created 20-APR-2018 17:20:39

J1419+2706 RSM02.UVDATA.1

Freq = 4.7995 GHz, Bw = 32.000 MH No calibration applied and no bandpass applied

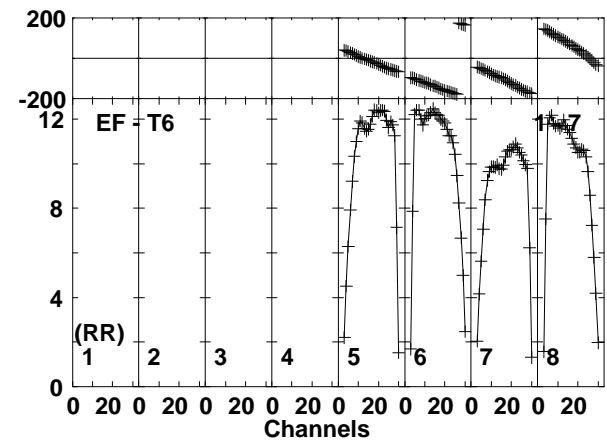
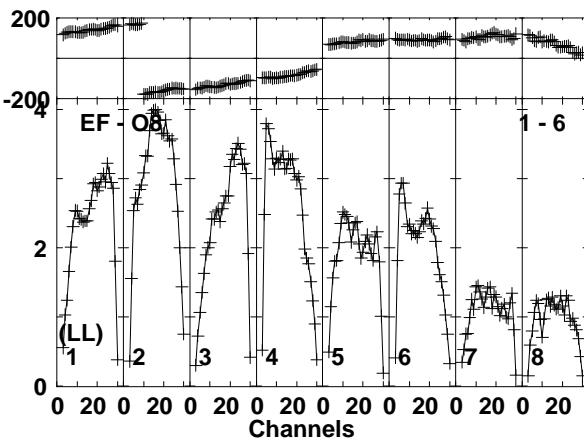
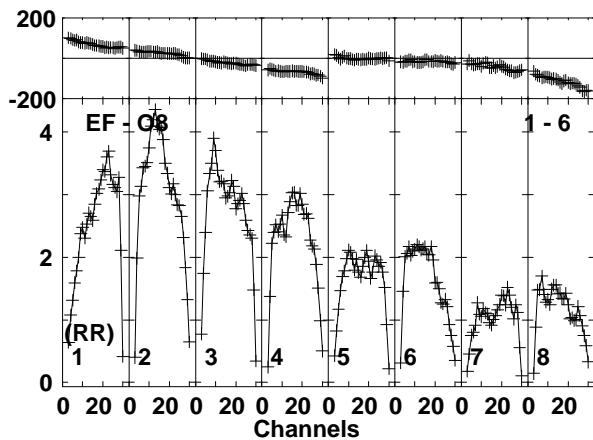
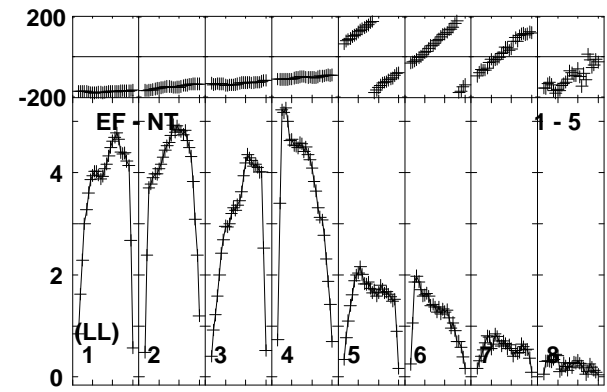
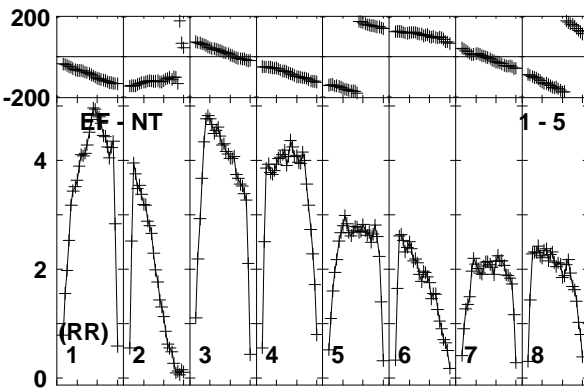
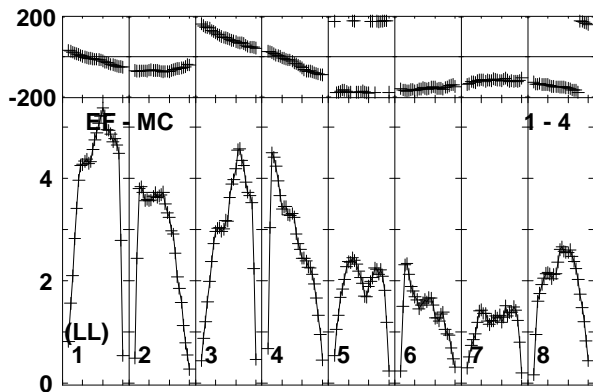
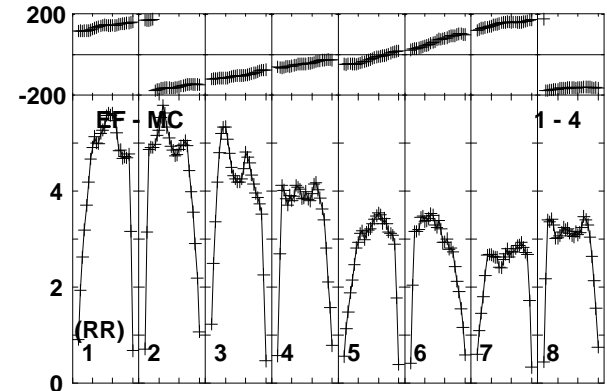
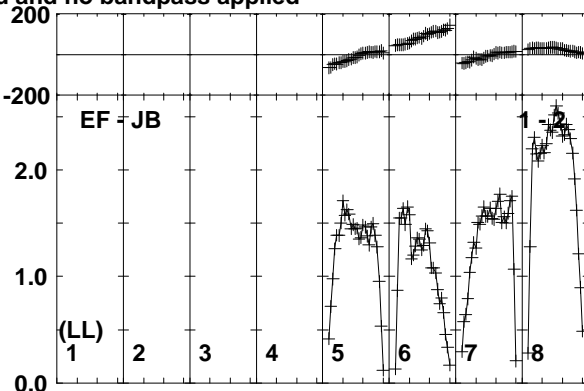
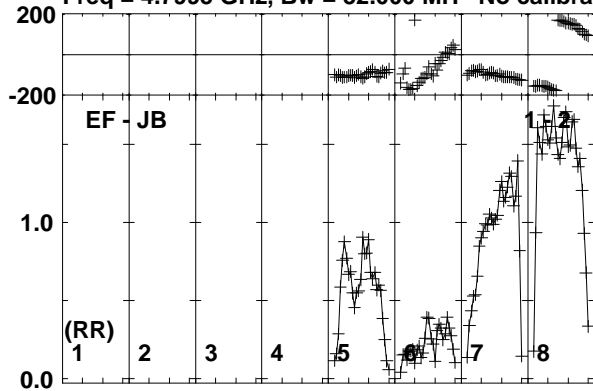

Lower frame: Milli Ampl Jy Top frame: Phas deg
Vector averaged cross-power spectrum Baseline: EF (01) - JB (02)
Timerange: 00/19:00:12 to 00/19:01:38

Plot file version 22 created 20-APR-2018 17:20:40

J1419+2706 RSM02.UVDATA.1

Freq = 4.7995 GHz, Bw = 32.000 MH No calibration applied and no bandpass applied

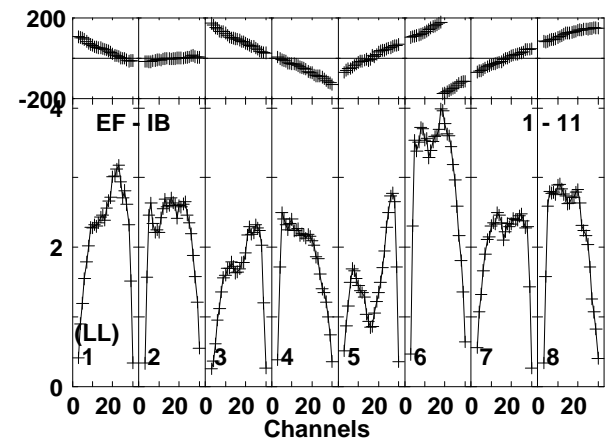
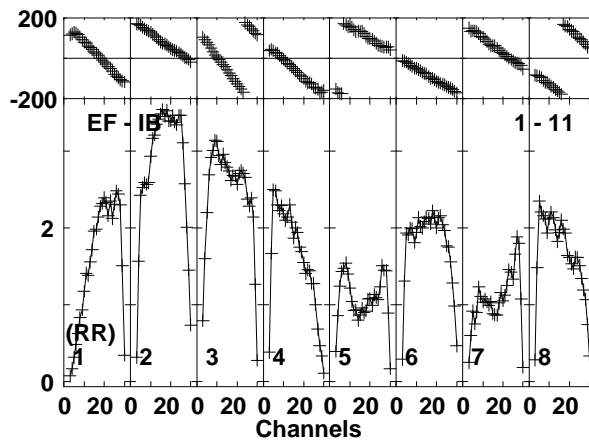
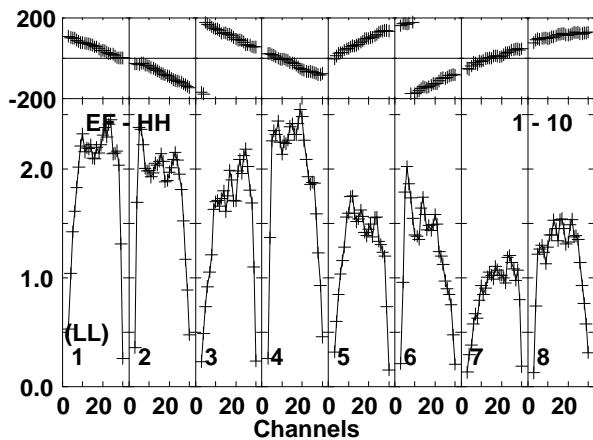
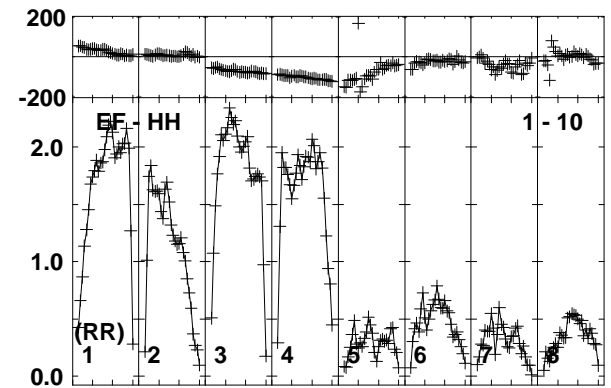
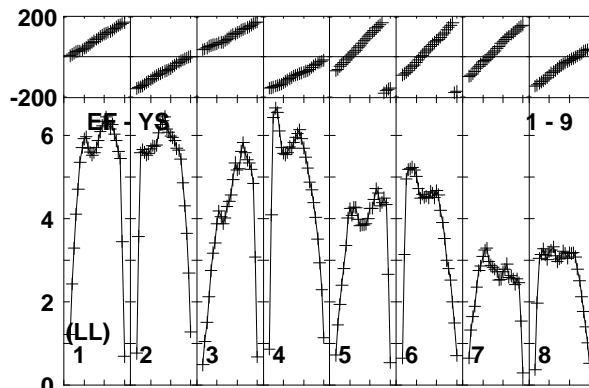
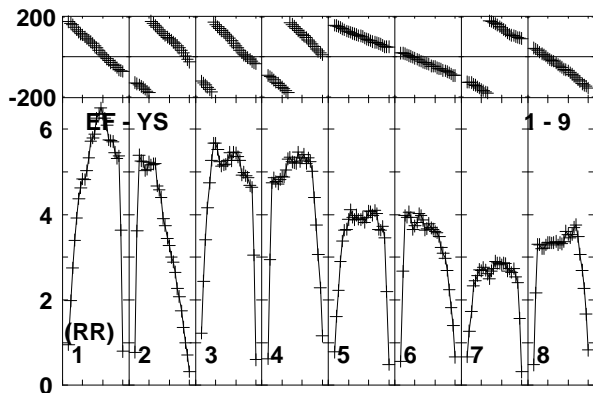
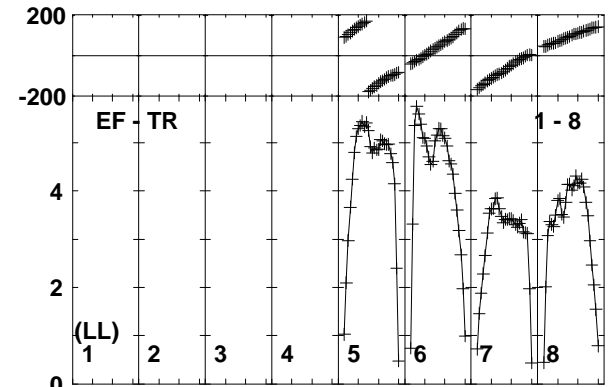
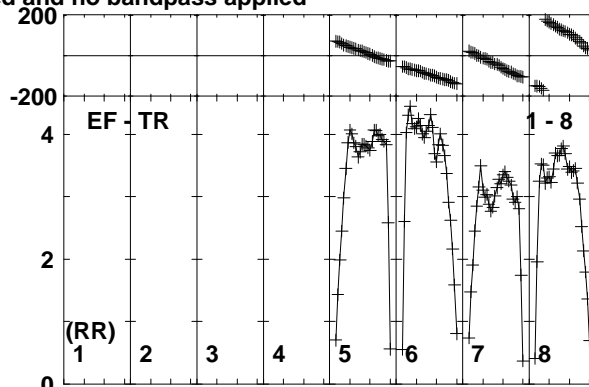
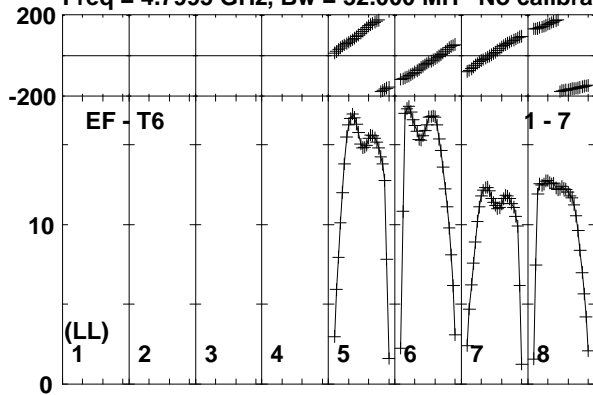

Lower frame: Milli Ampl Jy Top frame: Phas deg
Vector averaged cross-power spectrum Baseline: EF (01) - T6 (07)
Timerange: 00/19:00:12 to 00/19:01:38

Plot file version 23 created 20-APR-2018 17:20:40

J1427+2632 RSM02.UVDATA.1

Freq = 4.7995 GHz, Bw = 32.000 MH No calibration applied and no bandpass applied

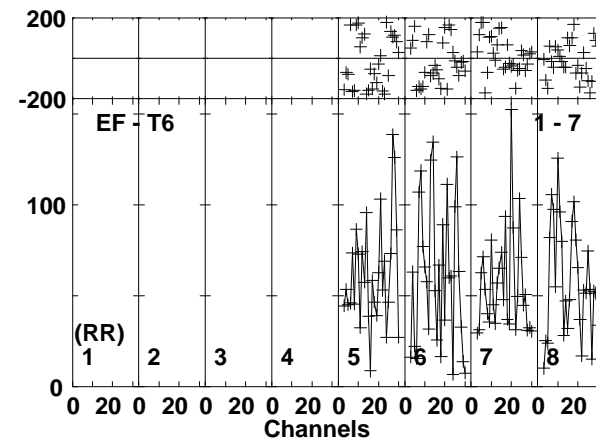
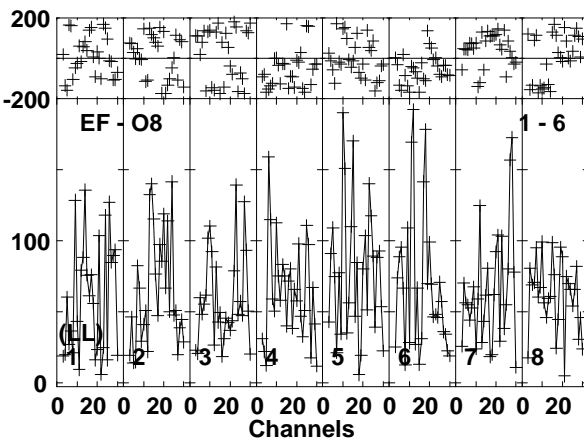
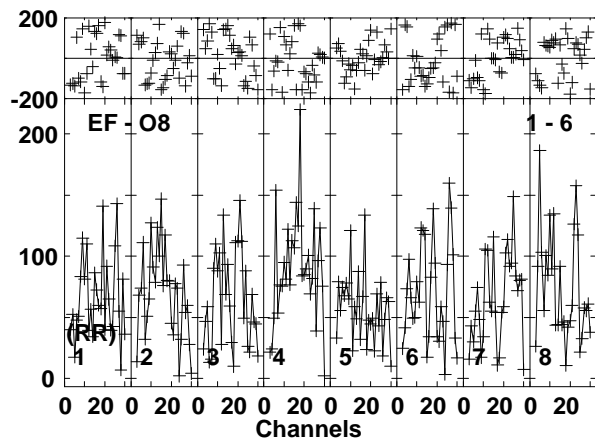
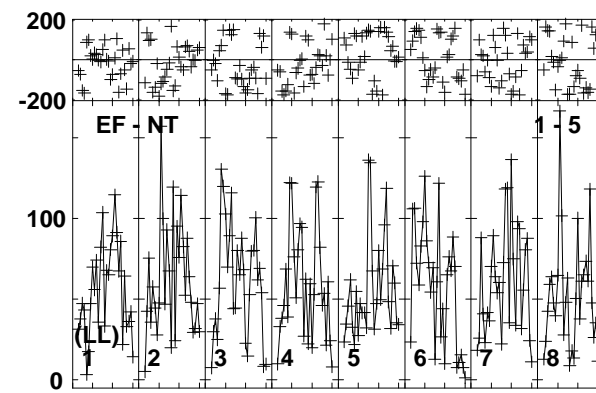
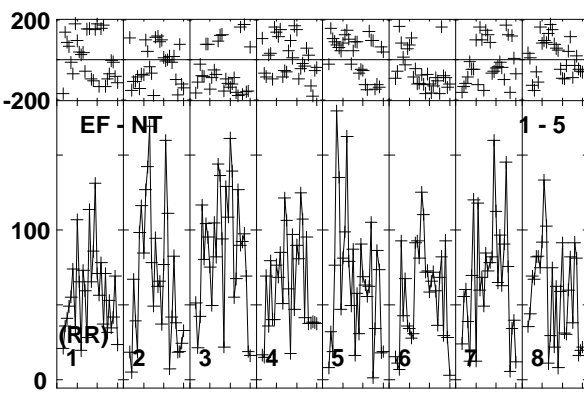
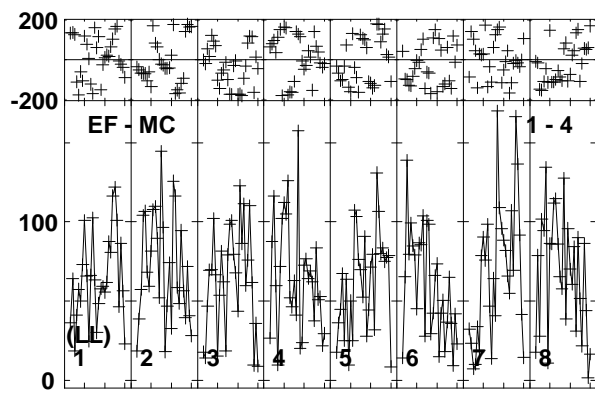
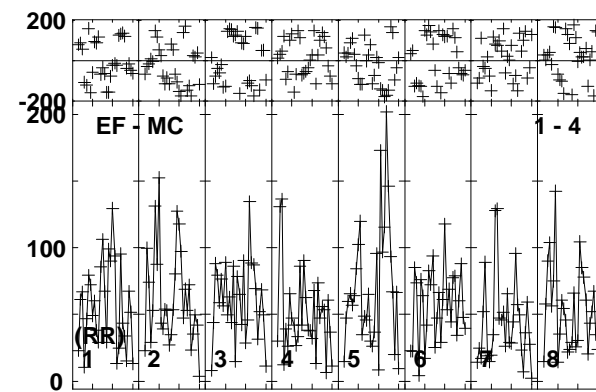
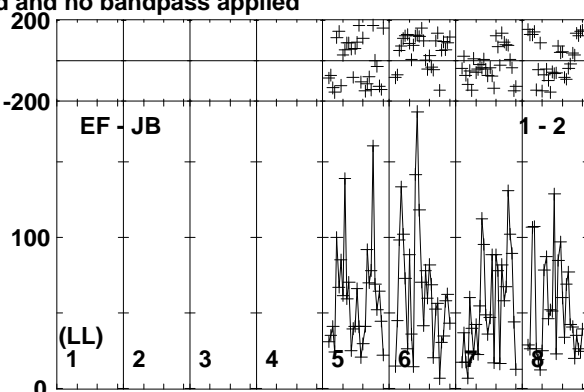
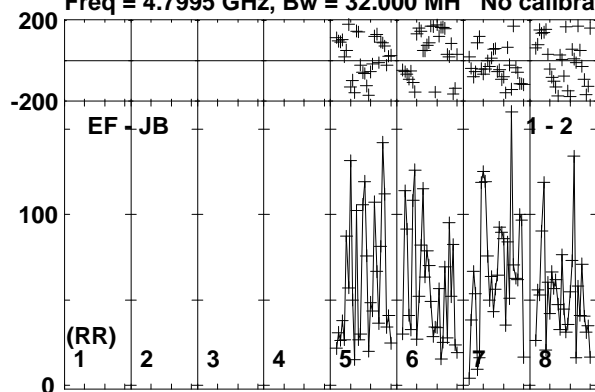

Lower frame: Micro Ampl Jy Top frame: Phas deg
Vector averaged cross-power spectrum Baseline: EF (01) - JB (02)
Timerange: 00/19:01:42 to 00/19:05:08

Plot file version 24 created 20-APR-2018 17:20:40

J1427+2632 RSM02.UVDATA.1

Freq = 4.7995 GHz, Bw = 32.000 MH No calibration applied and no bandpass applied

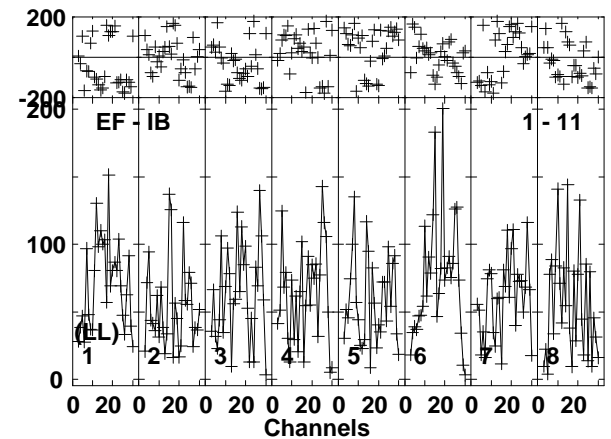
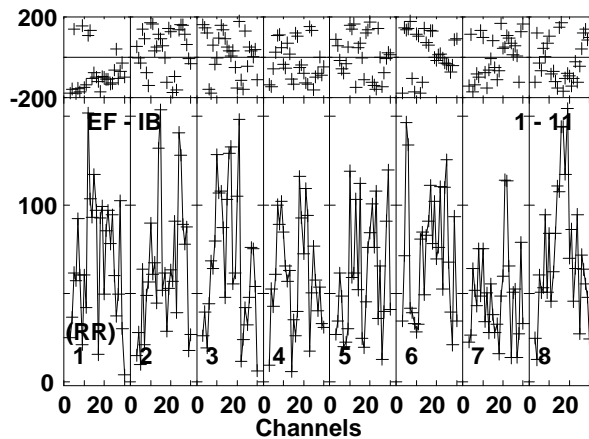
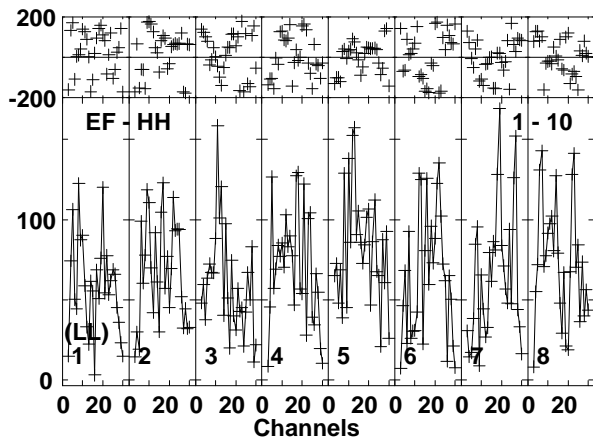
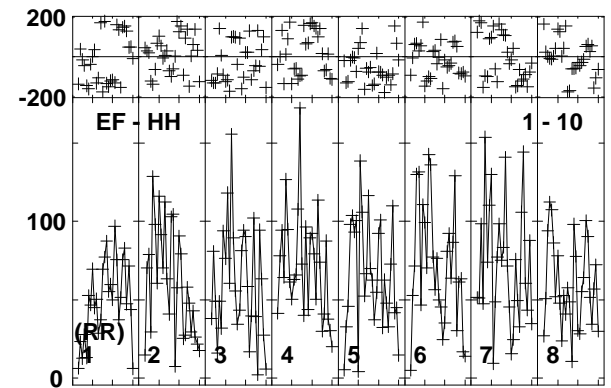
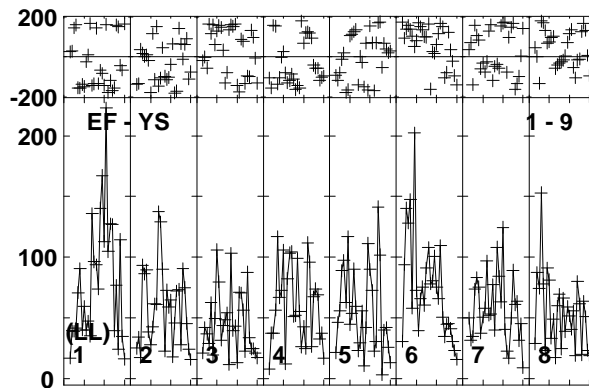
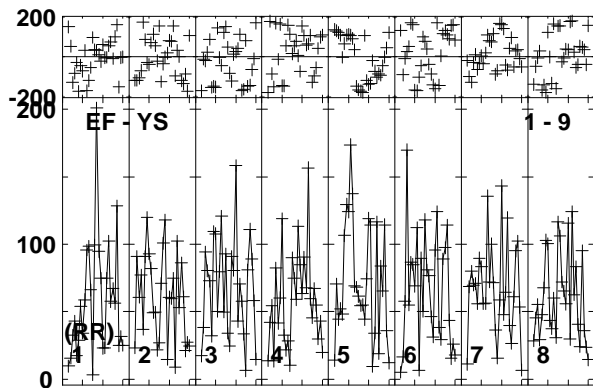
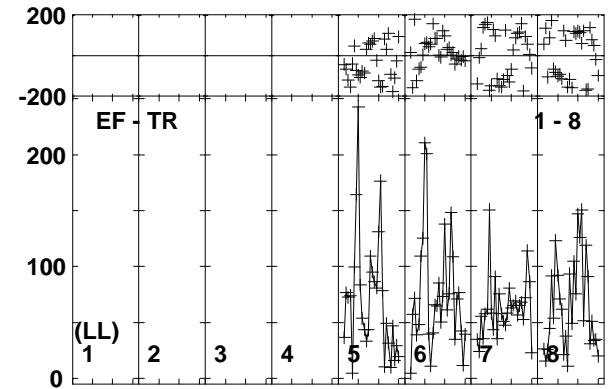
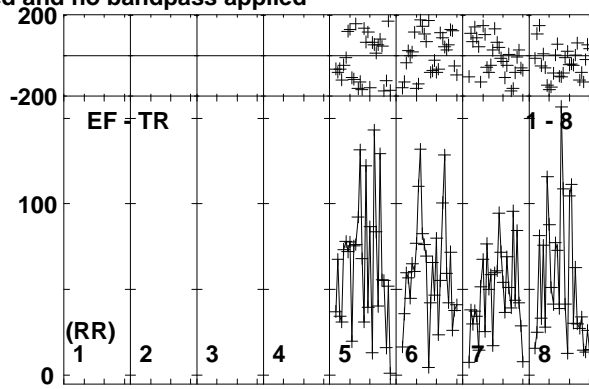
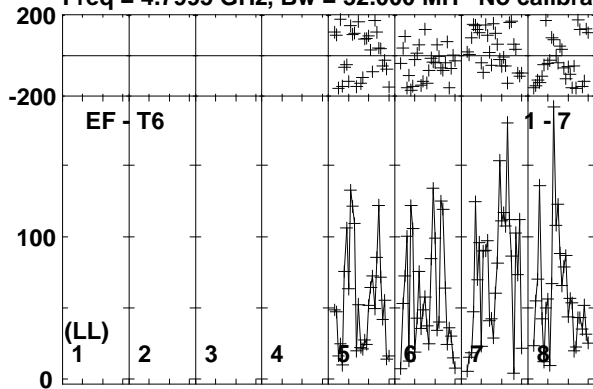

Lower frame: Micro Ampl Jy Top frame: Phas deg
Vector averaged cross-power spectrum Baseline: EF (01) - T6 (07)
Timerange: 00/19:01:42 to 00/19:05:08

Plot file version 25 created 20-APR-2018 17:20:40
 J1419+2706 RSM02.UVDATA.1

Freq = 4.7995 GHz, Bw = 32.000 MH No calibration applied and no bandpass applied

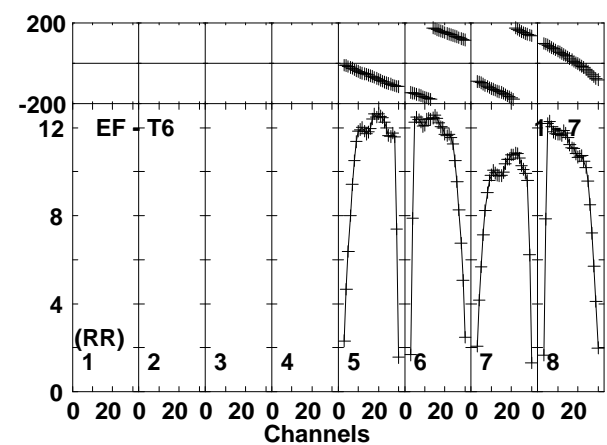
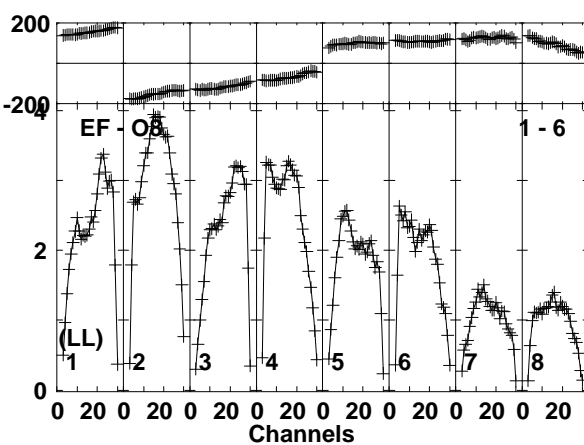
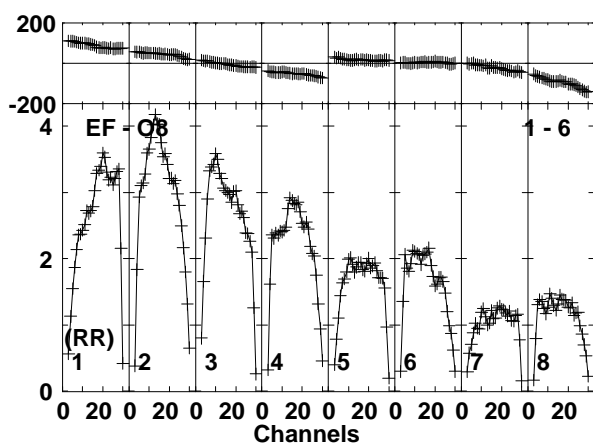
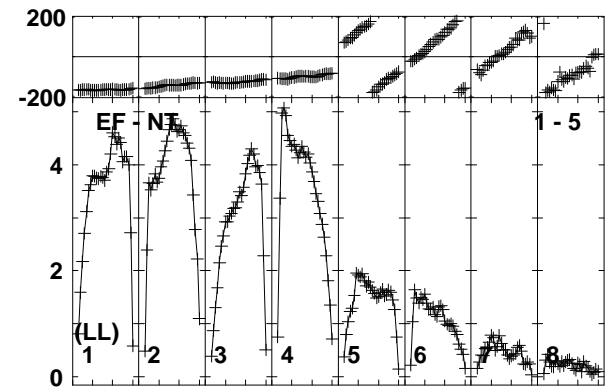
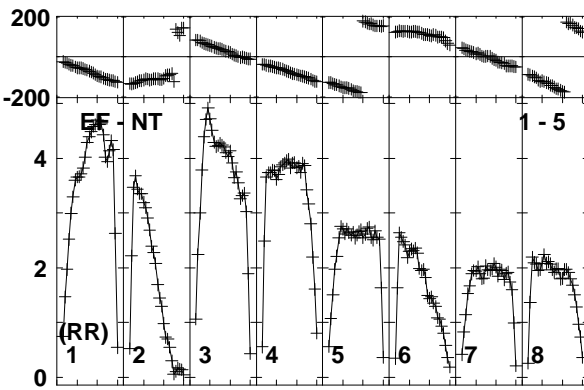
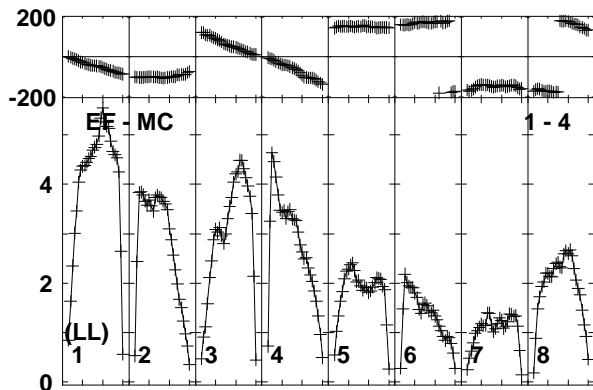
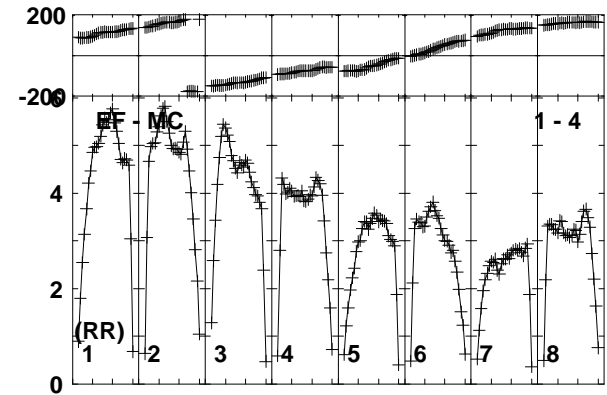
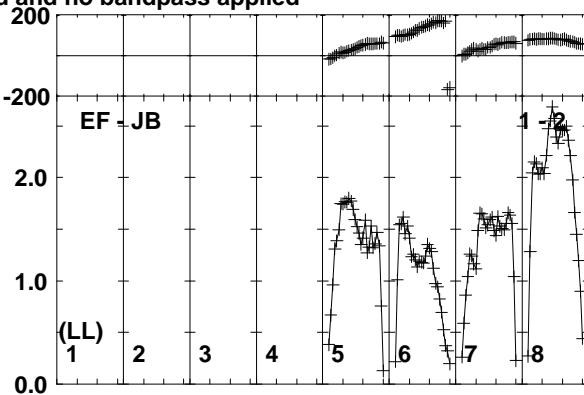
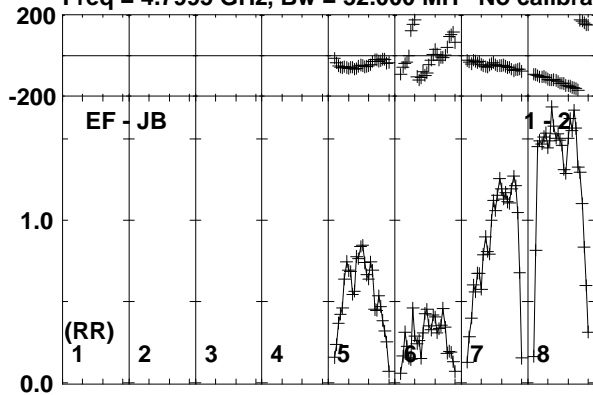

Lower frame: Milli Ampl Jy Top frame: Phas deg
 Vector averaged cross-power spectrum Baseline: EF (01) - JB (02)
 Timerange: 00:19:05:52 to 00:19:06:48

Plot file version 26 created 20-APR-2018 17:20:40
 J1419+2706 RSM02.UVDATA.1
 Freq = 4.7995 GHz, Bw = 32.000 MH No calibration applied and no bandpass applied

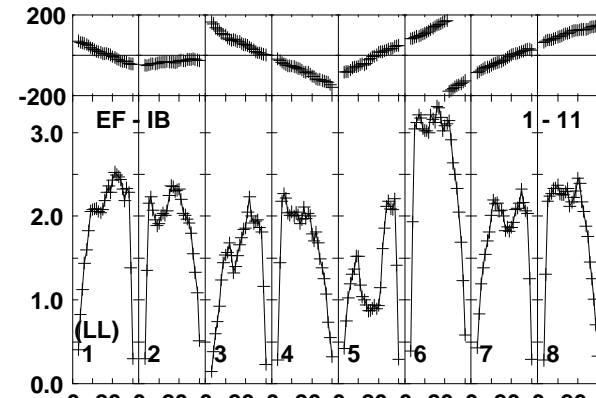
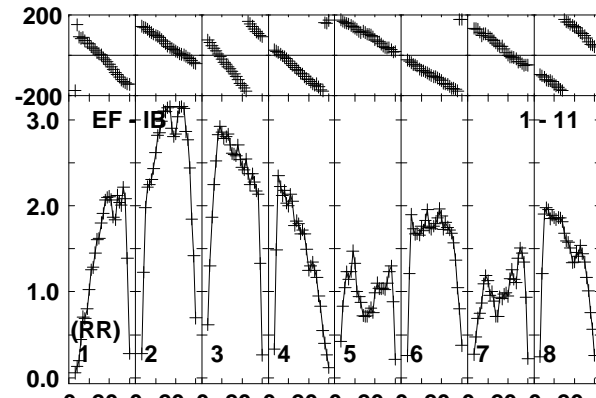
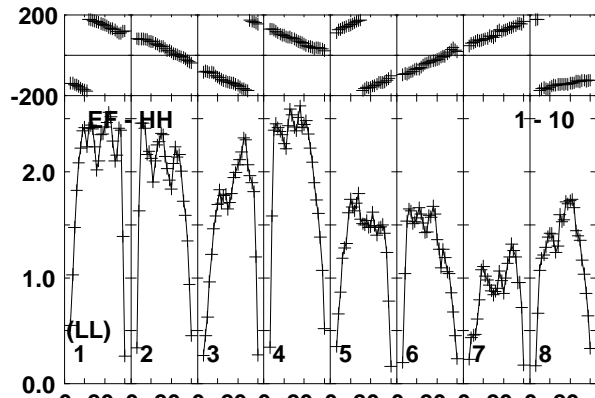
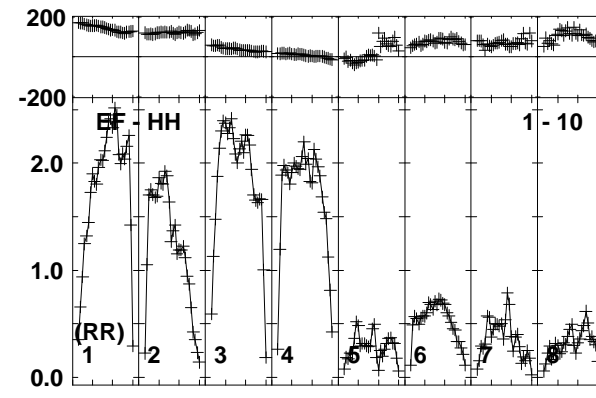
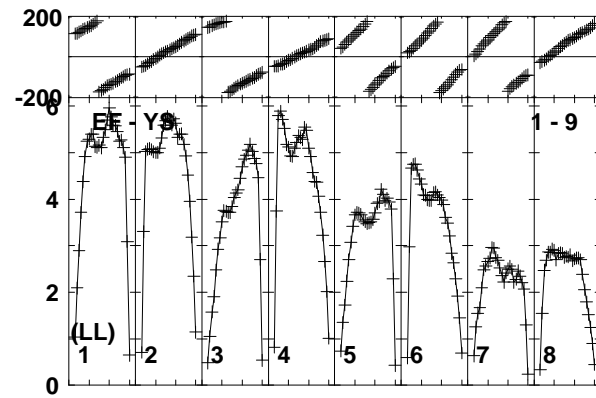
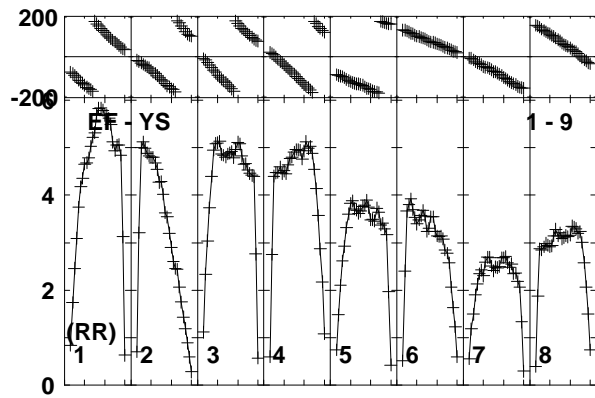
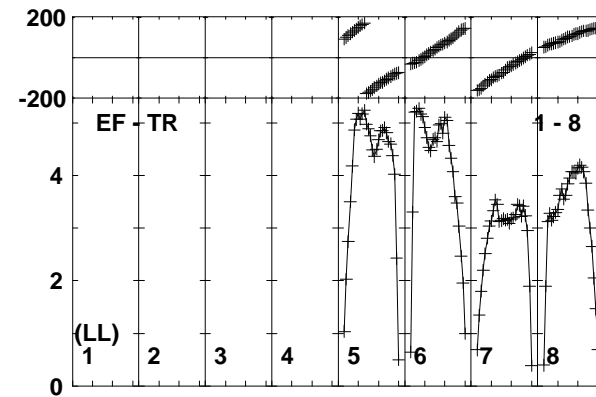
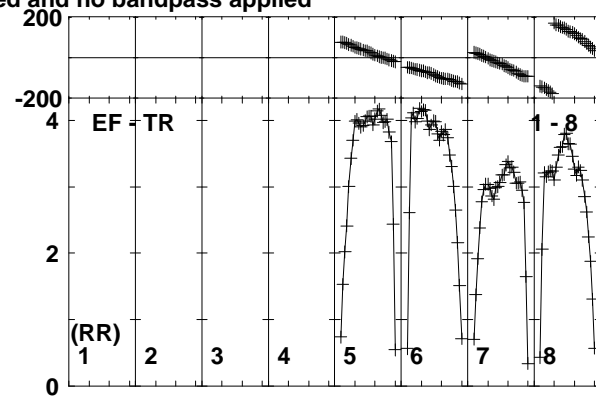
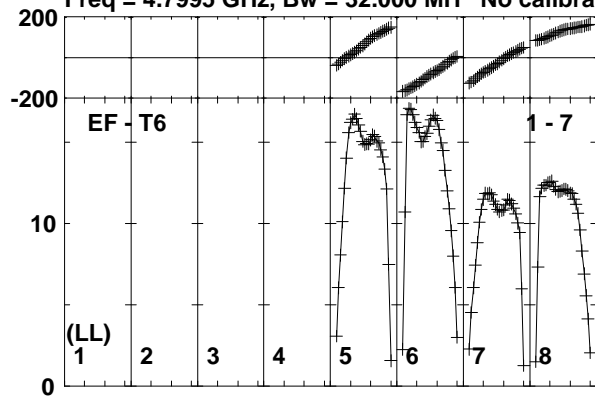

Lower frame: Milli Ampl Jy Top frame: Phas deg
 Vector averaged cross-power spectrum Baseline: EF (01) - T6 (07)
 Timerange: 00/19:05:52 to 00/19:06:48

Plot file version 27 created 20-APR-2018 17:20:40

J1427+2632 RSM02.UVDATA.1

Freq = 4.7995 GHz, Bw = 32.000 MH No calibration applied and no bandpass applied

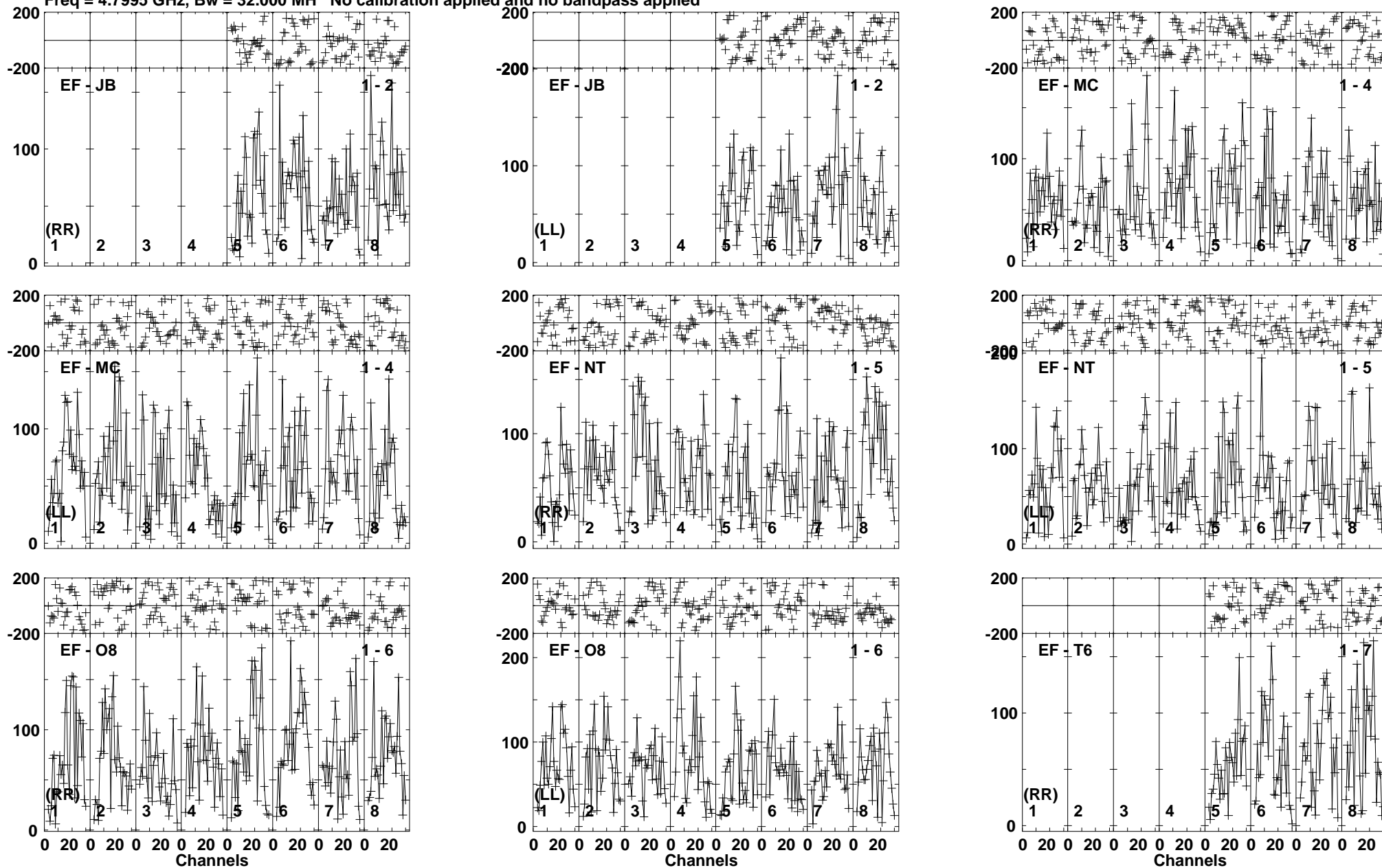

Lower frame: Micro Ampl Jy Top frame: Phas deg
Vector averaged cross-power spectrum Baseline: EF (01) - JB (02)
Timerange: 00:19:06:52 to 00:19:10:18

Plot file version 28 created 20-APR-2018 17:20:40

J1427+2632 RSM02.UVDATA.1

Freq = 4.7995 GHz, Bw = 32.000 MH No calibration applied and no bandpass applied

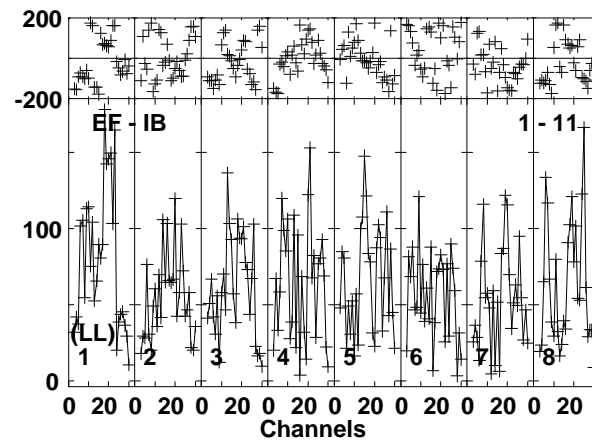
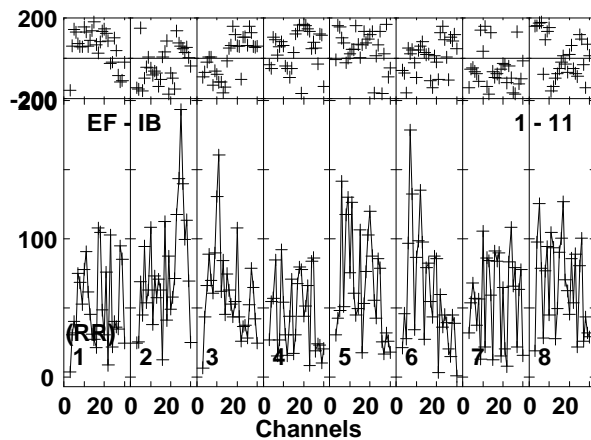
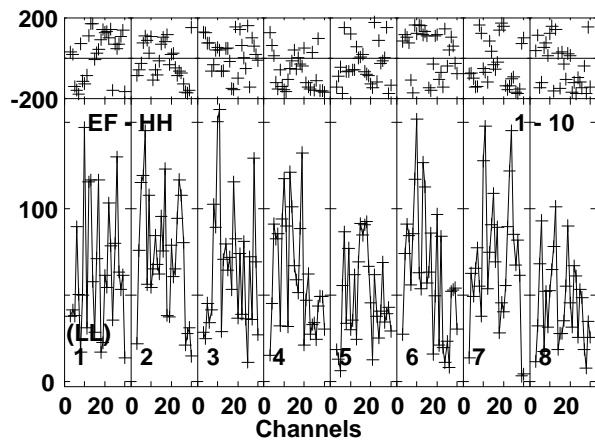
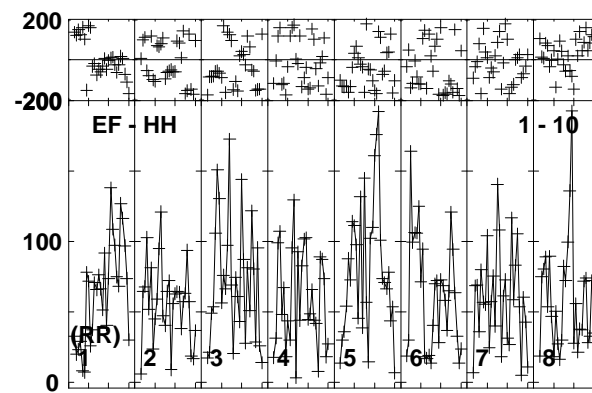
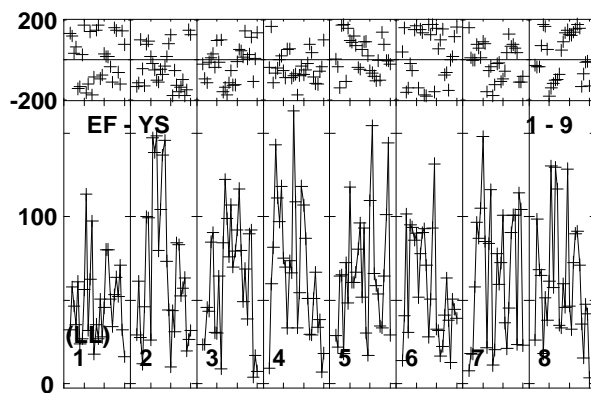
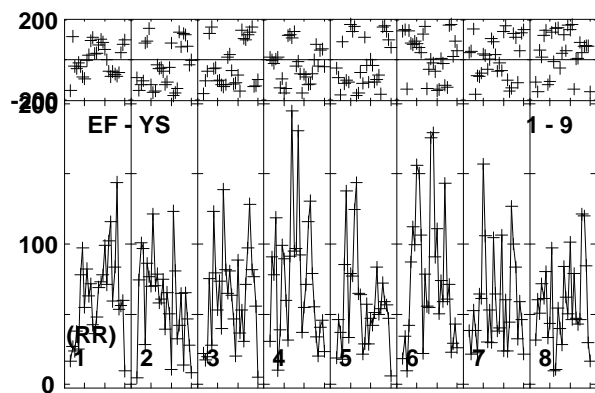
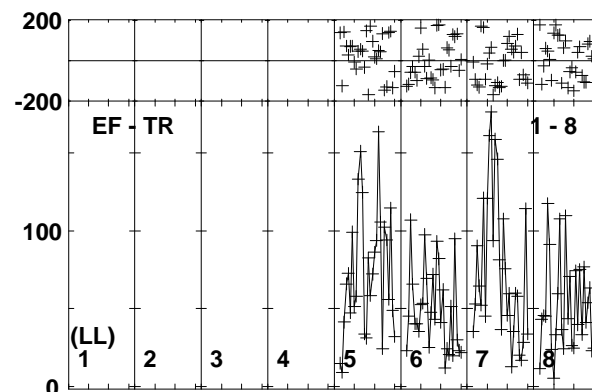
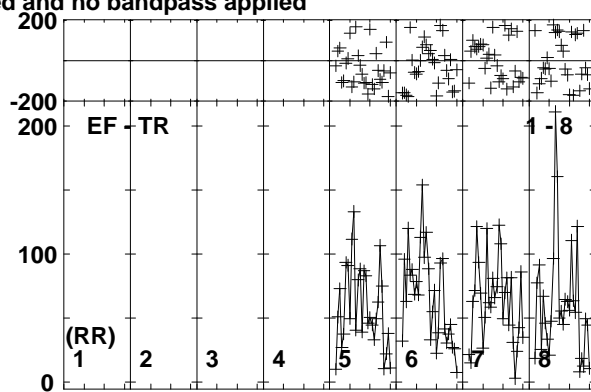
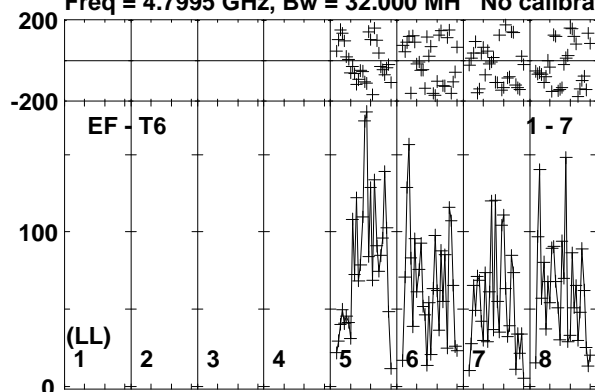

Lower frame: Micro Ampl Jy Top frame: Phas deg
Vector averaged cross-power spectrum Baseline: EF (01) - T6 (07)
Timerange: 00/19:06:52 to 00/19:10:18

Plot file version 29 created 20-APR-2018 17:20:40

J1419+2706 RSM02.UVDATA.1

Freq = 4.7995 GHz, Bw = 32.000 MH No calibration applied and no bandpass applied

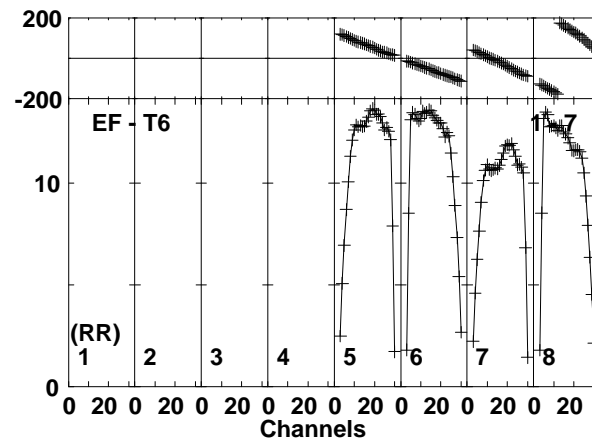
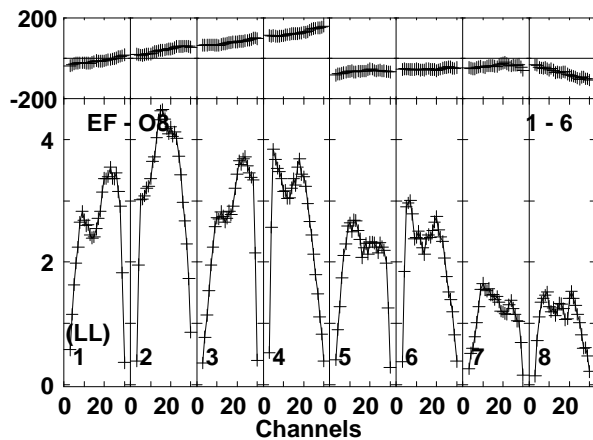
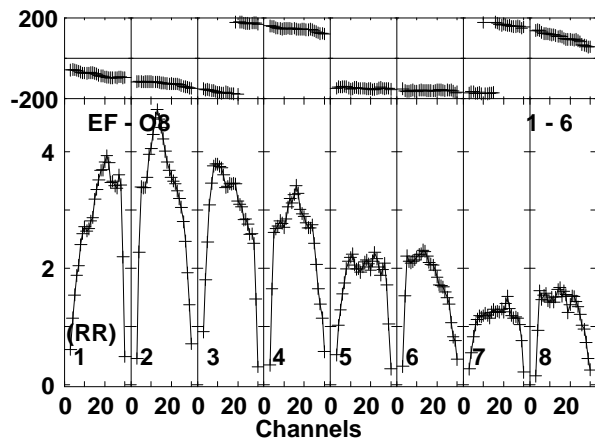
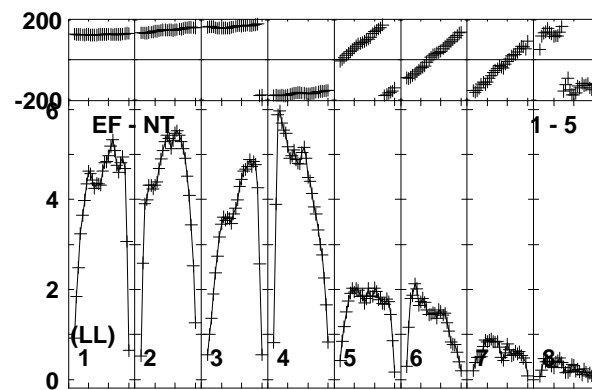
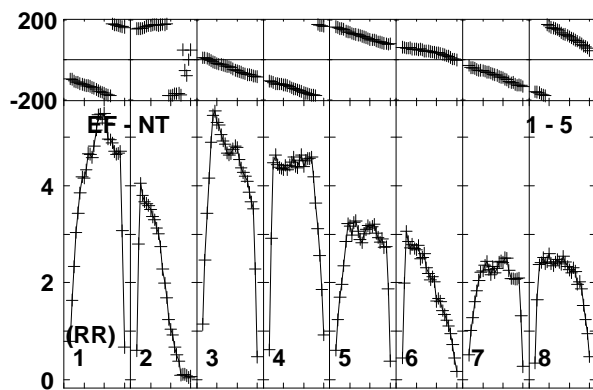
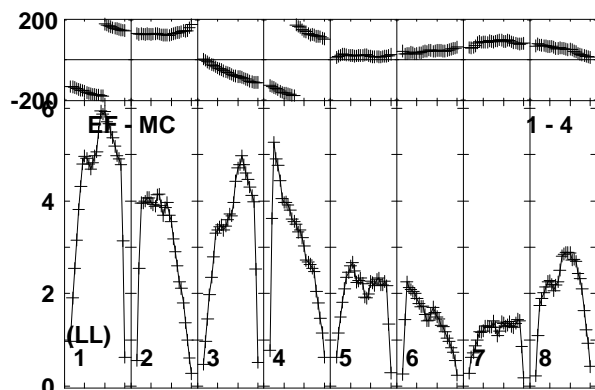
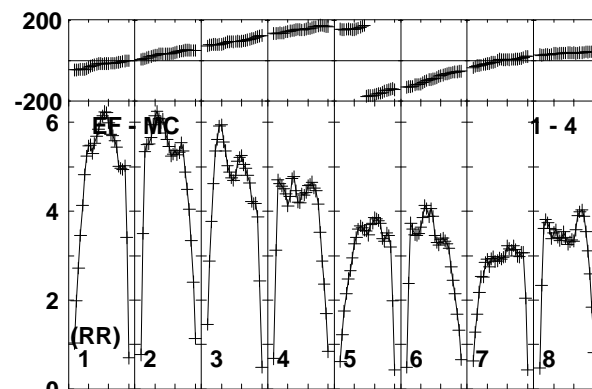
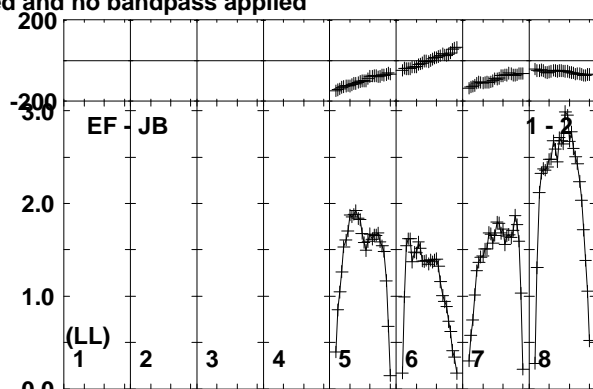
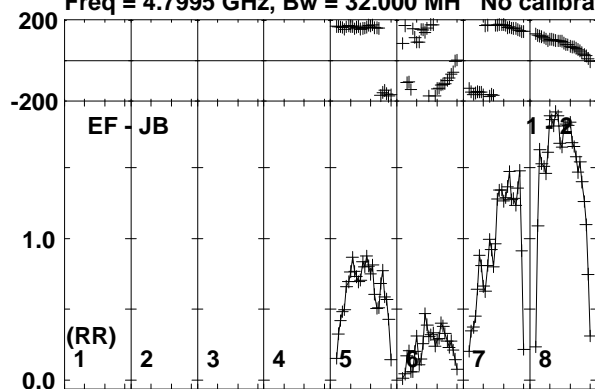

Lower frame: Milli Ampl Jy Top frame: Phas deg
Vector averaged cross-power spectrum Baseline: EF (01) - JB (02)
Timerange: 00:19:10:22 to 00:19:11:48

Plot file version 30 created 20-APR-2018 17:20:40

J1419+2706 RSM02.UVDATA.1

Freq = 4.7995 GHz, Bw = 32.000 MH No calibration applied and no bandpass applied

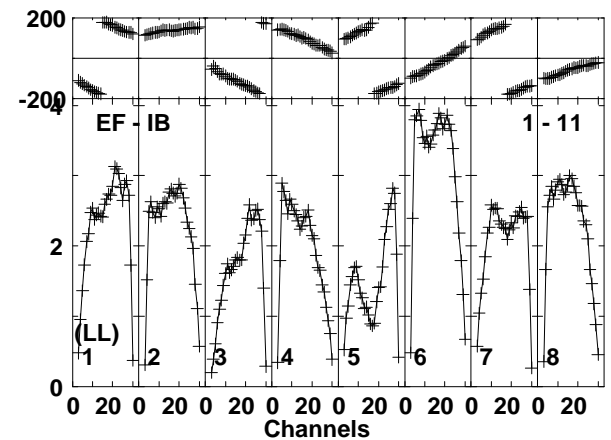
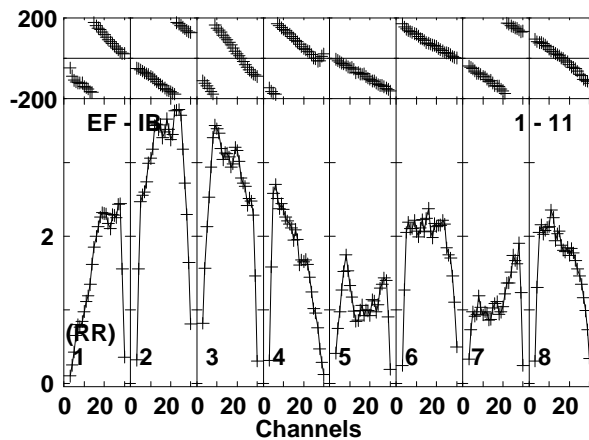
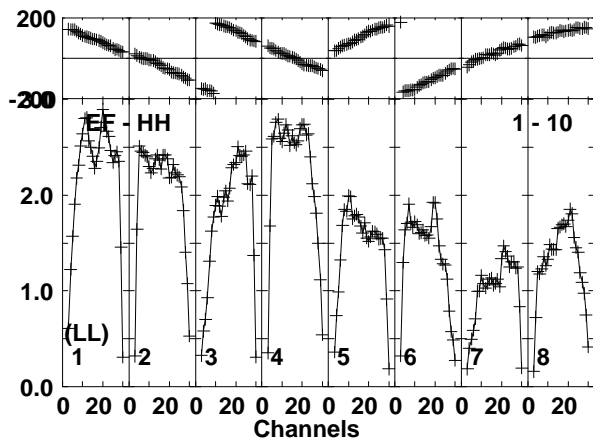
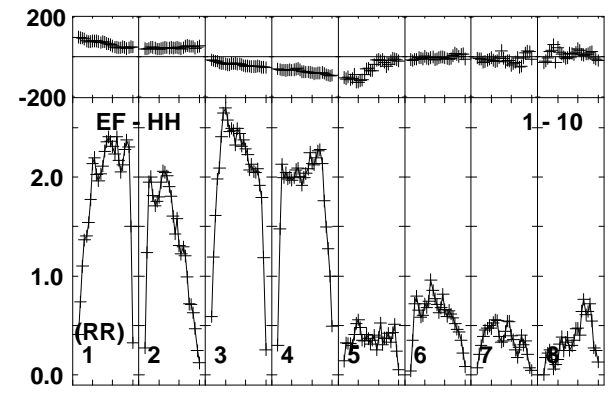
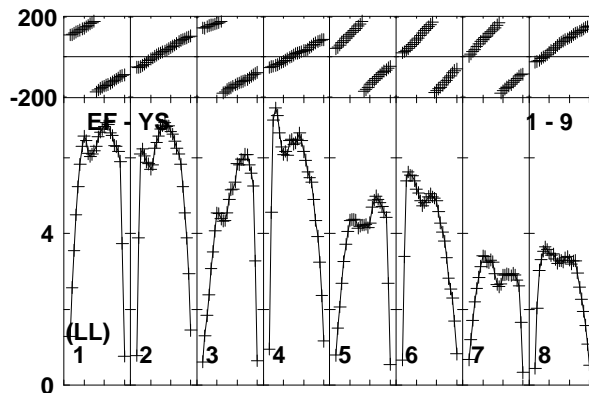
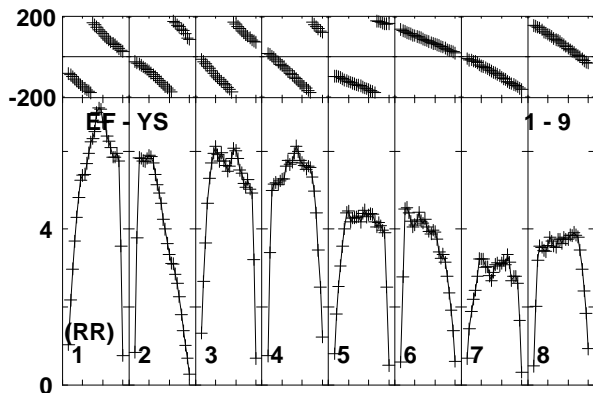
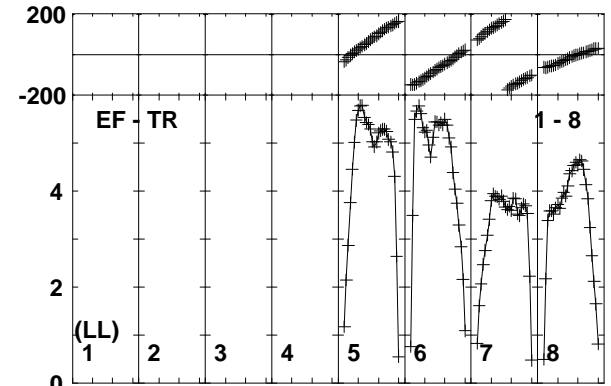
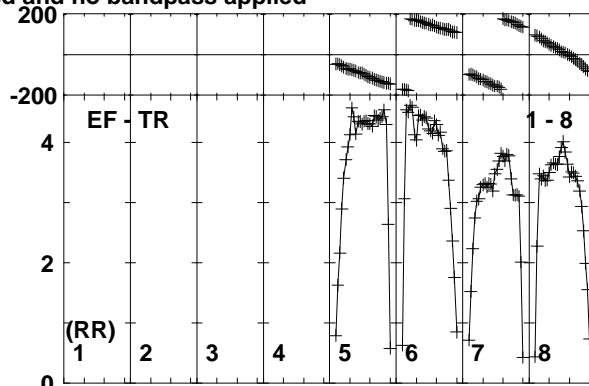
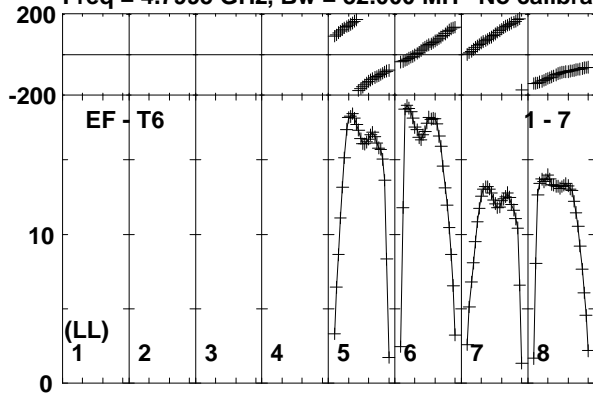

Lower frame: Milli Ampl Jy Top frame: Phas deg
Vector averaged cross-power spectrum Baseline: EF (01) - T6 (07)
Timerange: 00:19:10:22 to 00:19:11:48

Plot file version 31 created 20-APR-2018 17:20:40

J1427+2632 RSM02.UVDATA.1

Freq = 4.7995 GHz, Bw = 32.000 MH No calibration applied and no bandpass applied

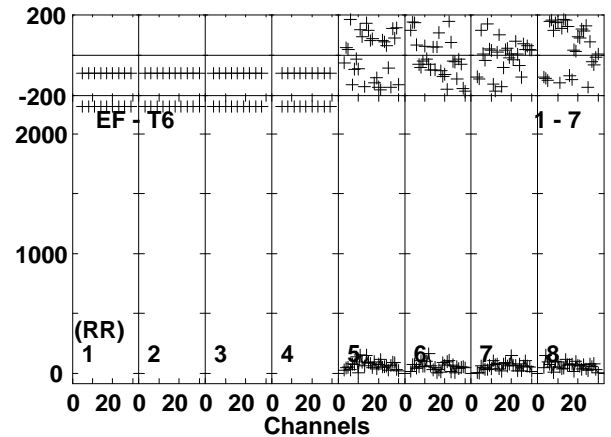
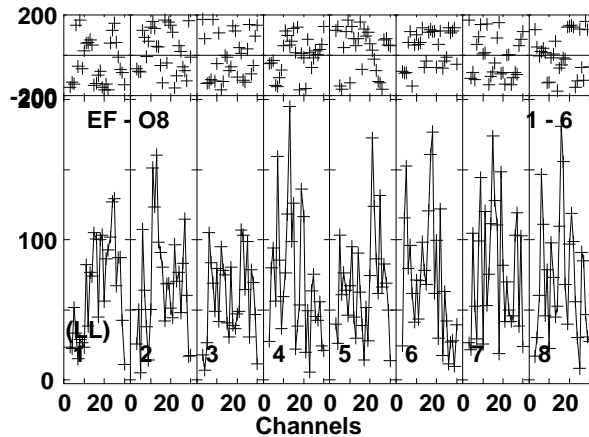
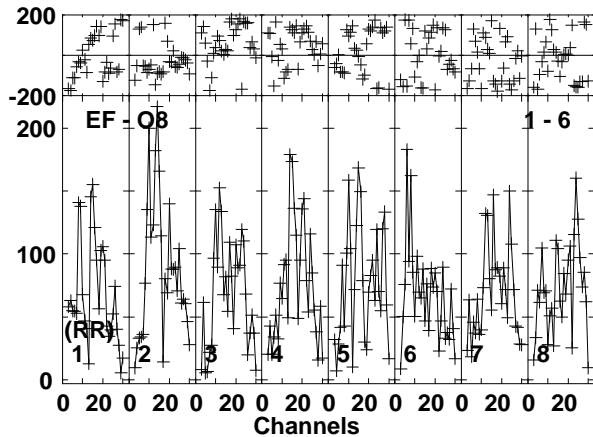
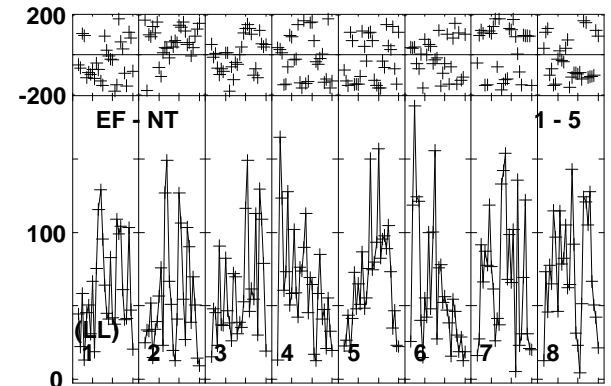
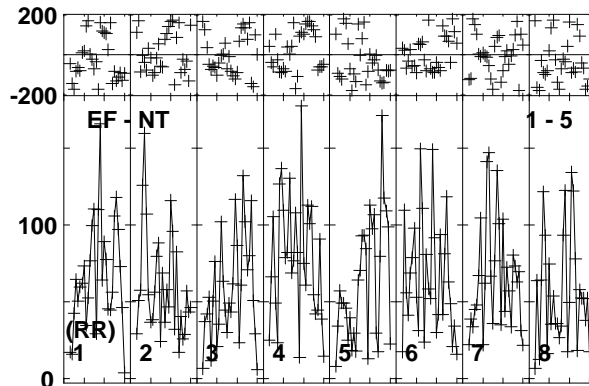
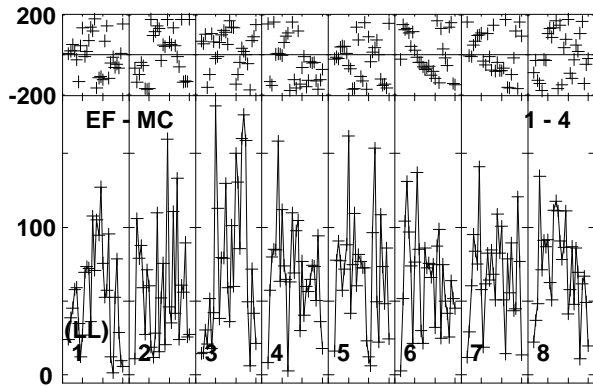
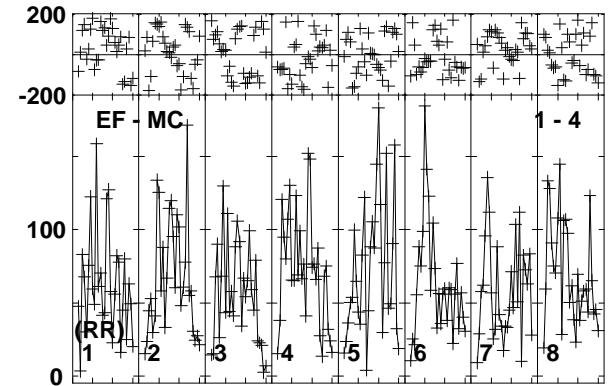
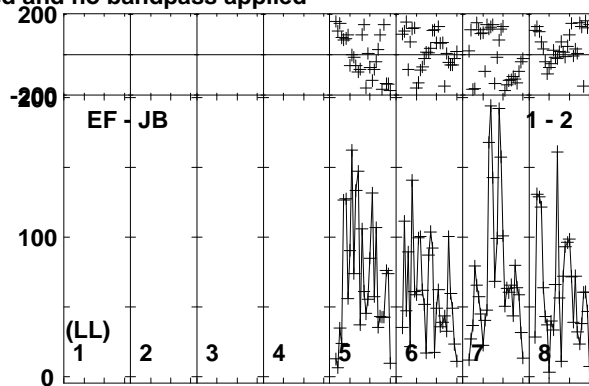
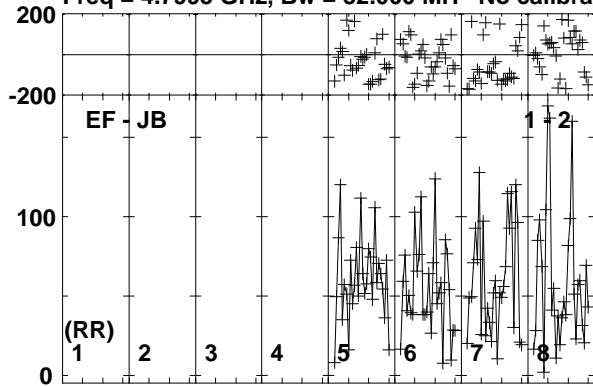

Lower frame: Micro Ampl Jy Top frame: Phas deg
Vector averaged cross-power spectrum Baseline: EF (01) - JB (02)
Timerange: 00/19:11:52 to 00/19:15:18

Plot file version 32 created 20-APR-2018 17:20:41

J1427+2632 RSM02.UVDATA.1

Freq = 4.7995 GHz, Bw = 32.000 MH No calibration applied and no bandpass applied

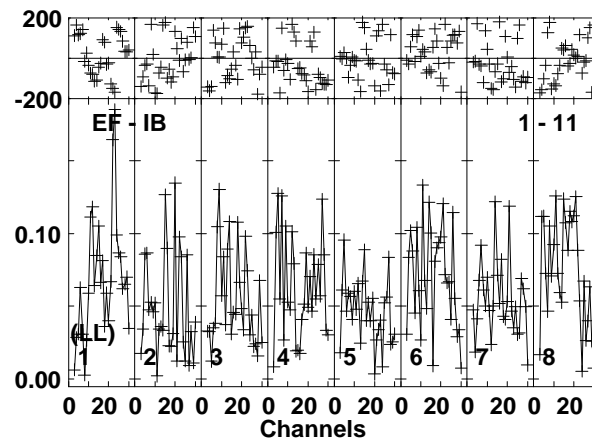
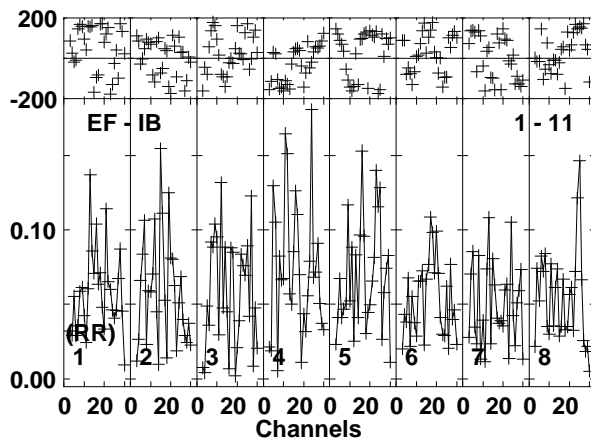
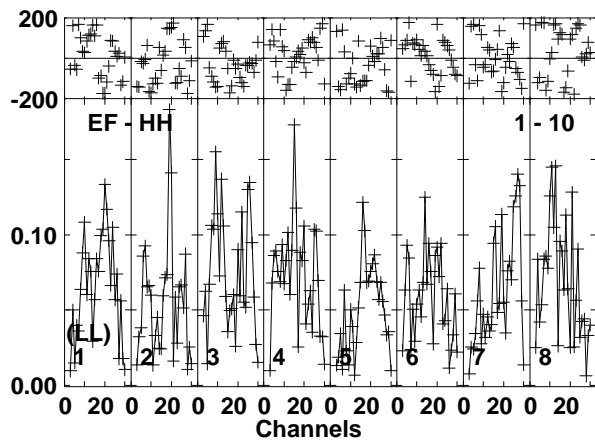
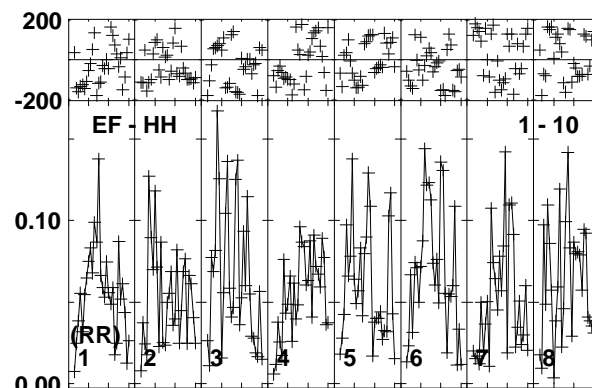
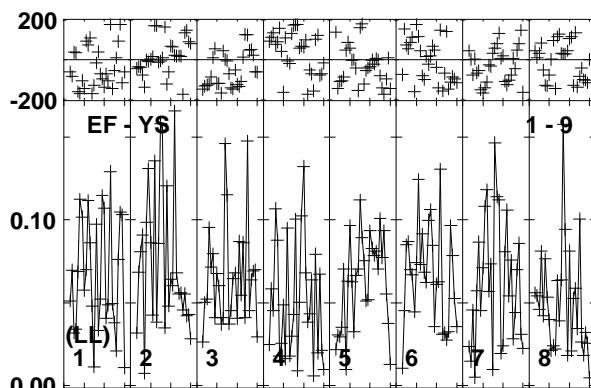
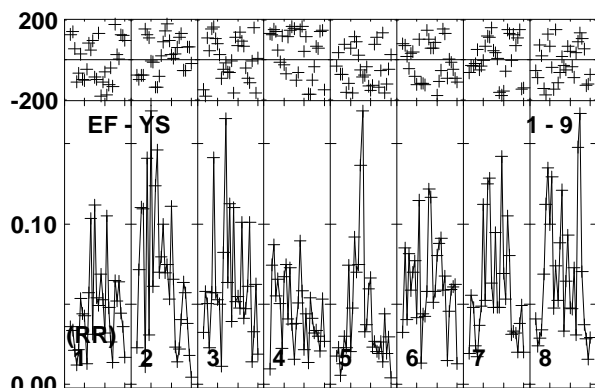
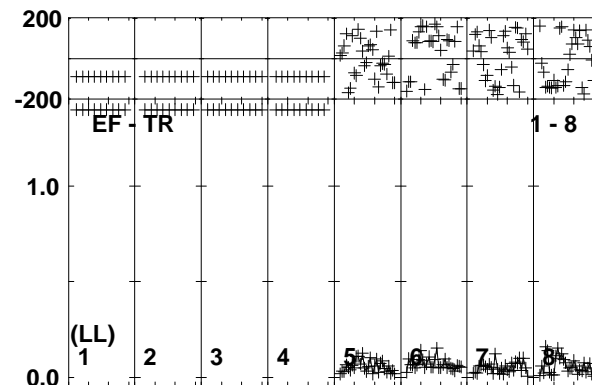
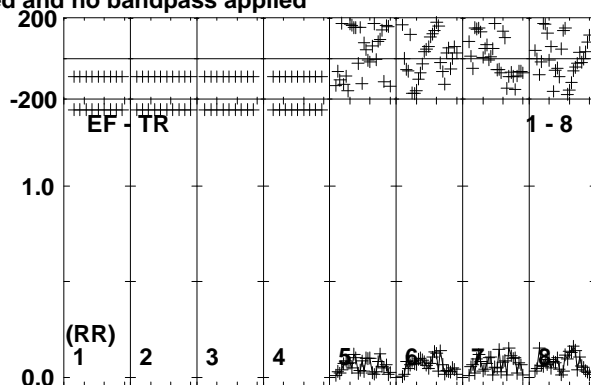
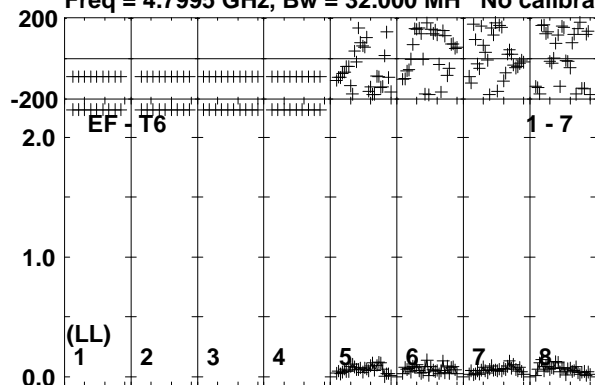

Lower frame: Milli Ampl Jy Top frame: Phas deg
Vector averaged cross-power spectrum Baseline: EF (01) - T6 (07)
Timerange: 00/19:11:52 to 00/19:15:18

Plot file version 33 created 20-APR-2018 17:20:41

J1419+2706 RSM02.UVDATA.1

Freq = 4.7995 GHz, Bw = 32.000 MH No calibration applied and no bandpass applied

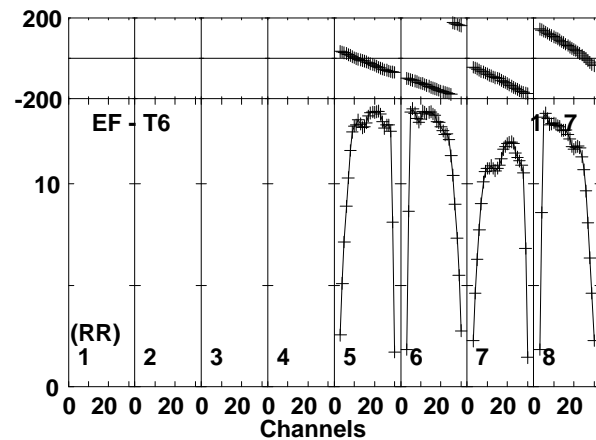
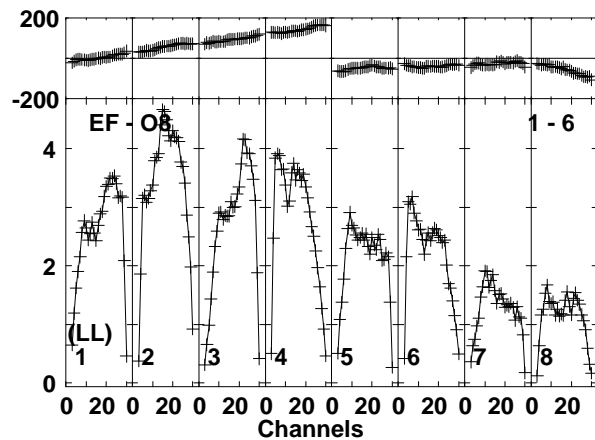
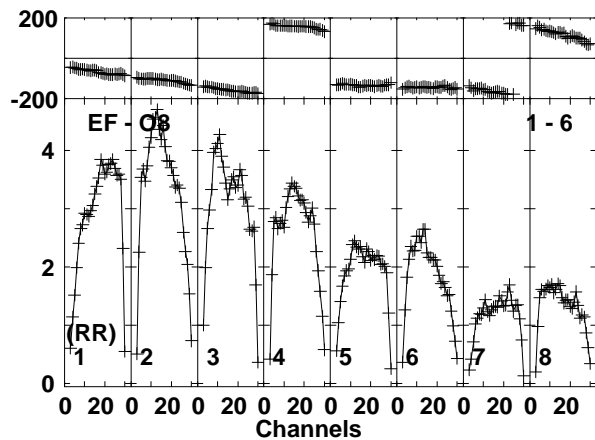
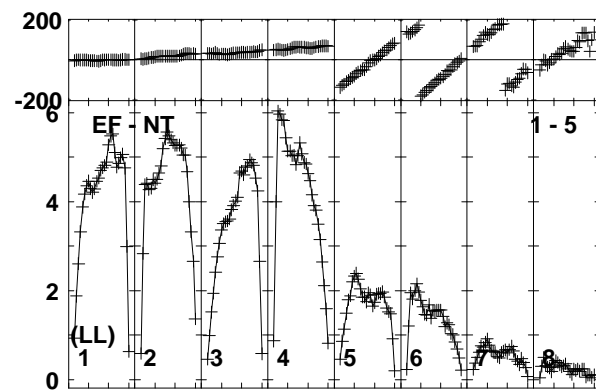
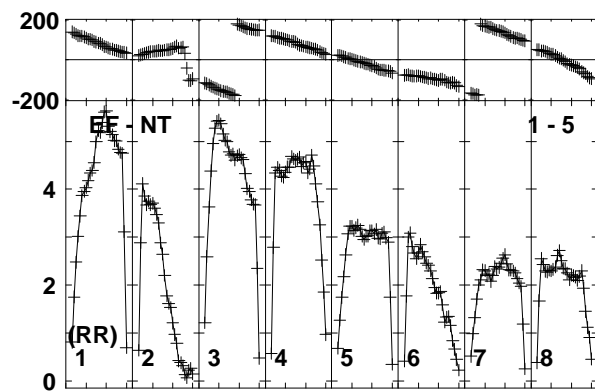
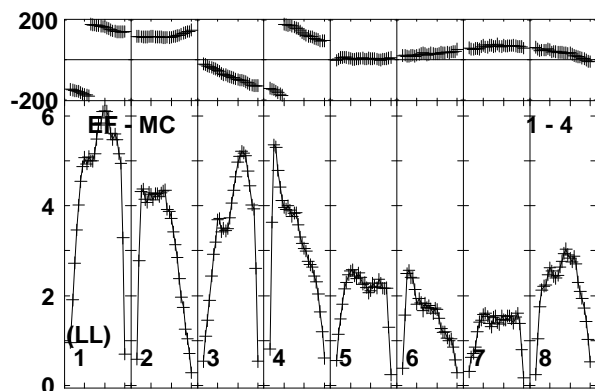
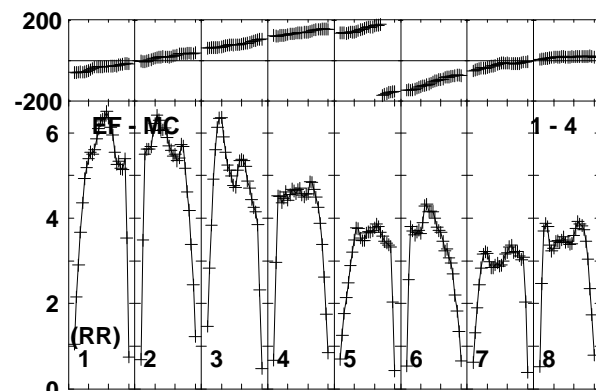
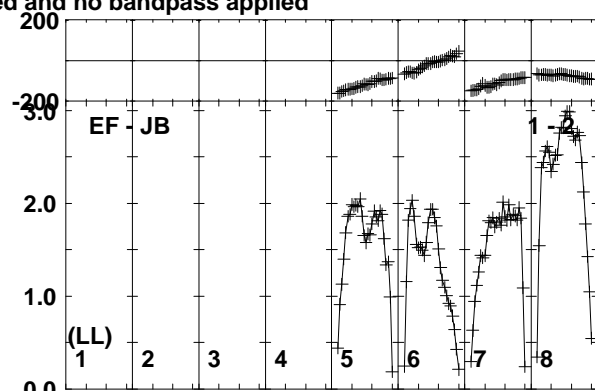
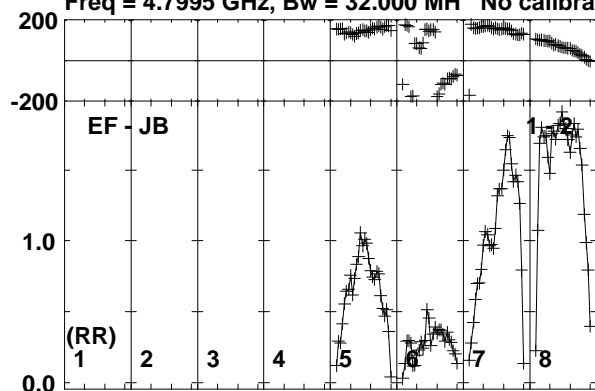

Lower frame: Milli Ampl Jy Top frame: Phas deg
Vector averaged cross-power spectrum Baseline: EF (01) - JB (02)
Timerange: 00:19:15:22 to 00:19:16:48

Plot file version 34 created 20-APR-2018 17:20:41

J1419+2706 RSM02.UVDATA.1

Freq = 4.7995 GHz, Bw = 32.000 MH No calibration applied and no bandpass applied

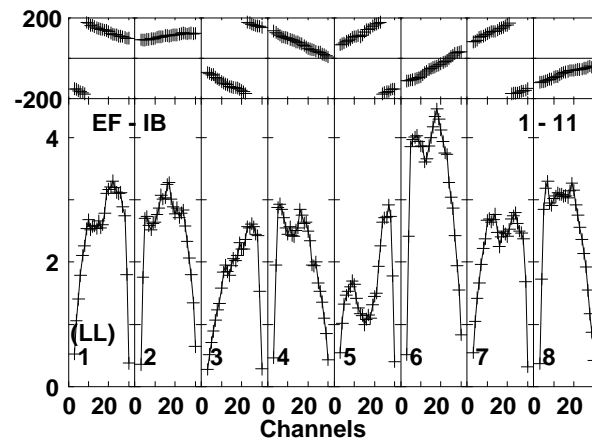
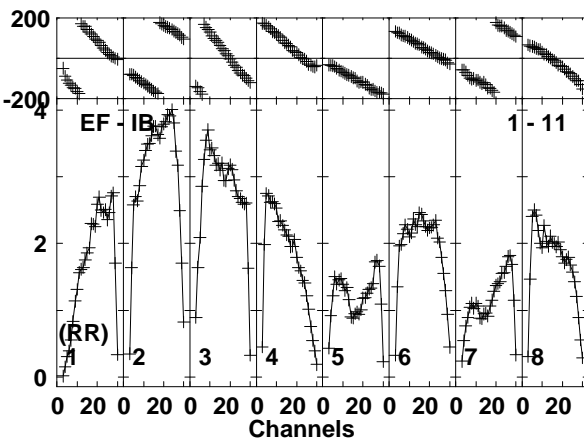
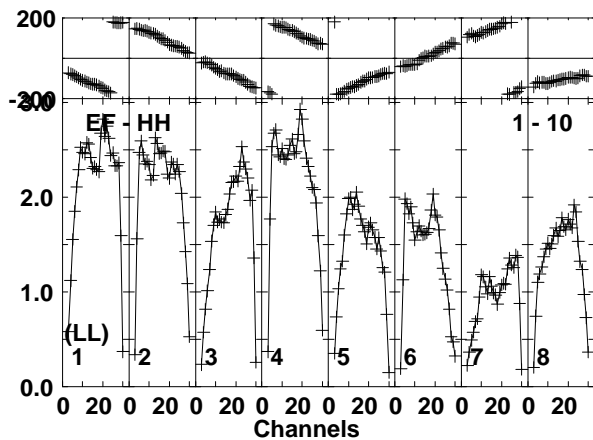
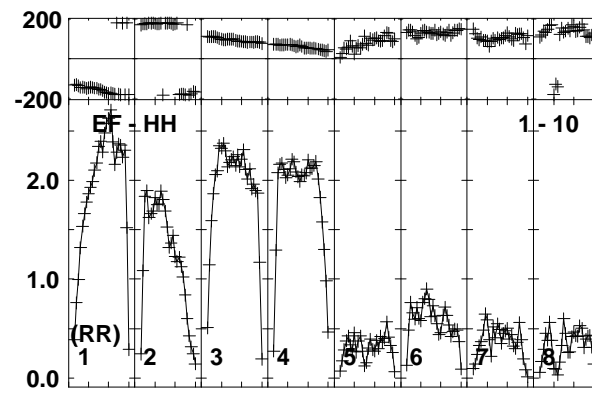
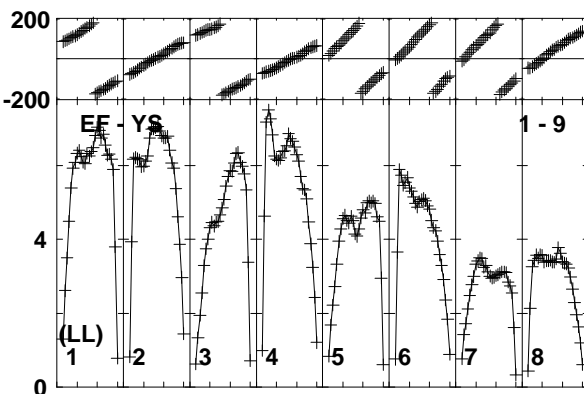
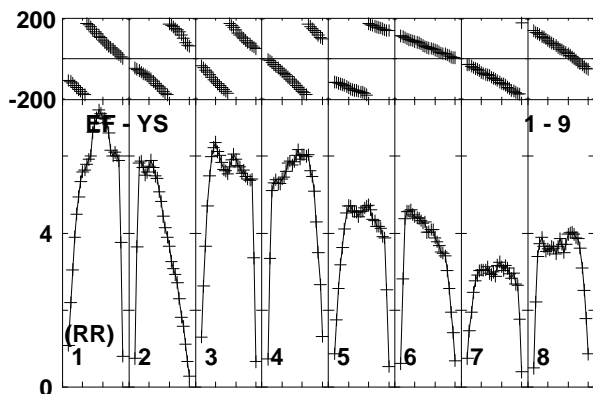
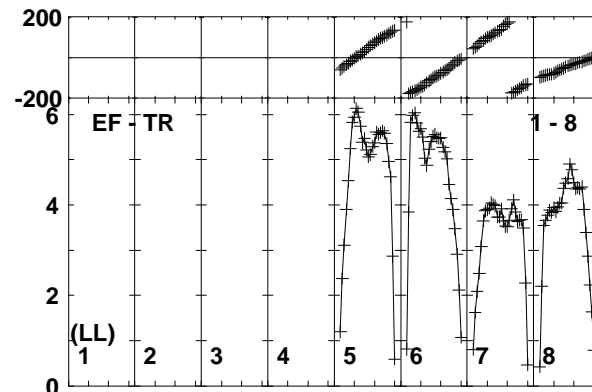
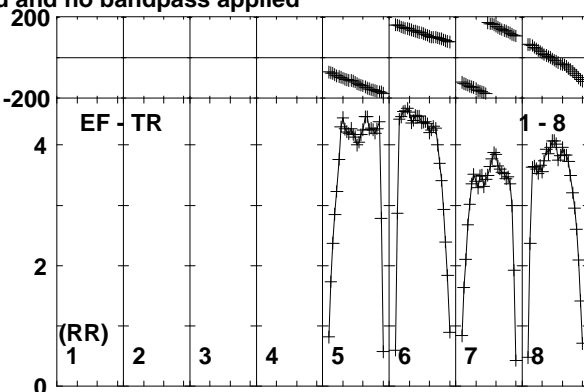
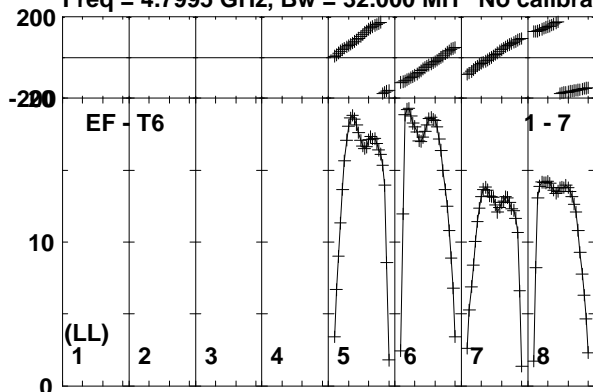

Lower frame: Milli Ampl Jy Top frame: Phas deg
Vector averaged cross-power spectrum Baseline: EF (01) - T6 (07)
Timerange: 00/19:15:22 to 00/19:16:48

Plot file version 35 created 20-APR-2018 17:20:41

J1427+2632 RSM02.UVDATA.1

Freq = 4.7995 GHz, Bw = 32.000 MH No calibration applied and no bandpass applied

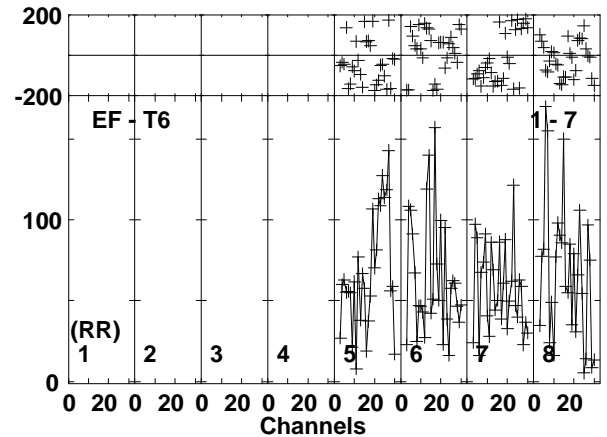
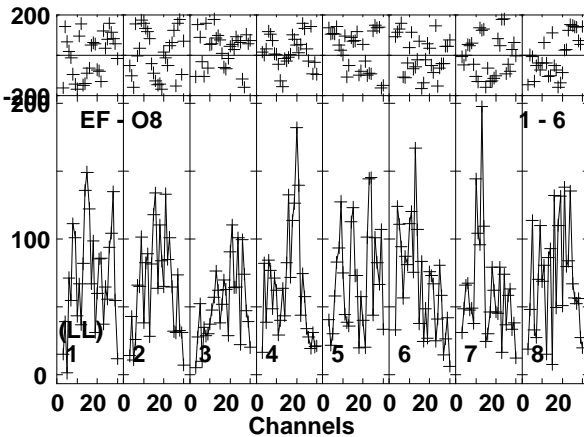
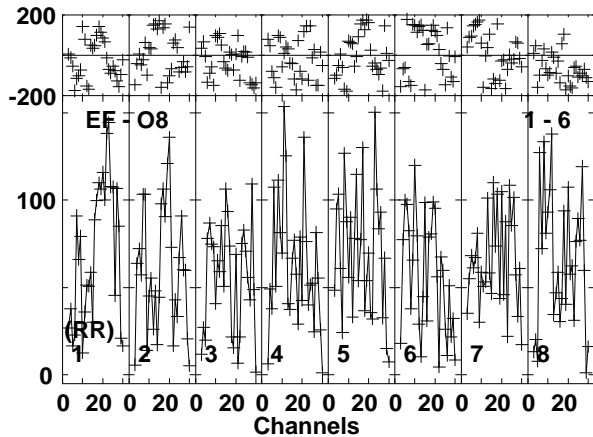
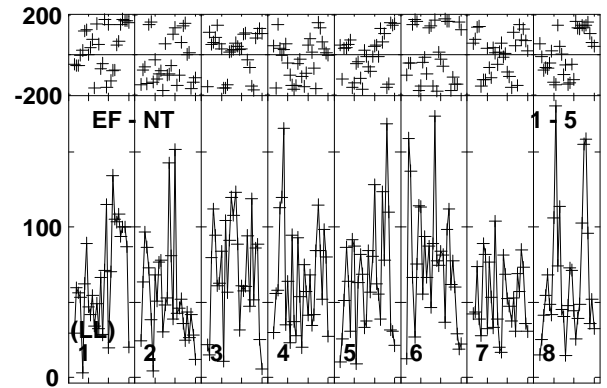
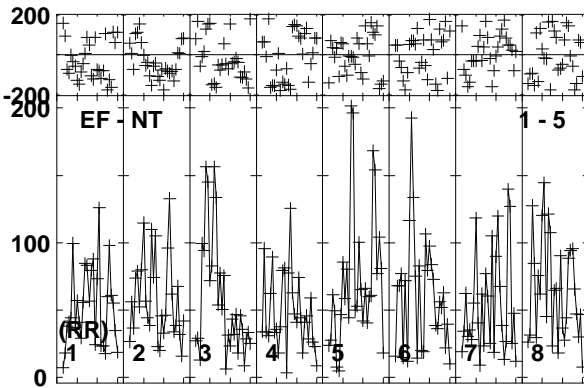
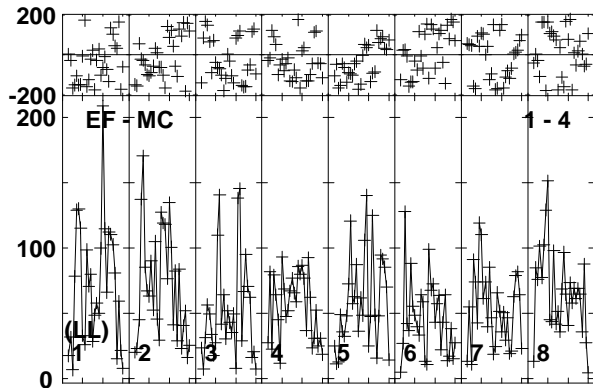
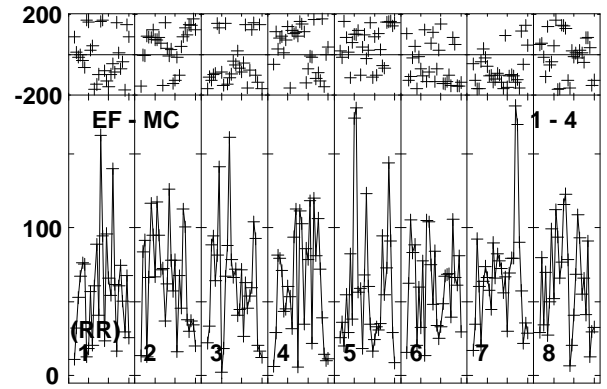
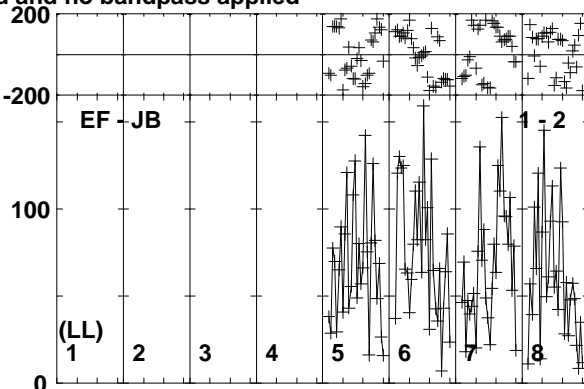
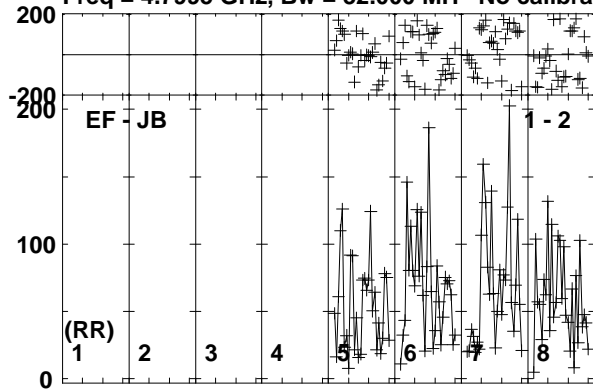

Lower frame: Micro Ampl Jy Top frame: Phas deg
Vector averaged cross-power spectrum Baseline: EF (01) - JB (02)
Timerange: 00/19:16:52 to 00/19:20:18

Plot file version 36 created 20-APR-2018 17:20:41

J1427+2632 RSM02.UVDATA.1

Freq = 4.7995 GHz, Bw = 32.000 MH No calibration applied and no bandpass applied

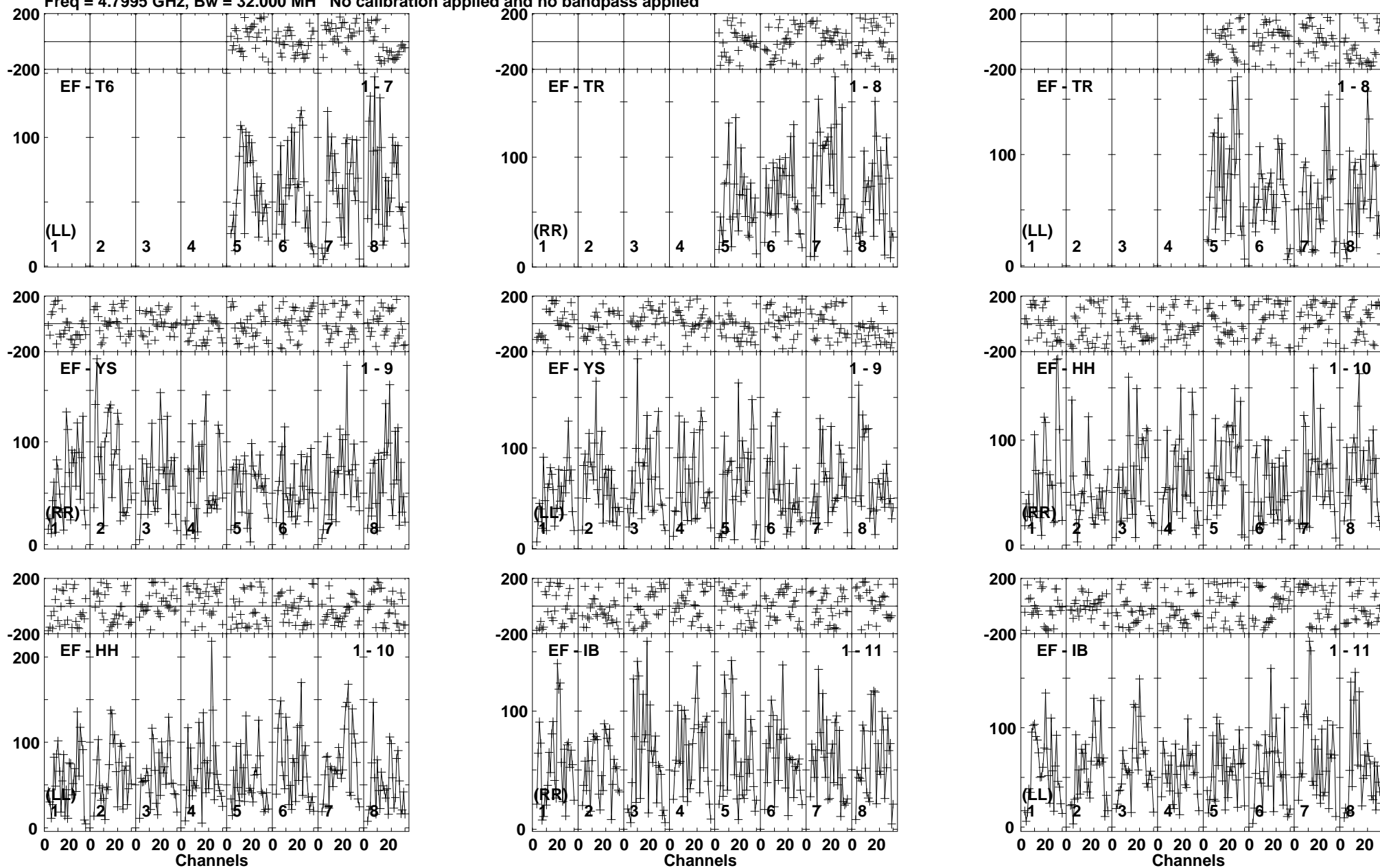

Lower frame: Micro Ampl Jy Top frame: Phas deg
Vector averaged cross-power spectrum Baseline: EF (01) - T6 (07)
Timerange: 00/19:16:52 to 00/19:20:18

Plot file version 37 created 20-APR-2018 17:20:41

J1419+2706 RSM02.UVDATA.1

Freq = 4.7995 GHz, Bw = 32.000 MH No calibration applied and no bandpass applied

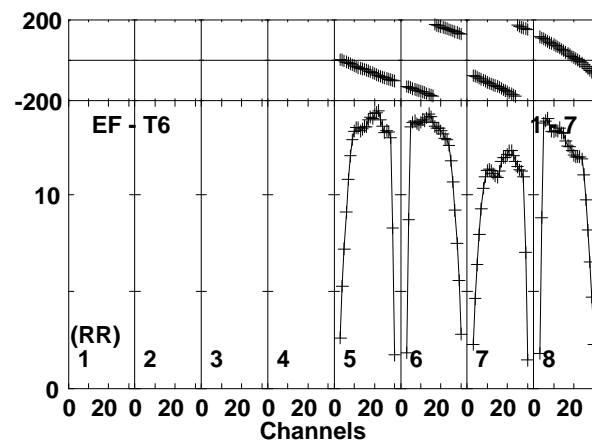
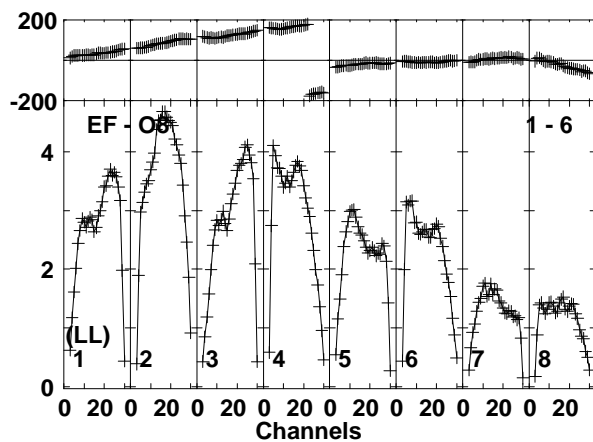
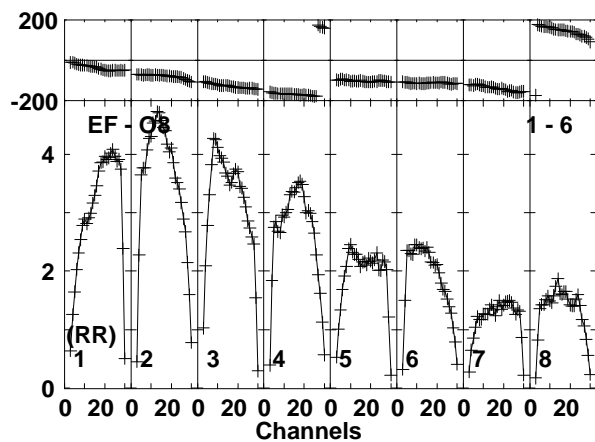
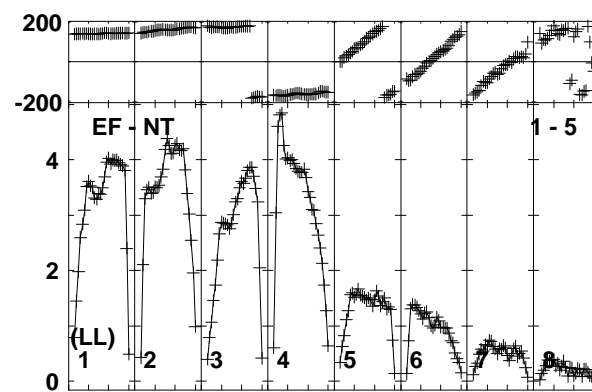
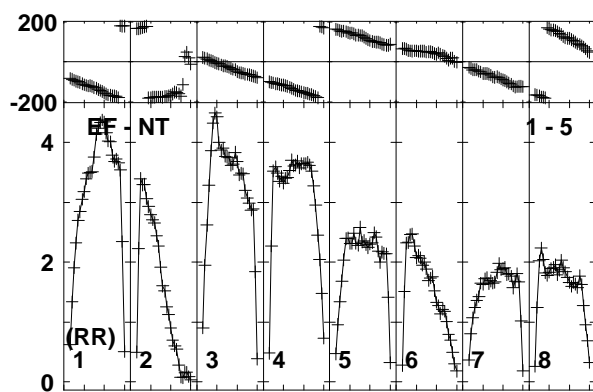
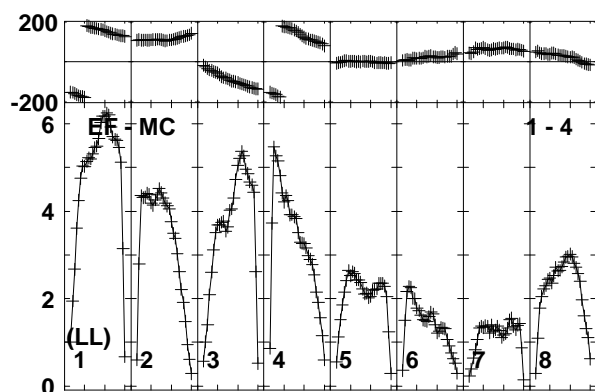
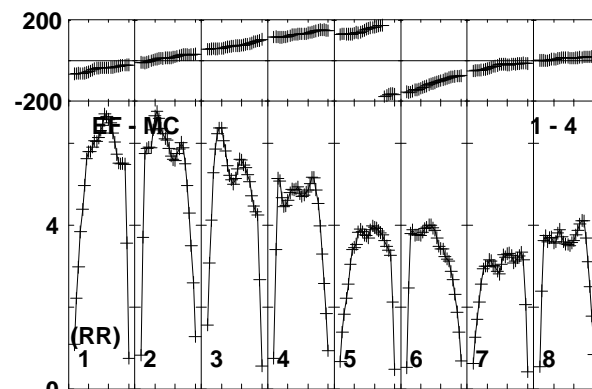
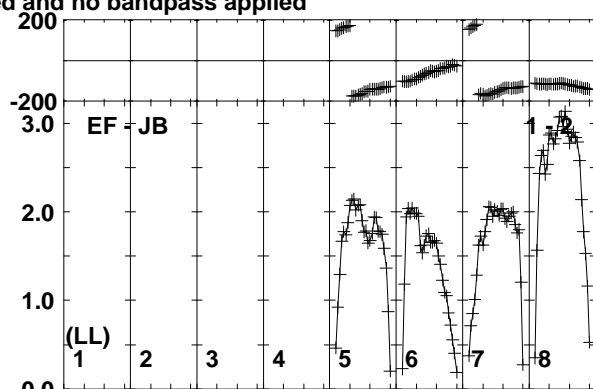
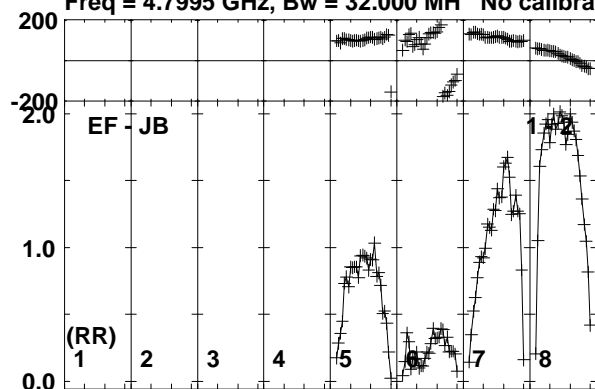

Lower frame: Milli Ampl Jy Top frame: Phas deg
Vector averaged cross-power spectrum Baseline: EF (01) - JB (02)
Timerange: 00/19:21:02 to 00/19:21:58

Plot file version 38 created 20-APR-2018 17:20:41

J1419+2706 RSM02.UVDATA.1

Freq = 4.7995 GHz, Bw = 32.000 MH No calibration applied and no bandpass applied

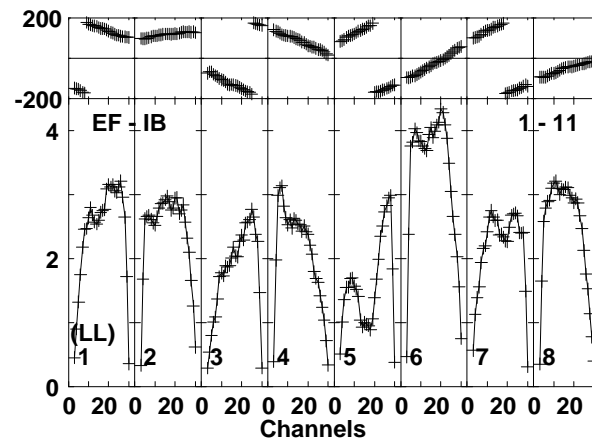
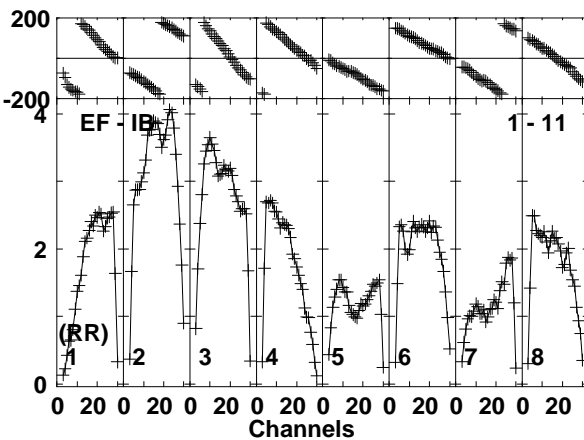
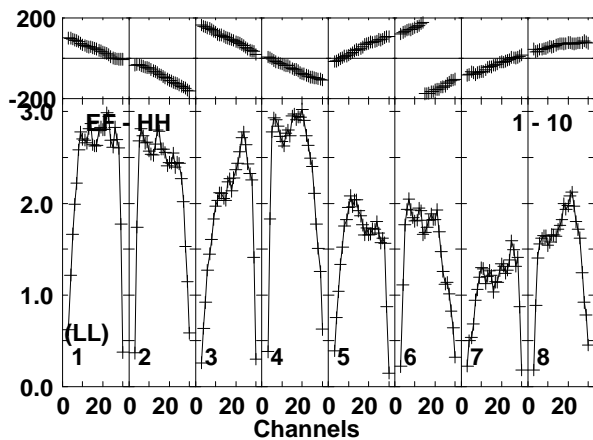
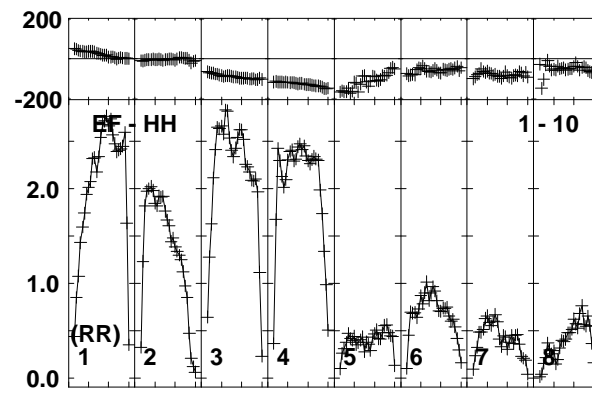
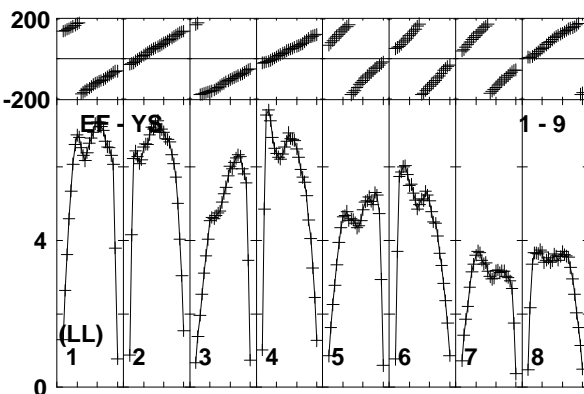
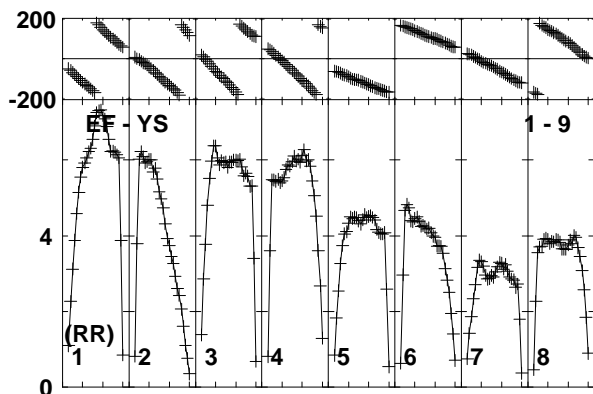
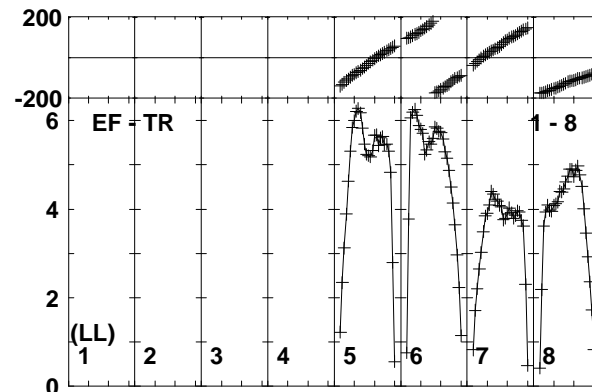
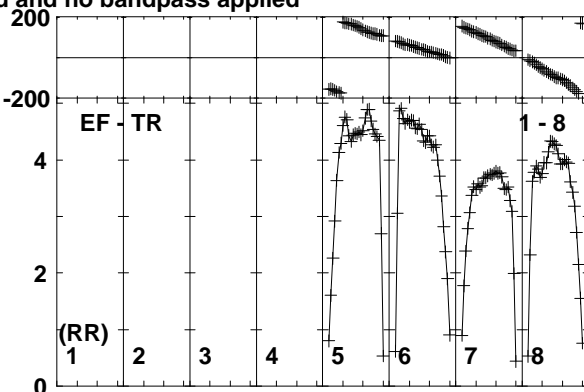
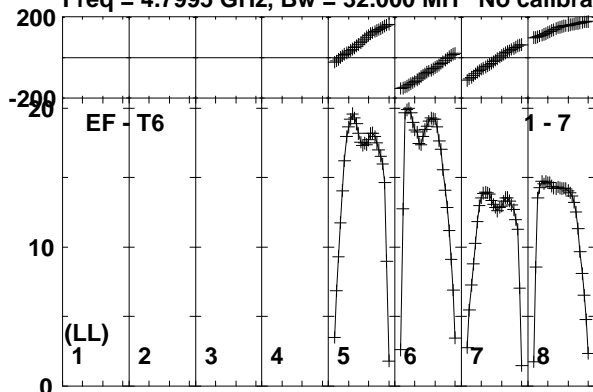

Lower frame: Milli Ampl Jy Top frame: Phas deg
Vector averaged cross-power spectrum Baseline: EF (01) - T6 (07)
Timerange: 00/19:21:02 to 00/19:21:58

Plot file version 39 created 20-APR-2018 17:20:41

J1427+2632 RSM02.UVDATA.1

Freq = 4.7995 GHz, Bw = 32.000 MH No calibration applied and no bandpass applied

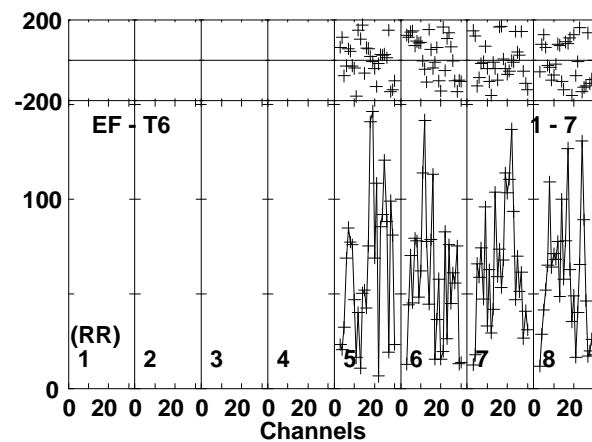
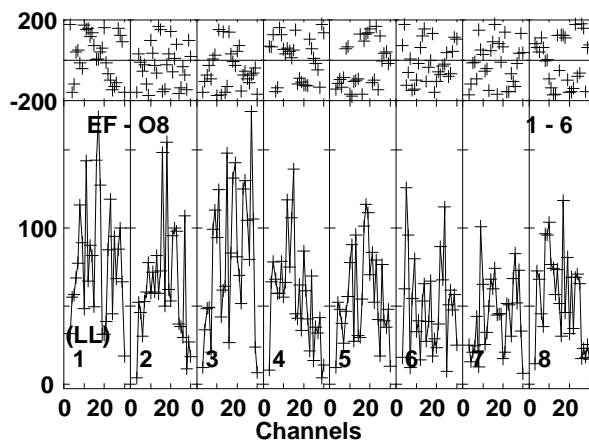
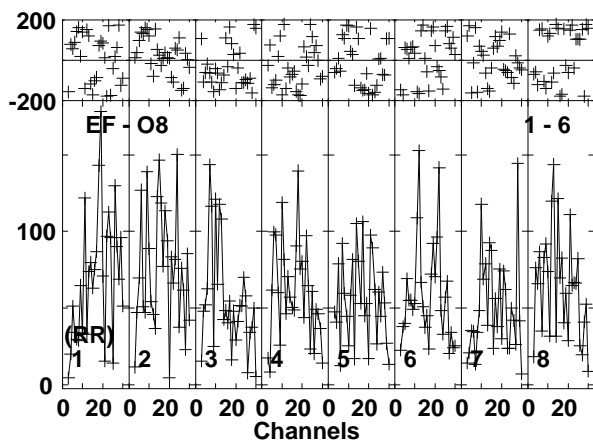
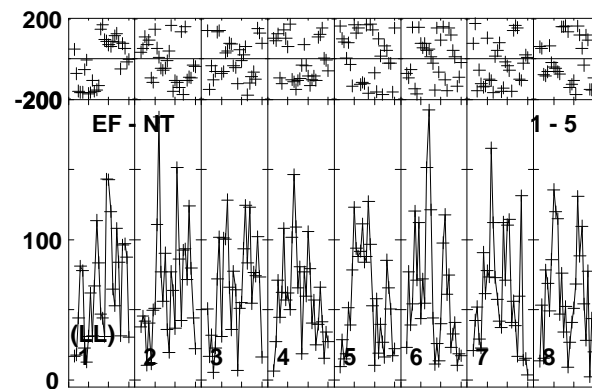
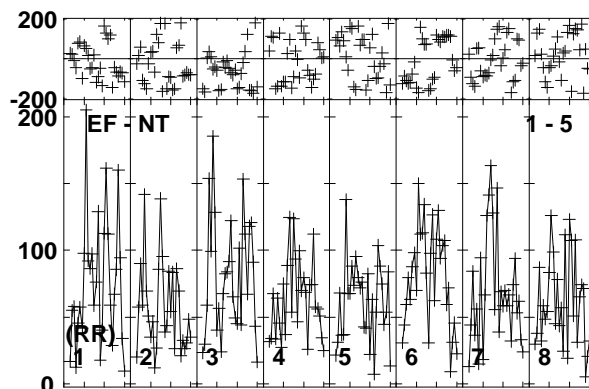
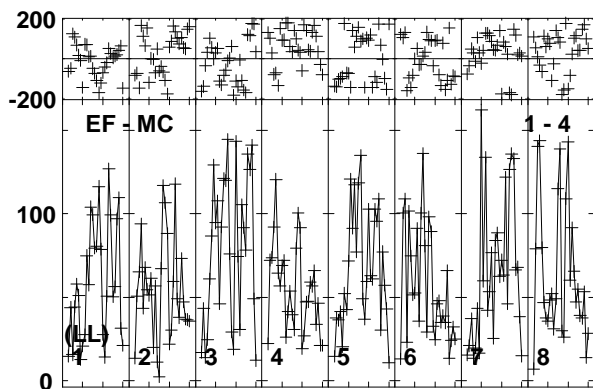
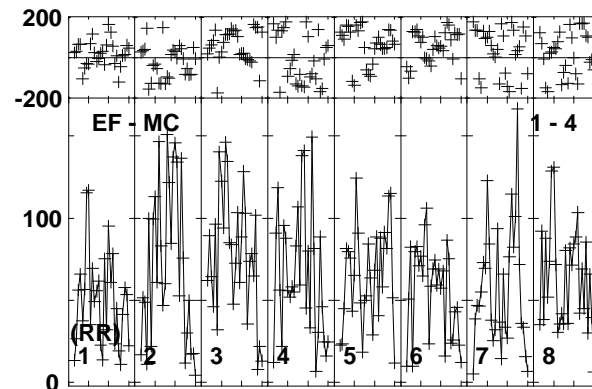
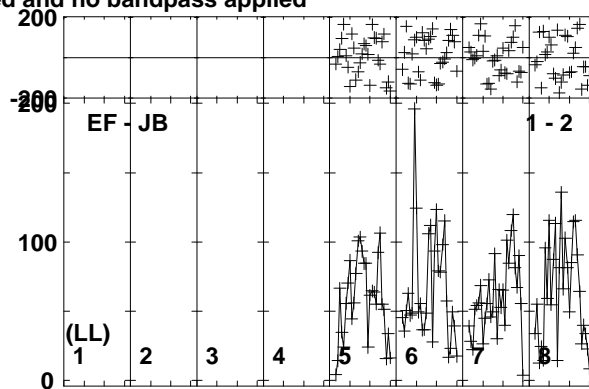
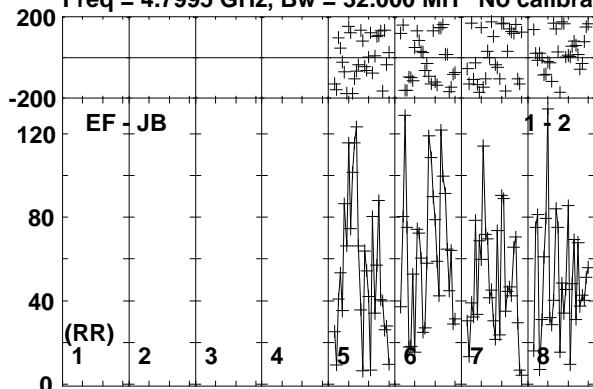

Lower frame: Micro Ampl Jy Top frame: Phas deg
Vector averaged cross-power spectrum Baseline: EF (01) - JB (02)
Timerange: 00/19:22:02 to 00/19:25:28

Plot file version 40 created 20-APR-2018 17:20:41

J1427+2632 RSM02.UVDATA.1

Freq = 4.7995 GHz, Bw = 32.000 MH No calibration applied and no bandpass applied

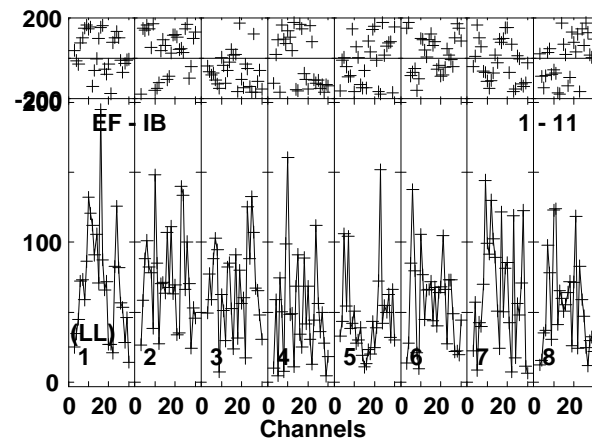
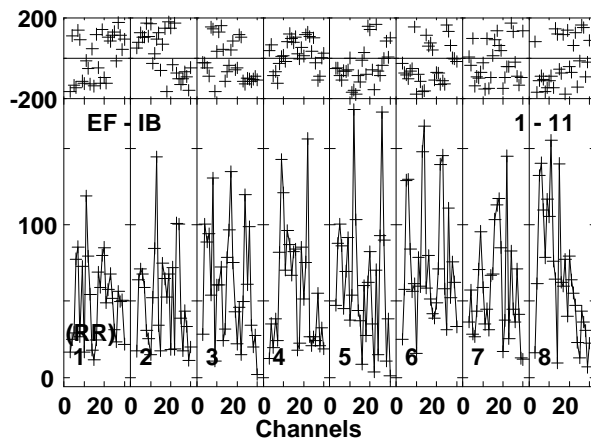
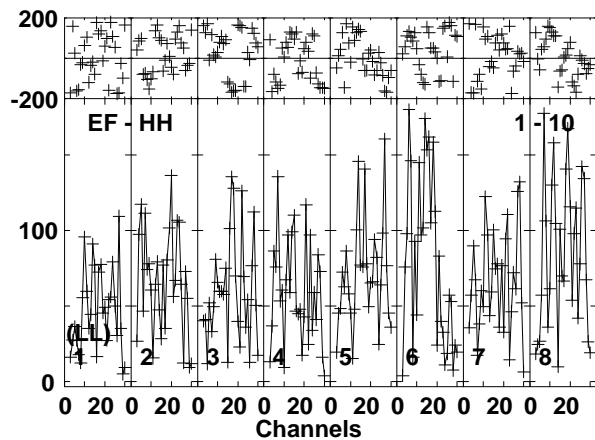
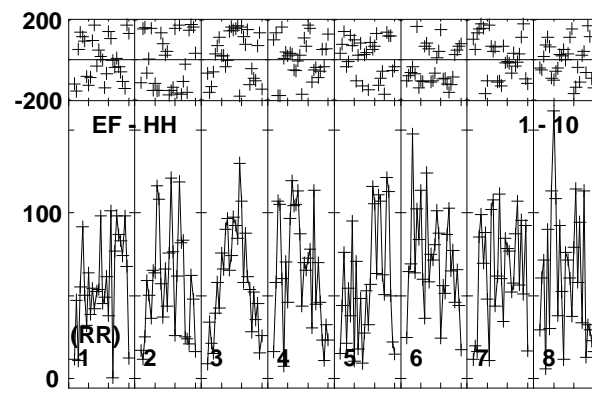
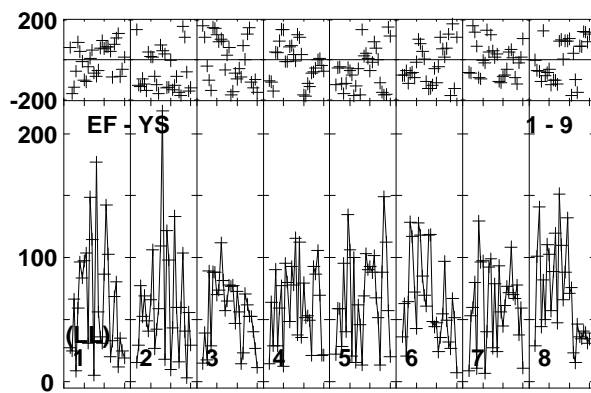
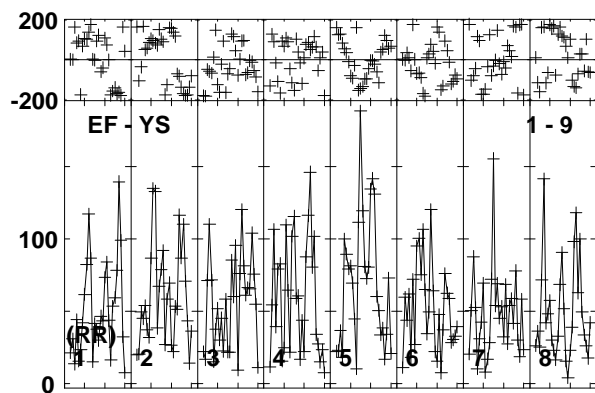
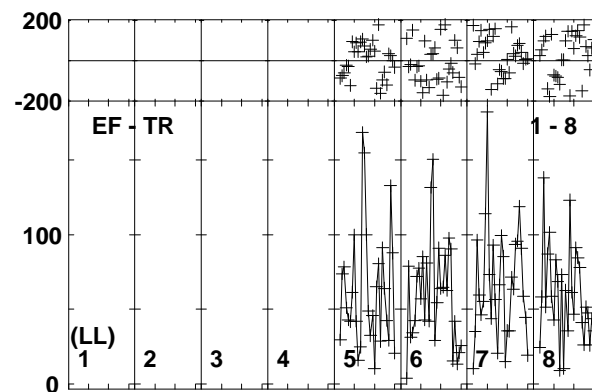
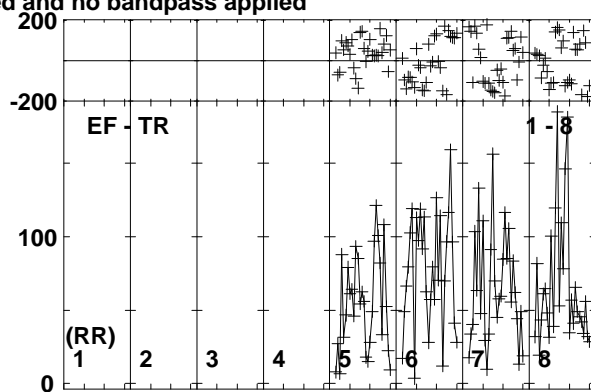
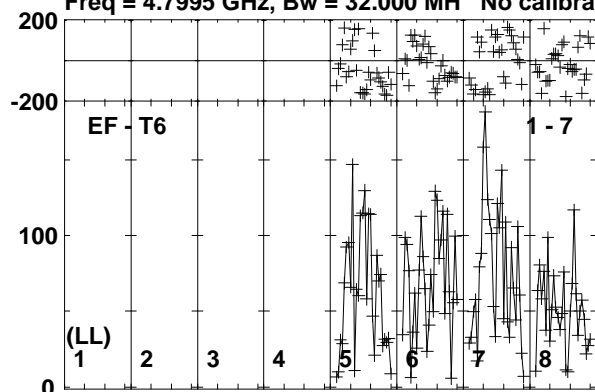

Lower frame: Micro Ampl Jy Top frame: Phas deg
Vector averaged cross-power spectrum Baseline: EF (01) - T6 (07)
Timerange: 00/19:22:02 to 00/19:25:28

Plot file version 41 created 20-APR-2018 17:20:42

J1419+2706 RSM02.UVDATA.1

Freq = 4.7995 GHz, Bw = 32.000 MH No calibration applied and no bandpass applied

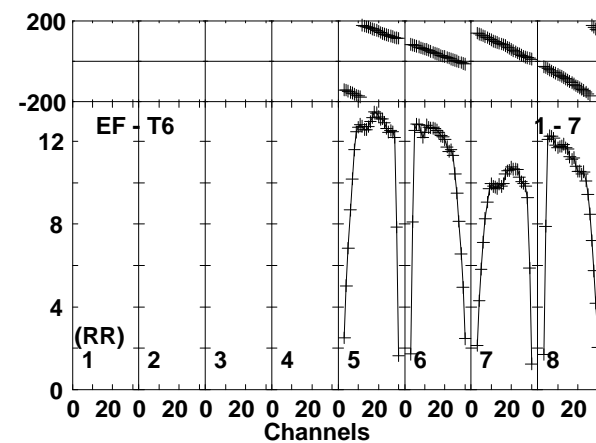
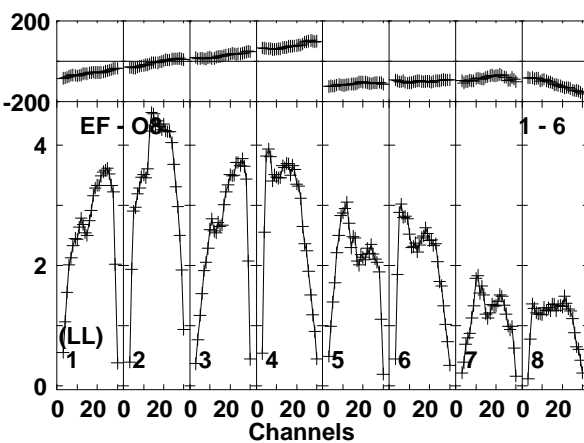
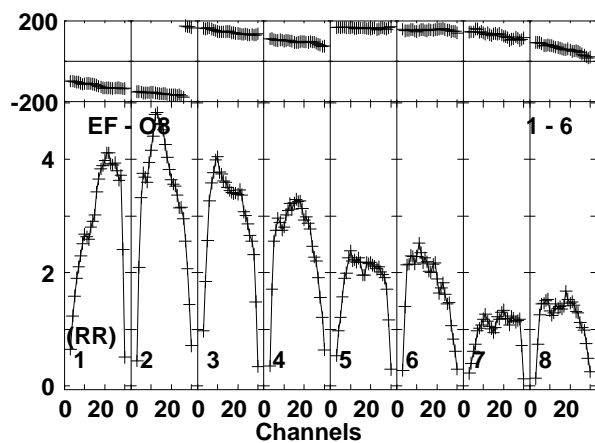
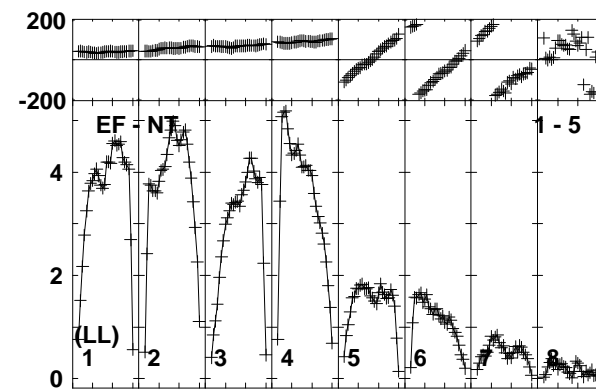
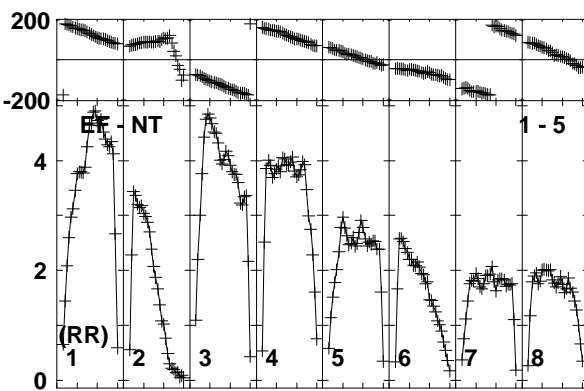
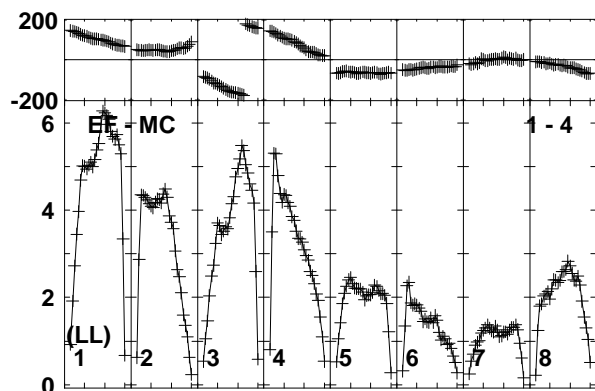
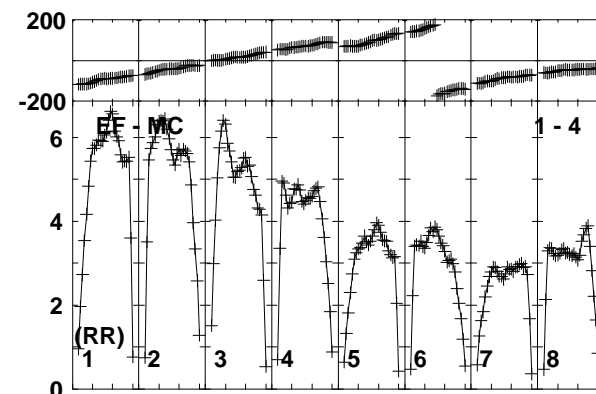
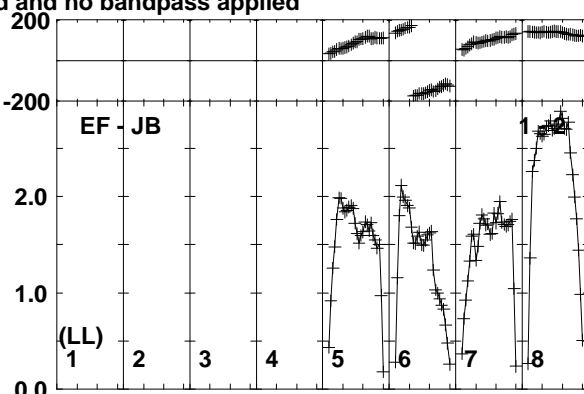
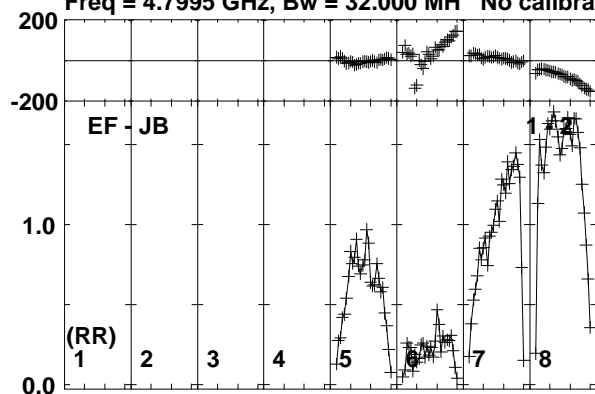

Lower frame: Milli Ampl Jy Top frame: Phas deg
Vector averaged cross-power spectrum Baseline: EF (01) - JB (02)
Timerange: 00/19:25:32 to 00/19:26:58

Plot file version 42 created 20-APR-2018 17:20:42

J1419+2706 RSM02.UVDATA.1

Freq = 4.7995 GHz, Bw = 32.000 MH No calibration applied and no bandpass applied

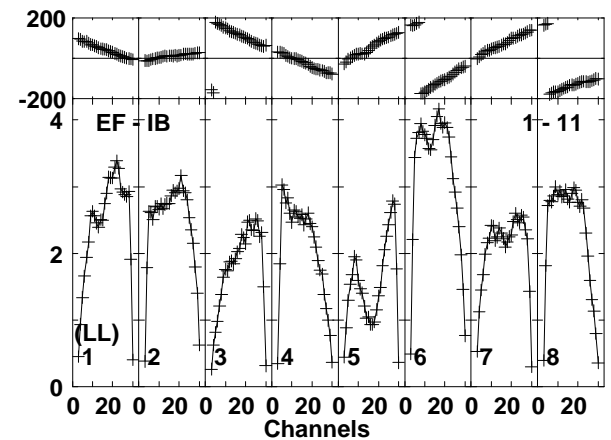
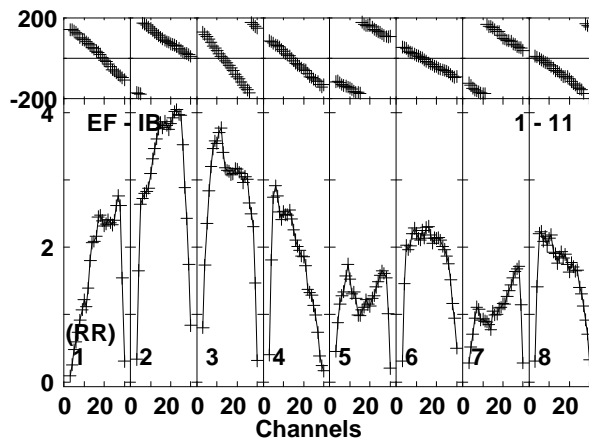
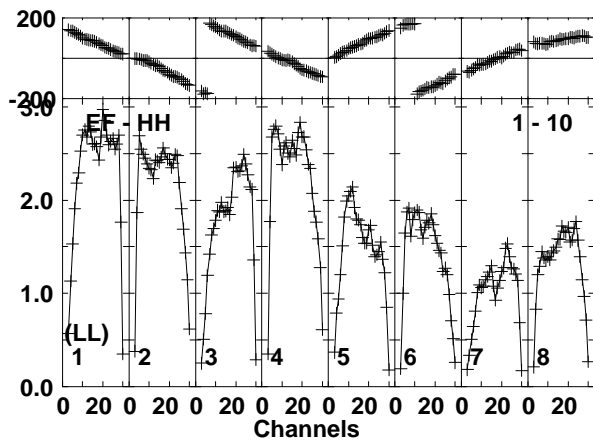
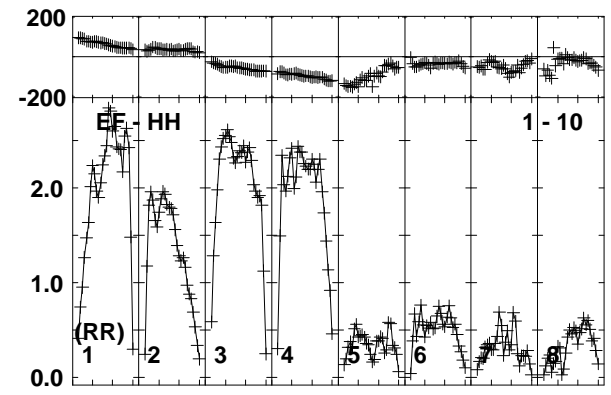
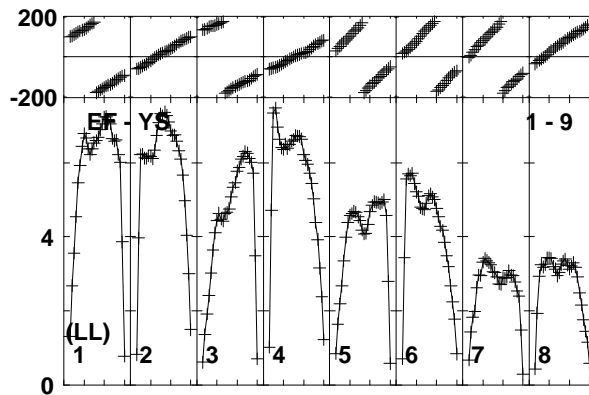
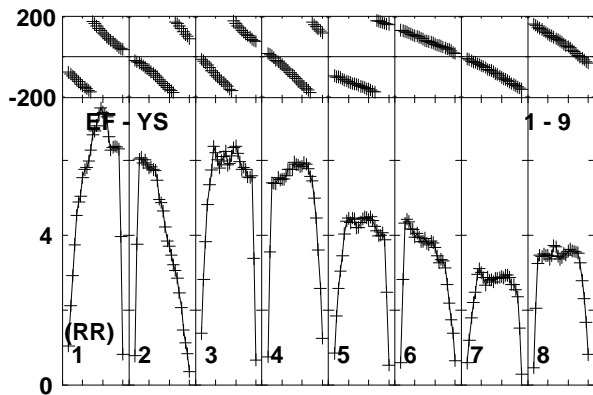
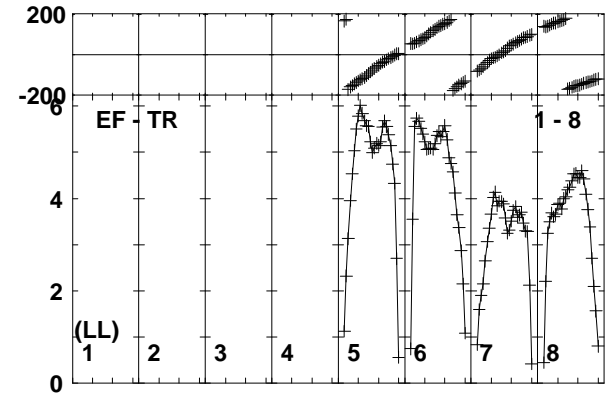
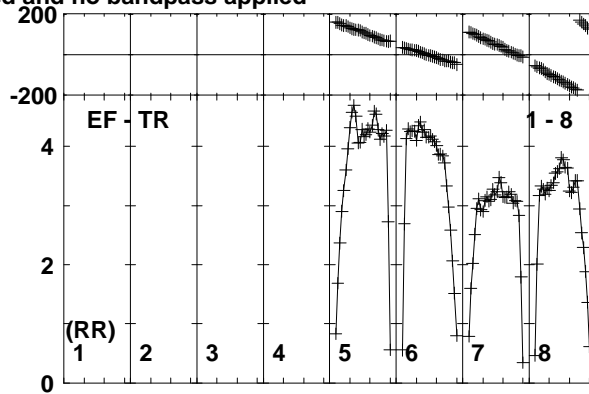
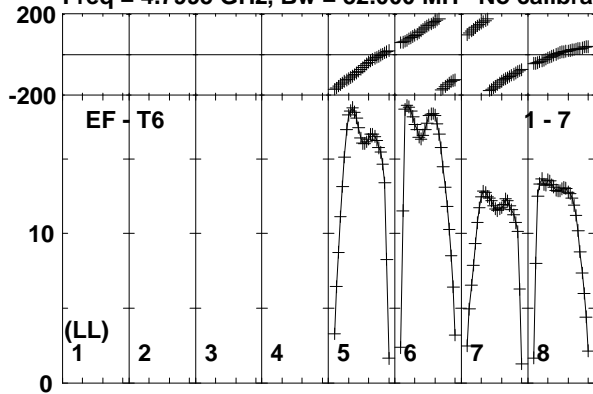

Lower frame: Milli Ampl Jy Top frame: Phas deg
Vector averaged cross-power spectrum Baseline: EF (01) - T6 (07)
Timerange: 00/19:25:32 to 00/19:26:58

Plot file version 43 created 20-APR-2018 17:20:42

J1427+2632 RSM02.UVDATA.1

Freq = 4.7995 GHz, Bw = 32.000 MH No calibration applied and no bandpass applied

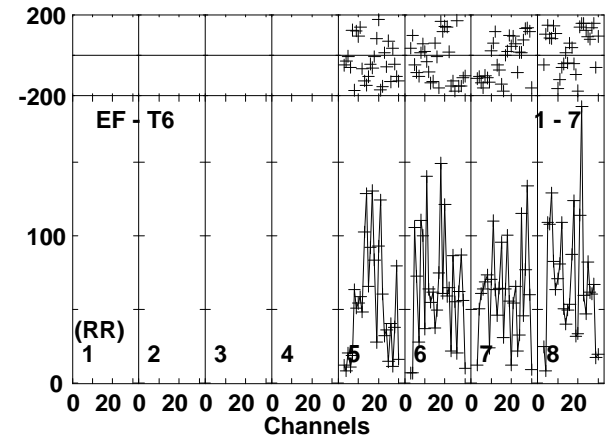
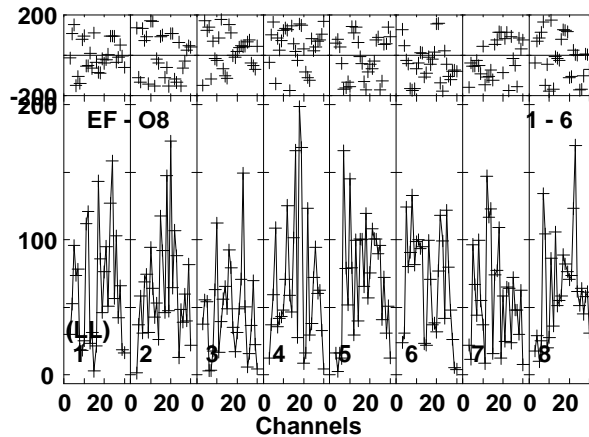
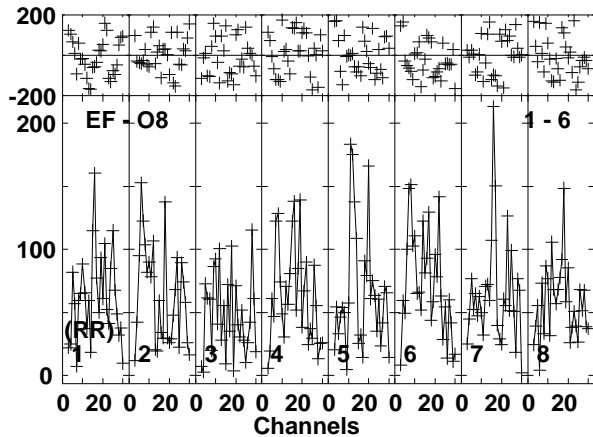
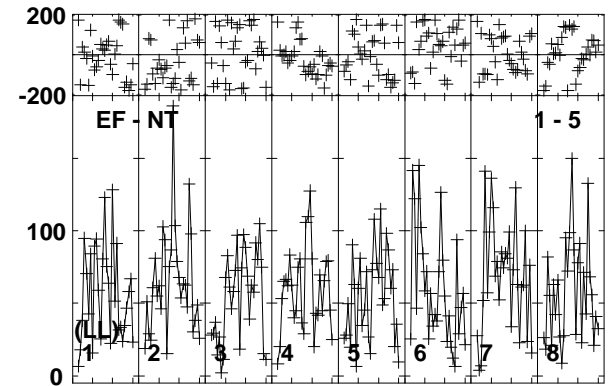
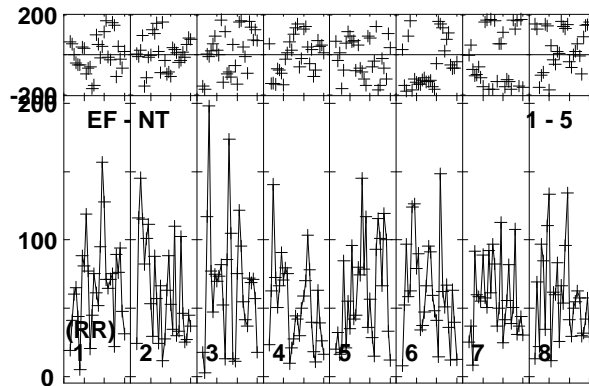
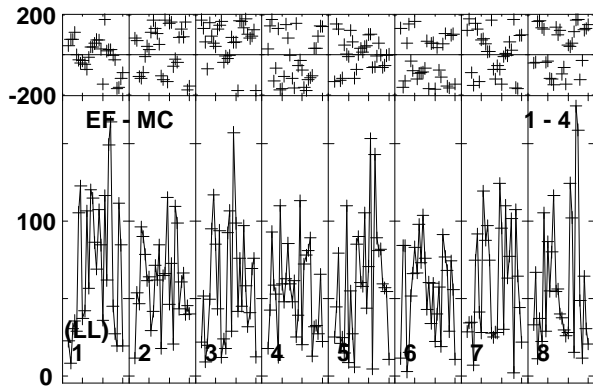
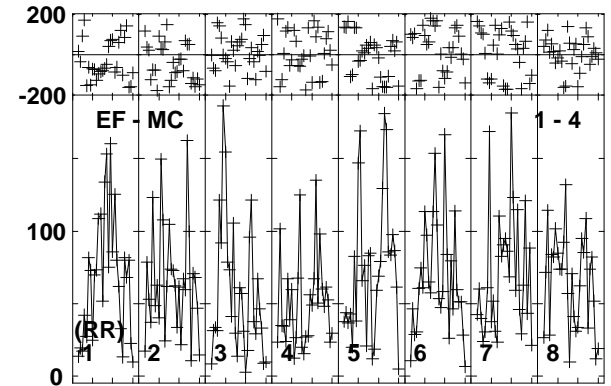
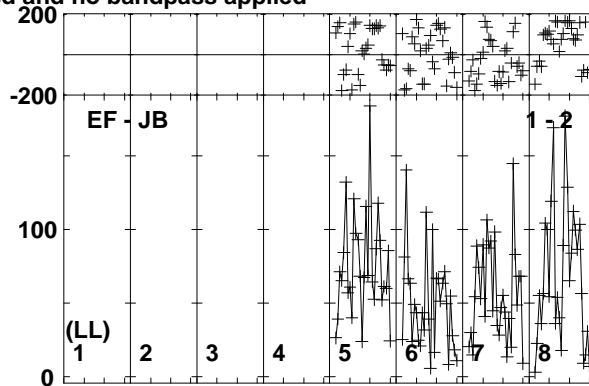
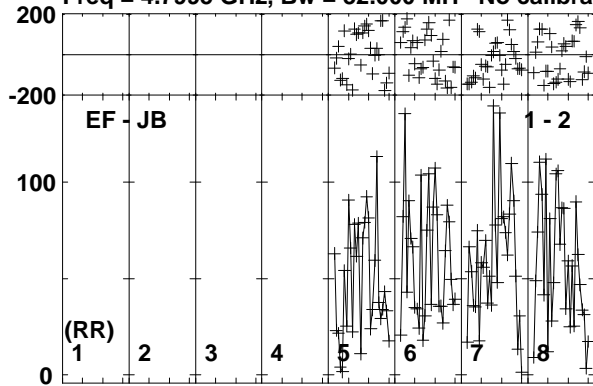

Lower frame: Micro Ampl Jy Top frame: Phas deg
Vector averaged cross-power spectrum Baseline: EF (01) - JB (02)
Timerange: 00:19:27:02 to 00:19:30:28

Plot file version 44 created 20-APR-2018 17:20:42

J1427+2632 RSM02.UVDATA.1

Freq = 4.7995 GHz, Bw = 32.000 MH No calibration applied and no bandpass applied

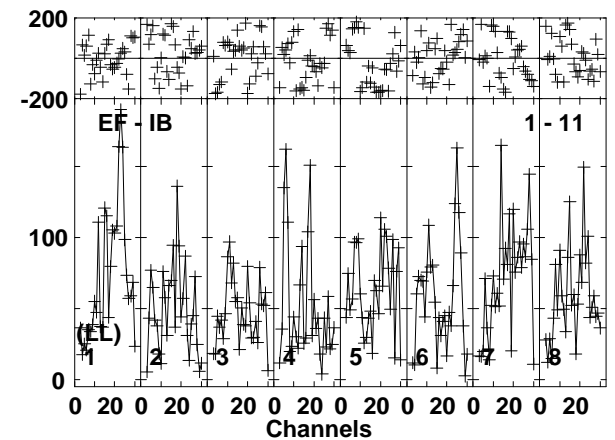
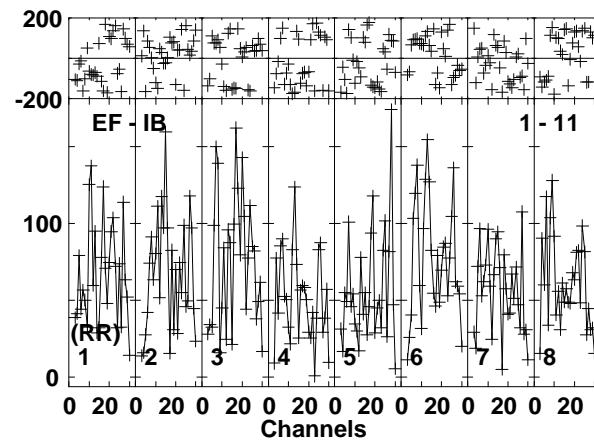
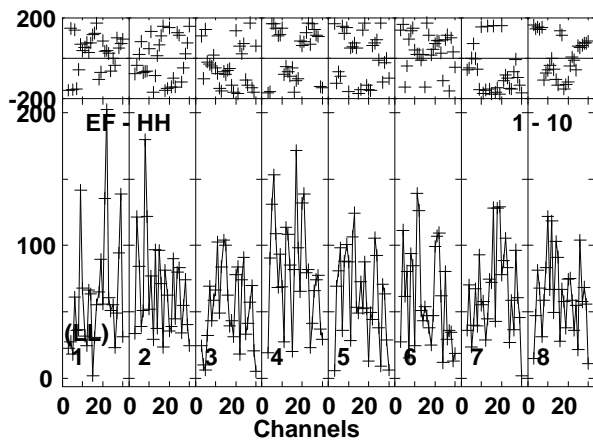
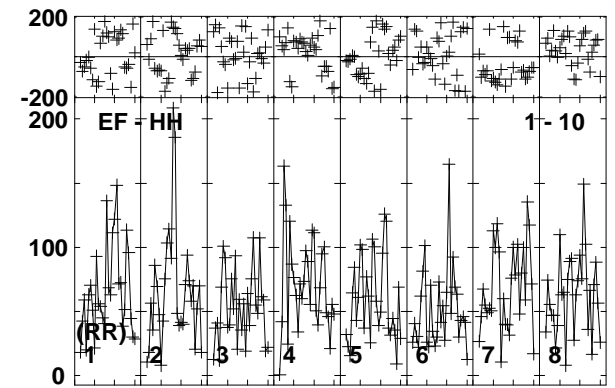
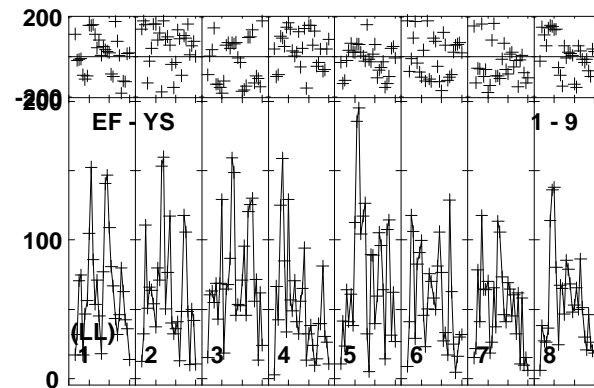
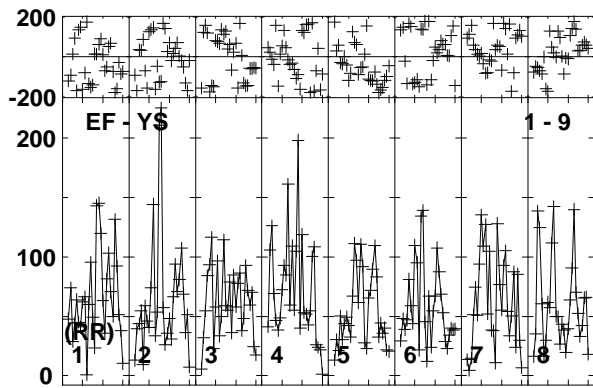
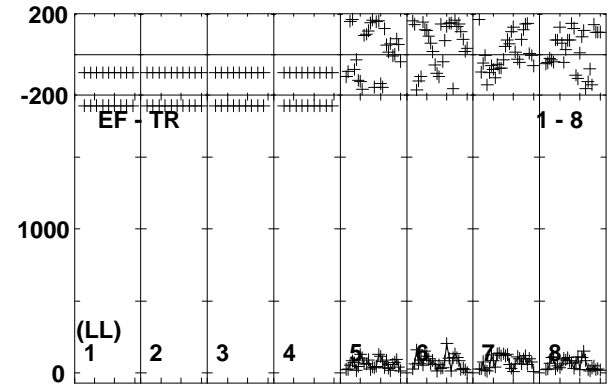
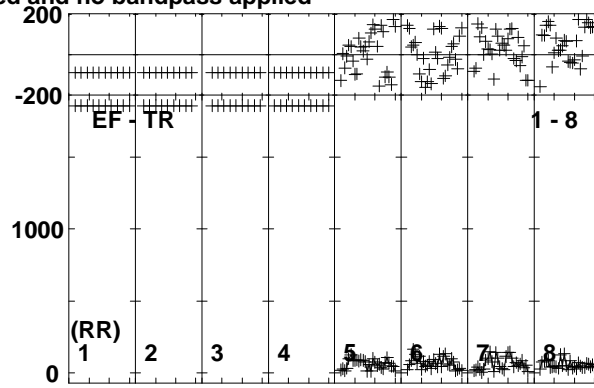
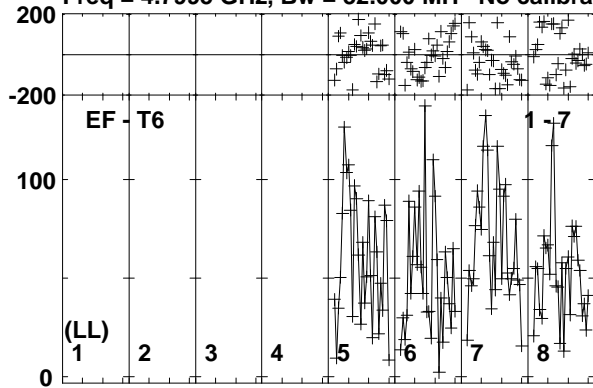

Lower frame: Micro Ampl Jy Top frame: Phas deg
Vector averaged cross-power spectrum Baseline: EF (01) - T6 (07)
Timerange: 00/19:27:02 to 00/19:30:28

Plot file version 45 created 20-APR-2018 17:20:42

J1419+2706 RSM02.UVDATA.1

Freq = 4.7995 GHz, Bw = 32.000 MH No calibration applied and no bandpass applied

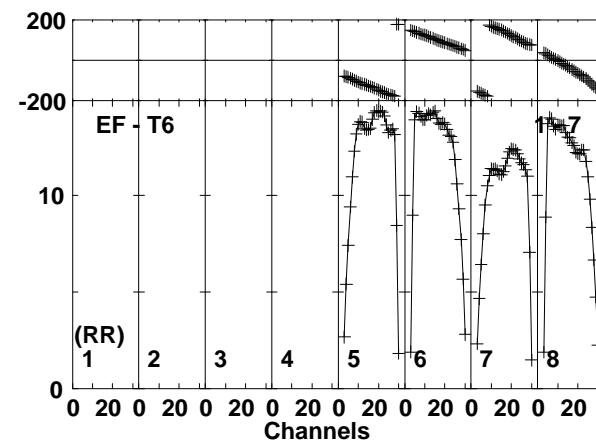
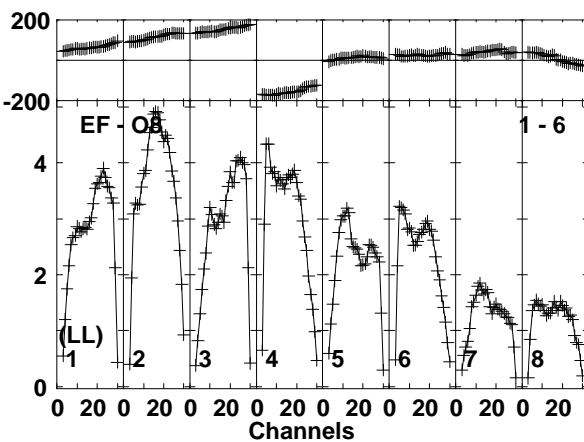
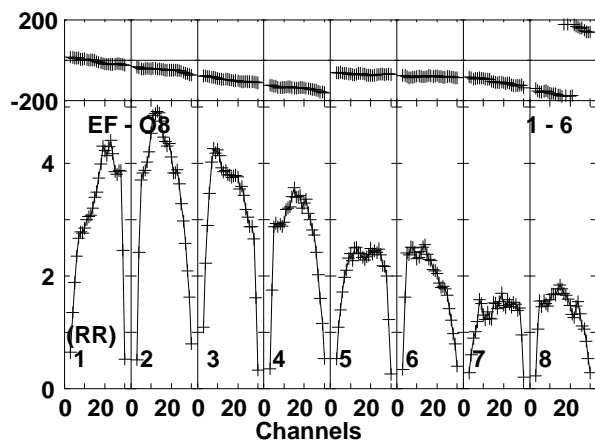
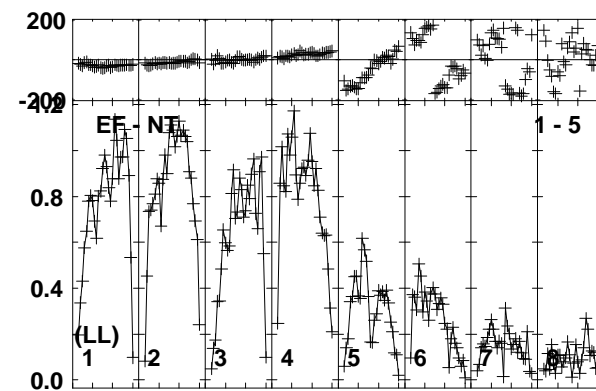
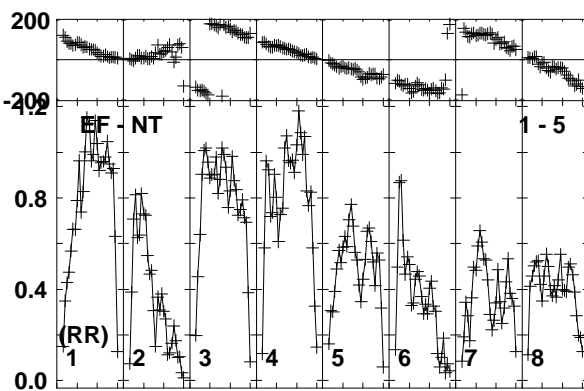
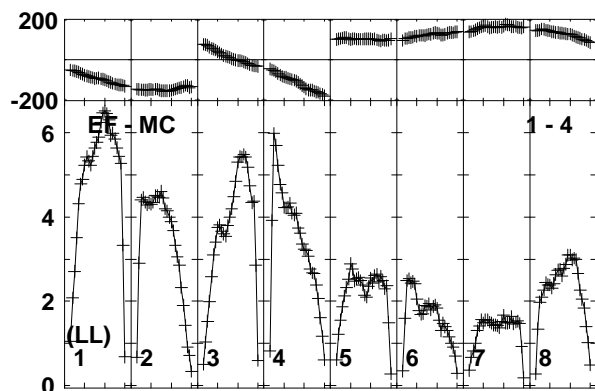
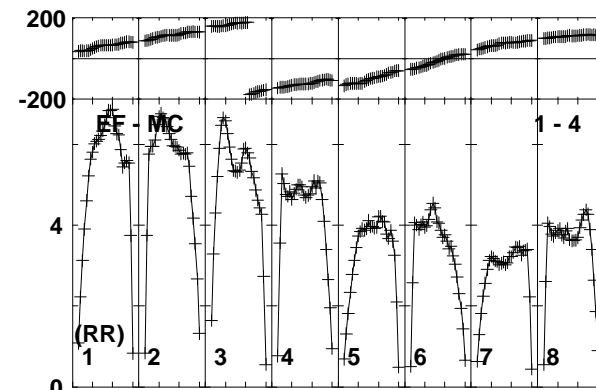
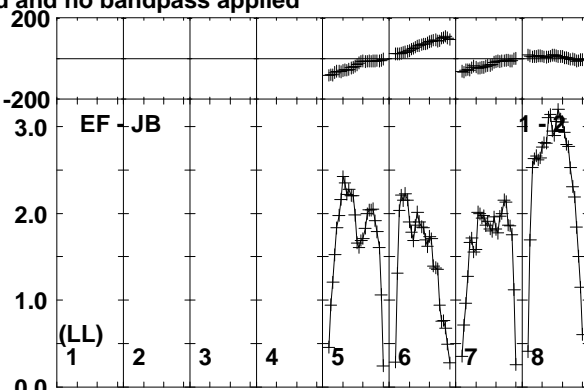
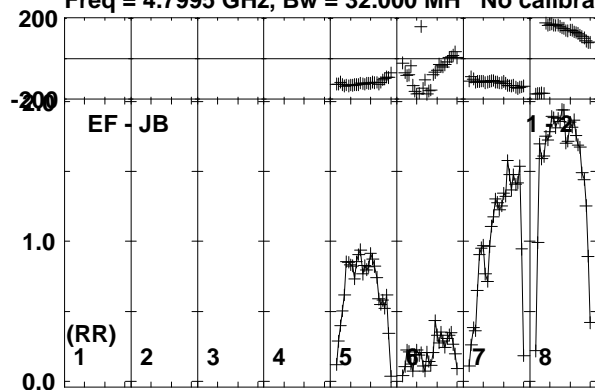

Lower frame: Milli Ampl Jy Top frame: Phas deg
Vector averaged cross-power spectrum Baseline: EF (01) - JB (02)
Timerange: 00:19:30:32 to 00:19:31:58

Plot file version 46 created 20-APR-2018 17:20:42

J1419+2706 RSM02.UVDATA.1

Freq = 4.7995 GHz, Bw = 32.000 MH No calibration applied and no bandpass applied

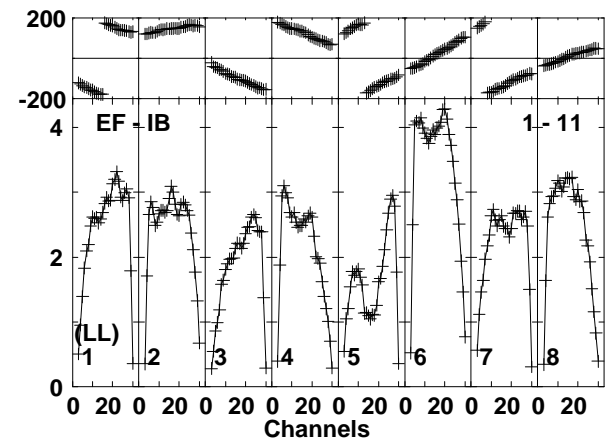
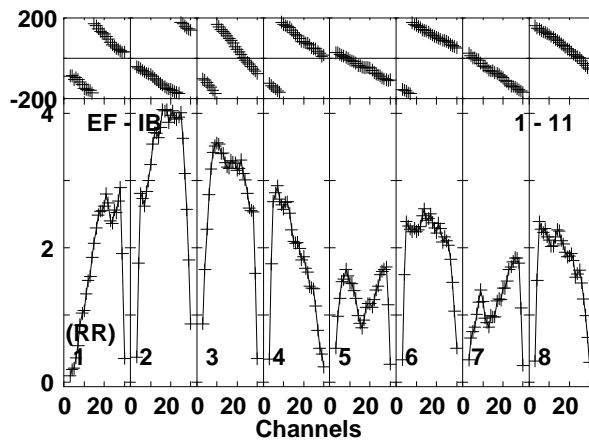
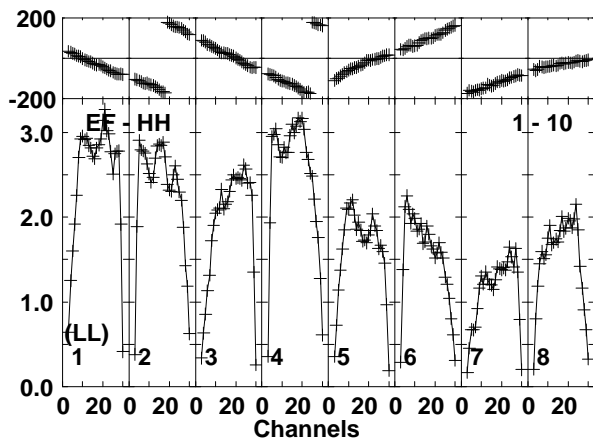
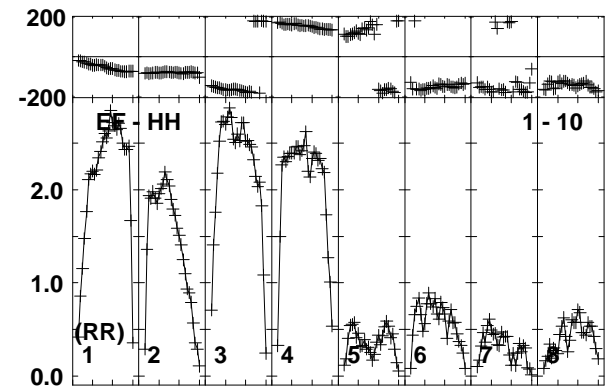
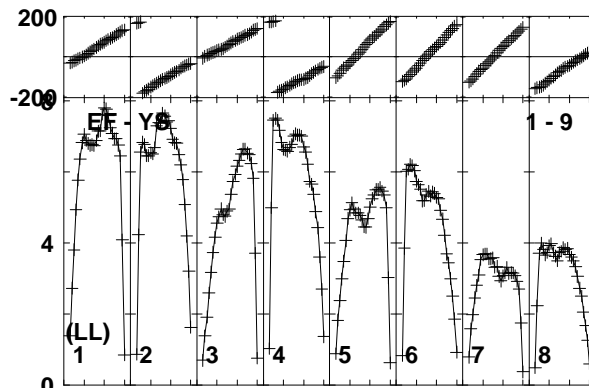
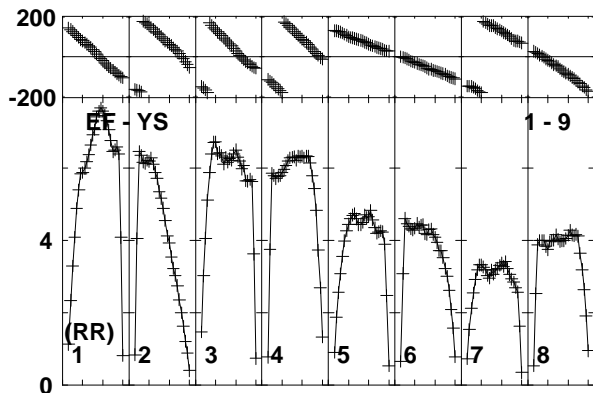
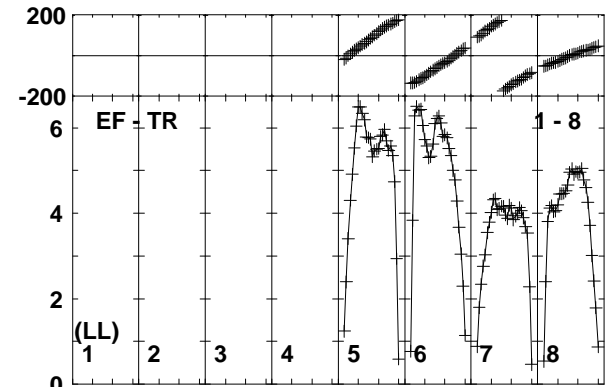
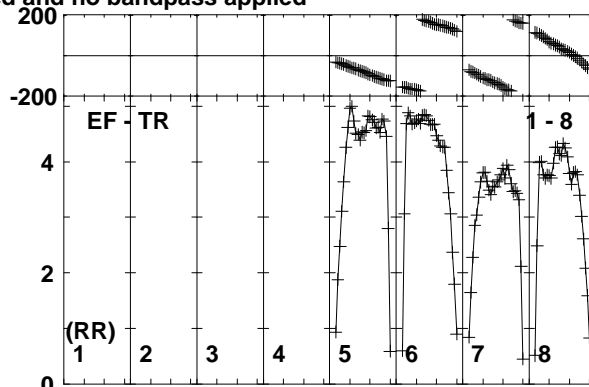
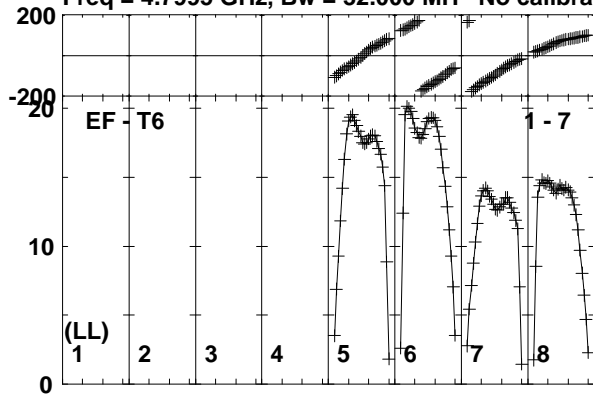

Lower frame: Milli Ampl Jy Top frame: Phas deg
Vector averaged cross-power spectrum Baseline: EF (01) - T6 (07)
Timerange: 00/19:30:32 to 00/19:31:58

Plot file version 47 created 20-APR-2018 17:20:42

J1427+2632 RSM02.UVDATA.1

Freq = 4.7995 GHz, Bw = 32.000 MH No calibration applied and no bandpass applied

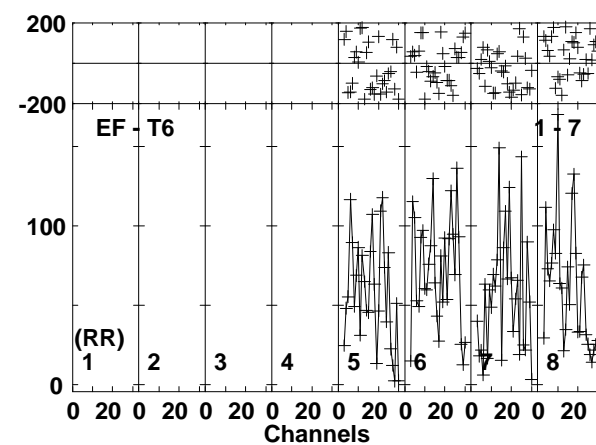
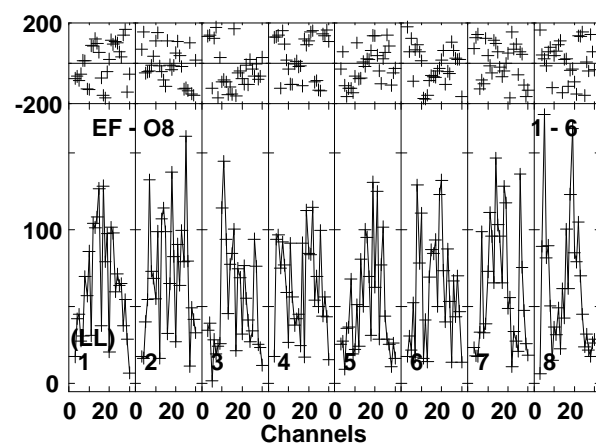
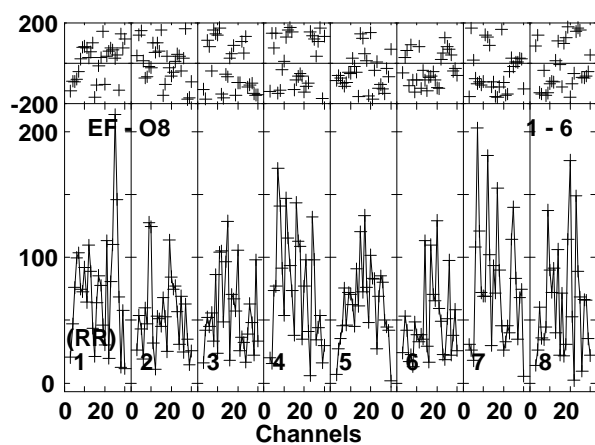
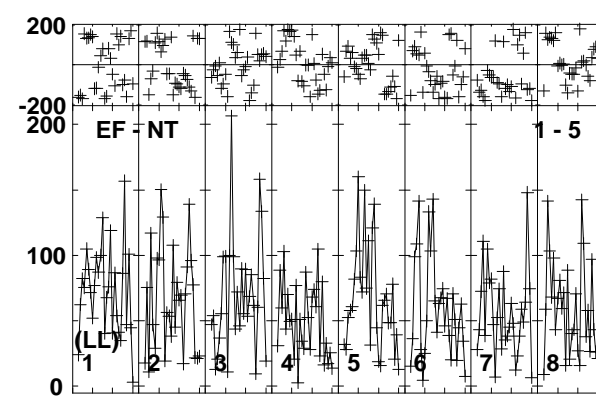
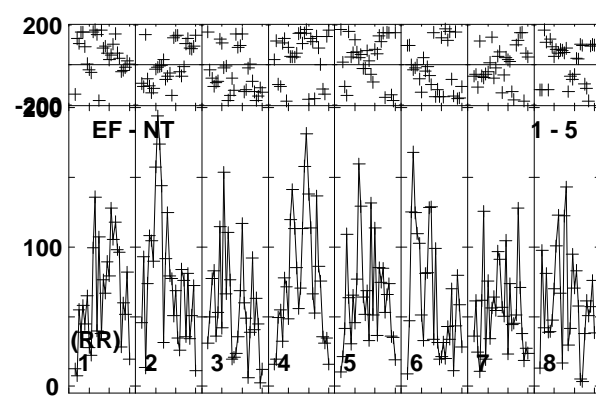
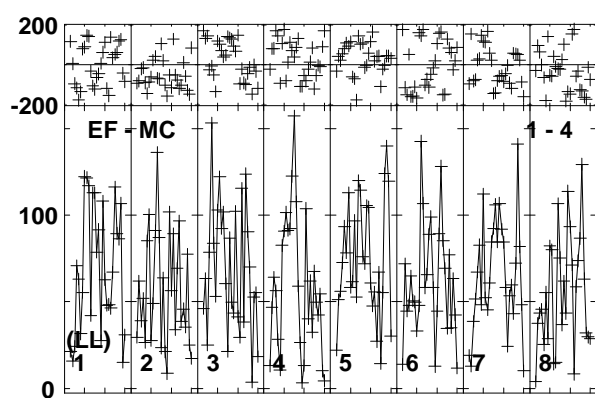
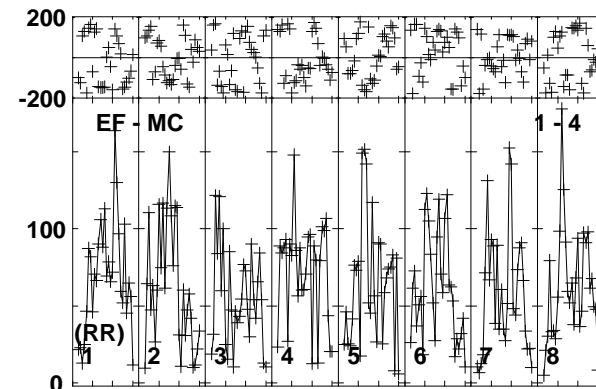
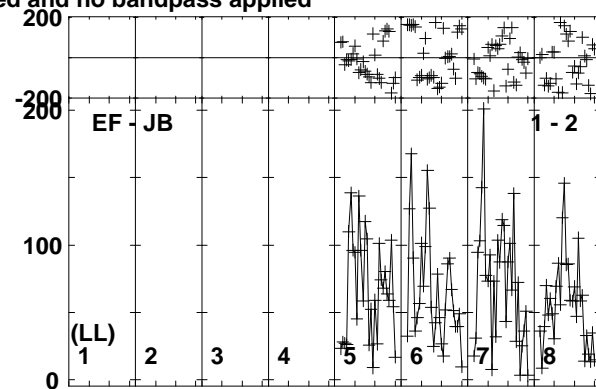
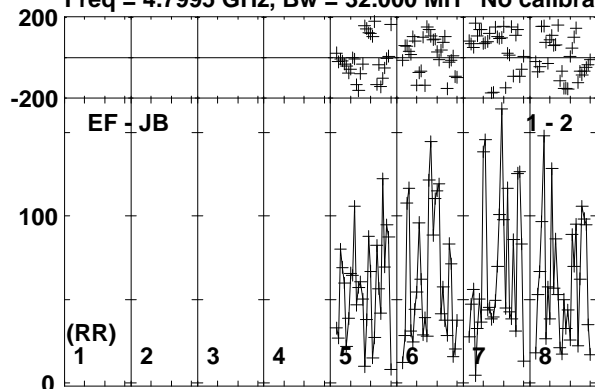

Lower frame: Micro Ampl Jy Top frame: Phas deg
Vector averaged cross-power spectrum Baseline: EF (01) - JB (02)
Timerange: 00/19:32:02 to 00/19:35:28

Plot file version 48 created 20-APR-2018 17:20:42

J1427+2632 RSM02.UVDATA.1

Freq = 4.7995 GHz, Bw = 32.000 MH No calibration applied and no bandpass applied

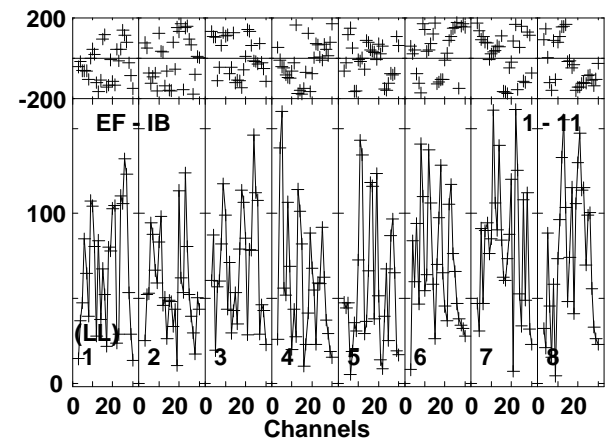
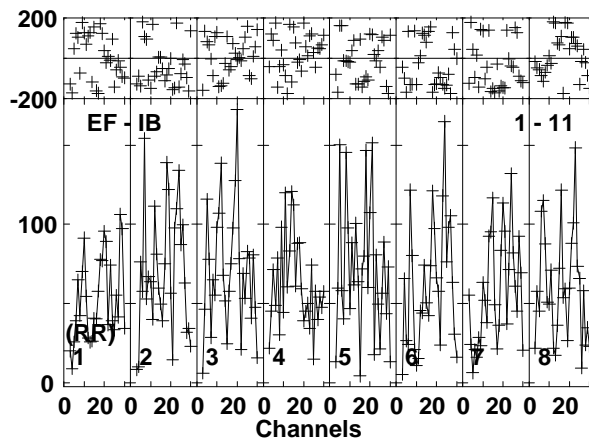
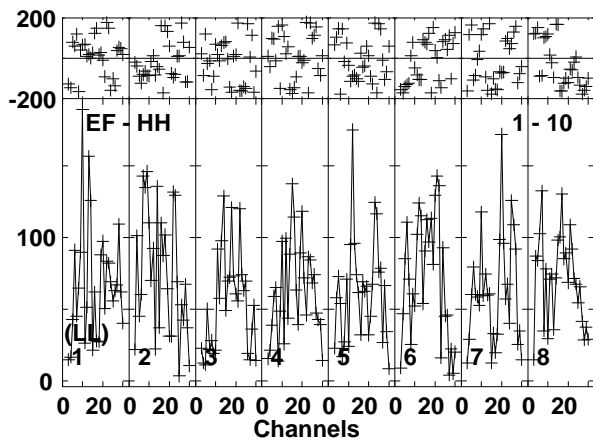
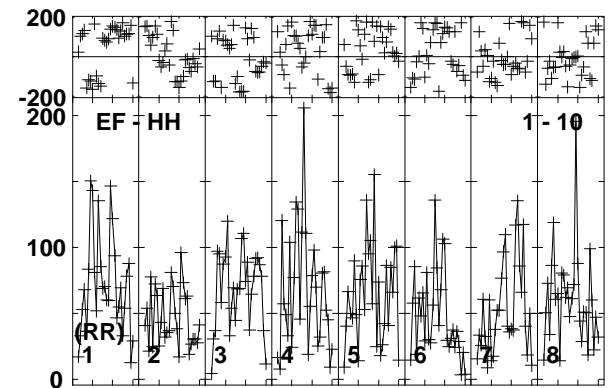
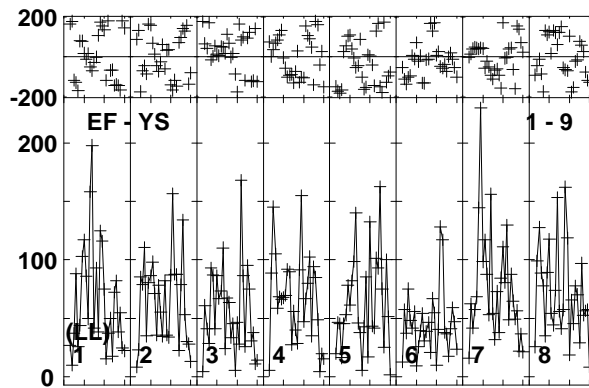
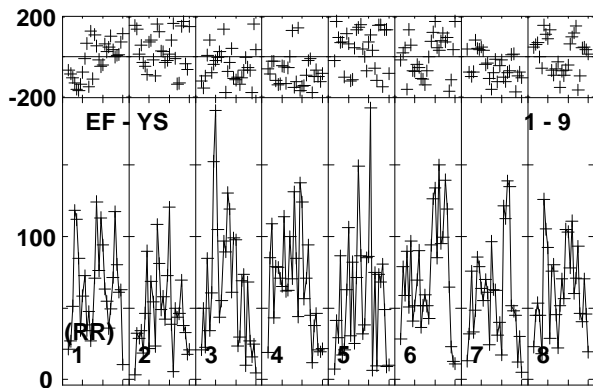
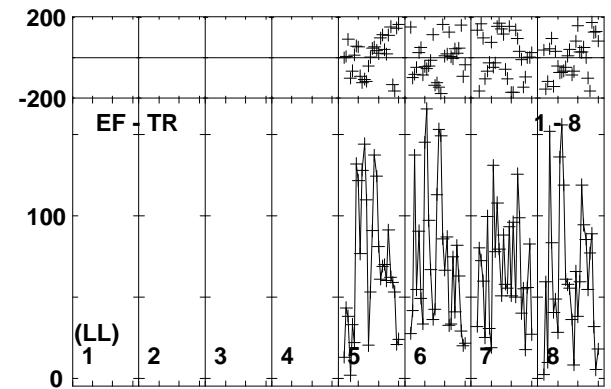
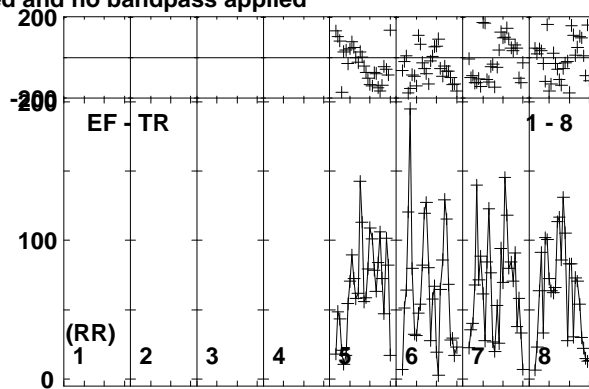
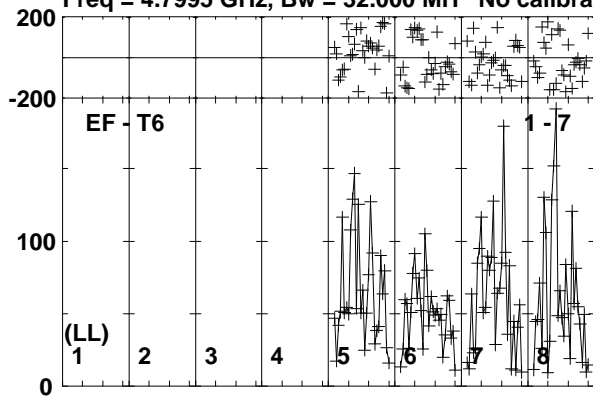

Lower frame: Micro Ampl Jy Top frame: Phas deg
Vector averaged cross-power spectrum Baseline: EF (01) - T6 (07)
Timerange: 00/19:32:02 to 00/19:35:28

Plot file version 49 created 20-APR-2018 17:20:42
 J1419+2706 RSM02.UVDATA.1
 Freq = 4.7995 GHz, Bw = 32.000 MH No calibration applied and no bandpass applied

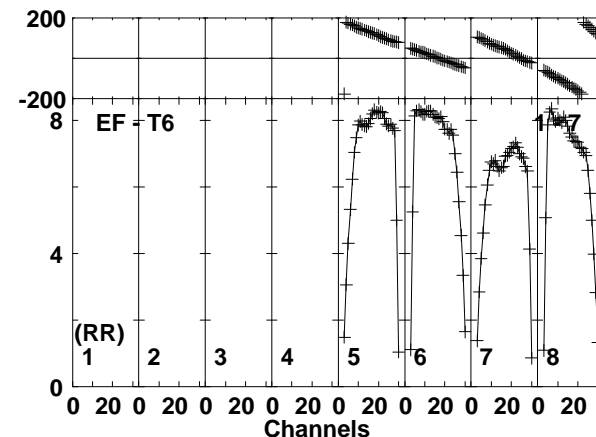
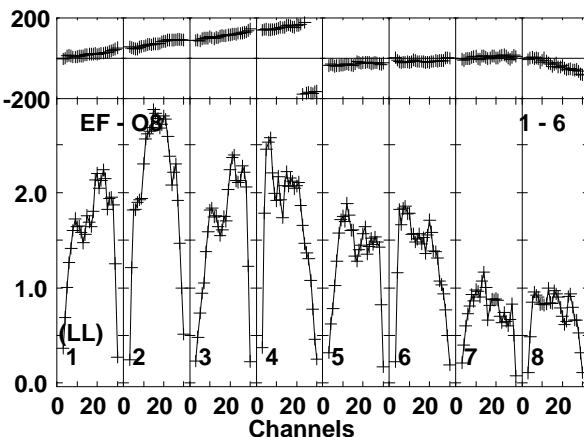
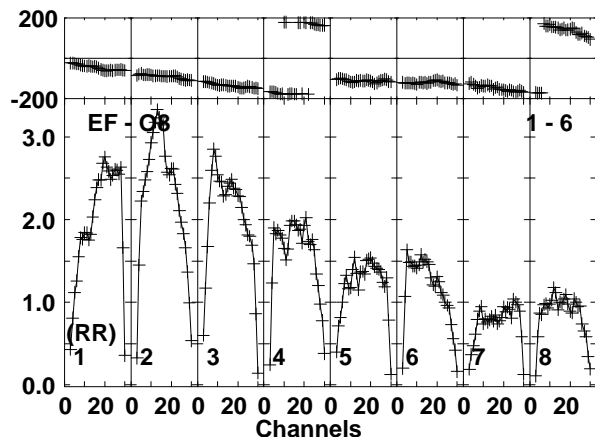
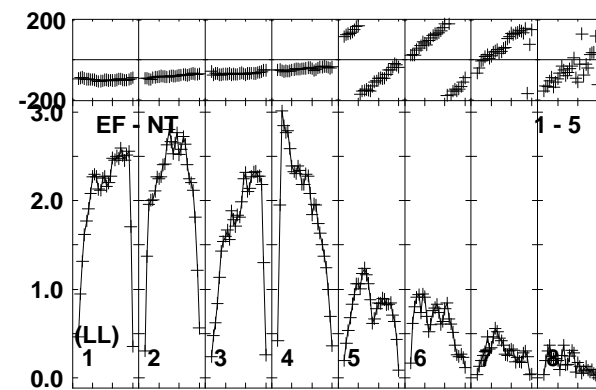
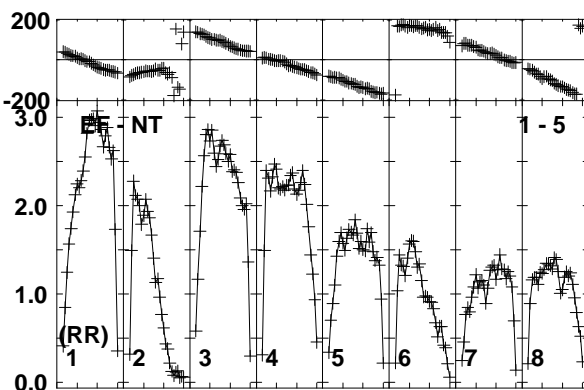
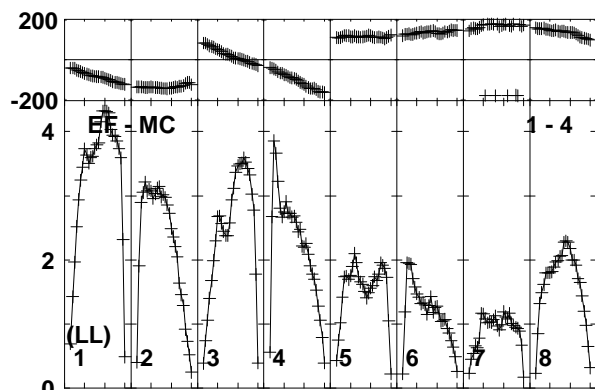
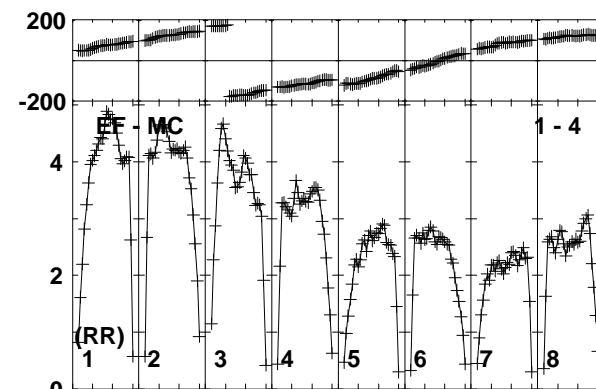
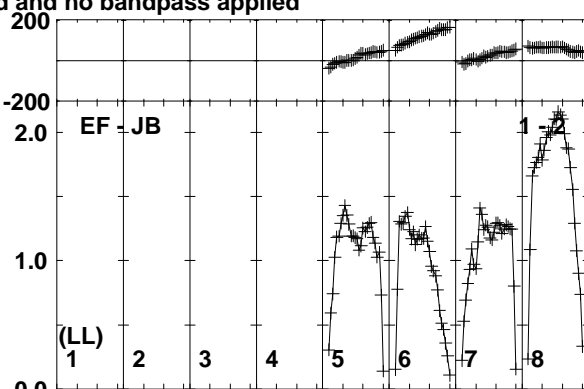
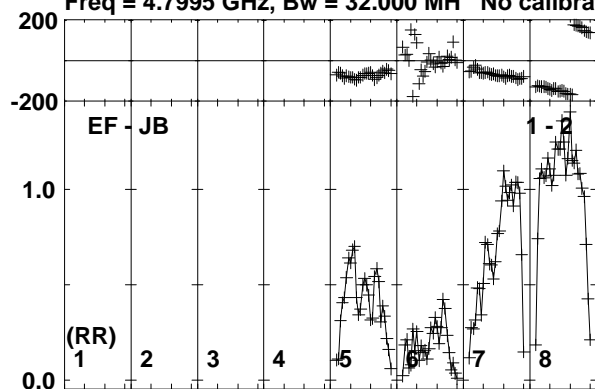

Lower frame: Milli Ampl Jy Top frame: Phas deg
 Vector averaged cross-power spectrum Baseline: EF (01) - JB (02)
 Timerange: 00/19:36:12 to 00/19:37:08

Plot file version 50 created 20-APR-2018 17:20:43
 J1419+2706 RSM02.UVDATA.1
 Freq = 4.7995 GHz, Bw = 32.000 MH No calibration applied and no bandpass applied

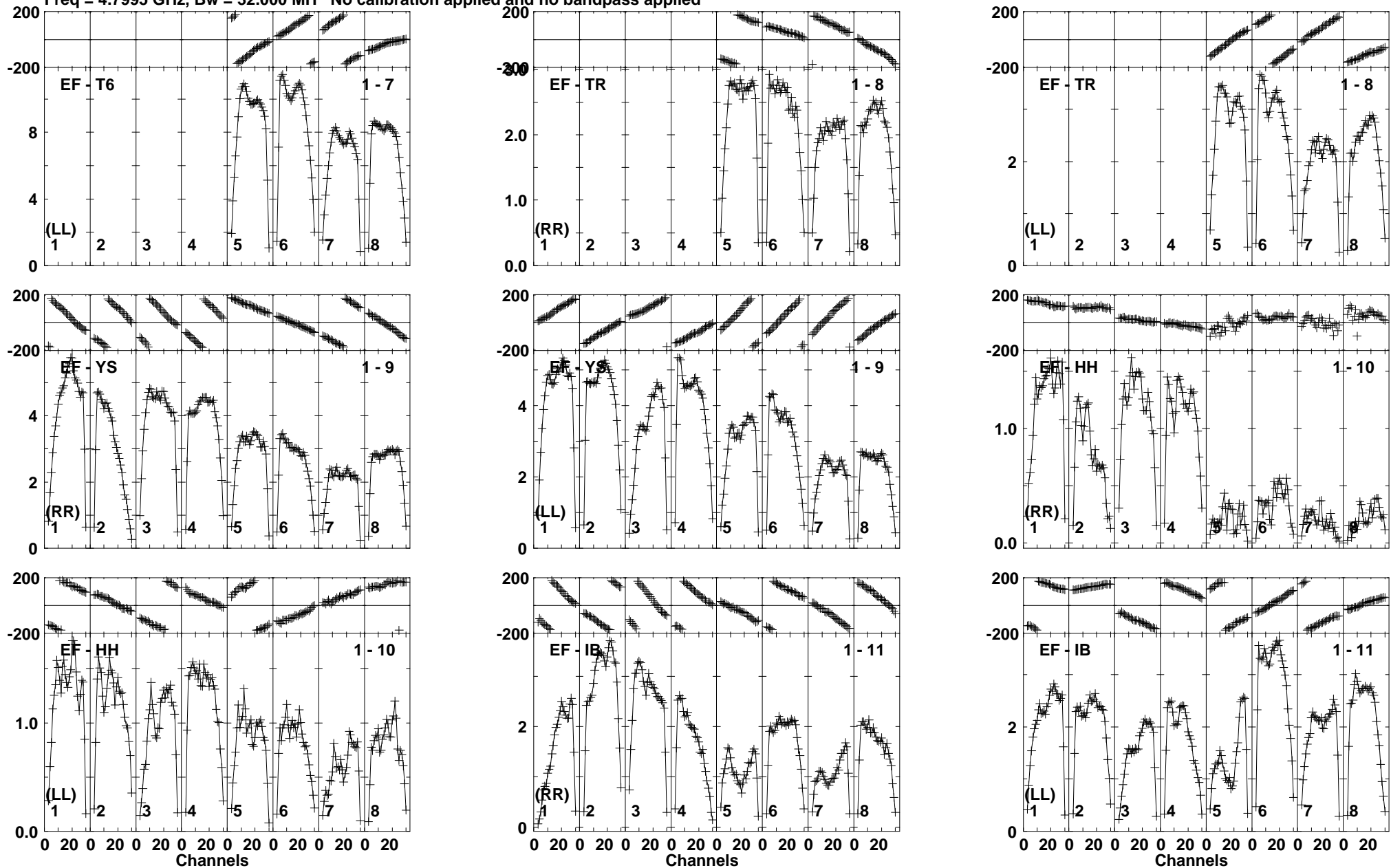

Lower frame: Milli Ampl Jy Top frame: Phas deg
 Vector averaged cross-power spectrum Baseline: EF (01) - T6 (07)
 Timerange: 00/19:36:12 to 00/19:37:08

Plot file version 51 created 20-APR-2018 17:20:43

J1427+2632 RSM02.UVDATA.1

Freq = 4.7995 GHz, Bw = 32.000 MH No calibration applied and no bandpass applied

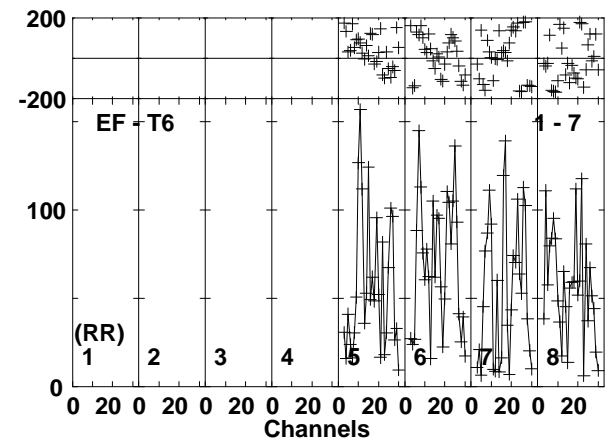
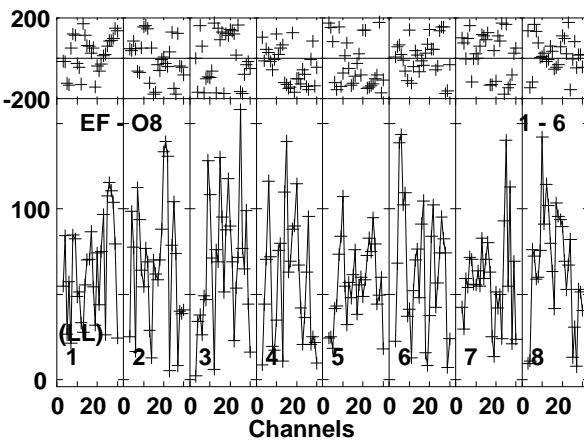
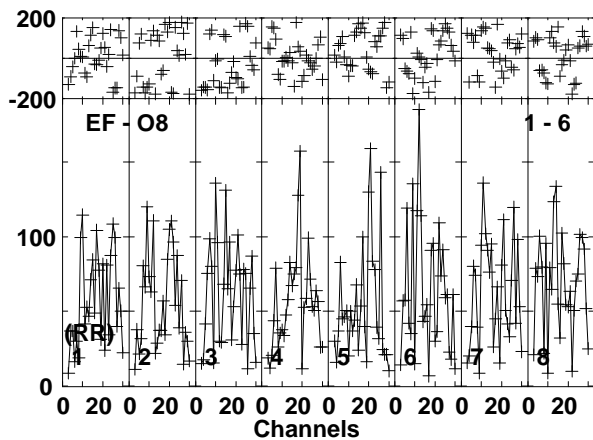
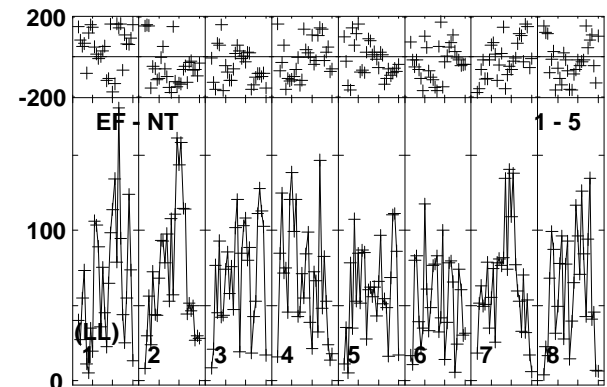
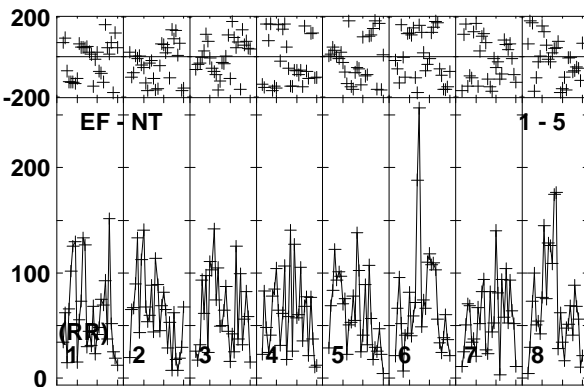
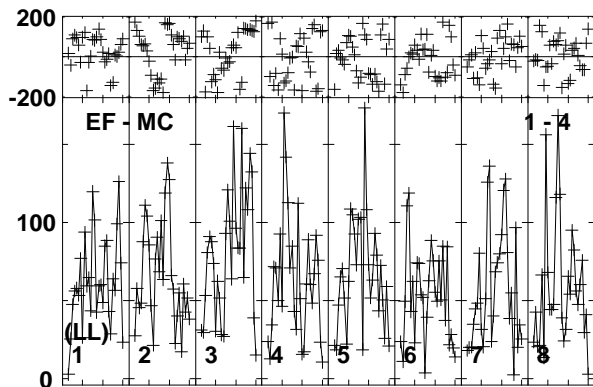
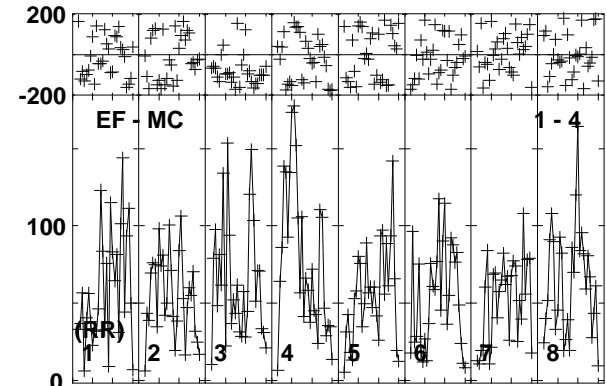
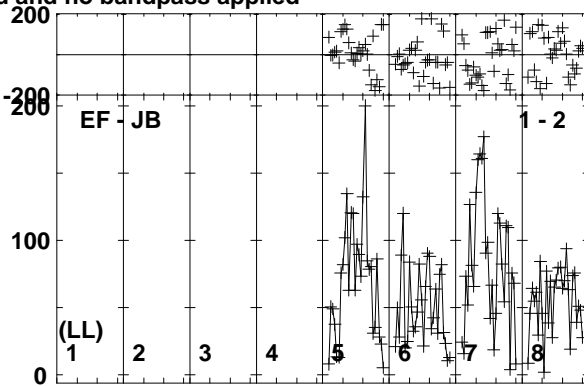
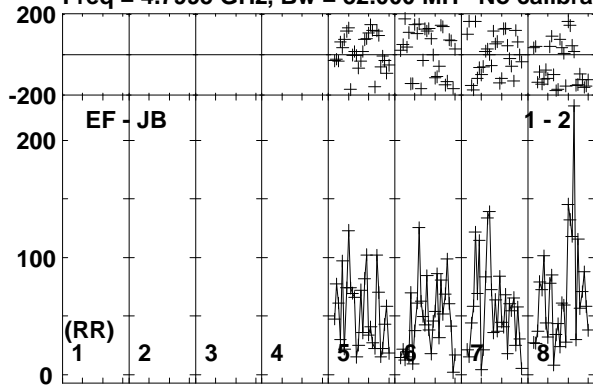

Lower frame: Micro Ampl Jy Top frame: Phas deg
Vector averaged cross-power spectrum Baseline: EF (01) - JB (02)
Timerange: 00/19:37:12 to 00/19:40:38

Plot file version 52 created 20-APR-2018 17:20:43

J1427+2632 RSM02.UVDATA.1

Freq = 4.7995 GHz, Bw = 32.000 MH No calibration applied and no bandpass applied

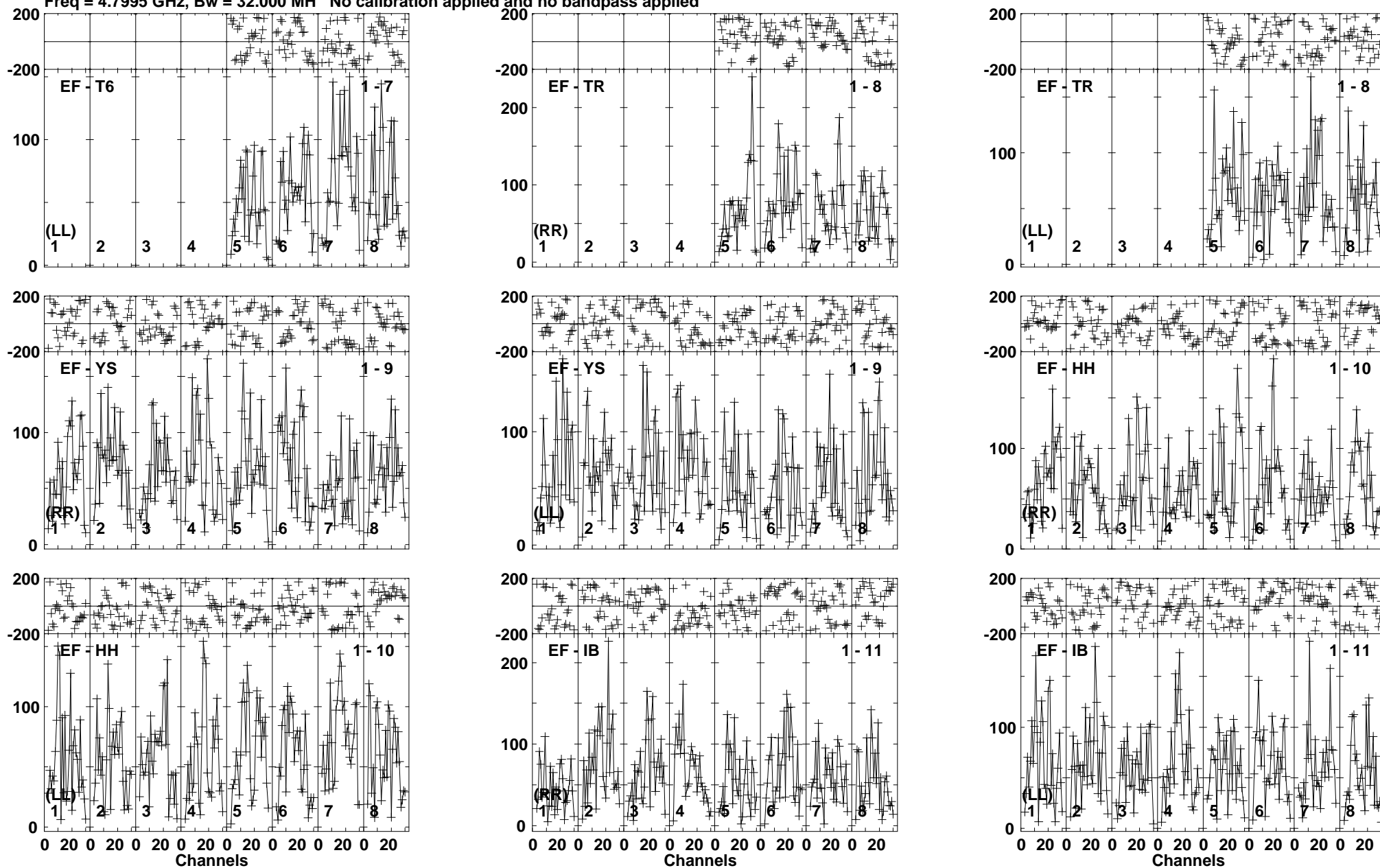

Lower frame: Micro Ampl Jy Top frame: Phas deg
Vector averaged cross-power spectrum Baseline: EF (01) - T6 (07)
Timerange: 00/19:37:12 to 00/19:40:38

Plot file version 53 created 20-APR-2018 17:20:43
 J1419+2706 RSM02.UVDATA.1
 Freq = 4.7995 GHz, Bw = 32.000 MH No calibration applied and no bandpass applied

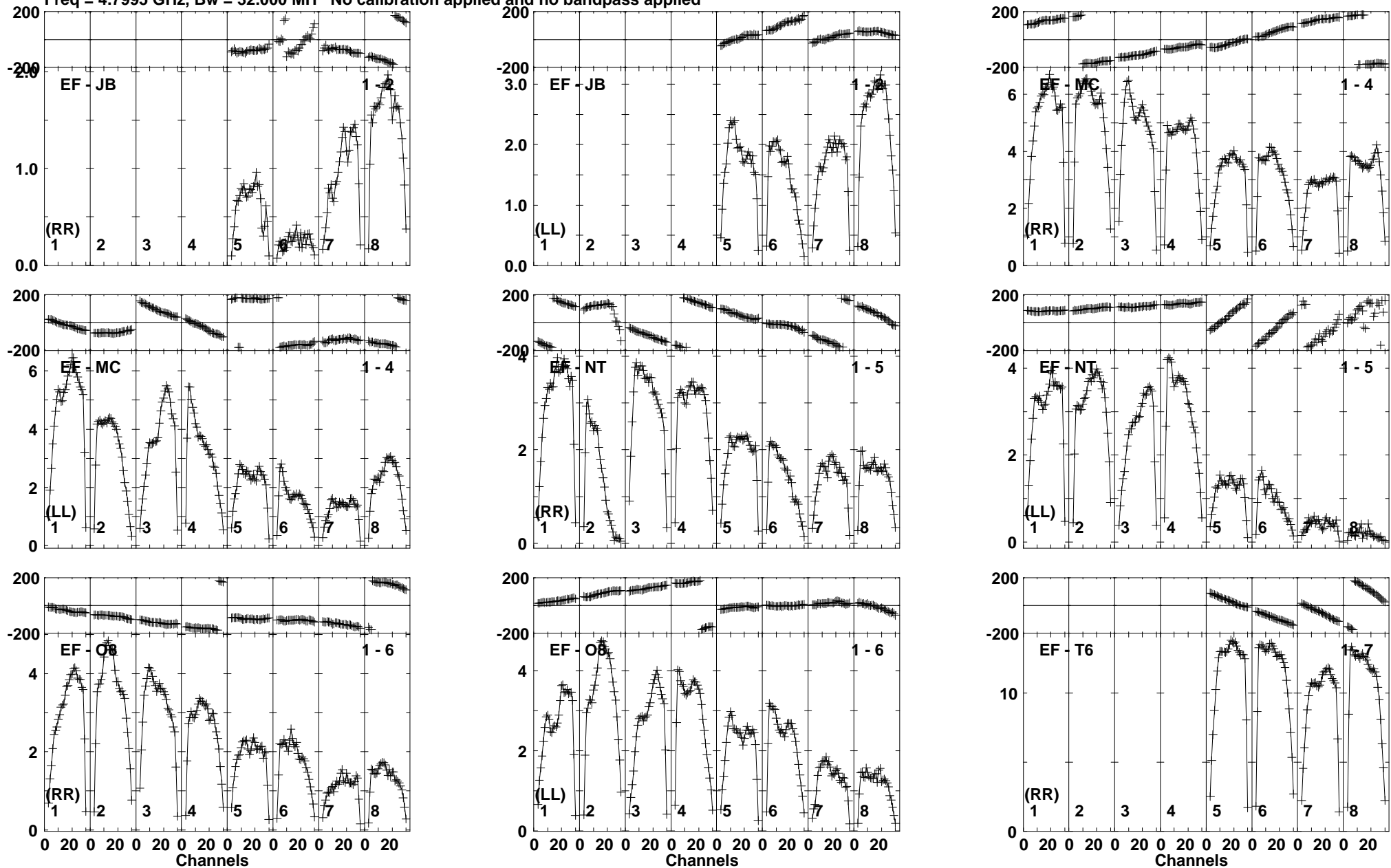

Lower frame: Milli Ampl Jy Top frame: Phas deg
 Vector averaged cross-power spectrum Baseline: EF (01) - JB (02)
 Timerange: 00:19:40:42 to 00:19:42:08

Plot file version 54 created 20-APR-2018 17:20:43
 J1419+2706 RSM02.UVDATA.1
 Freq = 4.7995 GHz, Bw = 32.000 MH No calibration applied and no bandpass applied

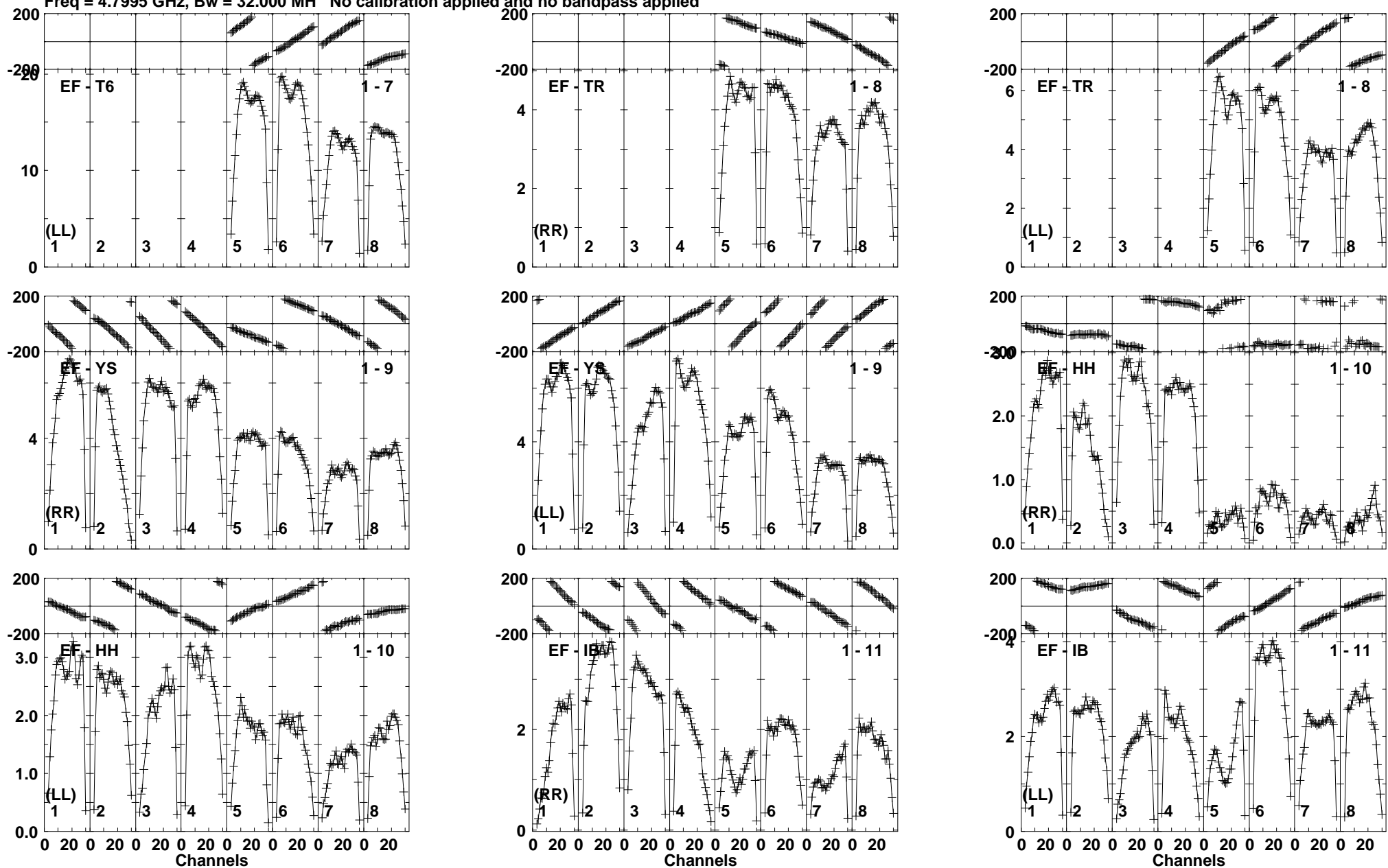

Lower frame: Milli Ampl Jy Top frame: Phas deg
 Vector averaged cross-power spectrum Baseline: EF (01) - T6 (07)
 Timerange: 00:19:40:42 to 00:19:42:08

Plot file version 55 created 20-APR-2018 17:20:43

J1427+2632 RSM02.UVDATA.1

Freq = 4.7995 GHz, Bw = 32.000 MH No calibration applied and no bandpass applied

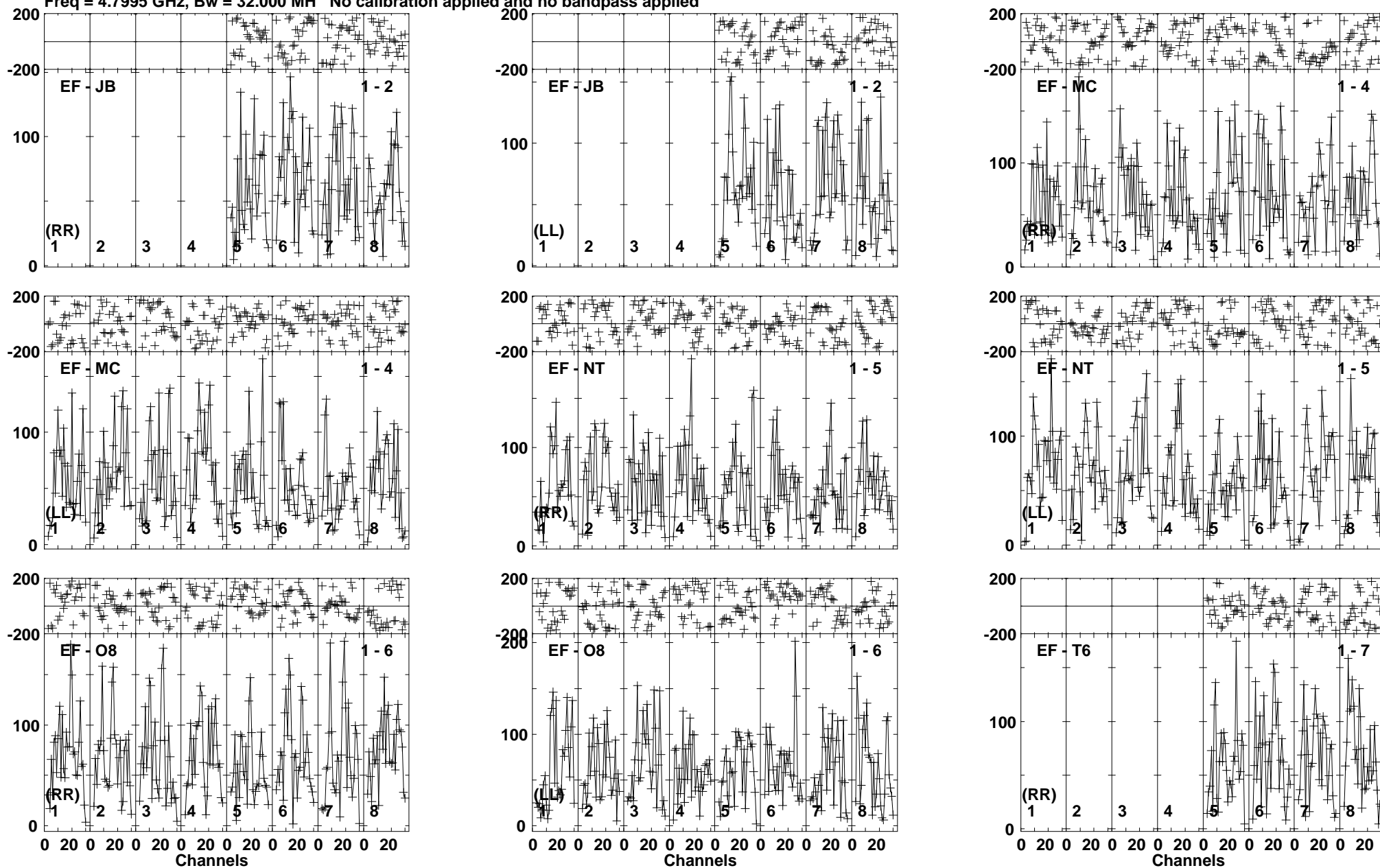

Lower frame: Micro Ampl Jy Top frame: Phas deg
Vector averaged cross-power spectrum Baseline: EF (01) - JB (02)
Timerange: 00:19:42:12 to 00:19:45:38

Plot file version 56 created 20-APR-2018 17:20:43

J1427+2632 RSM02.UVDATA.1

Freq = 4.7995 GHz, Bw = 32.000 MH No calibration applied and no bandpass applied

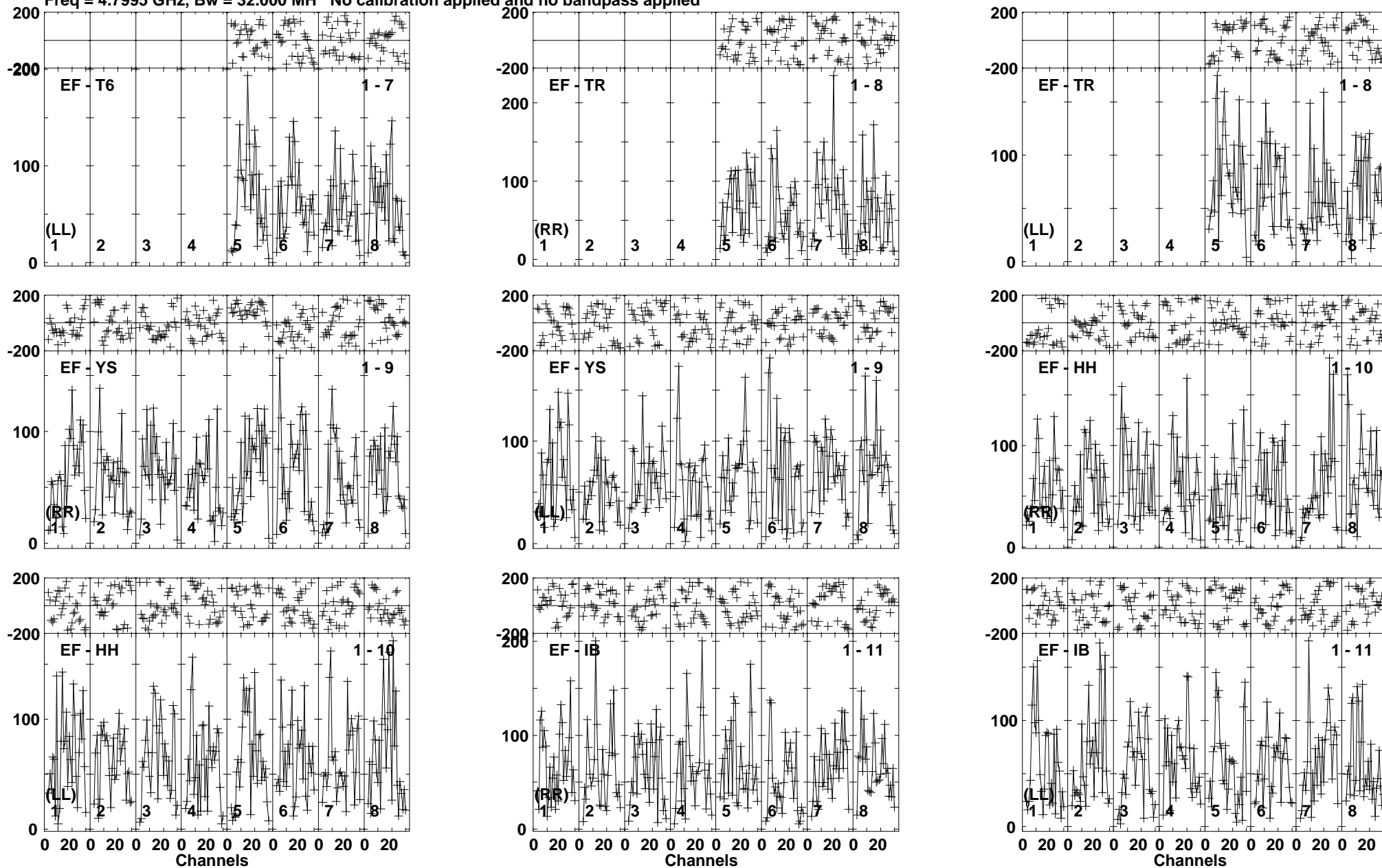

Lower frame: Micro Ampl Jy Top frame: Phas deg
Vector averaged cross-power spectrum Baseline: EF (01) - T6 (07)
Timerange: 00/19:42:12 to 00/19:45:38

Plot file version 57 created 20-APR-2018 17:20:43

J1419+2706 RSM02.UVDATA.1

Freq = 4.7995 GHz, Bw = 32.000 MH No calibration applied and no bandpass applied

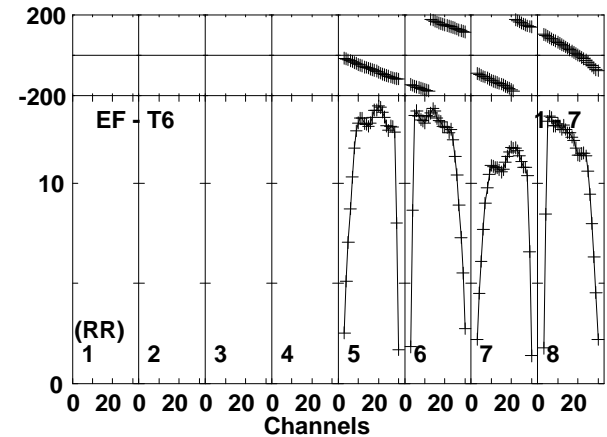
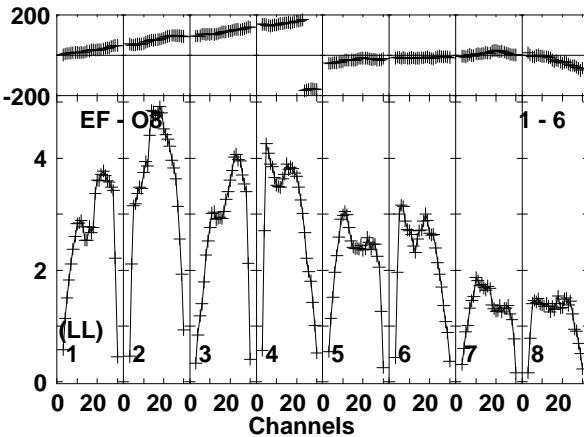
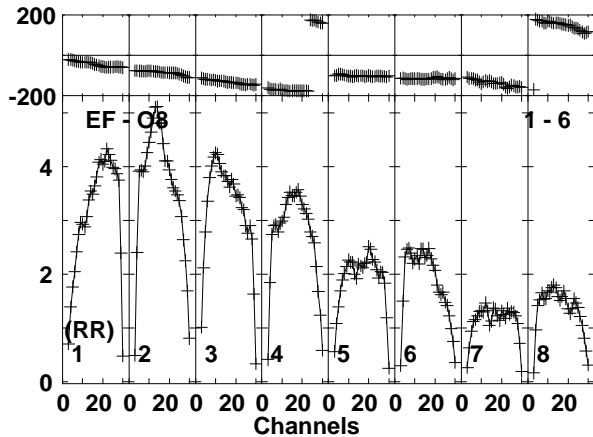
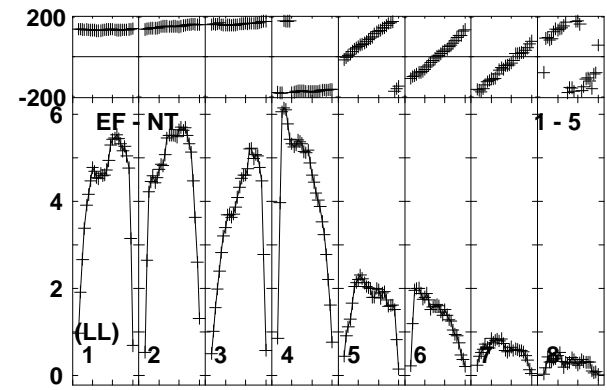
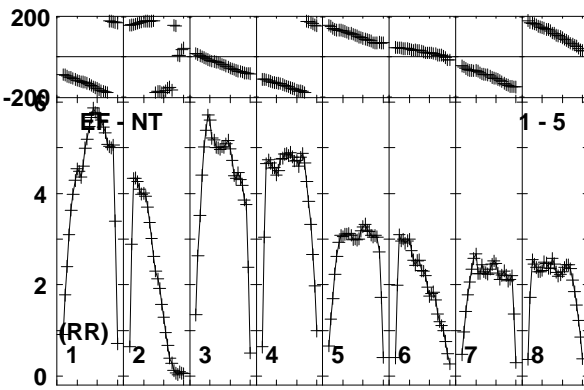
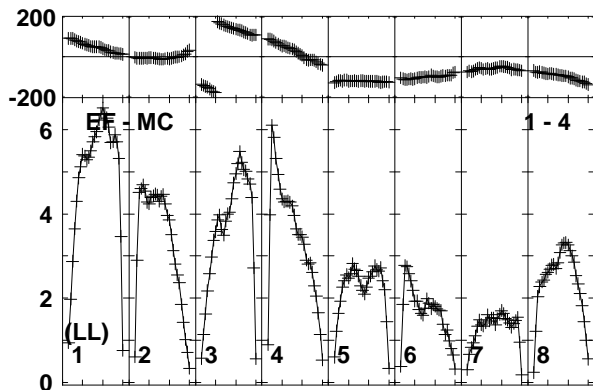
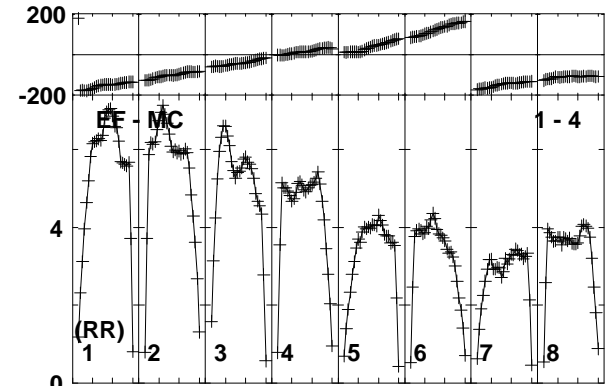
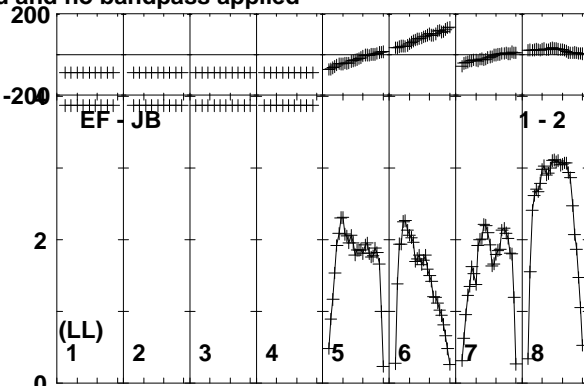
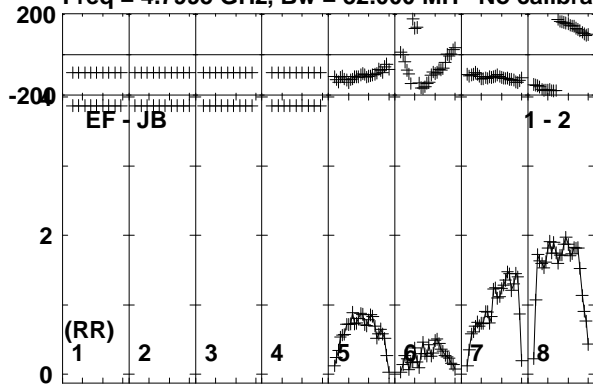

Lower frame: Milli Ampl Jy Top frame: Phas deg
Vector averaged cross-power spectrum Baseline: EF (01) - JB (02)
Timerange: 00:19:45:42 to 00:19:47:08

Plot file version 58 created 20-APR-2018 17:20:43

J1419+2706 RSM02.UVDATA.1

Freq = 4.7995 GHz, Bw = 32.000 MH No calibration applied and no bandpass applied

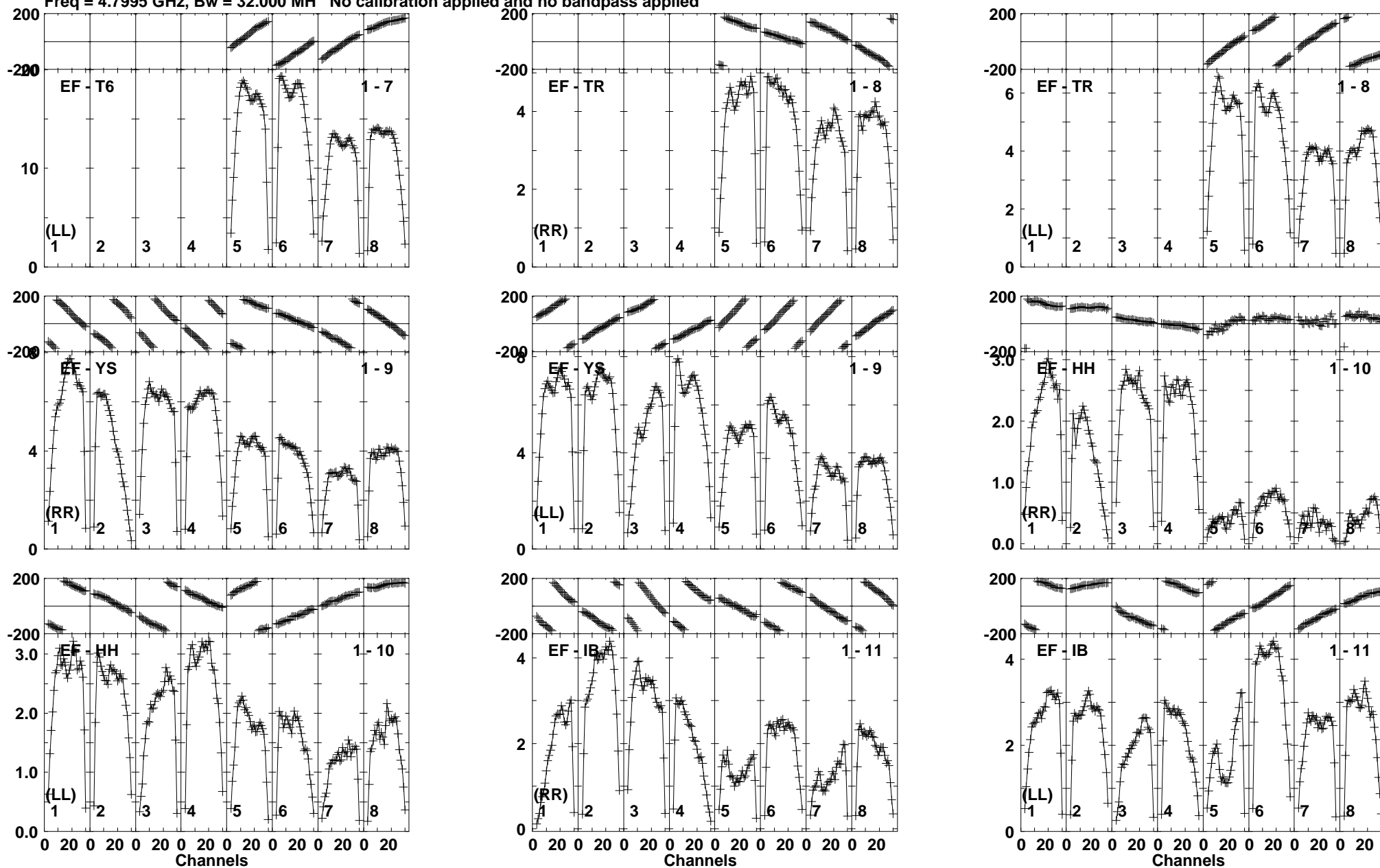

Lower frame: Milli Ampl Jy Top frame: Phas deg
Vector averaged cross-power spectrum Baseline: EF (01) - T6 (07)
Timerange: 00:19:45:42 to 00:19:47:08

Plot file version 59 created 20-APR-2018 17:20:43

J1427+2632 RSM02.UVDATA.1

Freq = 4.7995 GHz, Bw = 32.000 MH No calibration applied and no bandpass applied

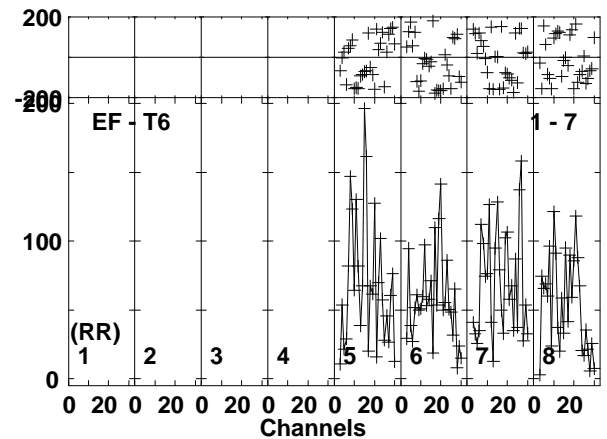
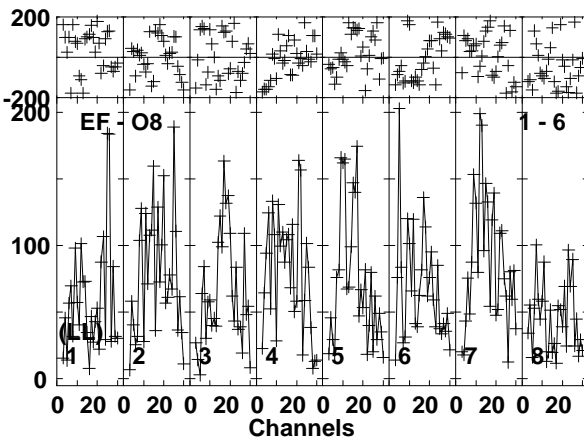
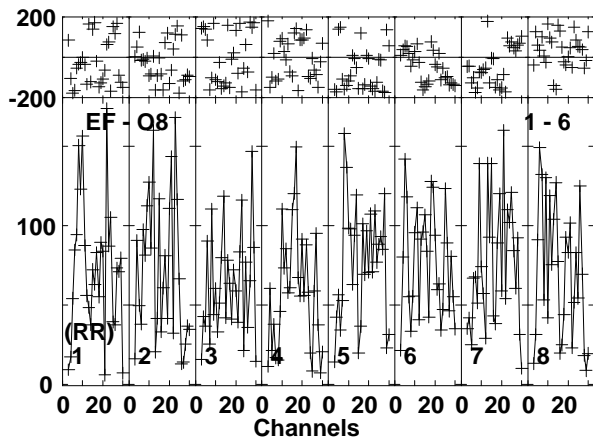
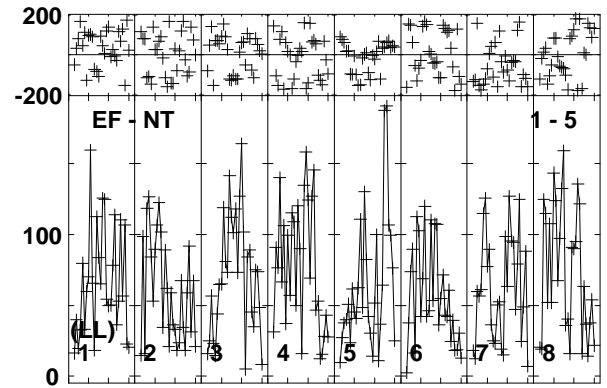
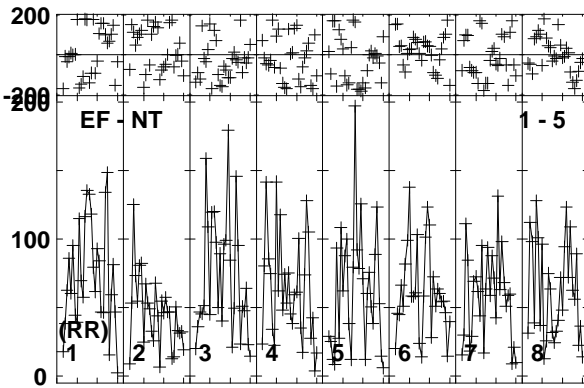
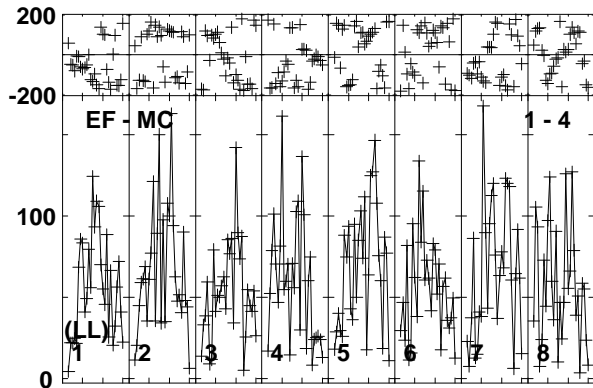
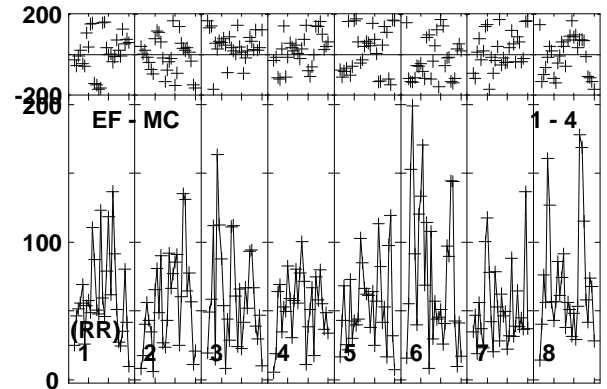
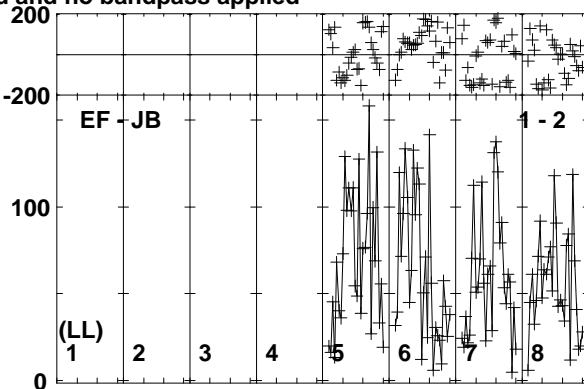
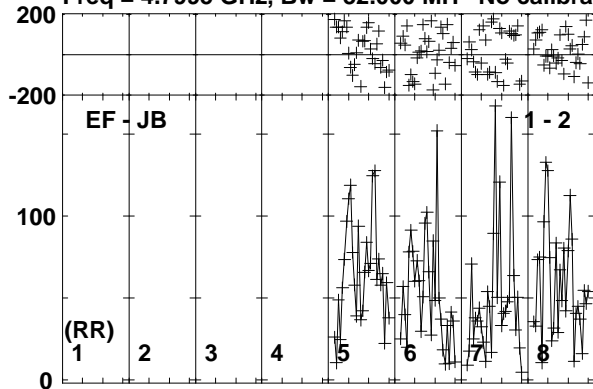

Lower frame: Micro Ampl Jy Top frame: Phas deg
Vector averaged cross-power spectrum Baseline: EF (01) - JB (02)
Timerange: 00/19:47:12 to 00/19:50:38

Plot file version 60 created 20-APR-2018 17:20:44

J1427+2632 RSM02.UVDATA.1

Freq = 4.7995 GHz, Bw = 32.000 MH No calibration applied and no bandpass applied

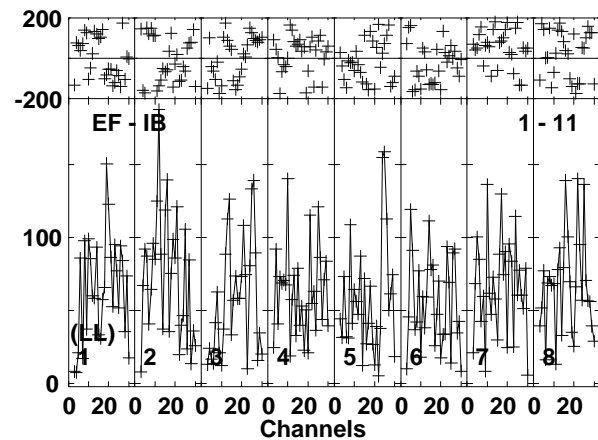
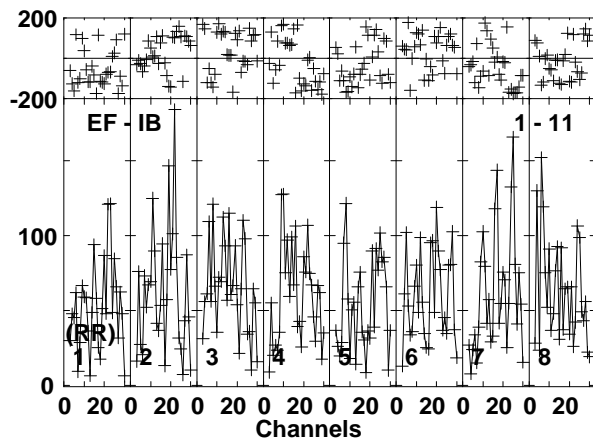
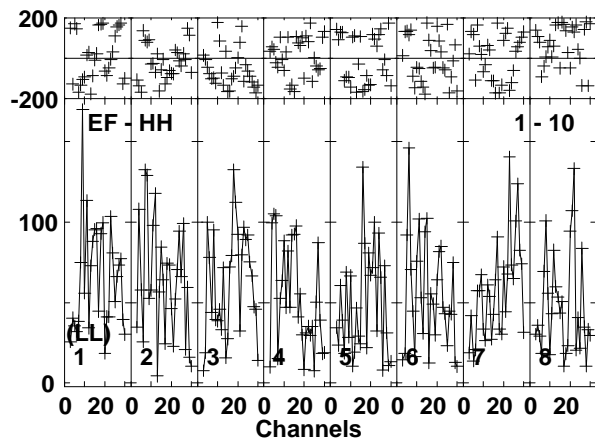
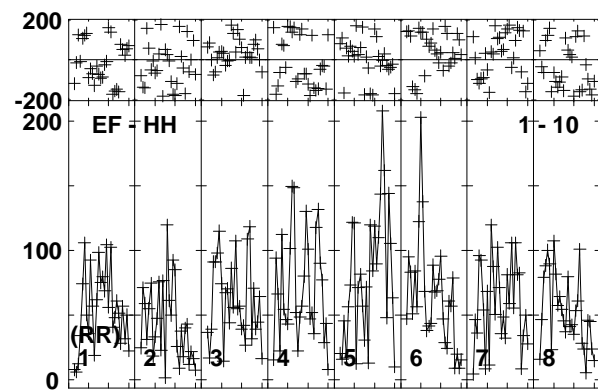
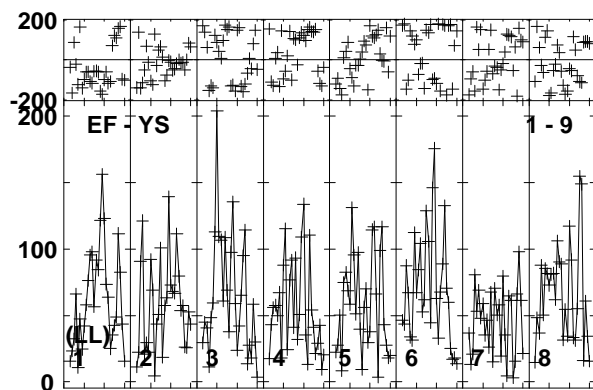
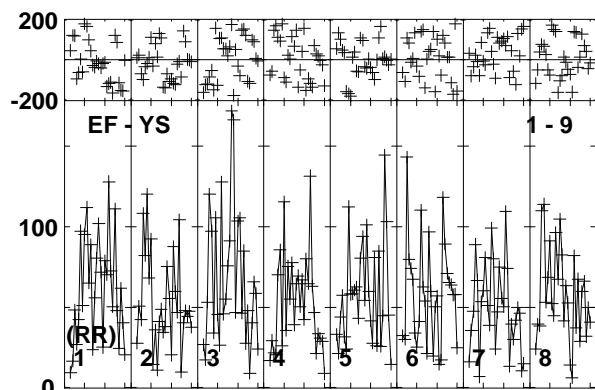
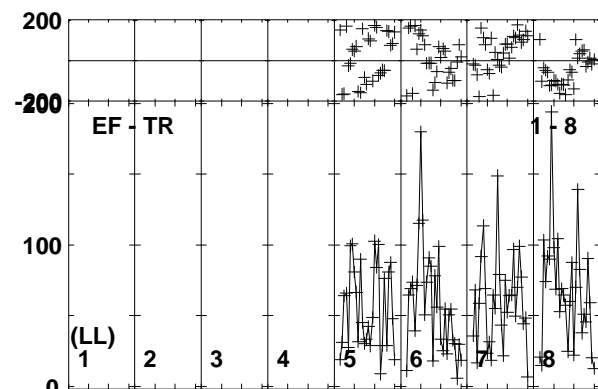
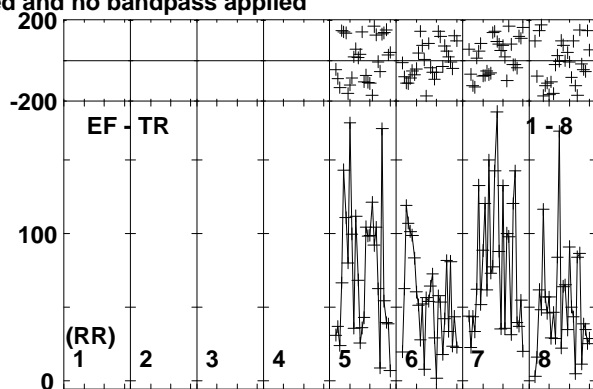
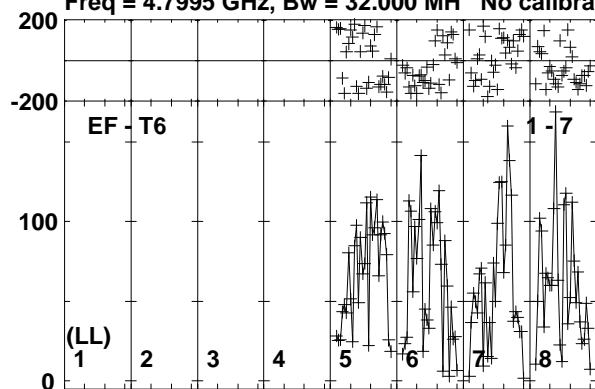

Lower frame: Micro Ampl Jy Top frame: Phas deg
Vector averaged cross-power spectrum Baseline: EF (01) - T6 (07)
Timerange: 00/19:47:12 to 00/19:50:38

Plot file version 61 created 20-APR-2018 17:20:44

J1419+2706 RSM02.UVDATA.1

Freq = 4.7995 GHz, Bw = 32.000 MH No calibration applied and no bandpass applied

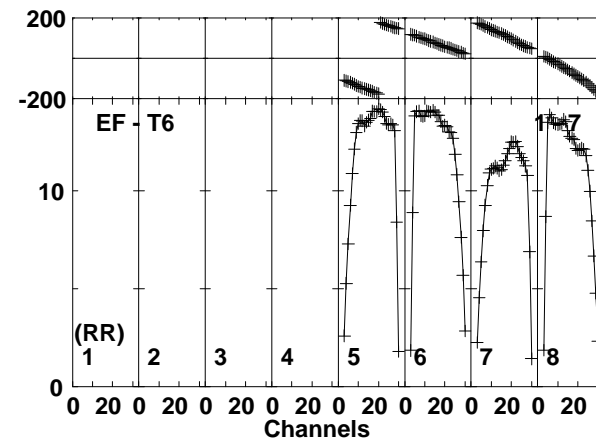
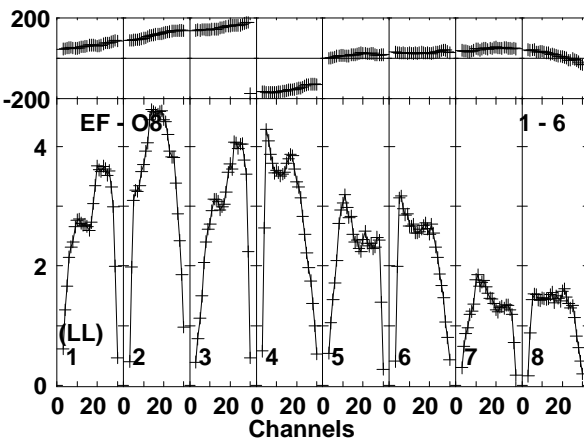
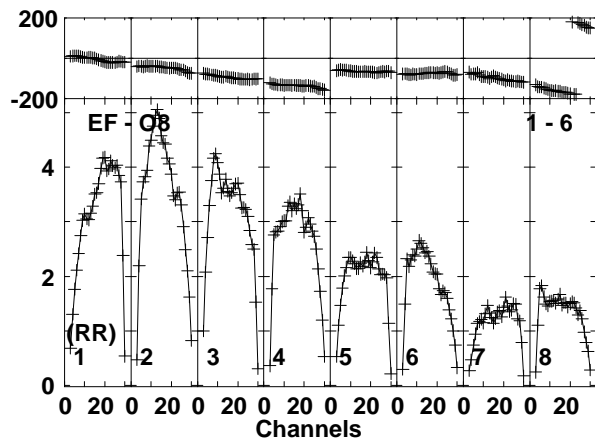
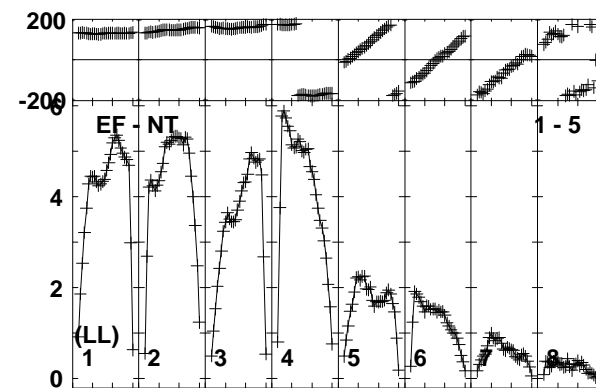
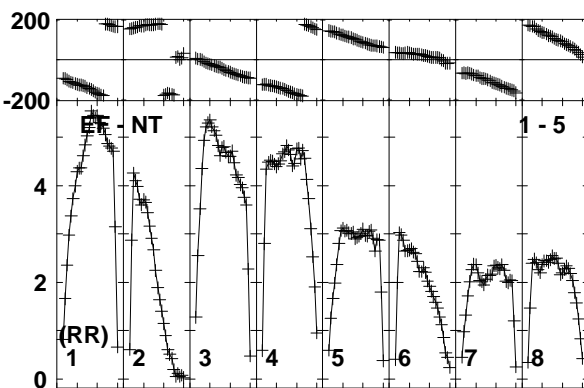
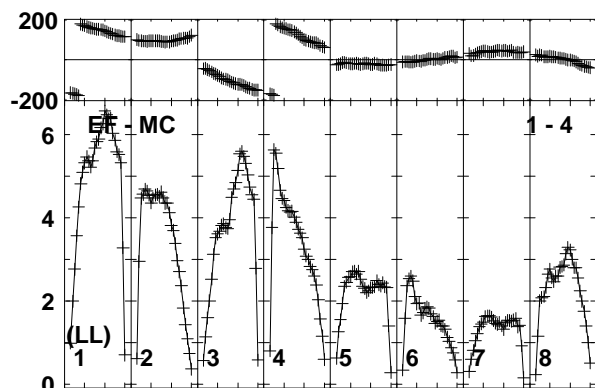
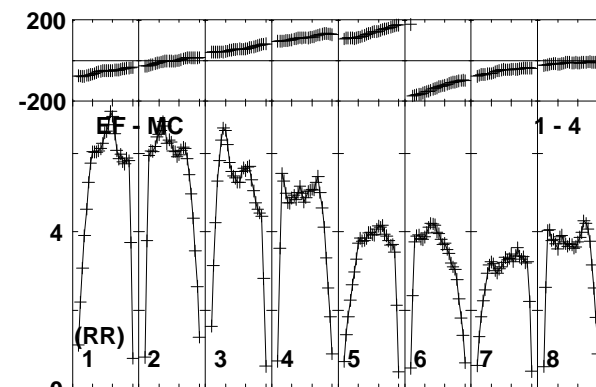
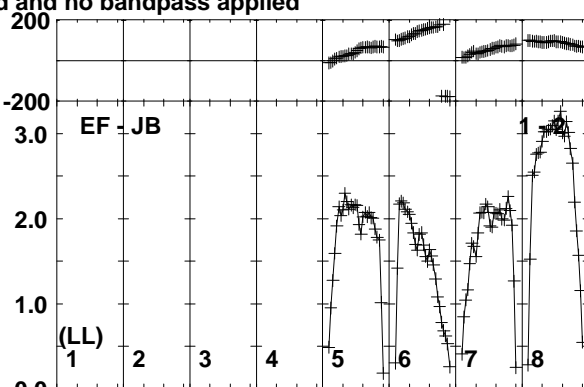
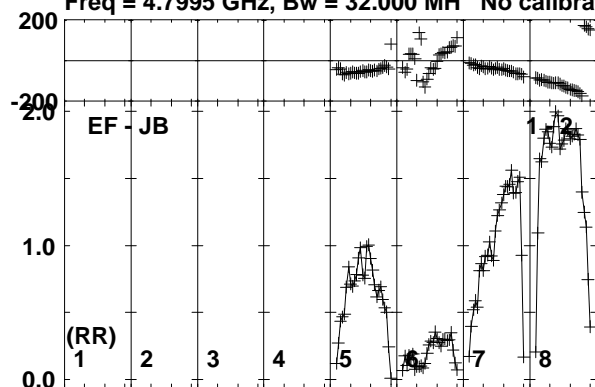

Lower frame: Milli Ampl Jy Top frame: Phas deg
Vector averaged cross-power spectrum Baseline: EF (01) - JB (02)
Timerange: 00:19:51:22 to 00:19:52:18

Plot file version 62 created 20-APR-2018 17:20:44

J1419+2706 RSM02.UVDATA.1

Freq = 4.7995 GHz, Bw = 32.000 MH No calibration applied and no bandpass applied

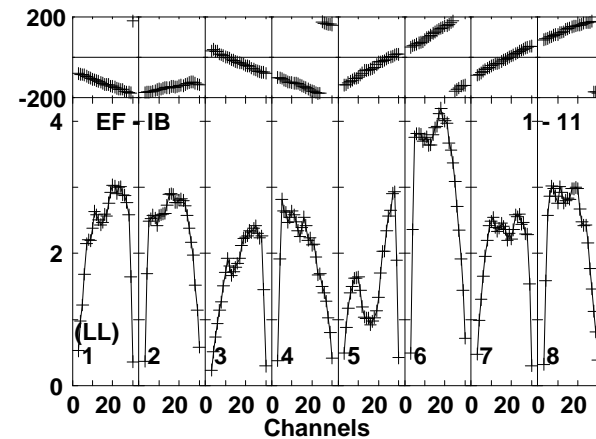
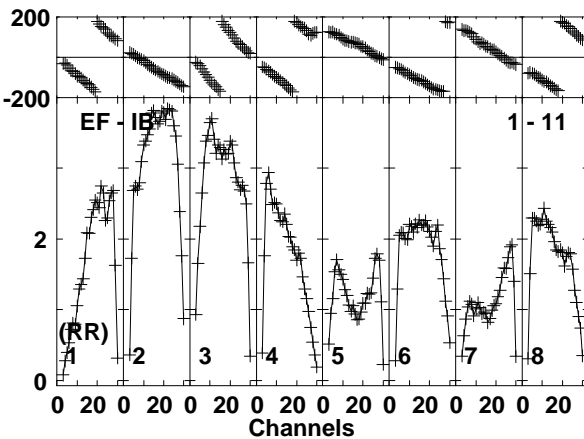
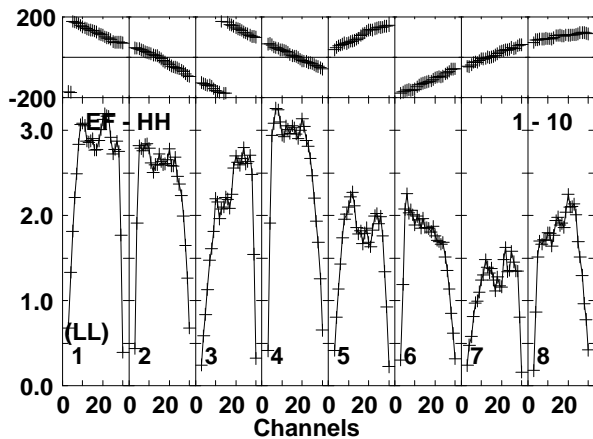
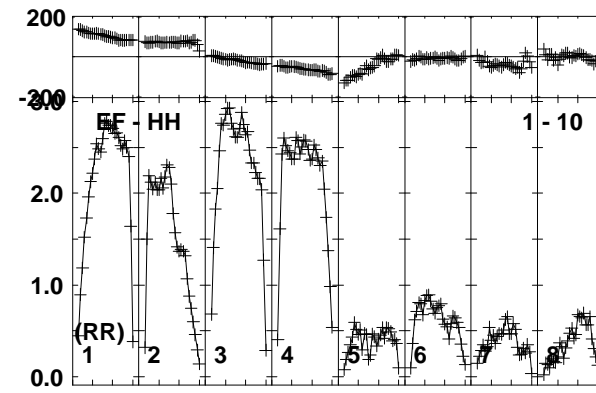
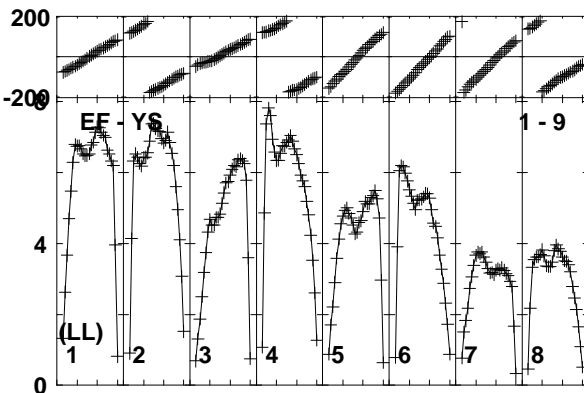
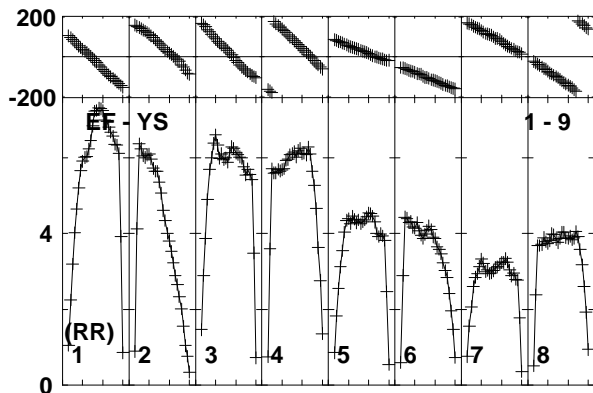
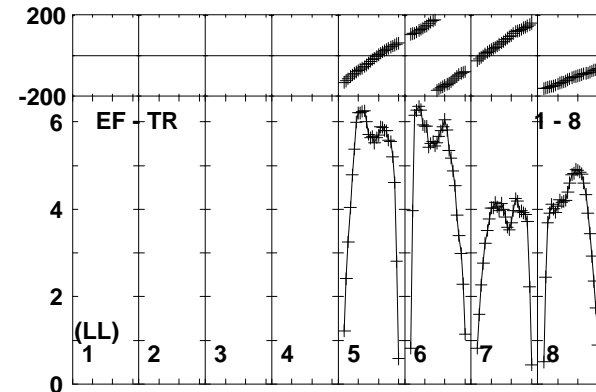
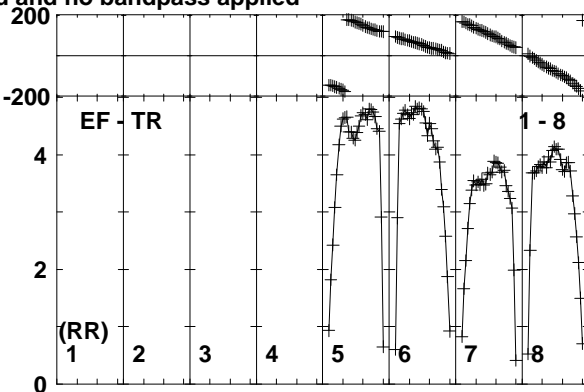
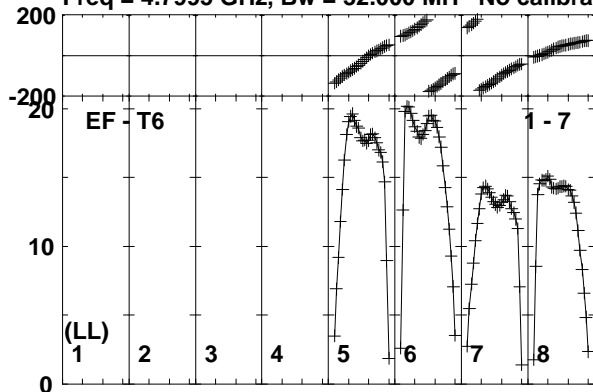

Lower frame: Milli Ampl Jy Top frame: Phas deg
Vector averaged cross-power spectrum Baseline: EF (01) - T6 (07)
Timerange: 00:19:51:22 to 00:19:52:18

Plot file version 63 created 20-APR-2018 17:20:44
 J1427+2632 RSM02.UVDATA.1

Freq = 4.7995 GHz, Bw = 32.000 MH No calibration applied and no bandpass applied

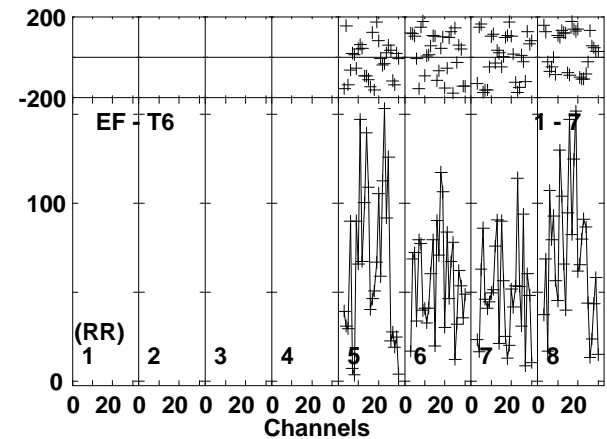
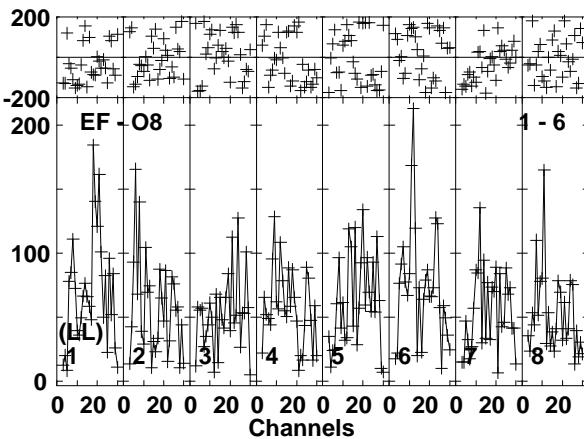
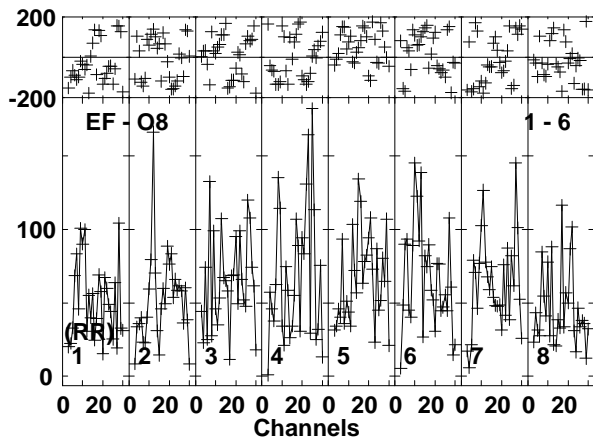
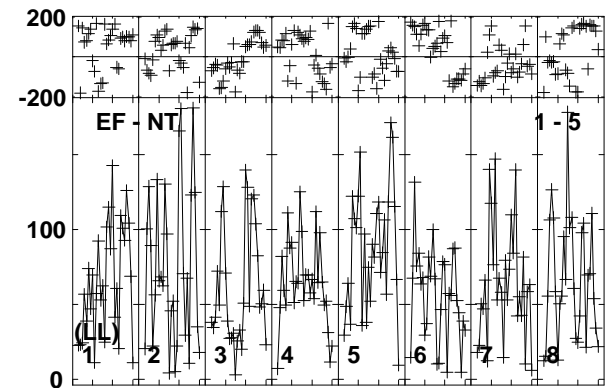
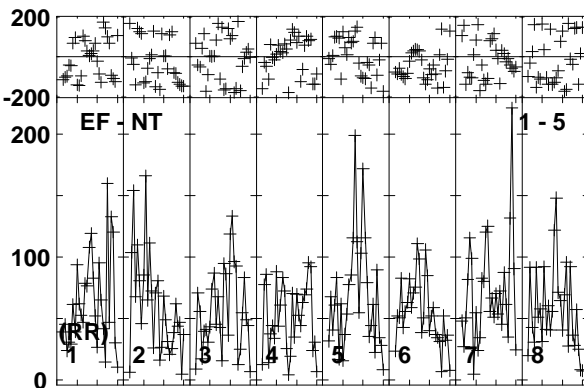
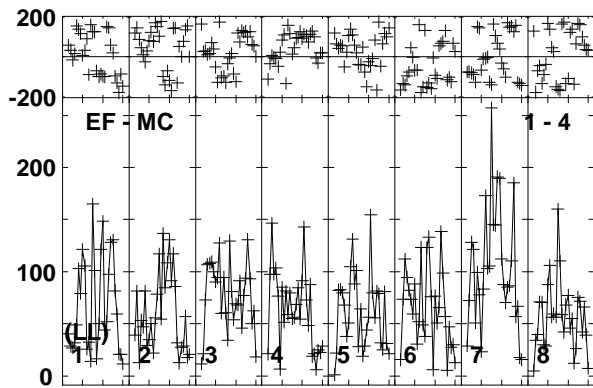
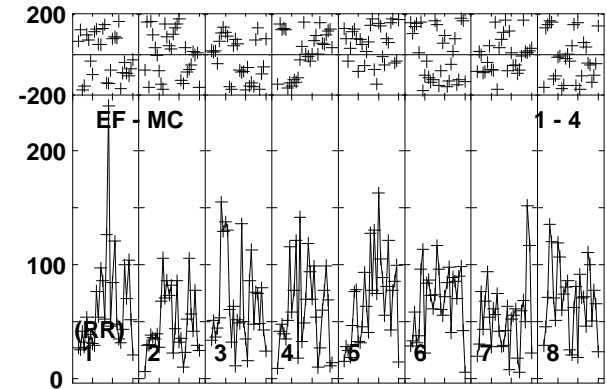
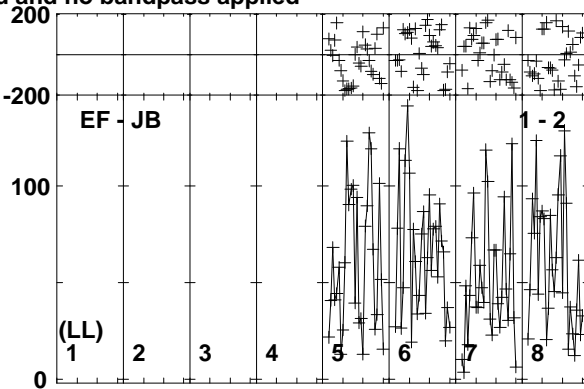
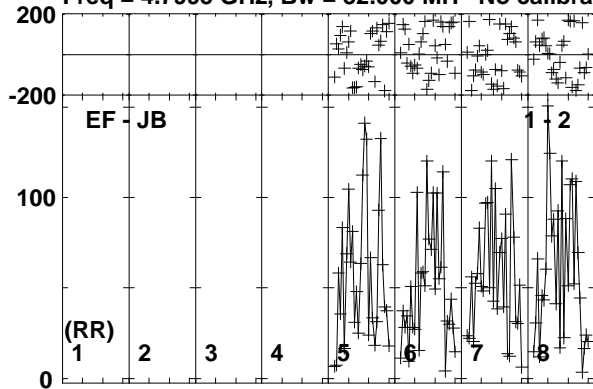

Lower frame: Micro Ampl Jy Top frame: Phas deg
 Vector averaged cross-power spectrum Baseline: EF (01) - JB (02)
 Timerange: 00:19:52:22 to 00:19:55:48

Plot file version 64 created 20-APR-2018 17:20:44

J1427+2632 RSM02.UVDATA.1

Freq = 4.7995 GHz, Bw = 32.000 MH No calibration applied and no bandpass applied

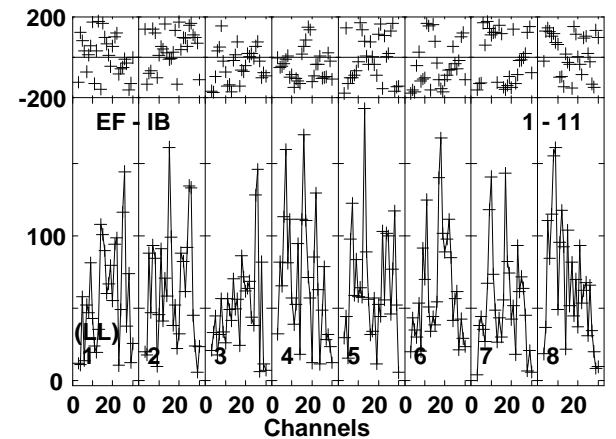
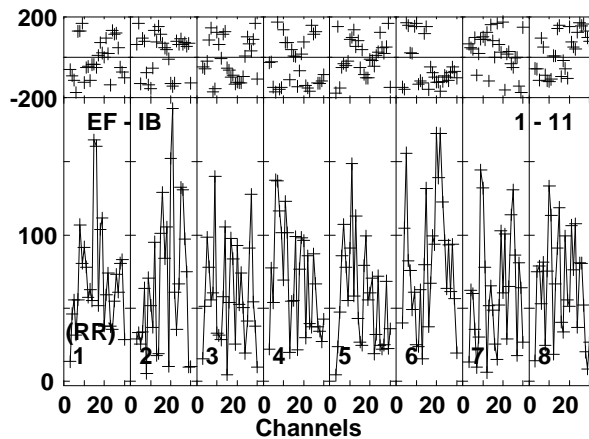
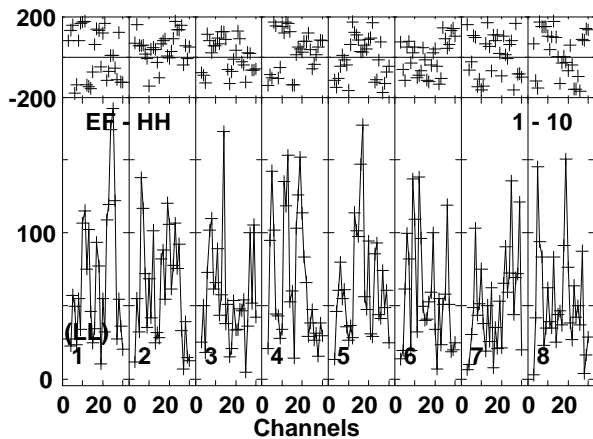
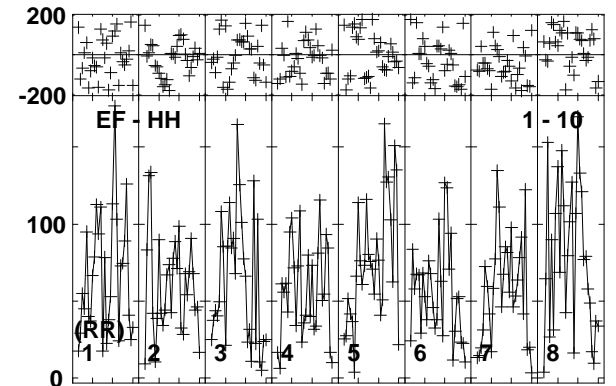
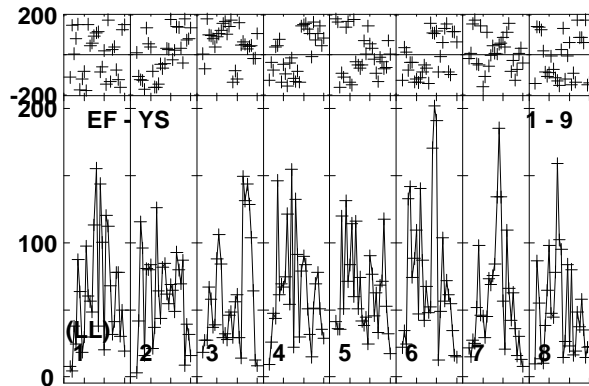
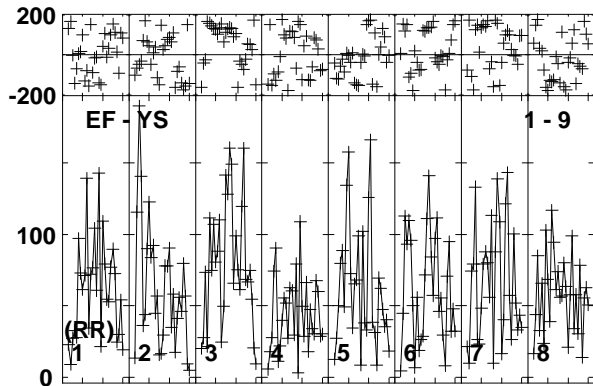
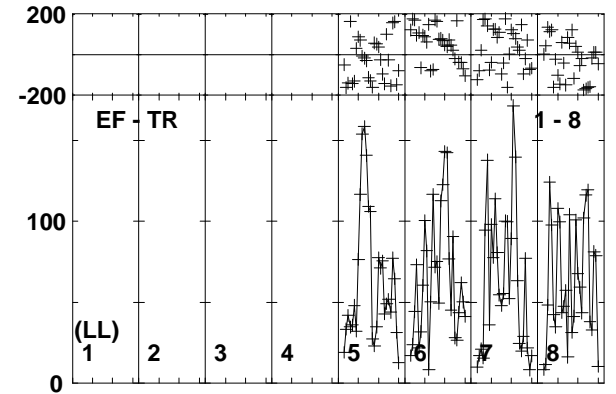
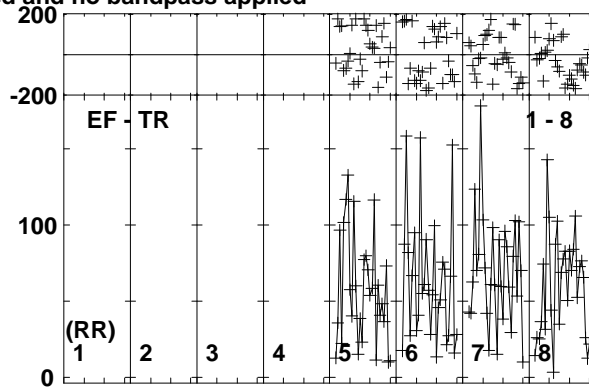
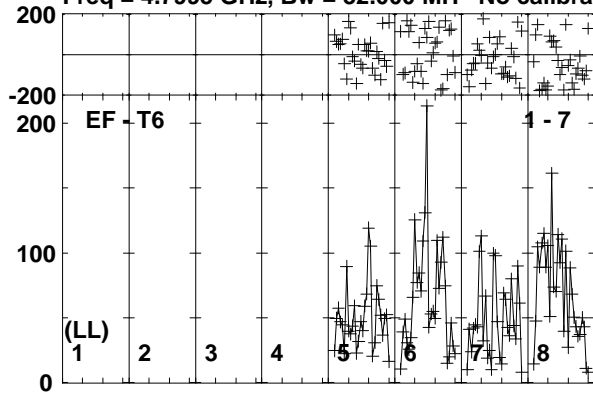

Lower frame: Micro Ampl Jy Top frame: Phas deg
Vector averaged cross-power spectrum Baseline: EF (01) - T6 (07)
Timerange: 00/19:52:22 to 00/19:55:48

Plot file version 65 created 20-APR-2018 17:20:44

J1419+2706 RSM02.UVDATA.1

Freq = 4.7995 GHz, Bw = 32.000 MH No calibration applied and no bandpass applied

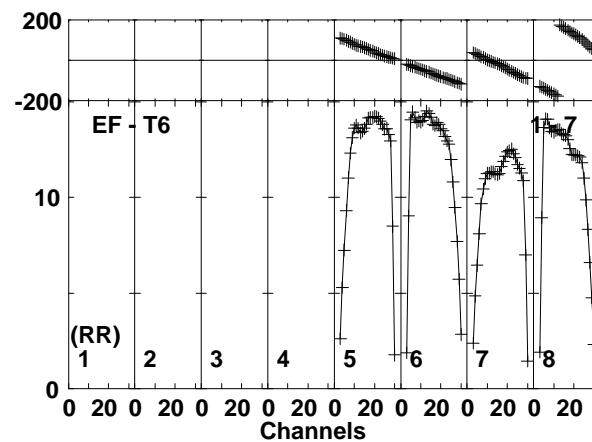
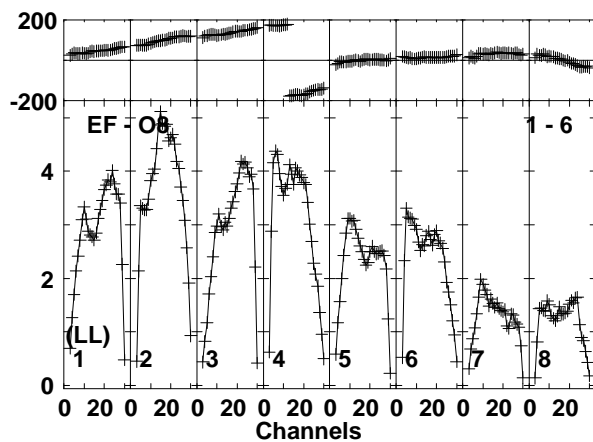
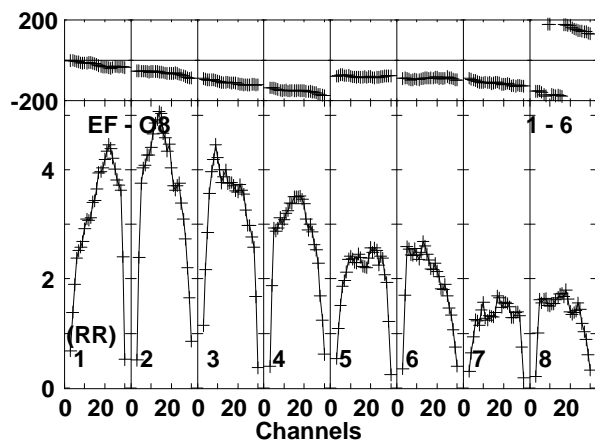
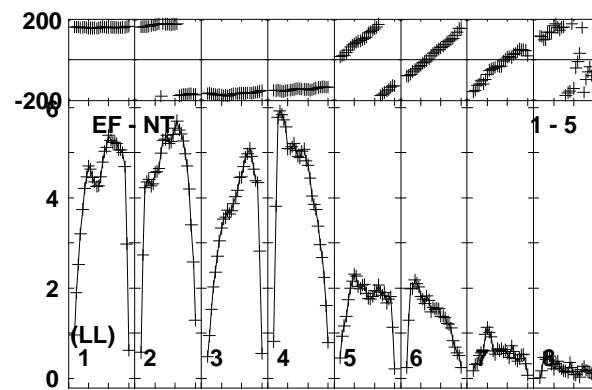
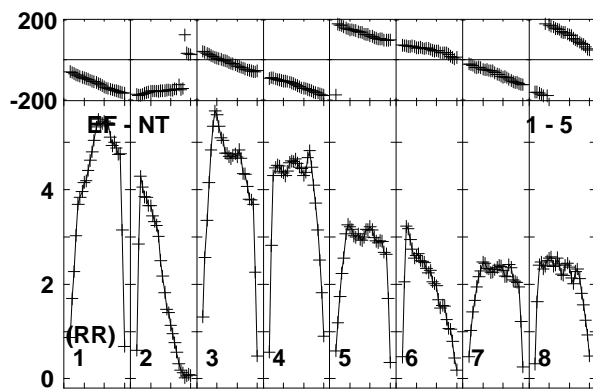
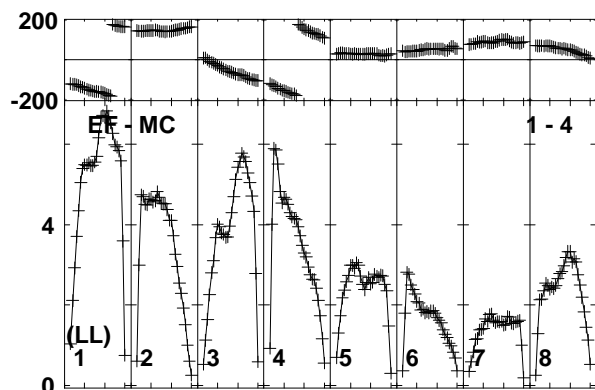
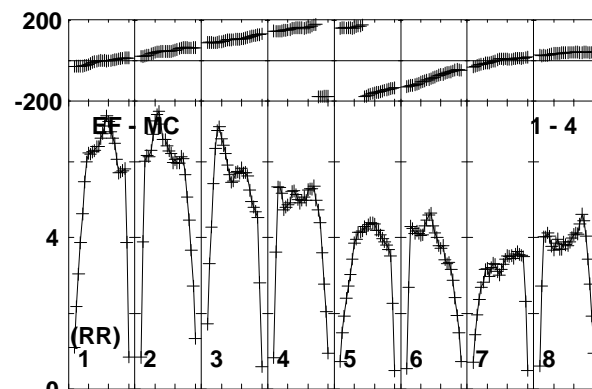
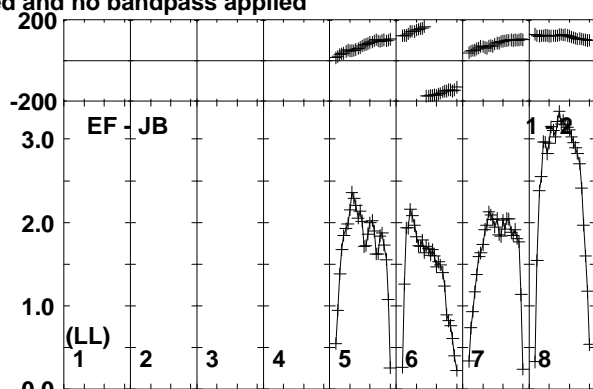
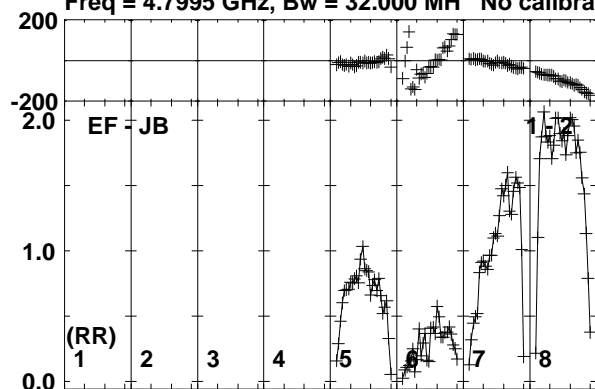

Lower frame: Milli Ampl Jy Top frame: Phas deg
Vector averaged cross-power spectrum Baseline: EF (01) - JB (02)
Timerange: 00:19:55:52 to 00:19:57:18

Plot file version 66 created 20-APR-2018 17:20:44
 J1419+2706 RSM02.UVDATA.1
 Freq = 4.7995 GHz, Bw = 32.000 MH No calibration applied and no bandpass applied

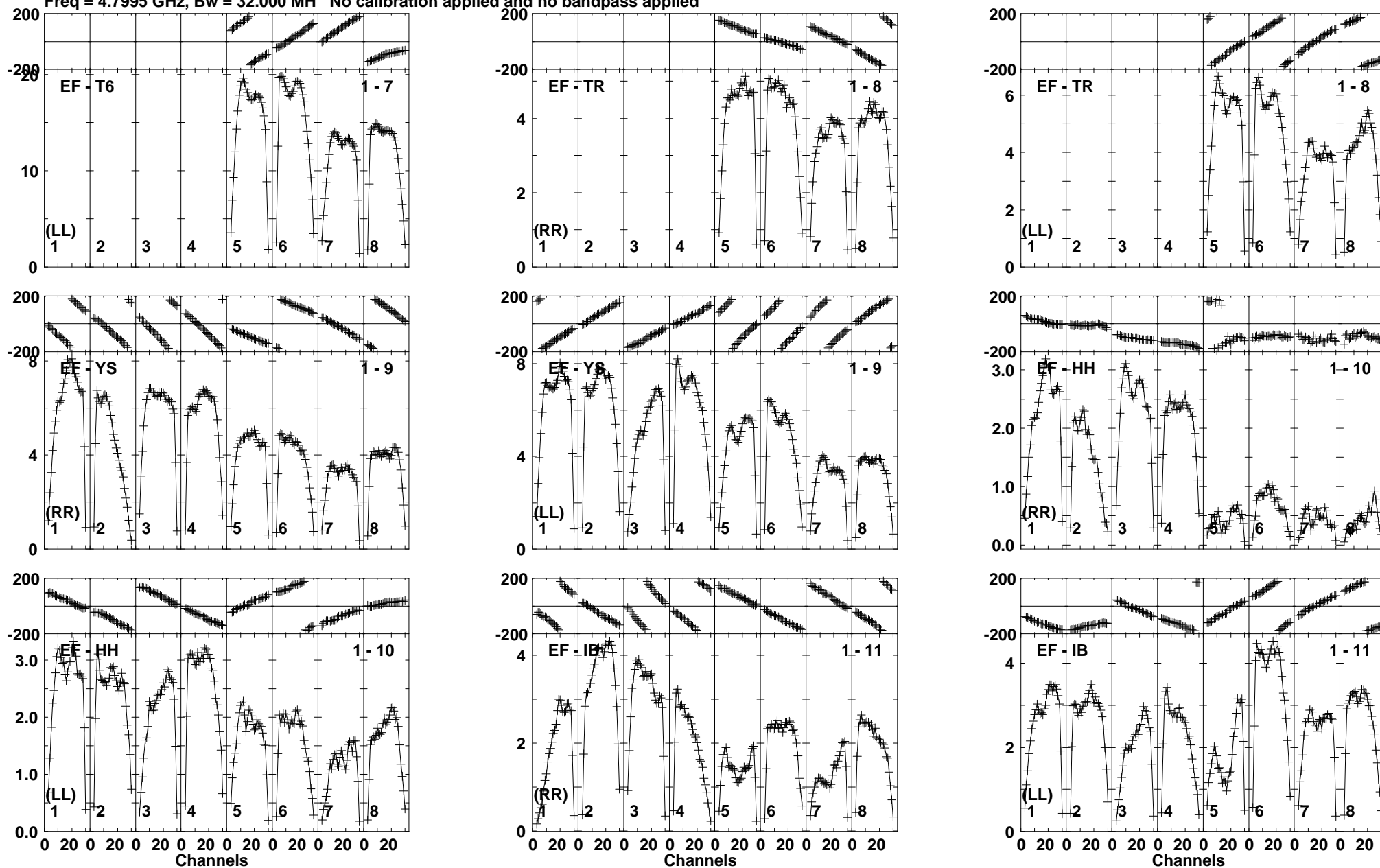

Lower frame: Milli Ampl Jy Top frame: Phas deg
 Vector averaged cross-power spectrum Baseline: EF (01) - T6 (07)
 Timerange: 00:19:55:52 to 00:19:57:18

Plot file version 67 created 20-APR-2018 17:20:44

J1427+2632 RSM02.UVDATA.1

Freq = 4.7995 GHz, Bw = 32.000 MH No calibration applied and no bandpass applied

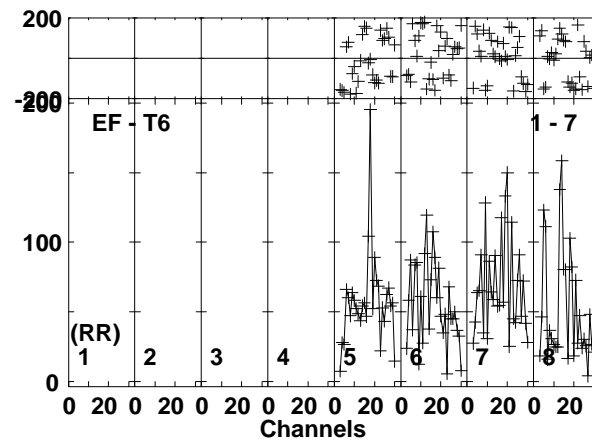
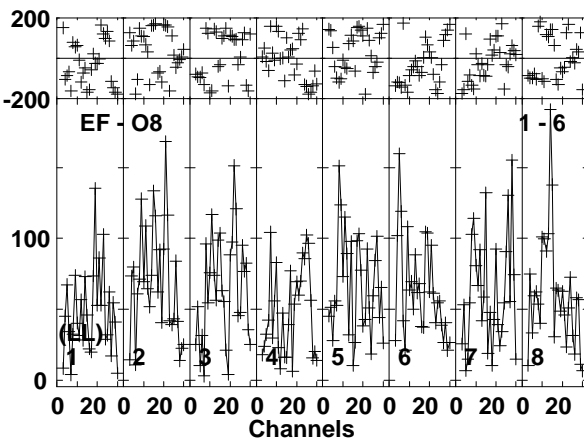
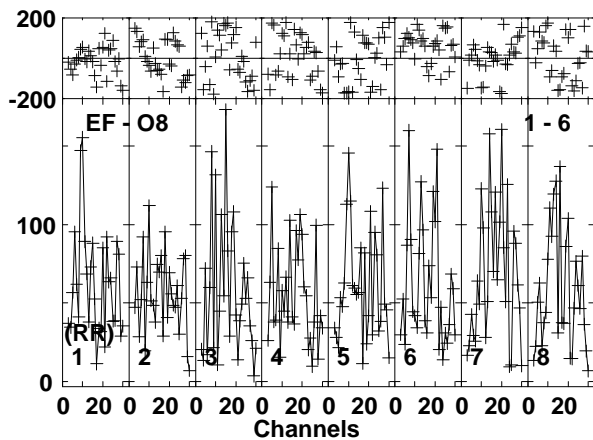
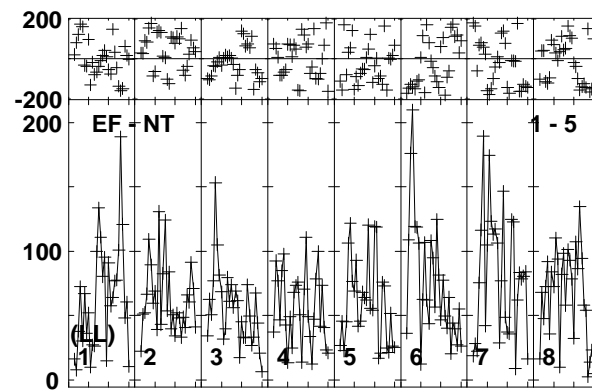
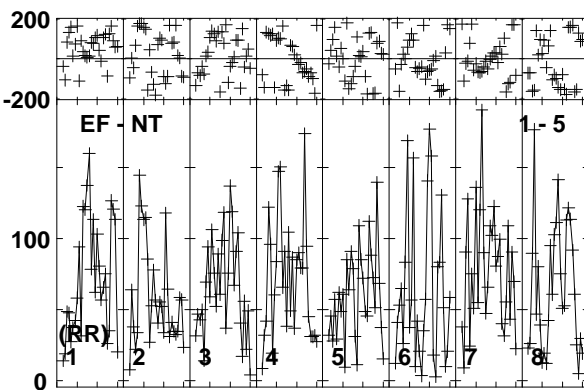
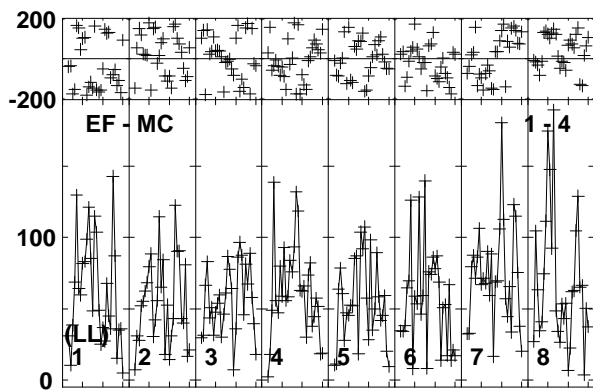
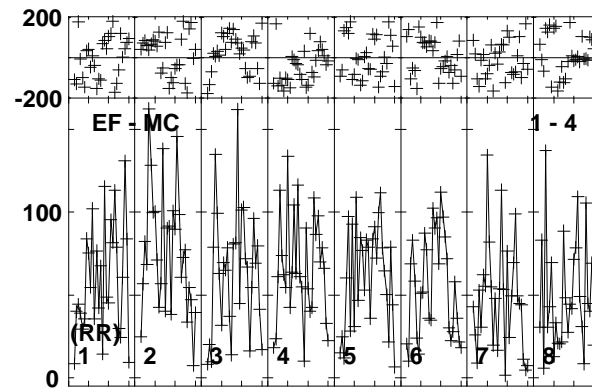
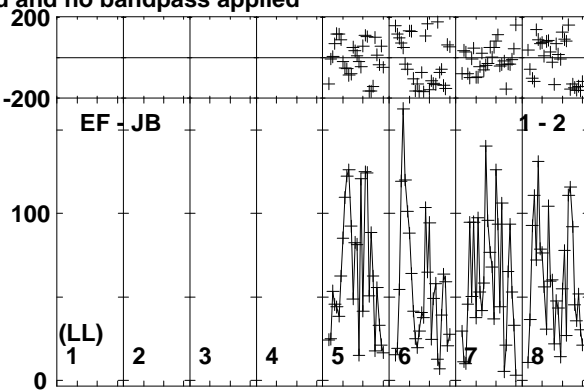
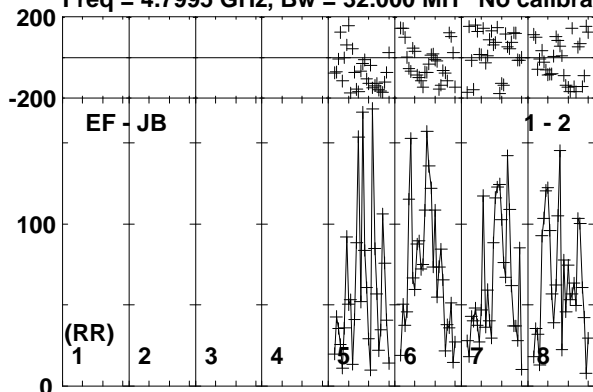

Lower frame: Micro Ampl Jy Top frame: Phas deg
Vector averaged cross-power spectrum Baseline: EF (01) - JB (02)
Timerange: 00/19:57:22 to 00/20:00:48

Plot file version 68 created 20-APR-2018 17:20:44

J1427+2632 RSM02.UVDATA.1

Freq = 4.7995 GHz, Bw = 32.000 MH No calibration applied and no bandpass applied

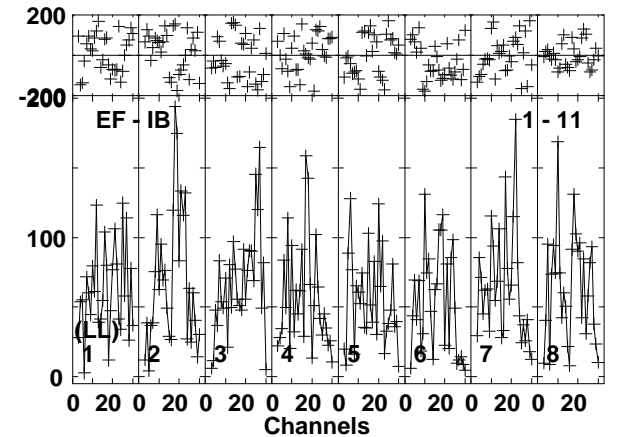
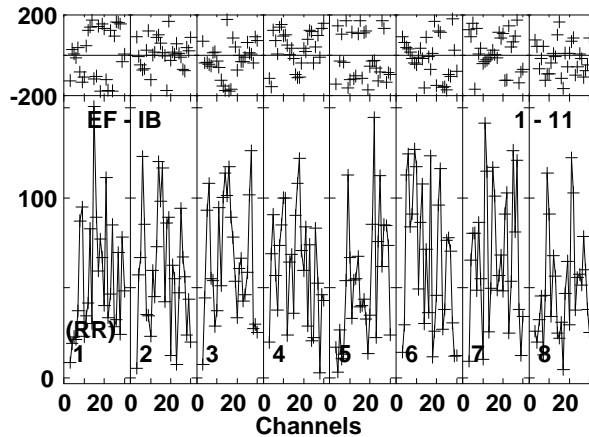
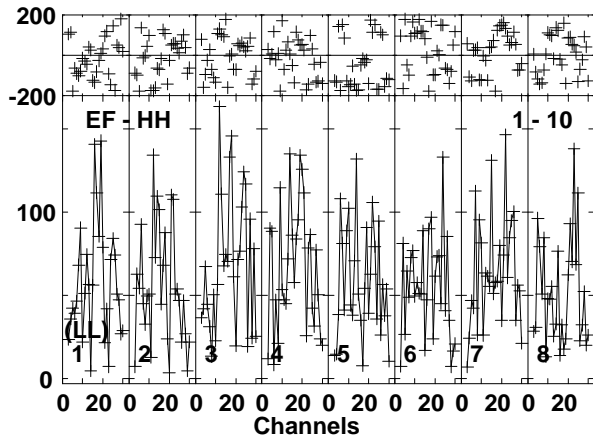
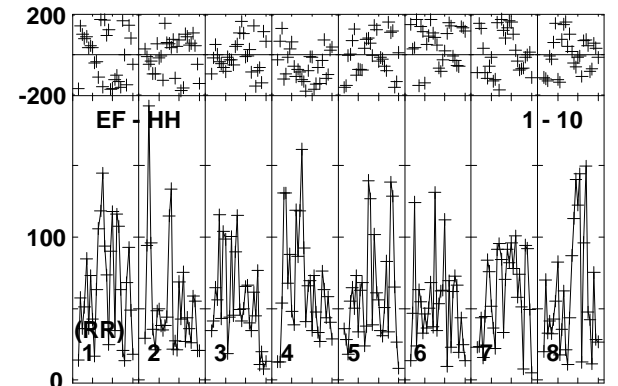
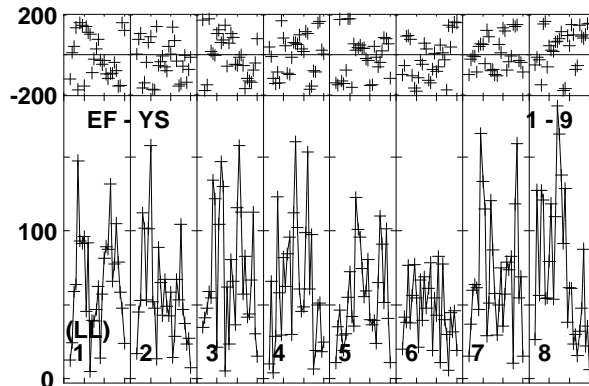
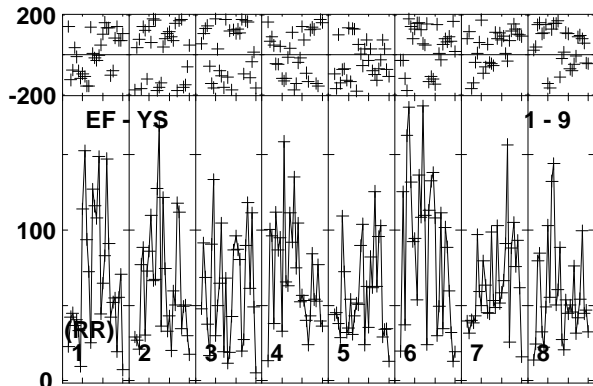
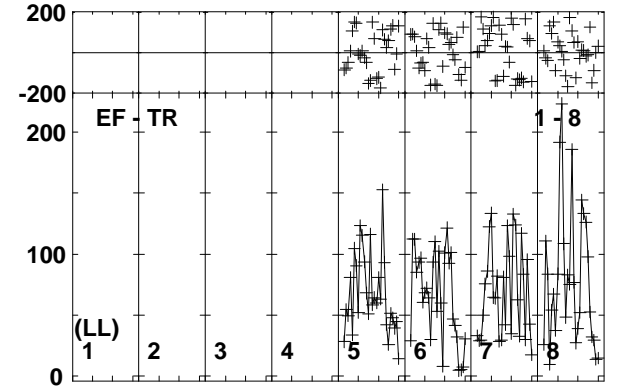
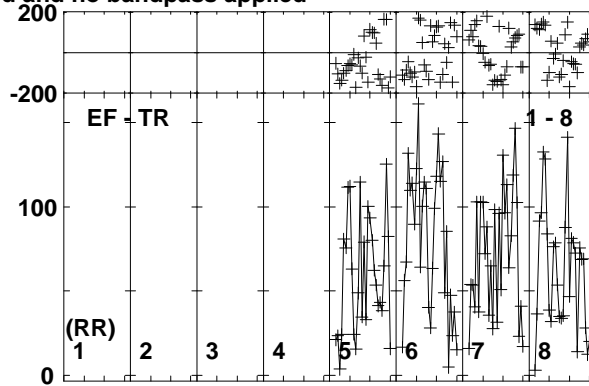
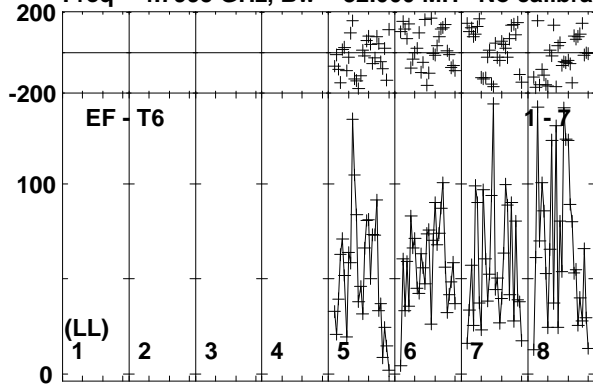

Lower frame: Micro Ampl Jy Top frame: Phas deg
Vector averaged cross-power spectrum Baseline: EF (01) - T6 (07)
Timerange: 00:19:57:22 to 00:20:00:48

Plot file version 69 created 20-APR-2018 17:20:44

J1419+2706 RSM02.UVDATA.1

Freq = 4.7995 GHz, Bw = 32.000 MH No calibration applied and no bandpass applied

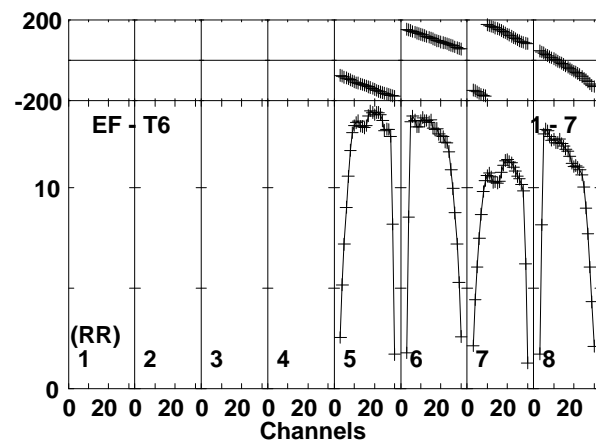
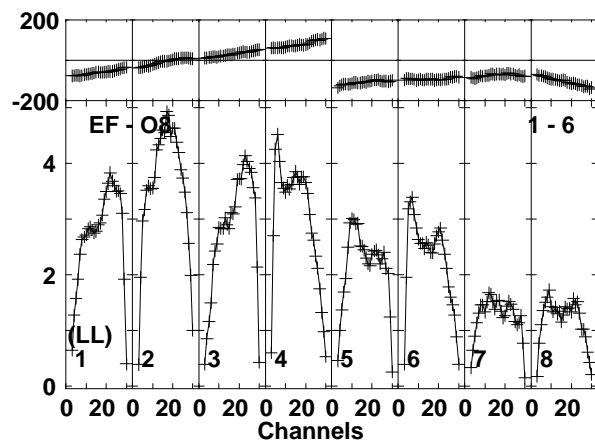
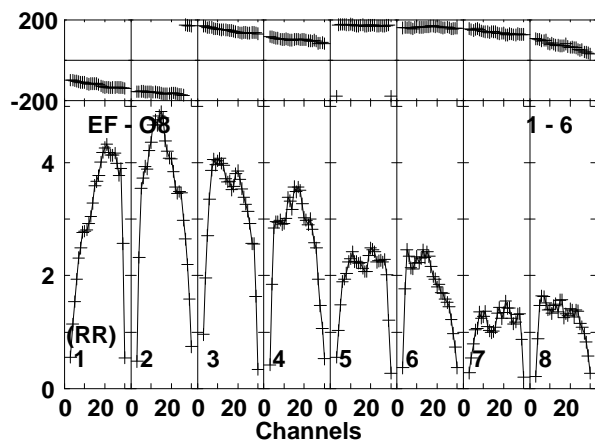
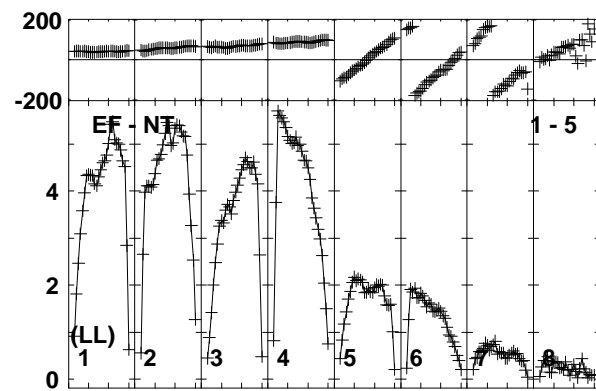
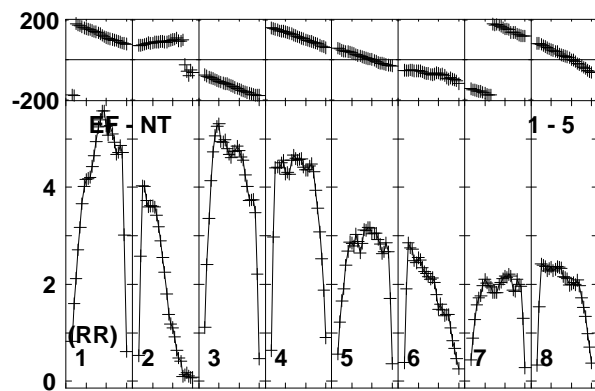
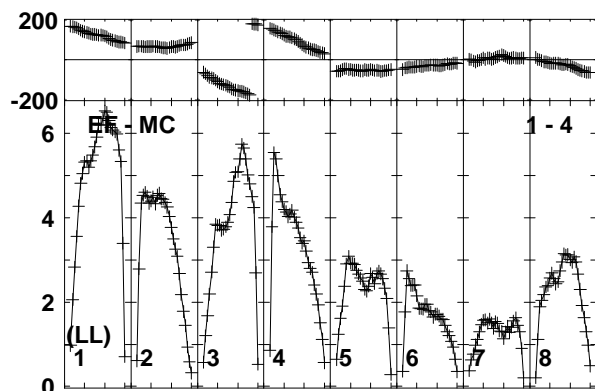
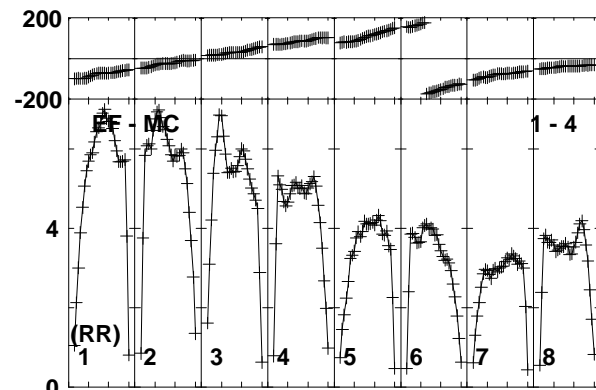
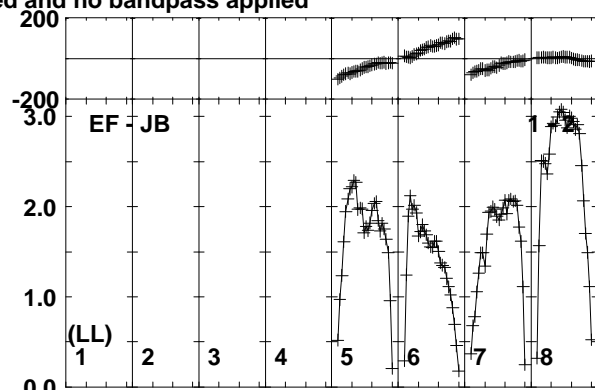
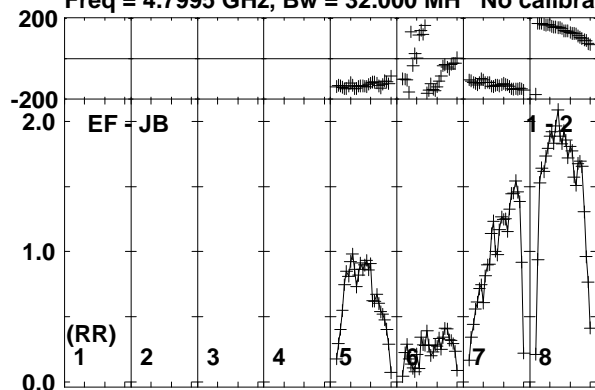

Lower frame: Milli Ampl Jy Top frame: Phas deg
Vector averaged cross-power spectrum Baseline: EF (01) - JB (02)
Timerange: 00/20:00:52 to 00/20:02:18

Plot file version 70 created 20-APR-2018 17:20:45
 J1419+2706 RSM02.UVDATA.1
 Freq = 4.7995 GHz, Bw = 32.000 MH No calibration applied and no bandpass applied

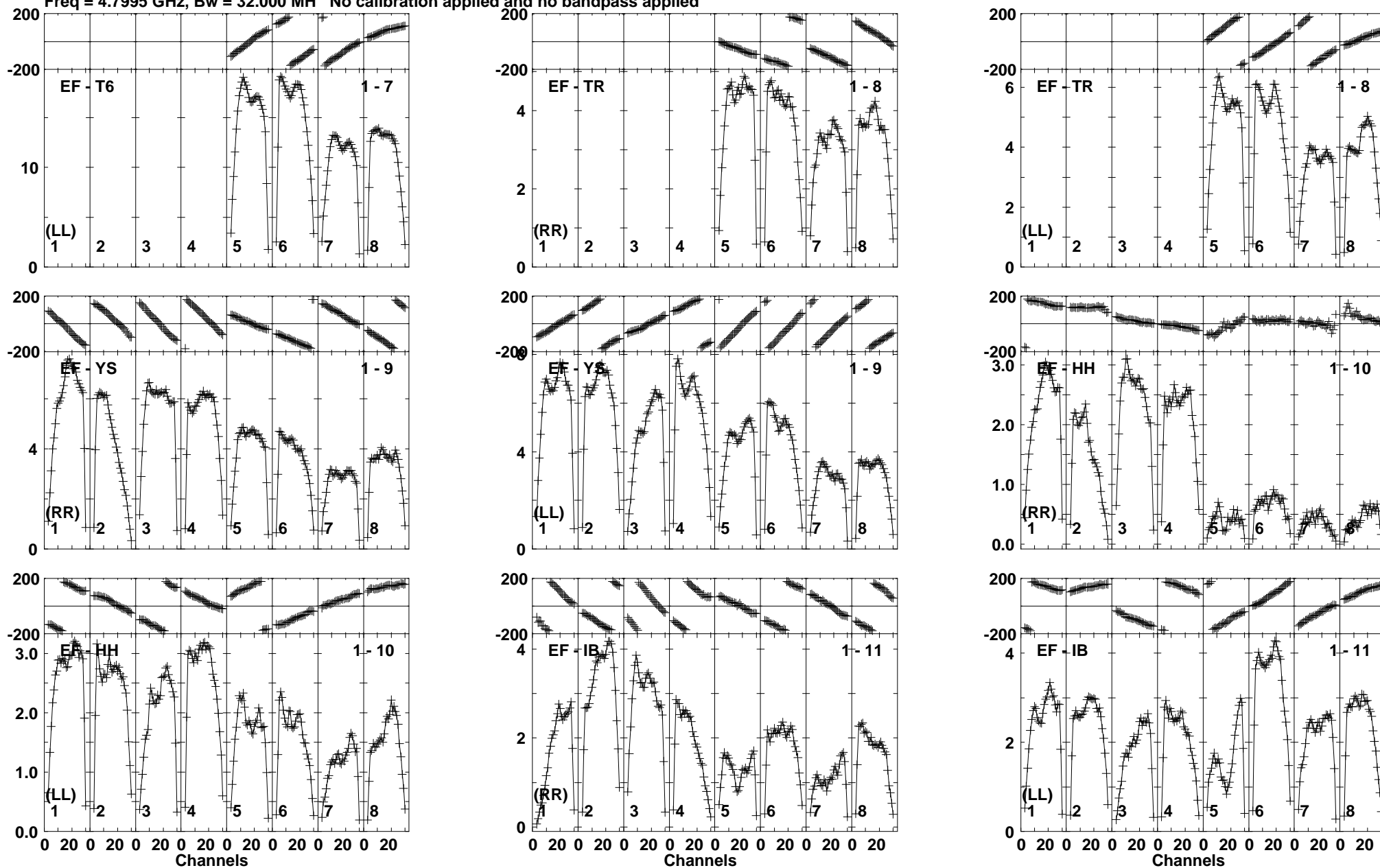

Lower frame: Milli Ampl Jy Top frame: Phas deg
 Vector averaged cross-power spectrum Baseline: EF (01) - T6 (07)
 Timerange: 00/20:00:52 to 00/20:02:18

Plot file version 71 created 20-APR-2018 17:20:45

J1427+2632 RSM02.UVDATA.1

Freq = 4.7995 GHz, Bw = 32.000 MH No calibration applied and no bandpass applied

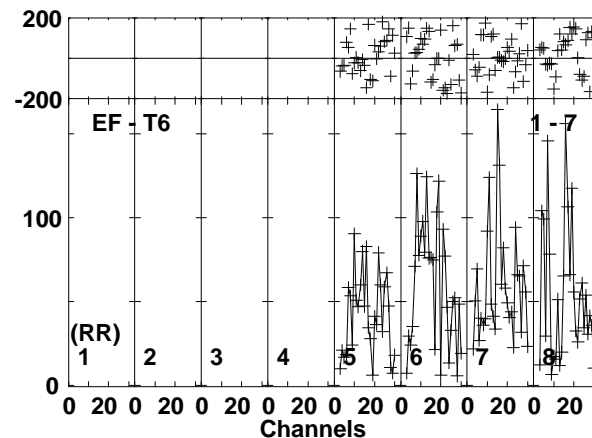
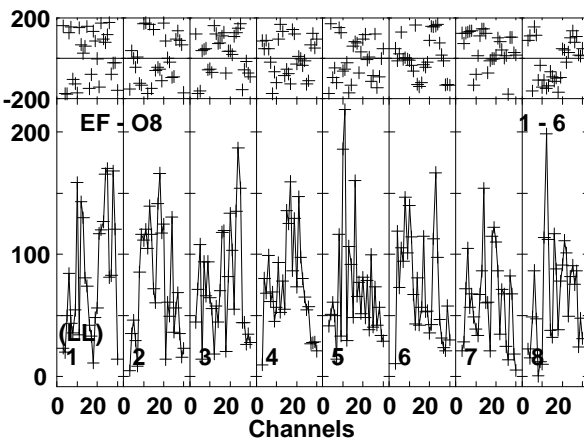
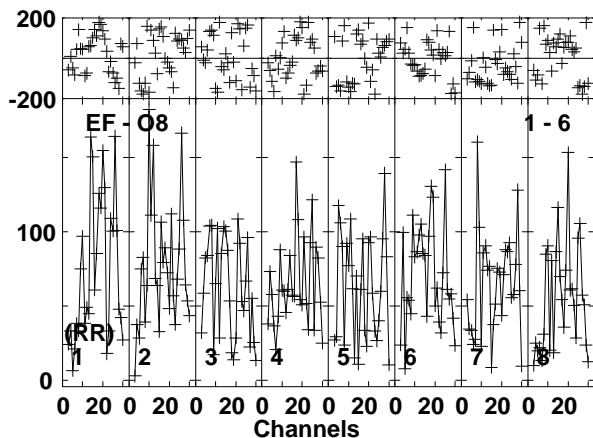
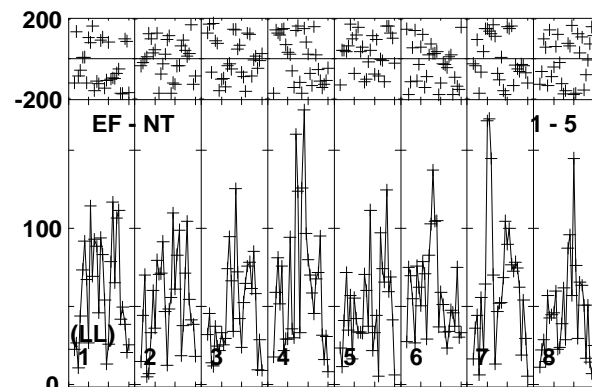
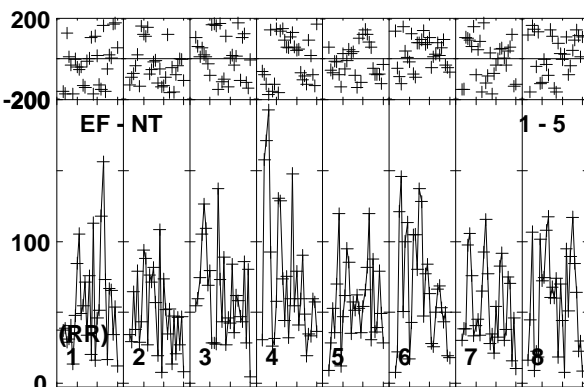
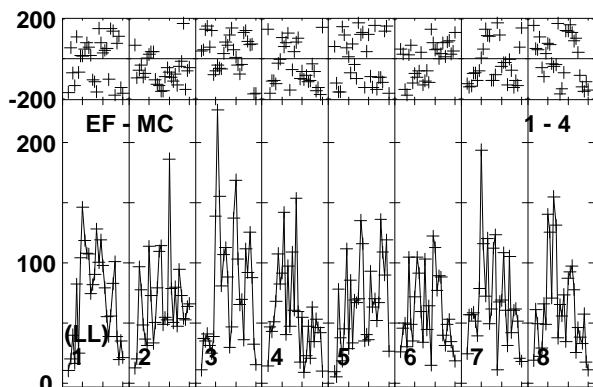
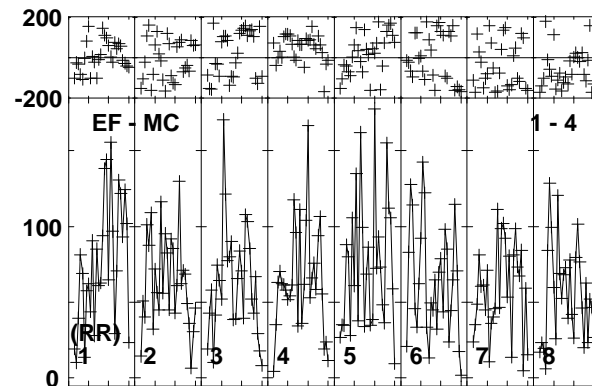
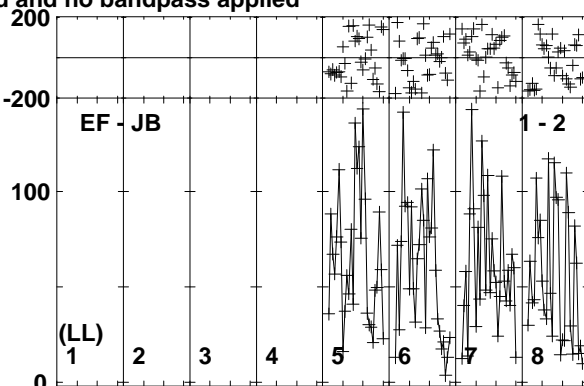
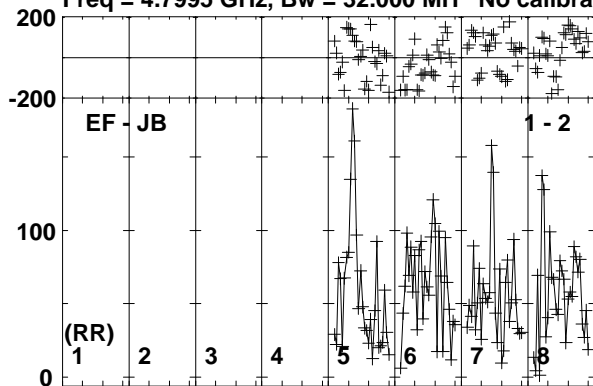

Lower frame: Micro Ampl Jy Top frame: Phas deg
Vector averaged cross-power spectrum Baseline: EF (01) - JB (02)
Timerange: 00/20:02:22 to 00/20:05:48

Plot file version 72 created 20-APR-2018 17:20:45

J1427+2632 RSM02.UVDATA.1

Freq = 4.7995 GHz, Bw = 32.000 MH No calibration applied and no bandpass applied

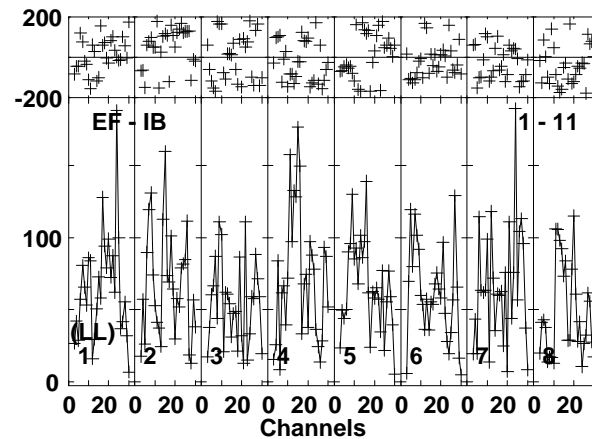
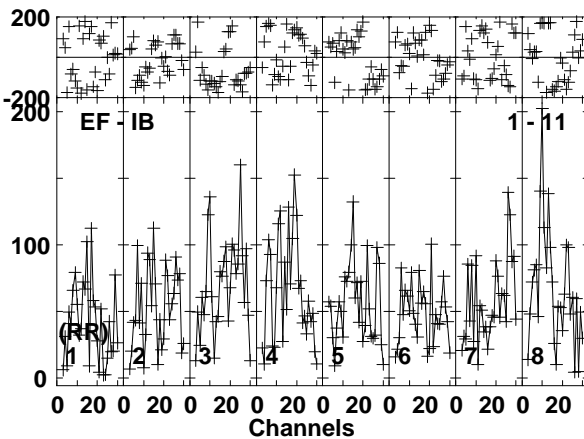
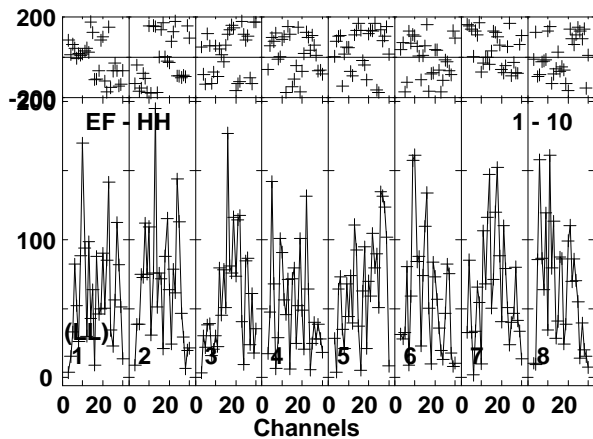
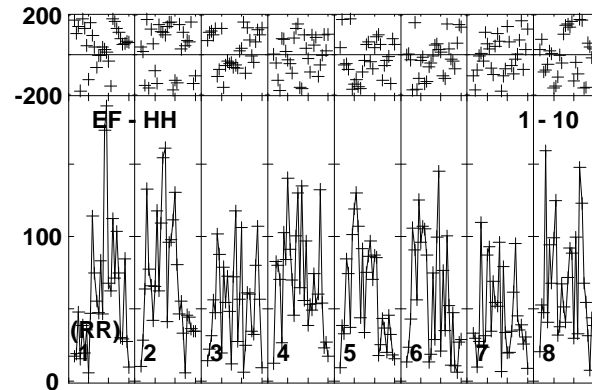
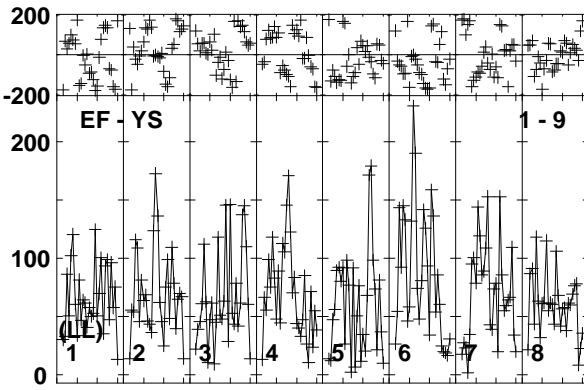
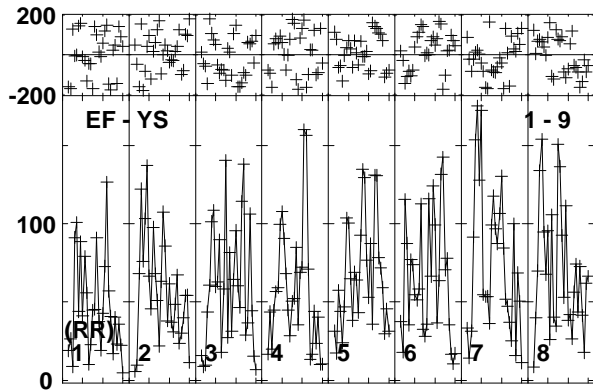
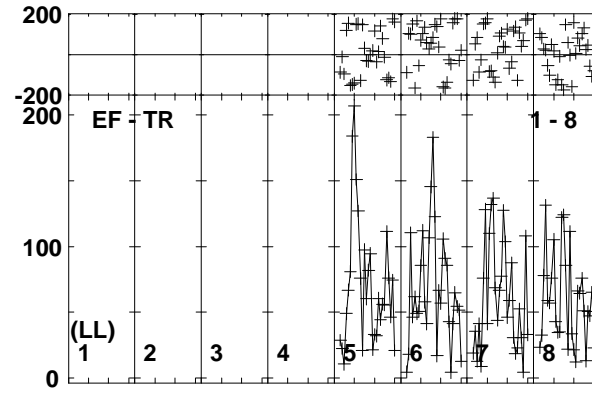
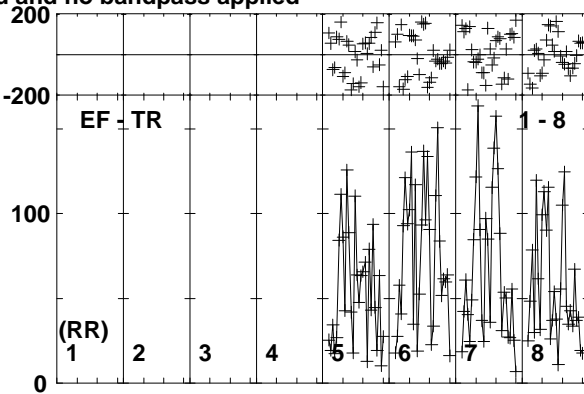
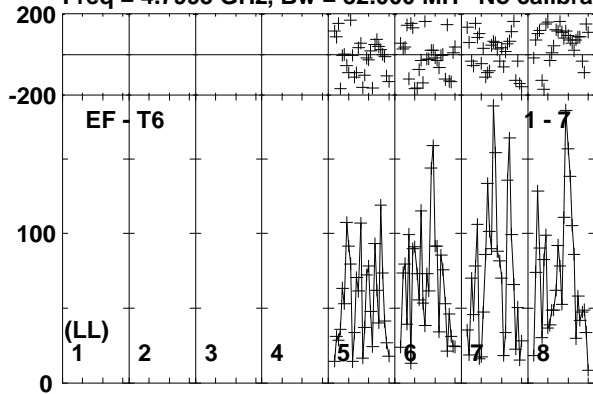

Lower frame: Micro Ampl Jy Top frame: Phas deg
Vector averaged cross-power spectrum Baseline: EF (01) - T6 (07)
Timerange: 00/20:02:22 to 00/20:05:48

Plot file version 73 created 20-APR-2018 17:20:45

J1419+2706 RSM02.UVDATA.1

Freq = 4.7995 GHz, Bw = 32.000 MH No calibration applied and no bandpass applied

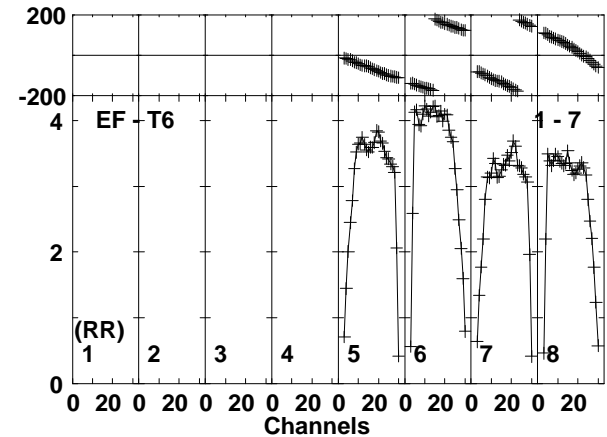
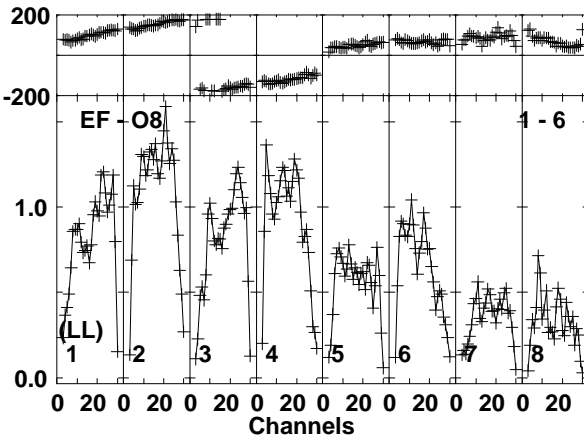
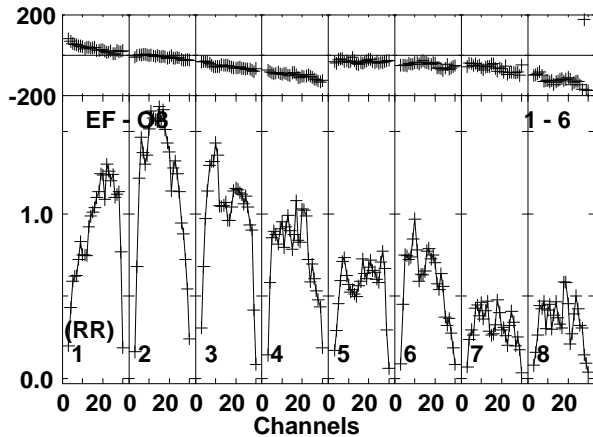
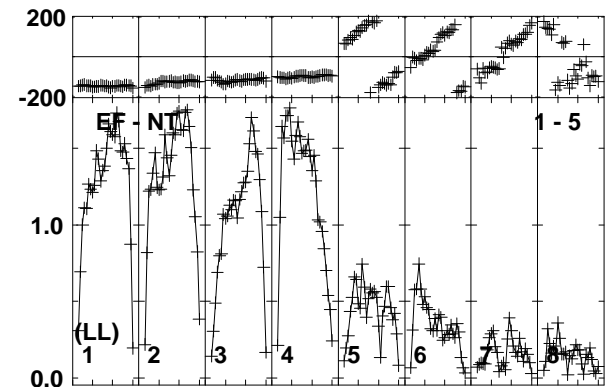
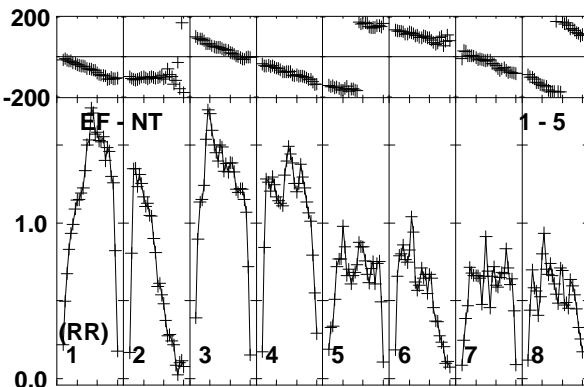
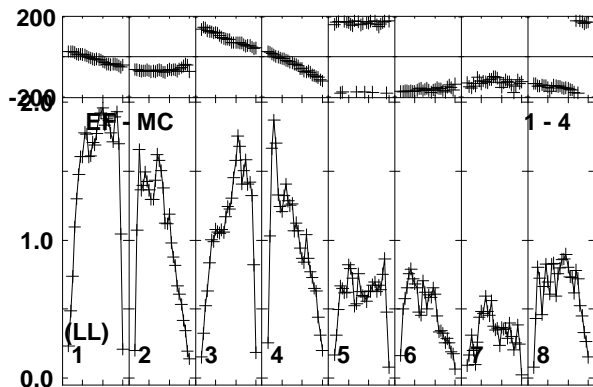
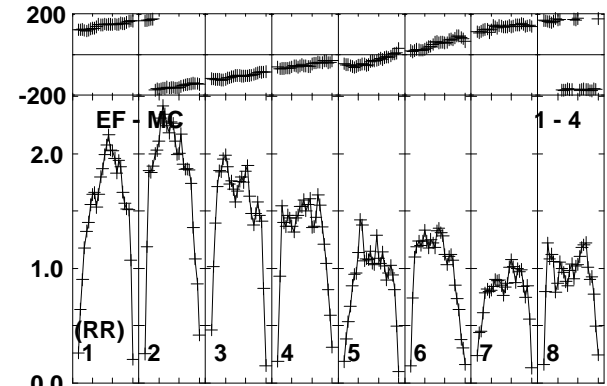
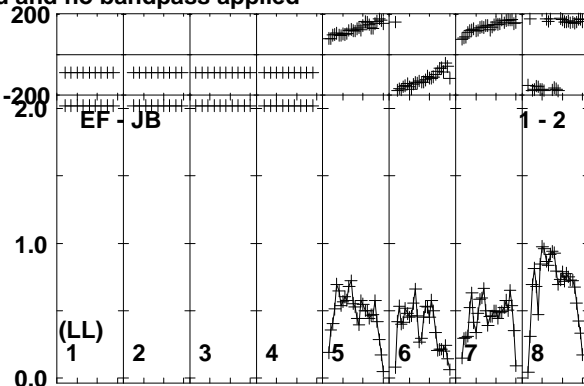
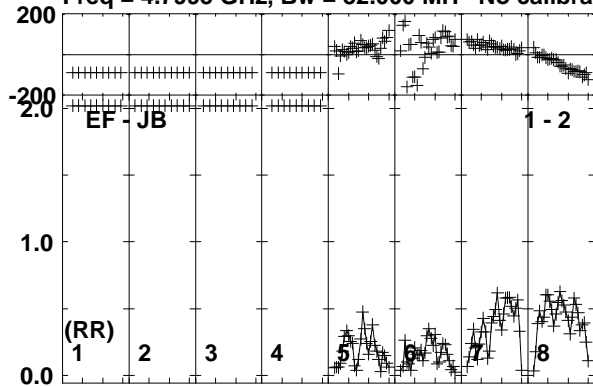

Lower frame: Milli Ampl Jy Top frame: Phas deg
Vector averaged cross-power spectrum Baseline: EF (01) - JB (02)
Timerange: 00/20:06:32 to 00/20:07:28

Plot file version 74 created 20-APR-2018 17:20:45

J1419+2706 RSM02.UVDATA.1

Freq = 4.7995 GHz, Bw = 32.000 MH No calibration applied and no bandpass applied

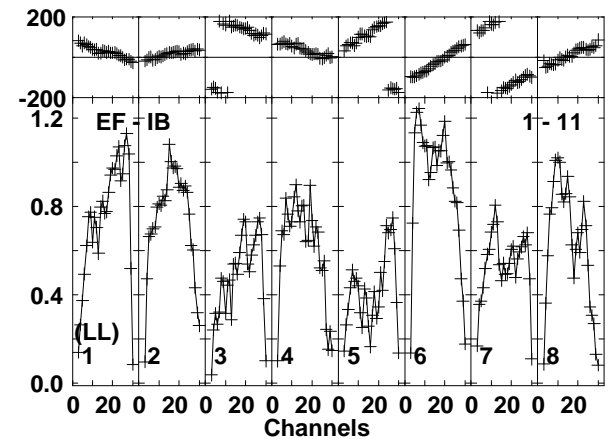
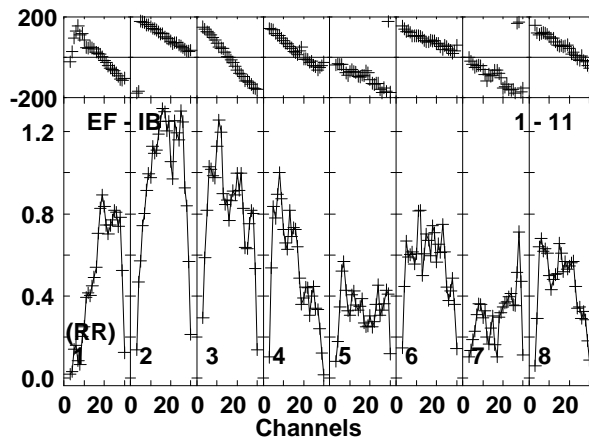
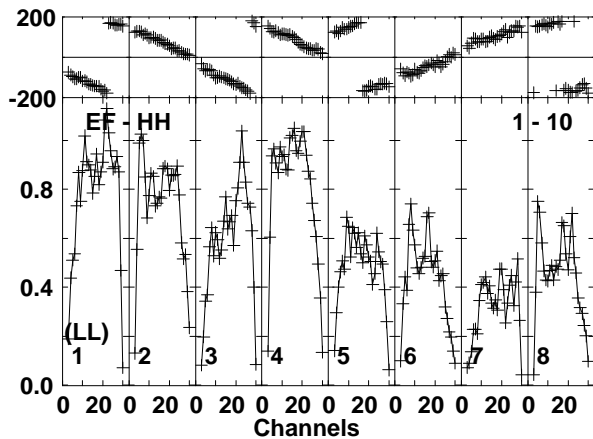
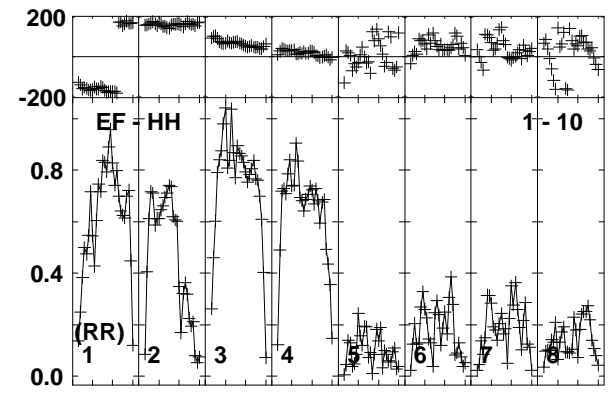
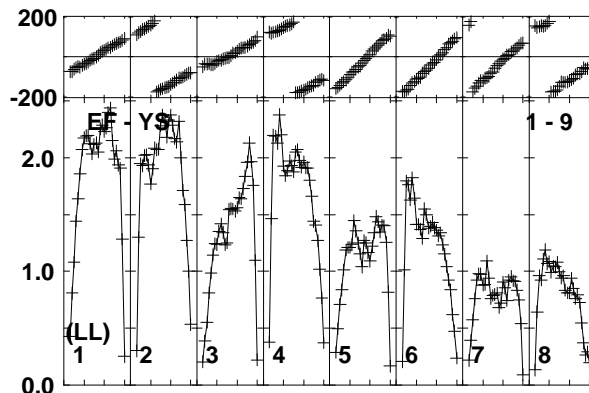
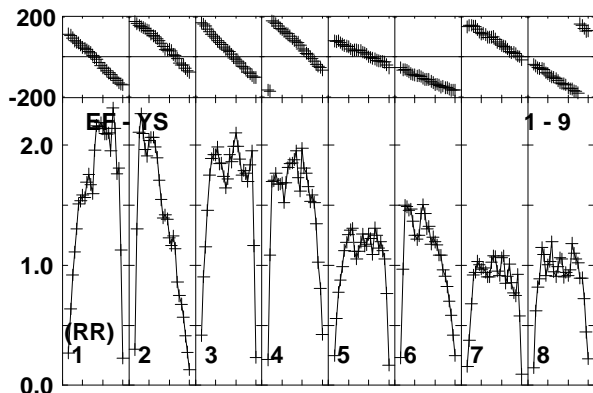
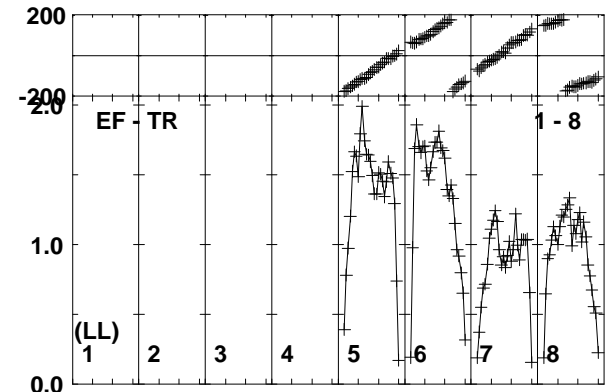
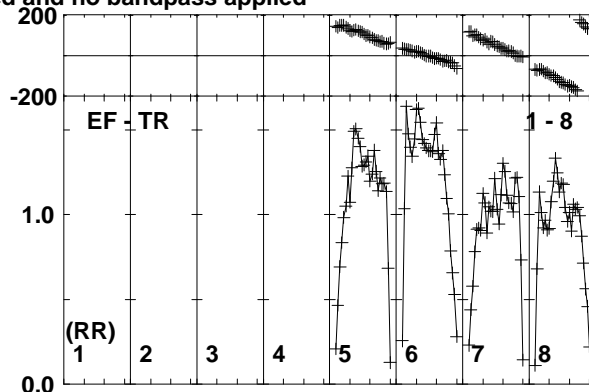
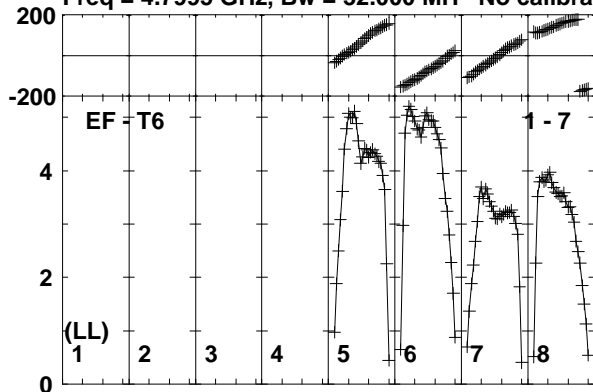

Lower frame: Milli Ampl Jy Top frame: Phas deg
Vector averaged cross-power spectrum Baseline: EF (01) - T6 (07)
Timerange: 00/20:06:32 to 00/20:07:28

Plot file version 75 created 20-APR-2018 17:20:45

J1427+2632 RSM02.UVDATA.1

Freq = 4.7995 GHz, Bw = 32.000 MH No calibration applied and no bandpass applied

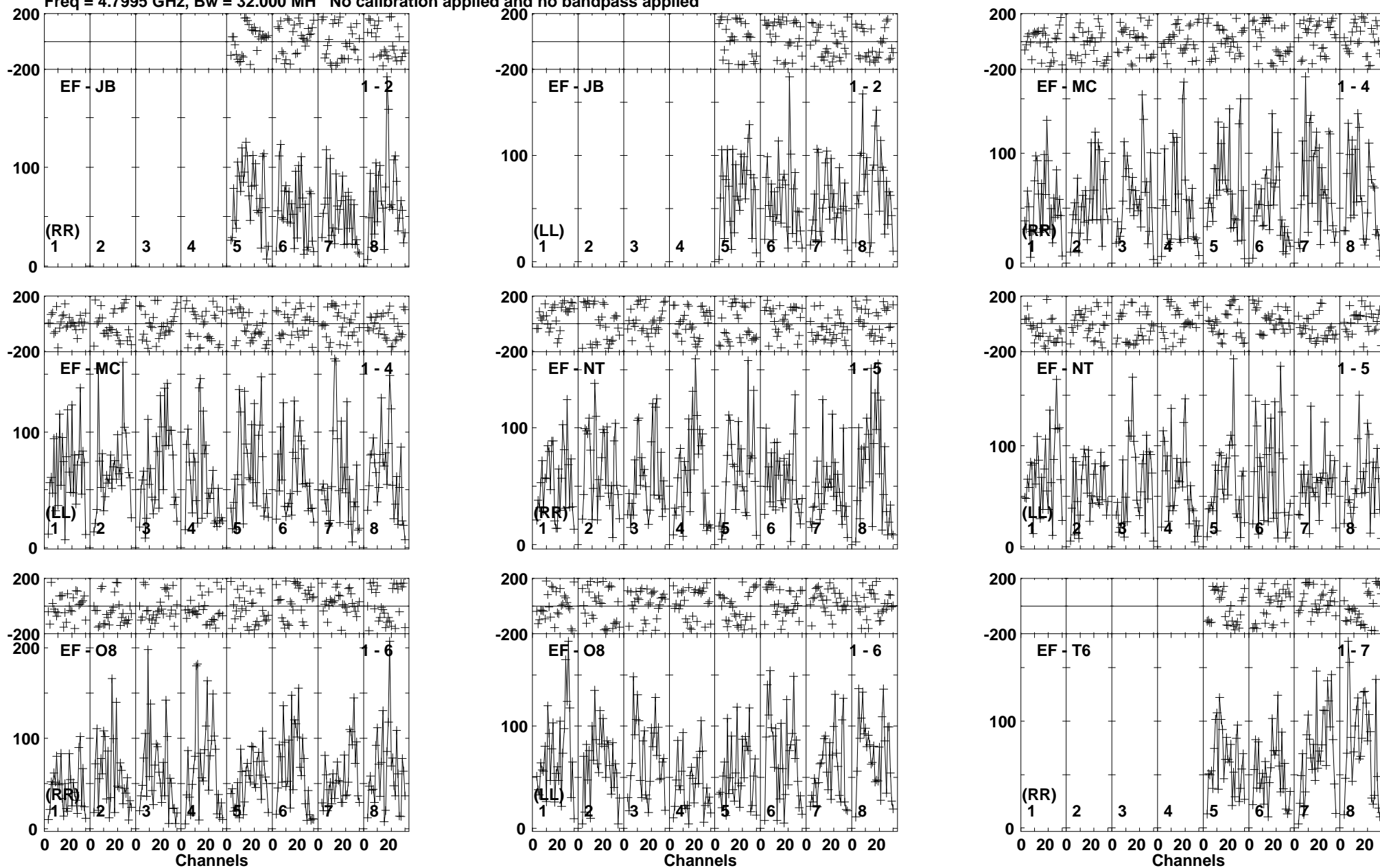

Lower frame: Micro Ampl Jy Top frame: Phas deg
Vector averaged cross-power spectrum Baseline: EF (01) - JB (02)
Timerange: 00/20:07:32 to 00/20:10:58

Plot file version 76 created 20-APR-2018 17:20:45

J1427+2632 RSM02.UVDATA.1

Freq = 4.7995 GHz, Bw = 32.000 MH No calibration applied and no bandpass applied

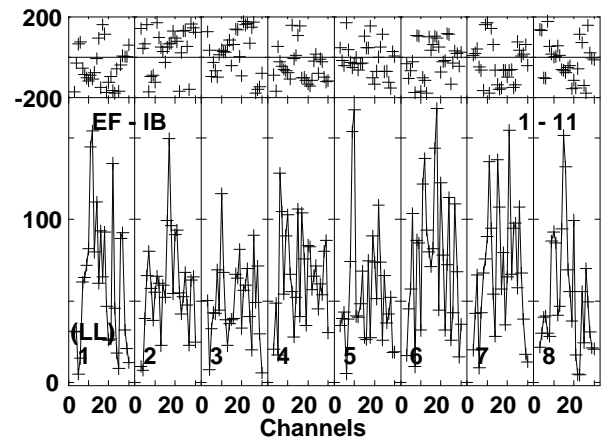
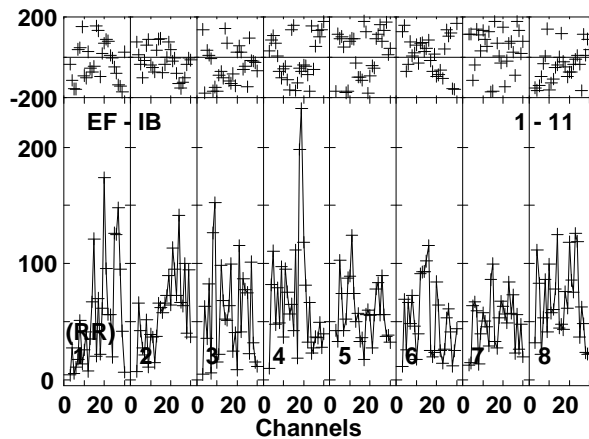
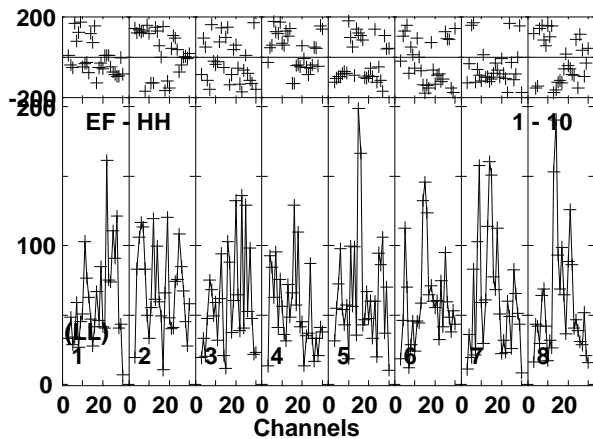
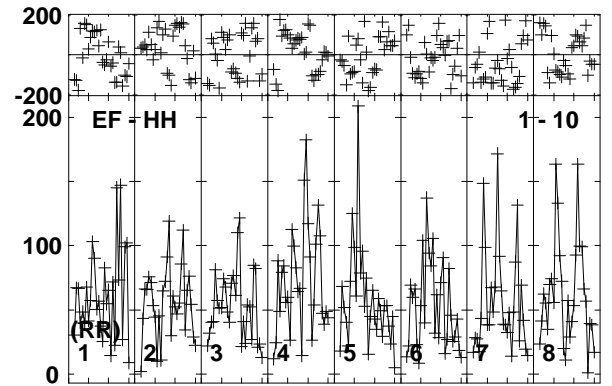
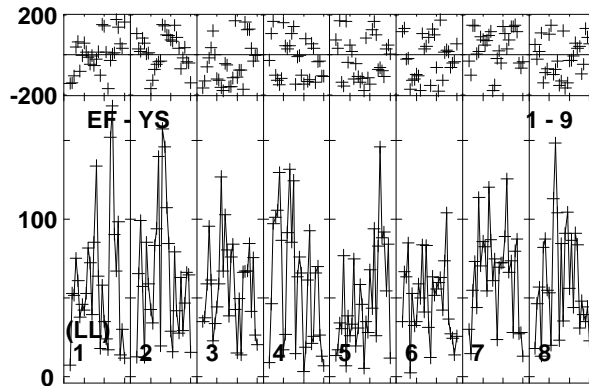
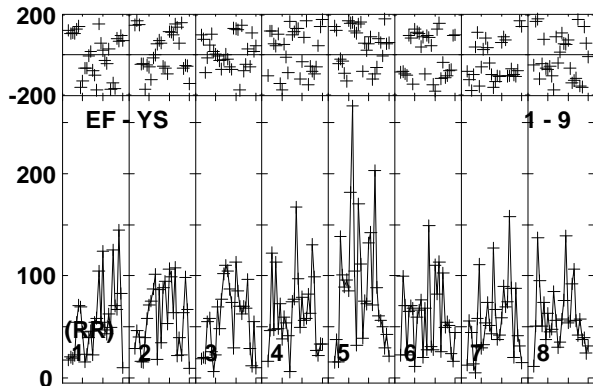
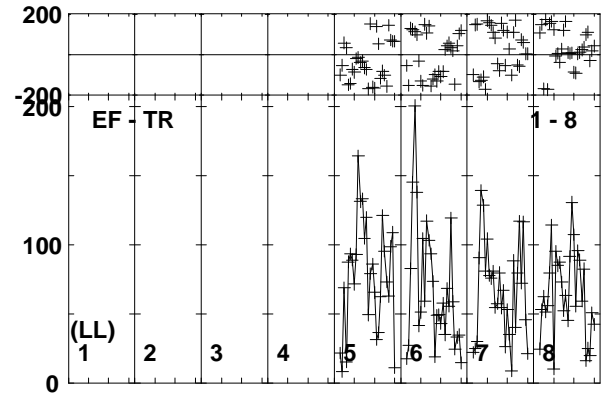
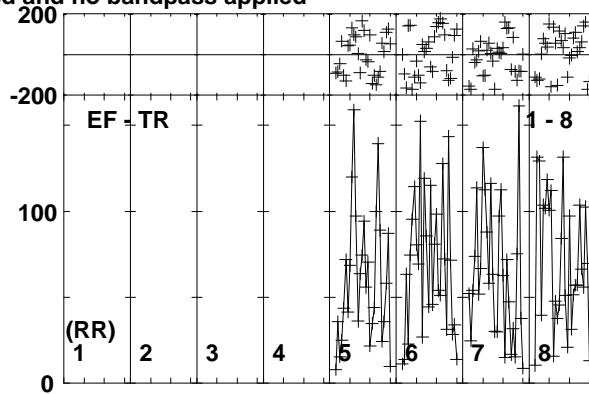
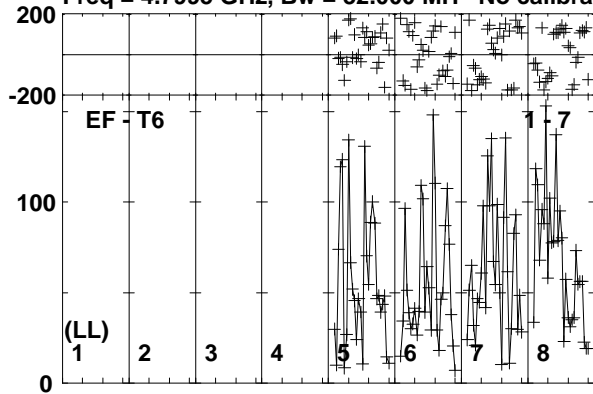

Lower frame: Micro Ampl Jy Top frame: Phas deg
Vector averaged cross-power spectrum Baseline: EF (01) - T6 (07)
Timerange: 00/20:07:32 to 00/20:10:58

Plot file version 77 created 20-APR-2018 17:20:45

J1419+2706 RSM02.UVDATA.1

Freq = 4.7995 GHz, Bw = 32.000 MH No calibration applied and no bandpass applied

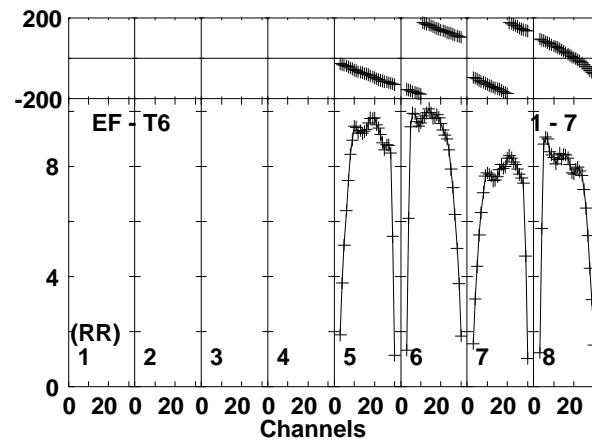
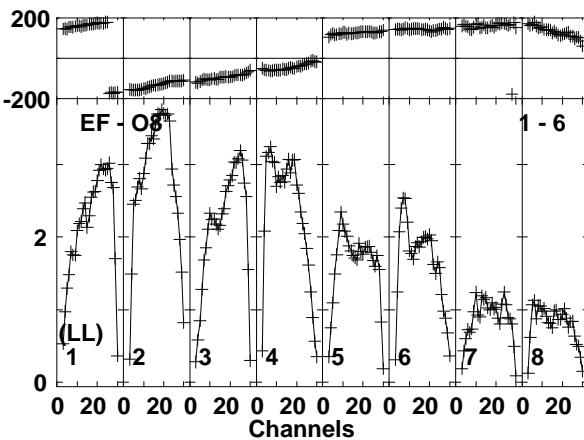
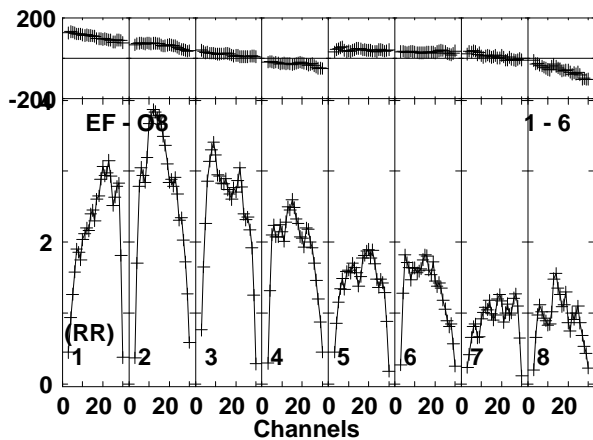
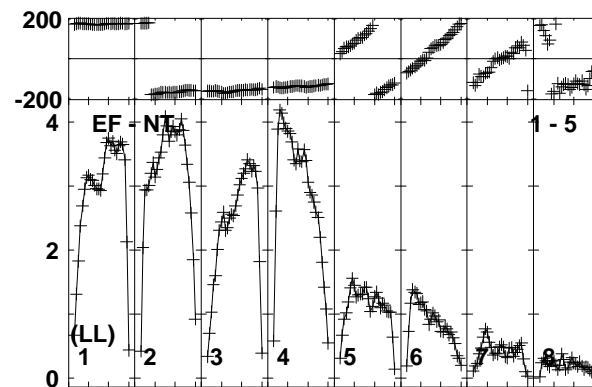
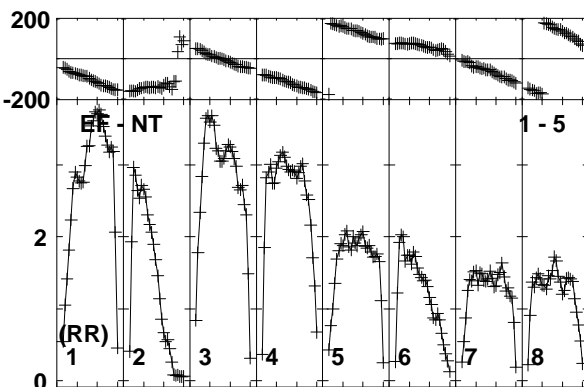
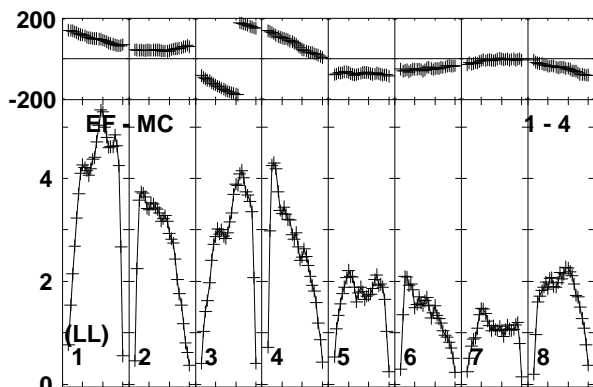
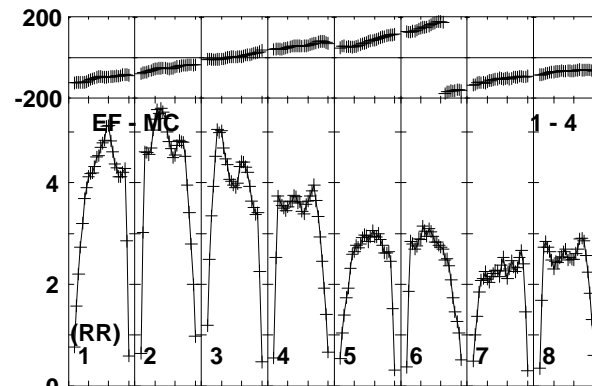
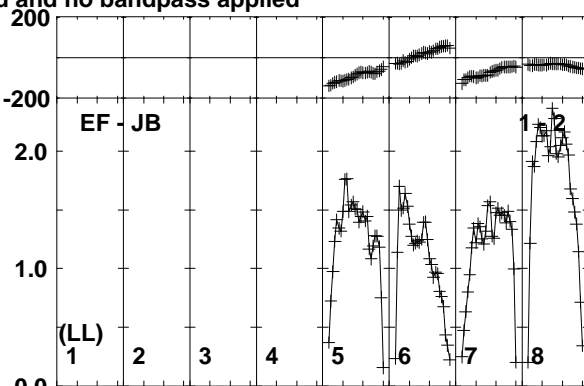
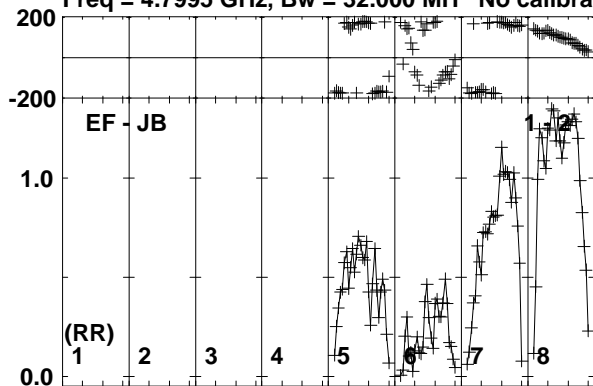

Lower frame: Milli Ampl Jy Top frame: Phas deg
Vector averaged cross-power spectrum Baseline: EF (01) - JB (02)
Timerange: 00/20:11:02 to 00/20:12:28

Plot file version 78 created 20-APR-2018 17:20:45
 J1419+2706 RSM02.UVDATA.1
 Freq = 4.7995 GHz, Bw = 32.000 MH No calibration applied and no bandpass applied

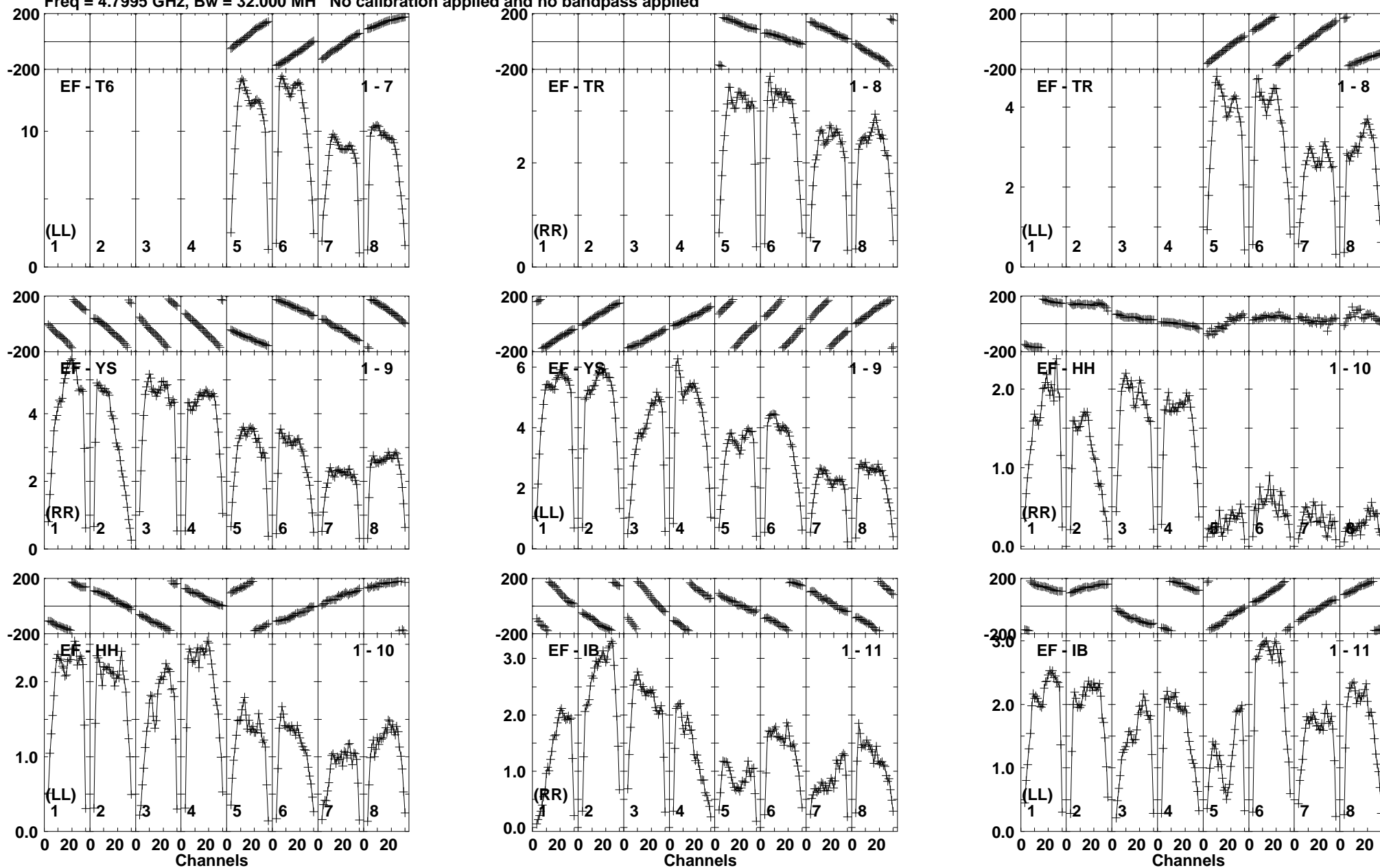

Lower frame: Milli Ampl Jy Top frame: Phas deg
 Vector averaged cross-power spectrum Baseline: EF (01) - T6 (07)
 Timerange: 00/20:11:02 to 00/20:12:28

Plot file version 80 created 20-APR-2018 17:20:46

J1427+2632 RSM02.UVDATA.1

Freq = 4.7995 GHz, Bw = 32.000 MH No calibration applied and no bandpass applied

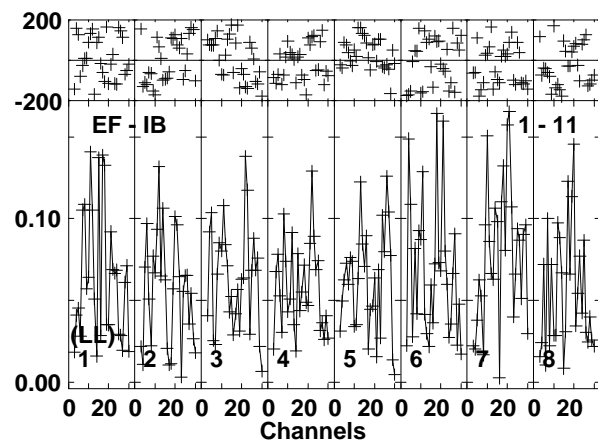
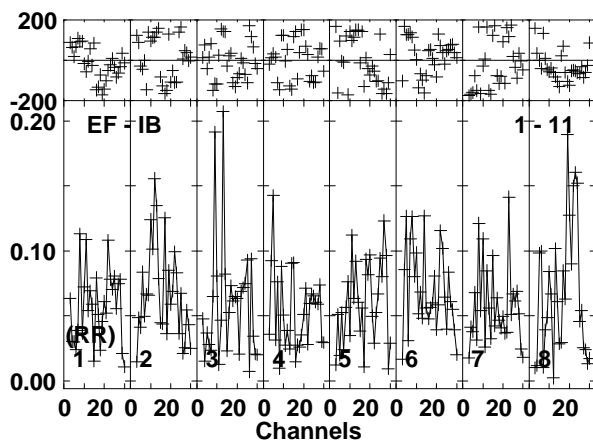
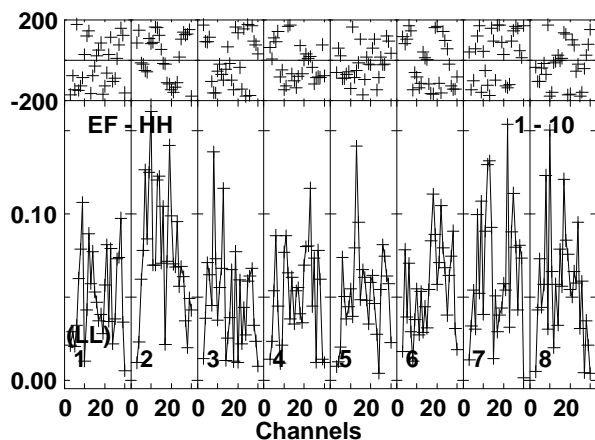
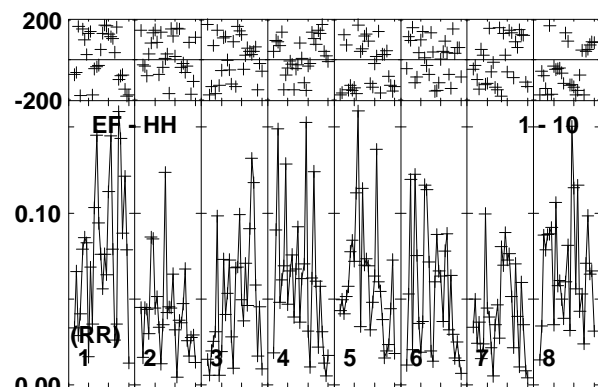
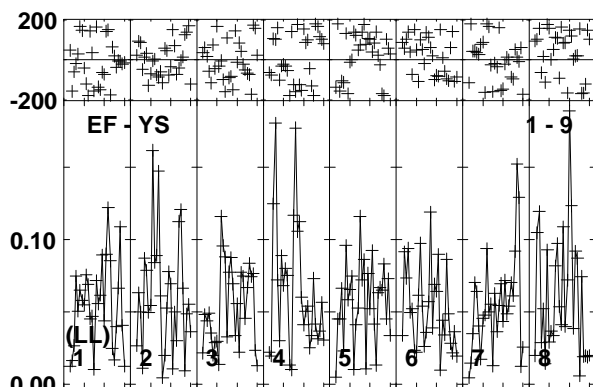
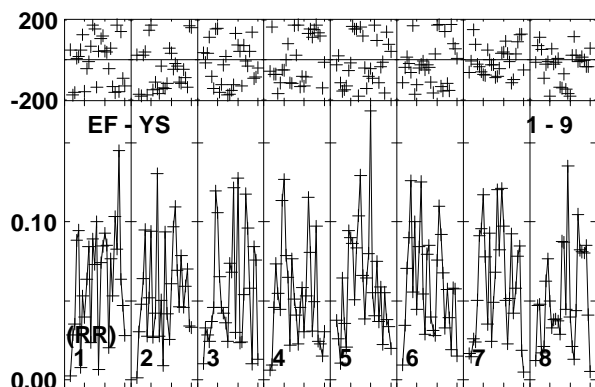
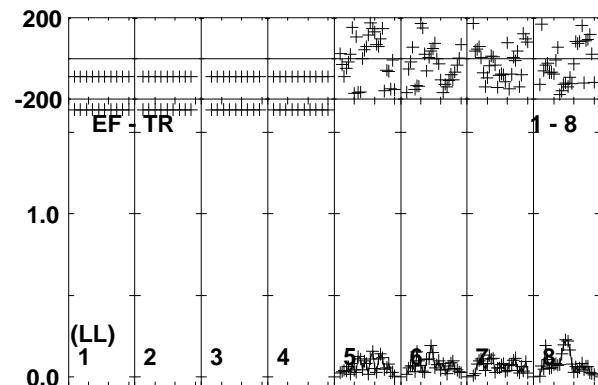
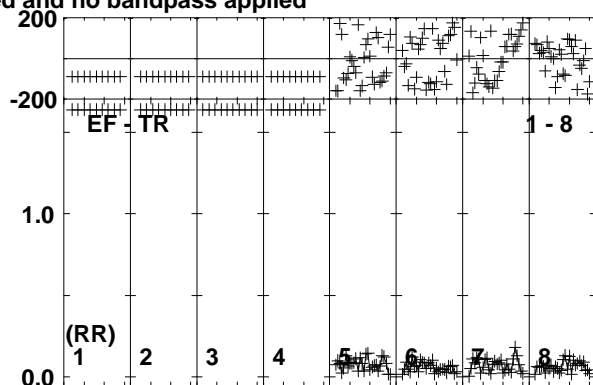
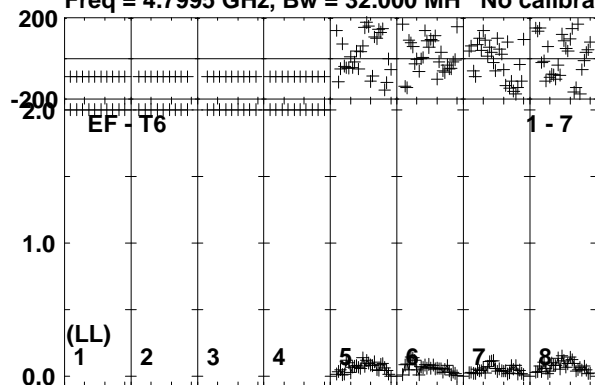

Lower frame: Milli Ampl Jy Top frame: Phas deg
Vector averaged cross-power spectrum Baseline: EF (01) - T6 (07)
Timerange: 00/20:12:32 to 00/20:15:58

Plot file version 81 created 20-APR-2018 17:20:46

J1419+2706 RSM02.UVDATA.1

Freq = 4.7995 GHz, Bw = 32.000 MH No calibration applied and no bandpass applied

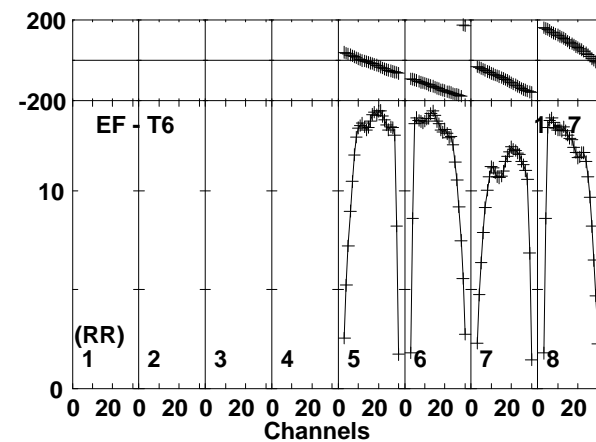
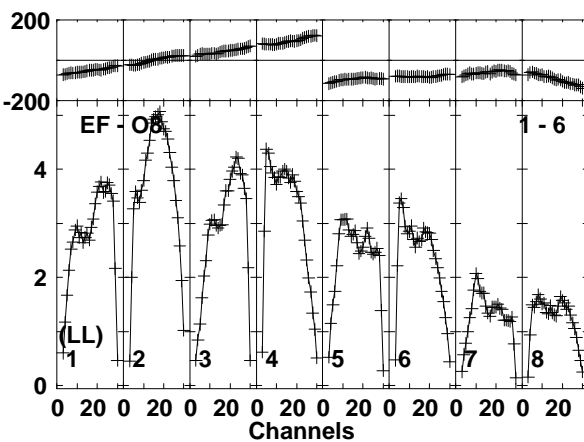
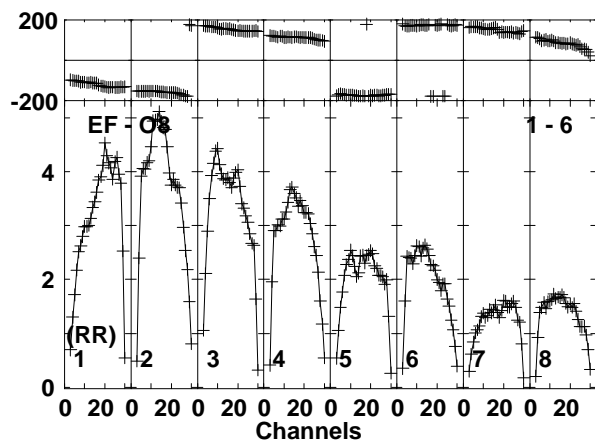
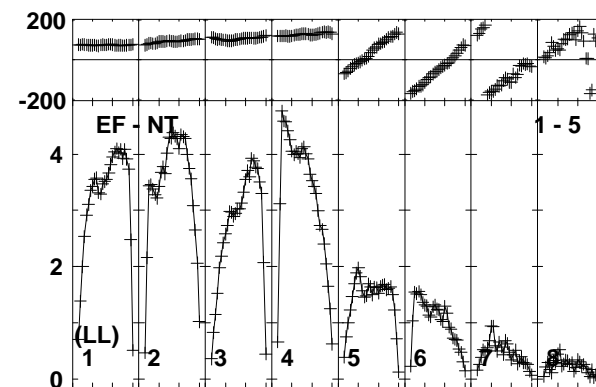
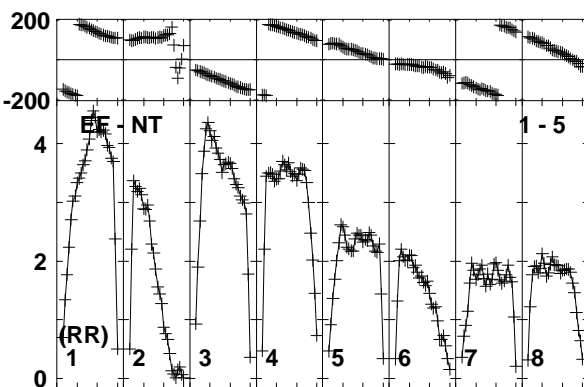
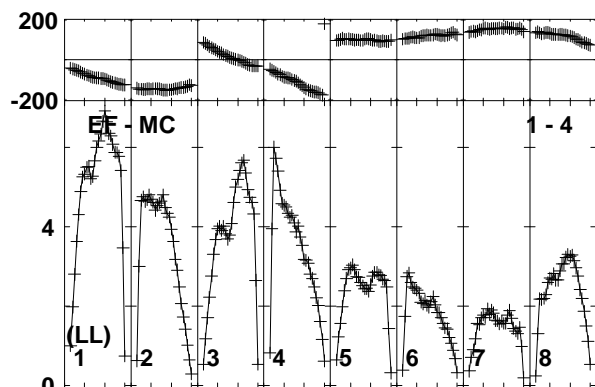
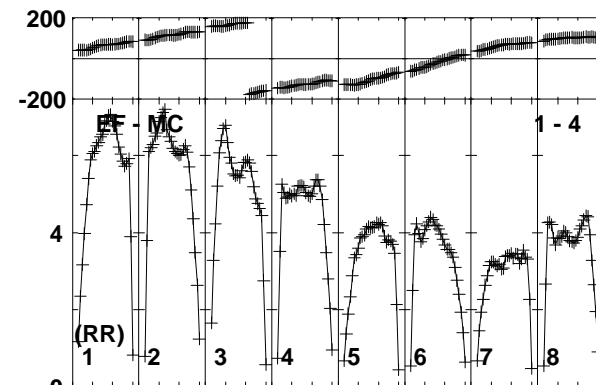
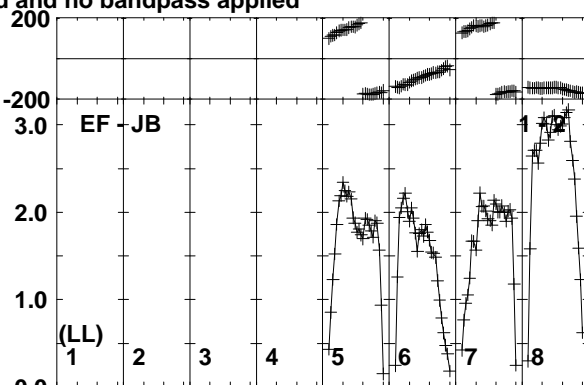
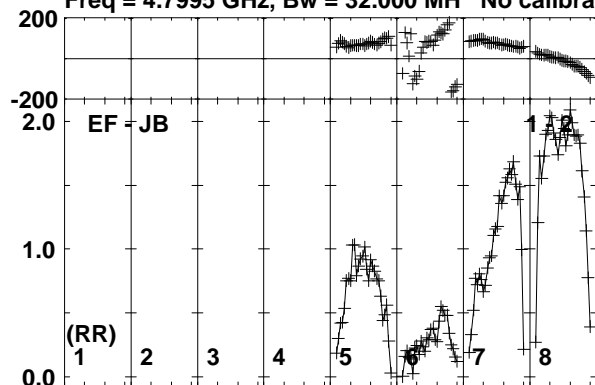

Lower frame: Milli Ampl Jy Top frame: Phas deg
Vector averaged cross-power spectrum Baseline: EF (01) - JB (02)
Timerange: 00/20:16:02 to 00/20:17:28

Plot file version 82 created 20-APR-2018 17:20:46
 J1419+2706 RSM02.UVDATA.1
 Freq = 4.7995 GHz, Bw = 32.000 MH No calibration applied and no bandpass applied

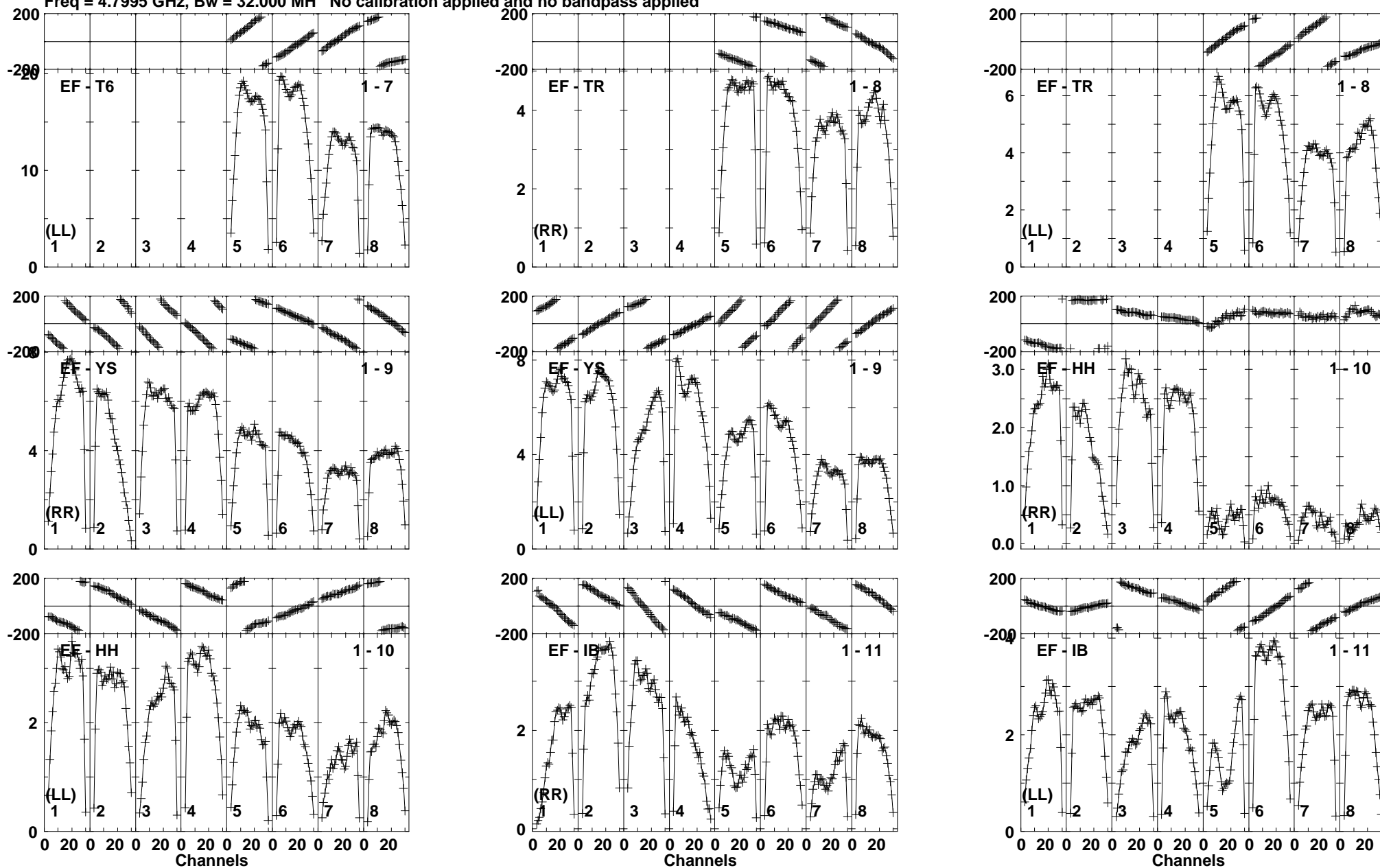

Lower frame: Milli Ampl Jy Top frame: Phas deg
 Vector averaged cross-power spectrum Baseline: EF (01) - T6 (07)
 Timerange: 00/20:16:02 to 00/20:17:28

Plot file version 83 created 20-APR-2018 17:20:46

J1427+2632 RSM02.UVDATA.1

Freq = 4.7995 GHz, Bw = 32.000 MH No calibration applied and no bandpass applied

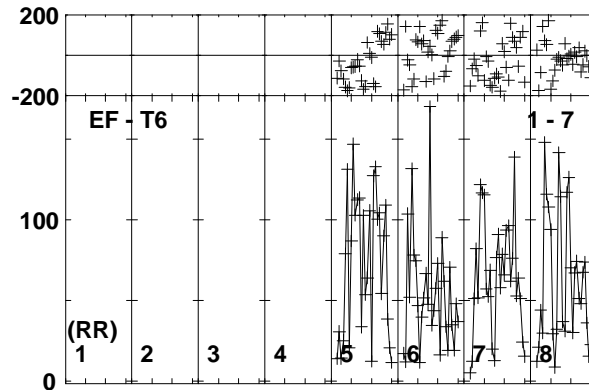
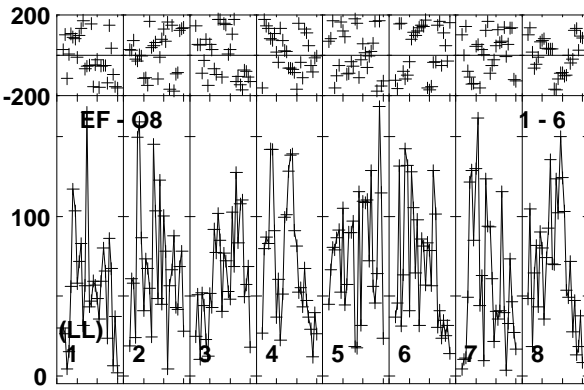
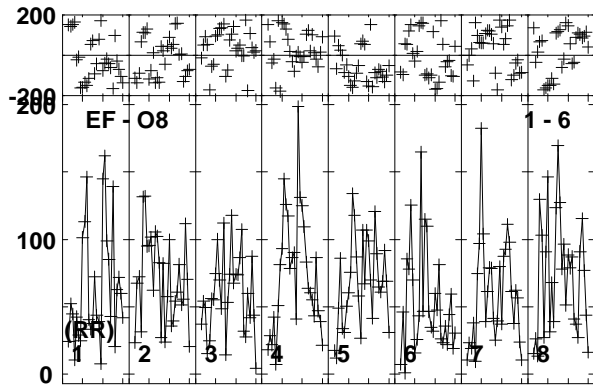
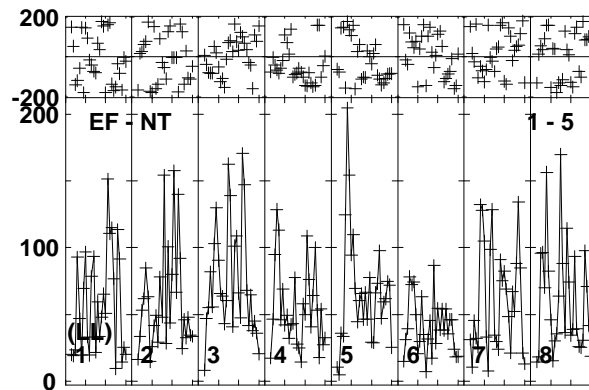
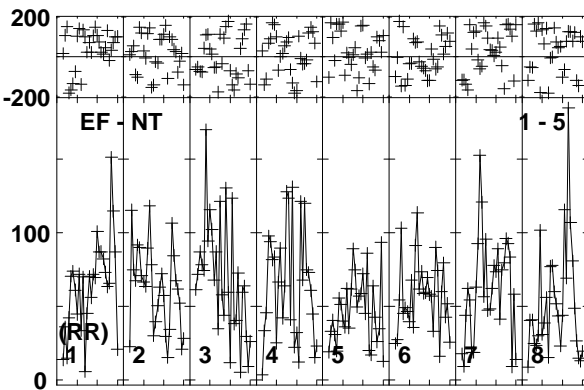
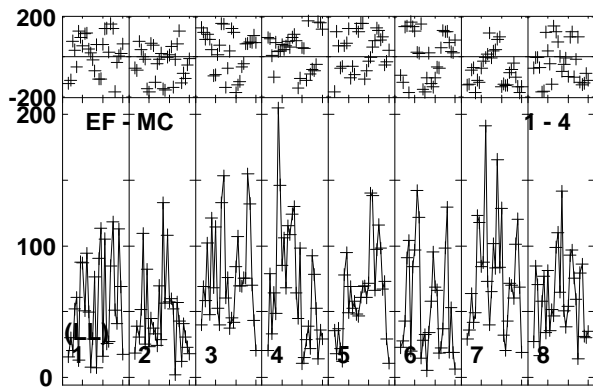
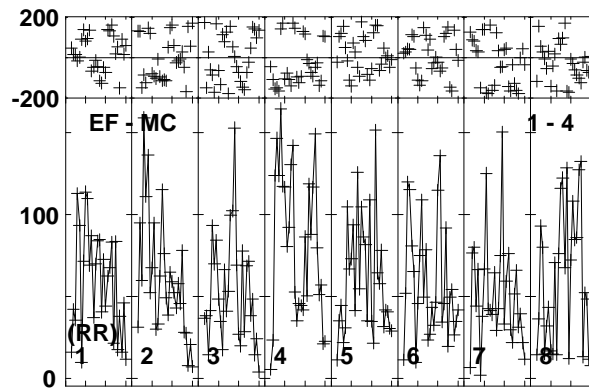
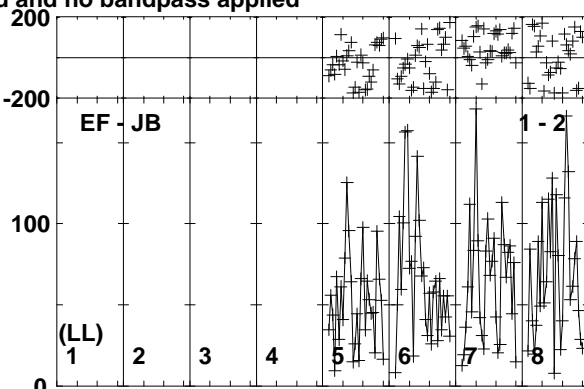
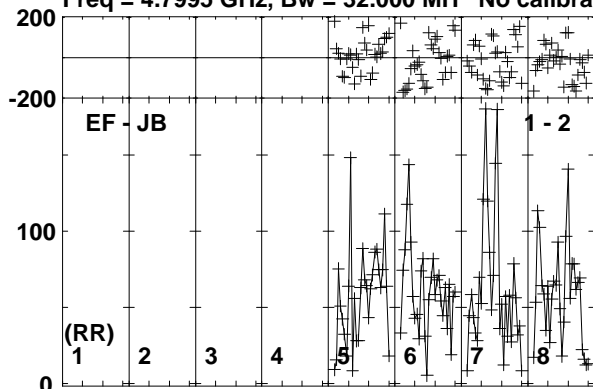

Lower frame: Micro Ampl Jy Top frame: Phas deg
Vector averaged cross-power spectrum Baseline: EF (01) - JB (02)
Timerange: 00/20:17:32 to 00/20:20:58

Plot file version 85 created 20-APR-2018 17:20:46

J1419+2706 RSM02.UVDATA.1

Freq = 4.7995 GHz, Bw = 32.000 MH No calibration applied and no bandpass applied

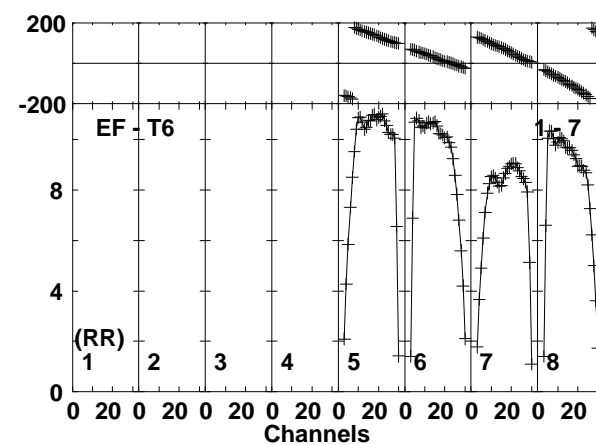
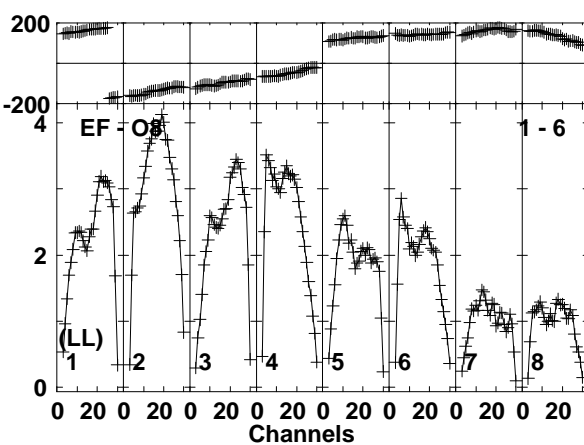
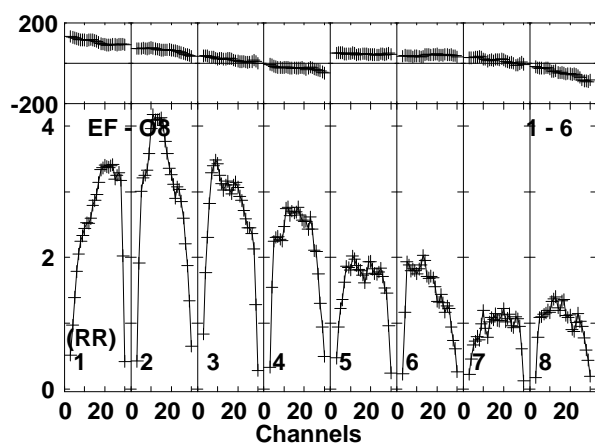
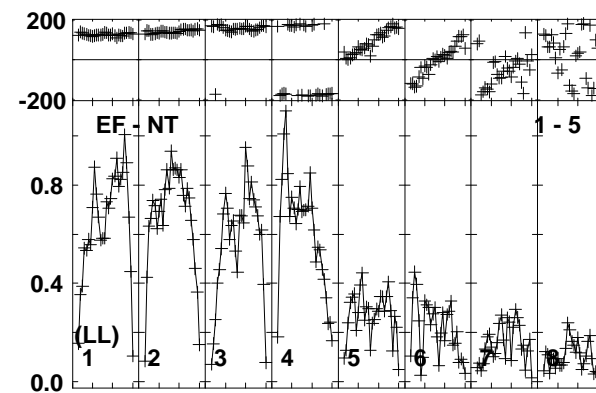
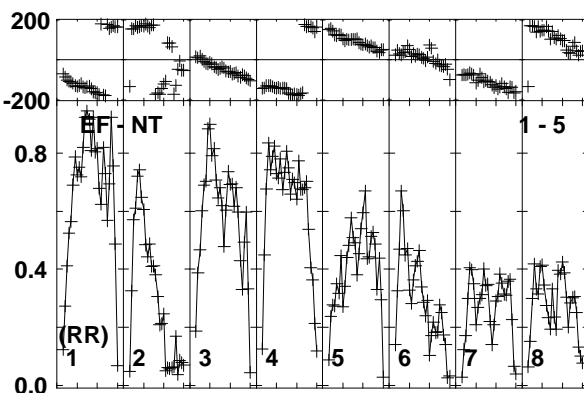
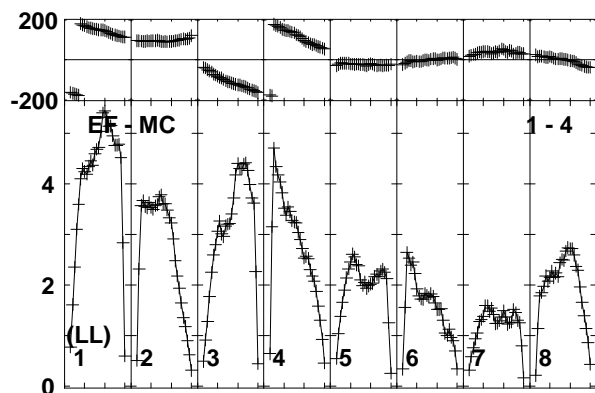
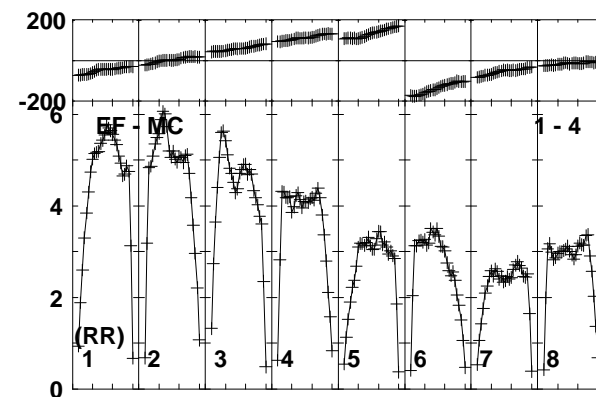
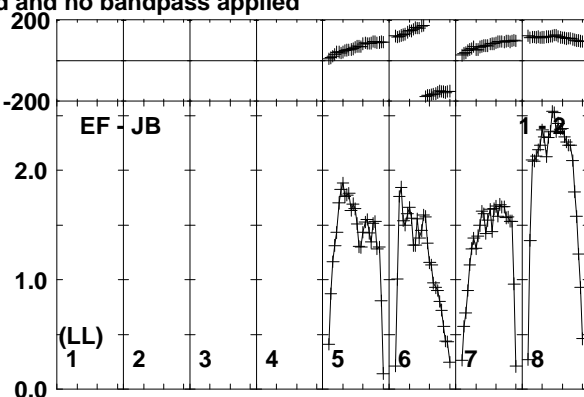
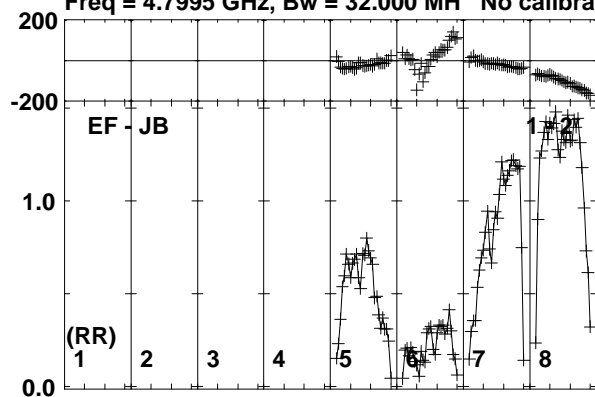

Lower frame: Milli Ampl Jy Top frame: Phas deg
Vector averaged cross-power spectrum Baseline: EF (01) - JB (02)
Timerange: 00/20:21:42 to 00/20:22:38

Plot file version 86 created 20-APR-2018 17:20:46

J1419+2706 RSM02.UVDATA.1

Freq = 4.7995 GHz, Bw = 32.000 MH No calibration applied and no bandpass applied

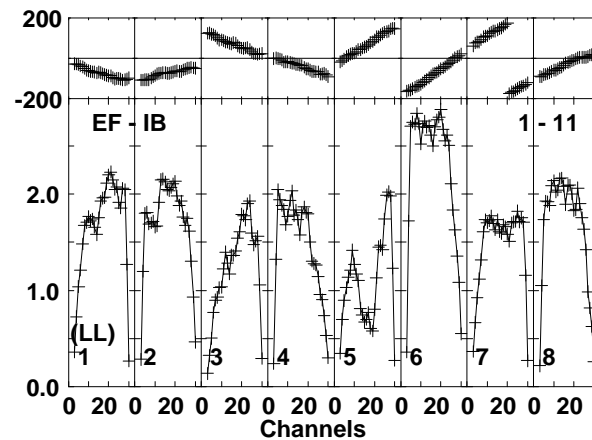
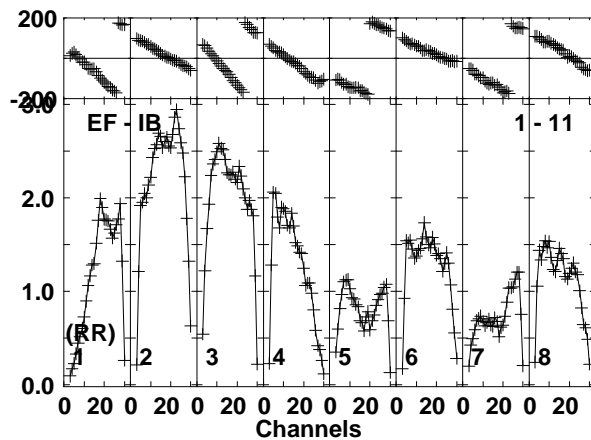
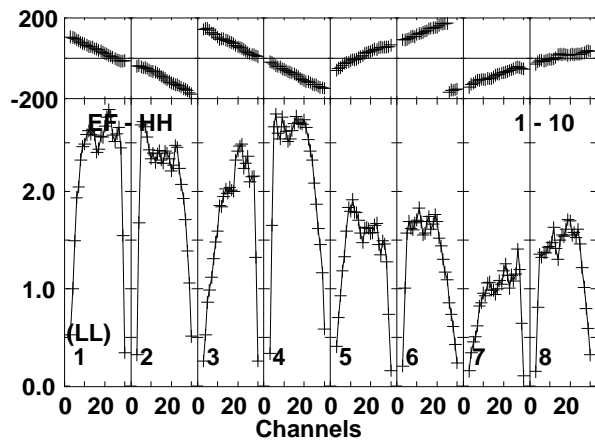
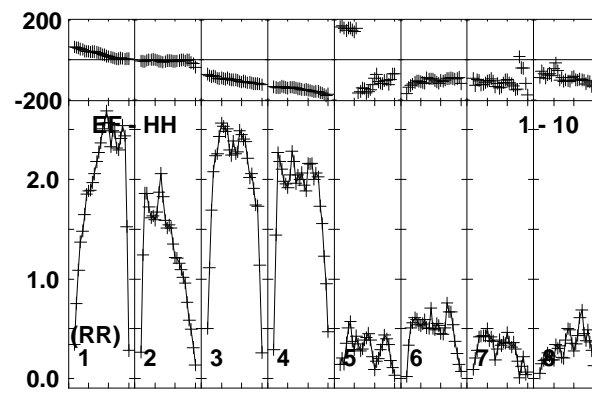
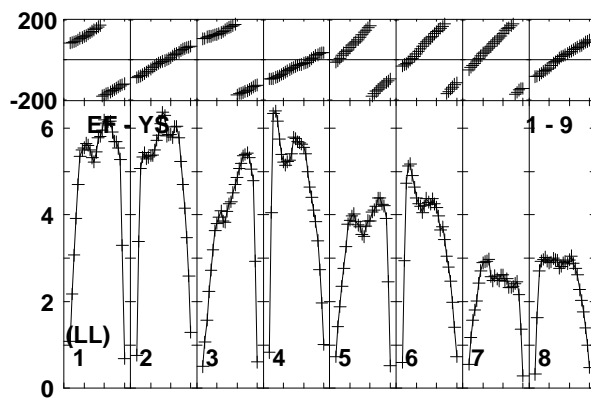
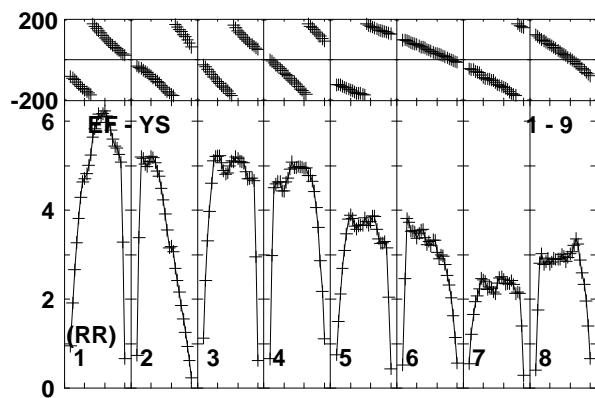
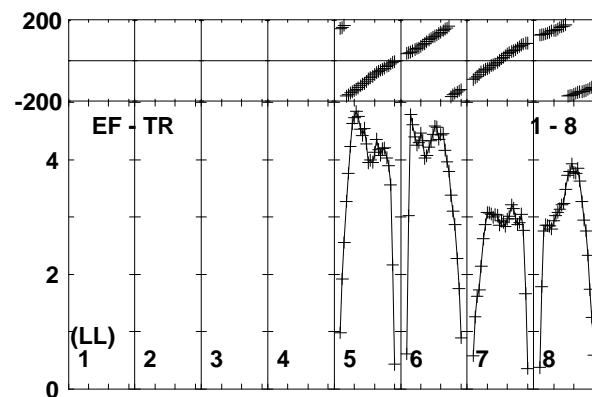
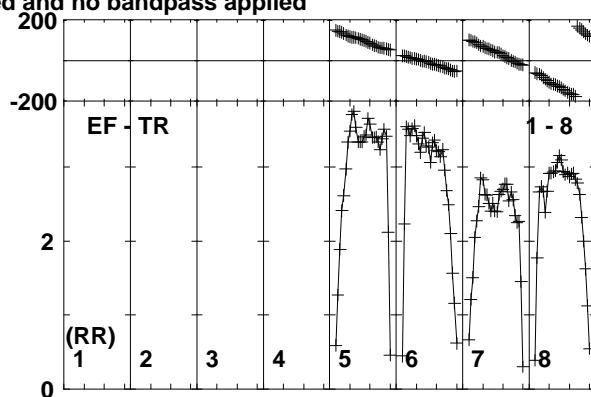
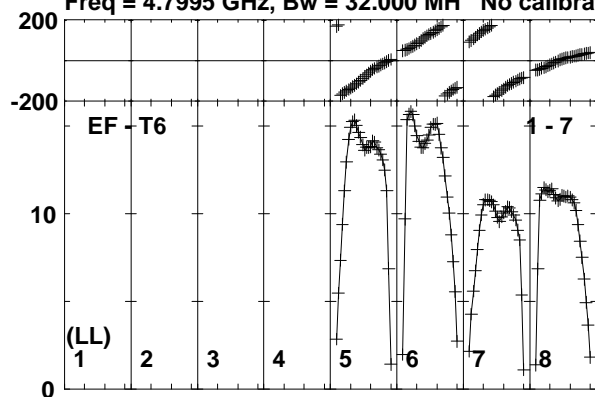

Lower frame: Milli Ampl Jy Top frame: Phas deg
Vector averaged cross-power spectrum Baseline: EF (01) - T6 (07)
Timerange: 00/20:21:42 to 00/20:22:38

Plot file version 87 created 20-APR-2018 17:20:46

J1427+2632 RSM02.UVDATA.1

Freq = 4.7995 GHz, Bw = 32.000 MH No calibration applied and no bandpass applied

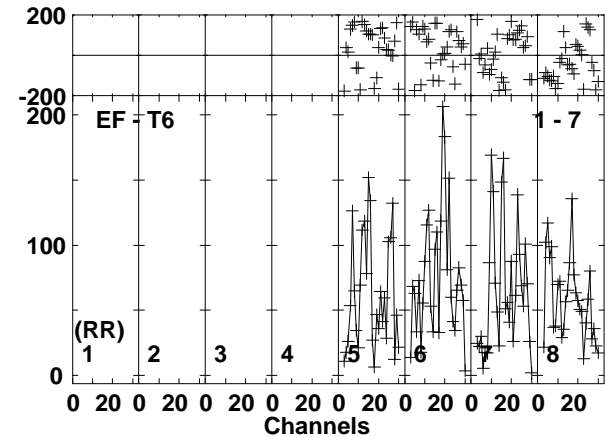
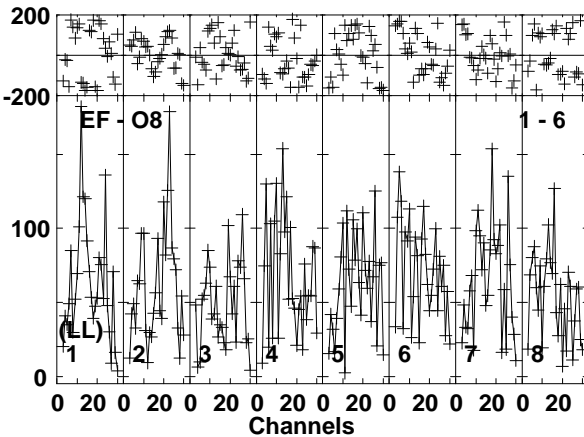
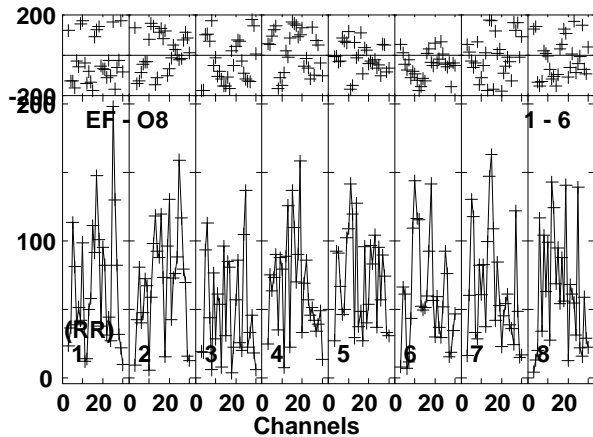
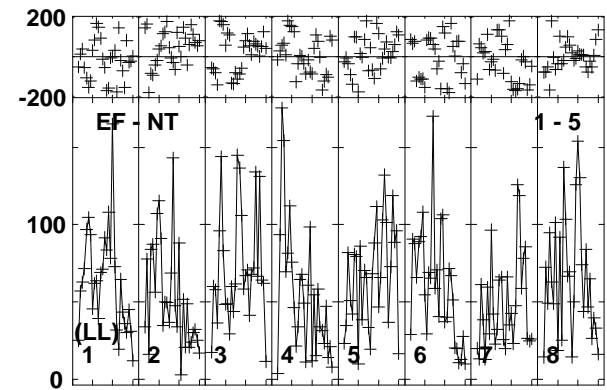
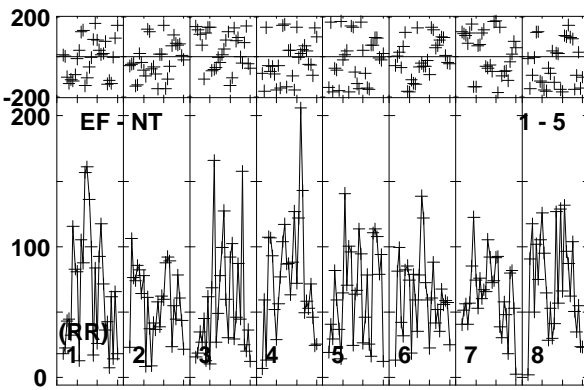
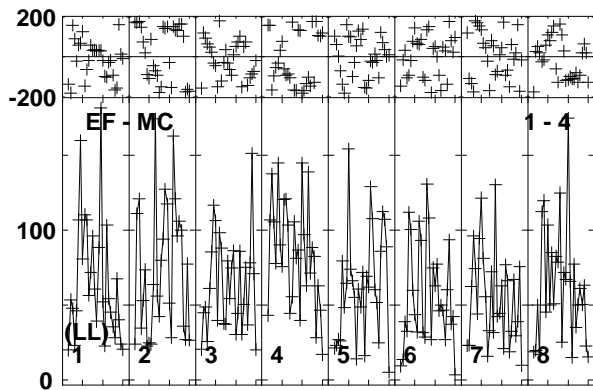
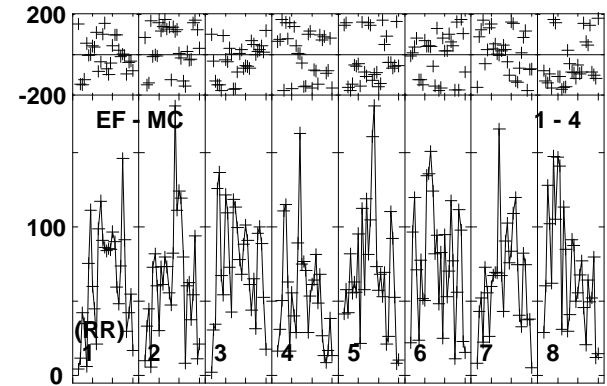
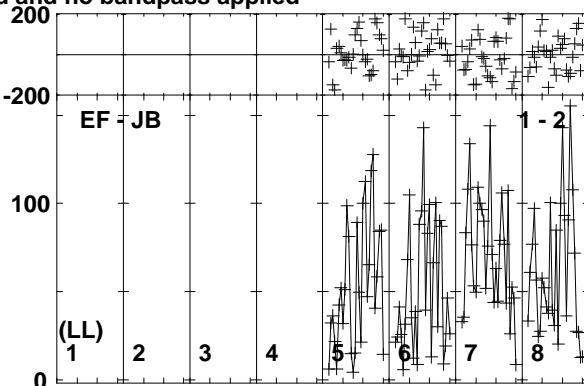
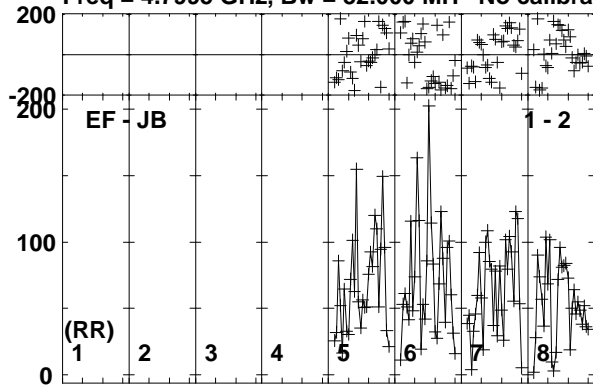

Lower frame: Micro Ampl Jy Top frame: Phas deg
Vector averaged cross-power spectrum Baseline: EF (01) - JB (02)
Timerange: 00/20:22:42 to 00/20:26:08

Plot file version 88 created 20-APR-2018 17:20:46

J1427+2632 RSM02.UVDATA.1

Freq = 4.7995 GHz, Bw = 32.000 MH No calibration applied and no bandpass applied

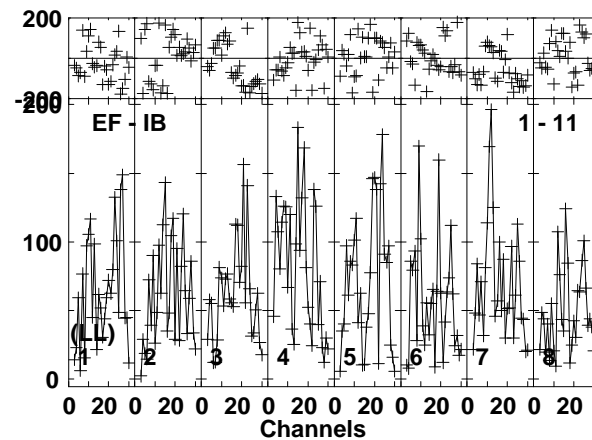
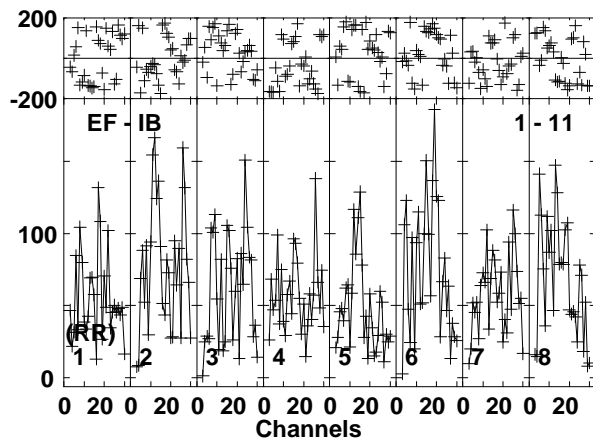
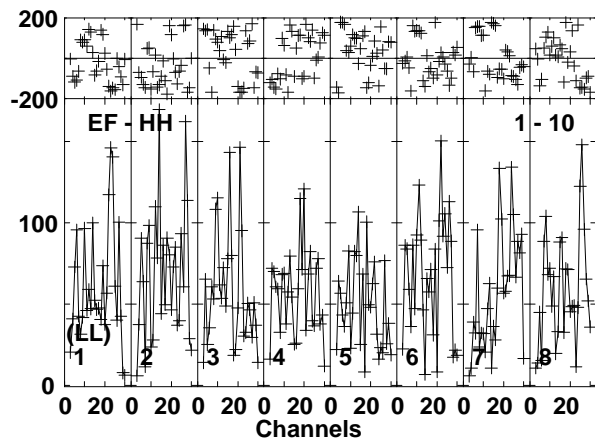
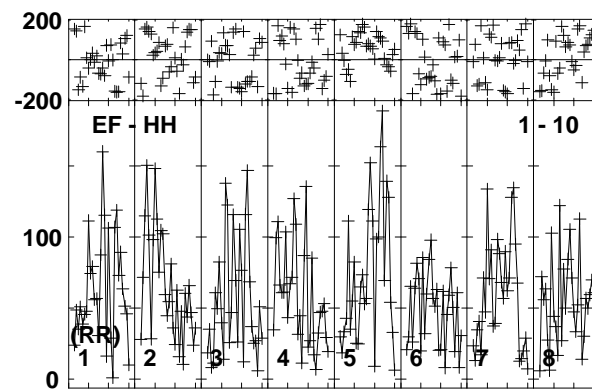
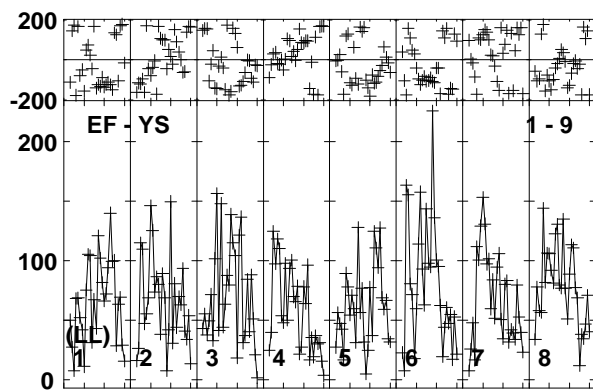
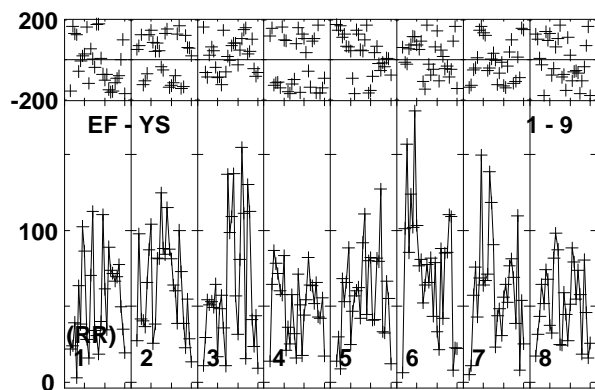
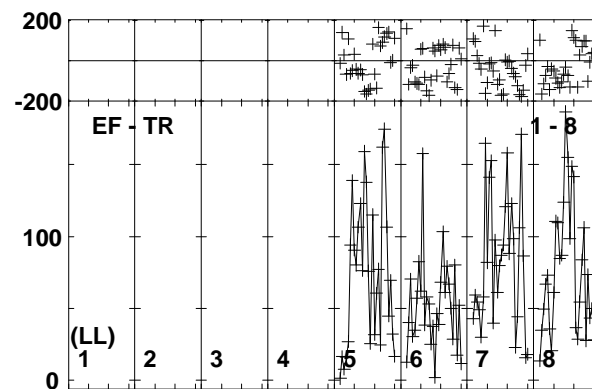
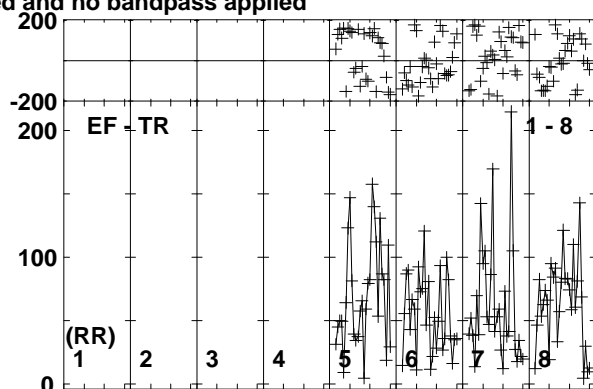
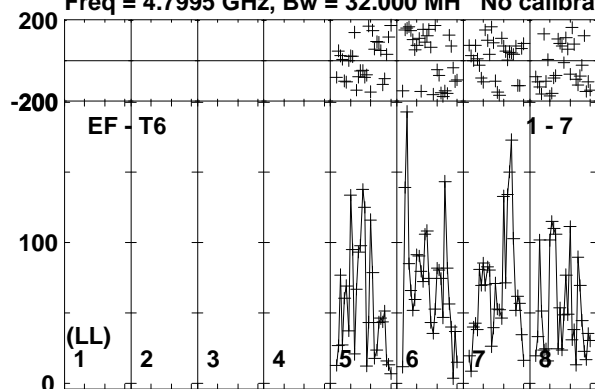

Lower frame: Micro Ampl Jy Top frame: Phas deg
Vector averaged cross-power spectrum Baseline: EF (01) - T6 (07)
Timerange: 00/20:22:42 to 00/20:26:08

Plot file version 89 created 20-APR-2018 17:20:46

J1419+2706 RSM02.UVDATA.1

Freq = 4.7995 GHz, Bw = 32.000 MH No calibration applied and no bandpass applied

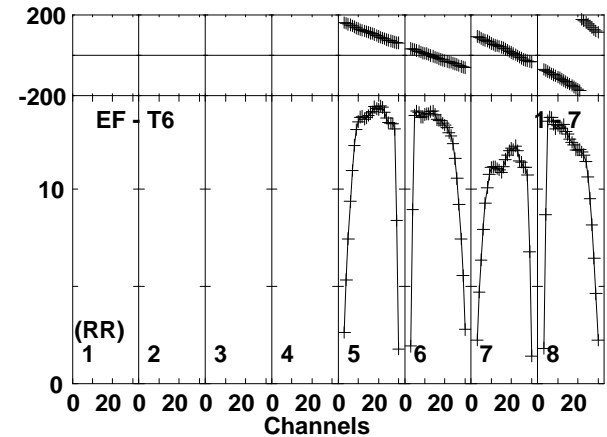
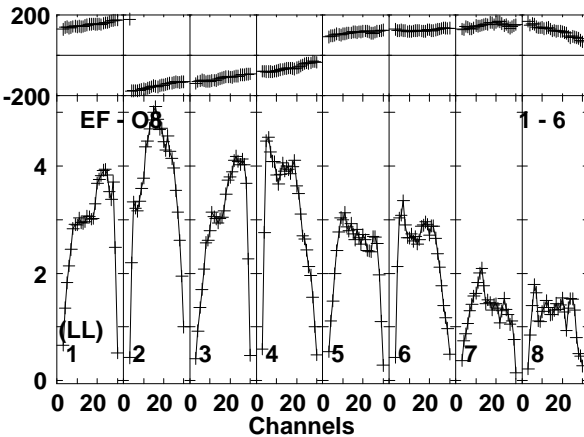
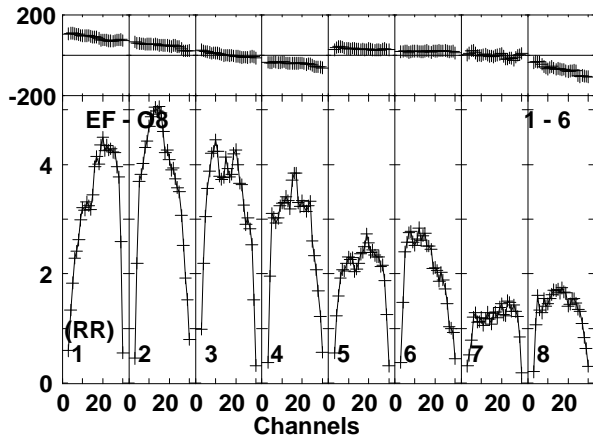
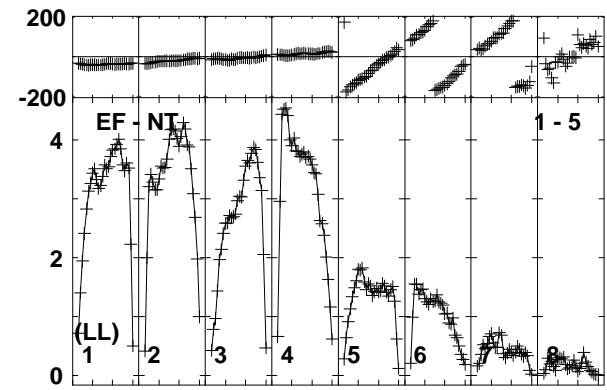
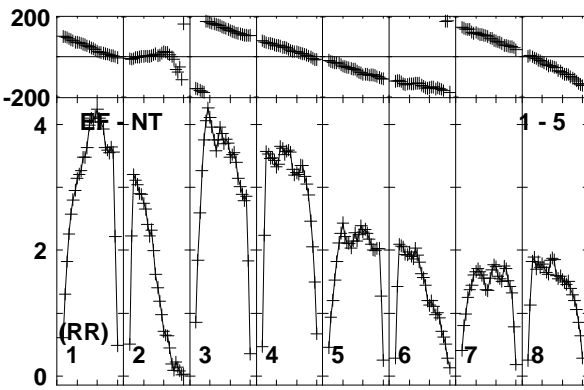
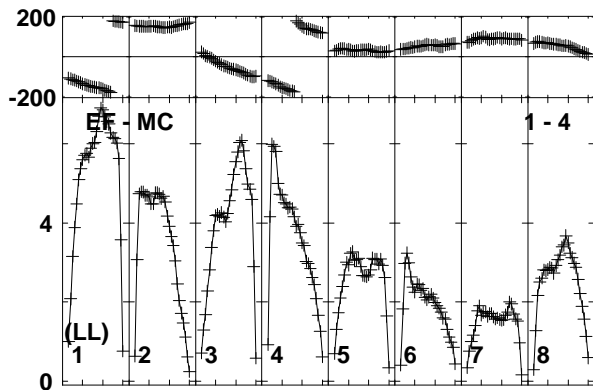
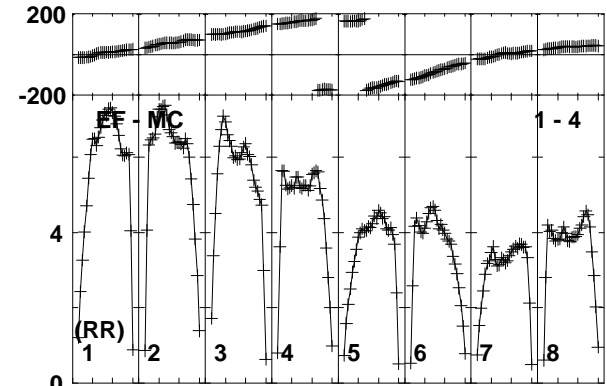
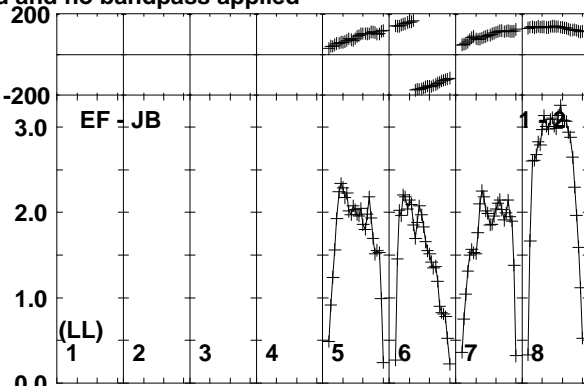
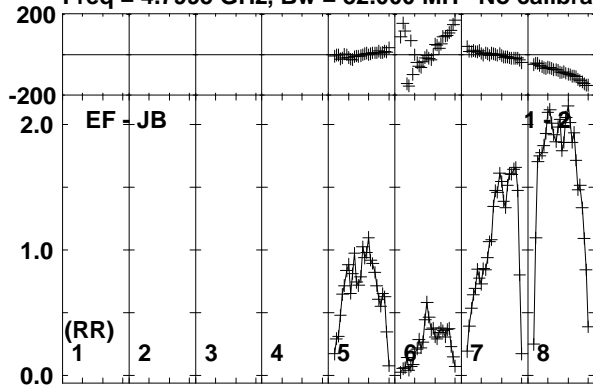

Lower frame: Milli Ampl Jy Top frame: Phas deg
Vector averaged cross-power spectrum Baseline: EF (01) - JB (02)
Timerange: 00/20:26:12 to 00/20:27:38

Plot file version 90 created 20-APR-2018 17:20:47

J1419+2706 RSM02.UVDATA.1

Freq = 4.7995 GHz, Bw = 32.000 MH No calibration applied and no bandpass applied

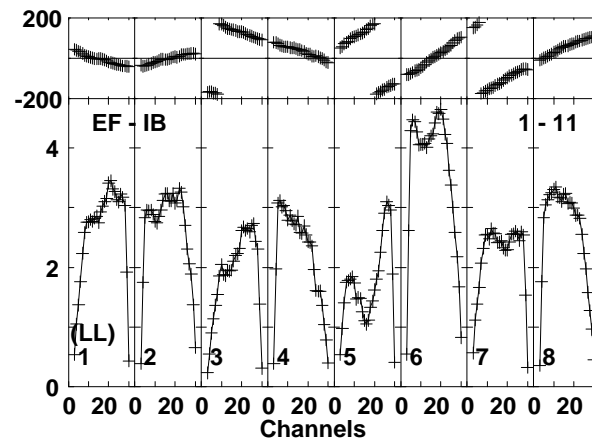
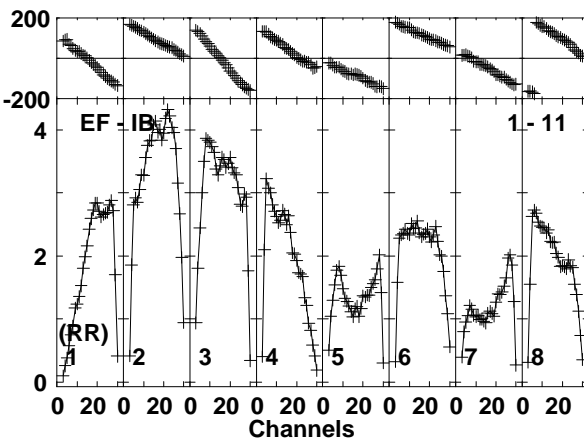
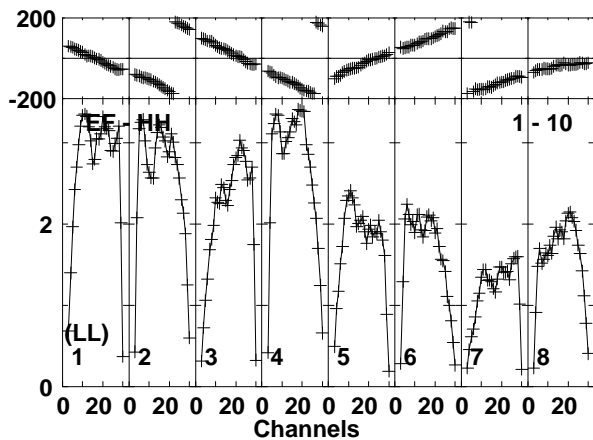
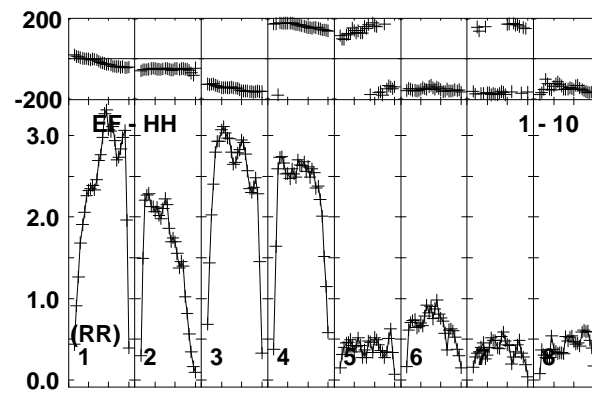
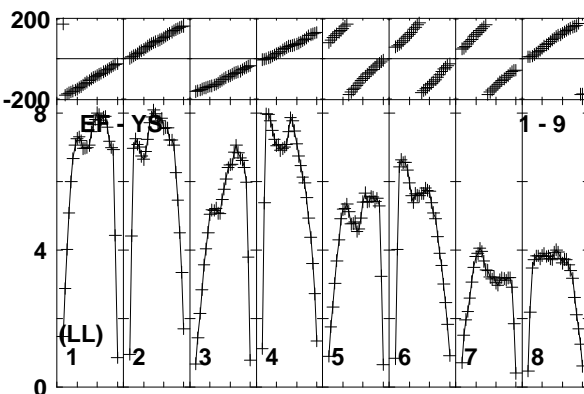
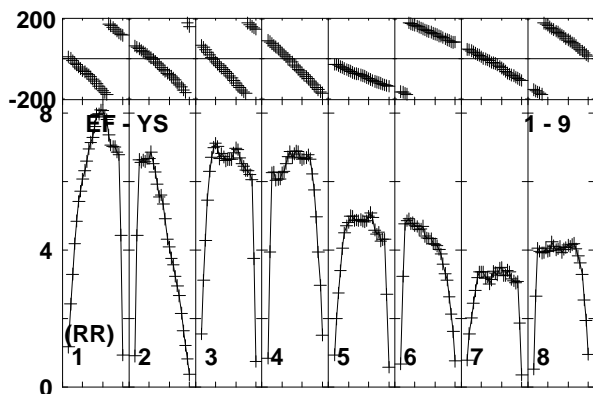
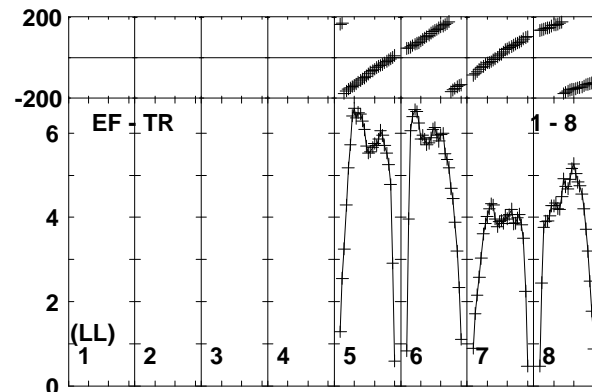
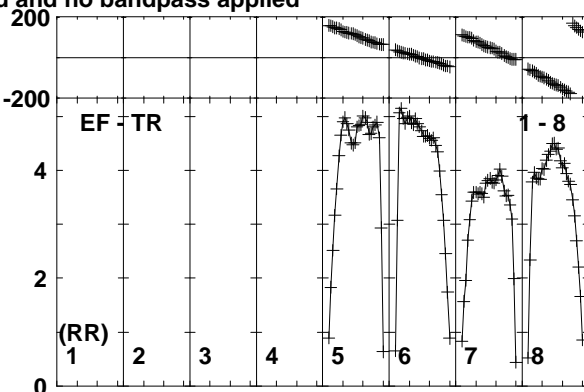
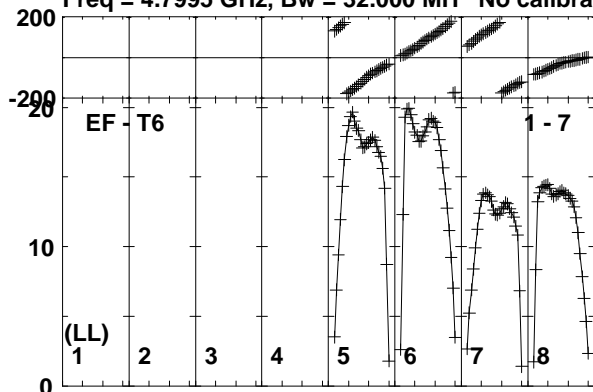

Lower frame: Milli Ampl Jy Top frame: Phas deg
Vector averaged cross-power spectrum Baseline: EF (01) - T6 (07)
Timerange: 00/20:26:12 to 00/20:27:38

Plot file version 91 created 20-APR-2018 17:20:47

J1427+2632 RSM02.UVDATA.1

Freq = 4.7995 GHz, Bw = 32.000 MH No calibration applied and no bandpass applied

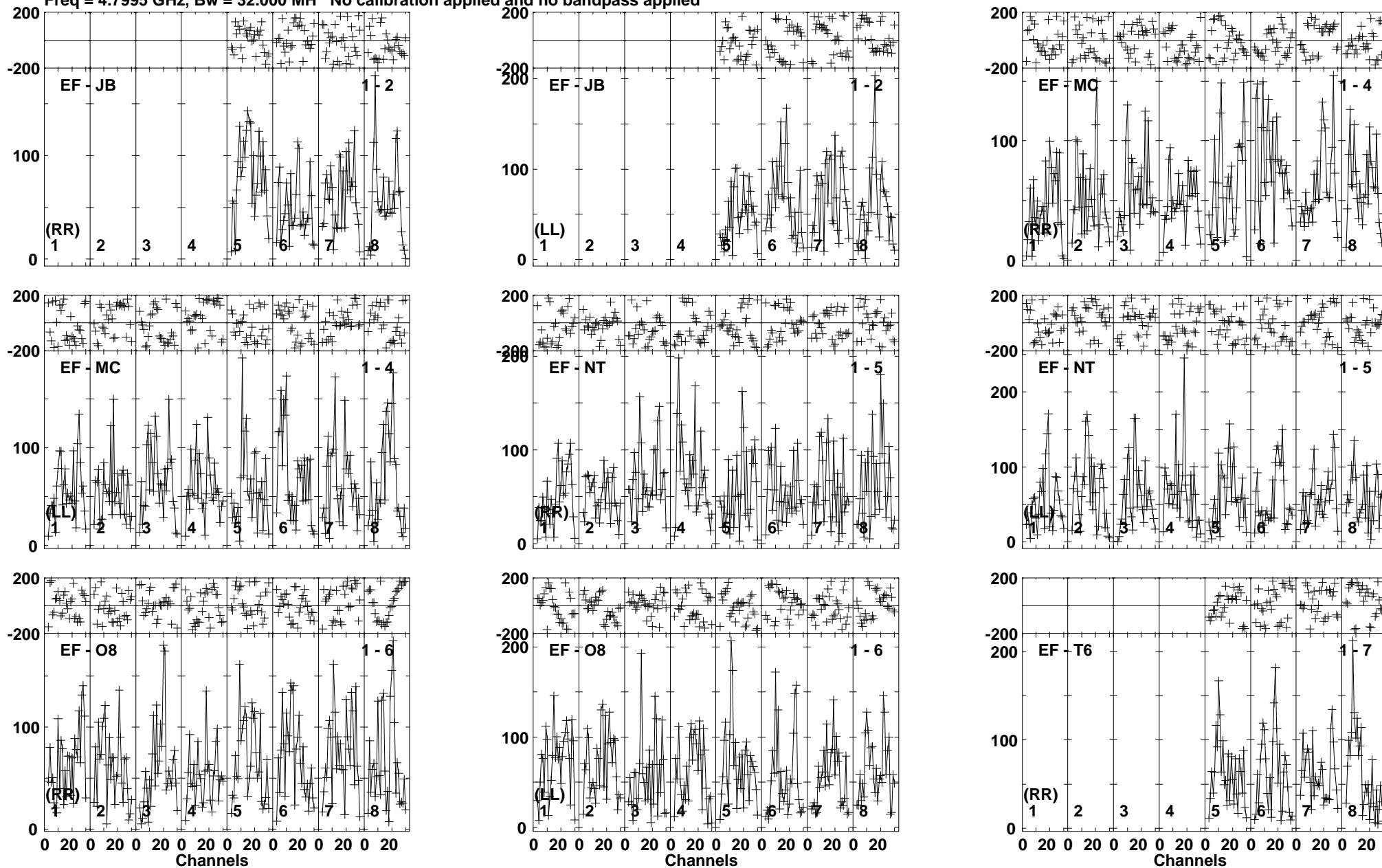

Lower frame: Micro Ampl Jy Top frame: Phas deg
Vector averaged cross-power spectrum Baseline: EF (01) - JB (02)
Timerange: 00/20:27:42 to 00/20:31:08

Plot file version 92 created 20-APR-2018 17:20:47

J1427+2632 RSM02.UVDATA.1

Freq = 4.7995 GHz, Bw = 32.000 MH No calibration applied and no bandpass applied

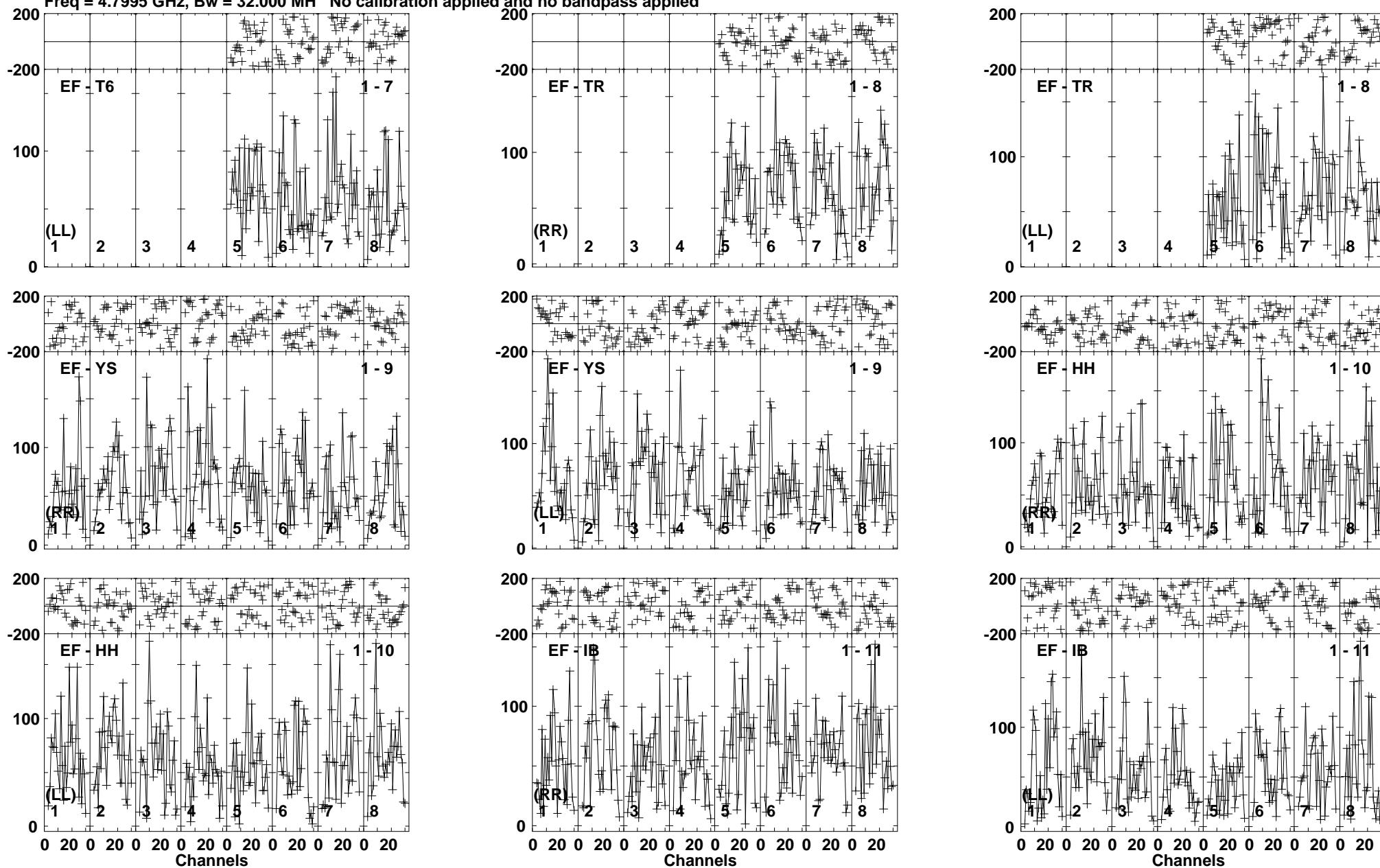

Lower frame: Micro Ampl Jy Top frame: Phas deg
Vector averaged cross-power spectrum Baseline: EF (01) - T6 (07)
Timerange: 00/20:27:42 to 00/20:31:08

Plot file version 93 created 20-APR-2018 17:20:47

J1419+2706 RSM02.UVDATA.1

Freq = 4.7995 GHz, Bw = 32.000 MH No calibration applied and no bandpass applied

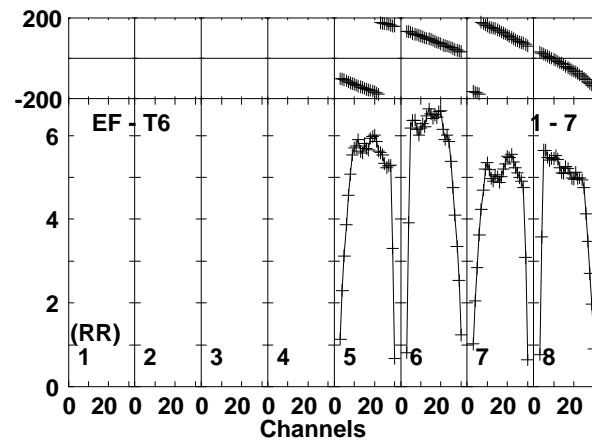
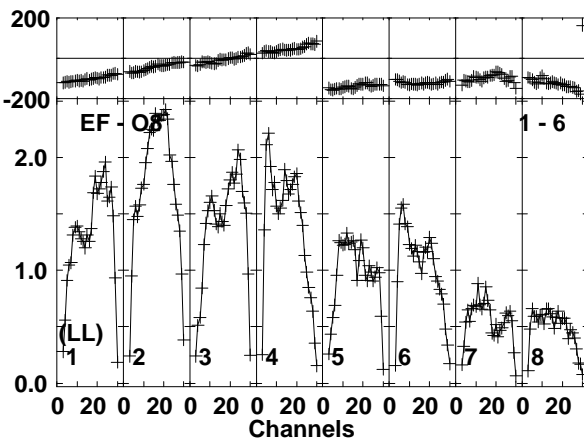
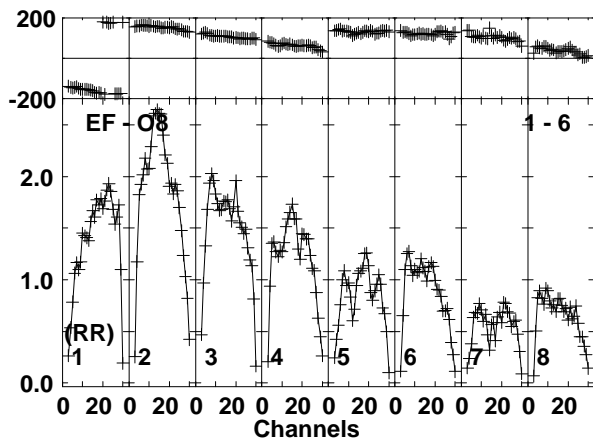
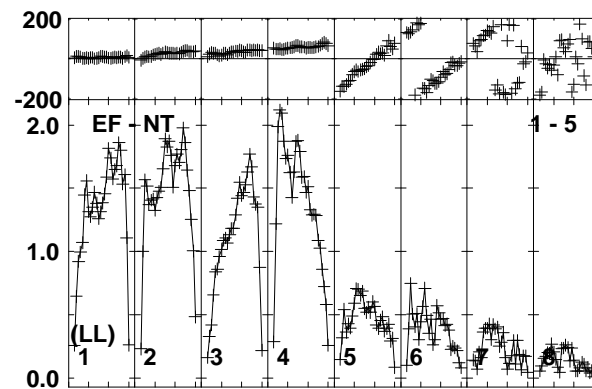
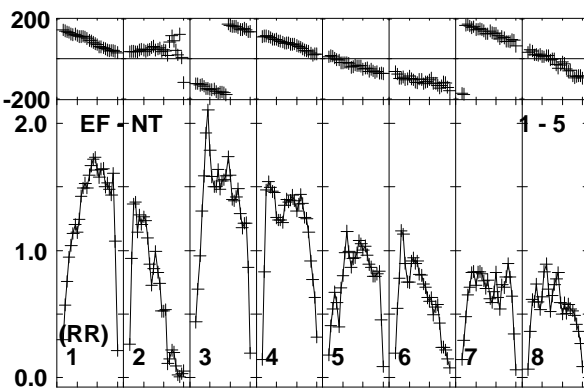
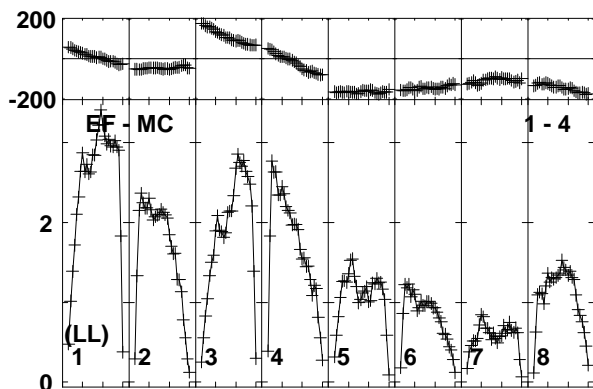
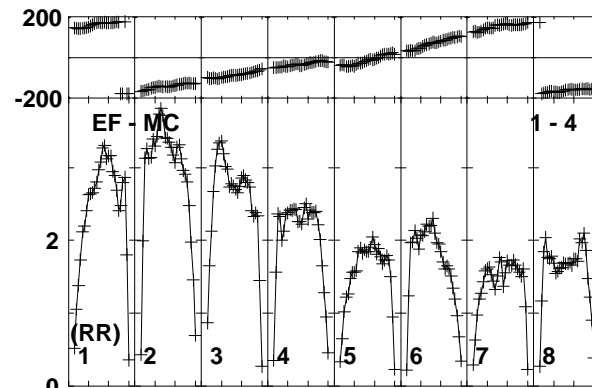
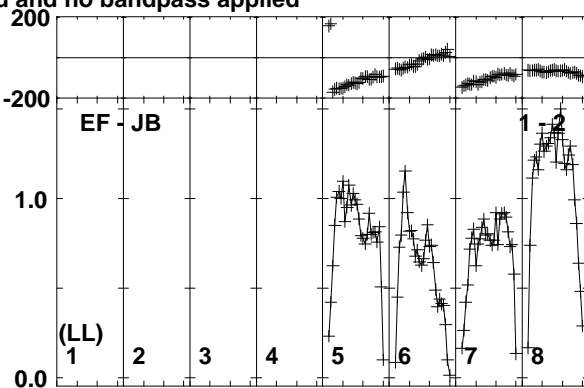
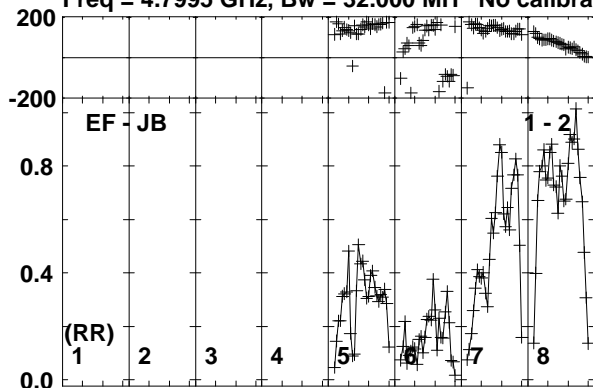

Lower frame: Milli Ampl Jy Top frame: Phas deg
Vector averaged cross-power spectrum Baseline: EF (01) - JB (02)
Timerange: 00/20:31:12 to 00/20:32:38

Plot file version 94 created 20-APR-2018 17:20:47

J1419+2706 RSM02.UVDATA.1

Freq = 4.7995 GHz, Bw = 32.000 MH No calibration applied and no bandpass applied

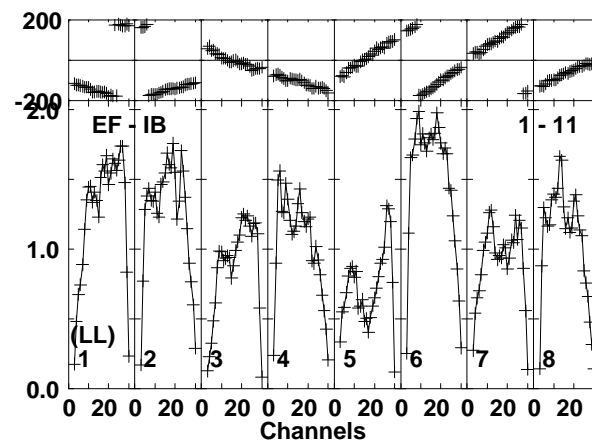
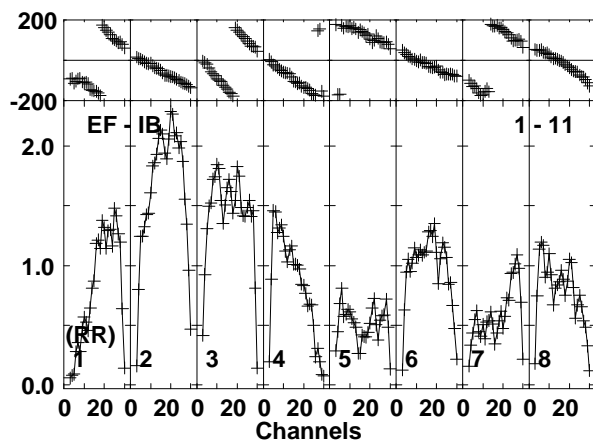
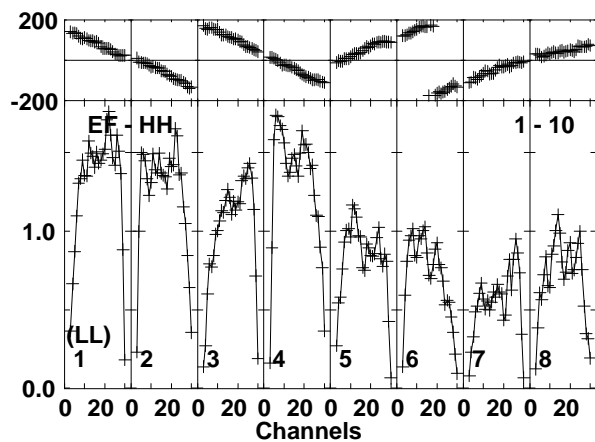
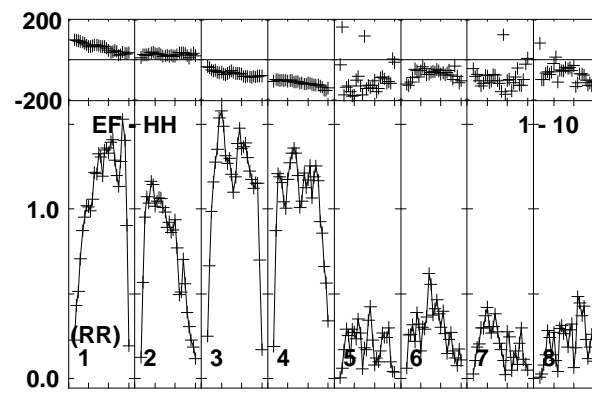
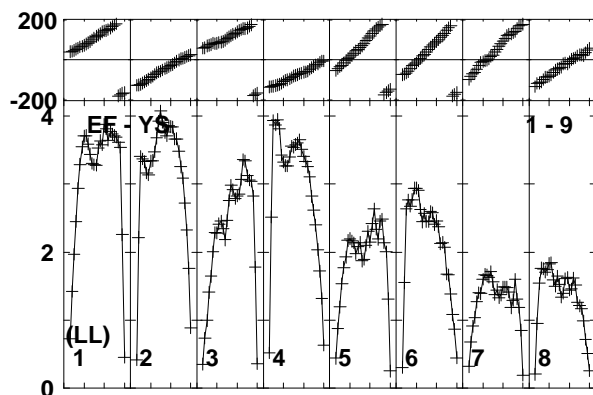
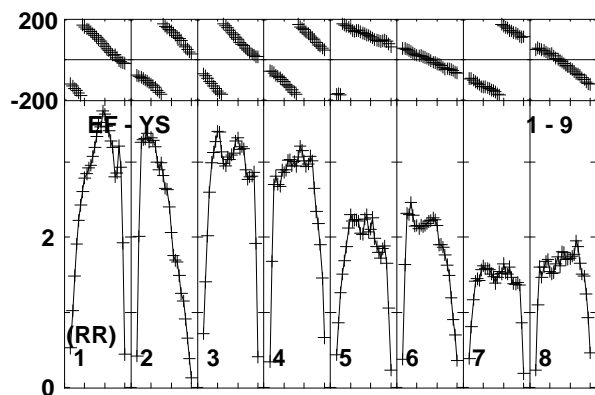
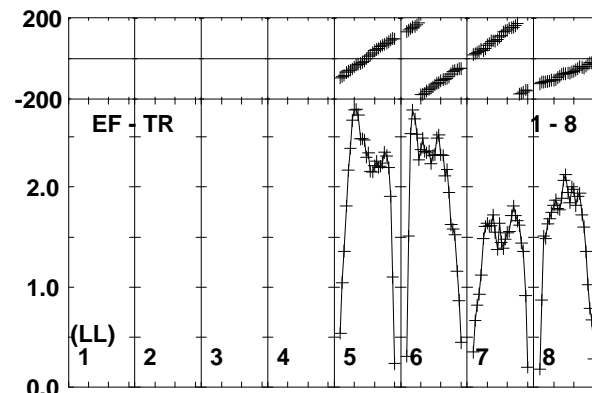
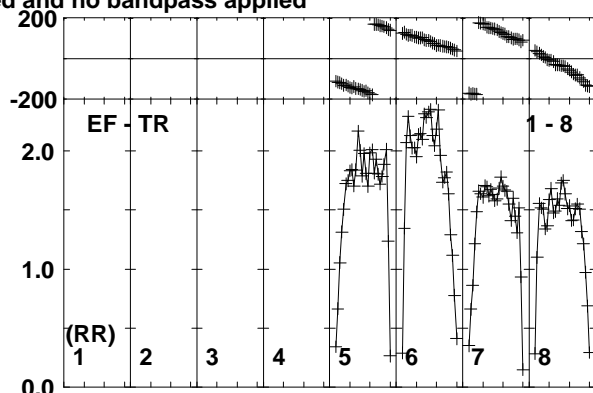
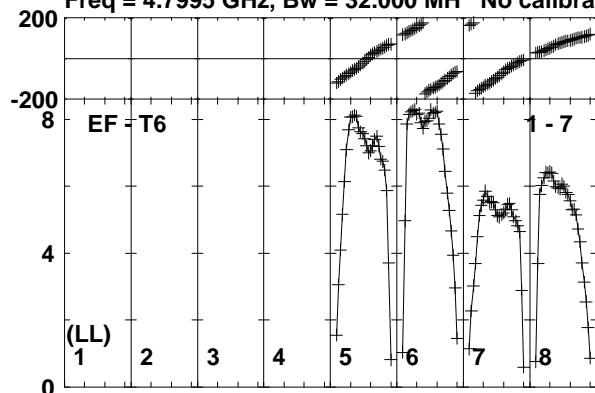

Lower frame: Milli Ampl Jy Top frame: Phas deg
Vector averaged cross-power spectrum Baseline: EF (01) - T6 (07)
Timerange: 00/20:31:12 to 00/20:32:38

Plot file version 95 created 20-APR-2018 17:20:47

J1427+2632 RSM02.UVDATA.1

Freq = 4.7995 GHz, Bw = 32.000 MH No calibration applied and no bandpass applied

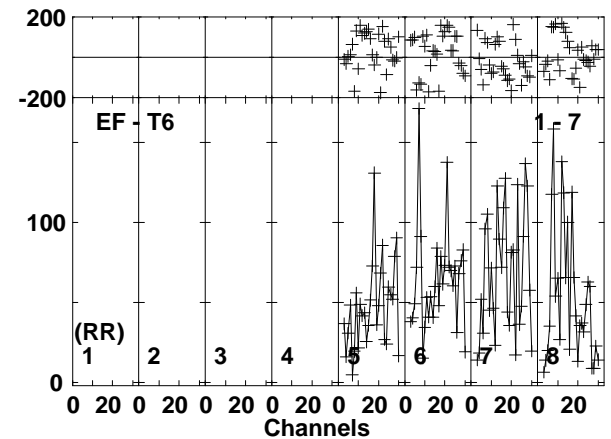
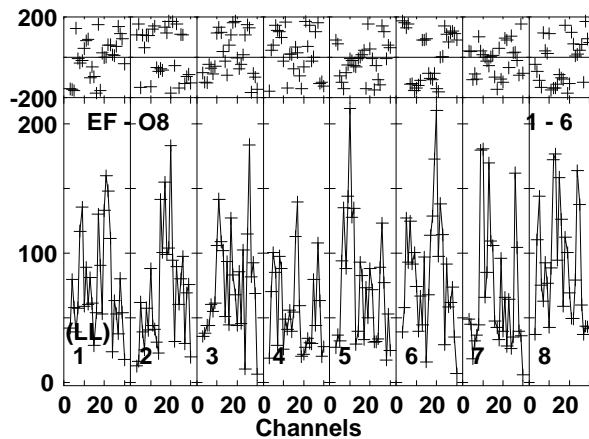
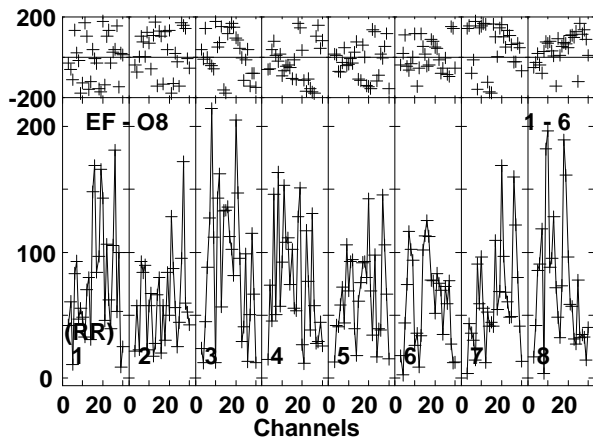
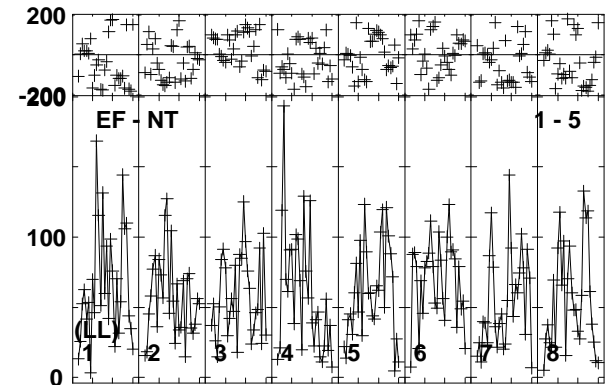
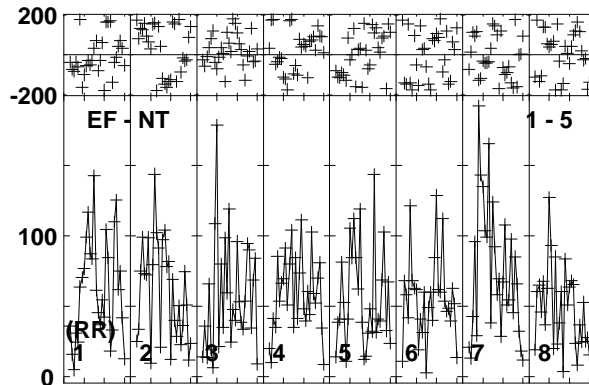
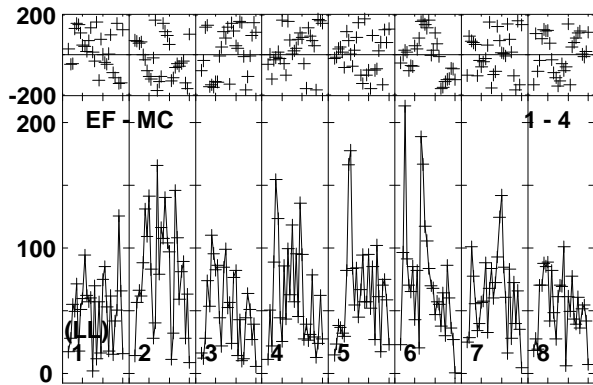
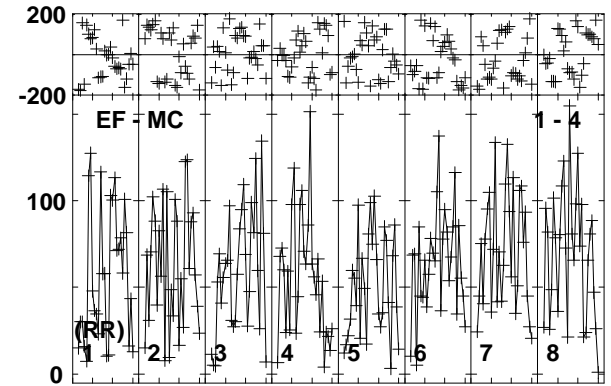
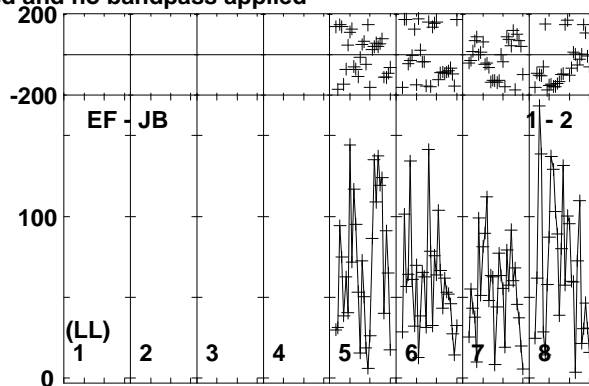
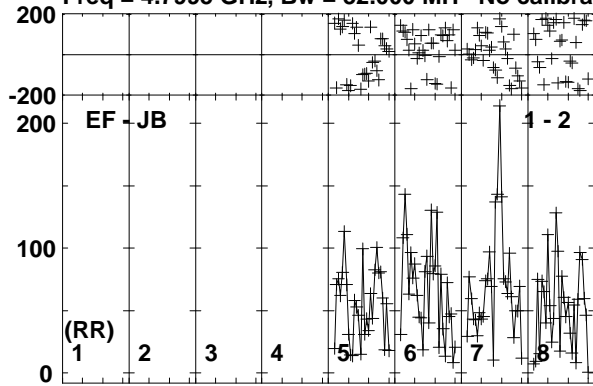

Lower frame: Micro Ampl Jy Top frame: Phas deg
Vector averaged cross-power spectrum Baseline: EF (01) - JB (02)
Timerange: 00/20:32:42 to 00/20:36:08

Plot file version 96 created 20-APR-2018 17:20:47

J1427+2632 RSM02.UVDATA.1

Freq = 4.7995 GHz, Bw = 32.000 MH No calibration applied and no bandpass applied

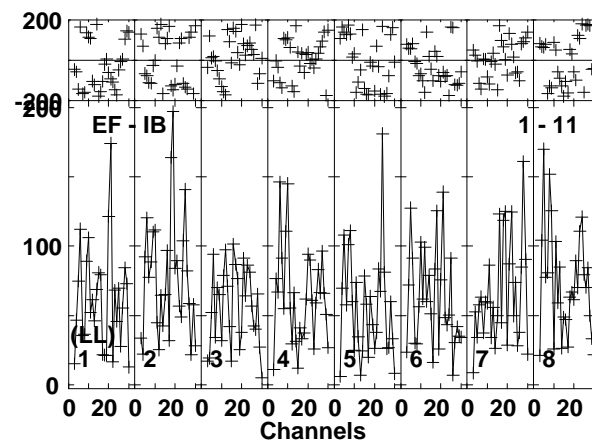
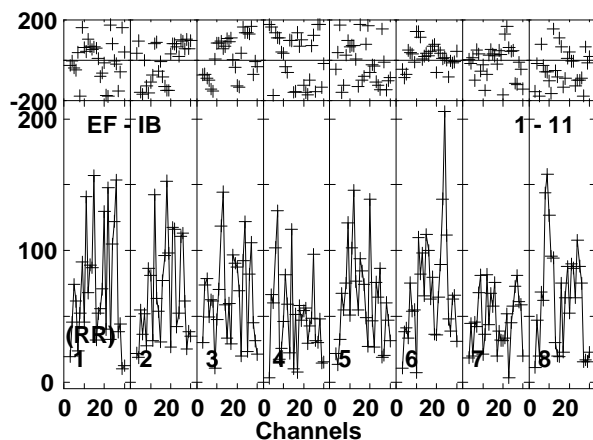
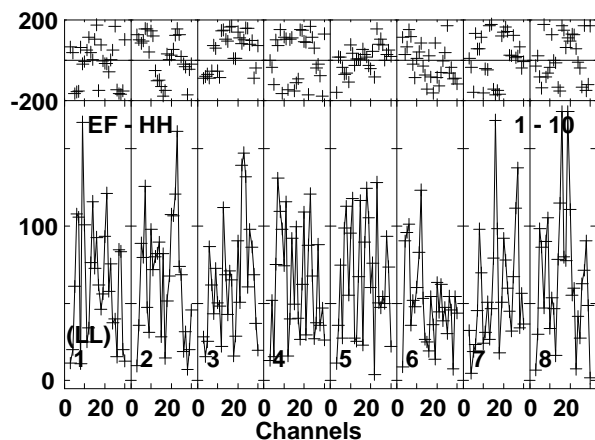
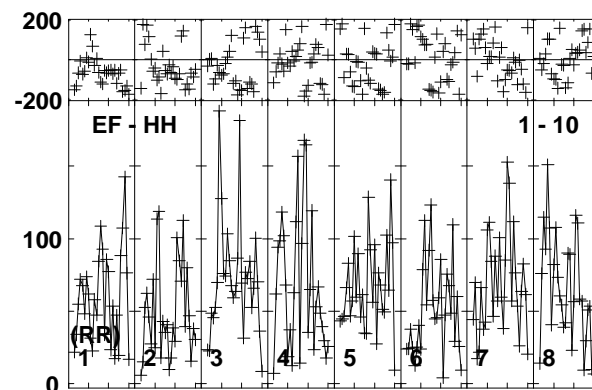
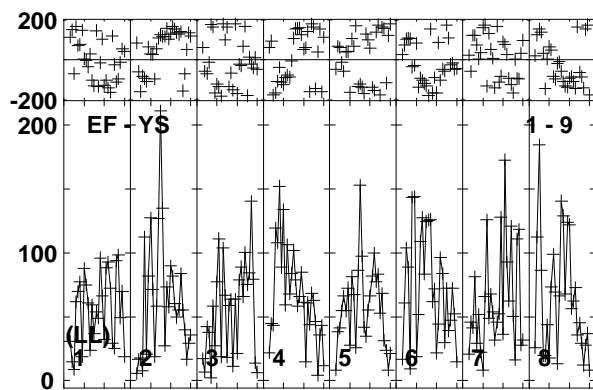
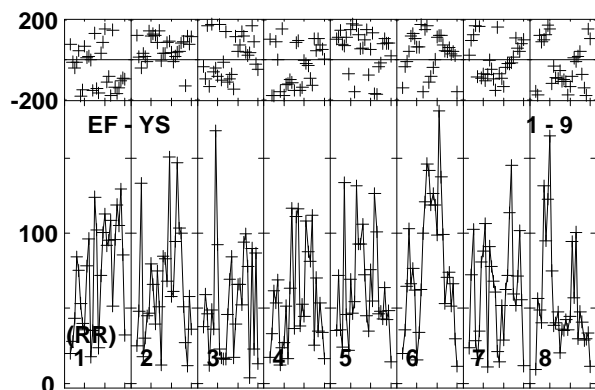
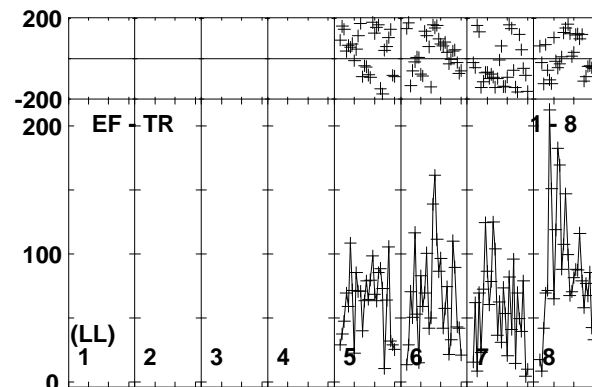
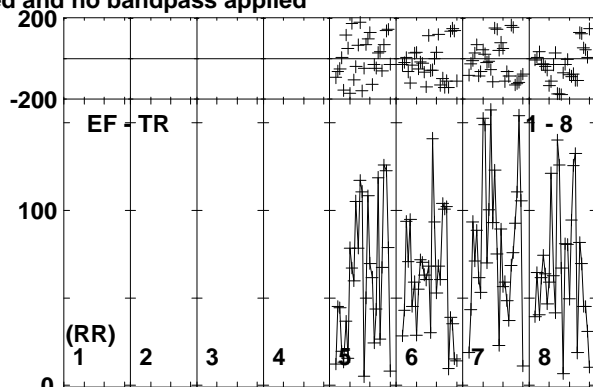
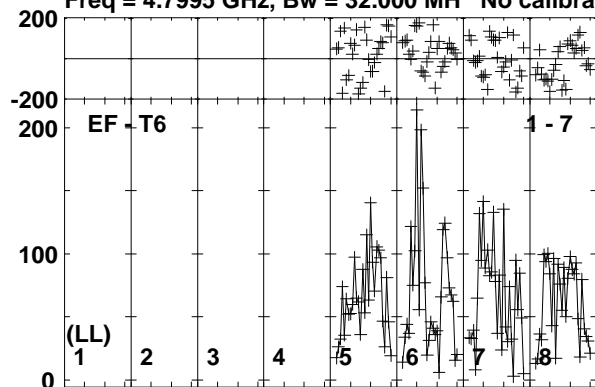

Lower frame: Micro Ampl Jy Top frame: Phas deg
Vector averaged cross-power spectrum Baseline: EF (01) - T6 (07)
Timerange: 00/20:32:42 to 00/20:36:08

Plot file version 97 created 20-APR-2018 17:20:47

J1419+2706 RSM02.UVDATA.1

Freq = 4.7995 GHz, Bw = 32.000 MH No calibration applied and no bandpass applied

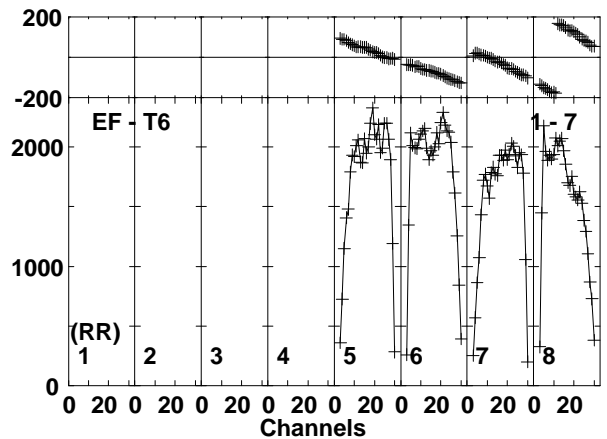
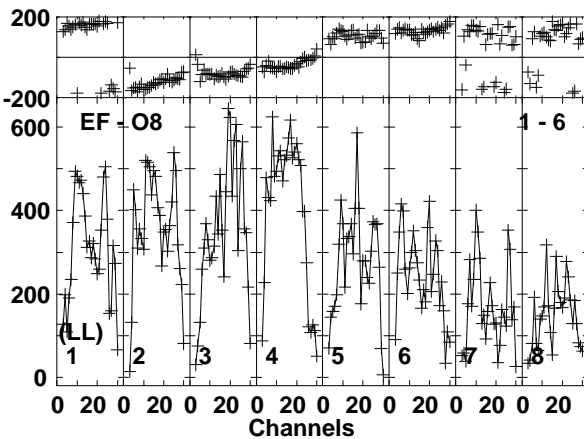
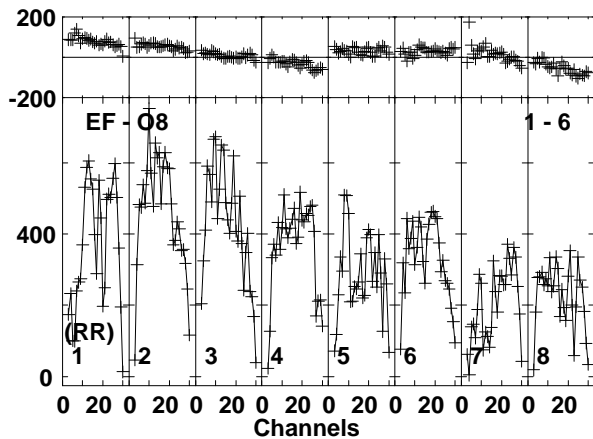
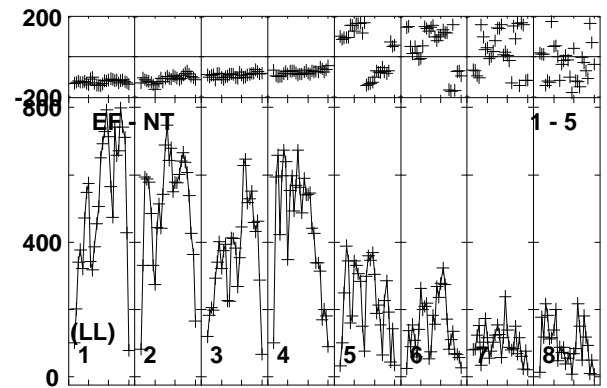
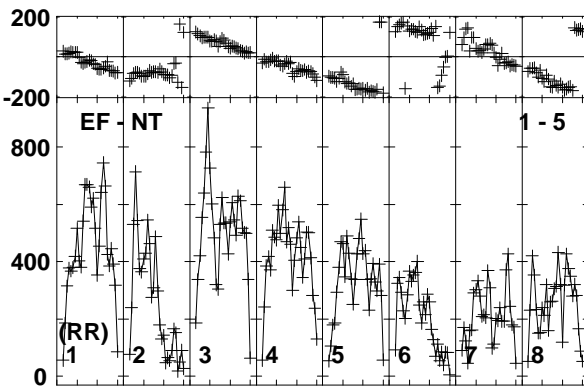
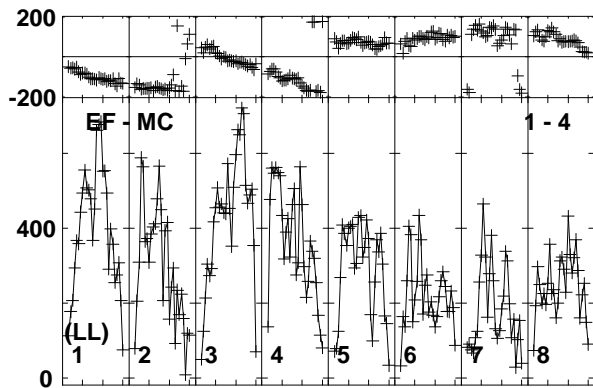
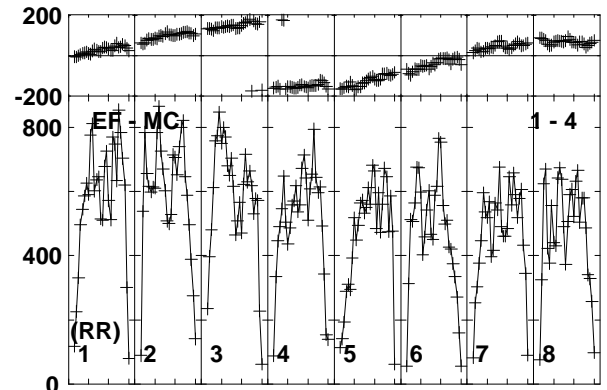
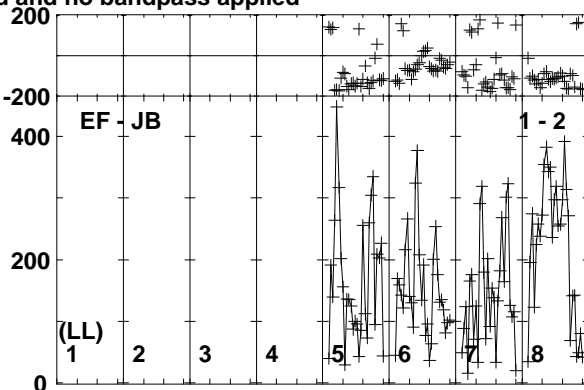
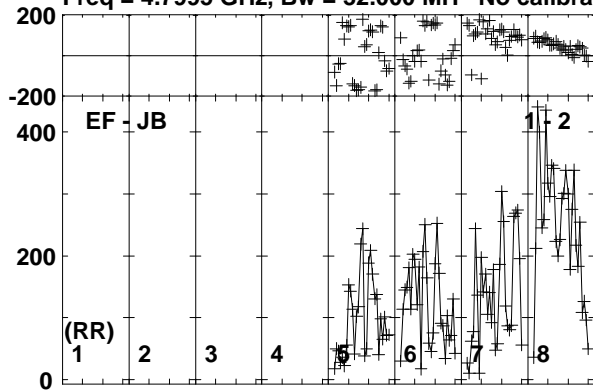

Lower frame: Micro Ampl Jy Top frame: Phas deg
Vector averaged cross-power spectrum Baseline: EF (01) - JB (02)
Timerange: 00/20:36:52 to 00/20:37:48

Plot file version 98 created 20-APR-2018 17:20:47

J1419+2706 RSM02.UVDATA.1

Freq = 4.7995 GHz, Bw = 32.000 MH No calibration applied and no bandpass applied

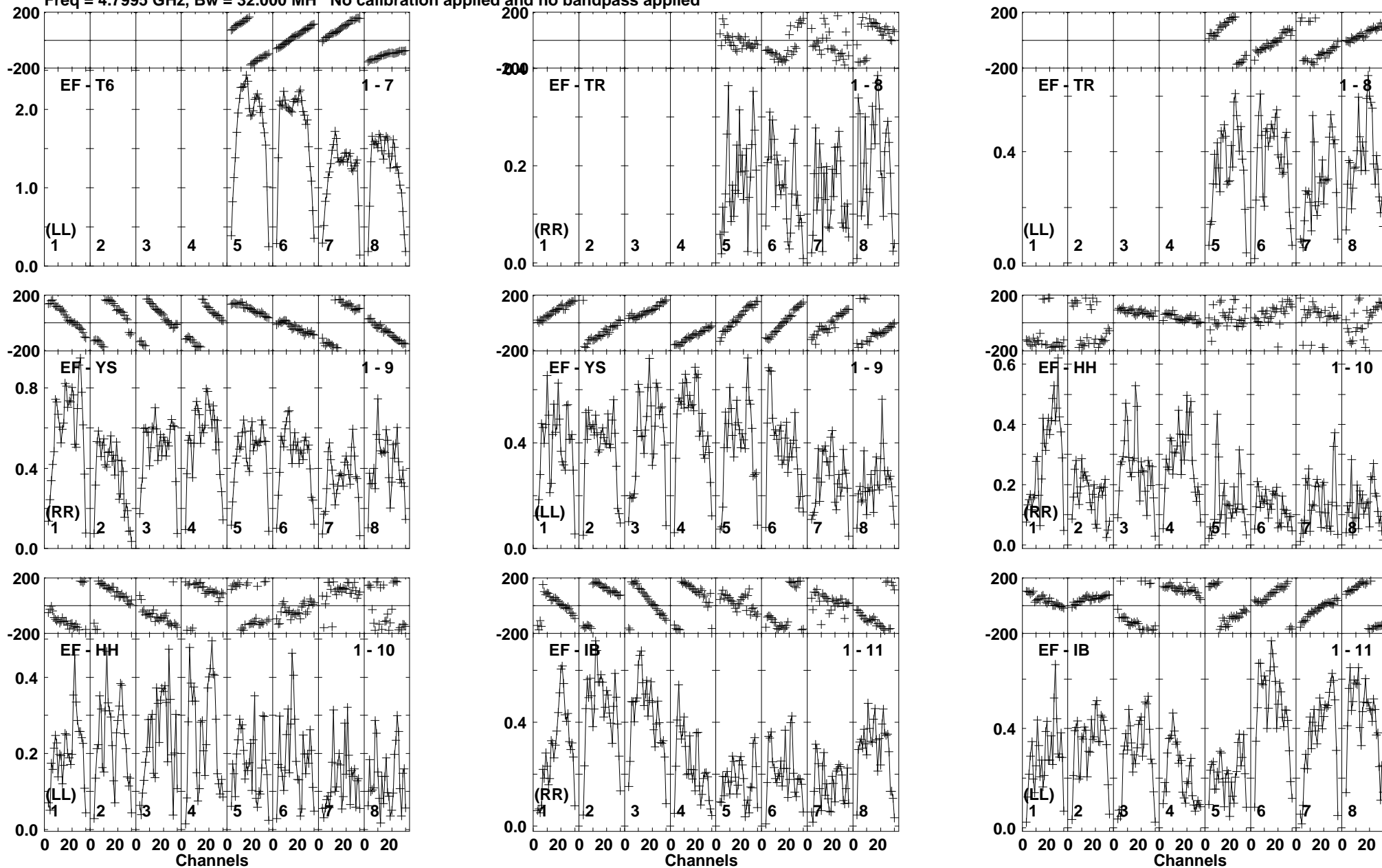

Lower frame: Milli Ampl Jy Top frame: Phas deg
Vector averaged cross-power spectrum Baseline: EF (01) - T6 (07)
Timerange: 00/20:36:52 to 00/20:37:48

Plot file version 99 created 20-APR-2018 17:20:47

J1427+2632 RSM02.UVDATA.1

Freq = 4.7995 GHz, Bw = 32.000 MH No calibration applied and no bandpass applied

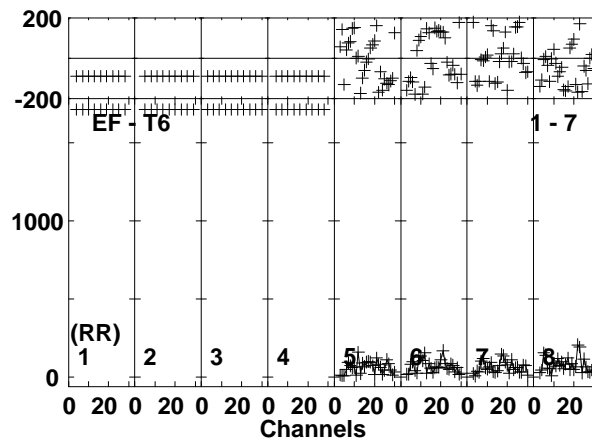
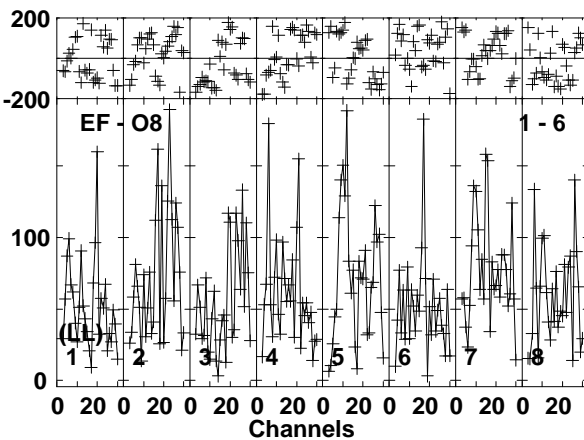
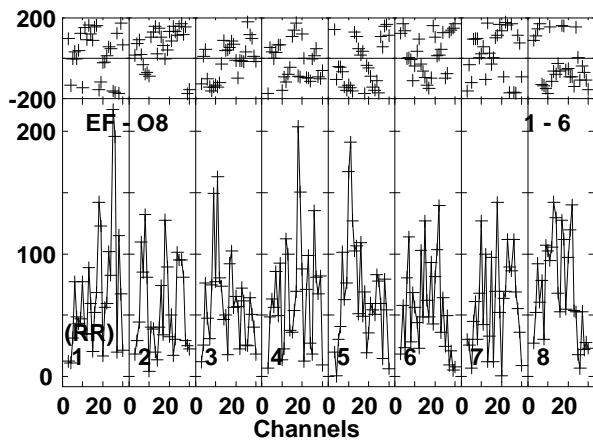
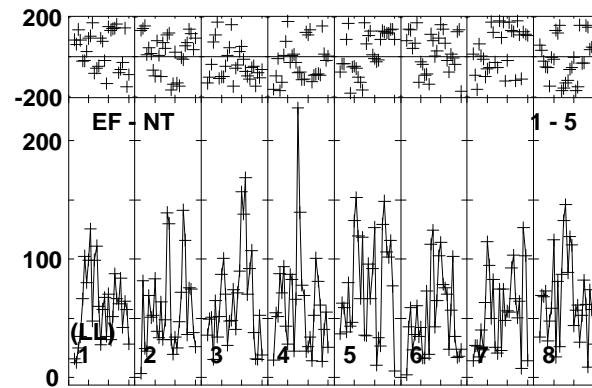
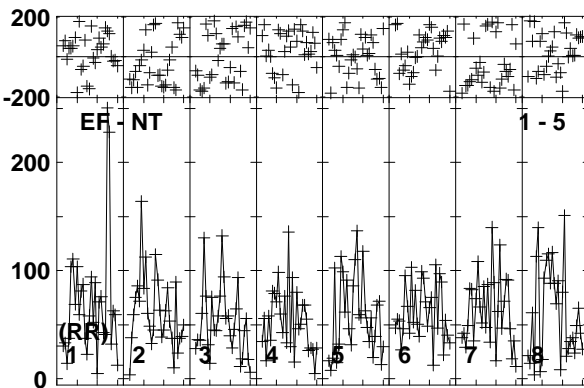
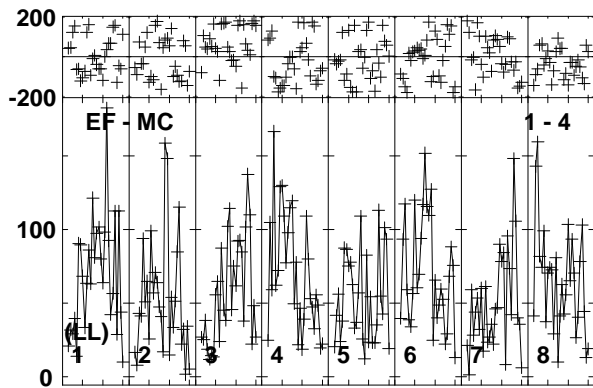
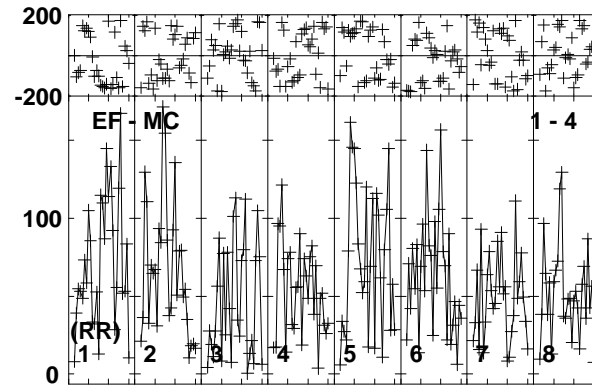
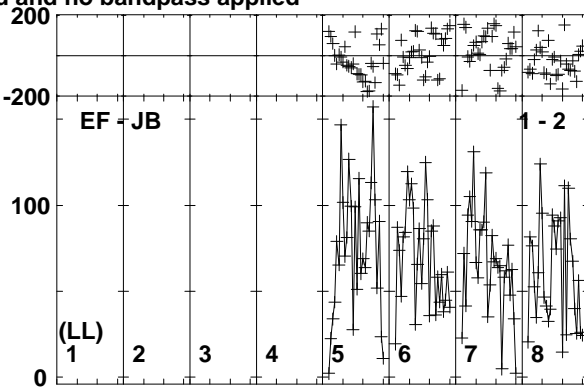
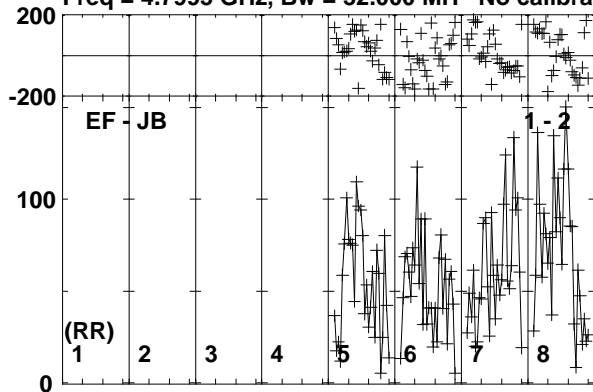

Lower frame: Micro Ampl Jy Top frame: Phas deg
Vector averaged cross-power spectrum Baseline: EF (01) - JB (02)
Timerange: 00/20:37:52 to 00/20:41:18

Plot file version 100 created 20-APR-2018 17:20:48

J1427+2632 RSM02.UVDATA.1

Freq = 4.7995 GHz, Bw = 32.000 MH No calibration applied and no bandpass applied

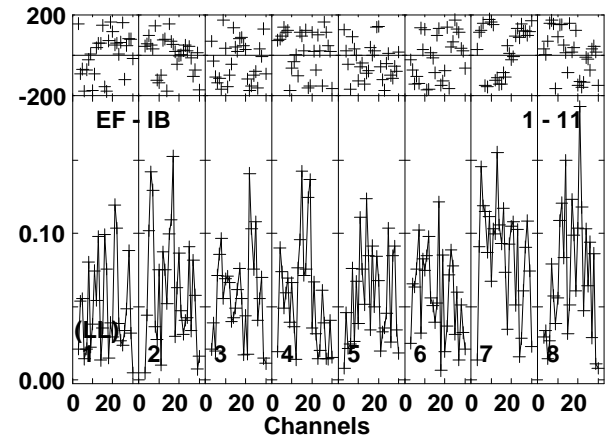
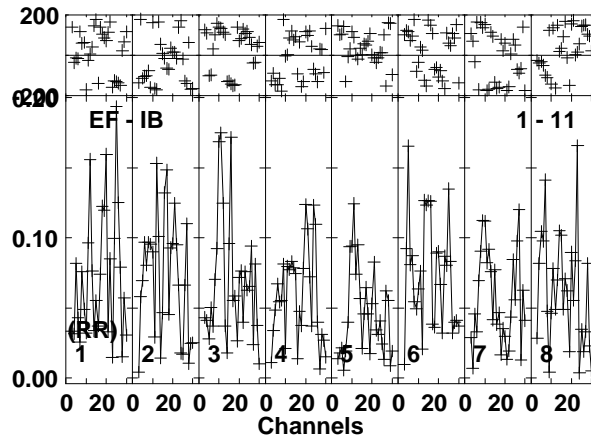
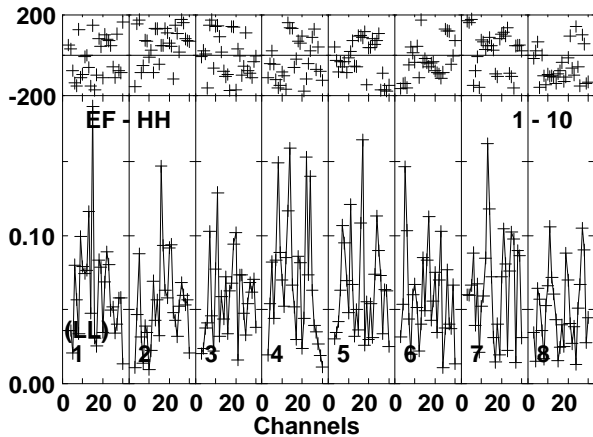
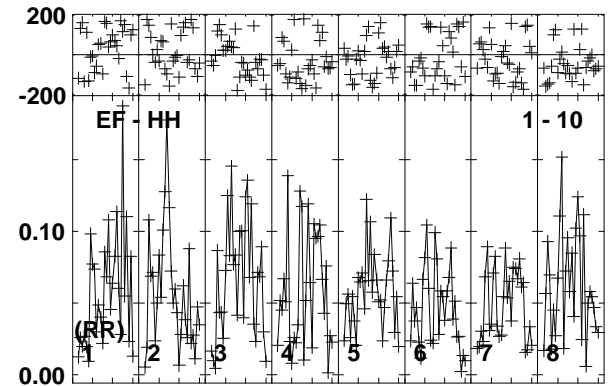
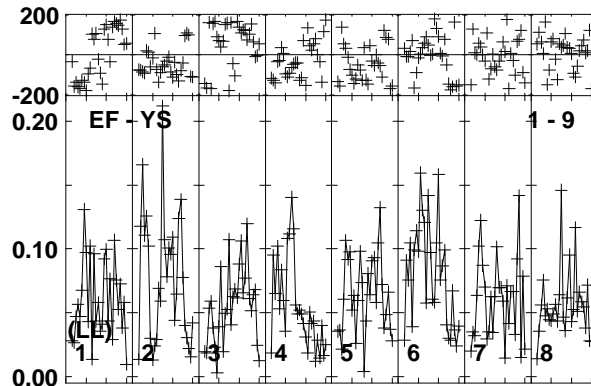
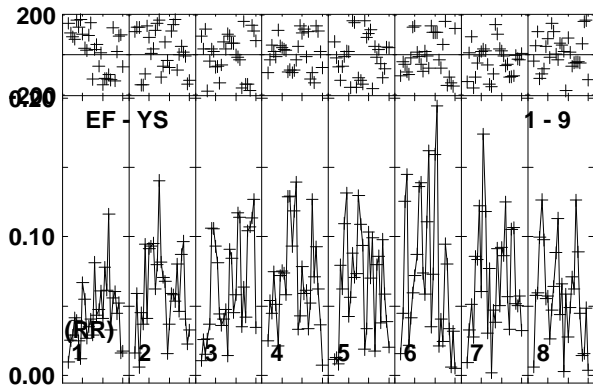
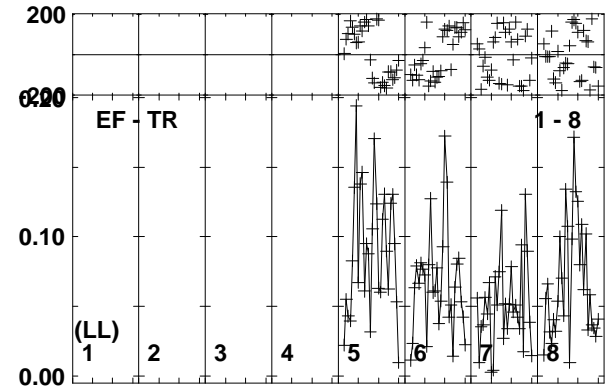
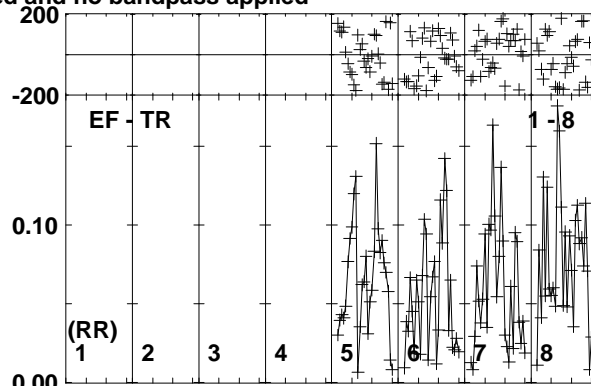
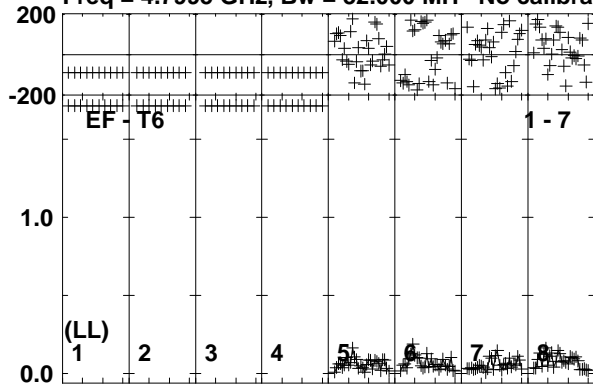

Lower frame: Milli Ampl Jy Top frame: Phas deg
Vector averaged cross-power spectrum Baseline: EF (01) - T6 (07)
Timerange: 00/20:37:52 to 00/20:41:18

Plot file version 101 created 20-APR-2018 17:20:48

J1419+2706 RSM02.UVDATA.1

Freq = 4.7995 GHz, Bw = 32.000 MH No calibration applied and no bandpass applied

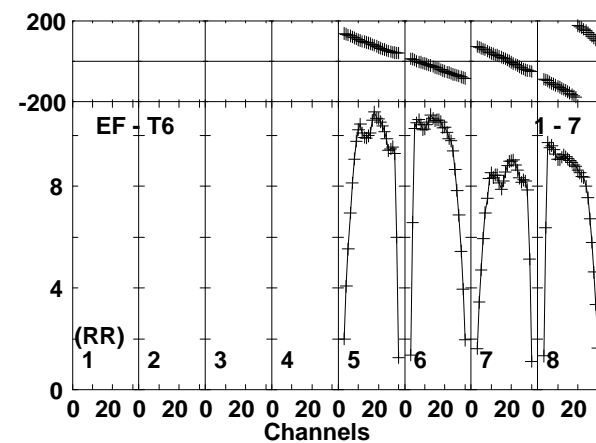
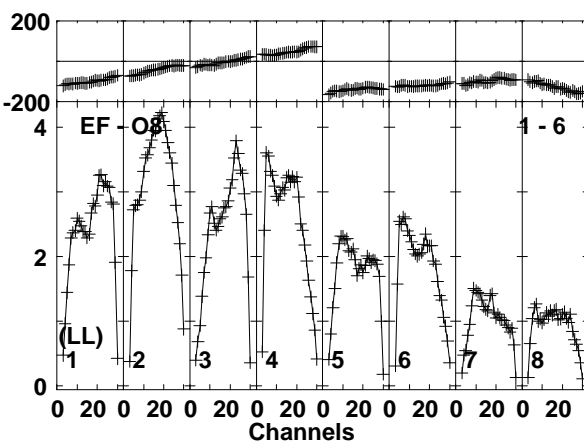
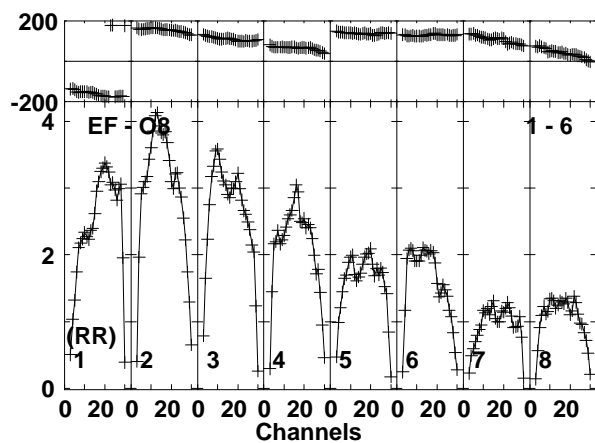
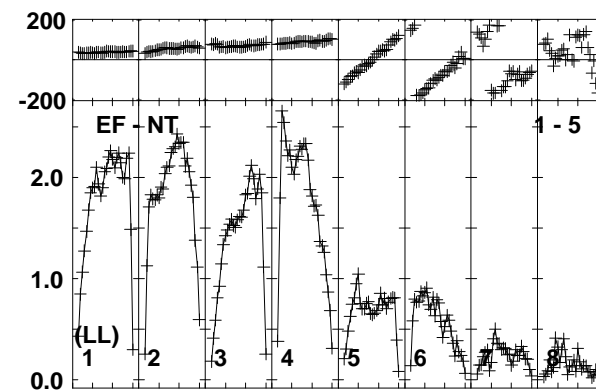
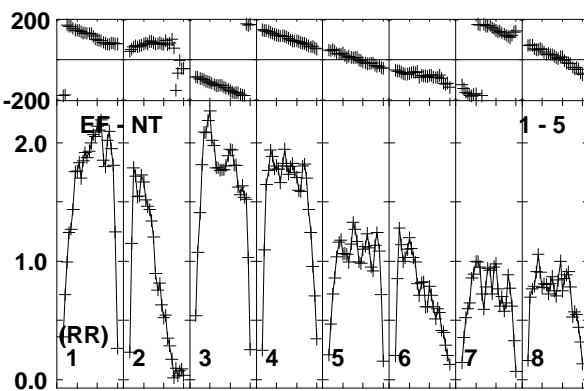
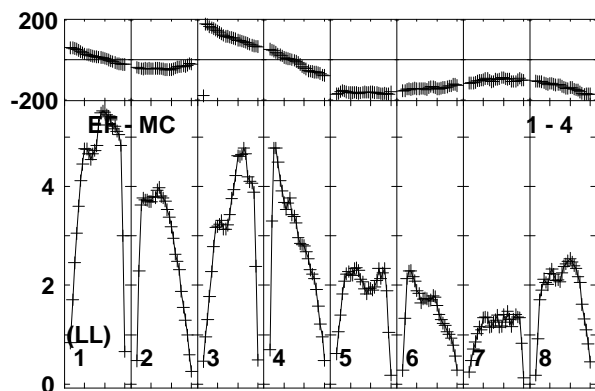
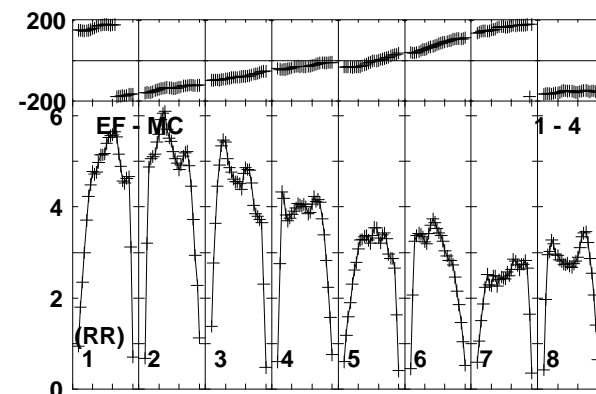
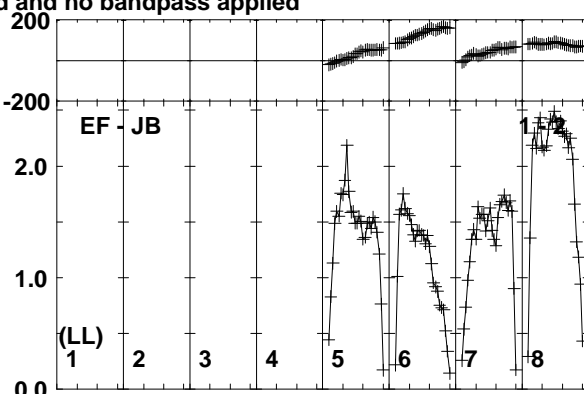
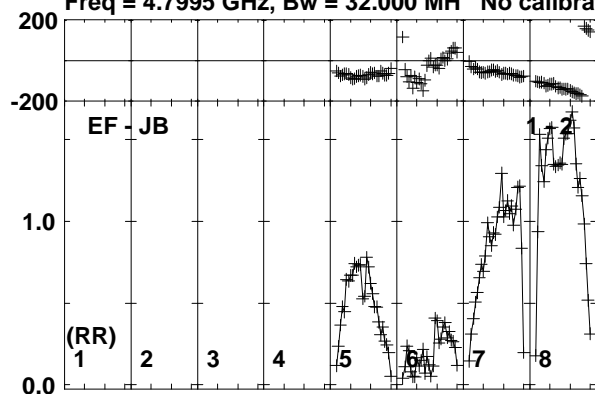

Lower frame: Milli Ampl Jy Top frame: Phas deg
Vector averaged cross-power spectrum Baseline: EF (01) - JB (02)
Timerange: 00/20:41:22 to 00/20:42:48

Plot file version 102 created 20-APR-2018 17:20:48

J1419+2706 RSM02.UVDATA.1

Freq = 4.7995 GHz, Bw = 32.000 MH No calibration applied and no bandpass applied

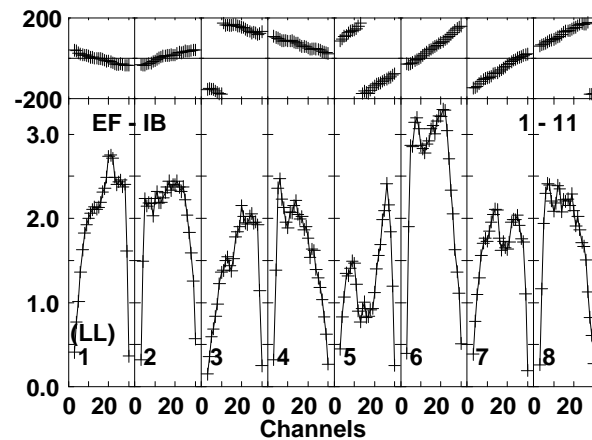
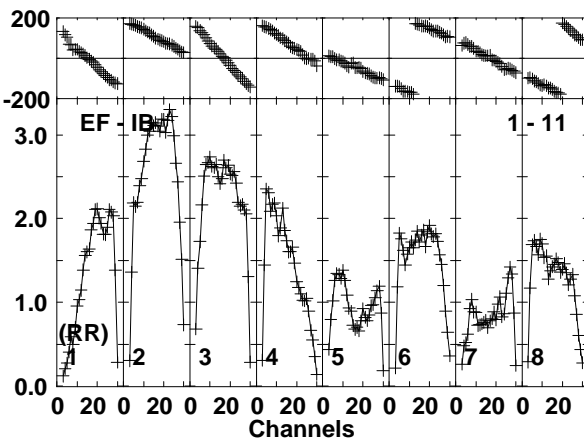
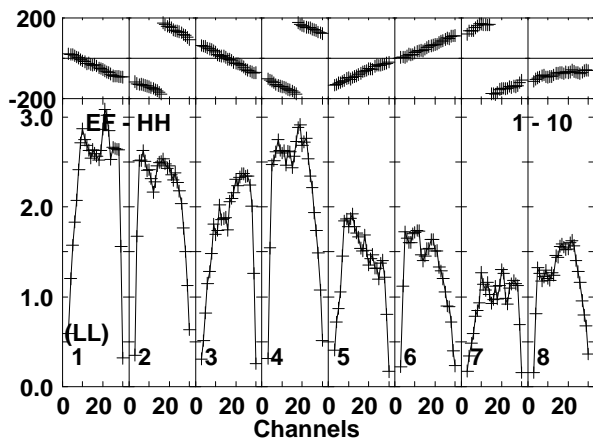
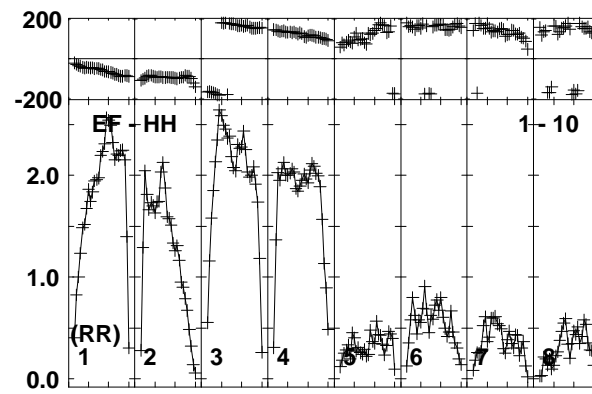
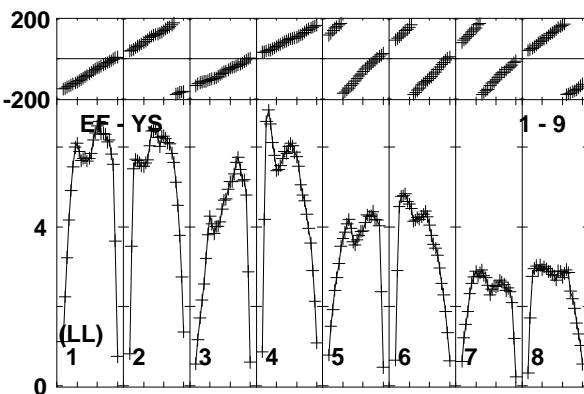
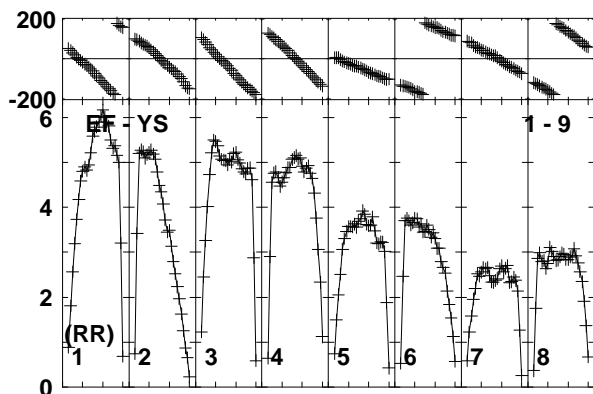
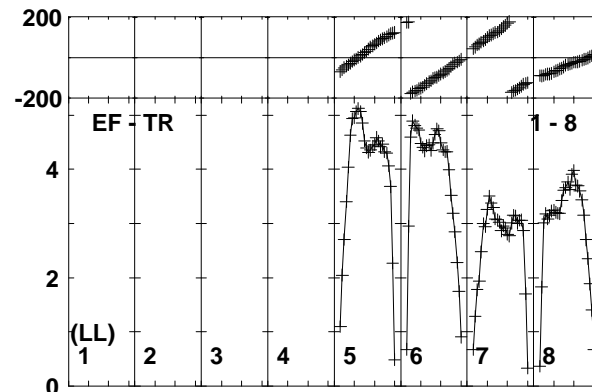
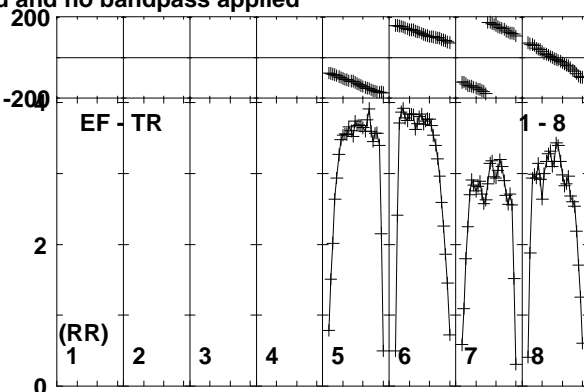
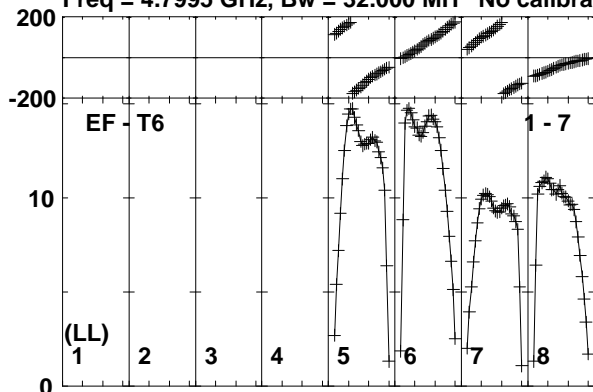

Lower frame: Milli Ampl Jy Top frame: Phas deg
Vector averaged cross-power spectrum Baseline: EF (01) - T6 (07)
Timerange: 00/20:41:22 to 00/20:42:48

Plot file version 103 created 20-APR-2018 17:20:48

J1427+2632 RSM02.UVDATA.1

Freq = 4.7995 GHz, Bw = 32.000 MH No calibration applied and no bandpass applied

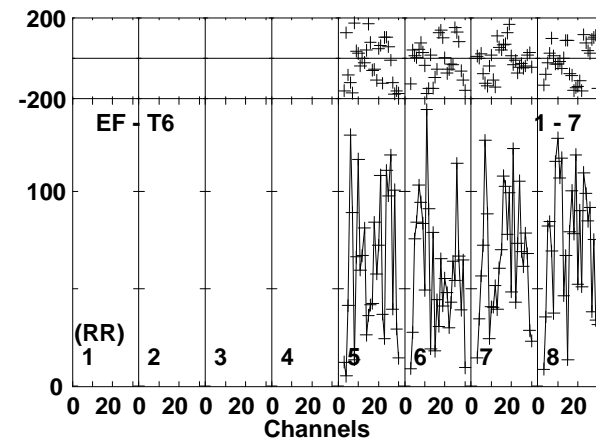
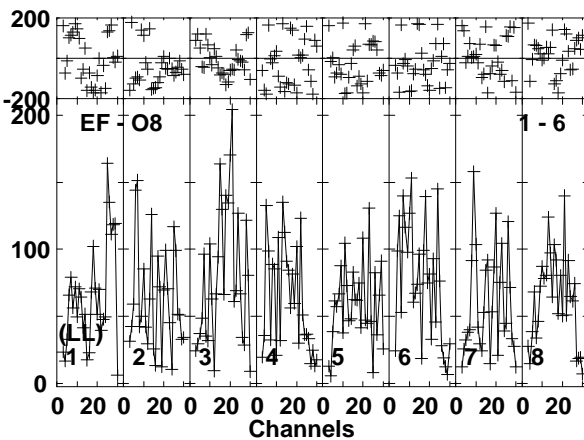
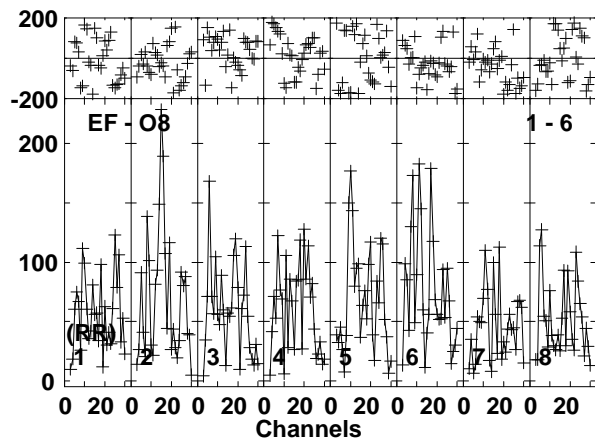
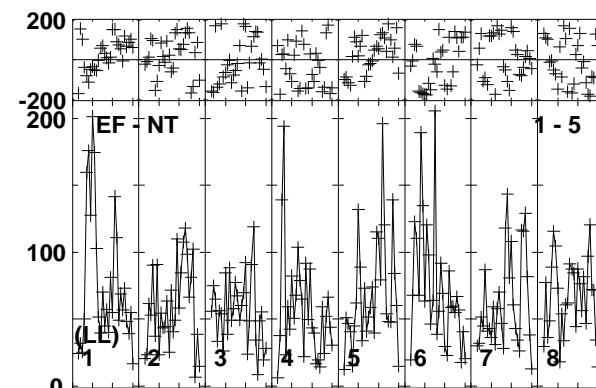
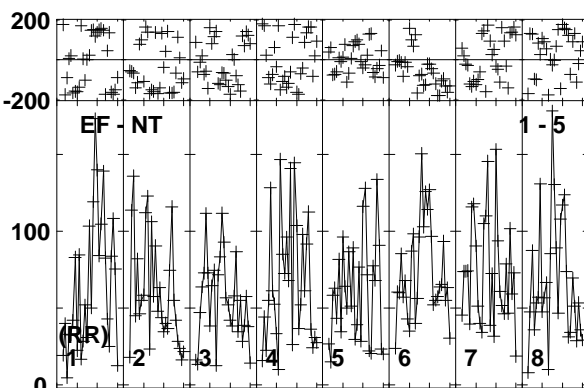
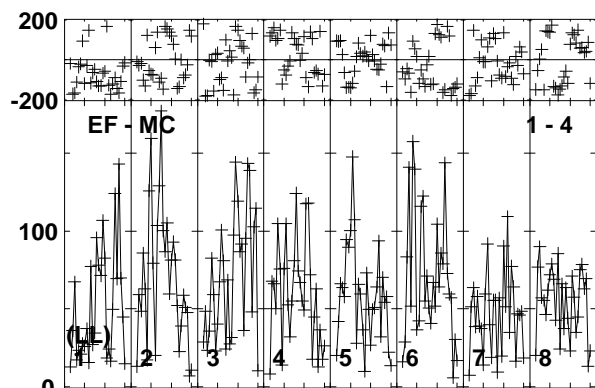
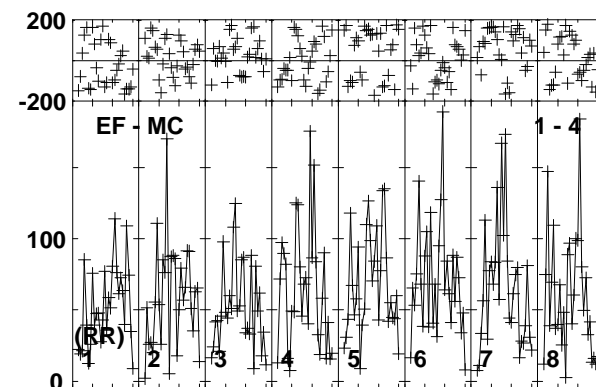
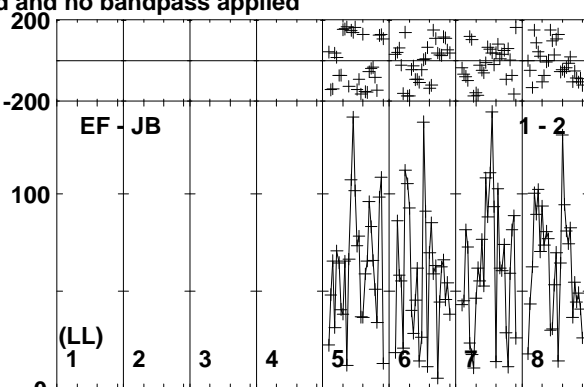
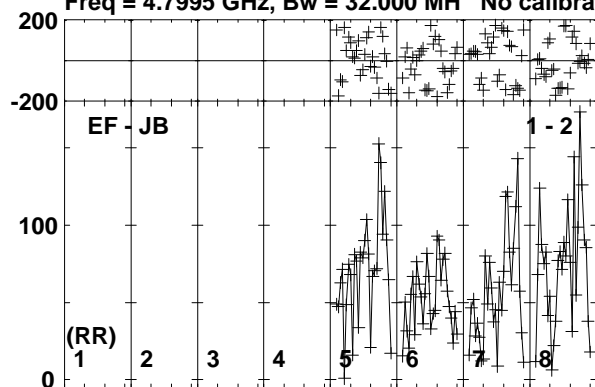

Lower frame: Micro Ampl Jy Top frame: Phas deg
Vector averaged cross-power spectrum Baseline: EF (01) - JB (02)
Timerange: 00/20:42:52 to 00/20:46:18

Plot file version 104 created 20-APR-2018 17:20:48

J1427+2632 RSM02.UVDATA.1

Freq = 4.7995 GHz, Bw = 32.000 MH No calibration applied and no bandpass applied

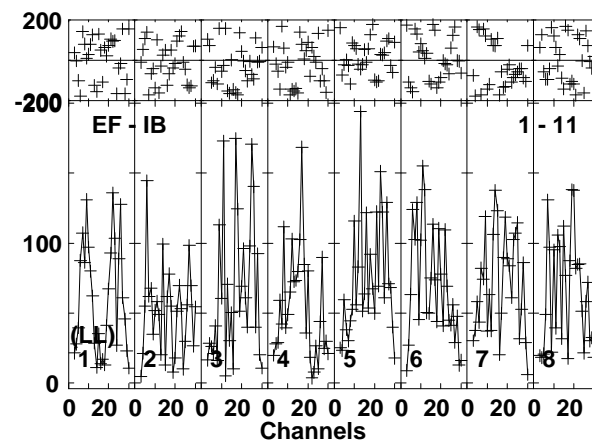
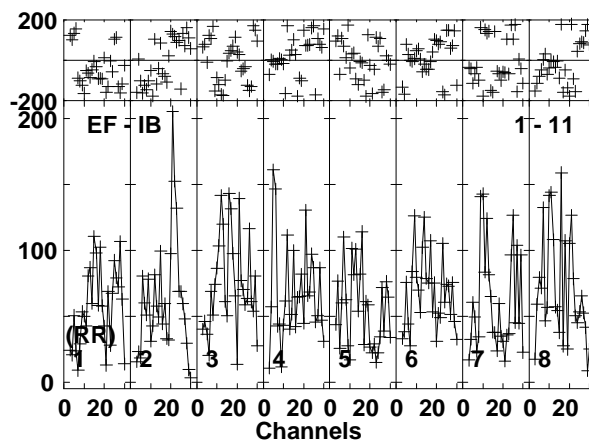
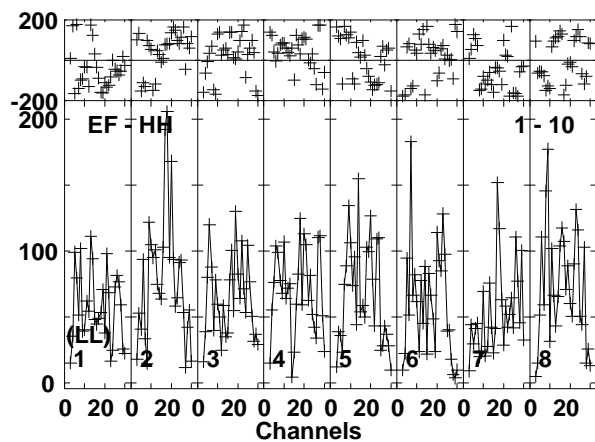
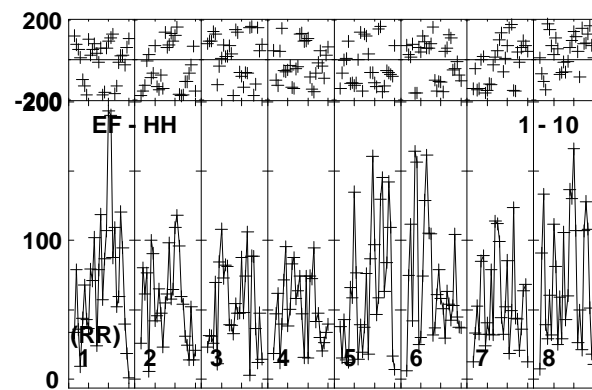
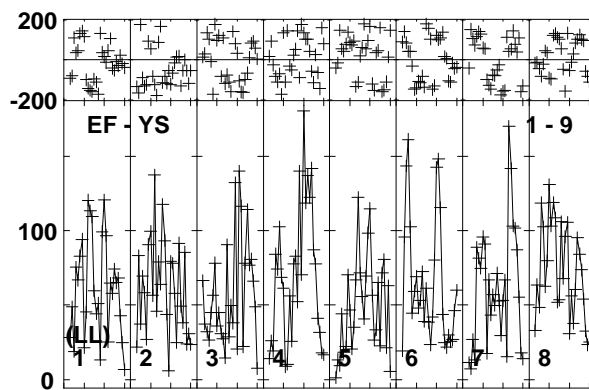
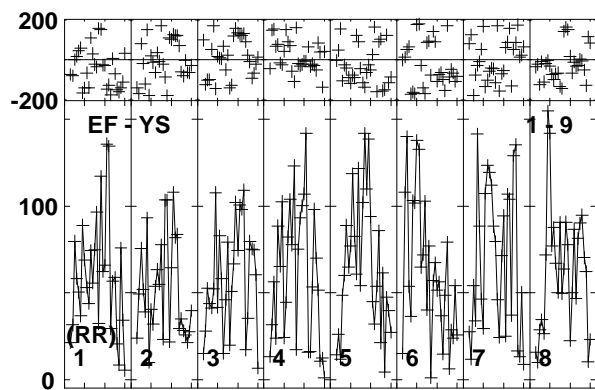
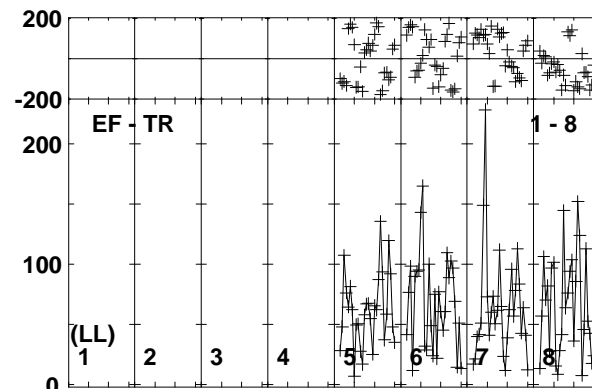
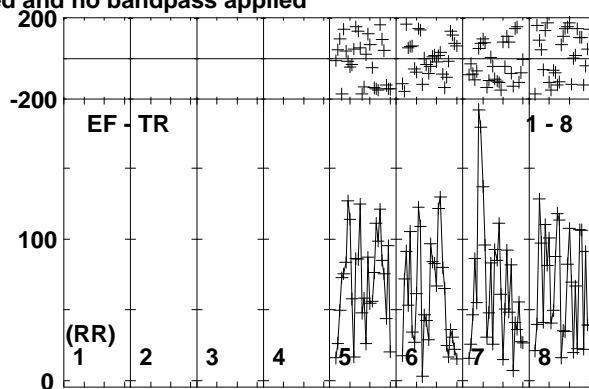
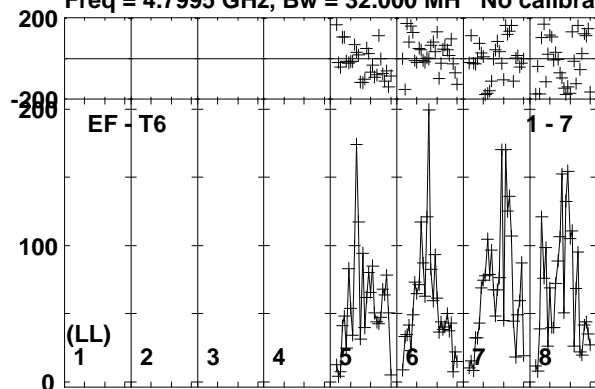

Lower frame: Micro Ampl Jy Top frame: Phas deg
Vector averaged cross-power spectrum Baseline: EF (01) - T6 (07)
Timerange: 00/20:42:52 to 00/20:46:18

Plot file version 105 created 20-APR-2018 17:20:48

J1419+2706 RSM02.UVDATA.1

Freq = 4.7995 GHz, Bw = 32.000 MH No calibration applied and no bandpass applied

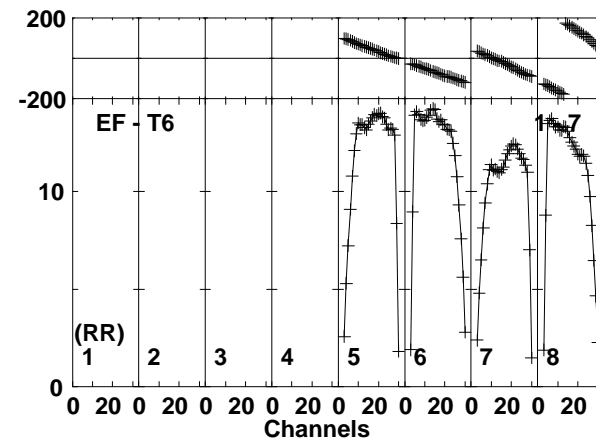
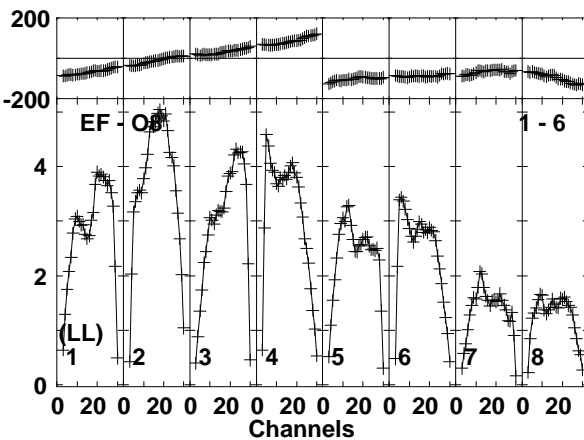
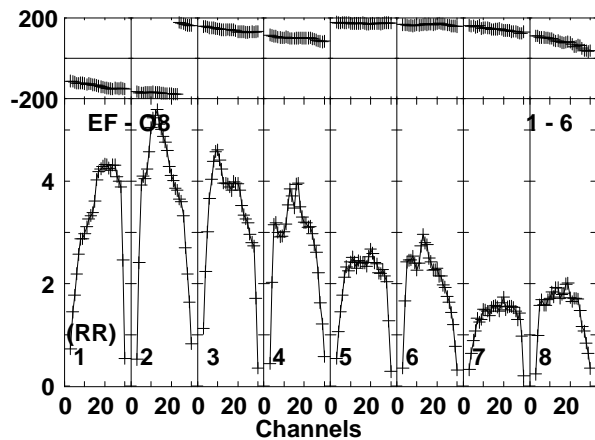
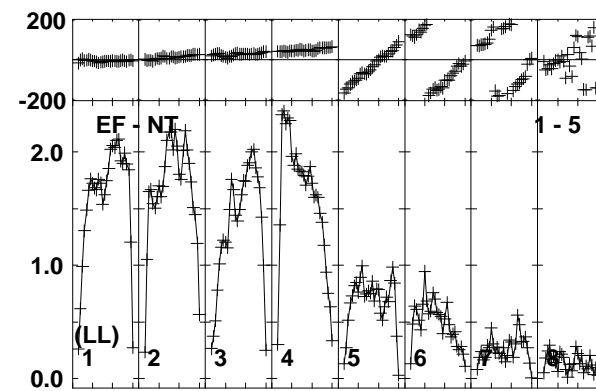
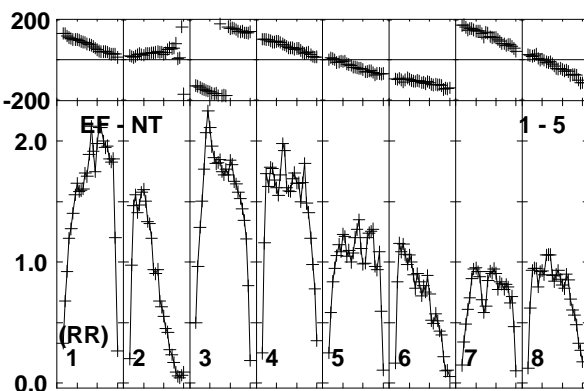
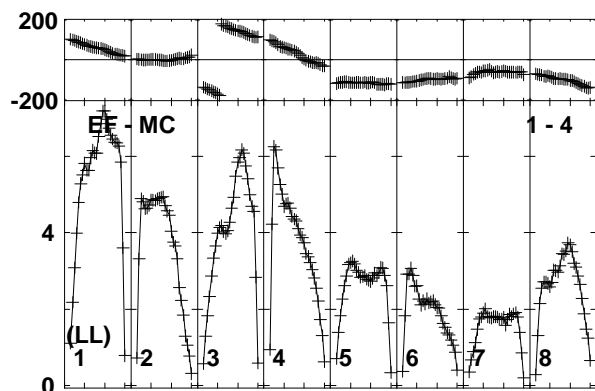
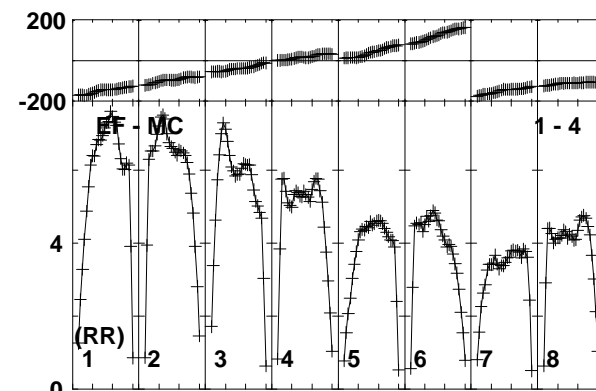
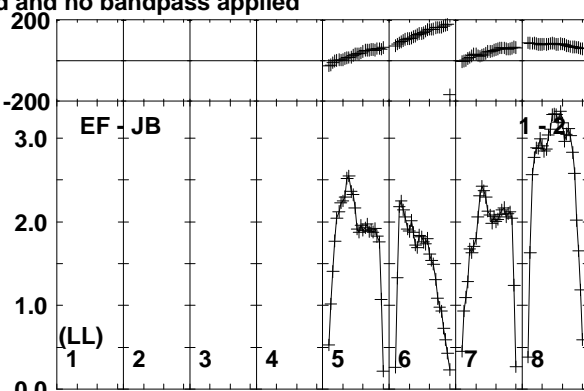
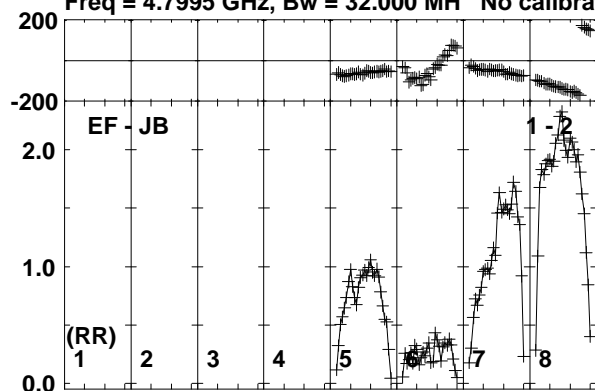

Lower frame: Milli Ampl Jy Top frame: Phas deg
Vector averaged cross-power spectrum Baseline: EF (01) - JB (02)
Timerange: 00/20:46:22 to 00/20:47:48

Plot file version 106 created 20-APR-2018 17:20:48

J1419+2706 RSM02.UVDATA.1

Freq = 4.7995 GHz, Bw = 32.000 MH No calibration applied and no bandpass applied

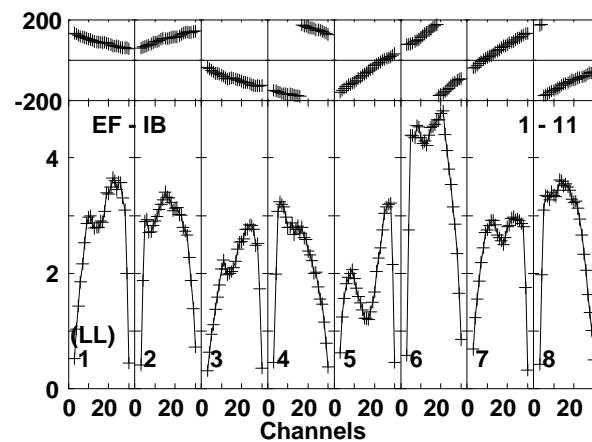
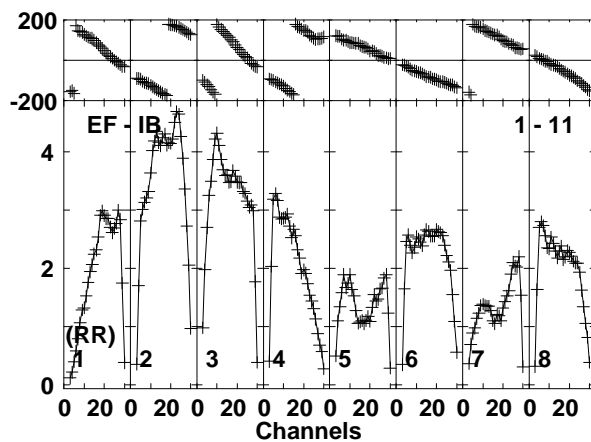
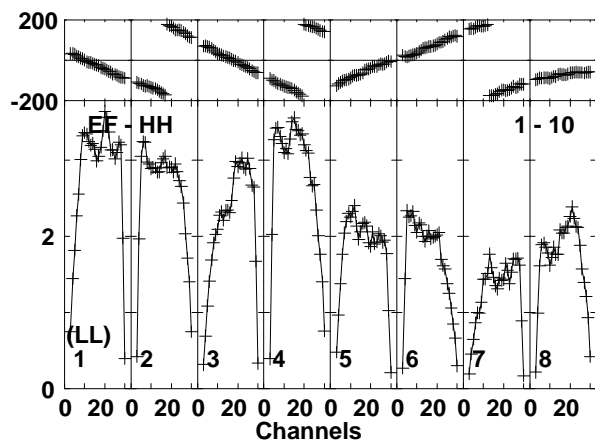
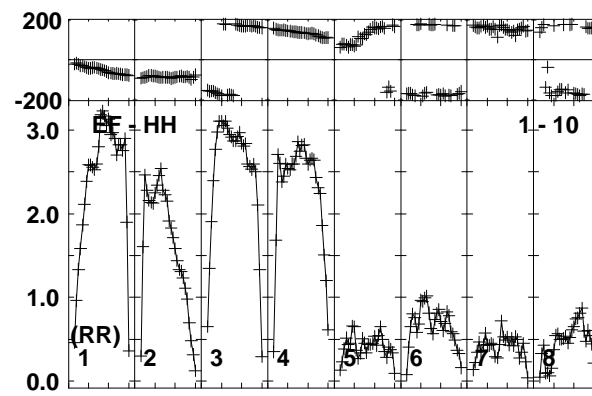
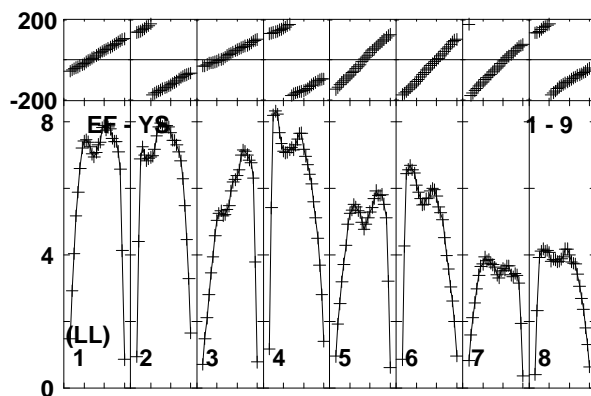
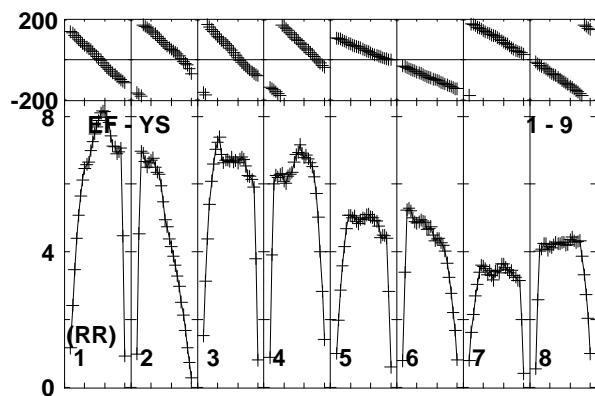
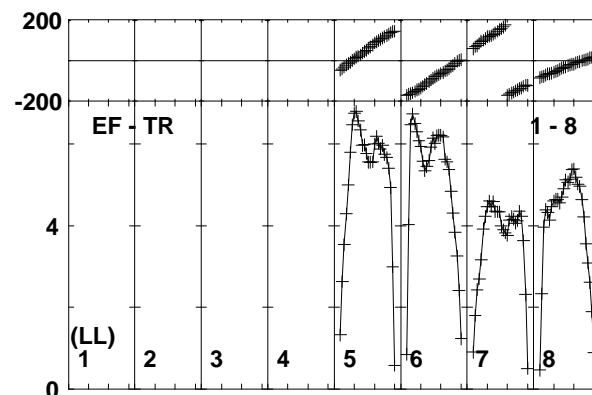
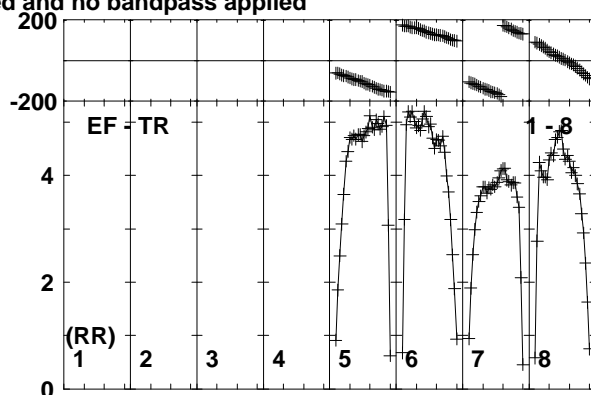
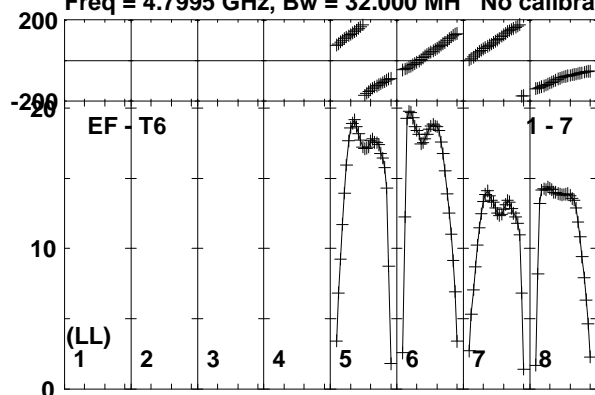

Lower frame: Milli Ampl Jy Top frame: Phas deg
Vector averaged cross-power spectrum Baseline: EF (01) - T6 (07)
Timerange: 00/20:46:22 to 00/20:47:48

Plot file version 107 created 20-APR-2018 17:20:48

J1427+2632 RSM02.UVDATA.1

Freq = 4.7995 GHz, Bw = 32.000 MH No calibration applied and no bandpass applied

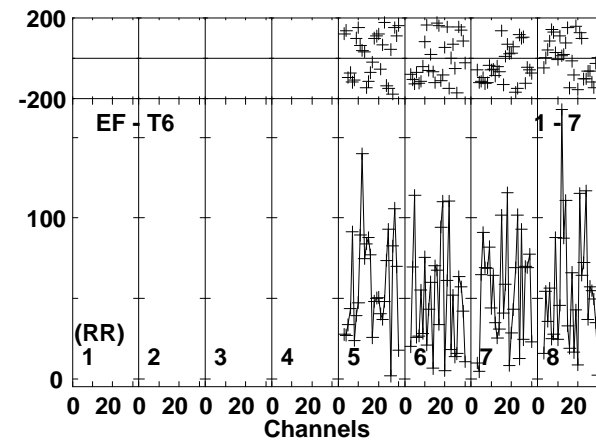
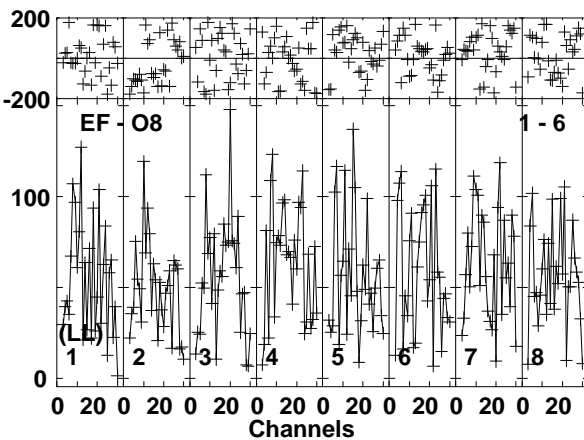
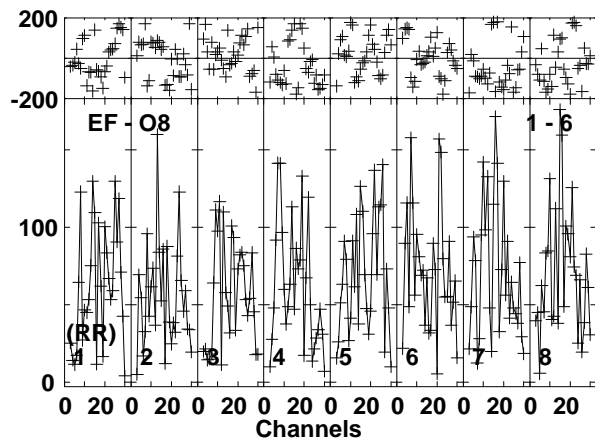
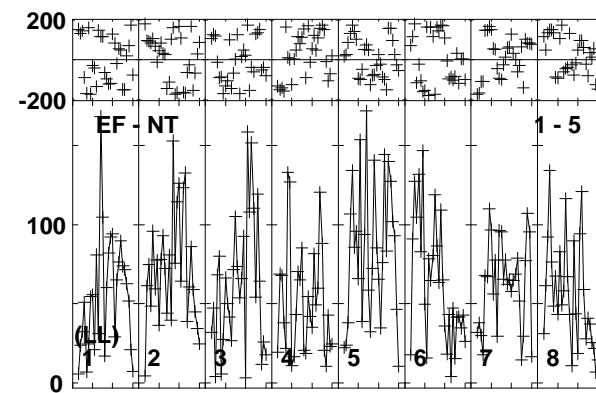
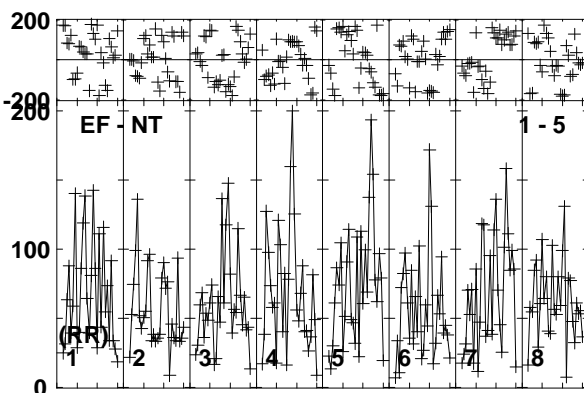
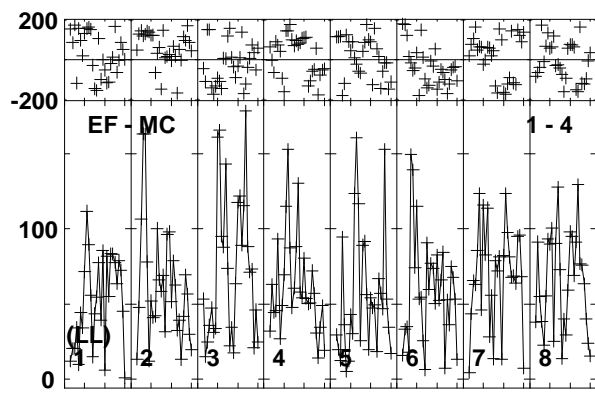
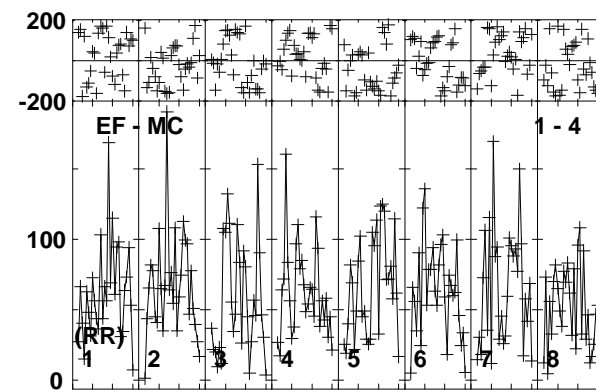
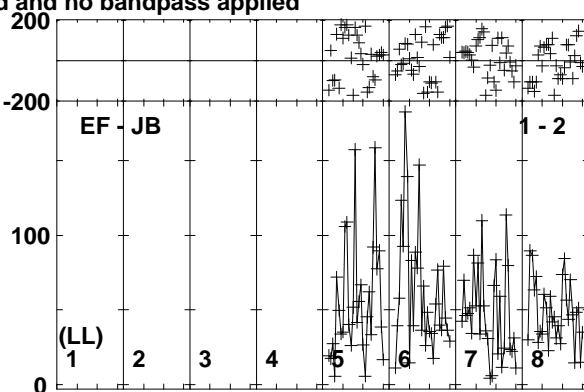
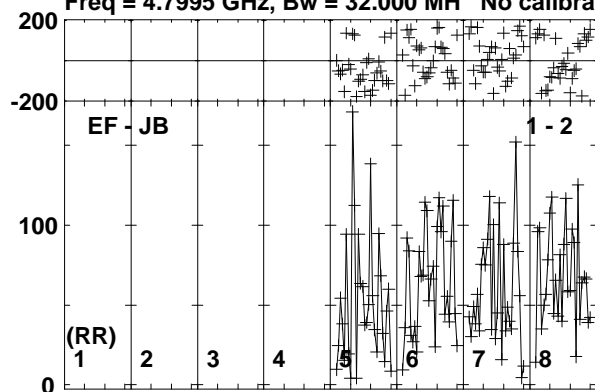

Lower frame: Micro Ampl Jy Top frame: Phas deg
Vector averaged cross-power spectrum Baseline: EF (01) - JB (02)
Timerange: 00/20:47:52 to 00/20:51:18

Plot file version 108 created 20-APR-2018 17:20:48

J1427+2632 RSM02.UVDATA.1

Freq = 4.7995 GHz, Bw = 32.000 MH No calibration applied and no bandpass applied

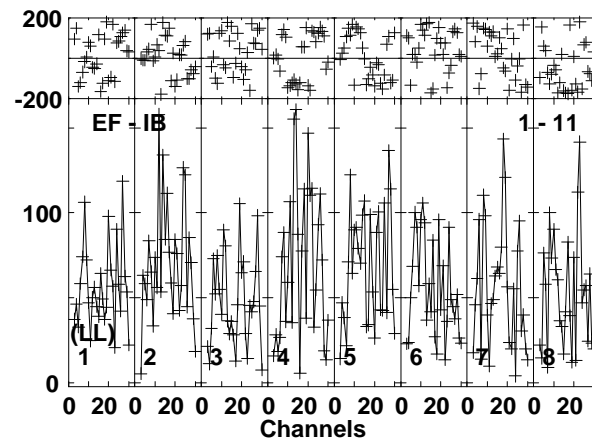
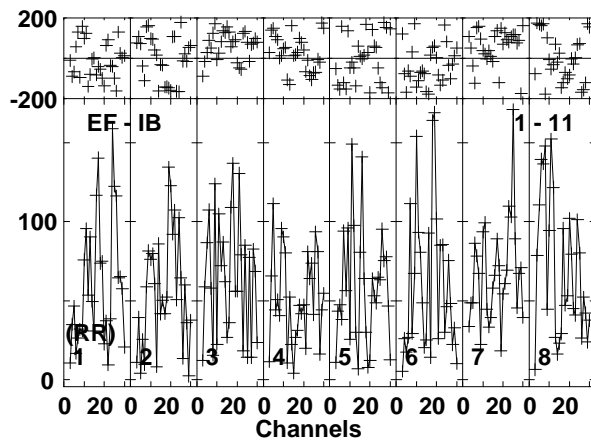
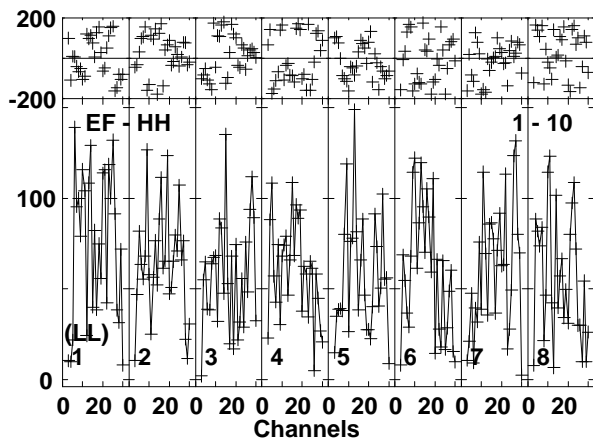
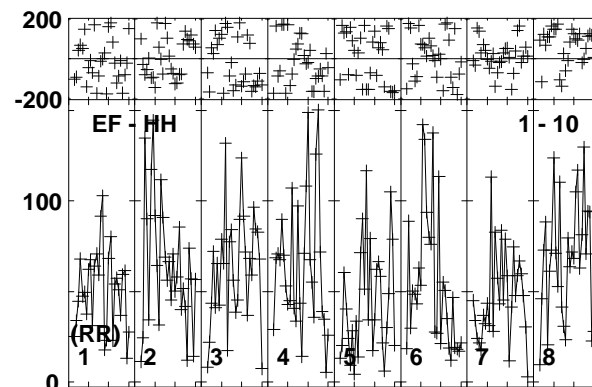
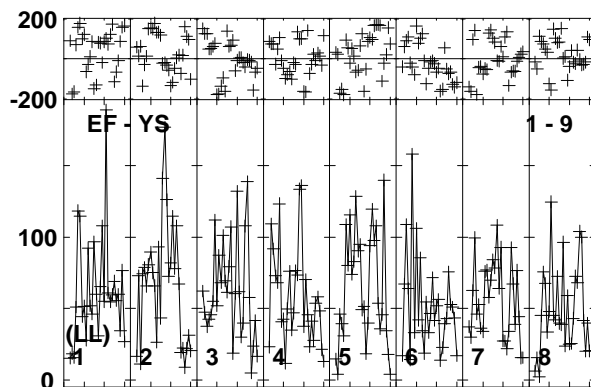
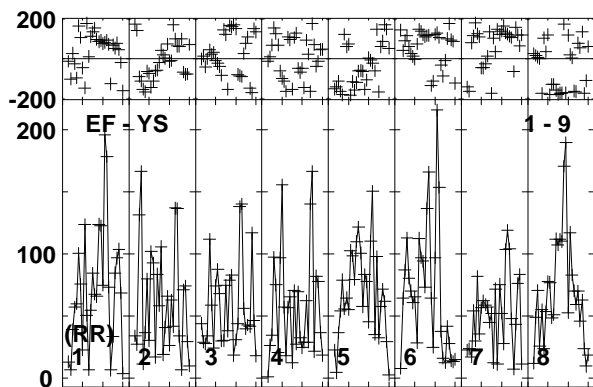
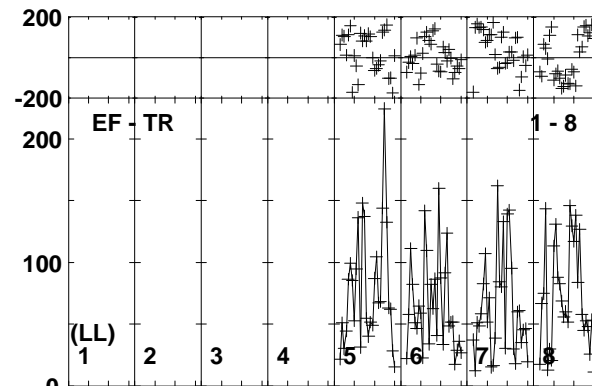
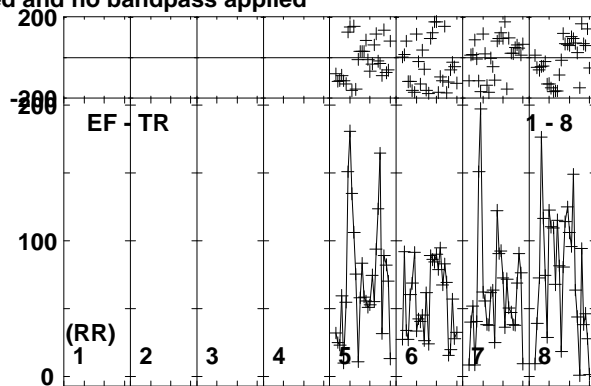
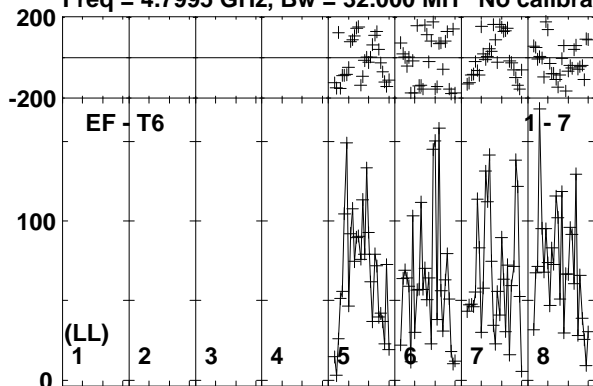

Lower frame: Micro Ampl Jy Top frame: Phas deg
Vector averaged cross-power spectrum Baseline: EF (01) - T6 (07)
Timerange: 00/20:47:52 to 00/20:51:18

Plot file version 109 created 20-APR-2018 17:20:48

J1419+2706 RSM02.UVDATA.1

Freq = 4.7995 GHz, Bw = 32.000 MH No calibration applied and no bandpass applied

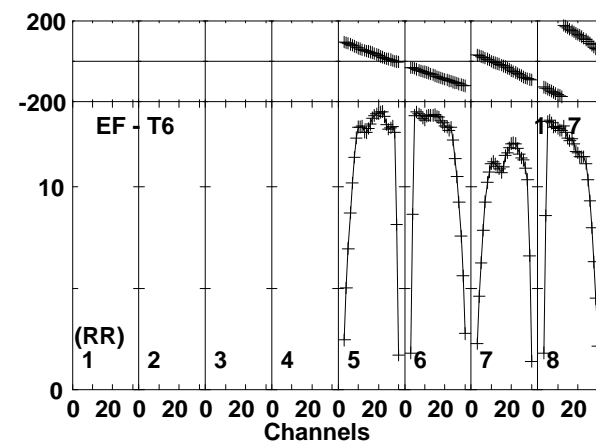
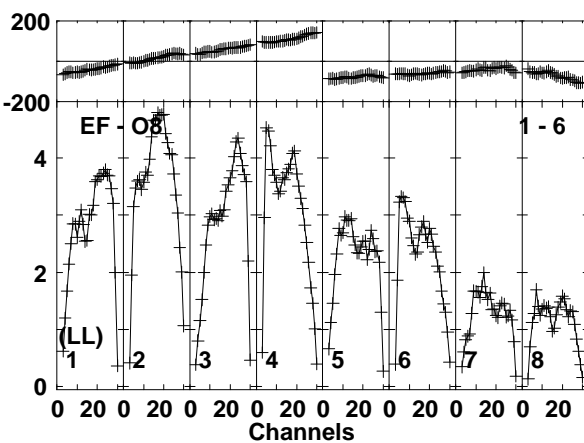
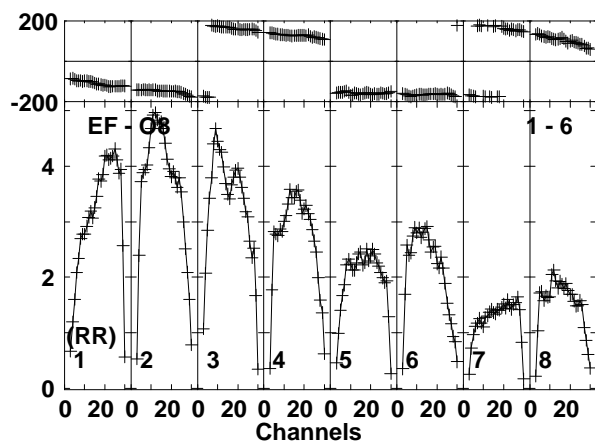
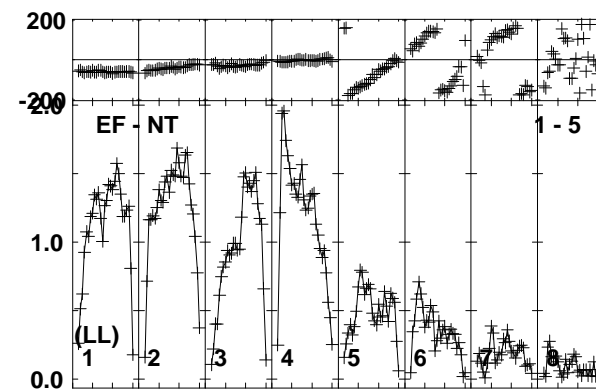
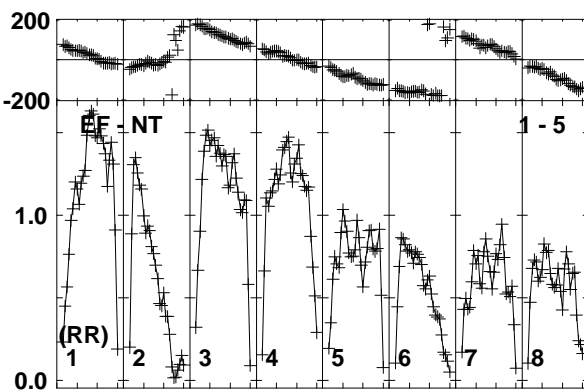
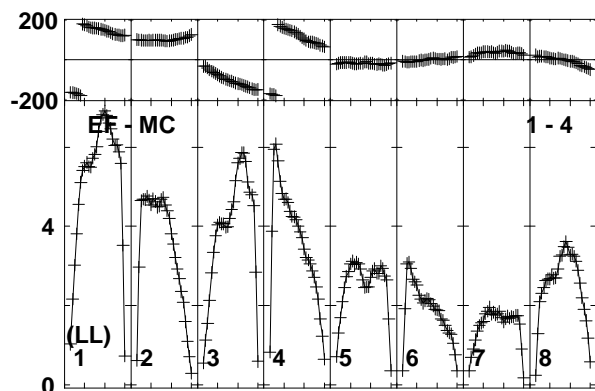
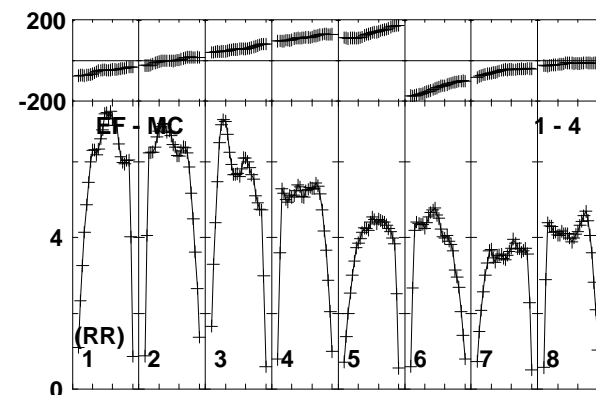
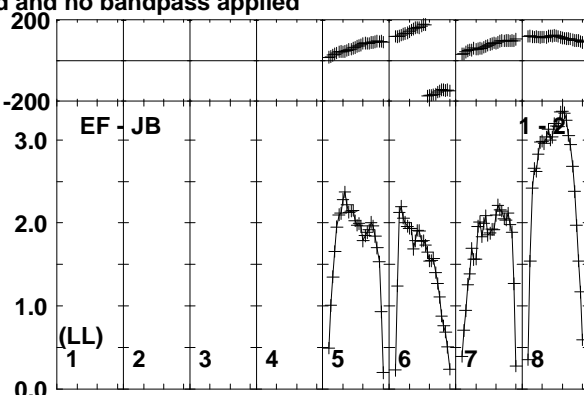
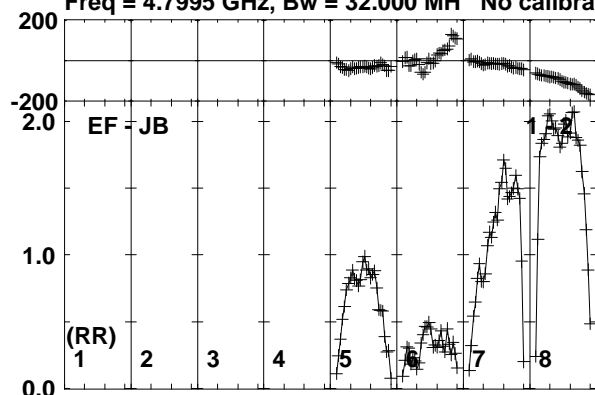

Lower frame: Milli Ampl Jy Top frame: Phas deg
Vector averaged cross-power spectrum Baseline: EF (01) - JB (02)
Timerange: 00/20:52:02 to 00/20:52:58

Plot file version 110 created 20-APR-2018 17:20:49

J1419+2706 RSM02.UVDATA.1

Freq = 4.7995 GHz, Bw = 32.000 MH No calibration applied and no bandpass applied

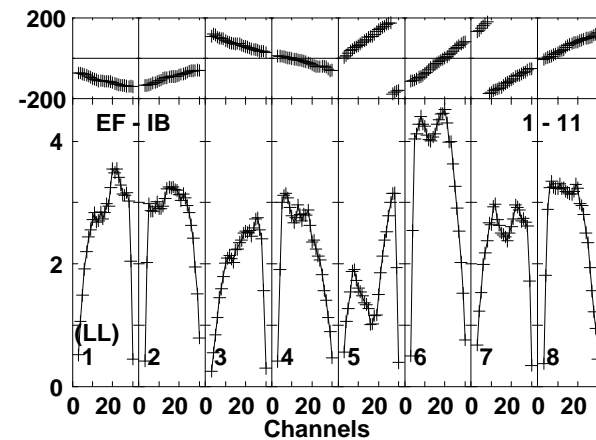
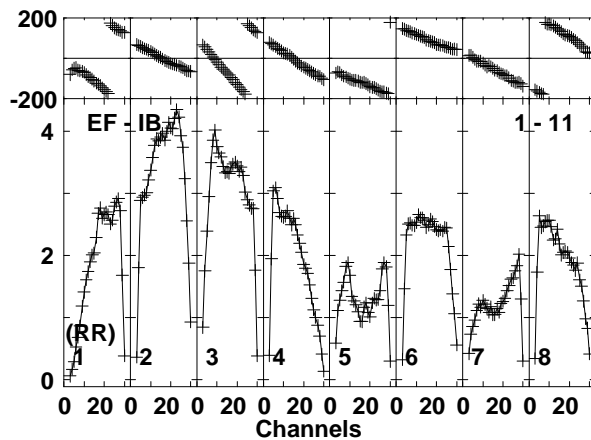
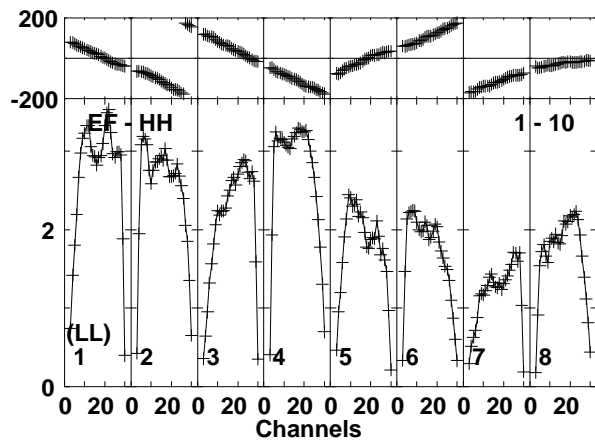
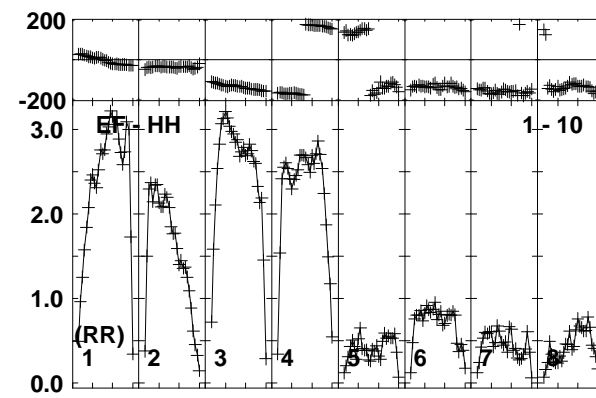
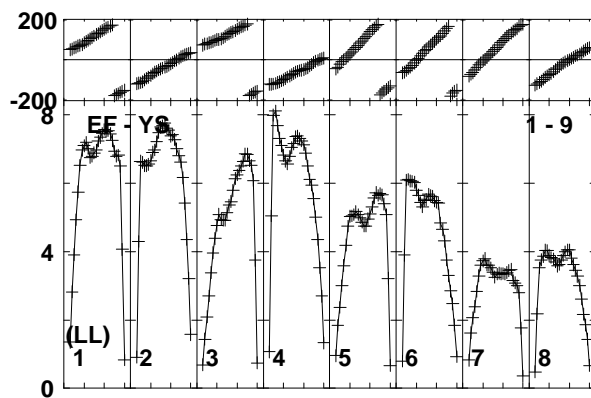
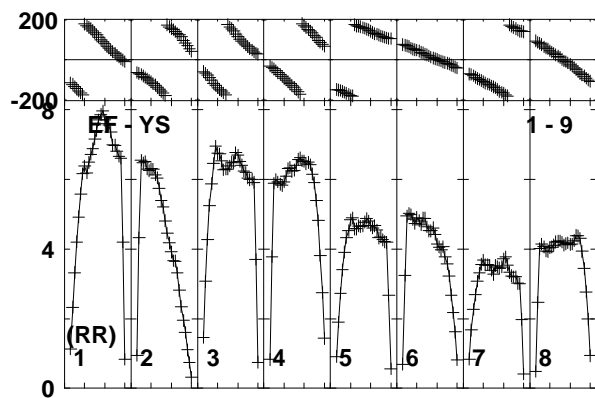
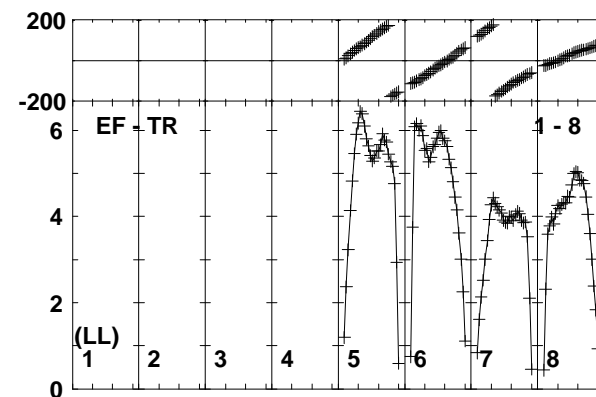
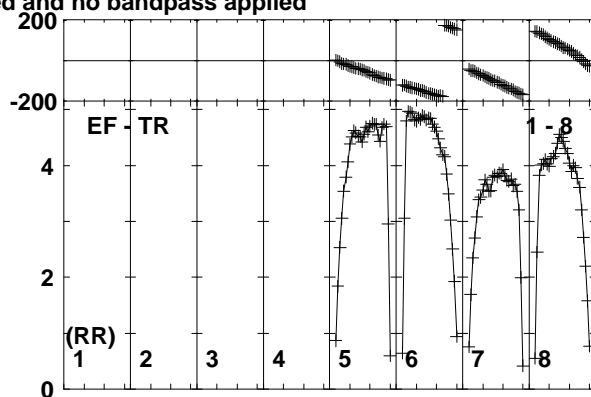
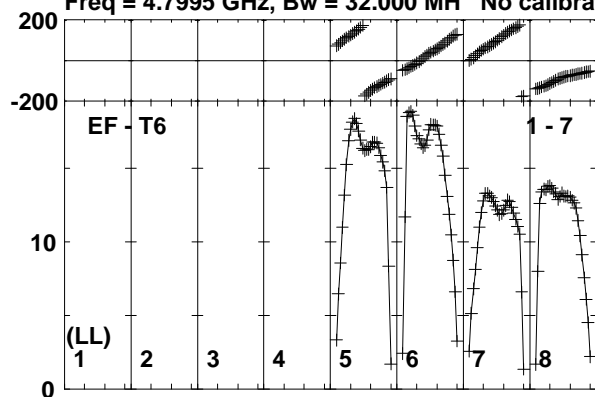

Lower frame: Milli Ampl Jy Top frame: Phas deg
Vector averaged cross-power spectrum Baseline: EF (01) - T6 (07)
Timerange: 00/20:52:02 to 00/20:52:58

Plot file version 111 created 20-APR-2018 17:20:49
 J1310+3220 RSM02.UVDATA.1

Freq = 4.7995 GHz, Bw = 32.000 MH No calibration applied and no bandpass applied

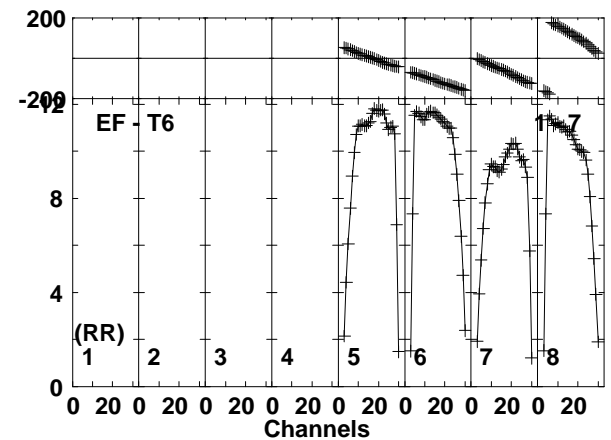
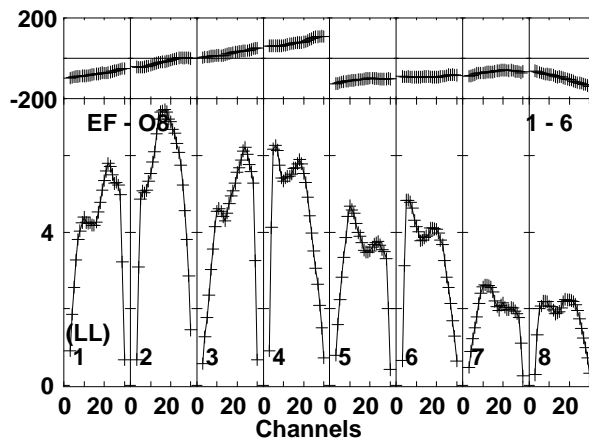
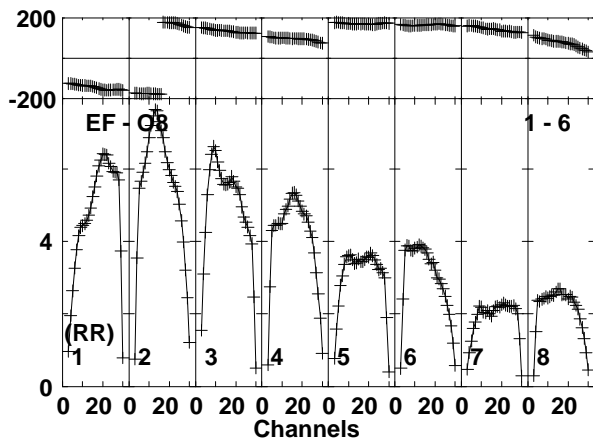
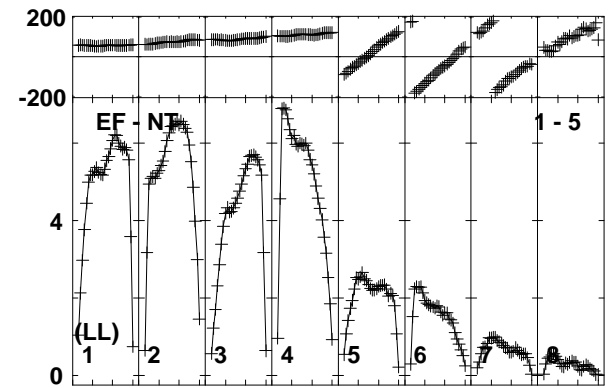
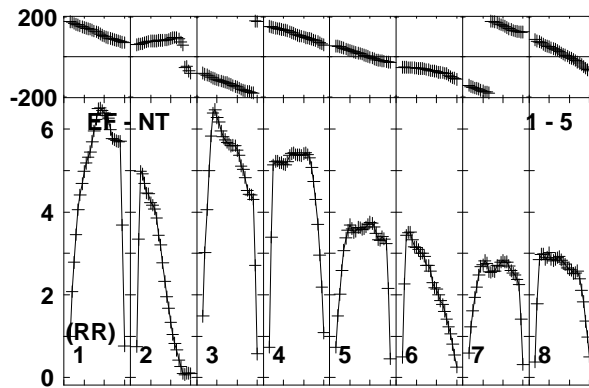
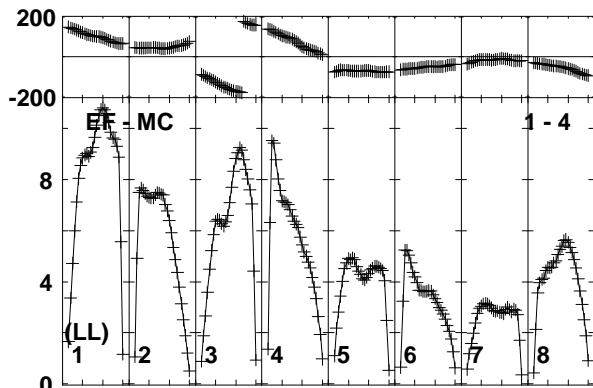
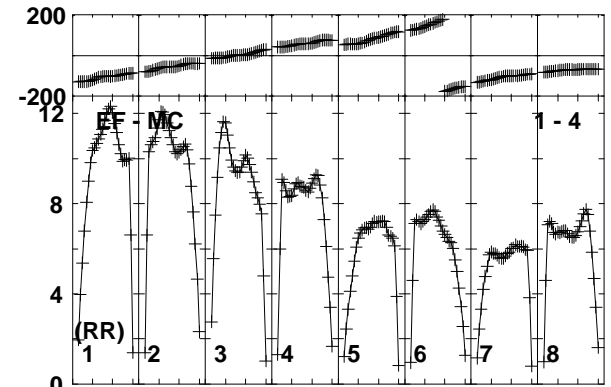
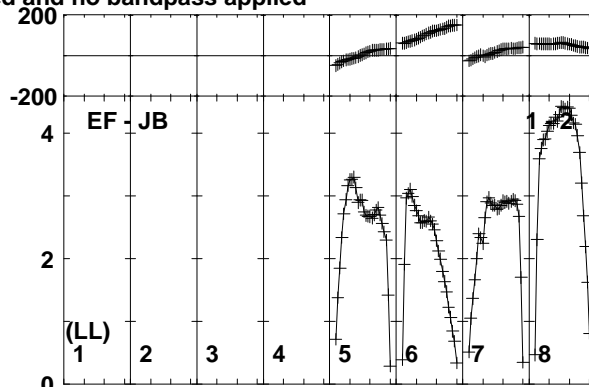
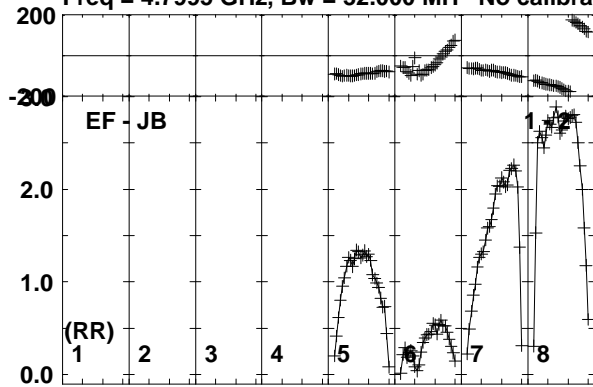

Lower frame: Milli Ampl Jy Top frame: Phas deg
 Vector averaged cross-power spectrum Baseline: EF (01) - JB (02)
 Timerange: 00/20:54:02 to 00/20:56:58

Plot file version 112 created 20-APR-2018 17:20:49

J1310+3220 RSM02.UVDATA.1

Freq = 4.7995 GHz, Bw = 32.000 MH No calibration applied and no bandpass applied

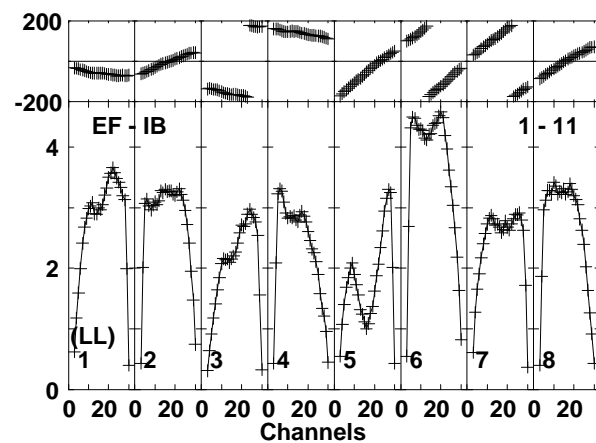
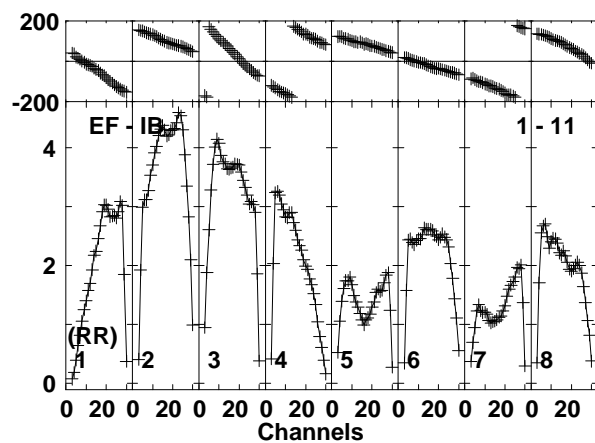
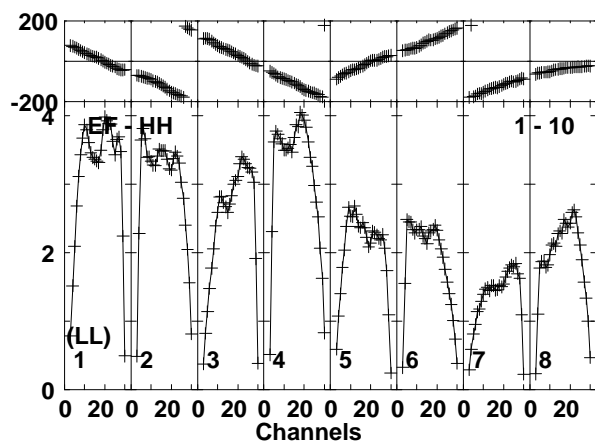
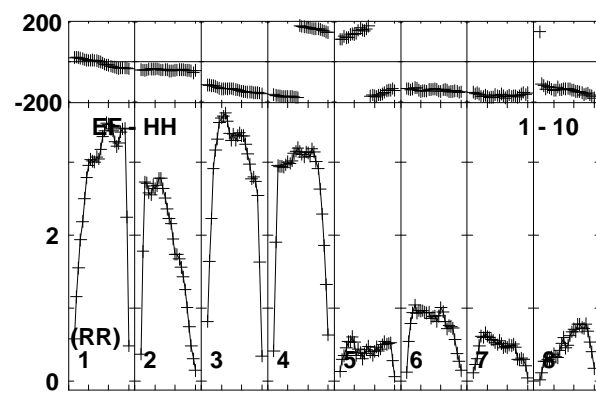
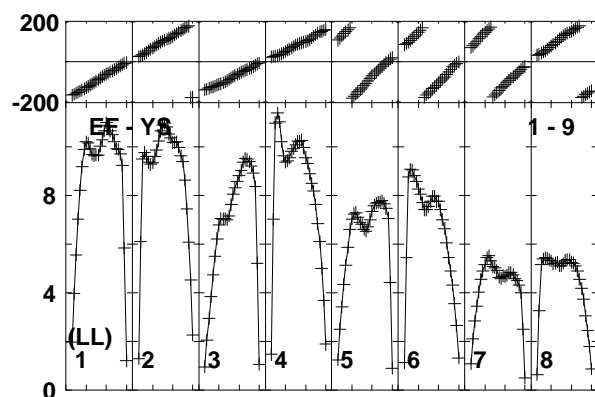
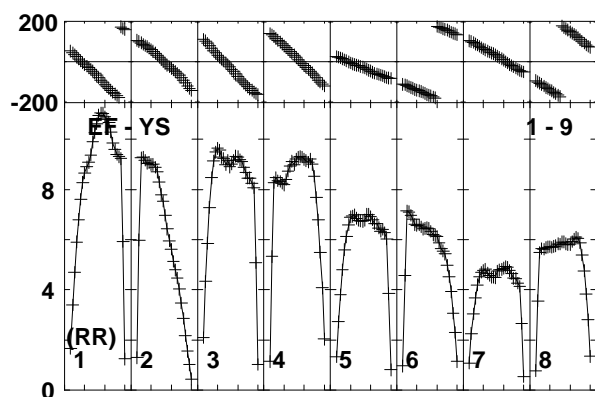
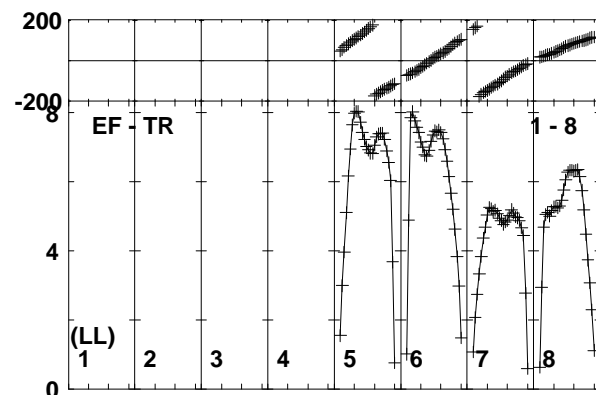
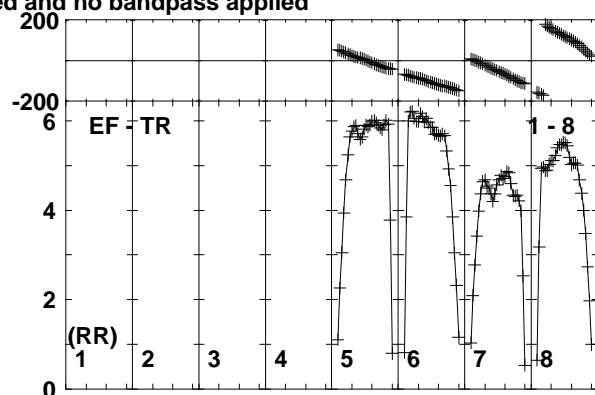
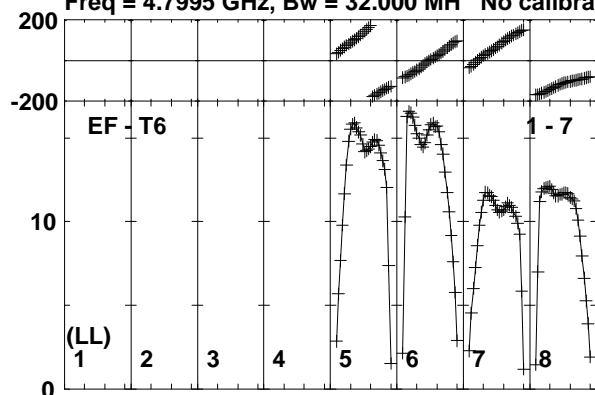

Lower frame: Milli Ampl Jy Top frame: Phas deg
Vector averaged cross-power spectrum Baseline: EF (01) - T6 (07)
Timerange: 00/20:54:02 to 00/20:56:58