

Plot file version 1 created 20-SEP-2019 15:50:49

3C345 RSM05.UVDATA.1

Freq = 4.7990 GHz, Bw = 32.000 MH No calibration applied and no bandpass applied

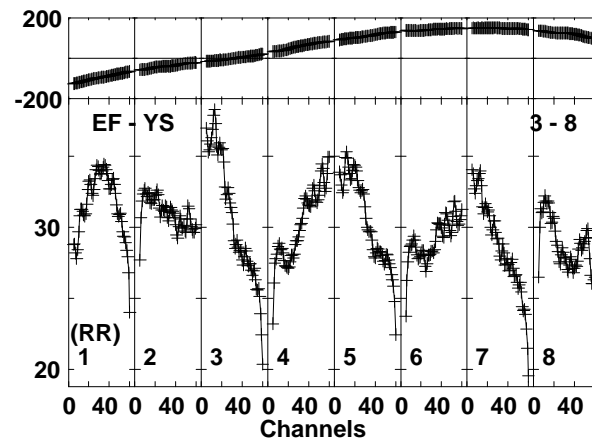
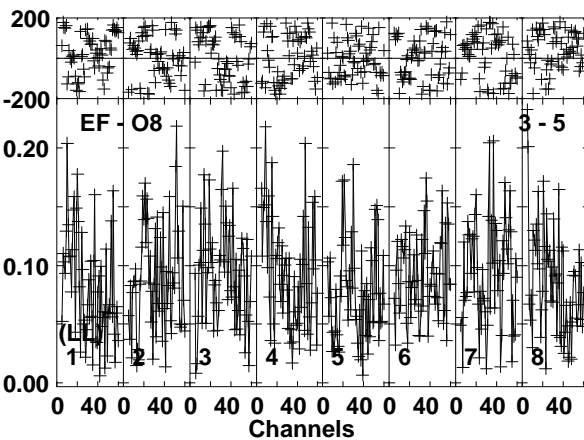
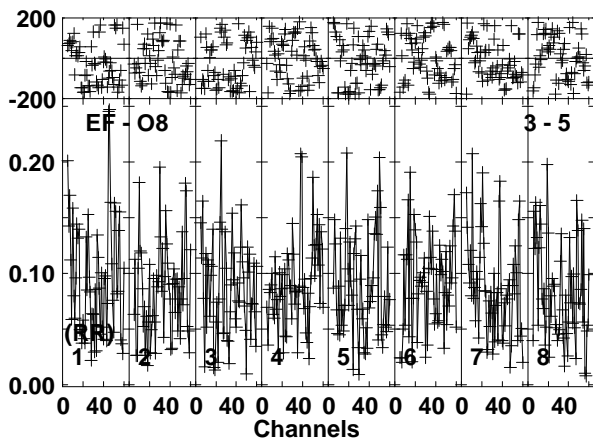
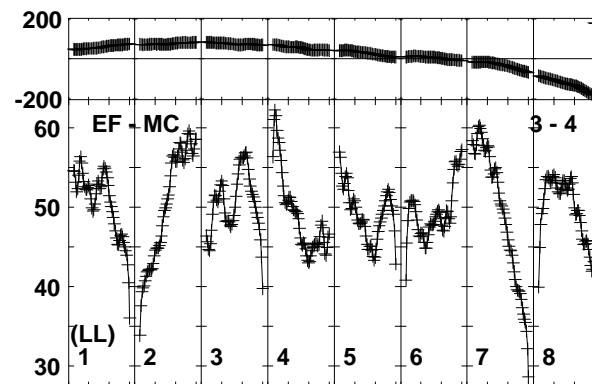
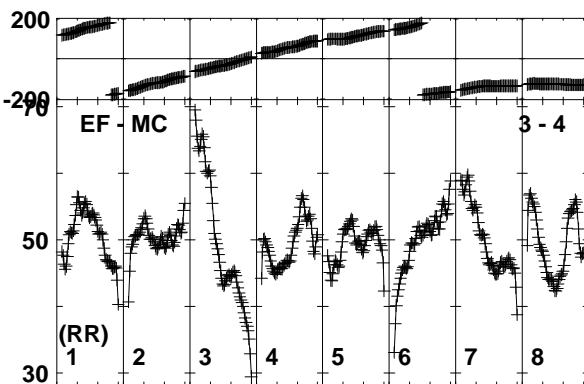
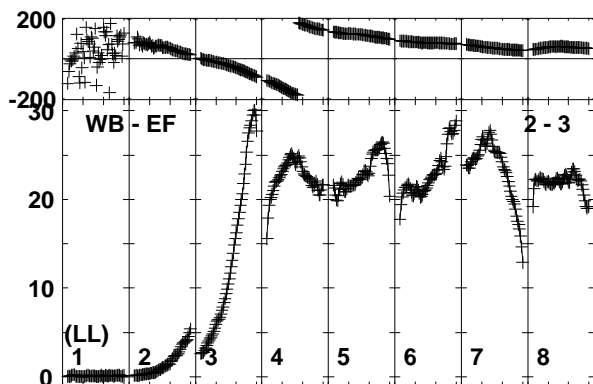
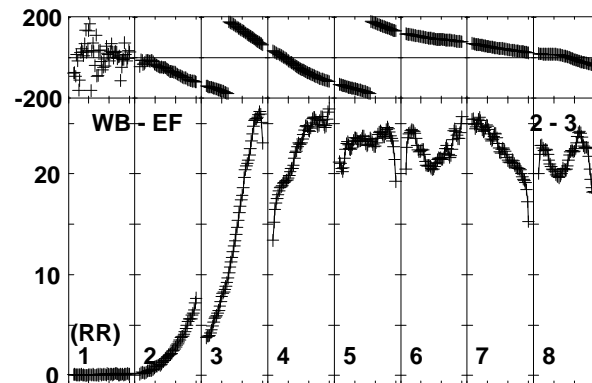
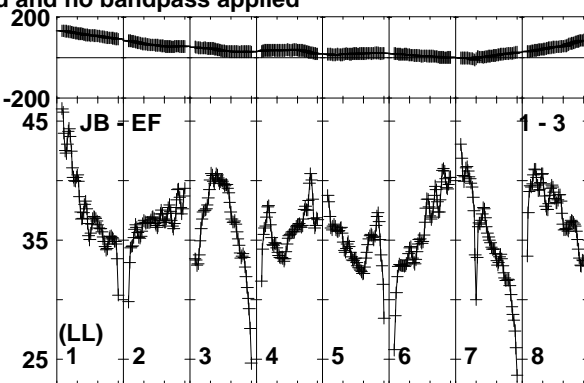
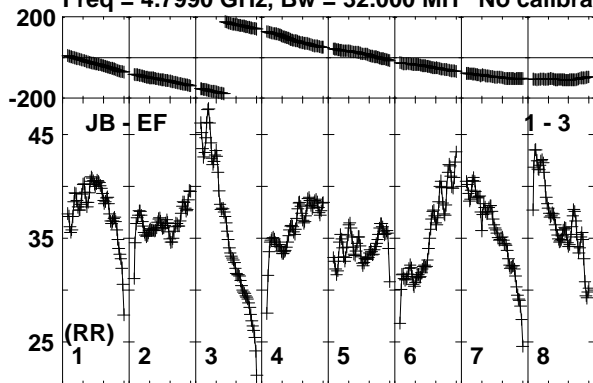

Lower frame: Milli Ampl Jy Top frame: Phas deg
Vector averaged cross-power spectrum Baseline: JB (01) - EF (03)
Timerange: 00/12:57:07 to 00/13:00:00

Plot file version 2 created 20-SEP-2019 15:50:49
 3C345 RSM05.UVDATA.1
 Freq = 4.7990 GHz, Bw = 32.000 MH No calibration applied and no bandpass applied

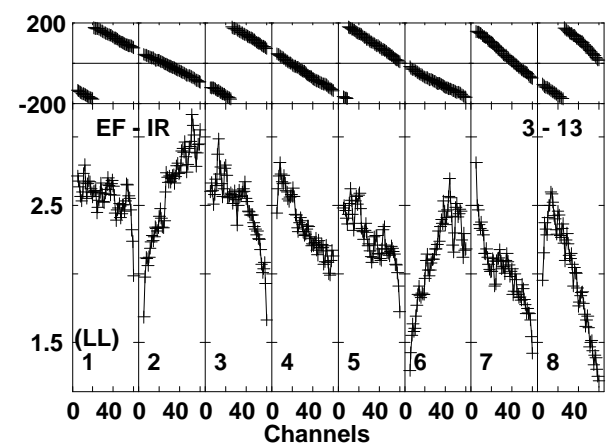
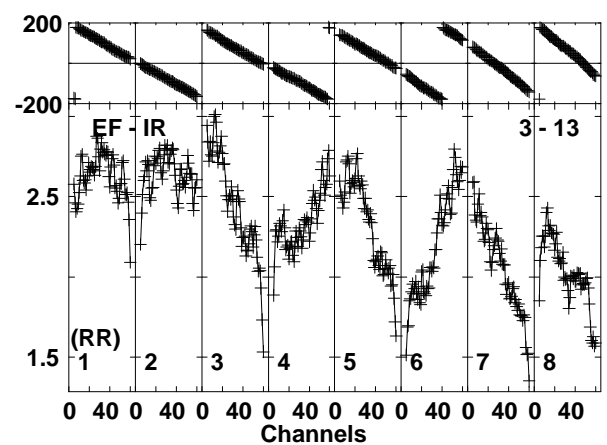
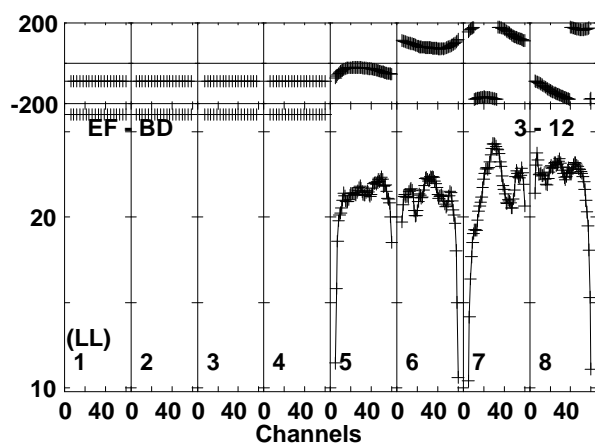
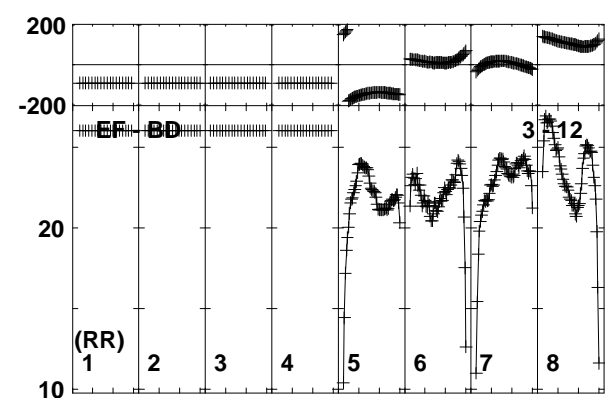
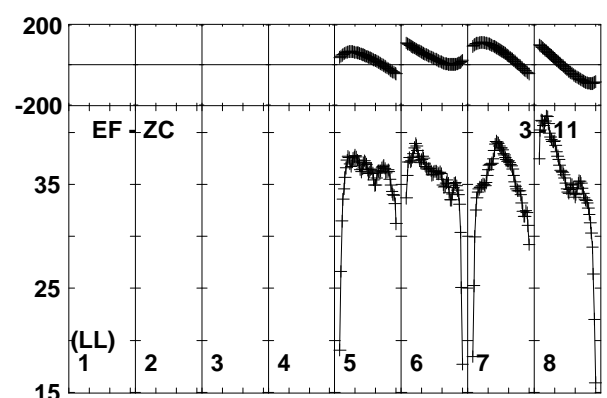
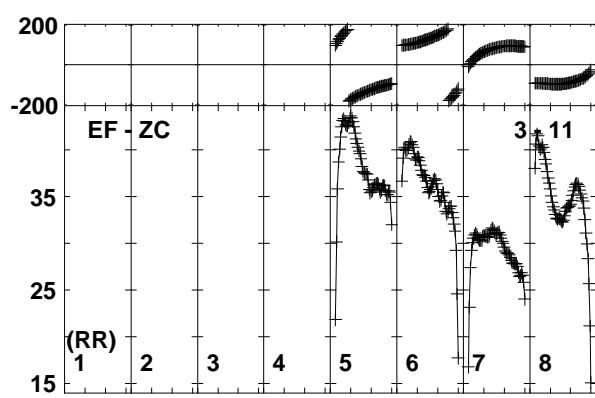
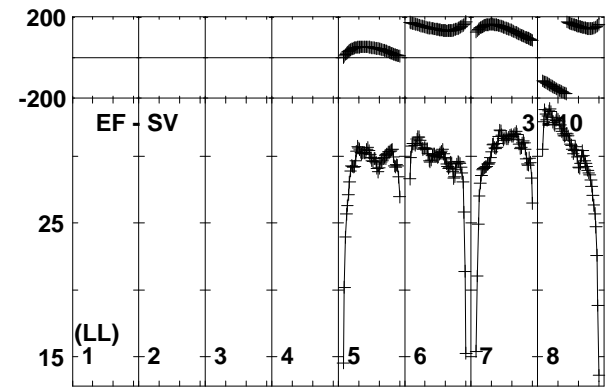
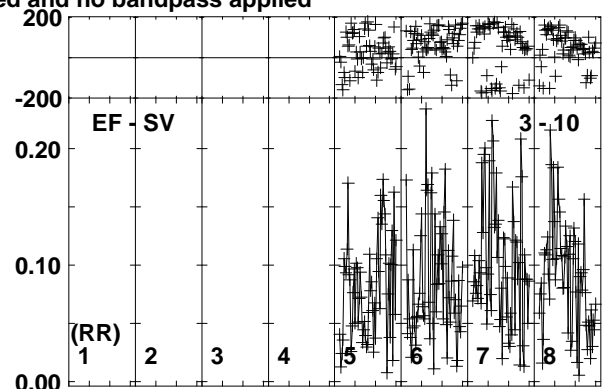
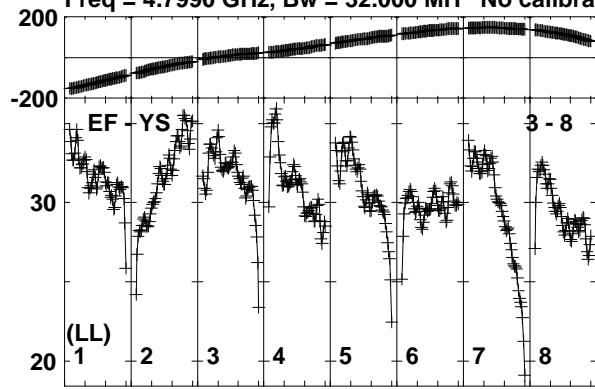

Lower frame: Milli Ampl Jy Top frame: Phas deg
 Vector averaged cross-power spectrum Baseline: EF (03) - YS (08)
 Timerange: 00/12:57:07 to 00/13:00:00

Plot file version 3 created 20-SEP-2019 15:50:50
 3C345 RSM05.UVDATA.1
 Freq = 4.7990 GHz, Bw = 32.000 MHz No calibration applied and no bandpass applied

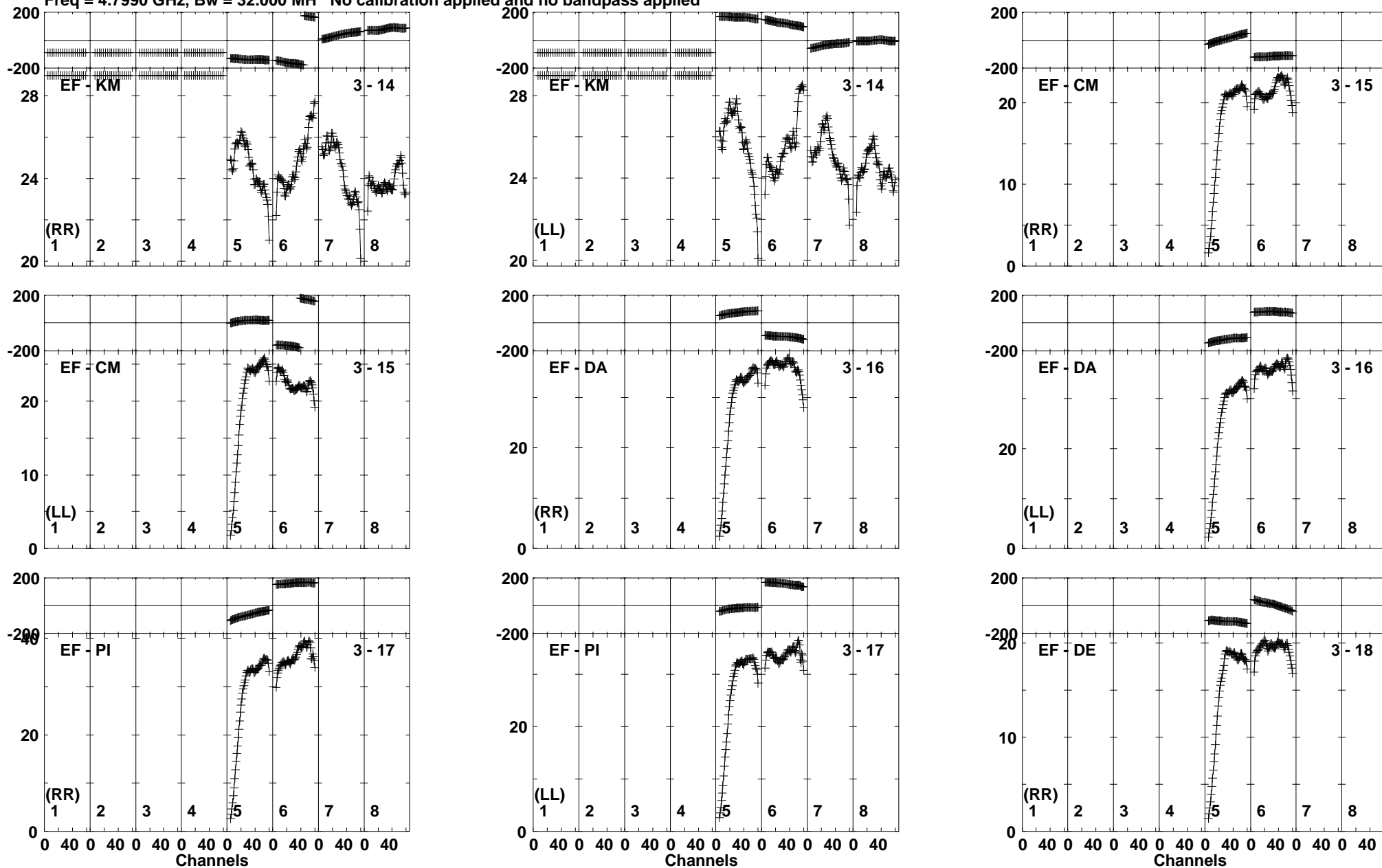

Lower frame: Milli Ampl Jy Top frame: Phas deg
 Vector averaged cross-power spectrum Baseline: EF (03) - KM (14)
 Timerange: 00/12:57:07 to 00/13:00:00

Plot file version 4 created 20-SEP-2019 15:50:50
3C345 RSM05.UVDATA.1
Freq = 4.7990 GHz, Bw = 32.000 MH No calibration applied and no bandpass applied

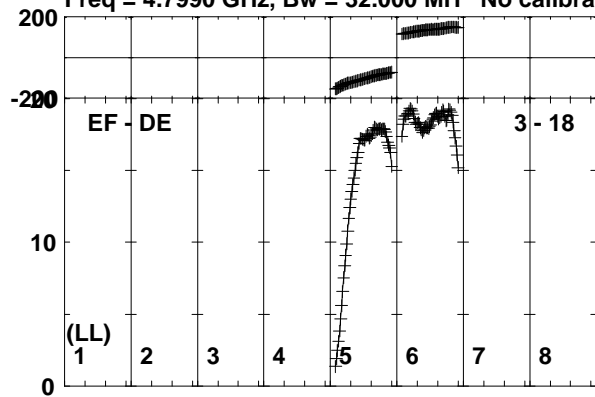

Lower frame: Milli Ampl Jy Top frame: Phas deg
Vector averaged cross-power spectrum Baseline: EF (03) - DE (18)
Timerange: 00/12:57:07 to 00/13:00:00

Plot file version 5 created 20-SEP-2019 15:50:50

J1408+5613 RSM05.UVDATA.1

Freq = 4.7990 GHz, Bw = 32.000 MH No calibration applied and no bandpass applied

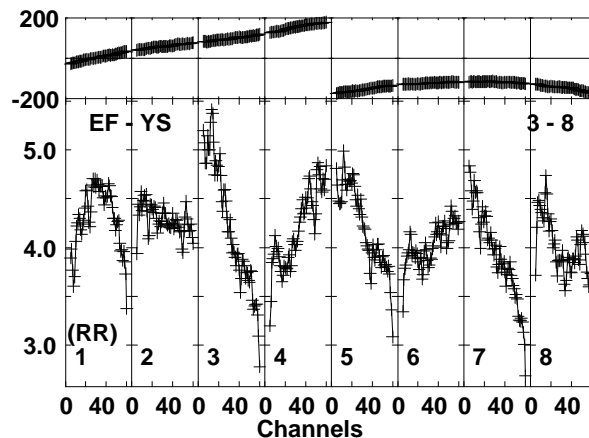
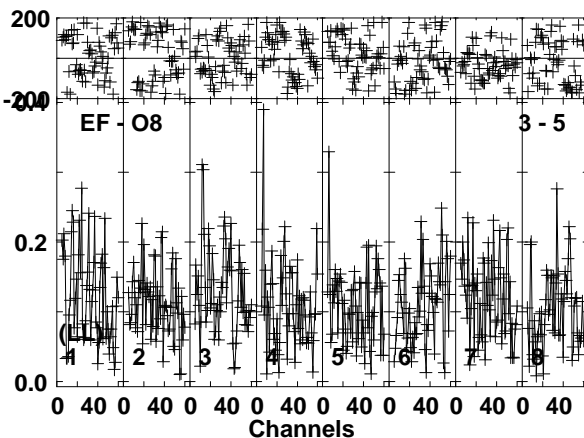
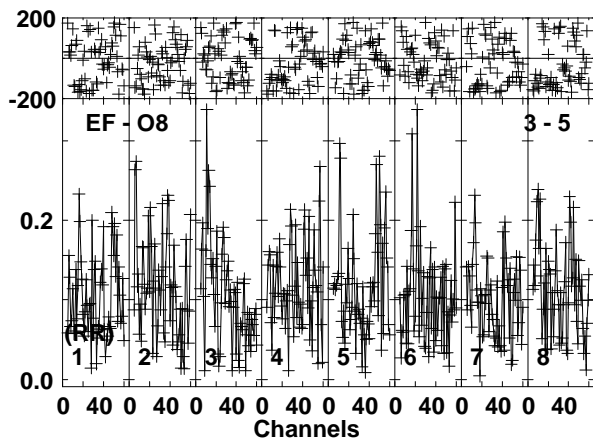
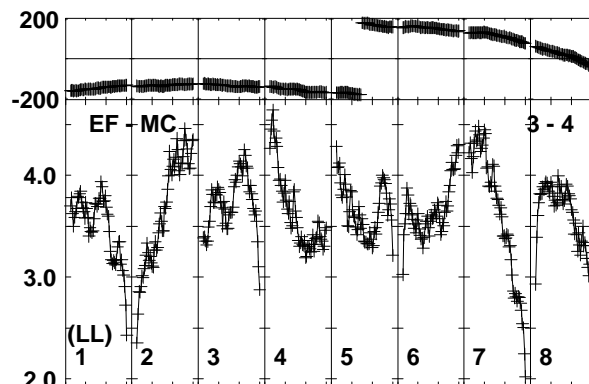
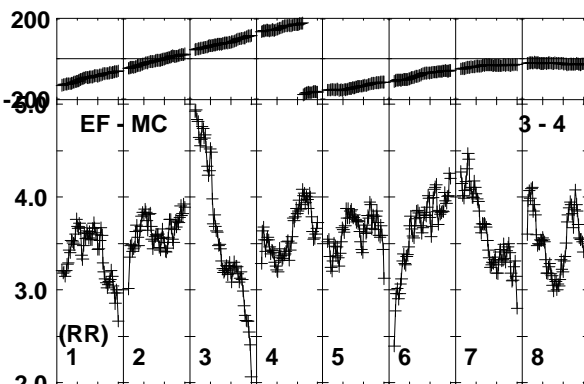
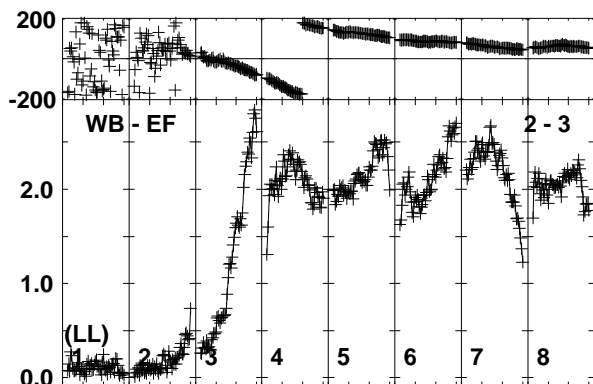
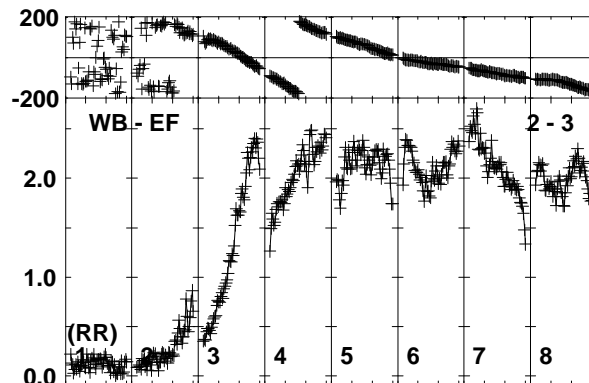
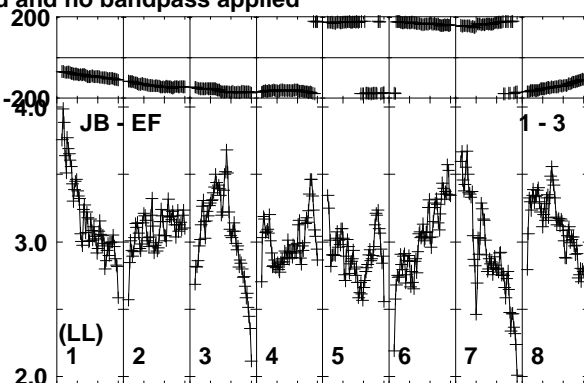
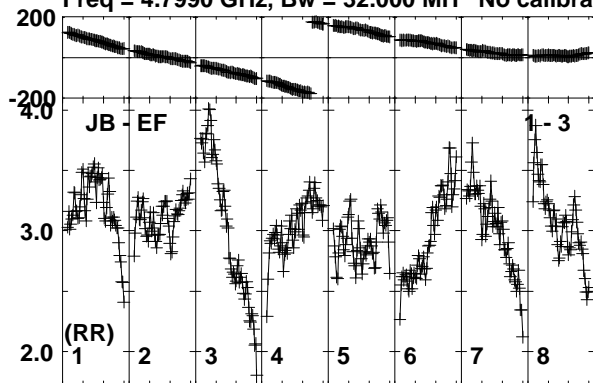

Lower frame: Milli Ampl Jy Top frame: Phas deg
Vector averaged cross-power spectrum Baseline: JB (01) - EF (03)
Timerange: 00/13:04:31 to 00/13:06:00

Plot file version 7 created 20-SEP-2019 15:50:51

J1408+5613 RSM05.UVDATA.1

Freq = 4.7990 GHz, Bw = 32.000 MH No calibration applied and no bandpass applied

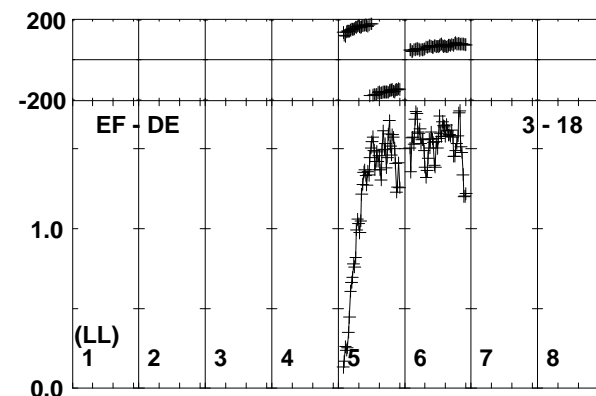
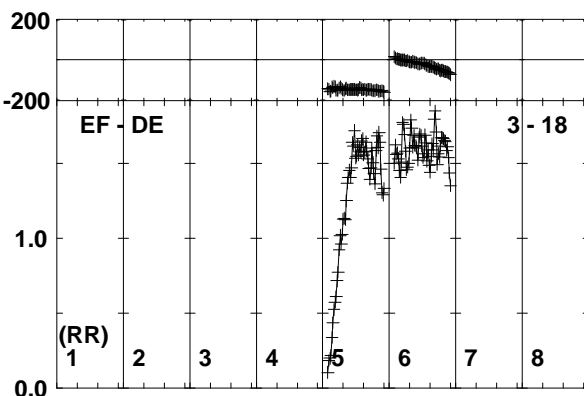
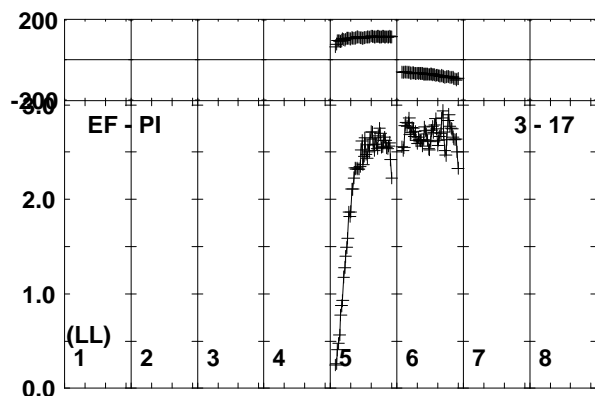
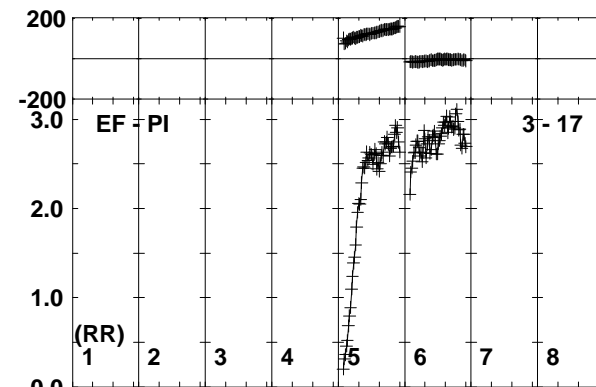
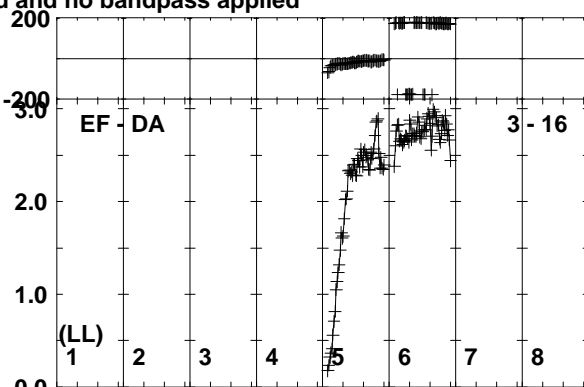
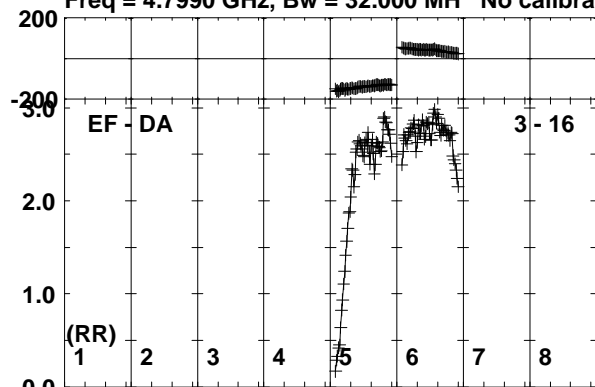

Lower frame: Milli Ampl Jy Top frame: Phas deg
Vector averaged cross-power spectrum Baseline: EF (03) - DA (16)
Timerange: 00/13:04:31 to 00/13:06:00

Plot file version 8 created 20-SEP-2019 15:50:51
 AT2019EHZ RSM05.UVDATA.1
 Freq = 4.7990 GHz, Bw = 32.000 MH No calibration applied and no bandpass applied

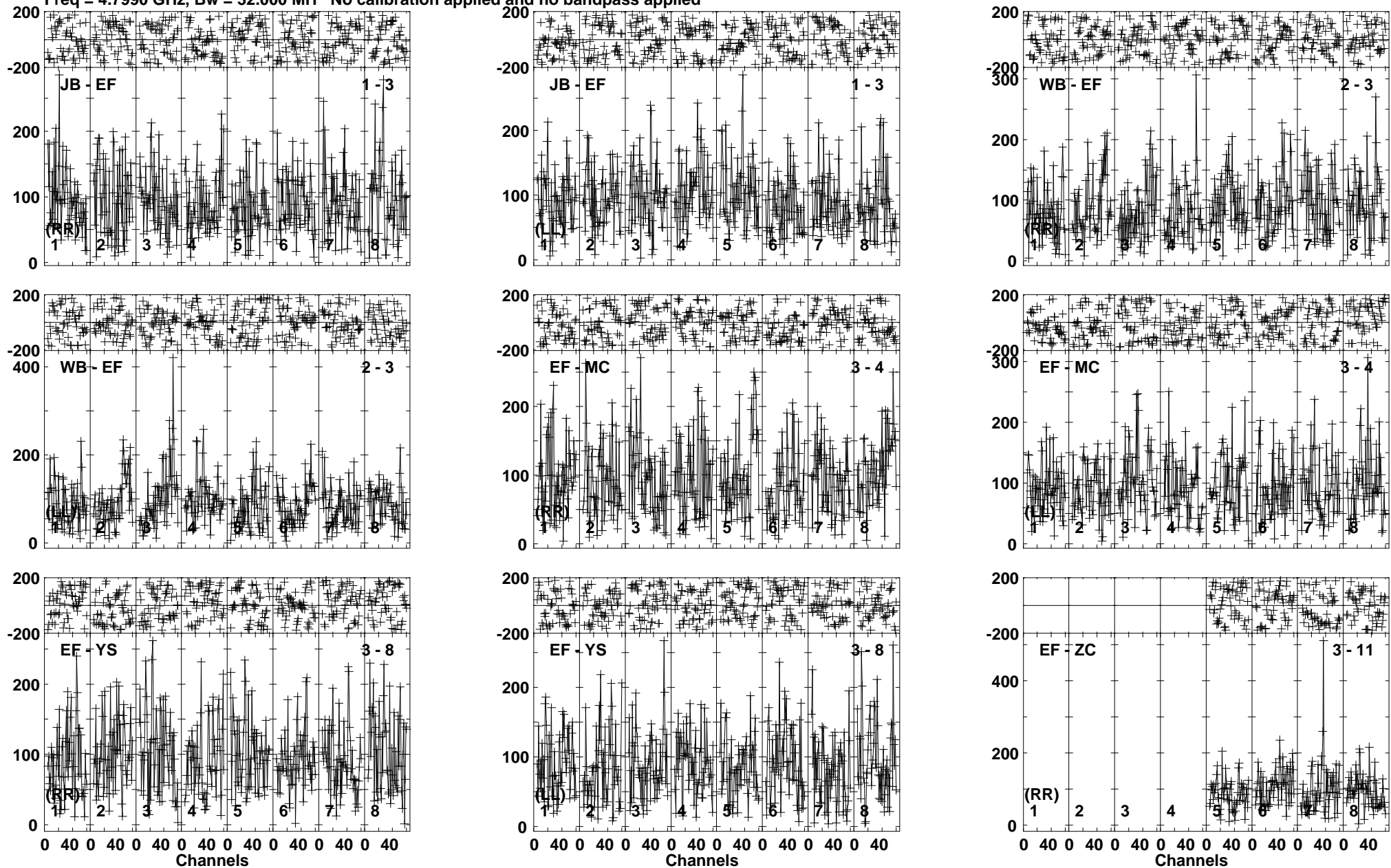

Lower frame: Micro Ampl Jy Top frame: Phas deg
 Vector averaged cross-power spectrum Baseline: JB (01) - EF (03)
 Timerange: 00/13:06:01 to 00/13:08:59

Plot file version 9 created 20-SEP-2019 15:50:52

AT2019EHZ RSM05.UVDATA.1

Freq = 4.7990 GHz, Bw = 32.000 MH No calibration applied and no bandpass applied

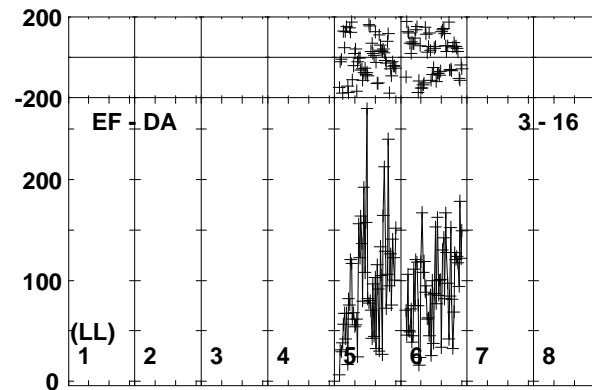
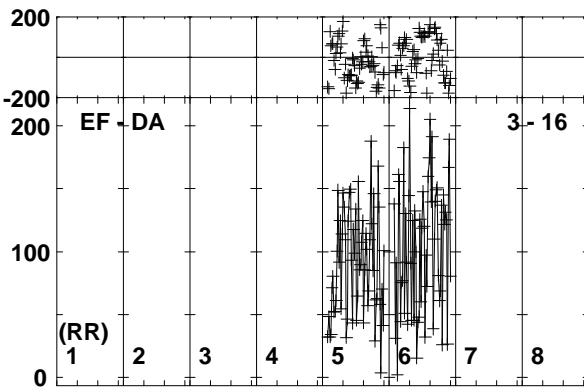
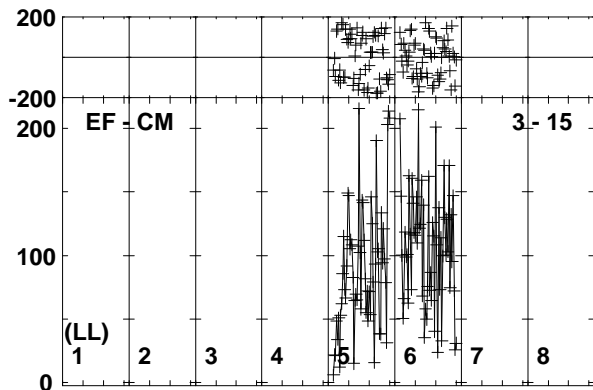
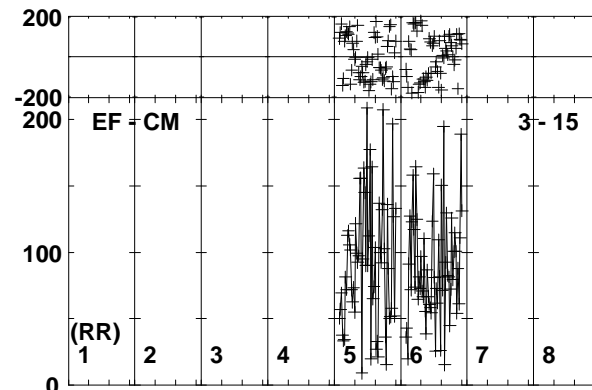
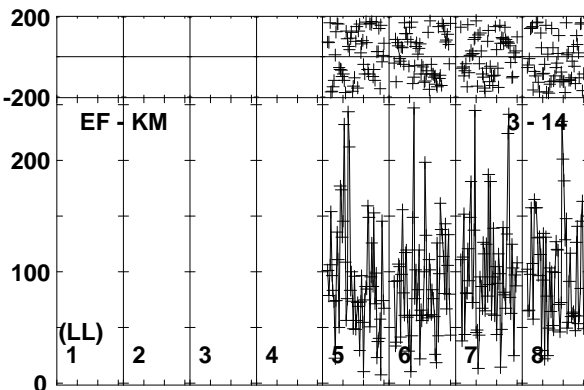
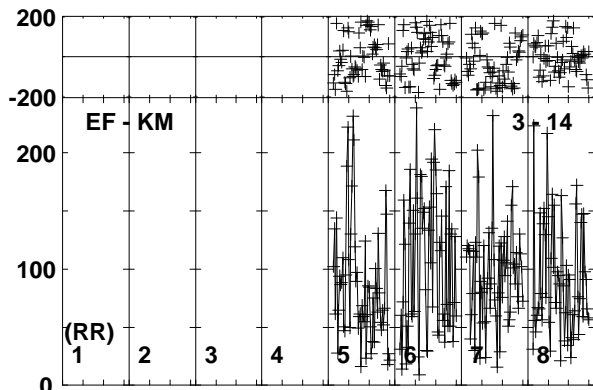
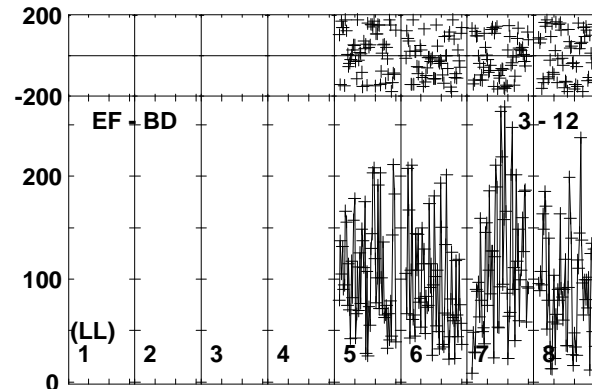
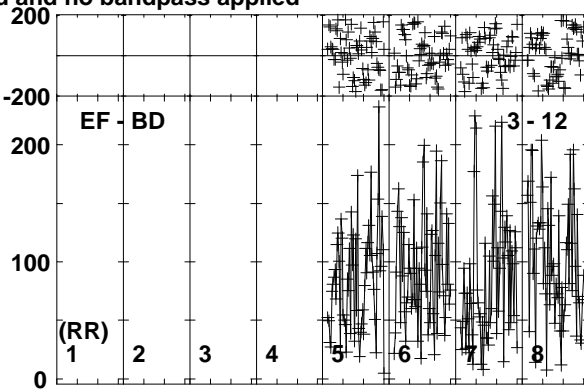
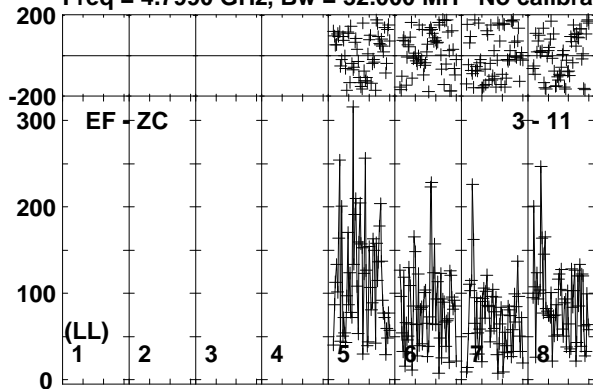

Lower frame: Micro Ampl Jy Top frame: Phas deg
Vector averaged cross-power spectrum Baseline: EF (03) - ZC (11)
Timerange: 00/13:06:01 to 00/13:08:59

Plot file version 10 created 20-SEP-2019 15:50:53
AT2019EHZ RSM05.UVDATA.1
Freq = 4.7990 GHz, Bw = 32.000 MH No calibration applied and no bandpass applied

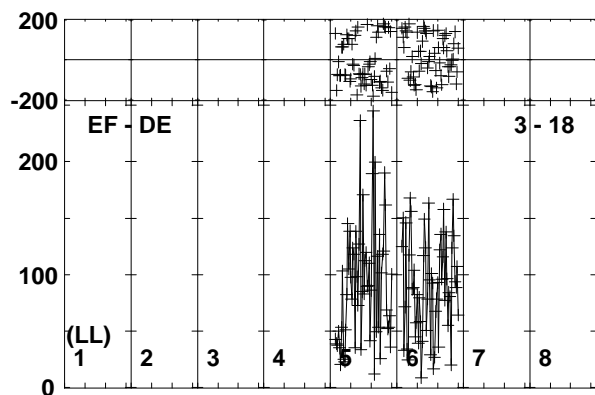
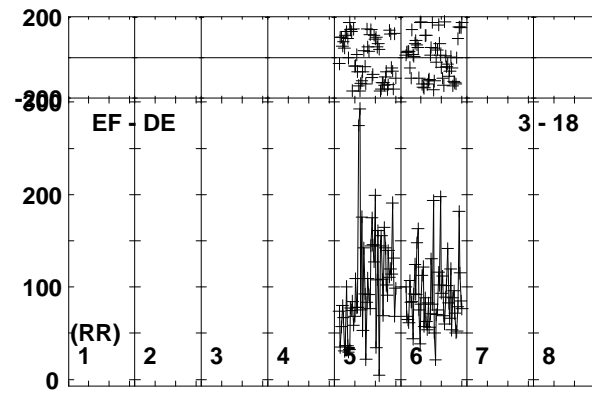
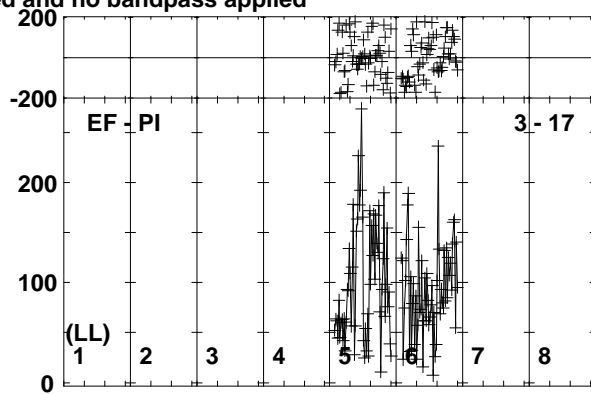
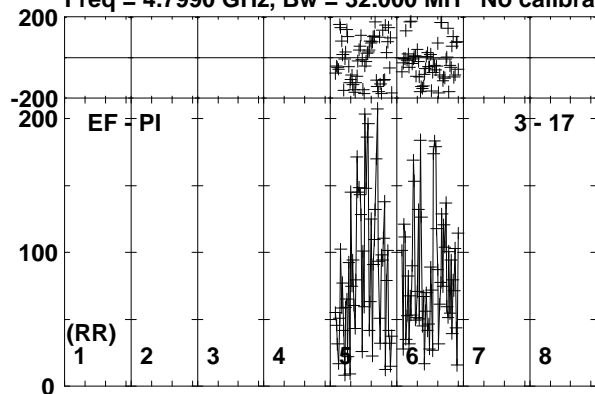

Lower frame: Micro Ampl Jy Top frame: Phas deg
Vector averaged cross-power spectrum Baseline: EF (03) - PI (17)
Timerange: 00/13:06:01 to 00/13:08:59

Plot file version 11 created 20-SEP-2019 15:50:53

J1408+5613 RSM05.UVDATA.1

Freq = 4.7990 GHz, Bw = 32.000 MH No calibration applied and no bandpass applied

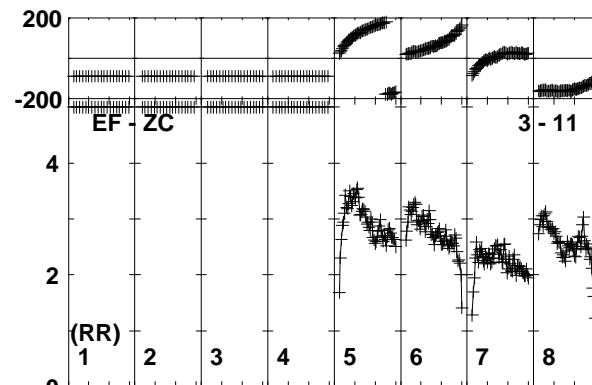
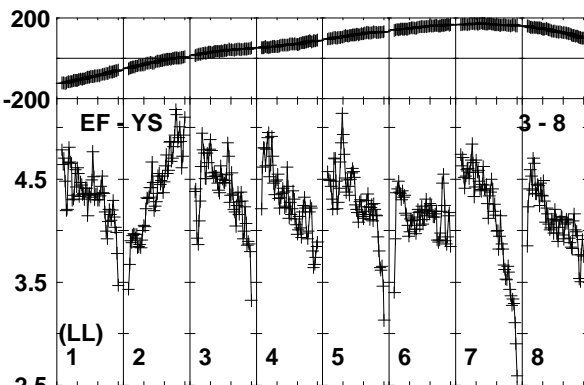
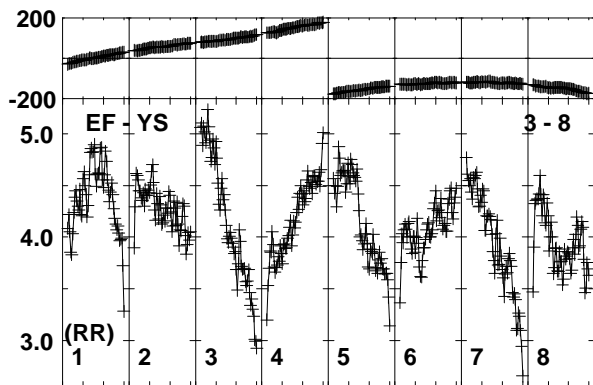
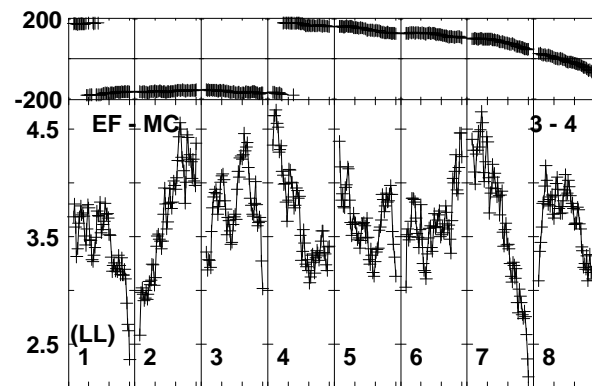
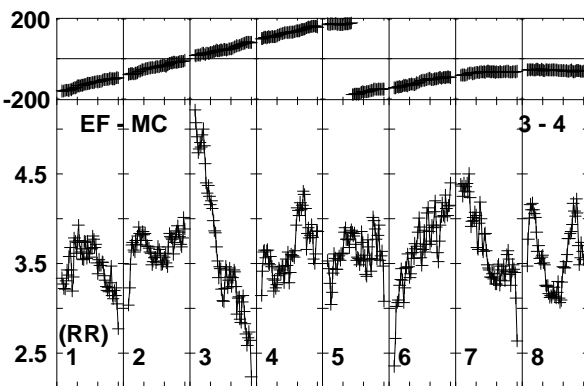
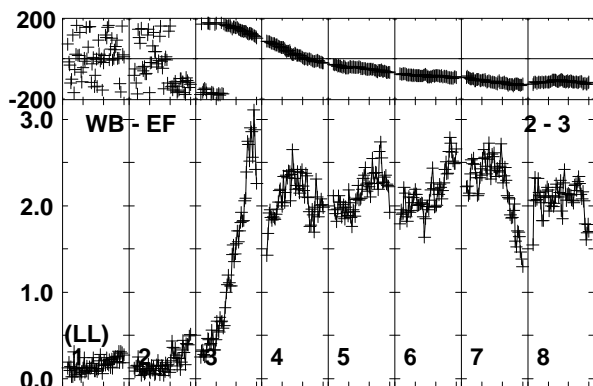
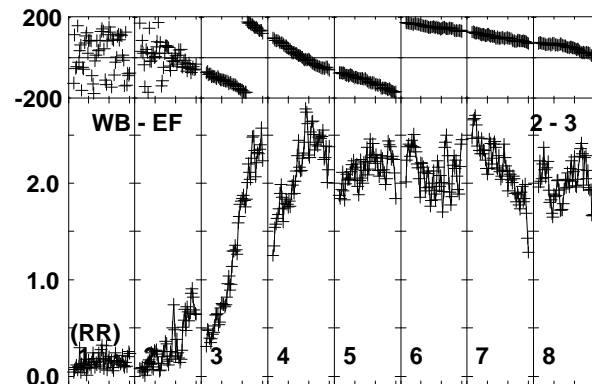
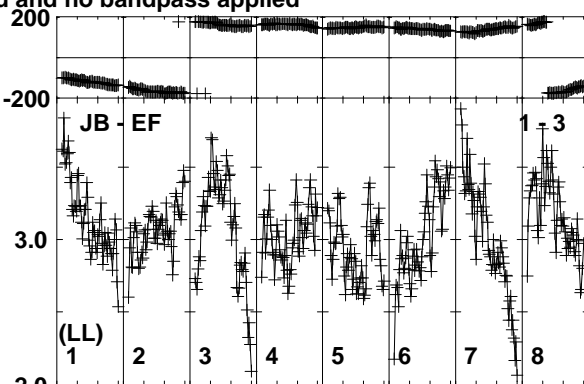
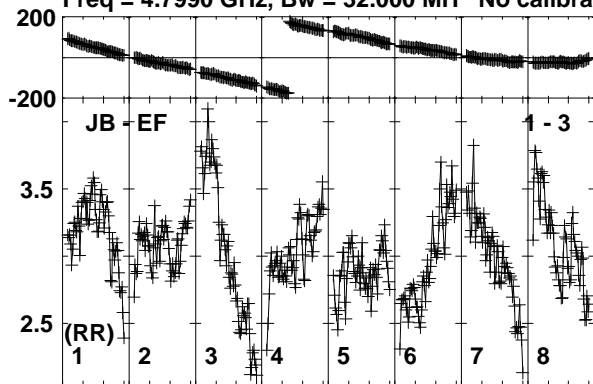

Lower frame: Milli Ampl Jy Top frame: Phas deg
Vector averaged cross-power spectrum Baseline: JB (01) - EF (03)
Timerange: 00/13:09:00 to 00/13:10:29

Plot file version 12 created 20-SEP-2019 15:50:53

J1408+5613 RSM05.UVDATA.1

Freq = 4.7990 GHz, Bw = 32.000 MH No calibration applied and no bandpass applied

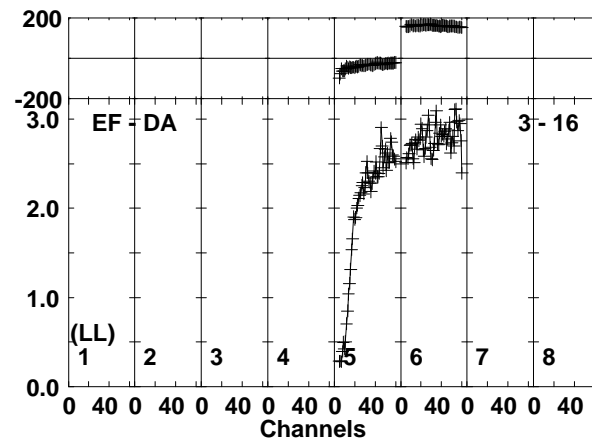
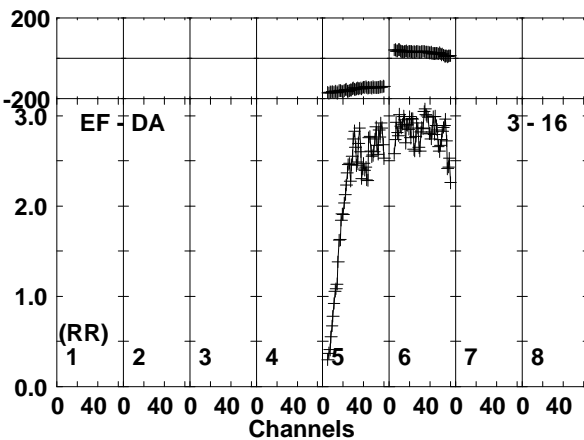
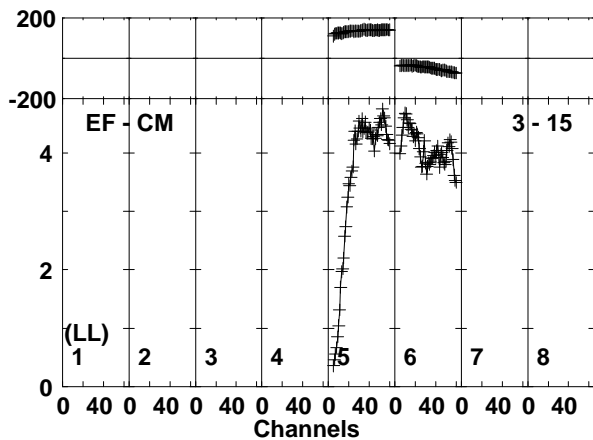
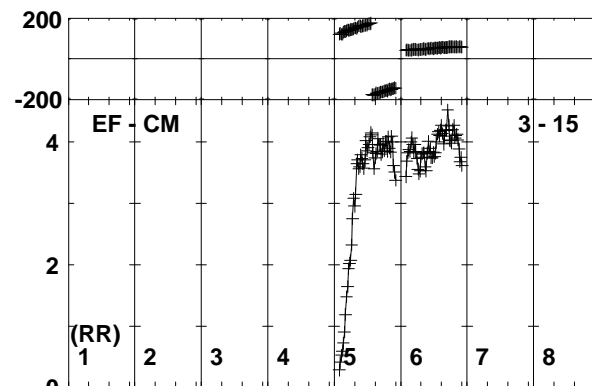
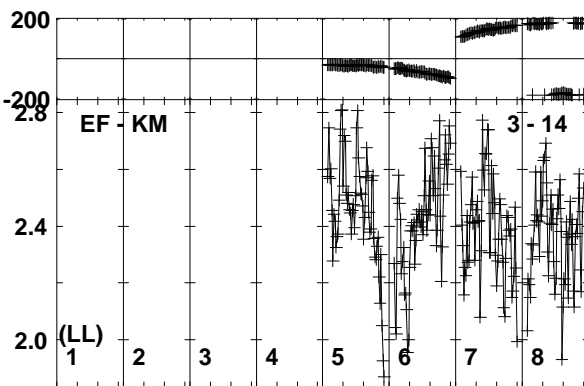
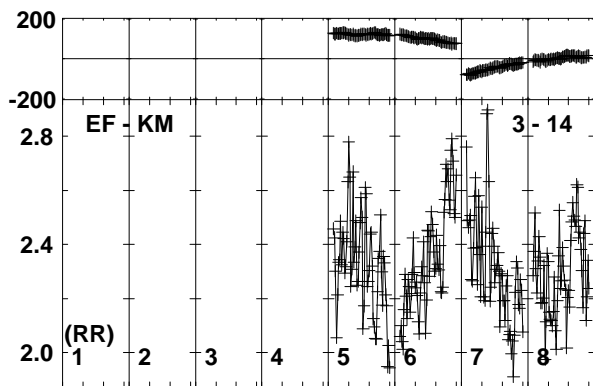
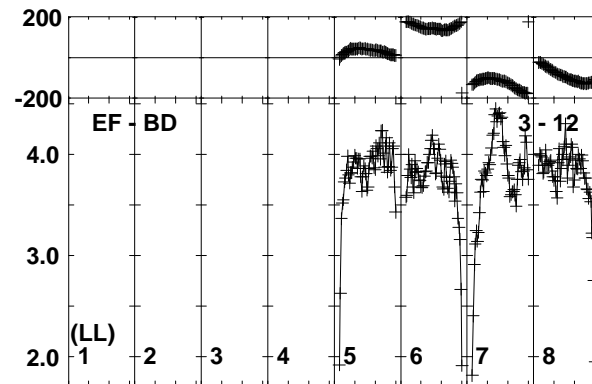
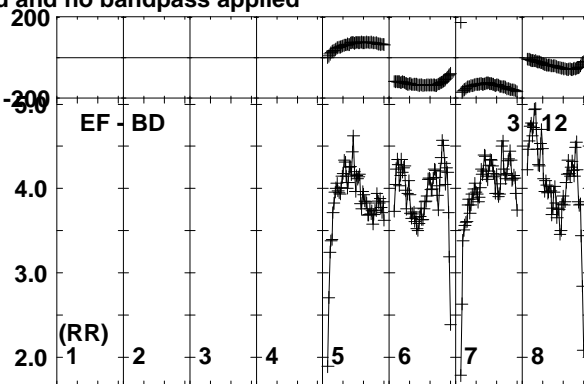
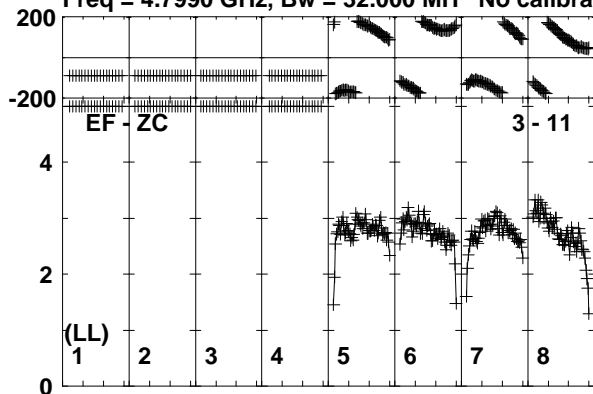

Lower frame: Milli Ampl Jy Top frame: Phas deg
Vector averaged cross-power spectrum Baseline: EF (03) - ZC (11)
Timerange: 00/13:09:00 to 00/13:10:29

Plot file version 13 created 20-SEP-2019 15:50:54

J1408+5613 RSM05.UVDATA.1

Freq = 4.7990 GHz, Bw = 32.000 MH No calibration applied and no bandpass applied

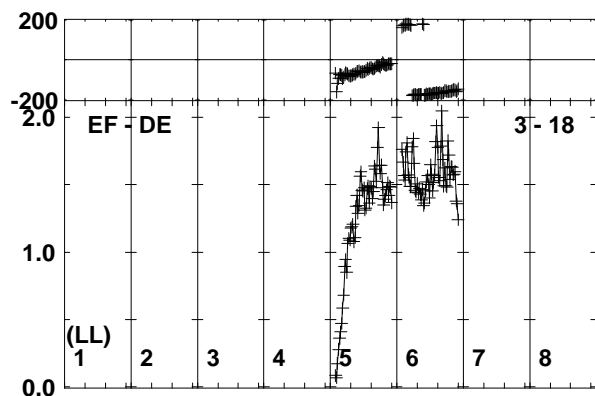
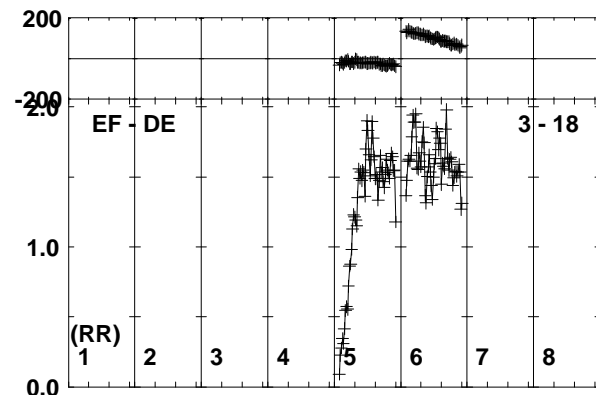
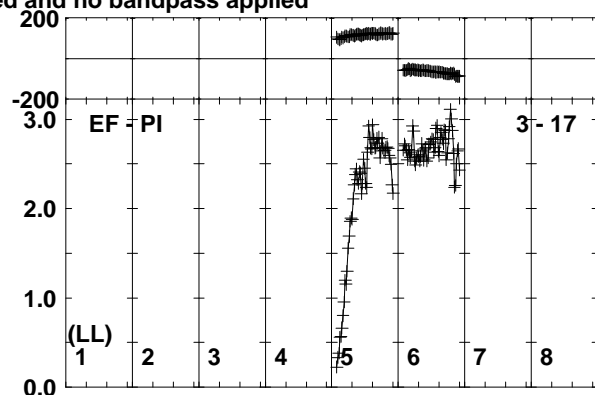
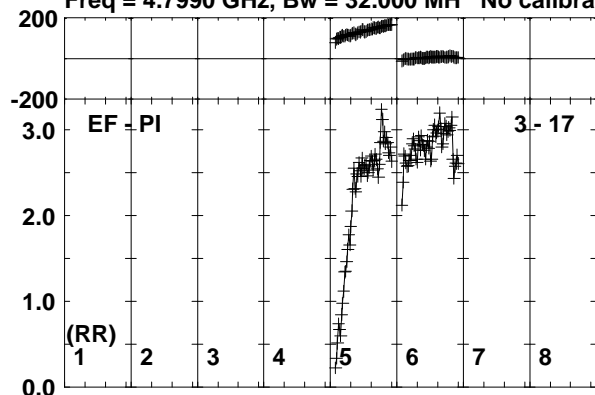

Lower frame: Milli Ampl Jy Top frame: Phas deg
Vector averaged cross-power spectrum Baseline: EF (03) - PI (17)
Timerange: 00/13:09:00 to 00/13:10:29

Plot file version 14 created 20-SEP-2019 15:50:54

AT2019EHZ RSM05.UVDATA.1

Freq = 4.7990 GHz, Bw = 32.000 MH No calibration applied and no bandpass applied

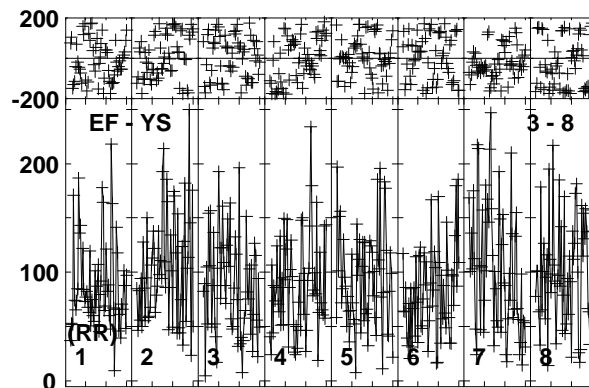
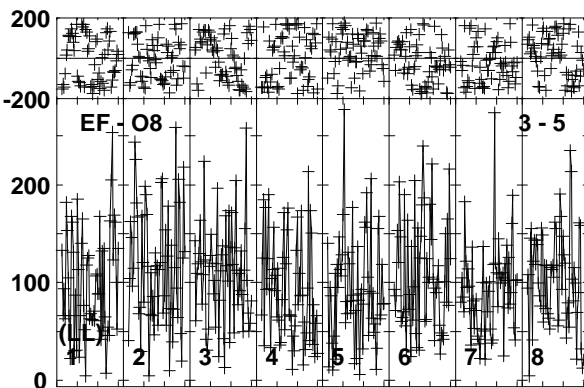
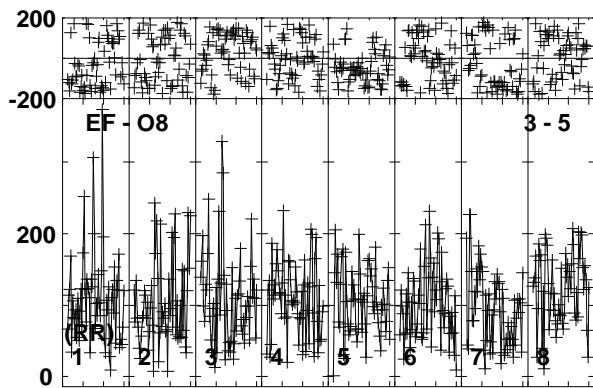
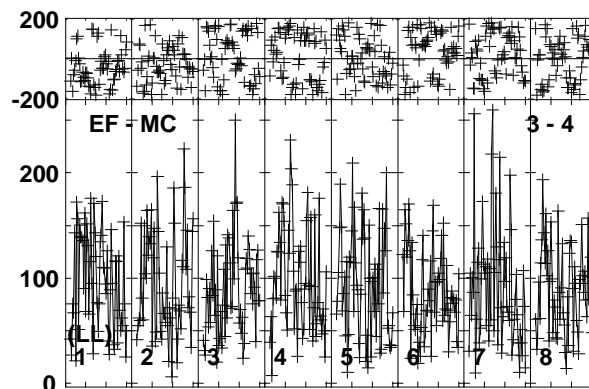
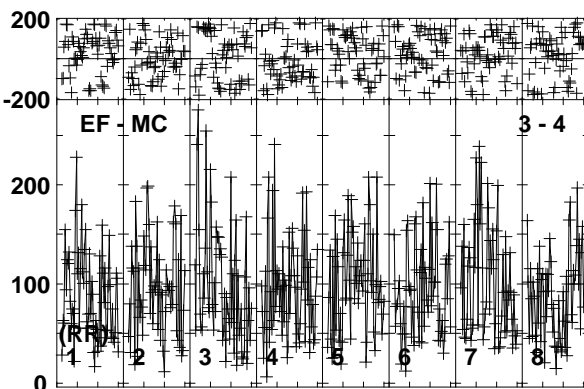
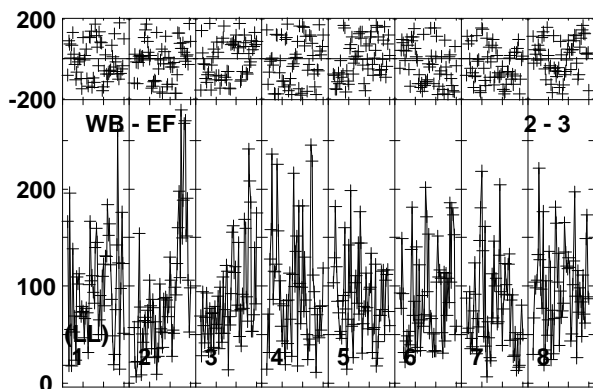
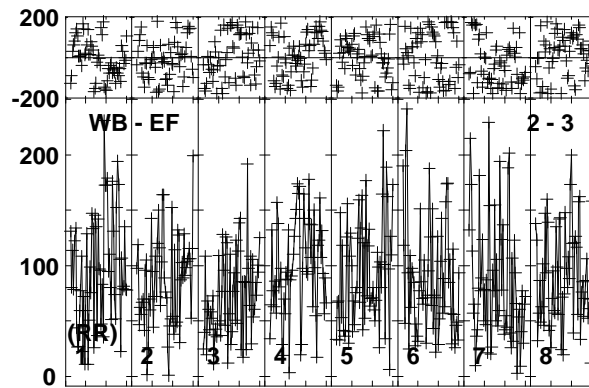
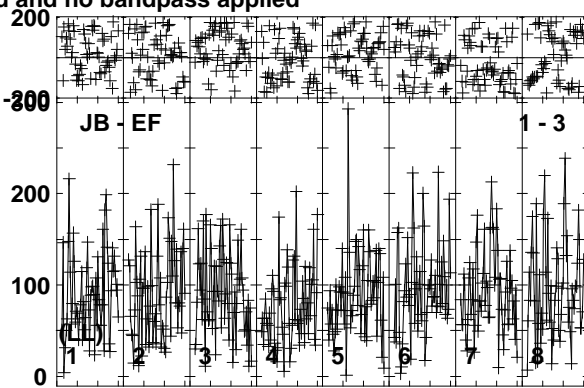
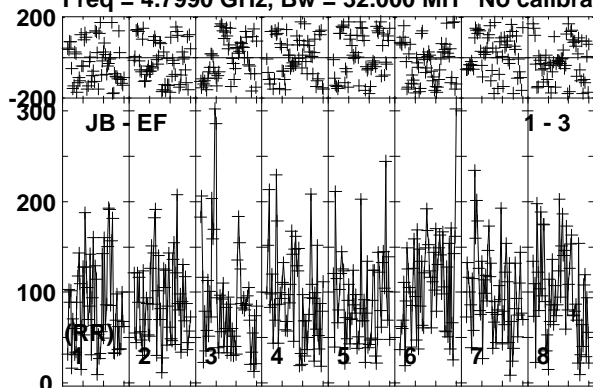

Lower frame: Micro Ampl Jy Top frame: Phas deg
Vector averaged cross-power spectrum Baseline: JB (01) - EF (03)
Timerange: 00/13:10:31 to 00/13:13:30

Plot file version 15 created 20-SEP-2019 15:50:54
 AT2019EHZ RSM05.UVDATA.1
 Freq = 4.7990 GHz, Bw = 32.000 MH No calibration applied and no bandpass applied

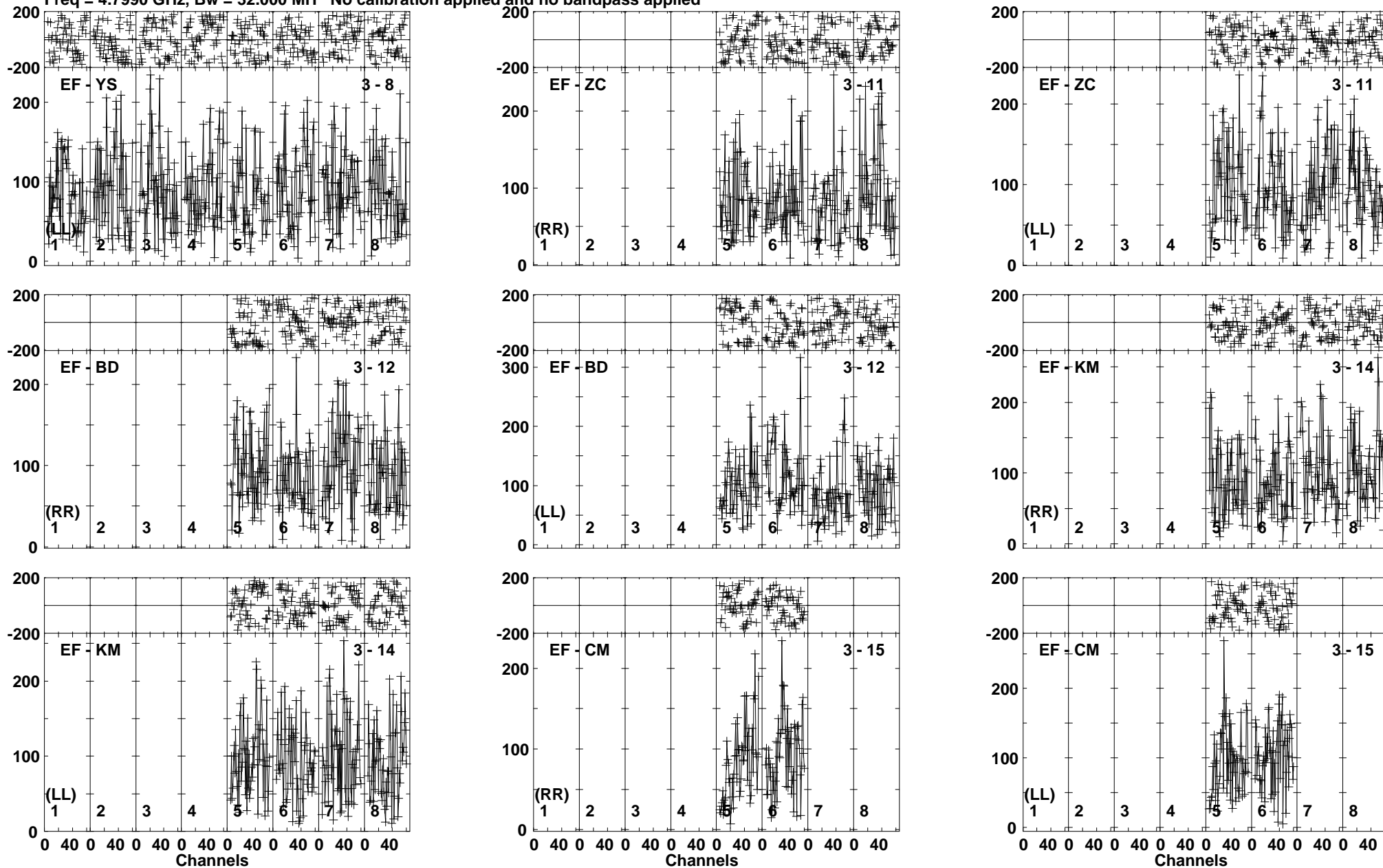

Lower frame: Micro Ampl Jy Top frame: Phas deg
 Vector averaged cross-power spectrum Baseline: EF (03) - YS (08)
 Timerange: 00/13:10:31 to 00/13:13:30

Plot file version 16 created 20-SEP-2019 15:50:55
 AT2019EHZ RSM05.UVDATA.1
 Freq = 4.7990 GHz, Bw = 32.000 MH No calibration applied and no bandpass applied

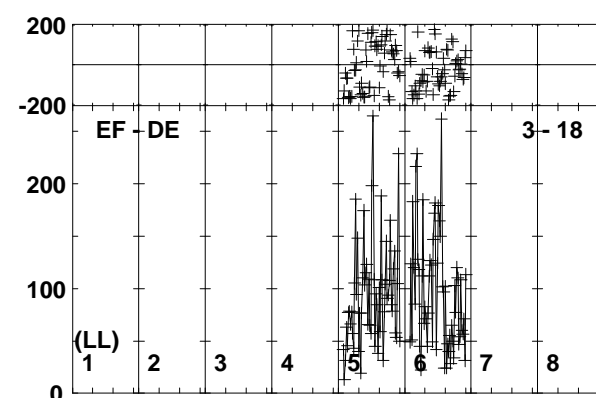
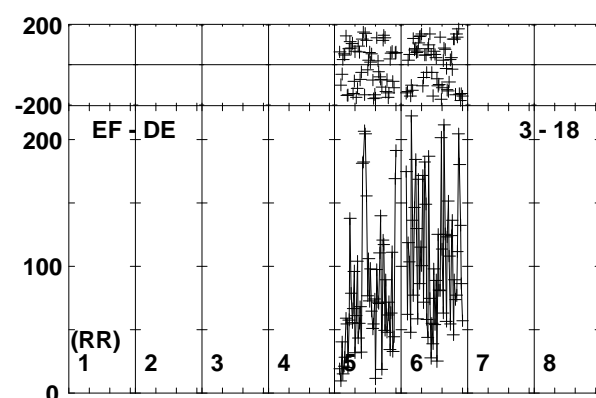
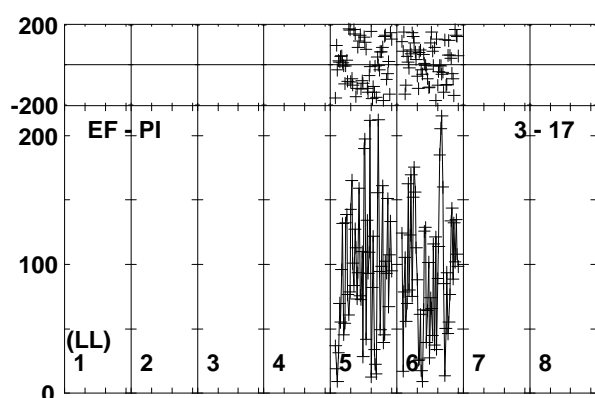
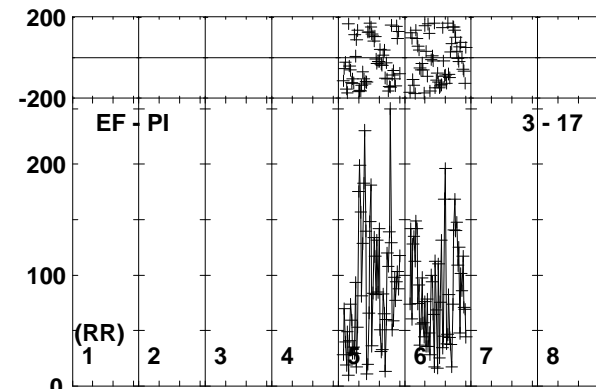
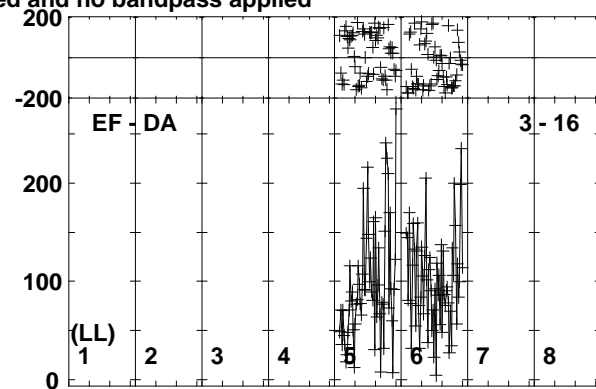
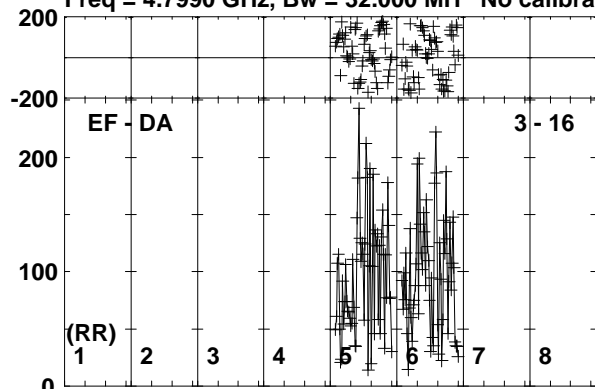

Lower frame: Micro Ampl Jy Top frame: Phas deg
 Vector averaged cross-power spectrum Baseline: EF (03) - DA (16)
 Timerange: 00/13:10:31 to 00/13:13:30

Plot file version 17 created 20-SEP-2019 15:50:55

J1408+5613 RSM05.UVDATA.1

Freq = 4.7990 GHz, Bw = 32.000 MH No calibration applied and no bandpass applied

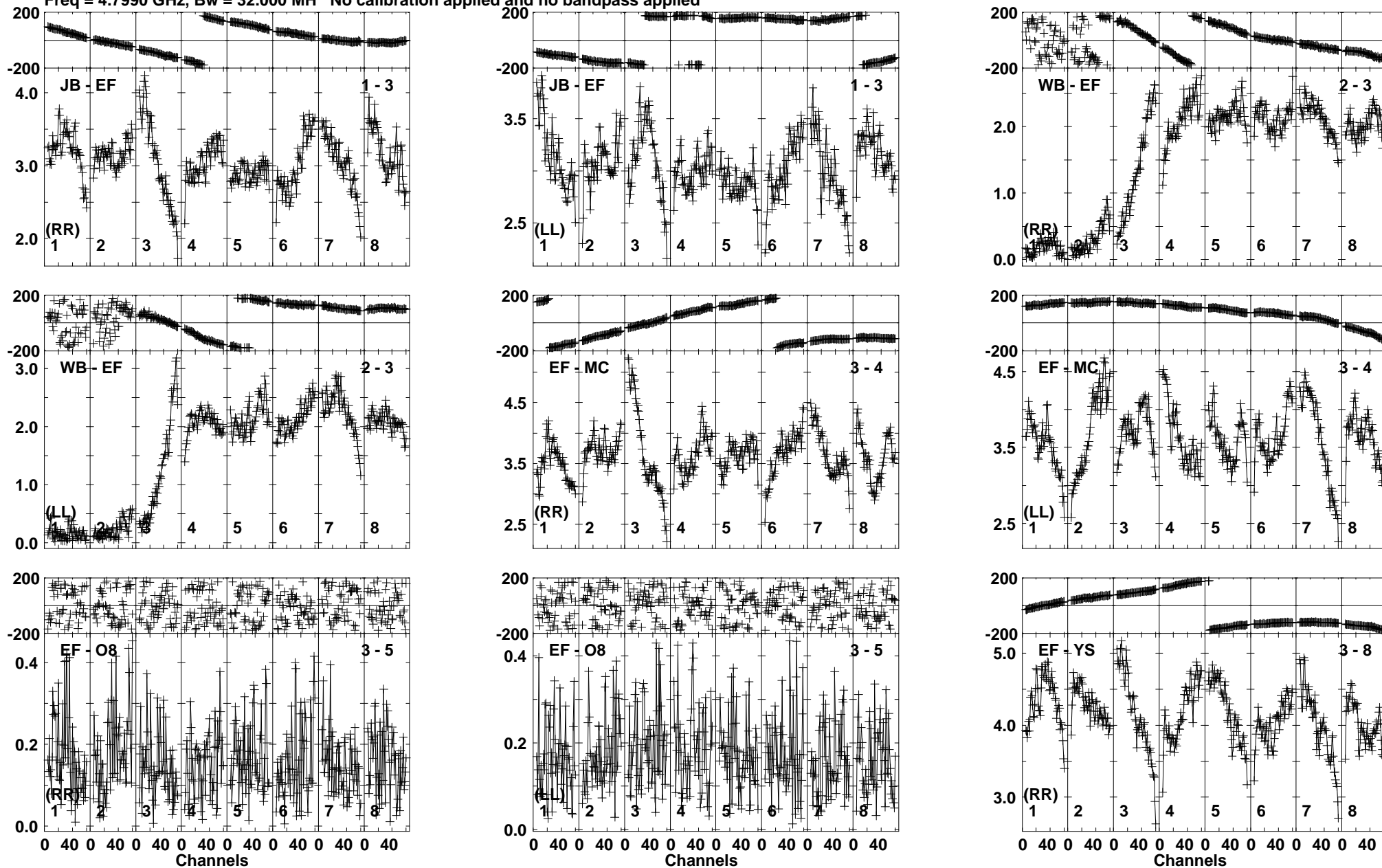

Lower frame: Milli Ampl Jy Top frame: Phas deg
Vector averaged cross-power spectrum Baseline: JB (01) - EF (03)
Timerange: 00/13:13:30 to 00/13:14:59

Plot file version 18 created 20-SEP-2019 15:50:56

J1408+5613 RSM05.UVDATA.1

Freq = 4.7990 GHz, Bw = 32.000 MH No calibration applied and no bandpass applied

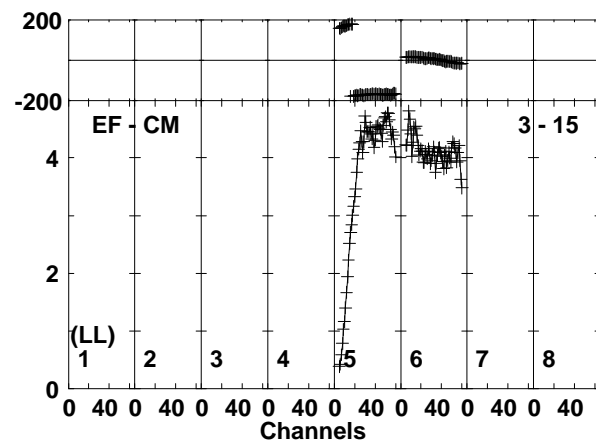
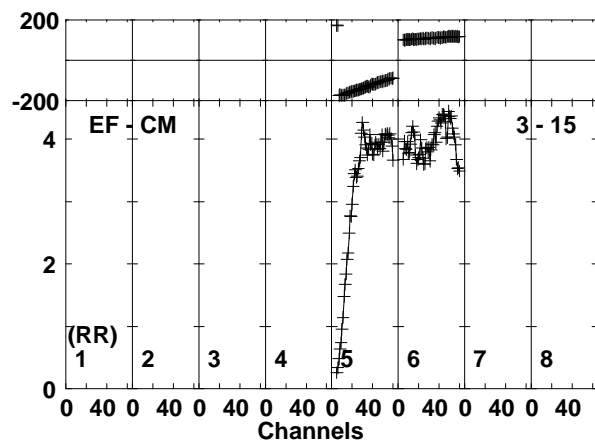
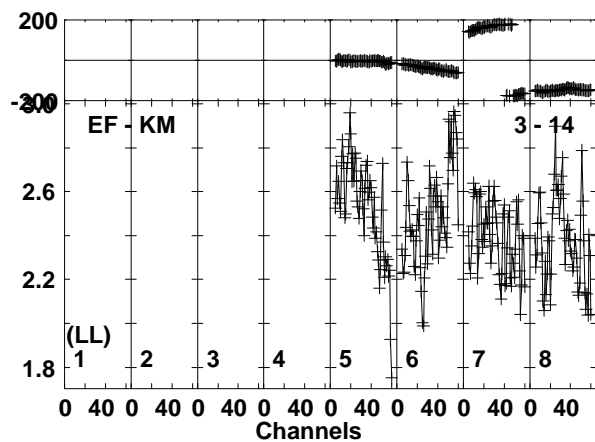
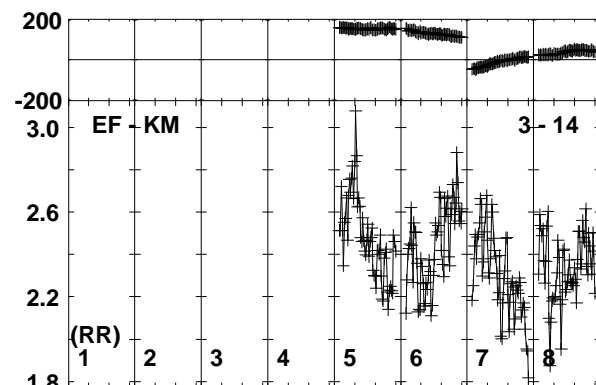
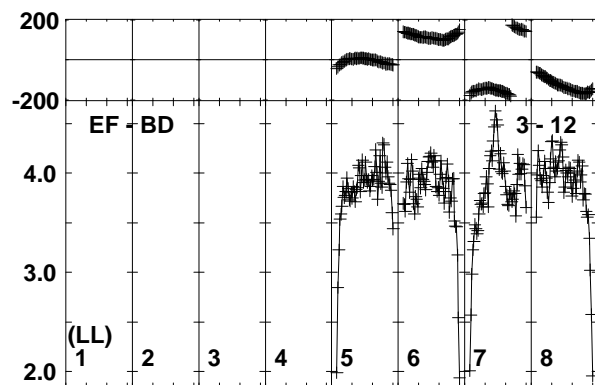
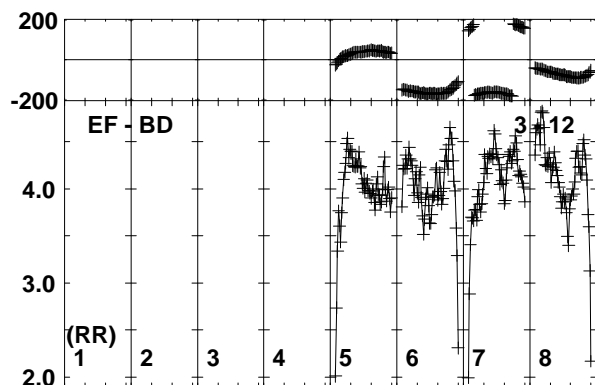
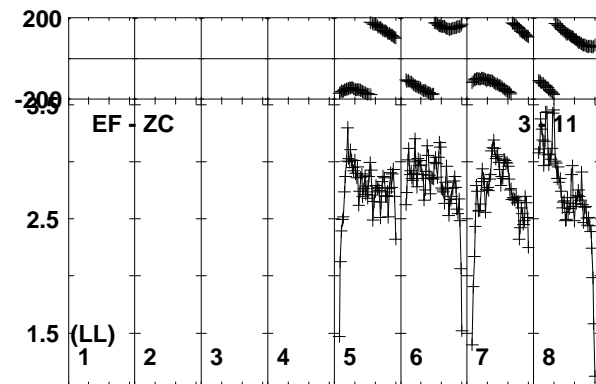
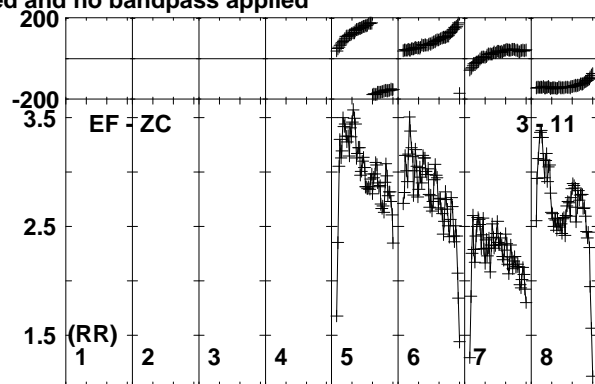
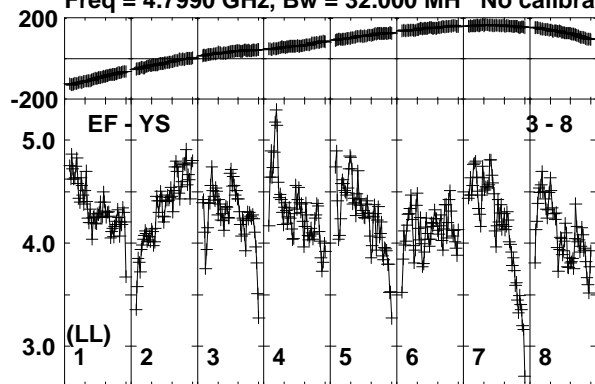

Lower frame: Milli Ampl Jy Top frame: Phas deg
Vector averaged cross-power spectrum Baseline: EF (03) - YS (08)
Timerange: 00/13:13:30 to 00/13:14:59

Plot file version 19 created 20-SEP-2019 15:50:57

J1408+5613 RSM05.UVDATA.1

Freq = 4.7990 GHz, Bw = 32.000 MH No calibration applied and no bandpass applied

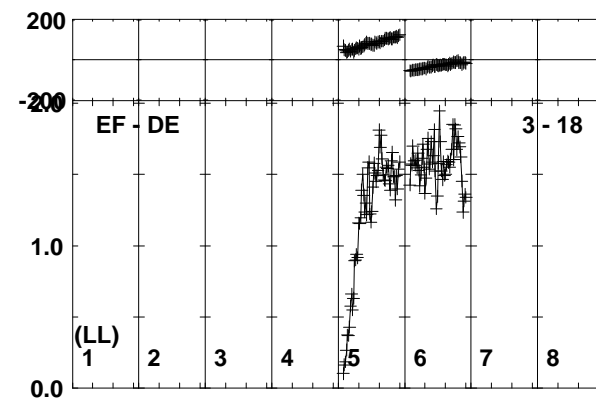
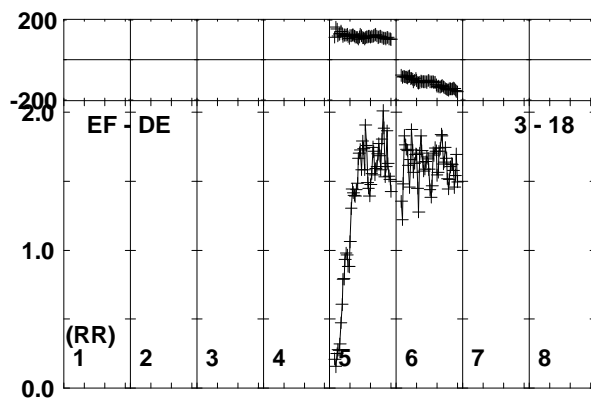
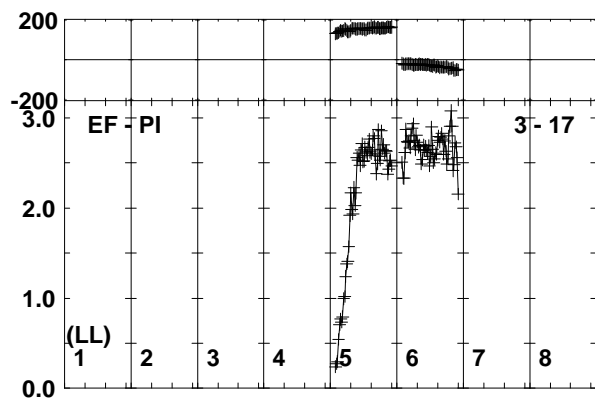
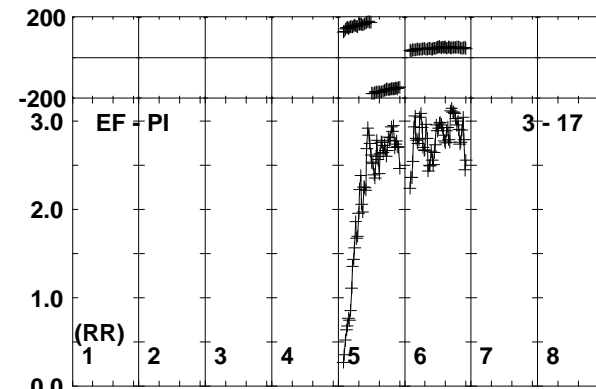
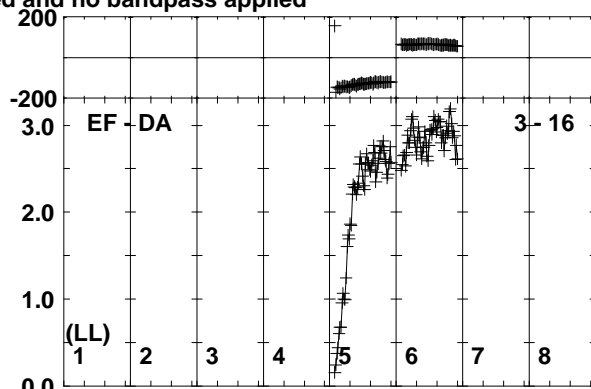
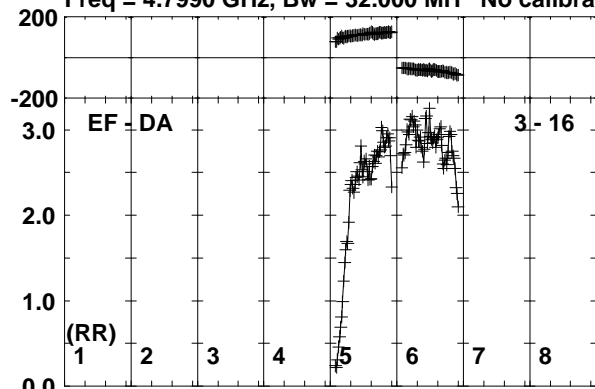

Lower frame: Milli Ampl Jy Top frame: Phas deg
Vector averaged cross-power spectrum Baseline: EF (03) - DA (16)
Timerange: 00/13:13:30 to 00/13:14:59

Plot file version 20 created 20-SEP-2019 15:50:57

AT2019EHZ RSM05.UVDATA.1

Freq = 4.7990 GHz, Bw = 32.000 MH No calibration applied and no bandpass applied

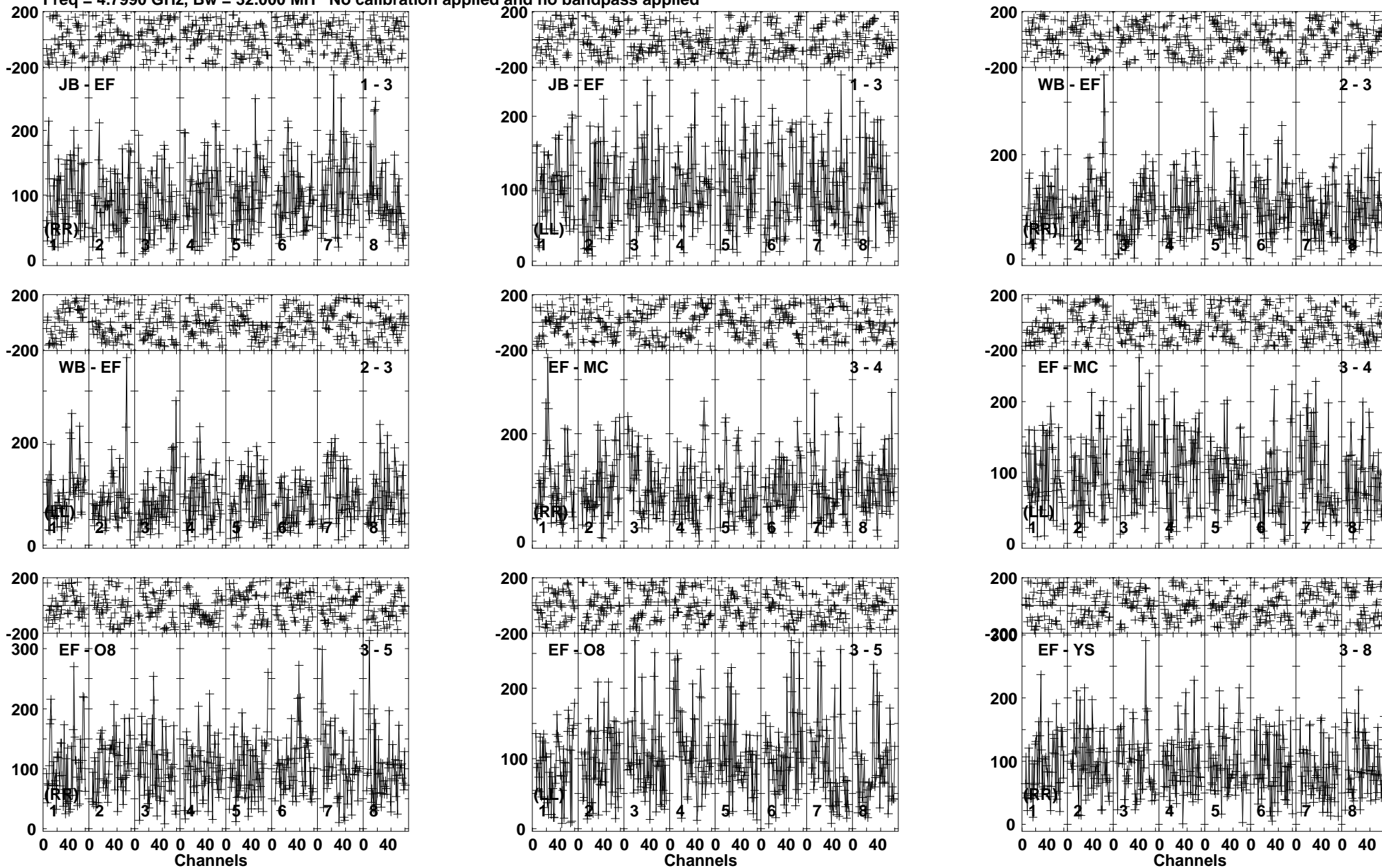

Lower frame: Micro Ampl Jy Top frame: Phas deg
Vector averaged cross-power spectrum Baseline: JB (01) - EF (03)
Timerange: 00/13:15:00 to 00/13:18:00

Plot file version 21 created 20-SEP-2019 15:50:57

AT2019EHZ RSM05.UVDATA.1

Freq = 4.7990 GHz, Bw = 32.000 MH No calibration applied and no bandpass applied

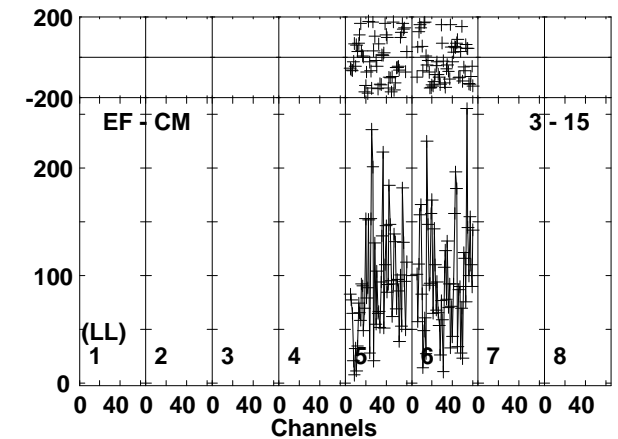
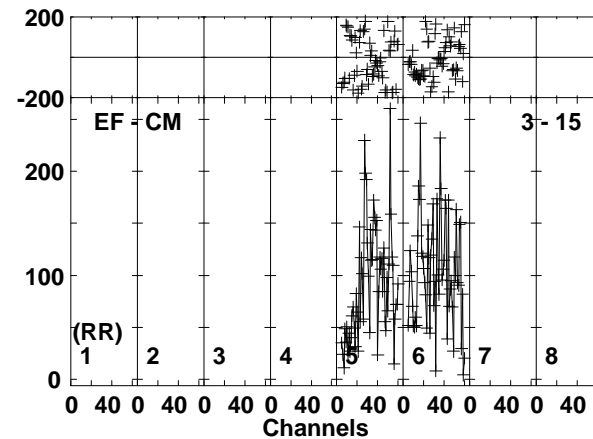
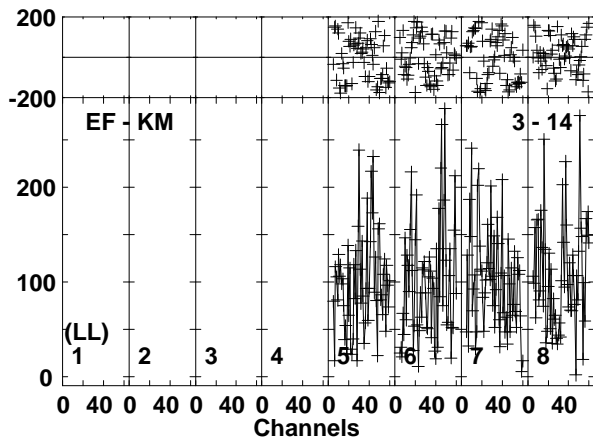
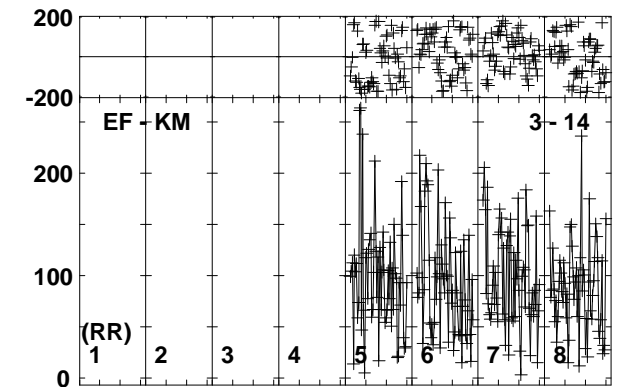
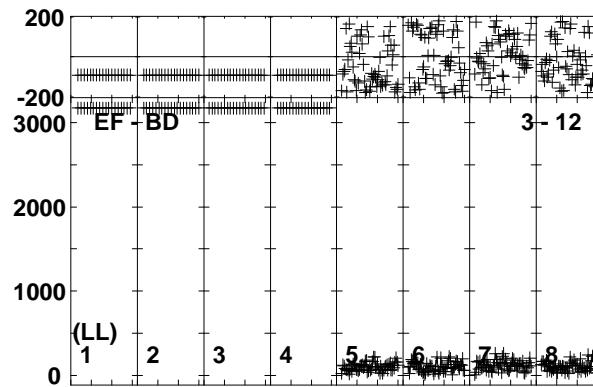
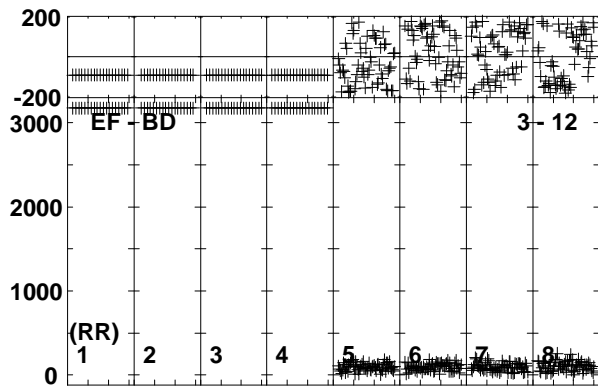
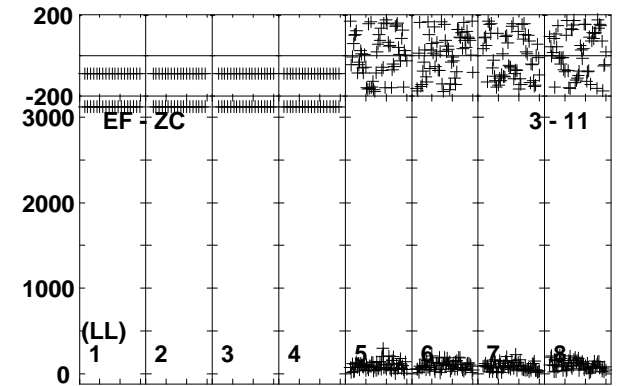
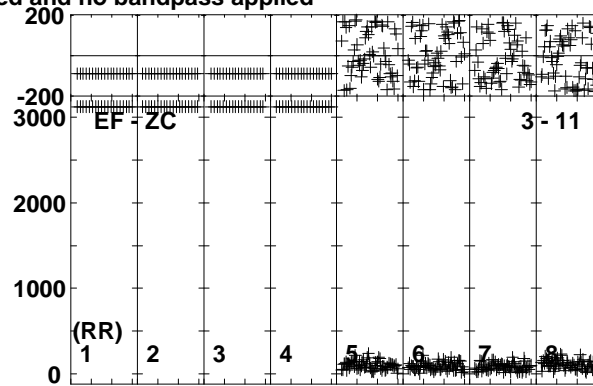
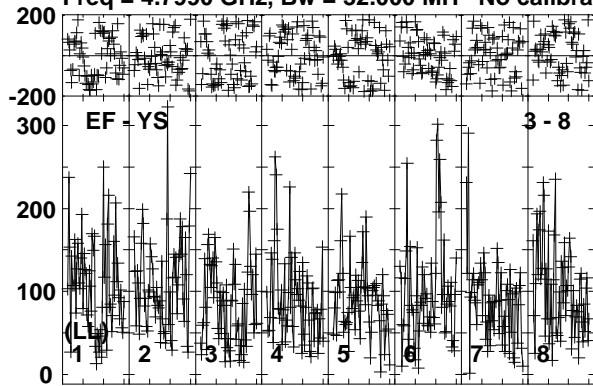

Lower frame: Micro Ampl Jy Top frame: Phas deg
Vector averaged cross-power spectrum Baseline: EF (03) - YS (08)
Timerange: 00/13:15:00 to 00/13:18:00

Plot file version 22 created 20-SEP-2019 15:50:58
 AT2019EHZ RSM05.UVDATA.1
 Freq = 4.7990 GHz, Bw = 32.000 MH No calibration applied and no bandpass applied

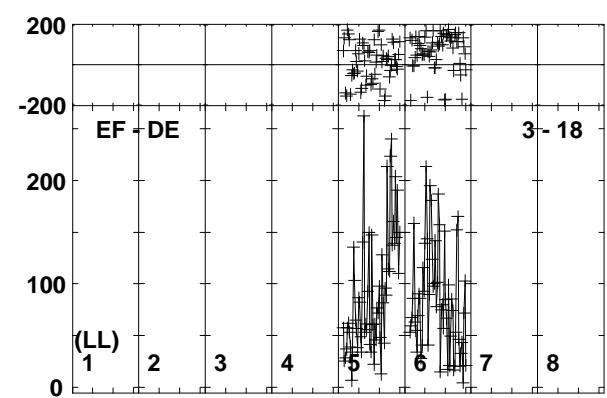
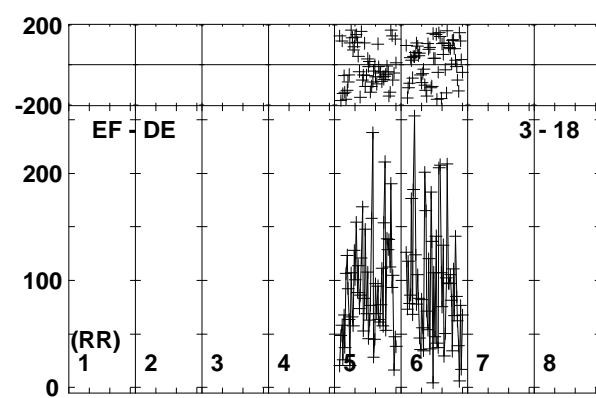
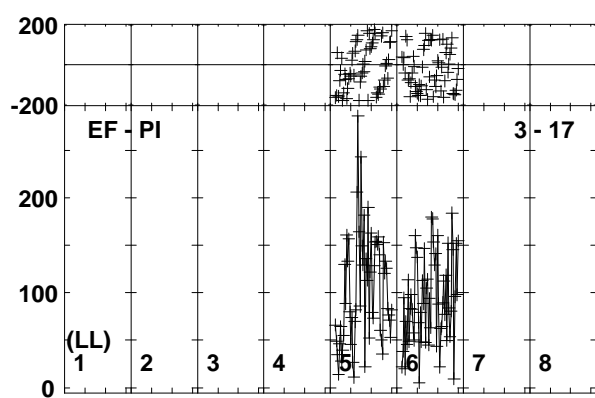
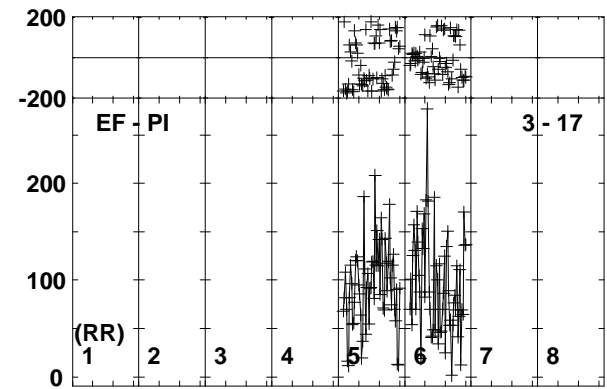
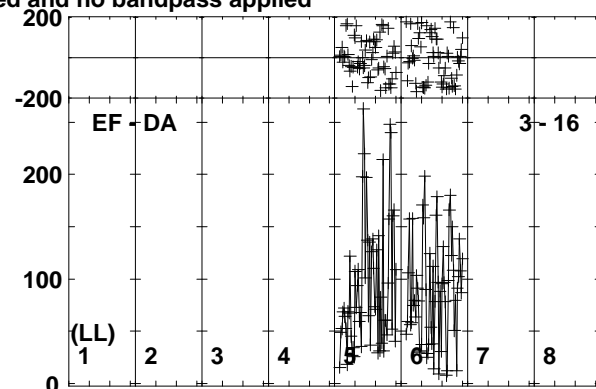
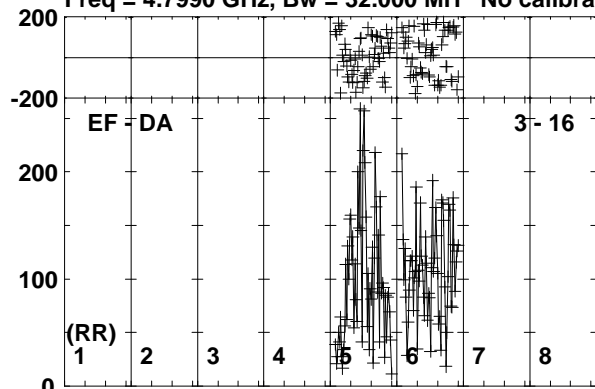

Lower frame: Micro Ampl Jy Top frame: Phas deg
 Vector averaged cross-power spectrum Baseline: EF (03) - DA (16)
 Timerange: 00/13:15:00 to 00/13:18:00

Plot file version 23 created 20-SEP-2019 15:50:59

J1408+5613 RSM05.UVDATA.1

Freq = 4.7990 GHz, Bw = 32.000 MH No calibration applied and no bandpass applied

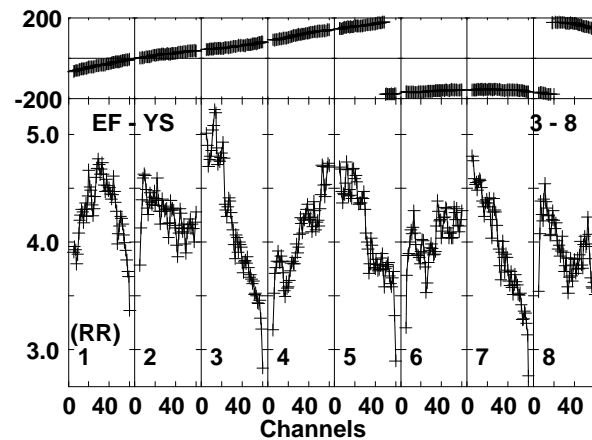
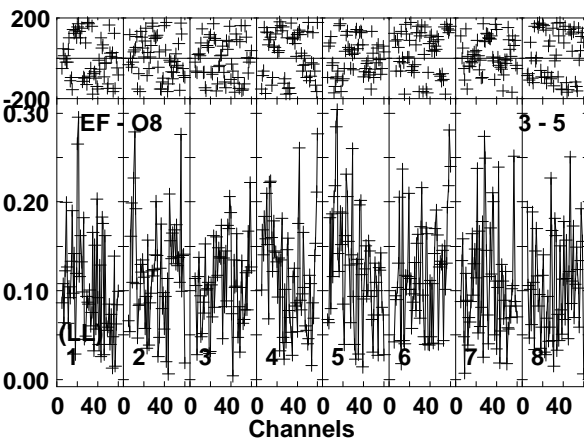
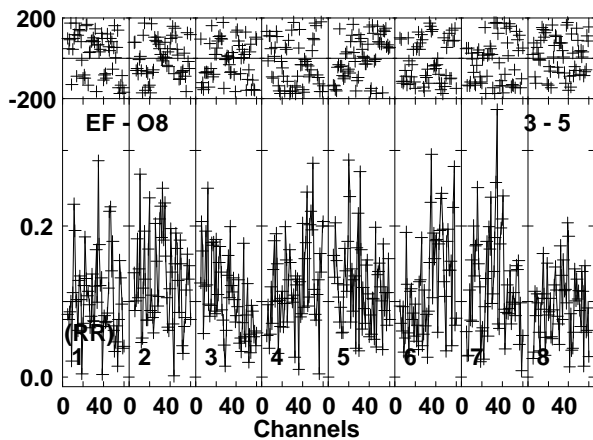
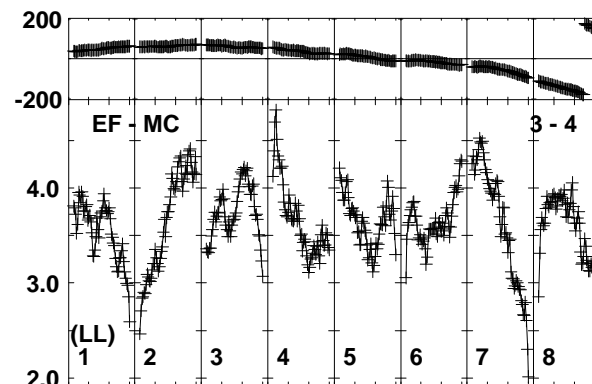
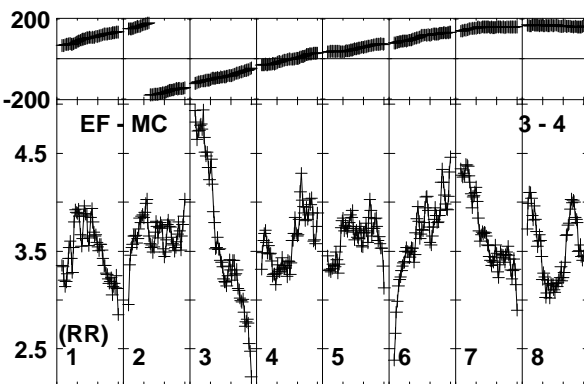
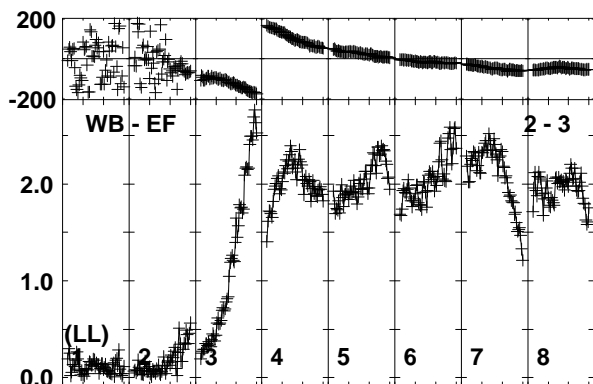
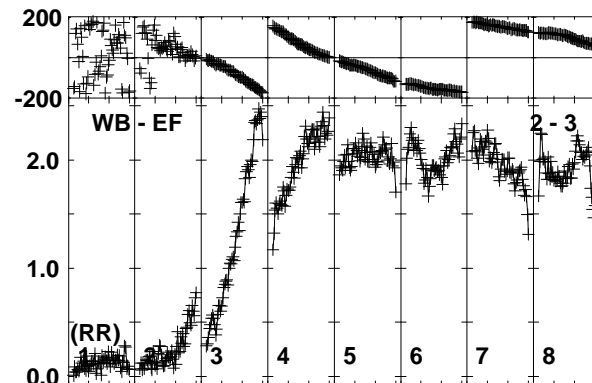
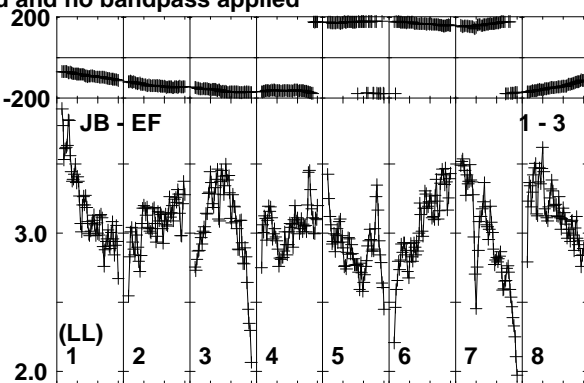
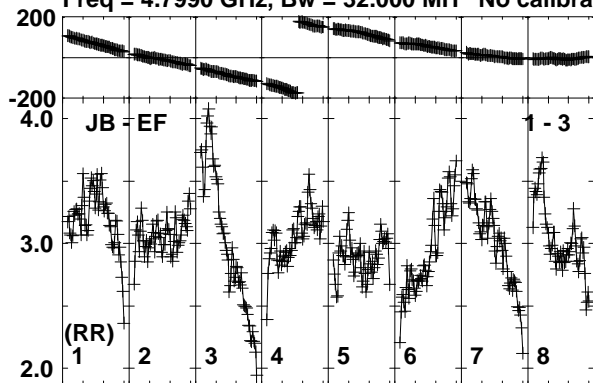

Lower frame: Milli Ampl Jy Top frame: Phas deg
Vector averaged cross-power spectrum Baseline: JB (01) - EF (03)
Timerange: 00/13:18:51 to 00/13:20:19

Plot file version 24 created 20-SEP-2019 15:50:59

J1408+5613 RSM05.UVDATA.1

Freq = 4.7990 GHz, Bw = 32.000 MH No calibration applied and no bandpass applied

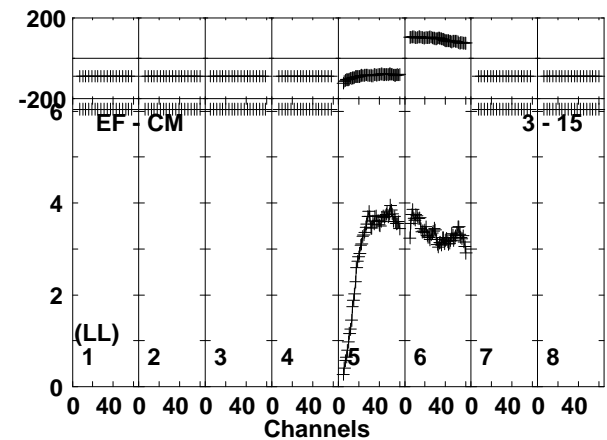
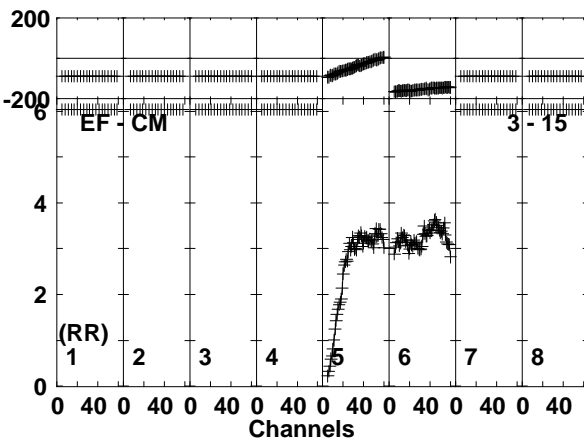
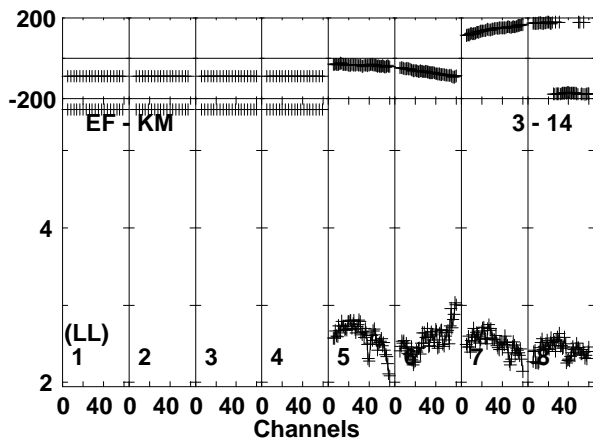
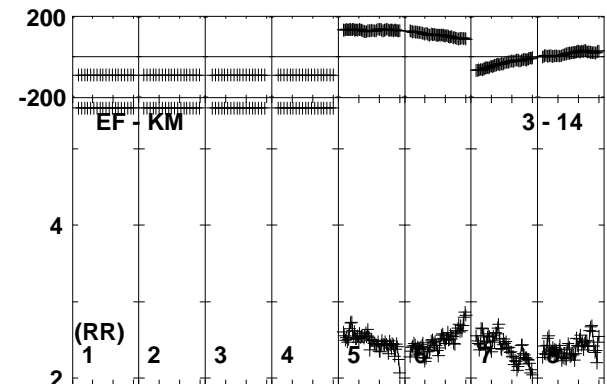
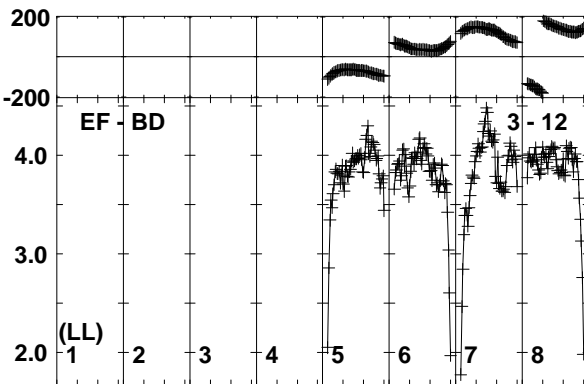
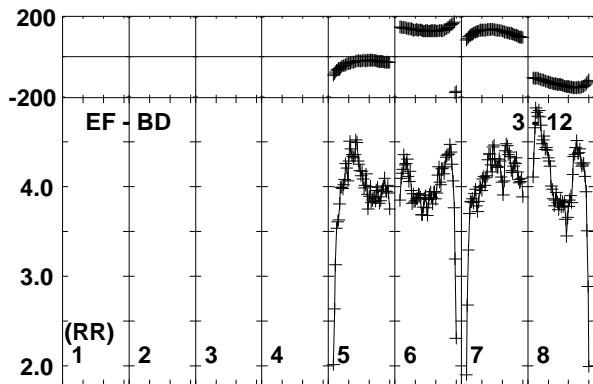
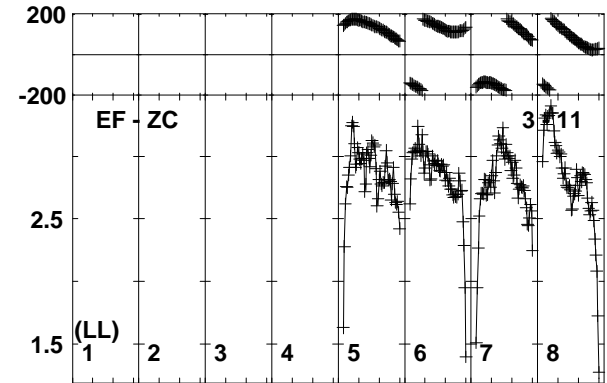
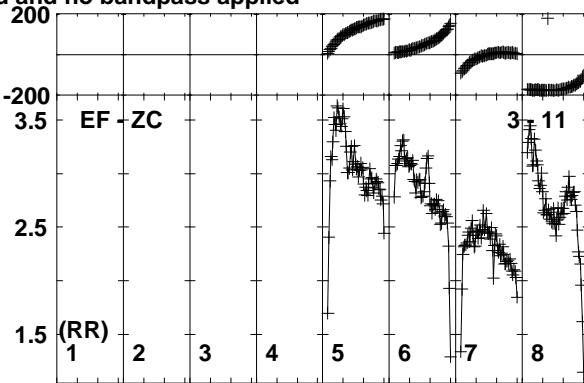
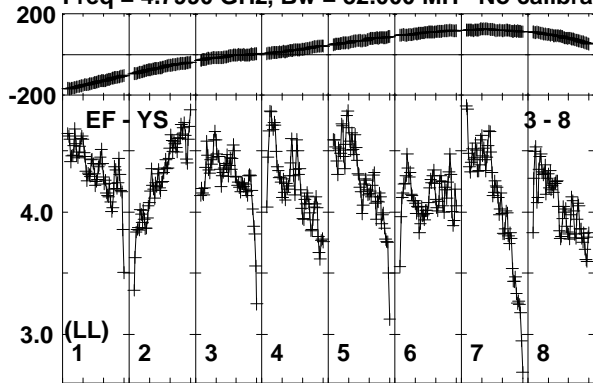

Lower frame: Milli Ampl Jy Top frame: Phas deg
Vector averaged cross-power spectrum Baseline: EF (03) - YS (08)
Timerange: 00/13:18:51 to 00/13:20:19

Plot file version 25 created 20-SEP-2019 15:51:00

J1408+5613 RSM05.UVDATA.1

Freq = 4.7990 GHz, Bw = 32.000 MH No calibration applied and no bandpass applied

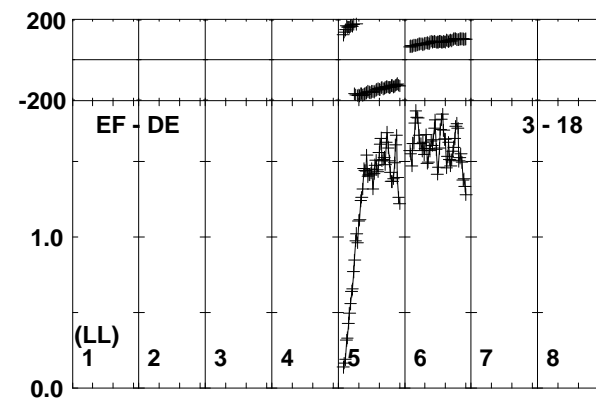
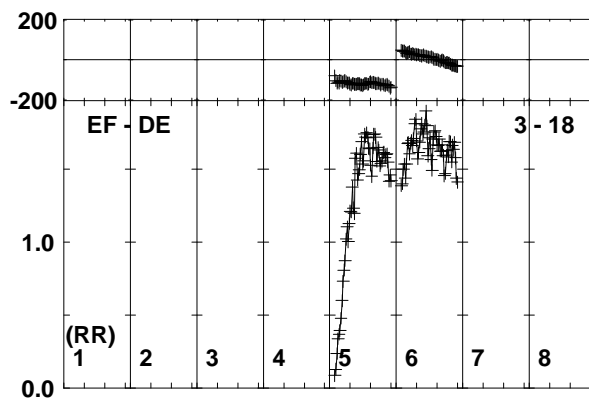
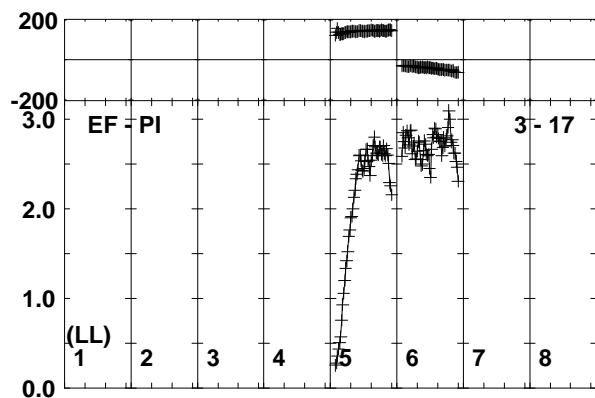
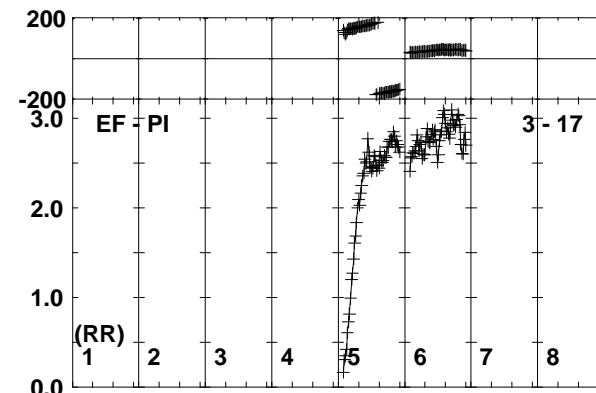
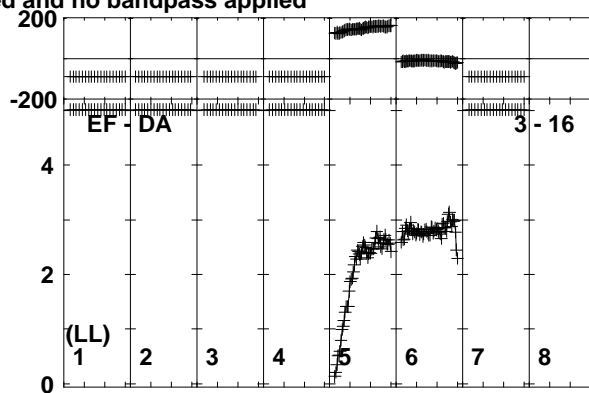
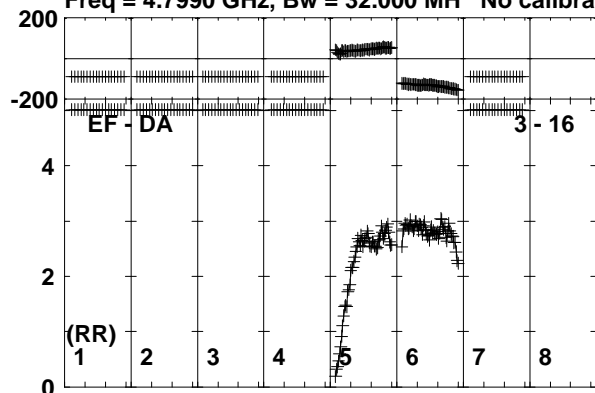

Lower frame: Milli Ampl Jy Top frame: Phas deg
Vector averaged cross-power spectrum Baseline: EF (03) - DA (16)
Timerange: 00/13:18:51 to 00/13:20:19

Plot file version 26 created 20-SEP-2019 15:51:00

AT2019EHZ RSM05.UVDATA.1

Freq = 4.7990 GHz, Bw = 32.000 MH No calibration applied and no bandpass applied

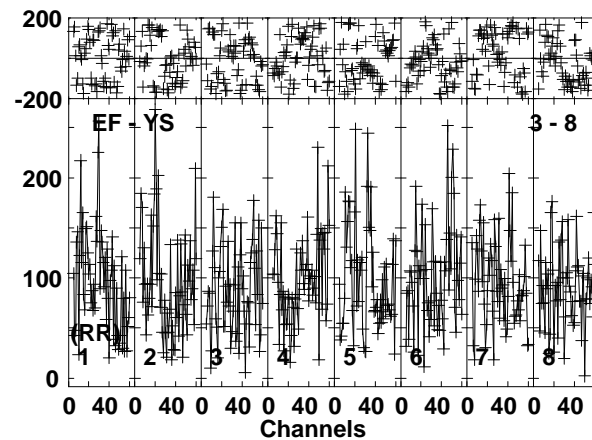
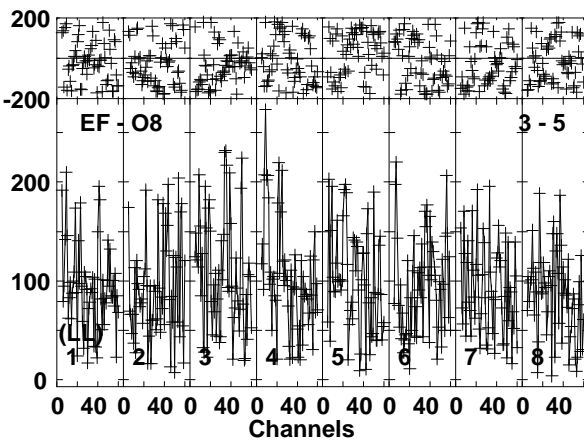
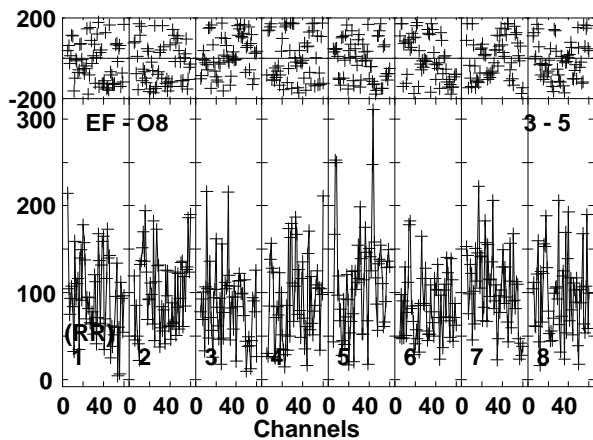
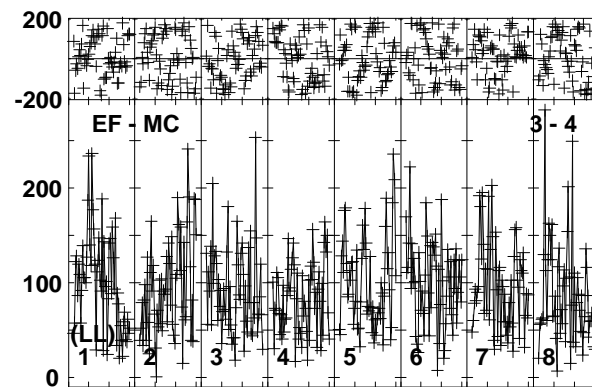
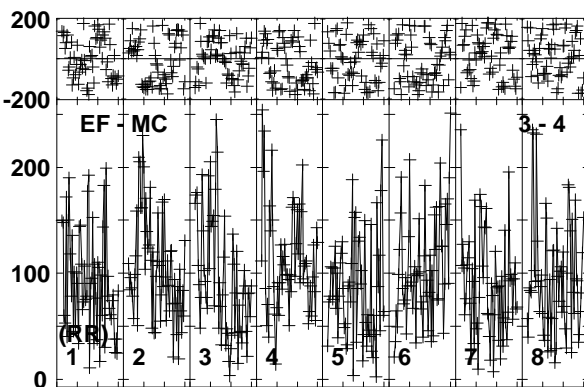
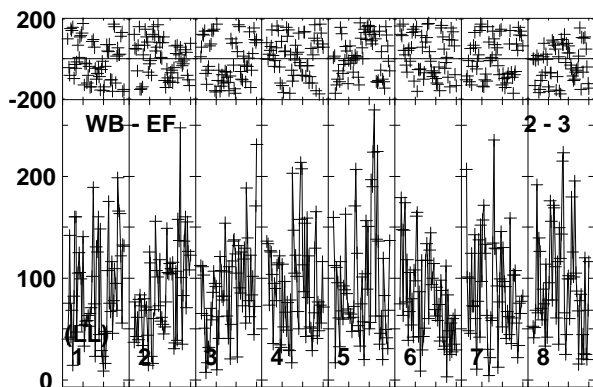
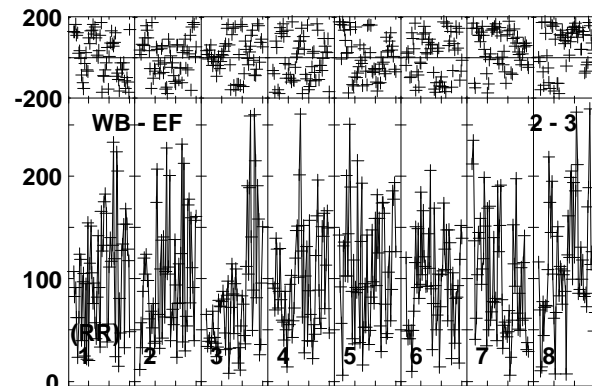
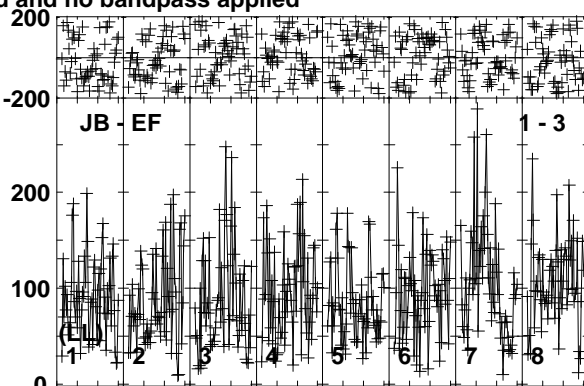
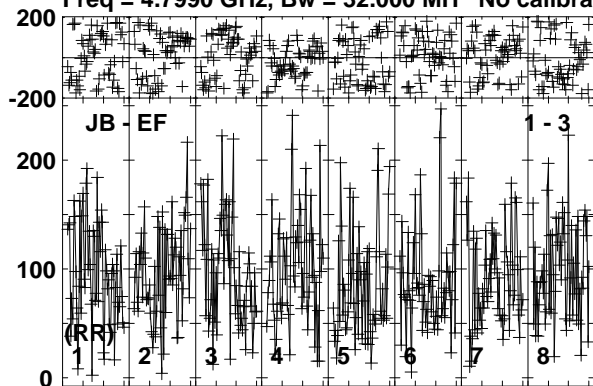

Lower frame: Micro Ampl Jy Top frame: Phas deg
Vector averaged cross-power spectrum Baseline: JB (01) - EF (03)
Timerange: 00/13:20:20 to 00/13:23:20

Plot file version 27 created 20-SEP-2019 15:51:00
 AT2019EHZ RSM05.UVDATA.1
 Freq = 4.7990 GHz, Bw = 32.000 MH No calibration applied and no bandpass applied

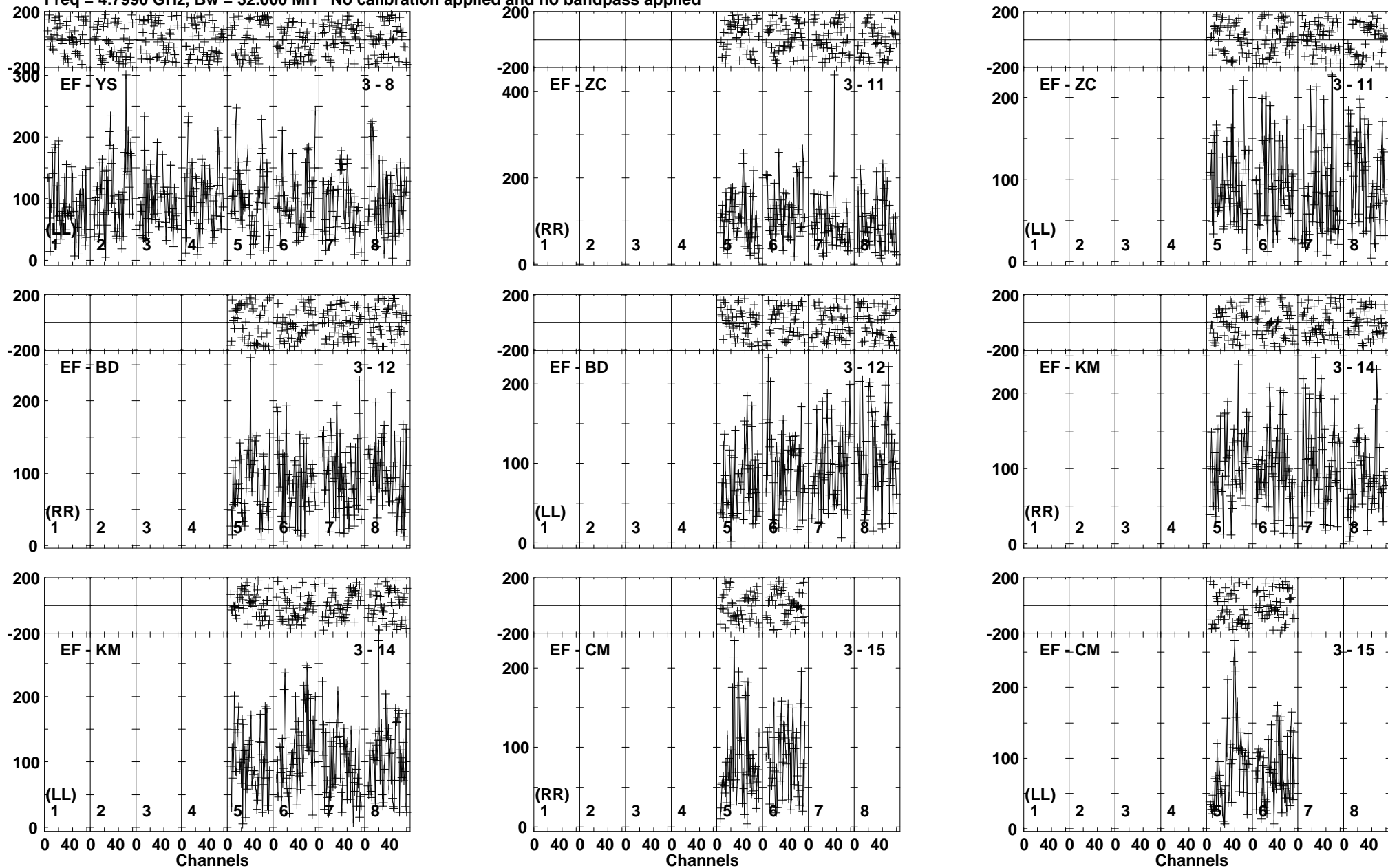

Lower frame: Micro Ampl Jy Top frame: Phas deg
 Vector averaged cross-power spectrum Baseline: EF (03) - YS (08)
 Timerange: 00/13:20:20 to 00/13:23:20

Plot file version 28 created 20-SEP-2019 15:51:01
 AT2019EHZ RSM05.UVDATA.1
 Freq = 4.7990 GHz, Bw = 32.000 MH No calibration applied and no bandpass applied

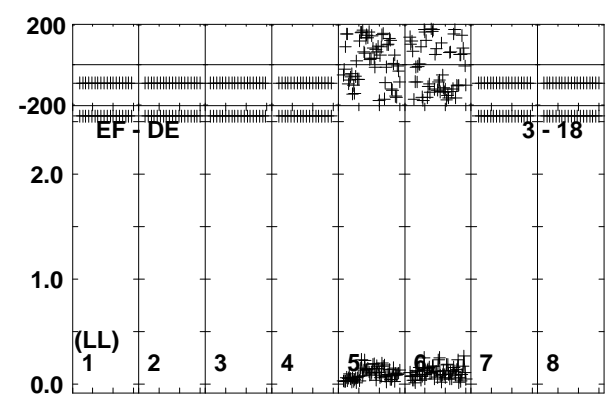
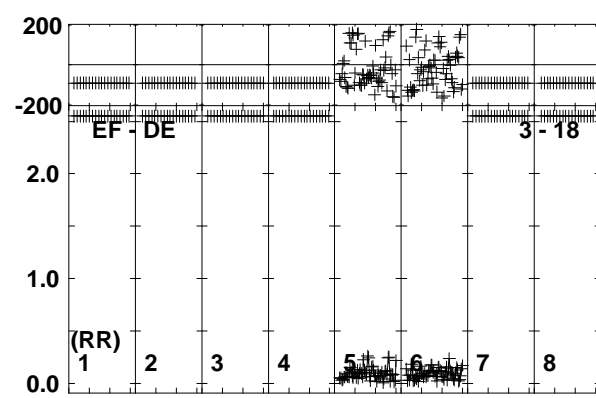
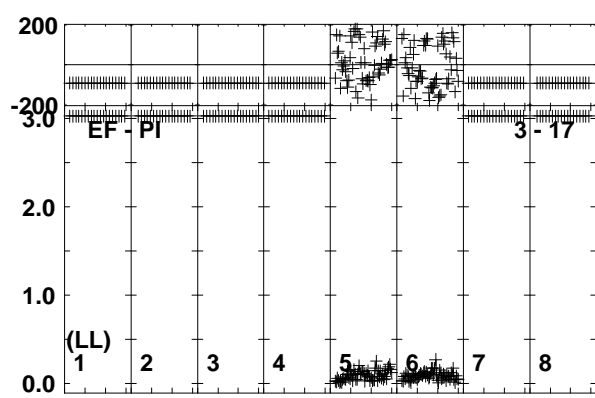
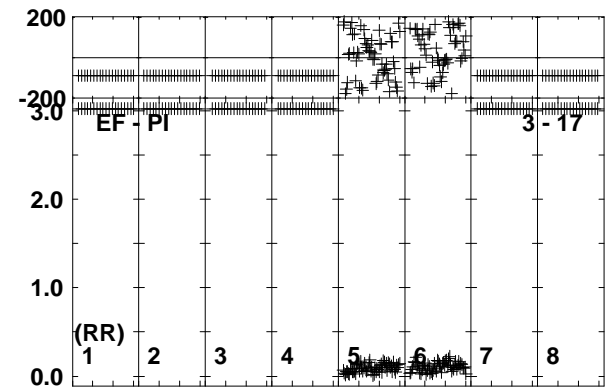
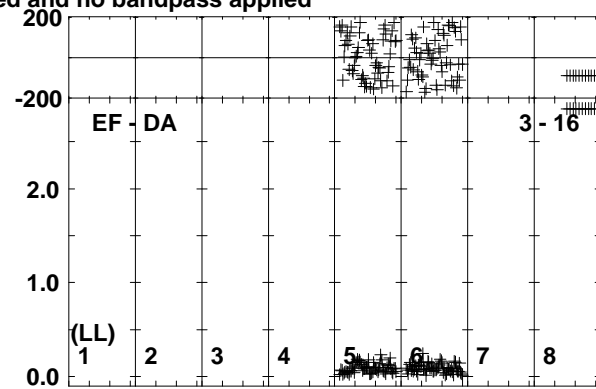
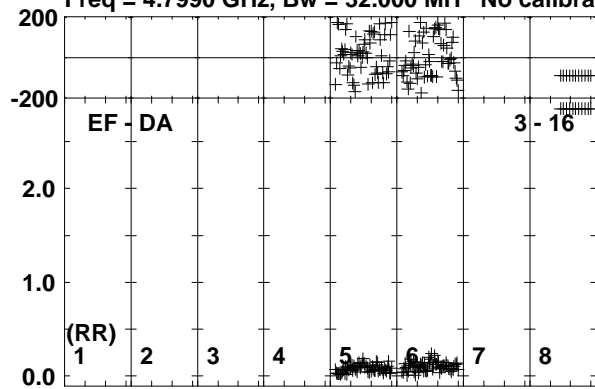

Lower frame: Milli Ampl Jy Top frame: Phas deg
 Vector averaged cross-power spectrum Baseline: EF (03) - DA (16)
 Timerange: 00/13:20:20 to 00/13:23:20

Plot file version 29 created 20-SEP-2019 15:51:01

J1408+5613 RSM05.UVDATA.1

Freq = 4.7990 GHz, Bw = 32.000 MH No calibration applied and no bandpass applied

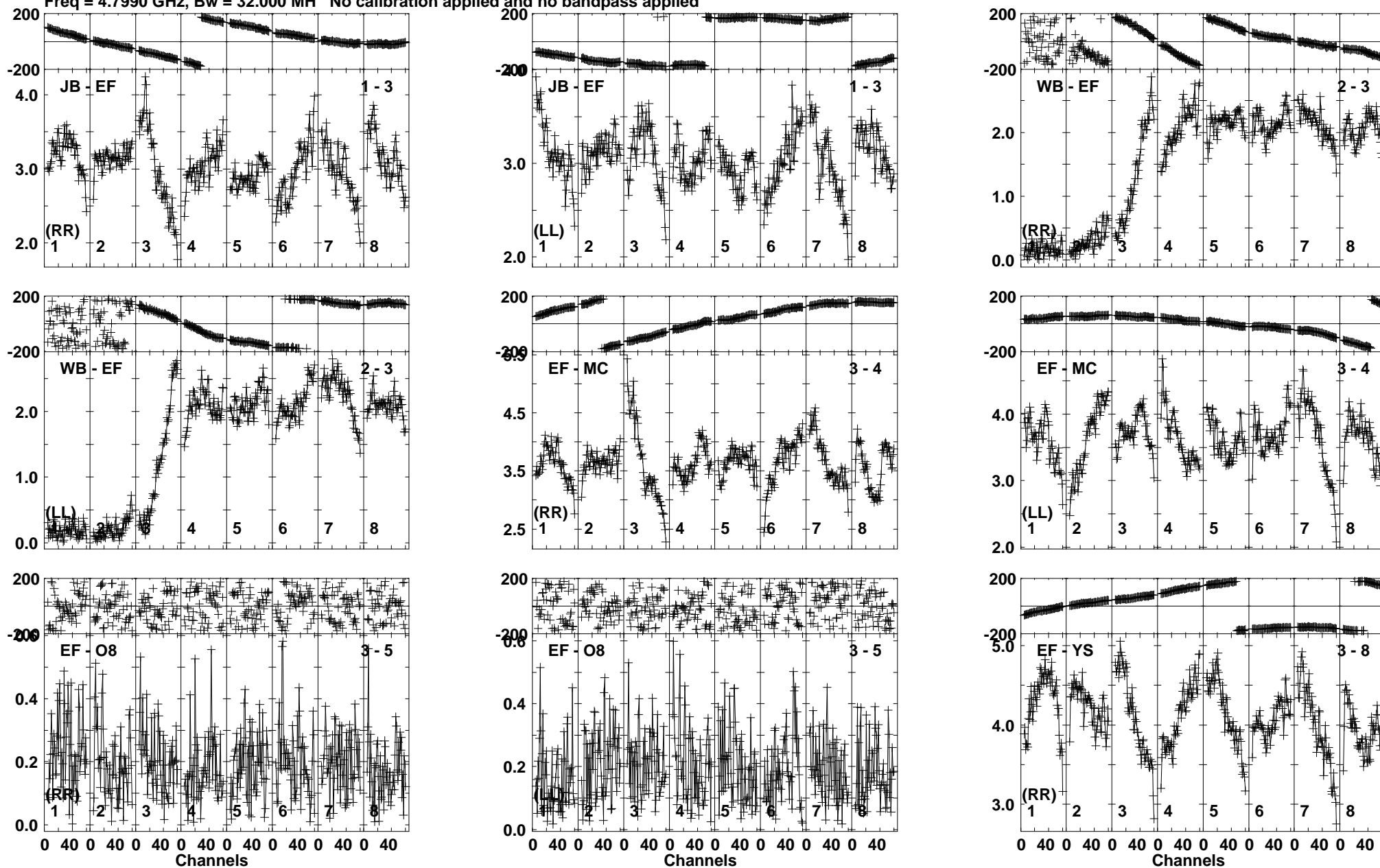

Lower frame: Milli Ampl Jy Top frame: Phas deg
Vector averaged cross-power spectrum Baseline: JB (01) - EF (03)
Timerange: 00/13:23:21 to 00/13:24:49

Plot file version 30 created 20-SEP-2019 15:51:02

J1408+5613 RSM05.UVDATA.1

Freq = 4.7990 GHz, Bw = 32.000 MH No calibration applied and no bandpass applied

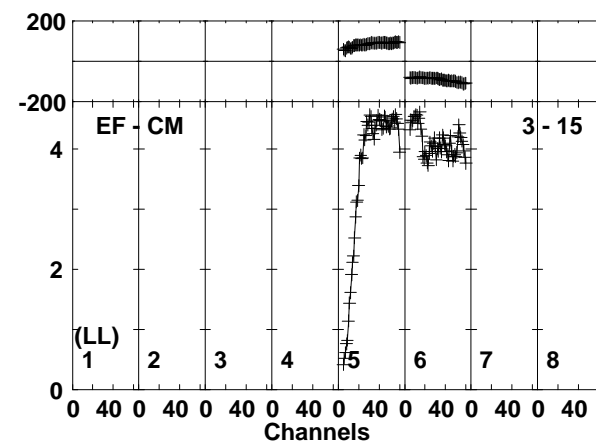
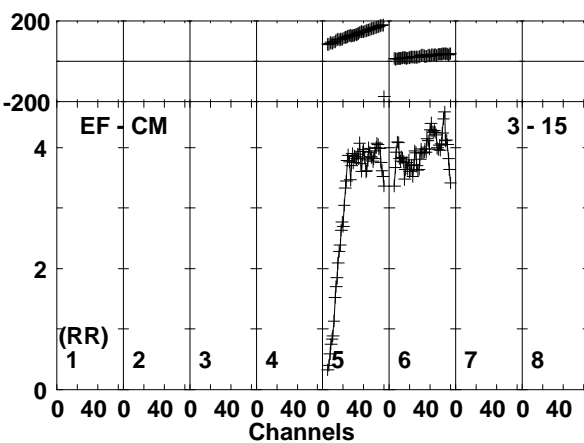
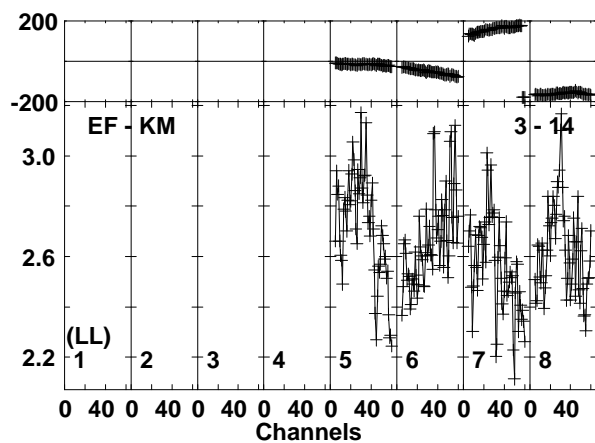
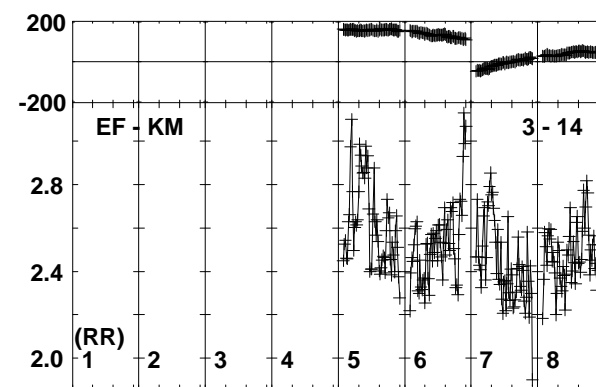
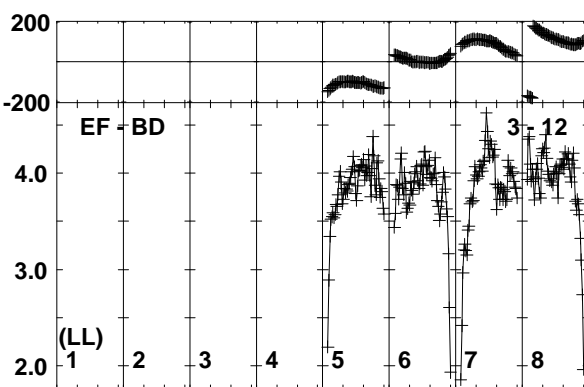
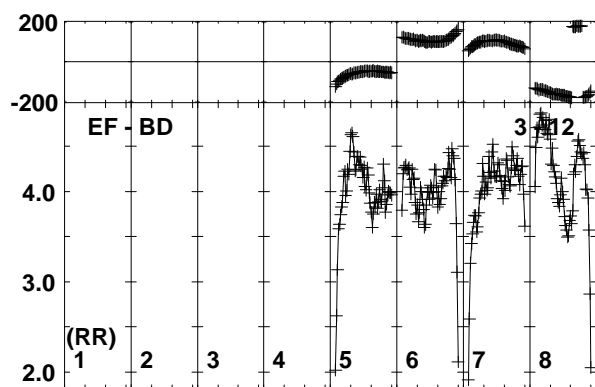
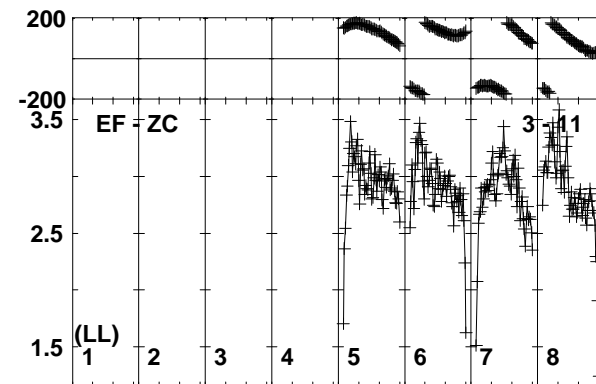
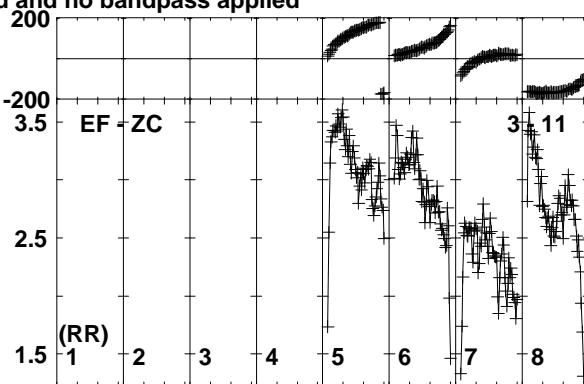
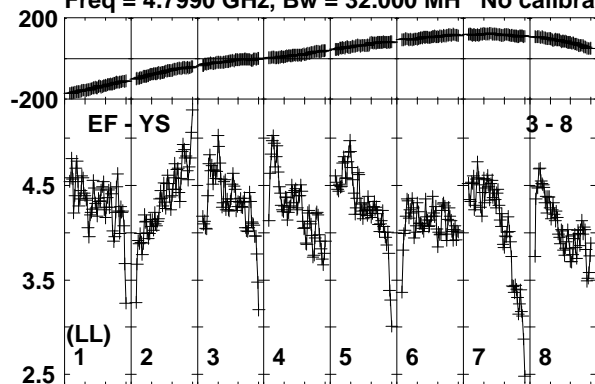

Lower frame: Milli Ampl Jy Top frame: Phas deg
Vector averaged cross-power spectrum Baseline: EF (03) - YS (08)
Timerange: 00/13:23:21 to 00/13:24:49

Plot file version 31 created 20-SEP-2019 15:51:02
 J1408+5613 RSM05.UVDATA.1
 Freq = 4.7990 GHz, Bw = 32.000 MH No calibration applied and no bandpass applied

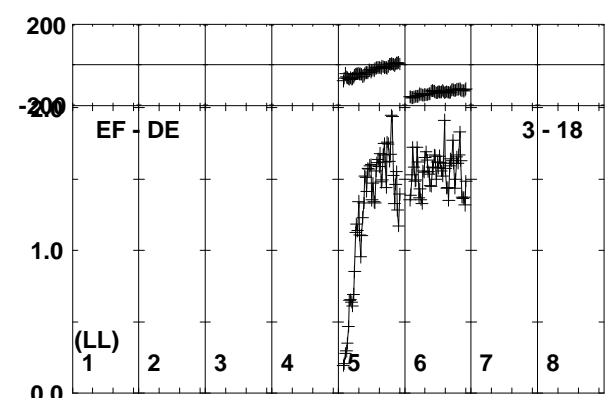
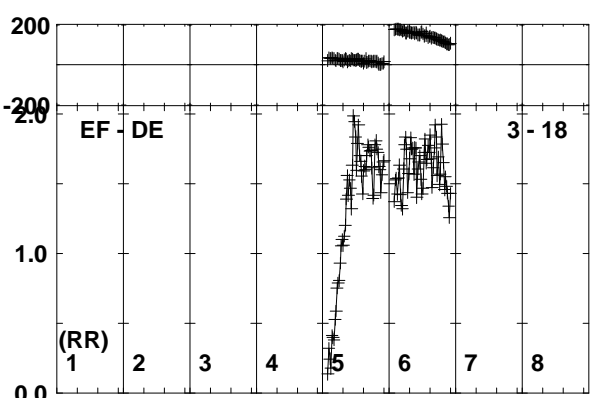
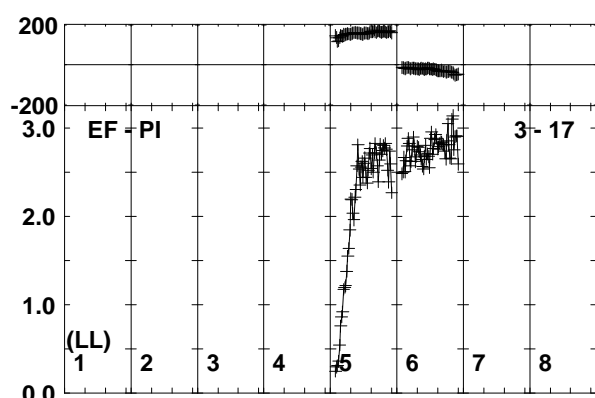
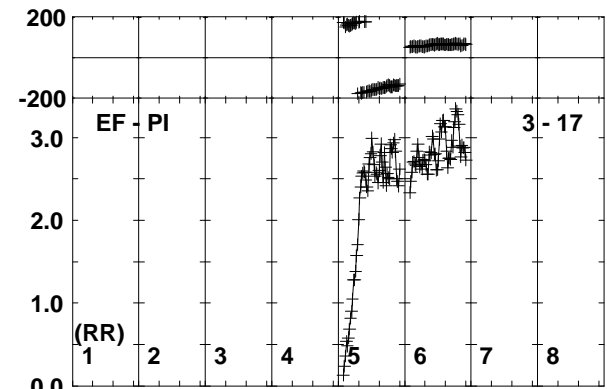
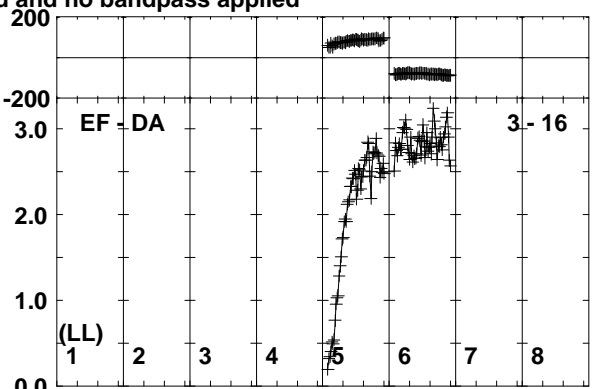
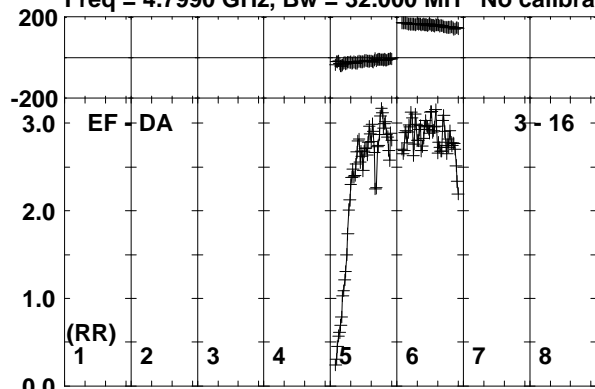

Lower frame: Milli Ampl Jy Top frame: Phas deg
 Vector averaged cross-power spectrum Baseline: EF (03) - DA (16)
 Timerange: 00/13:23:21 to 00/13:24:49

Plot file version 32 created 20-SEP-2019 15:51:02

AT2019EHZ RSM05.UVDATA.1

Freq = 4.7990 GHz, Bw = 32.000 MH No calibration applied and no bandpass applied

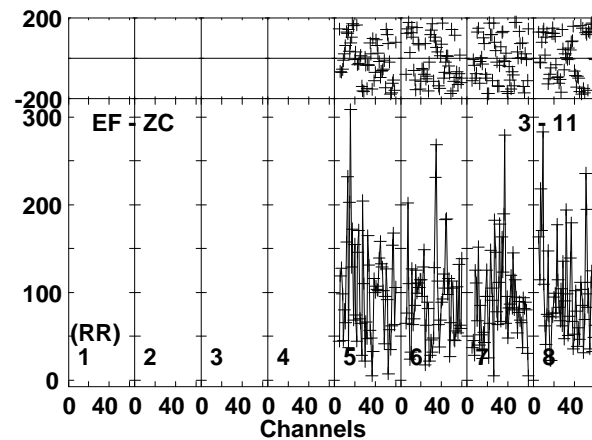
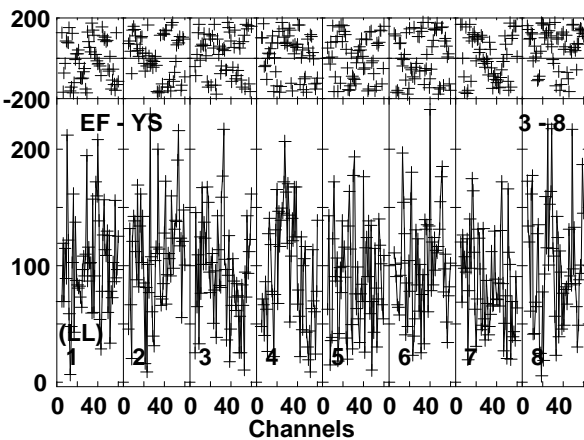
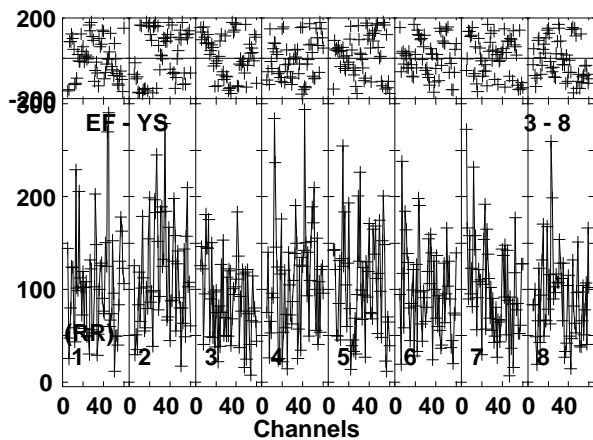
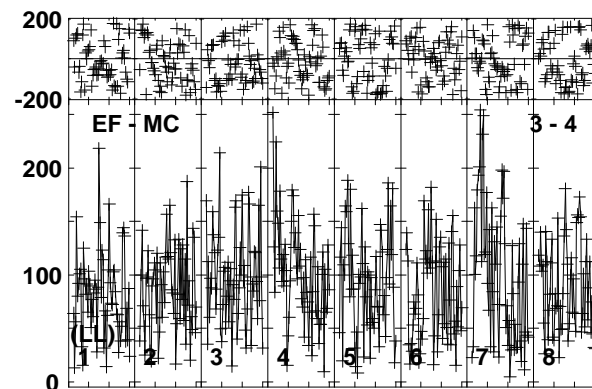
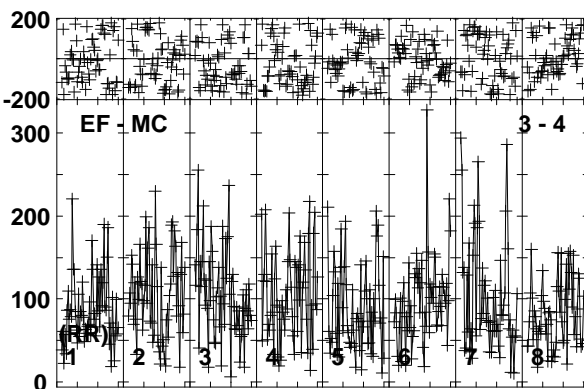
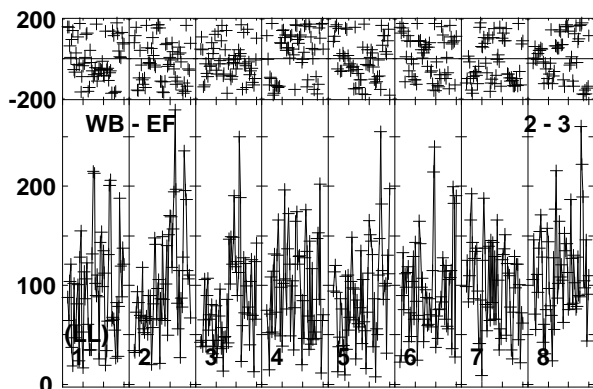
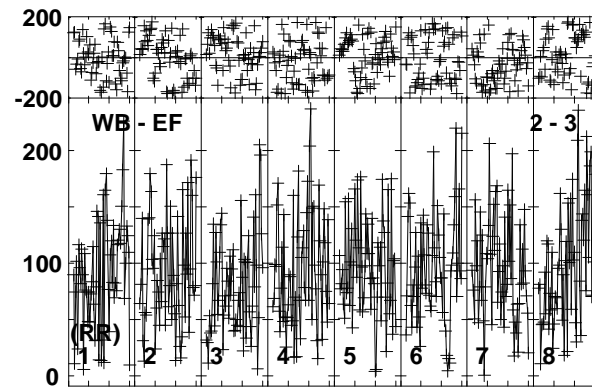
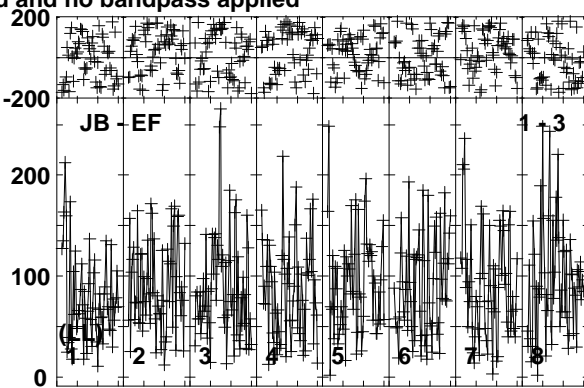
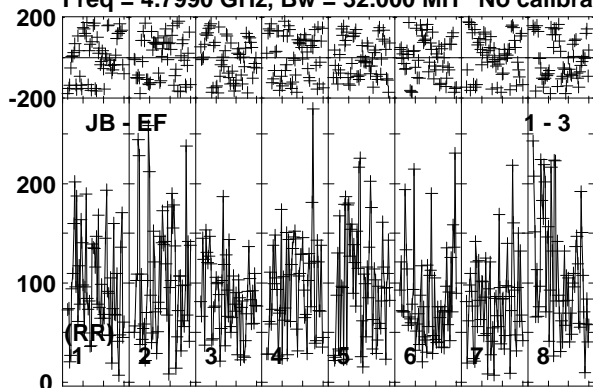

Lower frame: Micro Ampl Jy Top frame: Phas deg
Vector averaged cross-power spectrum Baseline: JB (01) - EF (03)
Timerange: 00/13:24:51 to 00/13:27:49

Plot file version 33 created 20-SEP-2019 15:51:03
 AT2019EHZ RSM05.UVDATA.1
 Freq = 4.7990 GHz, Bw = 32.000 MH No calibration applied and no bandpass applied

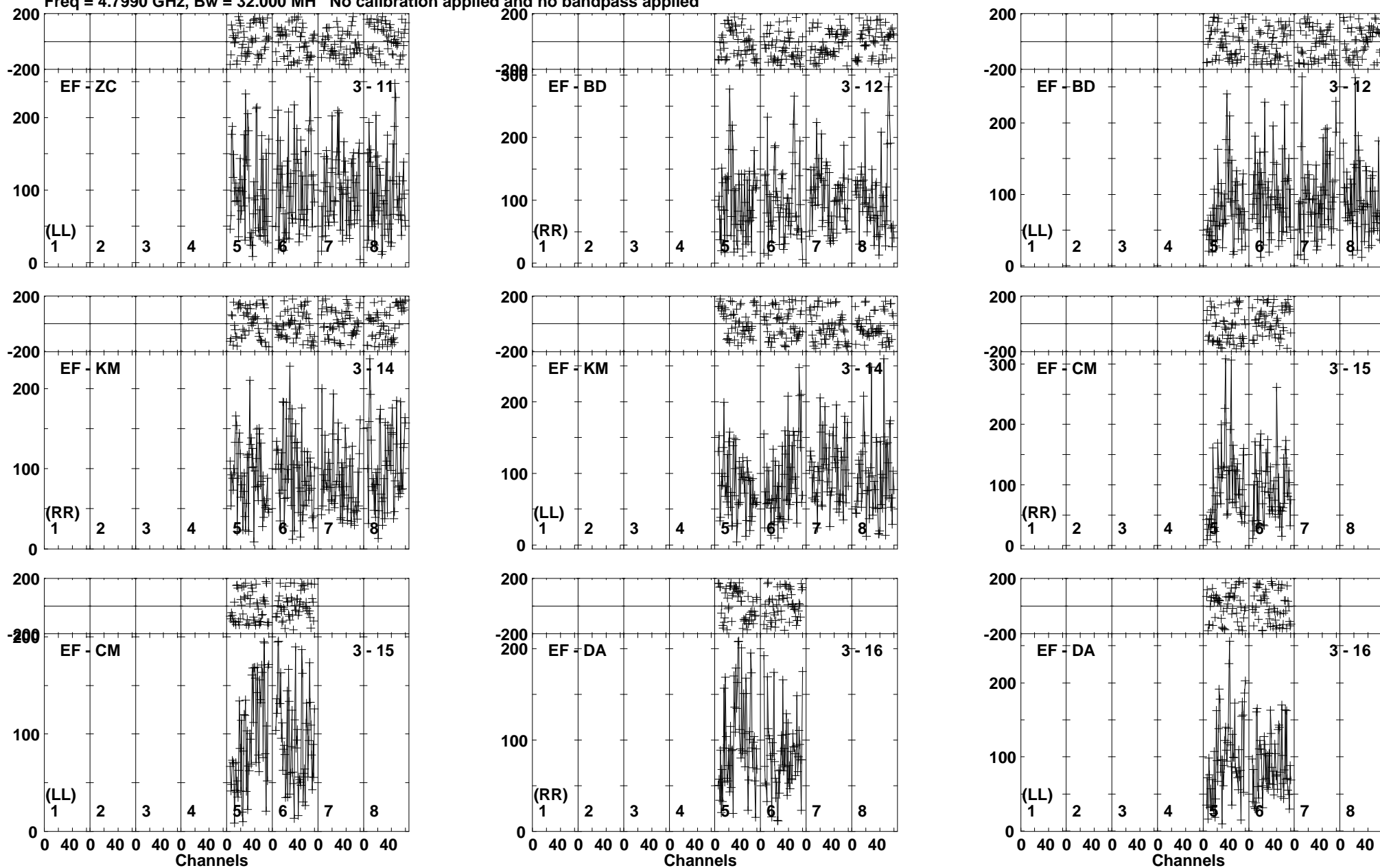

Lower frame: Micro Ampl Jy Top frame: Phas deg
 Vector averaged cross-power spectrum Baseline: EF (03) - ZC (11)
 Timerange: 00/13:24:51 to 00/13:27:49

Plot file version 34 created 20-SEP-2019 15:51:04
 AT2019EHZ RSM05.UVDATA.1
 Freq = 4.7990 GHz, Bw = 32.000 MH No calibration applied and no bandpass applied

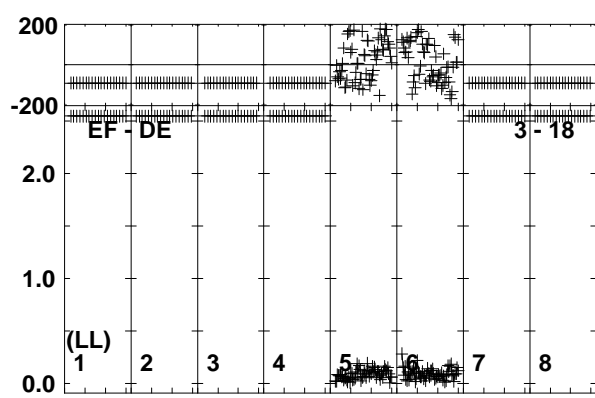
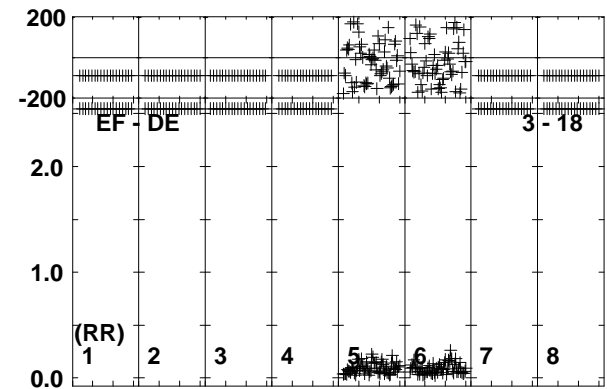
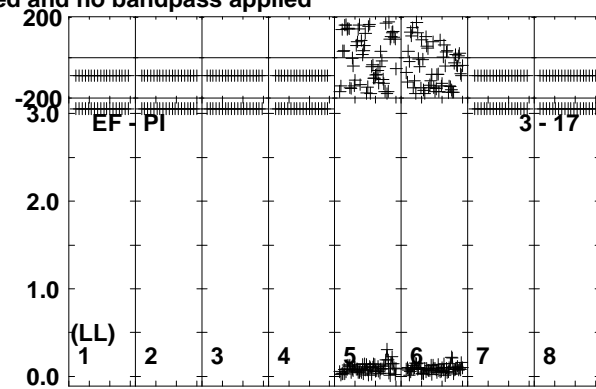
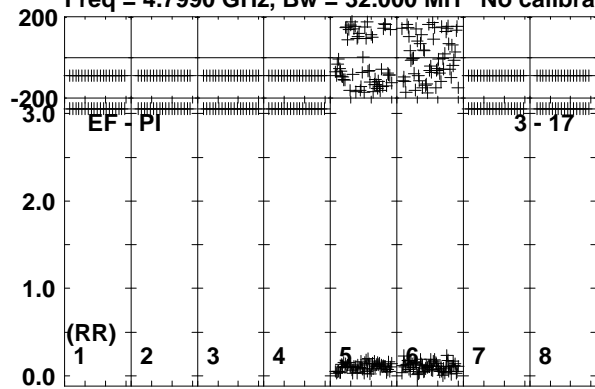

Lower frame: Milli Ampl Jy Top frame: Phas deg
 Vector averaged cross-power spectrum Baseline: EF (03) - PI (17)
 Timerange: 00/13:24:51 to 00/13:27:49

Plot file version 35 created 20-SEP-2019 15:51:04

J1408+5613 RSM05.UVDATA.1

Freq = 4.7990 GHz, Bw = 32.000 MH No calibration applied and no bandpass applied

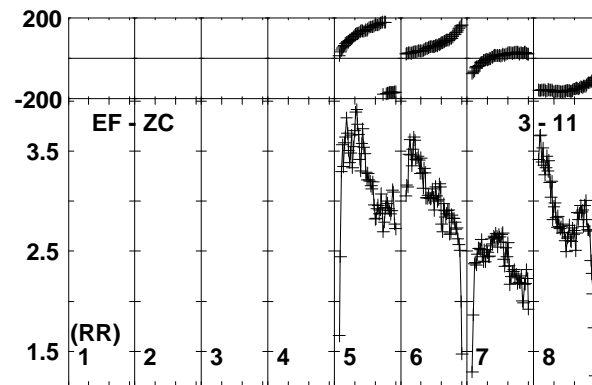
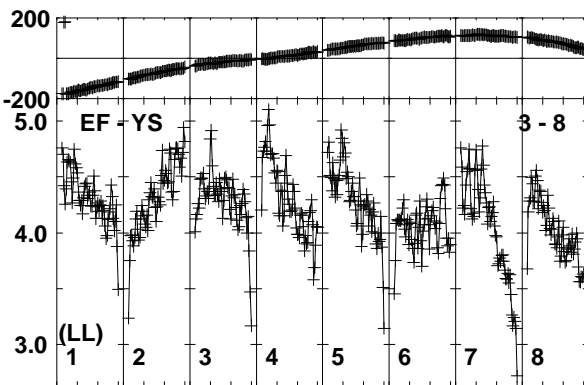
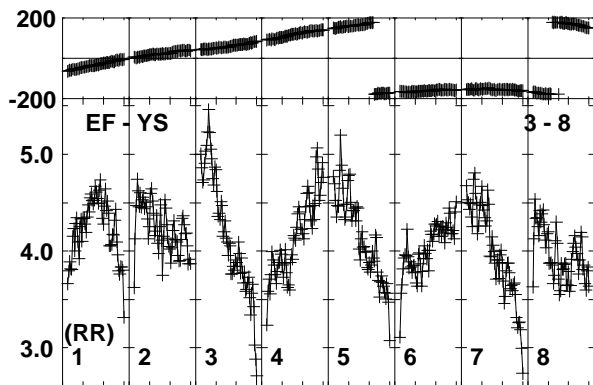
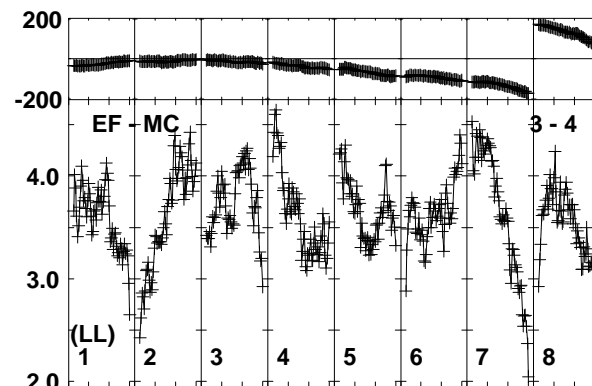
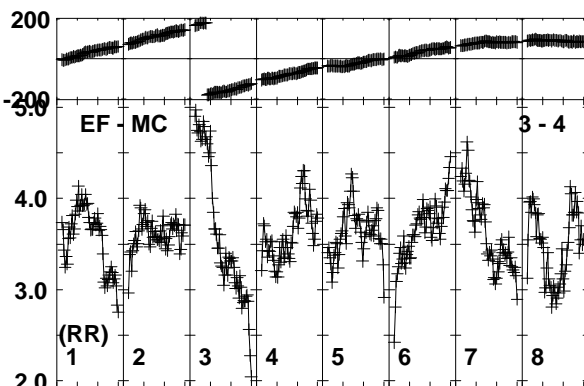
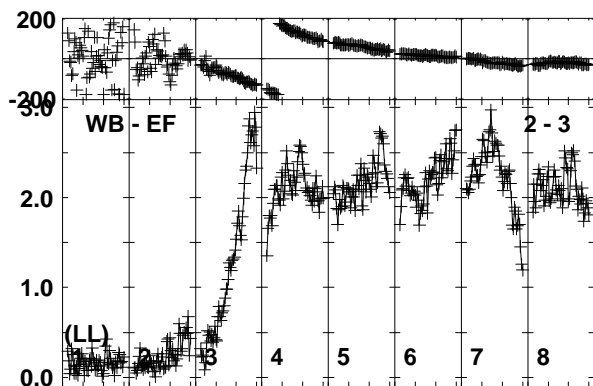
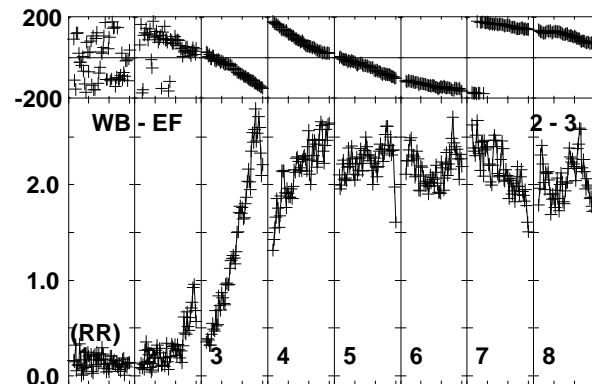
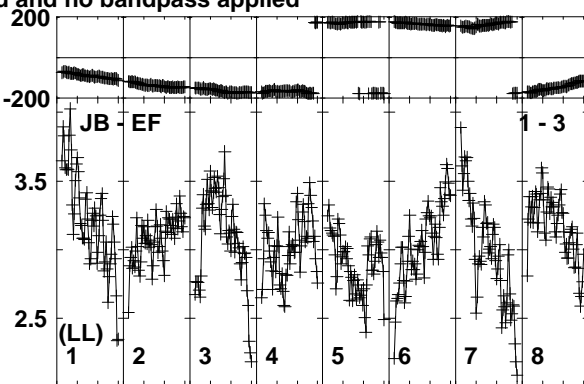
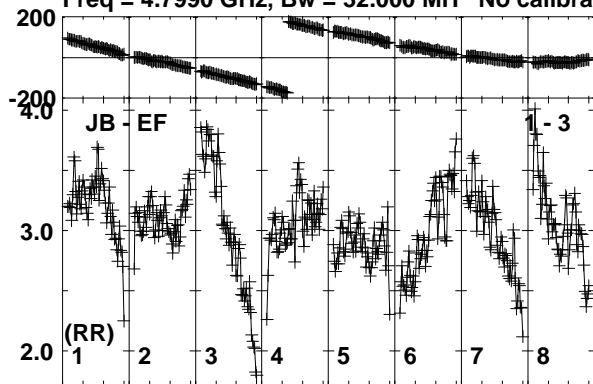

Lower frame: Milli Ampl Jy Top frame: Phas deg
Vector averaged cross-power spectrum Baseline: JB (01) - EF (03)
Timerange: 00/13:27:51 to 00/13:29:20

Plot file version 36 created 20-SEP-2019 15:51:04
 J1408+5613 RSM05.UVDATA.1
 Freq = 4.7990 GHz, Bw = 32.000 MH No calibration applied and no bandpass applied

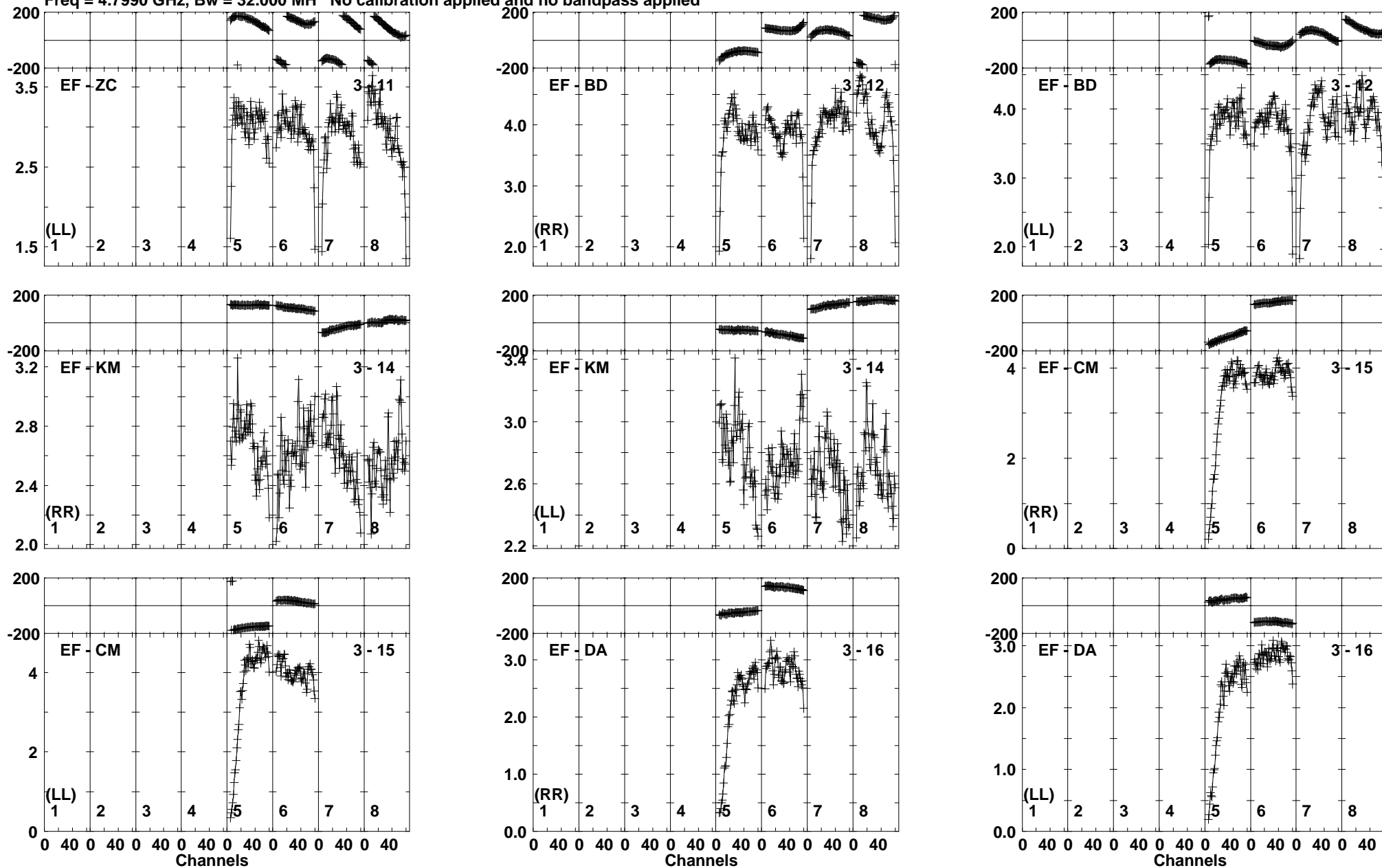

Lower frame: Milli Ampl Jy Top frame: Phas deg
 Vector averaged cross-power spectrum Baseline: EF (03) - ZC (11)
 Timerange: 00/13:27:51 to 00/13:29:20

Plot file version 37 created 20-SEP-2019 15:51:05

J1408+5613 RSM05.UVDATA.1

Freq = 4.7990 GHz, Bw = 32.000 MH No calibration applied and no bandpass applied

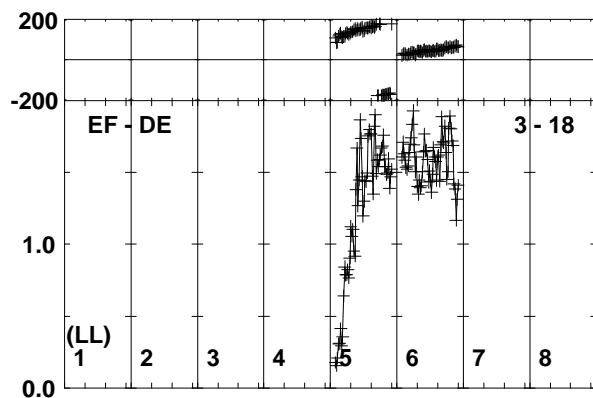
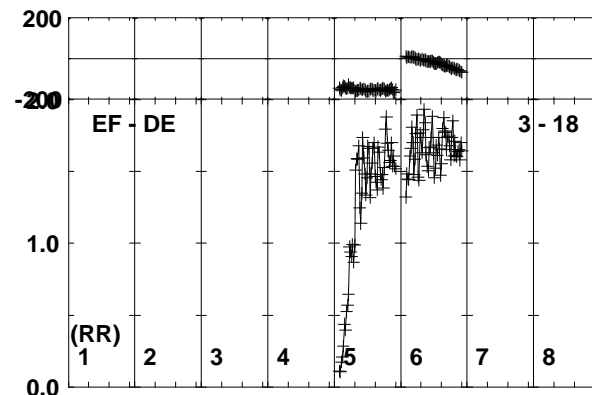
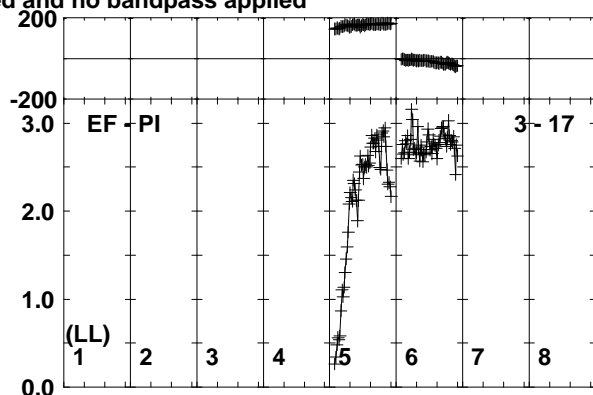
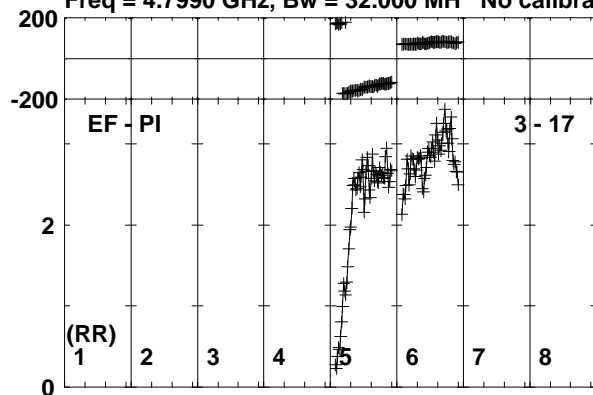

Lower frame: Milli Ampl Jy Top frame: Phas deg
Vector averaged cross-power spectrum Baseline: EF (03) - PI (17)
Timerange: 00/13:27:51 to 00/13:29:20

Plot file version 38 created 20-SEP-2019 15:51:05
 AT2019EHZ RSM05.UVDATA.1
 Freq = 4.7990 GHz, Bw = 32.000 MH No calibration applied and no bandpass applied

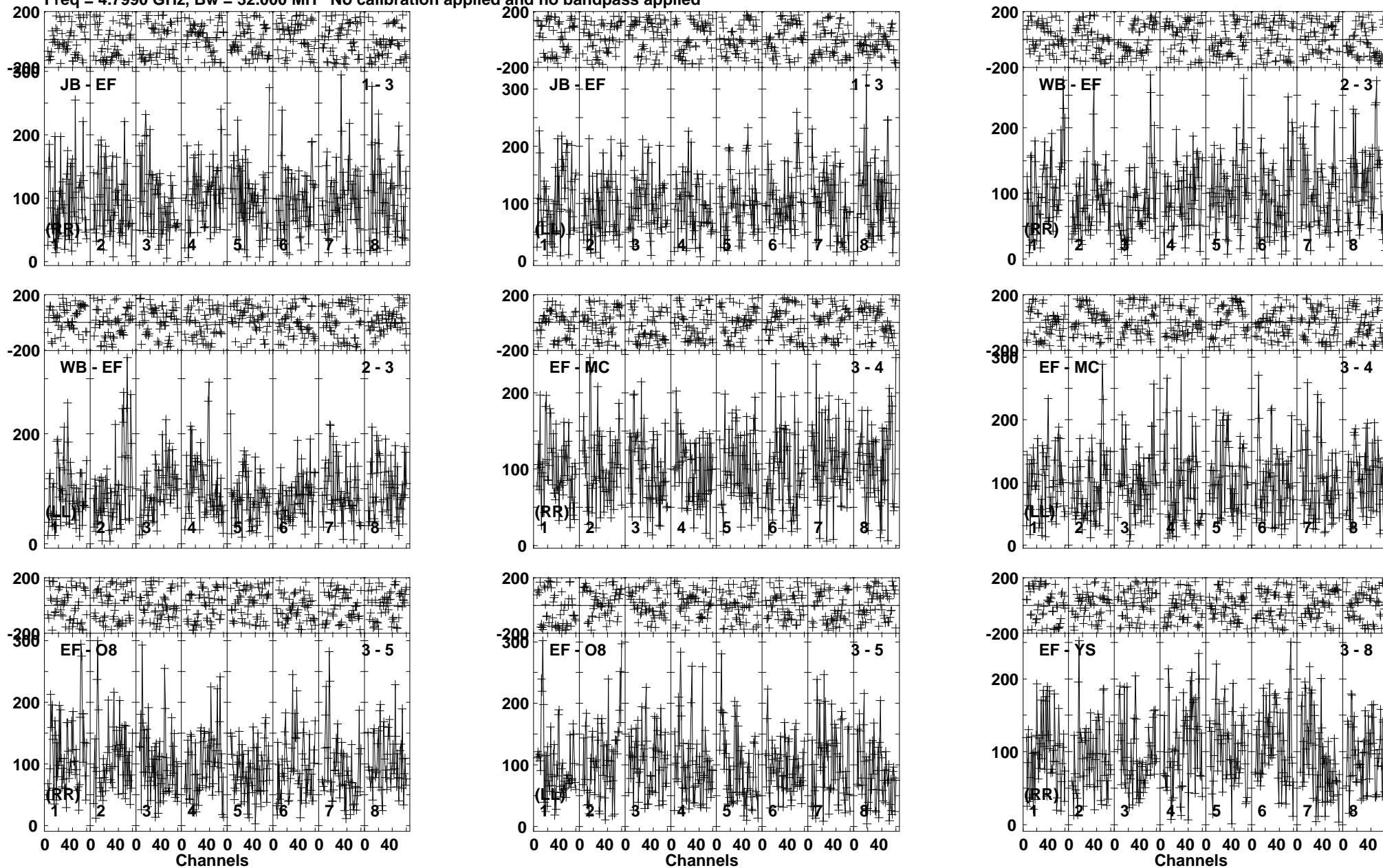

Lower frame: Micro Ampl Jy Top frame: Phas deg
 Vector averaged cross-power spectrum Baseline: JB (01) - EF (03)
 Timerange: 00/13:29:21 to 00/13:32:19

Plot file version 39 created 20-SEP-2019 15:51:06
 AT2019EHZ RSM05.UVDATA.1
 Freq = 4.7990 GHz, Bw = 32.000 MH No calibration applied and no bandpass applied

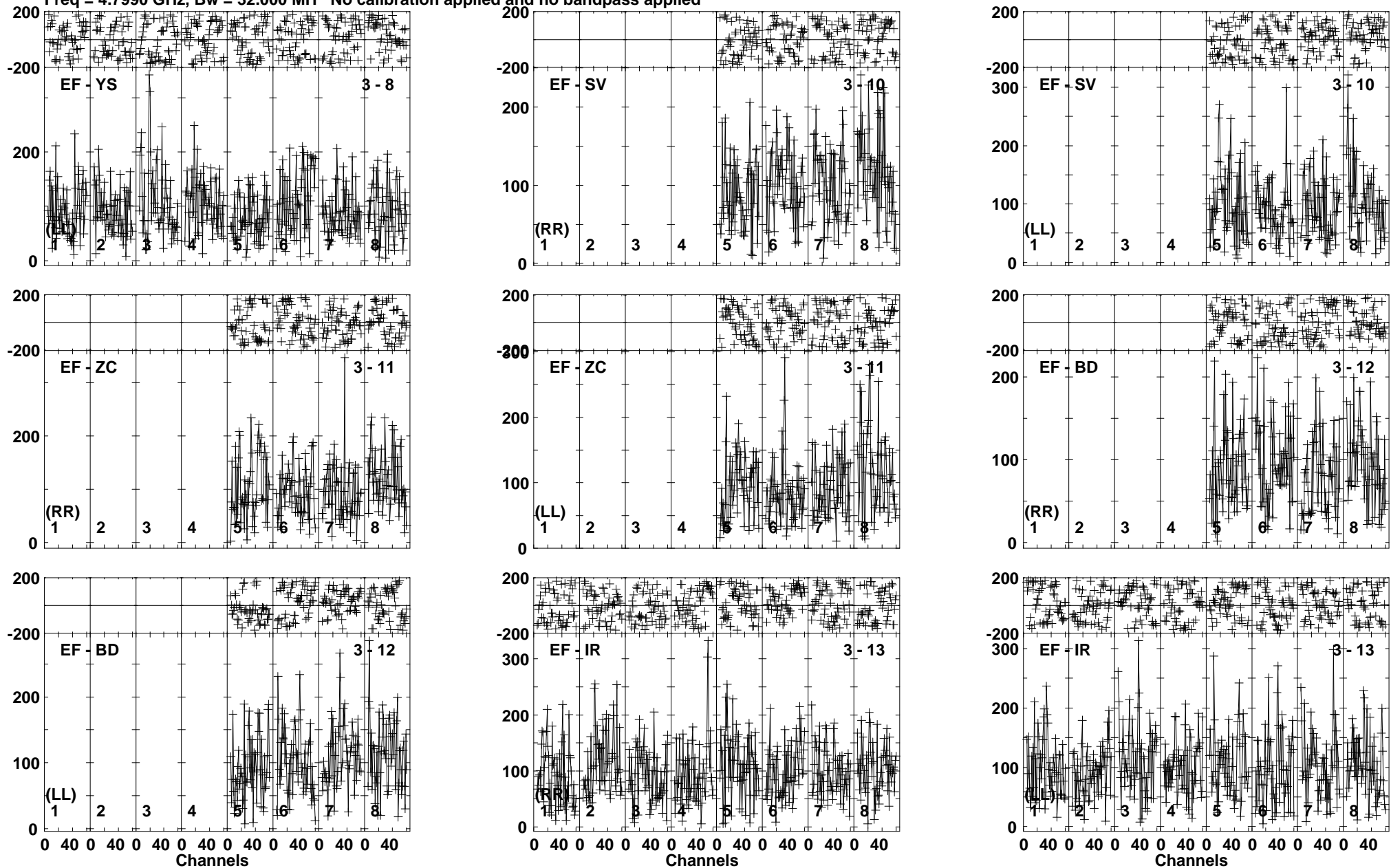

Lower frame: Micro Ampl Jy Top frame: Phas deg
 Vector averaged cross-power spectrum Baseline: EF (03) - YS (08)
 Timerange: 00/13:29:21 to 00/13:32:19

Plot file version 40 created 20-SEP-2019 15:51:06
 AT2019EHZ RSM05.UVDATA.1
 Freq = 4.7990 GHz, Bw = 32.000 MH No calibration applied and no bandpass applied

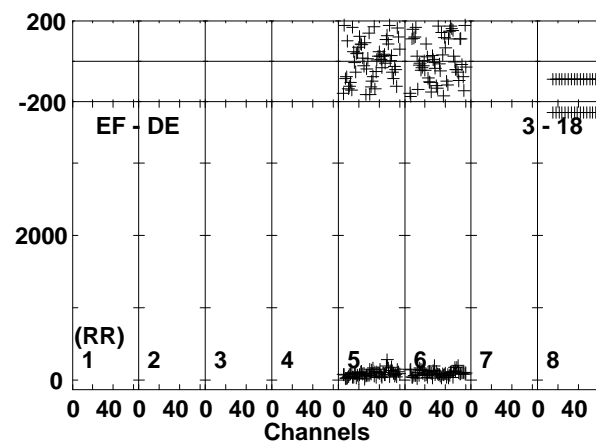
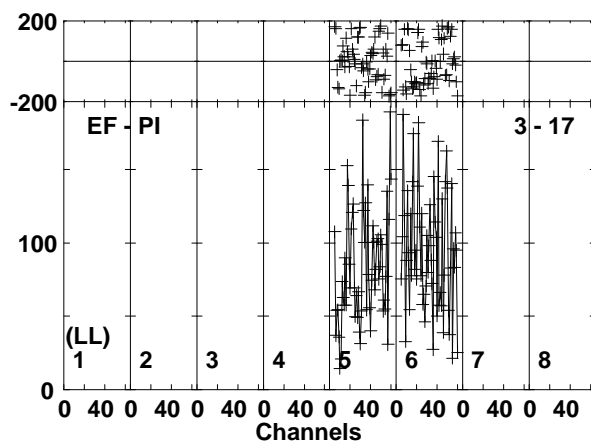
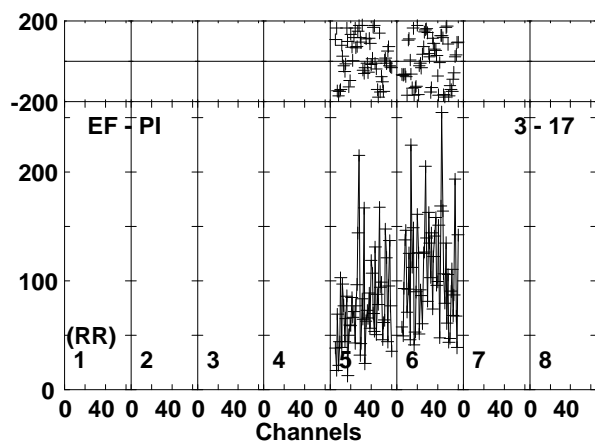
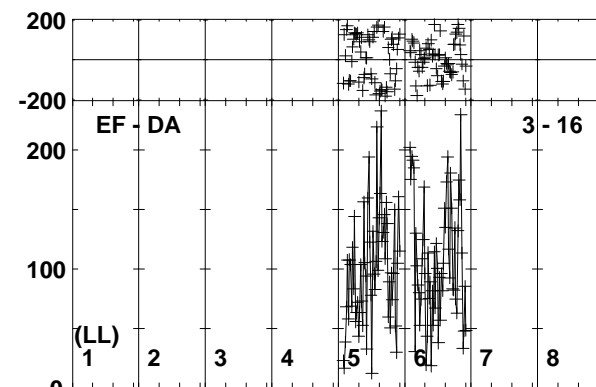
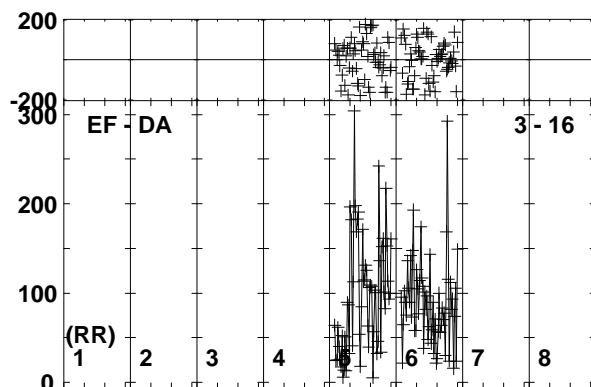
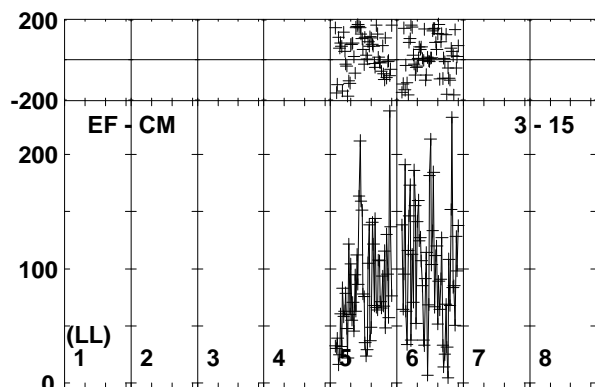
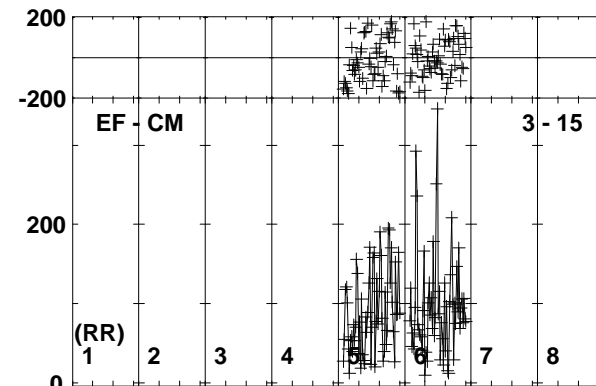
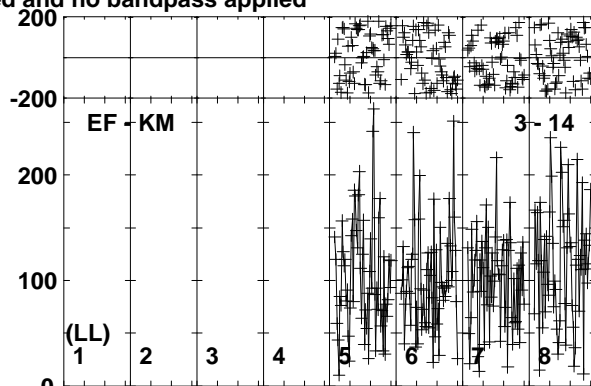
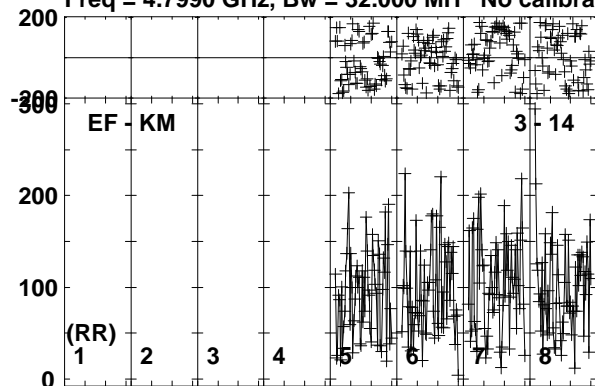

Lower frame: Micro Ampl Jy Top frame: Phas deg
 Vector averaged cross-power spectrum Baseline: EF (03) - KM (14)
 Timerange: 00/13:29:21 to 00/13:32:19

Plot file version 41 created 20-SEP-2019 15:51:07
AT2019EHZ RSM05.UVDATA.1
Freq = 4.7990 GHz, Bw = 32.000 MH No calibration applied and no bandpass applied

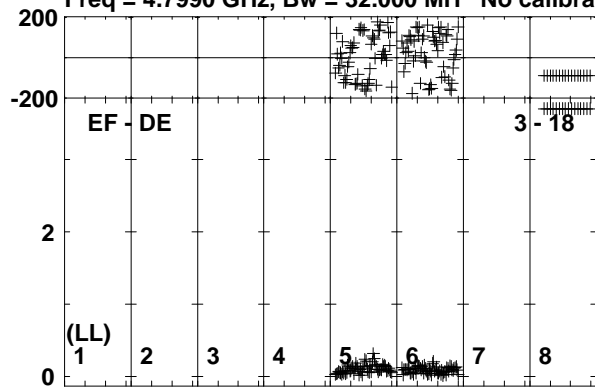

Lower frame: Milli Ampl Jy Top frame: Phas deg
Vector averaged cross-power spectrum Baseline: EF (03) - DE (18)
Timerange: 00/13:29:21 to 00/13:32:19

Plot file version 42 created 20-SEP-2019 15:51:07

J1408+5613 RSM05.UVDATA.1

Freq = 4.7990 GHz, Bw = 32.000 MH No calibration applied and no bandpass applied

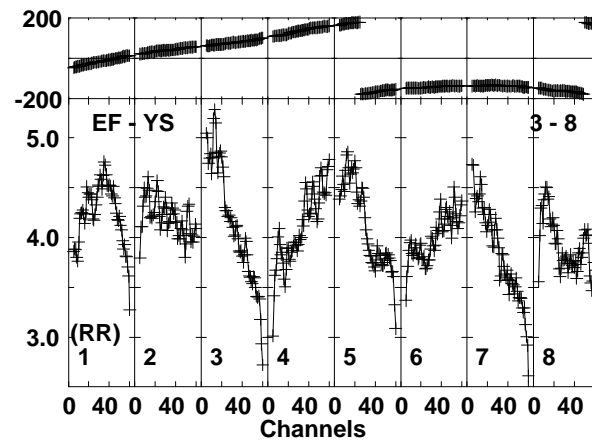
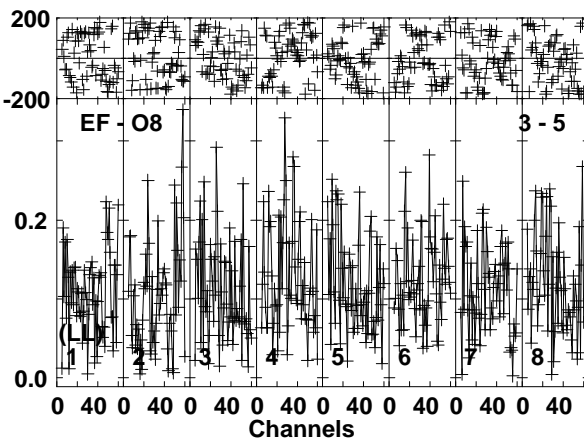
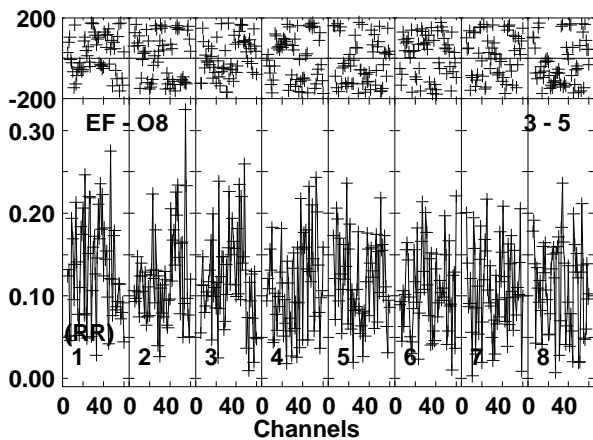
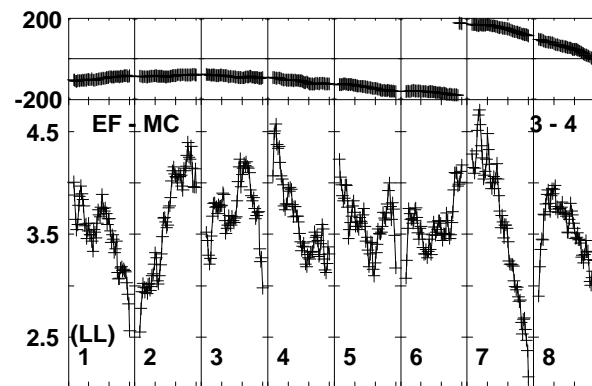
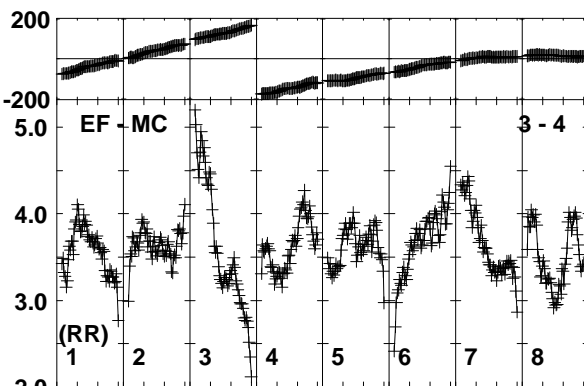
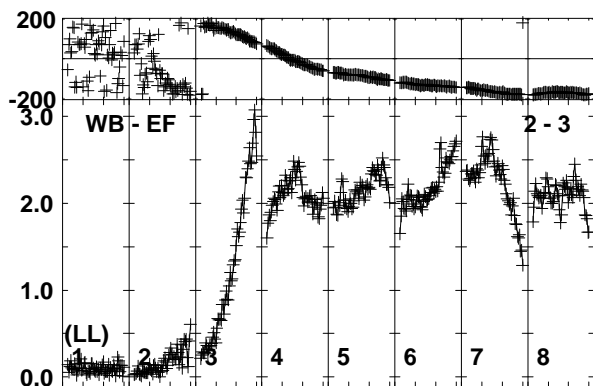
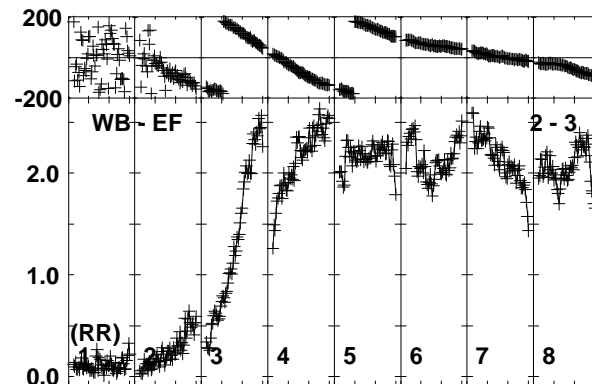
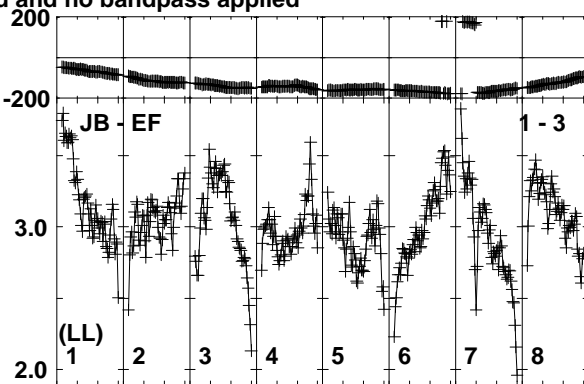
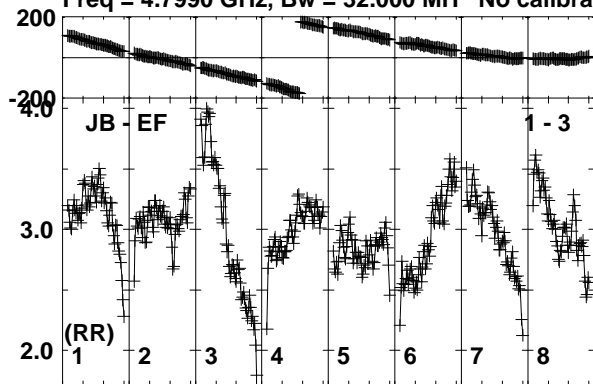

Lower frame: Milli Ampl Jy Top frame: Phas deg
Vector averaged cross-power spectrum Baseline: JB (01) - EF (03)
Timerange: 00/13:33:10 to 00/13:34:40

Plot file version 43 created 20-SEP-2019 15:51:07

J1408+5613 RSM05.UVDATA.1

Freq = 4.7990 GHz, Bw = 32.000 MH No calibration applied and no bandpass applied

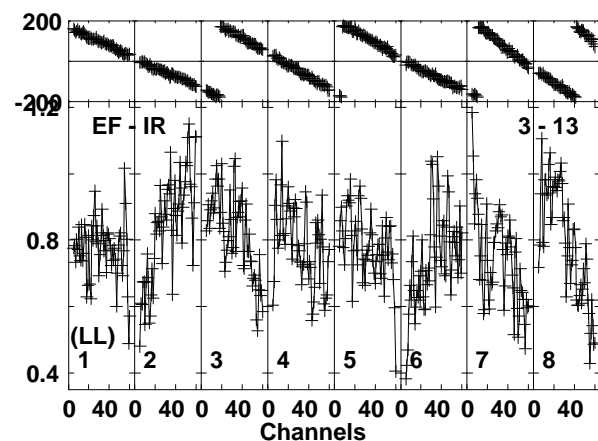
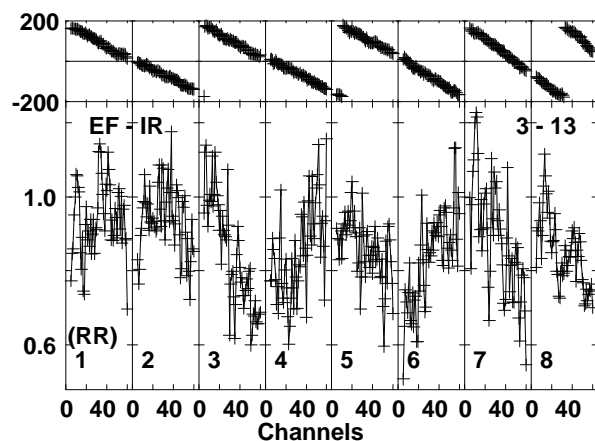
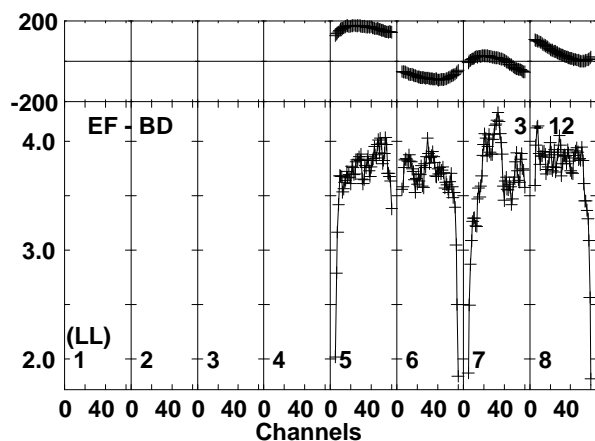
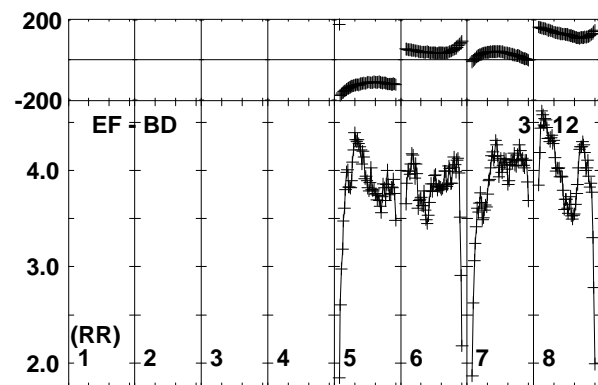
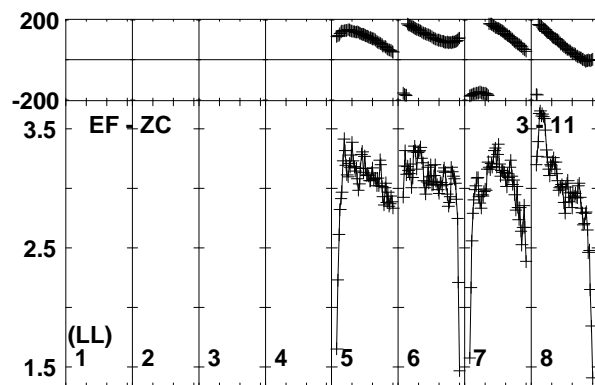
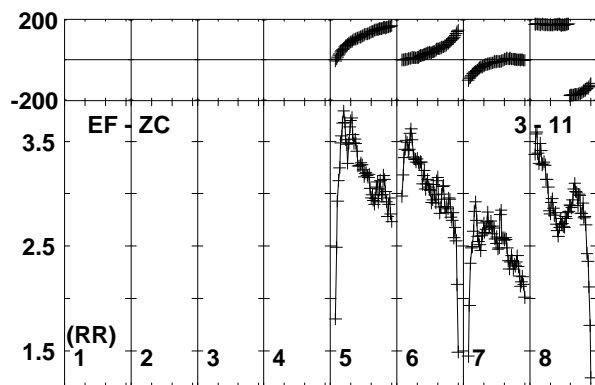
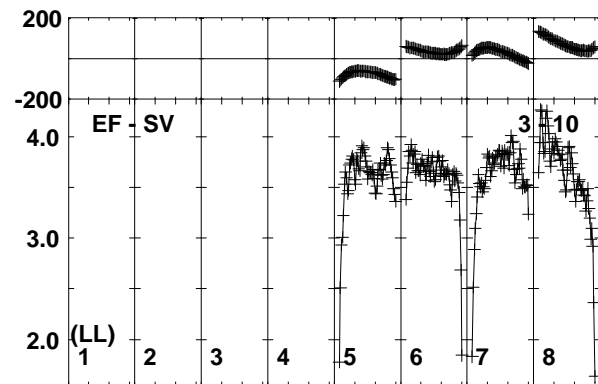
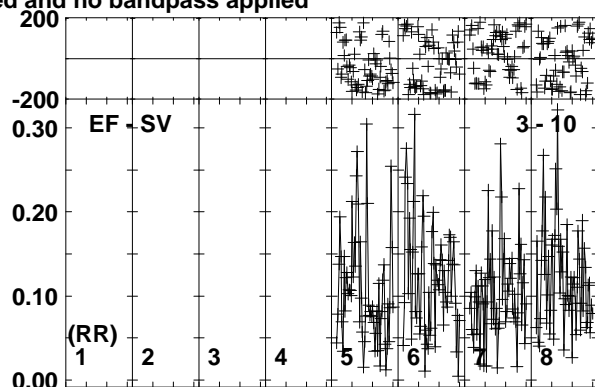
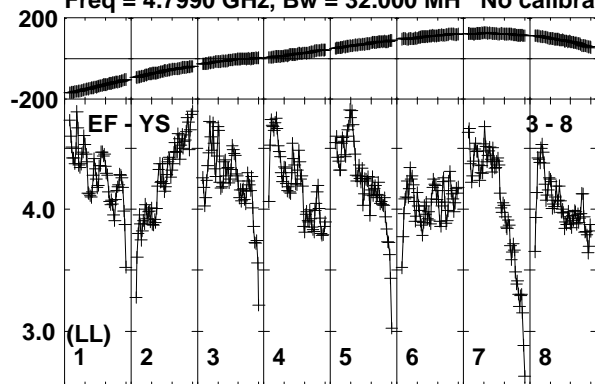

Lower frame: Milli Ampl Jy Top frame: Phas deg
Vector averaged cross-power spectrum Baseline: EF (03) - YS (08)
Timerange: 00/13:33:10 to 00/13:34:40

Plot file version 44 created 20-SEP-2019 15:51:08
 J1408+5613 RSM05.UVDATA.1
 Freq = 4.7990 GHz, Bw = 32.000 MH No calibration applied and no bandpass applied

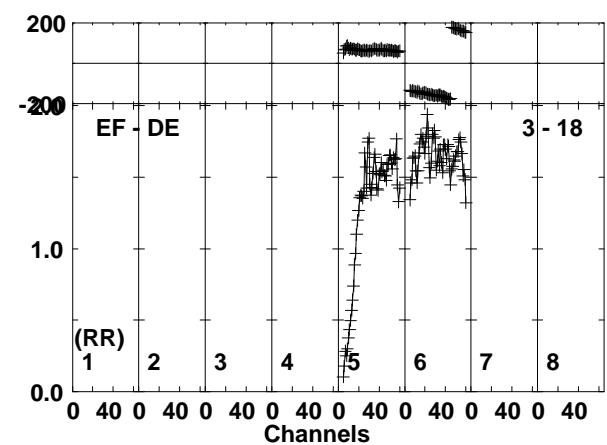
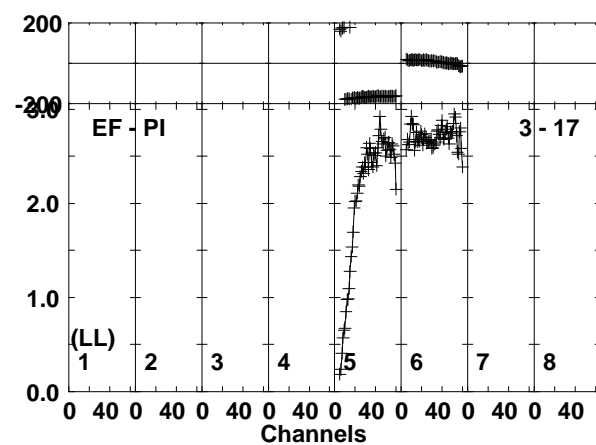
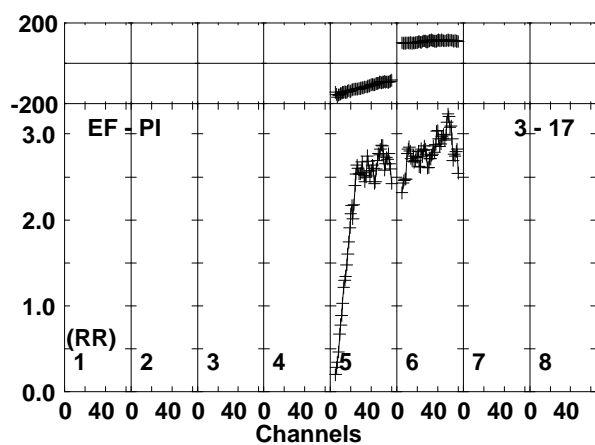
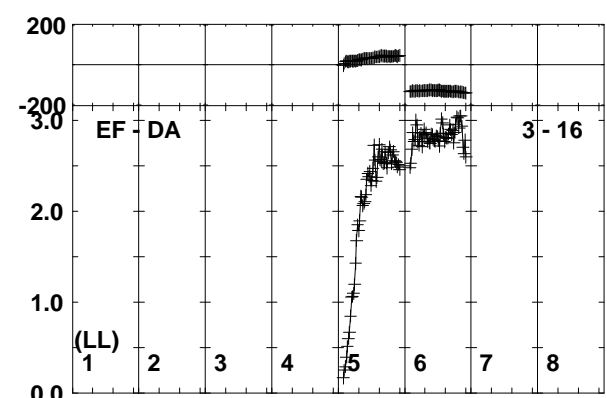
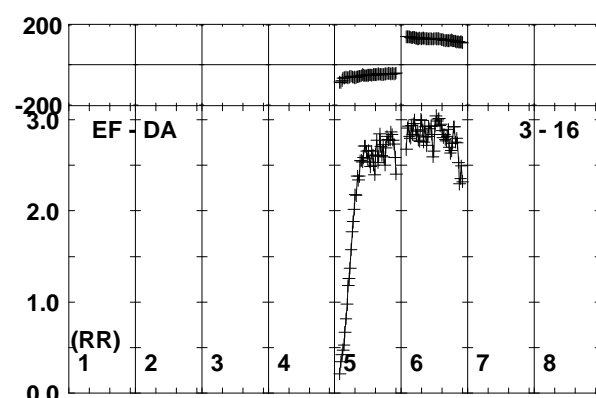
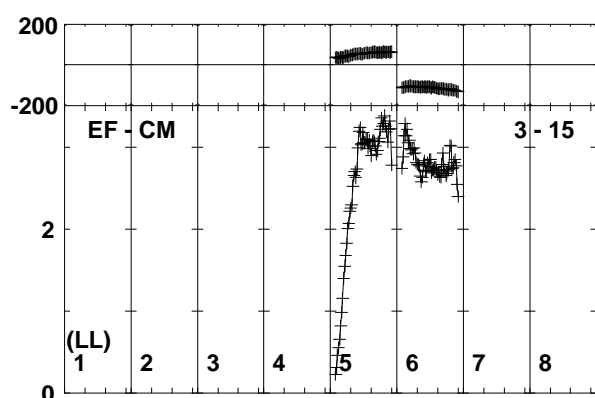
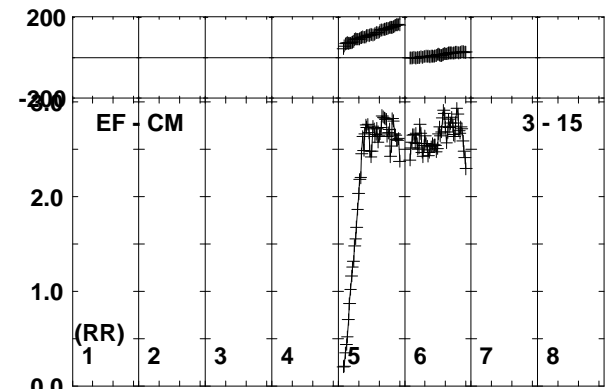
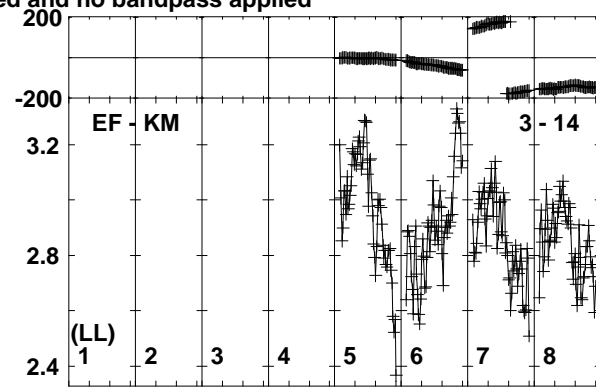
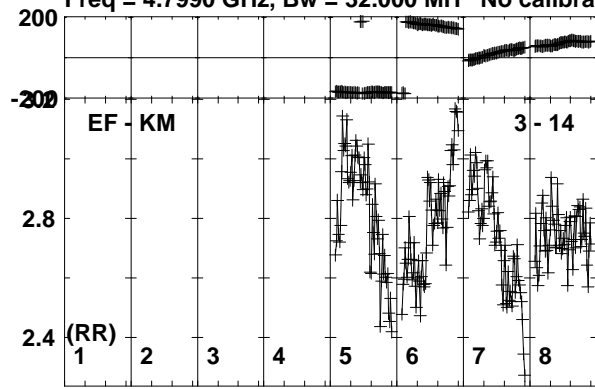

Lower frame: Milli Ampl Jy Top frame: Phas deg
 Vector averaged cross-power spectrum Baseline: EF (03) - KM (14)
 Timerange: 00/13:33:10 to 00/13:34:40

Plot file version 45 created 20-SEP-2019 15:51:08
J1408+5613 RSM05.UVDATA.1
Freq = 4.7990 GHz, Bw = 32.000 MH No calibration applied and no bandpass applied

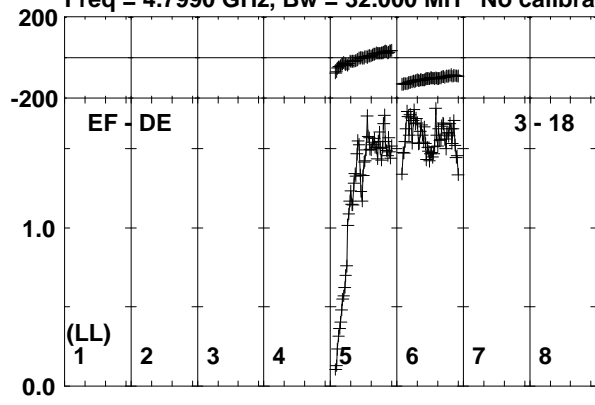

Lower frame: Milli Ampl Jy Top frame: Phas deg
Vector averaged cross-power spectrum Baseline: EF (03) - DE (18)
Timerange: 00/13:33:10 to 00/13:34:40

Plot file version 46 created 20-SEP-2019 15:51:08
 AT2019EHZ RSM05.UVDATA.1
 Freq = 4.7990 GHz, Bw = 32.000 MH No calibration applied and no bandpass applied

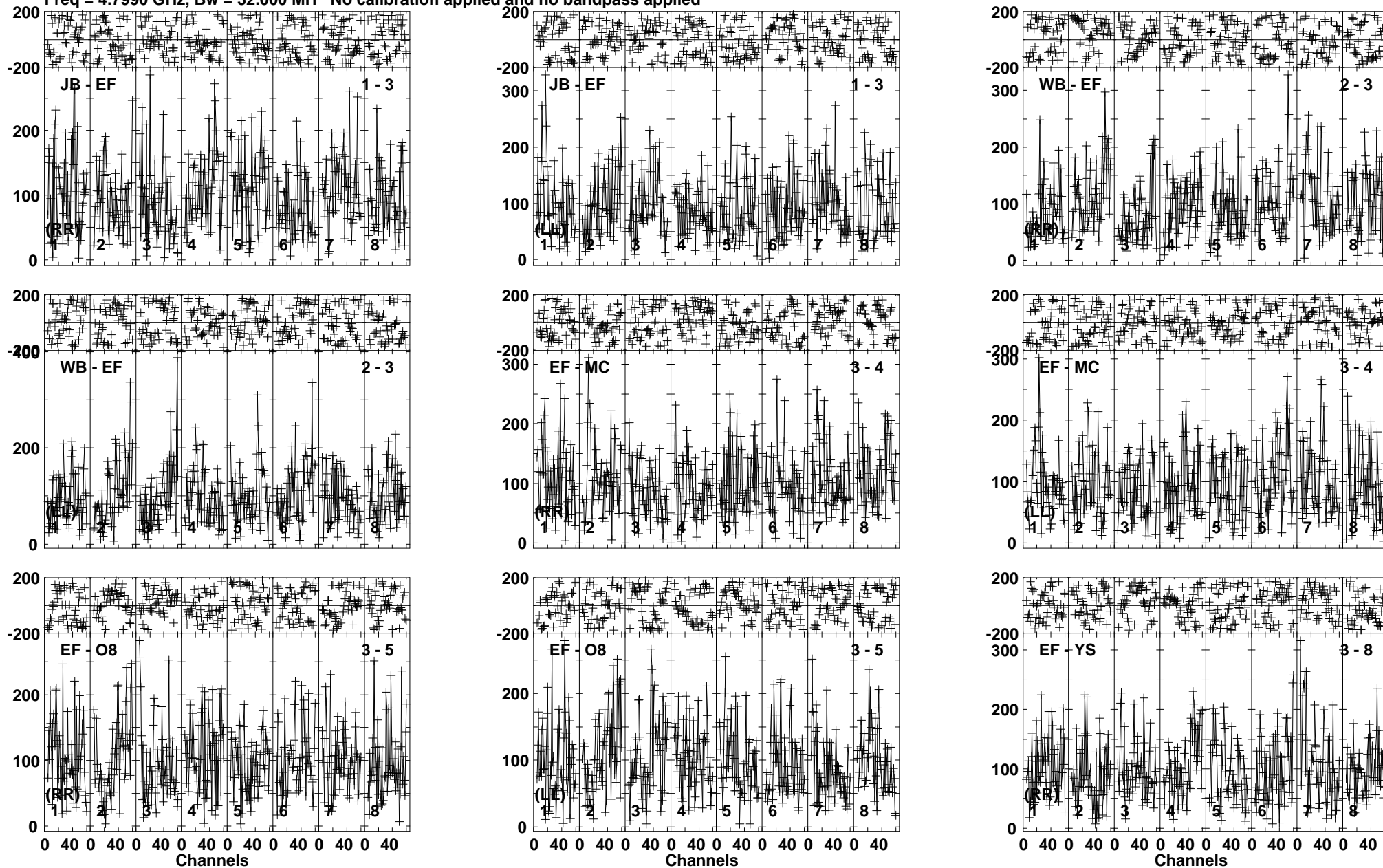

Lower frame: Micro Ampl Jy Top frame: Phas deg
 Vector averaged cross-power spectrum Baseline: JB (01) - EF (03)
 Timerange: 00/13:34:41 to 00/13:37:39

Plot file version 47 created 20-SEP-2019 15:51:09
 AT2019EHZ RSM05.UVDATA.1
 Freq = 4.7990 GHz, Bw = 32.000 MH No calibration applied and no bandpass applied

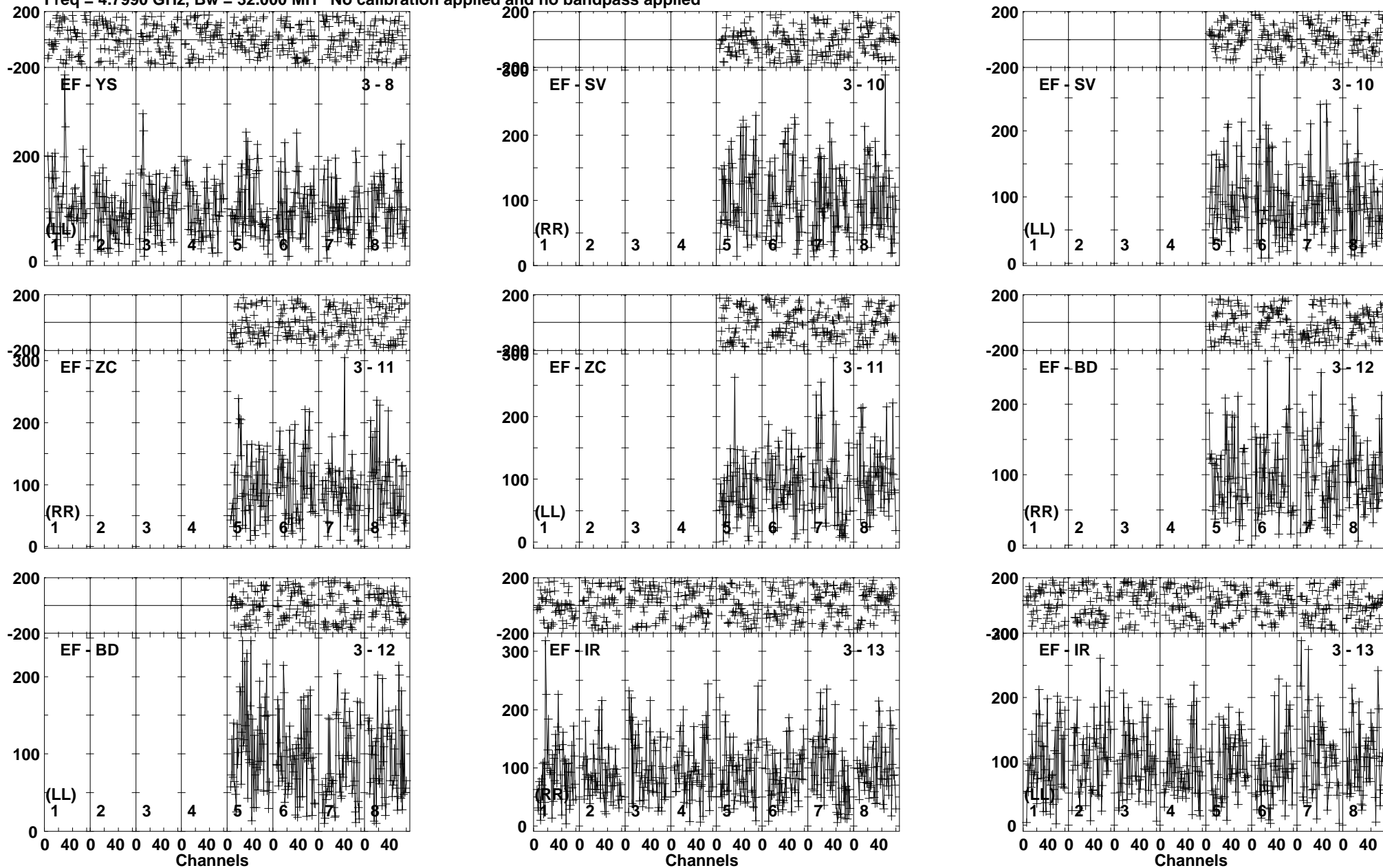

Lower frame: Micro Ampl Jy Top frame: Phas deg
 Vector averaged cross-power spectrum Baseline: EF (03) - YS (08)
 Timerange: 00/13:34:41 to 00/13:37:39

Plot file version 48 created 20-SEP-2019 15:51:10
 AT2019EHZ RSM05.UVDATA.1
 Freq = 4.7990 GHz, Bw = 32.000 MH No calibration applied and no bandpass applied

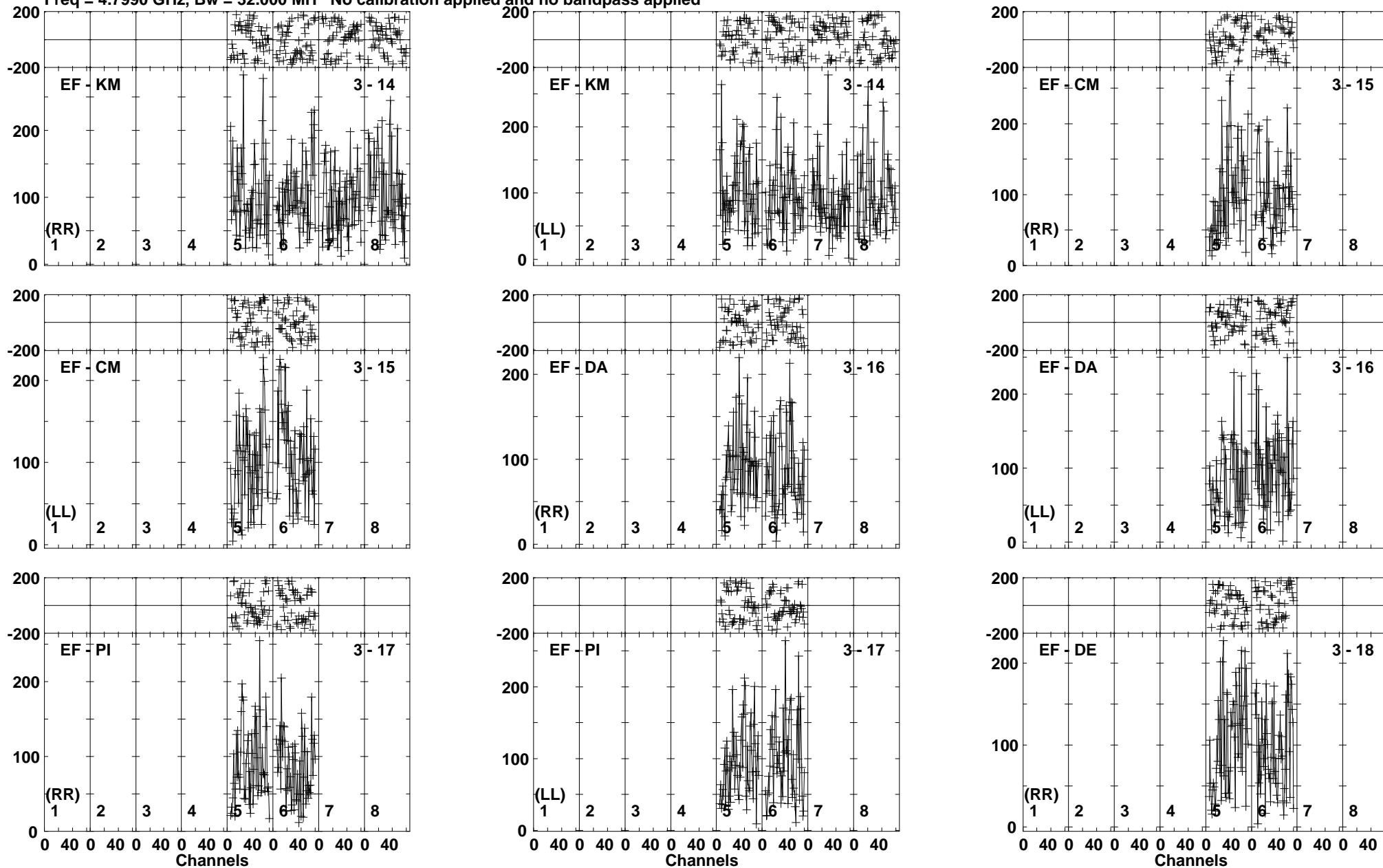

Lower frame: Micro Ampl Jy Top frame: Phas deg
 Vector averaged cross-power spectrum Baseline: EF (03) - KM (14)
 Timerange: 00/13:34:41 to 00/13:37:39

Plot file version 49 created 20-SEP-2019 15:51:10
AT2019EHZ RSM05.UVDATA.1
Freq = 4.7990 GHz, Bw = 32.000 MH No calibration applied and no bandpass applied

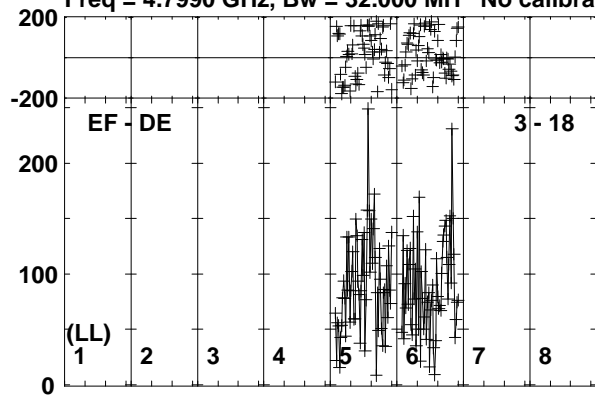

Lower frame: Micro Ampl Jy Top frame: Phas deg
Vector averaged cross-power spectrum Baseline: EF (03) - DE (18)
Timerange: 00/13:34:41 to 00/13:37:39

Plot file version 50 created 20-SEP-2019 15:51:10

J1408+5613 RSM05.UVDATA.1

Freq = 4.7990 GHz, Bw = 32.000 MH No calibration applied and no bandpass applied

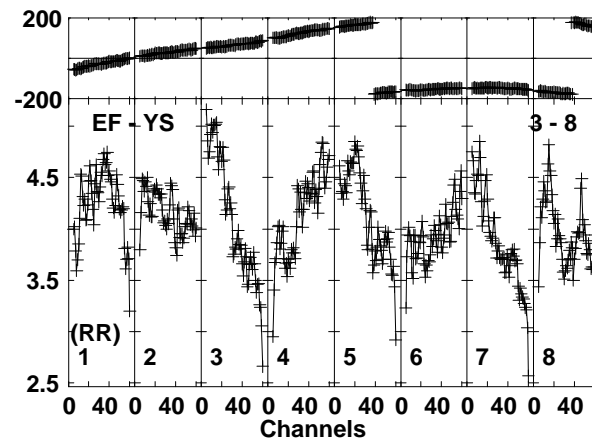
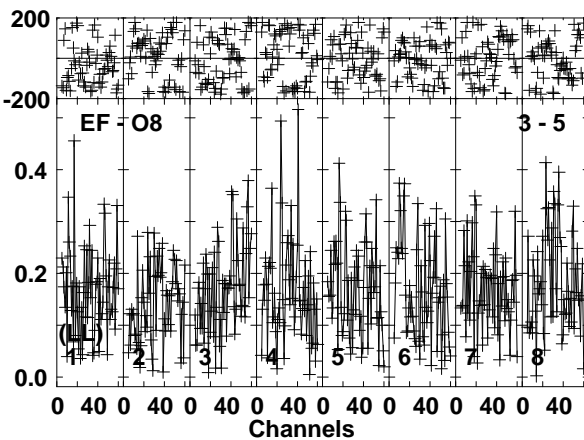
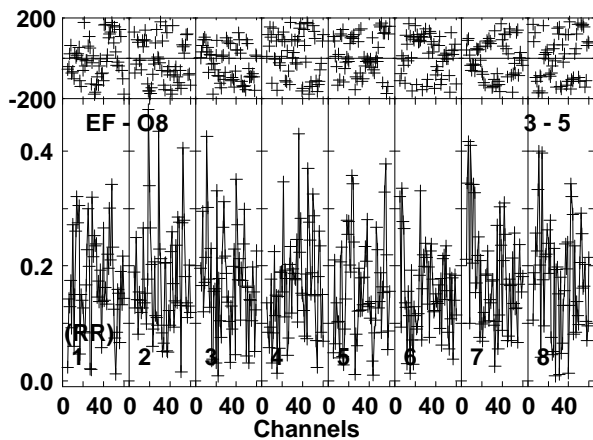
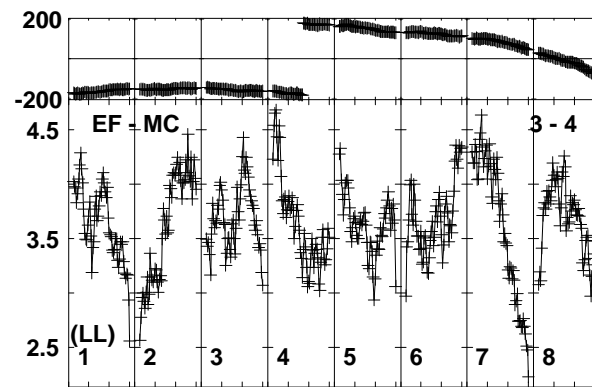
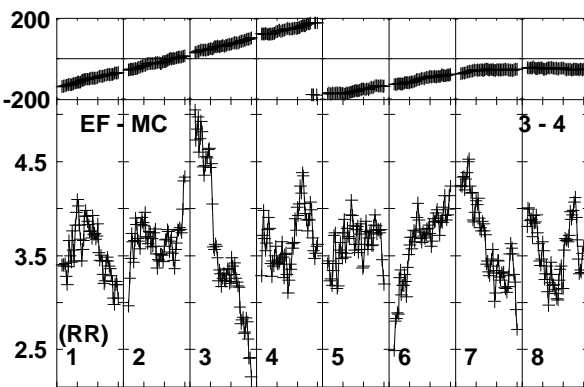
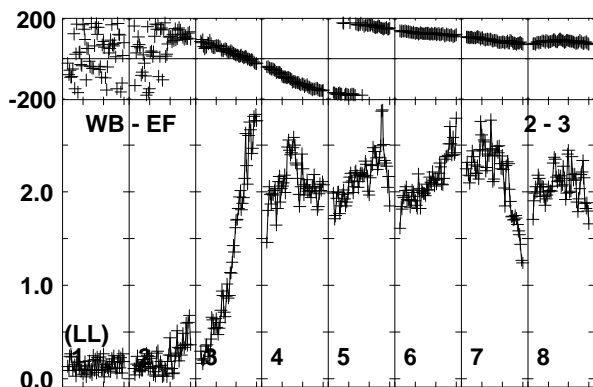
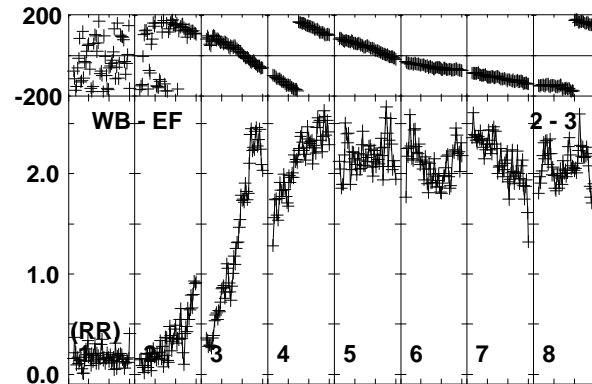
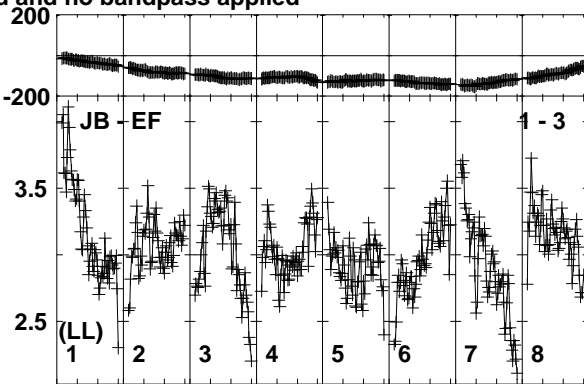
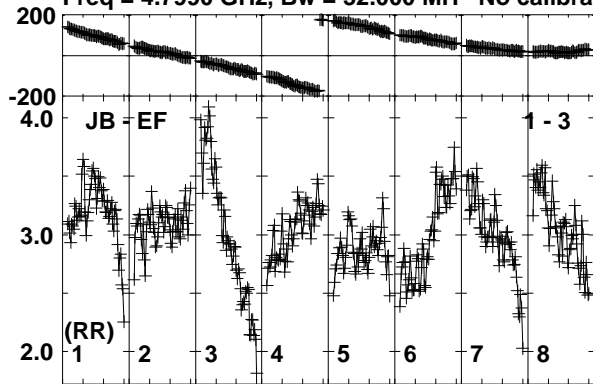

Lower frame: Milli Ampl Jy Top frame: Phas deg
Vector averaged cross-power spectrum Baseline: JB (01) - EF (03)
Timerange: 00/13:37:40 to 00/13:39:09

Plot file version 51 created 20-SEP-2019 15:51:11

J1408+5613 RSM05.UVDATA.1

Freq = 4.7990 GHz, Bw = 32.000 MH No calibration applied and no bandpass applied

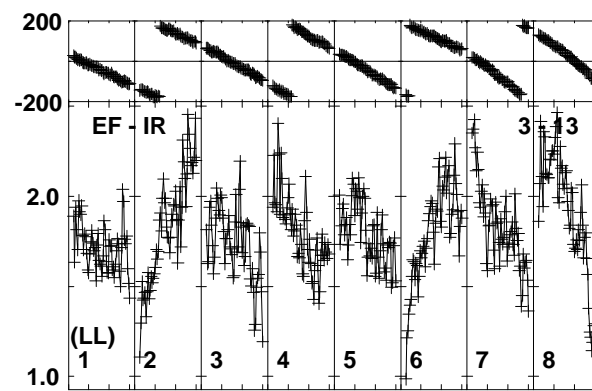
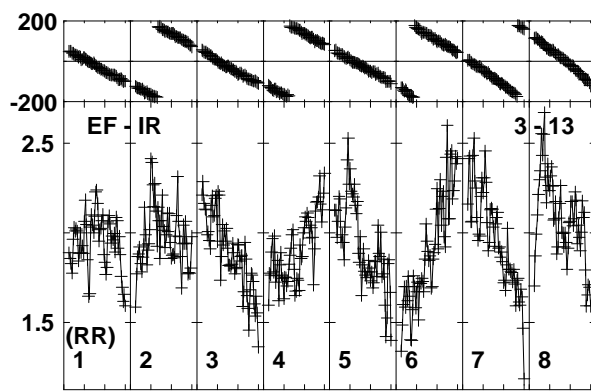
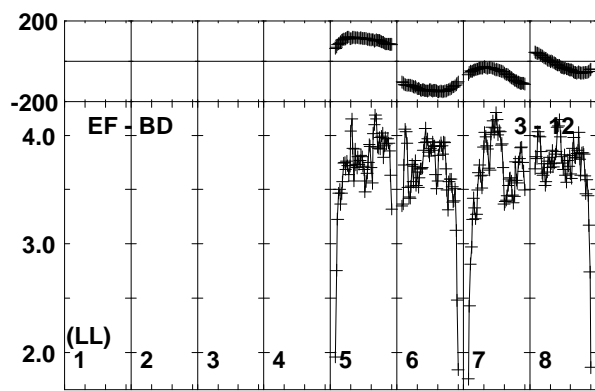
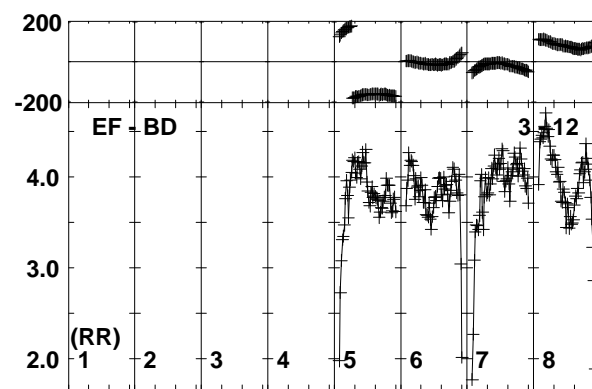
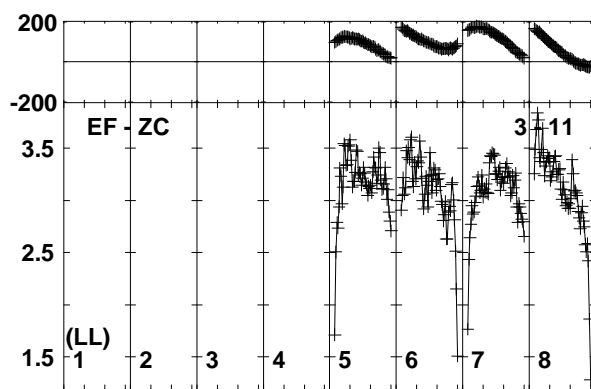
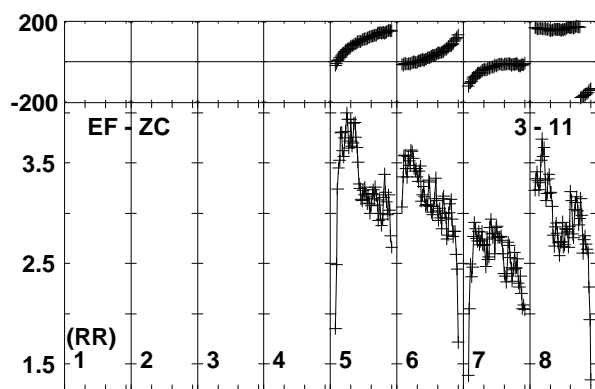
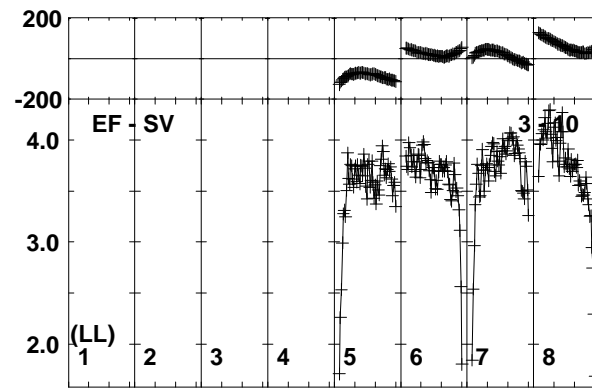
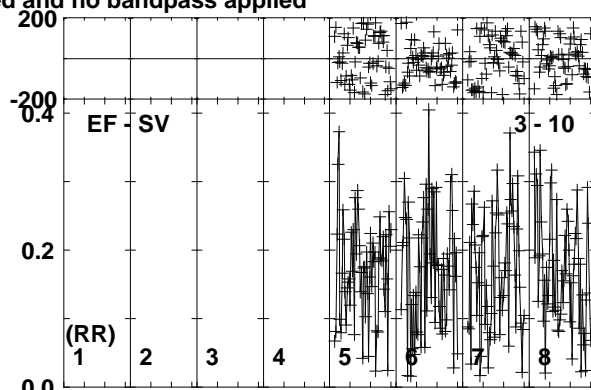
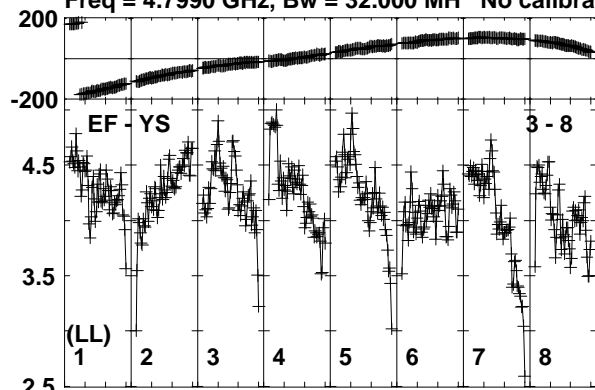

Lower frame: Milli Ampl Jy Top frame: Phas deg
Vector averaged cross-power spectrum Baseline: EF (03) - YS (08)
Timerange: 00/13:37:40 to 00/13:39:09

Plot file version 52 created 20-SEP-2019 15:51:11

J1408+5613 RSM05.UVDATA.1

Freq = 4.7990 GHz, Bw = 32.000 MH No calibration applied and no bandpass applied

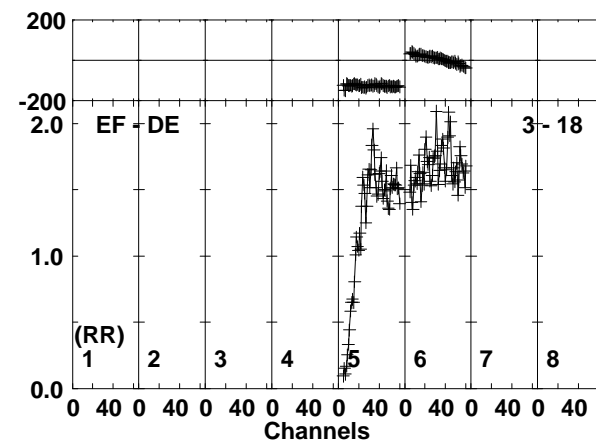
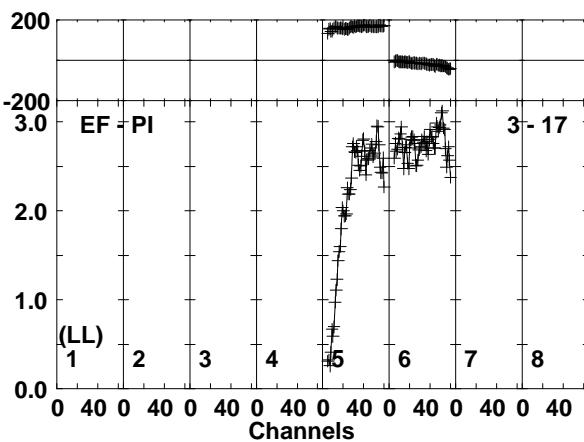
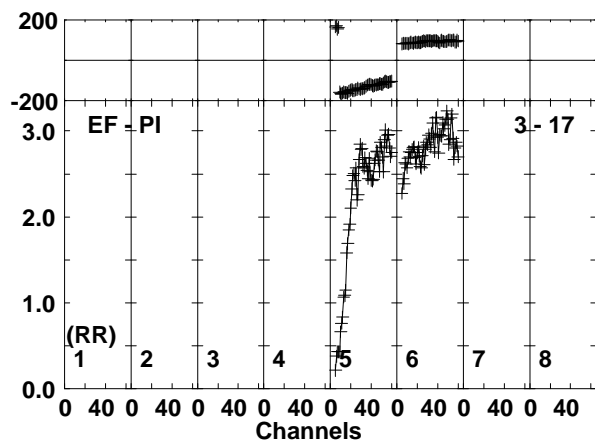
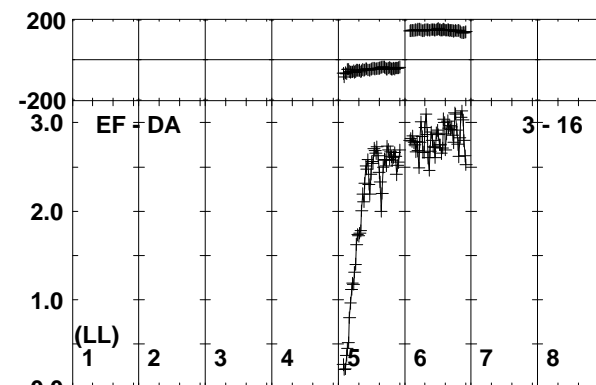
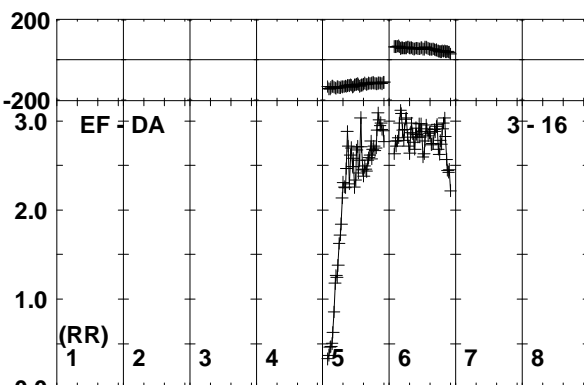
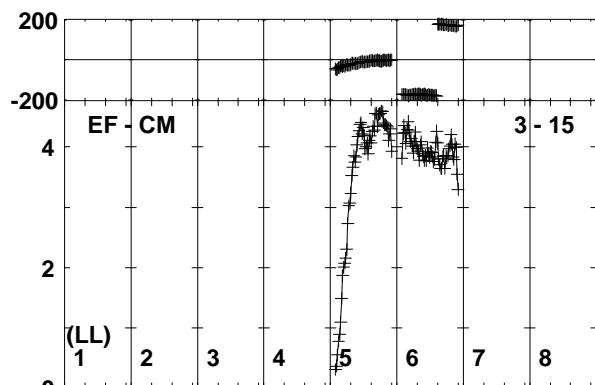
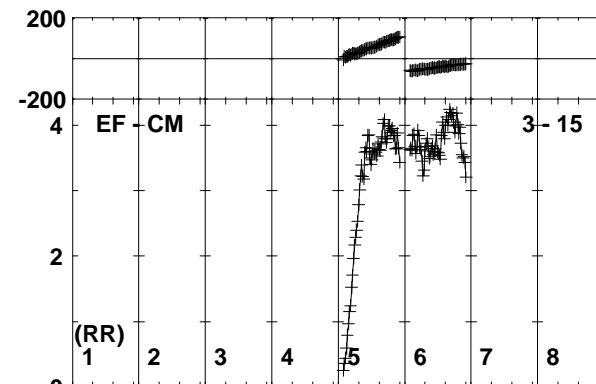
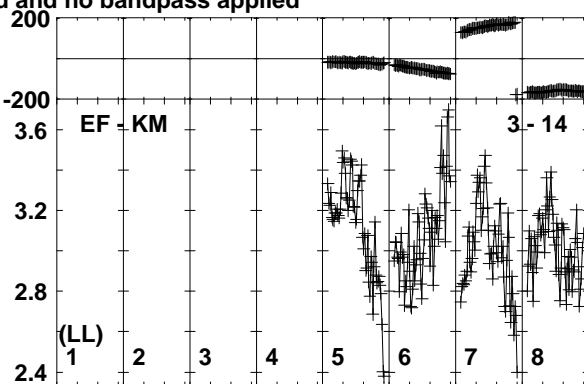
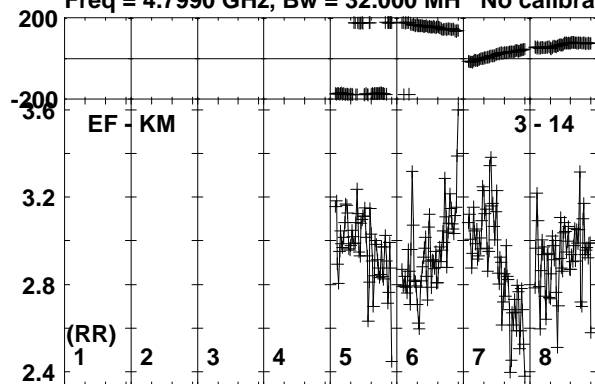

Lower frame: Milli Ampl Jy Top frame: Phas deg
Vector averaged cross-power spectrum Baseline: EF (03) - KM (14)
Timerange: 00/13:37:40 to 00/13:39:09

Plot file version 53 created 20-SEP-2019 15:51:12
J1408+5613 RSM05.UVDATA.1
Freq = 4.7990 GHz, Bw = 32.000 MH No calibration applied and no bandpass applied

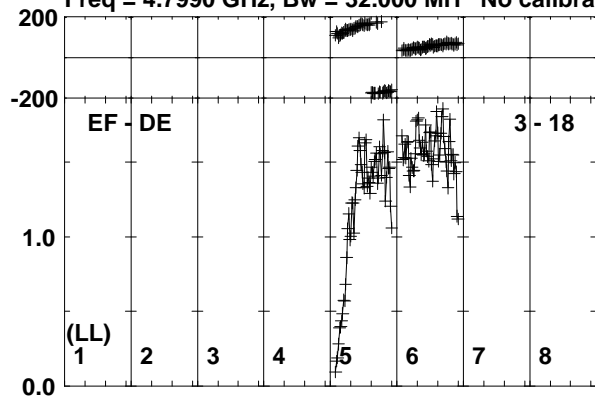

Lower frame: Milli Ampl Jy Top frame: Phas deg
Vector averaged cross-power spectrum Baseline: EF (03) - DE (18)
Timerange: 00/13:37:40 to 00/13:39:09

Plot file version 54 created 20-SEP-2019 15:51:12
 AT2019EHZ RSM05.UVDATA.1
 Freq = 4.7990 GHz, Bw = 32.000 MH No calibration applied and no bandpass applied

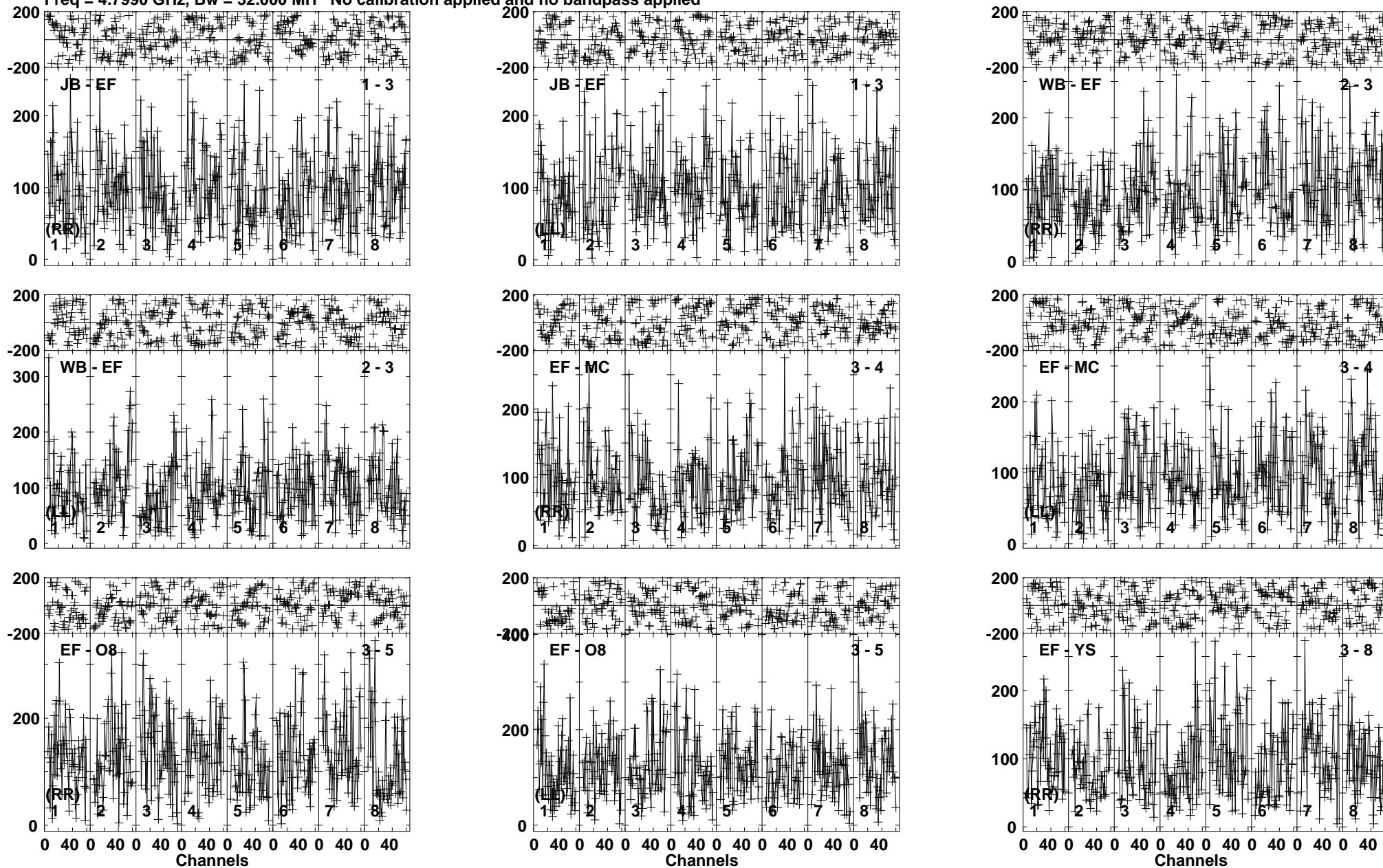

Lower frame: Micro Ampl Jy Top frame: Phas deg
 Vector averaged cross-power spectrum Baseline: JB (01) - EF (03)
 Timerange: 00:13:39:10 to 00:13:42:10

Plot file version 55 created 20-SEP-2019 15:51:12
 AT2019EHZ RSM05.UVDATA.1
 Freq = 4.7990 GHz, Bw = 32.000 MH No calibration applied and no bandpass applied

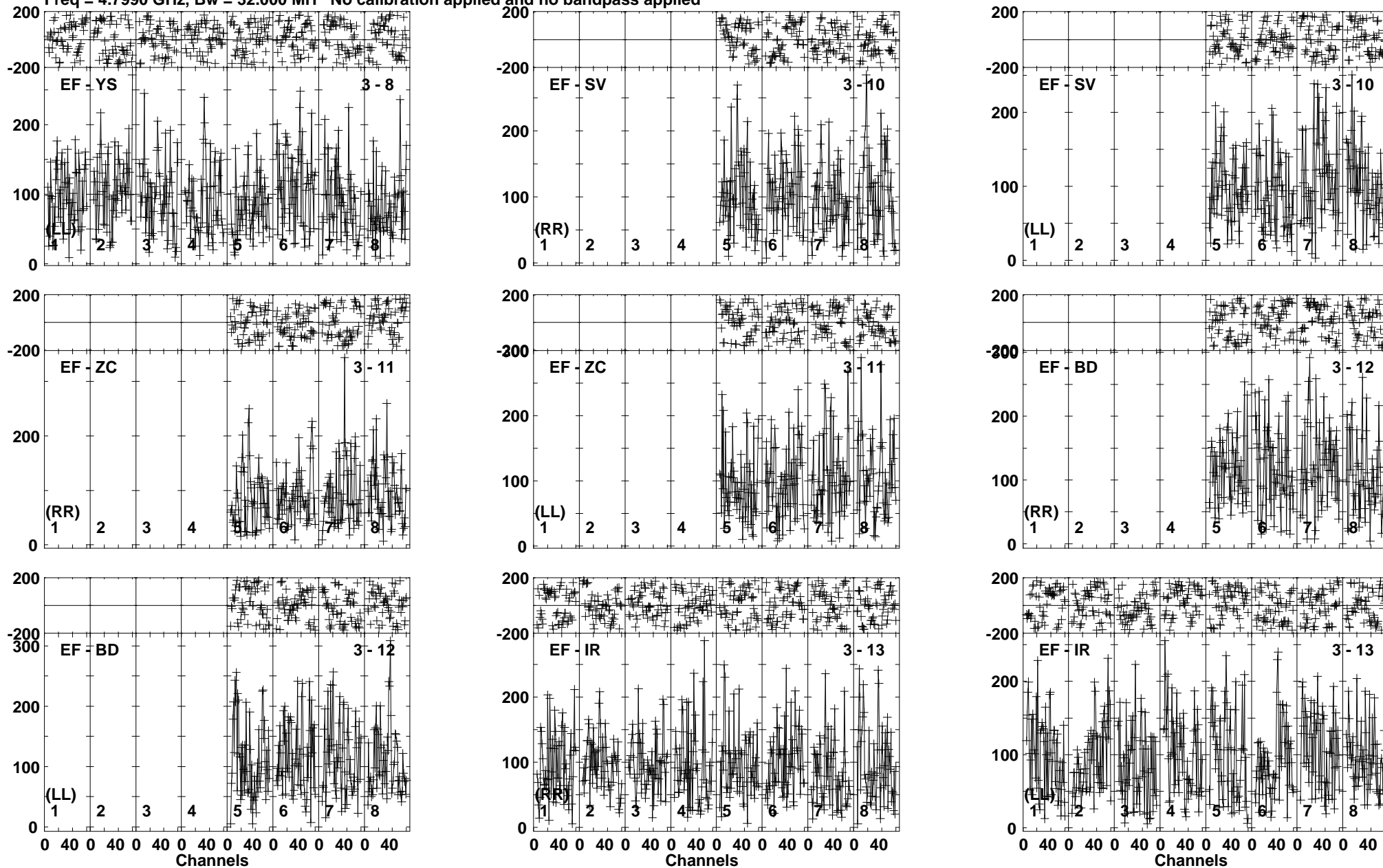

Lower frame: Micro Ampl Jy Top frame: Phas deg
 Vector averaged cross-power spectrum Baseline: EF (03) - YS (08)
 Timerange: 00/13:39:10 to 00/13:42:10

Plot file version 56 created 20-SEP-2019 15:51:13

AT2019EHZ RSM05.UVDATA.1

Freq = 4.7990 GHz, Bw = 32.000 MH No calibration applied and no bandpass applied

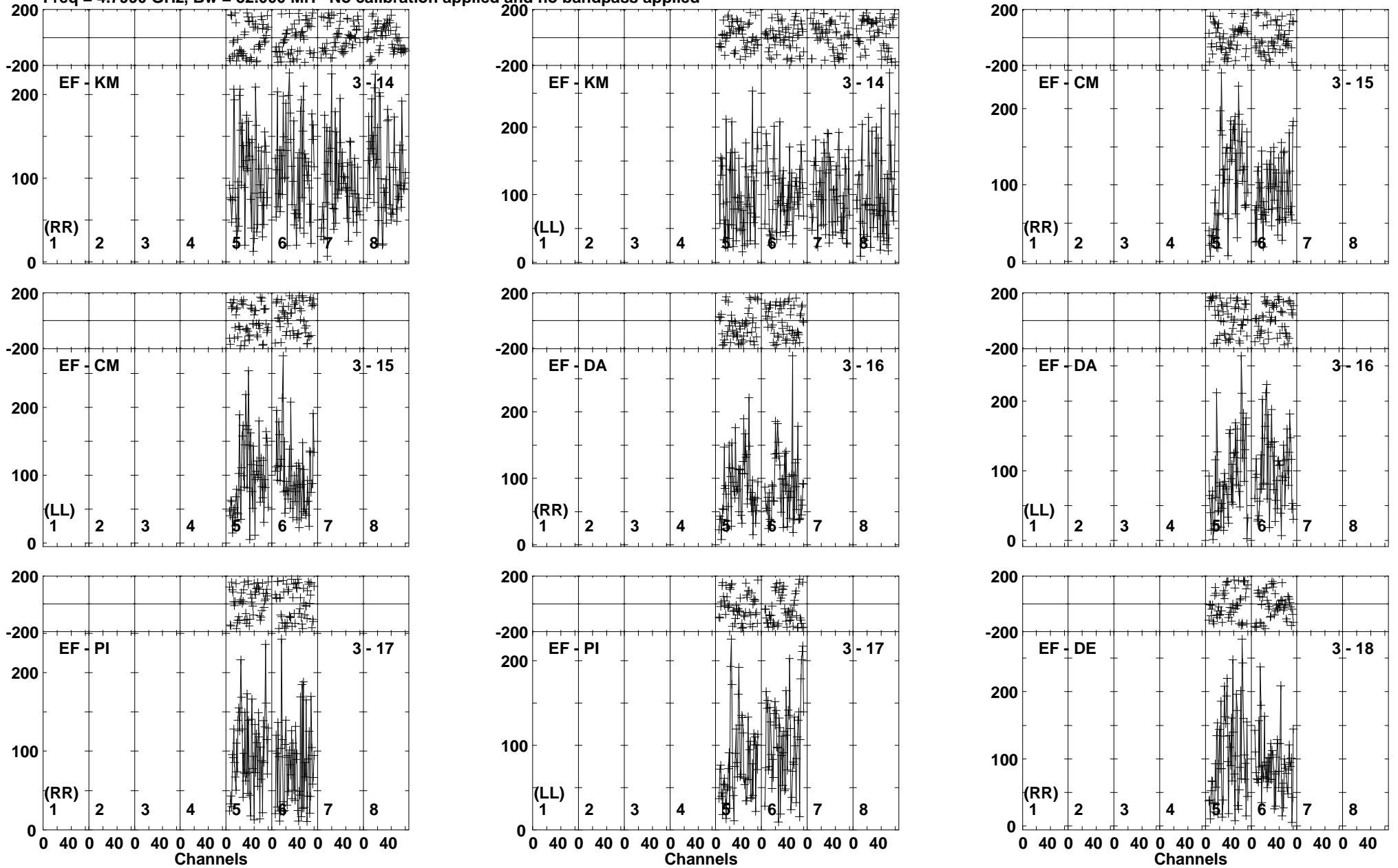

Lower frame: Micro Ampl Jy Top frame: Phas deg
Vector averaged cross-power spectrum Baseline: EF (03) - KM (14)
Timerange: 00/13:39:10 to 00/13:42:10

Plot file version 57 created 20-SEP-2019 15:51:13
AT2019EHZ RSM05.UVDATA.1
Freq = 4.7990 GHz, Bw = 32.000 MH No calibration applied and no bandpass applied

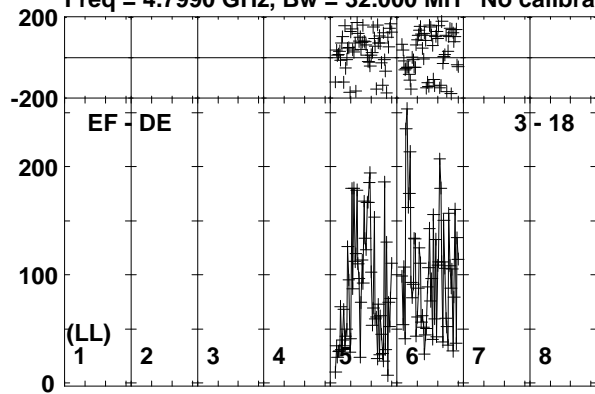

Lower frame: Micro Ampl Jy Top frame: Phas deg
Vector averaged cross-power spectrum Baseline: EF (03) - DE (18)
Timerange: 00/13:39:10 to 00/13:42:10

Plot file version 58 created 20-SEP-2019 15:51:13

J1408+5613 RSM05.UVDATA.1

Freq = 4.7990 GHz, Bw = 32.000 MH No calibration applied and no bandpass applied

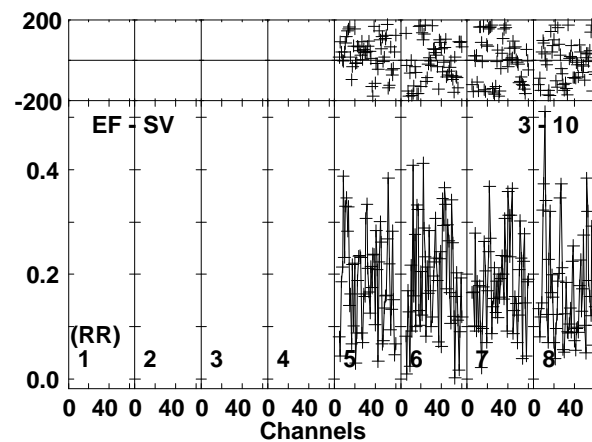
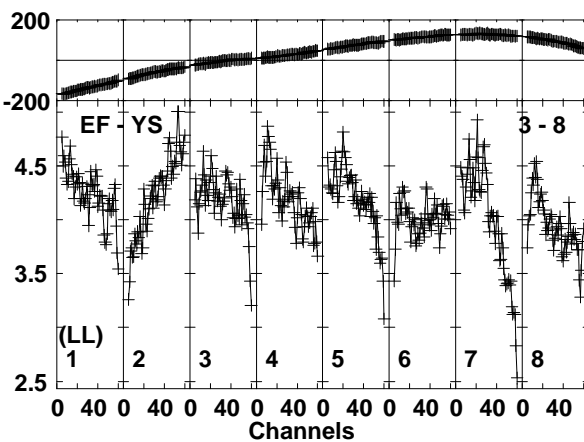
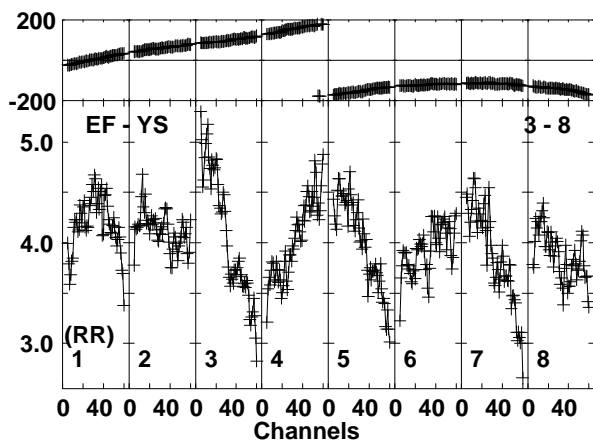
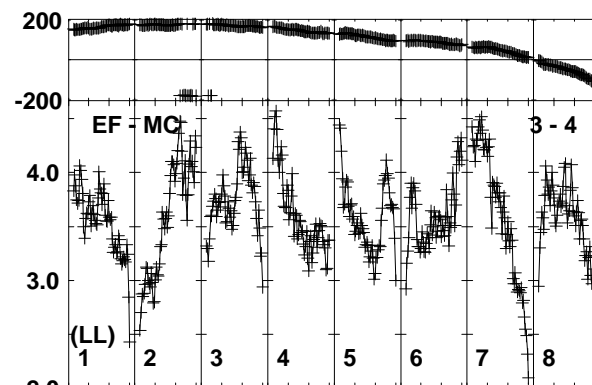
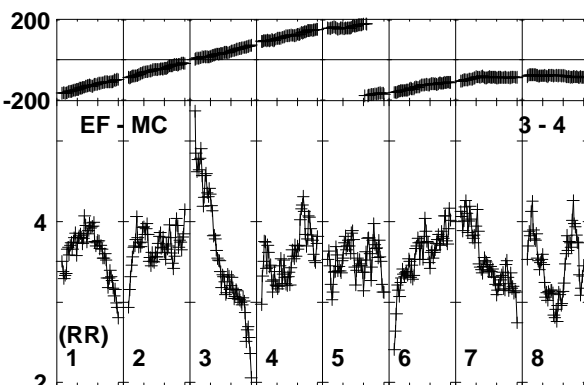
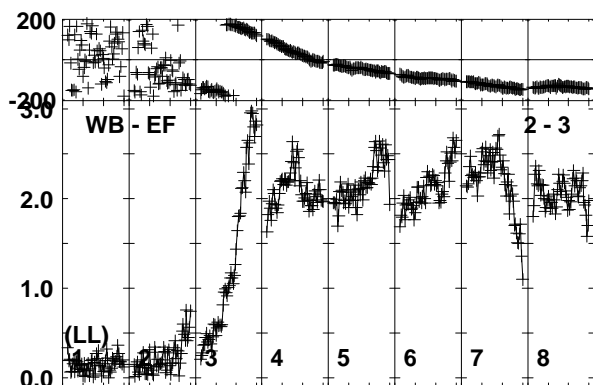
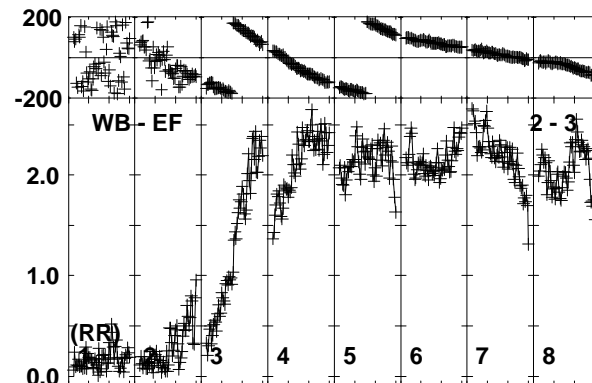
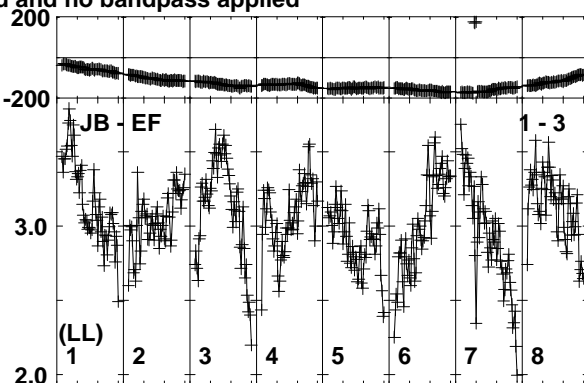
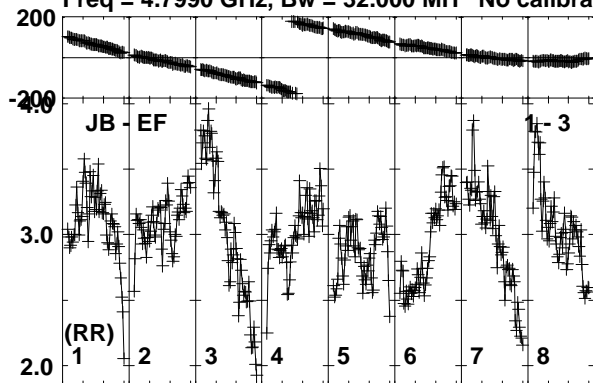

Lower frame: Milli Ampl Jy Top frame: Phas deg
Vector averaged cross-power spectrum Baseline: JB (01) - EF (03)
Timerange: 00/13:42:11 to 00/13:43:39

Plot file version 59 created 20-SEP-2019 15:51:14

J1408+5613 RSM05.UVDATA.1

Freq = 4.7990 GHz, Bw = 32.000 MH No calibration applied and no bandpass applied

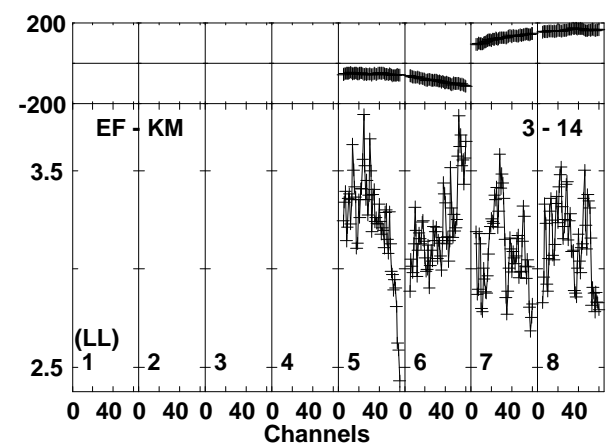
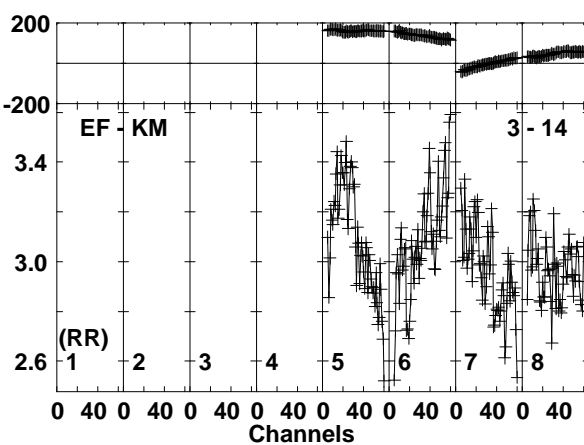
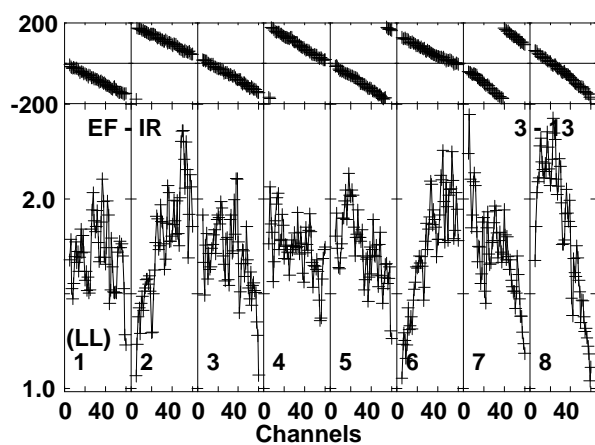
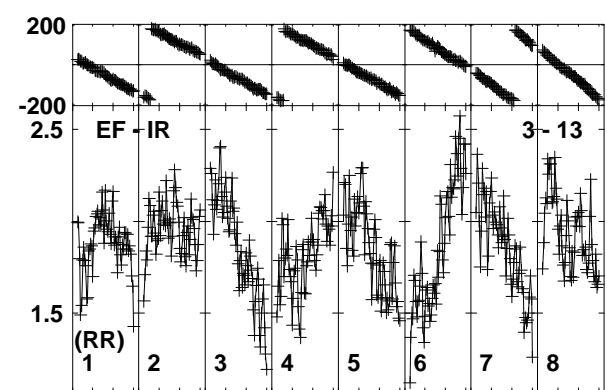
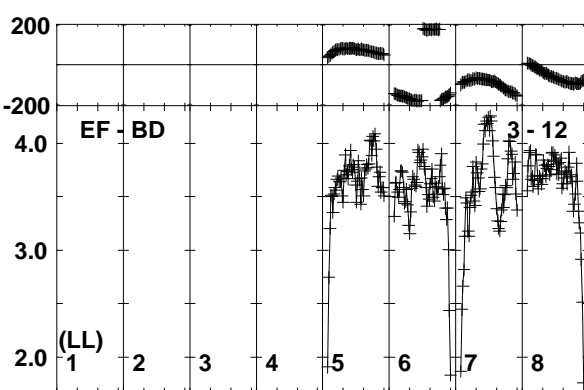
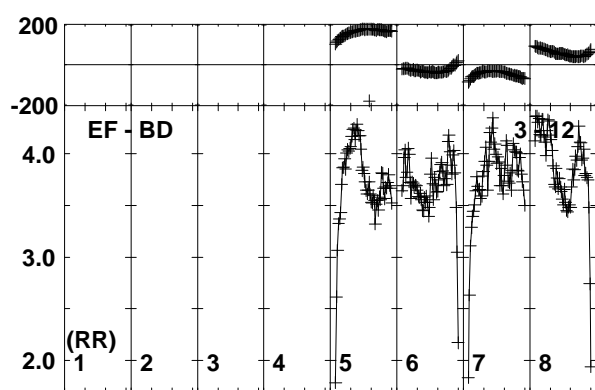
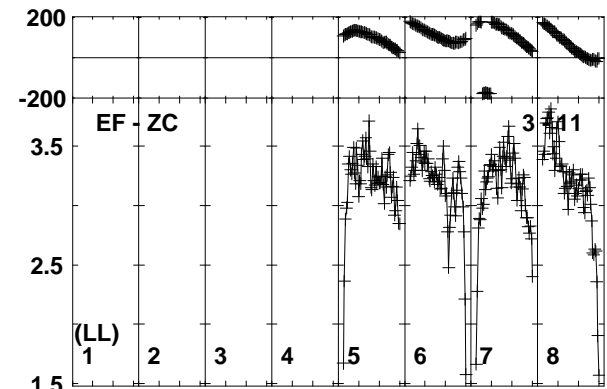
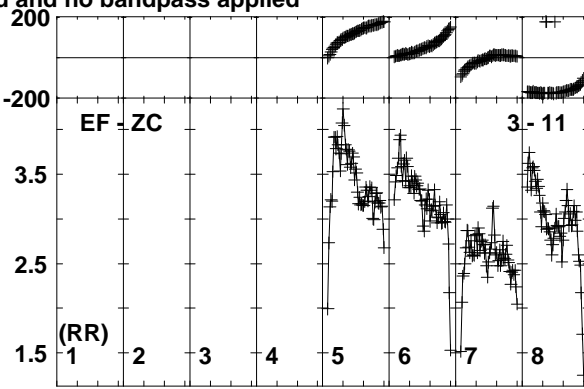
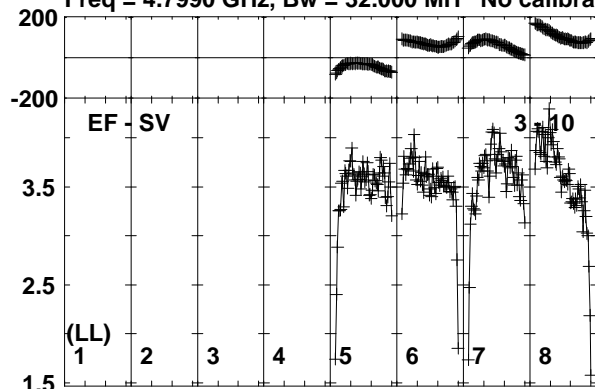

Lower frame: Milli Ampl Jy Top frame: Phas deg
Vector averaged cross-power spectrum Baseline: EF (03) - SV (10)
Timerange: 00/13:42:11 to 00/13:43:39

Plot file version 60 created 20-SEP-2019 15:51:14

J1408+5613 RSM05.UVDATA.1

Freq = 4.7990 GHz, Bw = 32.000 MH No calibration applied and no bandpass applied

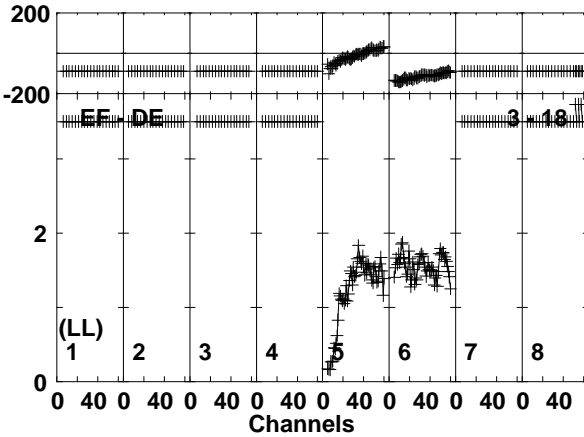
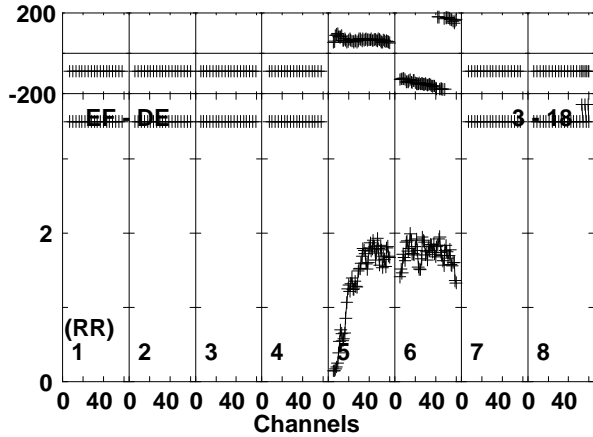
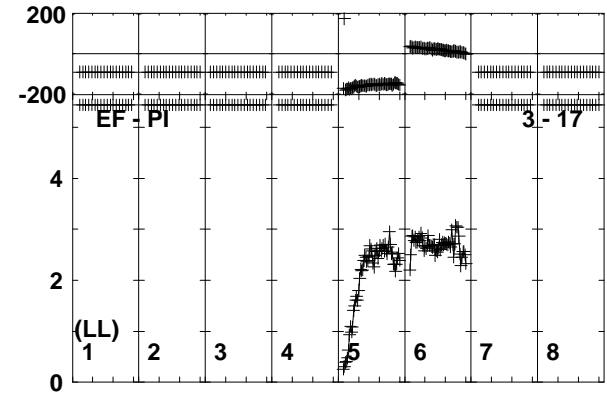
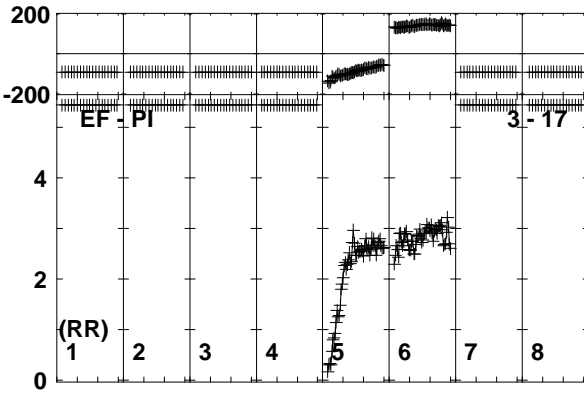
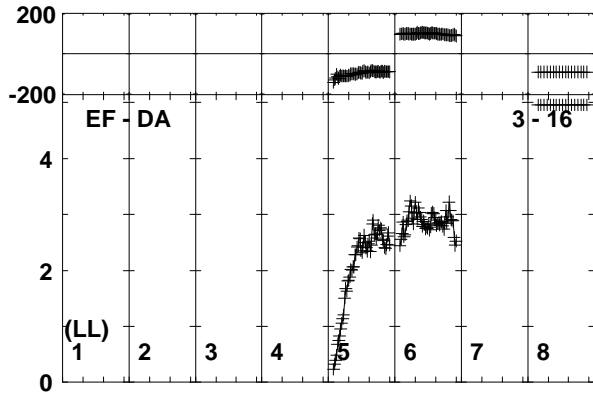
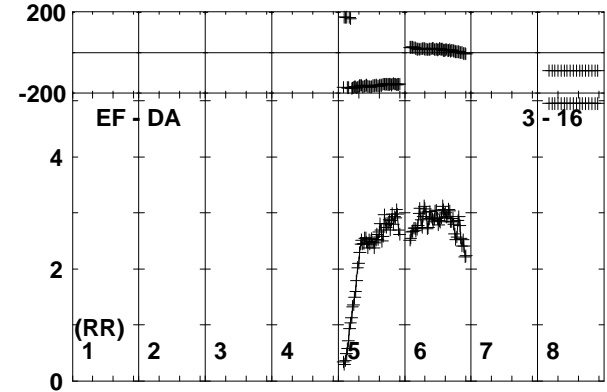
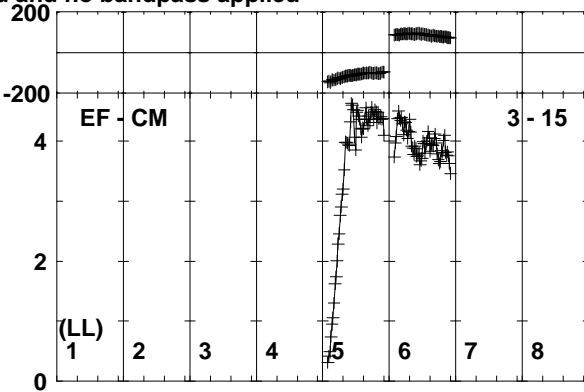
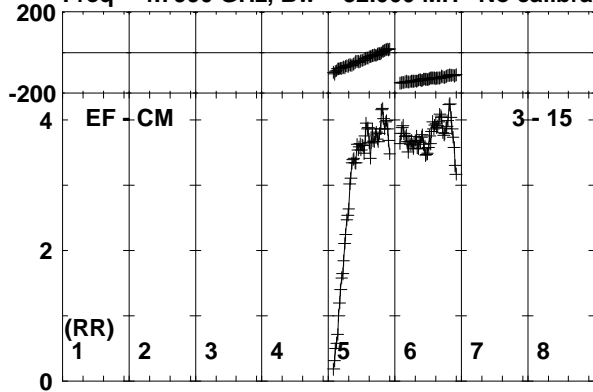

Lower frame: Milli Ampl Jy Top frame: Phas deg
 Vector averaged cross-power spectrum Baseline: EF (03) - CM (15)
 Timerange: 00/13:42:11 to 00/13:43:39

Plot file version 61 created 20-SEP-2019 15:51:15

AT2019EHZ RSM05.UVDATA.1

Freq = 4.7990 GHz, Bw = 32.000 MH No calibration applied and no bandpass applied

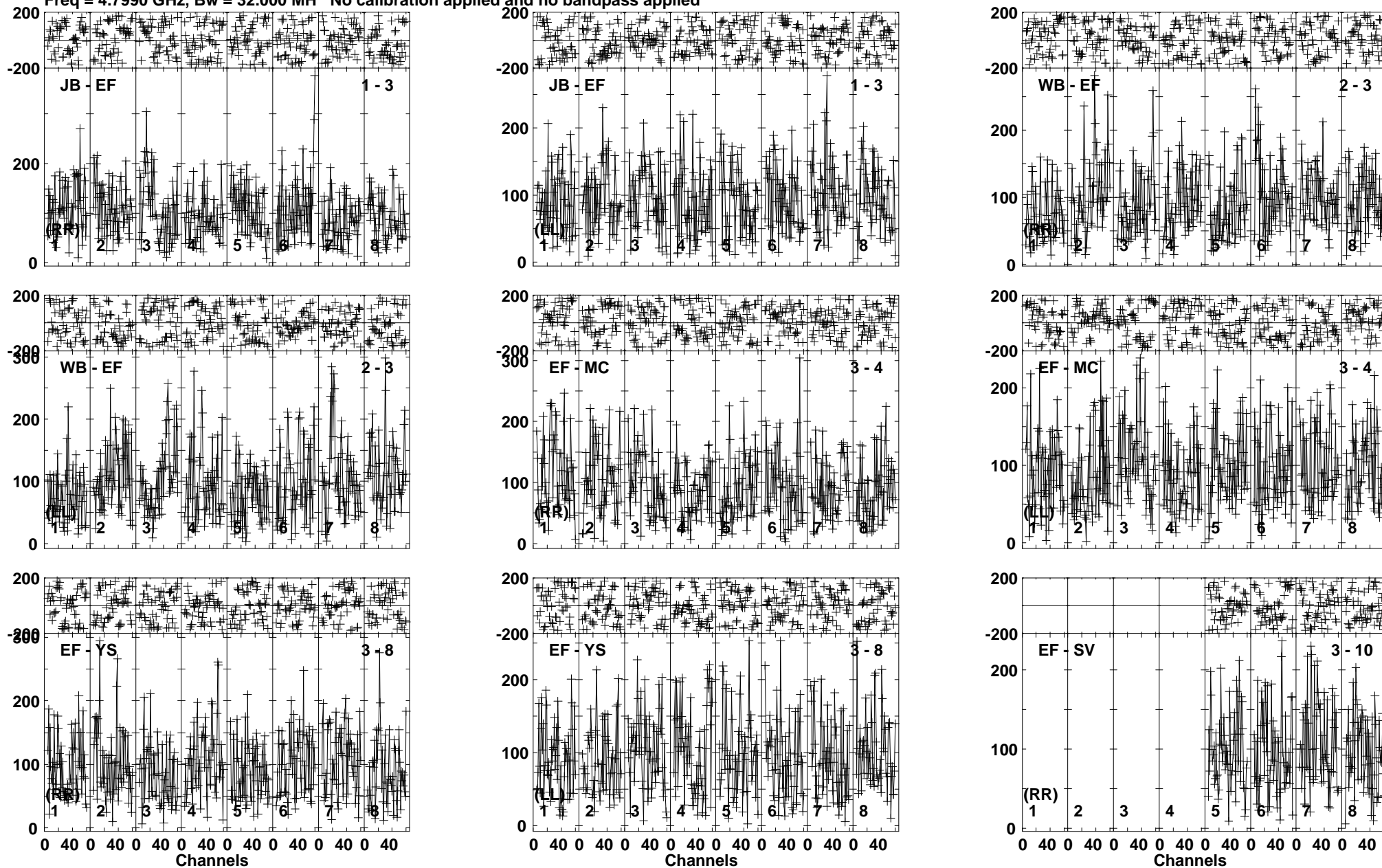

Lower frame: Micro Ampl Jy Top frame: Phas deg
Vector averaged cross-power spectrum Baseline: JB (01) - EF (03)
Timerange: 00/13:43:40 to 00/13:46:40

Plot file version 62 created 20-SEP-2019 15:51:15
 AT2019EHZ RSM05.UVDATA.1
 Freq = 4.7990 GHz, Bw = 32.000 MH No calibration applied and no bandpass applied

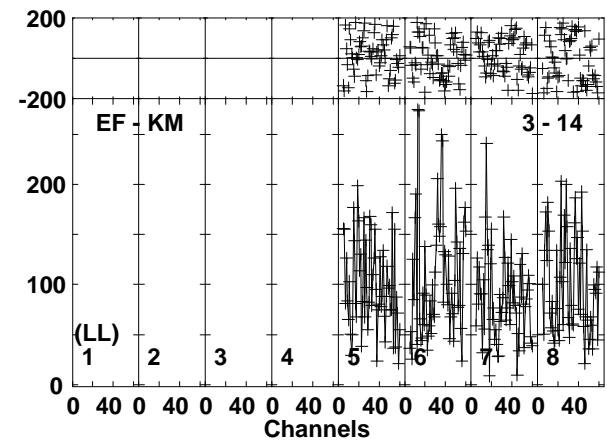
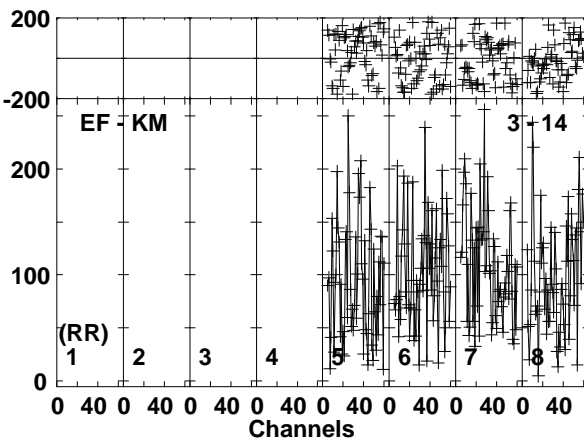
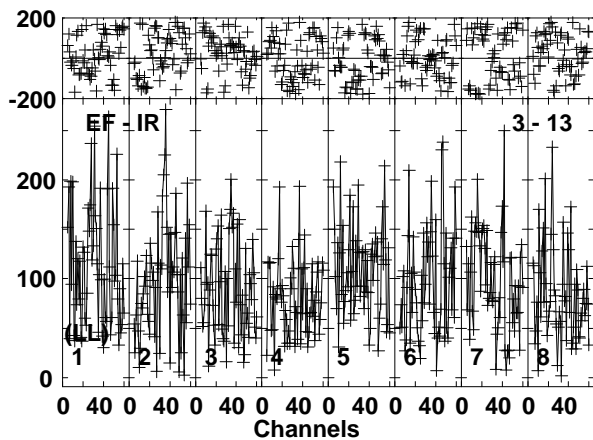
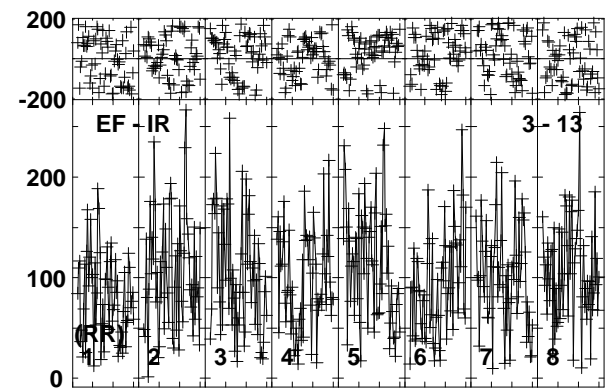
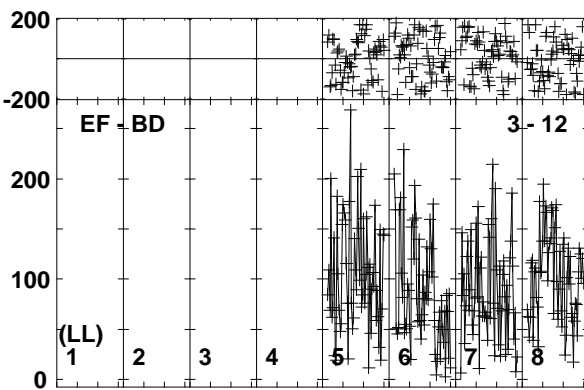
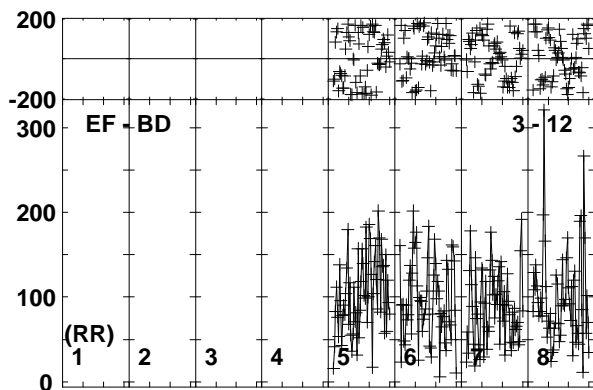
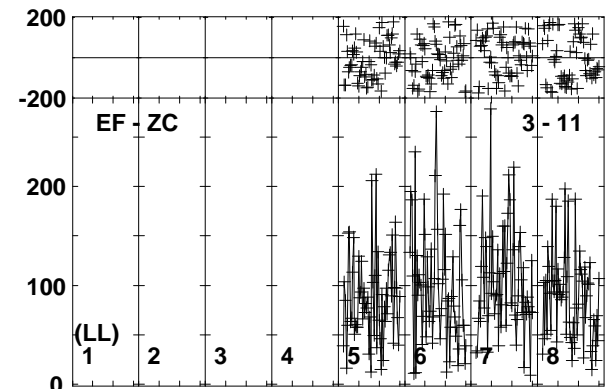
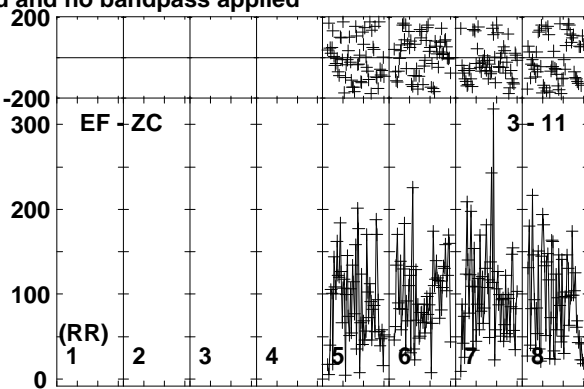
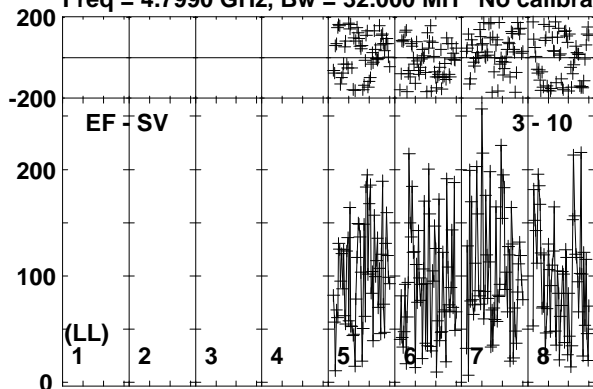

Lower frame: Micro Ampl Jy Top frame: Phas deg
 Vector averaged cross-power spectrum Baseline: EF (03) - SV (10)
 Timerange: 00/13:43:40 to 00/13:46:40

Plot file version 63 created 20-SEP-2019 15:51:16
 AT2019EHZ RSM05.UVDATA.1
 Freq = 4.7990 GHz, Bw = 32.000 MH No calibration applied and no bandpass applied

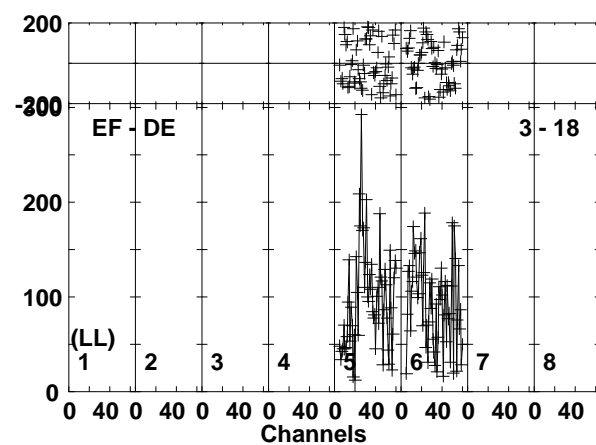
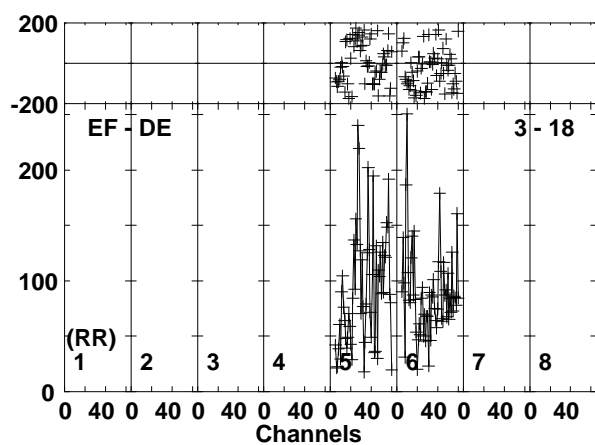
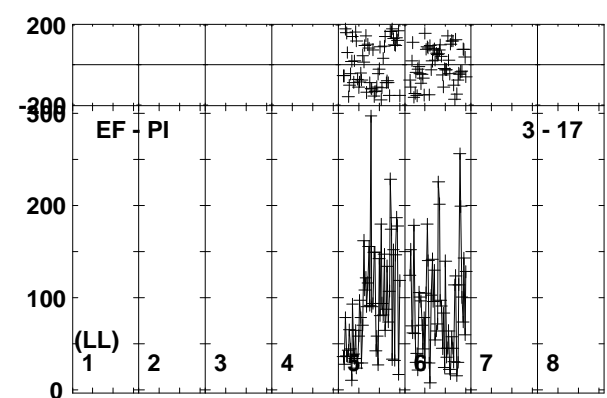
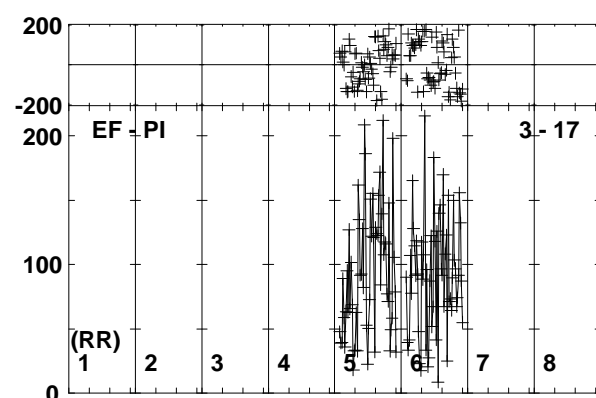
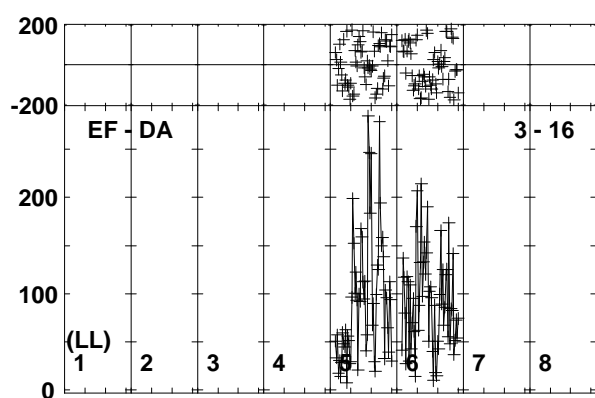
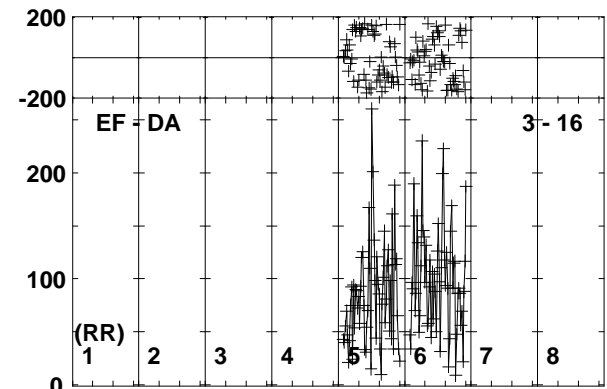
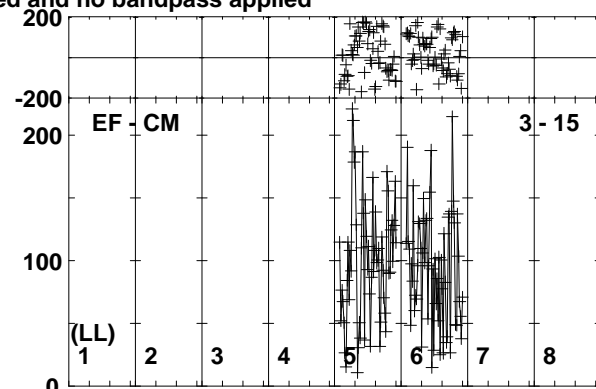
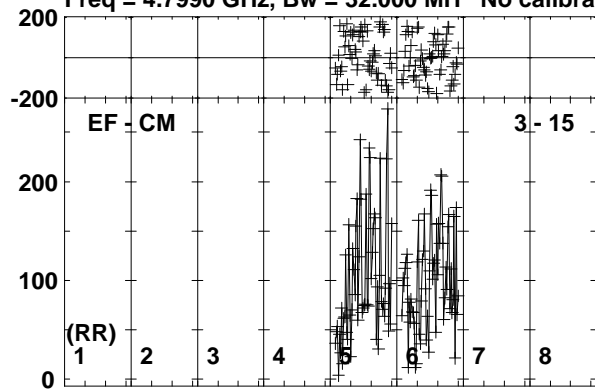

Lower frame: Micro Ampl Jy Top frame: Phas deg
 Vector averaged cross-power spectrum Baseline: EF (03) - CM (15)
 Timerange: 00/13:43:40 to 00/13:46:40

Plot file version 64 created 20-SEP-2019 15:51:16

J1408+5613 RSM05.UVDATA.1

Freq = 4.7990 GHz, Bw = 32.000 MH No calibration applied and no bandpass applied

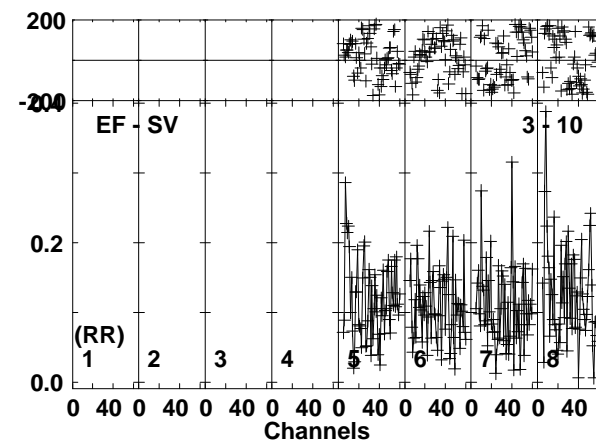
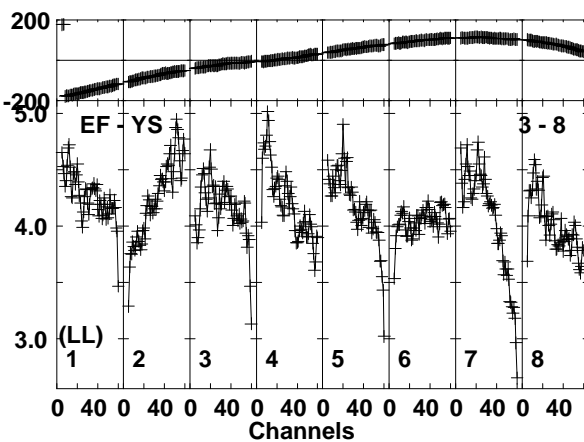
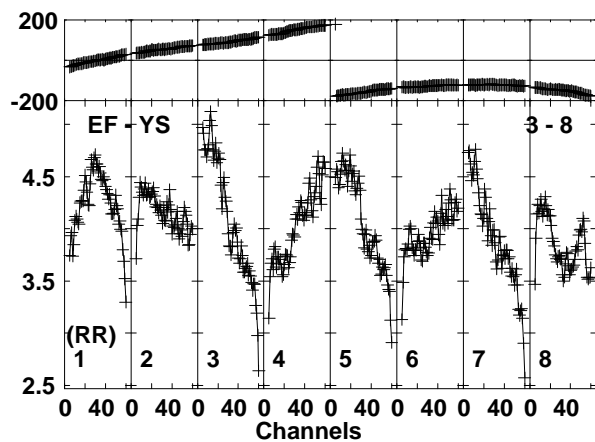
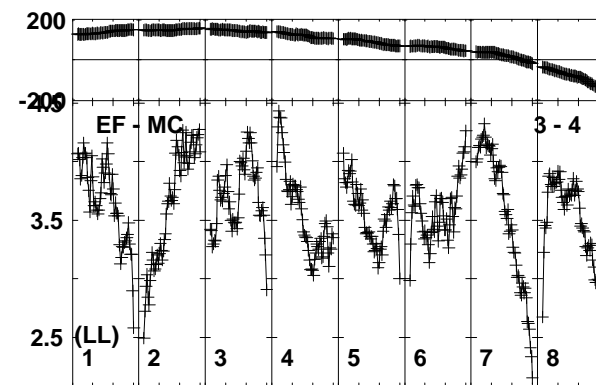
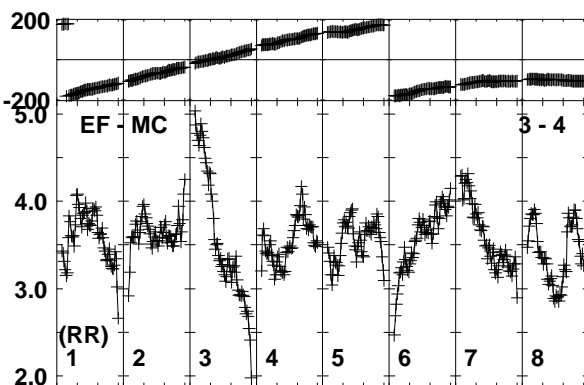
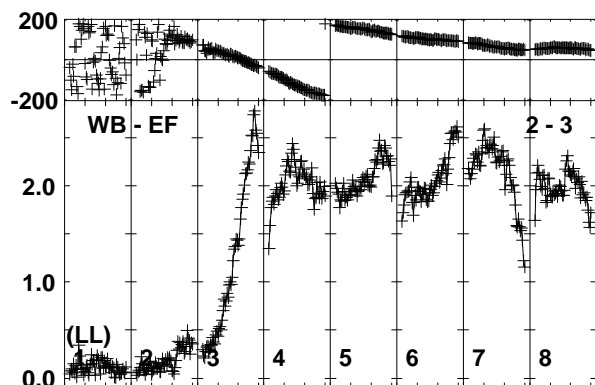
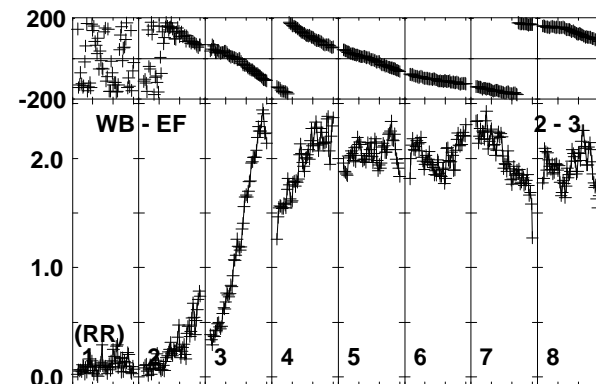
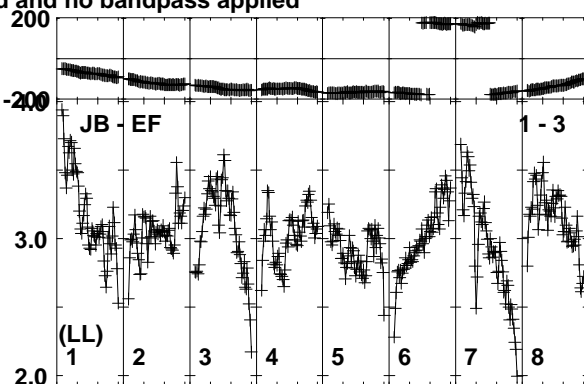
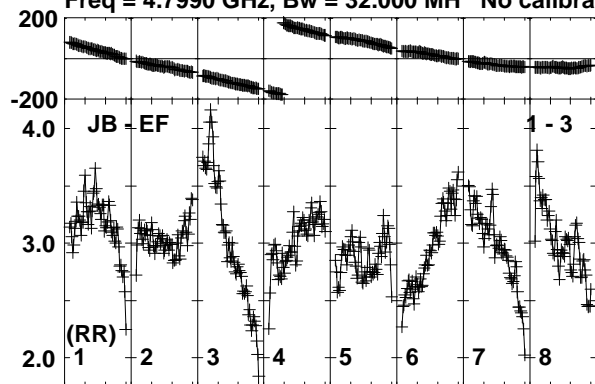

Lower frame: Milli Ampl Jy Top frame: Phas deg
Vector averaged cross-power spectrum Baseline: JB (01) - EF (03)
Timerange: 00/13:47:30 to 00/13:49:00

Plot file version 65 created 20-SEP-2019 15:51:17

J1408+5613 RSM05.UVDATA.1

Freq = 4.7990 GHz, Bw = 32.000 MH No calibration applied and no bandpass applied

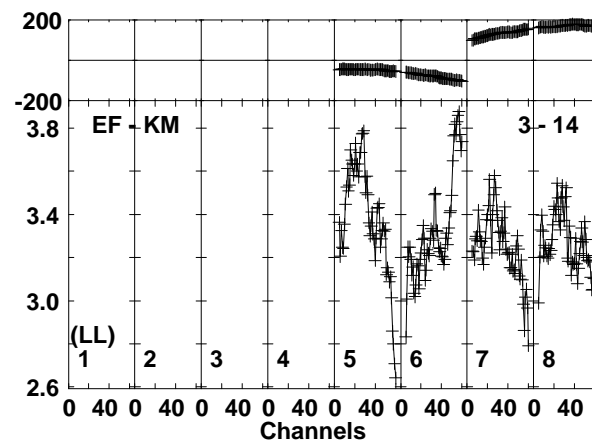
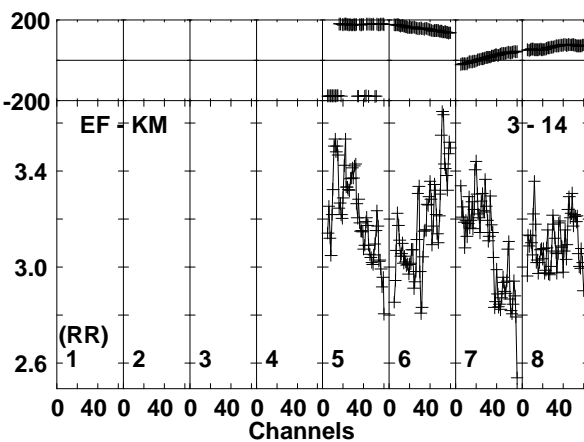
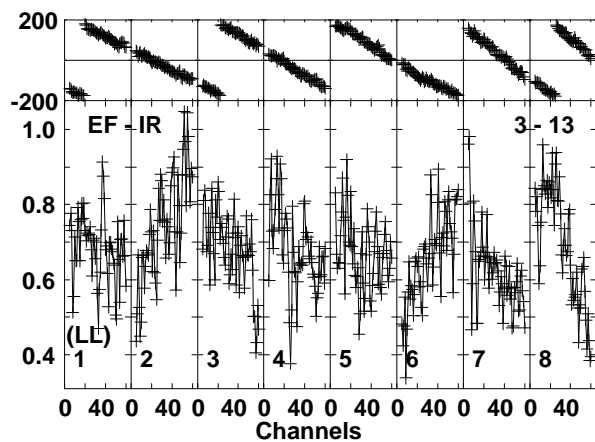
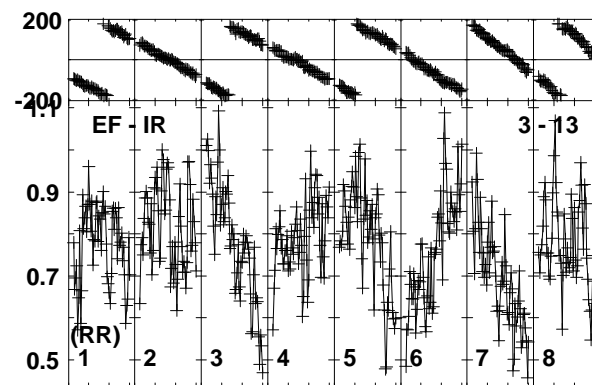
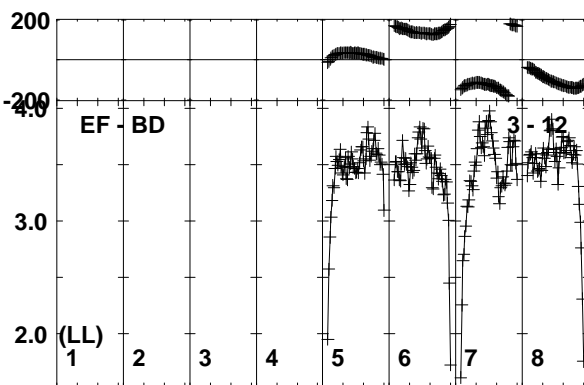
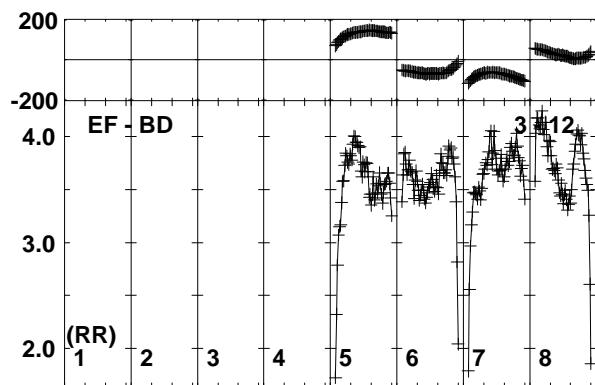
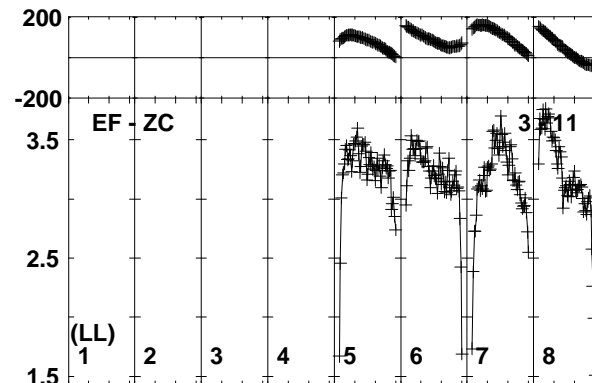
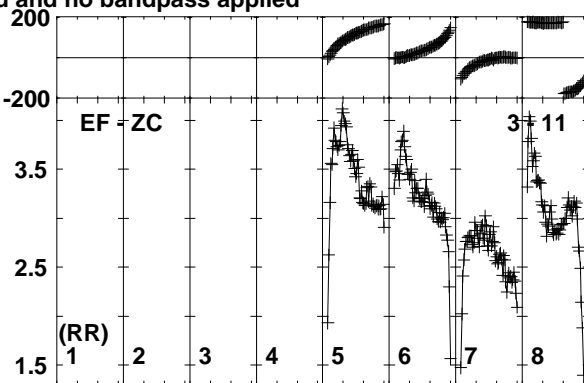
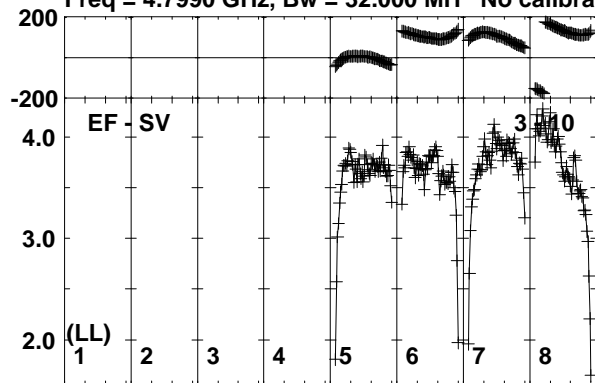

Lower frame: Milli Ampl Jy Top frame: Phas deg
Vector averaged cross-power spectrum Baseline: EF (03) - SV (10)
Timerange: 00/13:47:30 to 00/13:49:00

Plot file version 66 created 20-SEP-2019 15:51:17

J1408+5613 RSM05.UVDATA.1

Freq = 4.7990 GHz, Bw = 32.000 MH No calibration applied and no bandpass applied

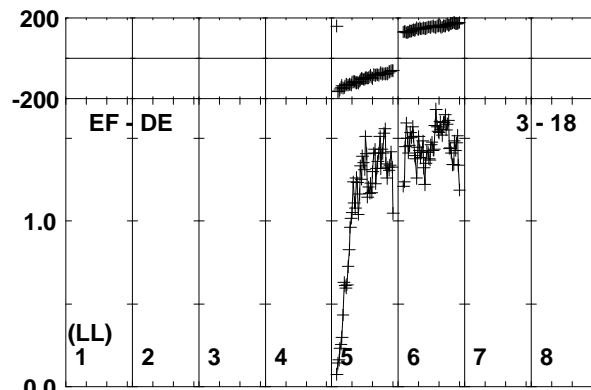
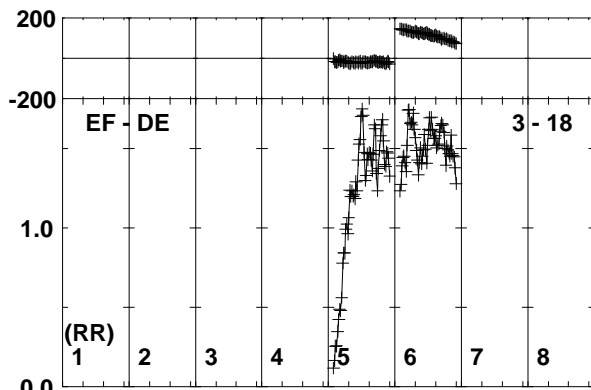
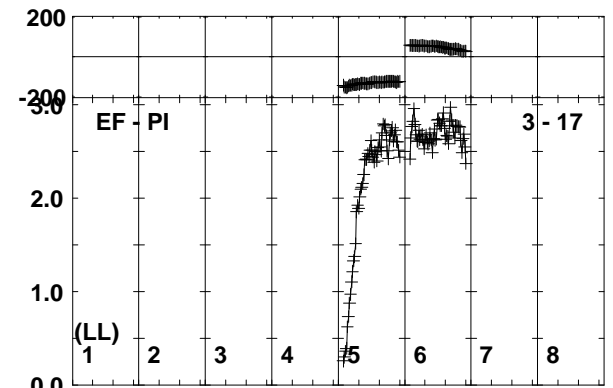
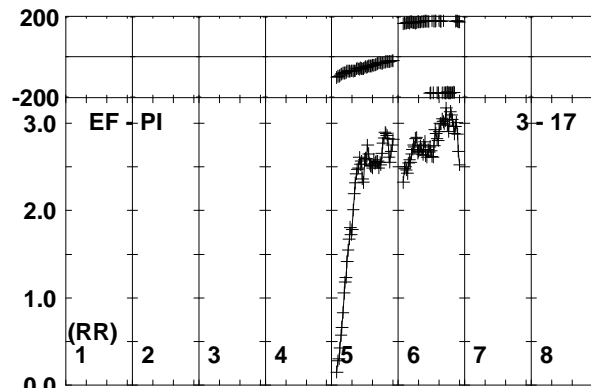
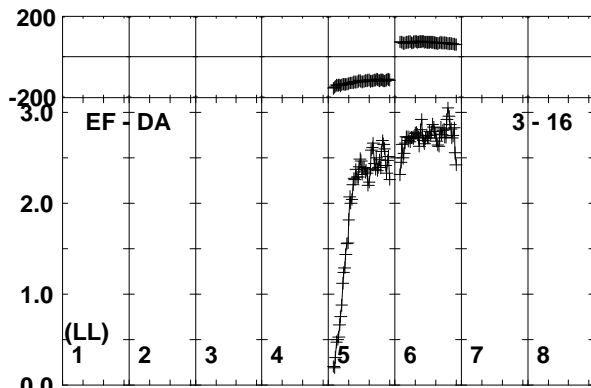
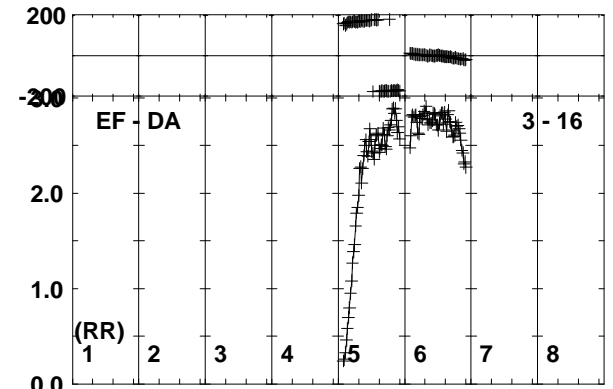
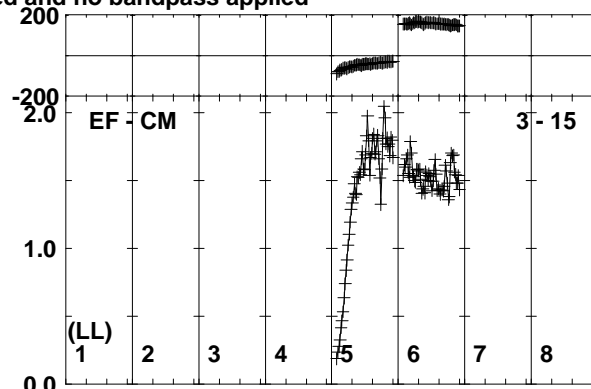
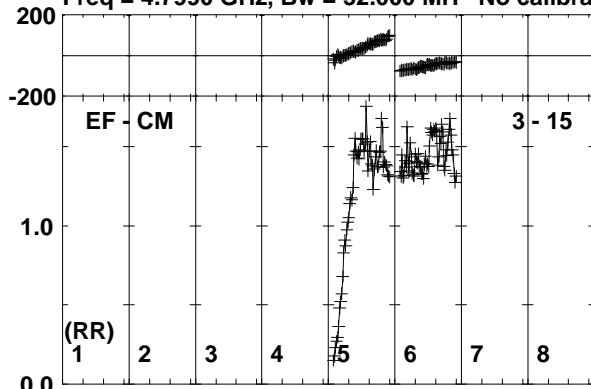

Lower frame: Milli Ampl Jy Top frame: Phas deg
Vector averaged cross-power spectrum Baseline: EF (03) - CM (15)
Timerange: 00/13:47:30 to 00/13:49:00

Plot file version 67 created 20-SEP-2019 15:51:17
 AT2019EHZ RSM05.UVDATA.1
 Freq = 4.7990 GHz, Bw = 32.000 MH No calibration applied and no bandpass applied

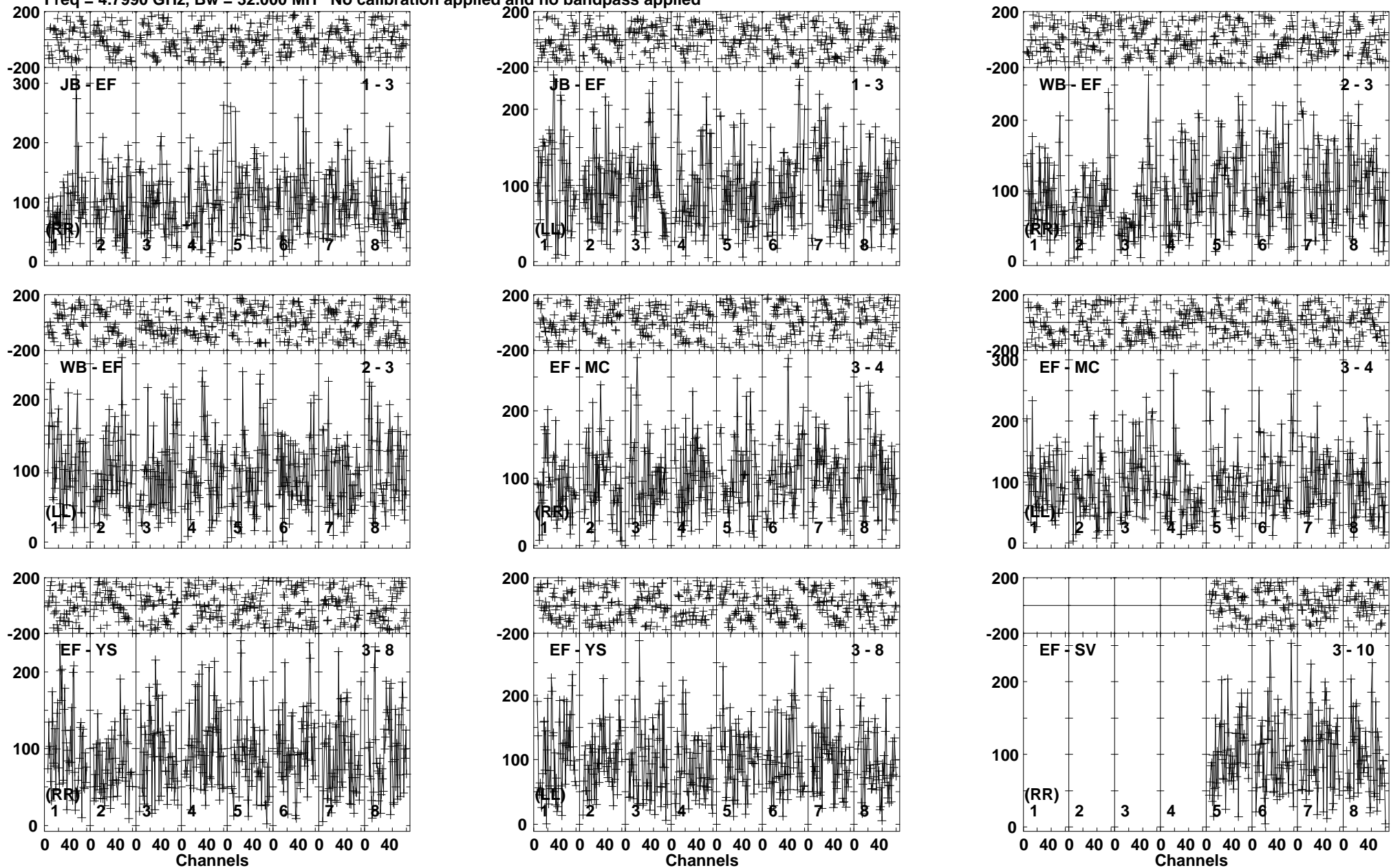

Lower frame: Micro Ampl Jy Top frame: Phas deg
 Vector averaged cross-power spectrum Baseline: JB (01) - EF (03)
 Timerange: 00/13:49:00 to 00/13:51:59

Plot file version 68 created 20-SEP-2019 15:51:18
 AT2019EHZ RSM05.UVDATA.1
 Freq = 4.7990 GHz, Bw = 32.000 MH No calibration applied and no bandpass applied

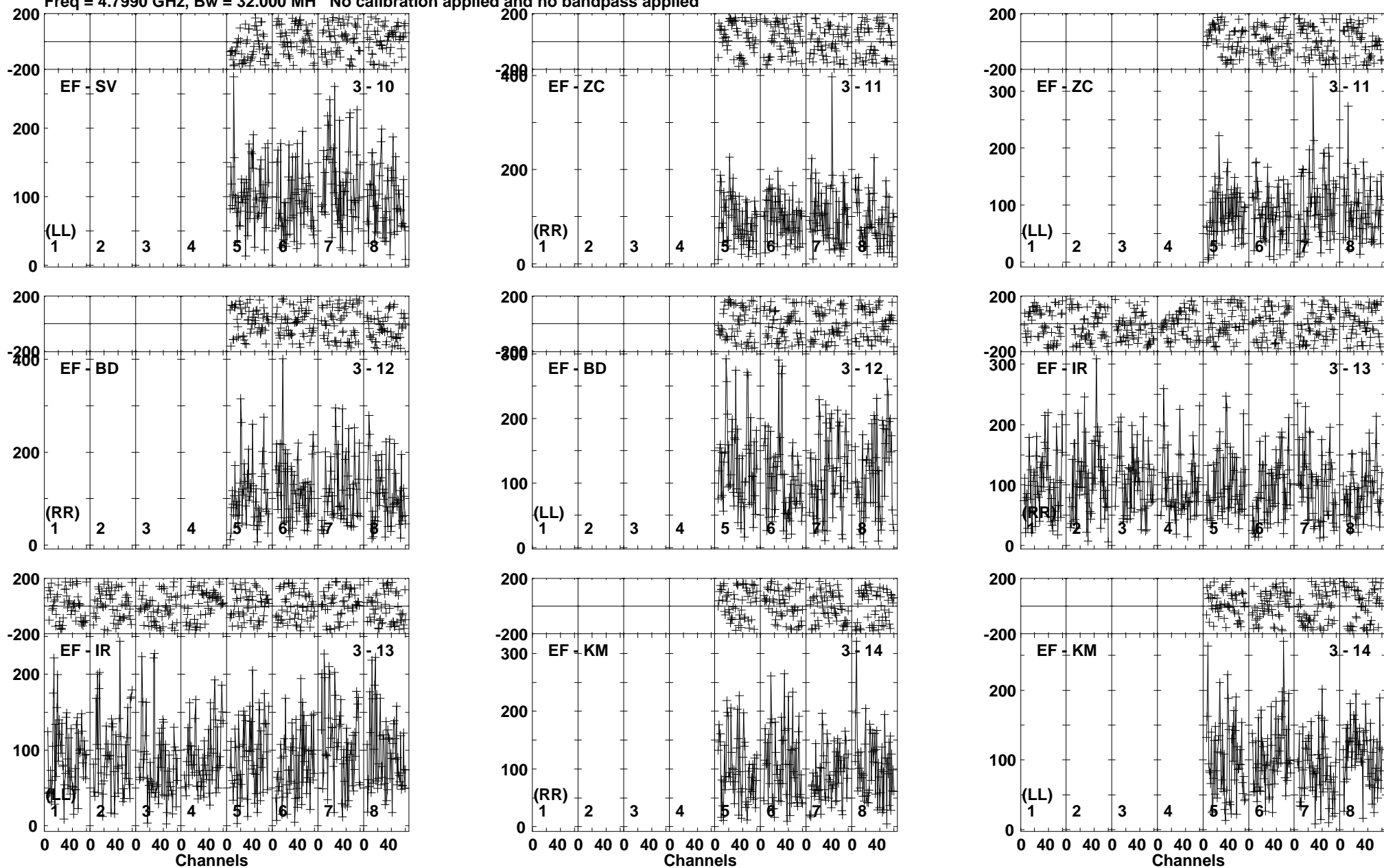

Lower frame: Micro Ampl Jy Top frame: Phas deg
 Vector averaged cross-power spectrum Baseline: EF (03) - SV (10)
 Timerange: 00/13:49:00 to 00/13:51:59

Plot file version 69 created 20-SEP-2019 15:51:19
 AT2019EHZ RSM05.UVDATA.1
 Freq = 4.7990 GHz, Bw = 32.000 MH No calibration applied and no bandpass applied

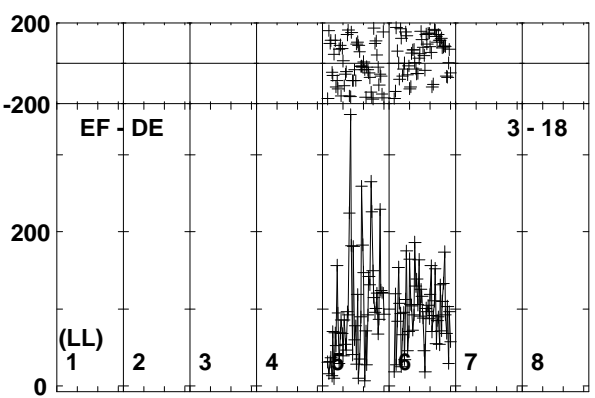
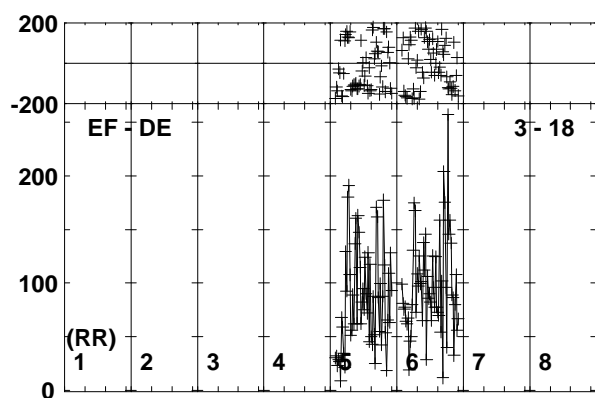
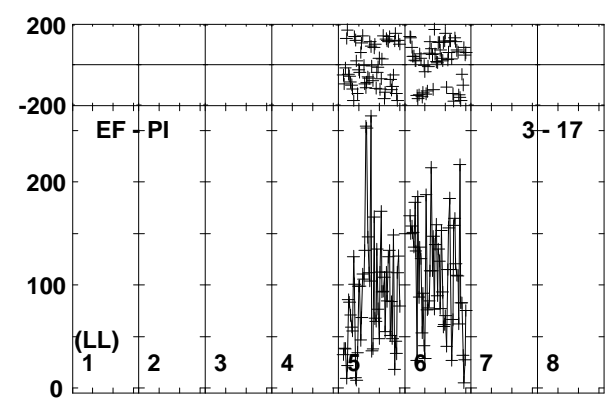
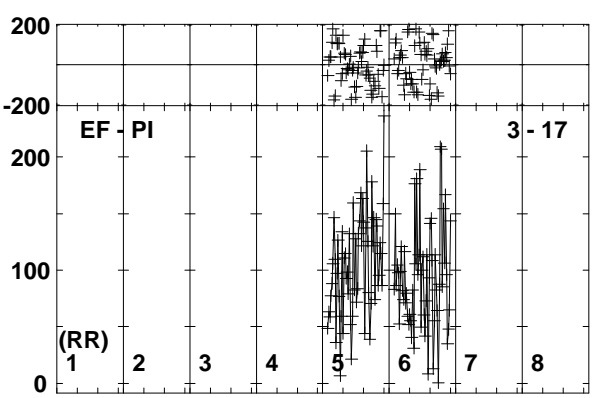
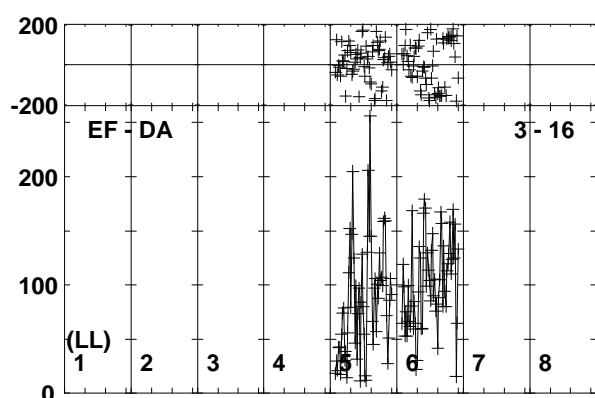
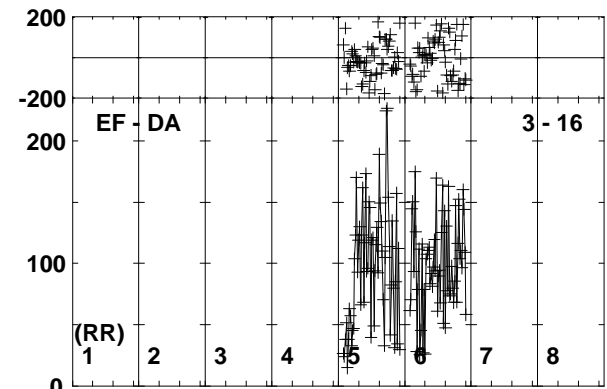
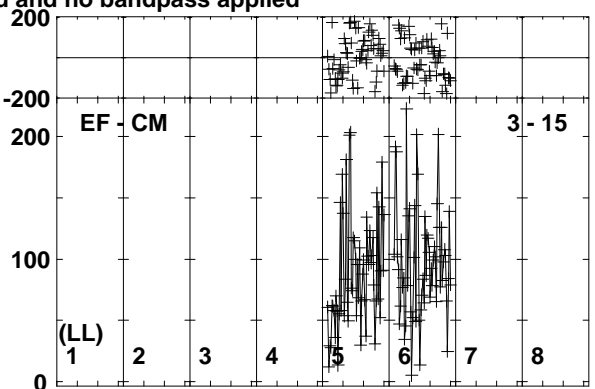
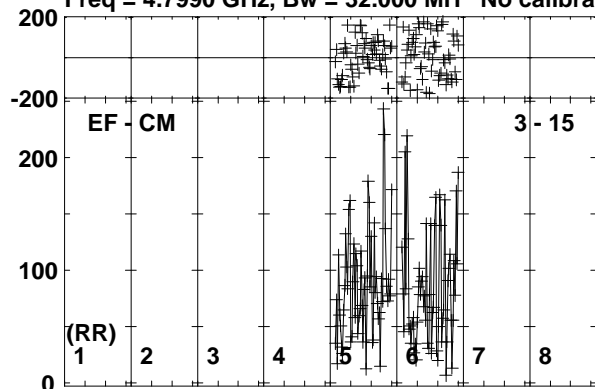

Lower frame: Micro Ampl Jy Top frame: Phas deg
 Vector averaged cross-power spectrum Baseline: EF (03) - CM (15)
 Timerange: 00/13:49:00 to 00/13:51:59

Plot file version 70 created 20-SEP-2019 15:51:19

J1408+5613 RSM05.UVDATA.1

Freq = 4.7990 GHz, Bw = 32.000 MH No calibration applied and no bandpass applied

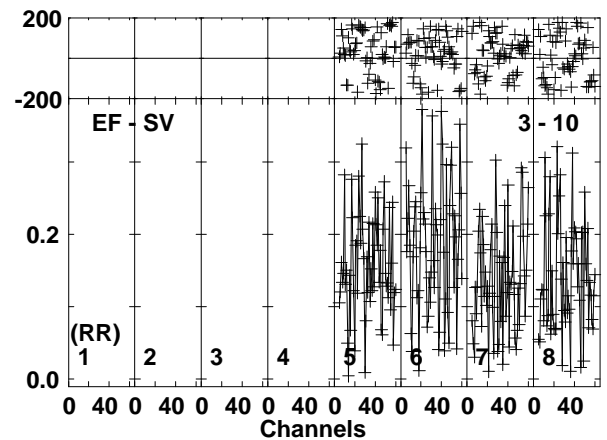
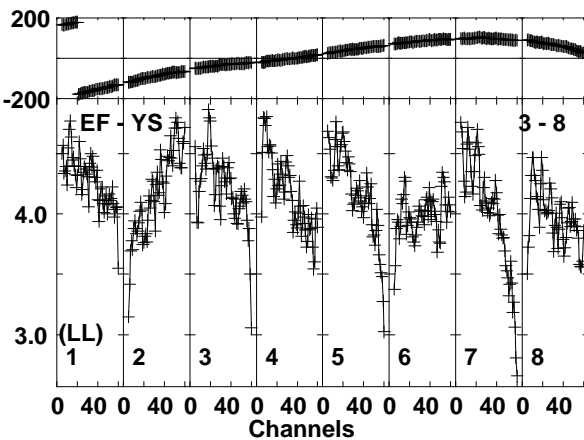
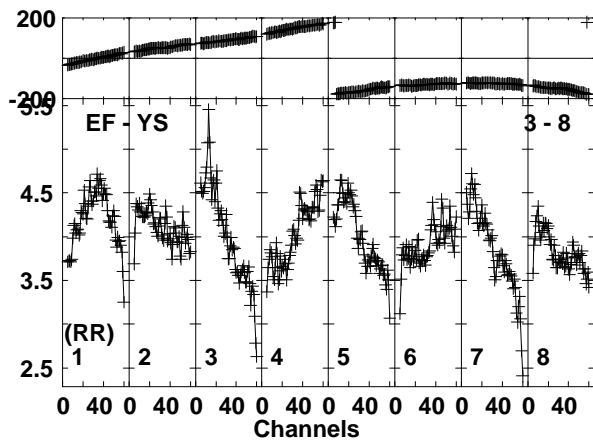
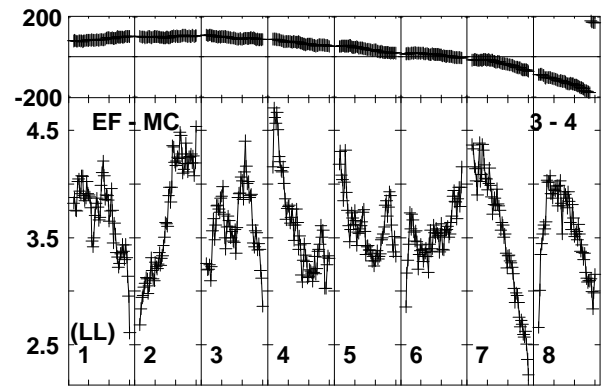
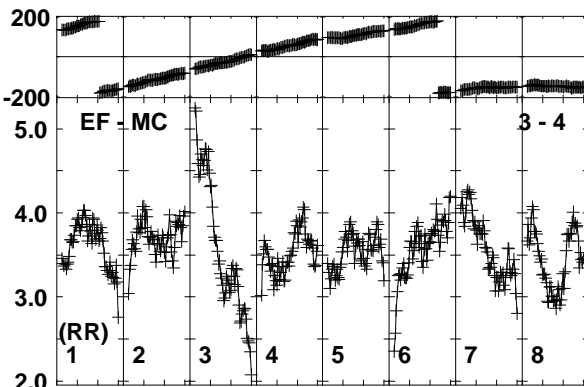
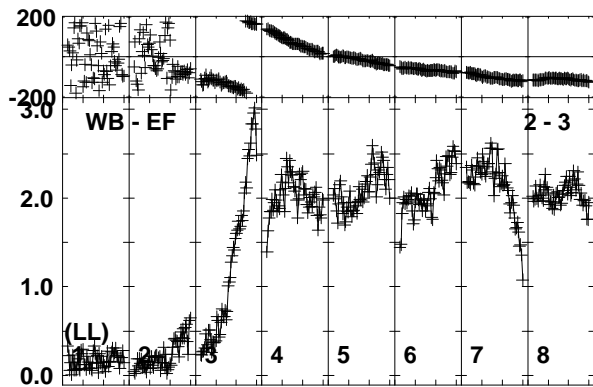
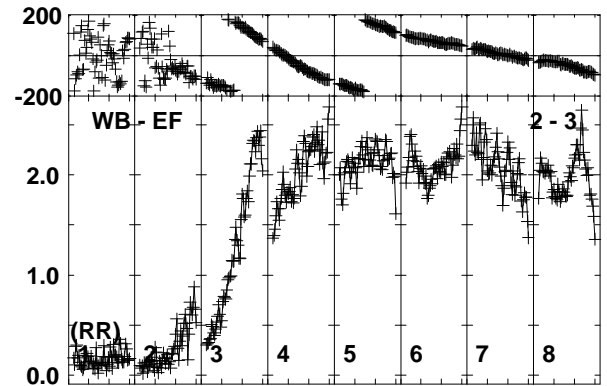
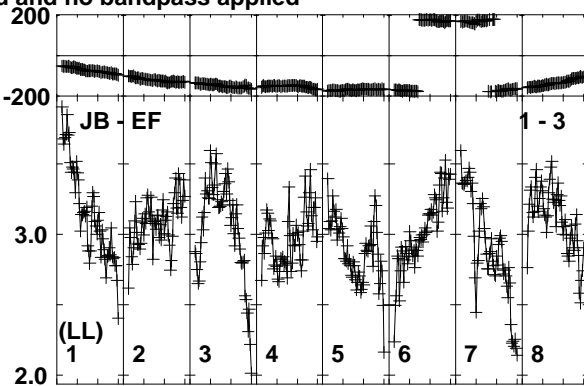
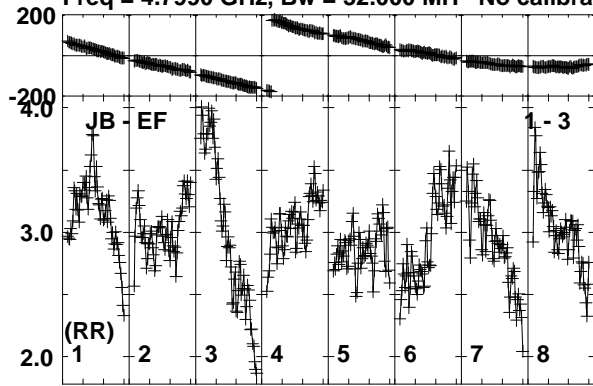

Lower frame: Milli Ampl Jy Top frame: Phas deg
Vector averaged cross-power spectrum Baseline: JB (01) - EF (03)
Timerange: 00/13:52:01 to 00/13:53:30

Plot file version 71 created 20-SEP-2019 15:51:20

J1408+5613 RSM05.UVDATA.1

Freq = 4.7990 GHz, Bw = 32.000 MH No calibration applied and no bandpass applied

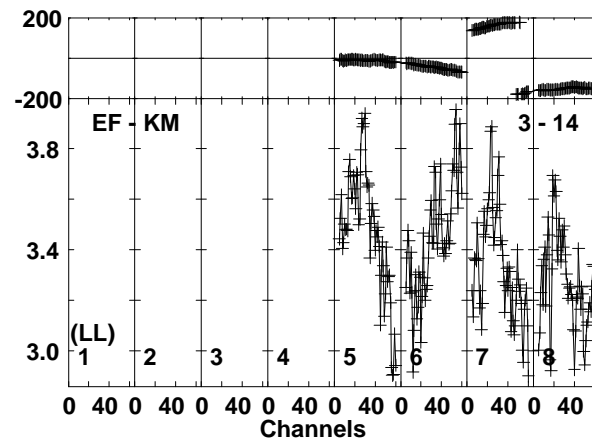
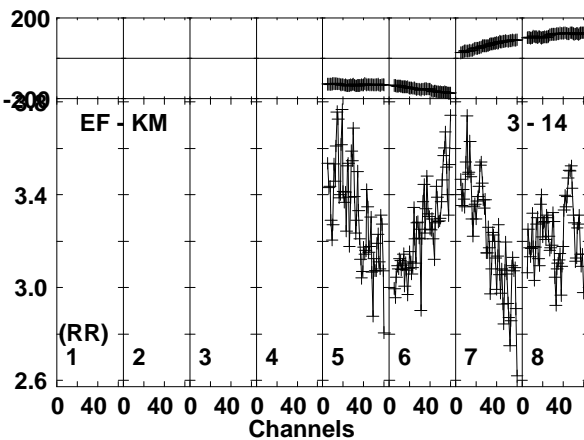
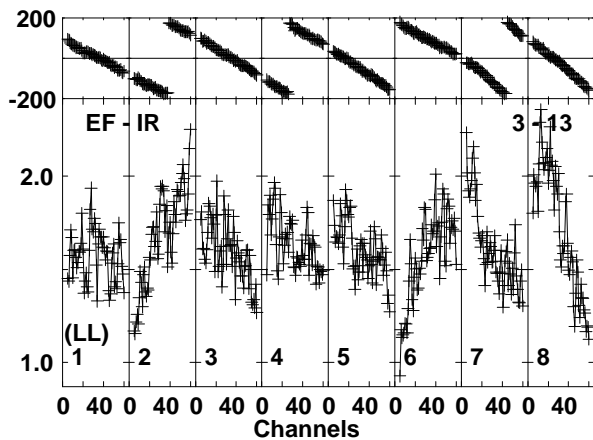
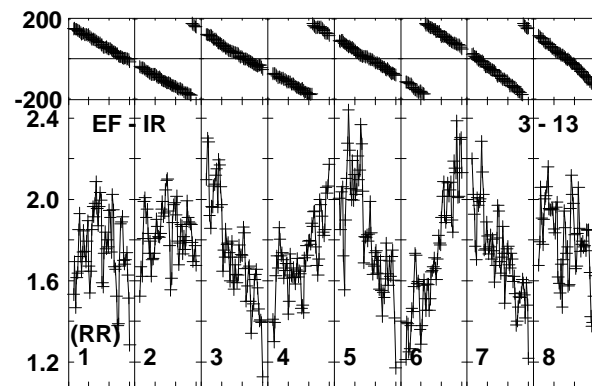
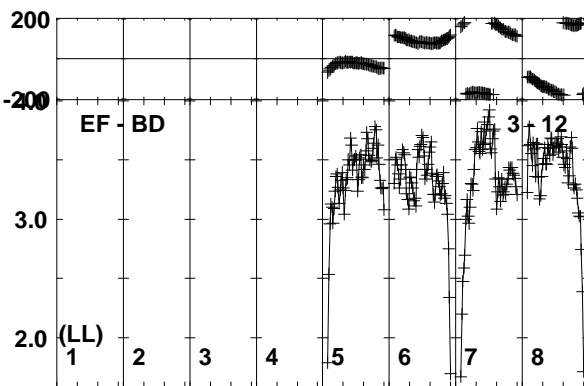
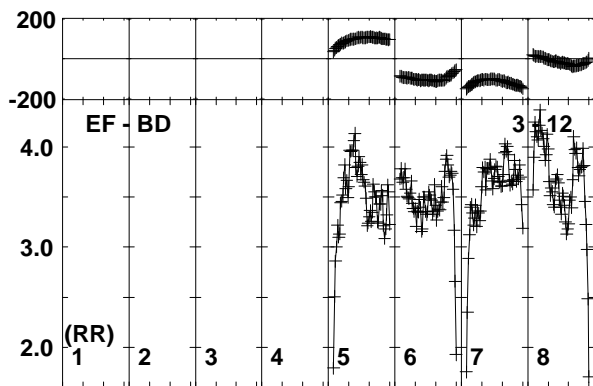
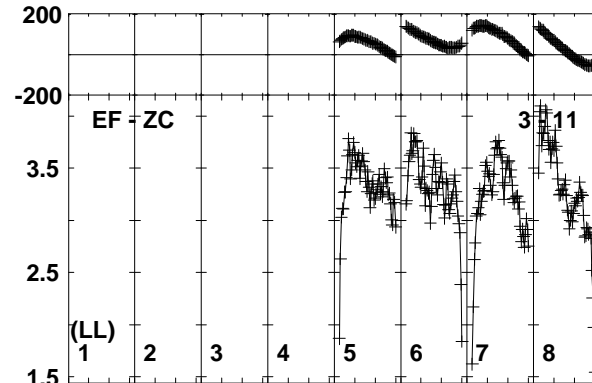
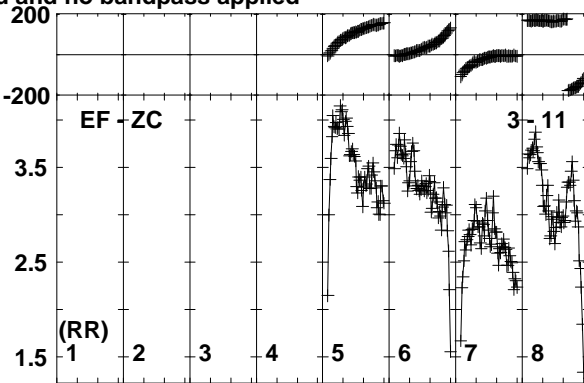
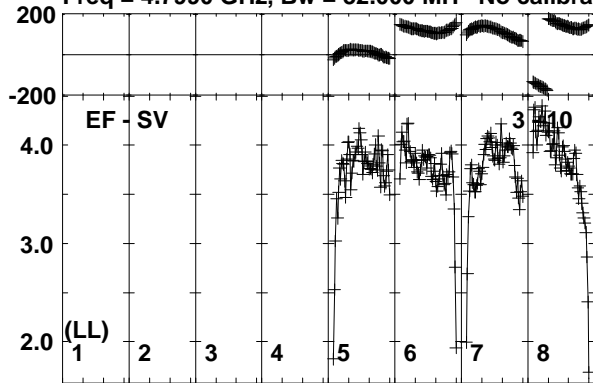

Lower frame: Milli Ampl Jy Top frame: Phas deg
Vector averaged cross-power spectrum Baseline: EF (03) - SV (10)
Timerange: 00/13:52:01 to 00/13:53:30

Plot file version 72 created 20-SEP-2019 15:51:20

J1408+5613 RSM05.UVDATA.1

Freq = 4.7990 GHz, Bw = 32.000 MH No calibration applied and no bandpass applied

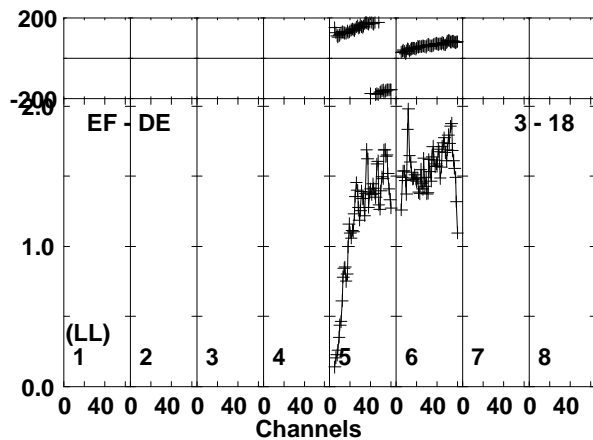
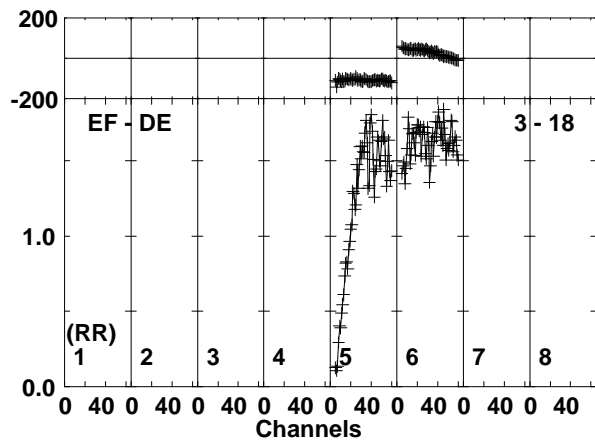
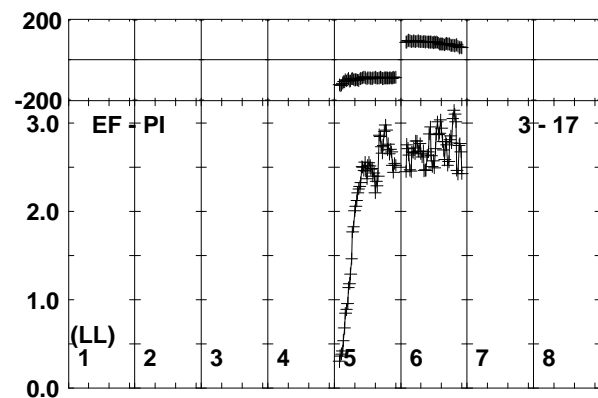
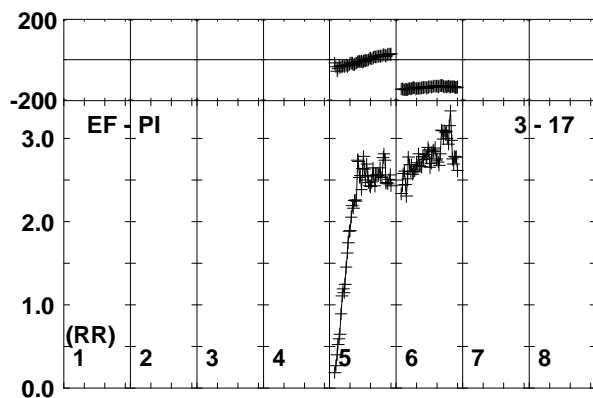
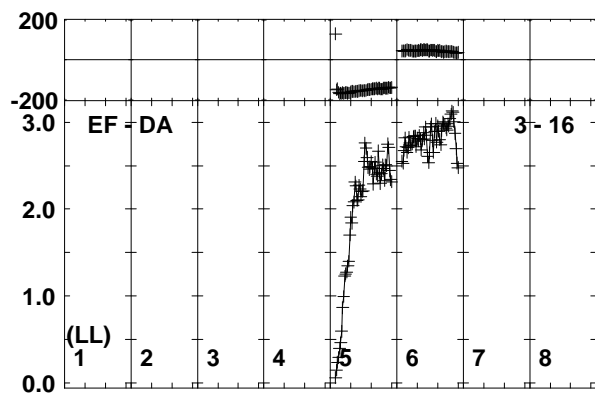
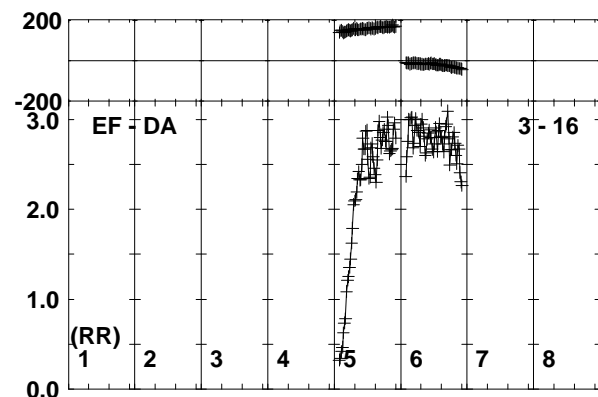
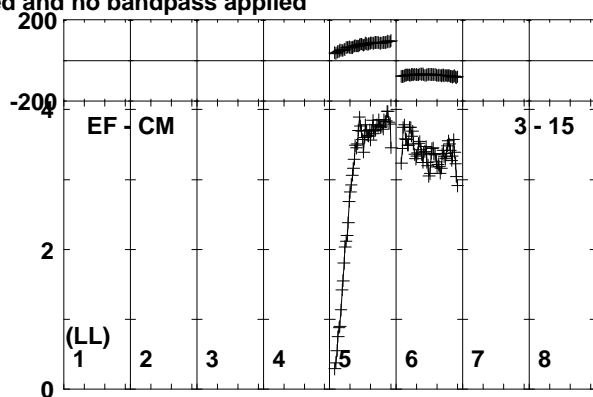
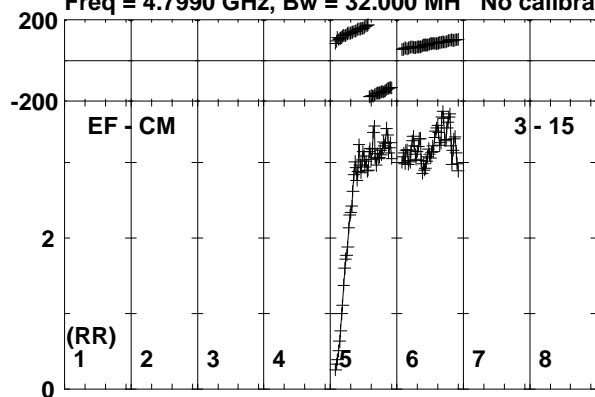

Lower frame: Milli Ampl Jy Top frame: Phas deg
Vector averaged cross-power spectrum Baseline: EF (03) - CM (15)
Timerange: 00/13:52:01 to 00/13:53:30

Plot file version 73 created 20-SEP-2019 15:51:21

AT2019EHZ RSM05.UVDATA.1

Freq = 4.7990 GHz, Bw = 32.000 MH No calibration applied and no bandpass applied

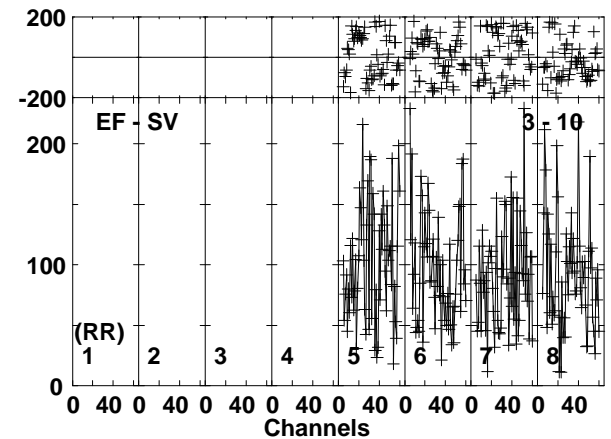
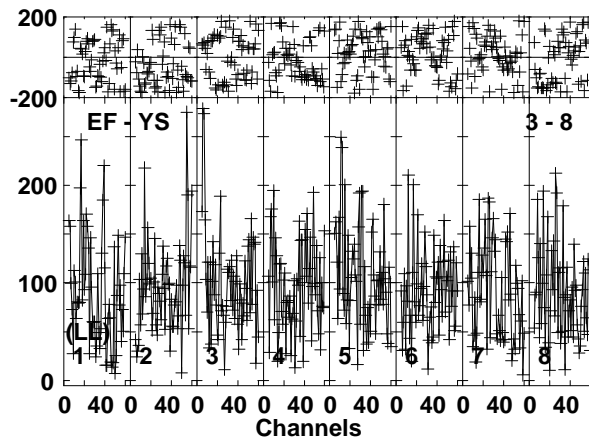
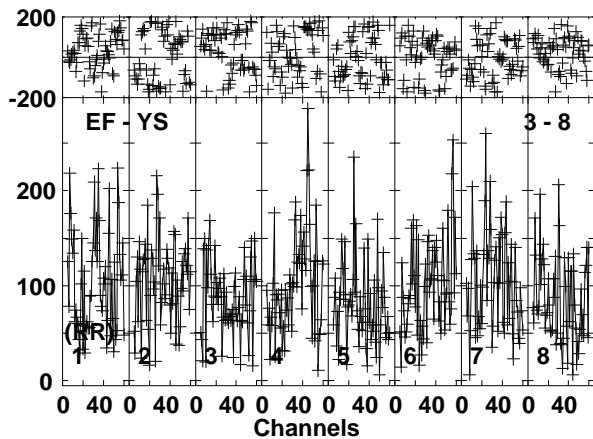
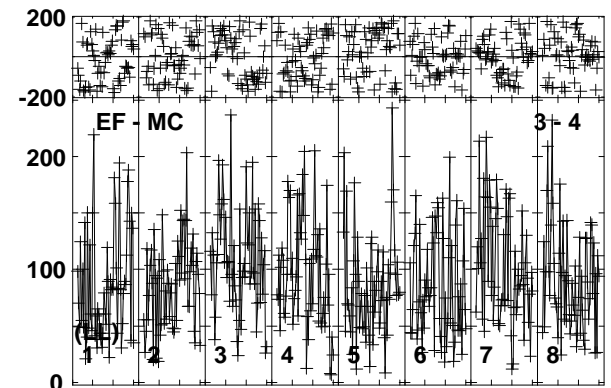
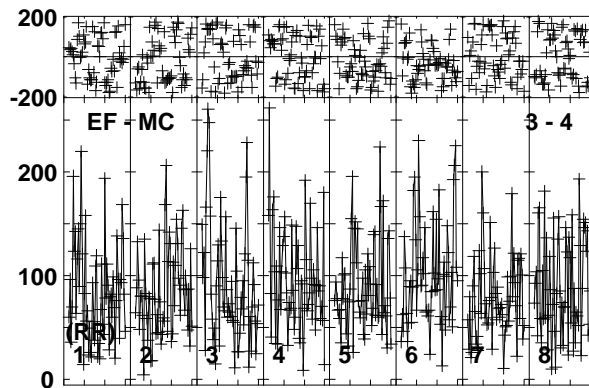
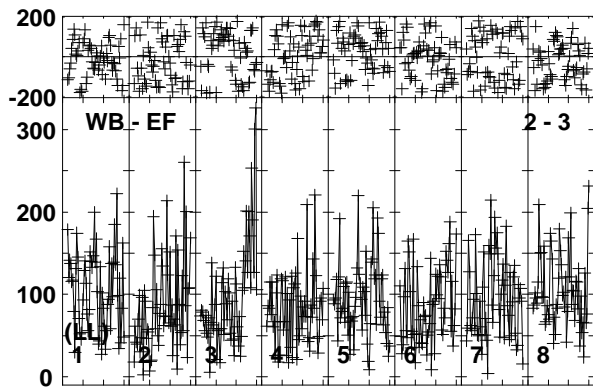
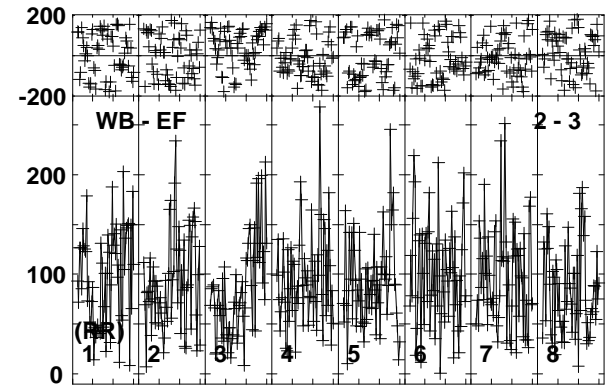
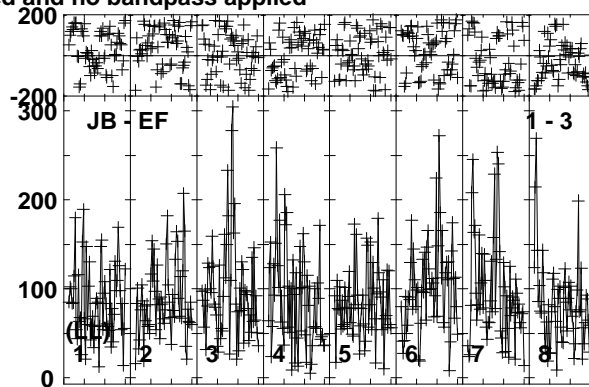
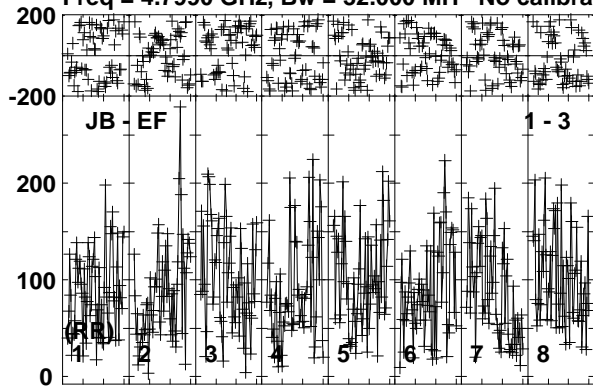

Lower frame: Micro Ampl Jy Top frame: Phas deg
Vector averaged cross-power spectrum Baseline: JB (01) - EF (03)
Timerange: 00/13:53:31 to 00/13:56:29

Plot file version 74 created 20-SEP-2019 15:51:21
 AT2019EHZ RSM05.UVDATA.1
 Freq = 4.7990 GHz, Bw = 32.000 MH No calibration applied and no bandpass applied

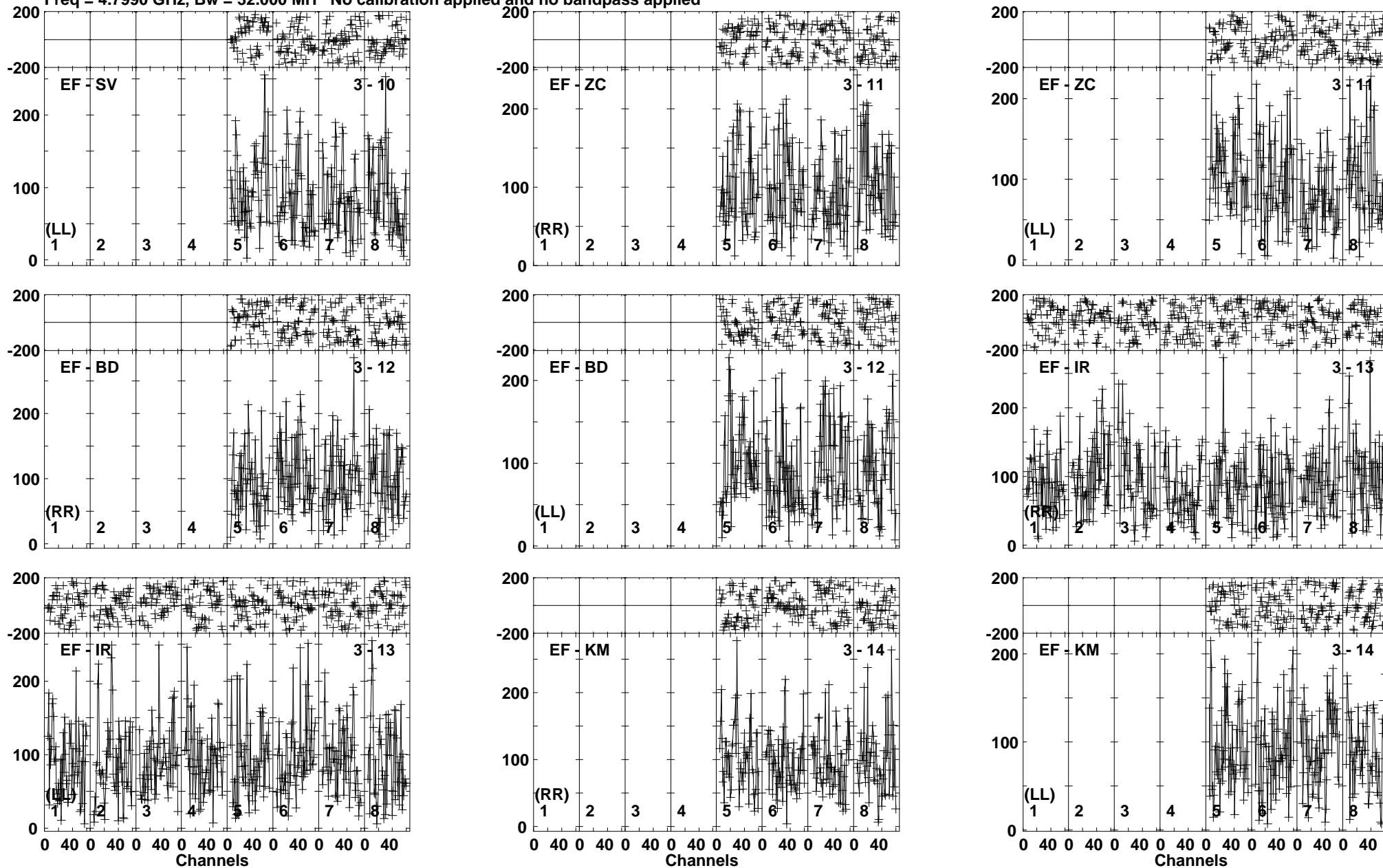

Lower frame: Micro Ampl Jy Top frame: Phas deg
 Vector averaged cross-power spectrum Baseline: EF (03) - SV (10)
 Timerange: 00/13:53:31 to 00/13:56:29

Plot file version 75 created 20-SEP-2019 15:51:22

AT2019EHZ RSM05.UVDATA.1

Freq = 4.7990 GHz, Bw = 32.000 MH No calibration applied and no bandpass applied

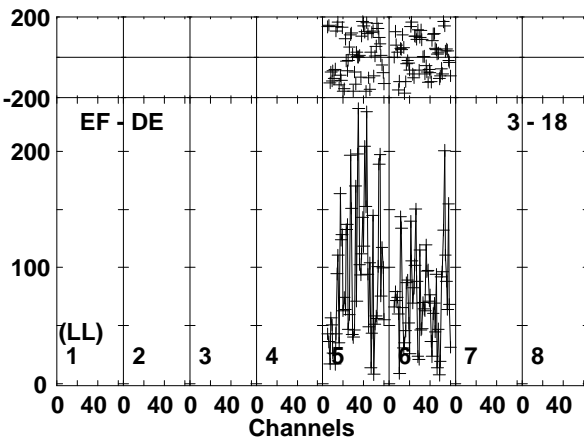
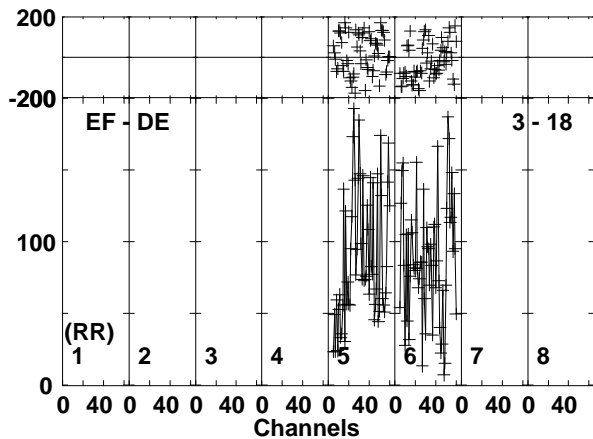
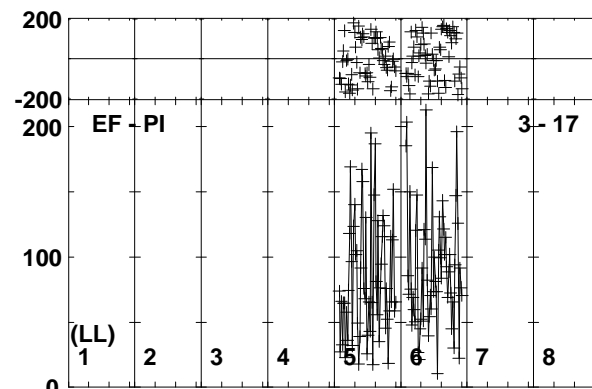
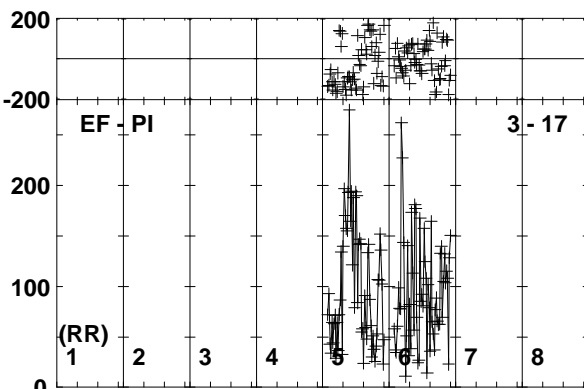
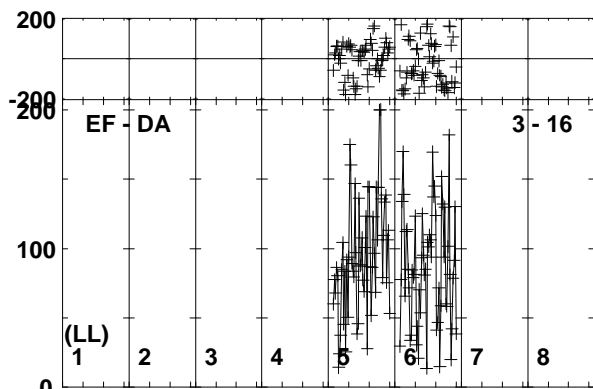
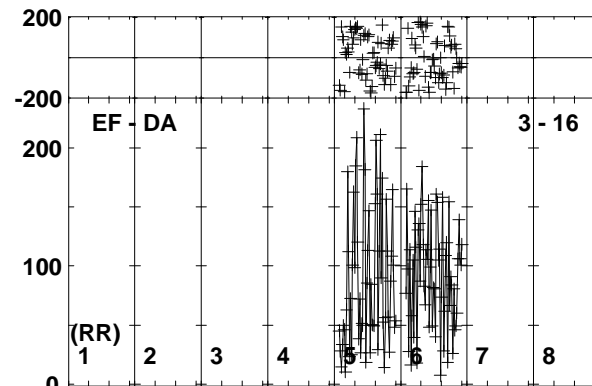
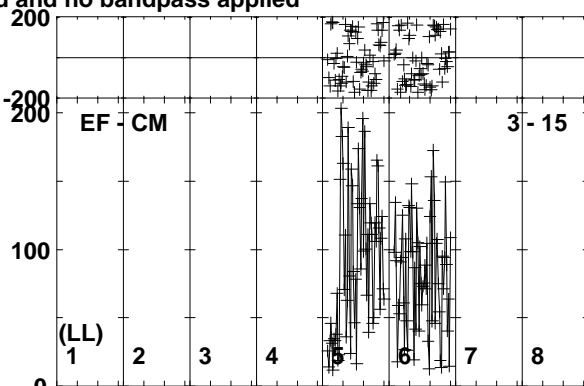
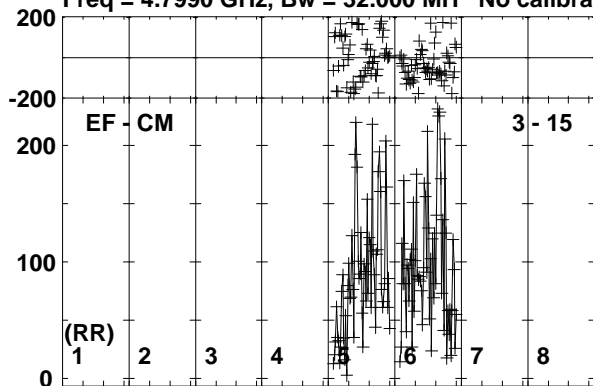

Lower frame: Micro Ampl Jy Top frame: Phas deg
Vector averaged cross-power spectrum Baseline: EF (03) - CM (15)
Timerange: 00/13:53:31 to 00/13:56:29

Plot file version 76 created 20-SEP-2019 15:51:22

J1408+5613 RSM05.UVDATA.1

Freq = 4.7990 GHz, Bw = 32.000 MH No calibration applied and no bandpass applied

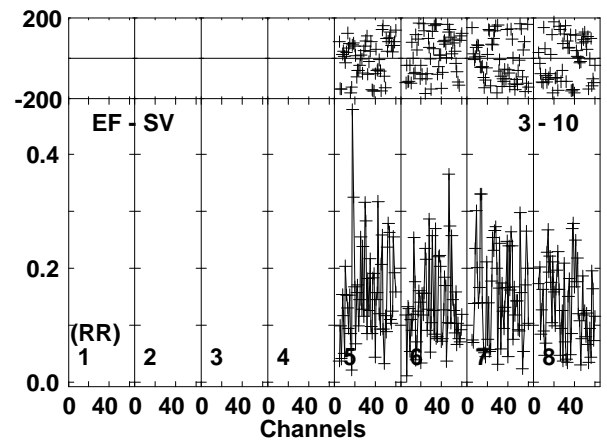
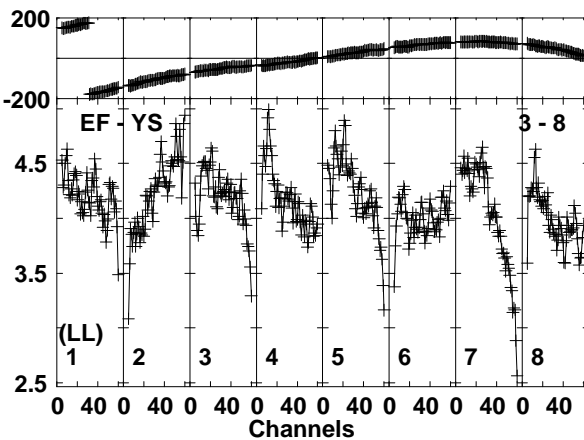
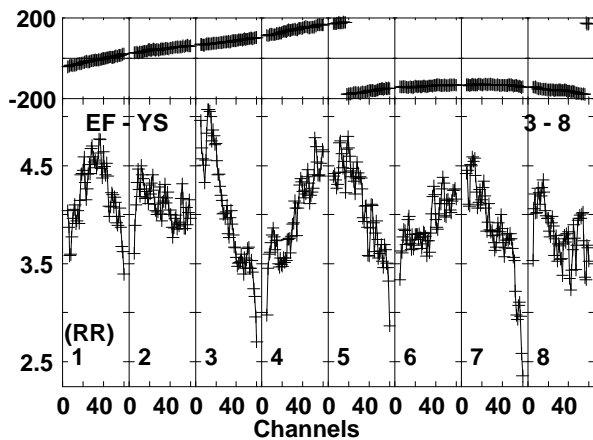
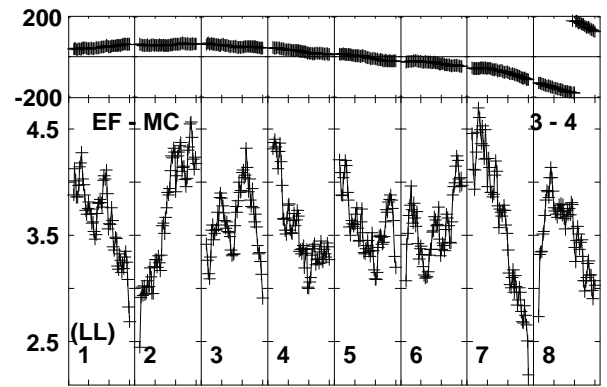
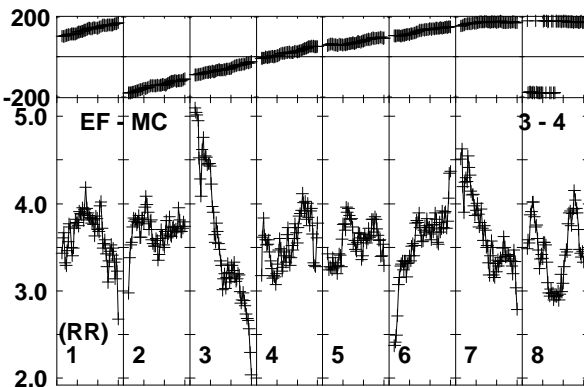
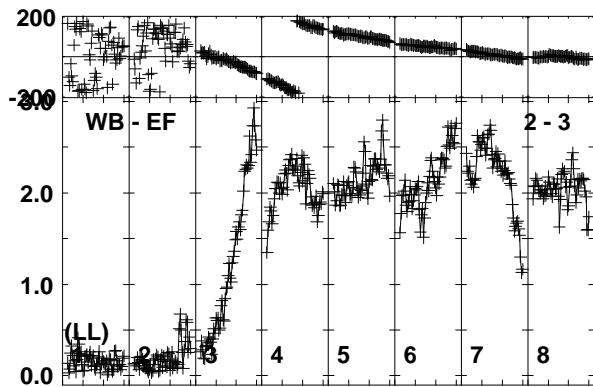
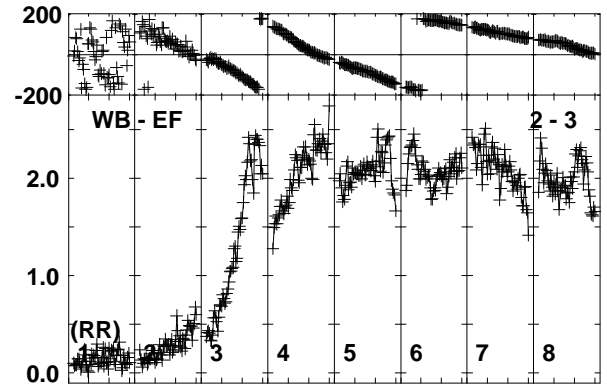
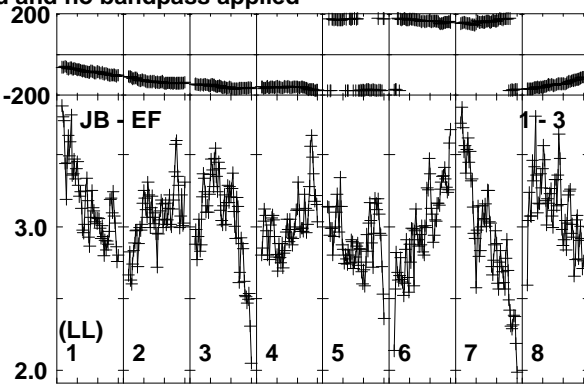
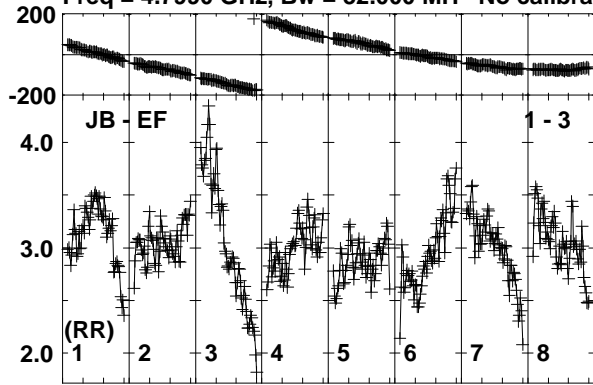

Lower frame: Milli Ampl Jy Top frame: Phas deg
Vector averaged cross-power spectrum Baseline: JB (01) - EF (03)
Timerange: 00/13:56:30 to 00/13:58:00

Plot file version 77 created 20-SEP-2019 15:51:23
J1408+5613 RSM05.UVDATA.1
Freq = 4.7990 GHz, Bw = 32.000 MH No calibration applied and no bandpass applied

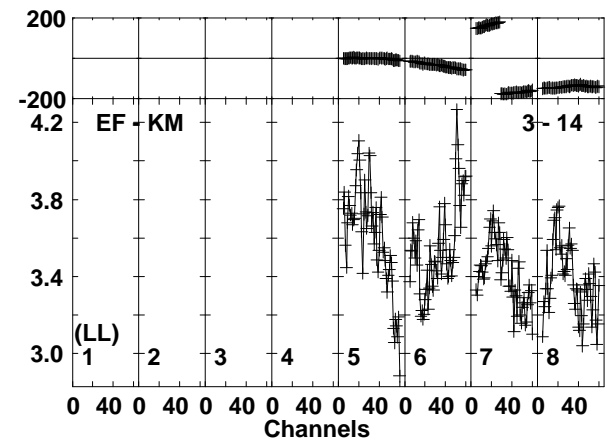
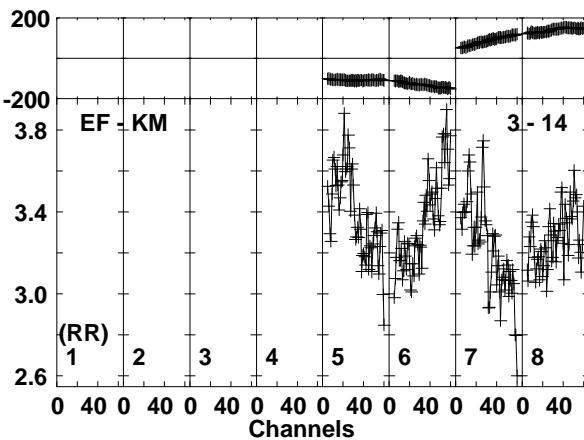
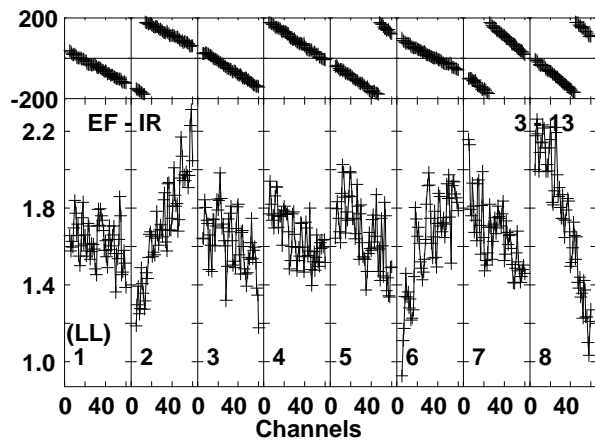
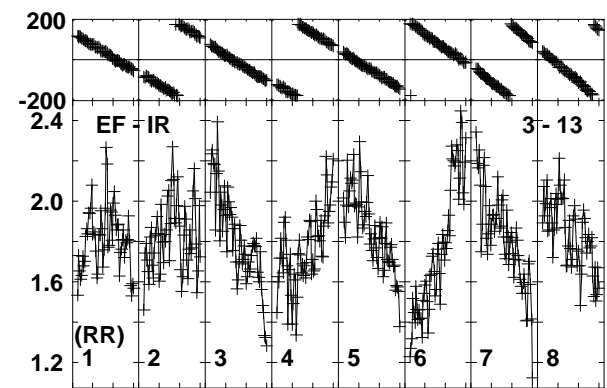
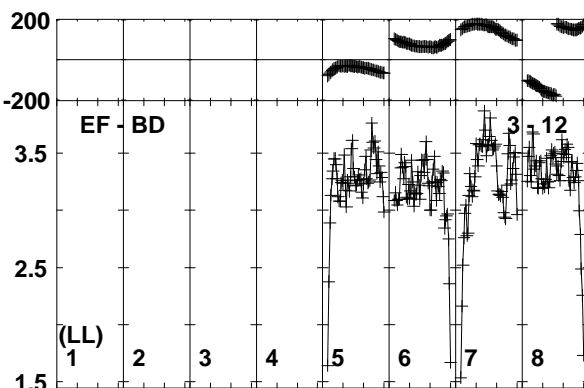
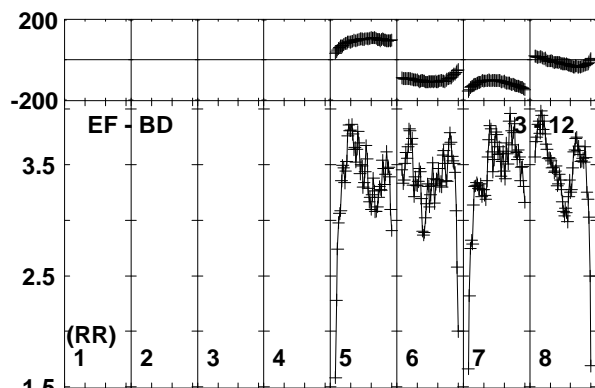
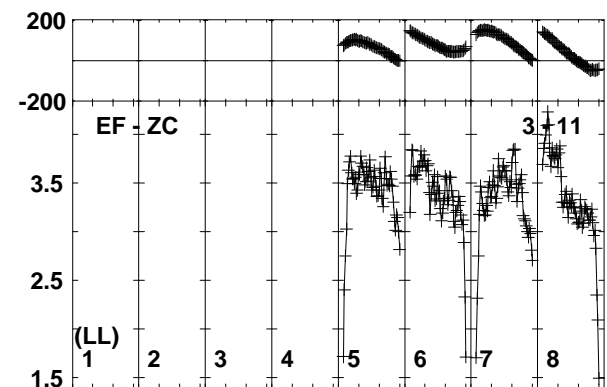
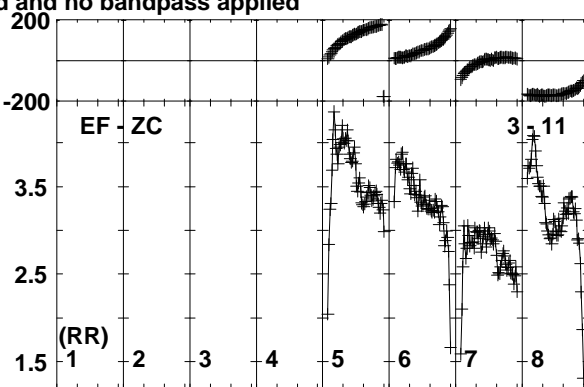
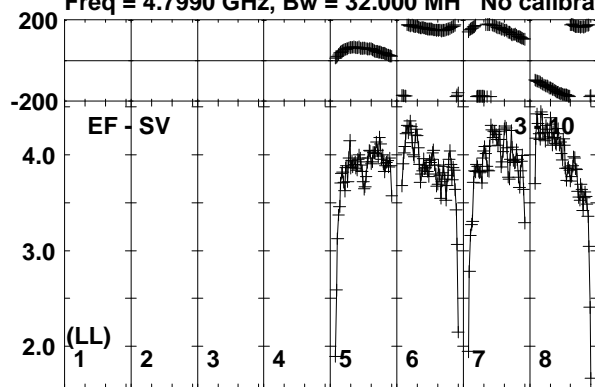

Lower frame: Milli Ampl Jy Top frame: Phas deg
Vector averaged cross-power spectrum Baseline: EF (03) - SV (10)
Timerange: 00/13:56:30 to 00/13:58:00

Plot file version 78 created 20-SEP-2019 15:51:23

J1408+5613 RSM05.UVDATA.1

Freq = 4.7990 GHz, Bw = 32.000 MH No calibration applied and no bandpass applied

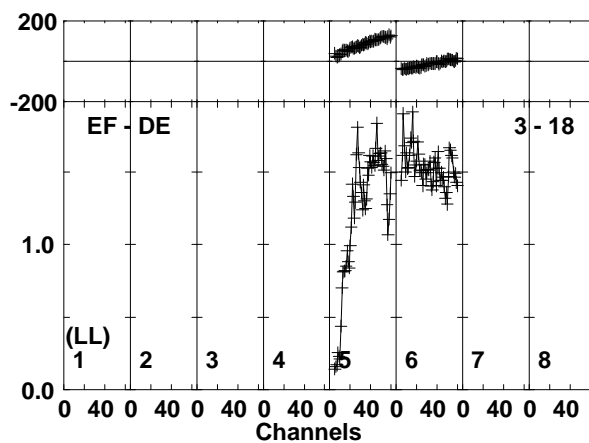
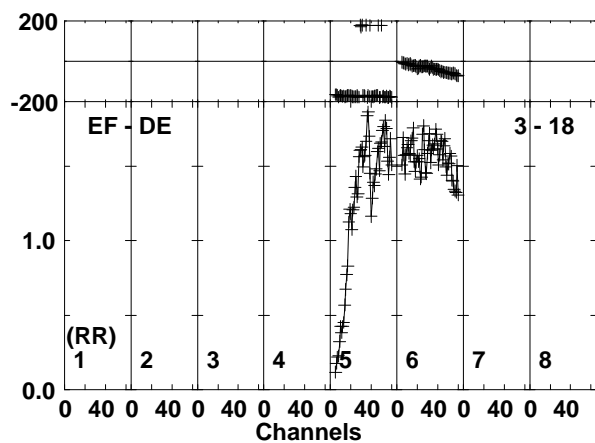
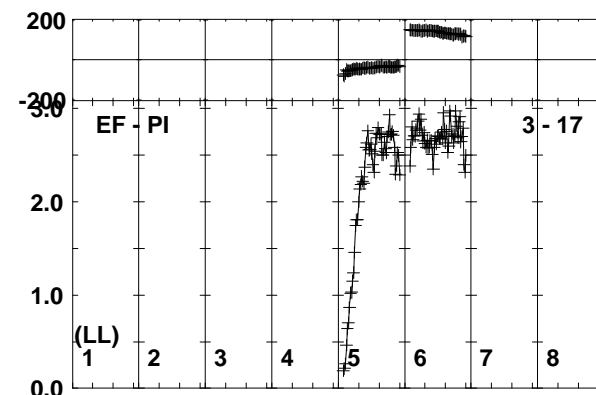
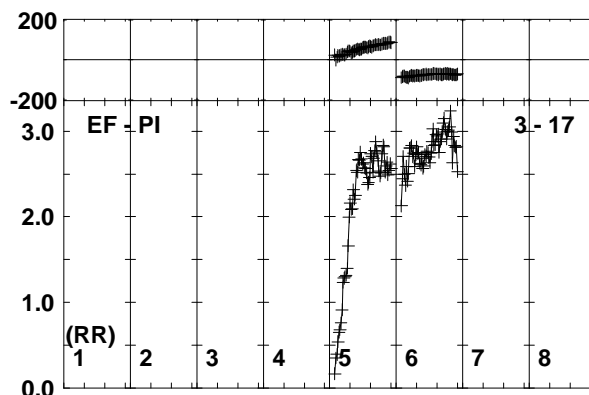
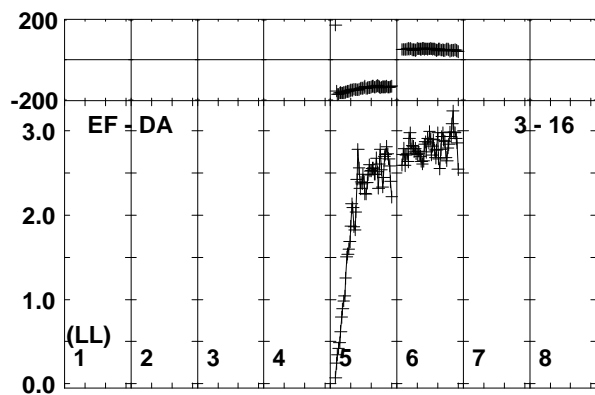
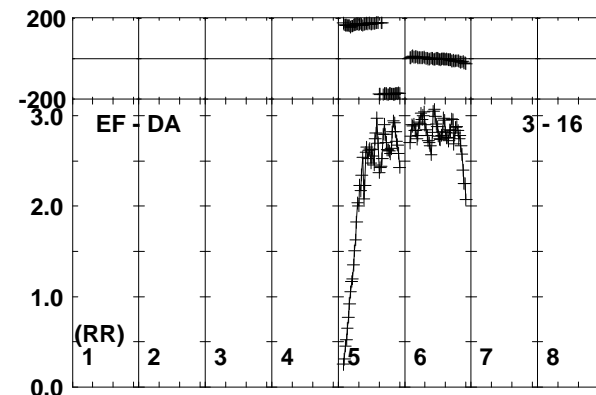
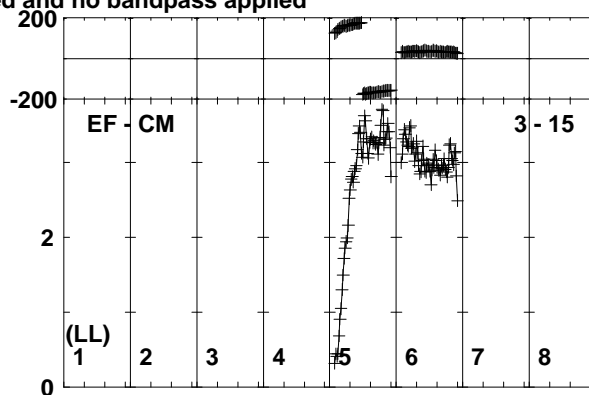
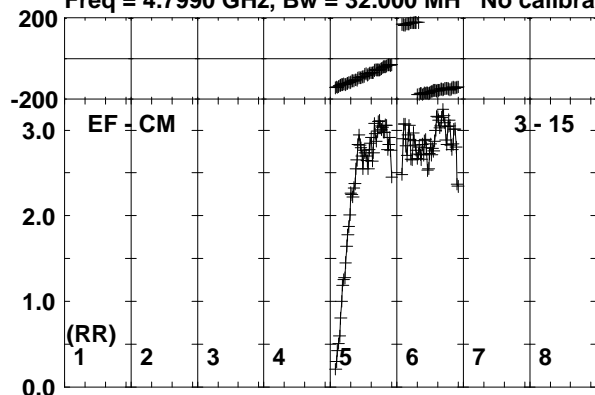

Lower frame: Milli Ampl Jy Top frame: Phas deg
 Vector averaged cross-power spectrum Baseline: EF (03) - CM (15)
 Timerange: 00/13:56:30 to 00/13:58:00

Plot file version 79 created 20-SEP-2019 15:51:24

AT2019EHZ RSM05.UVDATA.1

Freq = 4.7990 GHz, Bw = 32.000 MH No calibration applied and no bandpass applied

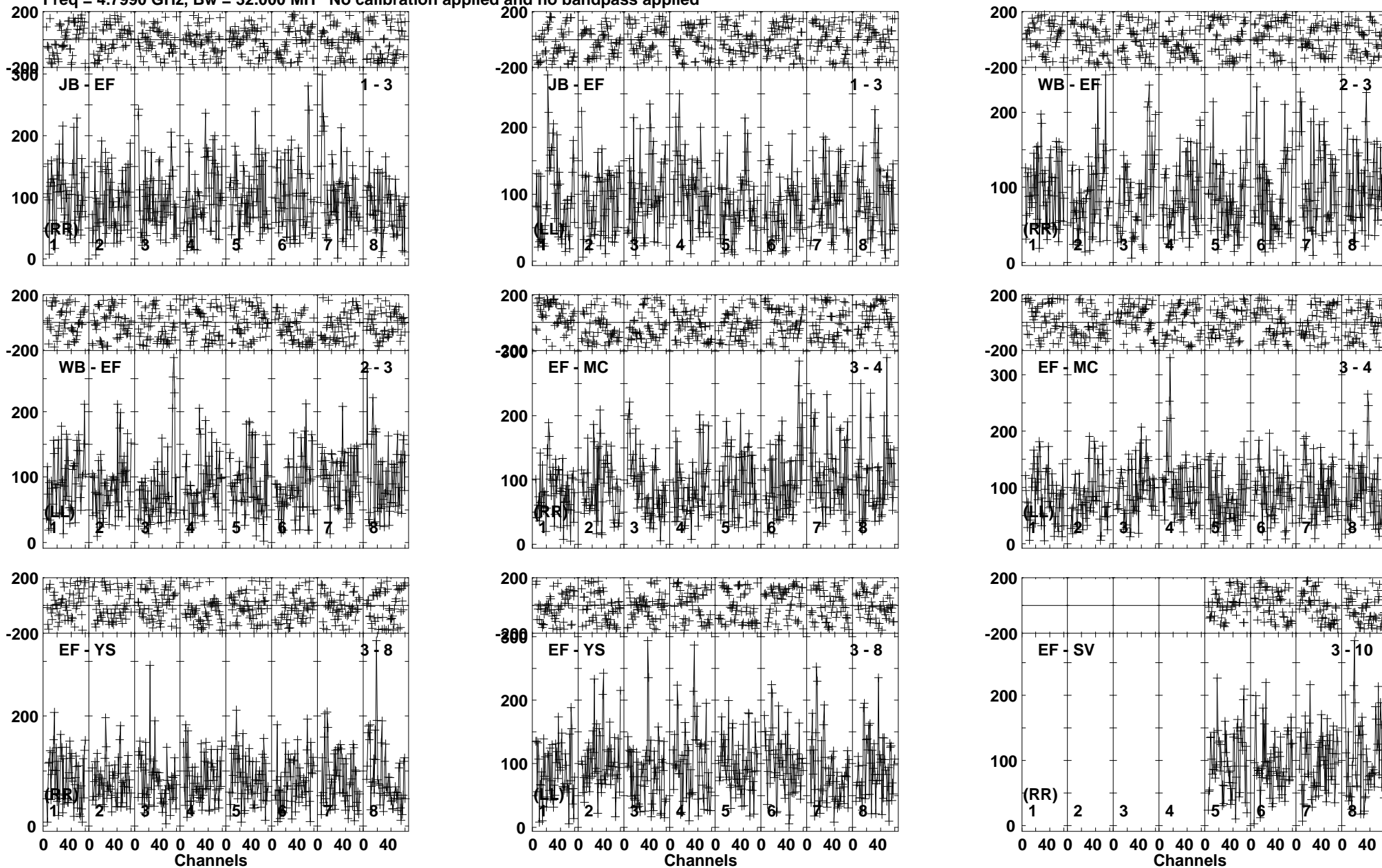

Lower frame: Micro Ampl Jy Top frame: Phas deg
Vector averaged cross-power spectrum Baseline: JB (01) - EF (03)
Timerange: 00/13:58:01 to 00/14:00:59

Plot file version 80 created 20-SEP-2019 15:51:24

AT2019EHZ RSM05.UVDATA.1

Freq = 4.7990 GHz, Bw = 32.000 MH No calibration applied and no bandpass applied

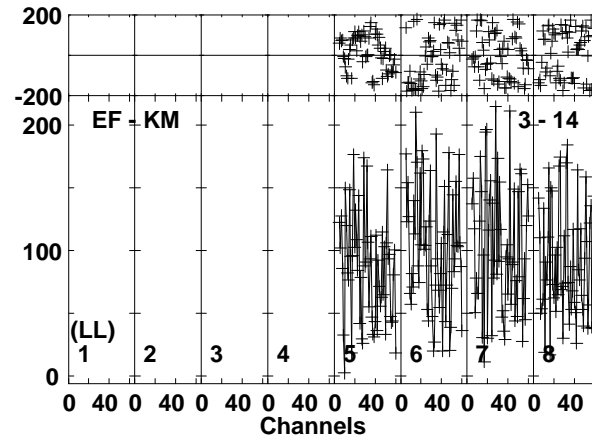
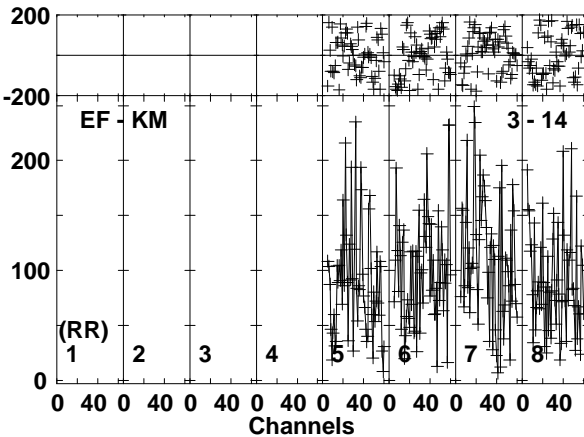
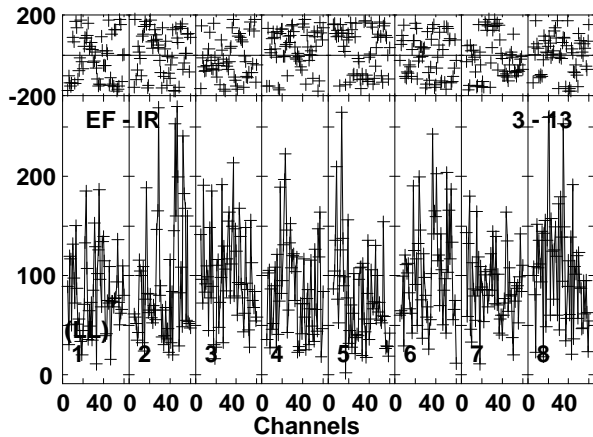
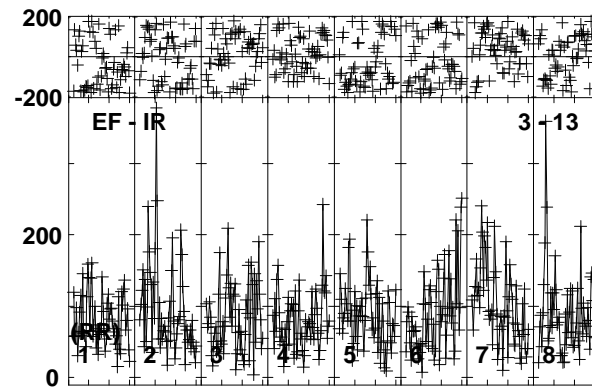
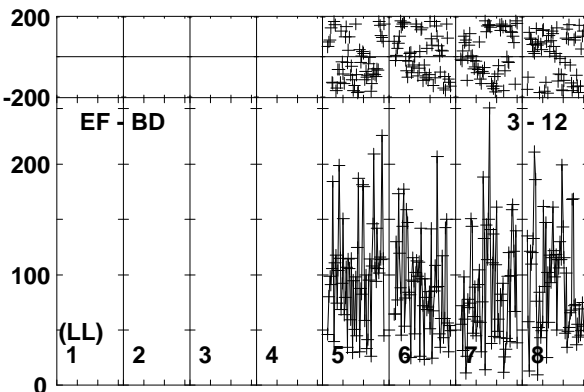
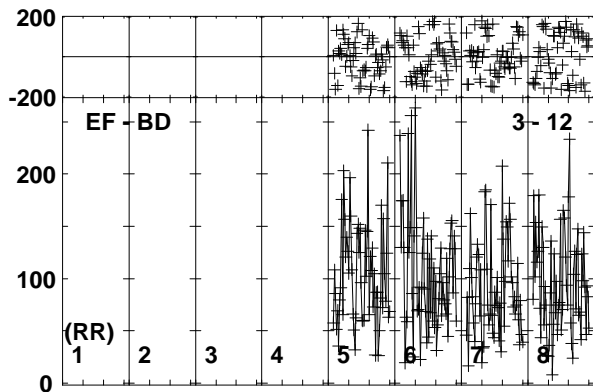
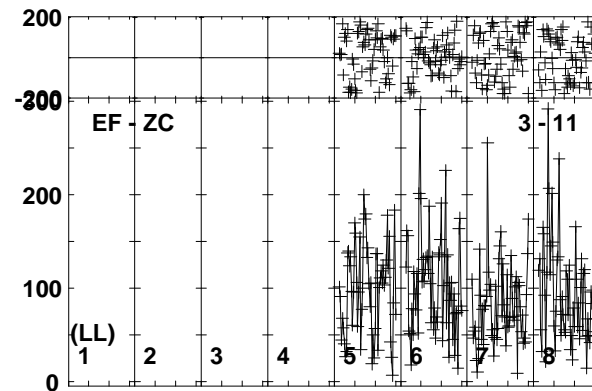
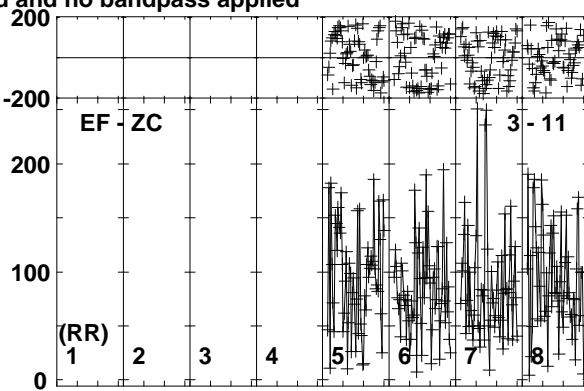
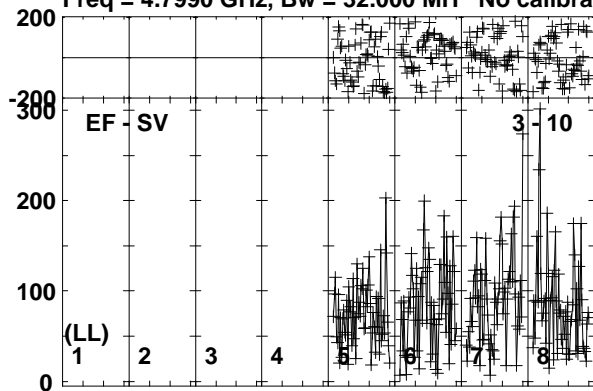

Lower frame: Micro Ampl Jy Top frame: Phas deg
Vector averaged cross-power spectrum Baseline: EF (03) - SV (10)
Timerange: 00/13:58:01 to 00/14:00:59

Plot file version 81 created 20-SEP-2019 15:51:25
 AT2019EHZ RSM05.UVDATA.1
 Freq = 4.7990 GHz, Bw = 32.000 MH No calibration applied and no bandpass applied

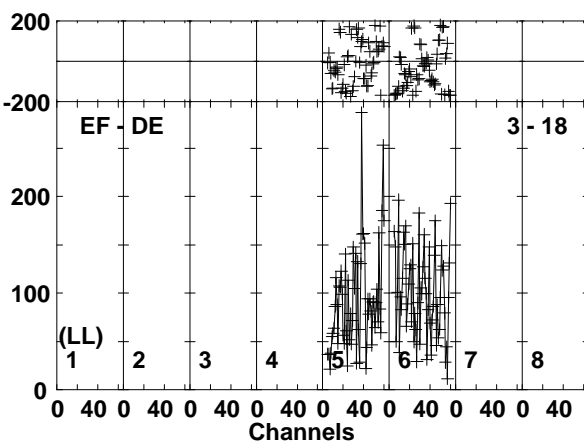
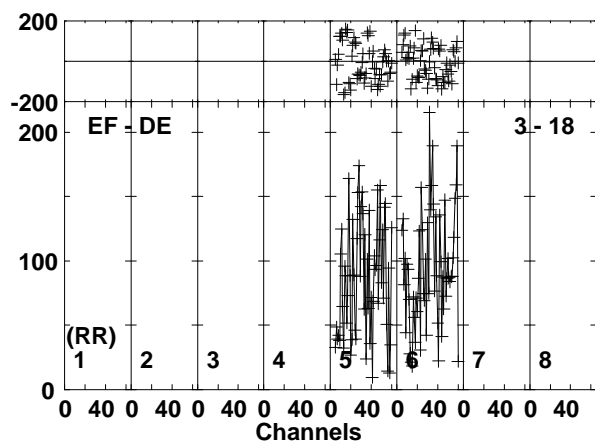
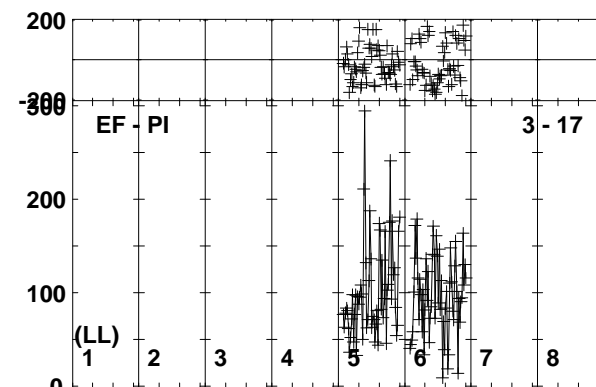
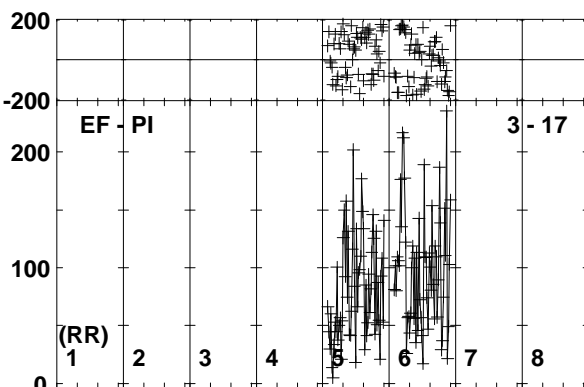
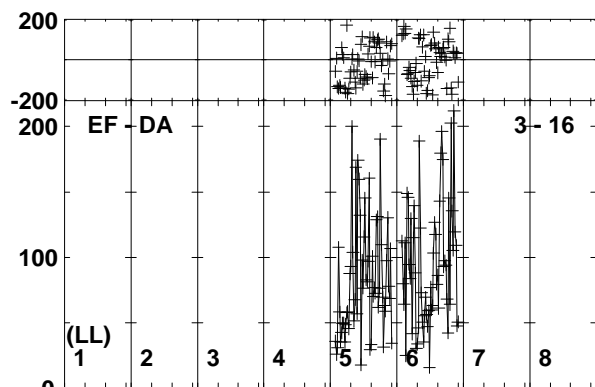
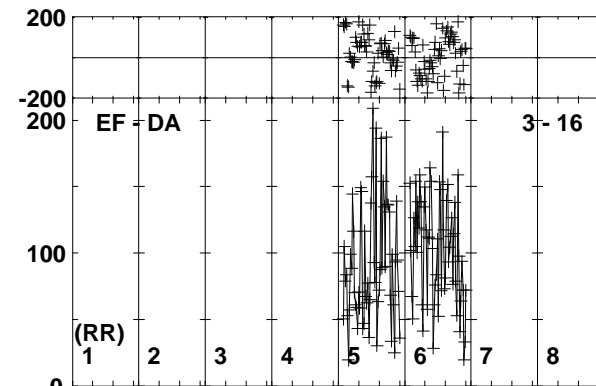
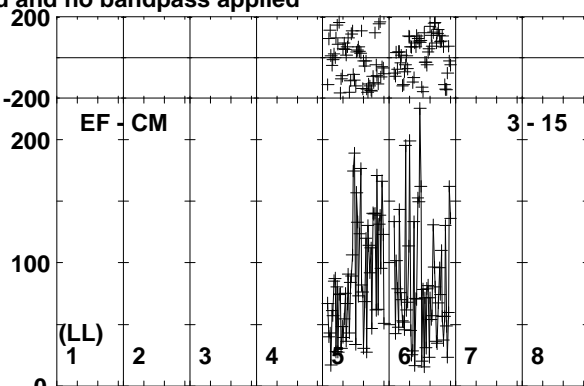
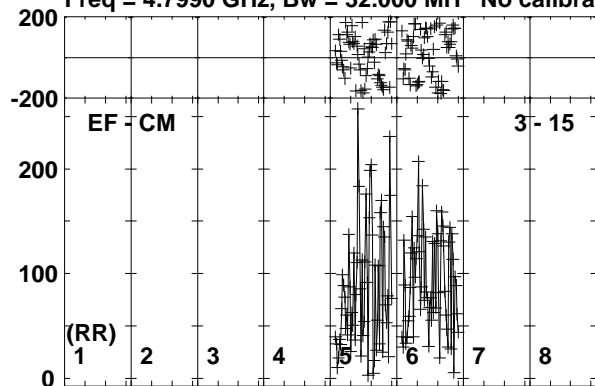

Lower frame: Micro Ampl Jy Top frame: Phas deg
 Vector averaged cross-power spectrum Baseline: EF (03) - CM (15)
 Timerange: 00/13:58:01 to 00/14:00:59

Plot file version 82 created 20-SEP-2019 15:51:25

J1408+5613 RSM05.UVDATA.1

Freq = 4.7990 GHz, Bw = 32.000 MH No calibration applied and no bandpass applied

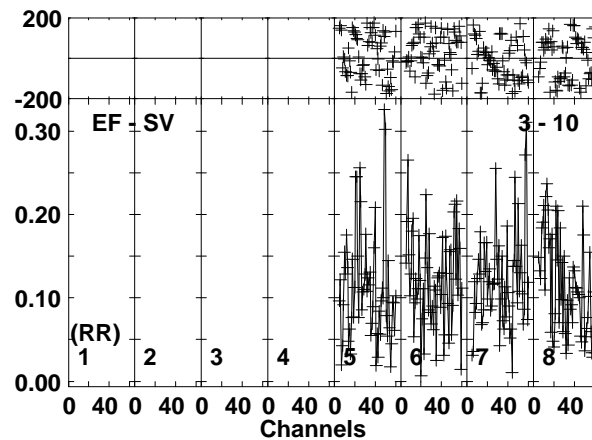
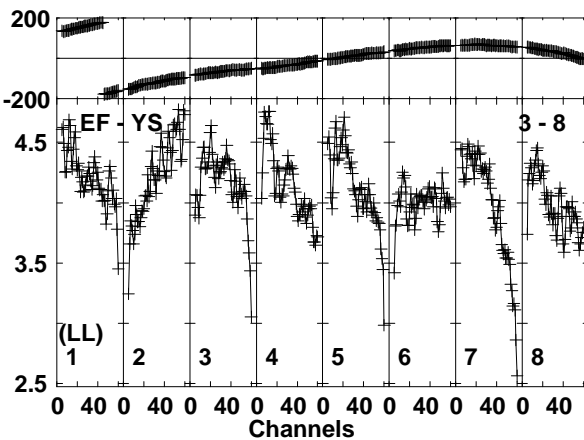
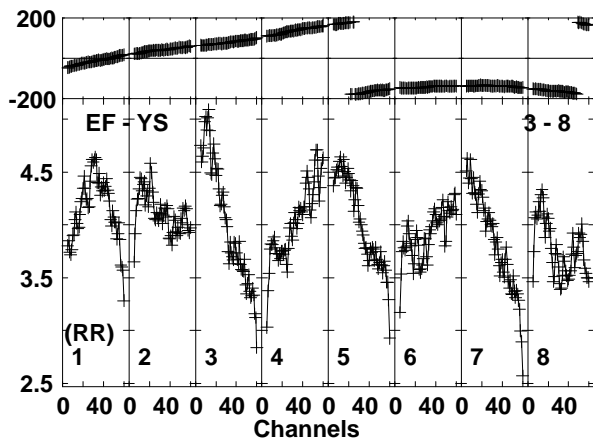
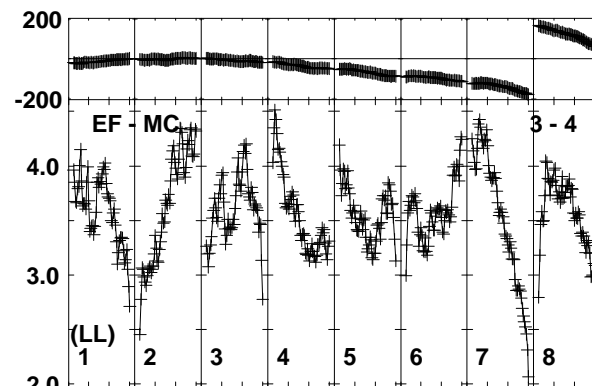
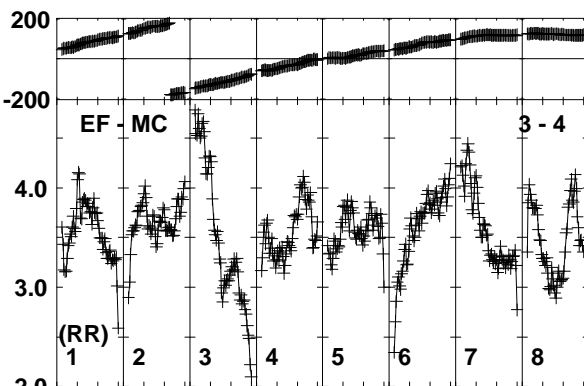
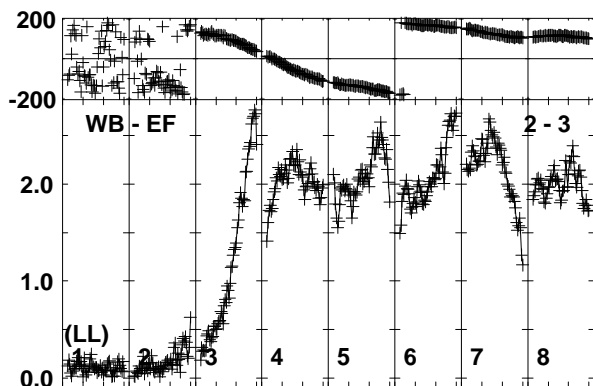
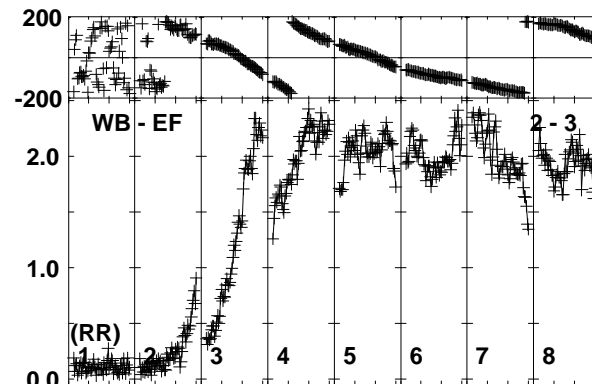
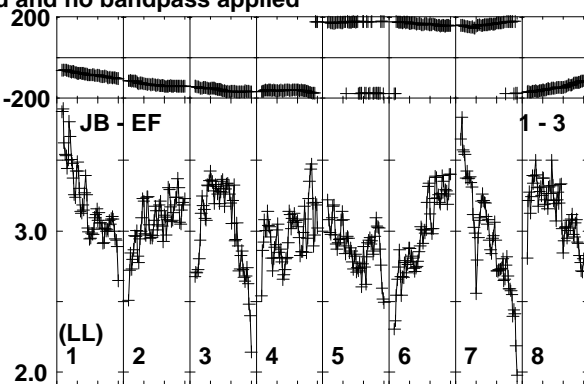
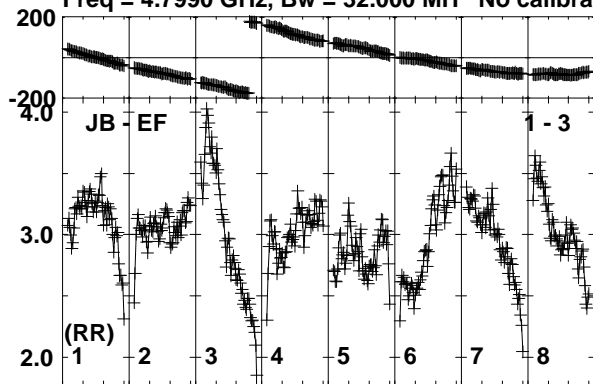

Lower frame: Milli Ampl Jy Top frame: Phas deg
Vector averaged cross-power spectrum Baseline: JB (01) - EF (03)
Timerange: 00/14:01:50 to 00/14:03:19

Plot file version 83 created 20-SEP-2019 15:51:26

J1408+5613 RSM05.UVDATA.1

Freq = 4.7990 GHz, Bw = 32.000 MH No calibration applied and no bandpass applied

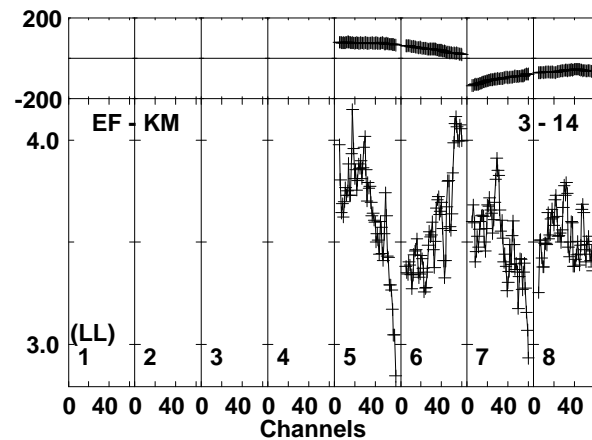
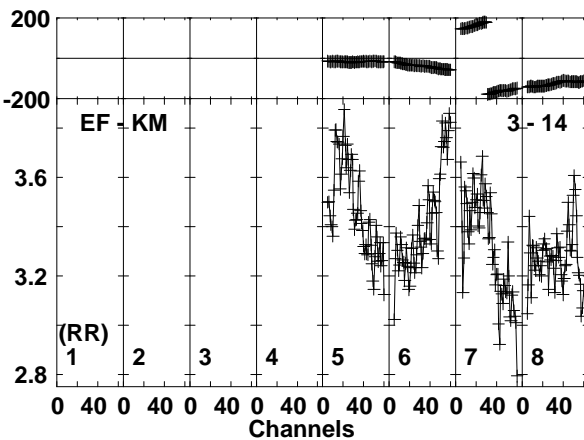
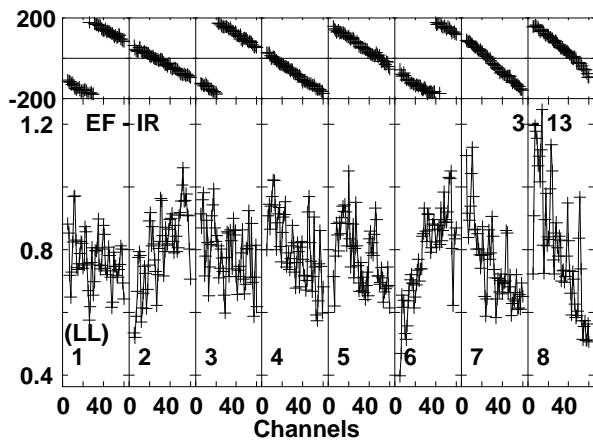
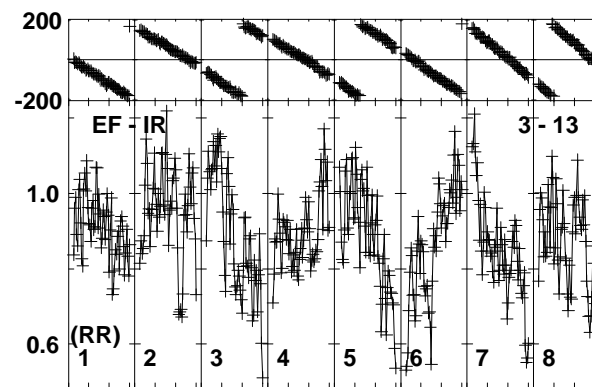
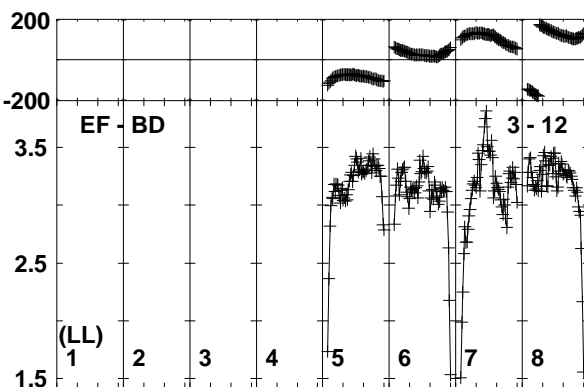
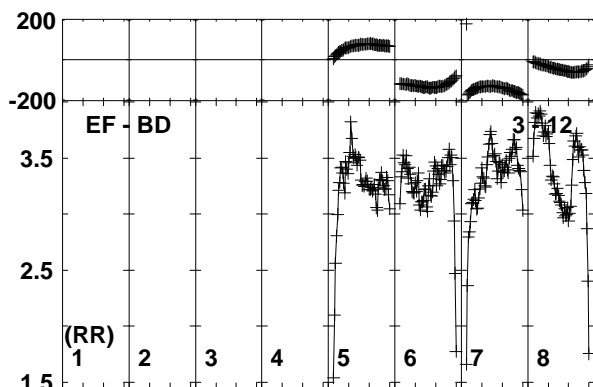
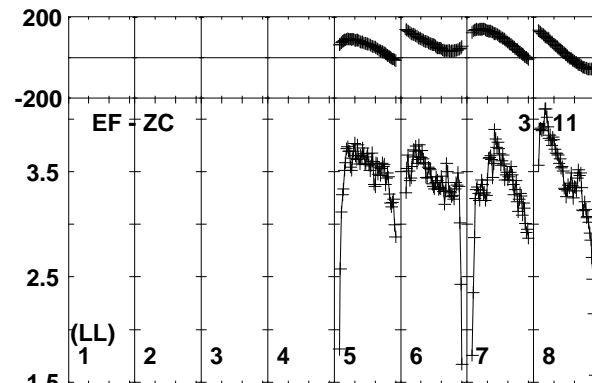
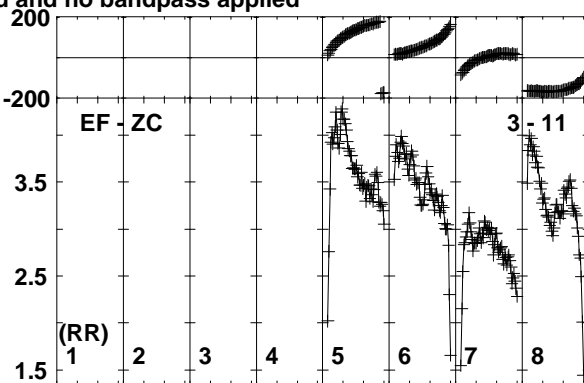
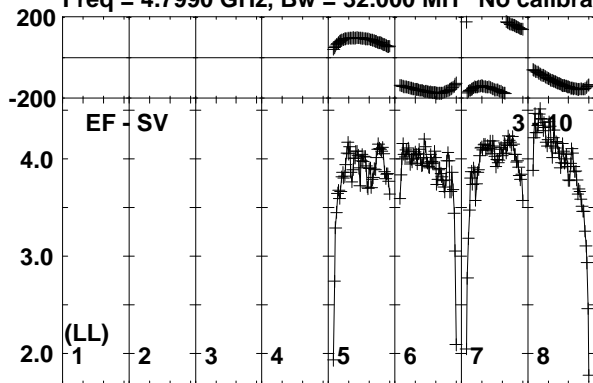

Lower frame: Milli Ampl Jy Top frame: Phas deg
Vector averaged cross-power spectrum Baseline: EF (03) - SV (10)
Timerange: 00/14:01:50 to 00/14:03:19

Plot file version 84 created 20-SEP-2019 15:51:26
 J1408+5613 RSM05.UVDATA.1
 Freq = 4.7990 GHz, Bw = 32.000 MH No calibration applied and no bandpass applied

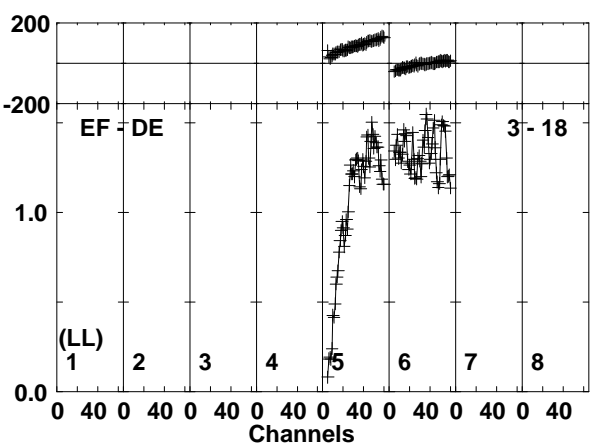
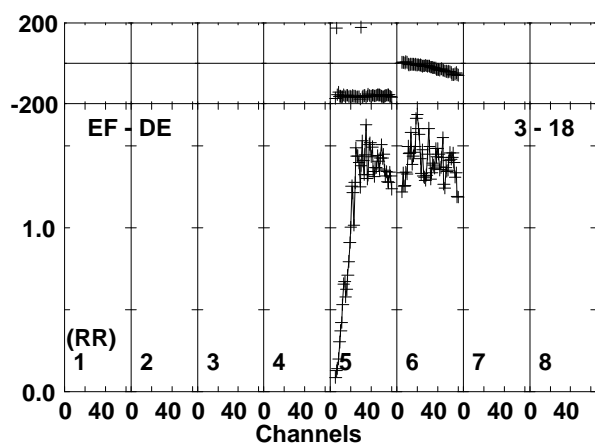
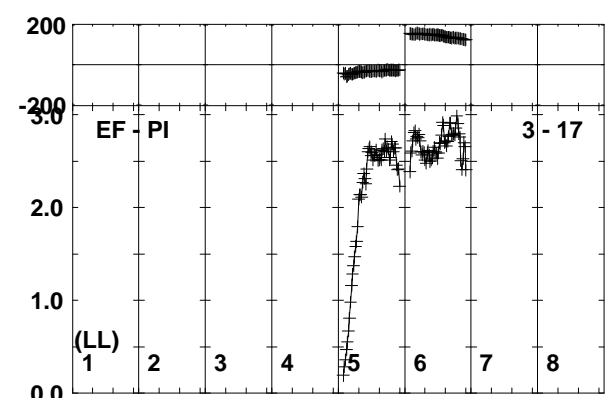
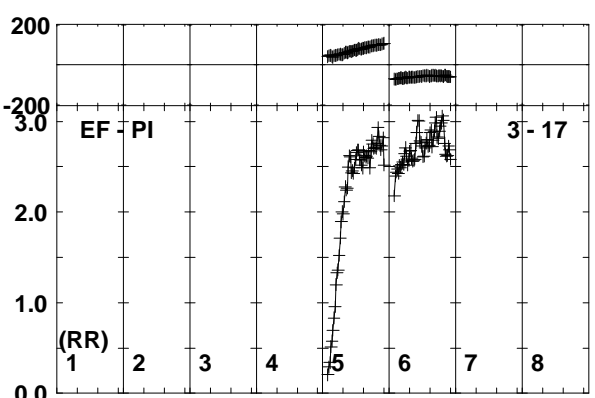
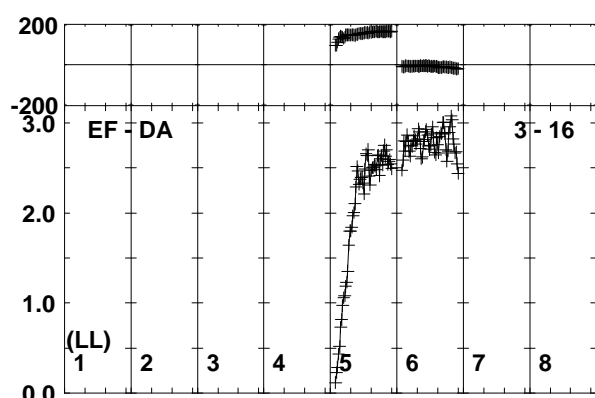
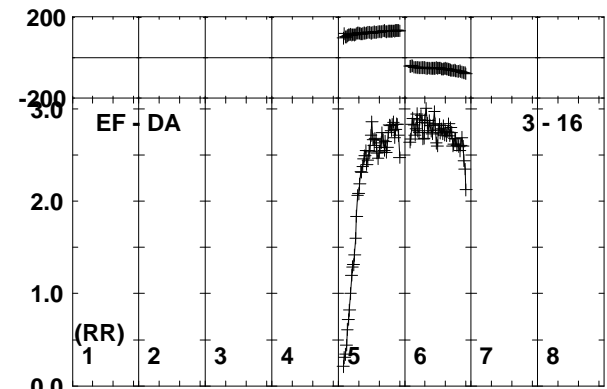
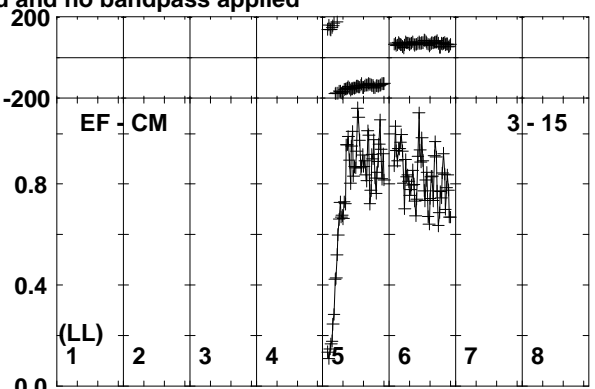
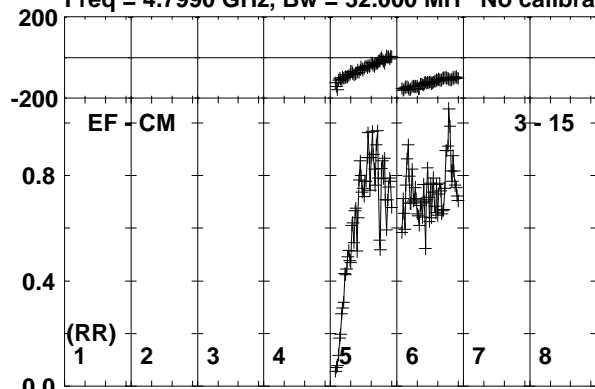

Lower frame: Milli Ampl Jy Top frame: Phas deg
 Vector averaged cross-power spectrum Baseline: EF (03) - CM (15)
 Timerange: 00/14:01:50 to 00/14:03:19

Plot file version 85 created 20-SEP-2019 15:51:26

AT2019EHZ RSM05.UVDATA.1

Freq = 4.7990 GHz, Bw = 32.000 MH No calibration applied and no bandpass applied

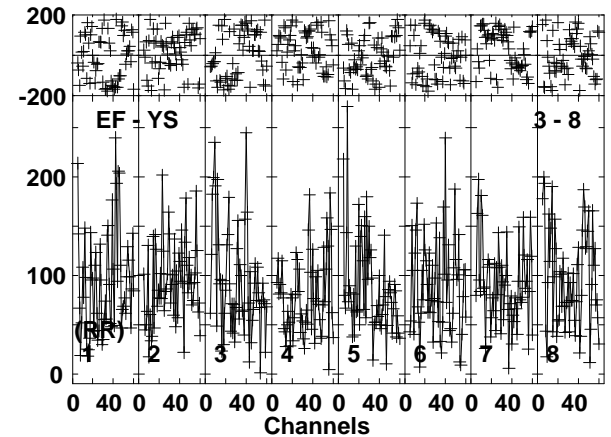
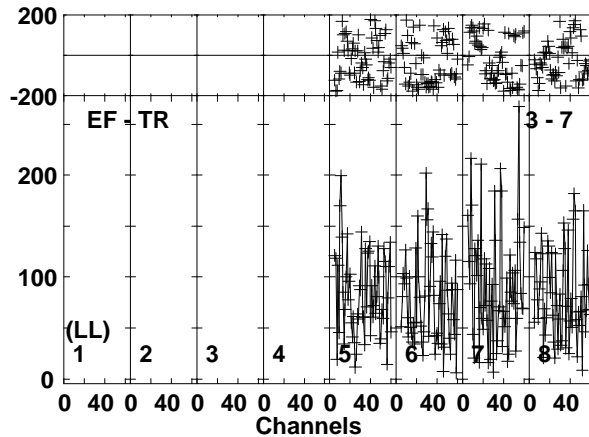
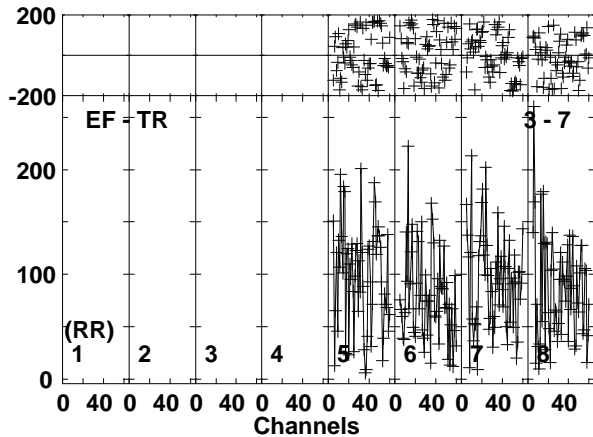
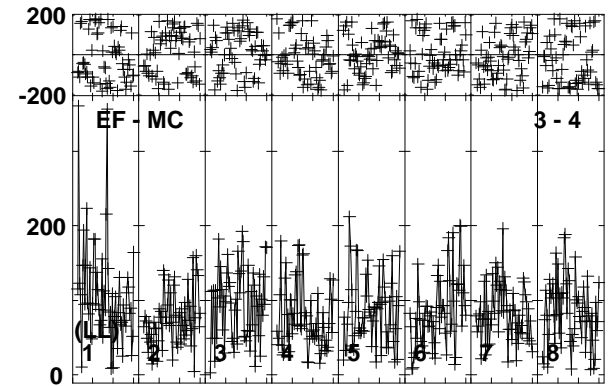
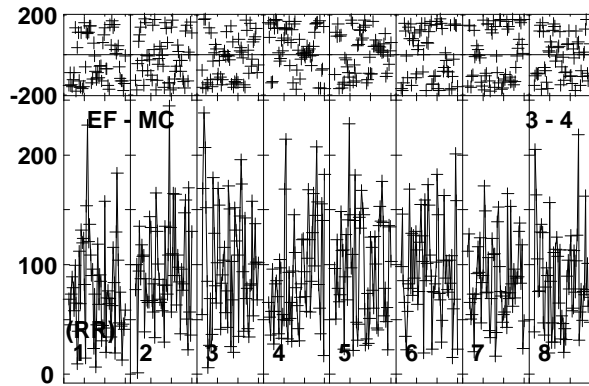
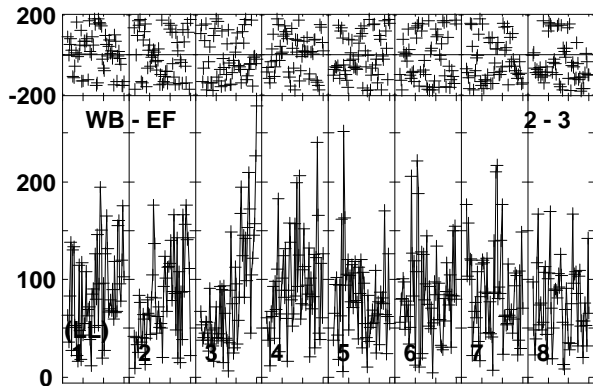
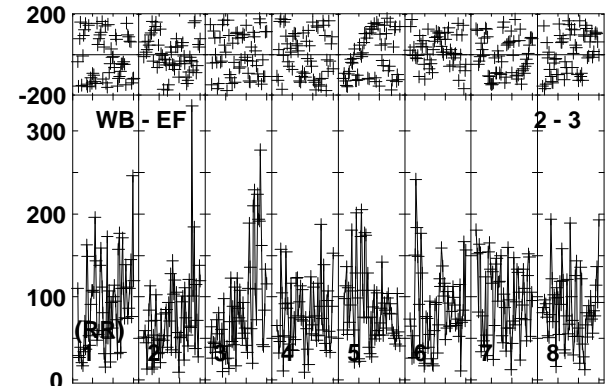
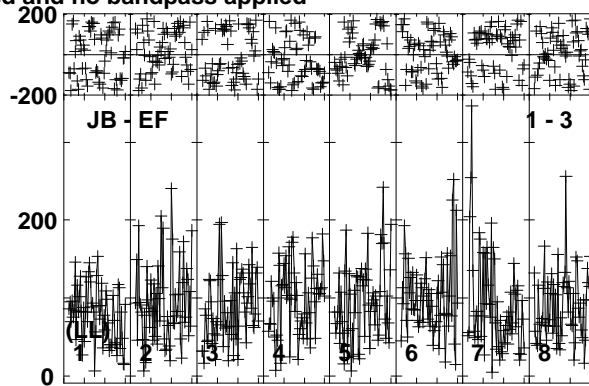
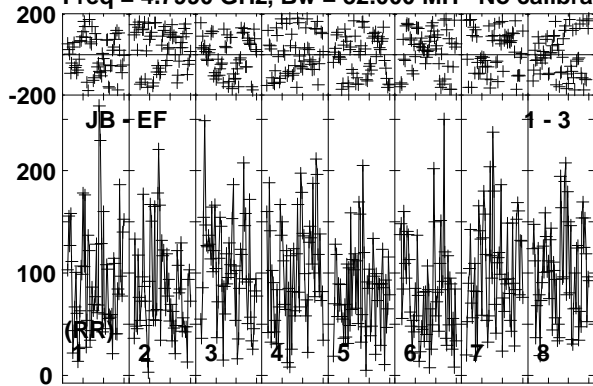

Lower frame: Micro Ampl Jy Top frame: Phas deg
Vector averaged cross-power spectrum Baseline: JB (01) - EF (03)
Timerange: 00/14:03:21 to 00/14:06:20

Plot file version 86 created 20-SEP-2019 15:51:27

AT2019EHZ RSM05.UVDATA.1

Freq = 4.7990 GHz, Bw = 32.000 MH No calibration applied and no bandpass applied

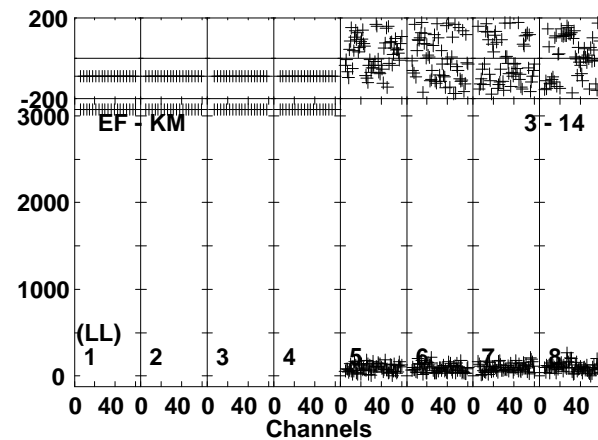
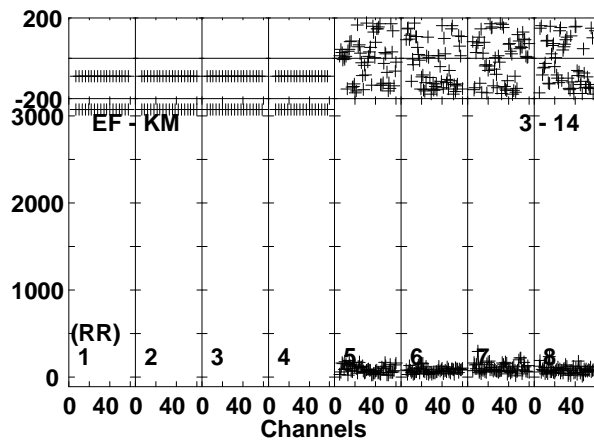
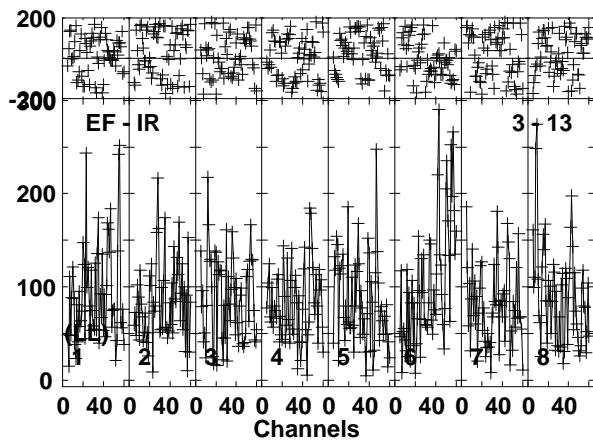
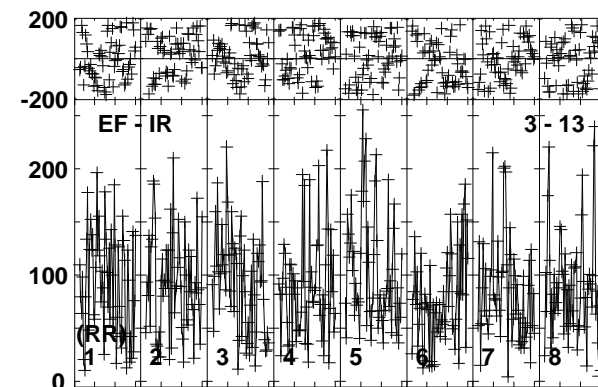
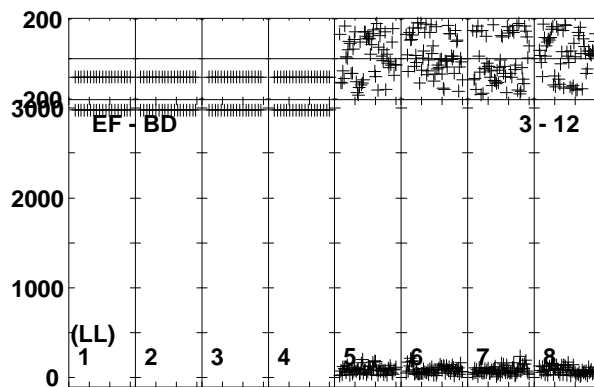
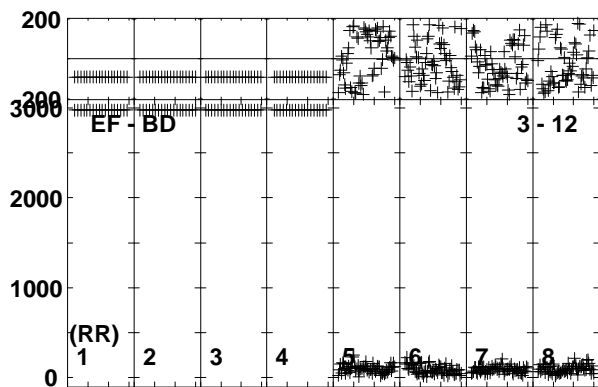
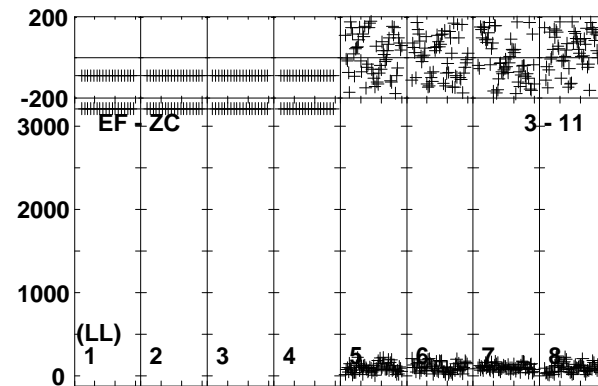
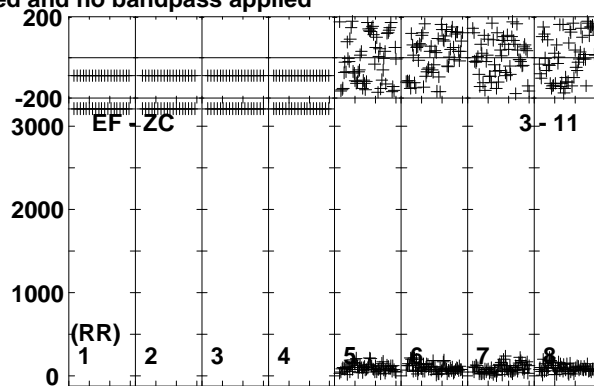
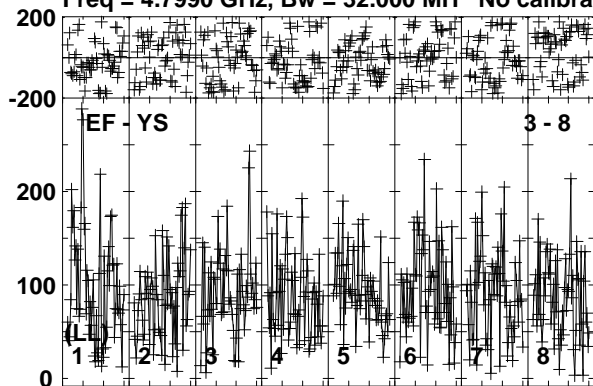

Lower frame: Micro Ampl Jy Top frame: Phas deg
Vector averaged cross-power spectrum Baseline: EF (03) - YS (08)
Timerange: 00/14:03:21 to 00/14:06:20

Plot file version 87 created 20-SEP-2019 15:51:28

AT2019EHZ RSM05.UVDATA.1

Freq = 4.7990 GHz, Bw = 32.000 MH No calibration applied and no bandpass applied

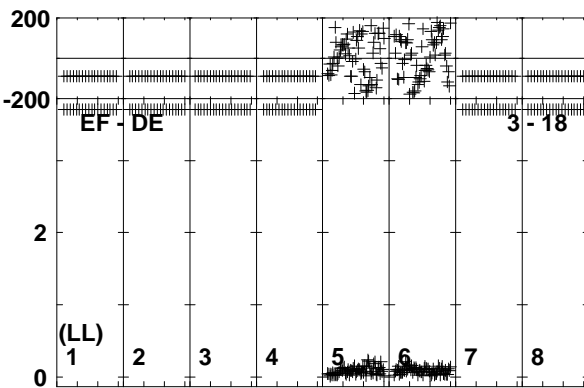
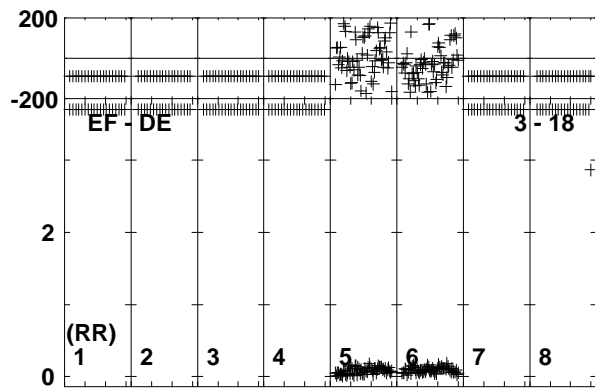
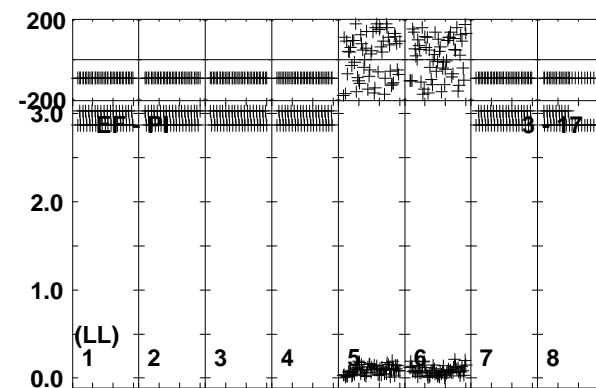
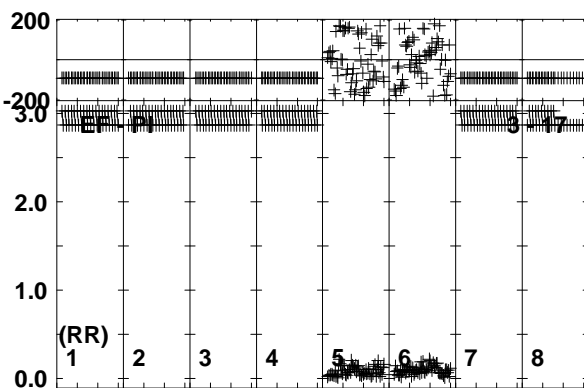
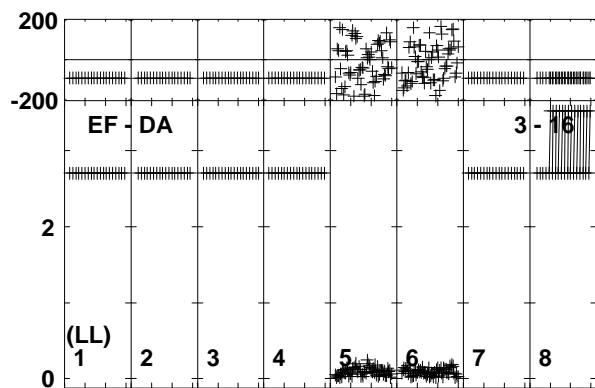
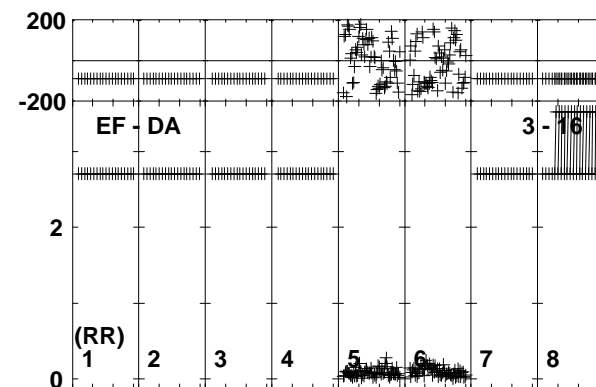
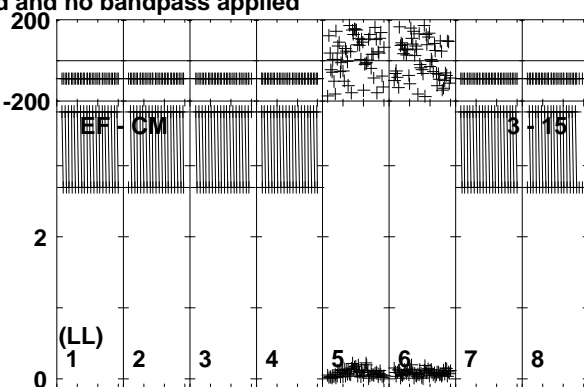
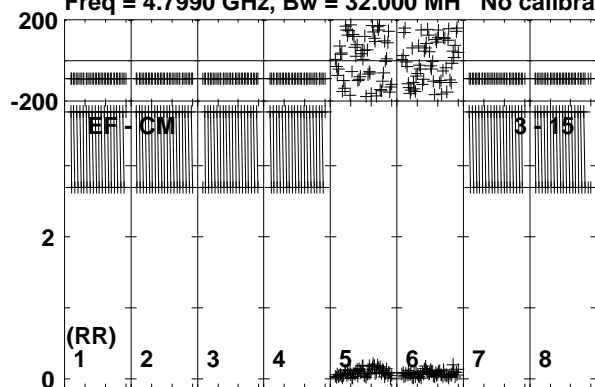

Lower frame: Milli Ampl Jy Top frame: Phas deg
Vector averaged cross-power spectrum Baseline: EF (03) - CM (15)
Timerange: 00/14:03:21 to 00/14:06:20

Plot file version 88 created 20-SEP-2019 15:51:28

J1408+5613 RSM05.UVDATA.1

Freq = 4.7990 GHz, Bw = 32.000 MH No calibration applied and no bandpass applied

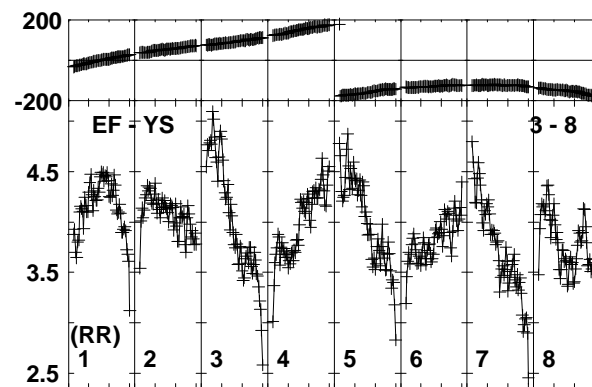
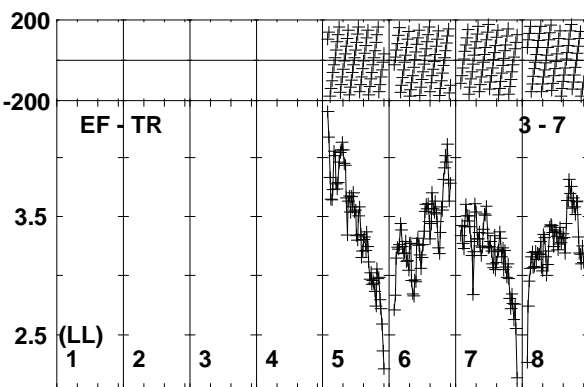
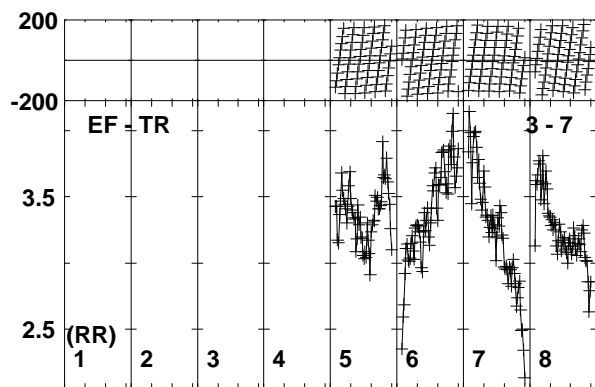
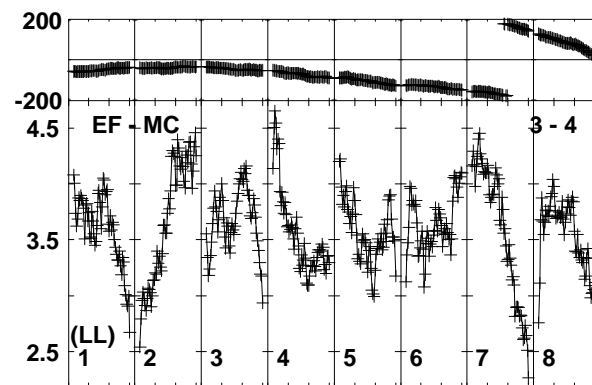
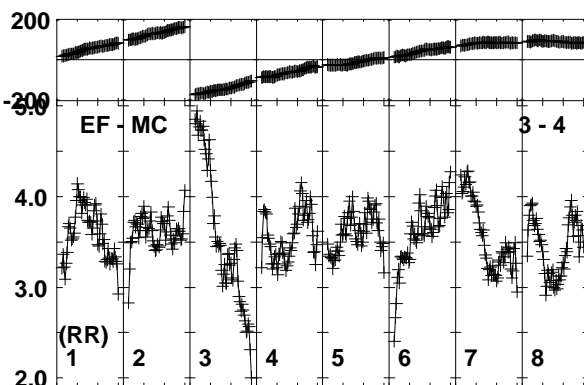
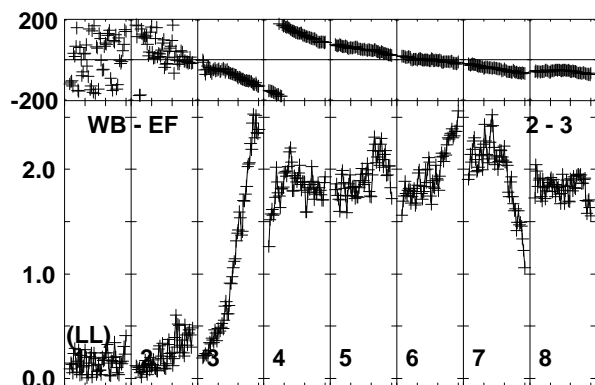
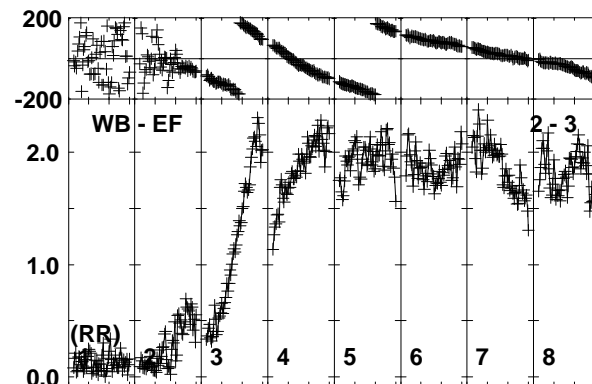
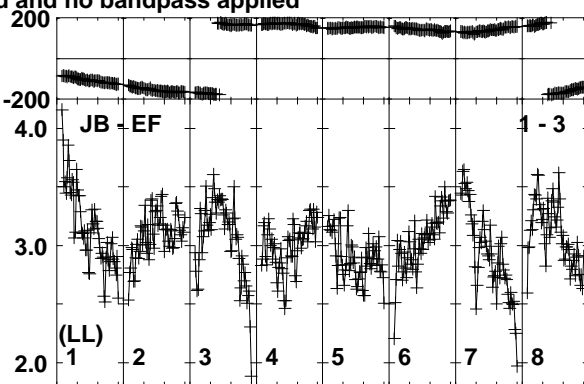
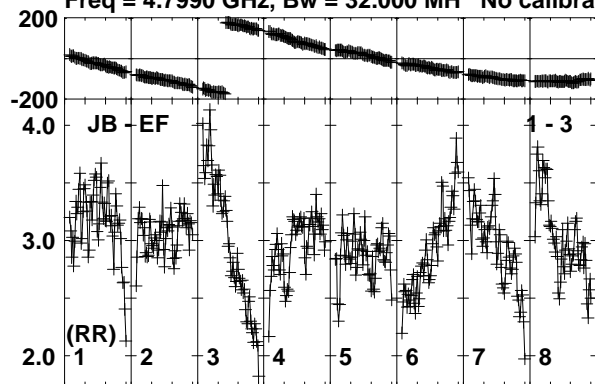

Lower frame: Milli Ampl Jy Top frame: Phas deg

Vector averaged cross-power spectrum Baseline: JB (01) - EF (03)

Timerange: 00/14:06:20 to 00/14:07:50

Plot file version 89 created 20-SEP-2019 15:51:29

J1408+5613 RSM05.UVDATA.1

Freq = 4.7990 GHz, Bw = 32.000 MH No calibration applied and no bandpass applied

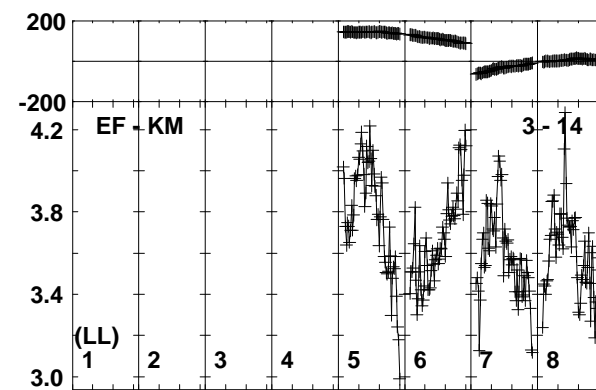
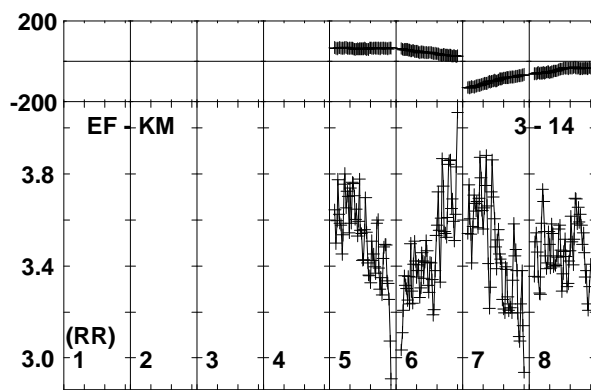
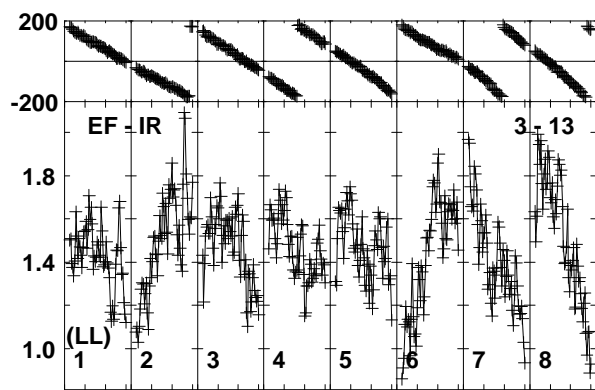
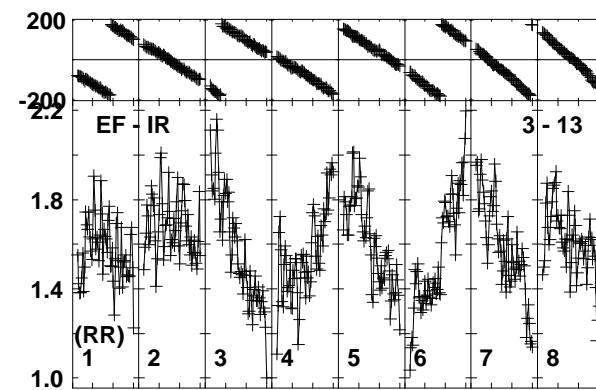
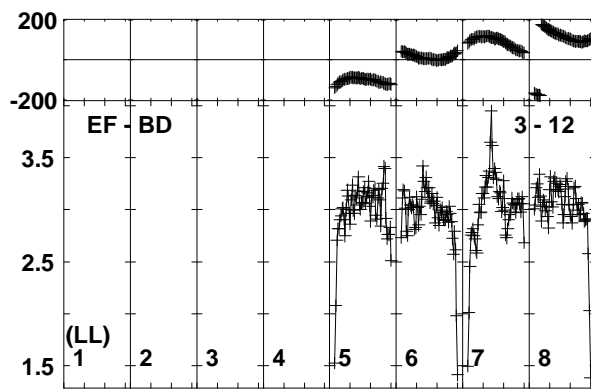
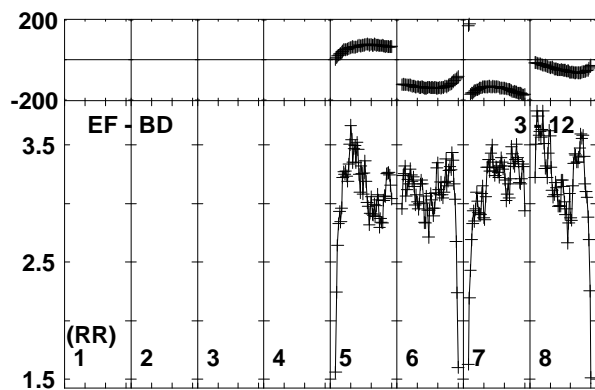
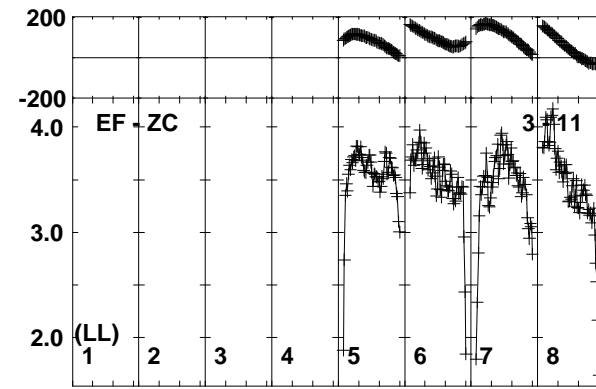
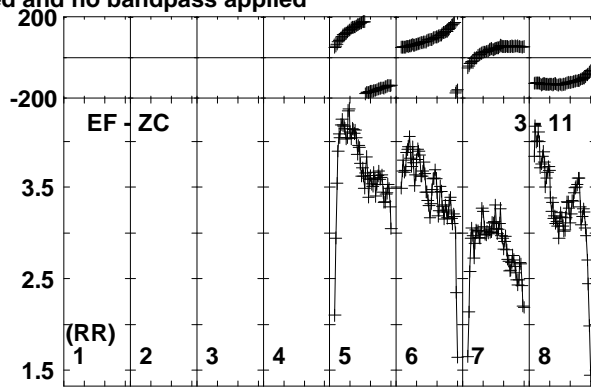
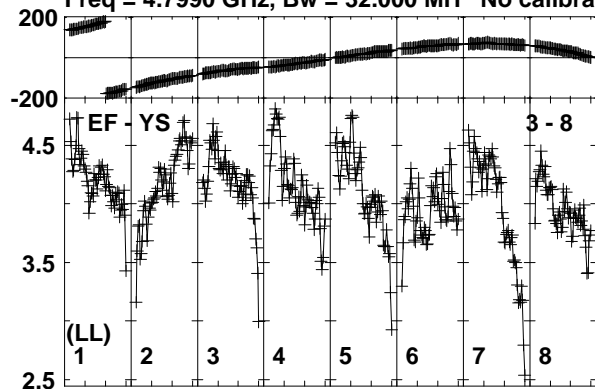

Lower frame: Milli Ampl Jy Top frame: Phas deg
Vector averaged cross-power spectrum Baseline: EF (03) - YS (08)
Timerange: 00/14:06:20 to 00/14:07:50

Plot file version 90 created 20-SEP-2019 15:51:29
 J1408+5613 RSM05.UVDATA.1
 Freq = 4.7990 GHz, Bw = 32.000 MH No calibration applied and no bandpass applied

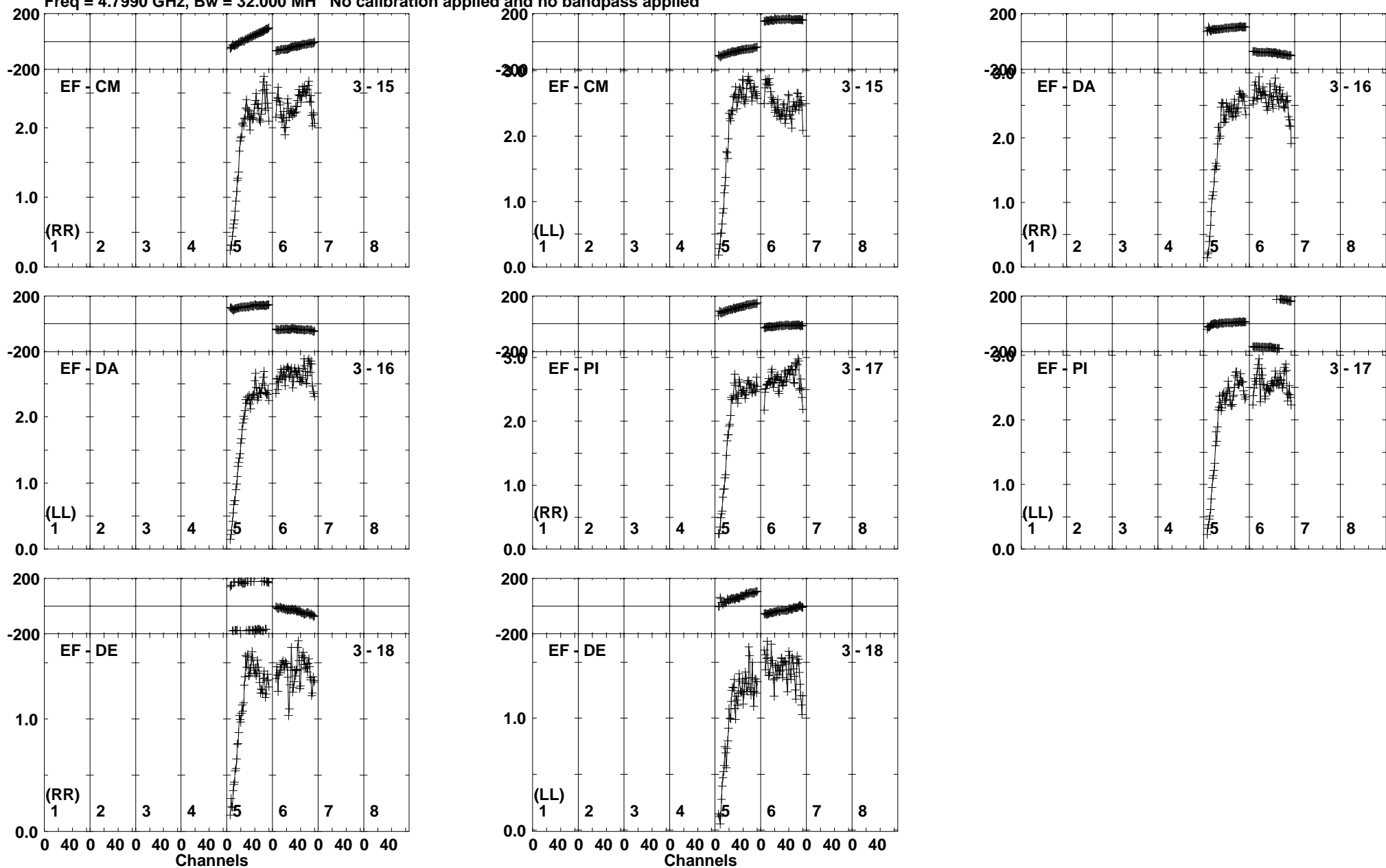

Lower frame: Milli Ampl Jy Top frame: Phas deg
 Vector averaged cross-power spectrum Baseline: EF (03) - CM (15)
 Timerange: 00/14:06:20 to 00/14:07:50

Plot file version 91 created 20-SEP-2019 15:51:29
 AT2019EHZ RSM05.UVDATA.1
 Freq = 4.7990 GHz, Bw = 32.000 MH No calibration applied and no bandpass applied

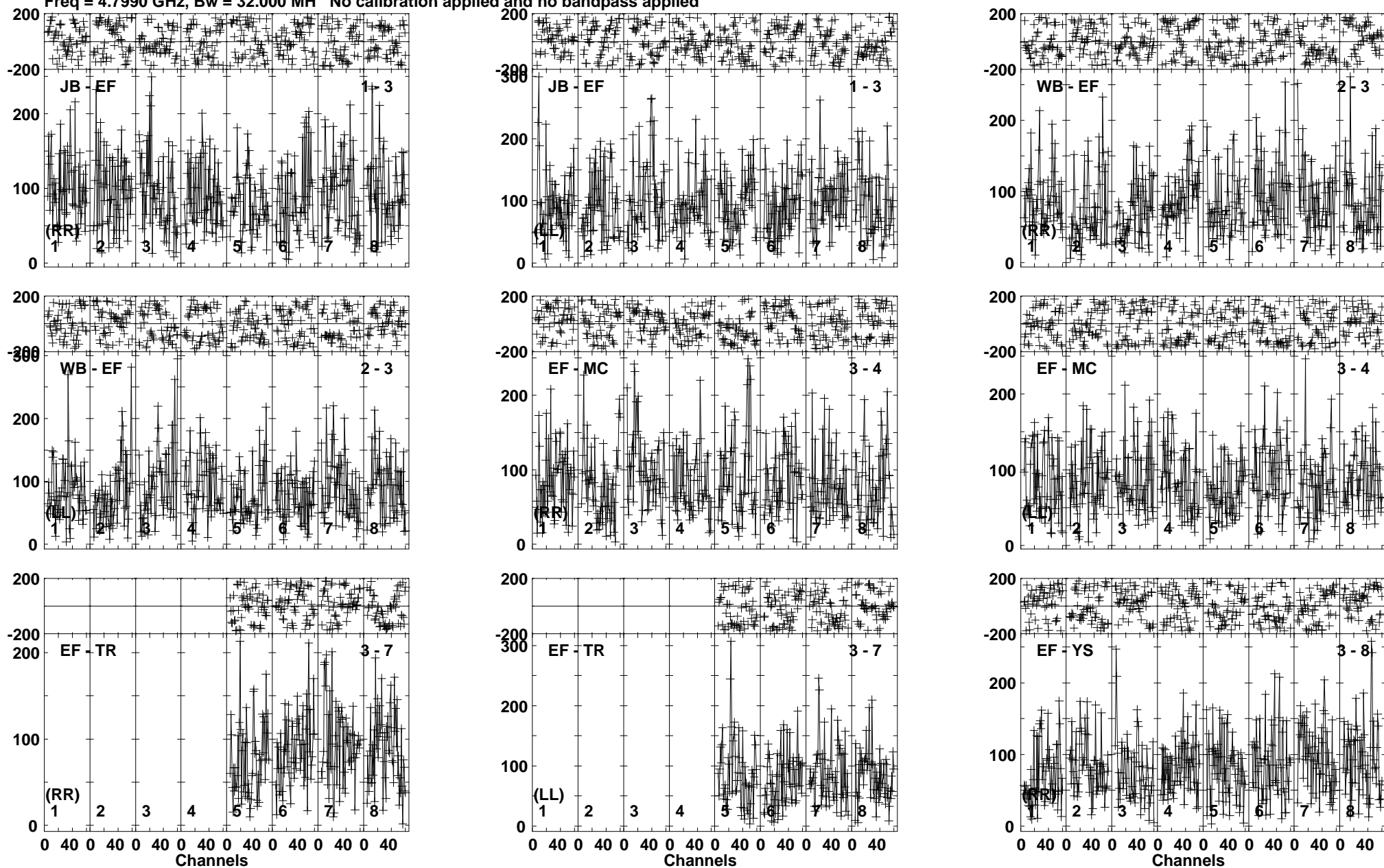

Lower frame: Micro Ampl Jy Top frame: Phas deg
 Vector averaged cross-power spectrum Baseline: JB (01) - EF (03)
 Timerange: 00/14:07:50 to 00/14:10:50

Plot file version 92 created 20-SEP-2019 15:51:30

AT2019EHZ RSM05.UVDATA.1

Freq = 4.7990 GHz, Bw = 32.000 MH No calibration applied and no bandpass applied

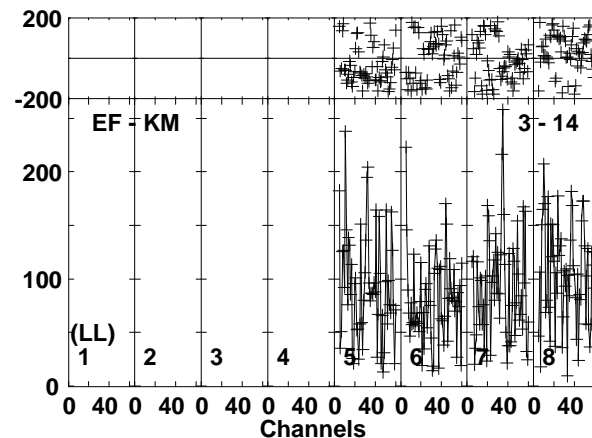
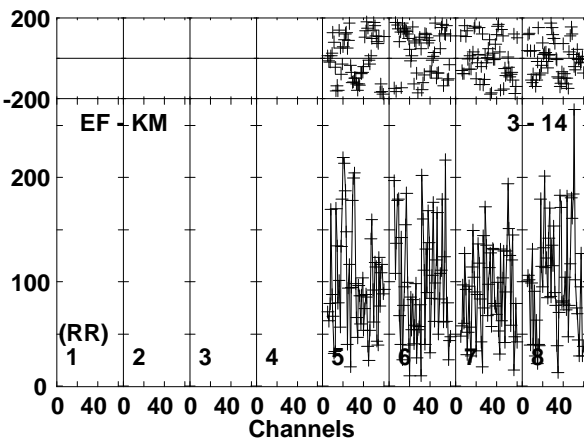
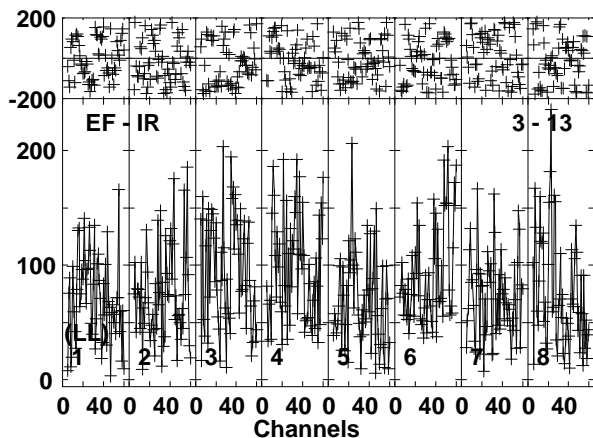
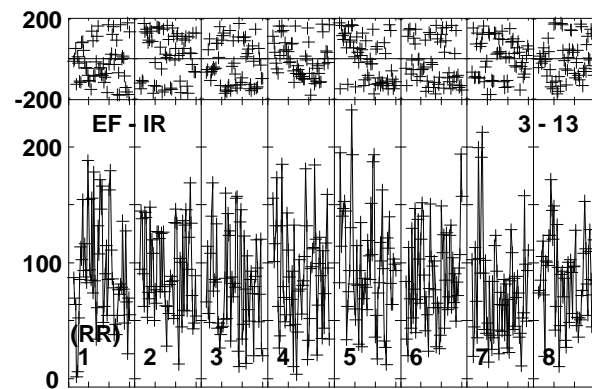
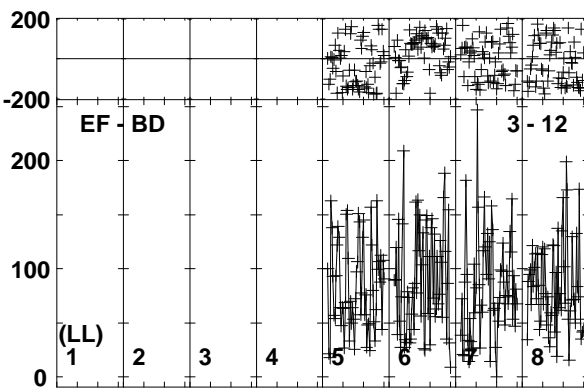
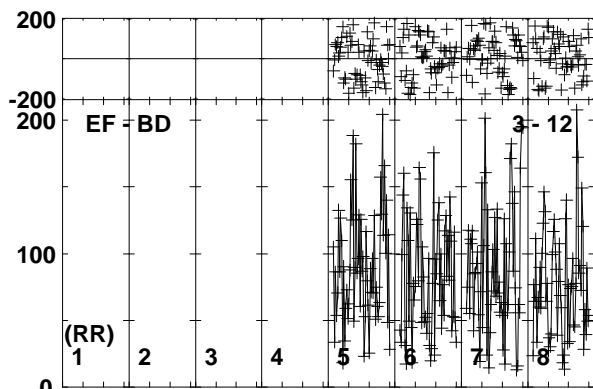
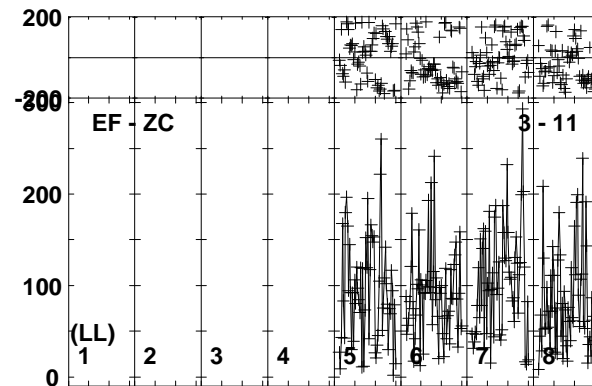
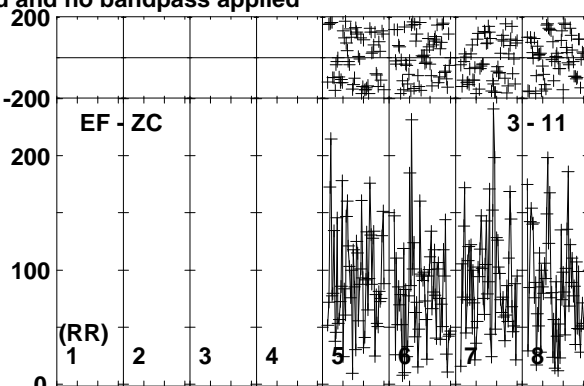
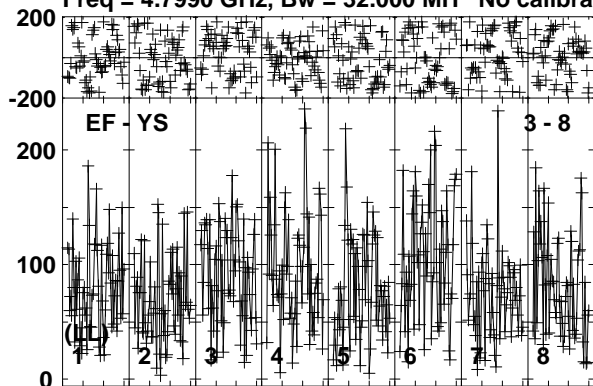

Lower frame: Micro Ampl Jy Top frame: Phas deg
Vector averaged cross-power spectrum Baseline: EF (03) - YS (08)
Timerange: 00/14:07:50 to 00/14:10:50

Plot file version 93 created 20-SEP-2019 15:51:31
 AT2019EHZ RSM05.UVDATA.1
 Freq = 4.7990 GHz, Bw = 32.000 MH No calibration applied and no bandpass applied

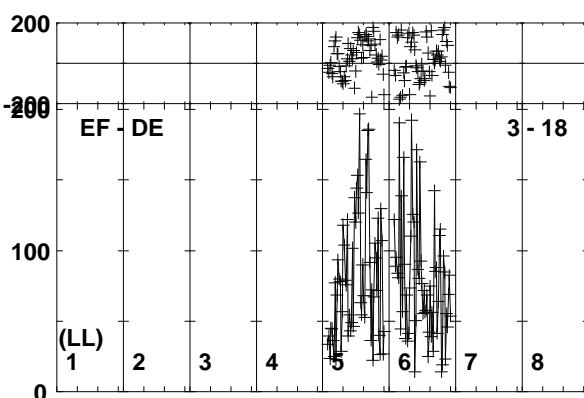
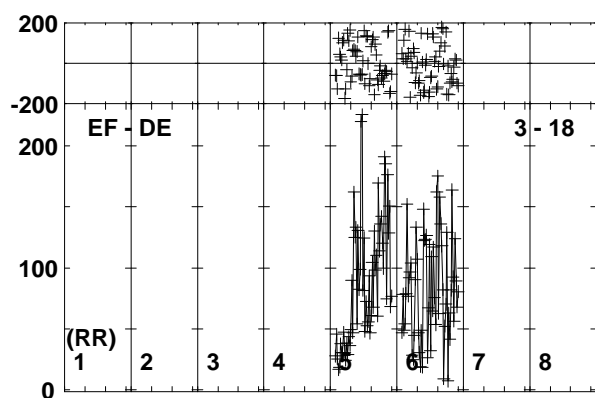
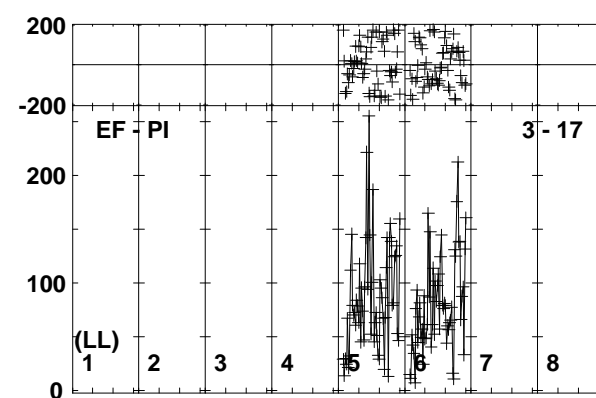
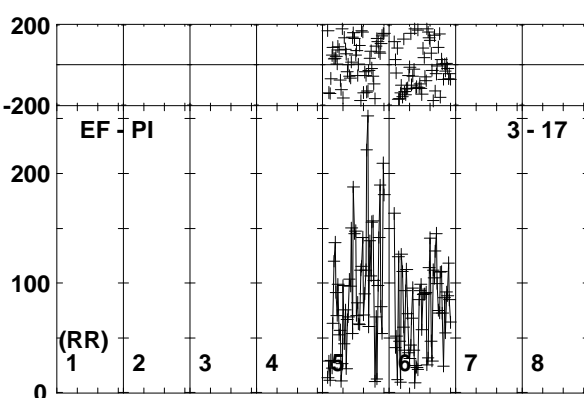
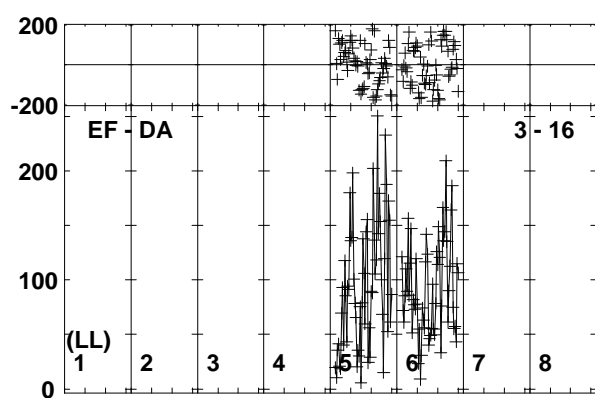
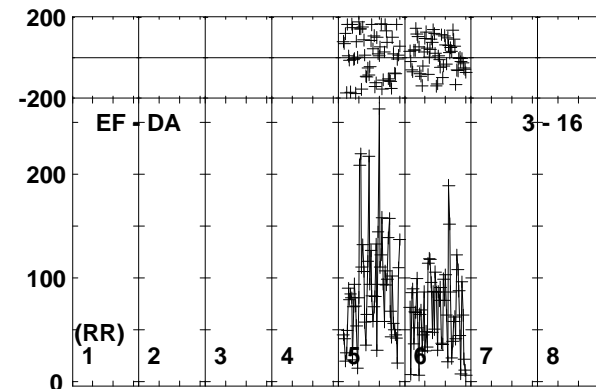
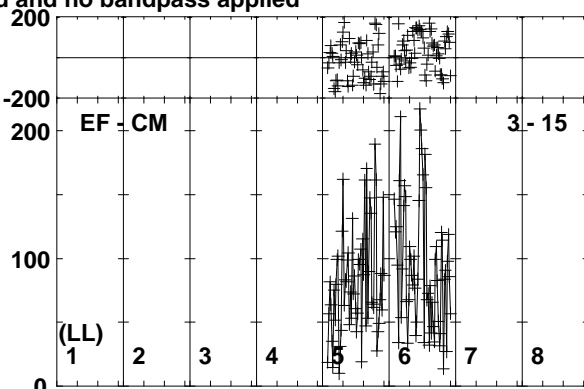
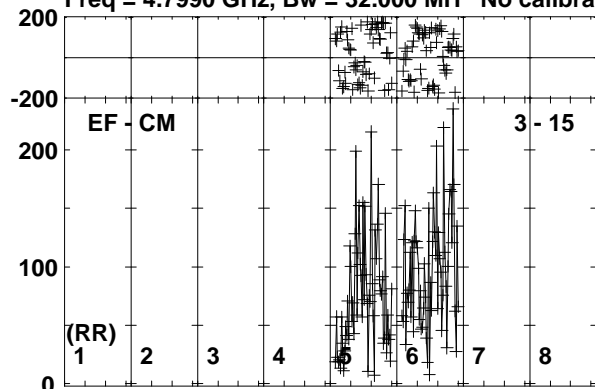

Lower frame: Micro Ampl Jy Top frame: Phas deg
 Vector averaged cross-power spectrum Baseline: EF (03) - CM (15)
 Timerange: 00/14:07:50 to 00/14:10:50

Plot file version 94 created 20-SEP-2019 15:51:31

J1408+5613 RSM05.UVDATA.1

Freq = 4.7990 GHz, Bw = 32.000 MH No calibration applied and no bandpass applied

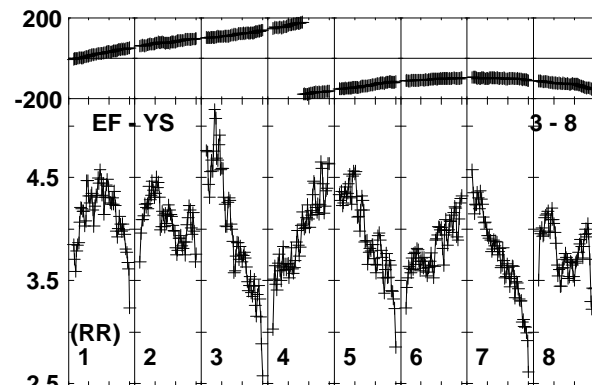
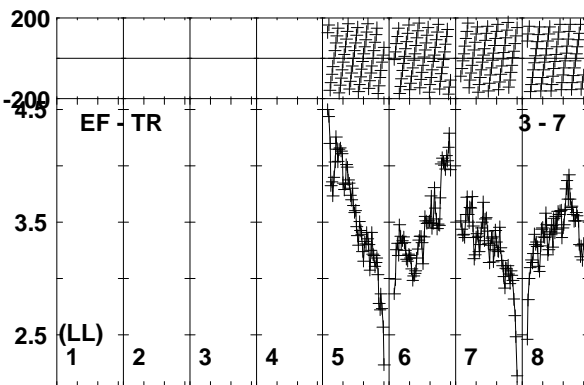
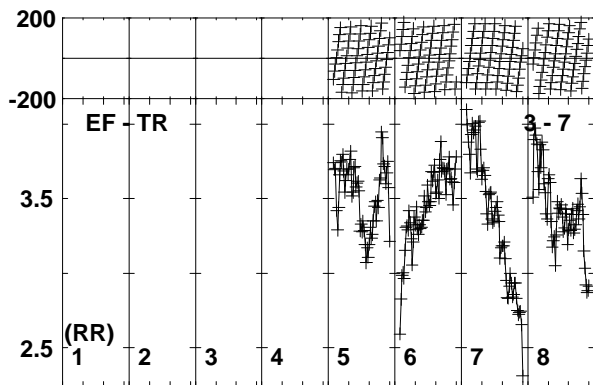
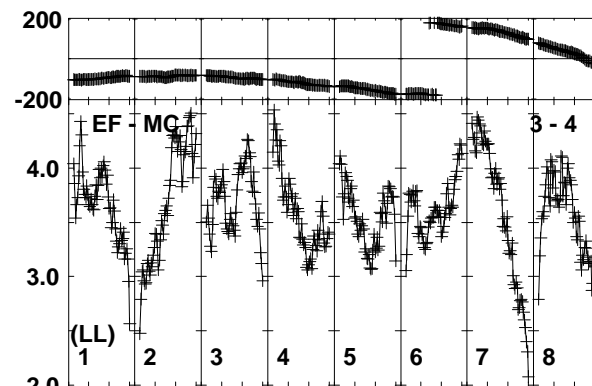
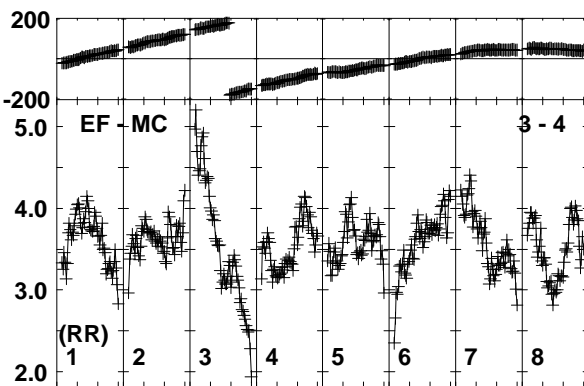
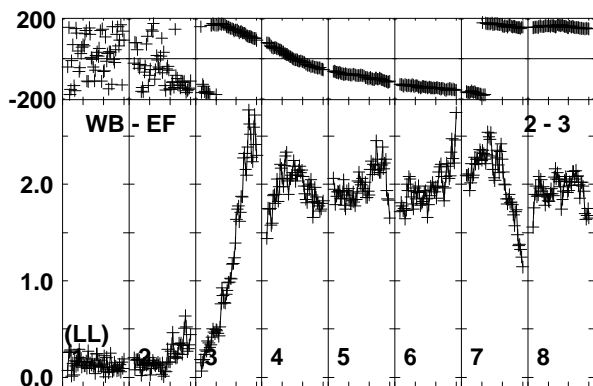
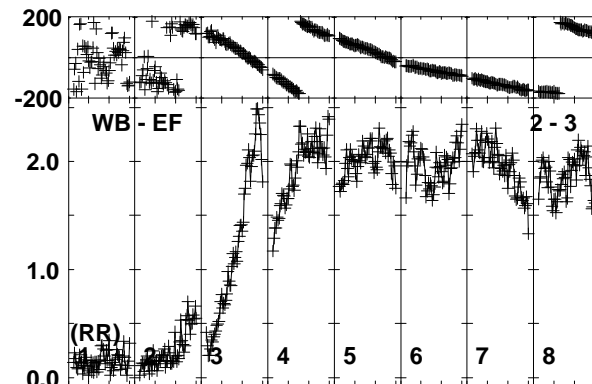
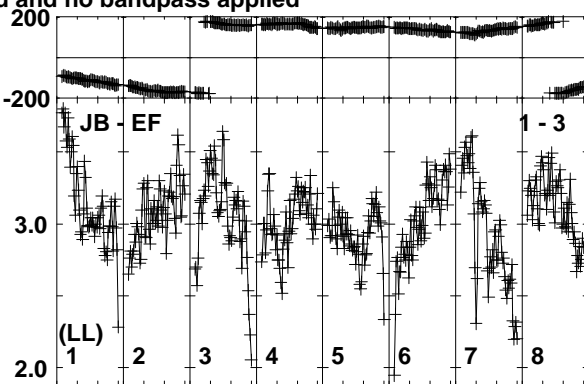
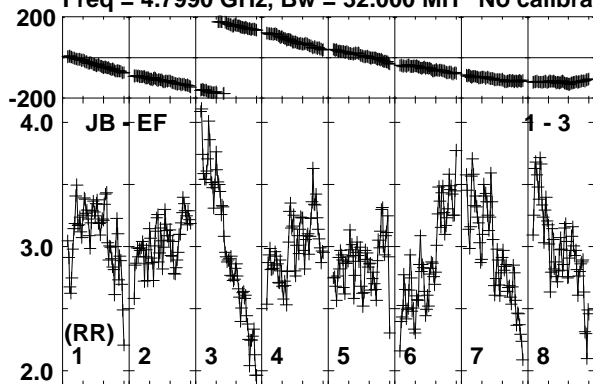

Lower frame: Milli Ampl Jy Top frame: Phas deg
Vector averaged cross-power spectrum Baseline: JB (01) - EF (03)
Timerange: 00/14:10:51 to 00/14:12:20

Plot file version 95 created 20-SEP-2019 15:51:31

J1408+5613 RSM05.UVDATA.1

Freq = 4.7990 GHz, Bw = 32.000 MH No calibration applied and no bandpass applied

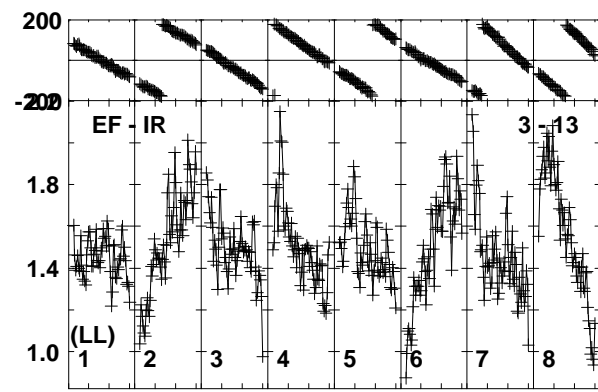
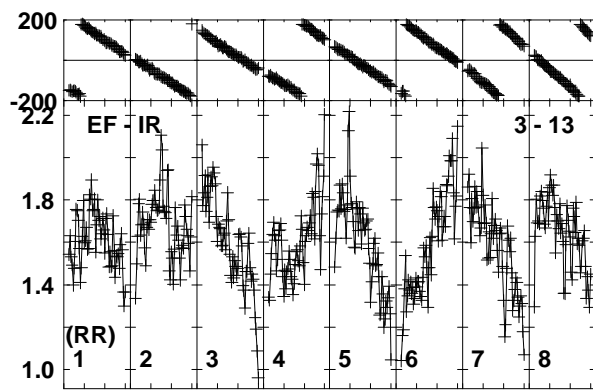
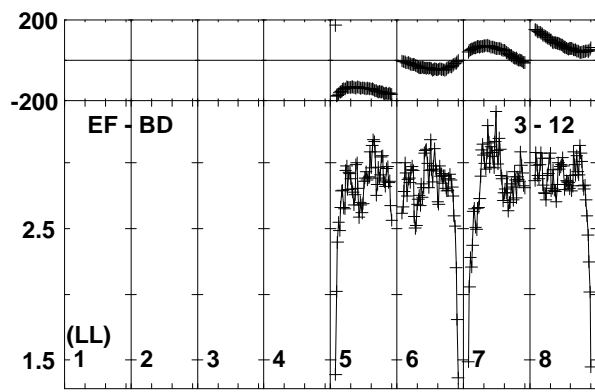
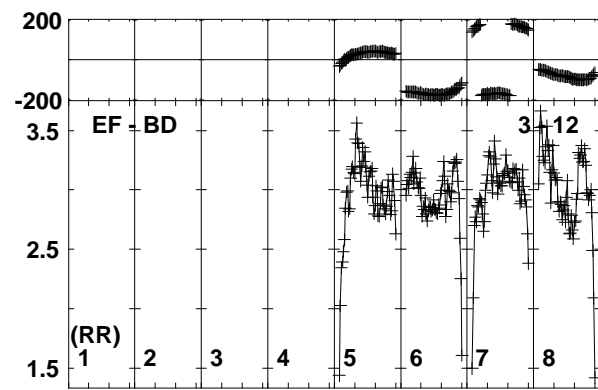
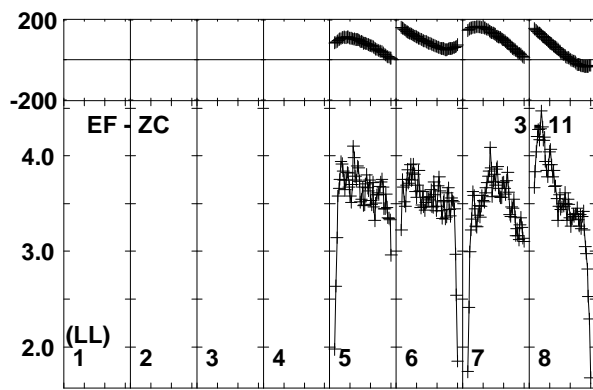
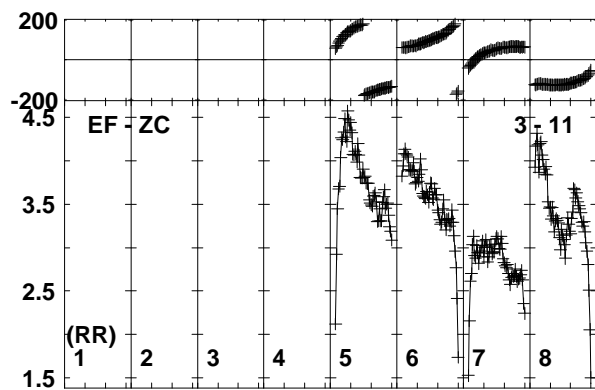
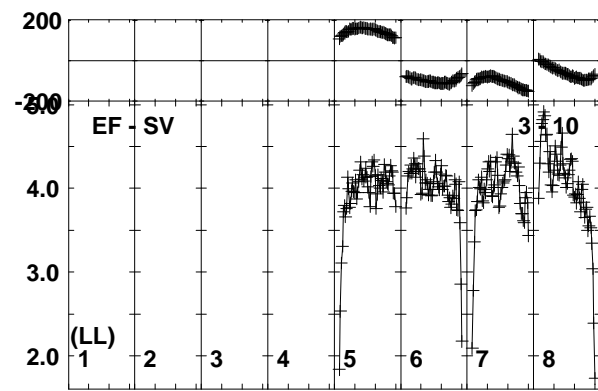
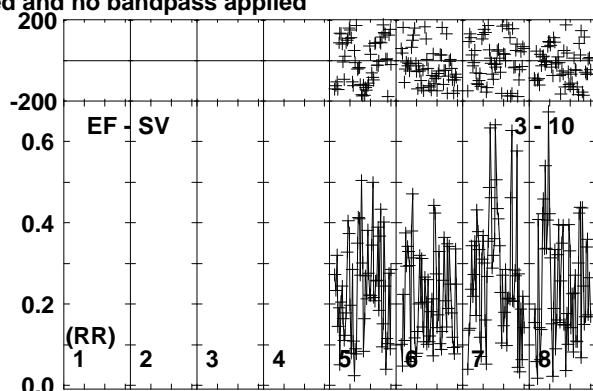
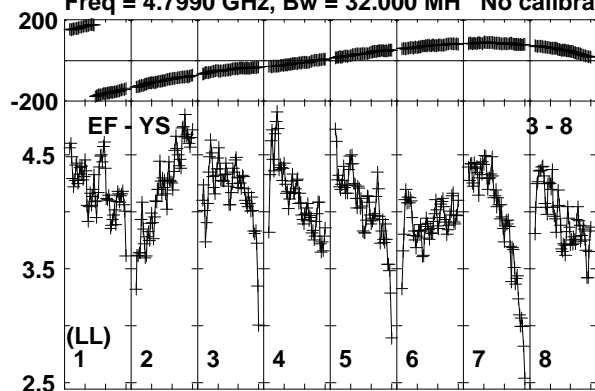

Lower frame: Milli Ampl Jy Top frame: Phas deg
Vector averaged cross-power spectrum Baseline: EF (03) - YS (08)
Timerange: 00/14:10:51 to 00/14:12:20

Plot file version 96 created 20-SEP-2019 15:51:32

J1408+5613 RSM05.UVDATA.1

Freq = 4.7990 GHz, Bw = 32.000 MH No calibration applied and no bandpass applied

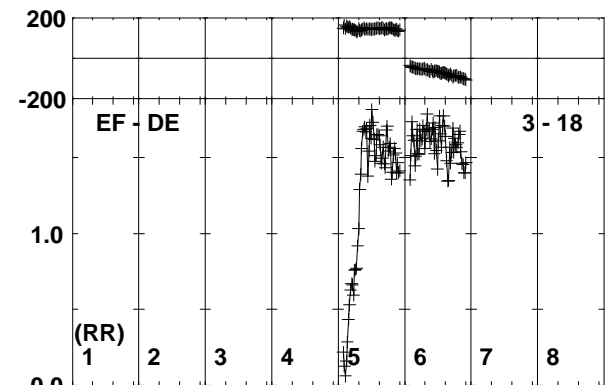
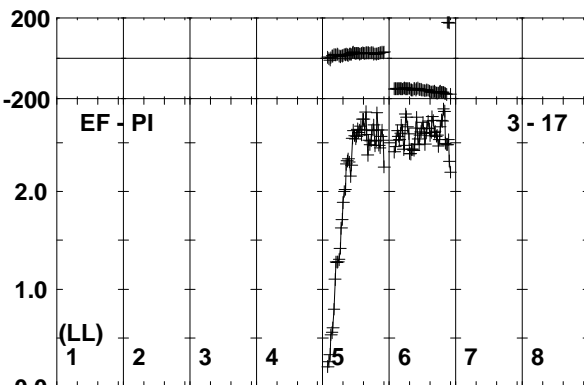
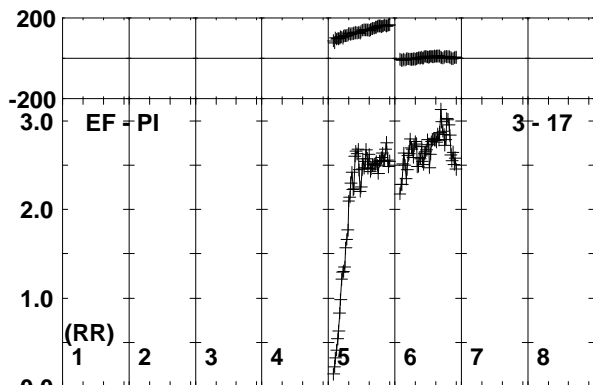
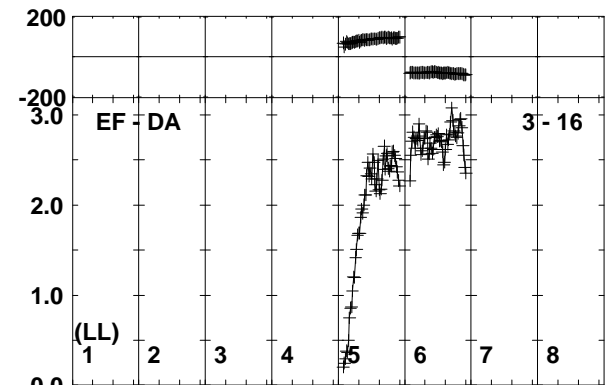
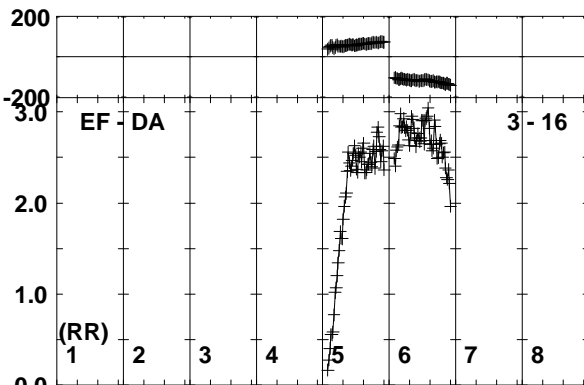
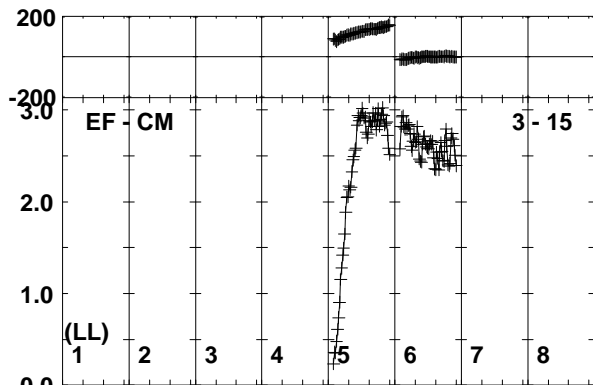
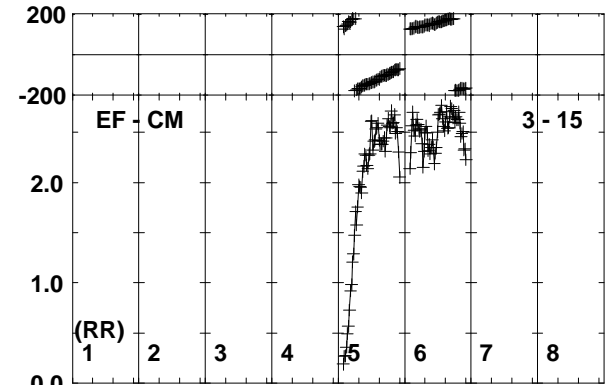
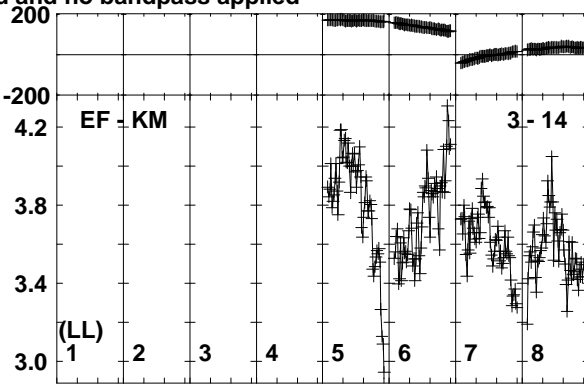
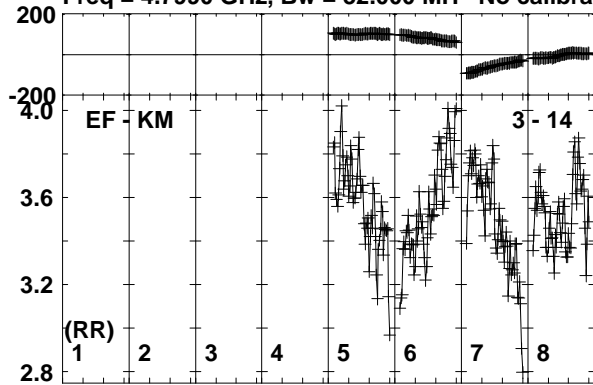

Lower frame: Milli Ampl Jy Top frame: Phas deg
Vector averaged cross-power spectrum Baseline: EF (03) - KM (14)
Timerange: 00/14:10:51 to 00/14:12:20

Plot file version 97 created 20-SEP-2019 15:51:32
J1408+5613 RSM05.UVDATA.1
Freq = 4.7990 GHz, Bw = 32.000 MH No calibration applied and no bandpass applied

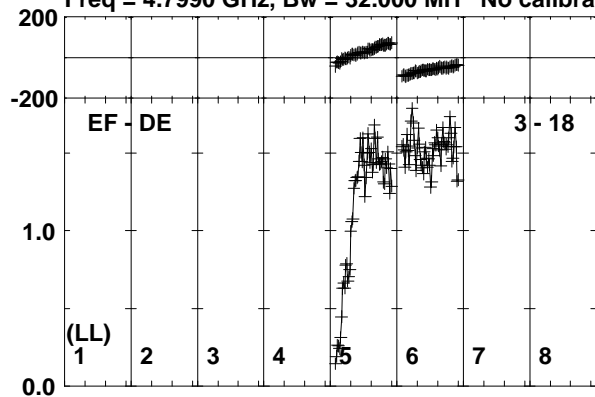

Lower frame: Milli Ampl Jy Top frame: Phas deg
Vector averaged cross-power spectrum Baseline: EF (03) - DE (18)
Timerange: 00/14:10:51 to 00/14:12:20

Plot file version 98 created 20-SEP-2019 15:51:32
 AT2019EHZ RSM05.UVDATA.1
 Freq = 4.7990 GHz, Bw = 32.000 MH No calibration applied and no bandpass applied

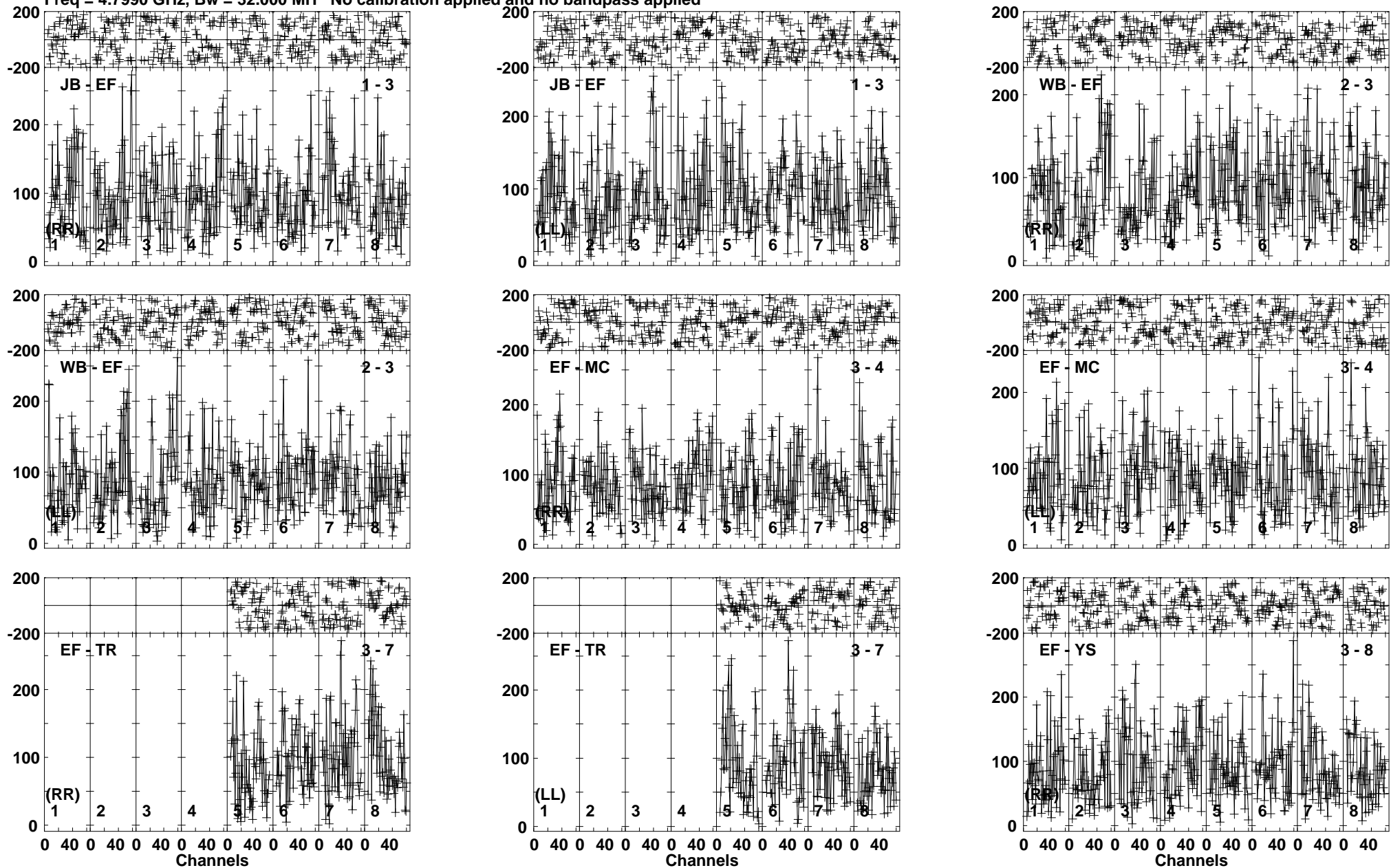

Lower frame: Micro Ampl Jy Top frame: Phas deg
 Vector averaged cross-power spectrum Baseline: JB (01) - EF (03)
 Timerange: 00/14:12:20 to 00/14:15:20

Plot file version 99 created 20-SEP-2019 15:51:33
 AT2019EHZ RSM05.UVDATA.1
 Freq = 4.7990 GHz, Bw = 32.000 MH No calibration applied and no bandpass applied

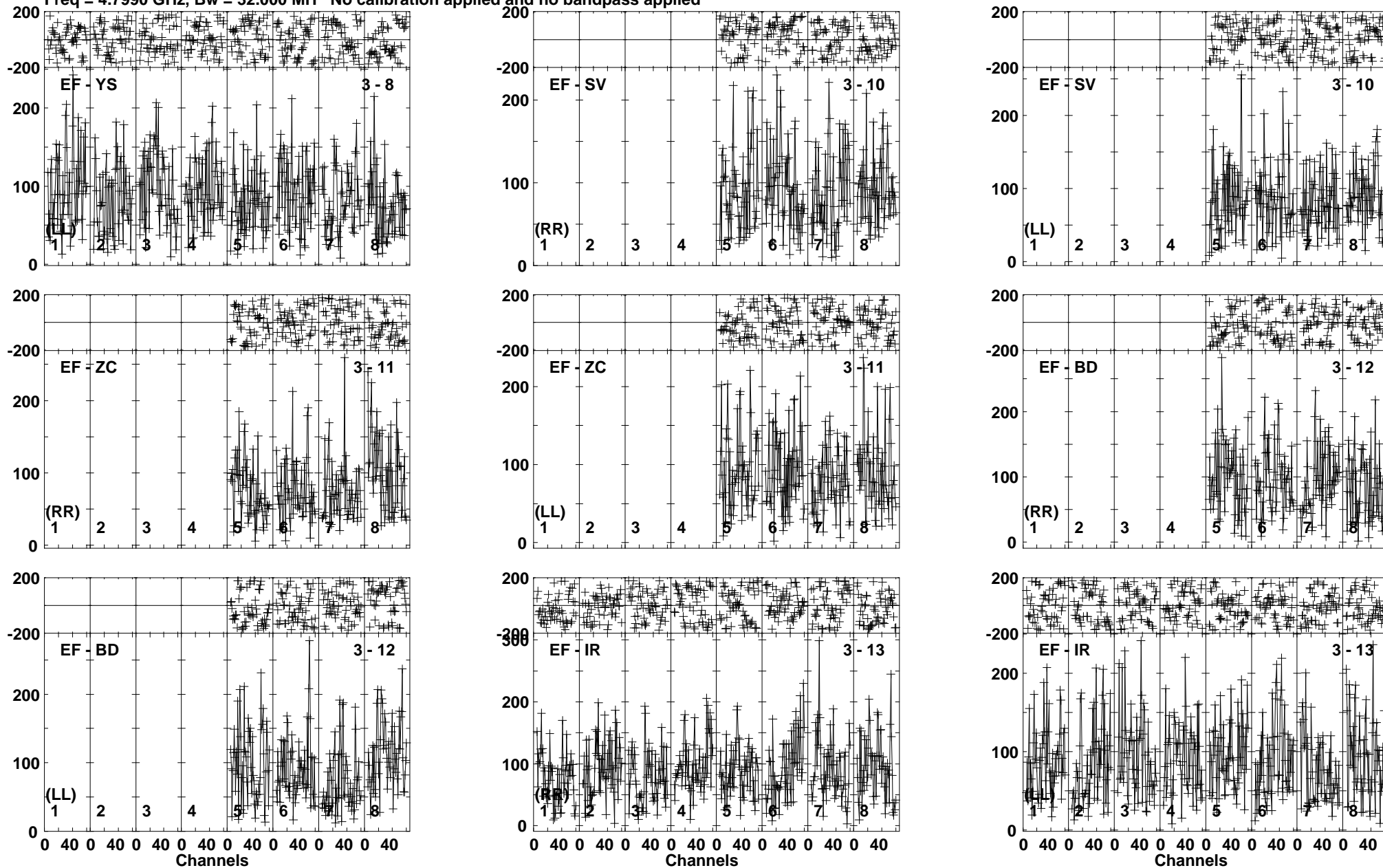

Lower frame: Micro Ampl Jy Top frame: Phas deg
 Vector averaged cross-power spectrum Baseline: EF (03) - YS (08)
 Timerange: 00/14:12:20 to 00/14:15:20

Plot file version 100 created 20-SEP-2019 15:51:33

AT2019EHZ RSM05.UVDATA.1

Freq = 4.7990 GHz, Bw = 32.000 MH No calibration applied and no bandpass applied

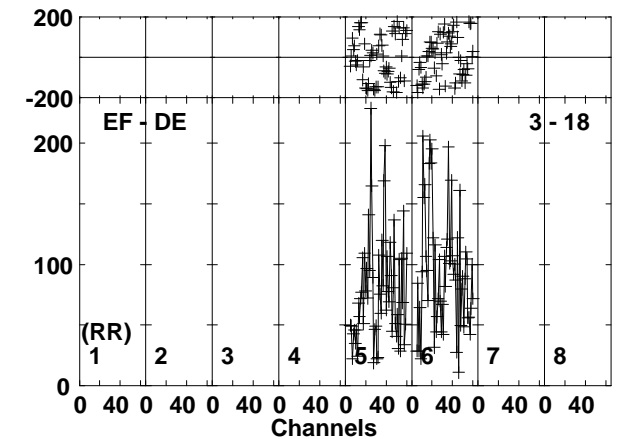
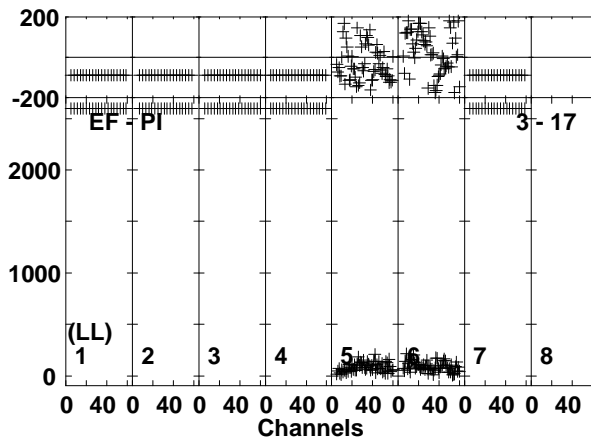
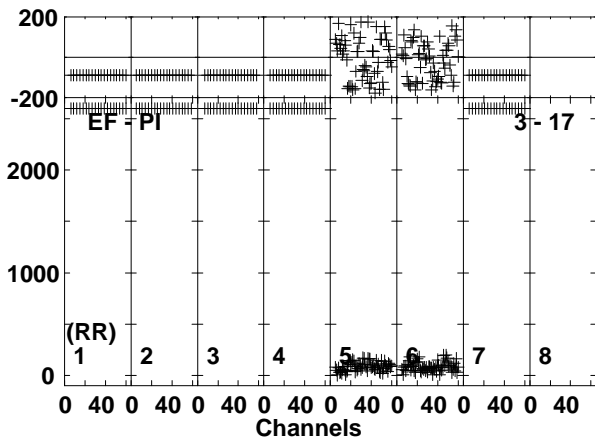
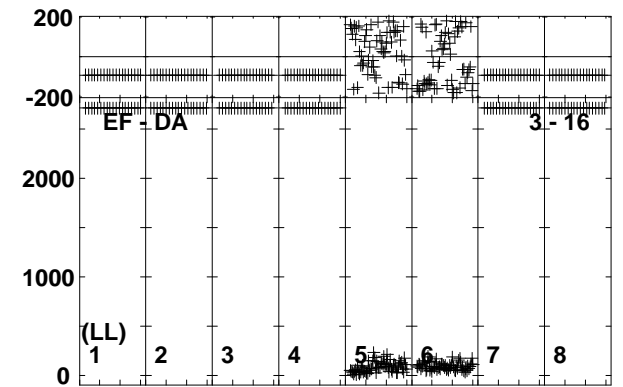
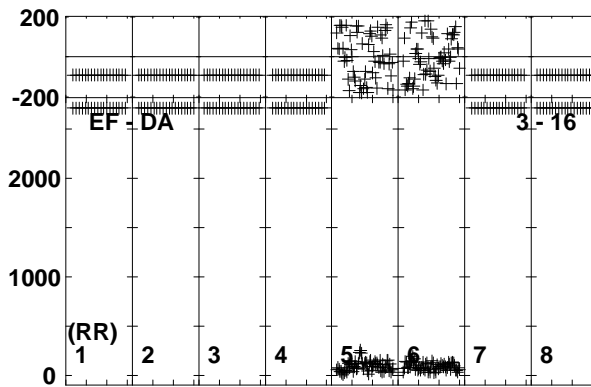
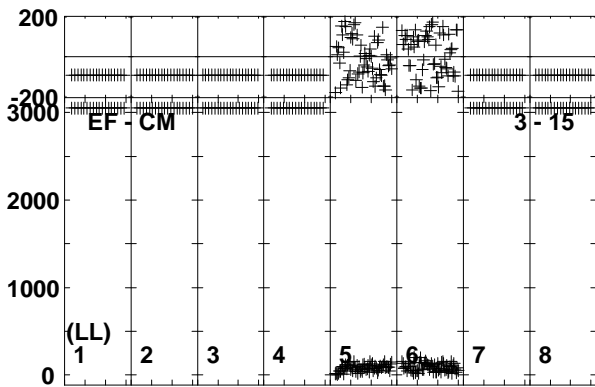
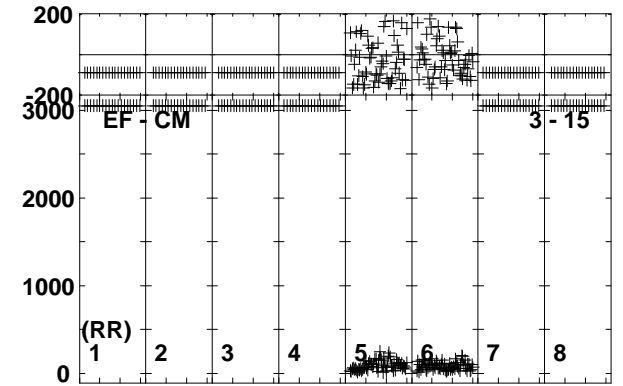
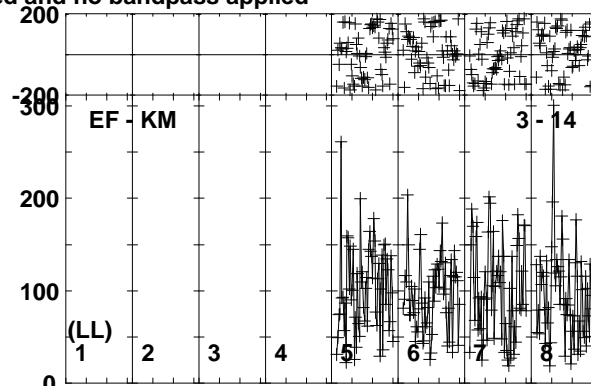
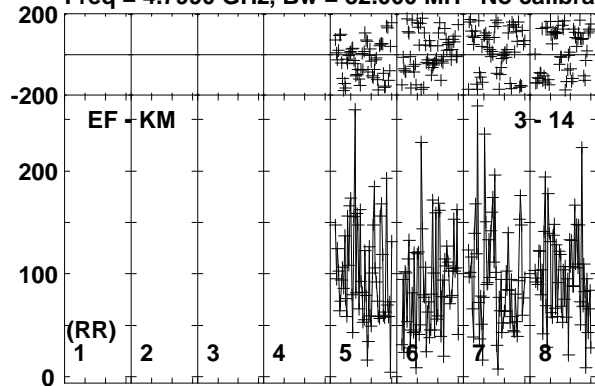

Lower frame: Micro Ampl Jy Top frame: Phas deg
Vector averaged cross-power spectrum Baseline: EF (03) - KM (14)
Timerange: 00/14:12:20 to 00/14:15:20

Plot file version 101 created 20-SEP-2019 15:51:34
AT2019EHZ RSM05.UVDATA.1
Freq = 4.7990 GHz, Bw = 32.000 MH No calibration applied and no bandpass applied

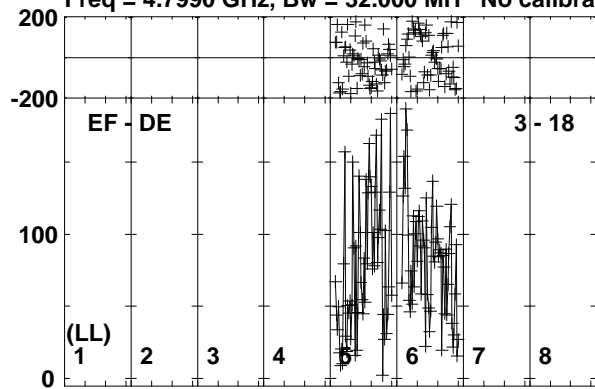

Lower frame: Micro Ampl Jy Top frame: Phas deg
Vector averaged cross-power spectrum Baseline: EF (03) - DE (18)
Timerange: 00/14:12:20 to 00/14:15:20

Plot file version 102 created 20-SEP-2019 15:51:34

J1408+5613 RSM05.UVDATA.1

Freq = 4.7990 GHz, Bw = 32.000 MH No calibration applied and no bandpass applied

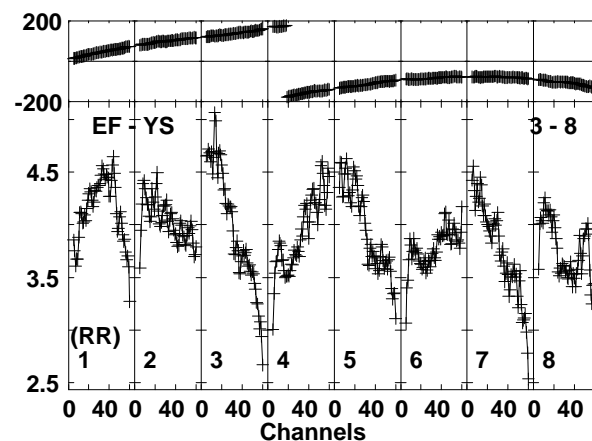
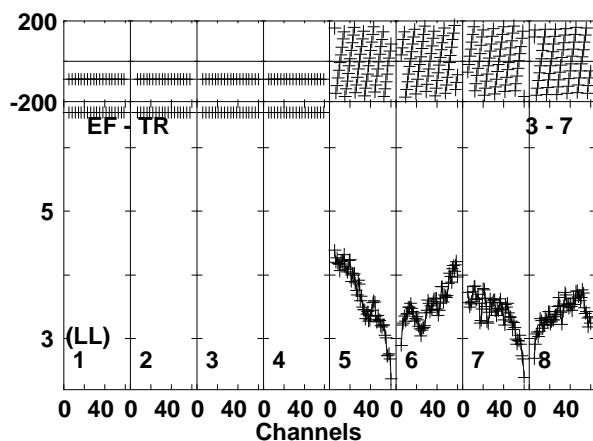
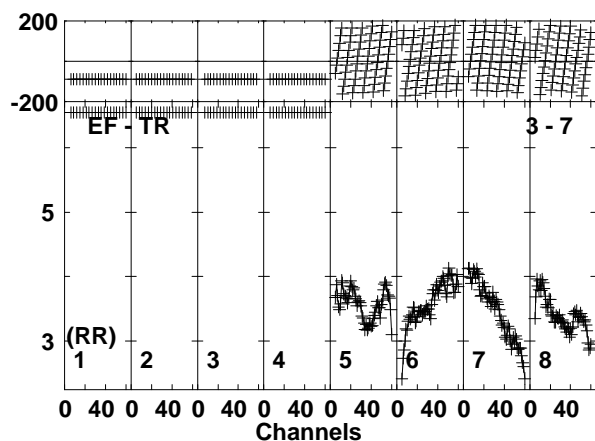
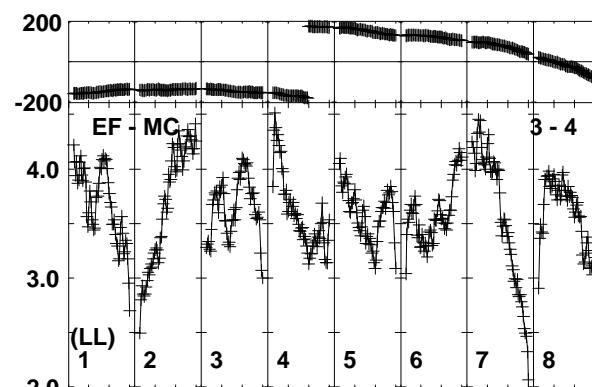
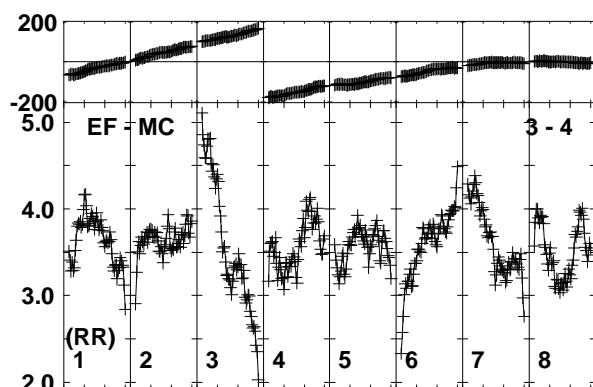
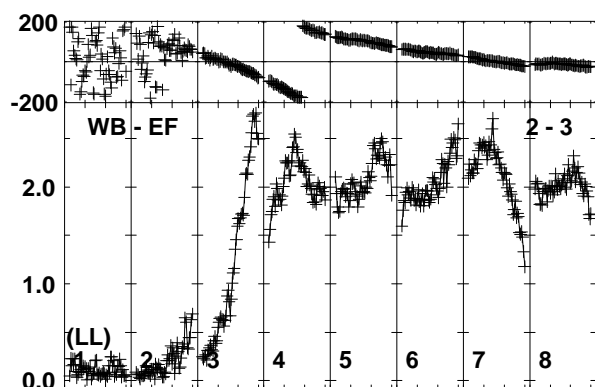
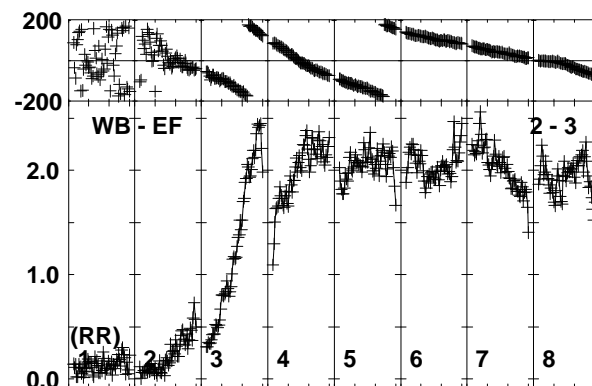
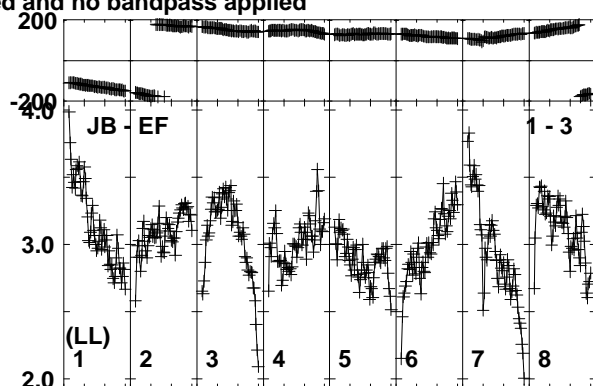
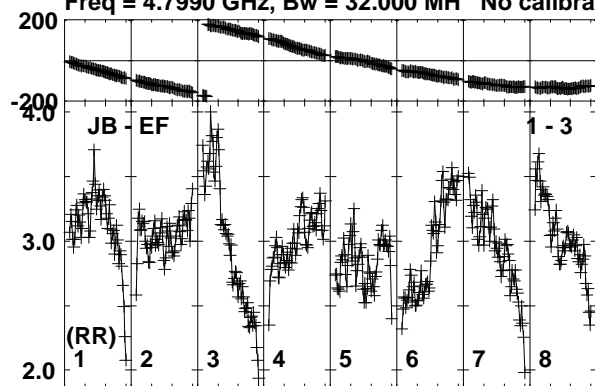

Lower frame: Milli Ampl Jy Top frame: Phas deg
Vector averaged cross-power spectrum Baseline: JB (01) - EF (03)
Timerange: 00/14:16:11 to 00/14:17:40

Plot file version 103 created 20-SEP-2019 15:51:35

J1408+5613 RSM05.UVDATA.1

Freq = 4.7990 GHz, Bw = 32.000 MH No calibration applied and no bandpass applied

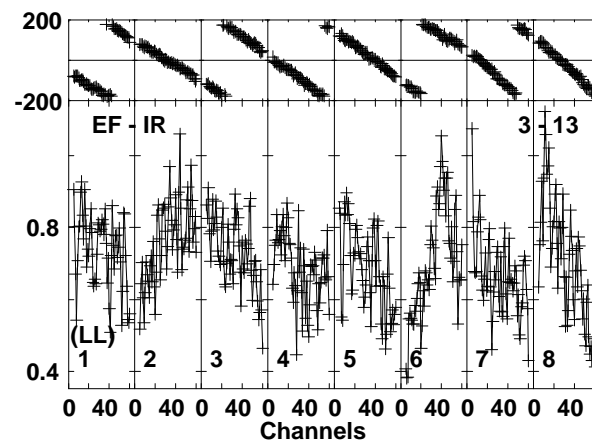
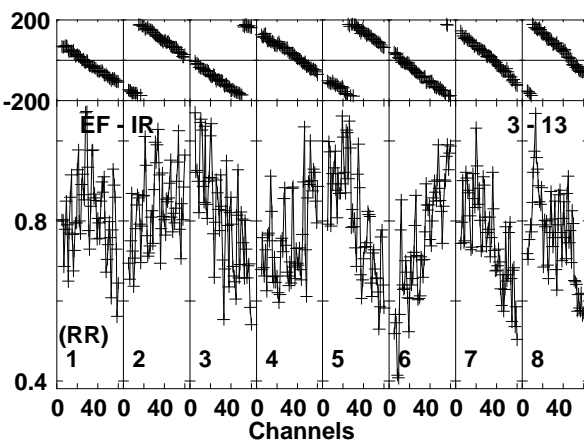
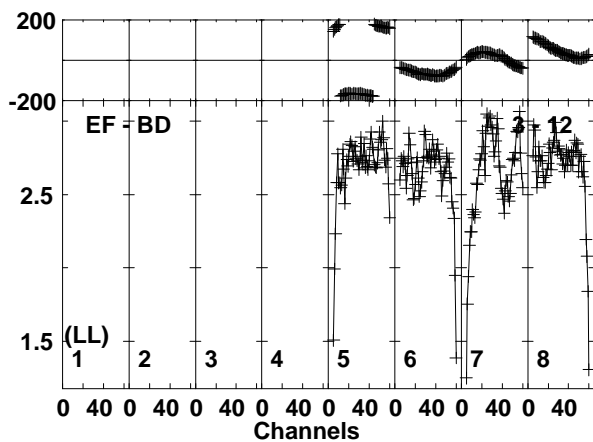
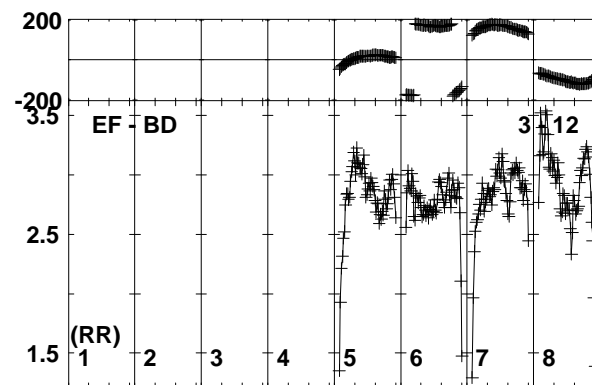
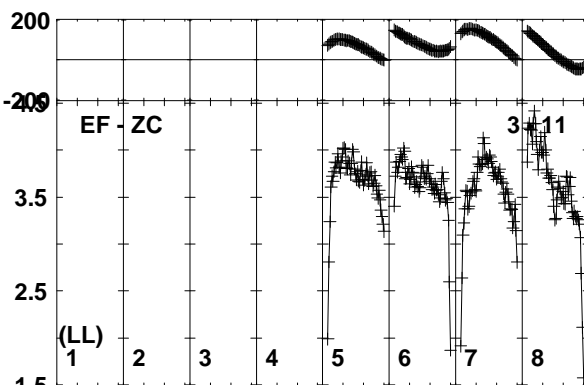
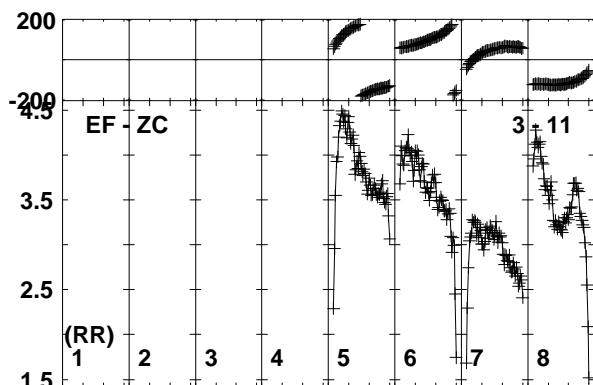
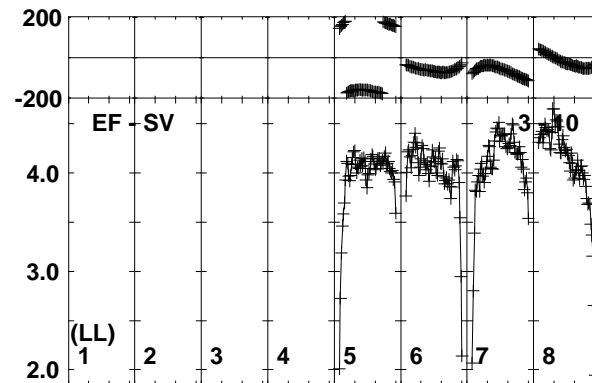
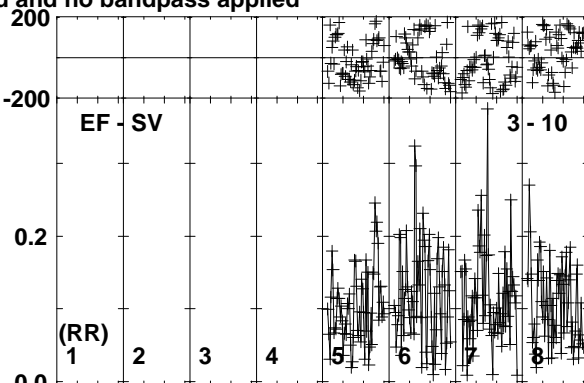
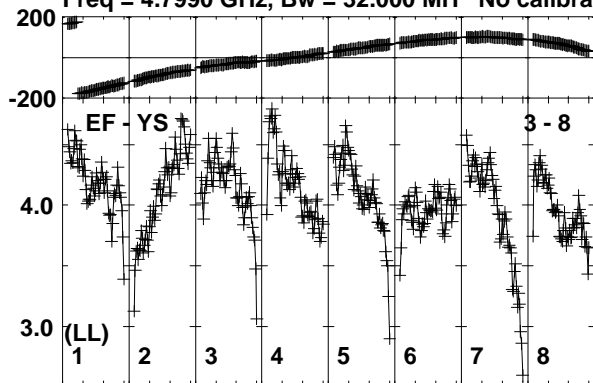

Lower frame: Milli Ampl Jy Top frame: Phas deg
Vector averaged cross-power spectrum Baseline: EF (03) - YS (08)
Timerange: 00/14:16:11 to 00/14:17:40

Plot file version 104 created 20-SEP-2019 15:51:35

J1408+5613 RSM05.UVDATA.1

Freq = 4.7990 GHz, Bw = 32.000 MH No calibration applied and no bandpass applied

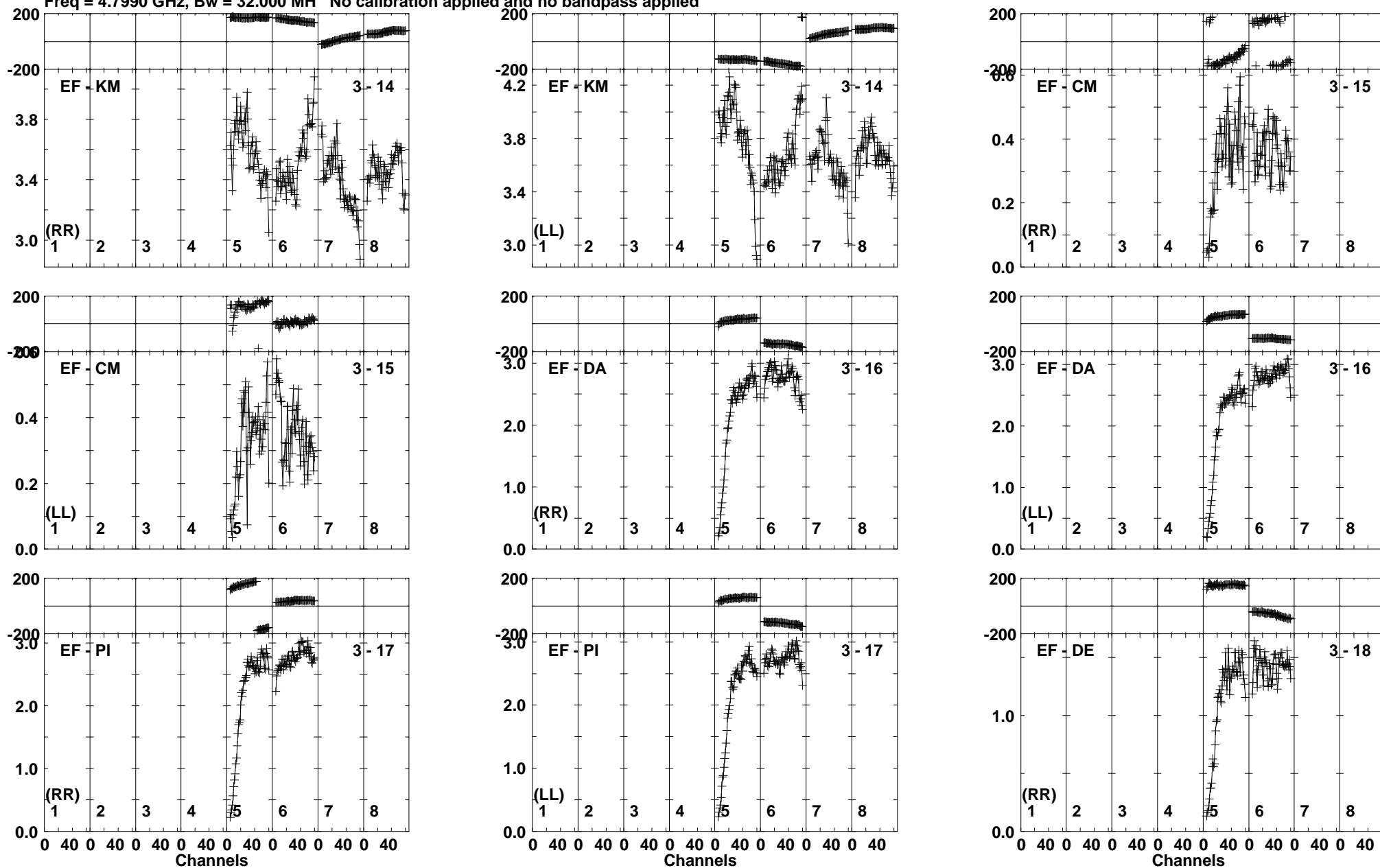

Lower frame: Milli Ampl Jy Top frame: Phas deg
Vector averaged cross-power spectrum Baseline: EF (03) - KM (14)
Timerange: 00/14:16:11 to 00/14:17:40

Plot file version 105 created 20-SEP-2019 15:51:35
J1408+5613 RSM05.UVDATA.1
Freq = 4.7990 GHz, Bw = 32.000 MH No calibration applied and no bandpass applied

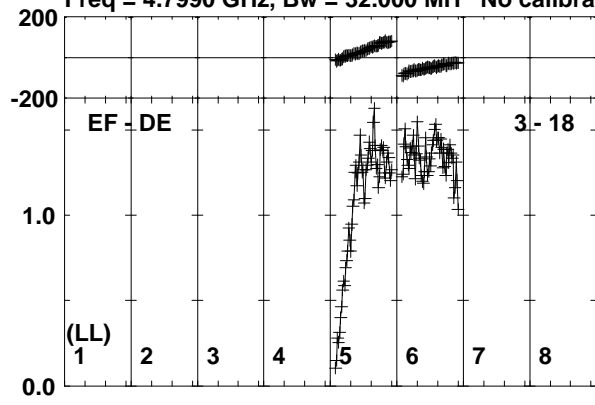

Lower frame: Milli Ampl Jy Top frame: Phas deg
Vector averaged cross-power spectrum Baseline: EF (03) - DE (18)
Timerange: 00/14:16:11 to 00/14:17:40

Plot file version 106 created 20-SEP-2019 15:51:36

AT2019EHZ RSM05.UVDATA.1

Freq = 4.7990 GHz, Bw = 32.000 MH No calibration applied and no bandpass applied

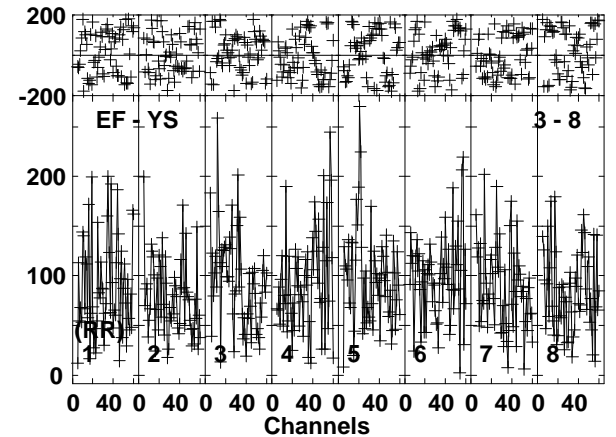
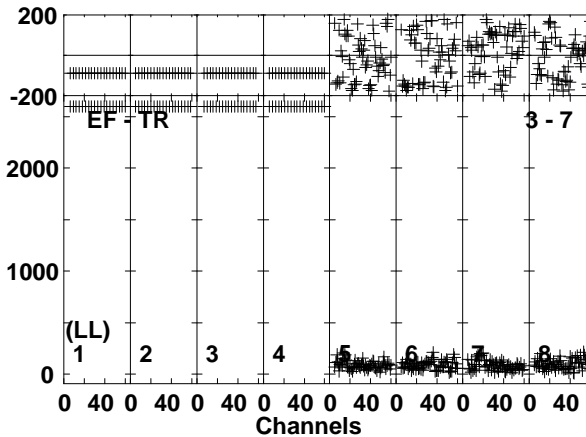
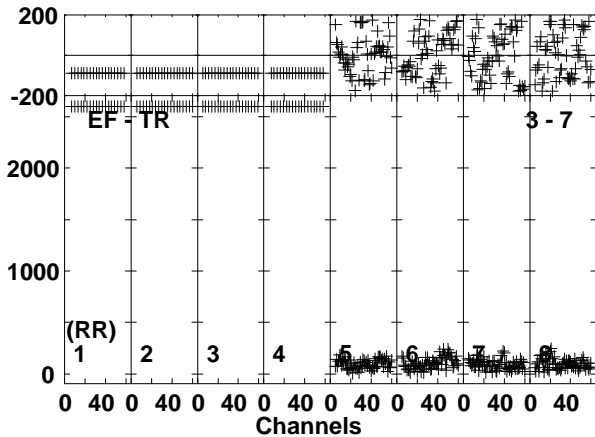
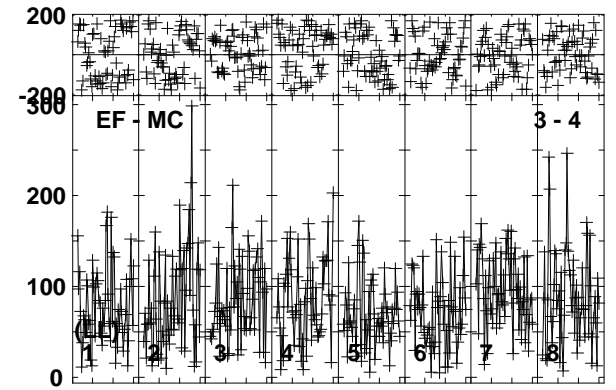
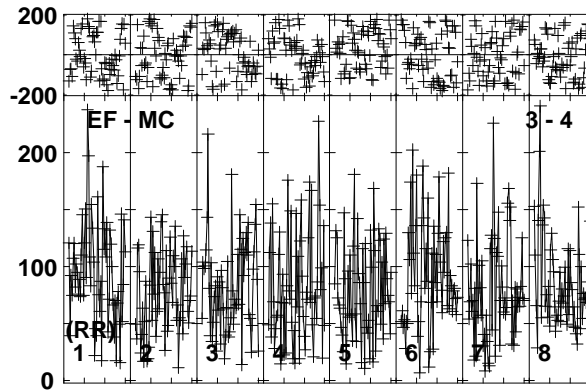
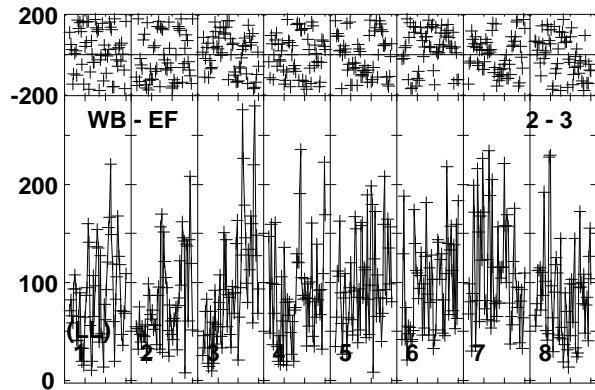
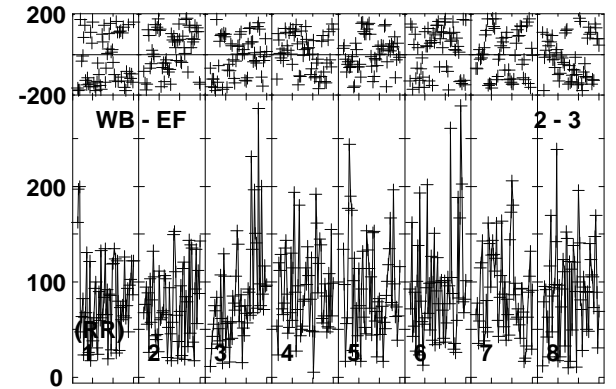
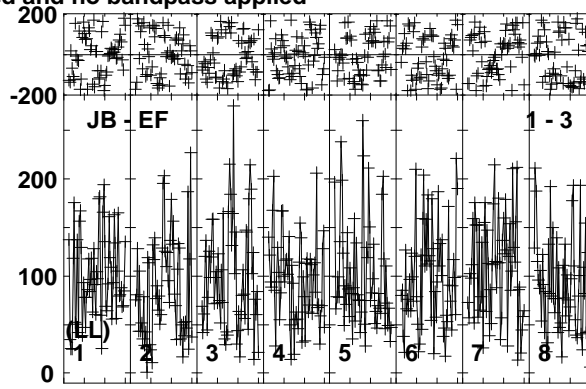
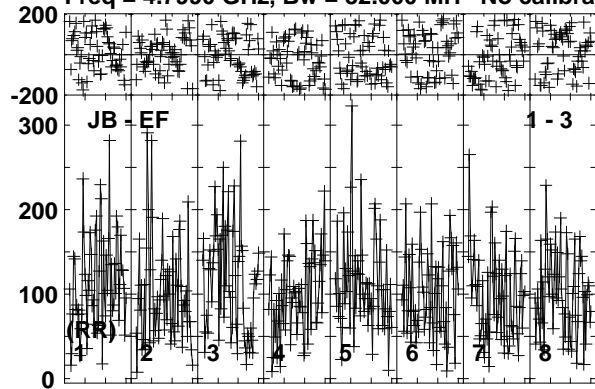

Lower frame: Micro Ampl Jy Top frame: Phas deg
Vector averaged cross-power spectrum Baseline: JB (01) - EF (03)
Timerange: 00/14:17:40 to 00/14:20:39

Plot file version 107 created 20-SEP-2019 15:51:36

AT2019EHZ RSM05.UVDATA.1

Freq = 4.7990 GHz, Bw = 32.000 MH No calibration applied and no bandpass applied

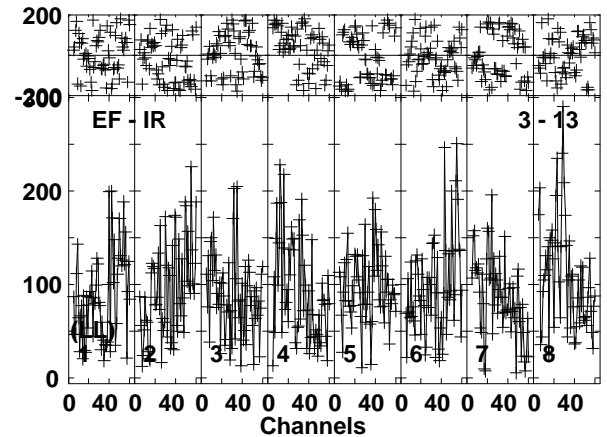
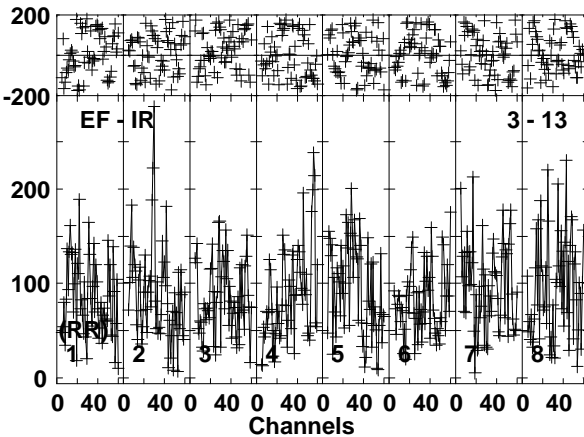
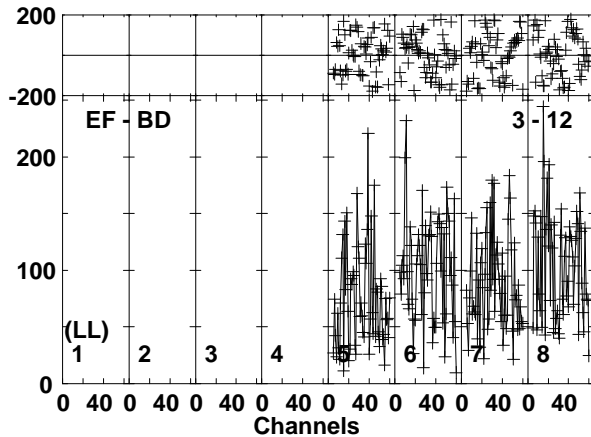
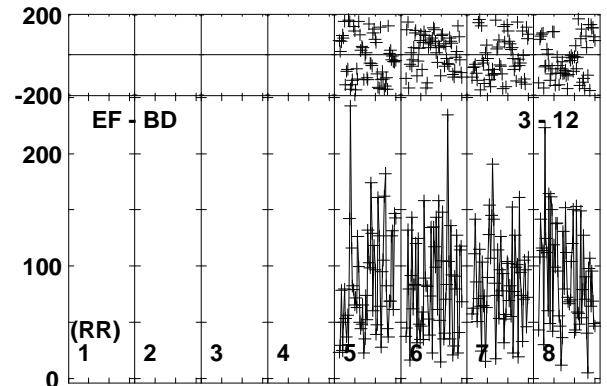
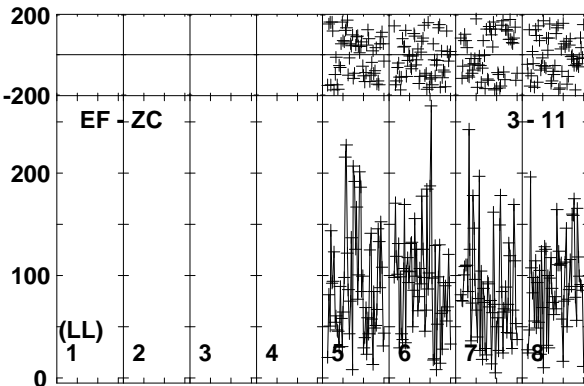
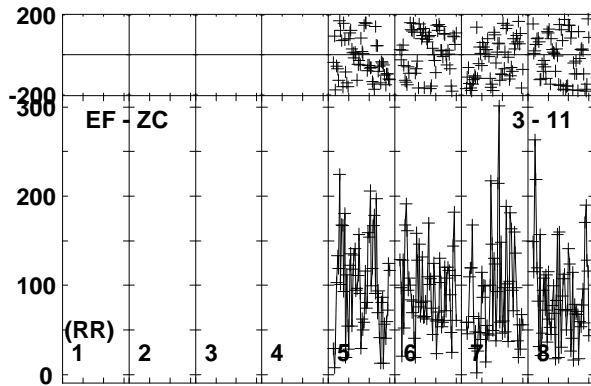
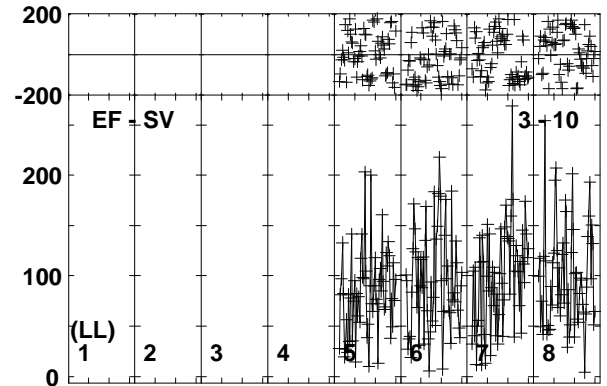
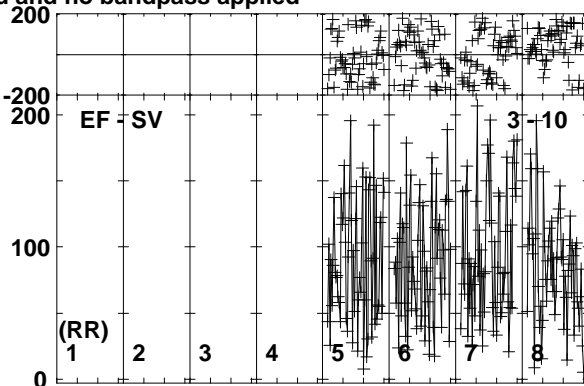
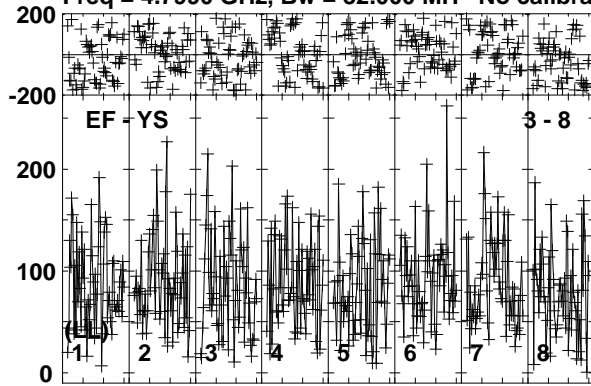

Lower frame: Micro Ampl Jy Top frame: Phas deg
Vector averaged cross-power spectrum Baseline: EF (03) - YS (08)
Timerange: 00/14:17:40 to 00/14:20:39

Plot file version 108 created 20-SEP-2019 15:51:37

AT2019EHZ RSM05.UVDATA.1

Freq = 4.7990 GHz, Bw = 32.000 MH No calibration applied and no bandpass applied

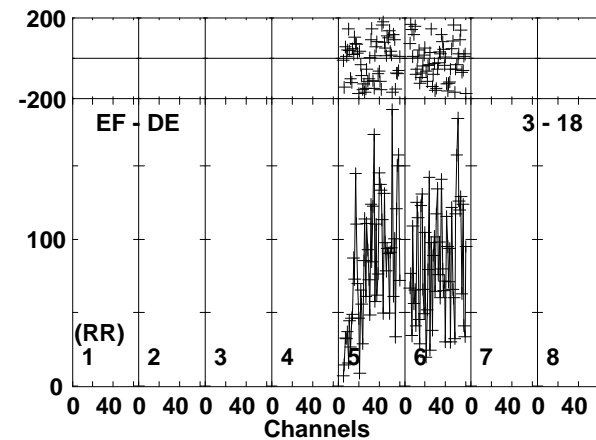
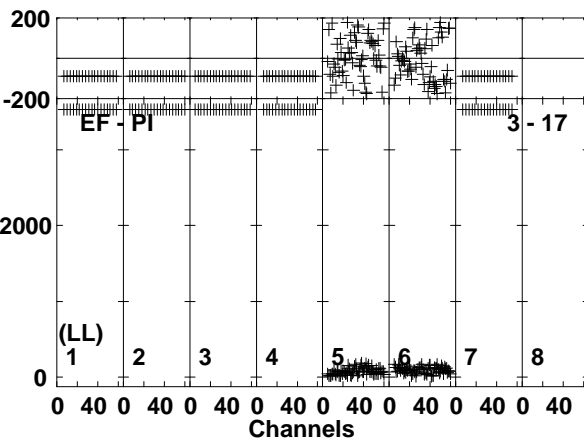
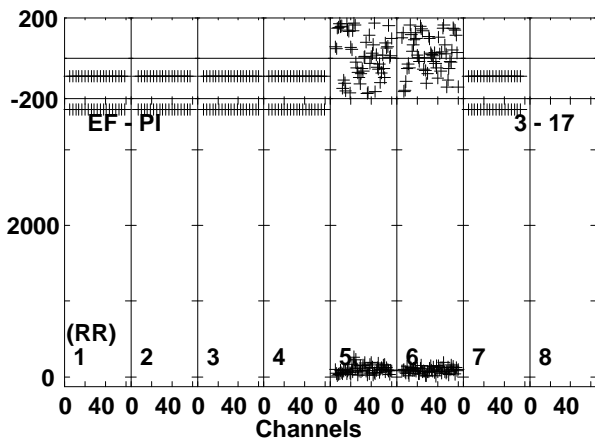
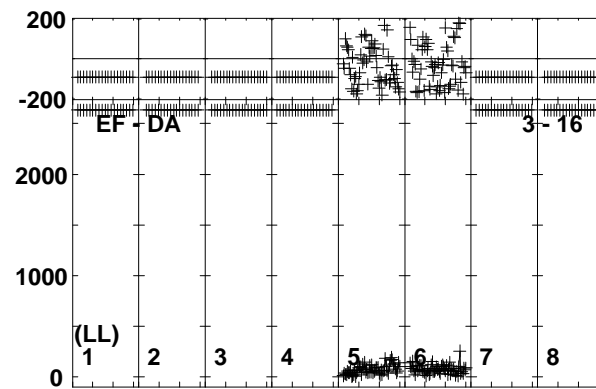
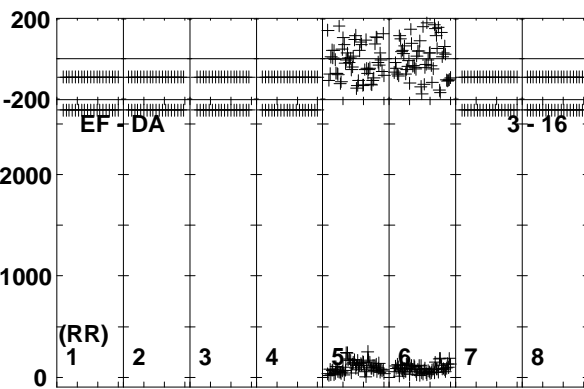
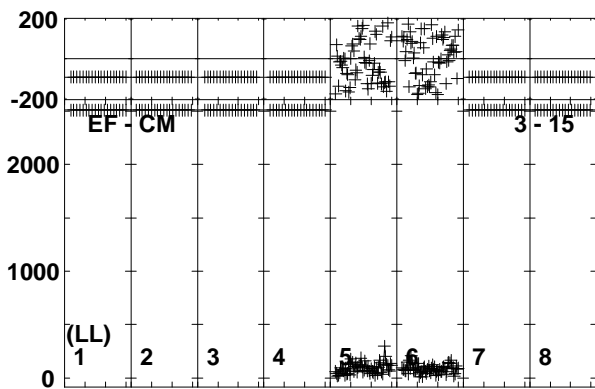
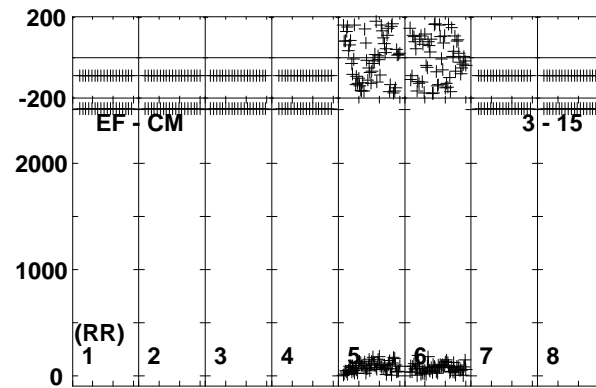
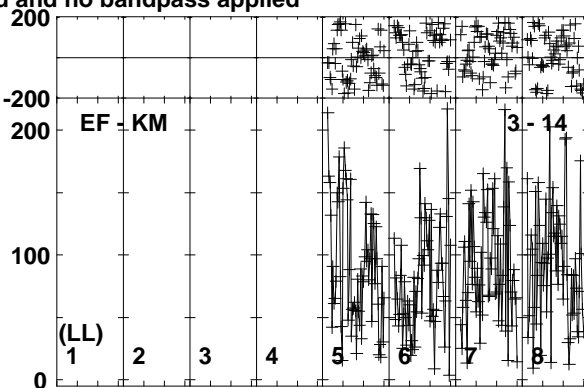
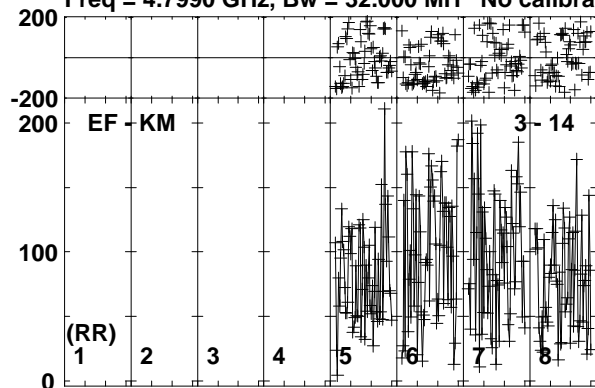

Lower frame: Micro Ampl Jy Top frame: Phas deg
Vector averaged cross-power spectrum Baseline: EF (03) - KM (14)
Timerange: 00/14:17:40 to 00/14:20:39

Plot file version 109 created 20-SEP-2019 15:51:37
AT2019EHZ RSM05.UVDATA.1
Freq = 4.7990 GHz, Bw = 32.000 MH No calibration applied and no bandpass applied

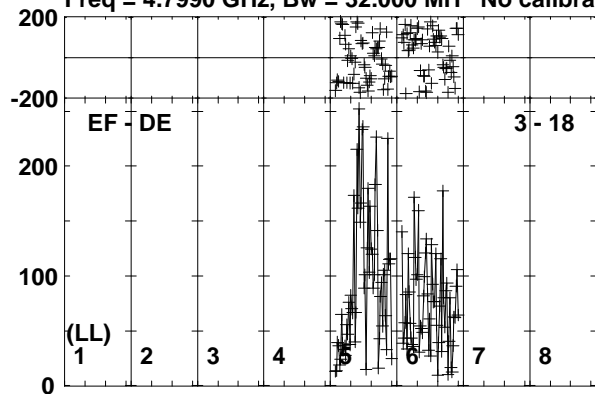

Lower frame: Micro Ampl Jy Top frame: Phas deg
Vector averaged cross-power spectrum Baseline: EF (03) - DE (18)
Timerange: 00/14:17:40 to 00/14:20:39

Plot file version 110 created 20-SEP-2019 15:51:37

J1408+5613 RSM05.UVDATA.1

Freq = 4.7990 GHz, Bw = 32.000 MH No calibration applied and no bandpass applied

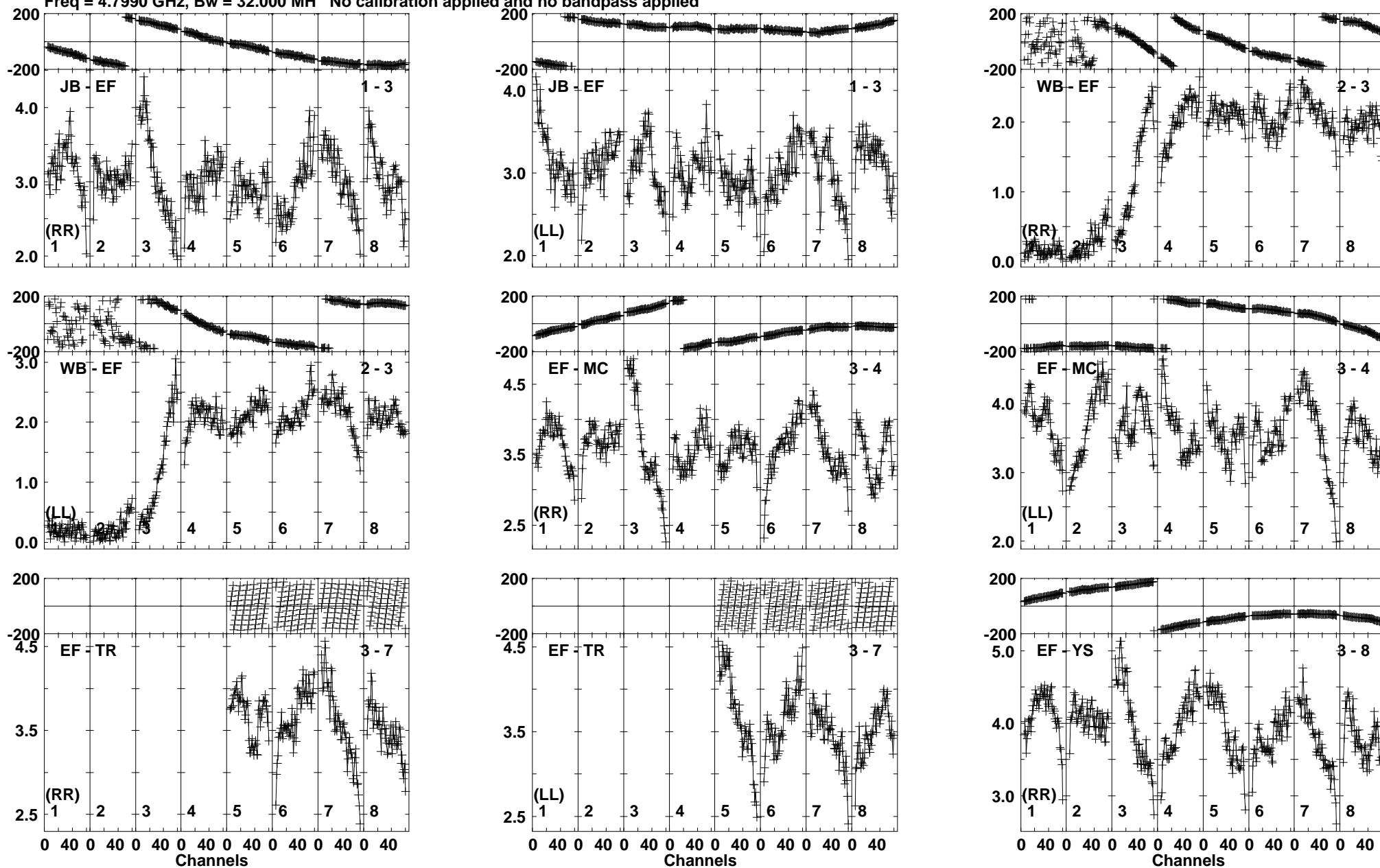

Lower frame: Milli Ampl Jy Top frame: Phas deg
Vector averaged cross-power spectrum Baseline: JB (01) - EF (03)
Timerange: 00/14:20:41 to 00/14:22:10

Plot file version 111 created 20-SEP-2019 15:51:38

J1408+5613 RSM05.UVDATA.1

Freq = 4.7990 GHz, Bw = 32.000 MH No calibration applied and no bandpass applied

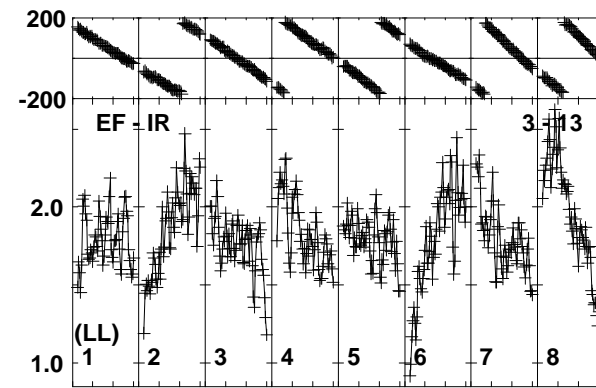
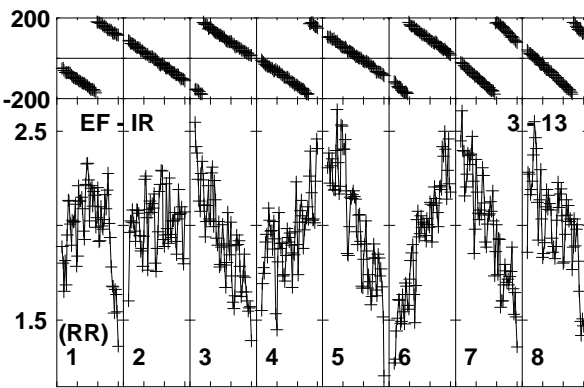
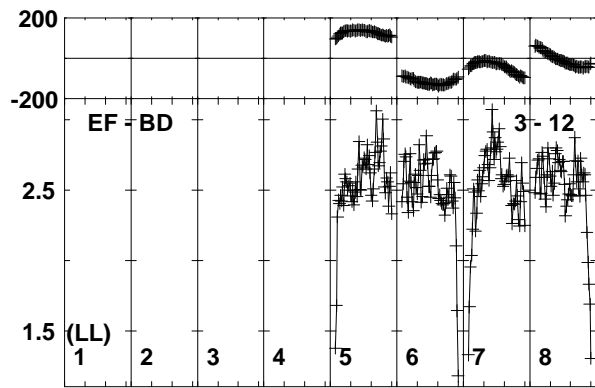
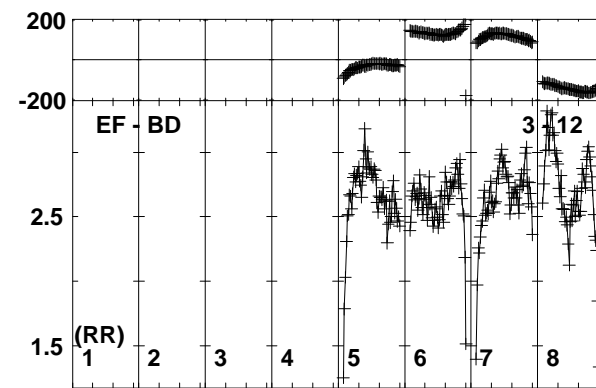
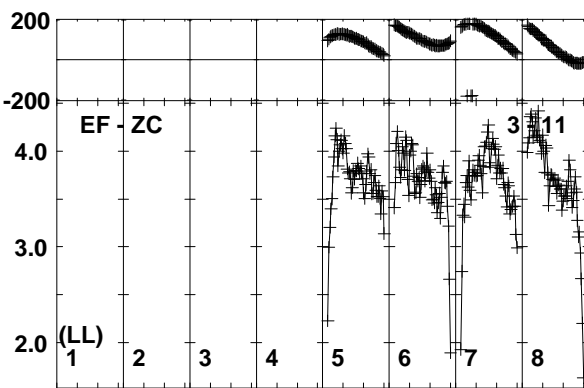
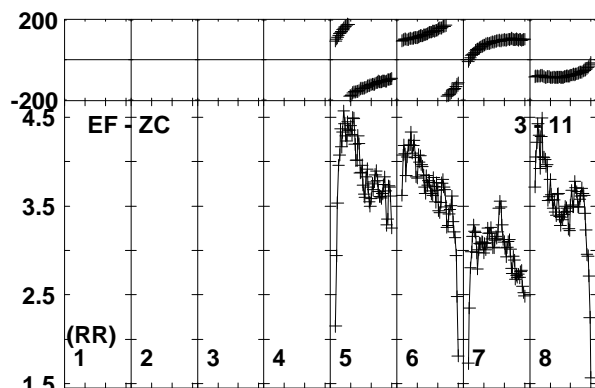
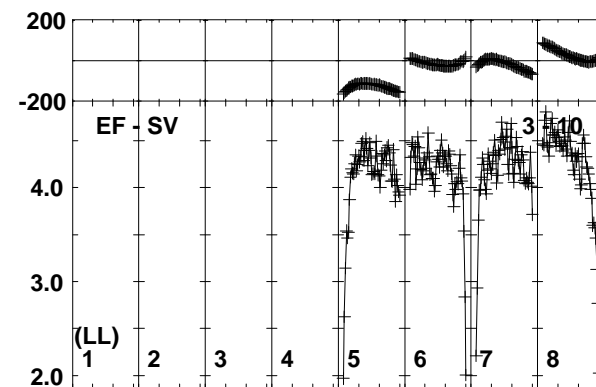
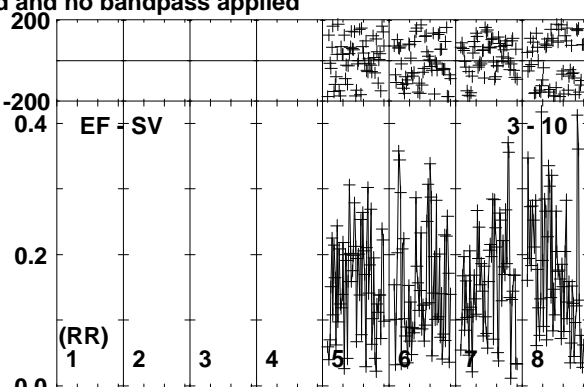
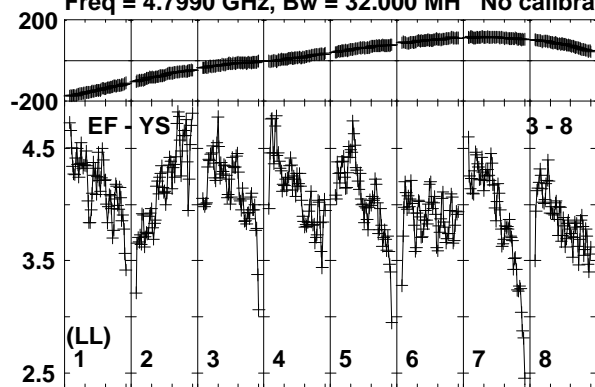

0 40 0 40 0 40 0 40 0 40 0 40 0 40 0 40 0 40 0 40
Channels
Lower frame: Milli Ampl Jy Top frame: Phas deg
Vector averaged cross-power spectrum Baseline: EF (03) - YS (08)
Timerange: 00/14:20:41 to 00/14:22:10

Plot file version 112 created 20-SEP-2019 15:51:38

J1408+5613 RSM05.UVDATA.1

Freq = 4.7990 GHz, Bw = 32.000 MH No calibration applied and no bandpass applied

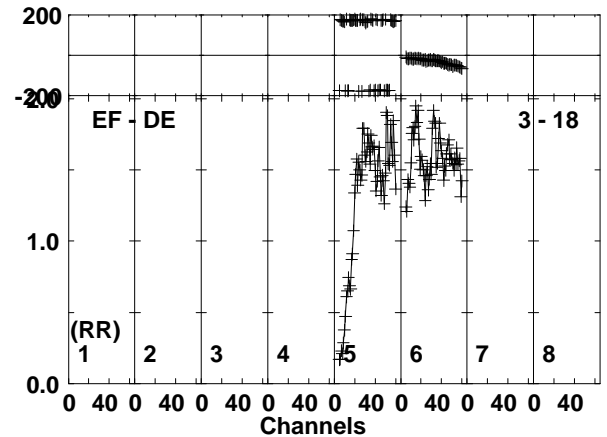
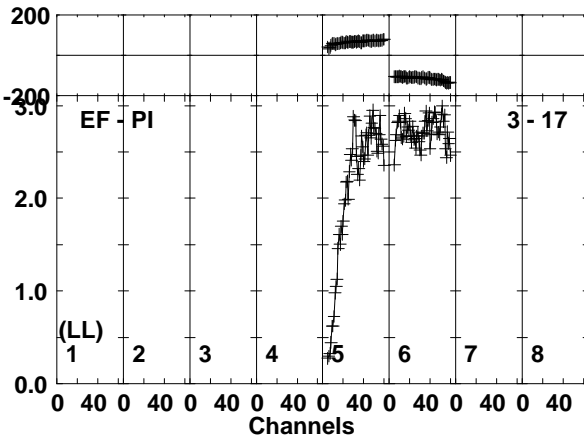
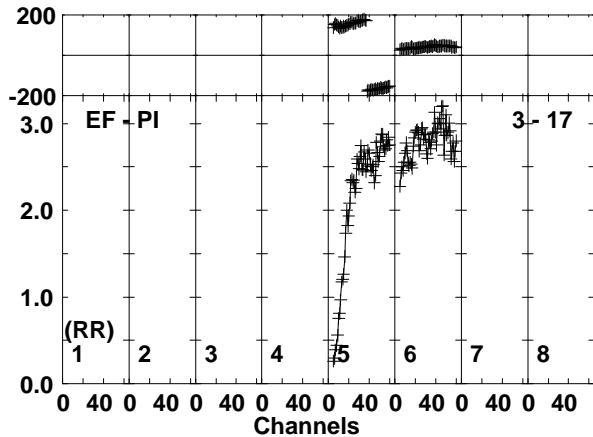
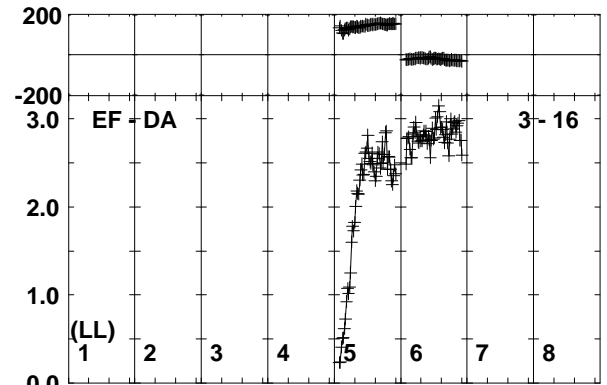
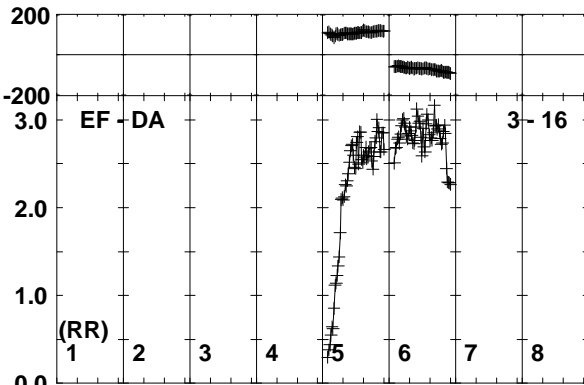
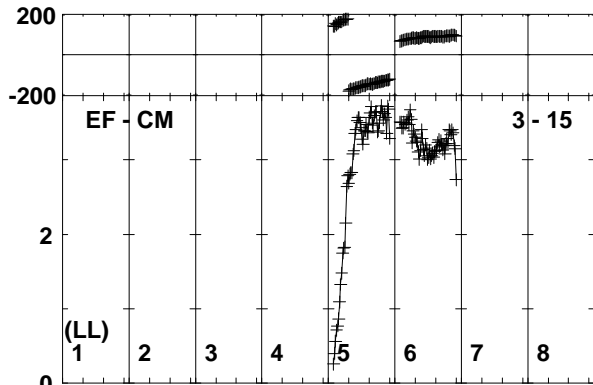
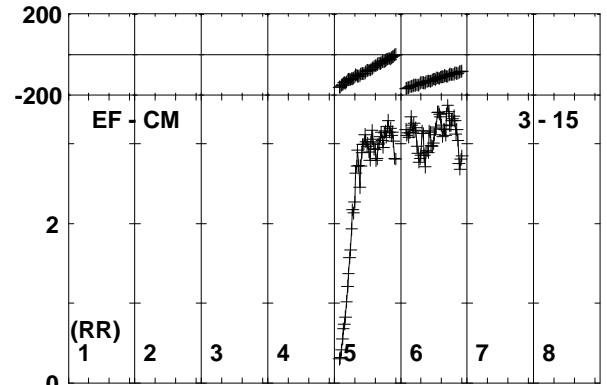
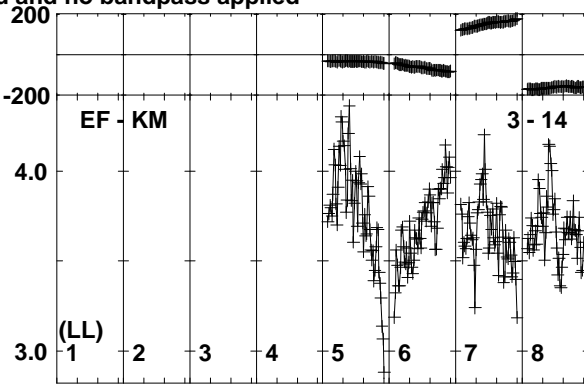
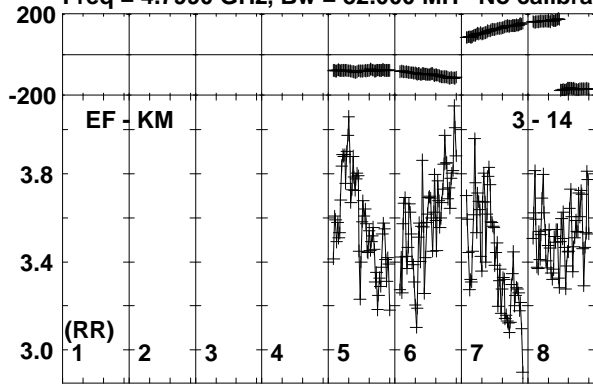

Lower frame: Milli Ampl Jy Top frame: Phas deg
Vector averaged cross-power spectrum Baseline: EF (03) - KM (14)
Timerange: 00/14:20:41 to 00/14:22:10

Plot file version 113 created 20-SEP-2019 15:51:39
J1408+5613 RSM05.UVDATA.1
Freq = 4.7990 GHz, Bw = 32.000 MH No calibration applied and no bandpass applied

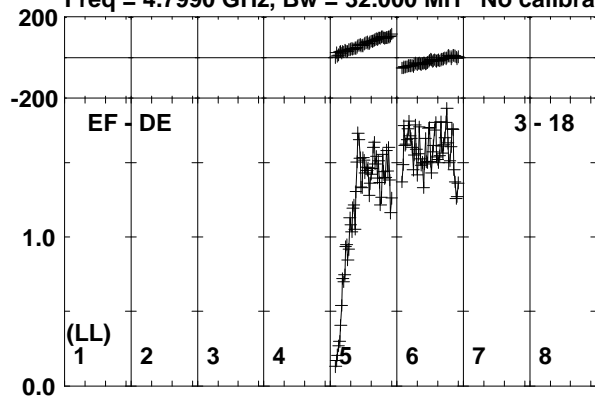

Lower frame: Milli Ampl Jy Top frame: Phas deg
Vector averaged cross-power spectrum Baseline: EF (03) - DE (18)
Timerange: 00/14:20:41 to 00/14:22:10

Plot file version 114 created 20-SEP-2019 15:51:39

AT2019EHZ RSM05.UVDATA.1

Freq = 4.7990 GHz, Bw = 32.000 MH No calibration applied and no bandpass applied

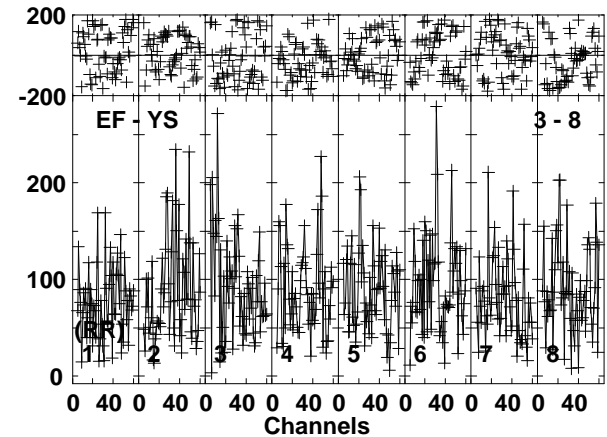
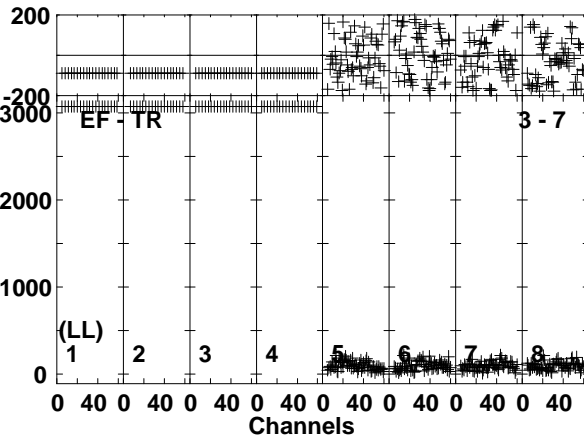
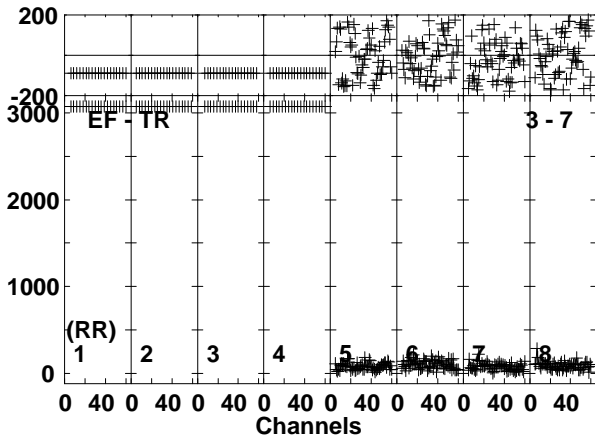
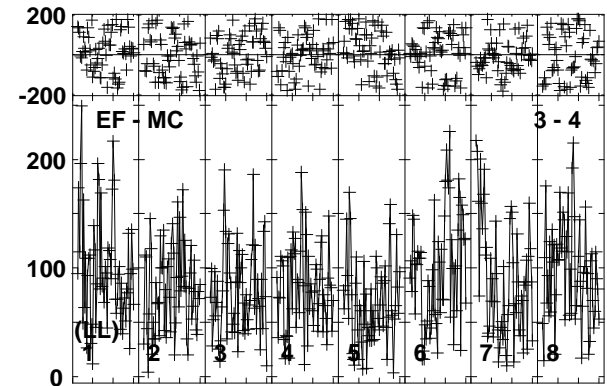
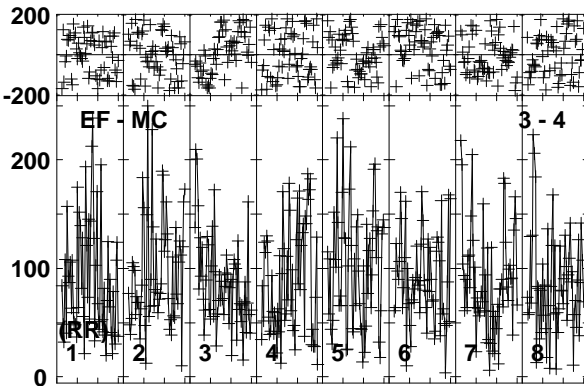
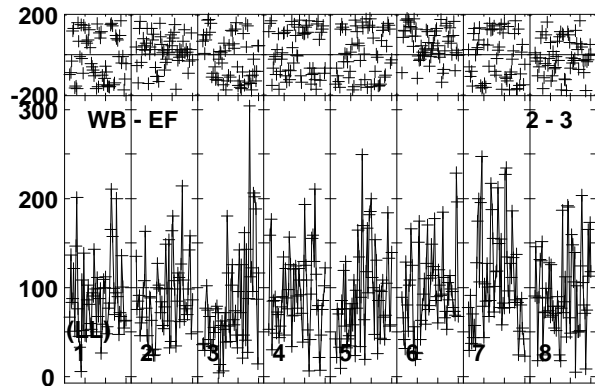
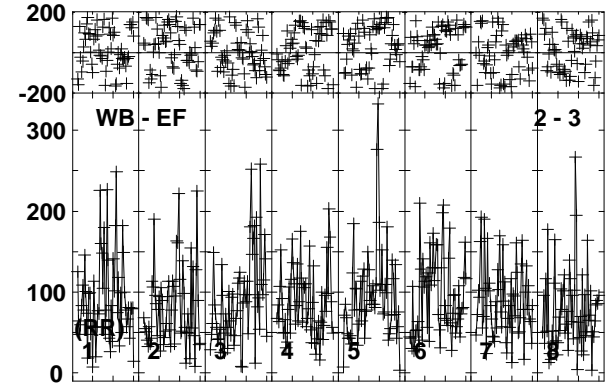
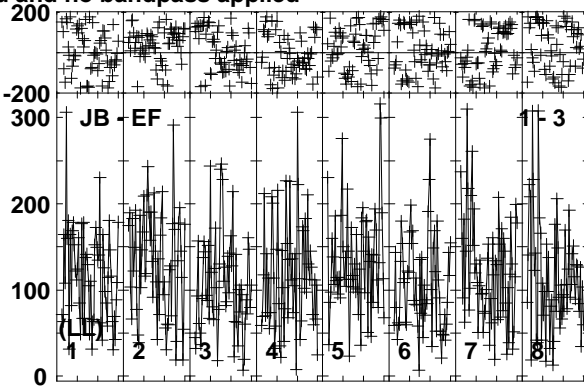
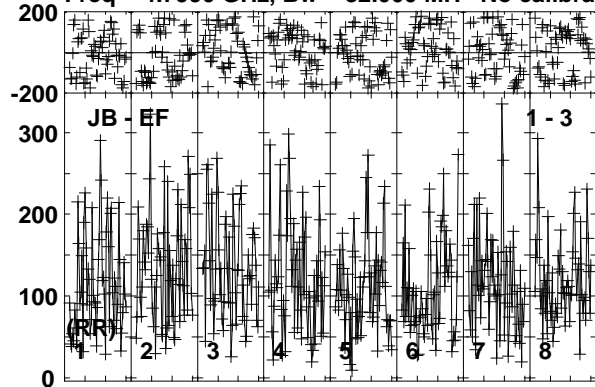

Lower frame: Micro Ampl Jy Top frame: Phas deg
Vector averaged cross-power spectrum Baseline: JB (01) - EF (03)
Timerange: 00/14:22:10 to 00/14:25:10

Plot file version 115 created 20-SEP-2019 15:51:39

AT2019EHZ RSM05.UVDATA.1

Freq = 4.7990 GHz, Bw = 32.000 MH No calibration applied and no bandpass applied

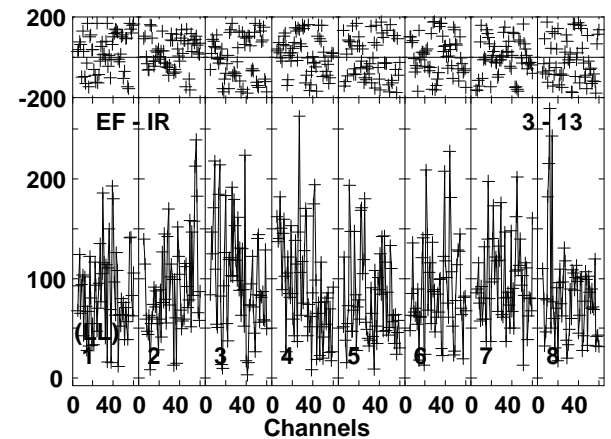
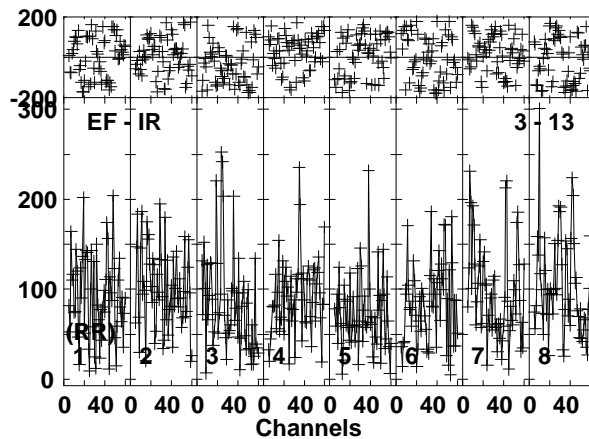
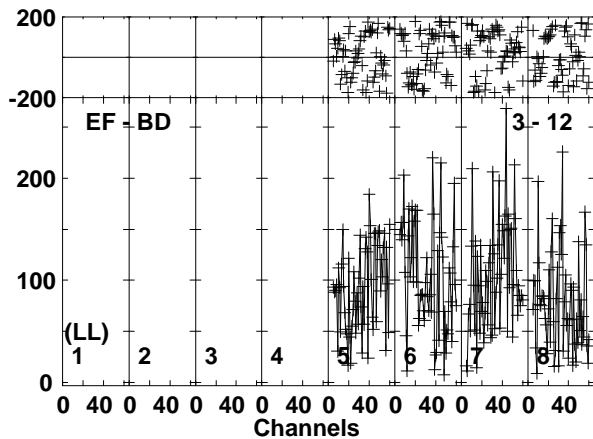
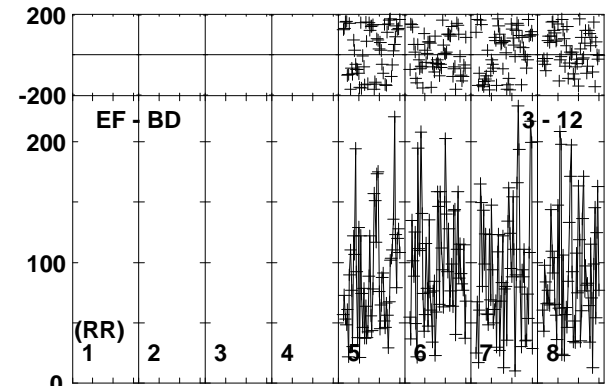
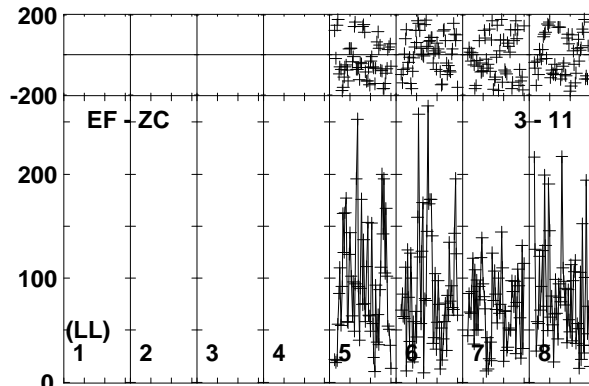
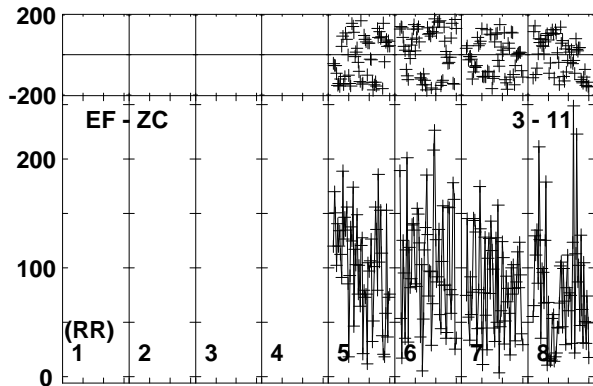
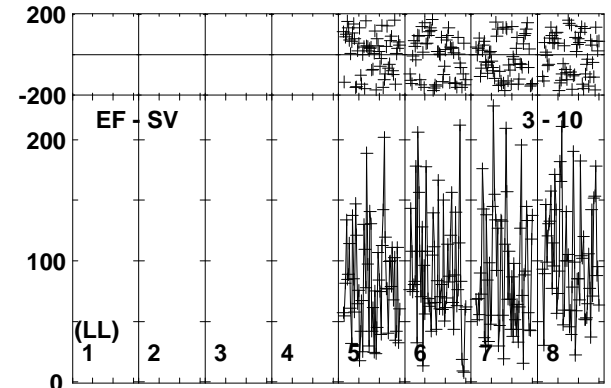
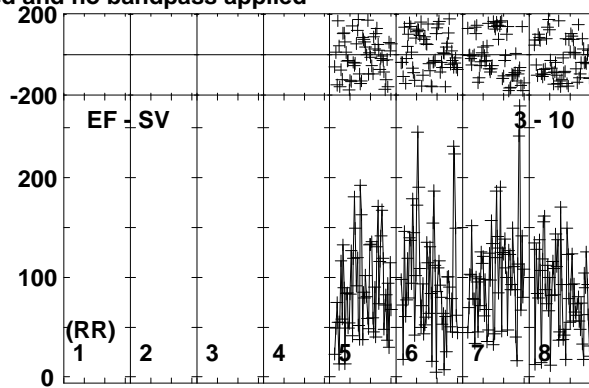
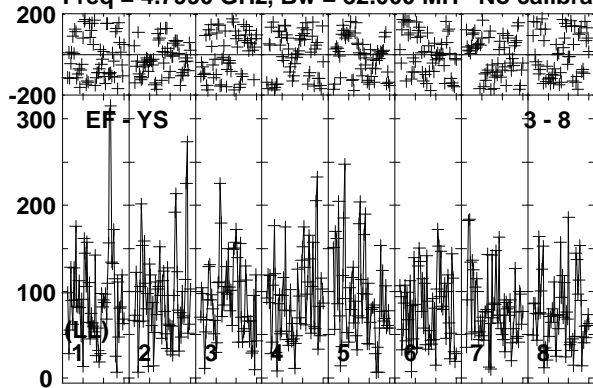

Lower frame: Micro Ampl Jy Top frame: Phas deg
Vector averaged cross-power spectrum Baseline: EF (03) - YS (08)
Timerange: 00/14:22:10 to 00/14:25:10

Plot file version 116 created 20-SEP-2019 15:51:40

AT2019EHZ RSM05.UVDATA.1

Freq = 4.7990 GHz, Bw = 32.000 MH No calibration applied and no bandpass applied

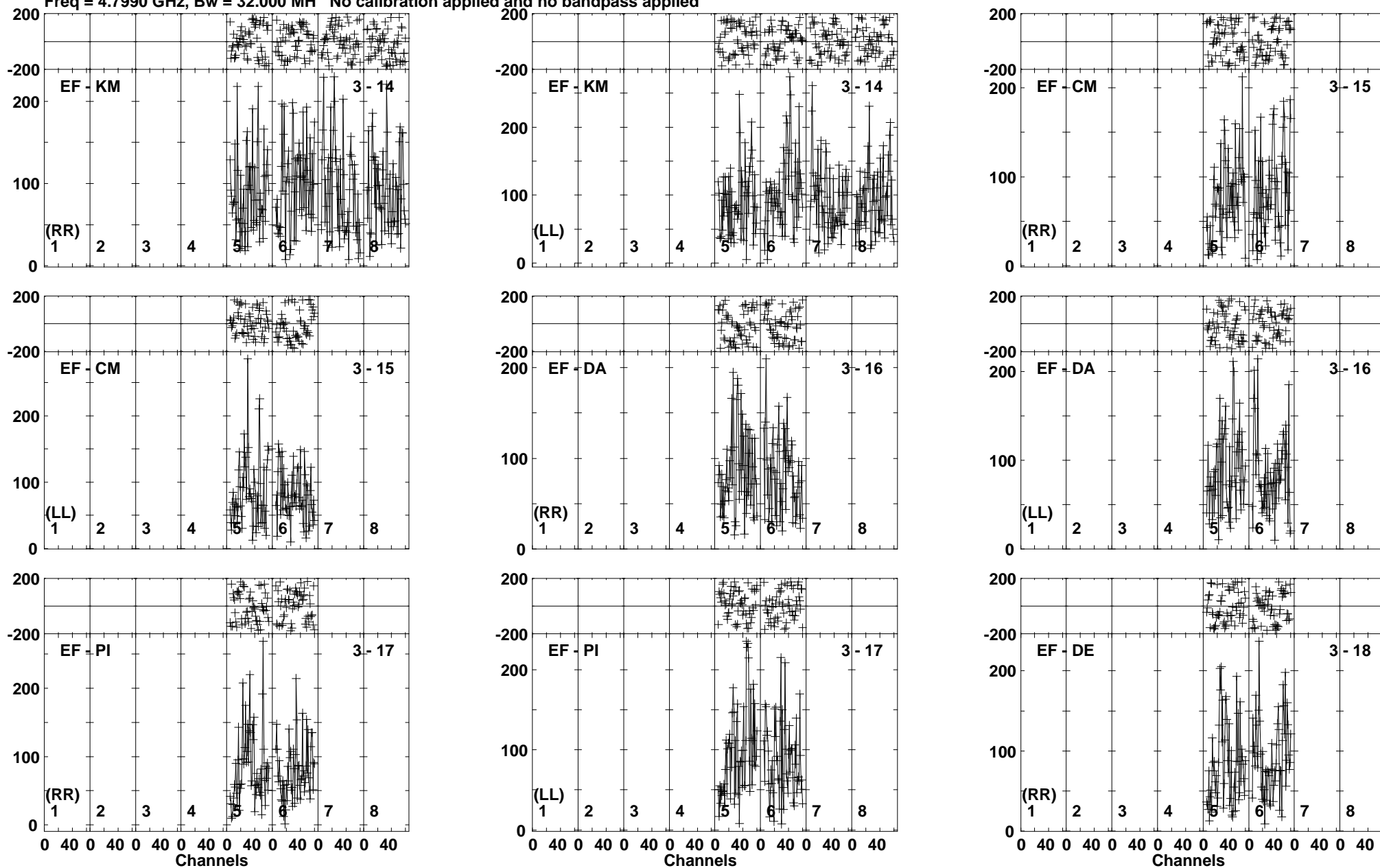

Lower frame: Micro Ampl Jy Top frame: Phas deg
Vector averaged cross-power spectrum Baseline: EF (03) - KM (14)
Timerange: 00/14:22:10 to 00/14:25:10

Plot file version 117 created 20-SEP-2019 15:51:40
AT2019EHZ RSM05.UVDATA.1
Freq = 4.7990 GHz, Bw = 32.000 MH No calibration applied and no bandpass applied

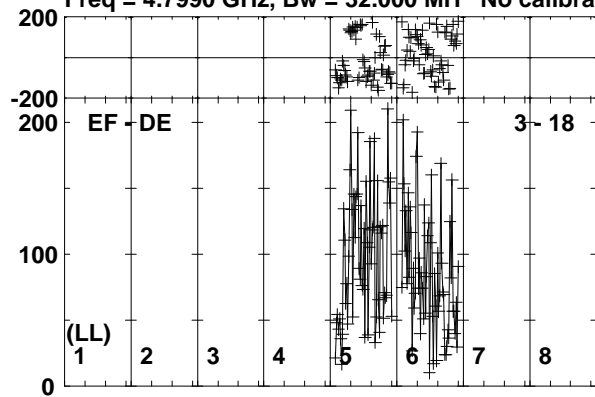

Lower frame: Micro Ampl Jy Top frame: Phas deg
Vector averaged cross-power spectrum Baseline: EF (03) - DE (18)
Timerange: 00/14:22:10 to 00/14:25:10

Plot file version 118 created 20-SEP-2019 15:51:40

J1408+5613 RSM05.UVDATA.1

Freq = 4.7990 GHz, Bw = 32.000 MH No calibration applied and no bandpass applied

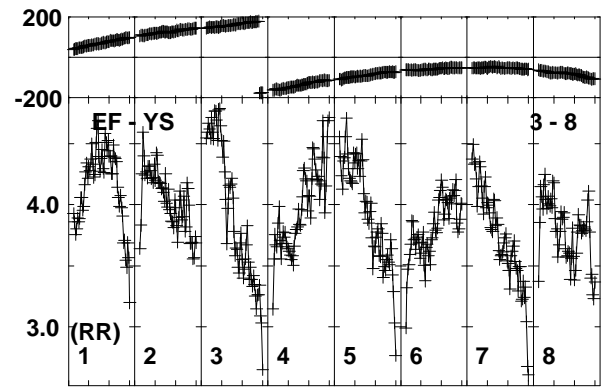
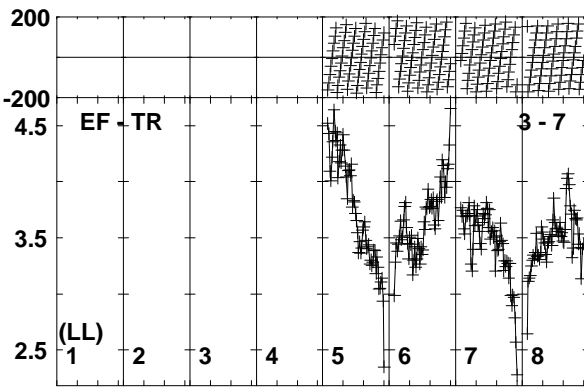
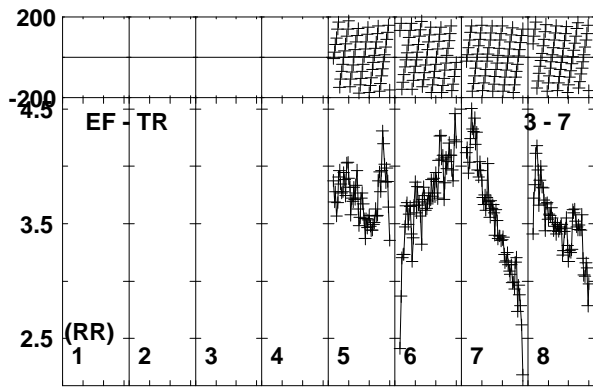
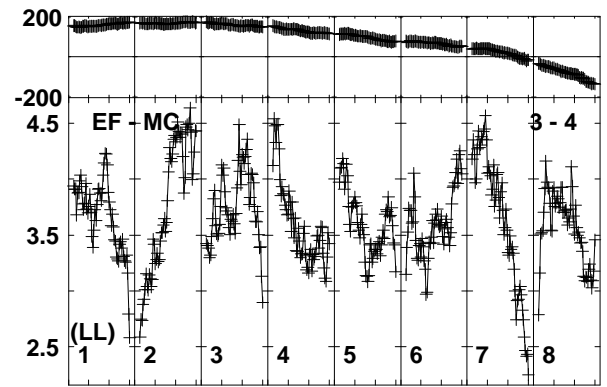
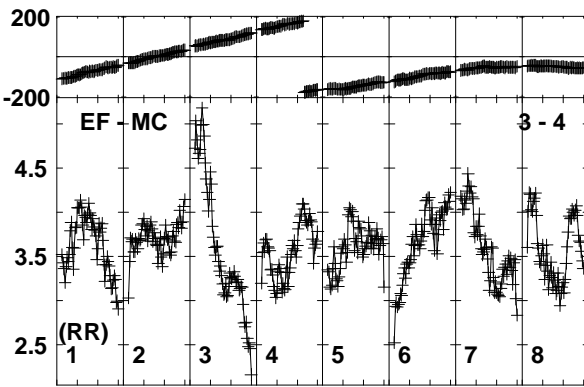
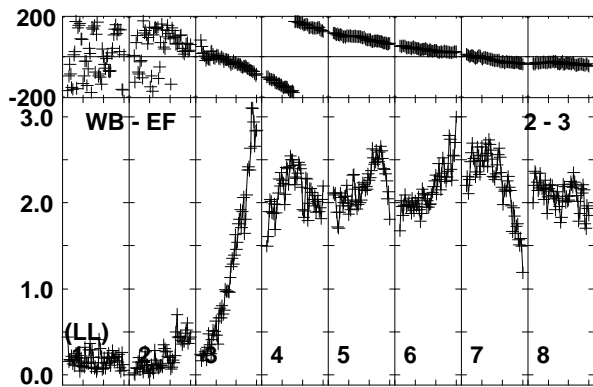
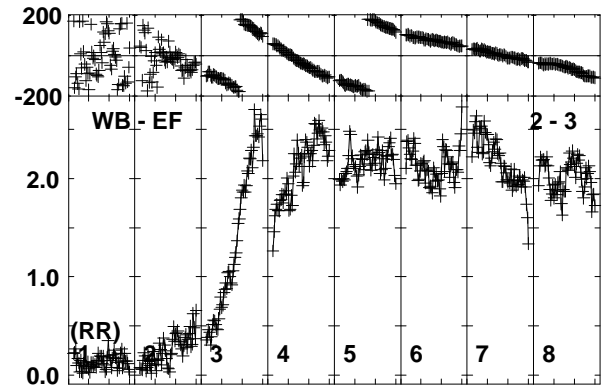
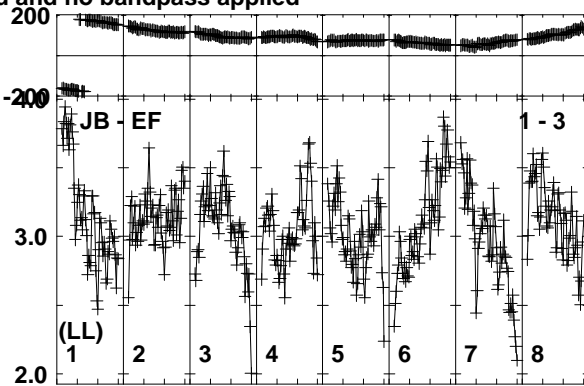
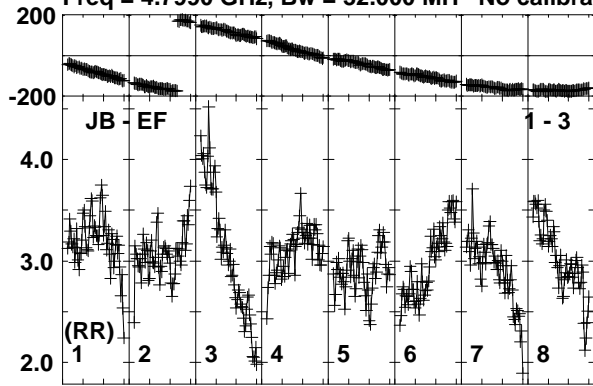

Lower frame: Milli Ampl Jy Top frame: Phas deg

Vector averaged cross-power spectrum Baseline: JB (01) - EF (03)

Timerange: 00/14:25:10 to 00/14:26:39

Plot file version 119 created 20-SEP-2019 15:51:41

J1408+5613 RSM05.UVDATA.1

Freq = 4.7990 GHz, Bw = 32.000 MH No calibration applied and no bandpass applied

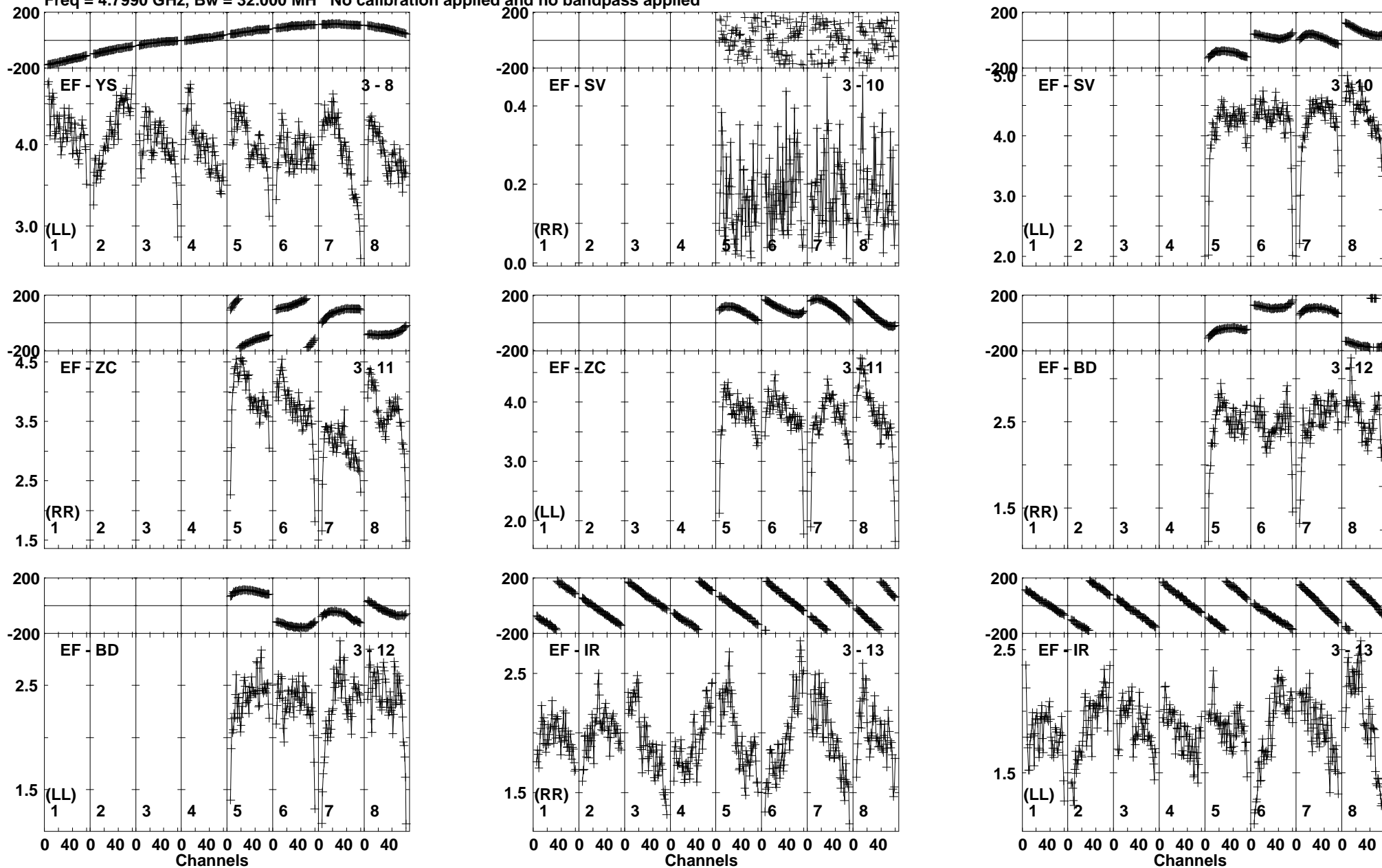

Lower frame: Milli Ampl Jy Top frame: Phas deg
Vector averaged cross-power spectrum Baseline: EF (03) - YS (08)
Timerange: 00/14:25:10 to 00/14:26:39

Plot file version 120 created 20-SEP-2019 15:51:41

J1408+5613 RSM05.UVDATA.1

Freq = 4.7990 GHz, Bw = 32.000 MH No calibration applied and no bandpass applied

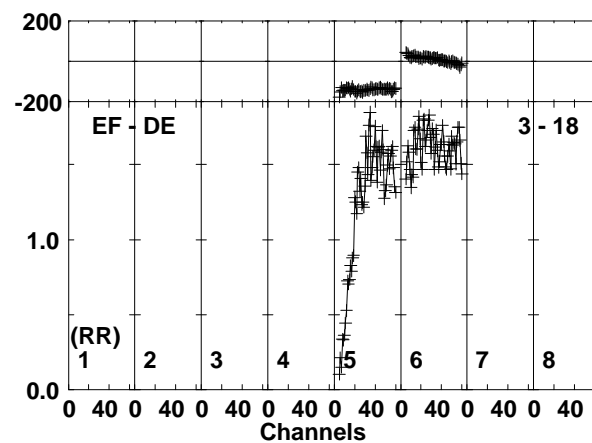
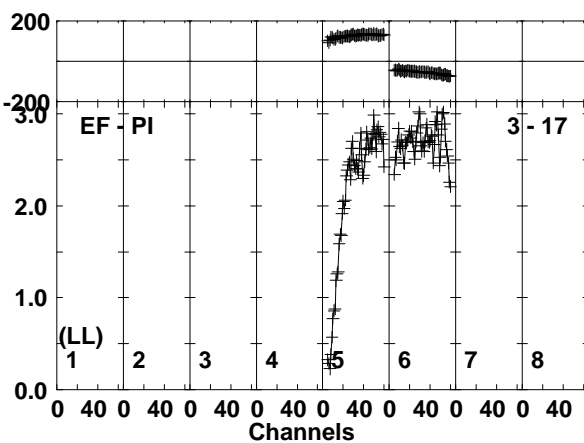
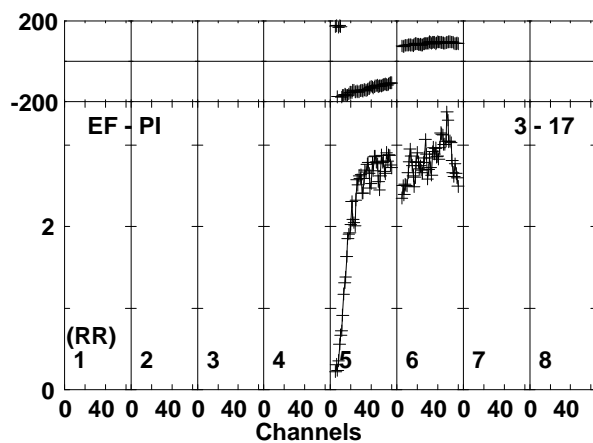
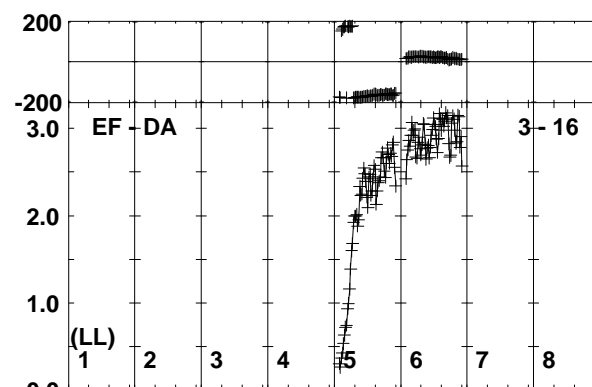
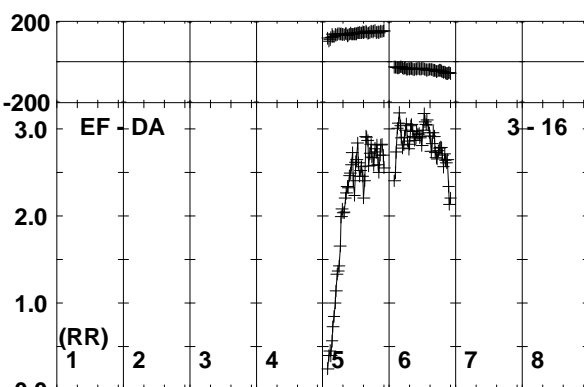
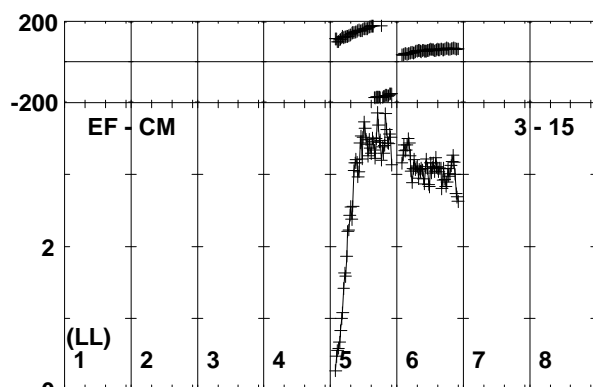
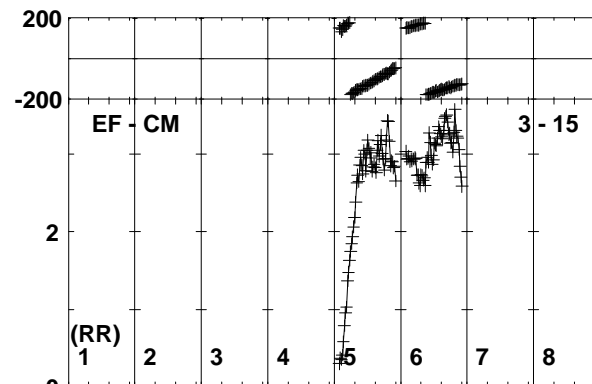
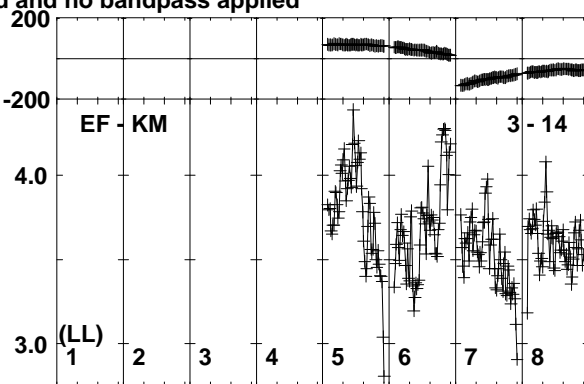
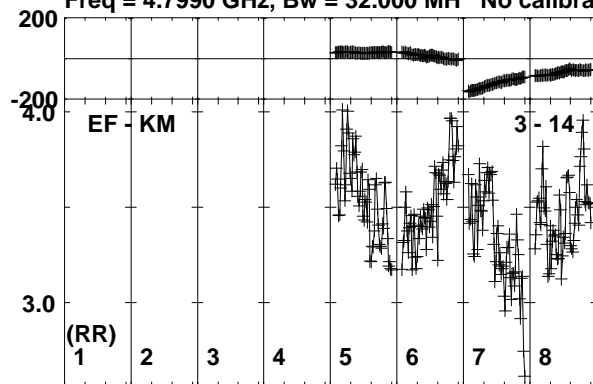

Lower frame: Milli Ampl Jy Top frame: Phas deg
Vector averaged cross-power spectrum Baseline: EF (03) - KM (14)
Timerange: 00/14:25:10 to 00/14:26:39

Plot file version 121 created 20-SEP-2019 15:51:42
J1408+5613 RSM05.UVDATA.1
Freq = 4.7990 GHz, Bw = 32.000 MH No calibration applied and no bandpass applied

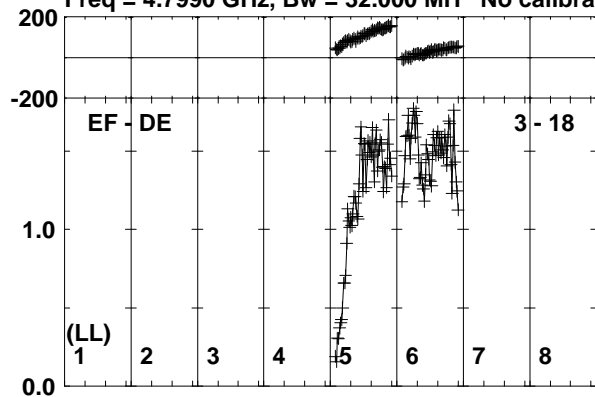

Lower frame: Milli Ampl Jy Top frame: Phas deg
Vector averaged cross-power spectrum Baseline: EF (03) - DE (18)
Timerange: 00/14:25:10 to 00/14:26:39

Plot file version 122 created 20-SEP-2019 15:51:42
 AT2019EHZ RSM05.UVDATA.1
 Freq = 4.7990 GHz, Bw = 32.000 MH No calibration applied and no bandpass applied

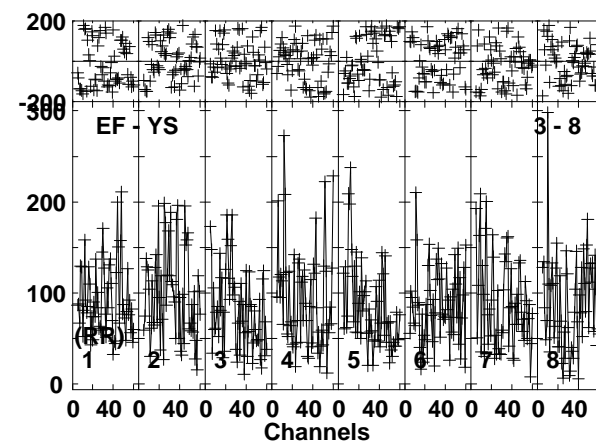
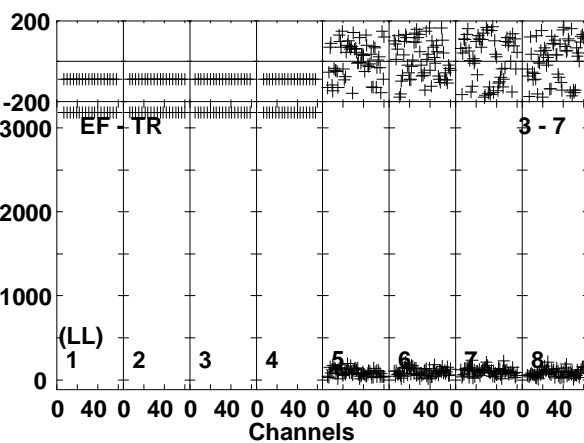
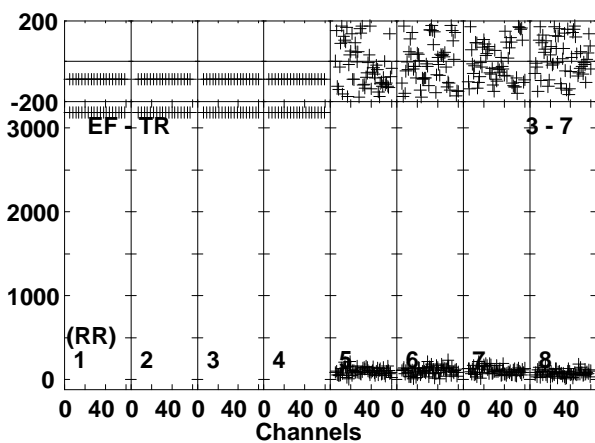
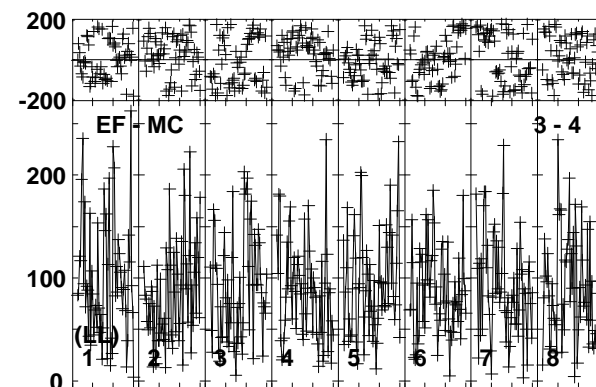
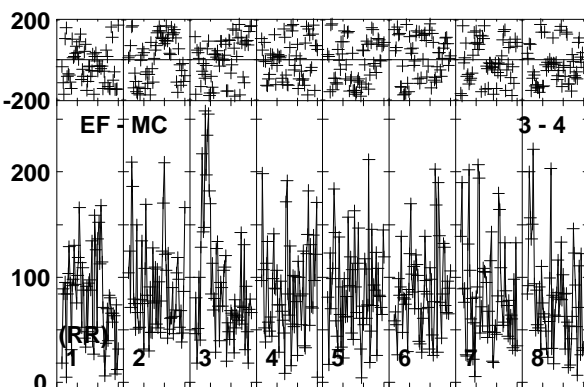
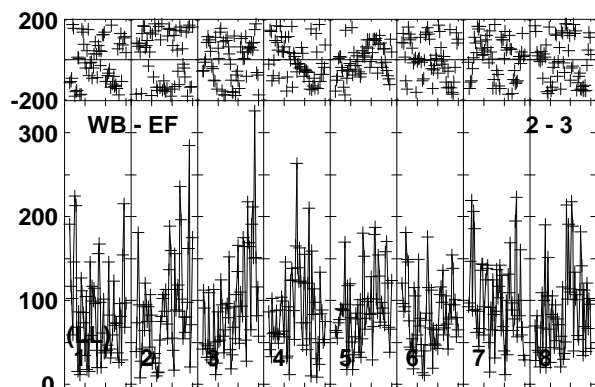
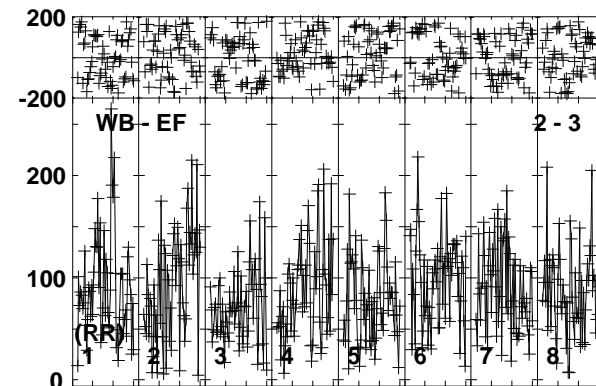
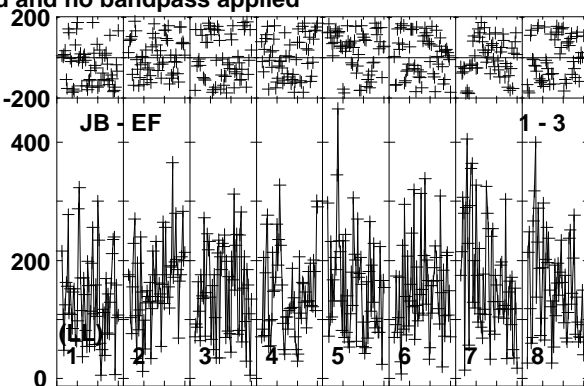
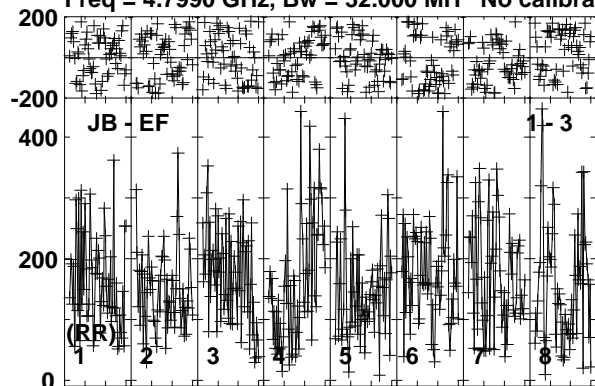

Lower frame: Micro Ampl Jy Top frame: Phas deg
 Vector averaged cross-power spectrum Baseline: JB (01) - EF (03)
 Timerange: 00/14:26:41 to 00/14:29:40

Plot file version 123 created 20-SEP-2019 15:51:42

AT2019EHZ RSM05.UVDATA.1

Freq = 4.7990 GHz, Bw = 32.000 MH No calibration applied and no bandpass applied

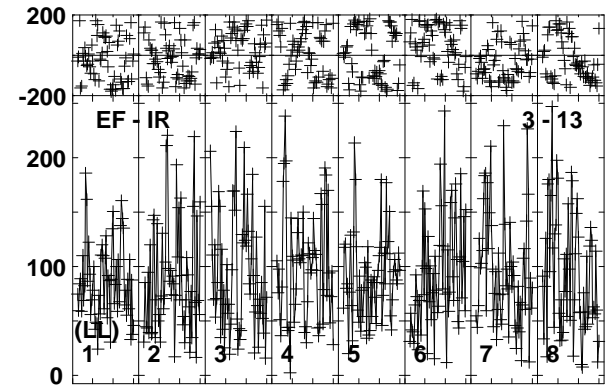
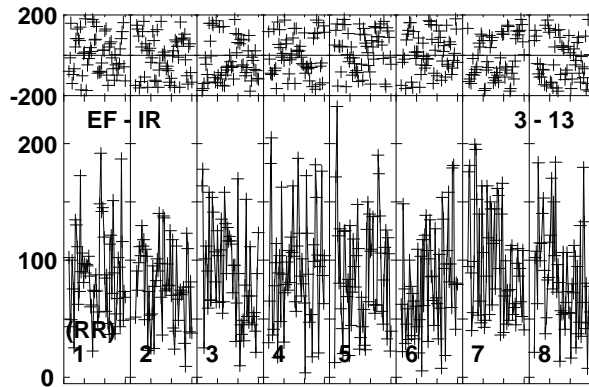
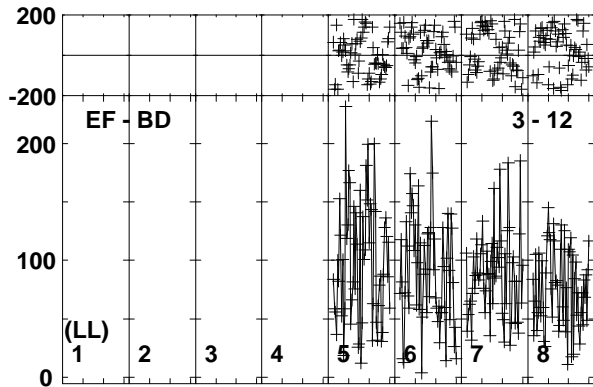
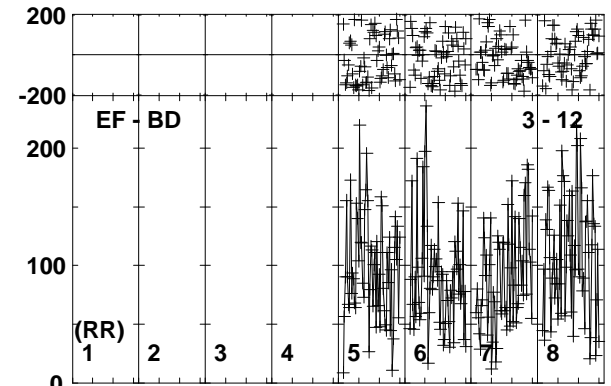
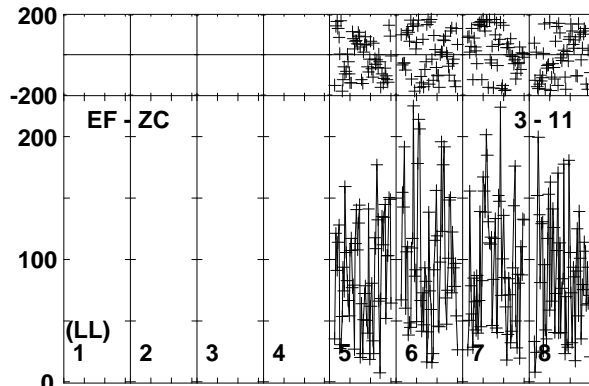
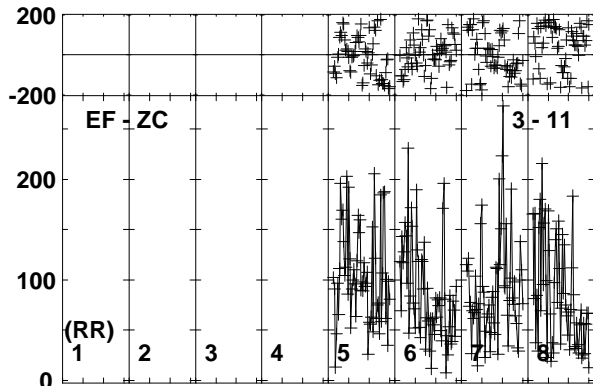
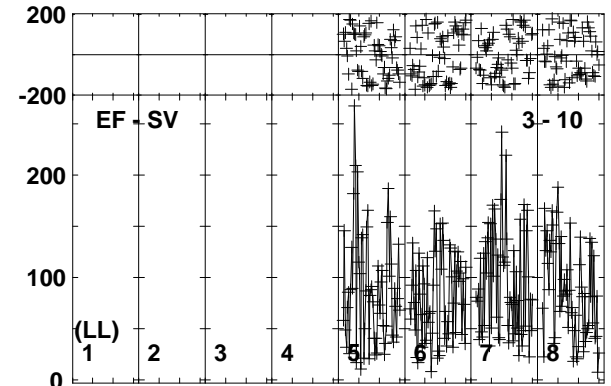
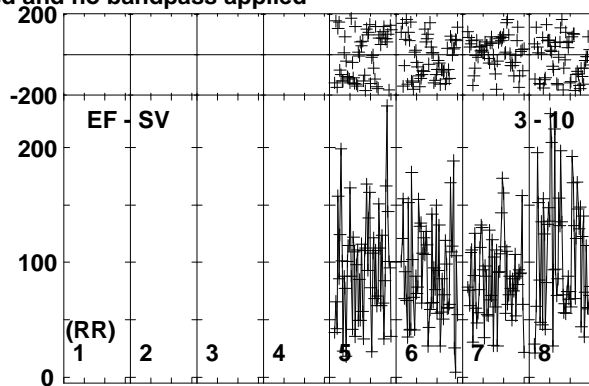
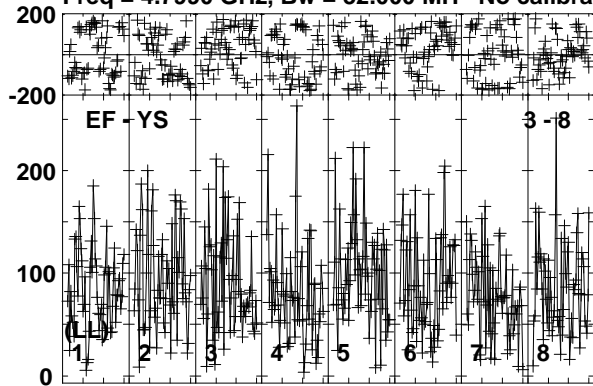

Lower frame: Micro Ampl Jy Top frame: Phas deg
Vector averaged cross-power spectrum Baseline: EF (03) - YS (08)
Timerange: 00/14:26:41 to 00/14:29:40

Plot file version 124 created 20-SEP-2019 15:51:43
 AT2019EHZ RSM05.UVDATA.1
 Freq = 4.7990 GHz, Bw = 32.000 MH No calibration applied and no bandpass applied

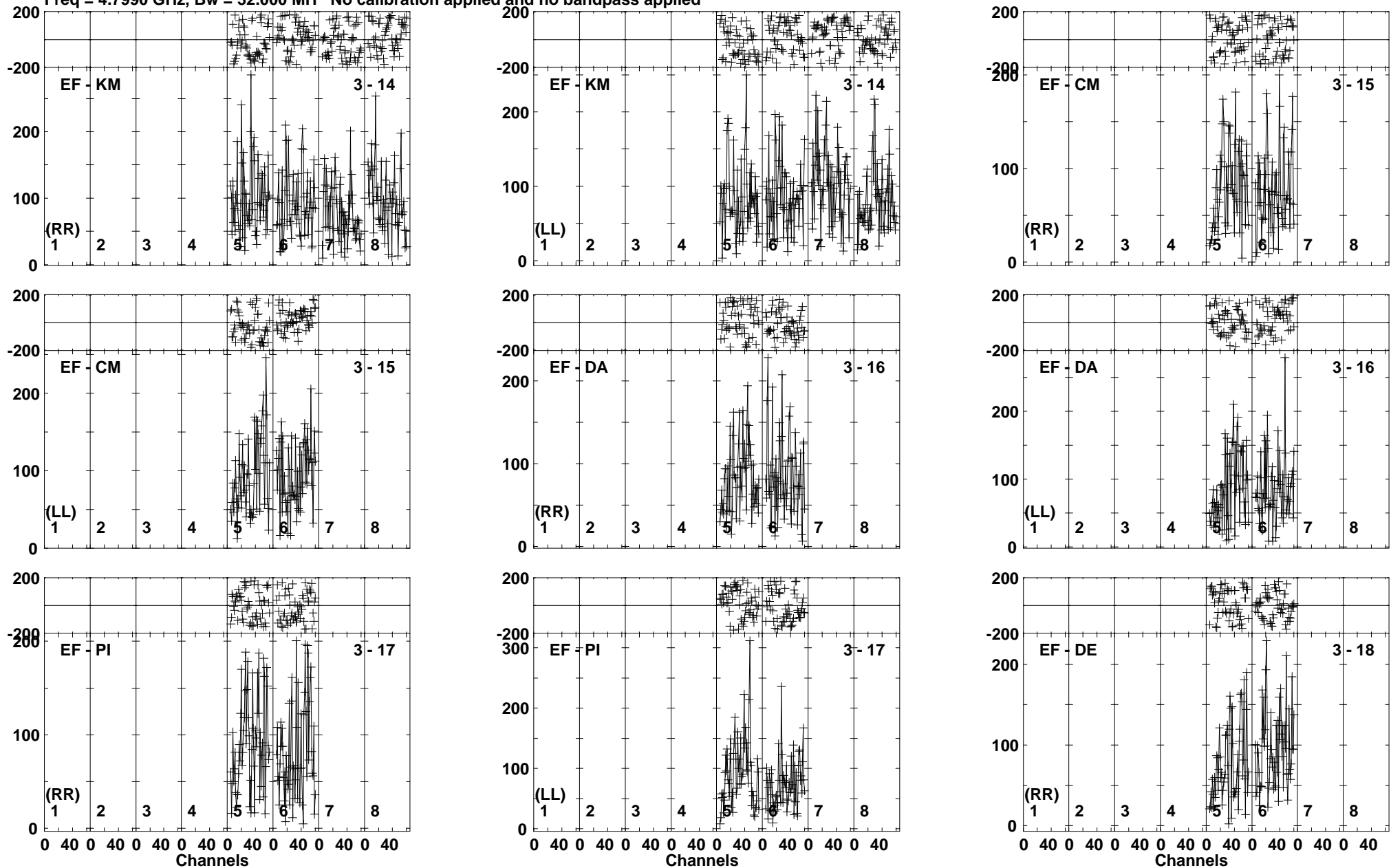

Lower frame: Micro Ampl Jy Top frame: Phas deg
 Vector averaged cross-power spectrum Baseline: EF (03) - KM (14)
 Timerange: 00/14:26:41 to 00/14:29:40

Plot file version 125 created 20-SEP-2019 15:51:43
AT2019EHZ RSM05.UVDATA.1
Freq = 4.7990 GHz, Bw = 32.000 MH No calibration applied and no bandpass applied

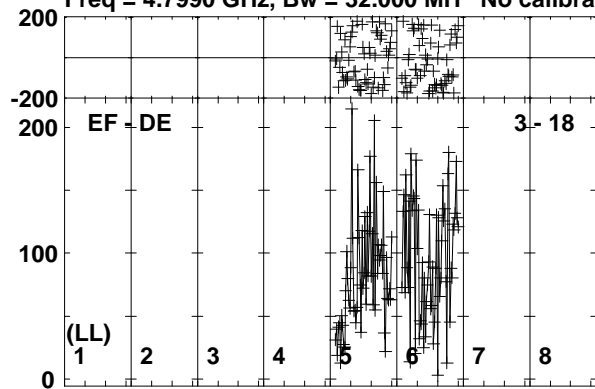

Lower frame: Micro Ampl Jy Top frame: Phas deg
Vector averaged cross-power spectrum Baseline: EF (03) - DE (18)
Timerange: 00/14:26:41 to 00/14:29:40

Plot file version 126 created 20-SEP-2019 15:51:43

J1408+5613 RSM05.UVDATA.1

Freq = 4.7990 GHz, Bw = 32.000 MH No calibration applied and no bandpass applied

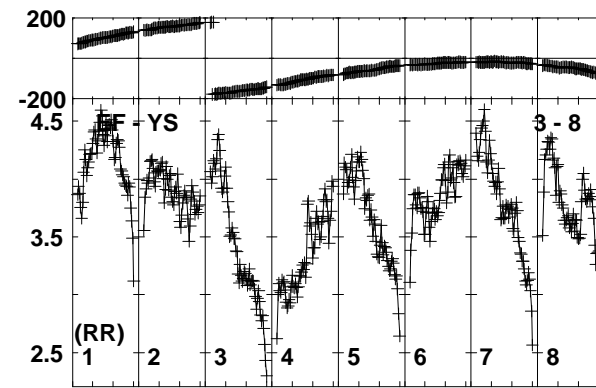
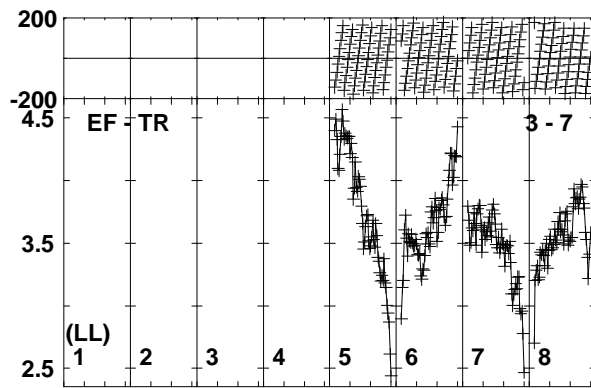
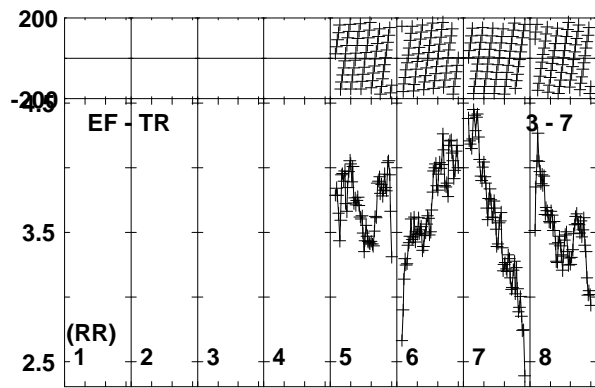
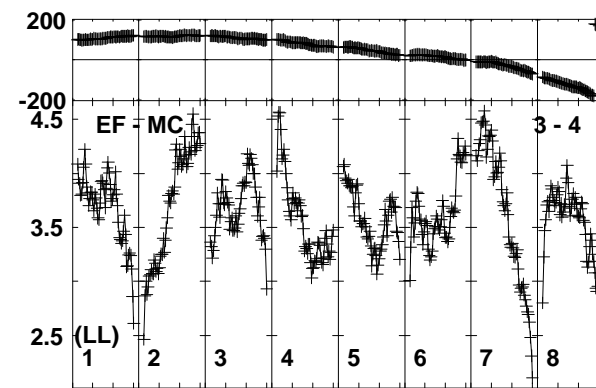
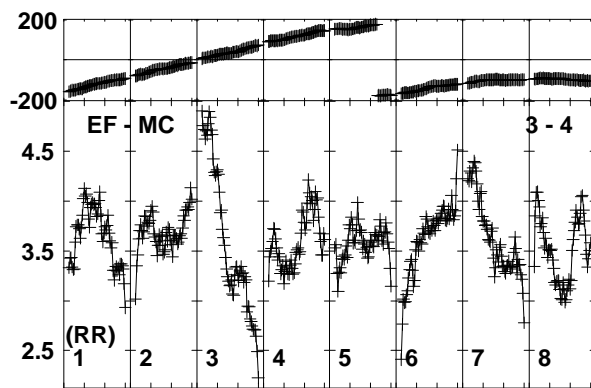
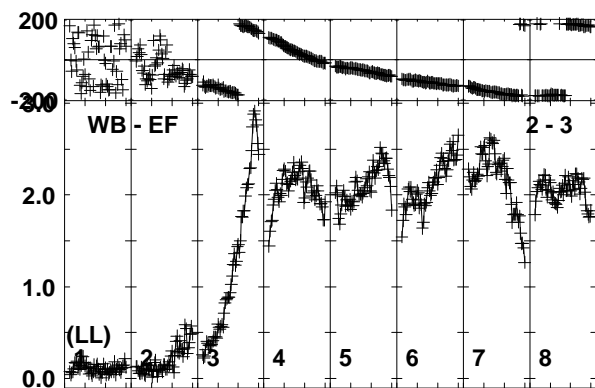
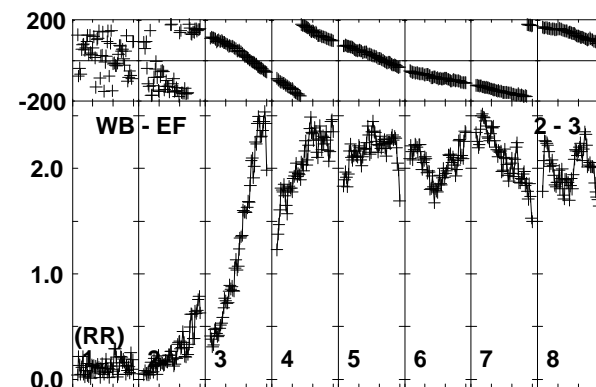
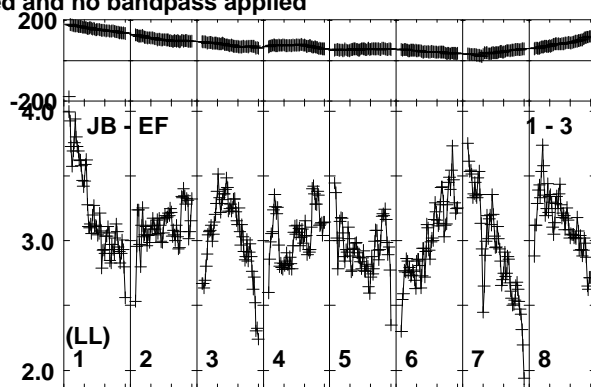
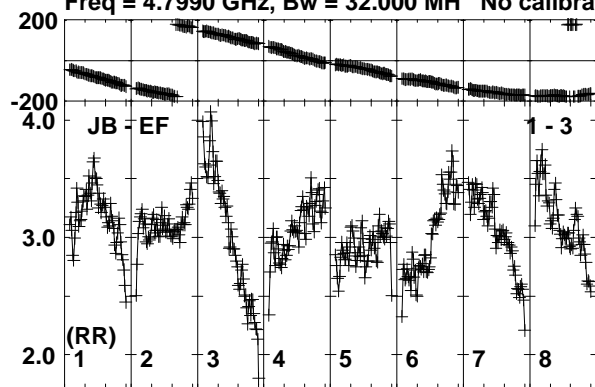

Lower frame: Milli Ampl Jy Top frame: Phas deg
Vector averaged cross-power spectrum Baseline: JB (01) - EF (03)
Timerange: 00/14:30:31 to 00/14:31:59

Plot file version 127 created 20-SEP-2019 15:51:44

J1408+5613 RSM05.UVDATA.1

Freq = 4.7990 GHz, Bw = 32.000 MH No calibration applied and no bandpass applied

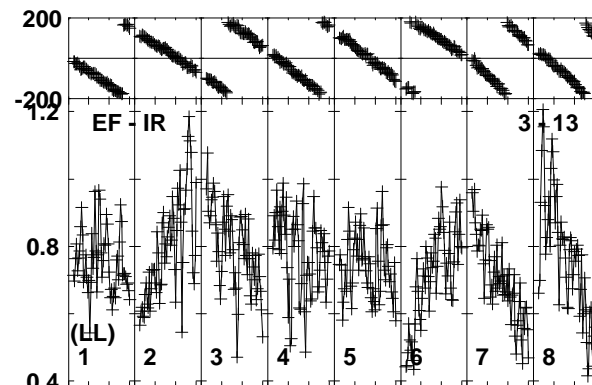
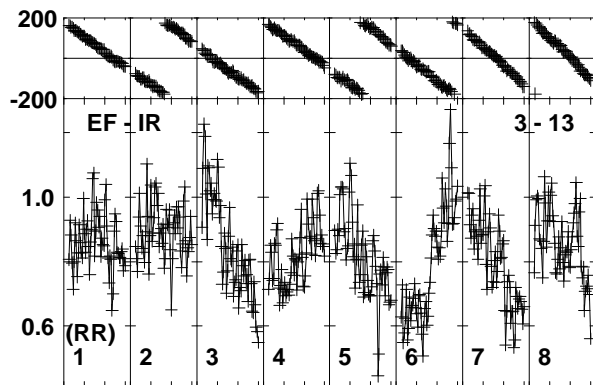
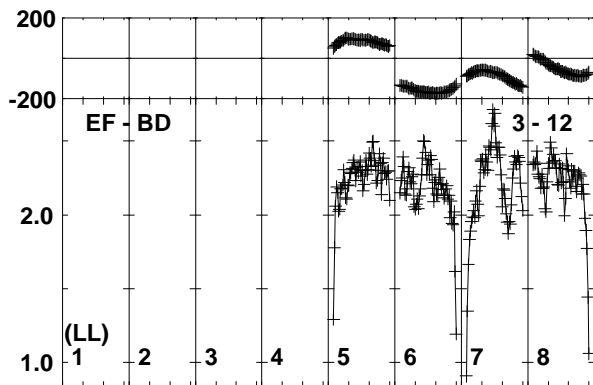
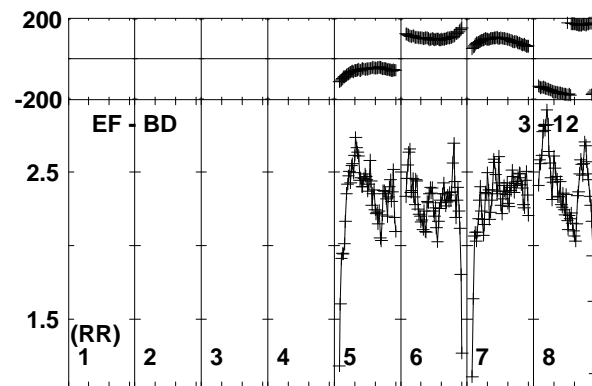
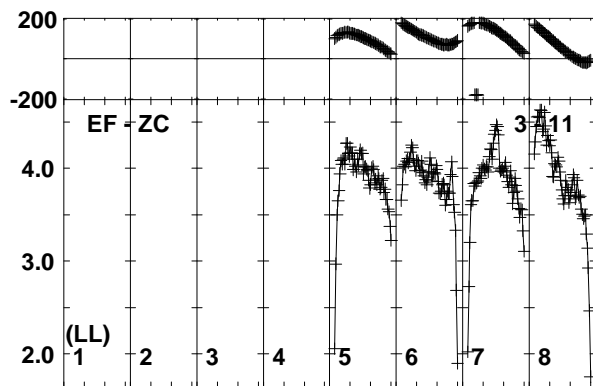
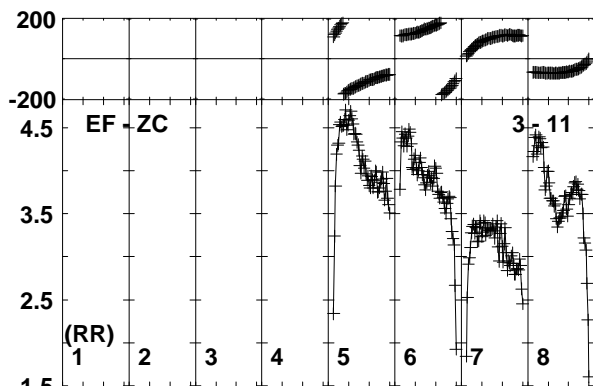
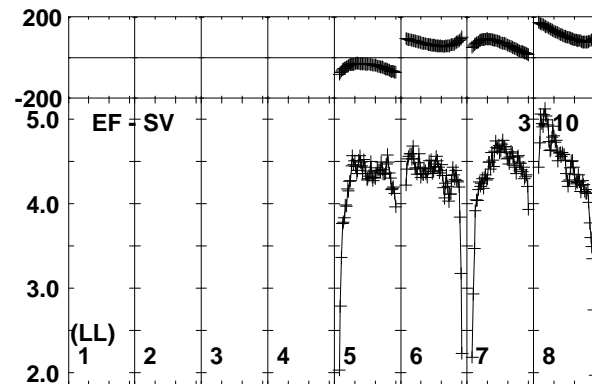
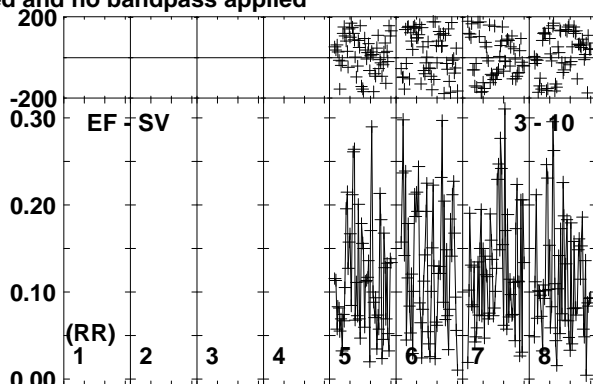
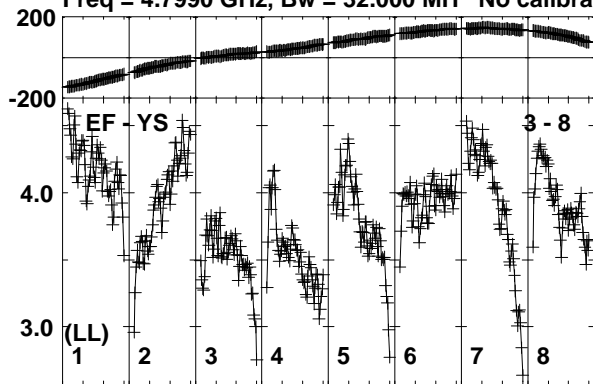

Lower frame: Milli Ampl Jy Top frame: Phas deg
Vector averaged cross-power spectrum Baseline: EF (03) - YS (08)
Timerange: 00/14:30:31 to 00/14:31:59

Plot file version 128 created 20-SEP-2019 15:51:44

J1408+5613 RSM05.UVDATA.1

Freq = 4.7990 GHz, Bw = 32.000 MH No calibration applied and no bandpass applied

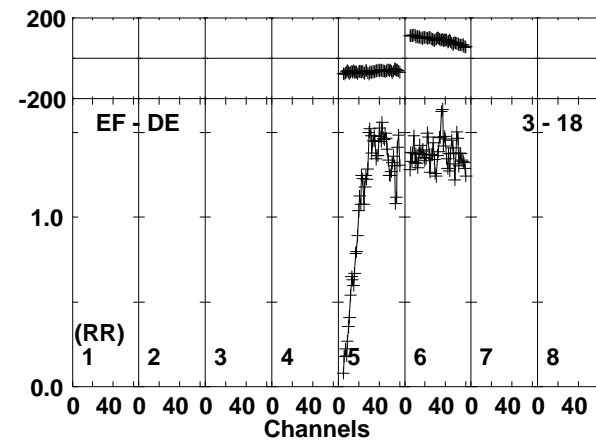
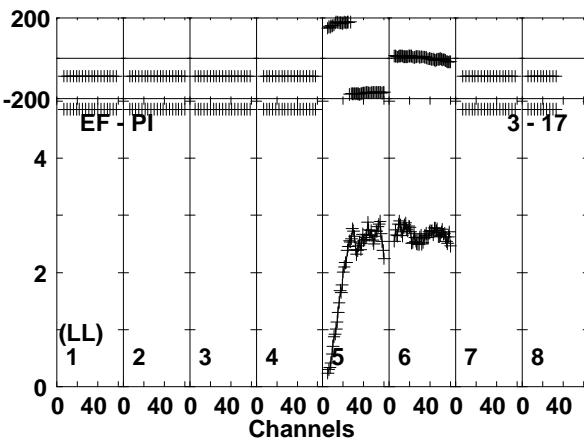
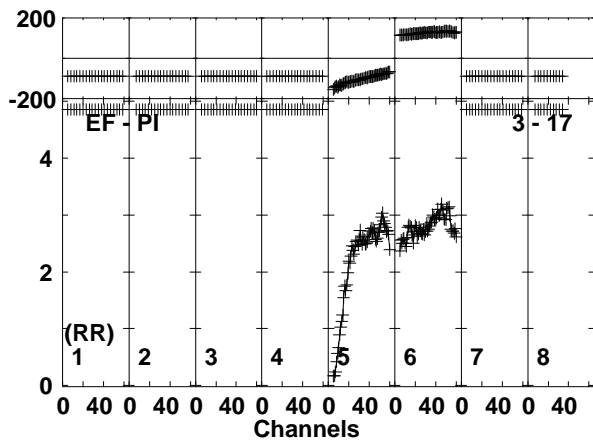
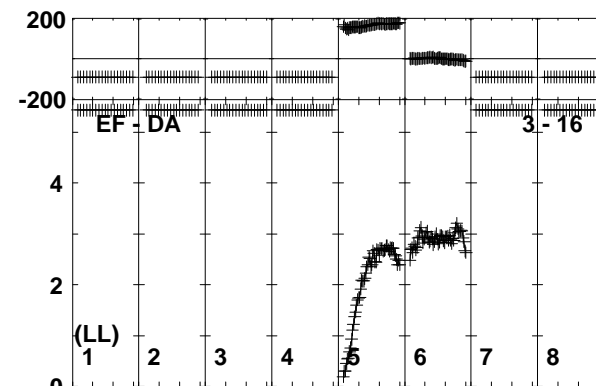
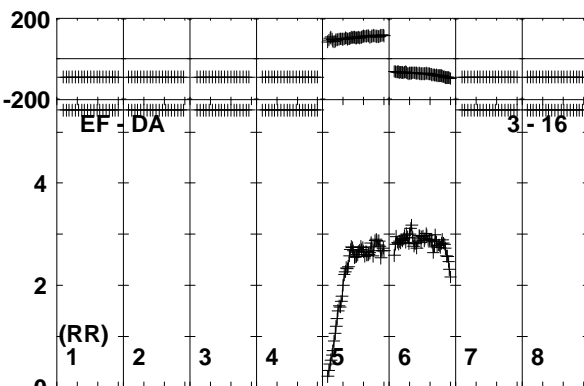
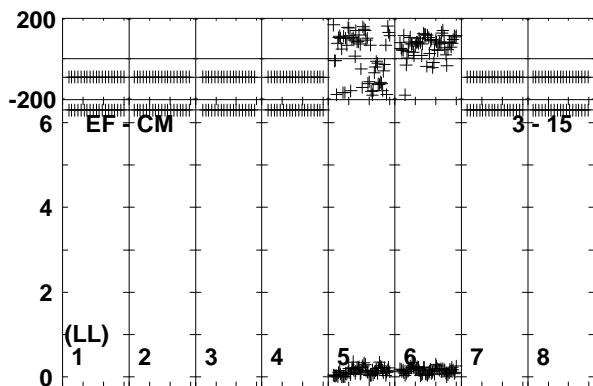
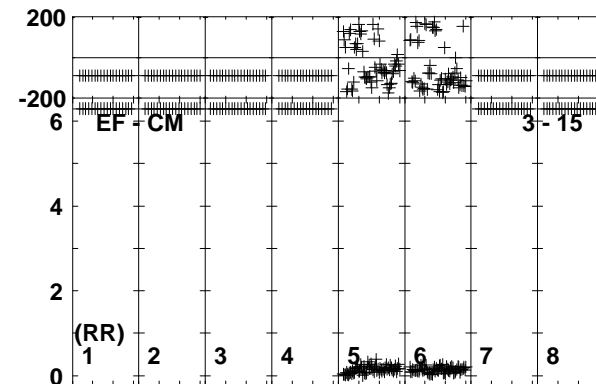
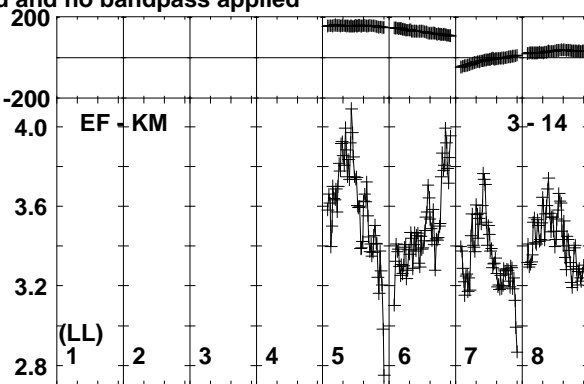
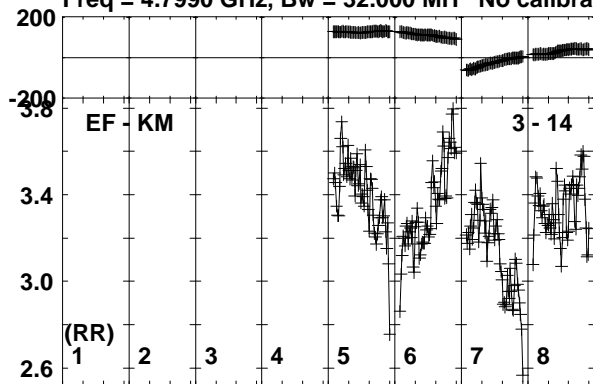

Lower frame: Milli Ampl Jy Top frame: Phas deg
Vector averaged cross-power spectrum Baseline: EF (03) - KM (14)
Timerange: 00/14:30:31 to 00/14:31:59

Plot file version 129 created 20-SEP-2019 15:51:45
J1408+5613 RSM05.UVDATA.1
Freq = 4.7990 GHz, Bw = 32.000 MH No calibration applied and no bandpass applied

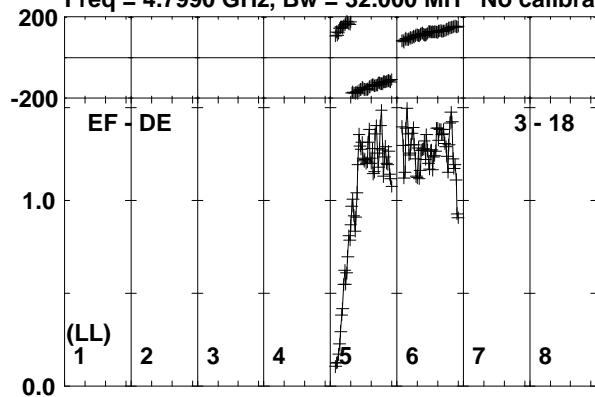

Lower frame: Milli Ampl Jy Top frame: Phas deg
Vector averaged cross-power spectrum Baseline: EF (03) - DE (18)
Timerange: 00/14:30:31 to 00/14:31:59

Plot file version 130 created 20-SEP-2019 15:51:45

AT2019EHZ RSM05.UVDATA.1

Freq = 4.7990 GHz, Bw = 32.000 MH No calibration applied and no bandpass applied

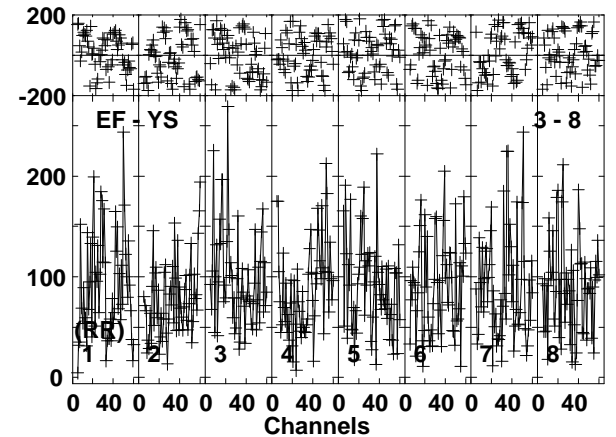
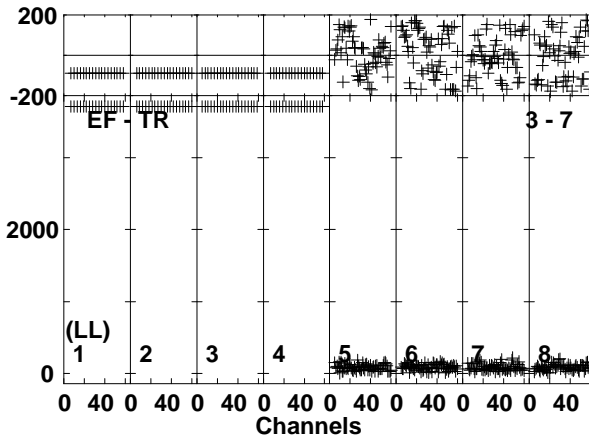
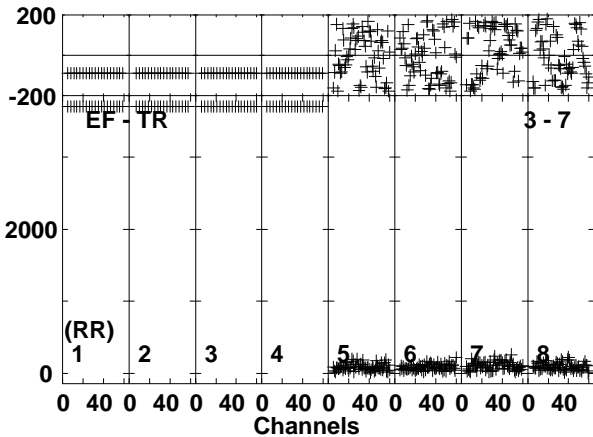
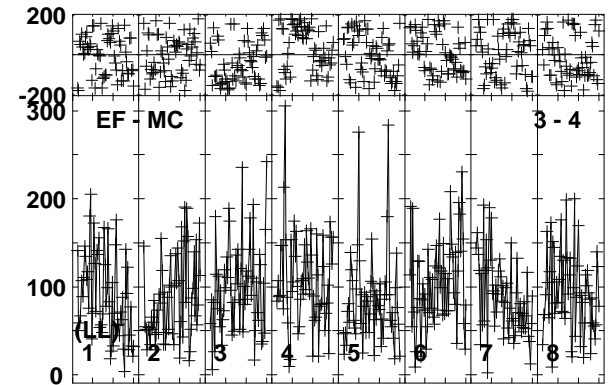
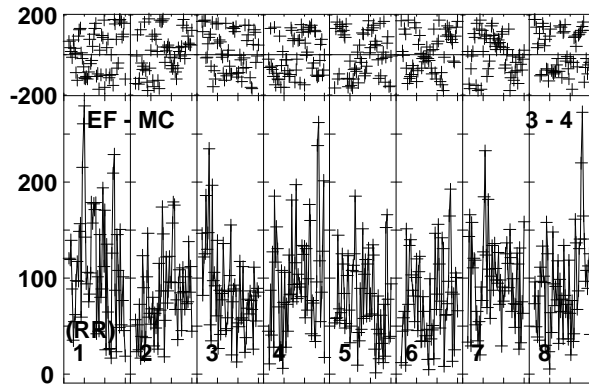
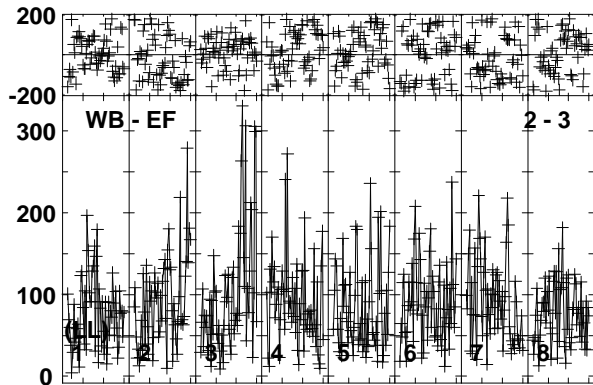
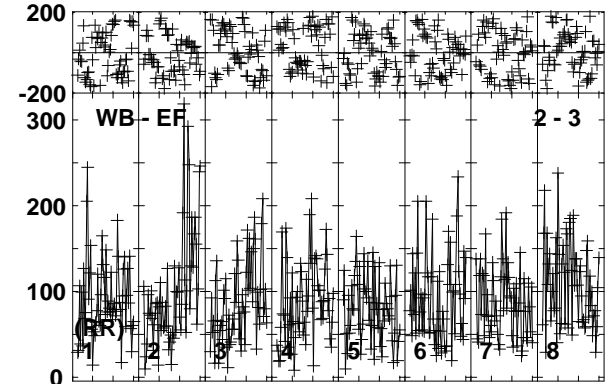
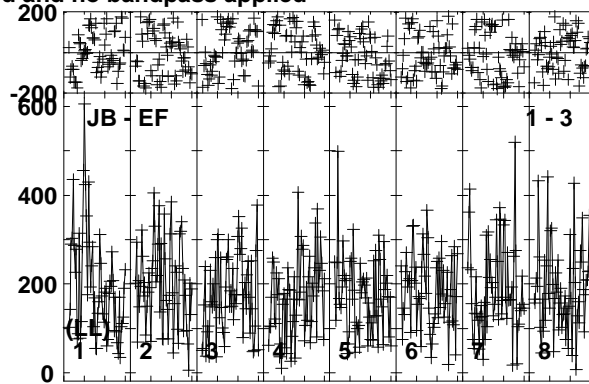
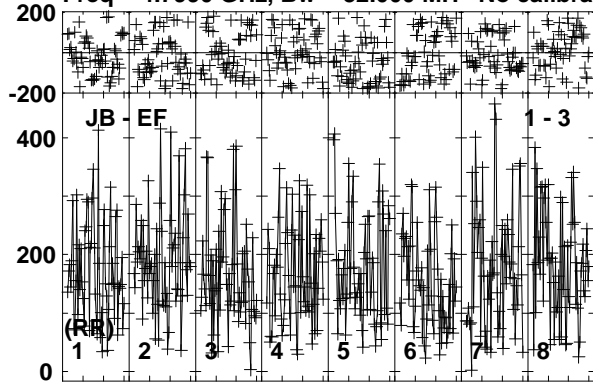

Lower frame: Micro Ampl Jy Top frame: Phas deg
Vector averaged cross-power spectrum Baseline: JB (01) - EF (03)
Timerange: 00/14:32:00 to 00/14:35:00

Plot file version 131 created 20-SEP-2019 15:51:46

AT2019EHZ RSM05.UVDATA.1

Freq = 4.7990 GHz, Bw = 32.000 MH No calibration applied and no bandpass applied

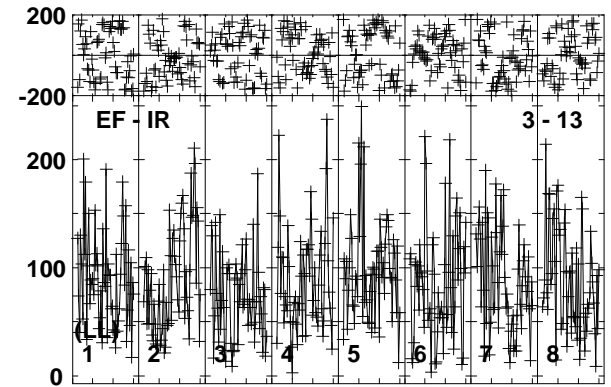
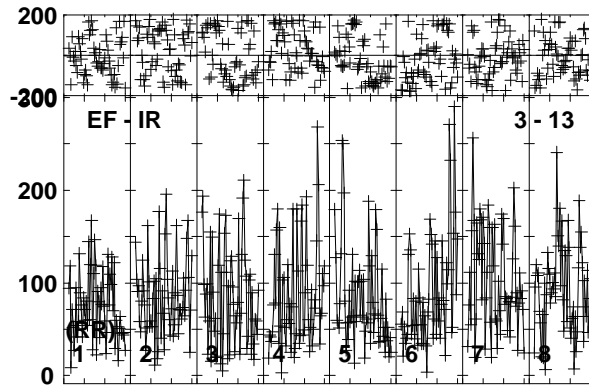
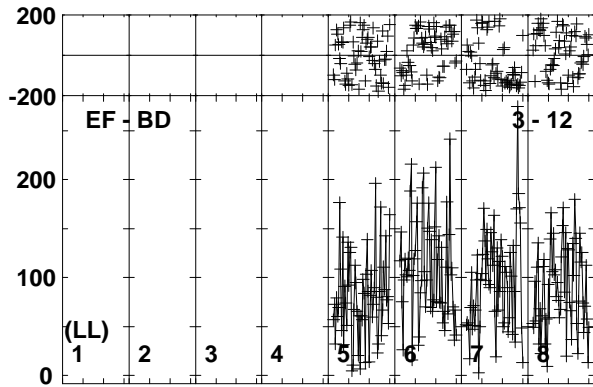
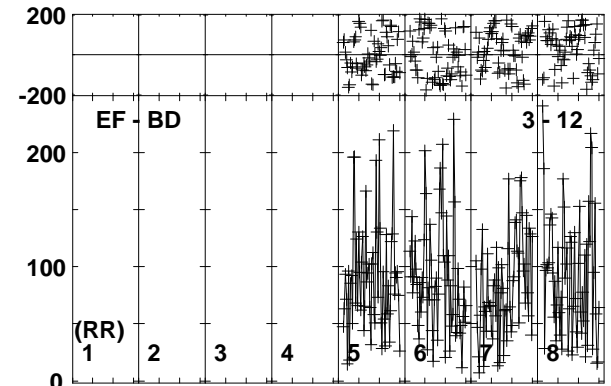
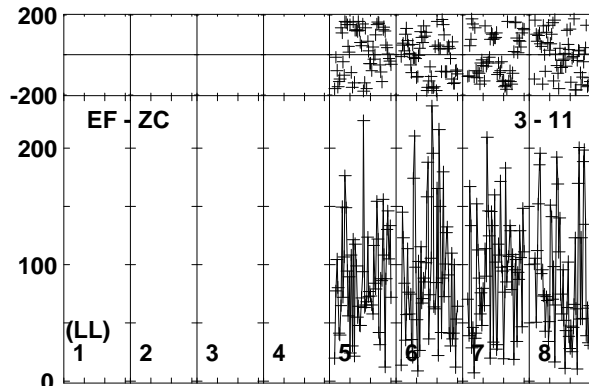
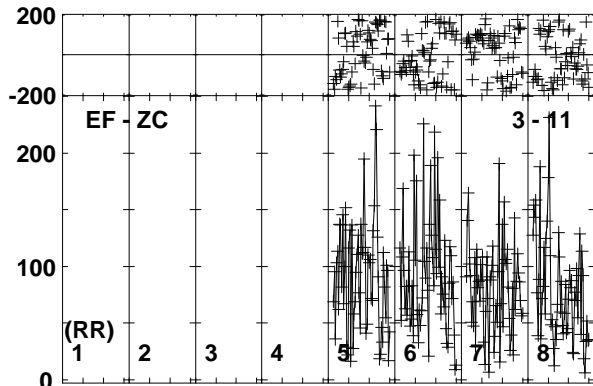
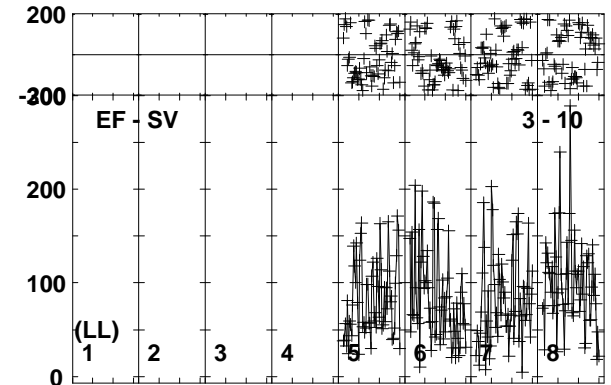
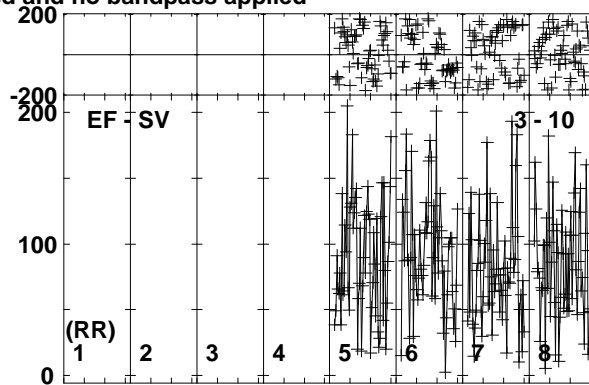
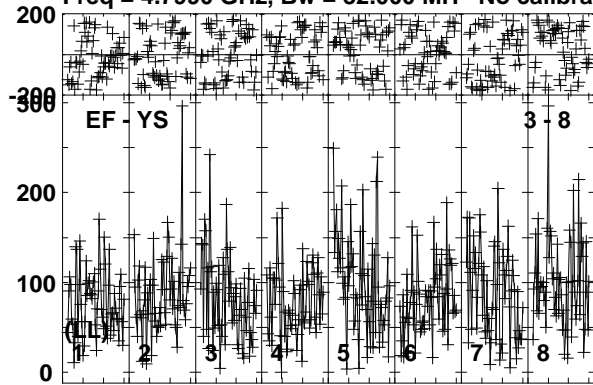

Lower frame: Micro Ampl Jy Top frame: Phas deg
Vector averaged cross-power spectrum Baseline: EF (03) - YS (08)
Timerange: 00/14:32:00 to 00/14:35:00

Plot file version 132 created 20-SEP-2019 15:51:46

AT2019EHZ RSM05.UVDATA.1

Freq = 4.7990 GHz, Bw = 32.000 MH No calibration applied and no bandpass applied

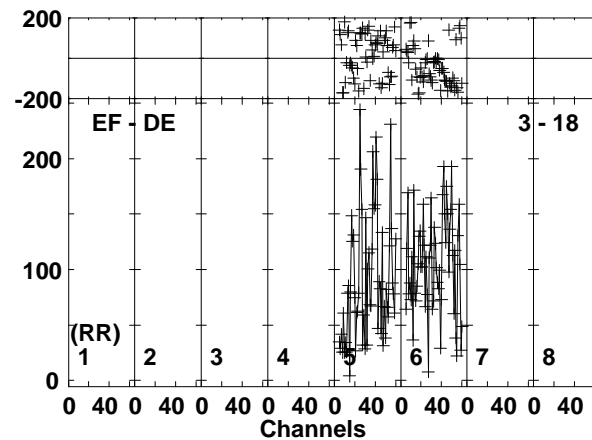
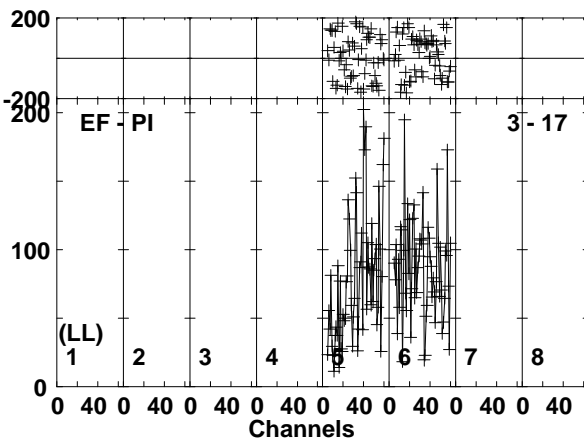
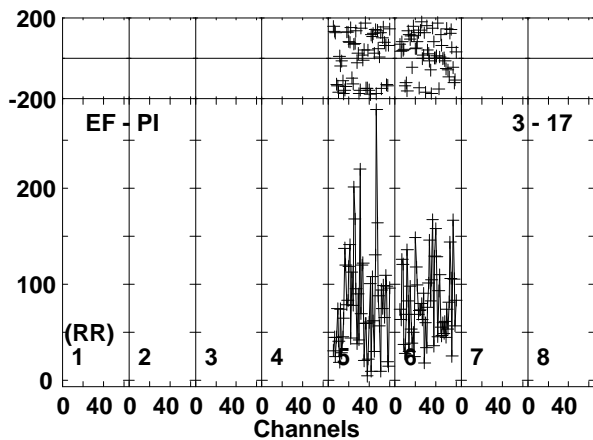
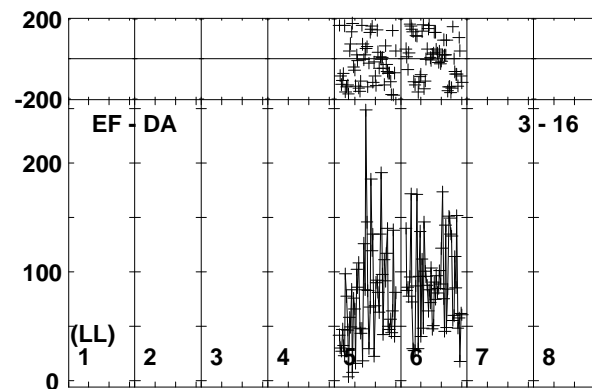
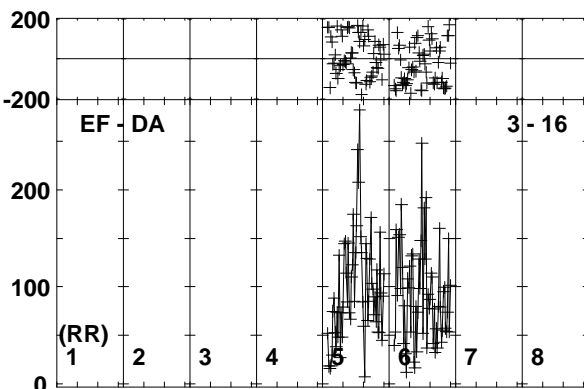
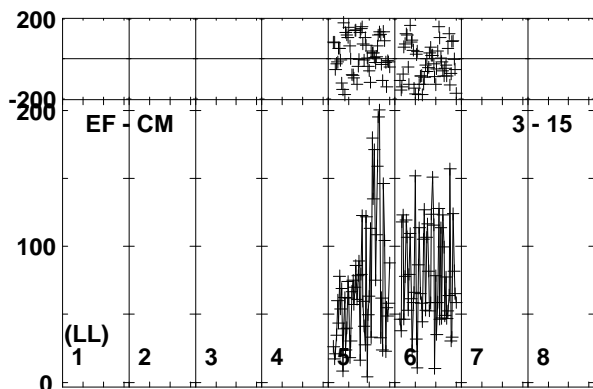
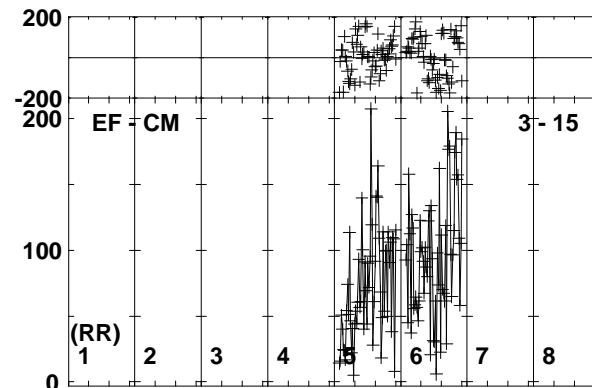
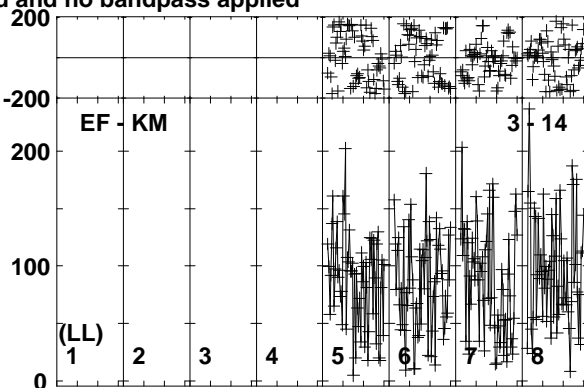
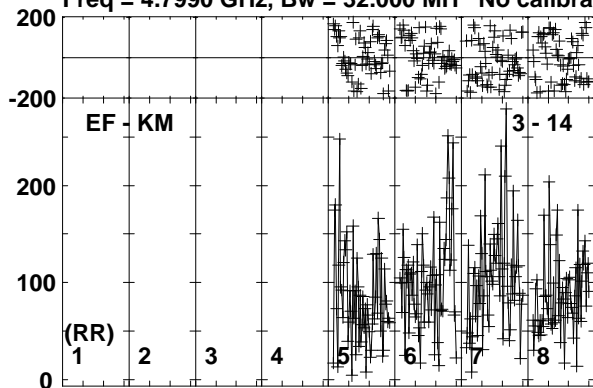

Lower frame: Micro Ampl Jy Top frame: Phas deg
Vector averaged cross-power spectrum Baseline: EF (03) - KM (14)
Timerange: 00/14:32:00 to 00/14:35:00

Plot file version 133 created 20-SEP-2019 15:51:47
AT2019EHZ RSM05.UVDATA.1
Freq = 4.7990 GHz, Bw = 32.000 MH No calibration applied and no bandpass applied

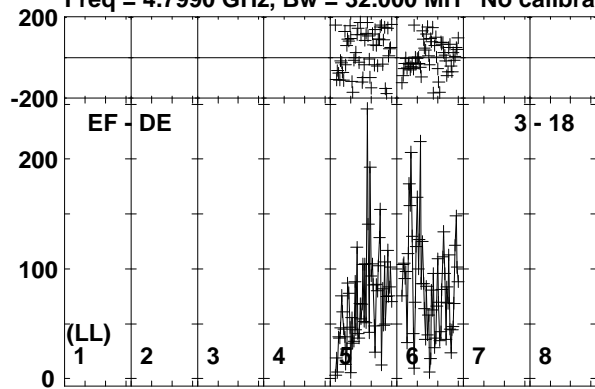

Lower frame: Micro Ampl Jy Top frame: Phas deg
Vector averaged cross-power spectrum Baseline: EF (03) - DE (18)
Timerange: 00/14:32:00 to 00/14:35:00

Plot file version 134 created 20-SEP-2019 15:51:47

J1408+5613 RSM05.UVDATA.1

Freq = 4.7990 GHz, Bw = 32.000 MH No calibration applied and no bandpass applied

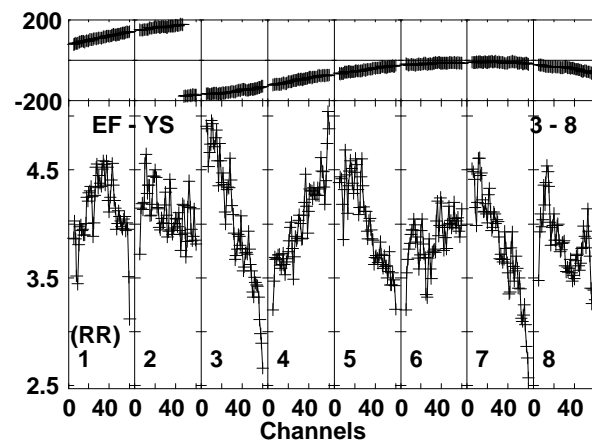
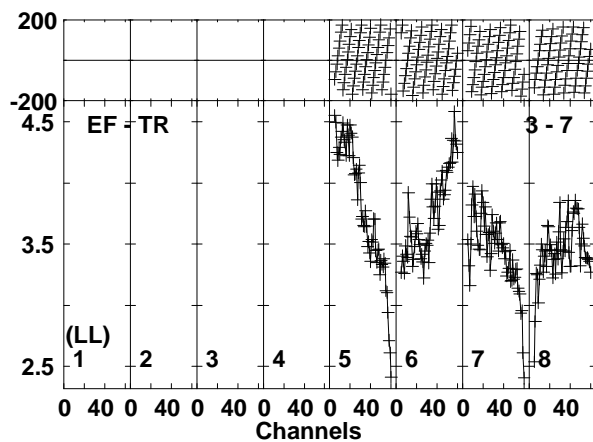
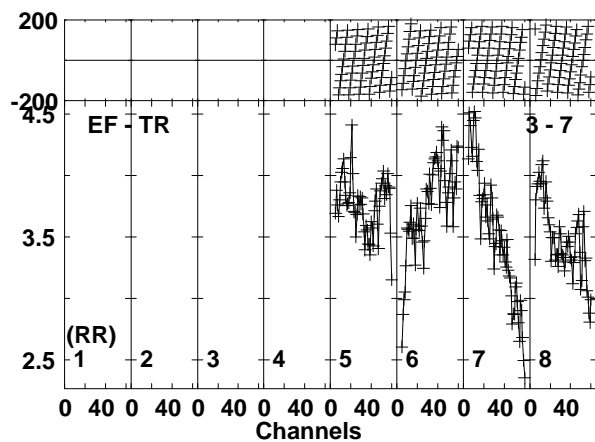
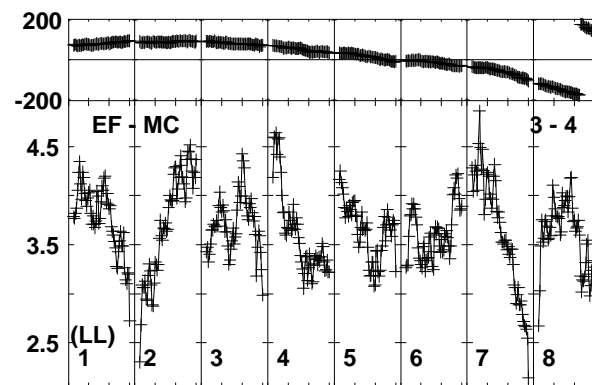
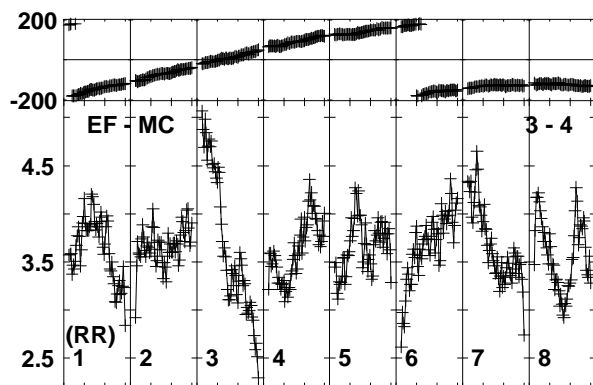
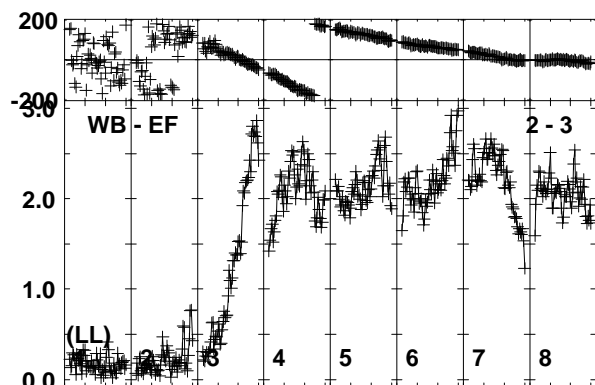
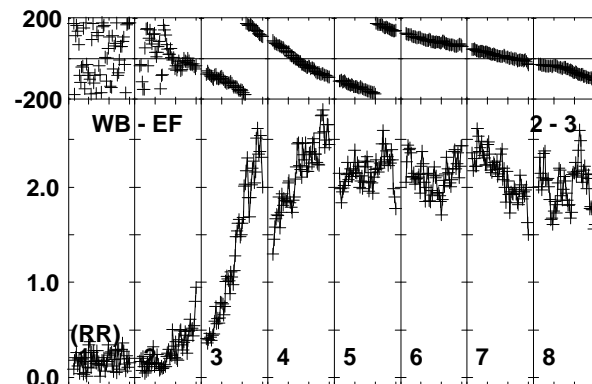
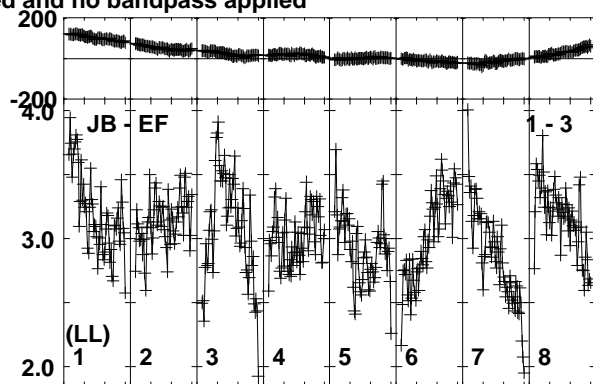
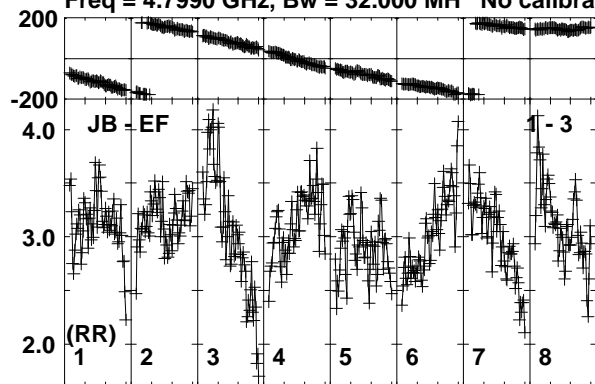

Lower frame: Milli Ampl Jy Top frame: Phas deg
Vector averaged cross-power spectrum Baseline: JB (01) - EF (03)
Timerange: 00/14:35:01 to 00/14:36:29

Plot file version 135 created 20-SEP-2019 15:51:47

J1408+5613 RSM05.UVDATA.1

Freq = 4.7990 GHz, Bw = 32.000 MH No calibration applied and no bandpass applied

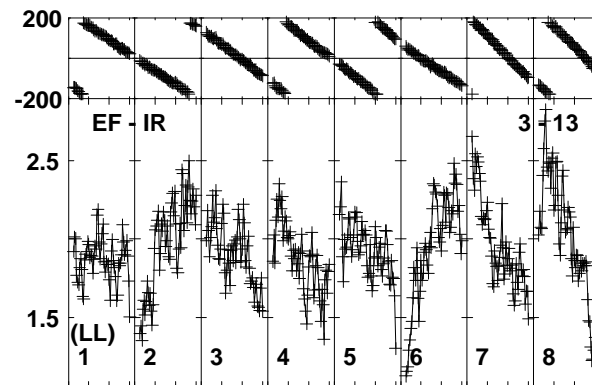
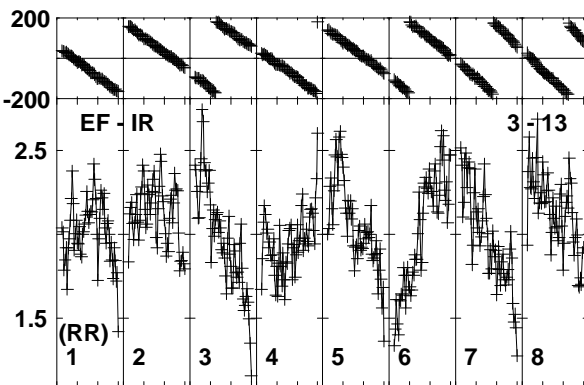
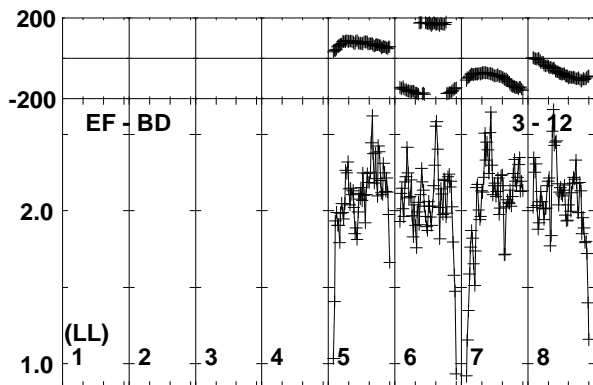
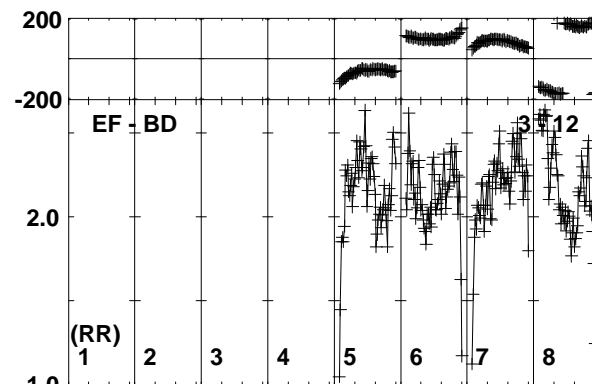
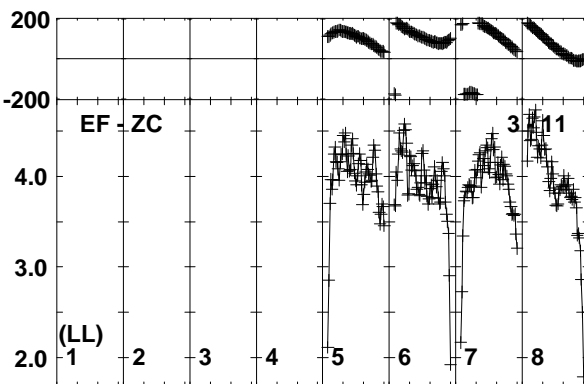
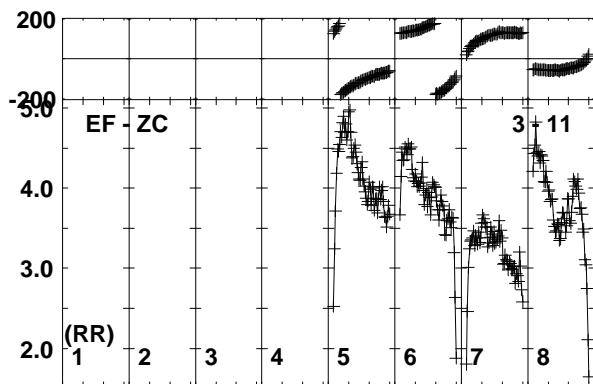
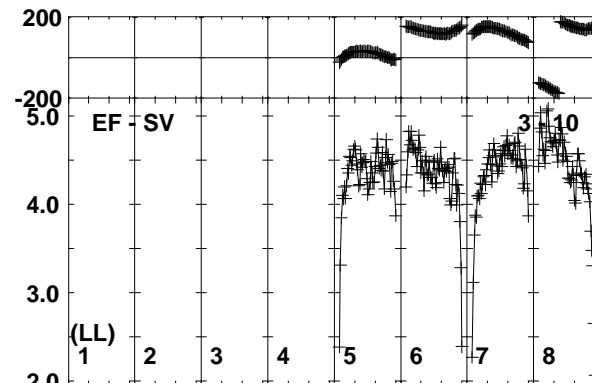
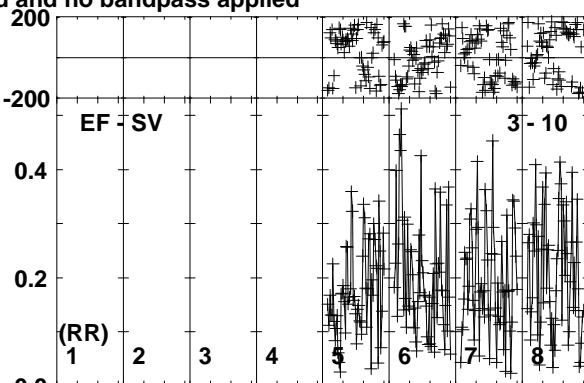
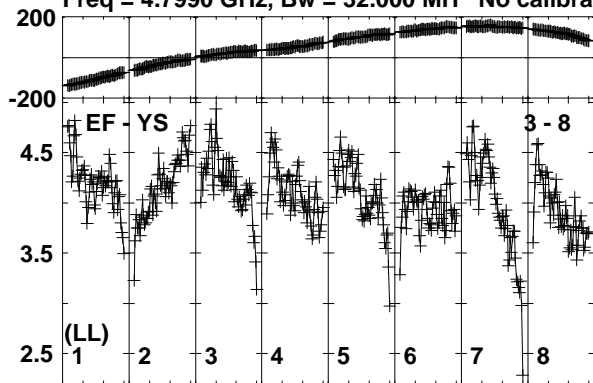

Lower frame: Milli Ampl Jy Top frame: Phas deg
Vector averaged cross-power spectrum Baseline: EF (03) - YS (08)
Timerange: 00/14:35:01 to 00/14:36:29

Plot file version 136 created 20-SEP-2019 15:51:48

J1408+5613 RSM05.UVDATA.1

Freq = 4.7990 GHz, Bw = 32.000 MH No calibration applied and no bandpass applied

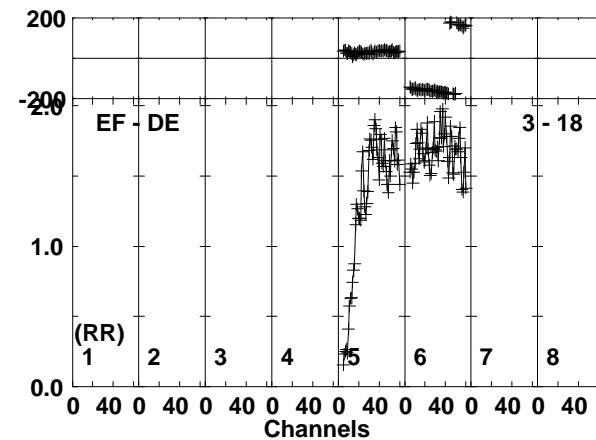
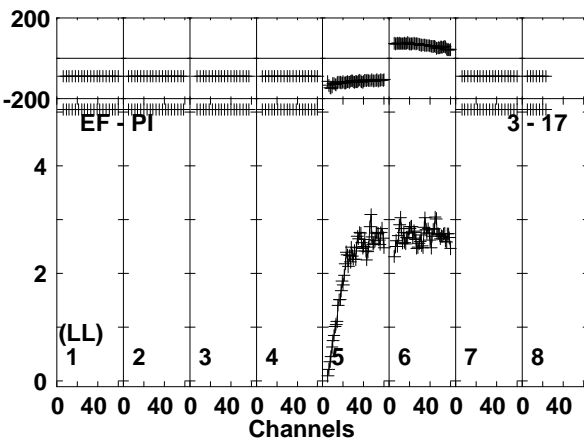
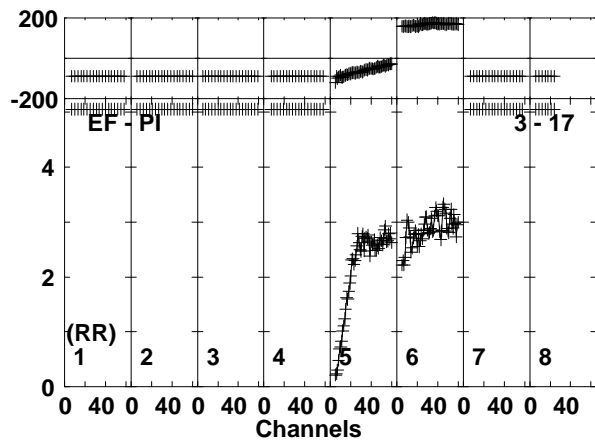
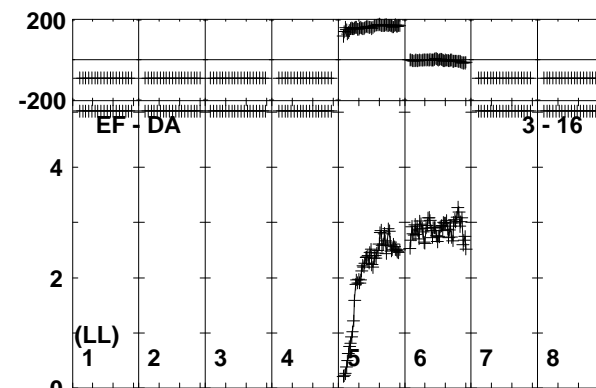
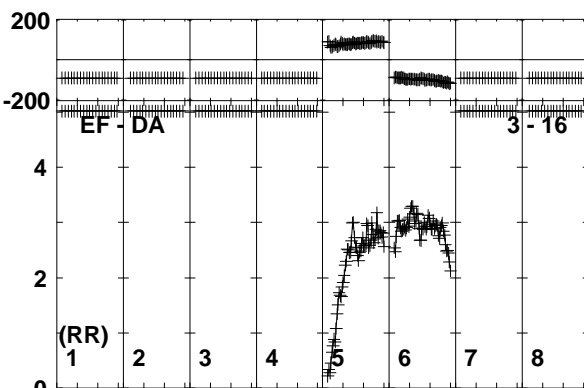
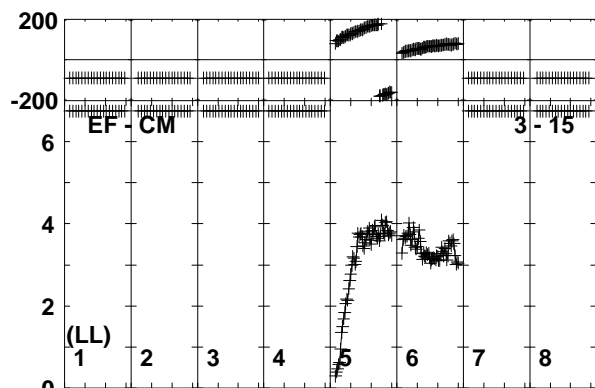
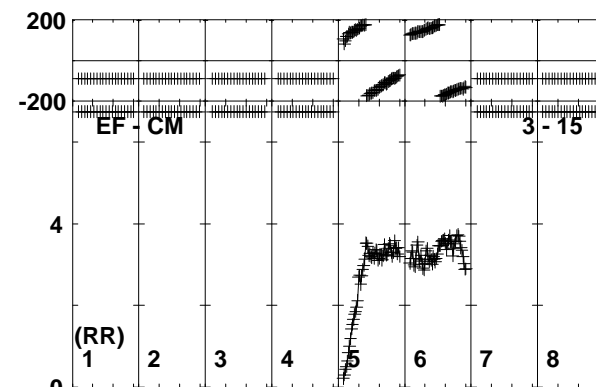
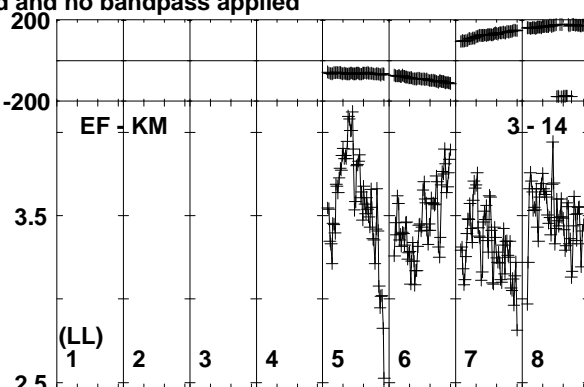
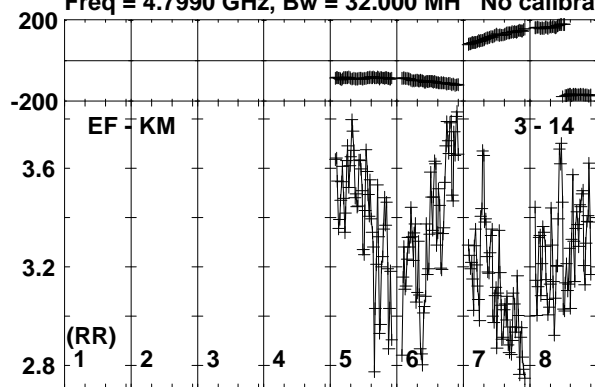

Lower frame: Milli Ampl Jy Top frame: Phas deg
Vector averaged cross-power spectrum Baseline: EF (03) - KM (14)
Timerange: 00/14:35:01 to 00/14:36:29

Plot file version 137 created 20-SEP-2019 15:51:48
J1408+5613 RSM05.UVDATA.1
Freq = 4.7990 GHz, Bw = 32.000 MH No calibration applied and no bandpass applied

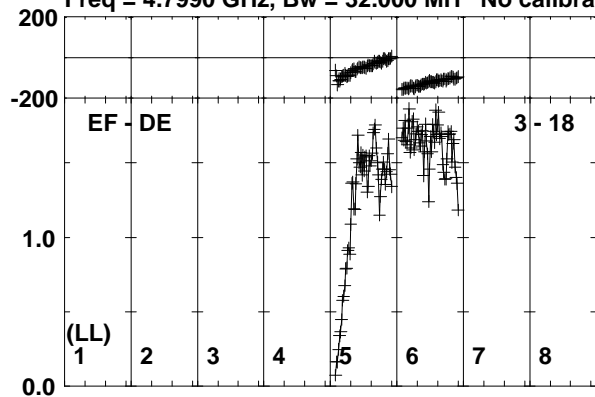

Lower frame: Milli Ampl Jy Top frame: Phas deg
Vector averaged cross-power spectrum Baseline: EF (03) - DE (18)
Timerange: 00/14:35:01 to 00/14:36:29

Plot file version 138 created 20-SEP-2019 15:51:48

AT2019EHZ RSM05.UVDATA.1

Freq = 4.7990 GHz, Bw = 32.000 MH No calibration applied and no bandpass applied

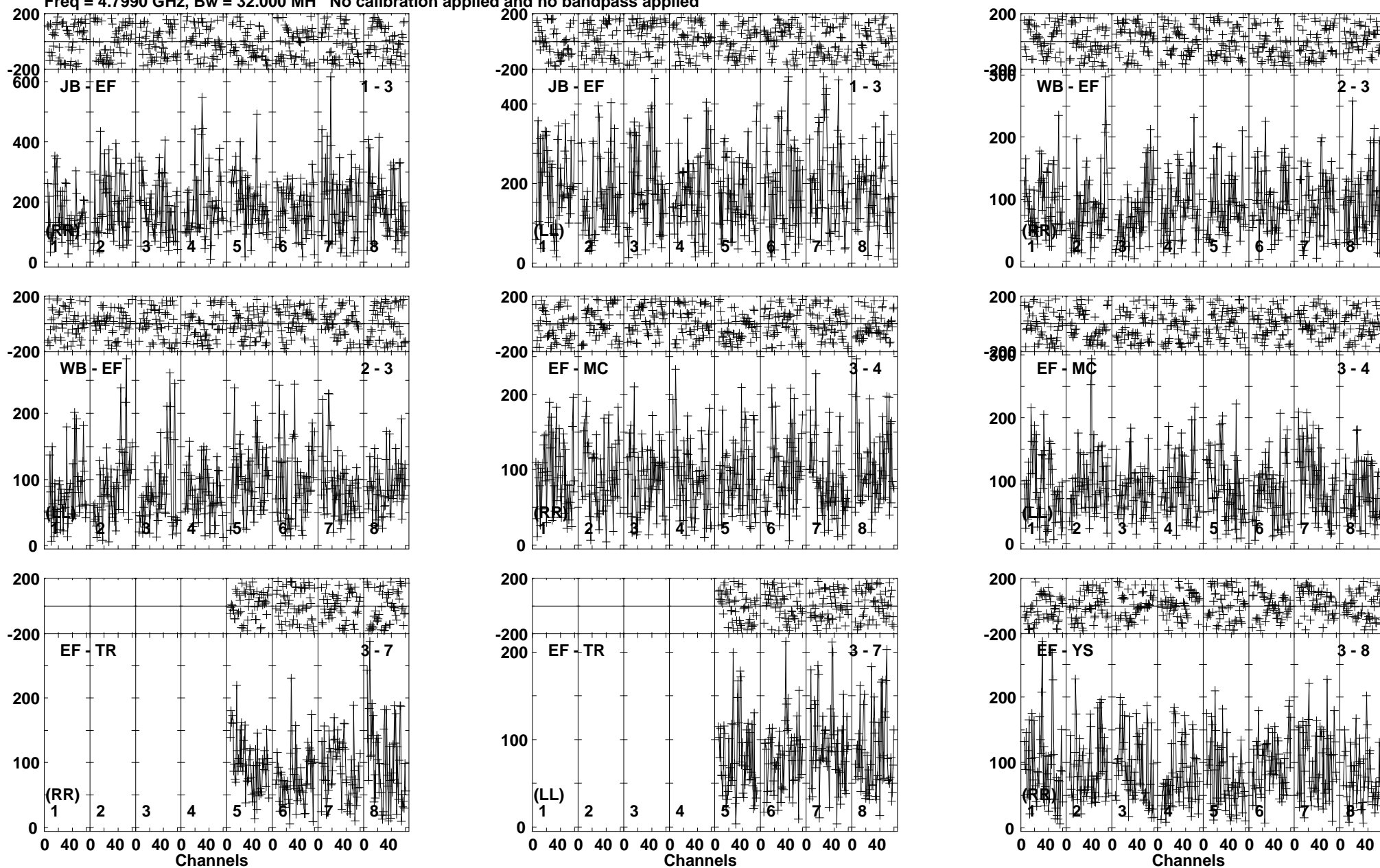

Lower frame: Micro Ampl Jy Top frame: Phas deg
Vector averaged cross-power spectrum Baseline: JB (01) - EF (03)
Timerange: 00/14:36:30 to 00/14:39:30

Plot file version 139 created 20-SEP-2019 15:51:49
 AT2019EHZ RSM05.UVDATA.1
 Freq = 4.7990 GHz, Bw = 32.000 MH No calibration applied and no bandpass applied

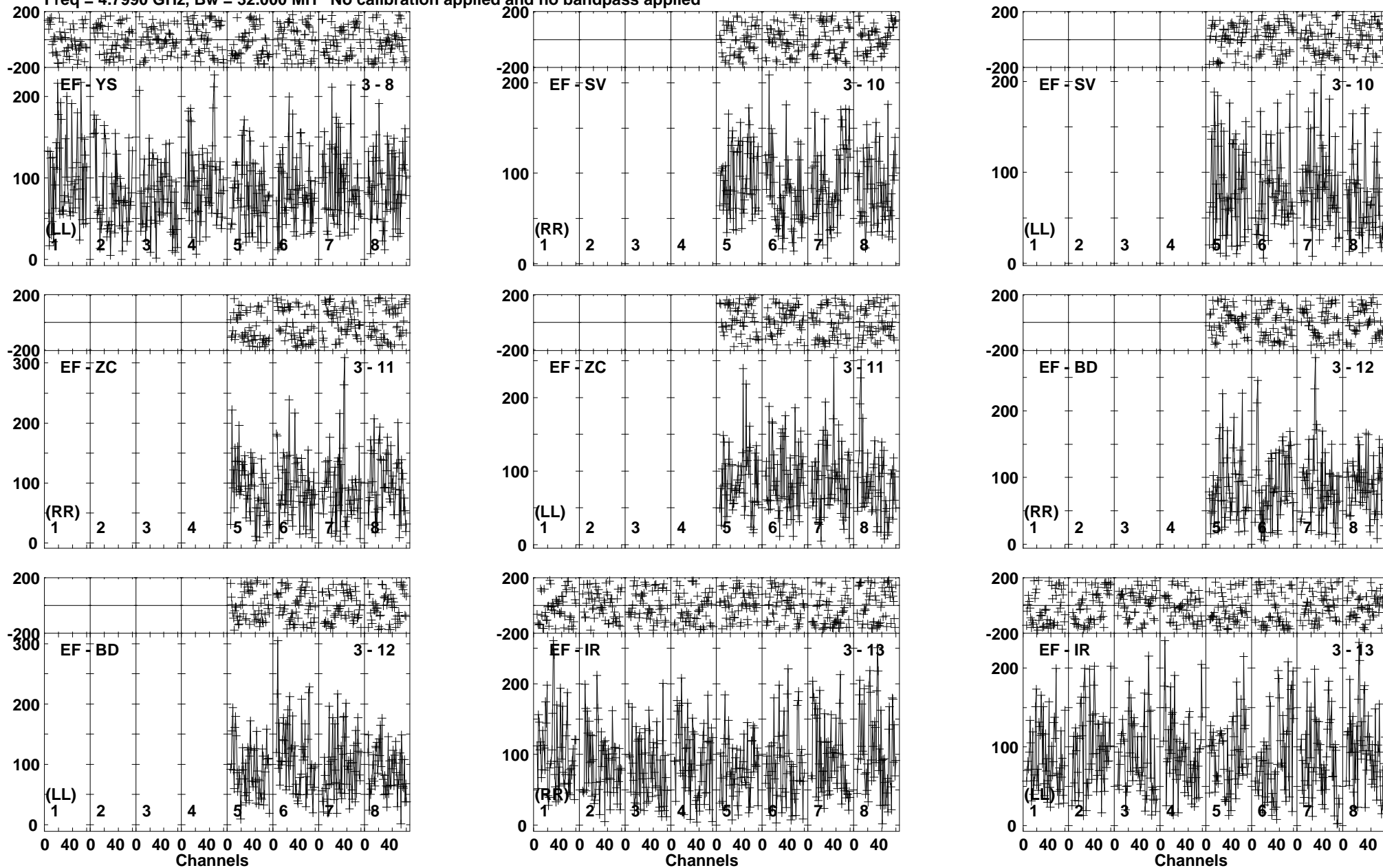

Lower frame: Micro Ampl Jy Top frame: Phas deg
 Vector averaged cross-power spectrum Baseline: EF (03) - YS (08)
 Timerange: 00/14:36:30 to 00/14:39:30

Plot file version 140 created 20-SEP-2019 15:51:49
 AT2019EHZ RSM05.UVDATA.1
 Freq = 4.7990 GHz, Bw = 32.000 MH No calibration applied and no bandpass applied

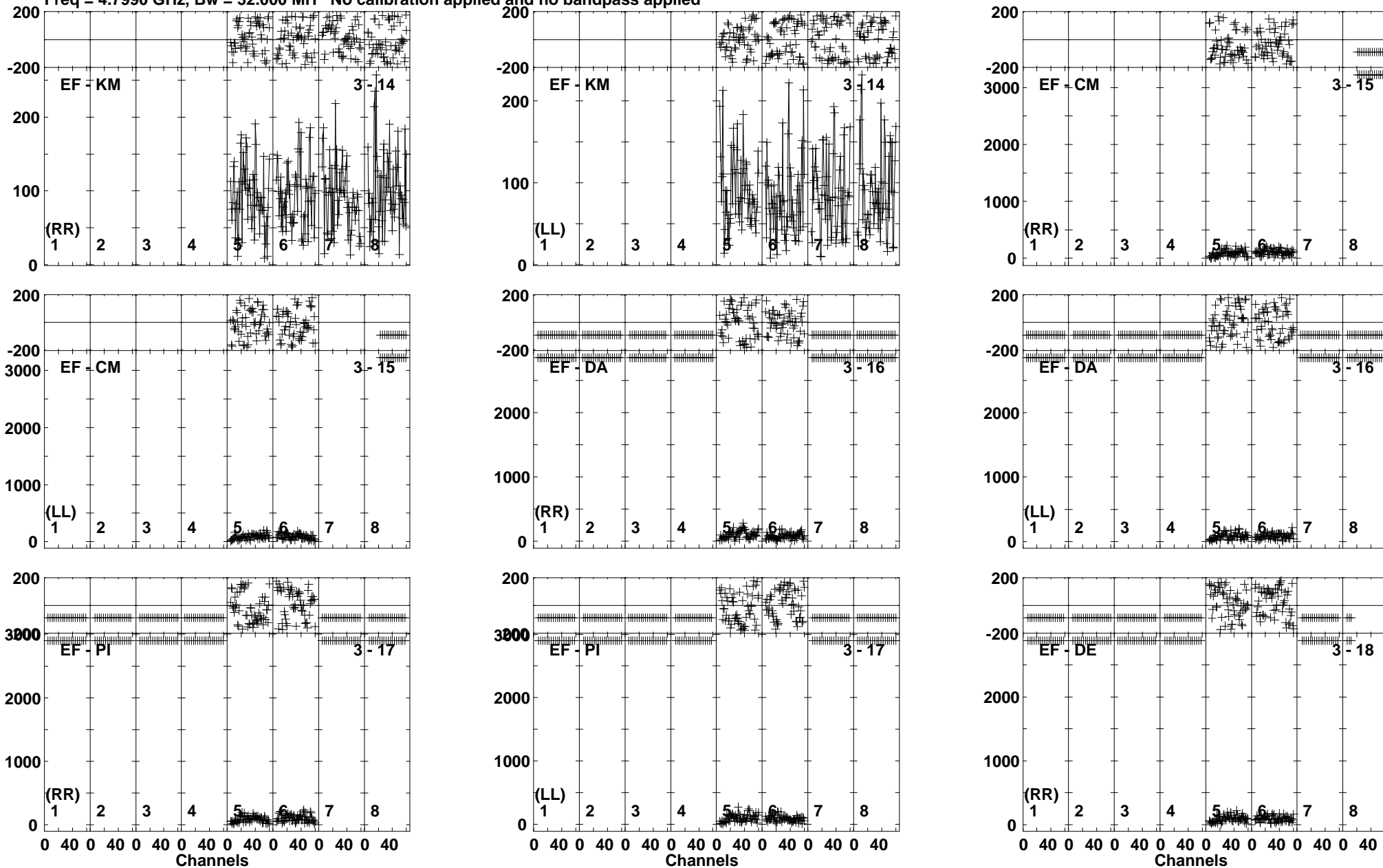

Lower frame: Micro Ampl Jy Top frame: Phas deg
 Vector averaged cross-power spectrum Baseline: EF (03) - KM (14)
 Timerange: 00/14:36:30 to 00/14:39:30

Plot file version 141 created 20-SEP-2019 15:51:50
AT2019EHZ RSM05.UVDATA.1
Freq = 4.7990 GHz, Bw = 32.000 MH No calibration applied and no bandpass applied

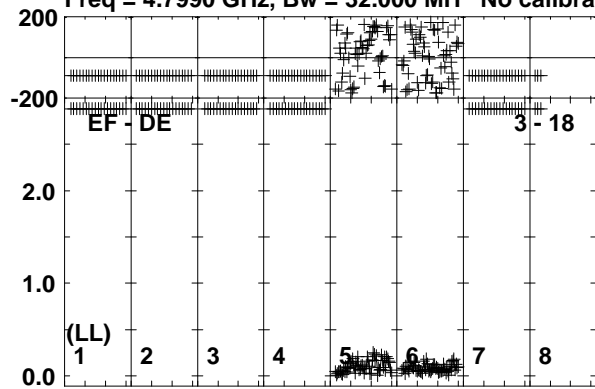

Lower frame: Milli Ampl Jy Top frame: Phas deg
Vector averaged cross-power spectrum Baseline: EF (03) - DE (18)
Timerange: 00/14:36:30 to 00/14:39:30

Plot file version 142 created 20-SEP-2019 15:51:50

J1408+5613 RSM05.UVDATA.1

Freq = 4.7990 GHz, Bw = 32.000 MH No calibration applied and no bandpass applied

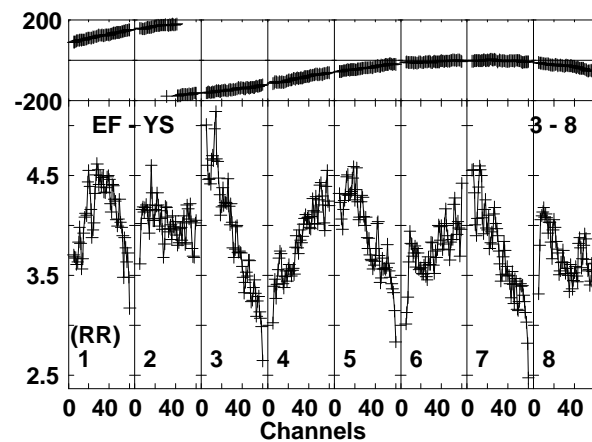
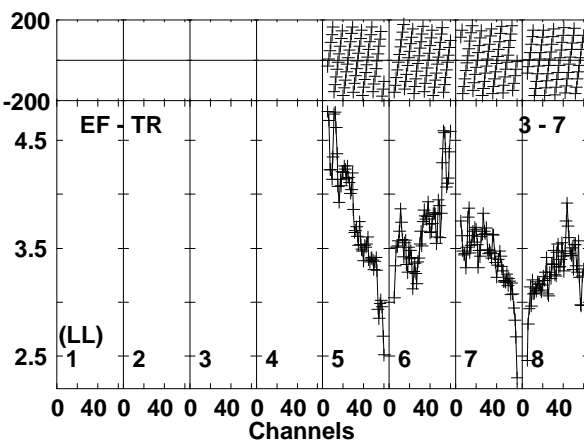
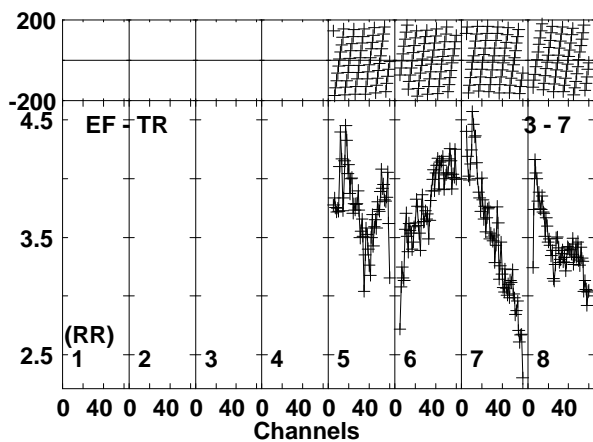
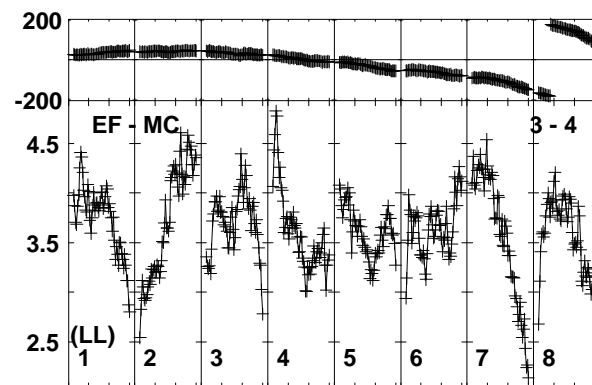
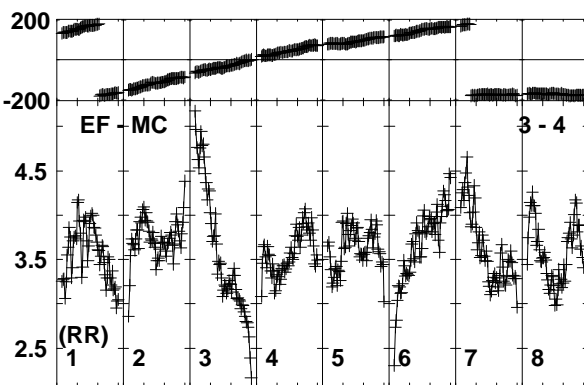
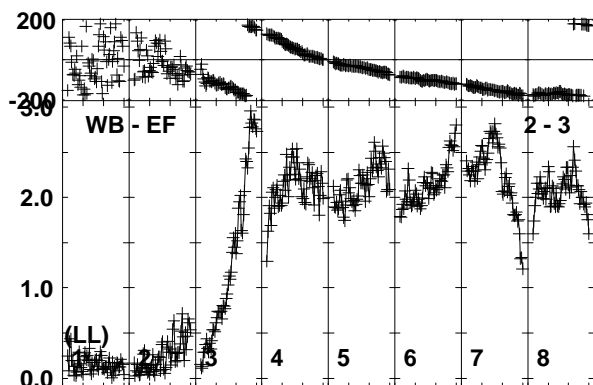
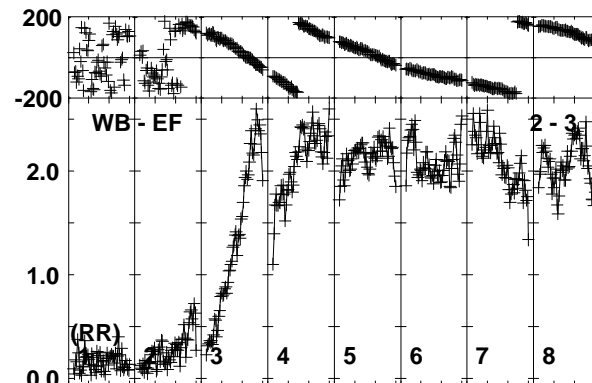
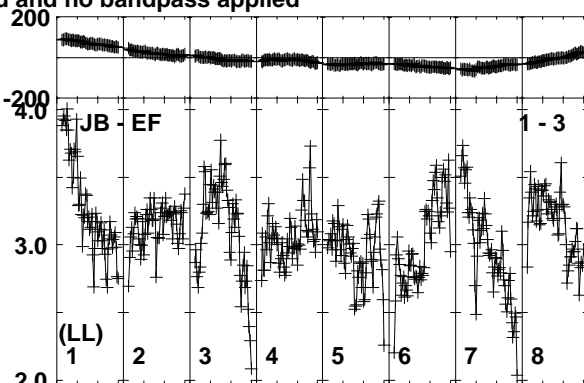
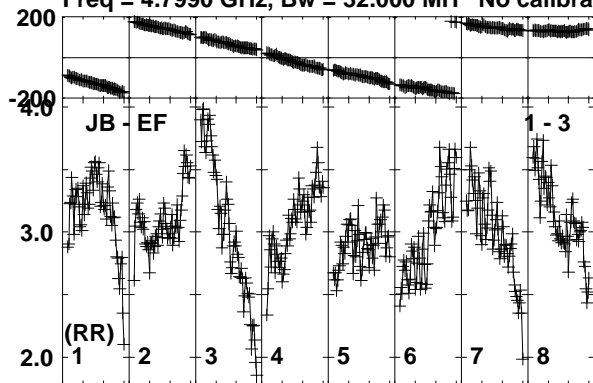

Lower frame: Milli Ampl Jy Top frame: Phas deg
Vector averaged cross-power spectrum Baseline: JB (01) - EF (03)
Timerange: 00/14:39:30 to 00/14:41:00

Plot file version 143 created 20-SEP-2019 15:51:50

J1408+5613 RSM05.UVDATA.1

Freq = 4.7990 GHz, Bw = 32.000 MH No calibration applied and no bandpass applied

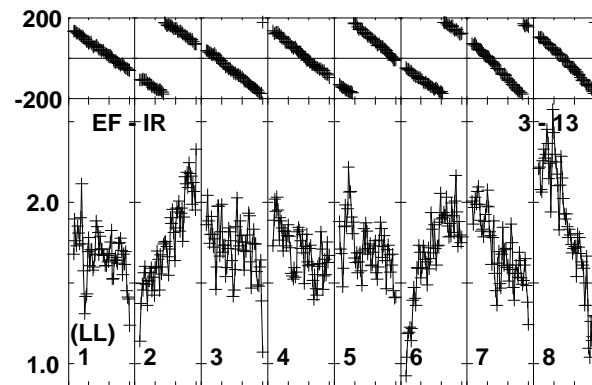
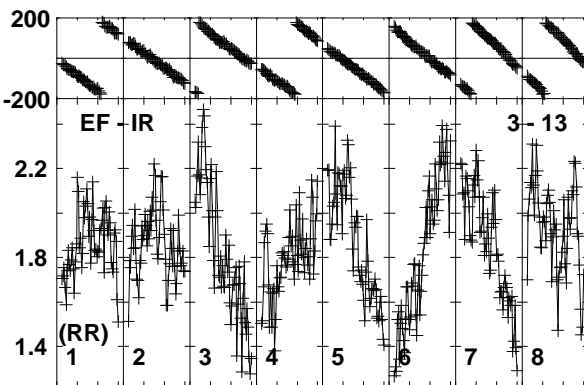
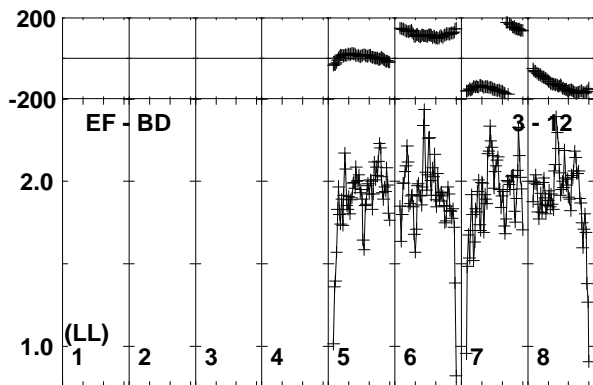
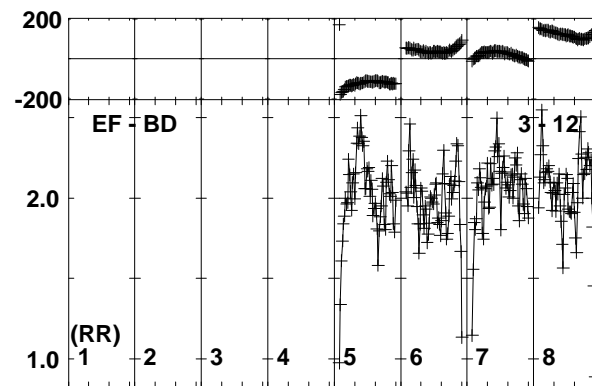
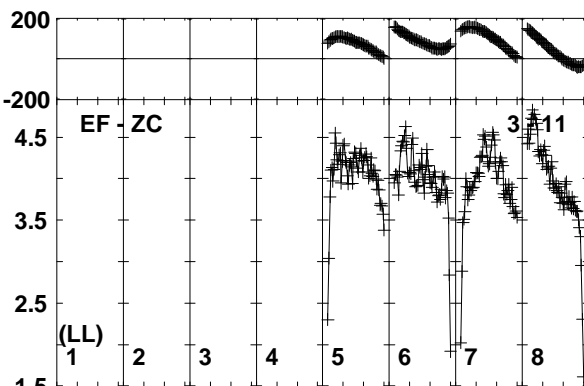
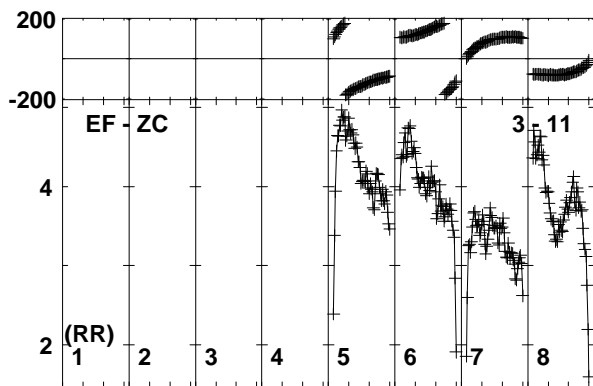
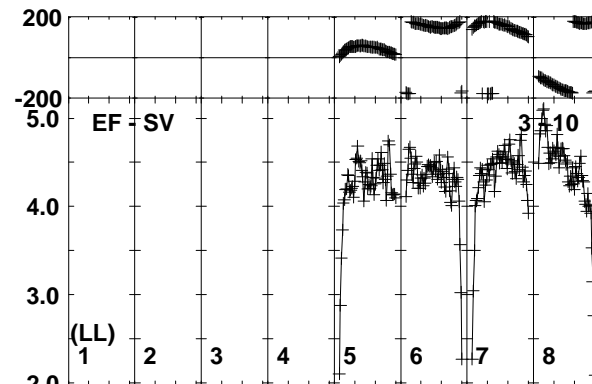
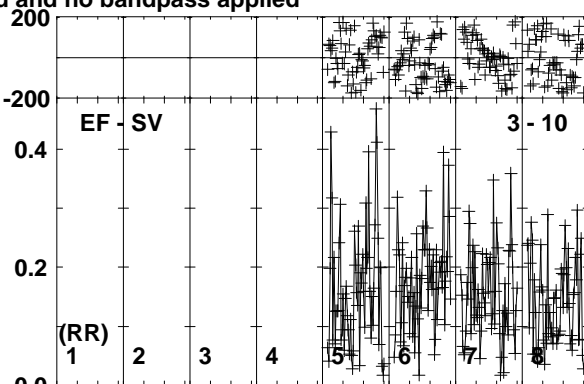
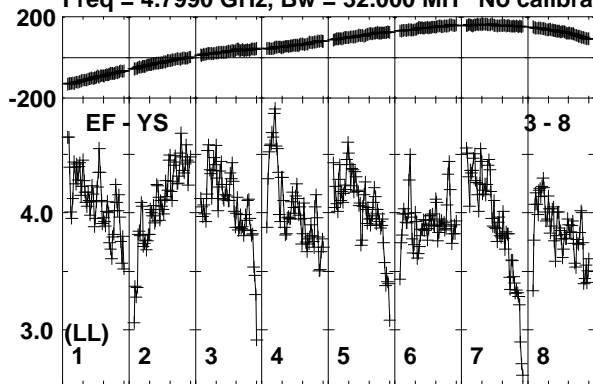

Lower frame: Milli Ampl Jy Top frame: Phas deg
Vector averaged cross-power spectrum Baseline: EF (03) - YS (08)
Timerange: 00/14:39:30 to 00/14:41:00

Plot file version 144 created 20-SEP-2019 15:51:51
 J1408+5613 RSM05.UVDATA.1
 Freq = 4.7990 GHz, Bw = 32.000 MH No calibration applied and no bandpass applied

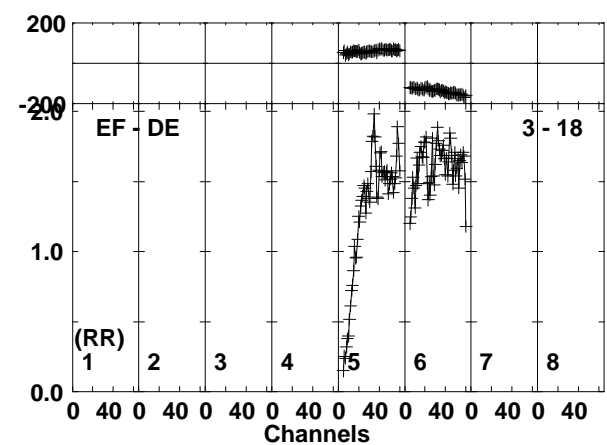
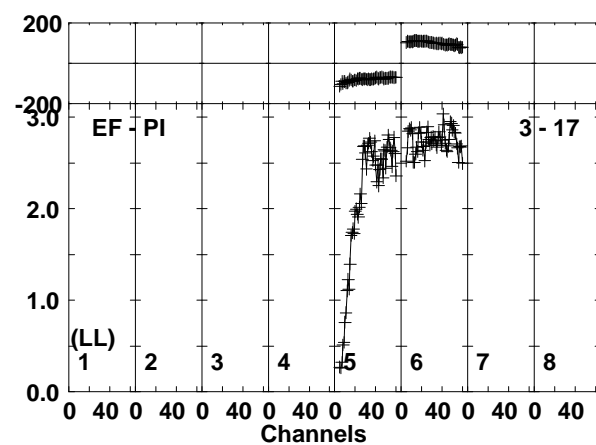
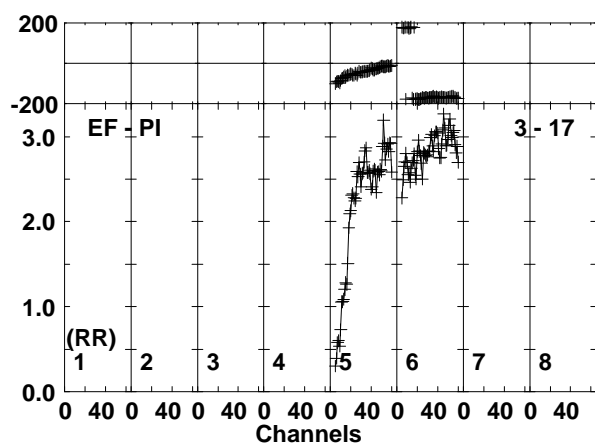
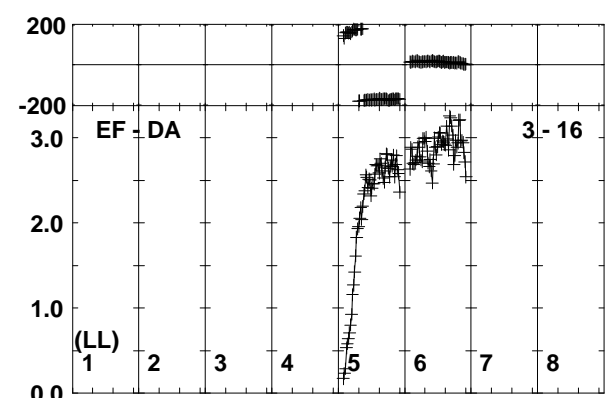
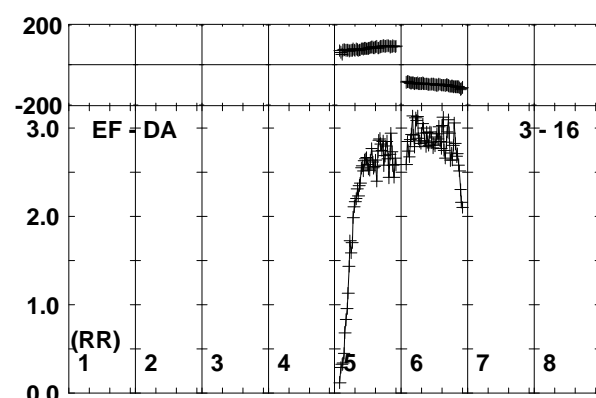
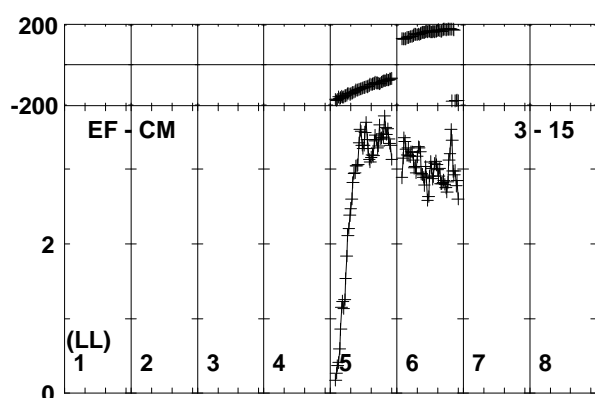
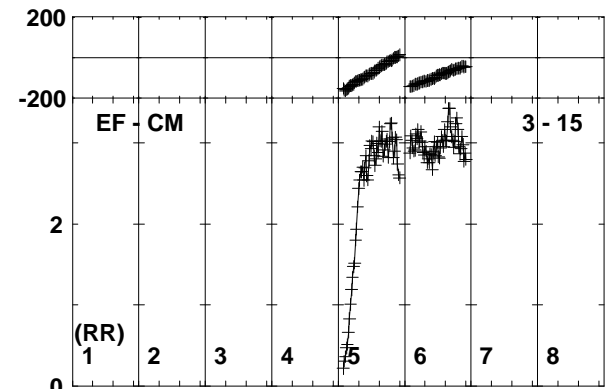
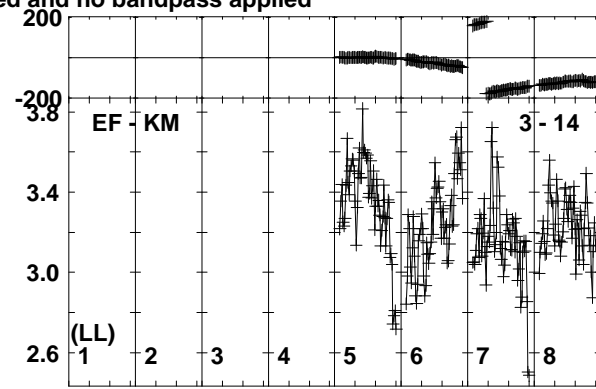
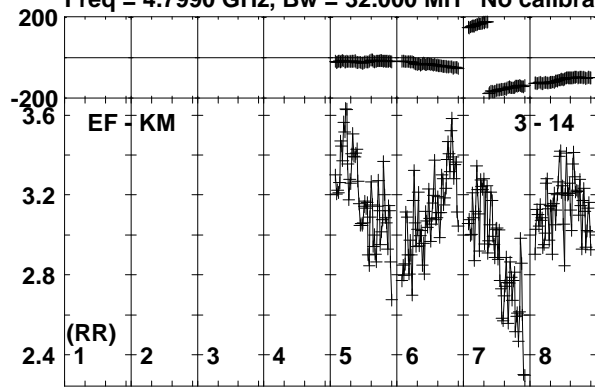

Lower frame: Milli Ampl Jy Top frame: Phas deg
 Vector averaged cross-power spectrum Baseline: EF (03) - KM (14)
 Timerange: 00/14:39:30 to 00/14:41:00

Plot file version 145 created 20-SEP-2019 15:51:51
J1408+5613 RSM05.UVDATA.1
Freq = 4.7990 GHz, Bw = 32.000 MH No calibration applied and no bandpass applied

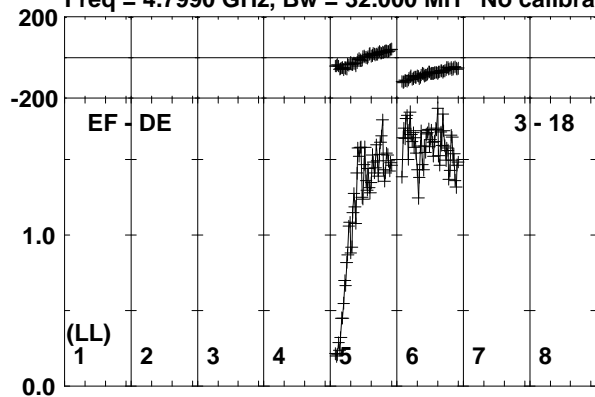

Lower frame: Milli Ampl Jy Top frame: Phas deg
Vector averaged cross-power spectrum Baseline: EF (03) - DE (18)
Timerange: 00/14:39:30 to 00/14:41:00

Plot file version 146 created 20-SEP-2019 15:51:52
 AT2019EHZ RSM05.UVDATA.1
 Freq = 4.7990 GHz, Bw = 32.000 MH No calibration applied and no bandpass applied

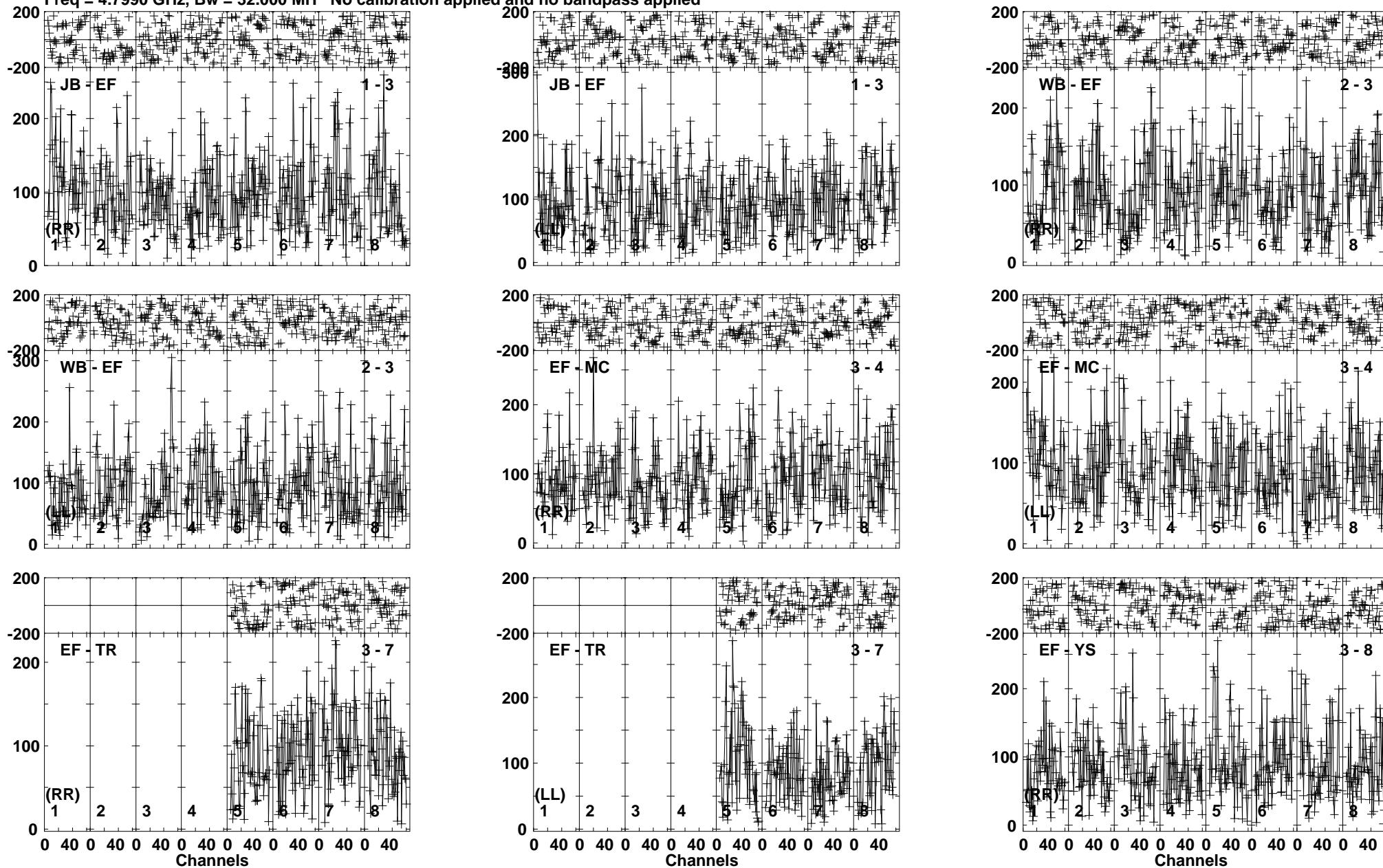

Lower frame: Micro Ampl Jy Top frame: Phas deg
 Vector averaged cross-power spectrum Baseline: JB (01) - EF (03)
 Timerange: 00/14:41:00 to 00/14:43:59

Plot file version 147 created 20-SEP-2019 15:51:52
 AT2019EHZ RSM05.UVDATA.1
 Freq = 4.7990 GHz, Bw = 32.000 MH No calibration applied and no bandpass applied

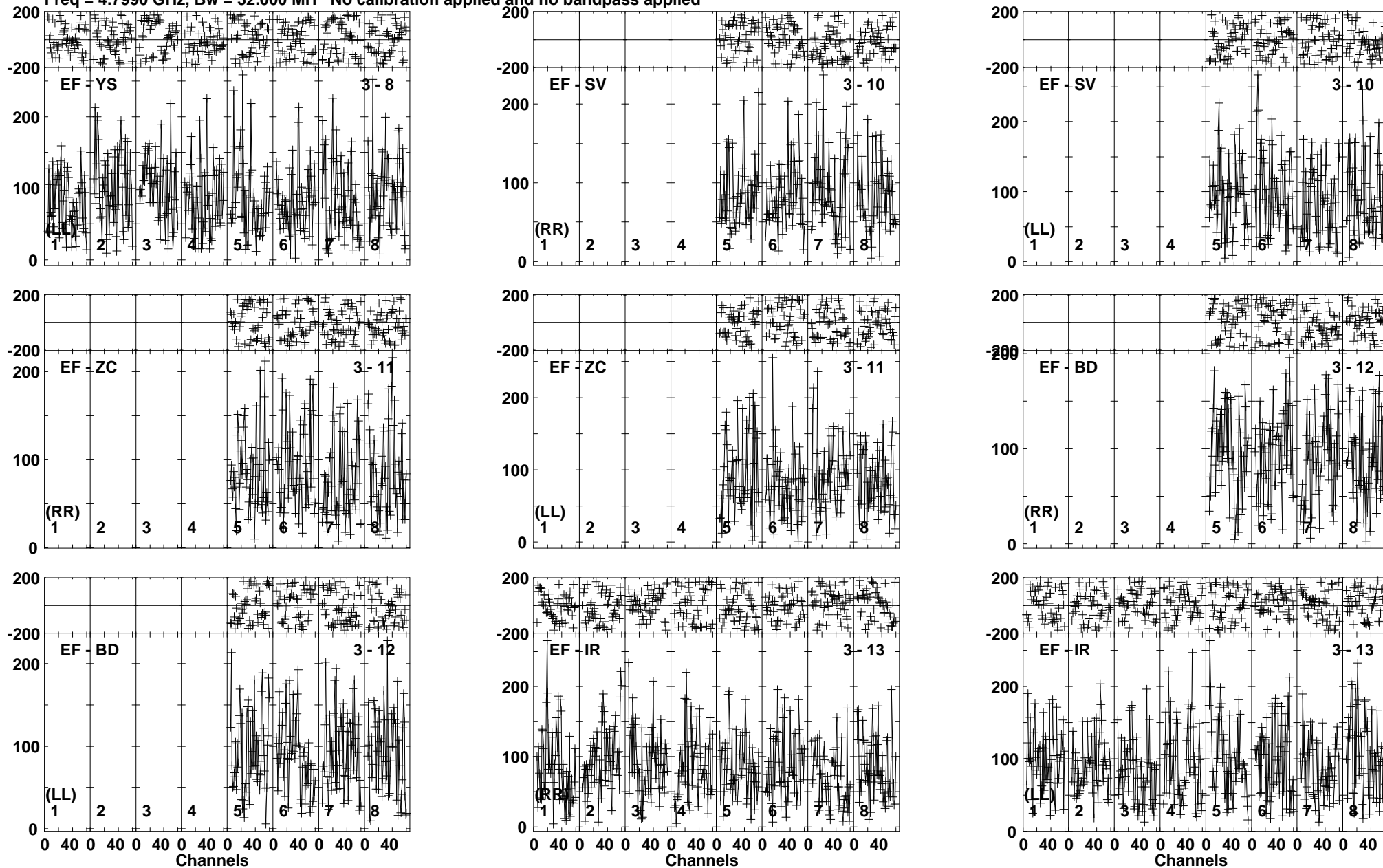

Lower frame: Micro Ampl Jy Top frame: Phas deg
 Vector averaged cross-power spectrum Baseline: EF (03) - YS (08)
 Timerange: 00/14:41:00 to 00/14:43:59

Plot file version 148 created 20-SEP-2019 15:51:53

AT2019EHZ RSM05.UVDATA.1

Freq = 4.7990 GHz, Bw = 32.000 MH No calibration applied and no bandpass applied

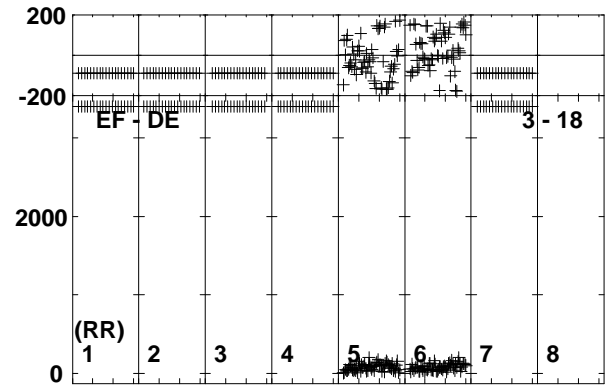
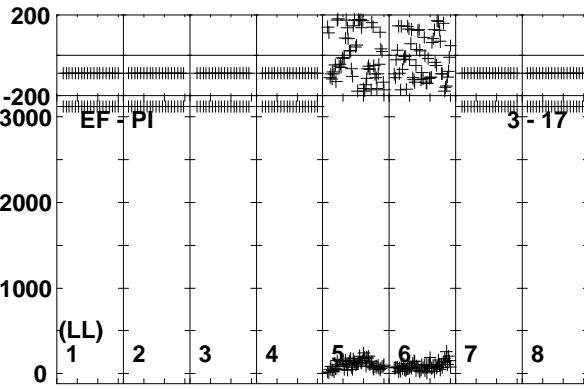
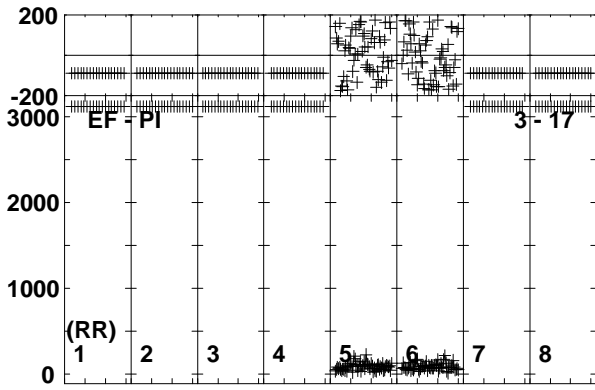
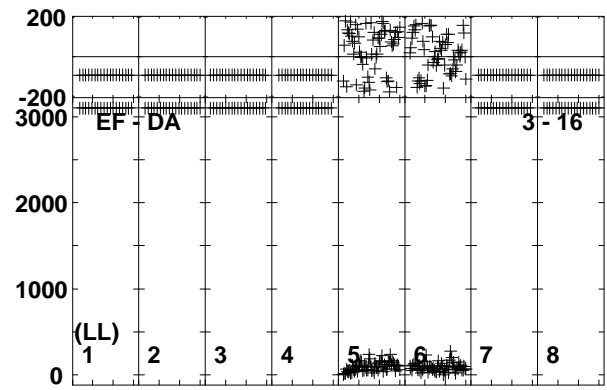
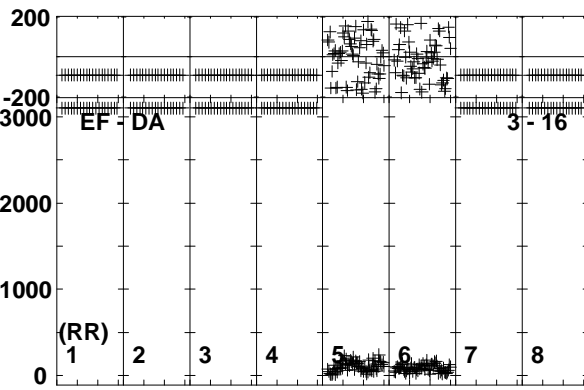
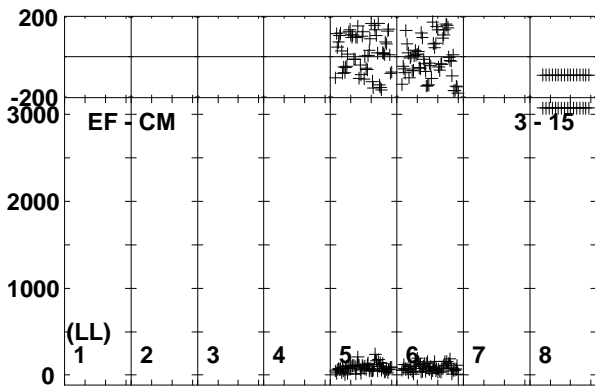
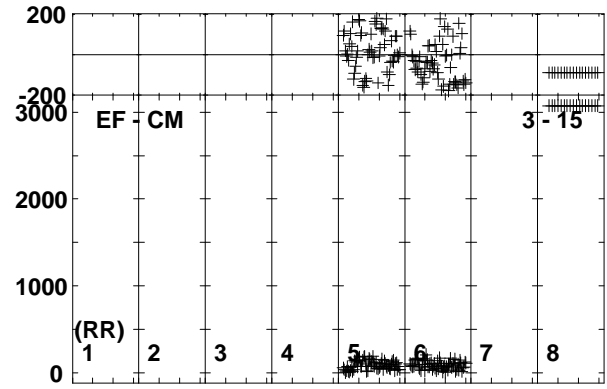
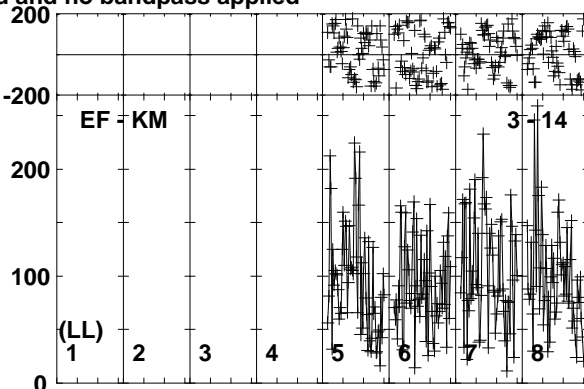
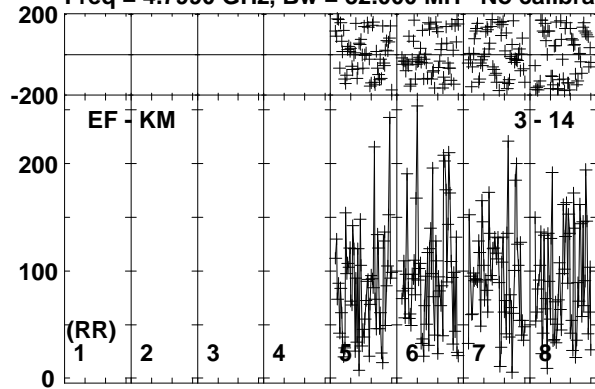

Lower frame: Micro Ampl Jy Top frame: Phas deg
Vector averaged cross-power spectrum Baseline: EF (03) - KM (14)
Timerange: 00/14:41:00 to 00/14:43:59

Plot file version 149 created 20-SEP-2019 15:51:53
AT2019EHZ RSM05.UVDATA.1
Freq = 4.7990 GHz, Bw = 32.000 MH No calibration applied and no bandpass applied

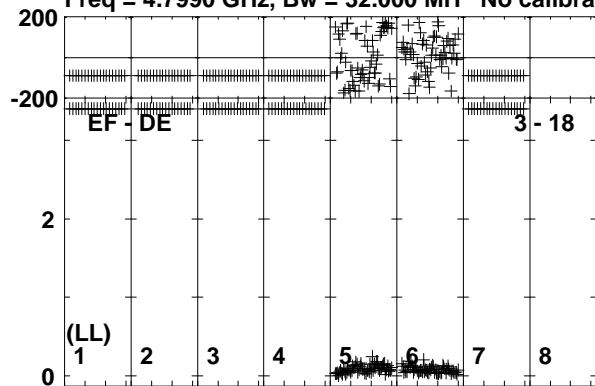

Lower frame: Milli Ampl Jy Top frame: Phas deg
Vector averaged cross-power spectrum Baseline: EF (03) - DE (18)
Timerange: 00/14:41:00 to 00/14:43:59

Plot file version 150 created 20-SEP-2019 15:51:53

J1408+5613 RSM05.UVDATA.1

Freq = 4.7990 GHz, Bw = 32.000 MH No calibration applied and no bandpass applied

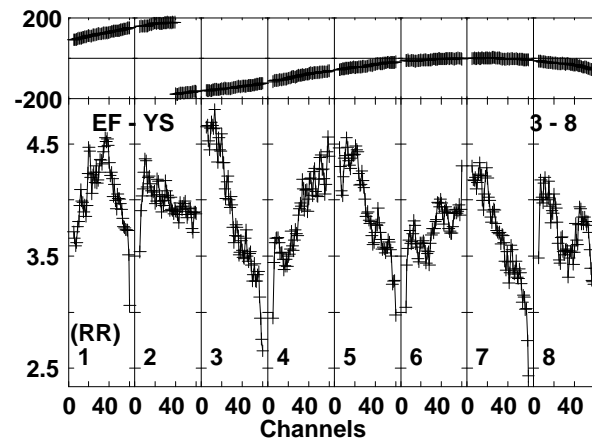
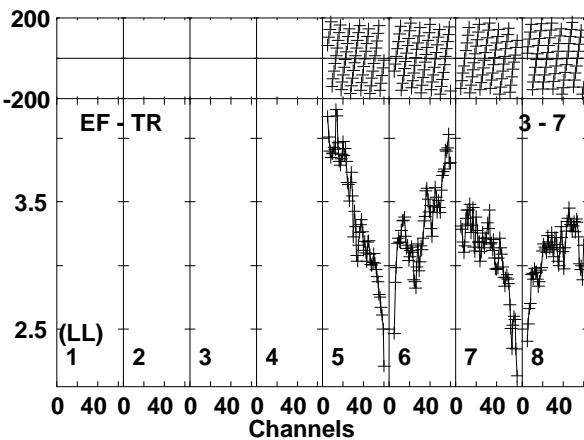
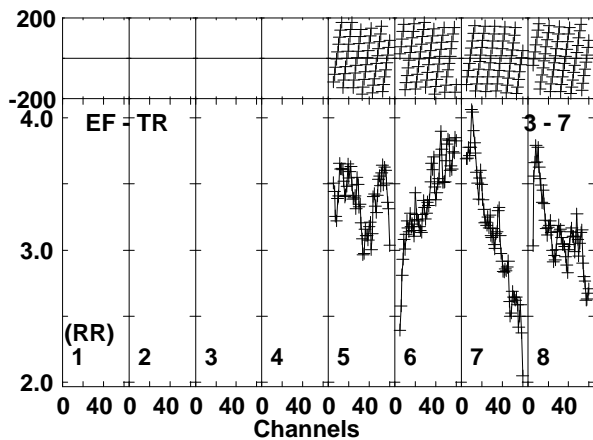
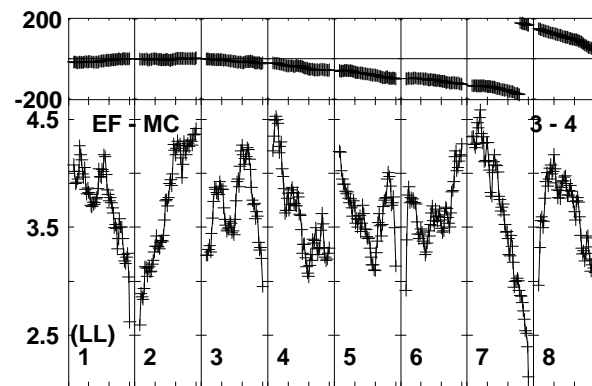
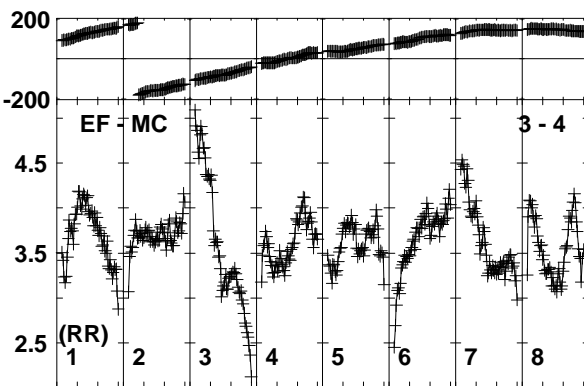
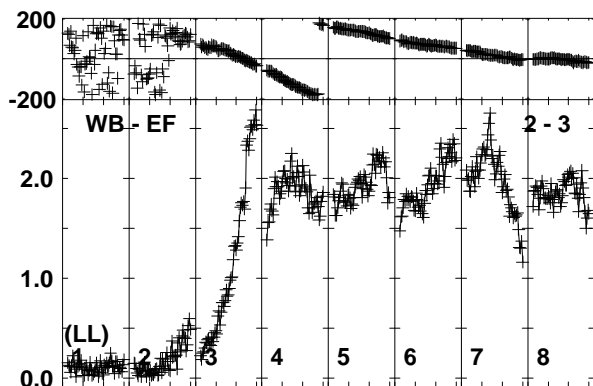
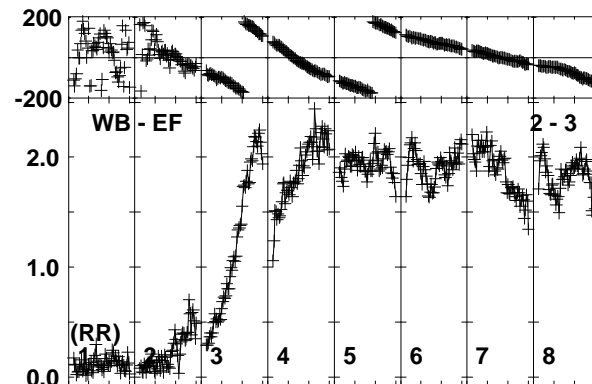
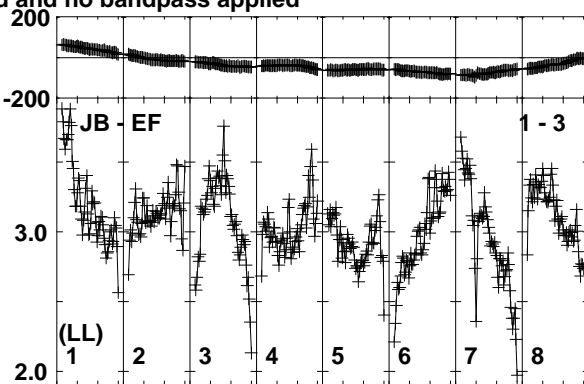
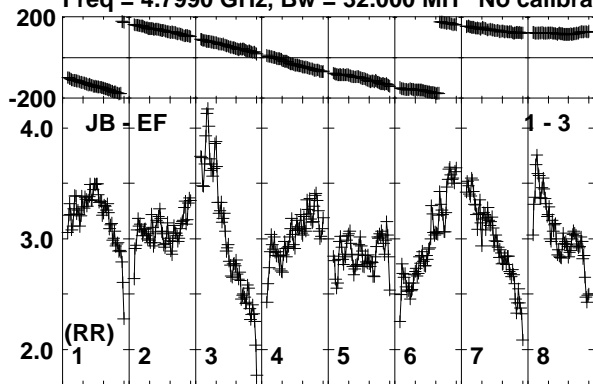

Lower frame: Milli Ampl Jy Top frame: Phas deg
Vector averaged cross-power spectrum Baseline: JB (01) - EF (03)
Timerange: 00/14:44:51 to 00/14:46:19

Plot file version 151 created 20-SEP-2019 15:51:54

J1408+5613 RSM05.UVDATA.1

Freq = 4.7990 GHz, Bw = 32.000 MH No calibration applied and no bandpass applied

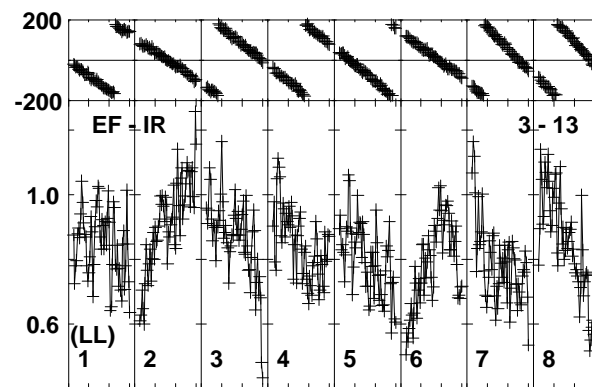
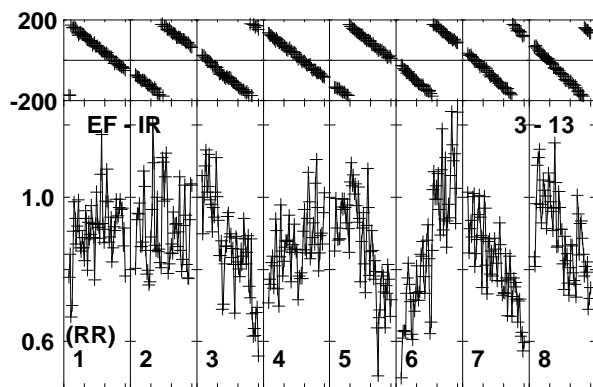
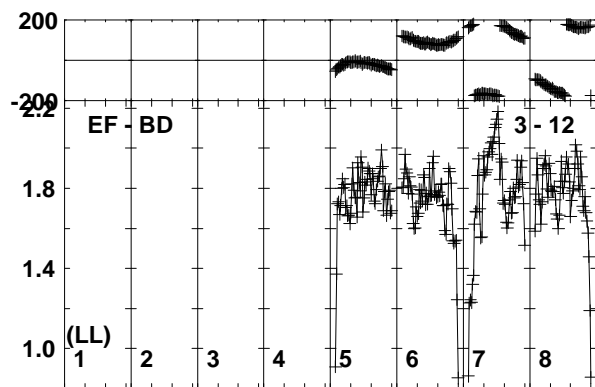
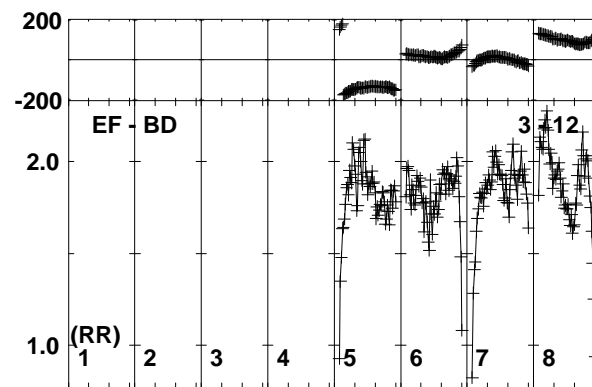
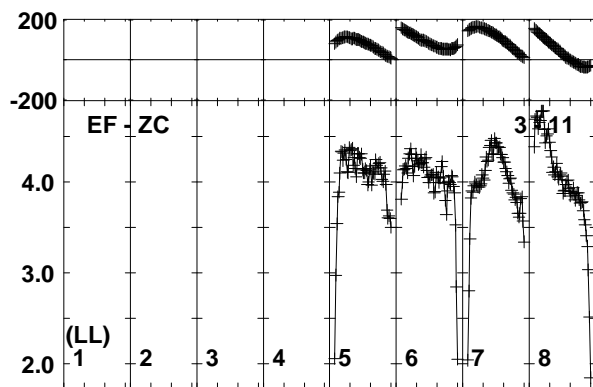
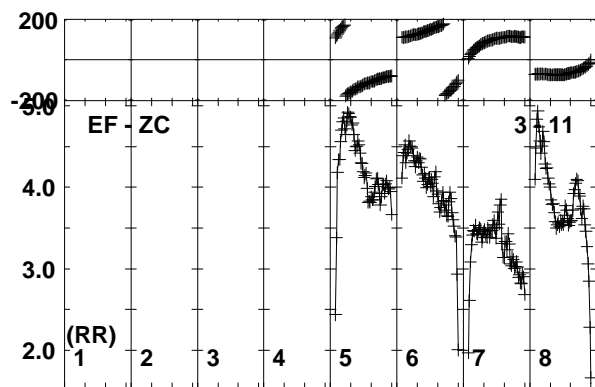
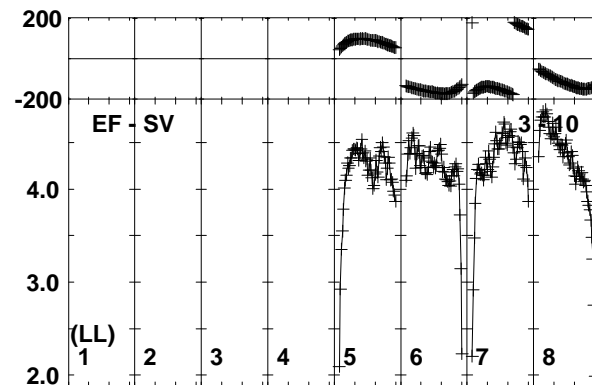
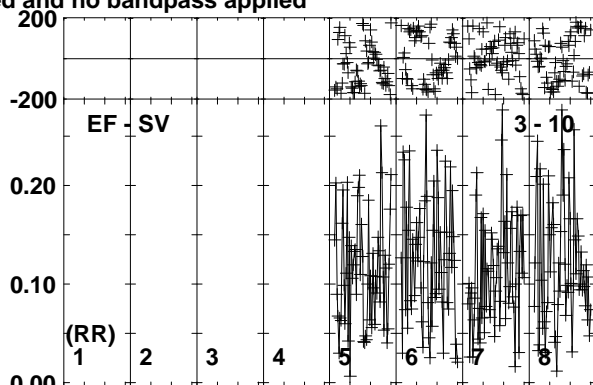
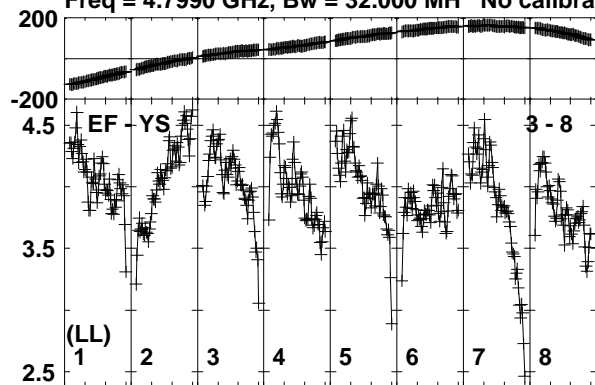

Lower frame: Milli Ampl Jy Top frame: Phas deg
Vector averaged cross-power spectrum Baseline: EF (03) - YS (08)
Timerange: 00/14:44:51 to 00/14:46:19

Plot file version 152 created 20-SEP-2019 15:51:55

J1408+5613 RSM05.UVDATA.1

Freq = 4.7990 GHz, Bw = 32.000 MH No calibration applied and no bandpass applied

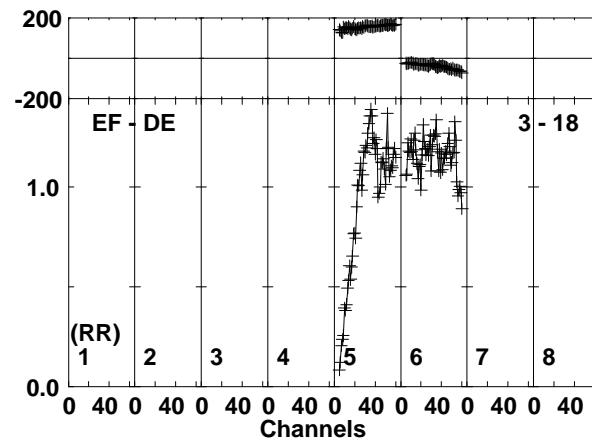
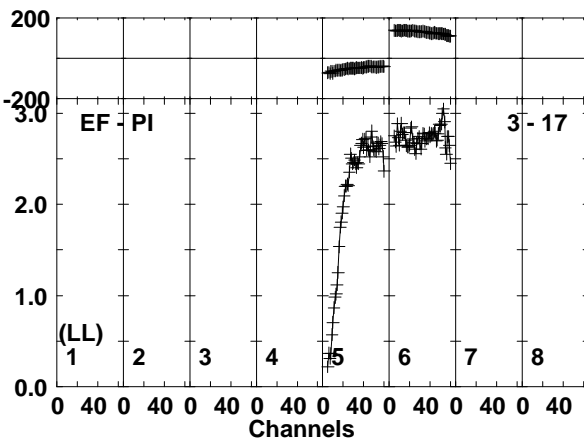
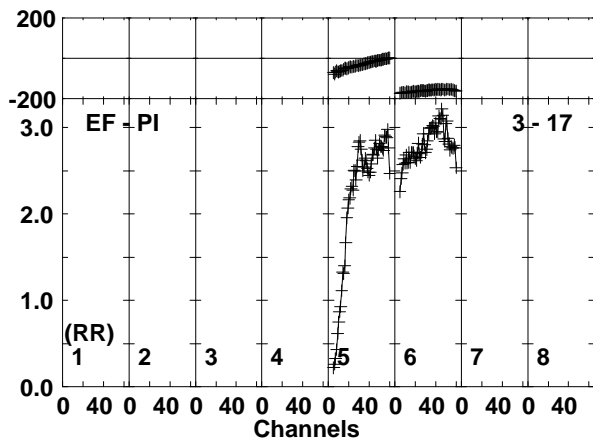
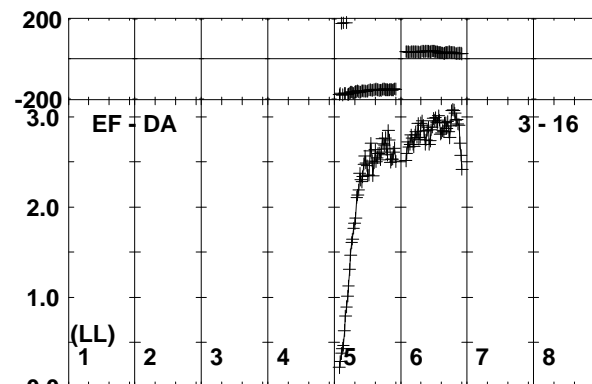
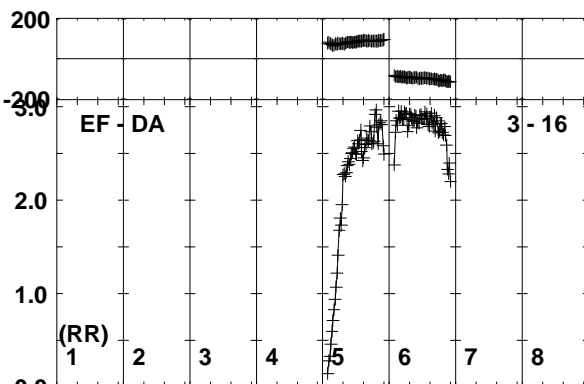
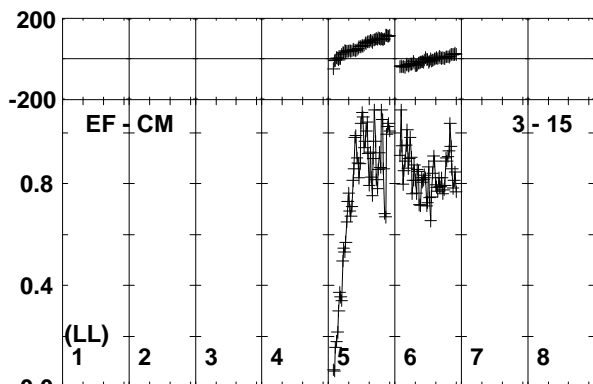
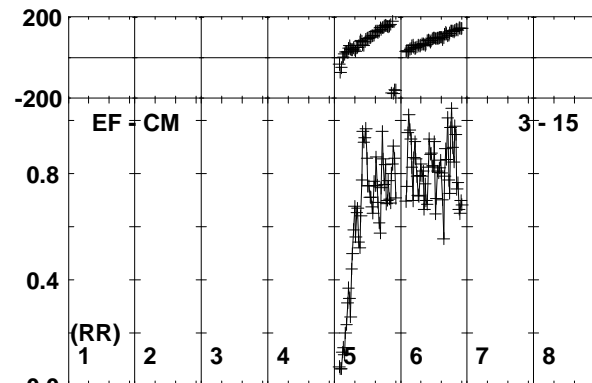
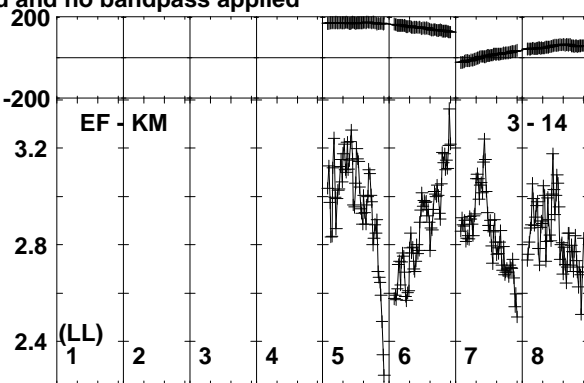
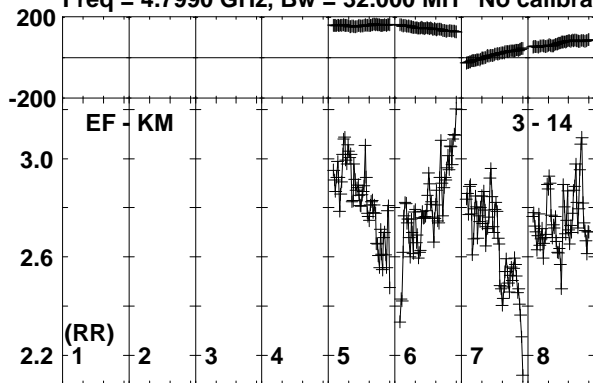

Lower frame: Milli Ampl Jy Top frame: Phas deg
Vector averaged cross-power spectrum Baseline: EF (03) - KM (14)
Timerange: 00/14:44:51 to 00/14:46:19

Plot file version 153 created 20-SEP-2019 15:51:55
J1408+5613 RSM05.UVDATA.1
Freq = 4.7990 GHz, Bw = 32.000 MH No calibration applied and no bandpass applied

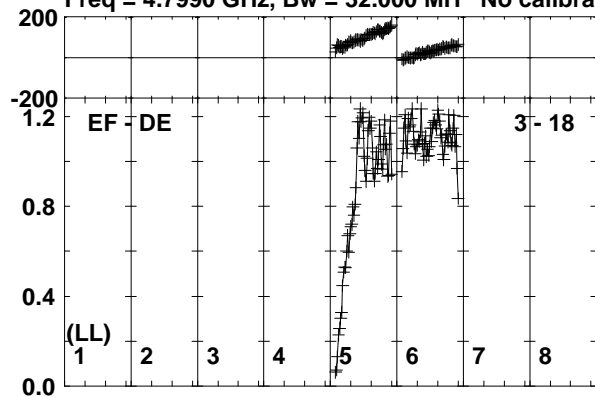

Lower frame: Milli Ampl Jy Top frame: Phas deg
Vector averaged cross-power spectrum Baseline: EF (03) - DE (18)
Timerange: 00/14:44:51 to 00/14:46:19

Plot file version 154 created 20-SEP-2019 15:51:55

AT2019EHZ RSM05.UVDATA.1

Freq = 4.7990 GHz, Bw = 32.000 MH No calibration applied and no bandpass applied

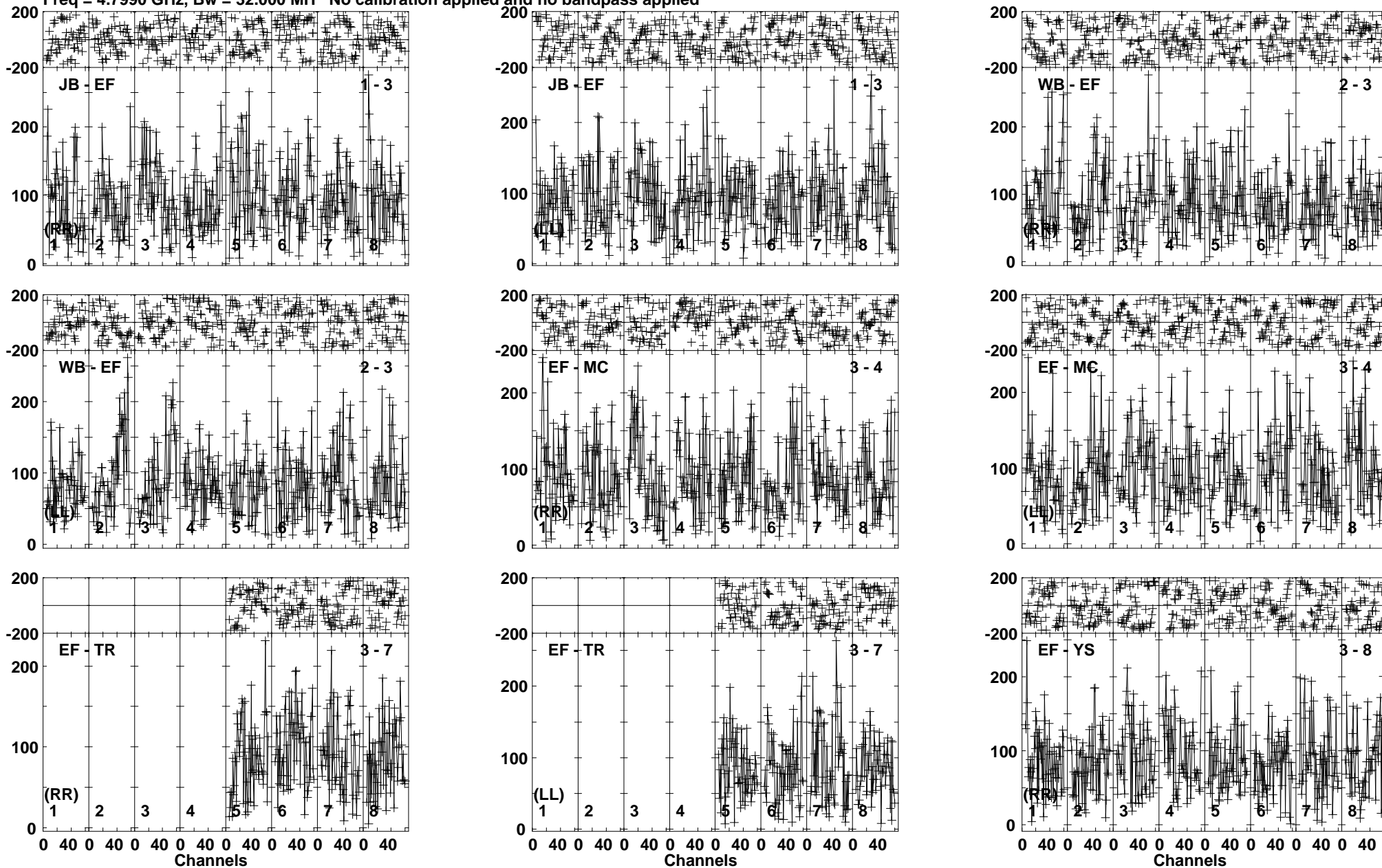

Lower frame: Micro Ampl Jy Top frame: Phas deg
Vector averaged cross-power spectrum Baseline: JB (01) - EF (03)
Timerange: 00/14:46:21 to 00/14:49:19

Plot file version 155 created 20-SEP-2019 15:51:56

AT2019EHZ RSM05.UVDATA.1

Freq = 4.7990 GHz, Bw = 32.000 MH No calibration applied and no bandpass applied

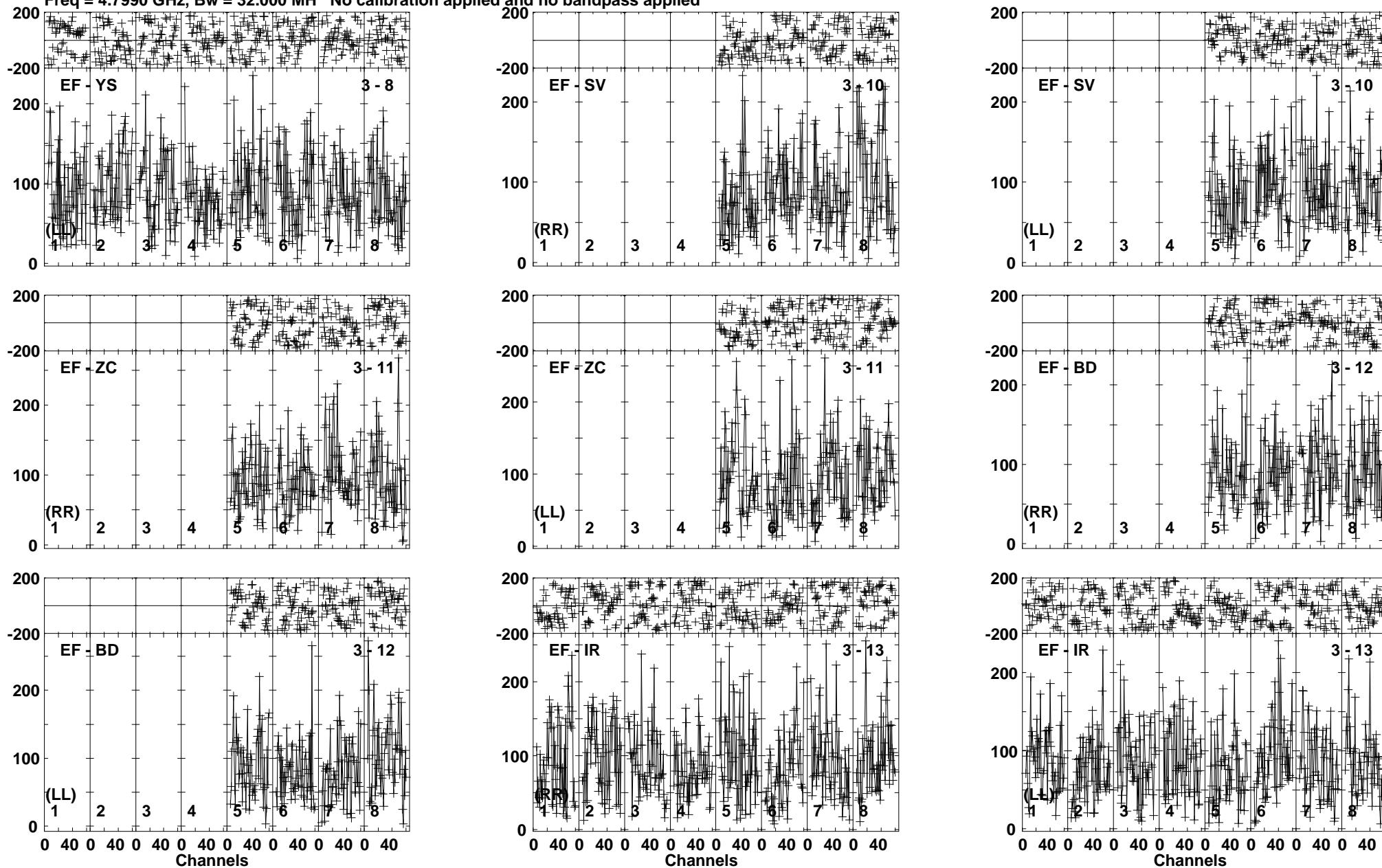

Lower frame: Micro Ampl Jy Top frame: Phas deg
Vector averaged cross-power spectrum Baseline: EF (03) - YS (08)
Timerange: 00/14:46:21 to 00/14:49:19

Plot file version 156 created 20-SEP-2019 15:51:56
 AT2019EHZ RSM05.UVDATA.1
 Freq = 4.7990 GHz, Bw = 32.000 MH No calibration applied and no bandpass applied

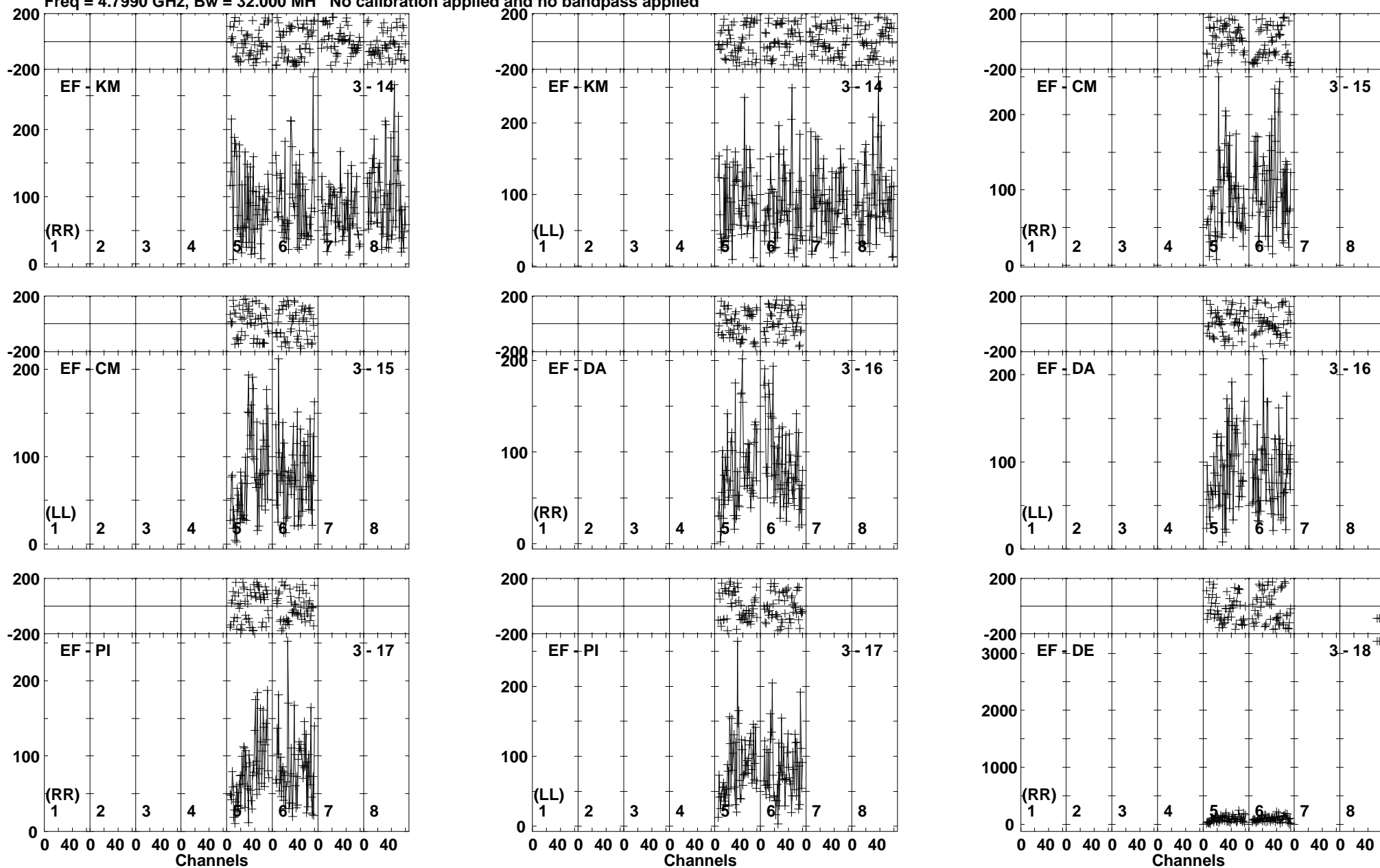

Lower frame: Micro Ampl Jy Top frame: Phas deg
 Vector averaged cross-power spectrum Baseline: EF (03) - KM (14)
 Timerange: 00/14:46:21 to 00/14:49:19

Plot file version 157 created 20-SEP-2019 15:51:57
AT2019EHZ RSM05.UVDATA.1
Freq = 4.7990 GHz, Bw = 32.000 MH No calibration applied and no bandpass applied

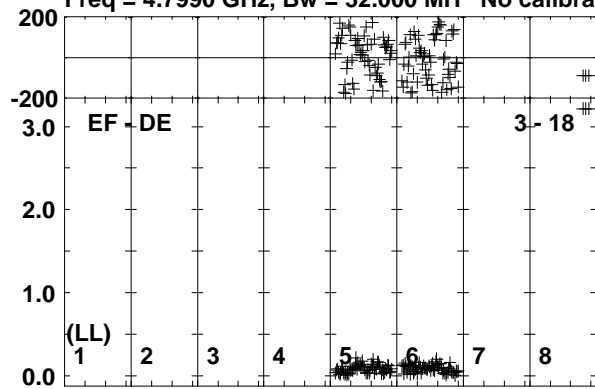

Lower frame: Milli Ampl Jy Top frame: Phas deg
Vector averaged cross-power spectrum Baseline: EF (03) - DE (18)
Timerange: 00/14:46:21 to 00/14:49:19

Plot file version 158 created 20-SEP-2019 15:51:57

J1408+5613 RSM05.UVDATA.1

Freq = 4.7990 GHz, Bw = 32.000 MH No calibration applied and no bandpass applied

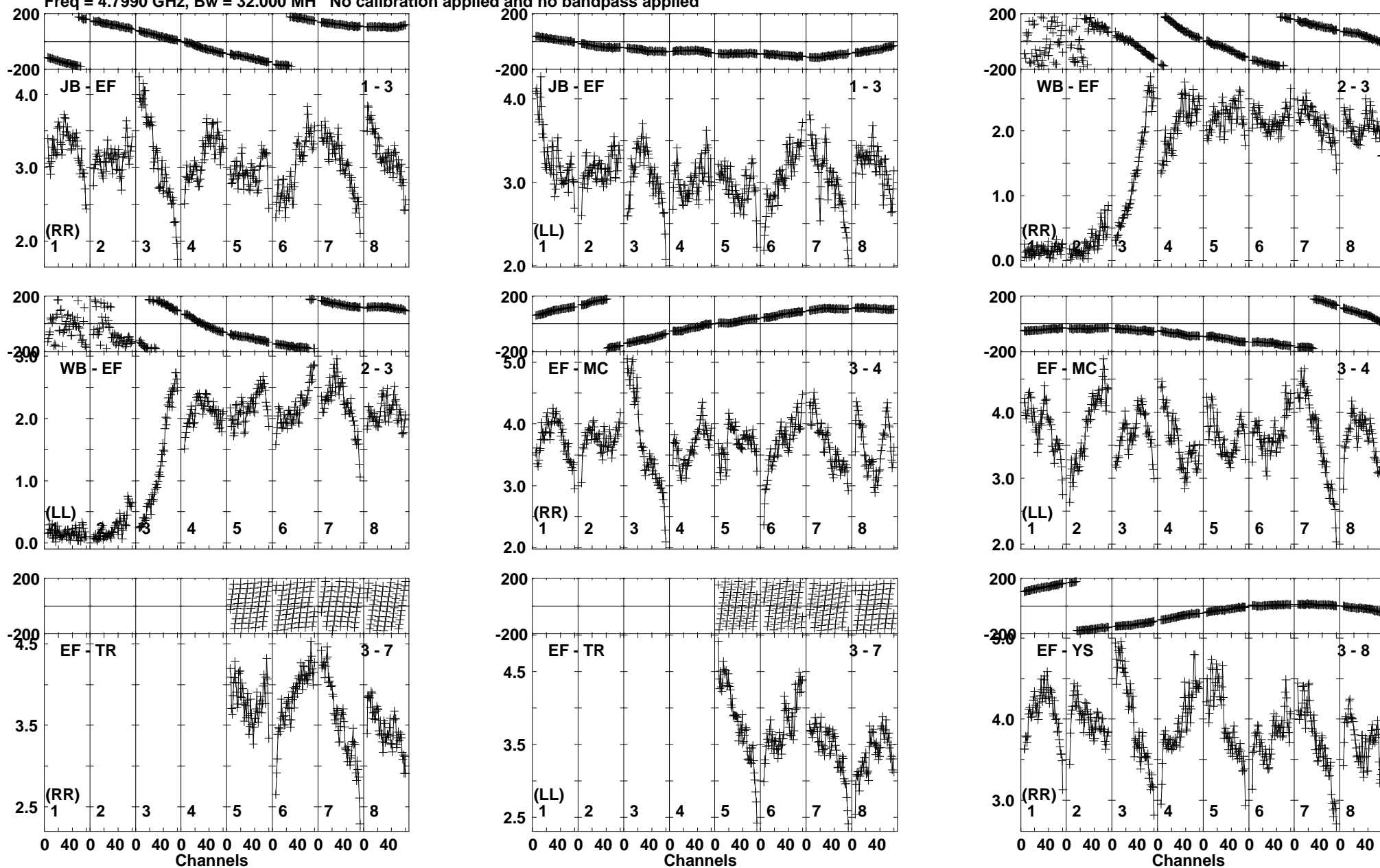

Lower frame: Milli Ampl Jy Top frame: Phas deg
Vector averaged cross-power spectrum Baseline: JB (01) - EF (03)
Timerange: 00/14:49:20 to 00/14:50:50

Plot file version 159 created 20-SEP-2019 15:51:57

J1408+5613 RSM05.UVDATA.1

Freq = 4.7990 GHz, Bw = 32.000 MH No calibration applied and no bandpass applied

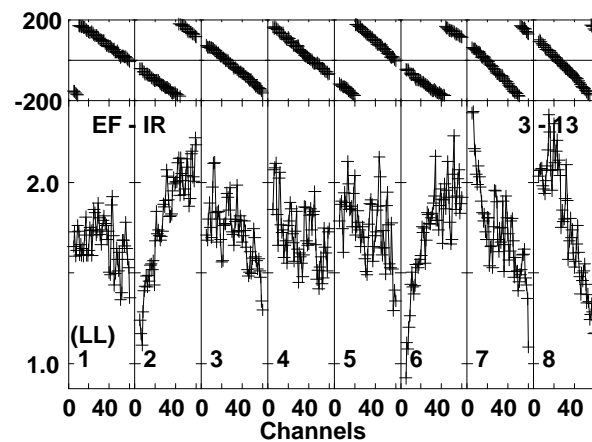
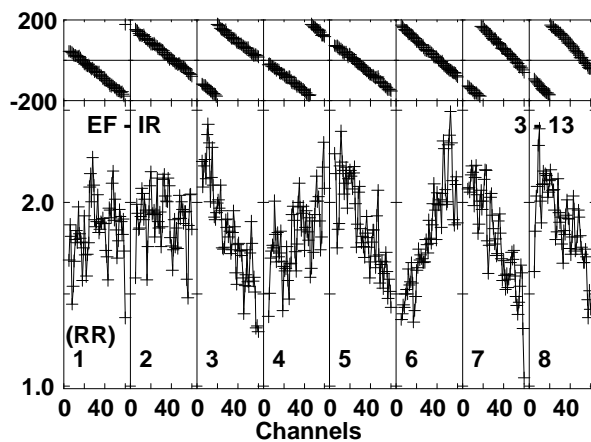
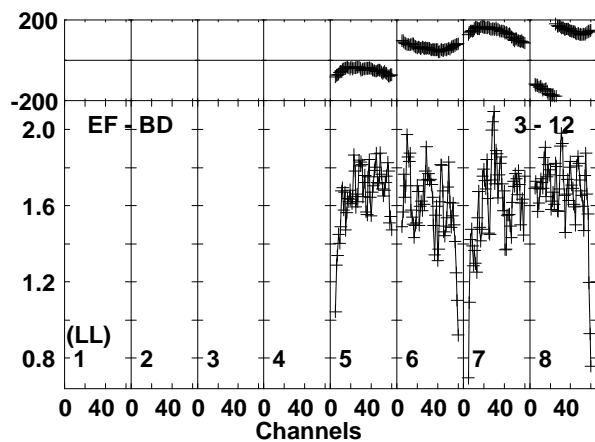
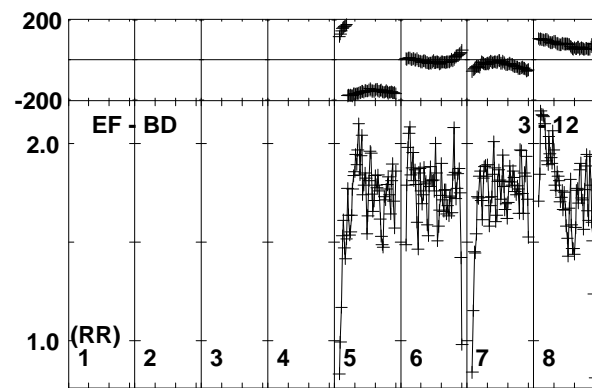
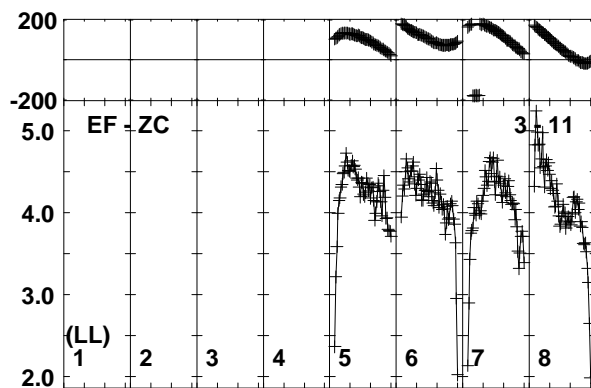
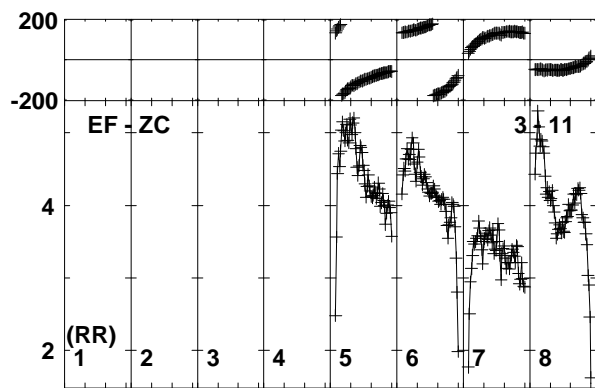
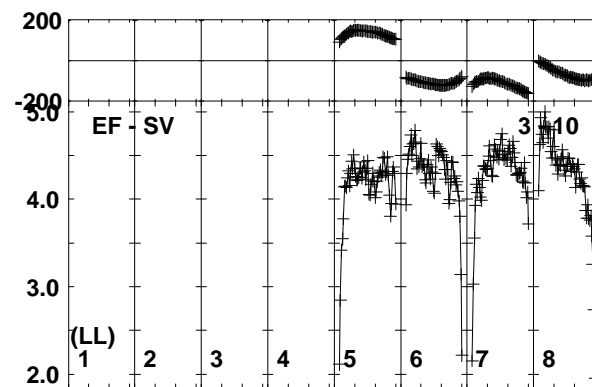
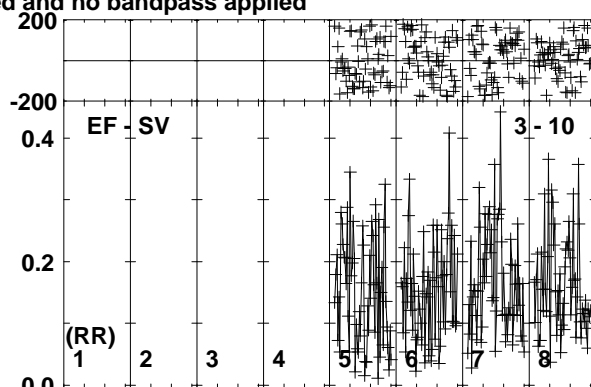
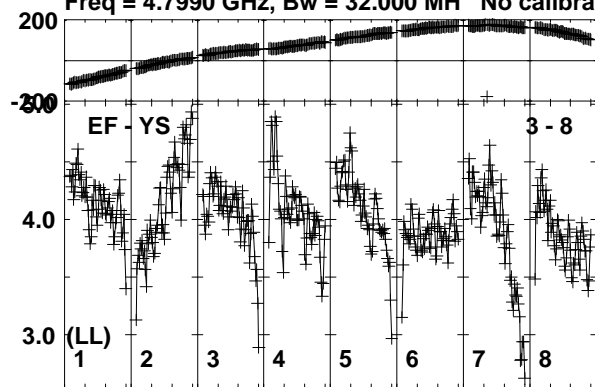

Lower frame: Milli Ampl Jy Top frame: Phas deg
Vector averaged cross-power spectrum Baseline: EF (03) - YS (08)
Timerange: 00/14:49:20 to 00/14:50:50

Plot file version 160 created 20-SEP-2019 15:51:58

J1408+5613 RSM05.UVDATA.1

Freq = 4.7990 GHz, Bw = 32.000 MH No calibration applied and no bandpass applied

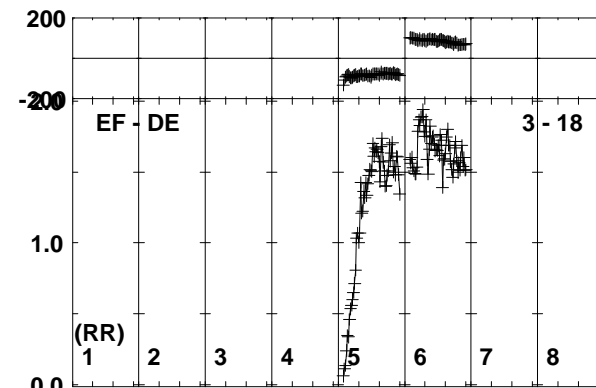
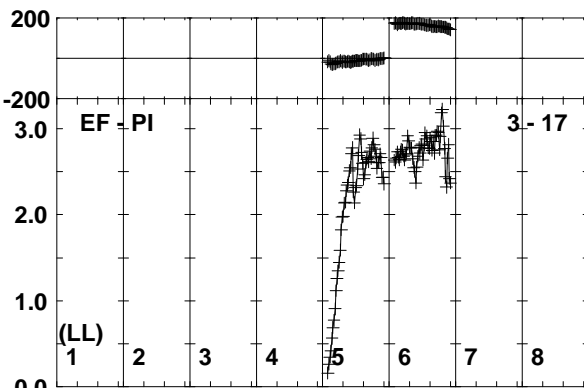
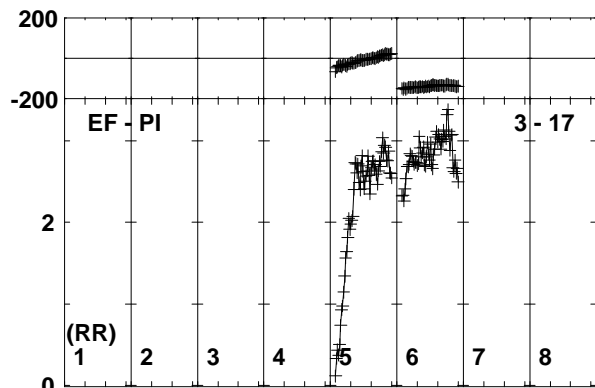
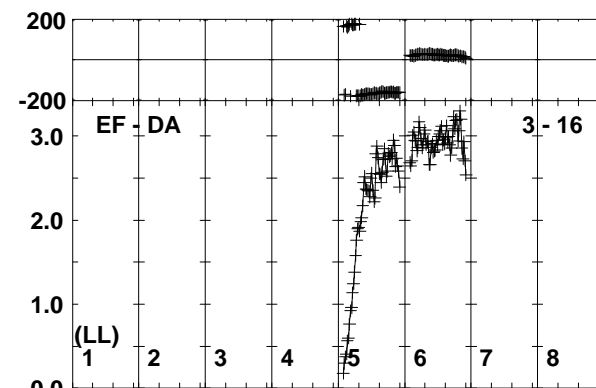
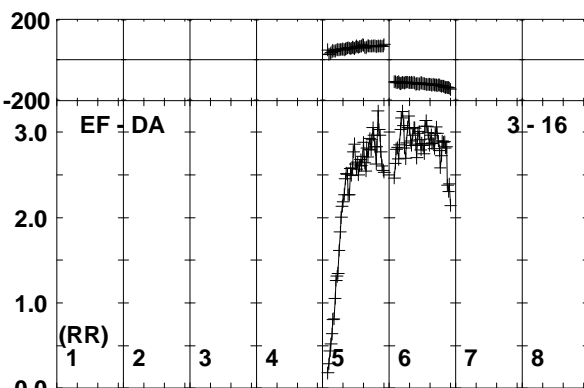
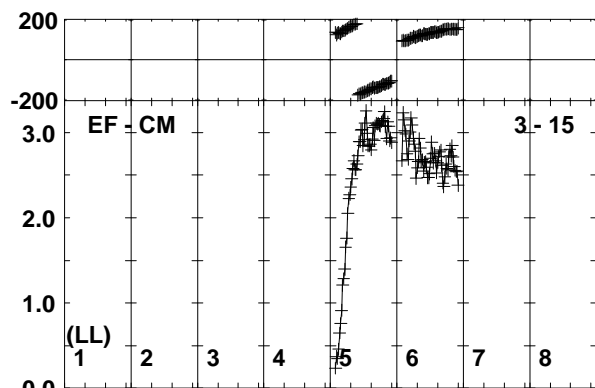
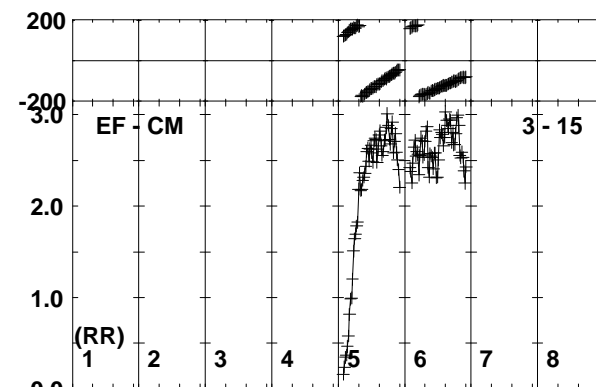
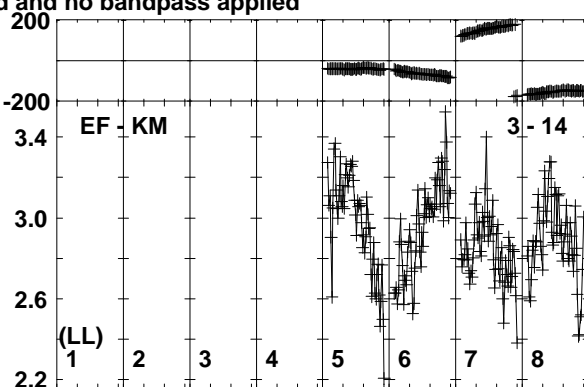
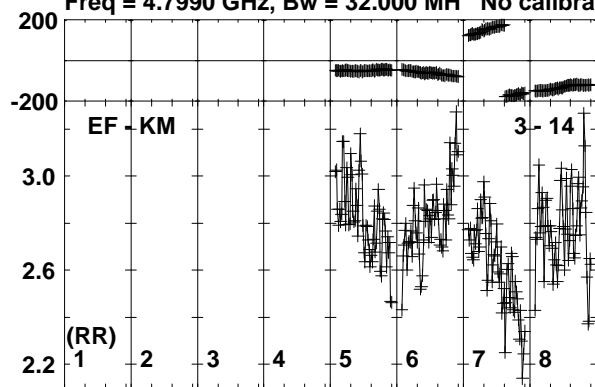

Lower frame: Milli Ampl Jy Top frame: Phas deg
Vector averaged cross-power spectrum Baseline: EF (03) - KM (14)
Timerange: 00/14:49:20 to 00/14:50:50

Plot file version 161 created 20-SEP-2019 15:51:58
J1408+5613 RSM05.UVDATA.1
Freq = 4.7990 GHz, Bw = 32.000 MH No calibration applied and no bandpass applied

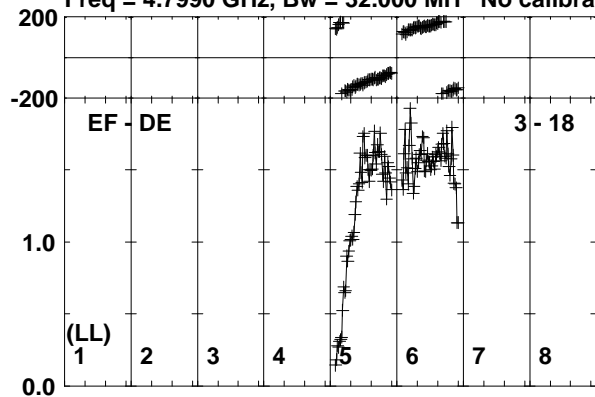

Lower frame: Milli Ampl Jy Top frame: Phas deg
Vector averaged cross-power spectrum Baseline: EF (03) - DE (18)
Timerange: 00/14:49:20 to 00/14:50:50

Plot file version 162 created 20-SEP-2019 15:51:58

AT2019EHZ RSM05.UVDATA.1

Freq = 4.7990 GHz, Bw = 32.000 MH No calibration applied and no bandpass applied

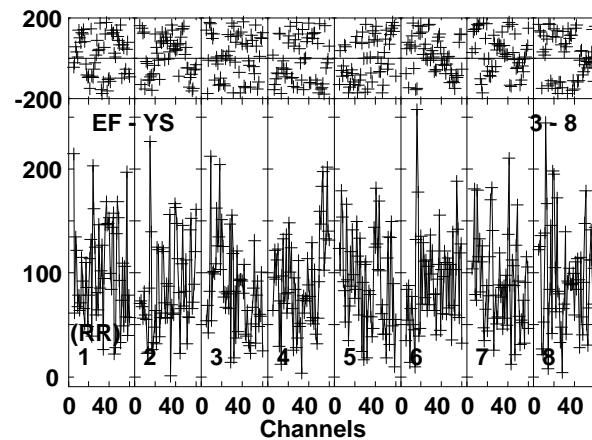
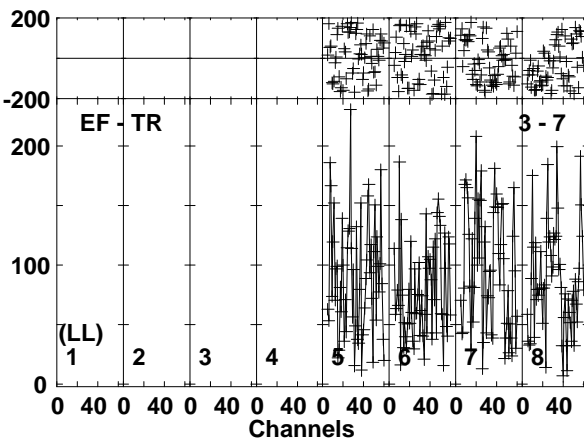
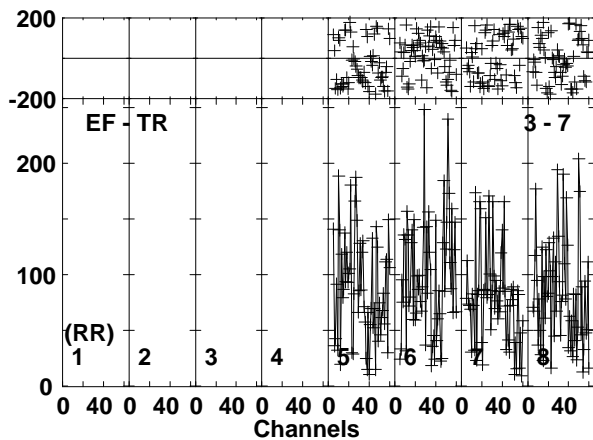
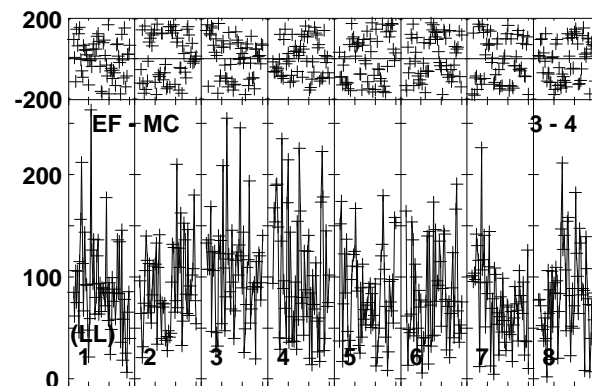
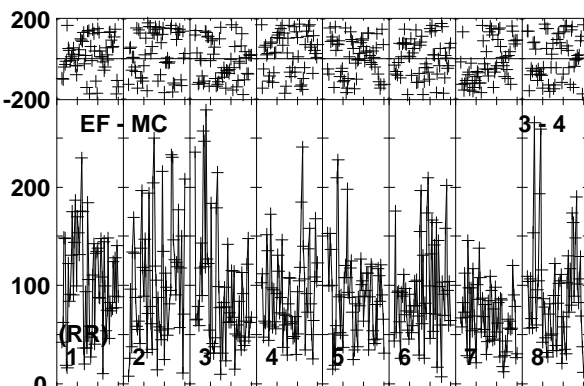
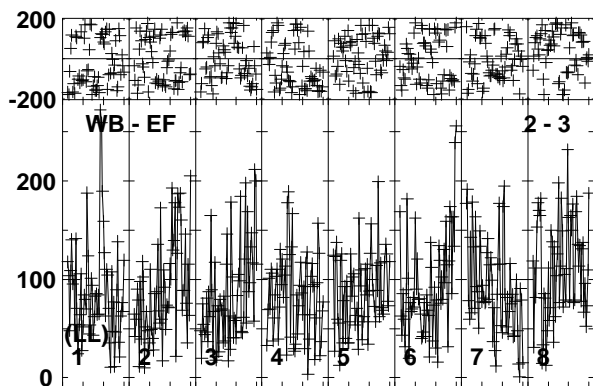
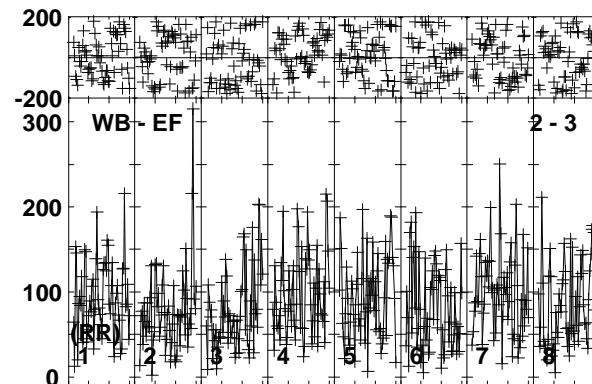
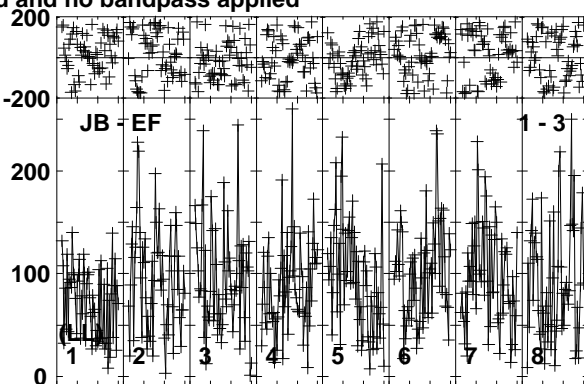
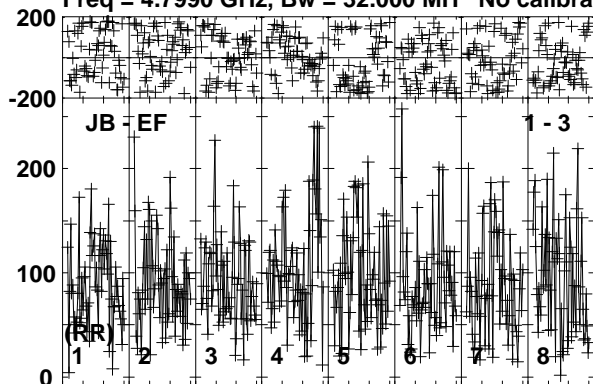

Lower frame: Micro Ampl Jy Top frame: Phas deg
Vector averaged cross-power spectrum Baseline: JB (01) - EF (03)
Timerange: 00:14:50:51 to 00:14:53:49

Plot file version 164 created 20-SEP-2019 15:51:59
 AT2019EHZ RSM05.UVDATA.1
 Freq = 4.7990 GHz, Bw = 32.000 MH No calibration applied and no bandpass applied

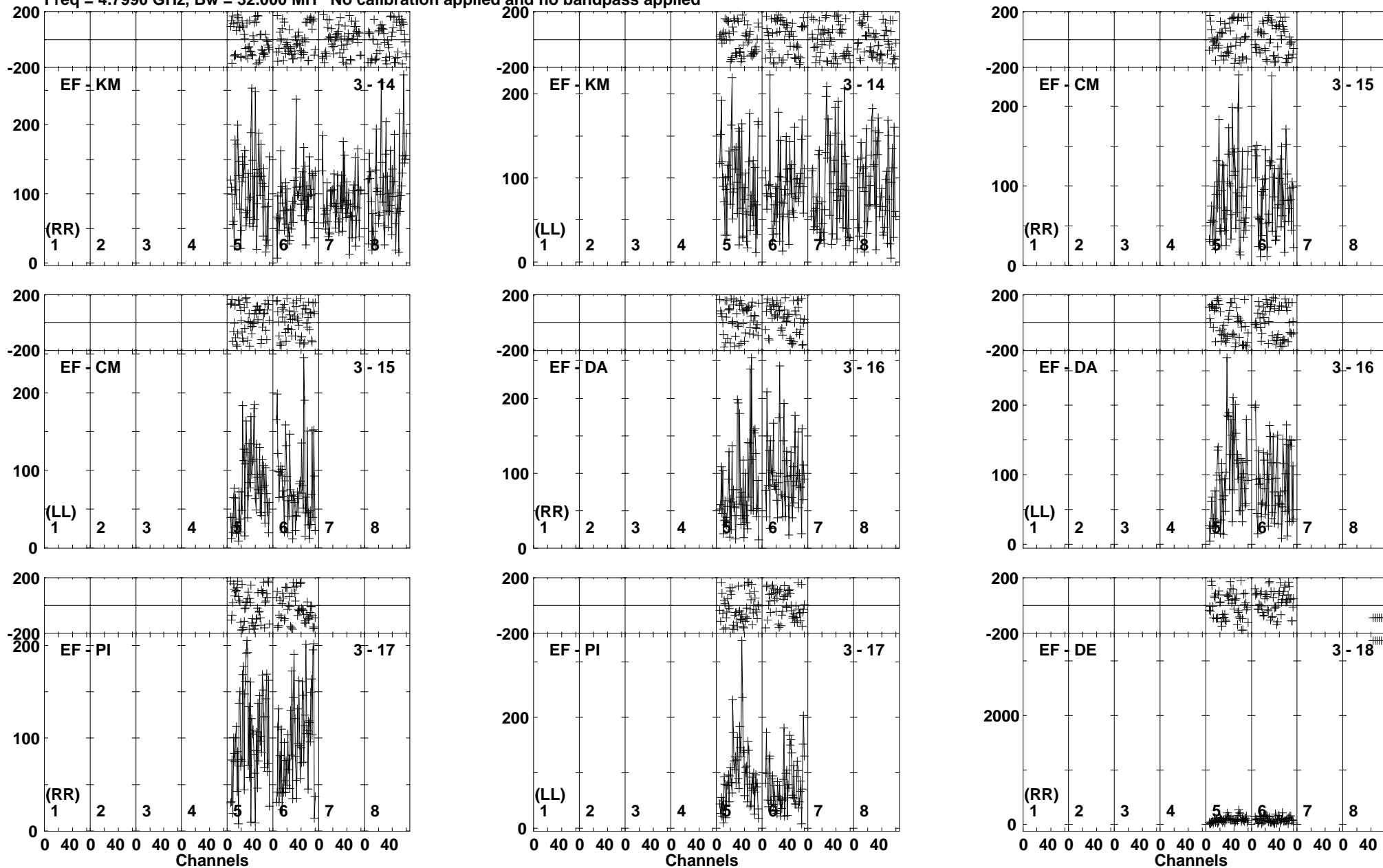

Lower frame: Micro Ampl Jy Top frame: Phas deg
 Vector averaged cross-power spectrum Baseline: EF (03) - KM (14)
 Timerange: 00/14:50:51 to 00/14:53:49

Plot file version 165 created 20-SEP-2019 15:52:00
AT2019EHZ RSM05.UVDATA.1
Freq = 4.7990 GHz, Bw = 32.000 MH No calibration applied and no bandpass applied

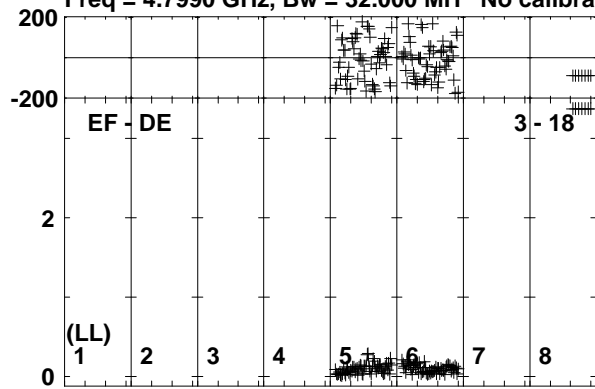

Lower frame: Milli Ampl Jy Top frame: Phas deg
Vector averaged cross-power spectrum Baseline: EF (03) - DE (18)
Timerange: 00/14:50:51 to 00/14:53:49

Plot file version 166 created 20-SEP-2019 15:52:00

J1408+5613 RSM05.UVDATA.1

Freq = 4.7990 GHz, Bw = 32.000 MH No calibration applied and no bandpass applied

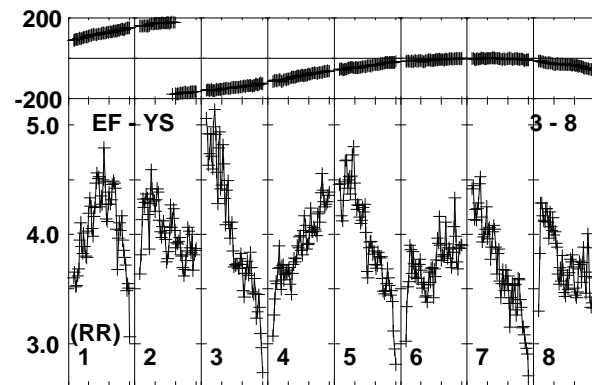
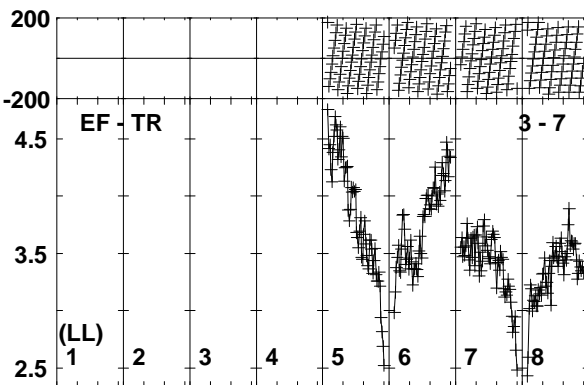
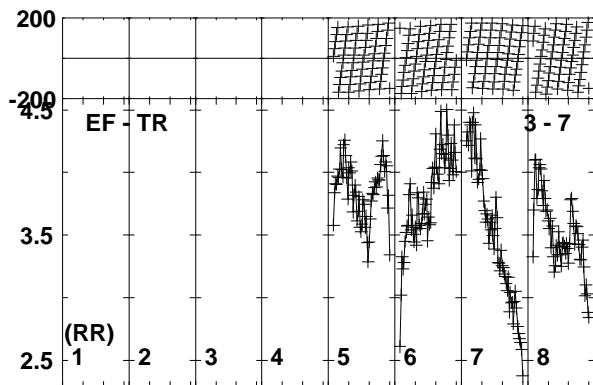
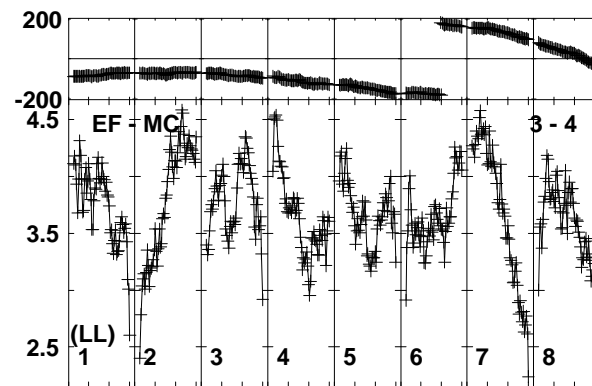
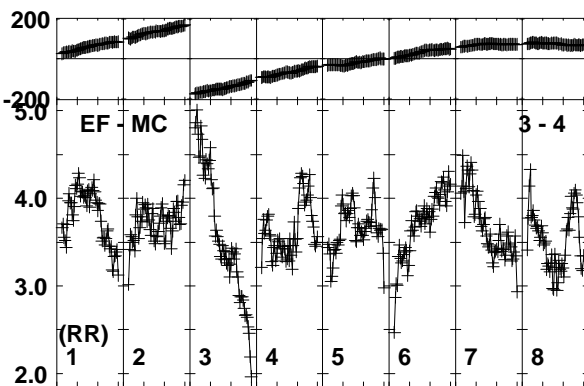
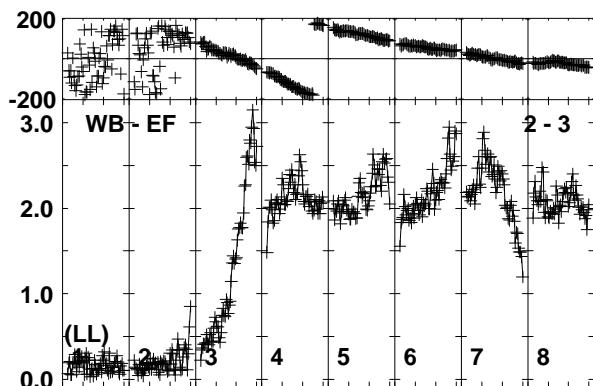
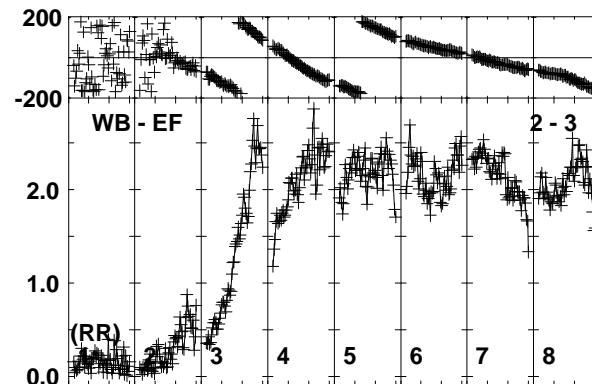
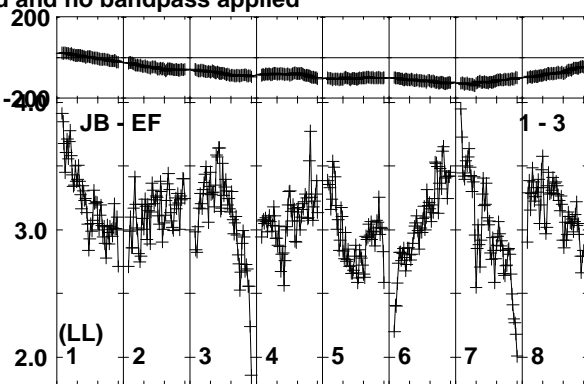
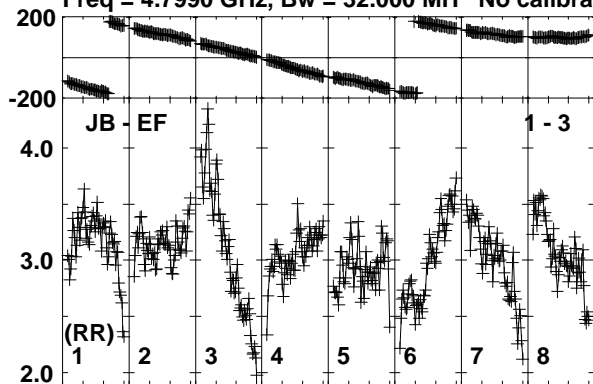

Lower frame: Milli Ampl Jy Top frame: Phas deg

Vector averaged cross-power spectrum Baseline: JB (01) - EF (03)

Timerange: 00/14:53:50 to 00/14:55:19

Plot file version 167 created 20-SEP-2019 15:52:00

J1408+5613 RSM05.UVDATA.1

Freq = 4.7990 GHz, Bw = 32.000 MH No calibration applied and no bandpass applied

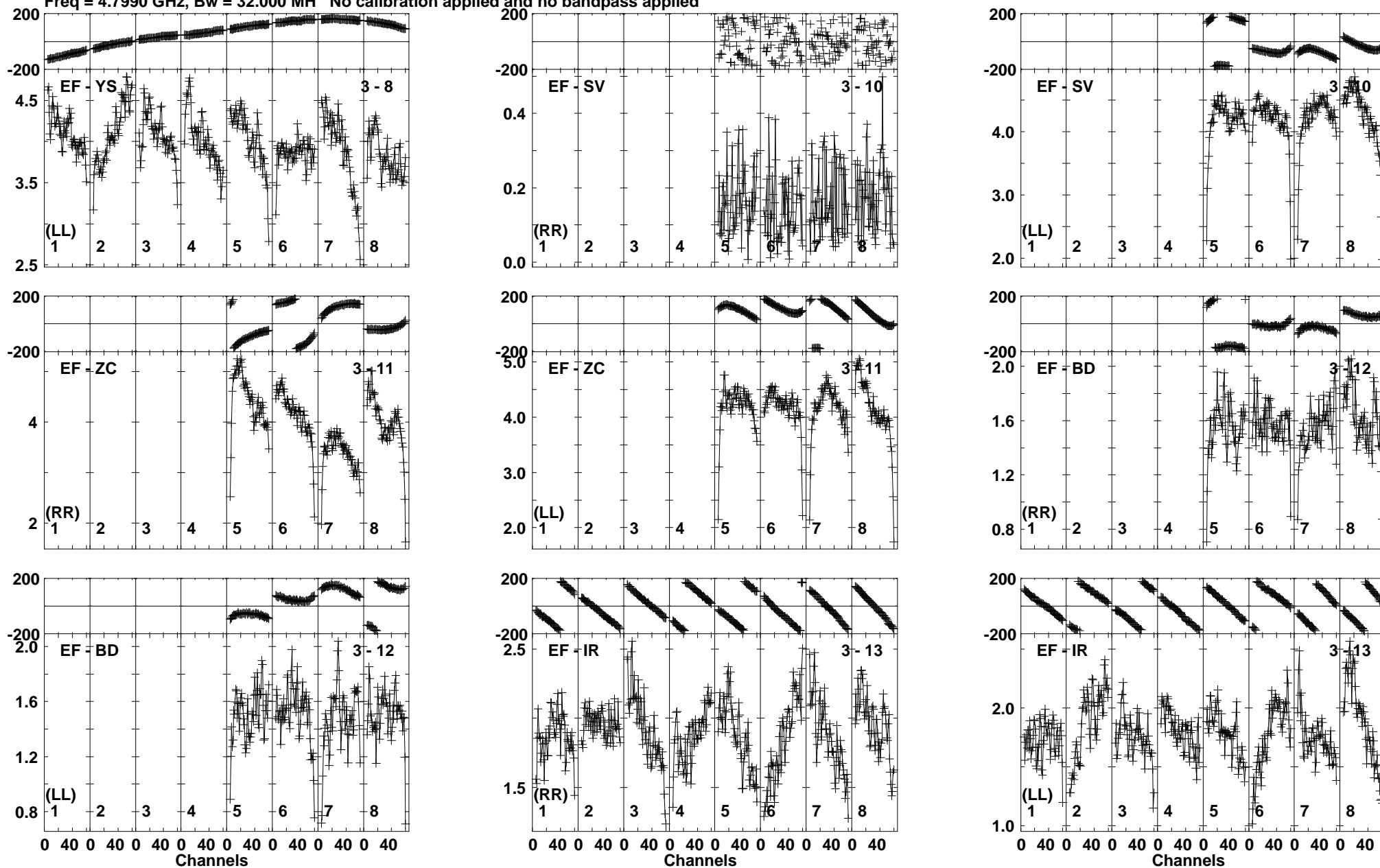

Lower frame: Milli Ampl Jy Top frame: Phas deg
Vector averaged cross-power spectrum Baseline: EF (03) - YS (08)
Timerange: 00/14:53:50 to 00/14:55:19

Plot file version 168 created 20-SEP-2019 15:52:01

J1408+5613 RSM05.UVDATA.1

Freq = 4.7990 GHz, Bw = 32.000 MH No calibration applied and no bandpass applied

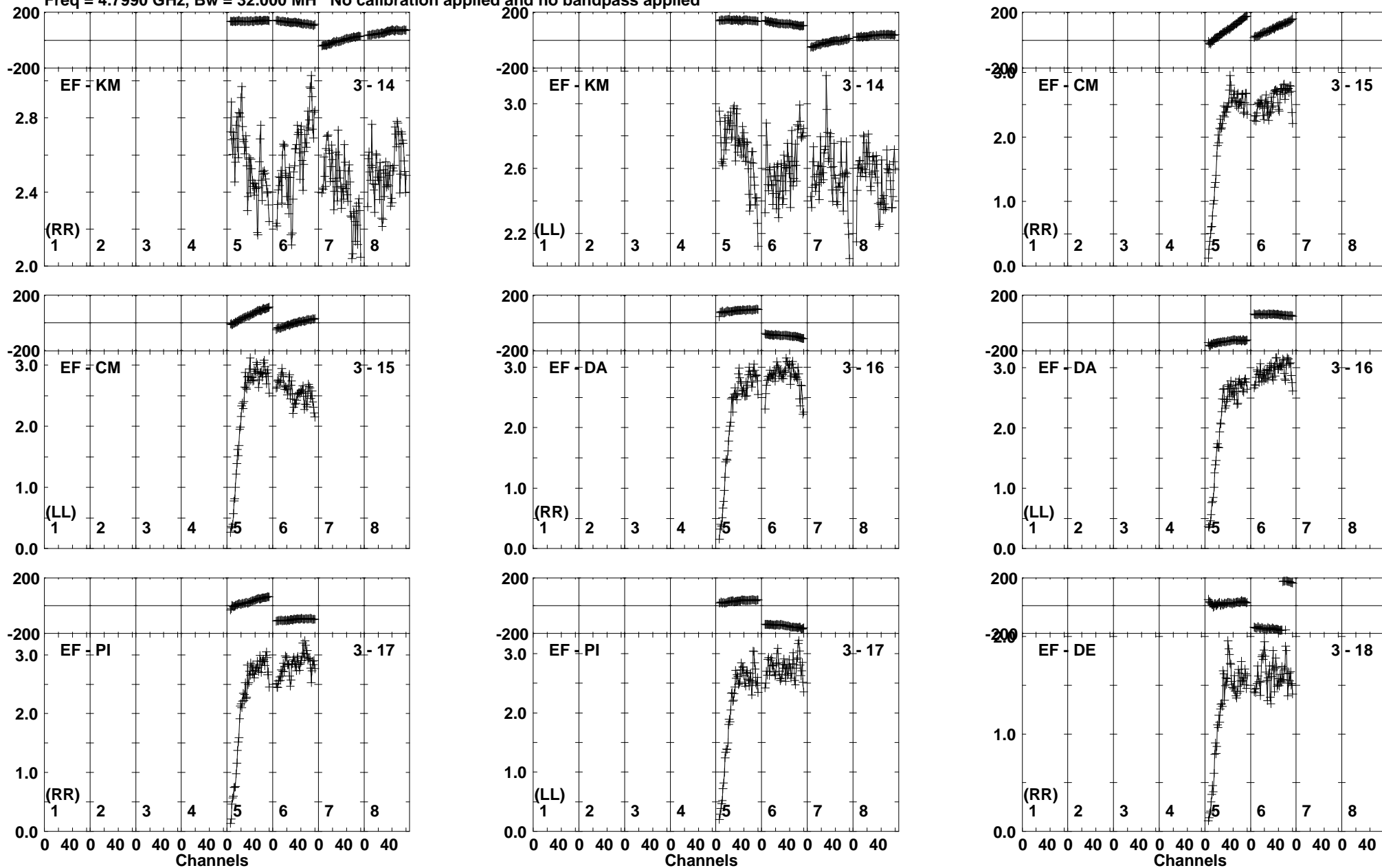

Lower frame: Milli Ampl Jy Top frame: Phas deg
Vector averaged cross-power spectrum Baseline: EF (03) - KM (14)
Timerange: 00/14:53:50 to 00/14:55:19

Plot file version 169 created 20-SEP-2019 15:52:01
J1408+5613 RSM05.UVDATA.1
Freq = 4.7990 GHz, Bw = 32.000 MH No calibration applied and no bandpass applied

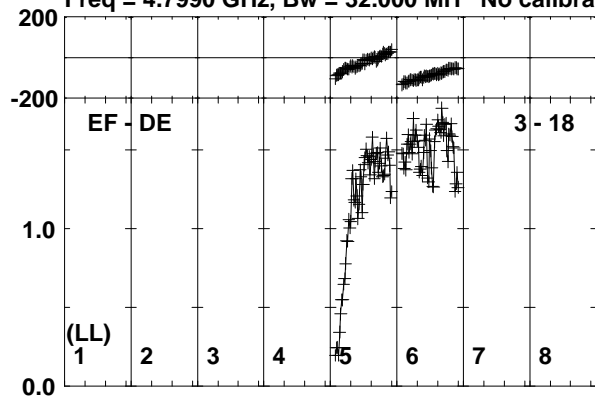

Lower frame: Milli Ampl Jy Top frame: Phas deg
Vector averaged cross-power spectrum Baseline: EF (03) - DE (18)
Timerange: 00/14:53:50 to 00/14:55:19

Plot file version 170 created 20-SEP-2019 15:52:01

AT2019EHZ RSM05.UVDATA.1

Freq = 4.7990 GHz, Bw = 32.000 MH No calibration applied and no bandpass applied

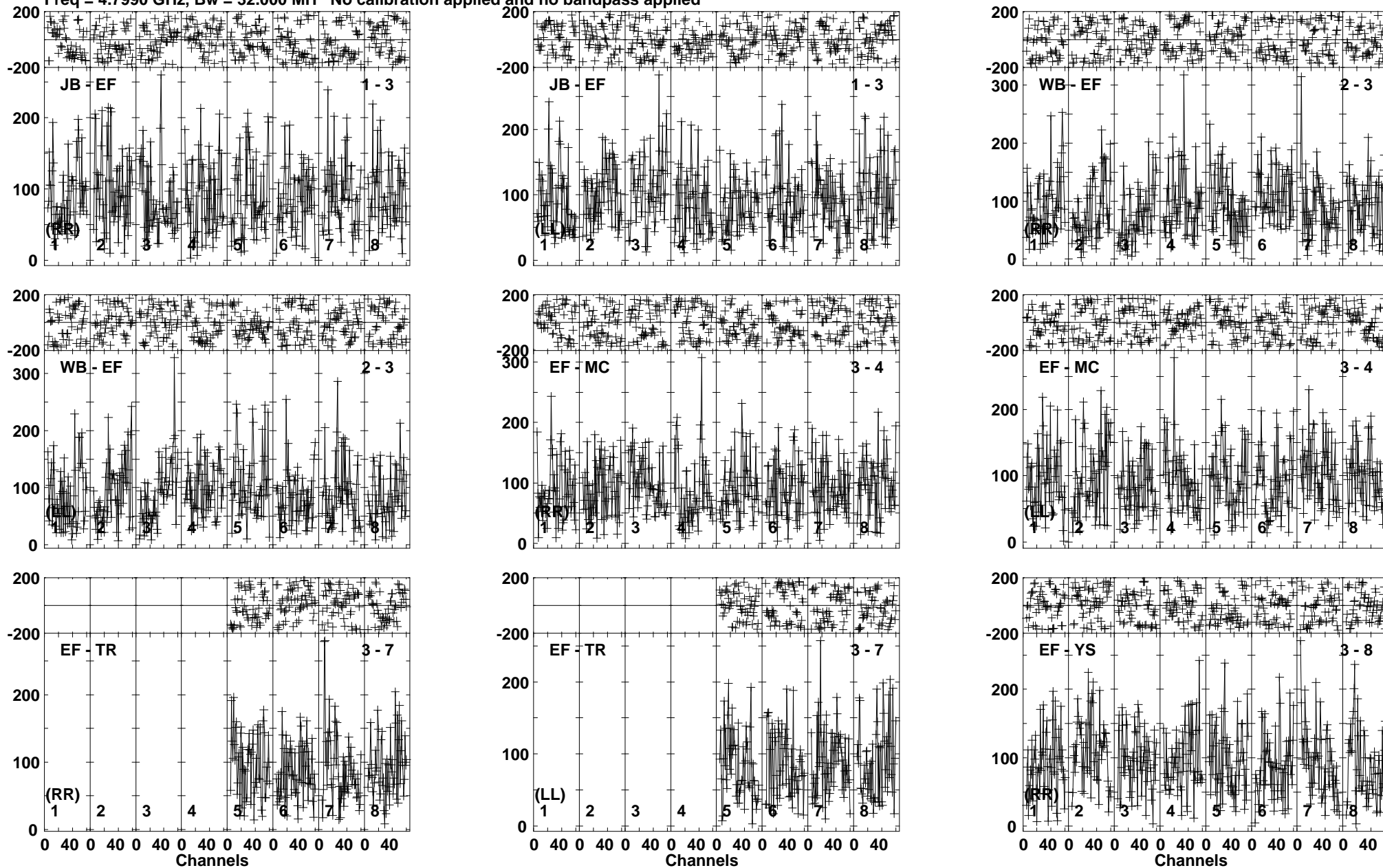

Lower frame: Micro Ampl Jy Top frame: Phas deg
Vector averaged cross-power spectrum Baseline: JB (01) - EF (03)
Timerange: 00/14:55:20 to 00/14:58:20

Plot file version 171 created 20-SEP-2019 15:52:02
 AT2019EHZ RSM05.UVDATA.1
 Freq = 4.7990 GHz, Bw = 32.000 MH No calibration applied and no bandpass applied

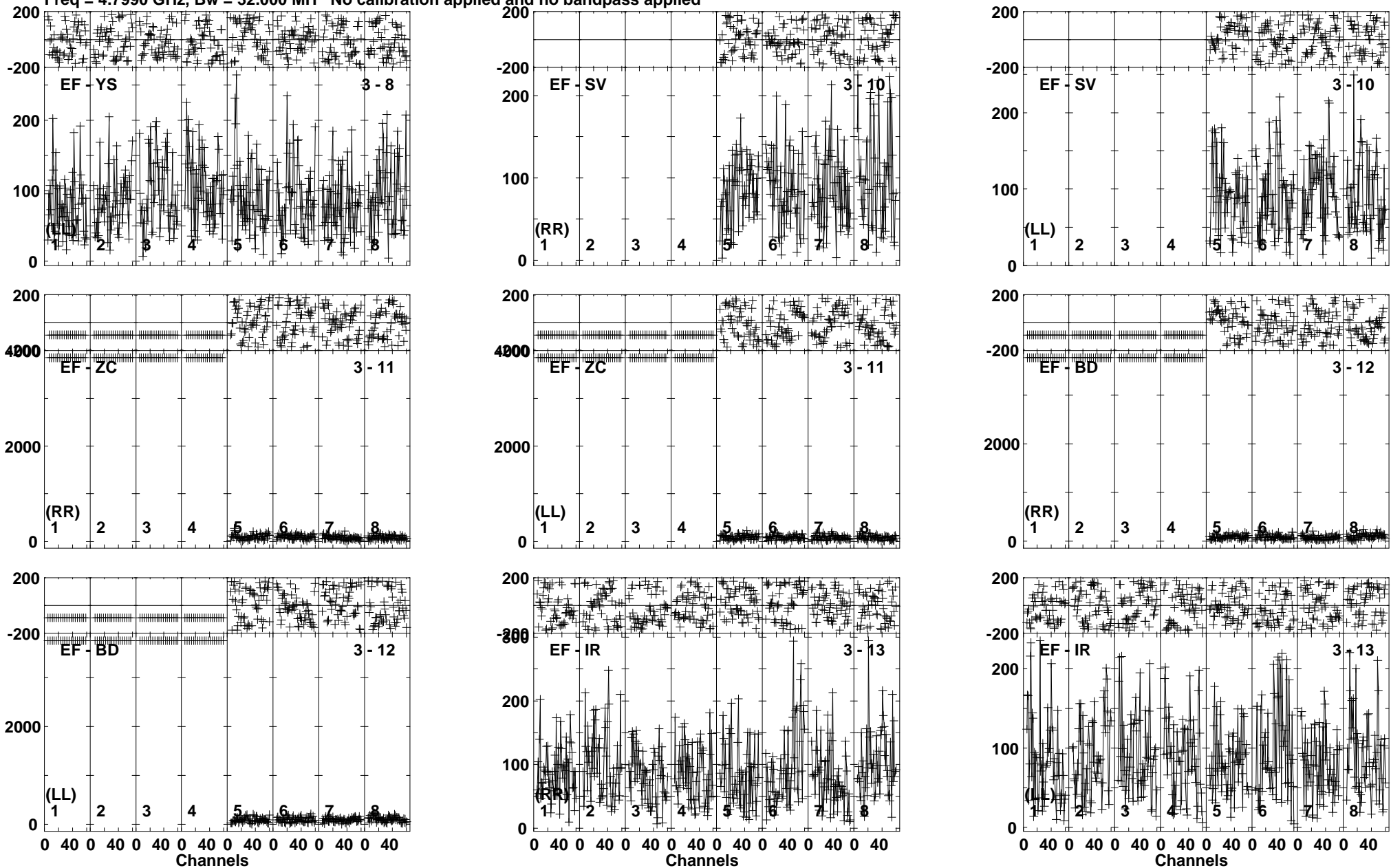

Lower frame: Micro Ampl Jy Top frame: Phas deg
 Vector averaged cross-power spectrum Baseline: EF (03) - YS (08)
 Timerange: 00/14:55:20 to 00/14:58:20

Plot file version 172 created 20-SEP-2019 15:52:03
 AT2019EHZ RSM05.UVDATA.1
 Freq = 4.7990 GHz, Bw = 32.000 MH No calibration applied and no bandpass applied

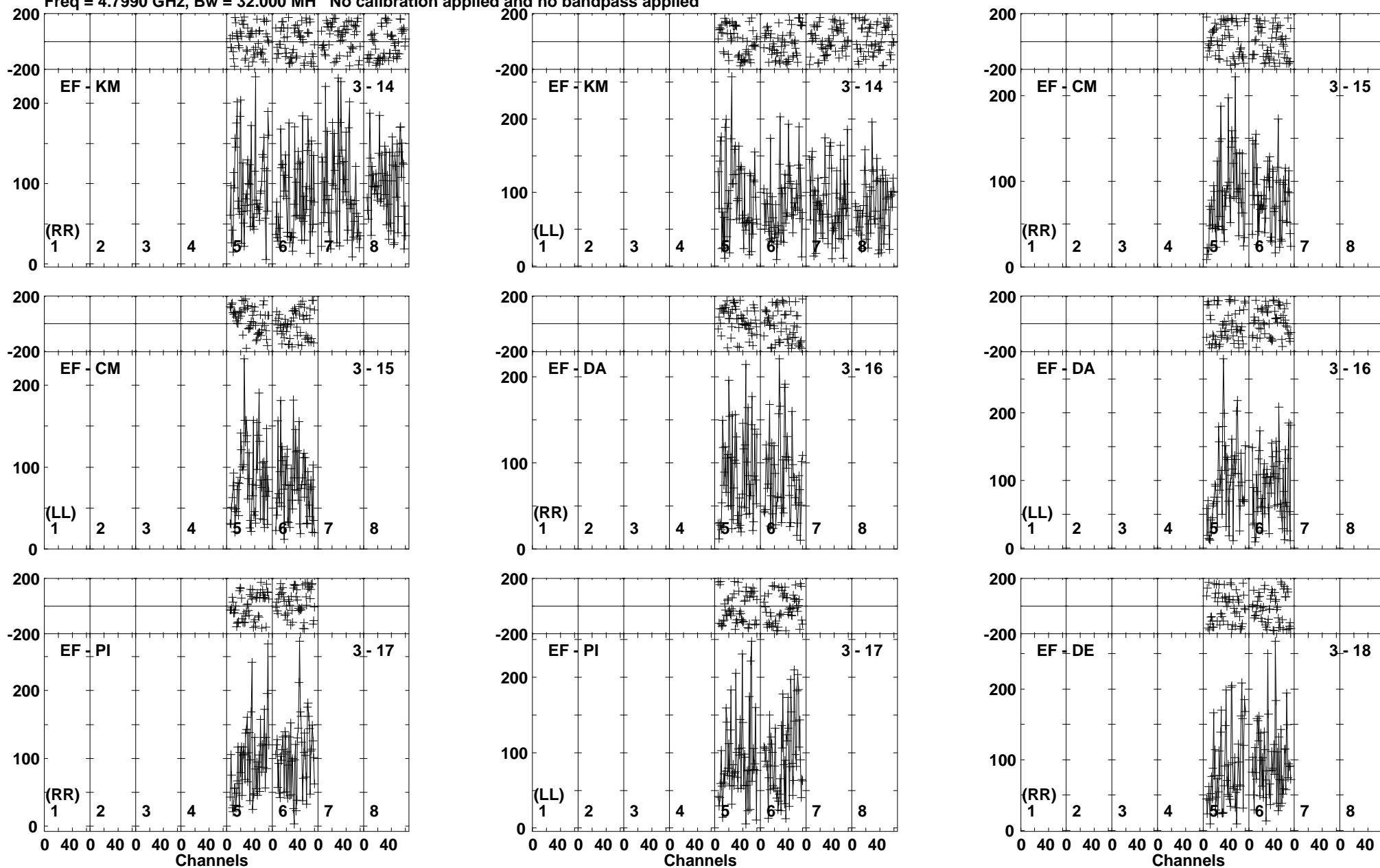

Lower frame: Micro Ampl Jy Top frame: Phas deg
 Vector averaged cross-power spectrum Baseline: EF (03) - KM (14)
 Timerange: 00/14:55:20 to 00/14:58:20

Plot file version 173 created 20-SEP-2019 15:52:03
AT2019EHZ RSM05.UVDATA.1
Freq = 4.7990 GHz, Bw = 32.000 MH No calibration applied and no bandpass applied

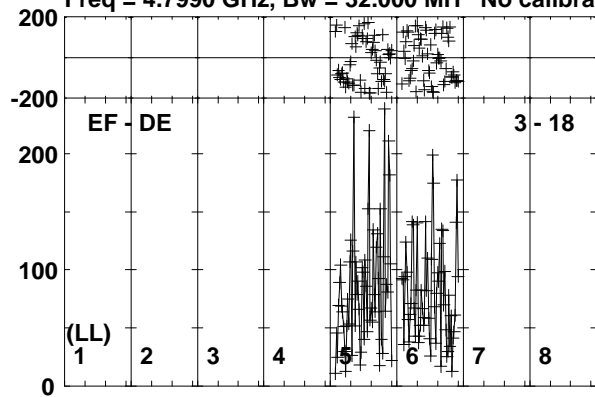

Lower frame: Micro Ampl Jy Top frame: Phas deg
Vector averaged cross-power spectrum Baseline: EF (03) - DE (18)
Timerange: 00/14:55:20 to 00/14:58:20

Plot file version 174 created 20-SEP-2019 15:52:03

J1408+5613 RSM05.UVDATA.1

Freq = 4.7990 GHz, Bw = 32.000 MH No calibration applied and no bandpass applied

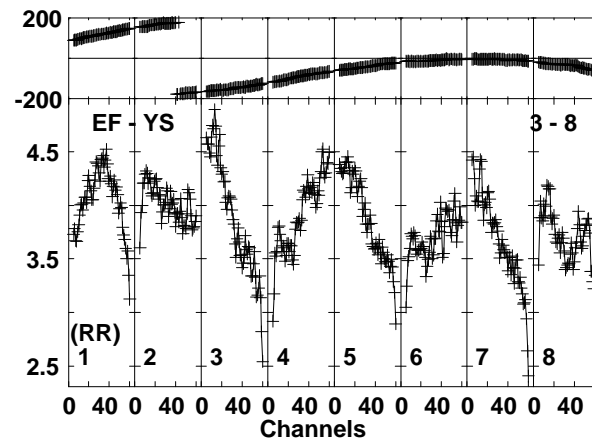
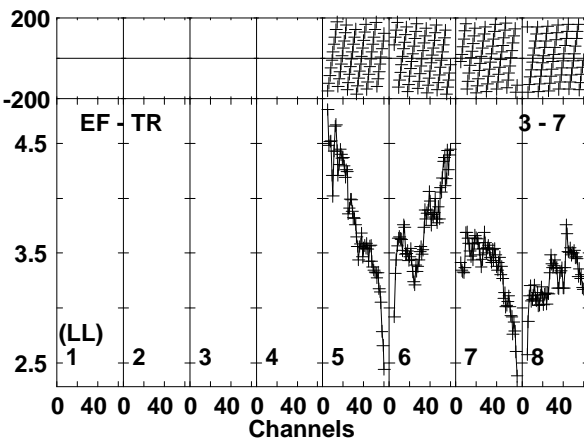
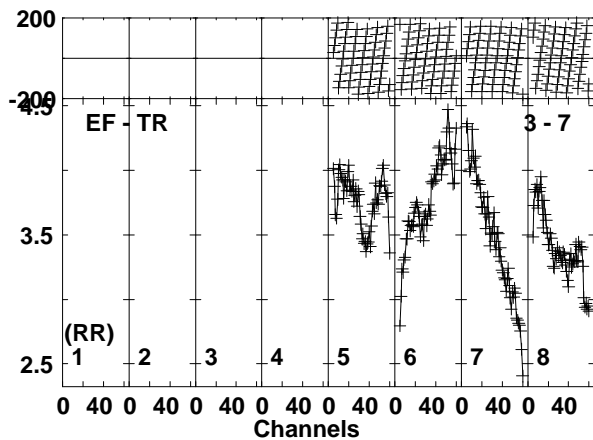
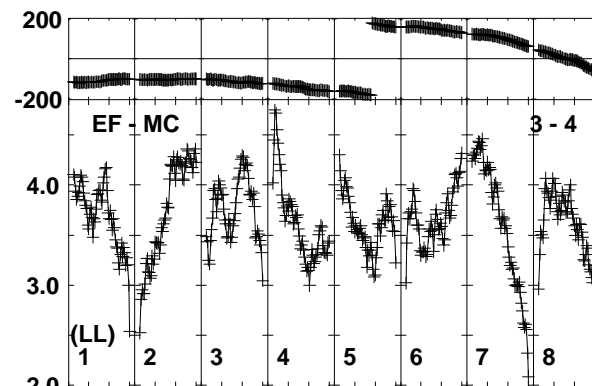
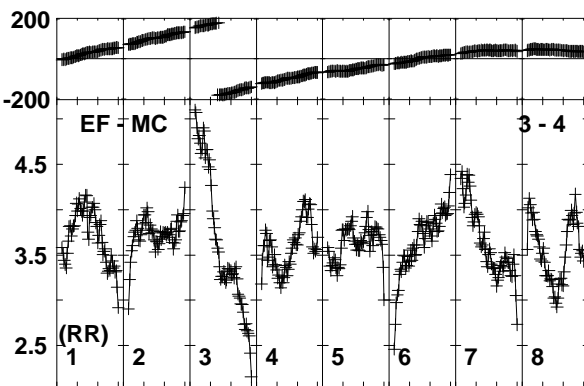
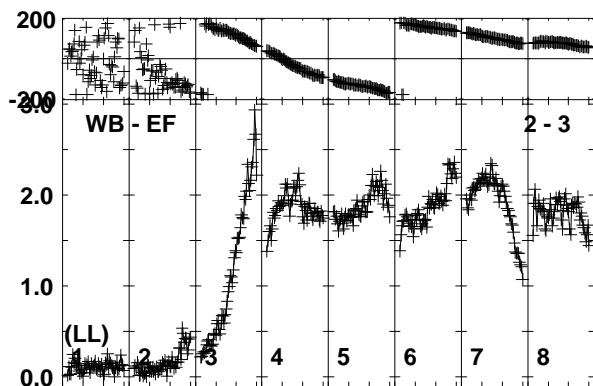
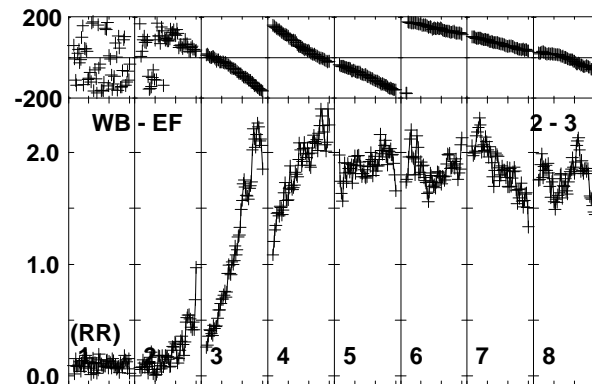
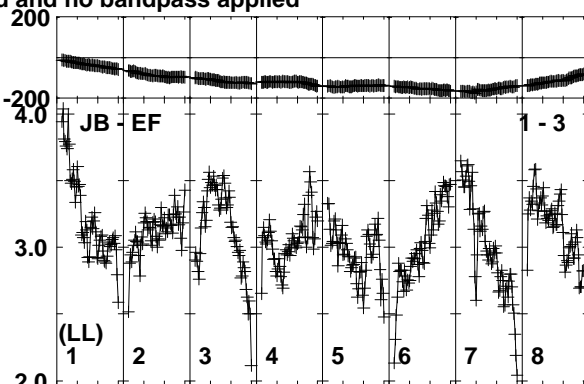
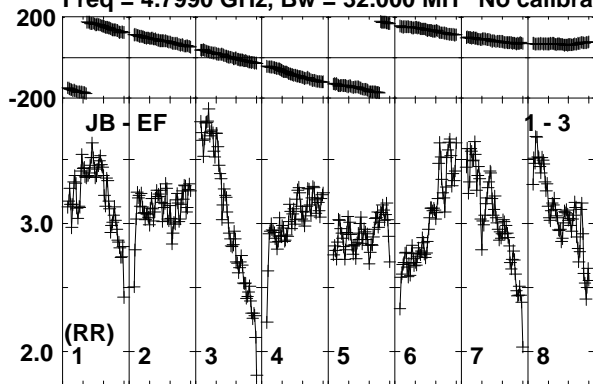

Lower frame: Milli Ampl Jy Top frame: Phas deg
Vector averaged cross-power spectrum Baseline: JB (01) - EF (03)
Timerange: 00/14:59:10 to 00/15:00:39

Plot file version 175 created 20-SEP-2019 15:52:04

J1408+5613 RSM05.UVDATA.1

Freq = 4.7990 GHz, Bw = 32.000 MH No calibration applied and no bandpass applied

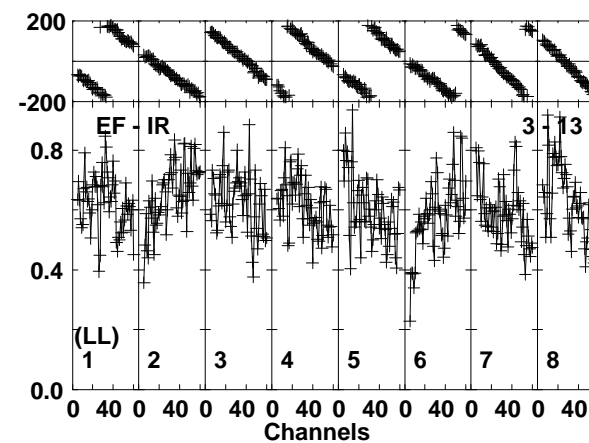
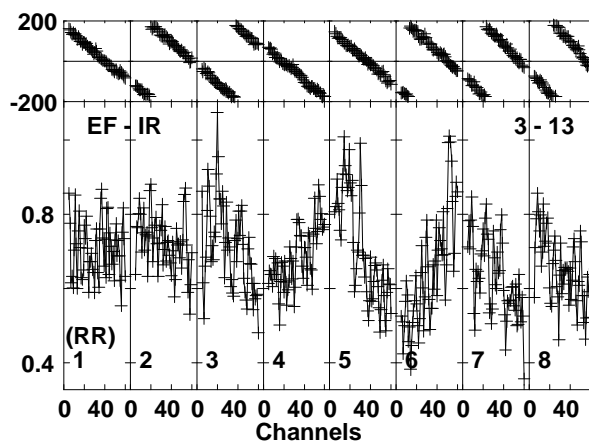
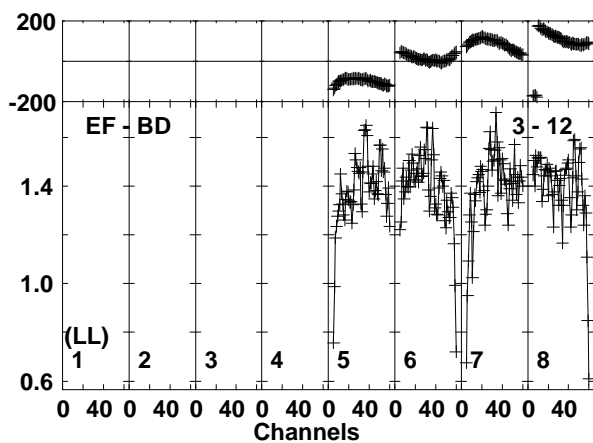
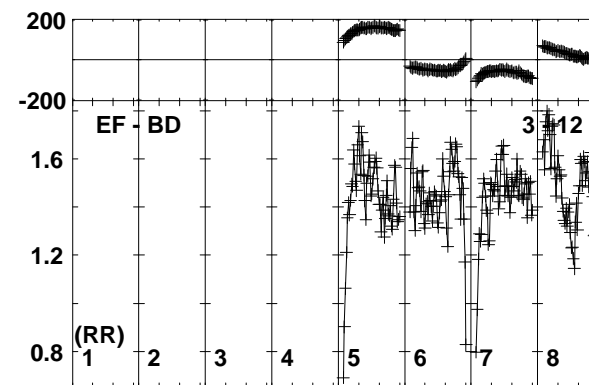
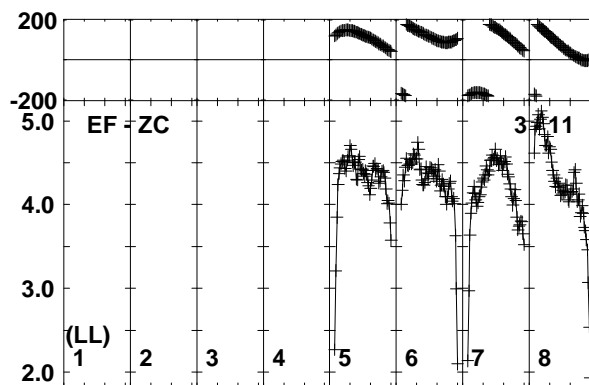
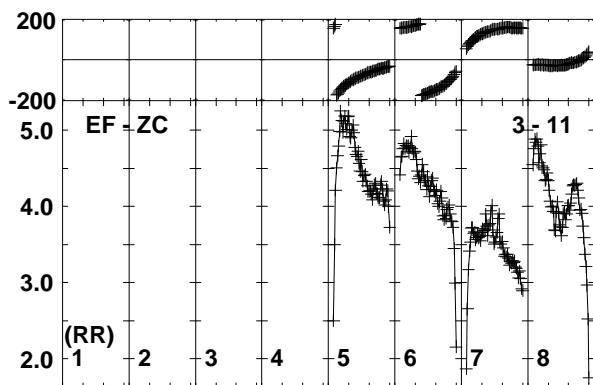
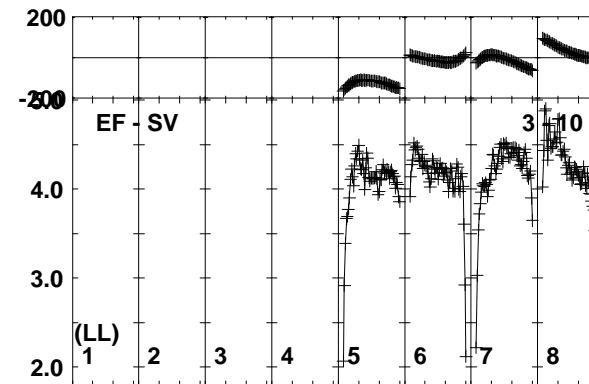
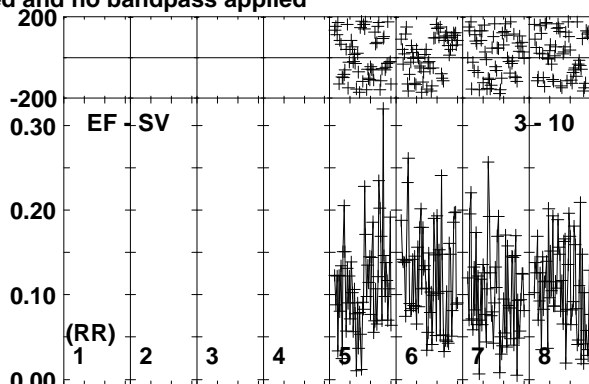
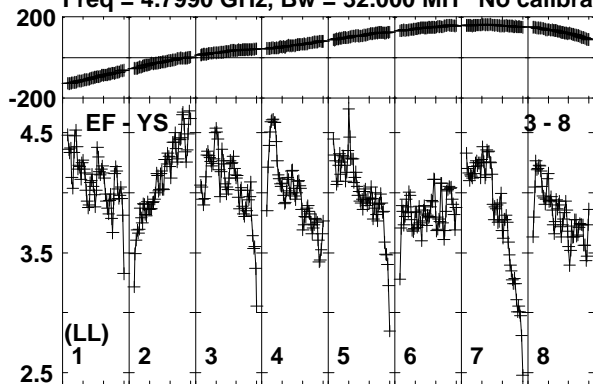

Lower frame: Milli Ampl Jy Top frame: Phas deg
Vector averaged cross-power spectrum Baseline: EF (03) - YS (08)
Timerange: 00/14:59:10 to 00/15:00:39

Plot file version 176 created 20-SEP-2019 15:52:04

J1408+5613 RSM05.UVDATA.1

Freq = 4.7990 GHz, Bw = 32.000 MH No calibration applied and no bandpass applied

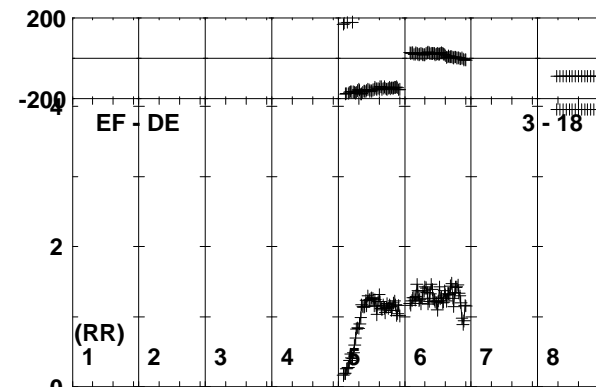
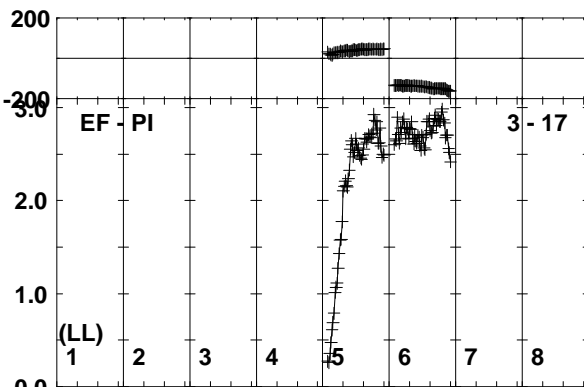
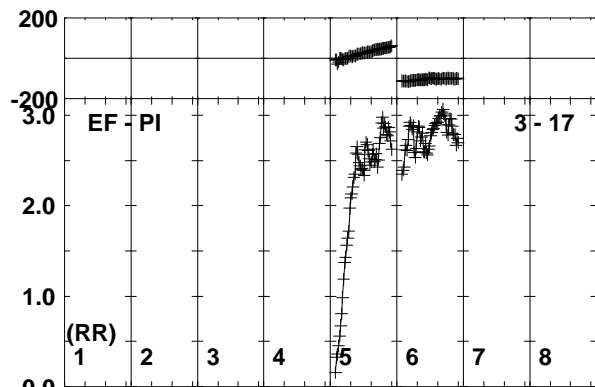
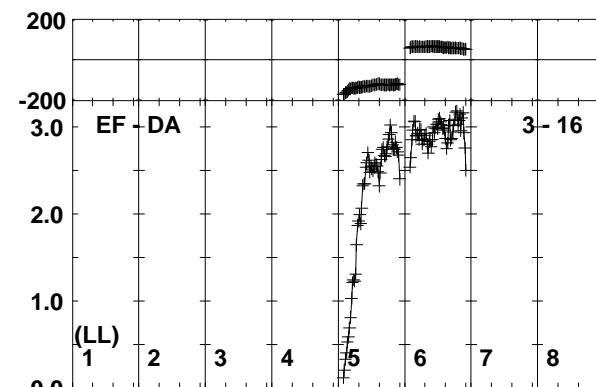
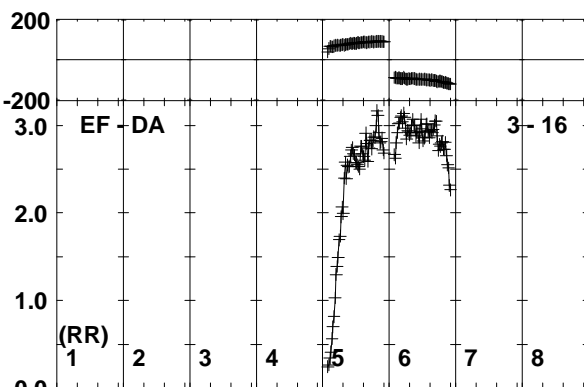
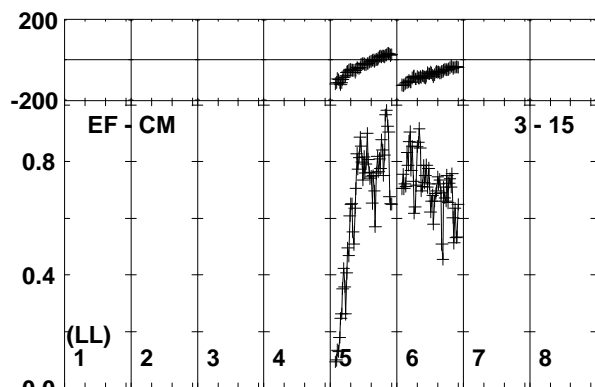
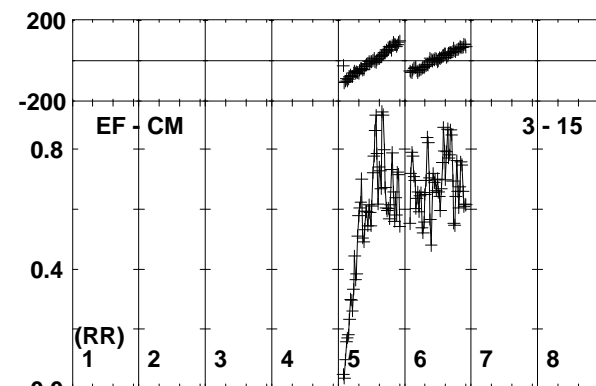
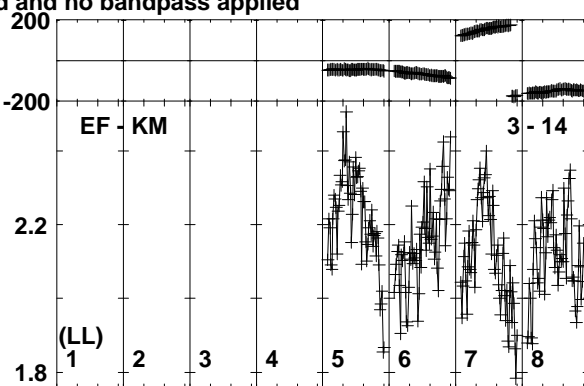
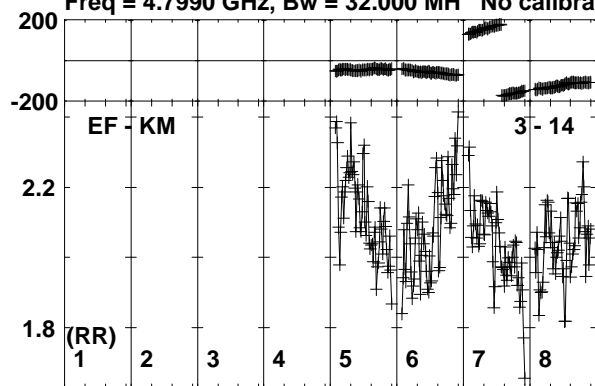

Lower frame: Milli Ampl Jy Top frame: Phas deg
Vector averaged cross-power spectrum Baseline: EF (03) - KM (14)
Timerange: 00/14:59:10 to 00/15:00:39

Plot file version 177 created 20-SEP-2019 15:52:05
J1408+5613 RSM05.UVDATA.1
Freq = 4.7990 GHz, Bw = 32.000 MH No calibration applied and no bandpass applied

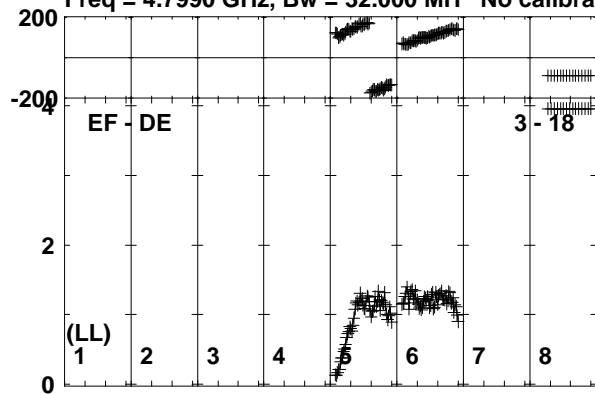

Lower frame: Milli Ampl Jy Top frame: Phas deg
Vector averaged cross-power spectrum Baseline: EF (03) - DE (18)
Timerange: 00/14:59:10 to 00/15:00:39

Plot file version 178 created 20-SEP-2019 15:52:05

AT2019EHZ RSM05.UVDATA.1

Freq = 4.7990 GHz, Bw = 32.000 MH No calibration applied and no bandpass applied

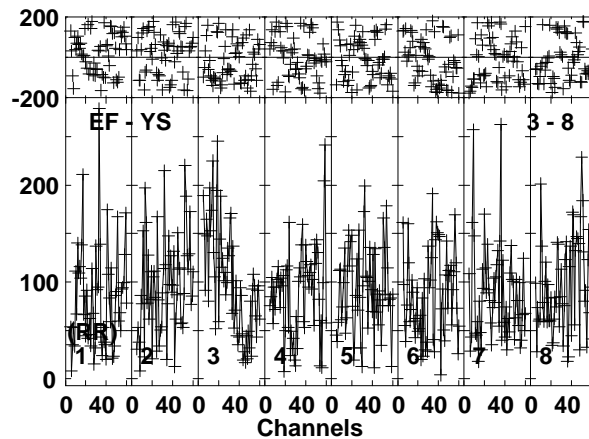
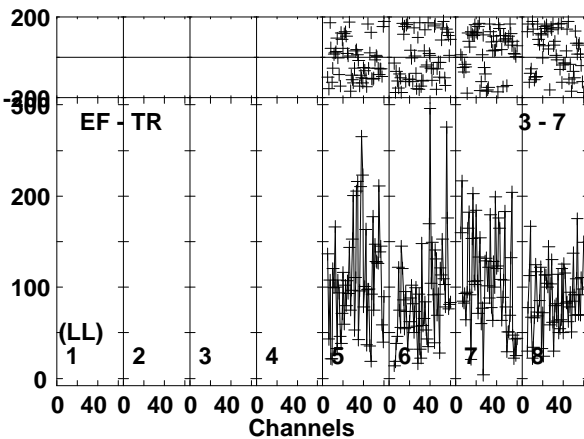
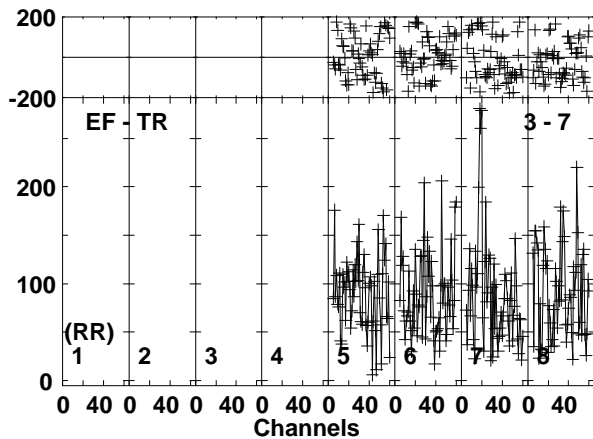
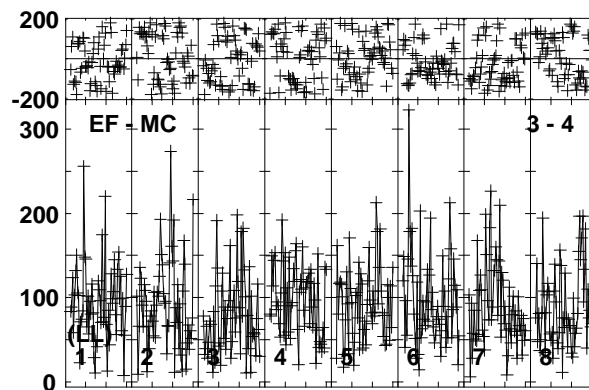
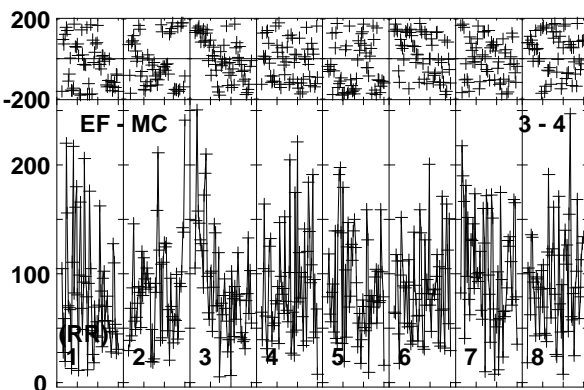
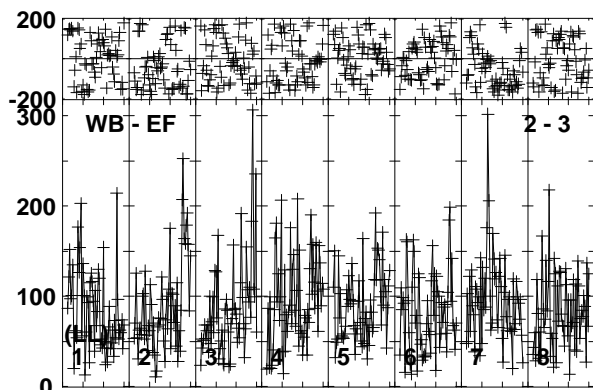
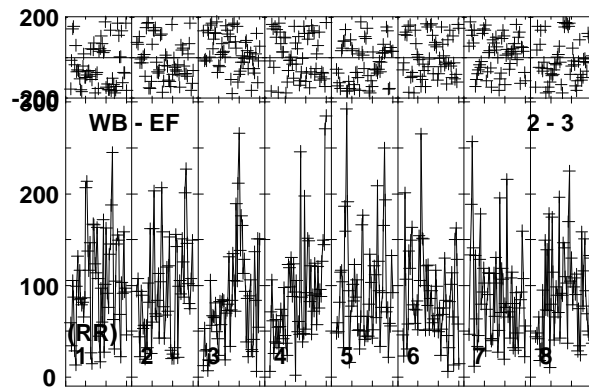
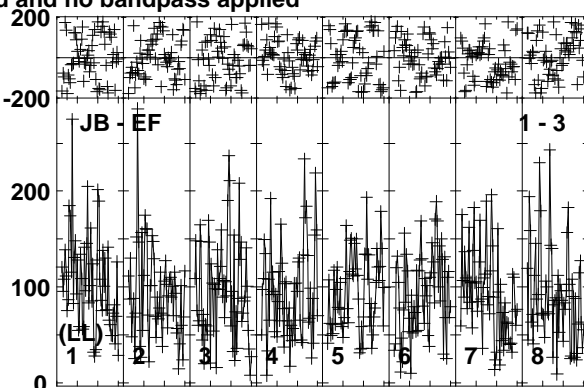
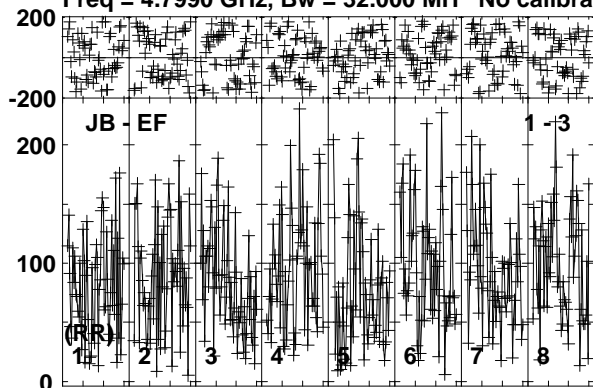

Lower frame: Micro Ampl Jy Top frame: Phas deg
Vector averaged cross-power spectrum Baseline: JB (01) - EF (03)
Timerange: 00/15:00:40 to 00/15:03:40

Plot file version 179 created 20-SEP-2019 15:52:05

AT2019EHZ RSM05.UVDATA.1

Freq = 4.7990 GHz, Bw = 32.000 MH No calibration applied and no bandpass applied

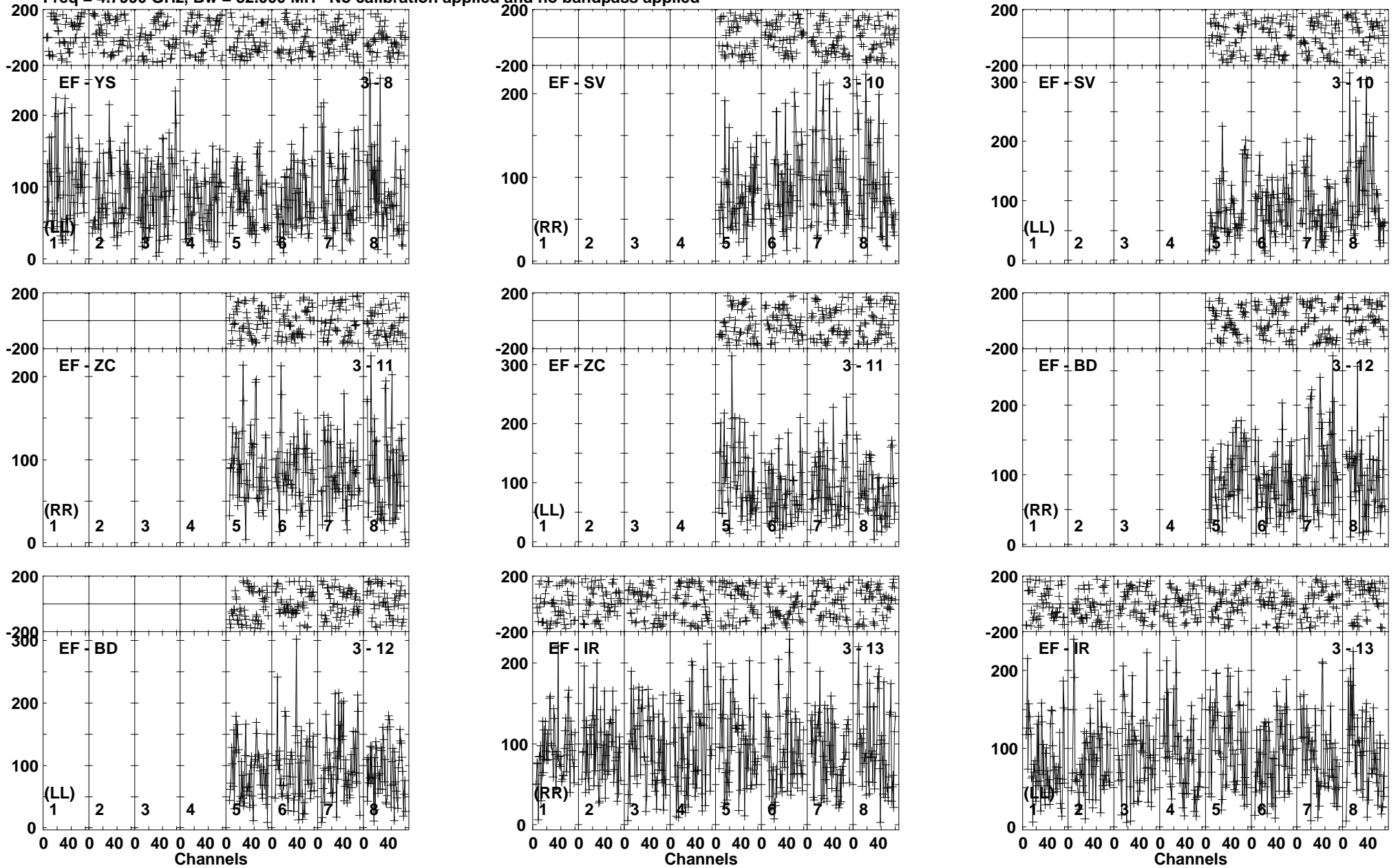

Lower frame: Micro Ampl Jy Top frame: Phas deg
Vector averaged cross-power spectrum Baseline: EF (03) - YS (08)
Timerange: 00/15:00:40 to 00/15:03:40

Plot file version 180 created 20-SEP-2019 15:52:06

AT2019EHZ RSM05.UVDATA.1

Freq = 4.7990 GHz, Bw = 32.000 MH No calibration applied and no bandpass applied

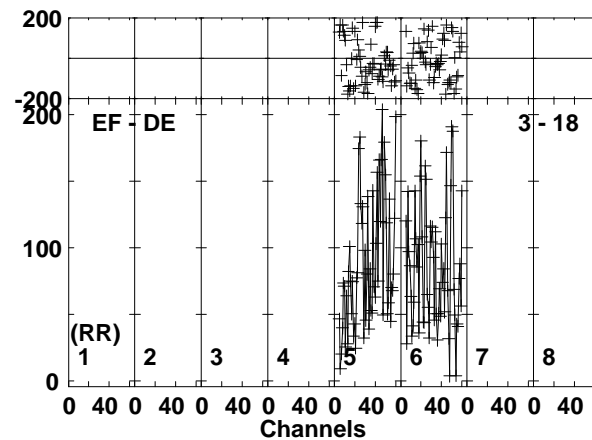
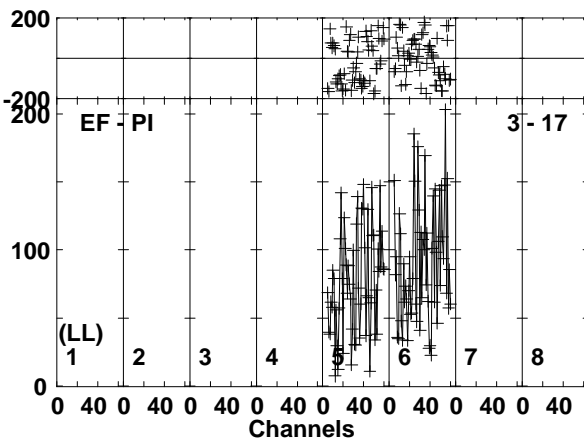
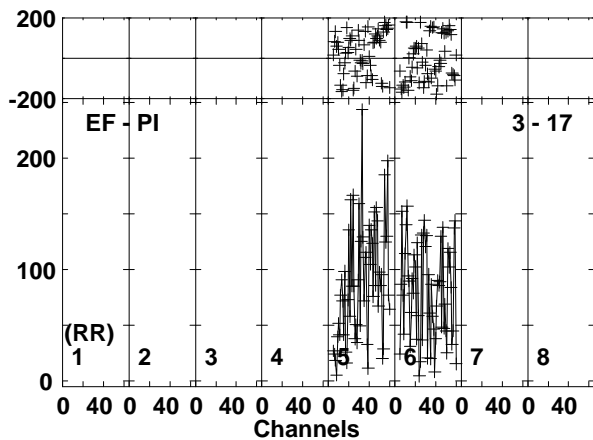
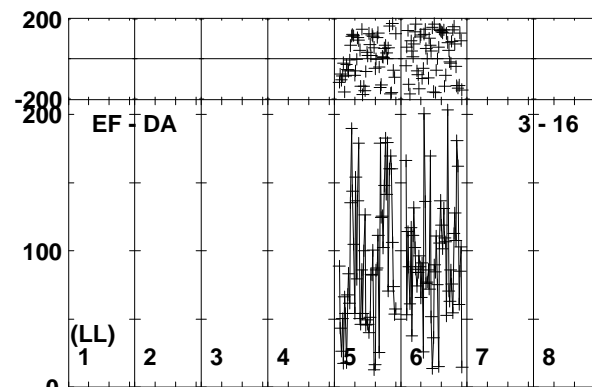
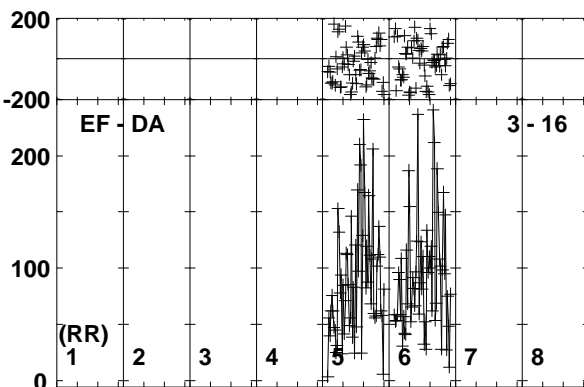
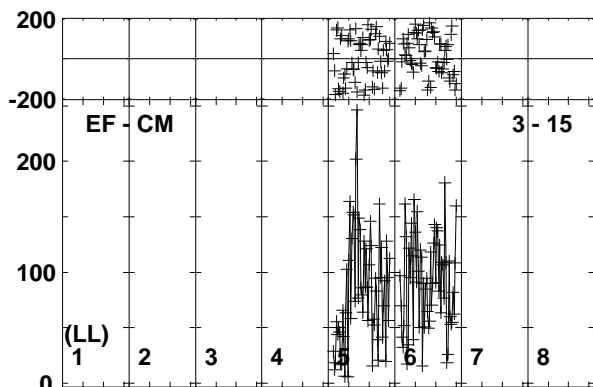
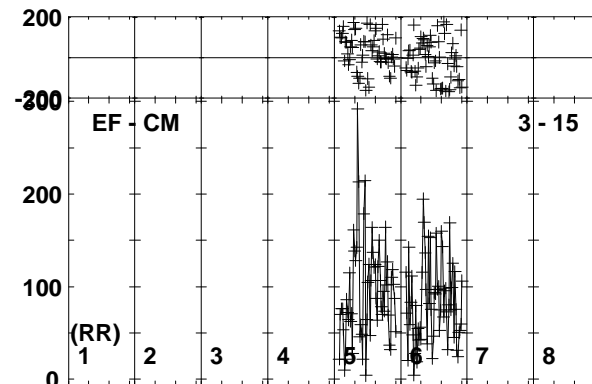
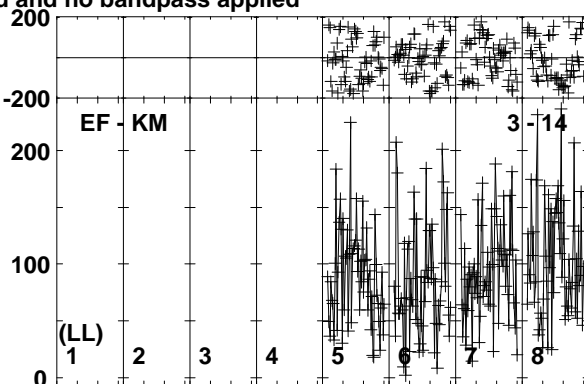
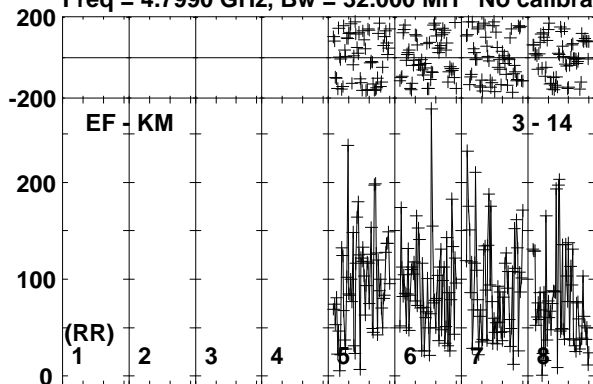

Lower frame: Micro Ampl Jy Top frame: Phas deg
Vector averaged cross-power spectrum Baseline: EF (03) - KM (14)
Timerange: 00/15:00:40 to 00/15:03:40

Plot file version 181 created 20-SEP-2019 15:52:06
AT2019EHZ RSM05.UVDATA.1
Freq = 4.7990 GHz, Bw = 32.000 MH No calibration applied and no bandpass applied

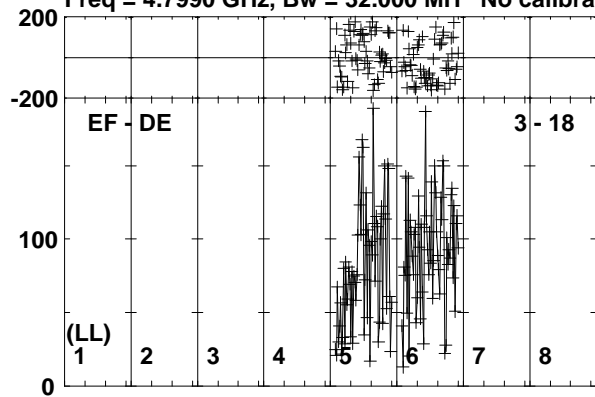

Lower frame: Micro Ampl Jy Top frame: Phas deg
Vector averaged cross-power spectrum Baseline: EF (03) - DE (18)
Timerange: 00/15:00:40 to 00/15:03:40

Plot file version 182 created 20-SEP-2019 15:52:07

J1408+5613 RSM05.UVDATA.1

Freq = 4.7990 GHz, Bw = 32.000 MH No calibration applied and no bandpass applied

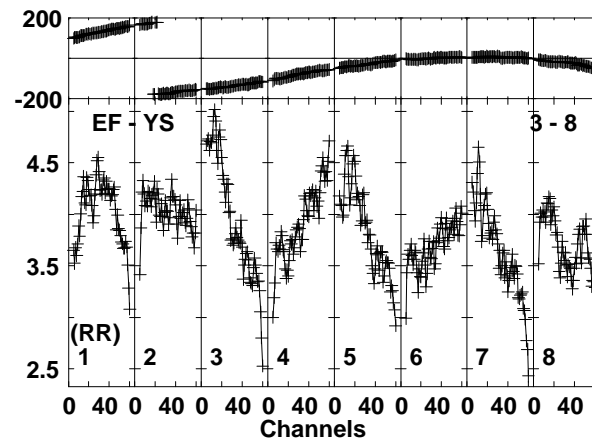
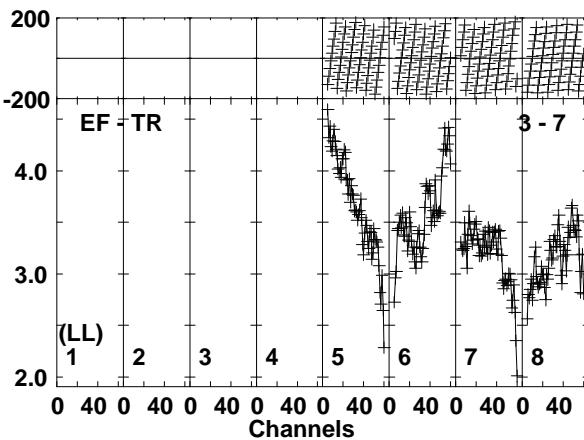
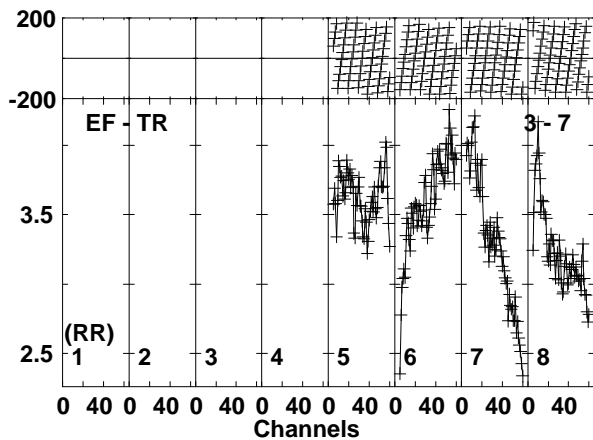
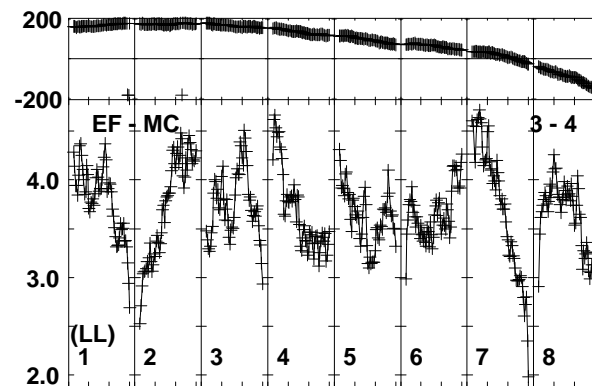
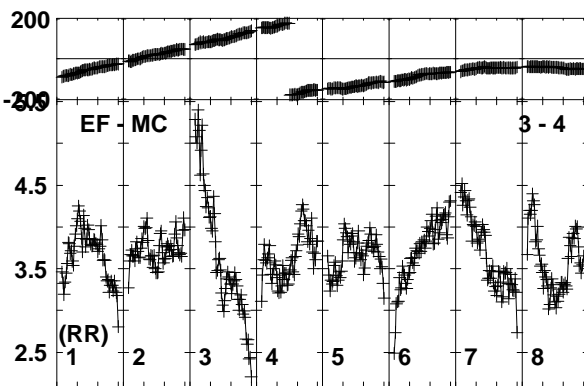
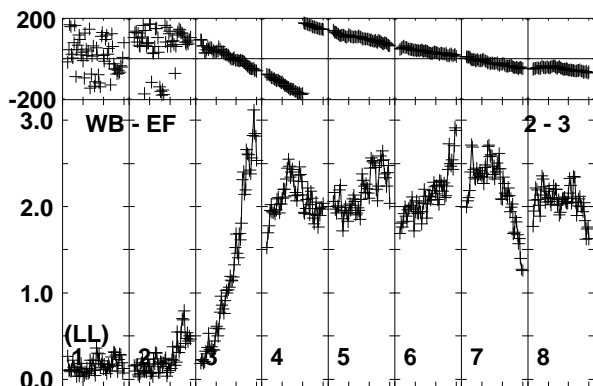
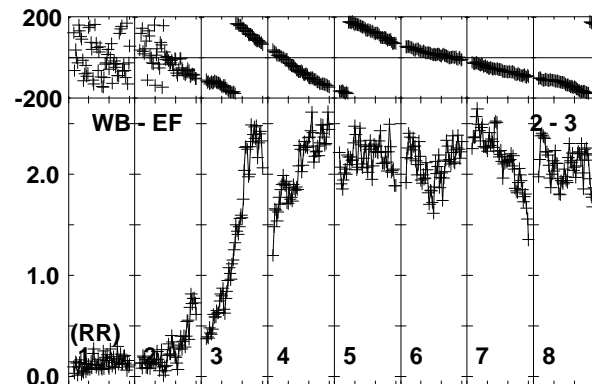
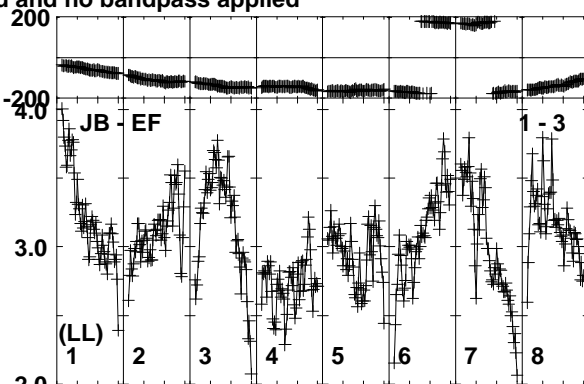
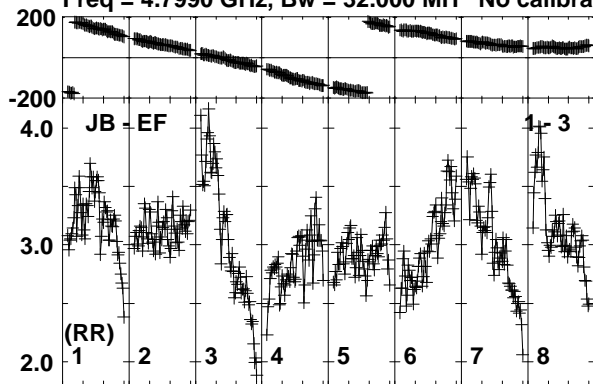

Lower frame: Milli Ampl Jy Top frame: Phas deg
Vector averaged cross-power spectrum Baseline: JB (01) - EF (03)
Timerange: 00/15:03:41 to 00/15:05:09

Plot file version 183 created 20-SEP-2019 15:52:07

J1408+5613 RSM05.UVDATA.1

Freq = 4.7990 GHz, Bw = 32.000 MH No calibration applied and no bandpass applied

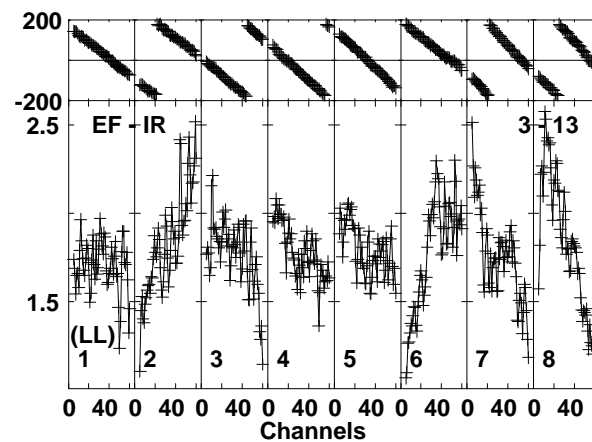
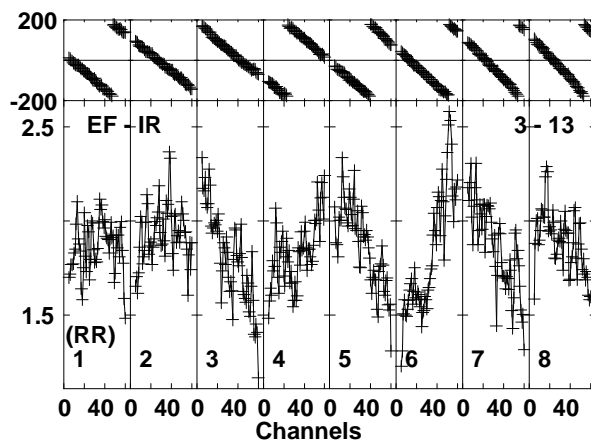
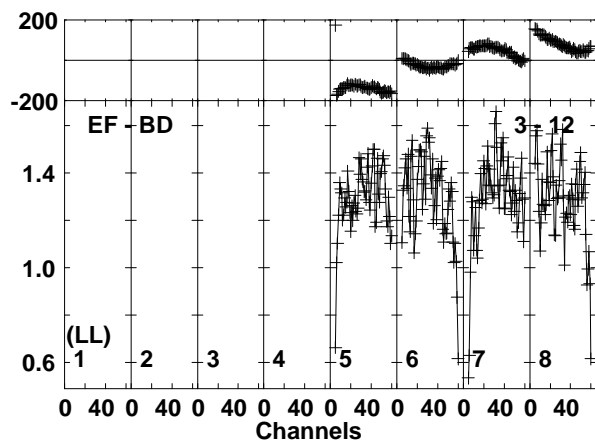
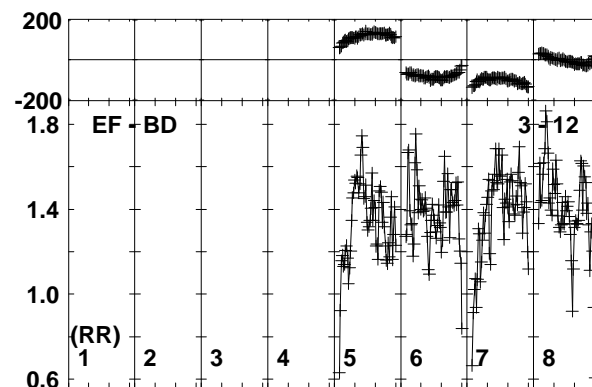
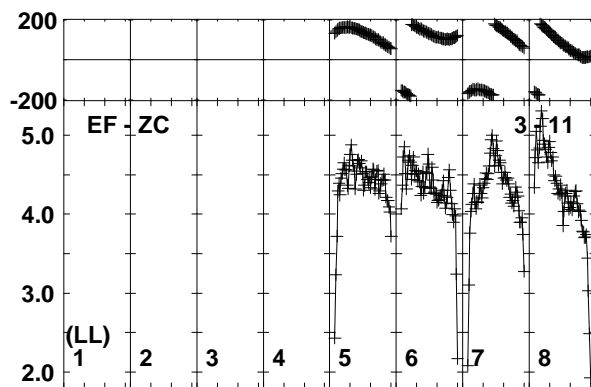
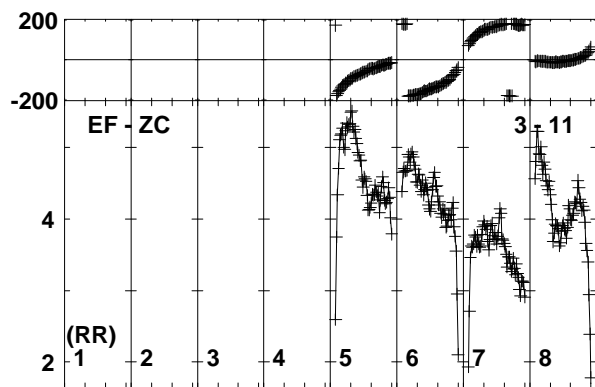
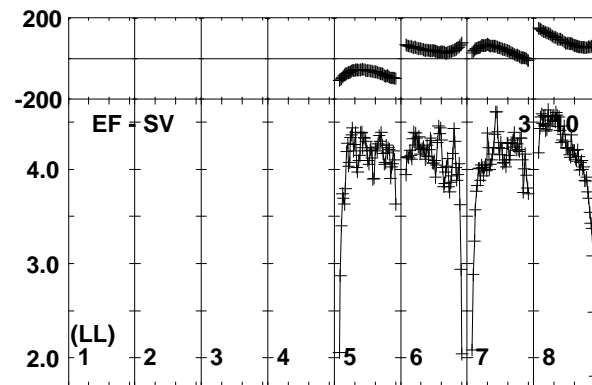
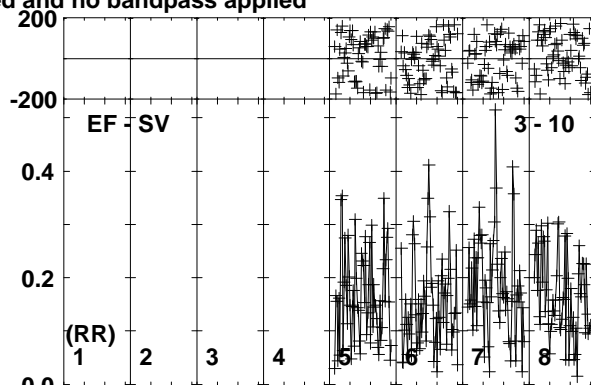
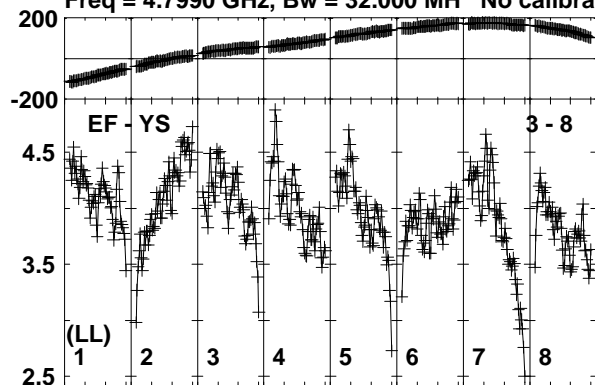

Lower frame: Milli Ampl Jy Top frame: Phas deg
Vector averaged cross-power spectrum Baseline: EF (03) - YS (08)
Timerange: 00/15:03:41 to 00/15:05:09

Plot file version 184 created 20-SEP-2019 15:52:08

J1408+5613 RSM05.UVDATA.1

Freq = 4.7990 GHz, Bw = 32.000 MH No calibration applied and no bandpass applied

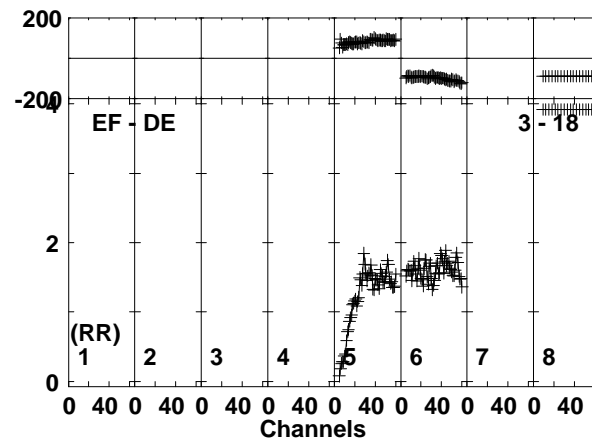
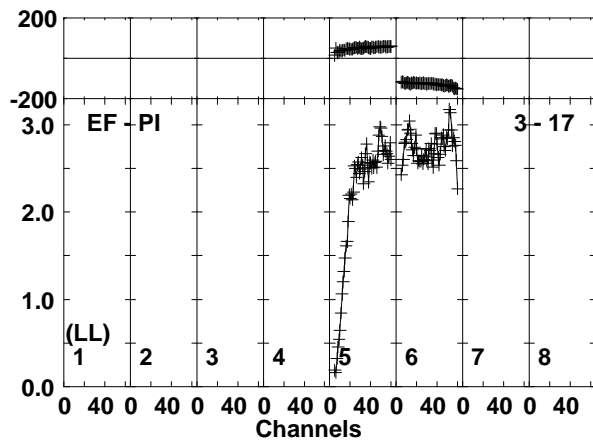
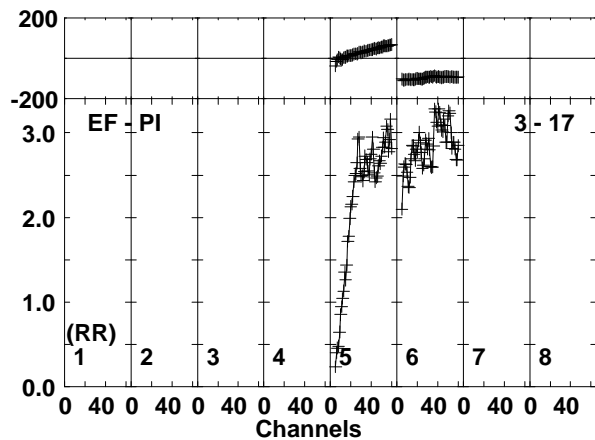
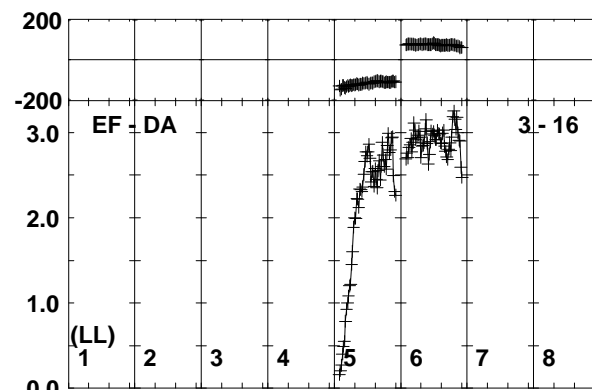
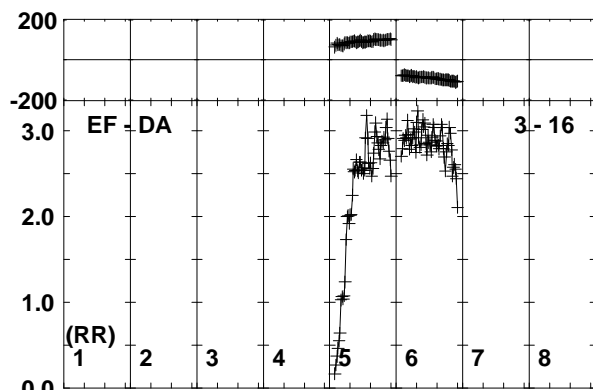
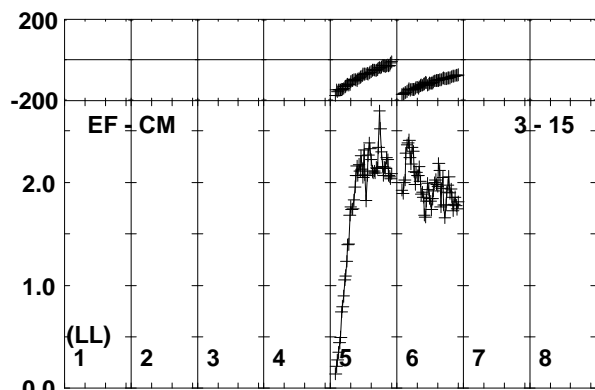
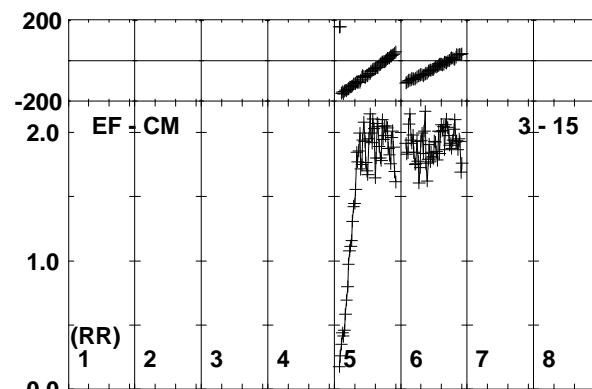
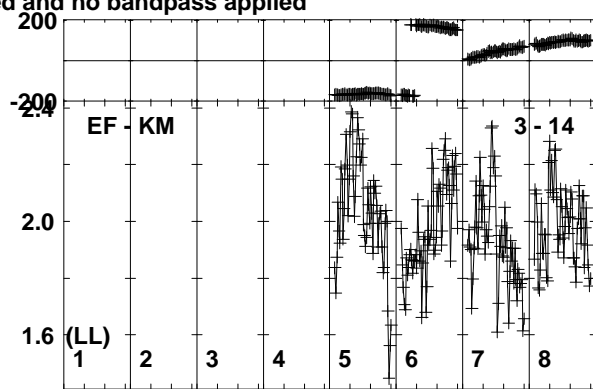
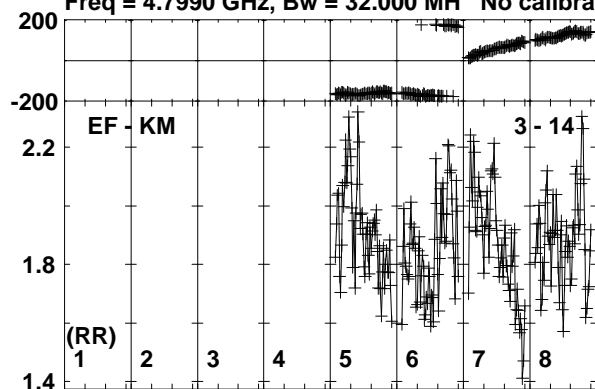

Lower frame: Milli Ampl Jy Top frame: Phas deg
Vector averaged cross-power spectrum Baseline: EF (03) - KM (14)
Timerange: 00/15:03:41 to 00/15:05:09

Plot file version 185 created 20-SEP-2019 15:52:08
J1408+5613 RSM05.UVDATA.1
Freq = 4.7990 GHz, Bw = 32.000 MH No calibration applied and no bandpass applied

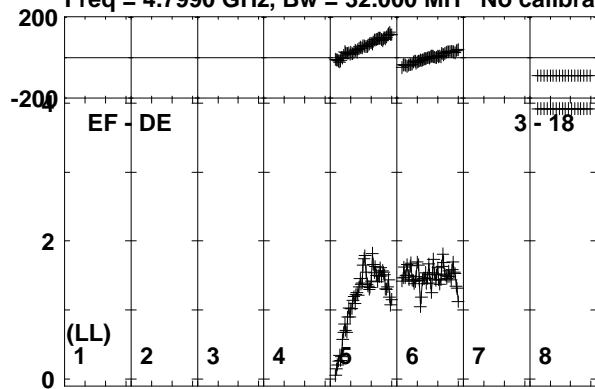

Lower frame: Milli Ampl Jy Top frame: Phas deg
Vector averaged cross-power spectrum Baseline: EF (03) - DE (18)
Timerange: 00/15:03:41 to 00/15:05:09

Plot file version 186 created 20-SEP-2019 15:52:08

AT2019EHZ RSM05.UVDATA.1

Freq = 4.7990 GHz, Bw = 32.000 MH No calibration applied and no bandpass applied

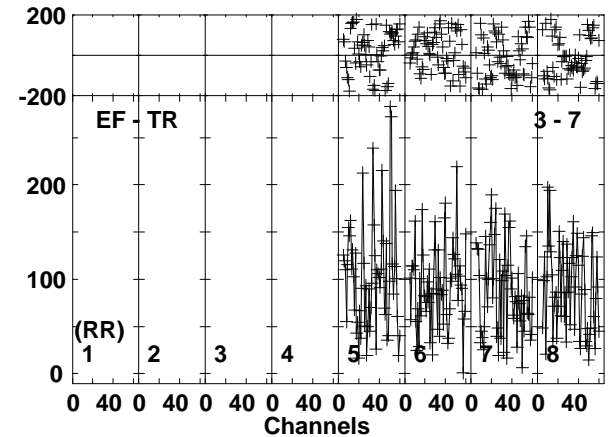
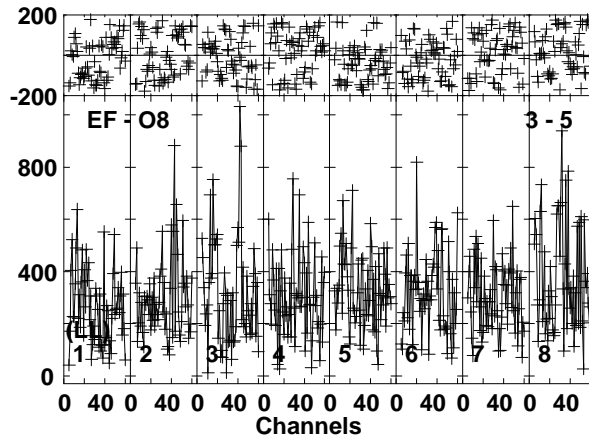
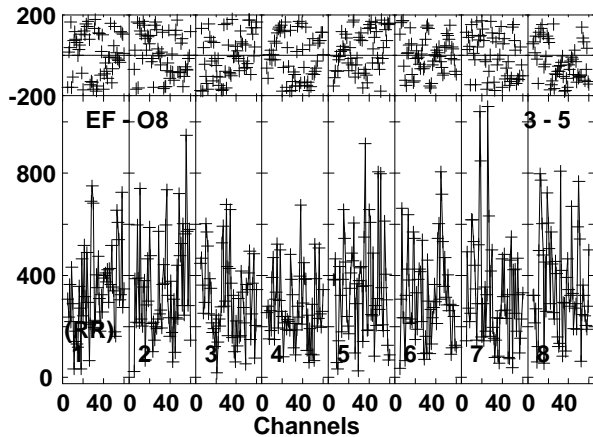
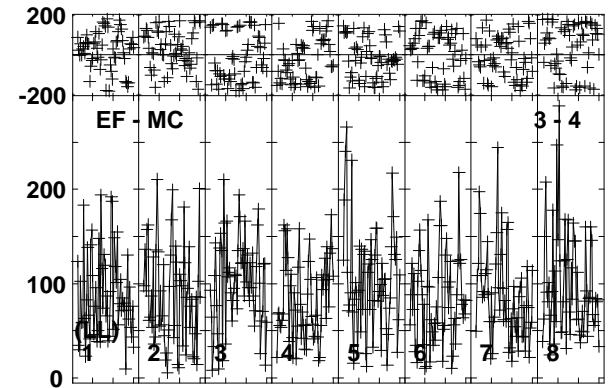
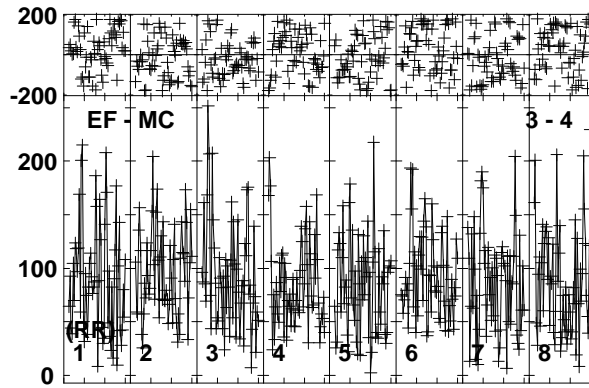
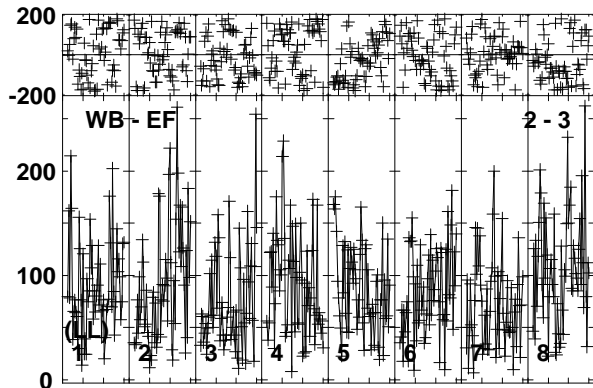
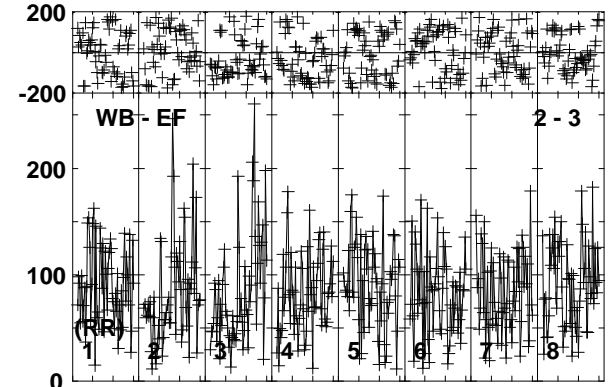
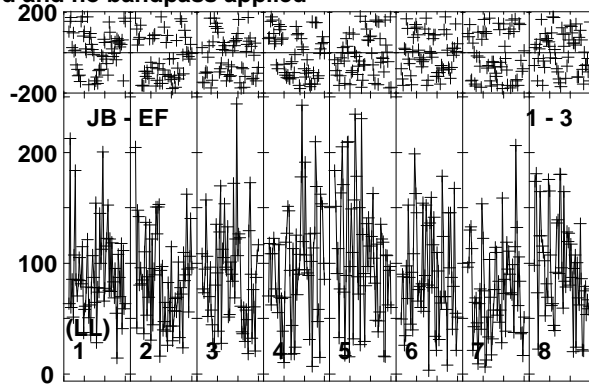
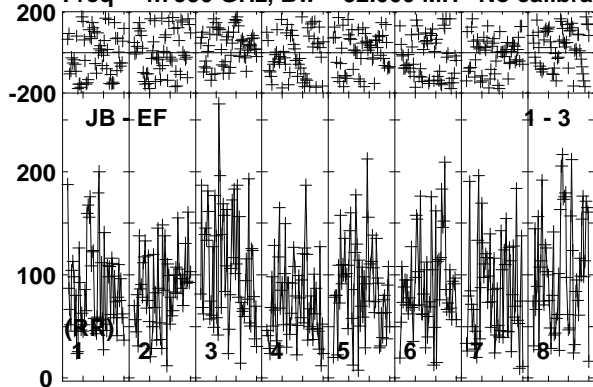

Lower frame: Micro Ampl Jy Top frame: Phas deg
Vector averaged cross-power spectrum Baseline: JB (01) - EF (03)
Timerange: 00/15:05:11 to 00/15:08:09

Plot file version 187 created 20-SEP-2019 15:52:09

AT2019EHZ RSM05.UVDATA.1

Freq = 4.7990 GHz, Bw = 32.000 MH No calibration applied and no bandpass applied

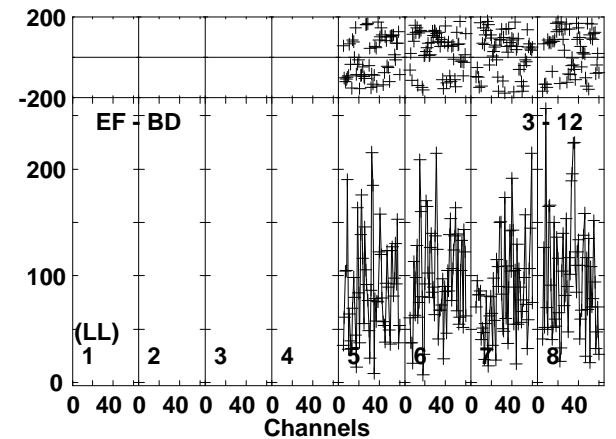
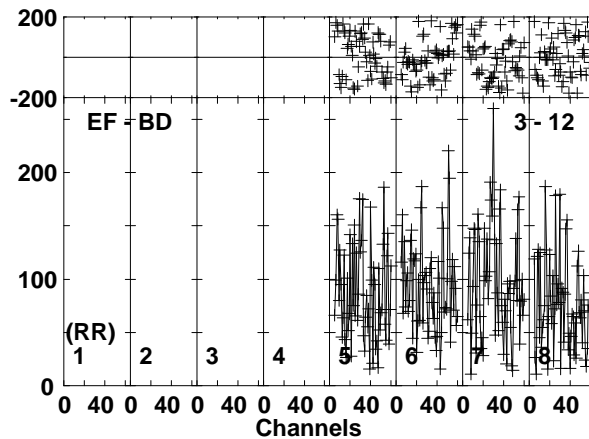
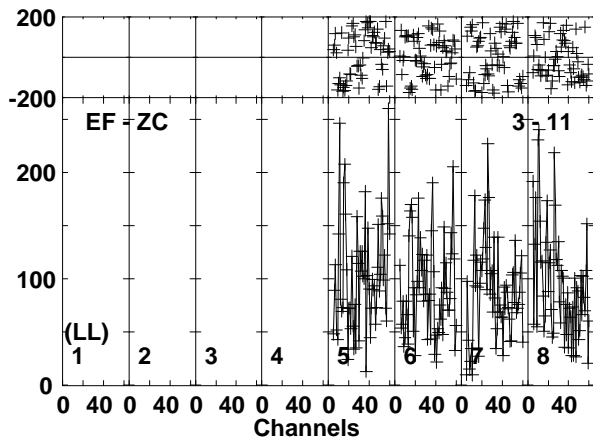
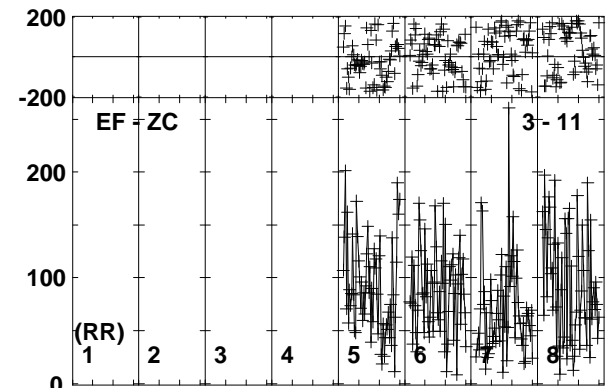
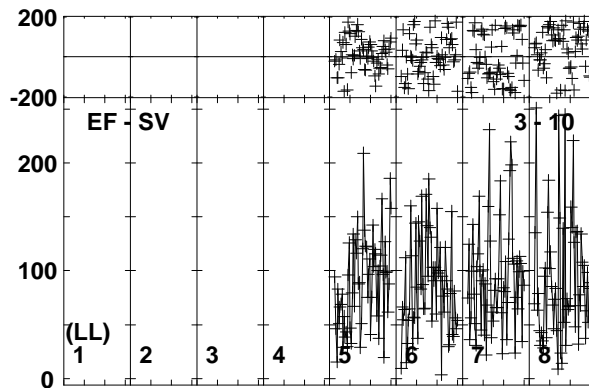
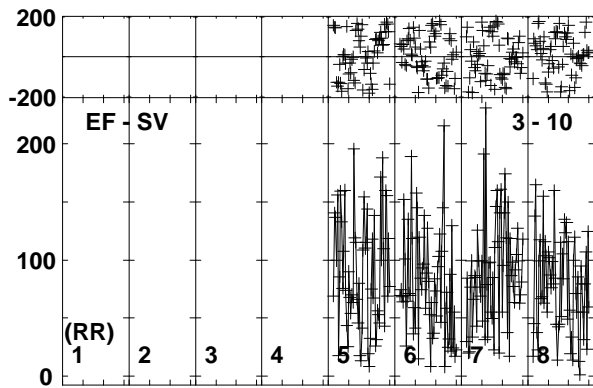
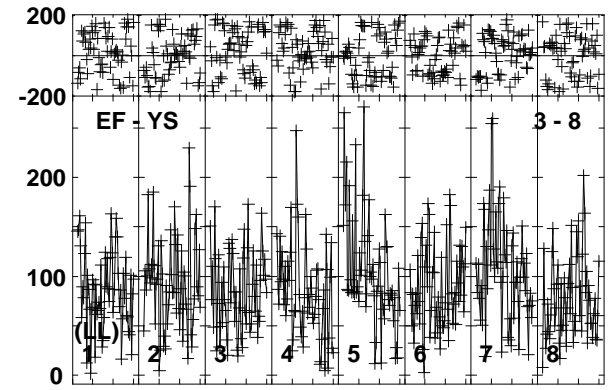
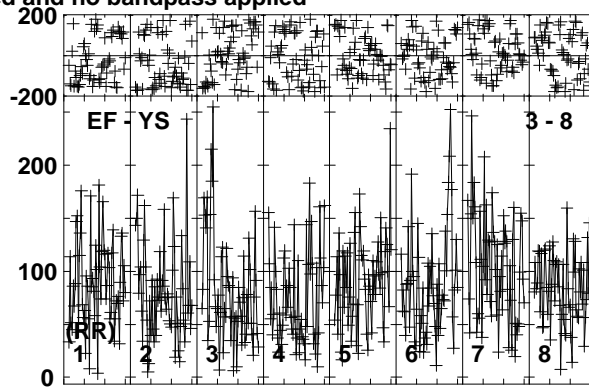
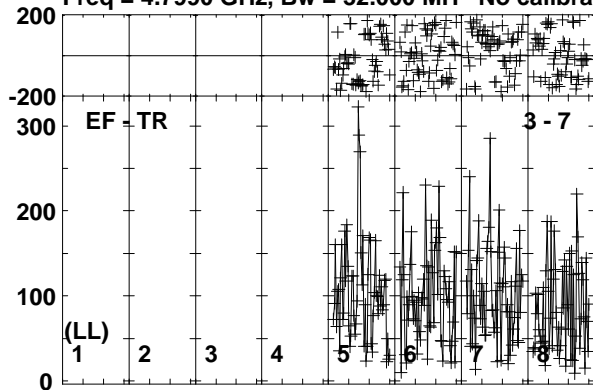

Lower frame: Micro Ampl Jy Top frame: Phas deg
Vector averaged cross-power spectrum Baseline: EF (03) - TR (07)
Timerange: 00/15:05:11 to 00/15:08:09

Plot file version 188 created 20-SEP-2019 15:52:09

AT2019EHZ RSM05.UVDATA.1

Freq = 4.7990 GHz, Bw = 32.000 MH No calibration applied and no bandpass applied

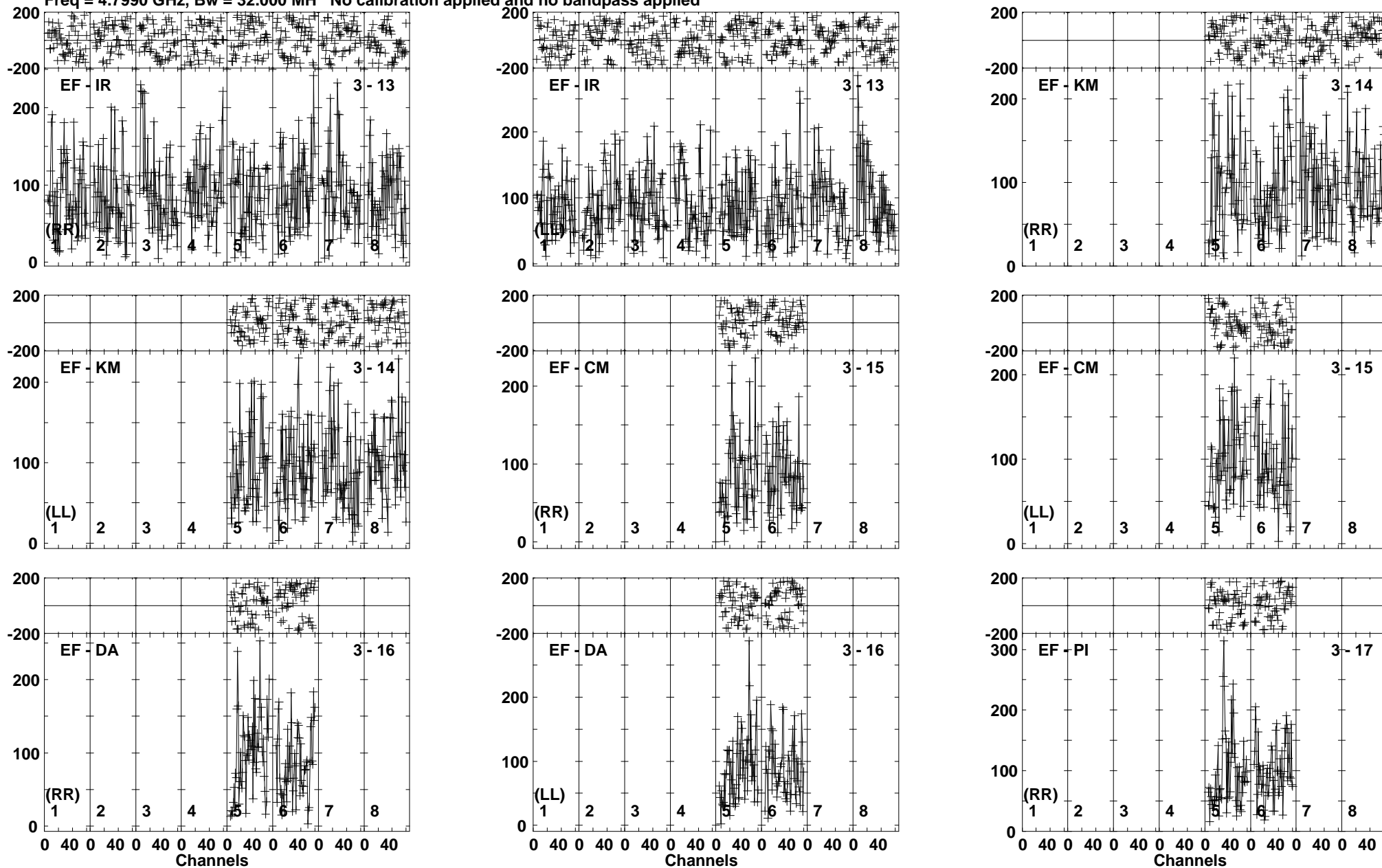

Lower frame: Micro Ampl Jy Top frame: Phas deg
Vector averaged cross-power spectrum Baseline: EF (03) - IR (13)
Timerange: 00/15:05:11 to 00/15:08:09

Plot file version 189 created 20-SEP-2019 15:52:10

AT2019EHZ RSM05.UVDATA.1

Freq = 4.7990 GHz, Bw = 32.000 MH No calibration applied and no bandpass applied

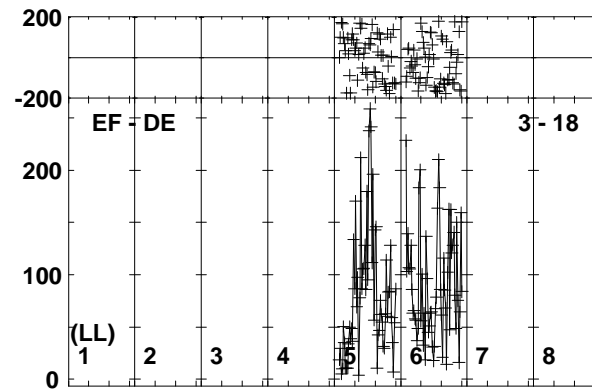
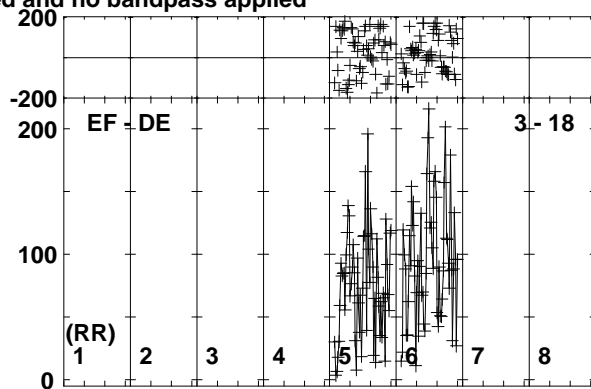
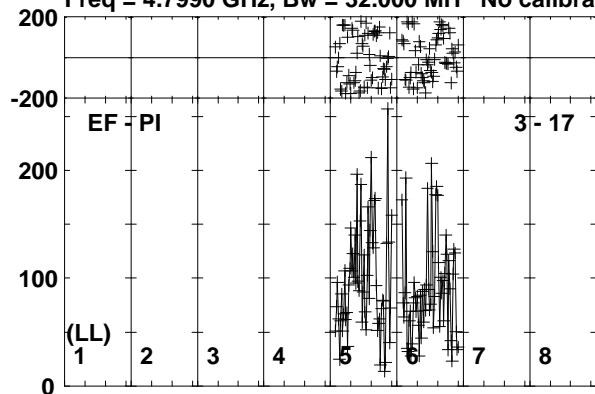

Lower frame: Micro Ampl Jy Top frame: Phas deg
Vector averaged cross-power spectrum Baseline: EF (03) - PI (17)
Timerange: 00/15:05:11 to 00/15:08:09

Plot file version 190 created 20-SEP-2019 15:52:10

J1408+5613 RSM05.UVDATA.1

Freq = 4.7990 GHz, Bw = 32.000 MH No calibration applied and no bandpass applied

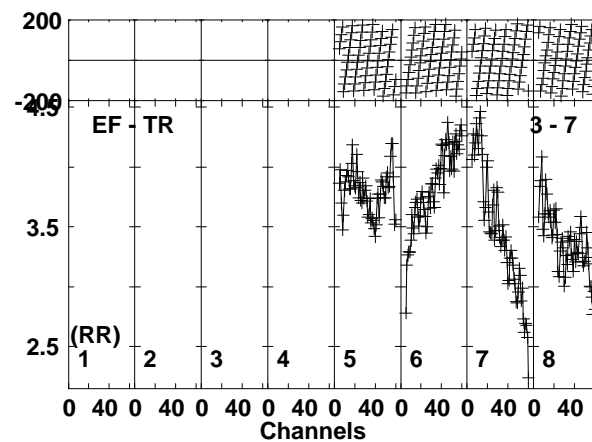
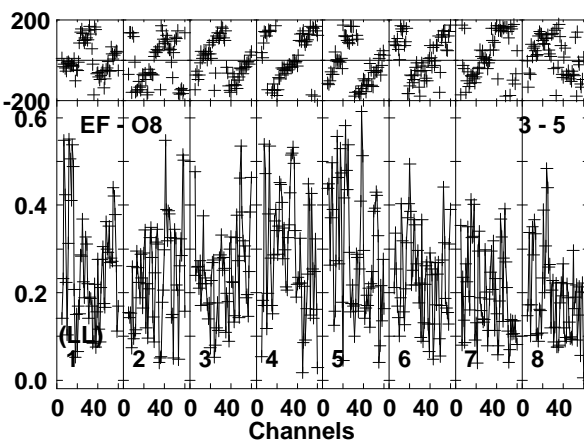
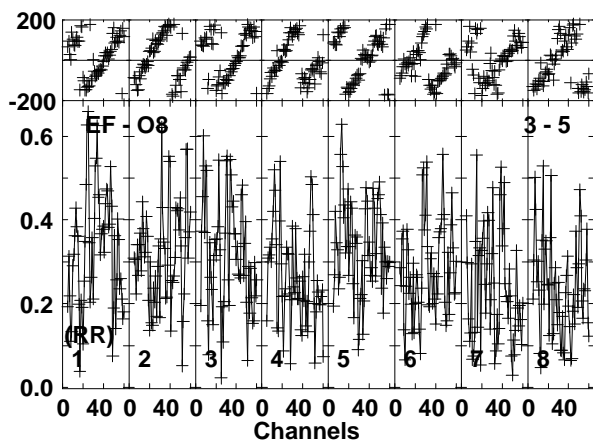
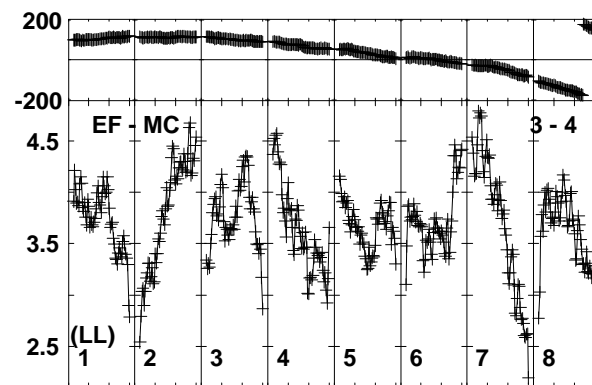
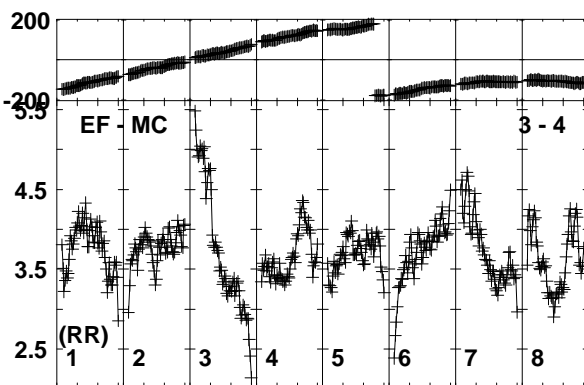
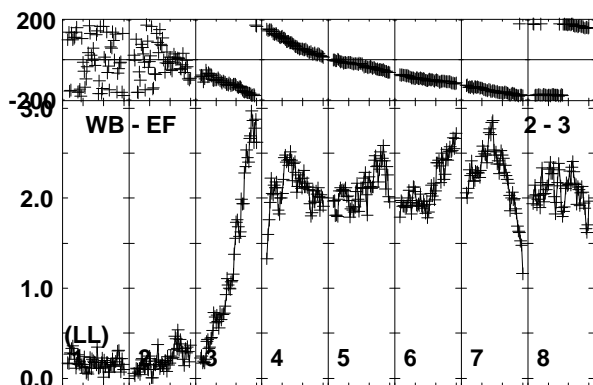
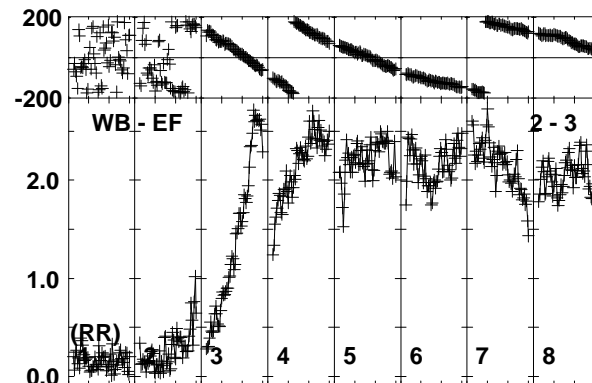
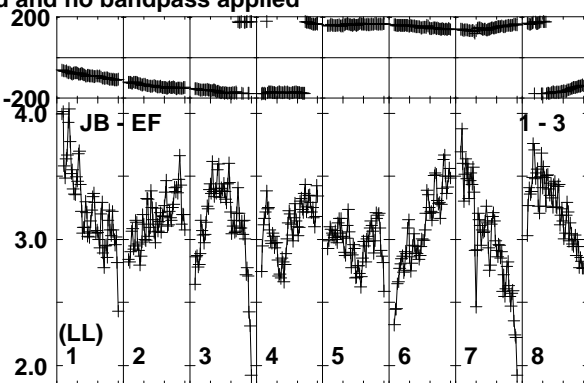
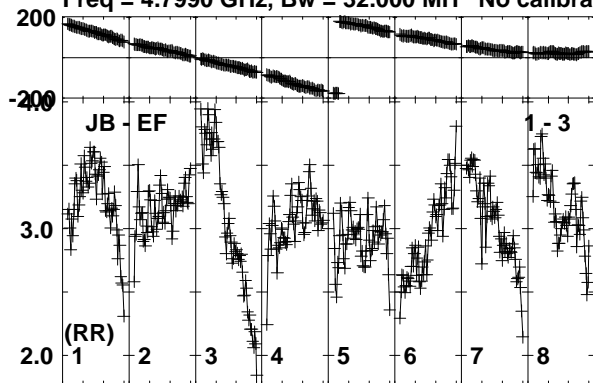

Lower frame: Milli Ampl Jy Top frame: Phas deg
Vector averaged cross-power spectrum Baseline: JB (01) - EF (03)
Timerange: 00/15:08:11 to 00/15:09:40

Plot file version 191 created 20-SEP-2019 15:52:10

J1408+5613 RSM05.UVDATA.1

Freq = 4.7990 GHz, Bw = 32.000 MH No calibration applied and no bandpass applied

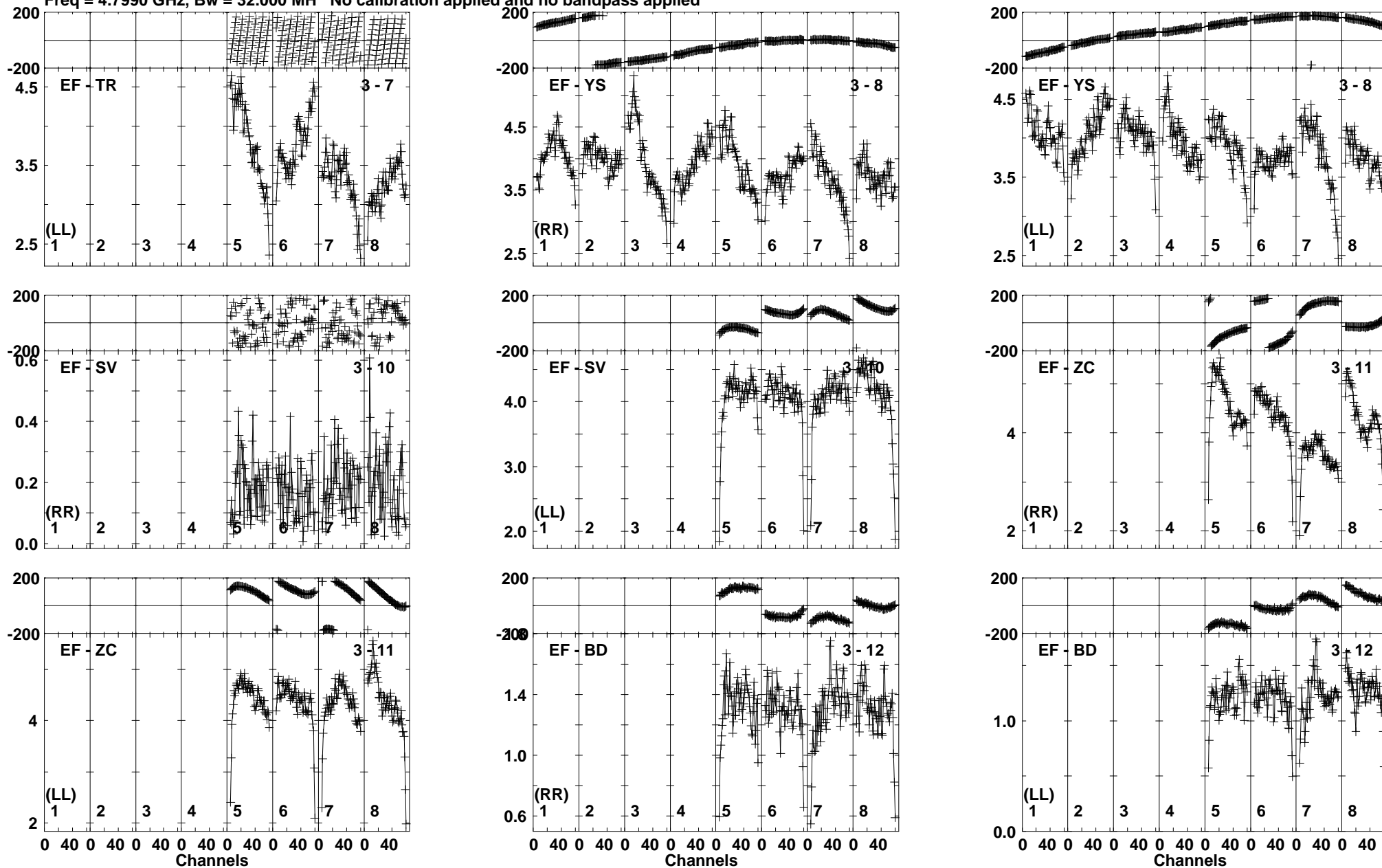

Lower frame: Milli Ampl Jy Top frame: Phas deg
Vector averaged cross-power spectrum Baseline: EF (03) - TR (07)
Timerange: 00/15:08:11 to 00/15:09:40

Plot file version 192 created 20-SEP-2019 15:52:11

J1408+5613 RSM05.UVDATA.1

Freq = 4.7990 GHz, Bw = 32.000 MH No calibration applied and no bandpass applied

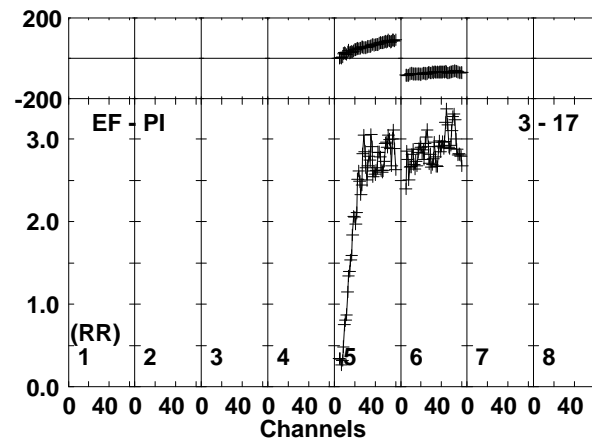
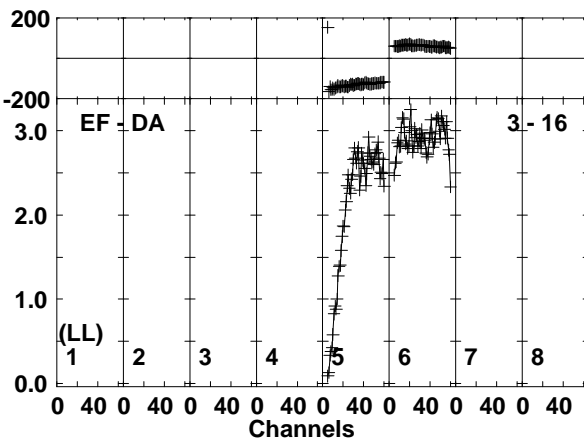
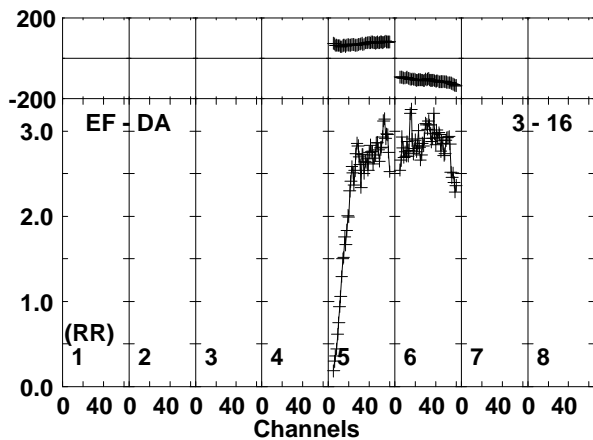
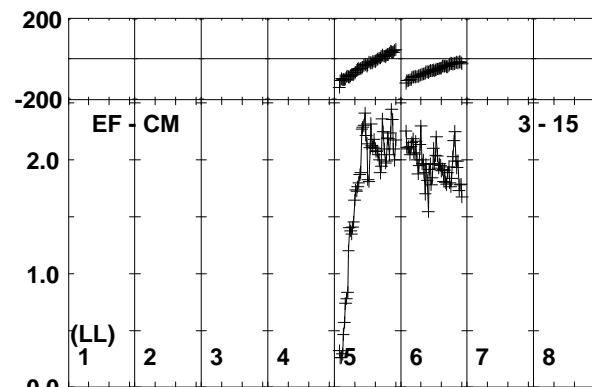
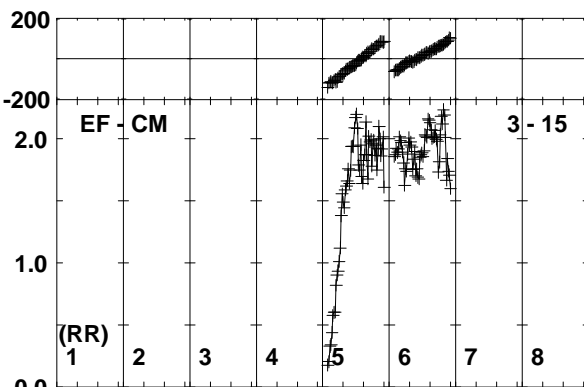
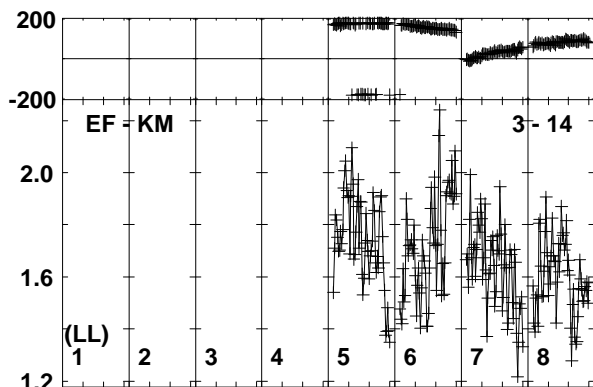
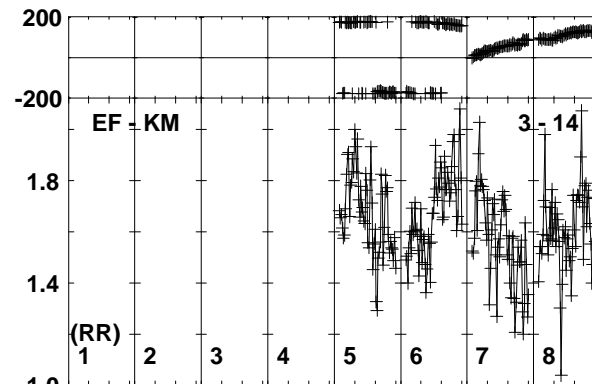
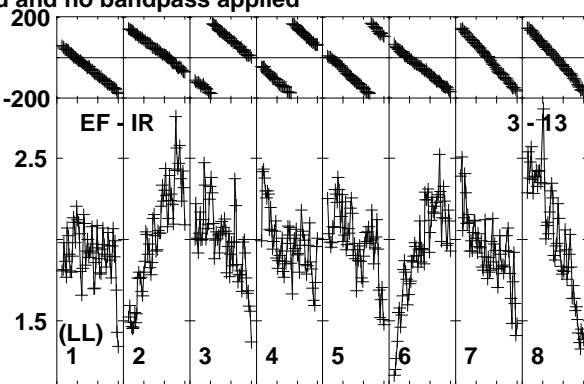
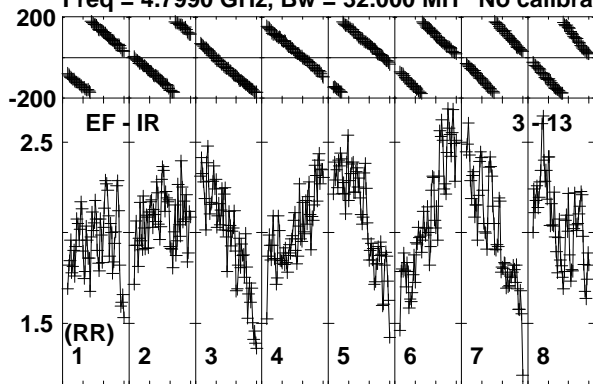

Lower frame: Milli Ampl Jy Top frame: Phas deg
Vector averaged cross-power spectrum Baseline: EF (03) - IR (13)
Timerange: 00/15:08:11 to 00/15:09:40

Plot file version 193 created 20-SEP-2019 15:52:11

J1408+5613 RSM05.UVDATA.1

Freq = 4.7990 GHz, Bw = 32.000 MH No calibration applied and no bandpass applied

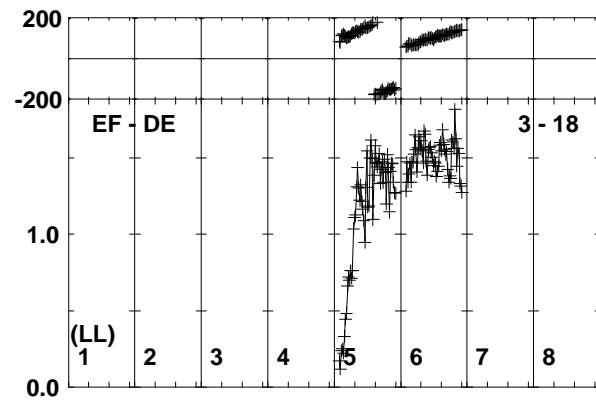
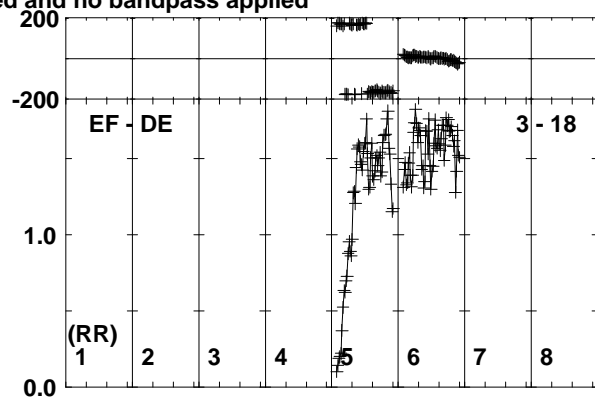
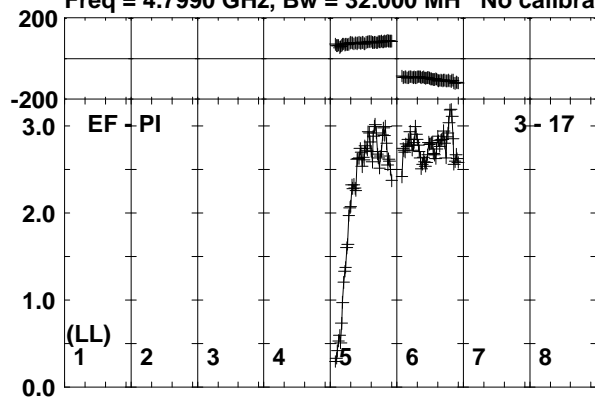

Lower frame: Milli Ampl Jy Top frame: Phas deg
Vector averaged cross-power spectrum Baseline: EF (03) - PI (17)
Timerange: 00/15:08:11 to 00/15:09:40

Plot file version 194 created 20-SEP-2019 15:52:12

AT2019EHZ RSM05.UVDATA.1

Freq = 4.7990 GHz, Bw = 32.000 MH No calibration applied and no bandpass applied

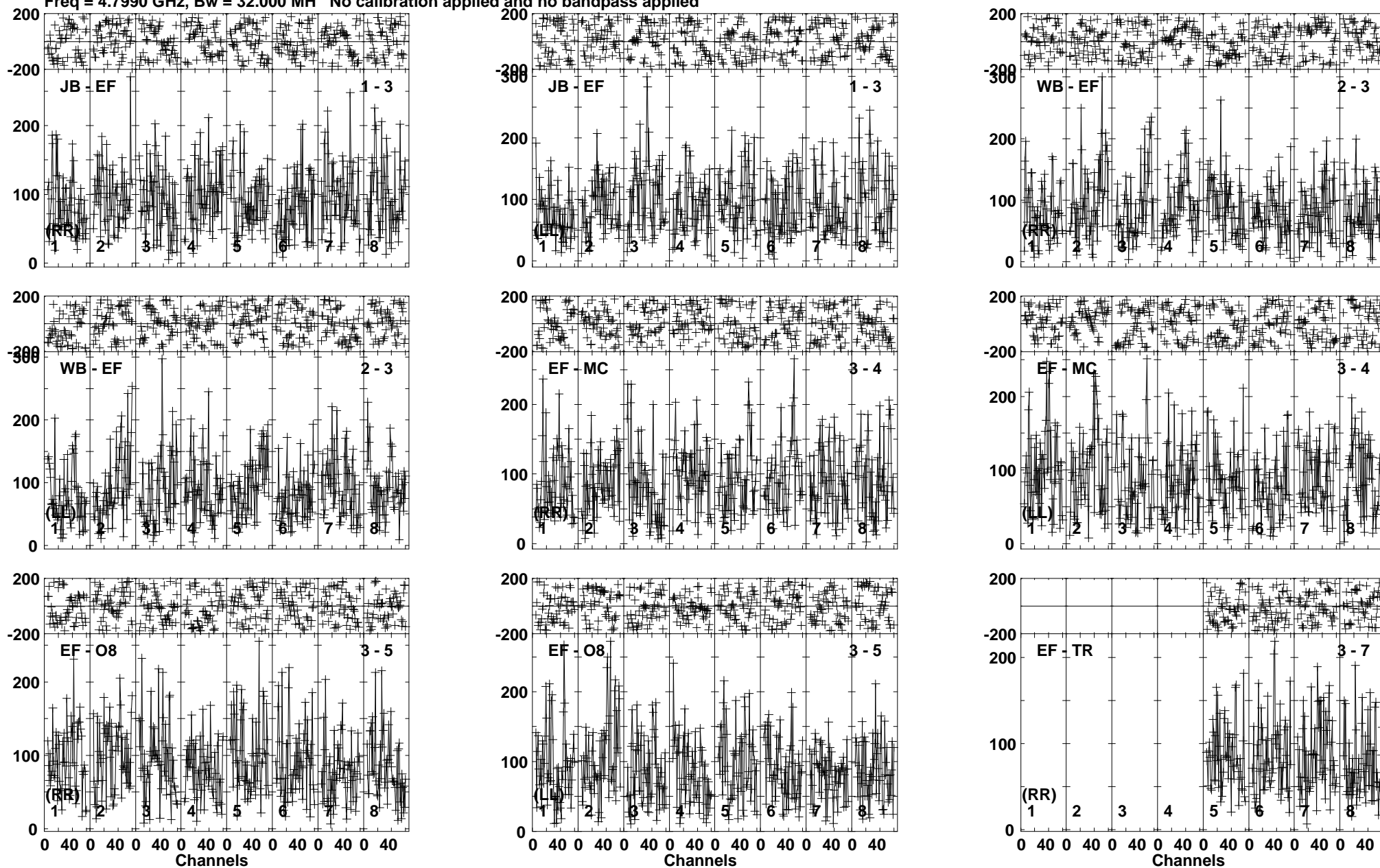

Lower frame: Micro Ampl Jy Top frame: Phas deg
Vector averaged cross-power spectrum Baseline: JB (01) - EF (03)
Timerange: 00/15:09:41 to 00/15:12:39

Plot file version 195 created 20-SEP-2019 15:52:12

AT2019EHZ RSM05.UVDATA.1

Freq = 4.7990 GHz, Bw = 32.000 MH No calibration applied and no bandpass applied

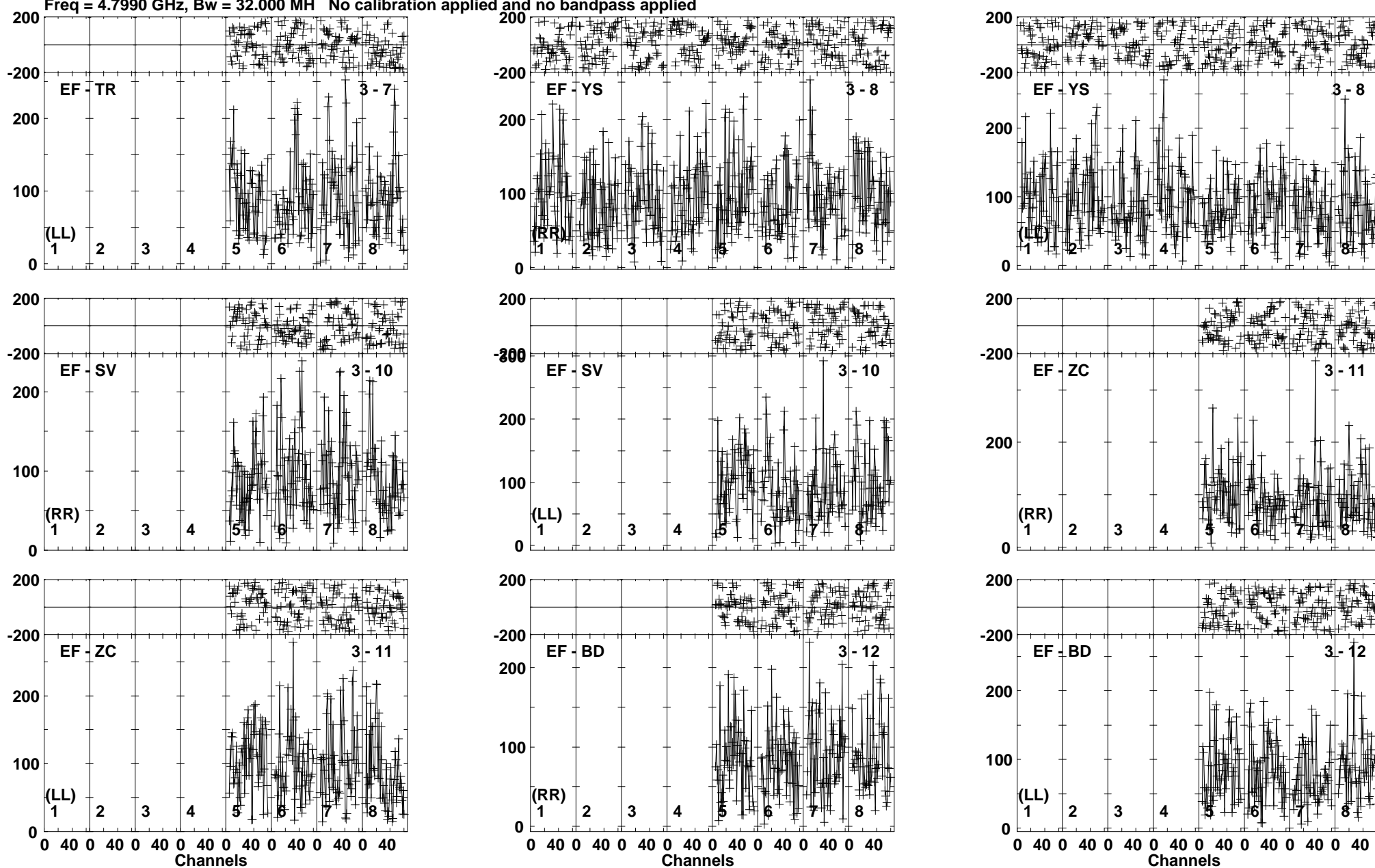

Lower frame: Micro Ampl Jy Top frame: Phas deg
Vector averaged cross-power spectrum Baseline: EF (03) - TR (07)
Timerange: 00/15:09:41 to 00/15:12:39

Plot file version 196 created 20-SEP-2019 15:52:13

AT2019EHZ RSM05.UVDATA.1

Freq = 4.7990 GHz, Bw = 32.000 MH No calibration applied and no bandpass applied

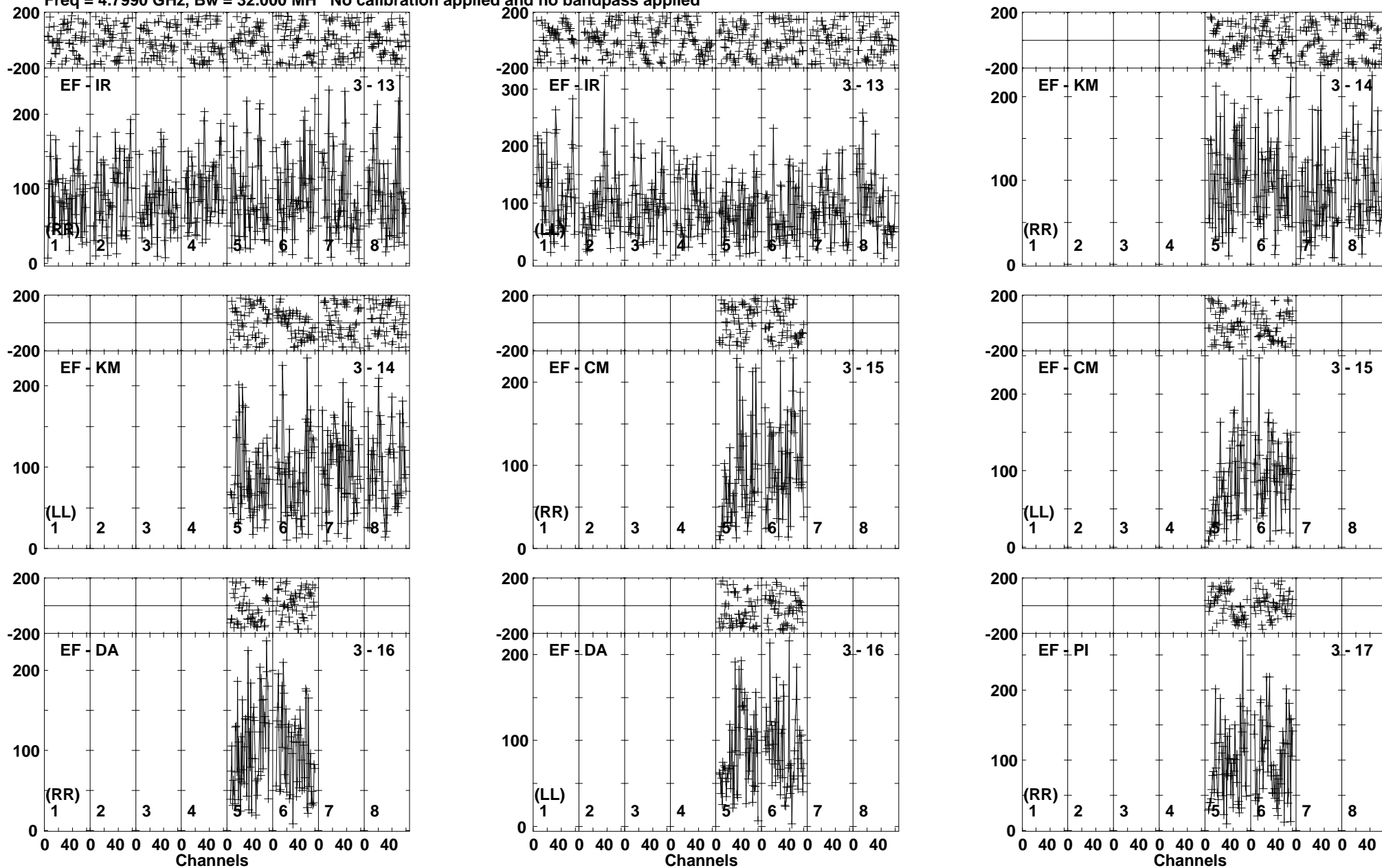

Plot file version 197 created 20-SEP-2019 15:52:13

AT2019EHZ RSM05.UVDATA.1

Freq = 4.7990 GHz, Bw = 32.000 MH No calibration applied and no bandpass applied

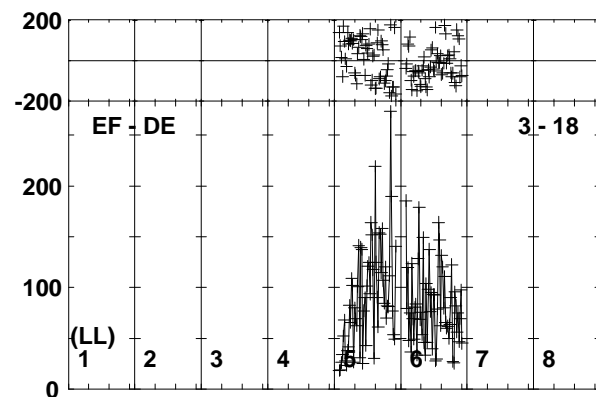
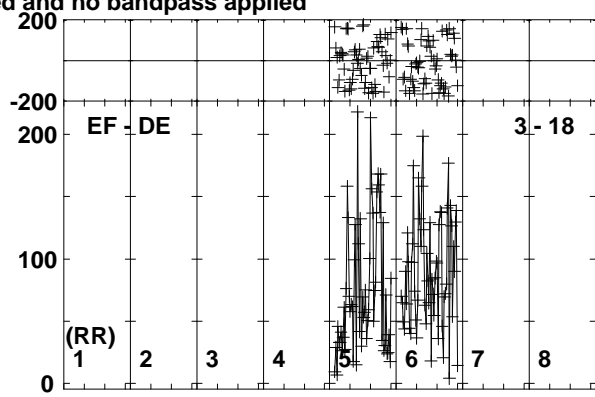
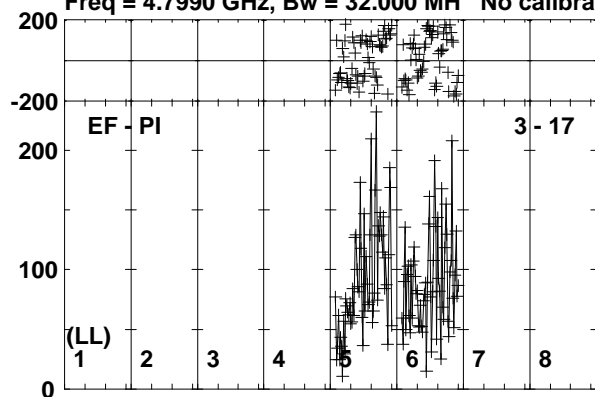

Lower frame: Micro Ampl Jy Top frame: Phas deg
Vector averaged cross-power spectrum Baseline: EF (03) - PI (17)
Timerange: 00/15:09:41 to 00/15:12:39

Plot file version 198 created 20-SEP-2019 15:52:13

J1408+5613 RSM05.UVDATA.1

Freq = 4.7990 GHz, Bw = 32.000 MH No calibration applied and no bandpass applied

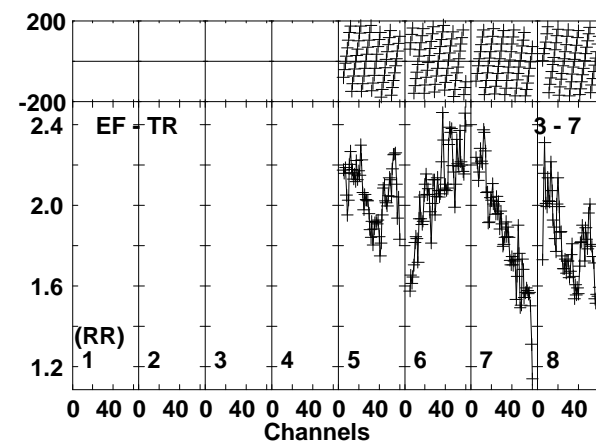
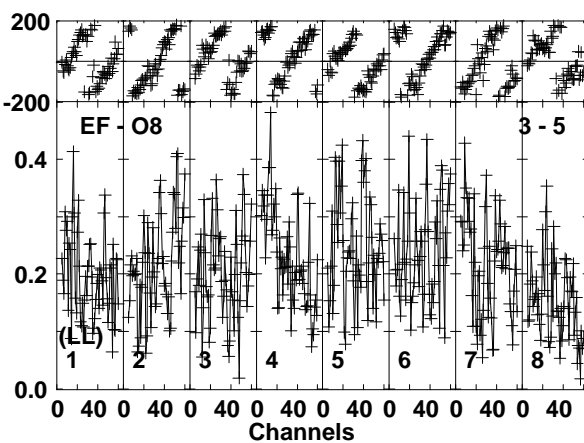
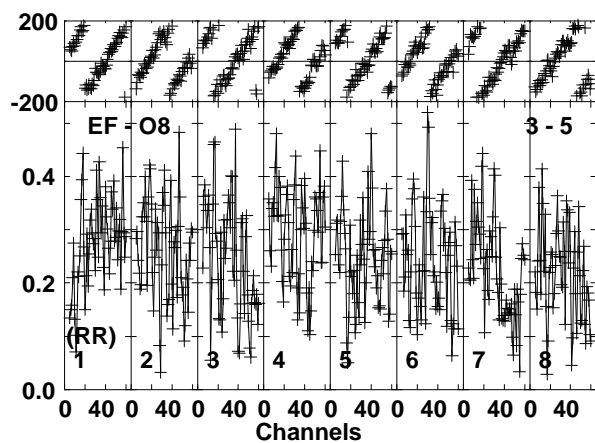
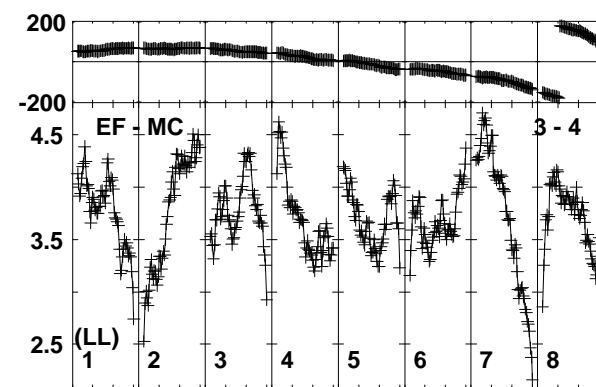
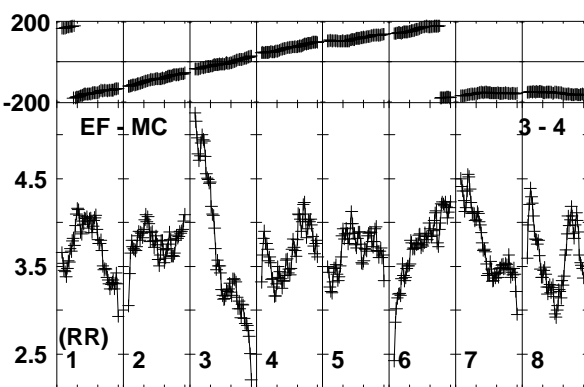
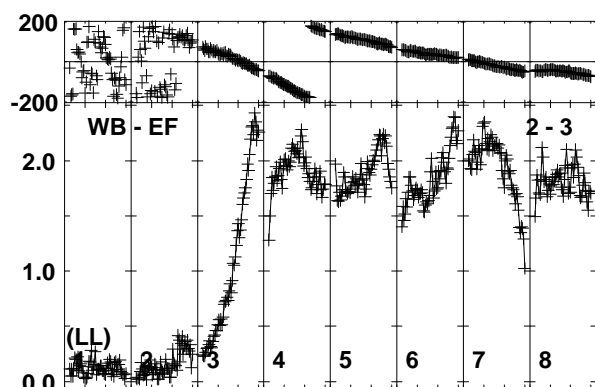
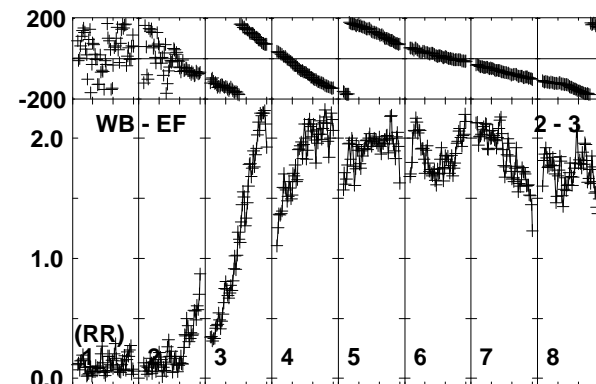
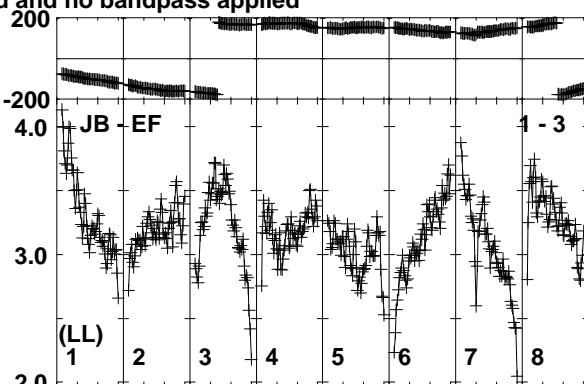
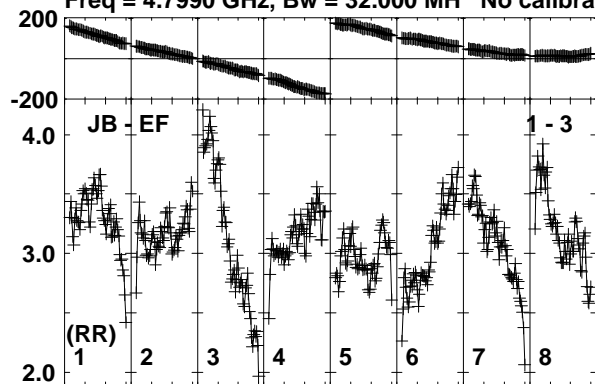

Lower frame: Milli Ampl Jy Top frame: Phas deg
Vector averaged cross-power spectrum Baseline: JB (01) - EF (03)
Timerange: 00/15:13:30 to 00/15:15:00

Plot file version 199 created 20-SEP-2019 15:52:14

J1408+5613 RSM05.UVDATA.1

Freq = 4.7990 GHz, Bw = 32.000 MH No calibration applied and no bandpass applied

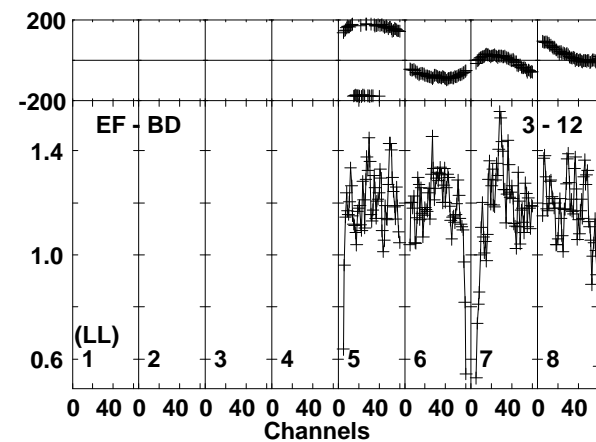
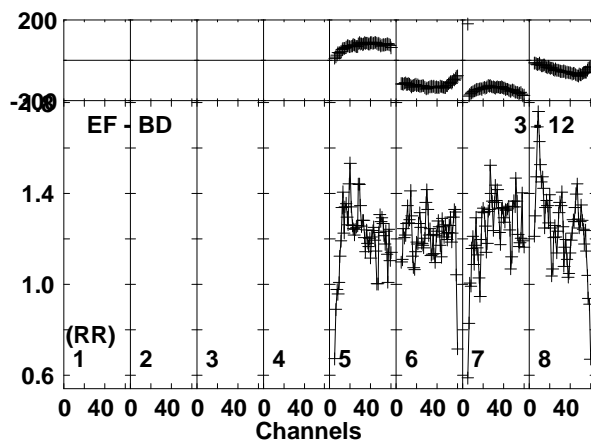
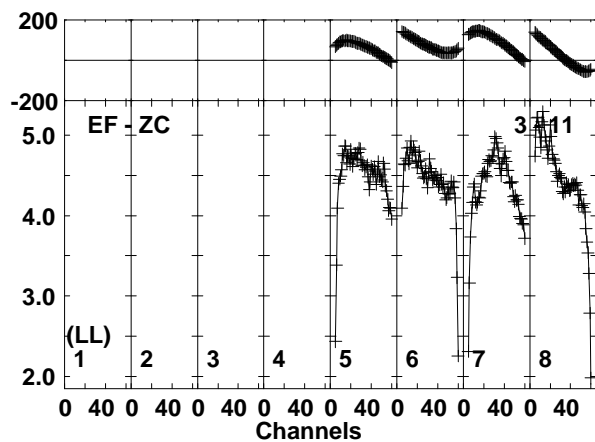
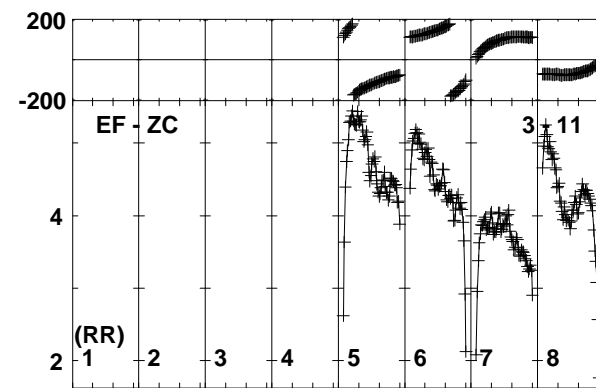
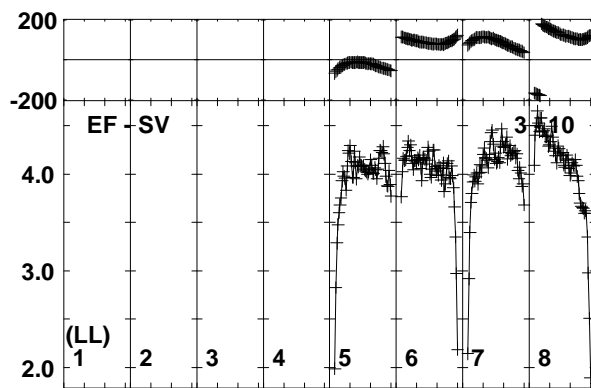
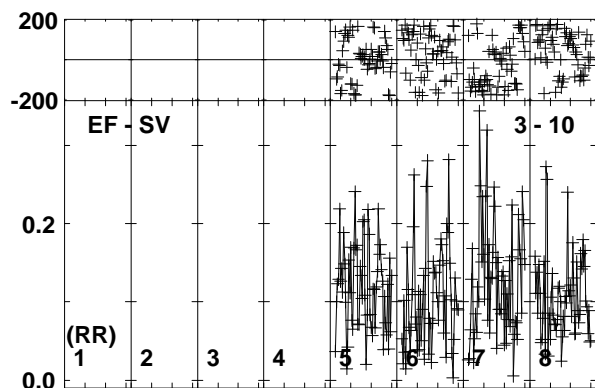
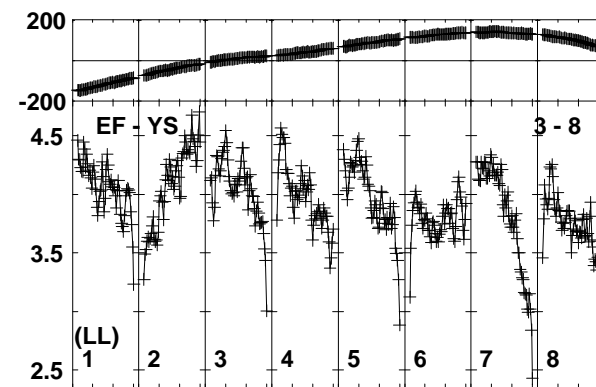
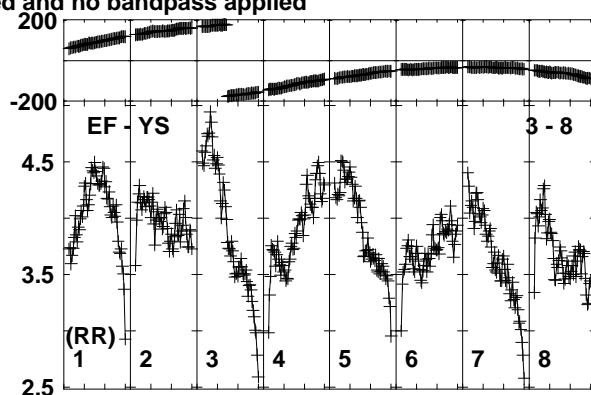
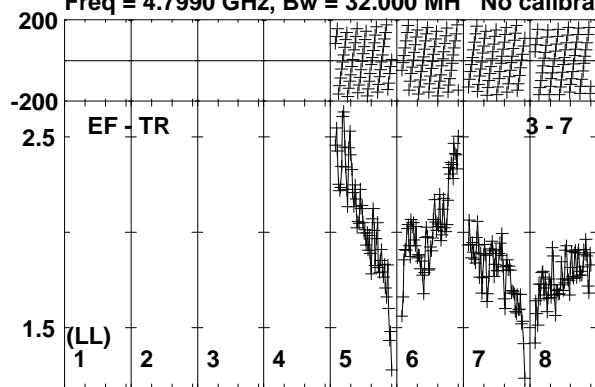

Lower frame: Milli Ampl Jy Top frame: Phas deg
Vector averaged cross-power spectrum Baseline: EF (03) - TR (07)
Timerange: 00/15:13:30 to 00/15:15:00

Plot file version 200 created 20-SEP-2019 15:52:14

J1408+5613 RSM05.UVDATA.1

Freq = 4.7990 GHz, Bw = 32.000 MH No calibration applied and no bandpass applied

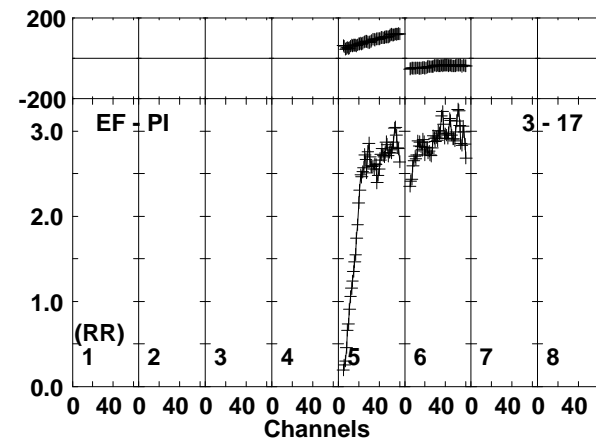
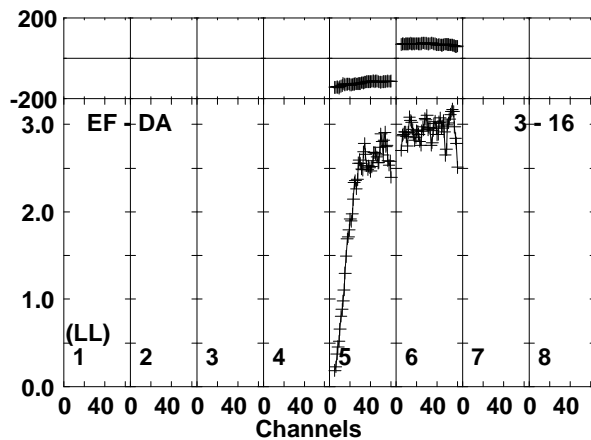
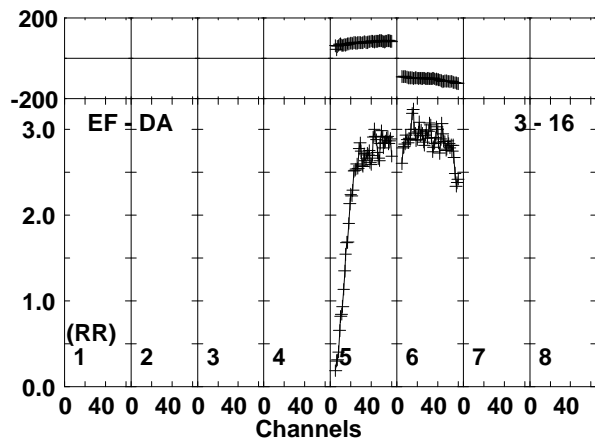
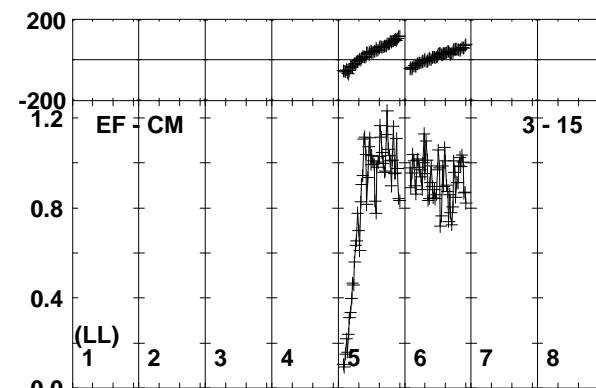
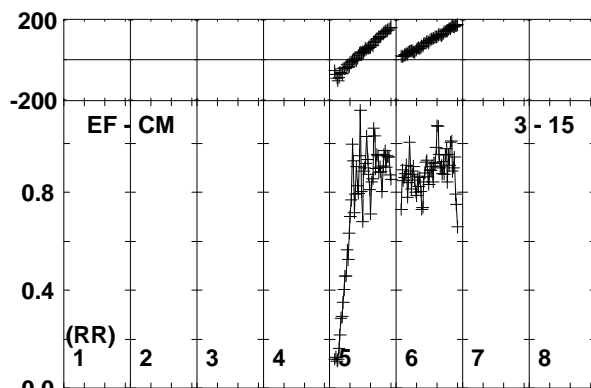
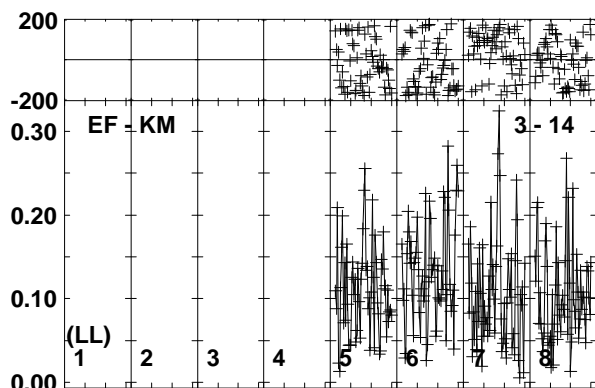
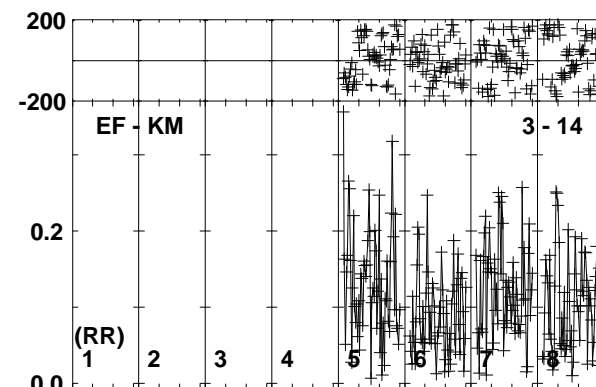
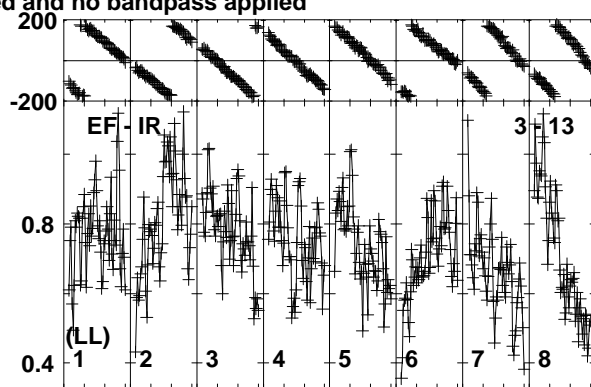
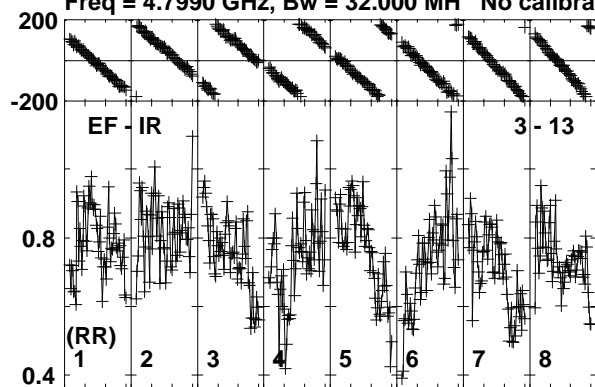

Lower frame: Milli Ampl Jy Top frame: Phas deg
Vector averaged cross-power spectrum Baseline: EF (03) - IR (13)
Timerange: 00/15:13:30 to 00/15:15:00

Plot file version 201 created 20-SEP-2019 15:52:15

J1408+5613 RSM05.UVDATA.1

Freq = 4.7990 GHz, Bw = 32.000 MH No calibration applied and no bandpass applied

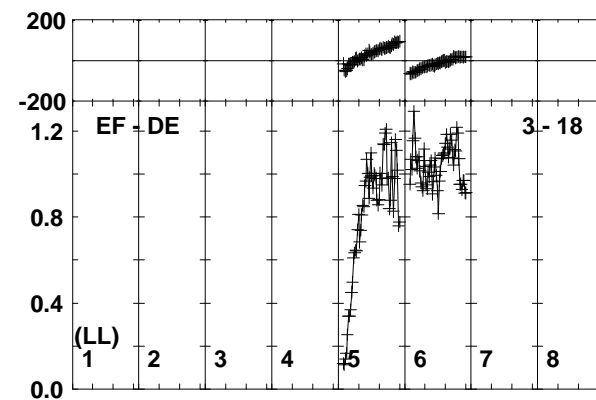
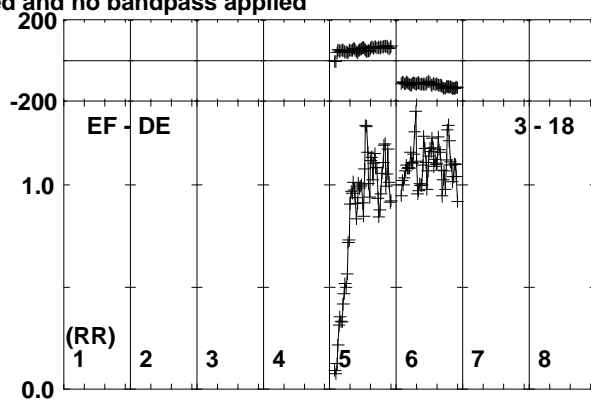
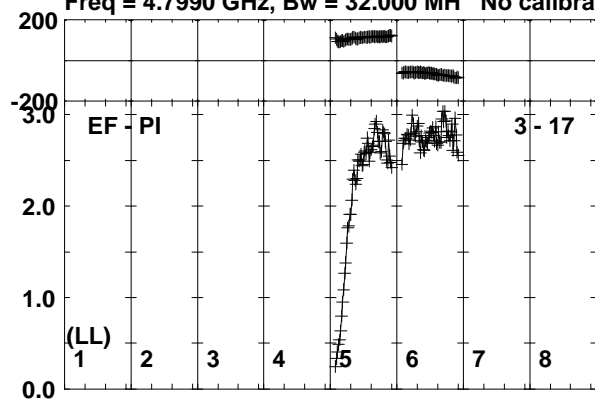

Lower frame: Milli Ampl Jy Top frame: Phas deg
Vector averaged cross-power spectrum Baseline: EF (03) - PI (17)
Timerange: 00/15:13:30 to 00/15:15:00

Plot file version 202 created 20-SEP-2019 15:52:15

AT2019EHZ RSM05.UVDATA.1

Freq = 4.7990 GHz, Bw = 32.000 MH No calibration applied and no bandpass applied

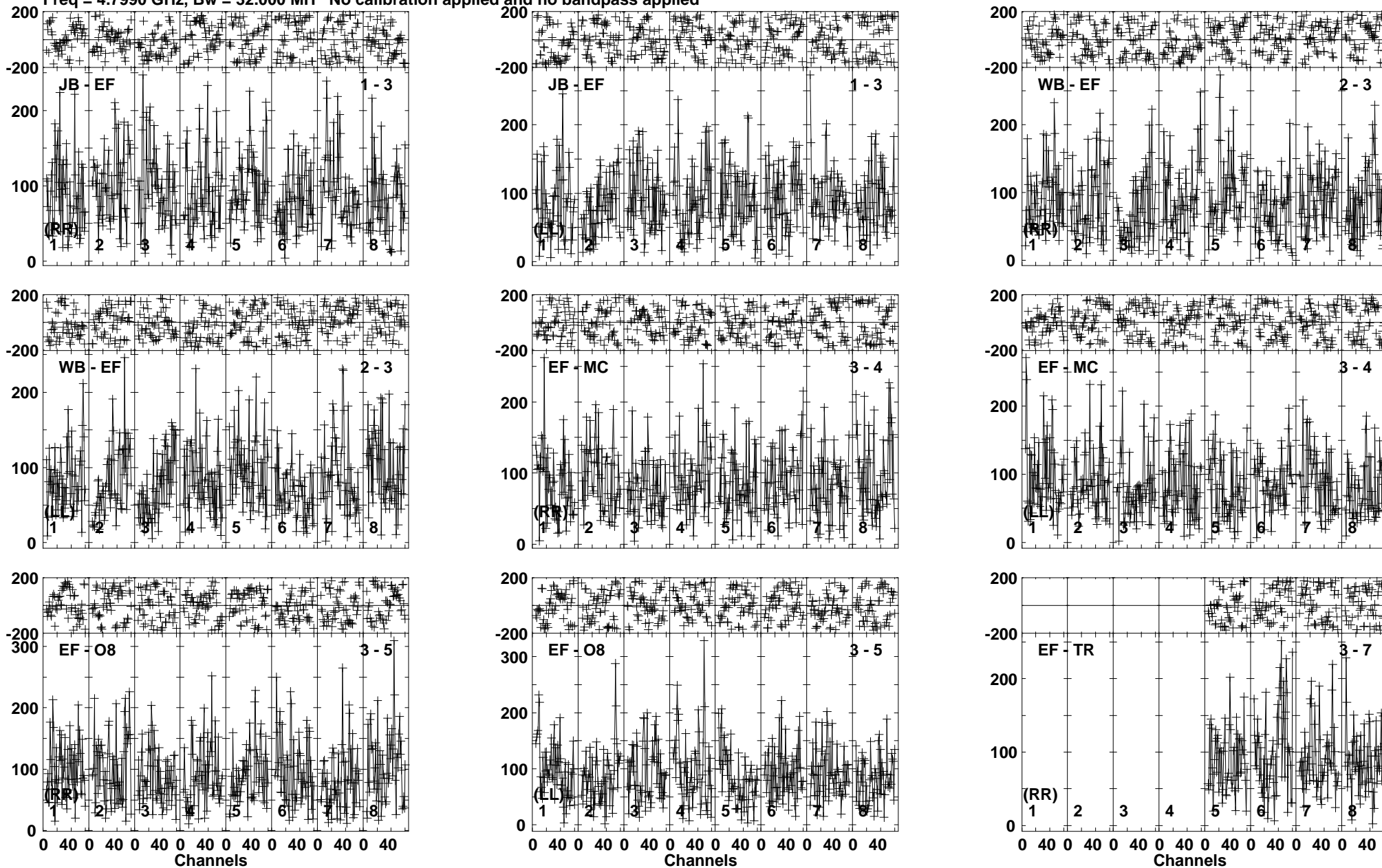

Lower frame: Micro Ampl Jy Top frame: Phas deg
Vector averaged cross-power spectrum Baseline: JB (01) - EF (03)
Timerange: 00/15:15:01 to 00/15:17:59

Plot file version 203 created 20-SEP-2019 15:52:16

AT2019EHZ RSM05.UVDATA.1

Freq = 4.7990 GHz, Bw = 32.000 MH No calibration applied and no bandpass applied

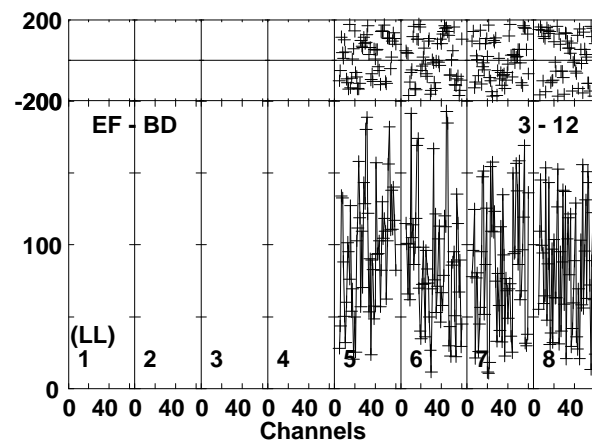
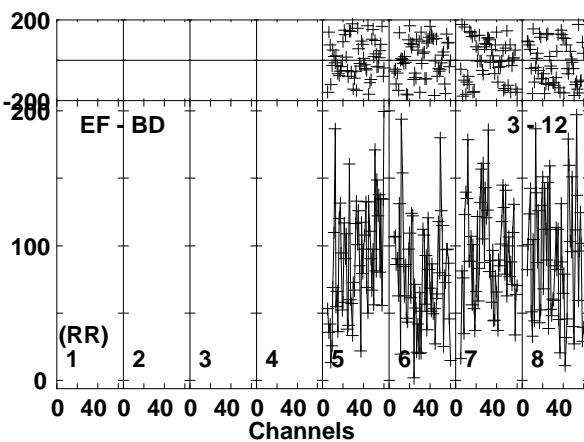
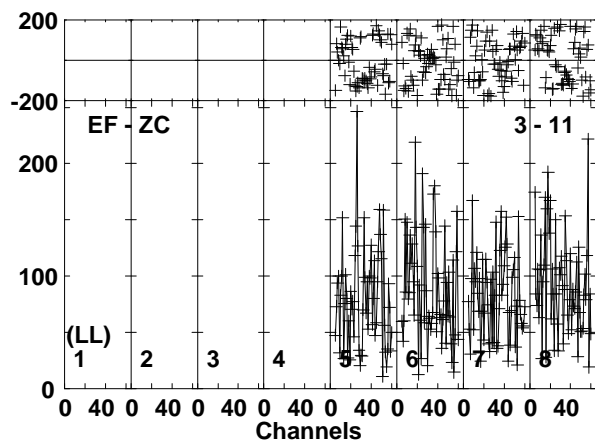
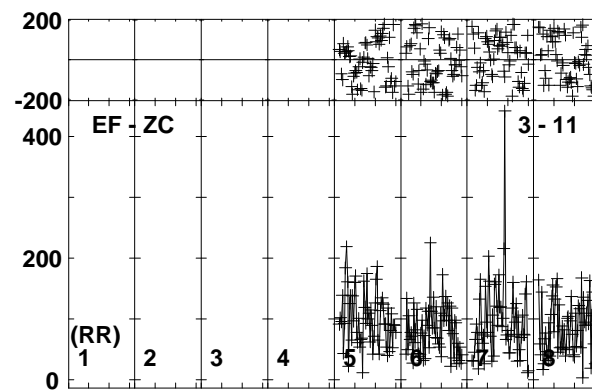
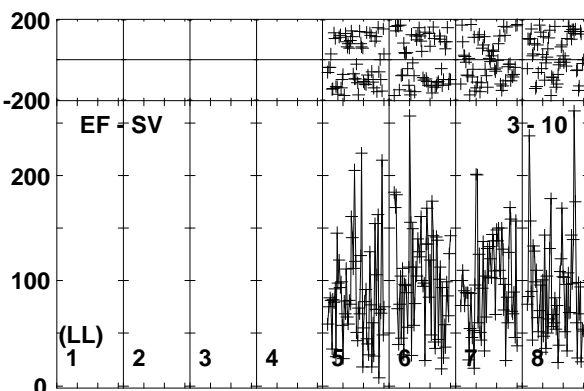
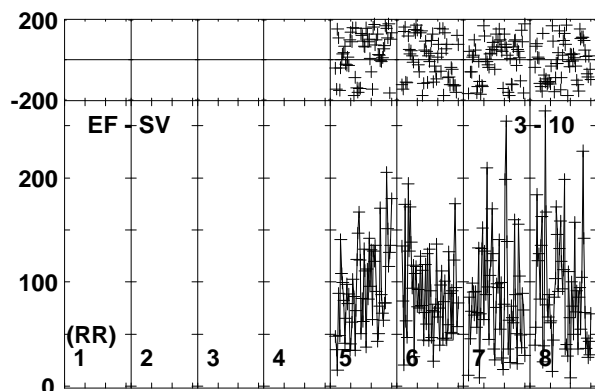
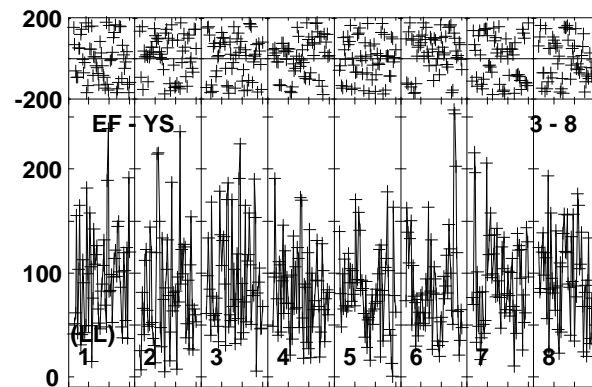
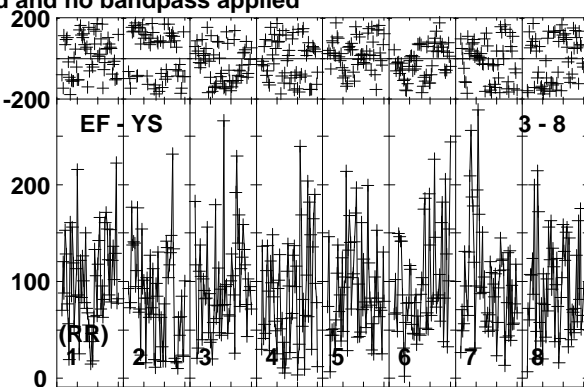
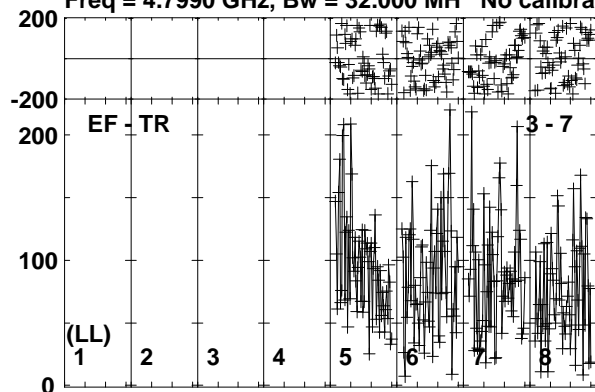

Lower frame: Micro Ampl Jy Top frame: Phas deg
Vector averaged cross-power spectrum Baseline: EF (03) - TR (07)
Timerange: 00/15:15:01 to 00/15:17:59

Plot file version 204 created 20-SEP-2019 15:52:16

AT2019EHZ RSM05.UVDATA.1

Freq = 4.7990 GHz, Bw = 32.000 MH No calibration applied and no bandpass applied

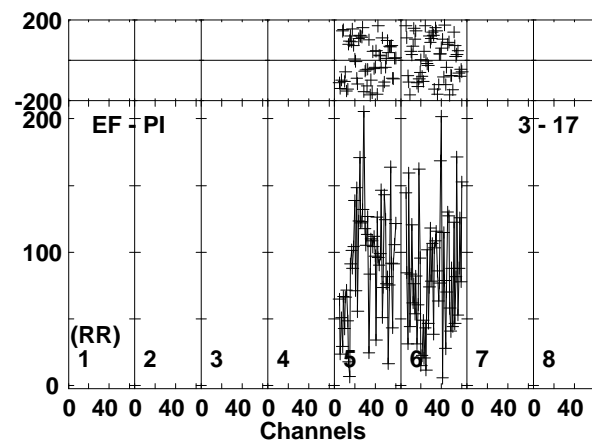
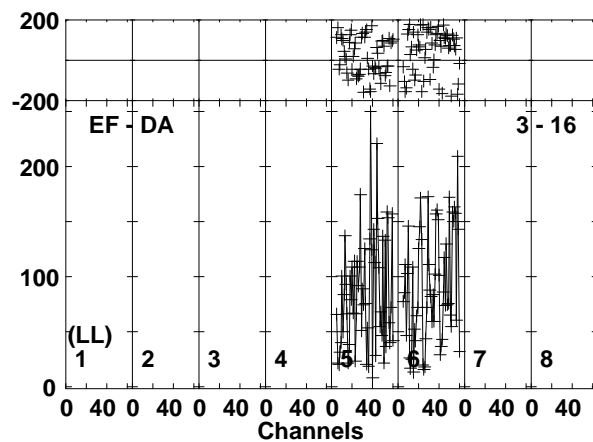
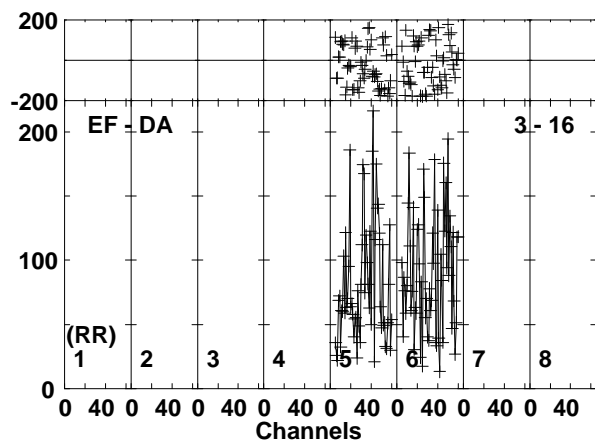
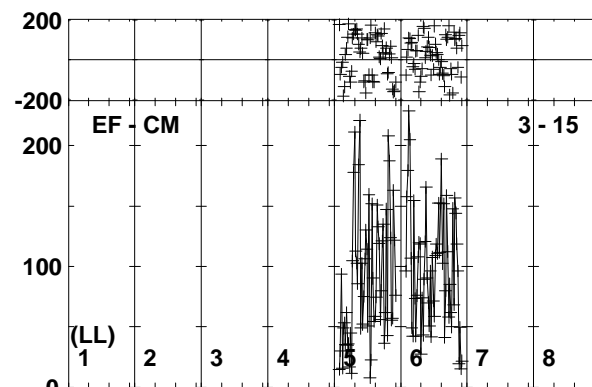
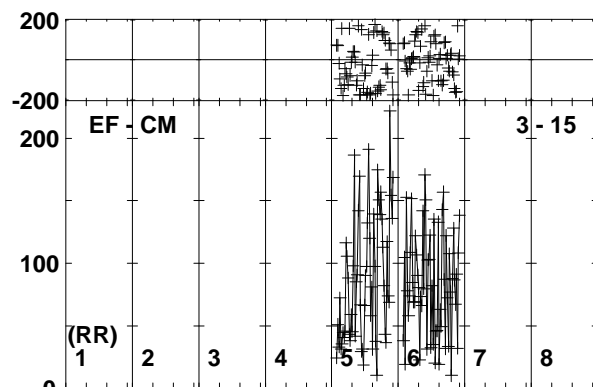
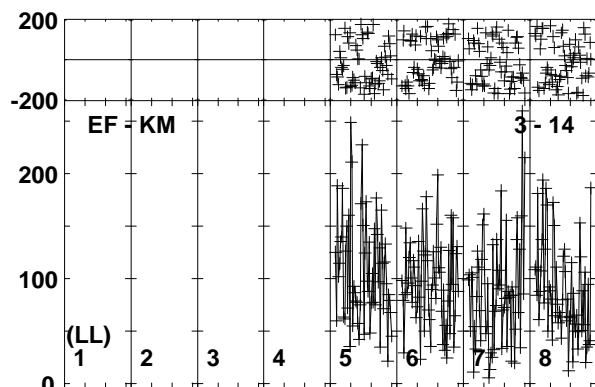
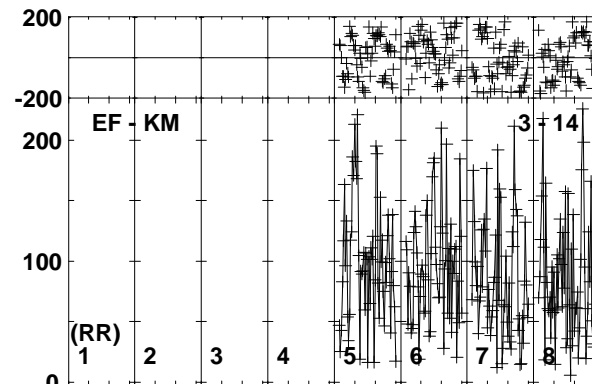
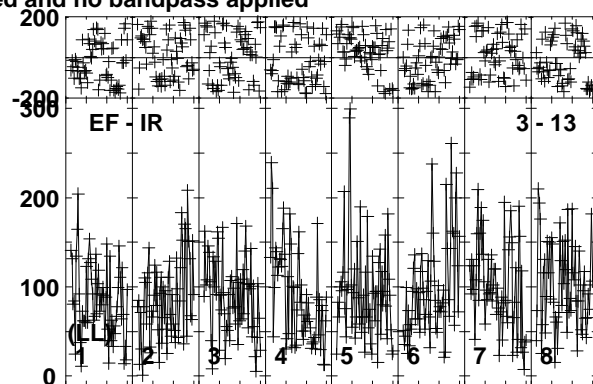
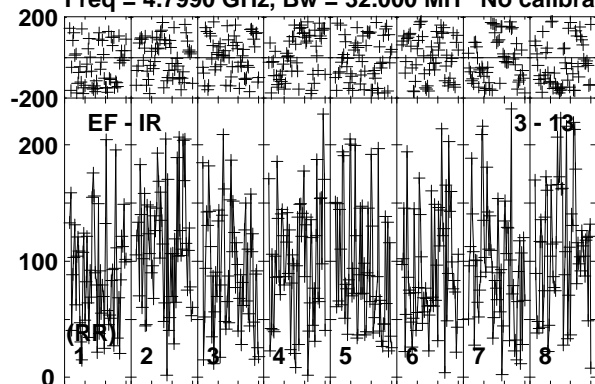

Lower frame: Micro Ampl Jy Top frame: Phas deg
Vector averaged cross-power spectrum Baseline: EF (03) - IR (13)
Timerange: 00/15:15:01 to 00/15:17:59

Plot file version 205 created 20-SEP-2019 15:52:17
AT2019EHZ RSM05.UVDATA.1
Freq = 4.7990 GHz, Bw = 32.000 MH No calibration applied and no bandpass applied

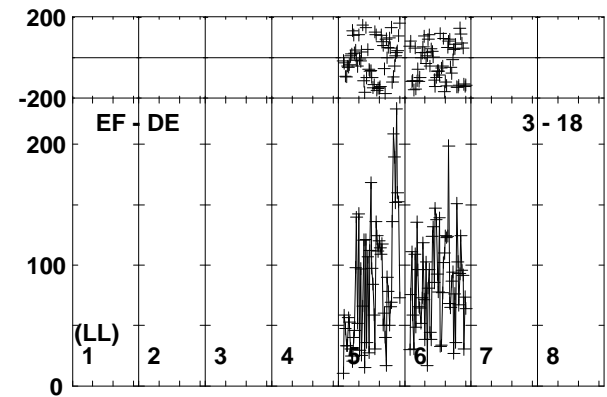
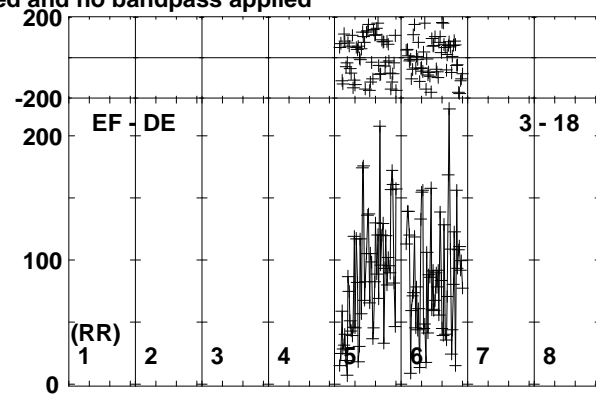
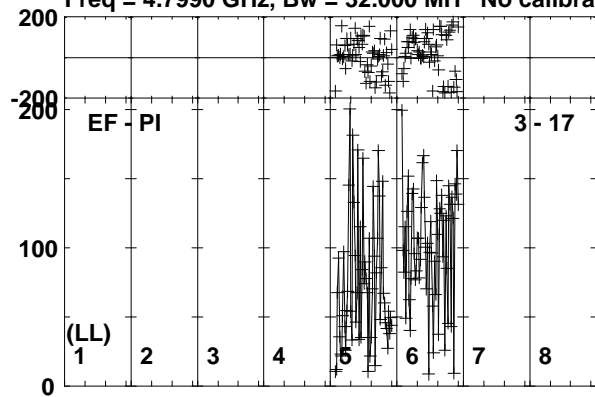

Lower frame: Micro Ampl Jy Top frame: Phas deg
Vector averaged cross-power spectrum Baseline: EF (03) - PI (17)
Timerange: 00/15:15:01 to 00/15:17:59

Plot file version 206 created 20-SEP-2019 15:52:17

J1408+5613 RSM05.UVDATA.1

Freq = 4.7990 GHz, Bw = 32.000 MH No calibration applied and no bandpass applied

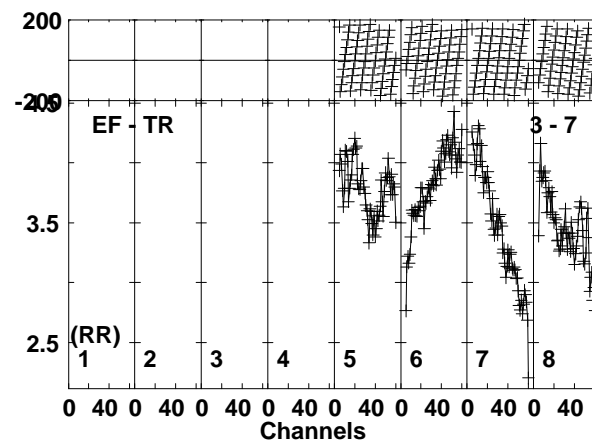
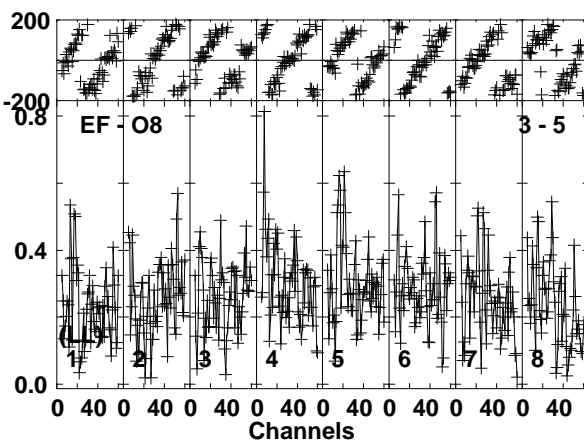
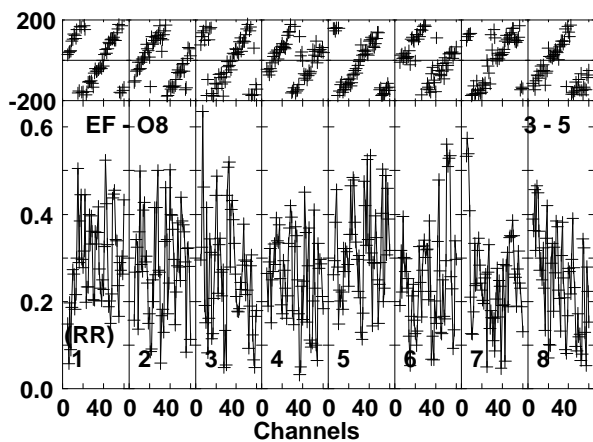
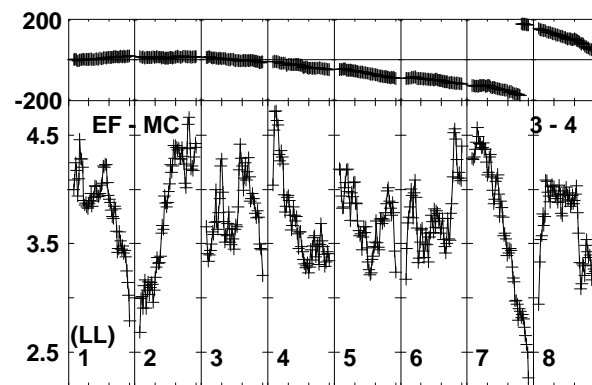
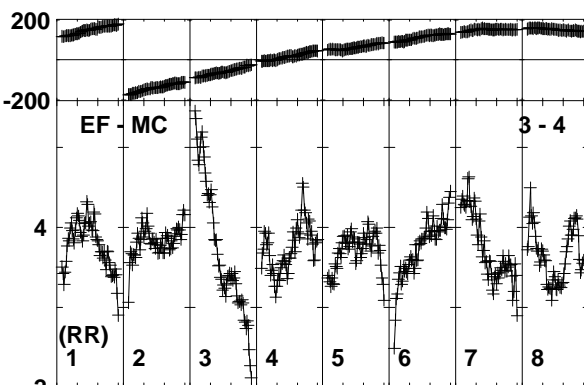
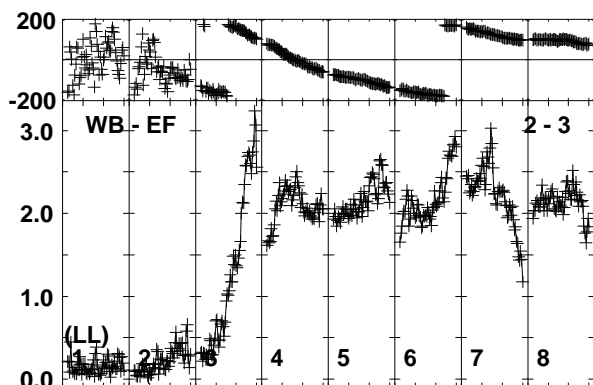
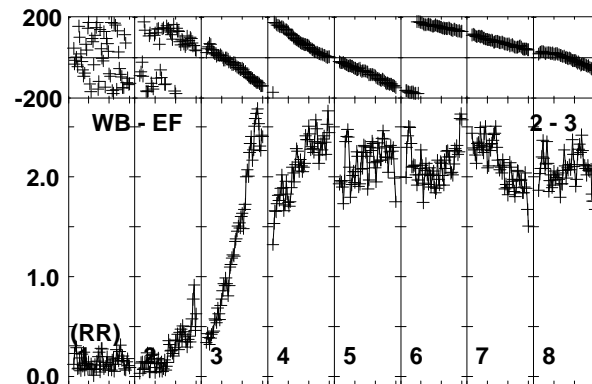
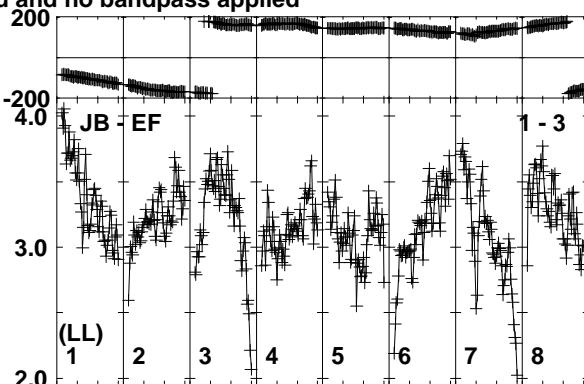
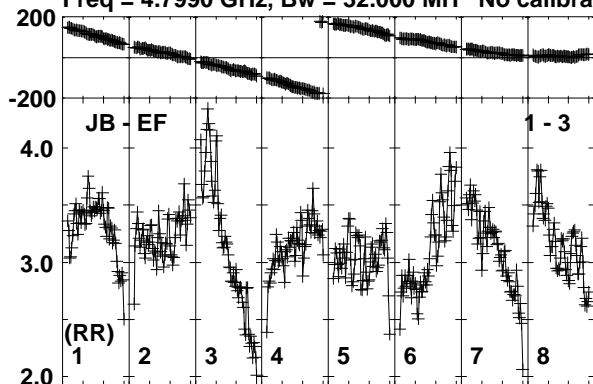

Lower frame: Milli Ampl Jy Top frame: Phas deg
Vector averaged cross-power spectrum Baseline: JB (01) - EF (03)
Timerange: 00/15:18:00 to 00/15:19:29

Plot file version 207 created 20-SEP-2019 15:52:17

J1408+5613 RSM05.UVDATA.1

Freq = 4.7990 GHz, Bw = 32.000 MH No calibration applied and no bandpass applied

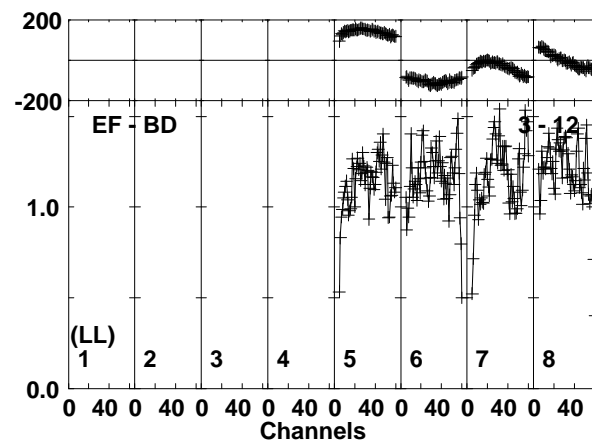
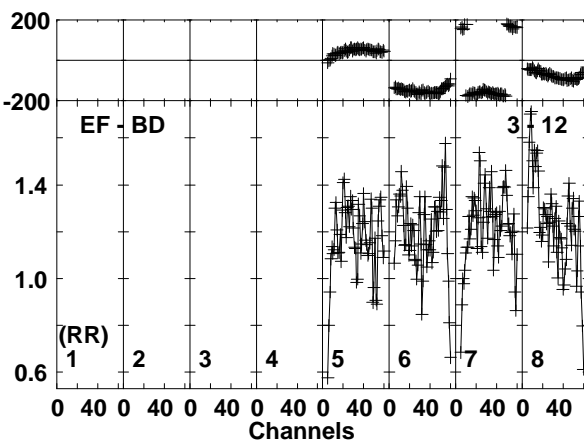
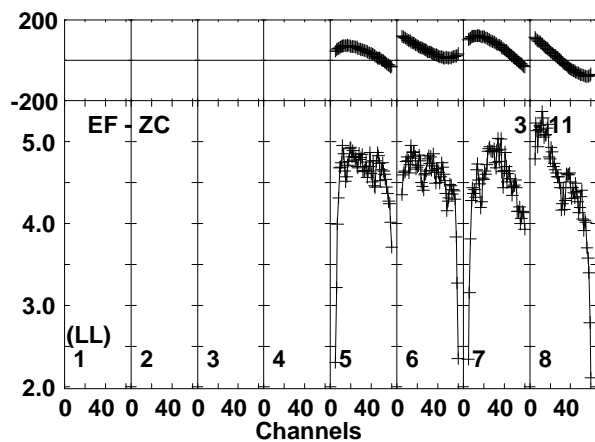
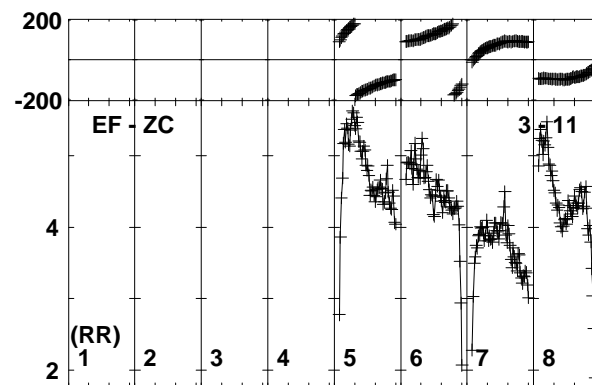
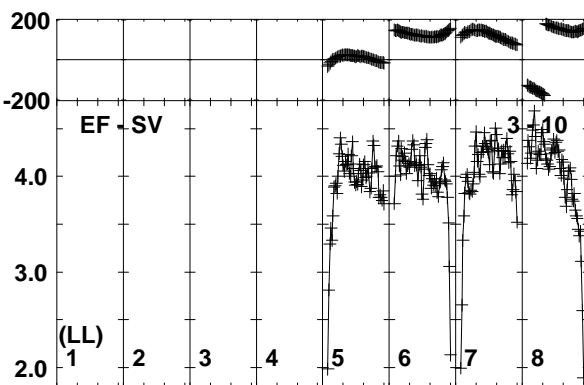
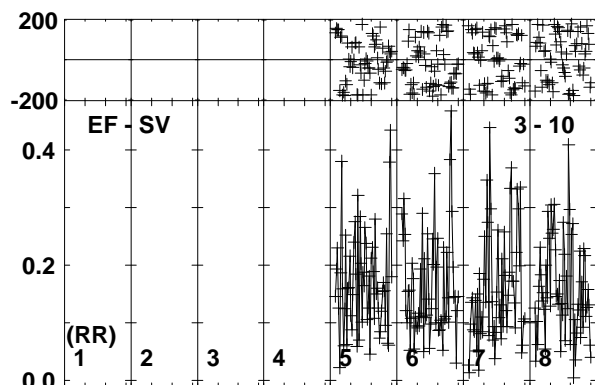
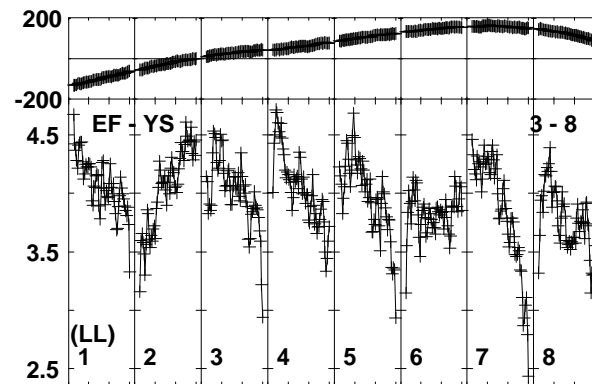
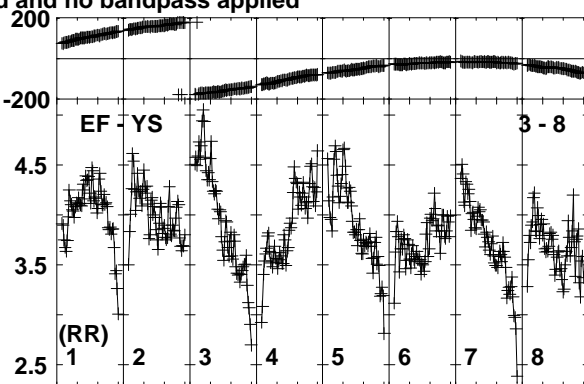
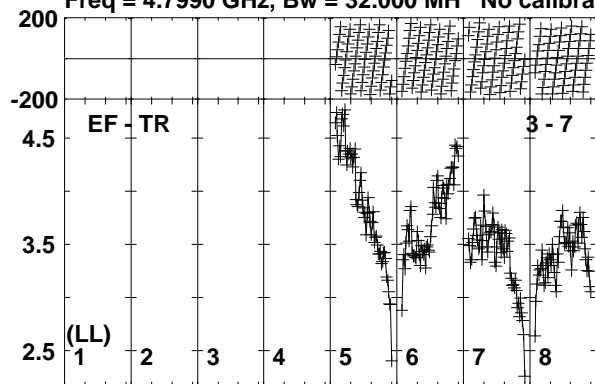

Lower frame: Milli Ampl Jy Top frame: Phas deg
Vector averaged cross-power spectrum Baseline: EF (03) - TR (07)
Timerange: 00/15:18:00 to 00/15:19:29

Plot file version 208 created 20-SEP-2019 15:52:18

J1408+5613 RSM05.UVDATA.1

Freq = 4.7990 GHz, Bw = 32.000 MH No calibration applied and no bandpass applied

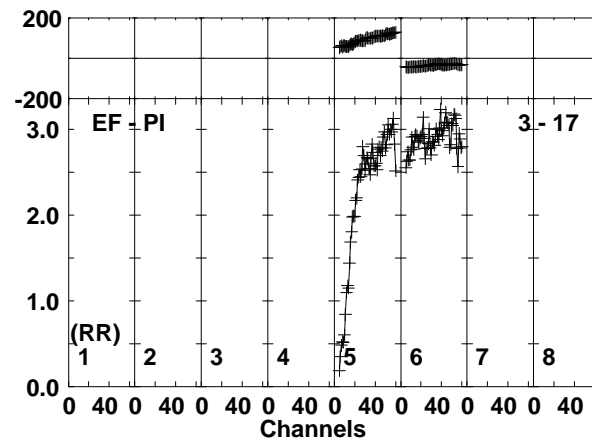
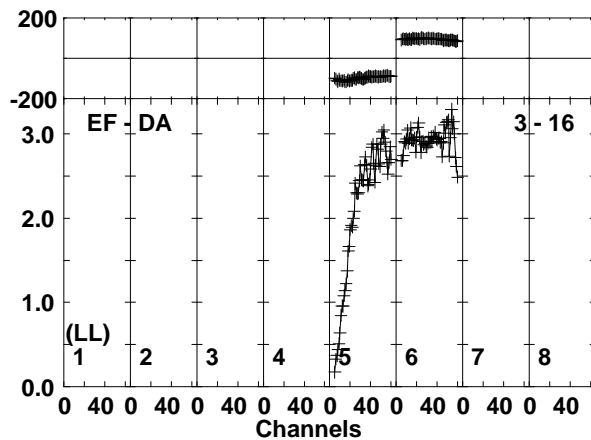
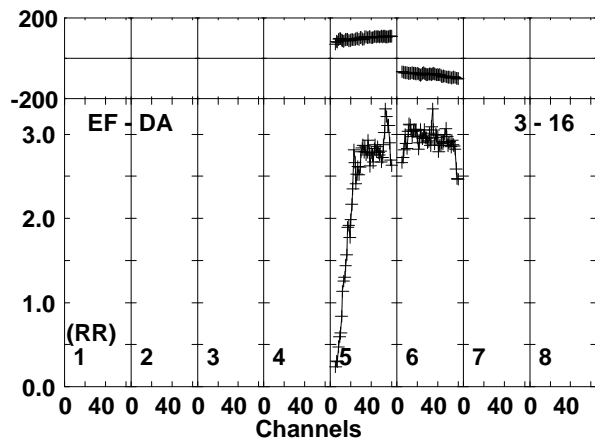
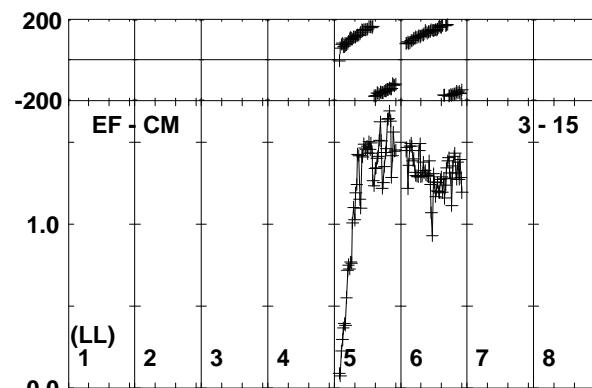
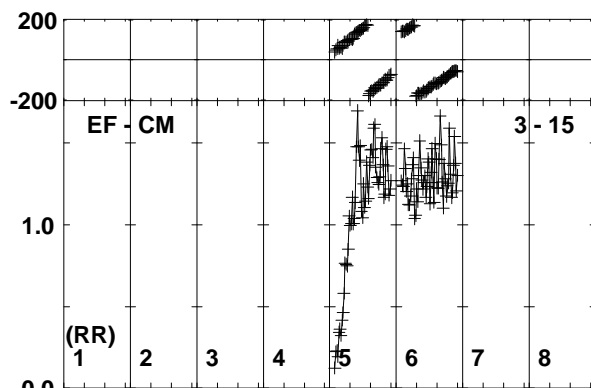
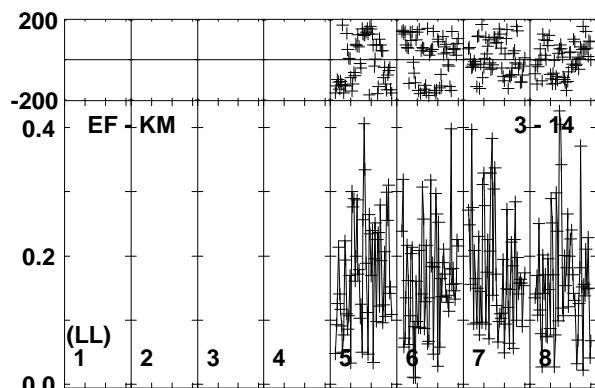
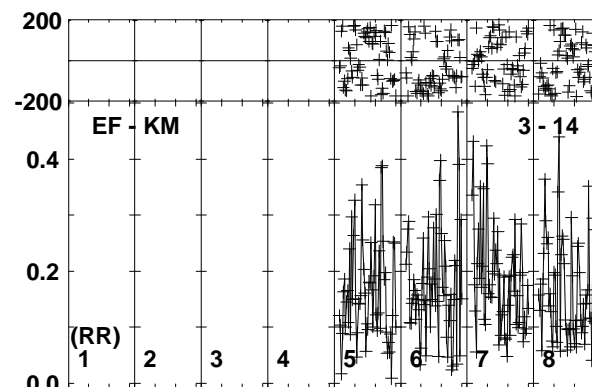
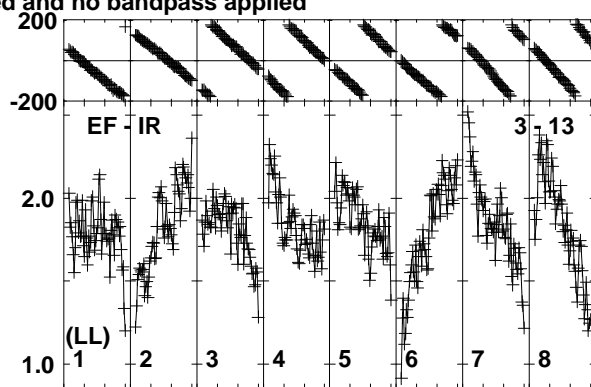
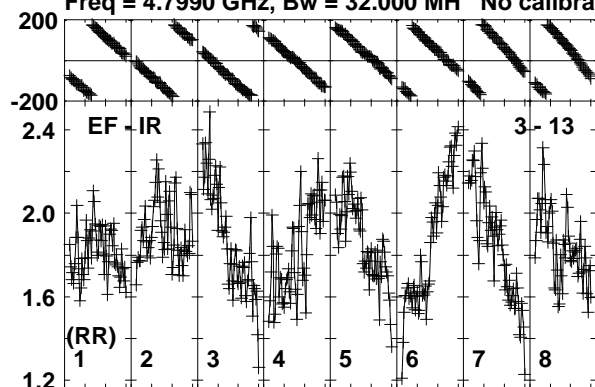

Lower frame: Milli Ampl Jy Top frame: Phas deg
Vector averaged cross-power spectrum Baseline: EF (03) - IR (13)
Timerange: 00/15:18:00 to 00/15:19:29

Plot file version 209 created 20-SEP-2019 15:52:18

J1408+5613 RSM05.UVDATA.1

Freq = 4.7990 GHz, Bw = 32.000 MH No calibration applied and no bandpass applied

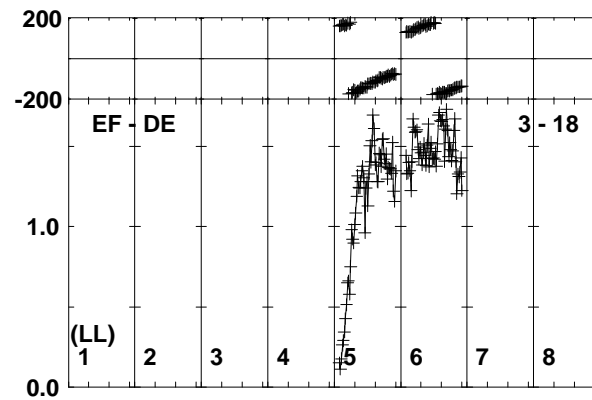
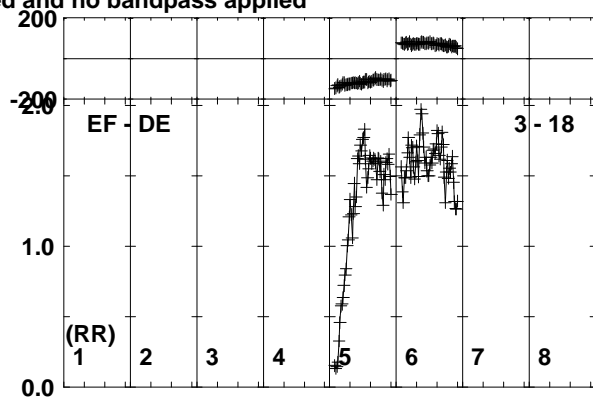
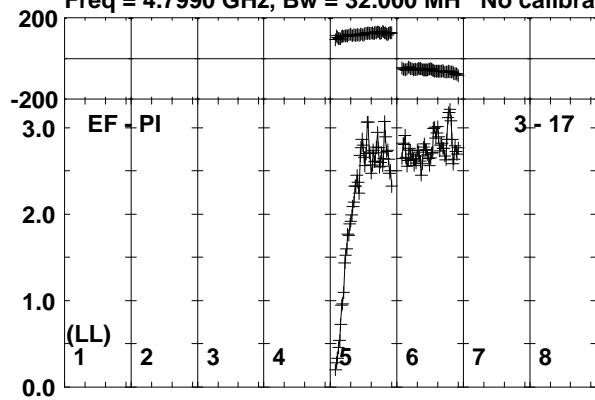

Lower frame: Milli Ampl Jy Top frame: Phas deg
Vector averaged cross-power spectrum Baseline: EF (03) - PI (17)
Timerange: 00/15:18:00 to 00/15:19:29

Plot file version 210 created 20-SEP-2019 15:52:19

AT2019EHZ RSM05.UVDATA.1

Freq = 4.7990 GHz, Bw = 32.000 MH No calibration applied and no bandpass applied

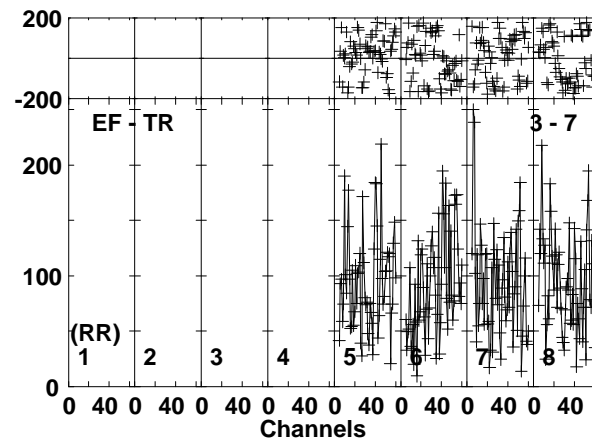
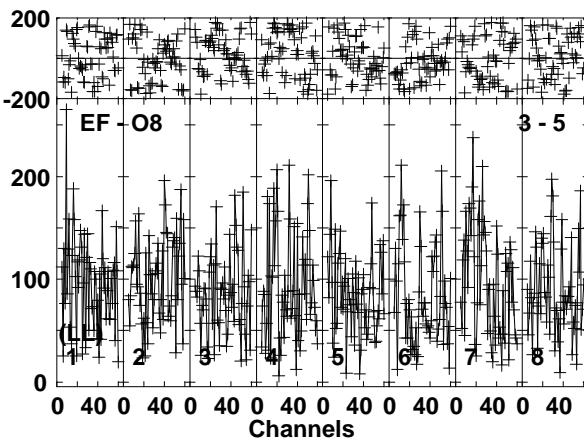
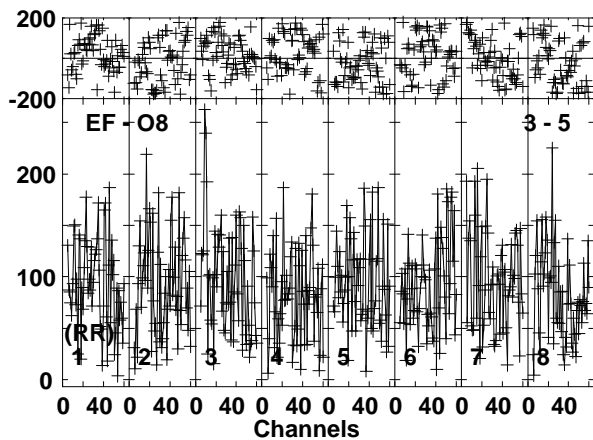
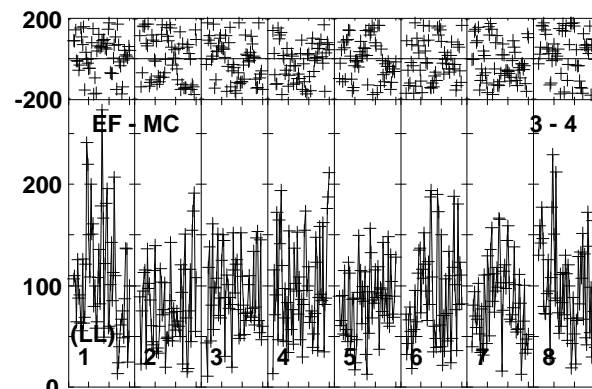
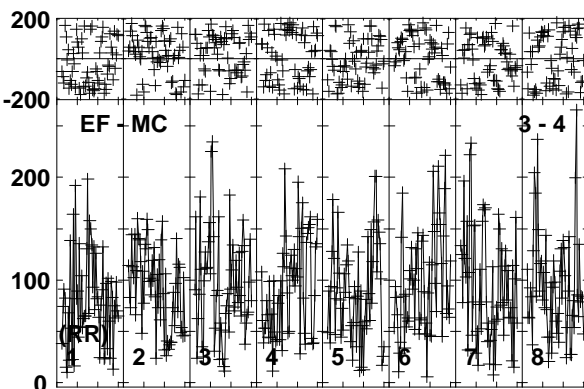
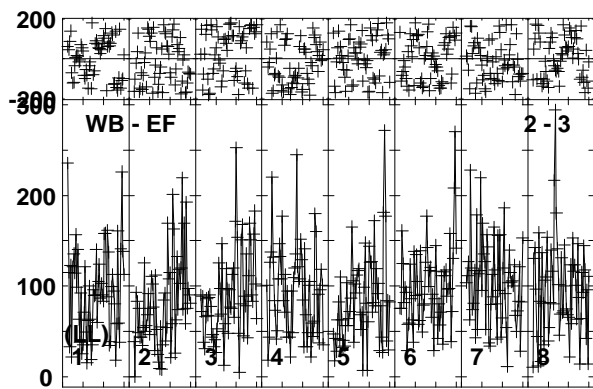
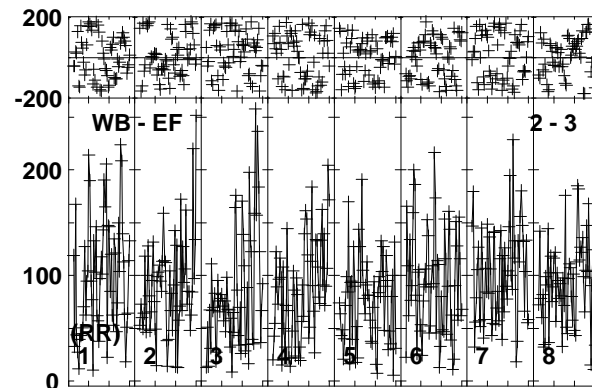
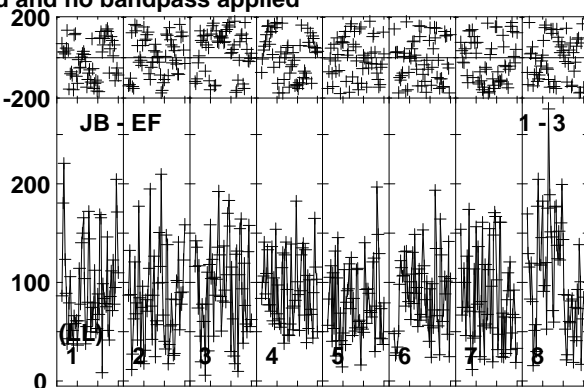
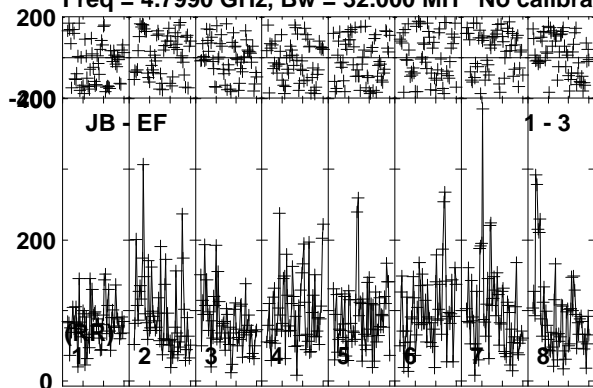

Lower frame: Micro Ampl Jy Top frame: Phas deg
Vector averaged cross-power spectrum Baseline: JB (01) - EF (03)
Timerange: 00/15:19:31 to 00/15:22:29

Plot file version 211 created 20-SEP-2019 15:52:19

AT2019EHZ RSM05.UVDATA.1

Freq = 4.7990 GHz, Bw = 32.000 MH No calibration applied and no bandpass applied

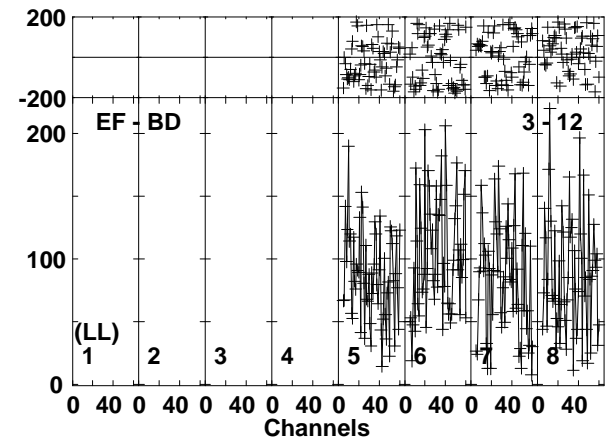
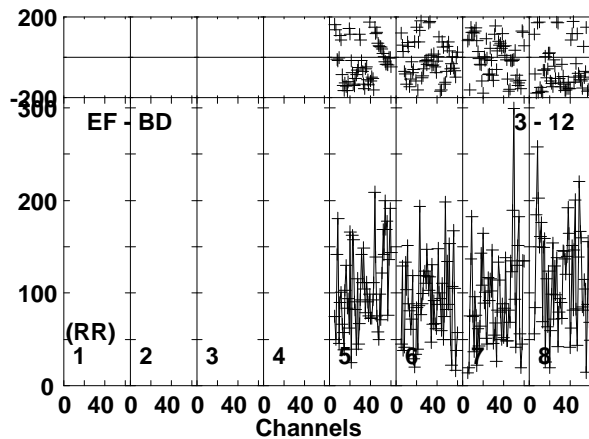
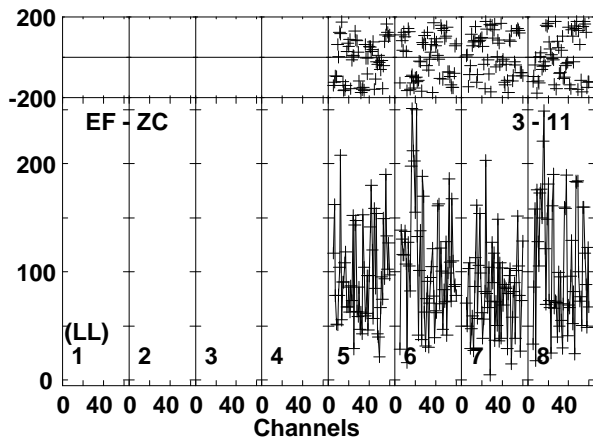
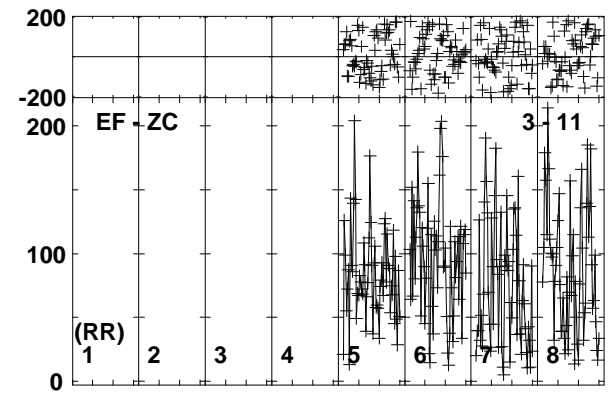
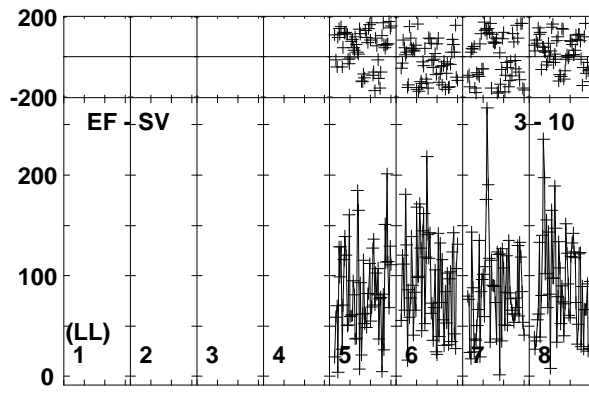
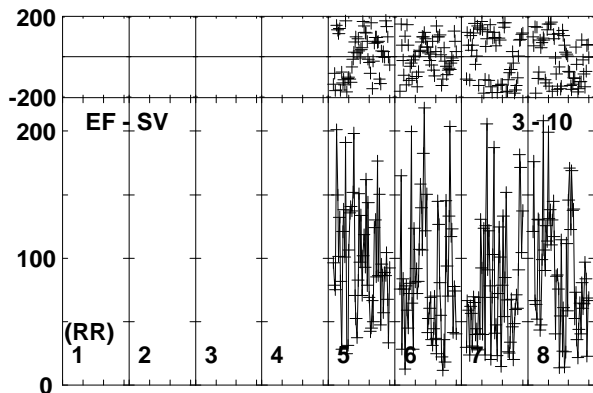
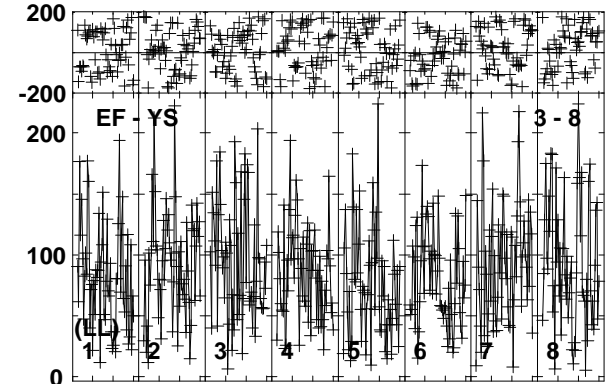
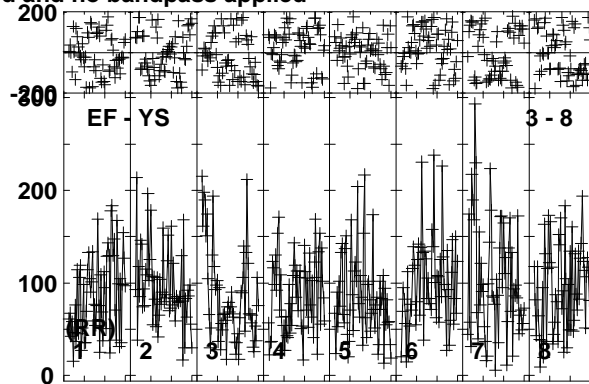
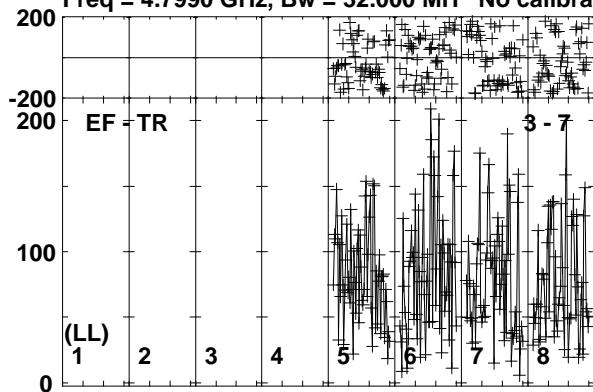

Lower frame: Micro Ampl Jy Top frame: Phas deg
Vector averaged cross-power spectrum Baseline: EF (03) - TR (07)
Timerange: 00/15:19:31 to 00/15:22:29

Plot file version 212 created 20-SEP-2019 15:52:20

AT2019EHZ RSM05.UVDATA.1

Freq = 4.7990 GHz, Bw = 32.000 MH No calibration applied and no bandpass applied

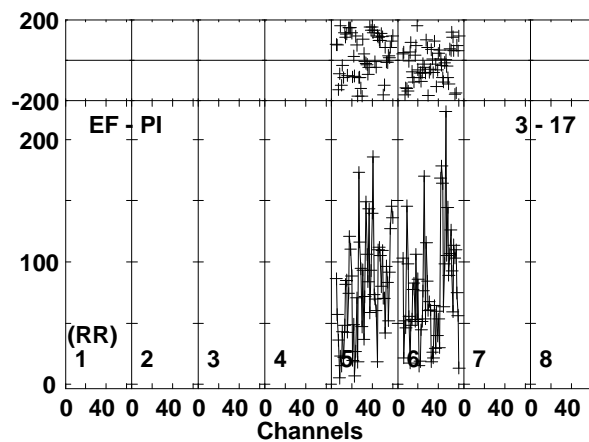
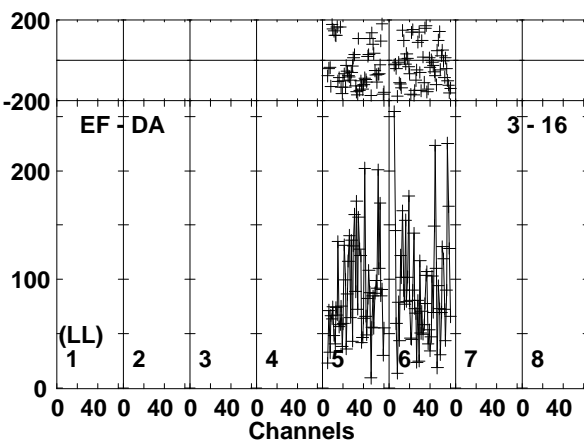
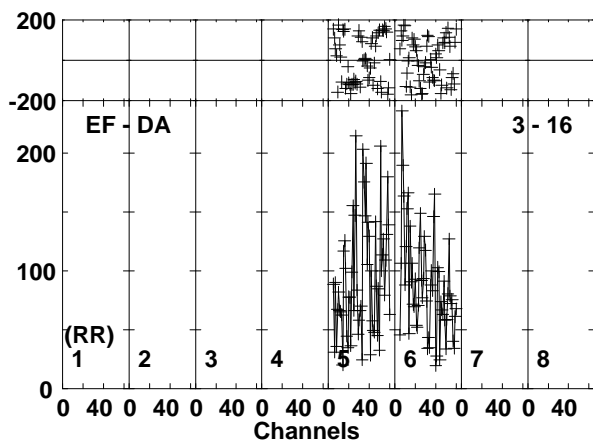
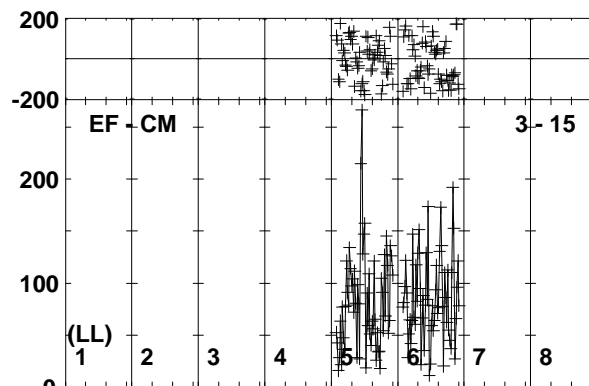
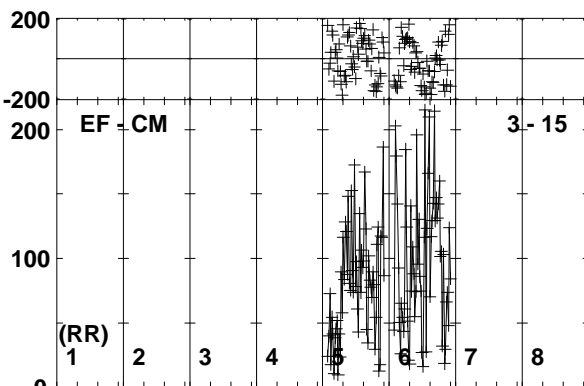
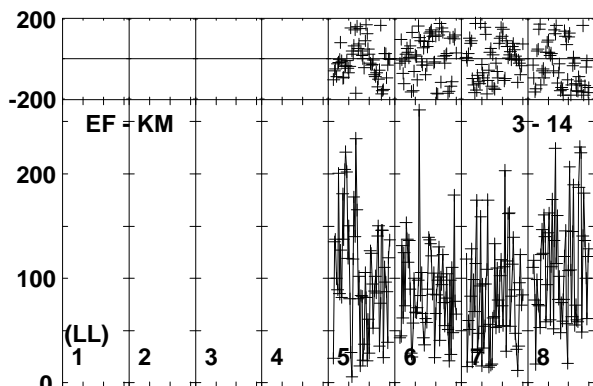
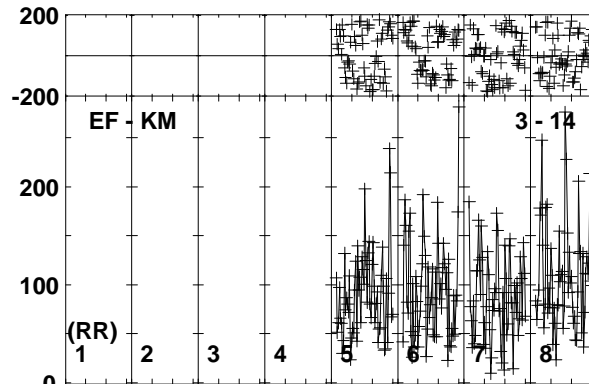
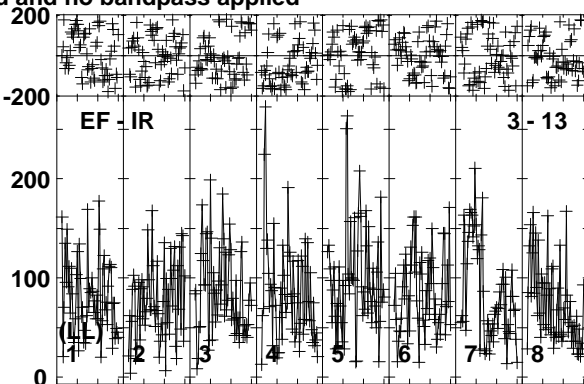
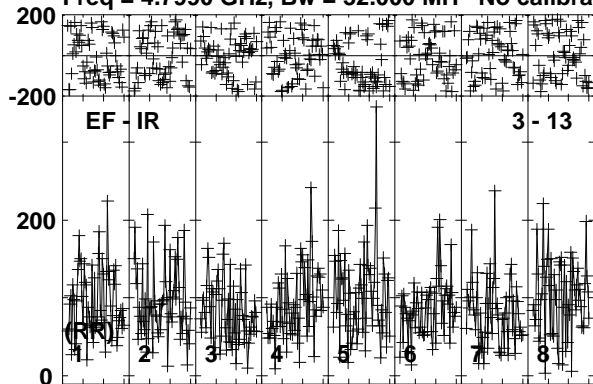

Lower frame: Micro Ampl Jy Top frame: Phas deg
Vector averaged cross-power spectrum Baseline: EF (03) - IR (13)
Timerange: 00/15:19:31 to 00/15:22:29

Plot file version 213 created 20-SEP-2019 15:52:20
AT2019EHZ RSM05.UVDATA.1
Freq = 4.7990 GHz, Bw = 32.000 MH No calibration applied and no bandpass applied

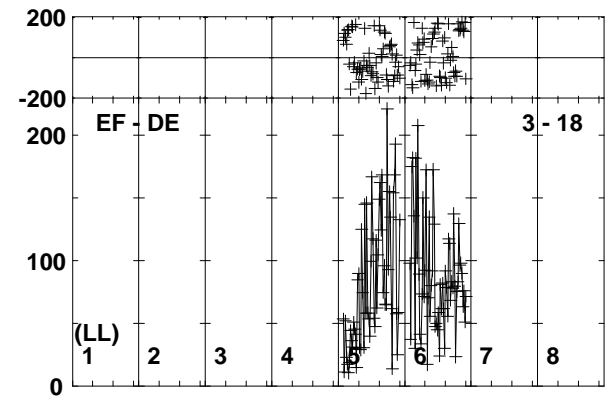
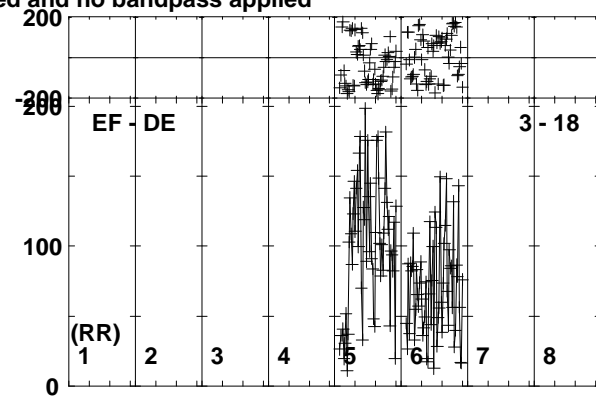
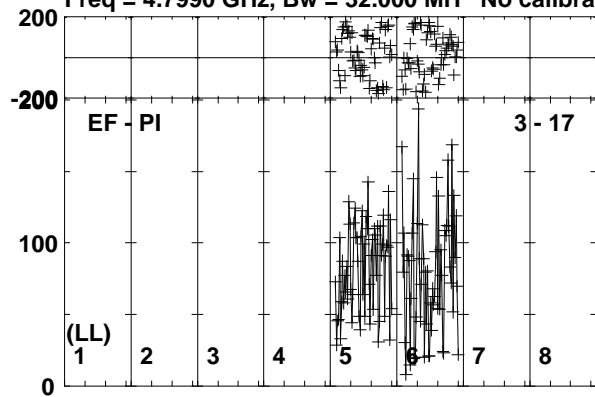

Lower frame: Micro Ampl Jy Top frame: Phas deg
Vector averaged cross-power spectrum Baseline: EF (03) - PI (17)
Timerange: 00/15:19:31 to 00/15:22:29

Plot file version 214 created 20-SEP-2019 15:52:20

J1408+5613 RSM05.UVDATA.1

Freq = 4.7990 GHz, Bw = 32.000 MH No calibration applied and no bandpass applied

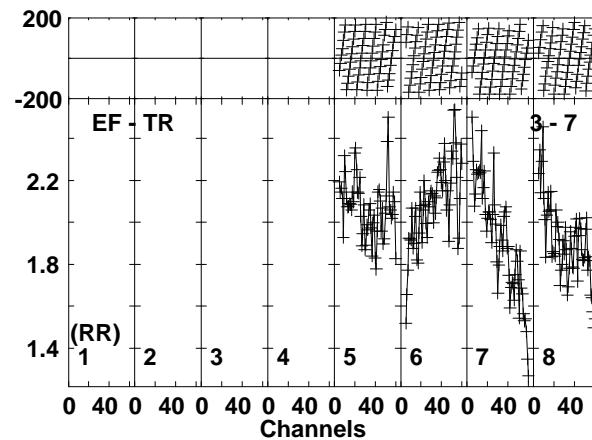
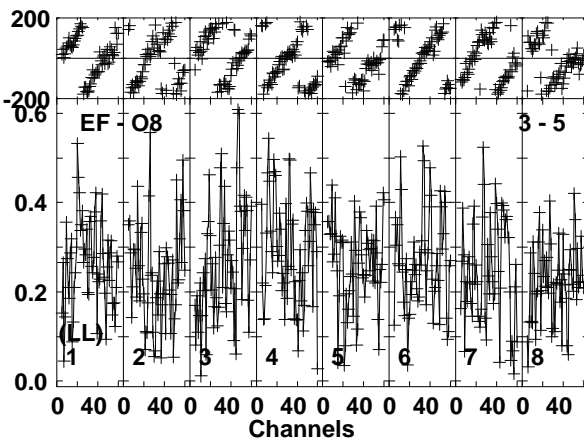
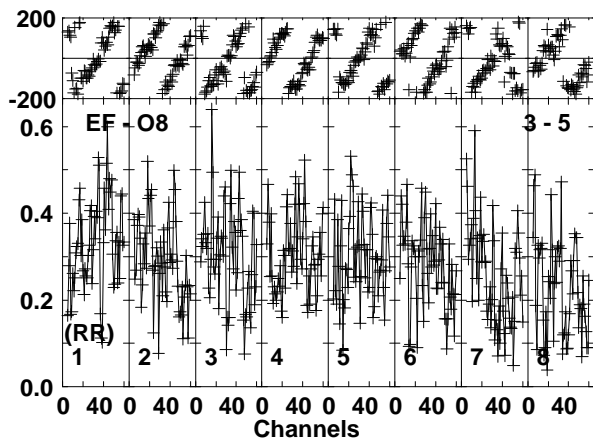
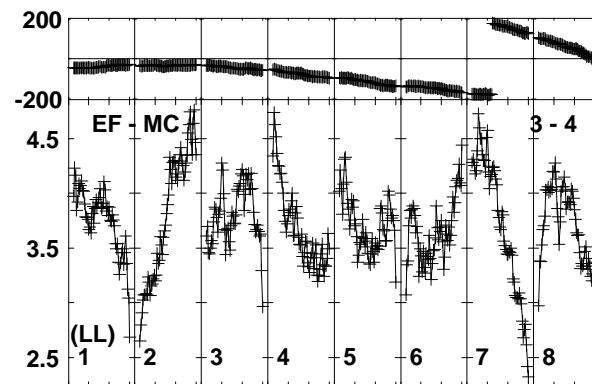
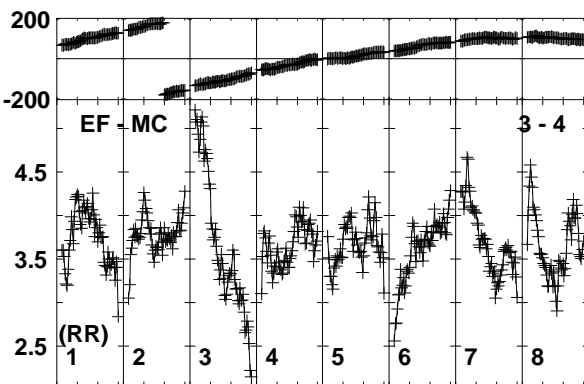
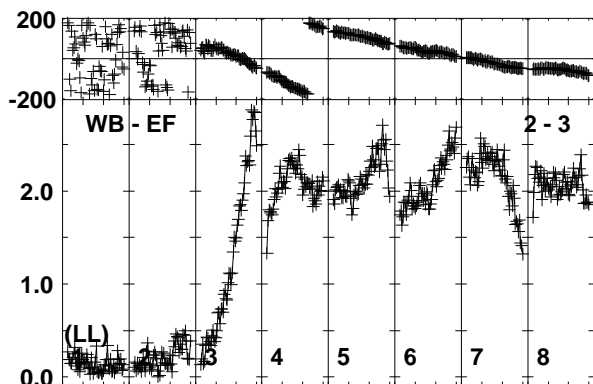
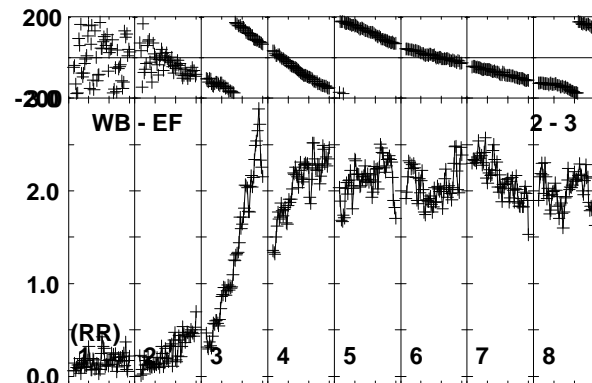
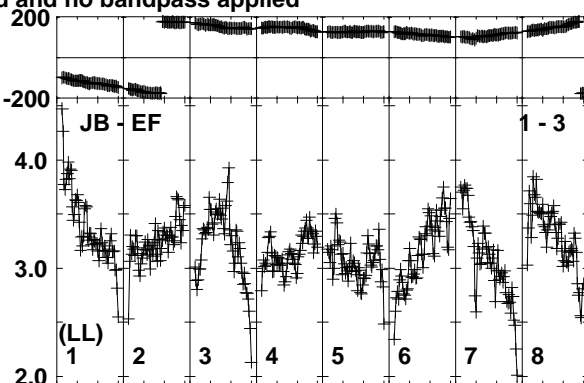
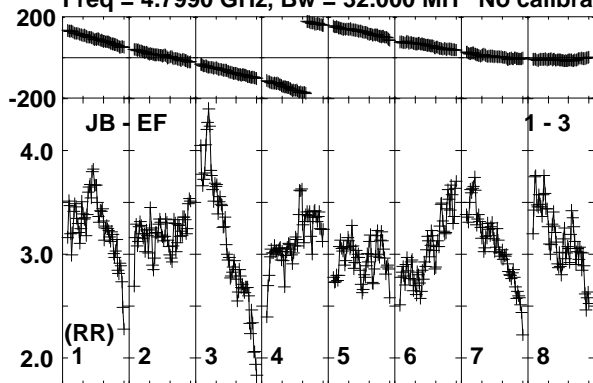

Lower frame: Milli Ampl Jy Top frame: Phas deg
Vector averaged cross-power spectrum Baseline: JB (01) - EF (03)
Timerange: 00/15:22:31 to 00/15:23:59

Plot file version 216 created 20-SEP-2019 15:52:22

J1408+5613 RSM05.UVDATA.1

Freq = 4.7990 GHz, Bw = 32.000 MH No calibration applied and no bandpass applied

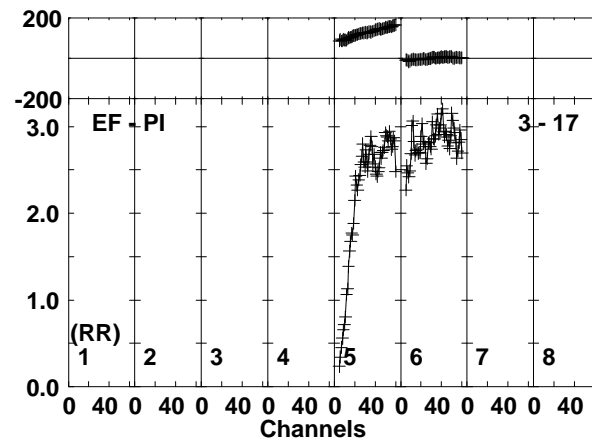
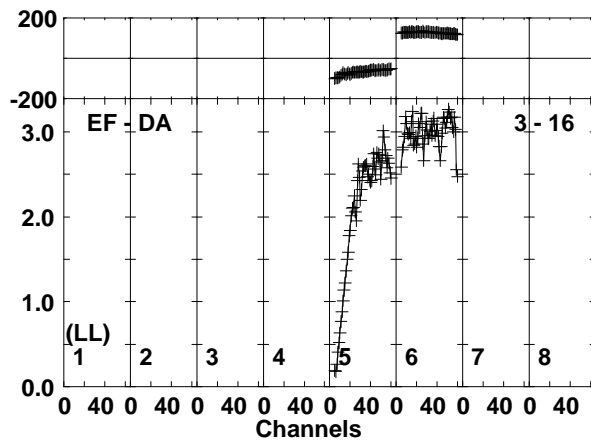
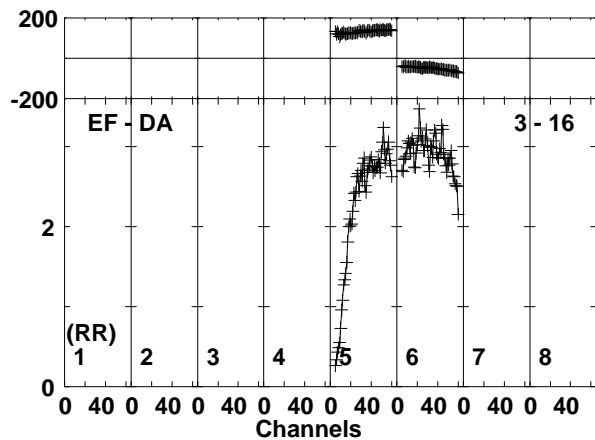
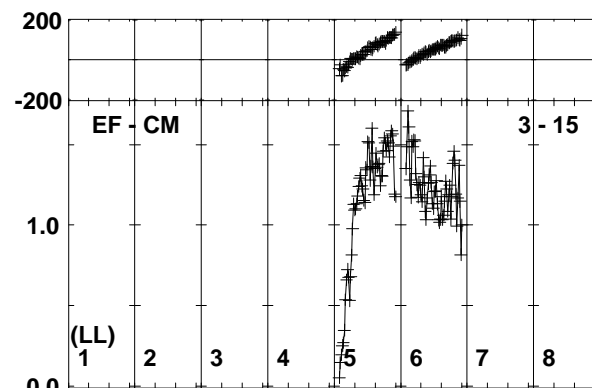
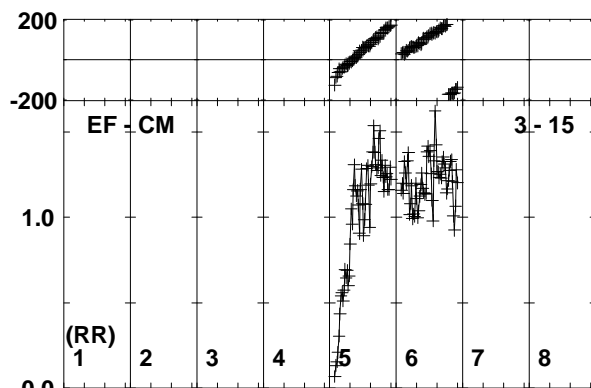
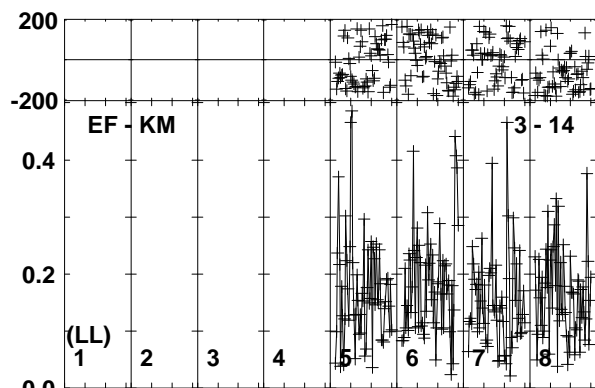
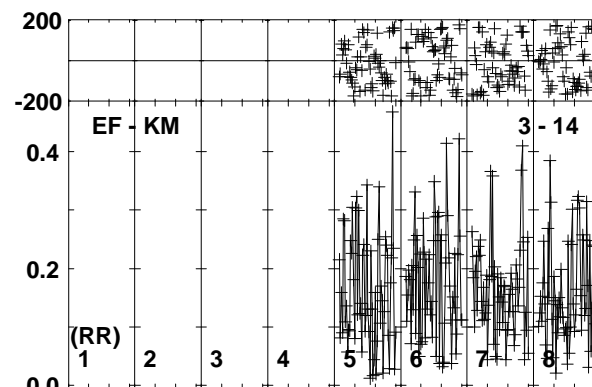
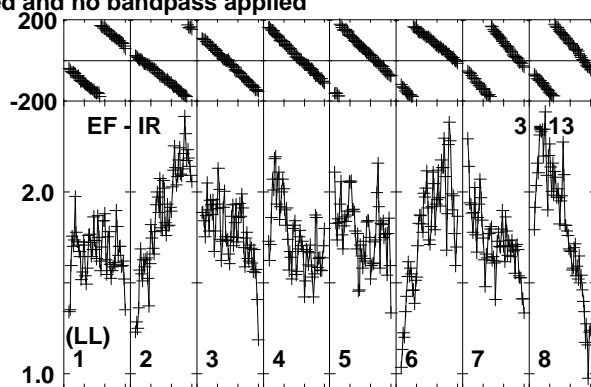
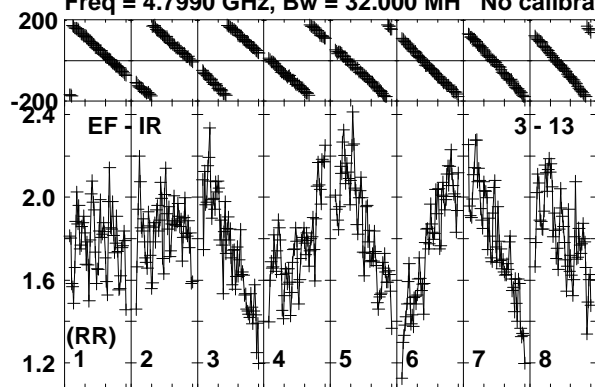

Lower frame: Milli Ampl Jy Top frame: Phas deg
Vector averaged cross-power spectrum Baseline: EF (03) - IR (13)
Timerange: 00/15:22:31 to 00/15:23:59

Plot file version 217 created 20-SEP-2019 15:52:22

J1408+5613 RSM05.UVDATA.1

Freq = 4.7990 GHz, Bw = 32.000 MH No calibration applied and no bandpass applied

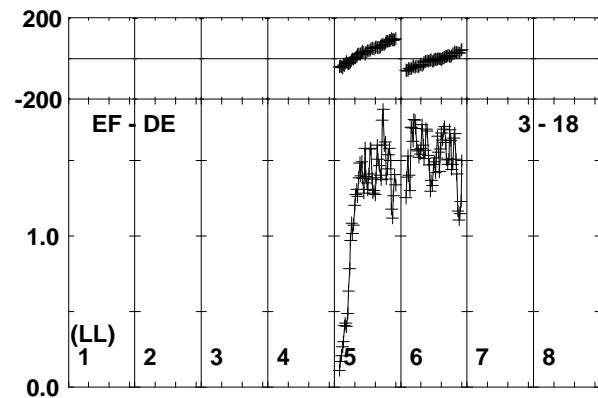
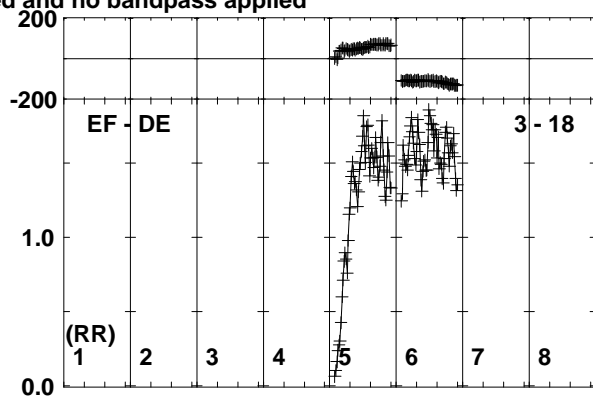
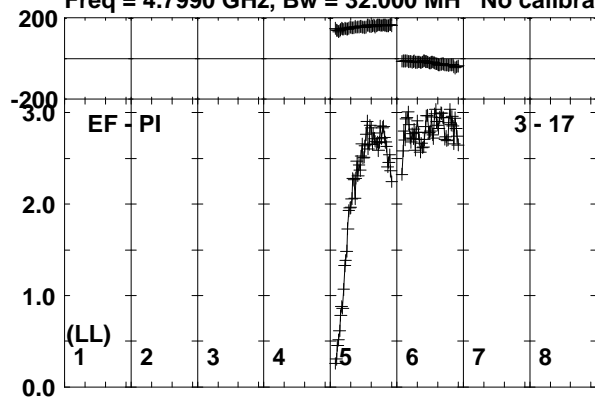

Lower frame: Milli Ampl Jy Top frame: Phas deg
Vector averaged cross-power spectrum Baseline: EF (03) - PI (17)
Timerange: 00/15:22:31 to 00/15:23:59

Plot file version 218 created 20-SEP-2019 15:52:22

AT2019EHZ RSM05.UVDATA.1

Freq = 4.7990 GHz, Bw = 32.000 MH No calibration applied and no bandpass applied

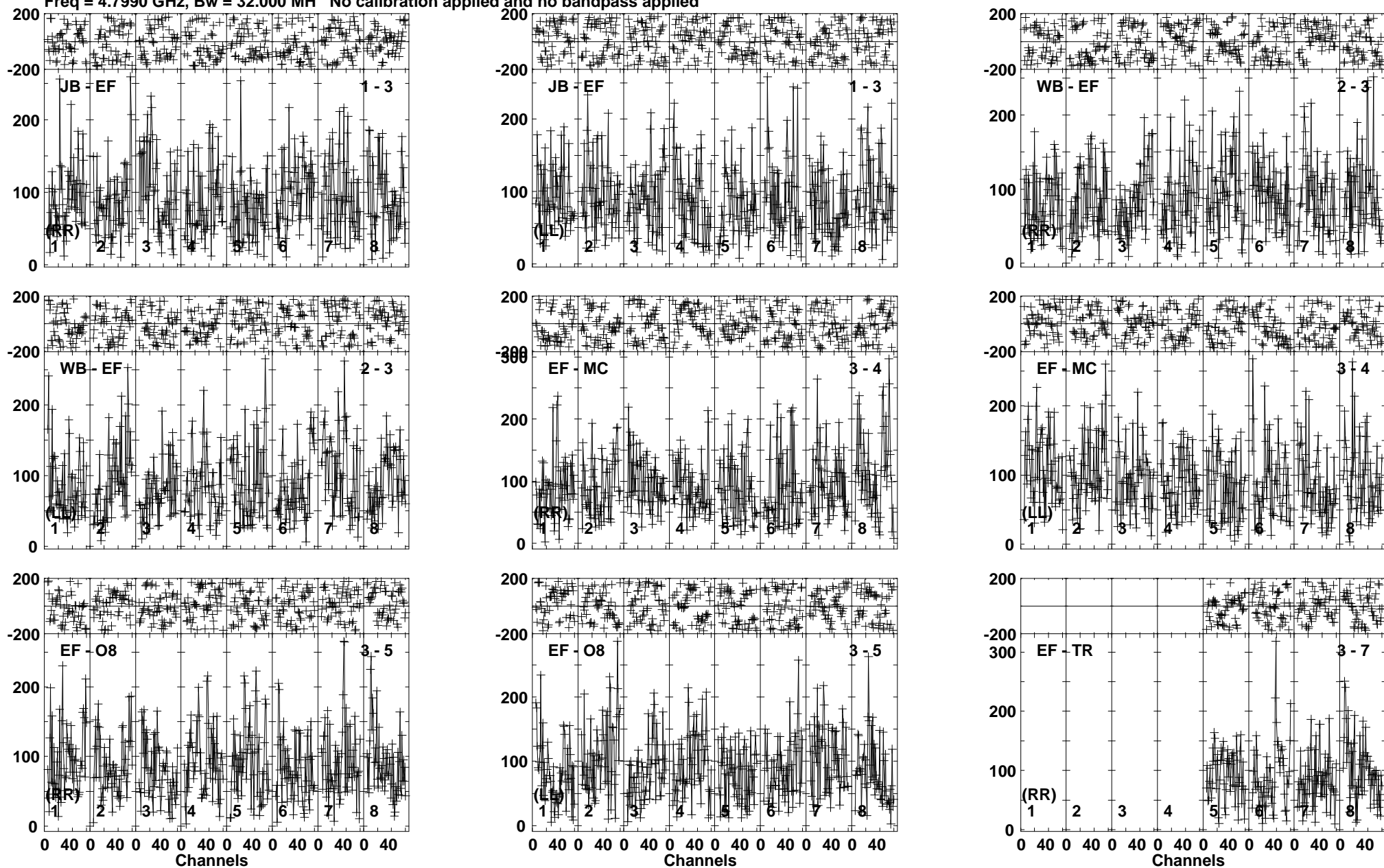

Lower frame: Micro Ampl Jy Top frame: Phas deg
Vector averaged cross-power spectrum Baseline: JB (01) - EF (03)
Timerange: 00/15:24:00 to 00/15:27:00

Plot file version 220 created 20-SEP-2019 15:52:23

AT2019EHZ RSM05.UVDATA.1

Freq = 4.7990 GHz, Bw = 32.000 MH No calibration applied and no bandpass applied

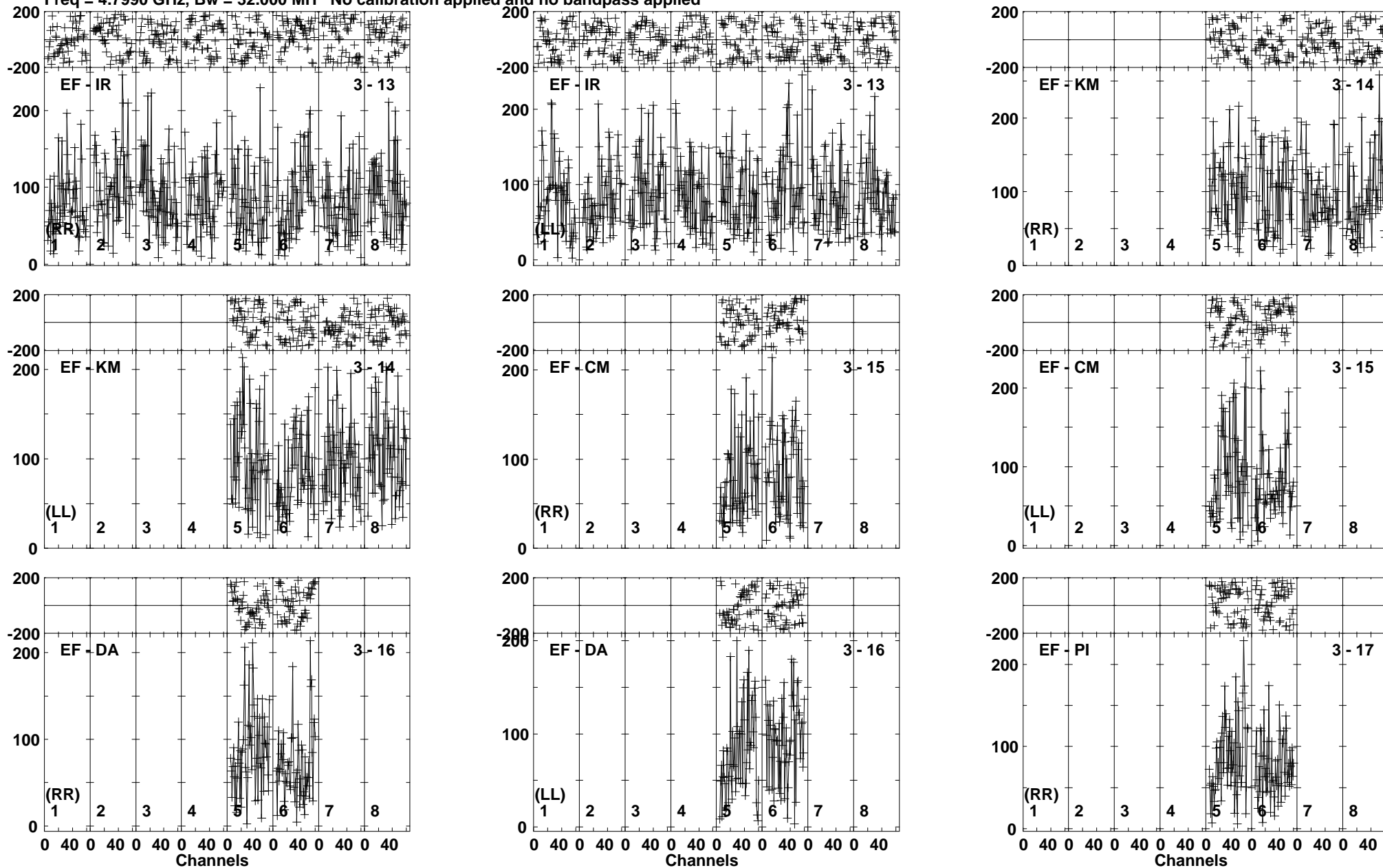

Lower frame: Micro Ampl Jy Top frame: Phas deg
Vector averaged cross-power spectrum Baseline: EF (03) - IR (13)
Timerange: 00/15:24:00 to 00/15:27:00

Plot file version 221 created 20-SEP-2019 15:52:24
AT2019EHZ RSM05.UVDATA.1
Freq = 4.7990 GHz, Bw = 32.000 MH No calibration applied and no bandpass applied

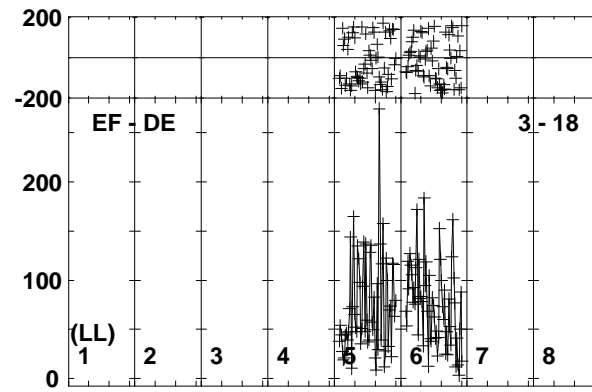
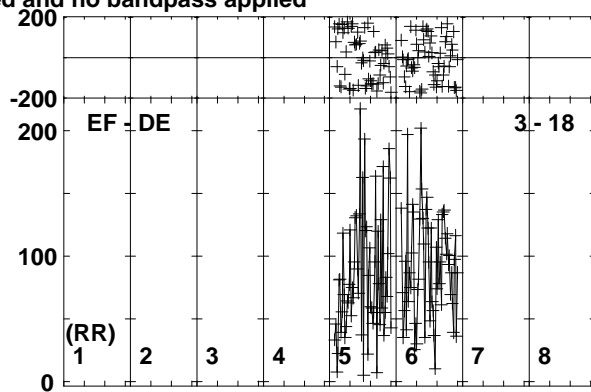
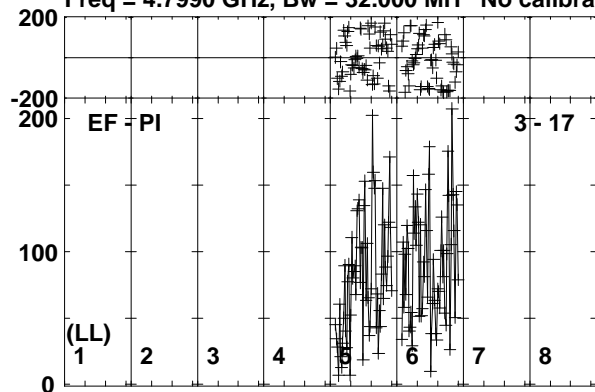

Lower frame: Micro Ampl Jy Top frame: Phas deg
Vector averaged cross-power spectrum Baseline: EF (03) - PI (17)
Timerange: 00/15:24:00 to 00/15:27:00

Plot file version 222 created 20-SEP-2019 15:52:24

J1408+5613 RSM05.UVDATA.1

Freq = 4.7990 GHz, Bw = 32.000 MH No calibration applied and no bandpass applied

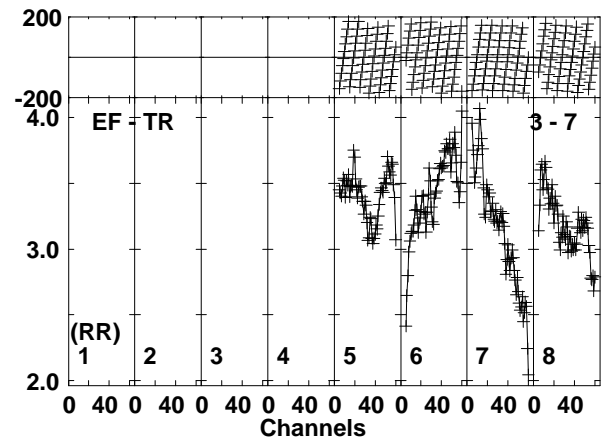
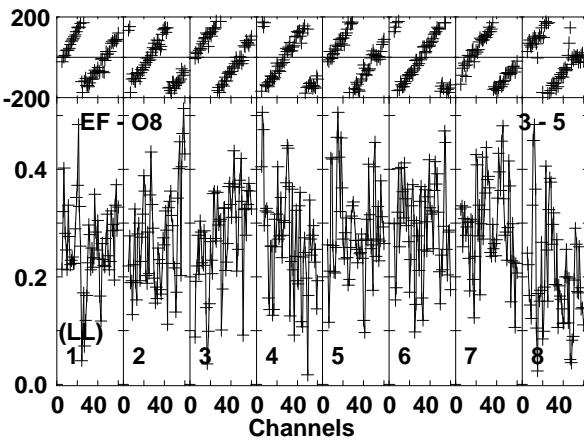
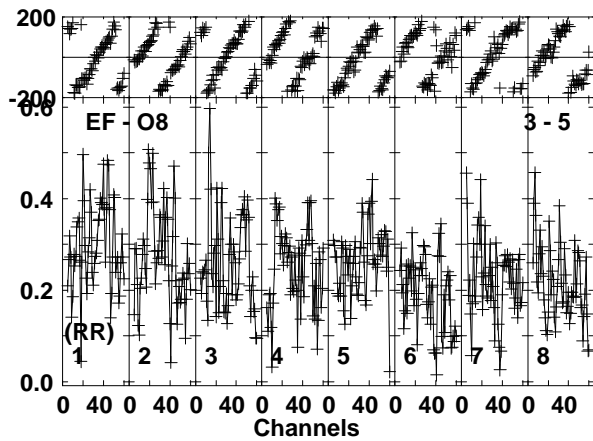
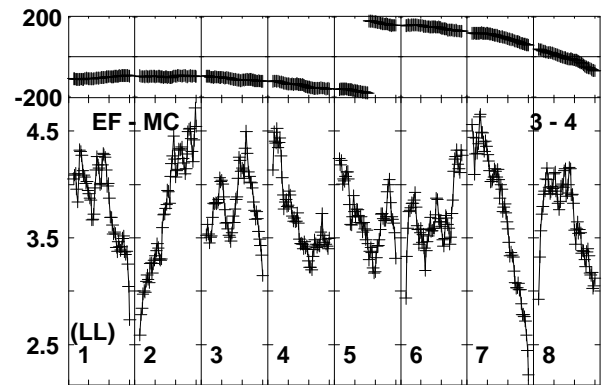
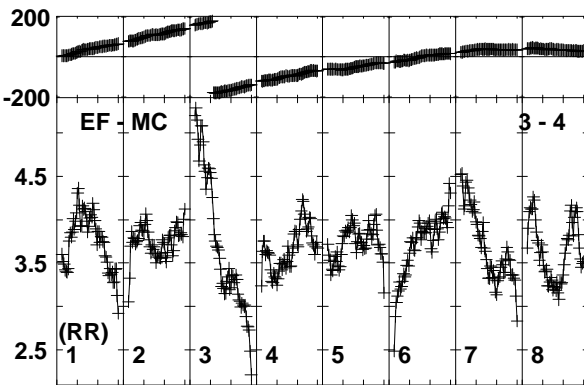
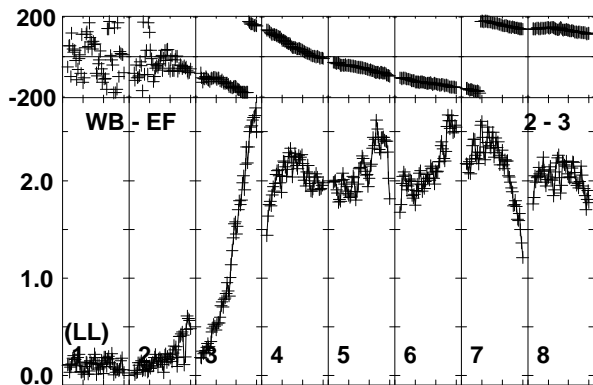
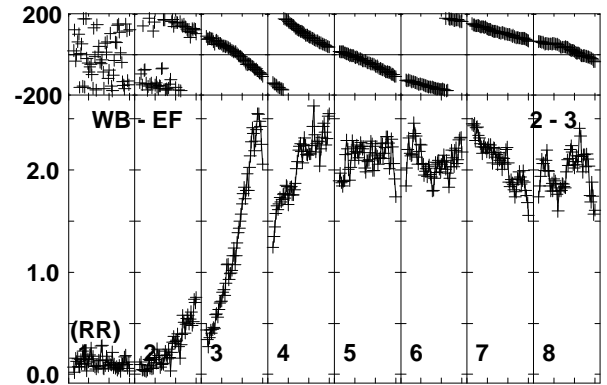
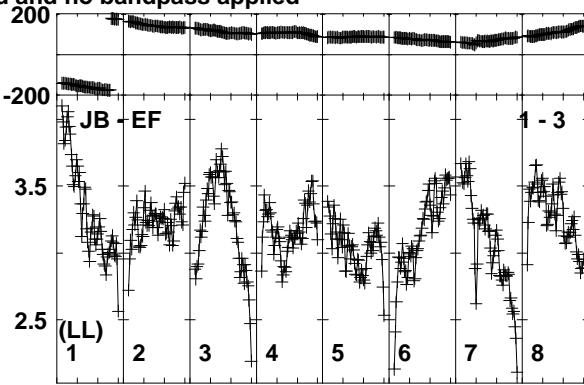
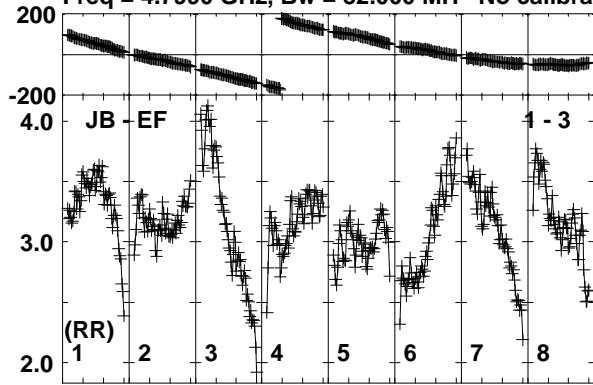

Lower frame: Milli Ampl Jy Top frame: Phas deg
Vector averaged cross-power spectrum Baseline: JB (01) - EF (03)
Timerange: 00/15:27:50 to 00/15:29:20

Plot file version 223 created 20-SEP-2019 15:52:25

J1408+5613 RSM05.UVDATA.1

Freq = 4.7990 GHz, Bw = 32.000 MH No calibration applied and no bandpass applied

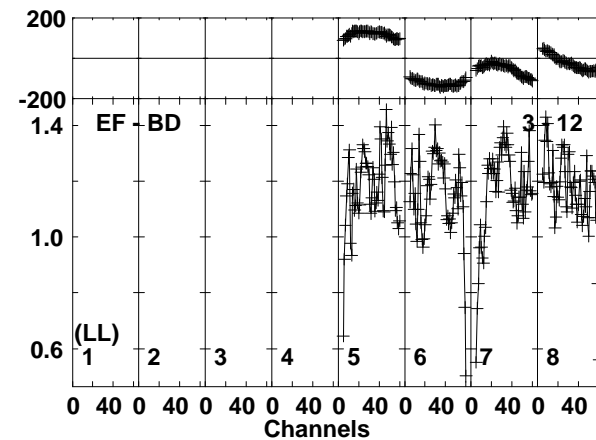
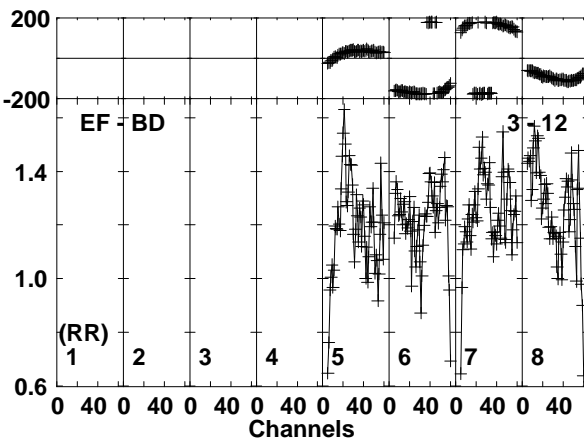
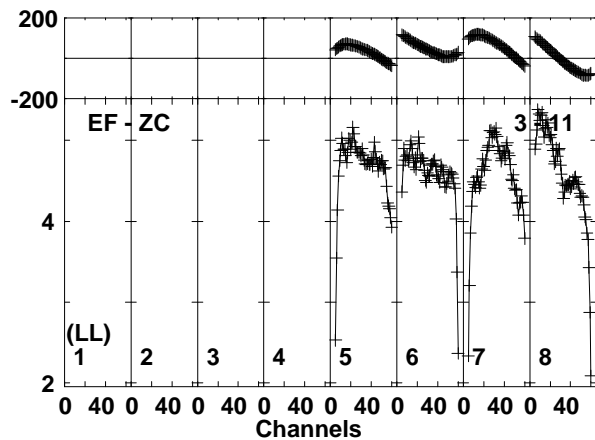
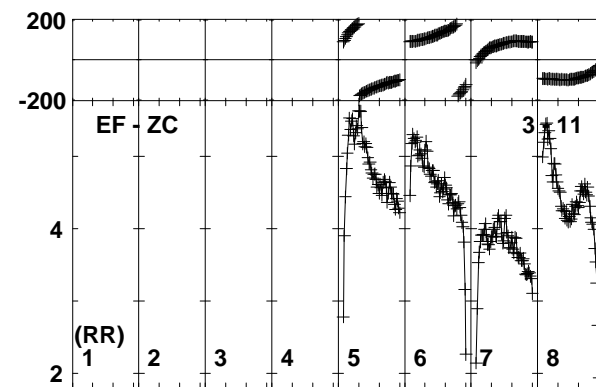
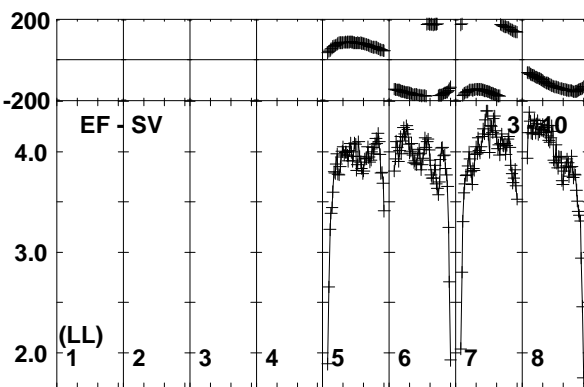
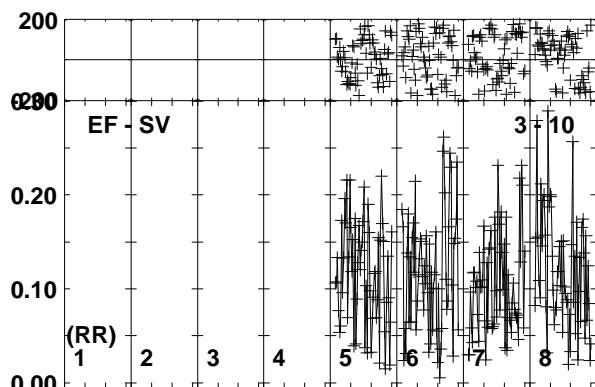
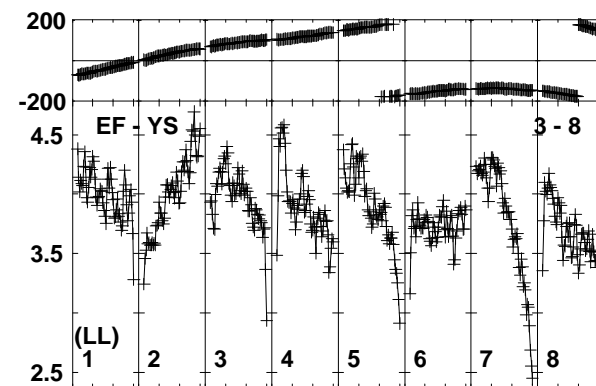
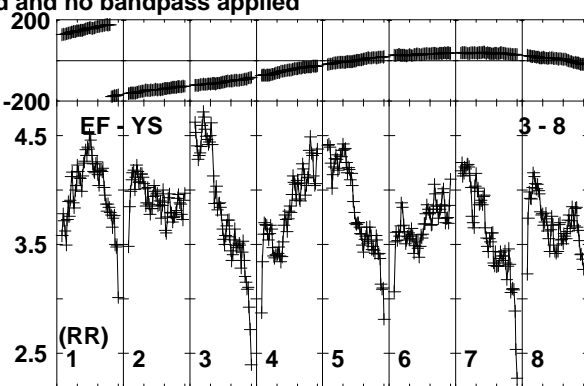
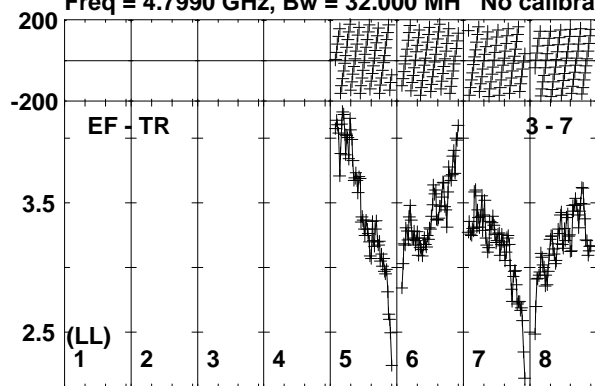

Lower frame: Milli Ampl Jy Top frame: Phas deg
Vector averaged cross-power spectrum Baseline: EF (03) - TR (07)
Timerange: 00/15:27:50 to 00/15:29:20

Plot file version 224 created 20-SEP-2019 15:52:25

J1408+5613 RSM05.UVDATA.1

Freq = 4.7990 GHz, Bw = 32.000 MH No calibration applied and no bandpass applied

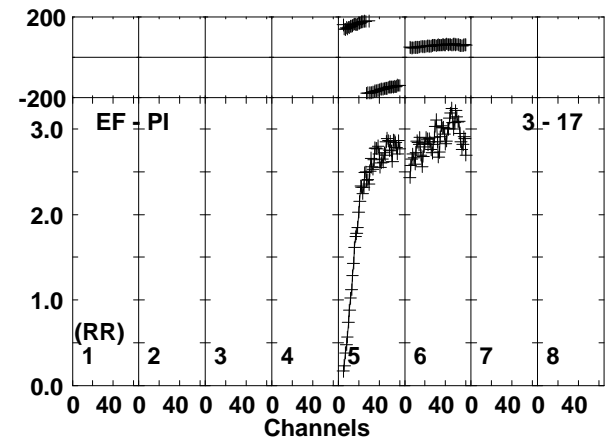
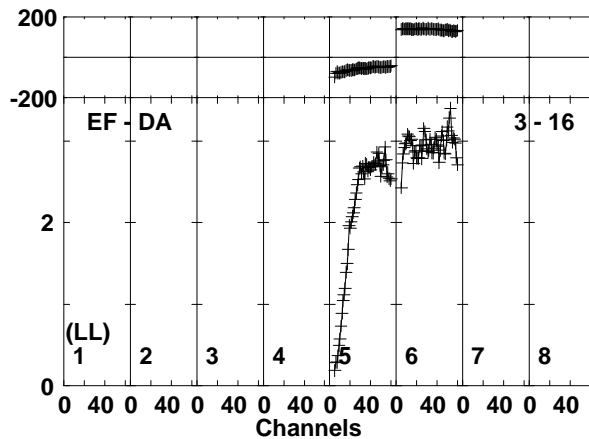
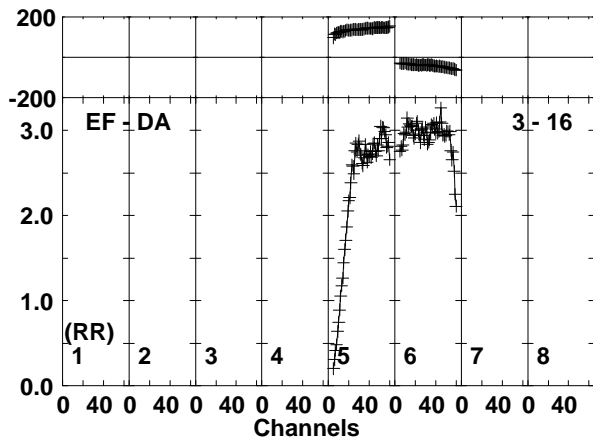
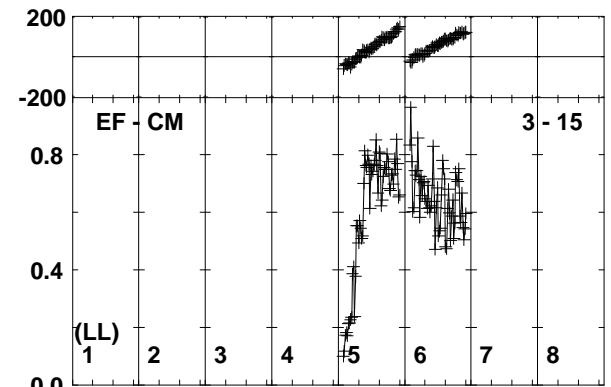
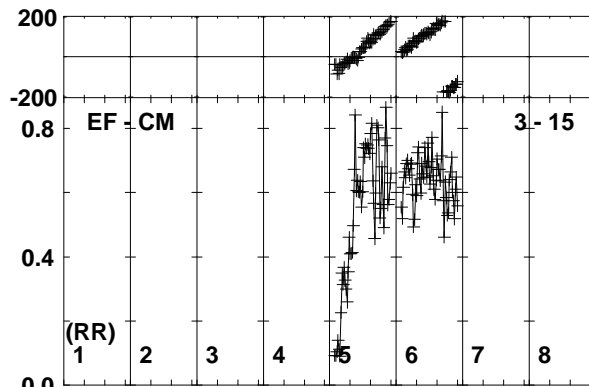
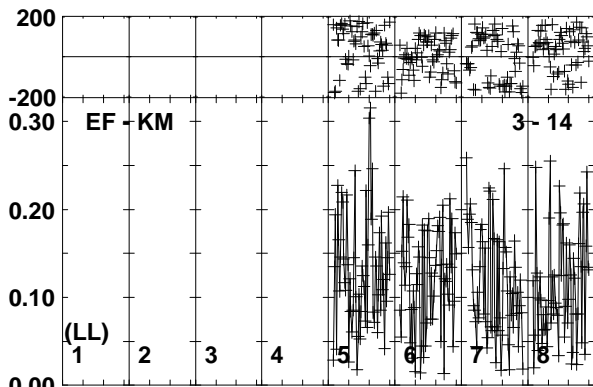
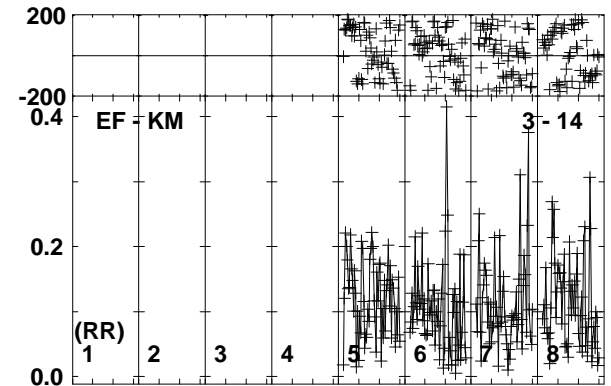
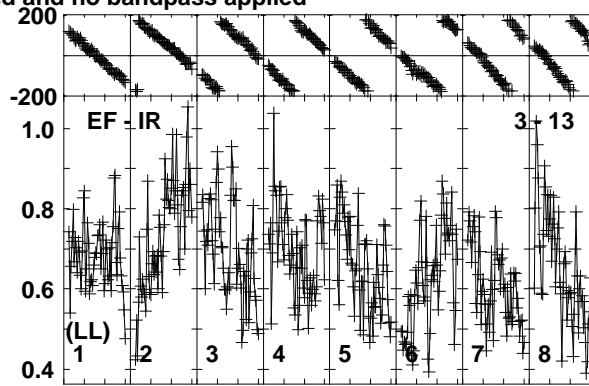
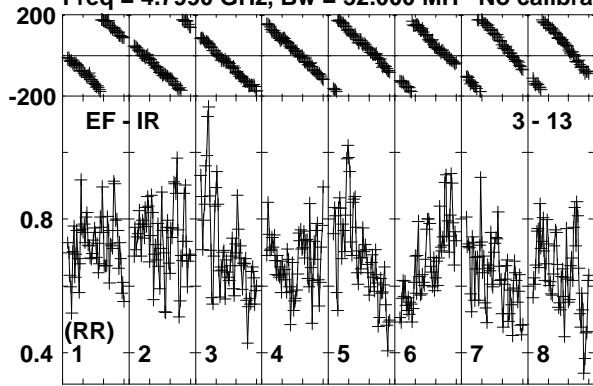

Lower frame: Milli Ampl Jy Top frame: Phas deg
Vector averaged cross-power spectrum Baseline: EF (03) - IR (13)
Timerange: 00/15:27:50 to 00/15:29:20

Plot file version 225 created 20-SEP-2019 15:52:26

J1408+5613 RSM05.UVDATA.1

Freq = 4.7990 GHz, Bw = 32.000 MH No calibration applied and no bandpass applied

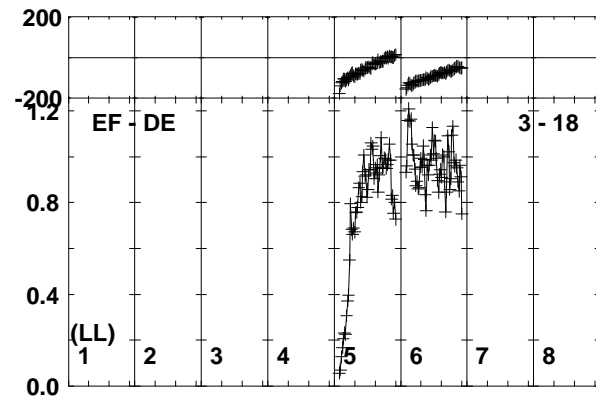
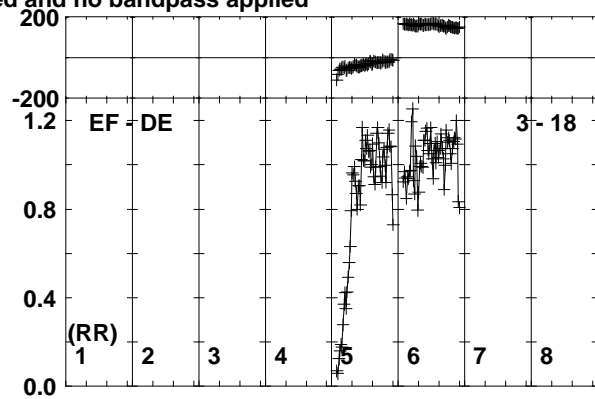
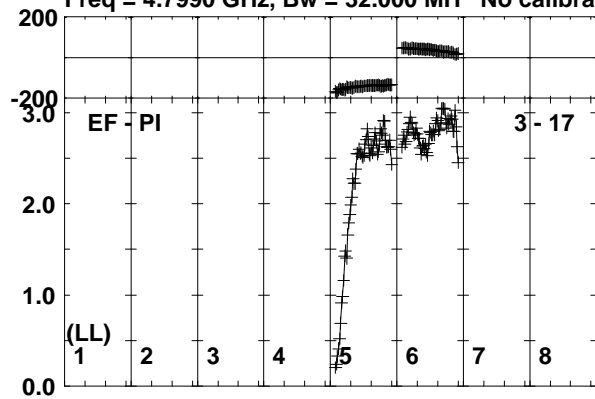

Lower frame: Milli Ampl Jy Top frame: Phas deg
Vector averaged cross-power spectrum Baseline: EF (03) - PI (17)
Timerange: 00/15:27:50 to 00/15:29:20

Plot file version 226 created 20-SEP-2019 15:52:26

AT2019EHZ RSM05.UVDATA.1

Freq = 4.7990 GHz, Bw = 32.000 MH No calibration applied and no bandpass applied

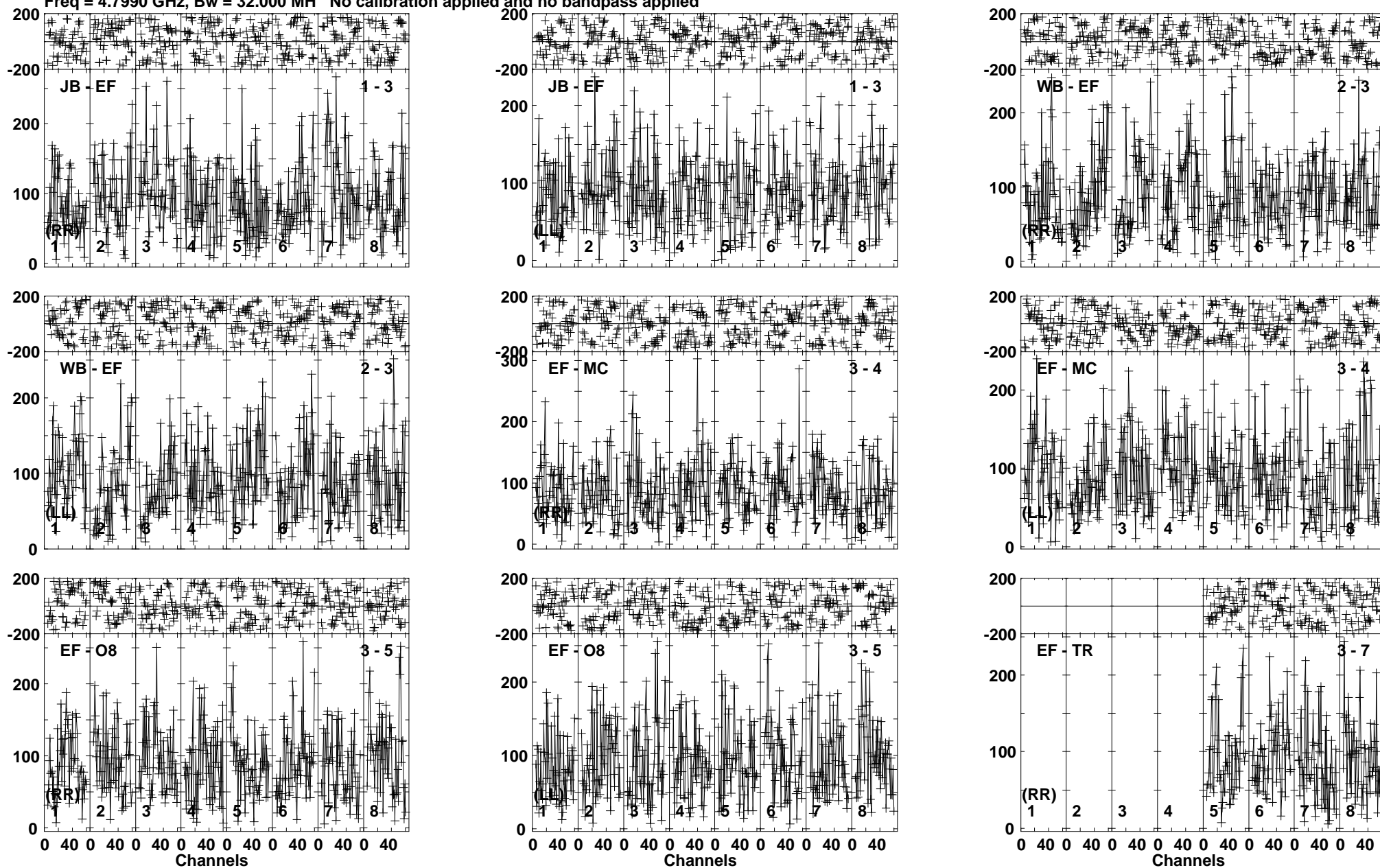

Lower frame: Micro Ampl Jy Top frame: Phas deg
Vector averaged cross-power spectrum Baseline: JB (01) - EF (03)
Timerange: 00/15:29:20 to 00/15:32:20

Plot file version 227 created 20-SEP-2019 15:52:26

AT2019EHZ RSM05.UVDATA.1

Freq = 4.7990 GHz, Bw = 32.000 MH No calibration applied and no bandpass applied

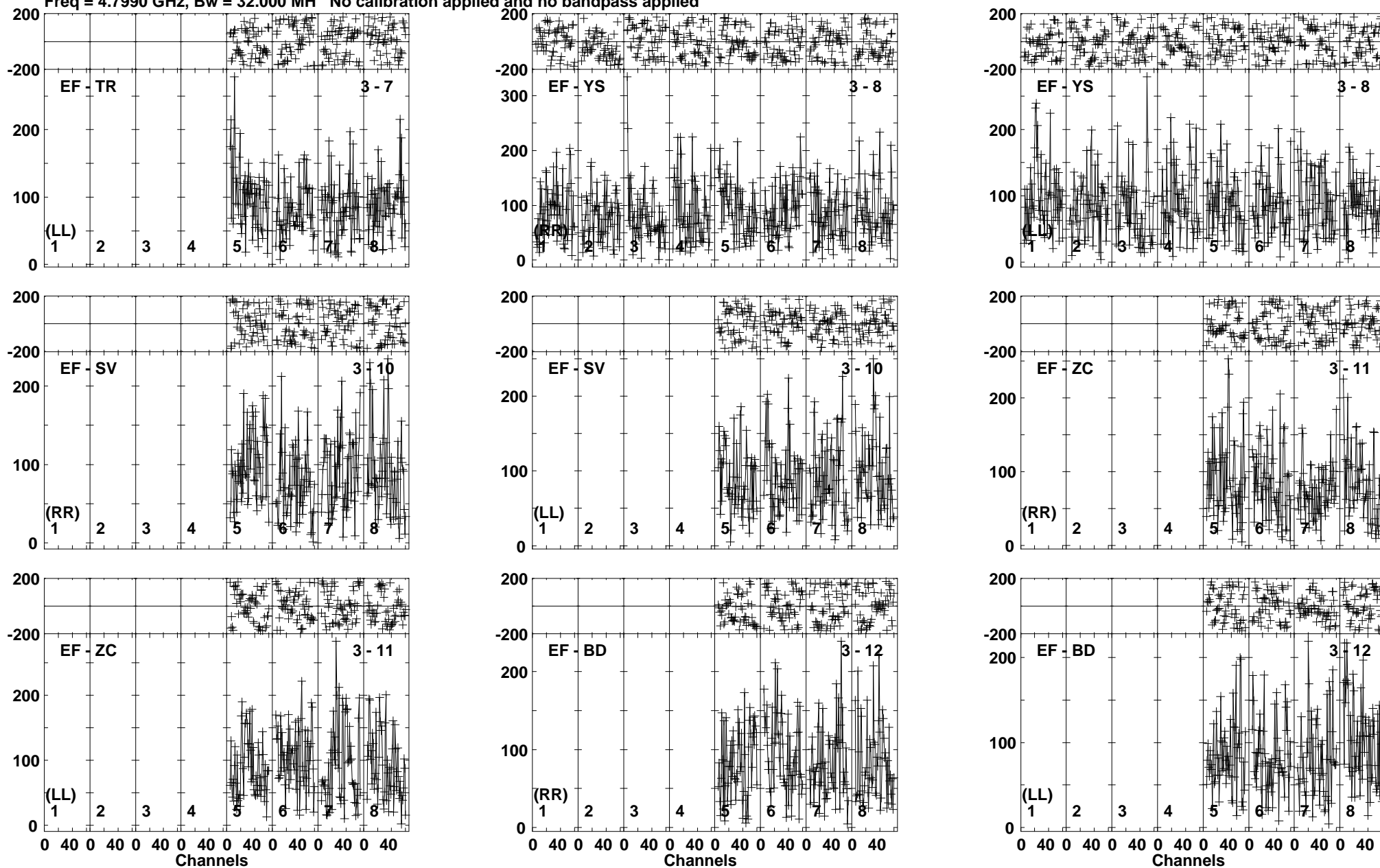

Lower frame: Micro Ampl Jy Top frame: Phas deg
Vector averaged cross-power spectrum Baseline: EF (03) - TR (07)
Timerange: 00/15:29:20 to 00/15:32:20

Plot file version 228 created 20-SEP-2019 15:52:27

AT2019EHZ RSM05.UVDATA.1

Freq = 4.7990 GHz, Bw = 32.000 MH No calibration applied and no bandpass applied

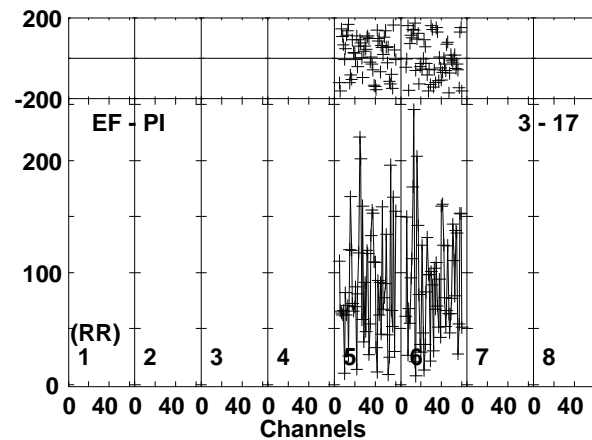
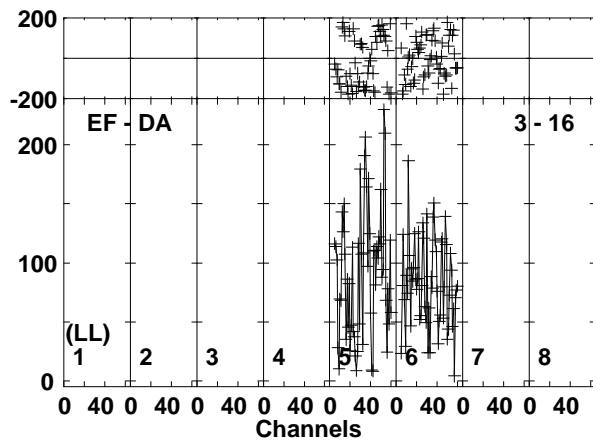
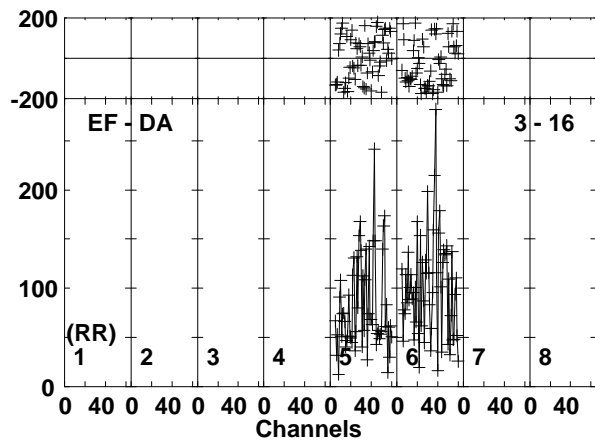
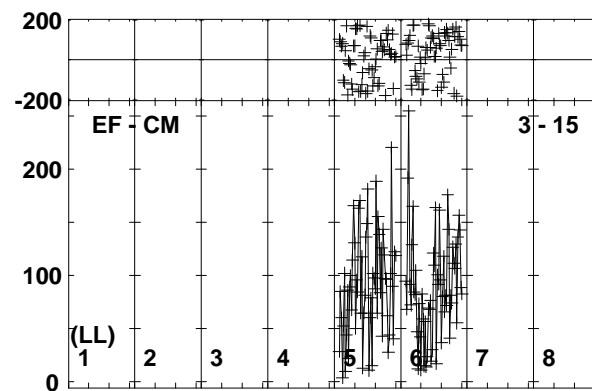
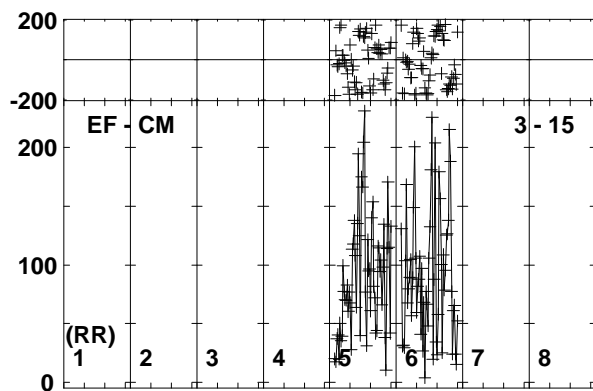
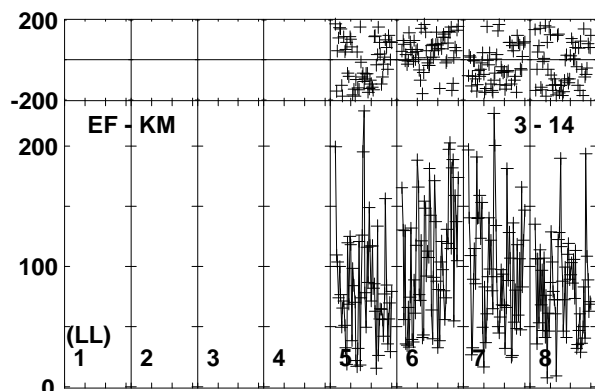
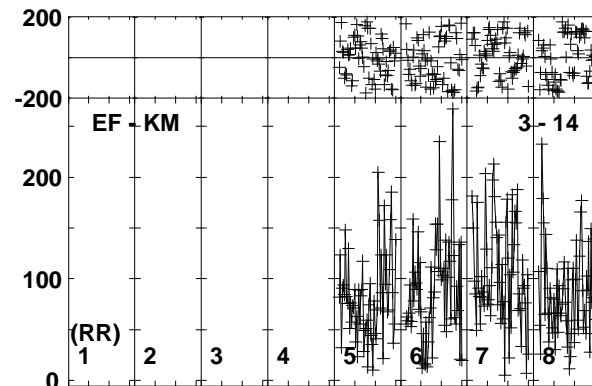
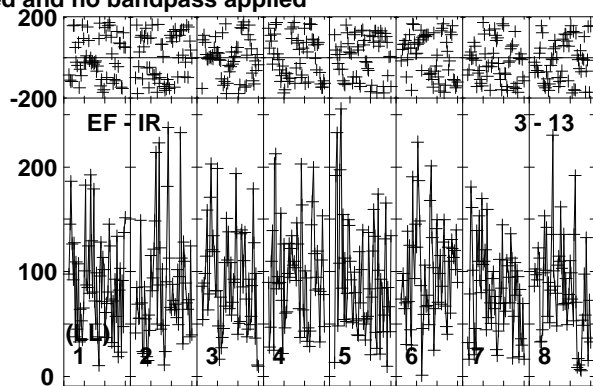
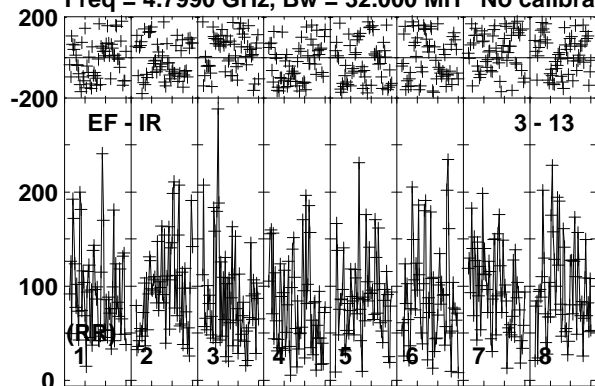

Lower frame: Micro Ampl Jy Top frame: Phas deg
Vector averaged cross-power spectrum Baseline: EF (03) - IR (13)
Timerange: 00/15:29:20 to 00/15:32:20

Plot file version 229 created 20-SEP-2019 15:52:28
AT2019EHZ RSM05.UVDATA.1
Freq = 4.7990 GHz, Bw = 32.000 MH No calibration applied and no bandpass applied

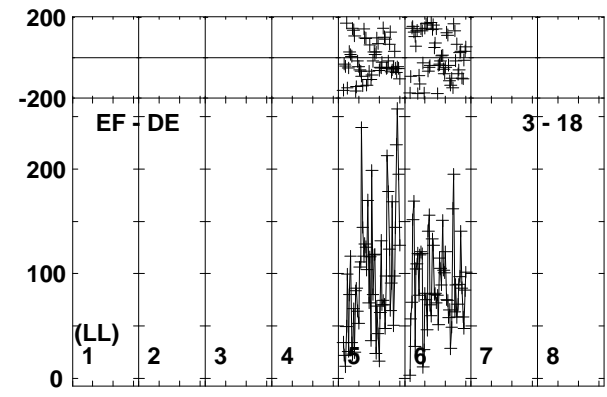
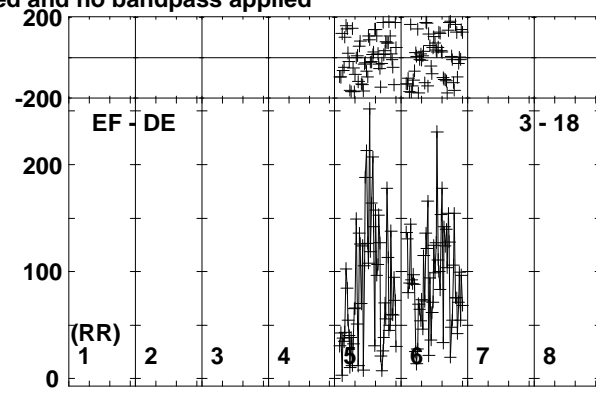
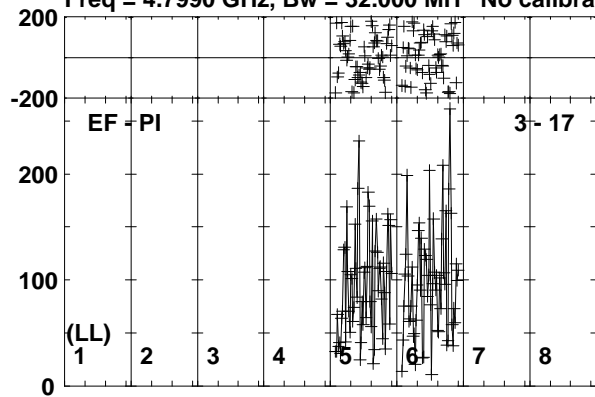

Lower frame: Micro Ampl Jy Top frame: Phas deg
Vector averaged cross-power spectrum Baseline: EF (03) - PI (17)
Timerange: 00/15:29:20 to 00/15:32:20

Plot file version 230 created 20-SEP-2019 15:52:28

J1408+5613 RSM05.UVDATA.1

Freq = 4.7990 GHz, Bw = 32.000 MH No calibration applied and no bandpass applied

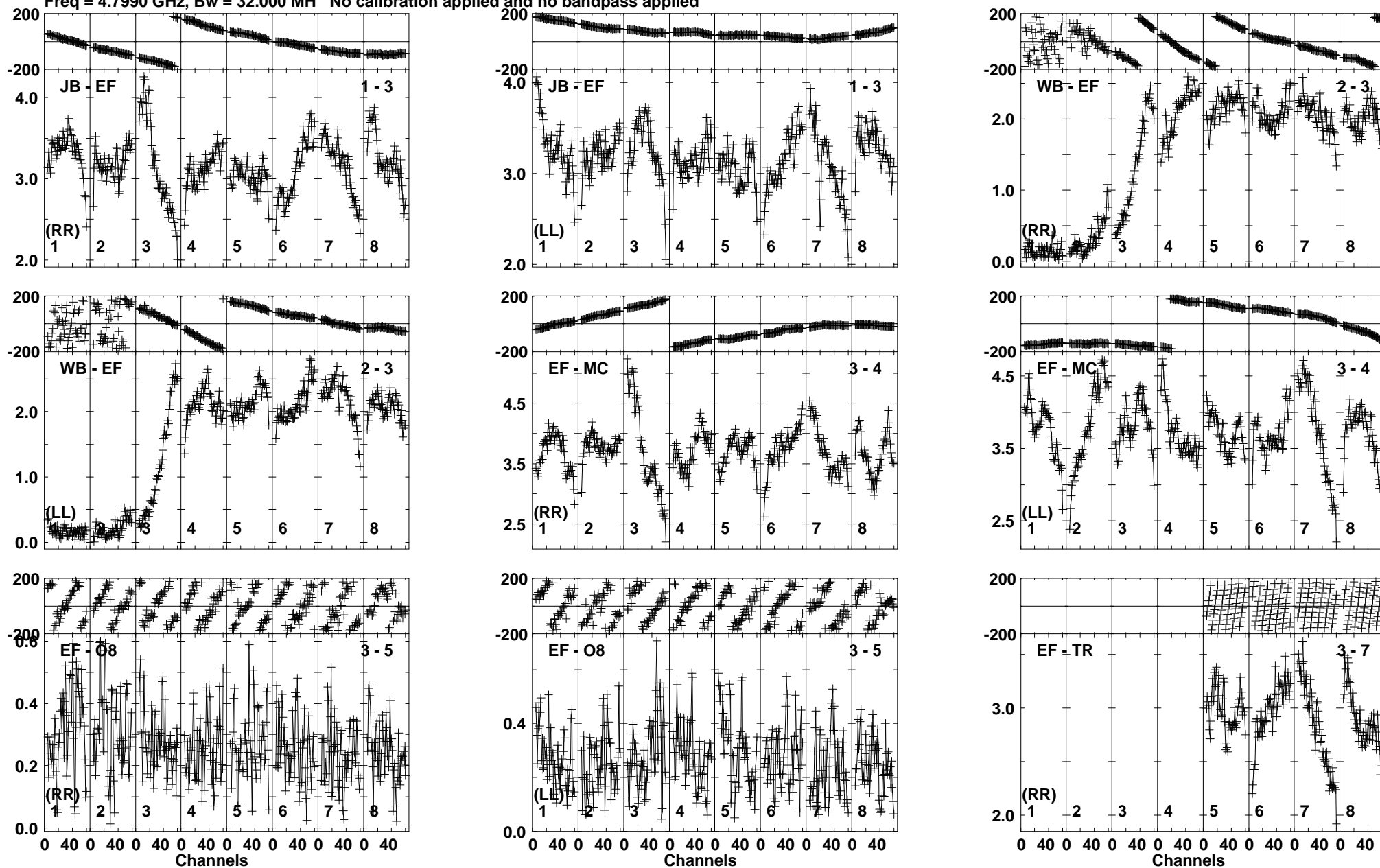

Lower frame: Milli Ampl Jy Top frame: Phas deg
Vector averaged cross-power spectrum Baseline: JB (01) - EF (03)
Timerange: 00/15:32:21 to 00/15:33:50

Plot file version 231 created 20-SEP-2019 15:52:28

J1408+5613 RSM05.UVDATA.1

Freq = 4.7990 GHz, Bw = 32.000 MH No calibration applied and no bandpass applied

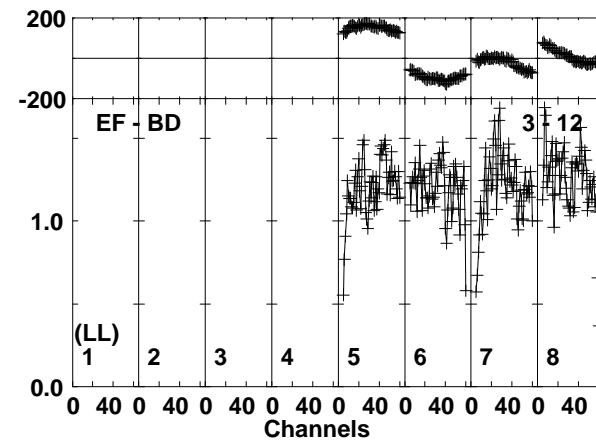
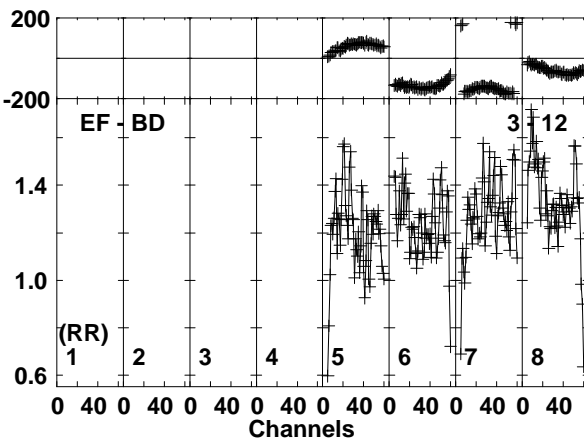
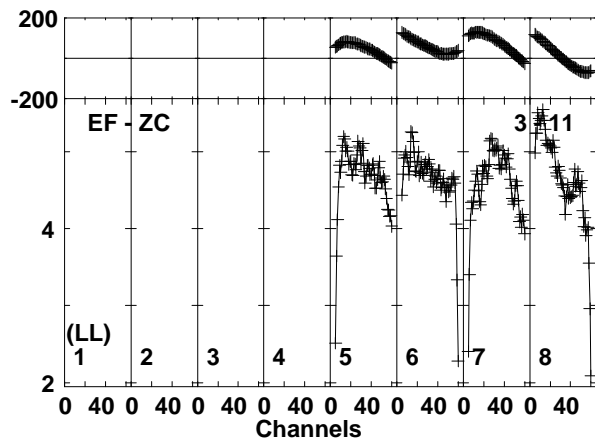
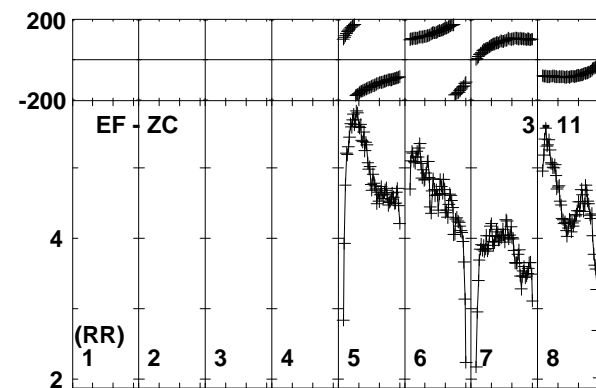
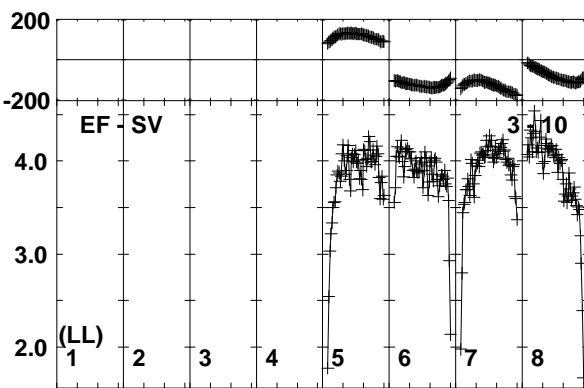
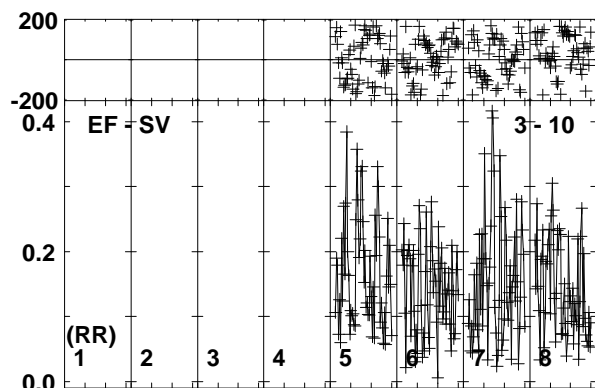
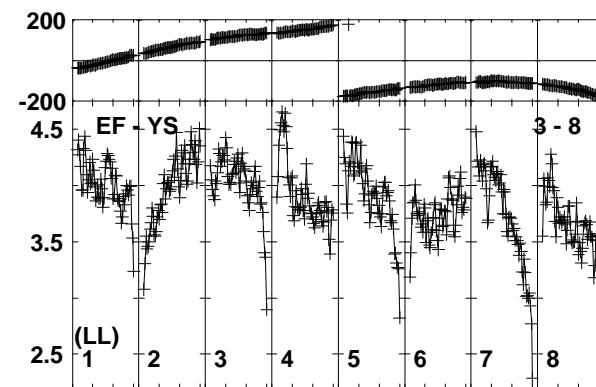
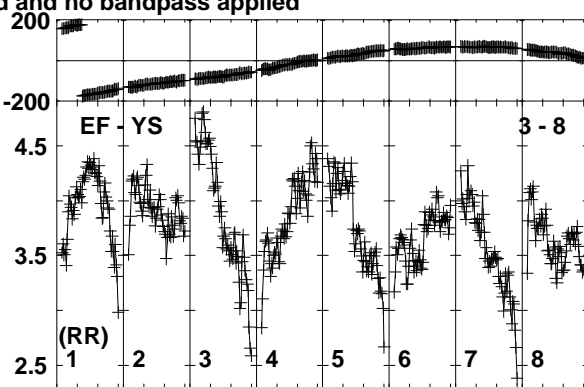
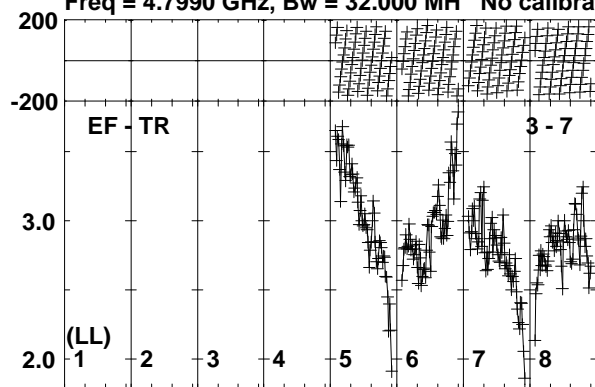

Lower frame: Milli Ampl Jy Top frame: Phas deg
Vector averaged cross-power spectrum Baseline: EF (03) - TR (07)
Timerange: 00/15:32:21 to 00/15:33:50

Plot file version 232 created 20-SEP-2019 15:52:29

J1408+5613 RSM05.UVDATA.1

Freq = 4.7990 GHz, Bw = 32.000 MH No calibration applied and no bandpass applied

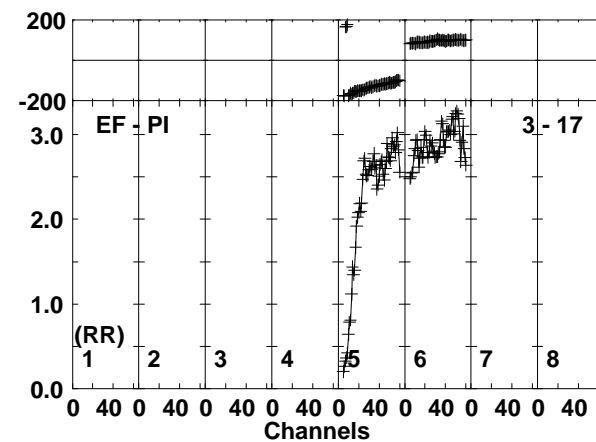
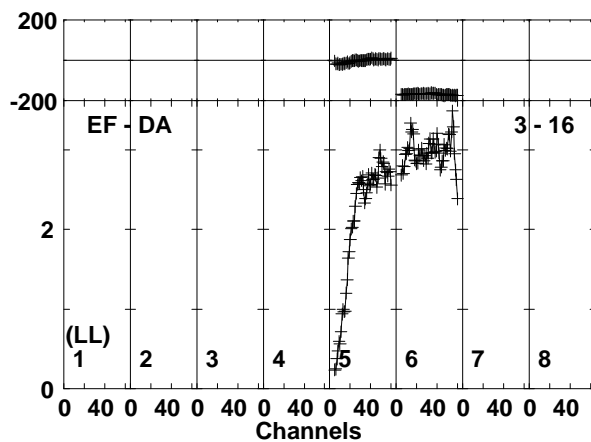
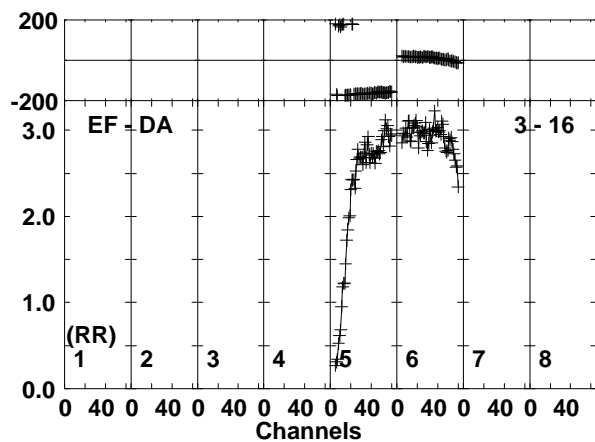
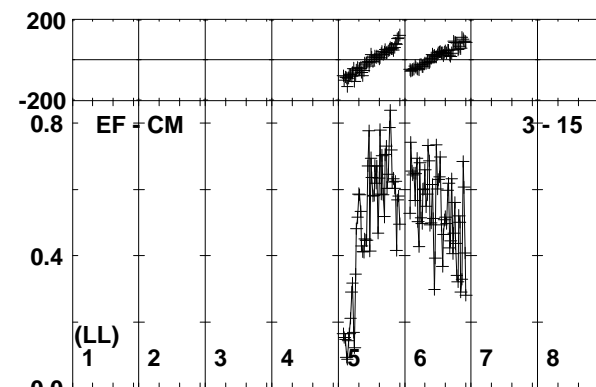
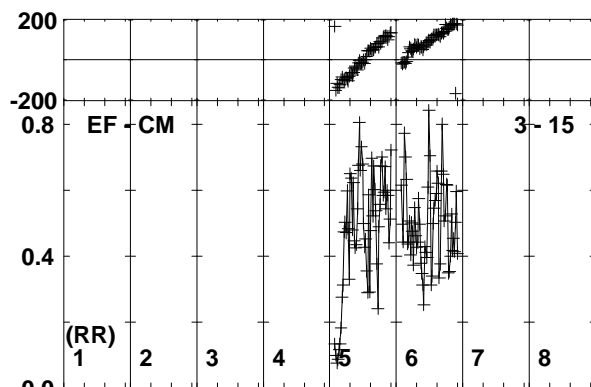
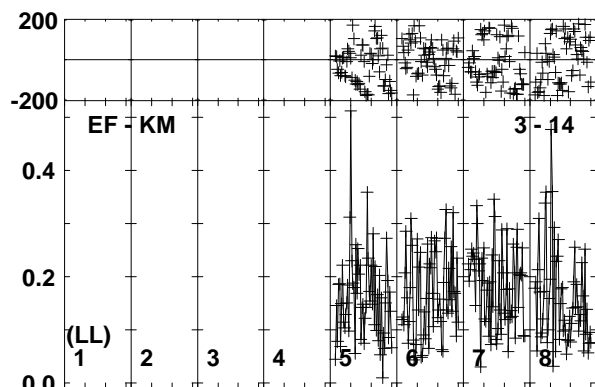
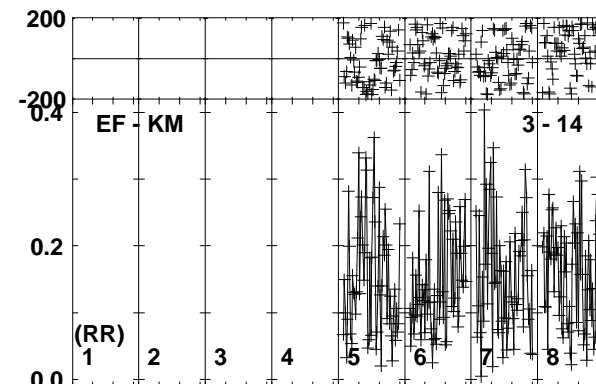
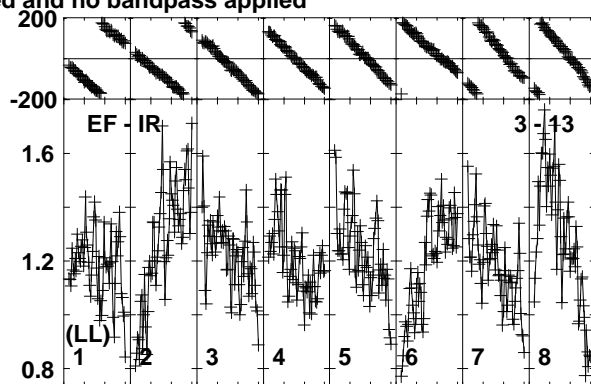
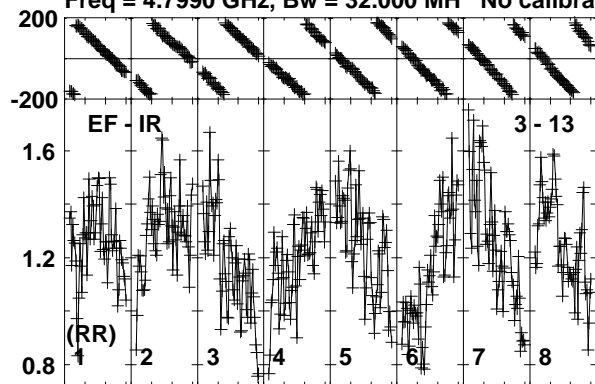

Lower frame: Milli Ampl Jy Top frame: Phas deg
Vector averaged cross-power spectrum Baseline: EF (03) - IR (13)
Timerange: 00/15:32:21 to 00/15:33:50

Plot file version 233 created 20-SEP-2019 15:52:29

J1408+5613 RSM05.UVDATA.1

Freq = 4.7990 GHz, Bw = 32.000 MH No calibration applied and no bandpass applied

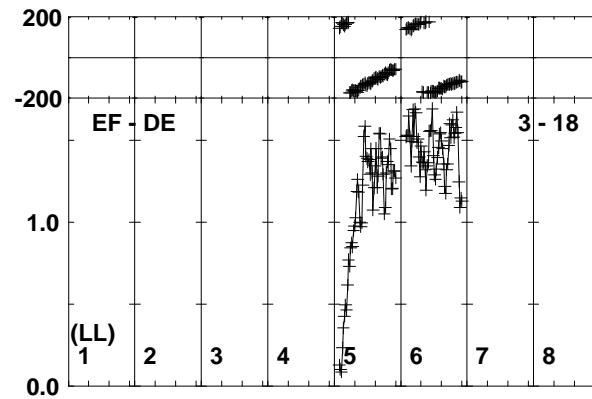
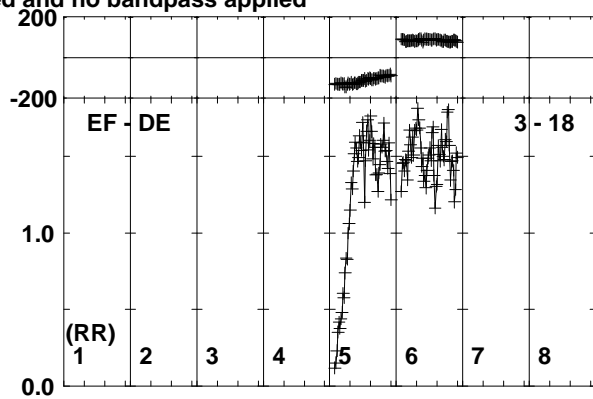
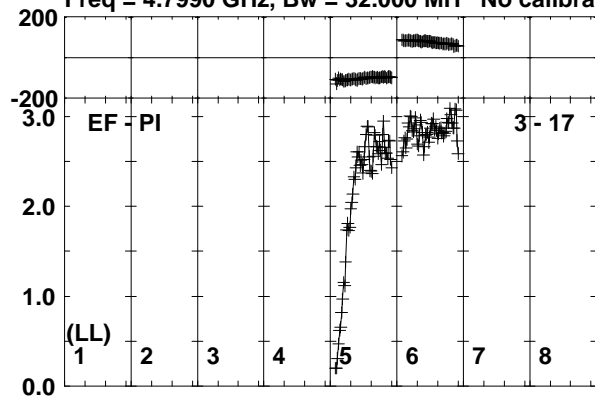

Lower frame: Milli Ampl Jy Top frame: Phas deg
Vector averaged cross-power spectrum Baseline: EF (03) - PI (17)
Timerange: 00/15:32:21 to 00/15:33:50

Plot file version 234 created 20-SEP-2019 15:52:29

AT2019EHZ RSM05.UVDATA.1

Freq = 4.7990 GHz, Bw = 32.000 MH No calibration applied and no bandpass applied

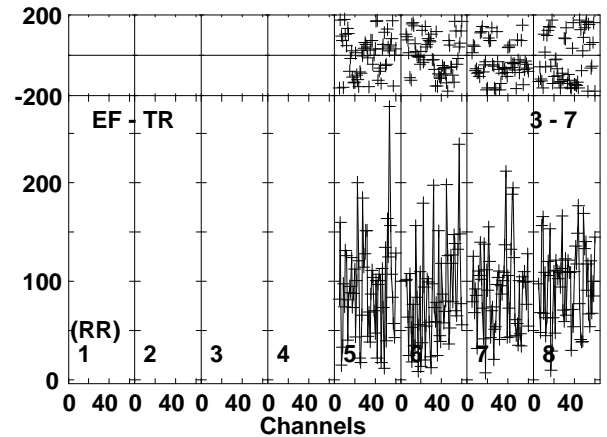
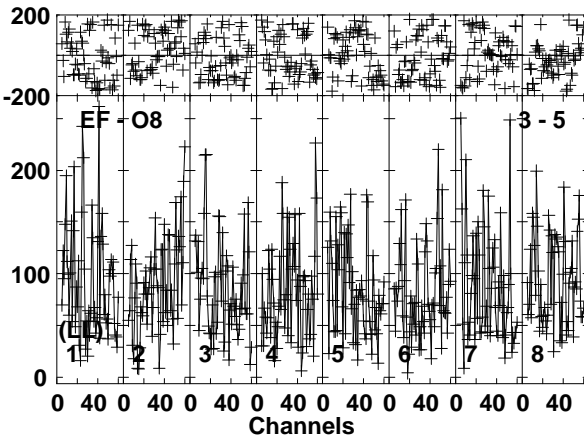
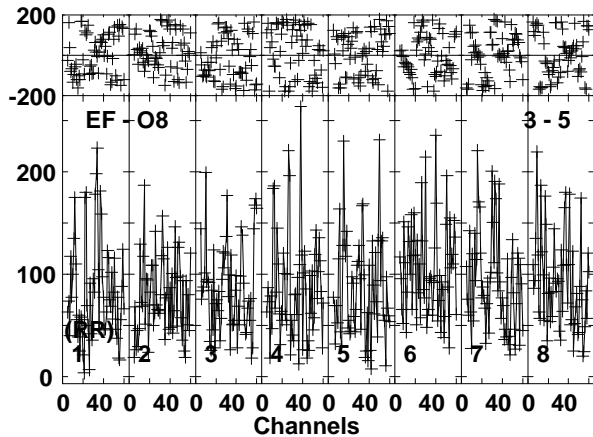
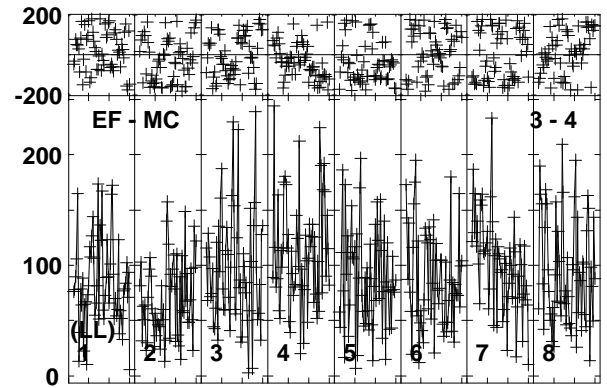
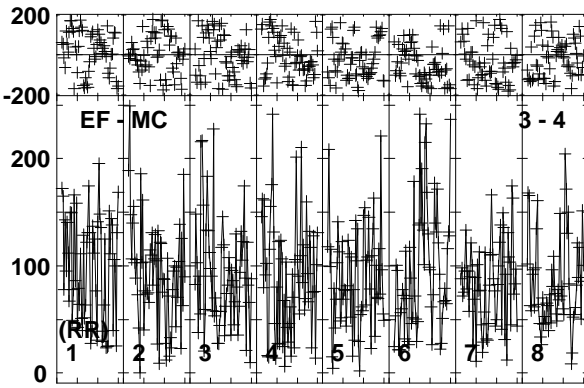
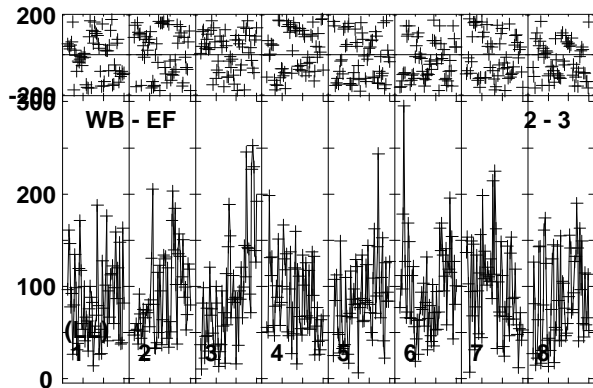
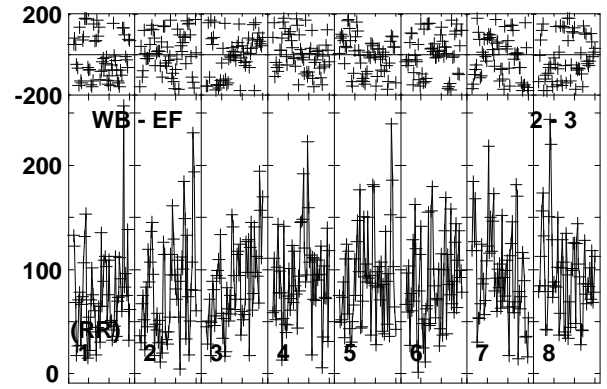
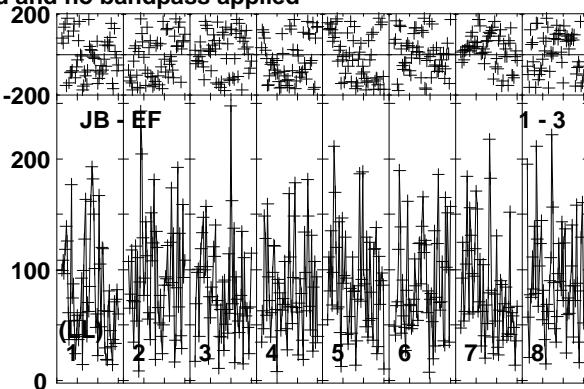
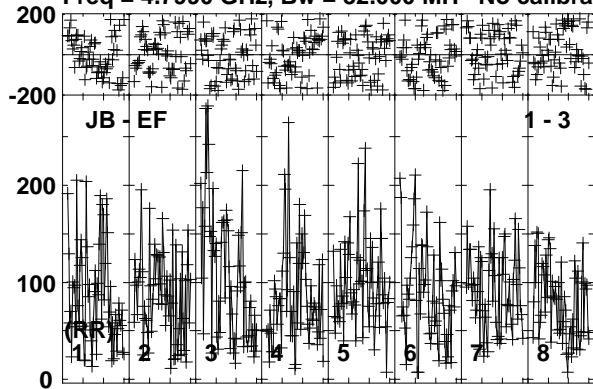

Lower frame: Micro Ampl Jy Top frame: Phas deg
Vector averaged cross-power spectrum Baseline: JB (01) - EF (03)
Timerange: 00/15:33:51 to 00/15:36:49

Plot file version 235 created 20-SEP-2019 15:52:30

AT2019EHZ RSM05.UVDATA.1

Freq = 4.7990 GHz, Bw = 32.000 MH No calibration applied and no bandpass applied

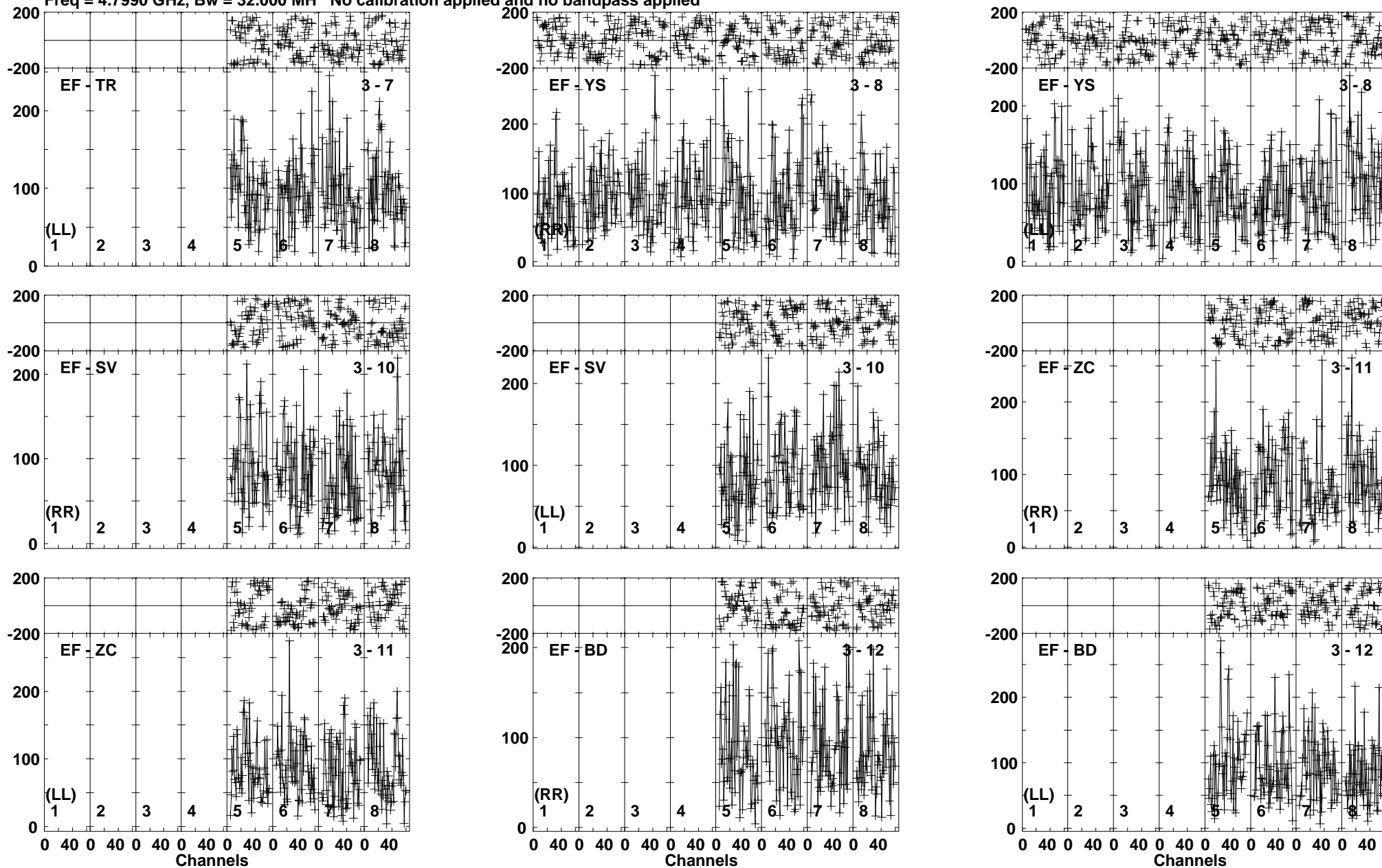

Lower frame: Micro Ampl Jy Top frame: Phas deg
Vector averaged cross-power spectrum Baseline: EF (03) - TR (07)
Timerange: 00/15:33:51 to 00/15:36:49

Plot file version 236 created 20-SEP-2019 15:52:31

AT2019EHZ RSM05.UVDATA.1

Freq = 4.7990 GHz, Bw = 32.000 MH No calibration applied and no bandpass applied

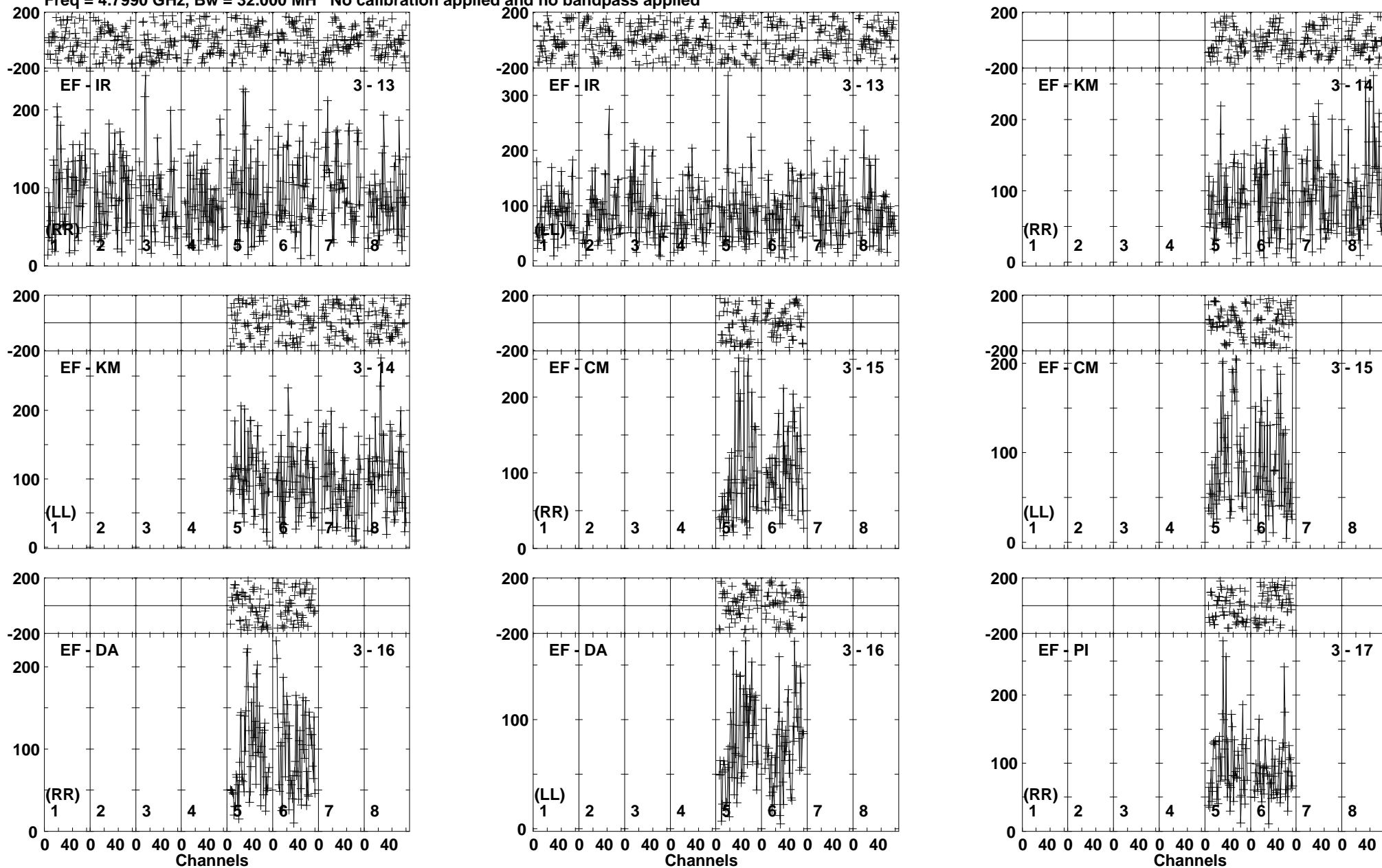

Lower frame: Micro Ampl Jy Top frame: Phas deg
Vector averaged cross-power spectrum Baseline: EF (03) - IR (13)
Timerange: 00/15:33:51 to 00/15:36:49

Plot file version 237 created 20-SEP-2019 15:52:31
AT2019EHZ RSM05.UVDATA.1
Freq = 4.7990 GHz, Bw = 32.000 MH No calibration applied and no bandpass applied

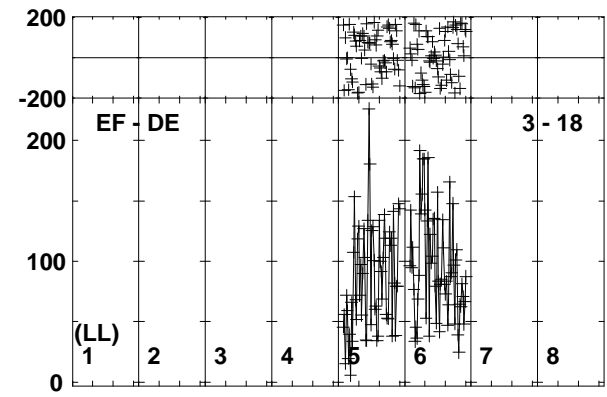
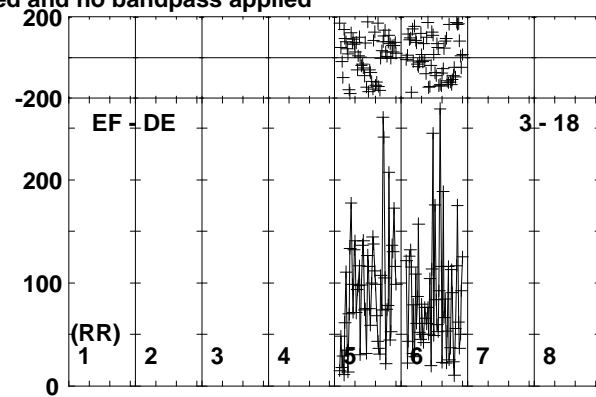
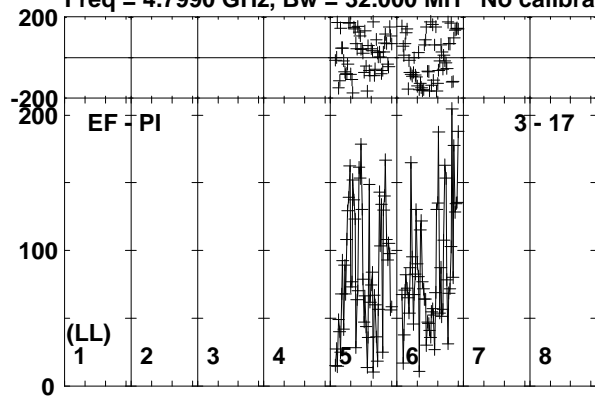

Lower frame: Micro Ampl Jy Top frame: Phas deg
Vector averaged cross-power spectrum Baseline: EF (03) - PI (17)
Timerange: 00/15:33:51 to 00/15:36:49

Plot file version 238 created 20-SEP-2019 15:52:31

J1408+5613 RSM05.UVDATA.1

Freq = 4.7990 GHz, Bw = 32.000 MH No calibration applied and no bandpass applied

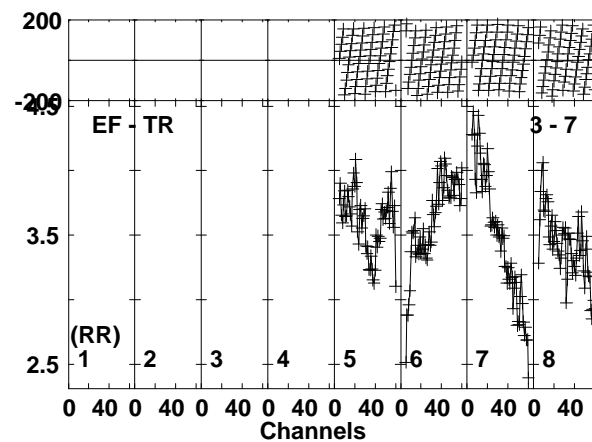
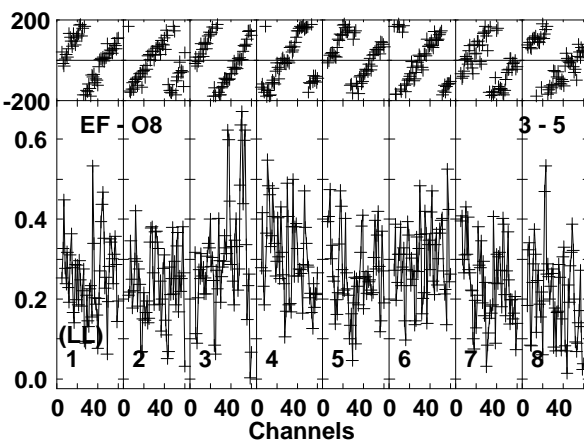
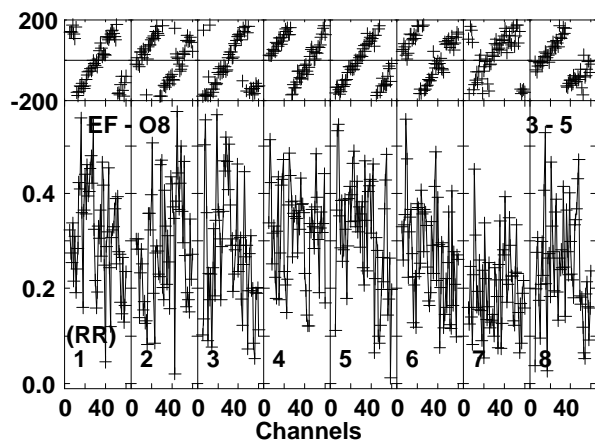
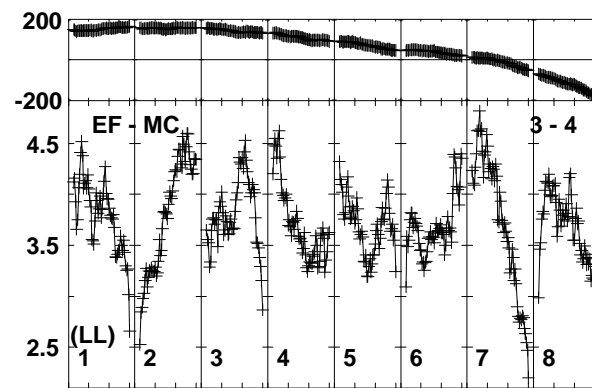
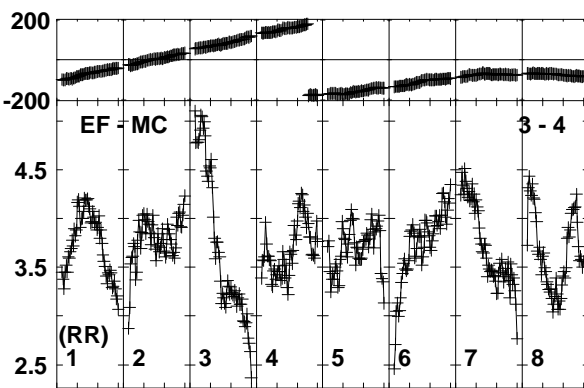
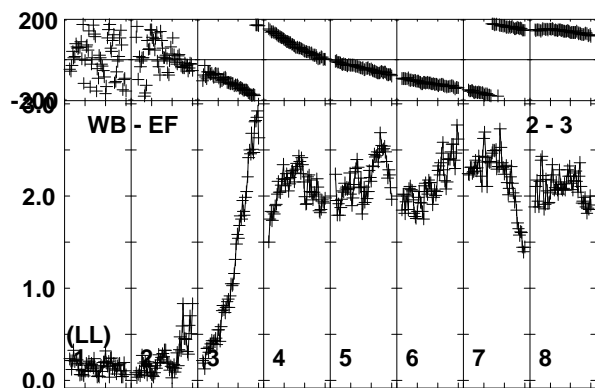
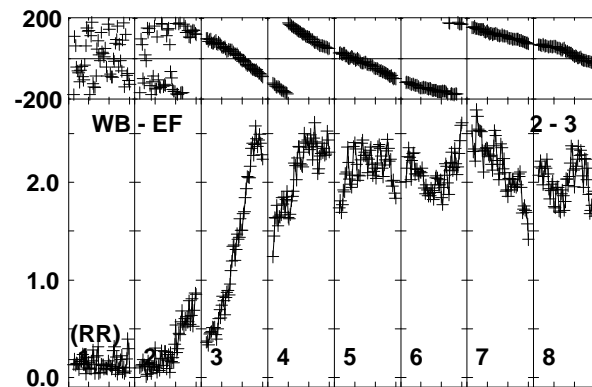
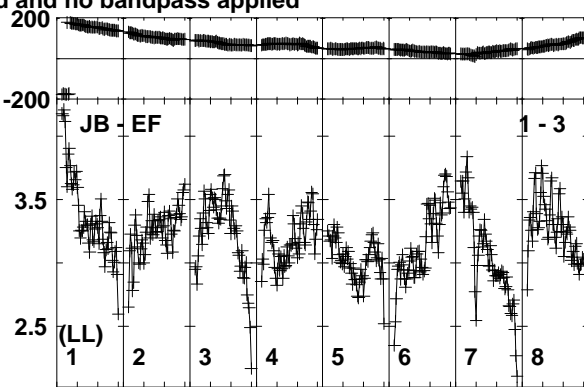
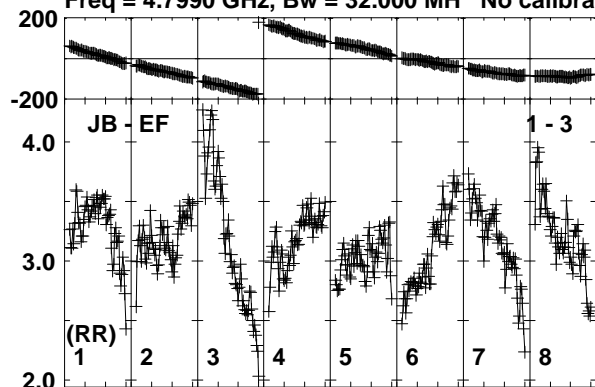

Lower frame: Milli Ampl Jy Top frame: Phas deg
Vector averaged cross-power spectrum Baseline: JB (01) - EF (03)
Timerange: 00/15:36:51 to 00/15:38:20

Plot file version 239 created 20-SEP-2019 15:52:32

J1408+5613 RSM05.UVDATA.1

Freq = 4.7990 GHz, Bw = 32.000 MH No calibration applied and no bandpass applied

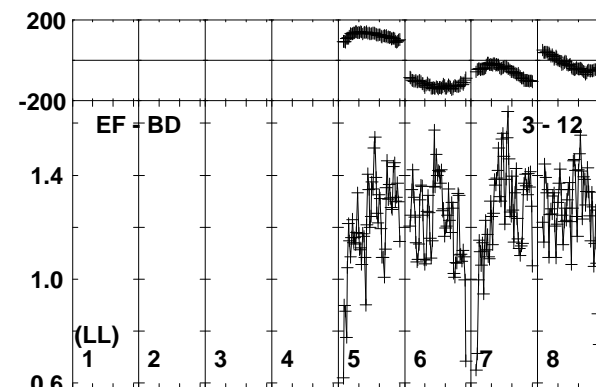
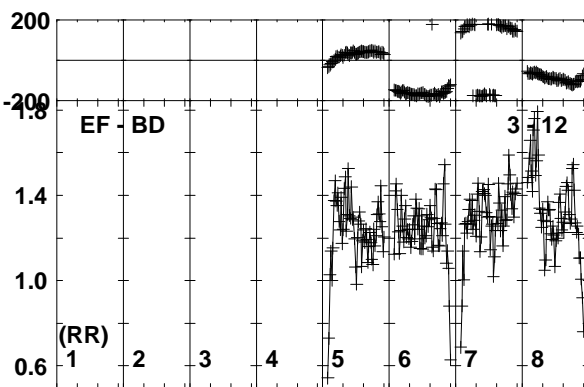
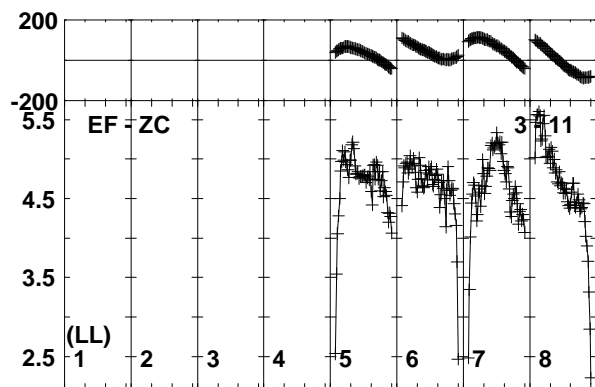
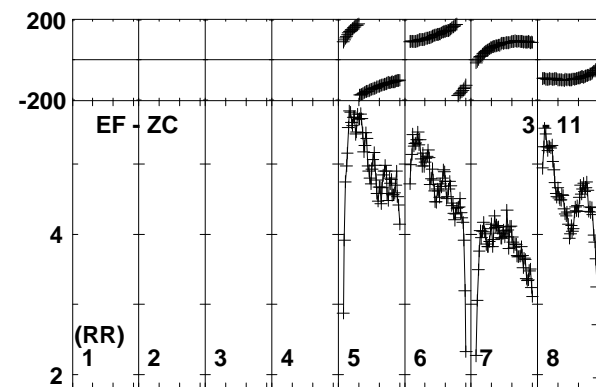
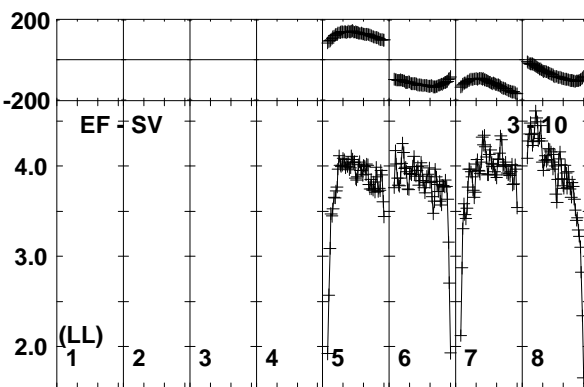
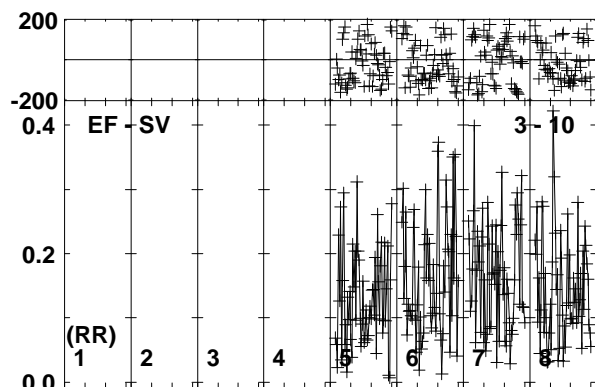
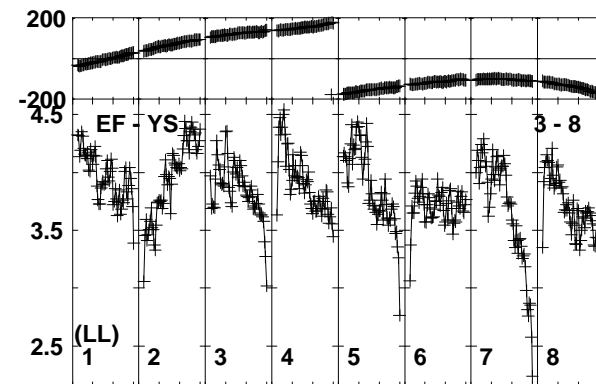
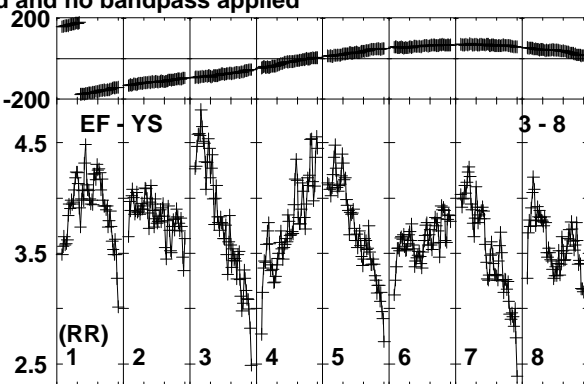
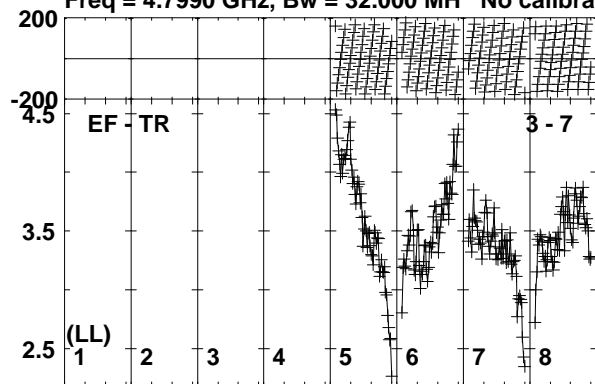

Lower frame: Milli Ampl Jy Top frame: Phas deg
Vector averaged cross-power spectrum Baseline: EF (03) - TR (07)
Timerange: 00/15:36:51 to 00/15:38:20

Plot file version 240 created 20-SEP-2019 15:52:32

J1408+5613 RSM05.UVDATA.1

Freq = 4.7990 GHz, Bw = 32.000 MH No calibration applied and no bandpass applied

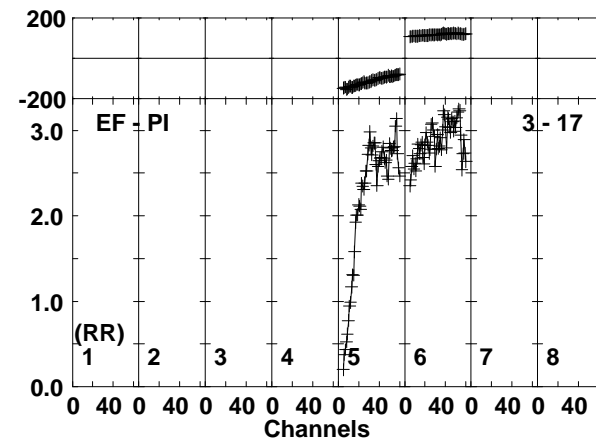
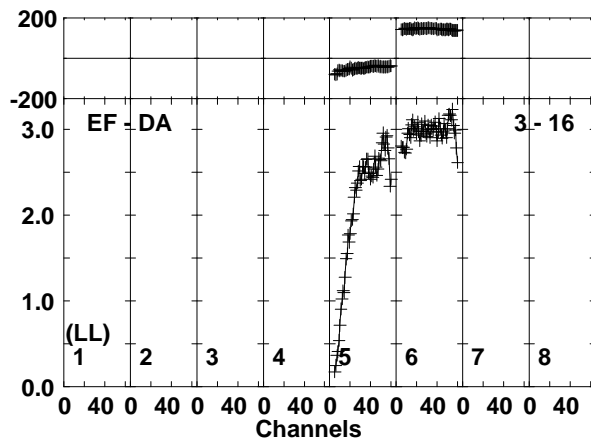
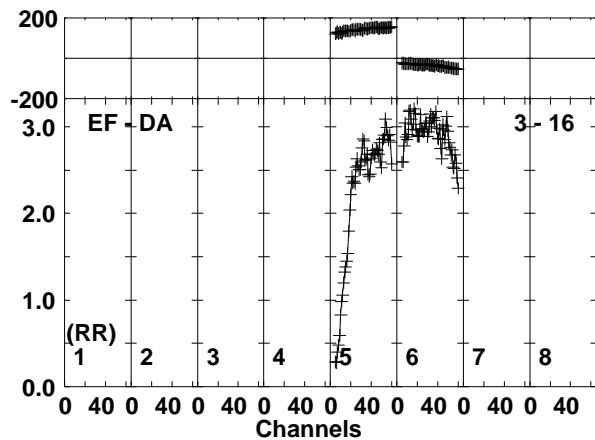
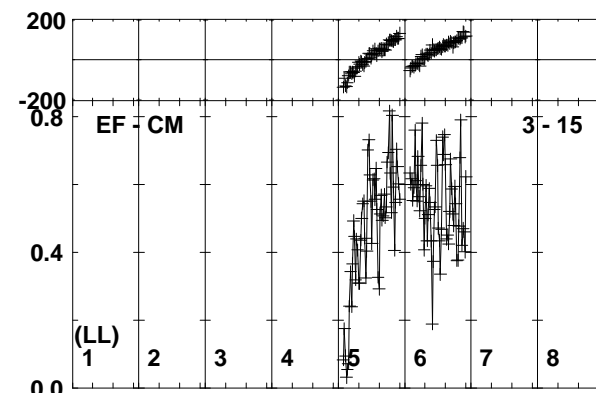
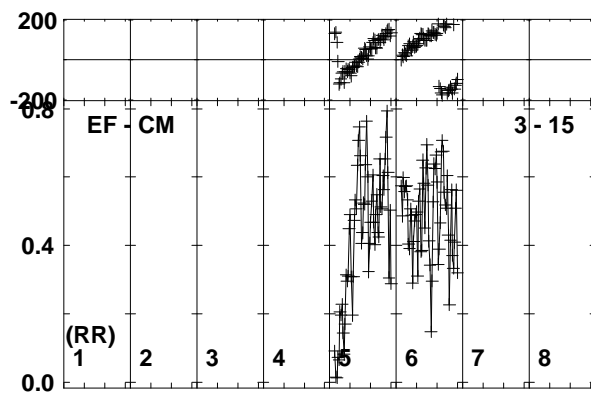
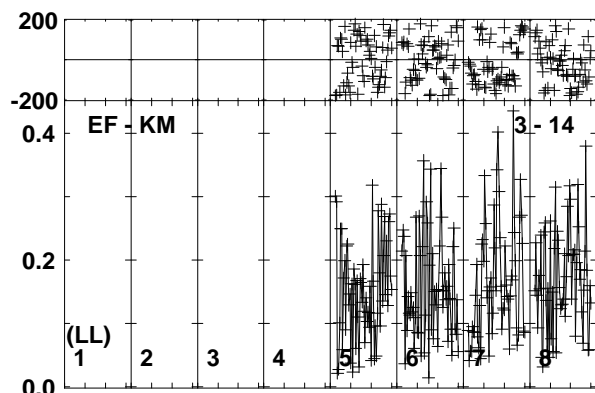
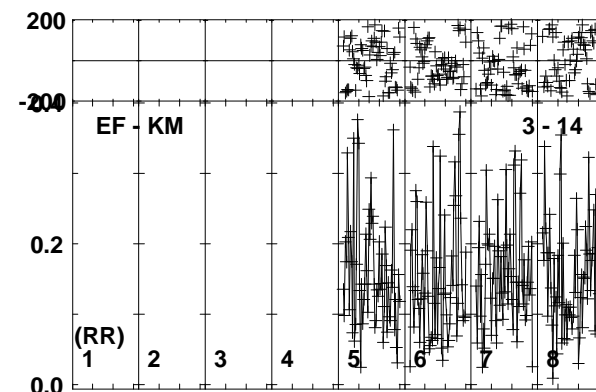
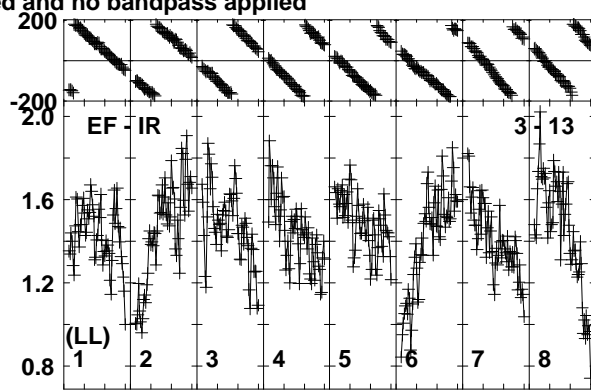
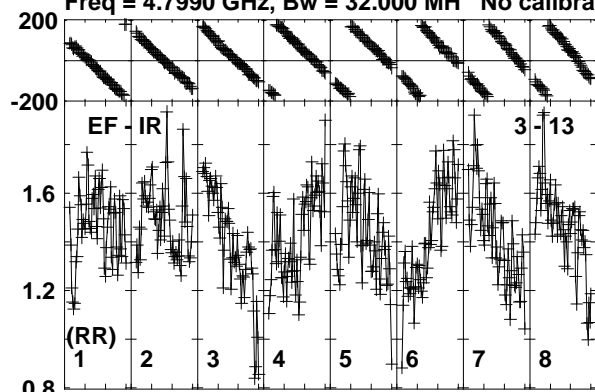

Lower frame: Milli Ampl Jy Top frame: Phas deg
Vector averaged cross-power spectrum Baseline: EF (03) - IR (13)
Timerange: 00/15:36:51 to 00/15:38:20

Plot file version 241 created 20-SEP-2019 15:52:33

J1408+5613 RSM05.UVDATA.1

Freq = 4.7990 GHz, Bw = 32.000 MH No calibration applied and no bandpass applied

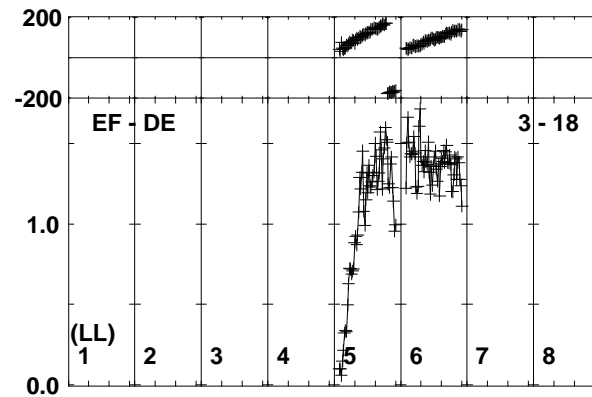
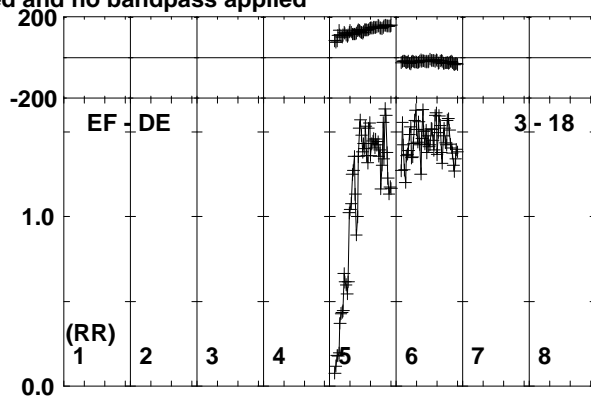
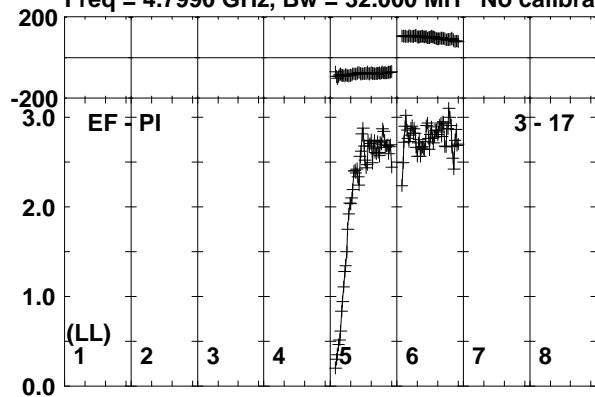

Lower frame: Milli Ampl Jy Top frame: Phas deg
Vector averaged cross-power spectrum Baseline: EF (03) - PI (17)
Timerange: 00/15:36:51 to 00/15:38:20

Plot file version 242 created 20-SEP-2019 15:52:33

AT2019EHZ RSM05.UVDATA.1

Freq = 4.7990 GHz, Bw = 32.000 MH No calibration applied and no bandpass applied

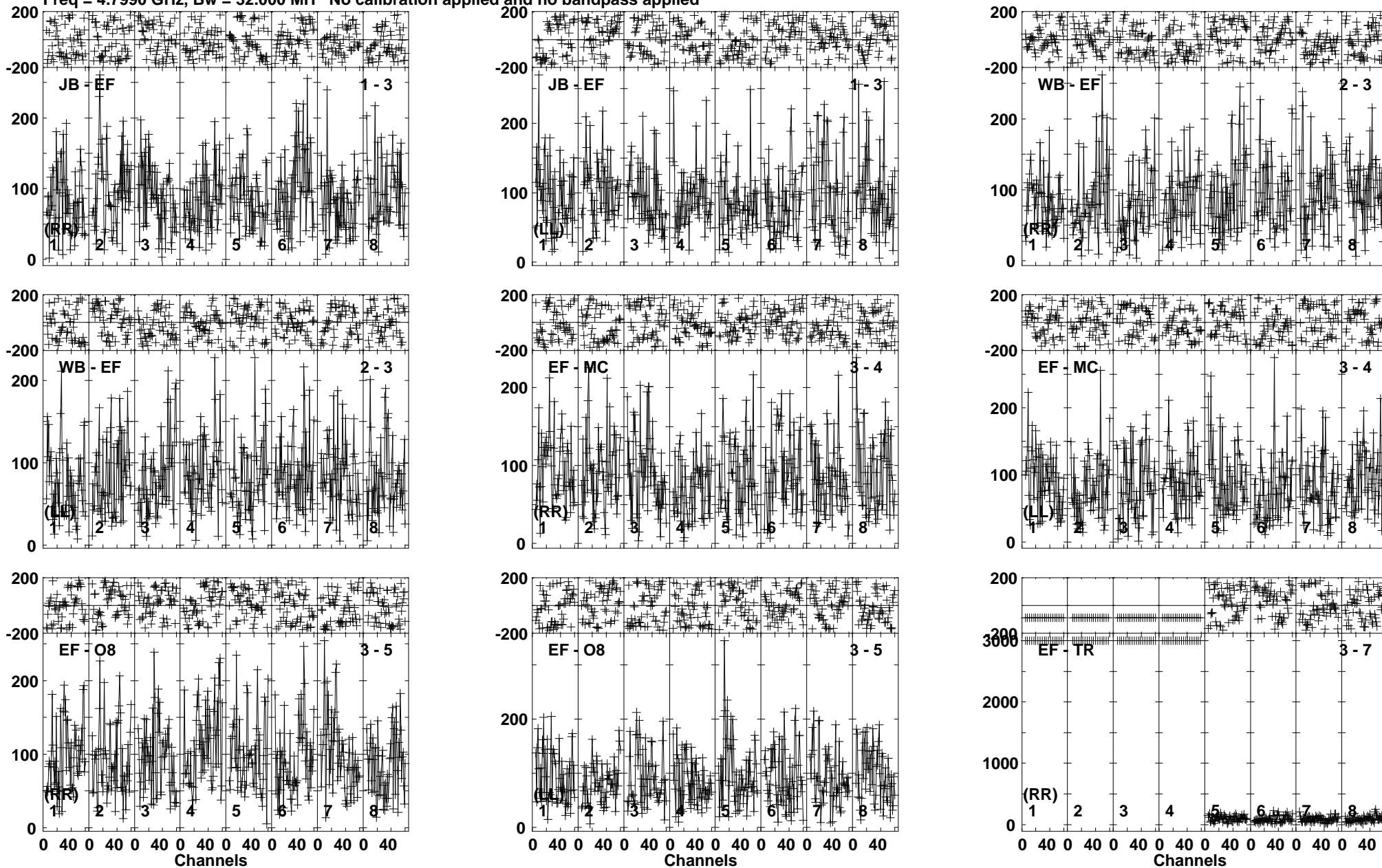

Lower frame: Micro Ampl Jy Top frame: Phas deg
Vector averaged cross-power spectrum Baseline: JB (01) - EF (03)
Timerange: 00/15:38:21 to 00/15:41:19

Plot file version 243 created 20-SEP-2019 15:52:33
 AT2019EHZ RSM05.UVDATA.1
 Freq = 4.7990 GHz, Bw = 32.000 MH No calibration applied and no bandpass applied

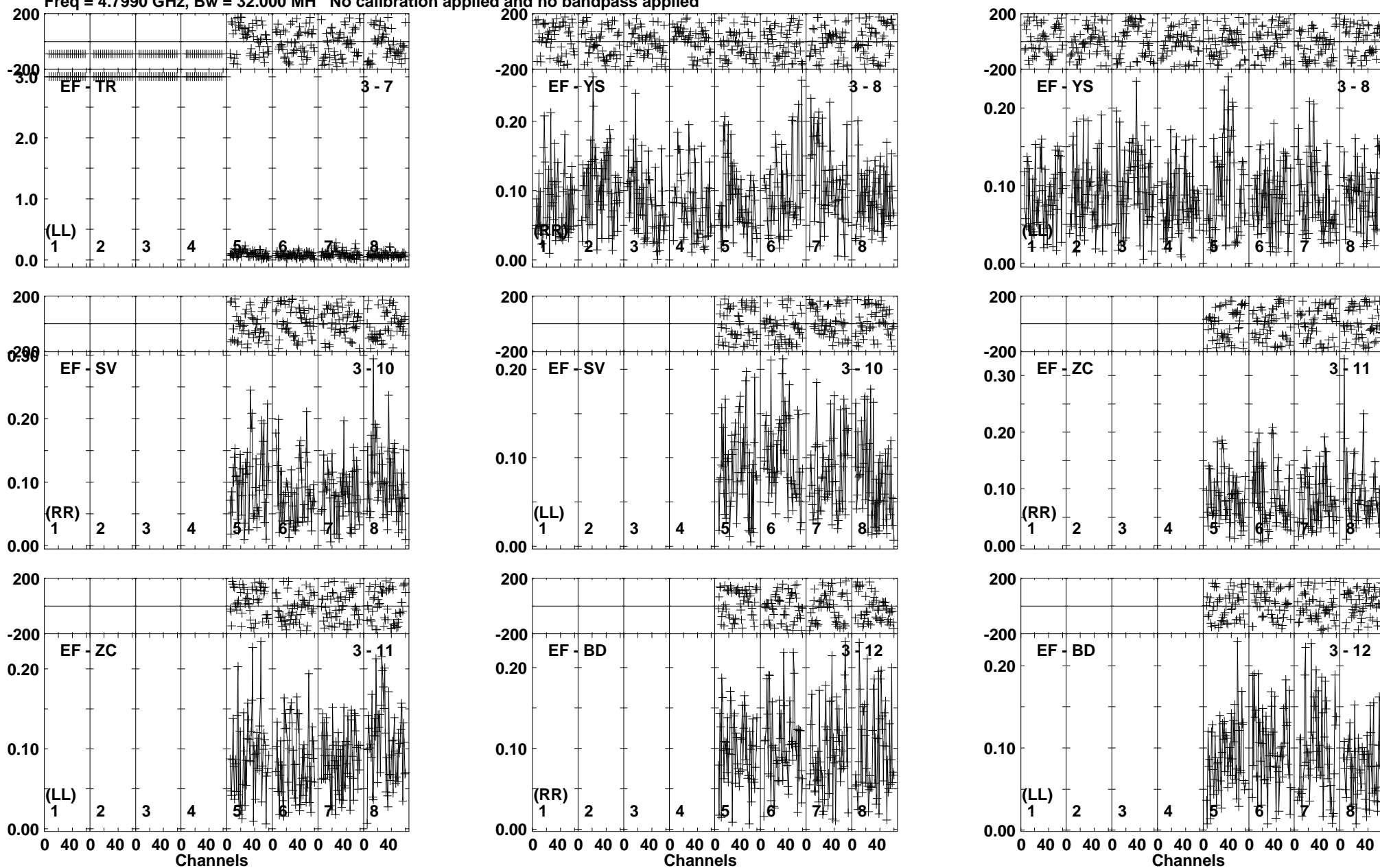

Lower frame: Milli Ampl Jy Top frame: Phas deg
 Vector averaged cross-power spectrum Baseline: EF (03) - TR (07)
 Timerange: 00/15:38:21 to 00/15:41:19

Plot file version 244 created 20-SEP-2019 15:52:34

AT2019EHZ RSM05.UVDATA.1

Freq = 4.7990 GHz, Bw = 32.000 MH No calibration applied and no bandpass applied

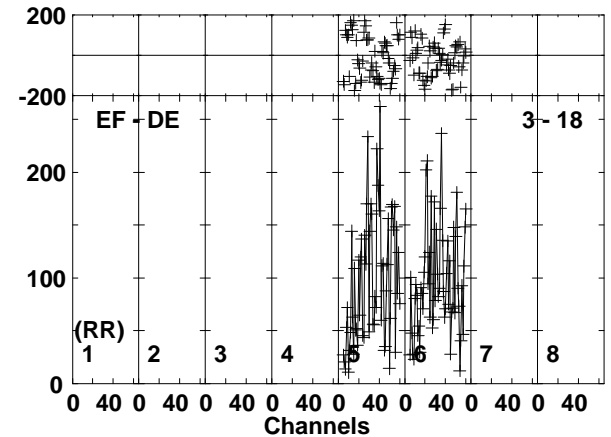
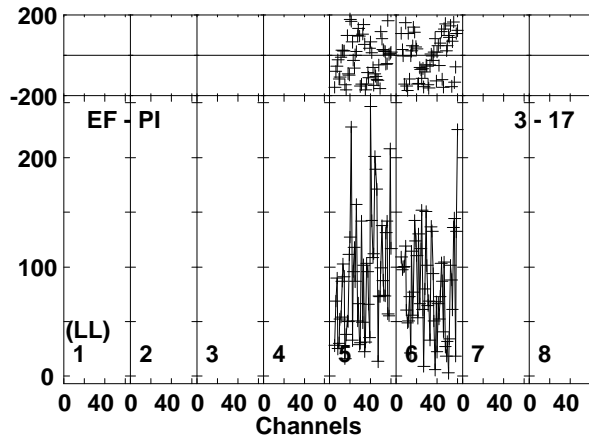
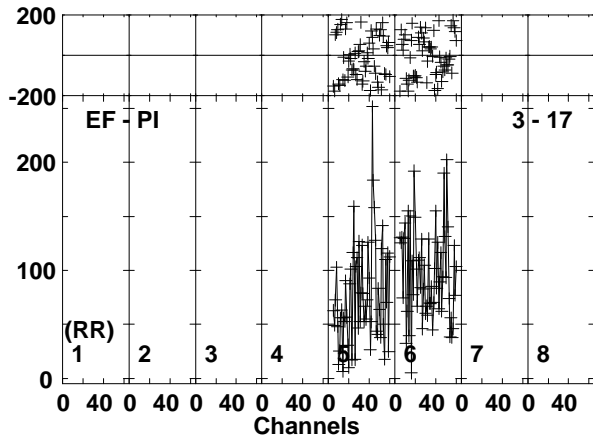
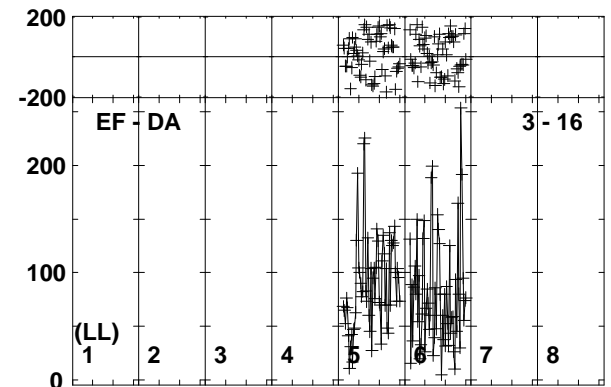
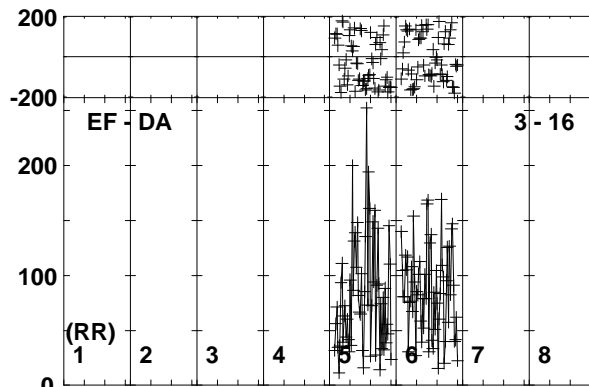
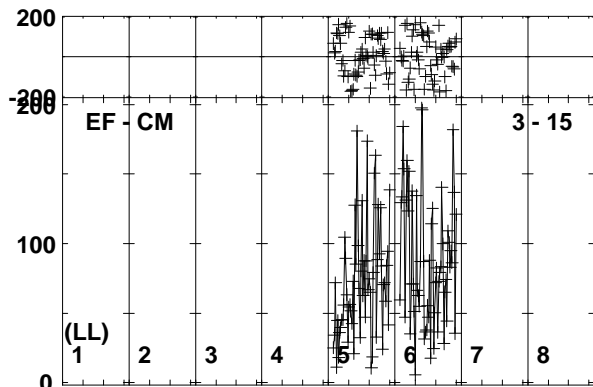
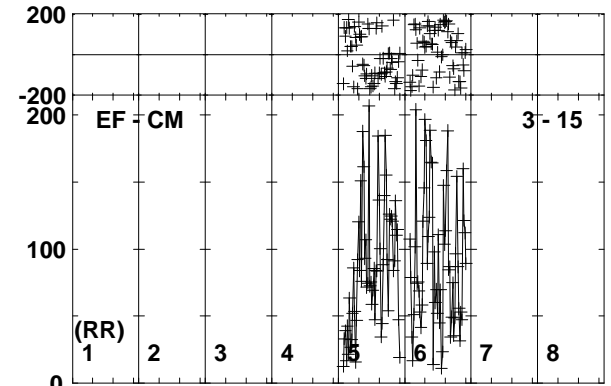
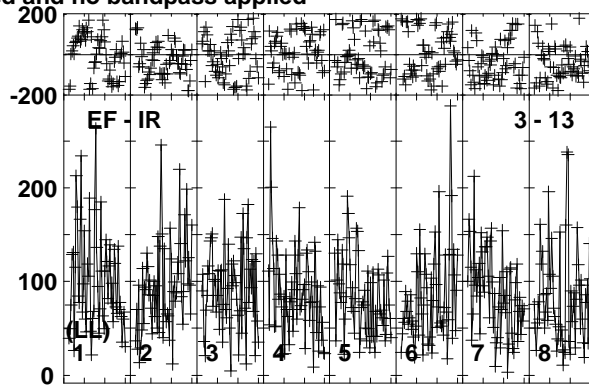
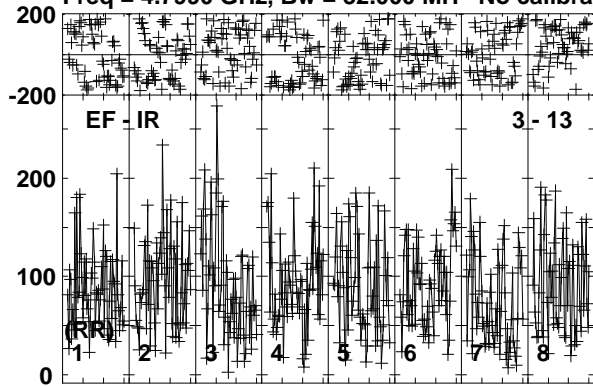

Lower frame: Micro Ampl Jy Top frame: Phas deg
Vector averaged cross-power spectrum Baseline: EF (03) - IR (13)
Timerange: 00/15:38:21 to 00/15:41:19

Plot file version 245 created 20-SEP-2019 15:52:35
AT2019EHZ RSM05.UVDATA.1
Freq = 4.7990 GHz, Bw = 32.000 MH No calibration applied and no bandpass applied

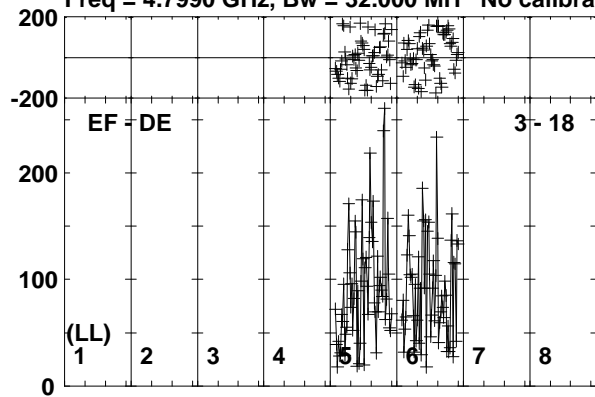

Lower frame: Micro Ampl Jy Top frame: Phas deg
Vector averaged cross-power spectrum Baseline: EF (03) - DE (18)
Timerange: 00/15:38:21 to 00/15:41:19

Plot file version 246 created 20-SEP-2019 15:52:35

J1408+5613 RSM05.UVDATA.1

Freq = 4.7990 GHz, Bw = 32.000 MH No calibration applied and no bandpass applied

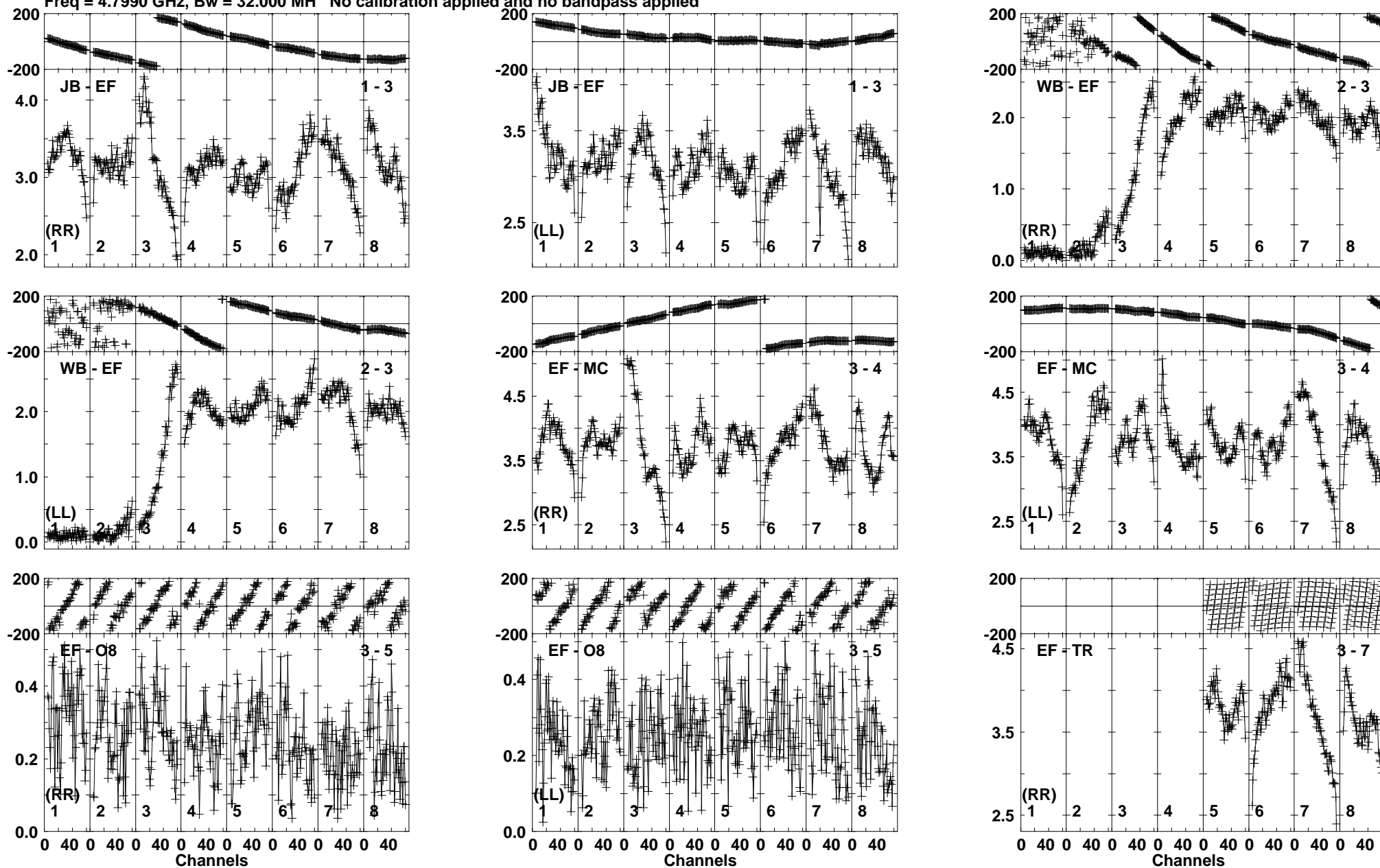

Lower frame: Milli Ampl Jy Top frame: Phas deg
Vector averaged cross-power spectrum Baseline: JB (01) - EF (03)
Timerange: 00:15:42:10 to 00:15:43:39

Plot file version 247 created 20-SEP-2019 15:52:35

J1408+5613 RSM05.UVDATA.1

Freq = 4.7990 GHz, Bw = 32.000 MH No calibration applied and no bandpass applied

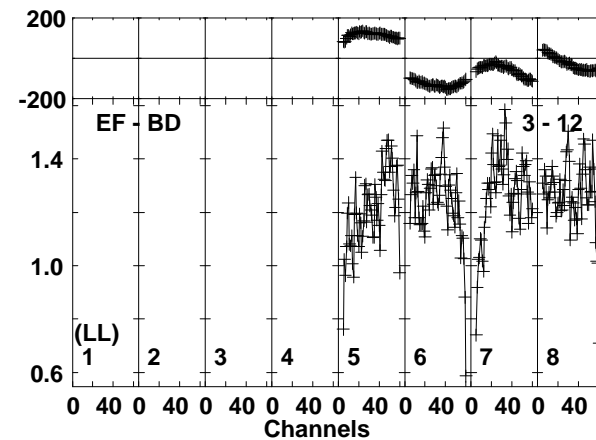
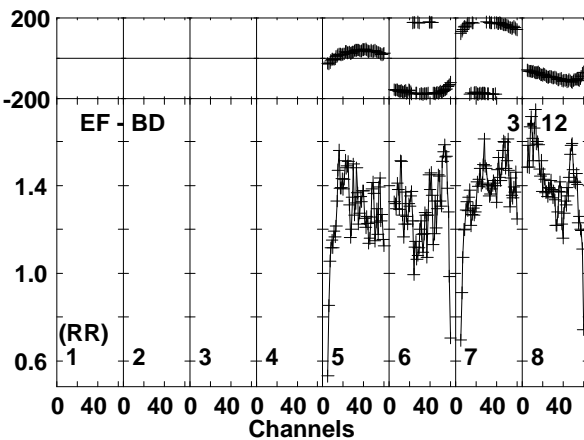
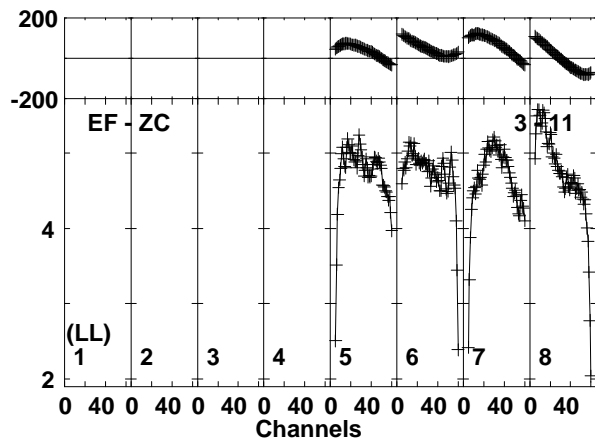
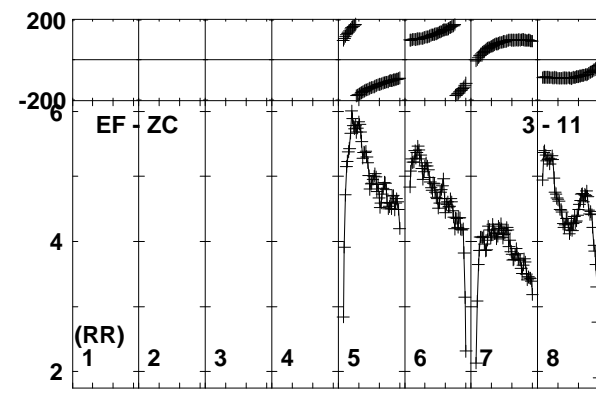
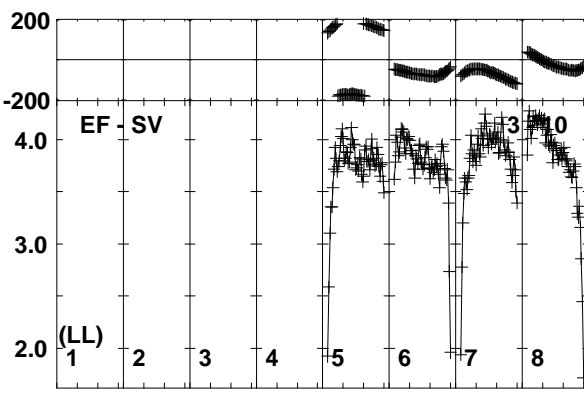
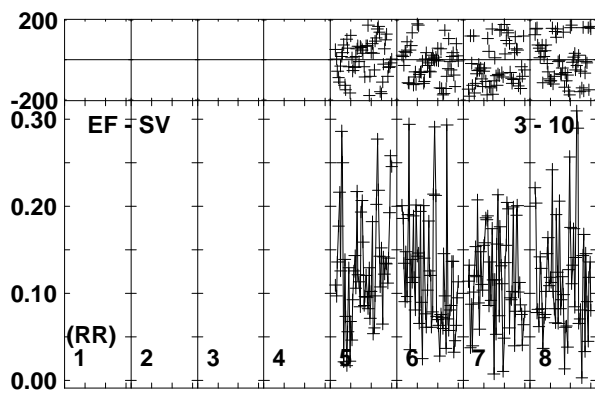
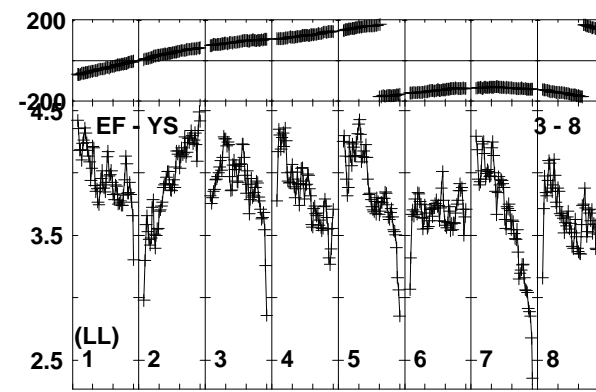
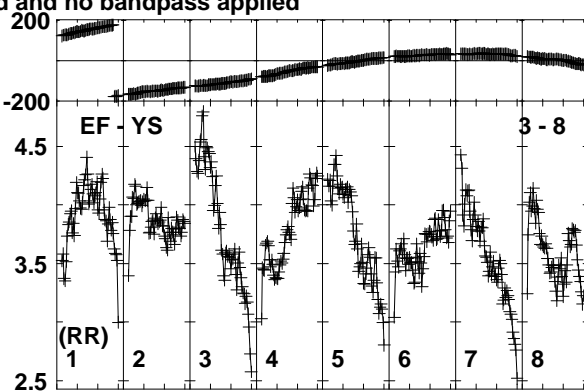
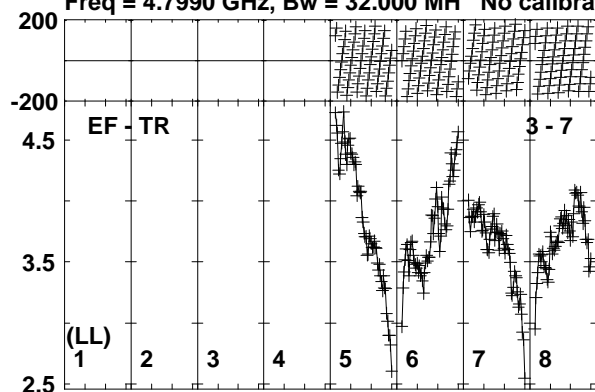

Lower frame: Milli Ampl Jy Top frame: Phas deg
Vector averaged cross-power spectrum Baseline: EF (03) - TR (07)
Timerange: 00/15:42:10 to 00/15:43:39

Plot file version 248 created 20-SEP-2019 15:52:36

J1408+5613 RSM05.UVDATA.1

Freq = 4.7990 GHz, Bw = 32.000 MH No calibration applied and no bandpass applied

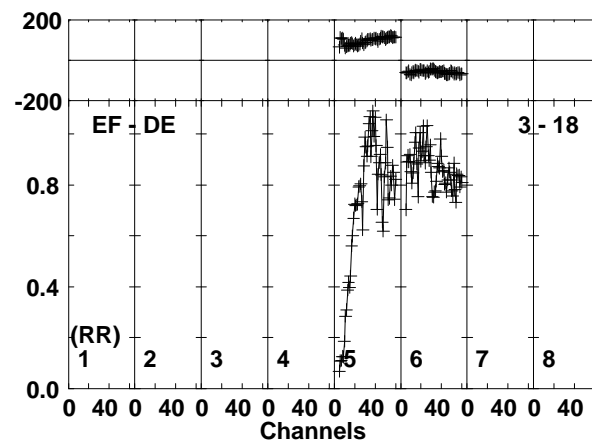
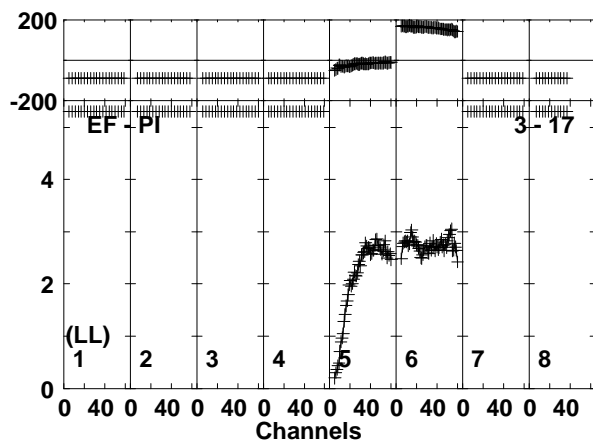
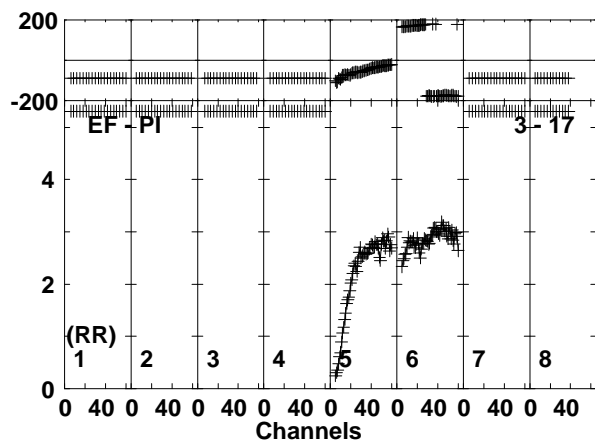
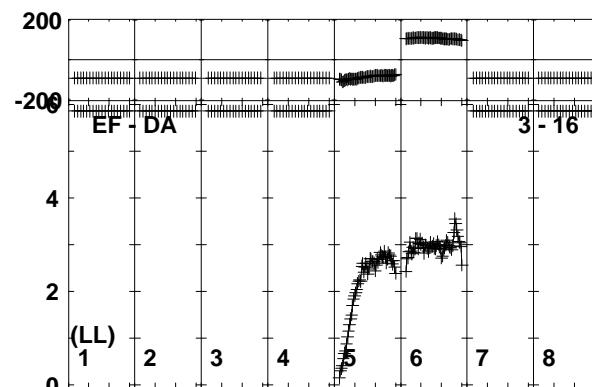
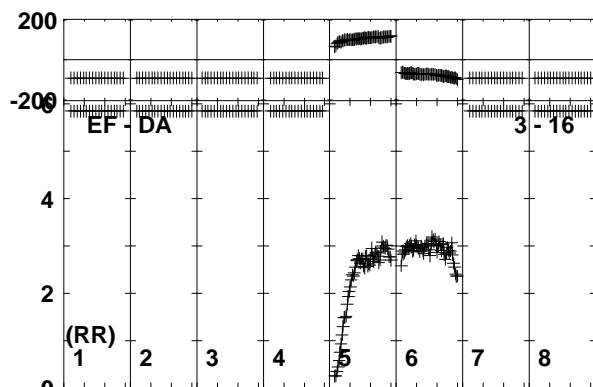
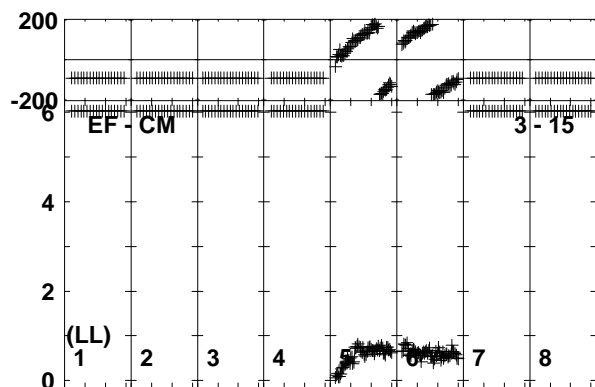
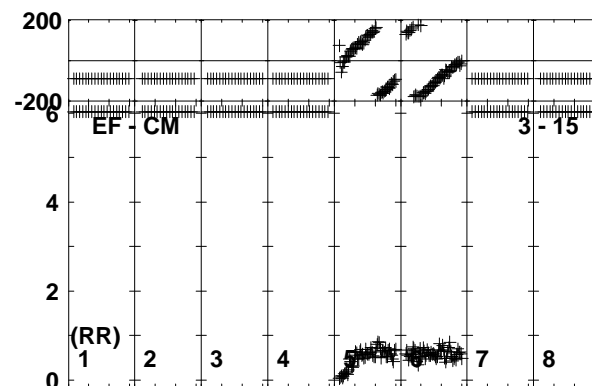
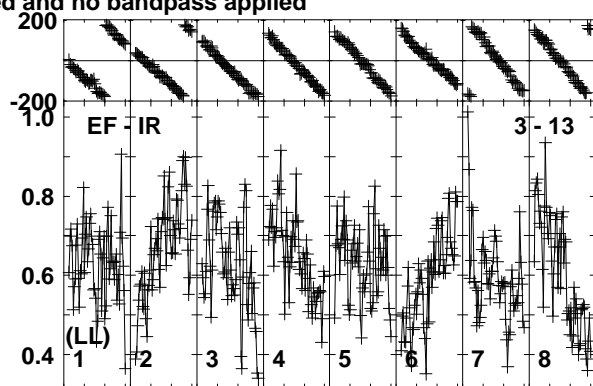
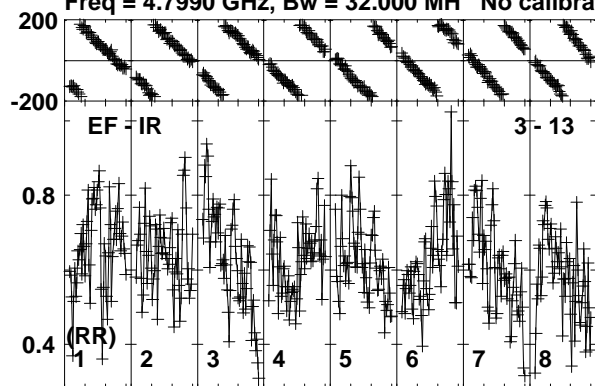

Lower frame: Milli Ampl Jy Top frame: Phas deg
Vector averaged cross-power spectrum Baseline: EF (03) - IR (13)
Timerange: 00/15:42:10 to 00/15:43:39

Plot file version 249 created 20-SEP-2019 15:52:36
J1408+5613 RSM05.UVDATA.1
Freq = 4.7990 GHz, Bw = 32.000 MH No calibration applied and no bandpass applied

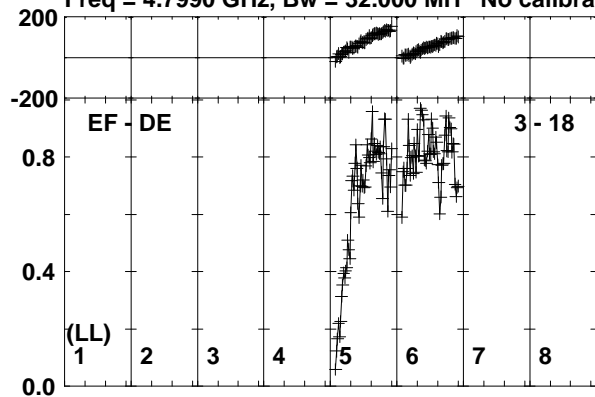

Lower frame: Milli Ampl Jy Top frame: Phas deg
Vector averaged cross-power spectrum Baseline: EF (03) - DE (18)
Timerange: 00/15:42:10 to 00/15:43:39

Plot file version 250 created 20-SEP-2019 15:52:36

AT2019EHZ RSM05.UVDATA.1

Freq = 4.7990 GHz, Bw = 32.000 MH No calibration applied and no bandpass applied

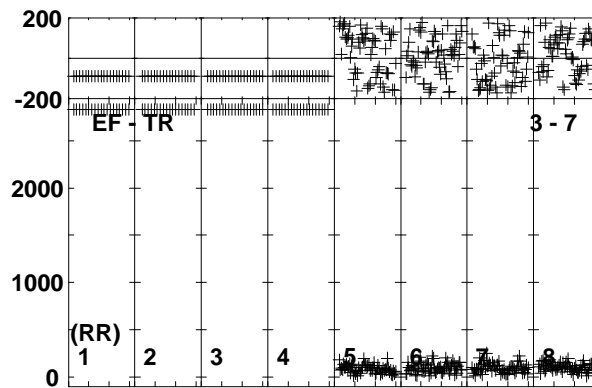
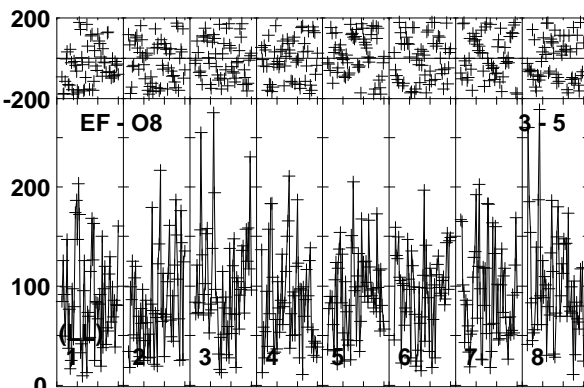
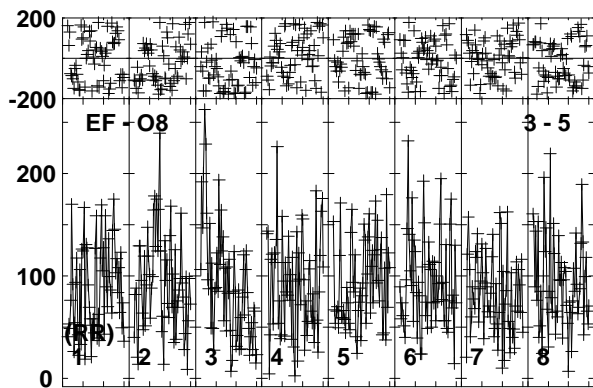
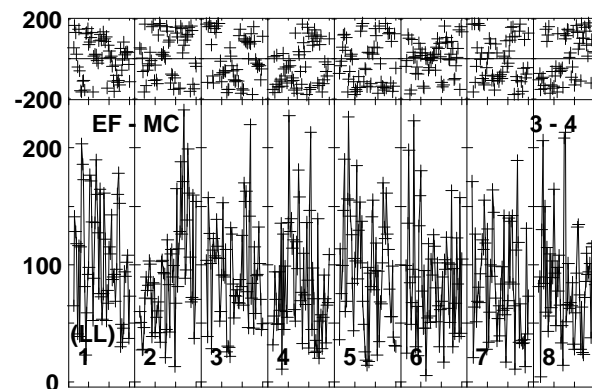
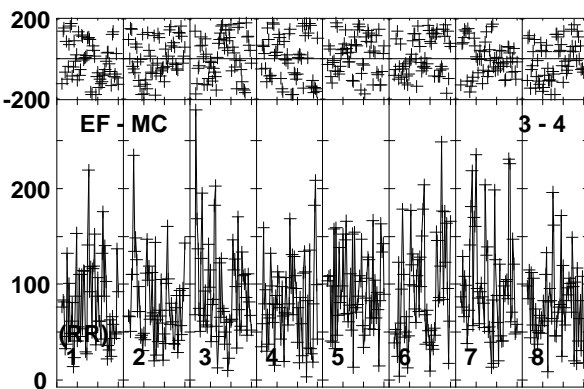
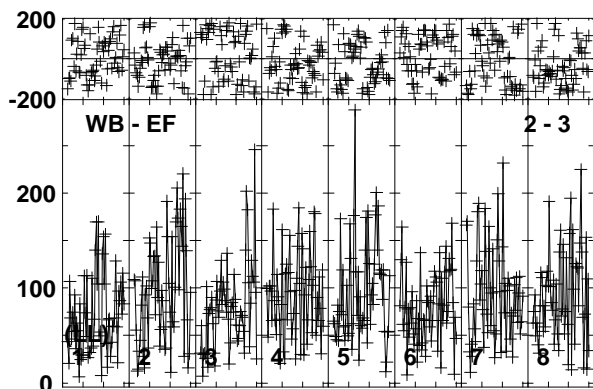
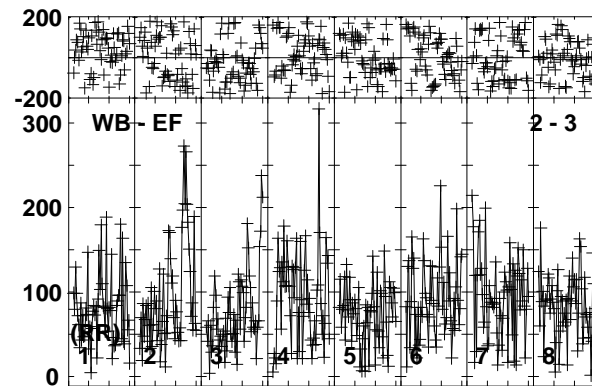
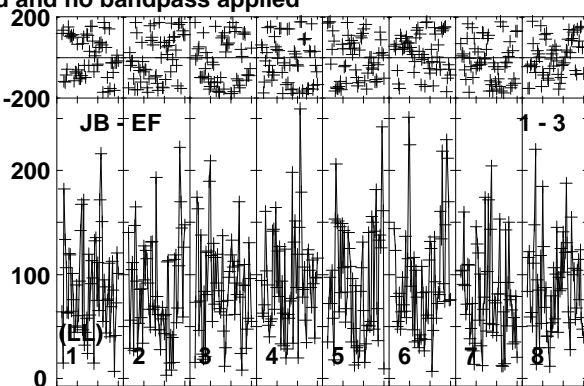
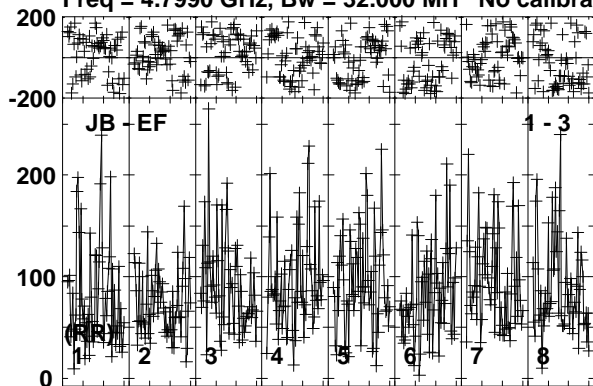

Lower frame: Micro Ampl Jy Top frame: Phas deg
Vector averaged cross-power spectrum Baseline: JB (01) - EF (03)
Timerange: 00/15:43:41 to 00/15:46:40

Plot file version 251 created 20-SEP-2019 15:52:37

AT2019EHZ RSM05.UVDATA.1

Freq = 4.7990 GHz, Bw = 32.000 MH No calibration applied and no bandpass applied

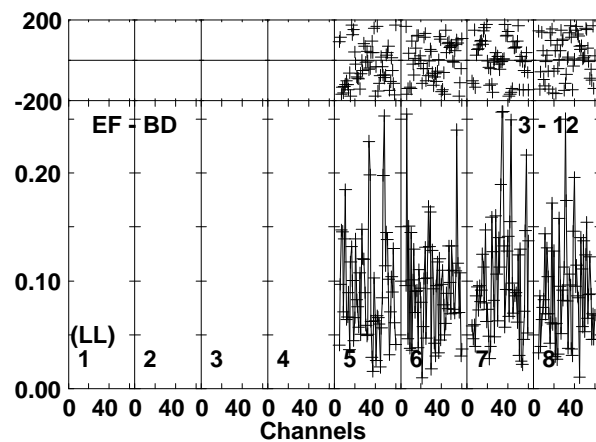
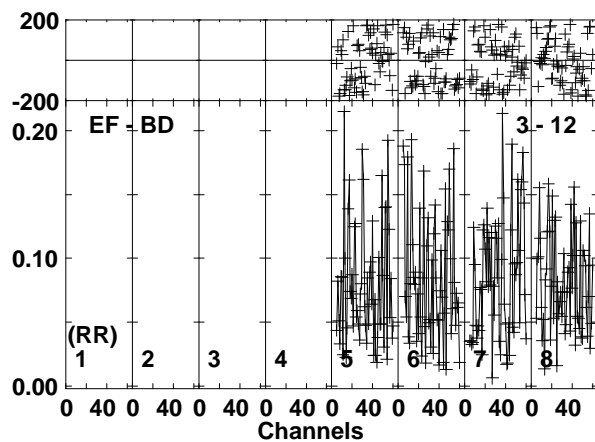
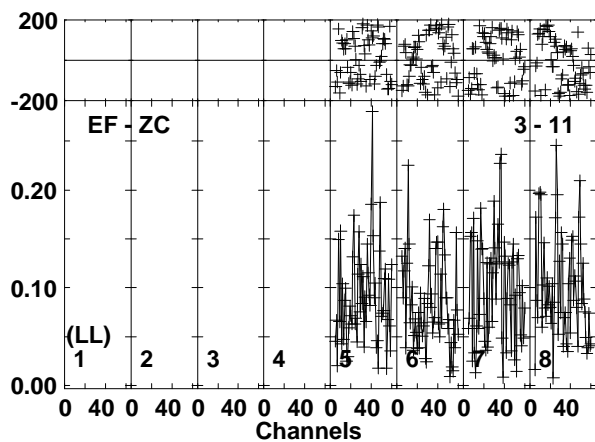
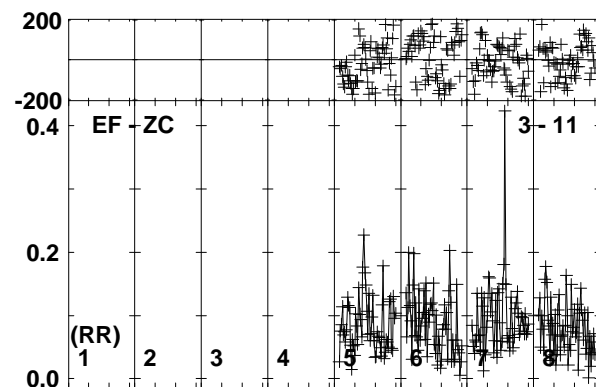
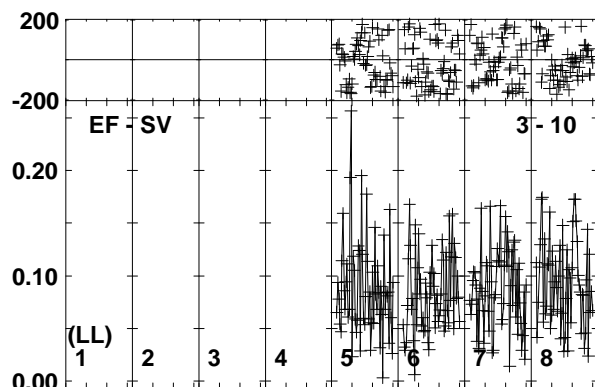
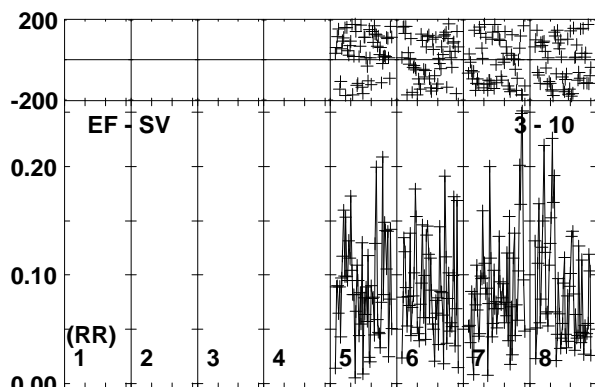
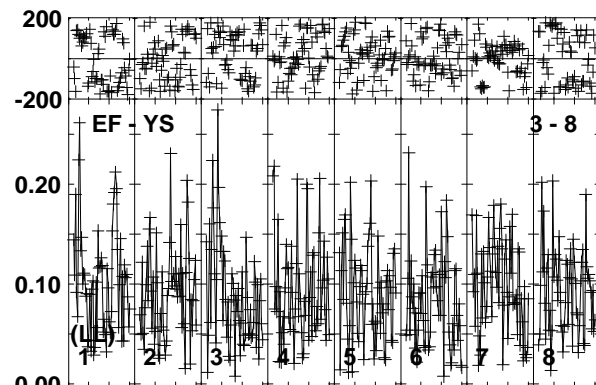
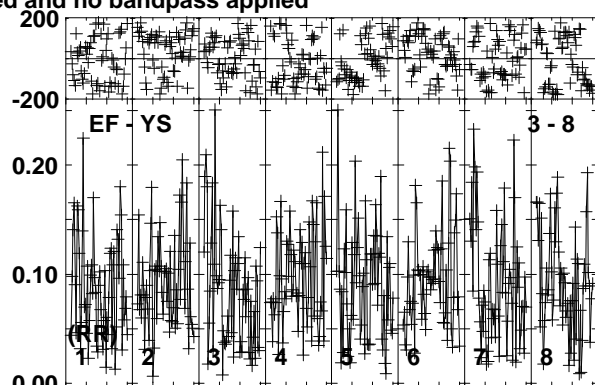
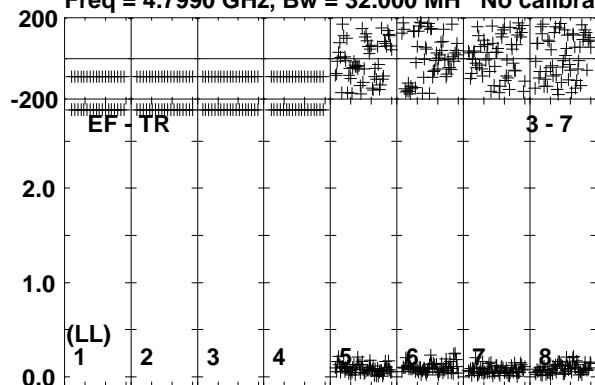

Lower frame: Milli Ampl Jy Top frame: Phas deg
Vector averaged cross-power spectrum Baseline: EF (03) - TR (07)
Timerange: 00/15:43:41 to 00/15:46:40

Plot file version 253 created 20-SEP-2019 15:52:38
AT2019EHZ RSM05.UVDATA.1
Freq = 4.7990 GHz, Bw = 32.000 MH No calibration applied and no bandpass applied

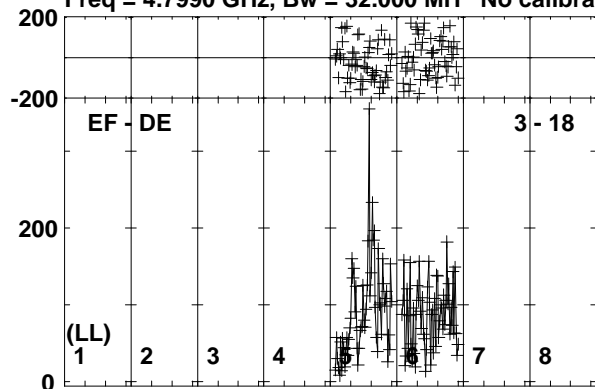

Lower frame: Micro Ampl Jy Top frame: Phas deg
Vector averaged cross-power spectrum Baseline: EF (03) - DE (18)
Timerange: 00/15:43:41 to 00/15:46:40

Plot file version 254 created 20-SEP-2019 15:52:38

J1408+5613 RSM05.UVDATA.1

Freq = 4.7990 GHz, Bw = 32.000 MH No calibration applied and no bandpass applied

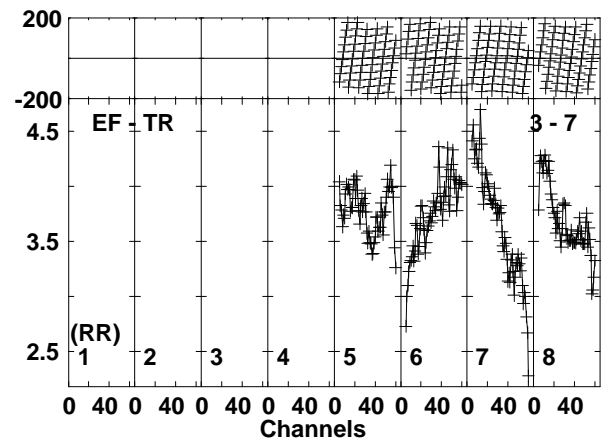
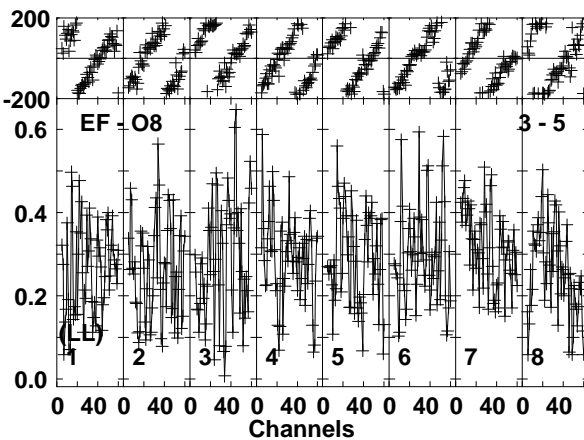
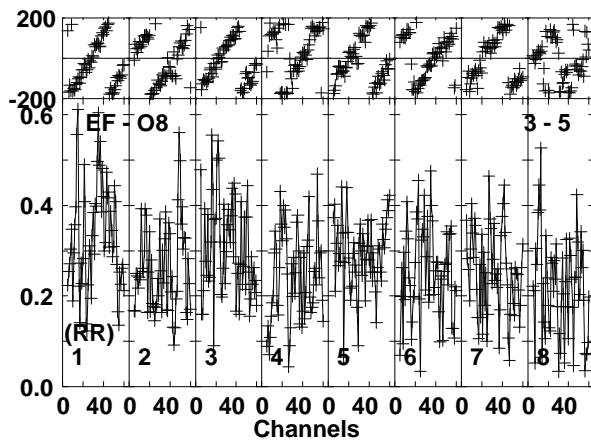
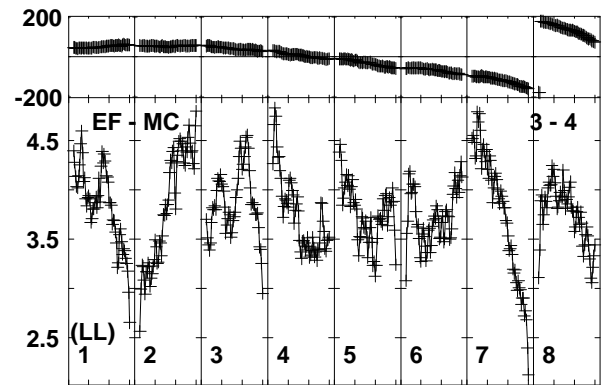
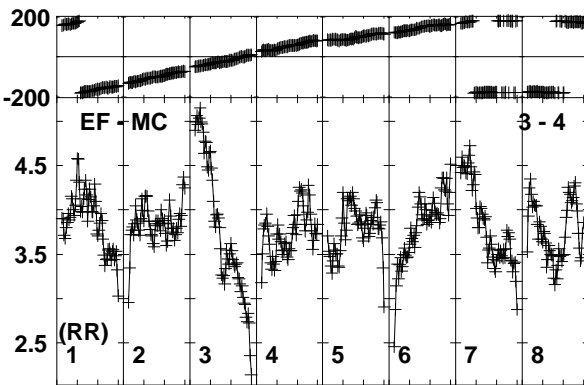
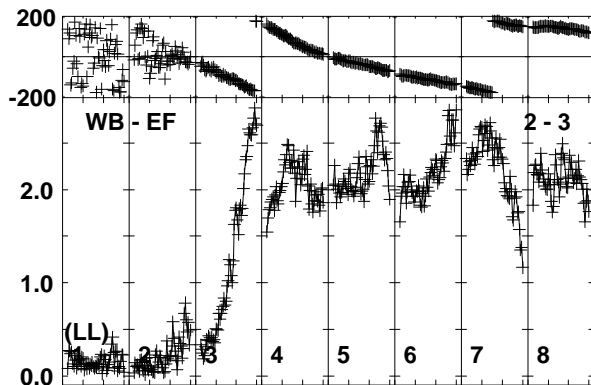
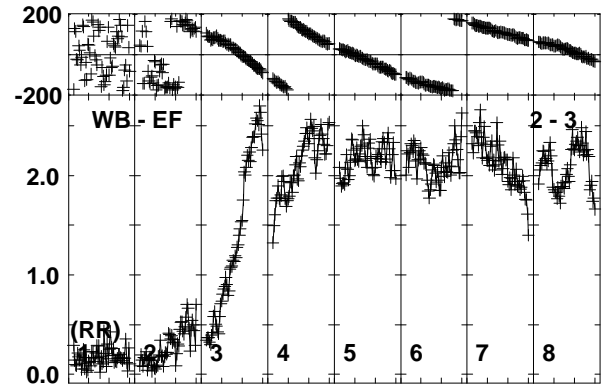
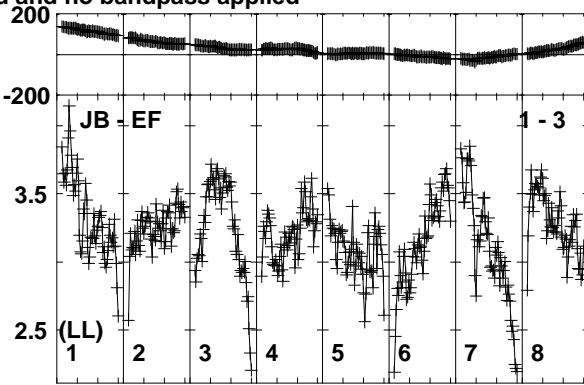
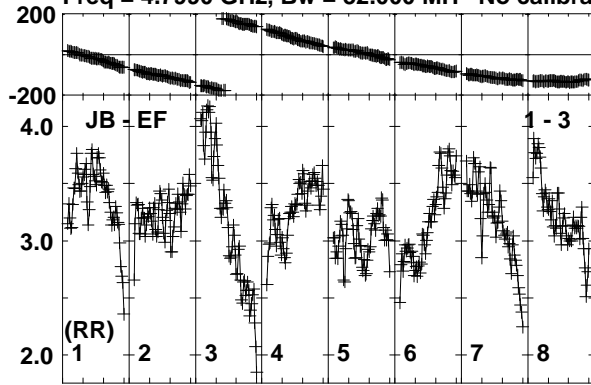

Lower frame: Milli Ampl Jy Top frame: Phas deg
Vector averaged cross-power spectrum Baseline: JB (01) - EF (03)
Timerange: 00:15:46:40 to 00:15:48:10

Plot file version 255 created 20-SEP-2019 15:52:38

J1408+5613 RSM05.UVDATA.1

Freq = 4.7990 GHz, Bw = 32.000 MH No calibration applied and no bandpass applied

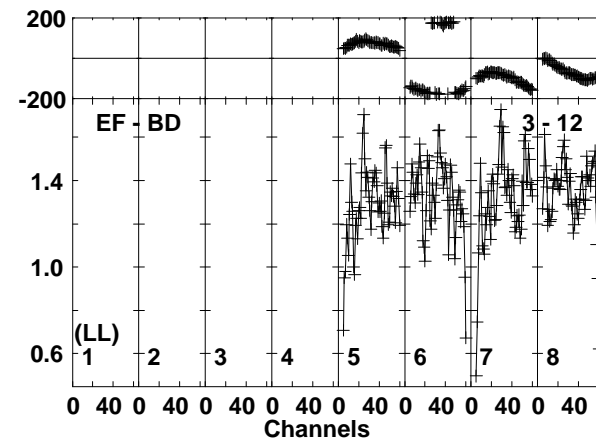
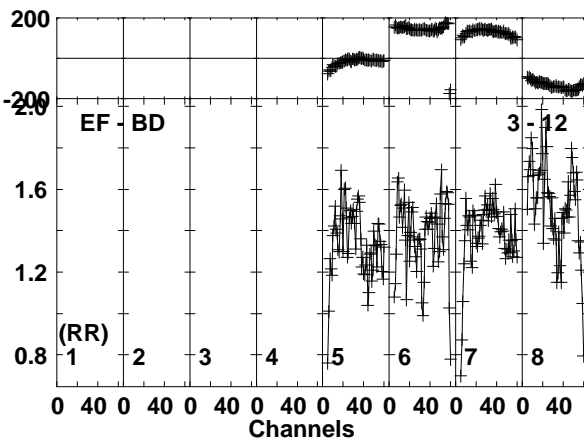
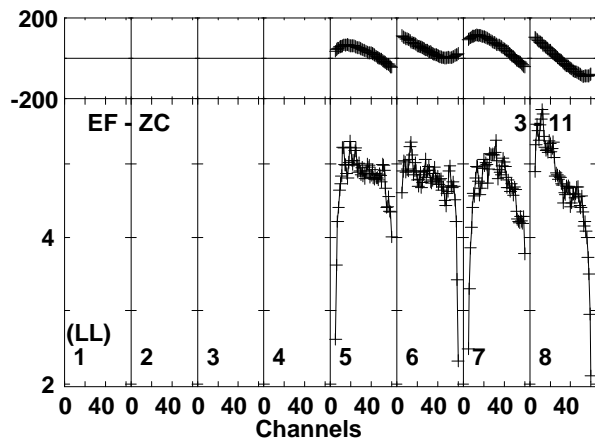
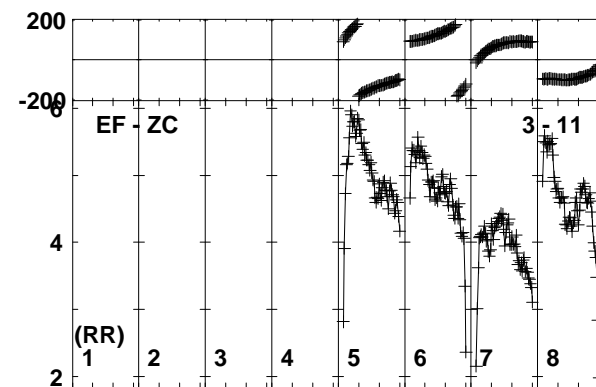
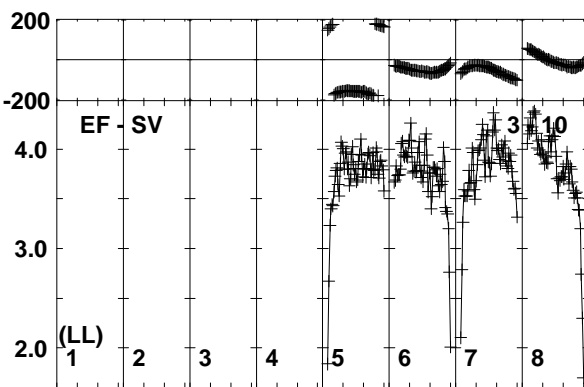
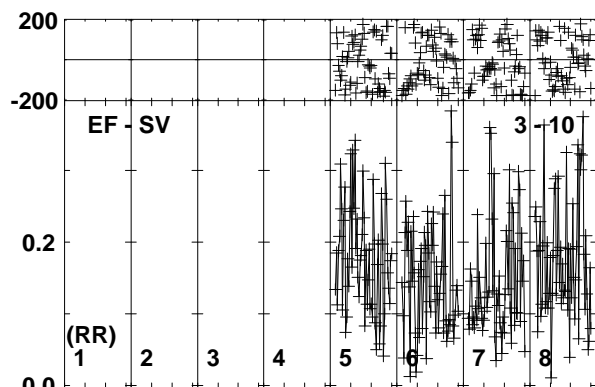
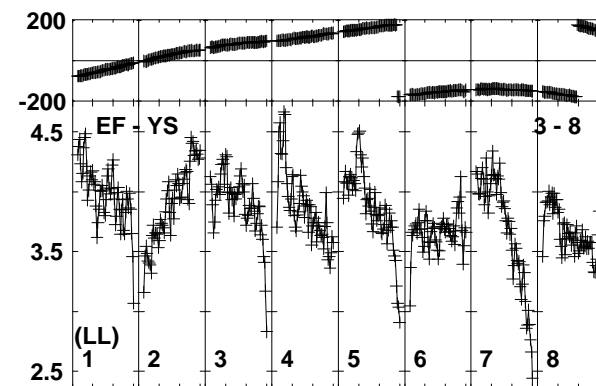
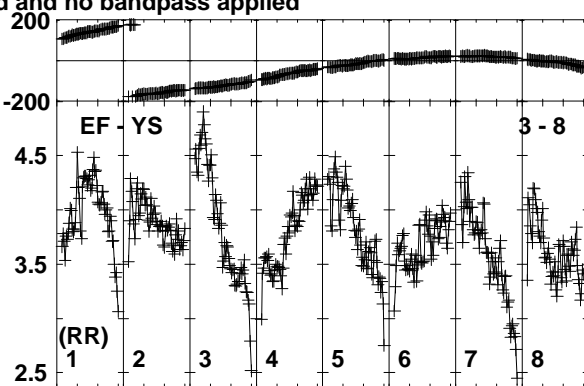
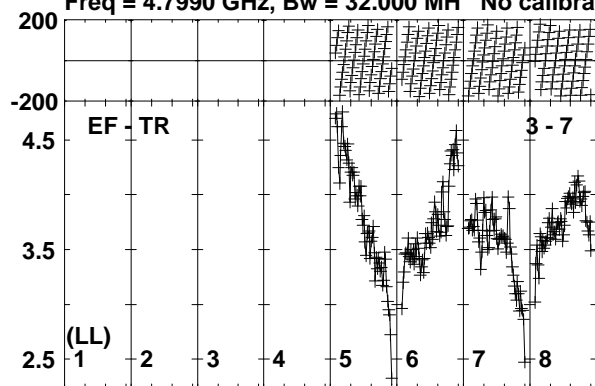

Lower frame: Milli Ampl Jy Top frame: Phas deg
Vector averaged cross-power spectrum Baseline: EF (03) - TR (07)
Timerange: 00/15:46:40 to 00/15:48:10

Plot file version 256 created 20-SEP-2019 15:52:39

J1408+5613 RSM05.UVDATA.1

Freq = 4.7990 GHz, Bw = 32.000 MH No calibration applied and no bandpass applied

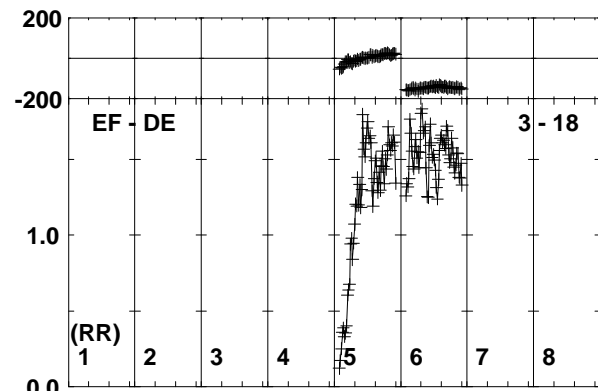
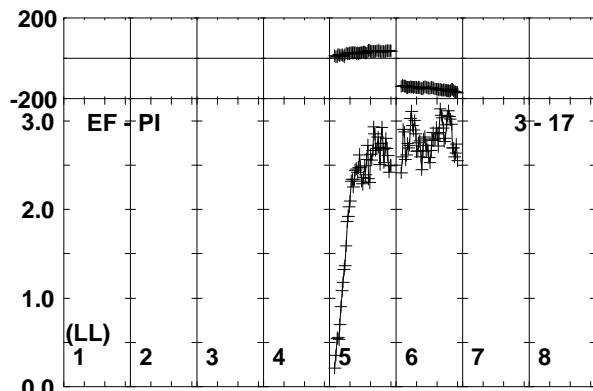
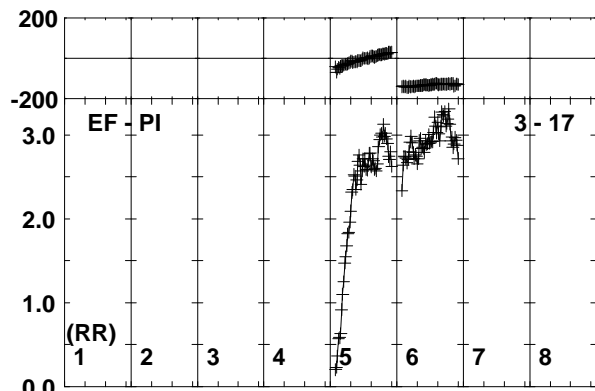
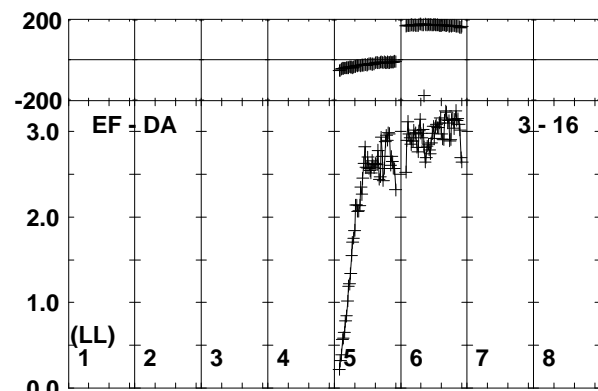
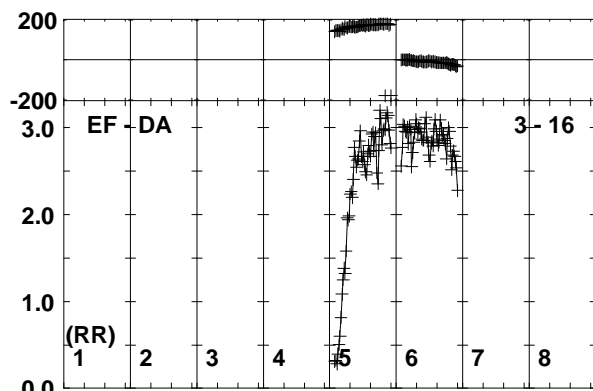
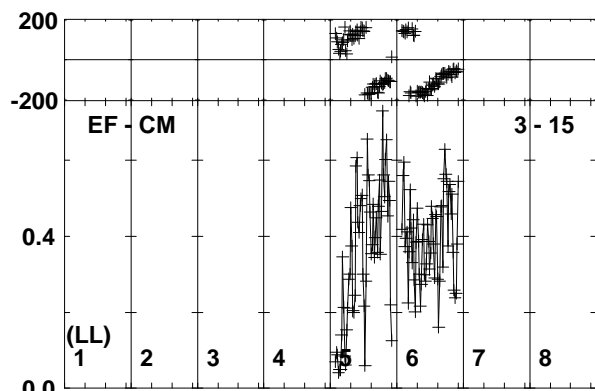
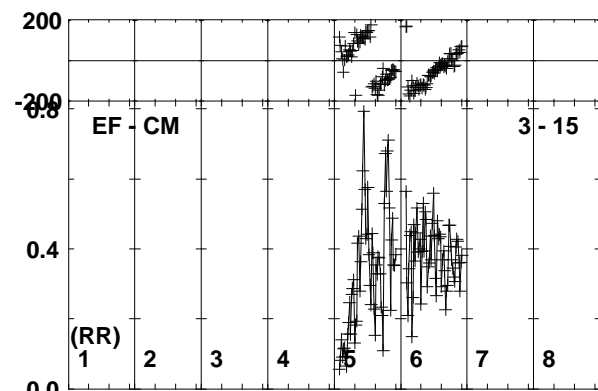
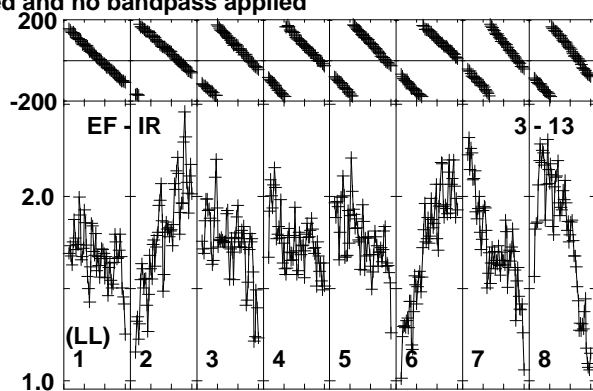
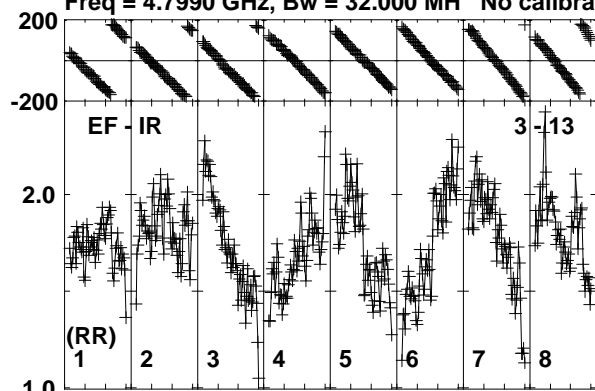

Lower frame: Milli Ampl Jy Top frame: Phas deg
Vector averaged cross-power spectrum Baseline: EF (03) - IR (13)
Timerange: 00/15:46:40 to 00/15:48:10

Plot file version 257 created 20-SEP-2019 15:52:39
J1408+5613 RSM05.UVDATA.1
Freq = 4.7990 GHz, Bw = 32.000 MH No calibration applied and no bandpass applied

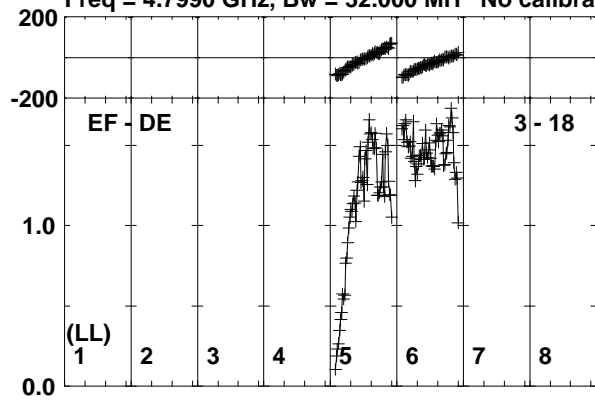

Lower frame: Milli Ampl Jy Top frame: Phas deg
Vector averaged cross-power spectrum Baseline: EF (03) - DE (18)
Timerange: 00/15:46:40 to 00/15:48:10

Plot file version 259 created 20-SEP-2019 15:52:40

AT2019EHZ RSM05.UVDATA.1

Freq = 4.7990 GHz, Bw = 32.000 MH No calibration applied and no bandpass applied

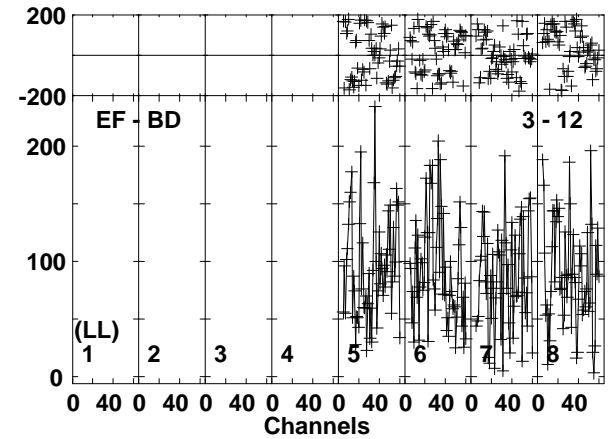
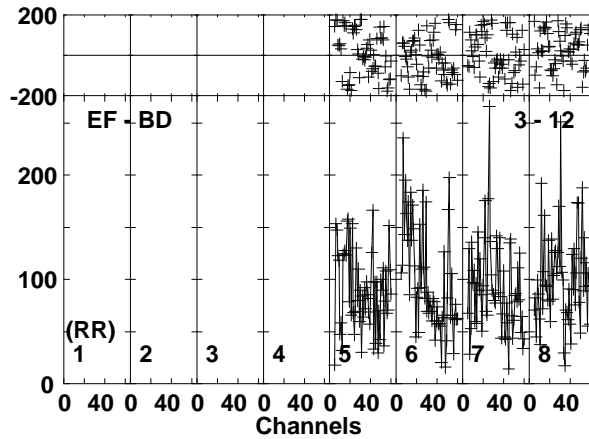
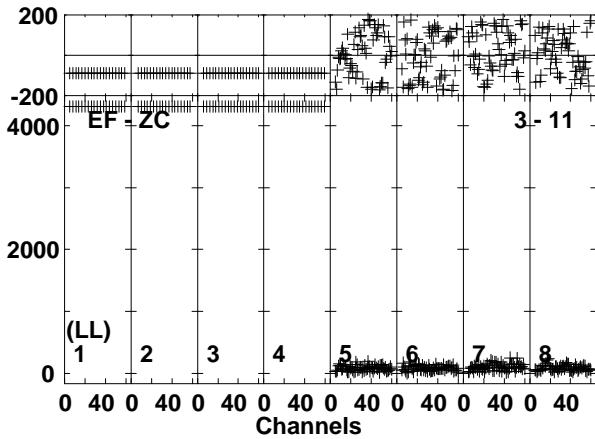
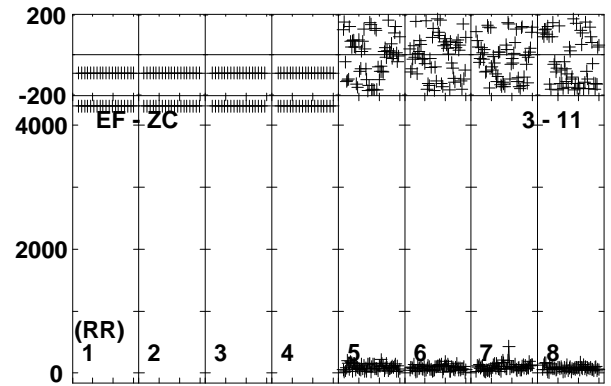
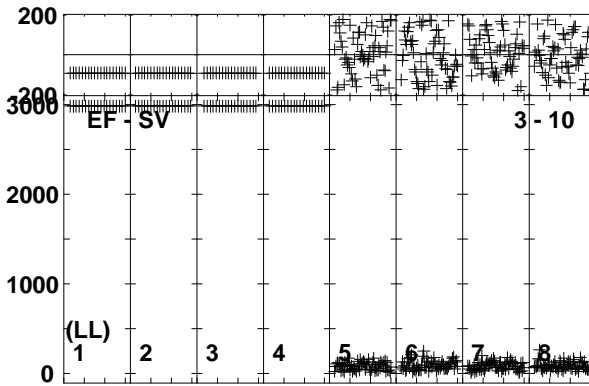
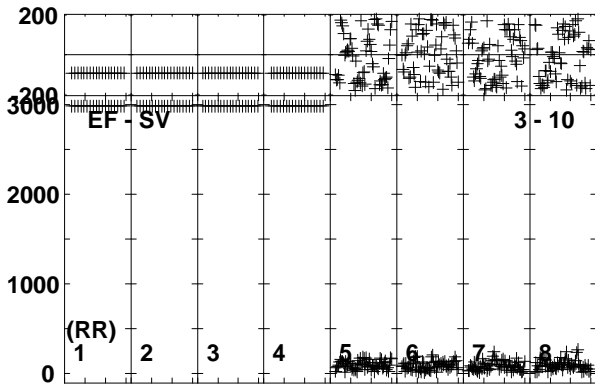
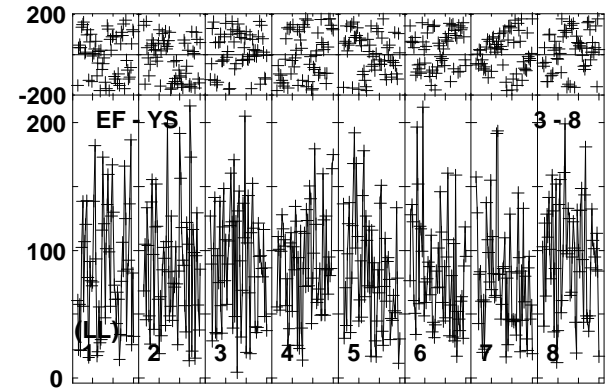
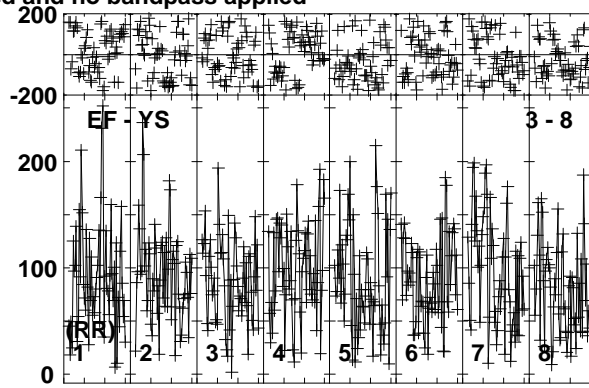
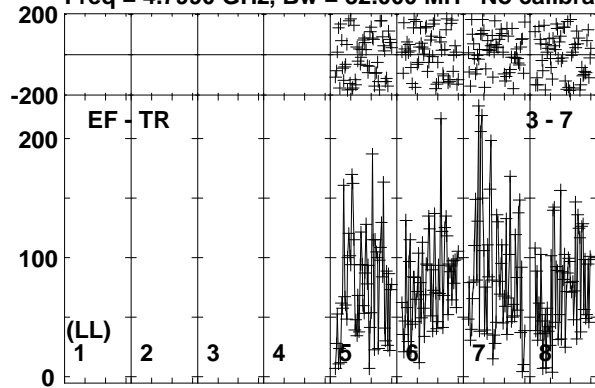

Lower frame: Micro Ampl Jy Top frame: Phas deg
Vector averaged cross-power spectrum Baseline: EF (03) - TR (07)
Timerange: 00/15:48:10 to 00/15:51:10

Plot file version 260 created 20-SEP-2019 15:52:40
 AT2019EHZ RSM05.UVDATA.1
 Freq = 4.7990 GHz, Bw = 32.000 MH No calibration applied and no bandpass applied

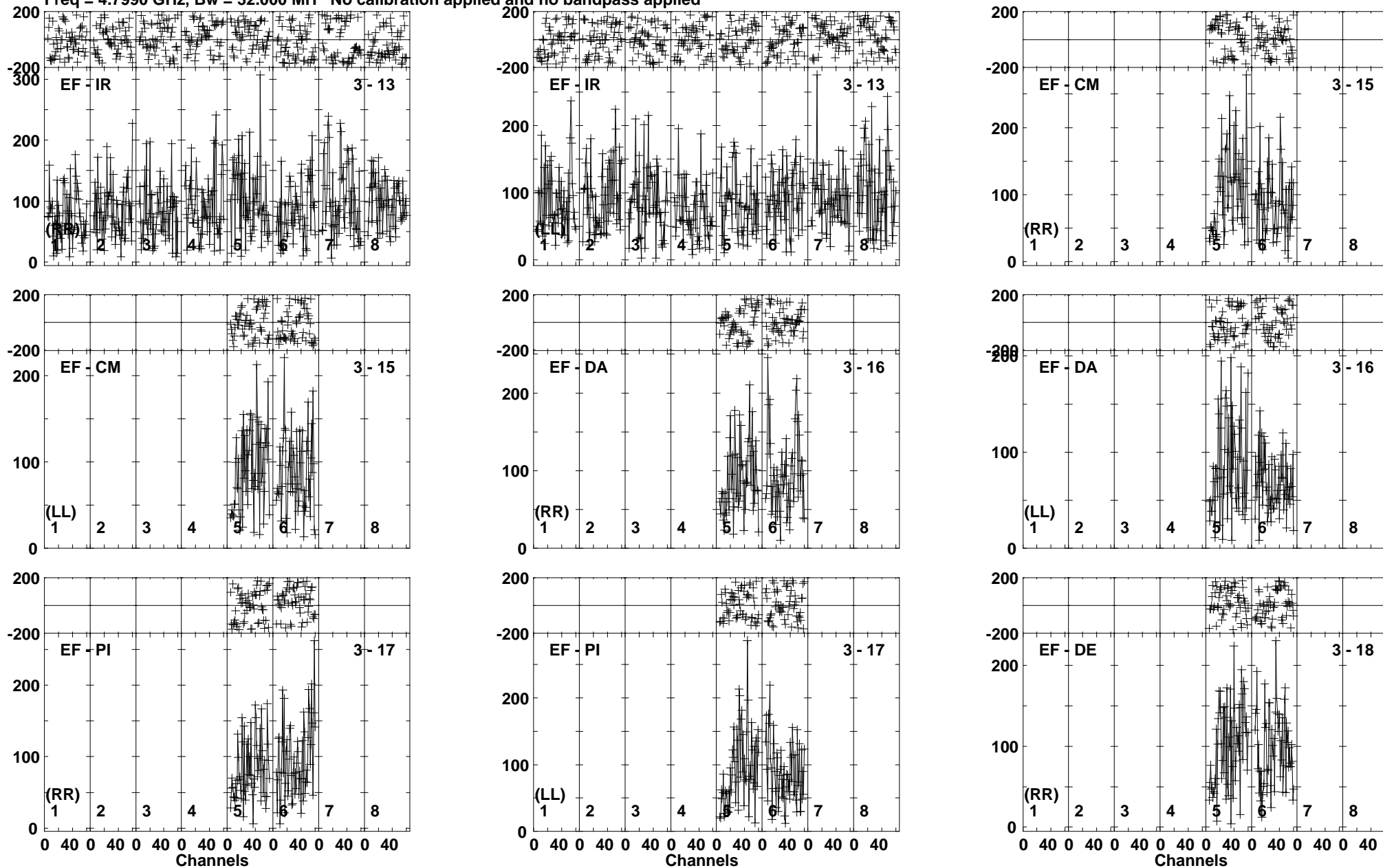

Lower frame: Micro Ampl Jy Top frame: Phas deg
 Vector averaged cross-power spectrum Baseline: EF (03) - IR (13)
 Timerange: 00/15:48:10 to 00/15:51:10

Plot file version 261 created 20-SEP-2019 15:52:41
AT2019EHZ RSM05.UVDATA.1
Freq = 4.7990 GHz, Bw = 32.000 MH No calibration applied and no bandpass applied

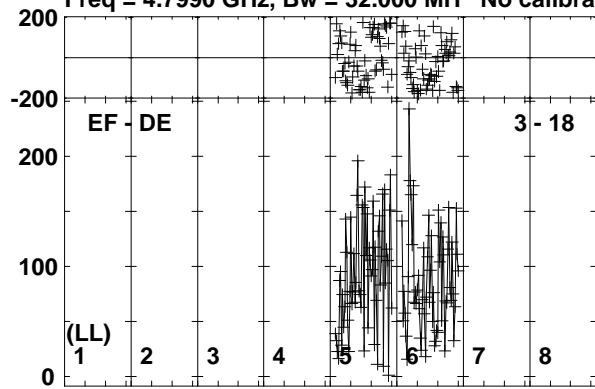

Lower frame: Micro Ampl Jy Top frame: Phas deg
Vector averaged cross-power spectrum Baseline: EF (03) - DE (18)
Timerange: 00/15:48:10 to 00/15:51:10

Plot file version 262 created 20-SEP-2019 15:52:41

J1408+5613 RSM05.UVDATA.1

Freq = 4.7990 GHz, Bw = 32.000 MH No calibration applied and no bandpass applied

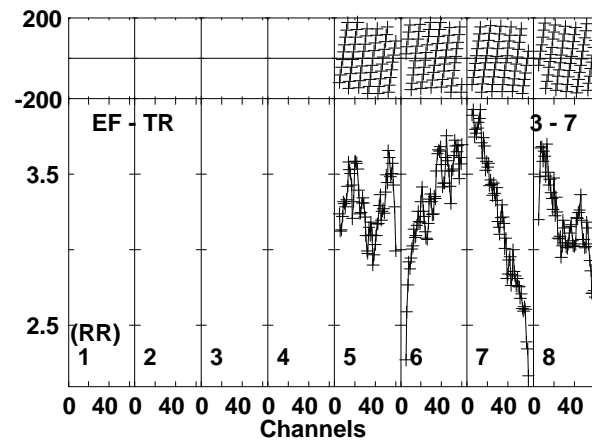
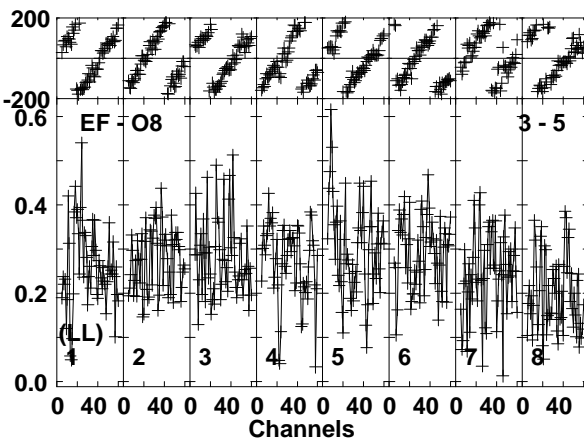
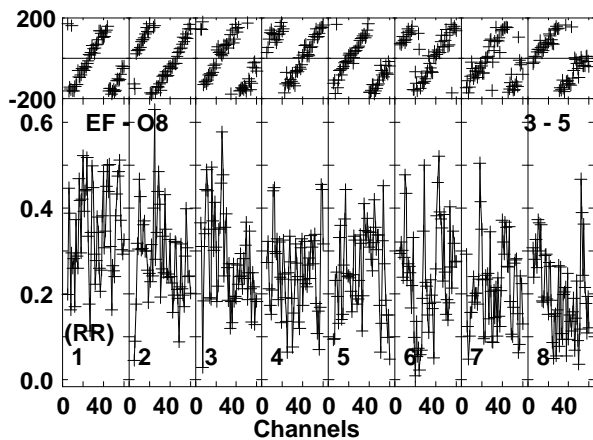
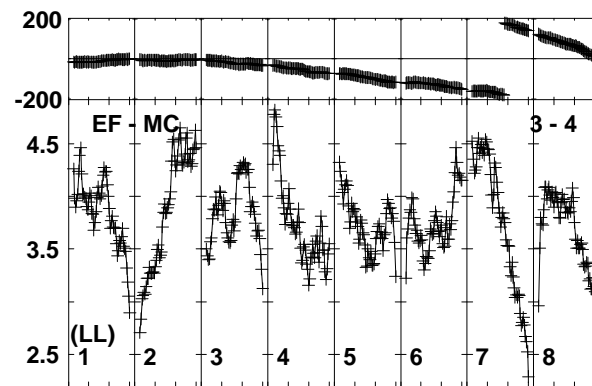
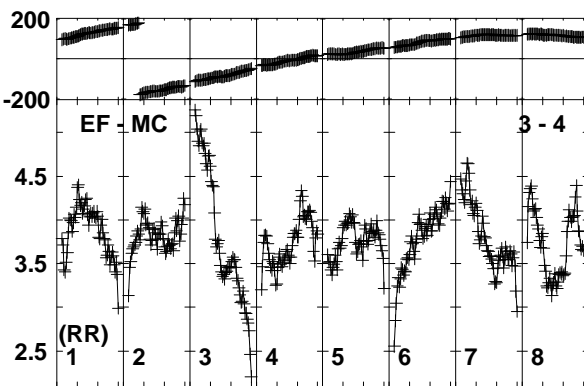
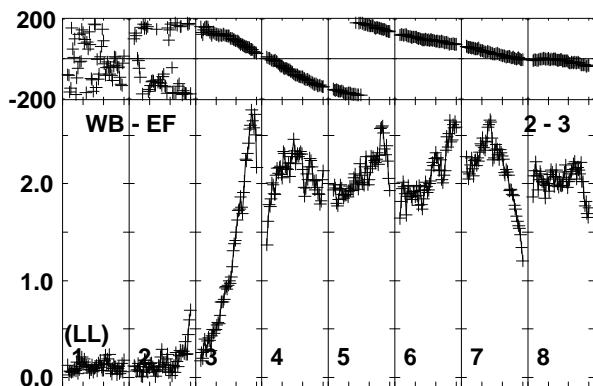
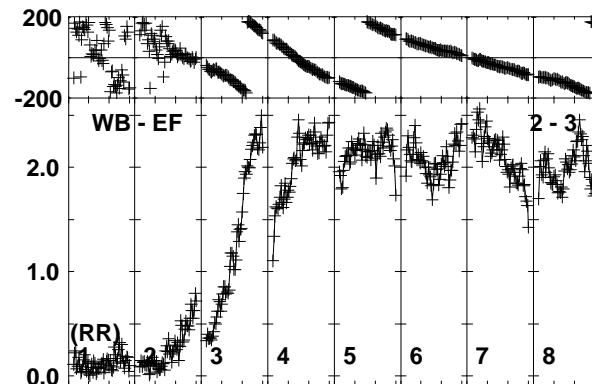
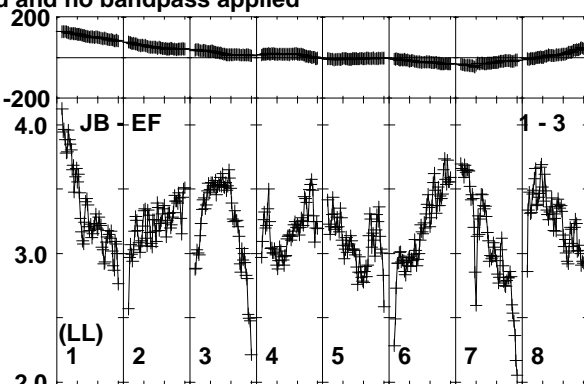
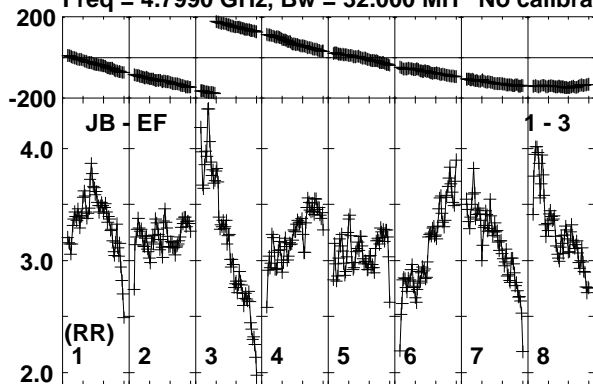

Lower frame: Milli Ampl Jy Top frame: Phas deg
Vector averaged cross-power spectrum Baseline: JB (01) - EF (03)
Timerange: 00/15:52:01 to 00/15:53:29

Plot file version 263 created 20-SEP-2019 15:52:42

J1408+5613 RSM05.UVDATA.1

Freq = 4.7990 GHz, Bw = 32.000 MH No calibration applied and no bandpass applied

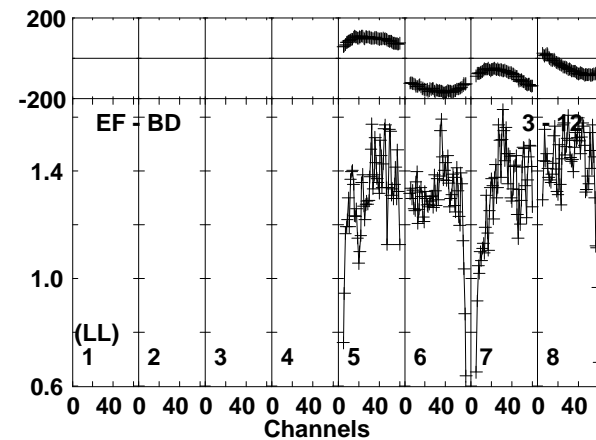
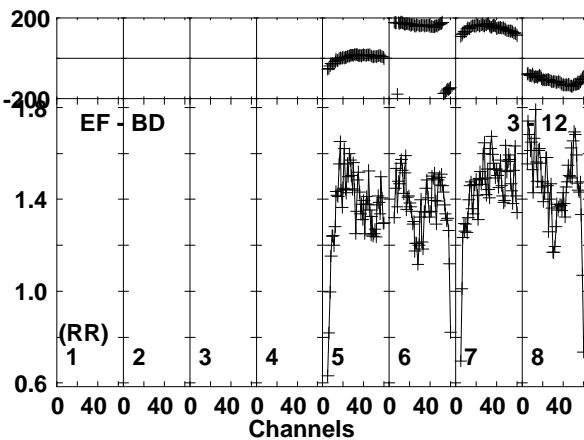
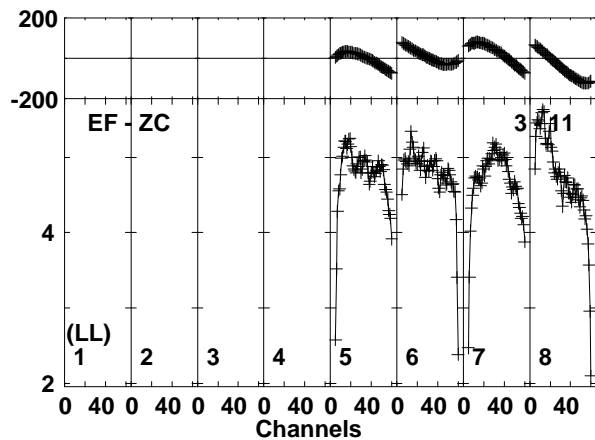
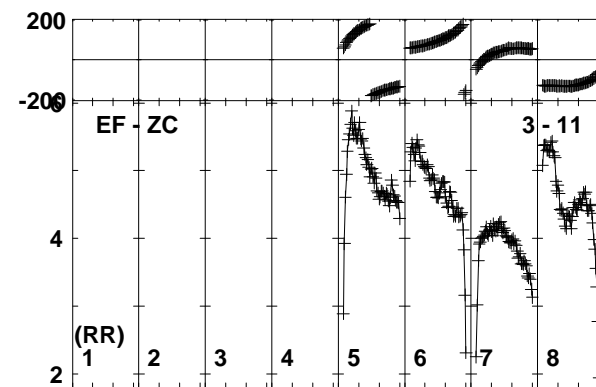
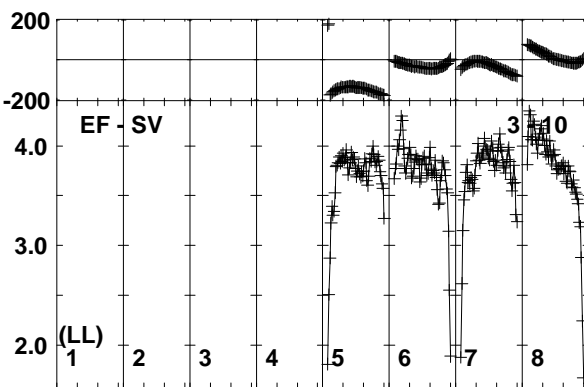
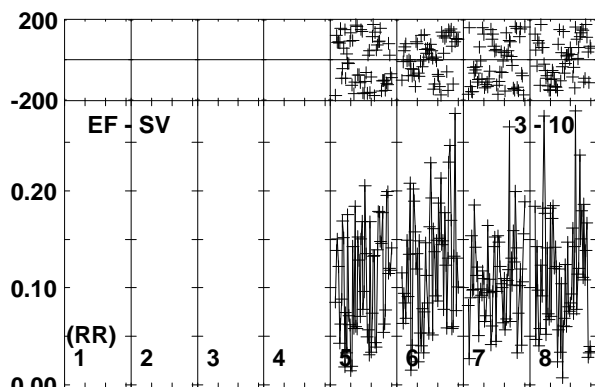
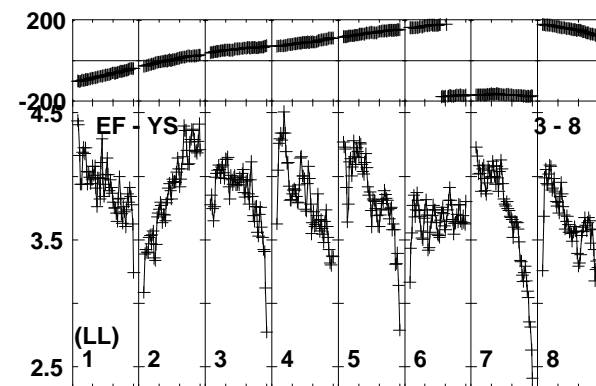
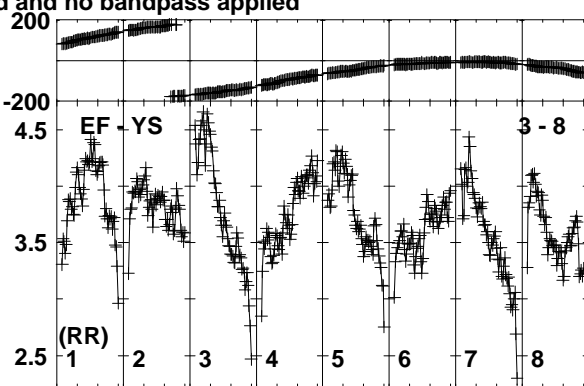
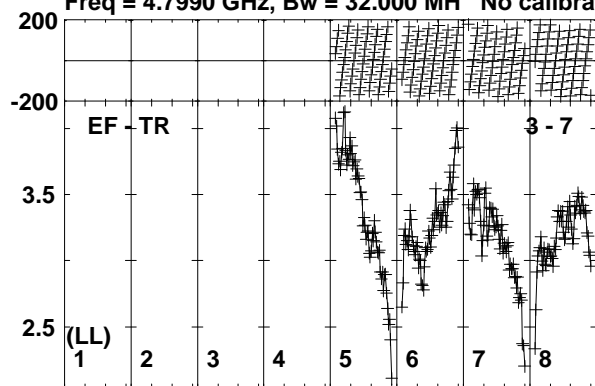

Lower frame: Milli Ampl Jy Top frame: Phas deg
Vector averaged cross-power spectrum Baseline: EF (03) - TR (07)
Timerange: 00/15:52:01 to 00/15:53:29

Plot file version 264 created 20-SEP-2019 15:52:42

J1408+5613 RSM05.UVDATA.1

Freq = 4.7990 GHz, Bw = 32.000 MH No calibration applied and no bandpass applied

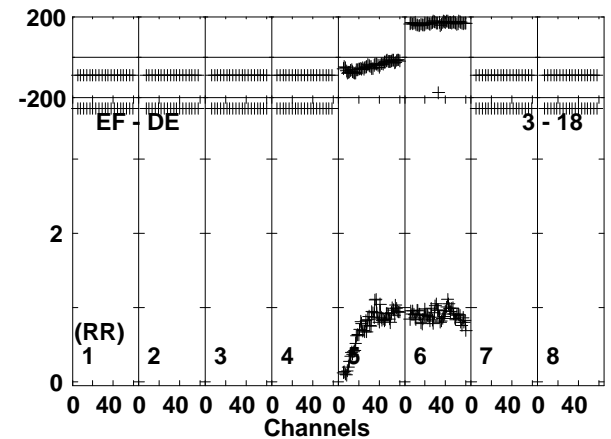
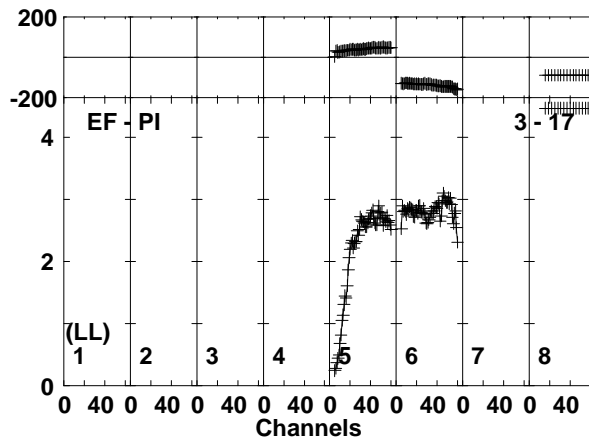
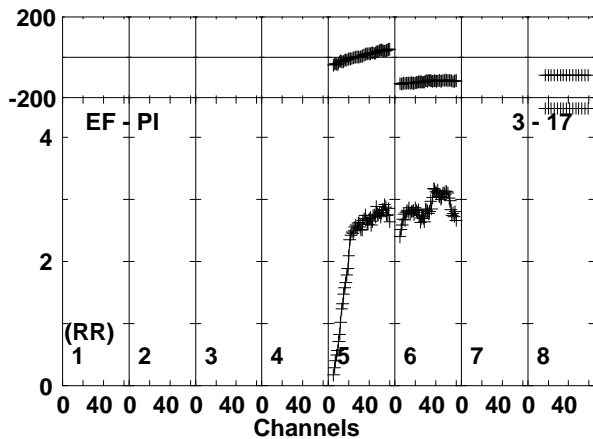
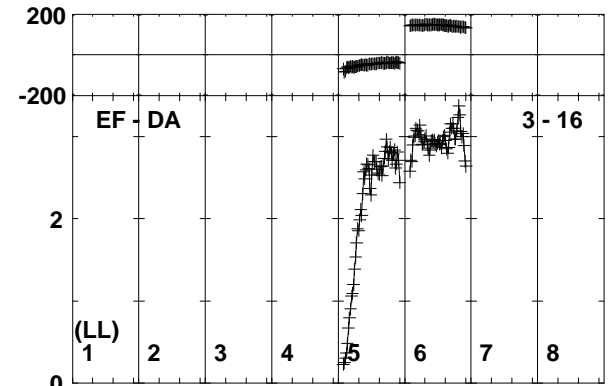
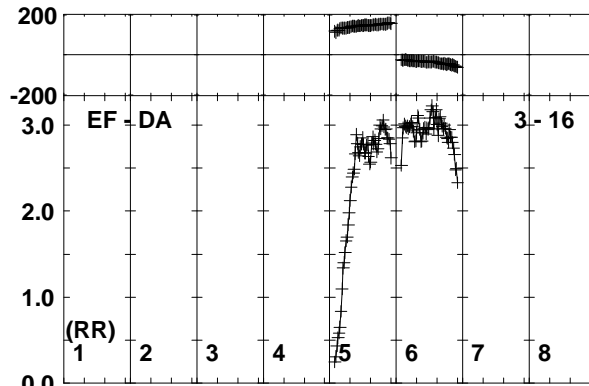
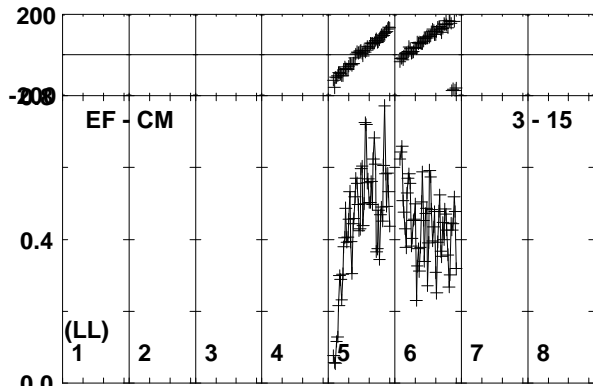
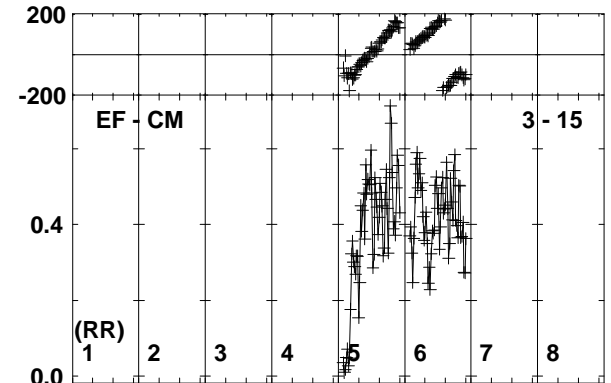
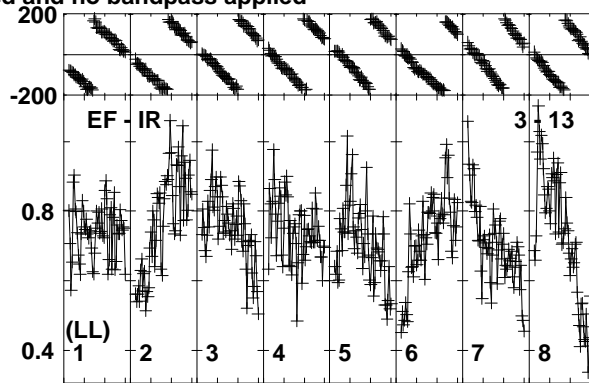
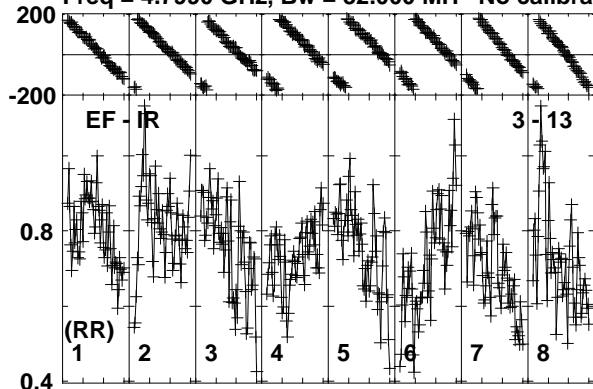

Lower frame: Milli Ampl Jy Top frame: Phas deg
Vector averaged cross-power spectrum Baseline: EF (03) - IR (13)
Timerange: 00/15:52:01 to 00/15:53:29

Plot file version 265 created 20-SEP-2019 15:52:43
J1408+5613 RSM05.UVDATA.1
Freq = 4.7990 GHz, Bw = 32.000 MH No calibration applied and no bandpass applied

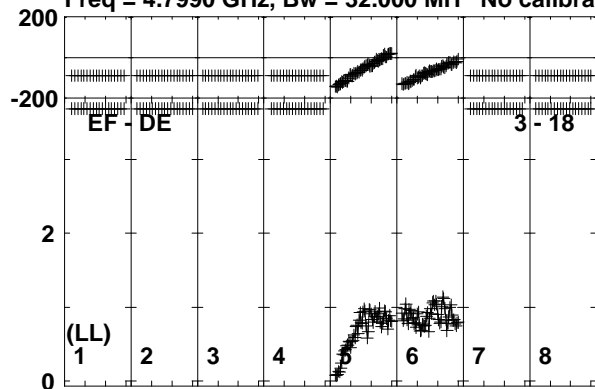

Lower frame: Milli Ampl Jy Top frame: Phas deg
Vector averaged cross-power spectrum Baseline: EF (03) - DE (18)
Timerange: 00/15:52:01 to 00/15:53:29

Plot file version 266 created 20-SEP-2019 15:52:43

J2031+1219 RSM05.UVDATA.1

Freq = 4.7990 GHz, Bw = 32.000 MH No calibration applied and no bandpass applied

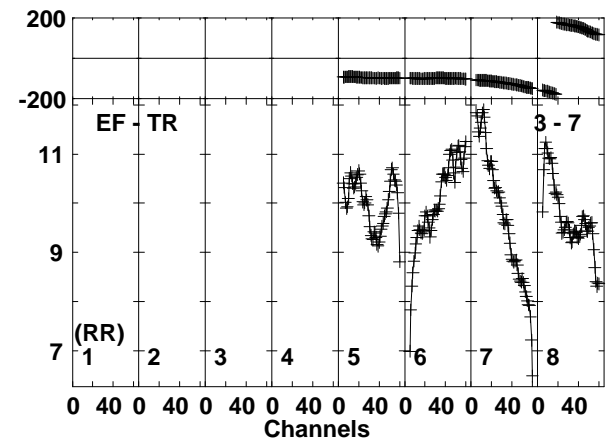
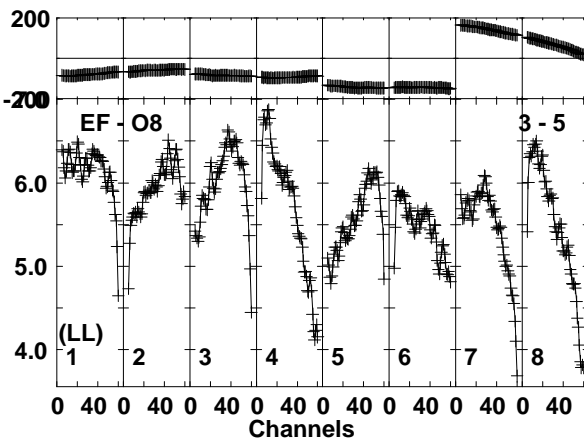
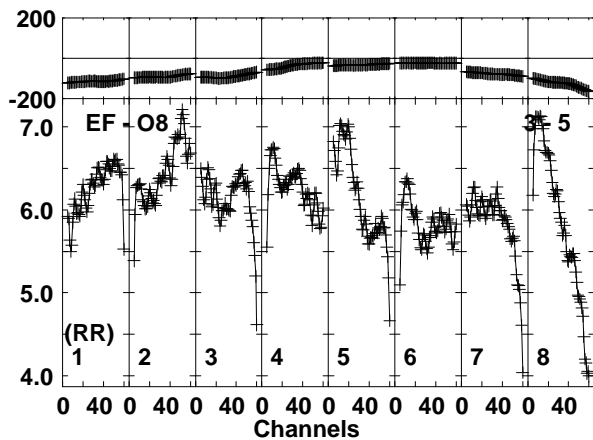
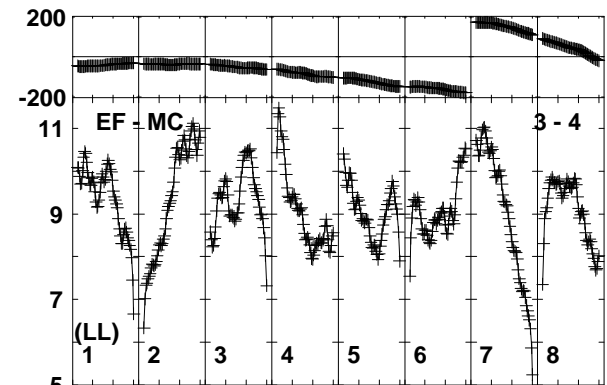
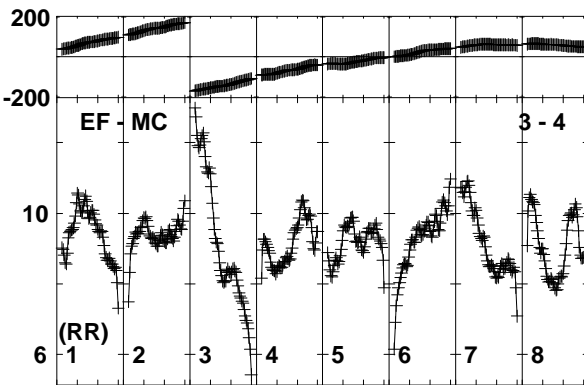
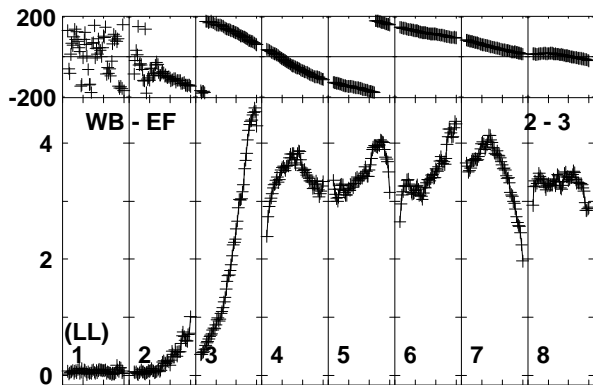
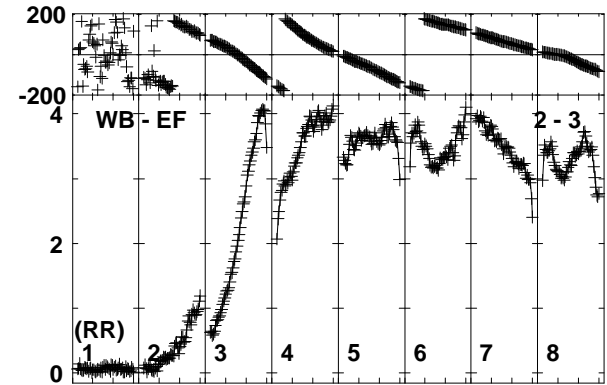
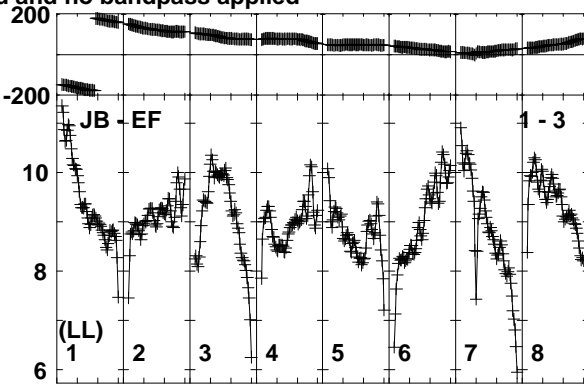
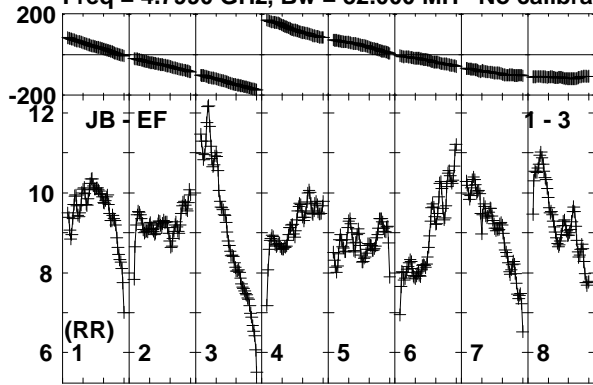

Lower frame: Milli Ampl Jy Top frame: Phas deg
Vector averaged cross-power spectrum Baseline: JB (01) - EF (03)
Timerange: 00/16:03:36 to 00/16:08:30

Plot file version 267 created 20-SEP-2019 15:52:44

J2031+1219 RSM05.UVDATA.1

Freq = 4.7990 GHz, Bw = 32.000 MH No calibration applied and no bandpass applied

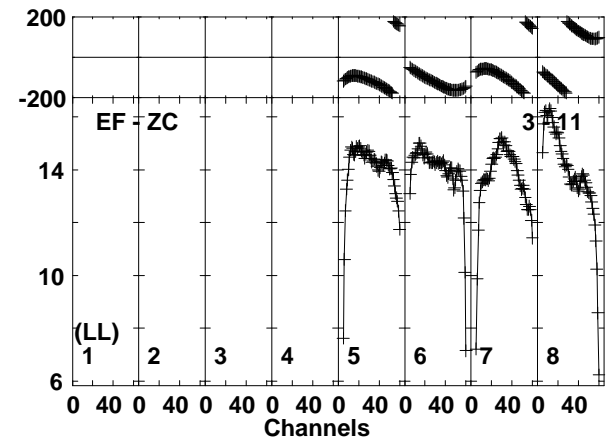
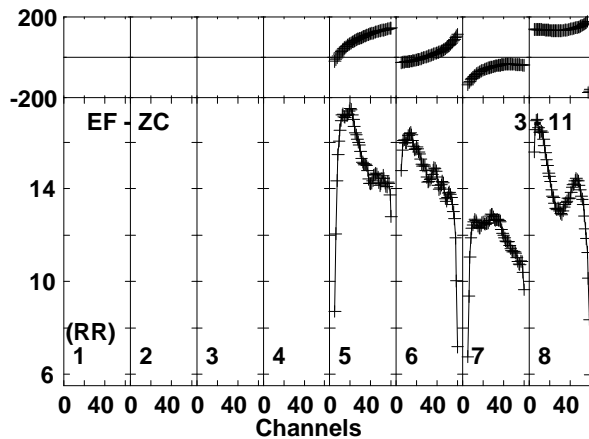
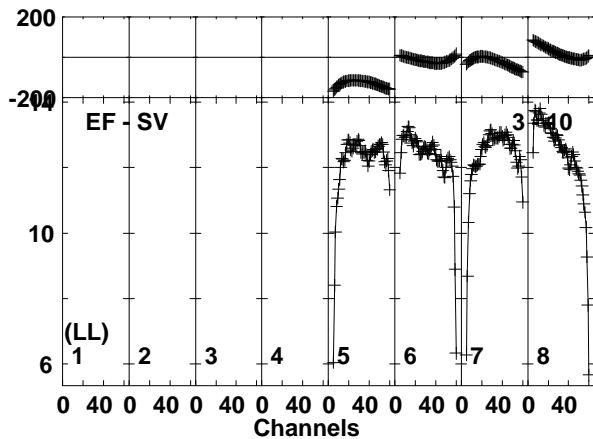
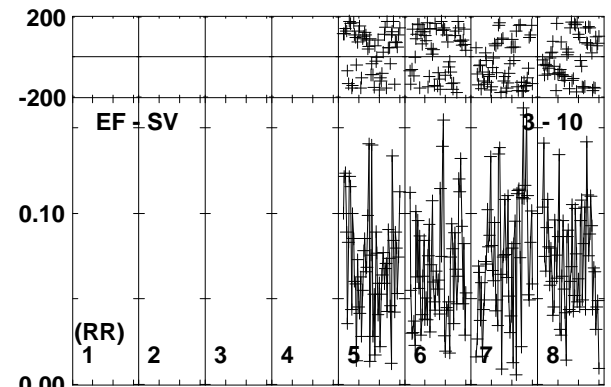
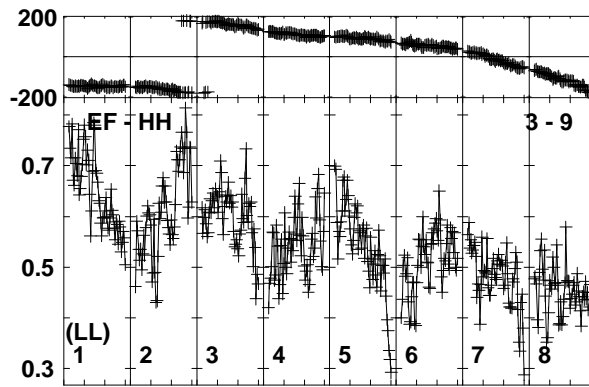
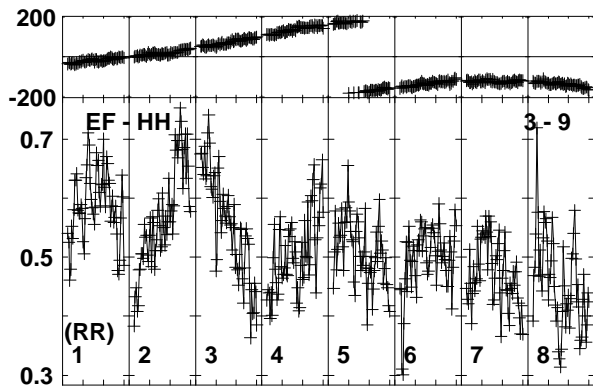
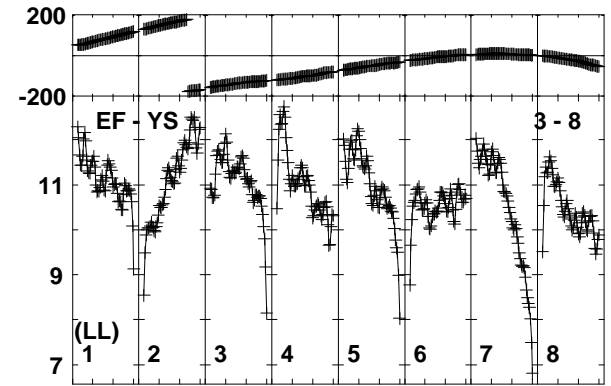
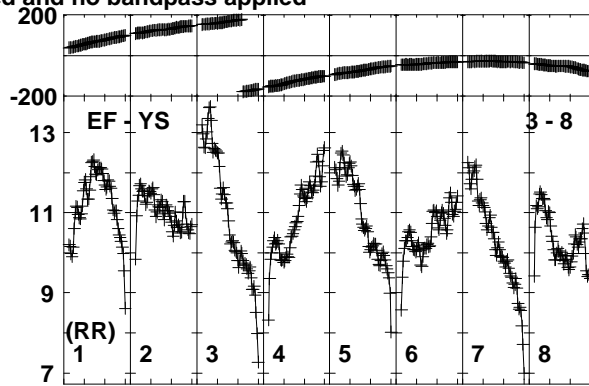
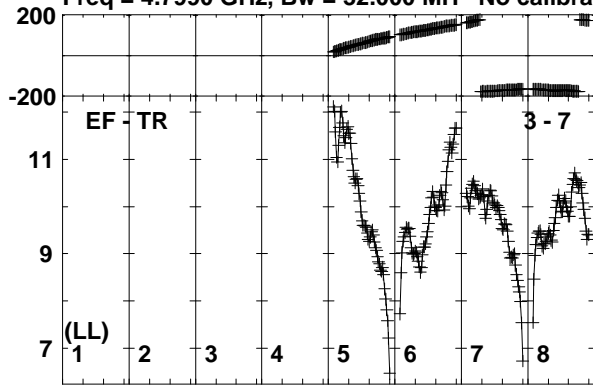

Lower frame: Milli Ampl Jy Top frame: Phas deg
Vector averaged cross-power spectrum Baseline: EF (03) - TR (07)
Timerange: 00/16:03:36 to 00/16:08:30

Plot file version 268 created 20-SEP-2019 15:52:45

J2031+1219 RSM05.UVDATA.1

Freq = 4.7990 GHz, Bw = 32.000 MH No calibration applied and no bandpass applied

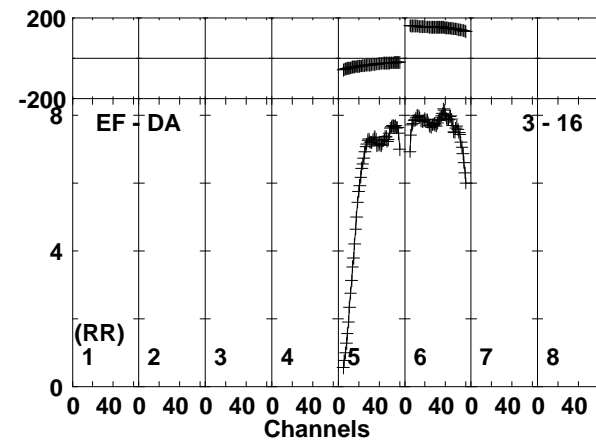
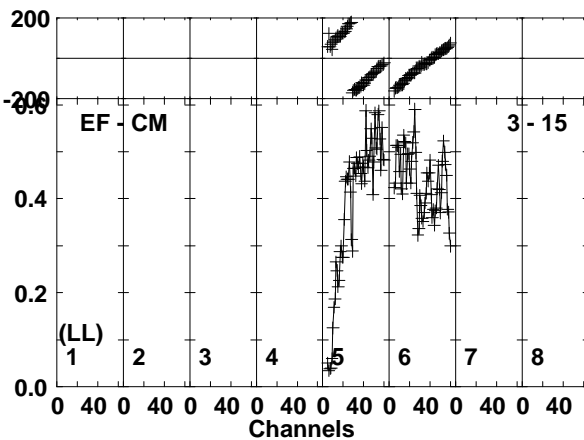
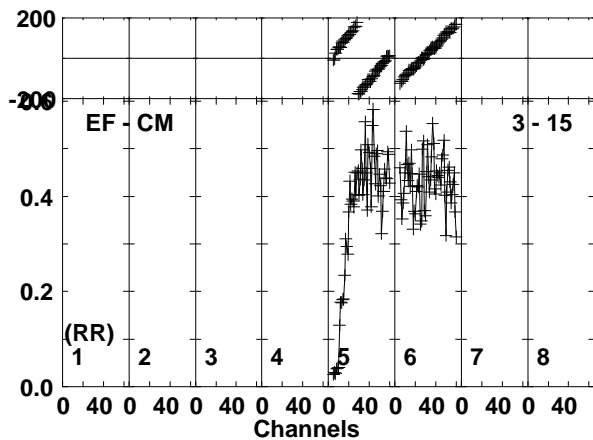
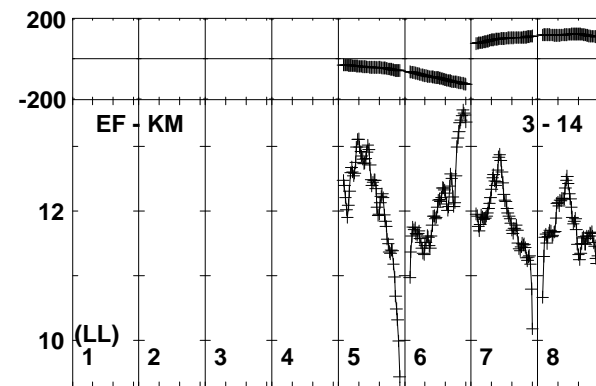
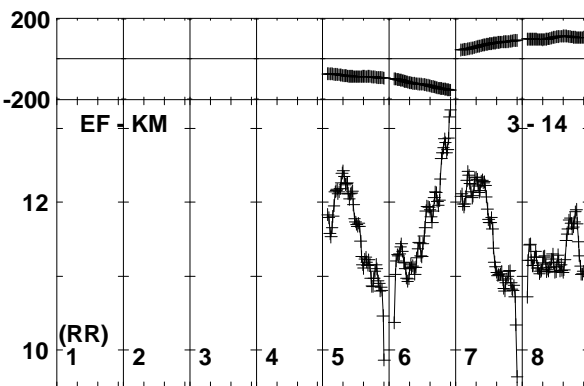
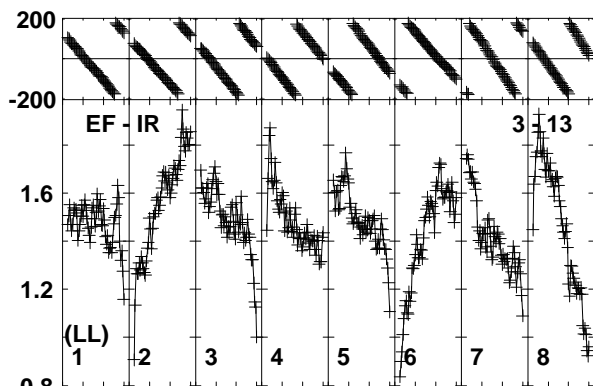
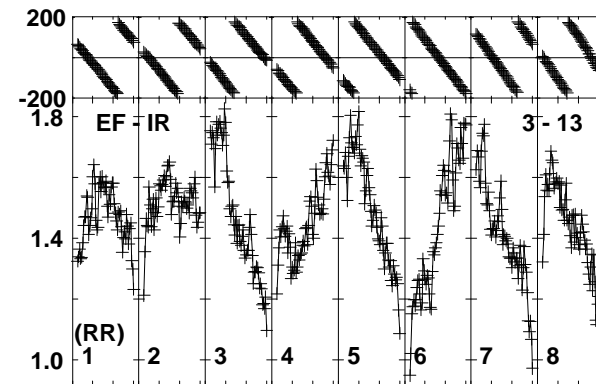
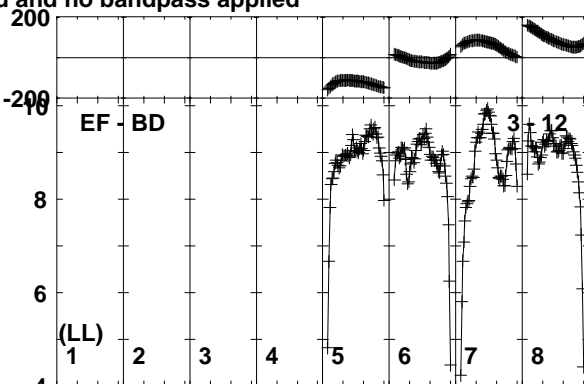
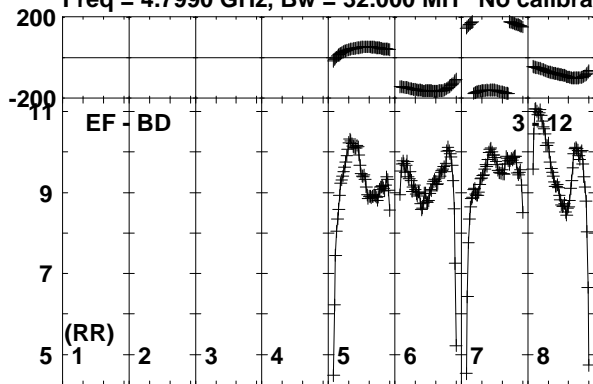

Lower frame: Milli Ampl Jy Top frame: Phas deg
Vector averaged cross-power spectrum Baseline: EF (03) - BD (12)
Timerange: 00/16:03:36 to 00/16:08:30

Plot file version 269 created 20-SEP-2019 15:52:45
 J2031+1219 RSM05.UVDATA.1
 Freq = 4.7990 GHz, Bw = 32.000 MH No calibration applied and no bandpass applied

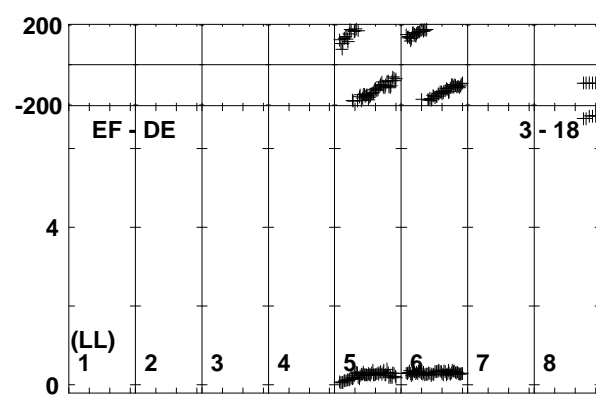
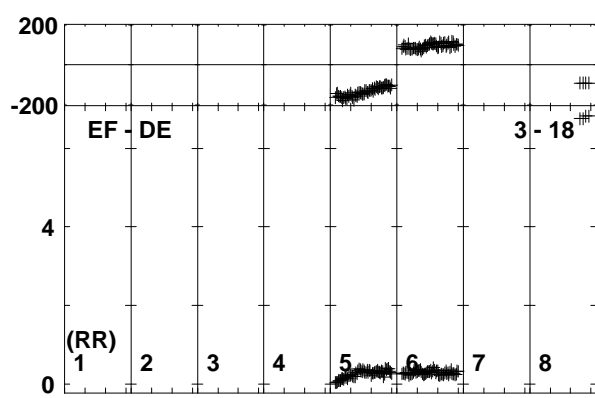
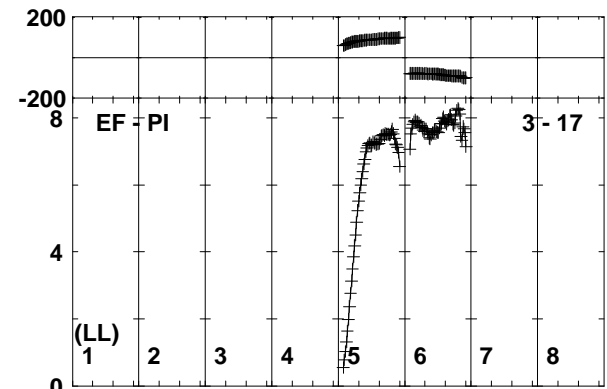
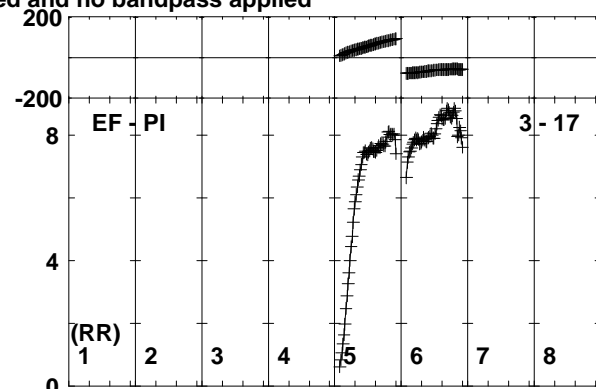
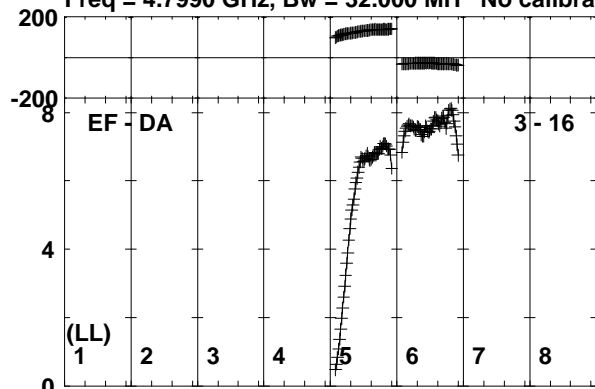

0 40 0 40 0 40 0 40 0 40 0 40 0 40 0 40 0 40 0 40
 Channels

Lower frame: Milli Ampl Jy Top frame: Phas deg
 Vector averaged cross-power spectrum Baseline: EF (03) - DA (16)
 Timerange: 00/16:03:36 to 00/16:08:30