

Plot file version 1 created 07-OCT-2010 14:25:48

4C39.25 RSP03.UVDATA.1

Freq = 1.6015 GHz, Bw = 16.000 MH No calibration applied and no bandpass applied

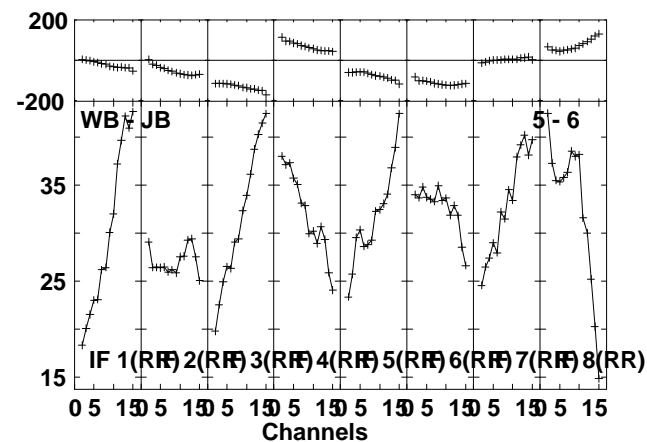
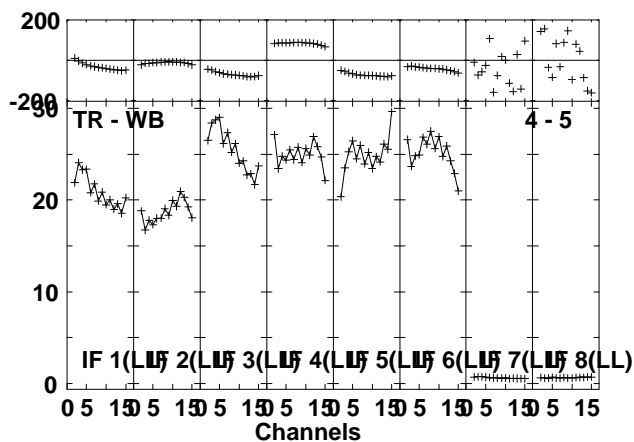
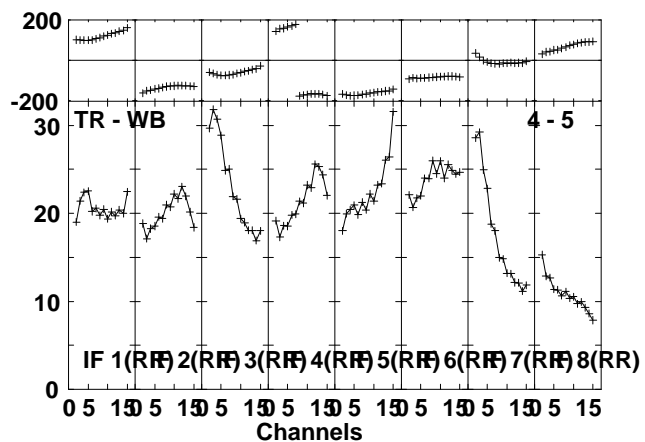
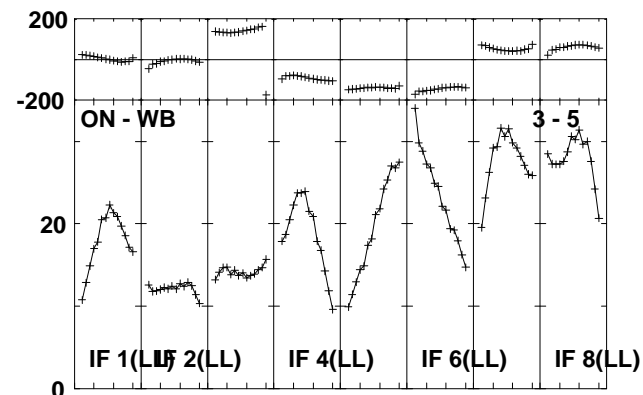
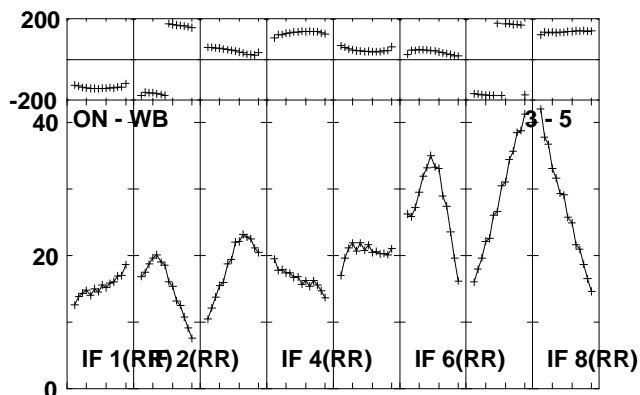
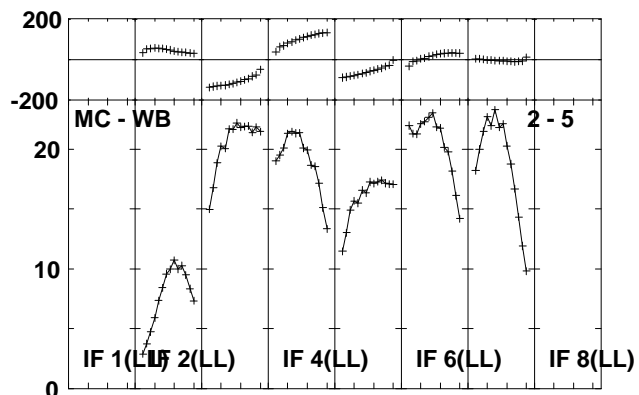
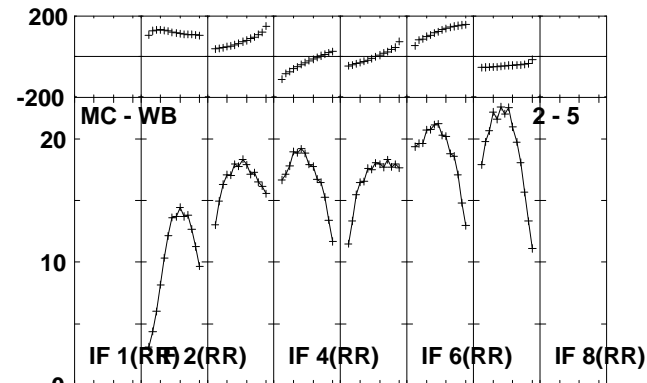
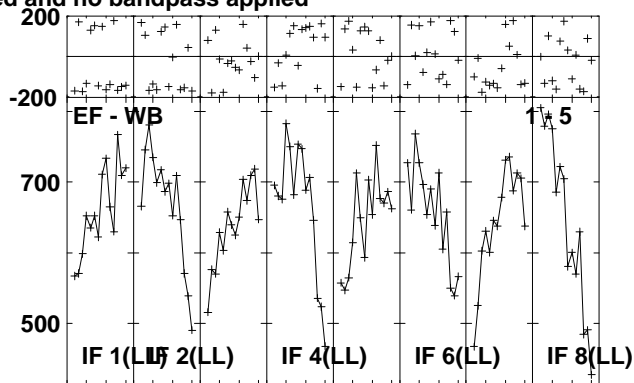
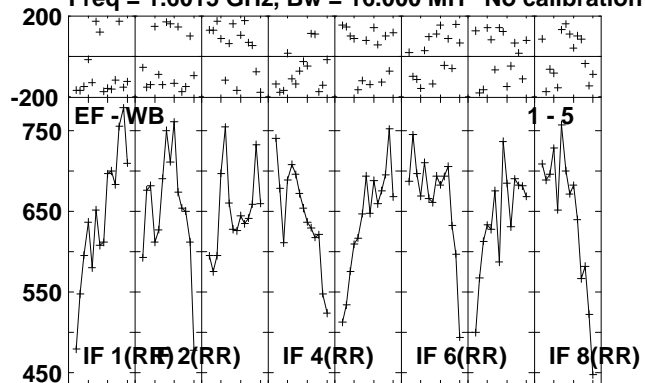

Lower frame: Micro Ampl Jy Top frame: Phas deg
Scalar averaged cross-power spectrum Several baselines displayed
Timerange: 00/06:30:42 to 00/06:44:58

Plot file version 2 created 07-OCT-2010 14:25:50

4C39.25 RSP03.UVDATA.1

Freq = 1.6015 GHz, Bw = 16.000 MH No calibration applied and no bandpass applied

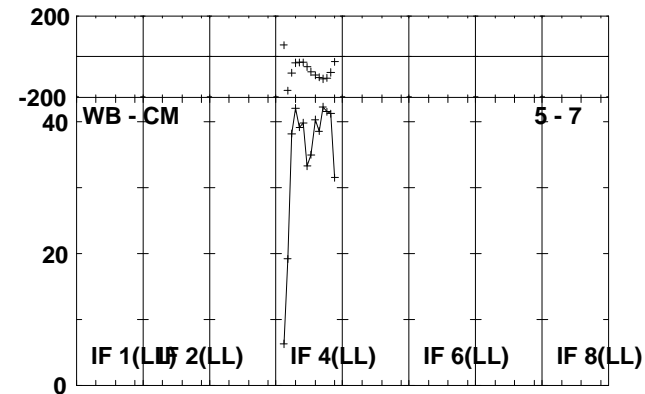
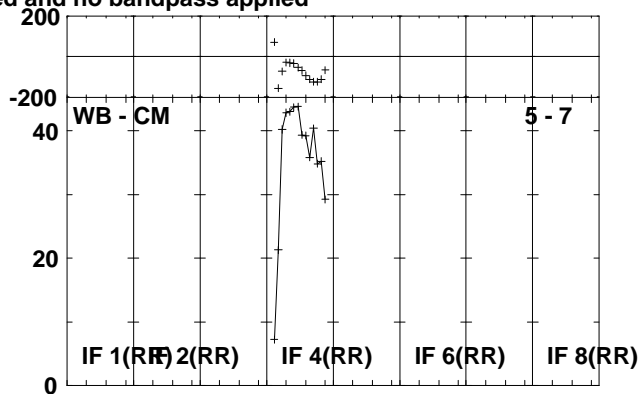
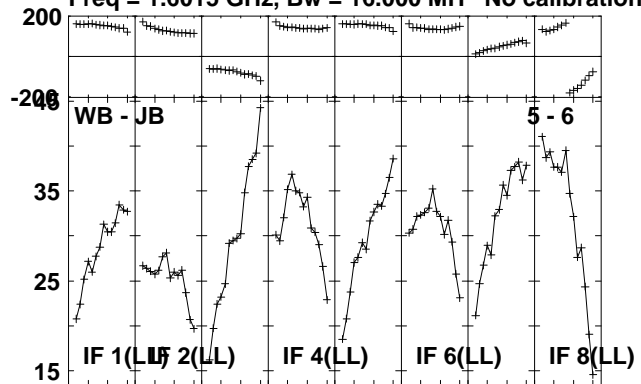

Lower frame: Milli Ampl Jy Top frame: Phas deg
Scalar averaged cross-power spectrum Several baselines displayed
Timerange: 00/06:30:42 to 00/06:44:58

Plot file version 3 created 07-OCT-2010 14:25:51

J1345+44 RSP03.UVDATA.1

Freq = 1.6015 GHz, Bw = 16.000 MH No calibration applied and no bandpass applied

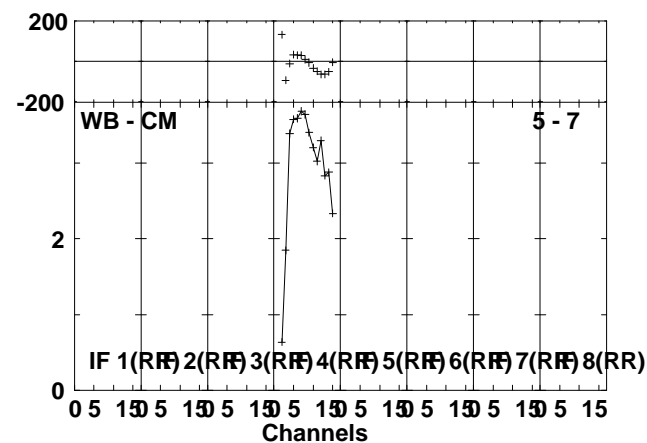
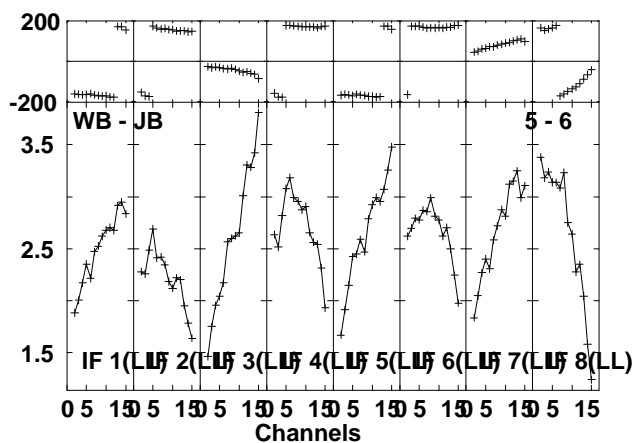
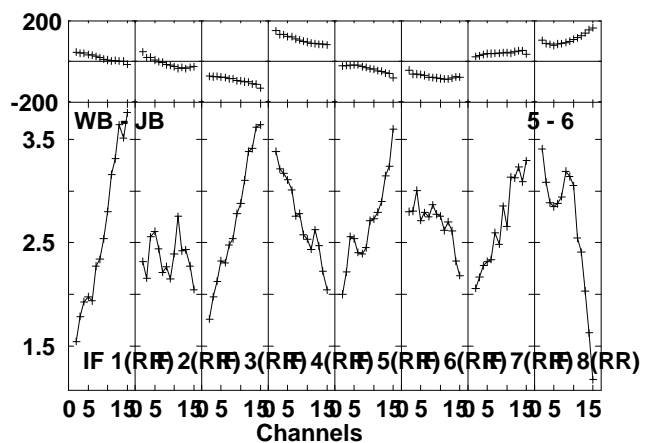
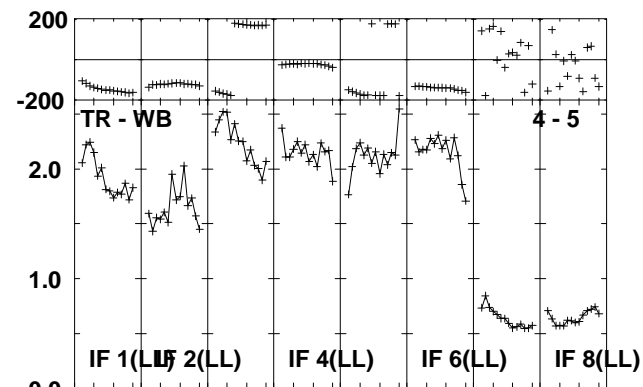
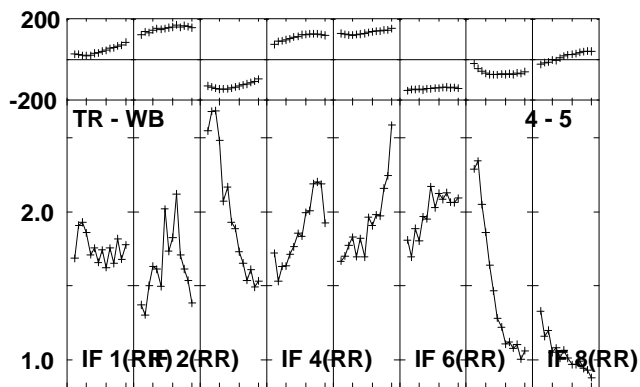
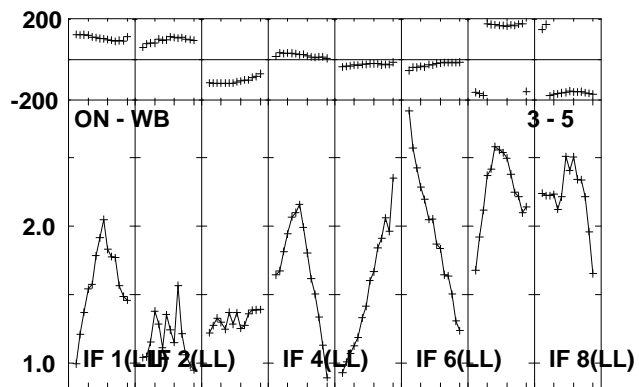
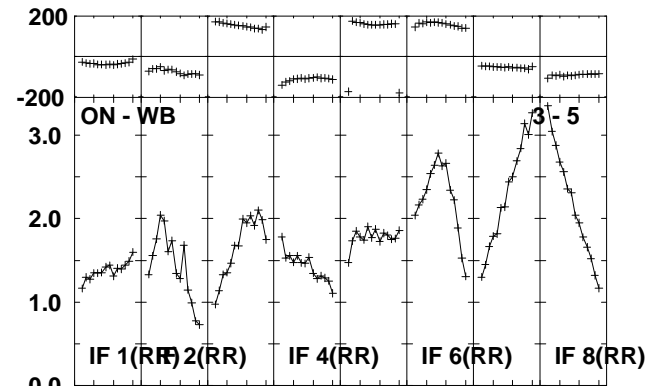
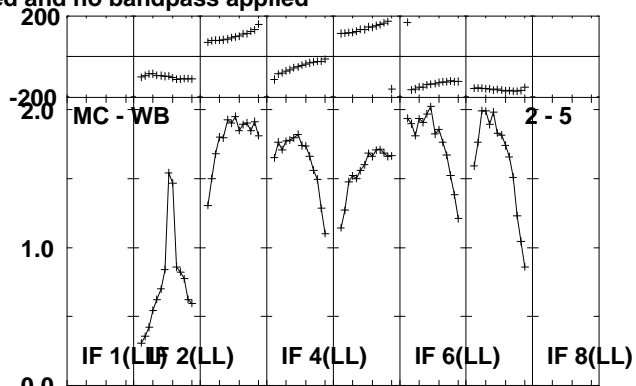
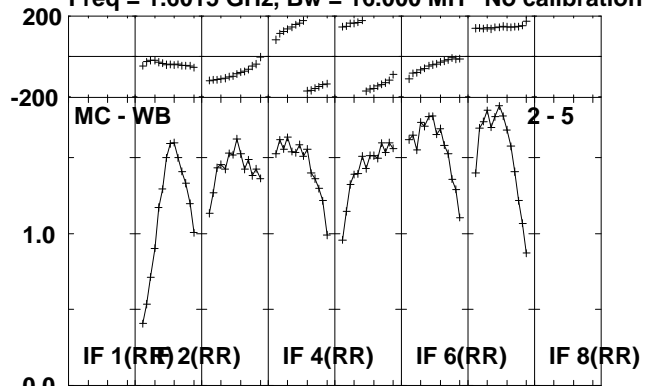

Lower frame: Milli Ampl Jy Top frame: Phas deg
Scalar averaged cross-power spectrum Several baselines displayed
Timerange: 00/06:47:02 to 00/06:59:58

Plot file version 4 created 07-OCT-2010 14:25:53
J1345+44 RSP03.UVDATA.1
Freq = 1.6015 GHz, Bw = 16.000 MH No calibration applied and no bandpass applied

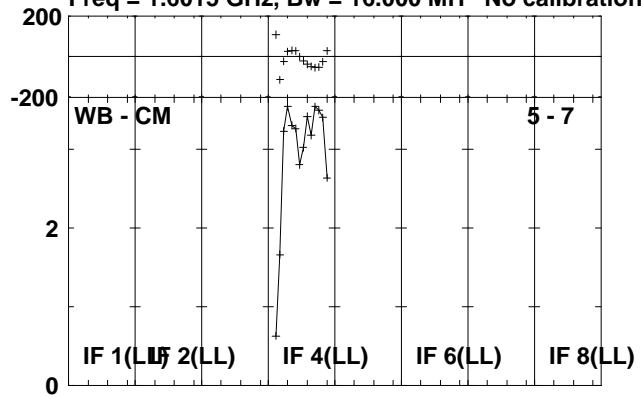

Lower frame: Milli Ampl Jy Top frame: Phas deg
Scalar averaged cross-power spectrum Several baselines displayed
Timerange: 00/06:47:02 to 00/06:59:58

Plot file version 5 created 07-OCT-2010 14:25:53

J134054 RSP03.UVDATA.1

Freq = 1.6015 GHz, Bw = 16.000 MH No calibration applied and no bandpass applied

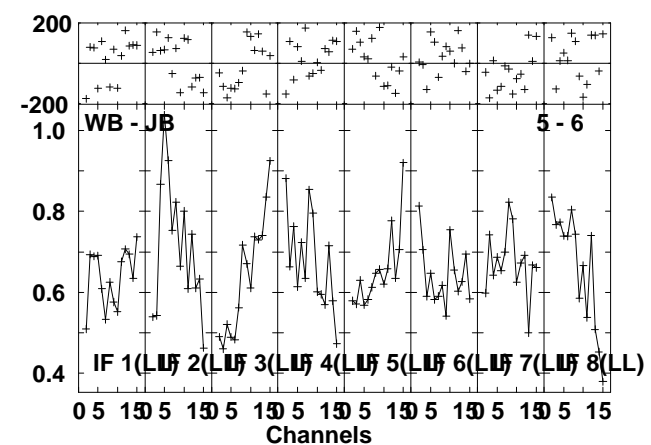
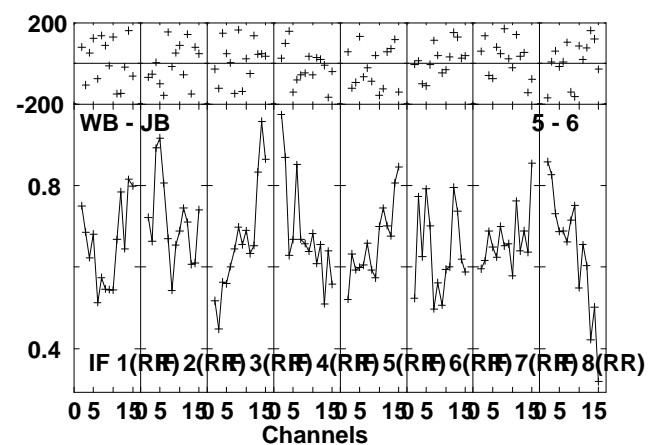
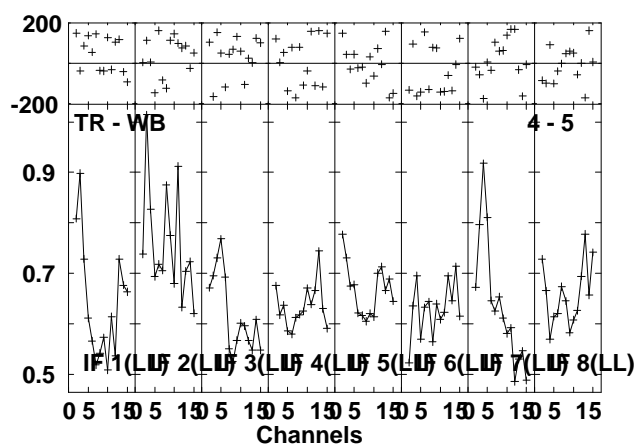
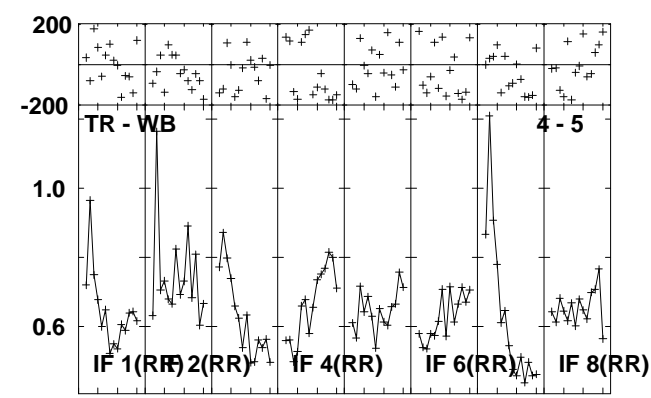
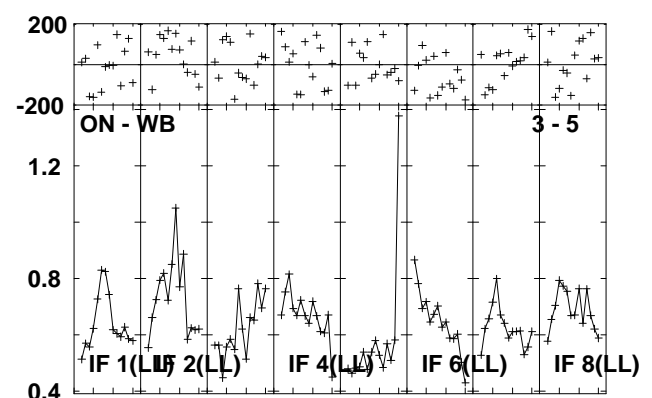
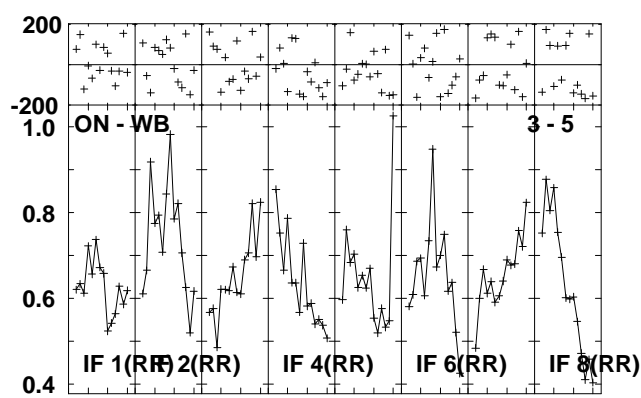
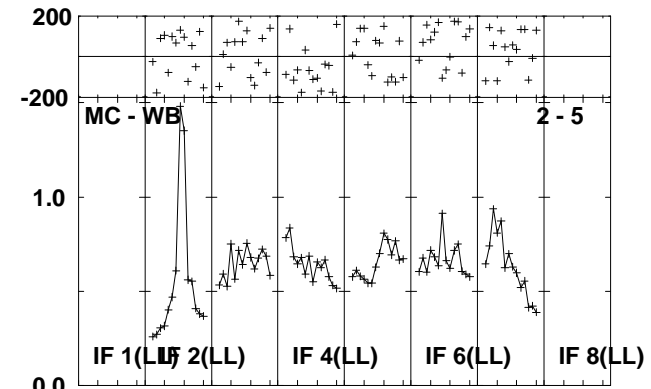
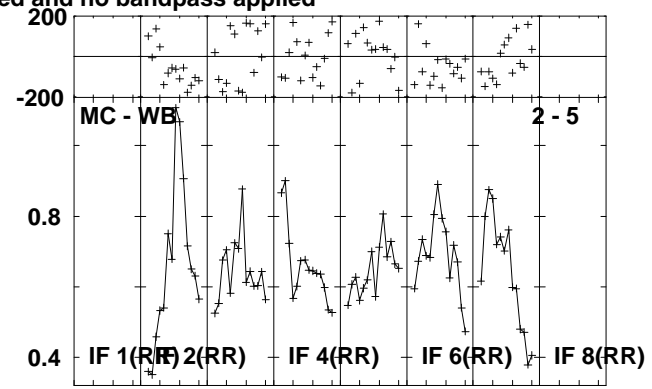
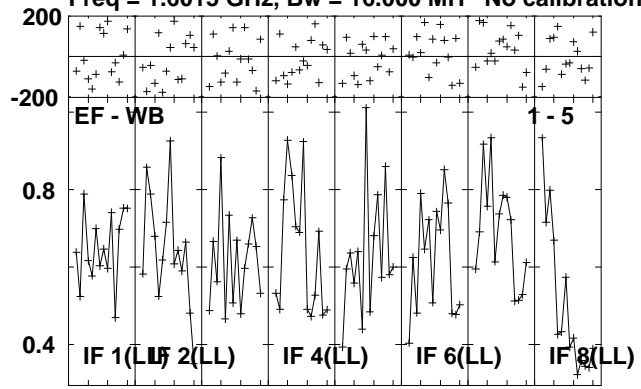

Lower frame: Milli Ampl Jy Top frame: Phas deg
Scalar averaged cross-power spectrum Several baselines displayed
Timerange: 00/07:00:02 to 00/07:04:38

Plot file version 6 created 07-OCT-2010 14:25:54

J134054 RSP03.UVDATA.1

Freq = 1.6015 GHz, Bw = 16.000 MH No calibration applied and no bandpass applied

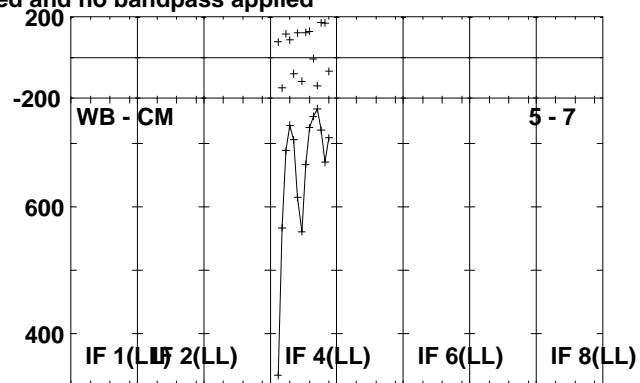
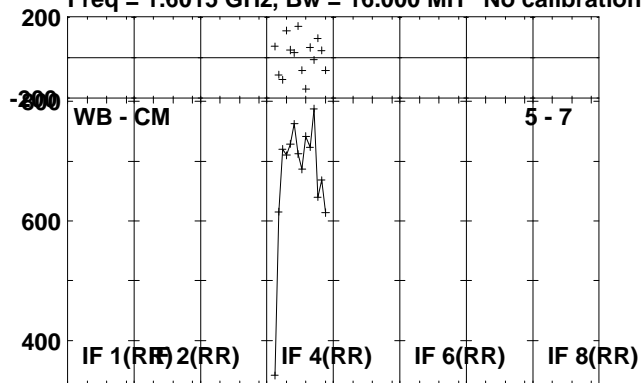

Lower frame: Micro Ampl Jy Top frame: Phas deg
Scalar averaged cross-power spectrum Several baselines displayed
Timerange: 00/07:00:02 to 00/07:04:38

Plot file version 7 created 07-OCT-2010 14:25:54

CAL1 RSP03.UVDATA.1

Freq = 1.6015 GHz, Bw = 16.000 MH No calibration applied and no bandpass applied

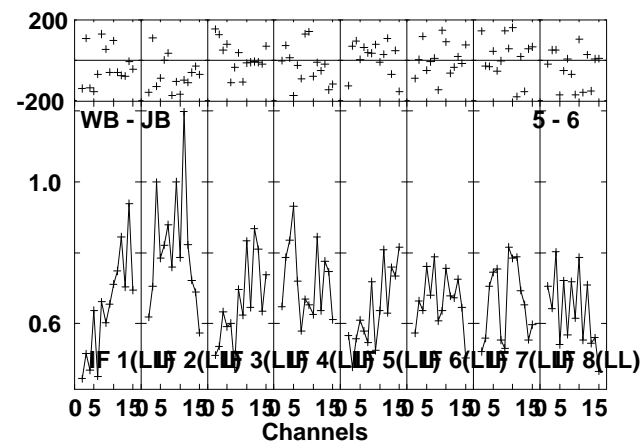
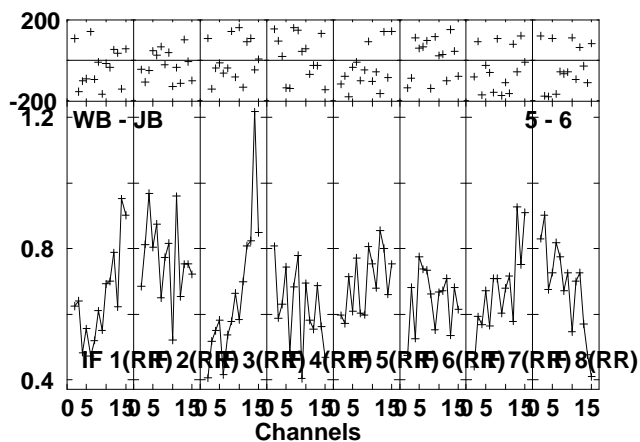
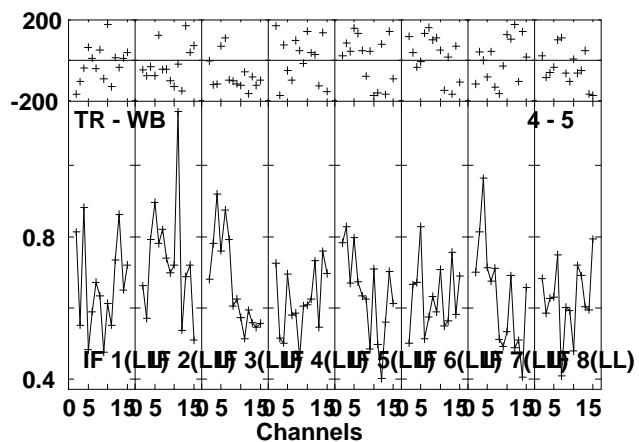
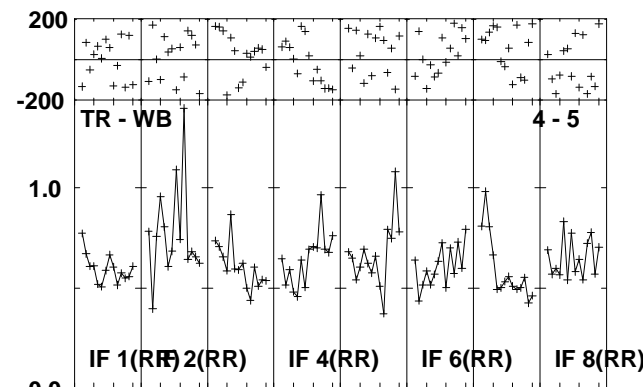
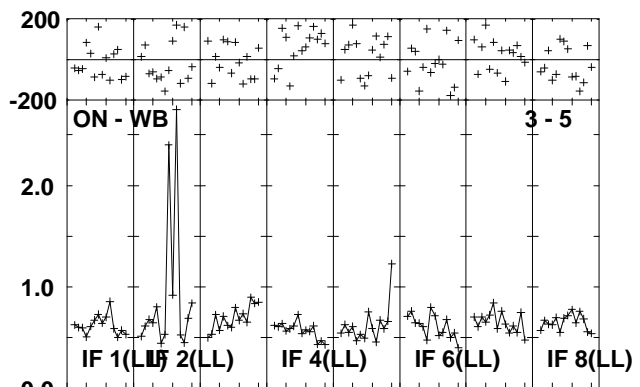
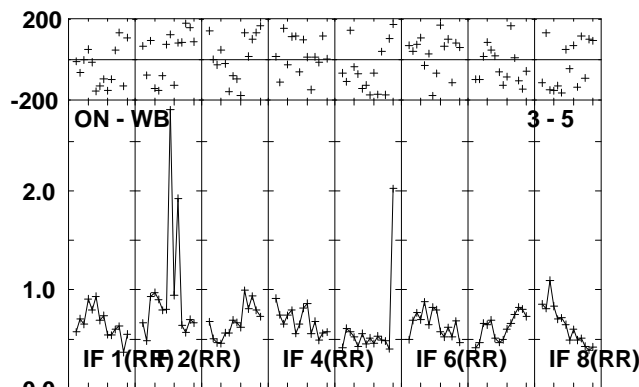
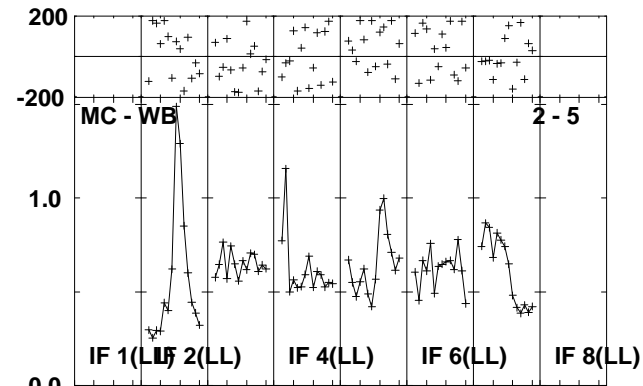
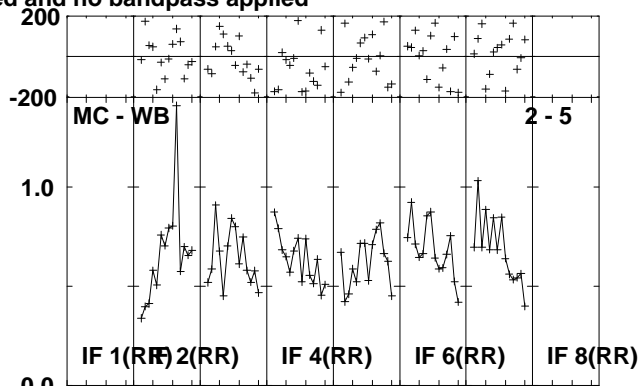
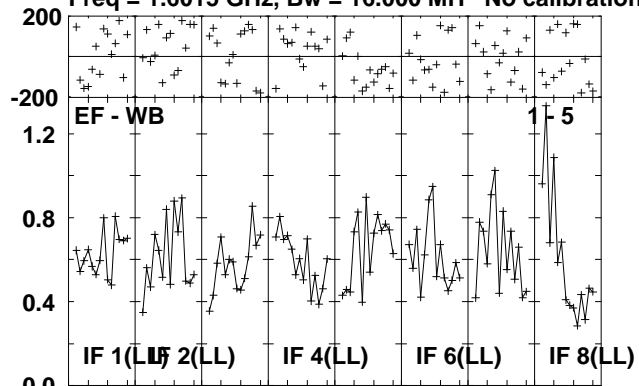

Lower frame: Milli Ampl Jy Top frame: Phas deg
Scalar averaged cross-power spectrum Several baselines displayed
Timerange: 00/07:04:42 to 00/07:05:54

Plot file version 8 created 07-OCT-2010 14:25:54

CAL1 RSP03.UVDATA.1

Freq = 1.6015 GHz, Bw = 16.000 MH No calibration applied and no bandpass applied

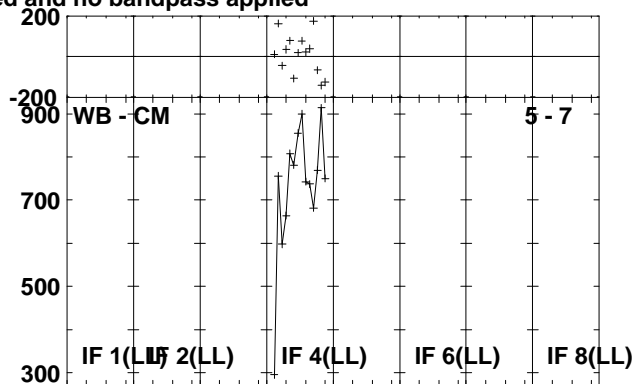
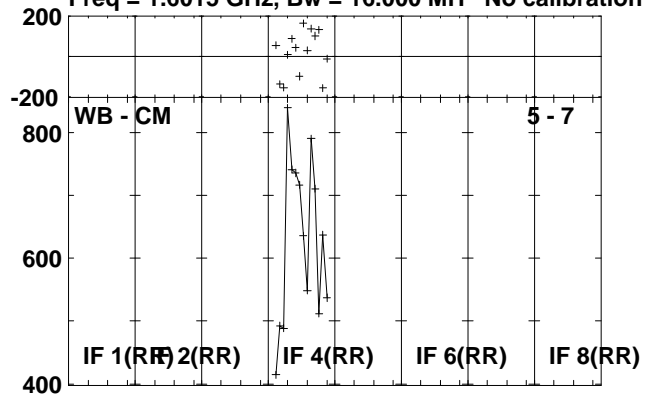

Lower frame: Micro Ampl Jy Top frame: Phas deg
Scalar averaged cross-power spectrum Several baselines displayed
Timerange: 00/07:04:42 to 00/07:05:54

Plot file version 9 created 07-OCT-2010 14:25:54
 J1345+44 RSP03.UVDATA.1

Freq = 1.6015 GHz, Bw = 16.000 MH No calibration applied and no bandpass applied

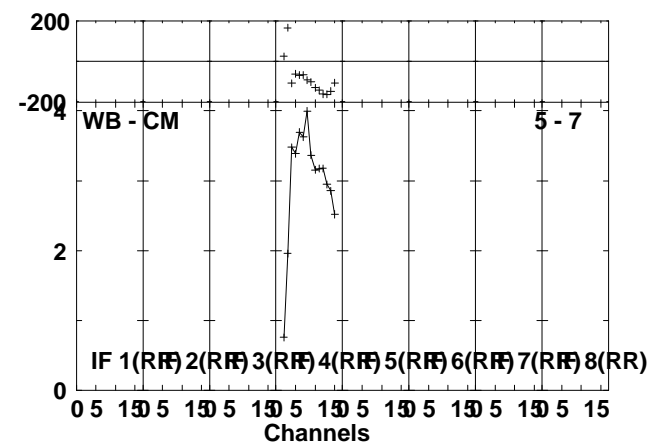
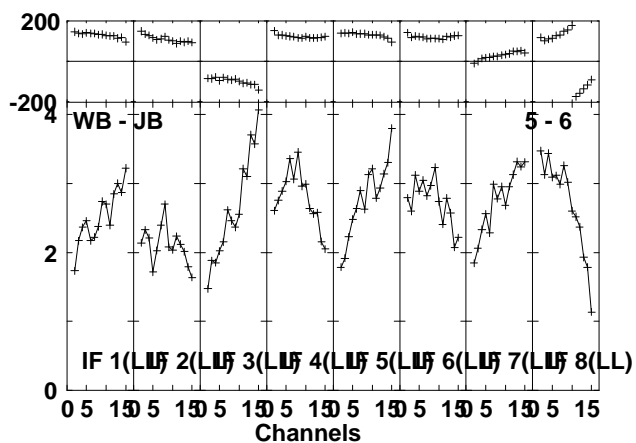
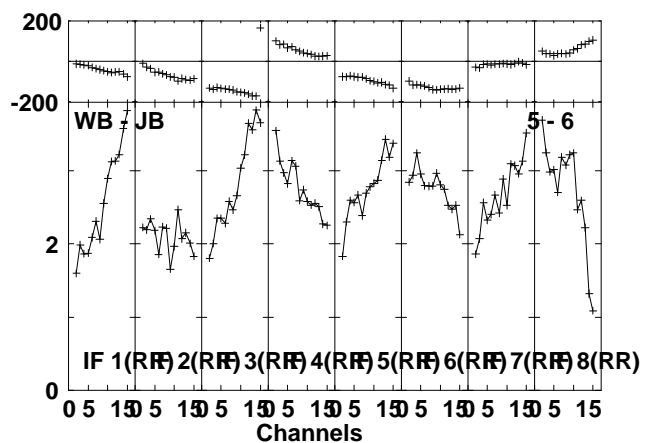
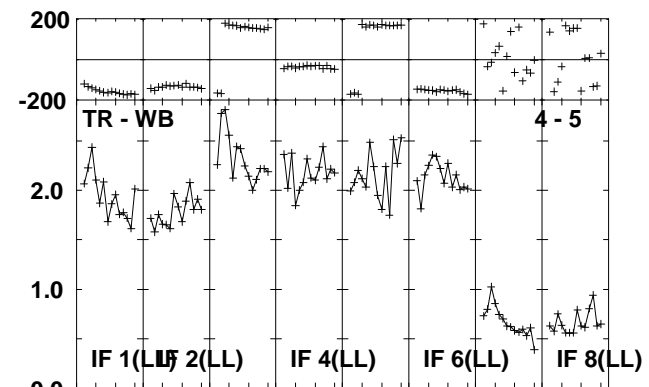
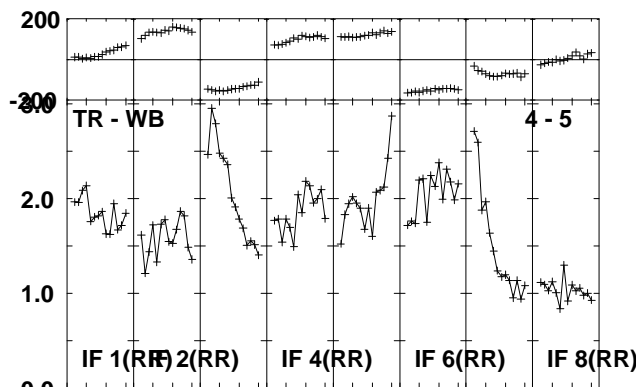
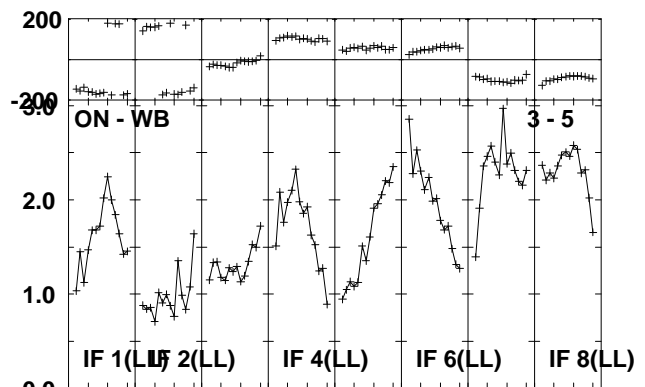
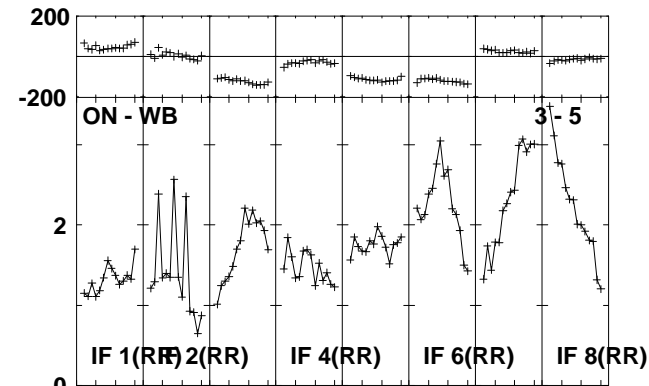
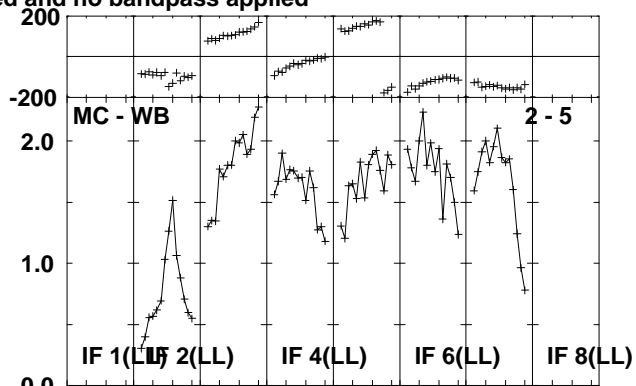
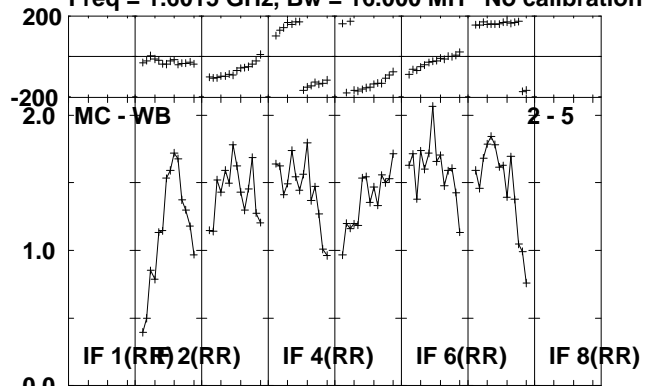

Lower frame: Milli Ampl Jy Top frame: Phas deg
 Scalar averaged cross-power spectrum Several baselines displayed
 Timerange: 00/07:05:58 to 00/07:07:22

Plot file version 10 created 07-OCT-2010 14:25:55
J1345+44 RSP03.UVDATA.1
Freq = 1.6015 GHz, Bw = 16.000 MH No calibration applied and no bandpass applied

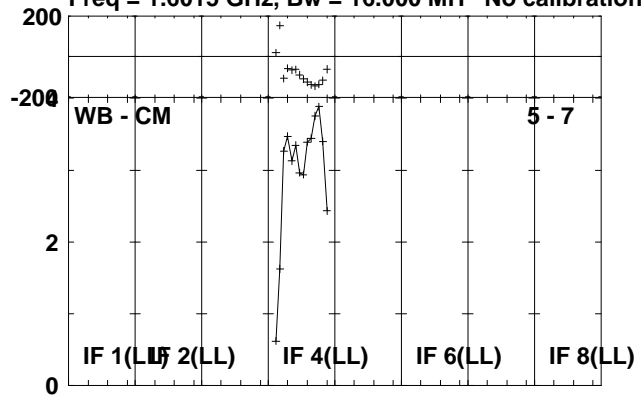

Lower frame: Milli Ampl Jy Top frame: Phas deg
Scalar averaged cross-power spectrum Several baselines displayed
Timerange: 00/07:05:58 to 00/07:07:22

Plot file version 11 created 07-OCT-2010 14:25:55

J134054 RSP03.UVDATA.1

Freq = 1.6015 GHz, Bw = 16.000 MH No calibration applied and no bandpass applied

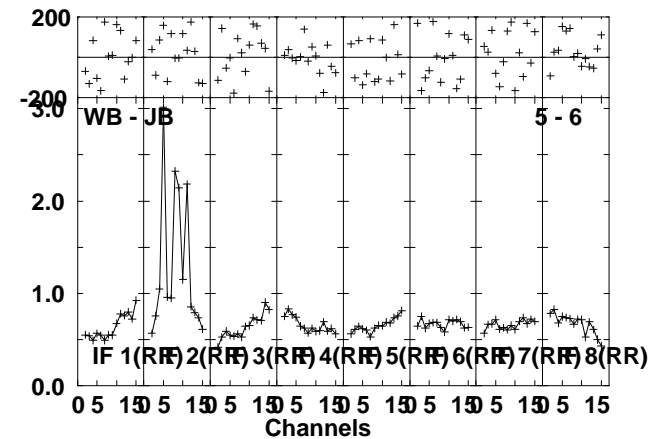
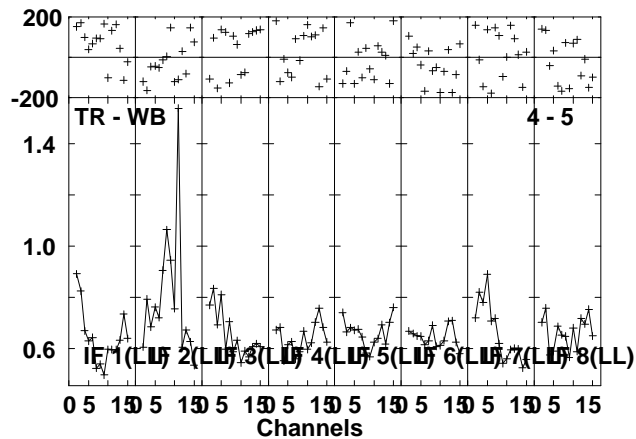
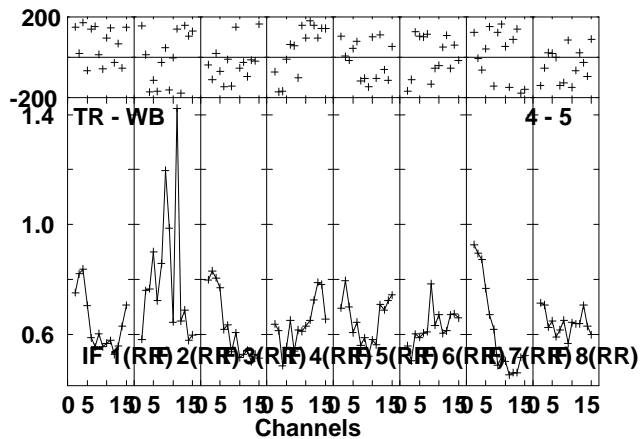
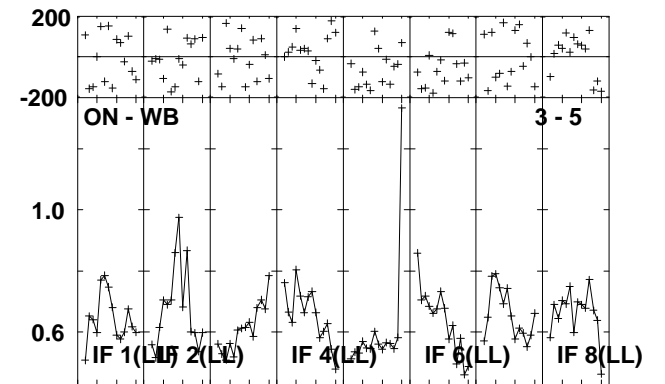
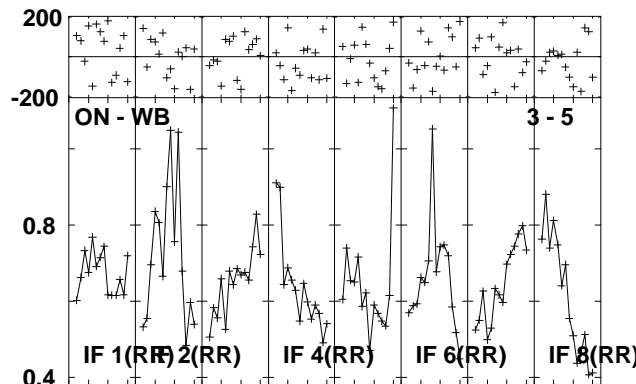
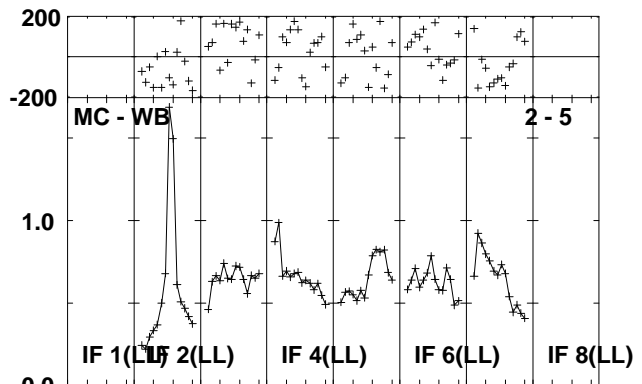
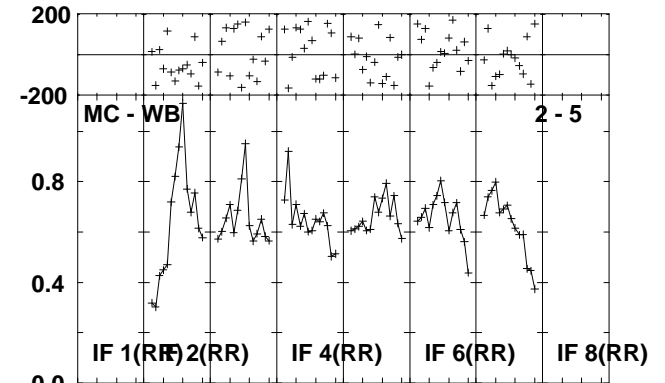
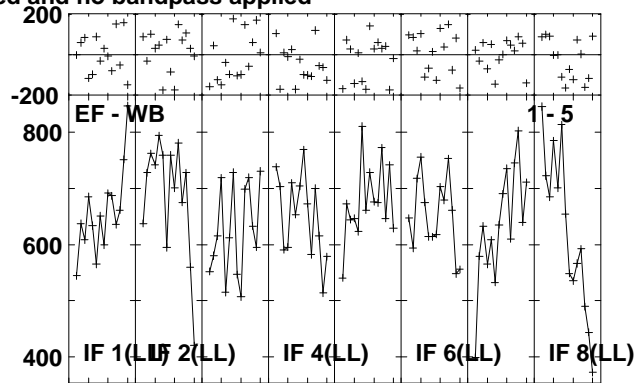
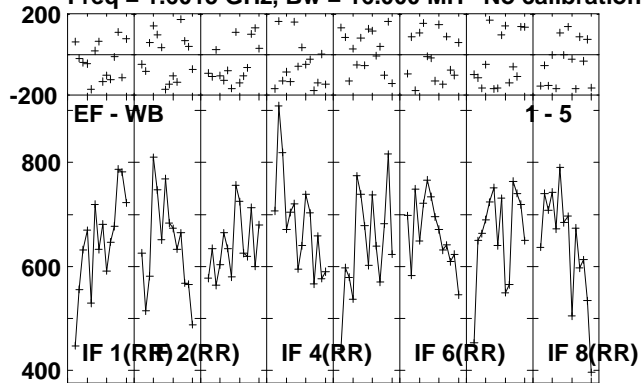

Lower frame: Micro Ampl Jy Top frame: Phas deg
Scalar averaged cross-power spectrum Several baselines displayed
Timerange: 00/07:07:26 to 00/07:12:02

Plot file version 12 created 07-OCT-2010 14:25:55

J134054 RSP03.UVDATA.1

Freq = 1.6015 GHz, Bw = 16.000 MH No calibration applied and no bandpass applied

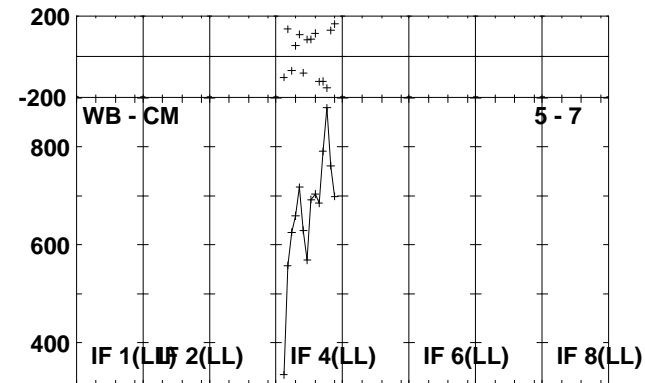
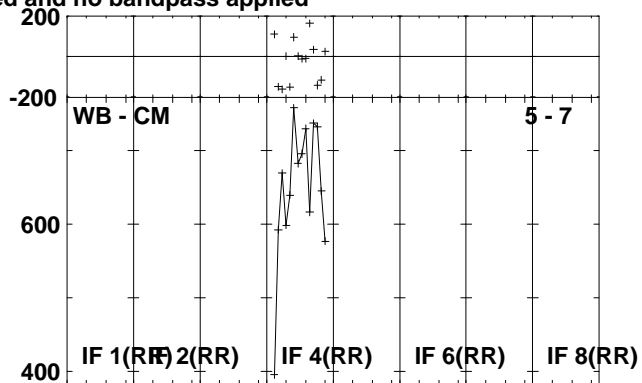
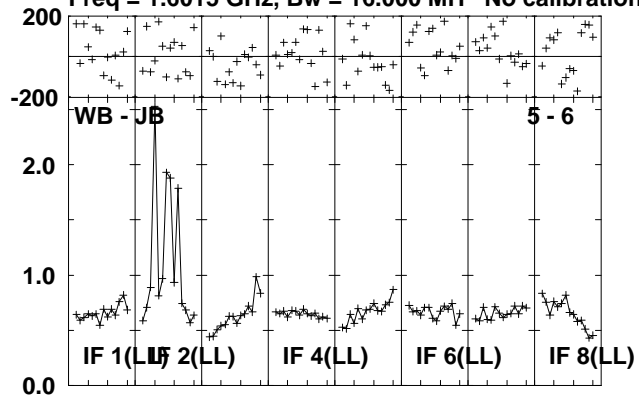

Lower frame: Milli Ampl Jy Top frame: Phas deg
Scalar averaged cross-power spectrum Several baselines displayed
Timerange: 00/07:07:26 to 00/07:12:02

Plot file version 13 created 07-OCT-2010 14:25:56

CAL2 RSP03.UVDATA.1

Freq = 1.6015 GHz, Bw = 16.000 MH No calibration applied and no bandpass applied

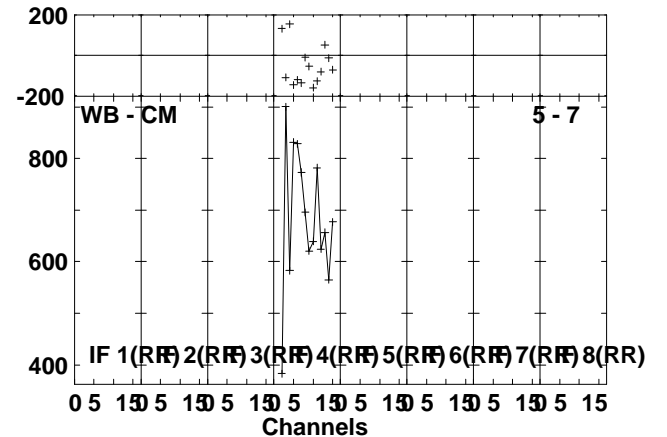
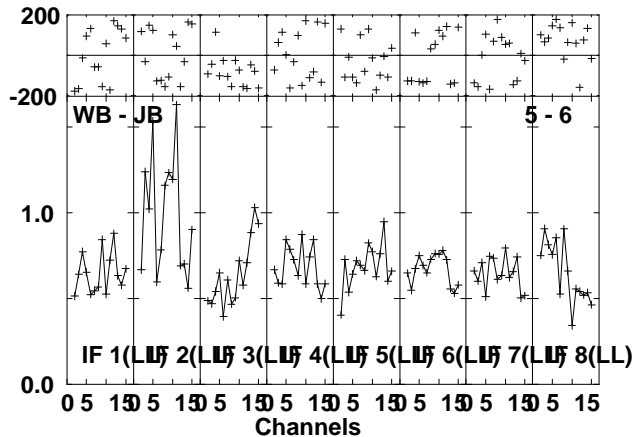
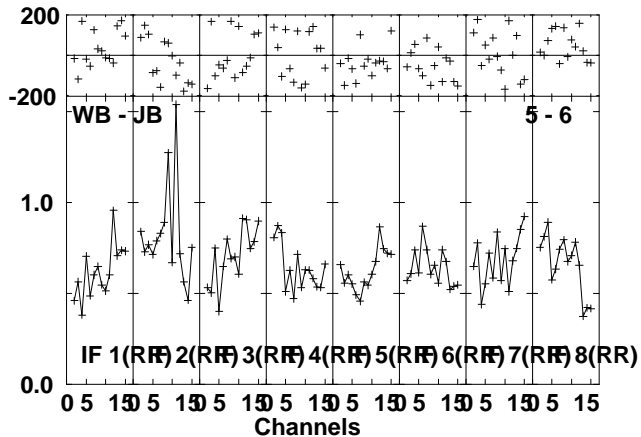
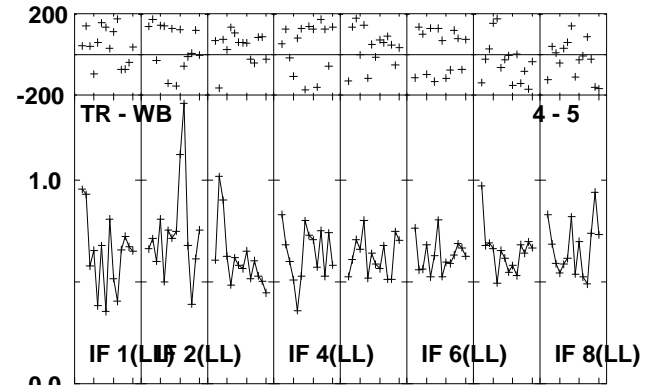
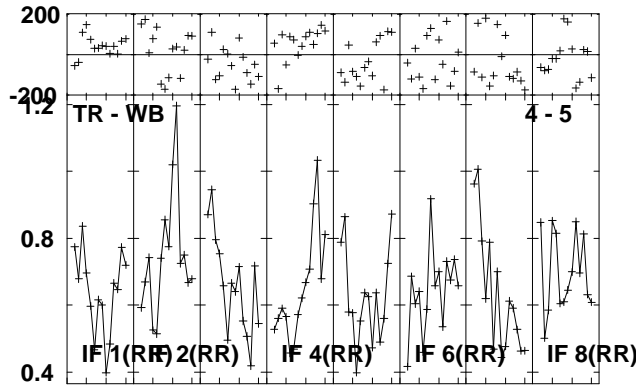
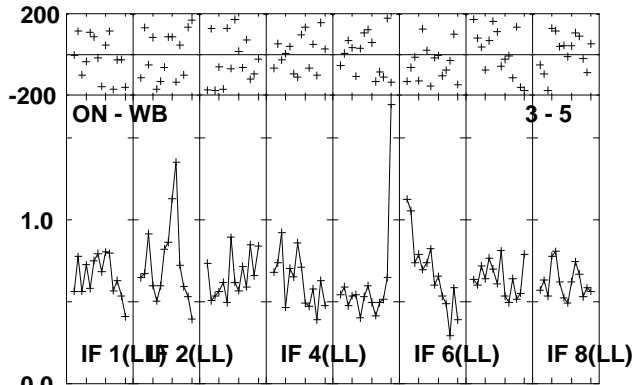
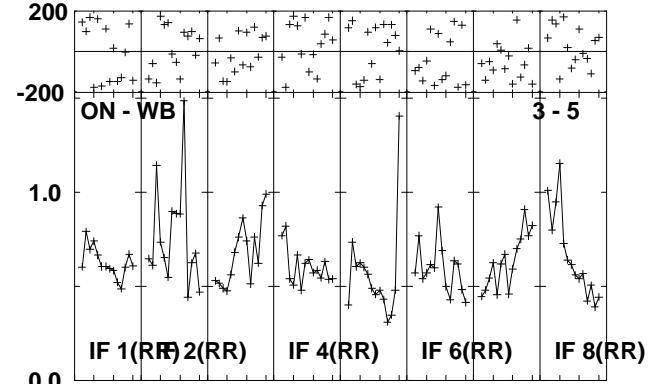
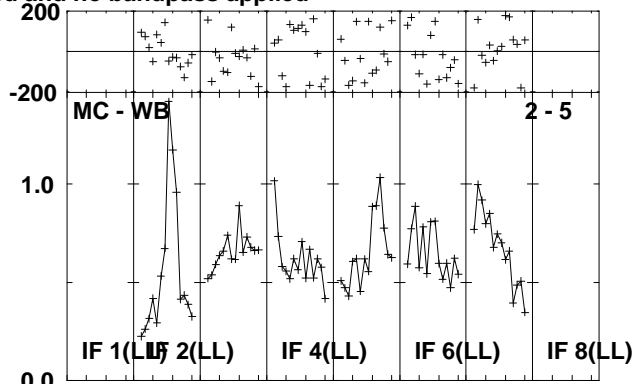
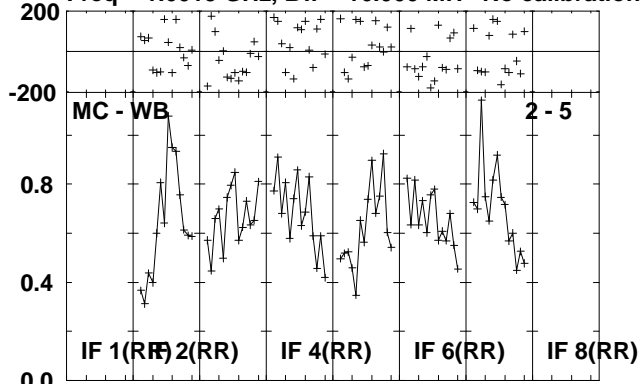

Lower frame: Milli Ampl Jy Top frame: Phas deg
 Scalar averaged cross-power spectrum Several baselines displayed
 Timerange: 00/07:12:06 to 00/07:13:18

Plot file version 14 created 07-OCT-2010 14:25:56
CAL2 RSP03.UVDATA.1
Freq = 1.6015 GHz, Bw = 16.000 MH No calibration applied and no bandpass applied

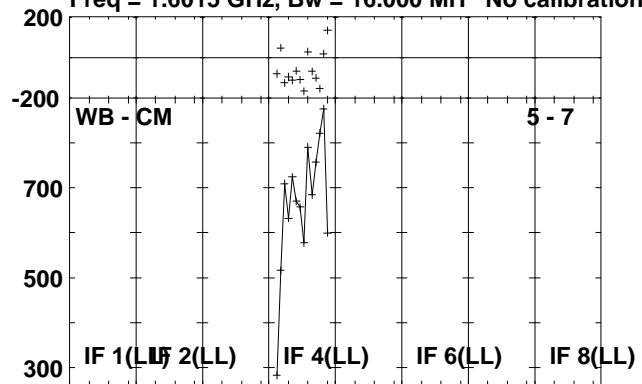

Lower frame: Micro Ampl Jy Top frame: Phas deg
Scalar averaged cross-power spectrum Several baselines displayed
Timerange: 00/07:12:06 to 00/07:13:18

Plot file version 15 created 07-OCT-2010 14:25:56

J1345+44 RSP03.UVDATA.1

Freq = 1.6015 GHz, Bw = 16.000 MH No calibration applied and no bandpass applied

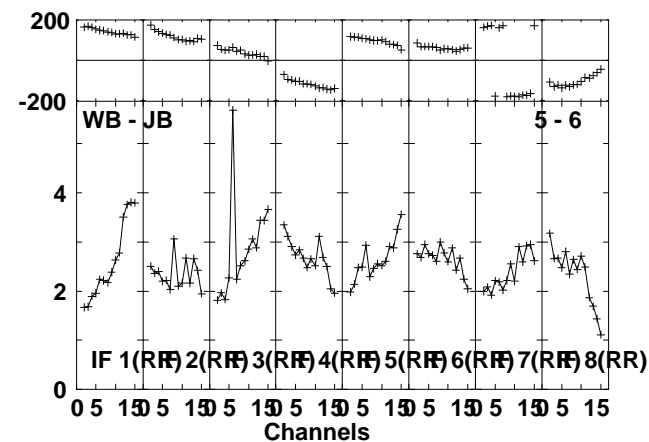
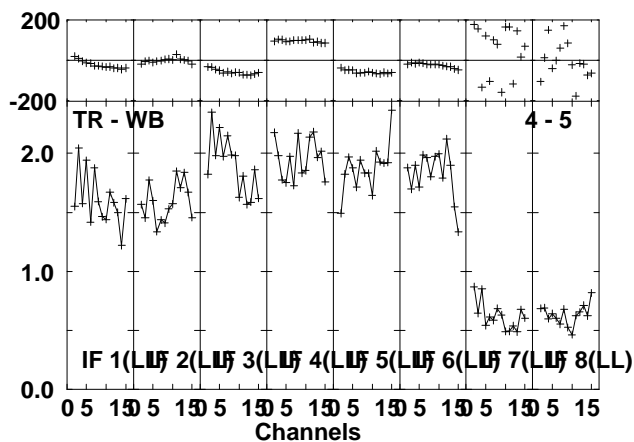
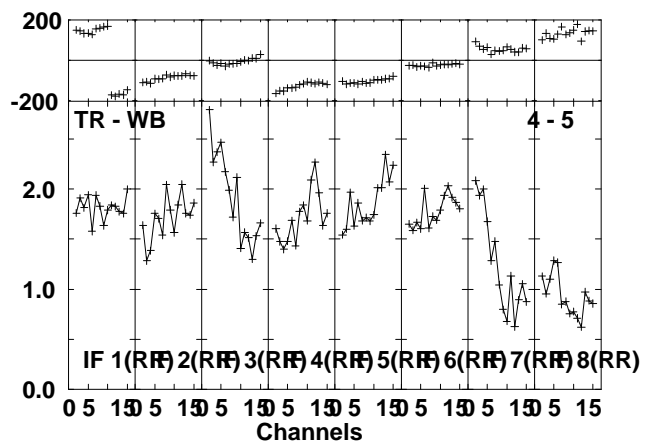
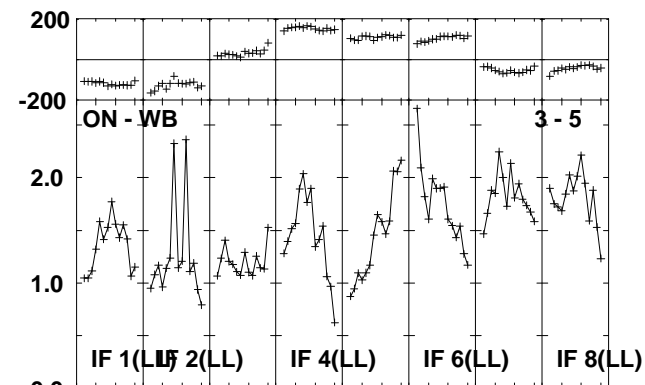
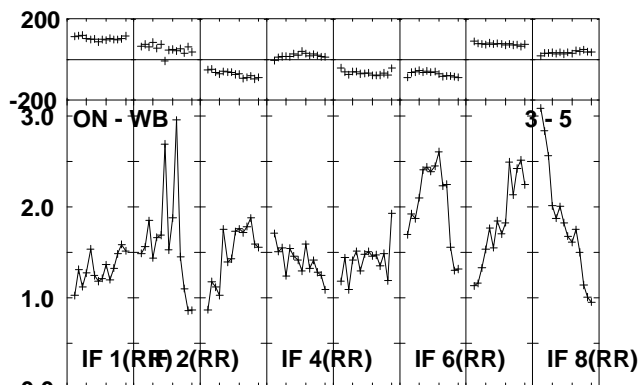
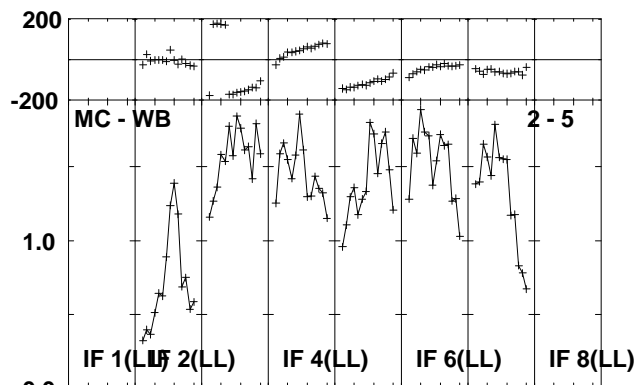
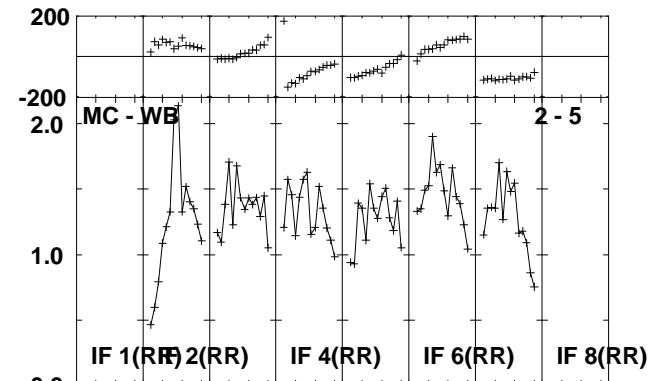
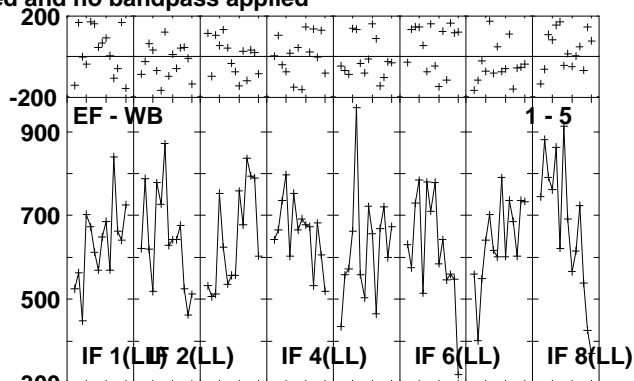
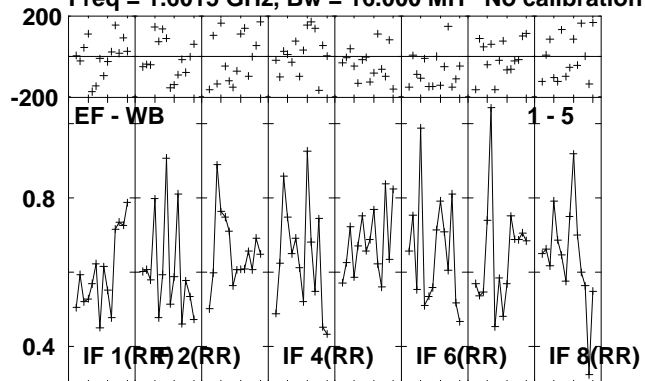

Lower frame: Milli Ampl Jy Top frame: Phas deg
Scalar averaged cross-power spectrum Several baselines displayed
Timerange: 00/07:14:02 to 00/07:14:58

Plot file version 16 created 07-OCT-2010 14:25:56

J1345+44 RSP03.UVDATA.1

Freq = 1.6015 GHz, Bw = 16.000 MH No calibration applied and no bandpass applied

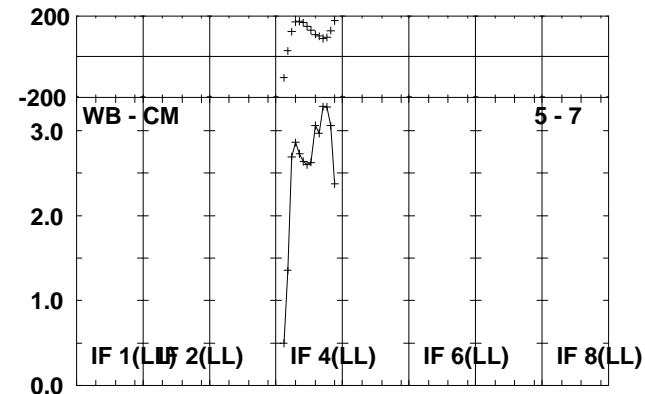
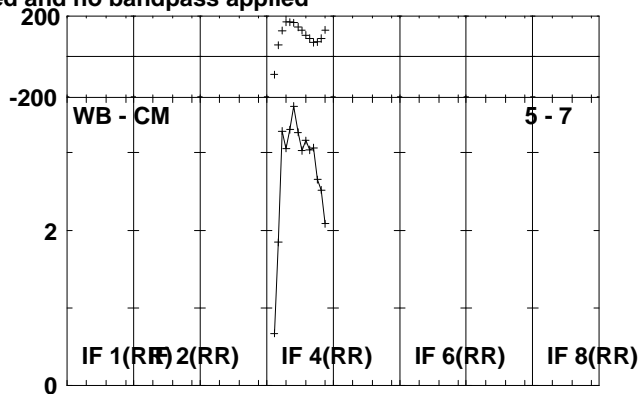
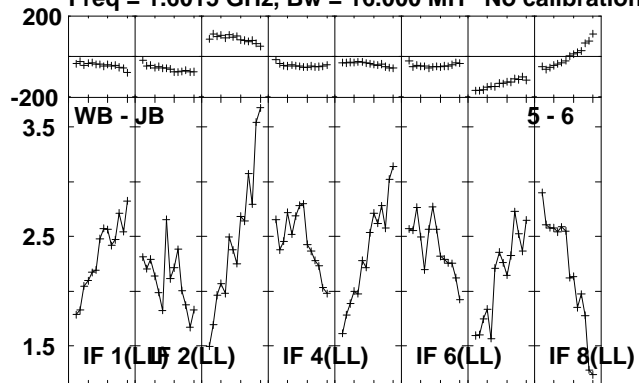

Lower frame: Milli Ampl Jy Top frame: Phas deg
Scalar averaged cross-power spectrum Several baselines displayed
Timerange: 00/07:14:02 to 00/07:14:58

Plot file version 17 created 07-OCT-2010 14:25:56

J134054 RSP03.UVDATA.1

Freq = 1.6015 GHz, Bw = 16.000 MH No calibration applied and no bandpass applied

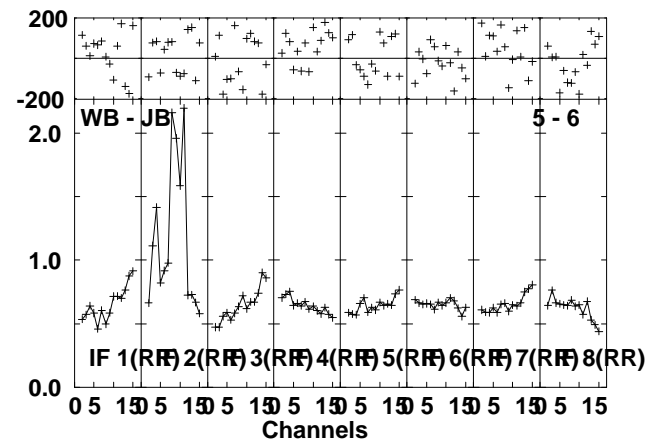
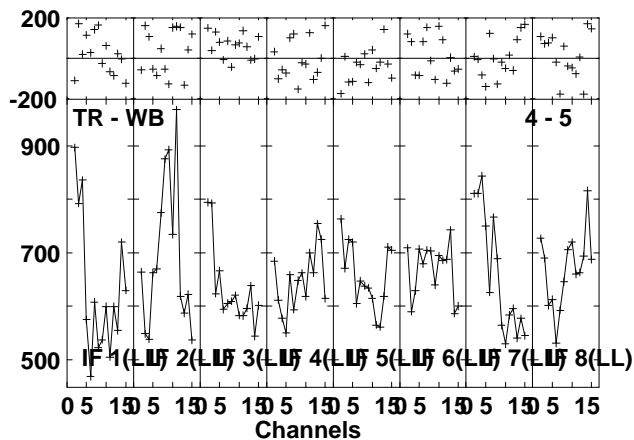
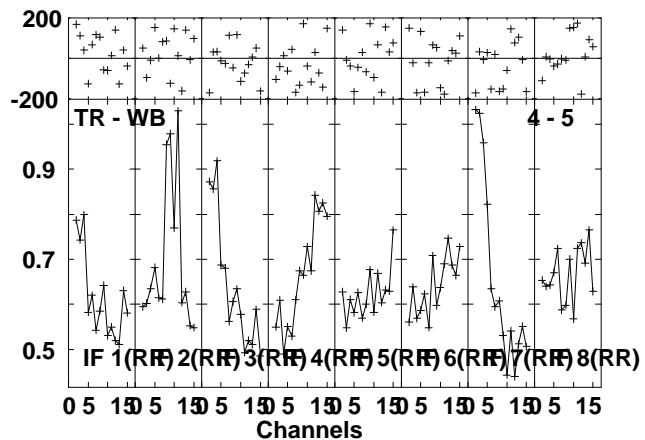
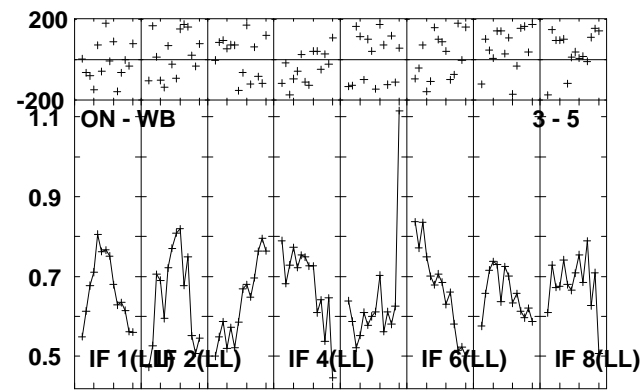
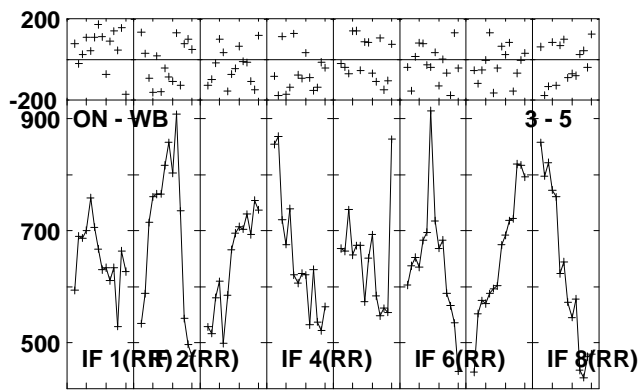
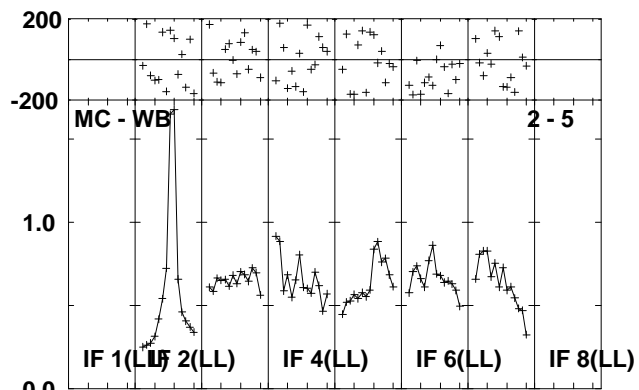
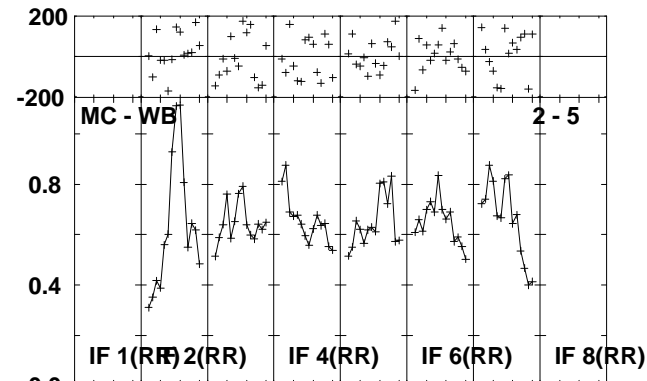
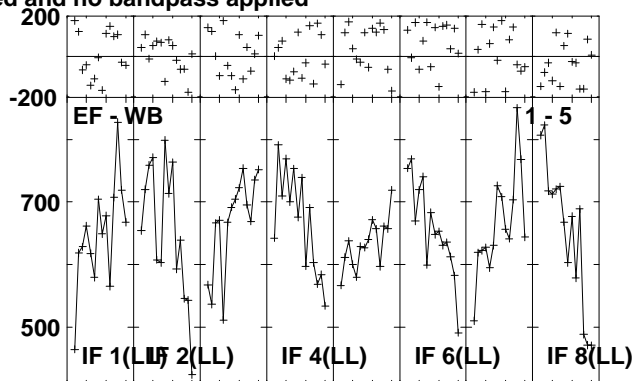
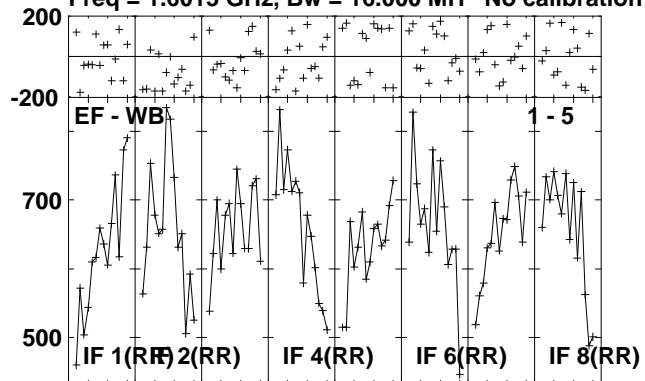

Lower frame: Micro Ampl Jy Top frame: Phas deg
Scalar averaged cross-power spectrum Several baselines displayed
Timerange: 00/07:15:02 to 00/07:19:38

Plot file version 18 created 07-OCT-2010 14:25:57

J134054 RSP03.UVDATA.1

Freq = 1.6015 GHz, Bw = 16.000 MH No calibration applied and no bandpass applied

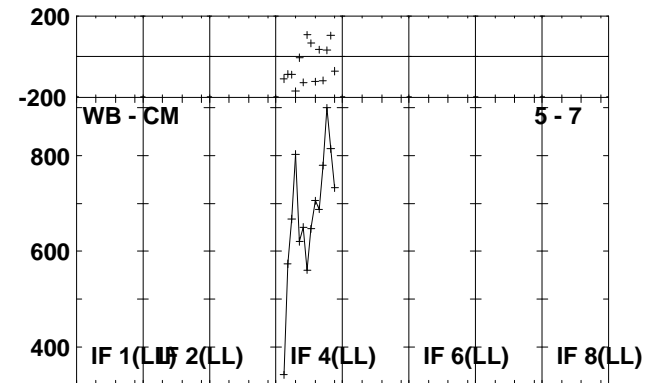
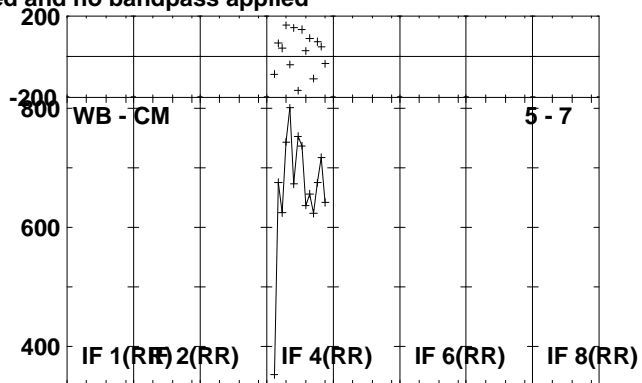
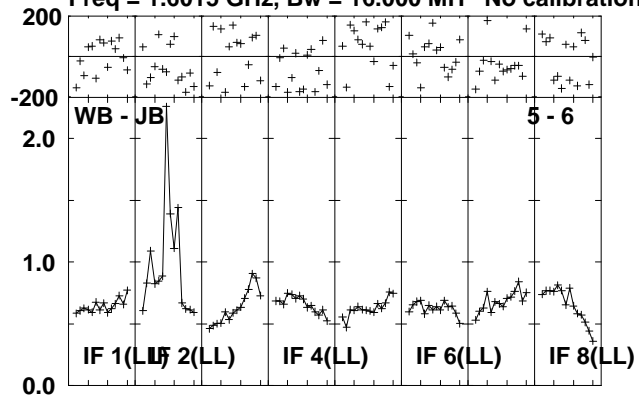

Lower frame: Milli Ampl Jy Top frame: Phas deg
Scalar averaged cross-power spectrum Several baselines displayed
Timerange: 00/07:15:02 to 00/07:19:38

Plot file version 19 created 07-OCT-2010 14:25:57

CAL1 RSP03.UVDATA.1

Freq = 1.6015 GHz, Bw = 16.000 MH No calibration applied and no bandpass applied

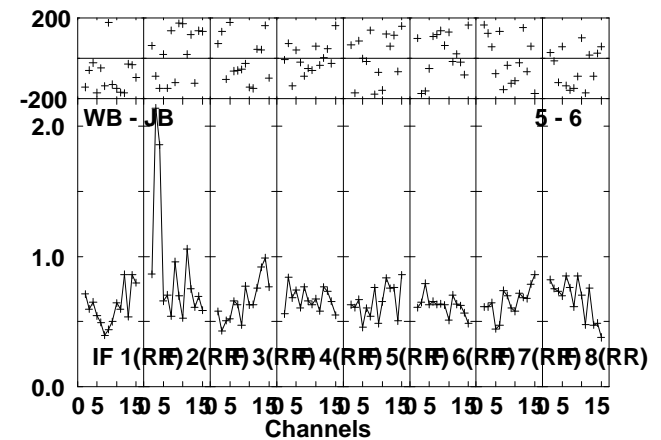
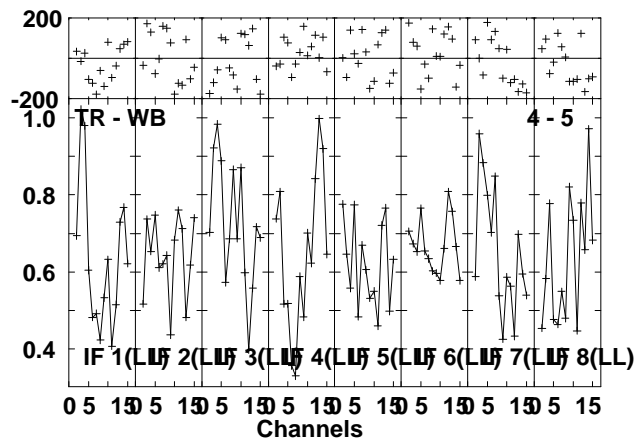
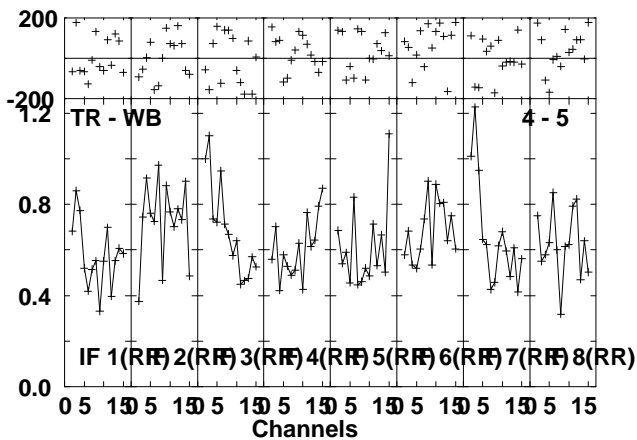
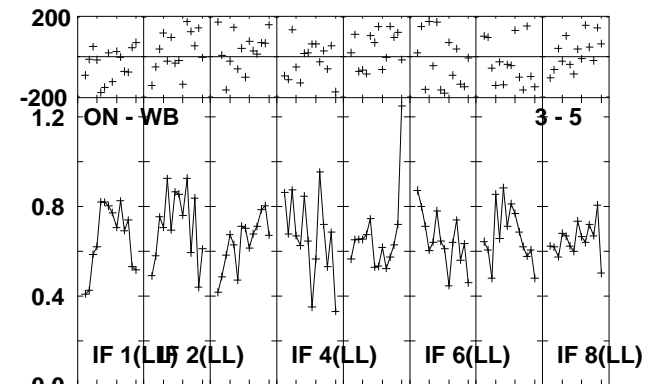
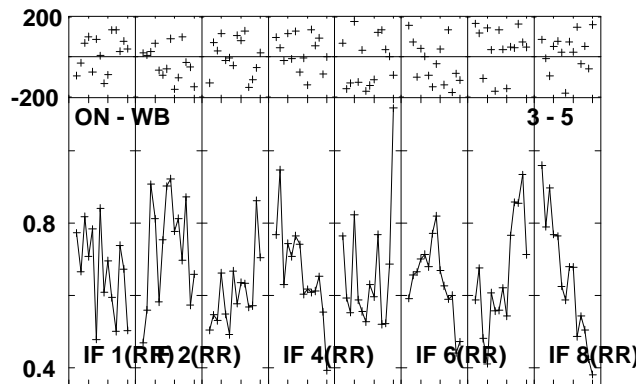
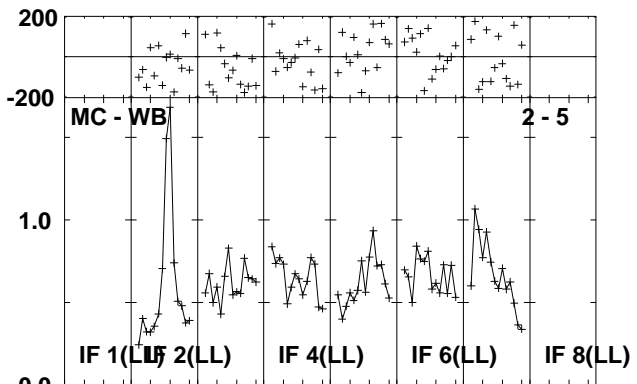
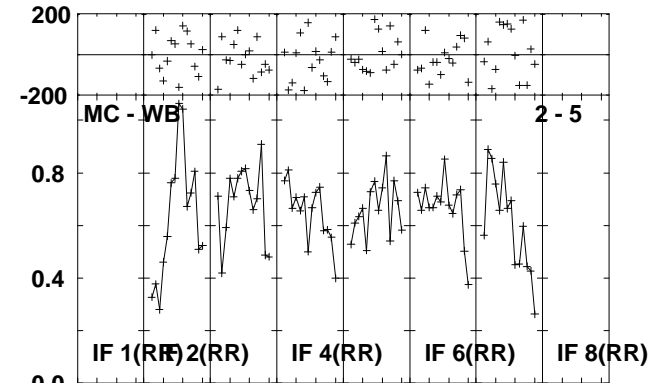
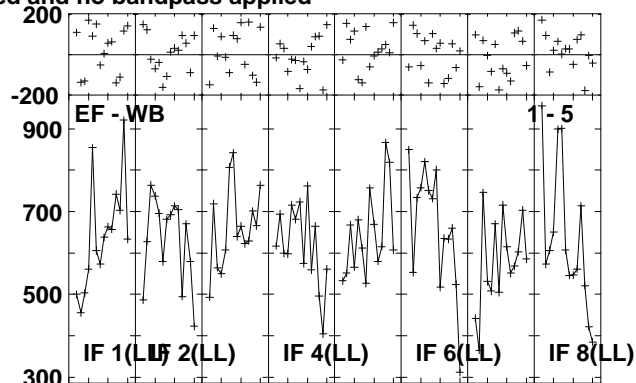
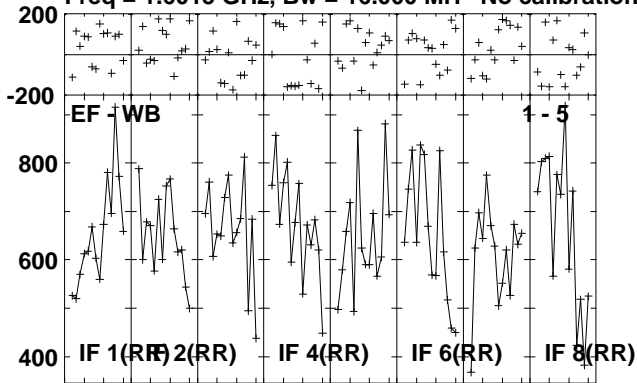

Lower frame: Micro Ampl Jy Top frame: Phas deg
Scalar averaged cross-power spectrum Several baselines displayed
Timerange: 00/07:19:42 to 00/07:20:54

Plot file version 20 created 07-OCT-2010 14:25:58

CAL1 RSP03.UVDATA.1

Freq = 1.6015 GHz, Bw = 16.000 MH No calibration applied and no bandpass applied

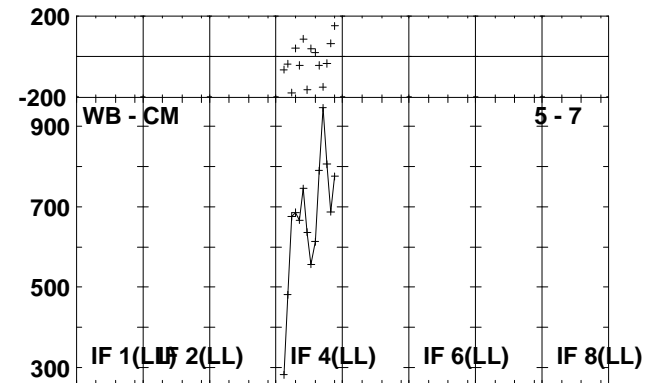
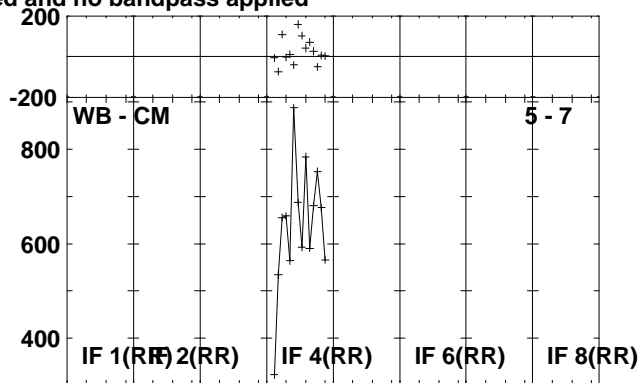
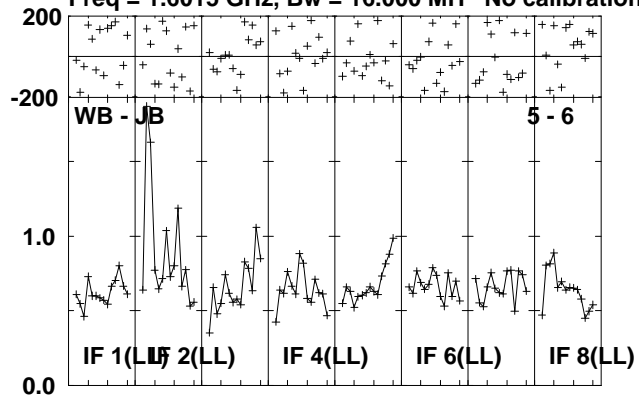

Lower frame: Milli Ampl Jy Top frame: Phas deg
Scalar averaged cross-power spectrum Several baselines displayed
Timerange: 00/07:19:42 to 00/07:20:54

Plot file version 21 created 07-OCT-2010 14:25:58
 J1345+44 RSP03.UVDATA.1

Freq = 1.6015 GHz, Bw = 16.000 MH No calibration applied and no bandpass applied

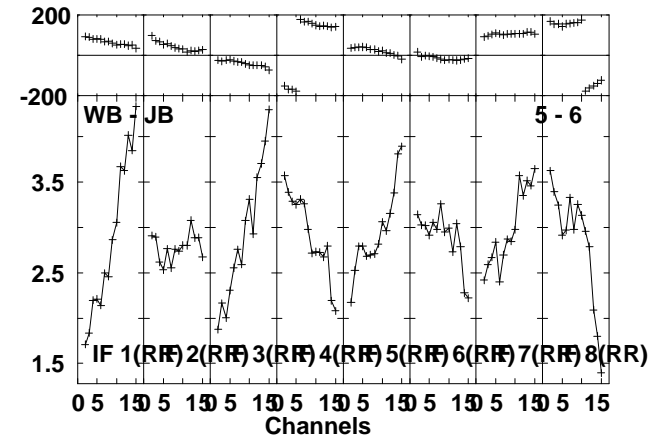
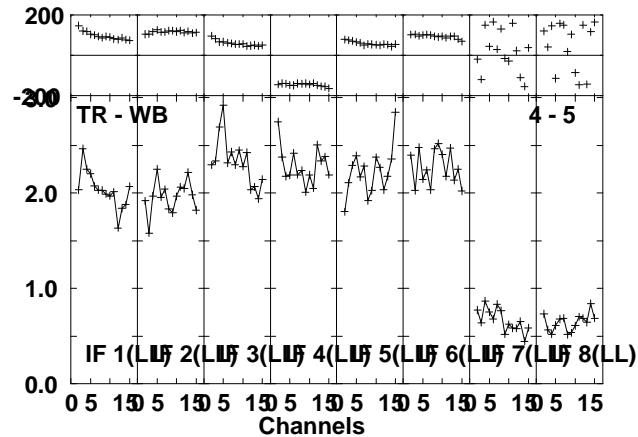
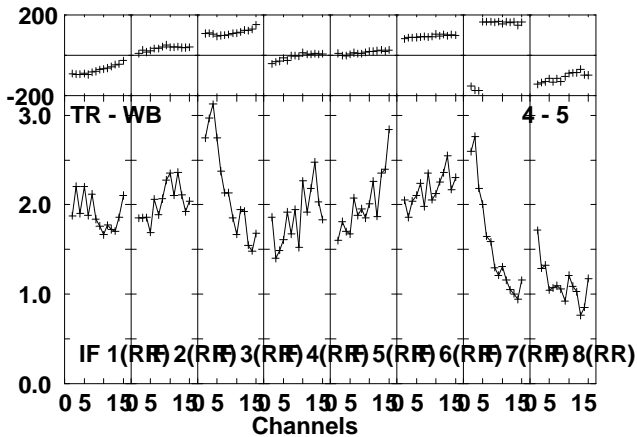
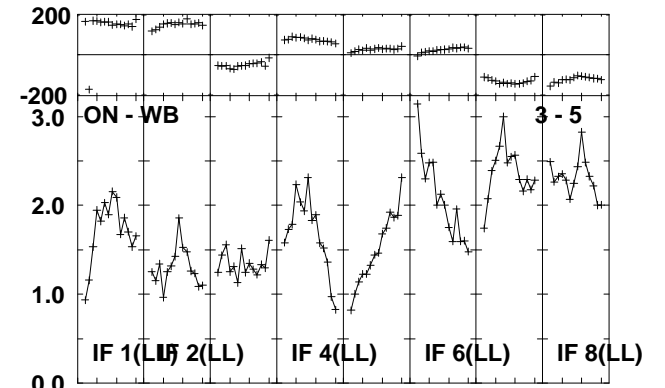
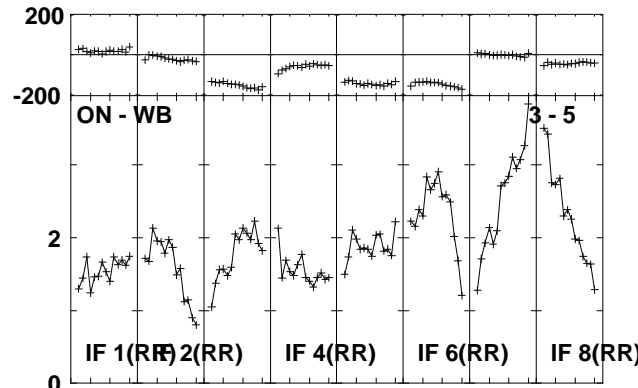
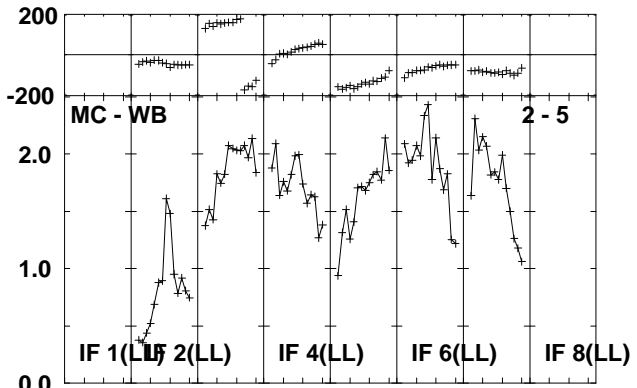
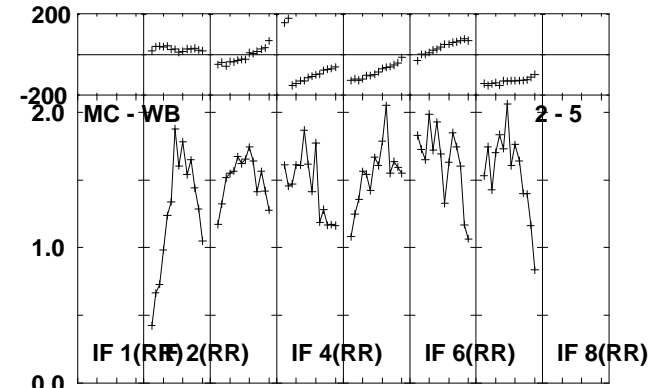
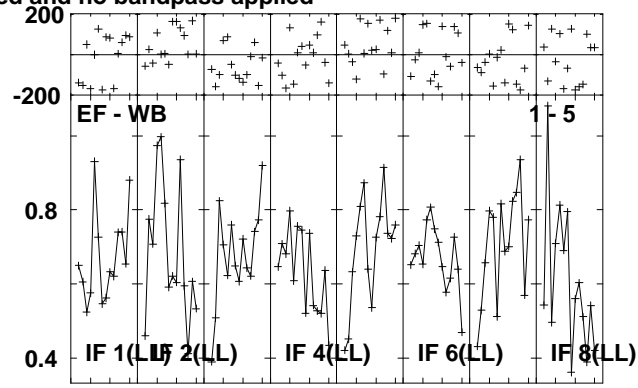
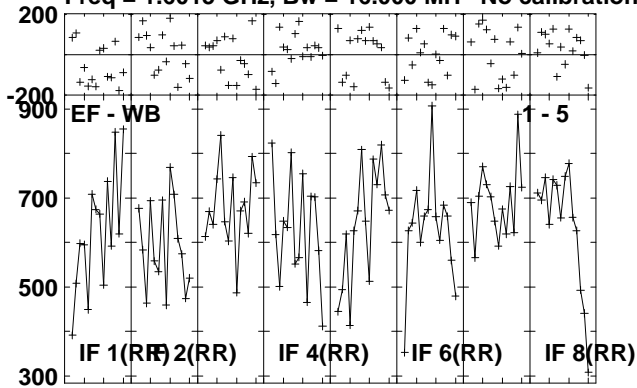

Lower frame: Micro Ampl Jy Top frame: Phas deg
 Scalar averaged cross-power spectrum Several baselines displayed
 Timerange: 00/07:20:58 to 00/07:22:22

Plot file version 22 created 07-OCT-2010 14:25:58

J1345+44 RSP03.UVDATA.1

Freq = 1.6015 GHz, Bw = 16.000 MH No calibration applied and no bandpass applied

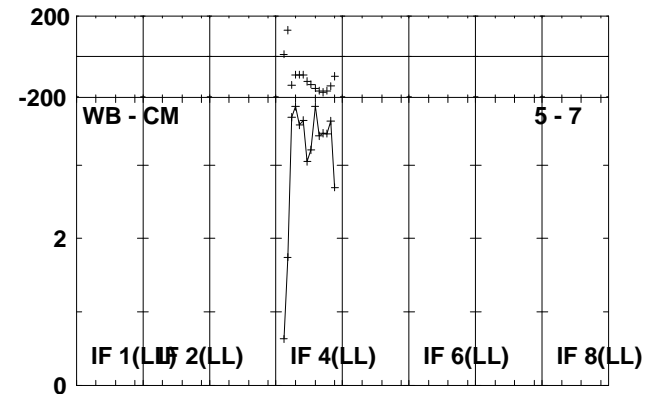
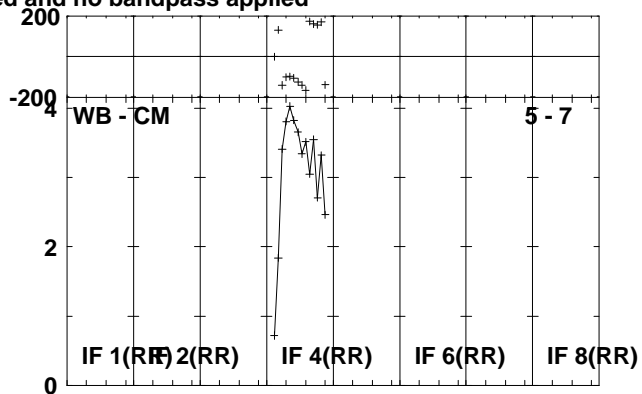
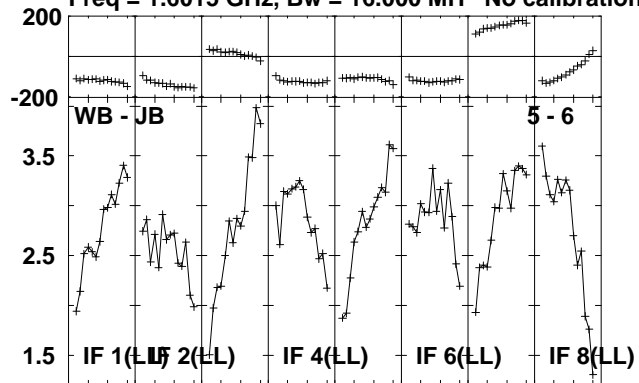

Lower frame: Milli Ampl Jy Top frame: Phas deg
Scalar averaged cross-power spectrum Several baselines displayed
Timerange: 00/07:20:58 to 00/07:22:22

Plot file version 23 created 07-OCT-2010 14:25:58

J134054 RSP03.UVDATA.1

Freq = 1.6015 GHz, Bw = 16.000 MH No calibration applied and no bandpass applied

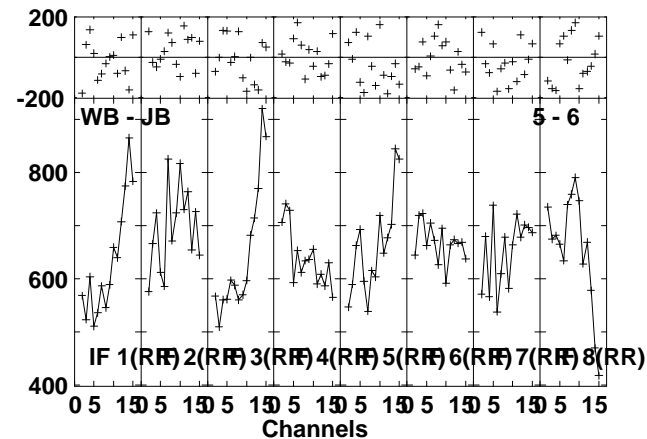
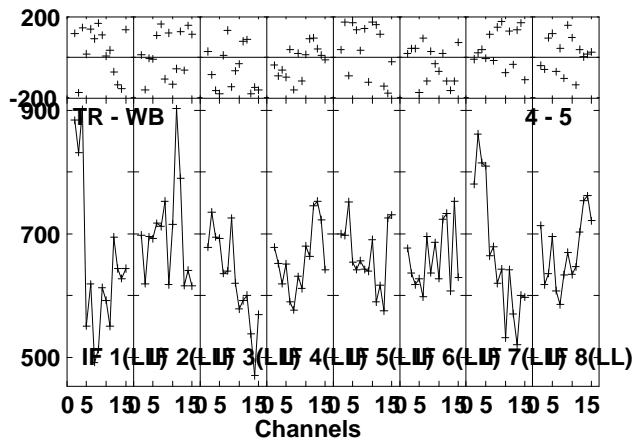
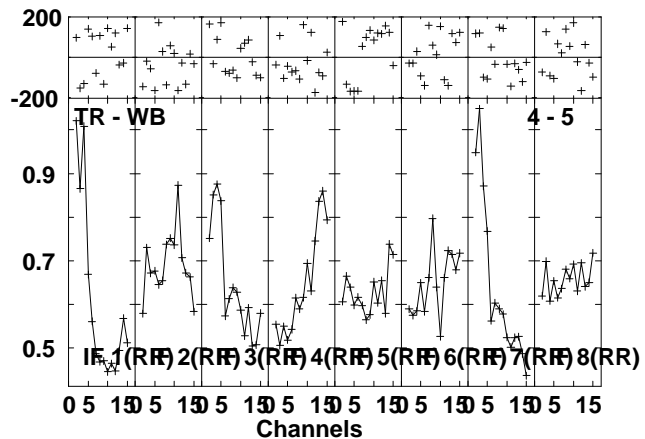
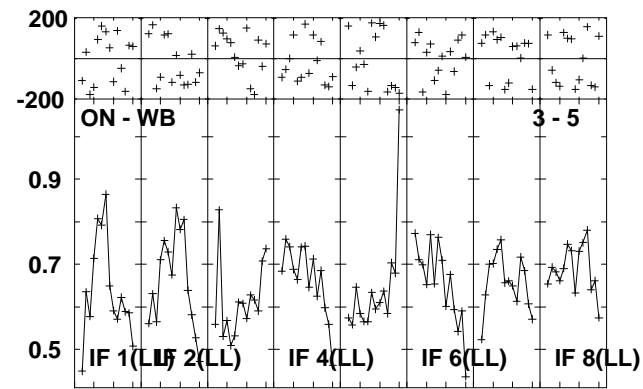
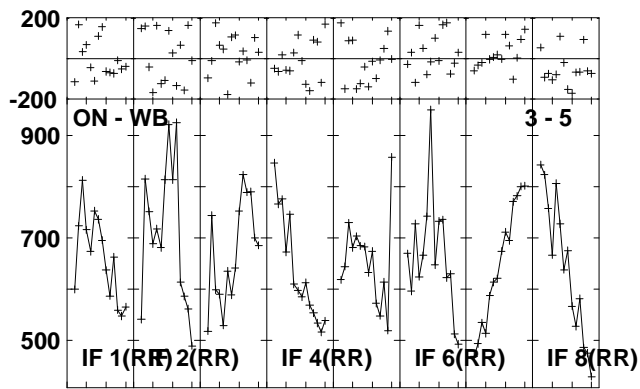
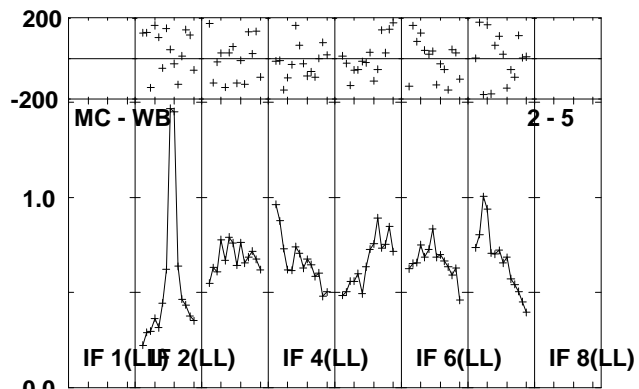
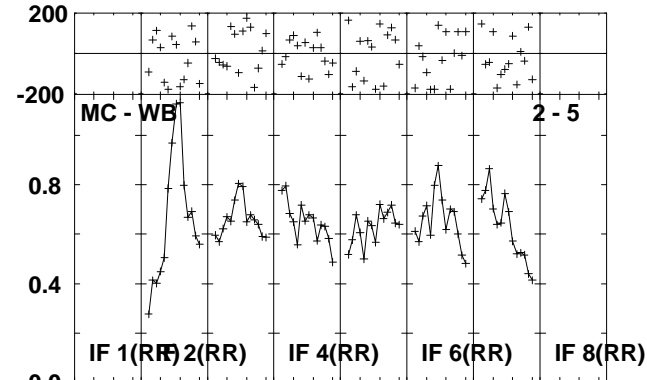
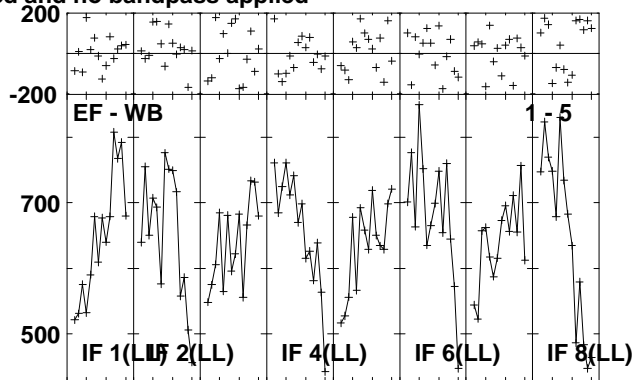
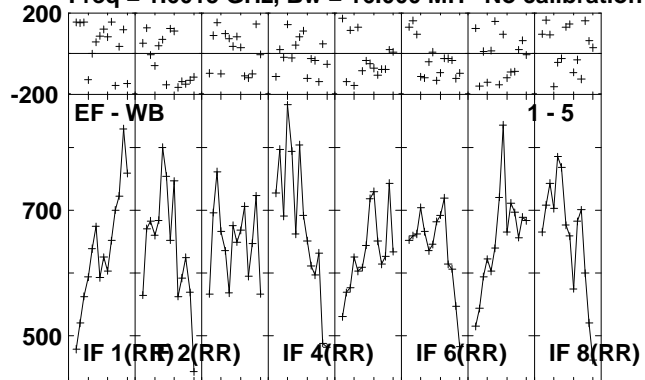

Lower frame: Micro Ampl Jy Top frame: Phas deg
Scalar averaged cross-power spectrum Several baselines displayed
Timerange: 00/07:22:26 to 00/07:27:02

Plot file version 24 created 07-OCT-2010 14:25:59

J134054 RSP03.UVDATA.1

Freq = 1.6015 GHz, Bw = 16.000 MH No calibration applied and no bandpass applied

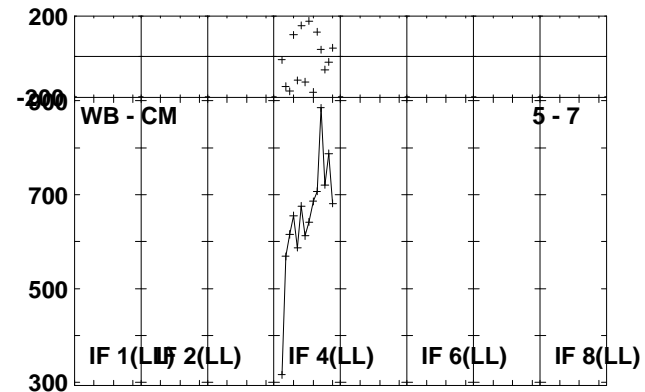
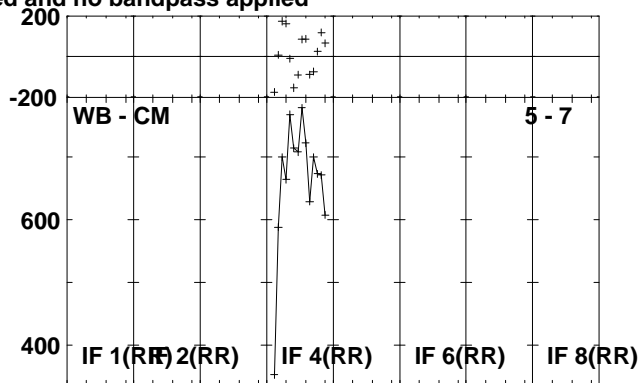
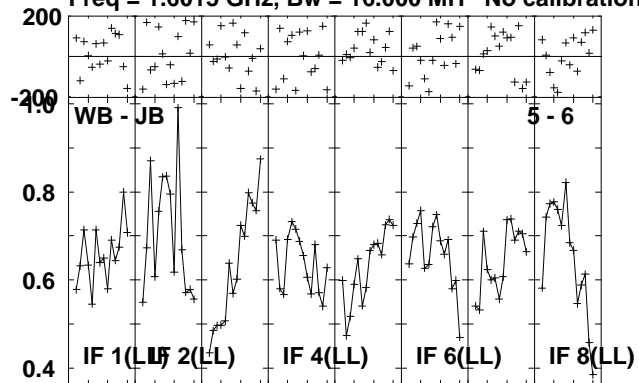

Lower frame: Milli Ampl Jy Top frame: Phas deg
Scalar averaged cross-power spectrum Several baselines displayed
Timerange: 00/07:22:26 to 00/07:27:02

Plot file version 25 created 07-OCT-2010 14:25:59

CAL2 RSP03.UVDATA.1

Freq = 1.6015 GHz, Bw = 16.000 MH No calibration applied and no bandpass applied

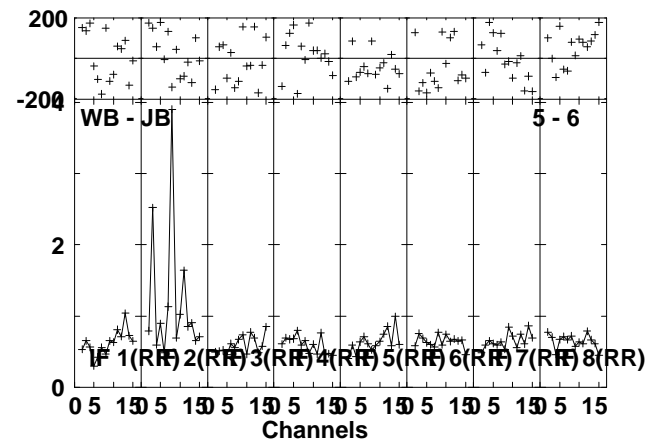
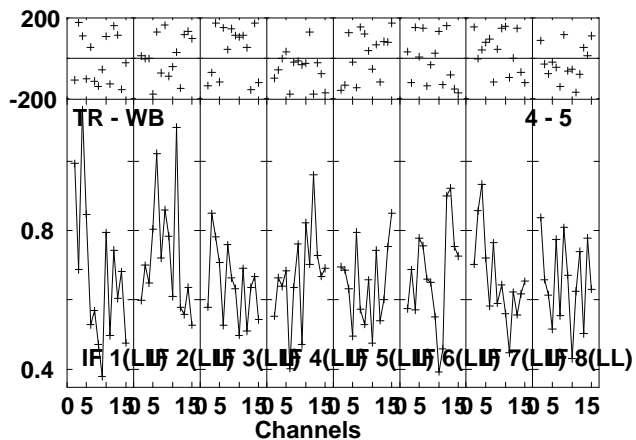
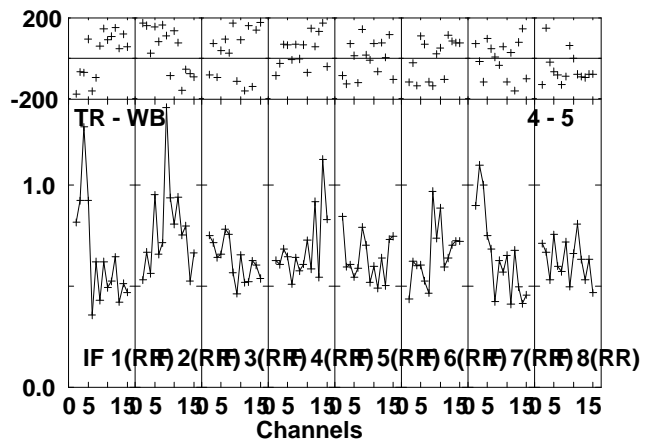
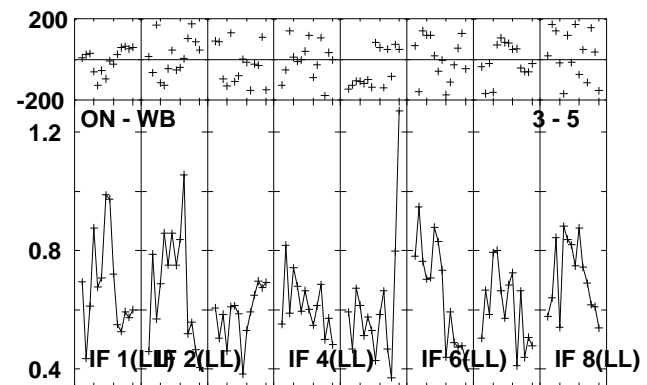
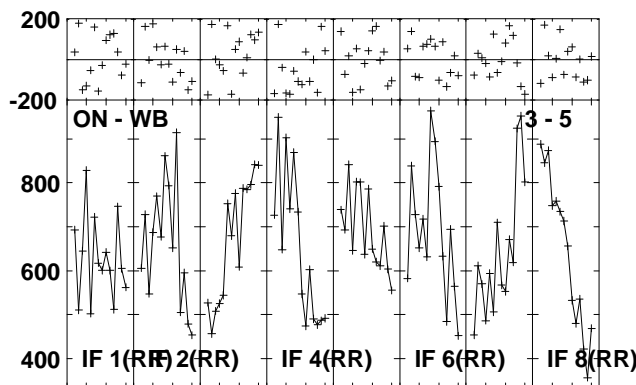
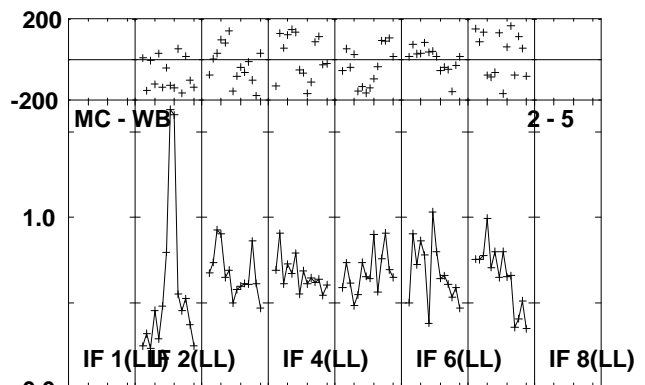
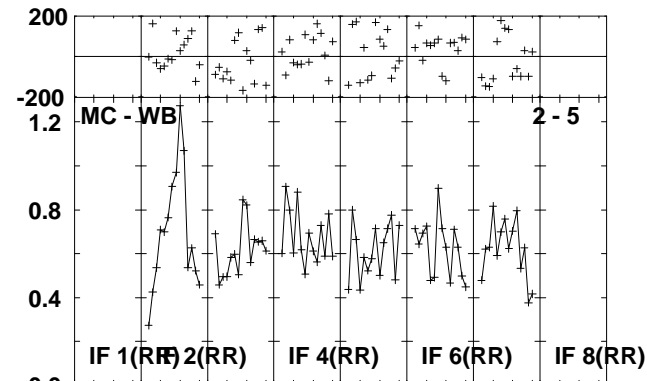
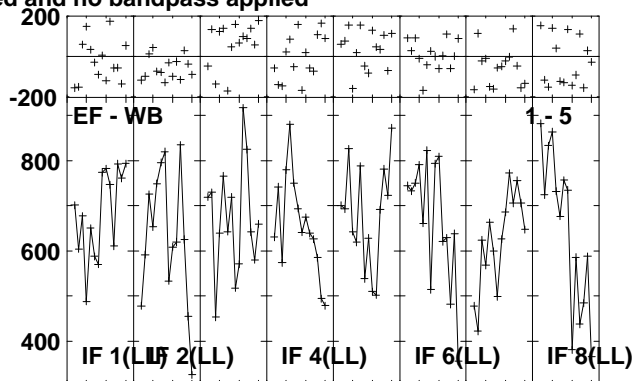
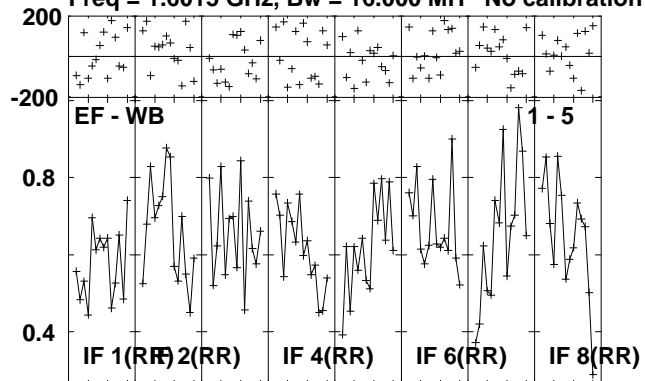

Lower frame: Milli Ampl Jy Top frame: Phas deg
Scalar averaged cross-power spectrum Several baselines displayed
Timerange: 00/07:27:06 to 00/07:28:18

Plot file version 26 created 07-OCT-2010 14:25:59

CAL2 RSP03.UVDATA.1

Freq = 1.6015 GHz, Bw = 16.000 MH No calibration applied and no bandpass applied

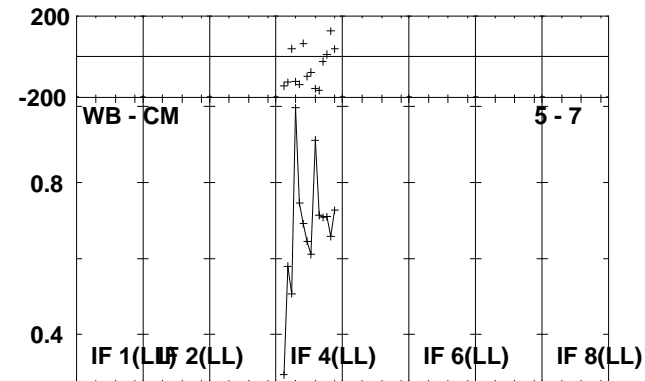
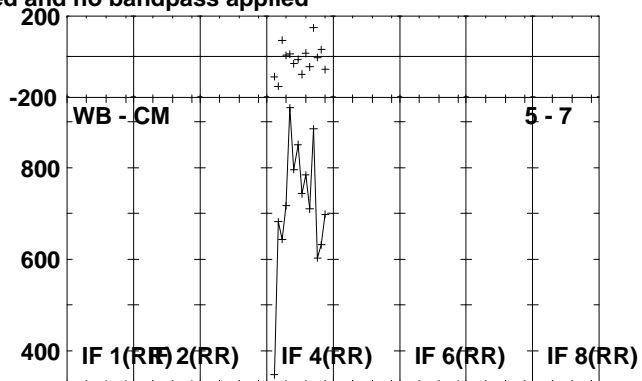
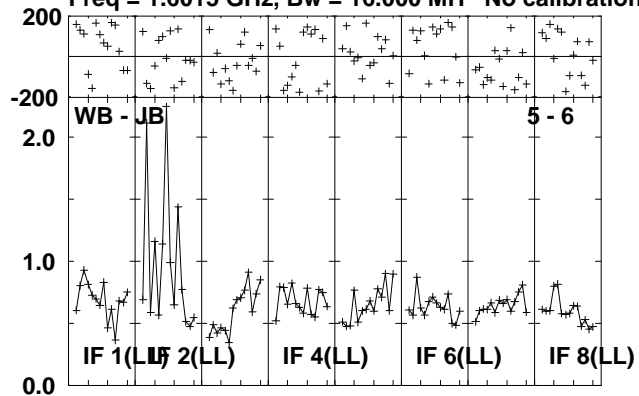

Lower frame: Milli Ampl Jy Top frame: Phas deg
Scalar averaged cross-power spectrum Several baselines displayed
Timerange: 00/07:27:06 to 00/07:28:18

Plot file version 27 created 07-OCT-2010 14:25:59

J1345+44 RSP03.UVDATA.1

Freq = 1.6015 GHz, Bw = 16.000 MH No calibration applied and no bandpass applied

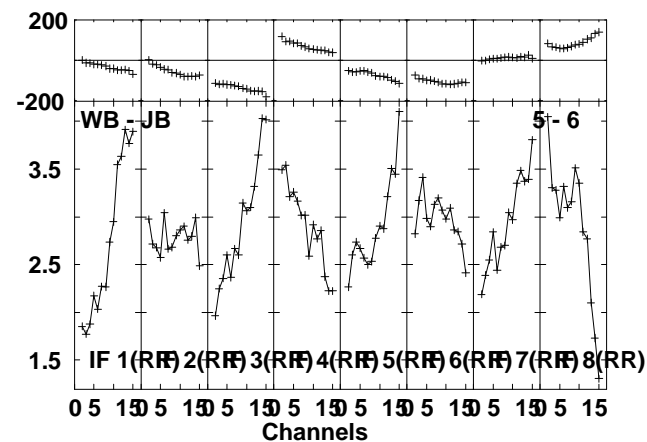
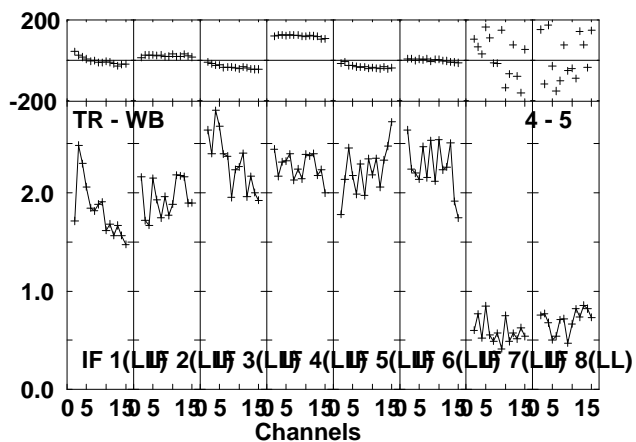
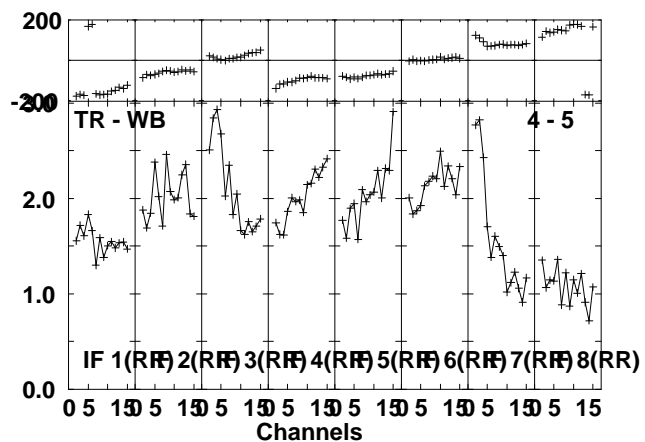
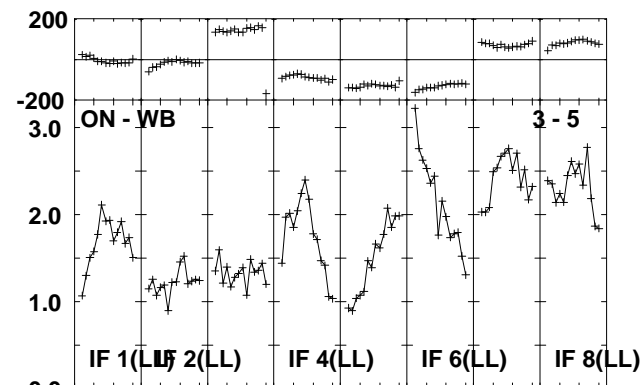
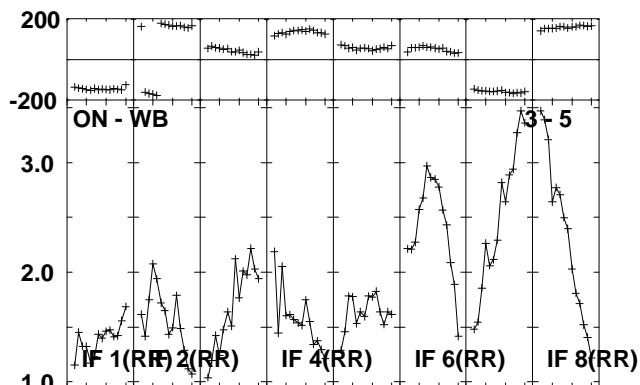
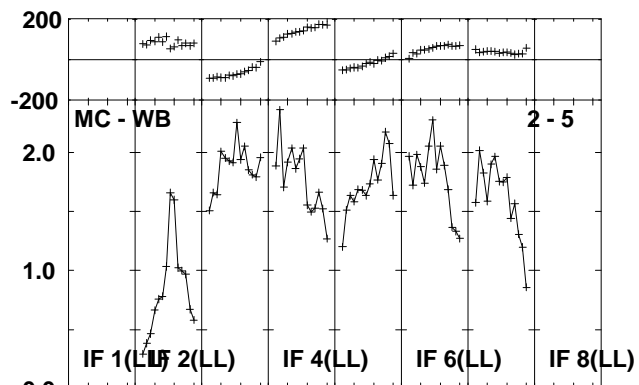
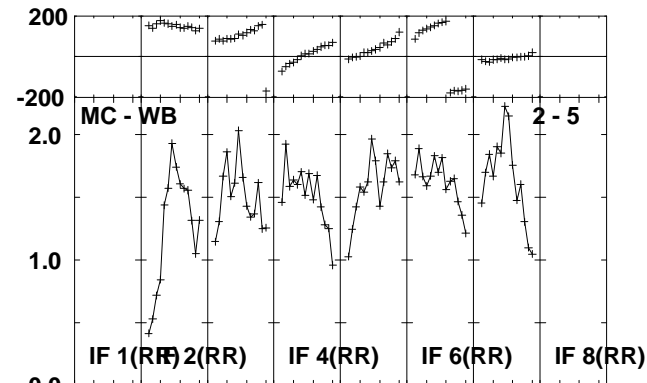
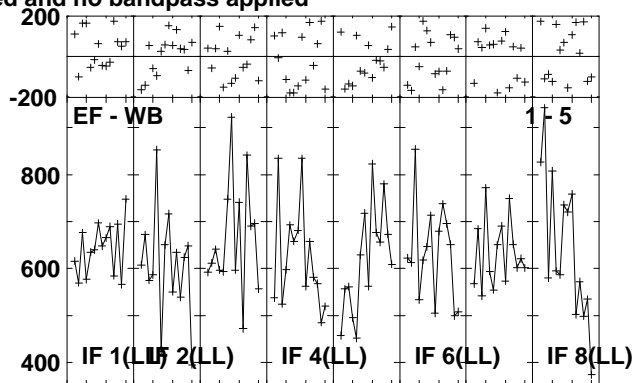
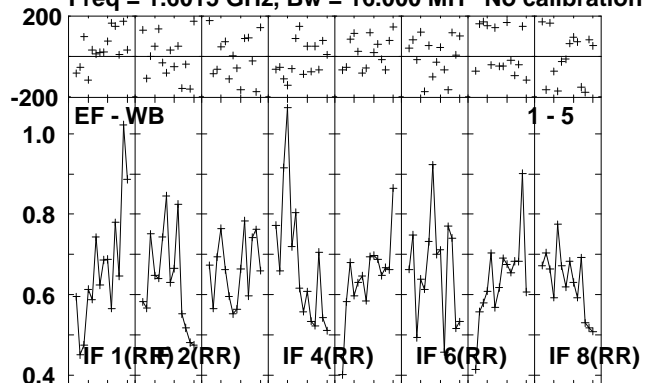

Lower frame: Milli Ampl Jy Top frame: Phas deg
Scalar averaged cross-power spectrum Several baselines displayed
Timerange: 00/07:29:02 to 00/07:29:58

Plot file version 28 created 07-OCT-2010 14:26:00

J1345+44 RSP03.UVDATA.1

Freq = 1.6015 GHz, Bw = 16.000 MH No calibration applied and no bandpass applied

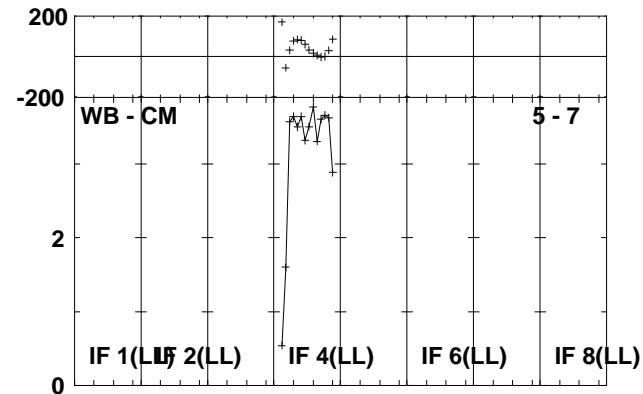
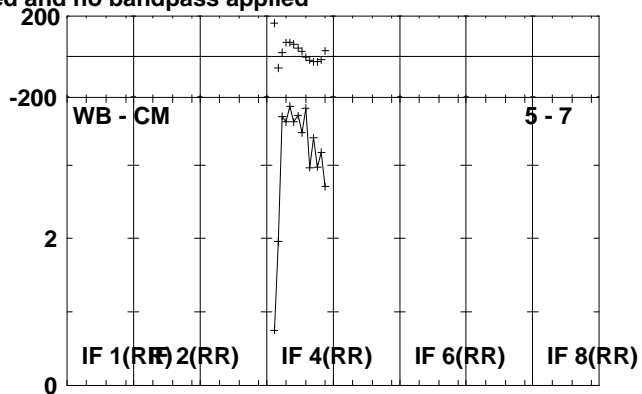
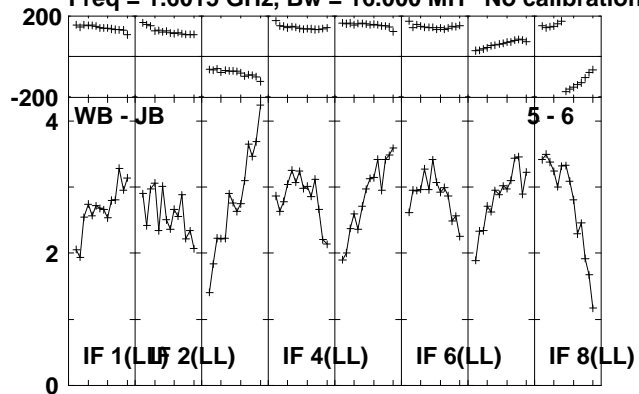

Lower frame: Milli Ampl Jy Top frame: Phas deg
Scalar averaged cross-power spectrum Several baselines displayed
Timerange: 00/07:29:02 to 00/07:29:58

Plot file version 29 created 07-OCT-2010 14:26:00

J134054 RSP03.UVDATA.1

Freq = 1.6015 GHz, Bw = 16.000 MH No calibration applied and no bandpass applied

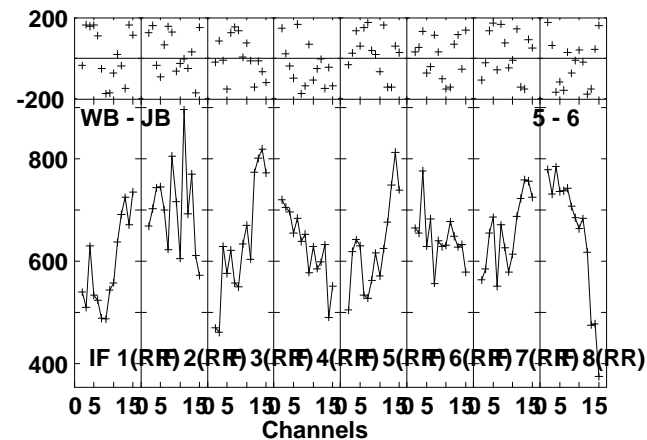
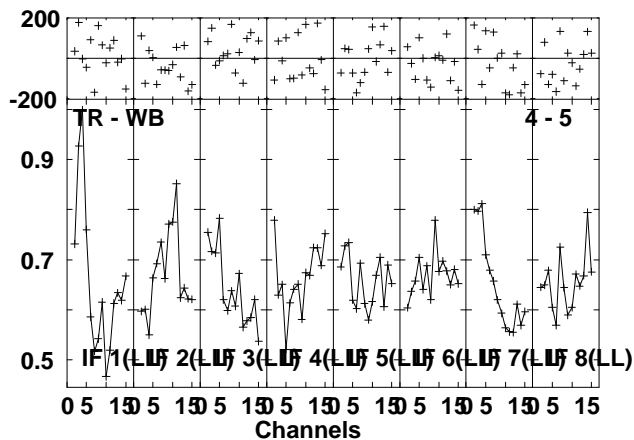
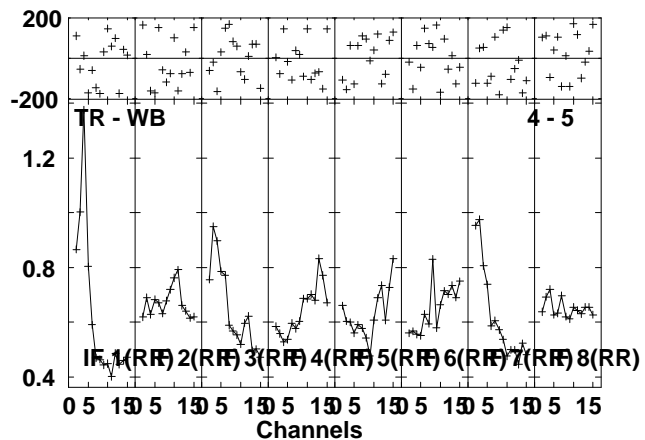
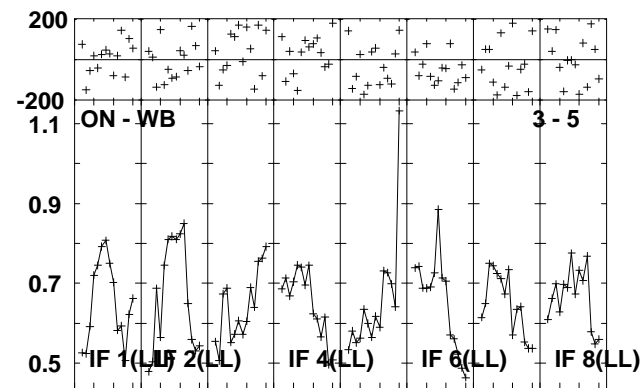
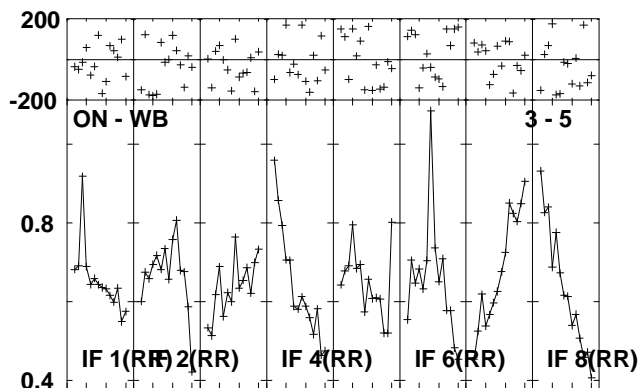
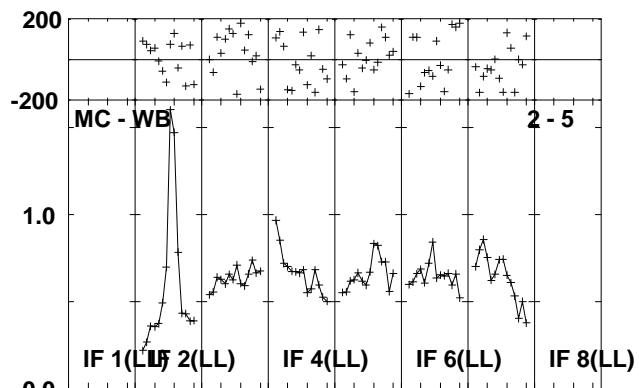
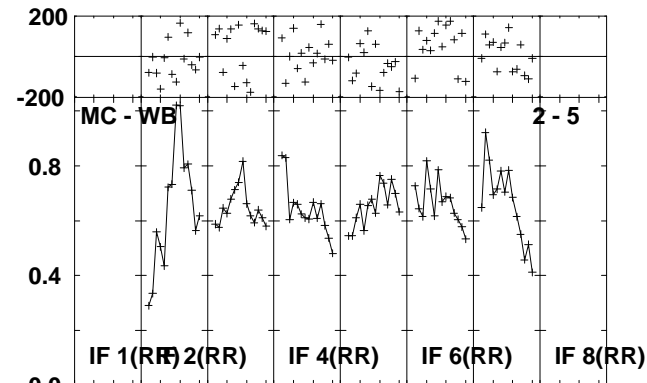
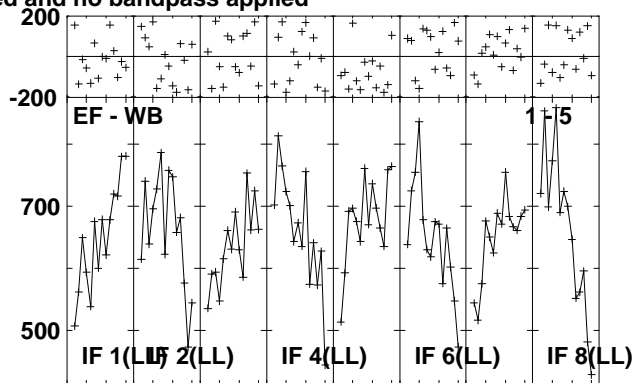
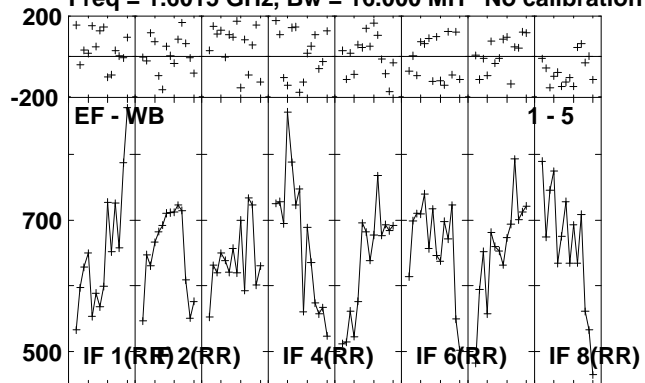

Lower frame: Micro Ampl Jy Top frame: Phas deg
Scalar averaged cross-power spectrum Several baselines displayed
Timerange: 00/07:30:02 to 00/07:34:38

Plot file version 30 created 07-OCT-2010 14:26:00

J134054 RSP03.UVDATA.1

Freq = 1.6015 GHz, Bw = 16.000 MH No calibration applied and no bandpass applied

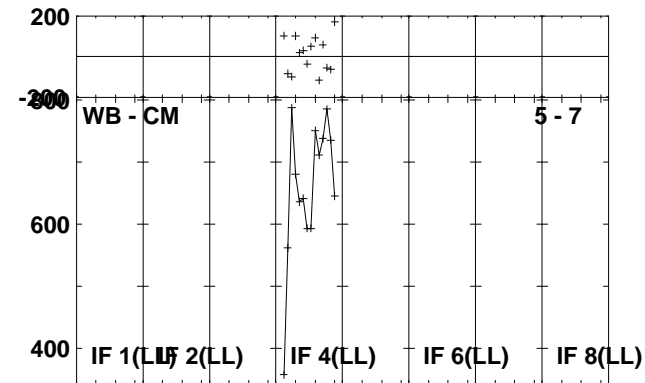
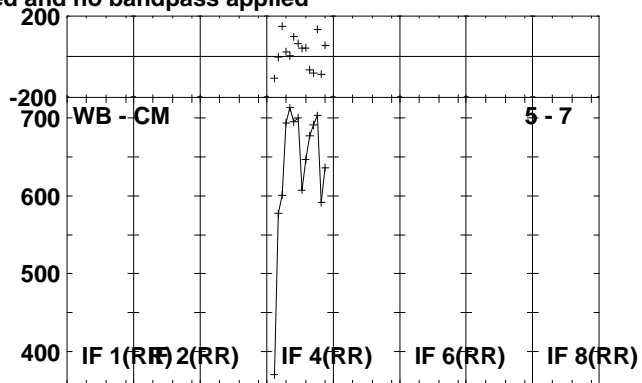
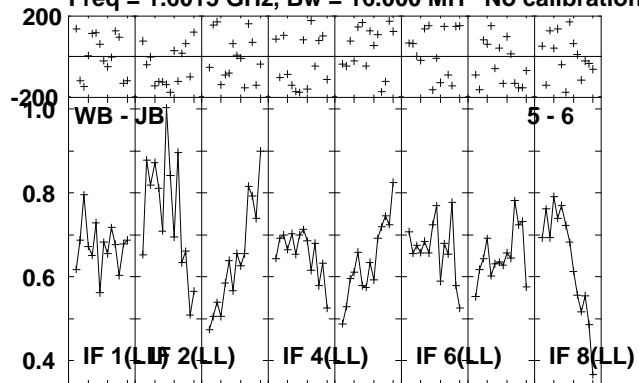

Lower frame: Milli Ampl Jy Top frame: Phas deg
Scalar averaged cross-power spectrum Several baselines displayed
Timerange: 00/07:30:02 to 00/07:34:38

Plot file version 31 created 07-OCT-2010 14:26:01

CAL1 RSP03.UVDATA.1

Freq = 1.6015 GHz, Bw = 16.000 MH No calibration applied and no bandpass applied

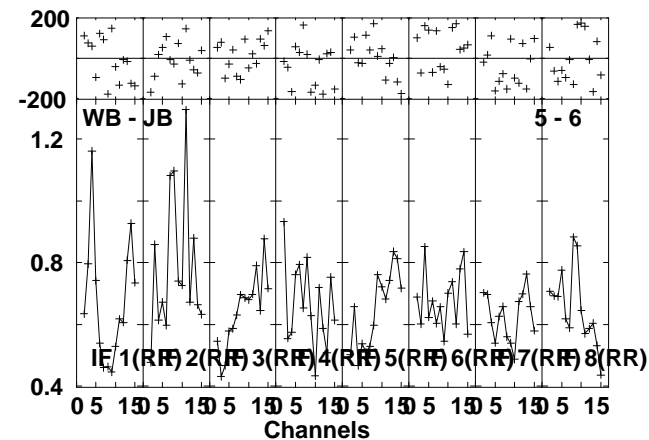
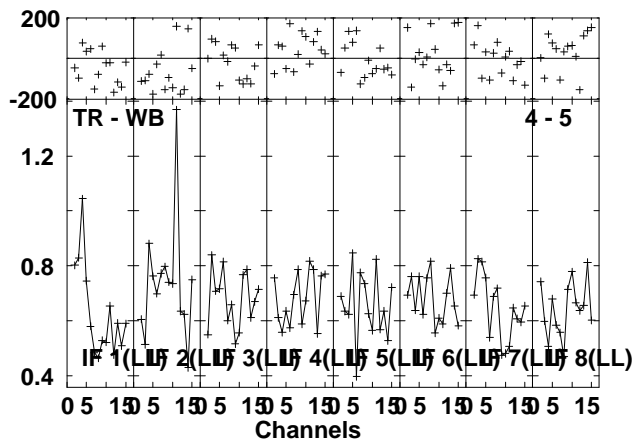
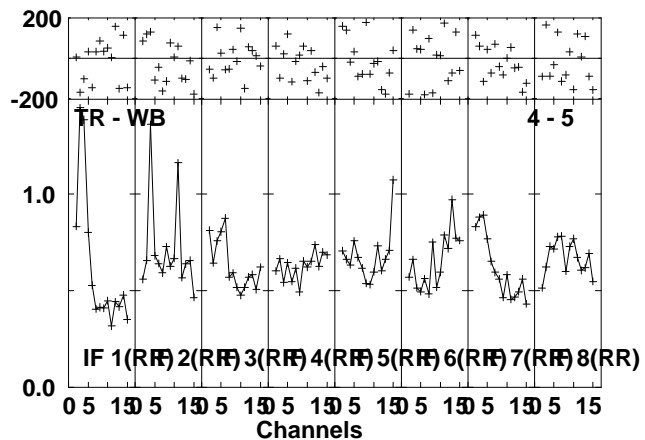
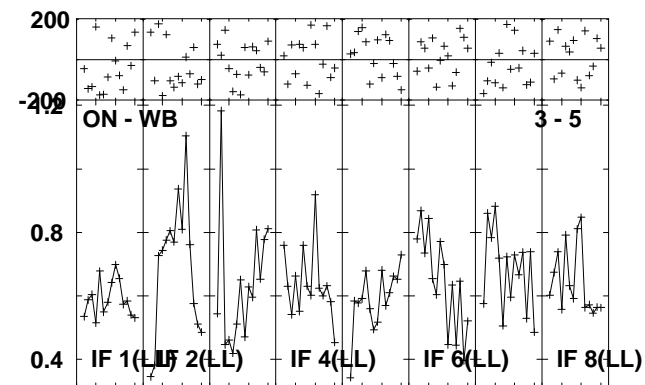
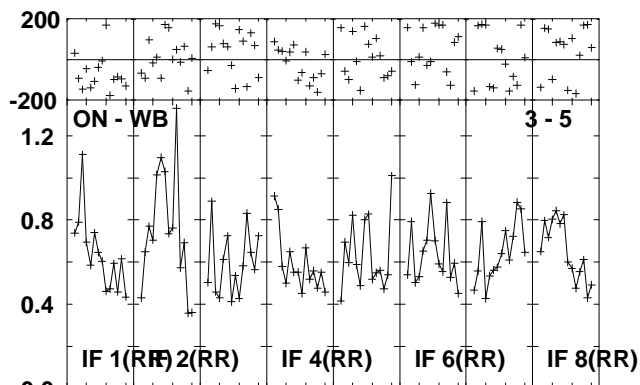
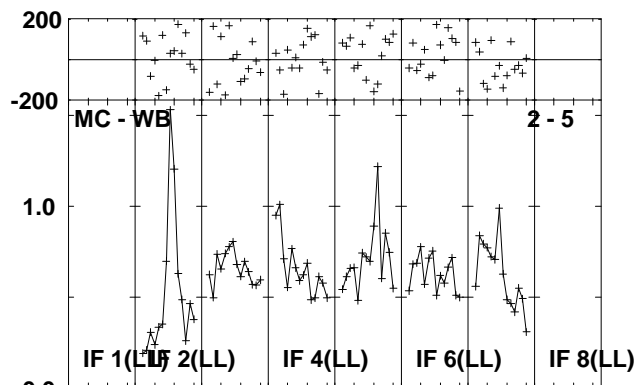
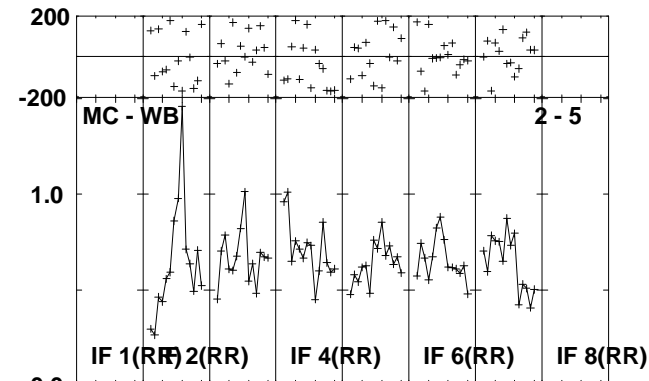
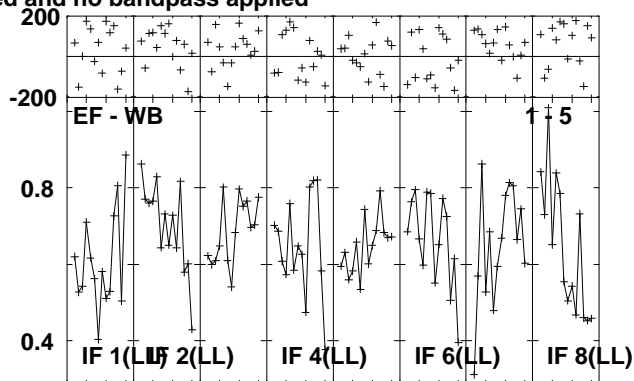
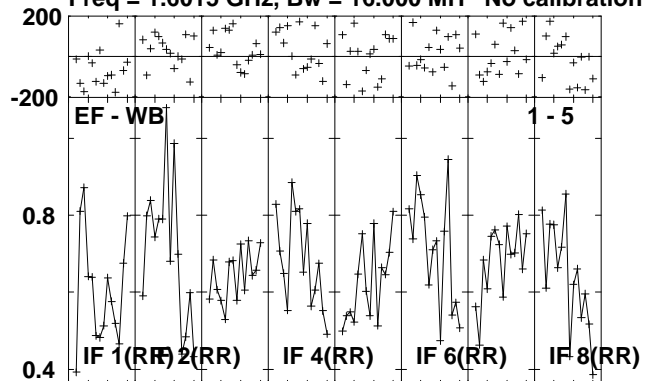

Lower frame: Milli Ampl Jy Top frame: Phas deg
Scalar averaged cross-power spectrum Several baselines displayed
Timerange: 00/07:34:42 to 00/07:35:54

Plot file version 32 created 07-OCT-2010 14:26:01

CAL1 RSP03.UVDATA.1

Freq = 1.6015 GHz, Bw = 16.000 MH No calibration applied and no bandpass applied

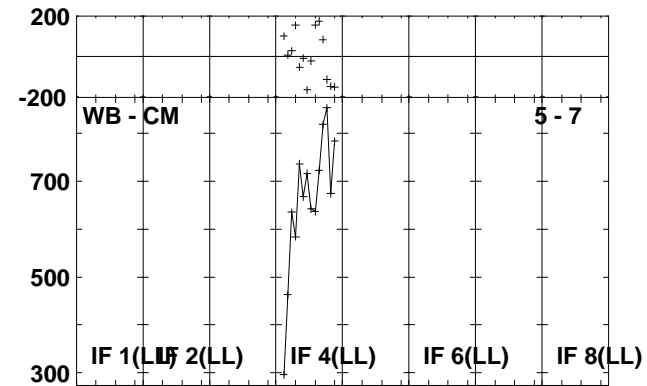
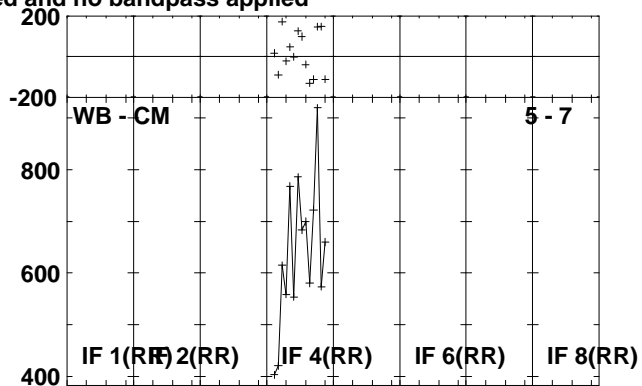
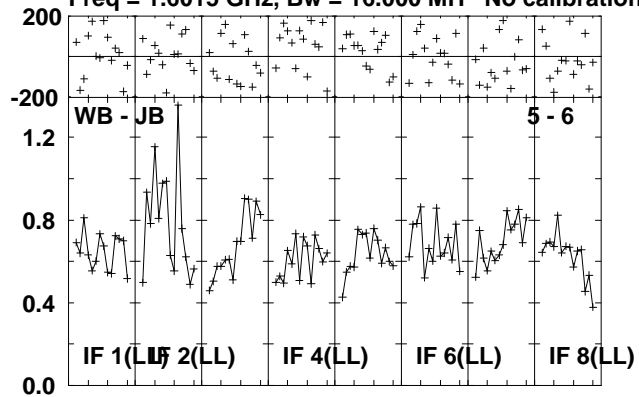

Lower frame: Milli Ampl Jy Top frame: Phas deg
Scalar averaged cross-power spectrum Several baselines displayed
Timerange: 00/07:34:42 to 00/07:35:54

Plot file version 33 created 07-OCT-2010 14:26:01

J1345+44 RSP03.UVDATA.1

Freq = 1.6015 GHz, Bw = 16.000 MH No calibration applied and no bandpass applied

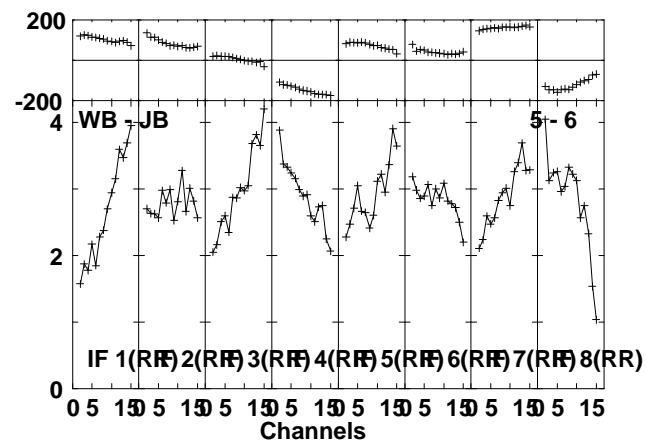
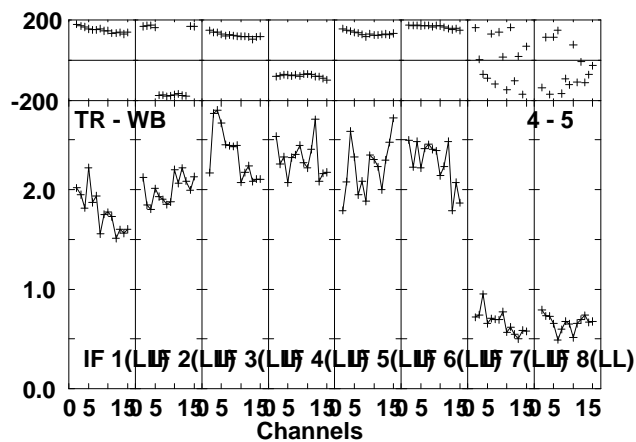
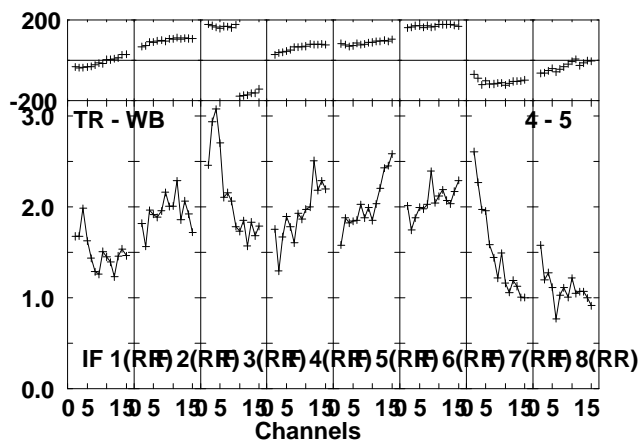
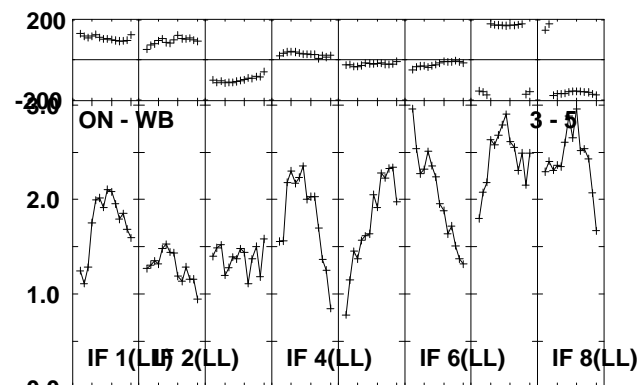
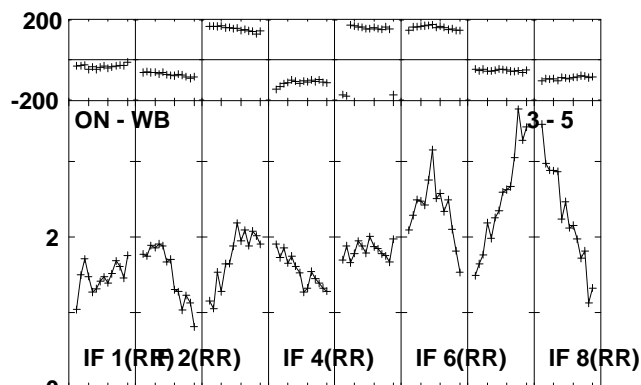
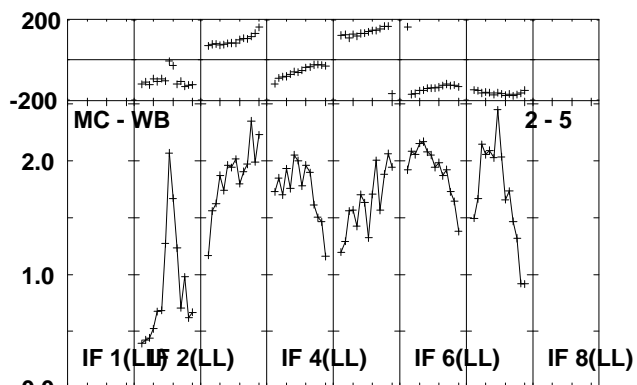
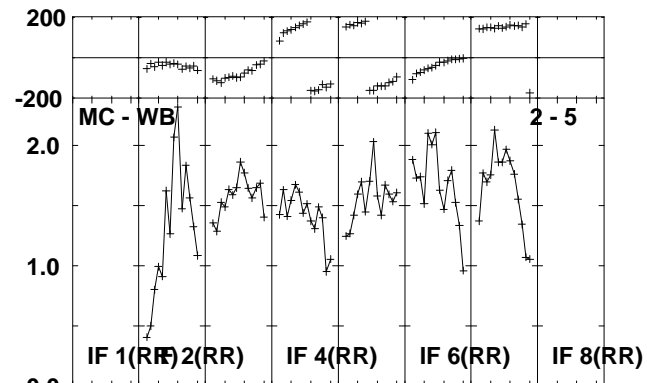
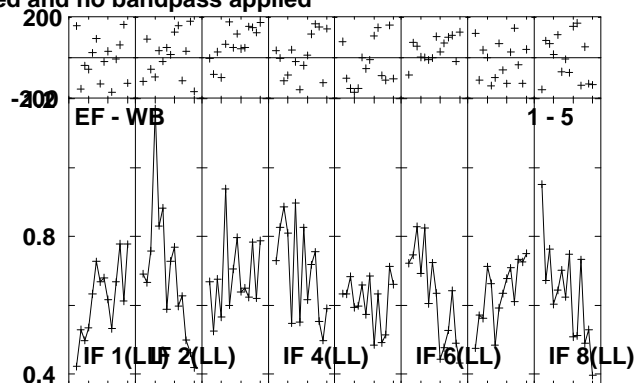
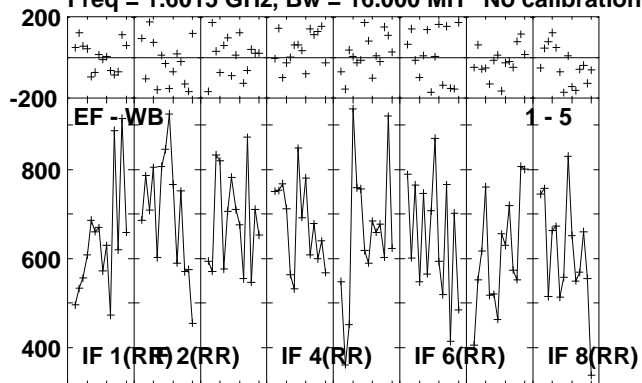

Lower frame: Micro Ampl Jy Top frame: Phas deg
Scalar averaged cross-power spectrum Several baselines displayed
Timerange: 00/07:35:58 to 00/07:37:22

Plot file version 34 created 07-OCT-2010 14:26:01

J1345+44 RSP03.UVDATA.1

Freq = 1.6015 GHz, Bw = 16.000 MH No calibration applied and no bandpass applied

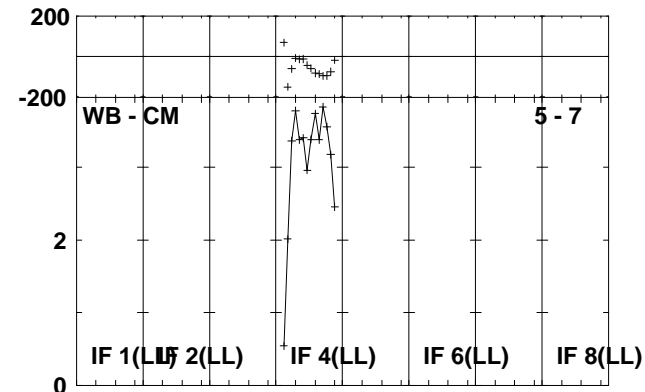
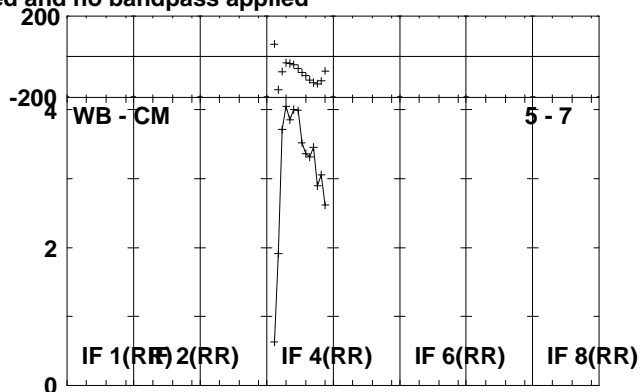
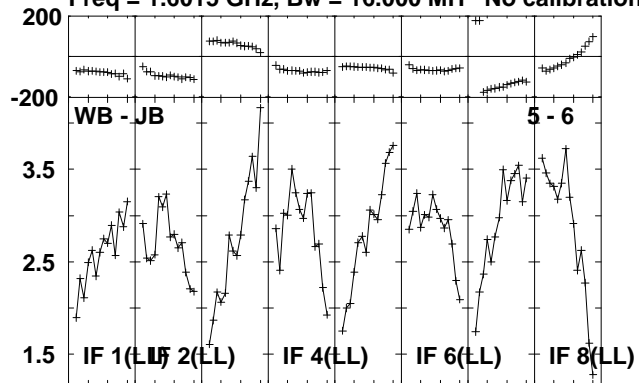

Lower frame: Milli Ampl Jy Top frame: Phas deg
Scalar averaged cross-power spectrum Several baselines displayed
Timerange: 00/07:35:58 to 00/07:37:22

Plot file version 35 created 07-OCT-2010 14:26:01

J134054 RSP03.UVDATA.1

Freq = 1.6015 GHz, Bw = 16.000 MH No calibration applied and no bandpass applied

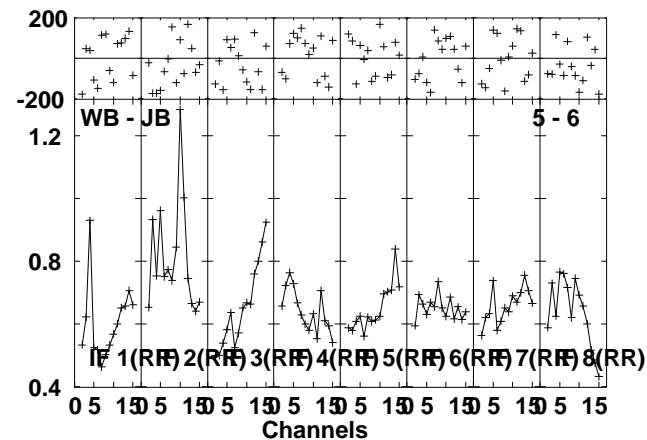
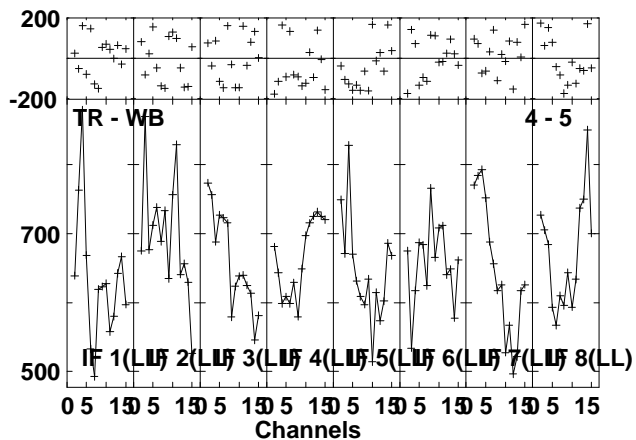
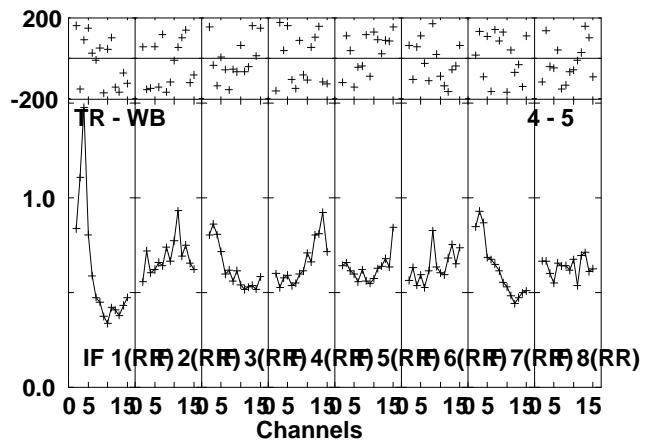
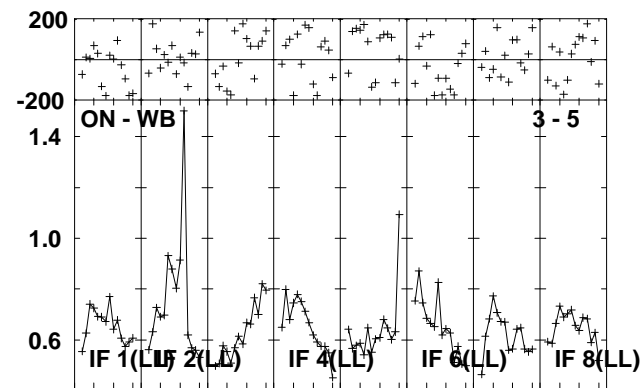
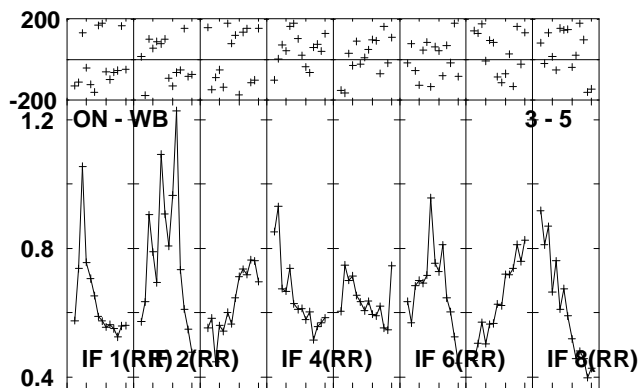
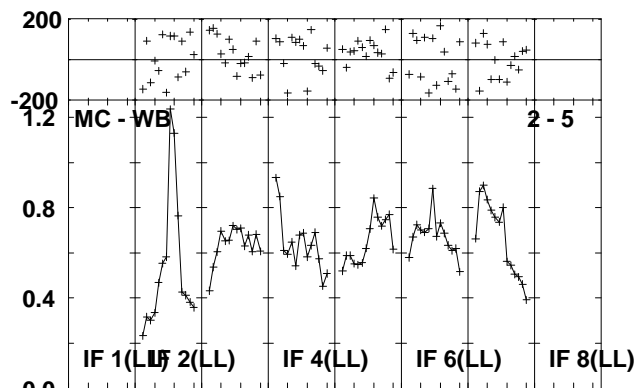
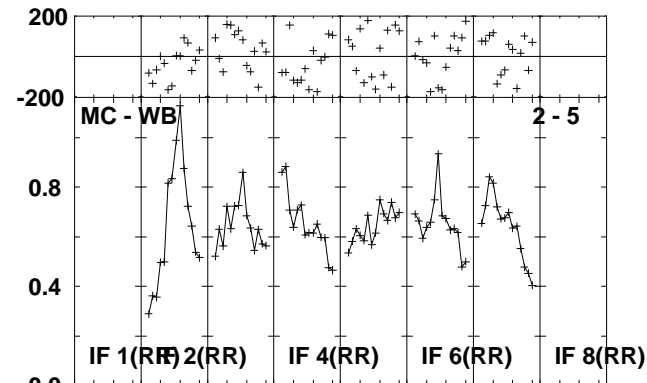
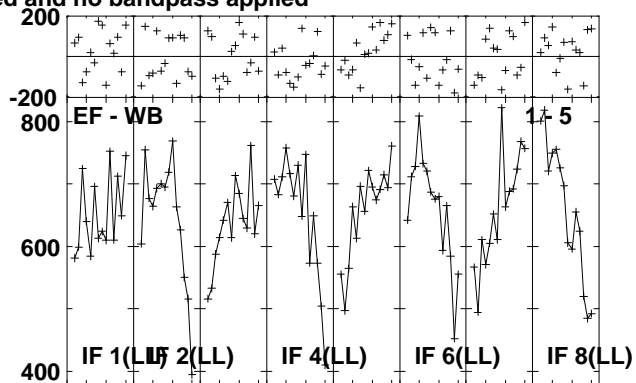
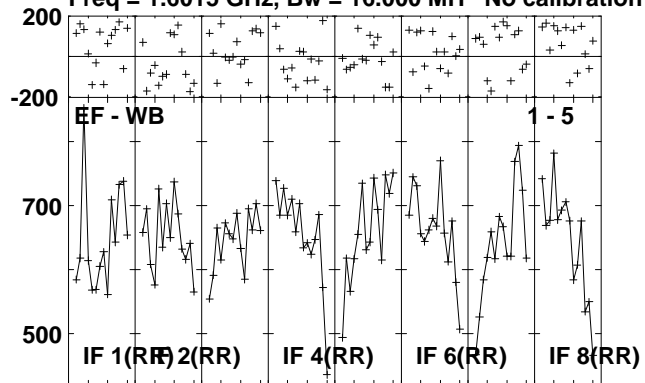

Lower frame: Micro Ampl Jy Top frame: Phas deg
Scalar averaged cross-power spectrum Several baselines displayed
Timerange: 00/07:37:26 to 00/07:42:02

Plot file version 36 created 07-OCT-2010 14:26:02

J134054 RSP03.UVDATA.1

Freq = 1.6015 GHz, Bw = 16.000 MH No calibration applied and no bandpass applied

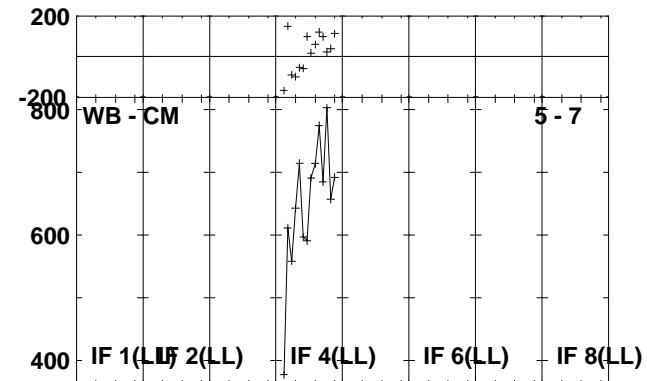
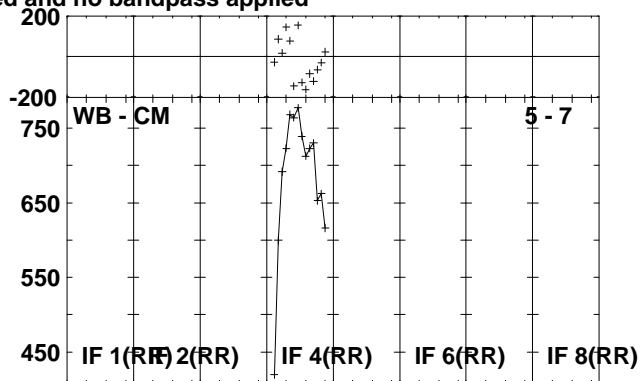
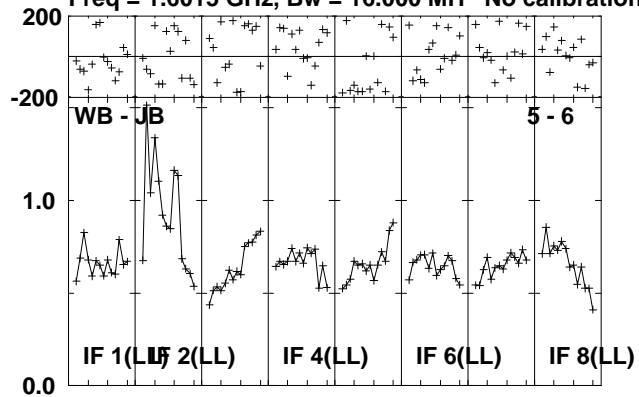

Lower frame: Milli Ampl Jy Top frame: Phas deg
Scalar averaged cross-power spectrum Several baselines displayed
Timerange: 00/07:37:26 to 00/07:42:02

Plot file version 37 created 07-OCT-2010 14:26:02

CAL2 RSP03.UVDATA.1

Freq = 1.6015 GHz, Bw = 16.000 MH No calibration applied and no bandpass applied

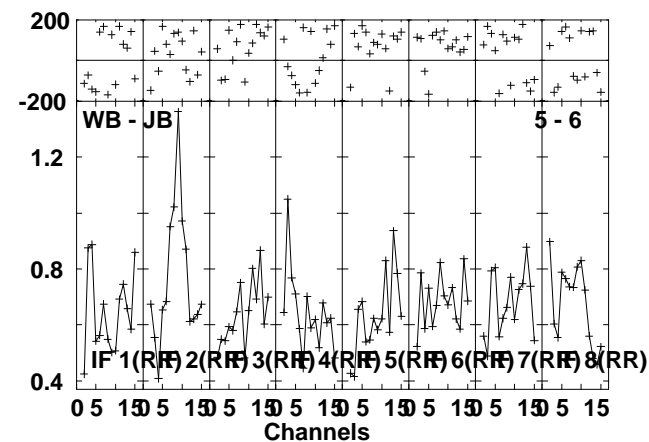
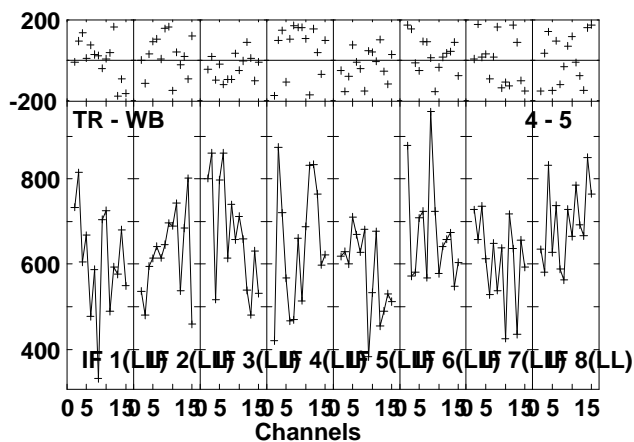
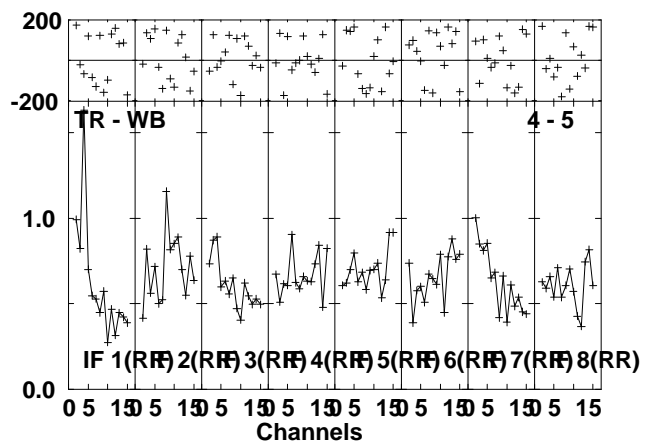
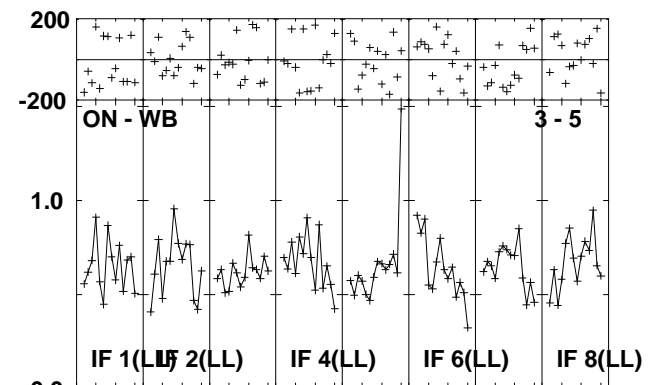
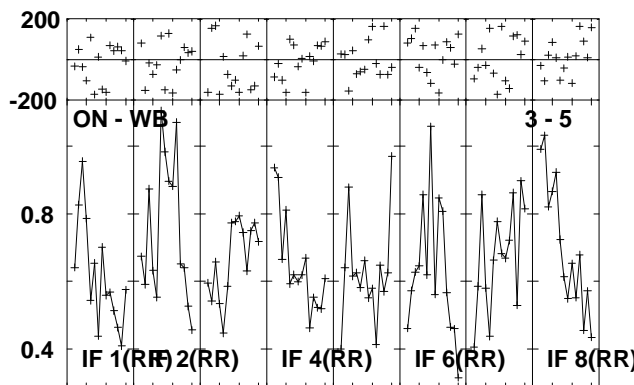
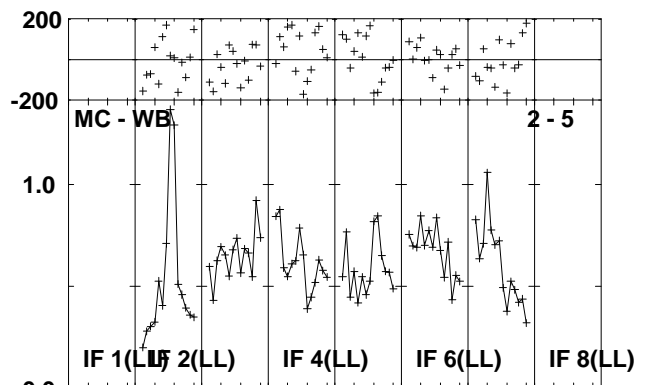
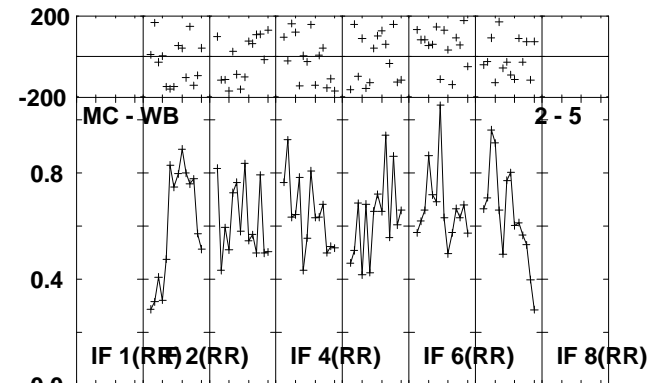
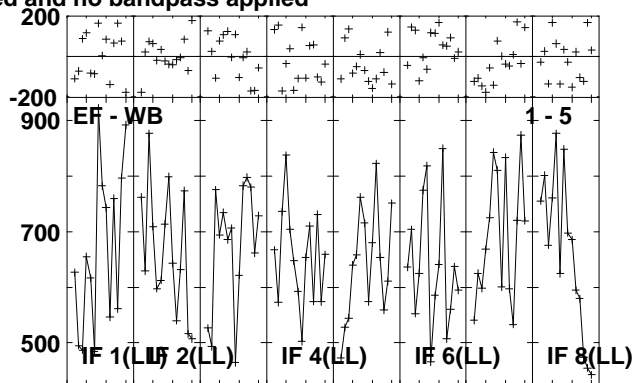
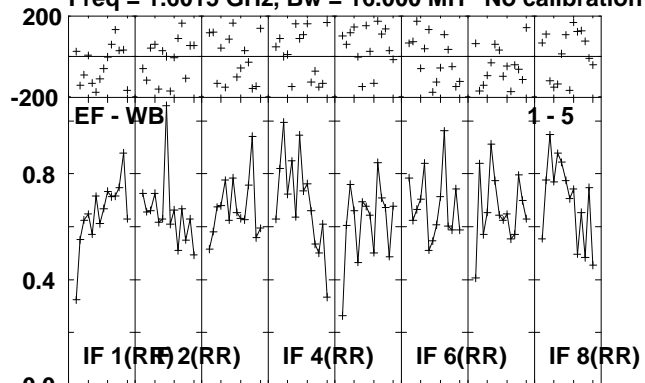

Lower frame: Milli Ampl Jy Top frame: Phas deg
Scalar averaged cross-power spectrum Several baselines displayed
Timerange: 00/07:42:06 to 00/07:43:18

Plot file version 38 created 07-OCT-2010 14:26:03

CAL2 RSP03.UVDATA.1

Freq = 1.6015 GHz, Bw = 16.000 MH No calibration applied and no bandpass applied

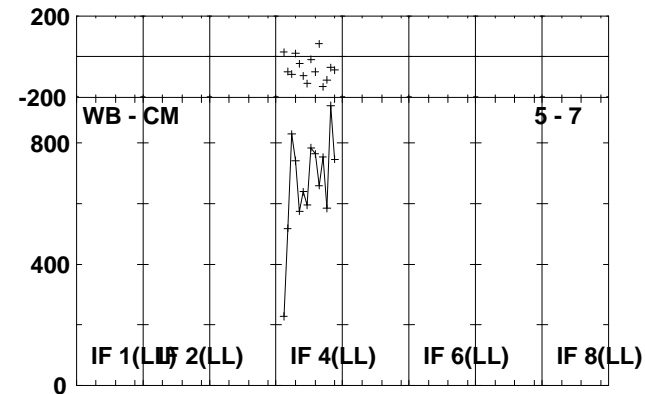
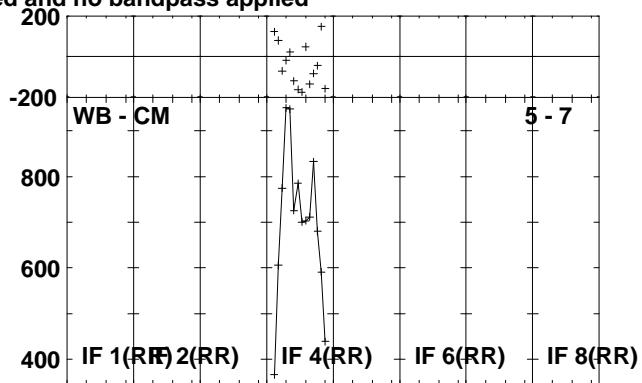
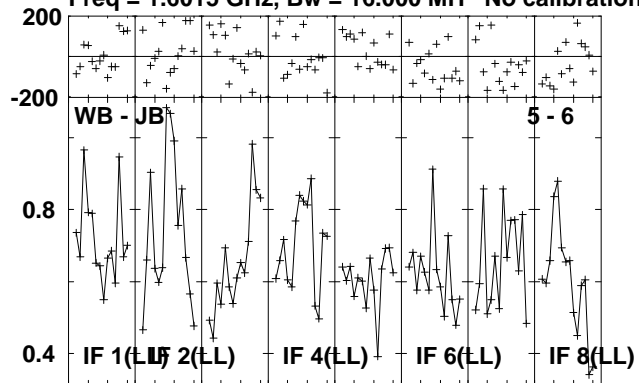

Lower frame: Milli Ampl Jy Top frame: Phas deg
Scalar averaged cross-power spectrum Several baselines displayed
Timerange: 00/07:42:06 to 00/07:43:18

Plot file version 39 created 07-OCT-2010 14:26:03

J1345+44 RSP03.UVDATA.1

Freq = 1.6015 GHz, Bw = 16.000 MH No calibration applied and no bandpass applied

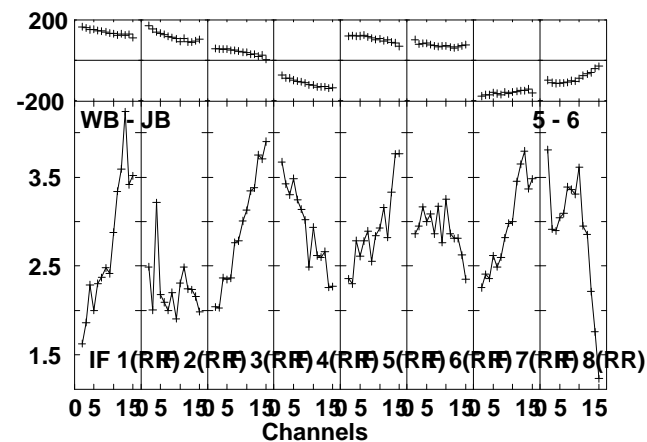
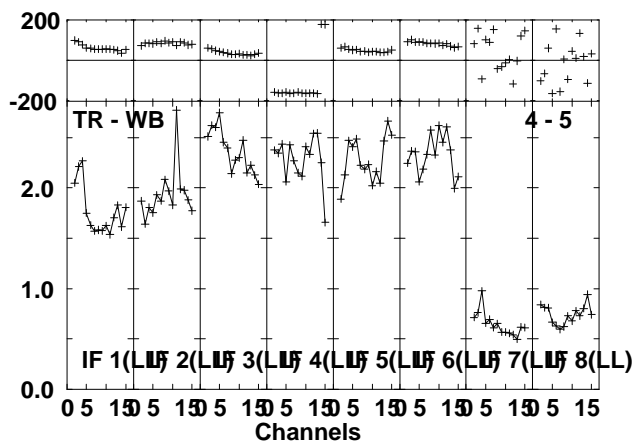
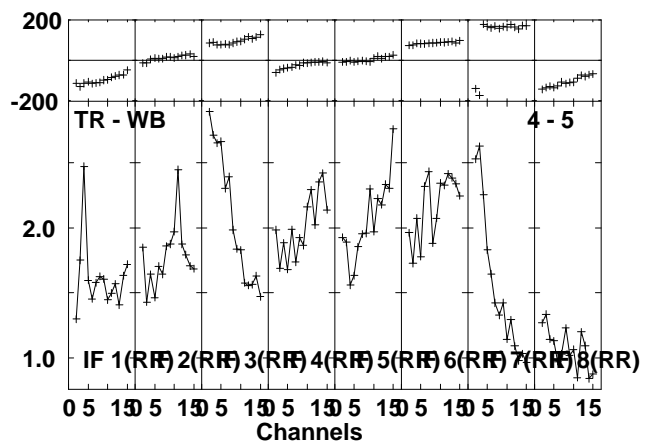
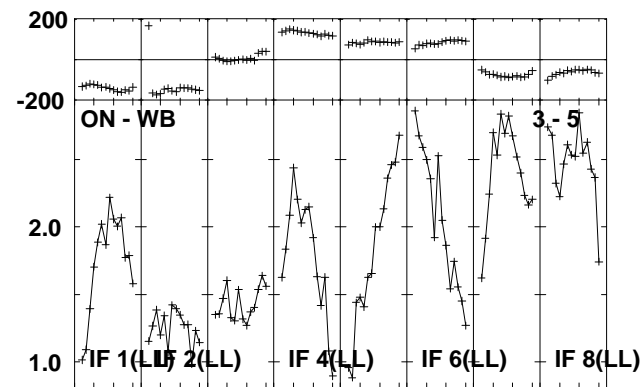
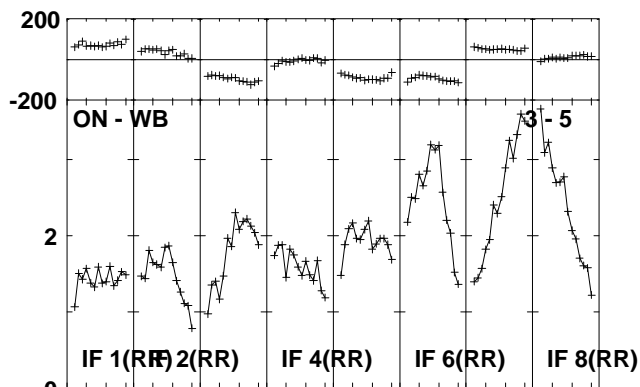
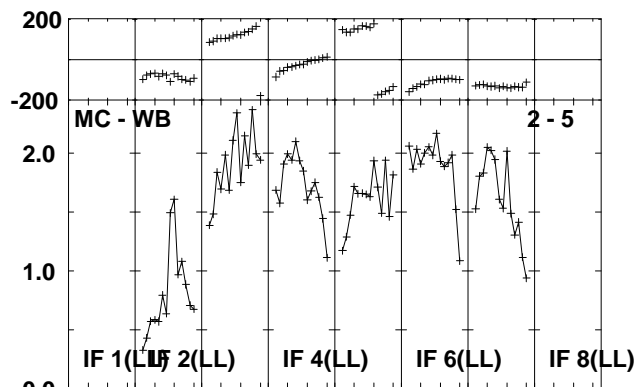
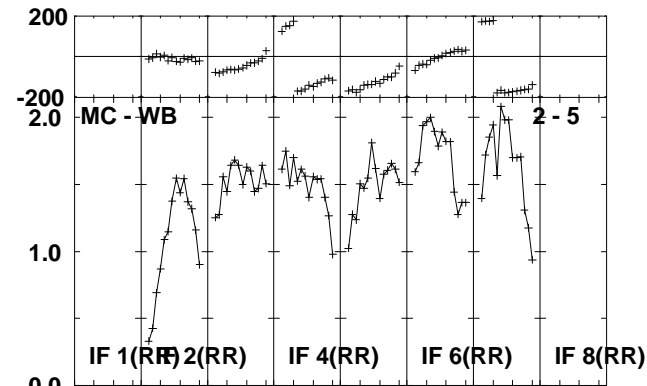
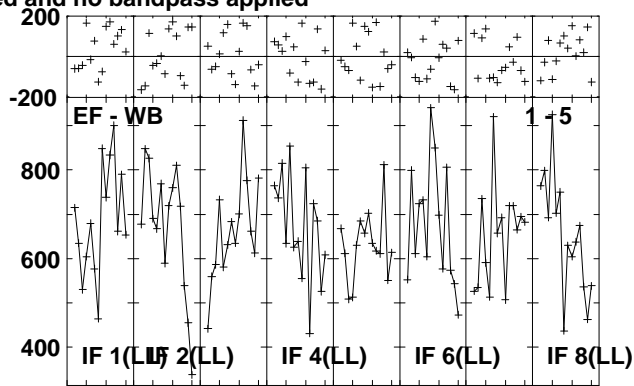
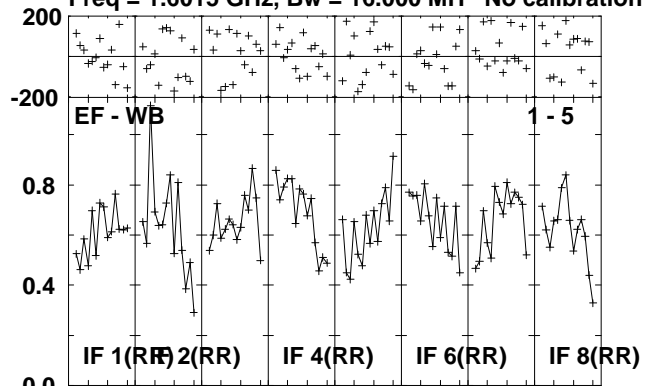

Lower frame: Milli Ampl Jy Top frame: Phas deg
Scalar averaged cross-power spectrum Several baselines displayed
Timerange: 00/07:44:02 to 00/07:44:58

Plot file version 40 created 07-OCT-2010 14:26:03

J1345+44 RSP03.UVDATA.1

Freq = 1.6015 GHz, Bw = 16.000 MH No calibration applied and no bandpass applied

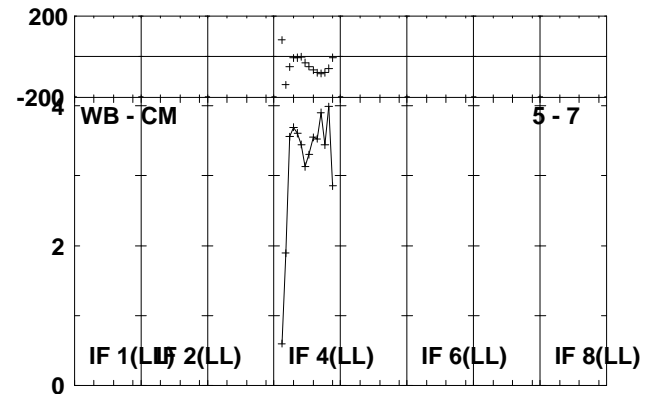
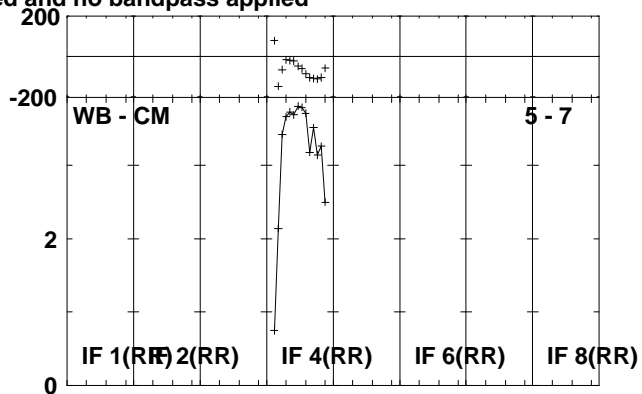
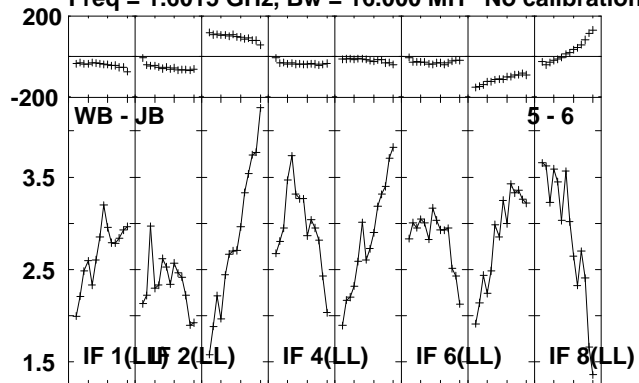

Lower frame: Milli Ampl Jy Top frame: Phas deg
Scalar averaged cross-power spectrum Several baselines displayed
Timerange: 00/07:44:02 to 00/07:44:58

Plot file version 41 created 07-OCT-2010 14:26:03

J134054 RSP03.UVDATA.1

Freq = 1.6015 GHz, Bw = 16.000 MH No calibration applied and no bandpass applied

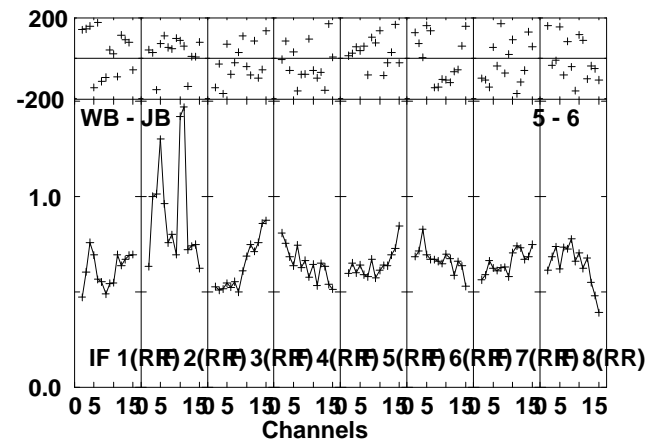
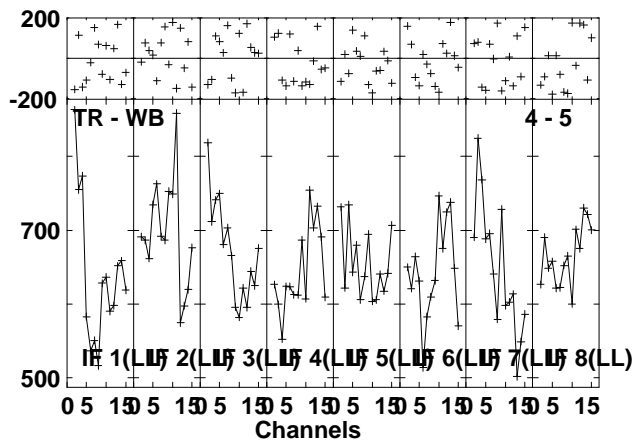
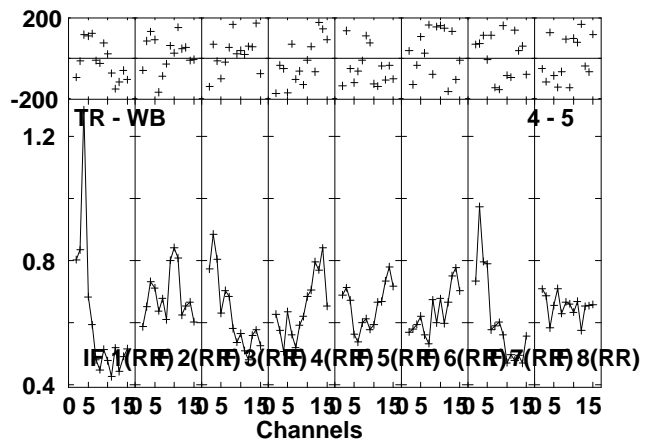
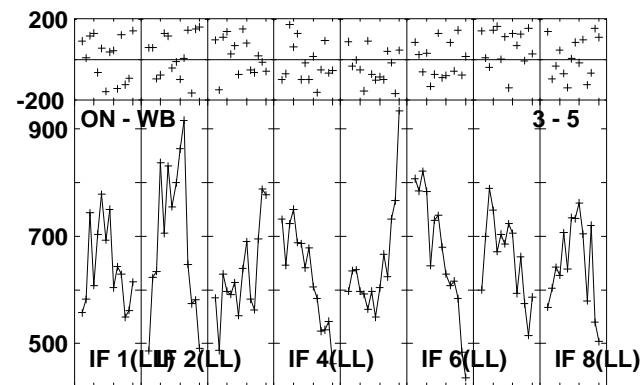
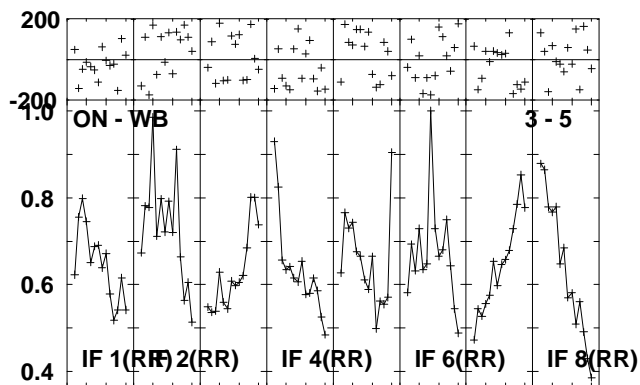
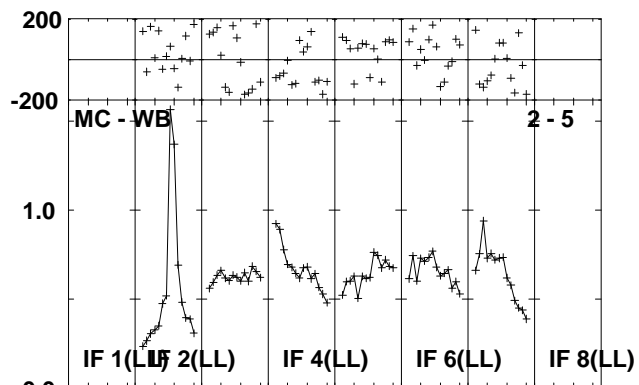
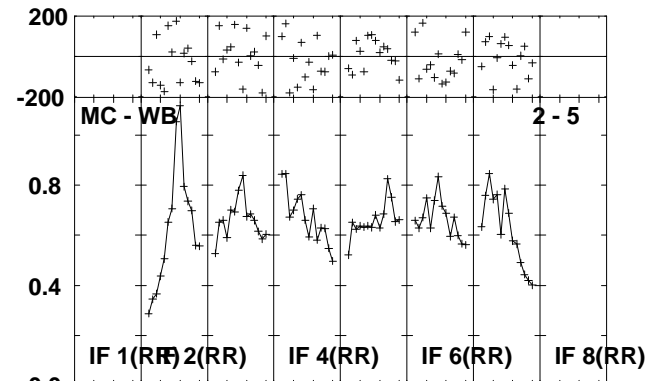
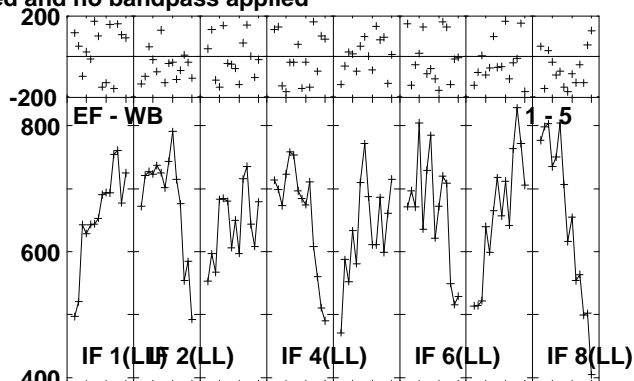
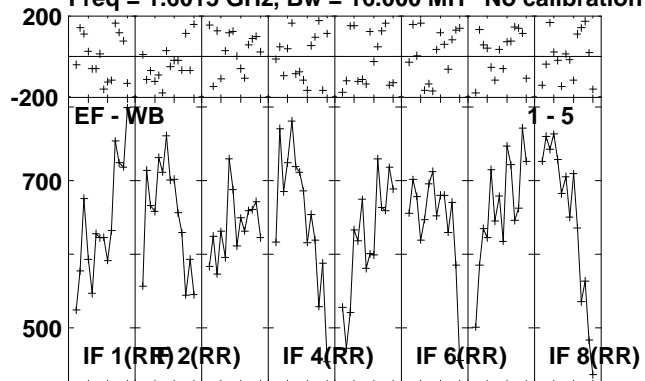

Lower frame: Micro Ampl Jy Top frame: Phas deg
Scalar averaged cross-power spectrum Several baselines displayed
Timerange: 00/07:45:02 to 00/07:49:38

Plot file version 42 created 07-OCT-2010 14:26:04

J134054 RSP03.UVDATA.1

Freq = 1.6015 GHz, Bw = 16.000 MH No calibration applied and no bandpass applied

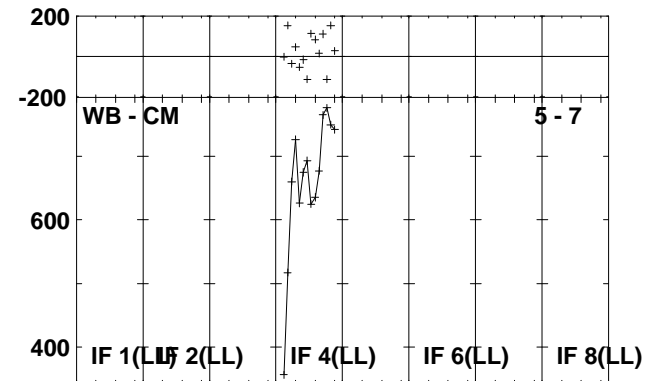
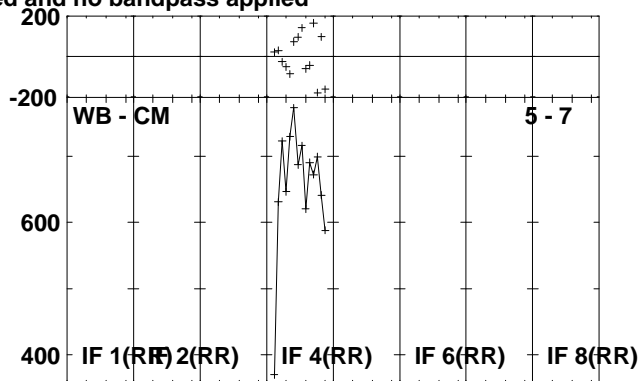
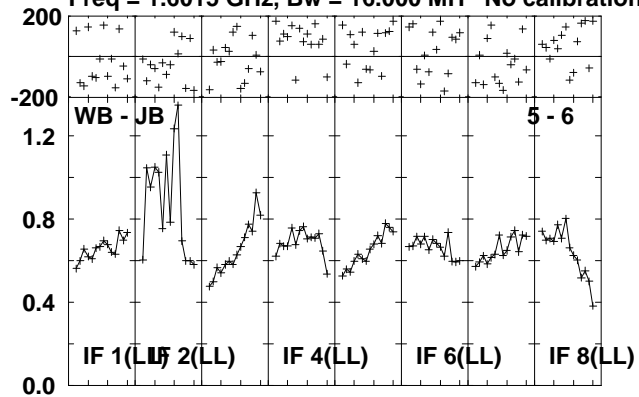

Lower frame: Milli Ampl Jy Top frame: Phas deg
Scalar averaged cross-power spectrum Several baselines displayed
Timerange: 00/07:45:02 to 00/07:49:38

Plot file version 43 created 07-OCT-2010 14:26:04

CAL1 RSP03.UVDATA.1

Freq = 1.6015 GHz, Bw = 16.000 MH No calibration applied and no bandpass applied

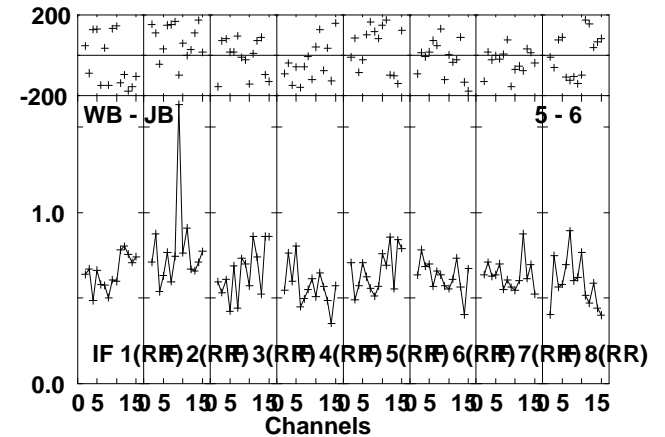
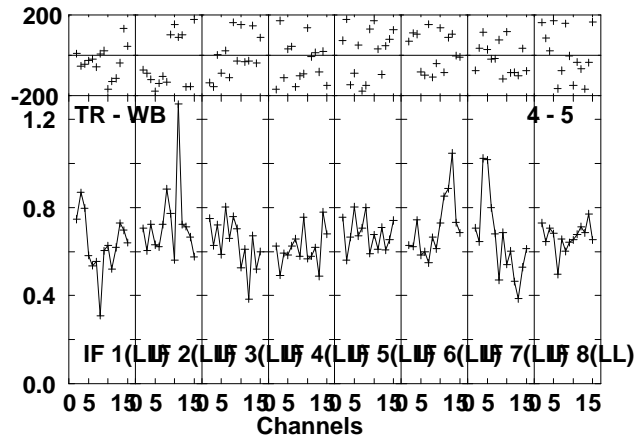
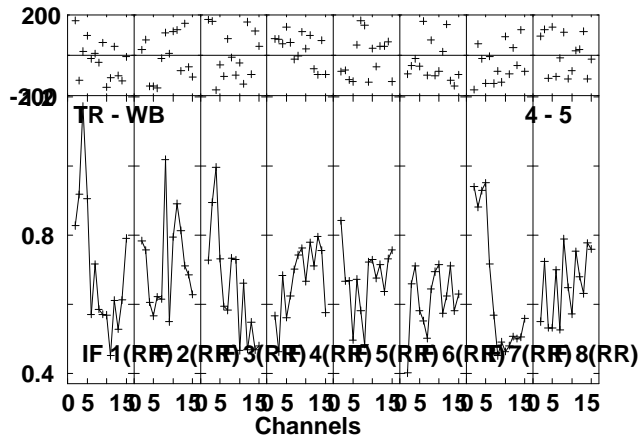
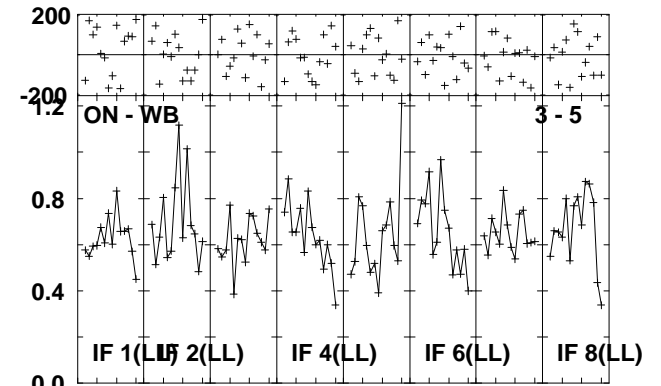
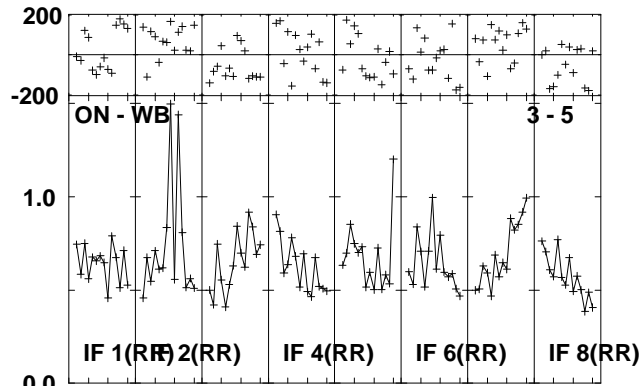
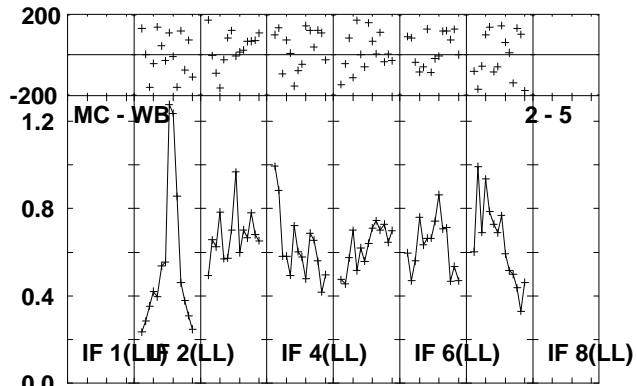
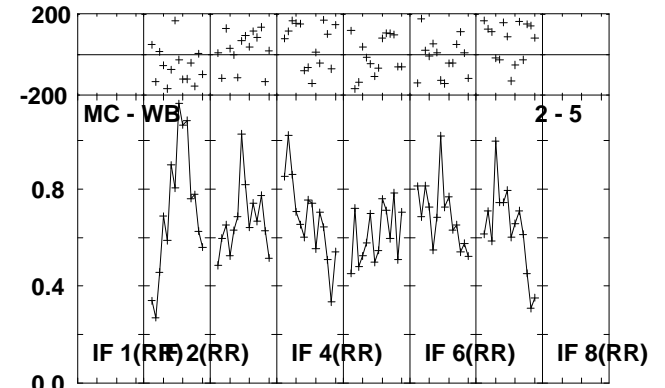
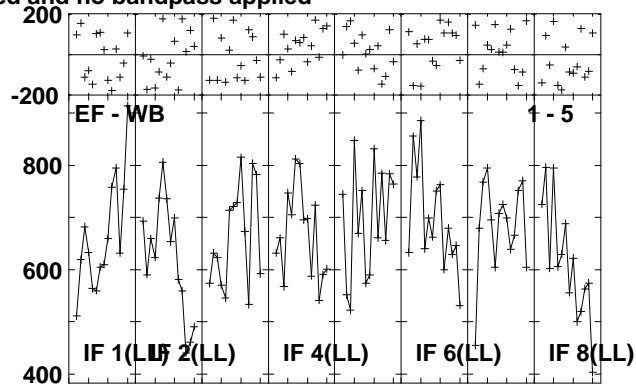
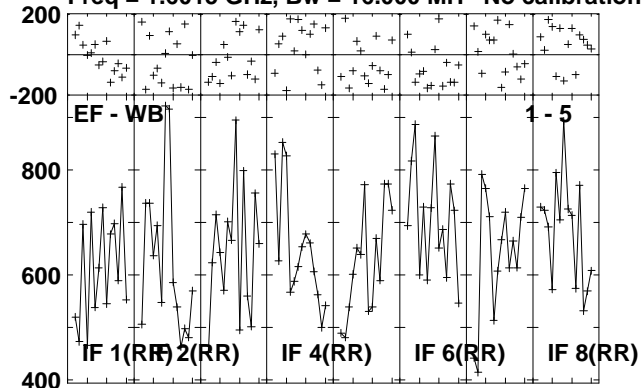

Lower frame: Micro Ampl Jy Top frame: Phas deg
Scalar averaged cross-power spectrum Several baselines displayed
Timerange: 00/07:49:42 to 00/07:50:54

Plot file version 44 created 07-OCT-2010 14:26:04

CAL1 RSP03.UVDATA.1

Freq = 1.6015 GHz, Bw = 16.000 MH No calibration applied and no bandpass applied

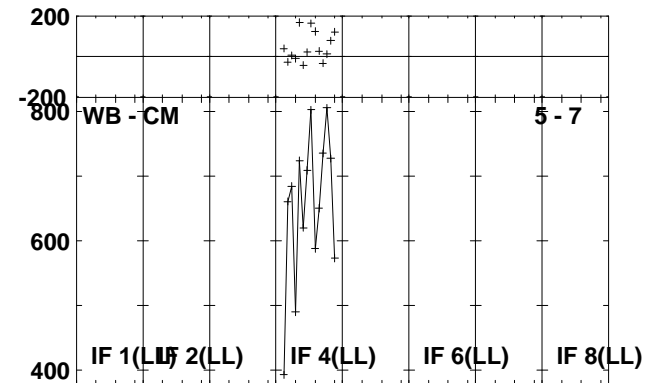
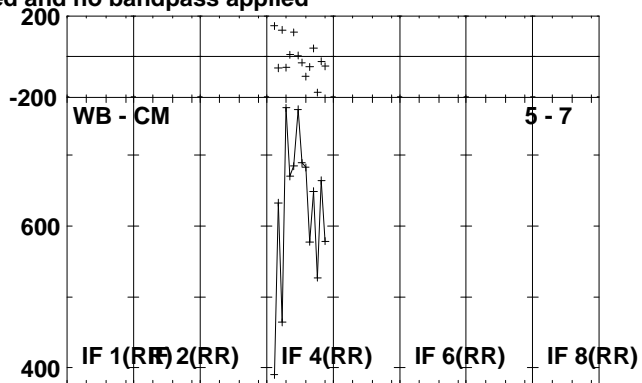
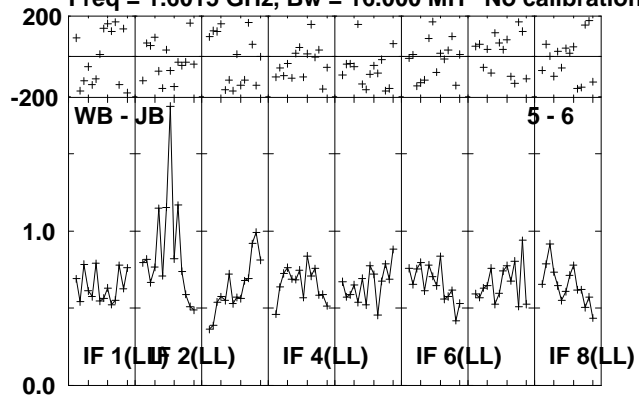

Lower frame: Milli Ampl Jy Top frame: Phas deg
Scalar averaged cross-power spectrum Several baselines displayed
Timerange: 00/07:49:42 to 00/07:50:54

Plot file version 45 created 07-OCT-2010 14:26:04

J1345+44 RSP03.UVDATA.1

Freq = 1.6015 GHz, Bw = 16.000 MH No calibration applied and no bandpass applied

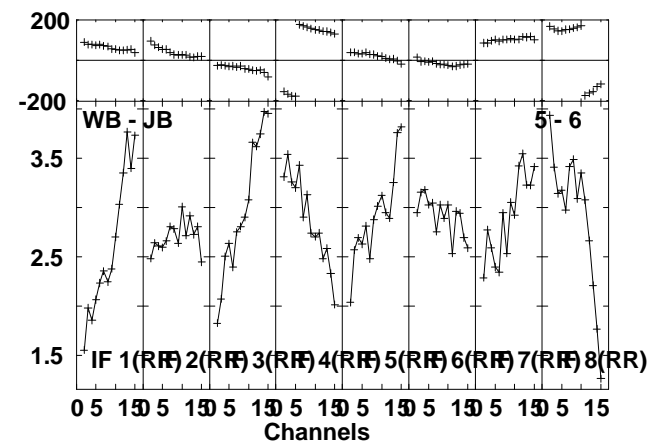
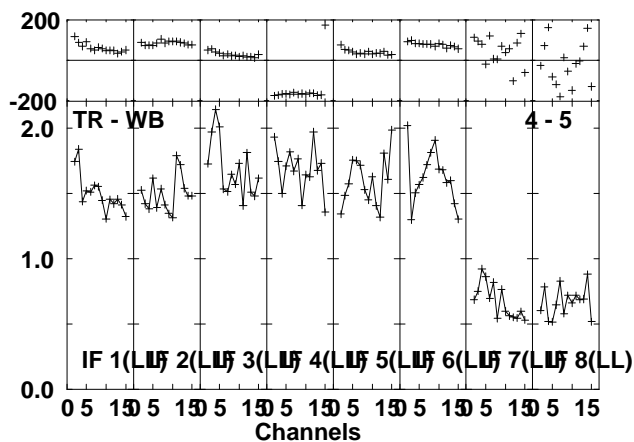
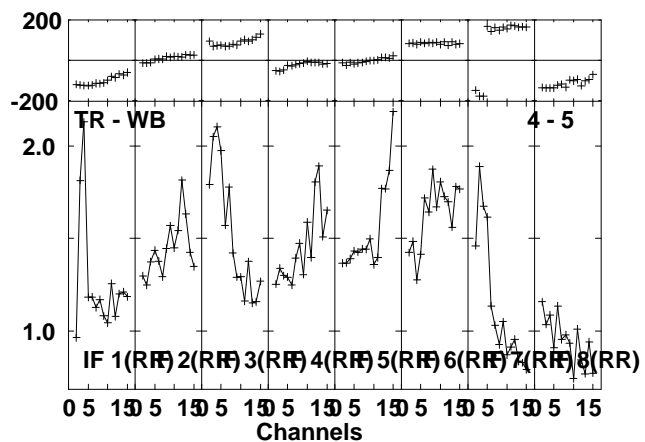
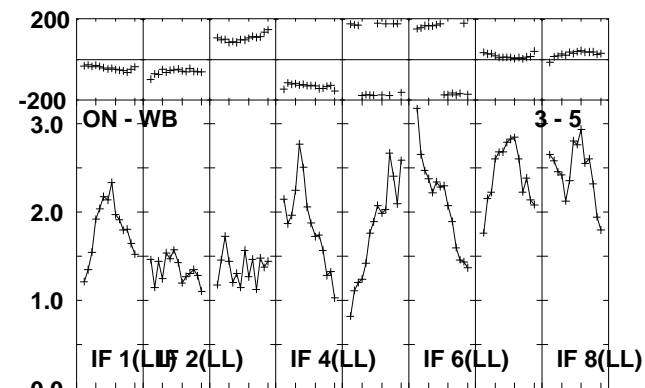
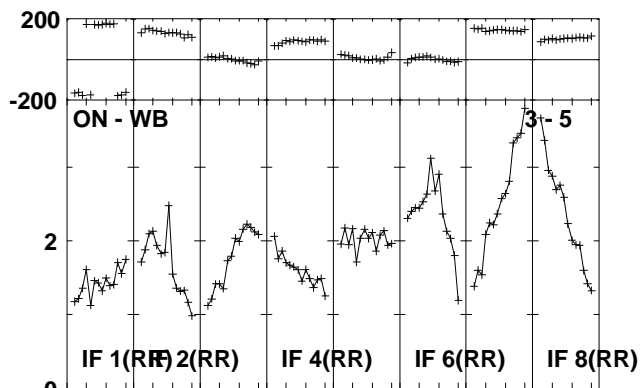
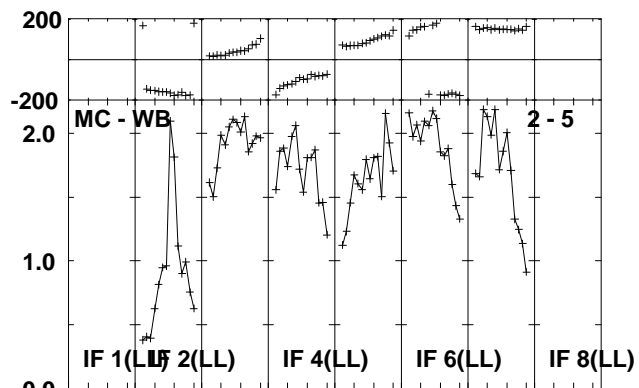
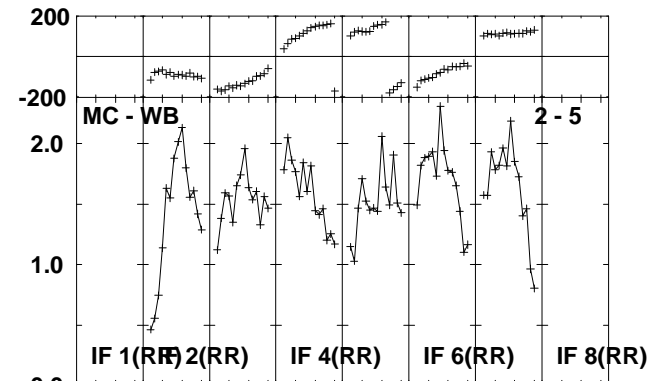
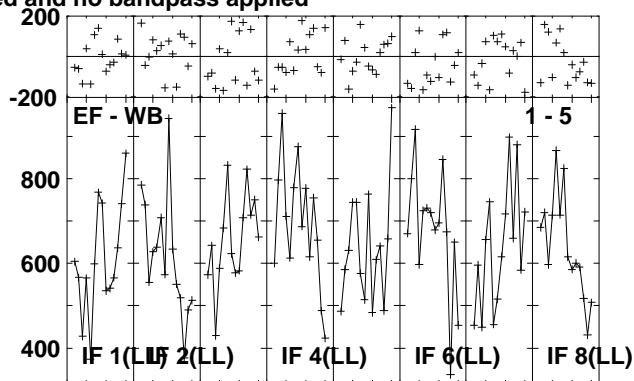
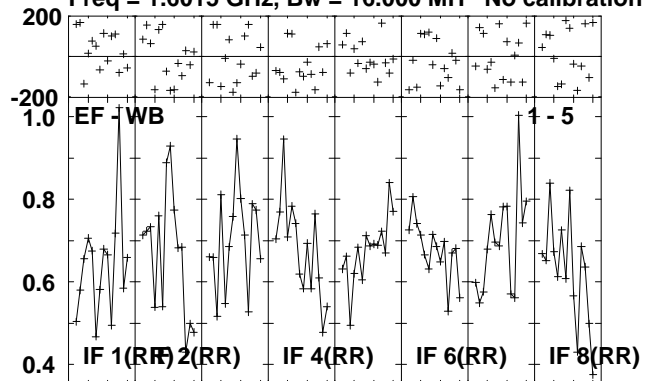

Lower frame: Milli Ampl Jy Top frame: Phas deg
Scalar averaged cross-power spectrum Several baselines displayed
Timerange: 00/07:50:58 to 00/07:52:22

Plot file version 46 created 07-OCT-2010 14:26:05

J1345+44 RSP03.UVDATA.1

Freq = 1.6015 GHz, Bw = 16.000 MH No calibration applied and no bandpass applied

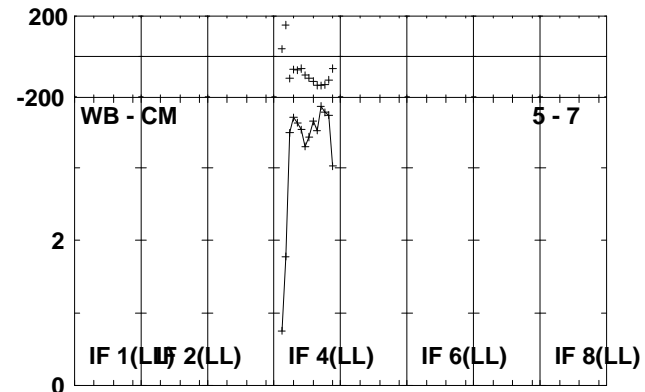
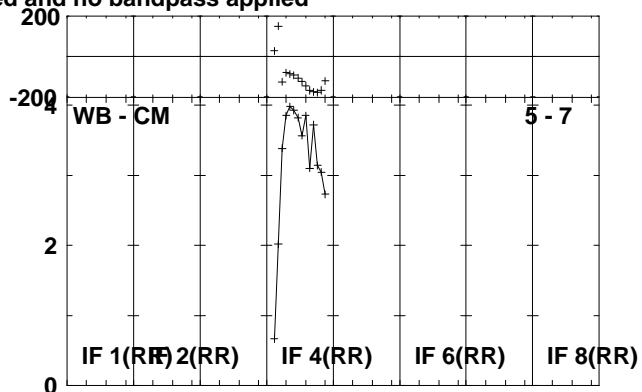
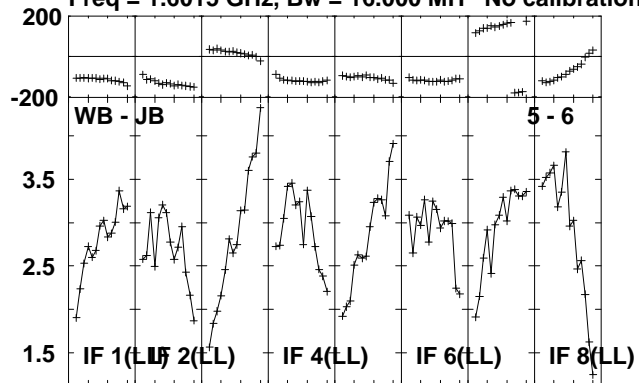

Lower frame: Milli Ampl Jy Top frame: Phas deg
Scalar averaged cross-power spectrum Several baselines displayed
Timerange: 00/07:50:58 to 00/07:52:22

Plot file version 47 created 07-OCT-2010 14:26:05

J134054 RSP03.UVDATA.1

Freq = 1.6015 GHz, Bw = 16.000 MH No calibration applied and no bandpass applied

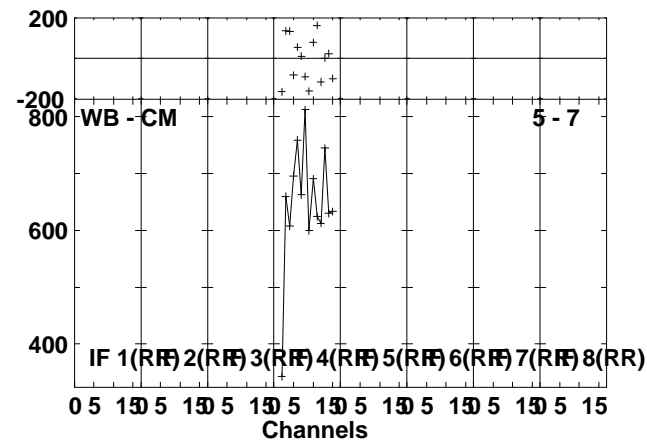
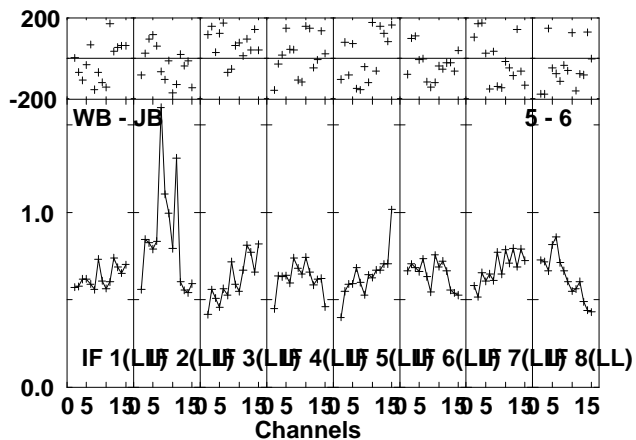
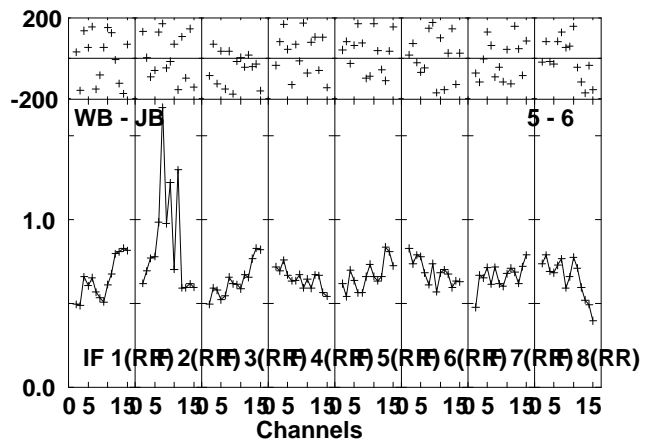
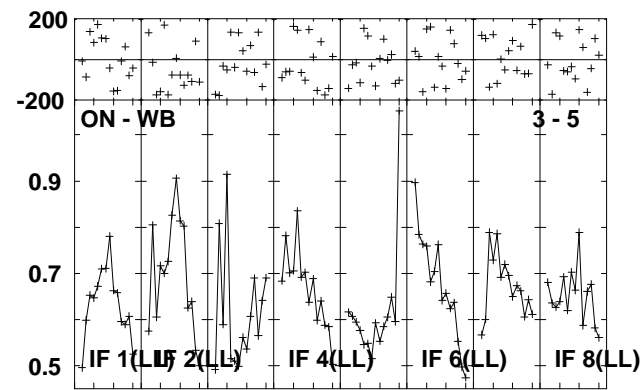
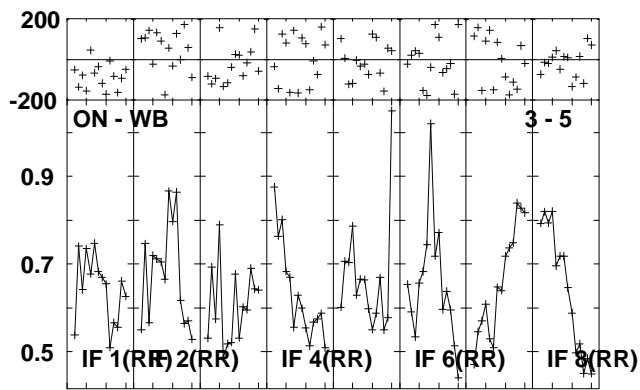
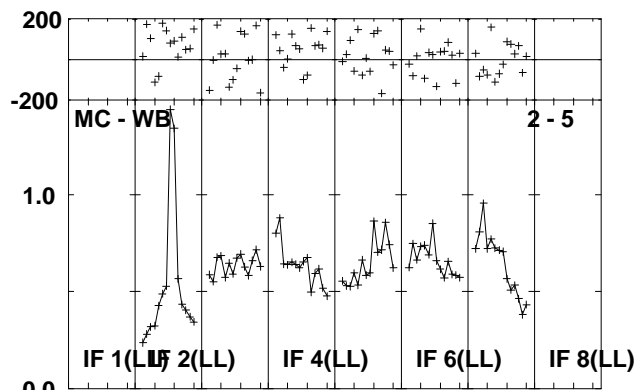
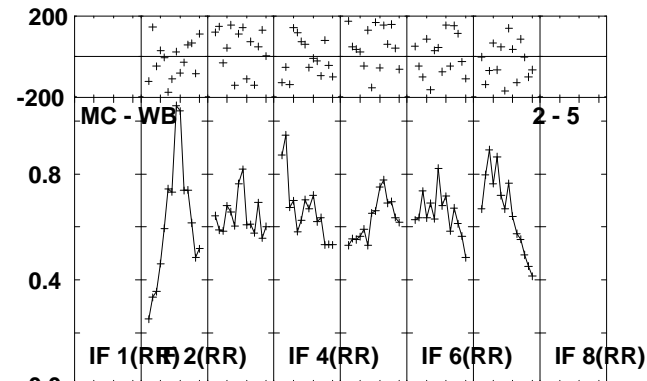
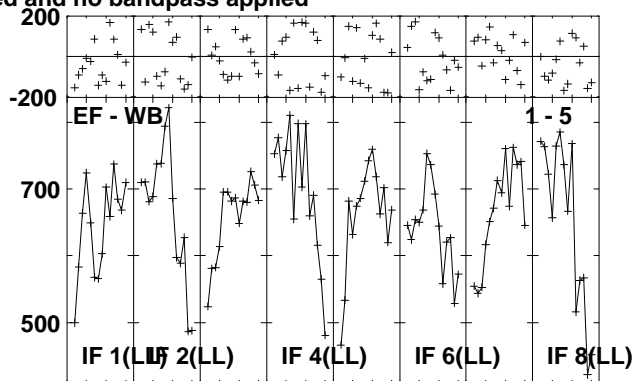
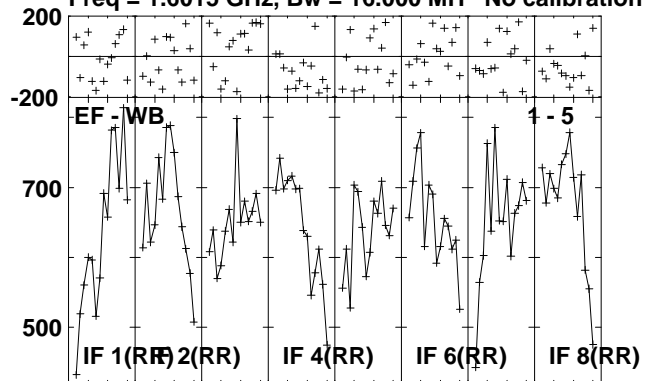

Lower frame: Micro Ampl Jy Top frame: Phas deg
Scalar averaged cross-power spectrum Several baselines displayed
Timerange: 00/07:52:26 to 00/07:57:02

Plot file version 48 created 07-OCT-2010 14:26:05
J134054 RSP03.UVDATA.1
Freq = 1.6015 GHz, Bw = 16.000 MH No calibration applied and no bandpass applied

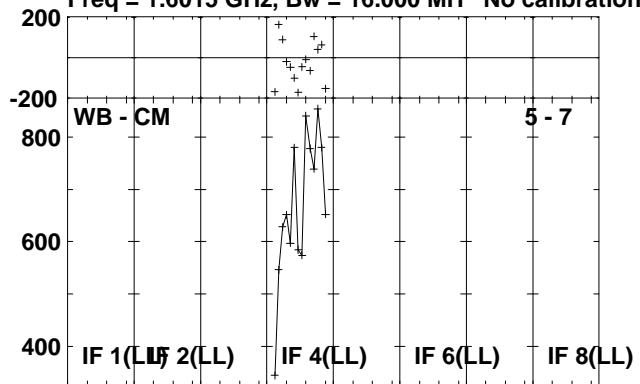

Lower frame: Micro Ampl Jy Top frame: Phas deg
Scalar averaged cross-power spectrum Several baselines displayed
Timerange: 00/07:52:26 to 00/07:57:02

Plot file version 49 created 07-OCT-2010 14:26:05

CAL2 RSP03.UVDATA.1

Freq = 1.6015 GHz, Bw = 16.000 MH No calibration applied and no bandpass applied

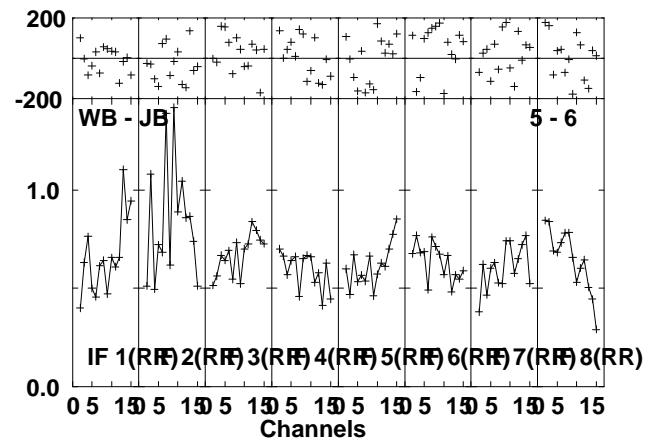
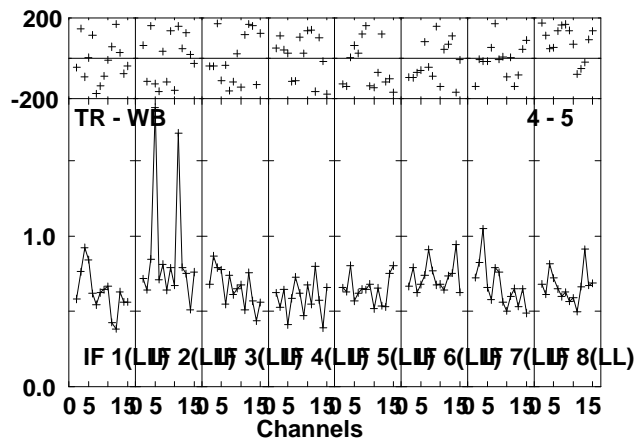
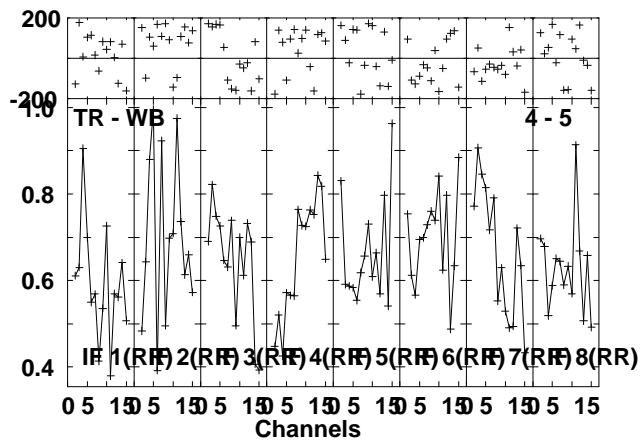
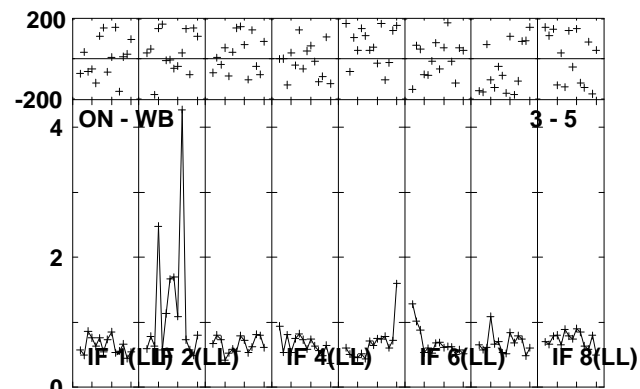
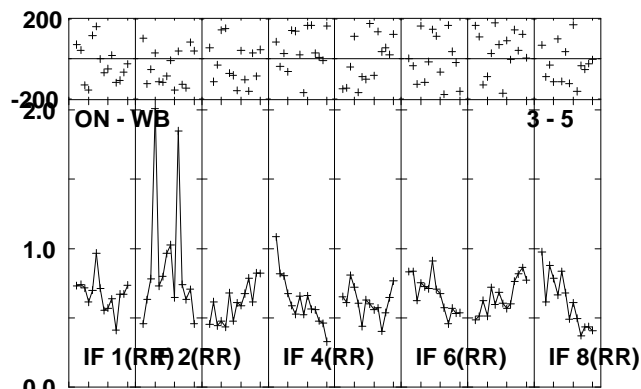
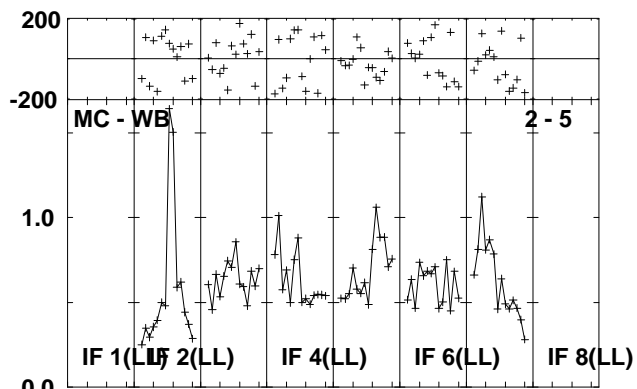
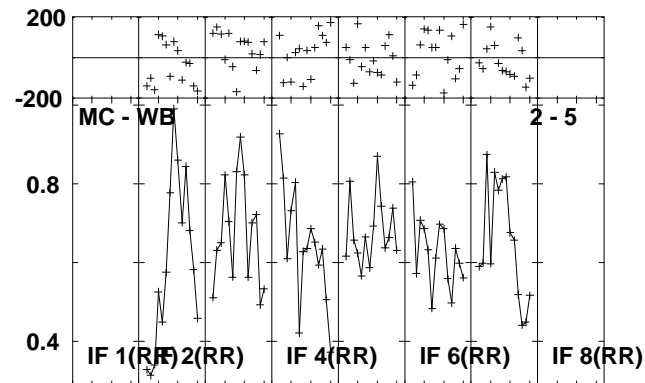
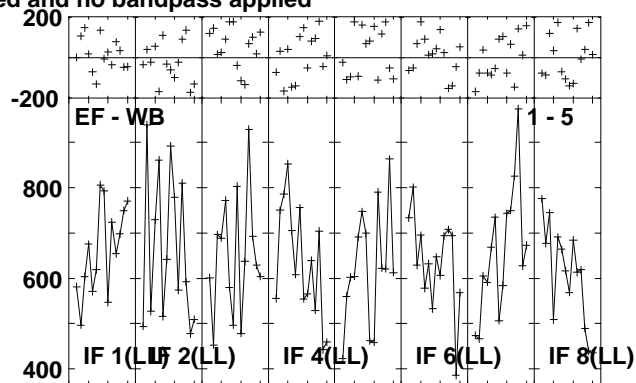
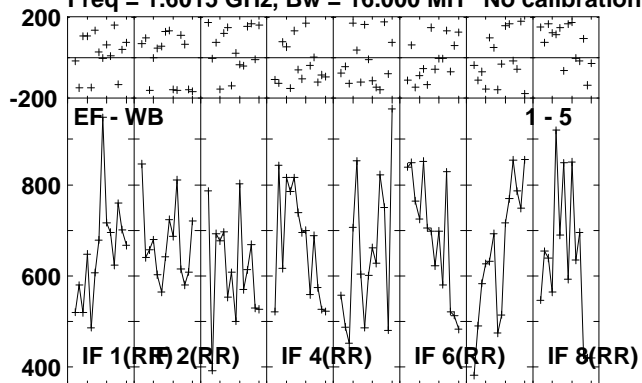

Lower frame: Micro Ampl Jy Top frame: Phas deg
Scalar averaged cross-power spectrum Several baselines displayed
Timerange: 00/07:57:06 to 00/07:58:18

Plot file version 50 created 07-OCT-2010 14:26:05

CAL2 RSP03.UVDATA.1

Freq = 1.6015 GHz, Bw = 16.000 MH No calibration applied and no bandpass applied

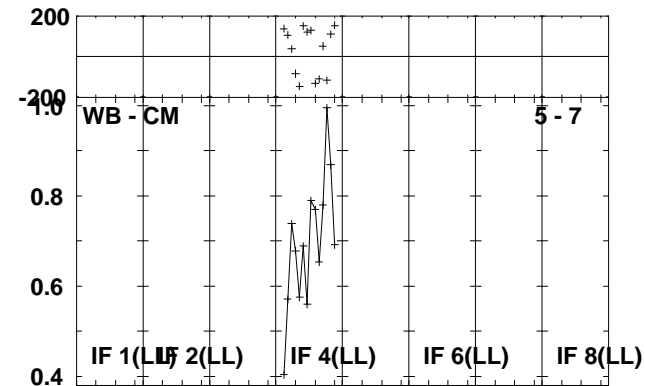
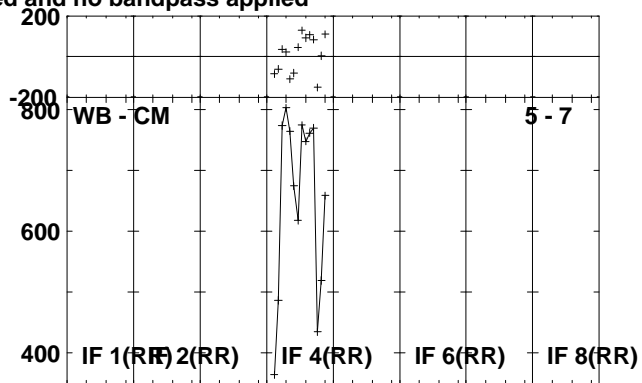
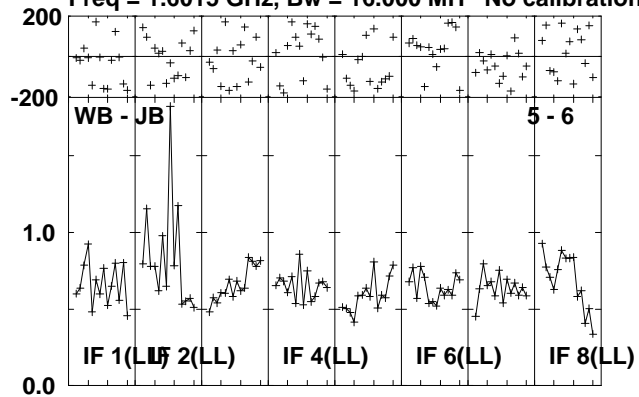

Lower frame: Milli Ampl Jy Top frame: Phas deg
Scalar averaged cross-power spectrum Several baselines displayed
Timerange: 00/07:57:06 to 00/07:58:18

Plot file version 51 created 07-OCT-2010 14:26:06
 J1345+44 RSP03.UVDATA.1

Freq = 1.6015 GHz, Bw = 16.000 MH No calibration applied and no bandpass applied

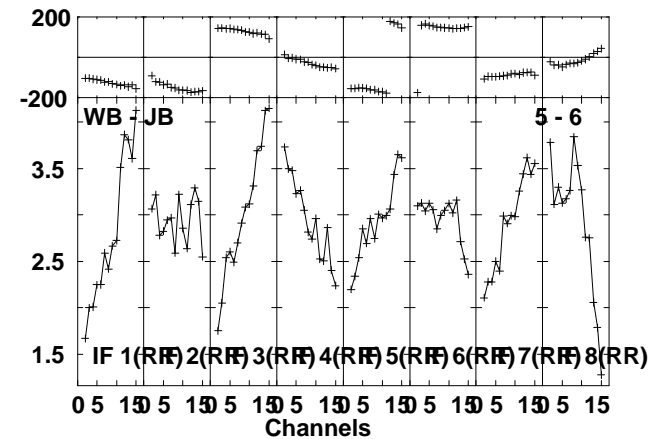
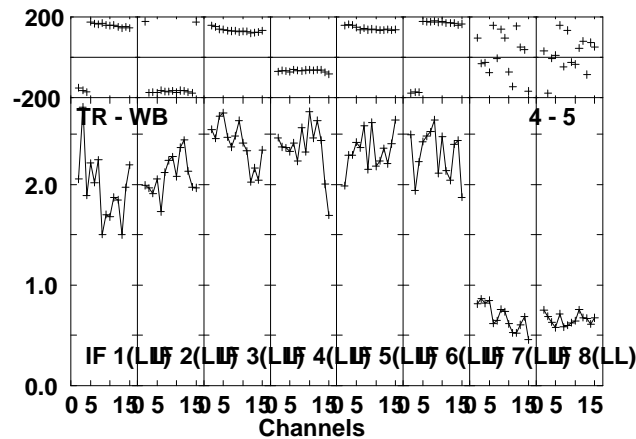
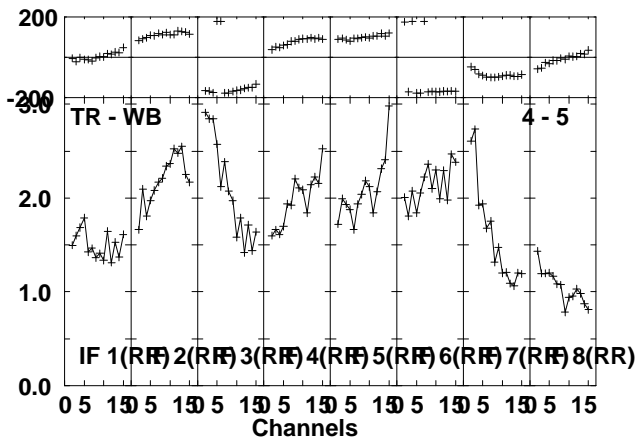
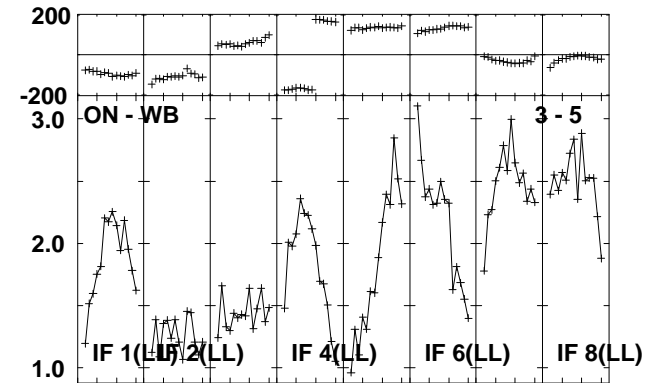
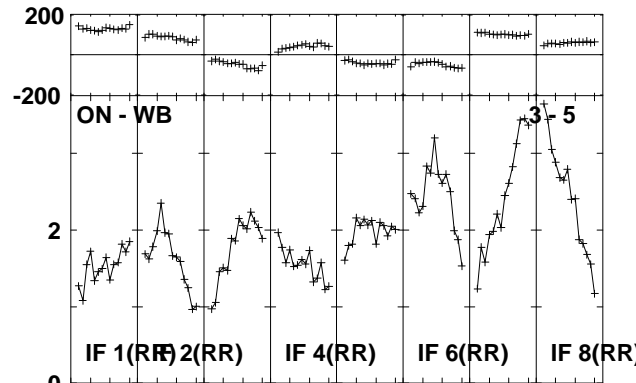
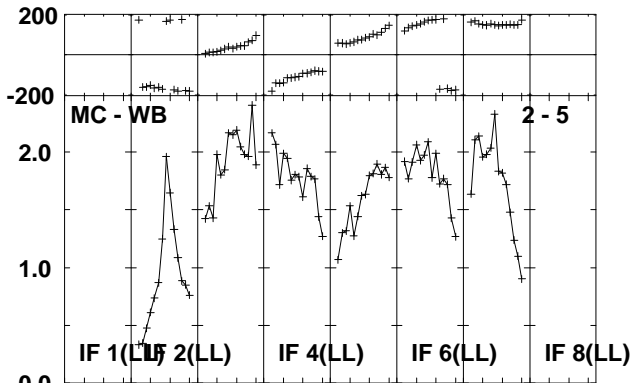
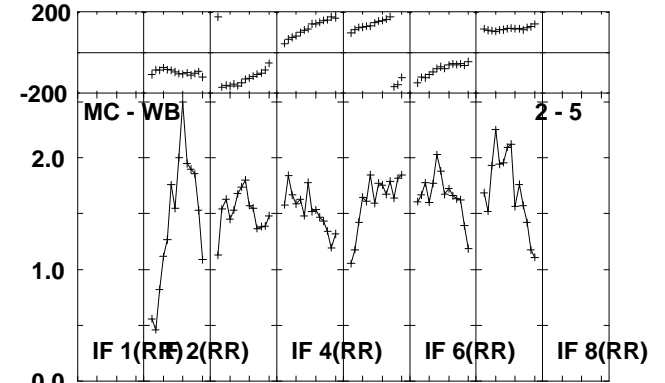
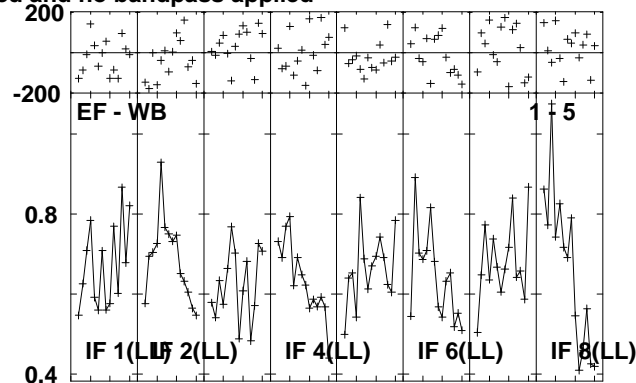
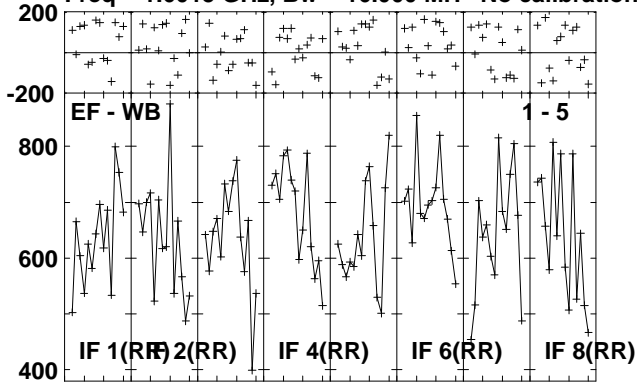

Lower frame: Micro Ampl Jy Top frame: Phas deg
 Scalar averaged cross-power spectrum Several baselines displayed
 Timerange: 00/07:59:02 to 00/07:59:58

Plot file version 52 created 07-OCT-2010 14:26:06

J1345+44 RSP03.UVDATA.1

Freq = 1.6015 GHz, Bw = 16.000 MH No calibration applied and no bandpass applied

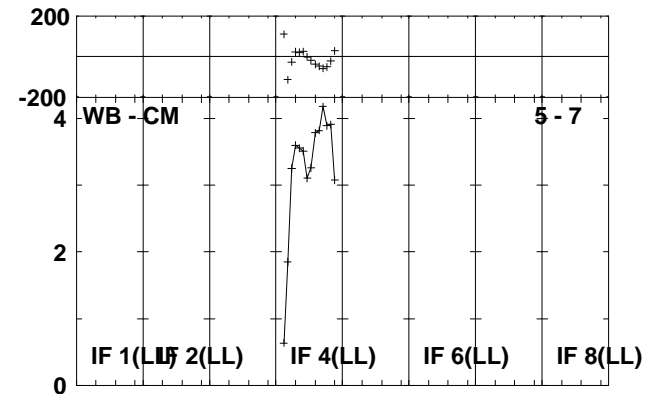
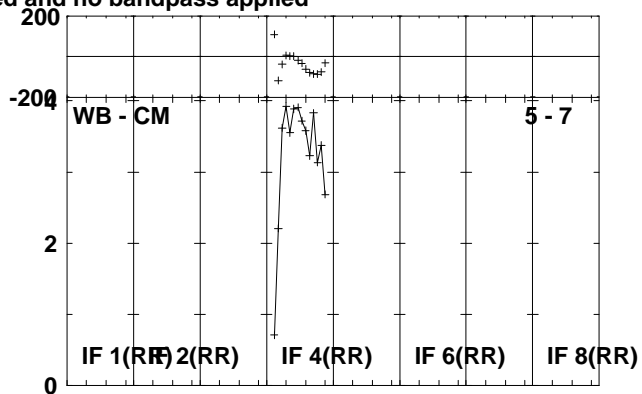
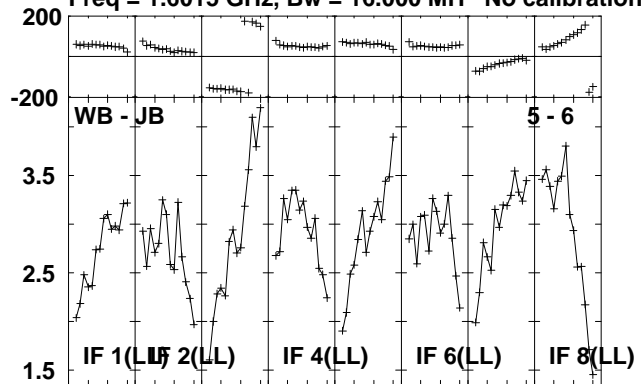

Lower frame: Milli Ampl Jy Top frame: Phas deg
Scalar averaged cross-power spectrum Several baselines displayed
Timerange: 00/07:59:02 to 00/07:59:58

Plot file version 53 created 07-OCT-2010 14:26:06

J134054 RSP03.UVDATA.1

Freq = 1.6015 GHz, Bw = 16.000 MH No calibration applied and no bandpass applied

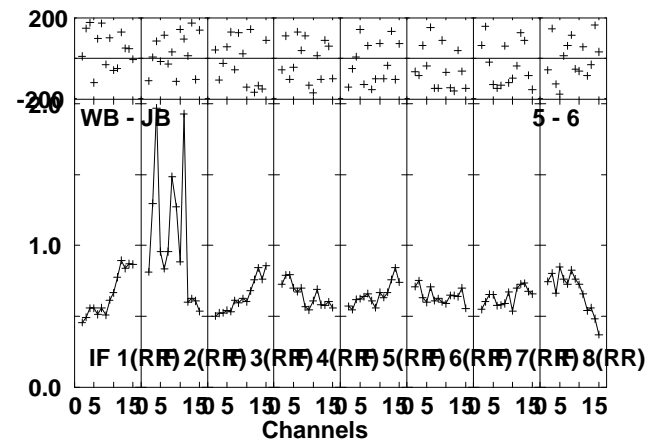
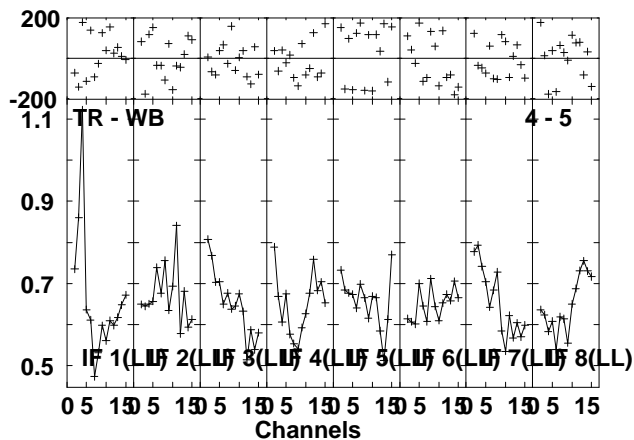
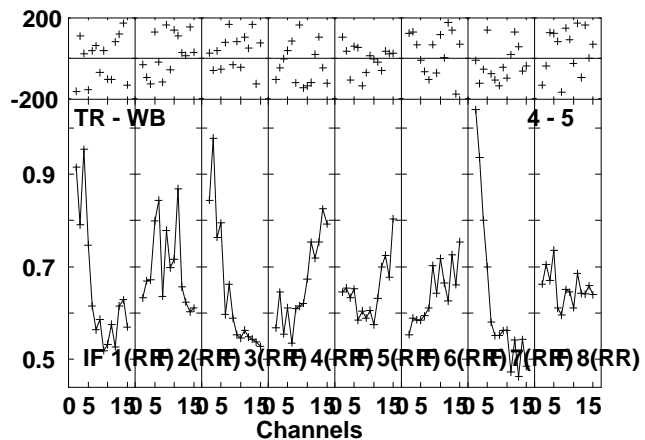
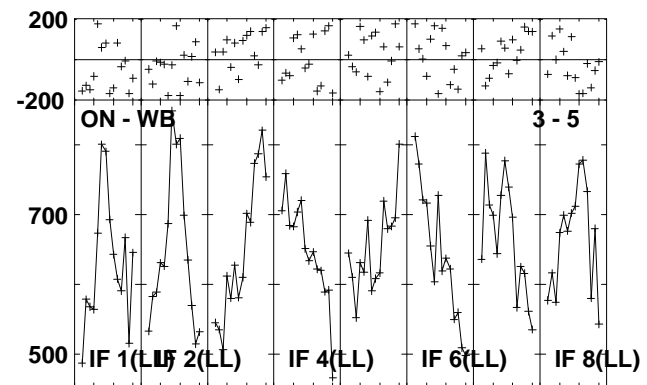
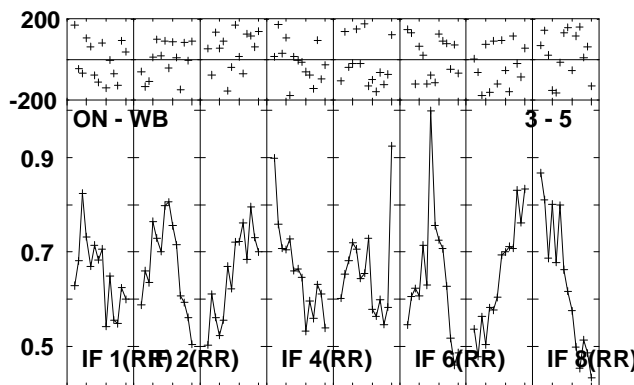
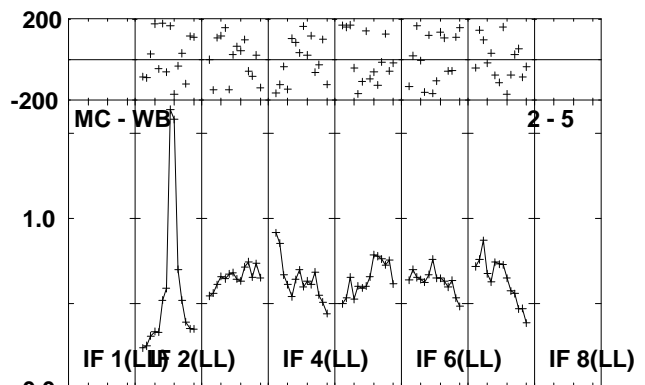
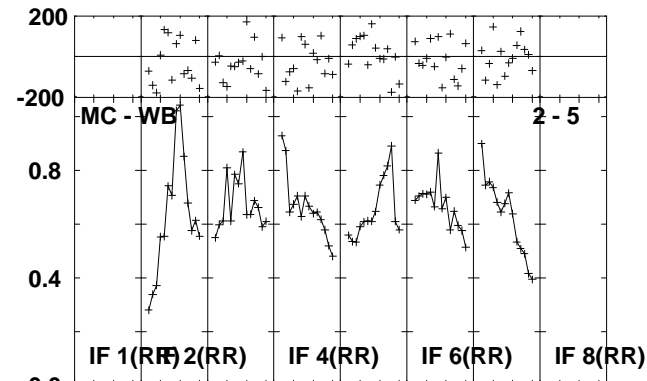
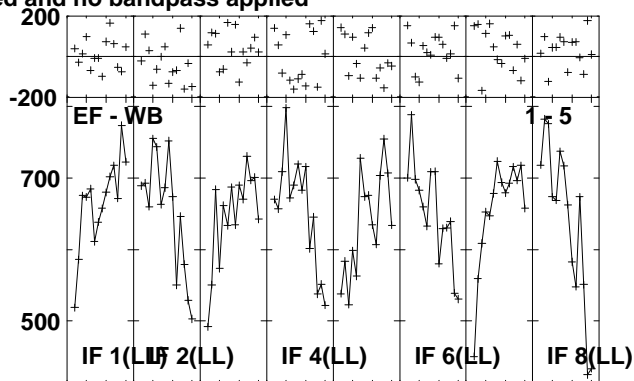
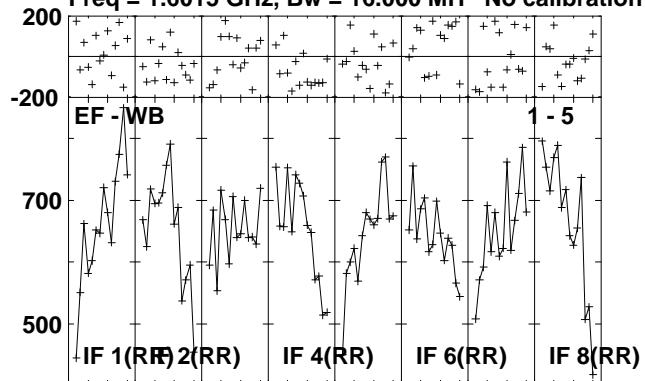

Lower frame: Micro Ampl Jy Top frame: Phas deg
Scalar averaged cross-power spectrum Several baselines displayed
Timerange: 00/08:00:02 to 00/08:04:38

Plot file version 54 created 07-OCT-2010 14:26:07

J134054 RSP03.UVDATA.1

Freq = 1.6015 GHz, Bw = 16.000 MH No calibration applied and no bandpass applied

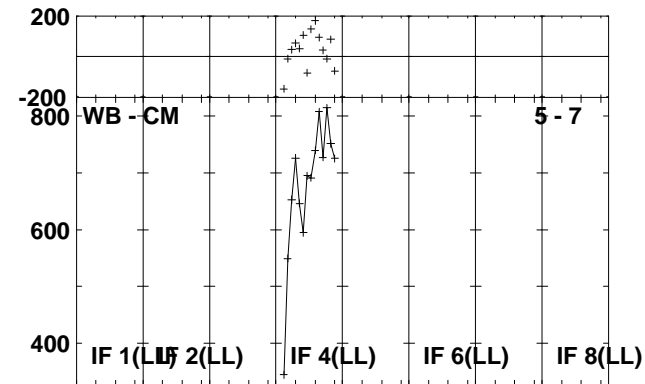
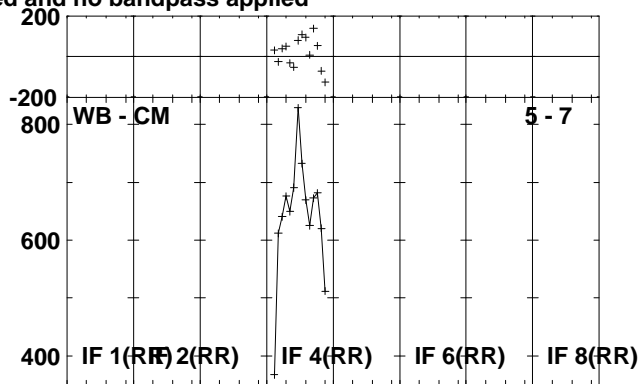
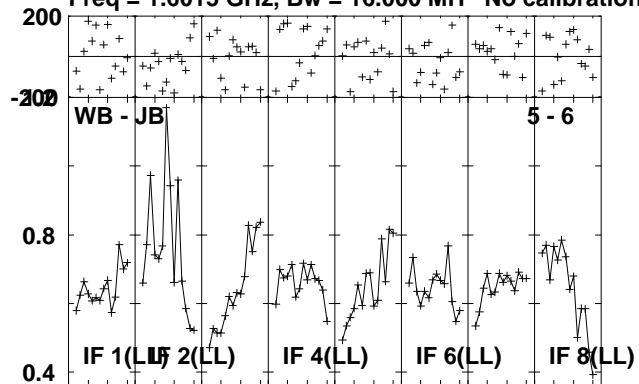

Lower frame: Milli Ampl Jy Top frame: Phas deg
Scalar averaged cross-power spectrum Several baselines displayed
Timerange: 00/08:00:02 to 00/08:04:38

Plot file version 55 created 07-OCT-2010 14:26:07

CAL1 RSP03.UVDATA.1

Freq = 1.6015 GHz, Bw = 16.000 MH No calibration applied and no bandpass applied

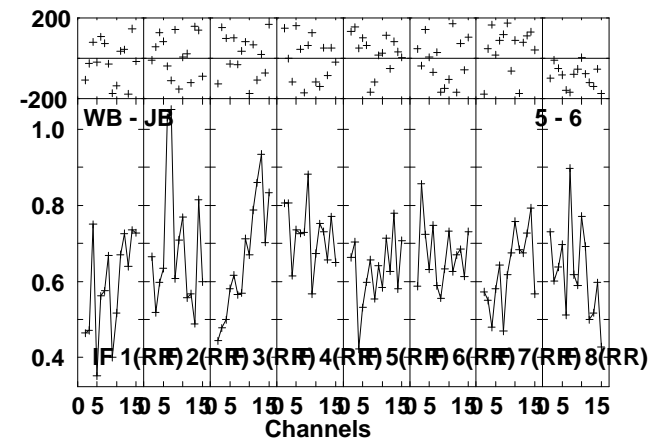
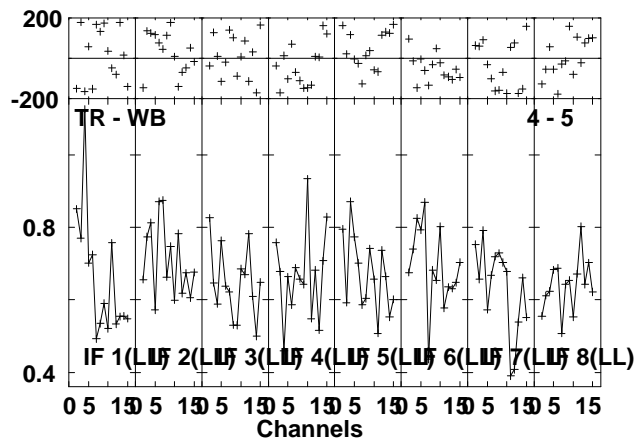
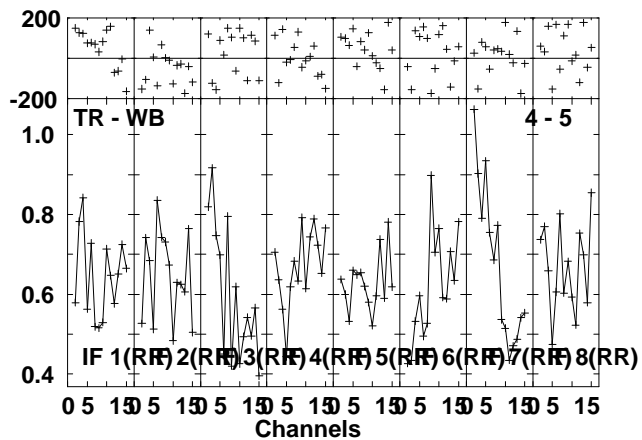
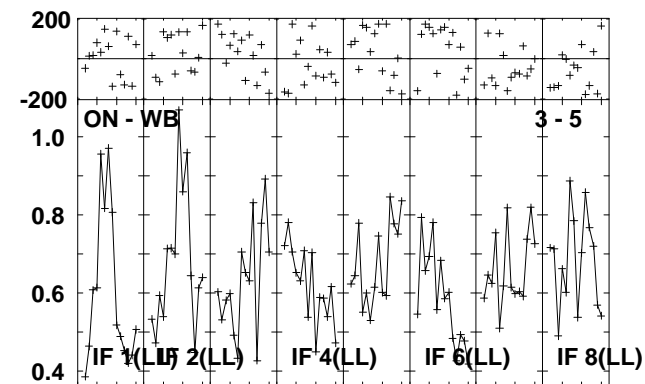
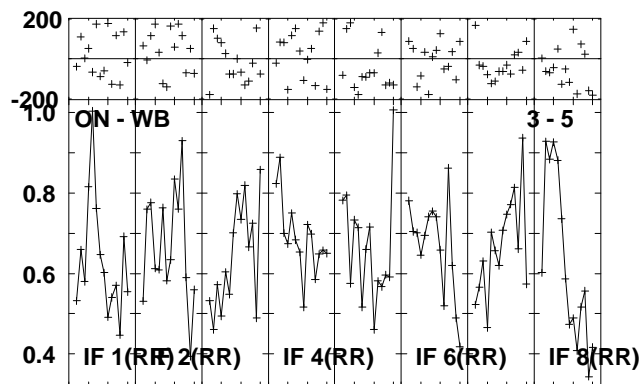
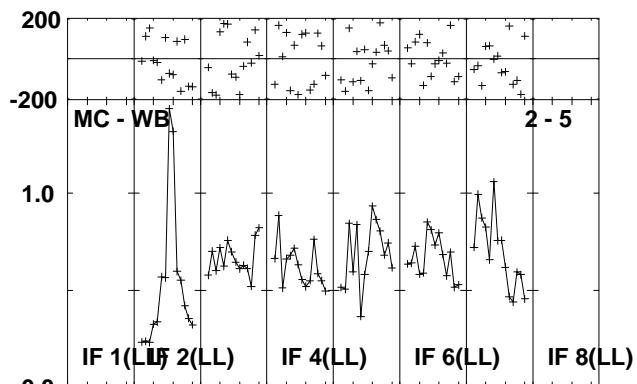
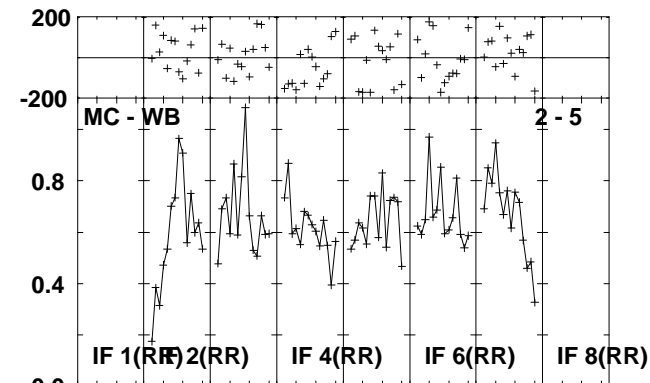
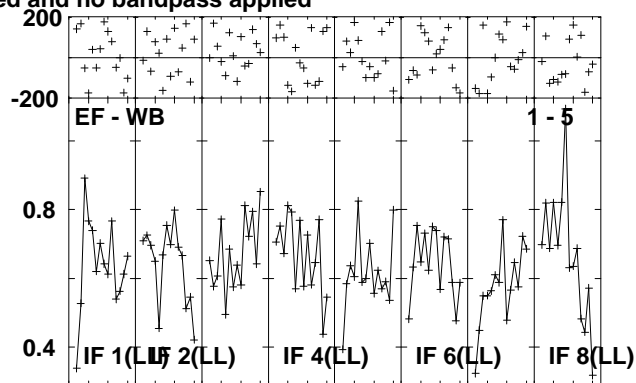
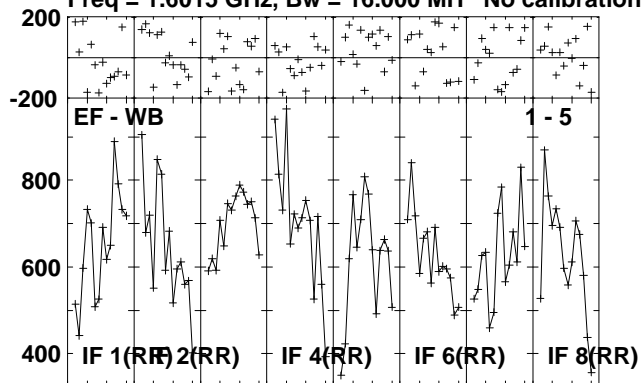

Lower frame: Micro Ampl Jy Top frame: Phas deg
Scalar averaged cross-power spectrum Several baselines displayed
Timerange: 00/08:04:42 to 00/08:05:54

Plot file version 56 created 07-OCT-2010 14:26:07

CAL1 RSP03.UVDATA.1

Freq = 1.6015 GHz, Bw = 16.000 MH No calibration applied and no bandpass applied

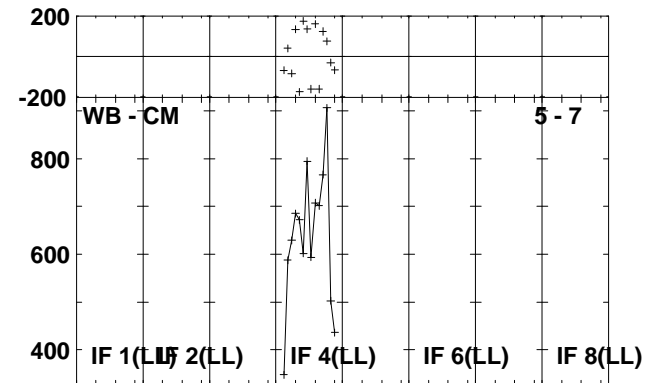
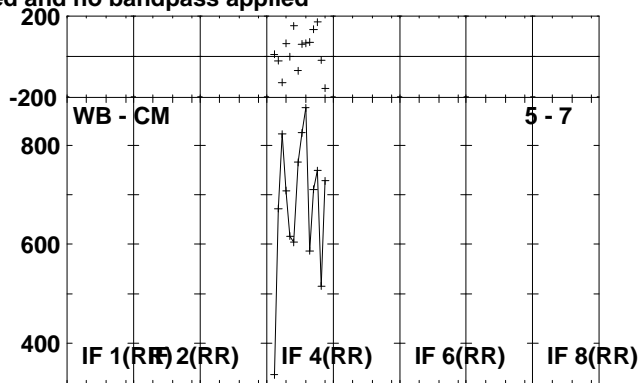
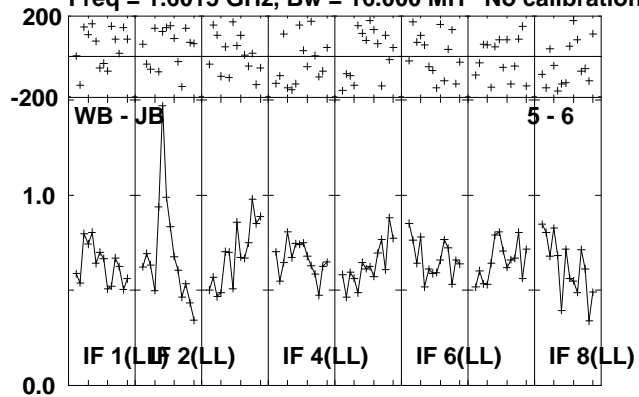

Lower frame: Milli Ampl Jy Top frame: Phas deg
Scalar averaged cross-power spectrum Several baselines displayed
Timerange: 00/08:04:42 to 00/08:05:54

Plot file version 57 created 07-OCT-2010 14:26:07

J1345+44 RSP03.UVDATA.1

Freq = 1.6015 GHz, Bw = 16.000 MH No calibration applied and no bandpass applied

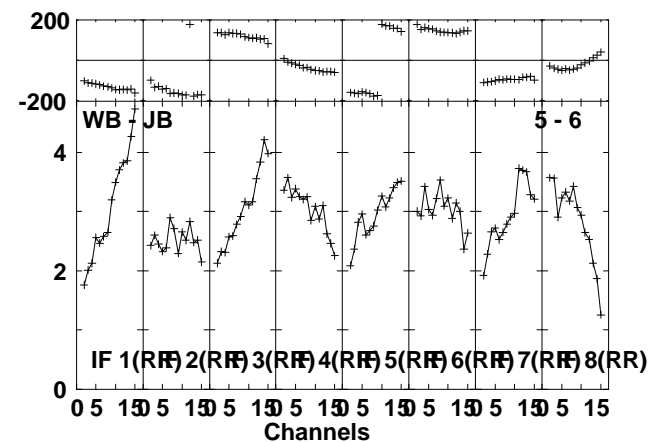
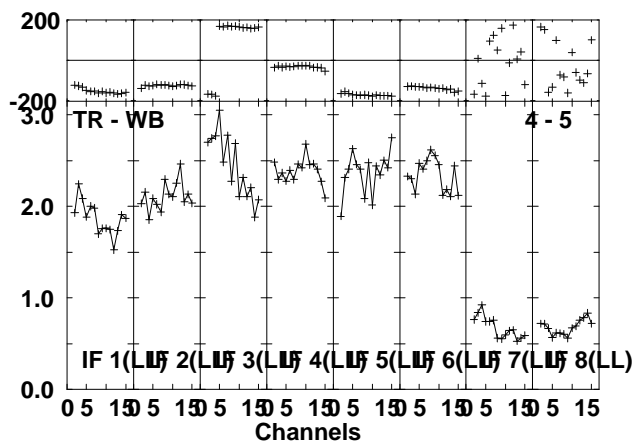
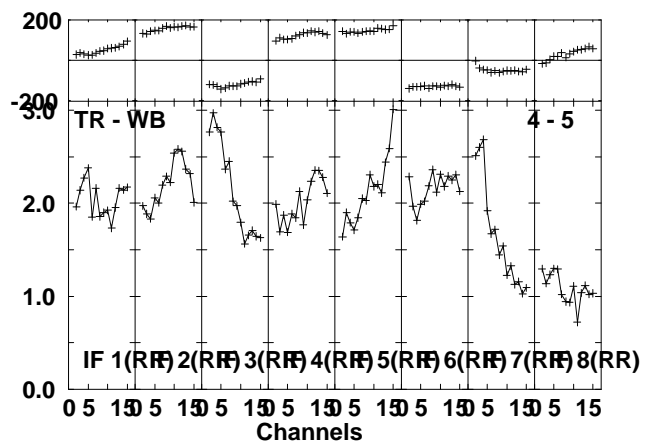
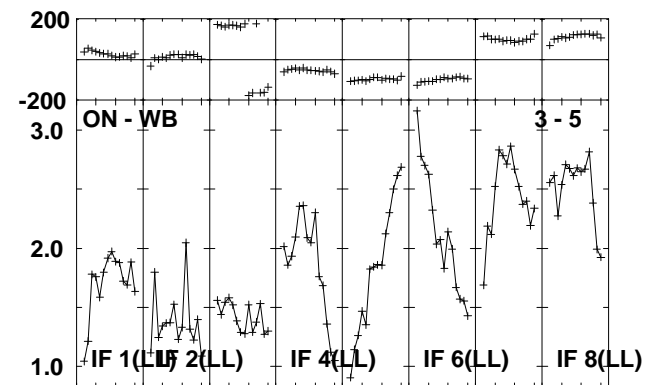
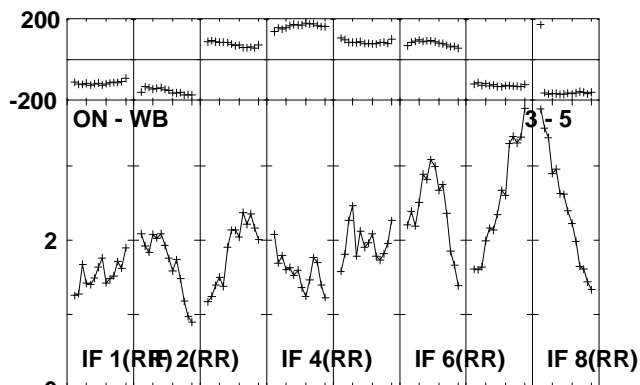
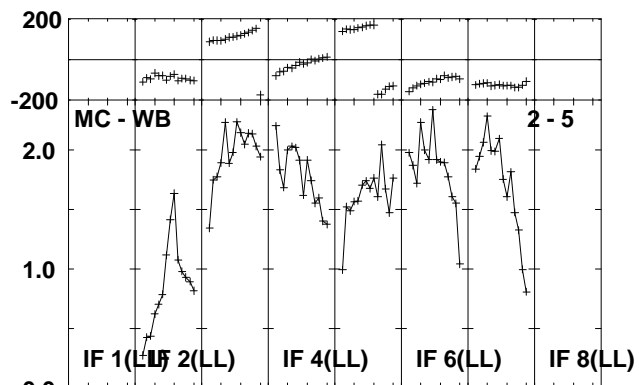
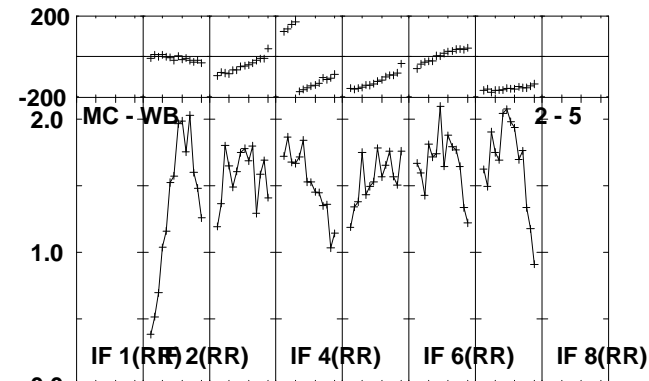
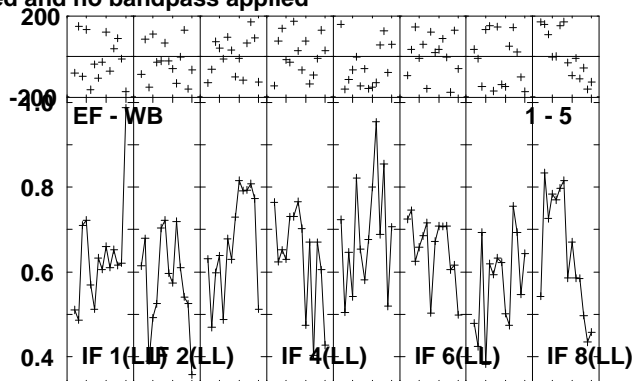
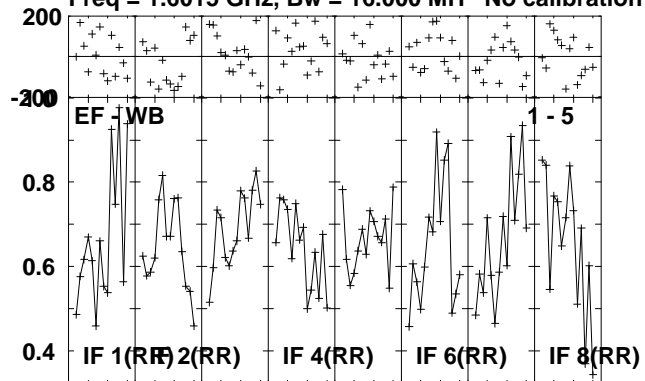

Lower frame: Milli Ampl Jy Top frame: Phas deg
Scalar averaged cross-power spectrum Several baselines displayed
Timerange: 00/08:05:58 to 00/08:07:22

Plot file version 58 created 07-OCT-2010 14:26:07

J1345+44 RSP03.UVDATA.1

Freq = 1.6015 GHz, Bw = 16.000 MH No calibration applied and no bandpass applied

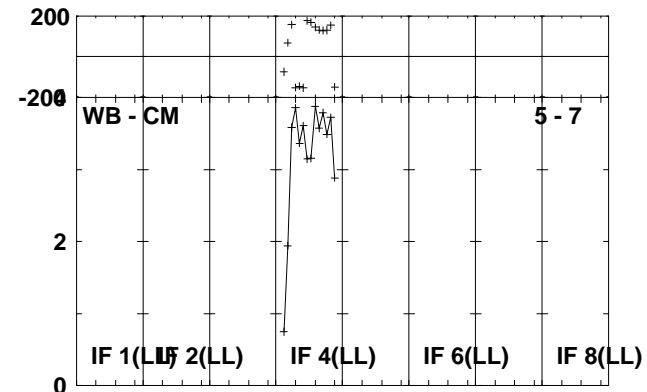
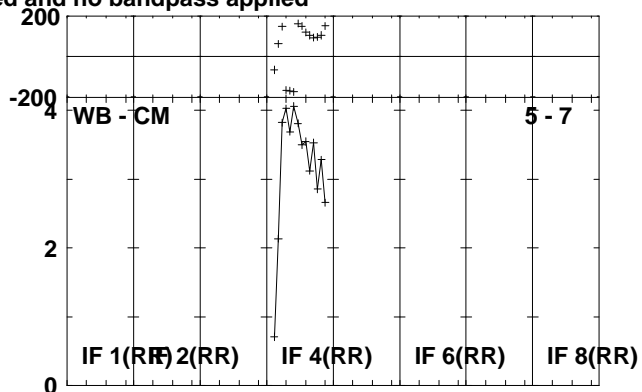
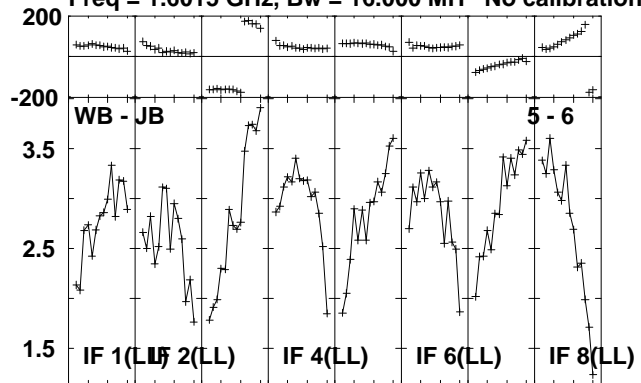

Lower frame: Milli Ampl Jy Top frame: Phas deg
Scalar averaged cross-power spectrum Several baselines displayed
Timerange: 00/08:05:58 to 00/08:07:22

Plot file version 59 created 07-OCT-2010 14:26:08

J134054 RSP03.UVDATA.1

Freq = 1.6015 GHz, Bw = 16.000 MH No calibration applied and no bandpass applied

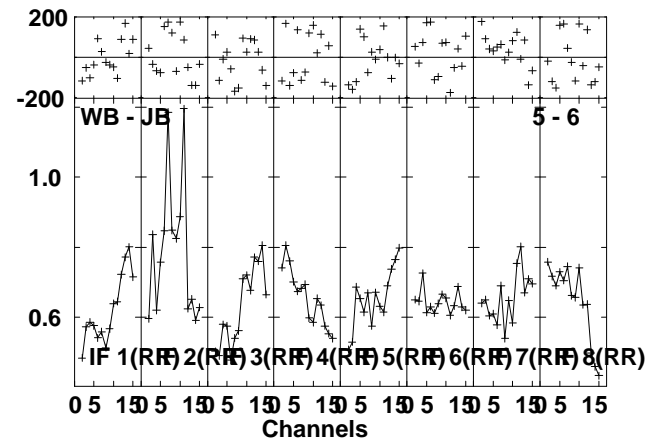
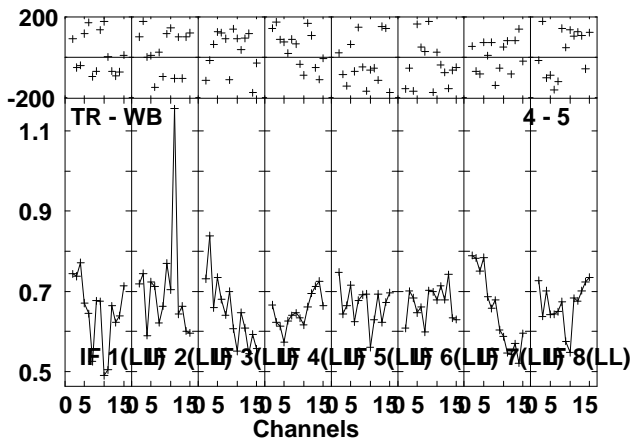
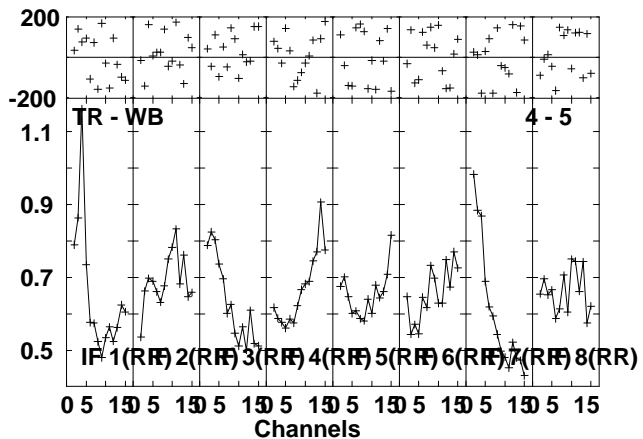
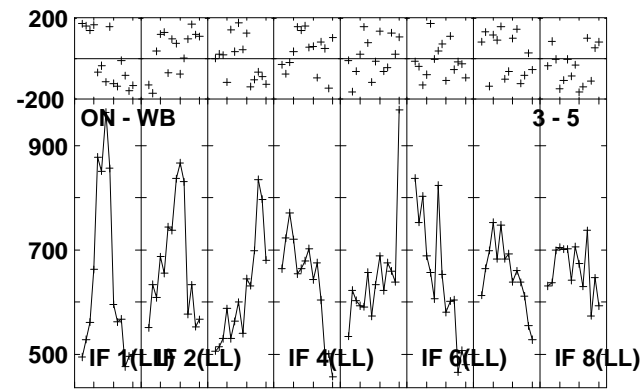
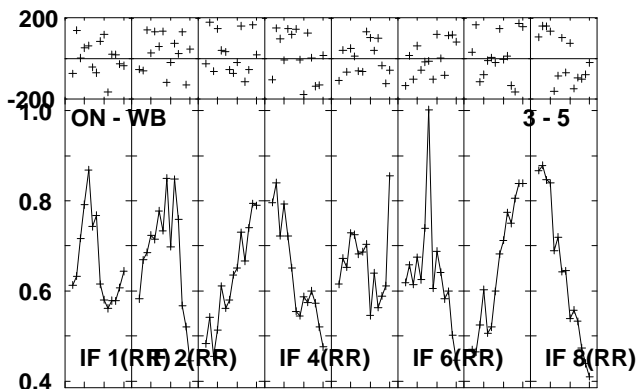
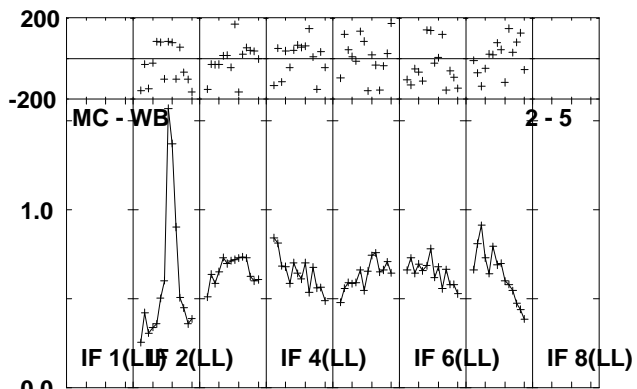
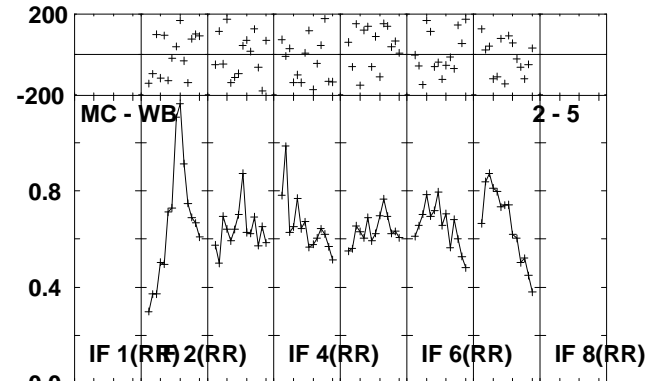
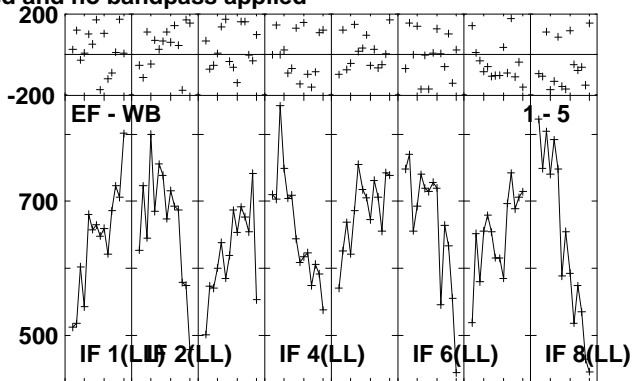
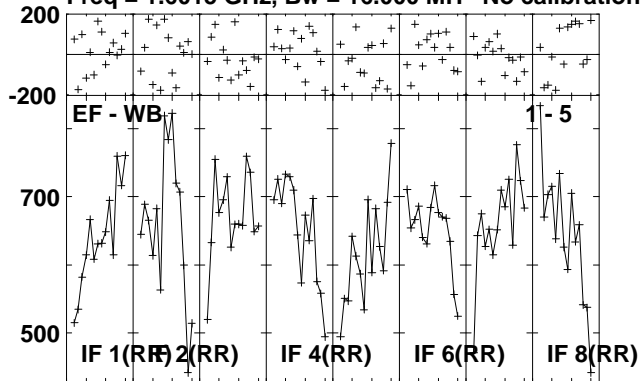

Lower frame: Micro Ampl Jy Top frame: Phas deg
Scalar averaged cross-power spectrum Several baselines displayed
Timerange: 00/08:07:26 to 00/08:12:02

Plot file version 60 created 07-OCT-2010 14:26:08

J134054 RSP03.UVDATA.1

Freq = 1.6015 GHz, Bw = 16.000 MH No calibration applied and no bandpass applied

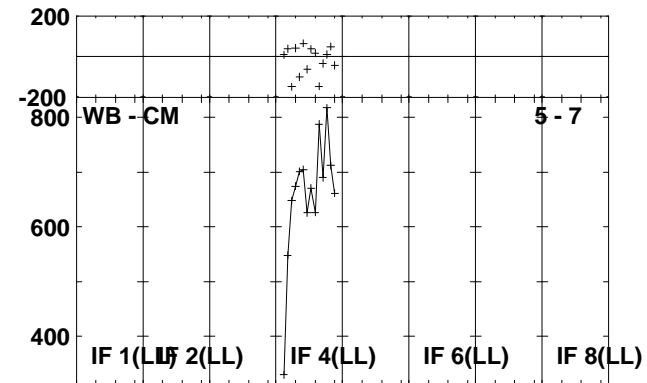
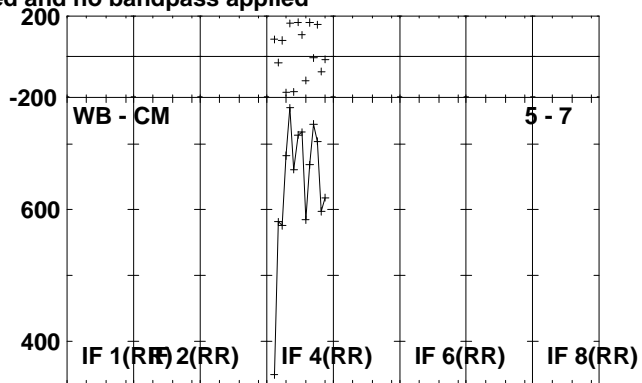
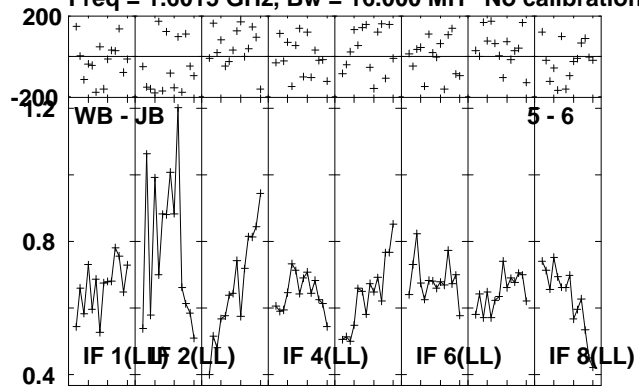

Lower frame: Milli Ampl Jy Top frame: Phas deg
Scalar averaged cross-power spectrum Several baselines displayed
Timerange: 00/08:07:26 to 00/08:12:02

Plot file version 61 created 07-OCT-2010 14:26:09

CAL2 RSP03.UVDATA.1

Freq = 1.6015 GHz, Bw = 16.000 MH No calibration applied and no bandpass applied

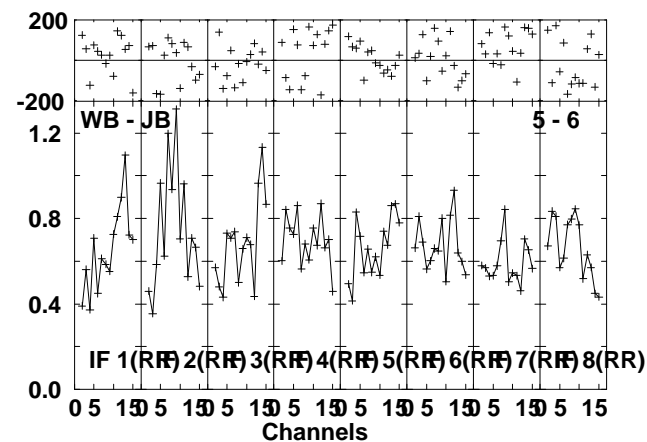
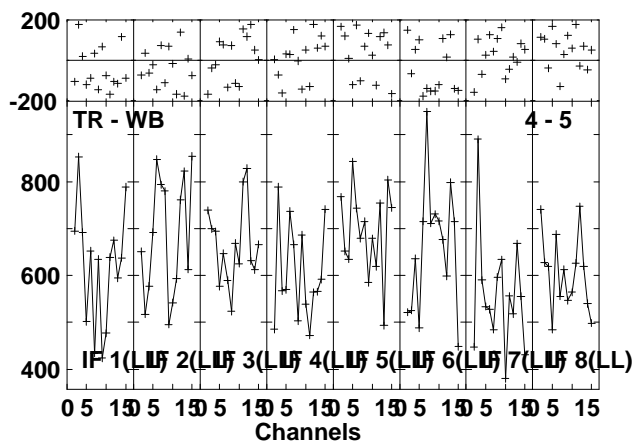
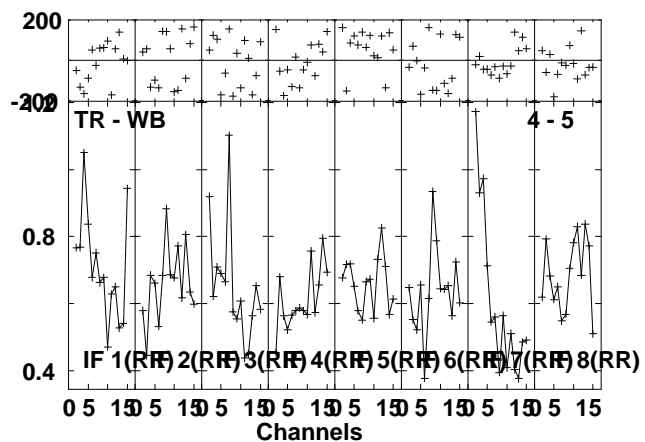
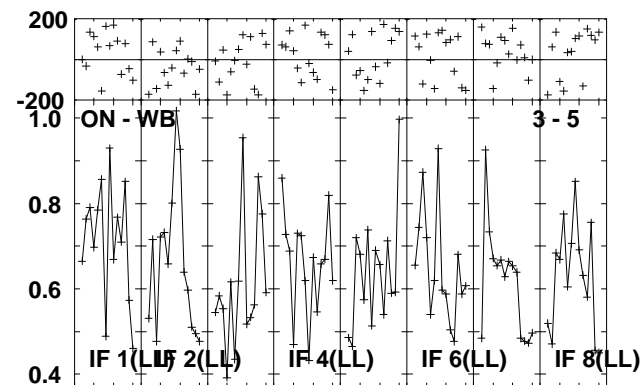
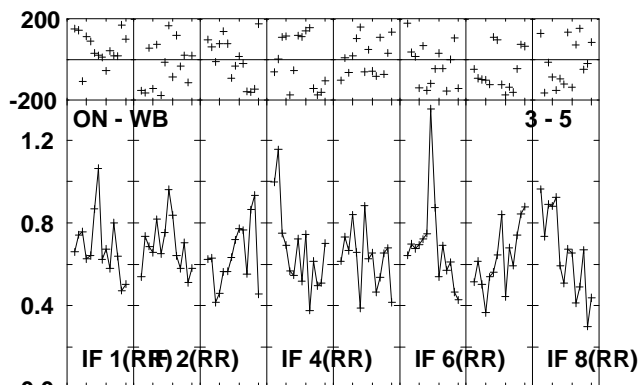
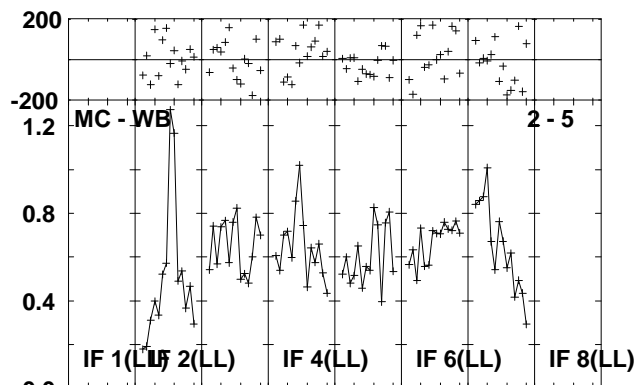
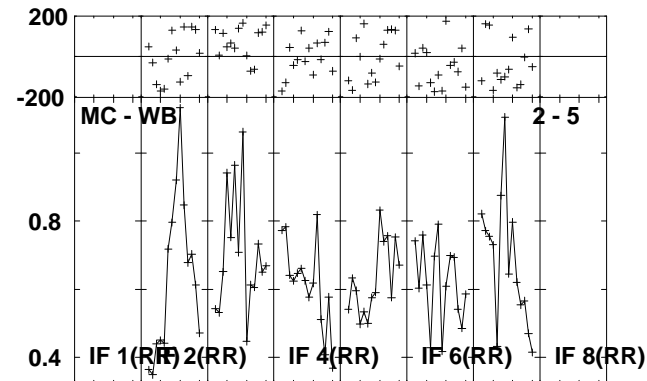
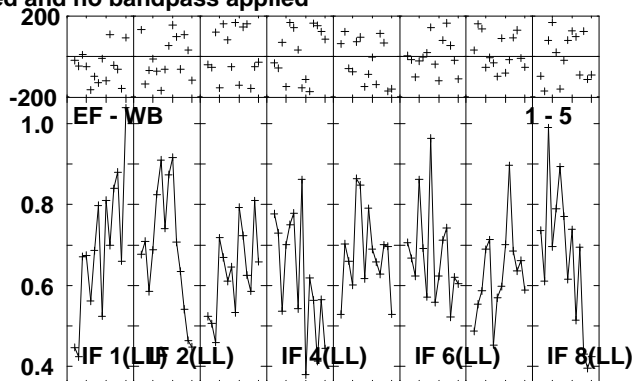
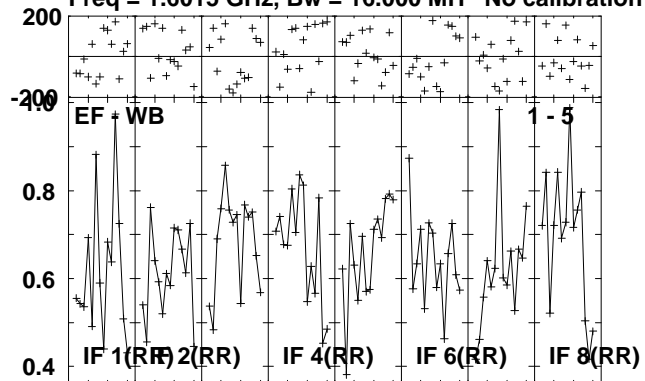

Lower frame: Milli Ampl Jy Top frame: Phas deg
Scalar averaged cross-power spectrum Several baselines displayed
Timerange: 00/08:12:06 to 00/08:13:18

Plot file version 62 created 07-OCT-2010 14:26:09

CAL2 RSP03.UVDATA.1

Freq = 1.6015 GHz, Bw = 16.000 MH No calibration applied and no bandpass applied

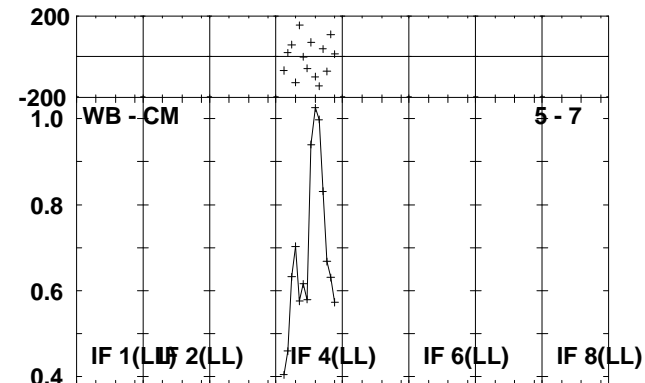
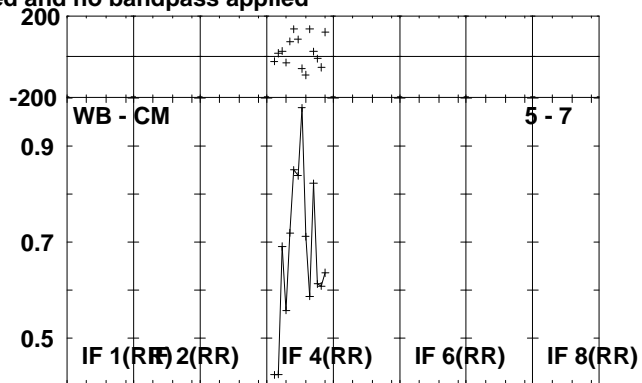
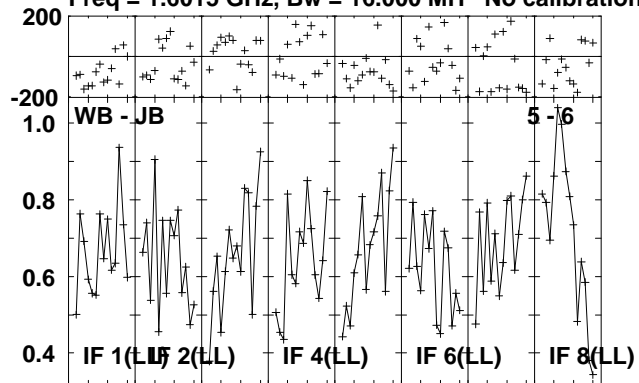

Lower frame: Milli Ampl Jy Top frame: Phas deg
Scalar averaged cross-power spectrum Several baselines displayed
Timerange: 00/08:12:06 to 00/08:13:18

Plot file version 63 created 07-OCT-2010 14:26:09

J1345+44 RSP03.UVDATA.1

Freq = 1.6015 GHz, Bw = 16.000 MH No calibration applied and no bandpass applied

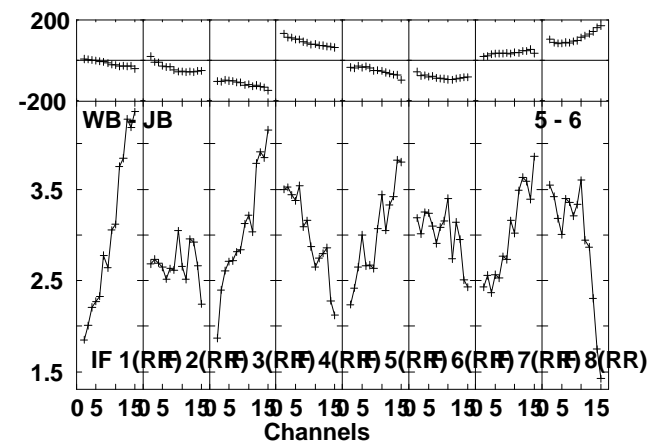
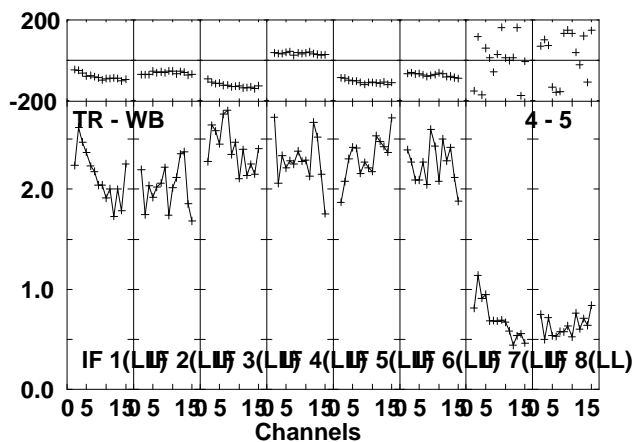
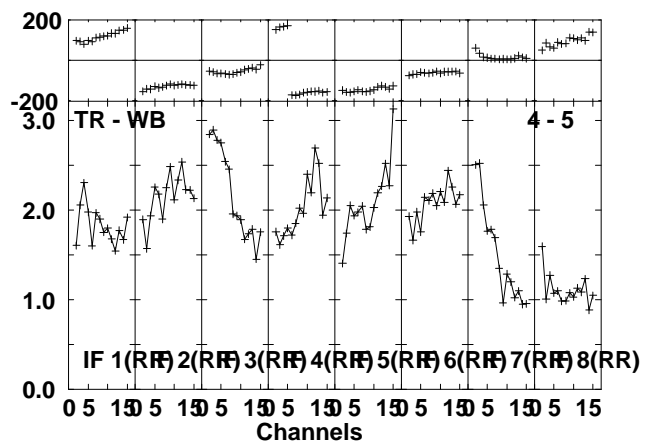
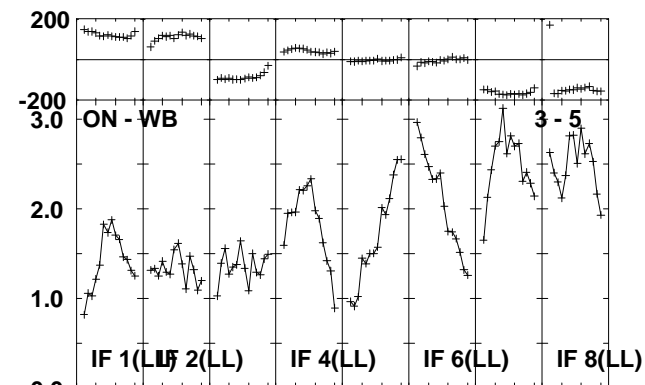
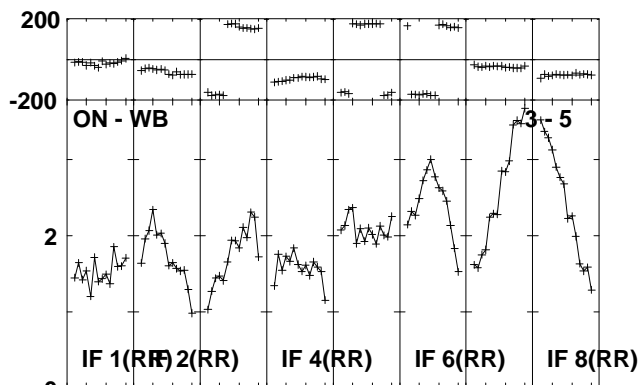
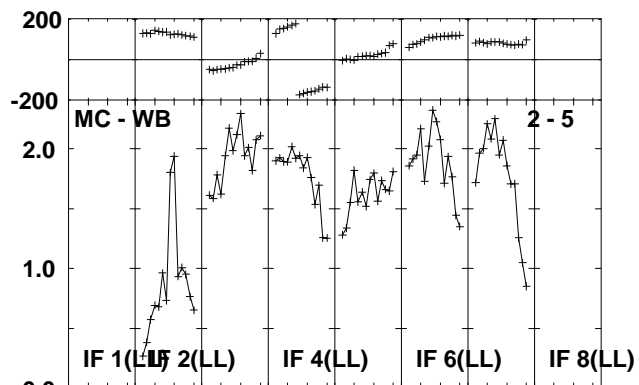
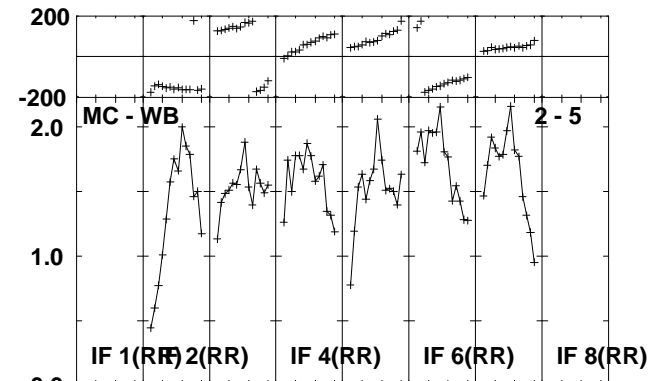
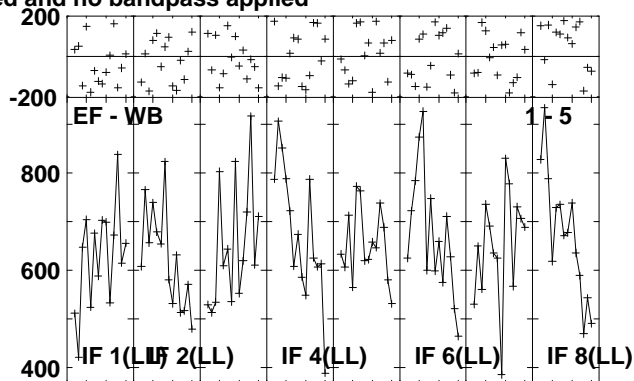
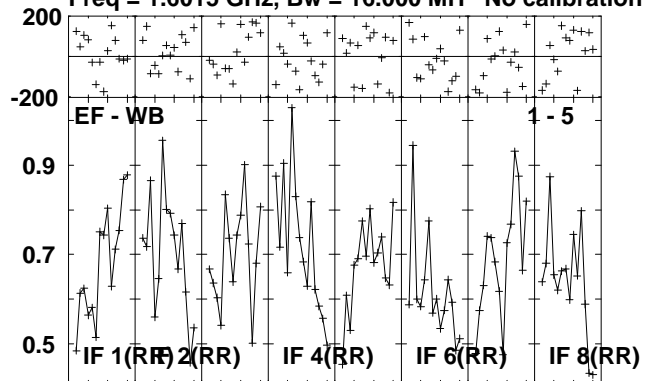

Lower frame: Milli Ampl Jy Top frame: Phas deg
Scalar averaged cross-power spectrum Several baselines displayed
Timerange: 00/08:14:02 to 00/08:14:58

Plot file version 64 created 07-OCT-2010 14:26:09

J1345+44 RSP03.UVDATA.1

Freq = 1.6015 GHz, Bw = 16.000 MH No calibration applied and no bandpass applied

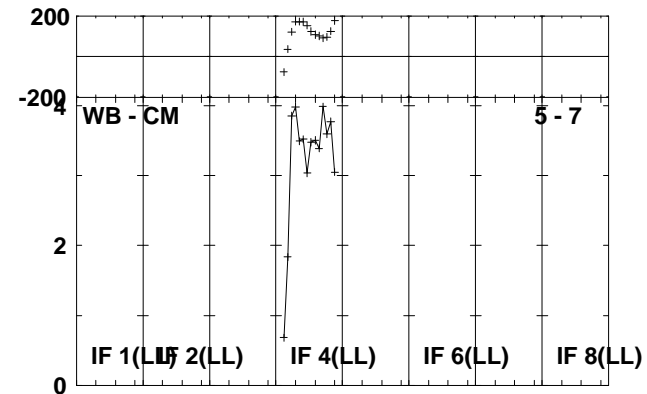
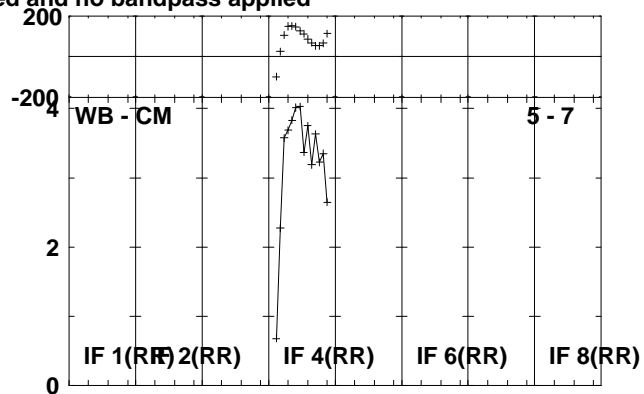
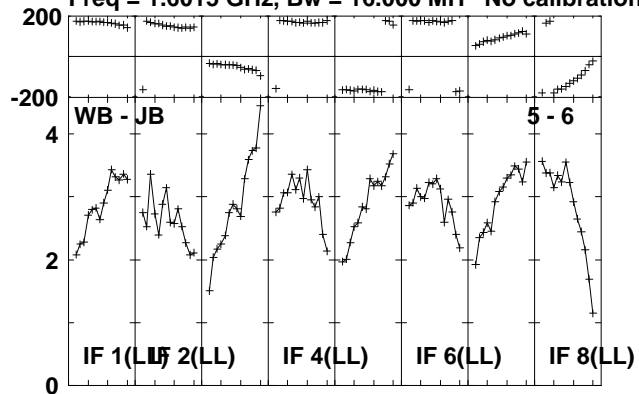

Lower frame: Milli Ampl Jy Top frame: Phas deg
Scalar averaged cross-power spectrum Several baselines displayed
Timerange: 00/08:14:02 to 00/08:14:58

Plot file version 65 created 07-OCT-2010 14:26:10

J134054 RSP03.UVDATA.1

Freq = 1.6015 GHz, Bw = 16.000 MH No calibration applied and no bandpass applied

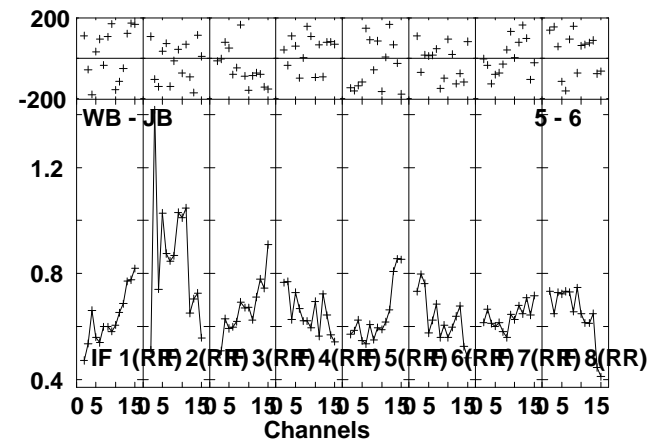
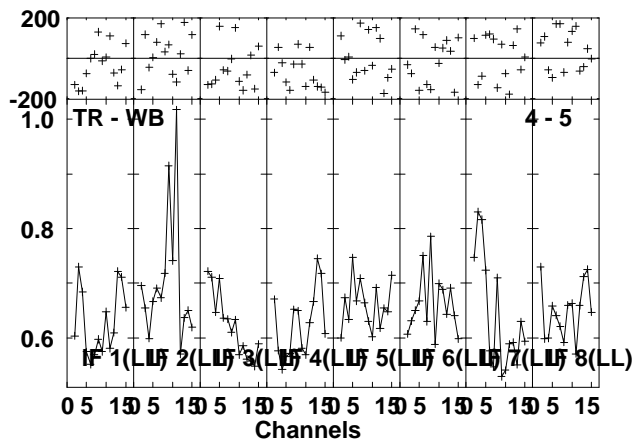
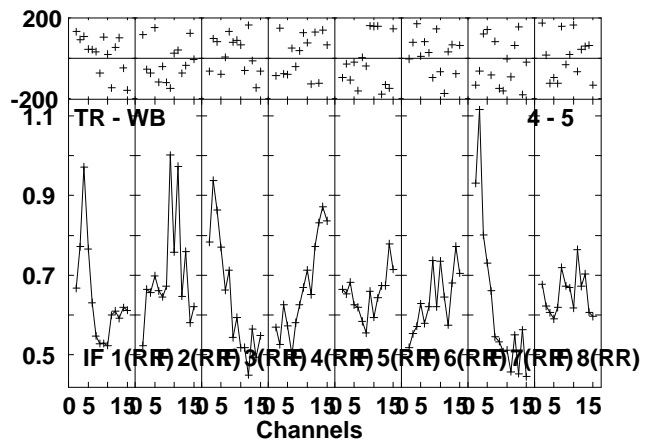
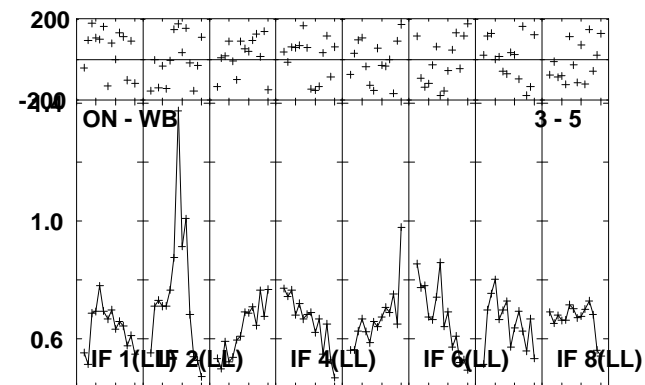
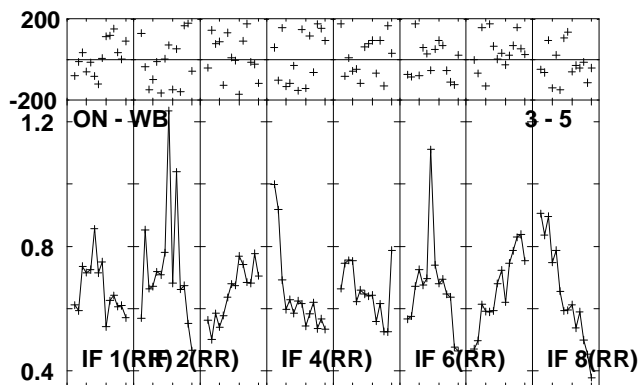
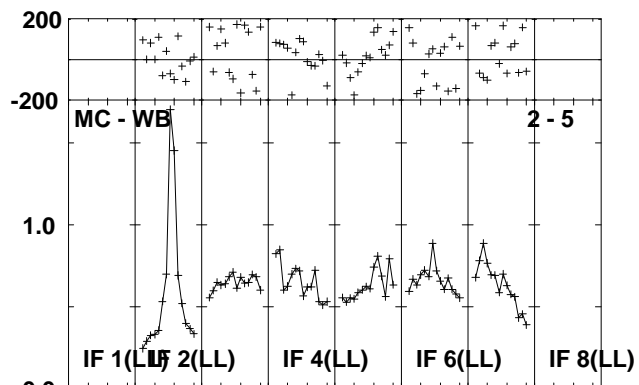
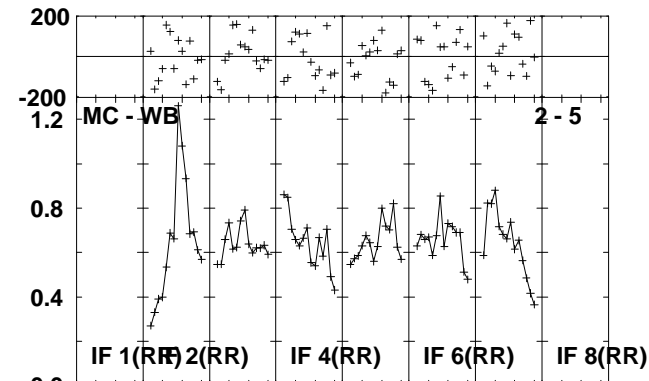
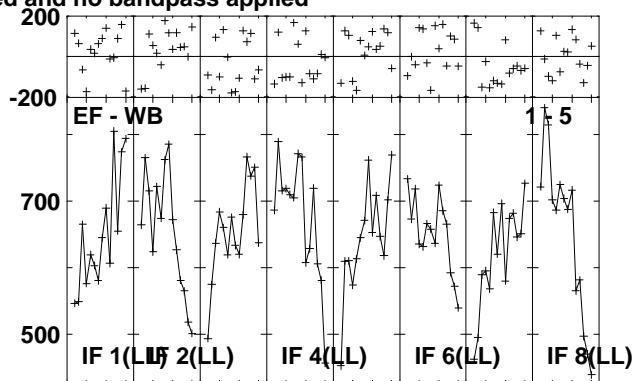
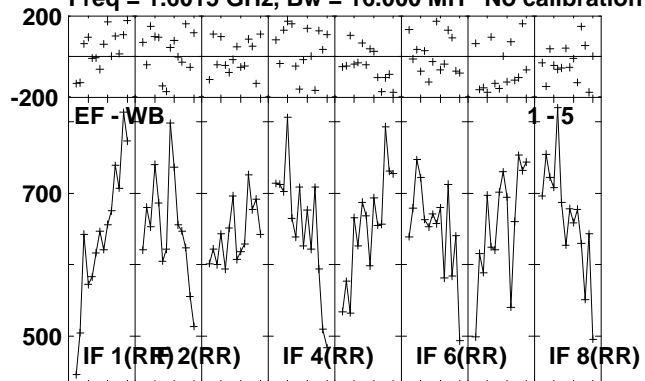

Lower frame: Micro Ampl Jy Top frame: Phas deg
Scalar averaged cross-power spectrum Several baselines displayed
Timerange: 00/08:15:02 to 00/08:19:38

Plot file version 66 created 07-OCT-2010 14:26:11

J134054 RSP03.UVDATA.1

Freq = 1.6015 GHz, Bw = 16.000 MH No calibration applied and no bandpass applied

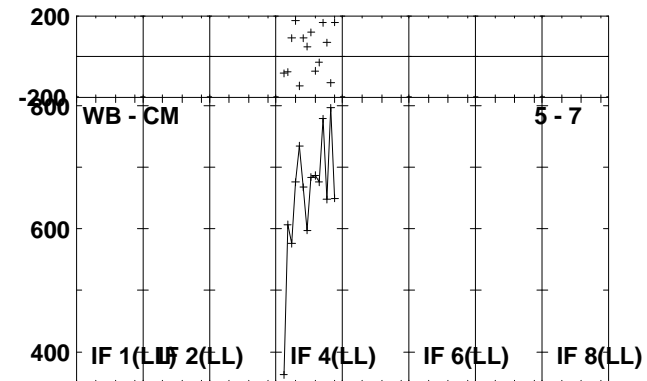
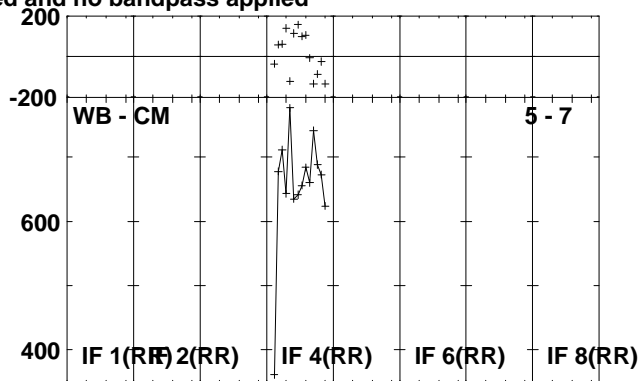
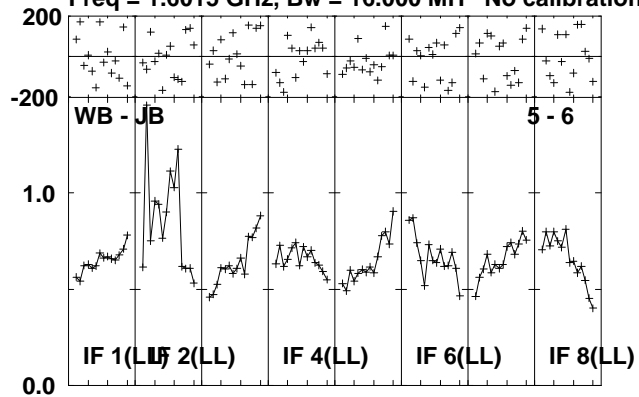

Lower frame: Milli Ampl Jy Top frame: Phas deg
Scalar averaged cross-power spectrum Several baselines displayed
Timerange: 00/08:15:02 to 00/08:19:38

Plot file version 67 created 07-OCT-2010 14:26:12

CAL1 RSP03.UVDATA.1

Freq = 1.6015 GHz, Bw = 16.000 MH No calibration applied and no bandpass applied

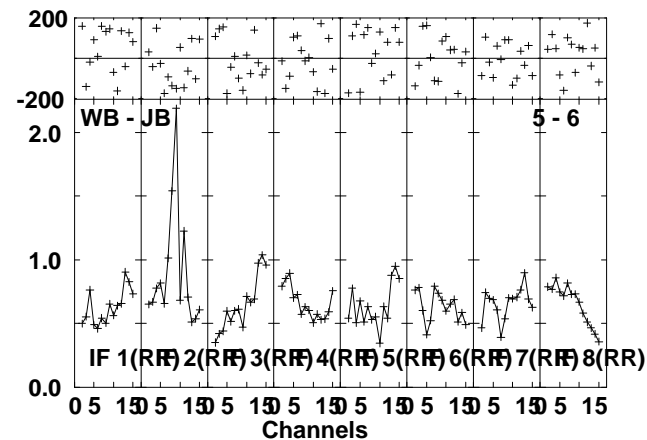
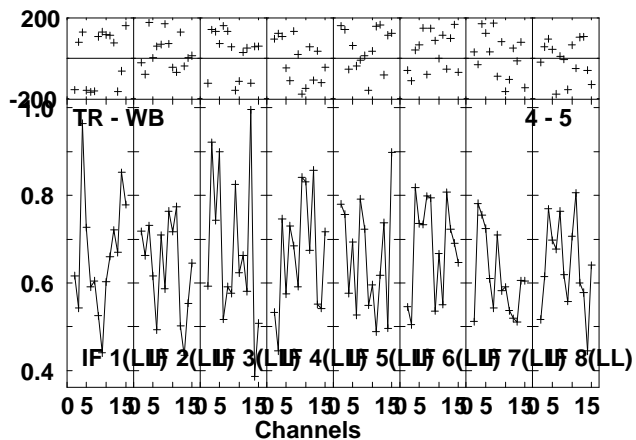
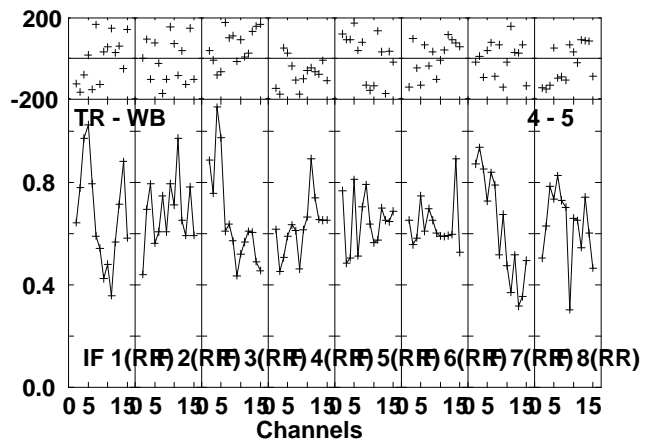
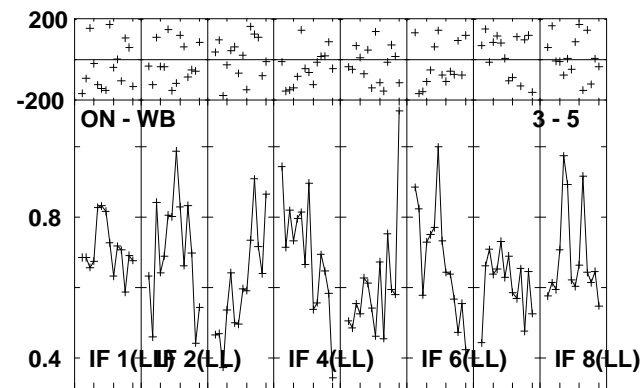
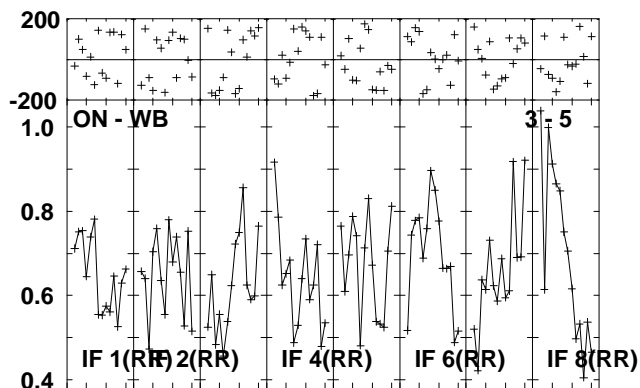
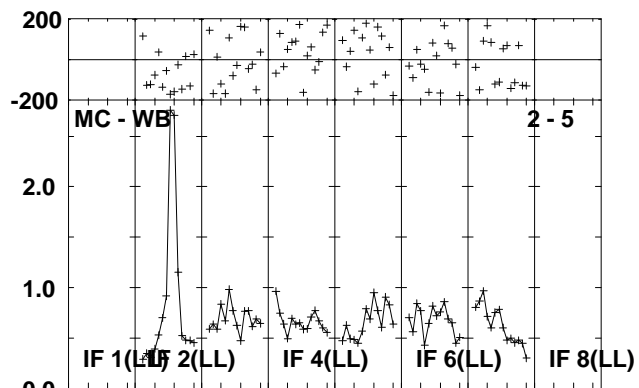
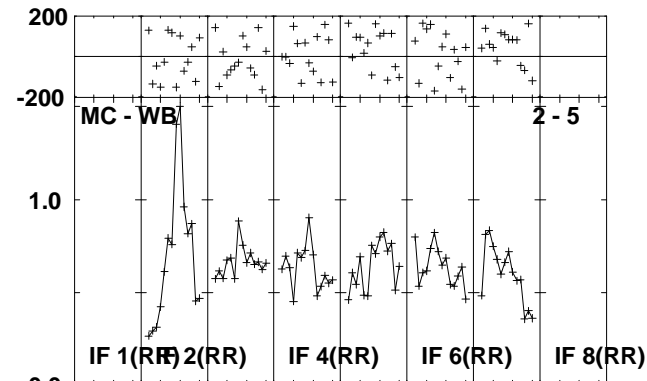
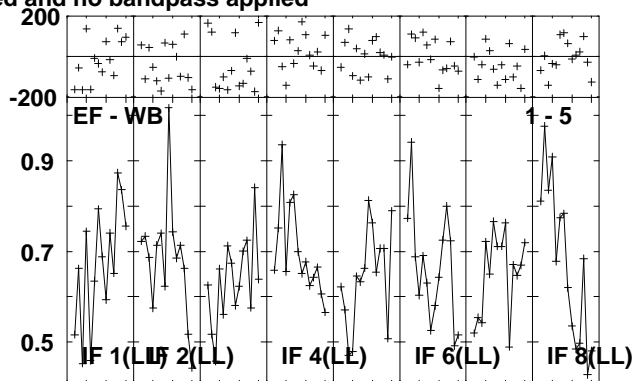
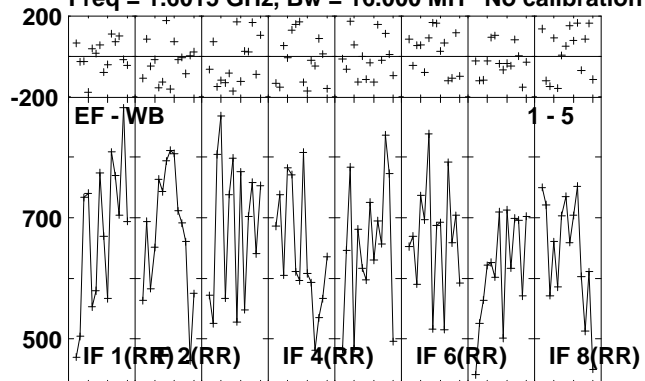

Lower frame: Micro Ampl Jy Top frame: Phas deg
Scalar averaged cross-power spectrum Several baselines displayed
Timerange: 00/08:19:42 to 00/08:20:54

Plot file version 68 created 07-OCT-2010 14:26:12

CAL1 RSP03.UVDATA.1

Freq = 1.6015 GHz, Bw = 16.000 MH No calibration applied and no bandpass applied

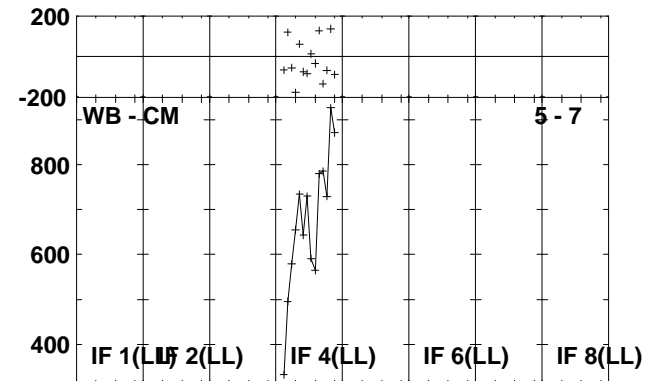
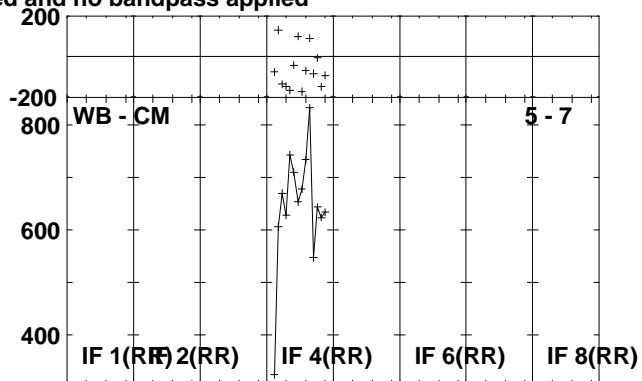
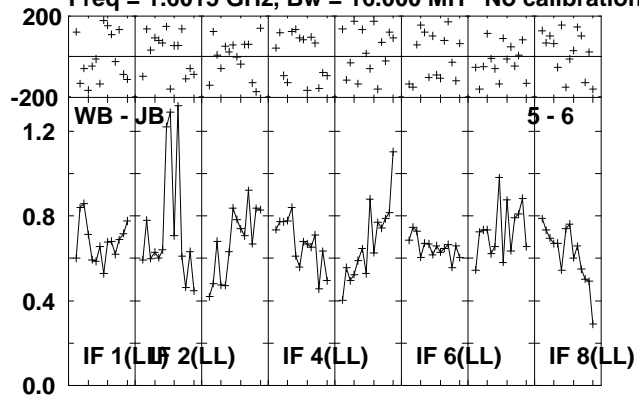

Lower frame: Milli Ampl Jy Top frame: Phas deg
Scalar averaged cross-power spectrum Several baselines displayed
Timerange: 00/08:19:42 to 00/08:20:54

Plot file version 69 created 07-OCT-2010 14:26:12

J1345+44 RSP03.UVDATA.1

Freq = 1.6015 GHz, Bw = 16.000 MH No calibration applied and no bandpass applied

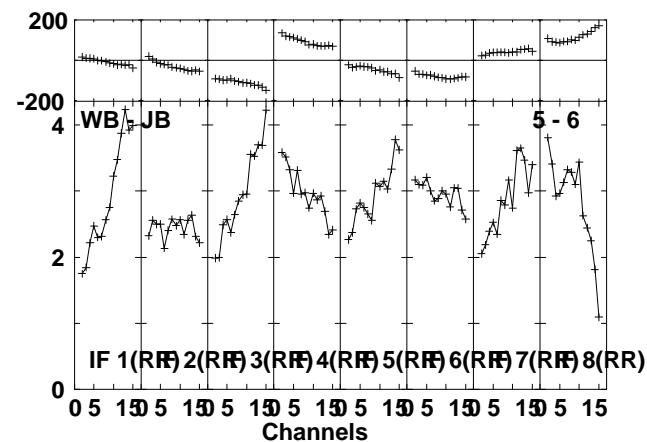
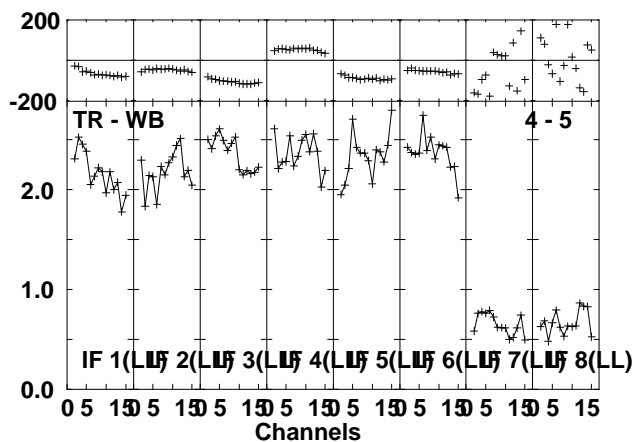
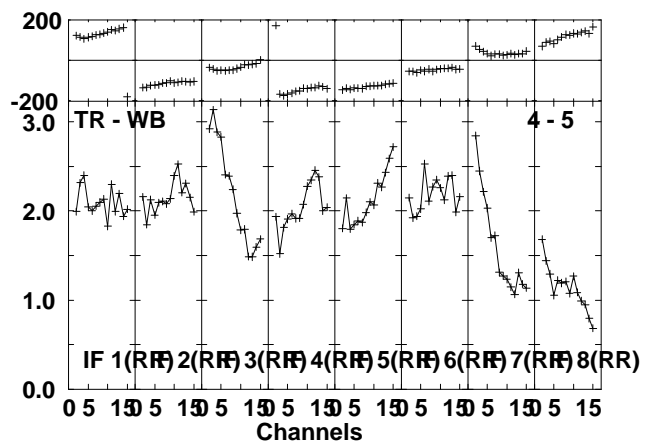
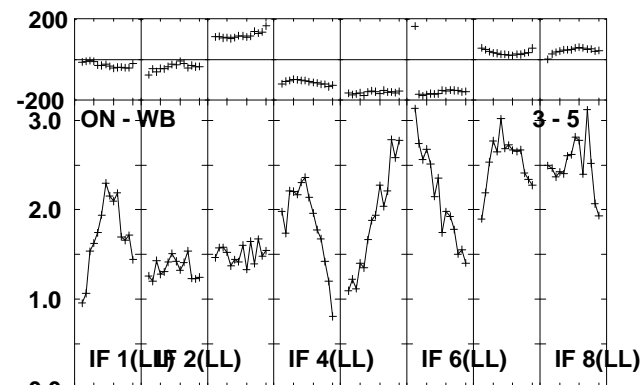
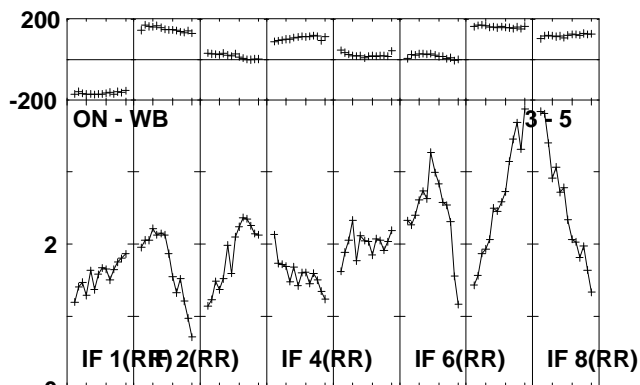
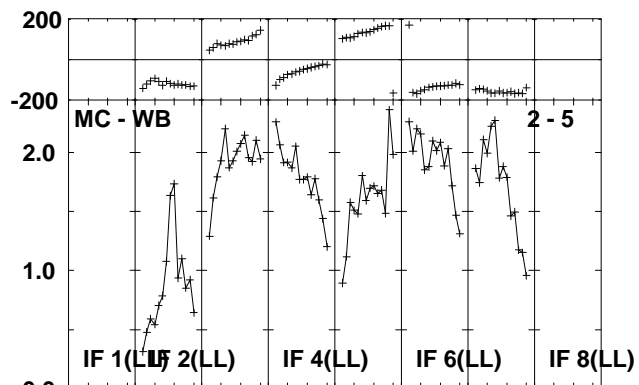
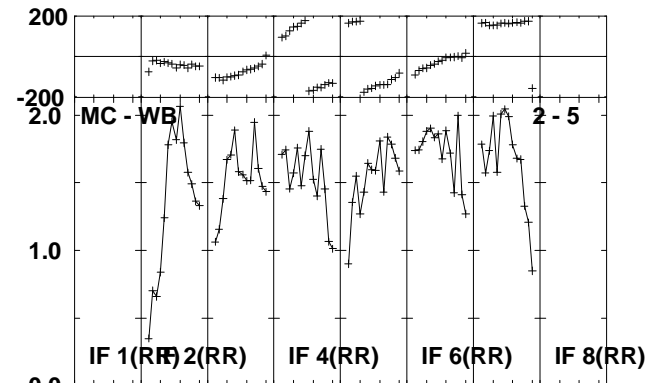
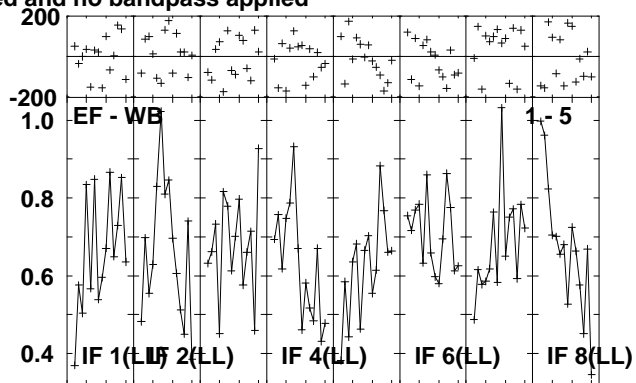
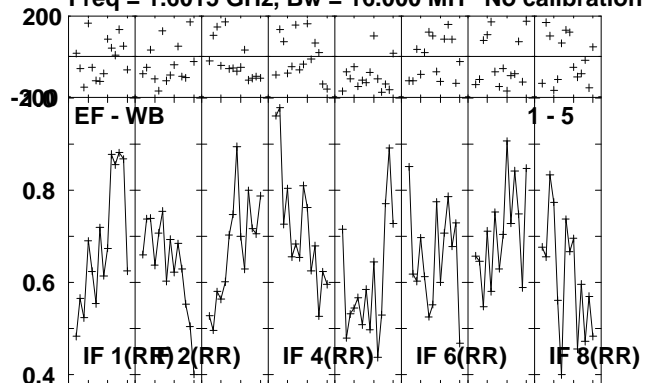

Lower frame: Milli Ampl Jy Top frame: Phas deg
Scalar averaged cross-power spectrum Several baselines displayed
Timerange: 00/08:20:58 to 00/08:22:22

Plot file version 70 created 07-OCT-2010 14:26:13

J1345+44 RSP03.UVDATA.1

Freq = 1.6015 GHz, Bw = 16.000 MH No calibration applied and no bandpass applied

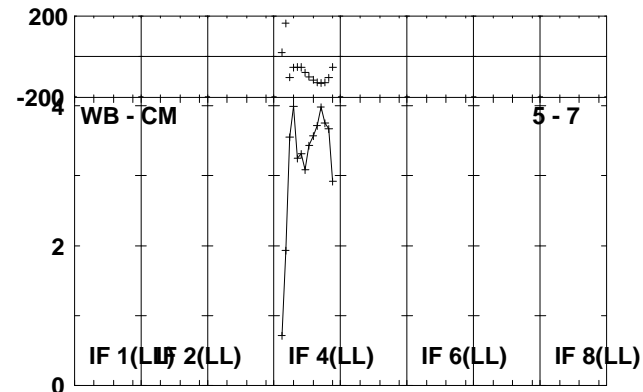
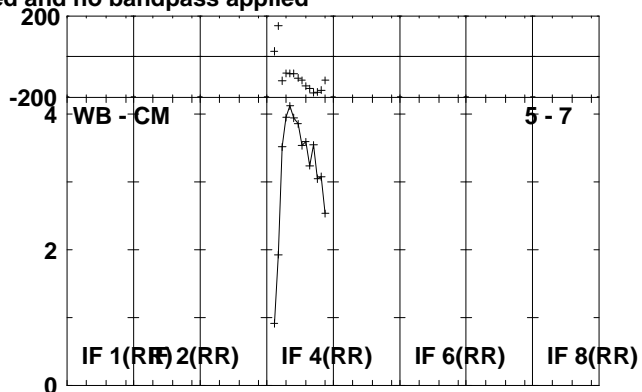
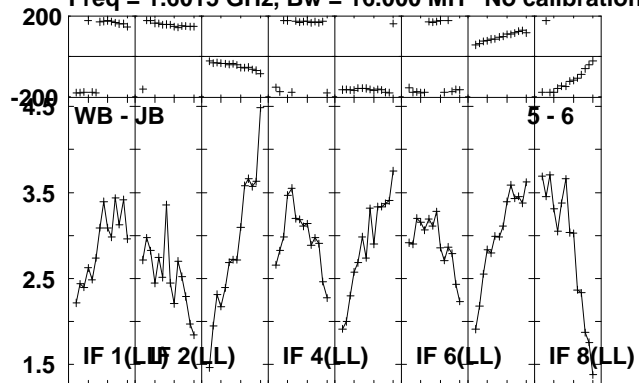

Lower frame: Milli Ampl Jy Top frame: Phas deg
Scalar averaged cross-power spectrum Several baselines displayed
Timerange: 00/08:20:58 to 00/08:22:22

Plot file version 71 created 07-OCT-2010 14:26:13

J134054 RSP03.UVDATA.1

Freq = 1.6015 GHz, Bw = 16.000 MH No calibration applied and no bandpass applied

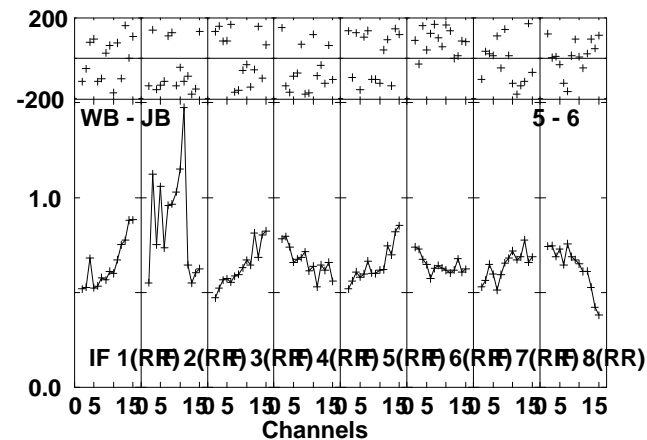
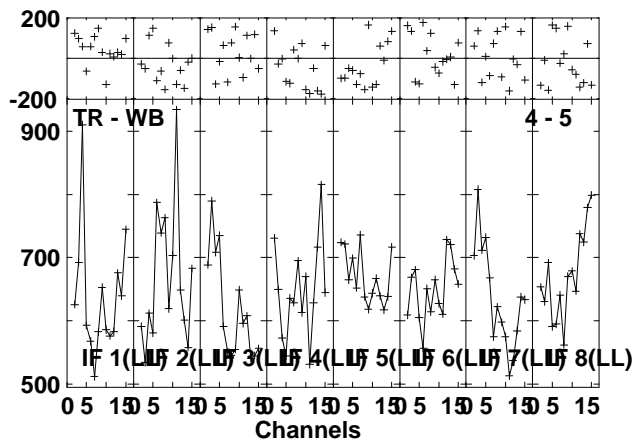
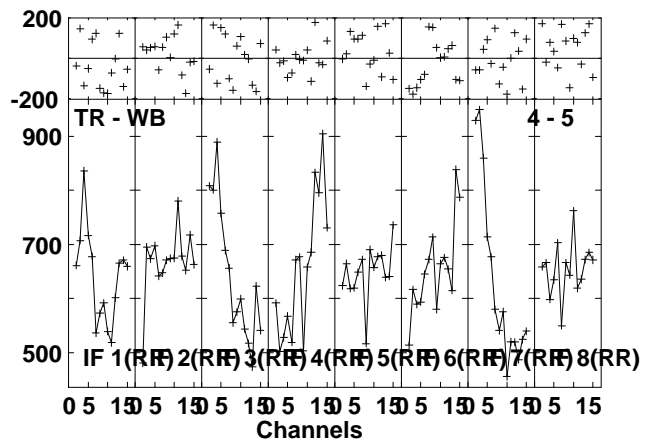
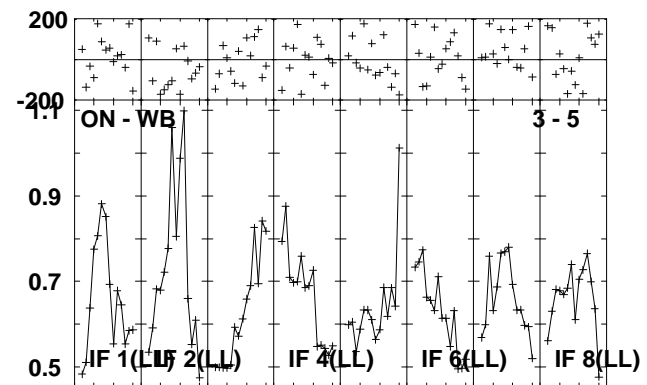
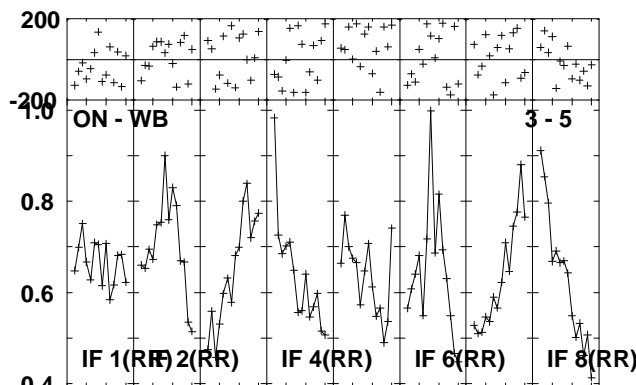
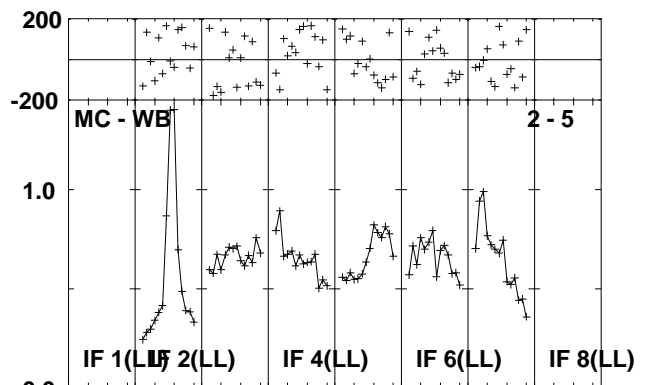
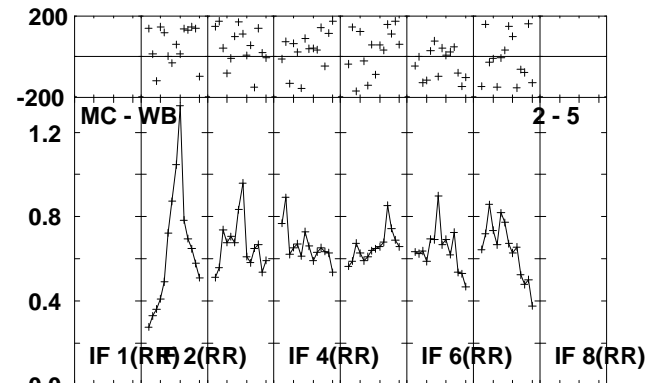
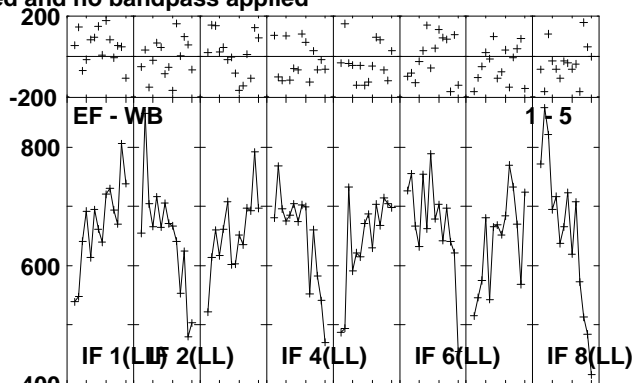
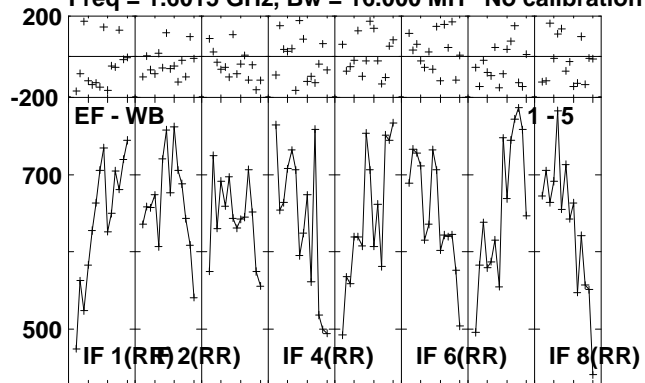

Lower frame: Micro Ampl Jy Top frame: Phas deg
Scalar averaged cross-power spectrum Several baselines displayed
Timerange: 00/08:22:26 to 00/08:27:02

Plot file version 72 created 07-OCT-2010 14:26:14

J134054 RSP03.UVDATA.1

Freq = 1.6015 GHz, Bw = 16.000 MH No calibration applied and no bandpass applied

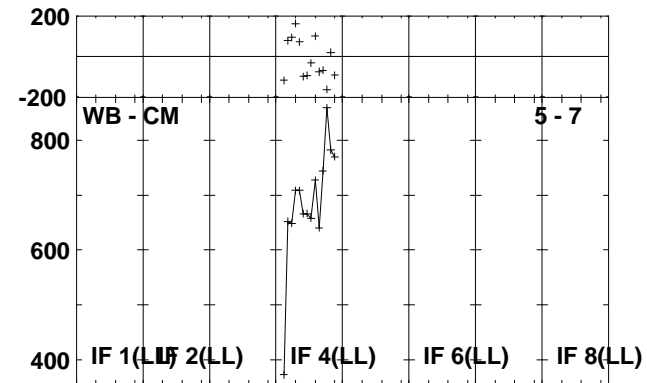
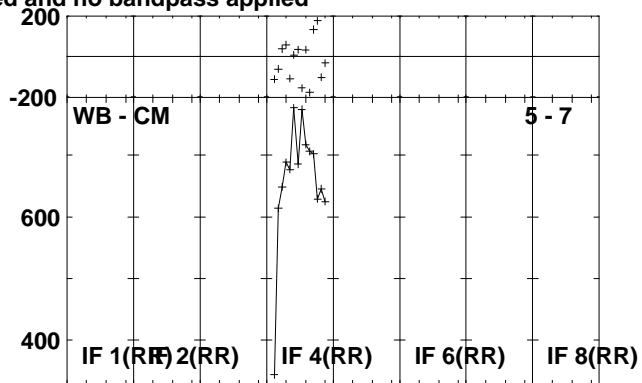
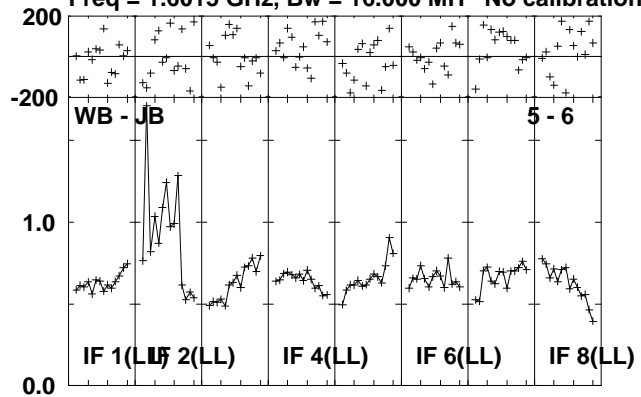

Lower frame: Milli Ampl Jy Top frame: Phas deg
Scalar averaged cross-power spectrum Several baselines displayed
Timerange: 00/08:22:26 to 00/08:27:02

Plot file version 73 created 07-OCT-2010 14:26:15

CAL2 RSP03.UVDATA.1

Freq = 1.6015 GHz, Bw = 16.000 MH No calibration applied and no bandpass applied

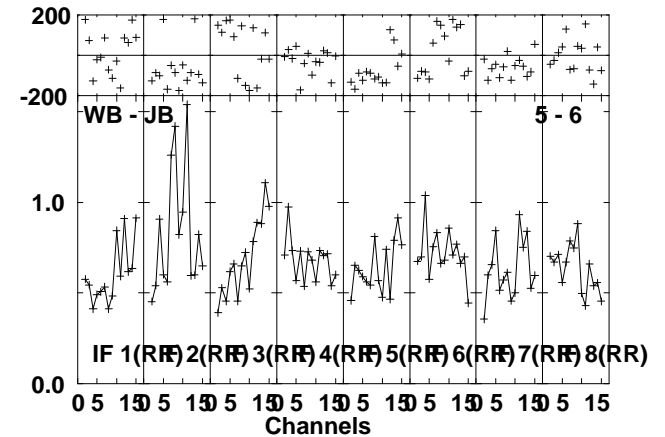
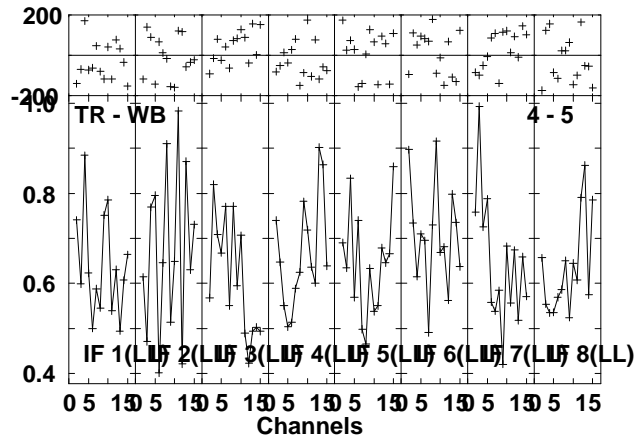
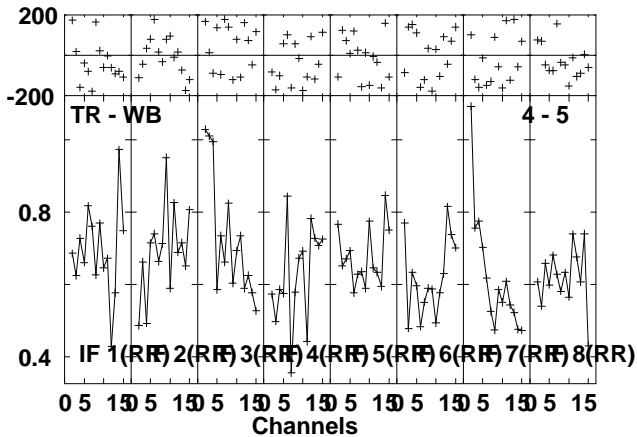
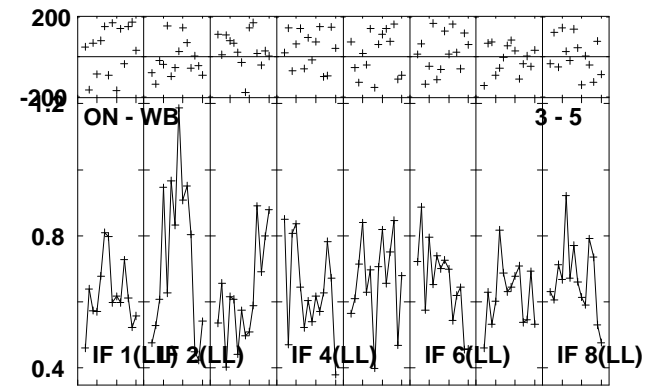
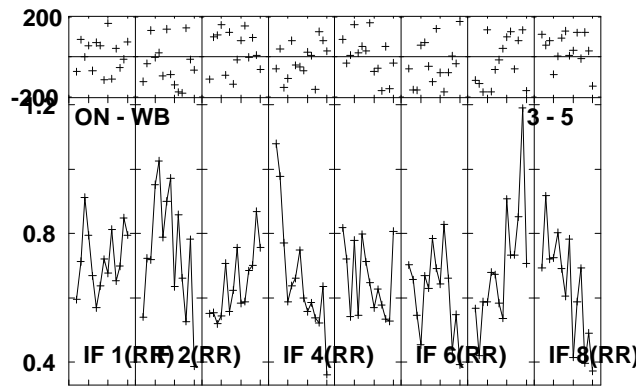
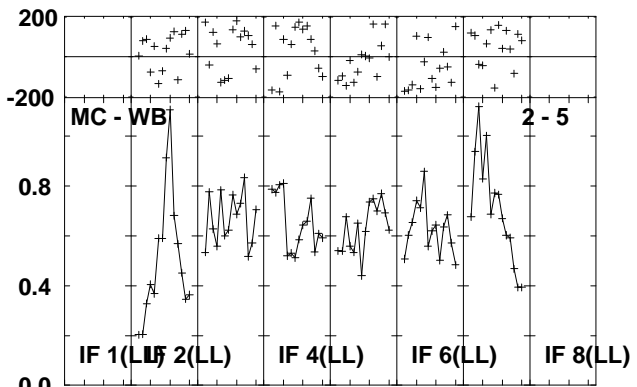
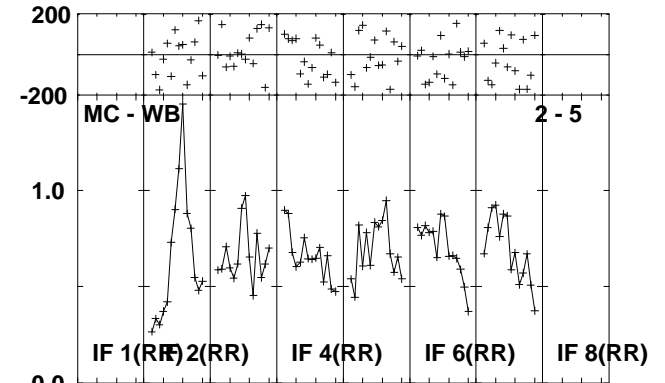
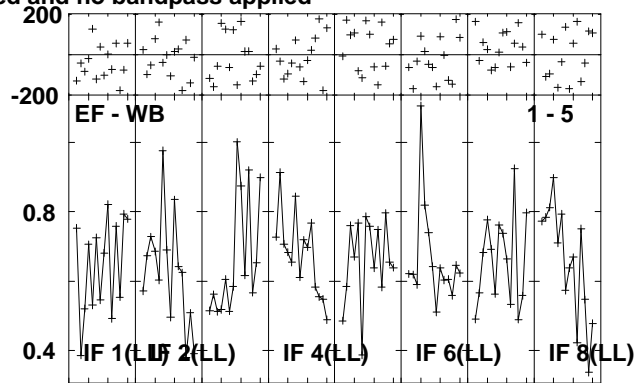
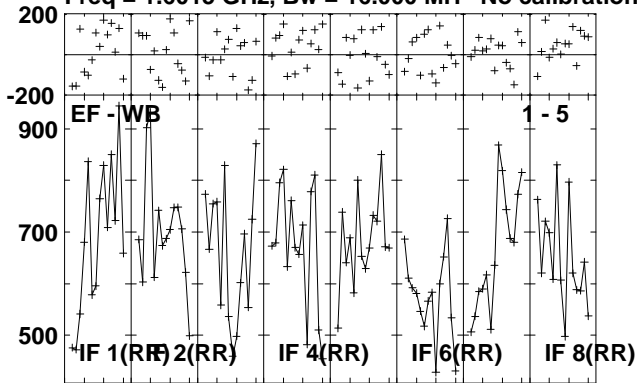

Lower frame: Micro Ampl Jy Top frame: Phas deg
Scalar averaged cross-power spectrum Several baselines displayed
Timerange: 00/08:27:06 to 00/08:28:18

Plot file version 74 created 07-OCT-2010 14:26:15

CAL2 RSP03.UVDATA.1

Freq = 1.6015 GHz, Bw = 16.000 MH No calibration applied and no bandpass applied

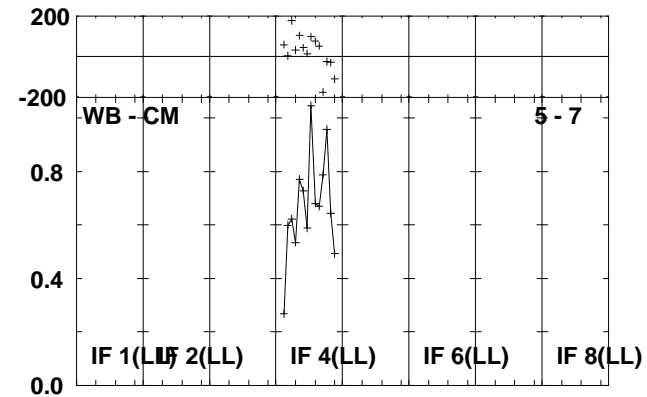
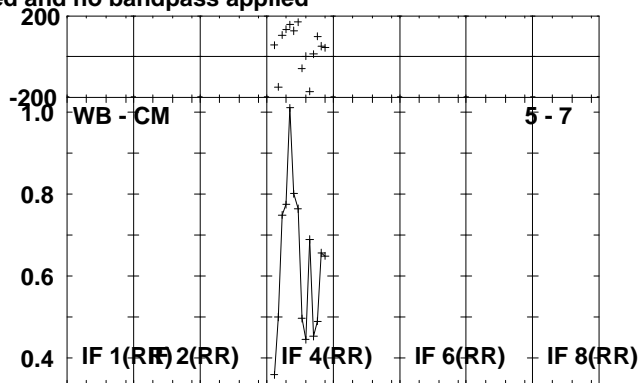
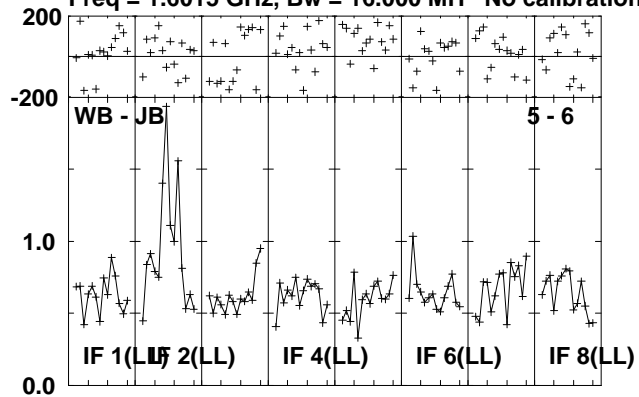

Lower frame: Milli Ampl Jy Top frame: Phas deg
Scalar averaged cross-power spectrum Several baselines displayed
Timerange: 00/08:27:06 to 00/08:28:18

Plot file version 75 created 07-OCT-2010 14:26:15

J1345+44 RSP03.UVDATA.1

Freq = 1.6015 GHz, Bw = 16.000 MH No calibration applied and no bandpass applied

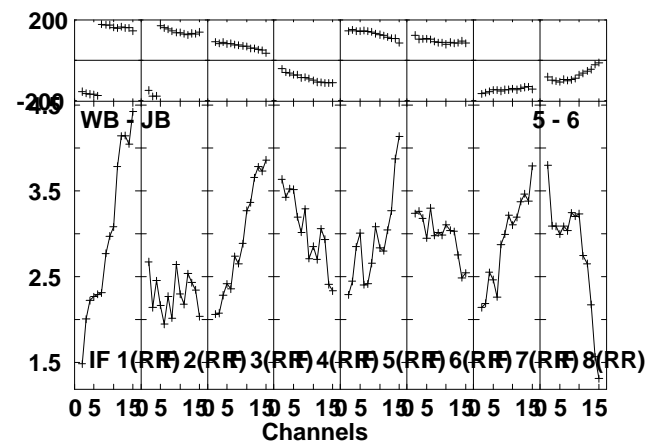
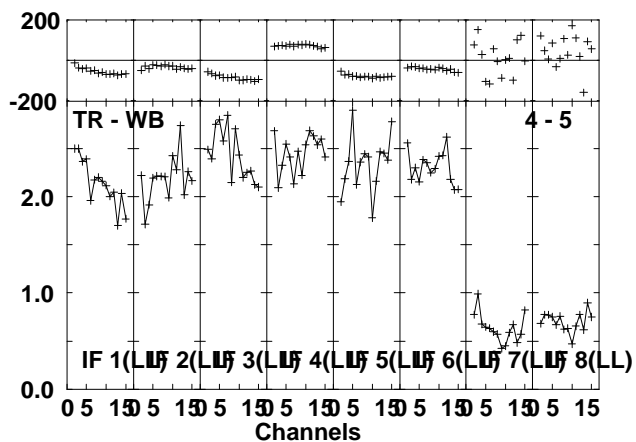
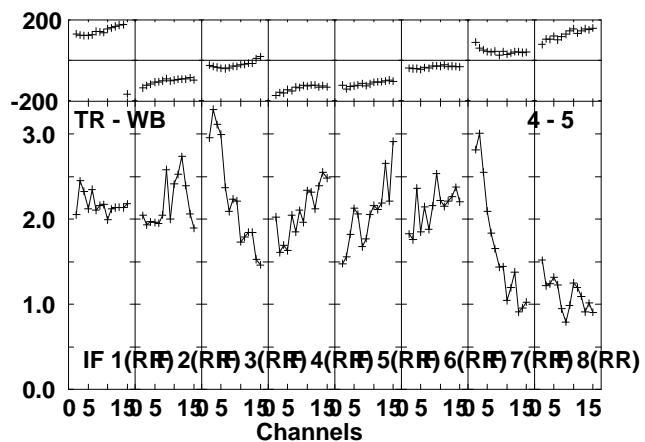
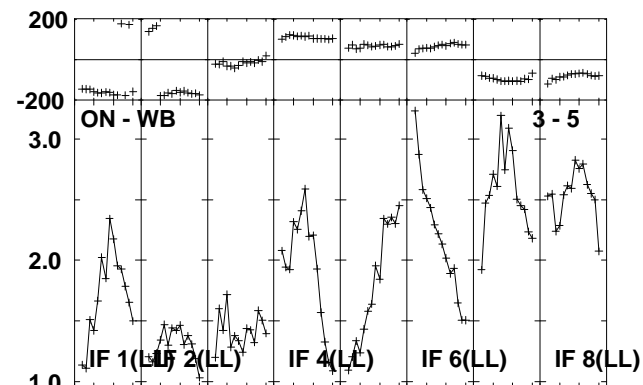
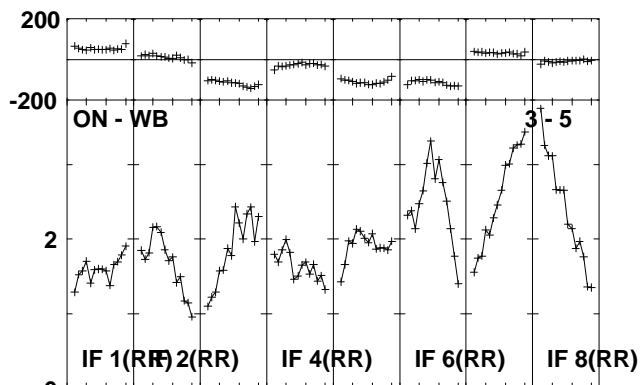
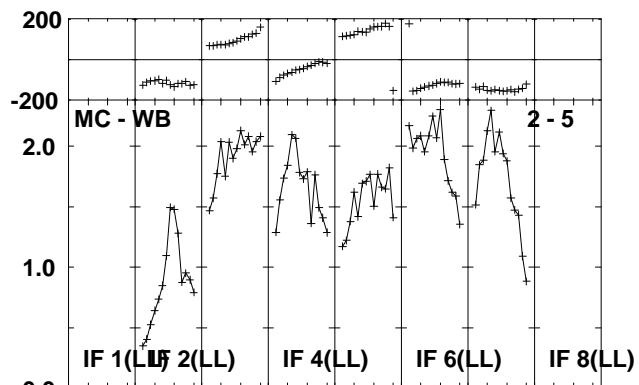
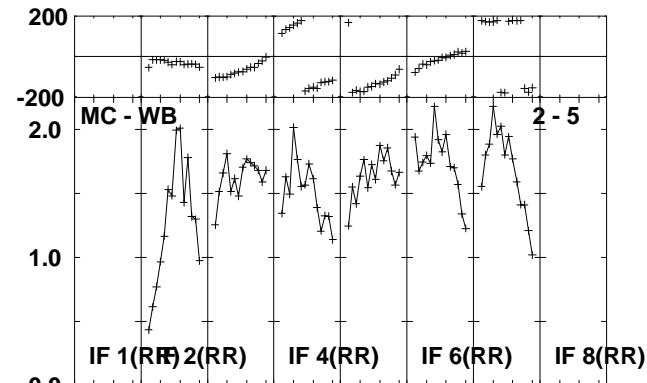
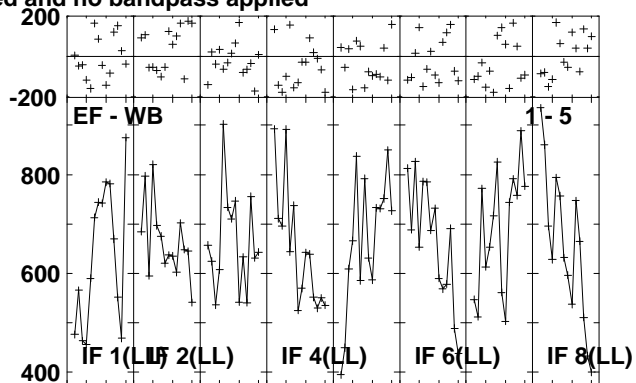
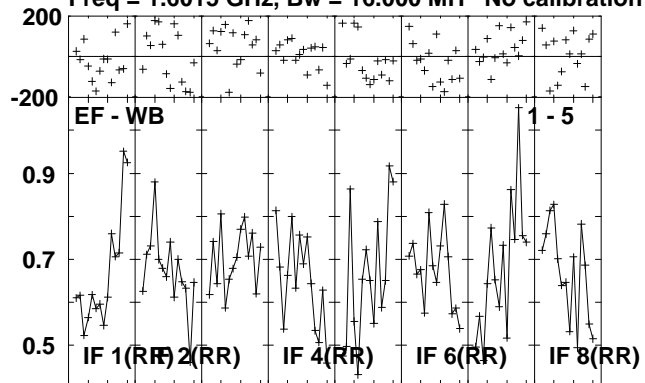

Lower frame: Milli Ampl Jy Top frame: Phas deg
Scalar averaged cross-power spectrum Several baselines displayed
Timerange: 00/08:29:02 to 00/08:29:58

Plot file version 76 created 07-OCT-2010 14:26:16

J1345+44 RSP03.UVDATA.1

Freq = 1.6015 GHz, Bw = 16.000 MH No calibration applied and no bandpass applied

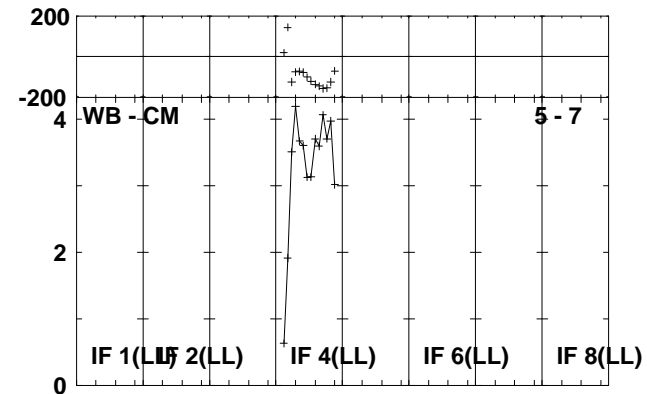
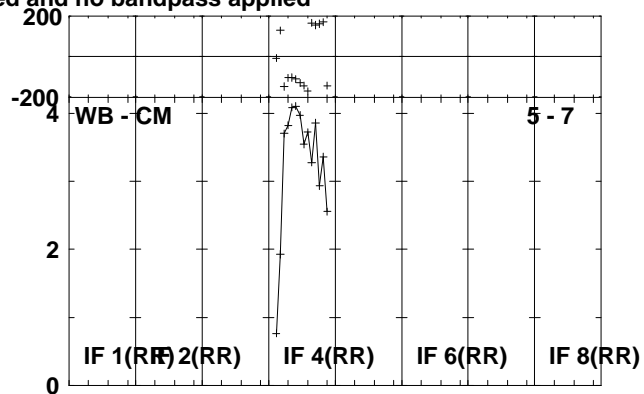
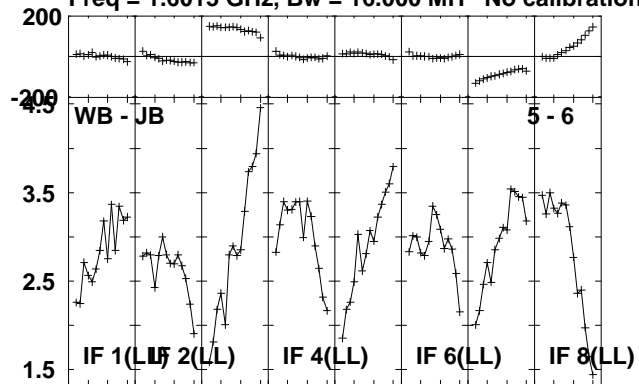

Lower frame: Milli Ampl Jy Top frame: Phas deg
Scalar averaged cross-power spectrum Several baselines displayed
Timerange: 00/08:29:02 to 00/08:29:58

Plot file version 77 created 07-OCT-2010 14:26:16

J134054 RSP03.UVDATA.1

Freq = 1.6015 GHz, Bw = 16.000 MH No calibration applied and no bandpass applied

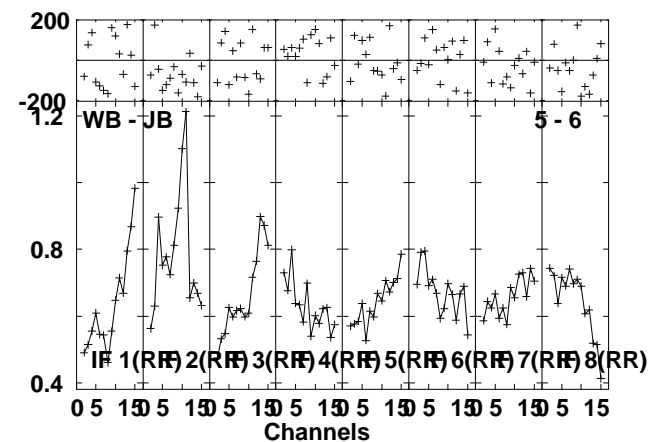
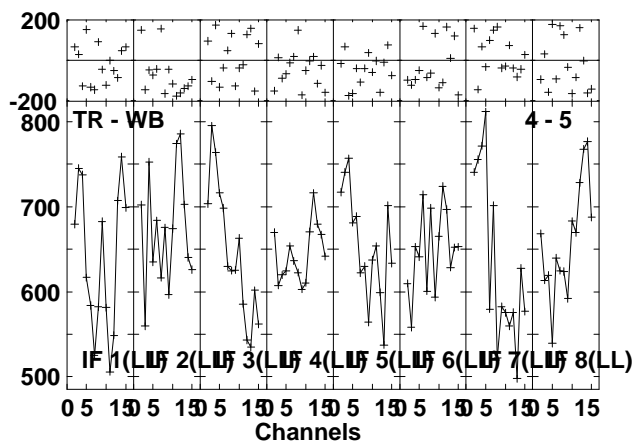
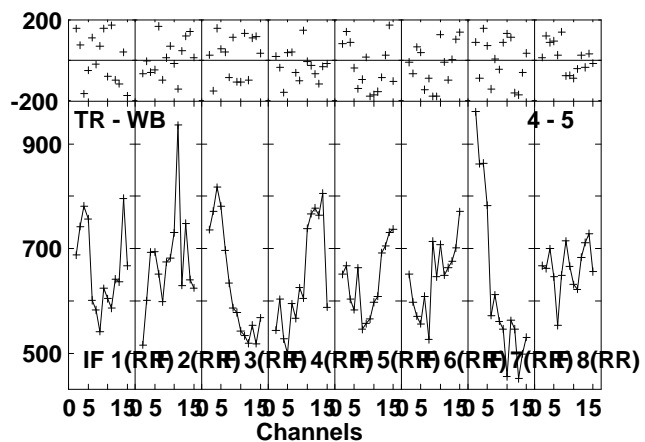
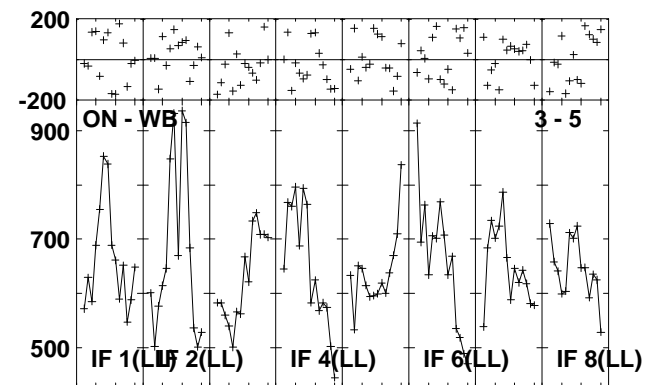
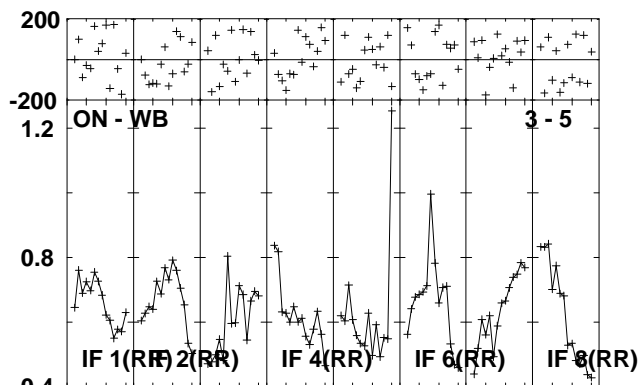
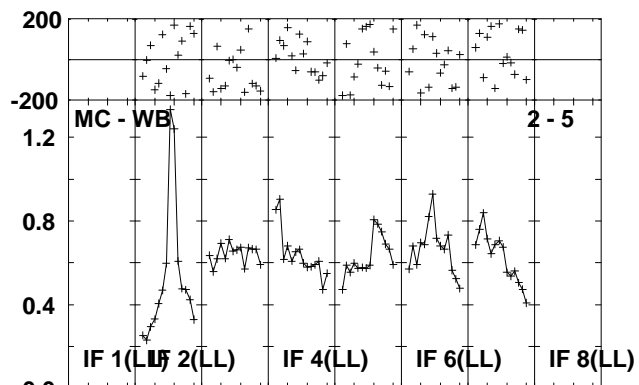
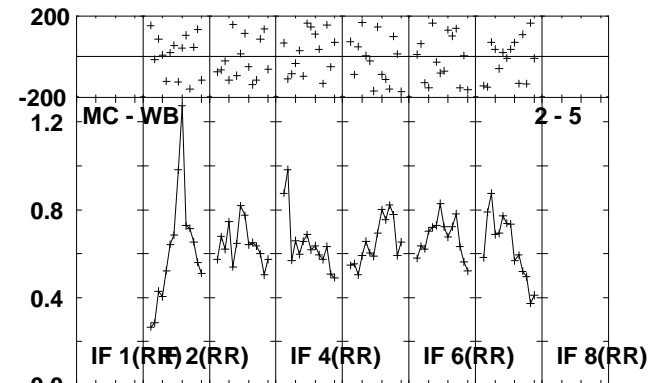
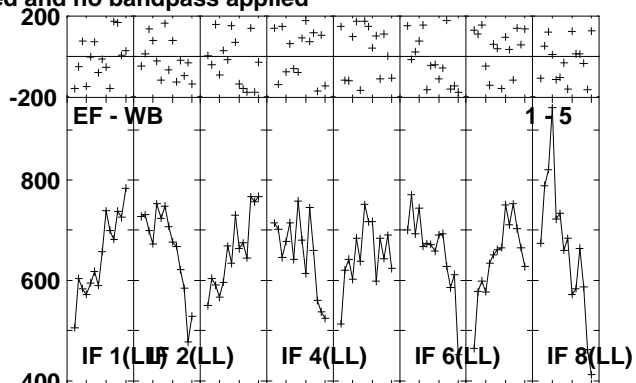
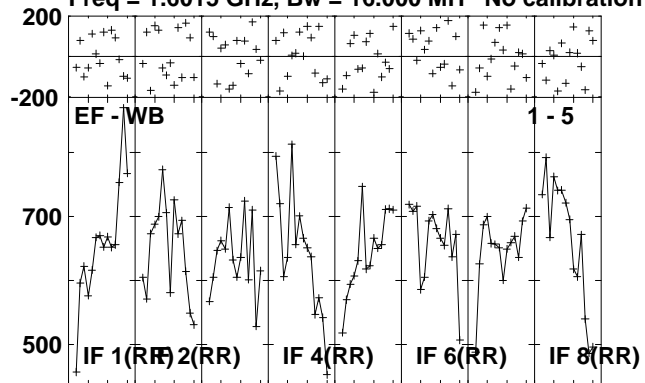

Lower frame: Micro Ampl Jy Top frame: Phas deg
Scalar averaged cross-power spectrum Several baselines displayed
Timerange: 00/08:30:02 to 00/08:34:38

Plot file version 78 created 07-OCT-2010 14:26:17

J134054 RSP03.UVDATA.1

Freq = 1.6015 GHz, Bw = 16.000 MH No calibration applied and no bandpass applied

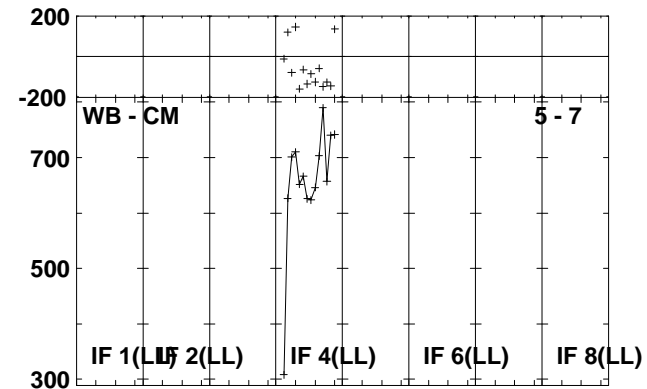
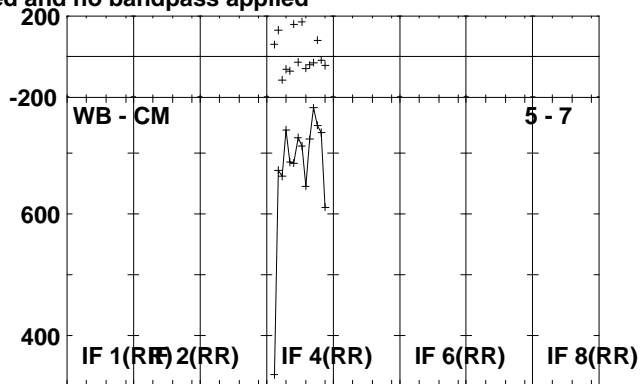
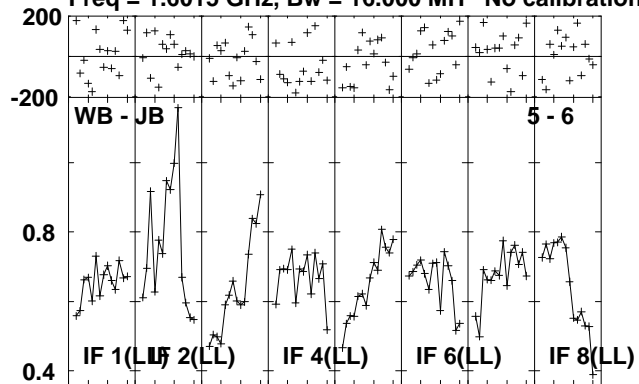

Lower frame: Milli Ampl Jy Top frame: Phas deg
Scalar averaged cross-power spectrum Several baselines displayed
Timerange: 00/08:30:02 to 00/08:34:38

Plot file version 79 created 07-OCT-2010 14:26:18

CAL1 RSP03.UVDATA.1

Freq = 1.6015 GHz, Bw = 16.000 MH No calibration applied and no bandpass applied

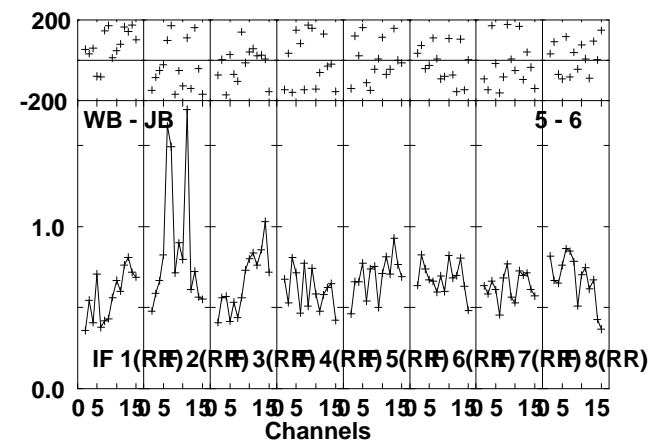
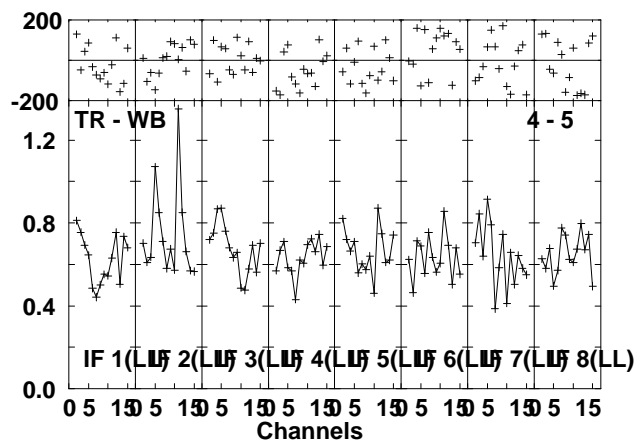
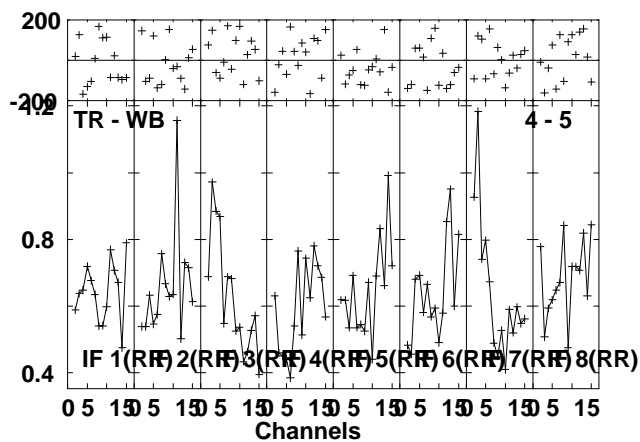
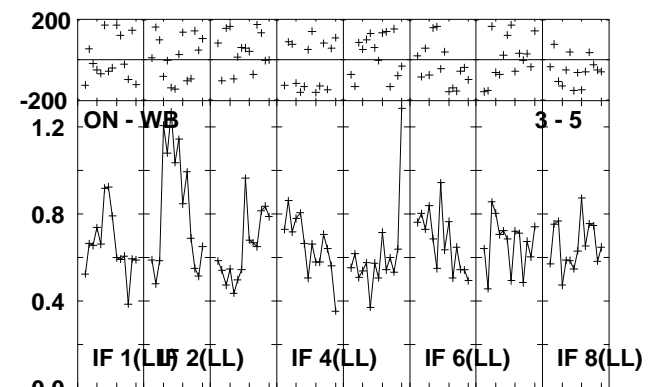
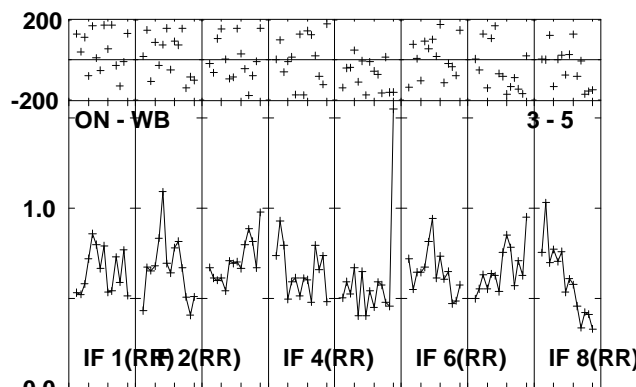
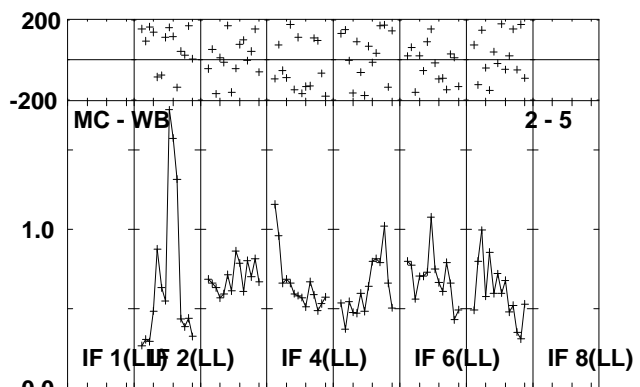
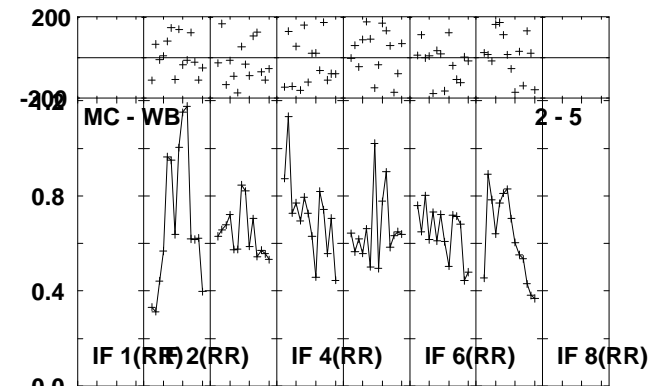
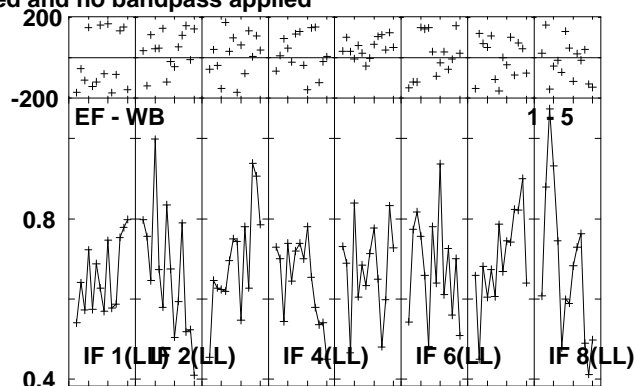
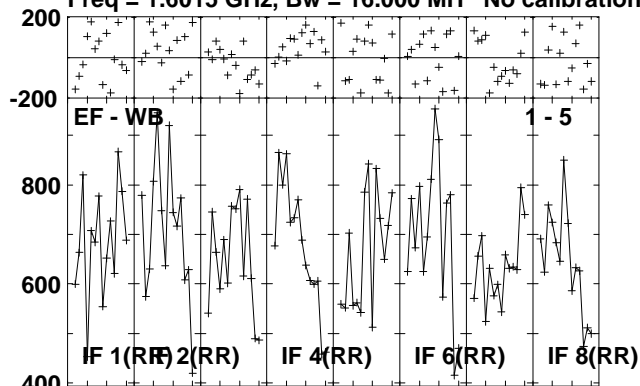

Lower frame: Micro Ampl Jy Top frame: Phas deg
Scalar averaged cross-power spectrum Several baselines displayed
Timerange: 00/08:34:42 to 00/08:35:54

Plot file version 80 created 07-OCT-2010 14:26:18

CAL1 RSP03.UVDATA.1

Freq = 1.6015 GHz, Bw = 16.000 MH No calibration applied and no bandpass applied

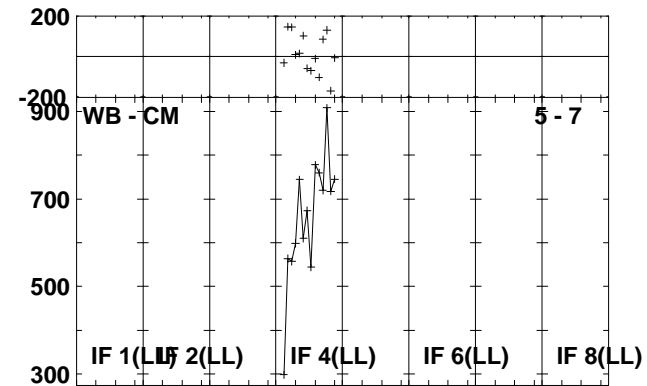
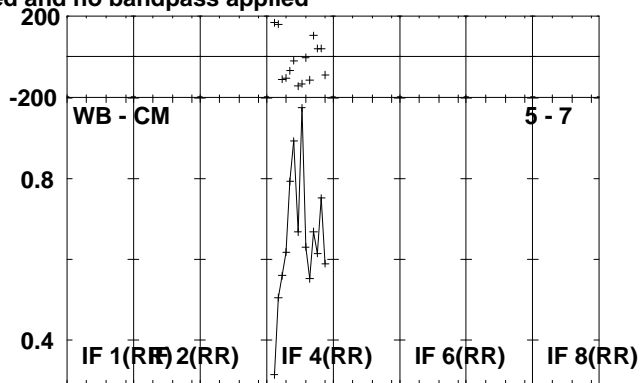
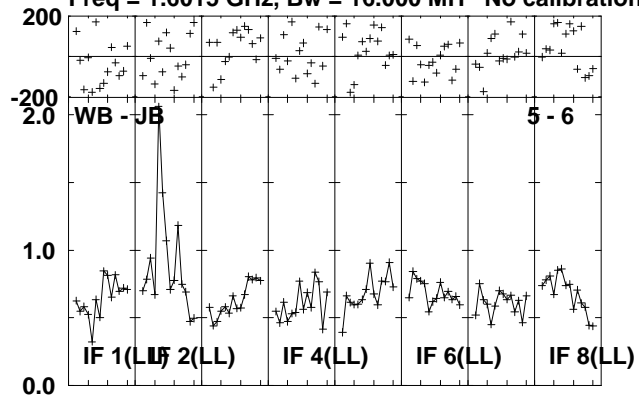

Lower frame: Milli Ampl Jy Top frame: Phas deg
Scalar averaged cross-power spectrum Several baselines displayed
Timerange: 00/08:34:42 to 00/08:35:54

Plot file version 81 created 07-OCT-2010 14:26:18

J1345+44 RSP03.UVDATA.1

Freq = 1.6015 GHz, Bw = 16.000 MH No calibration applied and no bandpass applied

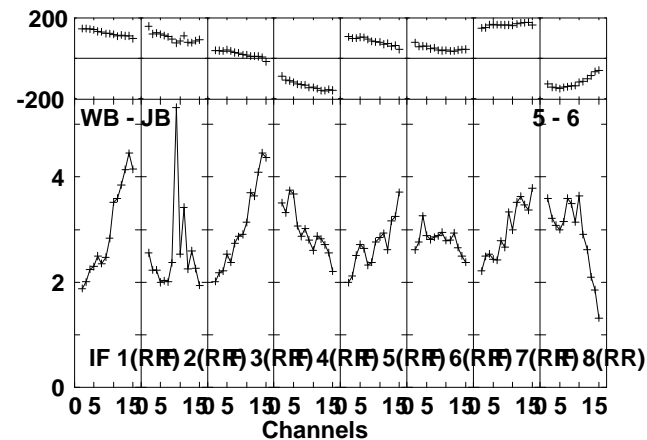
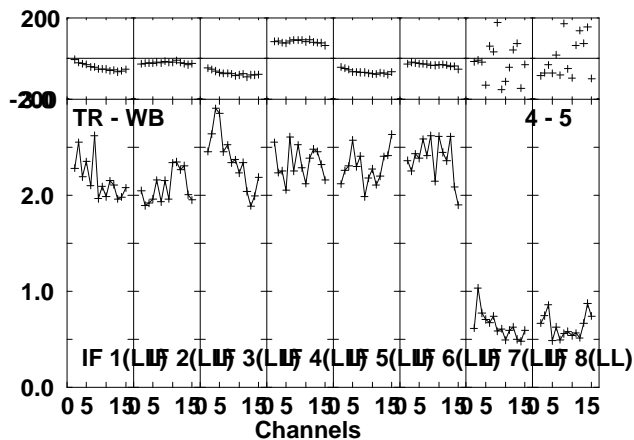
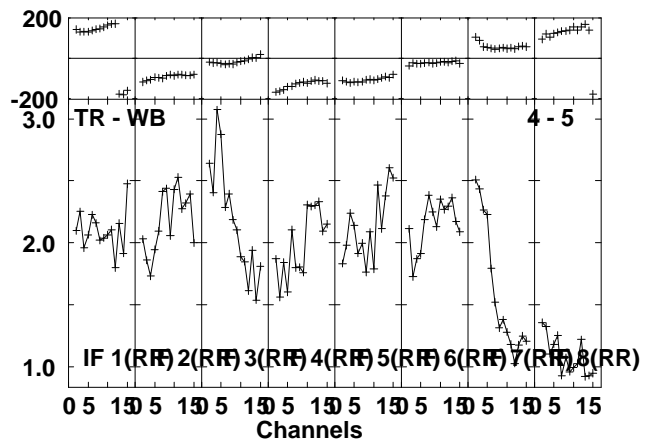
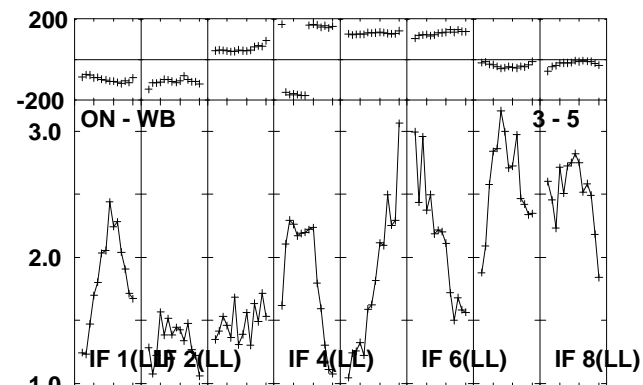
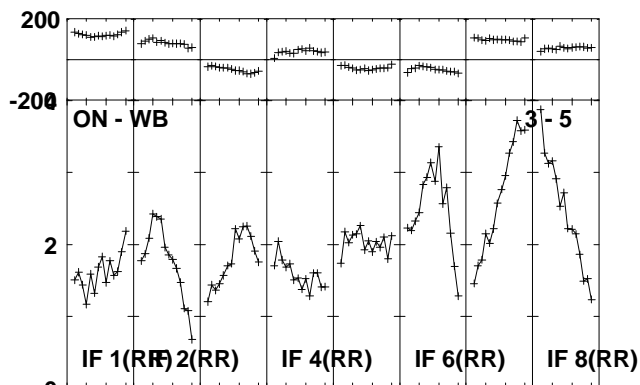
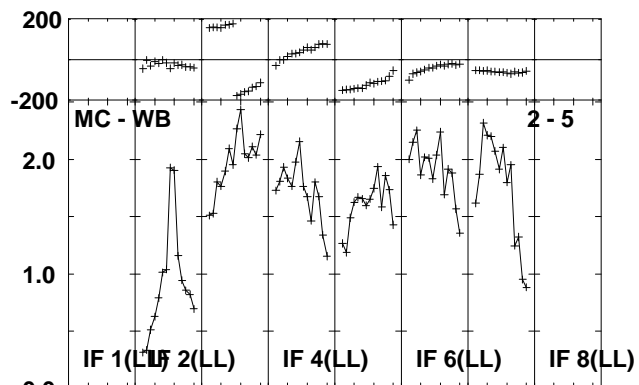
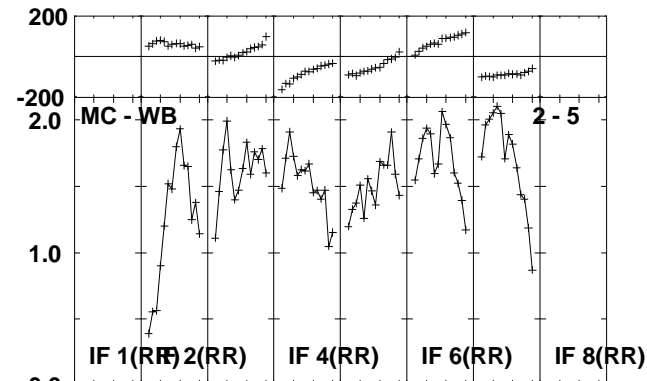
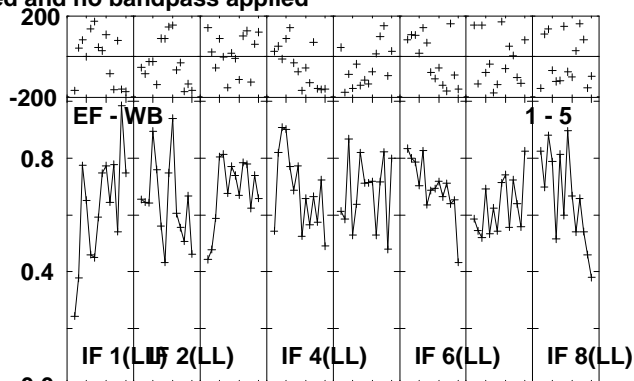
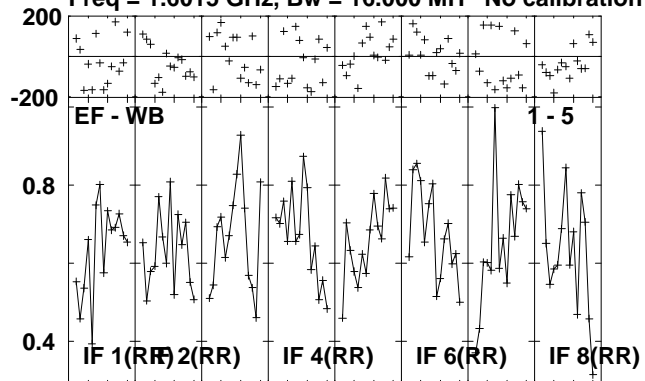

Lower frame: Milli Ampl Jy Top frame: Phas deg
Scalar averaged cross-power spectrum Several baselines displayed
Timerange: 00/08:35:58 to 00/08:37:22

Plot file version 82 created 07-OCT-2010 14:26:19

J1345+44 RSP03.UVDATA.1

Freq = 1.6015 GHz, Bw = 16.000 MH No calibration applied and no bandpass applied

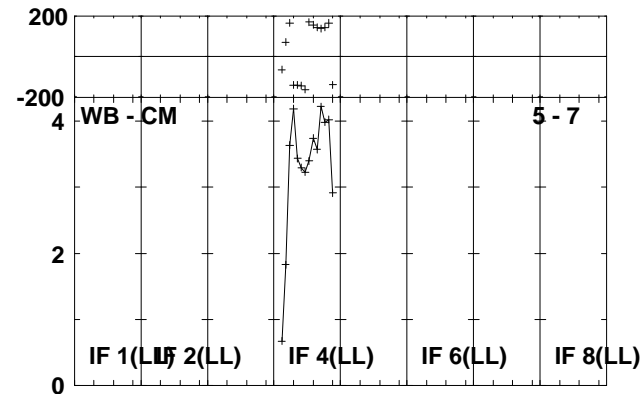
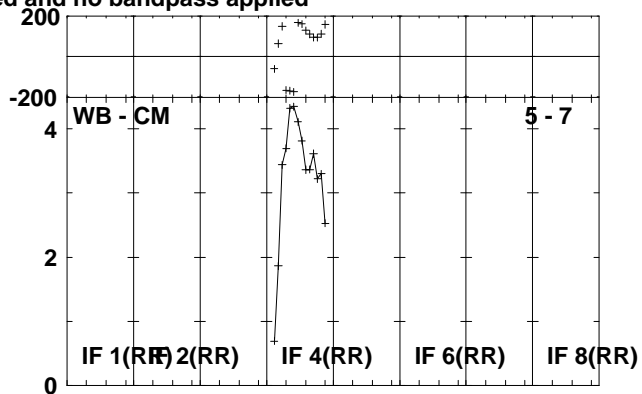
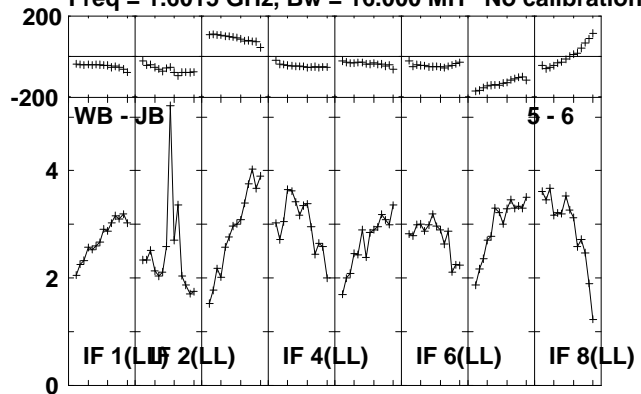

Lower frame: Milli Ampl Jy Top frame: Phas deg
Scalar averaged cross-power spectrum Several baselines displayed
Timerange: 00/08:35:58 to 00/08:37:22

Plot file version 83 created 07-OCT-2010 14:26:19

J134054 RSP03.UVDATA.1

Freq = 1.6015 GHz, Bw = 16.000 MH No calibration applied and no bandpass applied

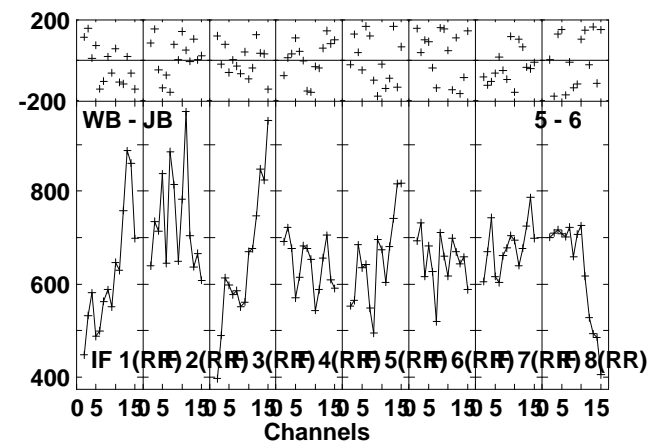
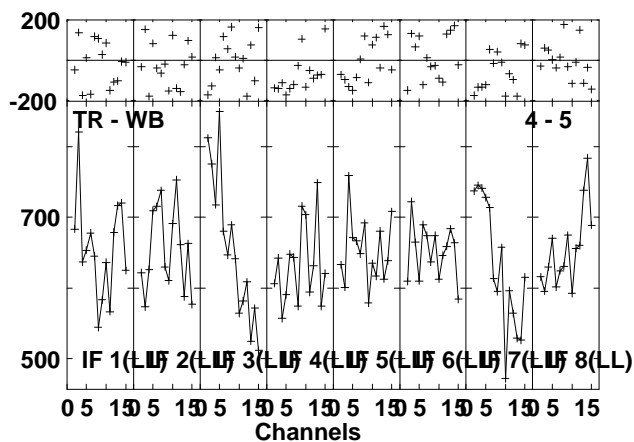
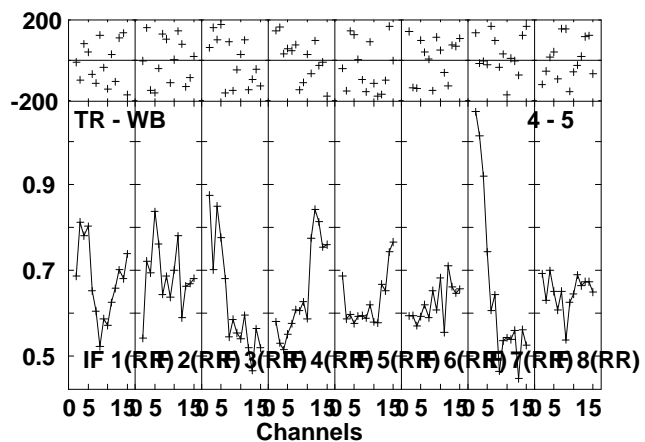
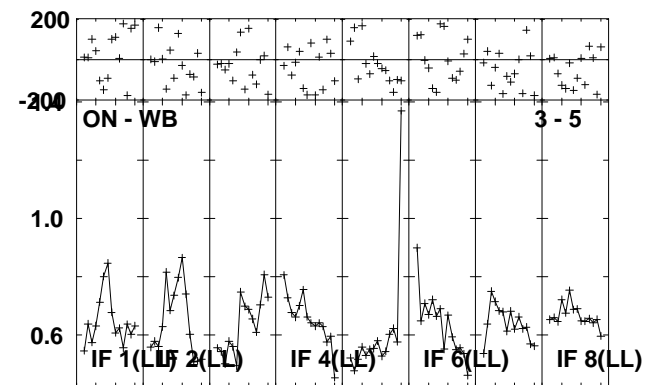
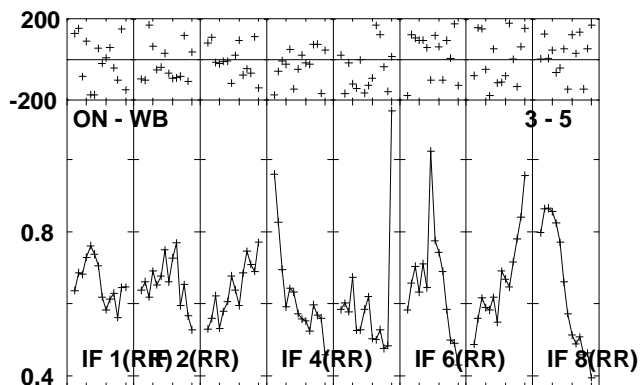
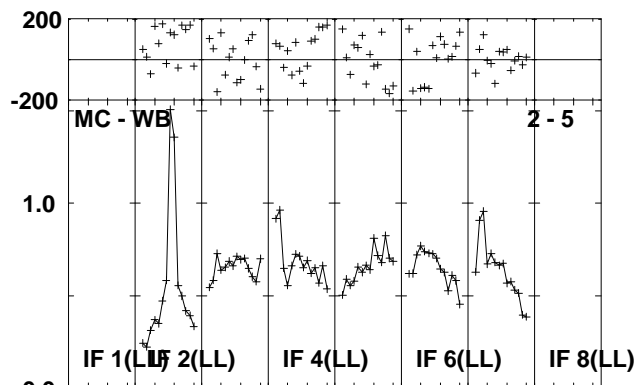
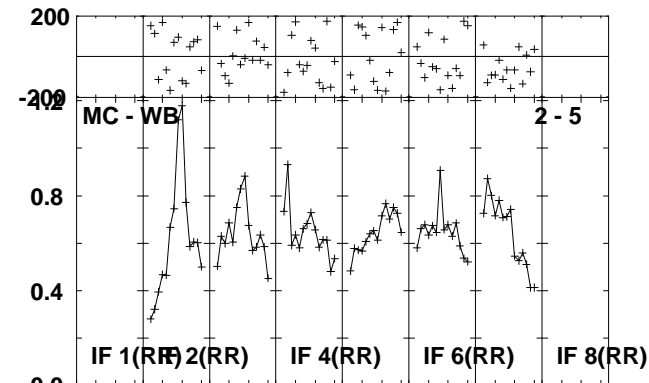
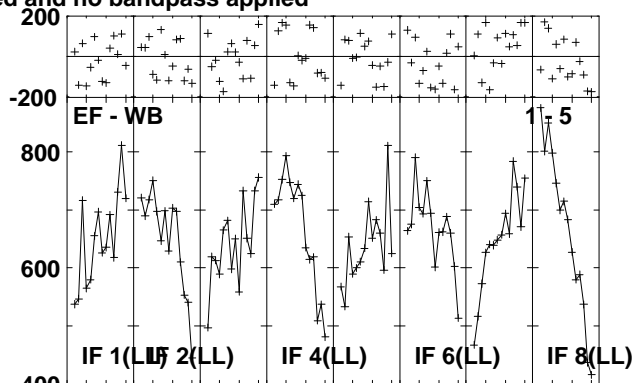
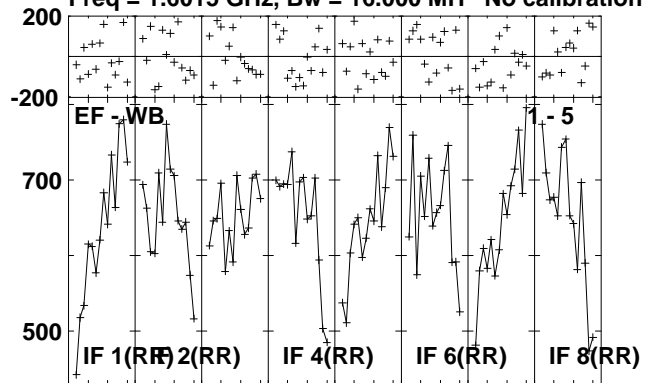

Lower frame: Micro Ampl Jy Top frame: Phas deg
Scalar averaged cross-power spectrum Several baselines displayed
Timerange: 00/08:37:26 to 00/08:42:02

Plot file version 84 created 07-OCT-2010 14:26:20

J134054 RSP03.UVDATA.1

Freq = 1.6015 GHz, Bw = 16.000 MH No calibration applied and no bandpass applied

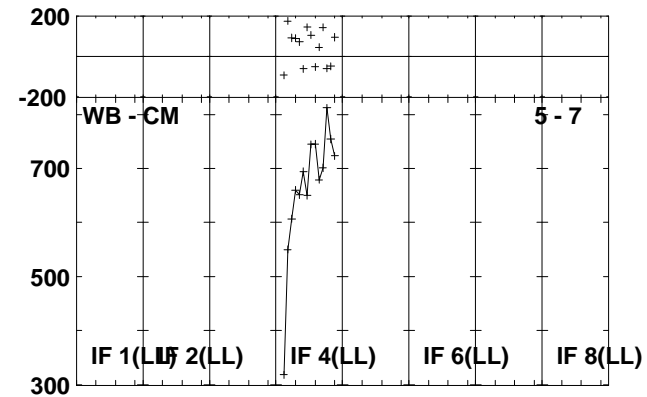
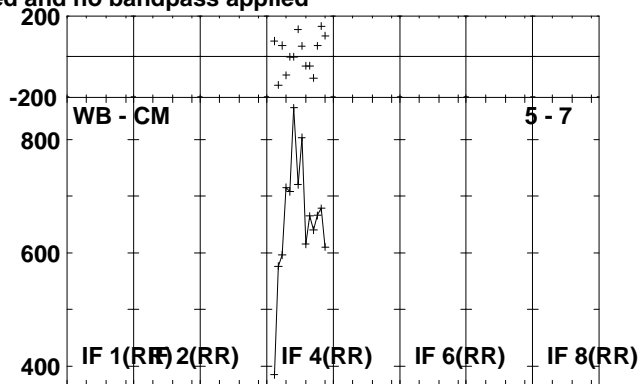
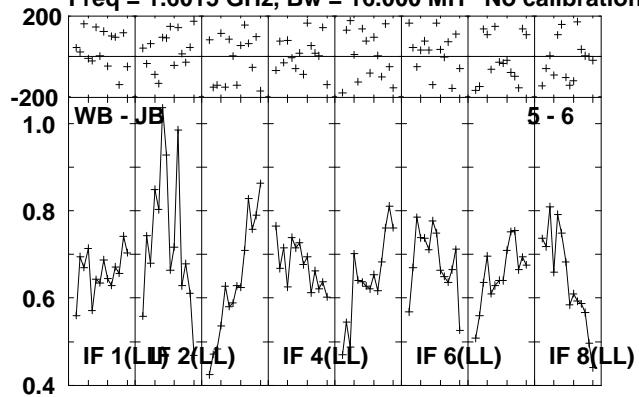

Lower frame: Milli Ampl Jy Top frame: Phas deg
Scalar averaged cross-power spectrum Several baselines displayed
Timerange: 00/08:37:26 to 00/08:42:02

Plot file version 85 created 07-OCT-2010 14:26:21

CAL2 RSP03.UVDATA.1

Freq = 1.6015 GHz, Bw = 16.000 MH No calibration applied and no bandpass applied

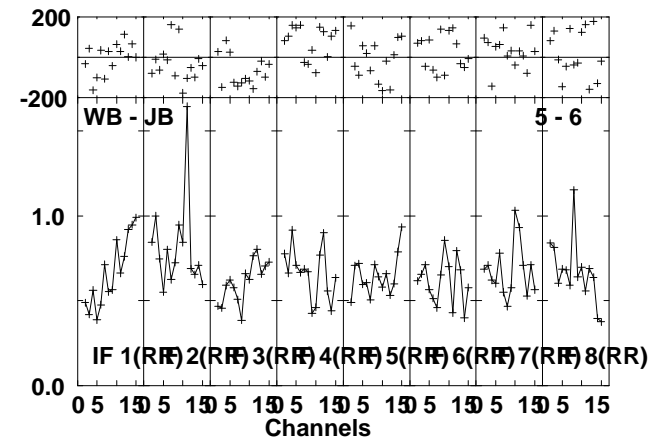
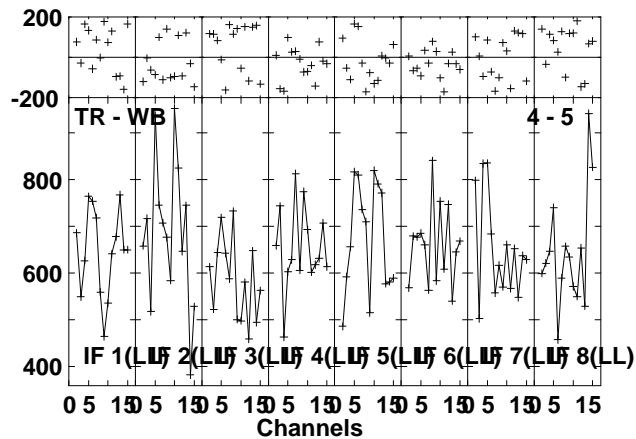
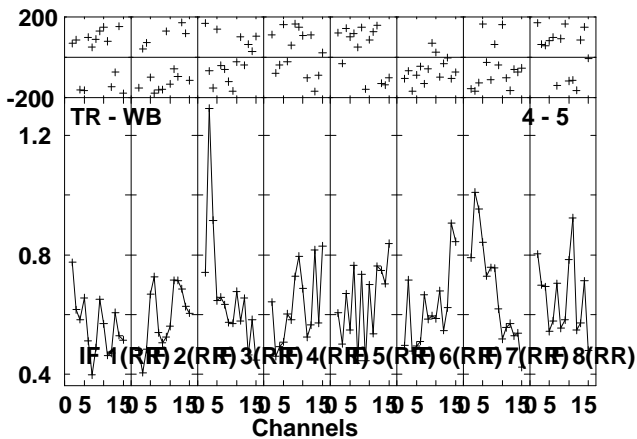
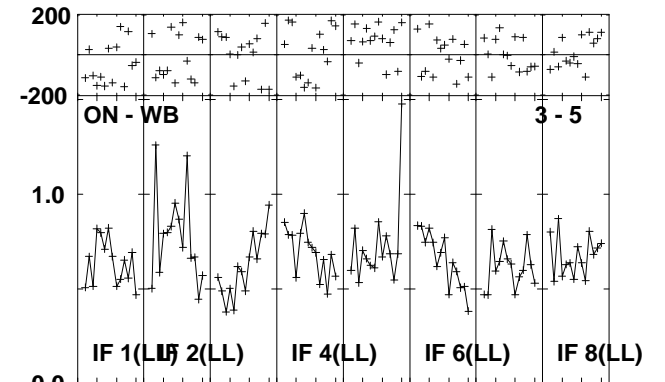
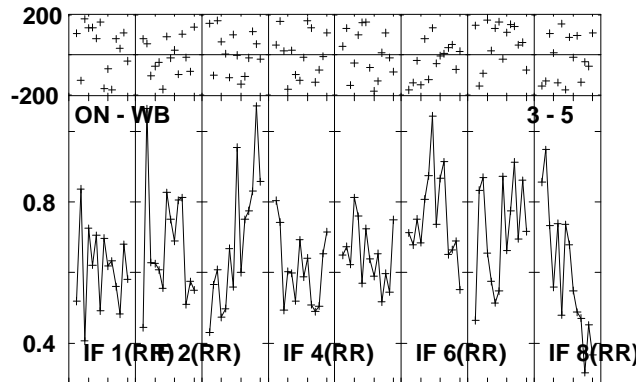
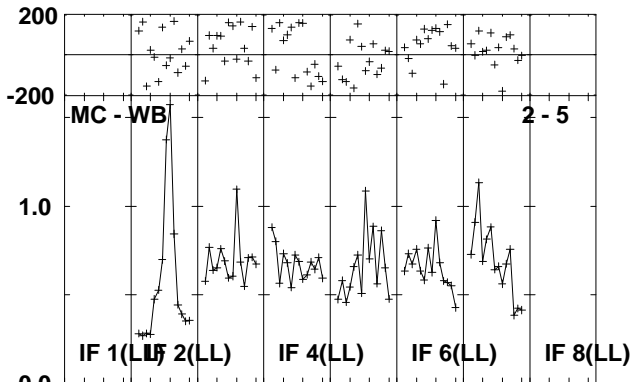
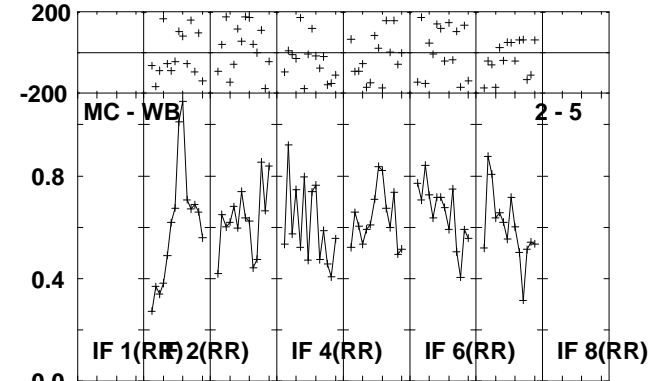
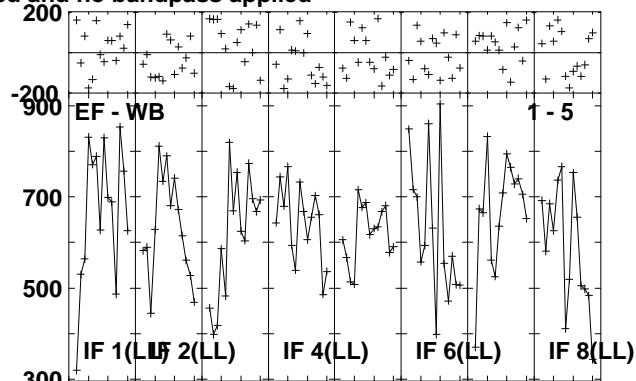
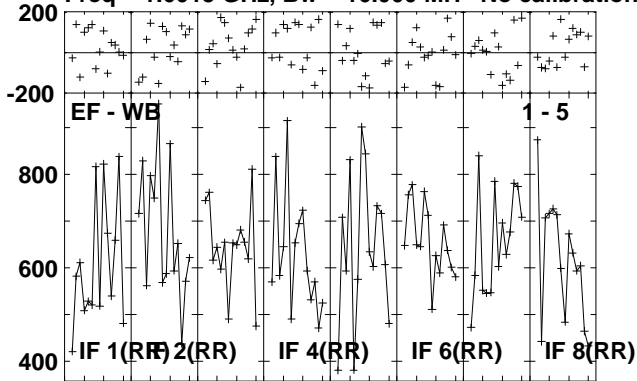

Lower frame: Micro Ampl Jy Top frame: Phas deg
Scalar averaged cross-power spectrum Several baselines displayed
Timerange: 00:08:42:06 to 00:08:43:18

Plot file version 86 created 07-OCT-2010 14:26:21

CAL2 RSP03.UVDATA.1

Freq = 1.6015 GHz, Bw = 16.000 MH No calibration applied and no bandpass applied

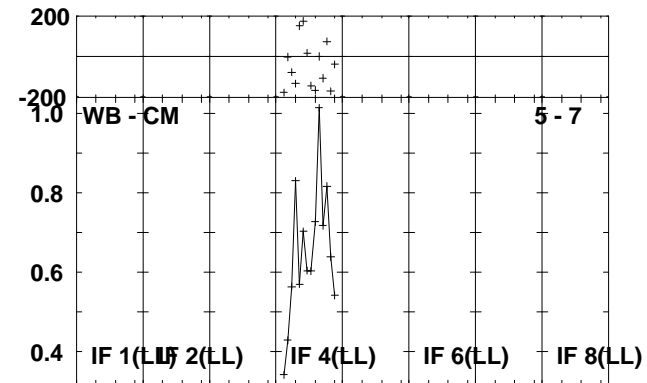
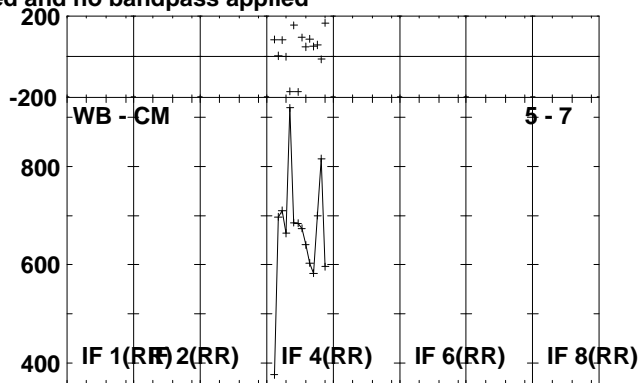
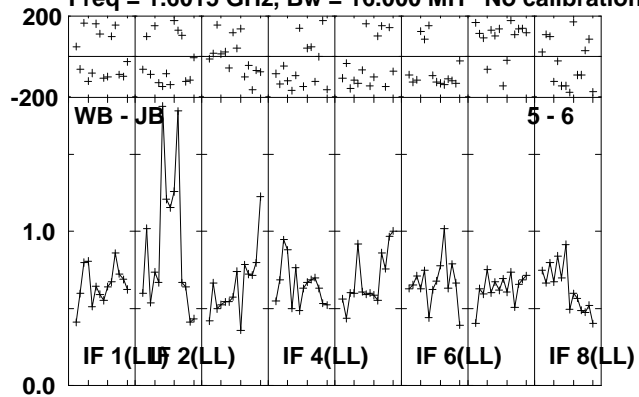

Lower frame: Milli Ampl Jy Top frame: Phas deg
Scalar averaged cross-power spectrum Several baselines displayed
Timerange: 00/08:42:06 to 00/08:43:18

Plot file version 87 created 07-OCT-2010 14:26:21

J1345+44 RSP03.UVDATA.1

Freq = 1.6015 GHz, Bw = 16.000 MH No calibration applied and no bandpass applied

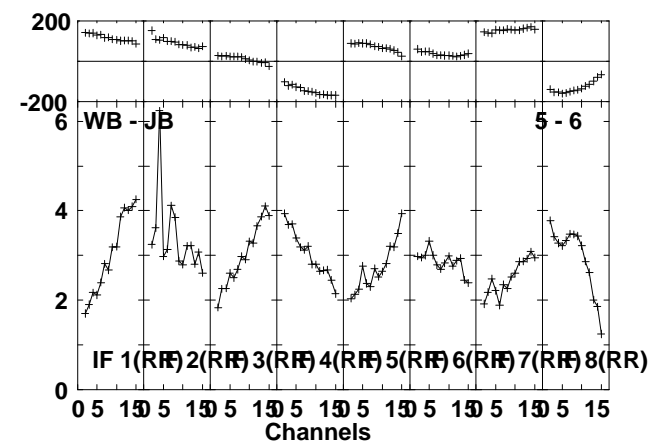
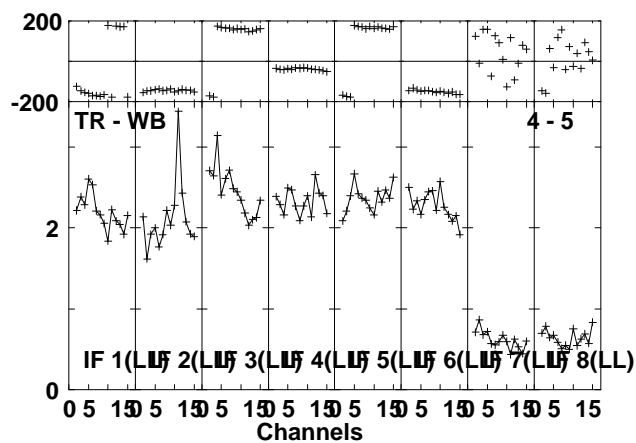
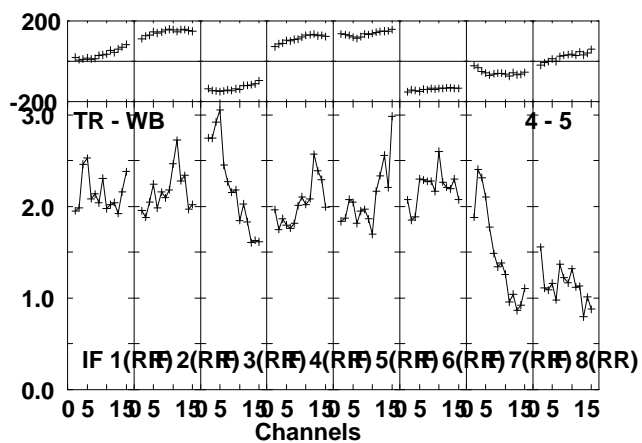
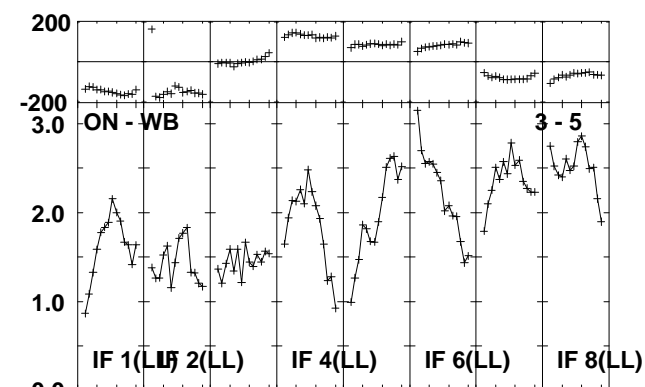
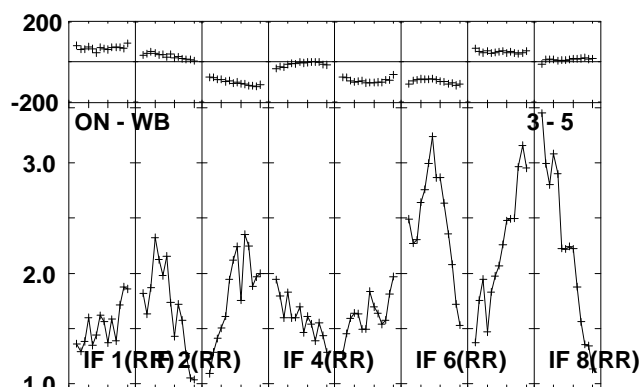
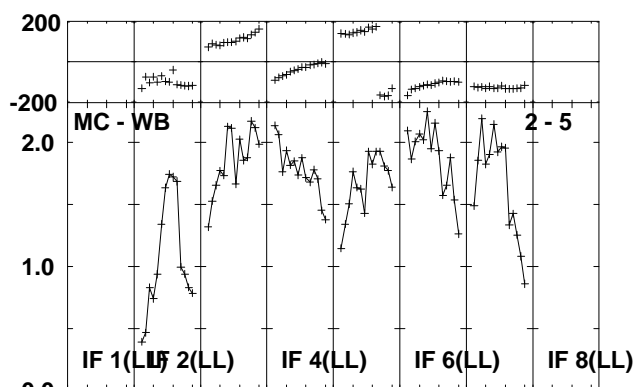
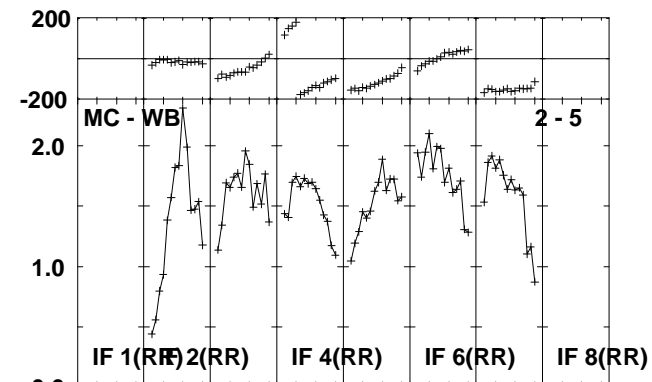
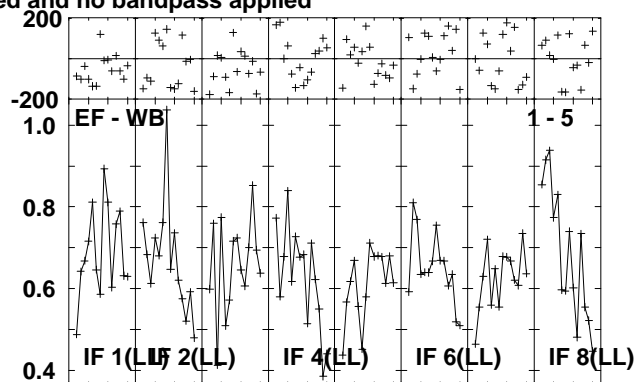
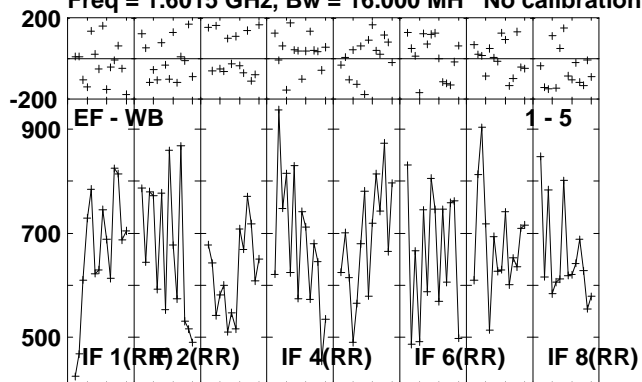

Lower frame: Micro Ampl Jy Top frame: Phas deg
Scalar averaged cross-power spectrum Several baselines displayed
Timerange: 00/08:44:02 to 00/08:44:58

Plot file version 88 created 07-OCT-2010 14:26:22

J1345+44 RSP03.UVDATA.1

Freq = 1.6015 GHz, Bw = 16.000 MH No calibration applied and no bandpass applied

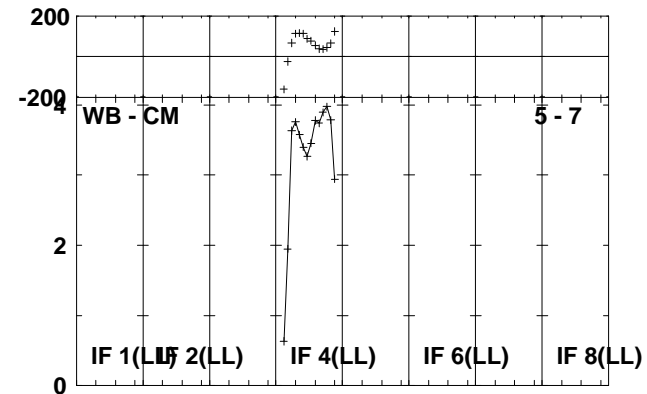
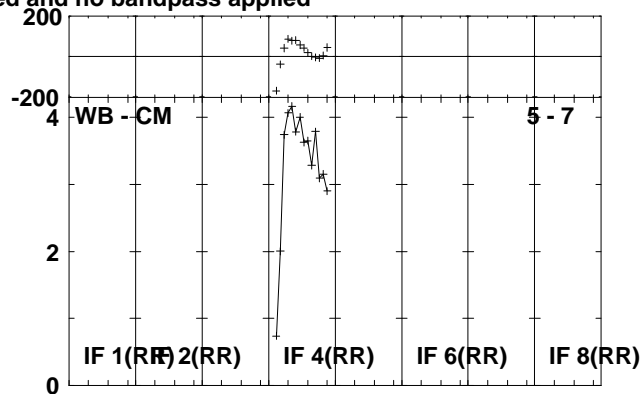
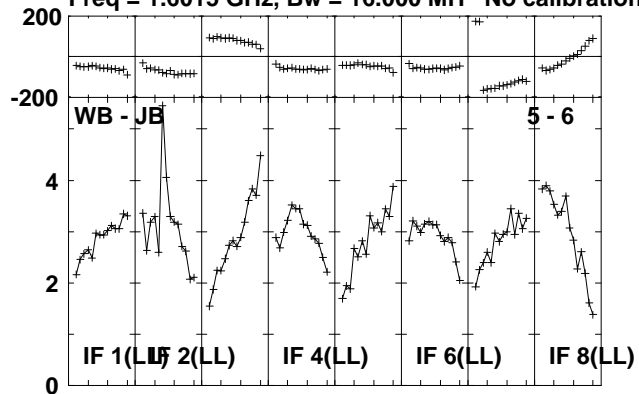

Lower frame: Milli Ampl Jy Top frame: Phas deg
Scalar averaged cross-power spectrum Several baselines displayed
Timerange: 00/08:44:02 to 00/08:44:58

Plot file version 89 created 07-OCT-2010 14:26:22

J134054 RSP03.UVDATA.1

Freq = 1.6015 GHz, Bw = 16.000 MH No calibration applied and no bandpass applied

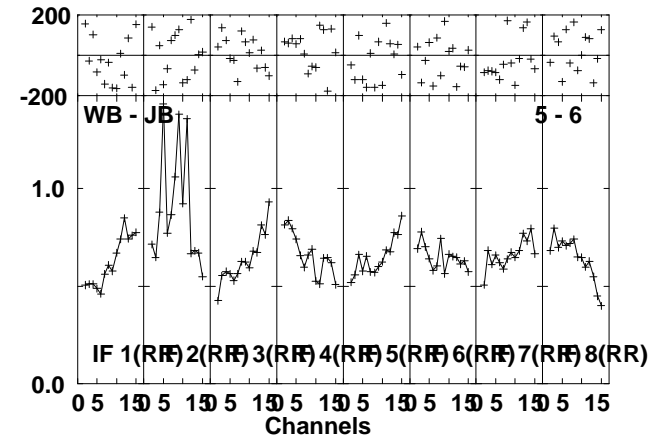
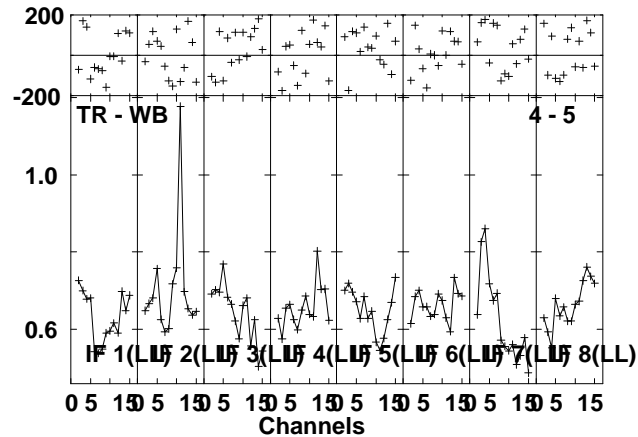
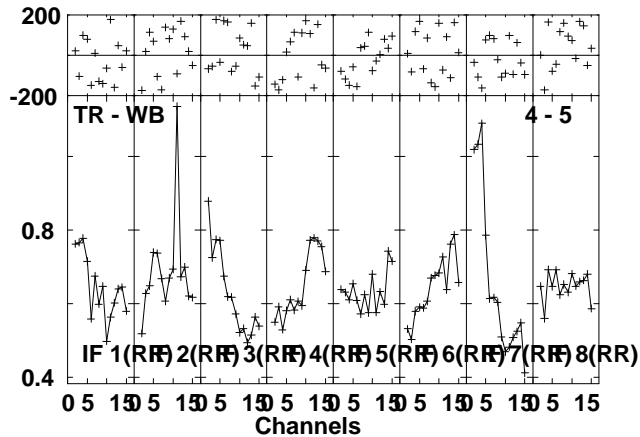
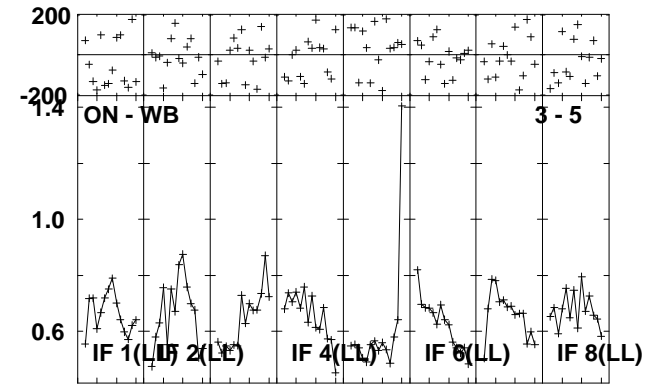
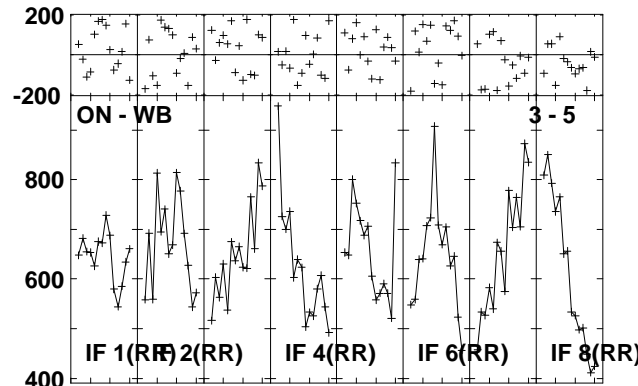
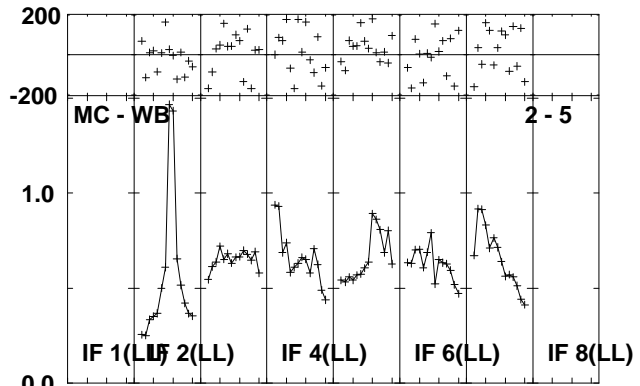
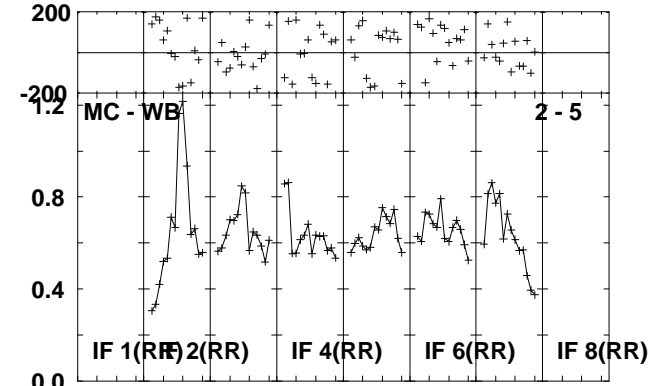
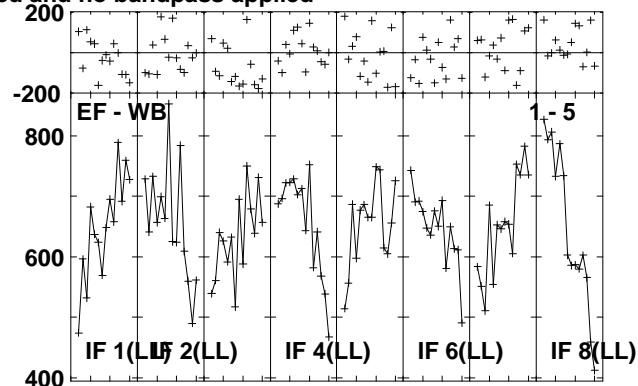
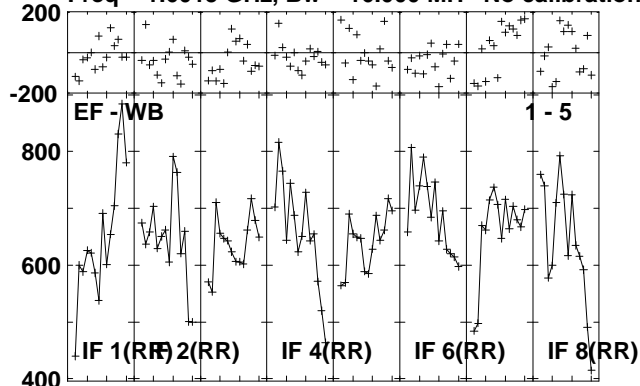

Lower frame: Micro Ampl Jy Top frame: Phas deg
Scalar averaged cross-power spectrum Several baselines displayed
Timerange: 00/08:45:02 to 00/08:49:38

Plot file version 90 created 07-OCT-2010 14:26:23

J134054 RSP03.UVDATA.1

Freq = 1.6015 GHz, Bw = 16.000 MH No calibration applied and no bandpass applied

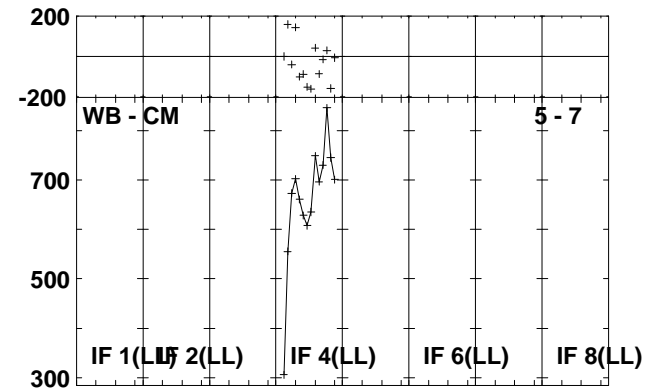
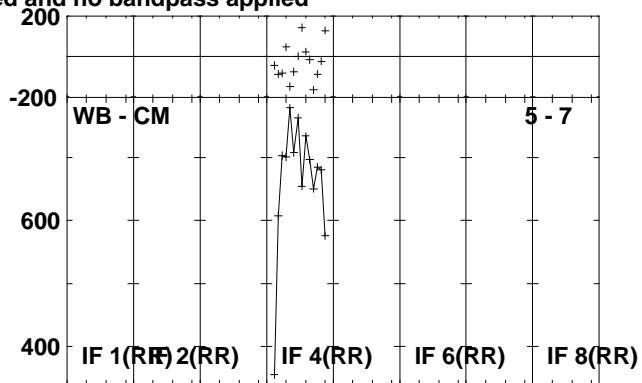
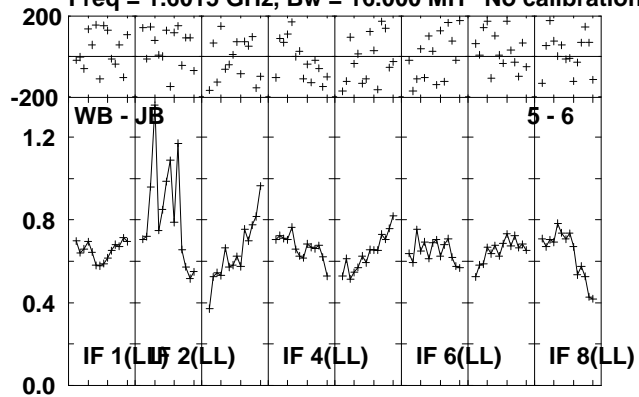

Lower frame: Milli Ampl Jy Top frame: Phas deg
Scalar averaged cross-power spectrum Several baselines displayed
Timerange: 00/08:45:02 to 00/08:49:38

Plot file version 91 created 07-OCT-2010 14:26:24

CAL1 RSP03.UVDATA.1

Freq = 1.6015 GHz, Bw = 16.000 MH No calibration applied and no bandpass applied

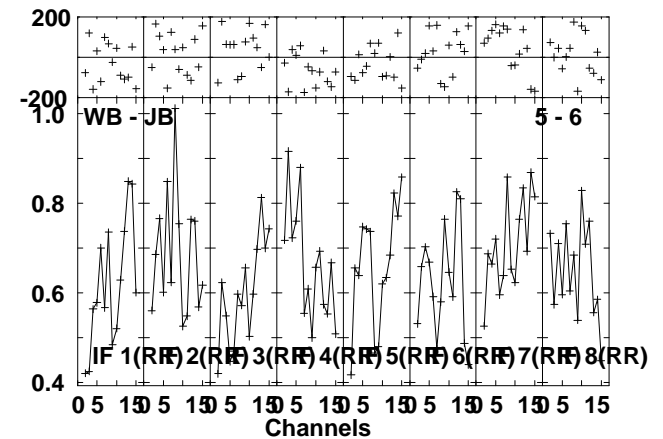
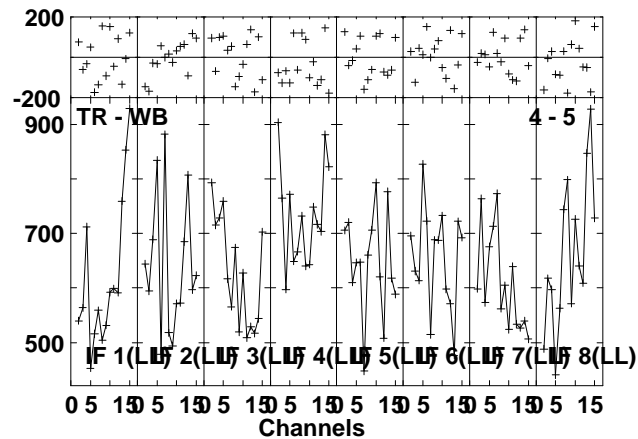
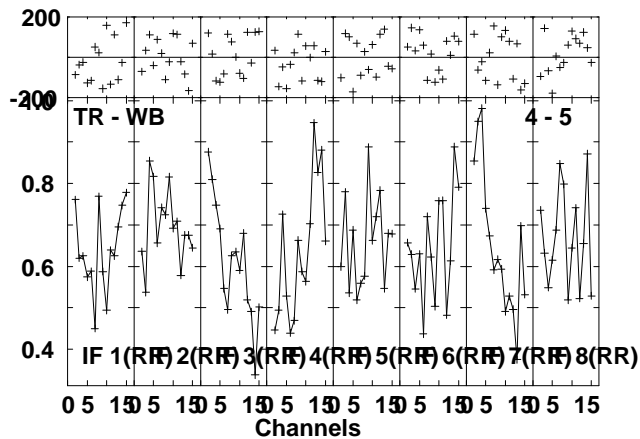
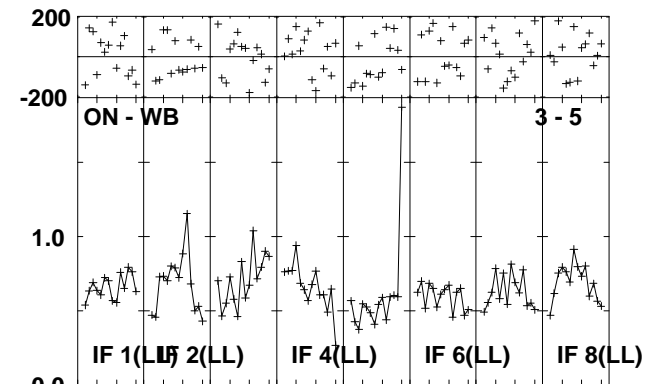
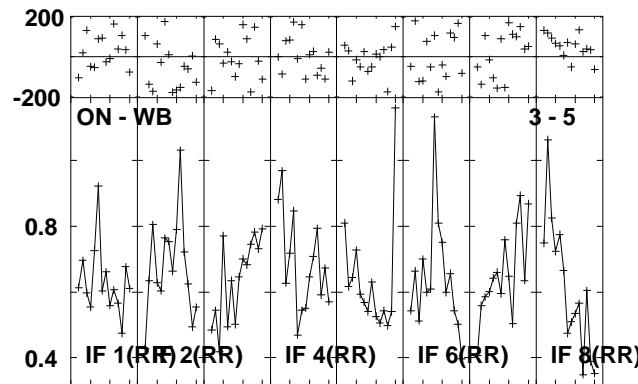
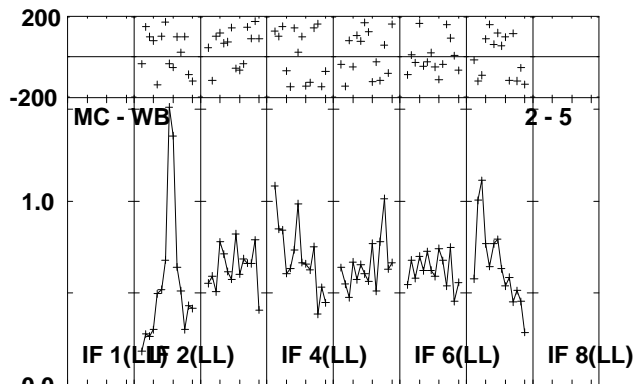
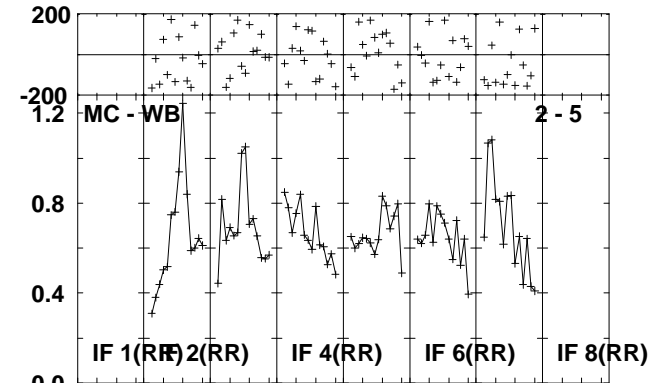
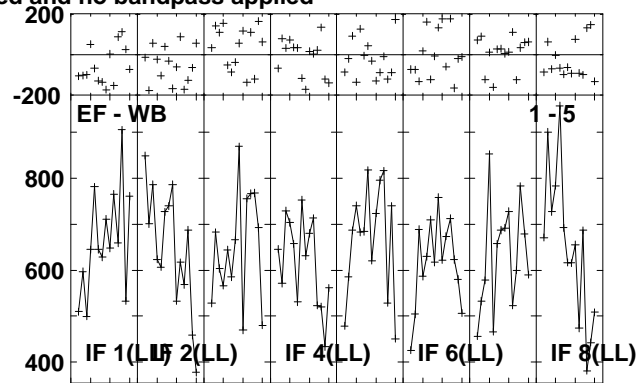
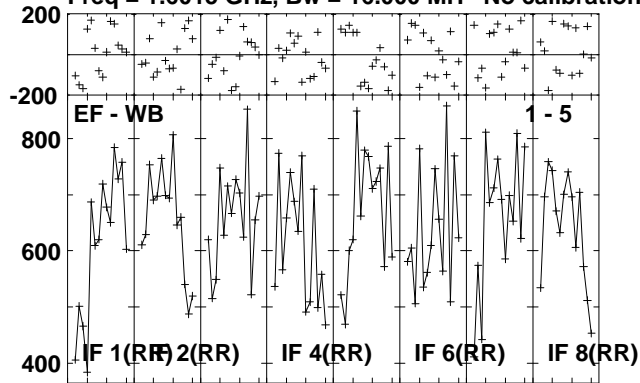

Lower frame: Micro Ampl Jy Top frame: Phas deg
Scalar averaged cross-power spectrum Several baselines displayed
Timerange: 00/08:49:42 to 00/08:50:54

Plot file version 92 created 07-OCT-2010 14:26:24

CAL1 RSP03.UVDATA.1

Freq = 1.6015 GHz, Bw = 16.000 MH No calibration applied and no bandpass applied

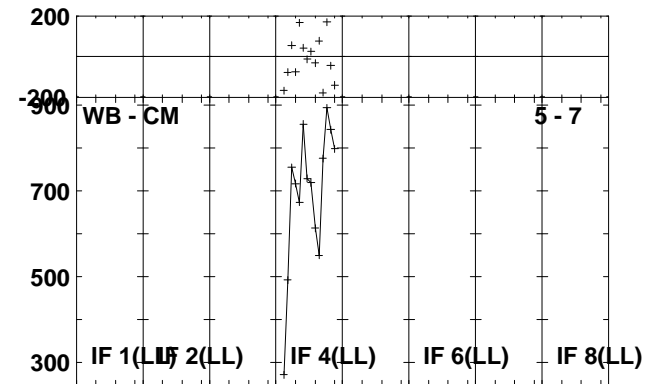
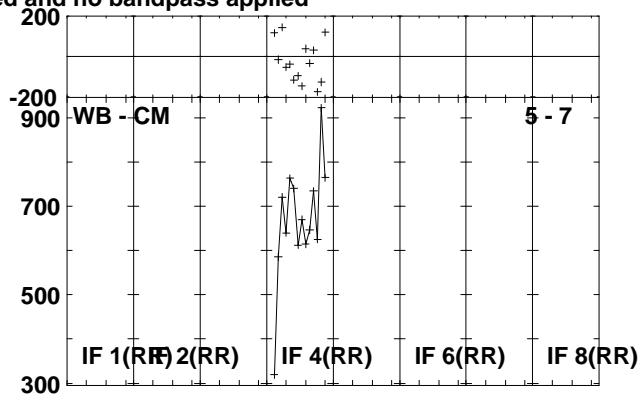
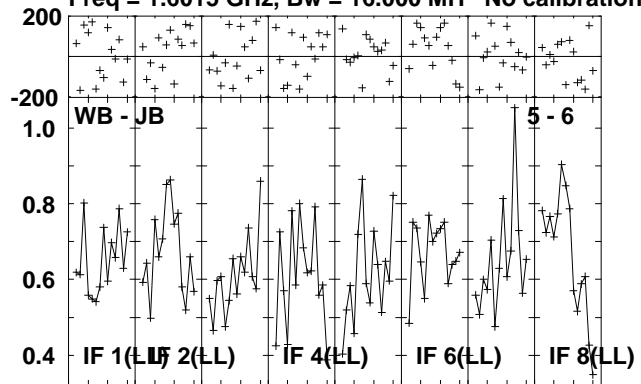

Lower frame: Milli Ampl Jy Top frame: Phas deg
Scalar averaged cross-power spectrum Several baselines displayed
Timerange: 00/08:49:42 to 00/08:50:54

Plot file version 93 created 07-OCT-2010 14:26:24
 J1345+44 RSP03.UVDATA.1

Freq = 1.6015 GHz, Bw = 16.000 MH No calibration applied and no bandpass applied

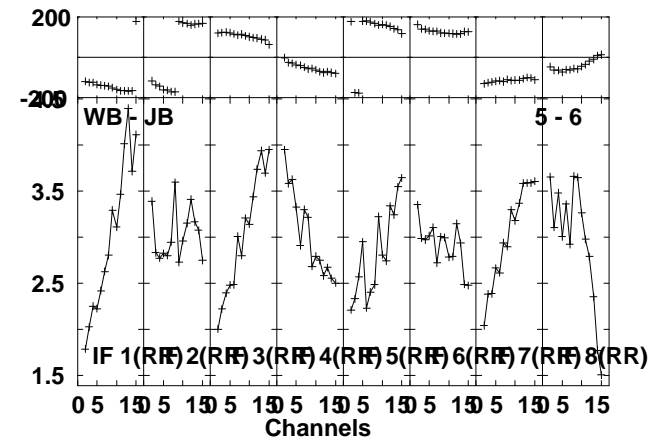
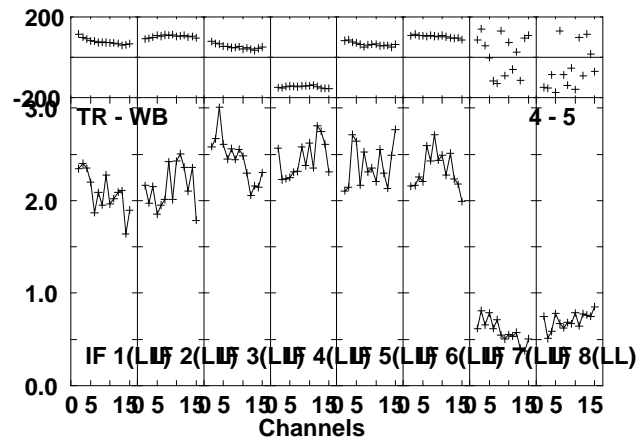
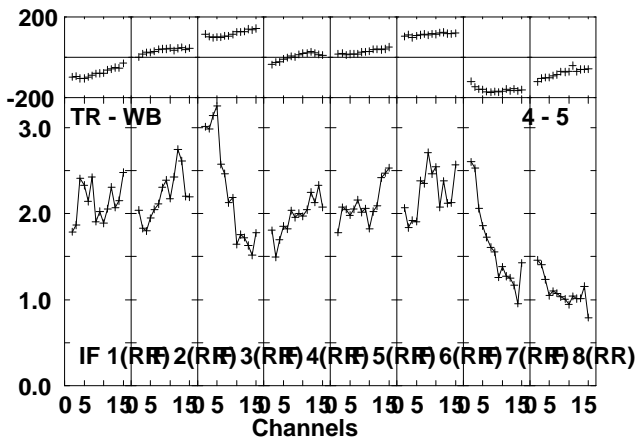
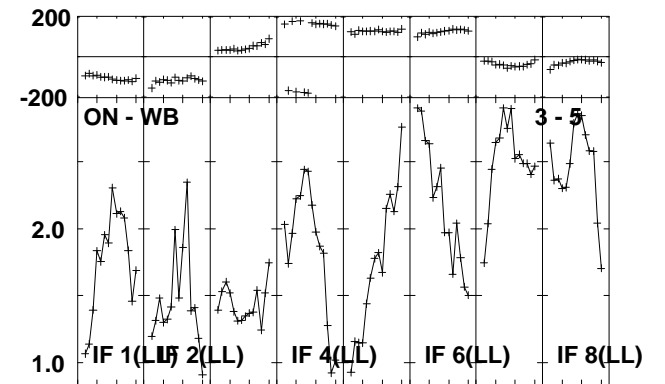
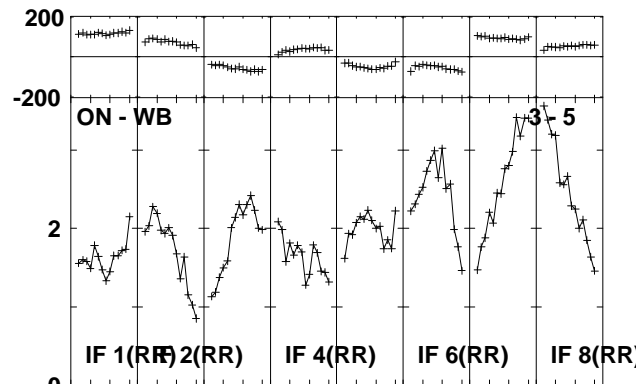
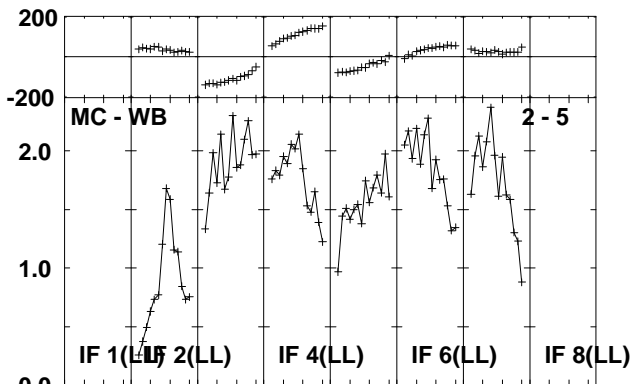
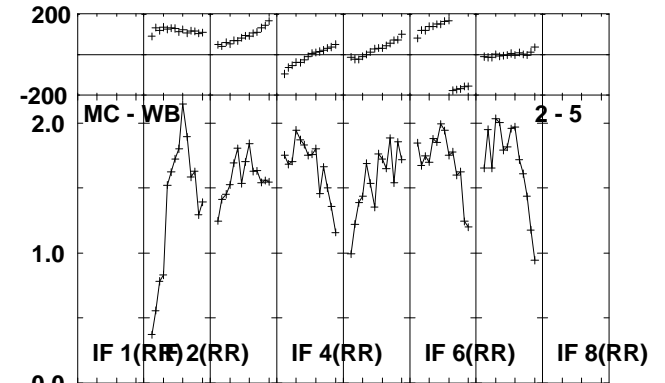
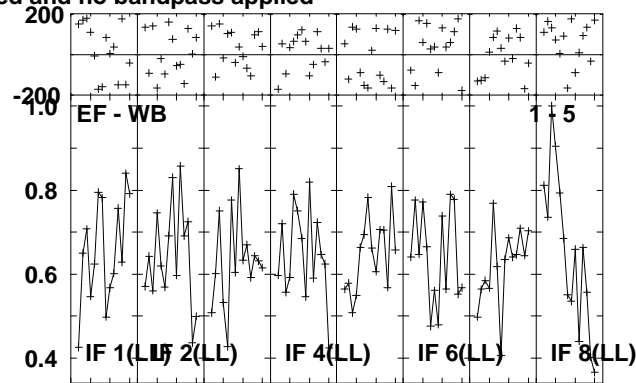
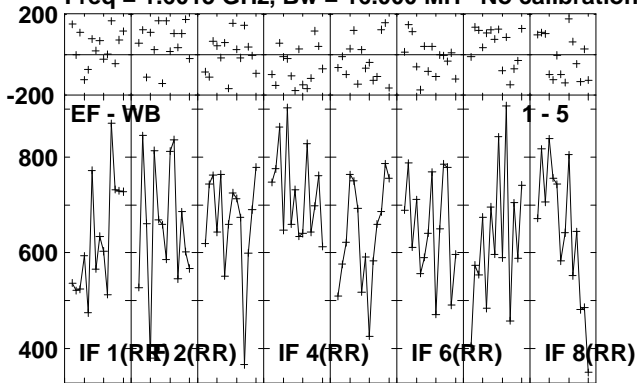

Lower frame: Micro Ampl Jy Top frame: Phas deg
 Scalar averaged cross-power spectrum Several baselines displayed
 Timerange: 00/08:50:58 to 00/08:52:22

Plot file version 94 created 07-OCT-2010 14:26:25

J1345+44 RSP03.UVDATA.1

Freq = 1.6015 GHz, Bw = 16.000 MH No calibration applied and no bandpass applied

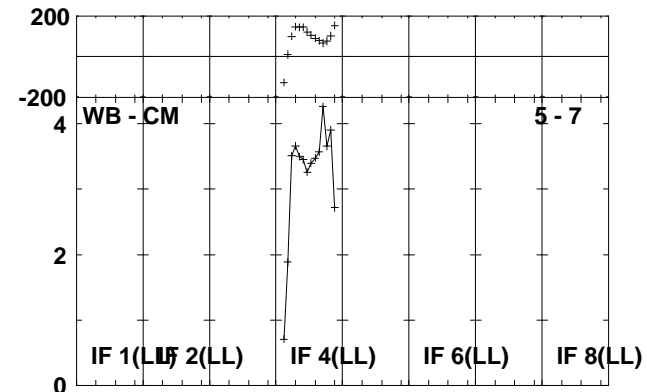
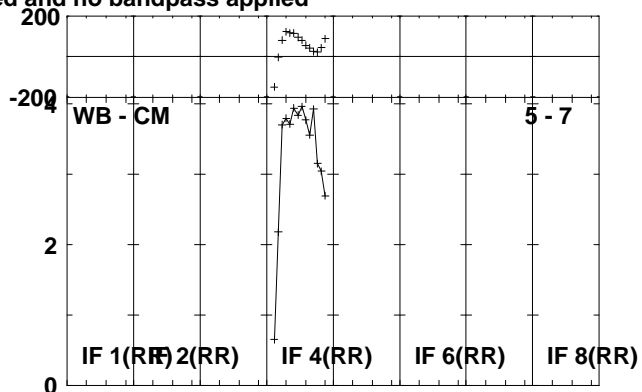
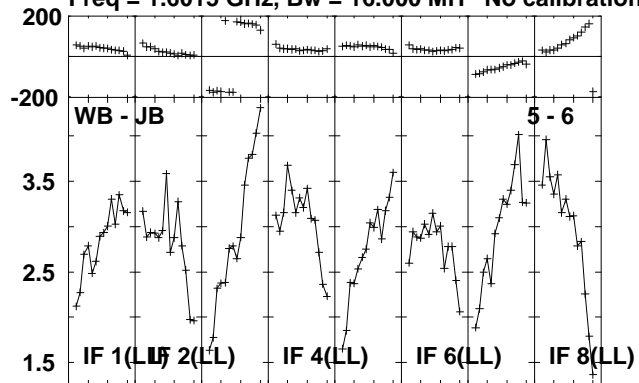

Lower frame: Milli Ampl Jy Top frame: Phas deg
Scalar averaged cross-power spectrum Several baselines displayed
Timerange: 00/08:50:58 to 00/08:52:22

Plot file version 95 created 07-OCT-2010 14:26:25

J134054 RSP03.UVDATA.1

Freq = 1.6015 GHz, Bw = 16.000 MH No calibration applied and no bandpass applied

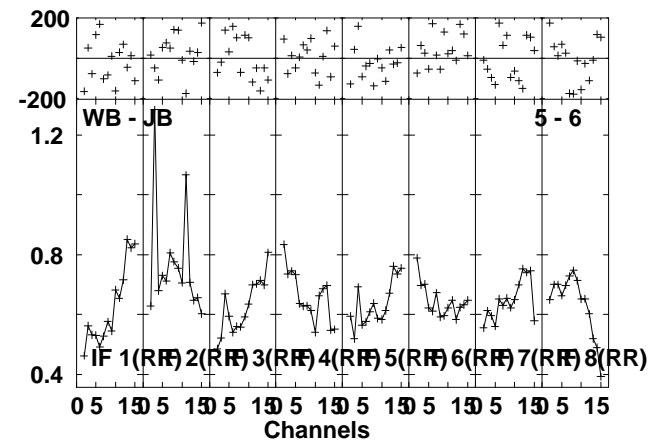
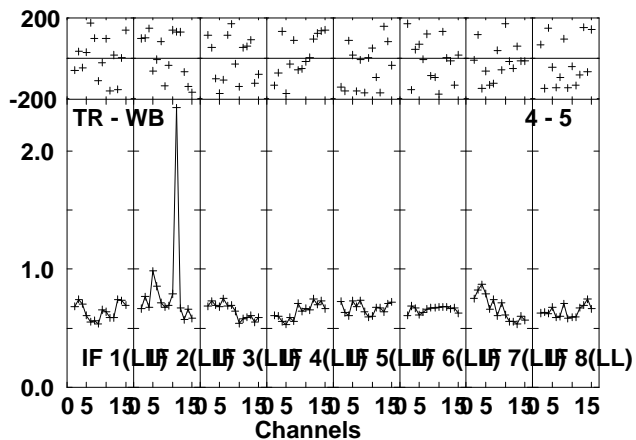
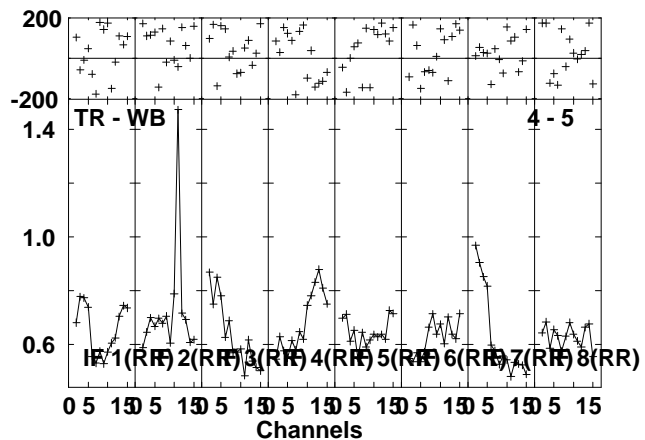
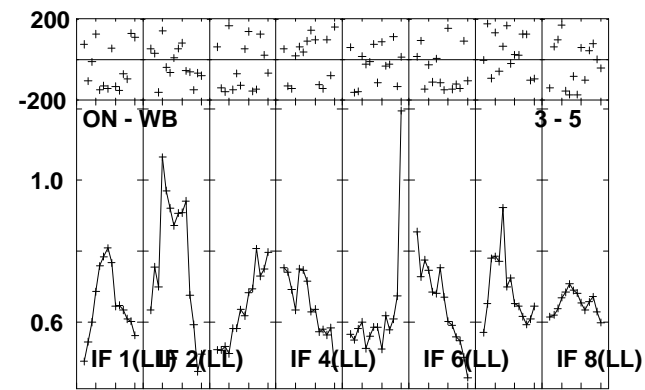
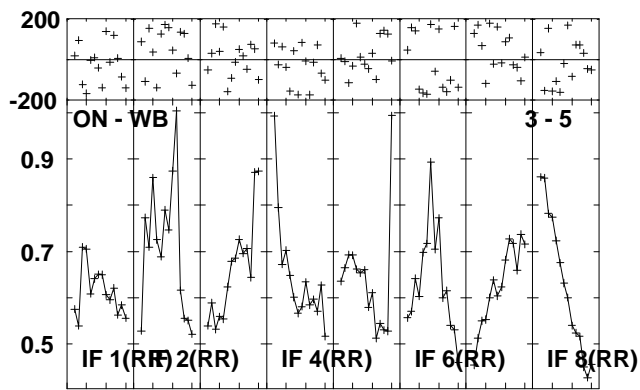
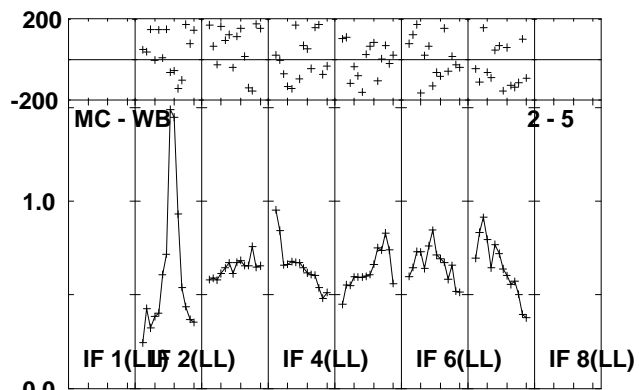
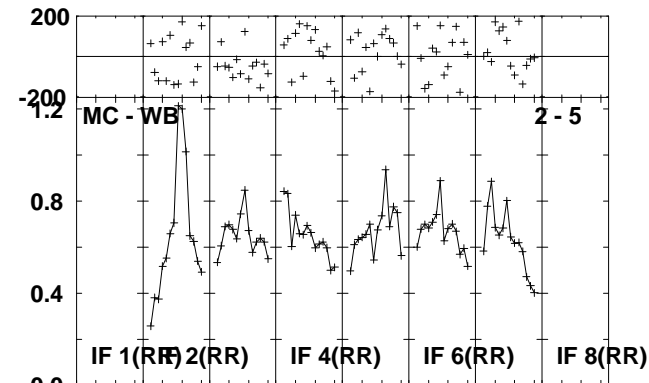
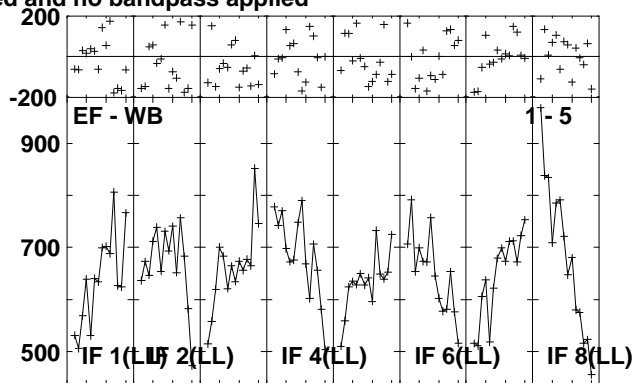
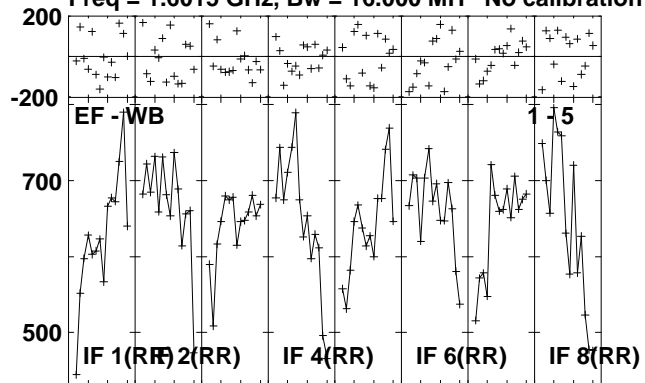

Lower frame: Micro Ampl Jy Top frame: Phas deg
Scalar averaged cross-power spectrum Several baselines displayed
Timerange: 00/08:52:26 to 00/08:57:02

Plot file version 96 created 07-OCT-2010 14:26:26

J134054 RSP03.UVDATA.1

Freq = 1.6015 GHz, Bw = 16.000 MH No calibration applied and no bandpass applied

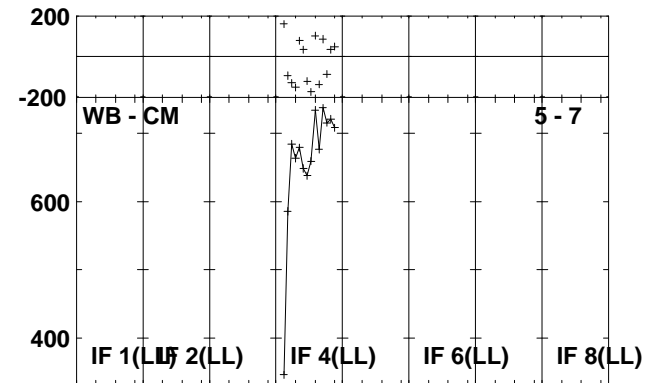
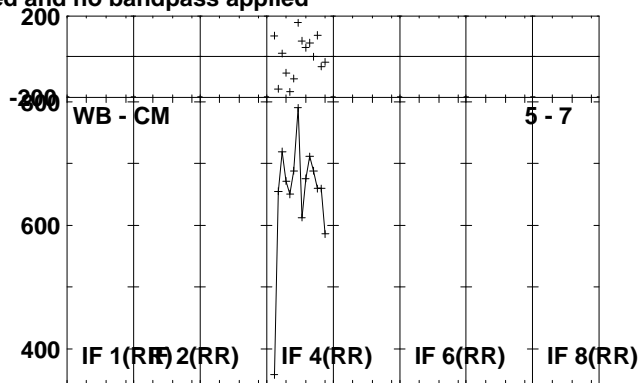
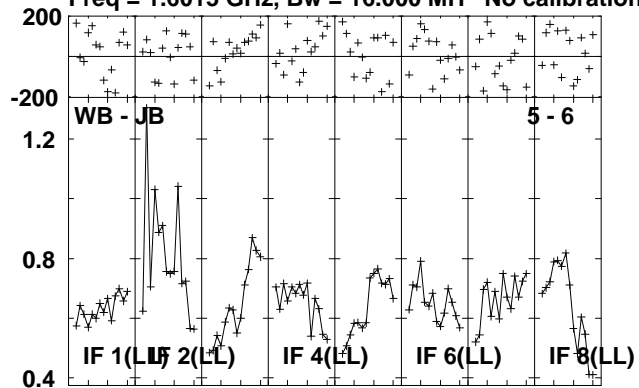

Lower frame: Milli Ampl Jy Top frame: Phas deg
Scalar averaged cross-power spectrum Several baselines displayed
Timerange: 00/08:52:26 to 00/08:57:02

Plot file version 97 created 07-OCT-2010 14:26:27

CAL2 RSP03.UVDATA.1

Freq = 1.6015 GHz, Bw = 16.000 MH No calibration applied and no bandpass applied

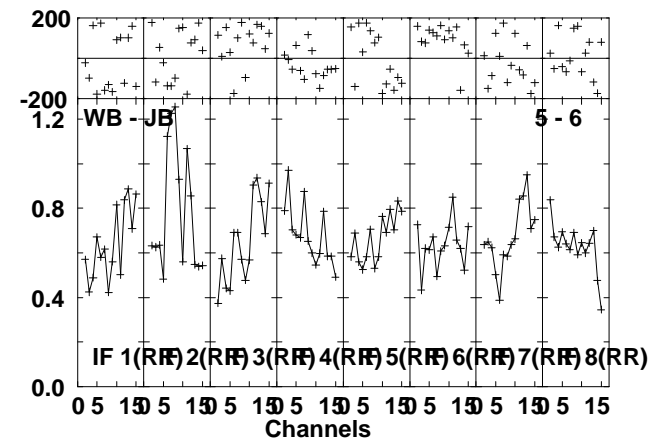
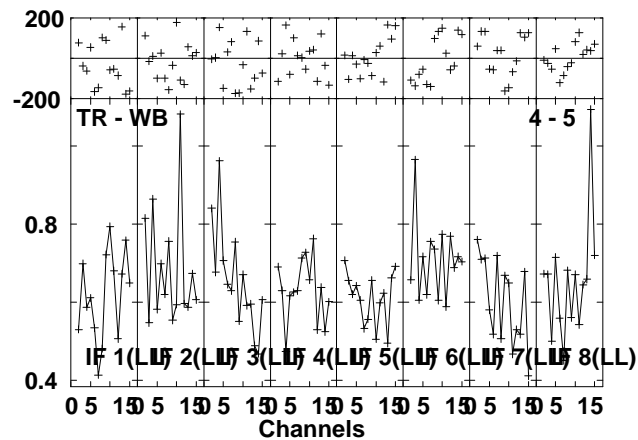
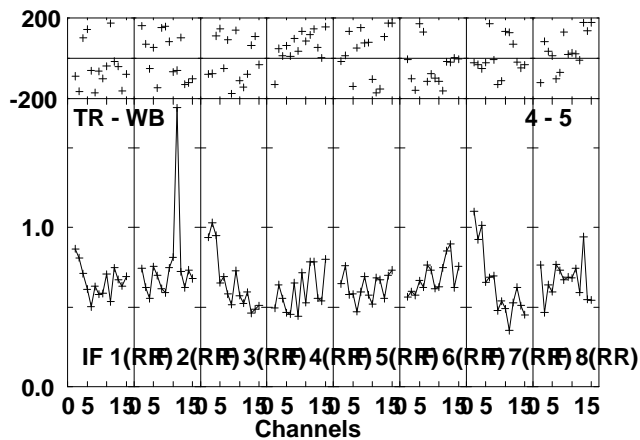
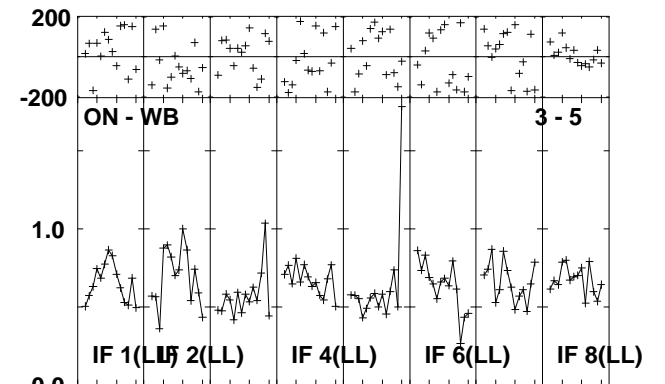
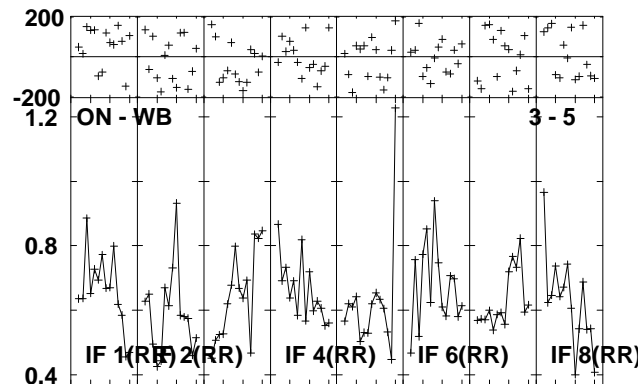
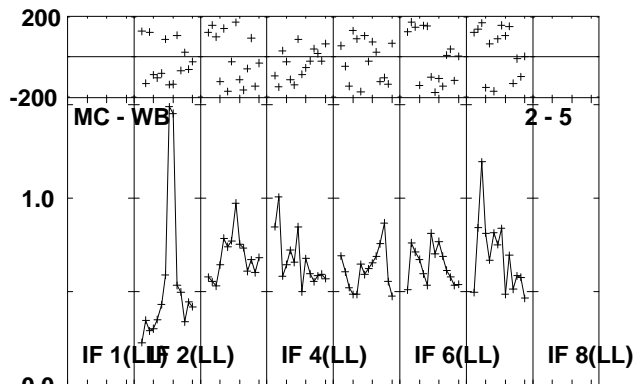
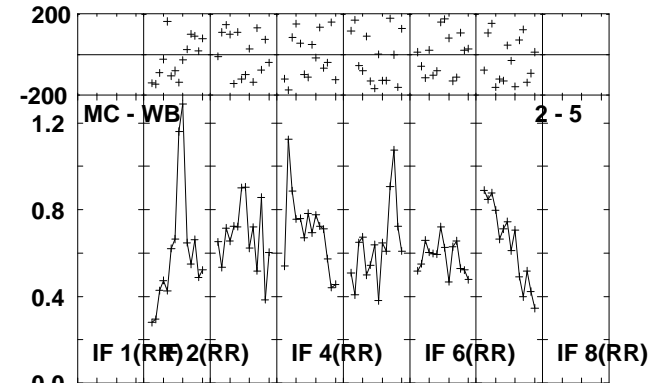
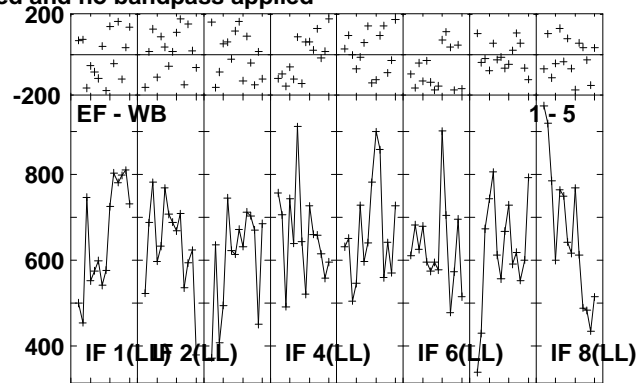
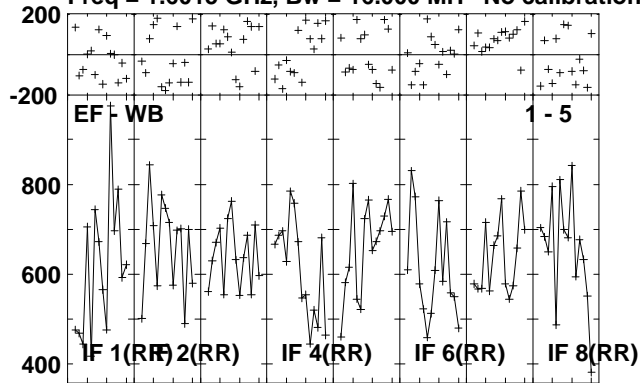

Lower frame: Micro Ampl Jy Top frame: Phas deg
Scalar averaged cross-power spectrum Several baselines displayed
Timerange: 00/08:57:06 to 00/08:58:18

Plot file version 98 created 07-OCT-2010 14:26:27

CAL2 RSP03.UVDATA.1

Freq = 1.6015 GHz, Bw = 16.000 MH No calibration applied and no bandpass applied

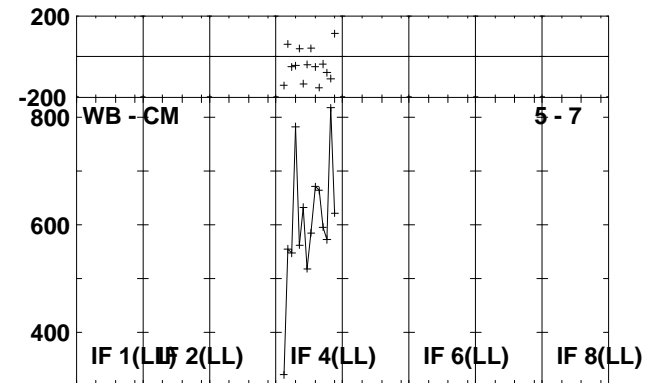
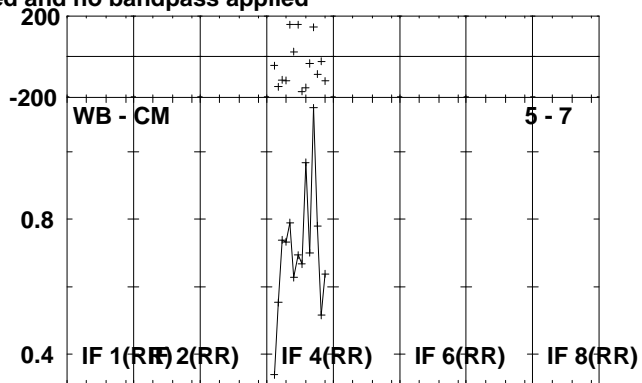
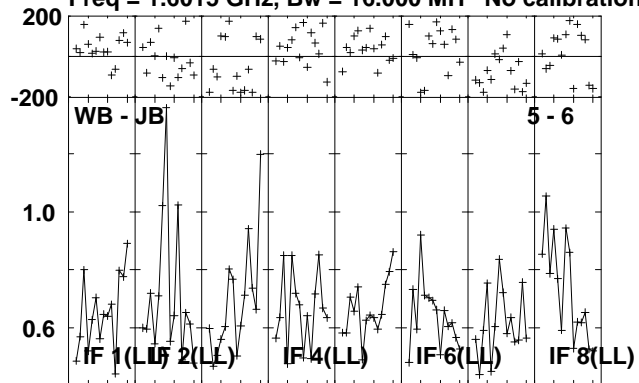

Lower frame: Milli Ampl Jy Top frame: Phas deg
Scalar averaged cross-power spectrum Several baselines displayed
Timerange: 00/08:57:06 to 00/08:58:18

Plot file version 99 created 07-OCT-2010 14:26:27

J1345+44 RSP03.UVDATA.1

Freq = 1.6015 GHz, Bw = 16.000 MH No calibration applied and no bandpass applied

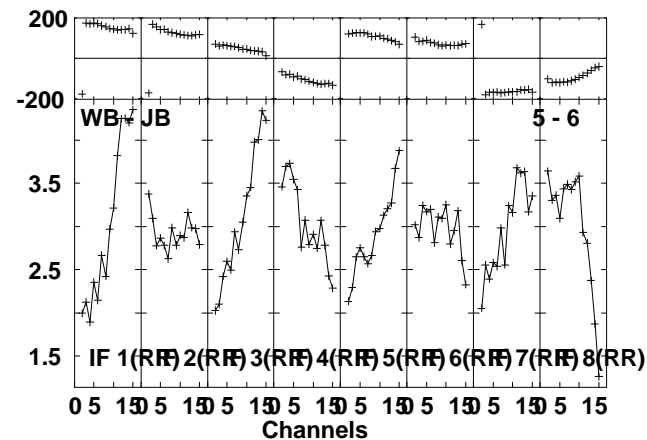
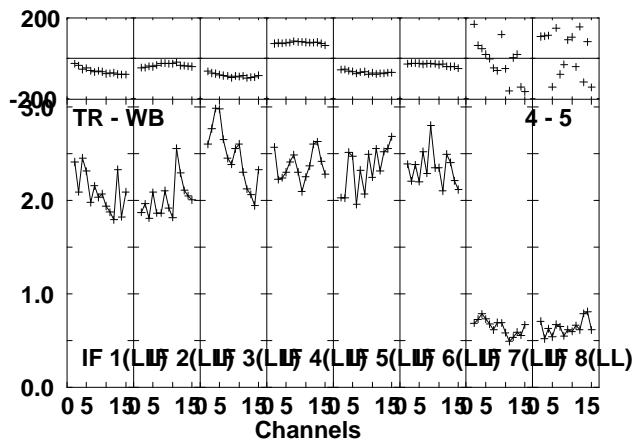
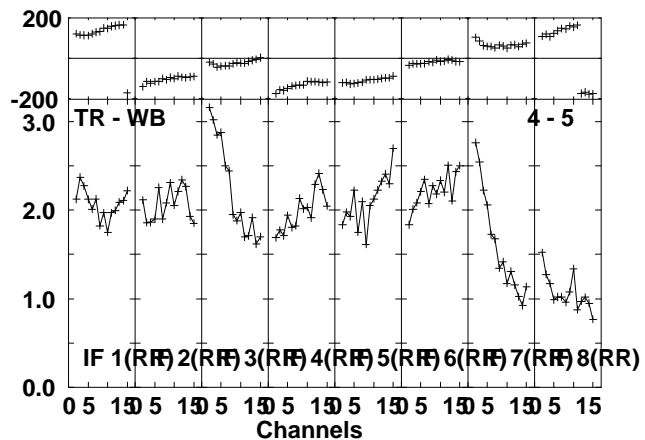
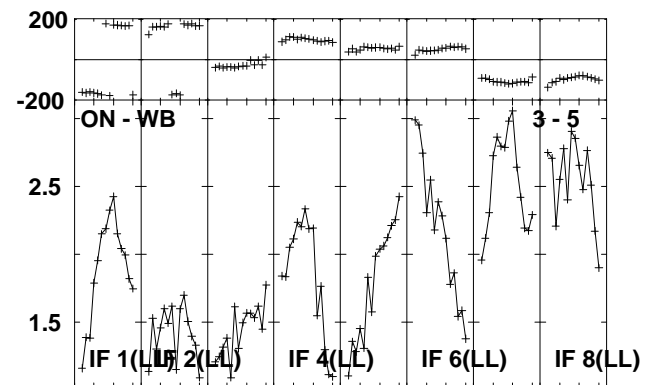
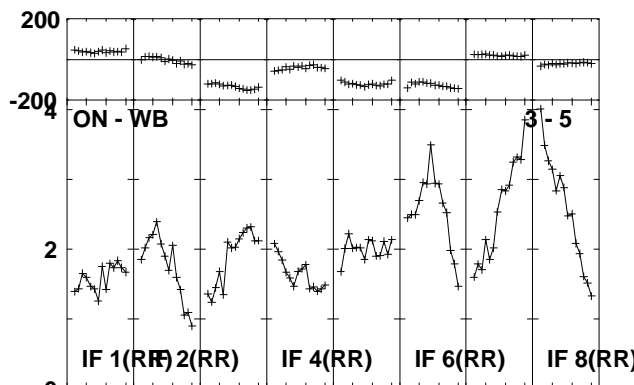
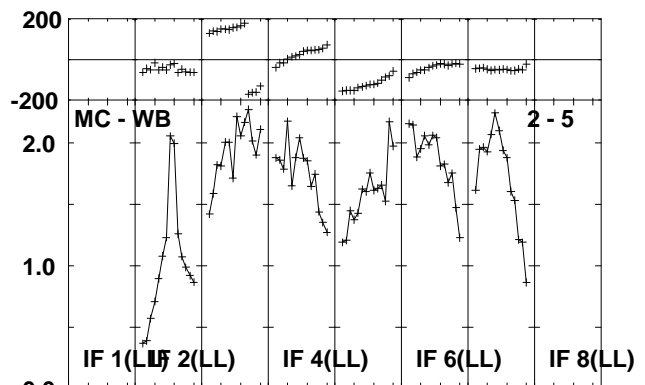
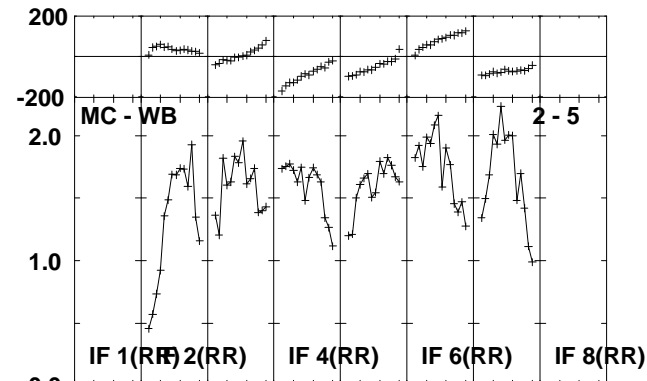
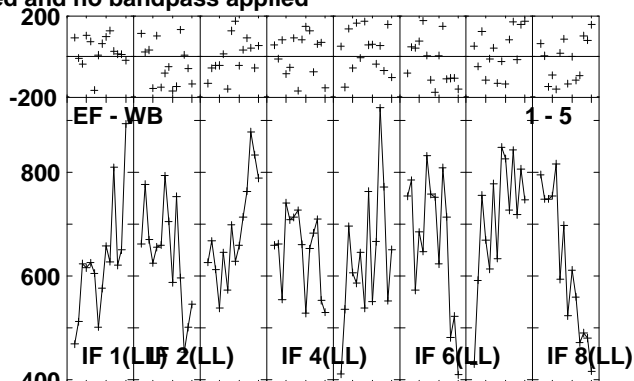
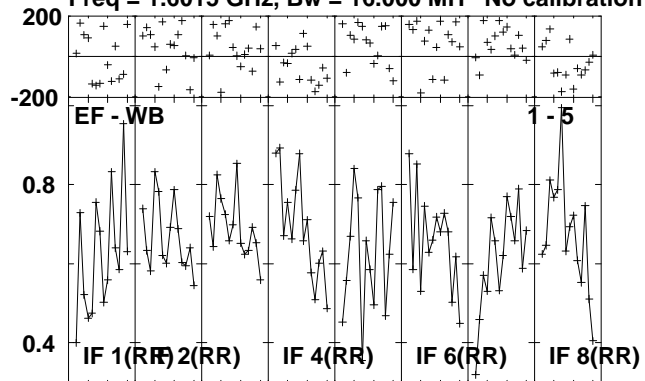

Lower frame: Milli Ampl Jy Top frame: Phas deg
Scalar averaged cross-power spectrum Several baselines displayed
Timerange: 00/08:59:02 to 00/08:59:58

Plot file version 100 created 07-OCT-2010 14:26:27

J1345+44 RSP03.UVDATA.1

Freq = 1.6015 GHz, Bw = 16.000 MH No calibration applied and no bandpass applied

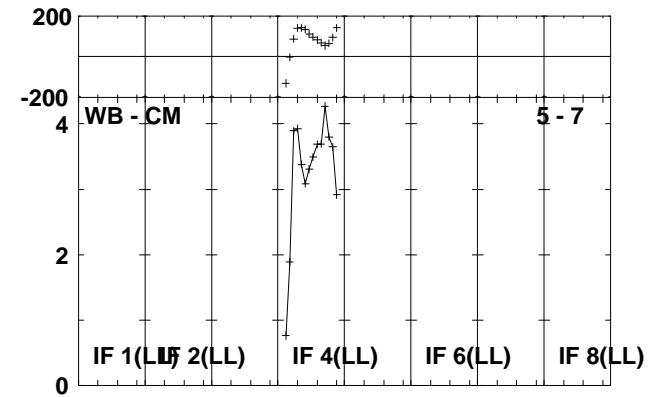
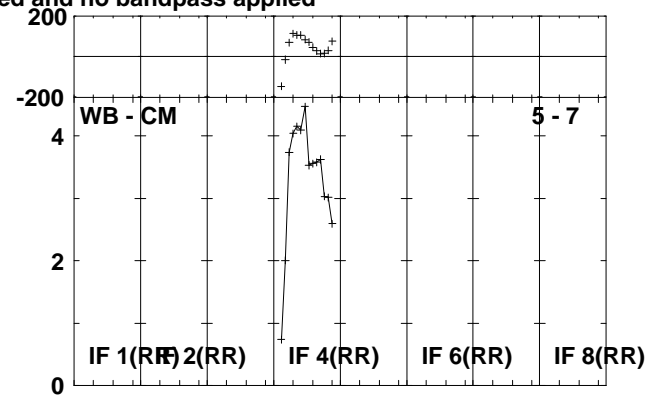
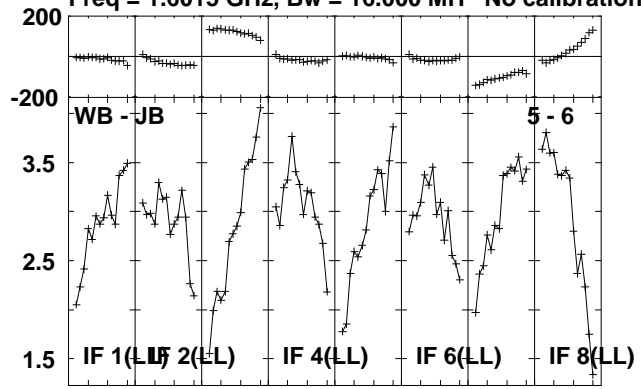

Lower frame: Milli Ampl Jy Top frame: Phas deg
Scalar averaged cross-power spectrum Several baselines displayed
Timerange: 00/08:59:02 to 00/08:59:58