

Plot file version 1 created 07-DEC-2009 16:05:37

SS433 RT006C.UVDATA.1

Freq = 4.9415 GHz, Bw = 16.000 MH No calibration applied and no bandpass applied

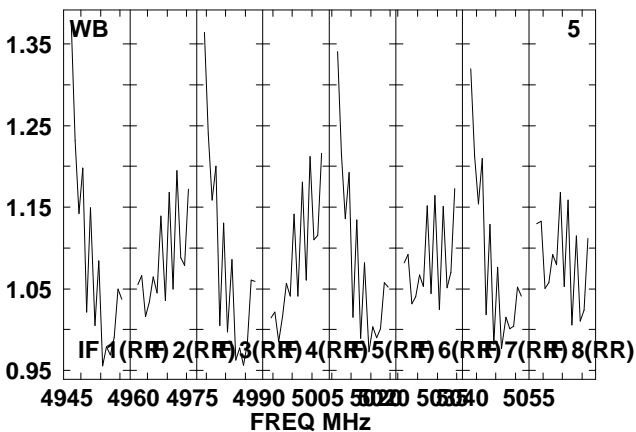
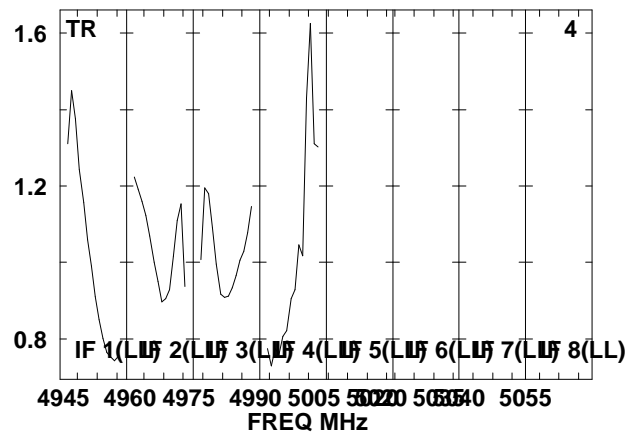
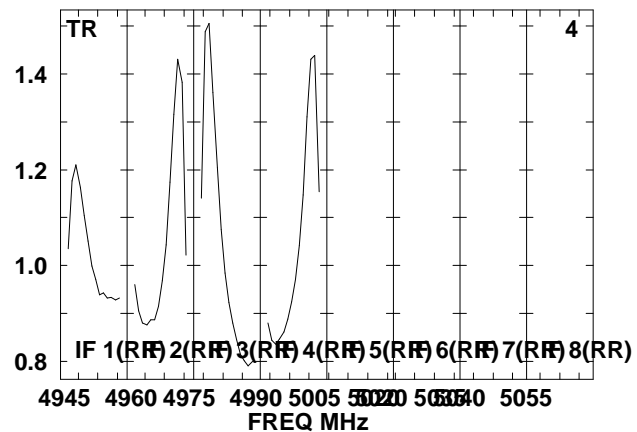
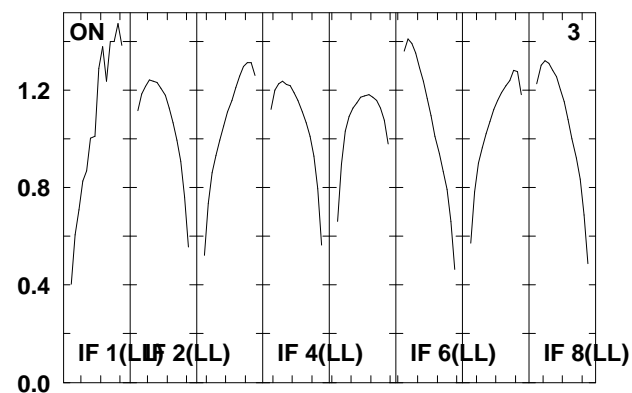
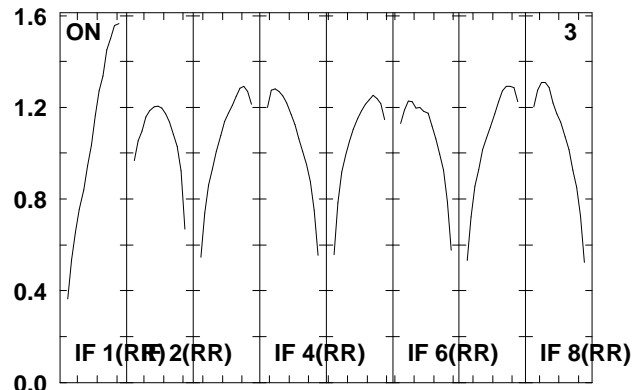
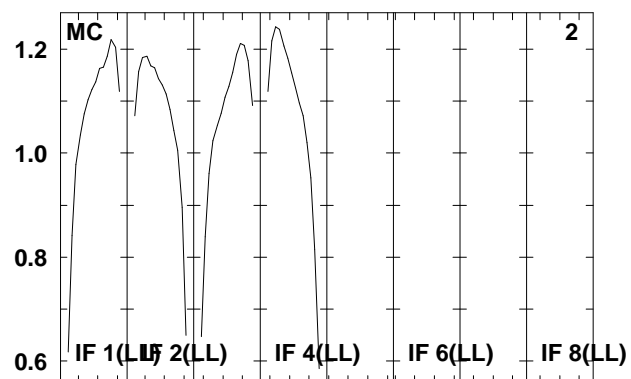
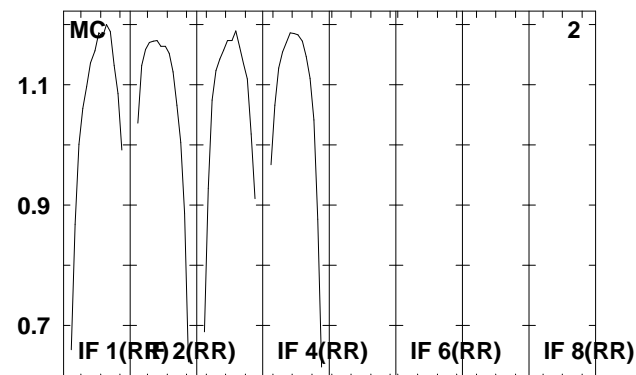
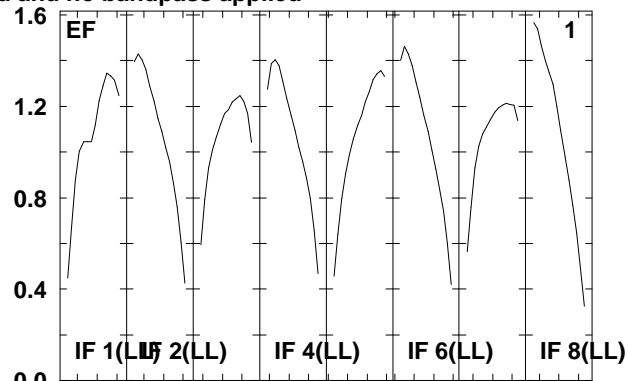
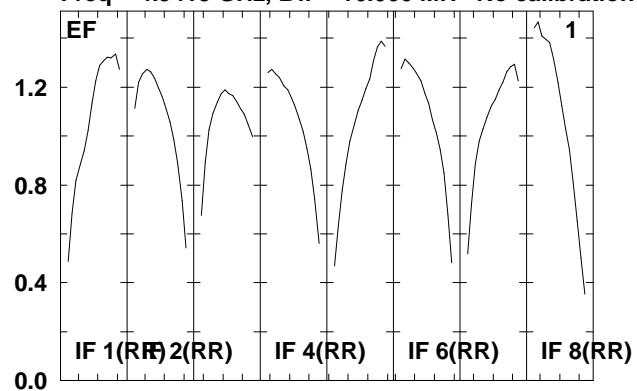

Lower frame: Real Jy

Total-power spectrum Antenna: \*

Timerange: 00/12:29:39 to 00/12:30:59

Plot file version 2 created 07-DEC-2009 16:05:38

SS433 RT006C.UVDATA.1

Freq = 4.9415 GHz, Bw = 16.000 MH No calibration applied and no bandpass applied

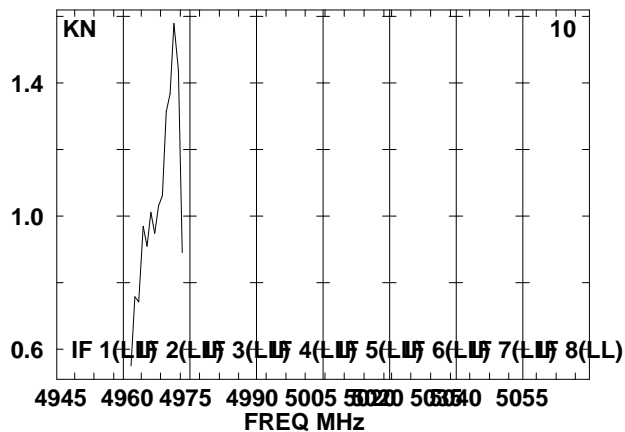
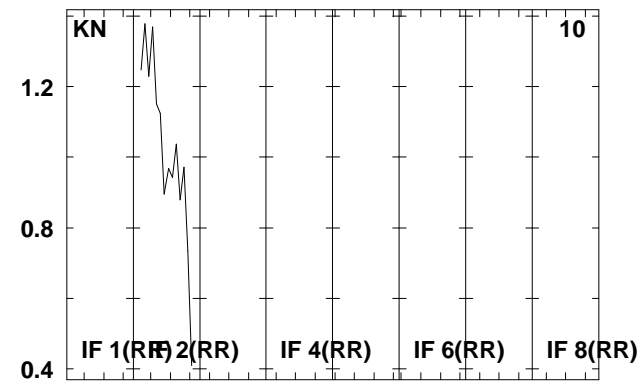
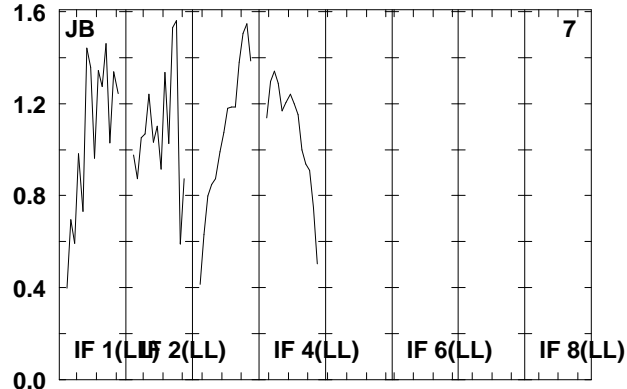
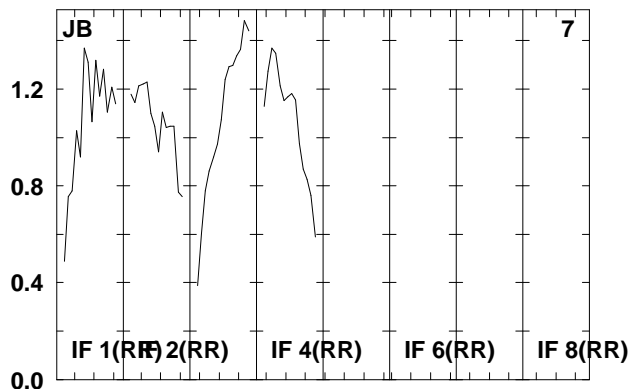
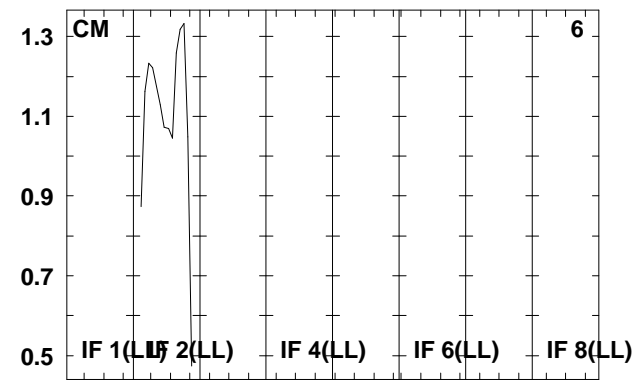
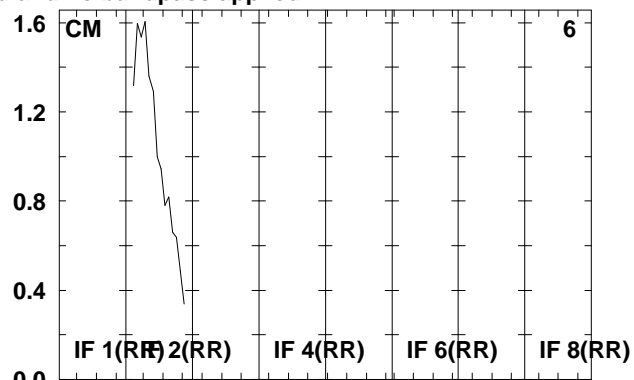
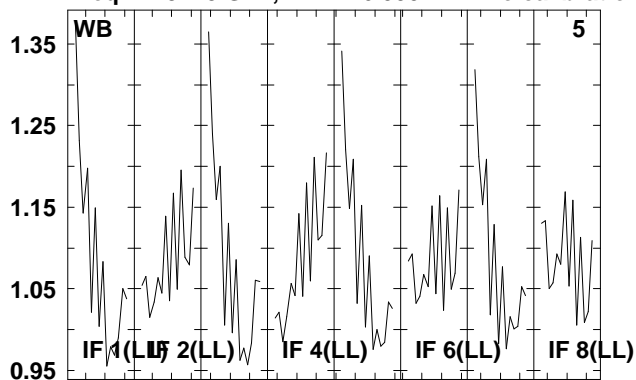

Lower frame: Real Jy

Total-power spectrum Antenna: \*

Timerange: 00/12:29:39 to 00/12:30:59

Plot file version 3 created 07-DEC-2009 16:05:38

J1912+05 RT006C.UVDATA.1

Freq = 4.9415 GHz, Bw = 16.000 MH No calibration applied and no bandpass applied

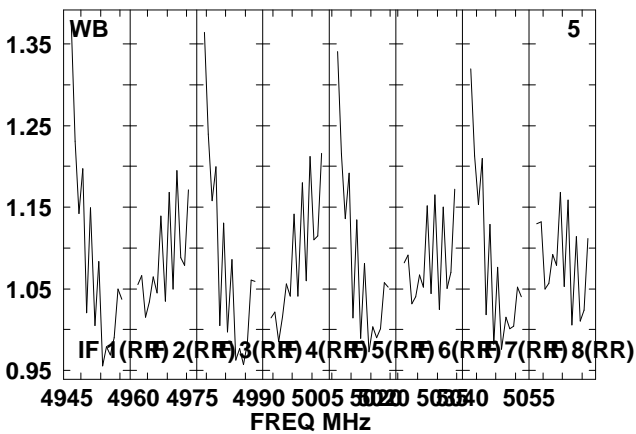
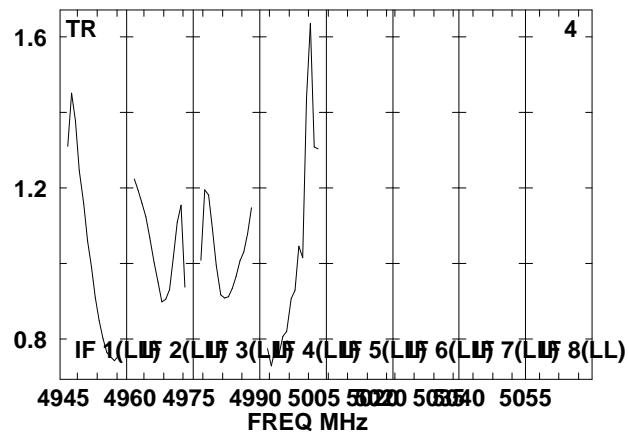
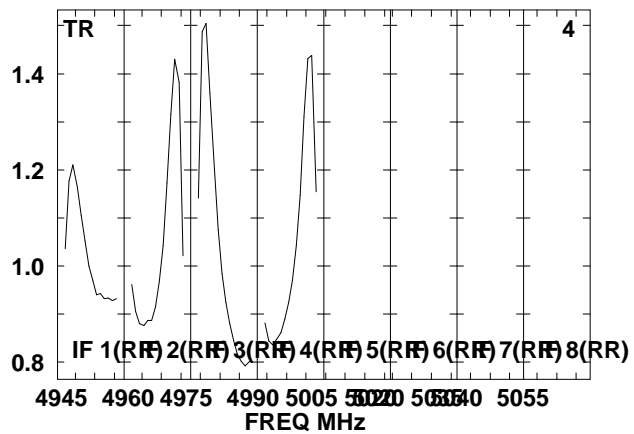
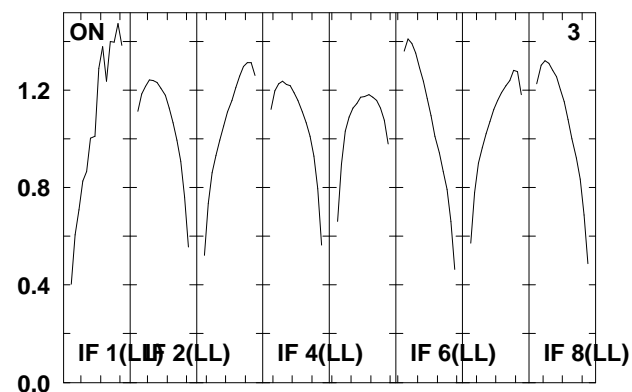
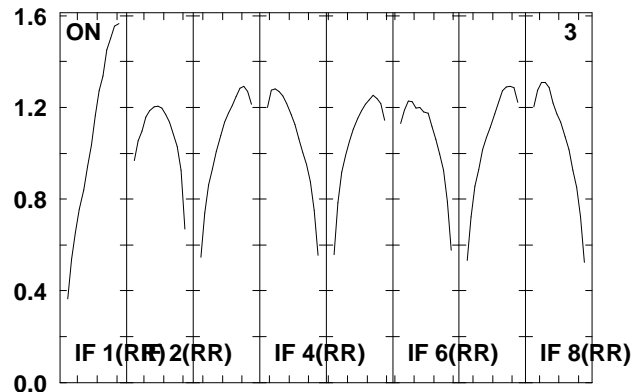
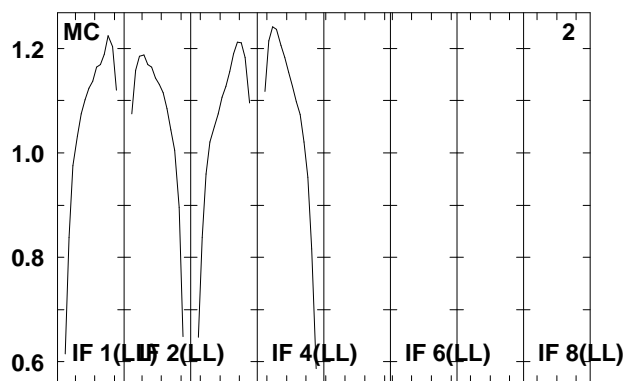
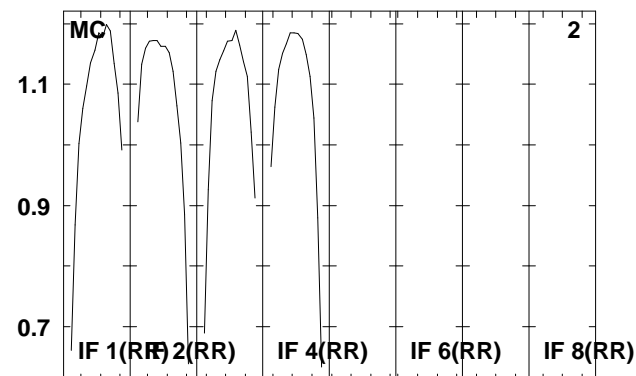
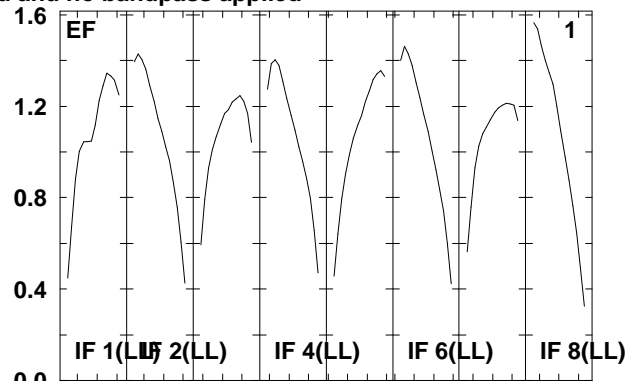
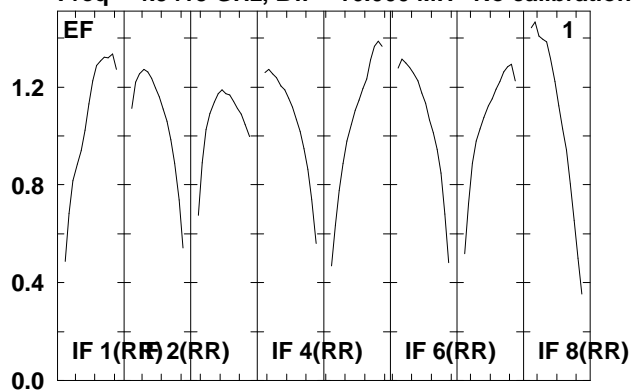

Lower frame: Real Jy

Total-power spectrum Antenna: \*

Timerange: 00/12:31:03 to 00/12:32:19

Plot file version 4 created 07-DEC-2009 16:05:38

J1912+05 RT006C.UVDATA.1

Freq = 4.9415 GHz, Bw = 16.000 MH No calibration applied and no bandpass applied

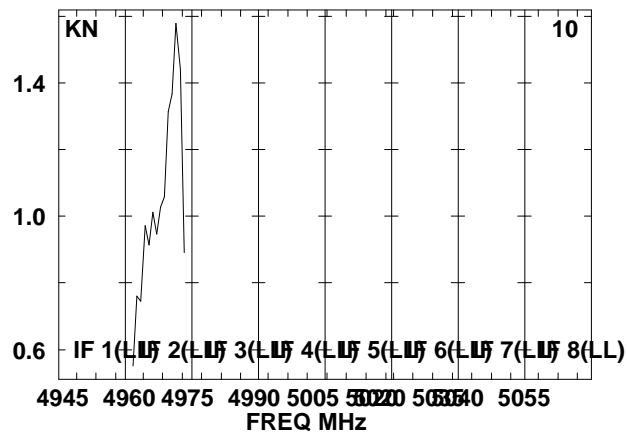
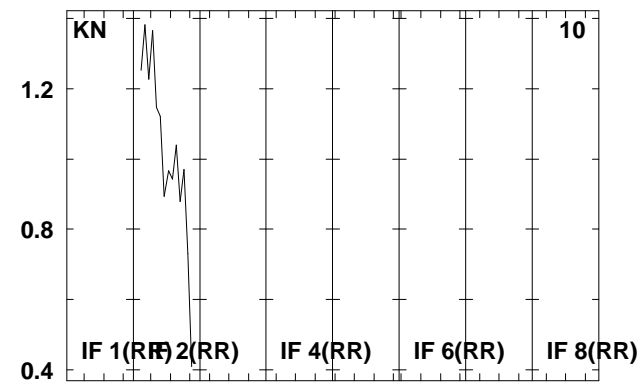
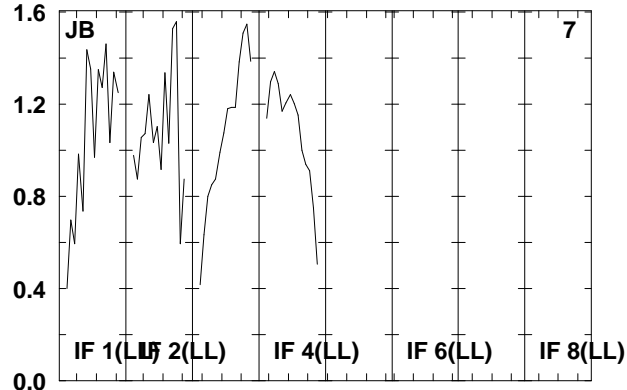
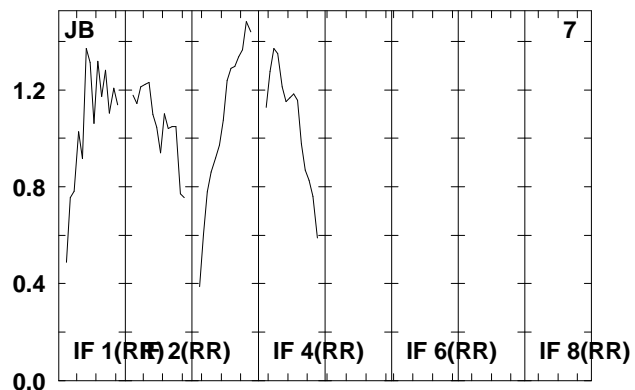
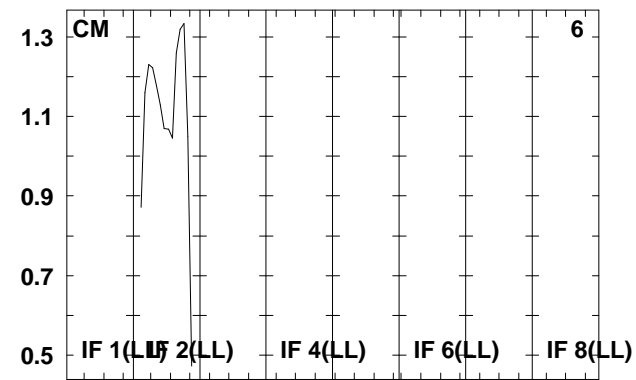
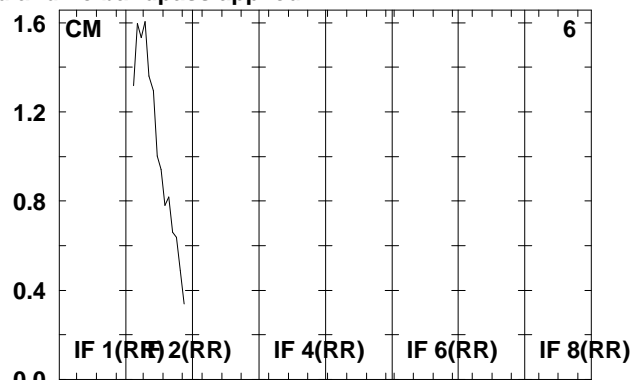
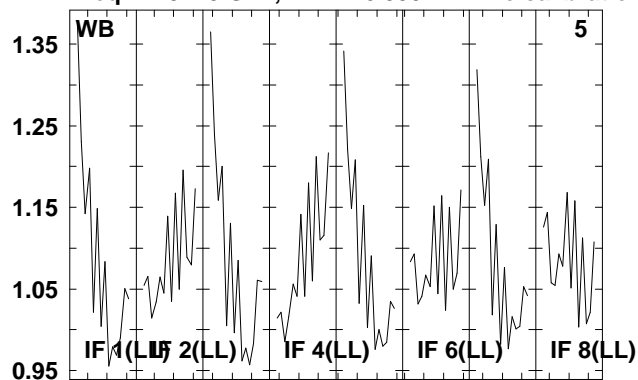

Lower frame: Real Jy

Total-power spectrum Antenna: \*

Timerange: 00/12:31:03 to 00/12:32:19

Plot file version 5 created 07-DEC-2009 16:05:38

SS433 RT006C.UVDATA.1

Freq = 4.9415 GHz, Bw = 16.000 MH No calibration applied and no bandpass applied

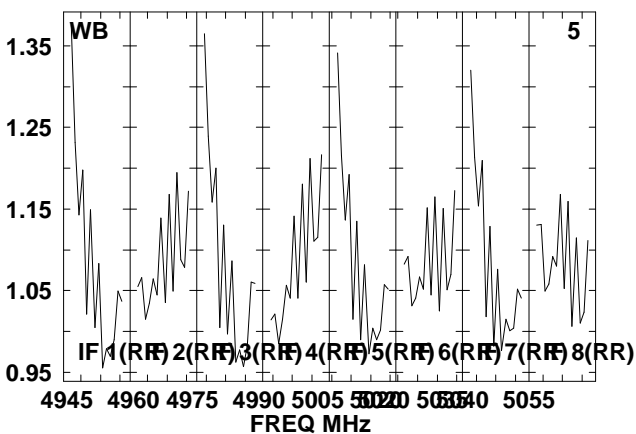
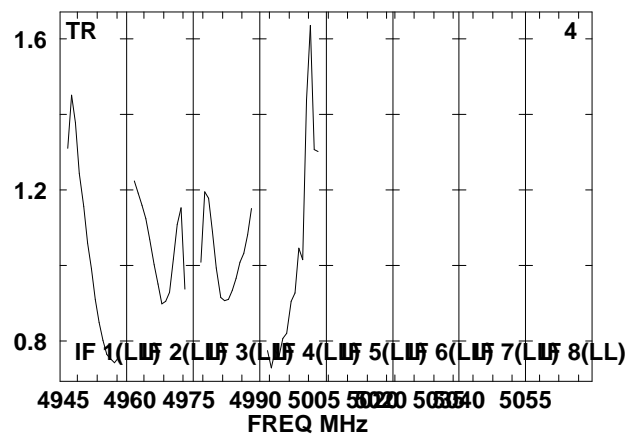
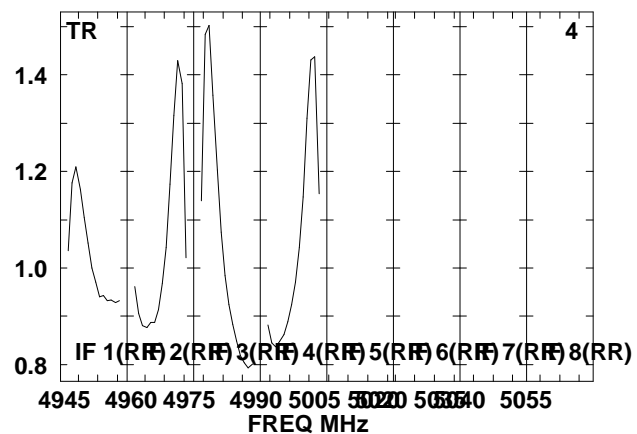
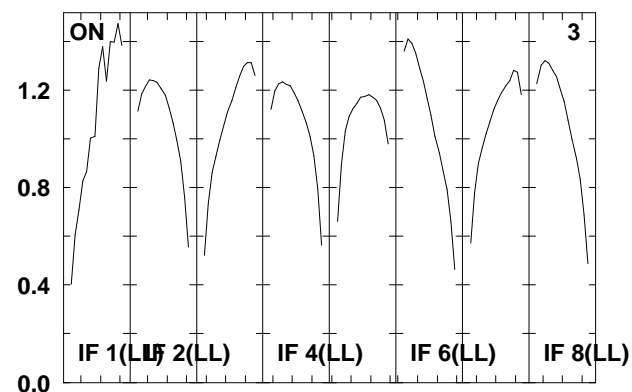
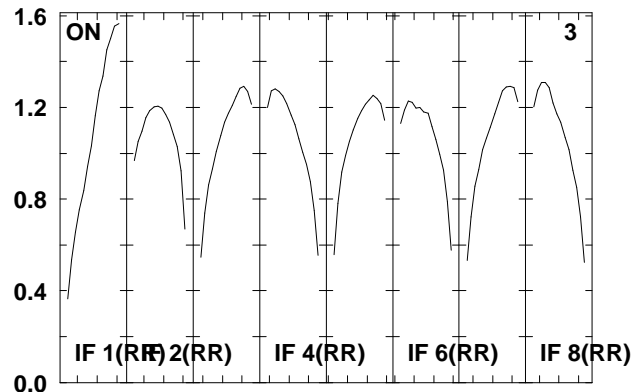
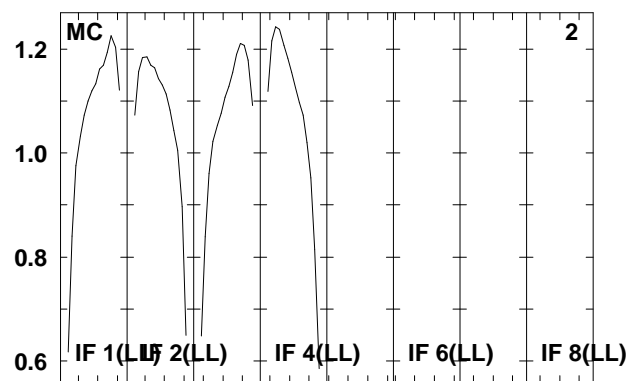
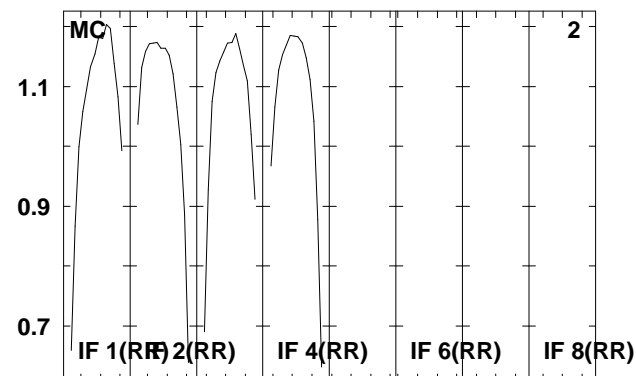
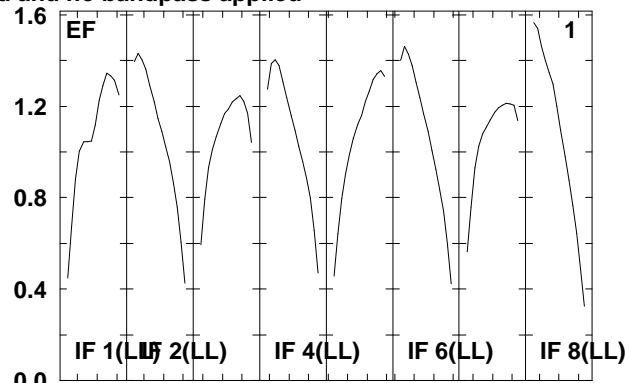
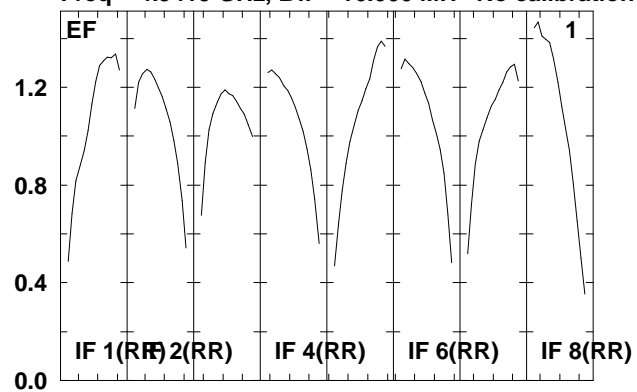

Lower frame: Real Jy  
Total-power spectrum Antenna: \*  
Timerange: 00/12:32:23 to 00/12:34:39

Plot file version 6 created 07-DEC-2009 16:05:38

SS433 RT006C.UVDATA.1

Freq = 4.9415 GHz, Bw = 16.000 MH No calibration applied and no bandpass applied

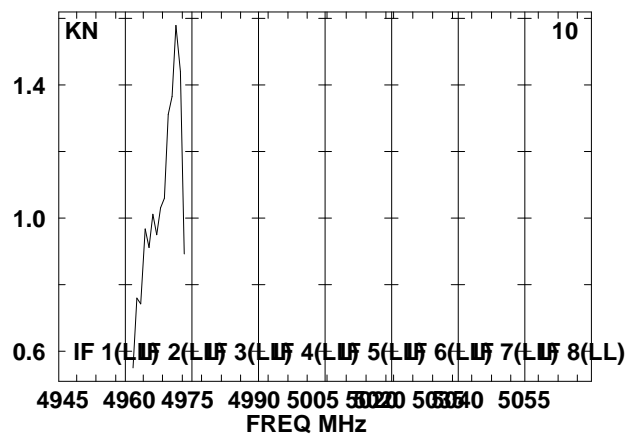
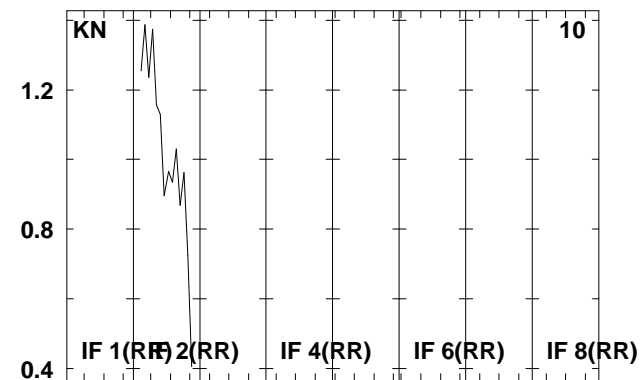
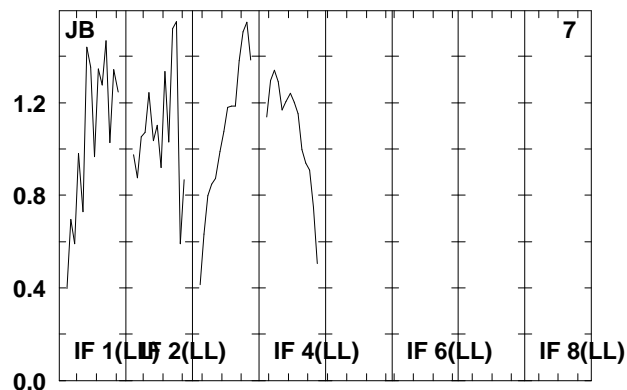
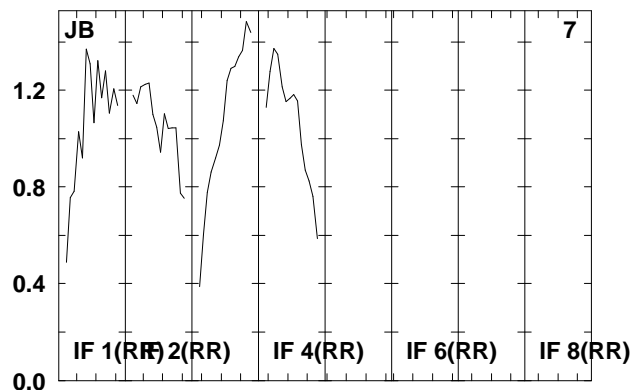
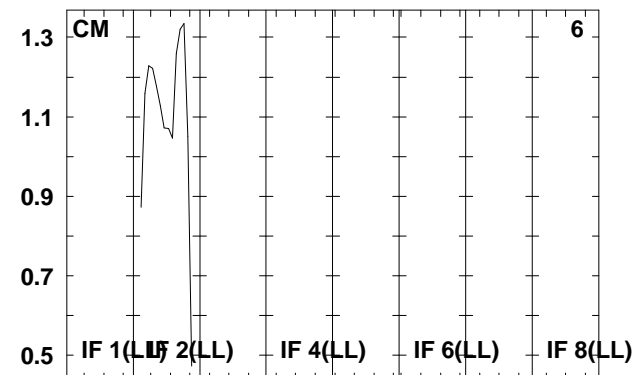
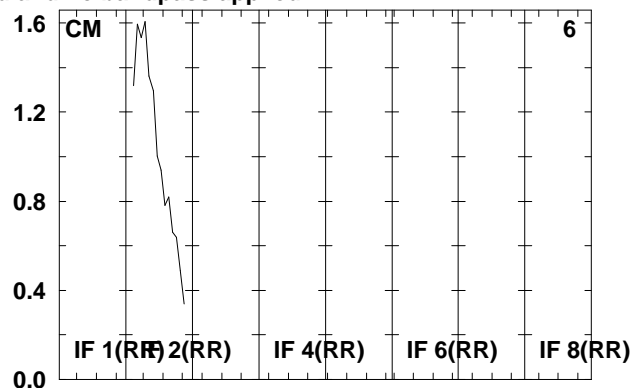
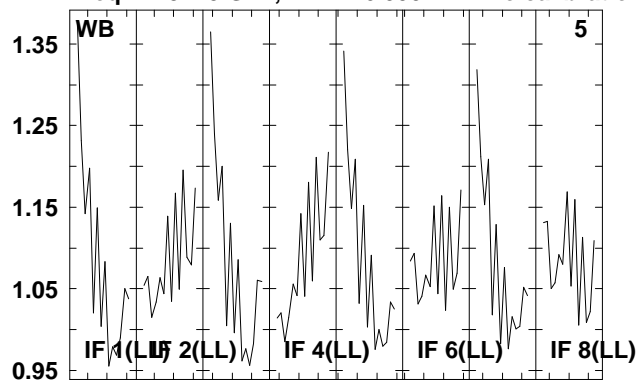

Lower frame: Real Jy

Total-power spectrum Antenna: \*

Timerange: 00/12:32:23 to 00/12:34:39

Plot file version 7 created 07-DEC-2009 16:05:39

J1912+05 RT006C.UVDATA.1

Freq = 4.9415 GHz, Bw = 16.000 MH No calibration applied and no bandpass applied

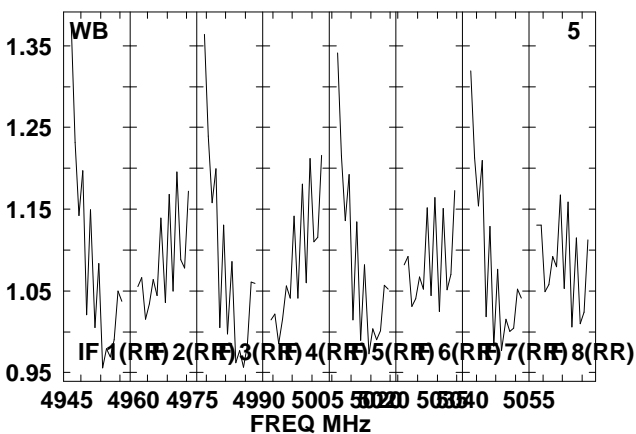
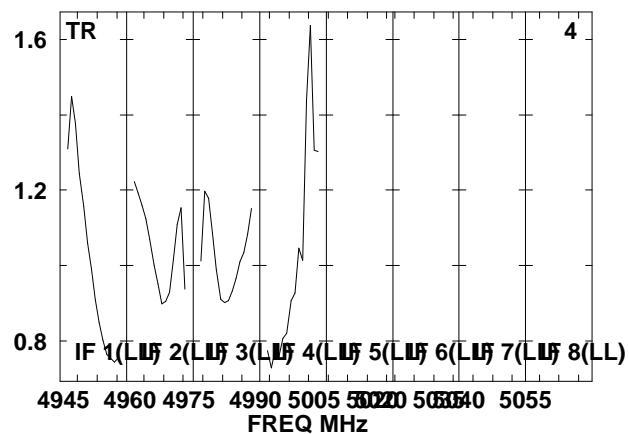
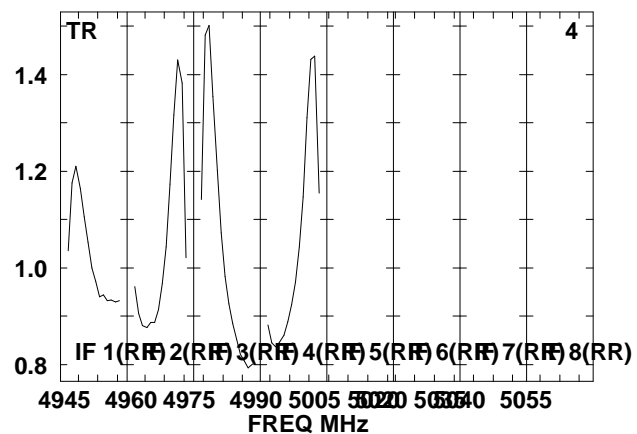
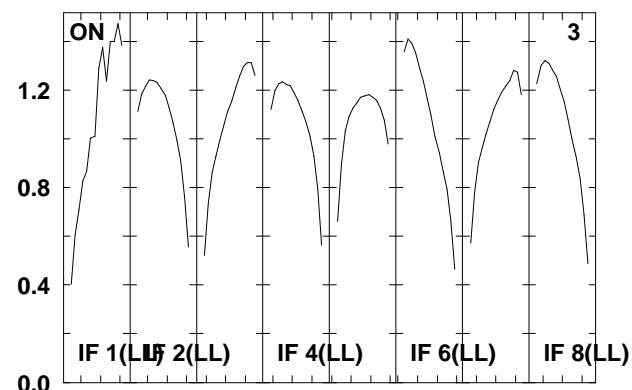
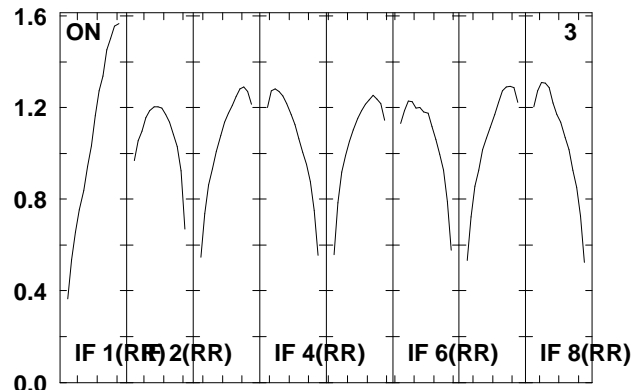
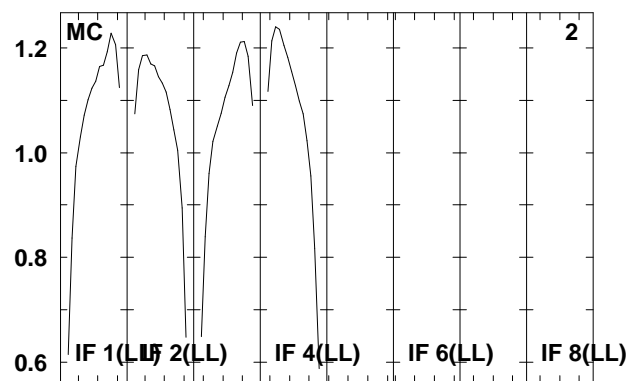
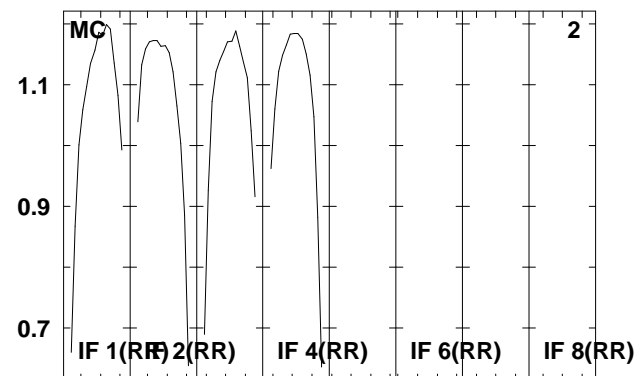
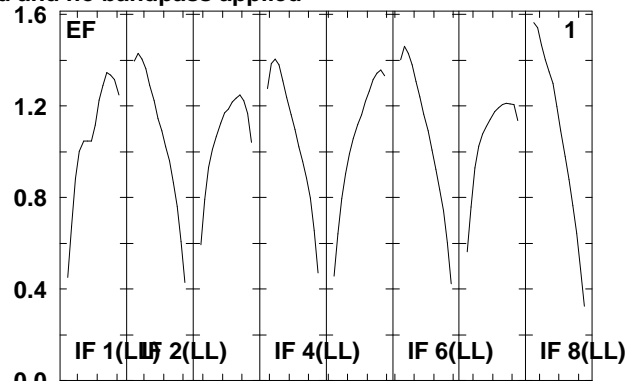
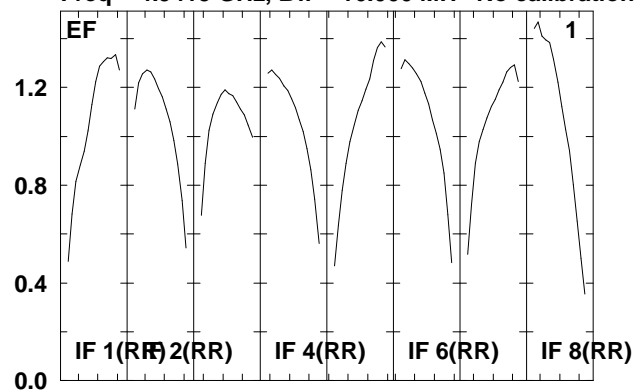

Lower frame: Real Jy  
Total-power spectrum Antenna: \*  
Timerange: 00/12:34:43 to 00/12:35:59

Plot file version 8 created 07-DEC-2009 16:05:39

J1912+05 RT006C.UVDATA.1

Freq = 4.9415 GHz, Bw = 16.000 MH No calibration applied and no bandpass applied

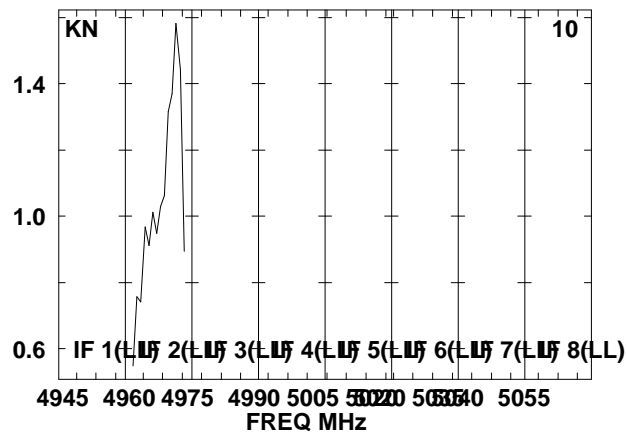
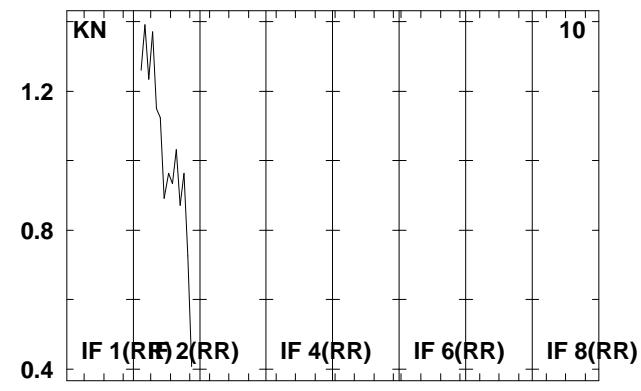
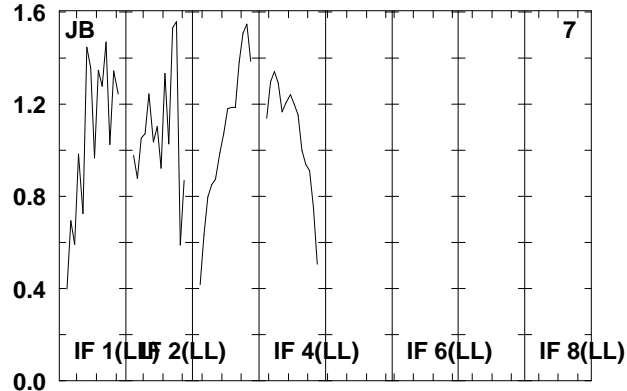
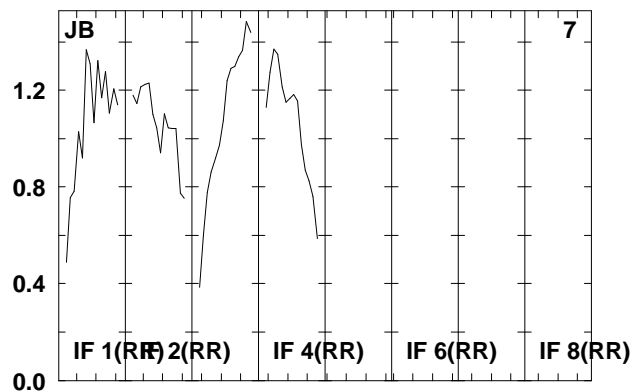
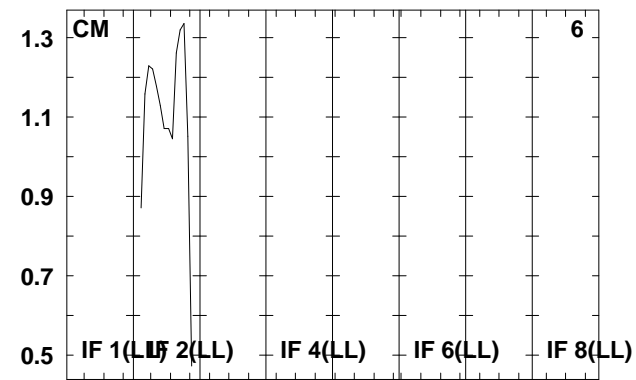
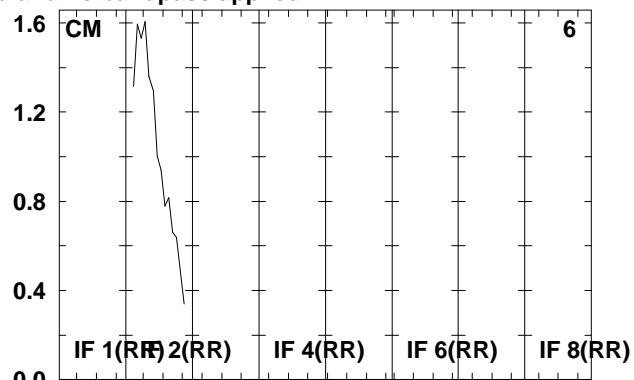
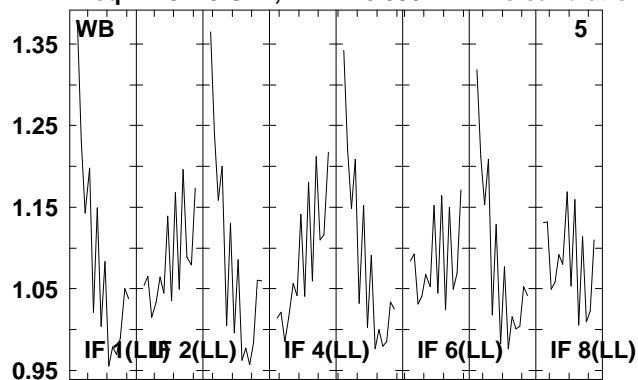

Lower frame: Real Jy

Total-power spectrum Antenna: \*

Timerange: 00/12:34:43 to 00/12:35:59



Plot file version 9 created 07-DEC-2009 16:05:39

SS433 RT006C.UVDATA.1

Freq = 4.9415 GHz, Bw = 16.000 MH No calibration applied and no bandpass applied

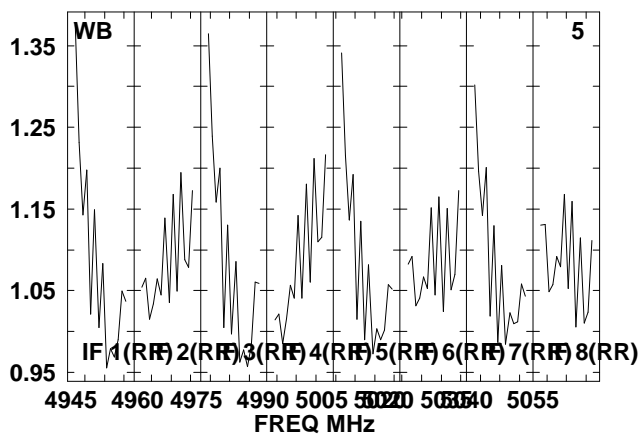
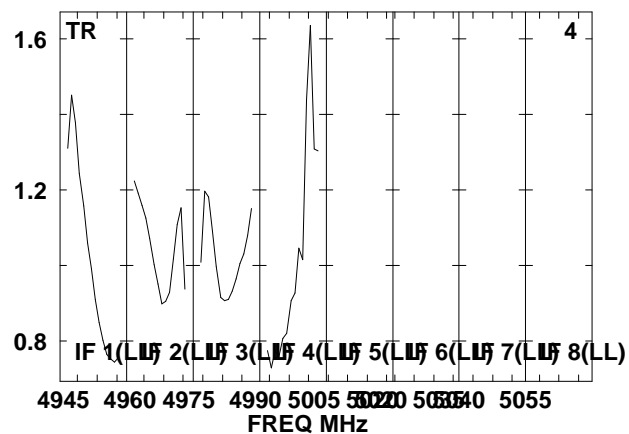
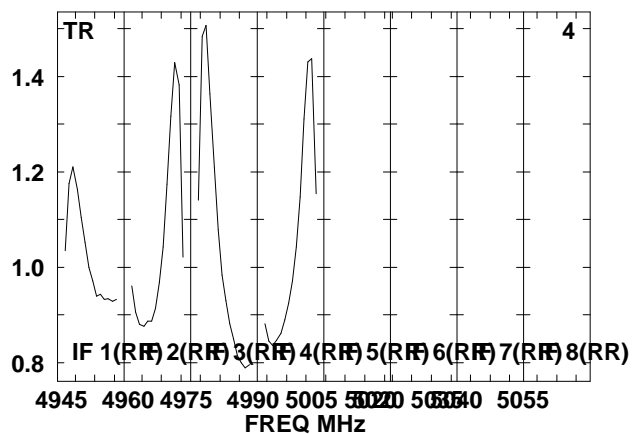
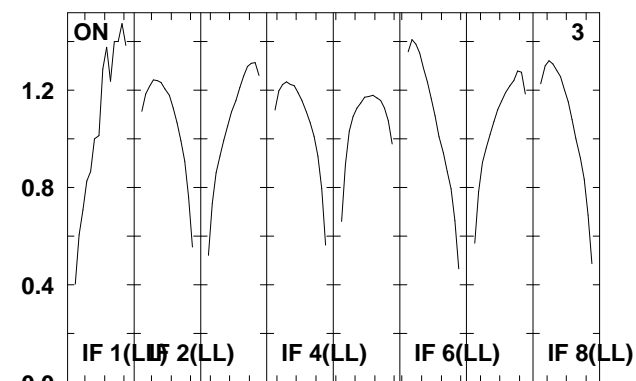
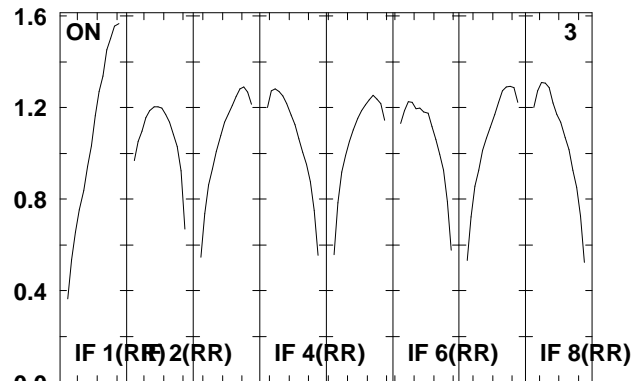
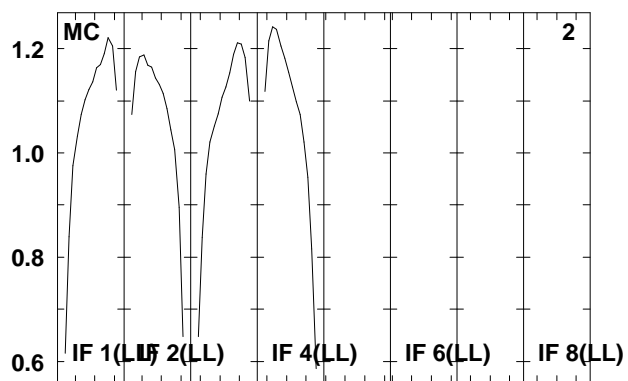
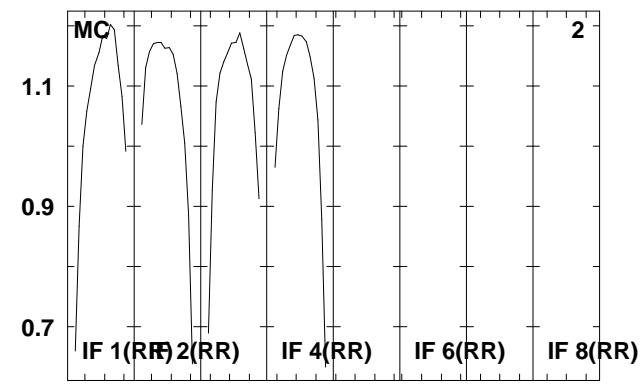
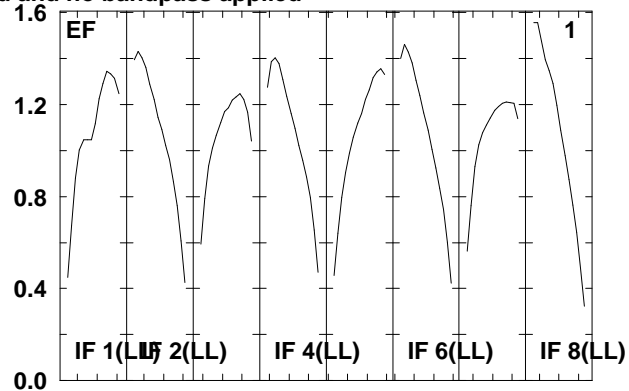
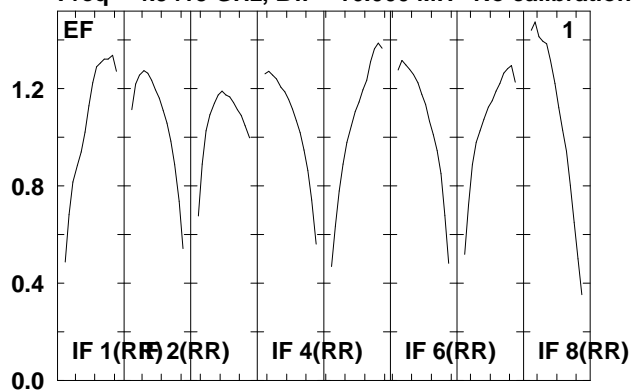

Lower frame: Real Jy  
Total-power spectrum Antenna: \*  
Timerange: 00/12:36:03 to 00/12:38:19

Plot file version 10 created 07-DEC-2009 16:05:39

SS433 RT006C.UVDATA.1

Freq = 4.9415 GHz, Bw = 16.000 MH No calibration applied and no bandpass applied

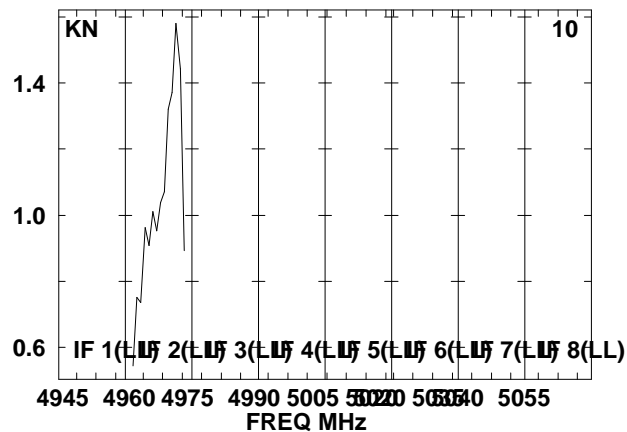
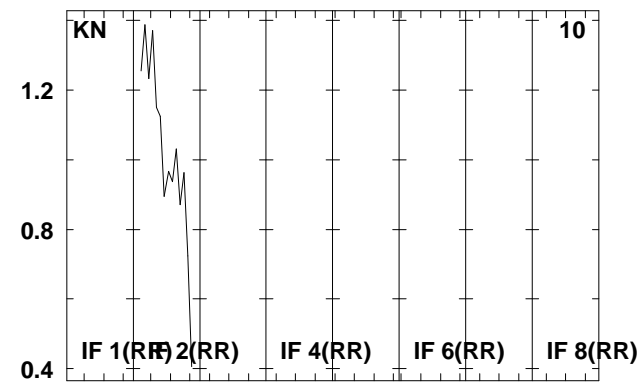
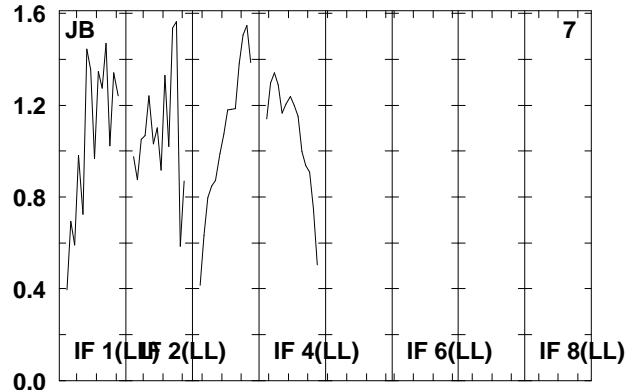
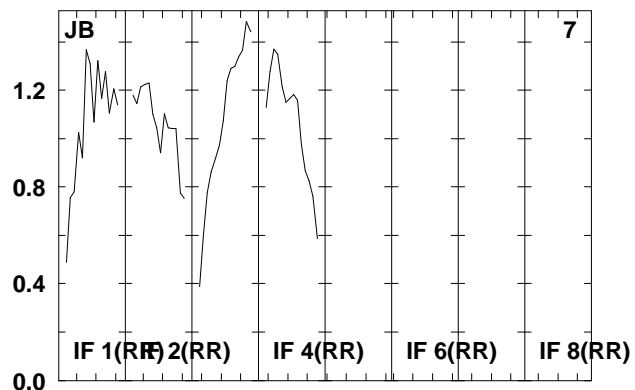
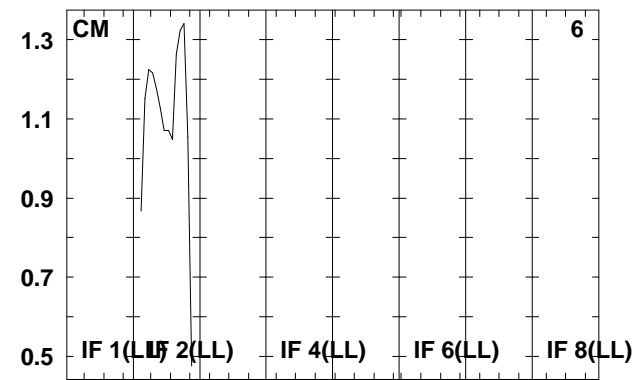
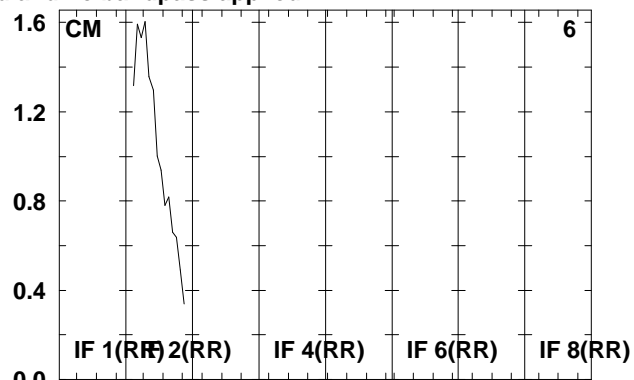
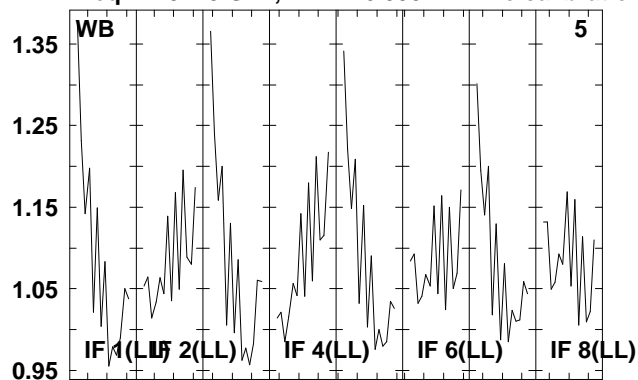

Lower frame: Real Jy

Total-power spectrum Antenna: \*

Timerange: 00/12:36:03 to 00/12:38:19

Plot file version 11 created 07-DEC-2009 16:05:39

J1912+05 RT006C.UVDATA.1

Freq = 4.9415 GHz, Bw = 16.000 MH No calibration applied and no bandpass applied

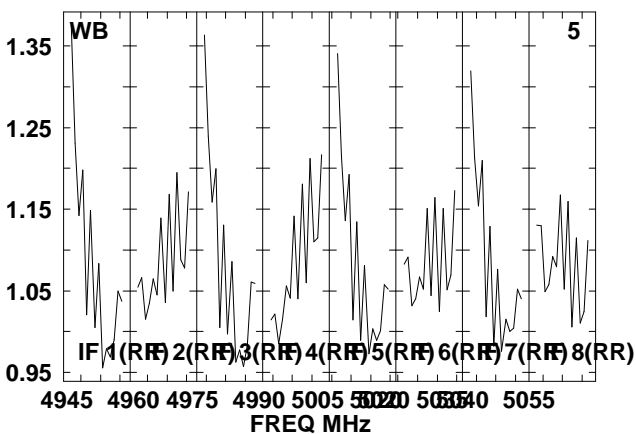
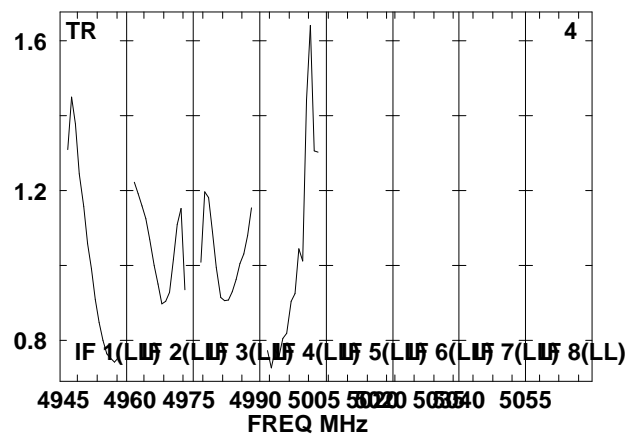
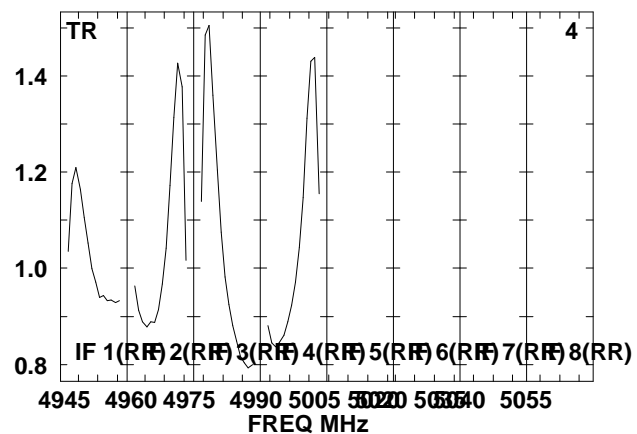
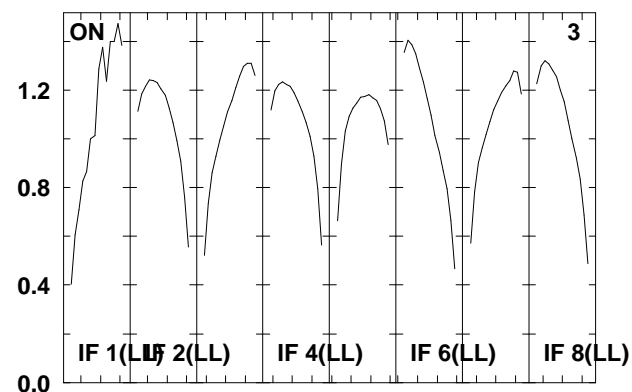
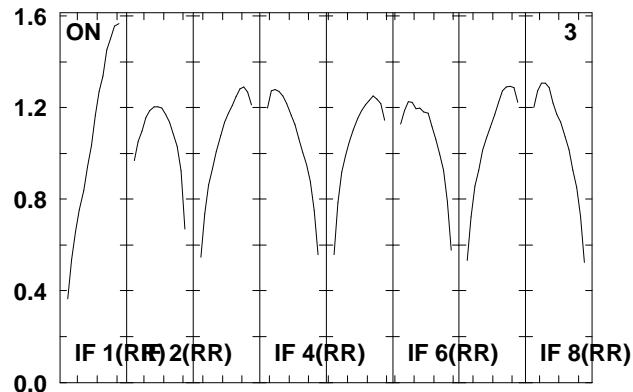
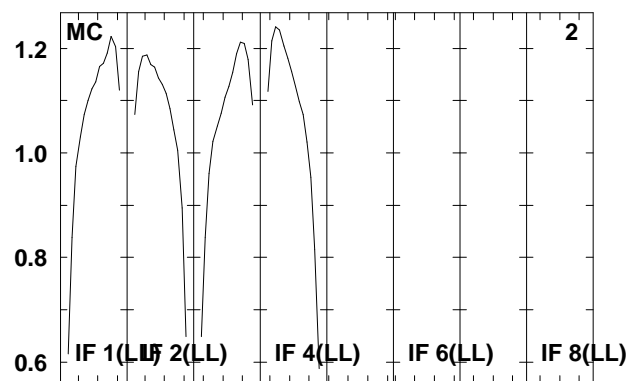
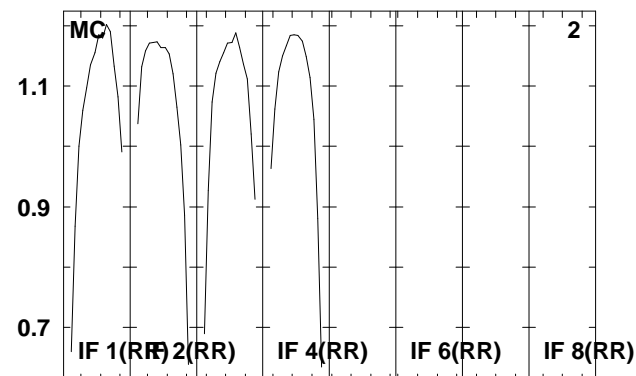
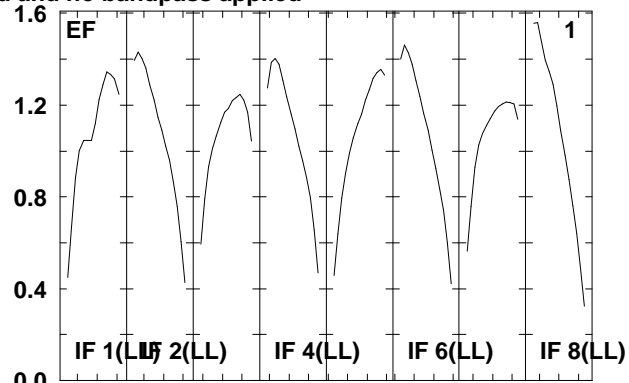
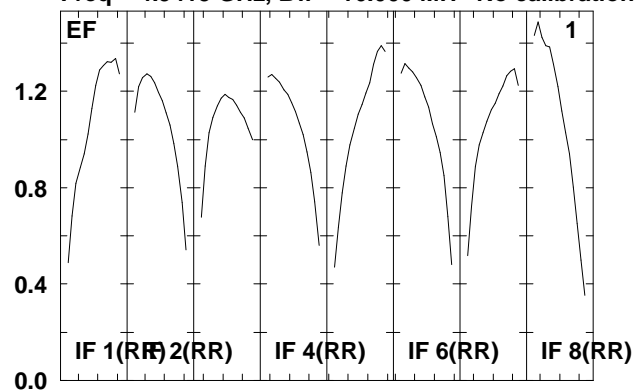

Lower frame: Real Jy  
Total-power spectrum Antenna: \*  
Timerange: 00/12:38:23 to 00/12:39:39

Plot file version 12 created 07-DEC-2009 16:05:40

J1912+05 RT006C.UVDATA.1

Freq = 4.9415 GHz, Bw = 16.000 MH No calibration applied and no bandpass applied

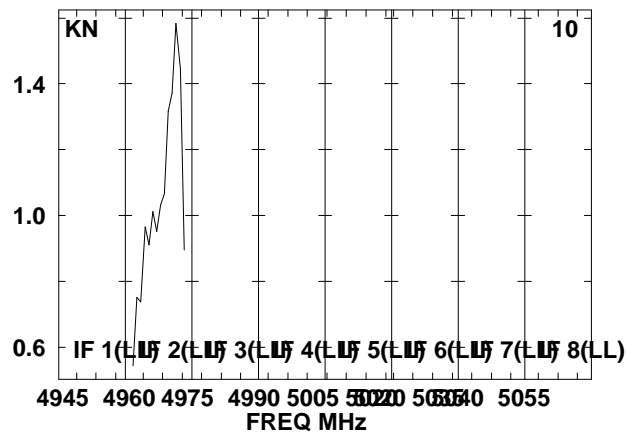
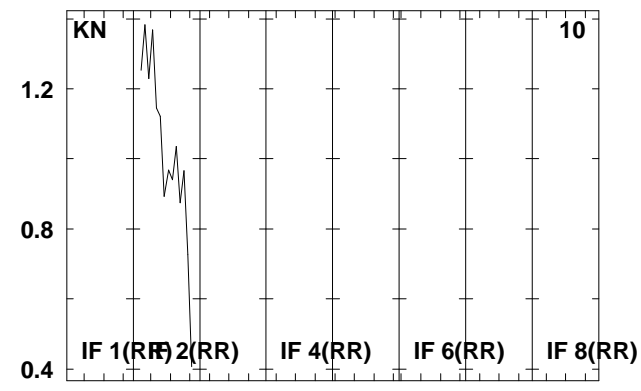
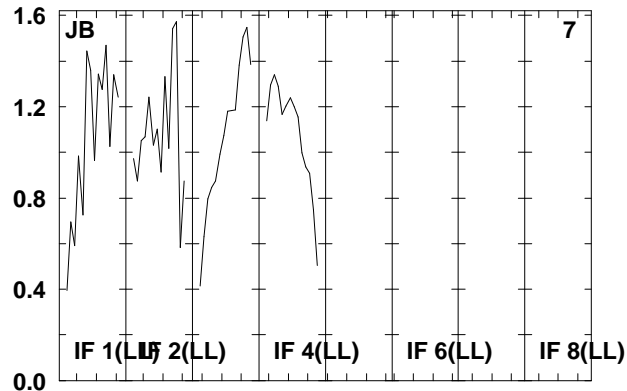
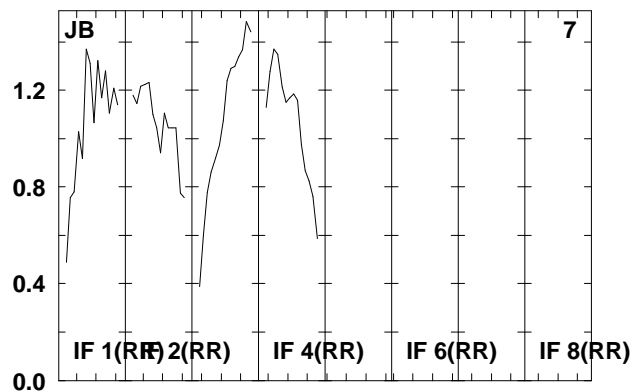
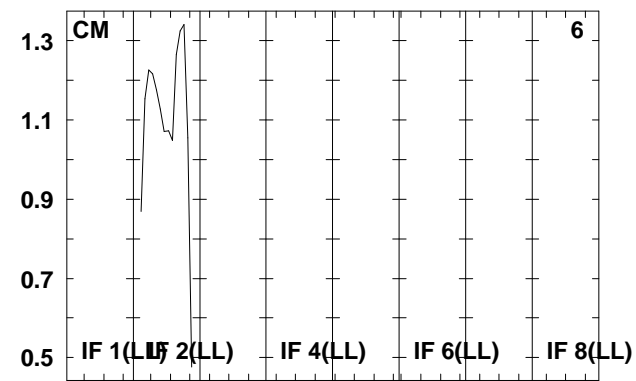
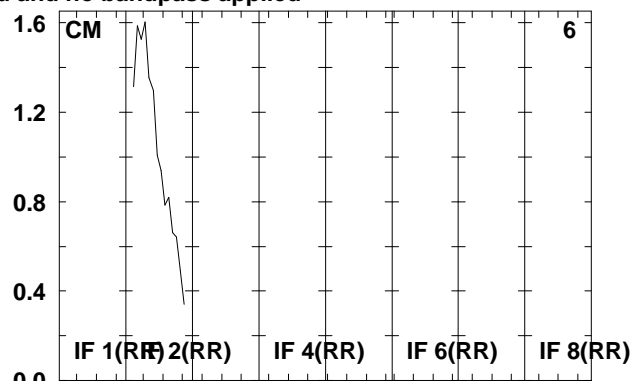
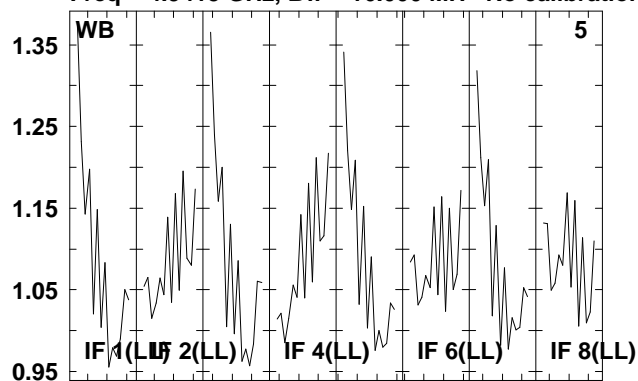

Lower frame: Real Jy

Total-power spectrum Antenna: \*

Timerange: 00/12:38:23 to 00/12:39:39

Plot file version 13 created 07-DEC-2009 16:05:40

SS433 RT006C.UVDATA.1

Freq = 4.9415 GHz, Bw = 16.000 MH No calibration applied and no bandpass applied

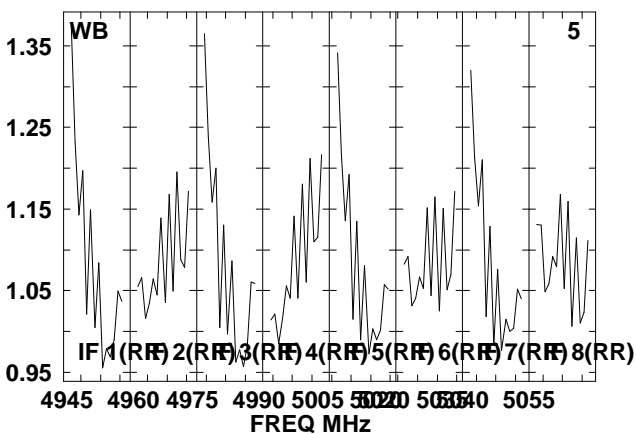
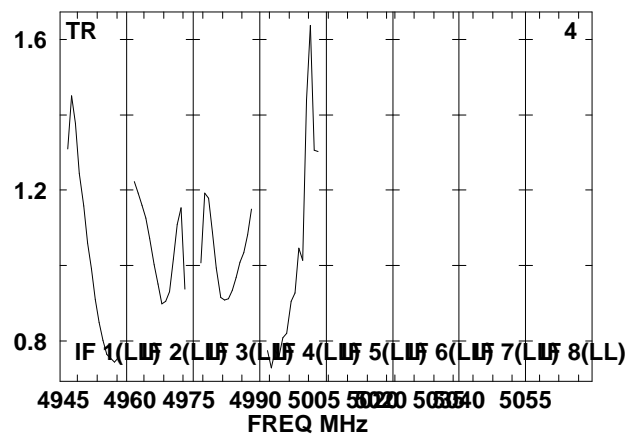
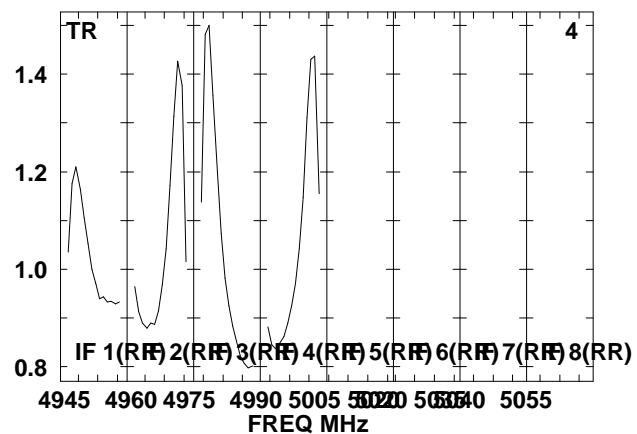
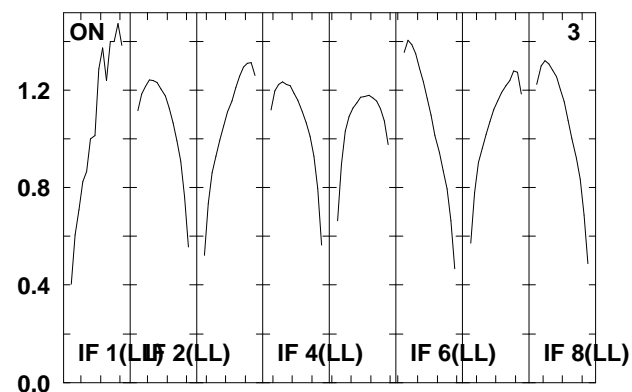
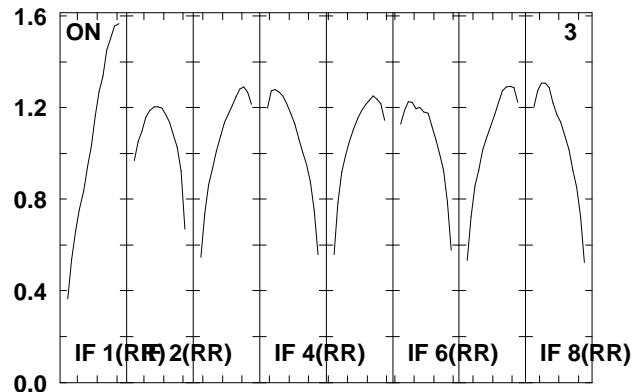
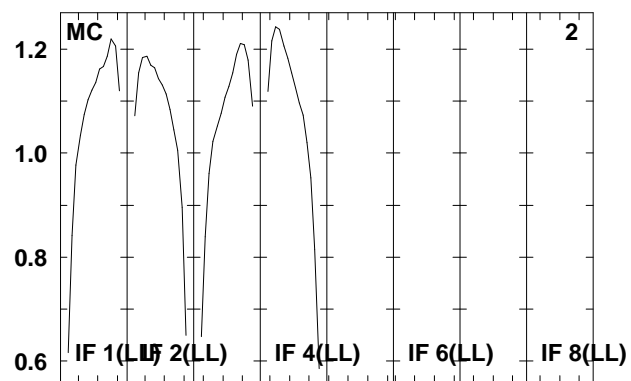
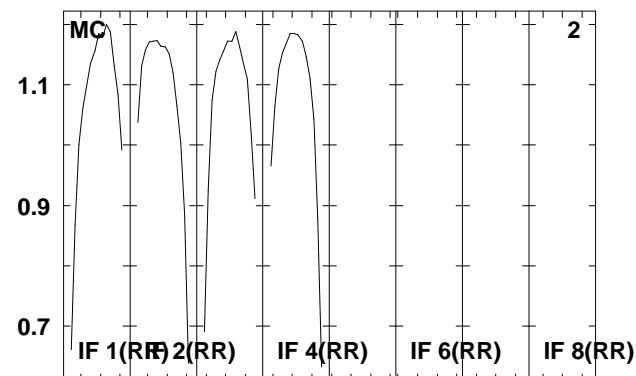
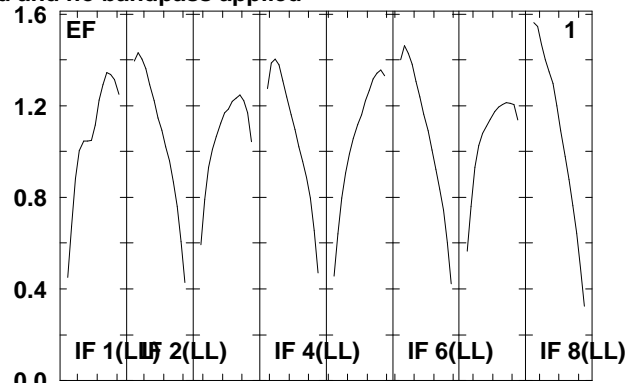
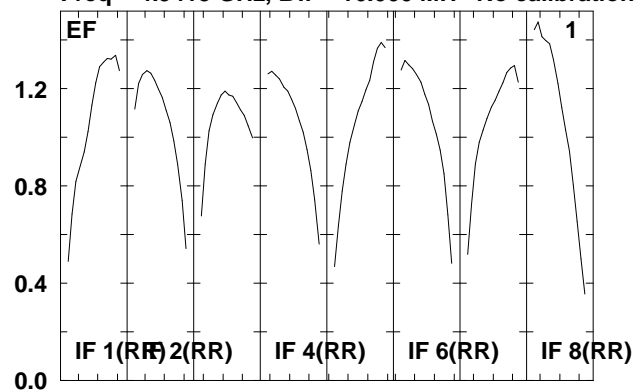

Lower frame: Real Jy

Total-power spectrum Antenna: \*

Timerange: 00/12:39:43 to 00/12:41:59

Plot file version 14 created 07-DEC-2009 16:05:40

SS433 RT006C.UVDATA.1

Freq = 4.9415 GHz, Bw = 16.000 MH No calibration applied and no bandpass applied

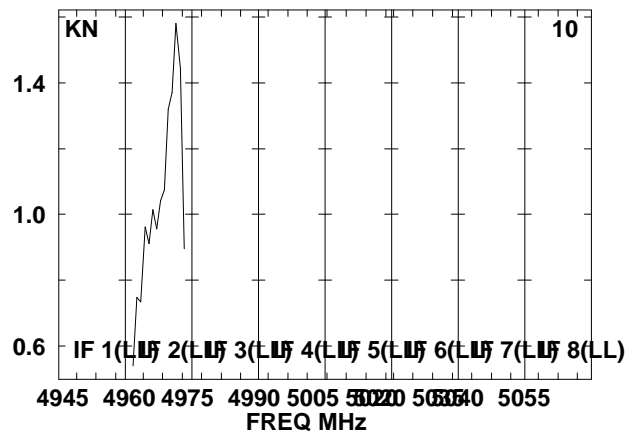
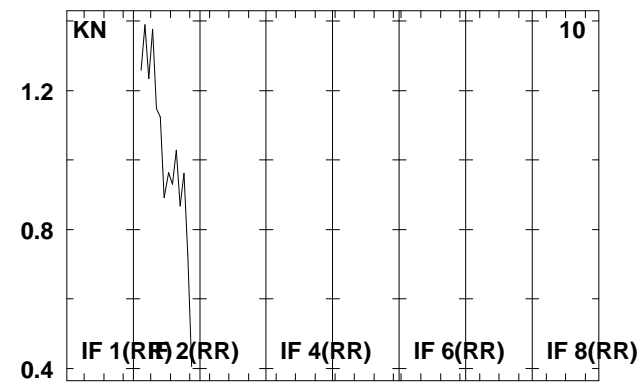
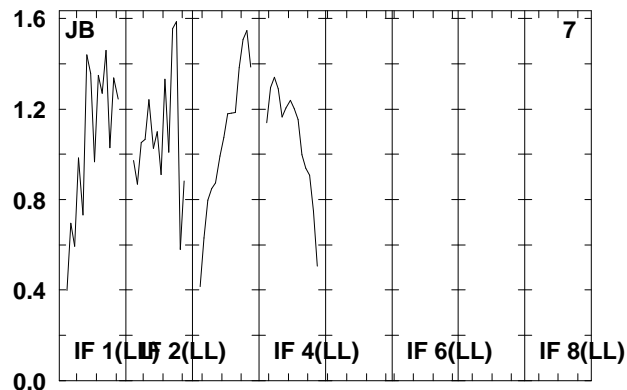
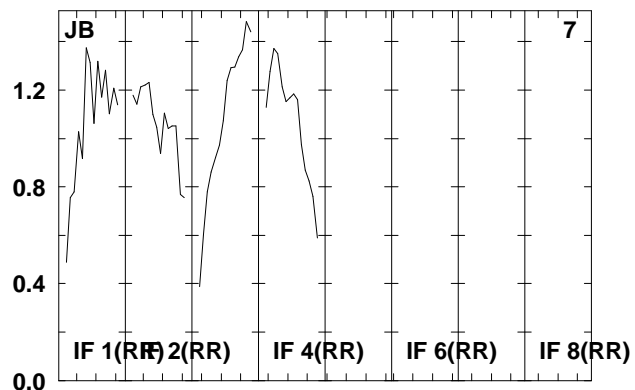
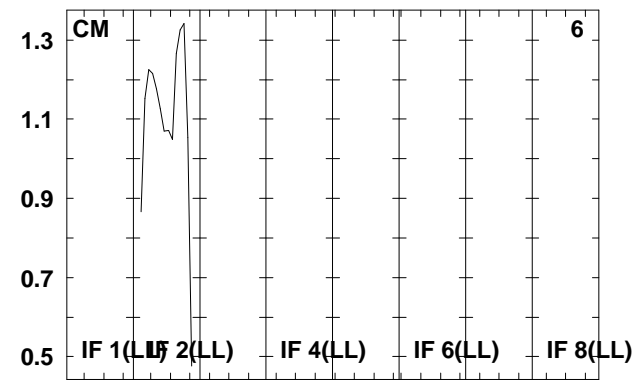
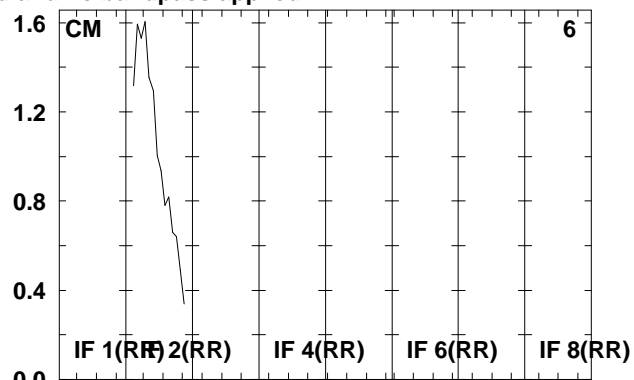
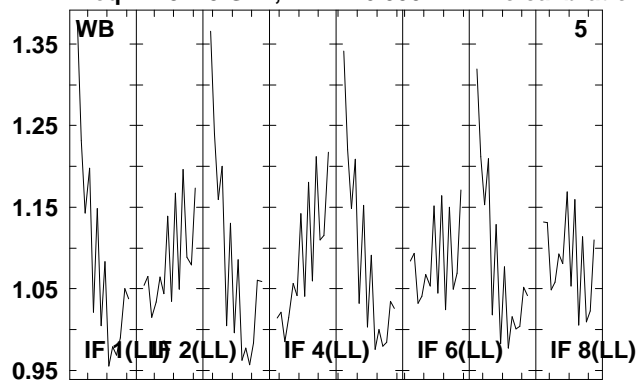

Lower frame: Real Jy

Total-power spectrum Antenna: \*

Timerange: 00/12:39:43 to 00/12:41:59

Plot file version 15 created 07-DEC-2009 16:05:40

J1911+16 RT006C.UVDATA.1

Freq = 4.9415 GHz, Bw = 16.000 MH No calibration applied and no bandpass applied

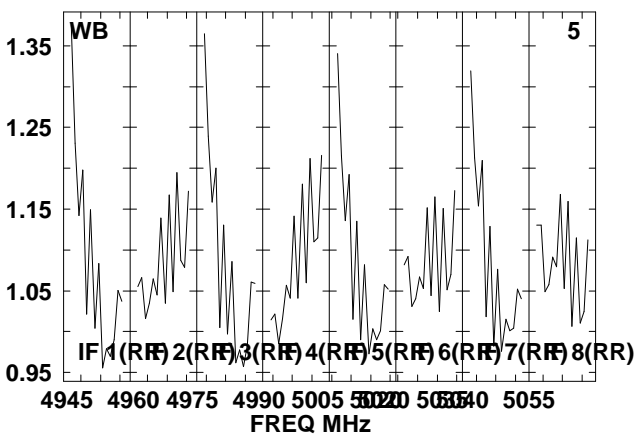
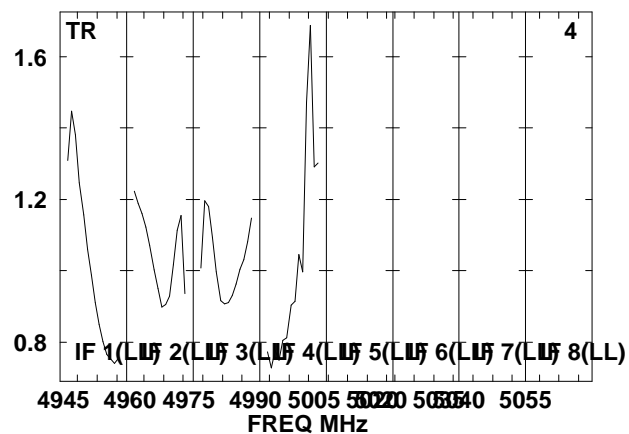
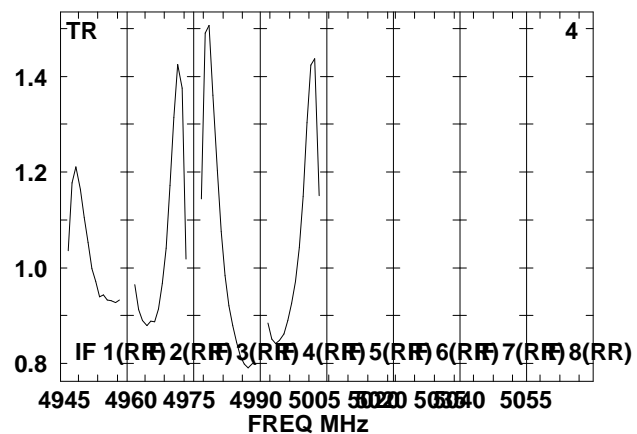
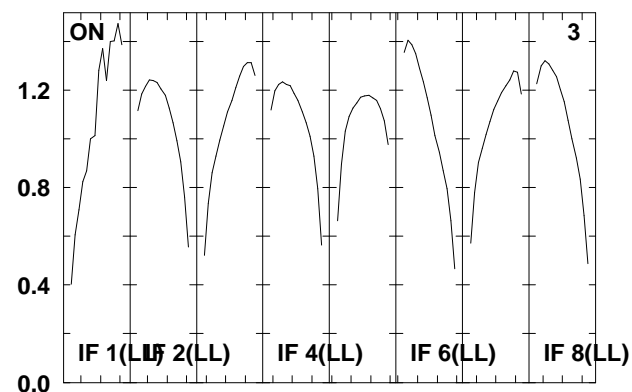
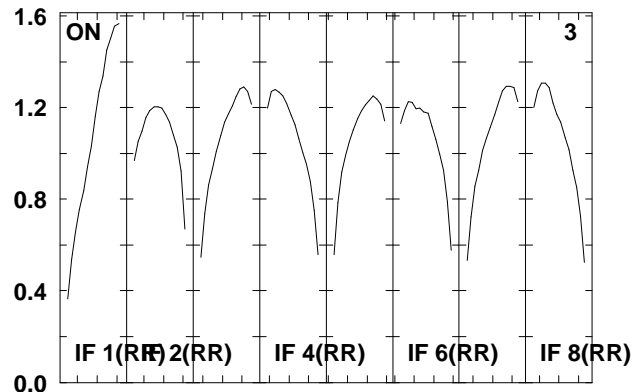
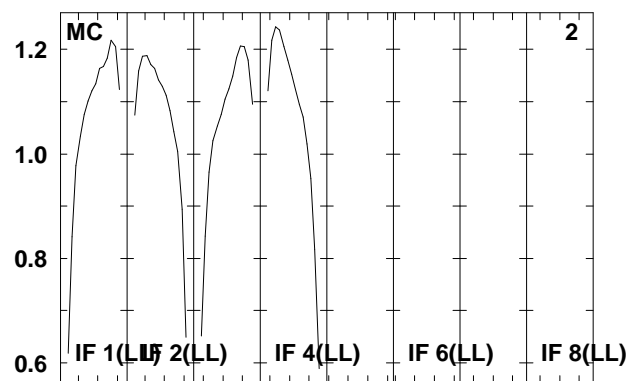
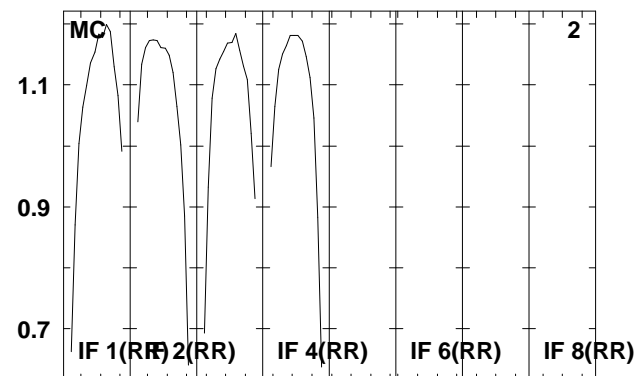
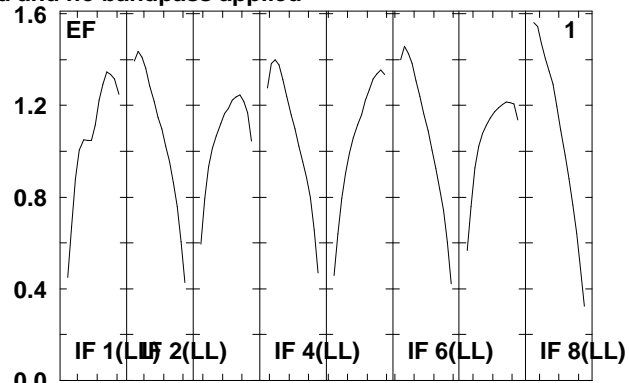
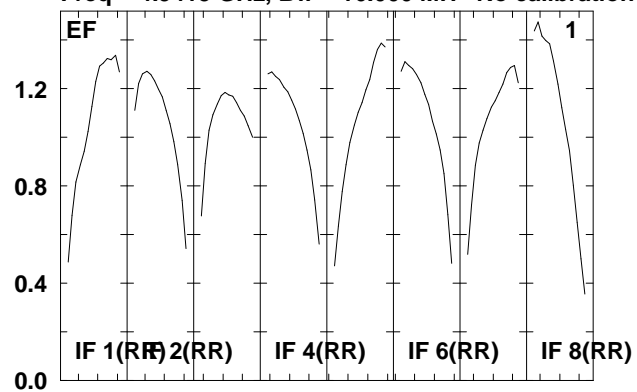

Lower frame: Real Jy  
Total-power spectrum Antenna: \*  
Timerange: 00/12:43:03 to 00/12:43:59

Plot file version 16 created 07-DEC-2009 16:05:40

J1911+16 RT006C.UVDATA.1

Freq = 4.9415 GHz, Bw = 16.000 MH No calibration applied and no bandpass applied

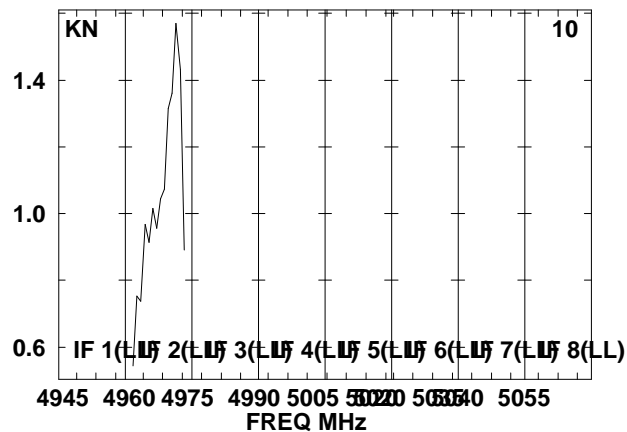
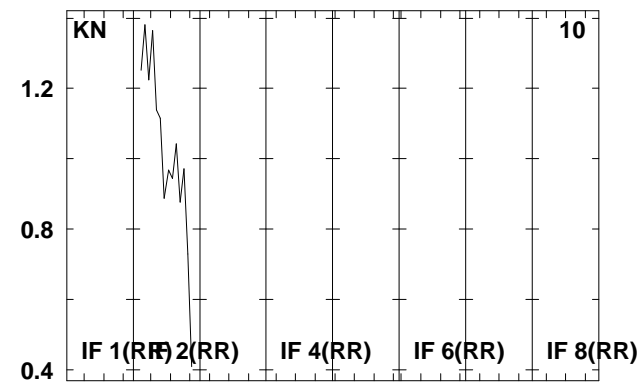
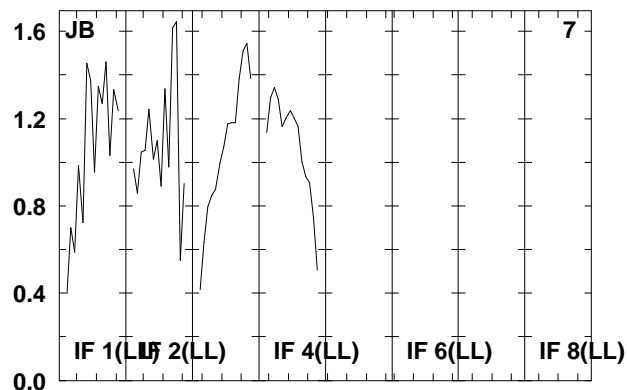
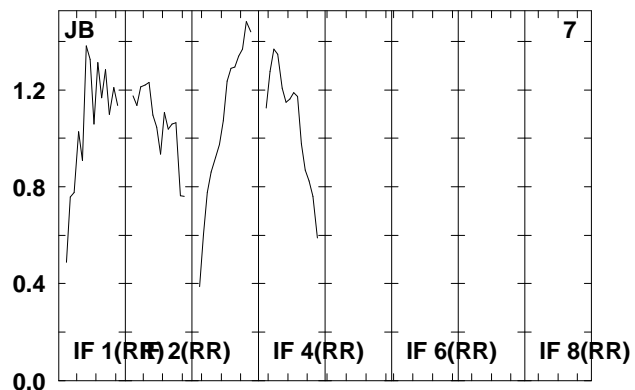
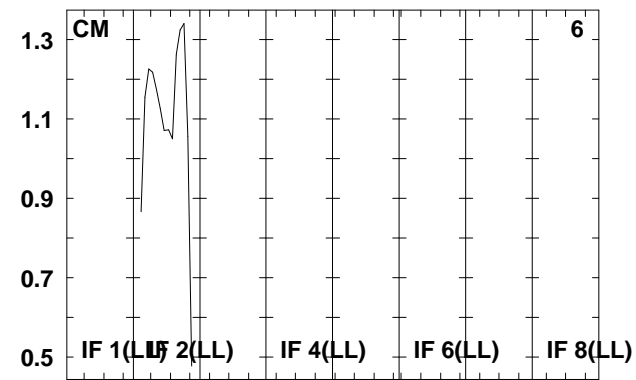
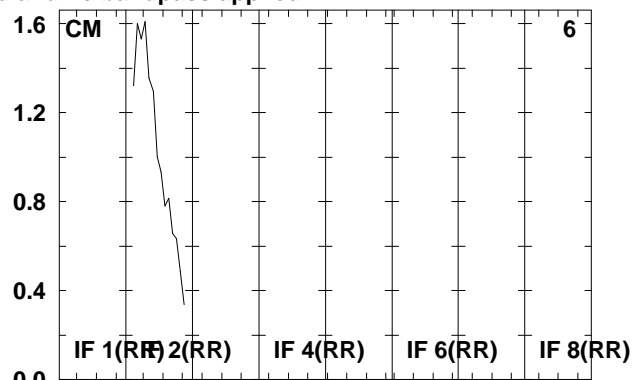
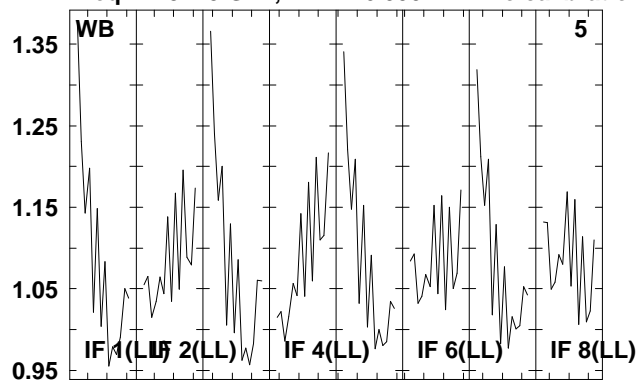

Lower frame: Real Jy

Total-power spectrum Antenna: \*

Timerange: 00/12:43:03 to 00/12:43:59



Plot file version 17 created 07-DEC-2009 16:05:40

J1912+05 RT006C.UVDATA.1

Freq = 4.9415 GHz, Bw = 16.000 MH No calibration applied and no bandpass applied

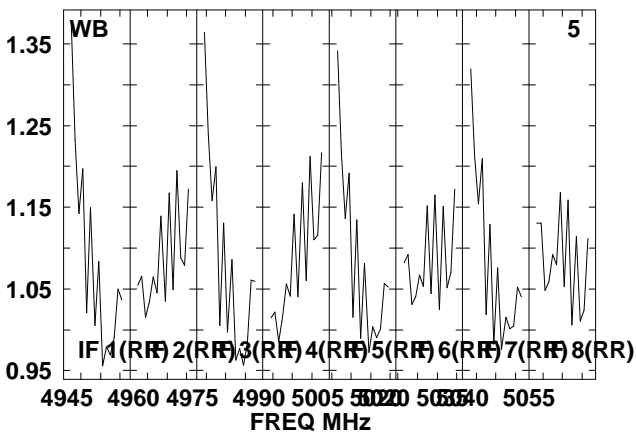
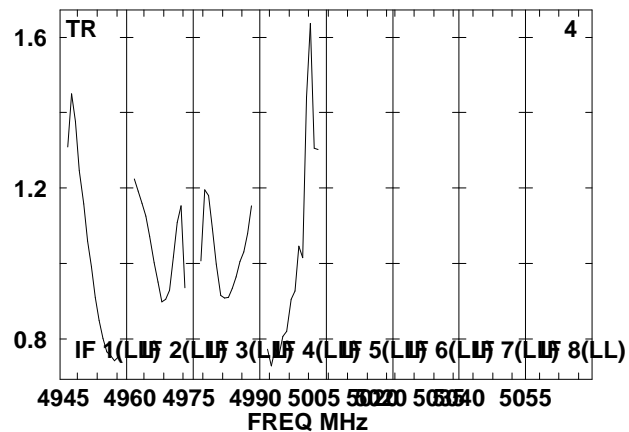
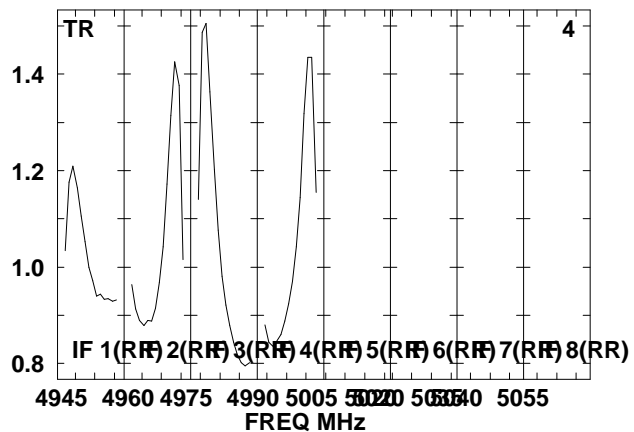
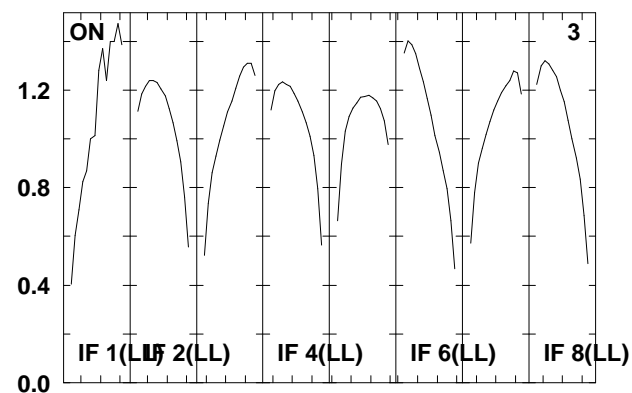
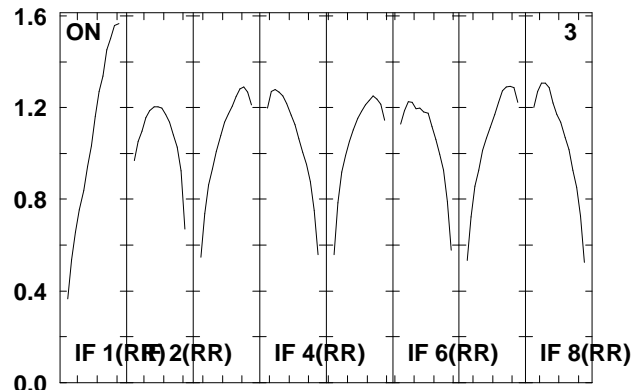
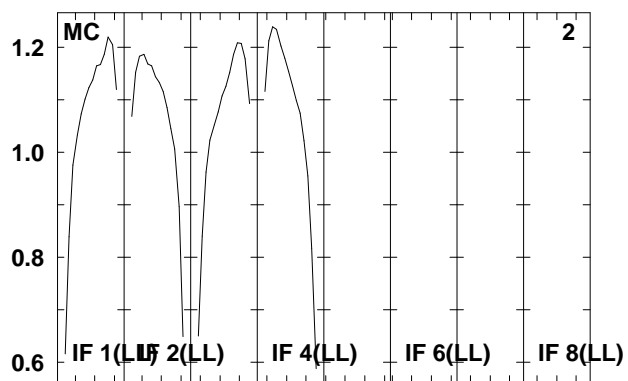
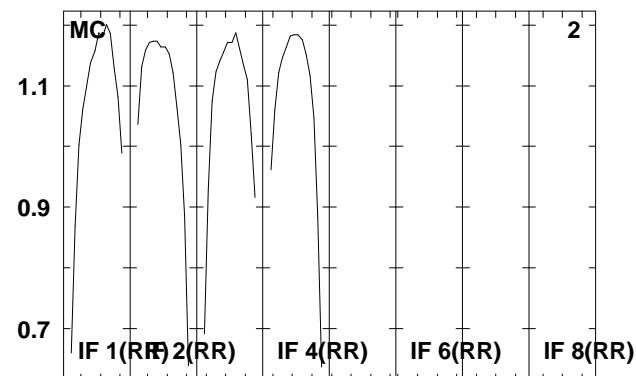
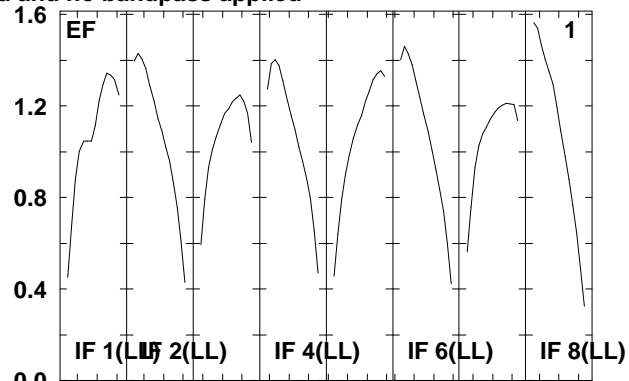
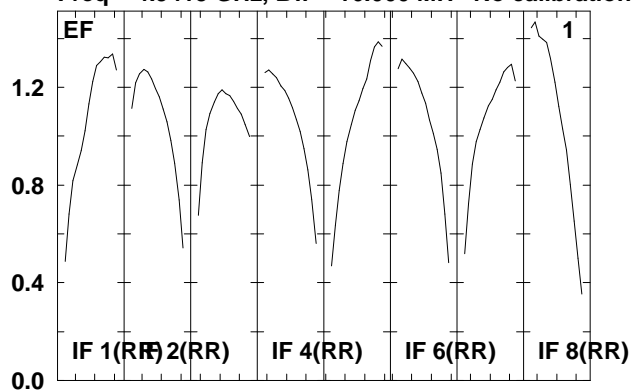

Lower frame: Real Jy  
Total-power spectrum Antenna: \*  
Timerange: 00/12:45:03 to 00/12:45:59

Plot file version 18 created 07-DEC-2009 16:05:41

J1912+05 RT006C.UVDATA.1

Freq = 4.9415 GHz, Bw = 16.000 MH No calibration applied and no bandpass applied

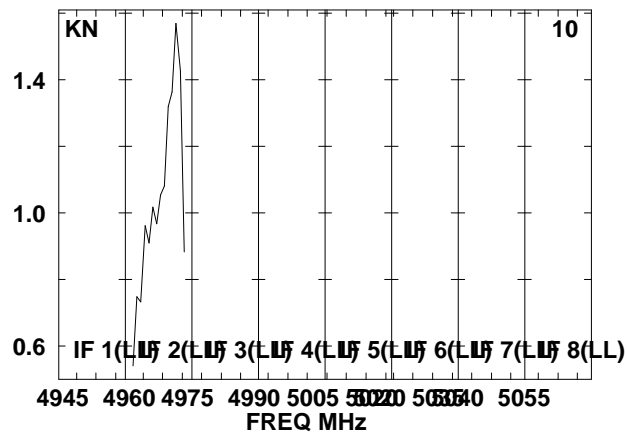
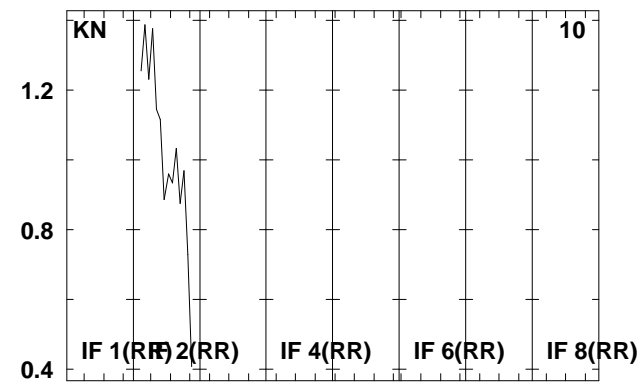
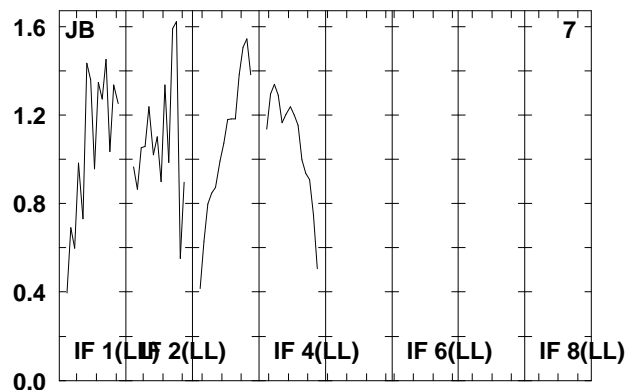
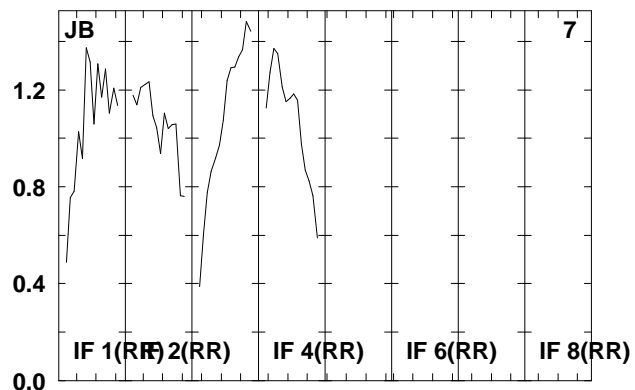
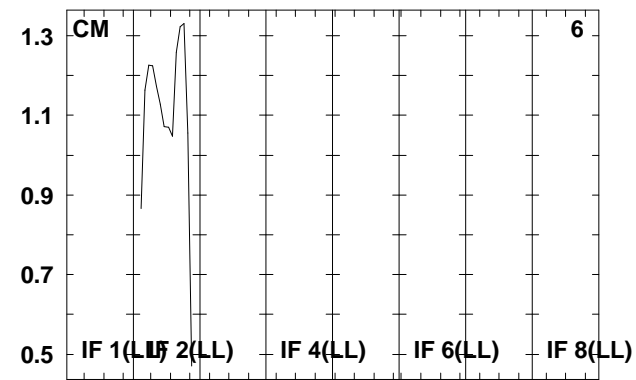
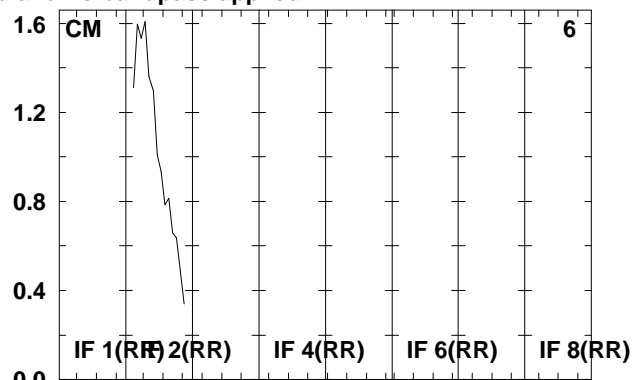
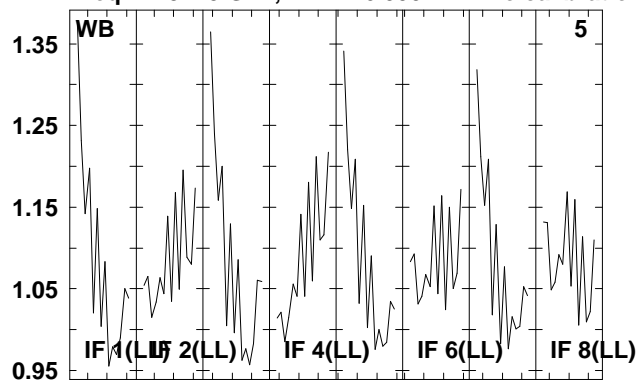

Lower frame: Real Jy

Total-power spectrum Antenna: \*

Timerange: 00/12:45:03 to 00/12:45:59

Plot file version 19 created 07-DEC-2009 16:05:41

SS433 RT006C.UVDATA.1

Freq = 4.9415 GHz, Bw = 16.000 MH No calibration applied and no bandpass applied

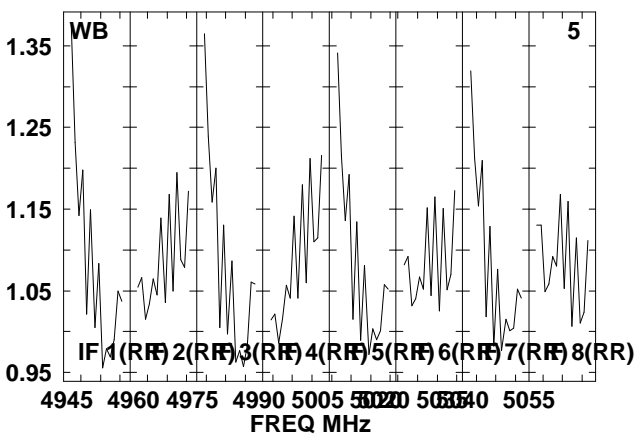
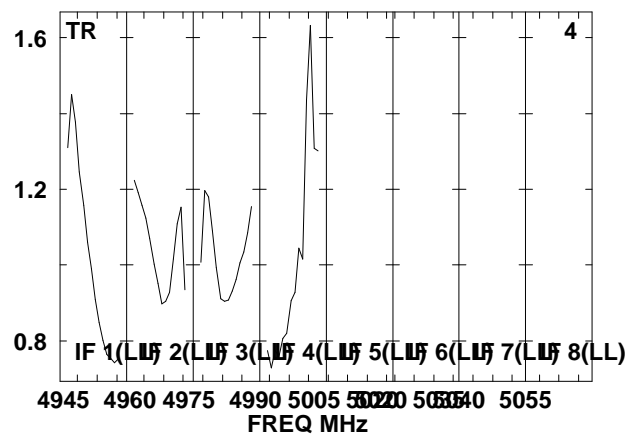
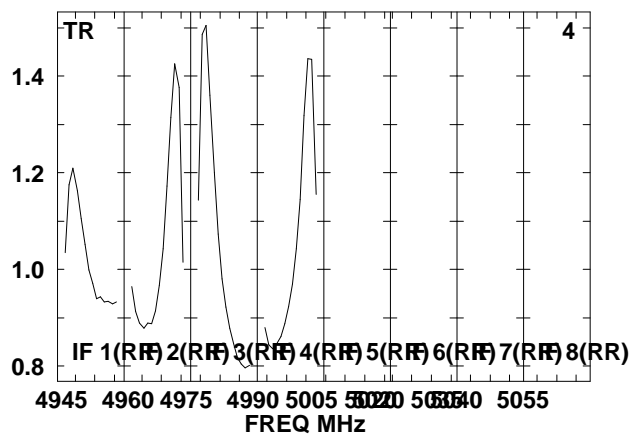
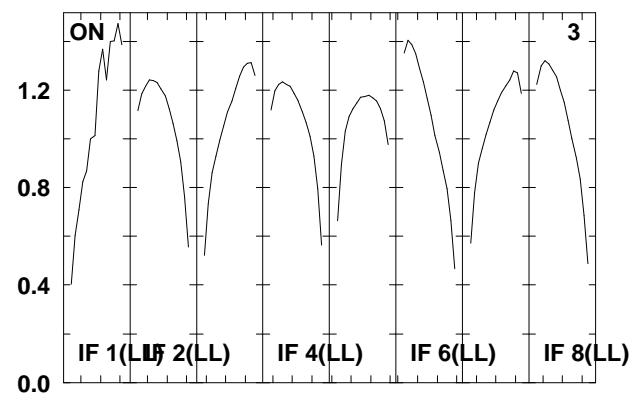
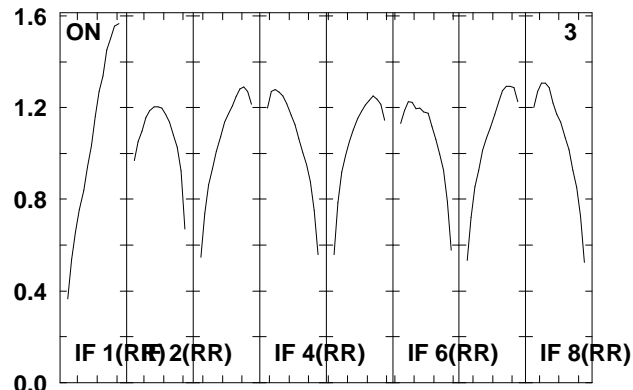
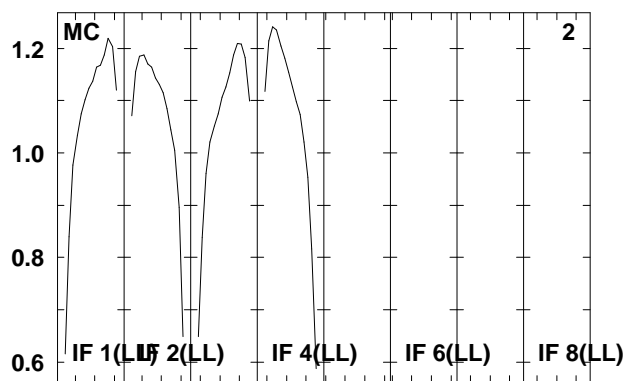
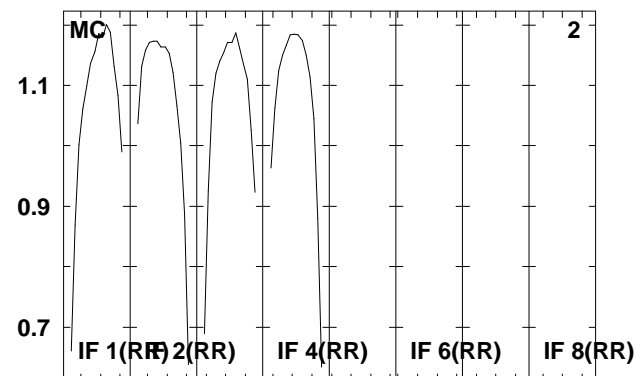
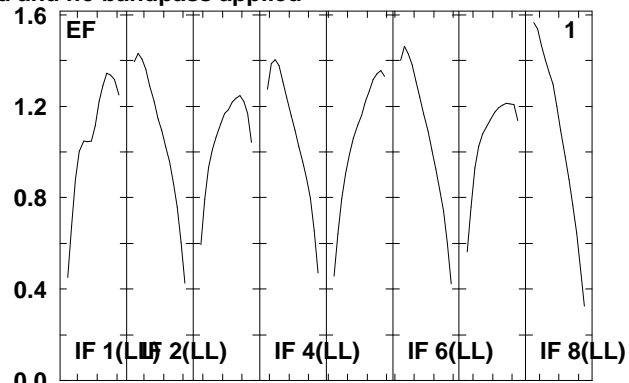
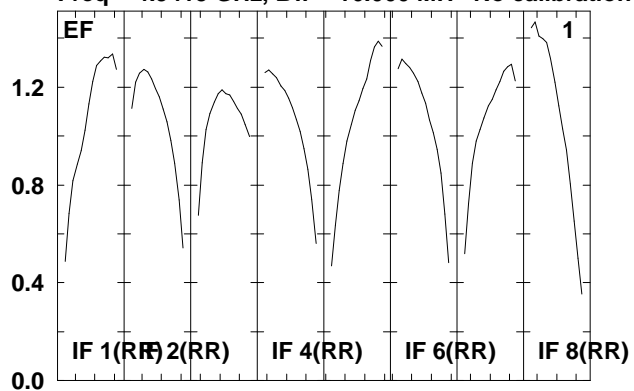

Lower frame: Real Jy

Total-power spectrum Antenna: \*

Timerange: 00/12:46:03 to 00/12:48:19

Plot file version 20 created 07-DEC-2009 16:05:41

SS433 RT006C.UVDATA.1

Freq = 4.9415 GHz, Bw = 16.000 MH No calibration applied and no bandpass applied

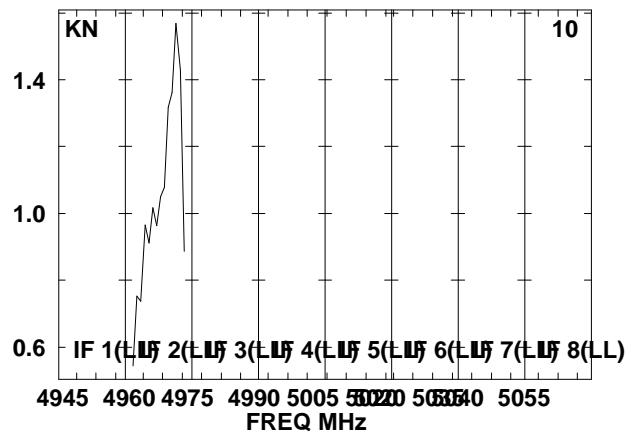
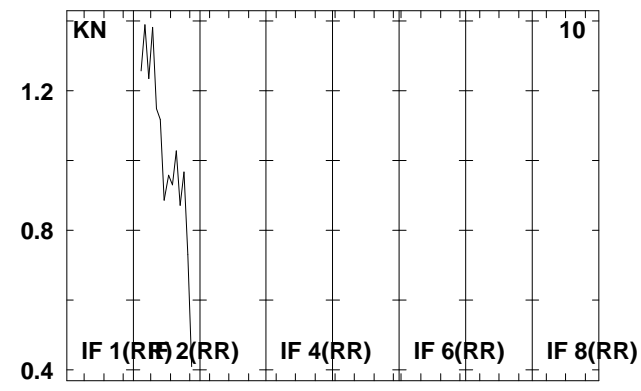
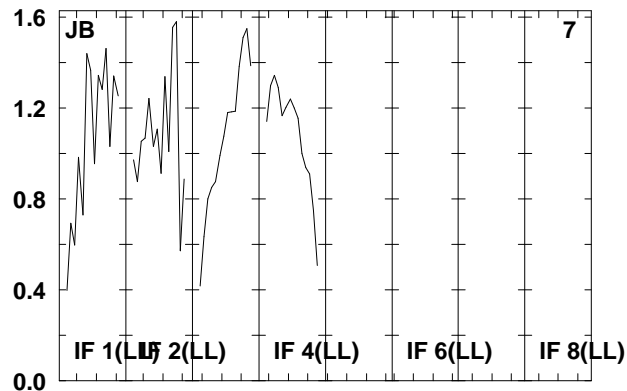
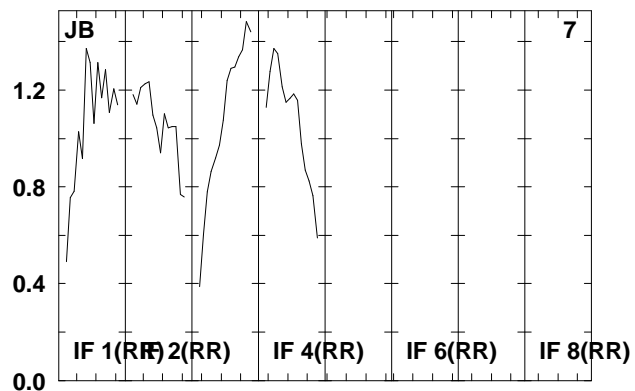
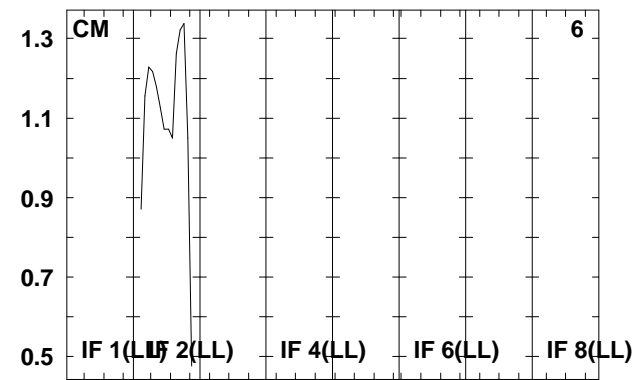
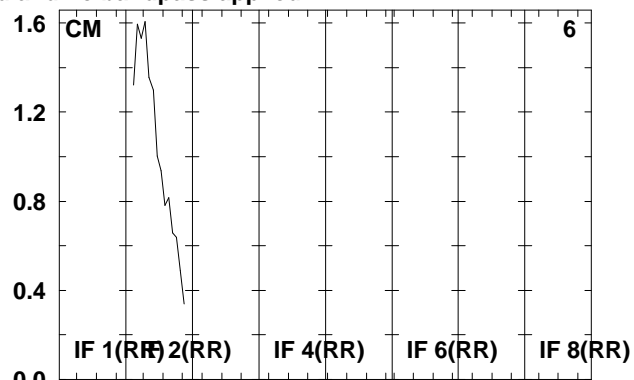
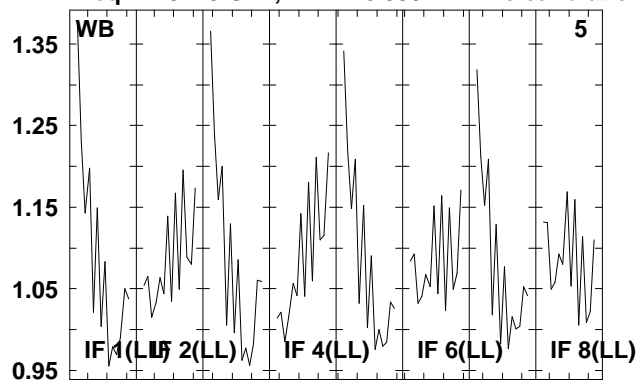

Lower frame: Real Jy

Total-power spectrum Antenna: \*

Timerange: 00/12:46:03 to 00/12:48:19

Plot file version 21 created 07-DEC-2009 16:05:41

J1912+05 RT006C.UVDATA.1

Freq = 4.9415 GHz, Bw = 16.000 MH No calibration applied and no bandpass applied

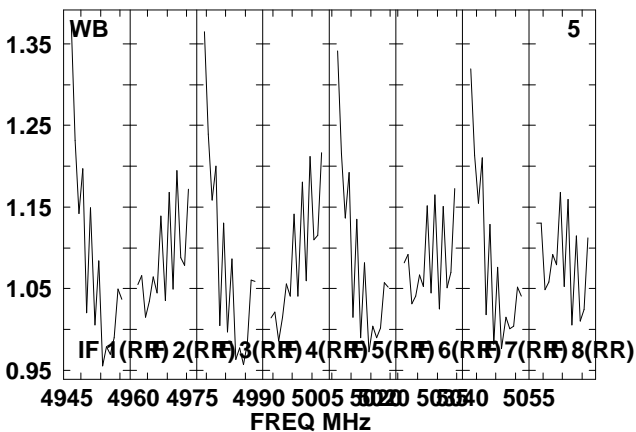
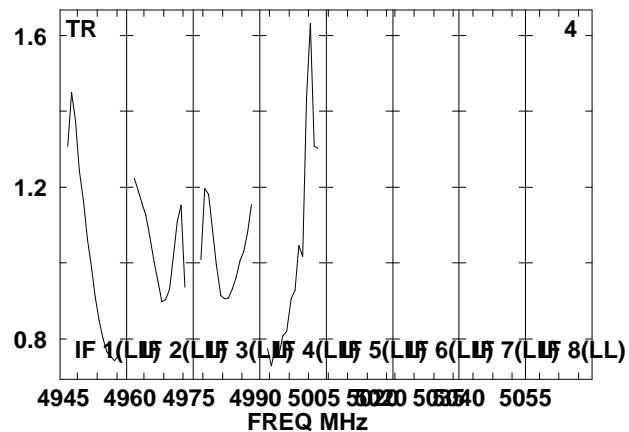
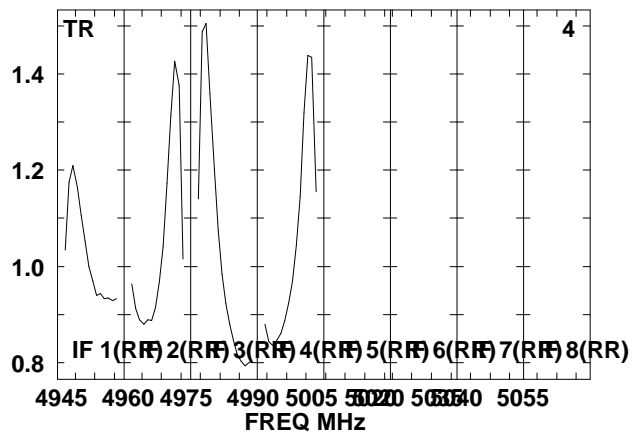
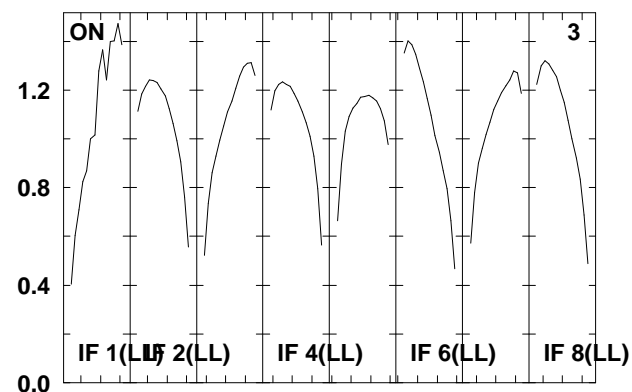
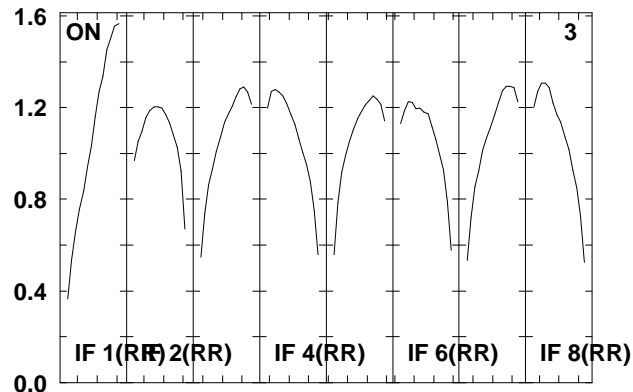
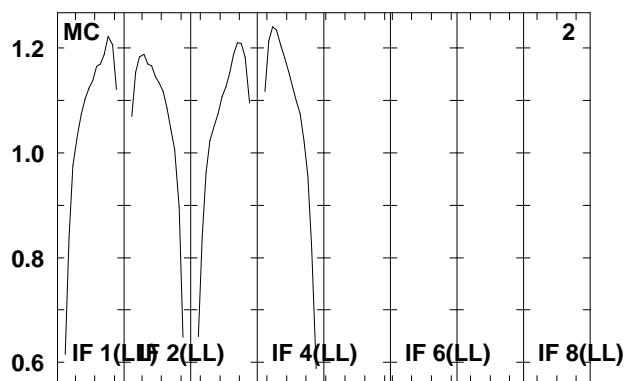
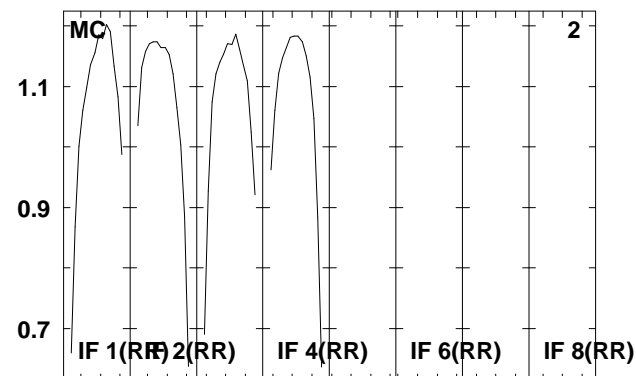
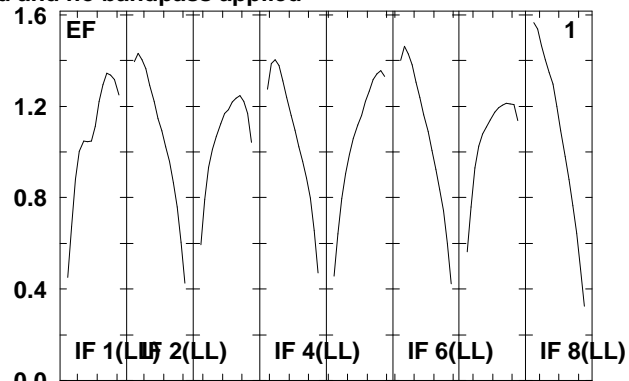
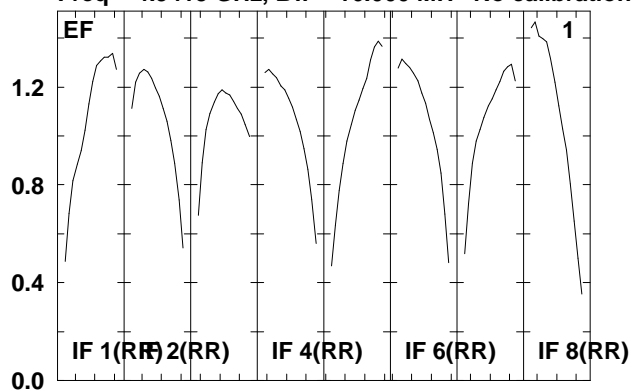

Lower frame: Real Jy  
Total-power spectrum Antenna: \*  
Timerange: 00/12:48:23 to 00/12:49:39

Plot file version 22 created 07-DEC-2009 16:05:41

J1912+05 RT006C.UVDATA.1

Freq = 4.9415 GHz, Bw = 16.000 MH No calibration applied and no bandpass applied

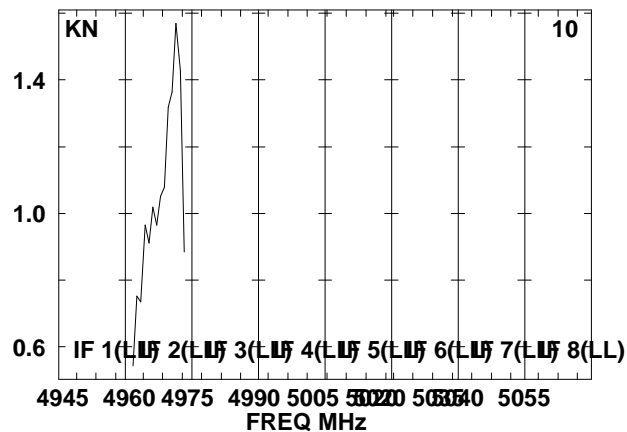
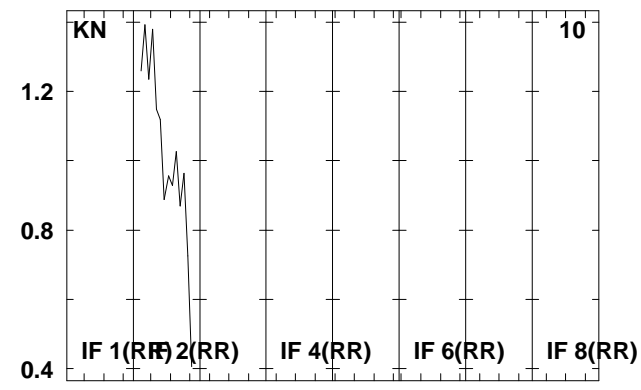
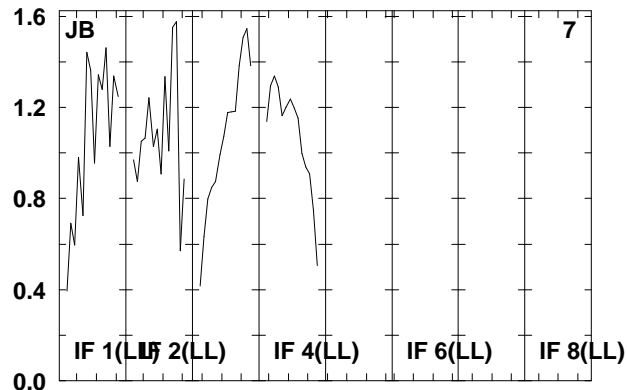
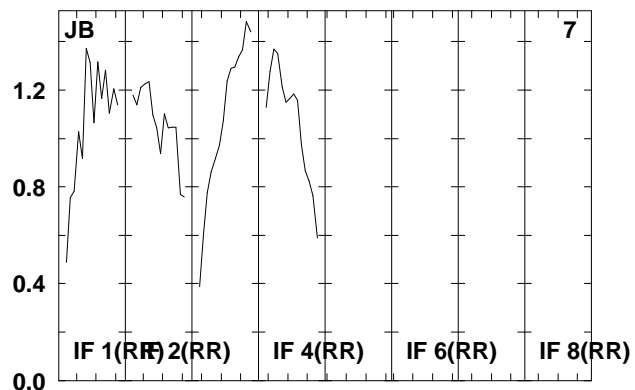
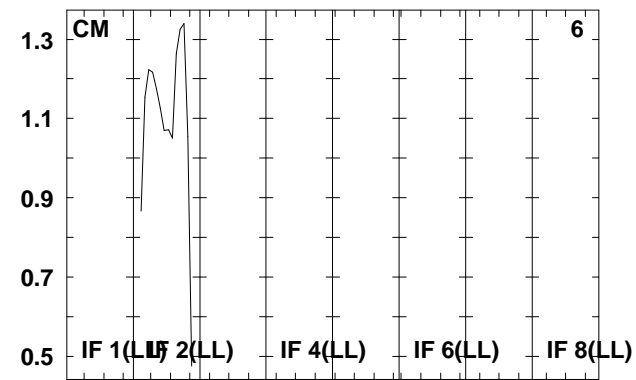
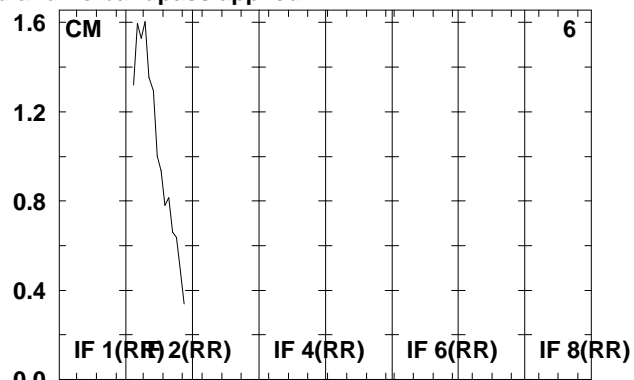
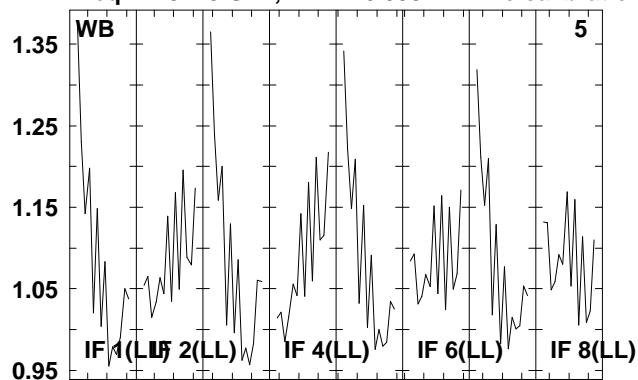

Lower frame: Real Jy

Total-power spectrum Antenna: \*

Timerange: 00/12:48:23 to 00/12:49:39

Plot file version 23 created 07-DEC-2009 16:05:42

SS433 RT006C.UVDATA.1

Freq = 4.9415 GHz, Bw = 16.000 MH No calibration applied and no bandpass applied

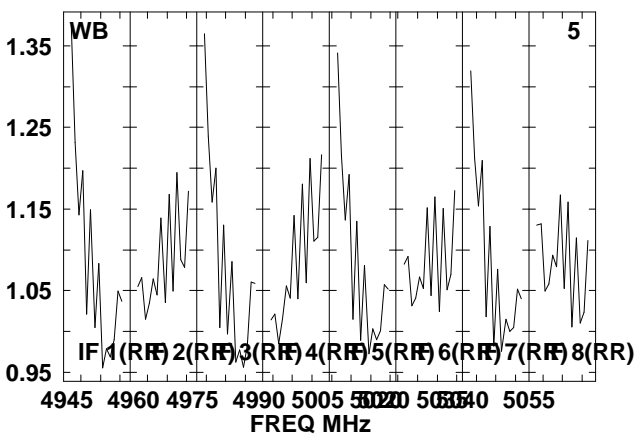
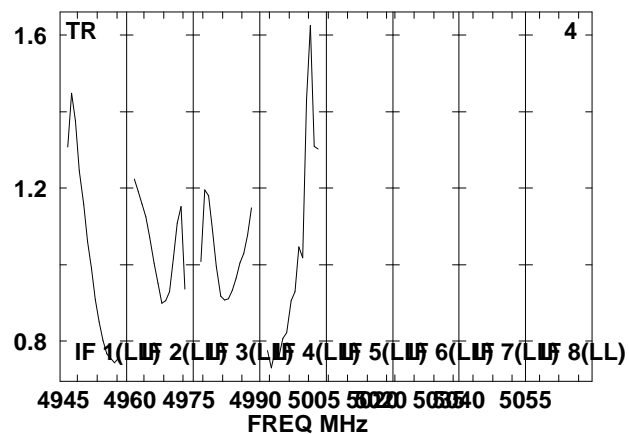
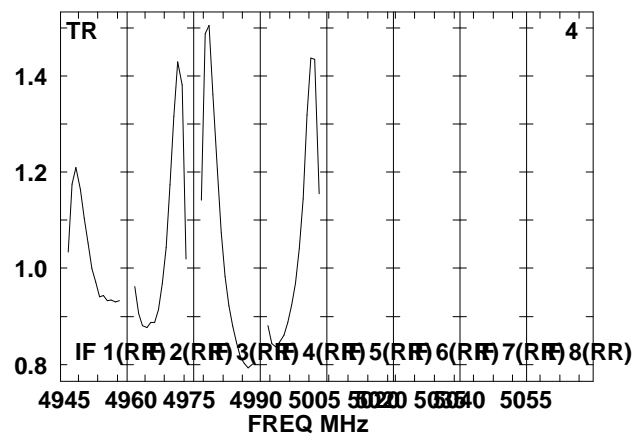
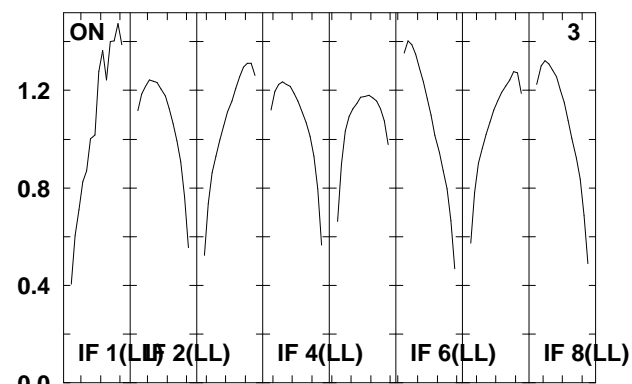
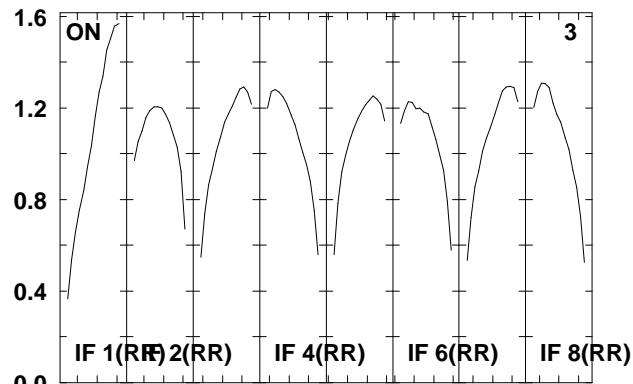
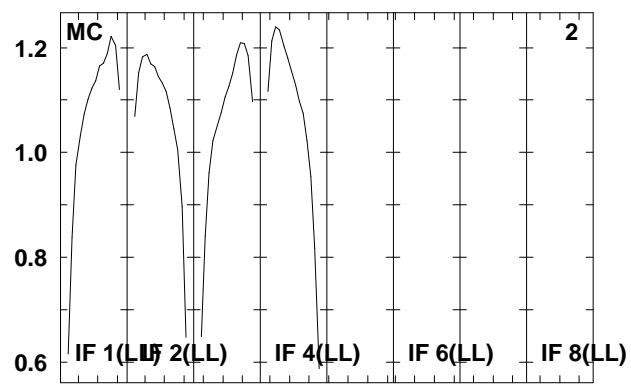
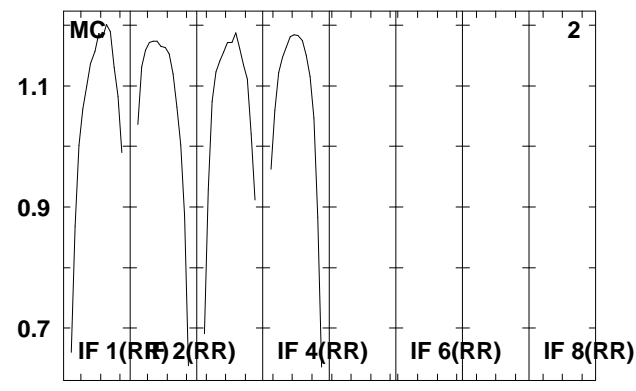
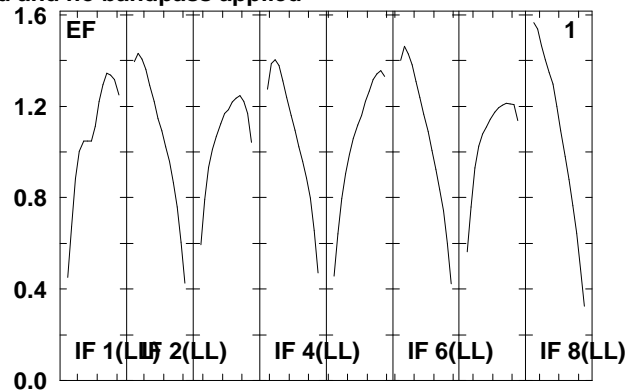
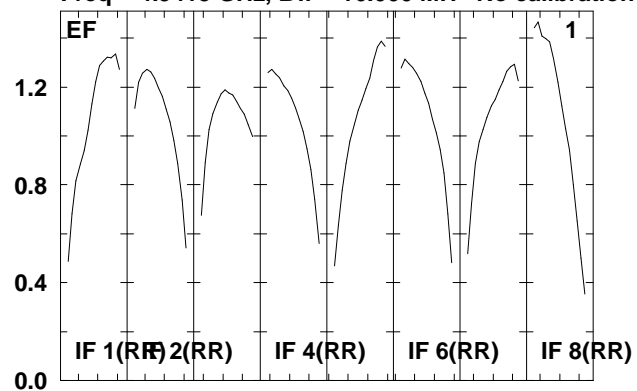

Lower frame: Real Jy  
Total-power spectrum Antenna: \*  
Timerange: 00/12:49:43 to 00/12:51:55

Plot file version 24 created 07-DEC-2009 16:05:42

SS433 RT006C.UVDATA.1

Freq = 4.9415 GHz, Bw = 16.000 MH No calibration applied and no bandpass applied

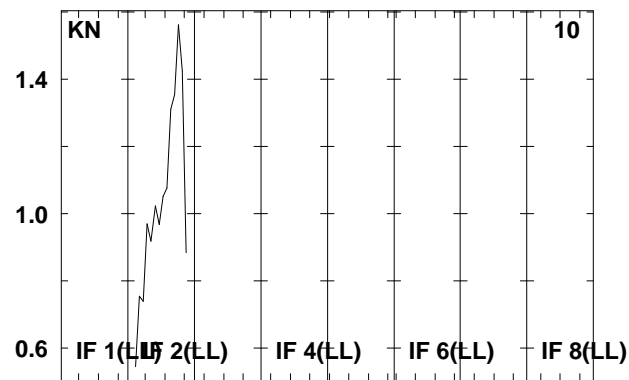
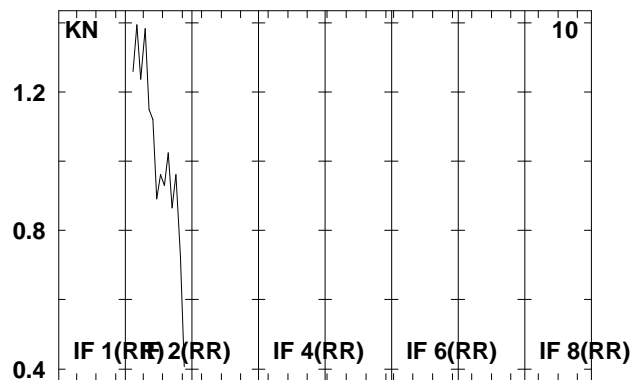
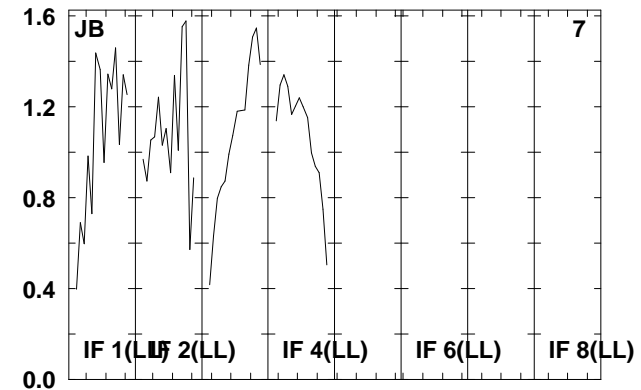
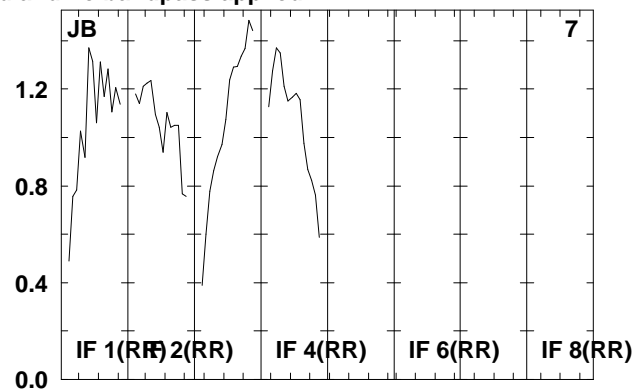
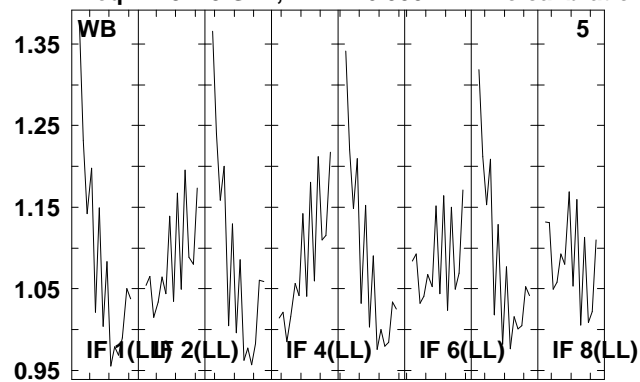

Lower frame: Real Jy  
Total-power spectrum Antenna: \*  
Timerange: 00/12:49:43 to 00/12:51:55



Plot file version 25 created 07-DEC-2009 16:05:42

J1912+05 RT006C.UVDATA.1

Freq = 4.9415 GHz, Bw = 16.000 MH No calibration applied and no bandpass applied

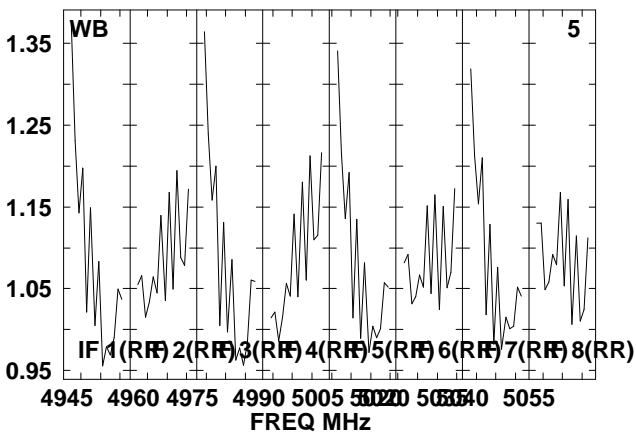
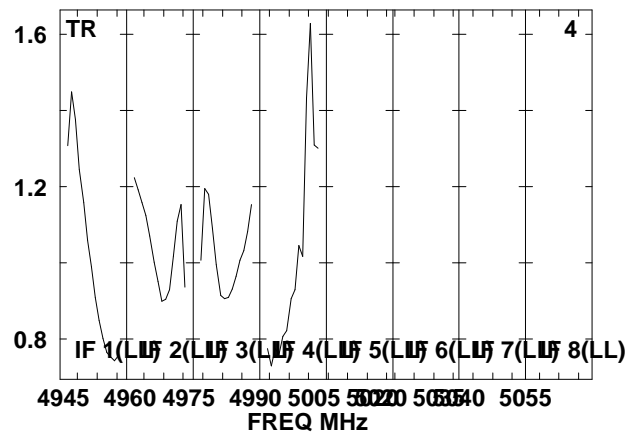
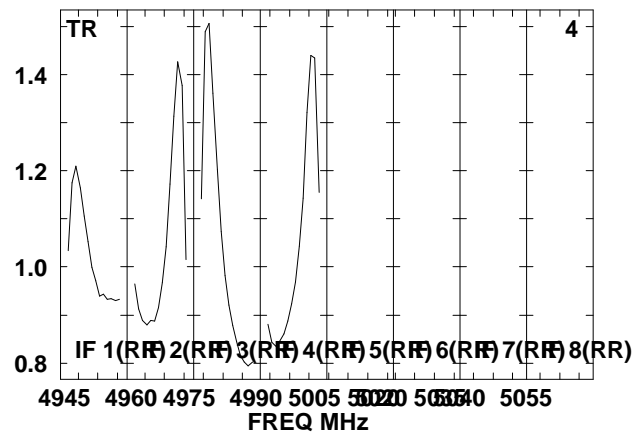
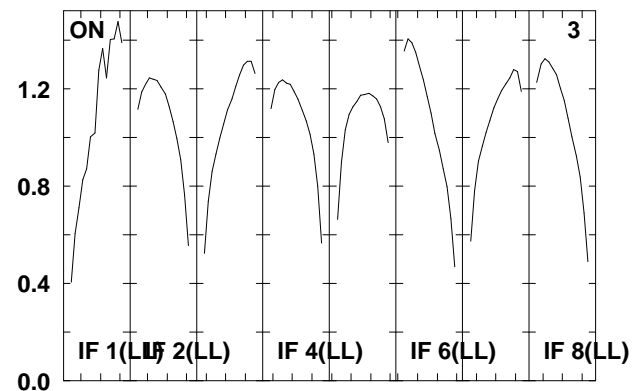
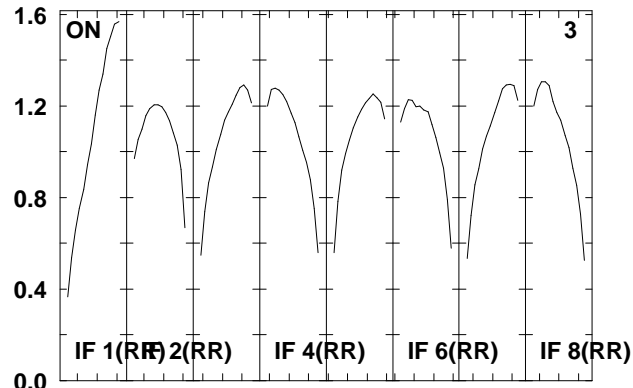
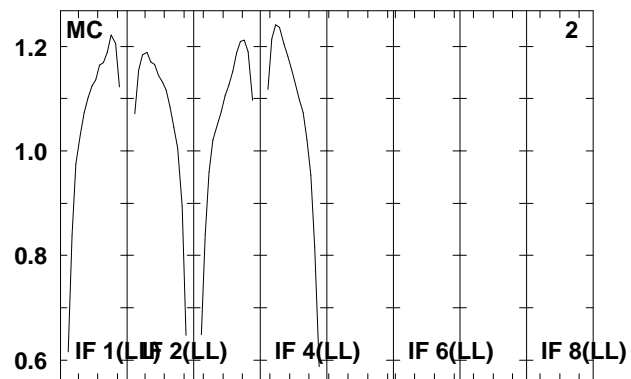
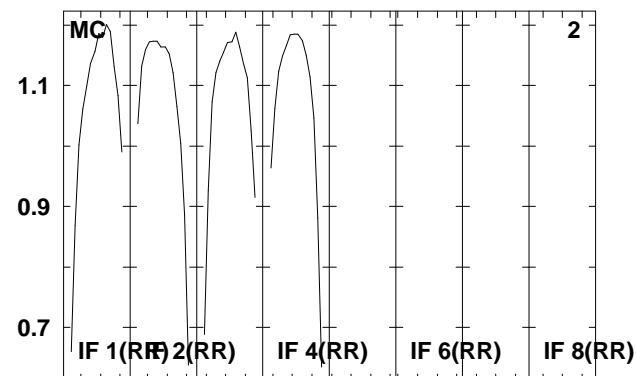
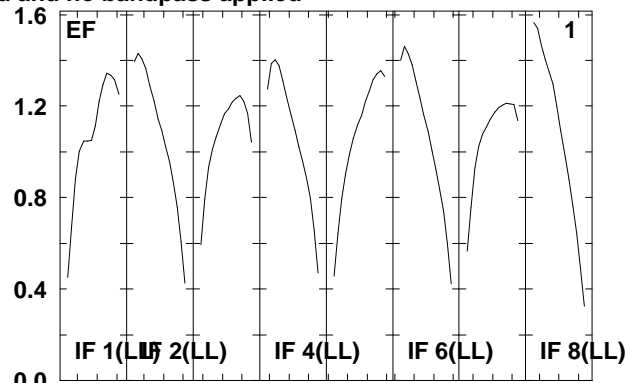
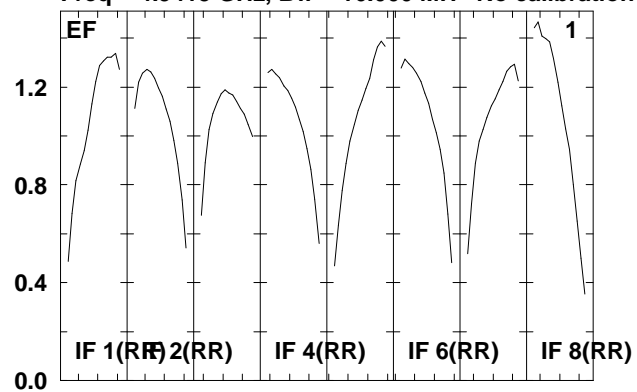

Lower frame: Real Jy  
Total-power spectrum Antenna: \*  
Timerange: 00/12:52:11 to 00/12:53:19

Plot file version 26 created 07-DEC-2009 16:05:42

J1912+05 RT006C.UVDATA.1

Freq = 4.9415 GHz, Bw = 16.000 MH No calibration applied and no bandpass applied

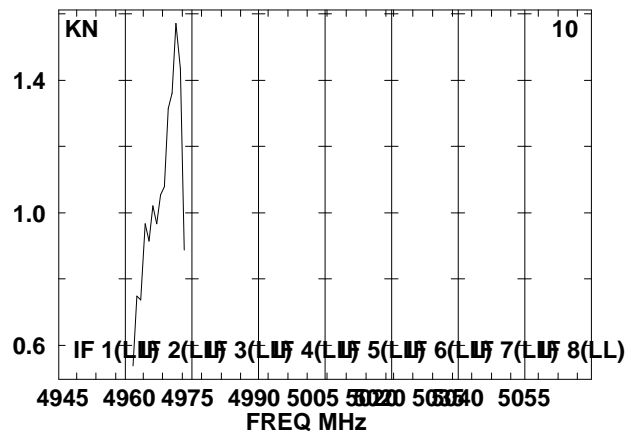
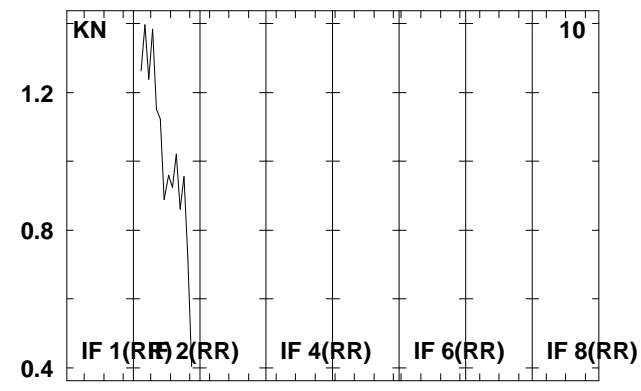
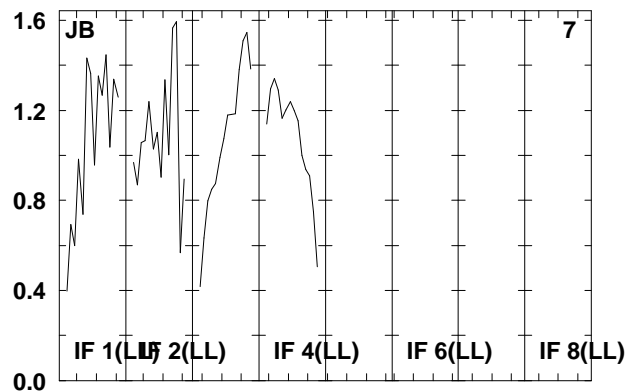
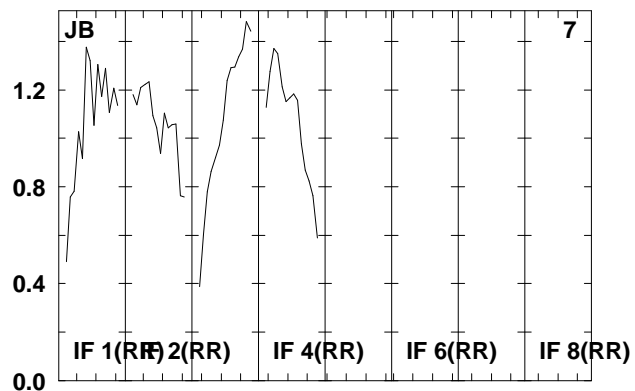
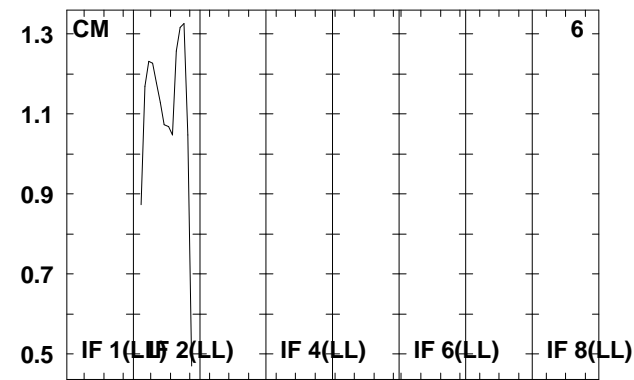
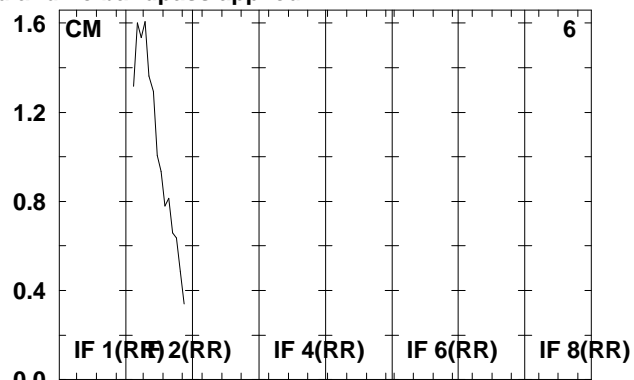
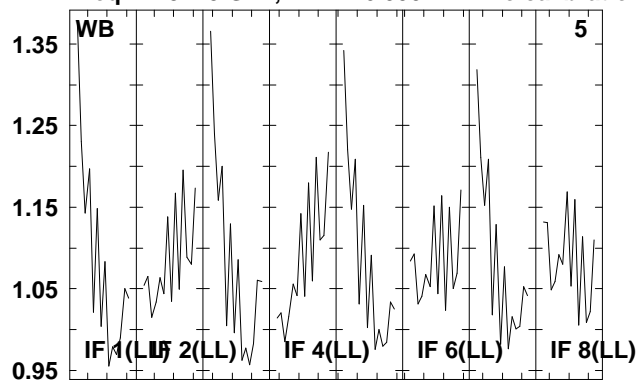

Lower frame: Real Jy

Total-power spectrum Antenna: \*

Timerange: 00/12:52:11 to 00/12:53:19

Plot file version 27 created 07-DEC-2009 16:05:42

SS433 RT006C.UVDATA.1

Freq = 4.9415 GHz, Bw = 16.000 MH No calibration applied and no bandpass applied

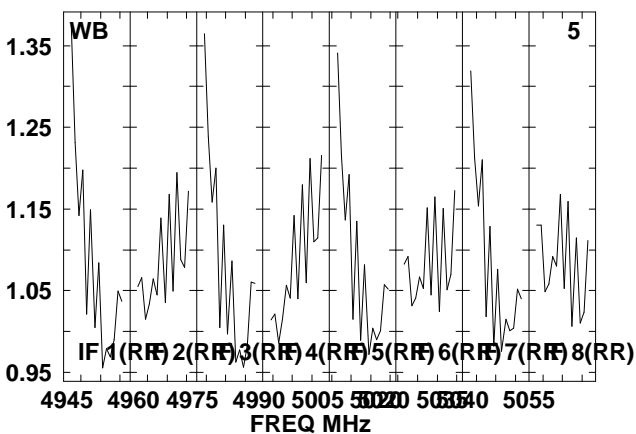
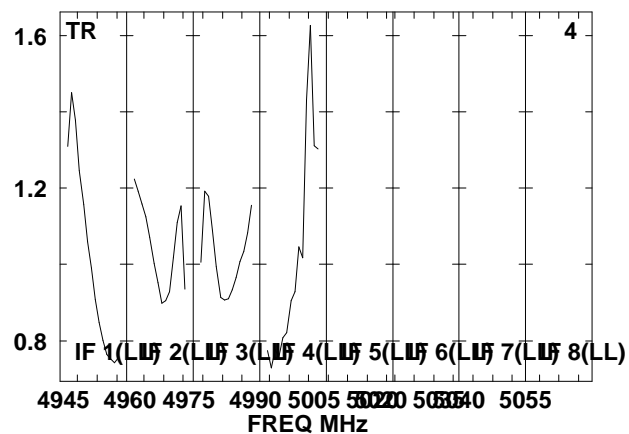
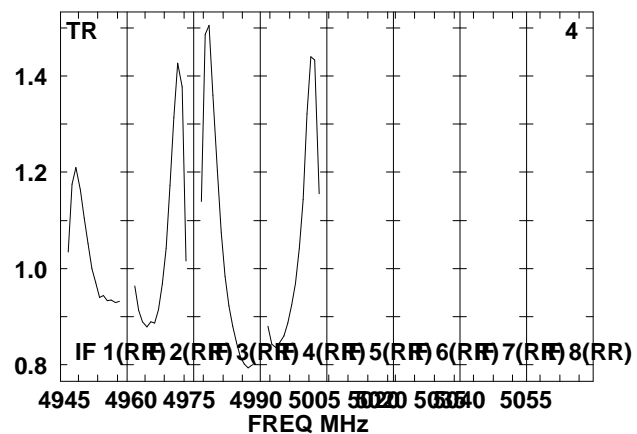
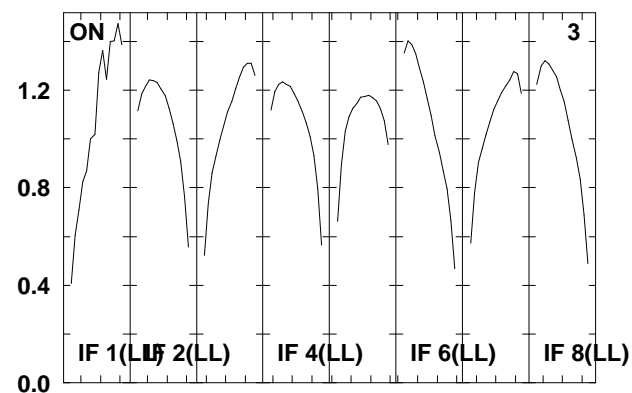
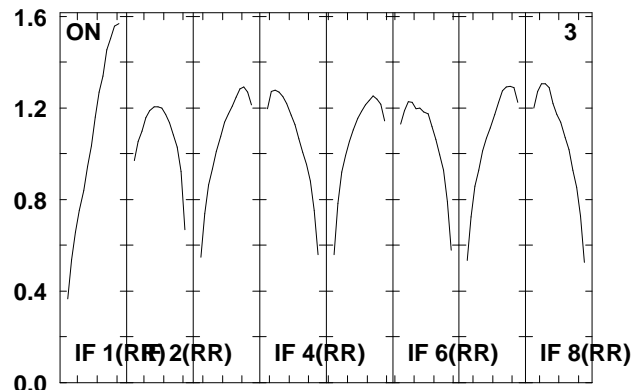
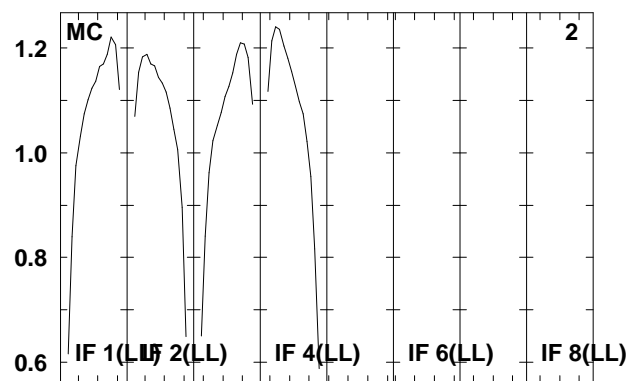
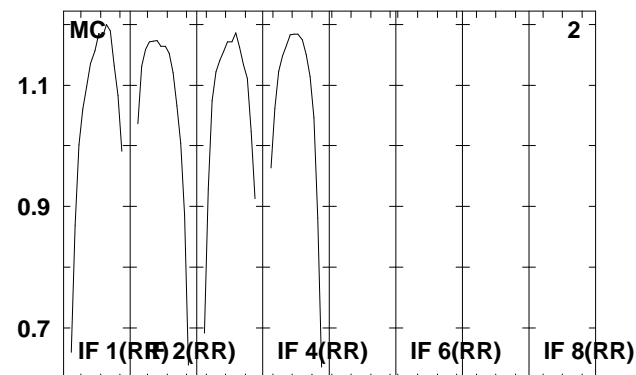
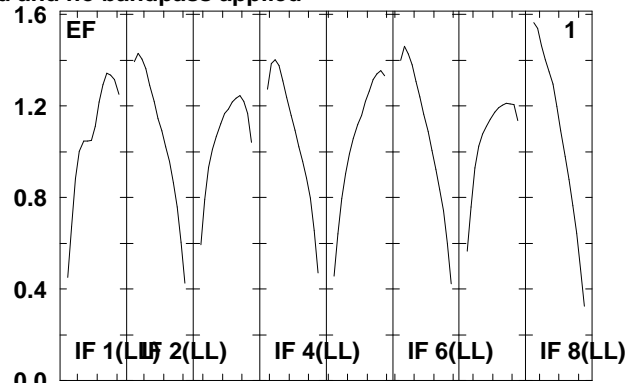
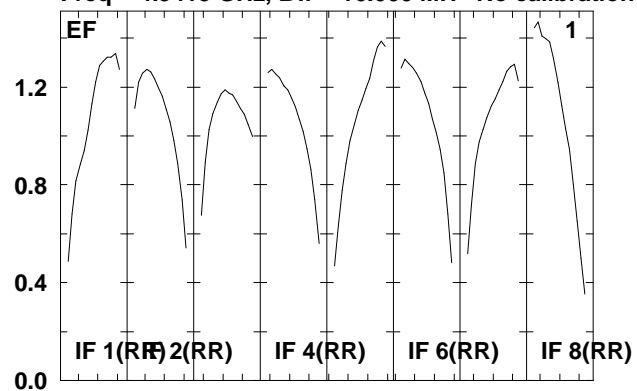

Lower frame: Real Jy

Total-power spectrum Antenna: \*

Timerange: 00/12:53:23 to 00/12:55:39

Plot file version 28 created 07-DEC-2009 16:05:42

SS433 RT006C.UVDATA.1

Freq = 4.9415 GHz, Bw = 16.000 MH No calibration applied and no bandpass applied

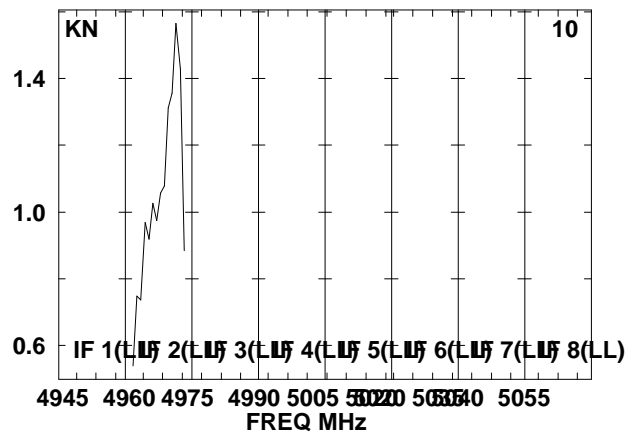
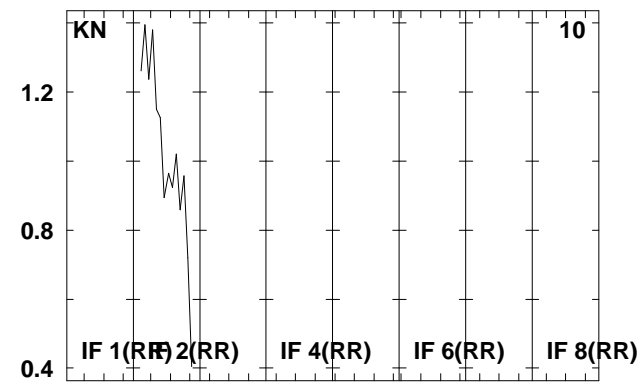
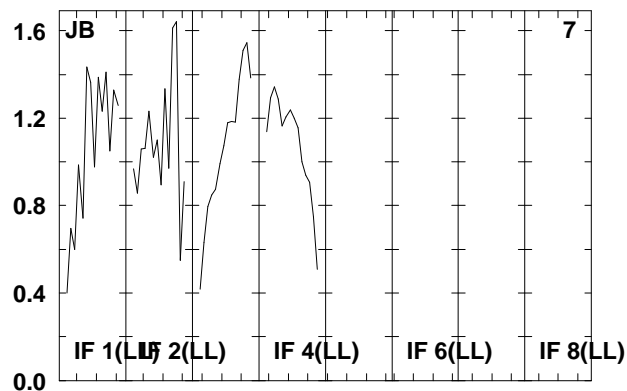
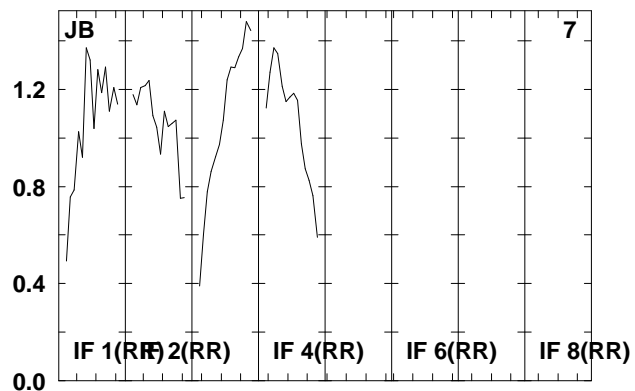
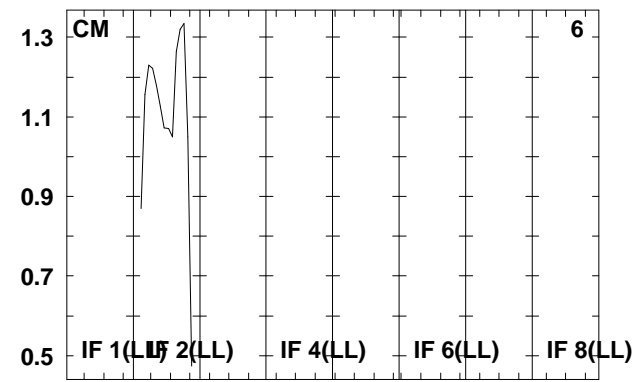
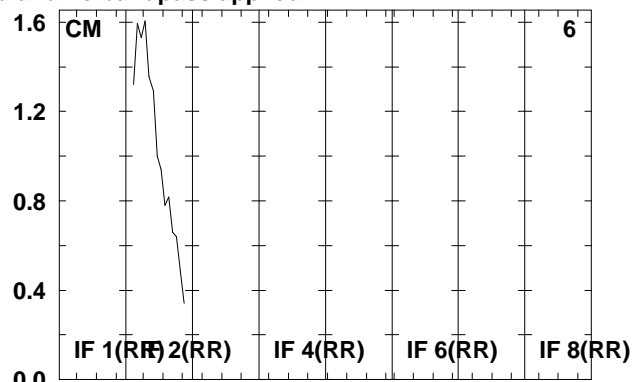
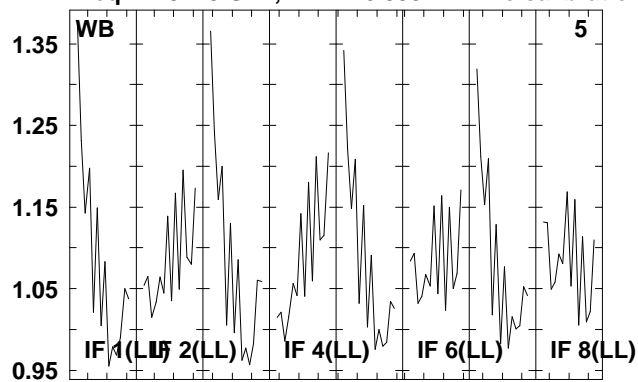

Lower frame: Real Jy

Total-power spectrum Antenna: \*

Timerange: 00/12:53:23 to 00/12:55:39

Plot file version 29 created 07-DEC-2009 16:05:43

J1912+05 RT006C.UVDATA.1

Freq = 4.9415 GHz, Bw = 16.000 MH No calibration applied and no bandpass applied

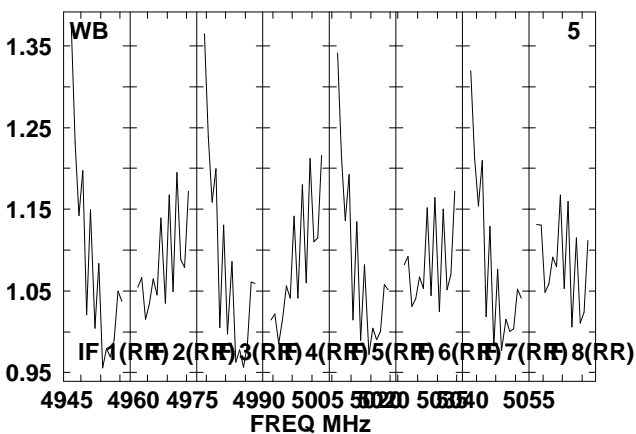
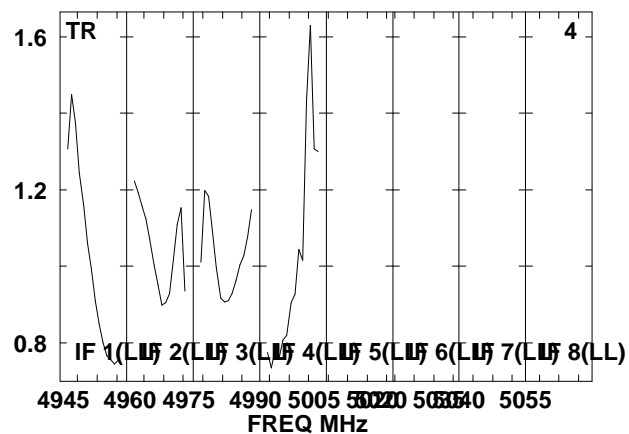
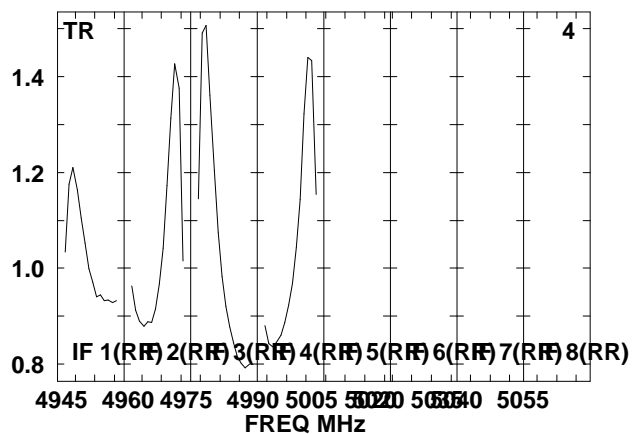
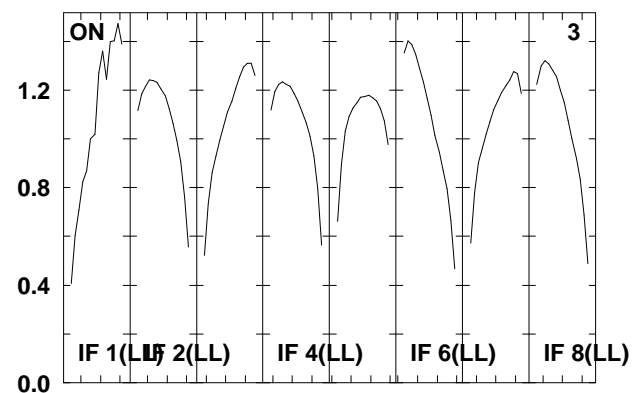
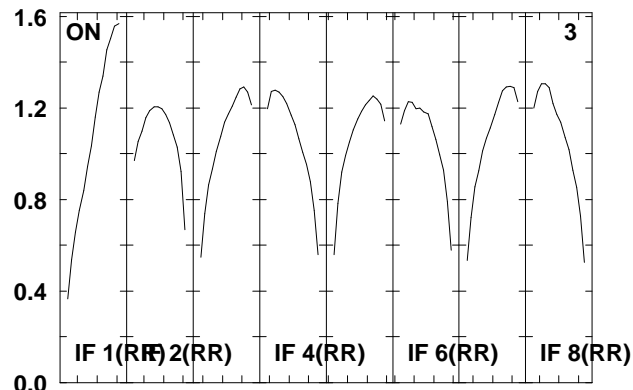
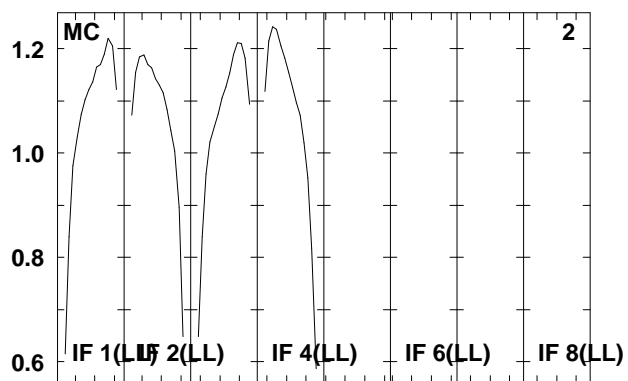
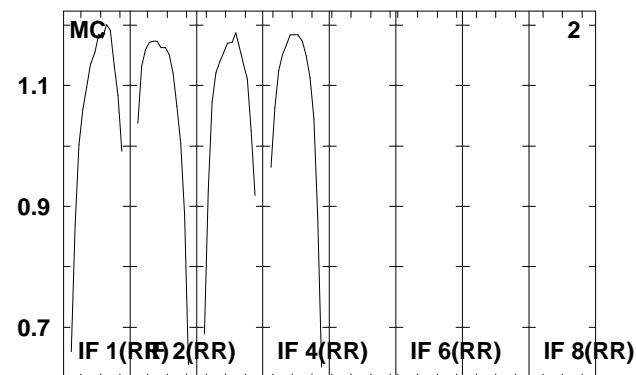
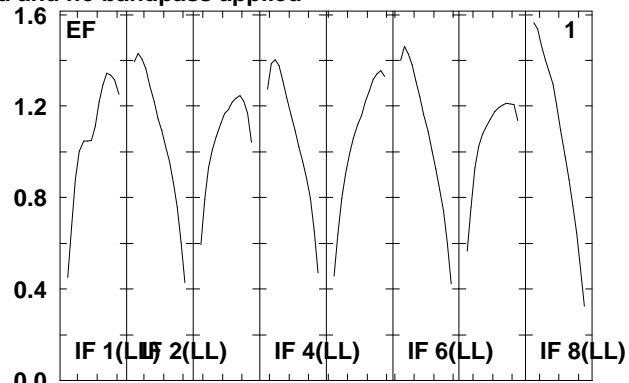
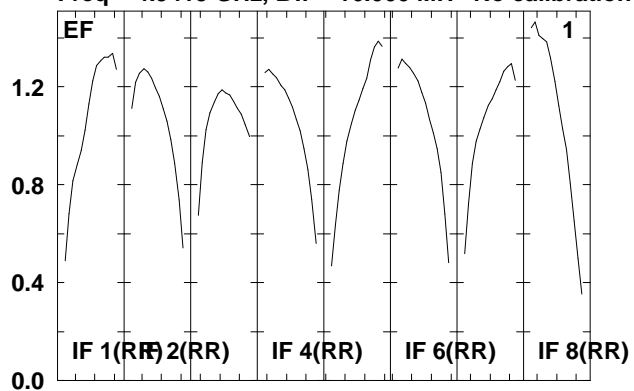

Lower frame: Real Jy  
Total-power spectrum Antenna: \*  
Timerange: 00/12:55:43 to 00/12:56:59

Plot file version 30 created 07-DEC-2009 16:05:43

J1912+05 RT006C.UVDATA.1

Freq = 4.9415 GHz, Bw = 16.000 MH No calibration applied and no bandpass applied

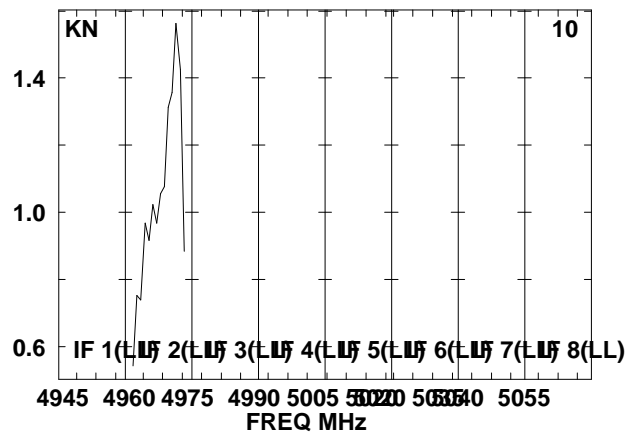
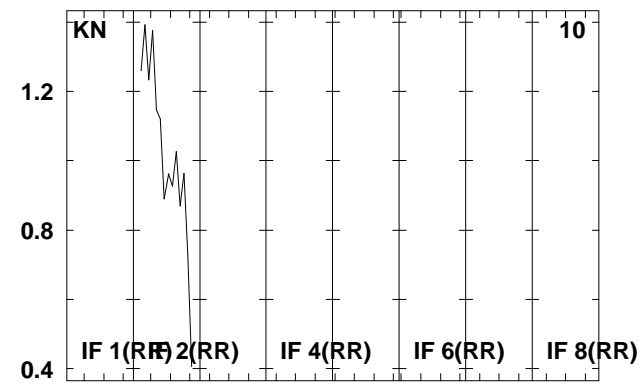
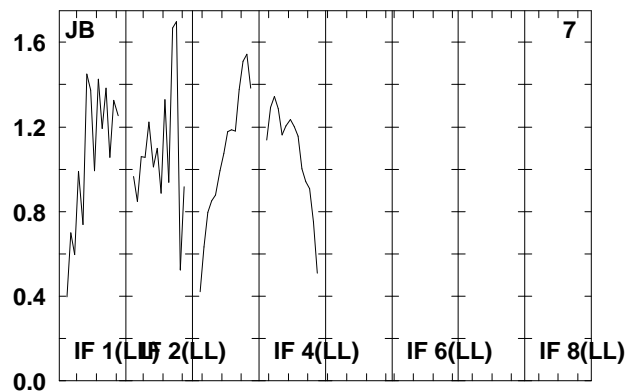
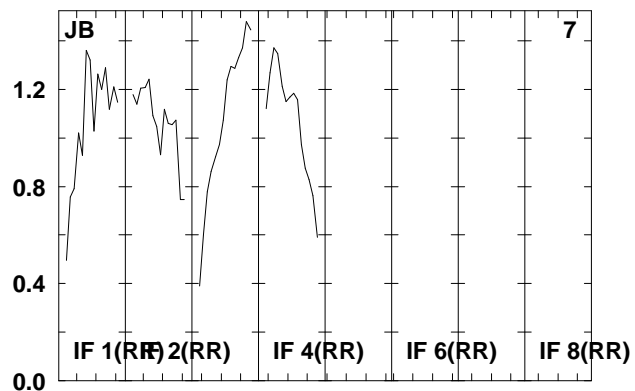
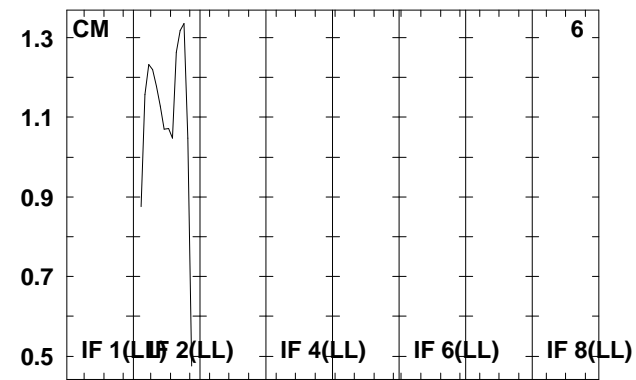
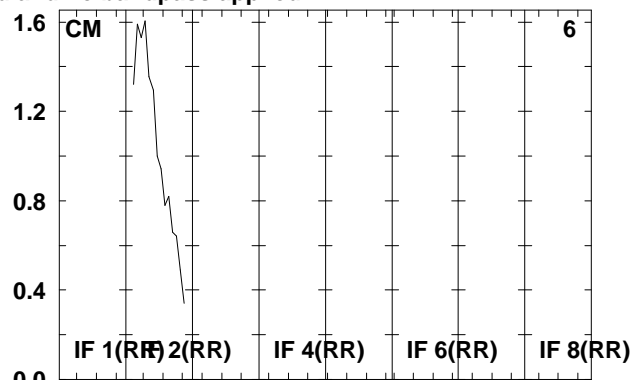
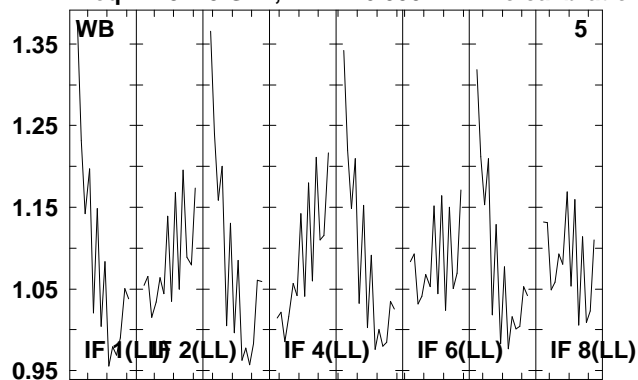

Lower frame: Real Jy

Total-power spectrum Antenna: \*

Timerange: 00/12:55:43 to 00/12:56:59

Plot file version 31 created 07-DEC-2009 16:05:43

SS433 RT006C.UVDATA.1

Freq = 4.9415 GHz, Bw = 16.000 MH No calibration applied and no bandpass applied

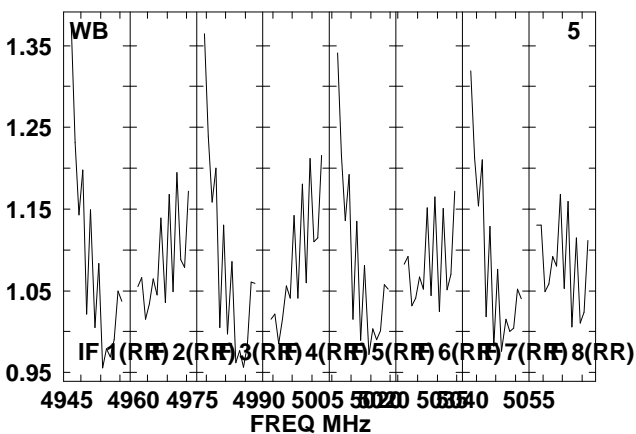
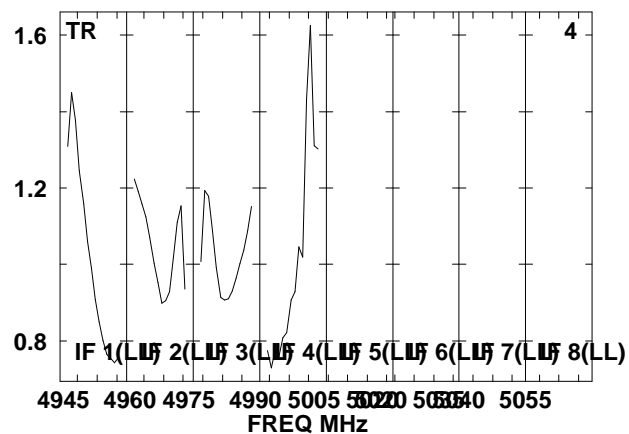
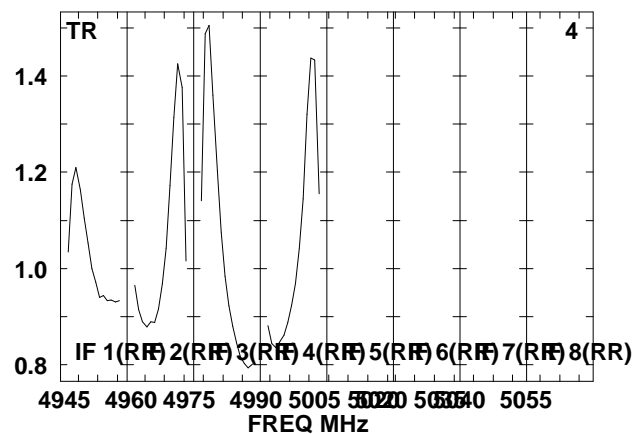
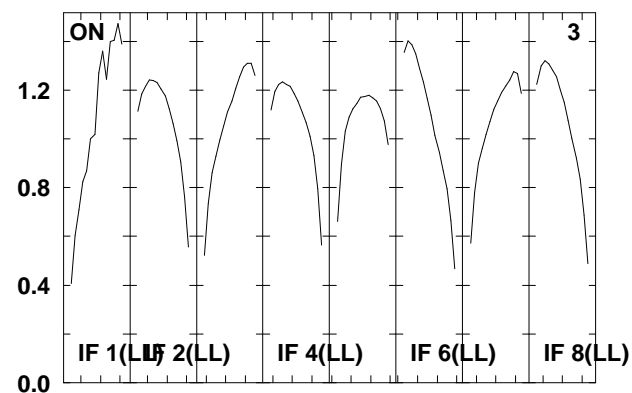
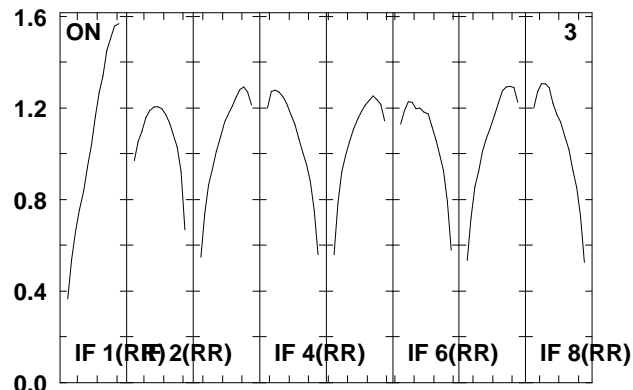
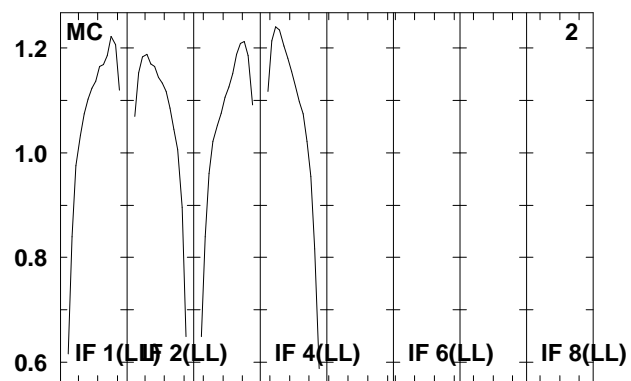
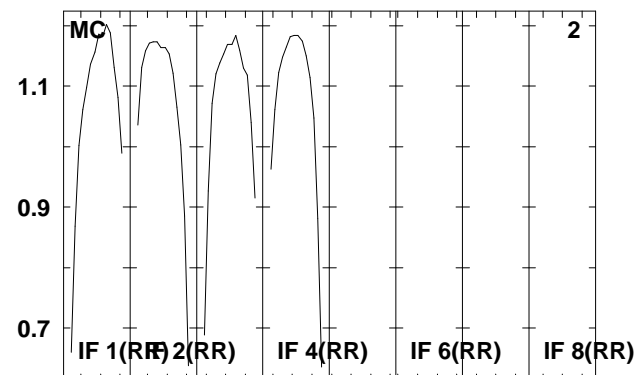
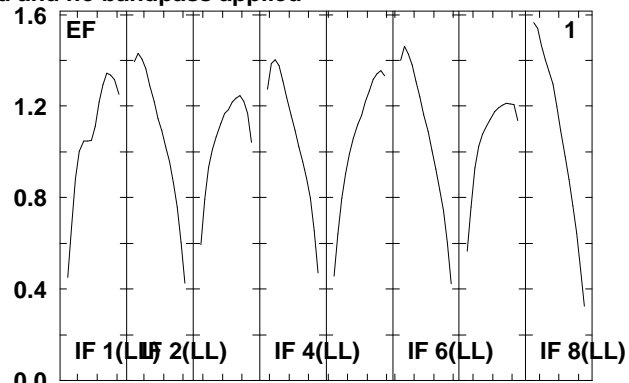
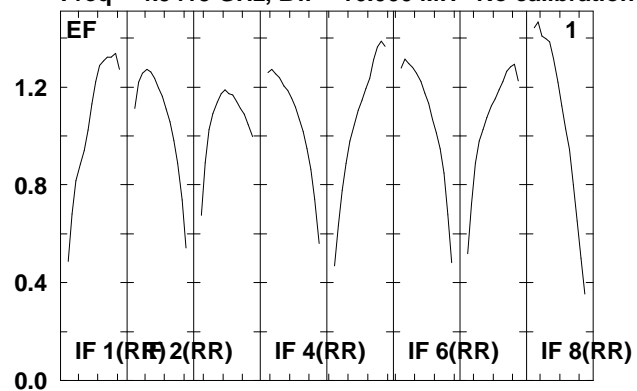

Lower frame: Real Jy

Total-power spectrum Antenna: \*

Timerange: 00/12:57:03 to 00/12:59:19

Plot file version 32 created 07-DEC-2009 16:05:44

SS433 RT006C.UVDATA.1

Freq = 4.9415 GHz, Bw = 16.000 MH No calibration applied and no bandpass applied

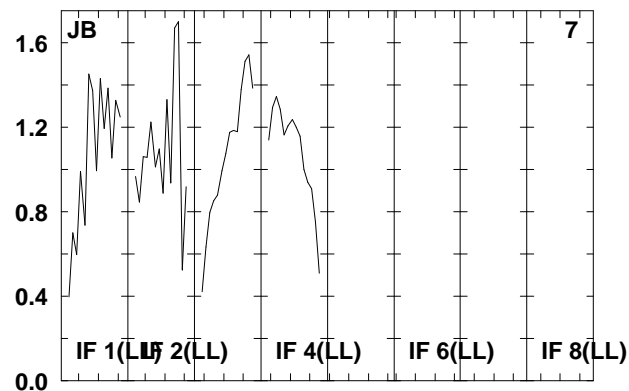
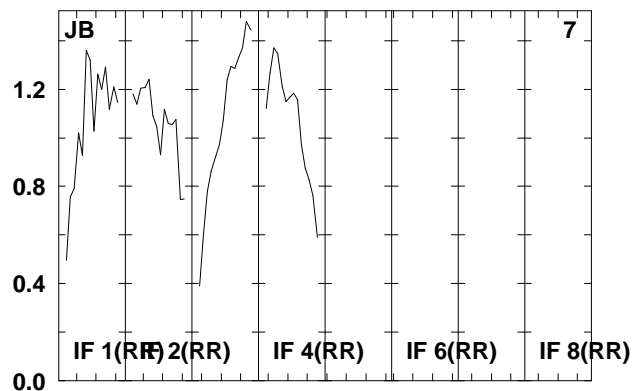
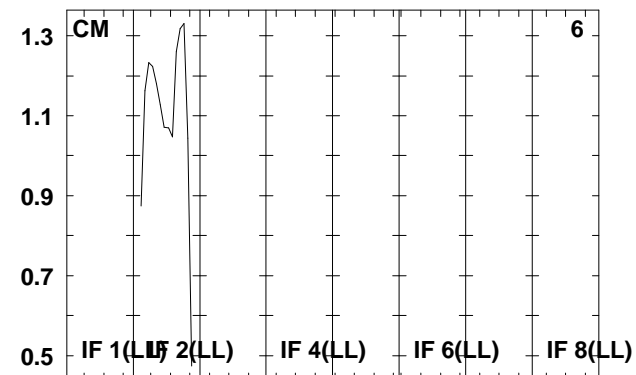
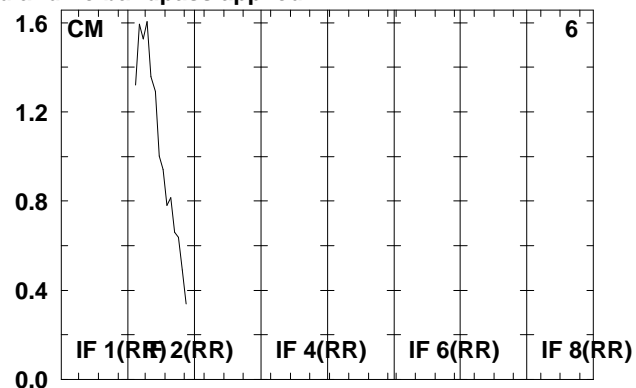
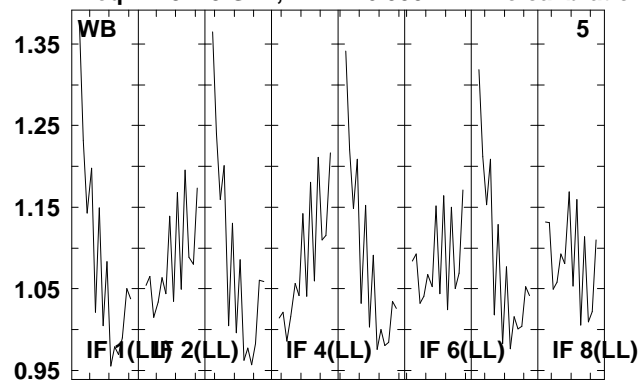

Lower frame: Real Jy  
Total-power spectrum Antenna: \*  
Timerange: 00/12:57:03 to 00/12:59:19



Plot file version 33 created 07-DEC-2009 16:05:44

J1911+16 RT006C.UVDATA.1

Freq = 4.9415 GHz, Bw = 16.000 MH No calibration applied and no bandpass applied

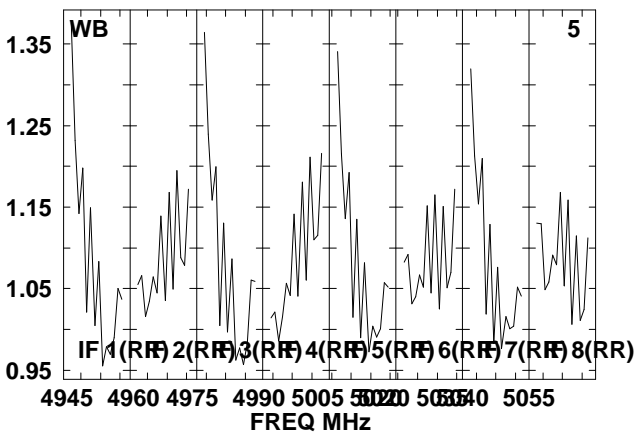
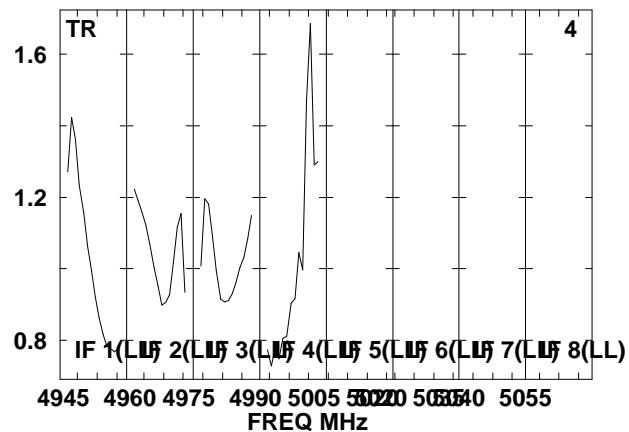
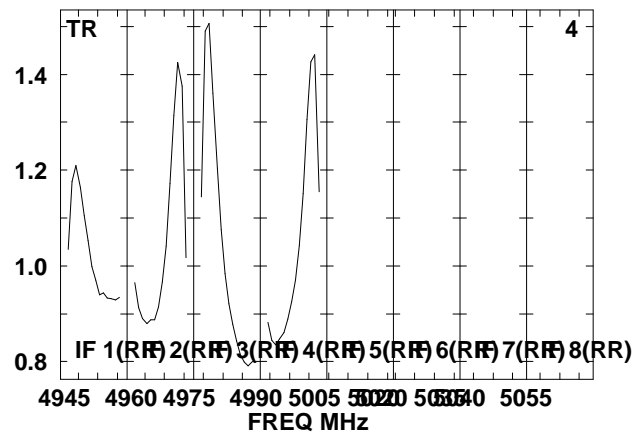
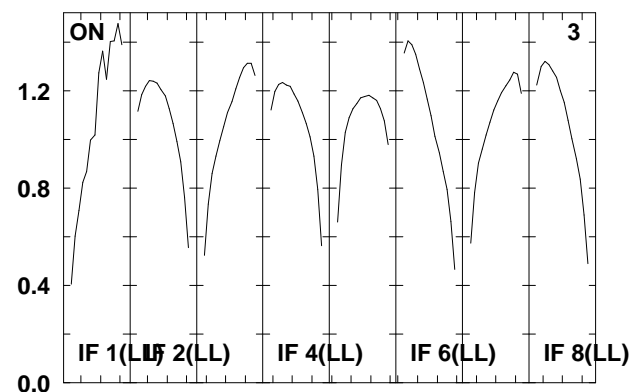
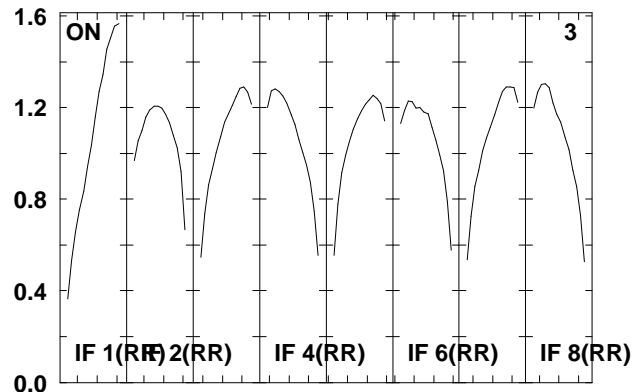
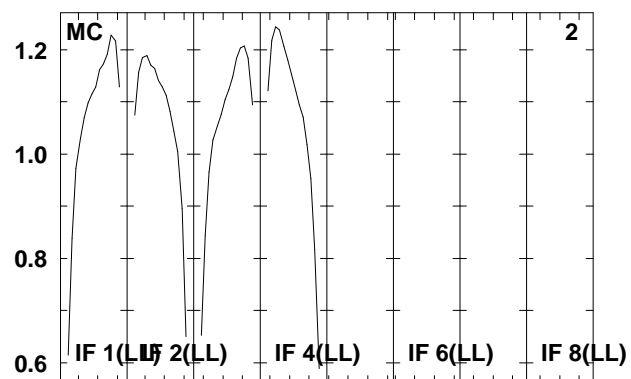
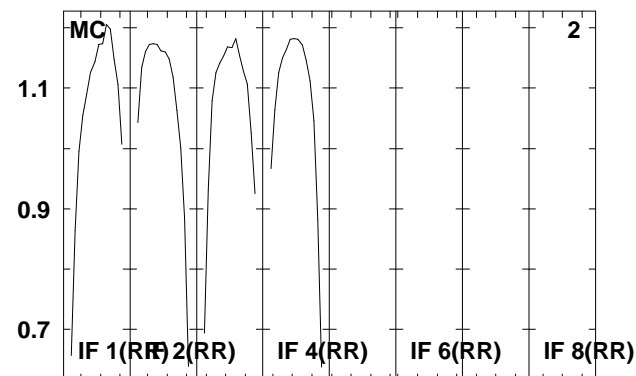
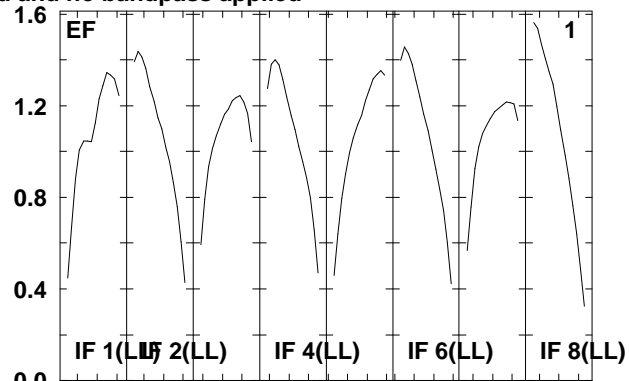
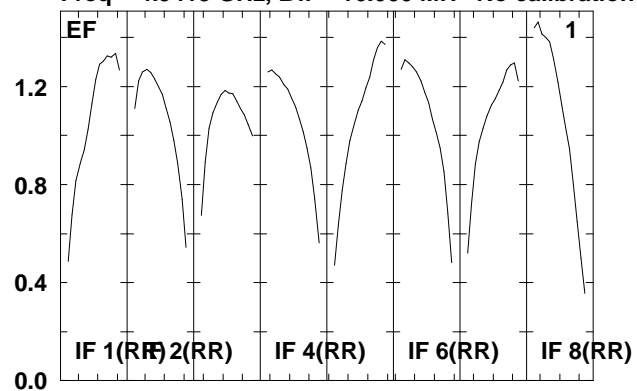

Lower frame: Real Jy

Total-power spectrum Antenna: \*

Timerange: 00/13:00:23 to 00/13:01:19

Plot file version 34 created 07-DEC-2009 16:05:44

J1911+16 RT006C.UVDATA.1

Freq = 4.9415 GHz, Bw = 16.000 MH No calibration applied and no bandpass applied

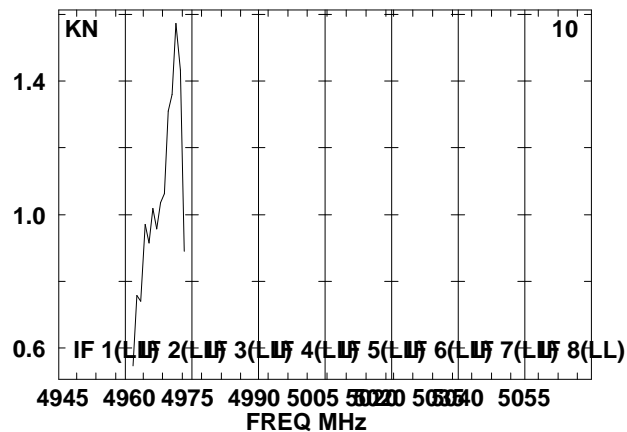
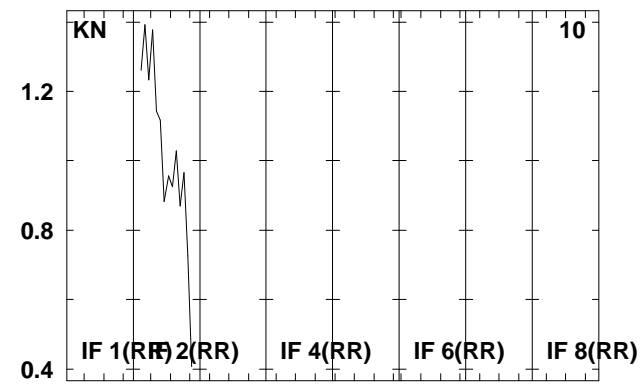
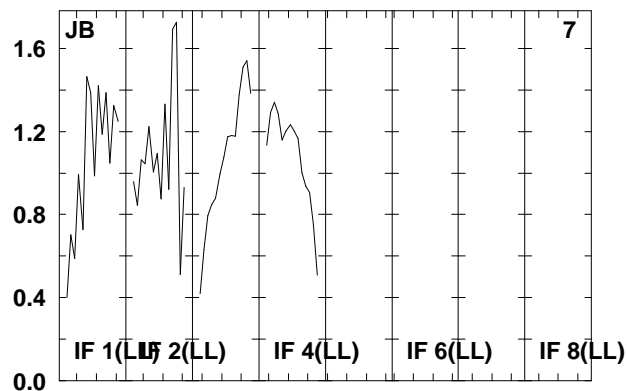
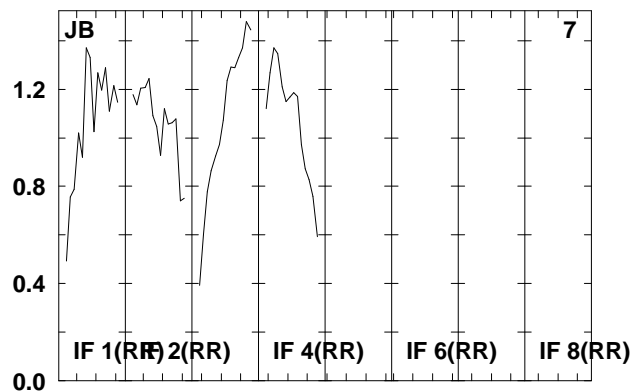
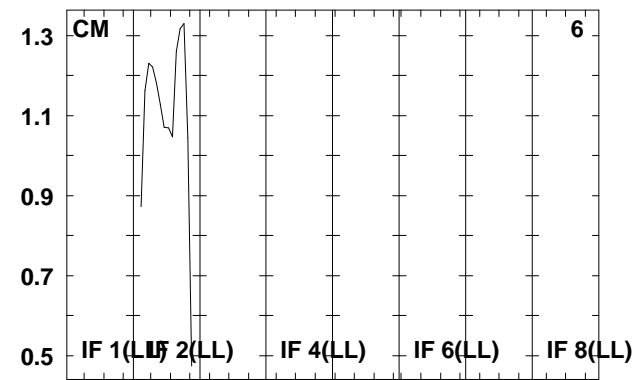
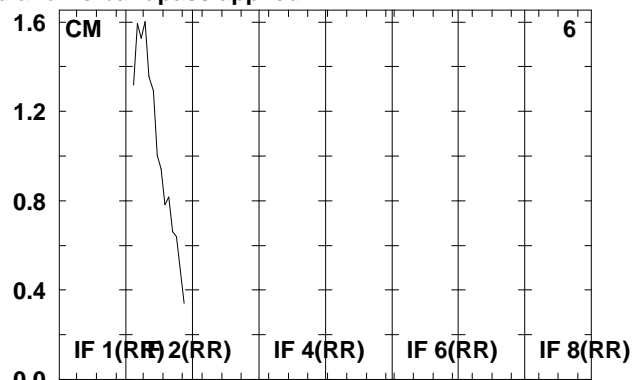
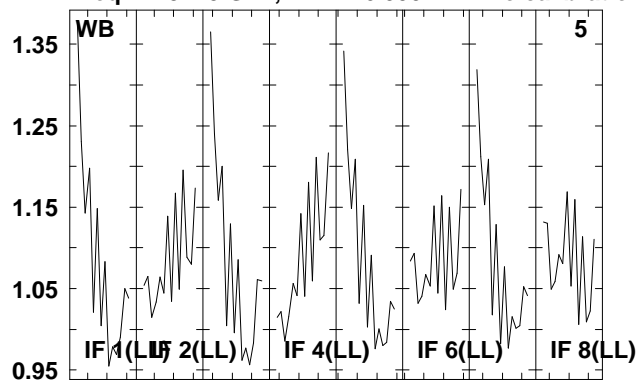

Lower frame: Real Jy

Total-power spectrum Antenna: \*

Timerange: 00/13:00:23 to 00/13:01:19

Plot file version 35 created 07-DEC-2009 16:05:44

J1912+05 RT006C.UVDATA.1

Freq = 4.9415 GHz, Bw = 16.000 MH No calibration applied and no bandpass applied

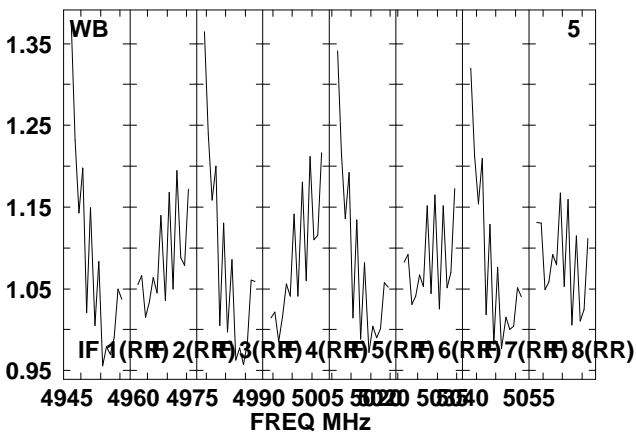
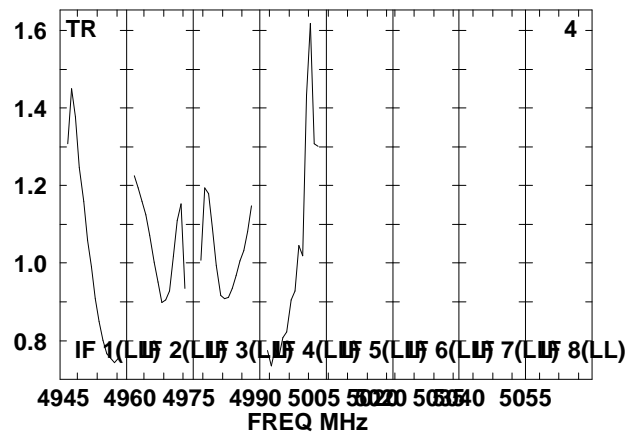
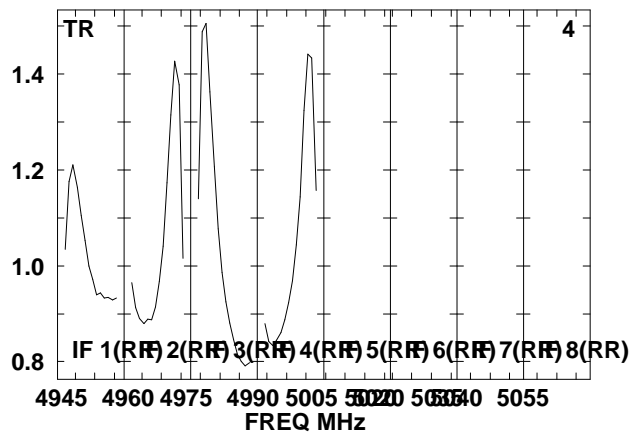
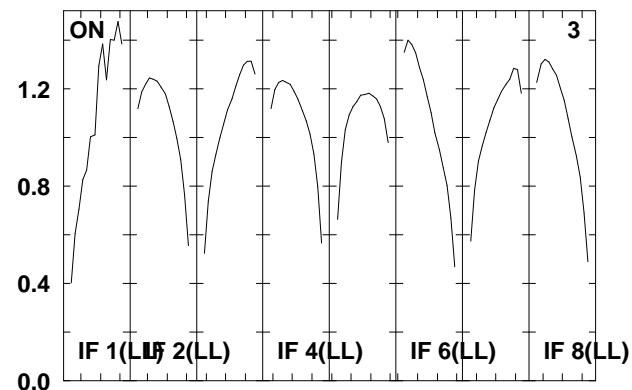
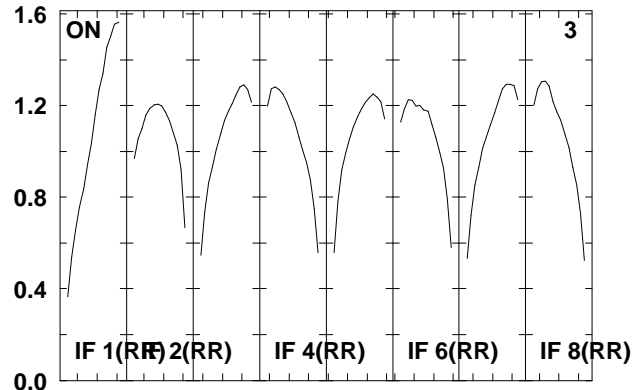
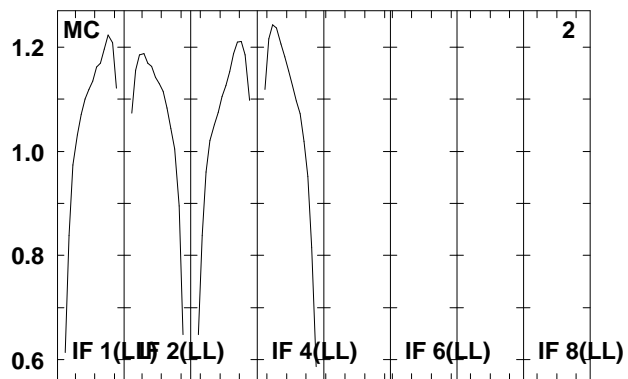
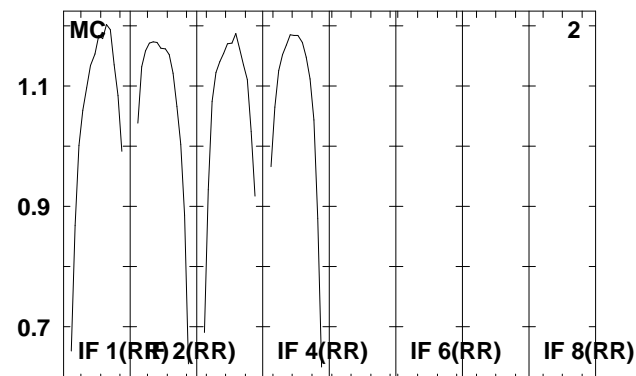
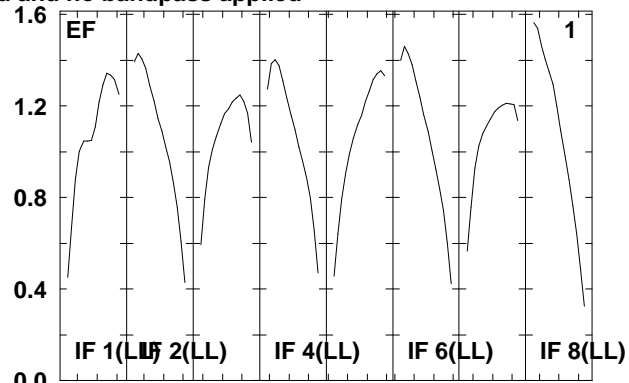
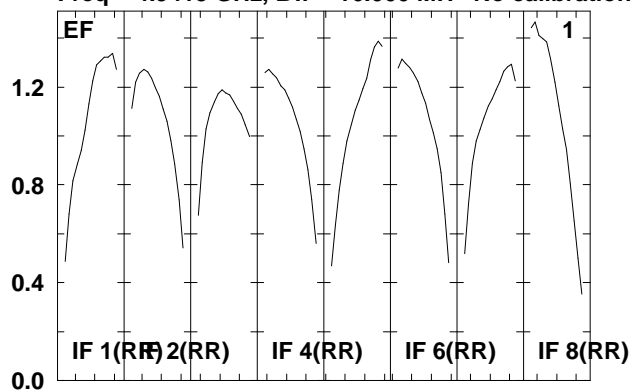

Lower frame: Real Jy  
Total-power spectrum Antenna: \*  
Timerange: 00/13:02:23 to 00/13:03:19

Plot file version 36 created 07-DEC-2009 16:05:44

J1912+05 RT006C.UVDATA.1

Freq = 4.9415 GHz, Bw = 16.000 MH No calibration applied and no bandpass applied

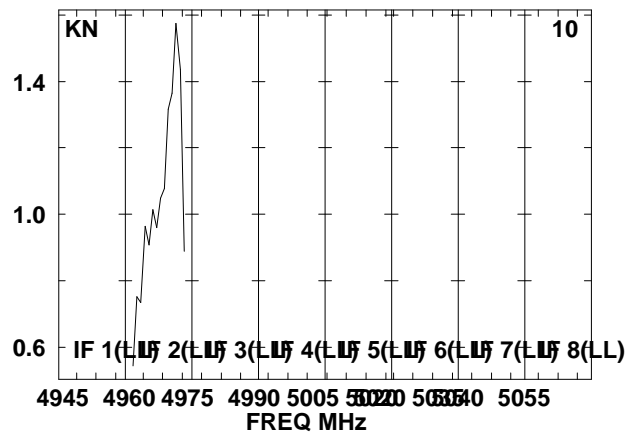
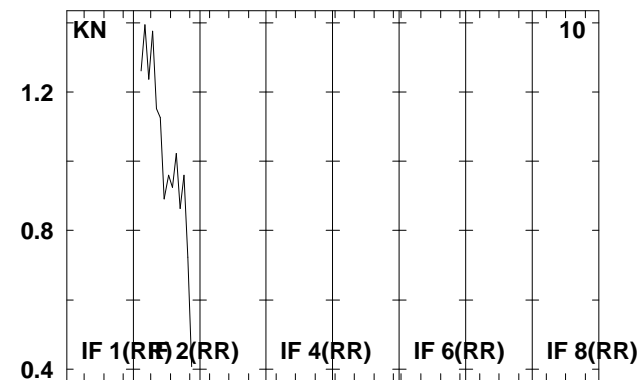
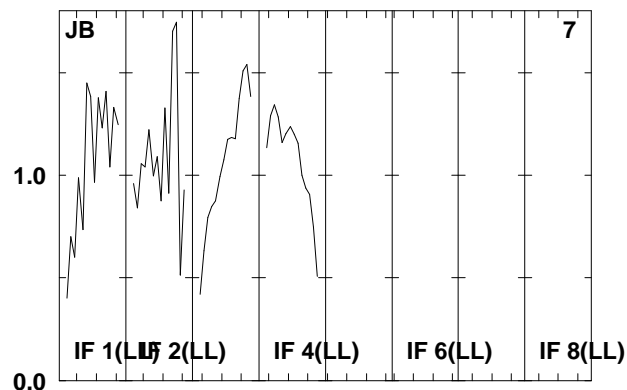
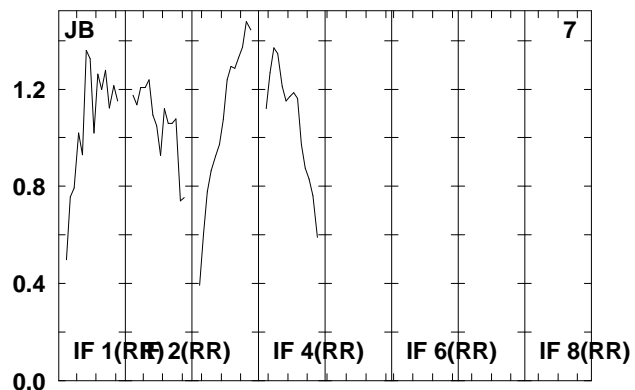
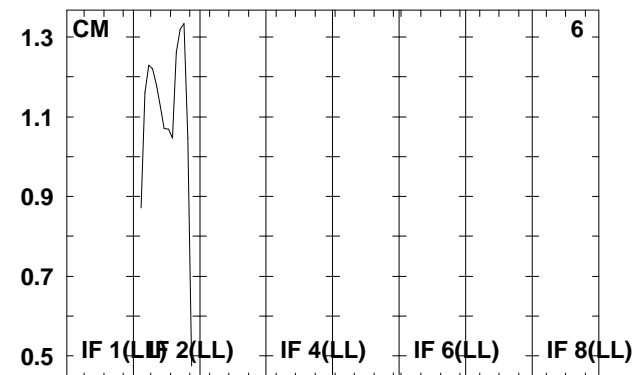
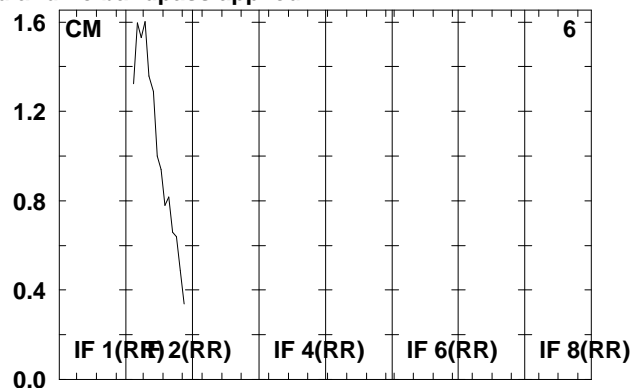
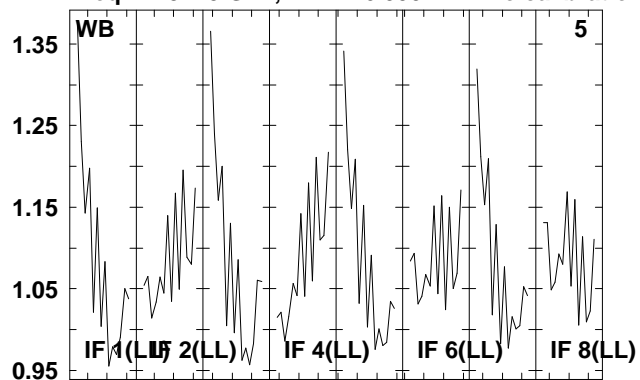

Lower frame: Real Jy

Total-power spectrum Antenna: \*

Timerange: 00/13:02:23 to 00/13:03:19

Plot file version 37 created 07-DEC-2009 16:05:44

SS433 RT006C.UVDATA.1

Freq = 4.9415 GHz, Bw = 16.000 MH No calibration applied and no bandpass applied

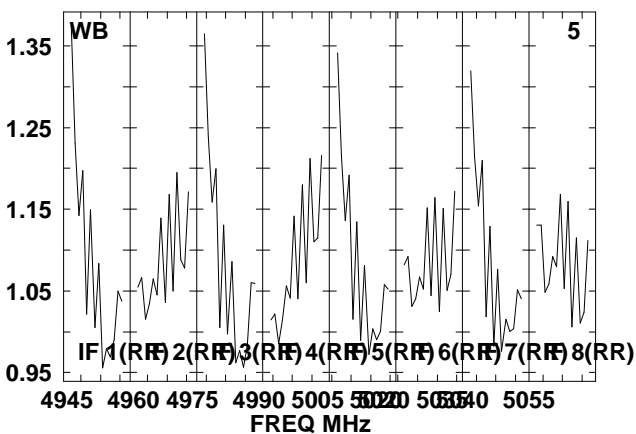
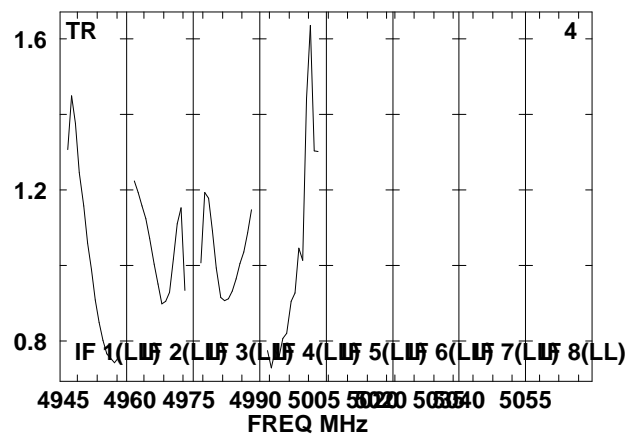
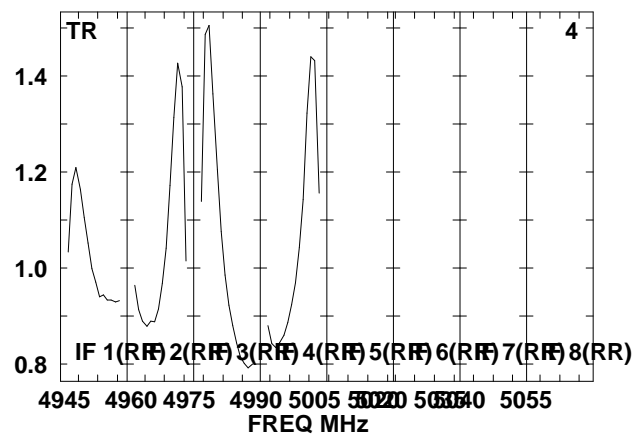
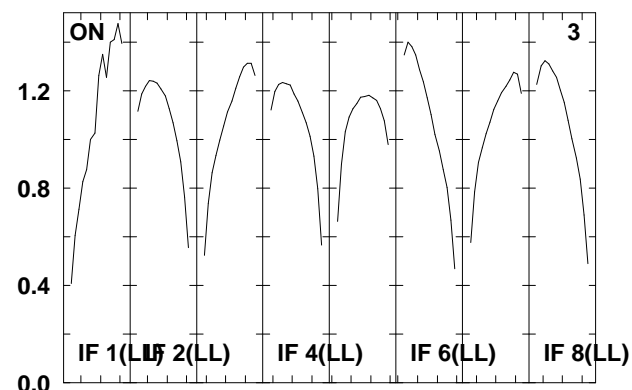
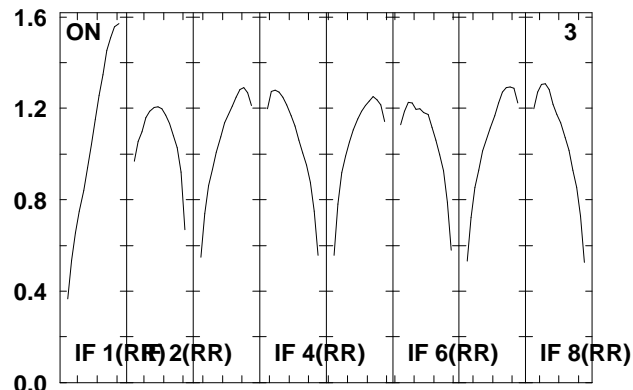
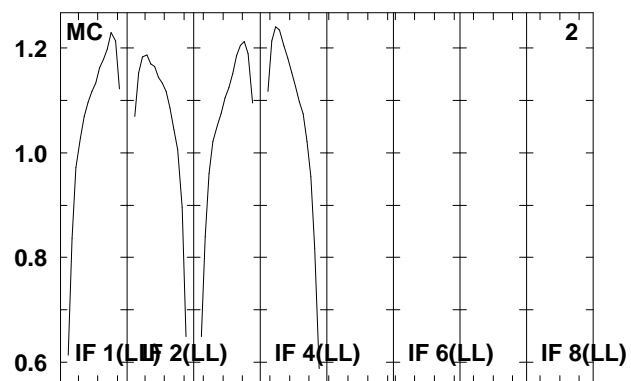
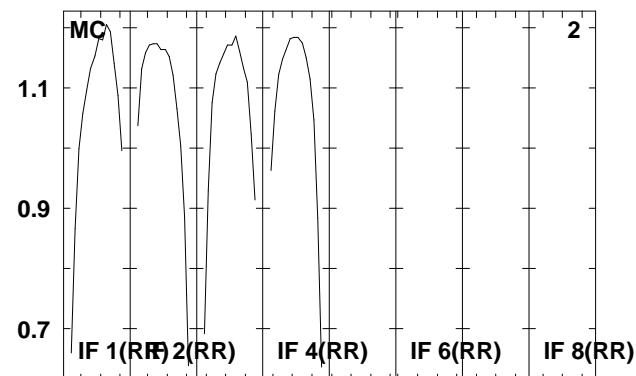
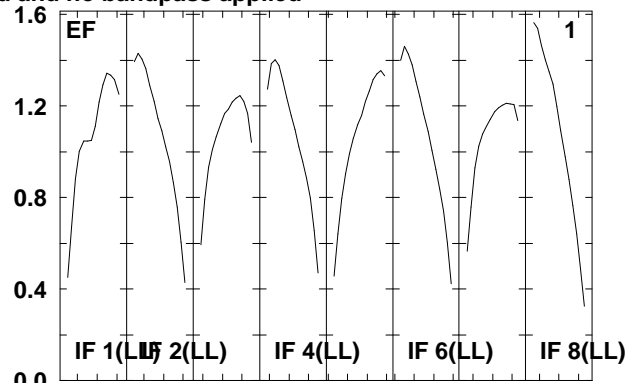
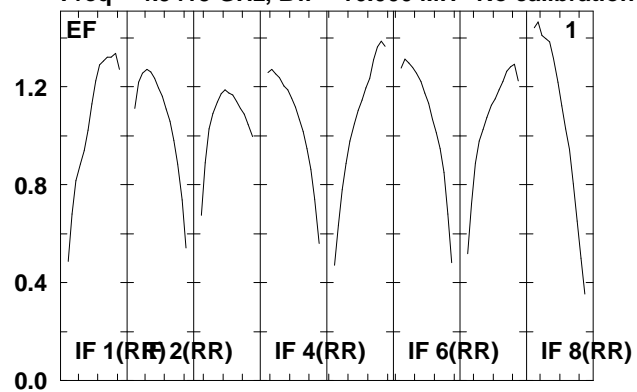

Lower frame: Real Jy

Total-power spectrum Antenna: \*

Timerange: 00/13:03:23 to 00/13:05:39

Plot file version 38 created 07-DEC-2009 16:05:44

SS433 RT006C.UVDATA.1

Freq = 4.9415 GHz, Bw = 16.000 MH No calibration applied and no bandpass applied

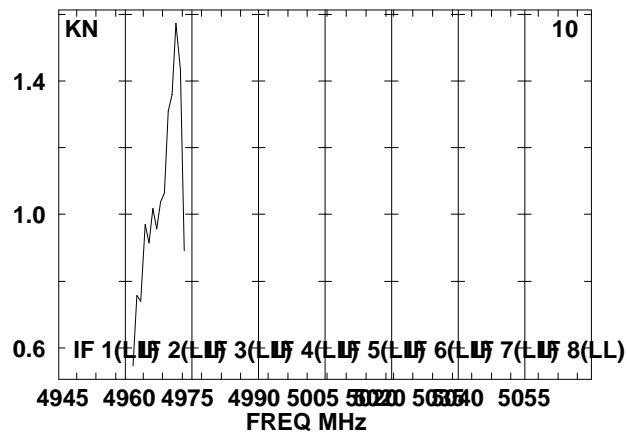
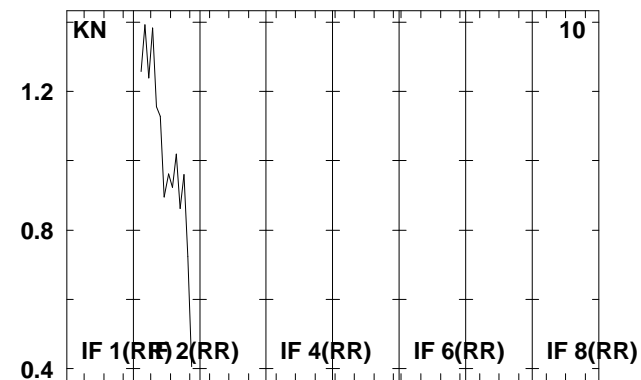
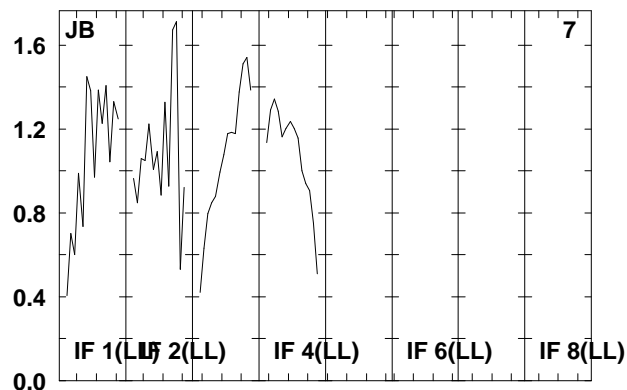
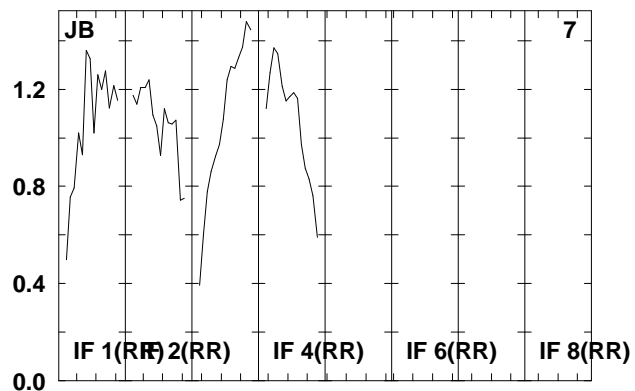
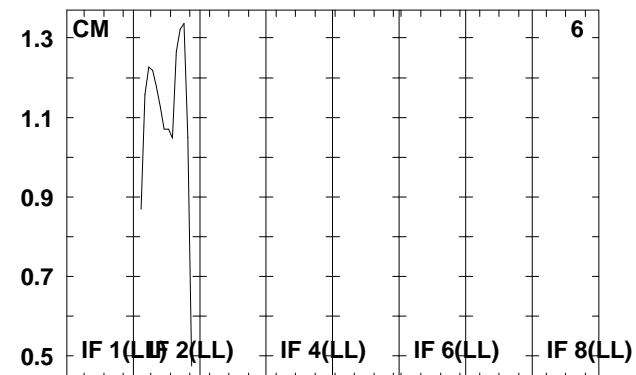
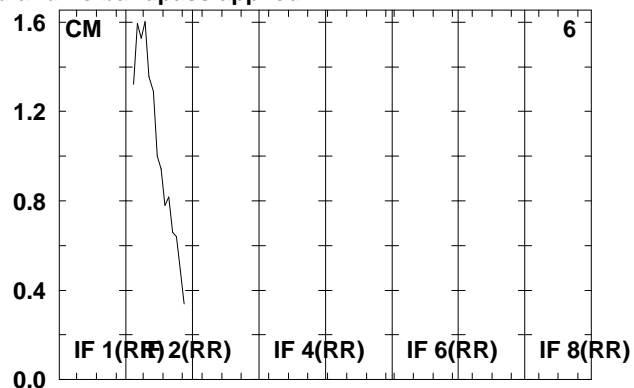
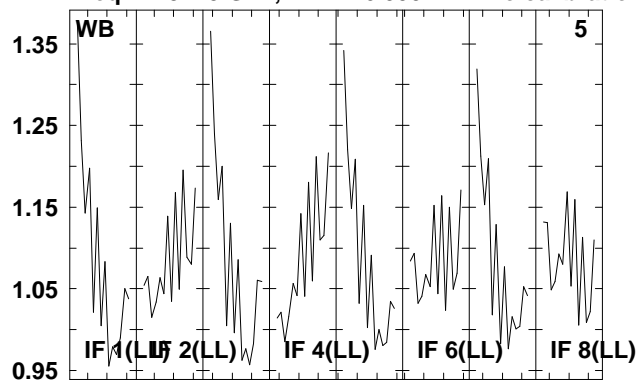

Lower frame: Real Jy

Total-power spectrum Antenna: \*

Timerange: 00/13:03:23 to 00/13:05:39

Plot file version 39 created 07-DEC-2009 16:05:45

J1912+05 RT006C.UVDATA.1

Freq = 4.9415 GHz, Bw = 16.000 MH No calibration applied and no bandpass applied

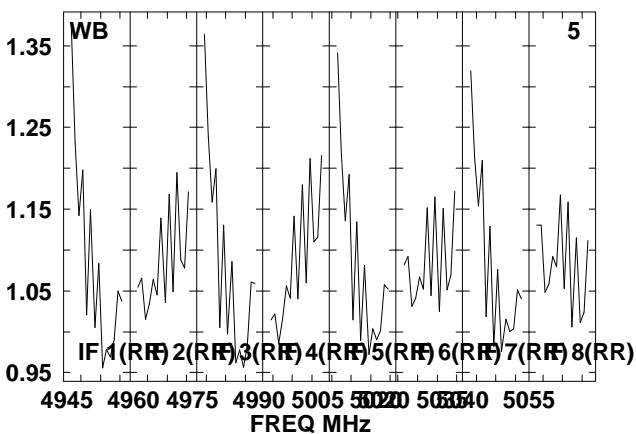
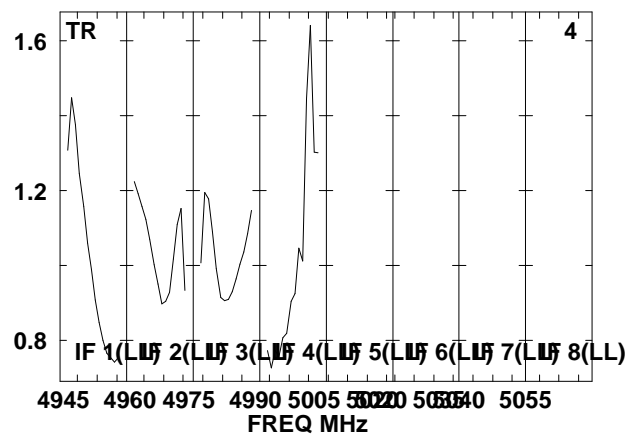
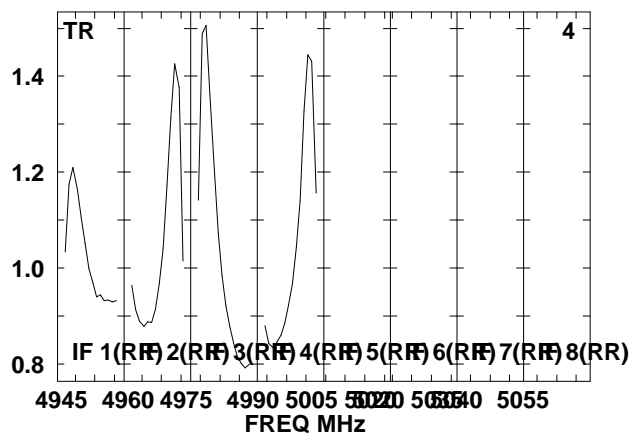
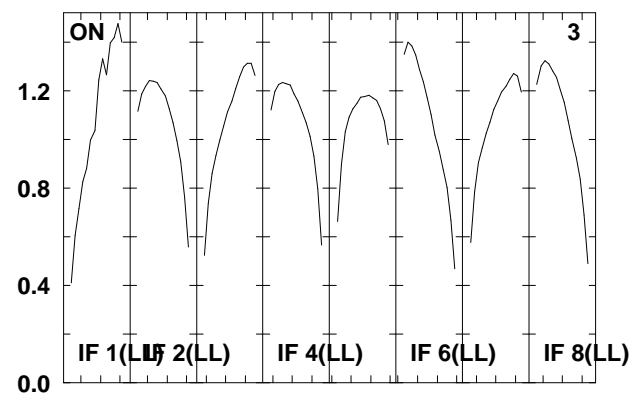
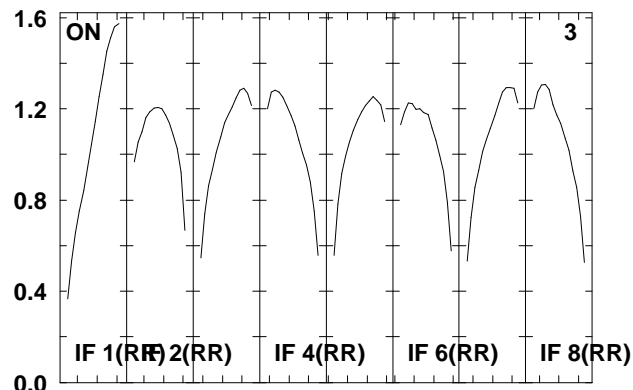
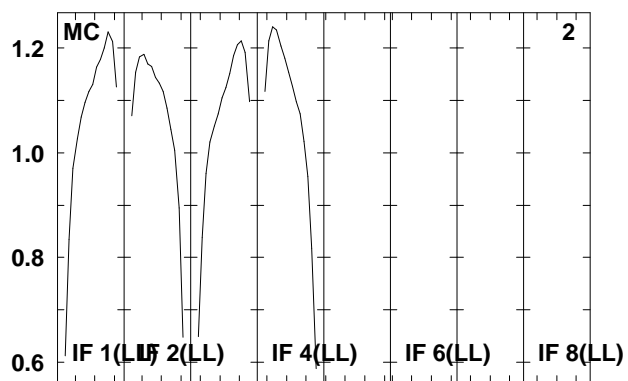
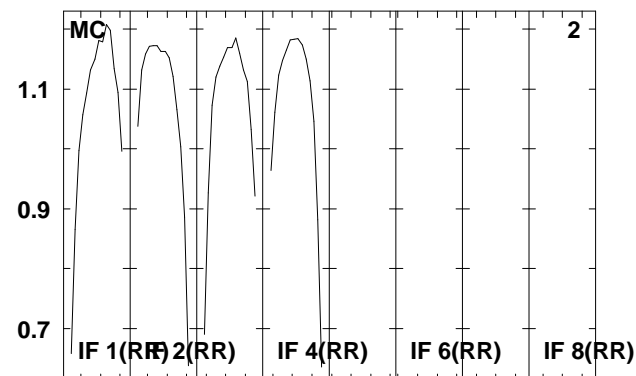
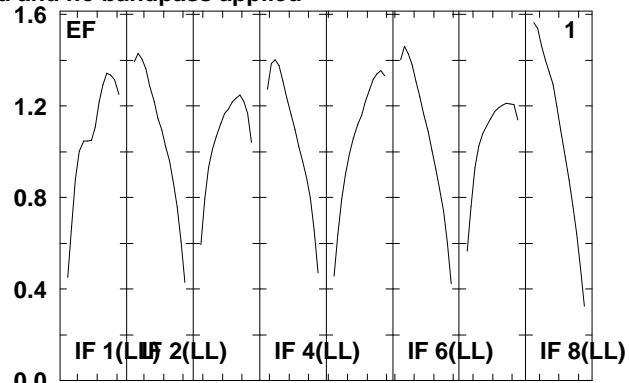
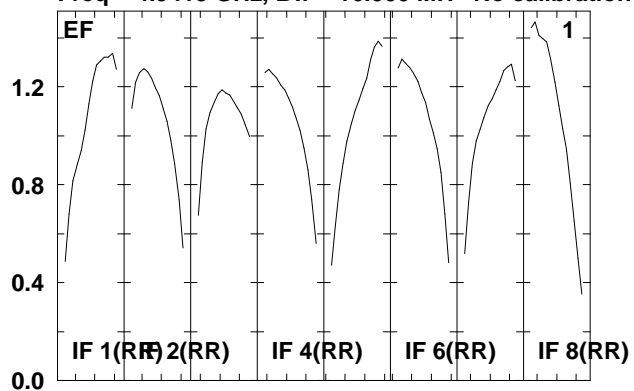

Lower frame: Real Jy  
Total-power spectrum Antenna: \*  
Timerange: 00/13:05:43 to 00/13:06:59

Plot file version 40 created 07-DEC-2009 16:05:45

J1912+05 RT006C.UVDATA.1

Freq = 4.9415 GHz, Bw = 16.000 MH No calibration applied and no bandpass applied

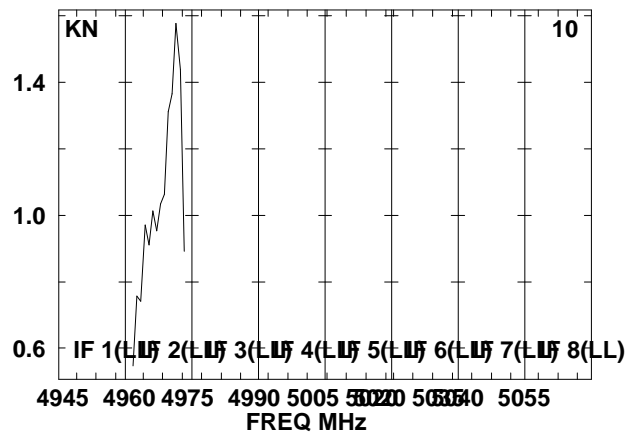
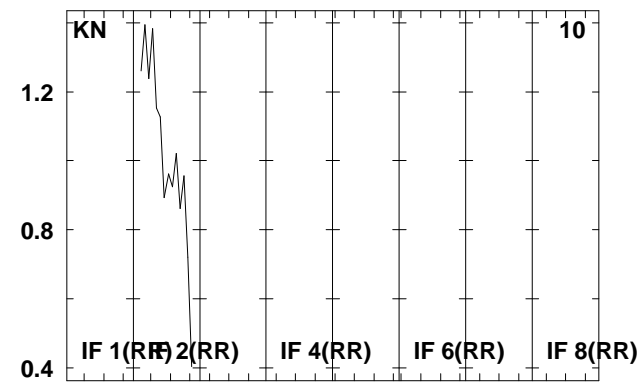
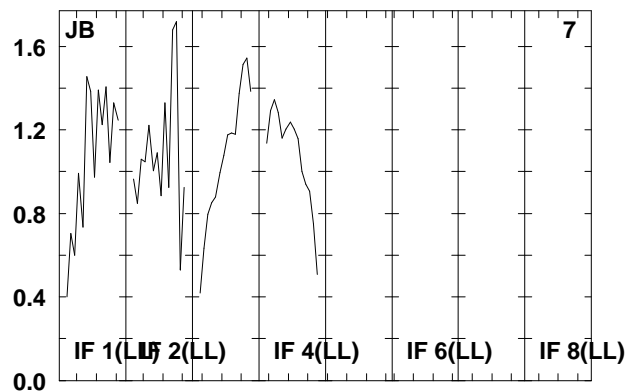
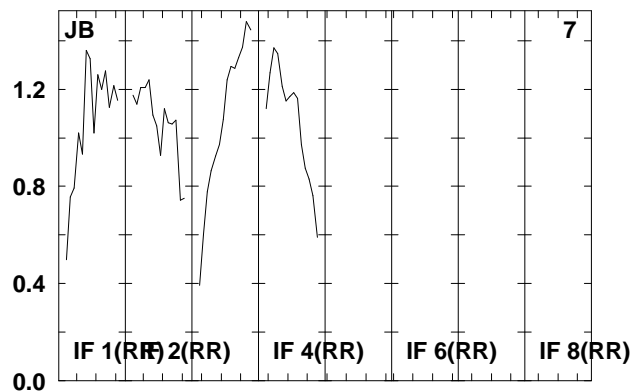
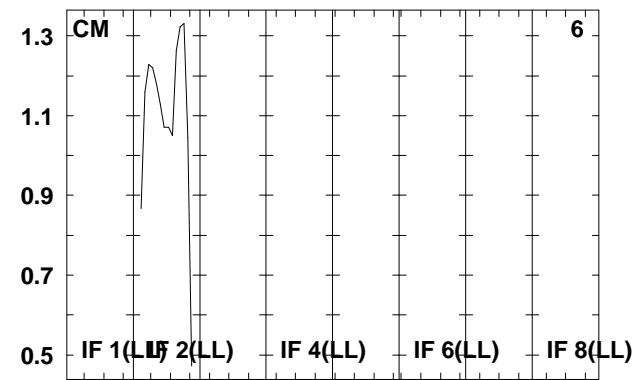
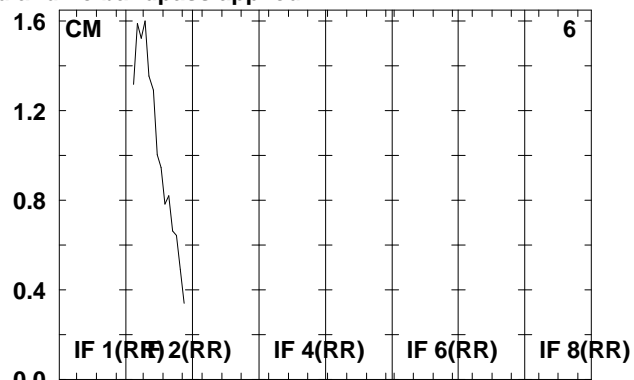
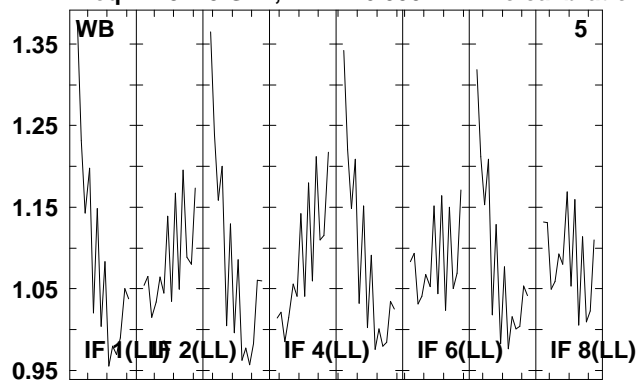

Lower frame: Real Jy

Total-power spectrum Antenna: \*

Timerange: 00/13:05:43 to 00/13:06:59



Plot file version 41 created 07-DEC-2009 16:05:45

SS433 RT006C.UVDATA.1

Freq = 4.9415 GHz, Bw = 16.000 MH No calibration applied and no bandpass applied

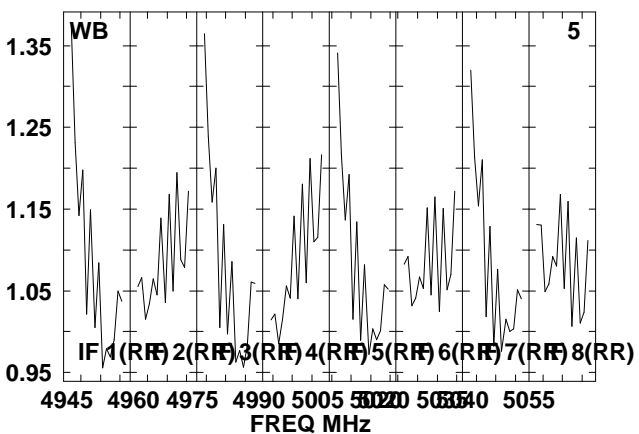
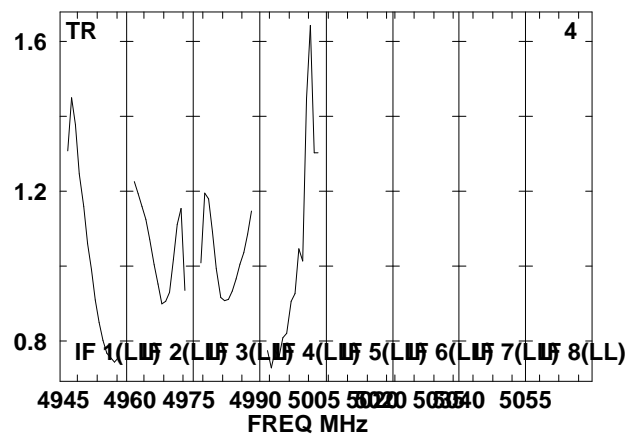
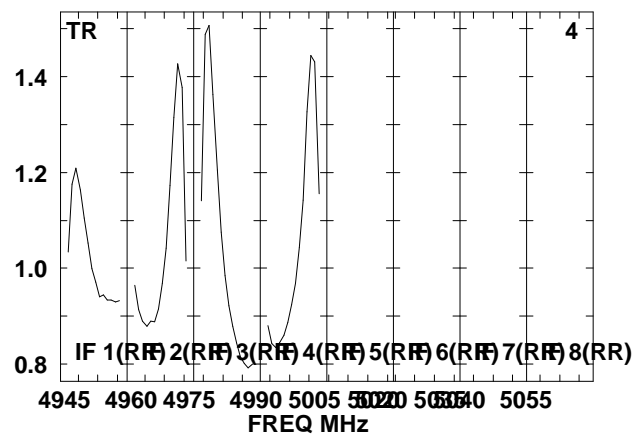
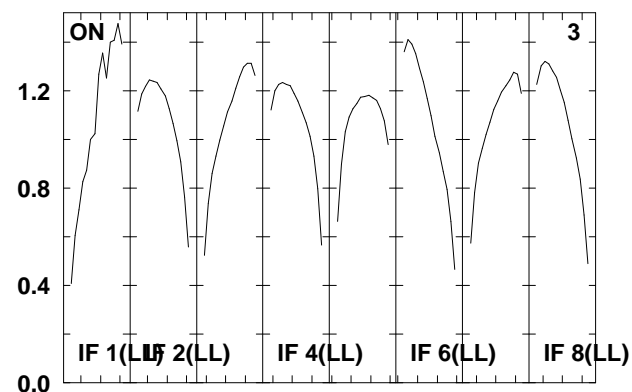
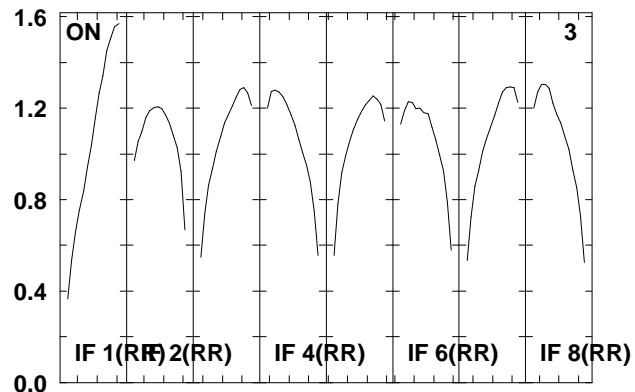
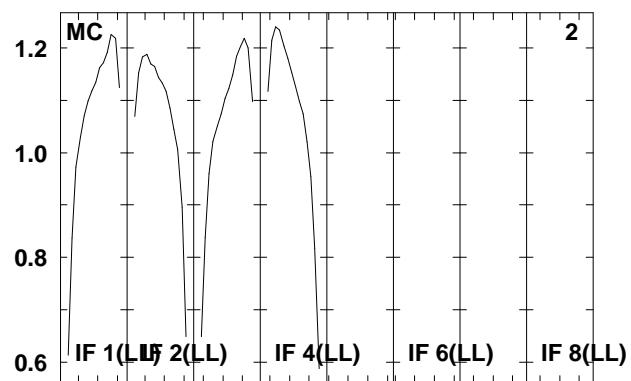
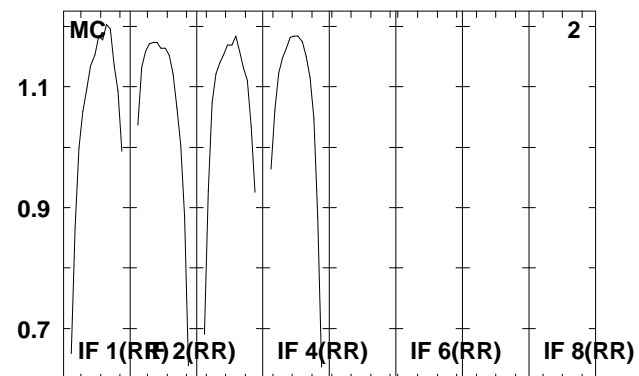
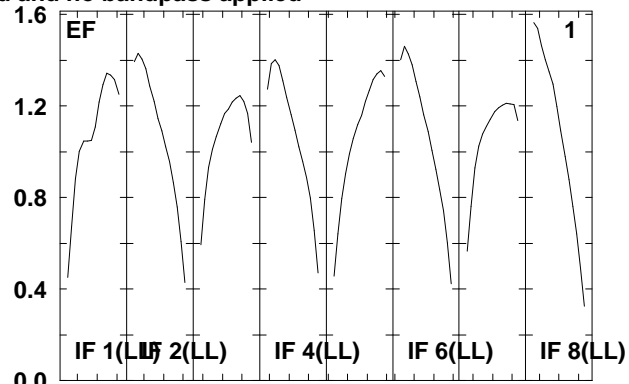
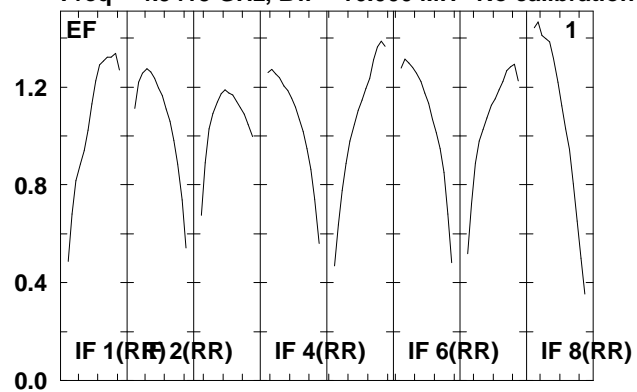

Lower frame: Real Jy

Total-power spectrum Antenna: \*

Timerange: 00/13:07:03 to 00/13:09:19

Plot file version 42 created 07-DEC-2009 16:05:45

SS433 RT006C.UVDATA.1

Freq = 4.9415 GHz, Bw = 16.000 MH No calibration applied and no bandpass applied

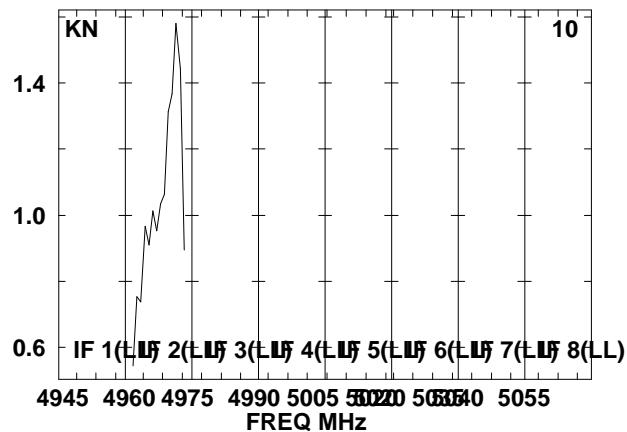
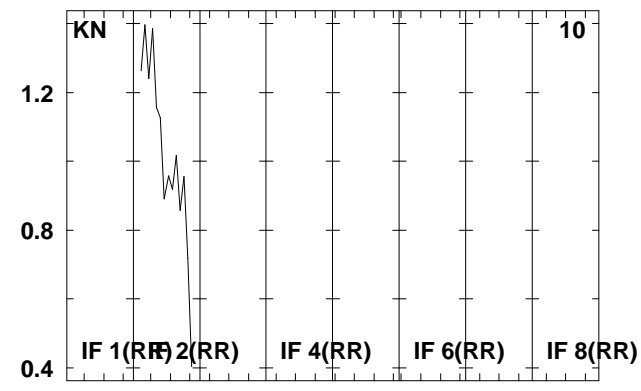
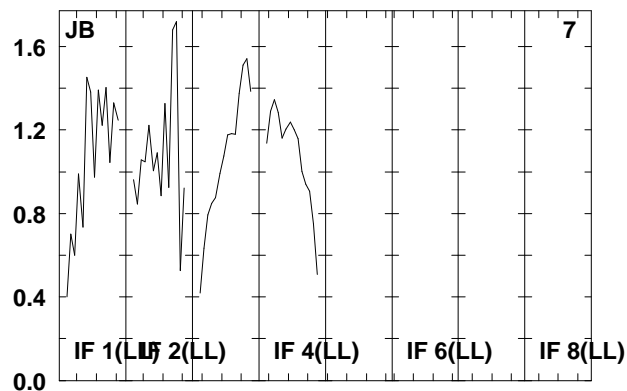
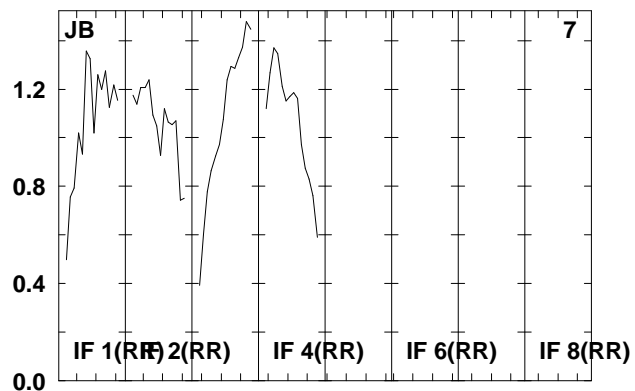
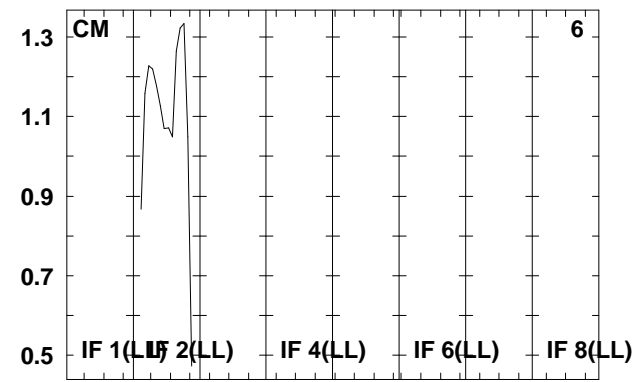
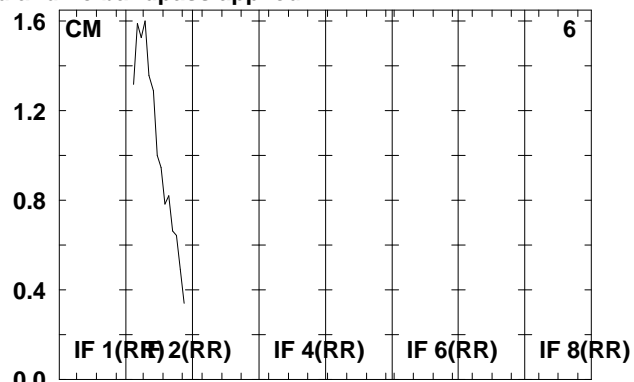
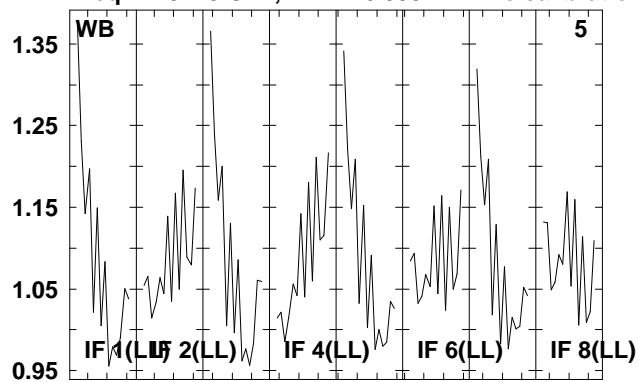

Lower frame: Real Jy

Total-power spectrum Antenna: \*

Timerange: 00/13:07:03 to 00/13:09:19

Plot file version 43 created 07-DEC-2009 16:05:46

J1912+05 RT006C.UVDATA.1

Freq = 4.9415 GHz, Bw = 16.000 MH No calibration applied and no bandpass applied

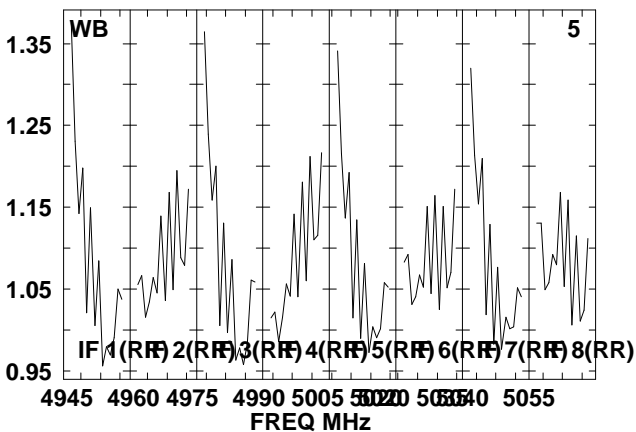
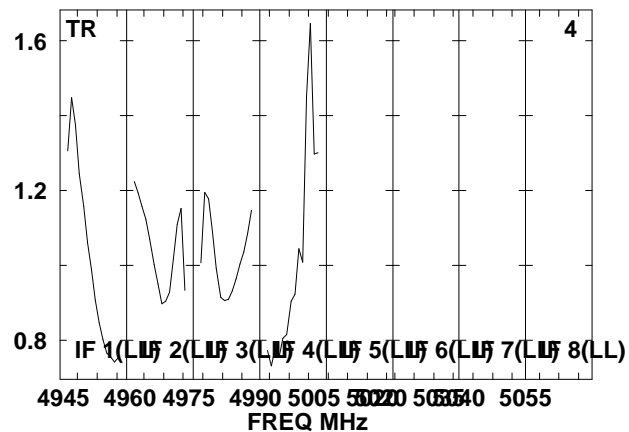
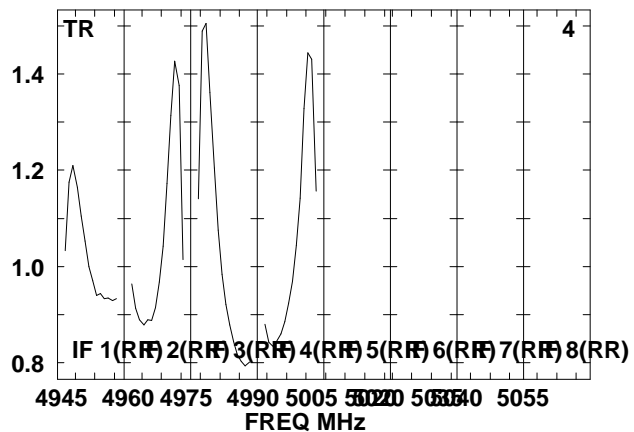
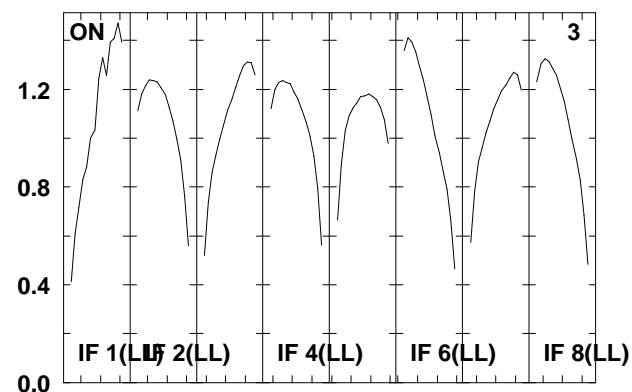
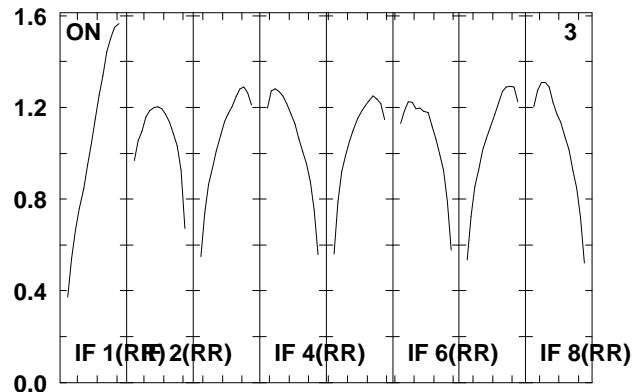
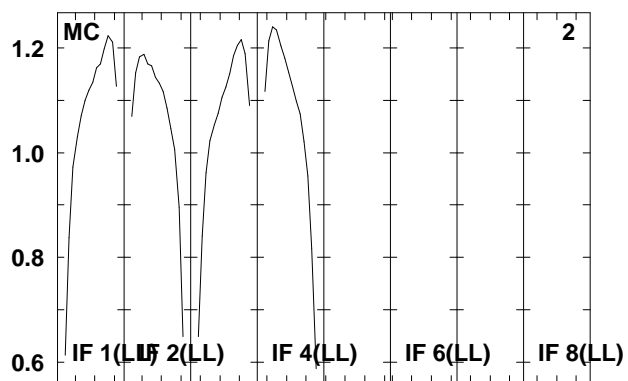
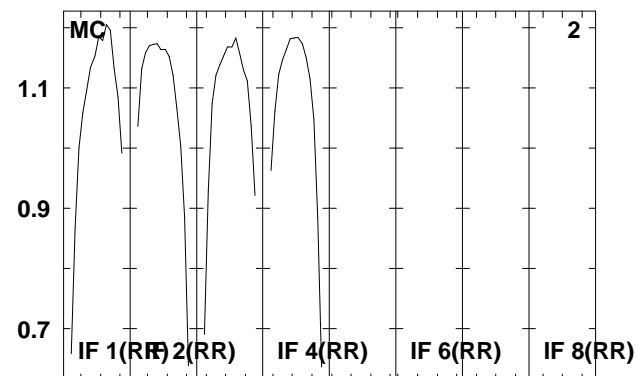
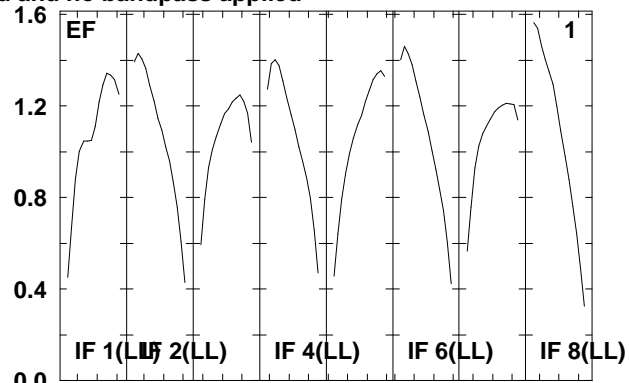
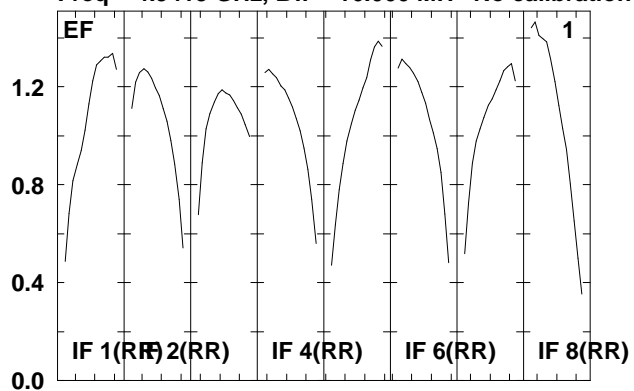

Lower frame: Real Jy  
Total-power spectrum Antenna: \*  
Timerange: 00/13:09:23 to 00/13:10:39

Plot file version 44 created 07-DEC-2009 16:05:46

J1912+05 RT006C.UVDATA.1

Freq = 4.9415 GHz, Bw = 16.000 MH No calibration applied and no bandpass applied

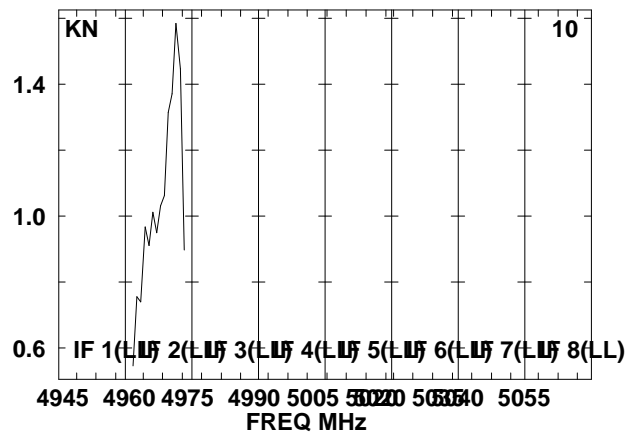
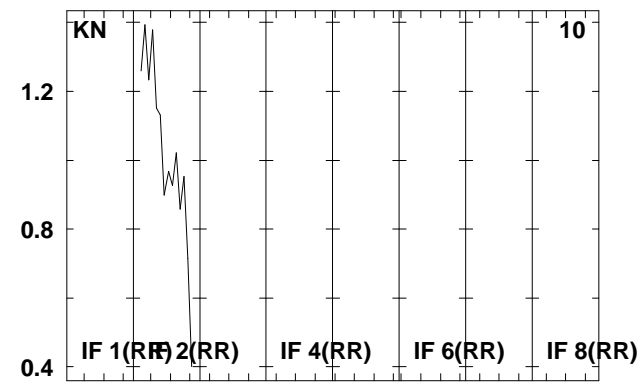
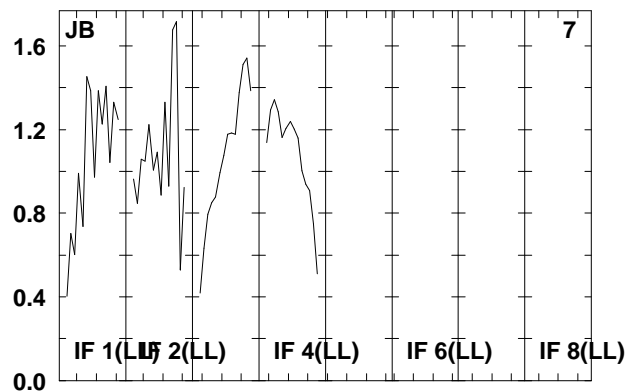
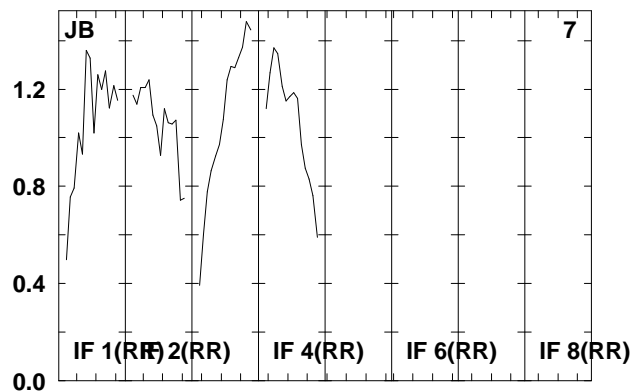
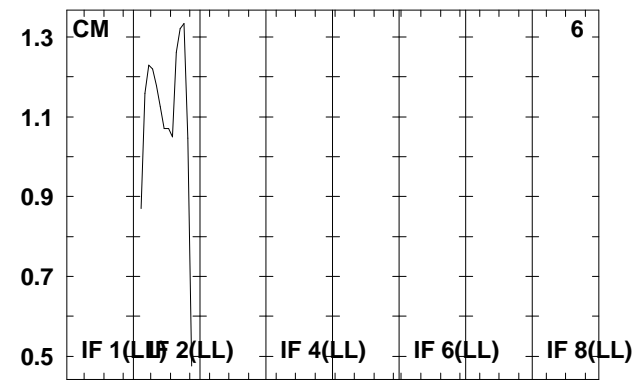
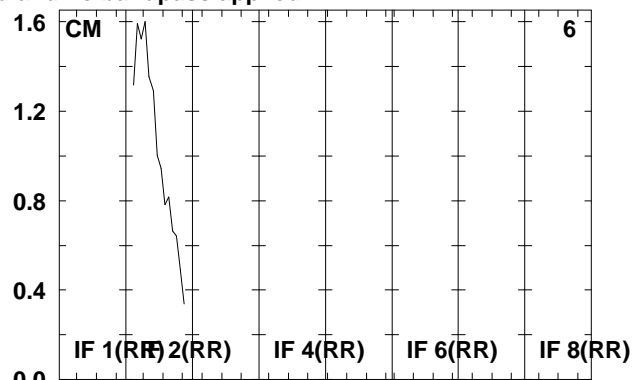
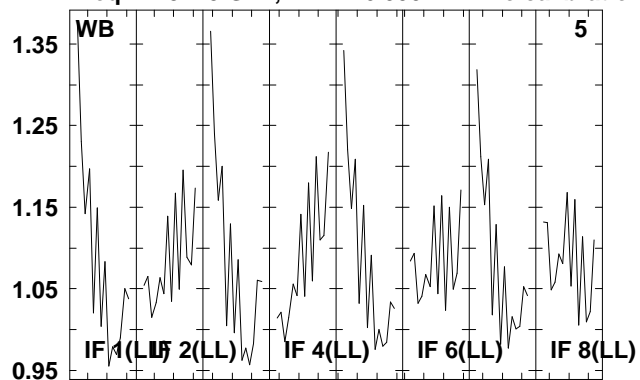

Lower frame: Real Jy

Total-power spectrum Antenna: \*

Timerange: 00/13:09:23 to 00/13:10:39

Plot file version 45 created 07-DEC-2009 16:05:46

SS433 RT006C.UVDATA.1

Freq = 4.9415 GHz, Bw = 16.000 MH No calibration applied and no bandpass applied

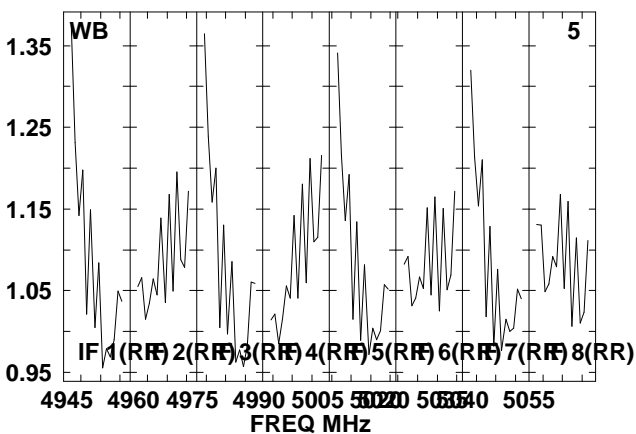
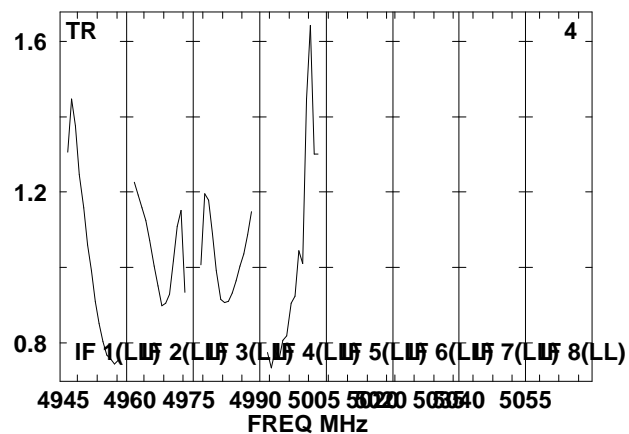
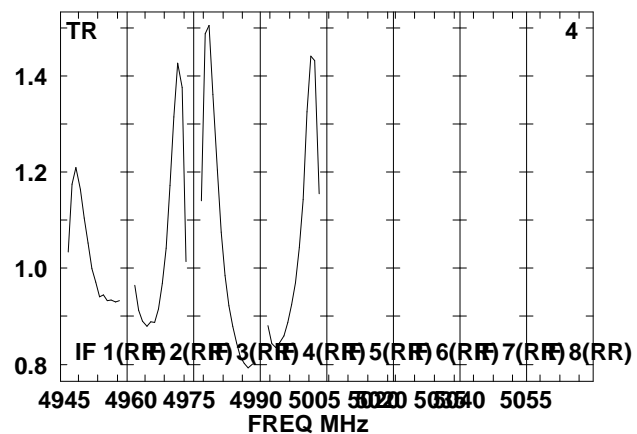
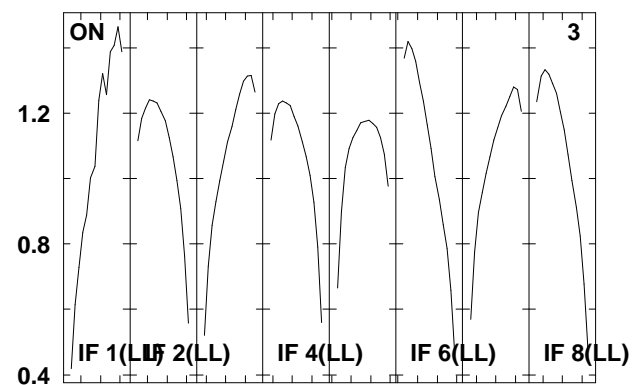
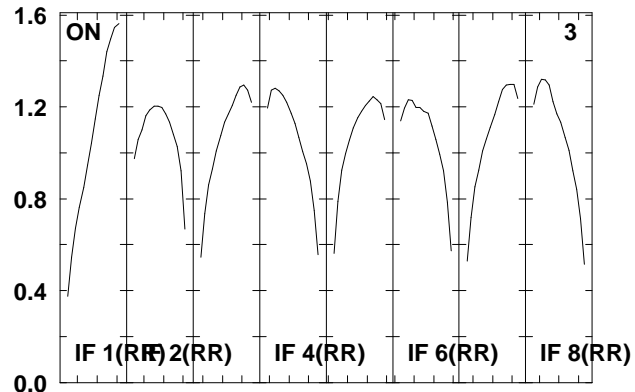
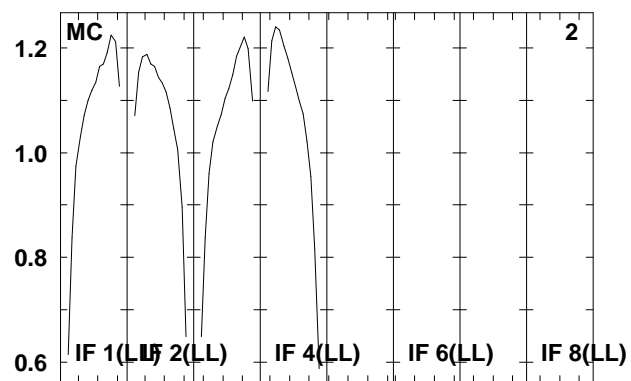
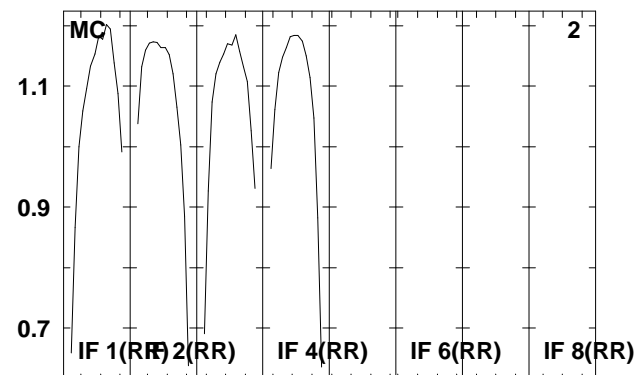
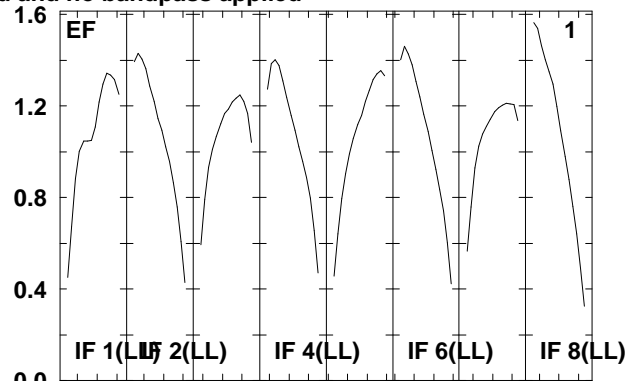
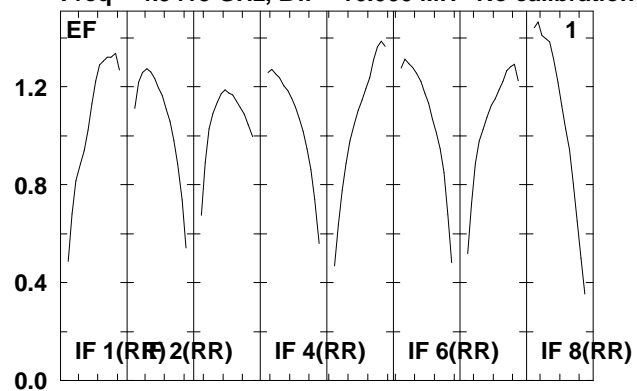

Lower frame: Real Jy

Total-power spectrum Antenna: \*

Timerange: 00/13:10:43 to 00/13:12:59

Plot file version 46 created 07-DEC-2009 16:05:46

SS433 RT006C.UVDATA.1

Freq = 4.9415 GHz, Bw = 16.000 MH No calibration applied and no bandpass applied

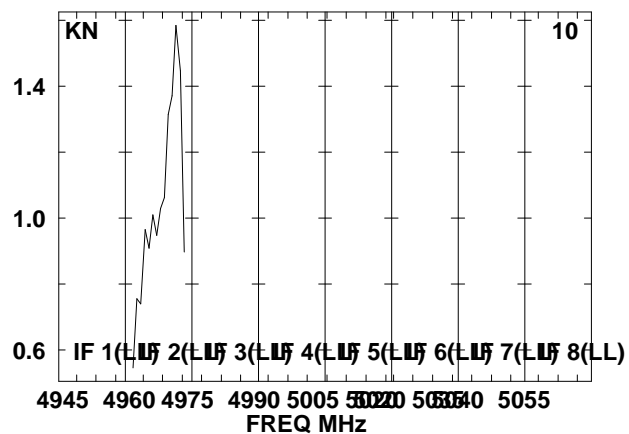
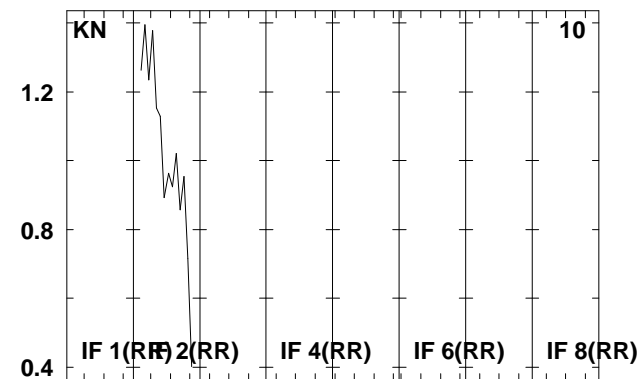
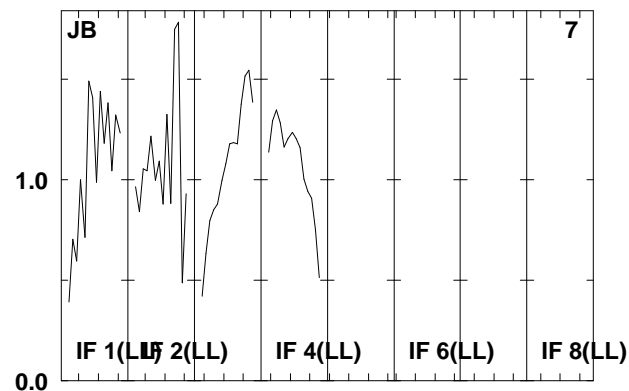
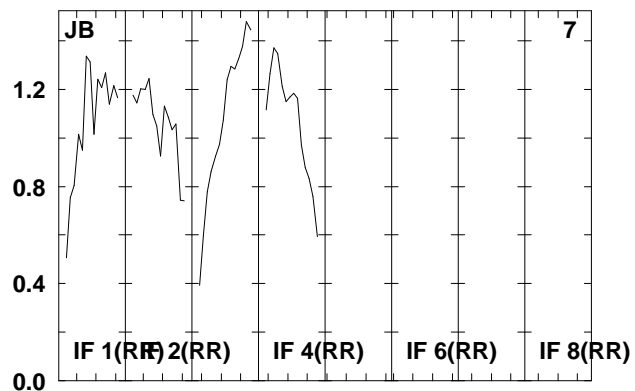
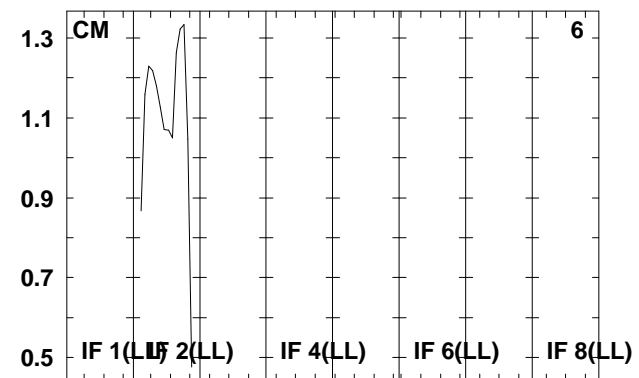
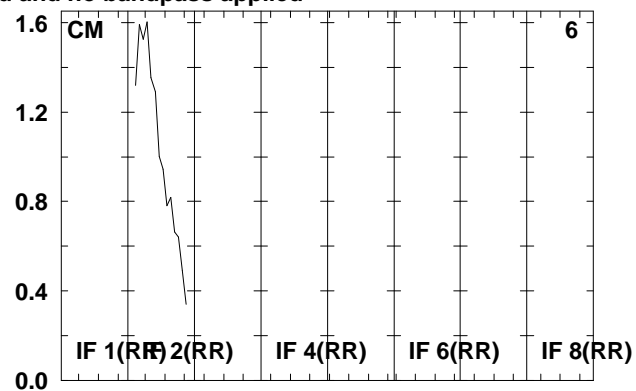
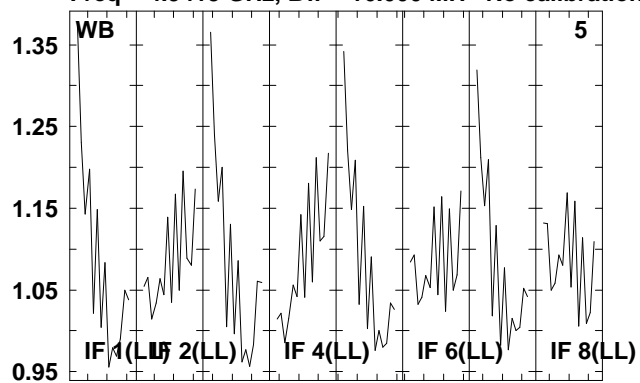

Lower frame: Real Jy

Total-power spectrum Antenna: \*

Timerange: 00/13:10:43 to 00/13:12:59

Plot file version 47 created 07-DEC-2009 16:05:46

J1912+05 RT006C.UVDATA.1

Freq = 4.9415 GHz, Bw = 16.000 MH No calibration applied and no bandpass applied

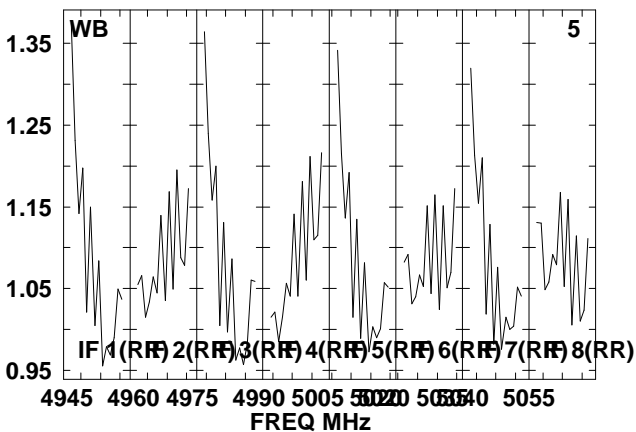
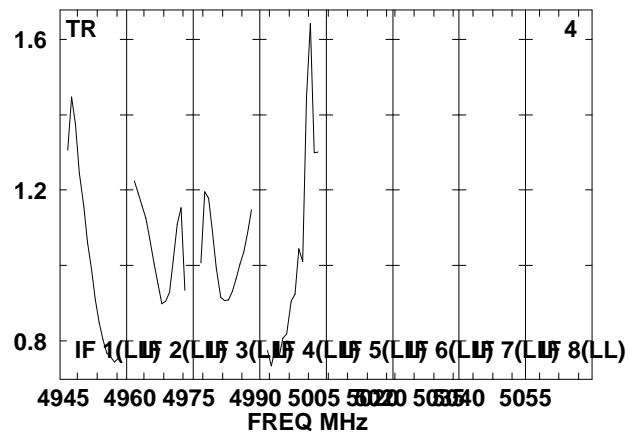
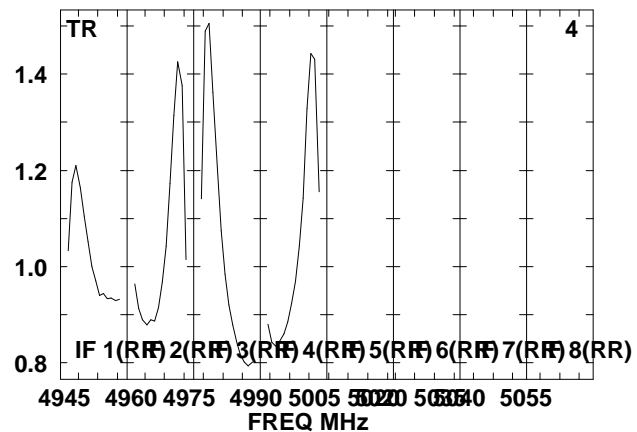
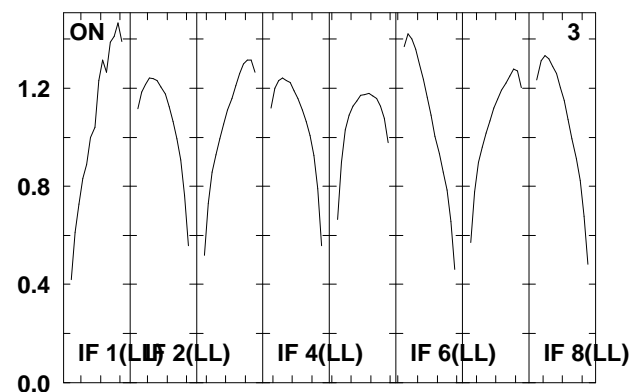
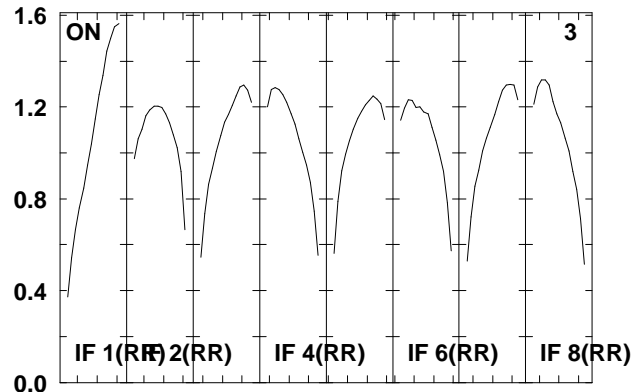
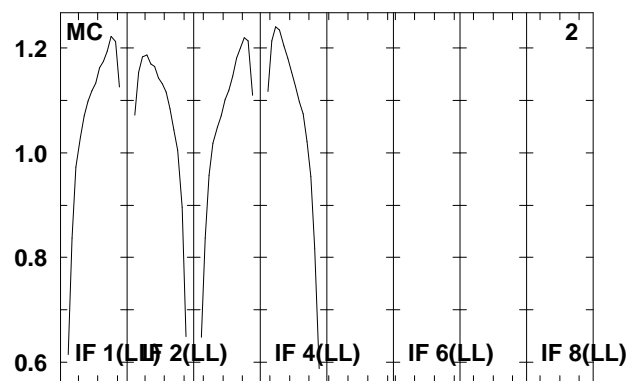
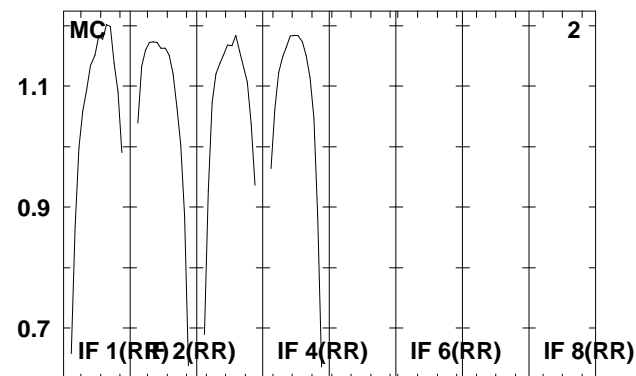
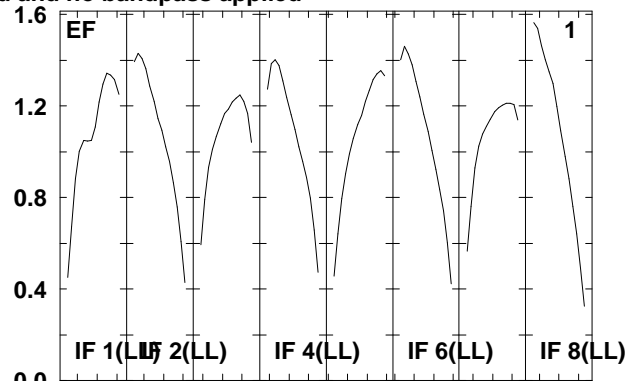
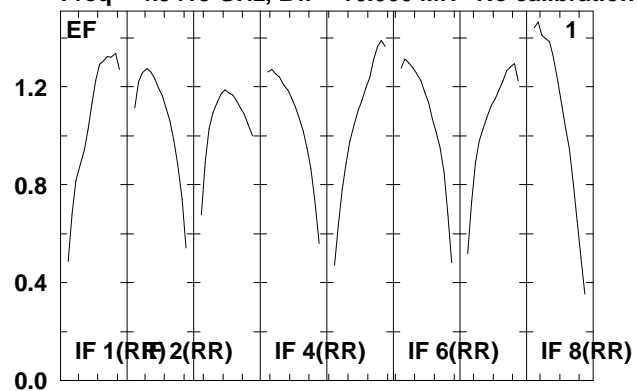

Lower frame: Real Jy  
Total-power spectrum Antenna: \*  
Timerange: 00/13:13:03 to 00/13:14:19

Plot file version 48 created 07-DEC-2009 16:05:47

J1912+05 RT006C.UVDATA.1

Freq = 4.9415 GHz, Bw = 16.000 MH No calibration applied and no bandpass applied

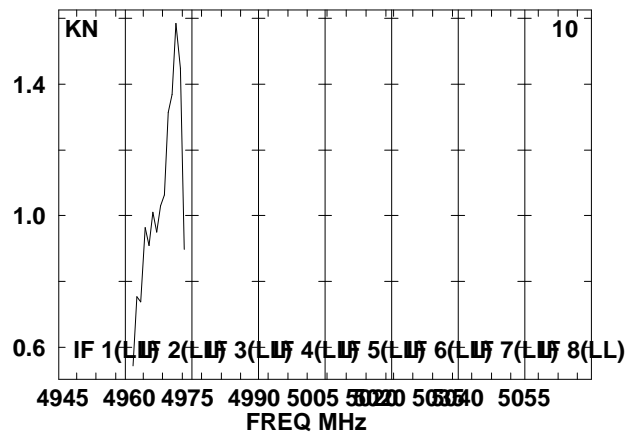
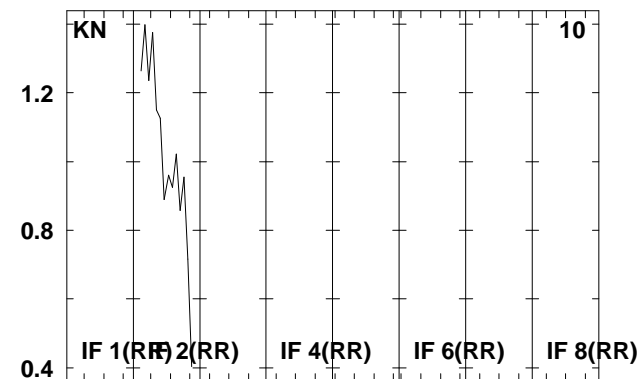
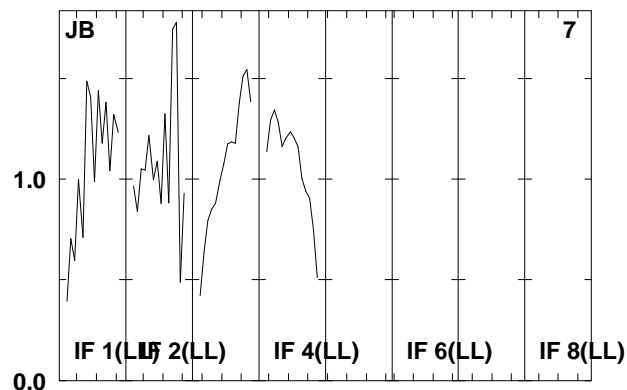
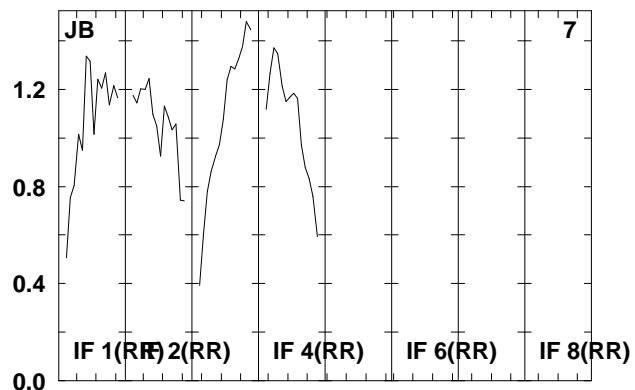
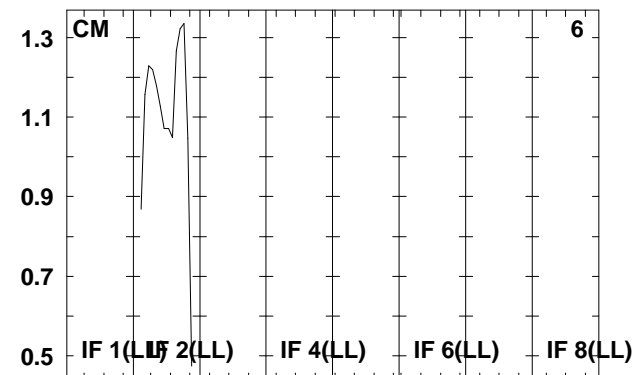
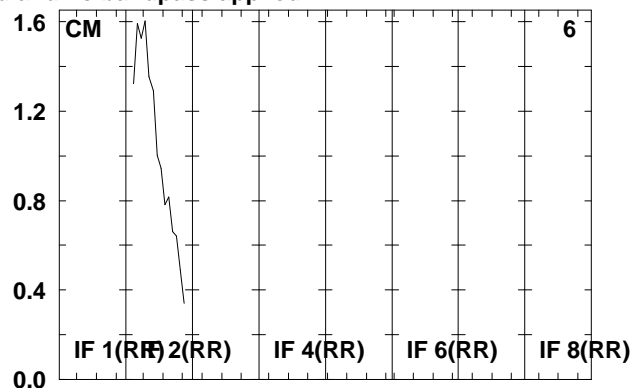
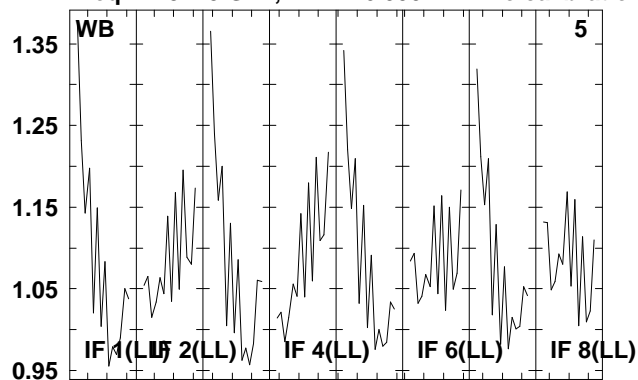

Lower frame: Real Jy

Total-power spectrum Antenna: \*

Timerange: 00/13:13:03 to 00/13:14:19



Plot file version 49 created 07-DEC-2009 16:05:47

SS433 RT006C.UVDATA.1

Freq = 4.9415 GHz, Bw = 16.000 MH No calibration applied and no bandpass applied

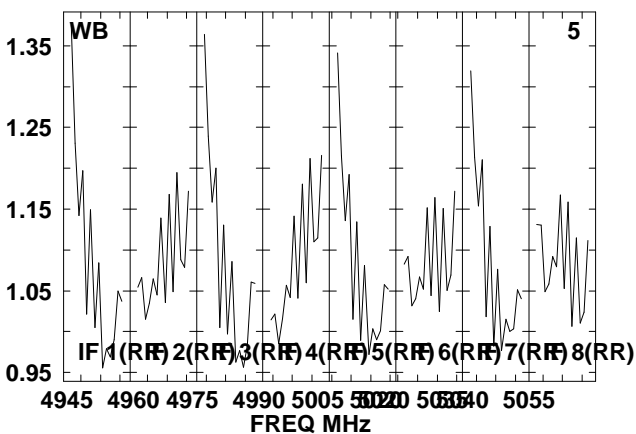
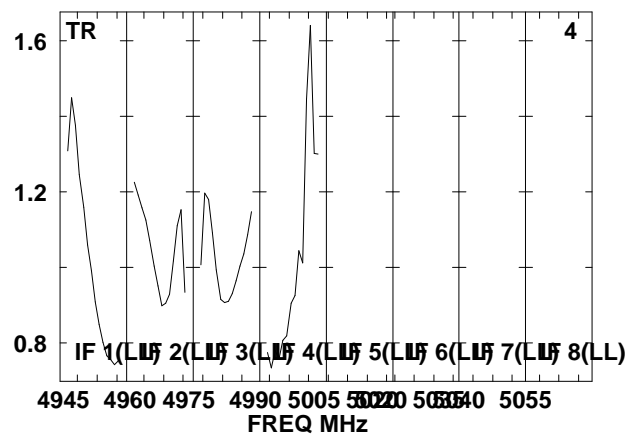
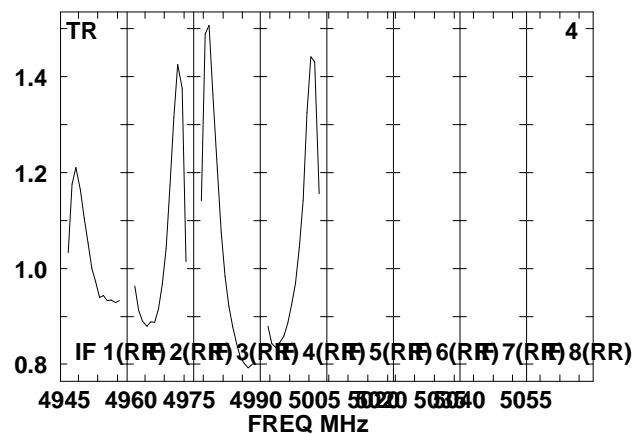
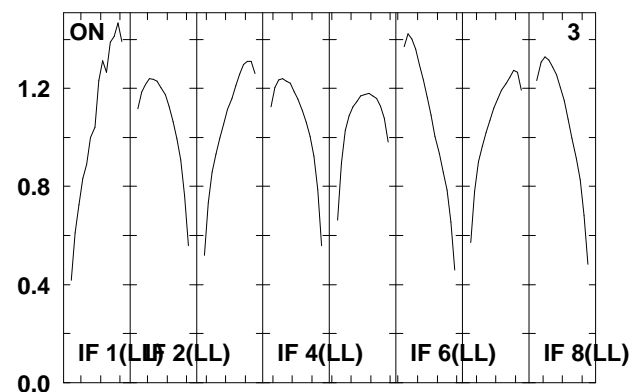
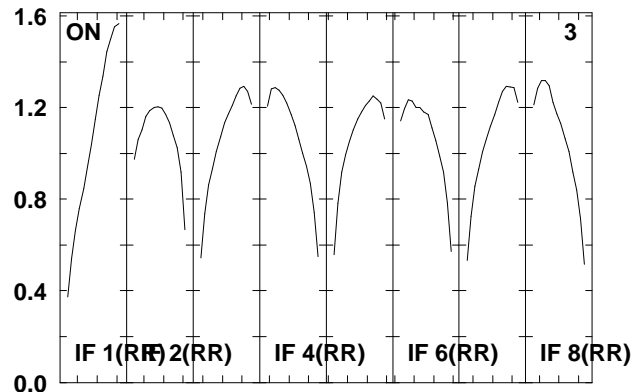
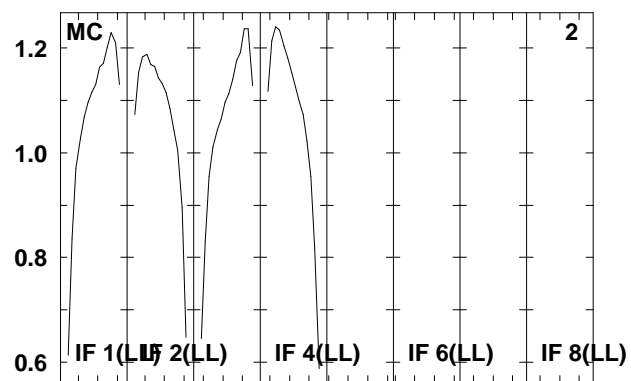
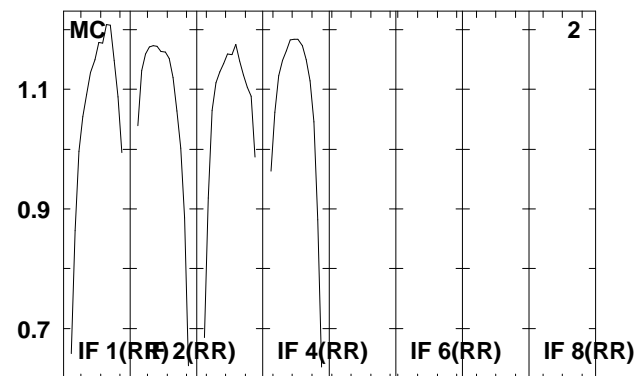
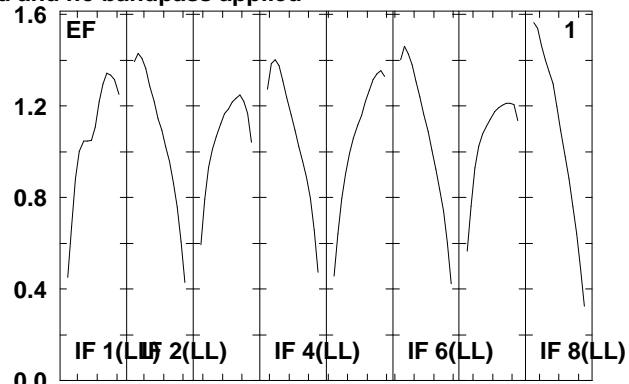
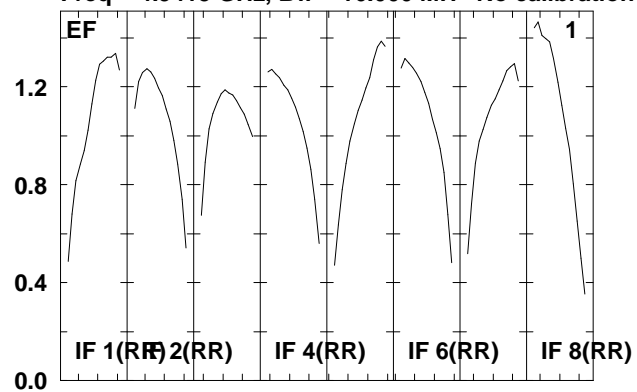

Lower frame: Real Jy  
Total-power spectrum Antenna: \*  
Timerange: 00/13:14:23 to 00/13:16:39

Plot file version 50 created 07-DEC-2009 16:05:47

SS433 RT006C.UVDATA.1

Freq = 4.9415 GHz, Bw = 16.000 MH No calibration applied and no bandpass applied

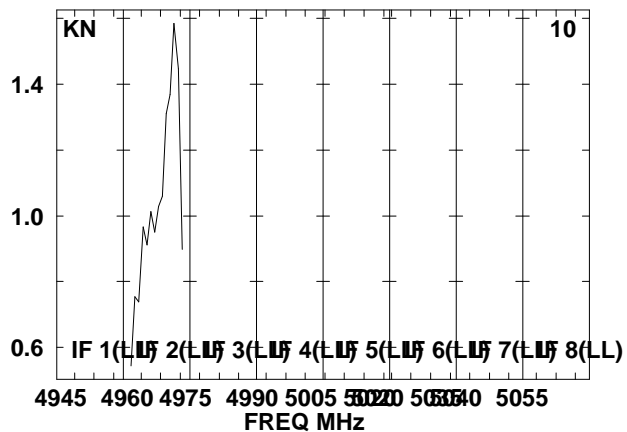
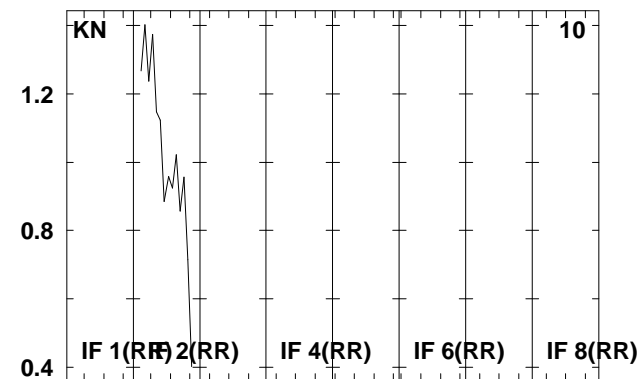
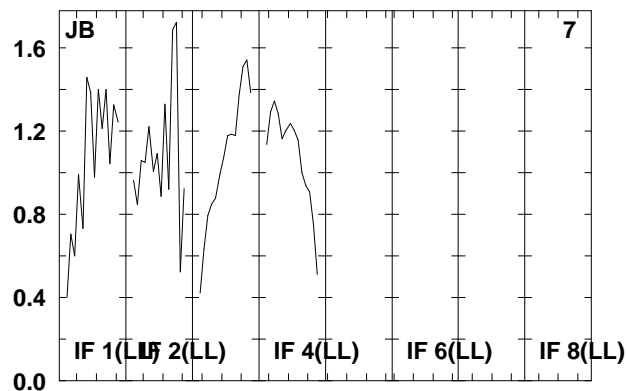
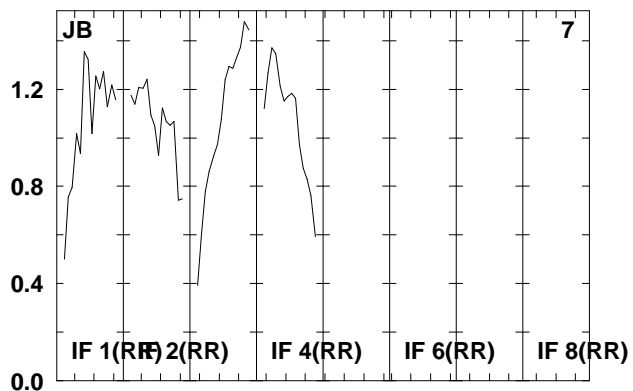
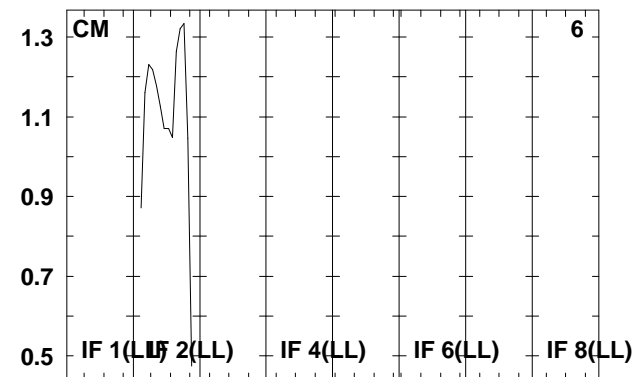
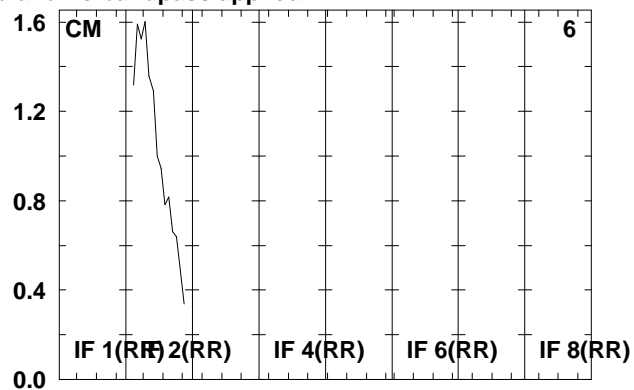
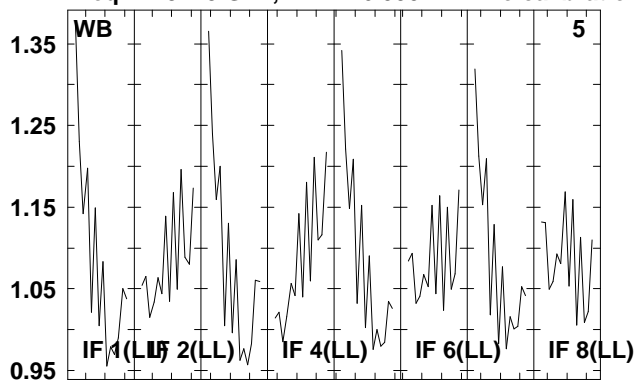

Lower frame: Real Jy

Total-power spectrum Antenna: \*

Timerange: 00/13:14:23 to 00/13:16:39

Plot file version 51 created 07-DEC-2009 16:05:47

J1911+16 RT006C.UVDATA.1

Freq = 4.9415 GHz, Bw = 16.000 MH No calibration applied and no bandpass applied

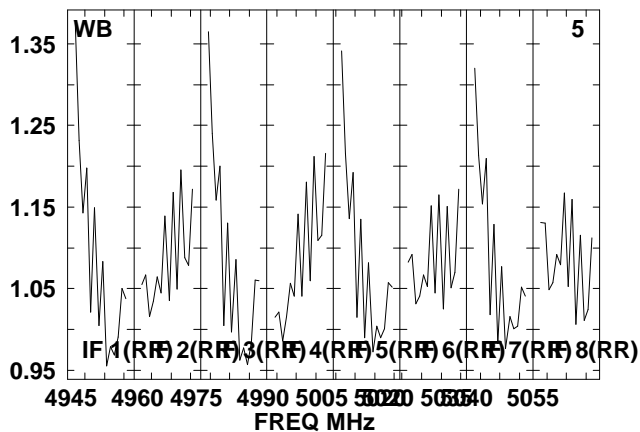
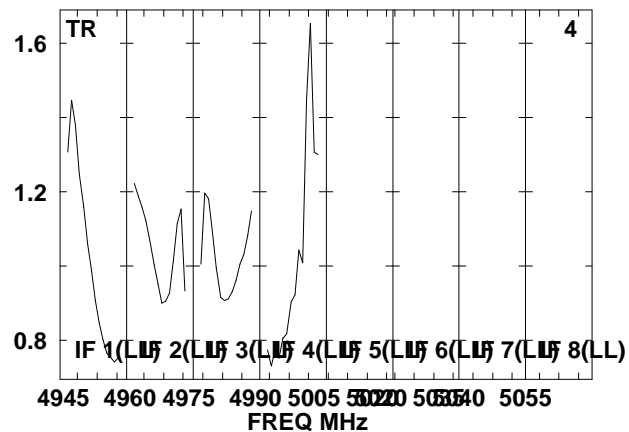
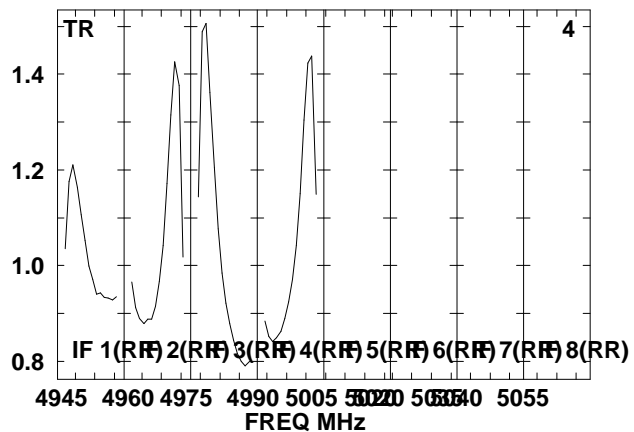
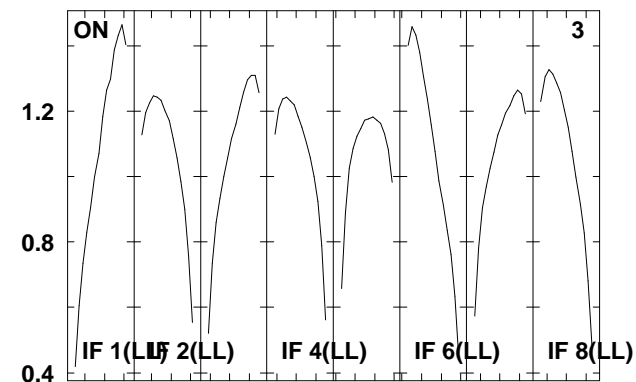
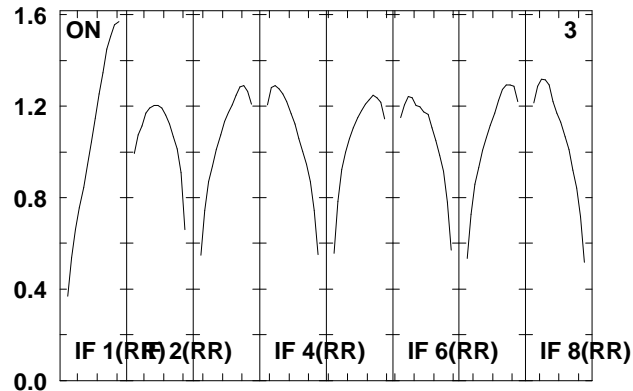
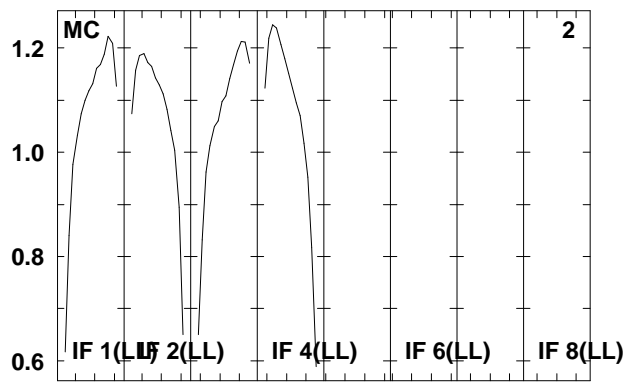
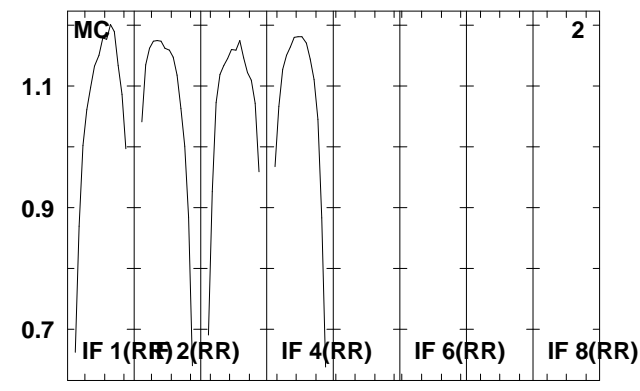
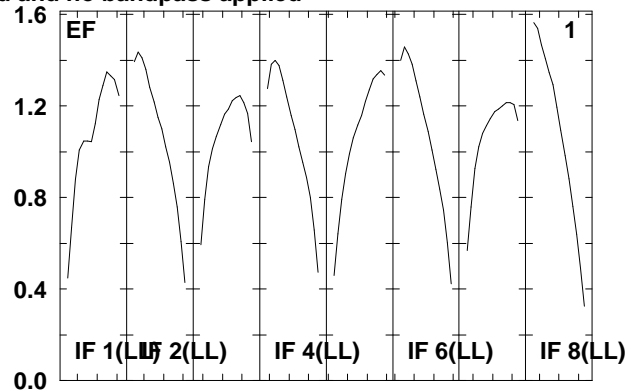
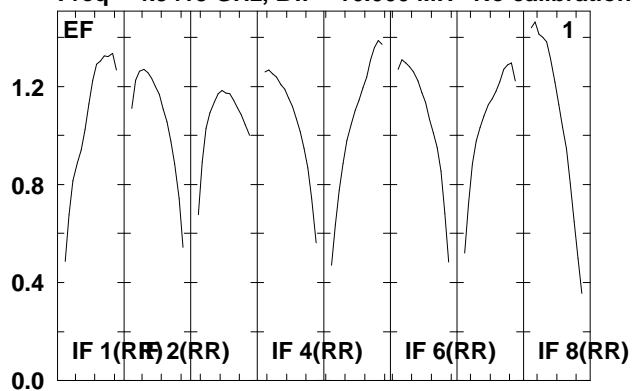

Lower frame: Real Jy  
Total-power spectrum Antenna: \*  
Timerange: 00/13:17:43 to 00/13:18:39

Plot file version 52 created 07-DEC-2009 16:05:47

J1911+16 RT006C.UVDATA.1

Freq = 4.9415 GHz, Bw = 16.000 MH No calibration applied and no bandpass applied

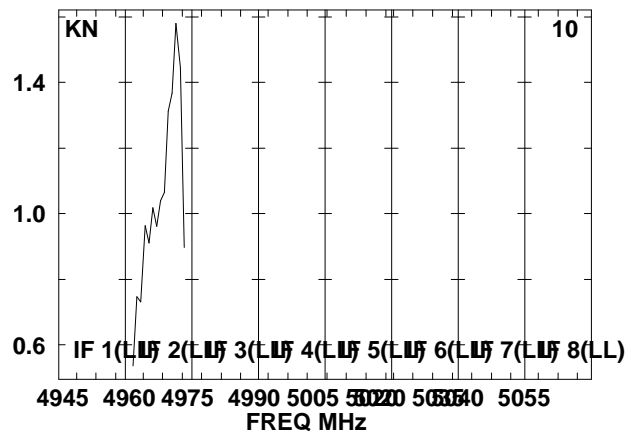
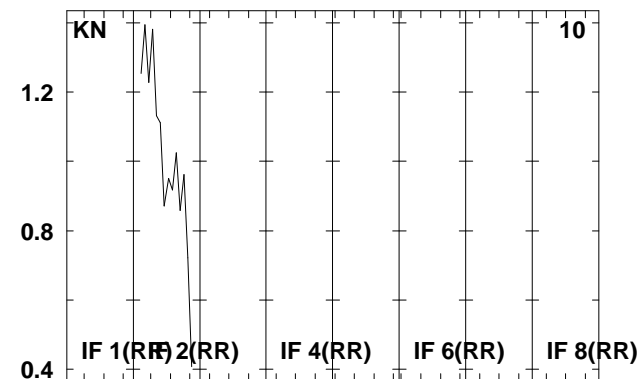
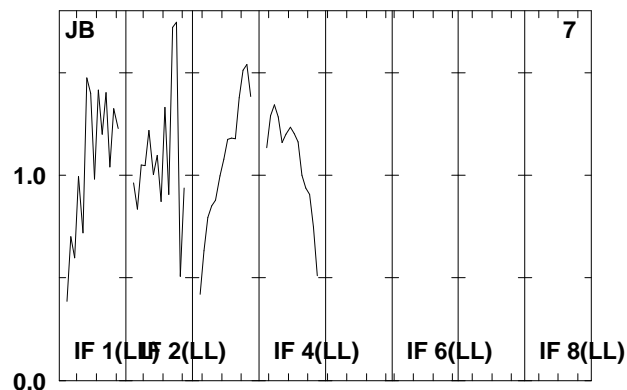
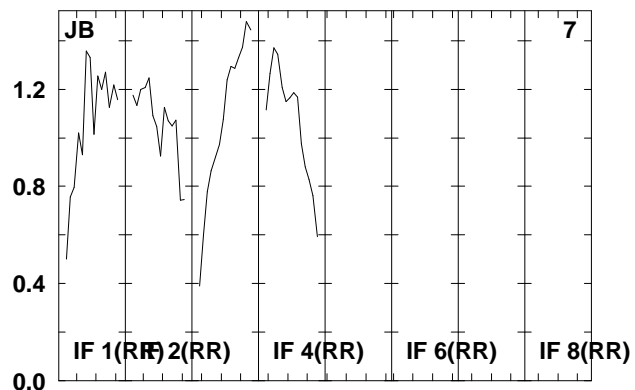
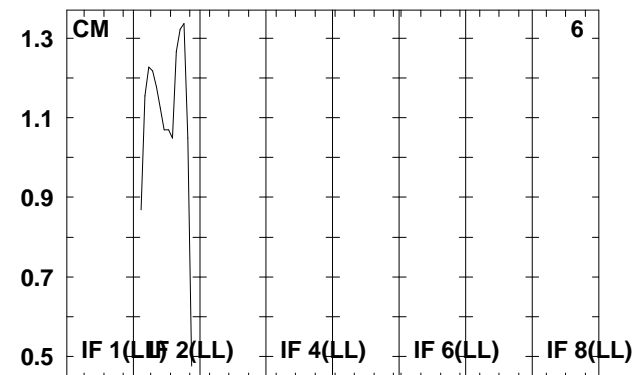
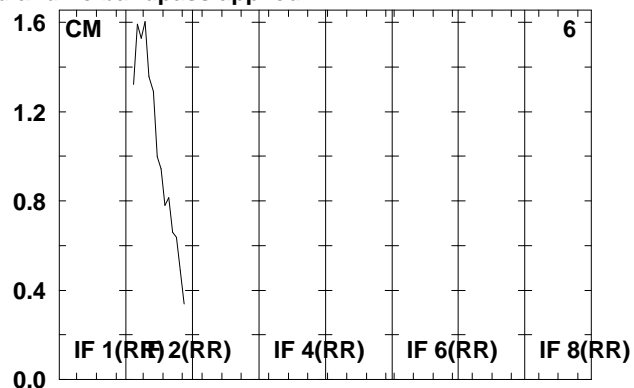
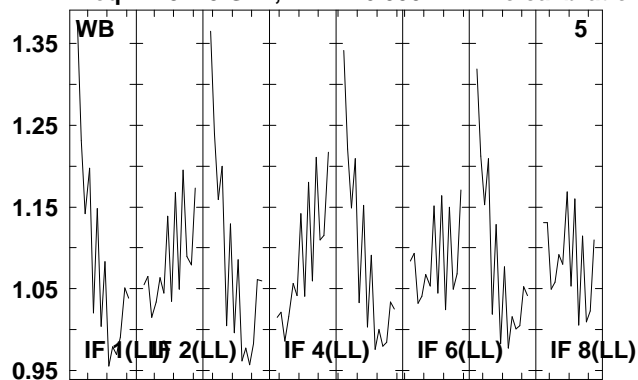

Lower frame: Real Jy

Total-power spectrum Antenna: \*

Timerange: 00/13:17:43 to 00/13:18:39

Plot file version 53 created 07-DEC-2009 16:05:48

J2002+47 RT006C.UVDATA.1

Freq = 4.9415 GHz, Bw = 16.000 MH No calibration applied and no bandpass applied

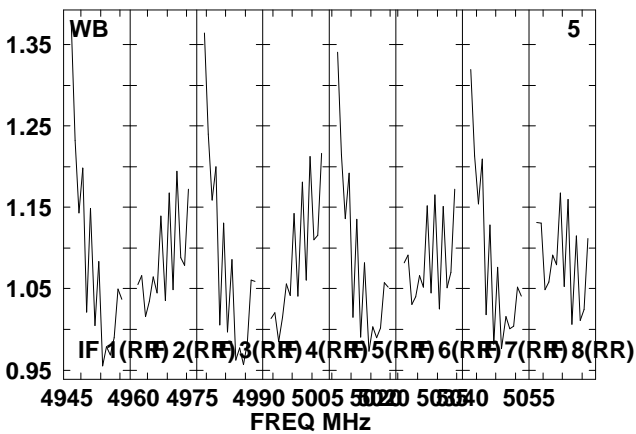
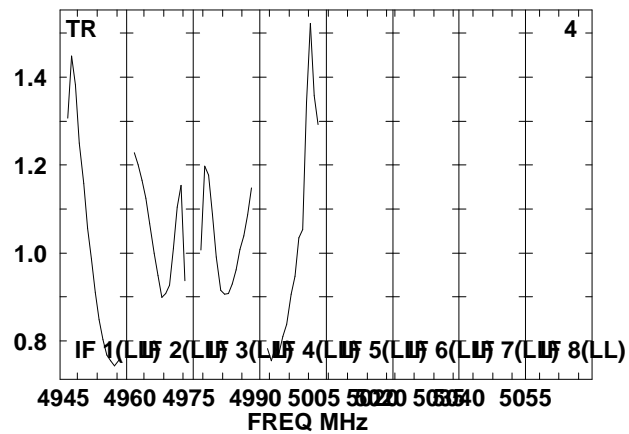
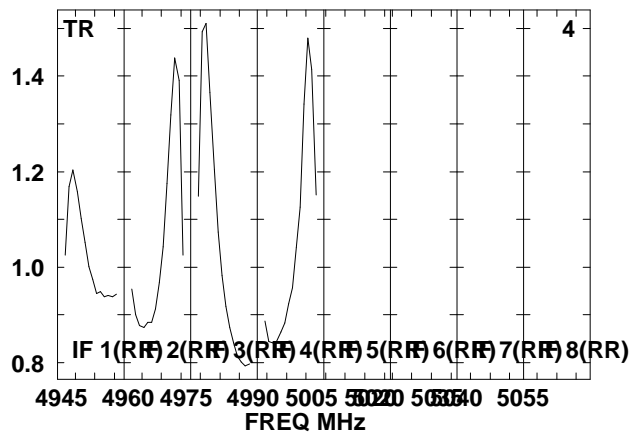
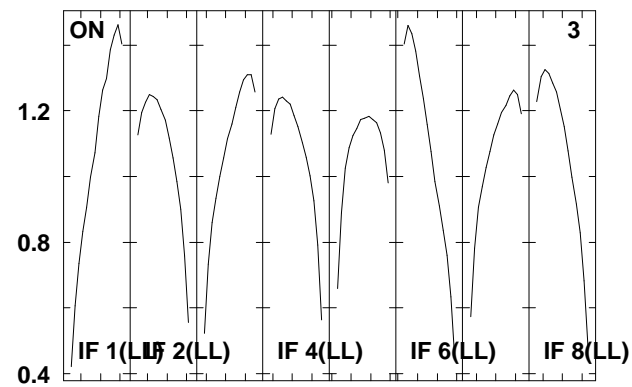
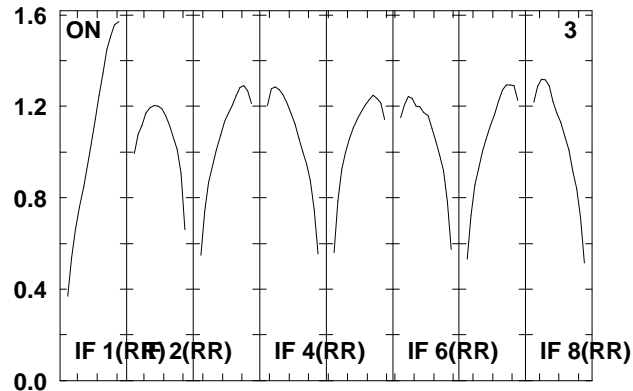
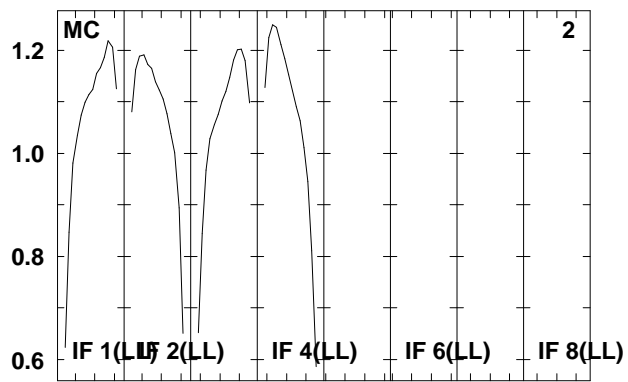
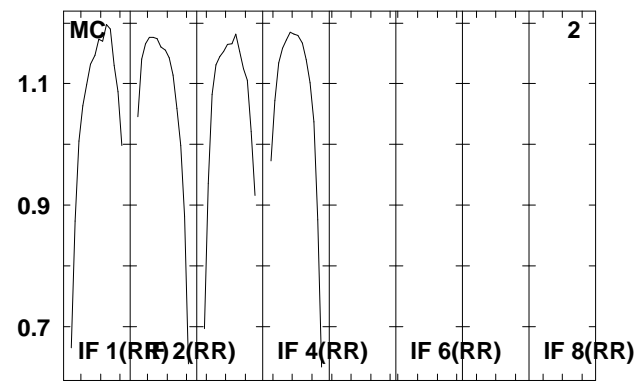
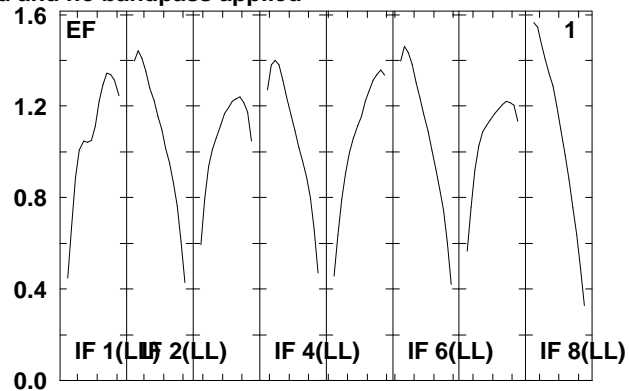
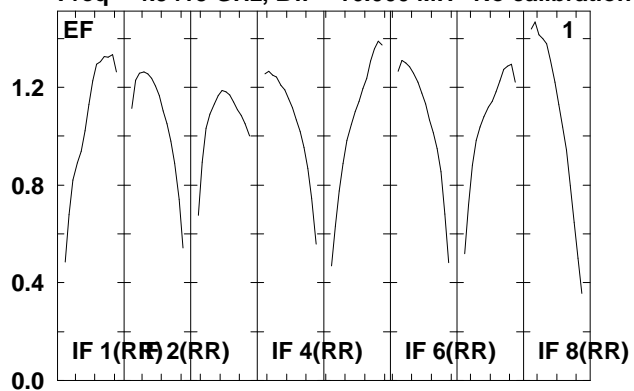

Lower frame: Real Jy  
Total-power spectrum Antenna: \*  
Timerange: 00/13:21:43 to 00/13:28:39

Plot file version 54 created 07-DEC-2009 16:05:48

J2002+47 RT006C.UVDATA.1

Freq = 4.9415 GHz, Bw = 16.000 MH No calibration applied and no bandpass applied

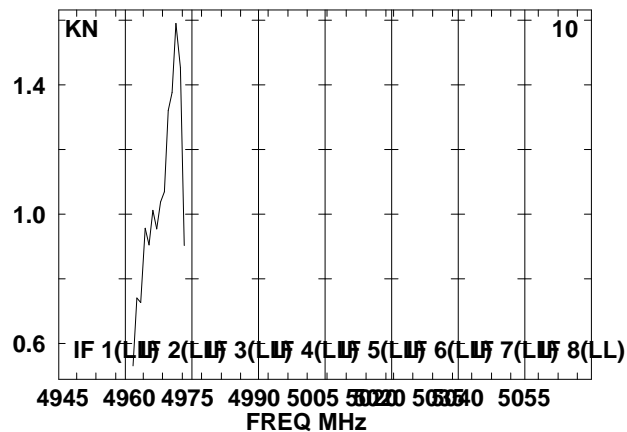
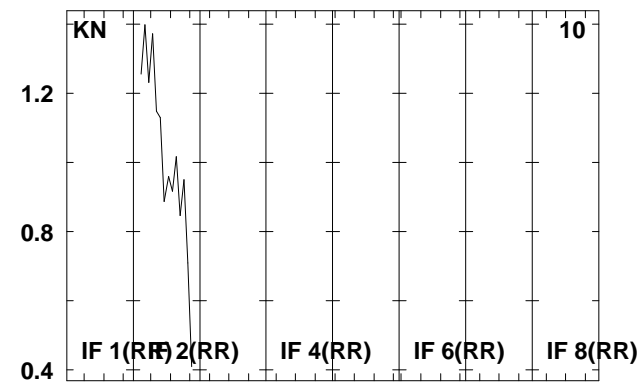
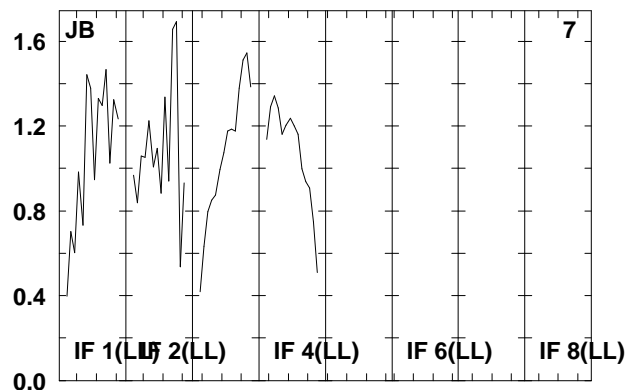
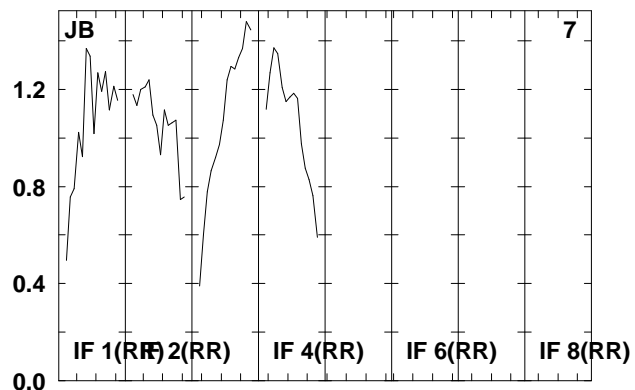
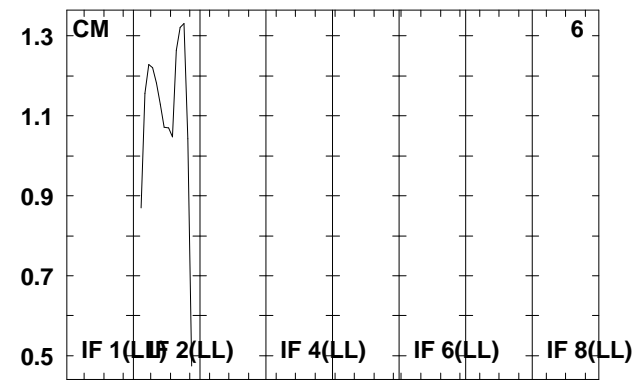
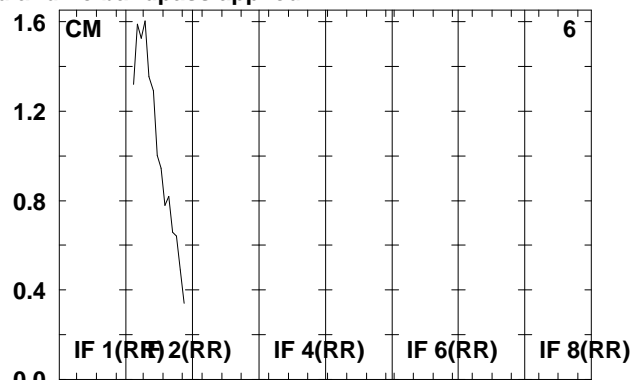
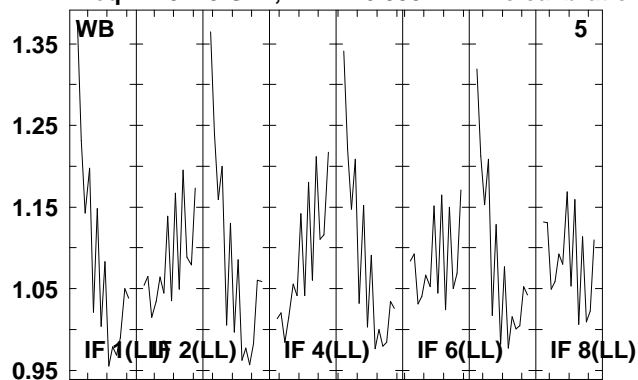

Lower frame: Real Jy

Total-power spectrum Antenna: \*

Timerange: 00/13:21:43 to 00/13:28:39

Plot file version 55 created 07-DEC-2009 16:05:49

J1912+05 RT006C.UVDATA.1

Freq = 4.9415 GHz, Bw = 16.000 MH No calibration applied and no bandpass applied

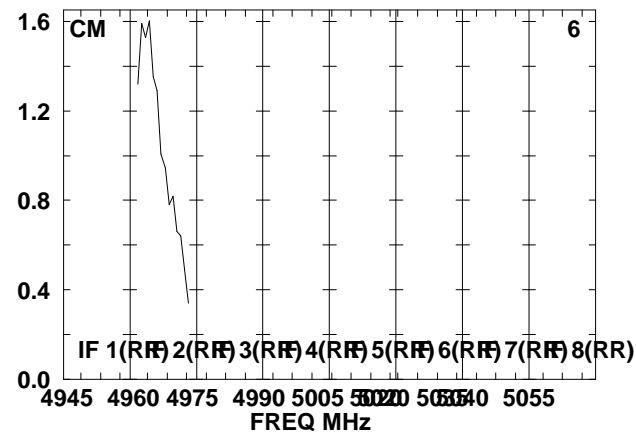
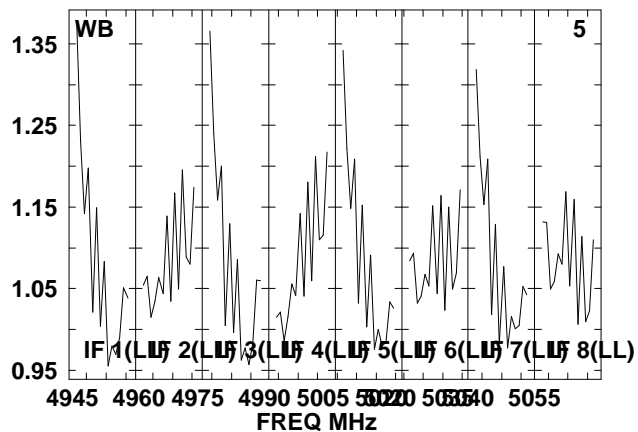
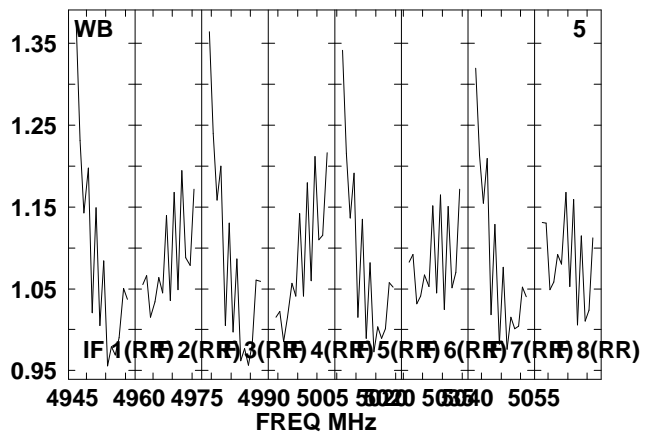
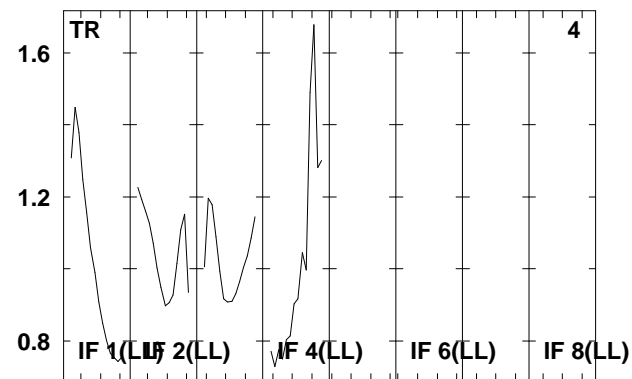
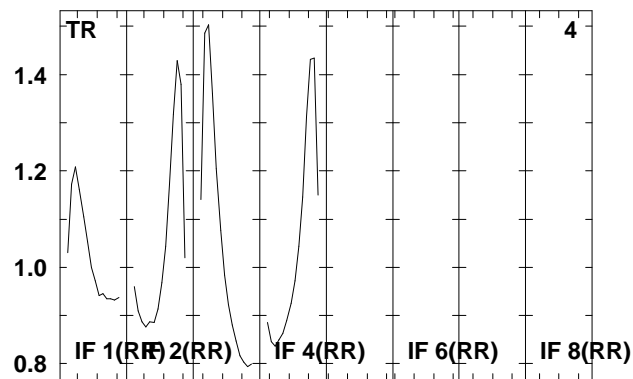
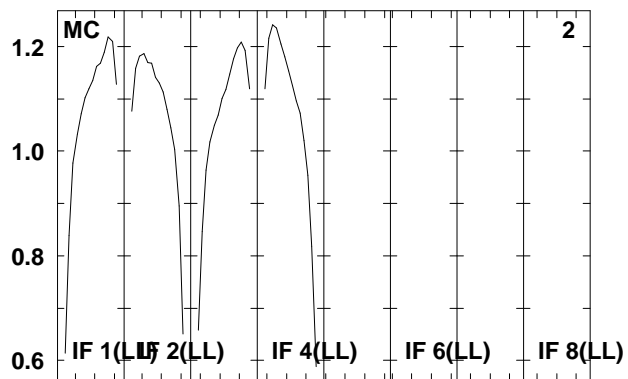
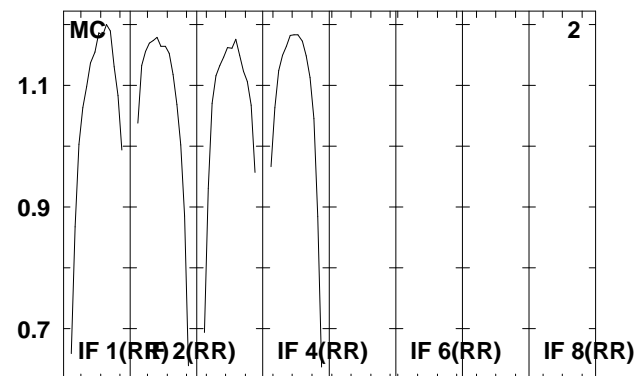
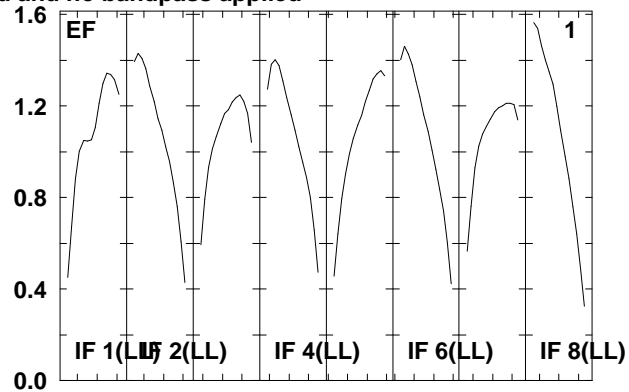
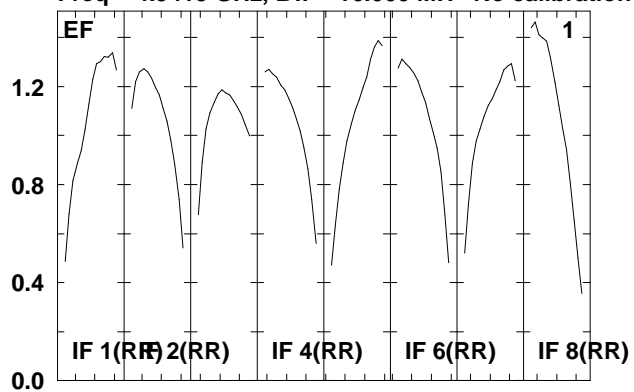

Lower frame: Real Jy  
Total-power spectrum Antenna: \*  
Timerange: 00/13:30:43 to 00/13:33:39

Plot file version 56 created 07-DEC-2009 16:05:49

J1912+05 RT006C.UVDATA.1

Freq = 4.9415 GHz, Bw = 16.000 MH No calibration applied and no bandpass applied

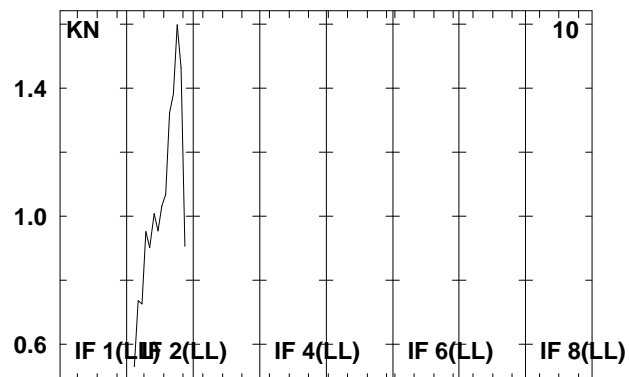
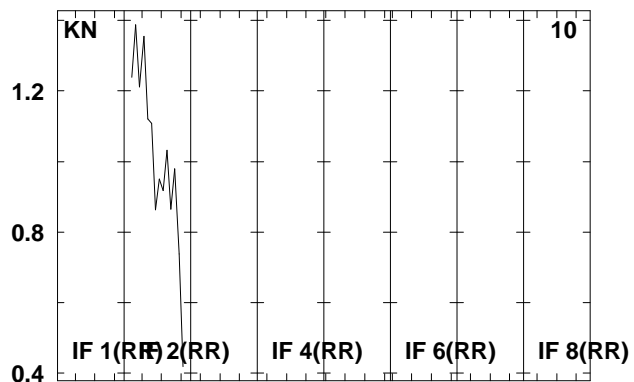
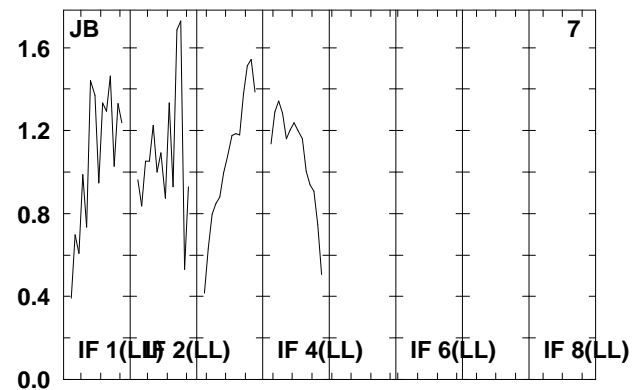
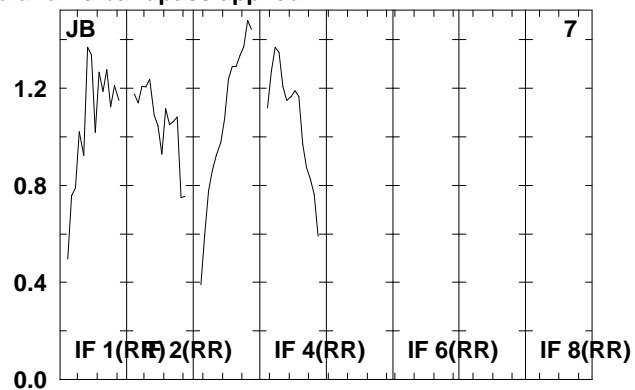
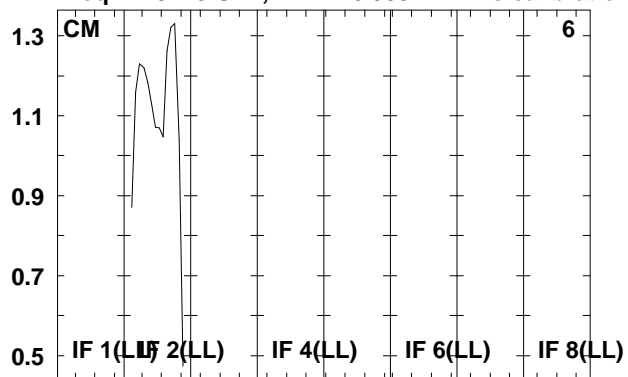

Lower frame: Real Jy  
Total-power spectrum Antenna: \*  
Timerange: 00/13:30:43 to 00/13:33:39



Plot file version 57 created 07-DEC-2009 16:05:49

SS433 RT006C.UVDATA.1

Freq = 4.9415 GHz, Bw = 16.000 MH No calibration applied and no bandpass applied

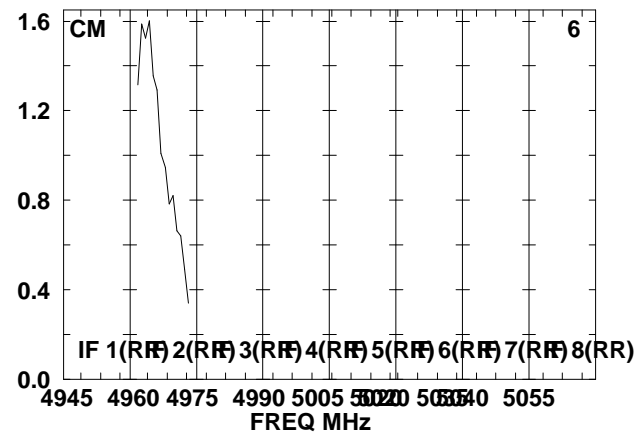
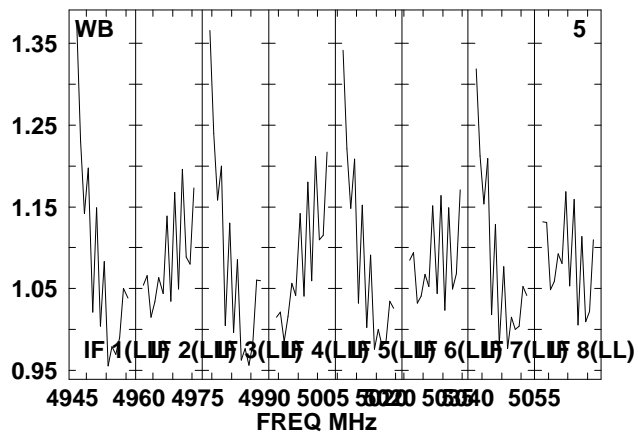
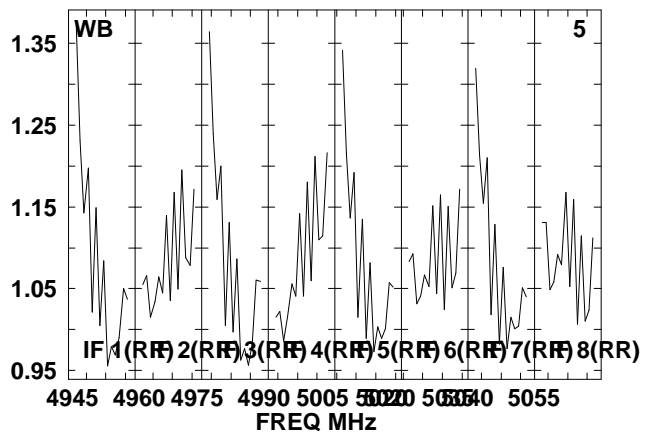
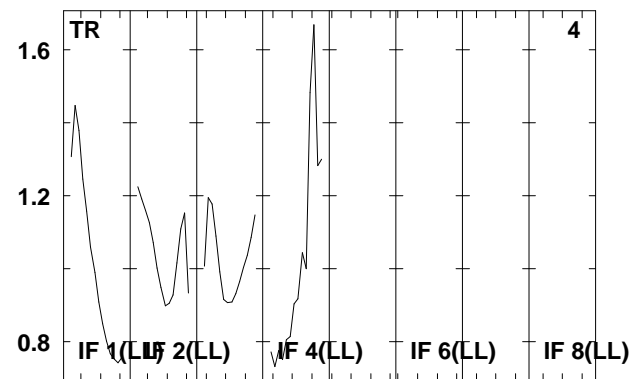
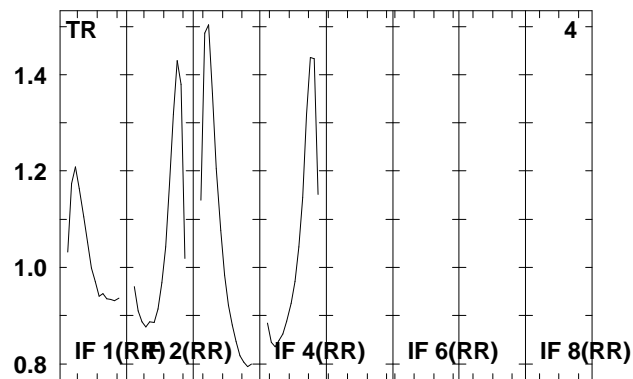
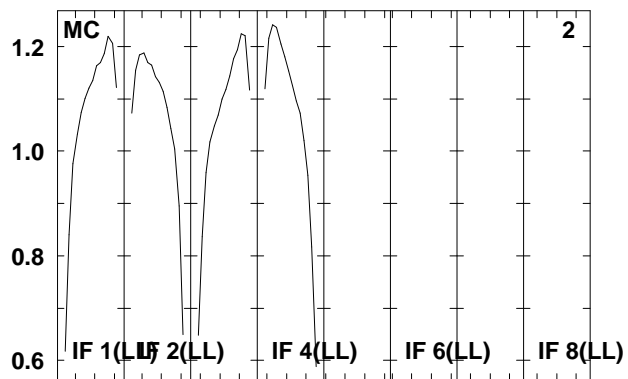
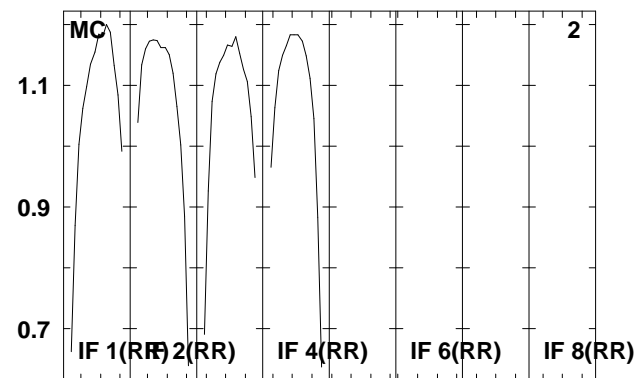
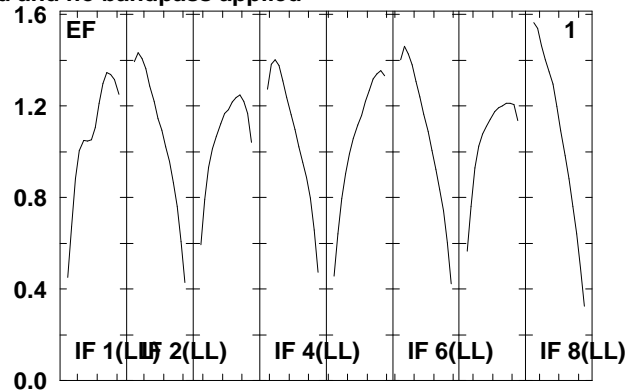
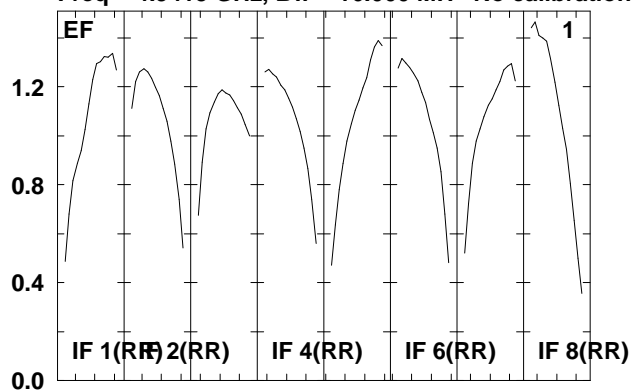

Lower frame: Real Jy  
Total-power spectrum Antenna: \*  
Timerange: 00/13:33:43 to 00/13:35:59

Plot file version 58 created 07-DEC-2009 16:05:49

SS433 RT006C.UVDATA.1

Freq = 4.9415 GHz, Bw = 16.000 MH No calibration applied and no bandpass applied

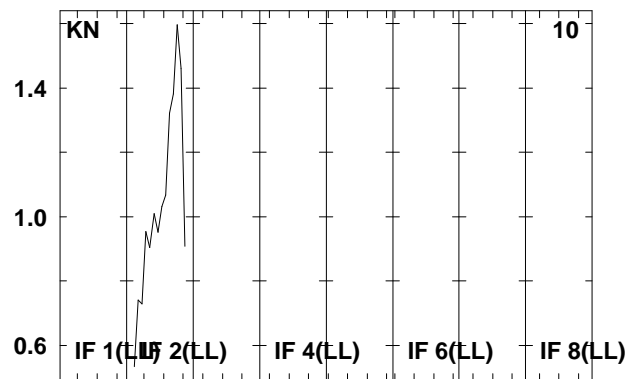
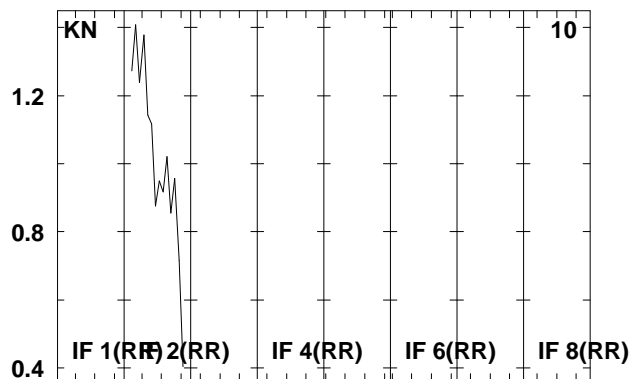
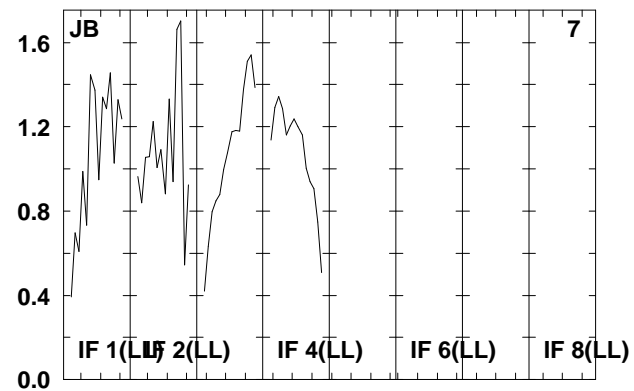
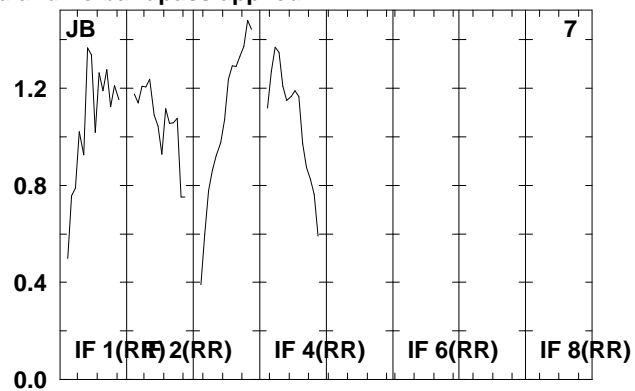
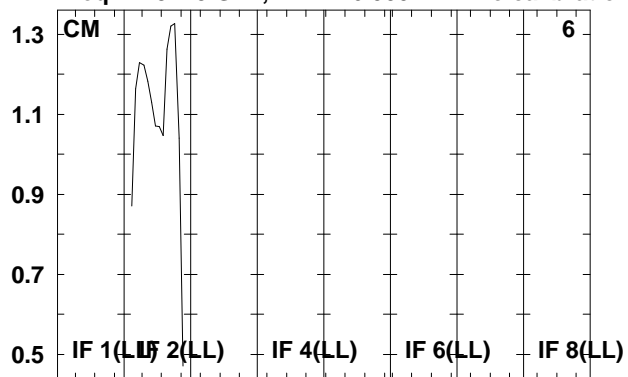

Lower frame: Real Jy  
Total-power spectrum Antenna: \*  
Timerange: 00/13:33:43 to 00/13:35:59

Plot file version 59 created 07-DEC-2009 16:05:50

J1912+05 RT006C.UVDATA.1

Freq = 4.9415 GHz, Bw = 16.000 MH No calibration applied and no bandpass applied

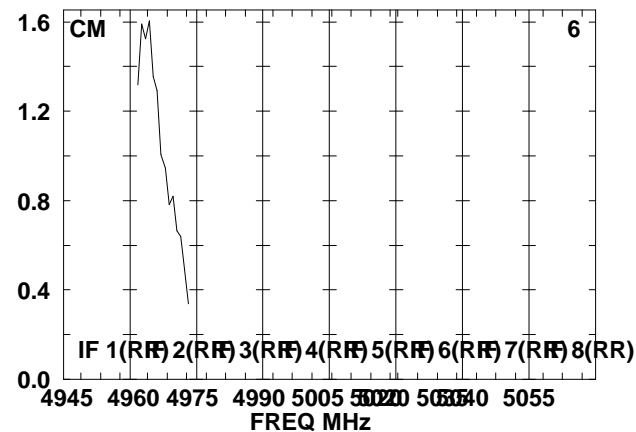
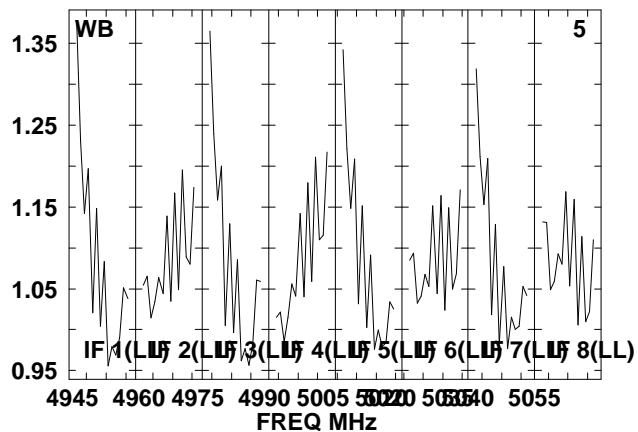
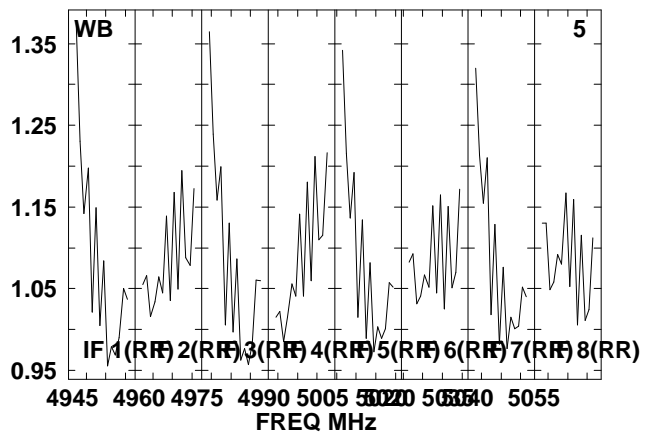
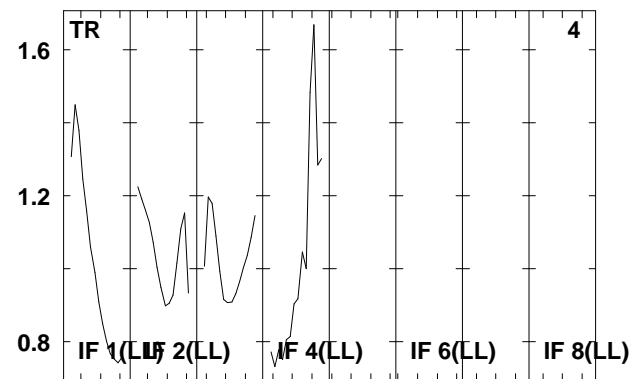
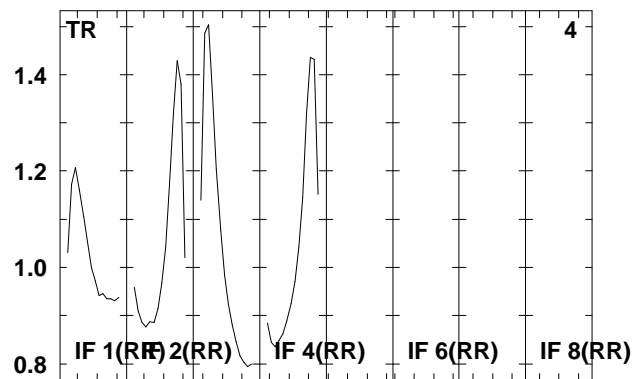
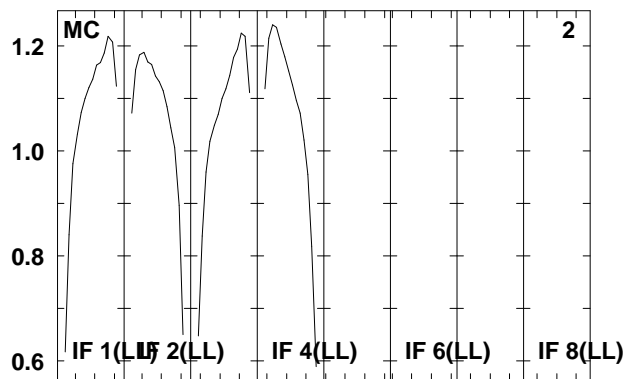
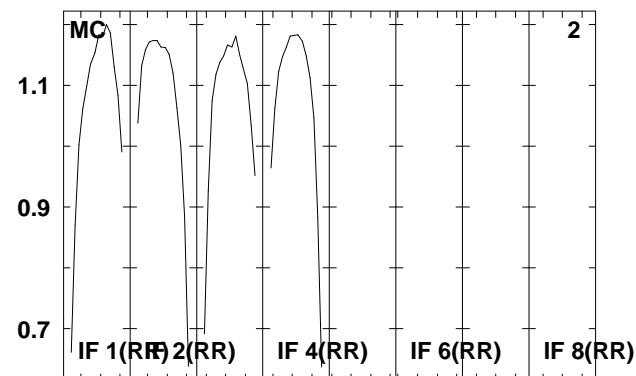
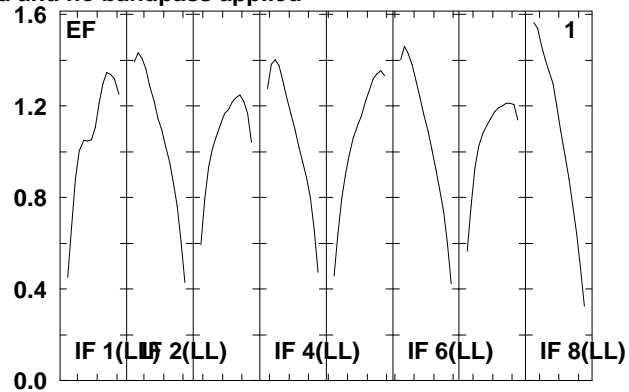
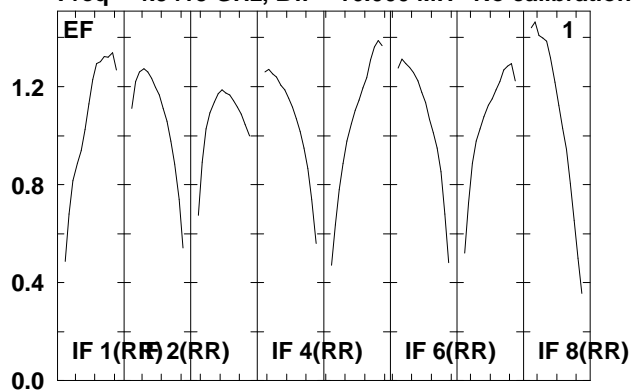

Lower frame: Real Jy  
Total-power spectrum Antenna: \*  
Timerange: 00/13:36:03 to 00/13:37:19

Plot file version 60 created 07-DEC-2009 16:05:50

J1912+05 RT006C.UVDATA.1

Freq = 4.9415 GHz, Bw = 16.000 MH No calibration applied and no bandpass applied

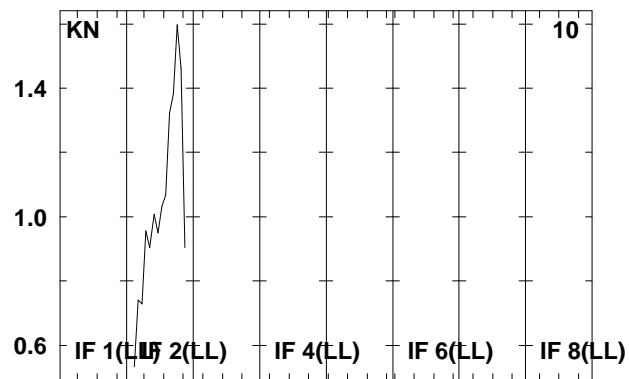
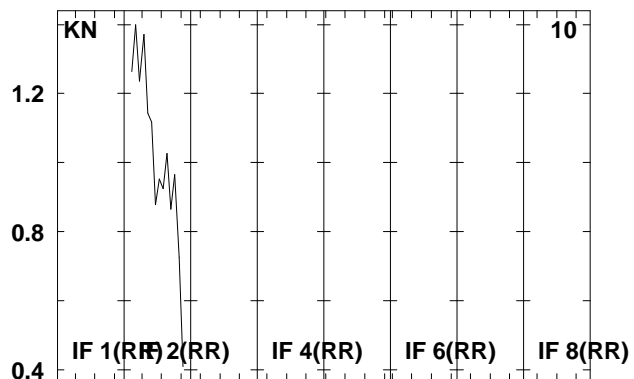
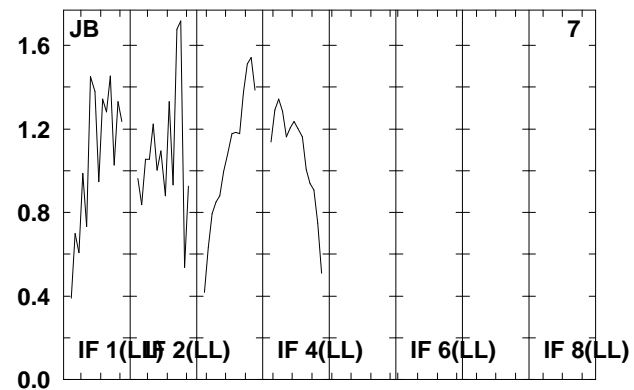
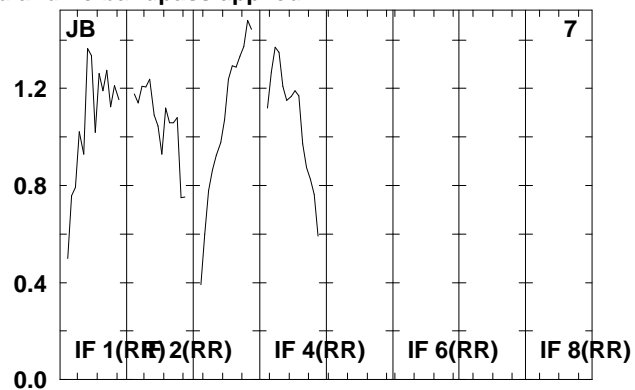
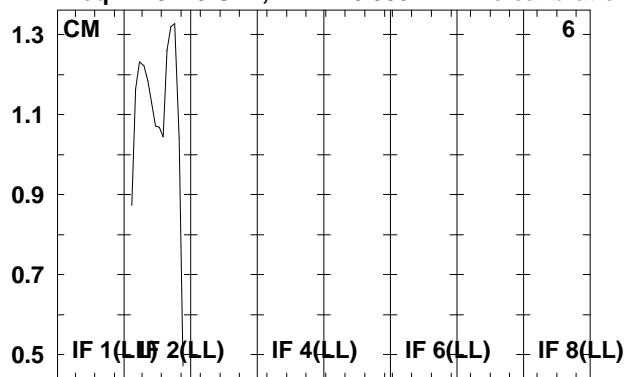

Lower frame: Real Jy  
Total-power spectrum Antenna: \*  
Timerange: 00/13:36:03 to 00/13:37:19

Plot file version 61 created 07-DEC-2009 16:05:50

SS433 RT006C.UVDATA.1

Freq = 4.9415 GHz, Bw = 16.000 MH No calibration applied and no bandpass applied

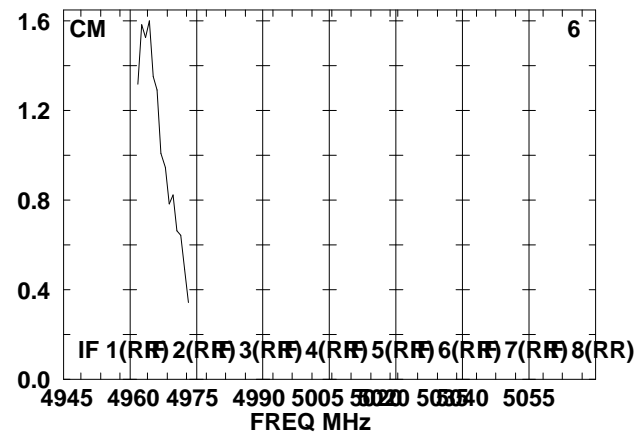
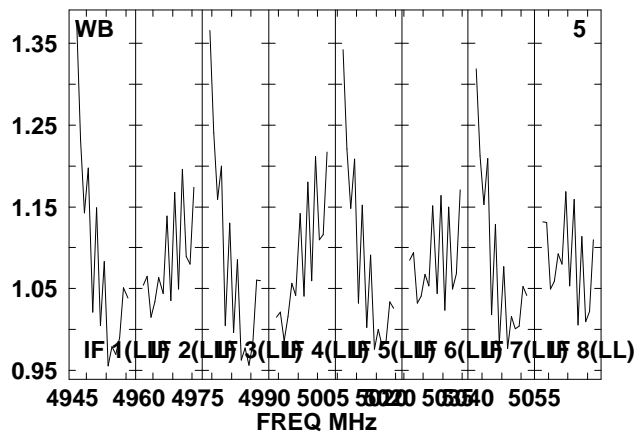
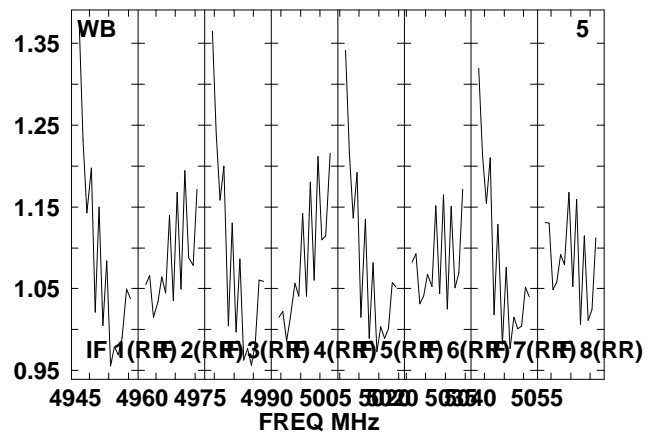
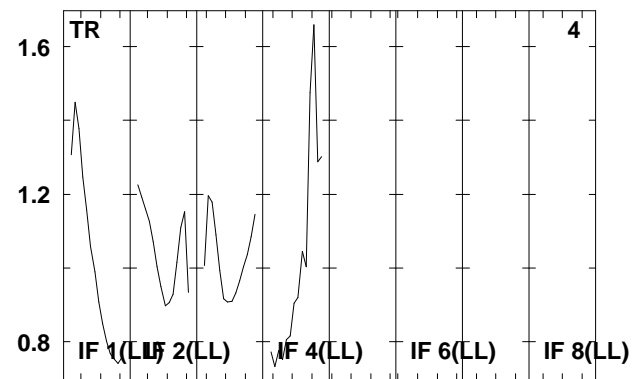
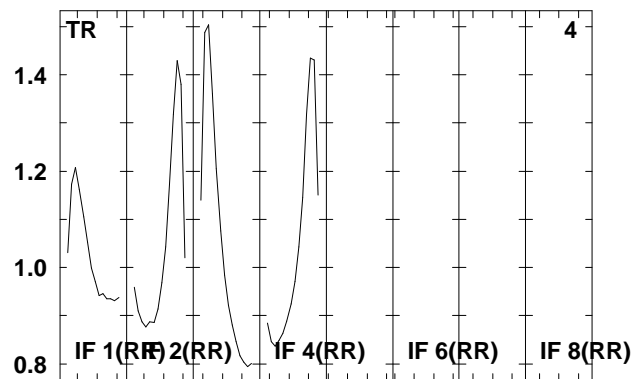
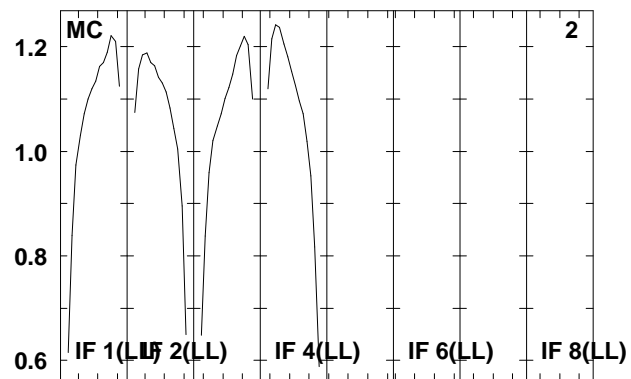
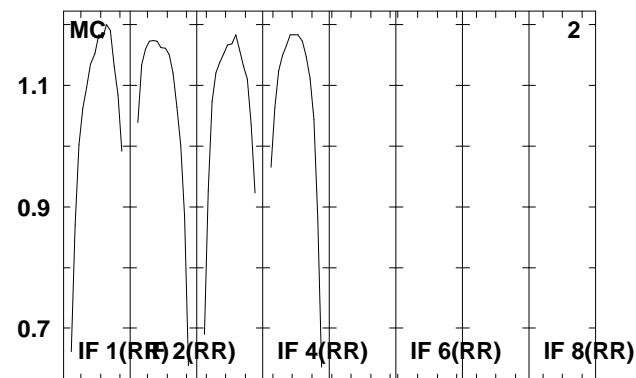
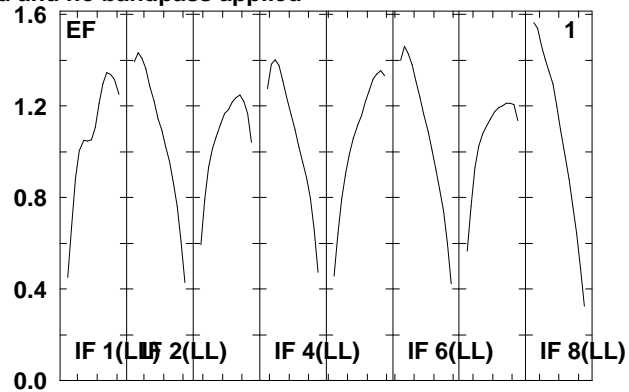
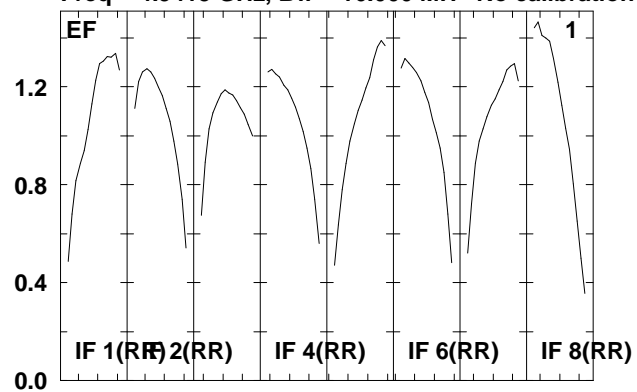

Lower frame: Real Jy  
Total-power spectrum Antenna: \*  
Timerange: 00/13:37:23 to 00/13:39:39

Plot file version 62 created 07-DEC-2009 16:05:50

SS433 RT006C.UVDATA.1

Freq = 4.9415 GHz, Bw = 16.000 MH No calibration applied and no bandpass applied

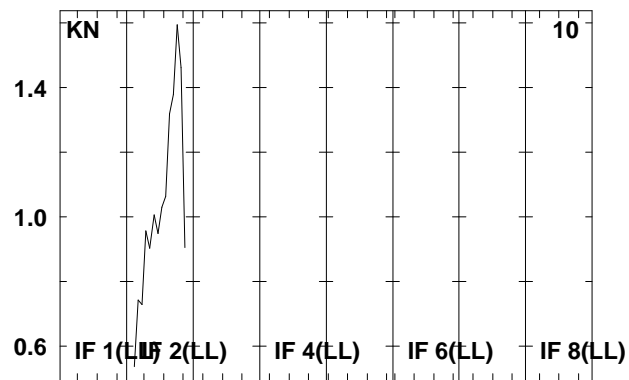
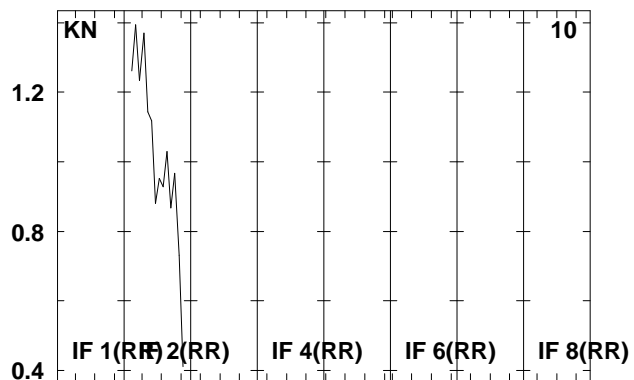
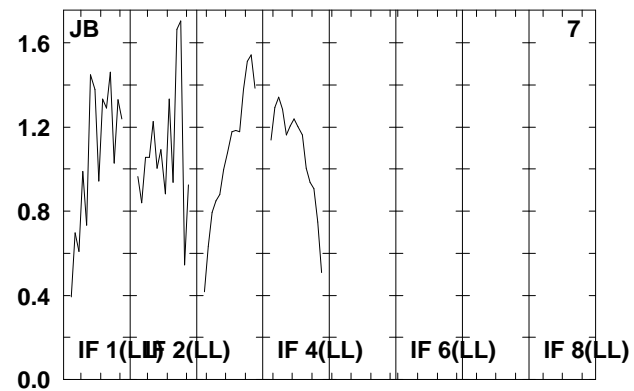
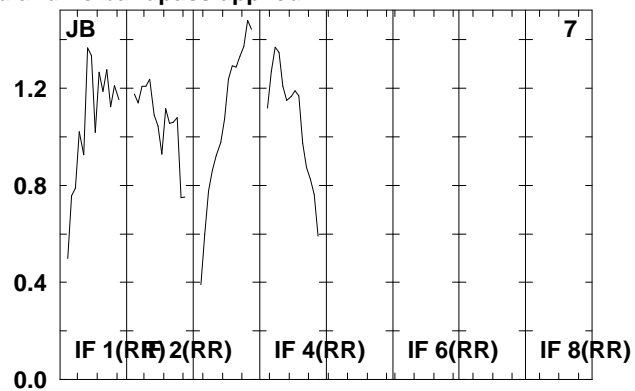
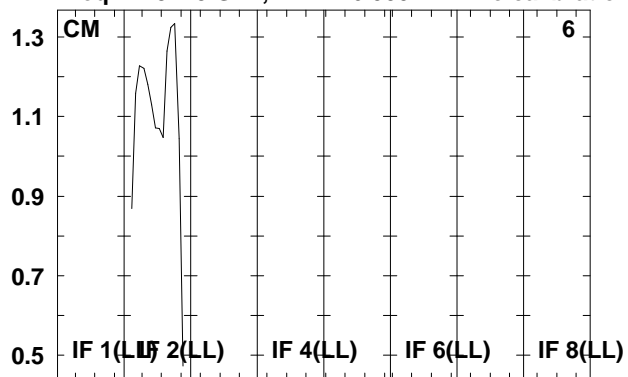

Lower frame: Real Jy  
Total-power spectrum Antenna: \*  
Timerange: 00/13:37:23 to 00/13:39:39

Plot file version 63 created 07-DEC-2009 16:05:50

J1912+05 RT006C.UVDATA.1

Freq = 4.9415 GHz, Bw = 16.000 MH No calibration applied and no bandpass applied

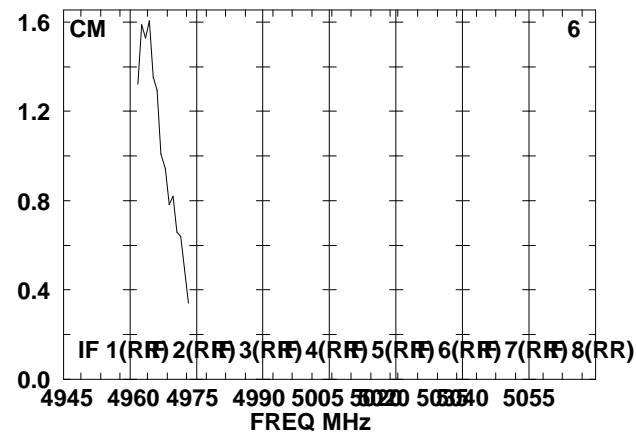
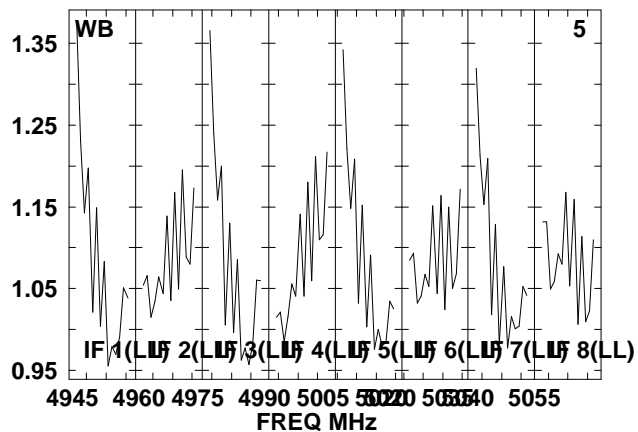
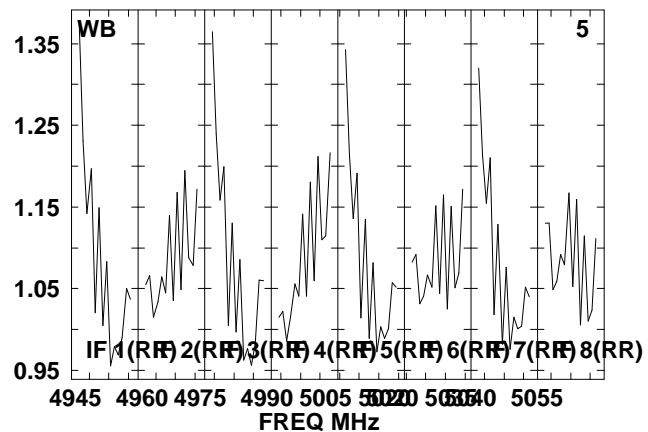
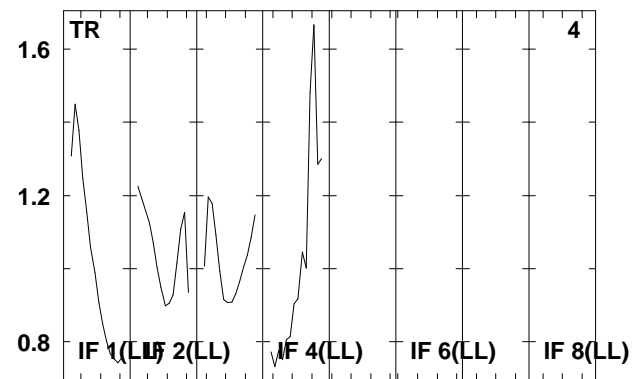
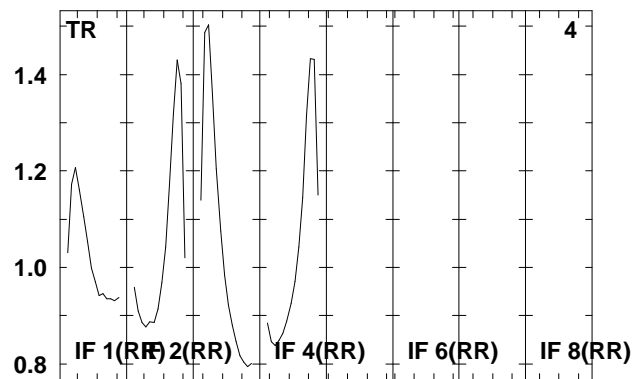
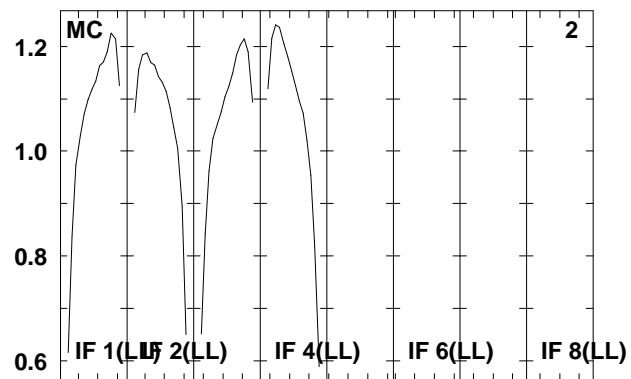
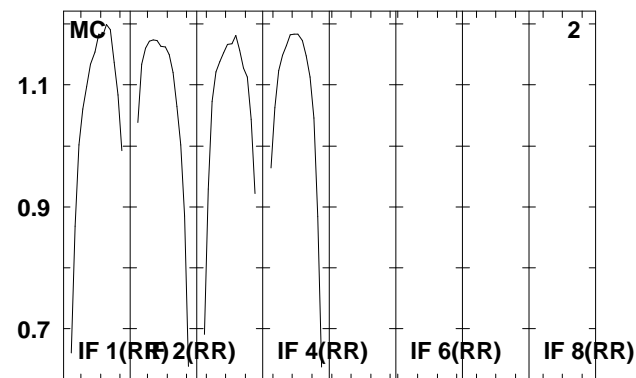
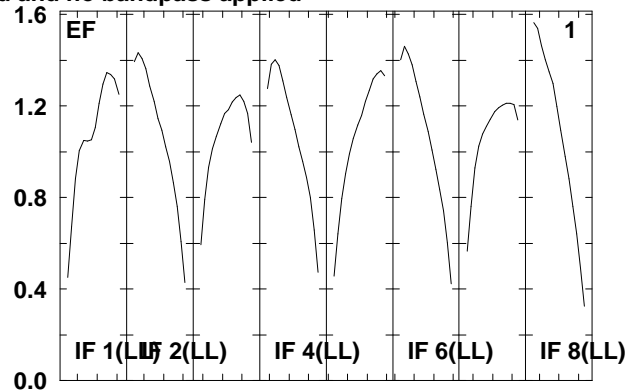
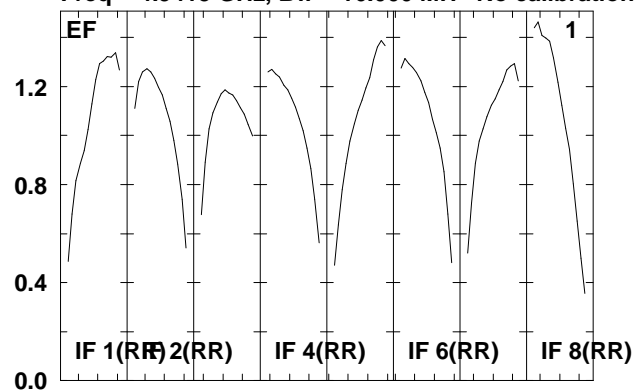

Lower frame: Real Jy  
Total-power spectrum Antenna: \*  
Timerange: 00/13:39:43 to 00/13:40:59

Plot file version 64 created 07-DEC-2009 16:05:50

J1912+05 RT006C.UVDATA.1

Freq = 4.9415 GHz, Bw = 16.000 MH No calibration applied and no bandpass applied

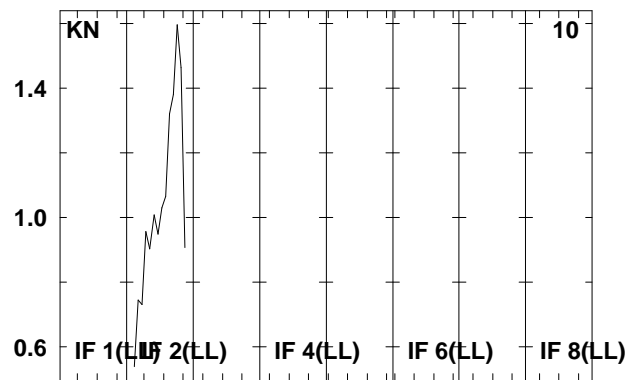
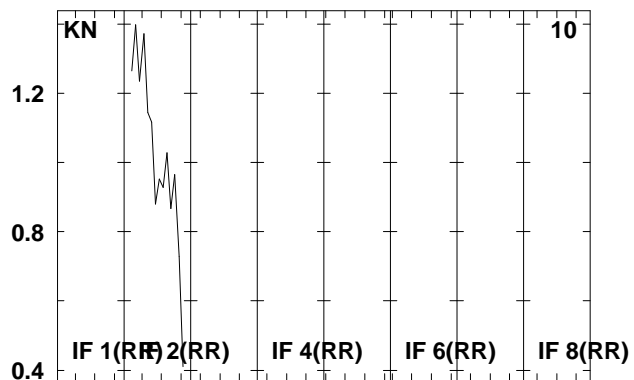
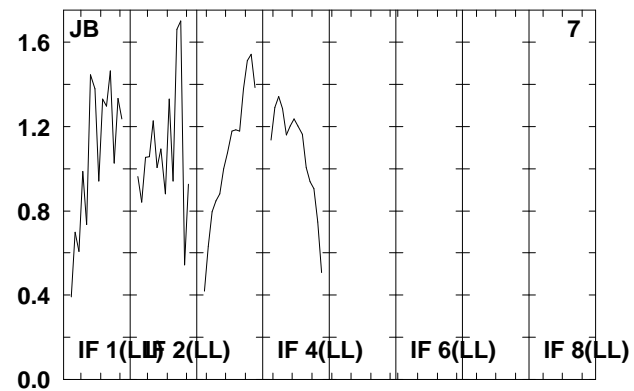
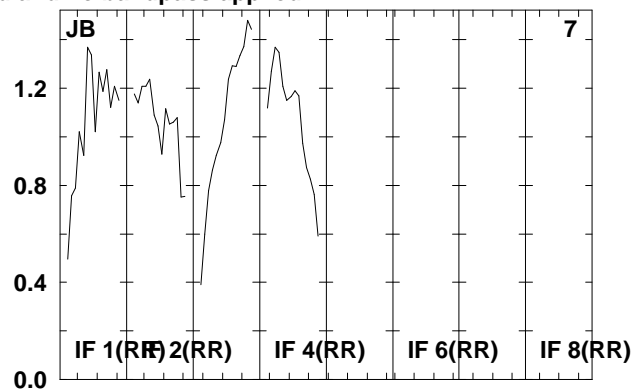
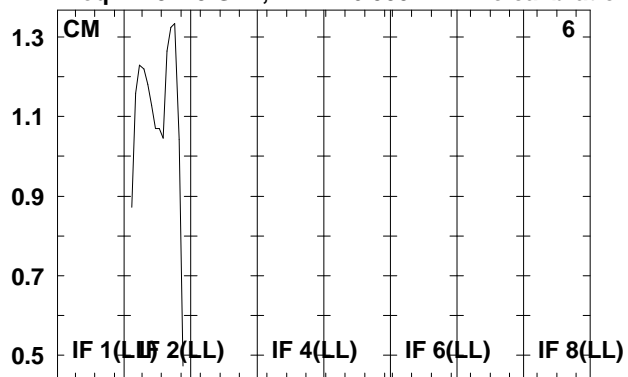

Lower frame: Real Jy  
Total-power spectrum Antenna: \*  
Timerange: 00/13:39:43 to 00/13:40:59



Plot file version 65 created 07-DEC-2009 16:05:50

SS433 RT006C.UVDATA.1

Freq = 4.9415 GHz, Bw = 16.000 MH No calibration applied and no bandpass applied

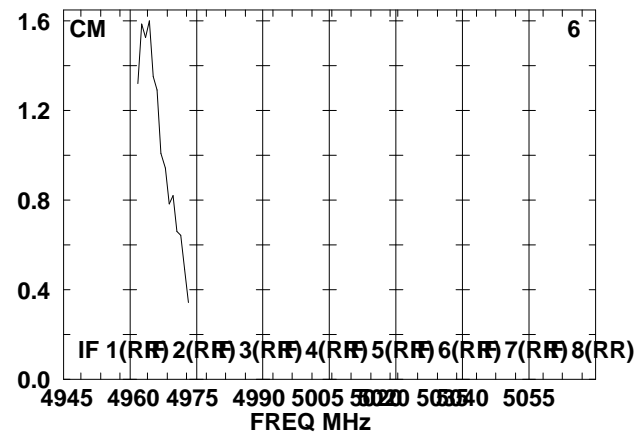
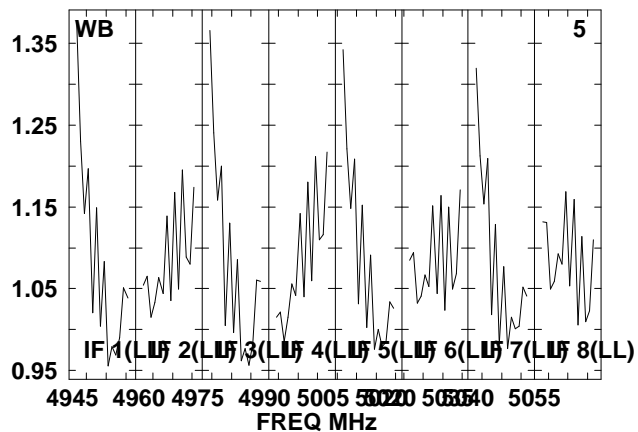
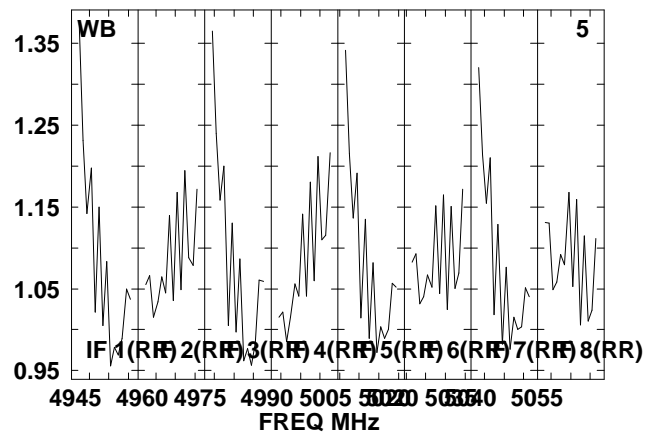
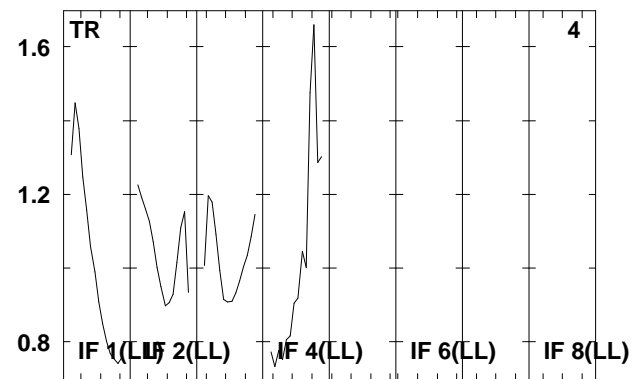
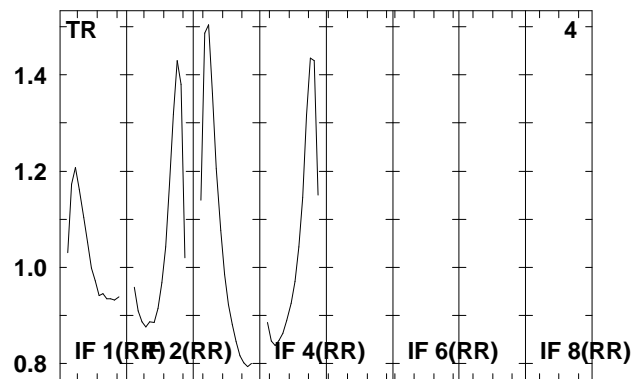
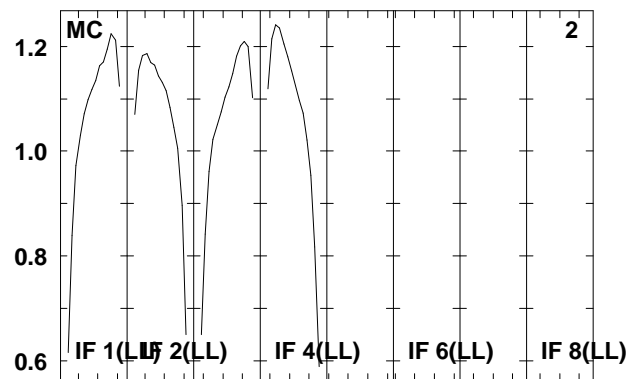
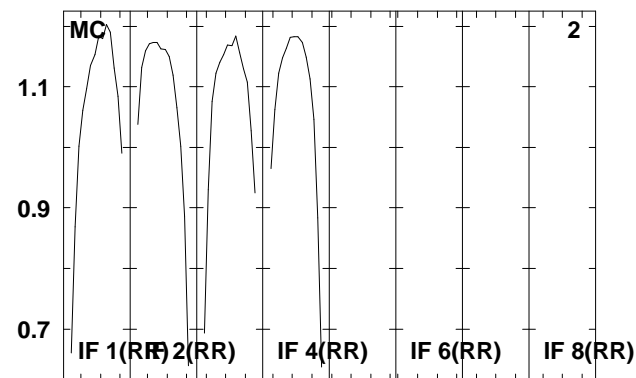
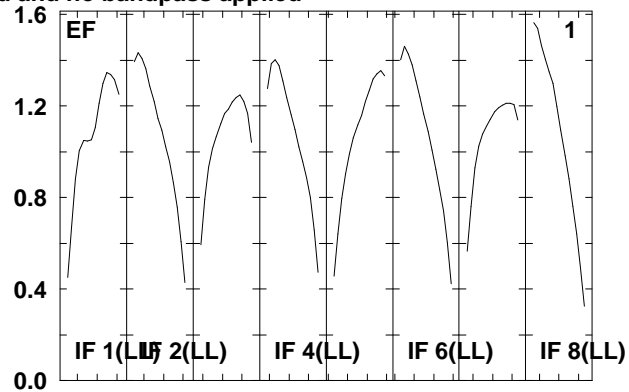
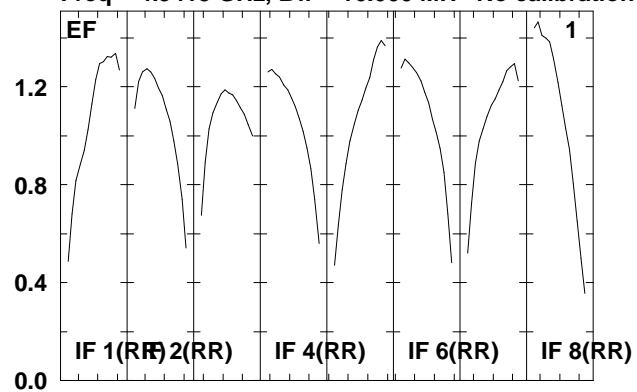

Lower frame: Real Jy  
Total-power spectrum Antenna: \*  
Timerange: 00/13:41:03 to 00/13:43:19

Plot file version 66 created 07-DEC-2009 16:05:51

SS433 RT006C.UVDATA.1

Freq = 4.9415 GHz, Bw = 16.000 MH No calibration applied and no bandpass applied

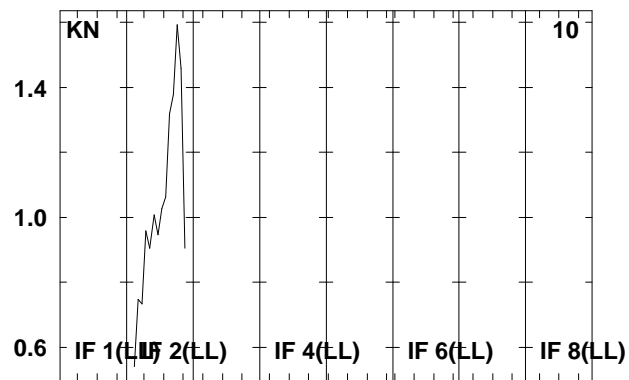
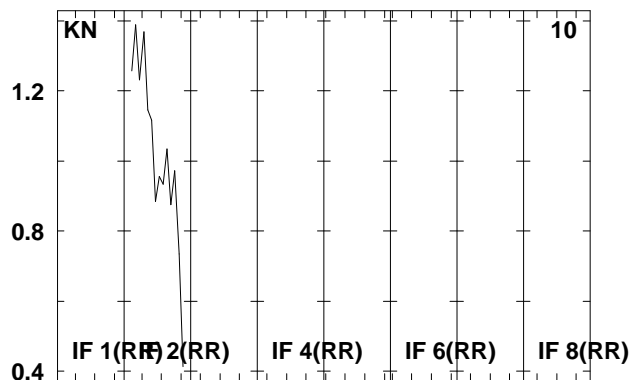
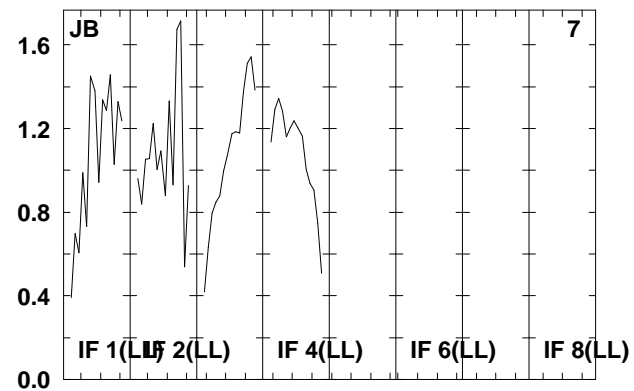
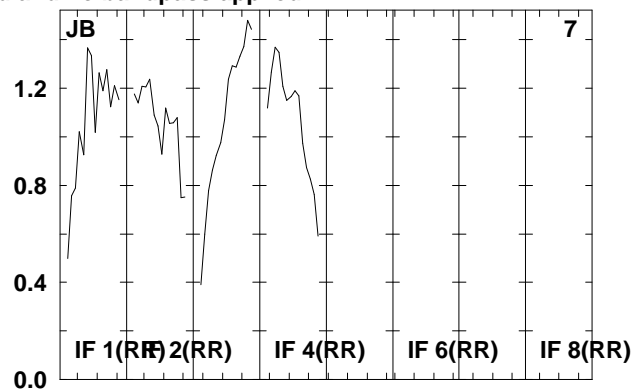
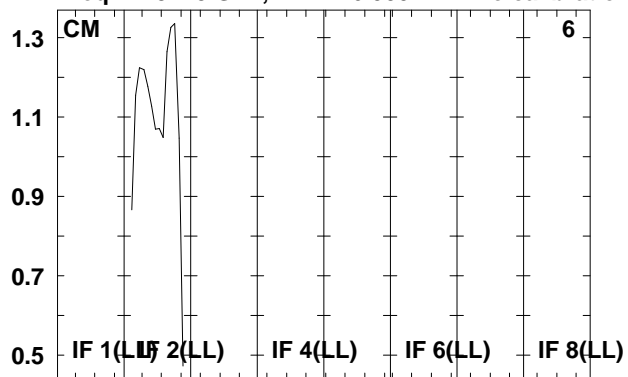

Lower frame: Real Jy  
Total-power spectrum Antenna: \*  
Timerange: 00/13:41:03 to 00/13:43:19

Plot file version 67 created 07-DEC-2009 16:05:51

J1912+05 RT006C.UVDATA.1

Freq = 4.9415 GHz, Bw = 16.000 MH No calibration applied and no bandpass applied

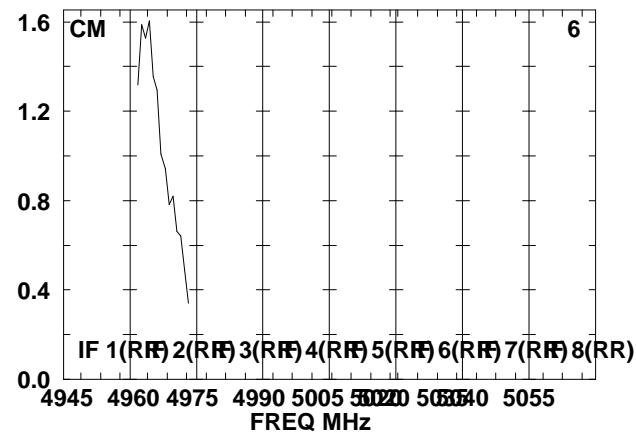
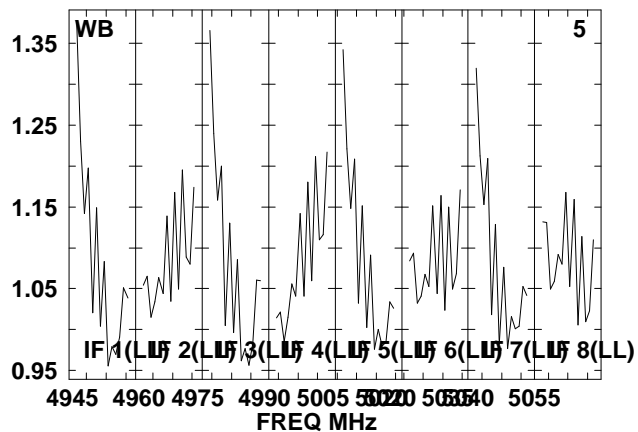
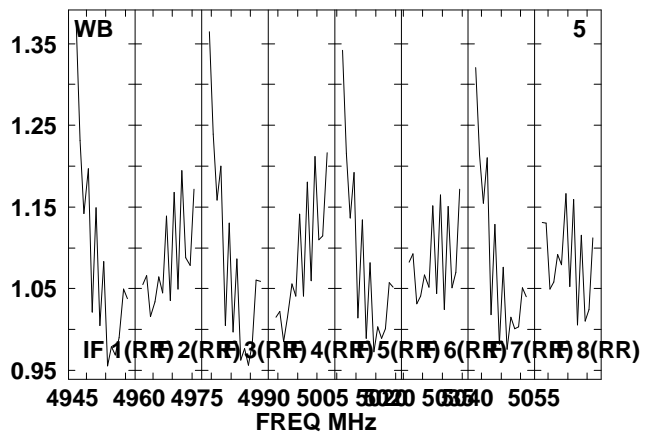
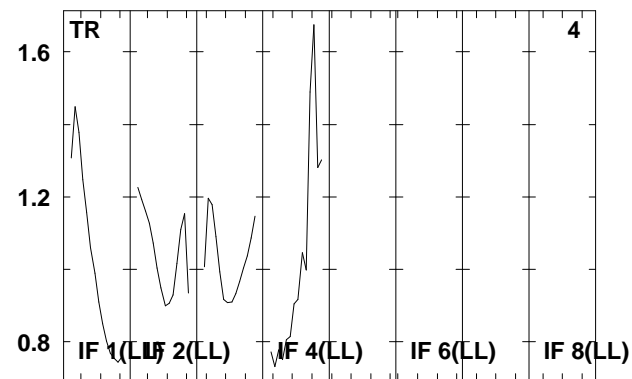
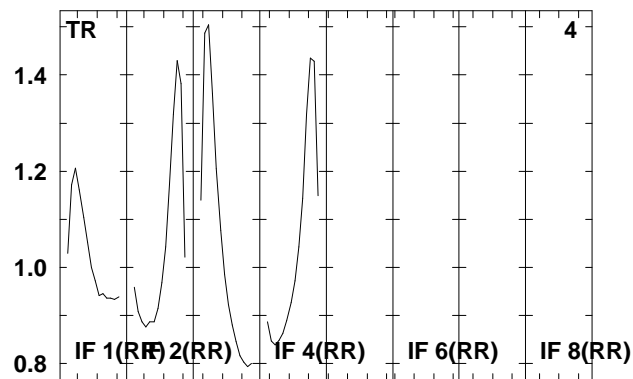
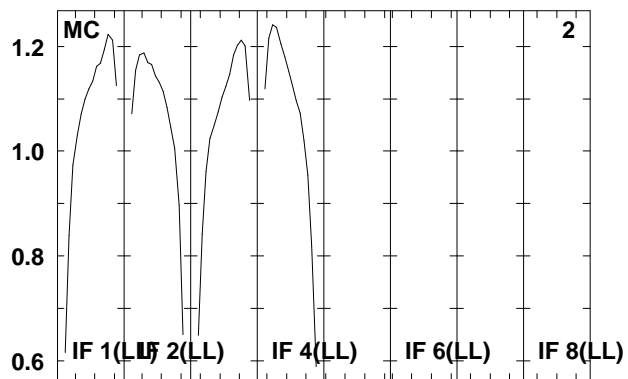
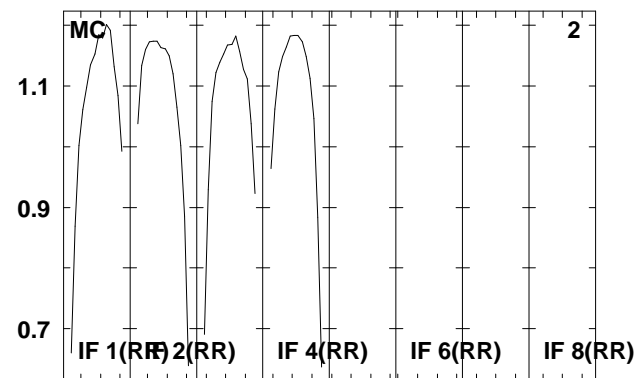
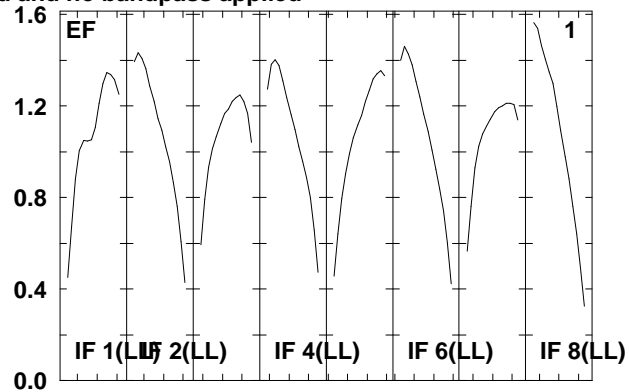
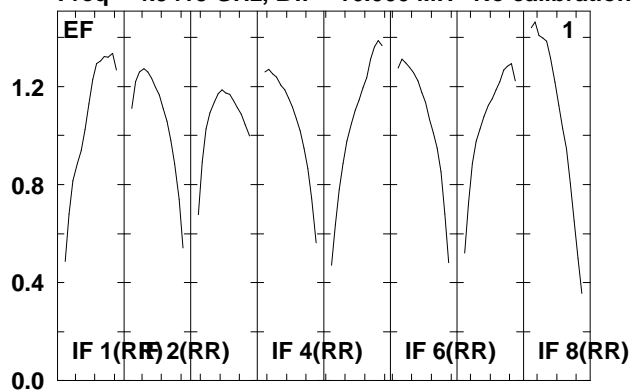

Lower frame: Real Jy  
Total-power spectrum Antenna: \*  
Timerange: 00/13:43:23 to 00/13:44:39

Plot file version 68 created 07-DEC-2009 16:05:51

J1912+05 RT006C.UVDATA.1

Freq = 4.9415 GHz, Bw = 16.000 MH No calibration applied and no bandpass applied

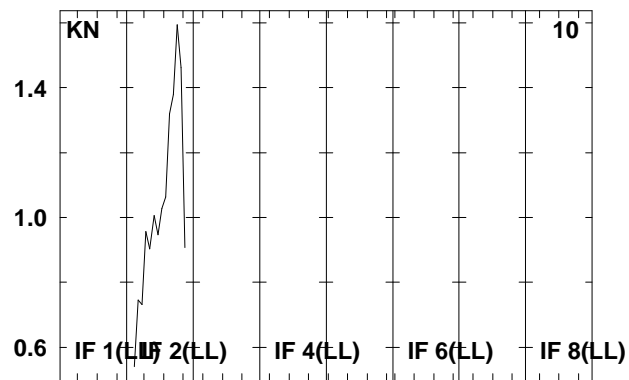
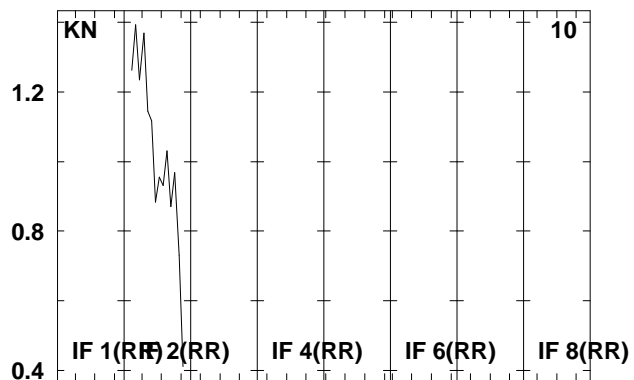
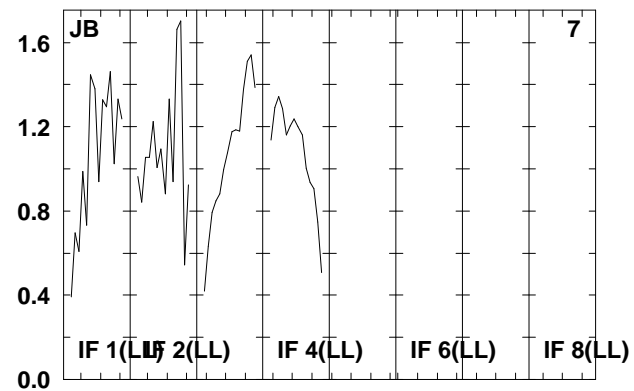
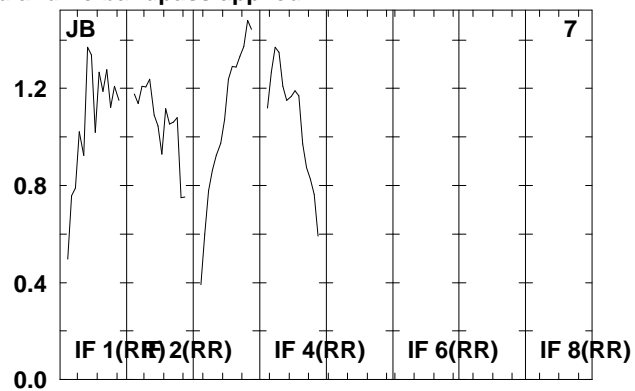
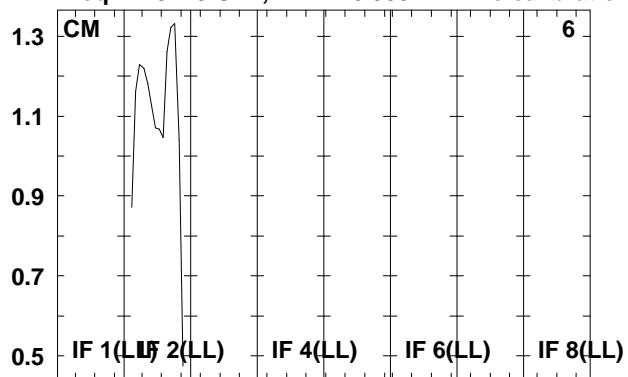

Lower frame: Real Jy  
Total-power spectrum Antenna: \*  
Timerange: 00/13:43:23 to 00/13:44:39

Plot file version 69 created 07-DEC-2009 16:05:51

SS433 RT006C.UVDATA.1

Freq = 4.9415 GHz, Bw = 16.000 MH No calibration applied and no bandpass applied

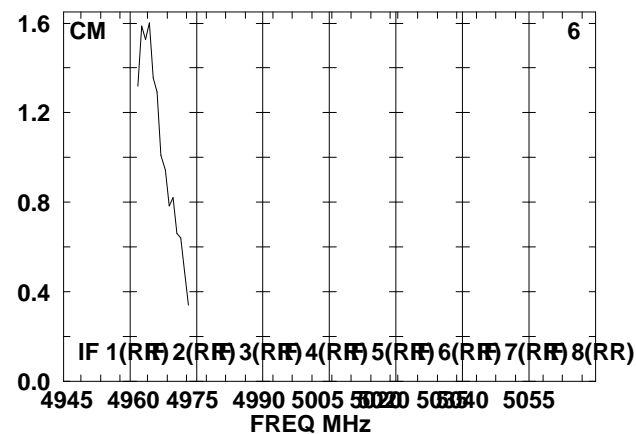
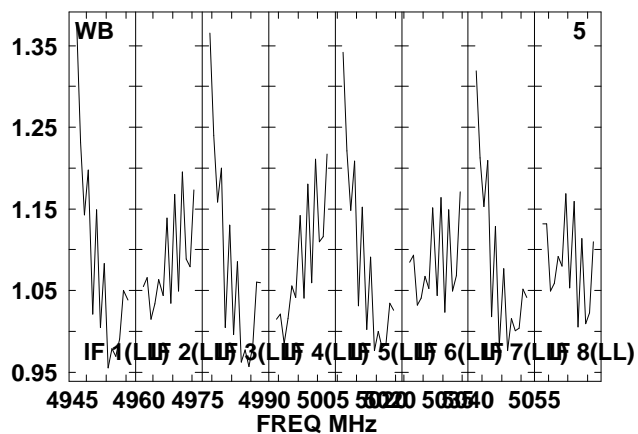
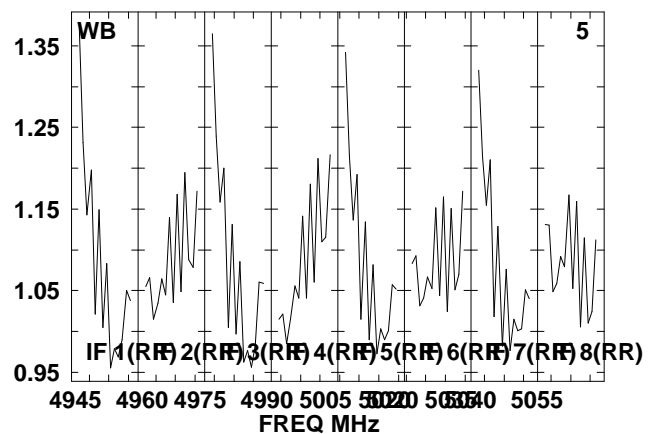
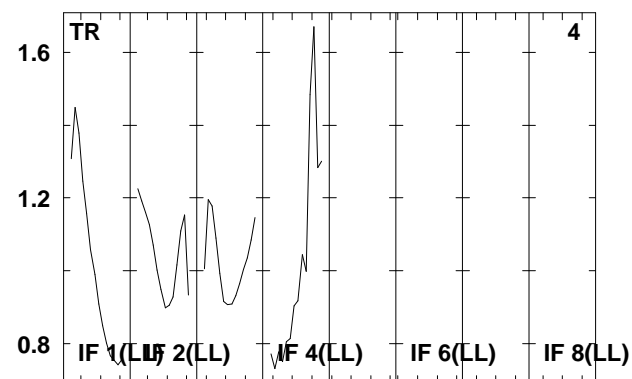
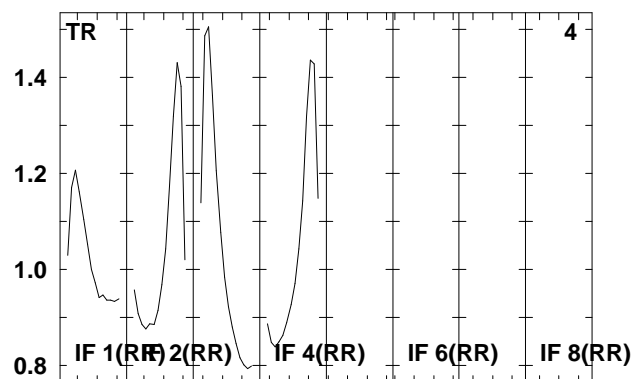
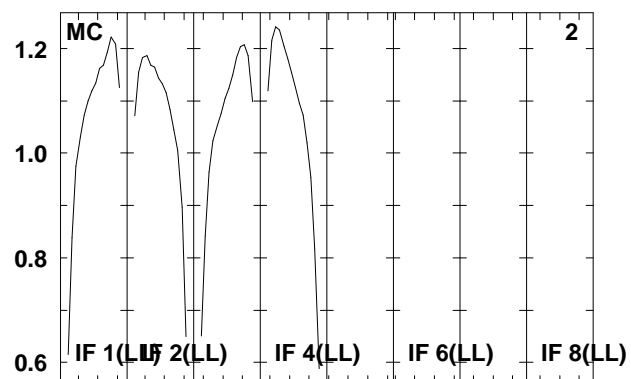
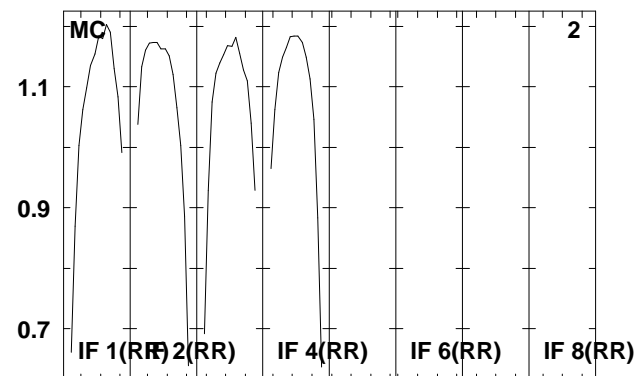
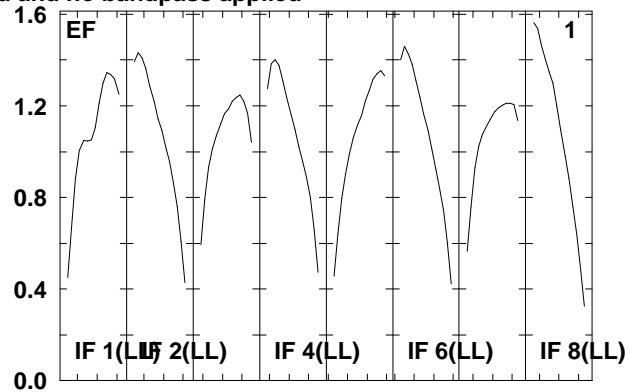
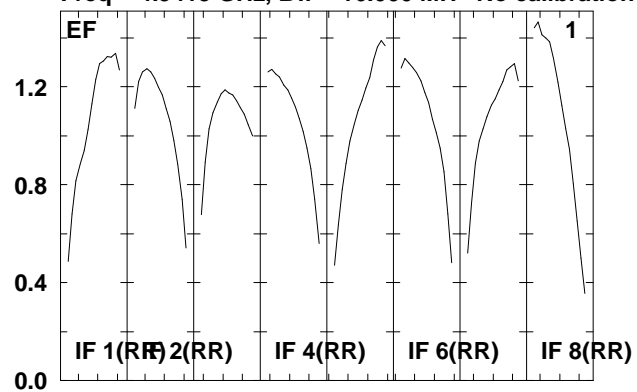

Lower frame: Real Jy  
Total-power spectrum Antenna: \*  
Timerange: 00/13:44:43 to 00/13:46:59

Plot file version 70 created 07-DEC-2009 16:05:51

SS433 RT006C.UVDATA.1

Freq = 4.9415 GHz, Bw = 16.000 MH No calibration applied and no bandpass applied

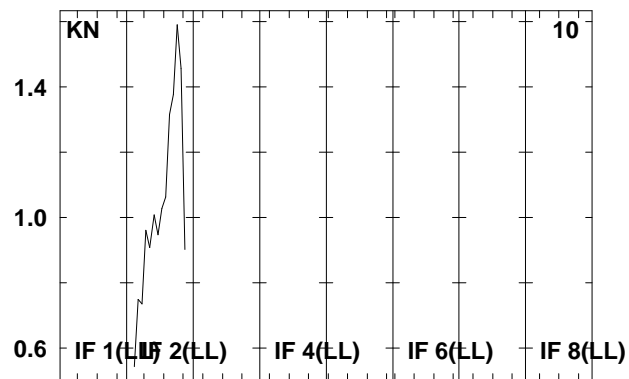
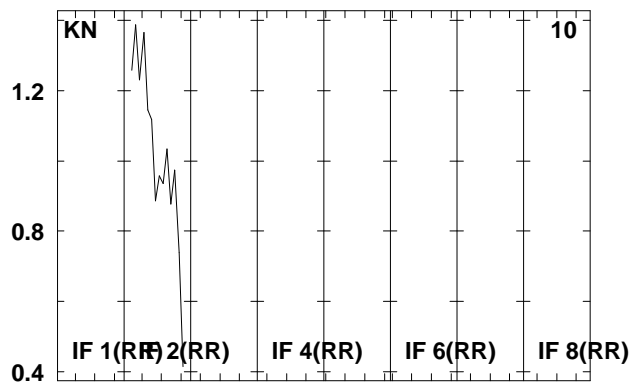
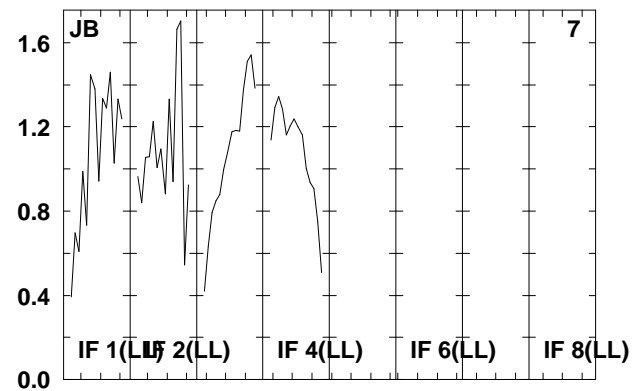
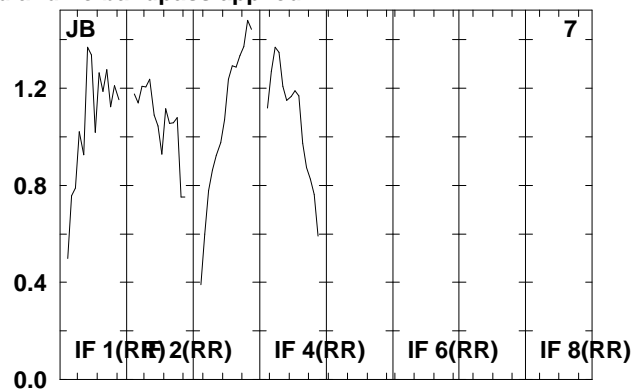
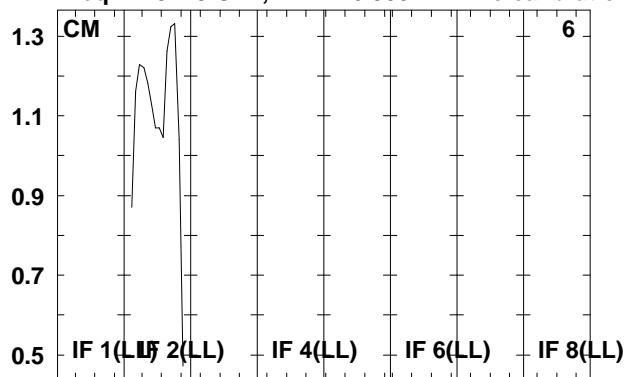

Lower frame: Real Jy  
Total-power spectrum Antenna: \*  
Timerange: 00/13:44:43 to 00/13:46:59

Plot file version 71 created 07-DEC-2009 16:05:52

J1911+16 RT006C.UVDATA.1

Freq = 4.9415 GHz, Bw = 16.000 MH No calibration applied and no bandpass applied

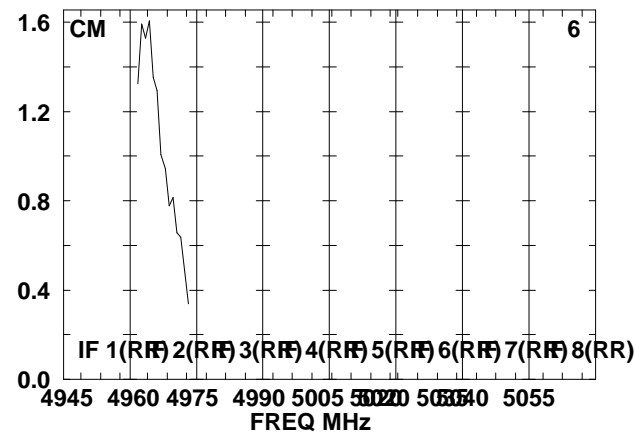
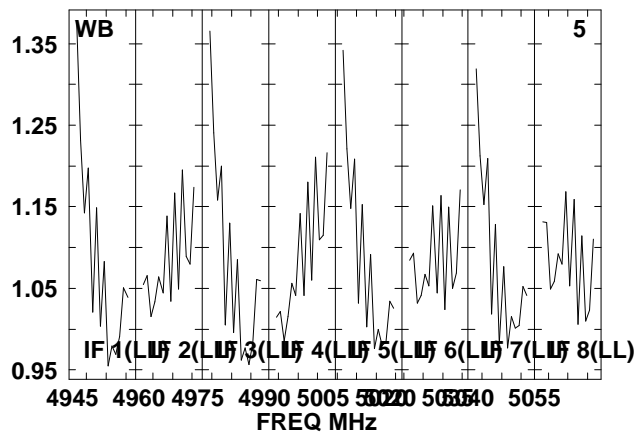
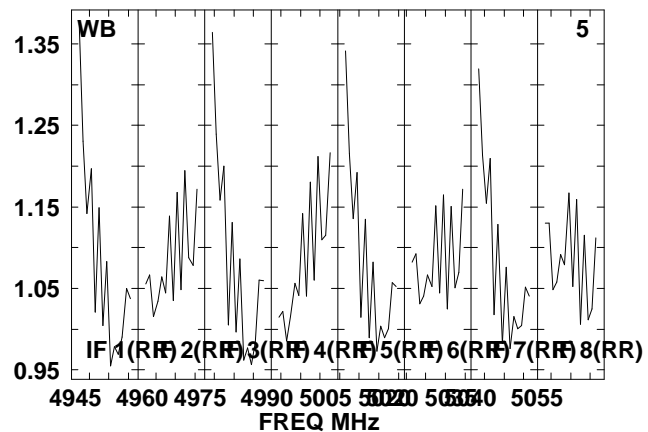
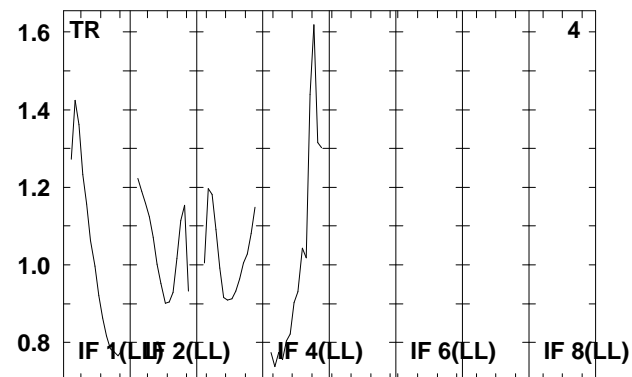
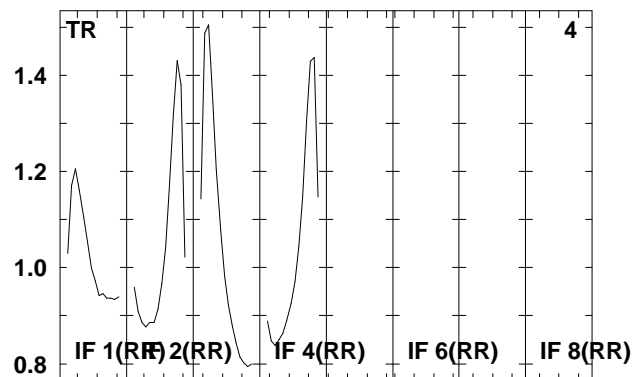
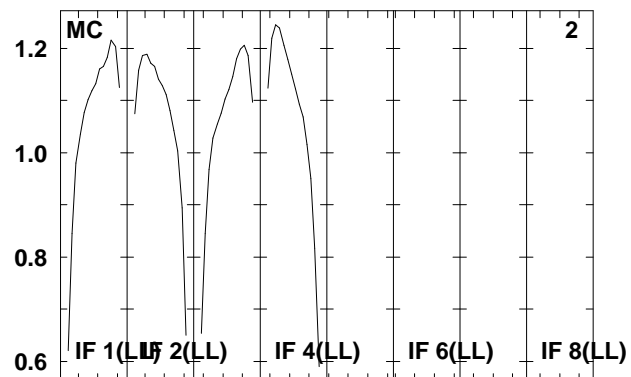
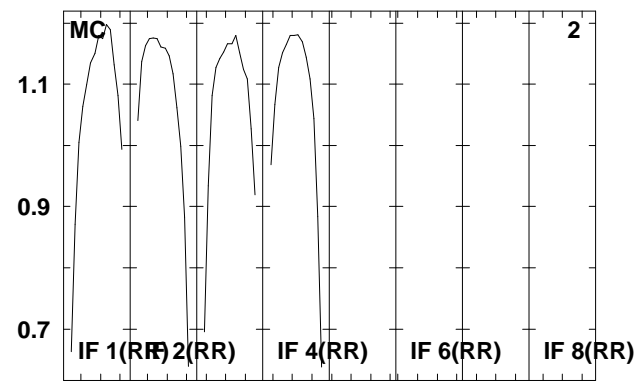
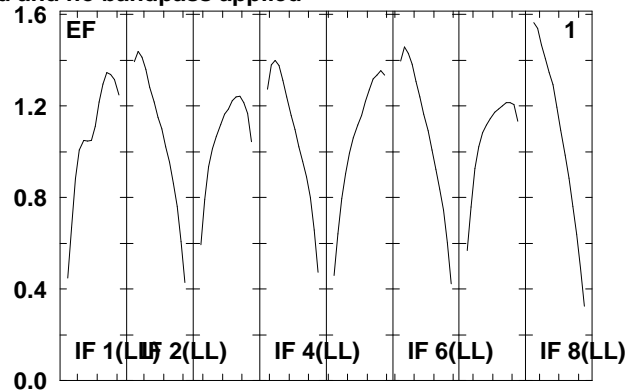
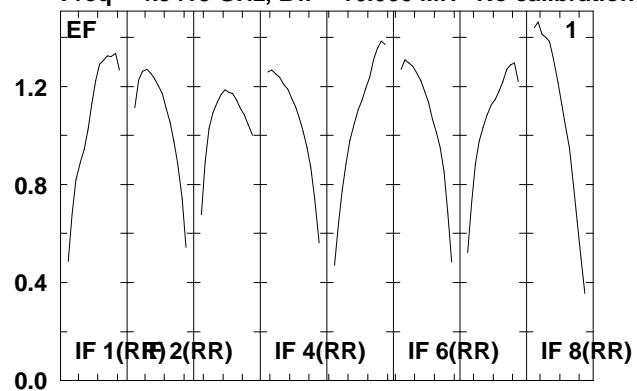

Lower frame: Real Jy

Total-power spectrum Antenna: \*

Timerange: 00/13:48:03 to 00/13:48:59

Plot file version 72 created 07-DEC-2009 16:05:52

J1911+16 RT006C.UVDATA.1

Freq = 4.9415 GHz, Bw = 16.000 MH No calibration applied and no bandpass applied

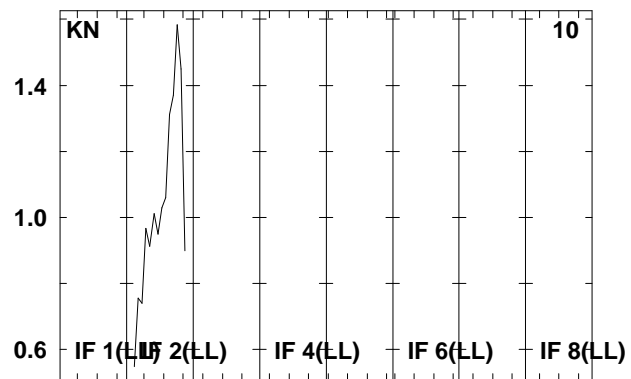
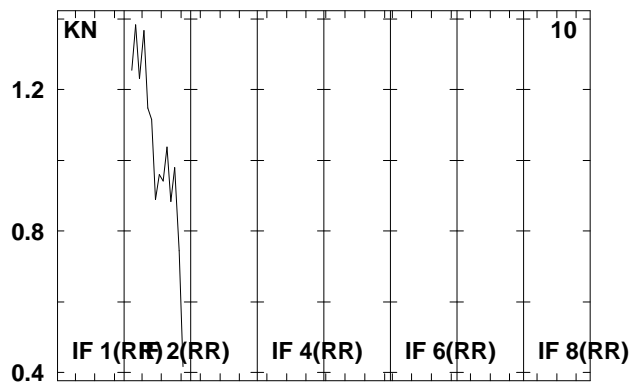
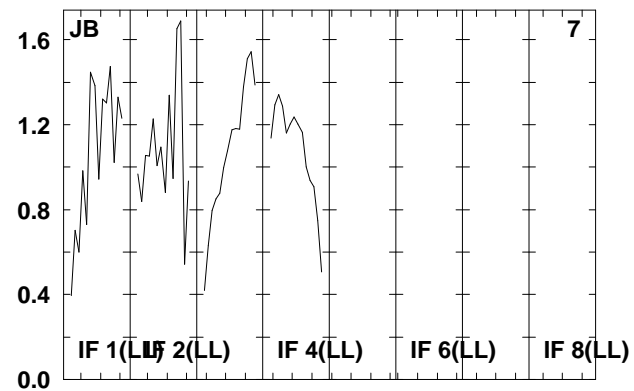
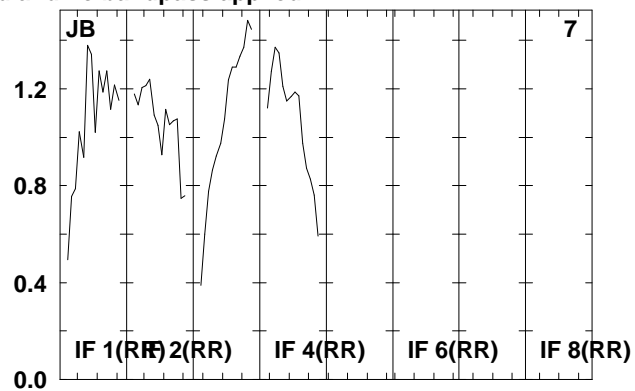
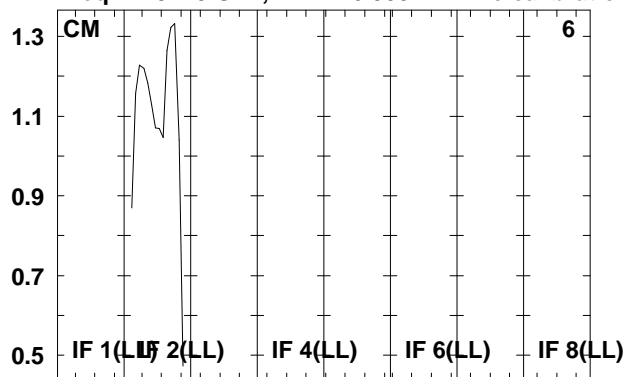

Lower frame: Real Jy  
Total-power spectrum Antenna: \*  
Timerange: 00/13:48:03 to 00/13:48:59



Plot file version 73 created 07-DEC-2009 16:05:52

J1912+05 RT006C.UVDATA.1

Freq = 4.9415 GHz, Bw = 16.000 MH No calibration applied and no bandpass applied

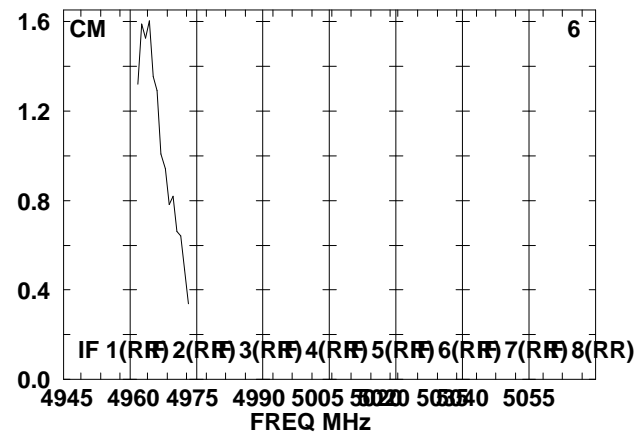
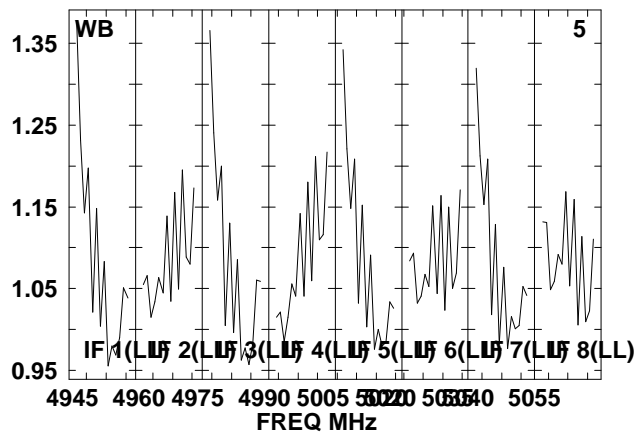
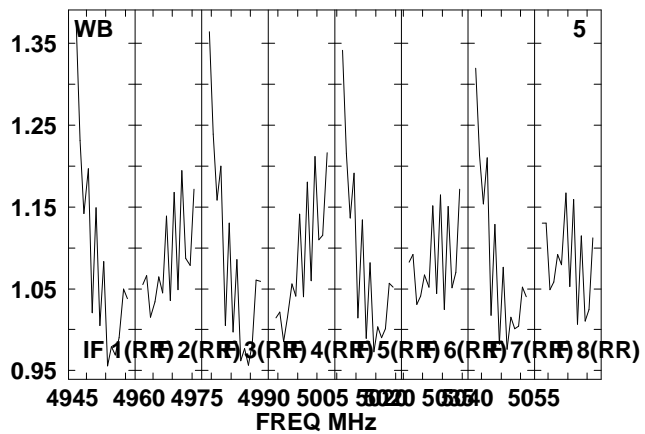
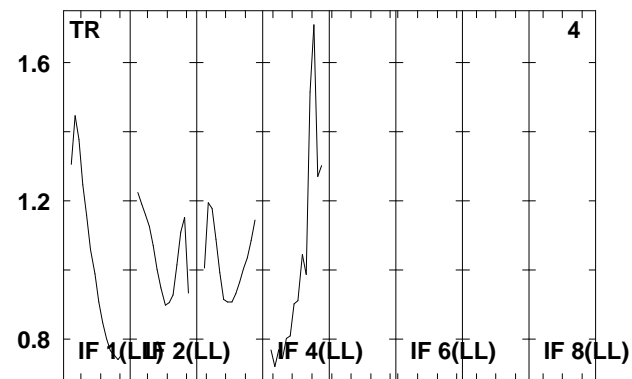
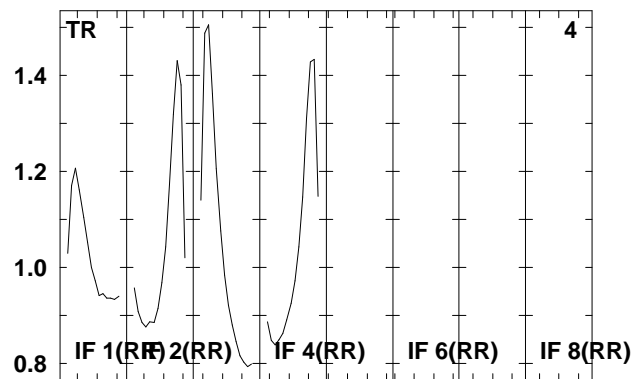
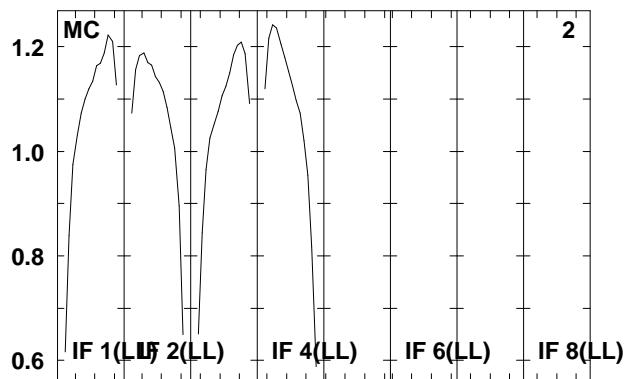
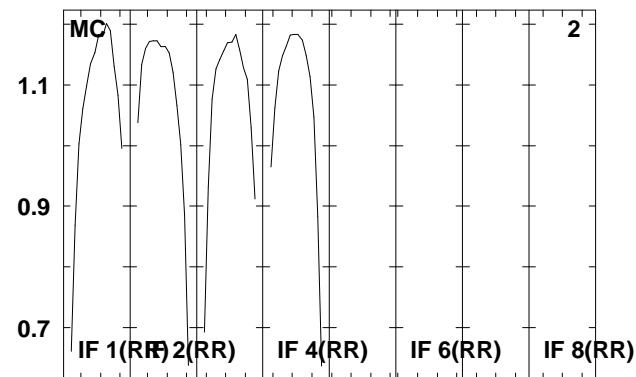
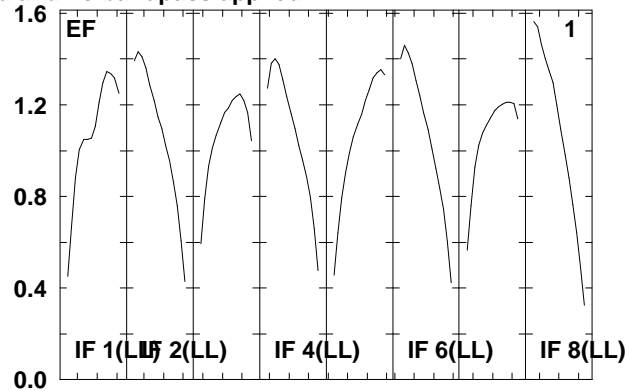
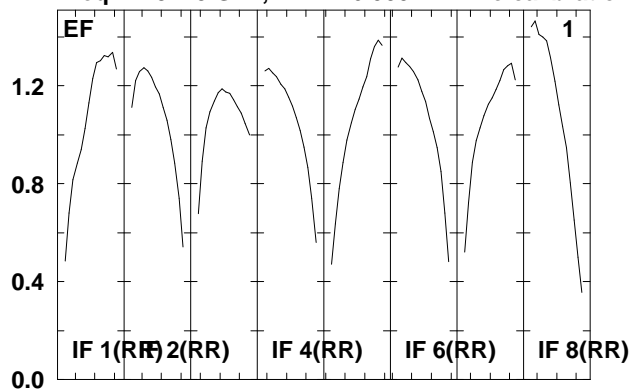

Lower frame: Real Jy  
Total-power spectrum Antenna: \*  
Timerange: 00/13:50:03 to 00/13:50:59

Plot file version 74 created 07-DEC-2009 16:05:52

J1912+05 RT006C.UVDATA.1

Freq = 4.9415 GHz, Bw = 16.000 MH No calibration applied and no bandpass applied

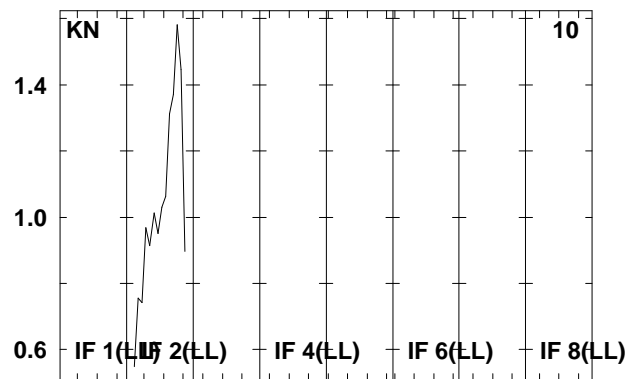
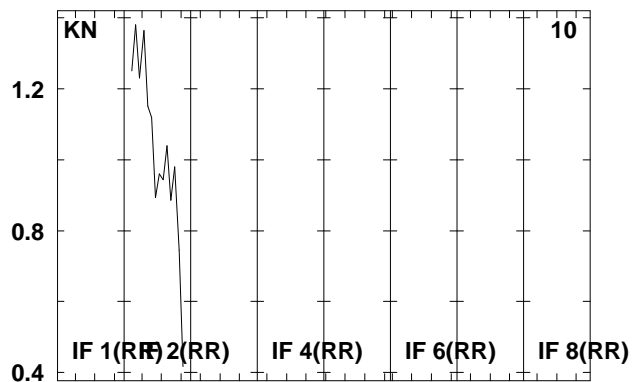
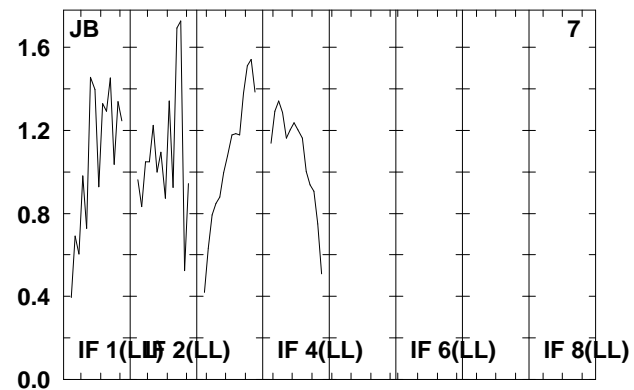
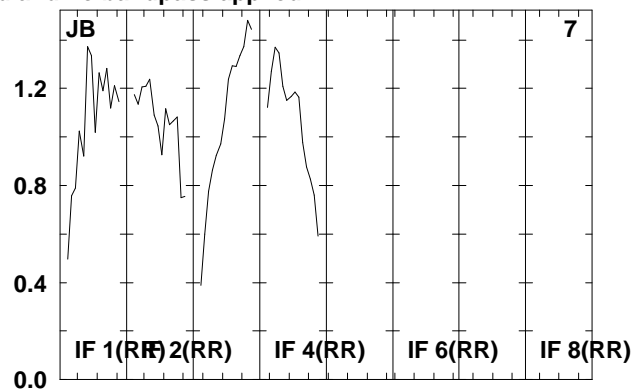
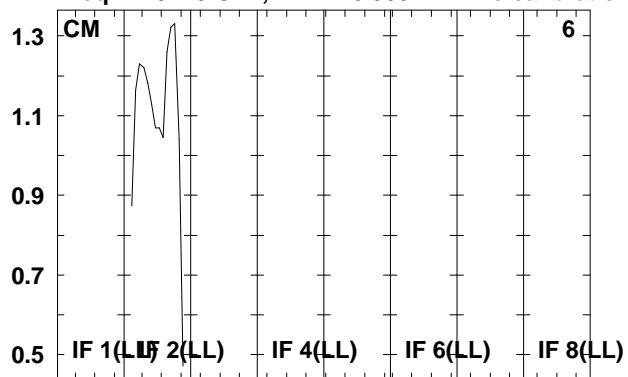

Lower frame: Real Jy  
Total-power spectrum Antenna: \*  
Timerange: 00/13:50:03 to 00/13:50:59

Plot file version 75 created 07-DEC-2009 16:05:52

SS433 RT006C.UVDATA.1

Freq = 4.9415 GHz, Bw = 16.000 MH No calibration applied and no bandpass applied

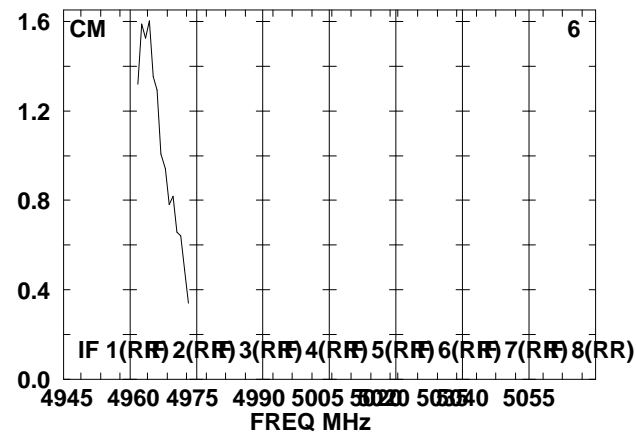
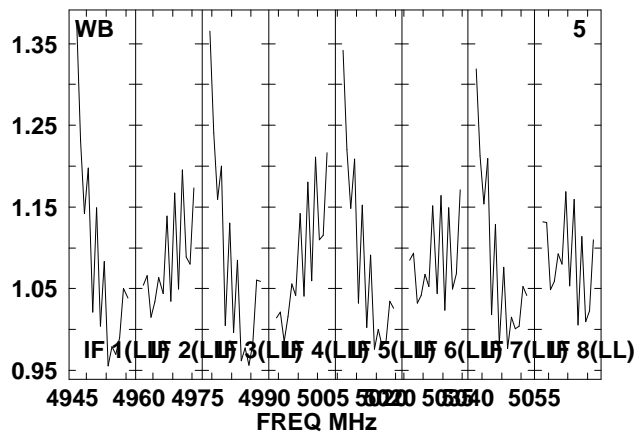
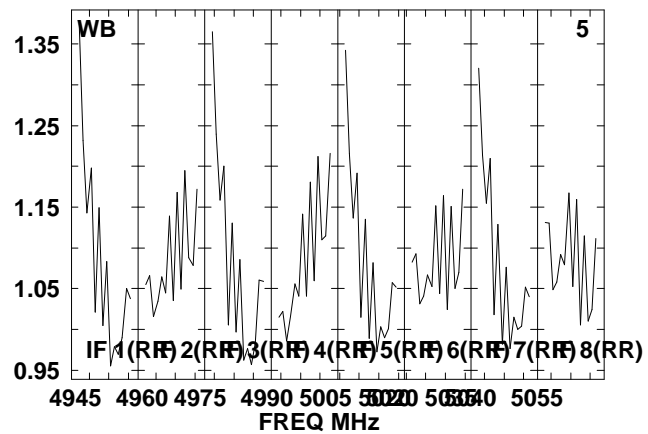
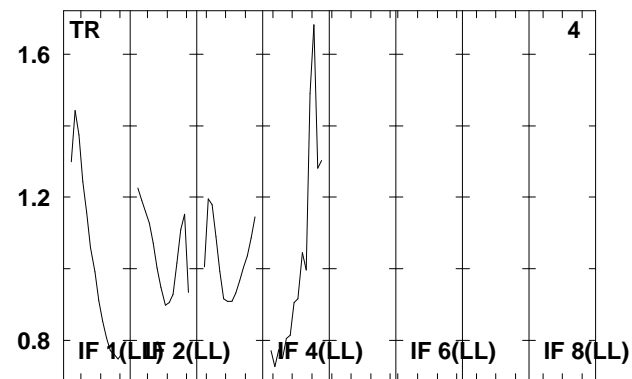
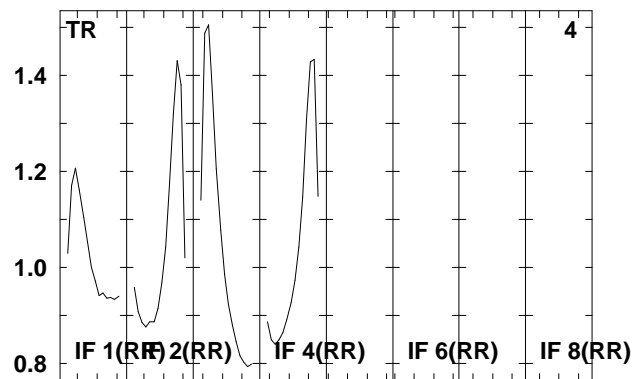
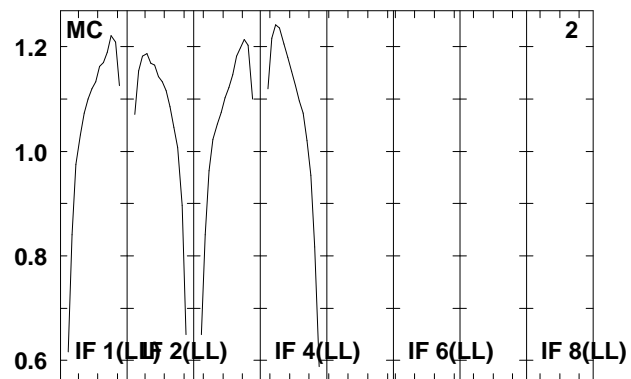
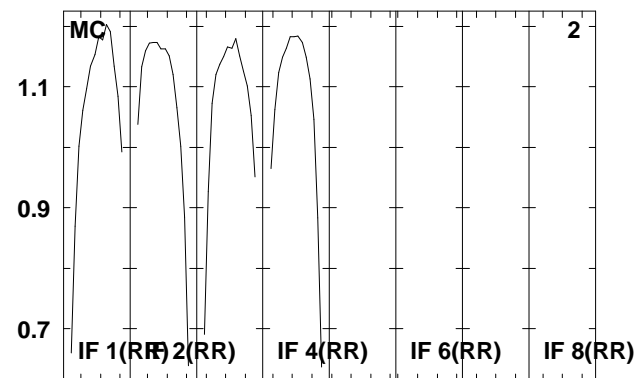
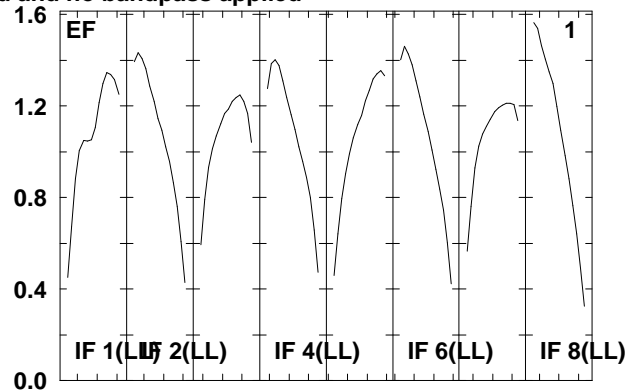
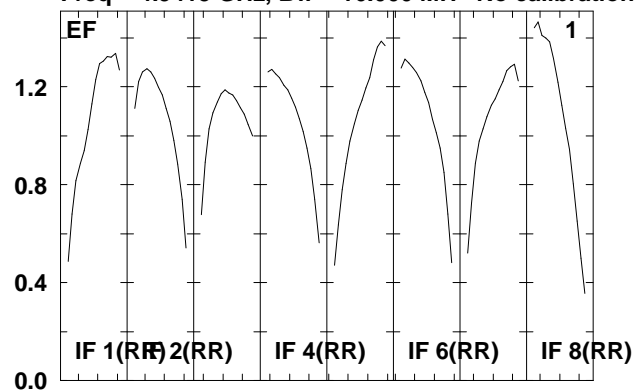

Lower frame: Real Jy  
Total-power spectrum Antenna: \*  
Timerange: 00/13:51:03 to 00/13:53:19

Plot file version 76 created 07-DEC-2009 16:05:52

SS433 RT006C.UVDATA.1

Freq = 4.9415 GHz, Bw = 16.000 MH No calibration applied and no bandpass applied

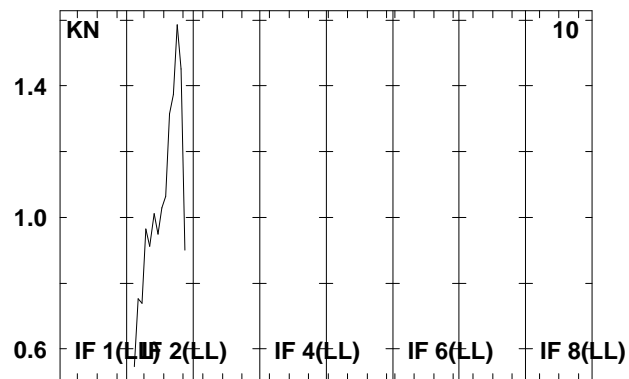
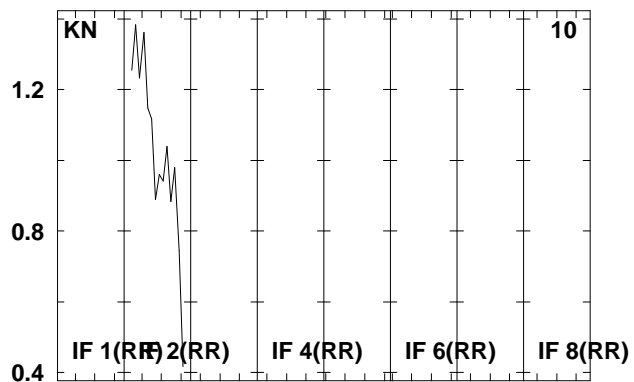
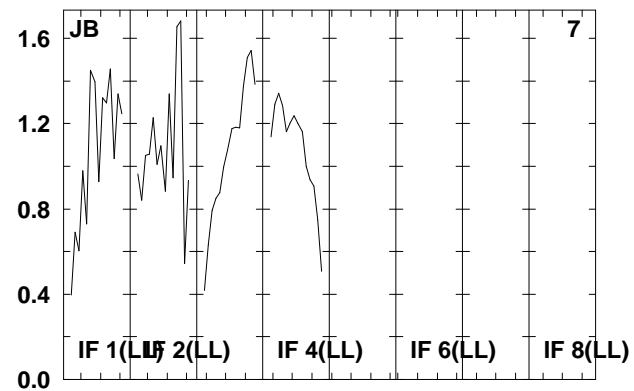
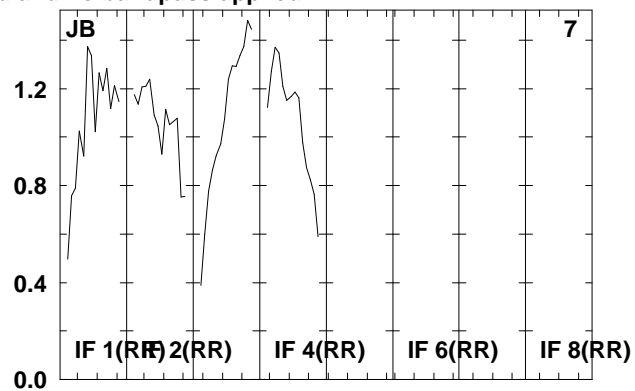
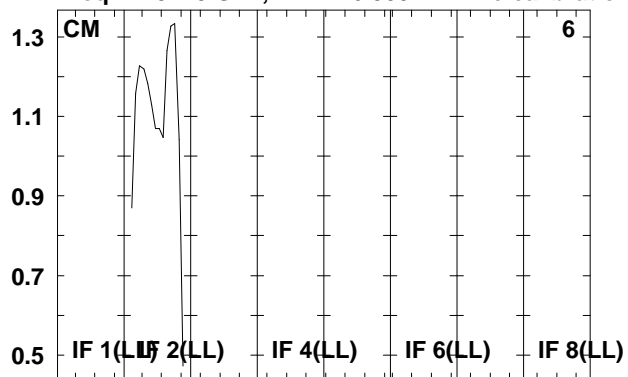

Lower frame: Real Jy  
Total-power spectrum Antenna: \*  
Timerange: 00/13:51:03 to 00/13:53:19

Plot file version 77 created 07-DEC-2009 16:05:52

J1912+05 RT006C.UVDATA.1

Freq = 4.9415 GHz, Bw = 16.000 MH No calibration applied and no bandpass applied

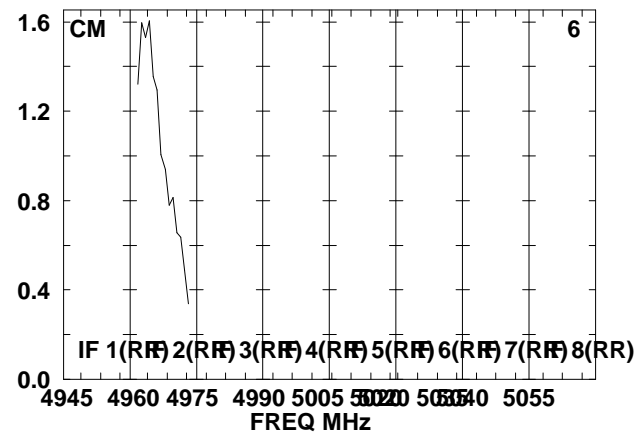
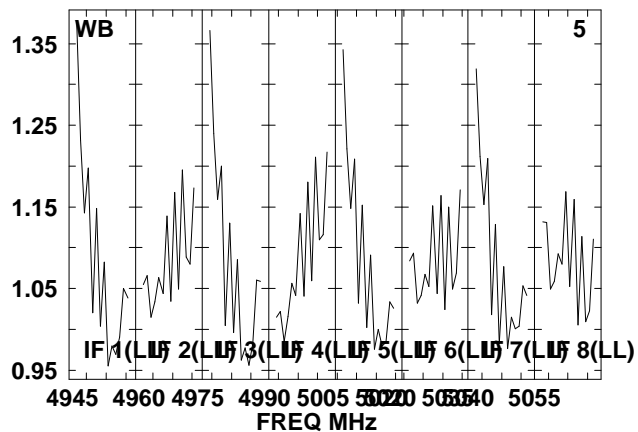
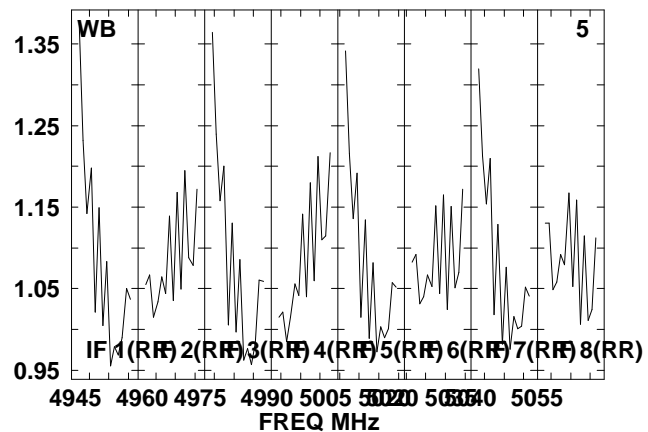
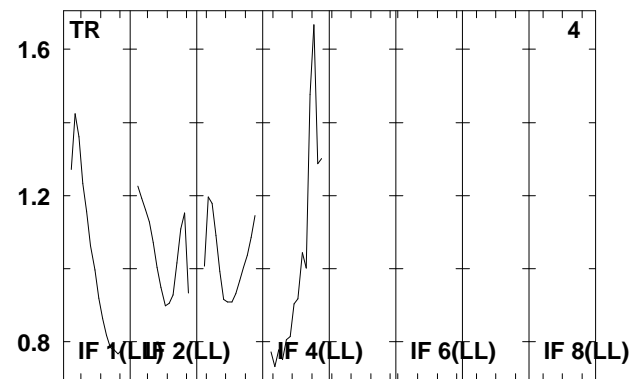
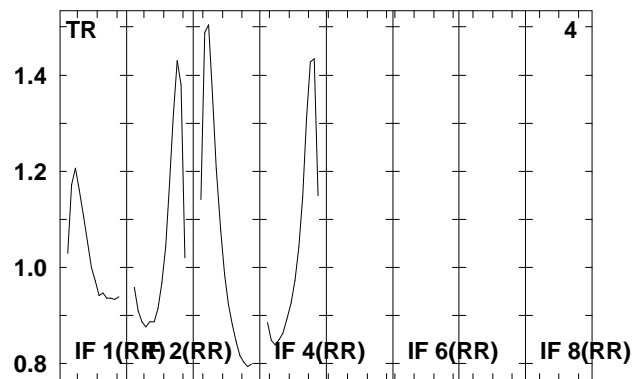
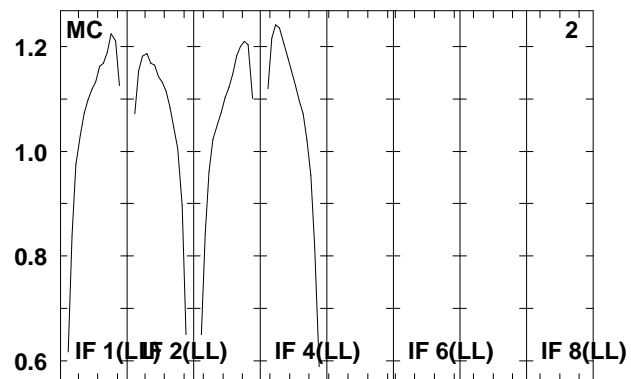
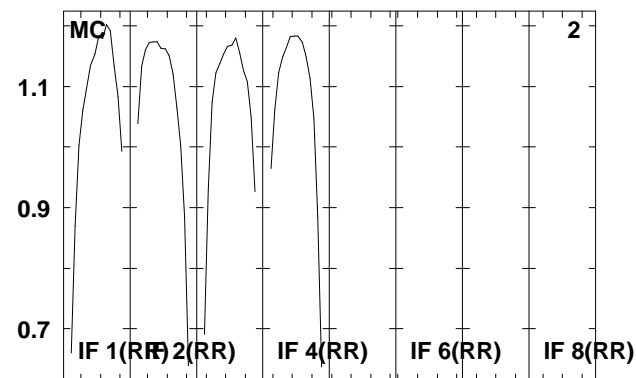
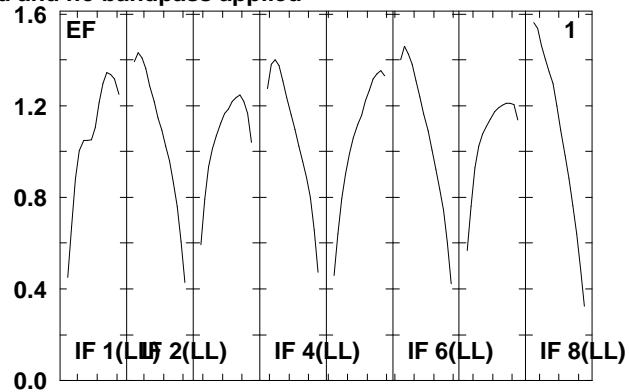
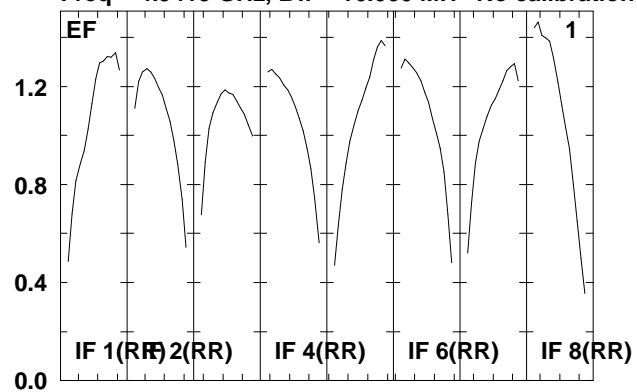

Lower frame: Real Jy  
Total-power spectrum Antenna: \*  
Timerange: 00/13:53:23 to 00/13:54:39

Plot file version 78 created 07-DEC-2009 16:05:53

J1912+05 RT006C.UVDATA.1

Freq = 4.9415 GHz, Bw = 16.000 MH No calibration applied and no bandpass applied

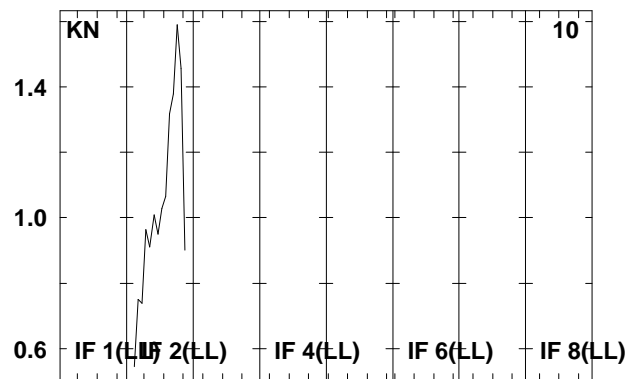
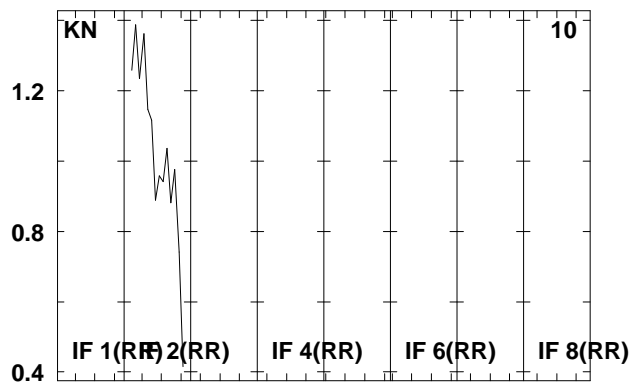
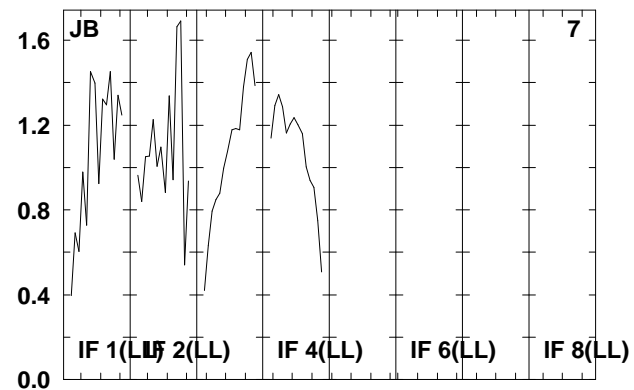
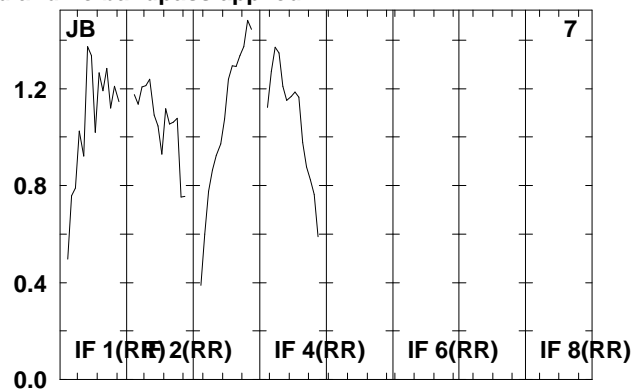
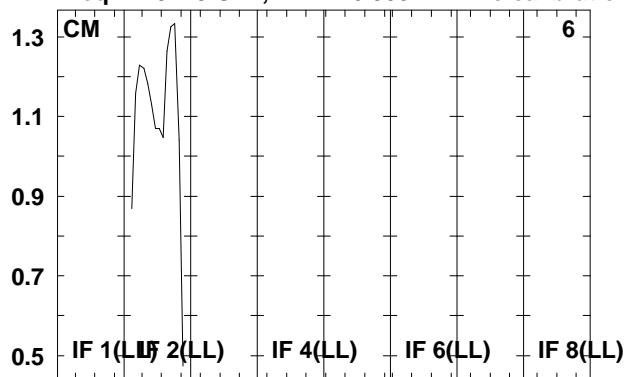

Lower frame: Real Jy  
Total-power spectrum Antenna: \*  
Timerange: 00/13:53:23 to 00/13:54:39

Plot file version 79 created 07-DEC-2009 16:05:53

SS433 RT006C.UVDATA.1

Freq = 4.9415 GHz, Bw = 16.000 MH No calibration applied and no bandpass applied

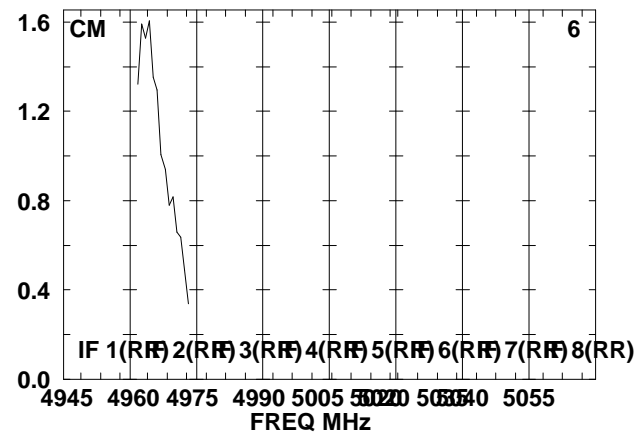
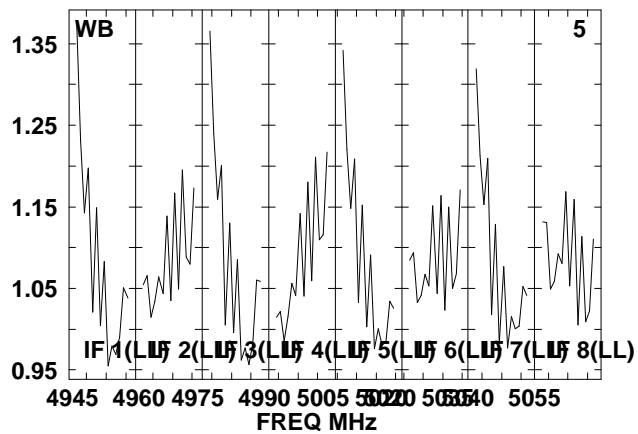
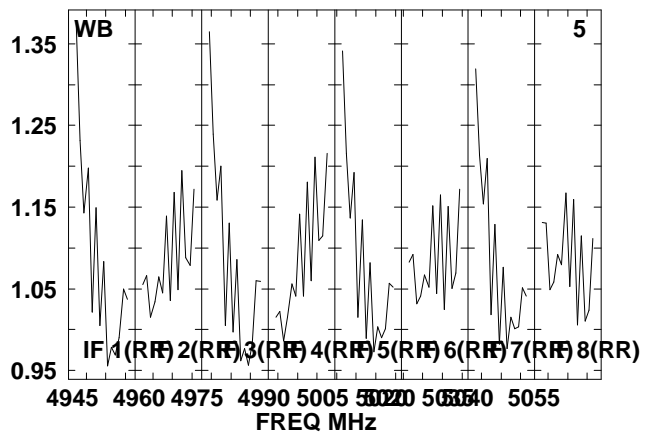
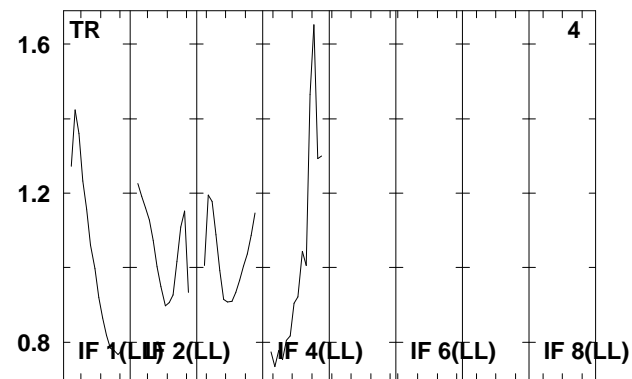
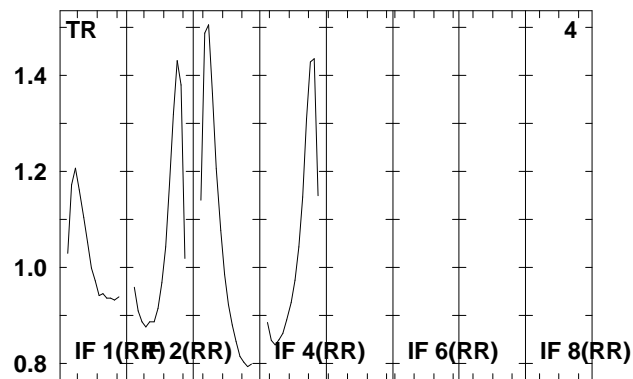
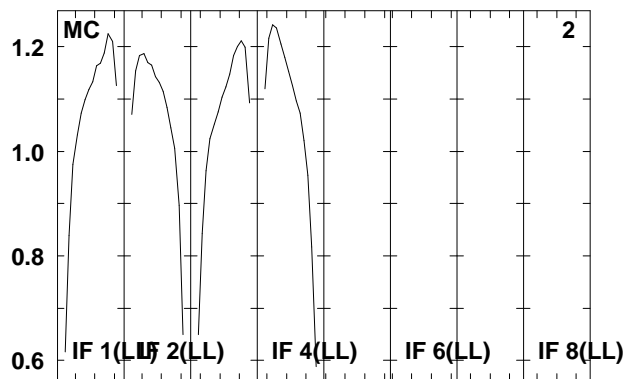
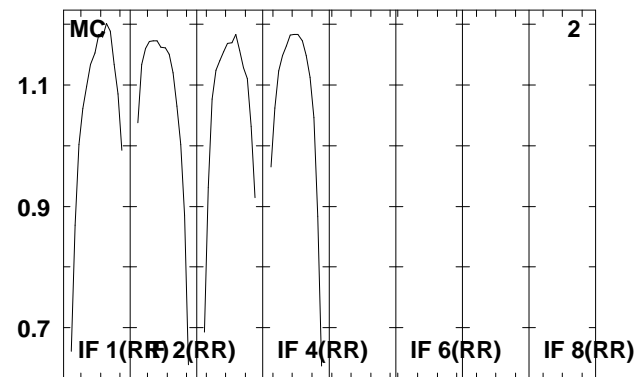
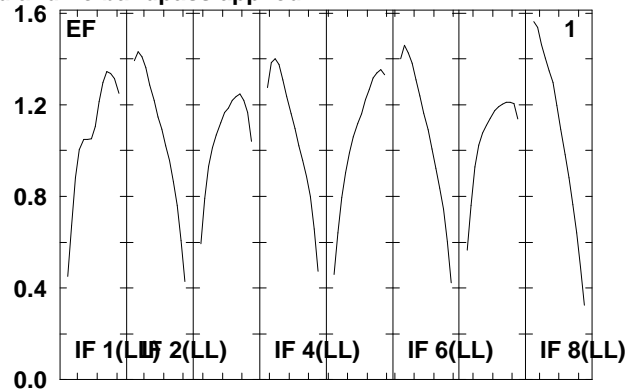
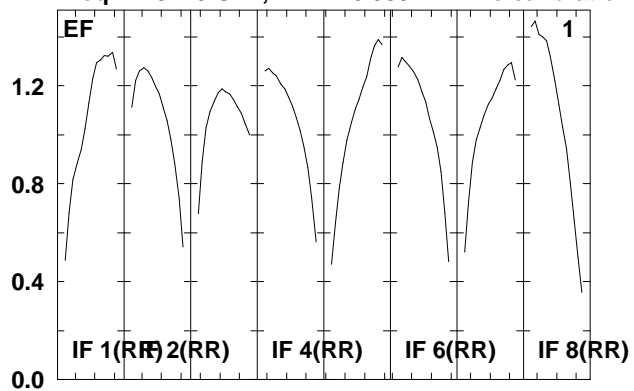

Lower frame: Real Jy  
Total-power spectrum Antenna: \*  
Timerange: 00/13:54:43 to 00/13:56:59

Plot file version 80 created 07-DEC-2009 16:05:53

SS433 RT006C.UVDATA.1

Freq = 4.9415 GHz, Bw = 16.000 MH No calibration applied and no bandpass applied

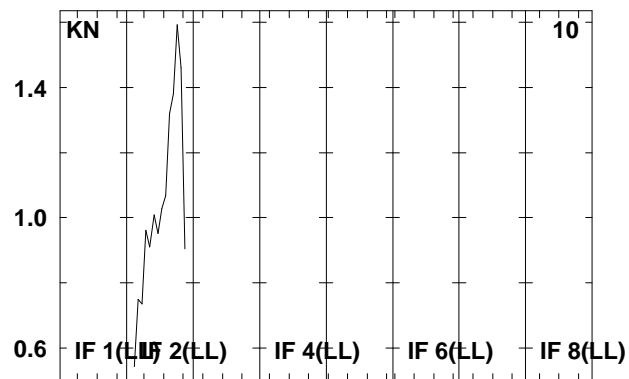
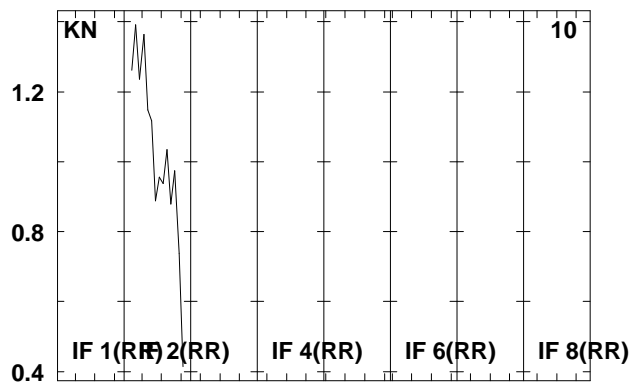
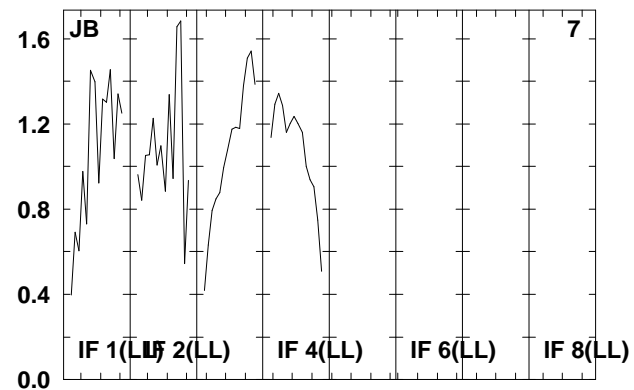
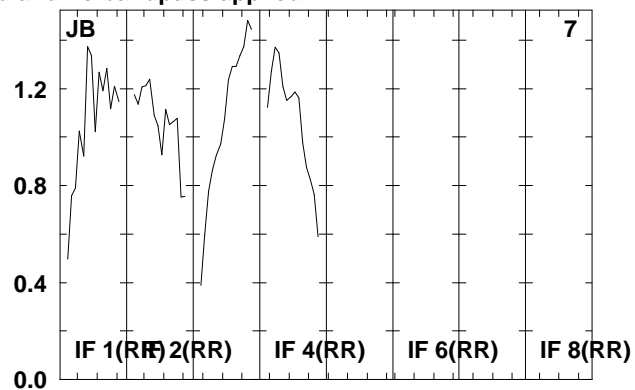
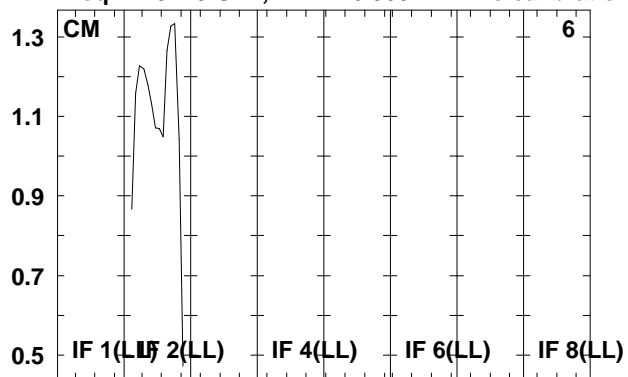

Lower frame: Real Jy  
Total-power spectrum Antenna: \*  
Timerange: 00/13:54:43 to 00/13:56:59



Plot file version 81 created 07-DEC-2009 16:05:54  
 J1912+05 RT006C.UVDATA.1  
 Freq = 4.9415 GHz, Bw = 16.000 MH No calibration applied and no bandpass applied

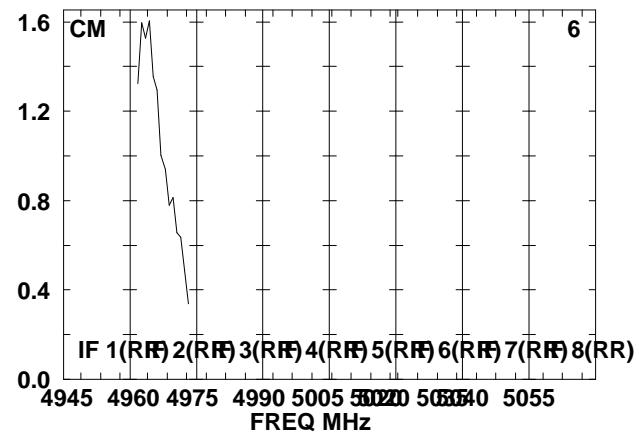
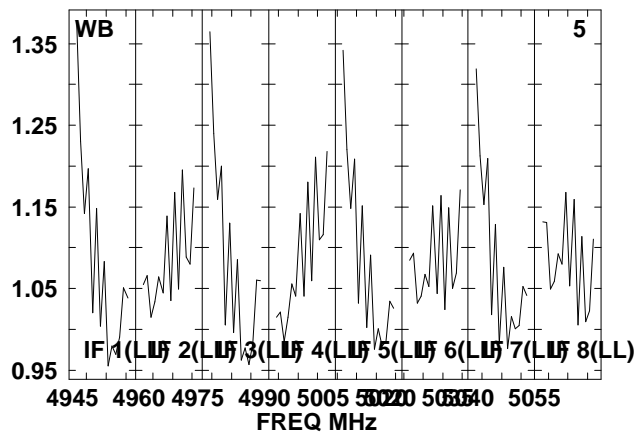
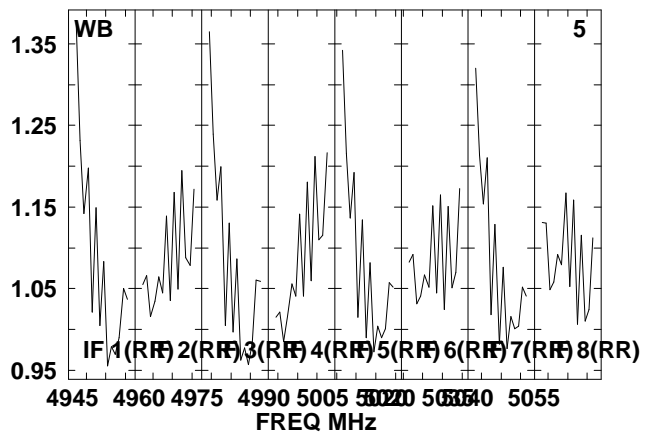
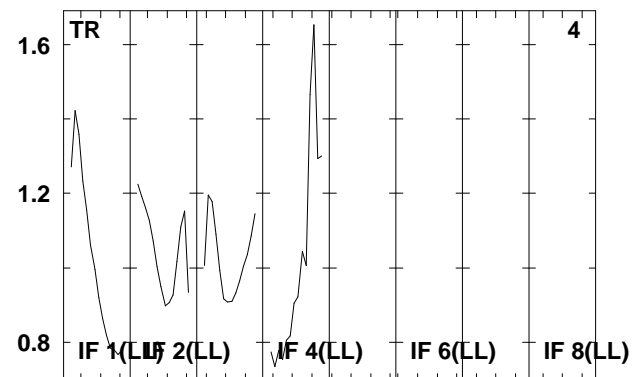
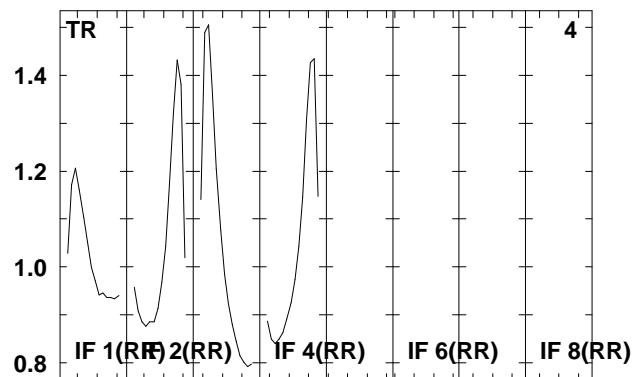
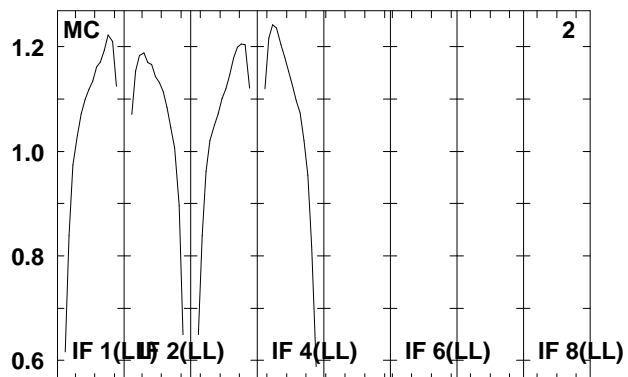
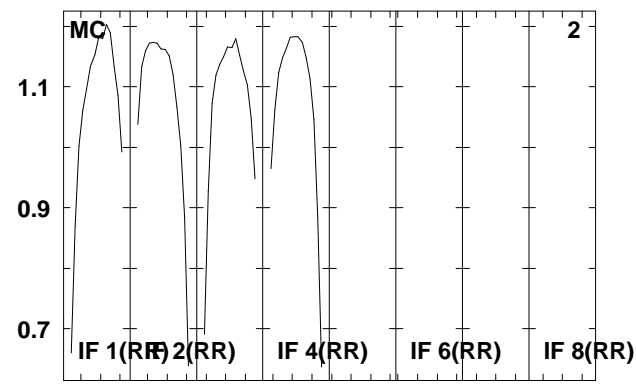
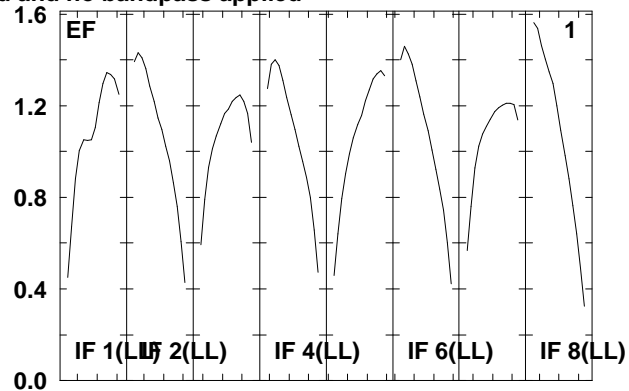
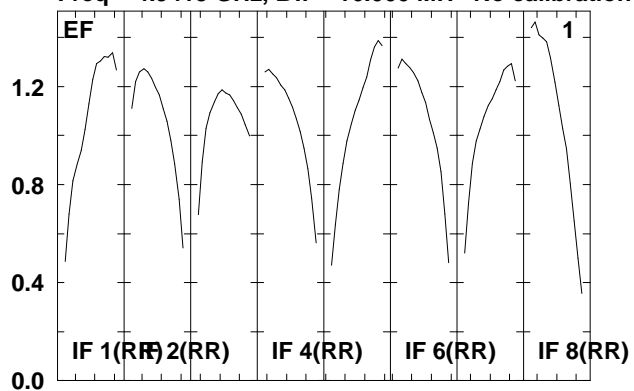

Lower frame: Real Jy  
 Total-power spectrum Antenna: \*  
 Timerange: 00/13:57:03 to 00/13:58:19

Plot file version 82 created 07-DEC-2009 16:05:54

J1912+05 RT006C.UVDATA.1

Freq = 4.9415 GHz, Bw = 16.000 MH No calibration applied and no bandpass applied

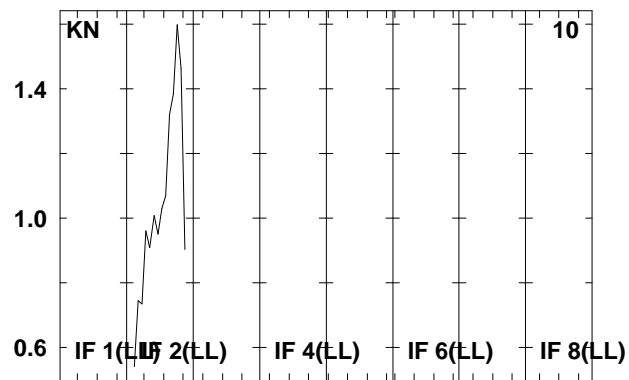
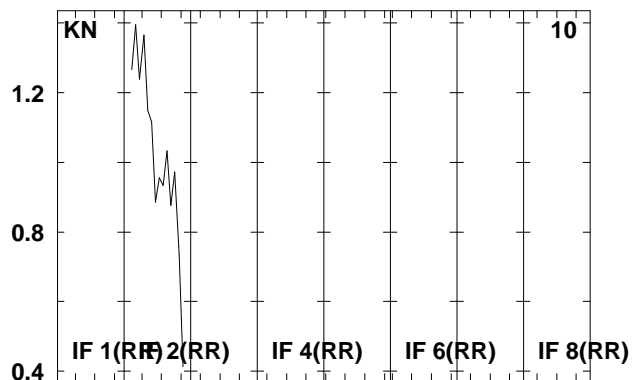
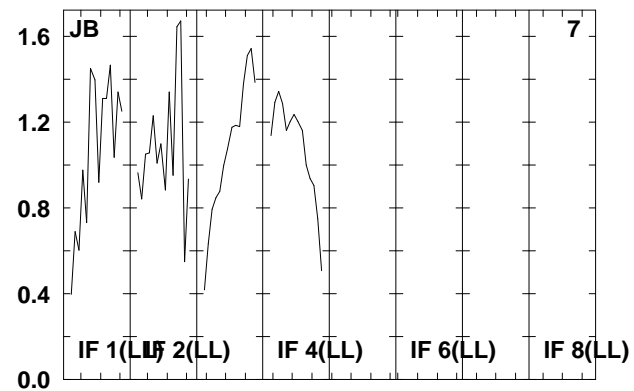
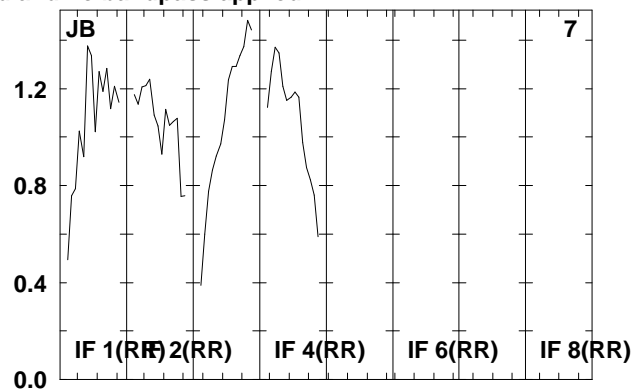
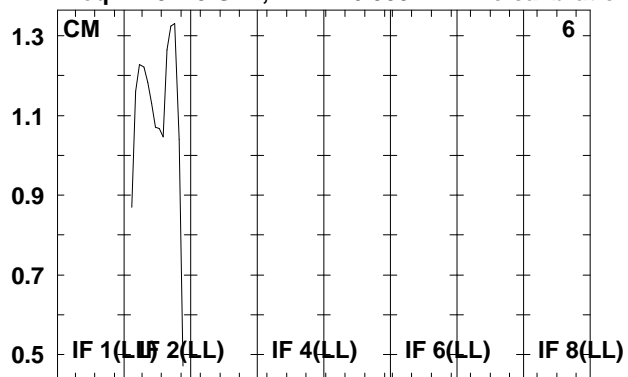

Lower frame: Real Jy  
Total-power spectrum Antenna: \*  
Timerange: 00/13:57:03 to 00/13:58:19

Plot file version 83 created 07-DEC-2009 16:05:54

SS433 RT006C.UVDATA.1

Freq = 4.9415 GHz, Bw = 16.000 MH No calibration applied and no bandpass applied

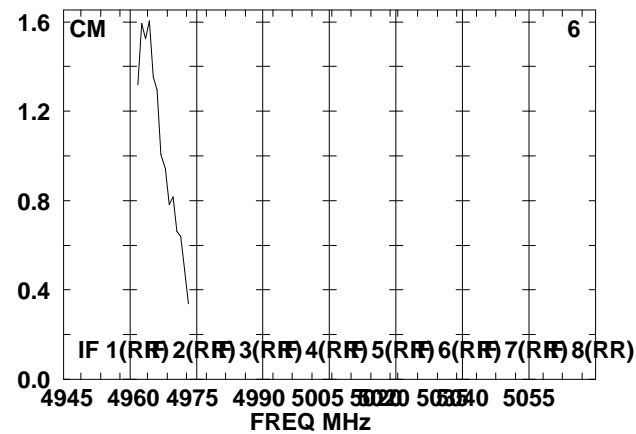
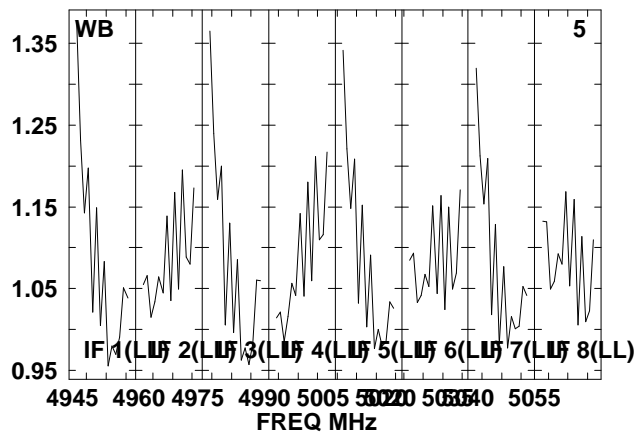
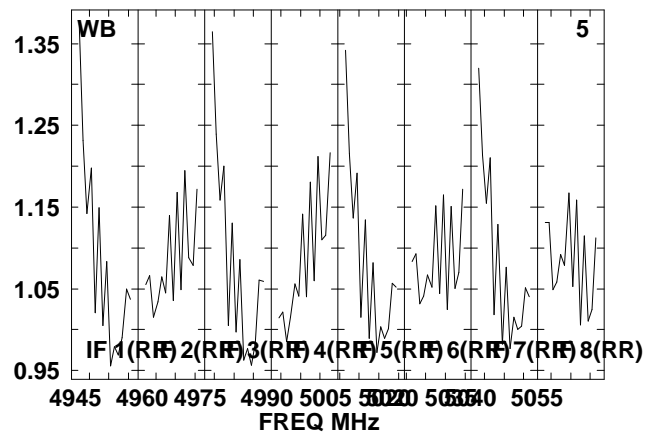
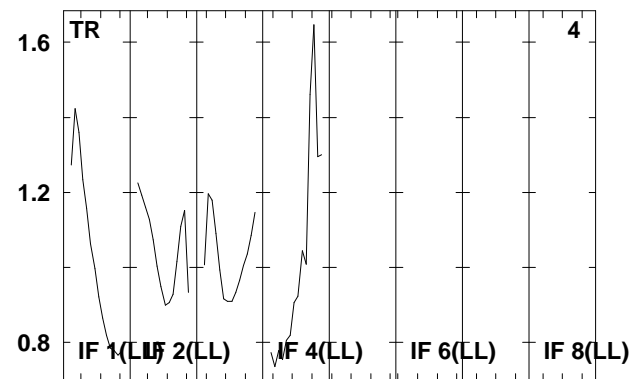
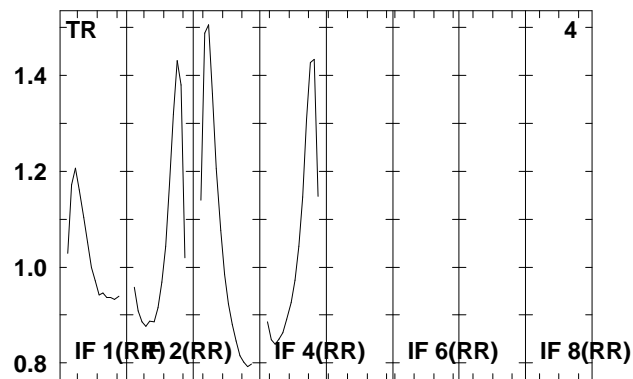
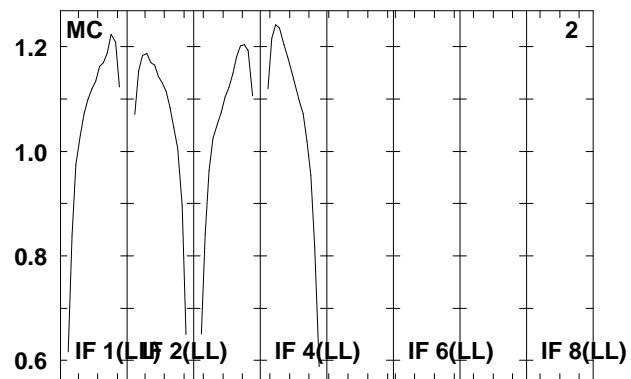
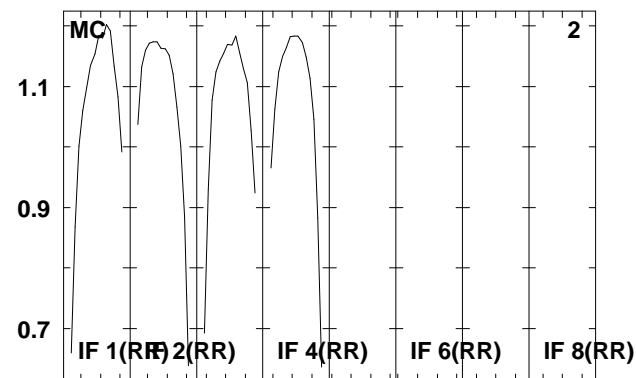
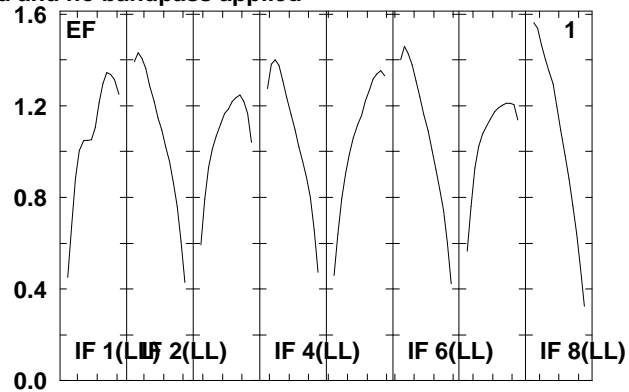
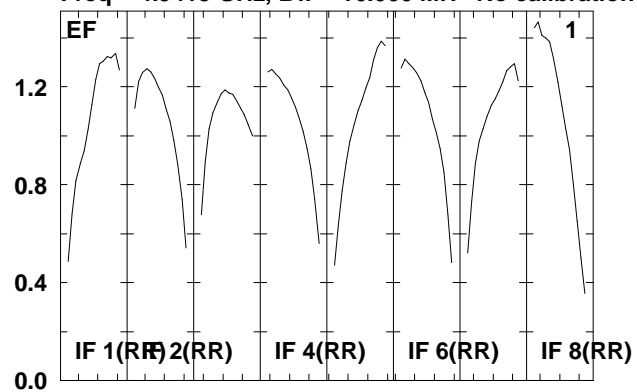

Lower frame: Real Jy  
Total-power spectrum Antenna: \*  
Timerange: 00/13:58:23 to 00/14:00:39

Plot file version 84 created 07-DEC-2009 16:05:54

SS433 RT006C.UVDATA.1

Freq = 4.9415 GHz, Bw = 16.000 MH No calibration applied and no bandpass applied

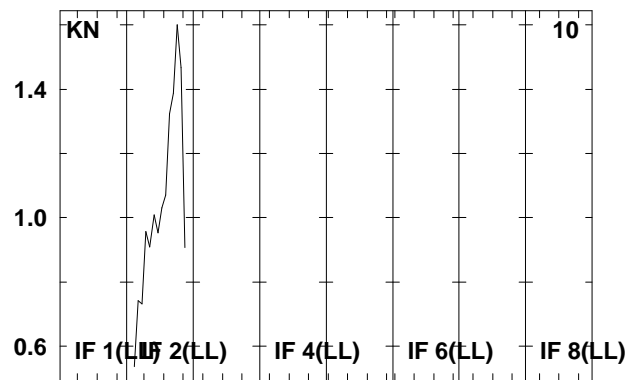
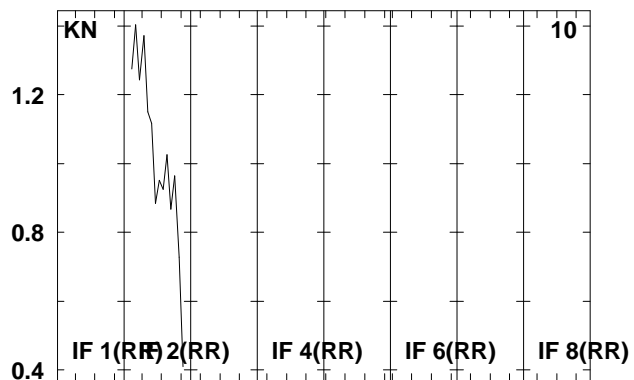
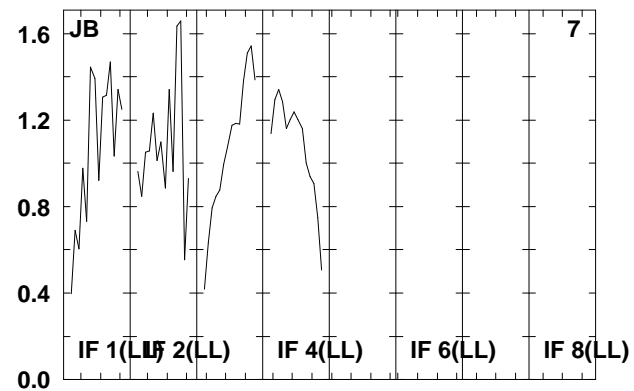
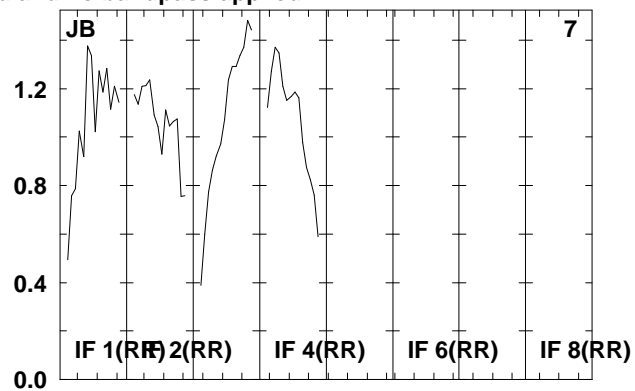
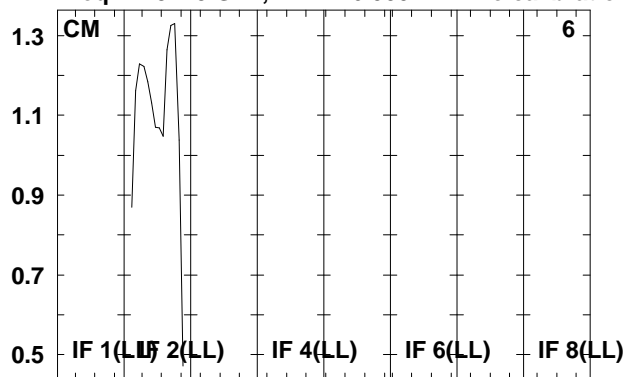

Lower frame: Real Jy  
Total-power spectrum Antenna: \*  
Timerange: 00/13:58:23 to 00/14:00:39

Plot file version 85 created 07-DEC-2009 16:05:54

J1912+05 RT006C.UVDATA.1

Freq = 4.9415 GHz, Bw = 16.000 MH No calibration applied and no bandpass applied

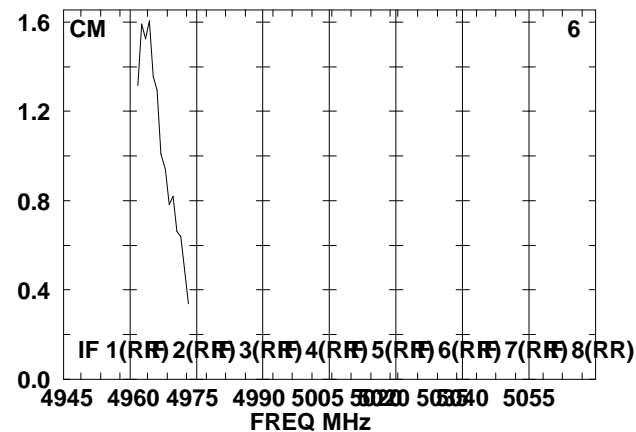
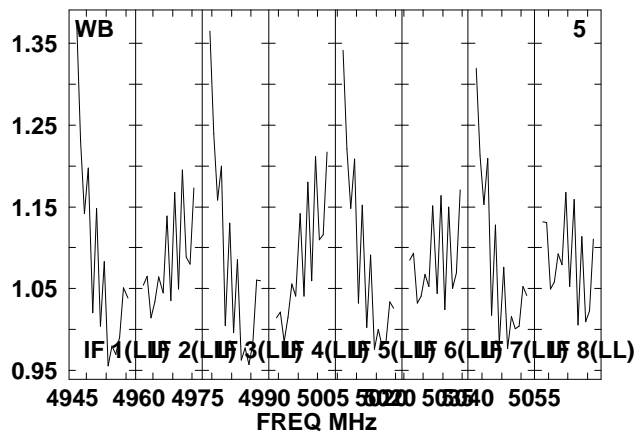
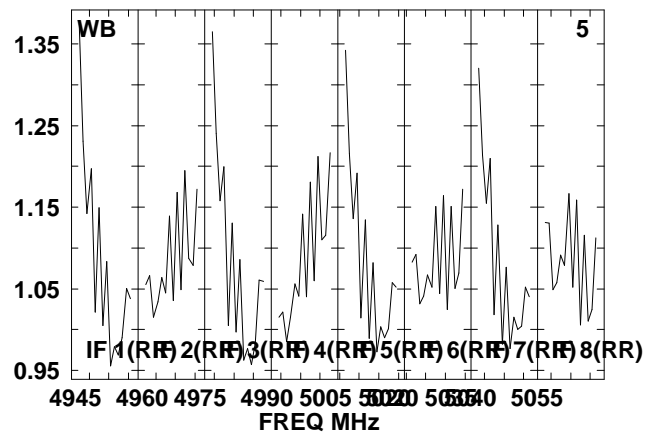
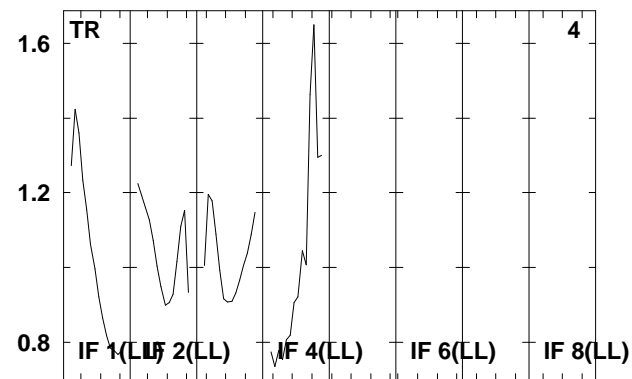
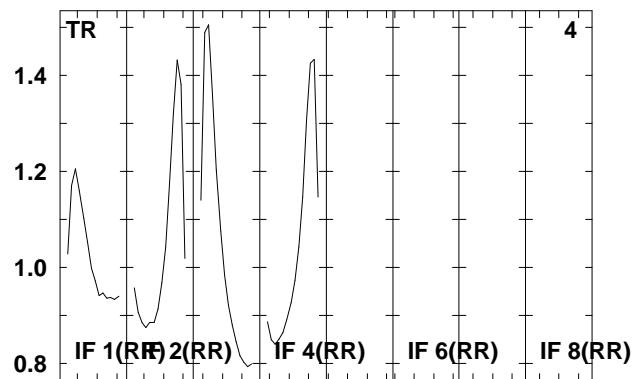
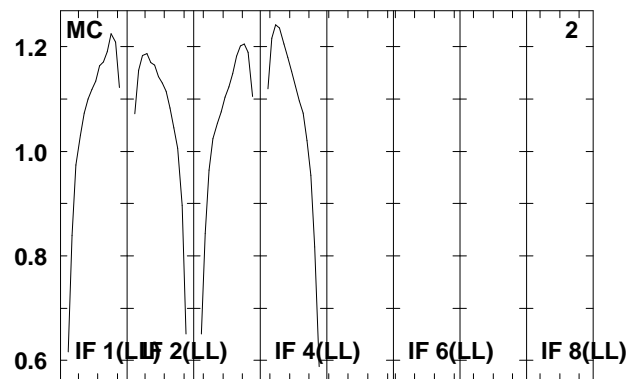
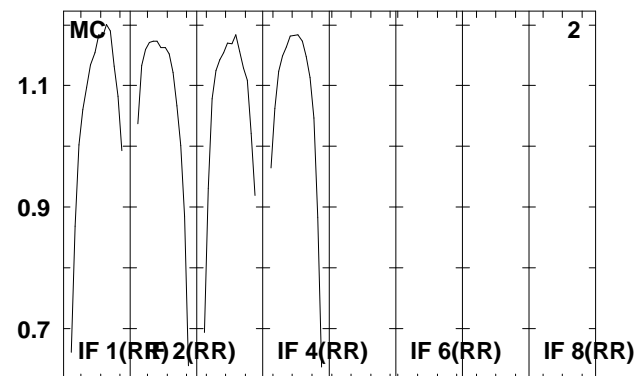
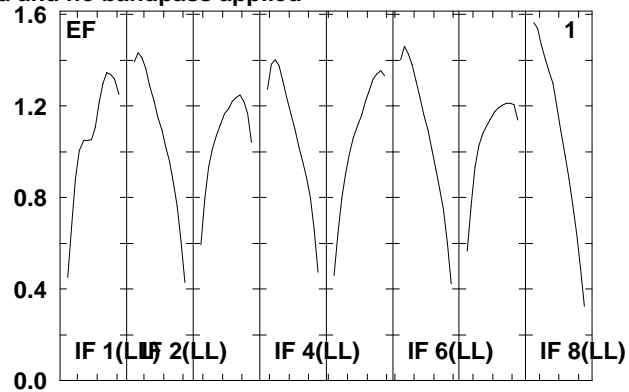
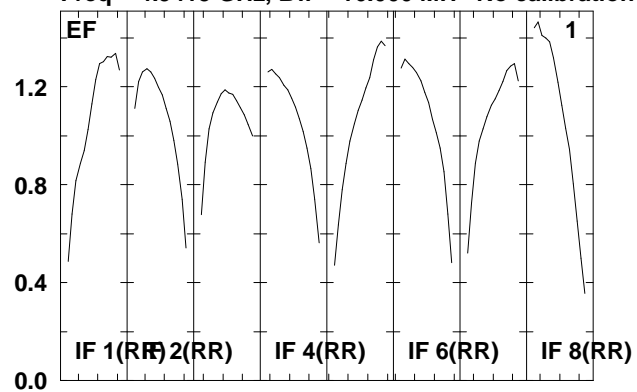

Lower frame: Real Jy  
Total-power spectrum Antenna: \*  
Timerange: 00/14:00:43 to 00/14:01:59

Plot file version 86 created 07-DEC-2009 16:05:54

J1912+05 RT006C.UVDATA.1

Freq = 4.9415 GHz, Bw = 16.000 MH No calibration applied and no bandpass applied

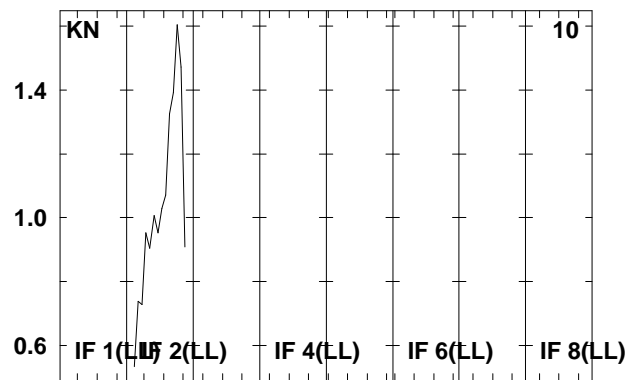
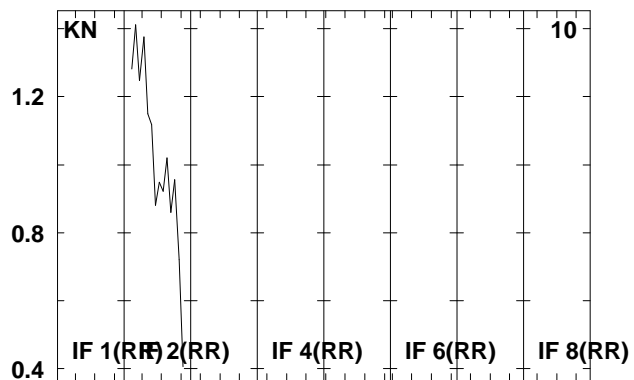
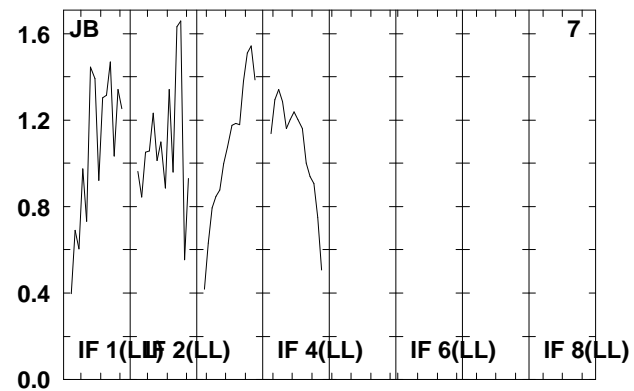
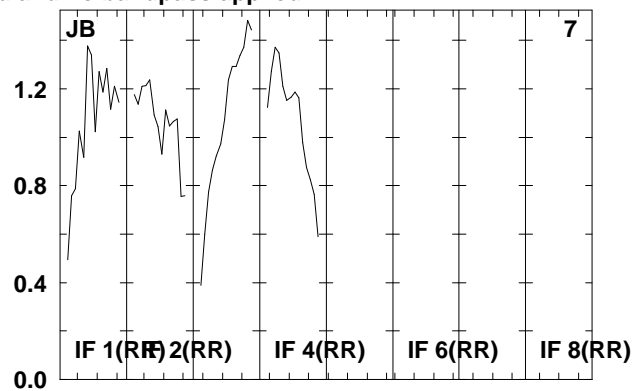
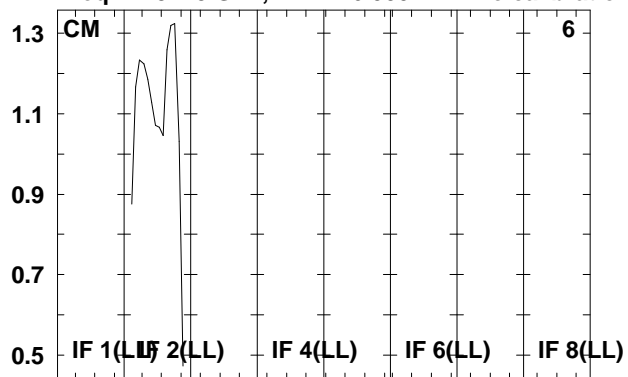

Lower frame: Real Jy  
Total-power spectrum Antenna: \*  
Timerange: 00/14:00:43 to 00/14:01:59

Plot file version 87 created 07-DEC-2009 16:05:55

SS433 RT006C.UVDATA.1

Freq = 4.9415 GHz, Bw = 16.000 MH No calibration applied and no bandpass applied

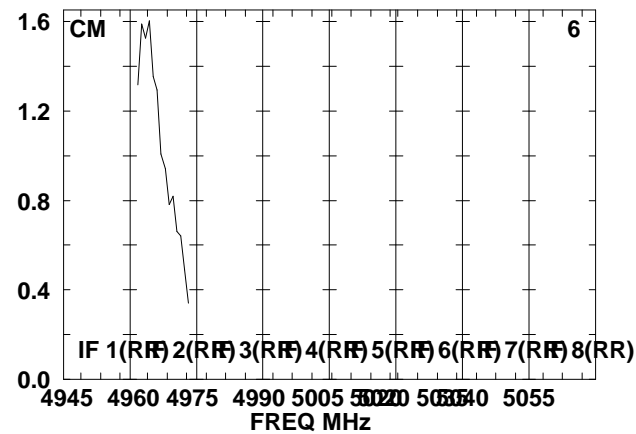
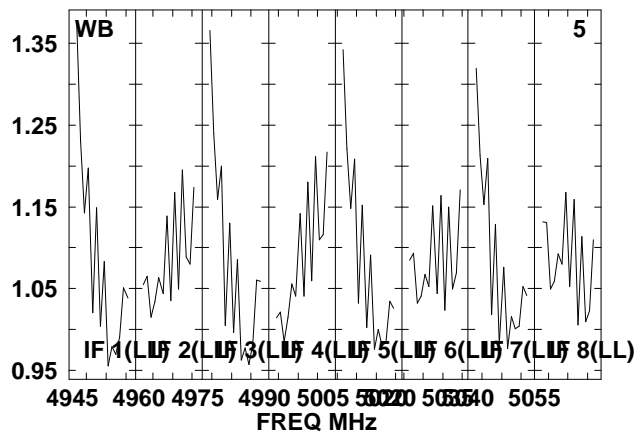
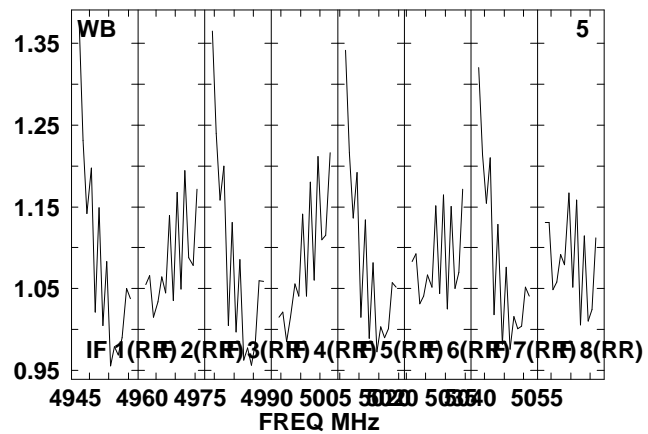
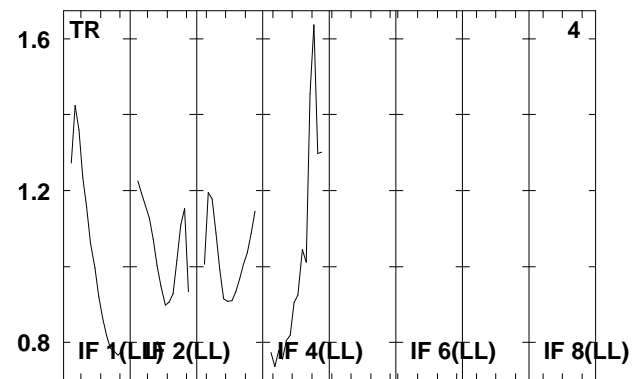
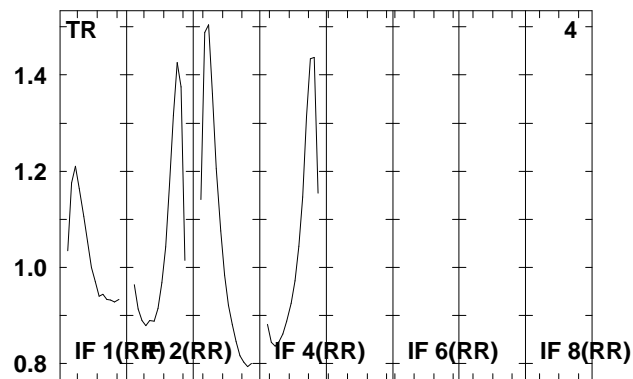
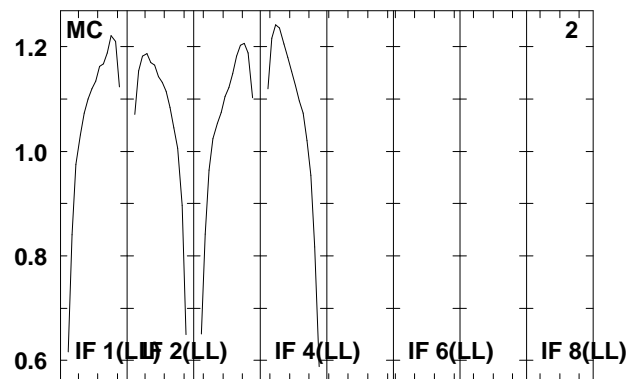
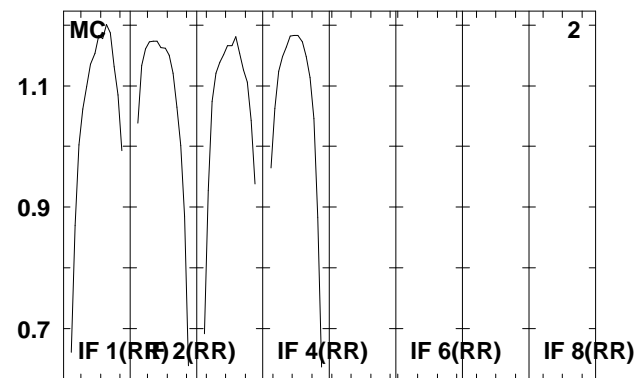
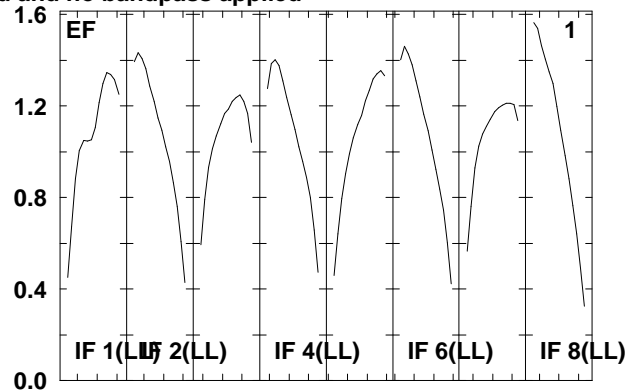
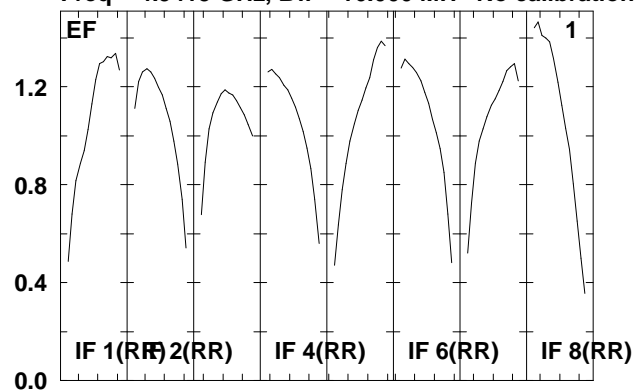

Lower frame: Real Jy  
Total-power spectrum Antenna: \*  
Timerange: 00/14:02:03 to 00/14:04:19

Plot file version 88 created 07-DEC-2009 16:05:55

SS433 RT006C.UVDATA.1

Freq = 4.9415 GHz, Bw = 16.000 MH No calibration applied and no bandpass applied

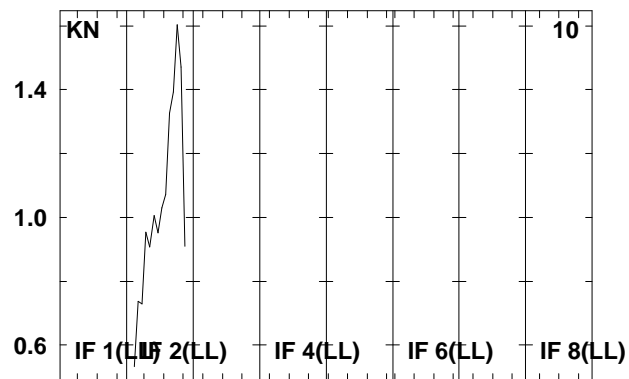
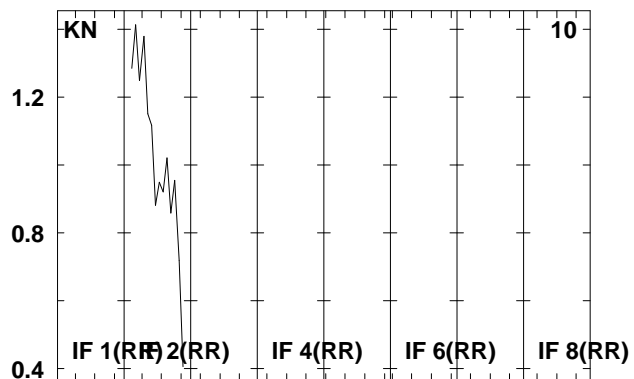
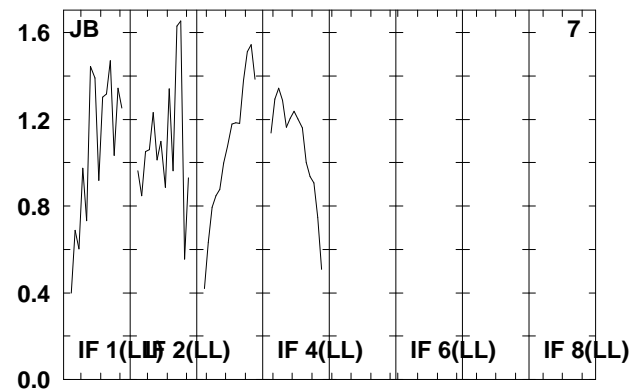
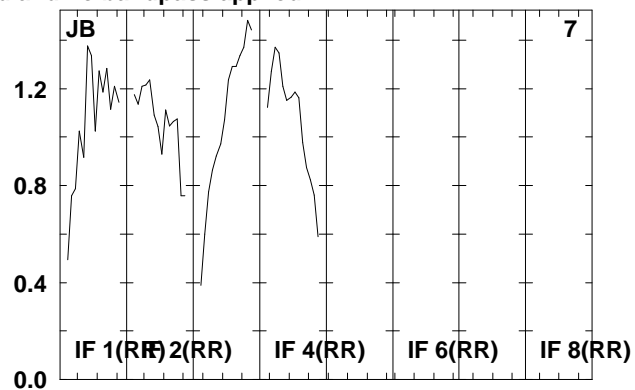
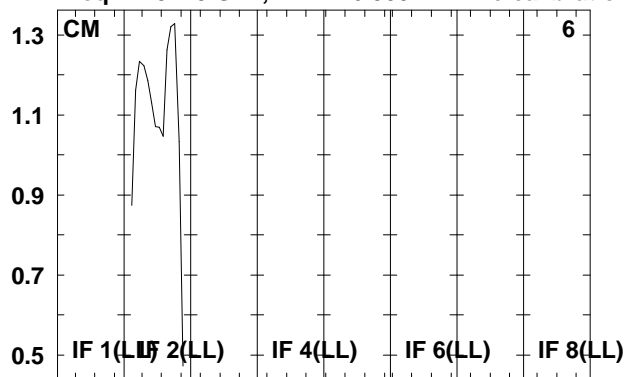

Lower frame: Real Jy  
Total-power spectrum Antenna: \*  
Timerange: 00/14:02:03 to 00/14:04:19



Plot file version 89 created 07-DEC-2009 16:05:55

J1911+16 RT006C.UVDATA.1

Freq = 4.9415 GHz, Bw = 16.000 MH No calibration applied and no bandpass applied

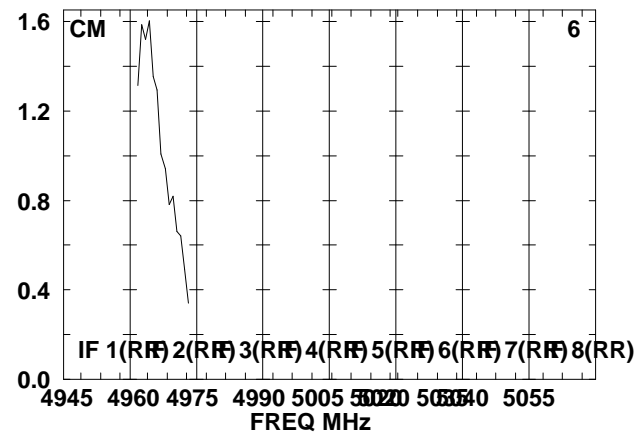
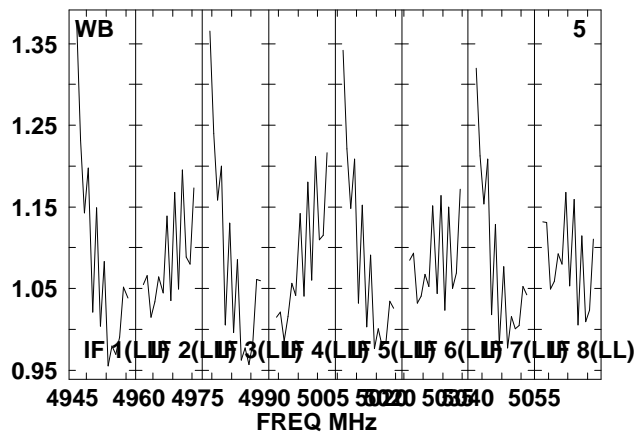
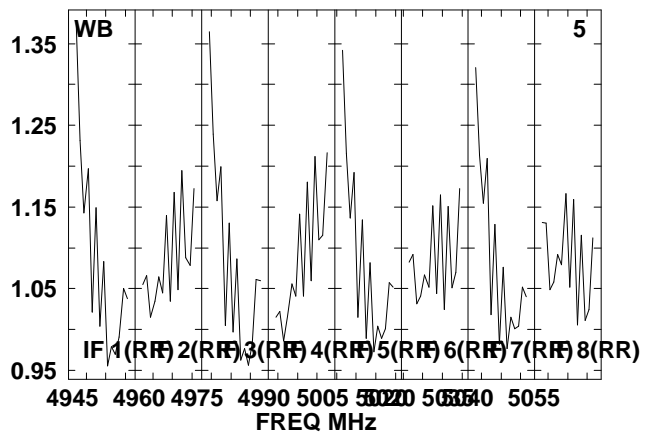
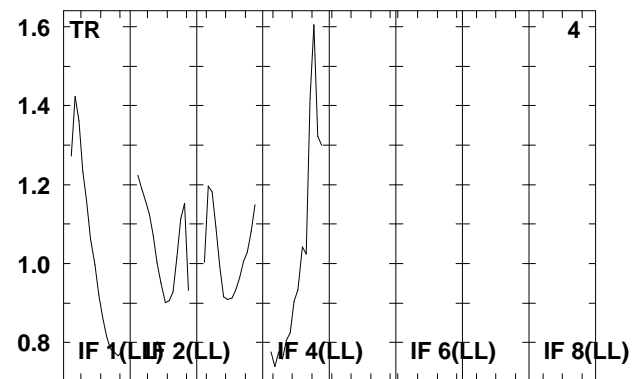
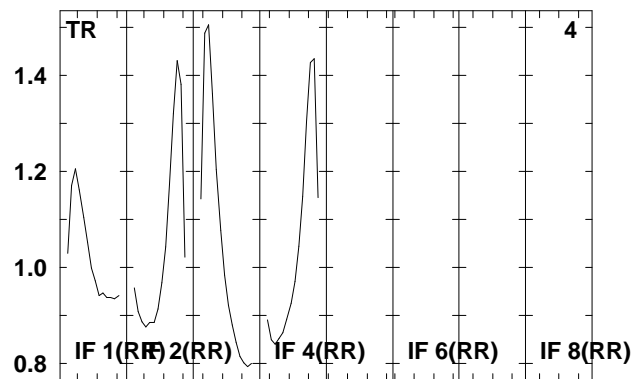
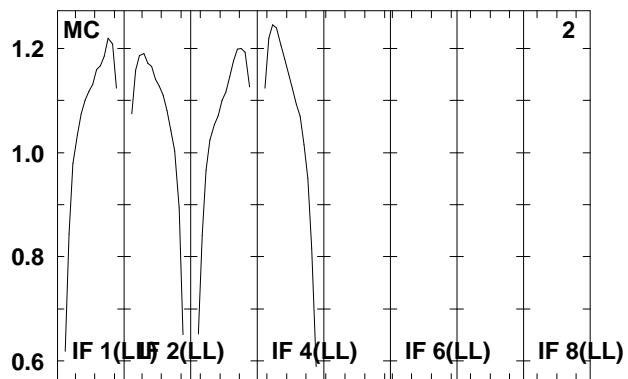
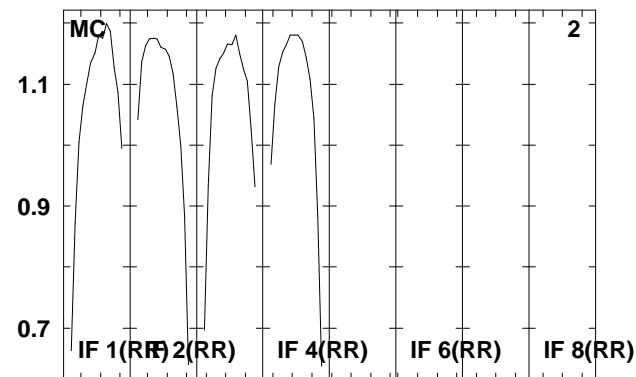
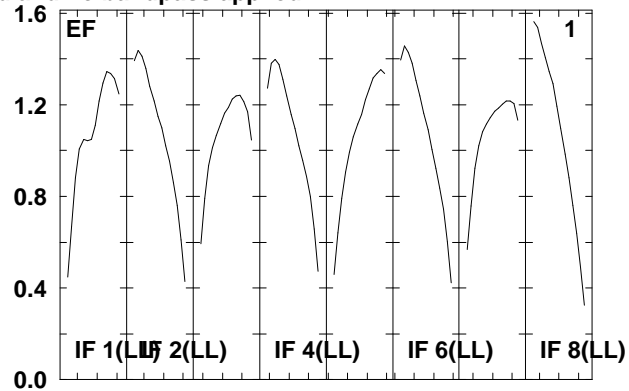
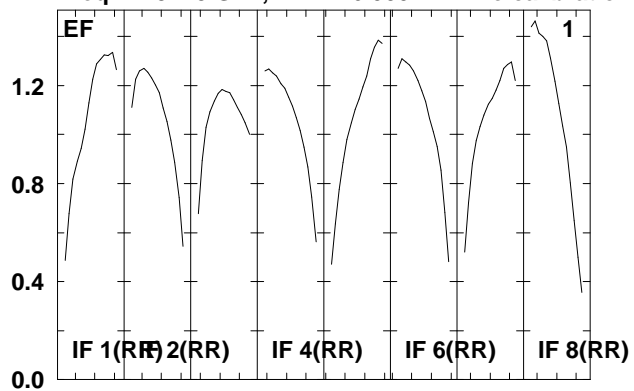

Lower frame: Real Jy  
Total-power spectrum Antenna: \*  
Timerange: 00/14:05:23 to 00/14:06:19

Plot file version 90 created 07-DEC-2009 16:05:55

J1911+16 RT006C.UVDATA.1

Freq = 4.9415 GHz, Bw = 16.000 MH No calibration applied and no bandpass applied

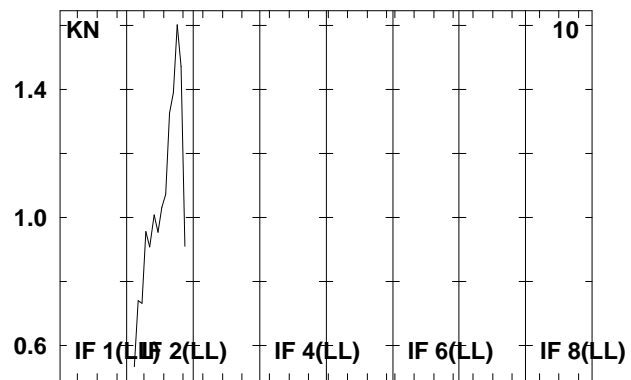
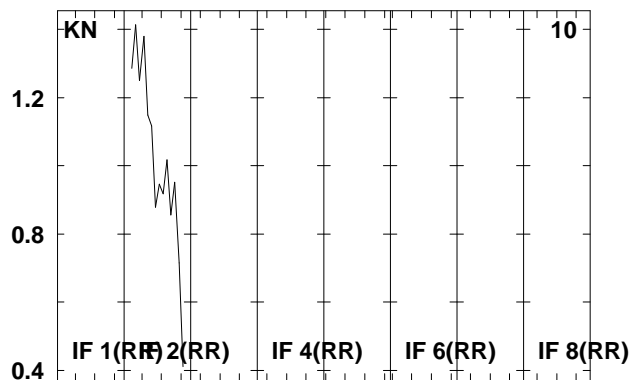
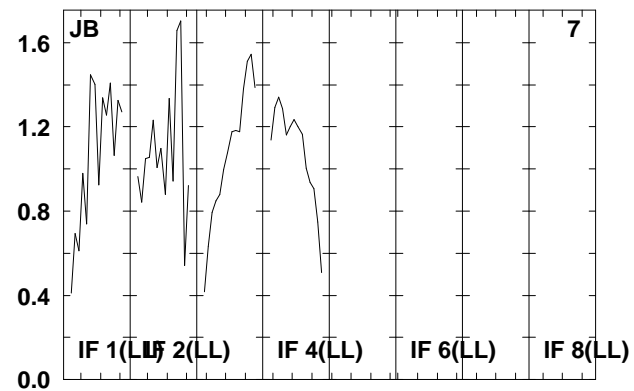
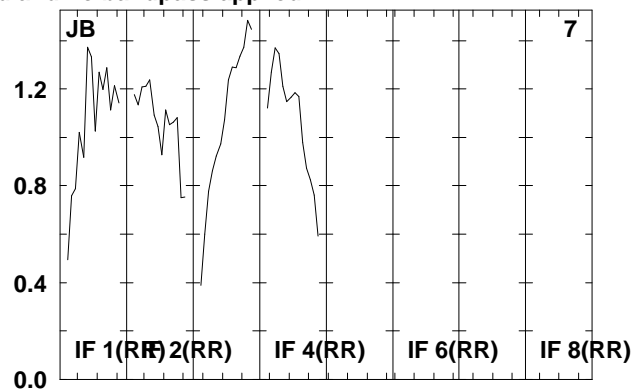
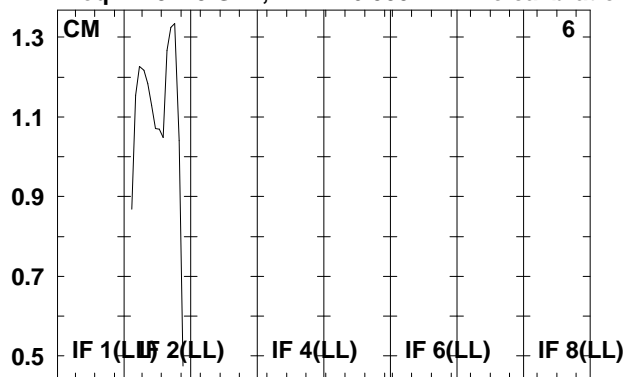

Lower frame: Real Jy  
Total-power spectrum Antenna: \*  
Timerange: 00/14:05:23 to 00/14:06:19

Plot file version 91 created 07-DEC-2009 16:05:55

J1912+05 RT006C.UVDATA.1

Freq = 4.9415 GHz, Bw = 16.000 MH No calibration applied and no bandpass applied

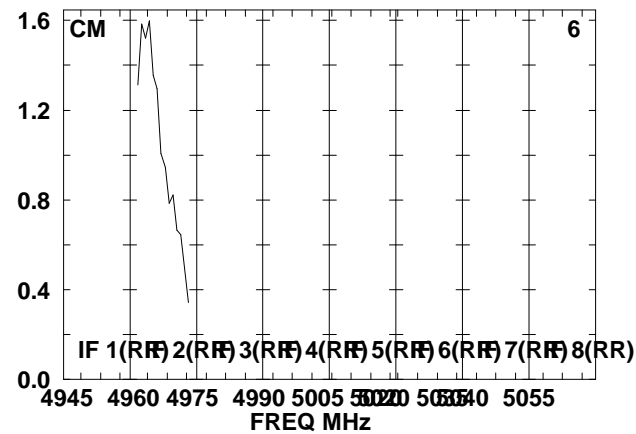
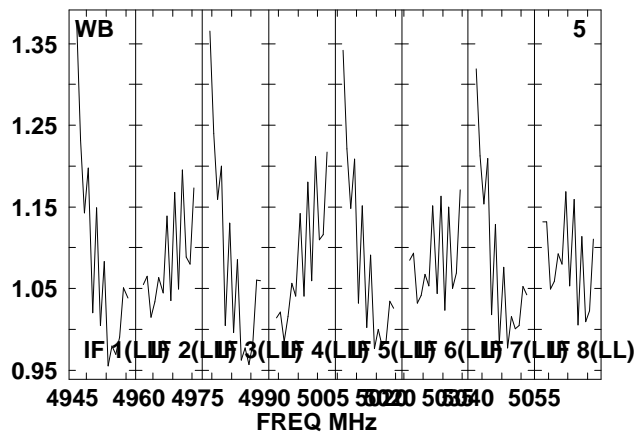
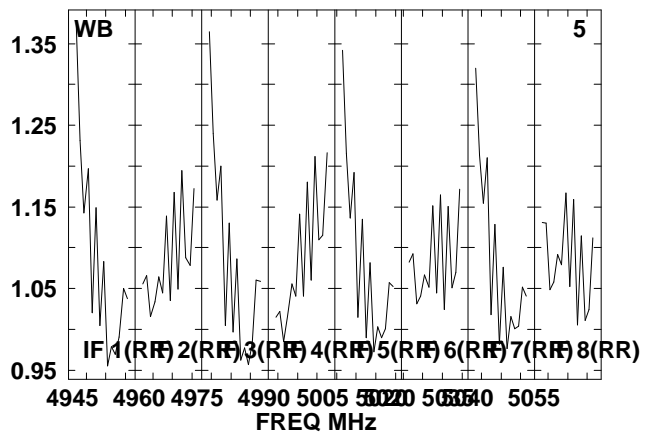
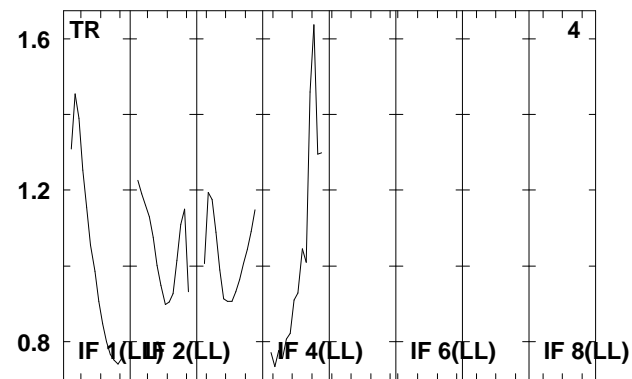
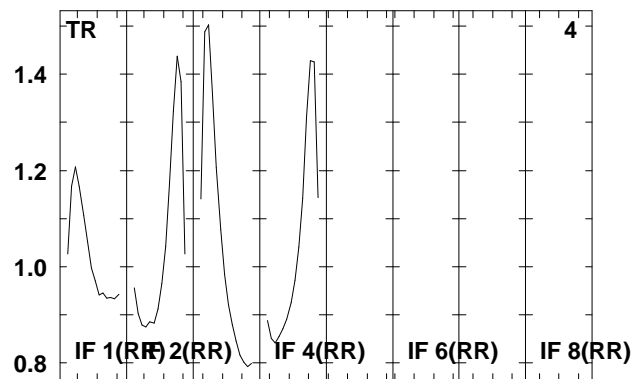
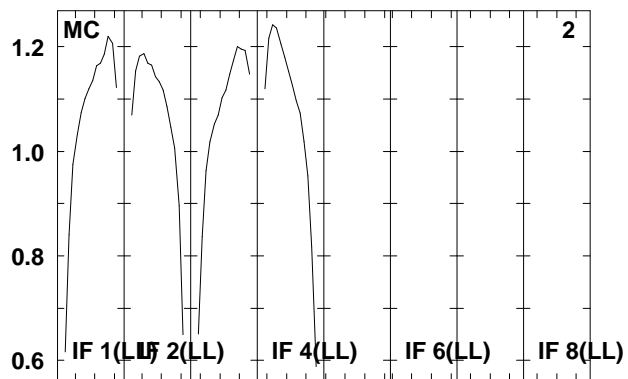
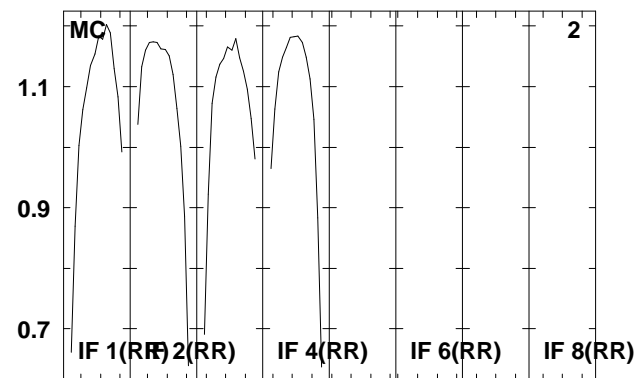
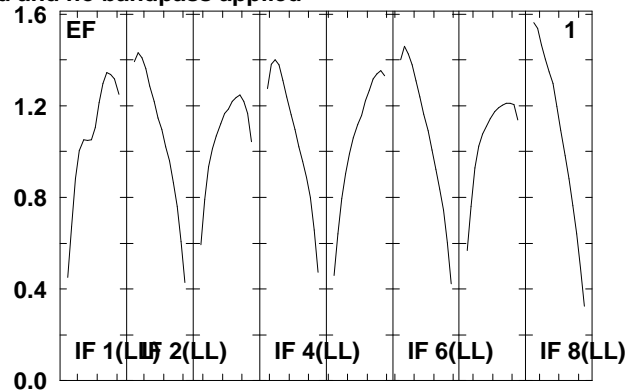
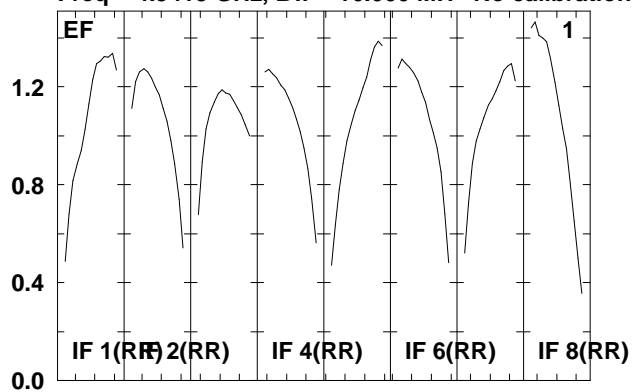

Lower frame: Real Jy  
Total-power spectrum Antenna: \*  
Timerange: 00/14:07:23 to 00/14:08:19

Plot file version 92 created 07-DEC-2009 16:05:55

J1912+05 RT006C.UVDATA.1

Freq = 4.9415 GHz, Bw = 16.000 MH No calibration applied and no bandpass applied

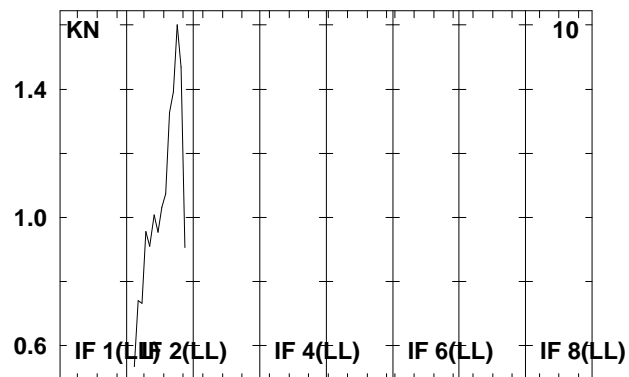
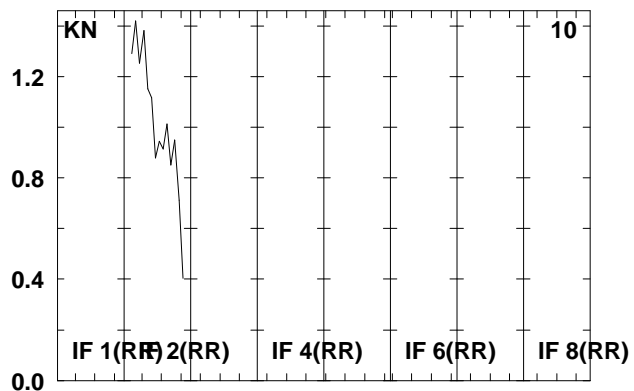
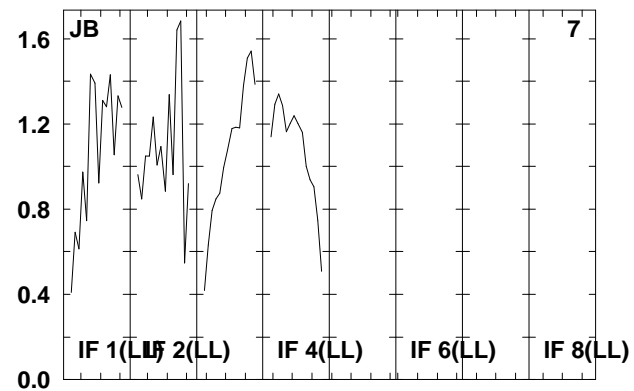
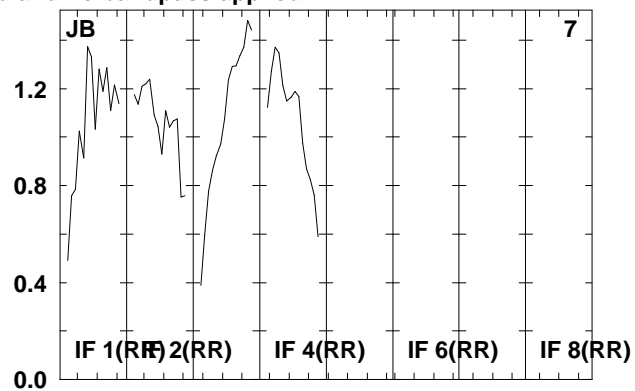
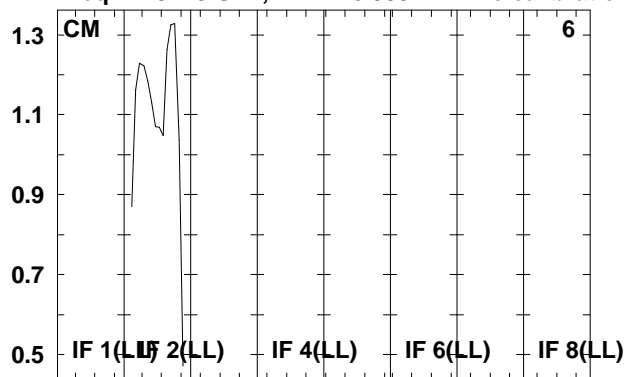

Lower frame: Real Jy  
Total-power spectrum Antenna: \*  
Timerange: 00/14:07:23 to 00/14:08:19

Plot file version 93 created 07-DEC-2009 16:05:55

SS433 RT006C.UVDATA.1

Freq = 4.9415 GHz, Bw = 16.000 MH No calibration applied and no bandpass applied

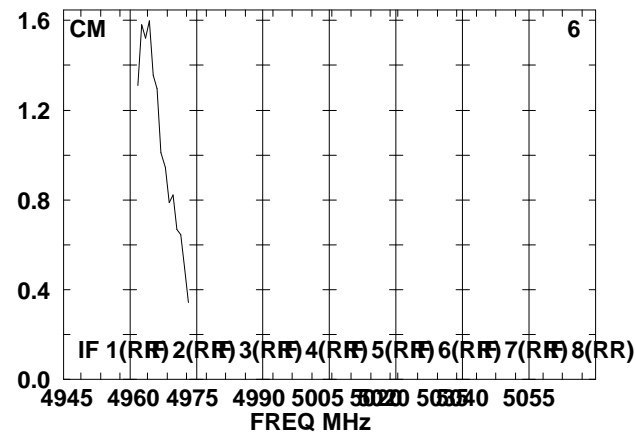
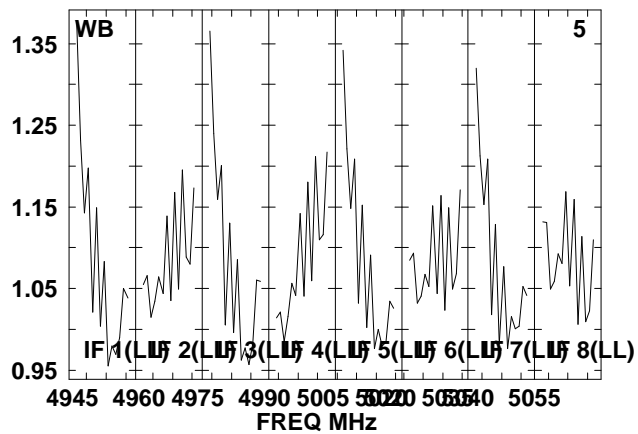
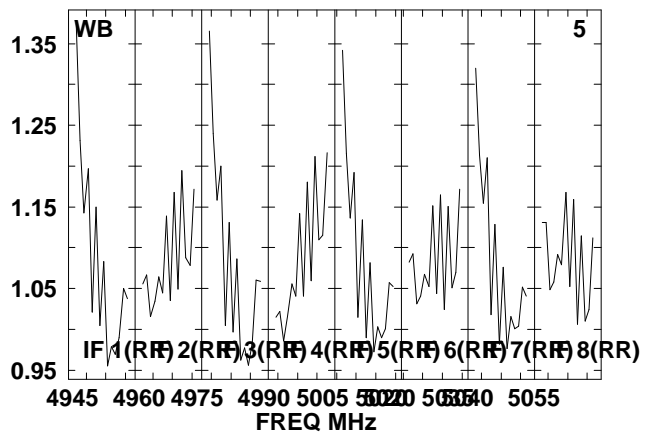
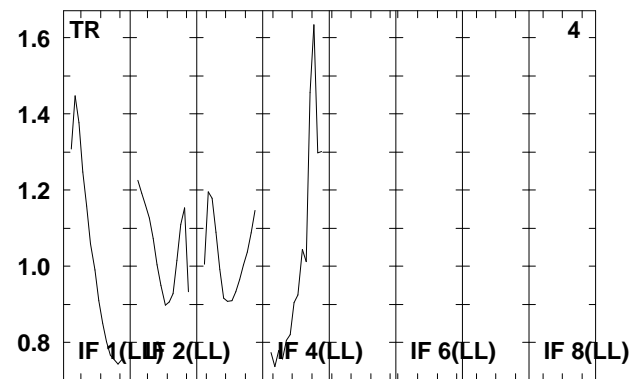
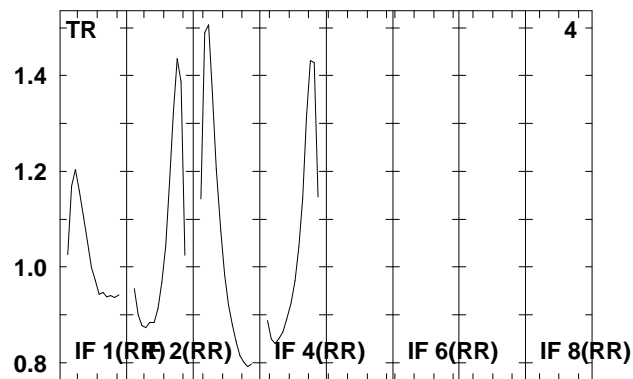
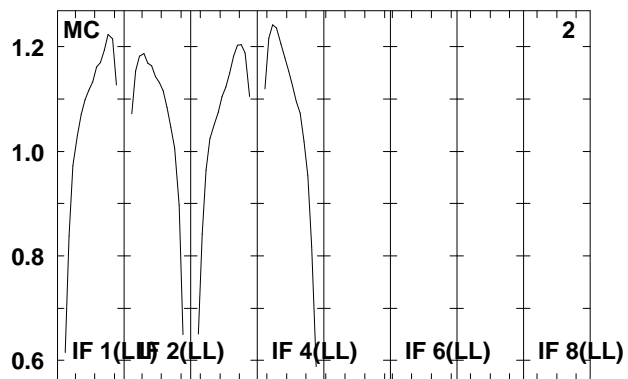
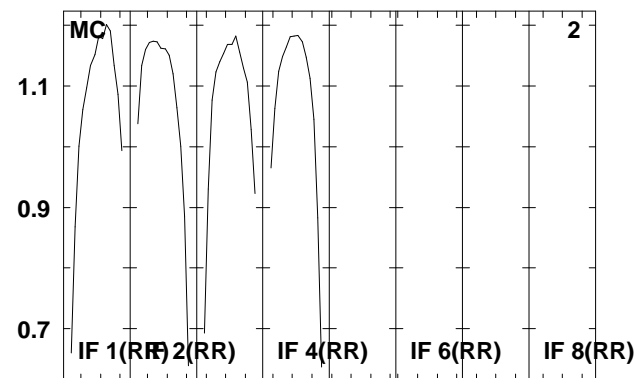
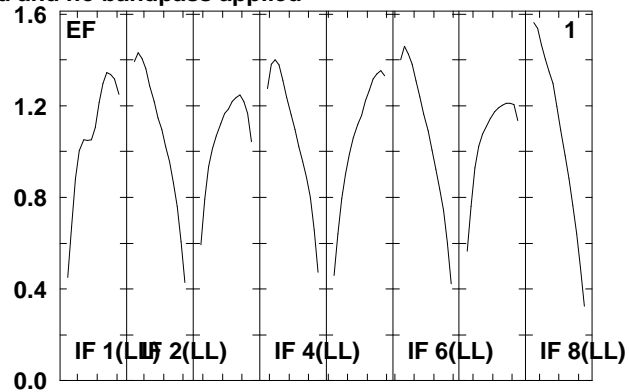
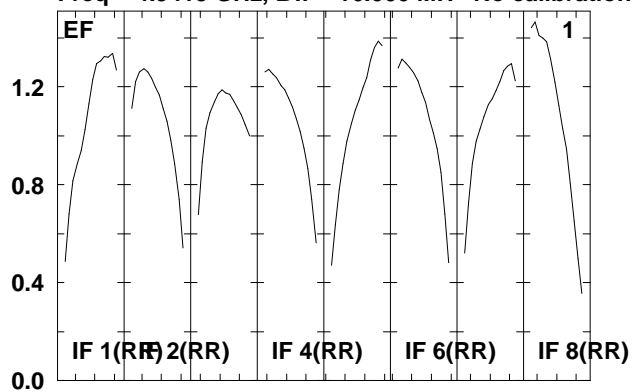

Lower frame: Real Jy  
Total-power spectrum Antenna: \*  
Timerange: 00/14:08:23 to 00/14:10:39

Plot file version 94 created 07-DEC-2009 16:05:56

SS433 RT006C.UVDATA.1

Freq = 4.9415 GHz, Bw = 16.000 MH No calibration applied and no bandpass applied

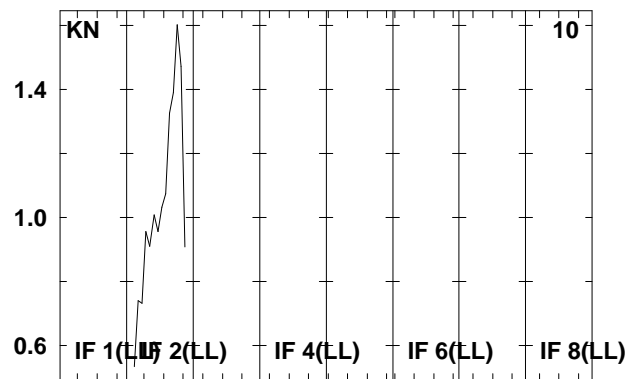
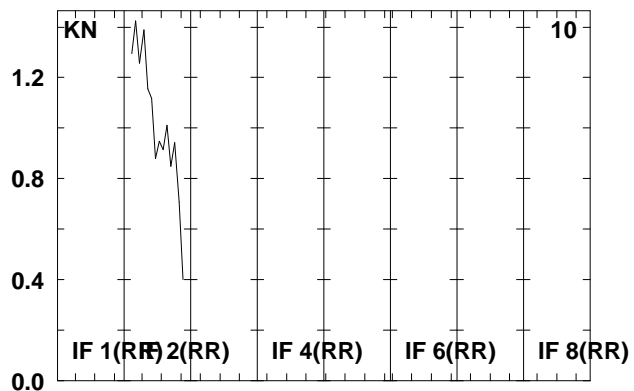
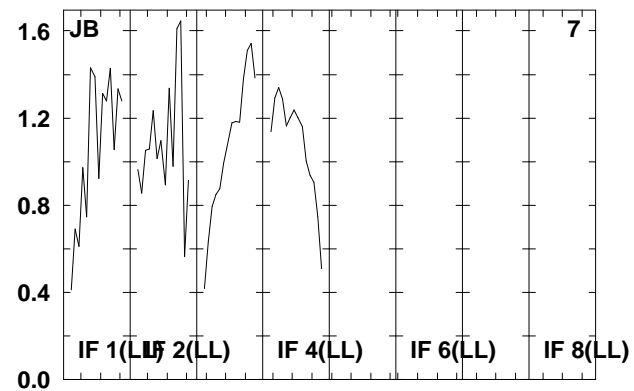
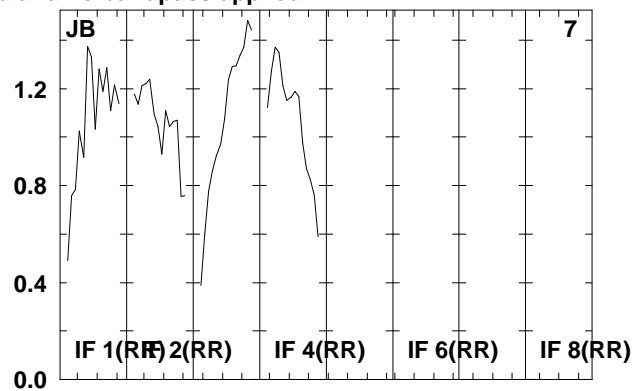
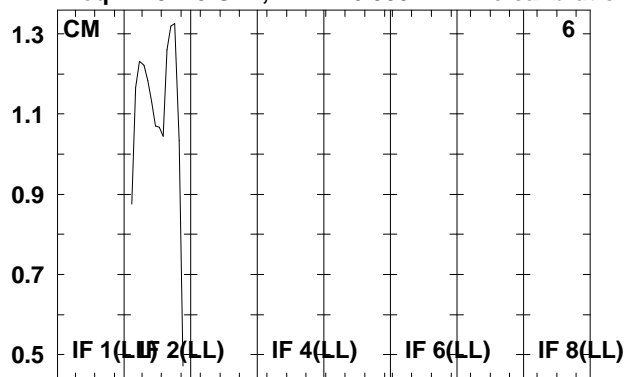

Lower frame: Real Jy  
Total-power spectrum Antenna: \*  
Timerange: 00/14:08:23 to 00/14:10:39

Plot file version 95 created 07-DEC-2009 16:05:56  
 J1912+05 RT006C.UVDATA.1  
 Freq = 4.9415 GHz, Bw = 16.000 MH No calibration applied and no bandpass applied

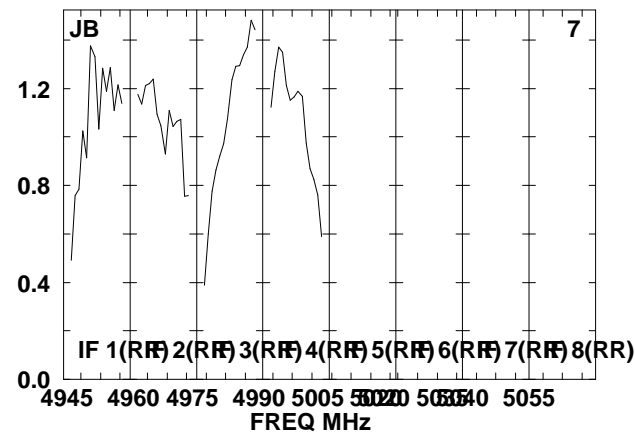
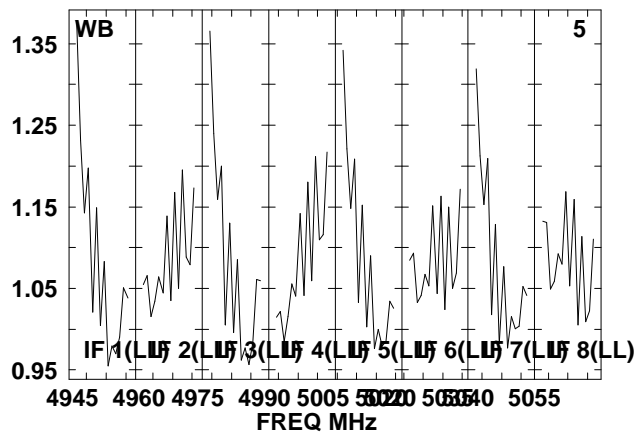
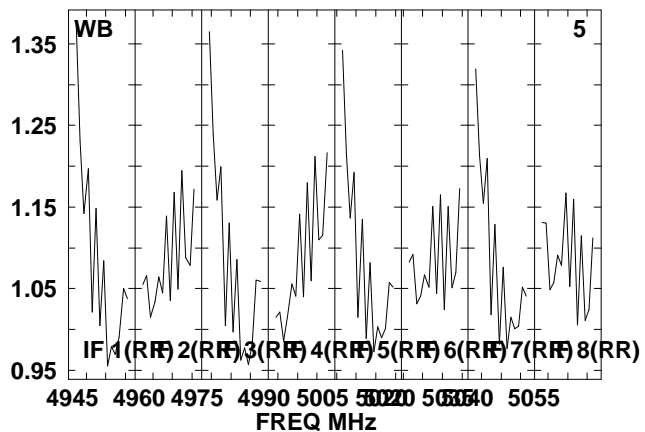
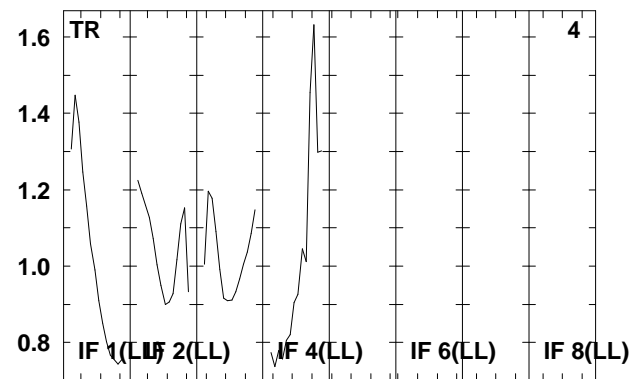
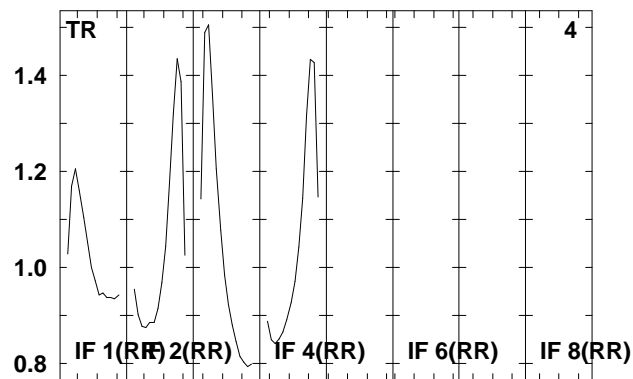
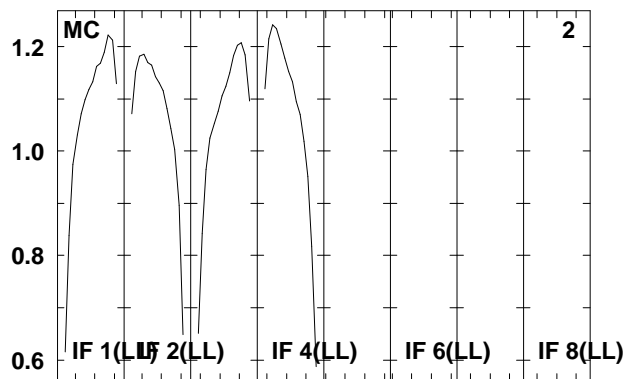
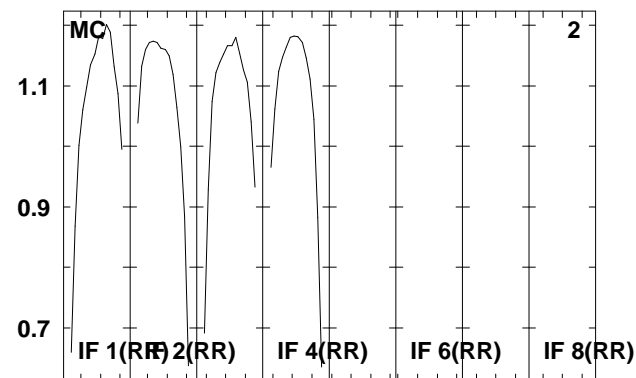
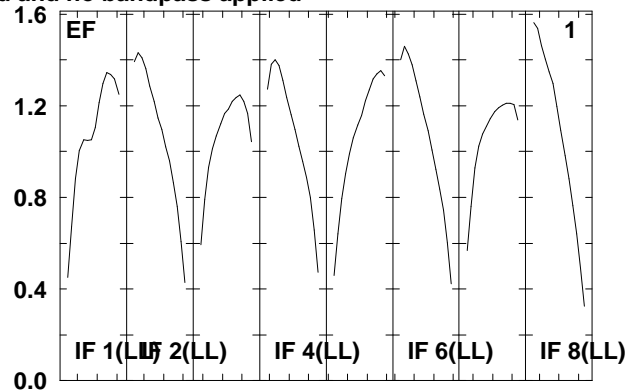
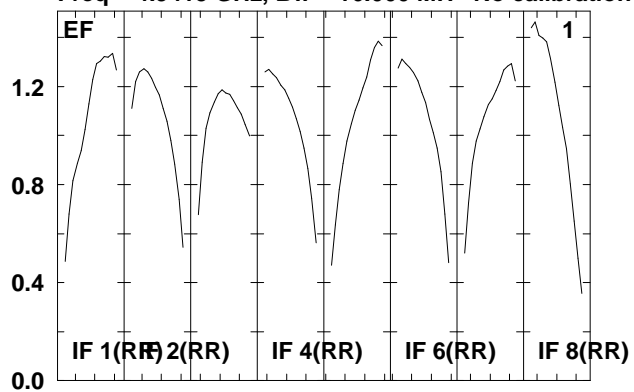

Lower frame: Real Jy  
 Total-power spectrum Antenna: \*  
 Timerange: 00/14:10:43 to 00/14:11:59

Plot file version 96 created 07-DEC-2009 16:05:56  
J1912+05 RT006C.UVDATA.1  
Freq = 4.9415 GHz, Bw = 16.000 MH No calibration applied and no bandpass applied

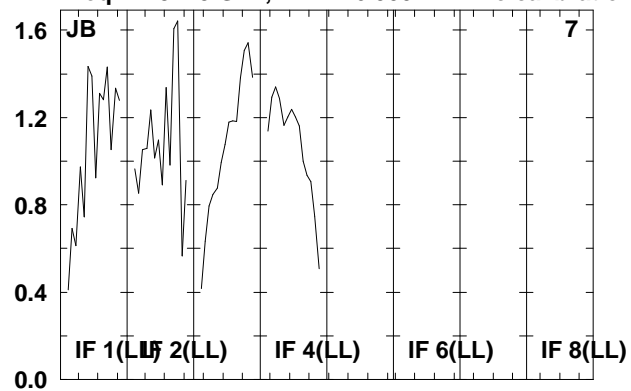

Lower frame: Real Jy  
Total-power spectrum Antenna: \*  
Timerange: 00/14:10:43 to 00/14:11:59



Plot file version 97 created 07-DEC-2009 16:05:56

SS433 RT006C.UVDATA.1

Freq = 4.9415 GHz, Bw = 16.000 MH No calibration applied and no bandpass applied

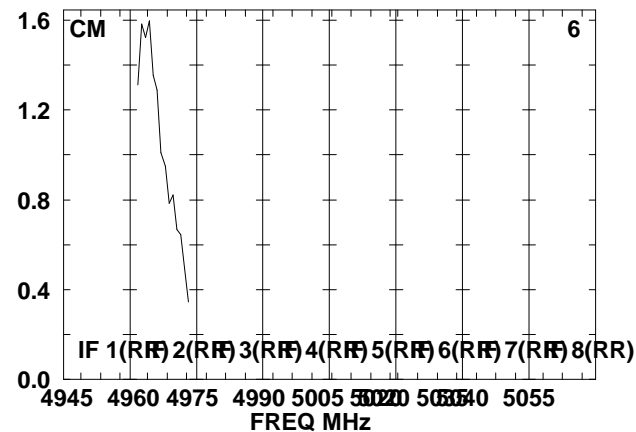
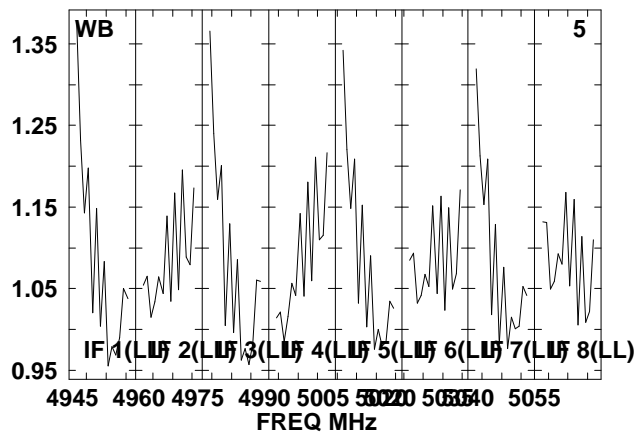
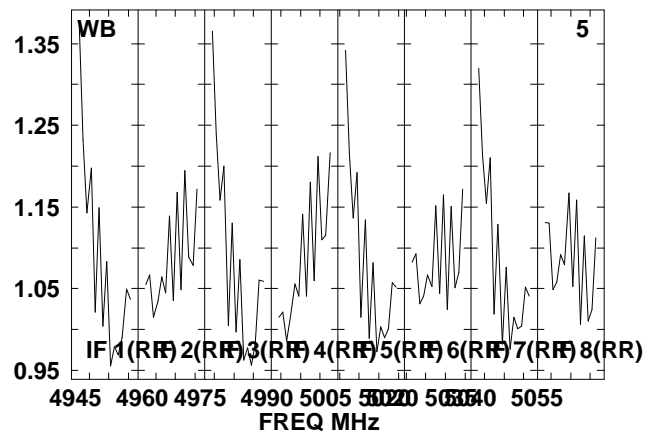
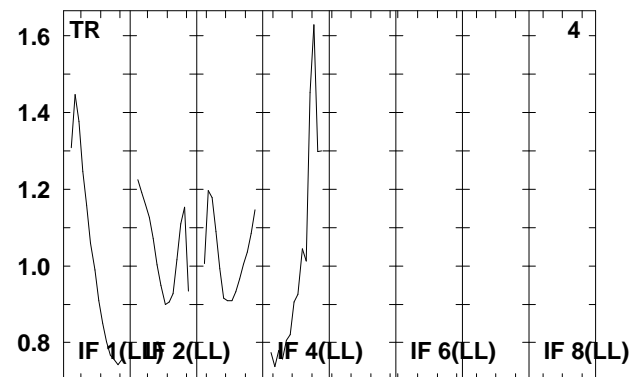
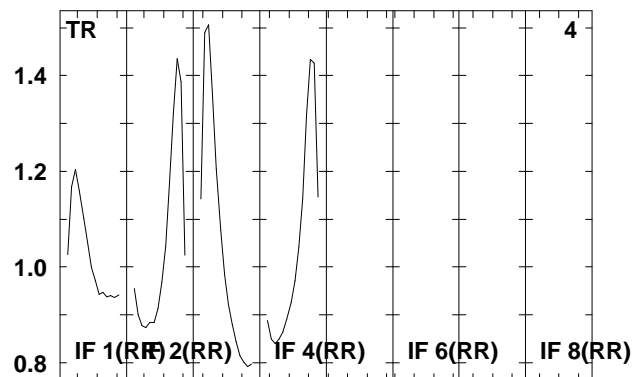
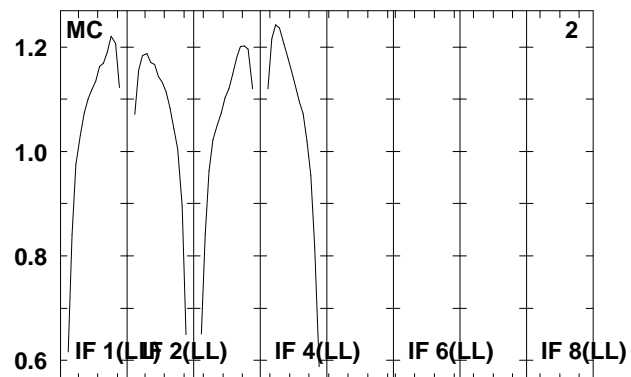
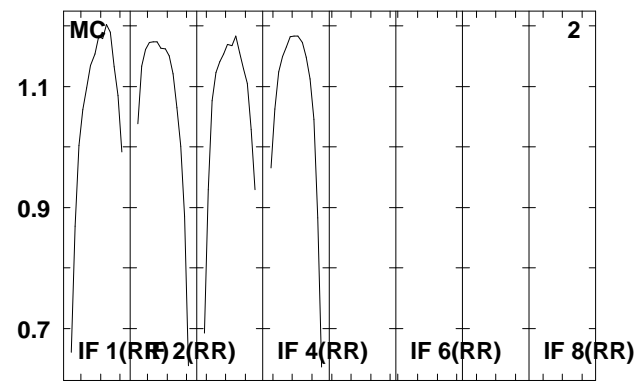
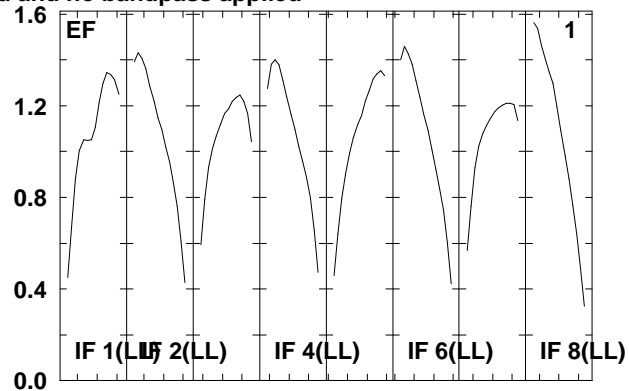
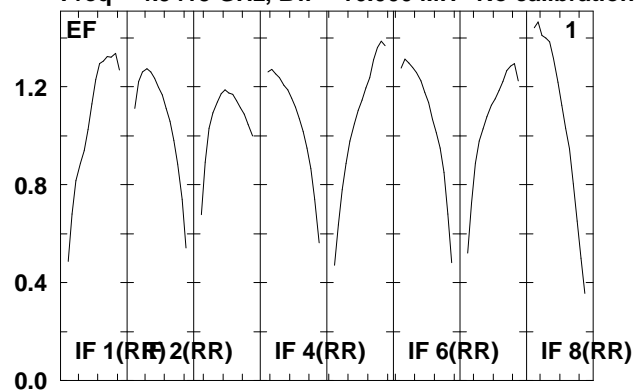

Lower frame: Real Jy

Total-power spectrum Antenna: \*

Timerange: 00/14:12:03 to 00/14:14:19

Plot file version 98 created 07-DEC-2009 16:05:56

SS433 RT006C.UVDATA.1

Freq = 4.9415 GHz, Bw = 16.000 MH No calibration applied and no bandpass applied

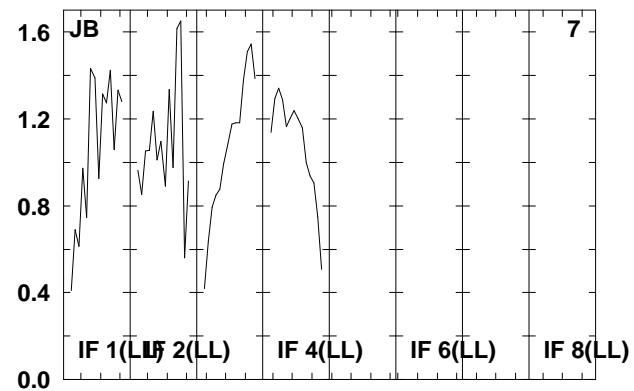
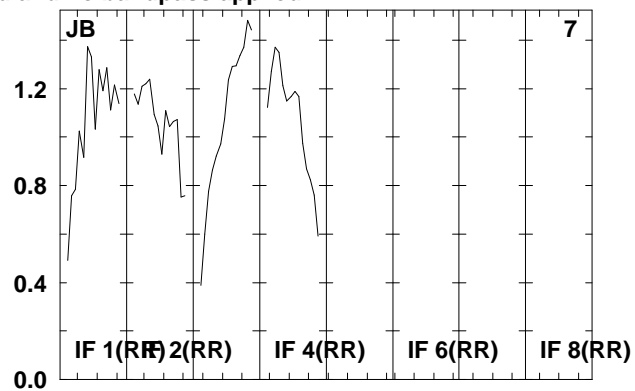
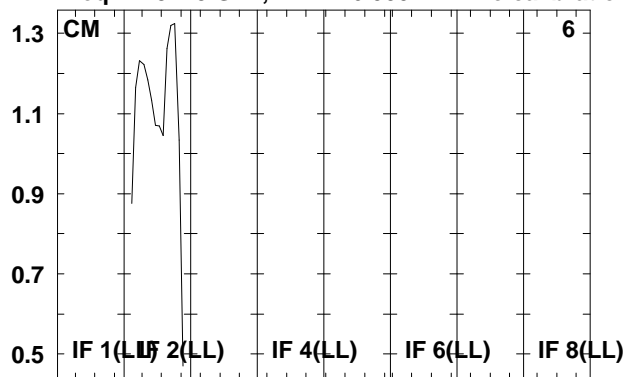

Lower frame: Real Jy  
Total-power spectrum Antenna: \*  
Timerange: 00/14:12:03 to 00/14:14:19

Plot file version 99 created 07-DEC-2009 16:05:56

J1912+05 RT006C.UVDATA.1

Freq = 4.9415 GHz, Bw = 16.000 MH No calibration applied and no bandpass applied

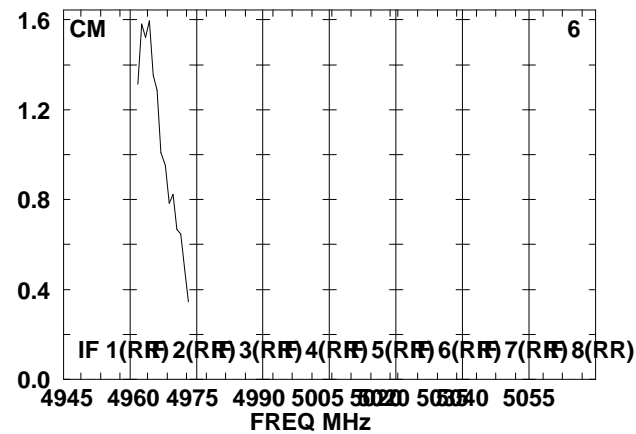
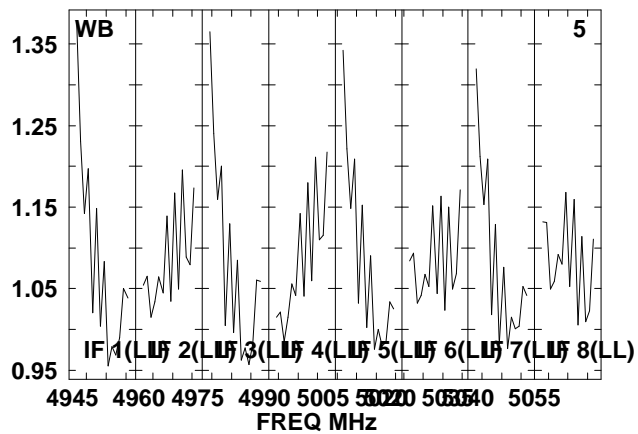
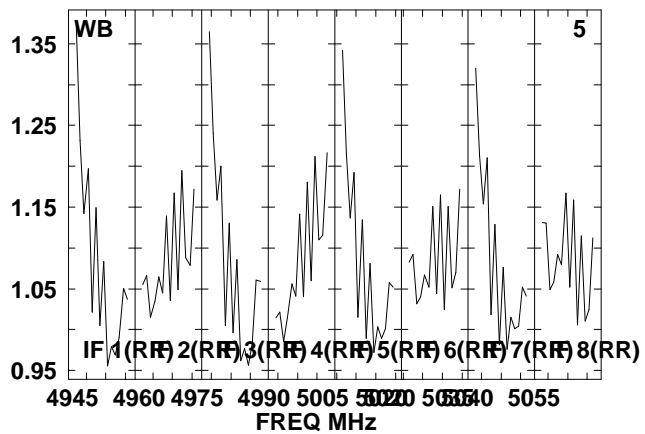
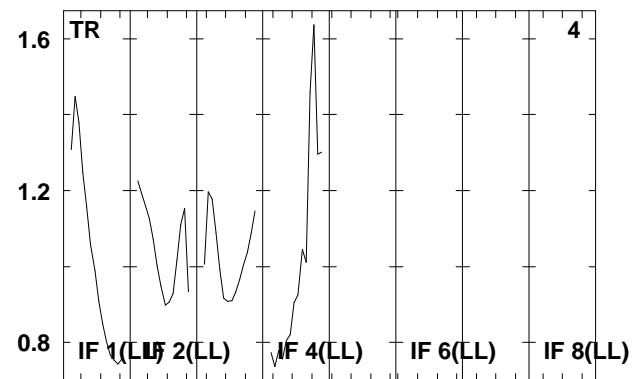
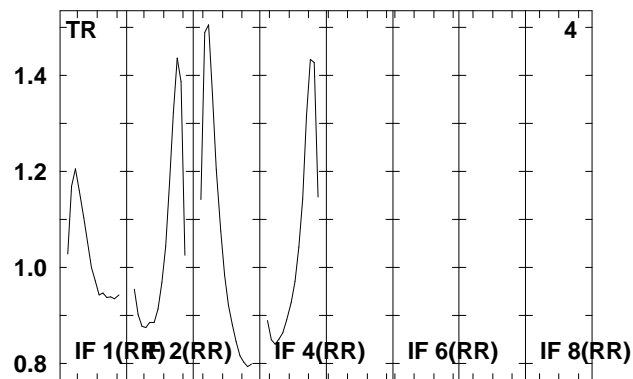
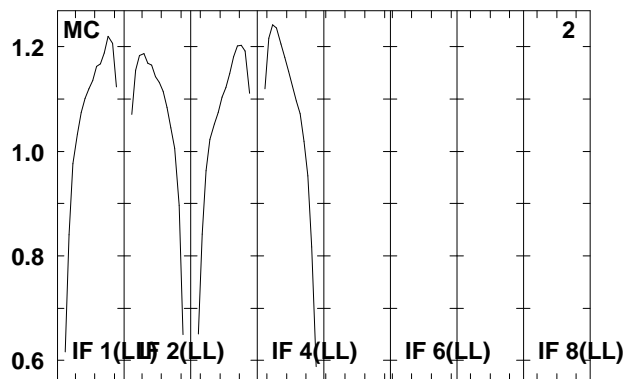
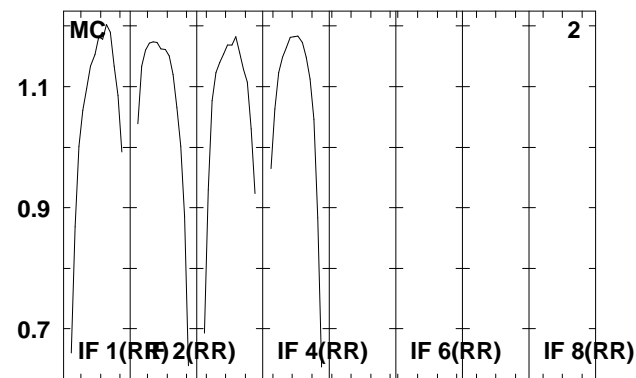
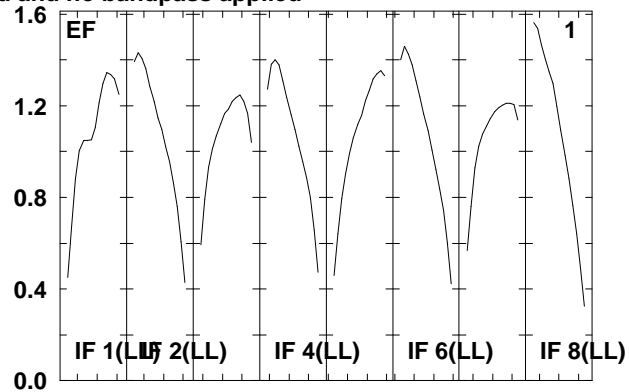
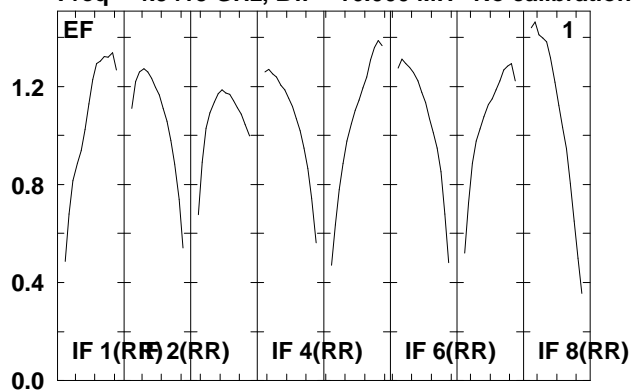

Lower frame: Real Jy  
Total-power spectrum Antenna: \*  
Timerange: 00/14:14:23 to 00/14:15:39

Plot file version 100 created 07-DEC-2009 16:05:56

J1912+05 RT006C.UVDATA.1

Freq = 4.9415 GHz, Bw = 16.000 MH No calibration applied and no bandpass applied

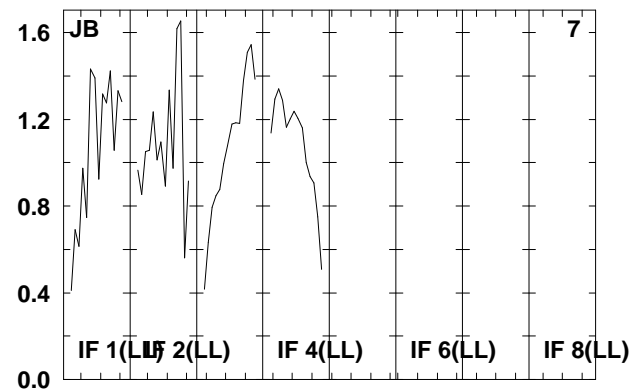
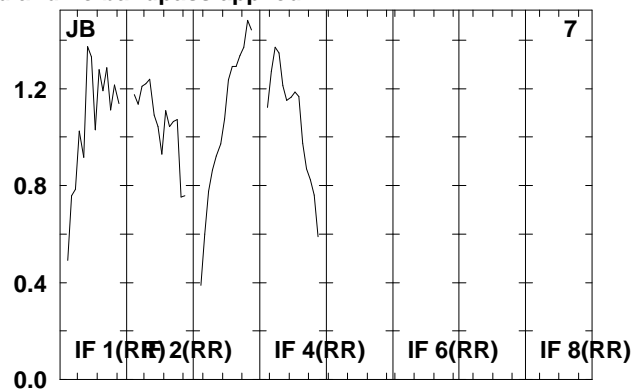
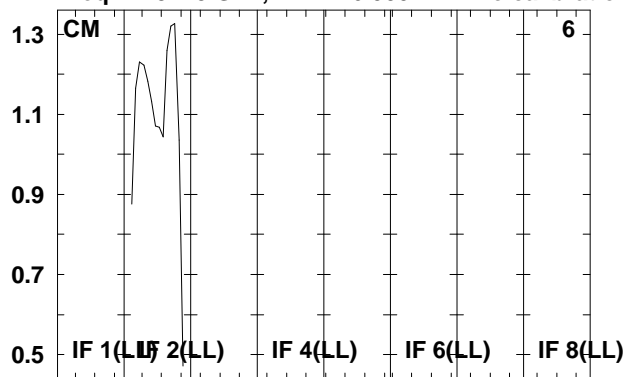

Lower frame: Real Jy  
Total-power spectrum Antenna: \*  
Timerange: 00/14:14:23 to 00/14:15:39

Plot file version 101 created 07-DEC-2009 16:05:57

SS433 RT006C.UVDATA.1

Freq = 4.9415 GHz, Bw = 16.000 MH No calibration applied and no bandpass applied

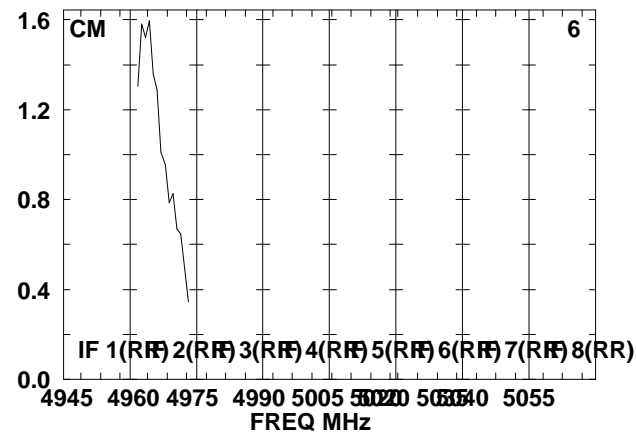
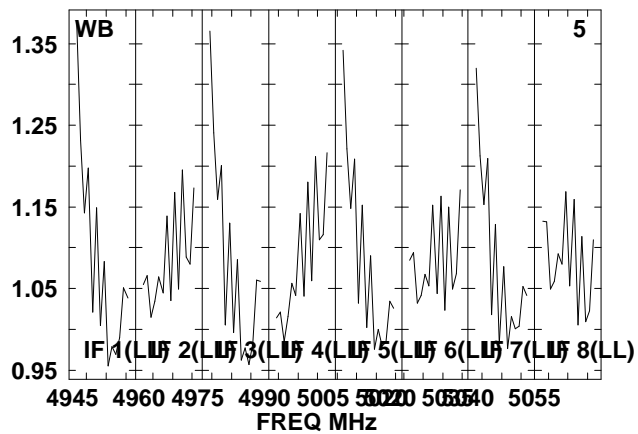
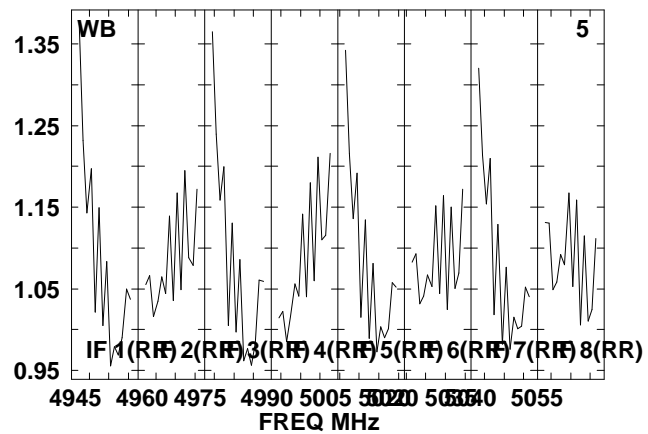
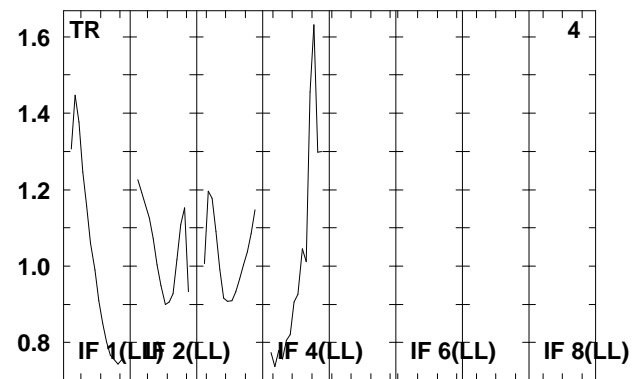
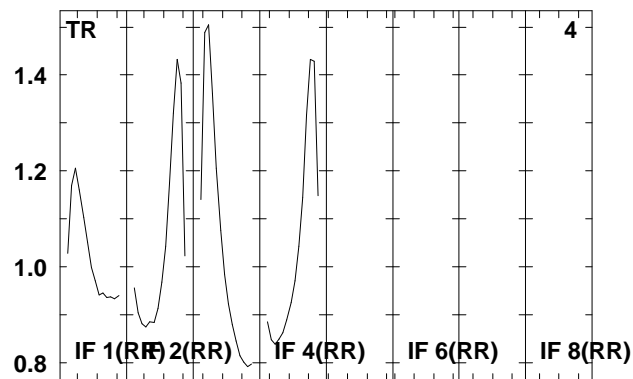
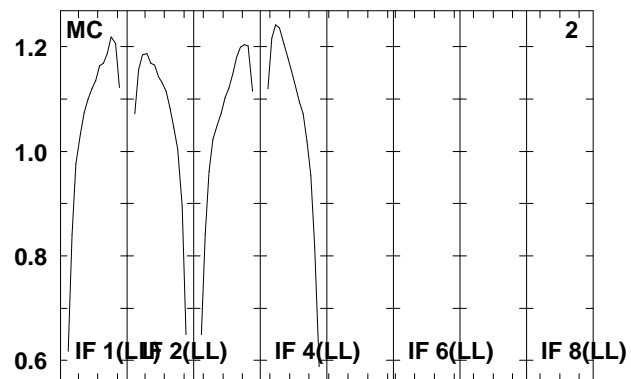
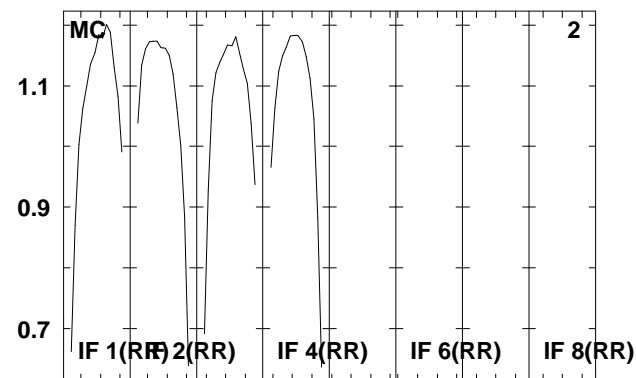
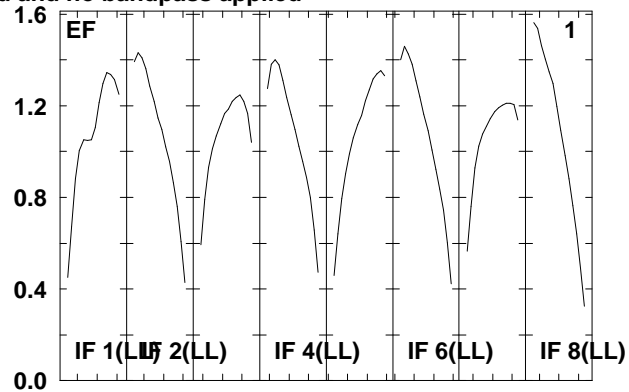
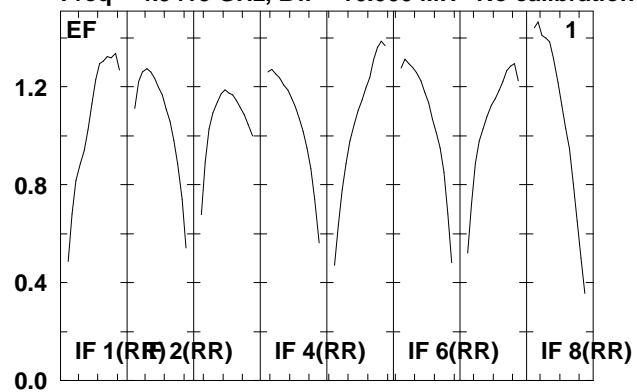

Lower frame: Real Jy  
Total-power spectrum Antenna: \*  
Timerange: 00/14:15:43 to 00/14:17:59

Plot file version 102 created 07-DEC-2009 16:05:57

SS433 RT006C.UVDATA.1

Freq = 4.9415 GHz, Bw = 16.000 MH No calibration applied and no bandpass applied

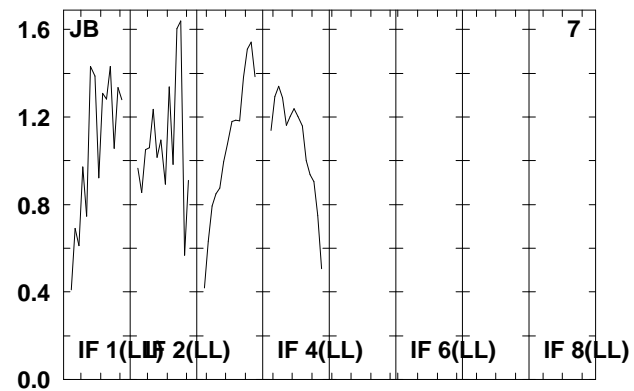
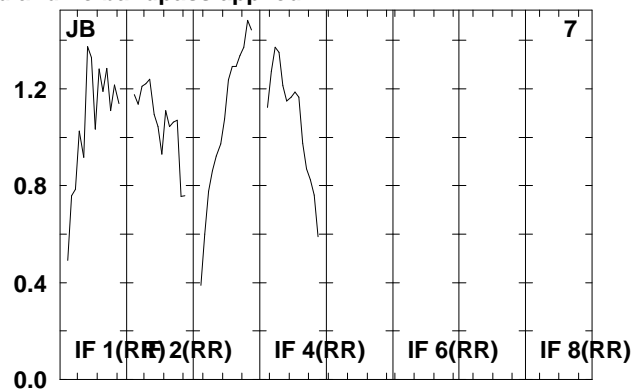
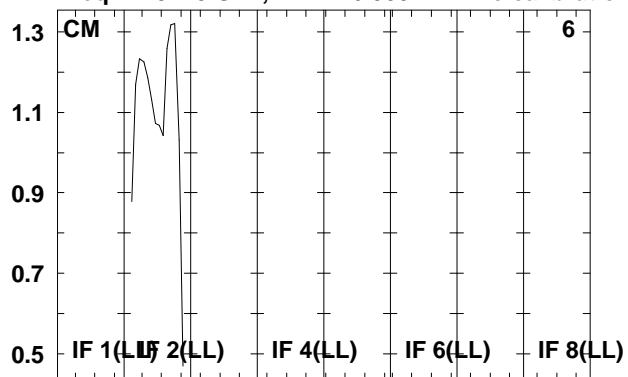

Lower frame: Real Jy  
Total-power spectrum Antenna: \*  
Timerange: 00/14:15:43 to 00/14:17:59

Plot file version 103 created 07-DEC-2009 16:05:57

J1912+05 RT006C.UVDATA.1

Freq = 4.9415 GHz, Bw = 16.000 MH No calibration applied and no bandpass applied

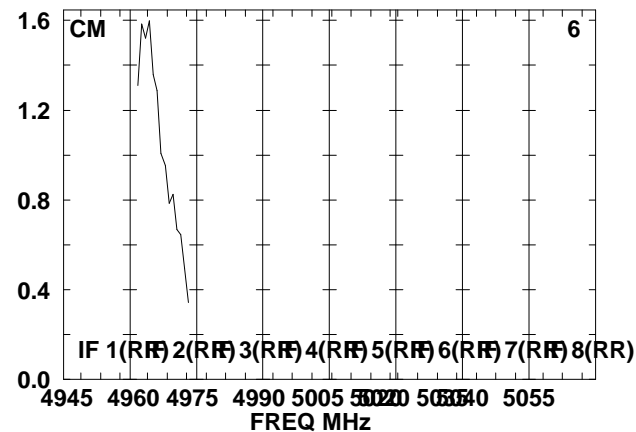
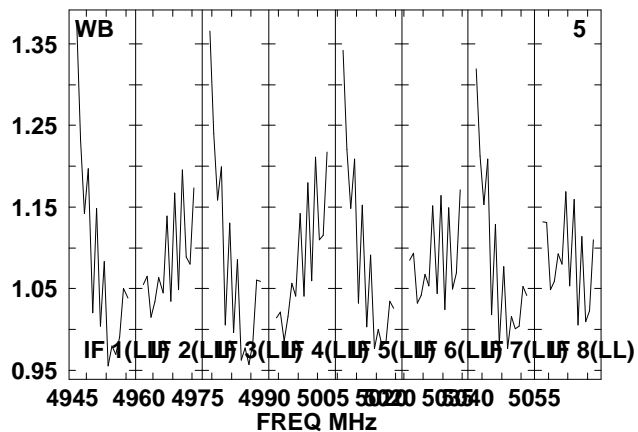
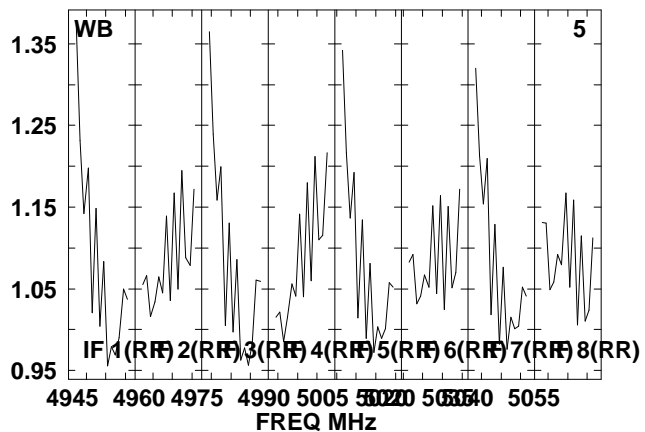
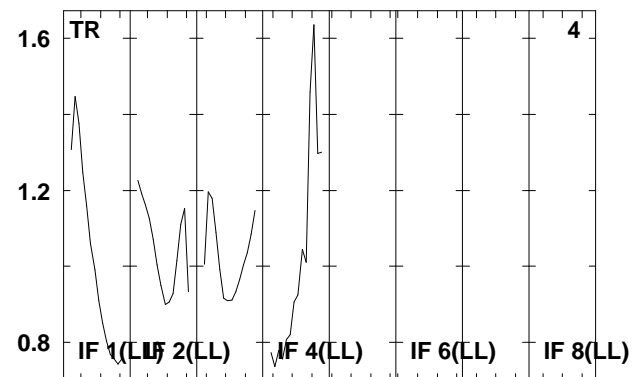
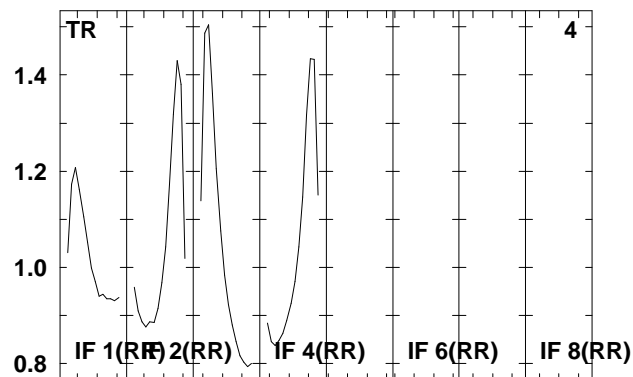
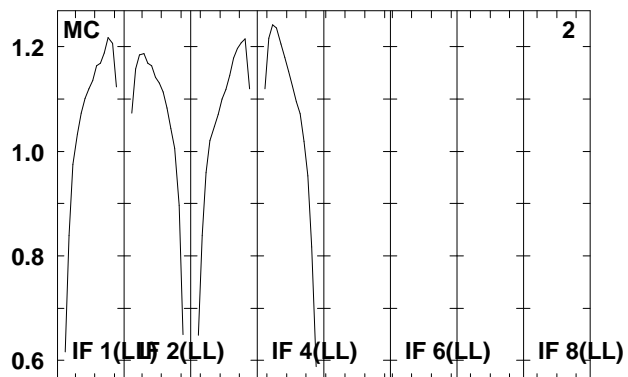
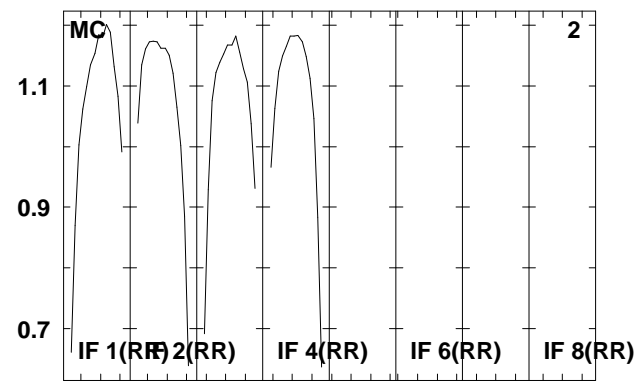
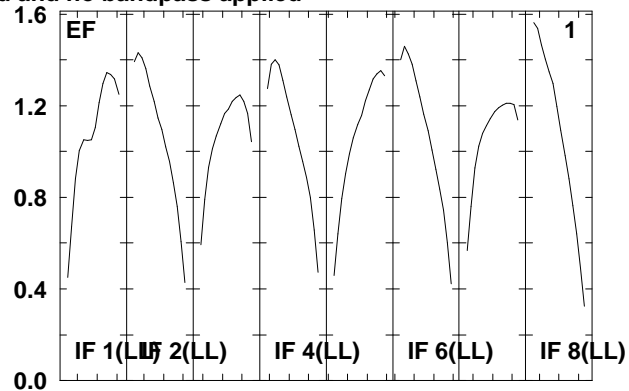
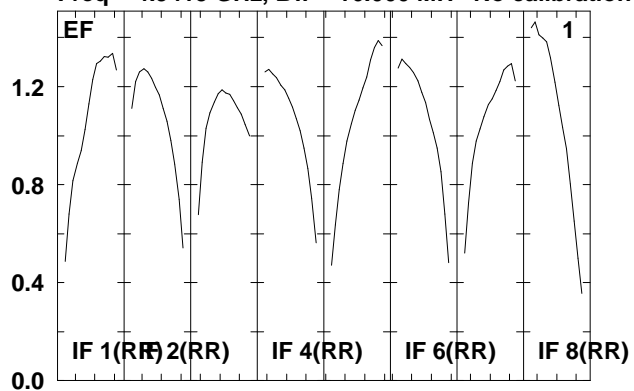

Lower frame: Real Jy

Total-power spectrum Antenna: \*

Timerange: 00/14:18:03 to 00/14:19:19

Plot file version 104 created 07-DEC-2009 16:05:57

J1912+05 RT006C.UVDATA.1

Freq = 4.9415 GHz, Bw = 16.000 MH No calibration applied and no bandpass applied

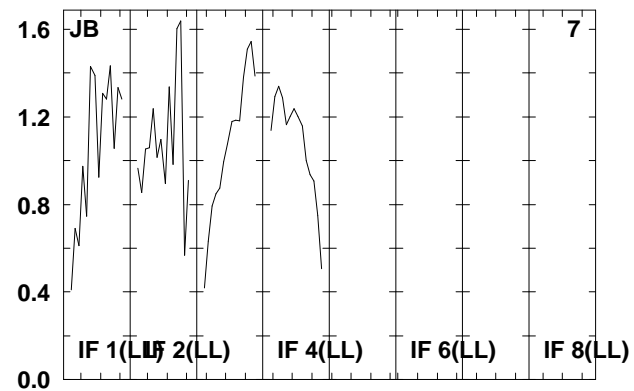
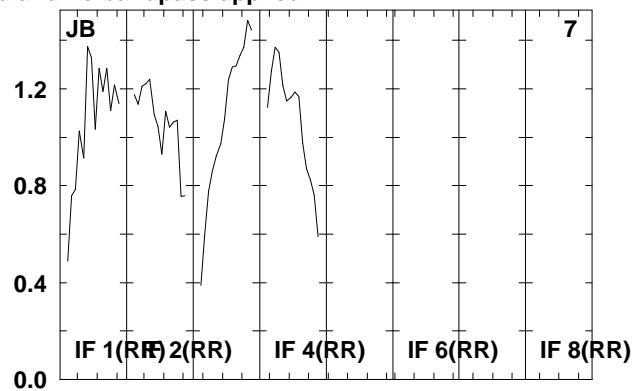
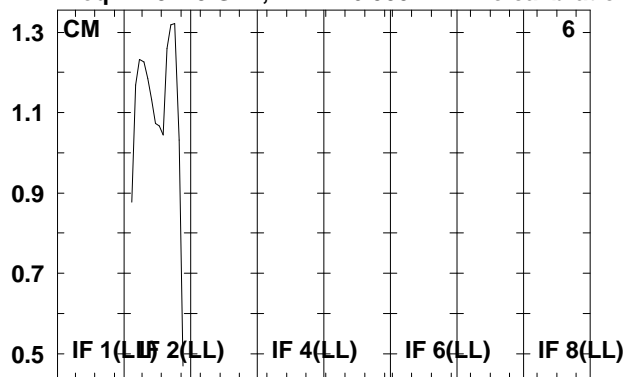

Lower frame: Real Jy  
Total-power spectrum Antenna: \*  
Timerange: 00/14:18:03 to 00/14:19:19



Plot file version 105 created 07-DEC-2009 16:05:57

SS433 RT006C.UVDATA.1

Freq = 4.9415 GHz, Bw = 16.000 MH No calibration applied and no bandpass applied

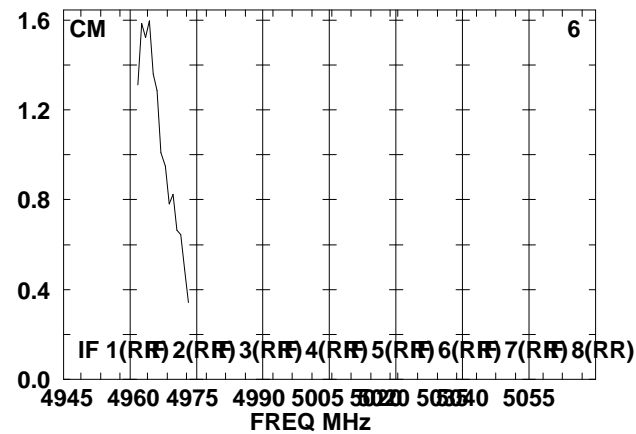
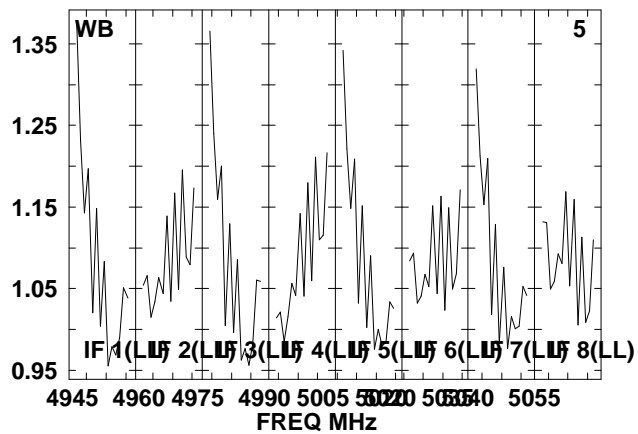
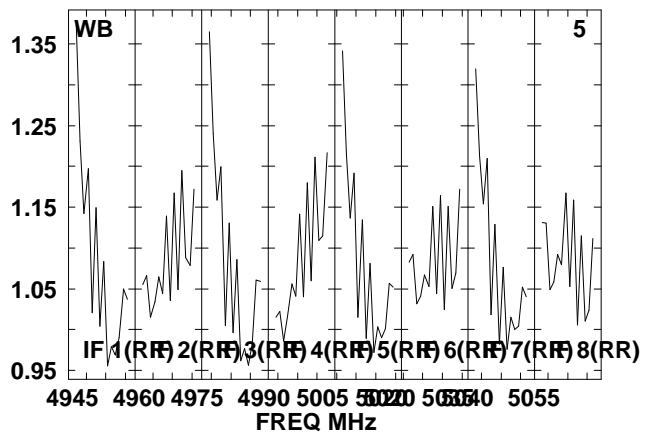
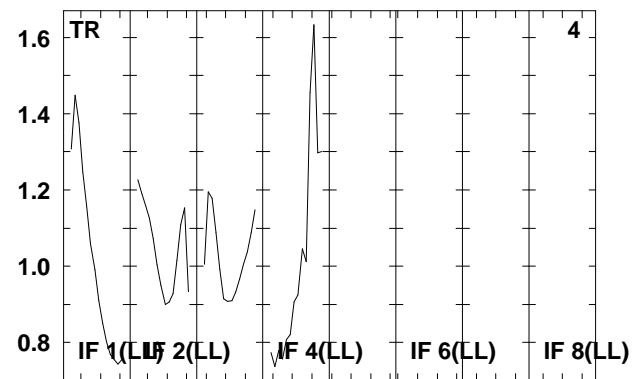
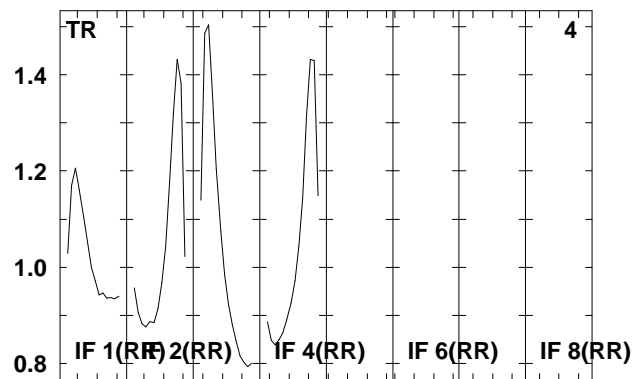
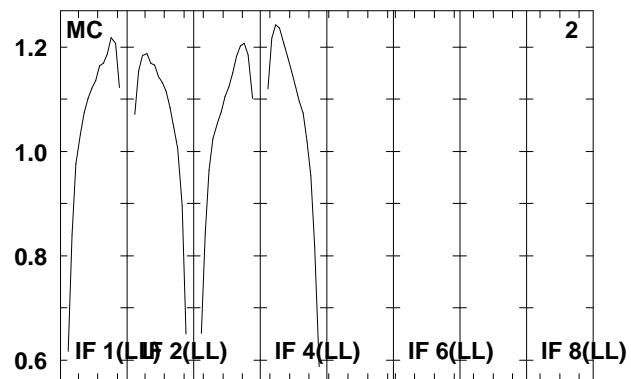
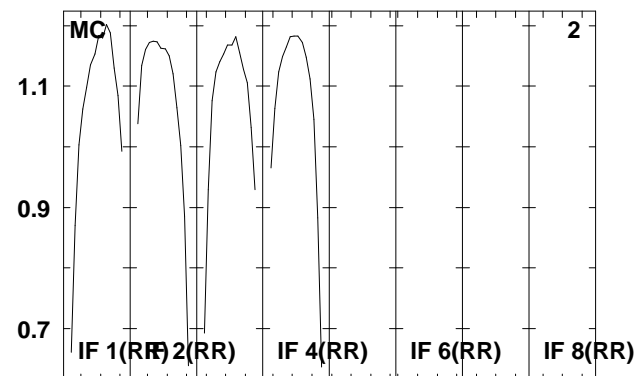
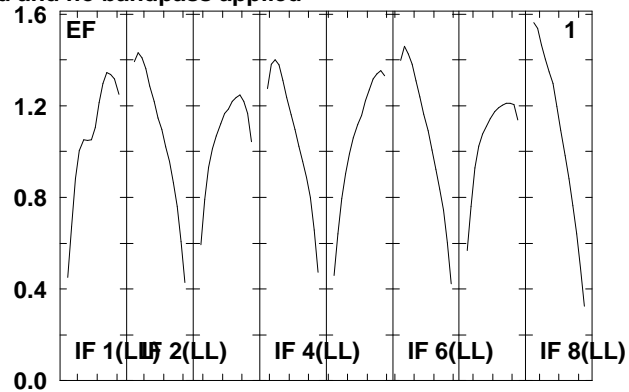
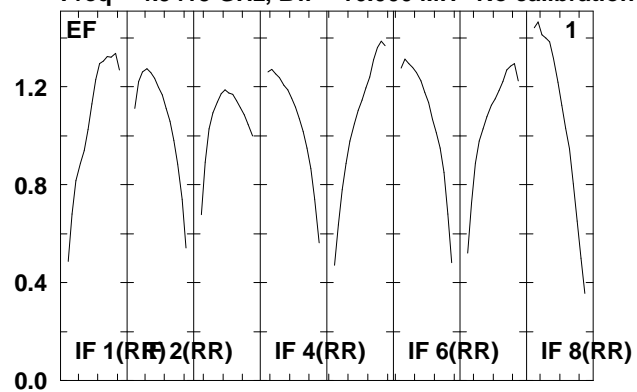

Lower frame: Real Jy  
Total-power spectrum Antenna: \*  
Timerange: 00/14:19:23 to 00/14:21:39

Plot file version 106 created 07-DEC-2009 16:05:57

SS433 RT006C.UVDATA.1

Freq = 4.9415 GHz, Bw = 16.000 MH No calibration applied and no bandpass applied

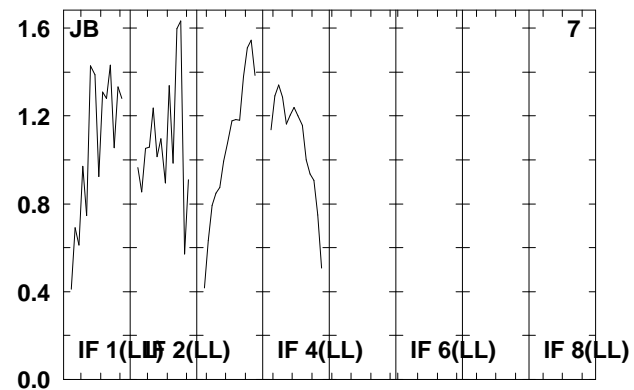
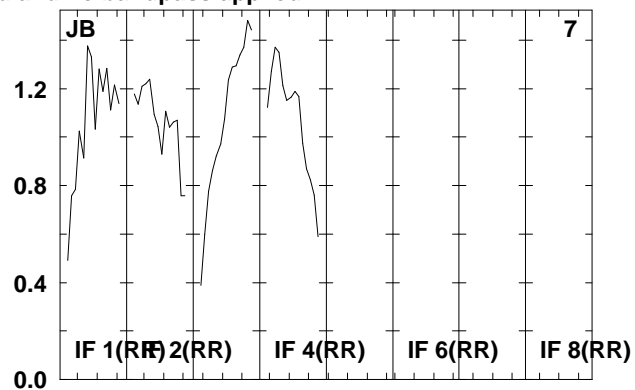
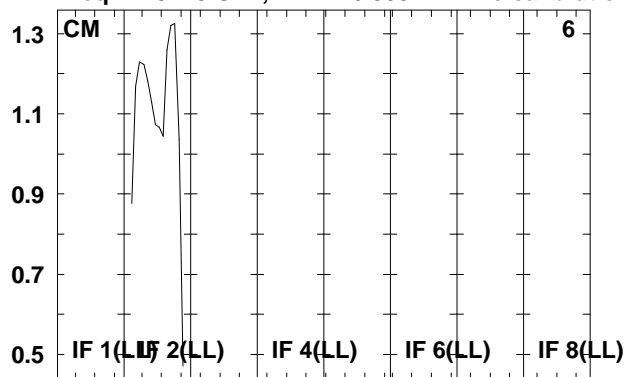

Lower frame: Real Jy  
Total-power spectrum Antenna: \*  
Timerange: 00/14:19:23 to 00/14:21:39

Plot file version 107 created 07-DEC-2009 16:05:58

J1911+16 RT006C.UVDATA.1

Freq = 4.9415 GHz, Bw = 16.000 MH No calibration applied and no bandpass applied

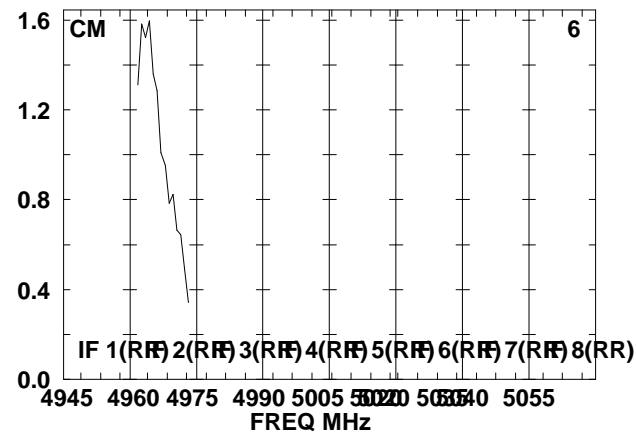
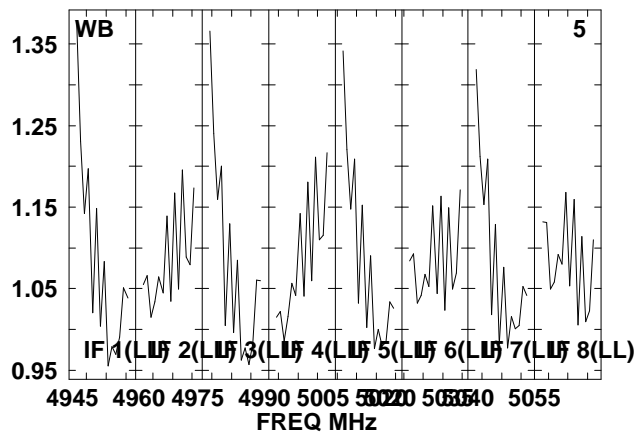
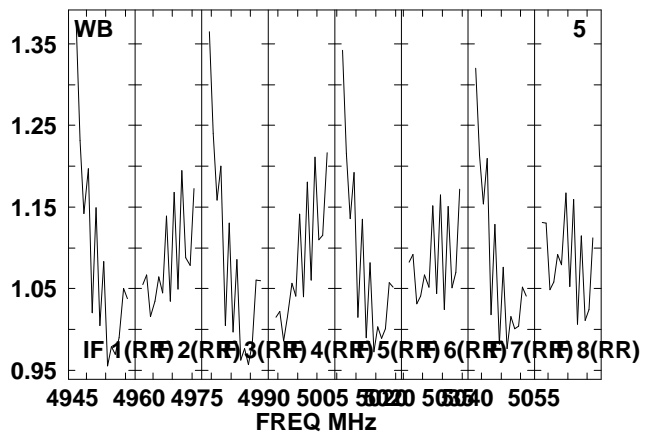
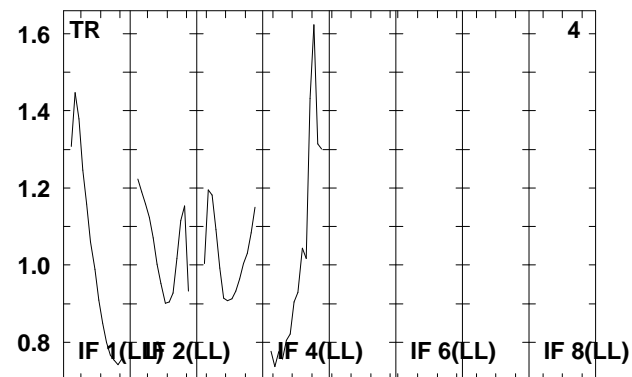
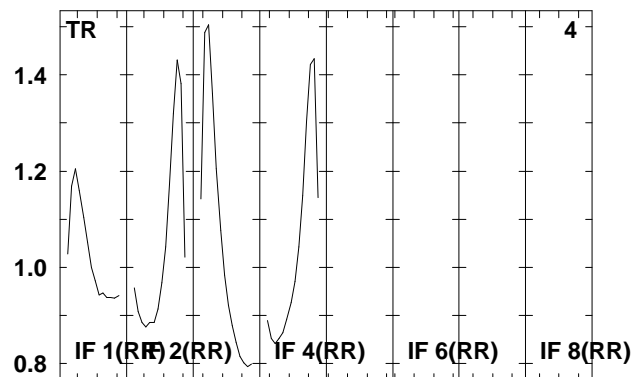
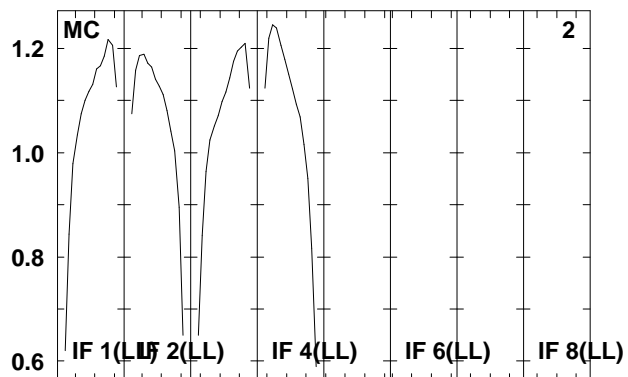
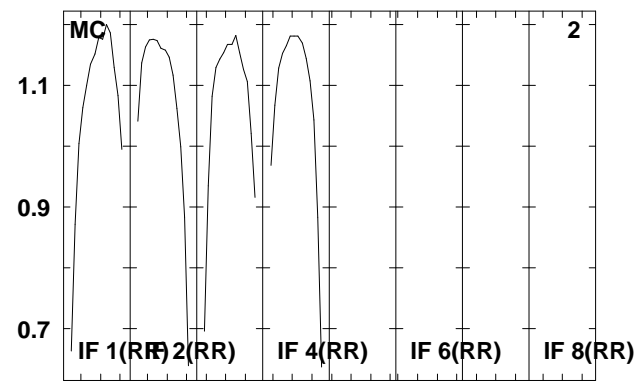
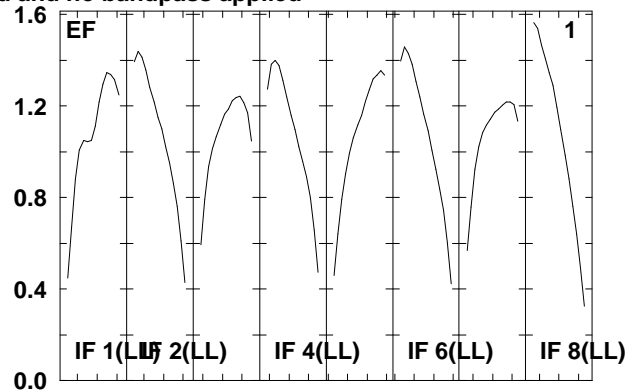
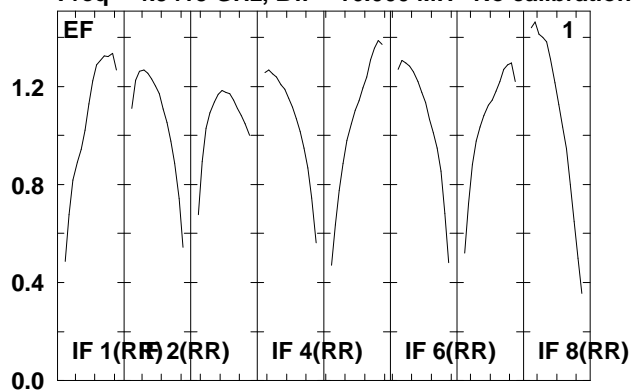

Lower frame: Real Jy  
Total-power spectrum Antenna: \*  
Timerange: 00/14:22:43 to 00/14:23:39

Plot file version 108 created 07-DEC-2009 16:05:58

J1911+16 RT006C.UVDATA.1

Freq = 4.9415 GHz, Bw = 16.000 MH No calibration applied and no bandpass applied

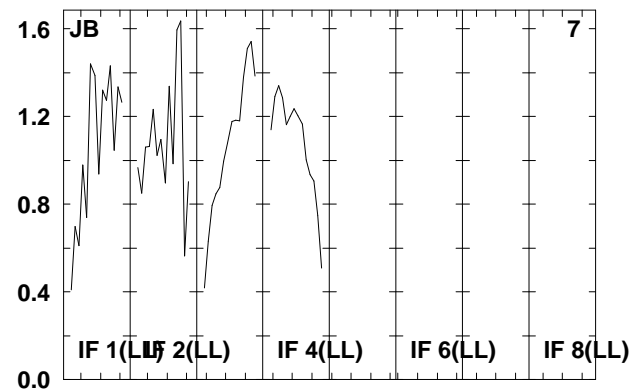
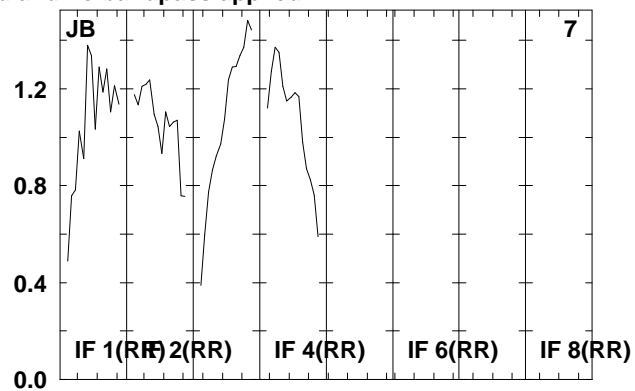
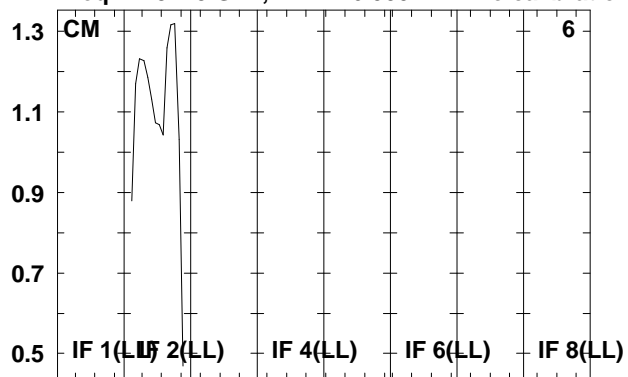

Lower frame: Real Jy  
Total-power spectrum Antenna: \*  
Timerange: 00/14:22:43 to 00/14:23:39

Plot file version 109 created 07-DEC-2009 16:05:58

J1912+05 RT006C.UVDATA.1

Freq = 4.9415 GHz, Bw = 16.000 MH No calibration applied and no bandpass applied

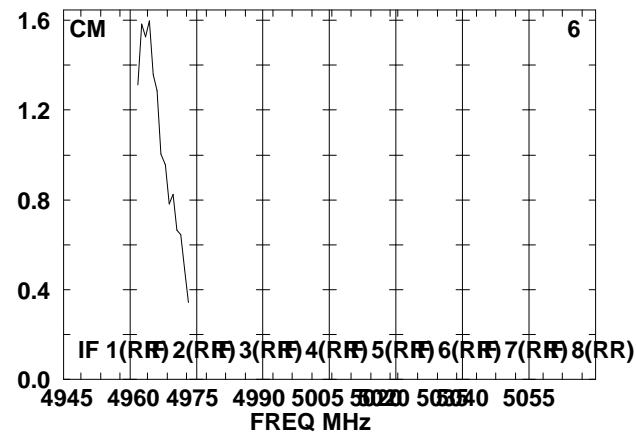
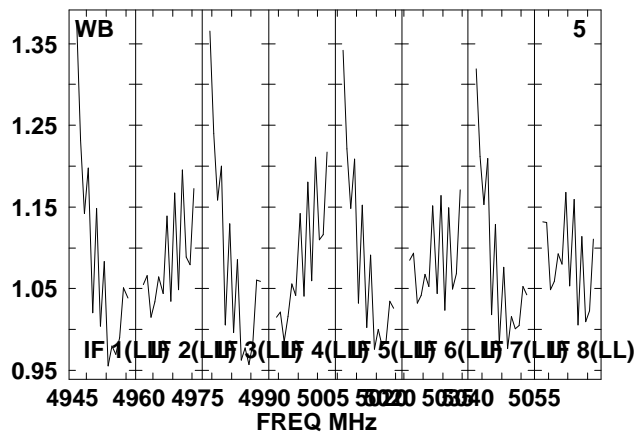
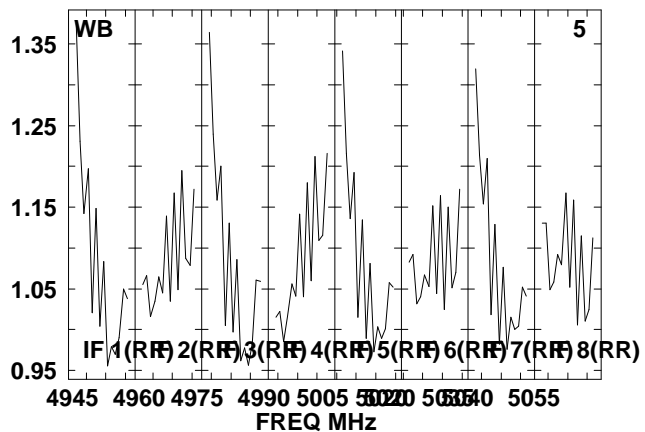
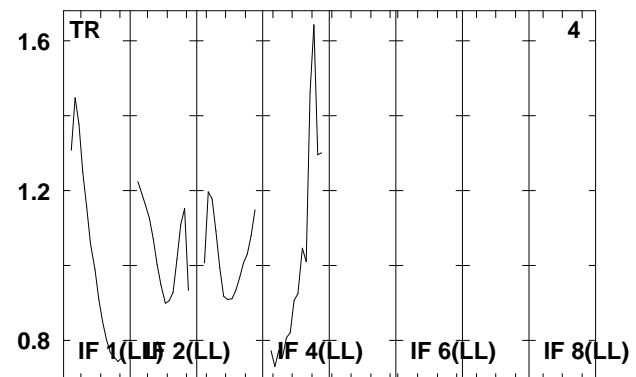
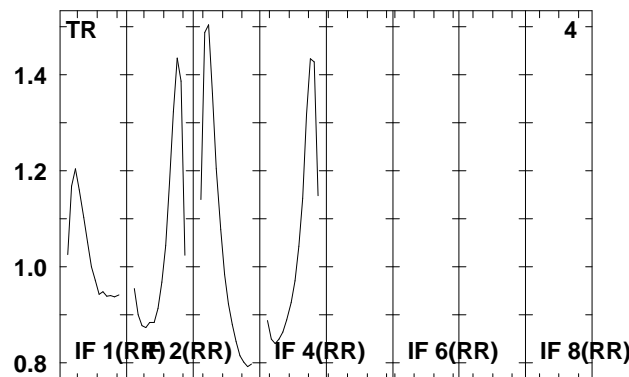
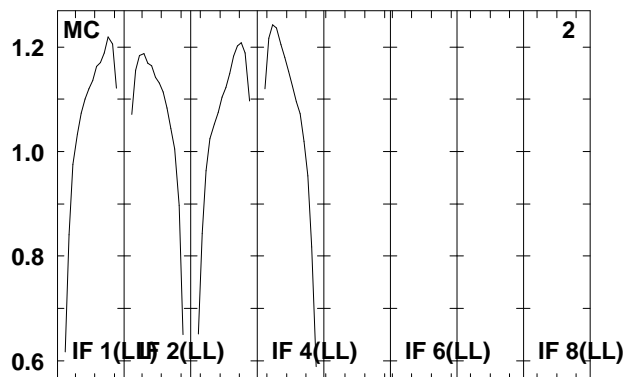
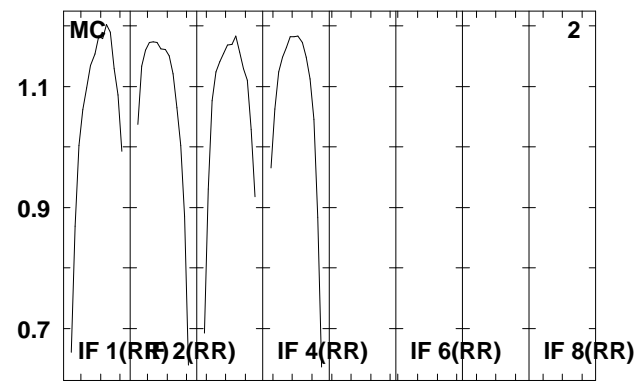
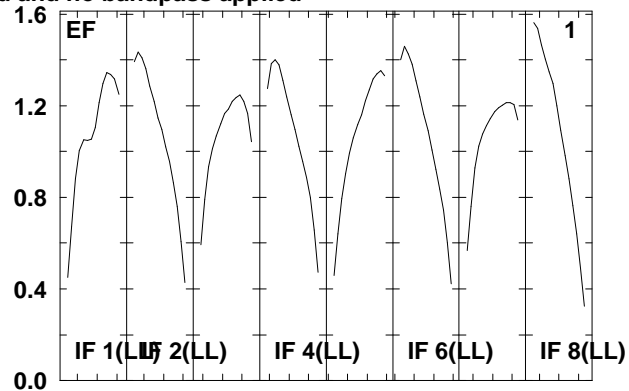
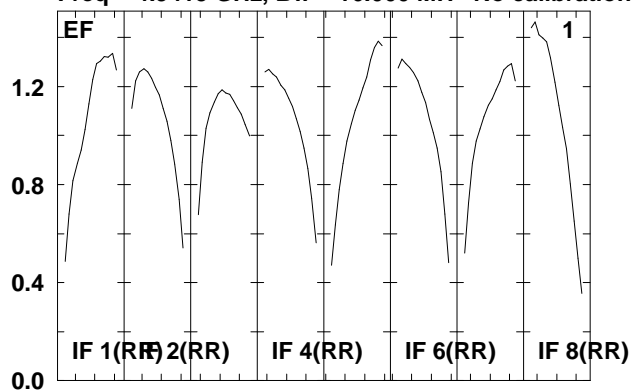

Lower frame: Real Jy  
Total-power spectrum Antenna: \*  
Timerange: 00/14:24:43 to 00/14:25:39

Plot file version 110 created 07-DEC-2009 16:05:58

J1912+05 RT006C.UVDATA.1

Freq = 4.9415 GHz, Bw = 16.000 MH No calibration applied and no bandpass applied

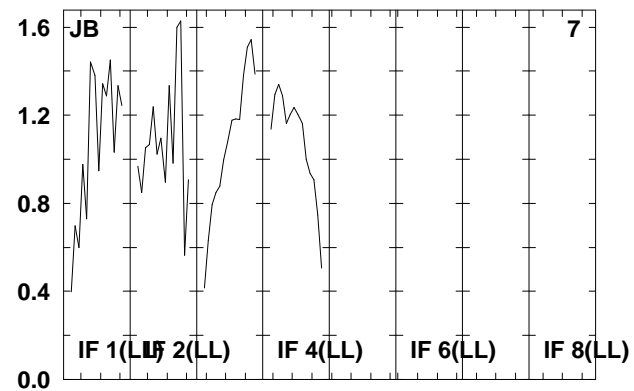
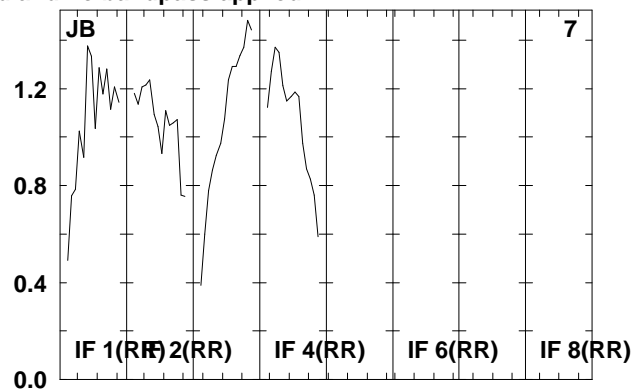
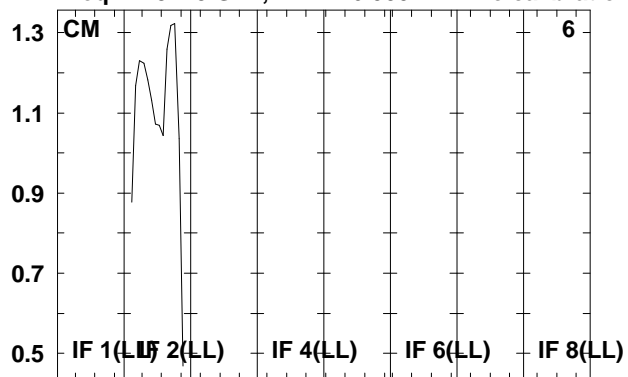

Lower frame: Real Jy  
Total-power spectrum Antenna: \*  
Timerange: 00/14:24:43 to 00/14:25:39

Plot file version 111 created 07-DEC-2009 16:05:58

SS433 RT006C.UVDATA.1

Freq = 4.9415 GHz, Bw = 16.000 MH No calibration applied and no bandpass applied

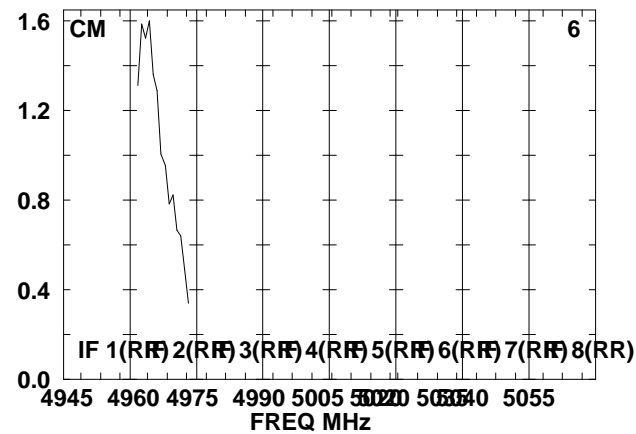
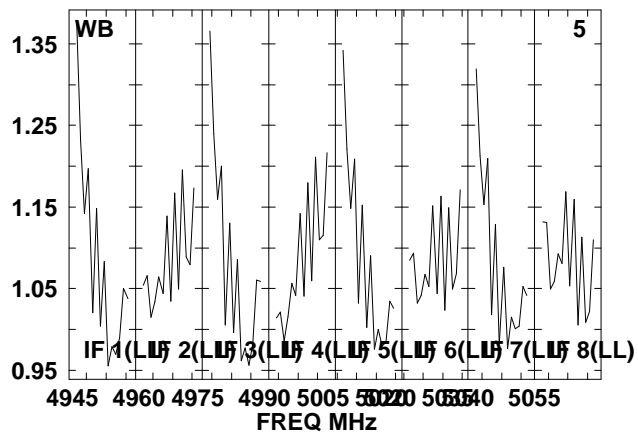
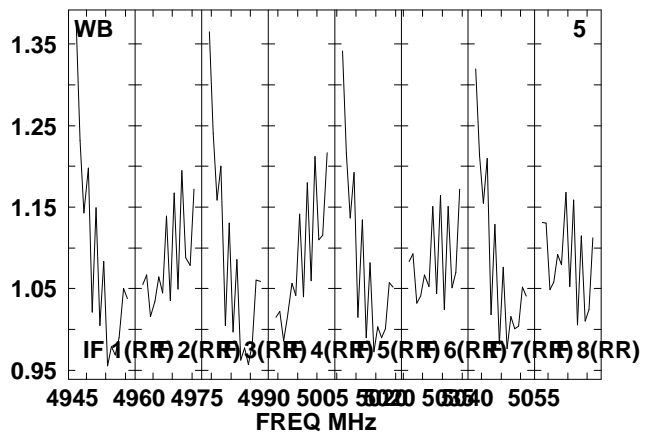
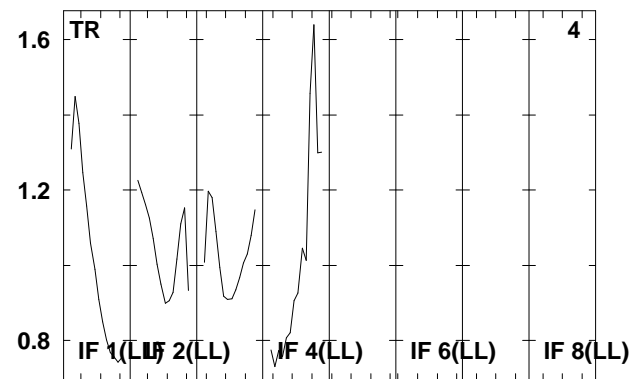
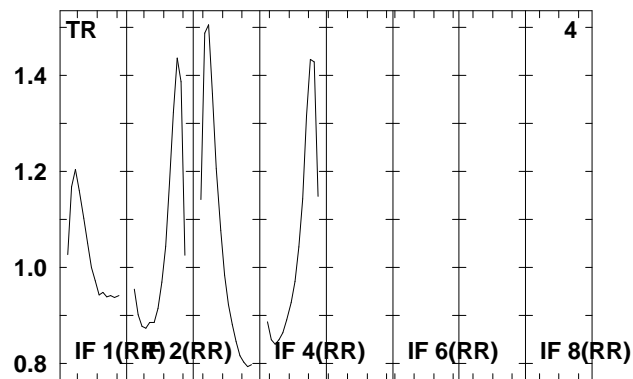
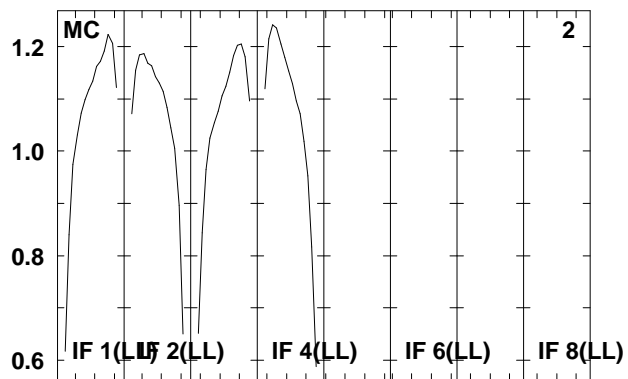
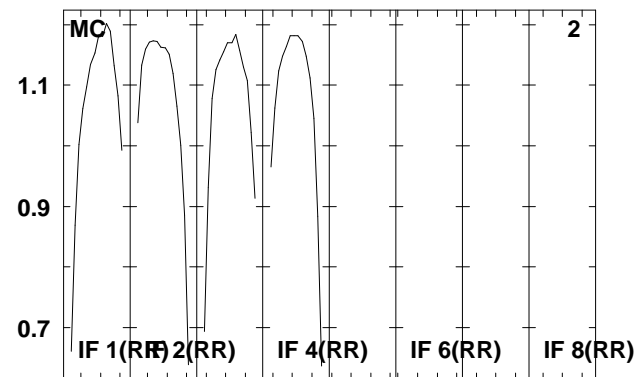
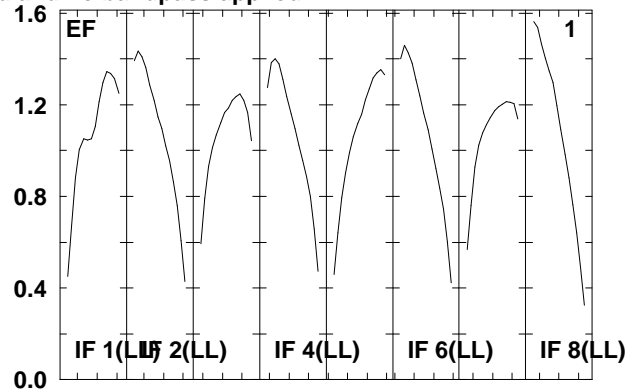
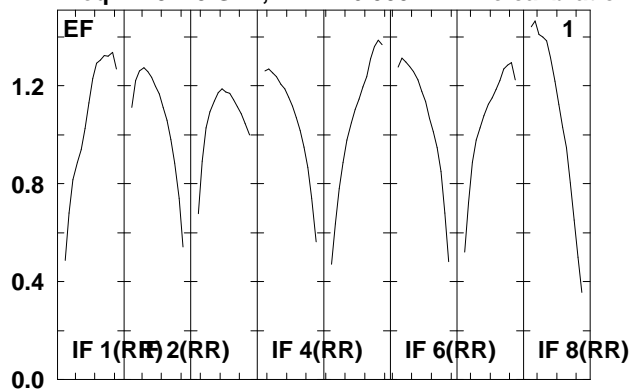

Lower frame: Real Jy  
Total-power spectrum Antenna: \*  
Timerange: 00/14:25:43 to 00/14:27:59

Plot file version 112 created 07-DEC-2009 16:05:58

SS433 RT006C.UVDATA.1

Freq = 4.9415 GHz, Bw = 16.000 MH No calibration applied and no bandpass applied

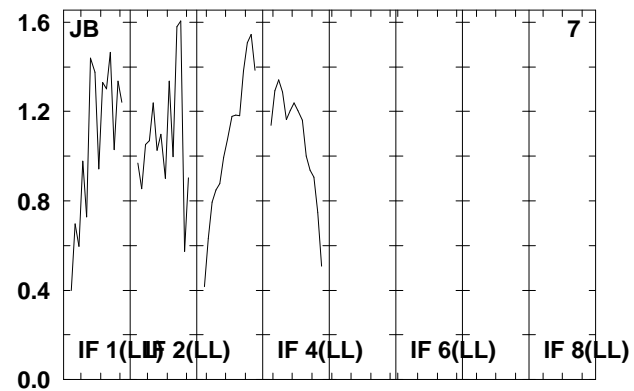
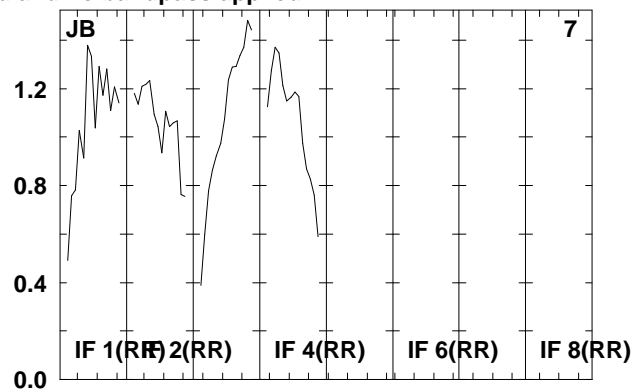
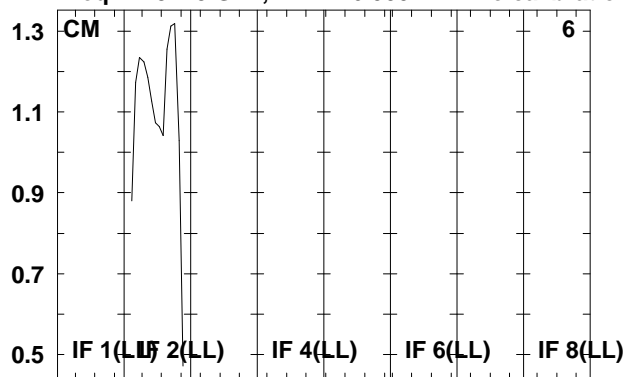

Lower frame: Real Jy  
Total-power spectrum Antenna: \*  
Timerange: 00/14:25:43 to 00/14:27:59



Plot file version 113 created 07-DEC-2009 16:05:59

J1912+05 RT006C.UVDATA.1

Freq = 4.9415 GHz, Bw = 16.000 MH No calibration applied and no bandpass applied

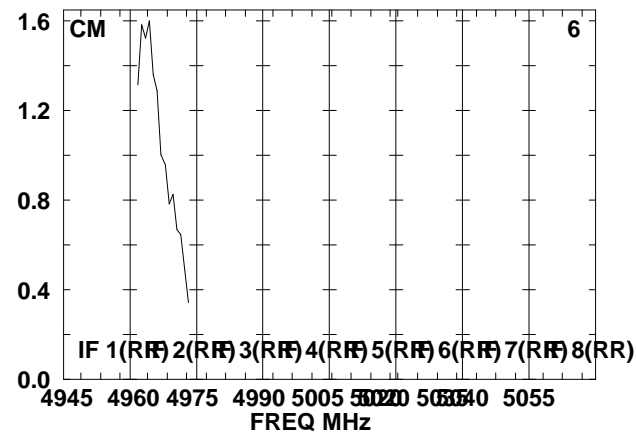
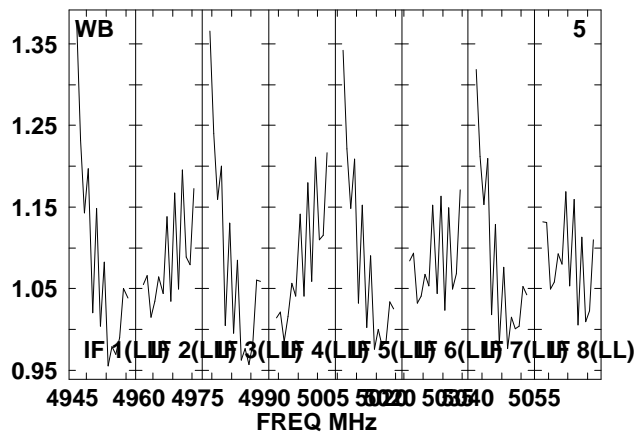
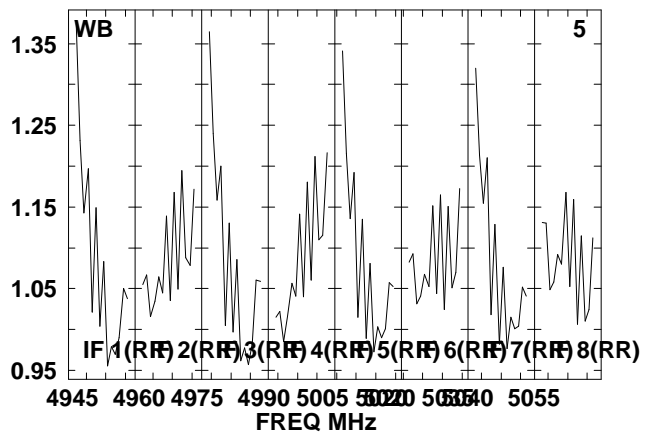
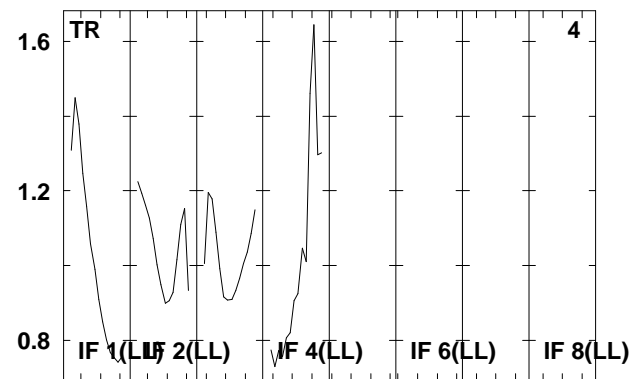
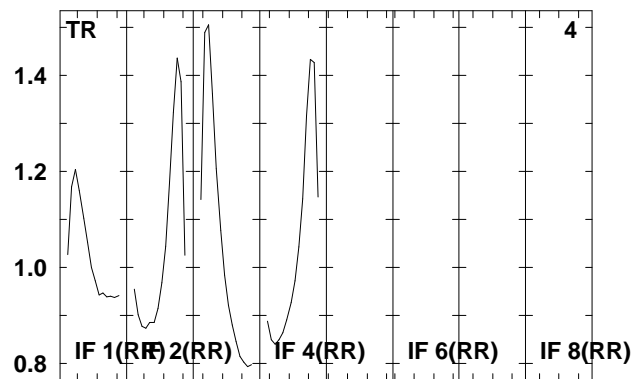
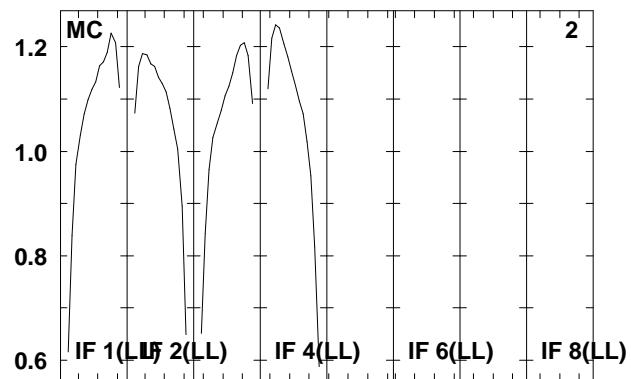
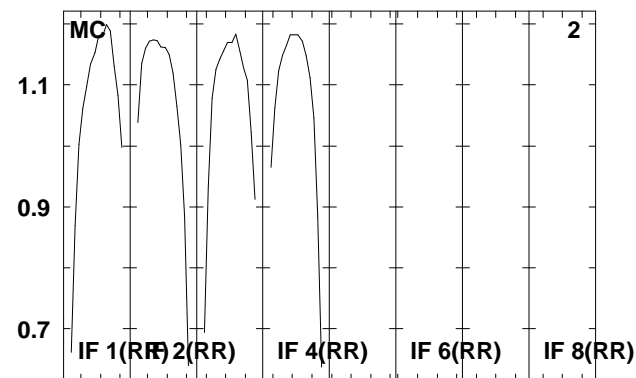
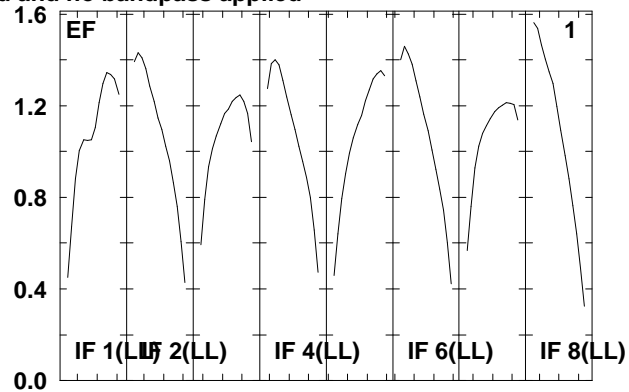
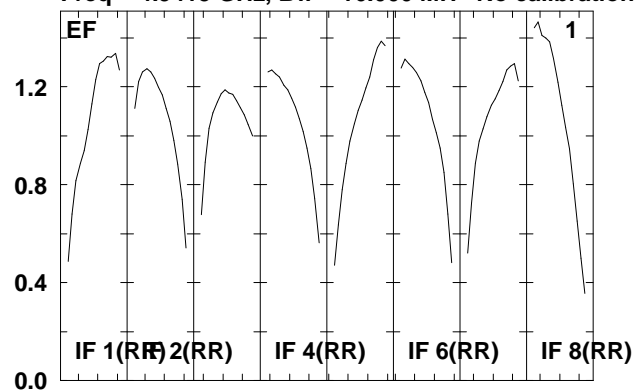

Lower frame: Real Jy  
Total-power spectrum Antenna: \*  
Timerange: 00/14:28:03 to 00/14:29:19

Plot file version 114 created 07-DEC-2009 16:05:59

J1912+05 RT006C.UVDATA.1

Freq = 4.9415 GHz, Bw = 16.000 MH No calibration applied and no bandpass applied

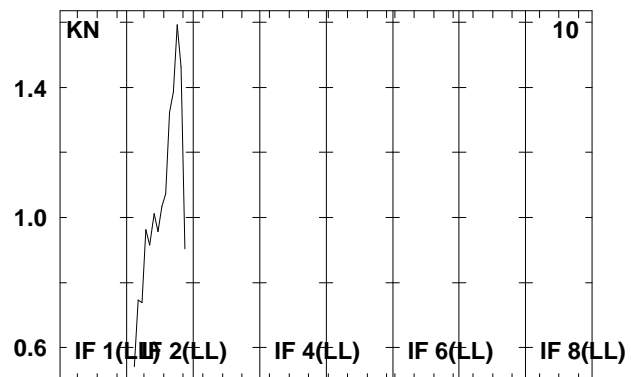
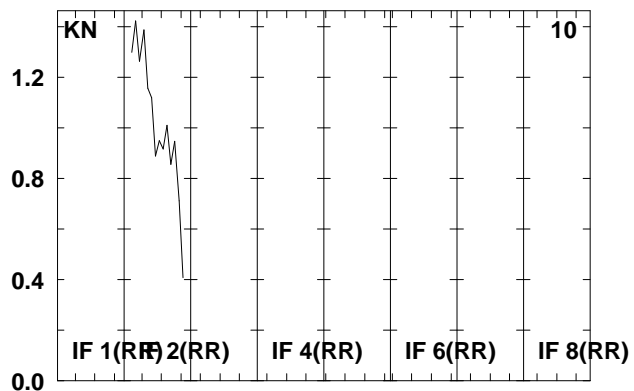
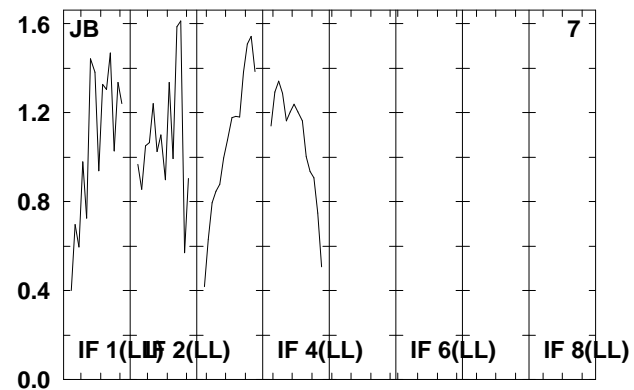
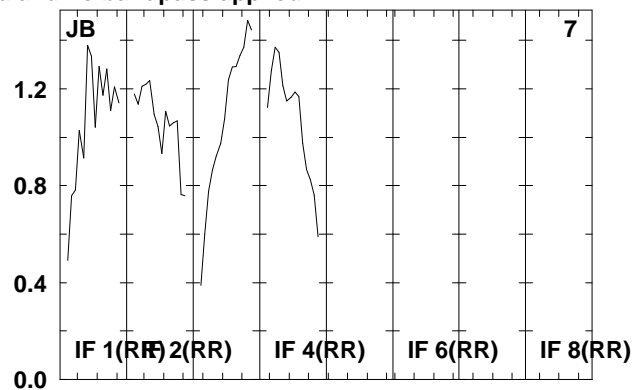
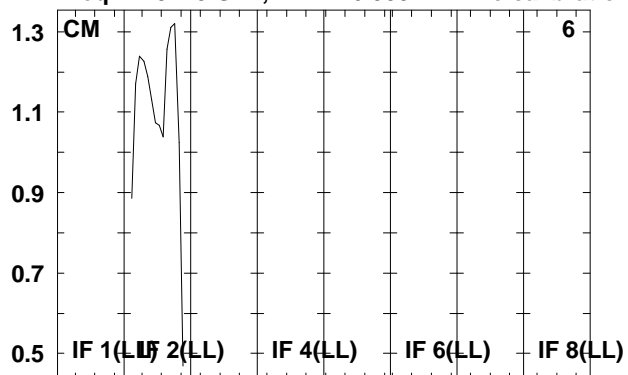

Lower frame: Real Jy  
Total-power spectrum Antenna: \*  
Timerange: 00/14:28:03 to 00/14:29:19

Plot file version 115 created 07-DEC-2009 16:05:59

SS433 RT006C.UVDATA.1

Freq = 4.9415 GHz, Bw = 16.000 MH No calibration applied and no bandpass applied

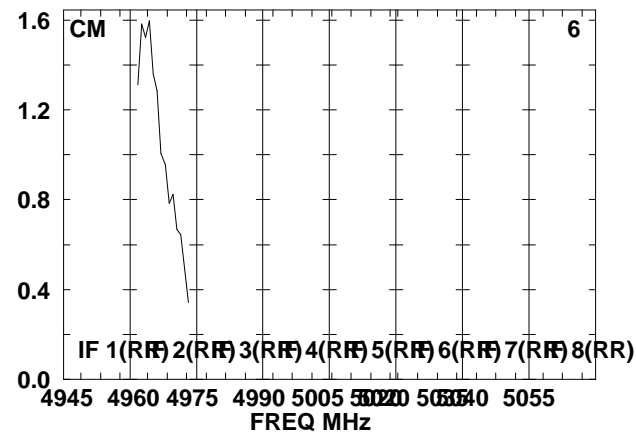
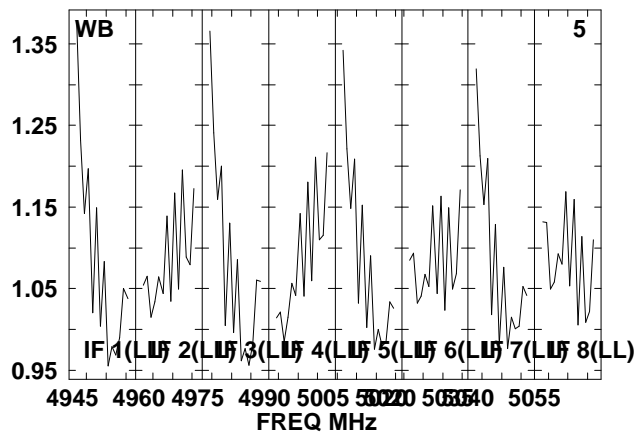
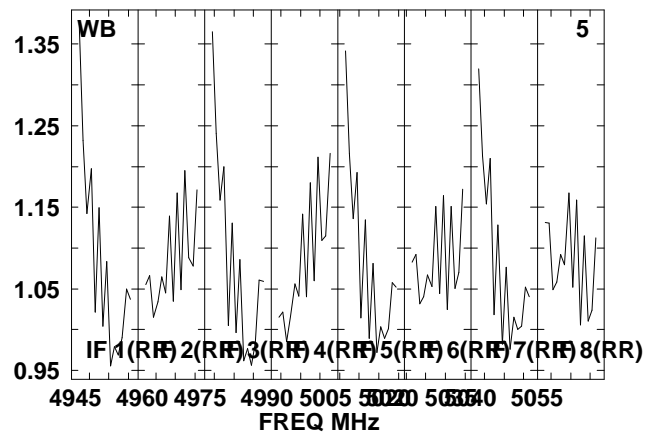
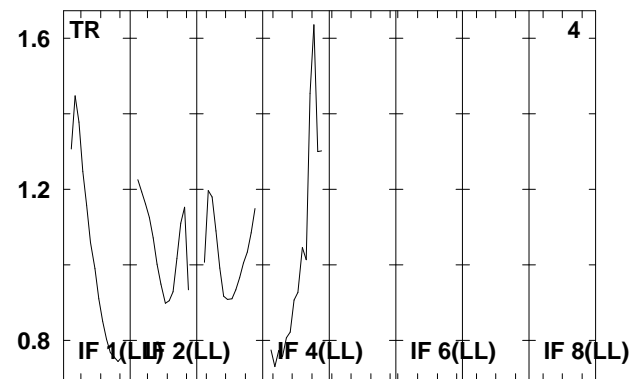
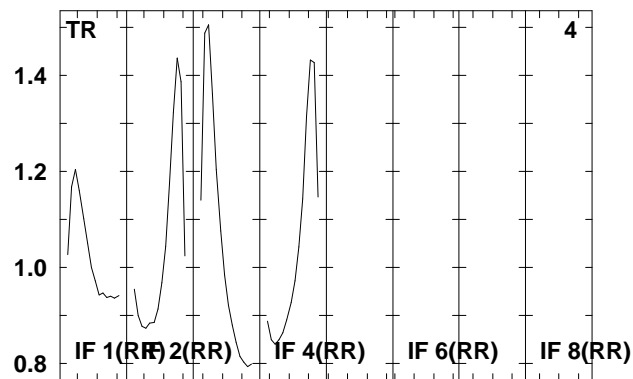
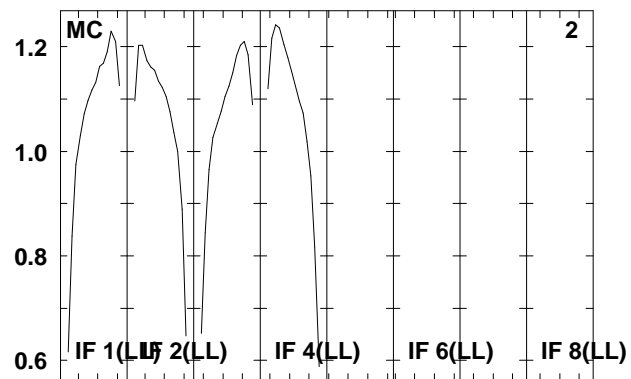
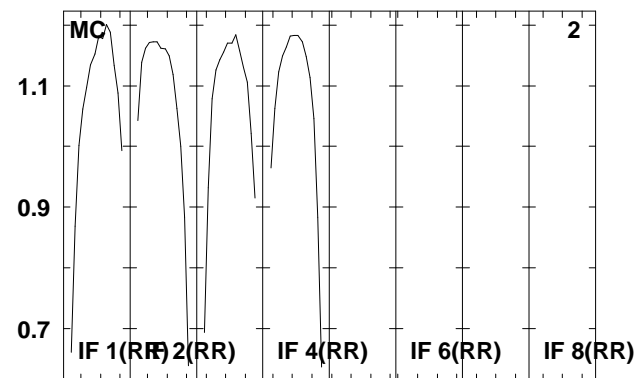
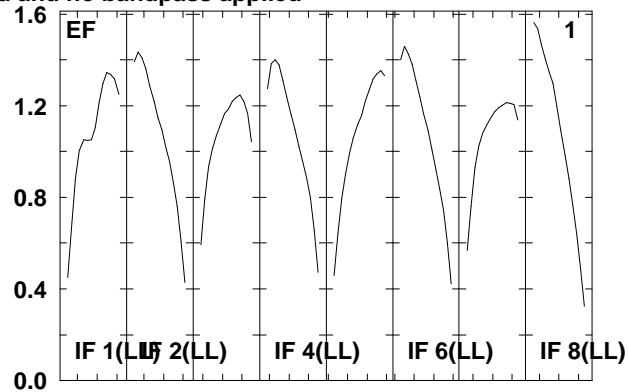
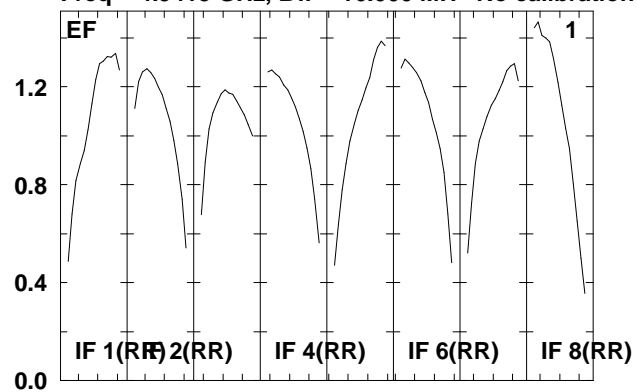

Lower frame: Real Jy  
Total-power spectrum Antenna: \*  
Timerange: 00/14:29:23 to 00/14:31:39

Plot file version 116 created 07-DEC-2009 16:05:59

SS433 RT006C.UVDATA.1

Freq = 4.9415 GHz, Bw = 16.000 MH No calibration applied and no bandpass applied

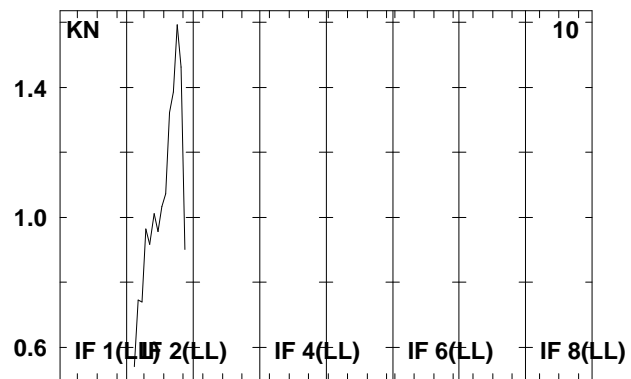
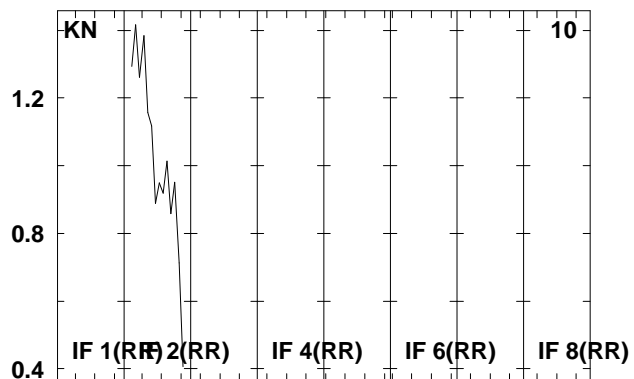
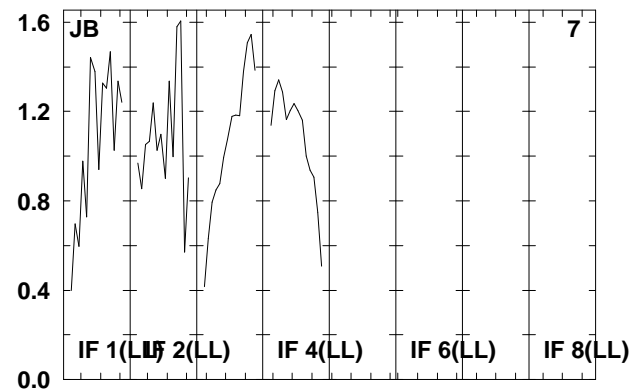
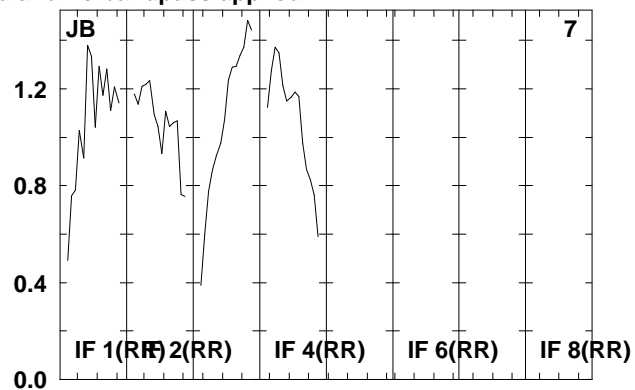
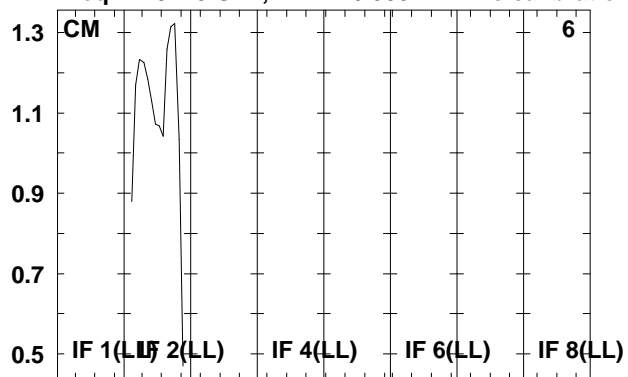

Lower frame: Real Jy  
Total-power spectrum Antenna: \*  
Timerange: 00/14:29:23 to 00/14:31:39

Plot file version 117 created 07-DEC-2009 16:05:59

J1912+05 RT006C.UVDATA.1

Freq = 4.9415 GHz, Bw = 16.000 MH No calibration applied and no bandpass applied

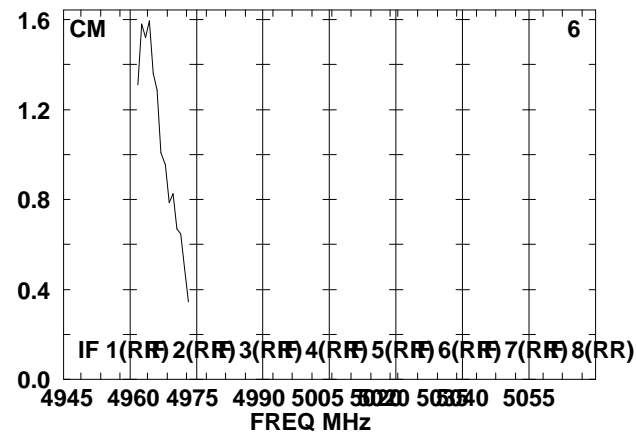
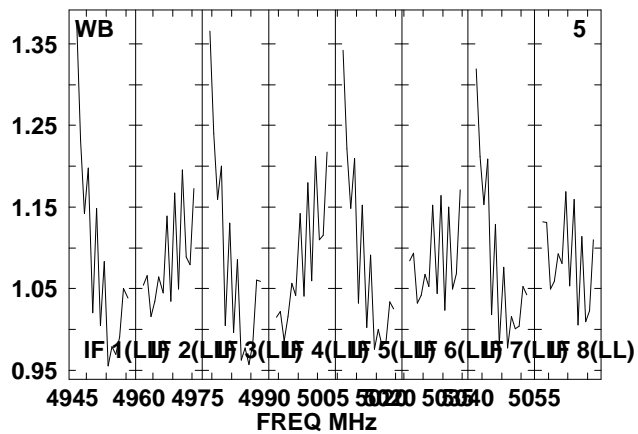
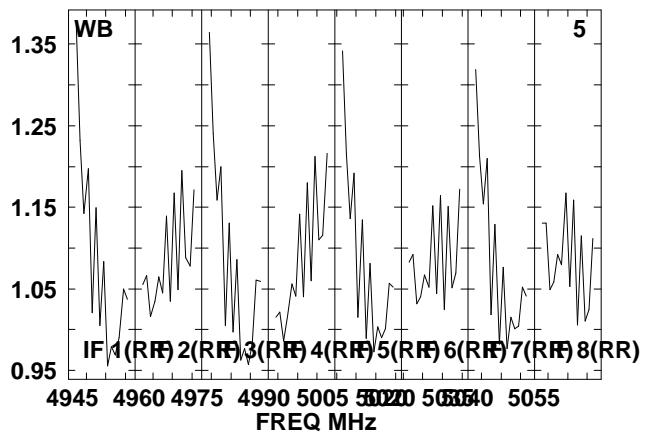
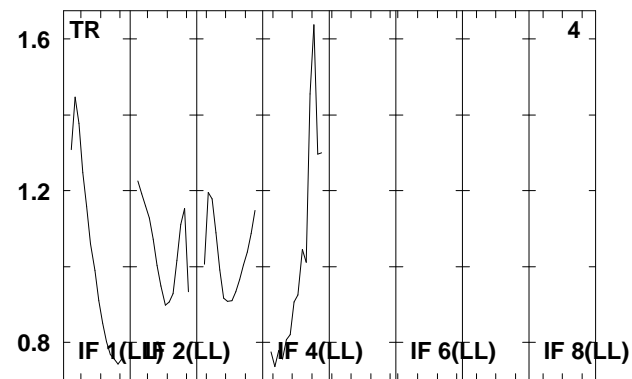
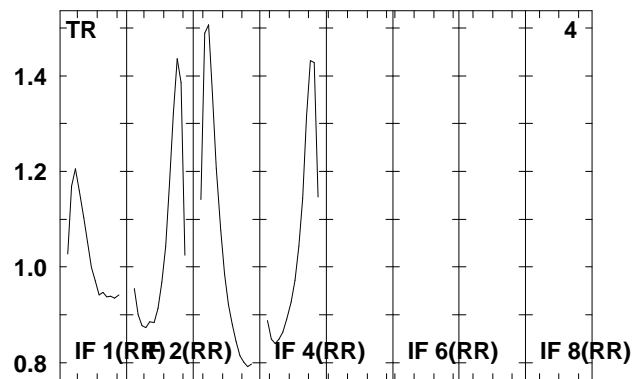
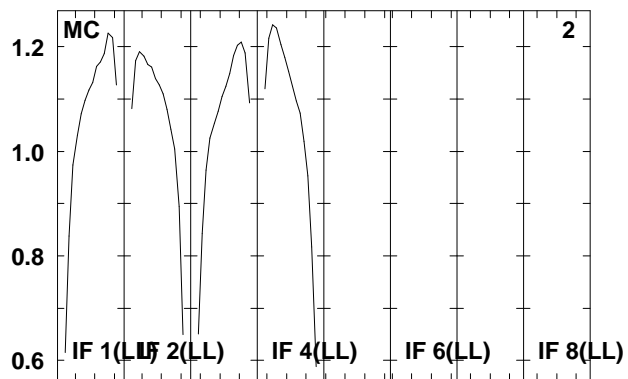
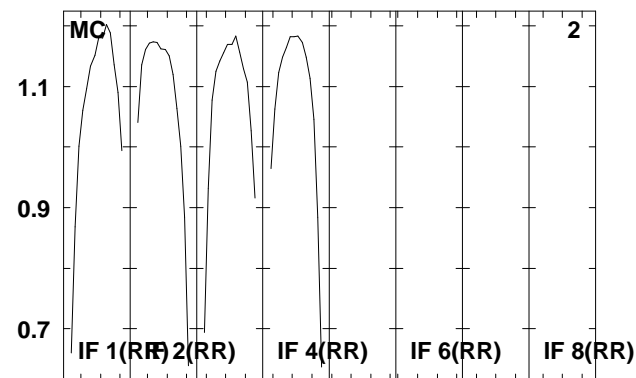
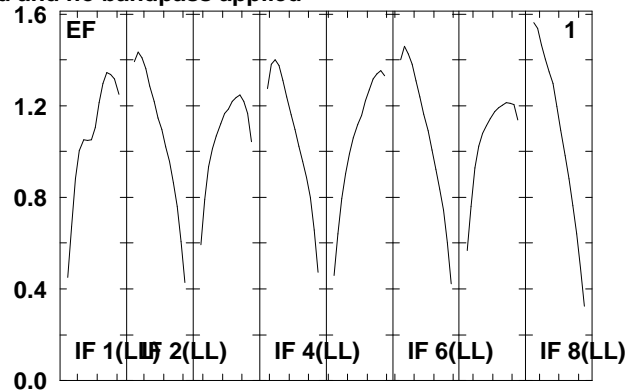
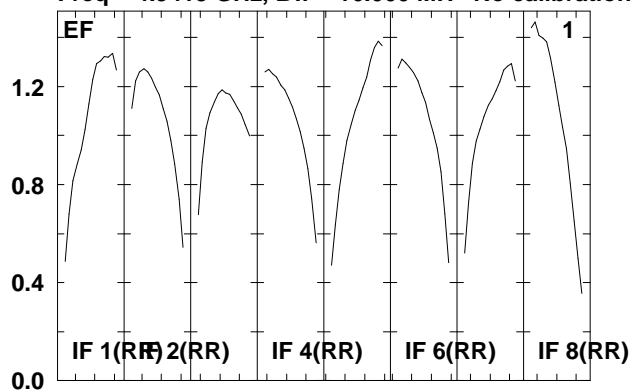

Lower frame: Real Jy  
Total-power spectrum Antenna: \*  
Timerange: 00/14:31:43 to 00/14:32:59

Plot file version 118 created 07-DEC-2009 16:05:59

J1912+05 RT006C.UVDATA.1

Freq = 4.9415 GHz, Bw = 16.000 MH No calibration applied and no bandpass applied

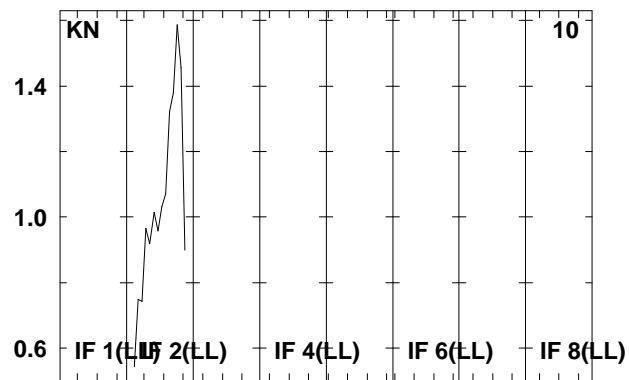
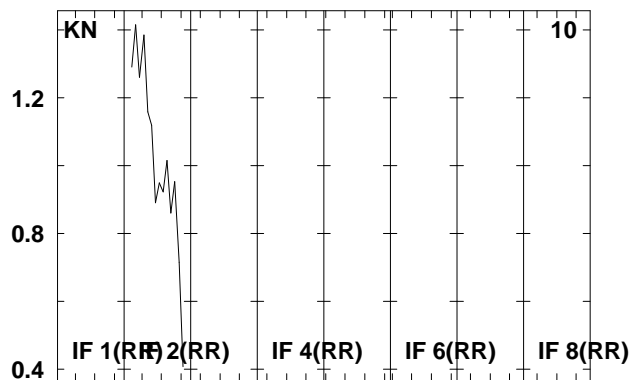
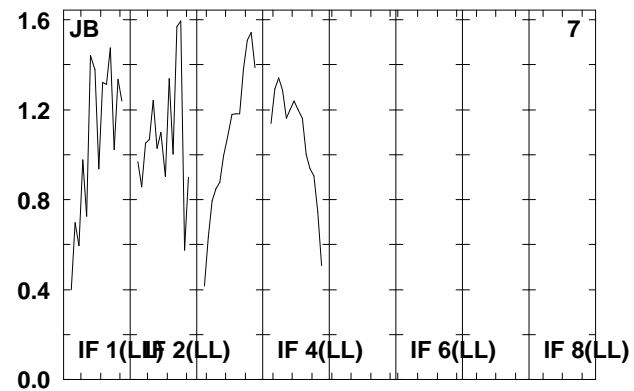
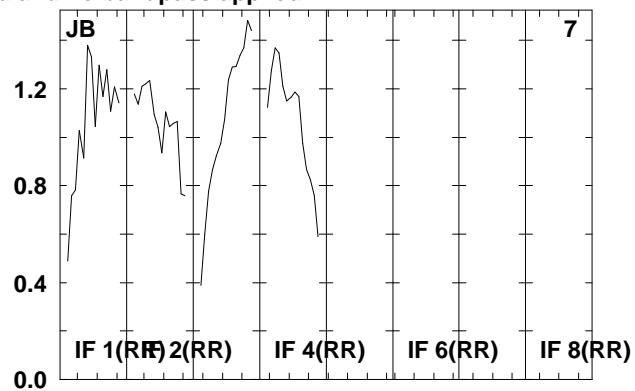
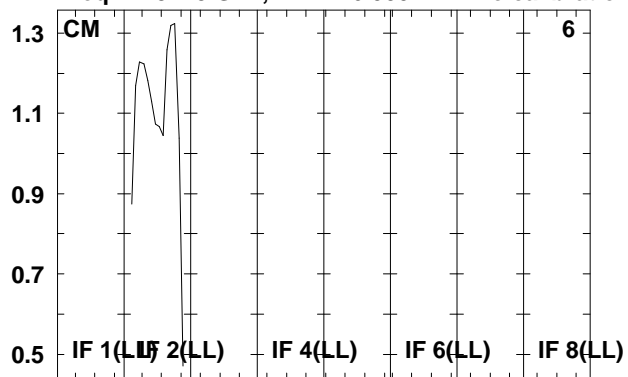

Lower frame: Real Jy  
Total-power spectrum Antenna: \*  
Timerange: 00/14:31:43 to 00/14:32:59

Plot file version 119 created 07-DEC-2009 16:06:00

SS433 RT006C.UVDATA.1

Freq = 4.9415 GHz, Bw = 16.000 MH No calibration applied and no bandpass applied

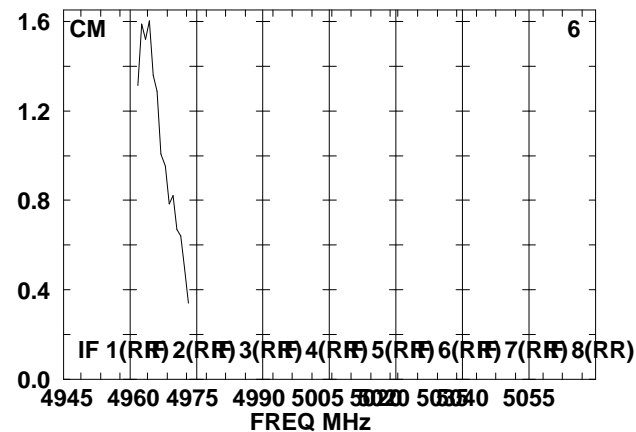
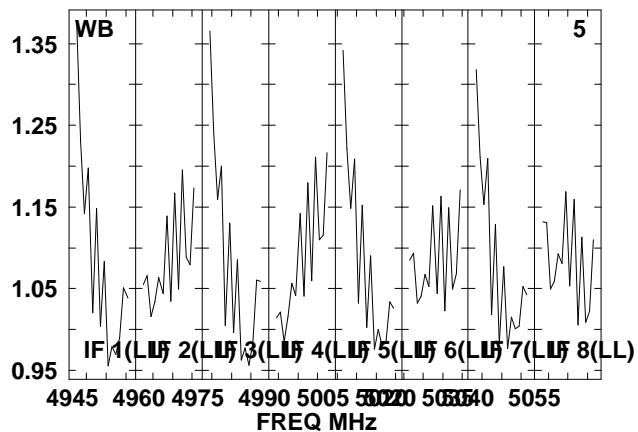
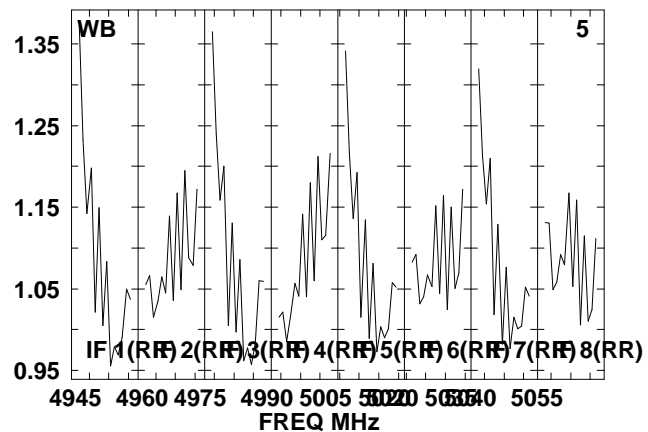
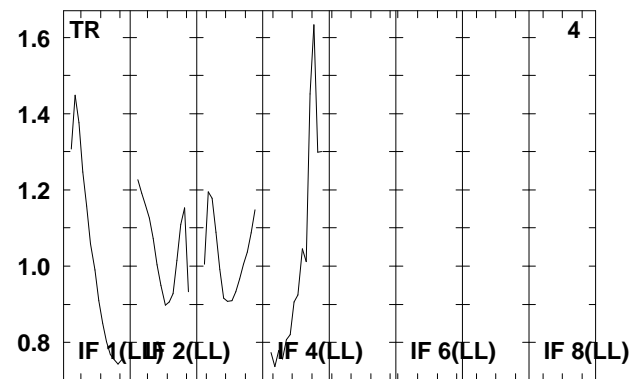
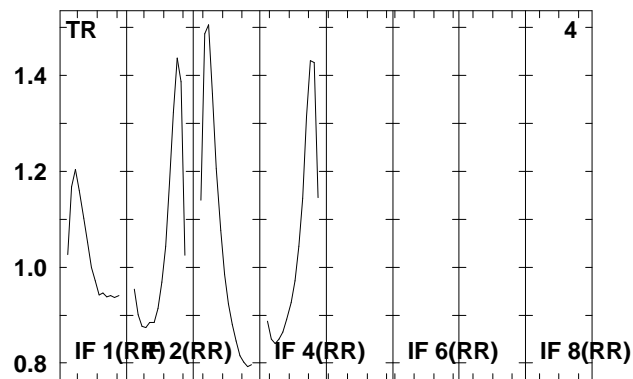
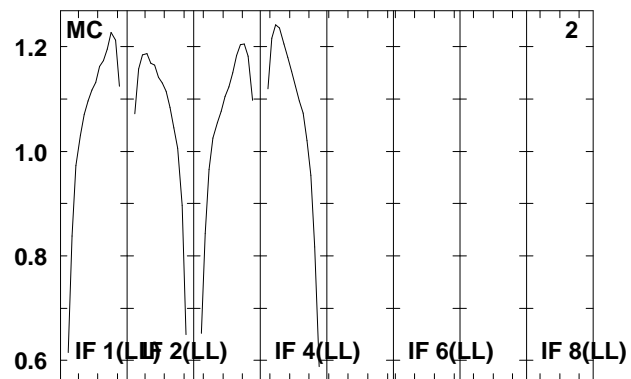
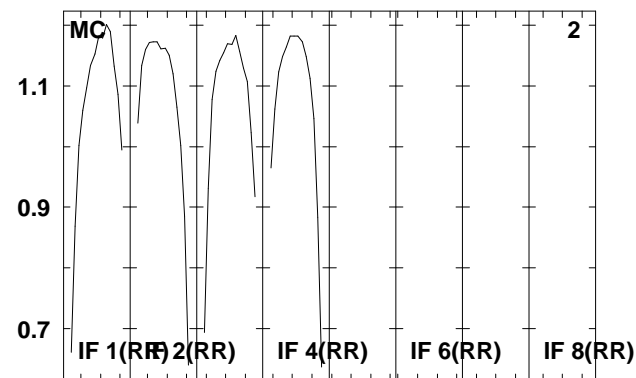
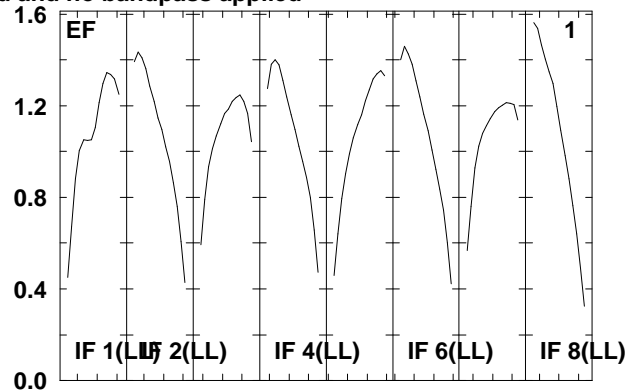
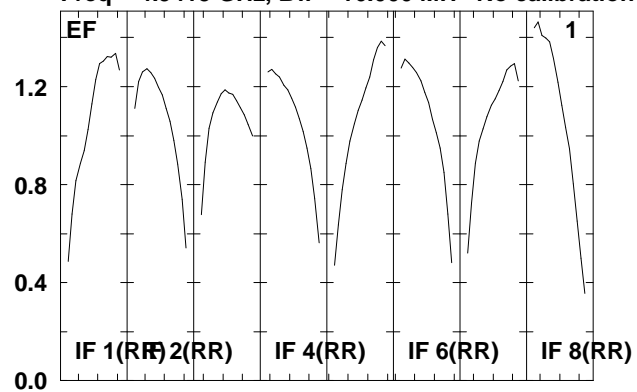

Lower frame: Real Jy

Total-power spectrum Antenna: \*

Timerange: 00/14:33:03 to 00/14:35:19

Plot file version 120 created 07-DEC-2009 16:06:00

SS433 RT006C.UVDATA.1

Freq = 4.9415 GHz, Bw = 16.000 MH No calibration applied and no bandpass applied

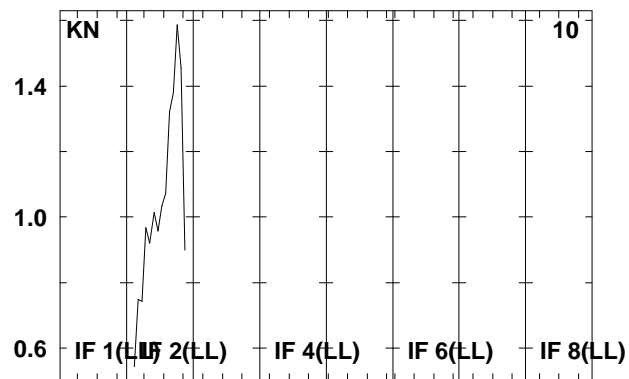
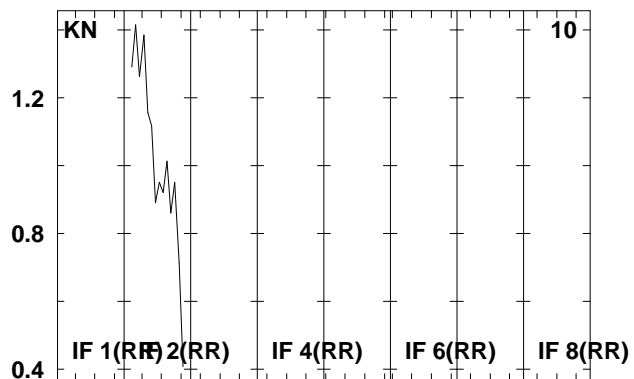
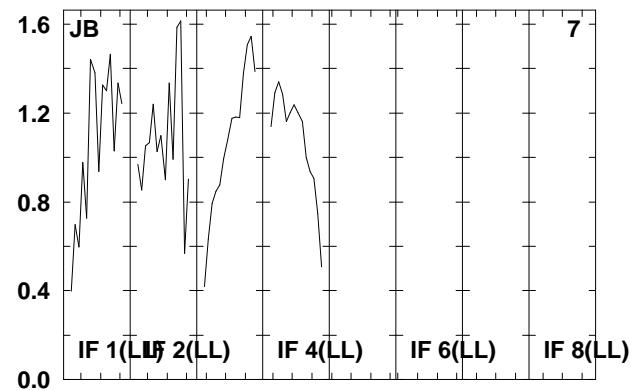
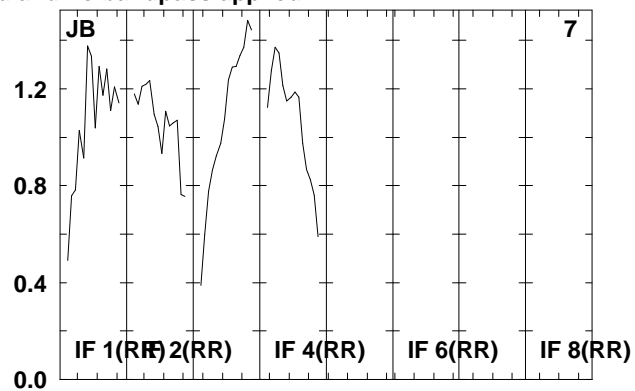
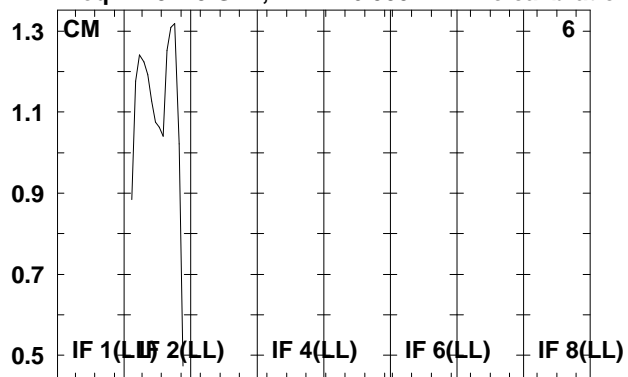

Lower frame: Real Jy  
Total-power spectrum Antenna: \*  
Timerange: 00/14:33:03 to 00/14:35:19



Plot file version 121 created 07-DEC-2009 16:06:00

J1912+05 RT006C.UVDATA.1

Freq = 4.9415 GHz, Bw = 16.000 MH No calibration applied and no bandpass applied

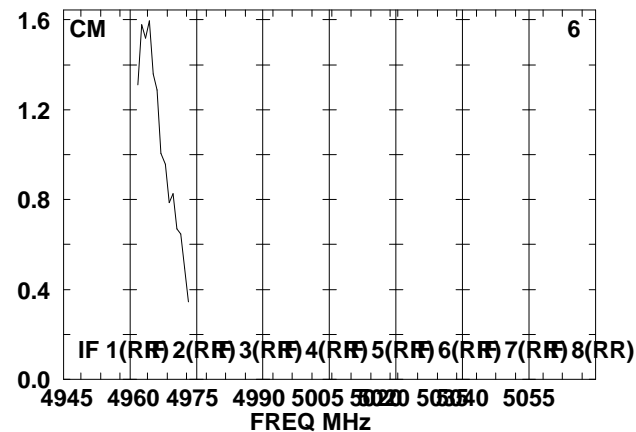
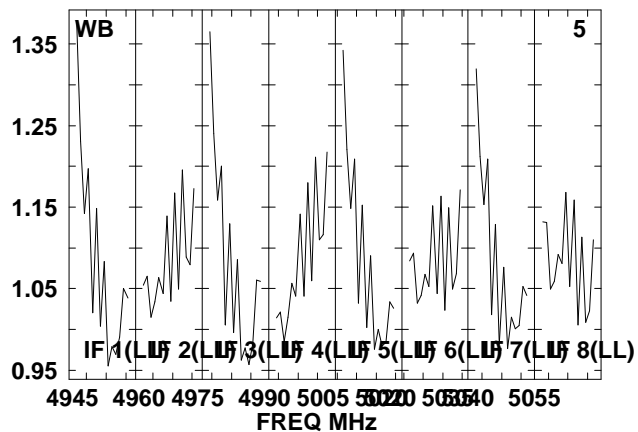
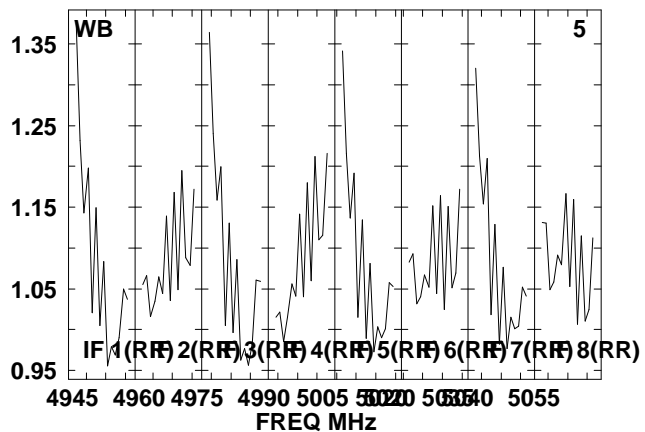
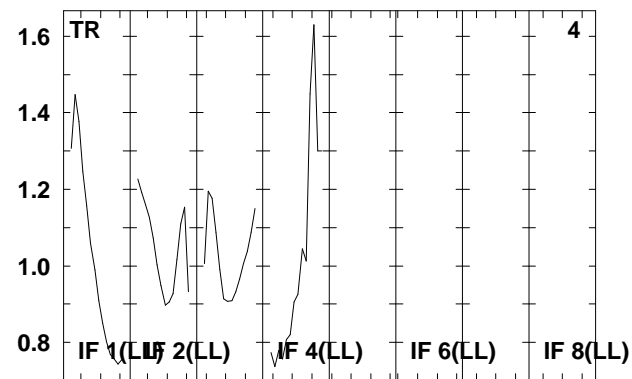
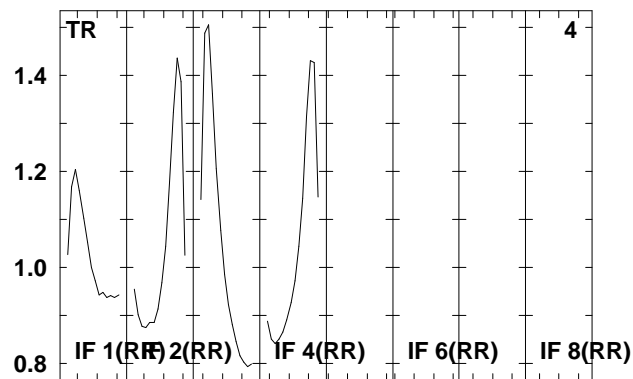
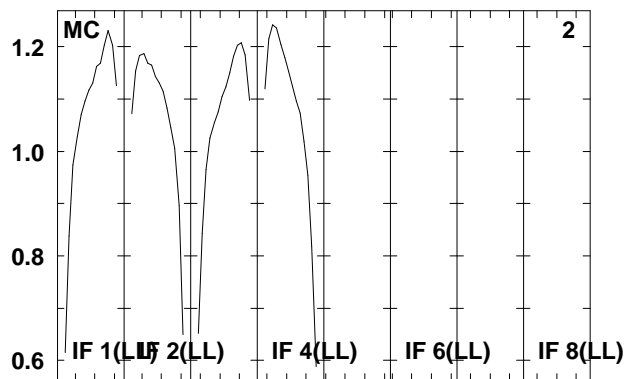
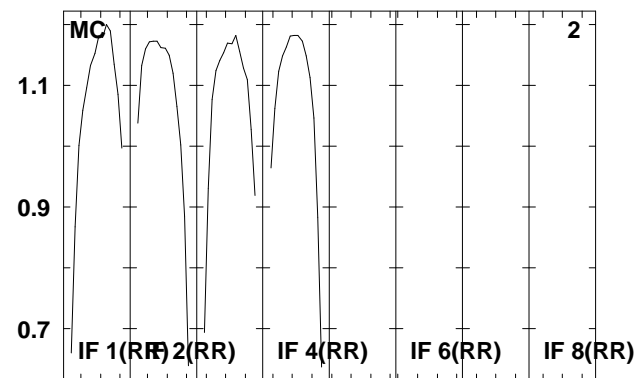
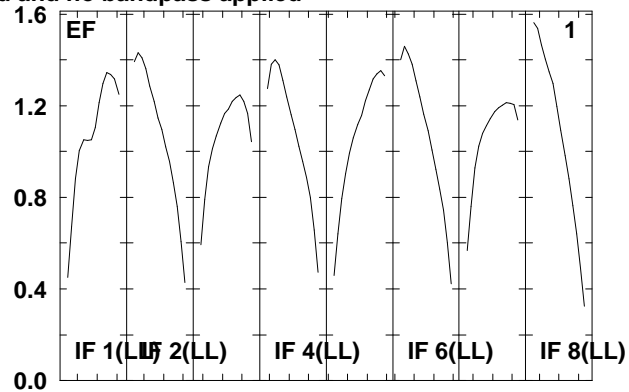
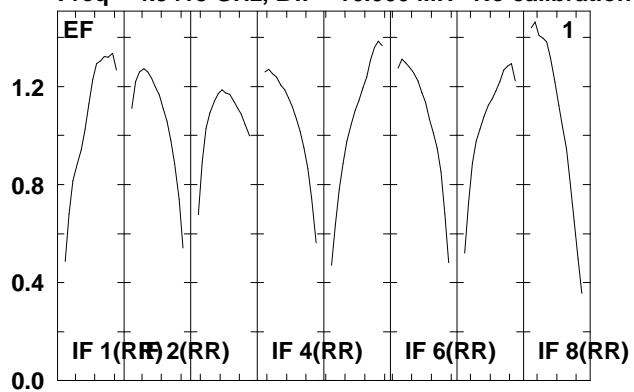

Lower frame: Real Jy

Total-power spectrum Antenna: \*

Timerange: 00/14:35:23 to 00/14:36:39

Plot file version 122 created 07-DEC-2009 16:06:00

J1912+05 RT006C.UVDATA.1

Freq = 4.9415 GHz, Bw = 16.000 MH No calibration applied and no bandpass applied

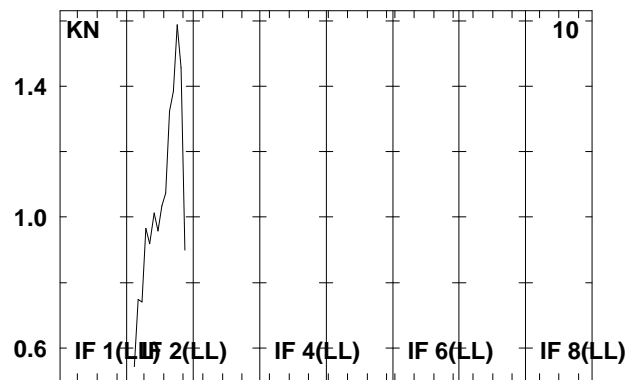
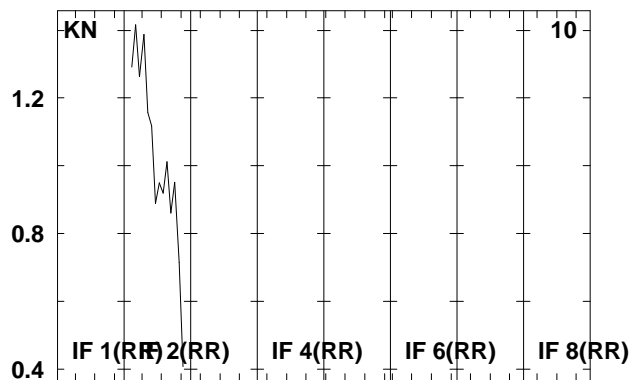
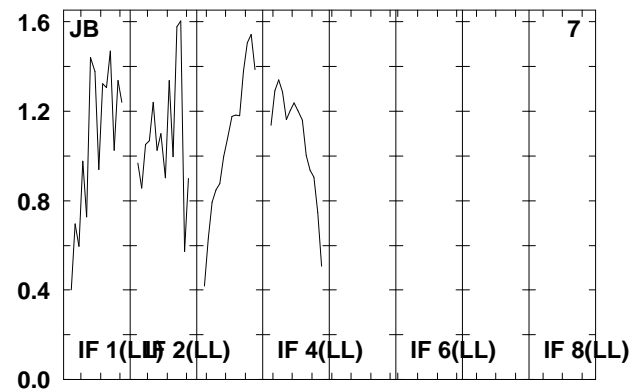
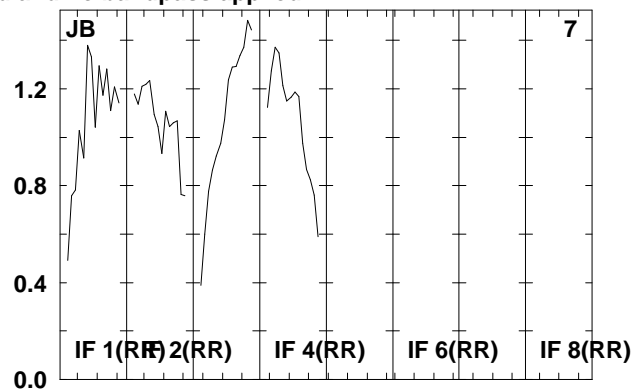
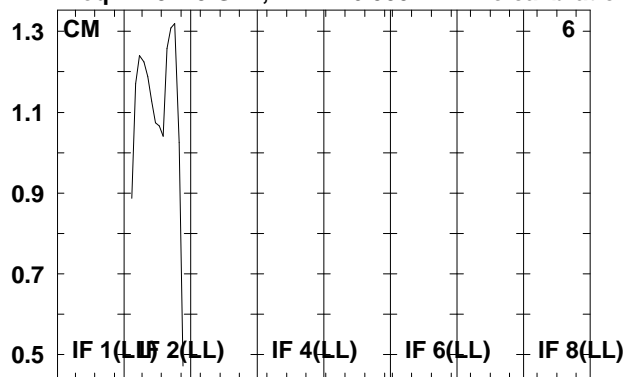

Lower frame: Real Jy  
Total-power spectrum Antenna: \*  
Timerange: 00/14:35:23 to 00/14:36:39

Plot file version 123 created 07-DEC-2009 16:06:00

SS433 RT006C.UVDATA.1

Freq = 4.9415 GHz, Bw = 16.000 MH No calibration applied and no bandpass applied

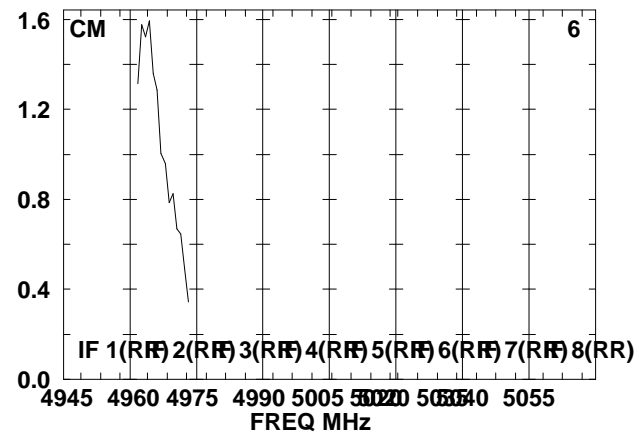
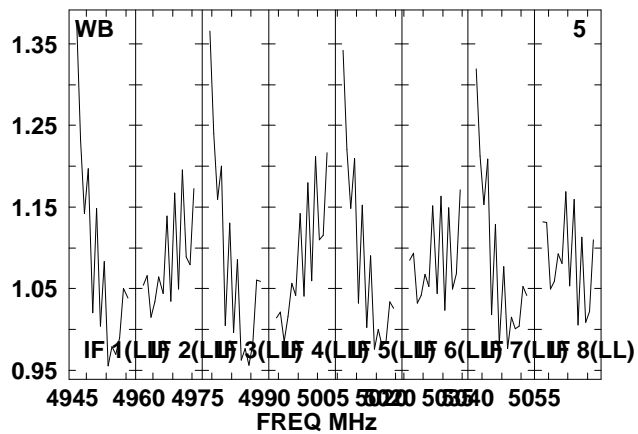
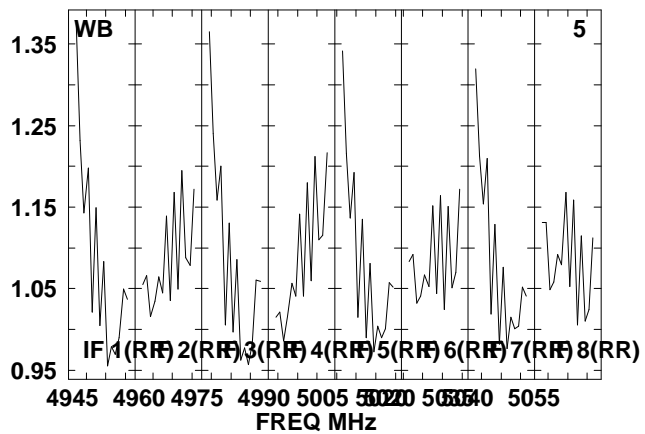
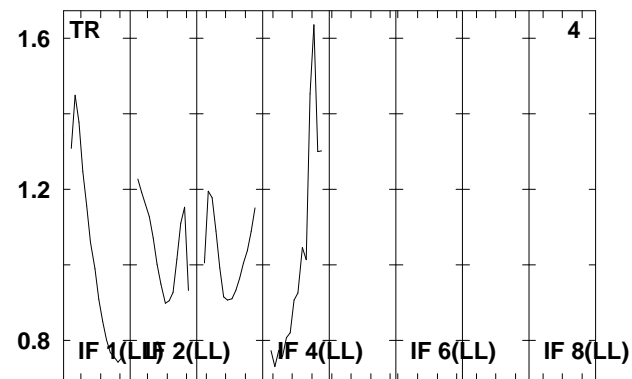
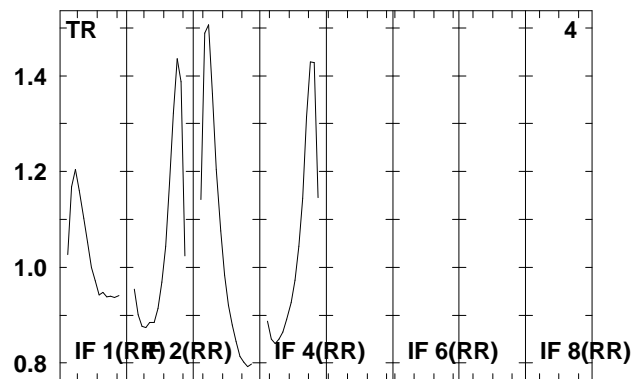
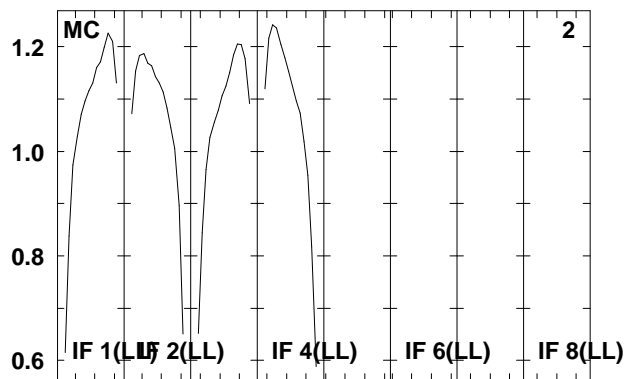
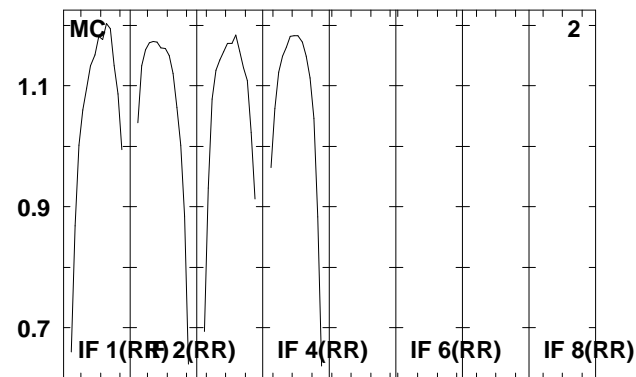
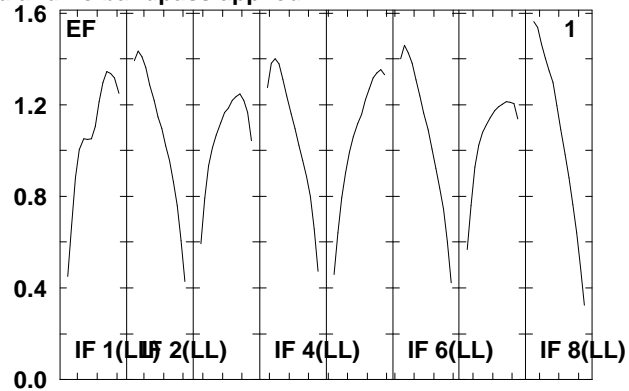
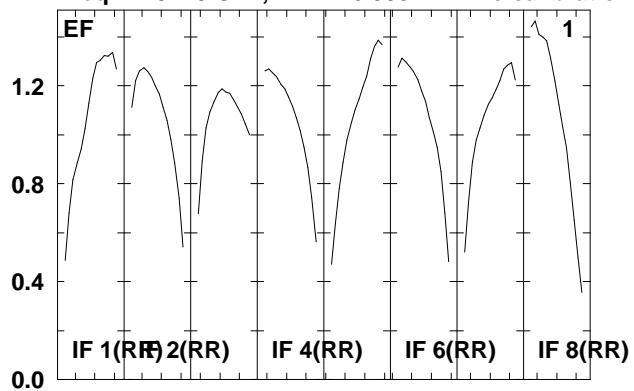

Lower frame: Real Jy  
Total-power spectrum Antenna: \*  
Timerange: 00/14:36:43 to 00/14:38:59

Plot file version 124 created 07-DEC-2009 16:06:01

SS433 RT006C.UVDATA.1

Freq = 4.9415 GHz, Bw = 16.000 MH No calibration applied and no bandpass applied

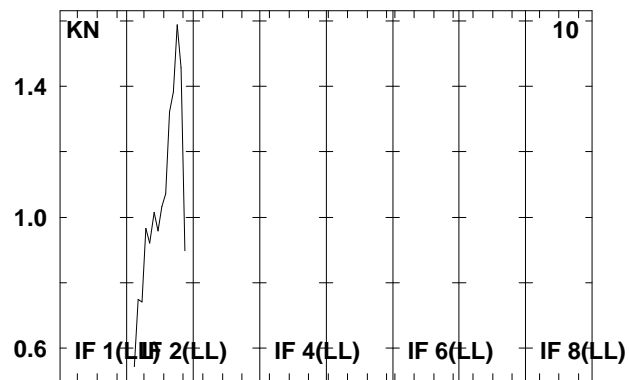
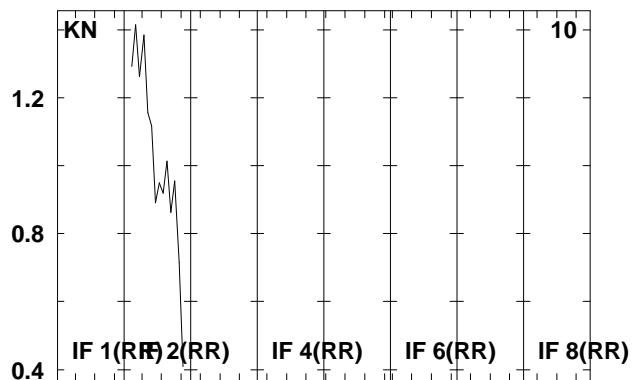
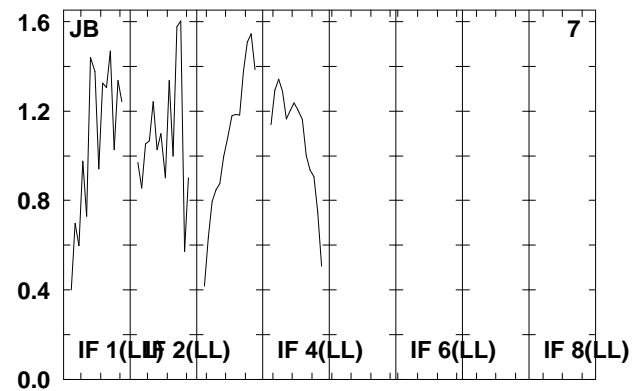
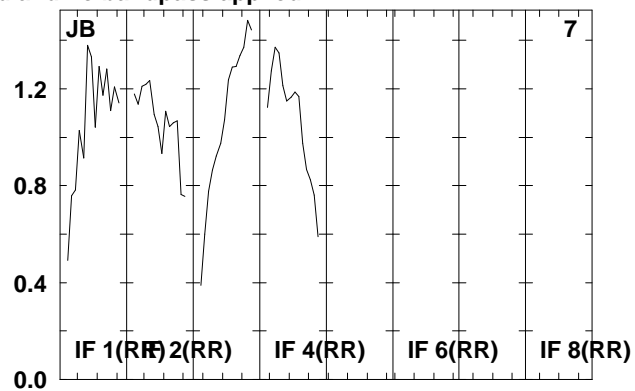
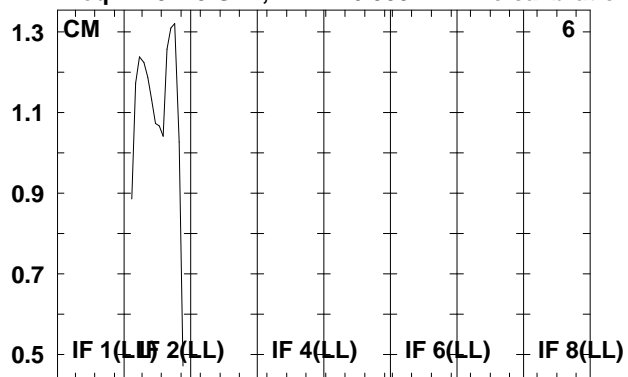

Lower frame: Real Jy  
Total-power spectrum Antenna: \*  
Timerange: 00/14:36:43 to 00/14:38:59

Plot file version 125 created 07-DEC-2009 16:06:01

J1911+16 RT006C.UVDATA.1

Freq = 4.9415 GHz, Bw = 16.000 MH No calibration applied and no bandpass applied

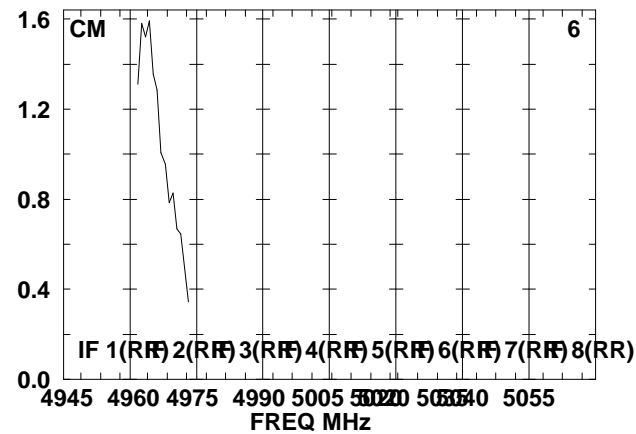
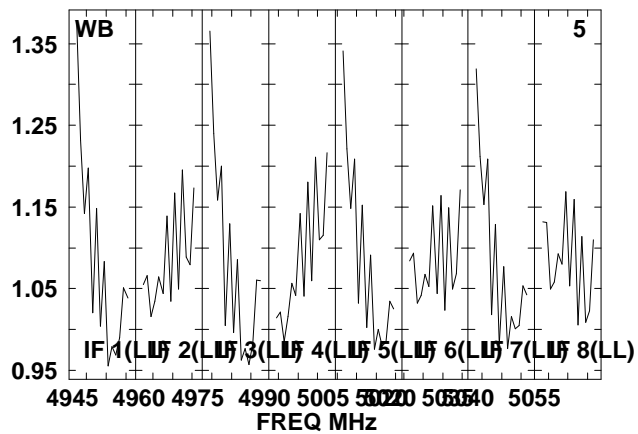
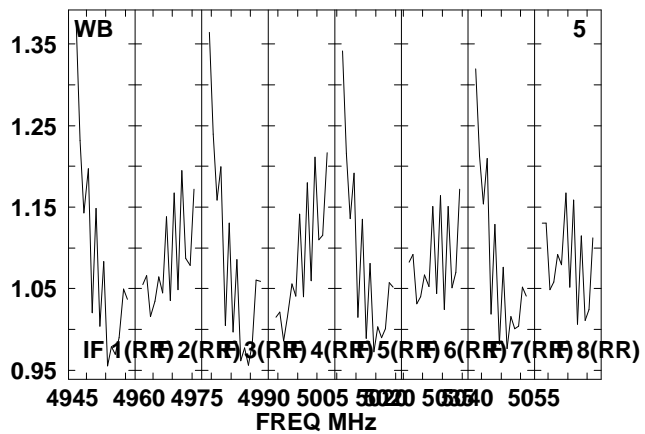
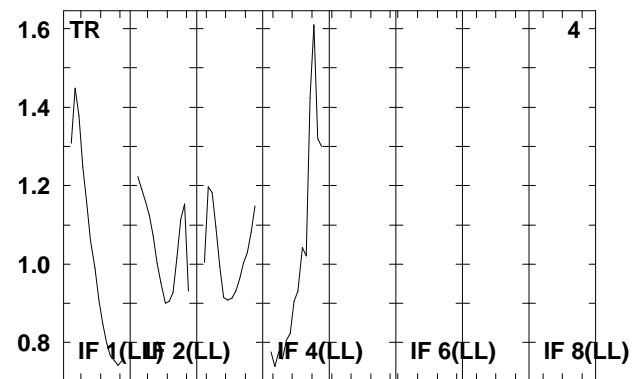
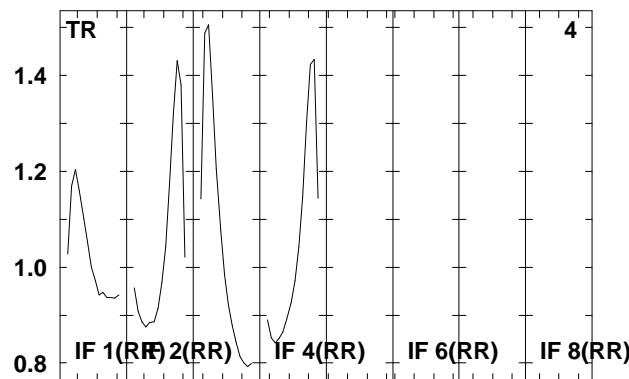
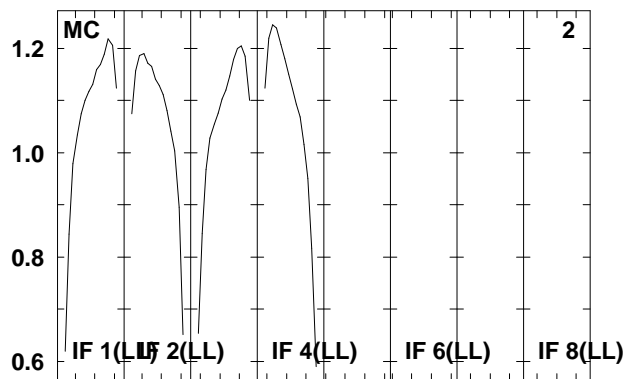
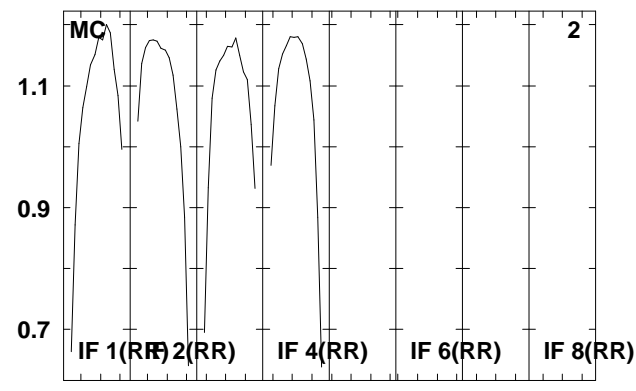
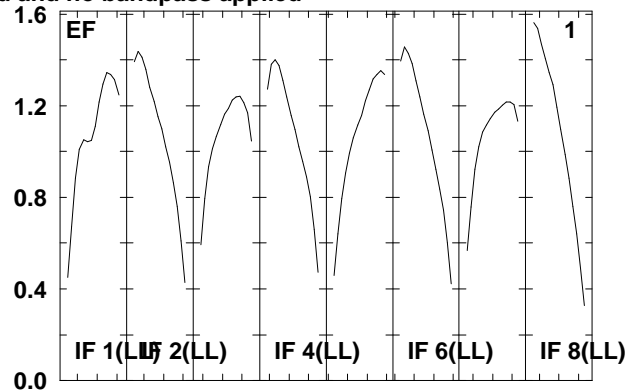
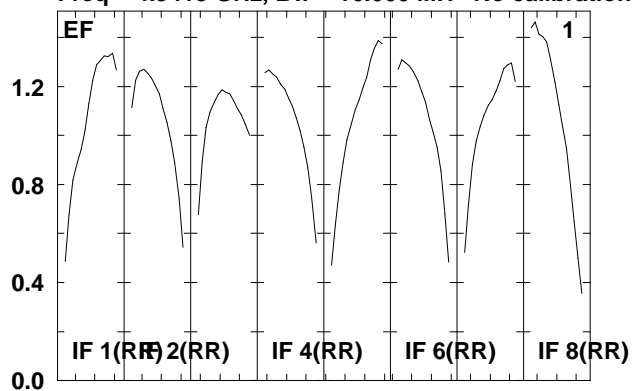

Lower frame: Real Jy  
Total-power spectrum Antenna: \*  
Timerange: 00/14:40:03 to 00/14:40:59

Plot file version 126 created 07-DEC-2009 16:06:01

J1911+16 RT006C.UVDATA.1

Freq = 4.9415 GHz, Bw = 16.000 MH No calibration applied and no bandpass applied

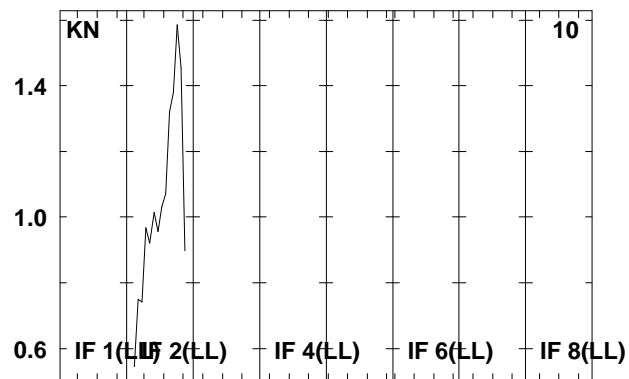
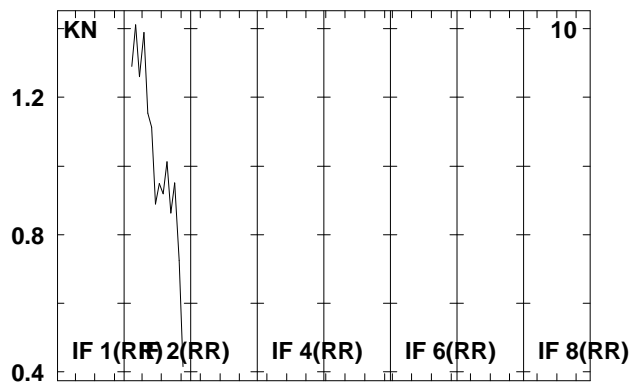
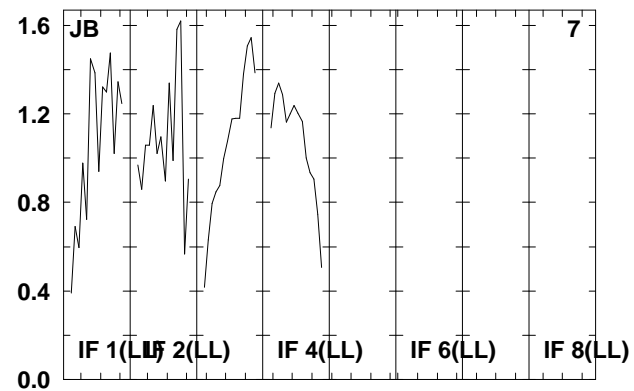
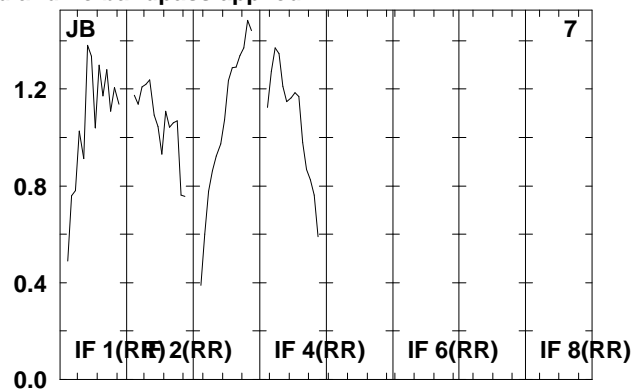
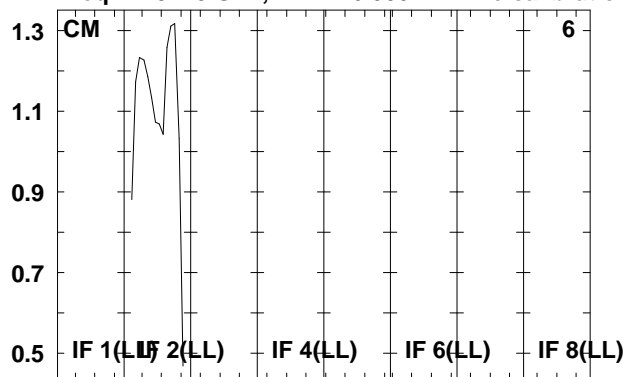

Lower frame: Real Jy  
Total-power spectrum Antenna: \*  
Timerange: 00/14:40:03 to 00/14:40:59

Plot file version 127 created 07-DEC-2009 16:06:01

OQ208 RT006C.UVDATA.1

Freq = 4.9415 GHz, Bw = 16.000 MH No calibration applied and no bandpass applied

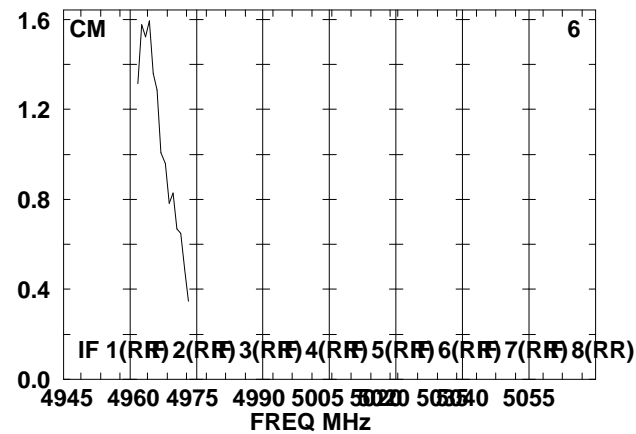
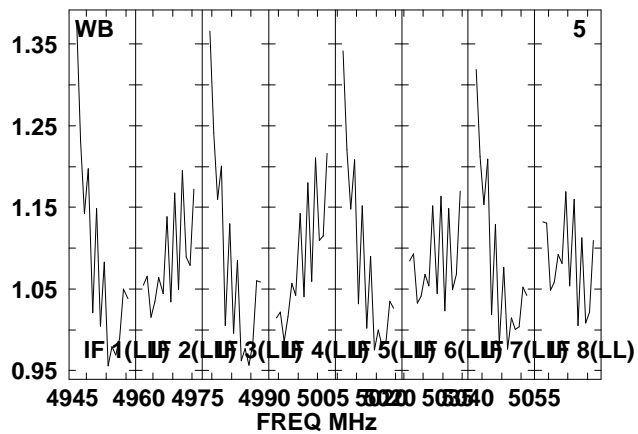
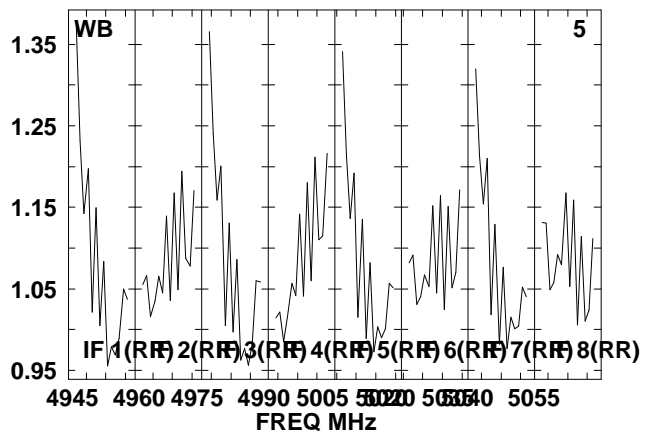
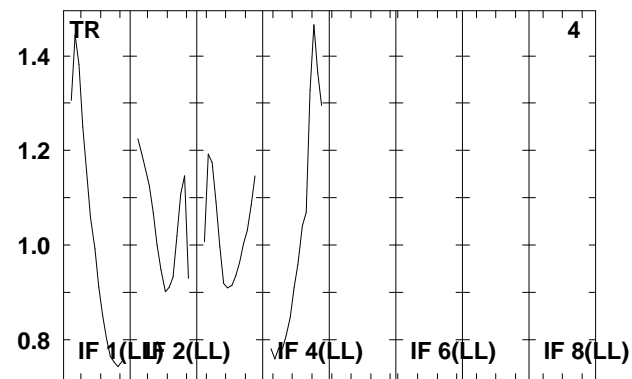
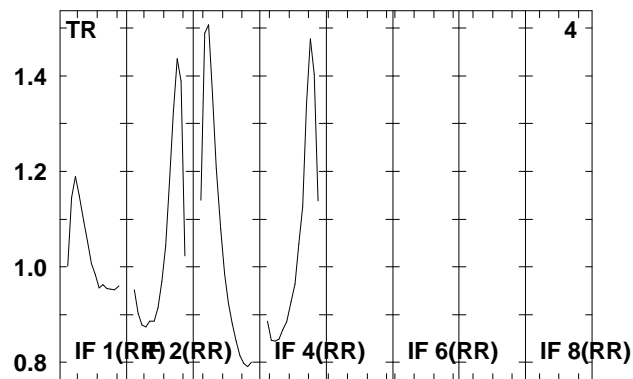
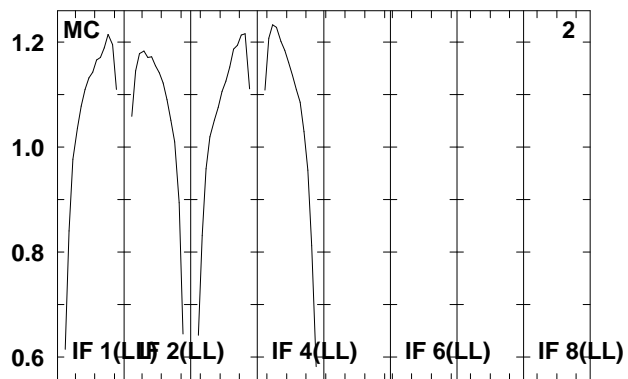
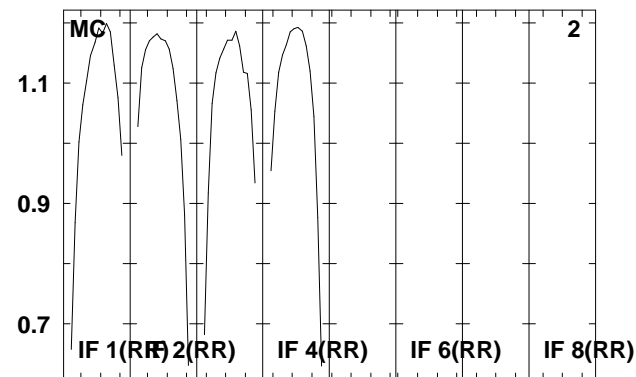
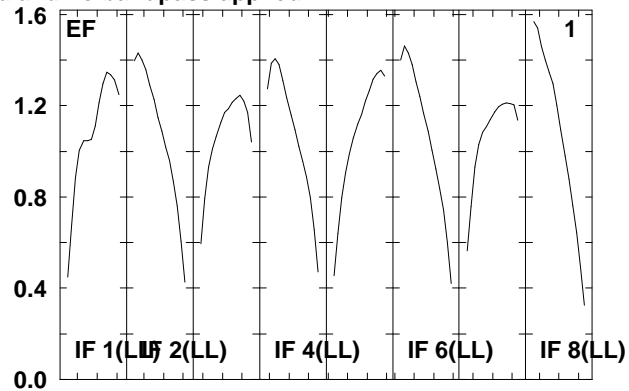
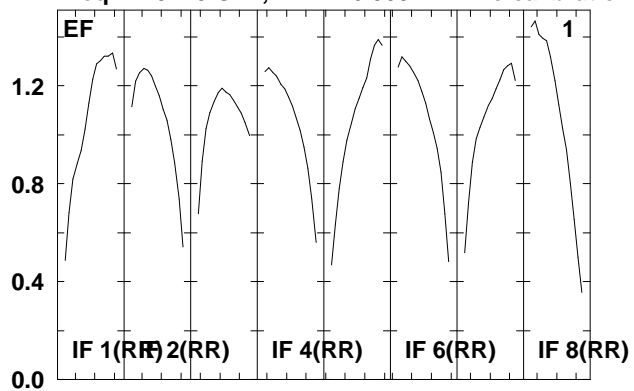

Lower frame: Real Jy  
Total-power spectrum Antenna: \*  
Timerange: 00/14:44:03 to 00/14:50:59

Plot file version 128 created 07-DEC-2009 16:06:02

OQ208 RT006C.UVDATA.1

Freq = 4.9415 GHz, Bw = 16.000 MH No calibration applied and no bandpass applied

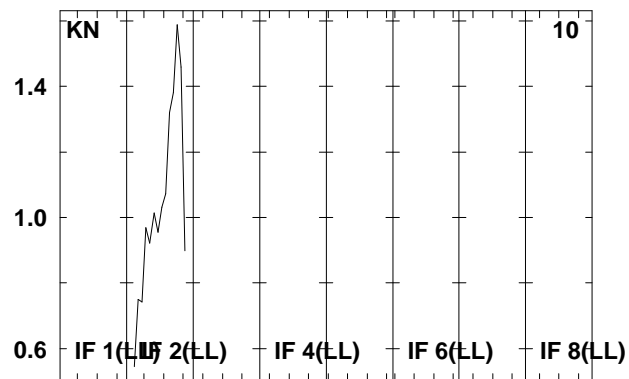
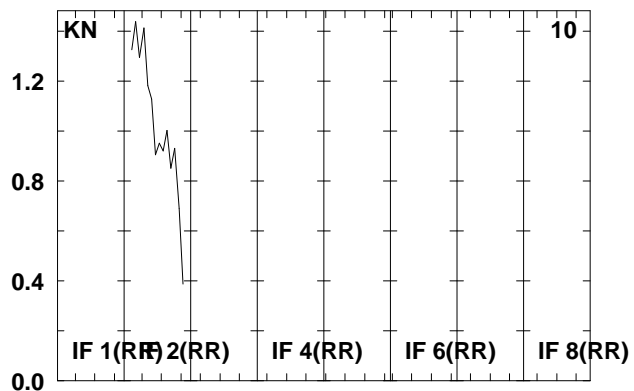
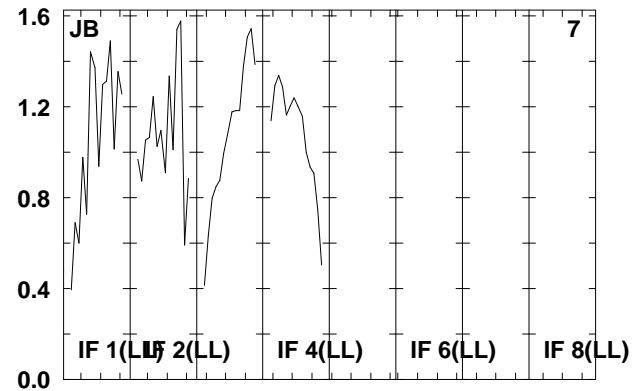
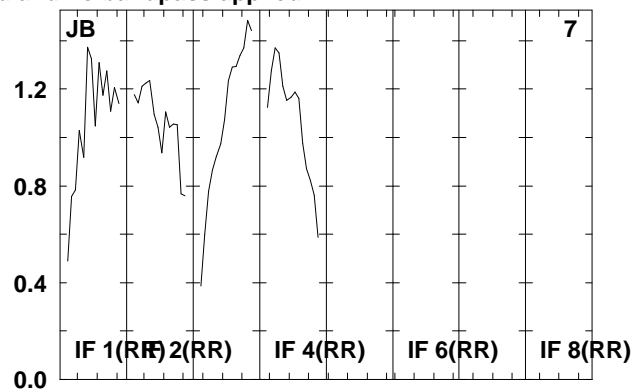
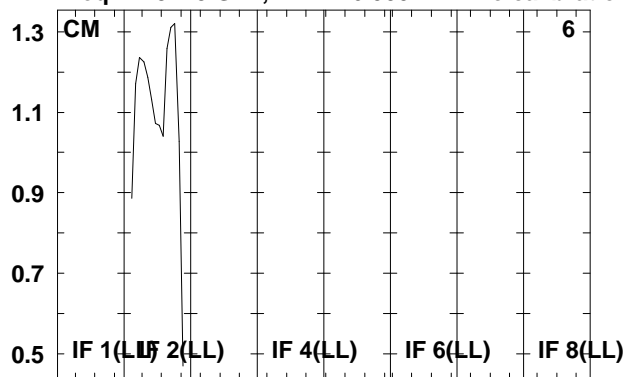

Lower frame: Real Jy  
Total-power spectrum Antenna: \*  
Timerange: 00/14:44:03 to 00/14:50:59



Plot file version 129 created 07-DEC-2009 16:06:02

J1912+05 RT006C.UVDATA.1

Freq = 4.9415 GHz, Bw = 16.000 MH No calibration applied and no bandpass applied

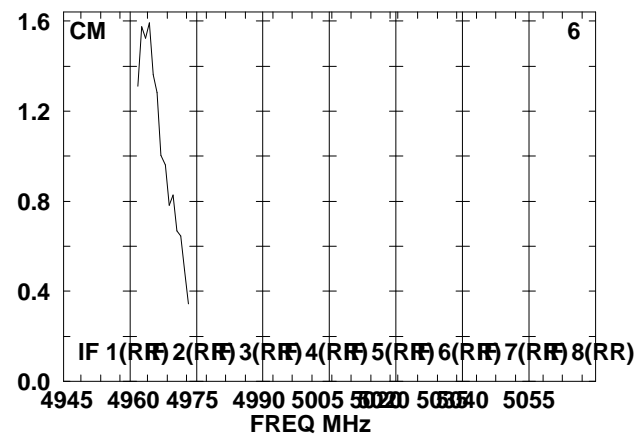
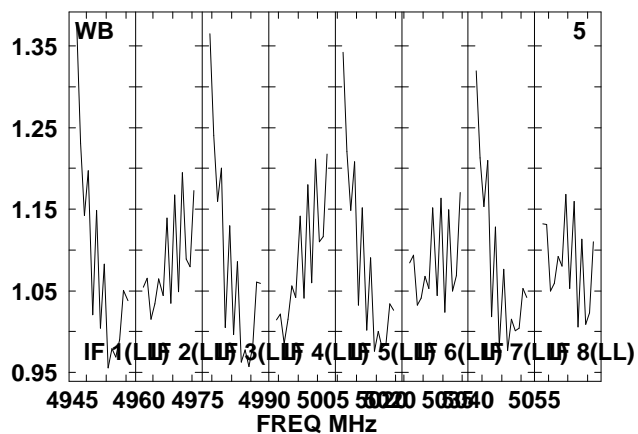
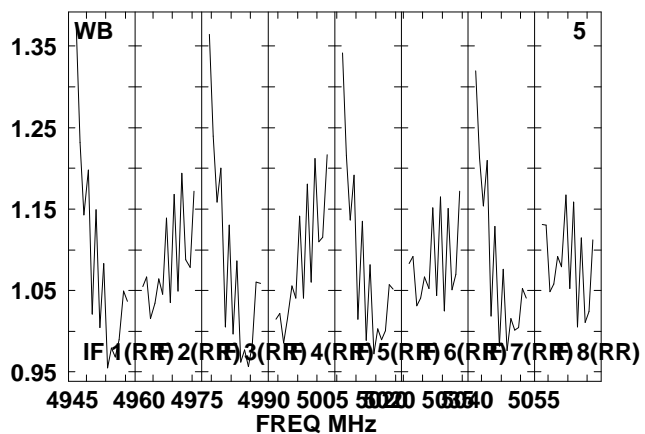
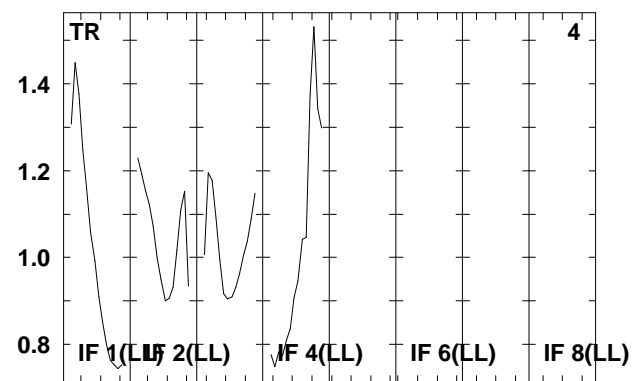
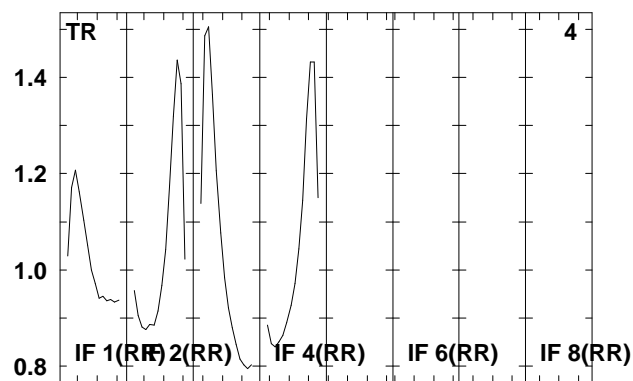
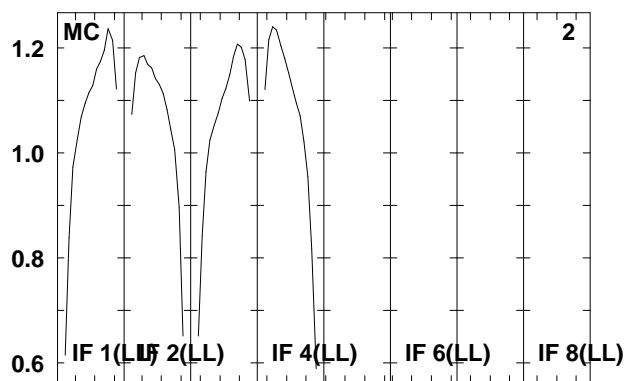
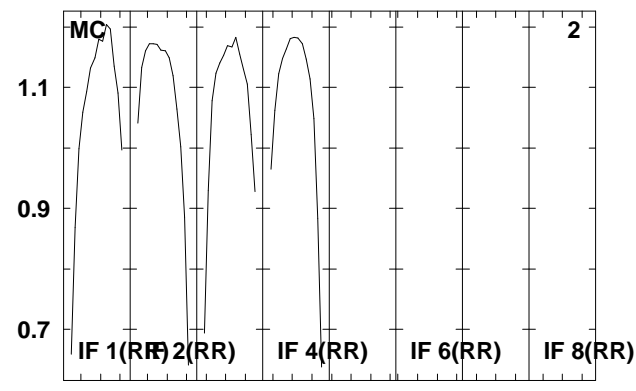
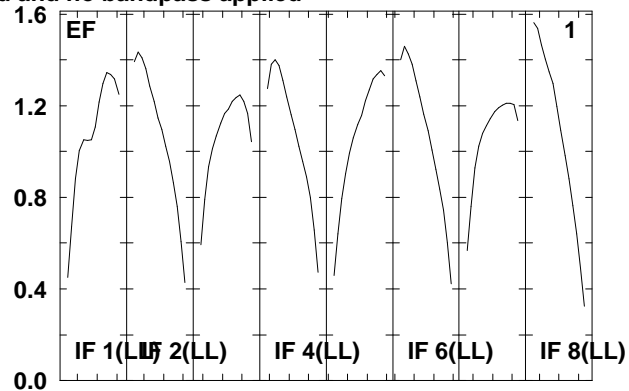
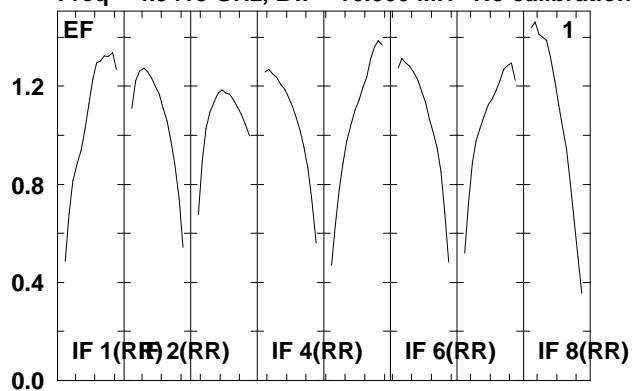

Lower frame: Real Jy  
Total-power spectrum Antenna: \*  
Timerange: 00/14:54:03 to 00/14:56:59

Plot file version 130 created 07-DEC-2009 16:06:02

J1912+05 RT006C.UVDATA.1

Freq = 4.9415 GHz, Bw = 16.000 MH No calibration applied and no bandpass applied

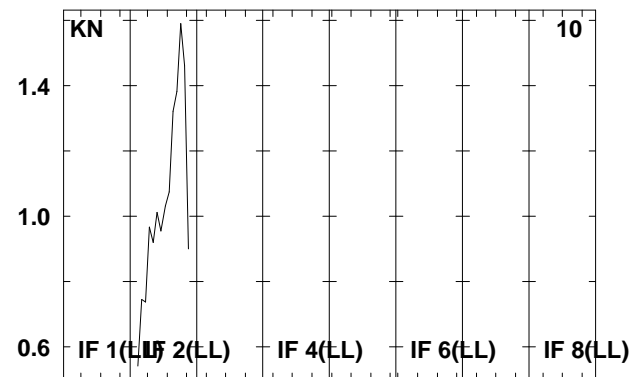
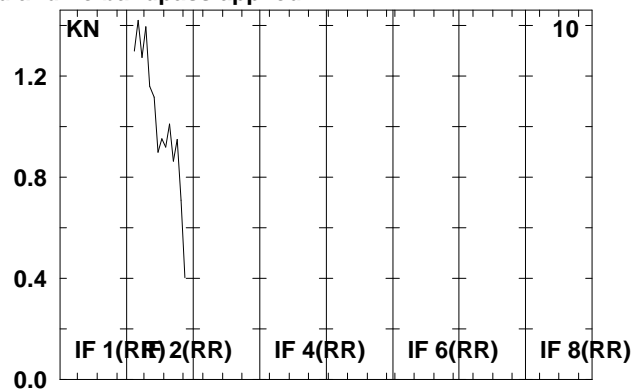
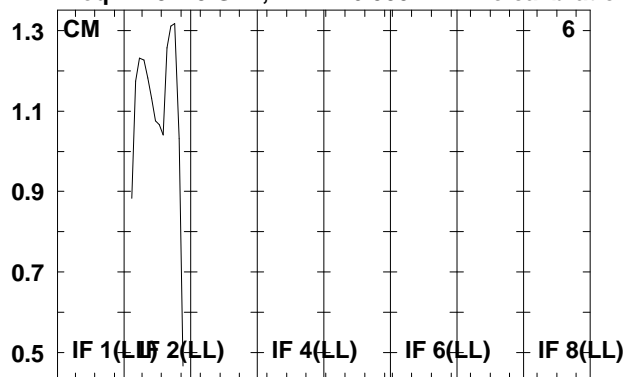

Lower frame: Real Jy  
Total-power spectrum Antenna: \*  
Timerange: 00/14:54:03 to 00/14:56:59

Plot file version 131 created 07-DEC-2009 16:06:03

SS433 RT006C.UVDATA.1

Freq = 4.9415 GHz, Bw = 16.000 MH No calibration applied and no bandpass applied

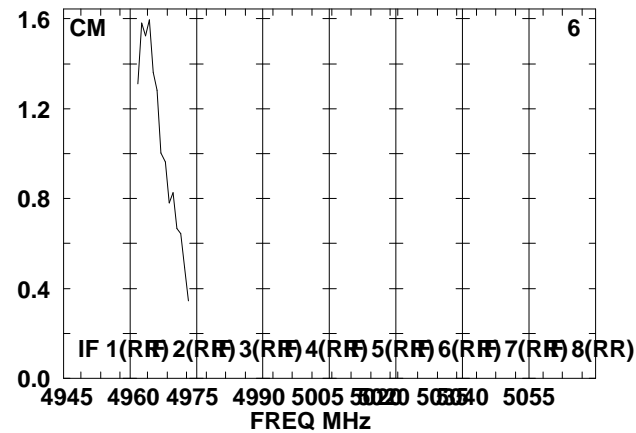
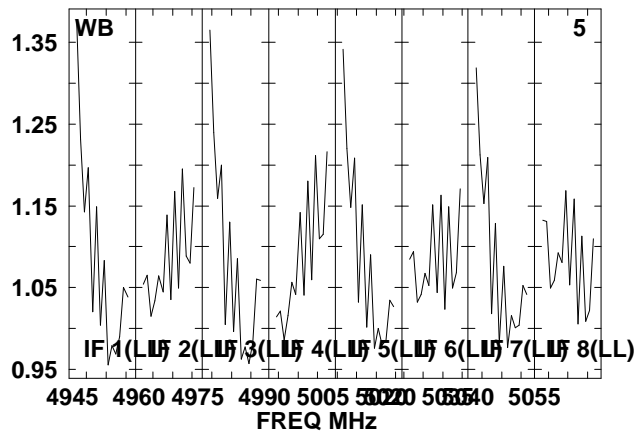
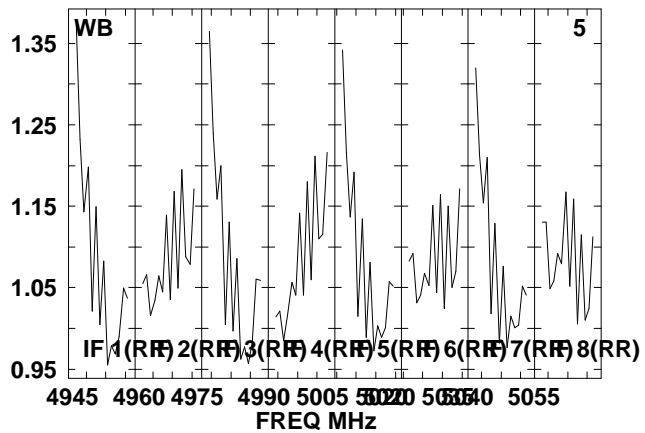
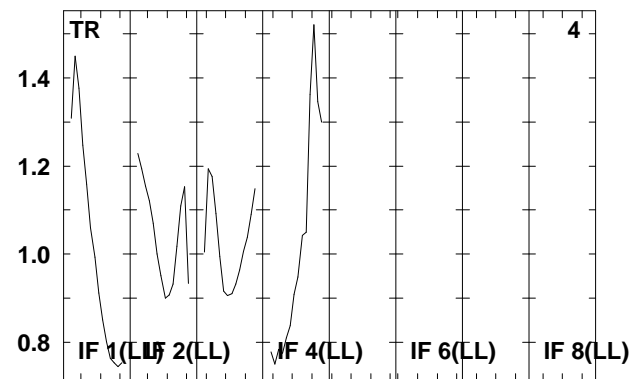
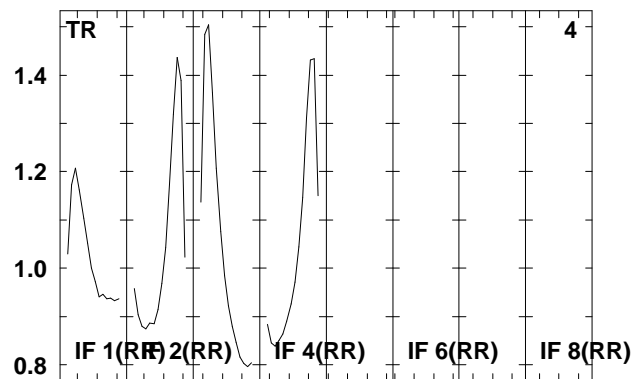
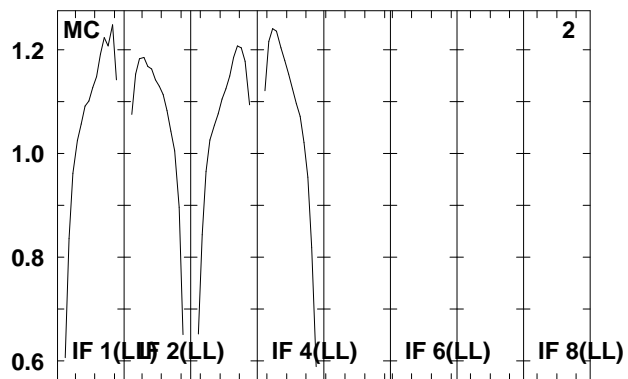
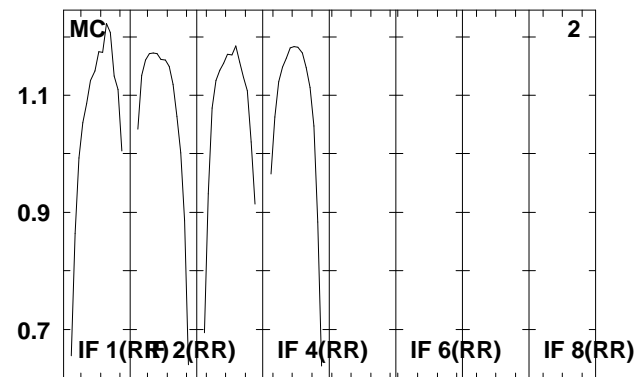
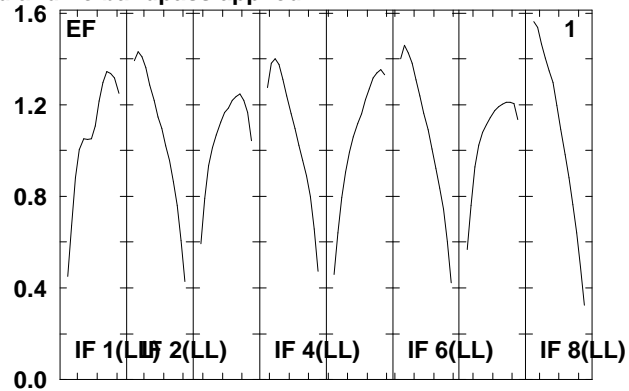
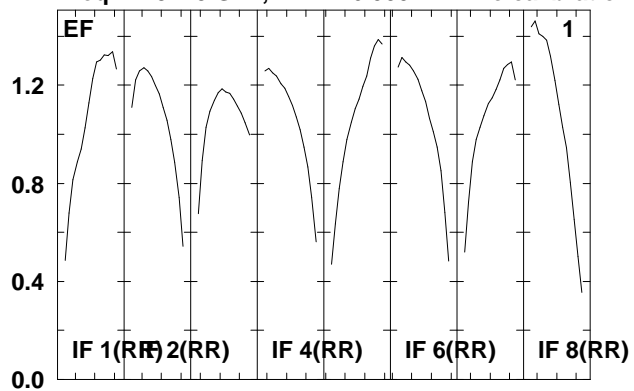

Lower frame: Real Jy  
Total-power spectrum Antenna: \*  
Timerange: 00/14:57:03 to 00/14:59:19

Plot file version 132 created 07-DEC-2009 16:06:03

SS433 RT006C.UVDATA.1

Freq = 4.9415 GHz, Bw = 16.000 MH No calibration applied and no bandpass applied

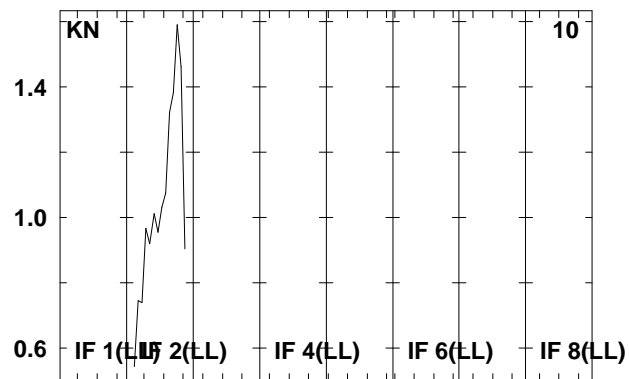
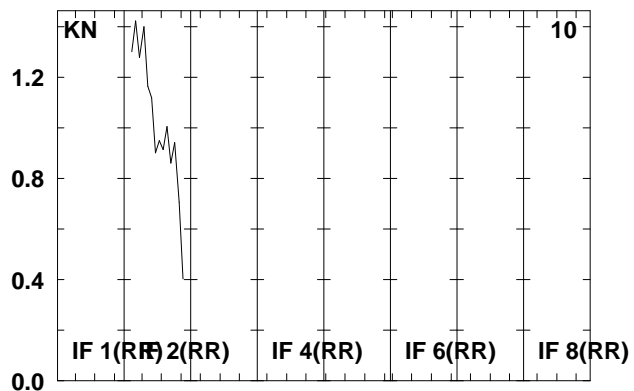
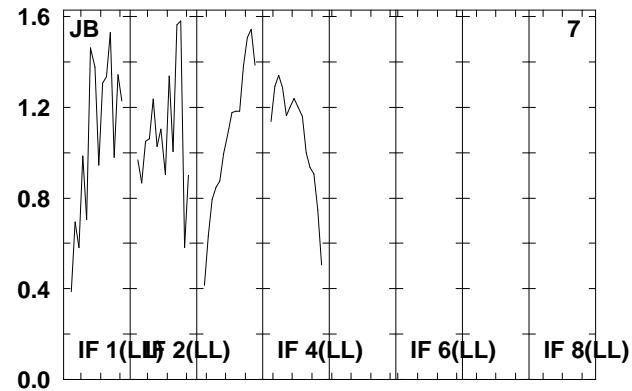
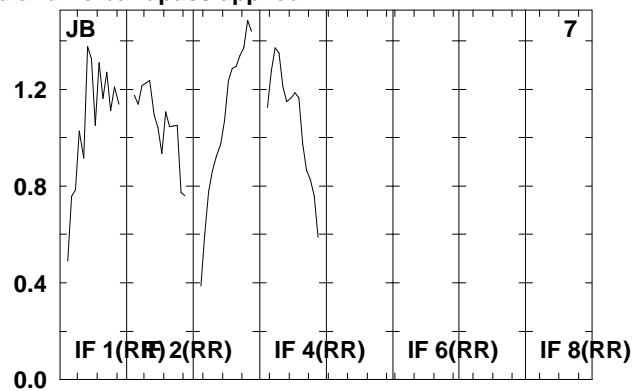
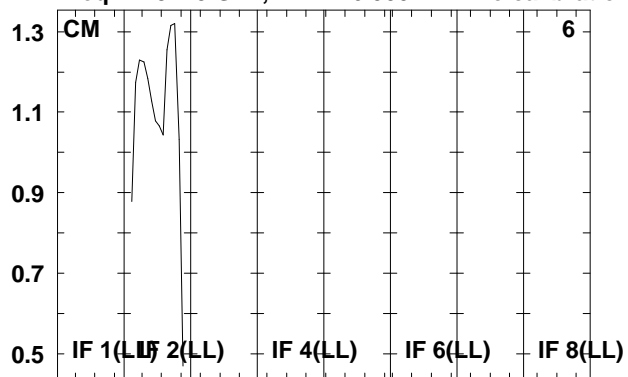

Lower frame: Real Jy  
Total-power spectrum Antenna: \*  
Timerange: 00/14:57:03 to 00/14:59:19

Plot file version 133 created 07-DEC-2009 16:06:03

J1912+05 RT006C.UVDATA.1

Freq = 4.9415 GHz, Bw = 16.000 MH No calibration applied and no bandpass applied

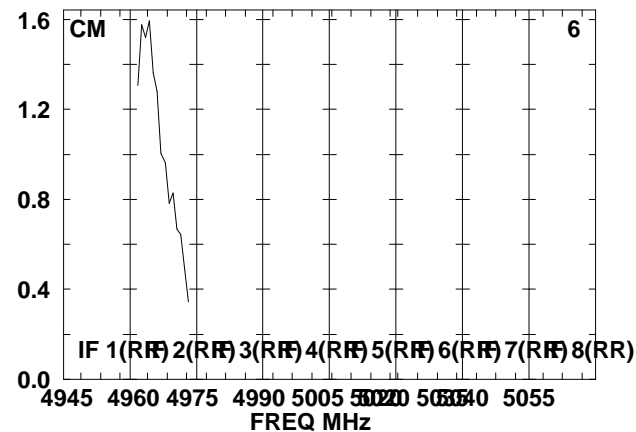
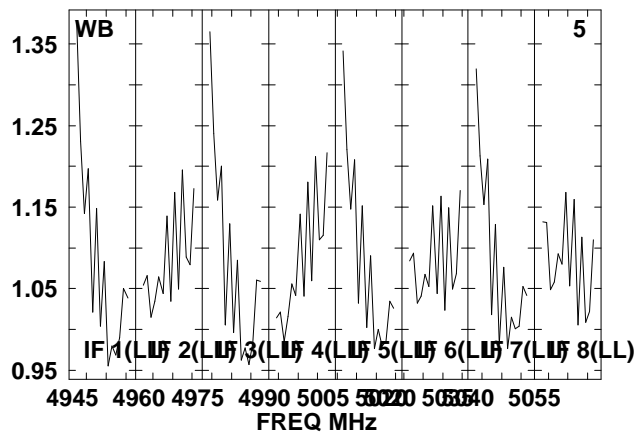
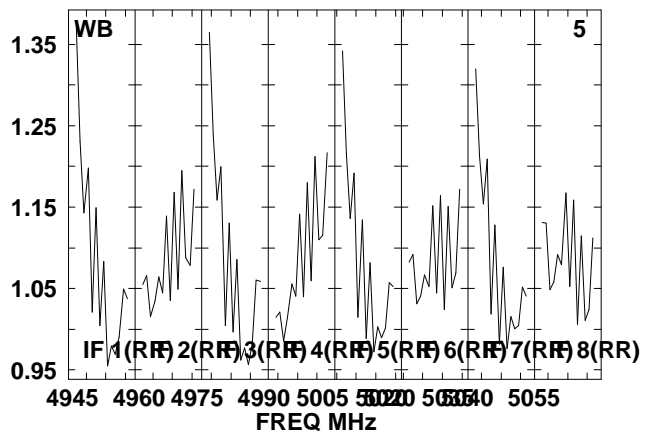
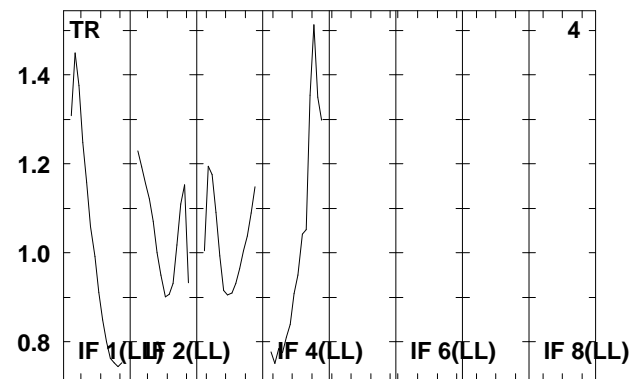
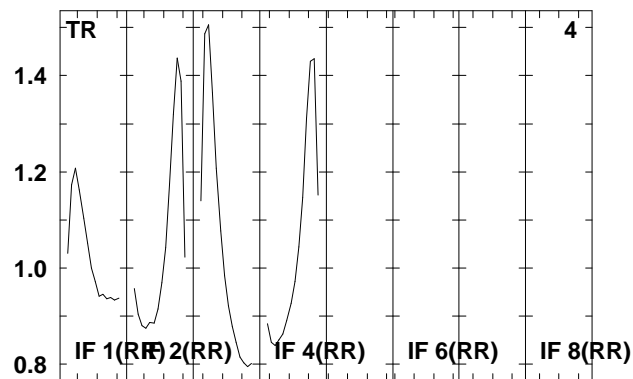
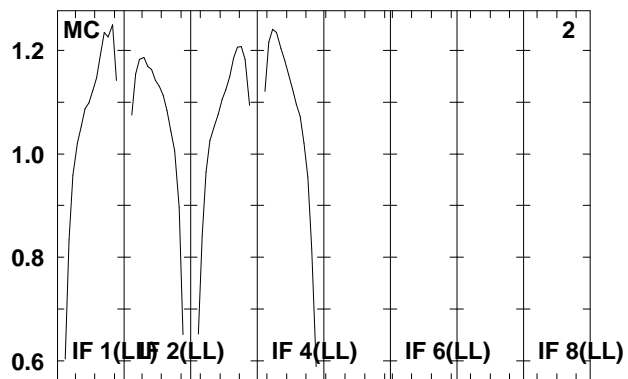
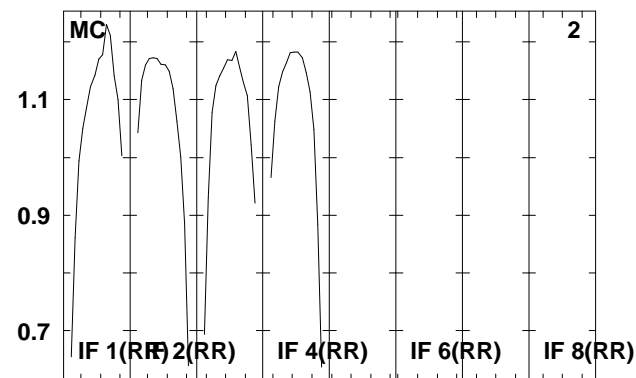
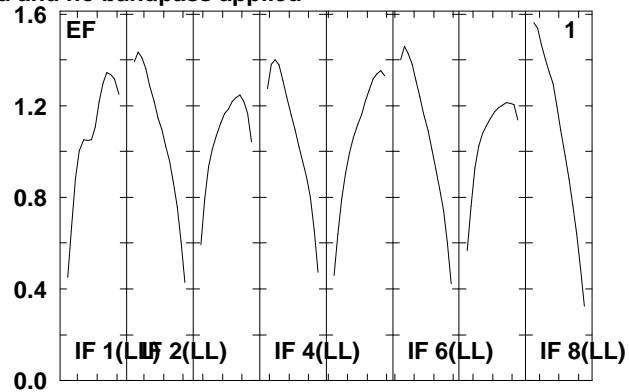
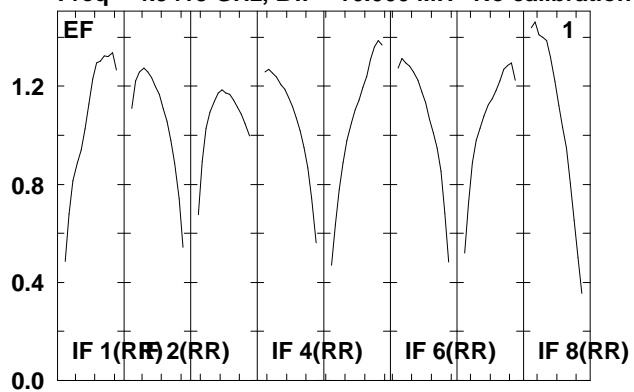

Lower frame: Real Jy  
Total-power spectrum Antenna: \*  
Timerange: 00/14:59:23 to 00/15:00:39

Plot file version 134 created 07-DEC-2009 16:06:04

J1912+05 RT006C.UVDATA.1

Freq = 4.9415 GHz, Bw = 16.000 MH No calibration applied and no bandpass applied

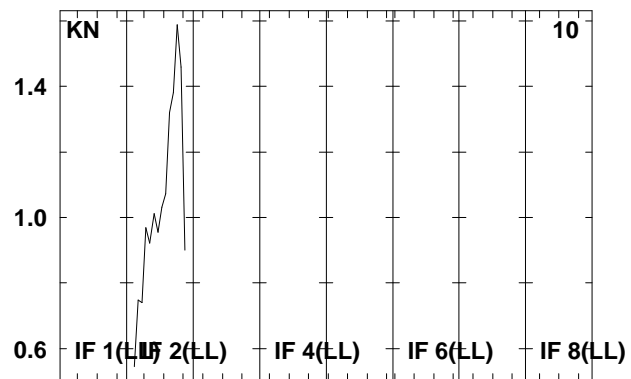
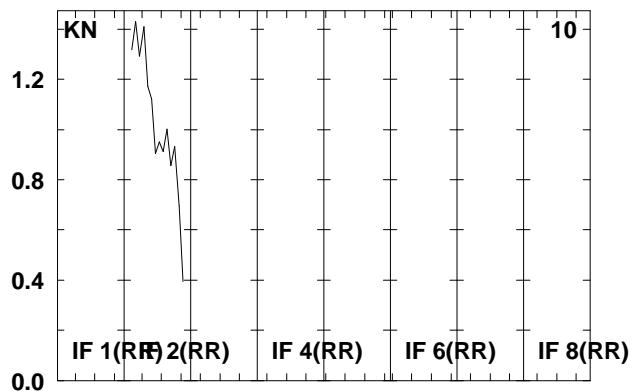
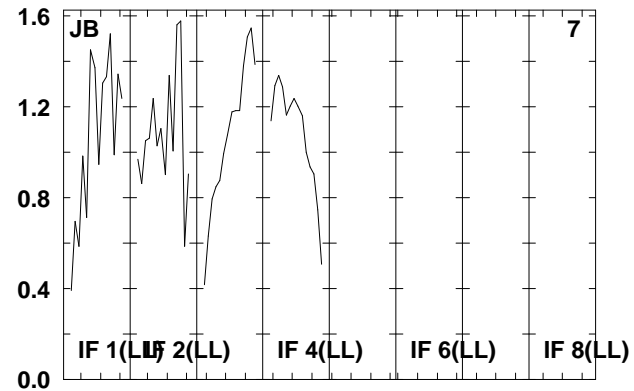
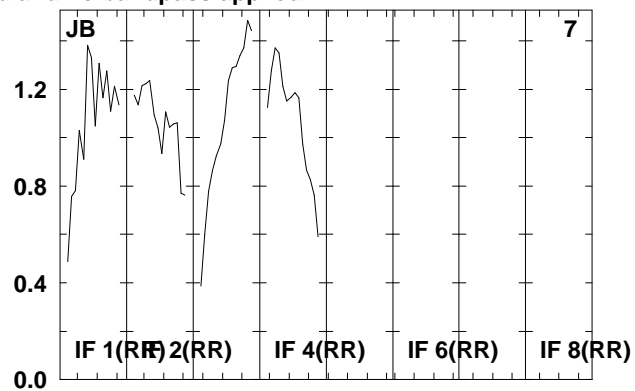
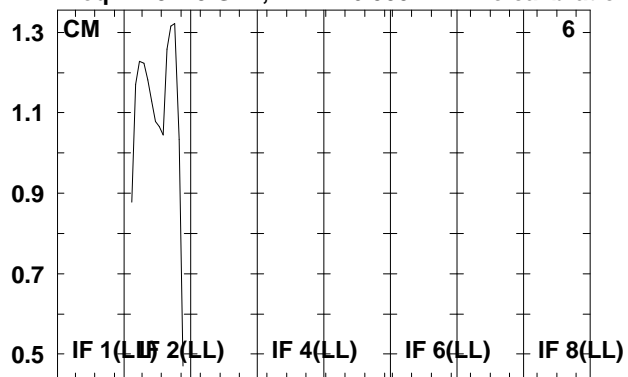

Lower frame: Real Jy  
Total-power spectrum Antenna: \*  
Timerange: 00/14:59:23 to 00/15:00:39

Plot file version 135 created 07-DEC-2009 16:06:04

SS433 RT006C.UVDATA.1

Freq = 4.9415 GHz, Bw = 16.000 MH No calibration applied and no bandpass applied

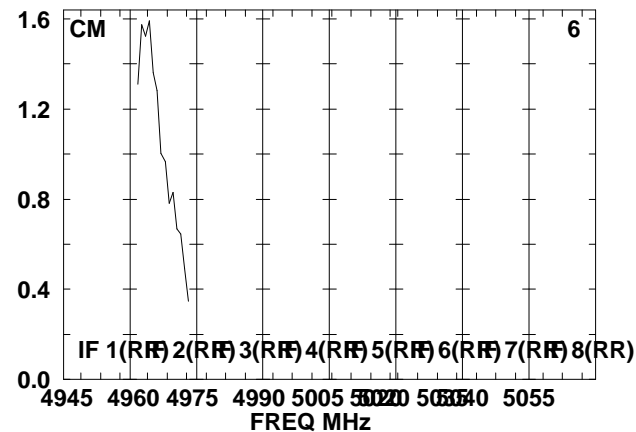
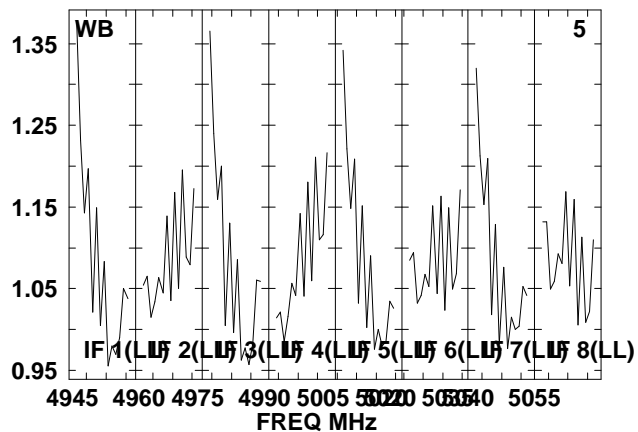
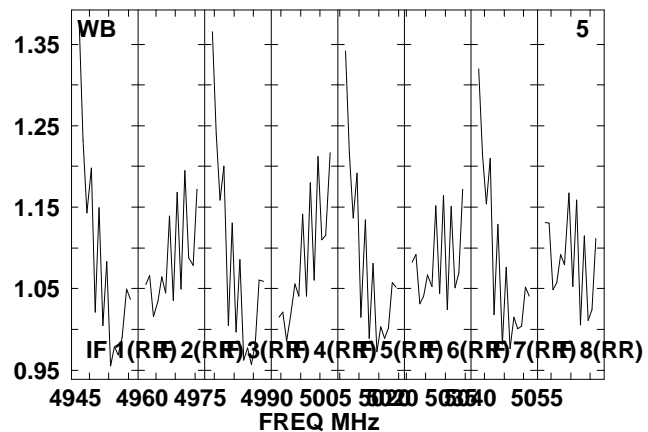
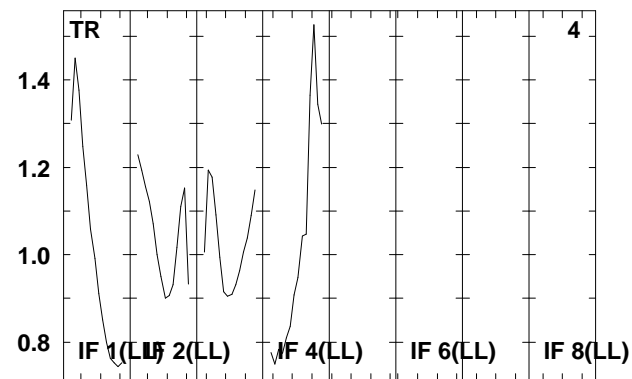
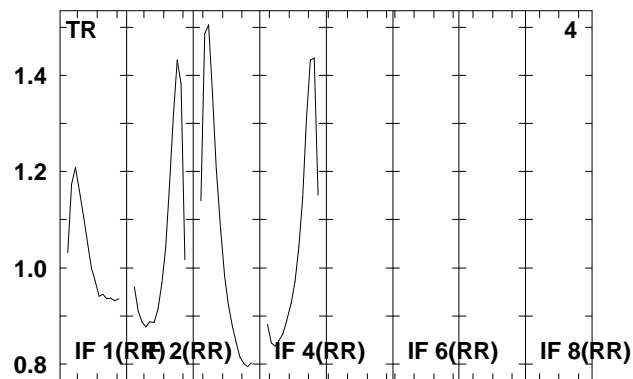
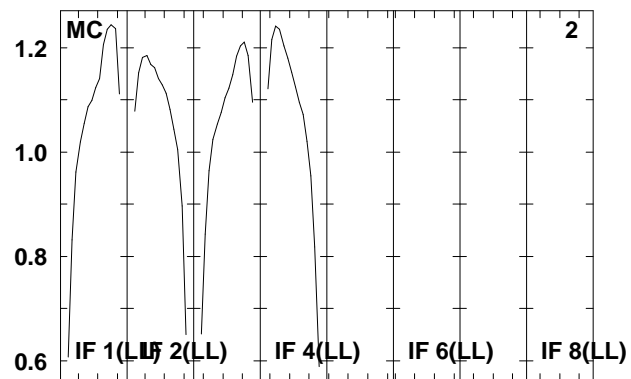
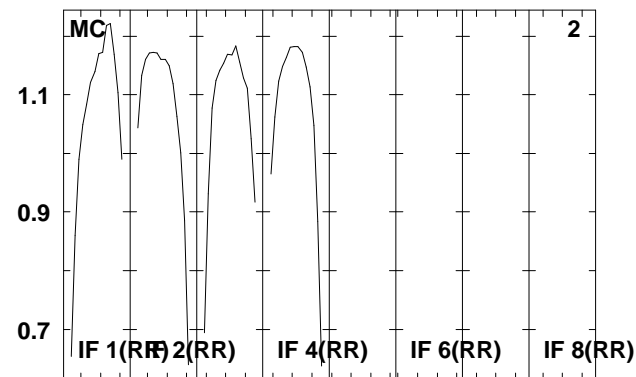
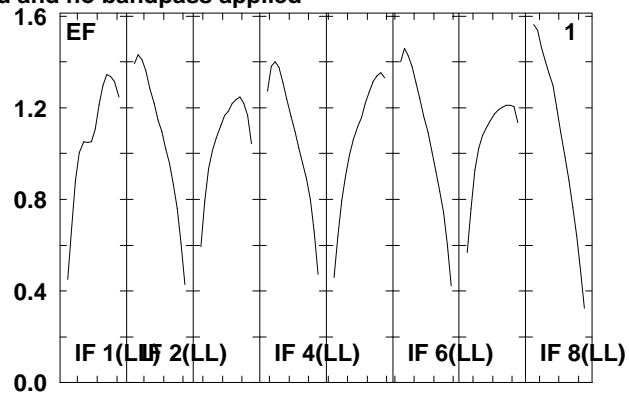
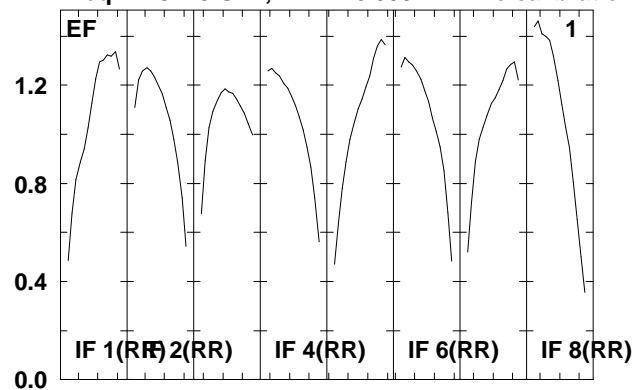

Lower frame: Real Jy

Total-power spectrum Antenna: \*

Timerange: 00/15:00:43 to 00/15:02:59

Plot file version 136 created 07-DEC-2009 16:06:04

SS433 RT006C.UVDATA.1

Freq = 4.9415 GHz, Bw = 16.000 MH No calibration applied and no bandpass applied

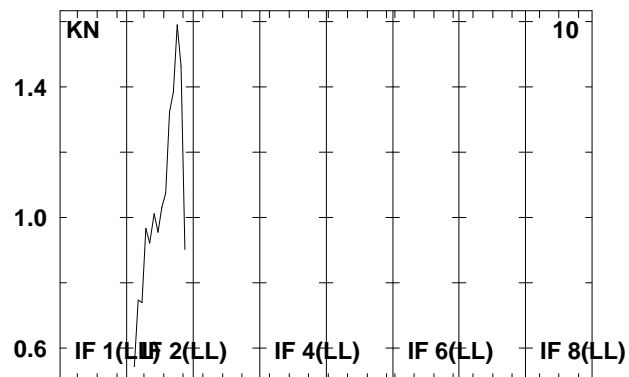
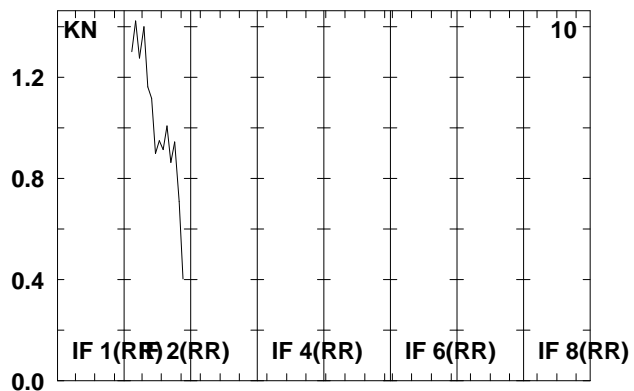
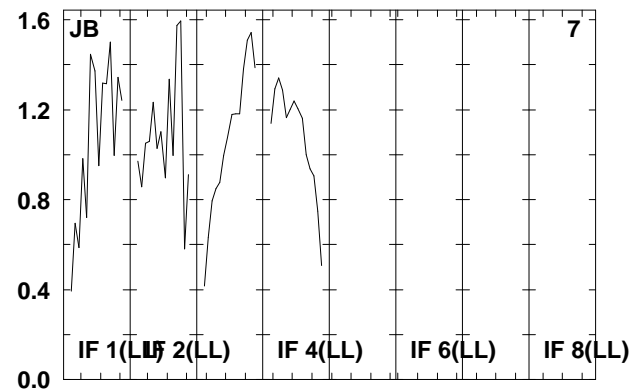
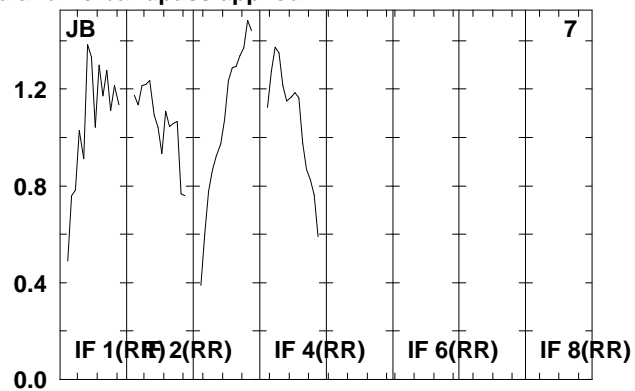
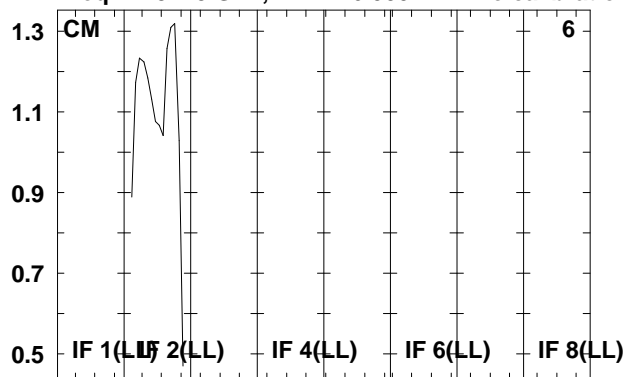

Lower frame: Real Jy  
Total-power spectrum Antenna: \*  
Timerange: 00/15:00:43 to 00/15:02:59



Plot file version 137 created 07-DEC-2009 16:06:04

J1912+05 RT006C.UVDATA.1

Freq = 4.9415 GHz, Bw = 16.000 MH No calibration applied and no bandpass applied

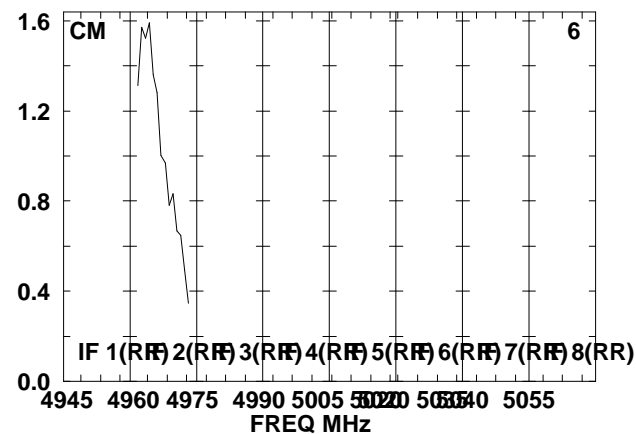
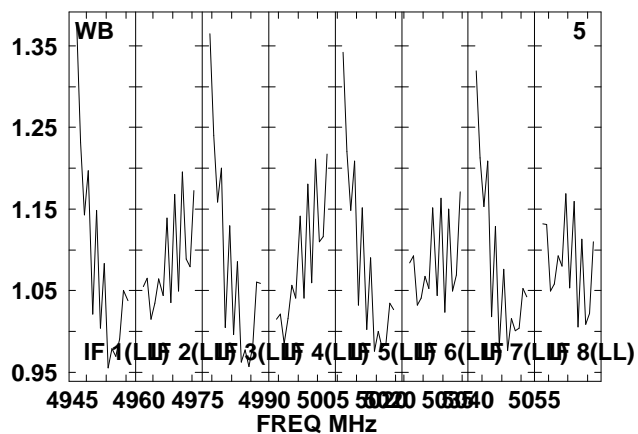
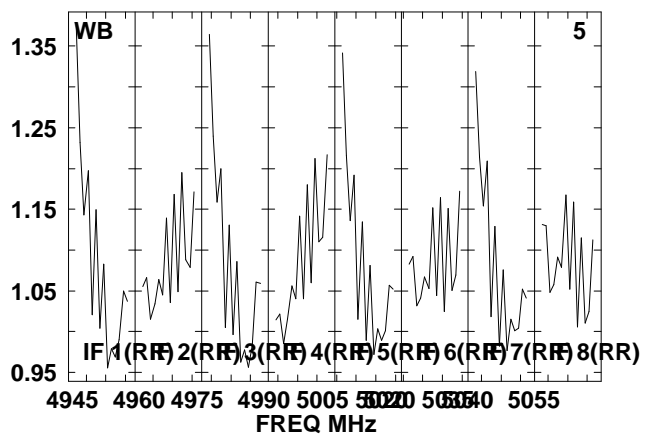
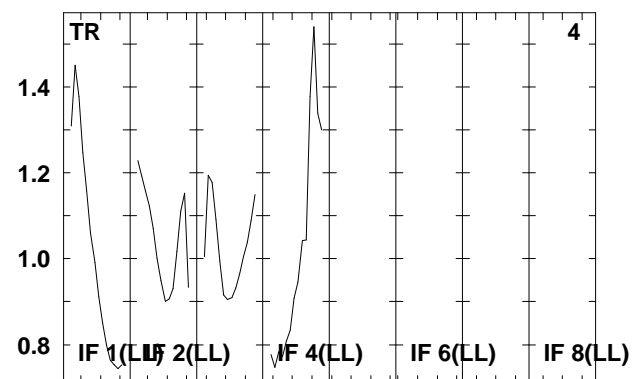
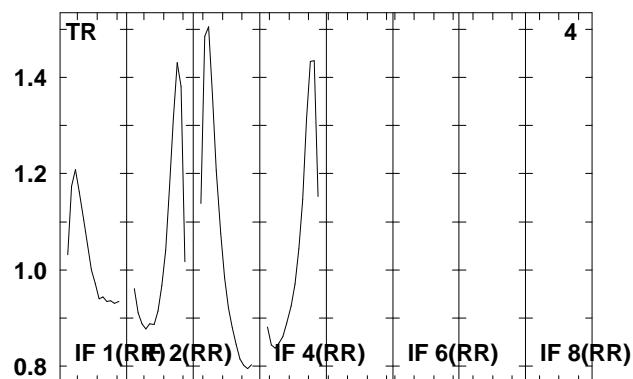
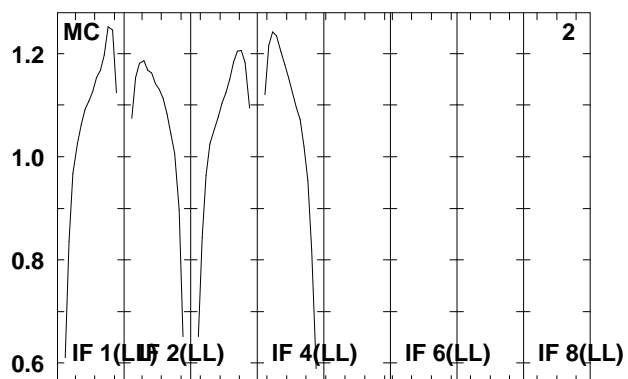
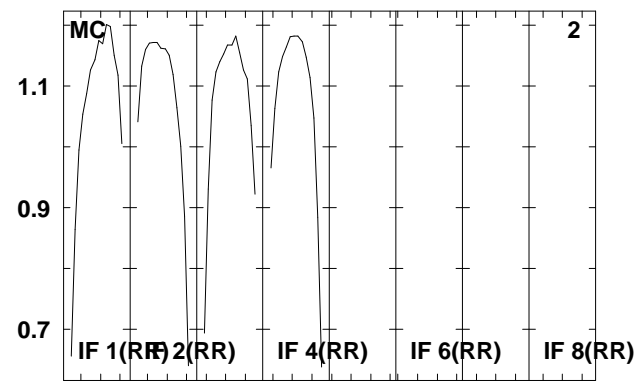
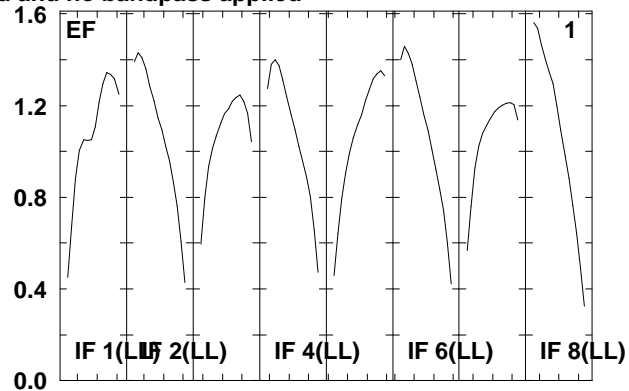
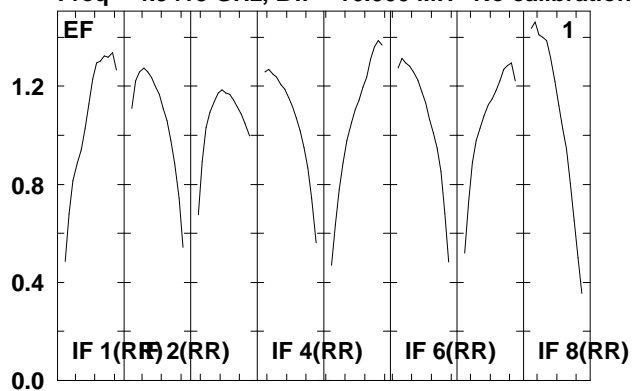

Lower frame: Real Jy

Total-power spectrum Antenna: \*

Timerange: 00/15:03:03 to 00/15:04:19

Plot file version 138 created 07-DEC-2009 16:06:04

J1912+05 RT006C.UVDATA.1

Freq = 4.9415 GHz, Bw = 16.000 MH No calibration applied and no bandpass applied

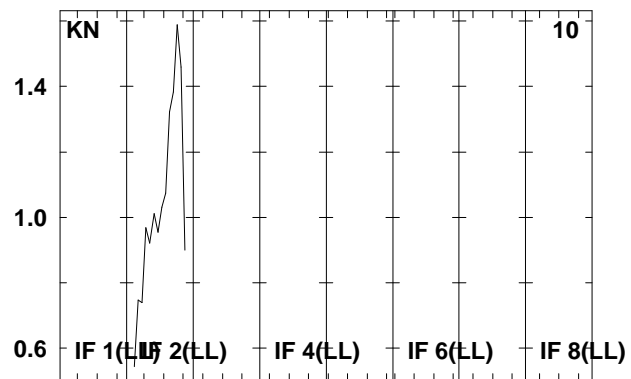
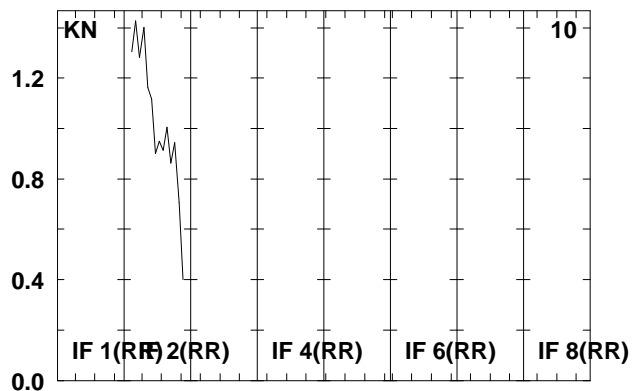
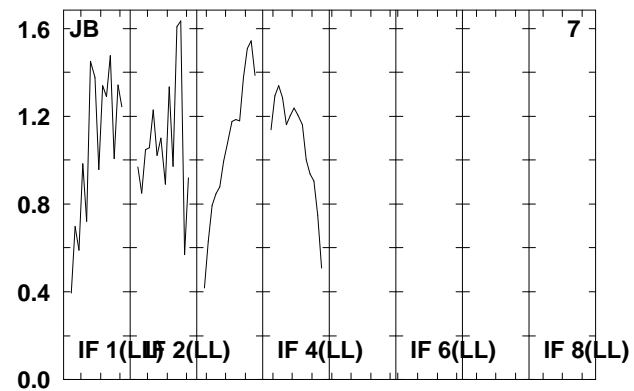
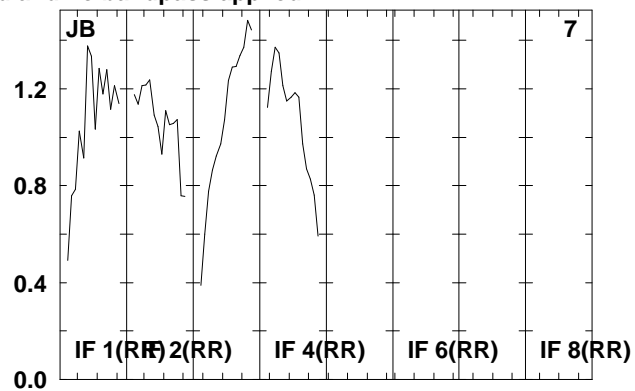
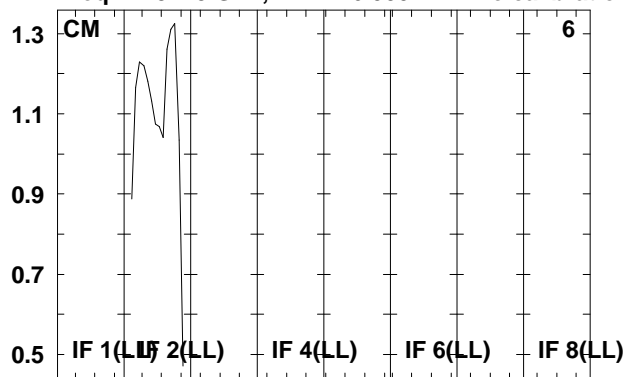

Lower frame: Real Jy  
Total-power spectrum Antenna: \*  
Timerange: 00/15:03:03 to 00/15:04:19

Plot file version 139 created 07-DEC-2009 16:06:05

SS433 RT006C.UVDATA.1

Freq = 4.9415 GHz, Bw = 16.000 MH No calibration applied and no bandpass applied

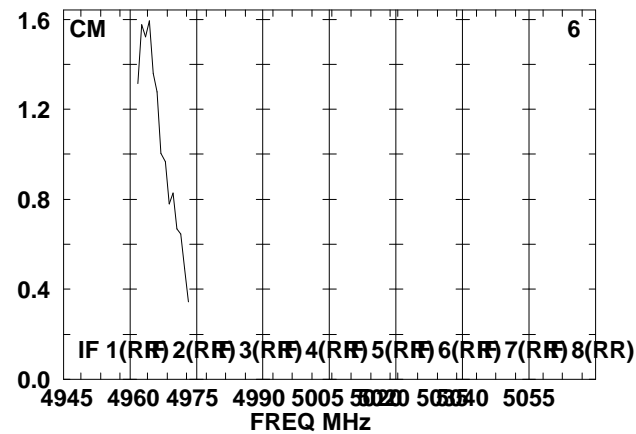
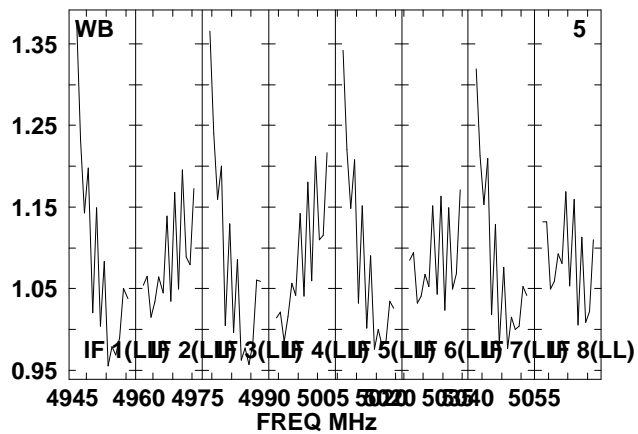
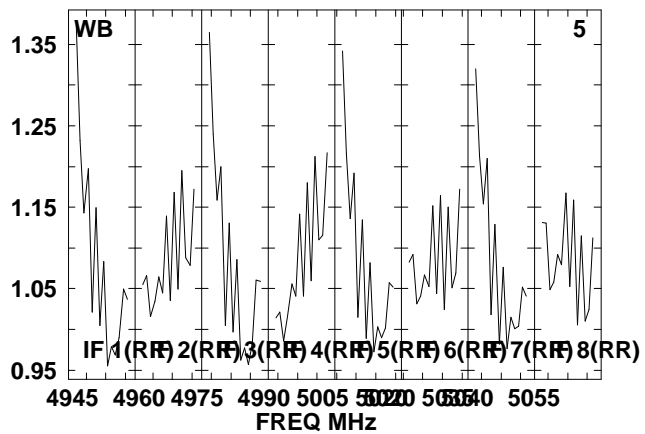
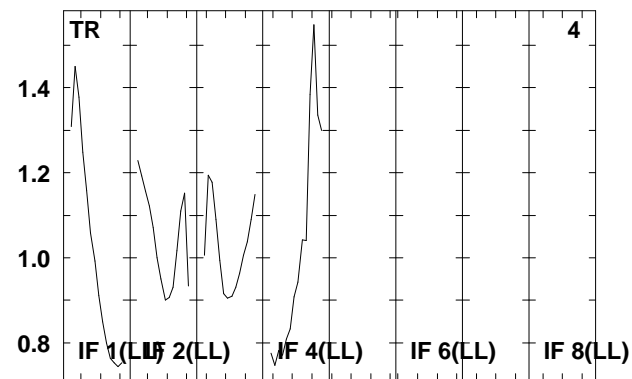
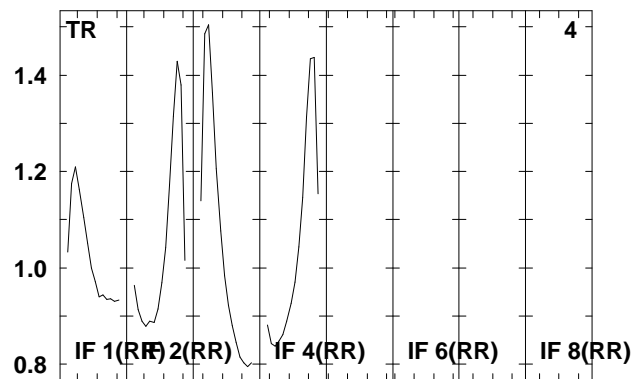
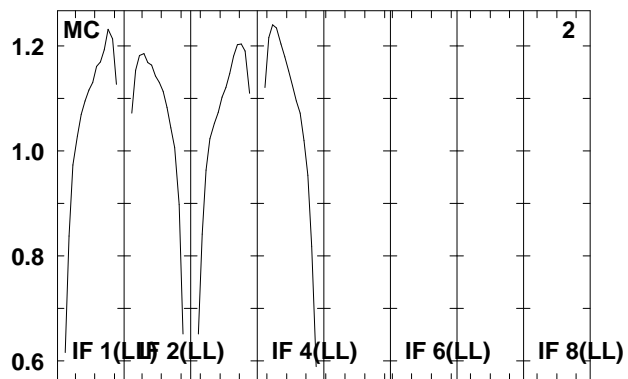
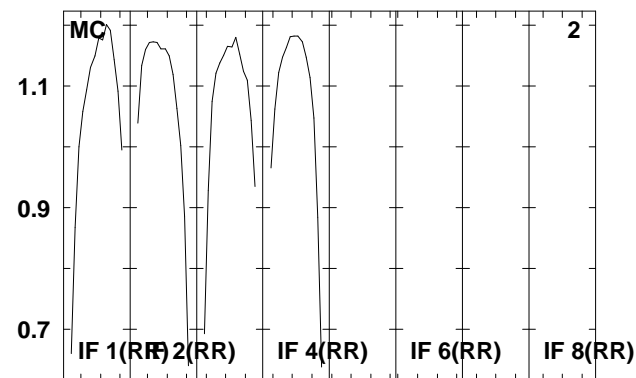
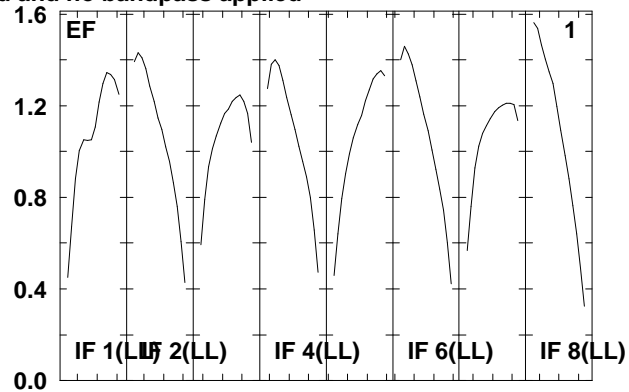
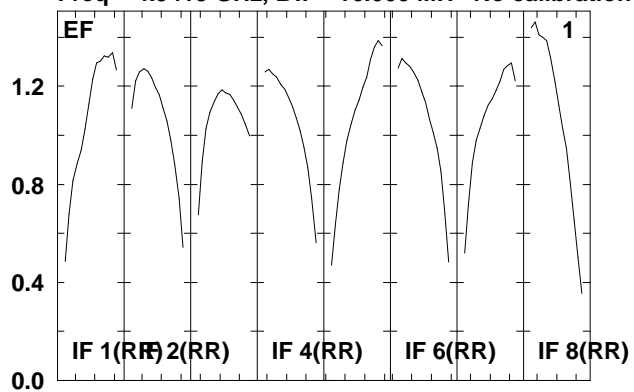

Lower frame: Real Jy

Total-power spectrum Antenna: \*

Timerange: 00/15:04:23 to 00/15:06:39

Plot file version 140 created 07-DEC-2009 16:06:05

SS433 RT006C.UVDATA.1

Freq = 4.9415 GHz, Bw = 16.000 MH No calibration applied and no bandpass applied

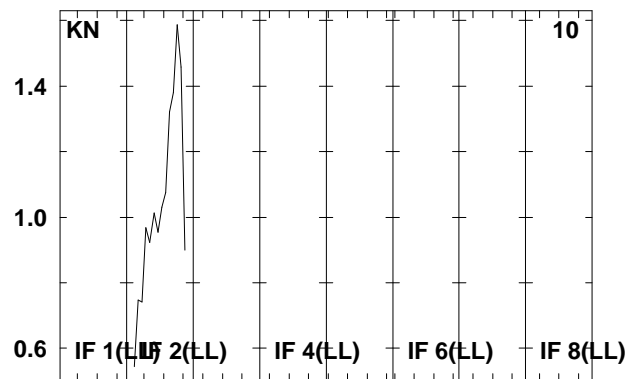
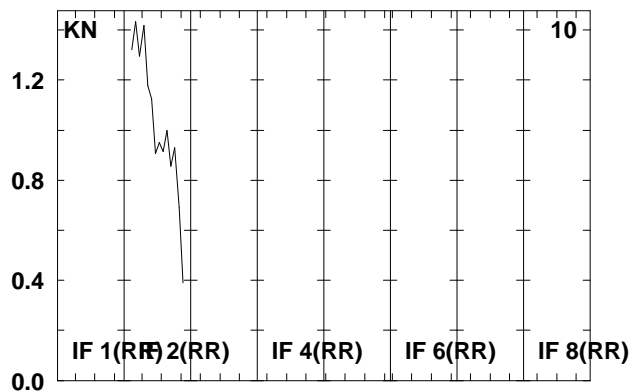
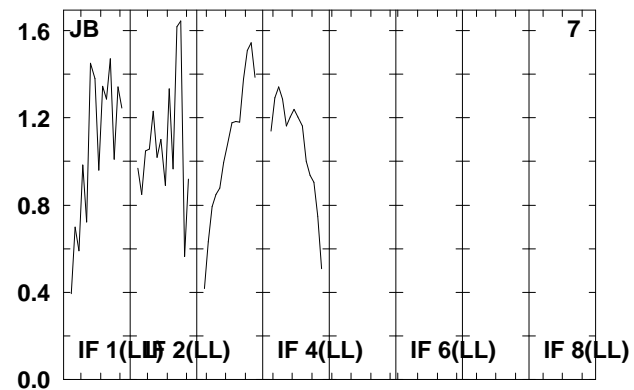
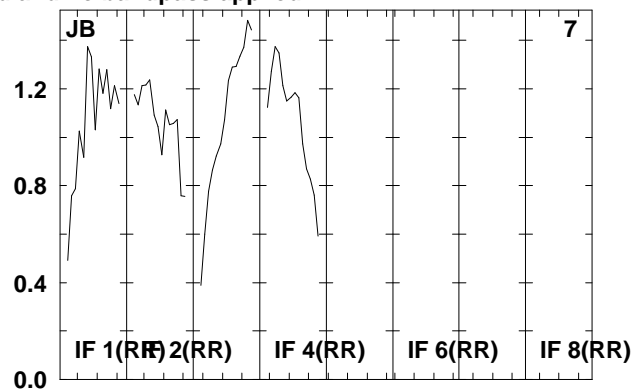
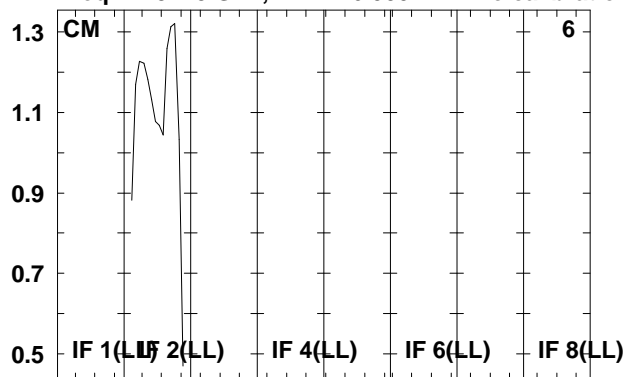

Lower frame: Real Jy  
Total-power spectrum Antenna: \*  
Timerange: 00/15:04:23 to 00/15:06:39

Plot file version 141 created 07-DEC-2009 16:06:05

J1912+05 RT006C.UVDATA.1

Freq = 4.9415 GHz, Bw = 16.000 MH No calibration applied and no bandpass applied

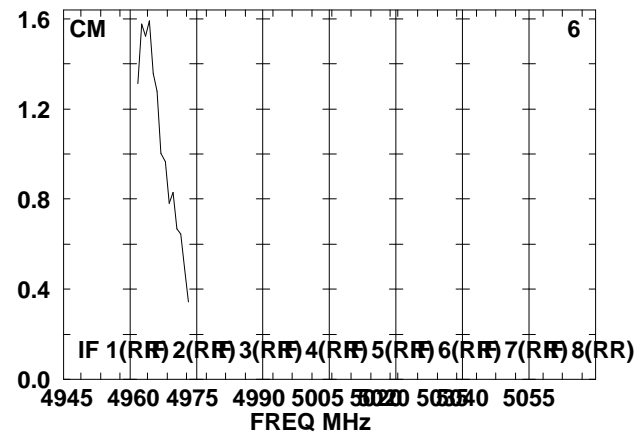
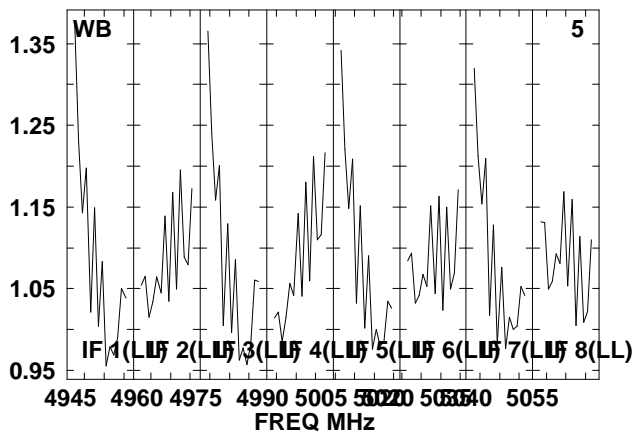
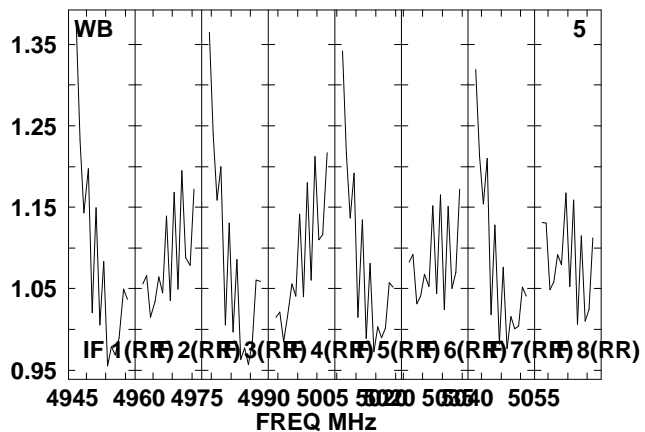
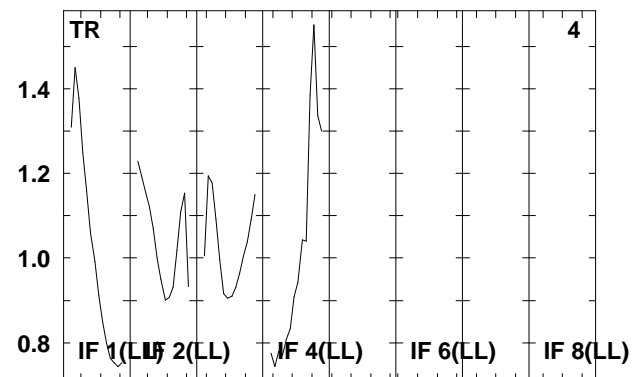
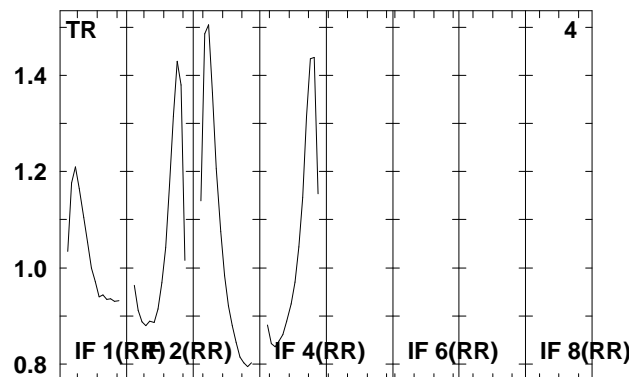
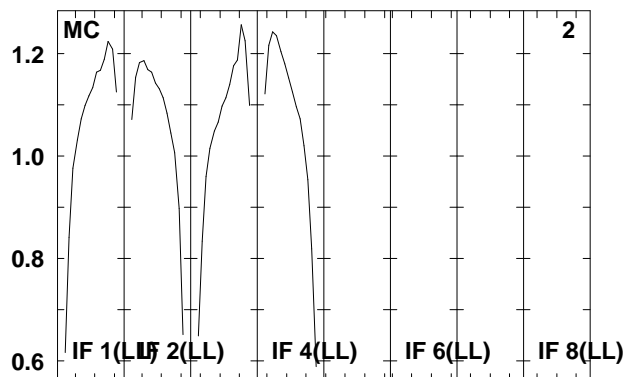
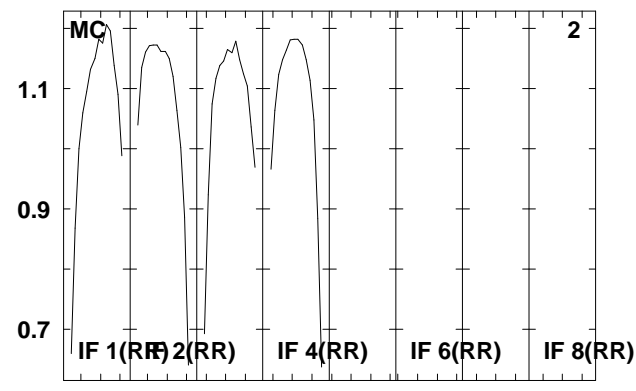
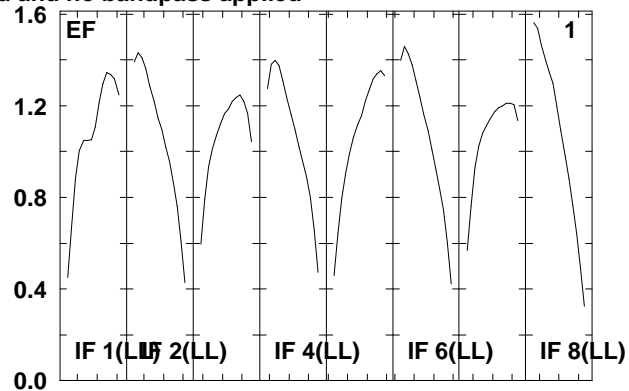
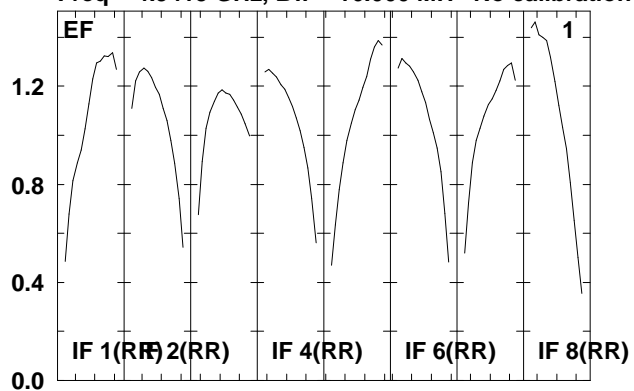

Lower frame: Real Jy  
Total-power spectrum Antenna: \*  
Timerange: 00/15:06:43 to 00/15:07:59

Plot file version 142 created 07-DEC-2009 16:06:05

J1912+05 RT006C.UVDATA.1

Freq = 4.9415 GHz, Bw = 16.000 MH No calibration applied and no bandpass applied

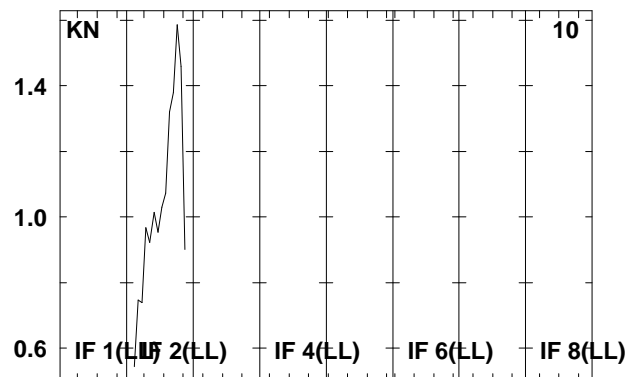
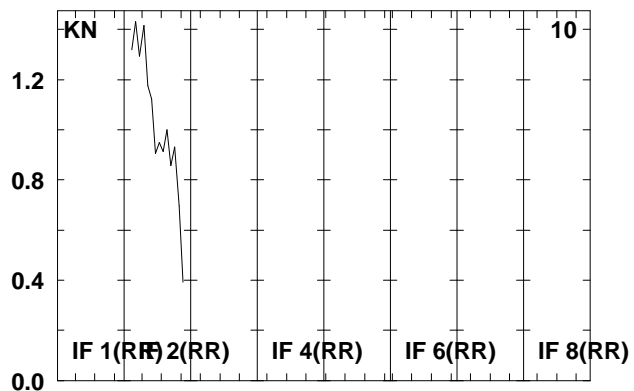
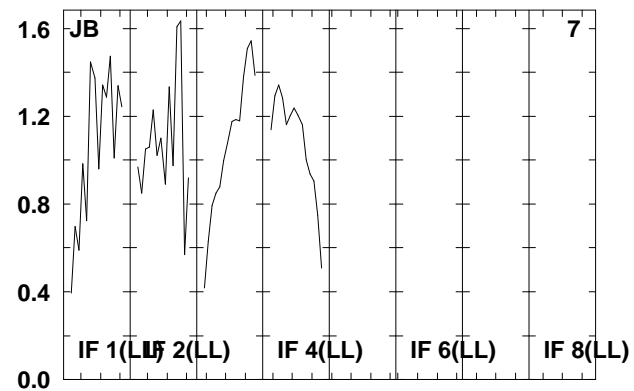
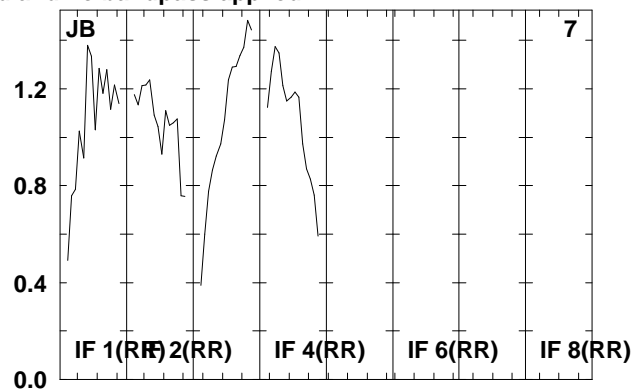
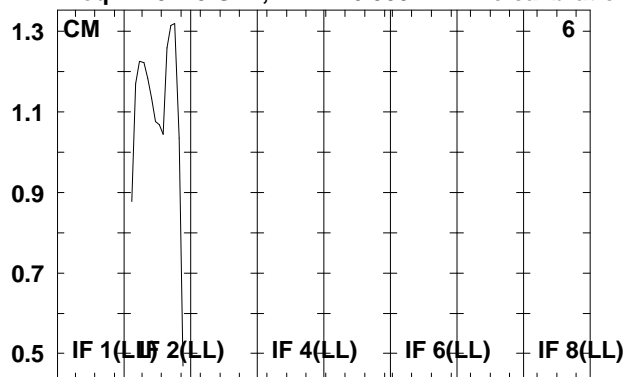

Lower frame: Real Jy  
Total-power spectrum Antenna: \*  
Timerange: 00/15:06:43 to 00/15:07:59

Plot file version 143 created 07-DEC-2009 16:06:05

SS433 RT006C.UVDATA.1

Freq = 4.9415 GHz, Bw = 16.000 MH No calibration applied and no bandpass applied

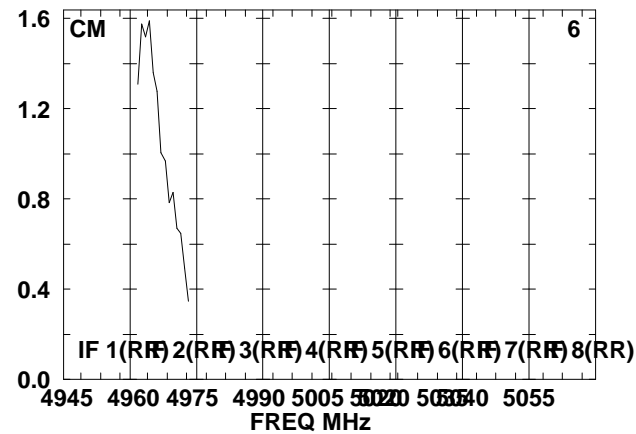
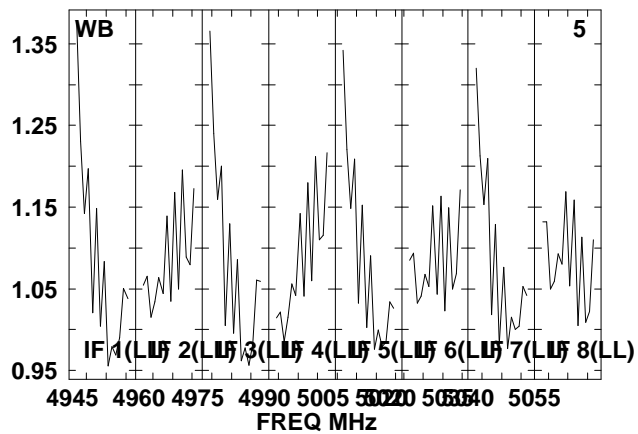
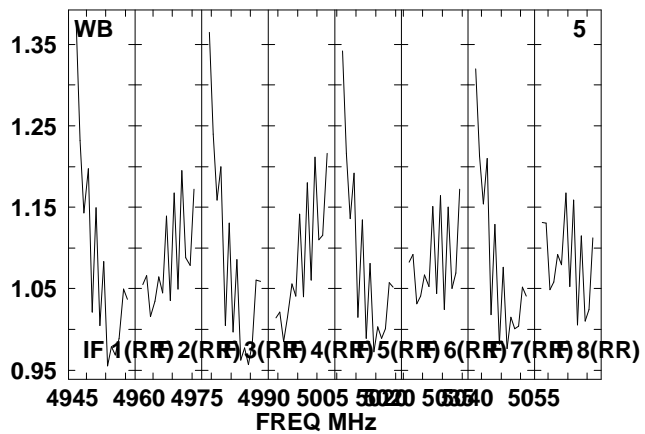
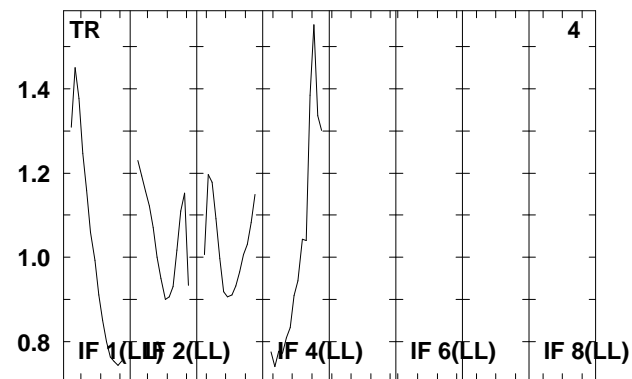
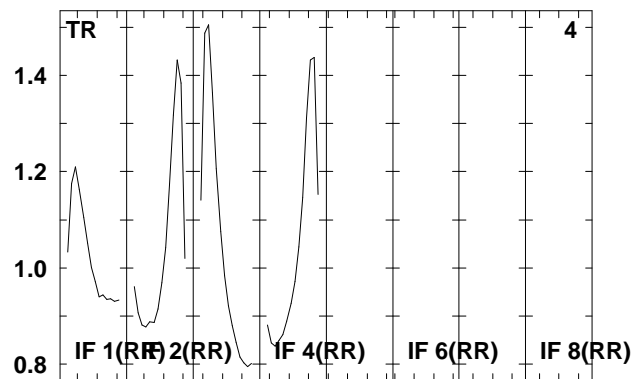
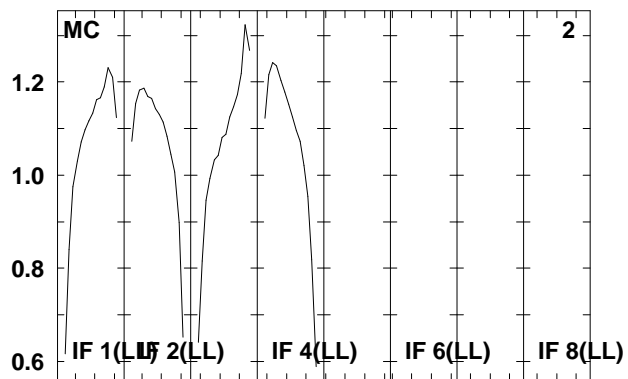
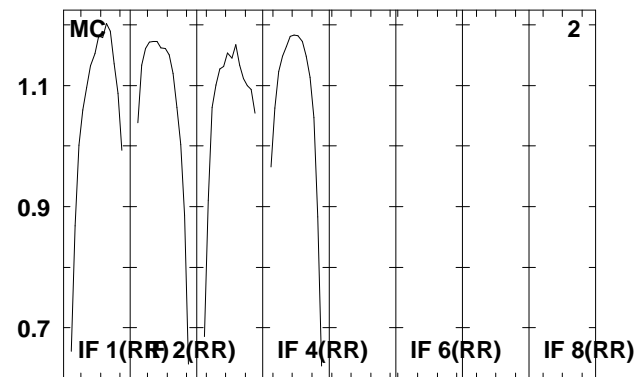
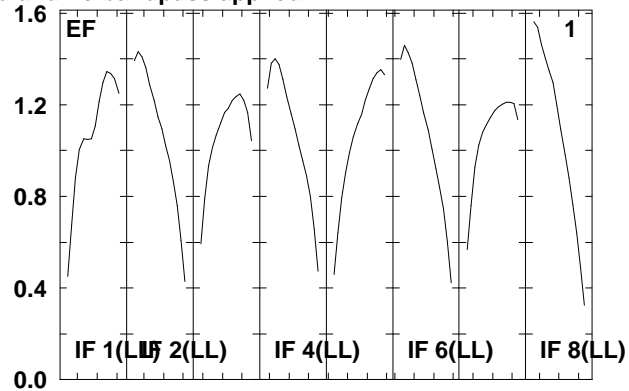
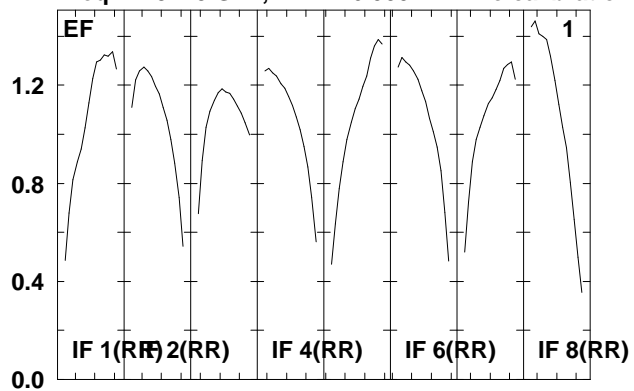

Lower frame: Real Jy  
Total-power spectrum Antenna: \*  
Timerange: 00/15:08:03 to 00/15:10:19

Plot file version 144 created 07-DEC-2009 16:06:06

SS433 RT006C.UVDATA.1

Freq = 4.9415 GHz, Bw = 16.000 MH No calibration applied and no bandpass applied

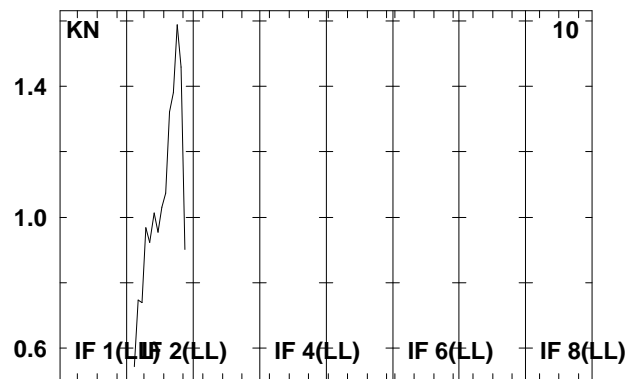
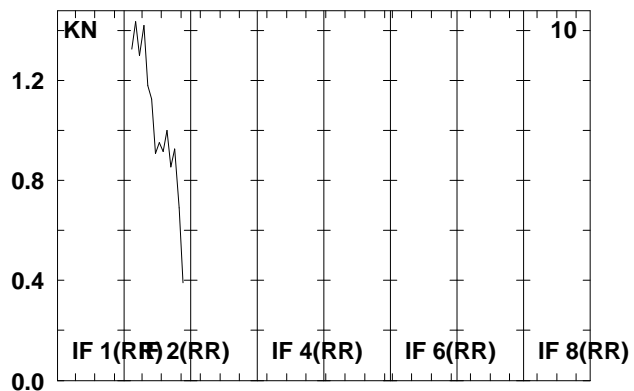
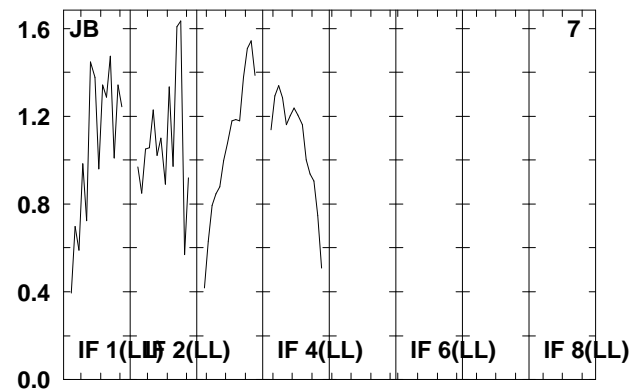
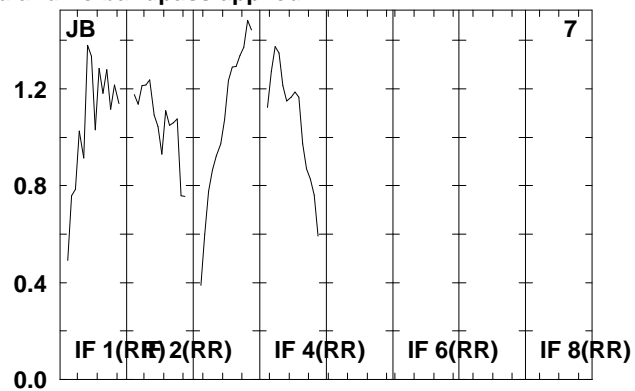
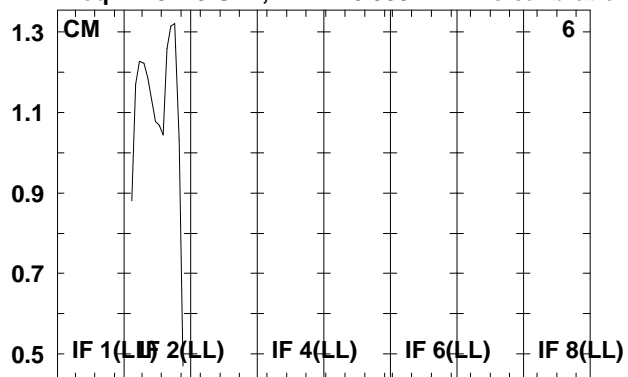

Lower frame: Real Jy  
Total-power spectrum Antenna: \*  
Timerange: 00/15:08:03 to 00/15:10:19



Plot file version 145 created 07-DEC-2009 16:06:06

J1911+16 RT006C.UVDATA.1

Freq = 4.9415 GHz, Bw = 16.000 MH No calibration applied and no bandpass applied

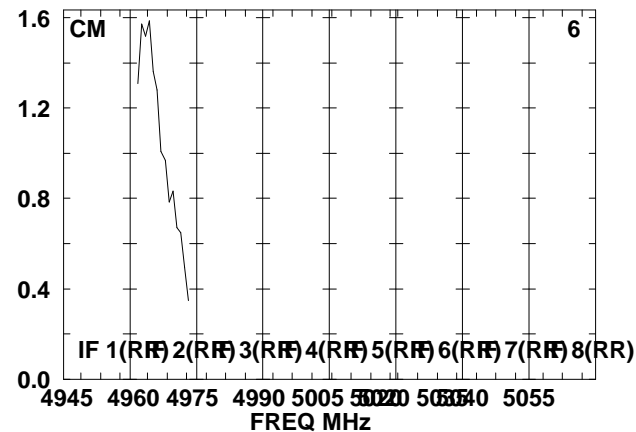
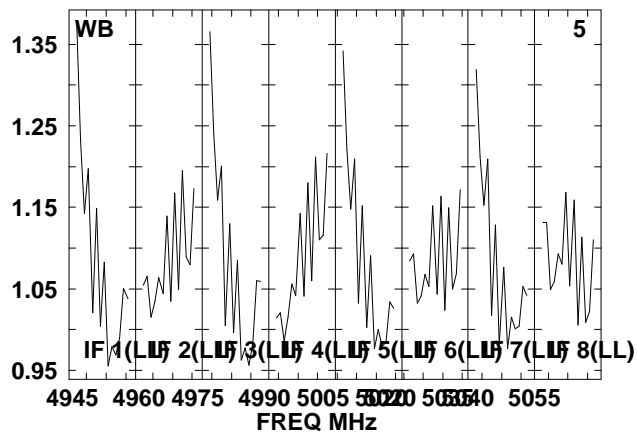
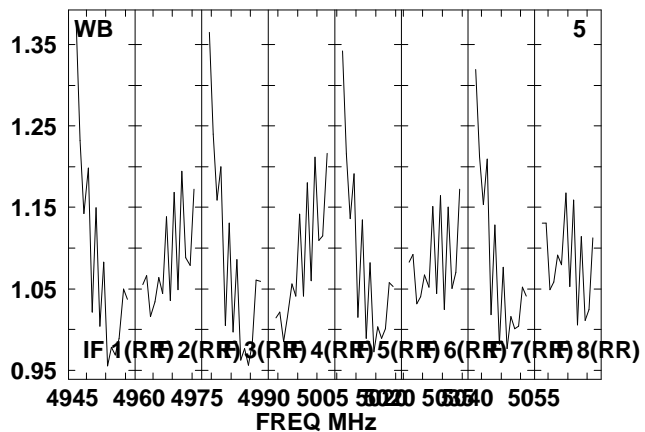
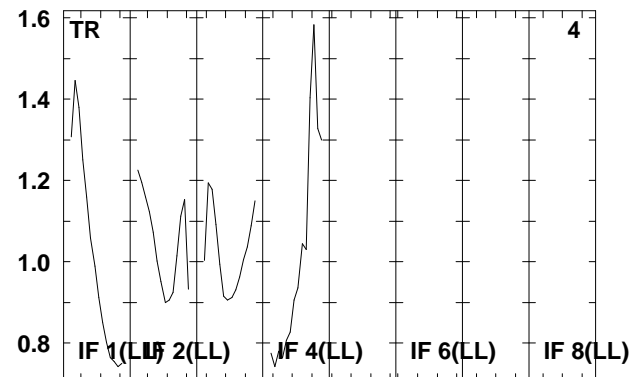
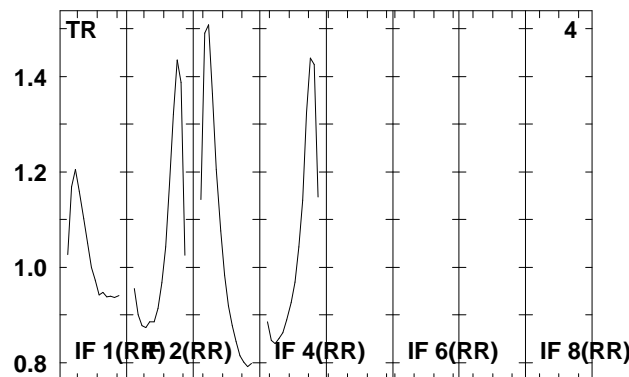
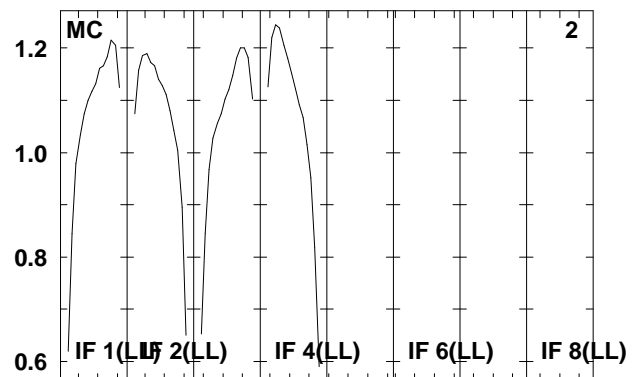
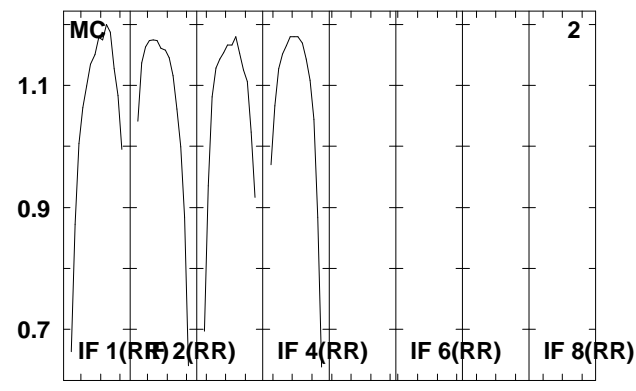
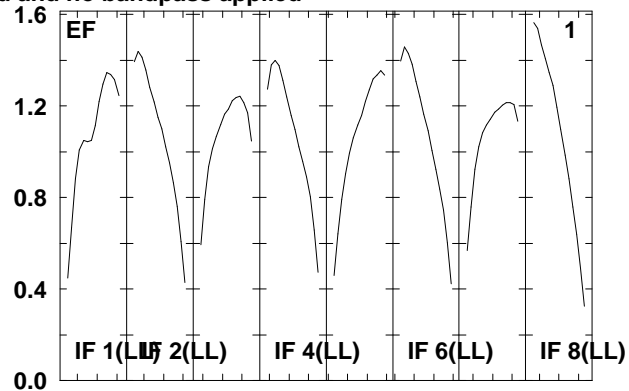
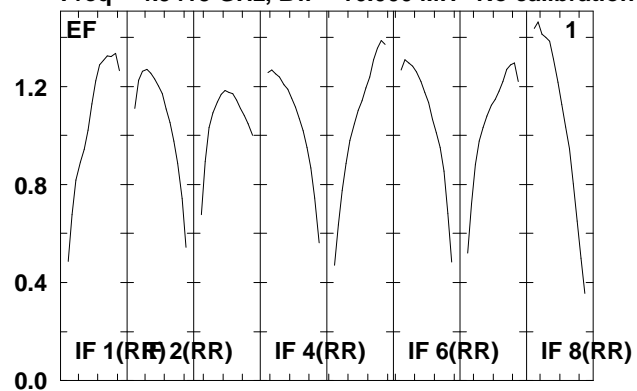

Lower frame: Real Jy  
Total-power spectrum Antenna: \*  
Timerange: 00/15:11:23 to 00/15:12:19

Plot file version 146 created 07-DEC-2009 16:06:06

J1911+16 RT006C.UVDATA.1

Freq = 4.9415 GHz, Bw = 16.000 MH No calibration applied and no bandpass applied

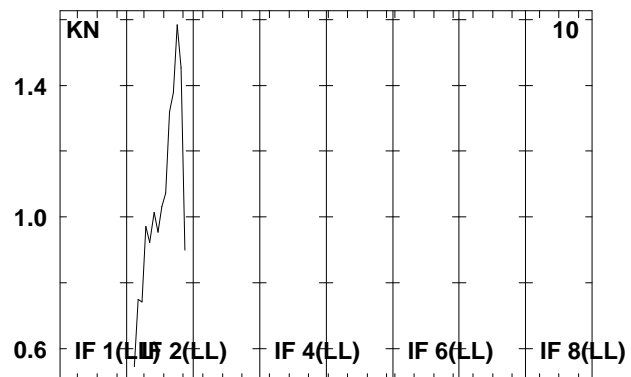
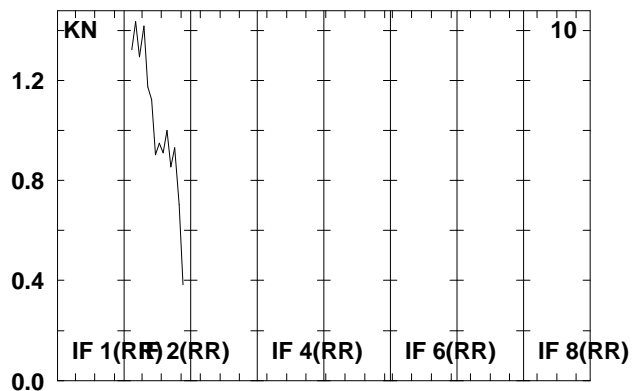
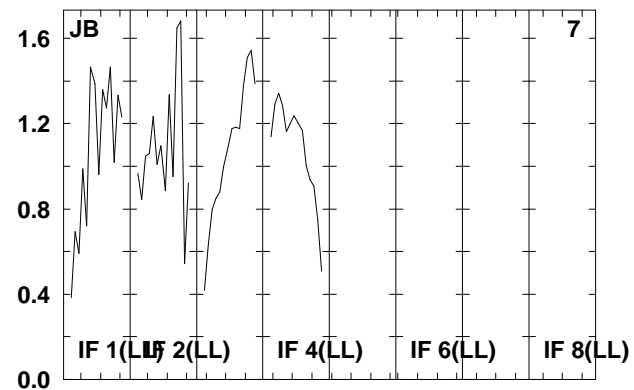
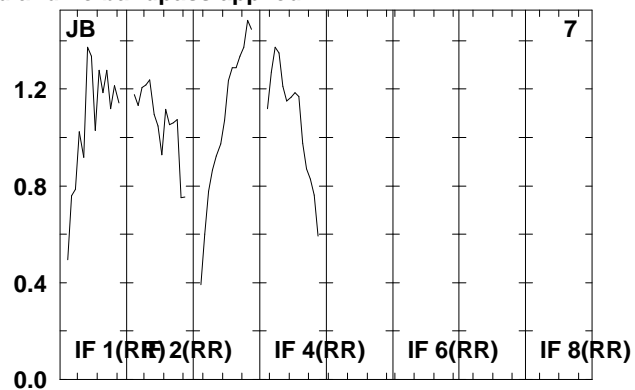
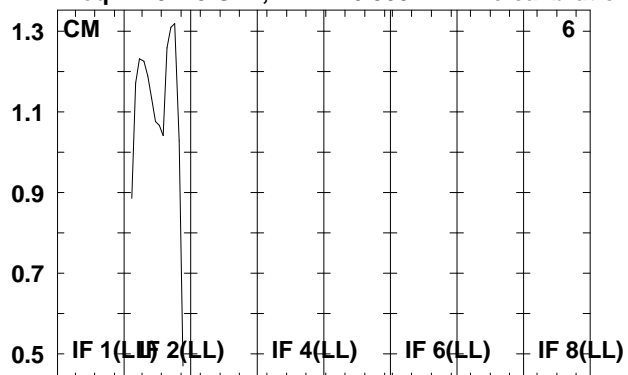

Lower frame: Real Jy  
Total-power spectrum Antenna: \*  
Timerange: 00/15:11:23 to 00/15:12:19

Plot file version 147 created 07-DEC-2009 16:06:06

J1912+05 RT006C.UVDATA.1

Freq = 4.9415 GHz, Bw = 16.000 MH No calibration applied and no bandpass applied

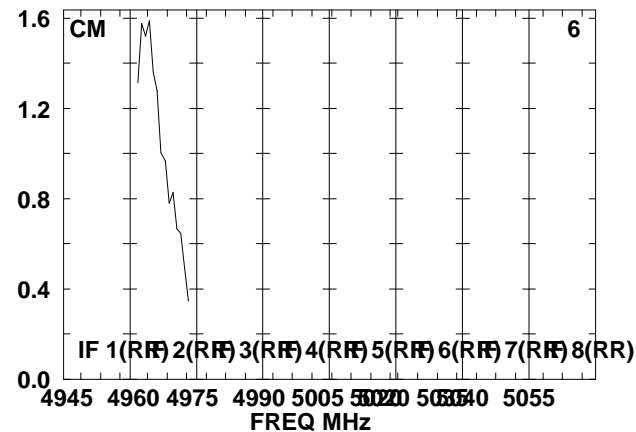
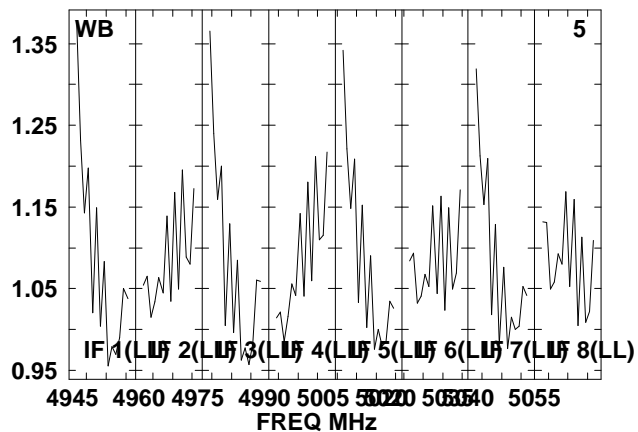
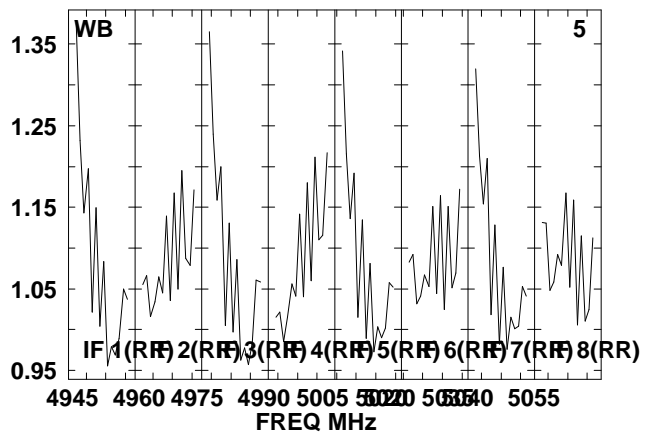
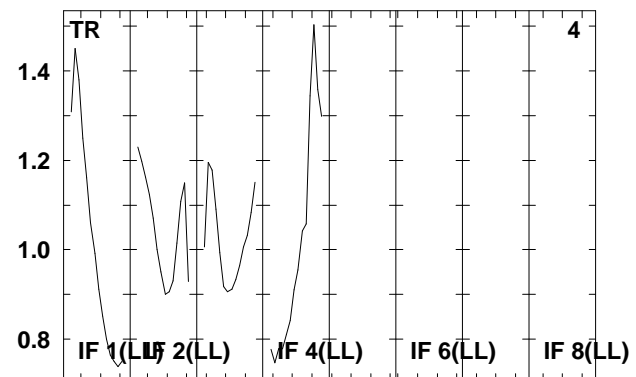
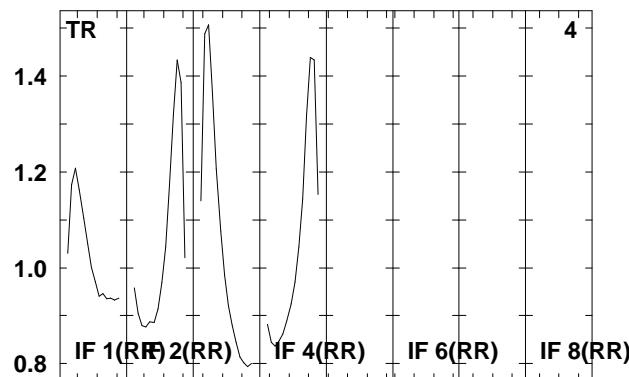
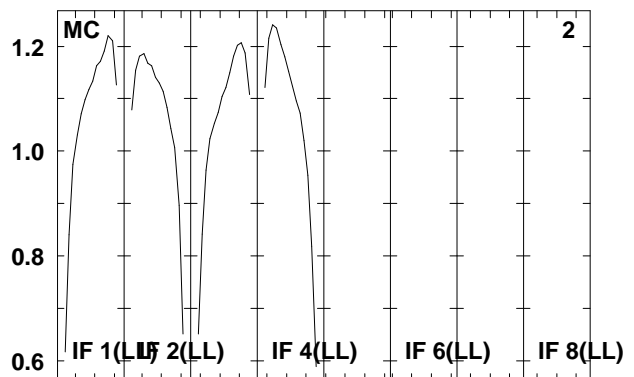
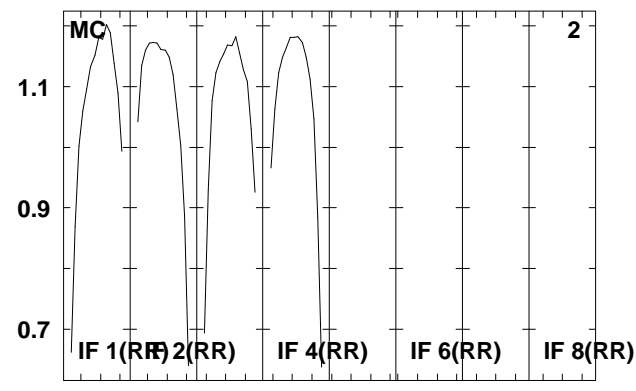
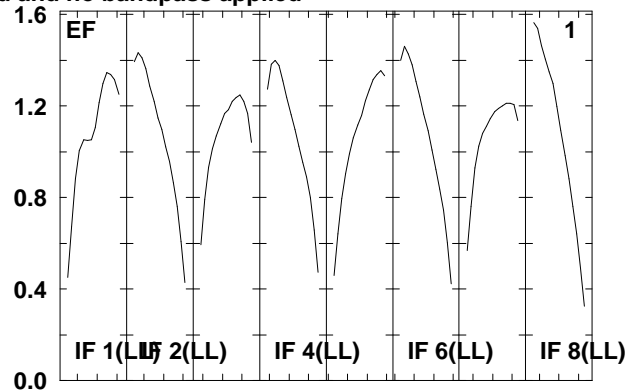
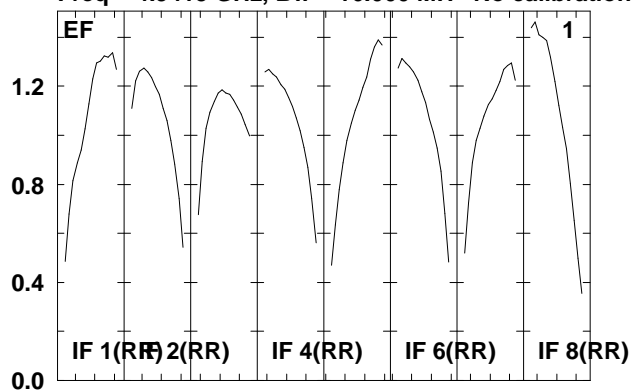

Lower frame: Real Jy  
Total-power spectrum Antenna: \*  
Timerange: 00/15:13:23 to 00/15:14:19

Plot file version 148 created 07-DEC-2009 16:06:06

J1912+05 RT006C.UVDATA.1

Freq = 4.9415 GHz, Bw = 16.000 MH No calibration applied and no bandpass applied

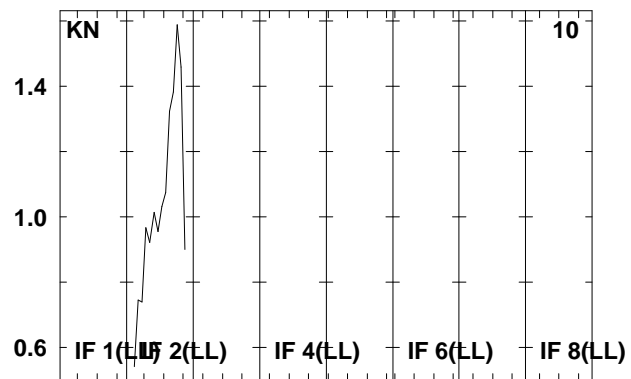
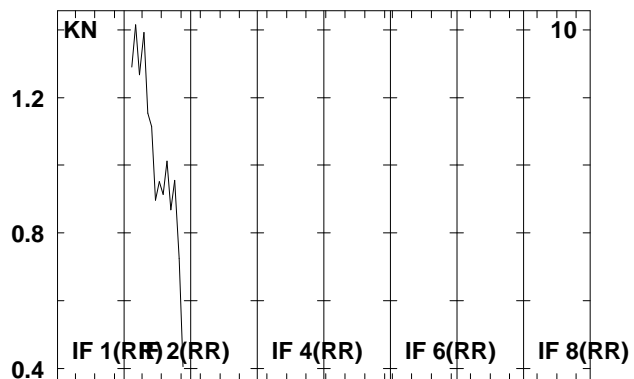
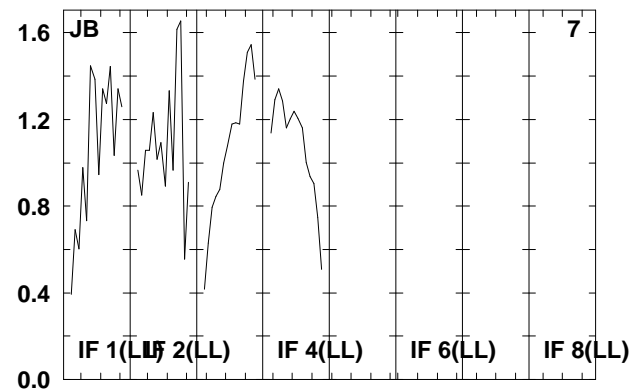
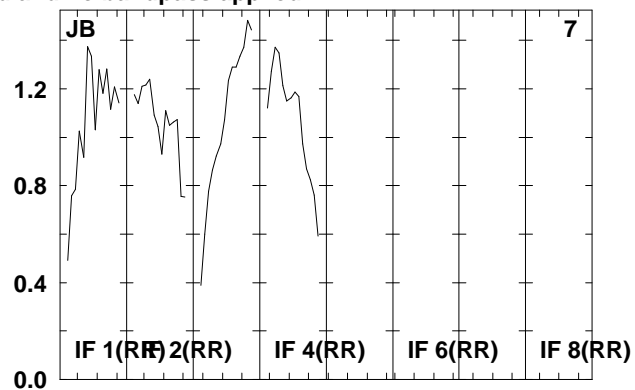
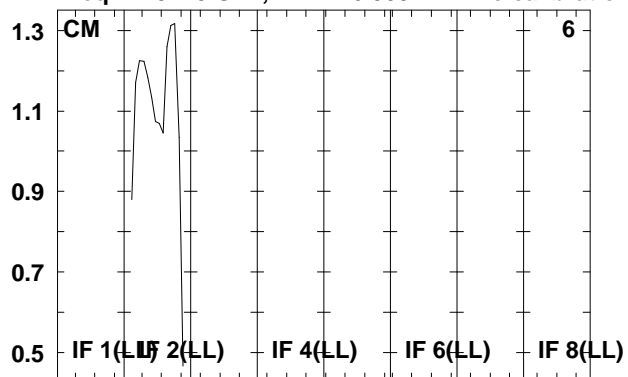

Lower frame: Real Jy  
Total-power spectrum Antenna: \*  
Timerange: 00/15:13:23 to 00/15:14:19

Plot file version 149 created 07-DEC-2009 16:06:06

SS433 RT006C.UVDATA.1

Freq = 4.9415 GHz, Bw = 16.000 MH No calibration applied and no bandpass applied

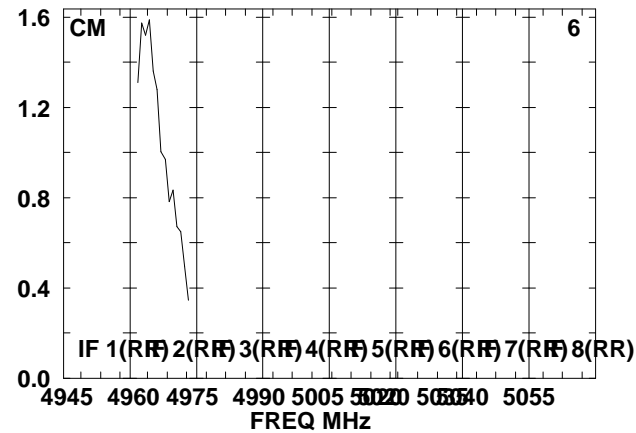
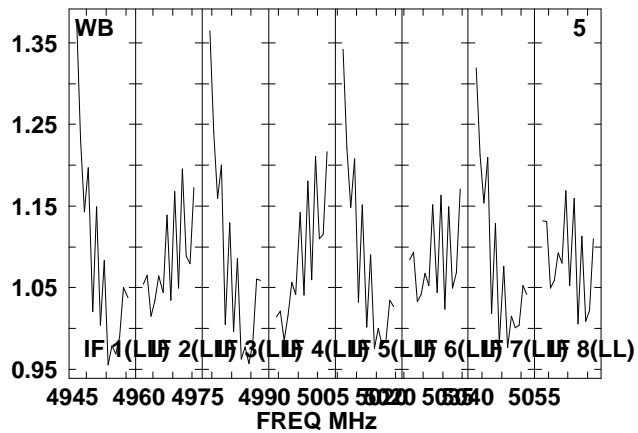
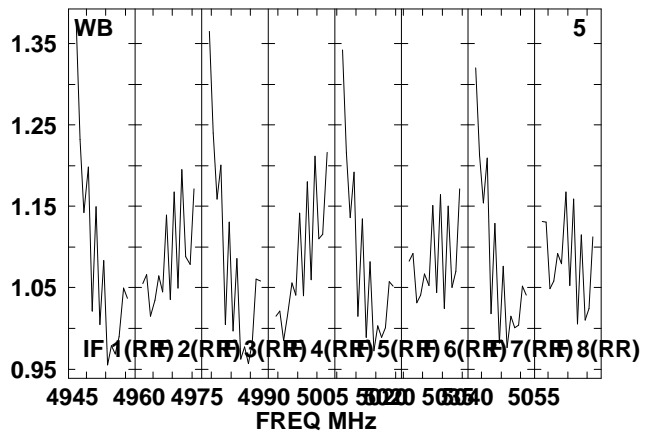
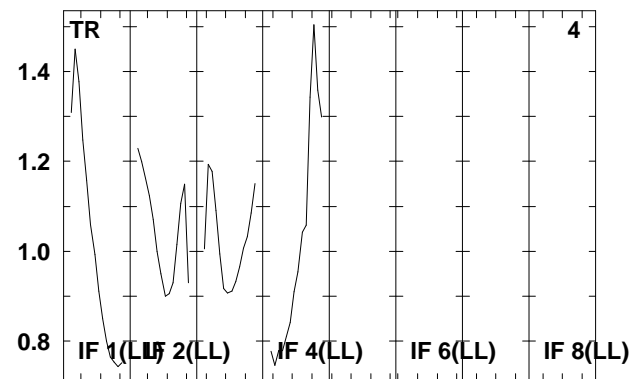
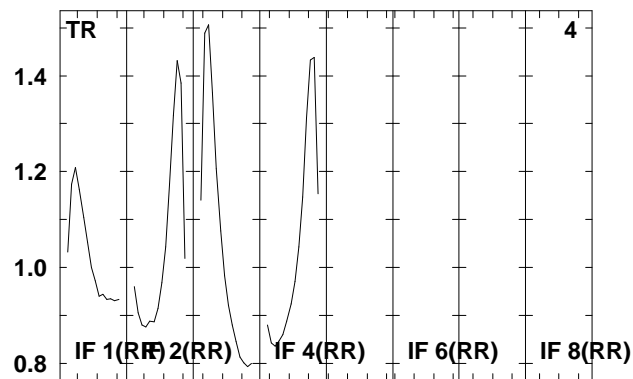
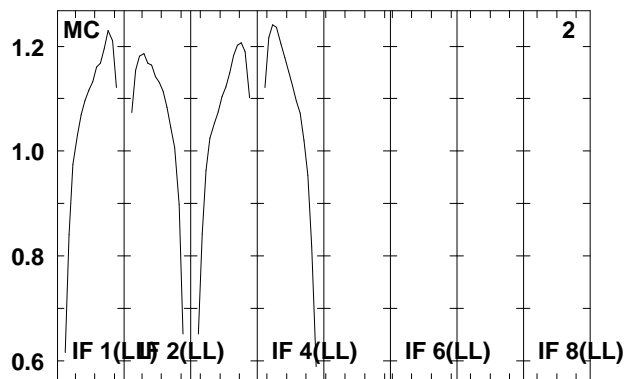
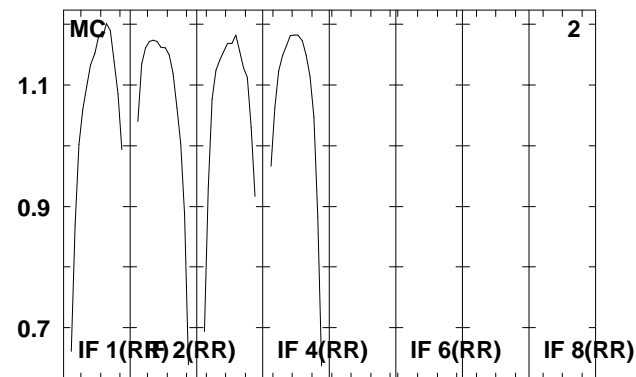
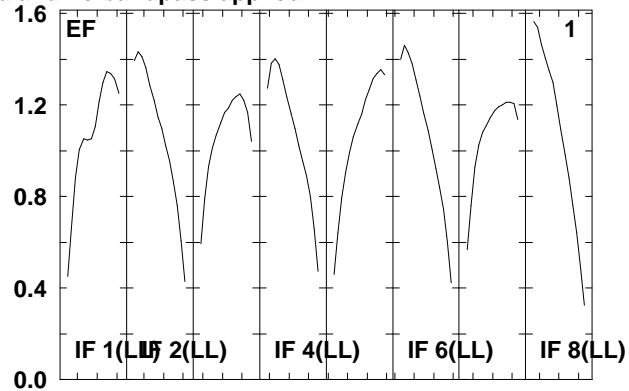
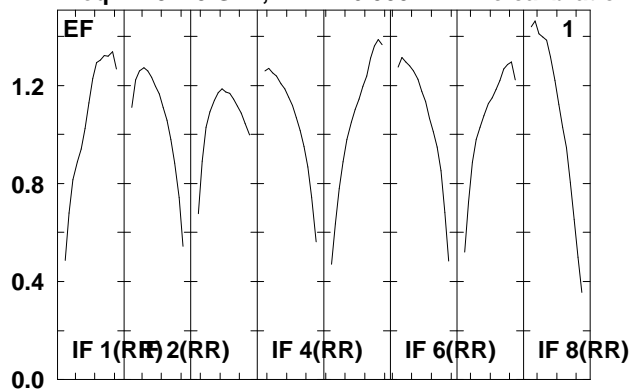

Lower frame: Real Jy  
Total-power spectrum Antenna: \*  
Timerange: 00/15:14:23 to 00/15:16:39

Plot file version 150 created 07-DEC-2009 16:06:06

SS433 RT006C.UVDATA.1

Freq = 4.9415 GHz, Bw = 16.000 MH No calibration applied and no bandpass applied

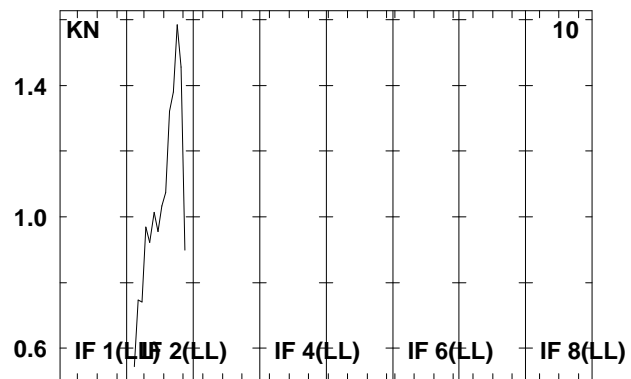
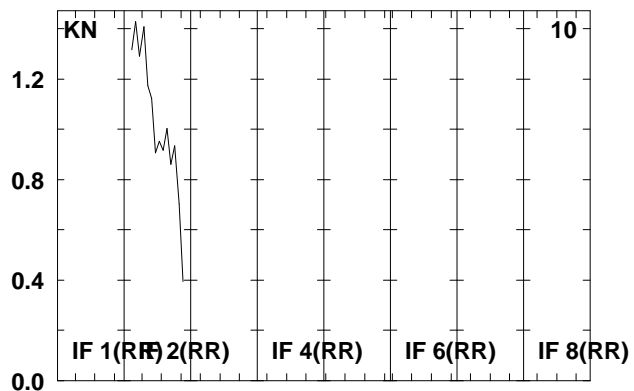
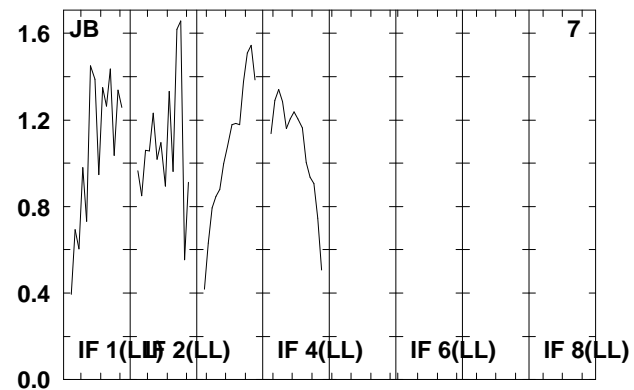
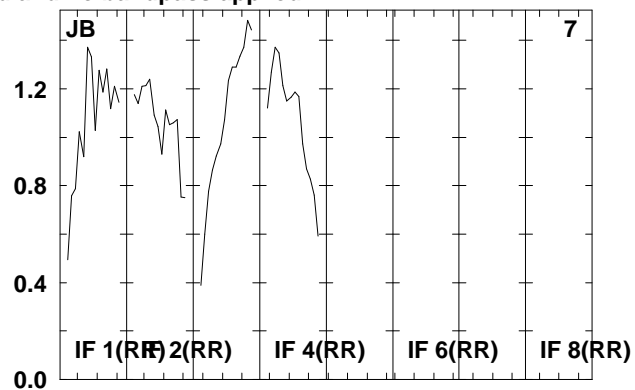
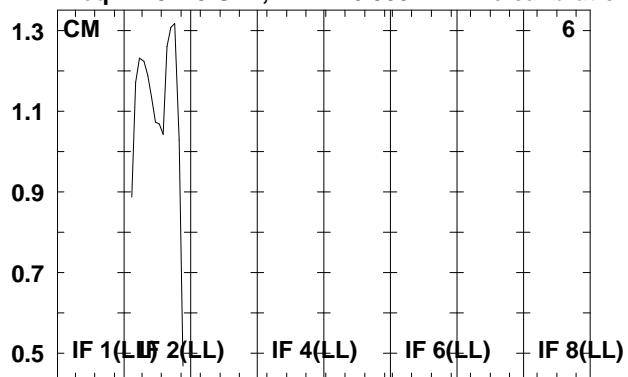

Lower frame: Real Jy  
Total-power spectrum Antenna: \*  
Timerange: 00/15:14:23 to 00/15:16:39

Plot file version 151 created 07-DEC-2009 16:06:07

J1912+05 RT006C.UVDATA.1

Freq = 4.9415 GHz, Bw = 16.000 MH No calibration applied and no bandpass applied

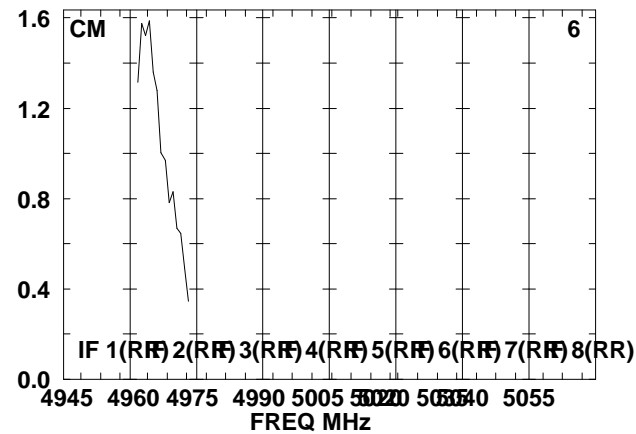
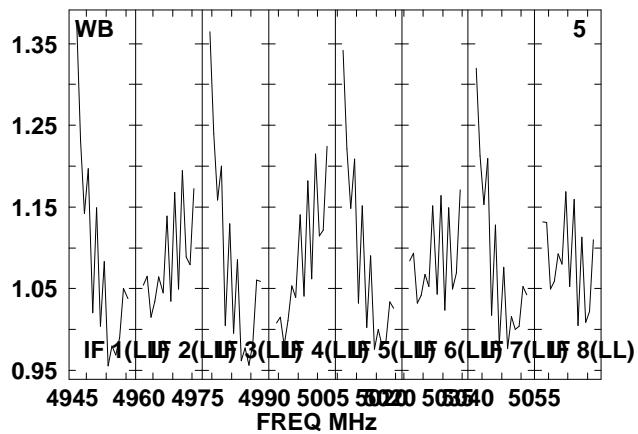
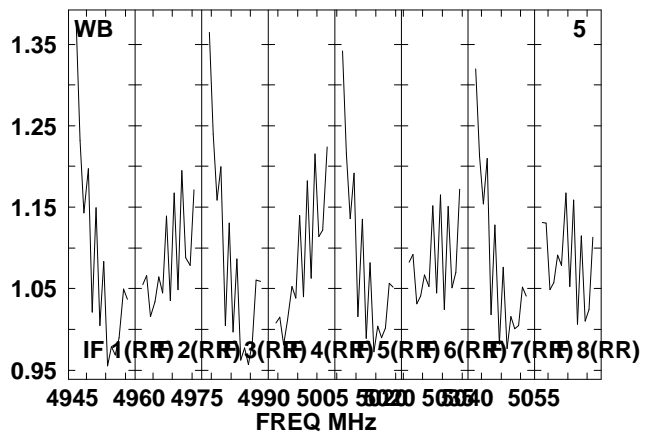
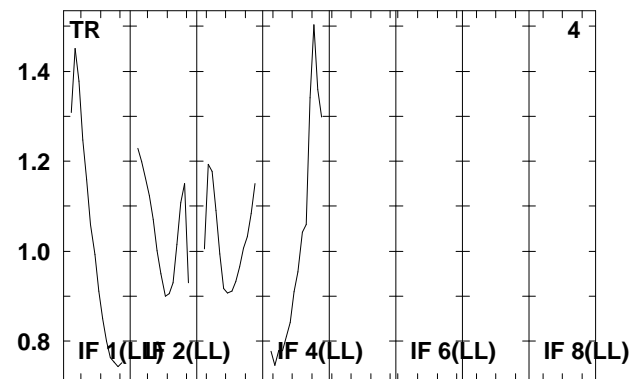
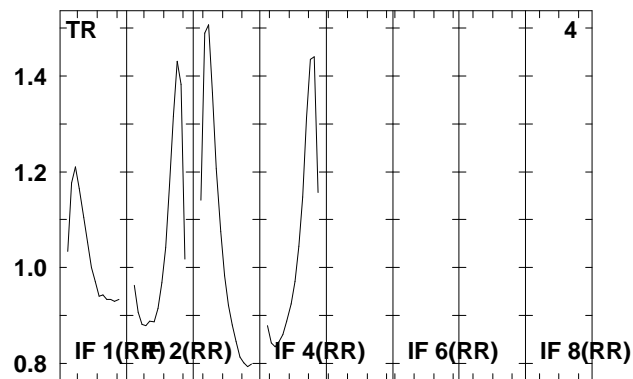
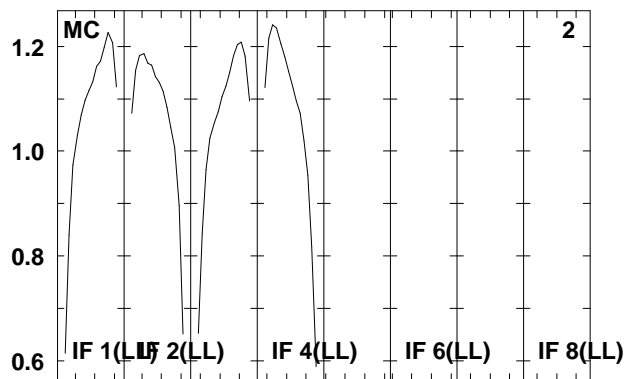
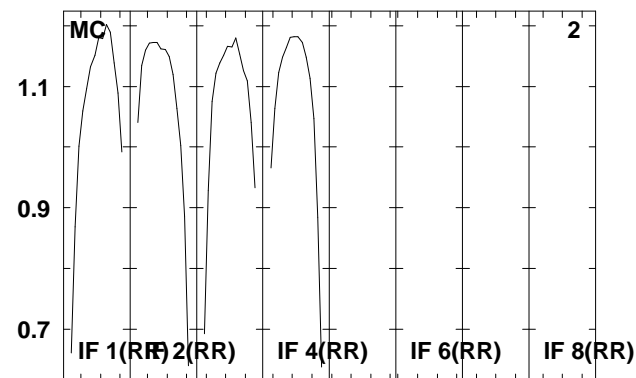
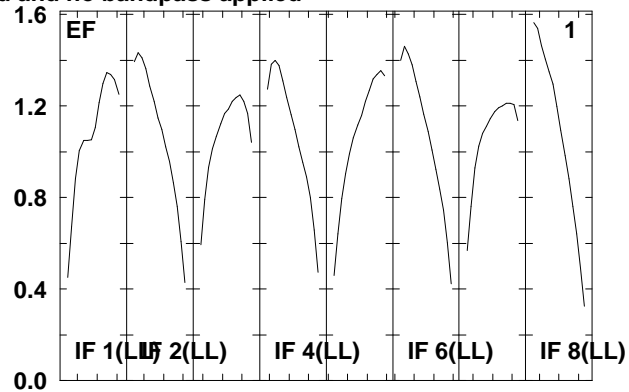
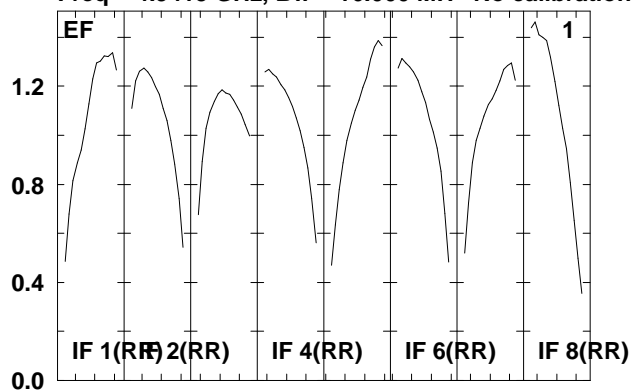

Lower frame: Real Jy  
Total-power spectrum Antenna: \*  
Timerange: 00/15:16:43 to 00/15:17:59

Plot file version 152 created 07-DEC-2009 16:06:07

J1912+05 RT006C.UVDATA.1

Freq = 4.9415 GHz, Bw = 16.000 MH No calibration applied and no bandpass applied

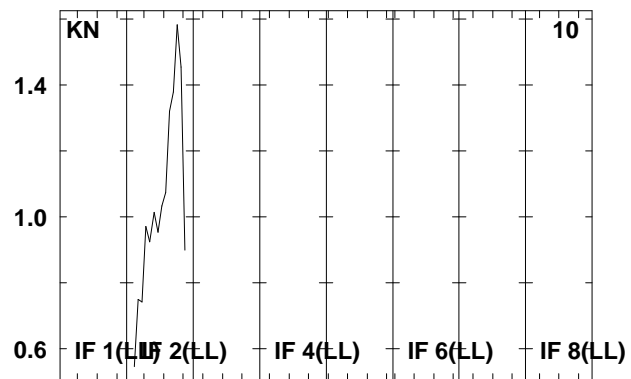
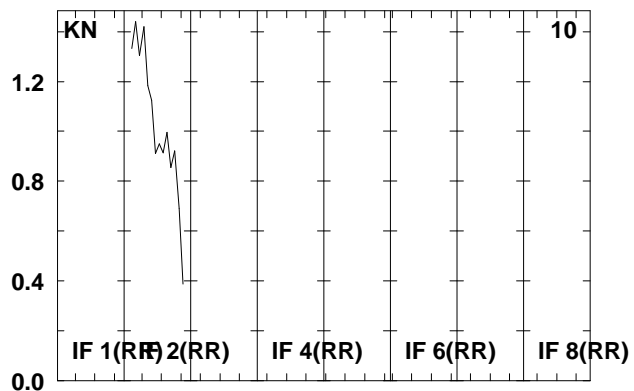
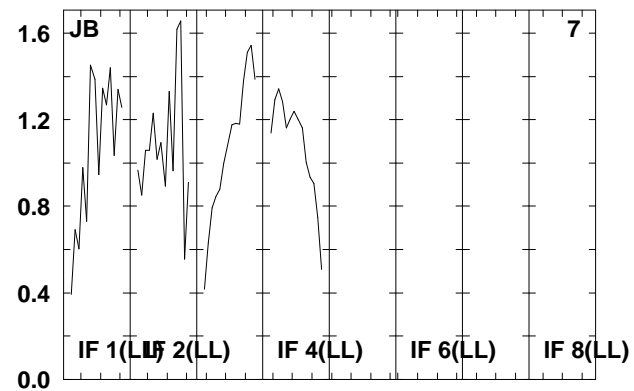
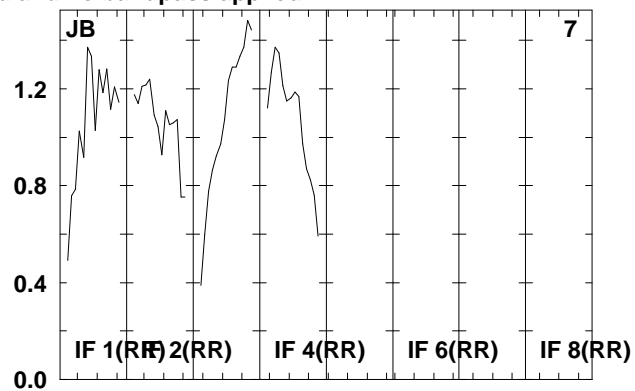
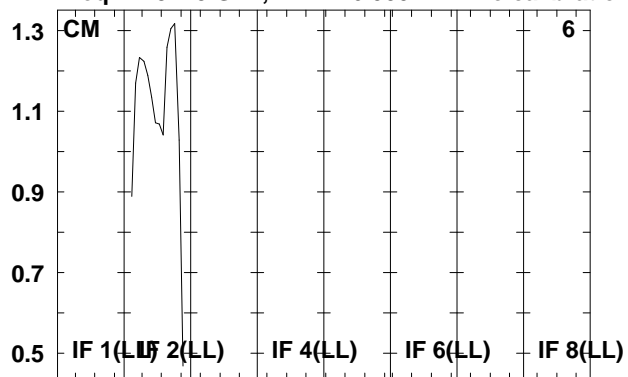

Lower frame: Real Jy  
Total-power spectrum Antenna: \*  
Timerange: 00/15:16:43 to 00/15:17:59



Plot file version 153 created 07-DEC-2009 16:06:07

SS433 RT006C.UVDATA.1

Freq = 4.9415 GHz, Bw = 16.000 MH No calibration applied and no bandpass applied

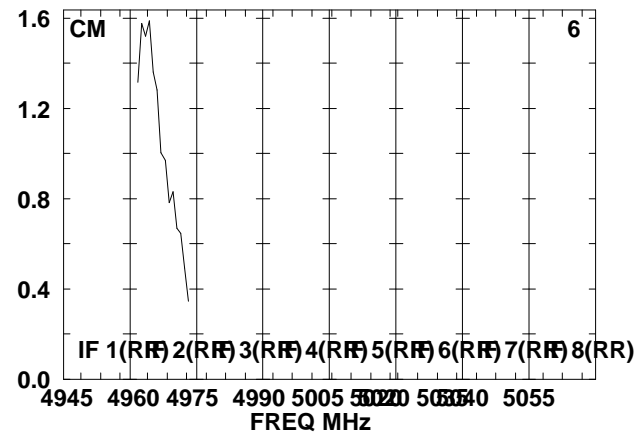
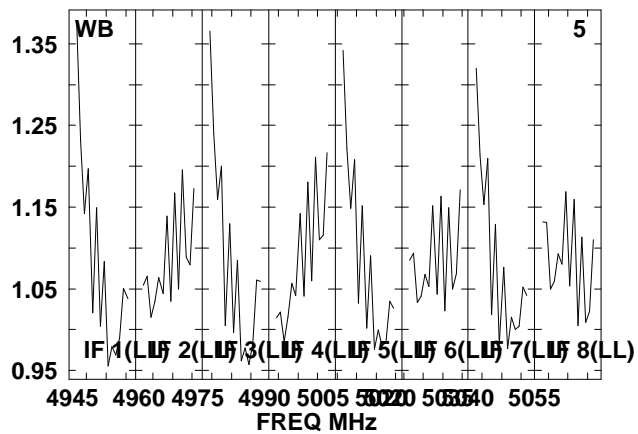
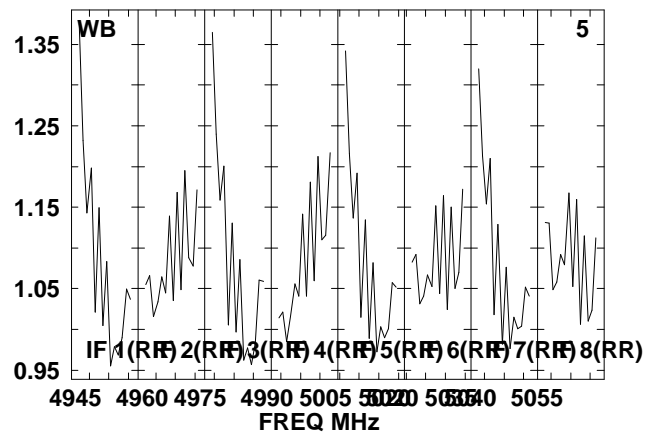
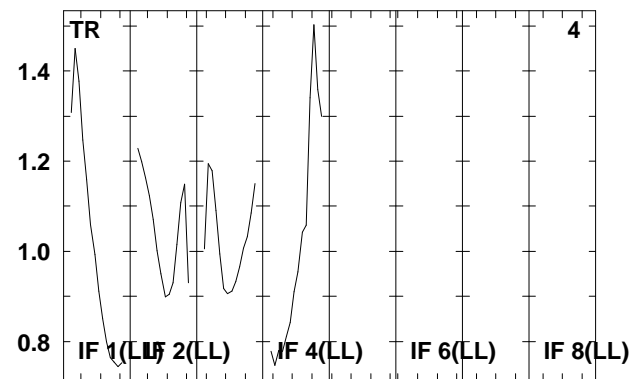
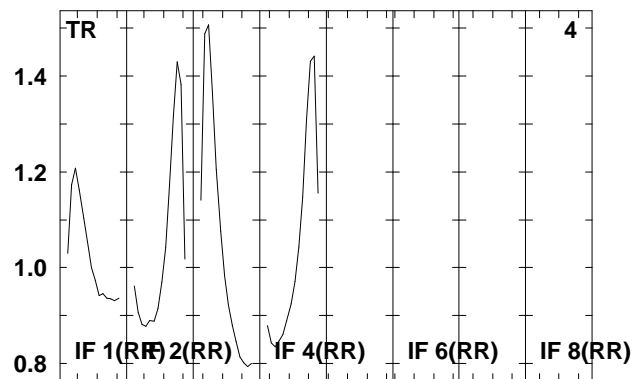
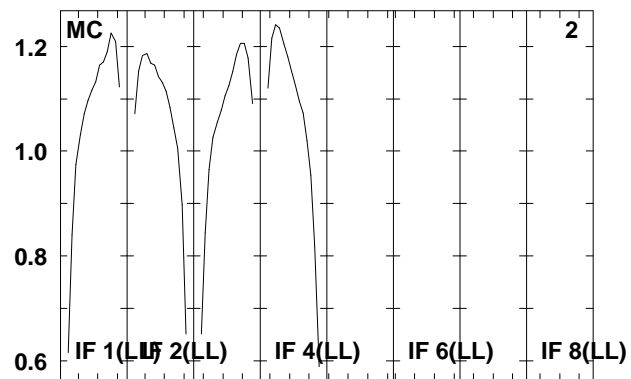
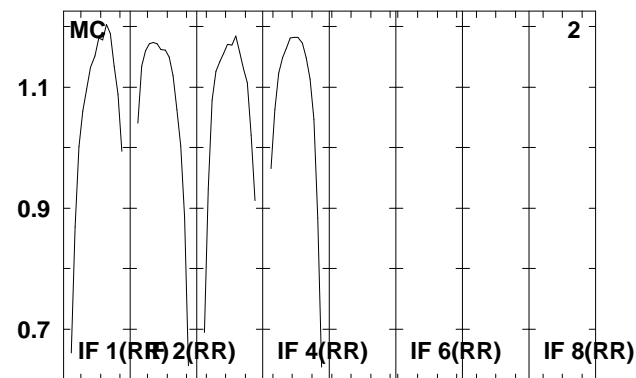
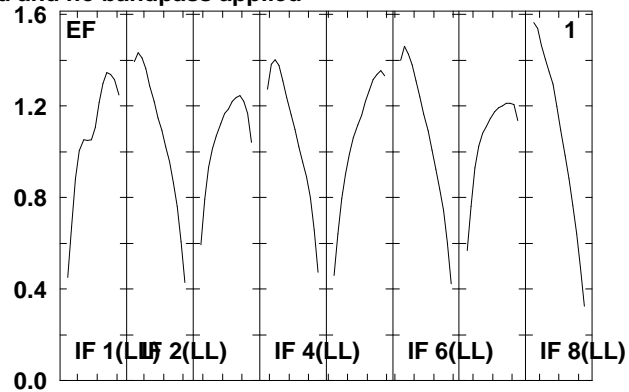
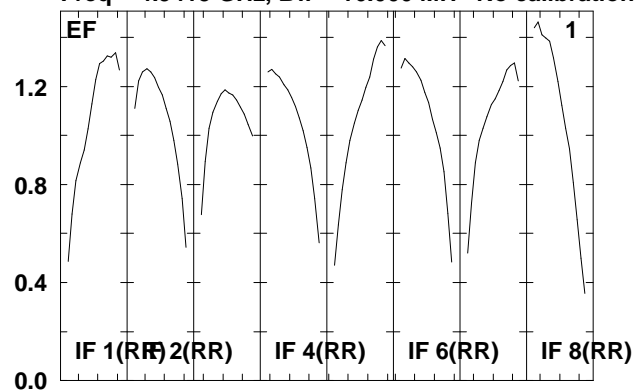

Lower frame: Real Jy  
Total-power spectrum Antenna: \*  
Timerange: 00/15:18:03 to 00/15:20:19

Plot file version 154 created 07-DEC-2009 16:06:07

SS433 RT006C.UVDATA.1

Freq = 4.9415 GHz, Bw = 16.000 MH No calibration applied and no bandpass applied

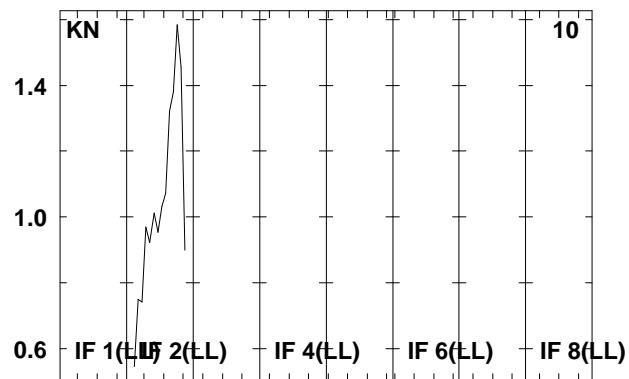
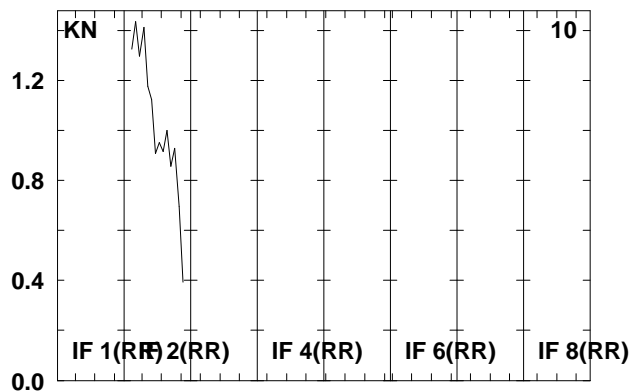
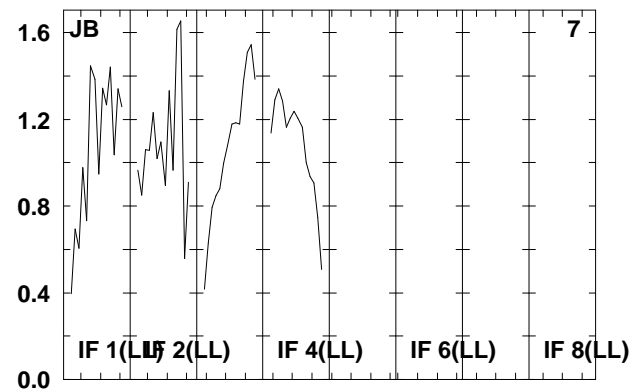
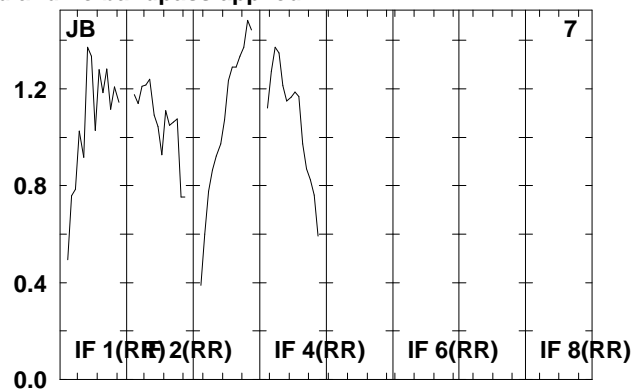
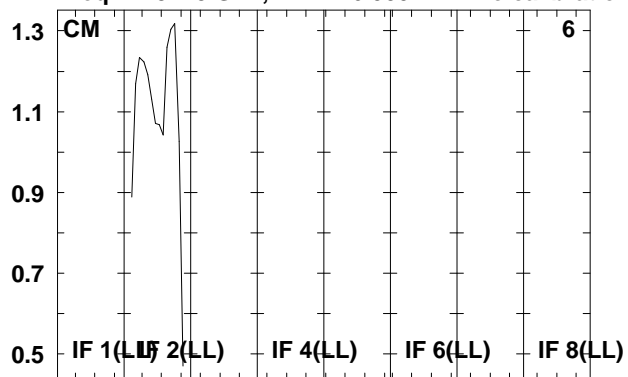

Lower frame: Real Jy  
Total-power spectrum Antenna: \*  
Timerange: 00/15:18:03 to 00/15:20:19

Plot file version 155 created 07-DEC-2009 16:06:07

J1912+05 RT006C.UVDATA.1

Freq = 4.9415 GHz, Bw = 16.000 MH No calibration applied and no bandpass applied

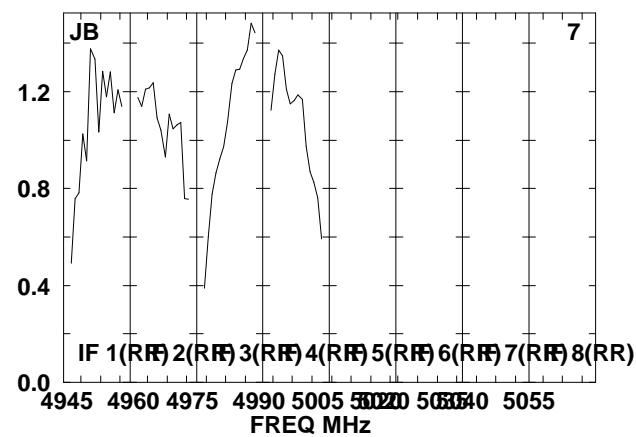
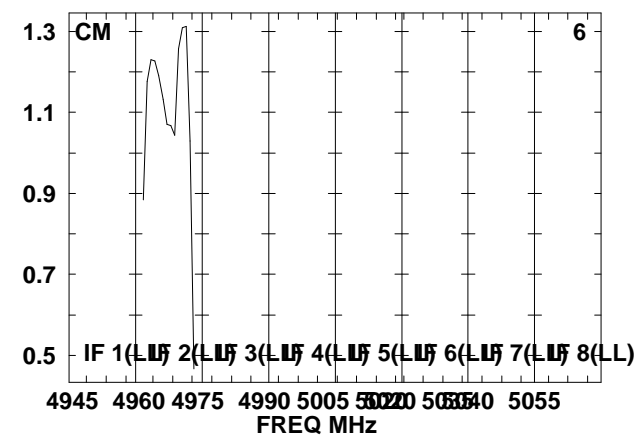
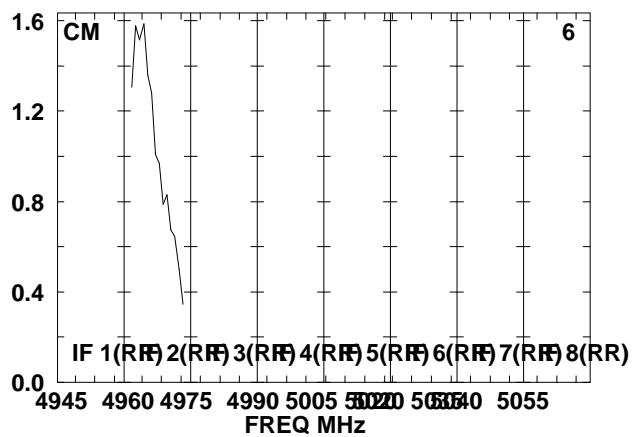
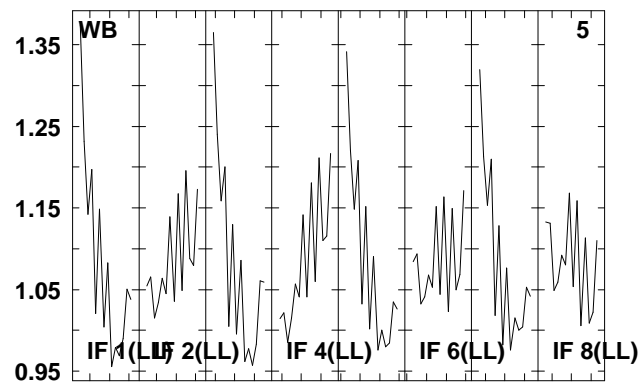
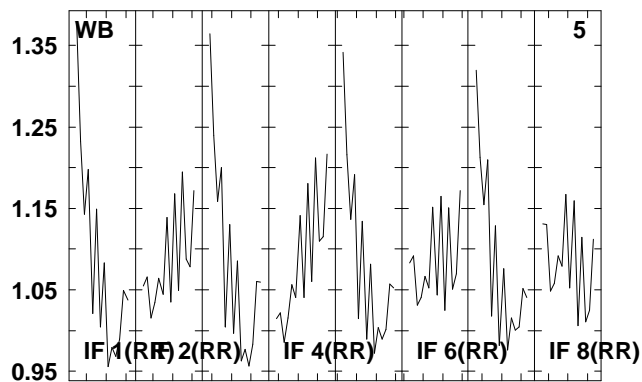
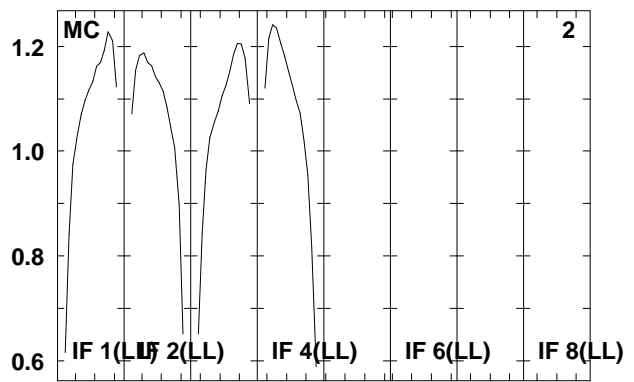
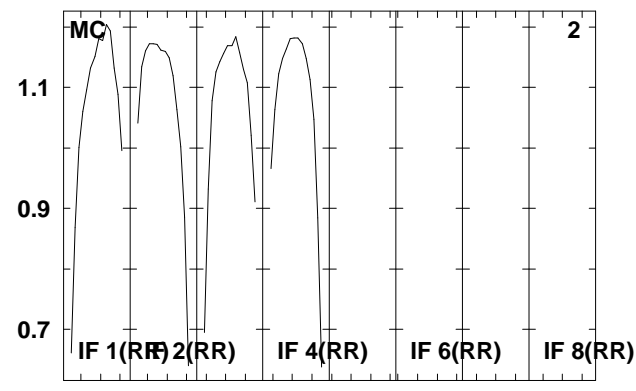
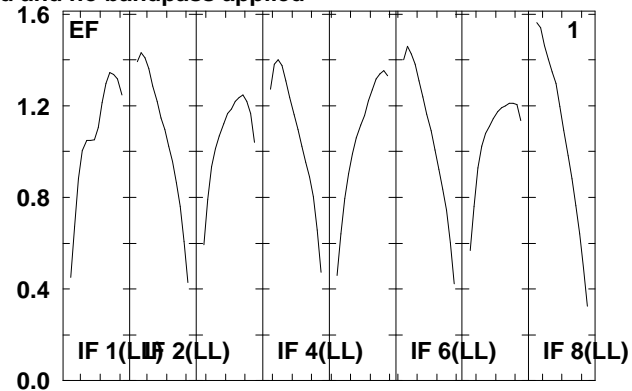
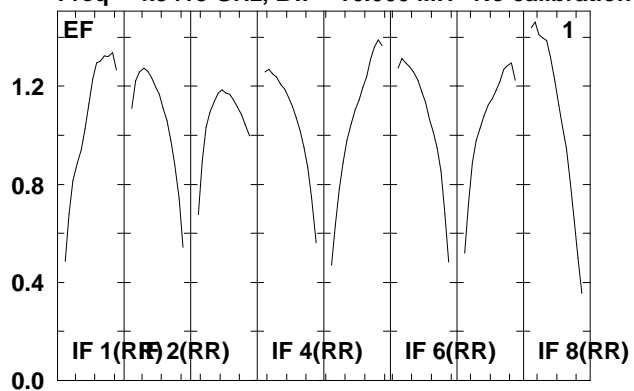

Lower frame: Real Jy  
Total-power spectrum Antenna: \*  
Timerange: 00/15:20:23 to 00/15:21:39

Plot file version 156 created 07-DEC-2009 16:06:07

J1912+05 RT006C.UVDATA.1

Freq = 4.9415 GHz, Bw = 16.000 MH No calibration applied and no bandpass applied

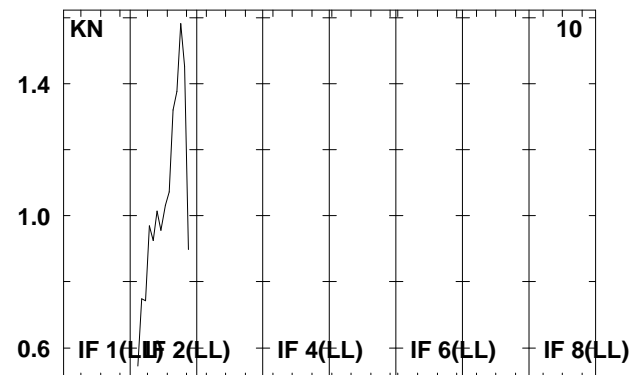
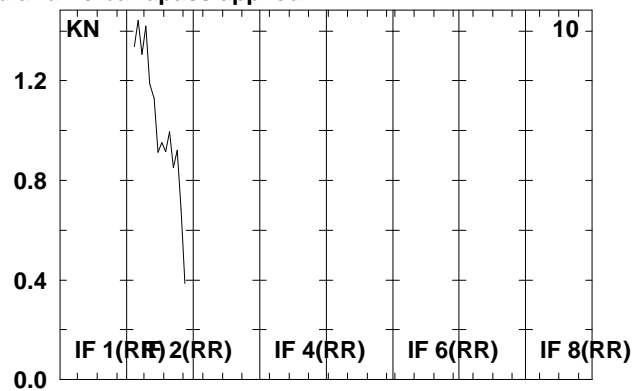
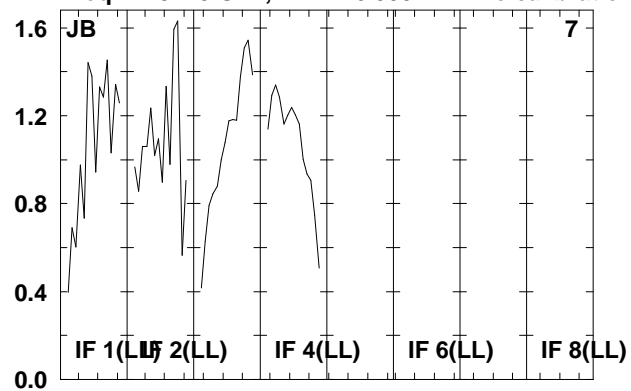

Lower frame: Real Jy  
Total-power spectrum Antenna: \*  
Timerange: 00/15:20:23 to 00/15:21:39

Plot file version 157 created 07-DEC-2009 16:06:08

SS433 RT006C.UVDATA.1

Freq = 4.9415 GHz, Bw = 16.000 MH No calibration applied and no bandpass applied

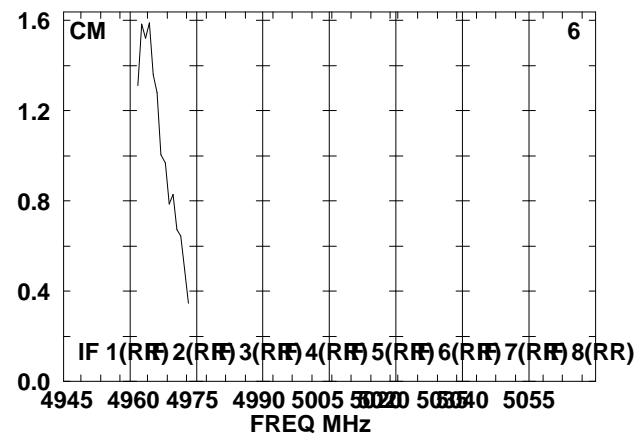
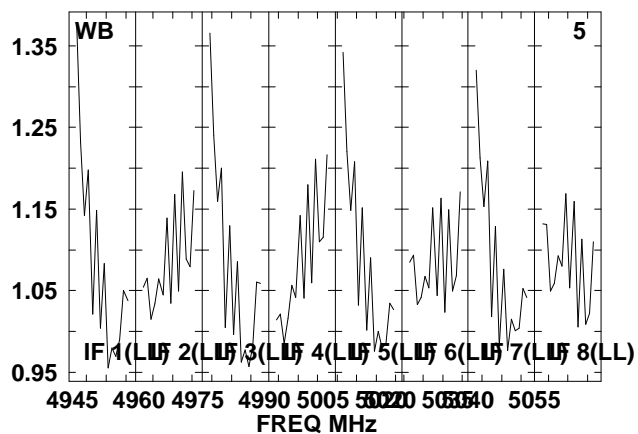
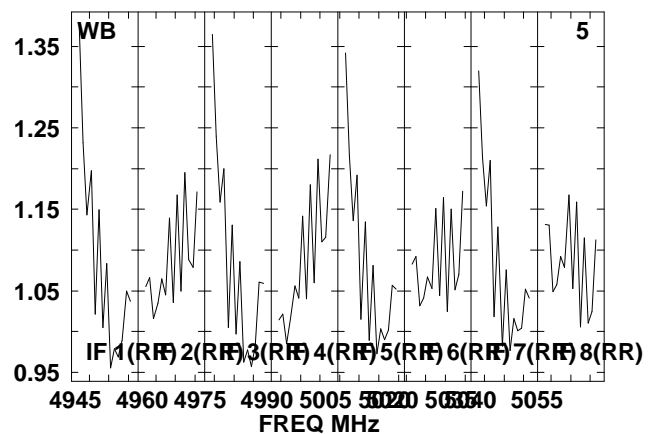
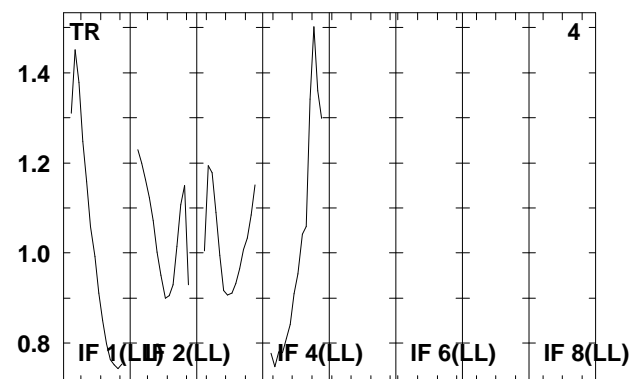
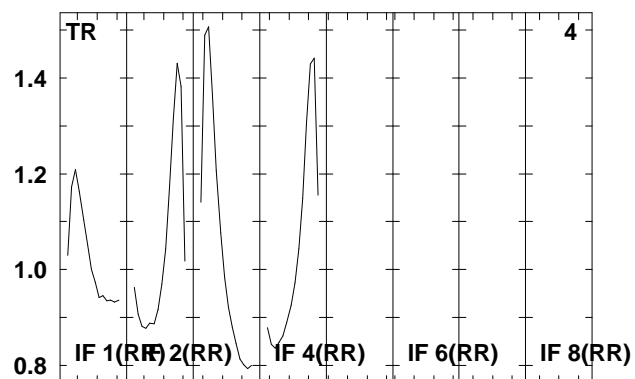
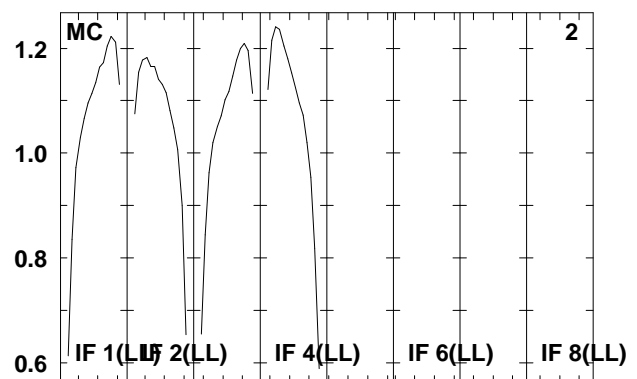
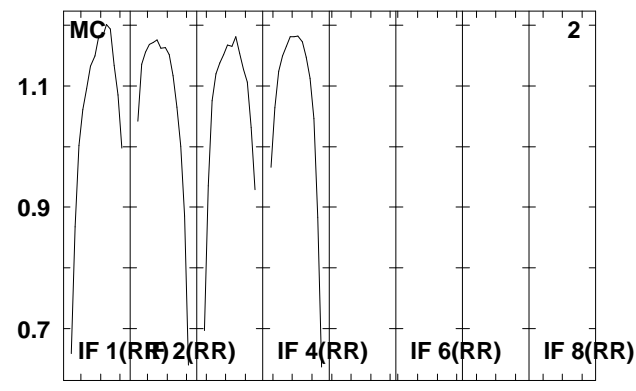
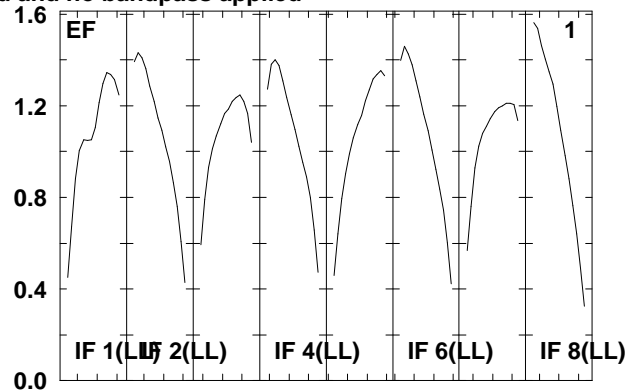
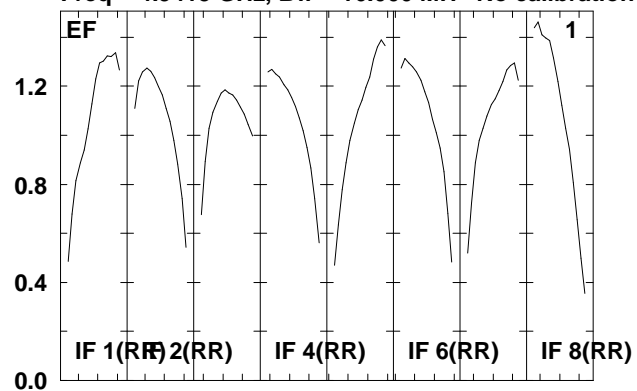

Lower frame: Real Jy  
Total-power spectrum Antenna: \*  
Timerange: 00/15:21:43 to 00/15:23:59

Plot file version 158 created 07-DEC-2009 16:06:08

SS433 RT006C.UVDATA.1

Freq = 4.9415 GHz, Bw = 16.000 MH No calibration applied and no bandpass applied

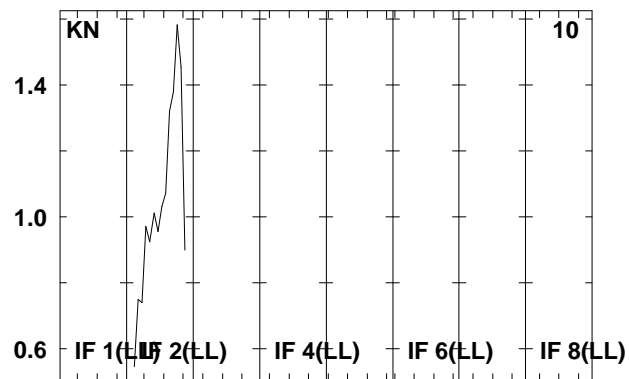
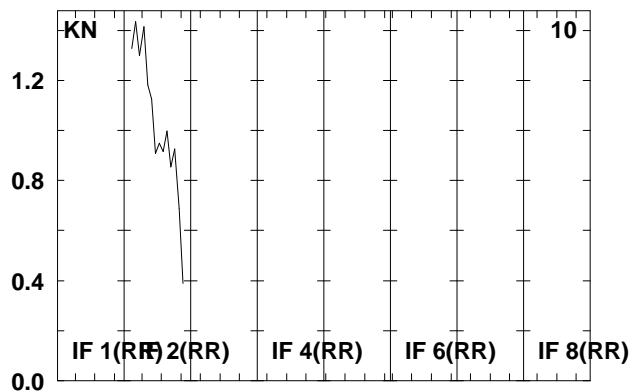
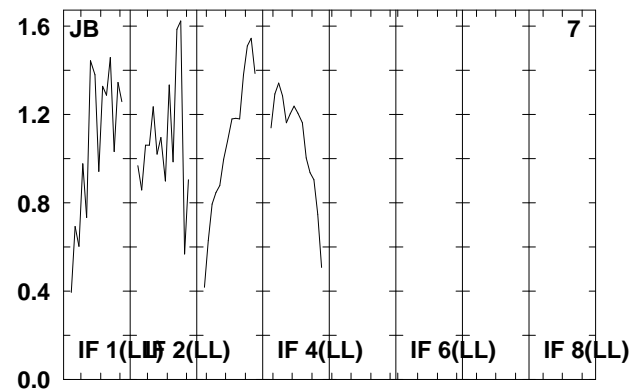
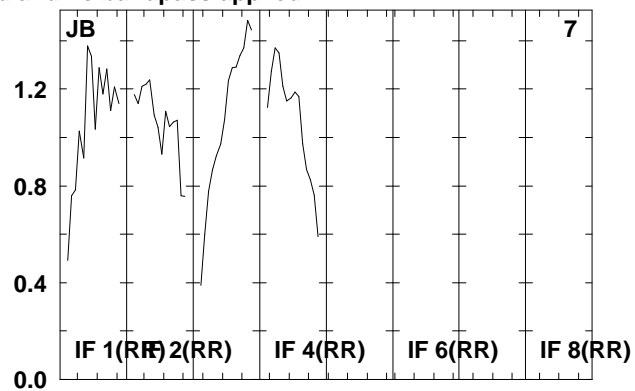
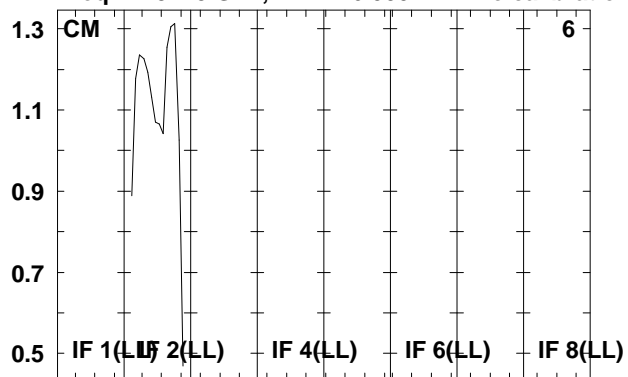

Lower frame: Real Jy  
Total-power spectrum Antenna: \*  
Timerange: 00/15:21:43 to 00/15:23:59

Plot file version 159 created 07-DEC-2009 16:06:09

J1912+05 RT006C.UVDATA.1

Freq = 4.9415 GHz, Bw = 16.000 MH No calibration applied and no bandpass applied

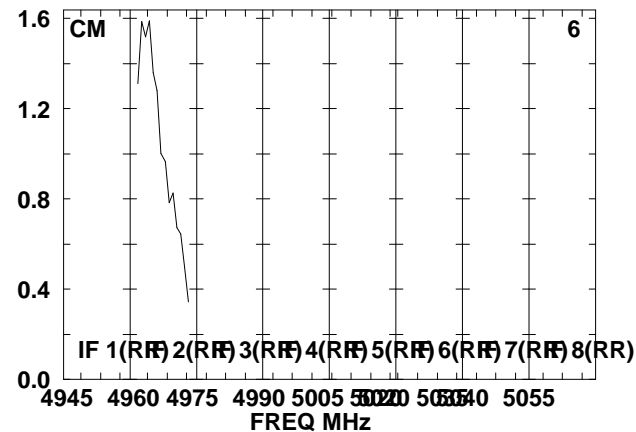
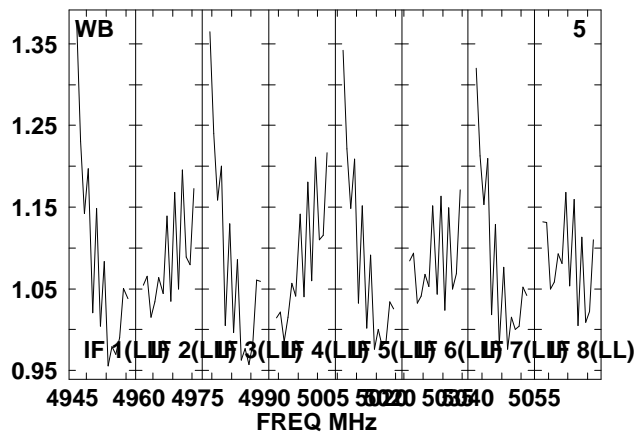
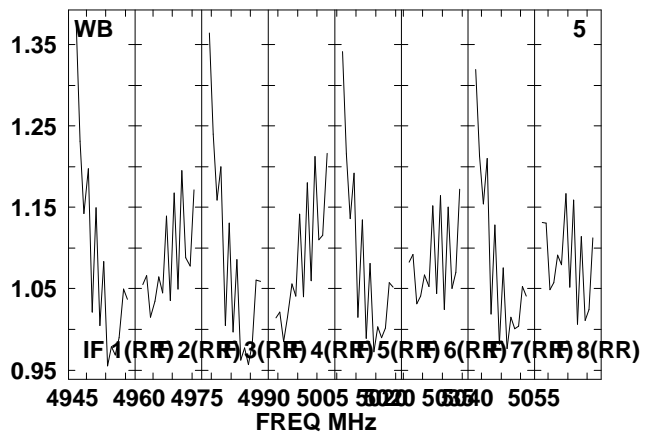
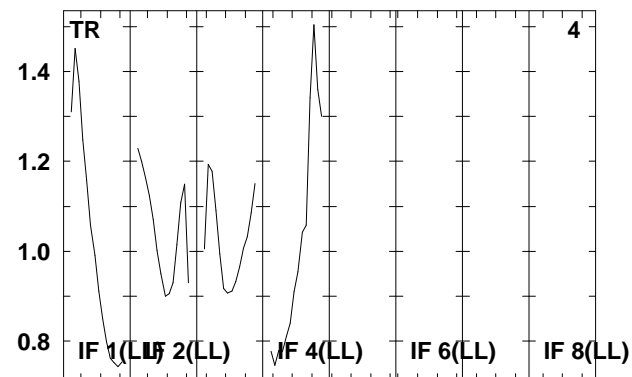
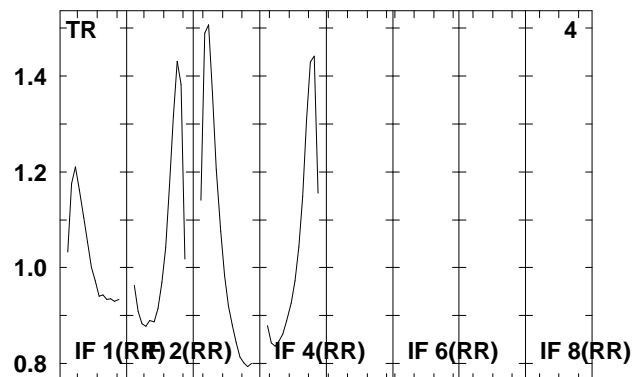
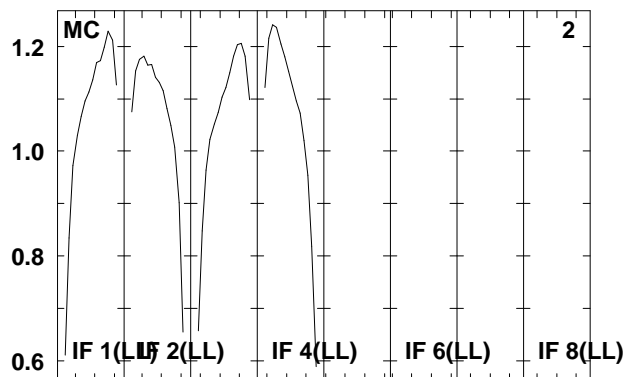
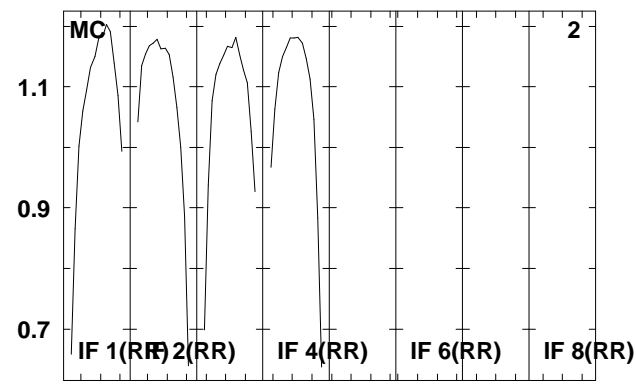
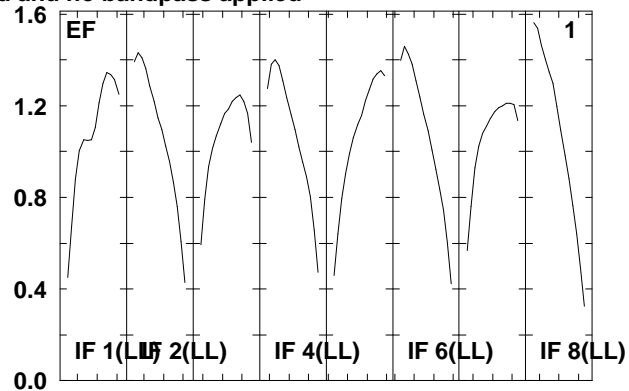
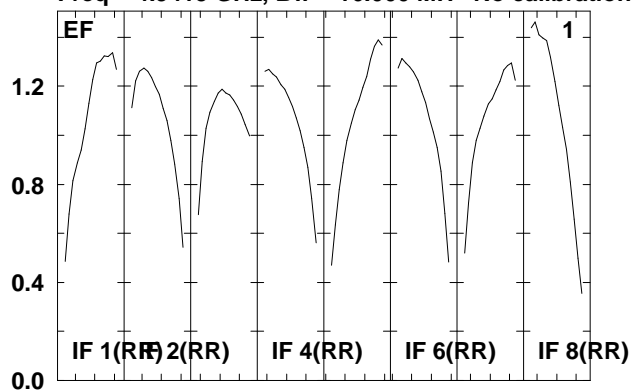

Lower frame: Real Jy

Total-power spectrum Antenna: \*

Timerange: 00/15:24:03 to 00/15:25:19

Plot file version 160 created 07-DEC-2009 16:06:09

J1912+05 RT006C.UVDATA.1

Freq = 4.9415 GHz, Bw = 16.000 MH No calibration applied and no bandpass applied

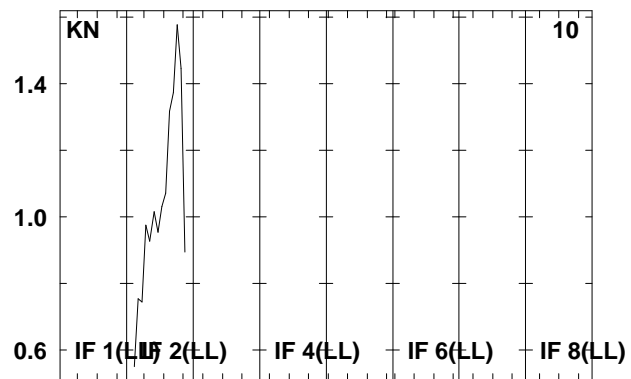
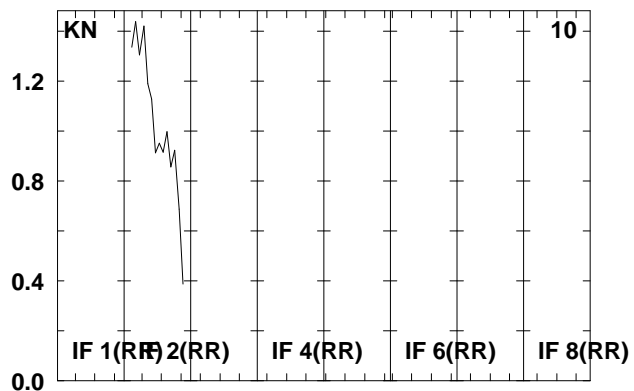
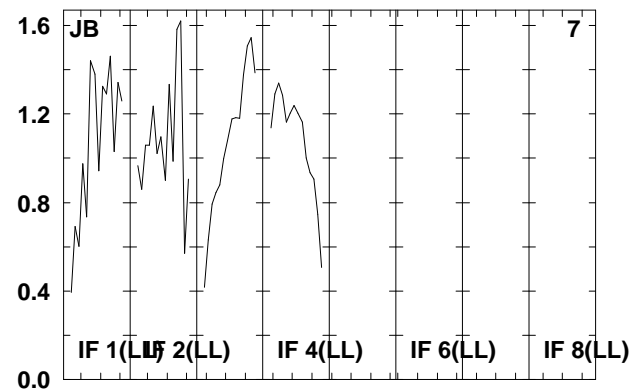
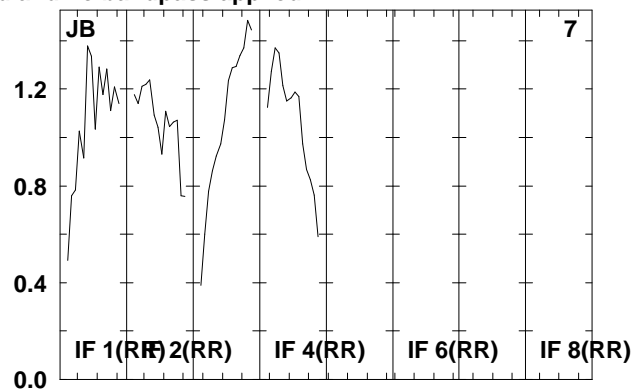
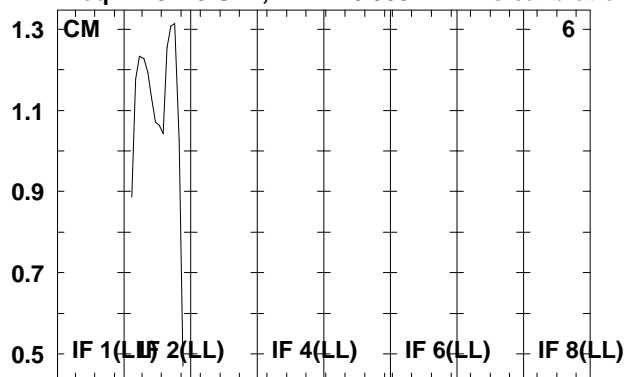

Lower frame: Real Jy  
Total-power spectrum Antenna: \*  
Timerange: 00/15:24:03 to 00/15:25:19



Plot file version 161 created 07-DEC-2009 16:06:09

SS433 RT006C.UVDATA.1

Freq = 4.9415 GHz, Bw = 16.000 MH No calibration applied and no bandpass applied

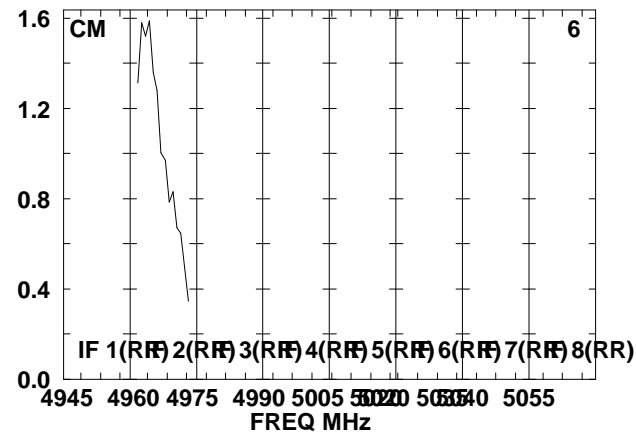
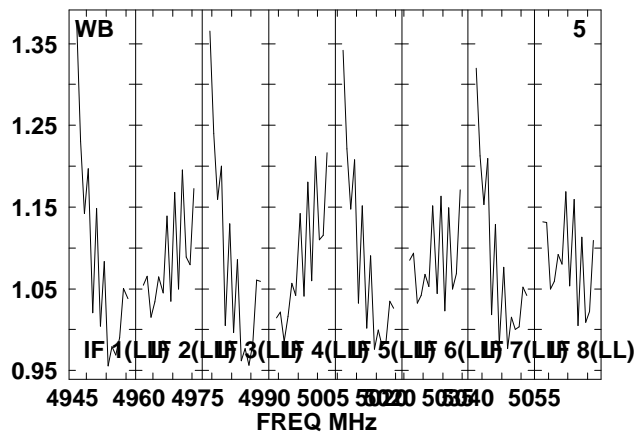
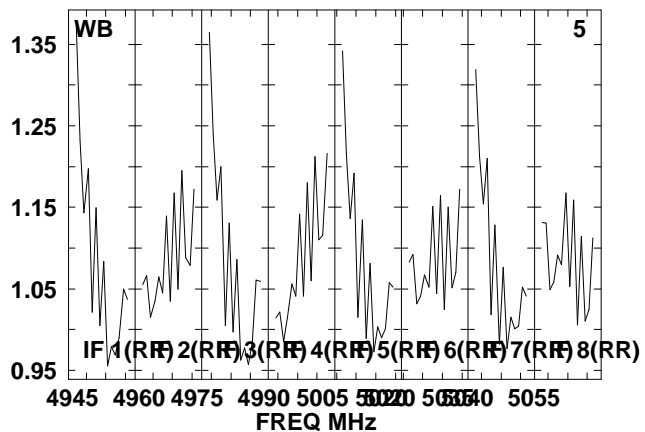
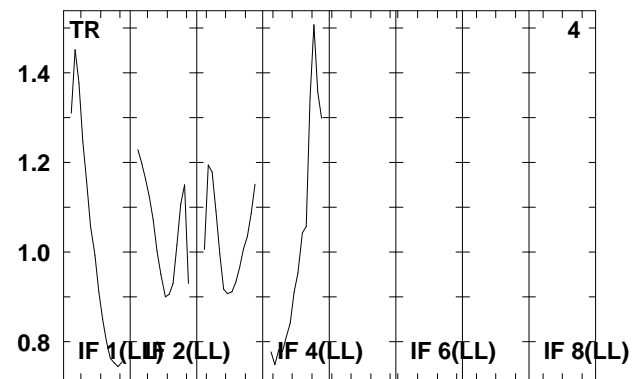
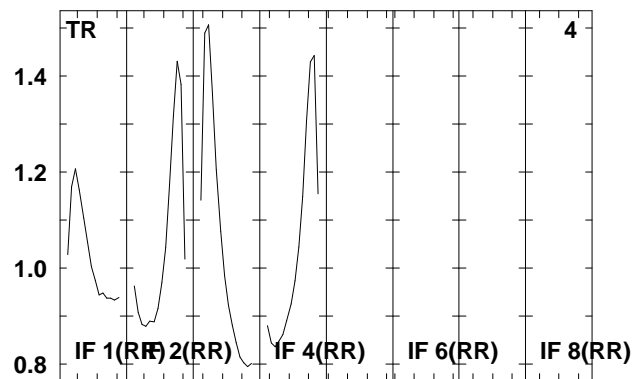
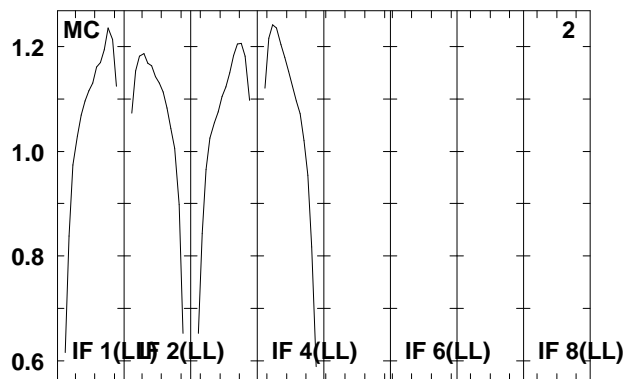
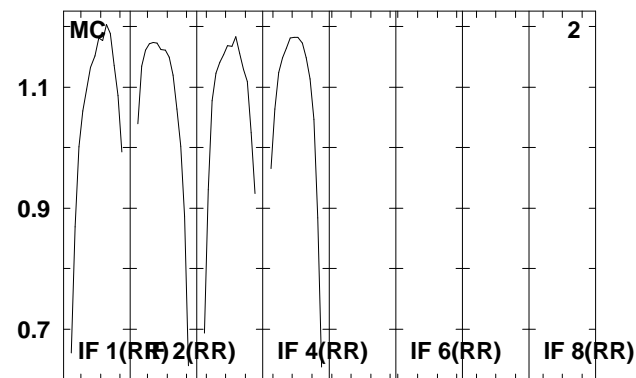
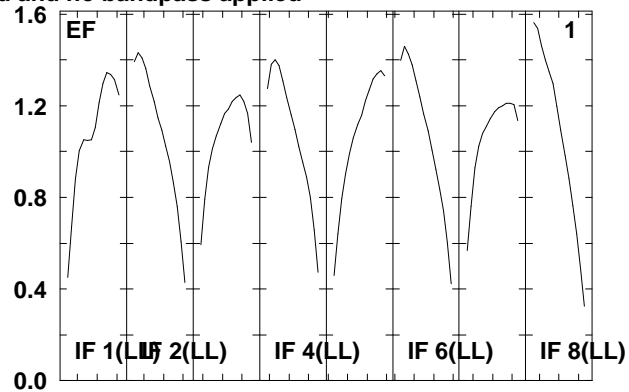
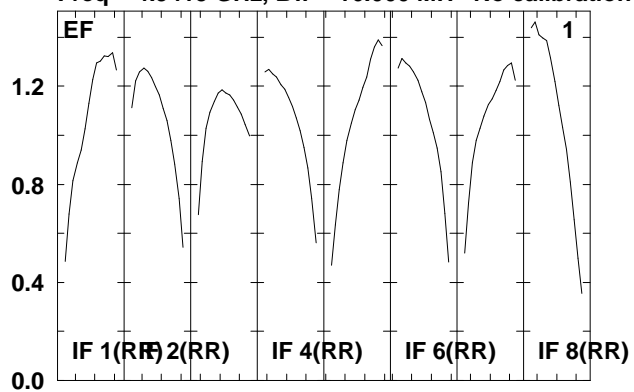

Lower frame: Real Jy  
Total-power spectrum Antenna: \*  
Timerange: 00/15:25:23 to 00/15:27:39

Plot file version 162 created 07-DEC-2009 16:06:09

SS433 RT006C.UVDATA.1

Freq = 4.9415 GHz, Bw = 16.000 MH No calibration applied and no bandpass applied

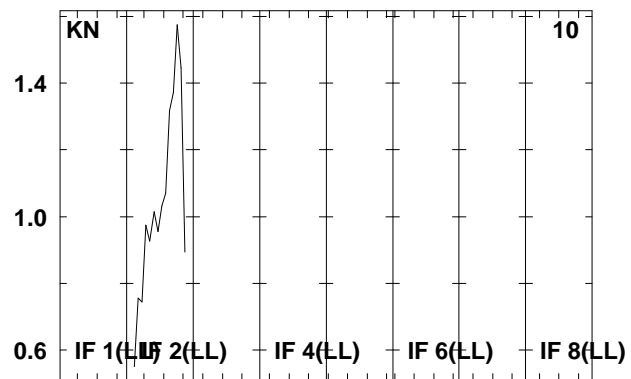
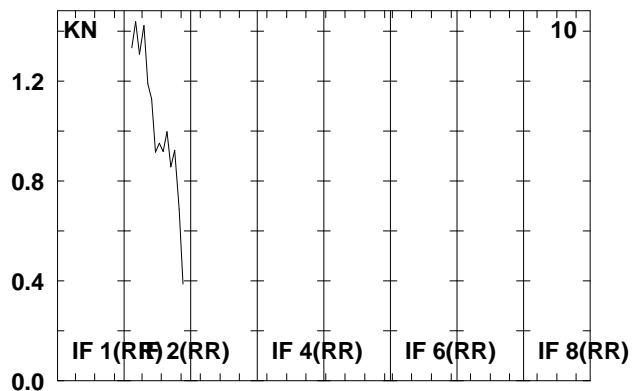
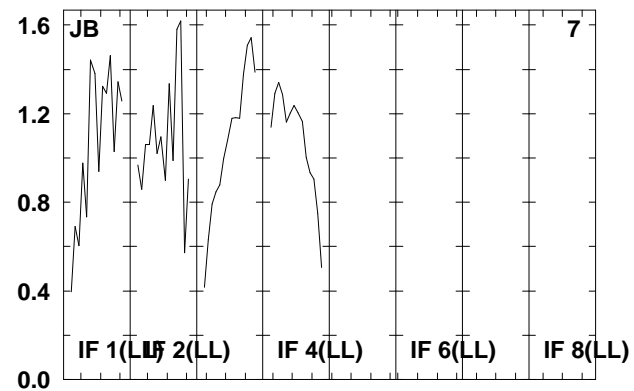
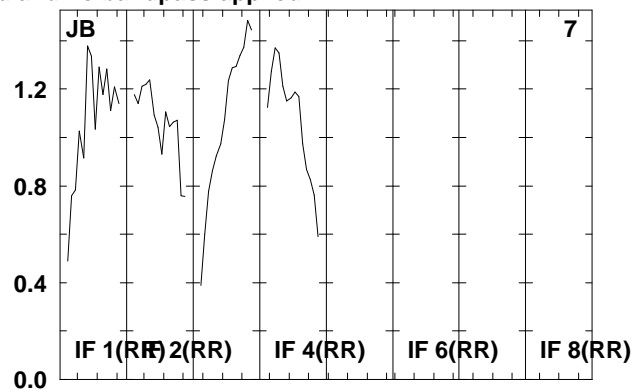
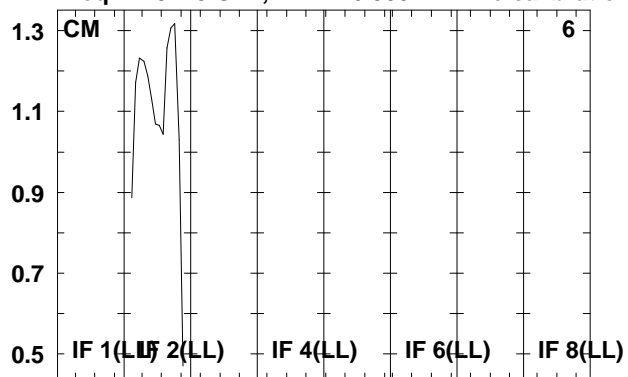

Lower frame: Real Jy  
Total-power spectrum Antenna: \*  
Timerange: 00/15:25:23 to 00/15:27:39

Plot file version 163 created 07-DEC-2009 16:06:09

J1911+16 RT006C.UVDATA.1

Freq = 4.9415 GHz, Bw = 16.000 MH No calibration applied and no bandpass applied

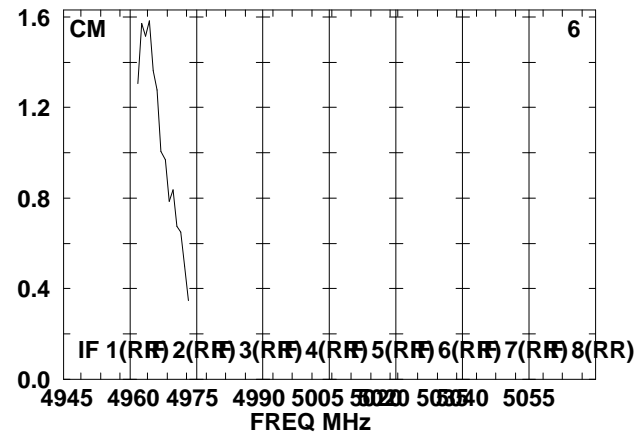
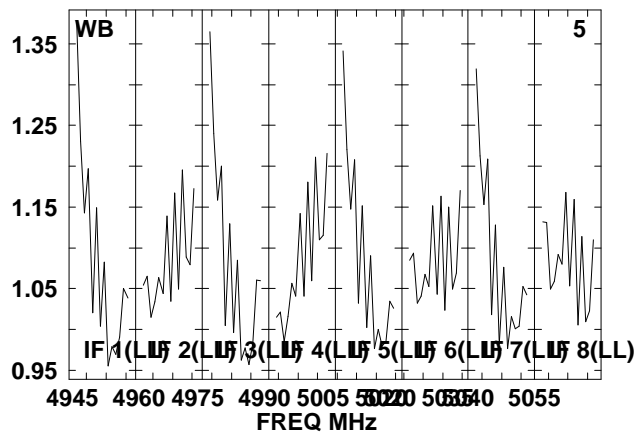
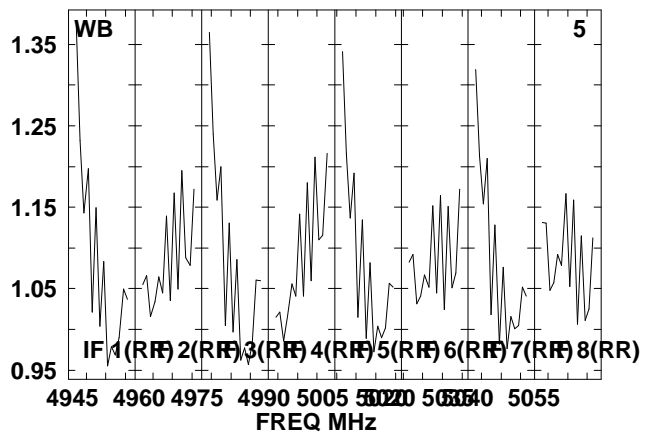
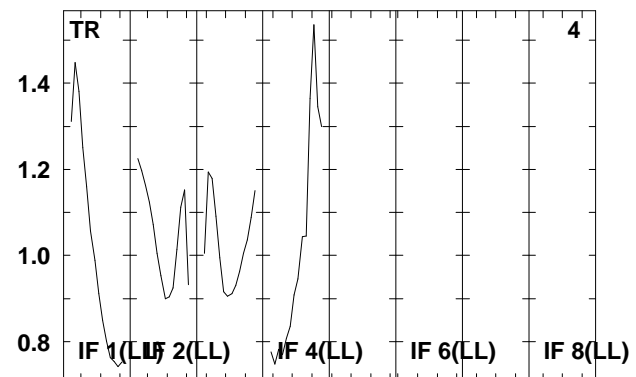
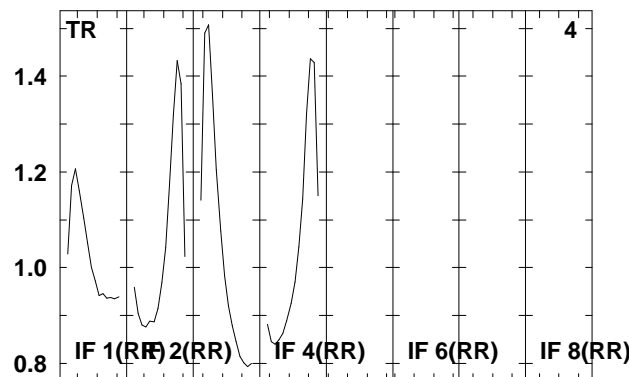
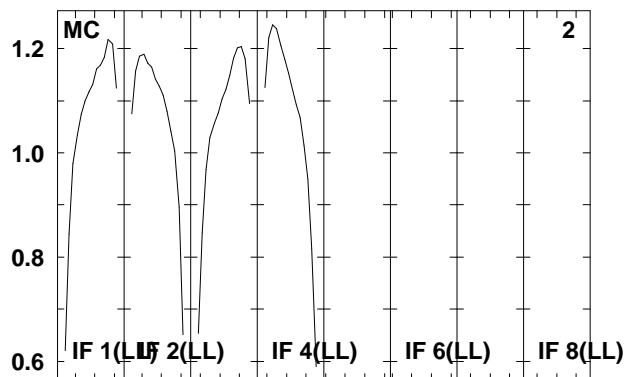
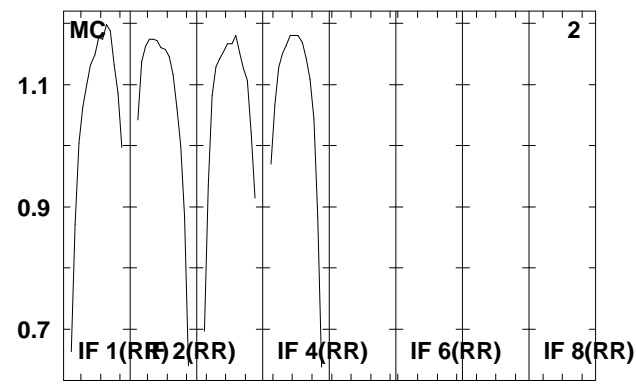
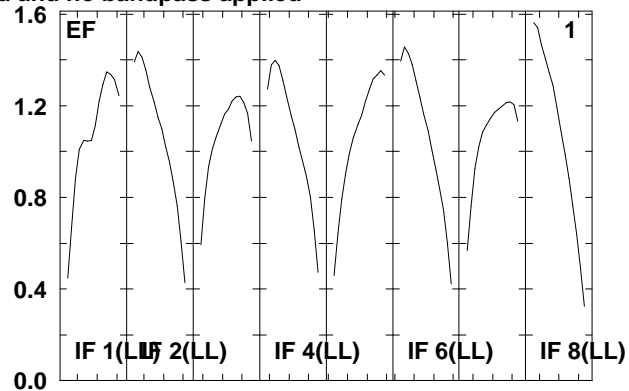
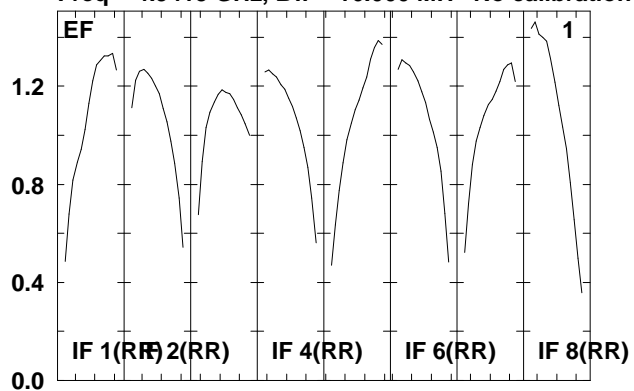

Lower frame: Real Jy  
Total-power spectrum Antenna: \*  
Timerange: 00/15:28:43 to 00/15:29:39

Plot file version 164 created 07-DEC-2009 16:06:09

J1911+16 RT006C.UVDATA.1

Freq = 4.9415 GHz, Bw = 16.000 MH No calibration applied and no bandpass applied

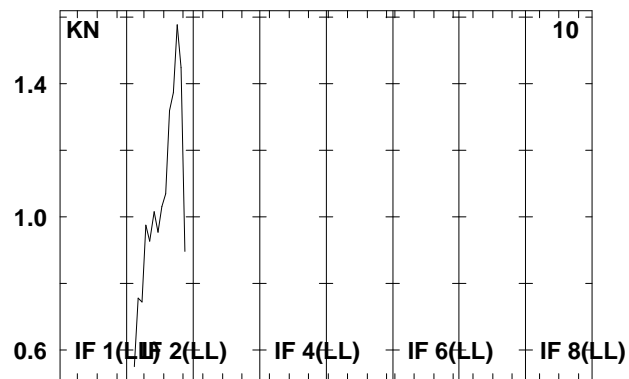
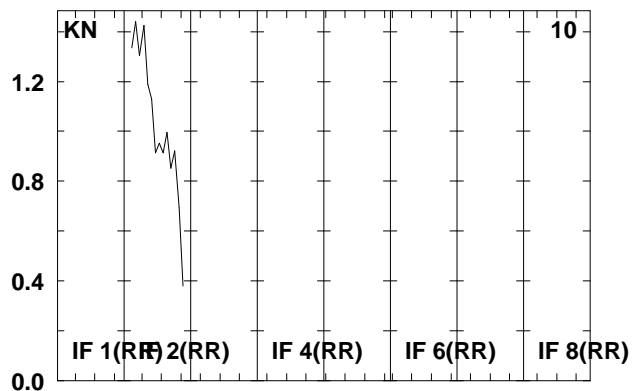
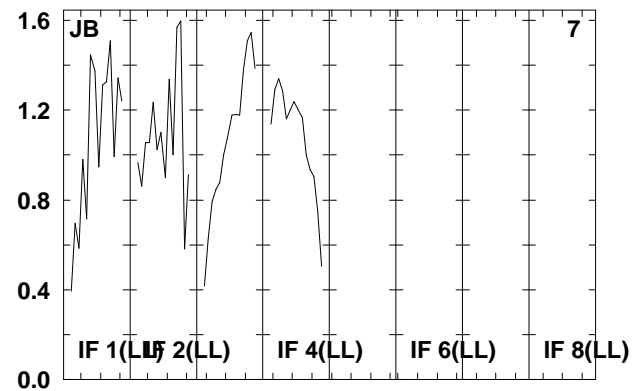
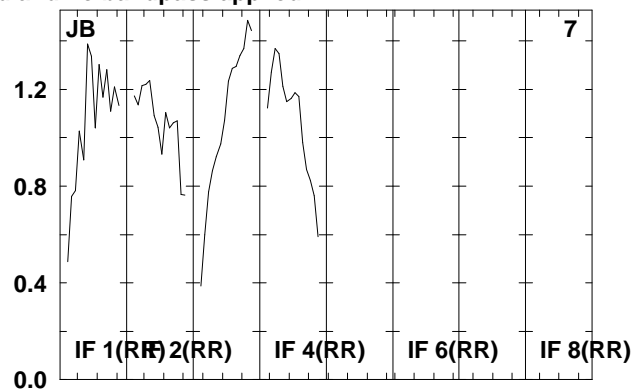
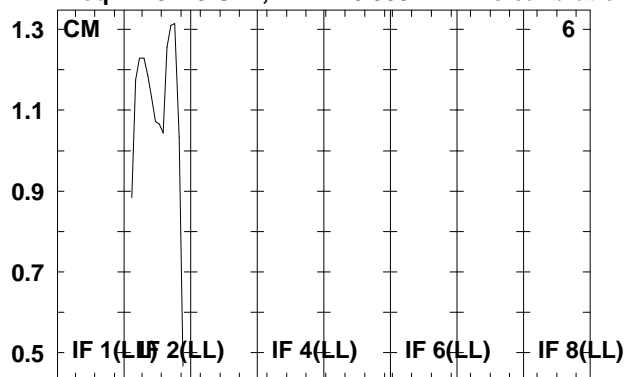

Lower frame: Real Jy  
Total-power spectrum Antenna: \*  
Timerange: 00/15:28:43 to 00/15:29:39

Plot file version 165 created 07-DEC-2009 16:06:09

J1912+05 RT006C.UVDATA.1

Freq = 4.9415 GHz, Bw = 16.000 MH No calibration applied and no bandpass applied

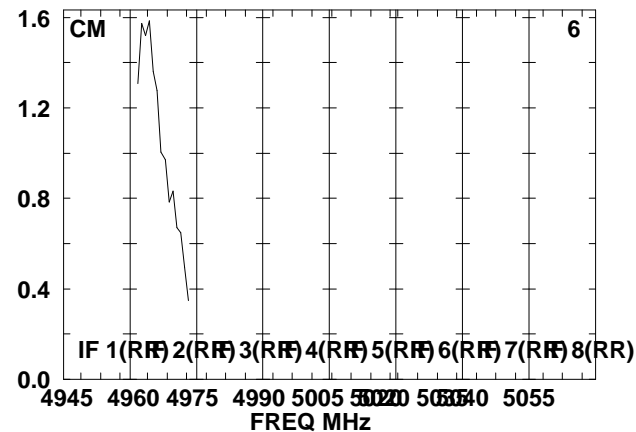
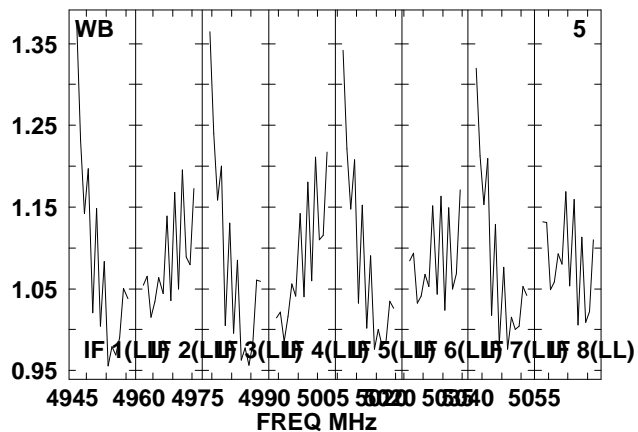
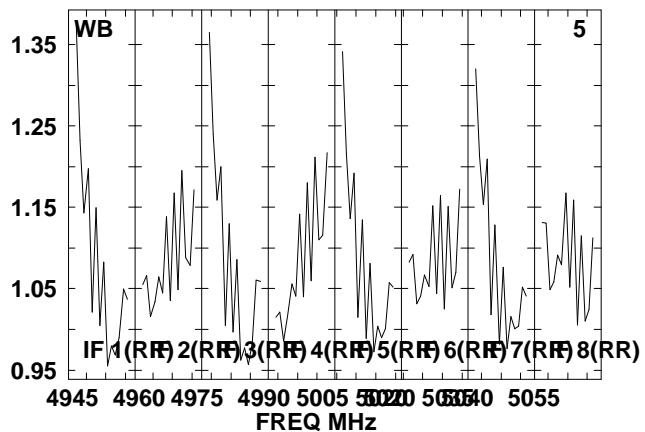
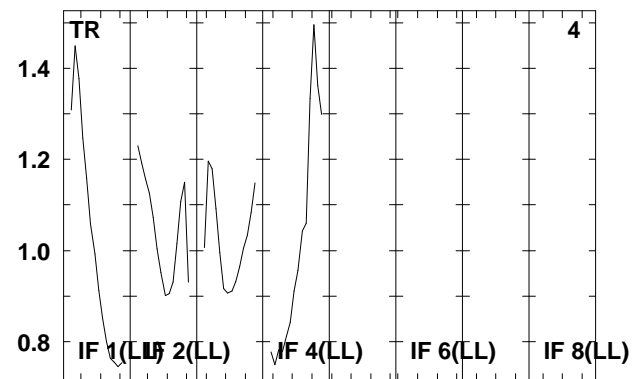
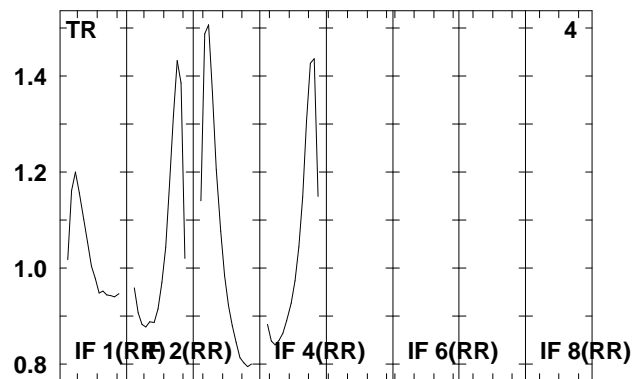
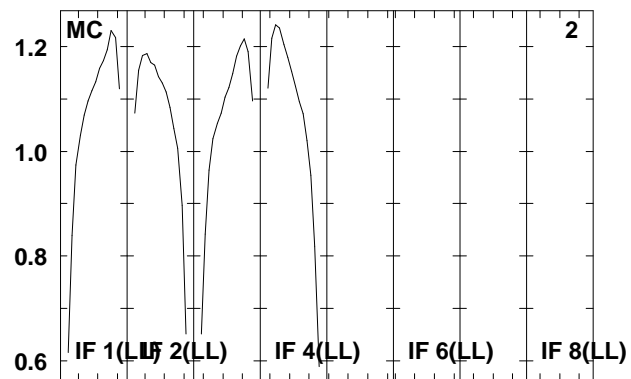
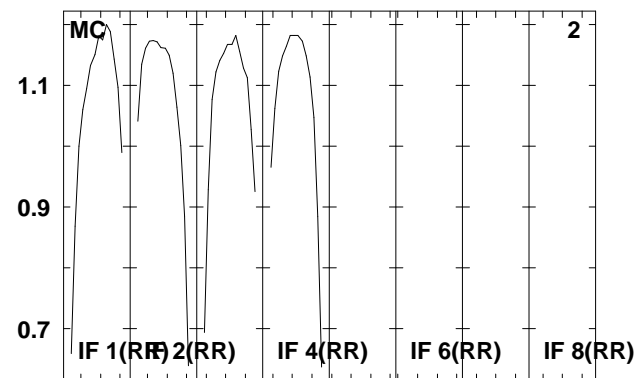
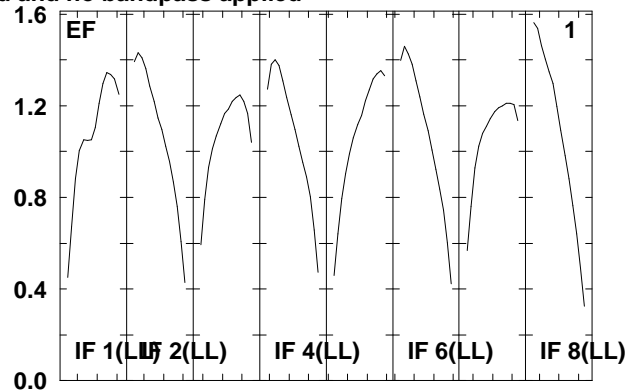
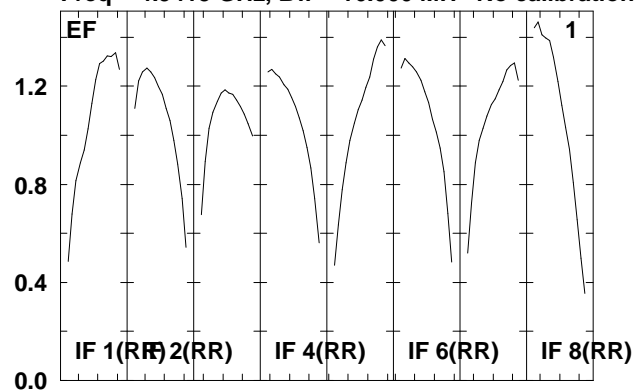

Lower frame: Real Jy  
Total-power spectrum Antenna: \*  
Timerange: 00/15:30:43 to 00/15:31:39

Plot file version 166 created 07-DEC-2009 16:06:10

J1912+05 RT006C.UVDATA.1

Freq = 4.9415 GHz, Bw = 16.000 MH No calibration applied and no bandpass applied

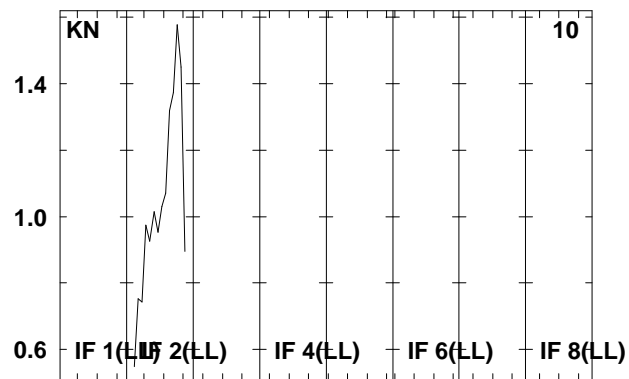
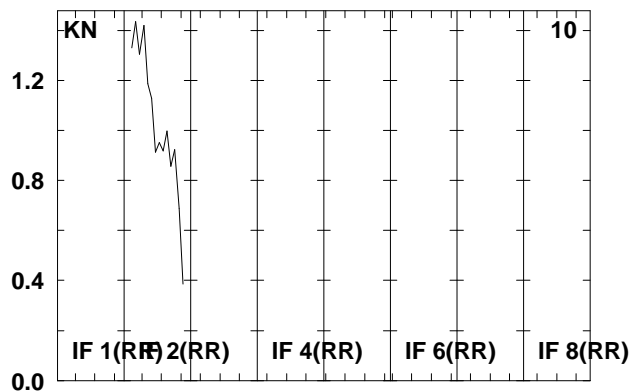
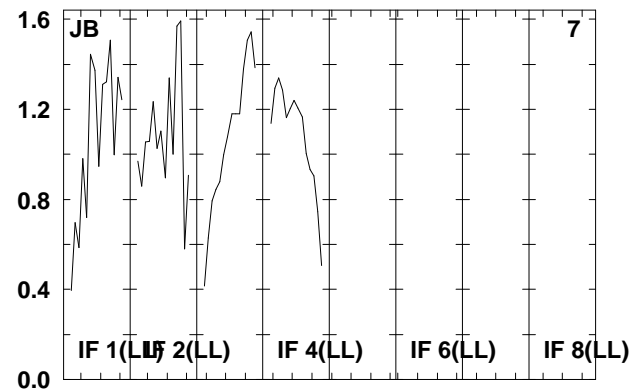
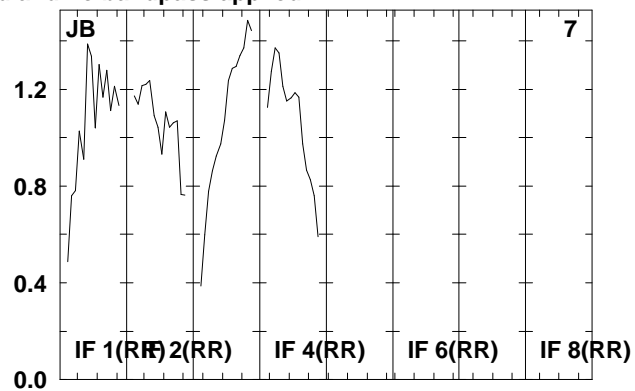
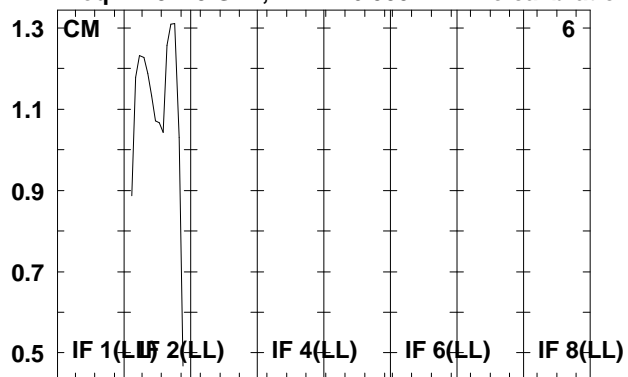

Lower frame: Real Jy  
Total-power spectrum Antenna: \*  
Timerange: 00/15:30:43 to 00/15:31:39

Plot file version 167 created 07-DEC-2009 16:06:10

SS433 RT006C.UVDATA.1

Freq = 4.9415 GHz, Bw = 16.000 MH No calibration applied and no bandpass applied

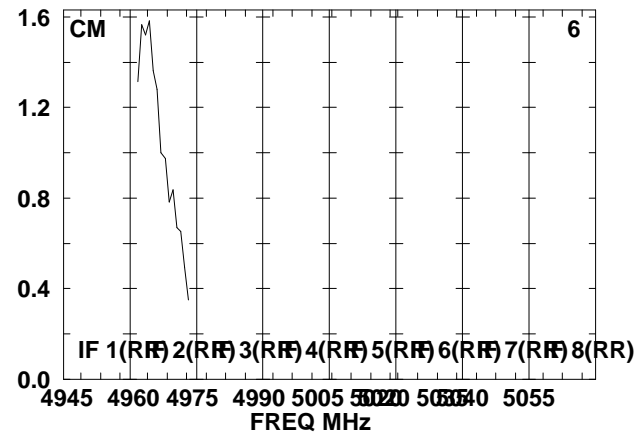
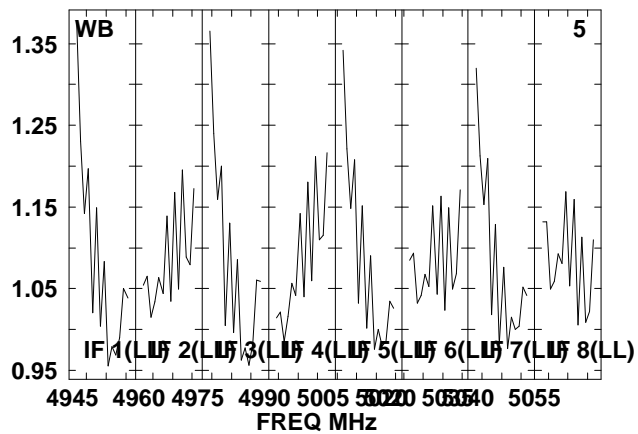
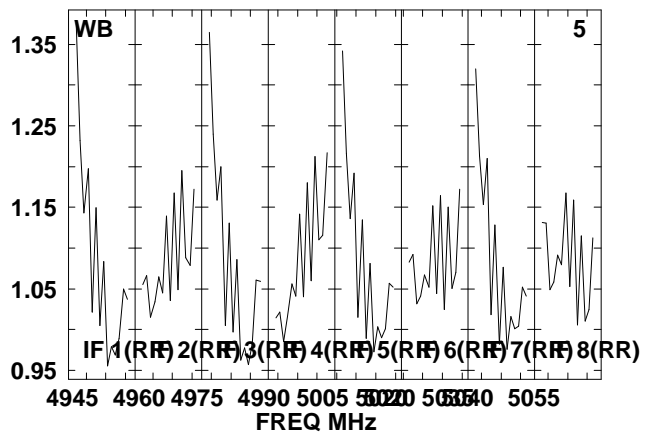
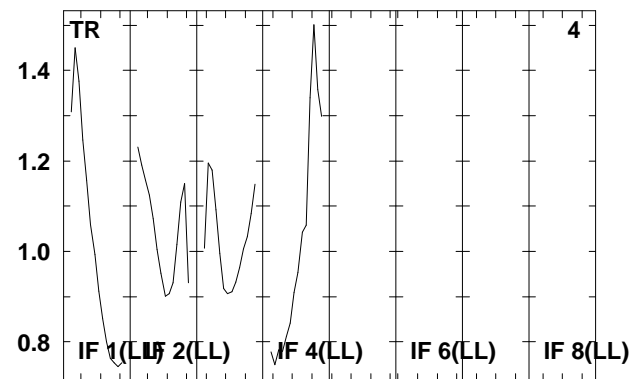
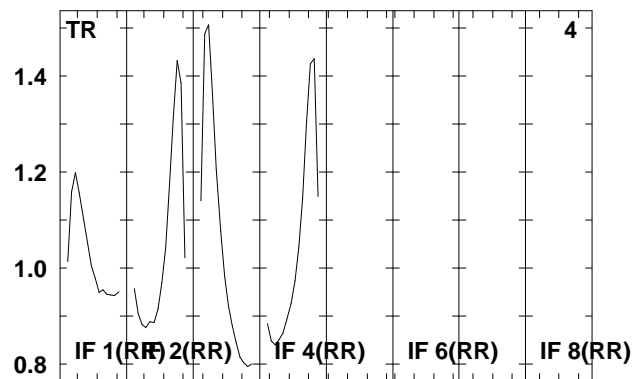
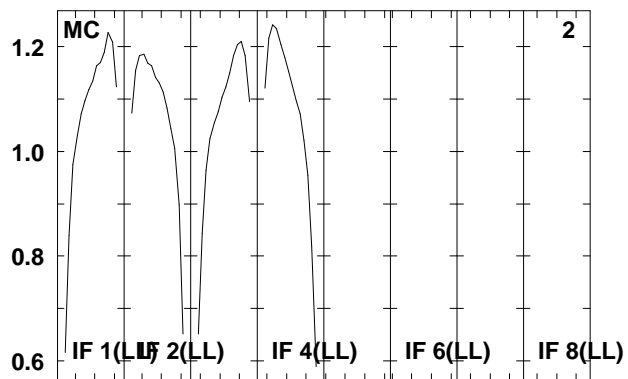
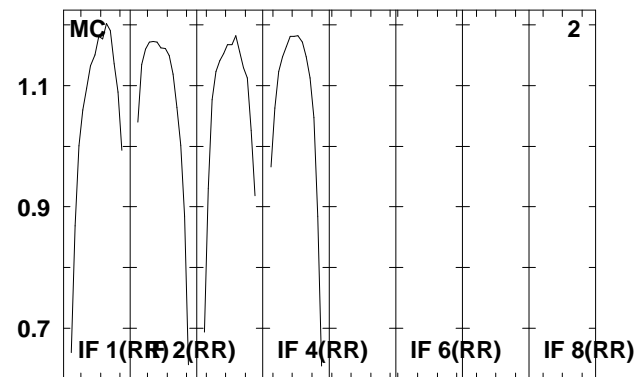
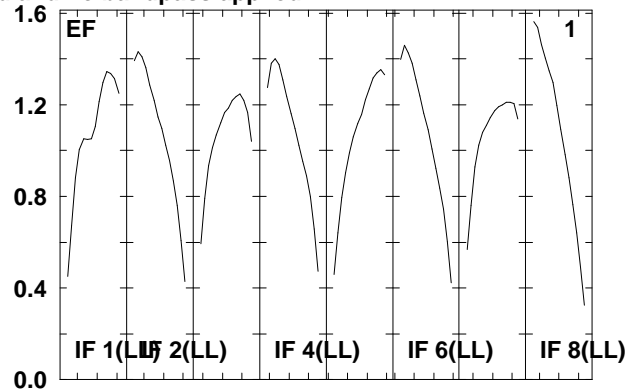
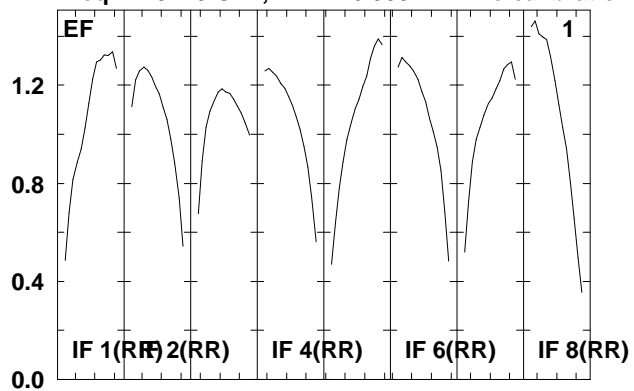

Lower frame: Real Jy  
Total-power spectrum Antenna: \*  
Timerange: 00/15:31:43 to 00/15:33:59

Plot file version 168 created 07-DEC-2009 16:06:10

SS433 RT006C.UVDATA.1

Freq = 4.9415 GHz, Bw = 16.000 MH No calibration applied and no bandpass applied

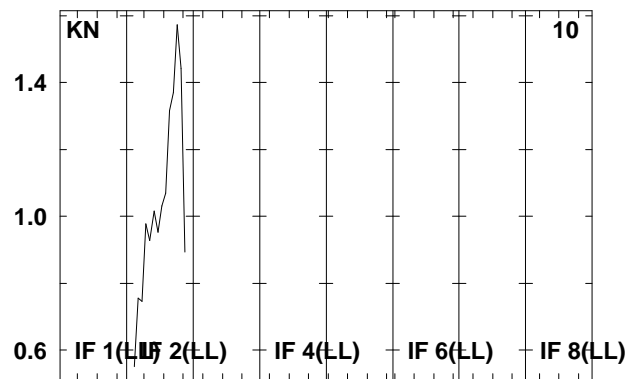
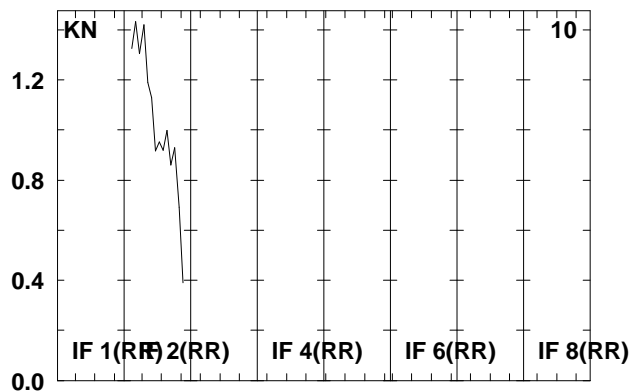
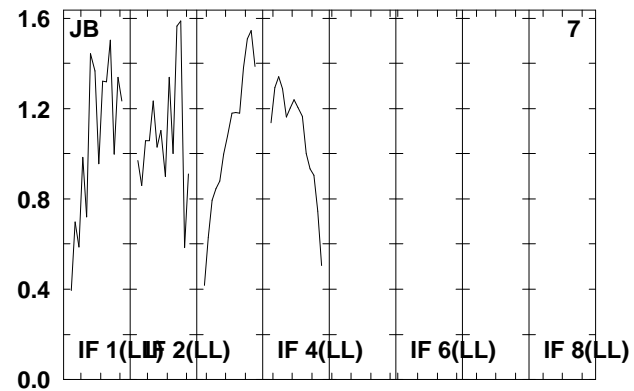
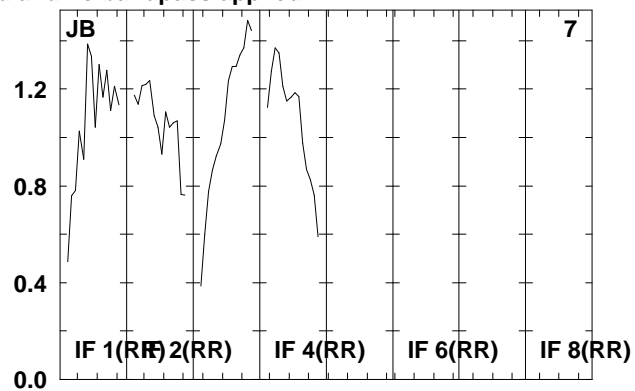
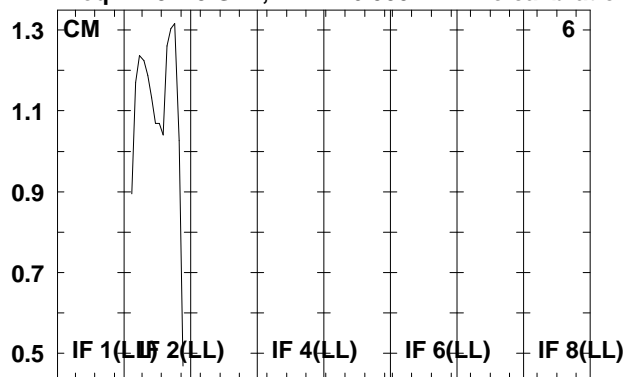

Lower frame: Real Jy  
Total-power spectrum Antenna: \*  
Timerange: 00/15:31:43 to 00/15:33:59



Plot file version 169 created 07-DEC-2009 16:06:10

J1912+05 RT006C.UVDATA.1

Freq = 4.9415 GHz, Bw = 16.000 MH No calibration applied and no bandpass applied

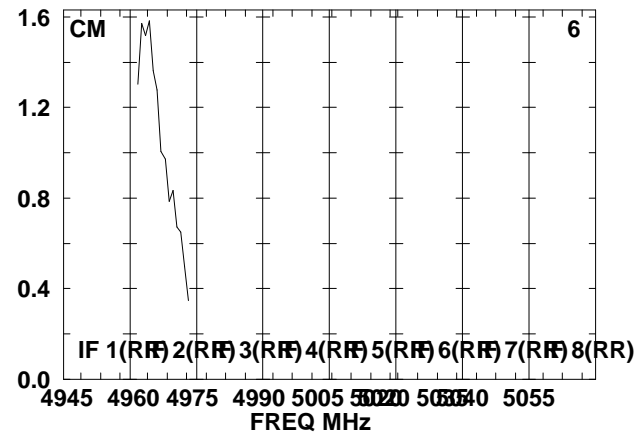
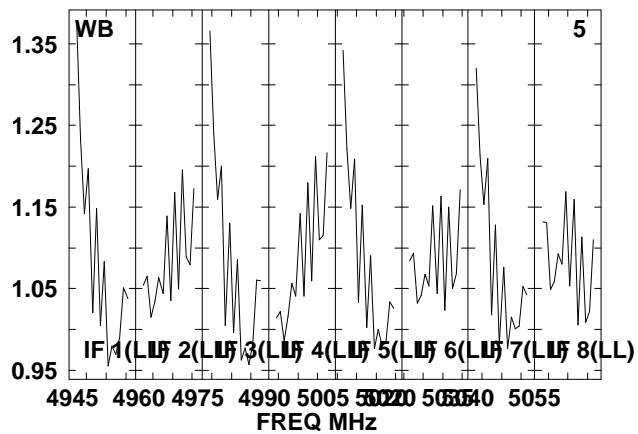
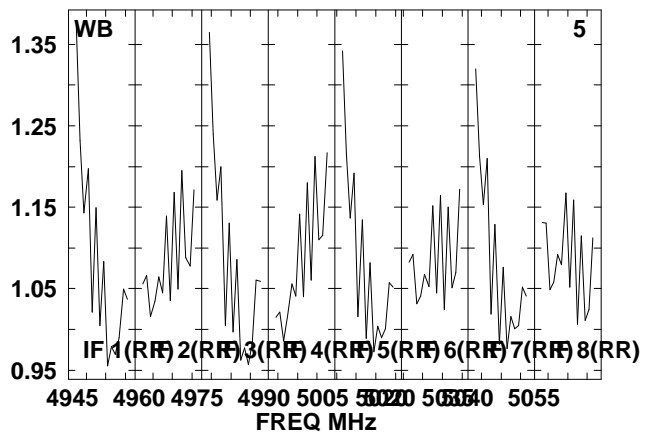
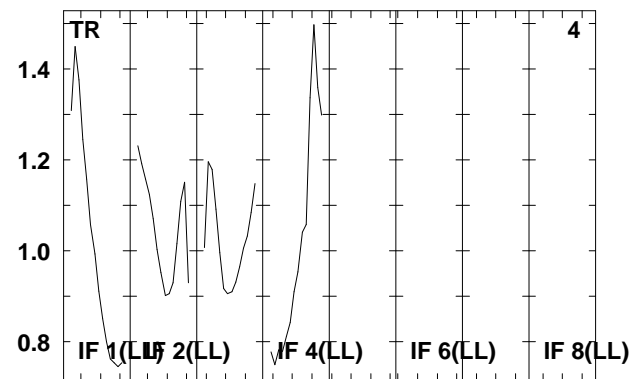
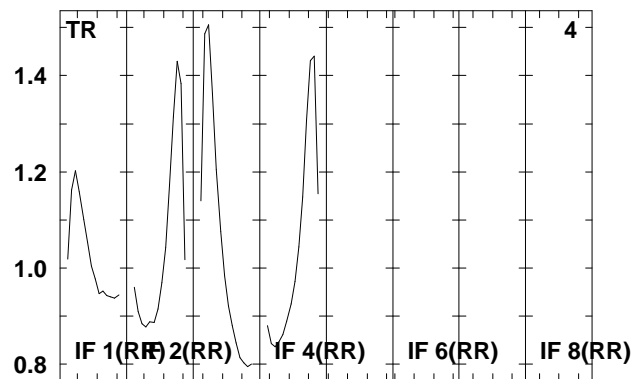
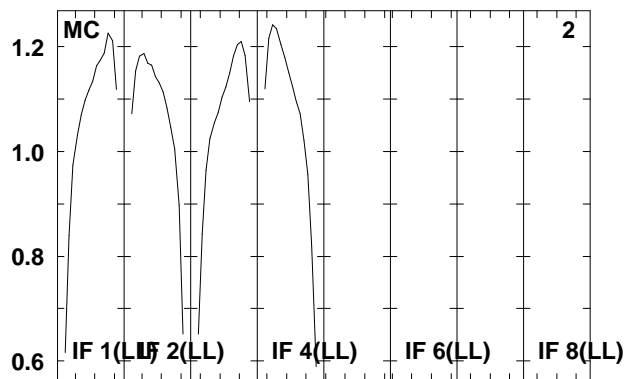
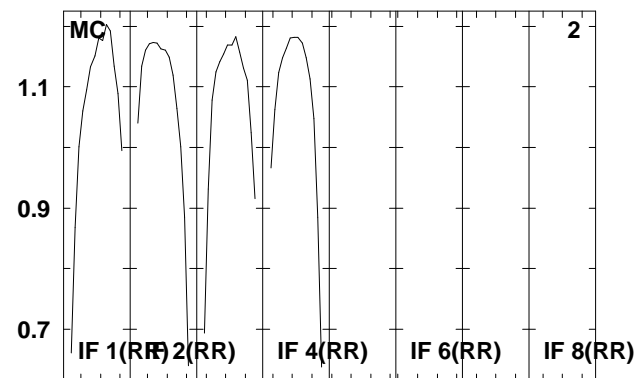
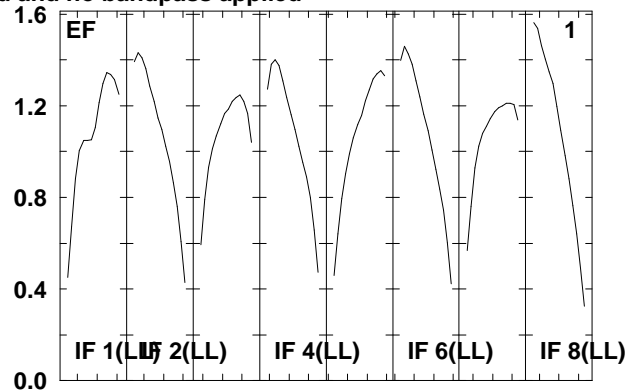
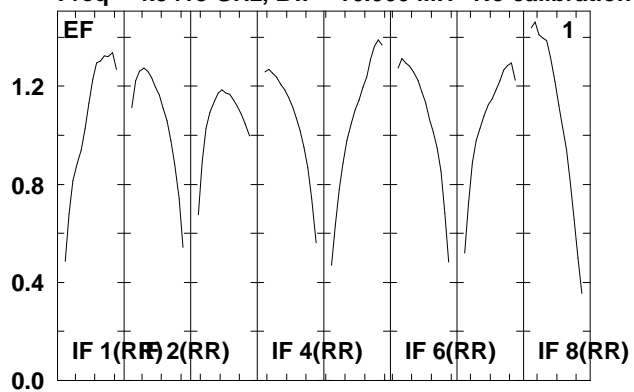

Lower frame: Real Jy

Total-power spectrum Antenna: \*

Timerange: 00/15:34:03 to 00/15:35:19

Plot file version 170 created 07-DEC-2009 16:06:10

J1912+05 RT006C.UVDATA.1

Freq = 4.9415 GHz, Bw = 16.000 MH No calibration applied and no bandpass applied

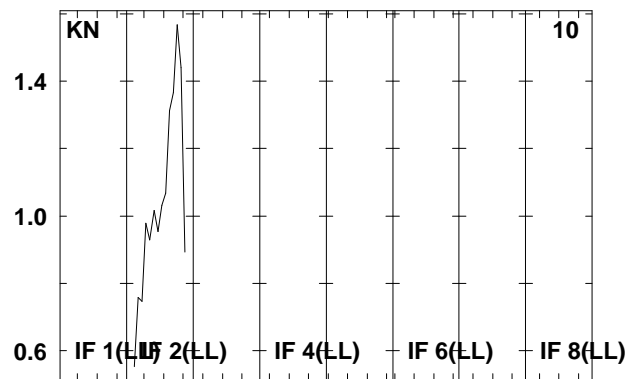
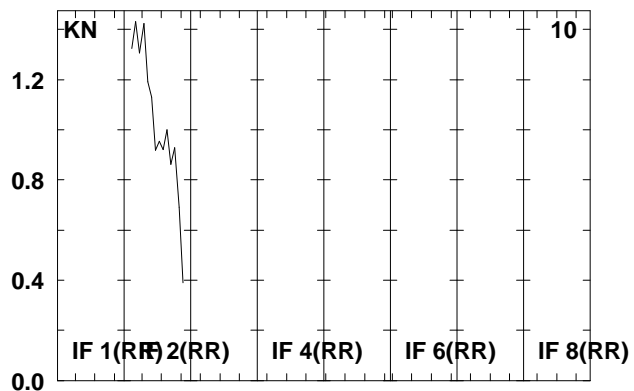
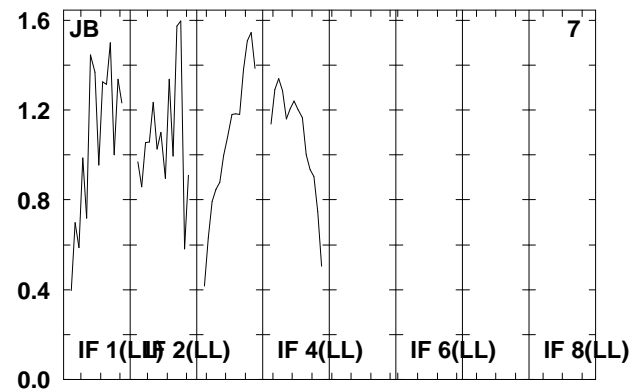
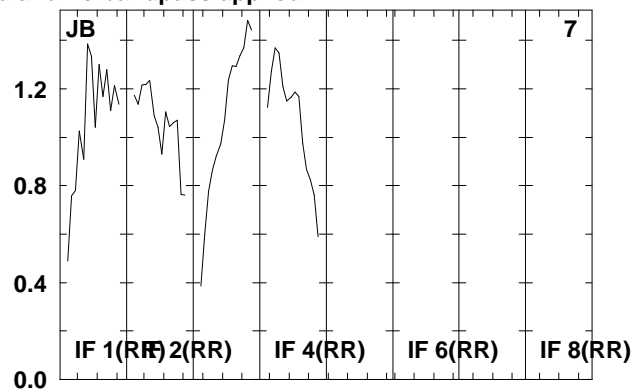
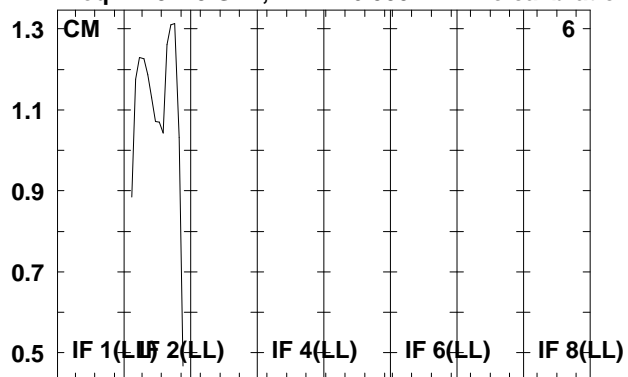

Lower frame: Real Jy  
Total-power spectrum Antenna: \*  
Timerange: 00/15:34:03 to 00/15:35:19

Plot file version 171 created 07-DEC-2009 16:06:10

SS433 RT006C.UVDATA.1

Freq = 4.9415 GHz, Bw = 16.000 MH No calibration applied and no bandpass applied

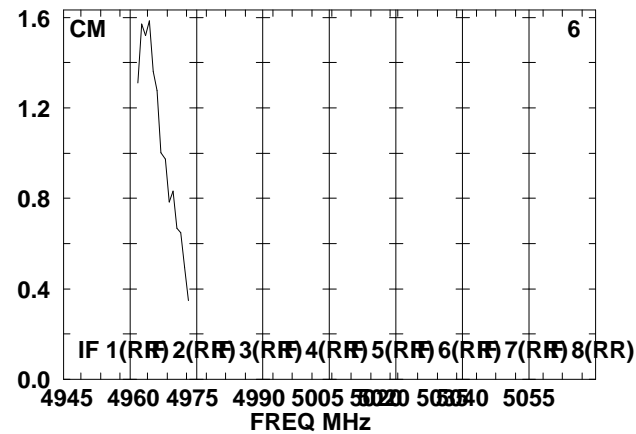
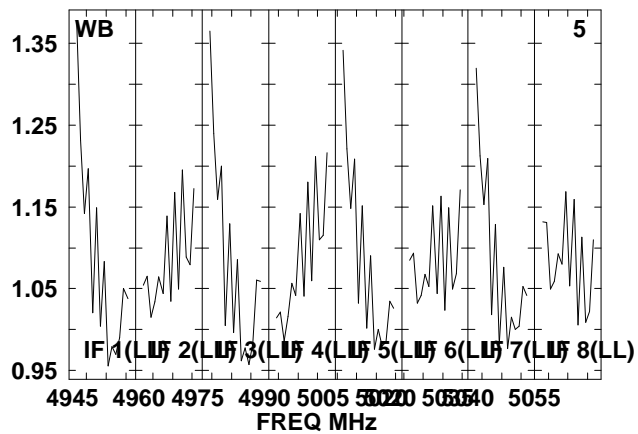
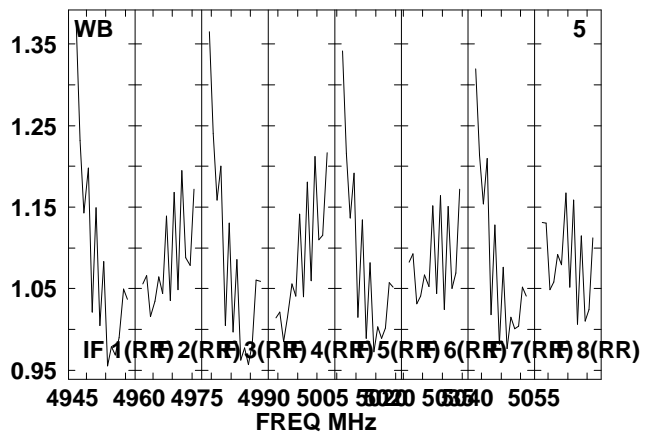
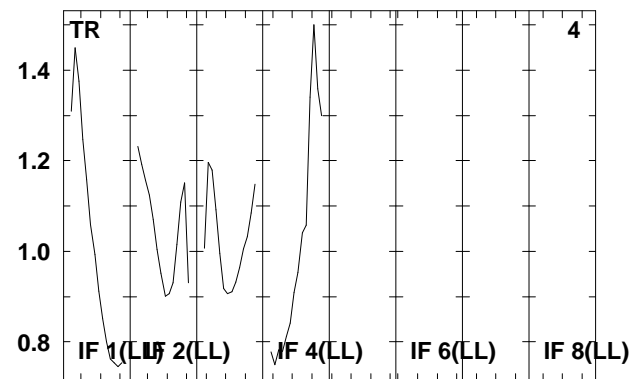
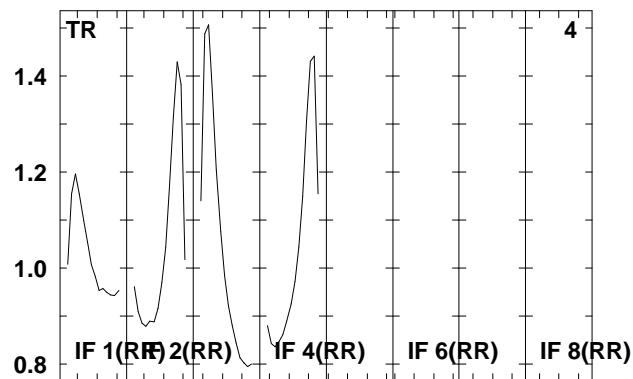
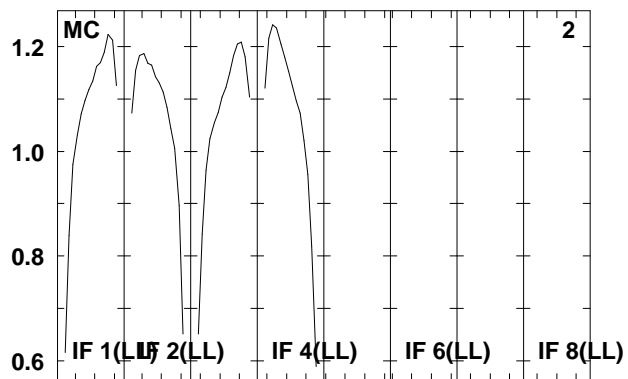
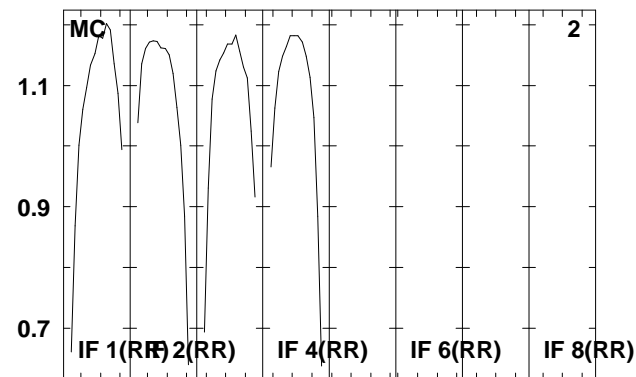
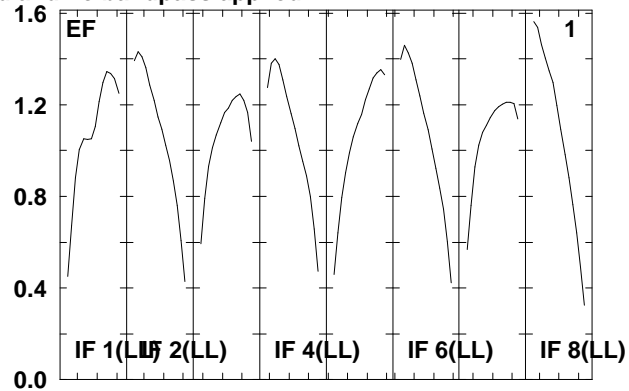
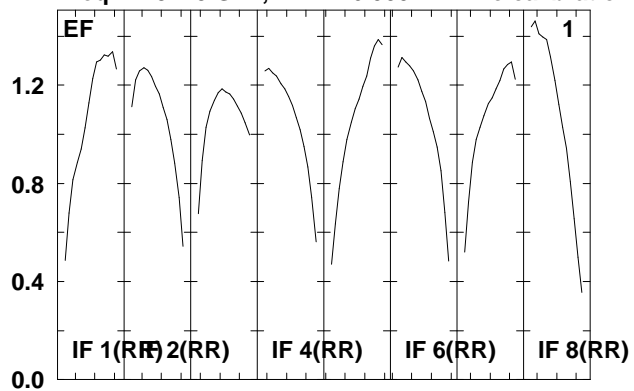

Lower frame: Real Jy  
Total-power spectrum Antenna: \*  
Timerange: 00/15:35:23 to 00/15:37:07

Plot file version 172 created 07-DEC-2009 16:06:11

SS433 RT006C.UVDATA.1

Freq = 4.9415 GHz, Bw = 16.000 MH No calibration applied and no bandpass applied

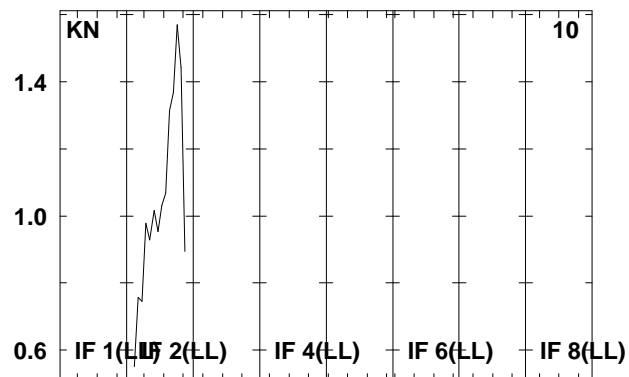
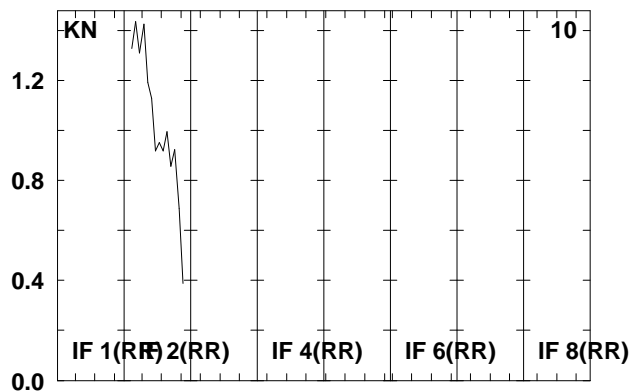
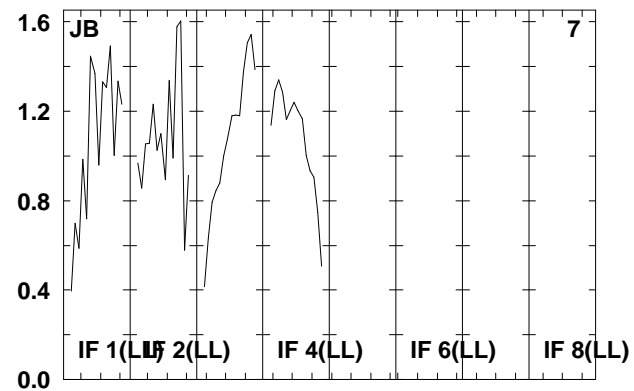
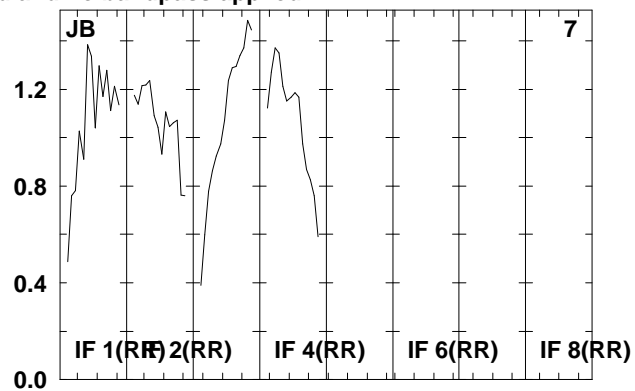
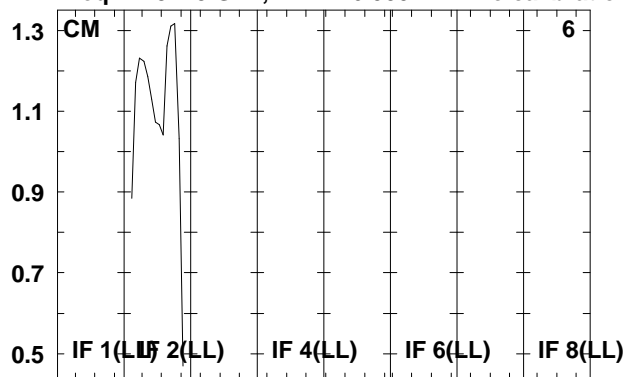

Lower frame: Real Jy  
Total-power spectrum Antenna: \*  
Timerange: 00/15:35:23 to 00/15:37:07

Plot file version 173 created 07-DEC-2009 16:06:11

SS433 RT006C.UVDATA.1

Freq = 4.9415 GHz, Bw = 16.000 MH No calibration applied and no bandpass applied

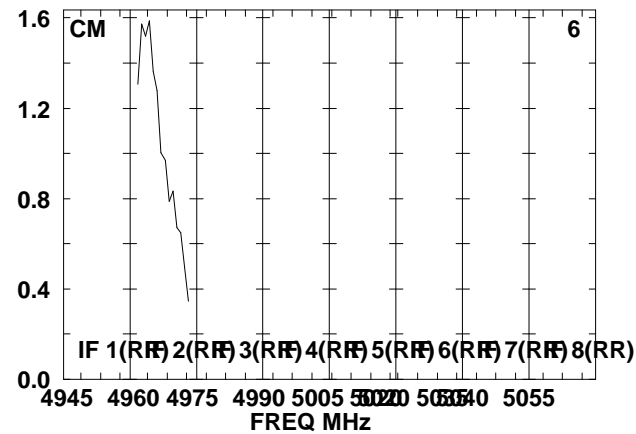
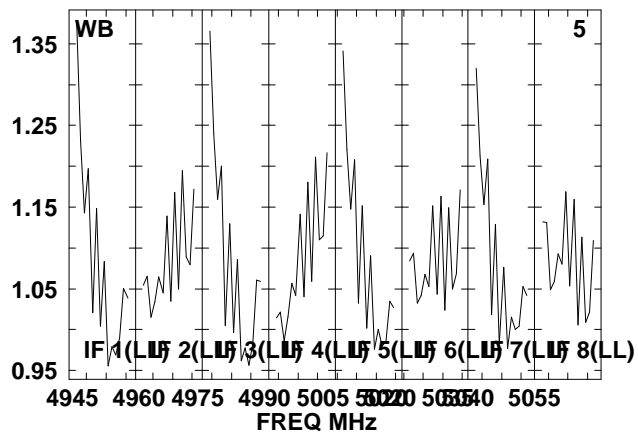
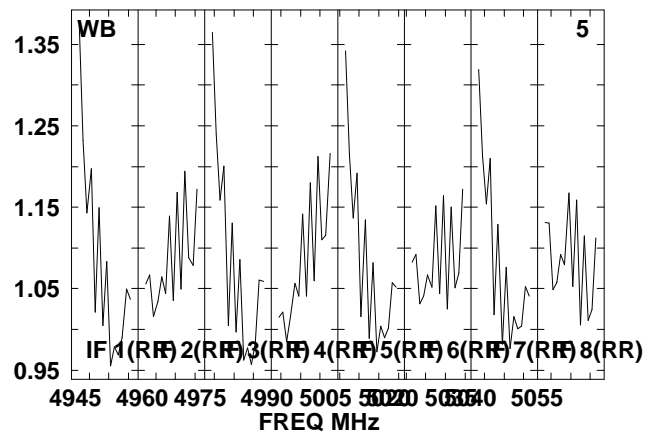
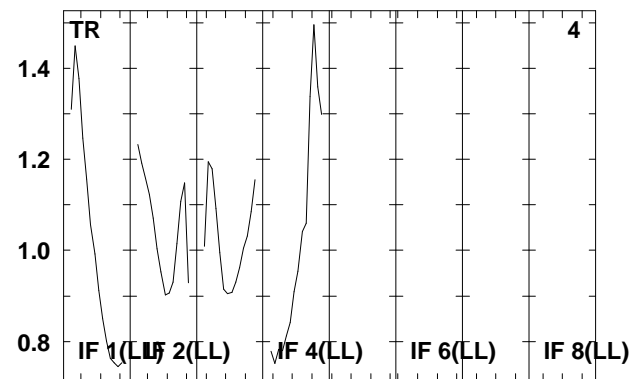
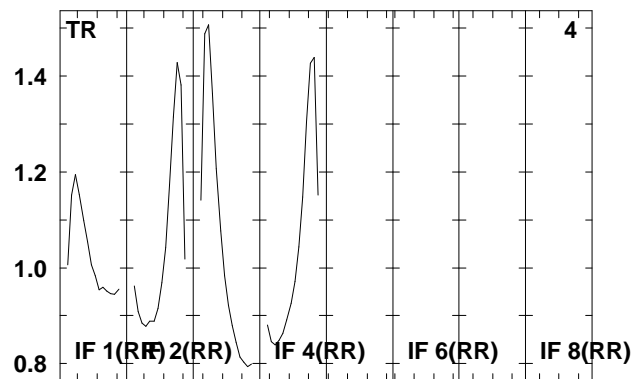
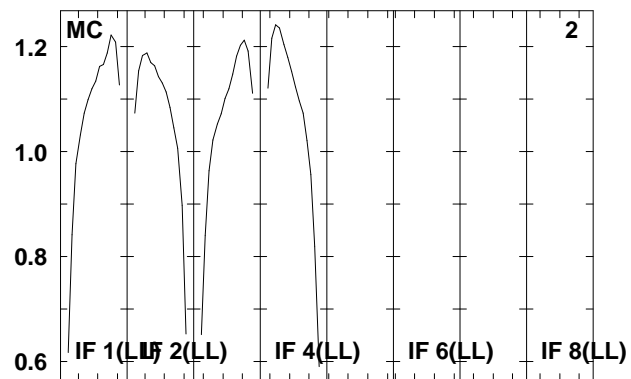
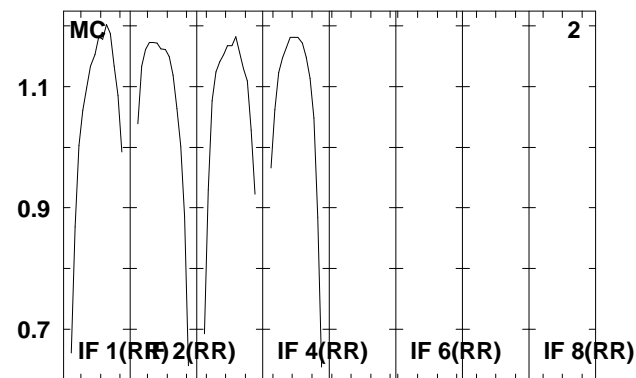
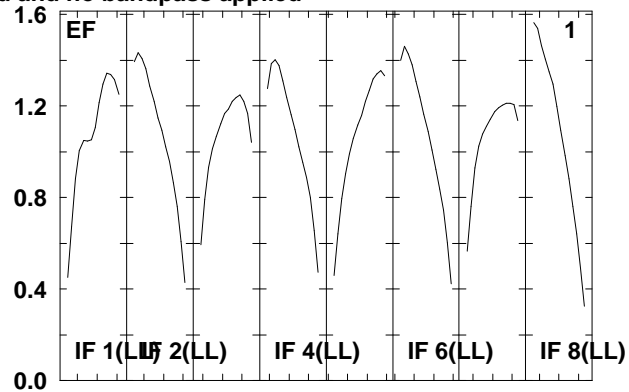
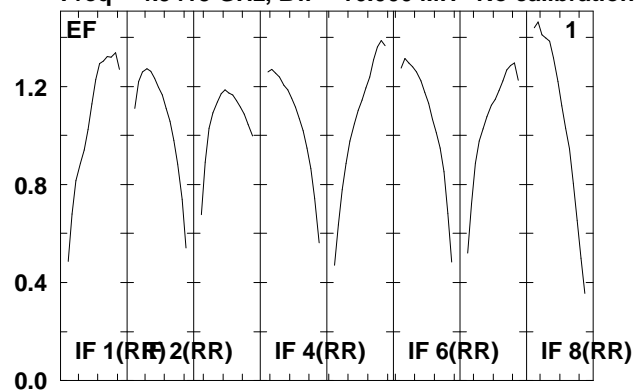

Lower frame: Real Jy  
Total-power spectrum Antenna: \*  
Timerange: 00/15:54:20 to 00/15:54:56

Plot file version 174 created 07-DEC-2009 16:06:11

SS433 RT006C.UVDATA.1

Freq = 4.9415 GHz, Bw = 16.000 MH No calibration applied and no bandpass applied

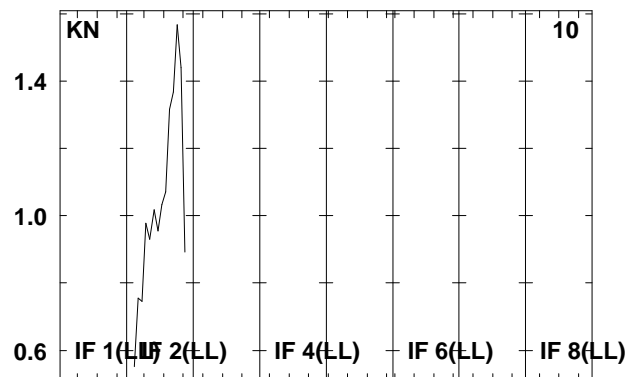
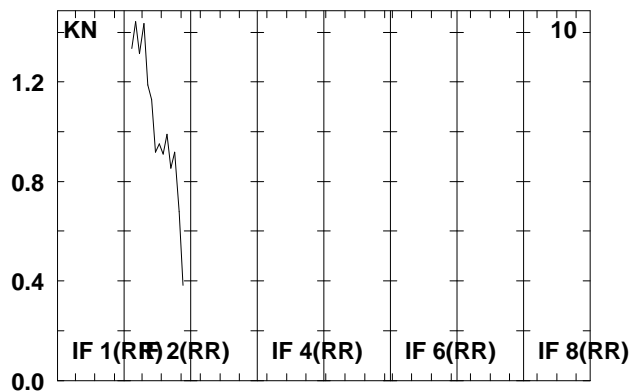
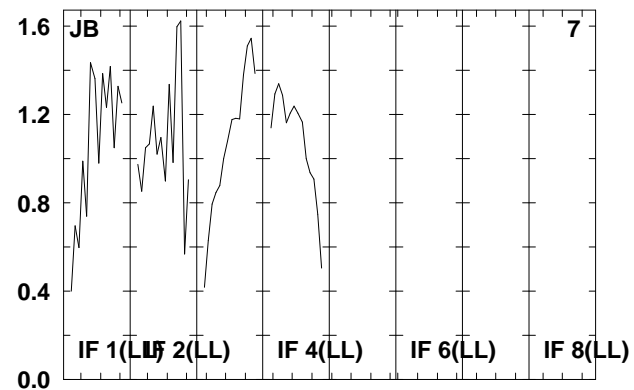
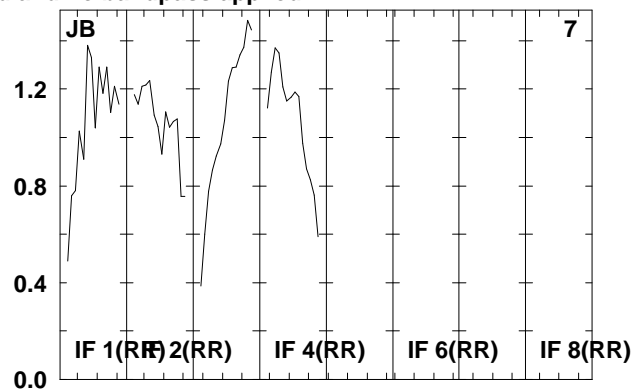
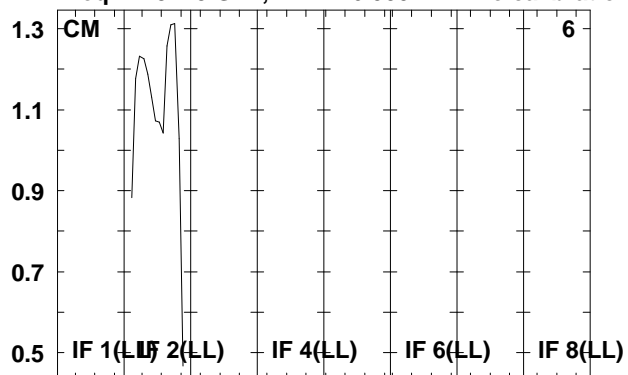

Lower frame: Real Jy  
Total-power spectrum Antenna: \*  
Timerange: 00/15:54:20 to 00/15:54:56

Plot file version 175 created 07-DEC-2009 16:06:11

J1912+05 RT006C.UVDATA.1

Freq = 4.9415 GHz, Bw = 16.000 MH No calibration applied and no bandpass applied

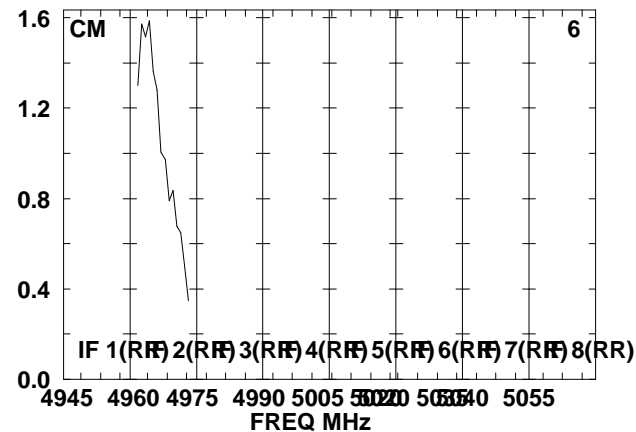
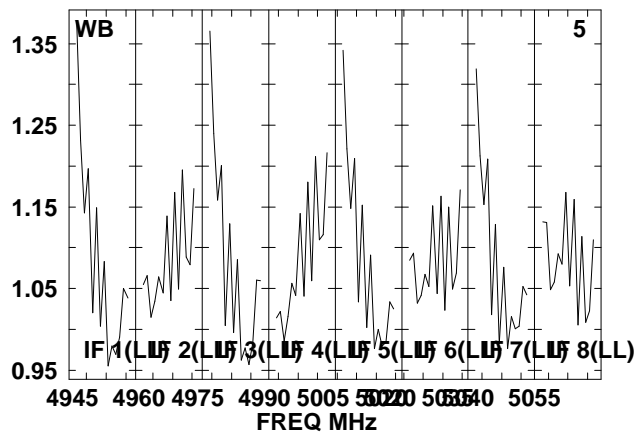
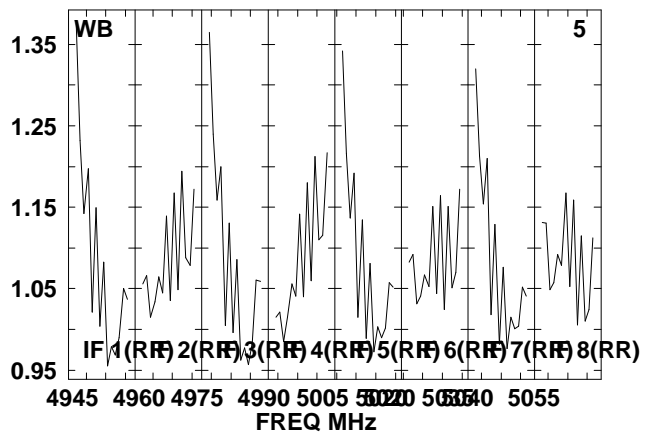
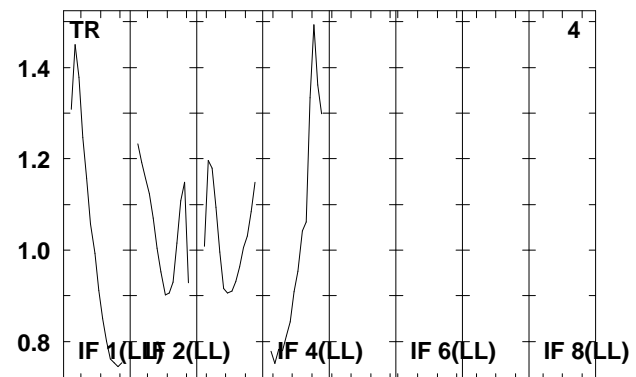
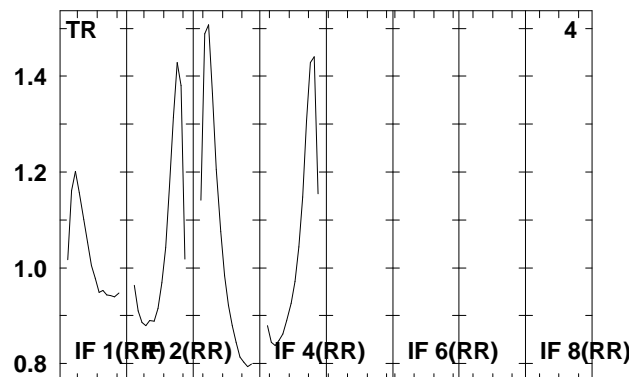
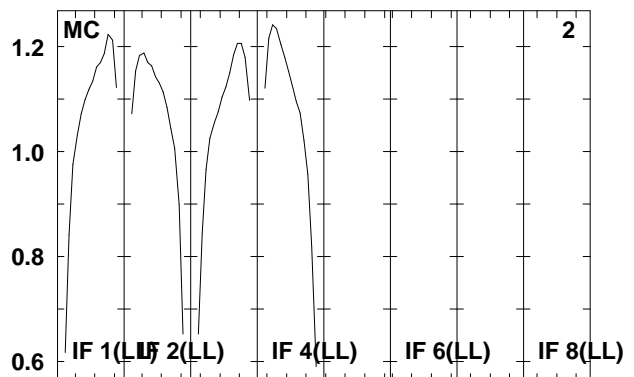
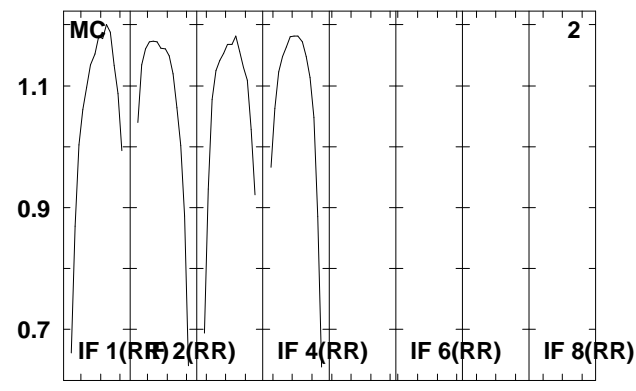
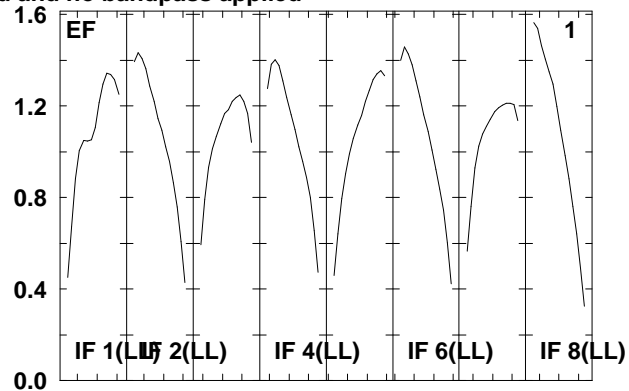
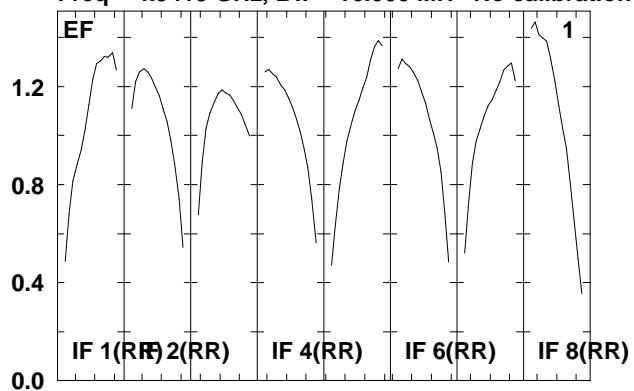

Lower frame: Real Jy

Total-power spectrum Antenna: \*

Timerange: 00/15:55:00 to 00/15:56:16

Plot file version 176 created 07-DEC-2009 16:06:11

J1912+05 RT006C.UVDATA.1

Freq = 4.9415 GHz, Bw = 16.000 MH No calibration applied and no bandpass applied

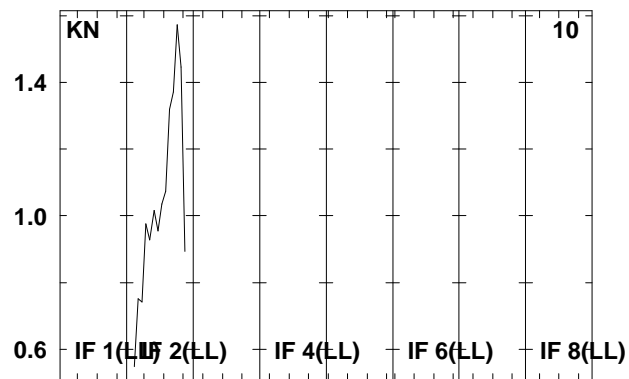
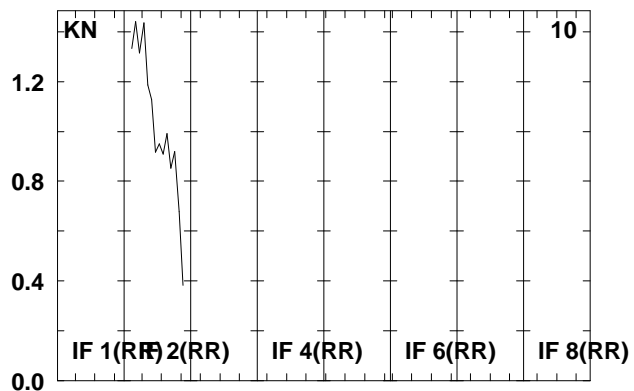
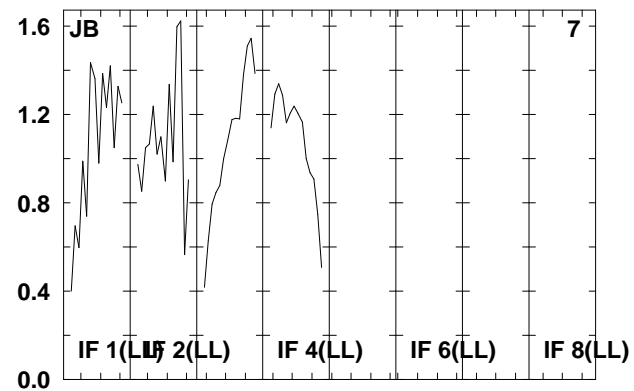
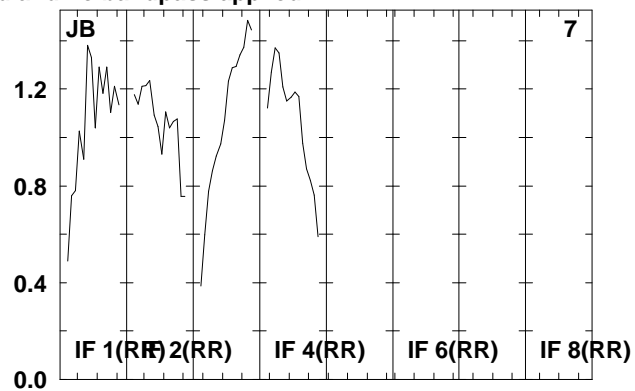
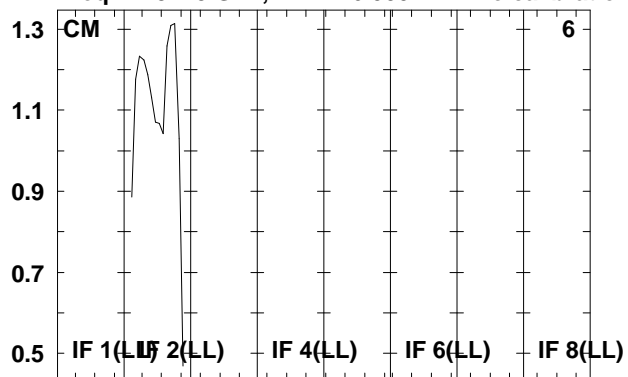

Lower frame: Real Jy  
Total-power spectrum Antenna: \*  
Timerange: 00/15:55:00 to 00/15:56:16



Plot file version 177 created 07-DEC-2009 16:06:11

SS433 RT006C.UVDATA.1

Freq = 4.9415 GHz, Bw = 16.000 MH No calibration applied and no bandpass applied

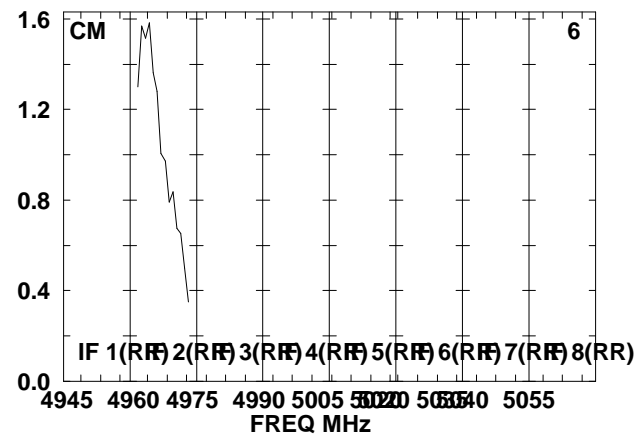
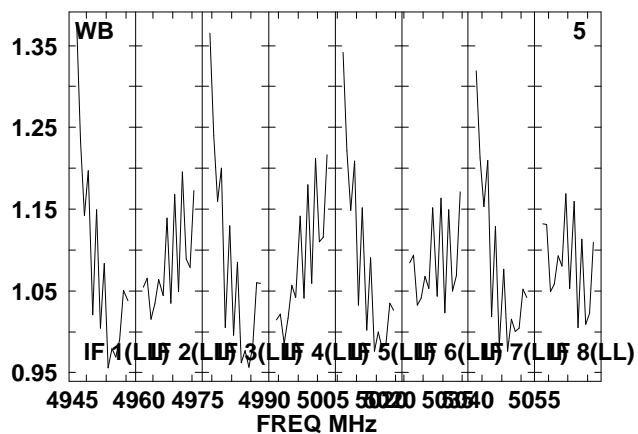
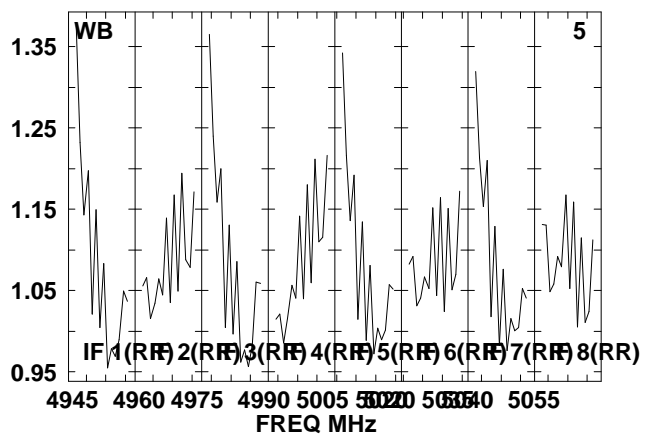
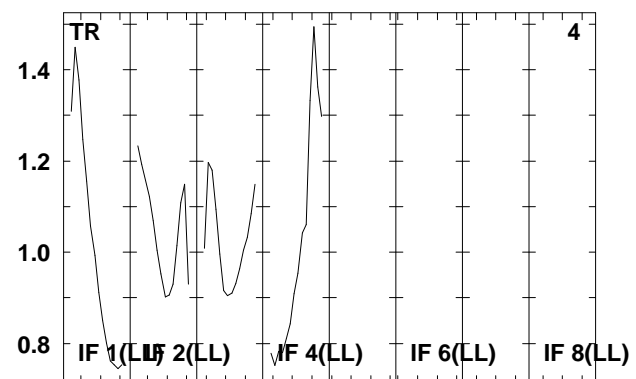
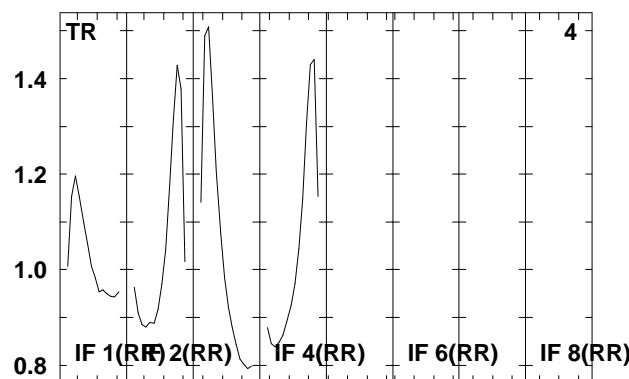
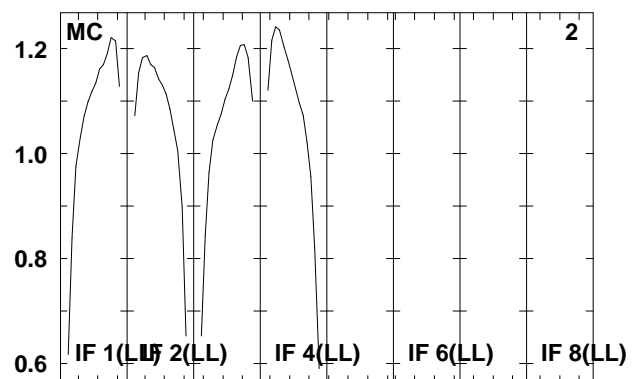
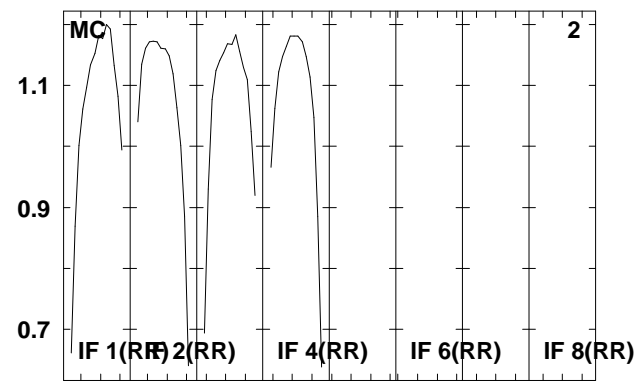
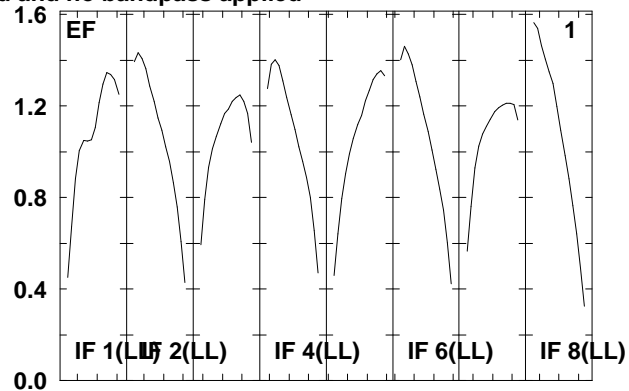
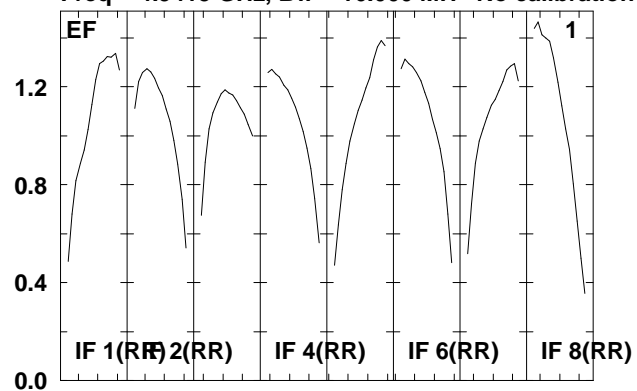

Lower frame: Real Jy  
Total-power spectrum Antenna: \*  
Timerange: 00/15:56:20 to 00/15:58:36

Plot file version 178 created 07-DEC-2009 16:06:11

SS433 RT006C.UVDATA.1

Freq = 4.9415 GHz, Bw = 16.000 MH No calibration applied and no bandpass applied

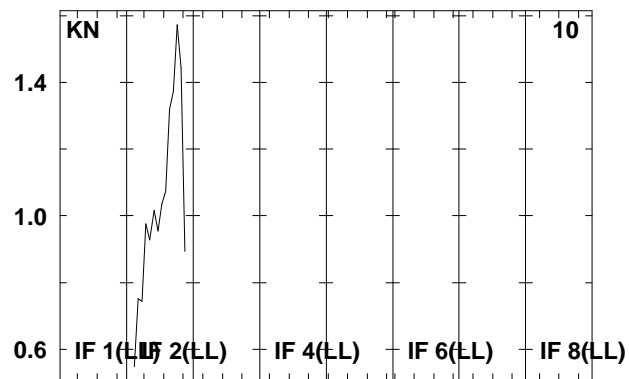
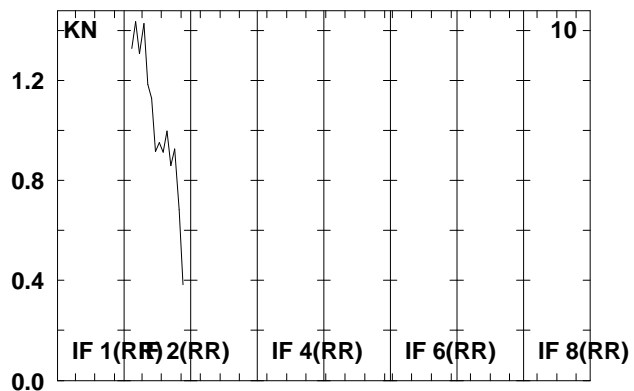
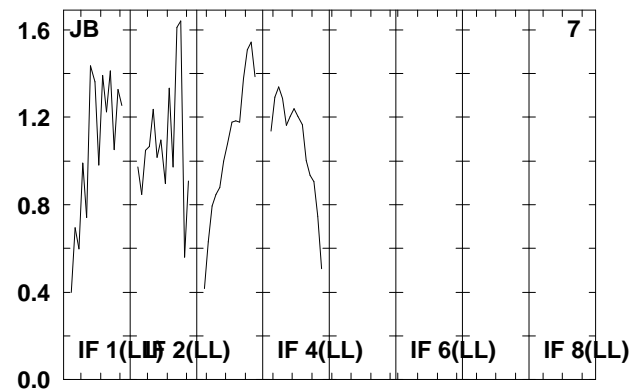
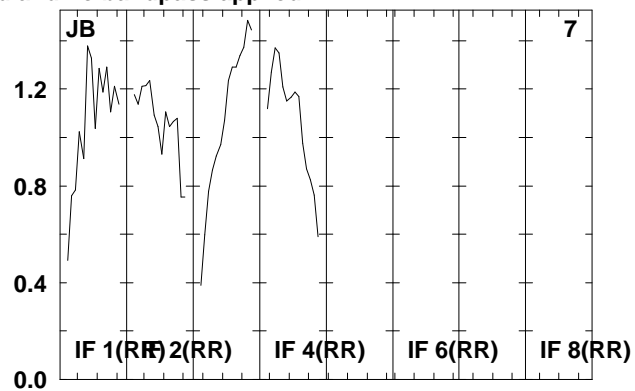
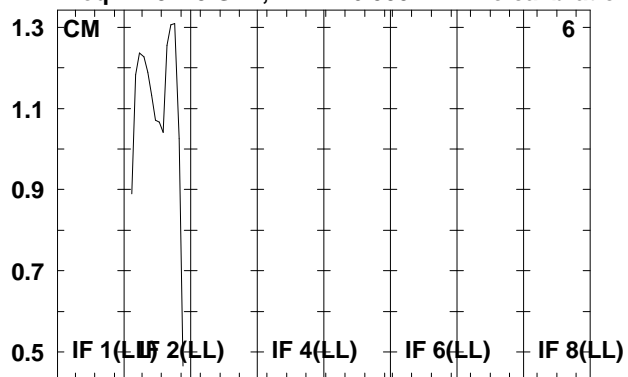

Lower frame: Real Jy  
Total-power spectrum Antenna: \*  
Timerange: 00/15:56:20 to 00/15:58:36

Plot file version 179 created 07-DEC-2009 16:06:12

J1912+05 RT006C.UVDATA.1

Freq = 4.9415 GHz, Bw = 16.000 MH No calibration applied and no bandpass applied

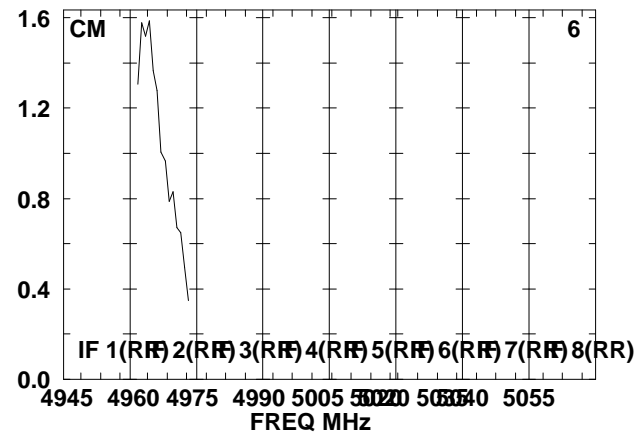
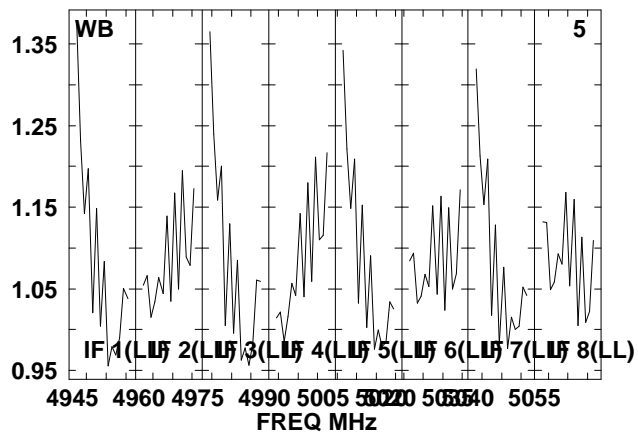
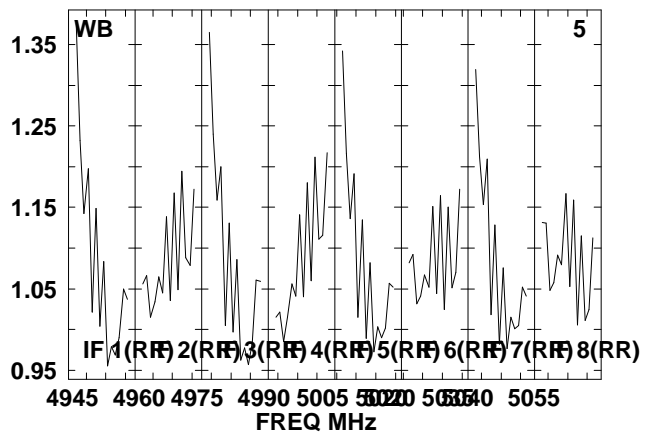
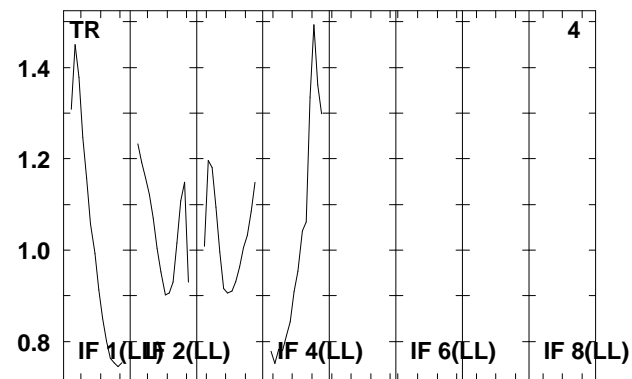
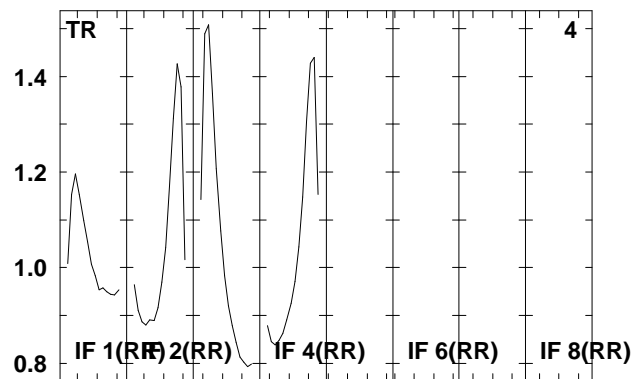
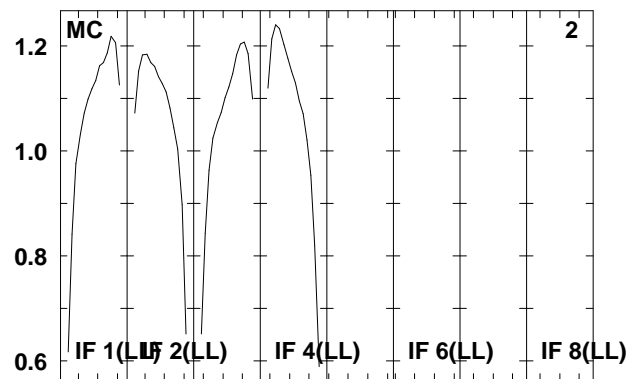
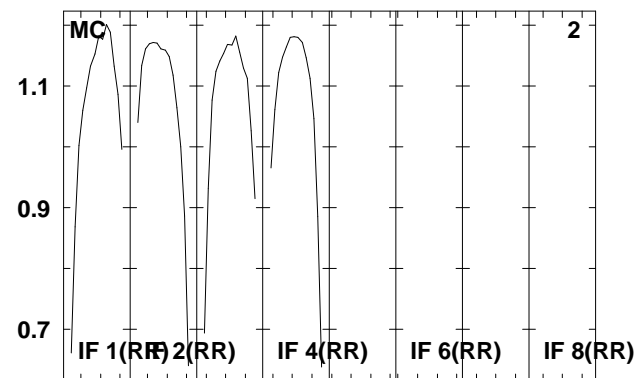
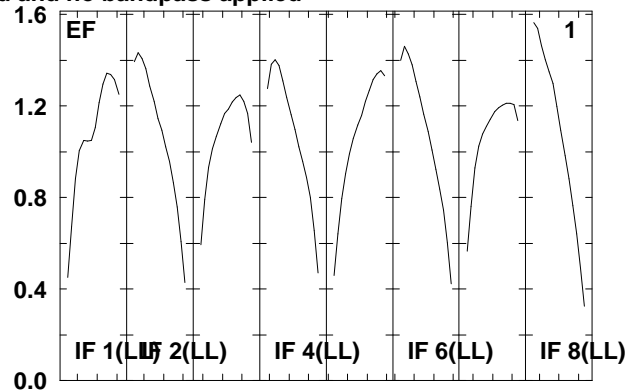
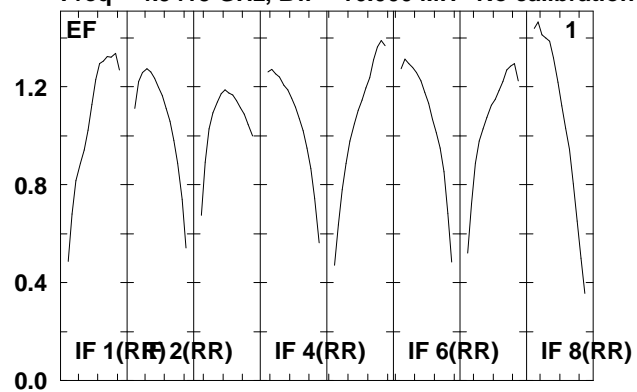

Lower frame: Real Jy  
Total-power spectrum Antenna: \*  
Timerange: 00/15:58:40 to 00/16:00:00

Plot file version 180 created 07-DEC-2009 16:06:12

J1912+05 RT006C.UVDATA.1

Freq = 4.9415 GHz, Bw = 16.000 MH No calibration applied and no bandpass applied

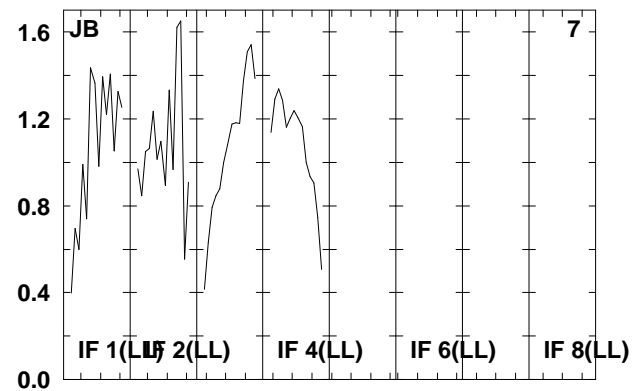
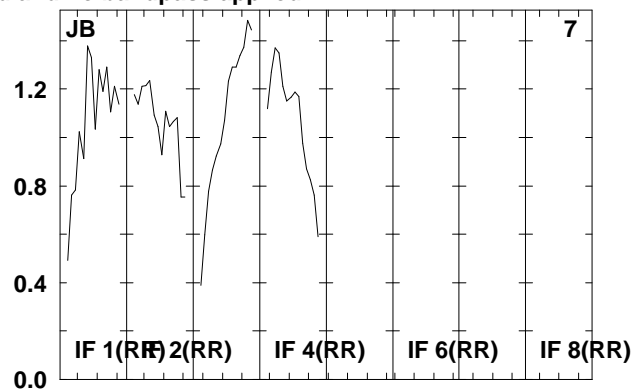
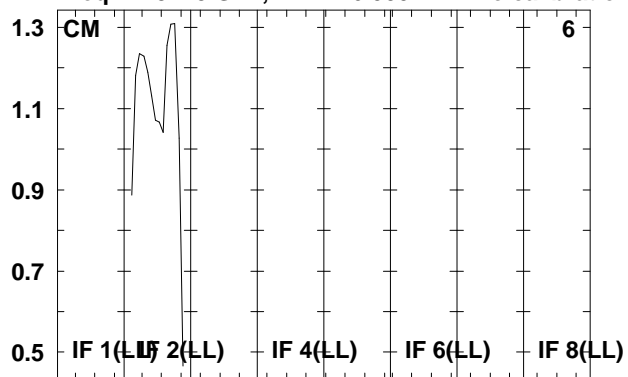

Lower frame: Real Jy  
Total-power spectrum Antenna: \*  
Timerange: 00/15:58:40 to 00/16:00:00

Plot file version 181 created 07-DEC-2009 16:06:12

SS433 RT006C.UVDATA.1

Freq = 4.9415 GHz, Bw = 16.000 MH No calibration applied and no bandpass applied

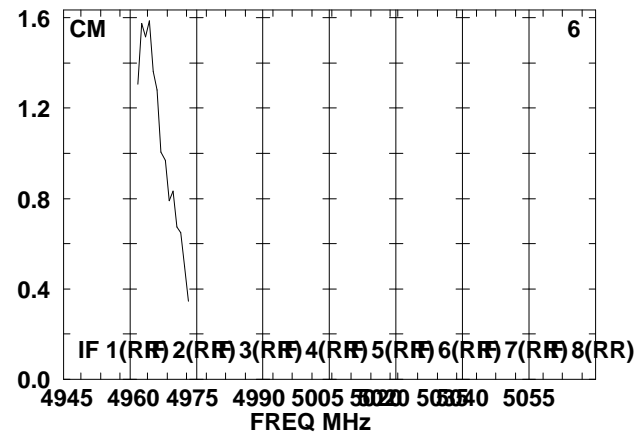
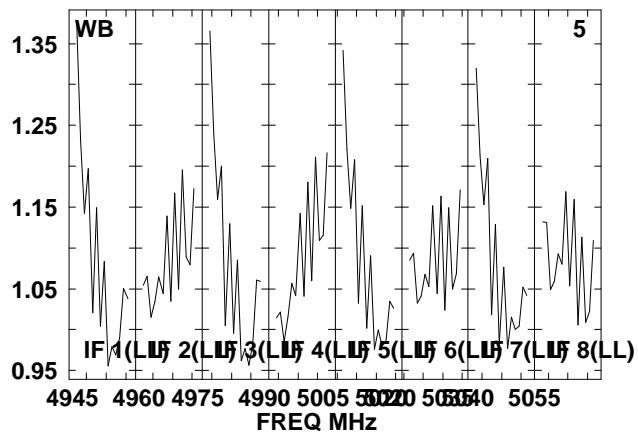
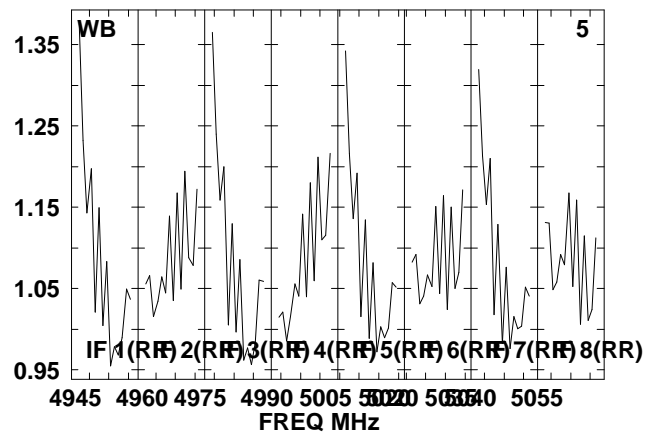
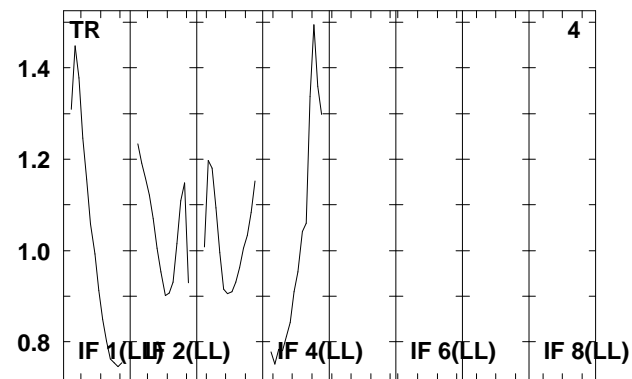
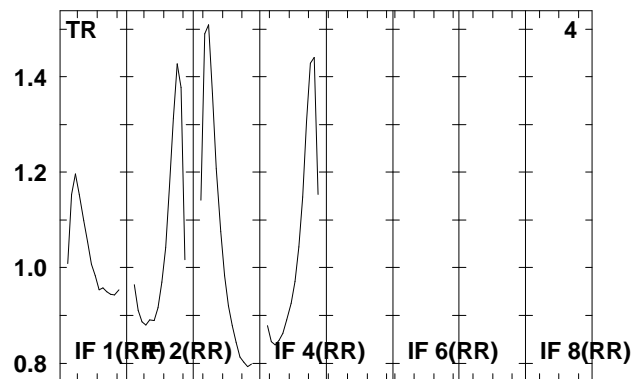
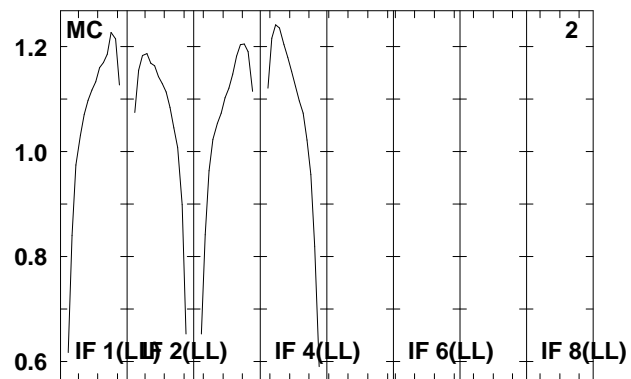
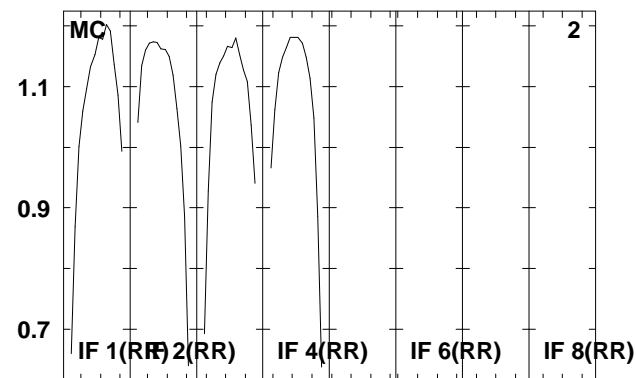
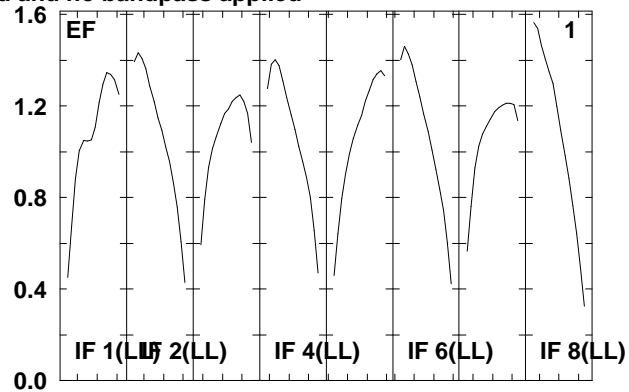
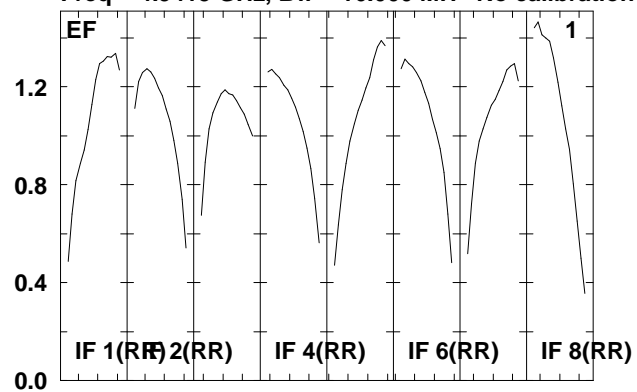

Lower frame: Real Jy  
Total-power spectrum Antenna: \*  
Timerange: 00/16:00:04 to 00/16:02:16

Plot file version 182 created 07-DEC-2009 16:06:12

SS433 RT006C.UVDATA.1

Freq = 4.9415 GHz, Bw = 16.000 MH No calibration applied and no bandpass applied

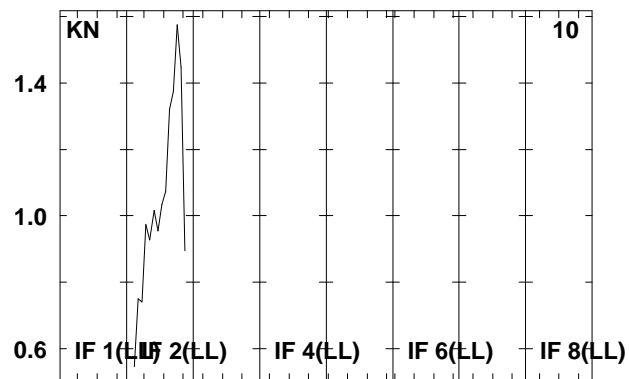
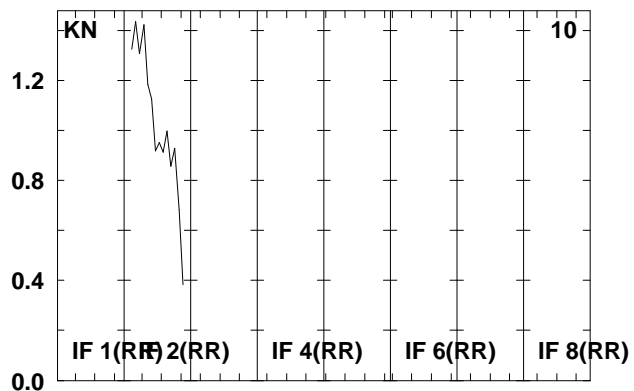
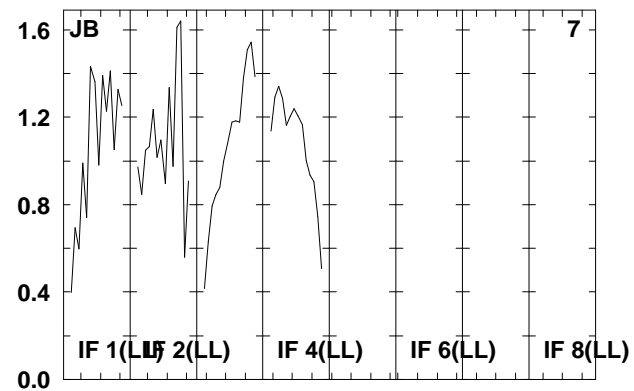
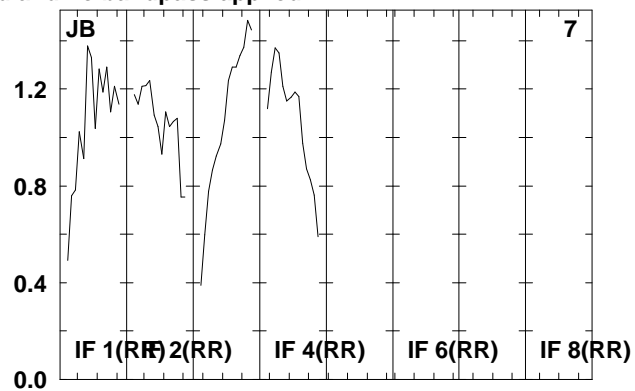
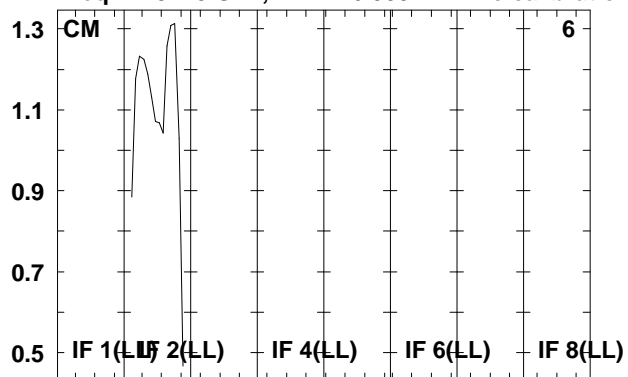

Lower frame: Real Jy  
Total-power spectrum Antenna: \*  
Timerange: 00/16:00:04 to 00/16:02:16

Plot file version 183 created 07-DEC-2009 16:06:12

J1911+16 RT006C.UVDATA.1

Freq = 4.9415 GHz, Bw = 16.000 MH No calibration applied and no bandpass applied

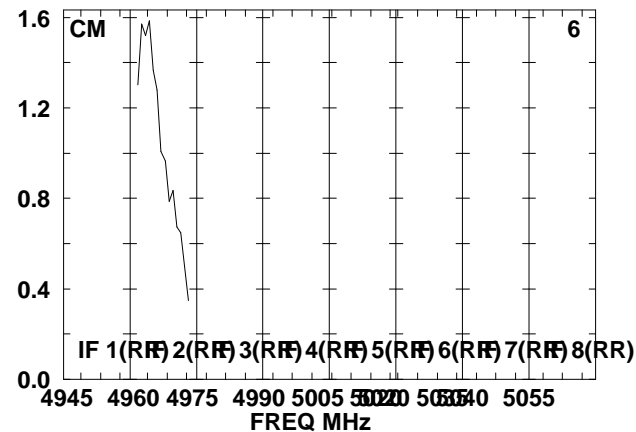
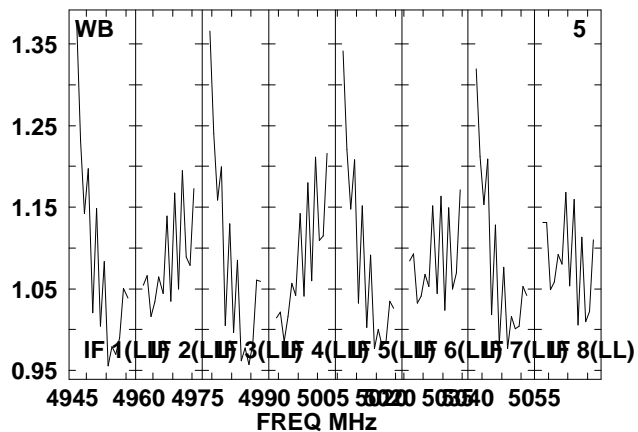
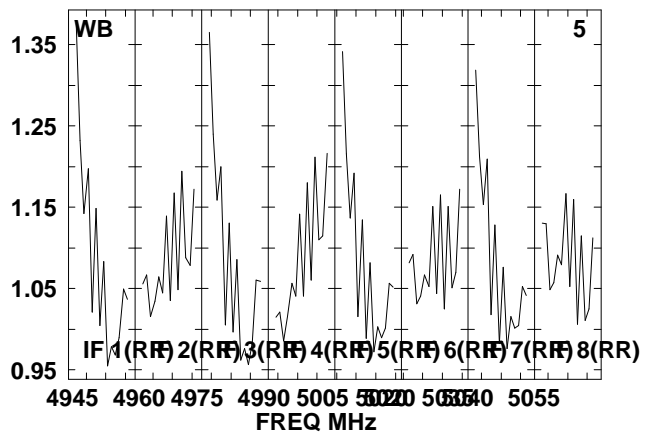
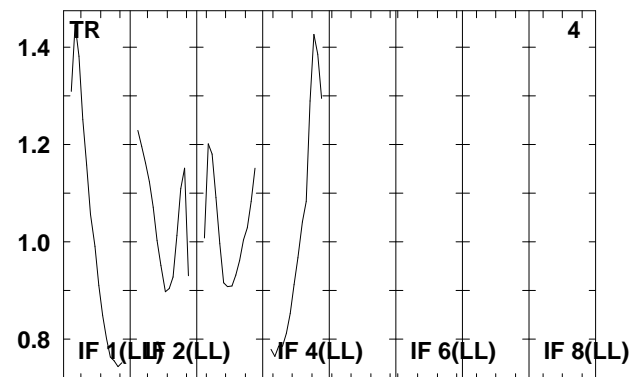
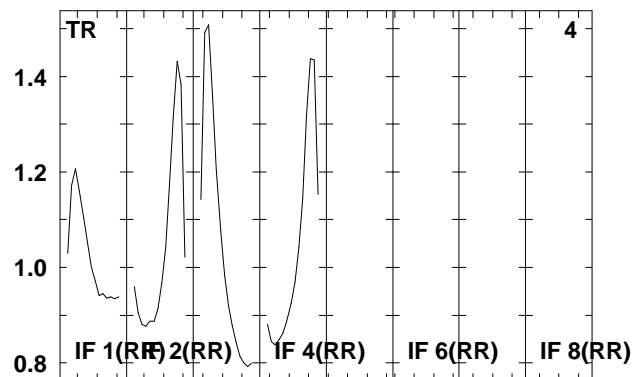
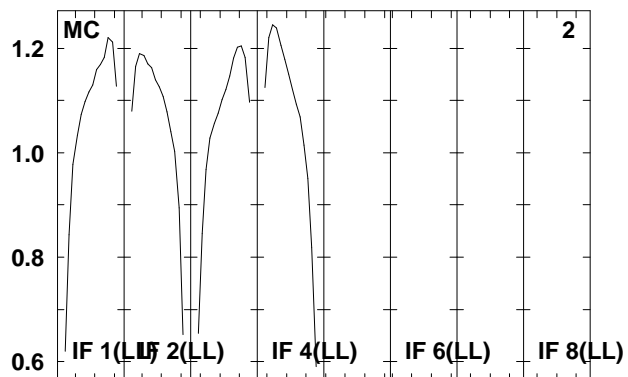
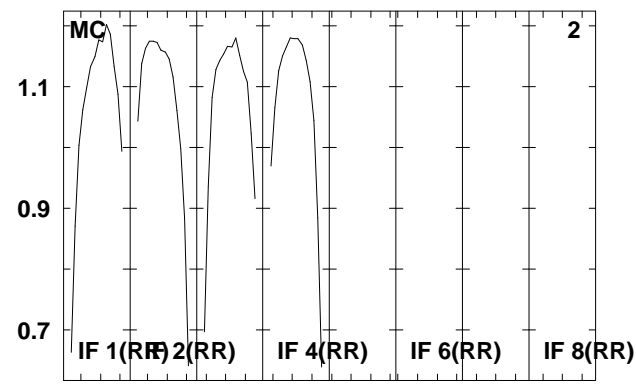
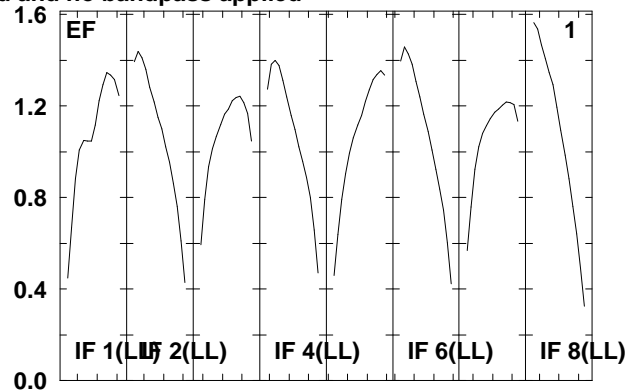
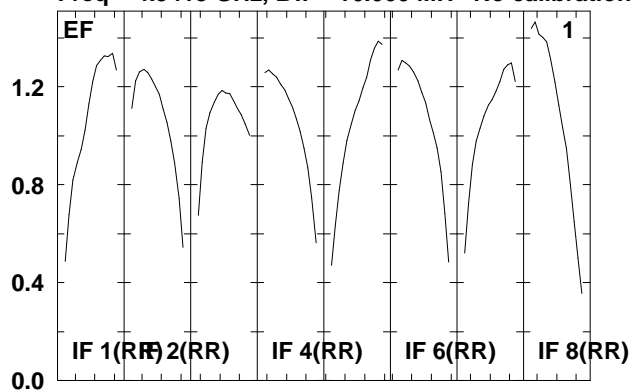

Lower frame: Real Jy  
Total-power spectrum Antenna: \*  
Timerange: 00/16:03:20 to 00/16:04:16

Plot file version 184 created 07-DEC-2009 16:06:12

J1911+16 RT006C.UVDATA.1

Freq = 4.9415 GHz, Bw = 16.000 MH No calibration applied and no bandpass applied

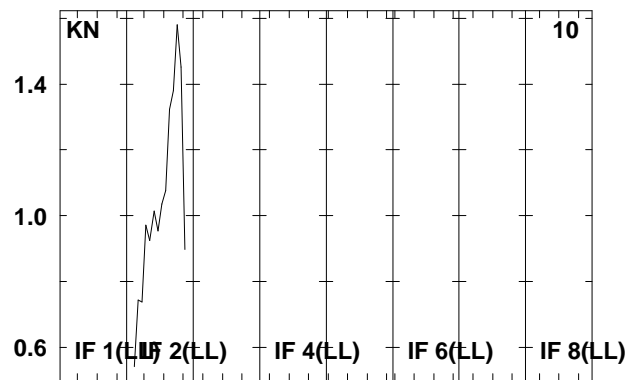
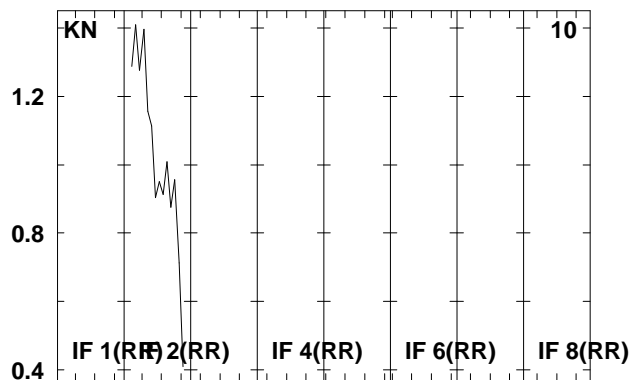
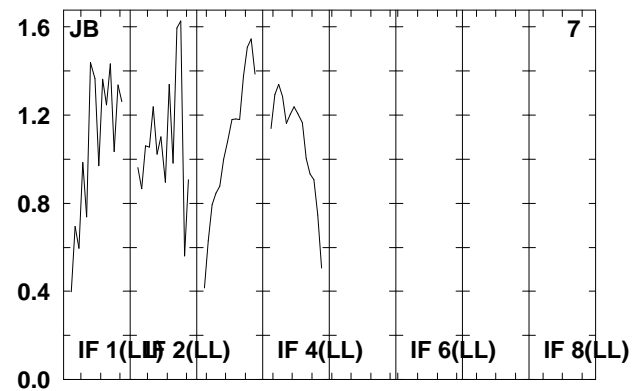
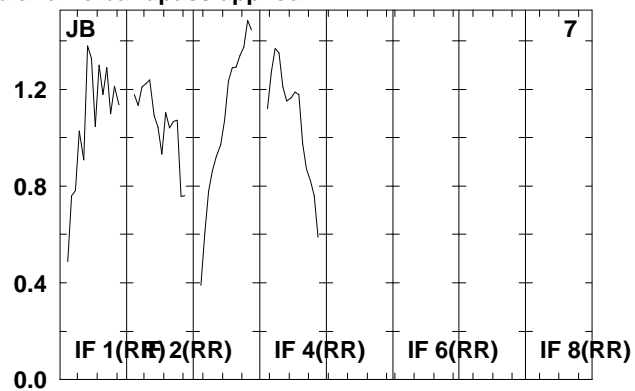
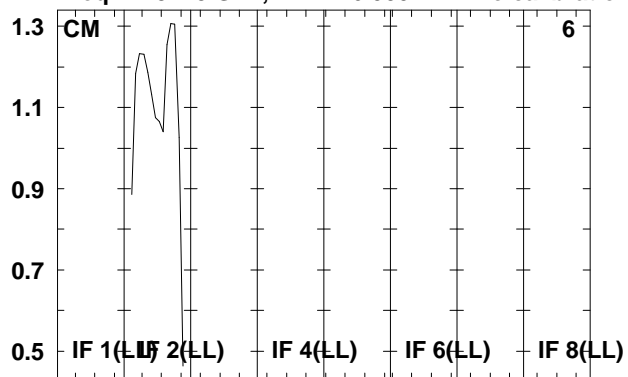

Lower frame: Real Jy  
Total-power spectrum Antenna: \*  
Timerange: 00/16:03:20 to 00/16:04:16



Plot file version 185 created 07-DEC-2009 16:06:13

J2002+47 RT006C.UVDATA.1

Freq = 4.9415 GHz, Bw = 16.000 MH No calibration applied and no bandpass applied

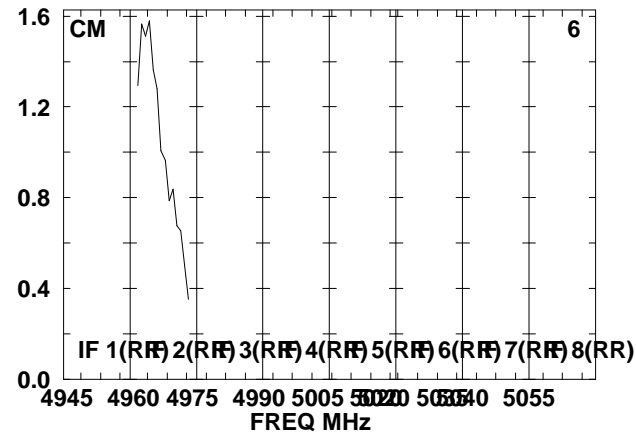
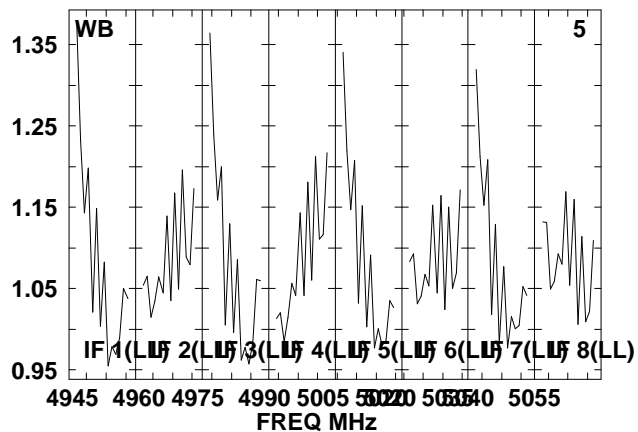
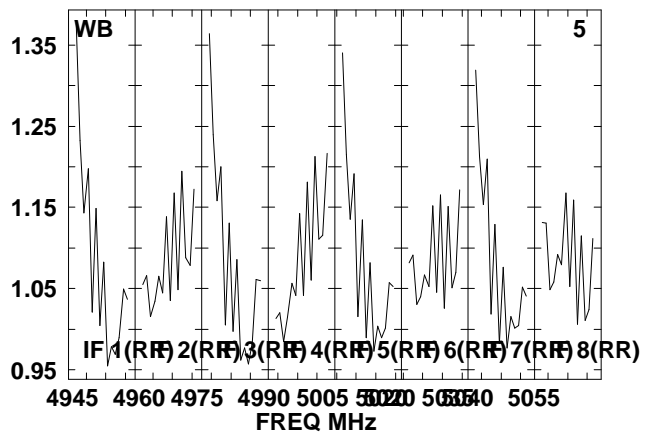
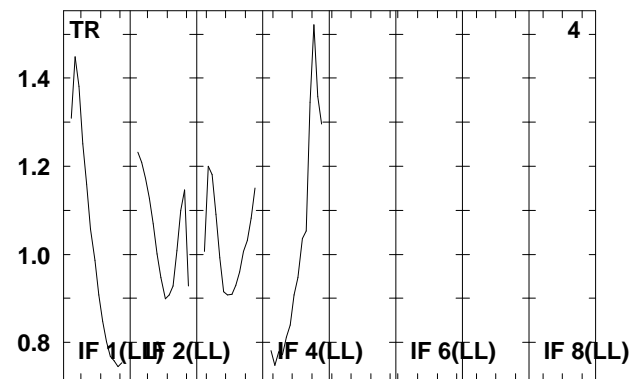
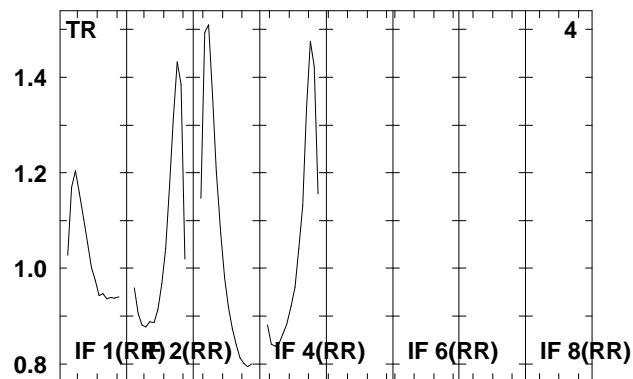
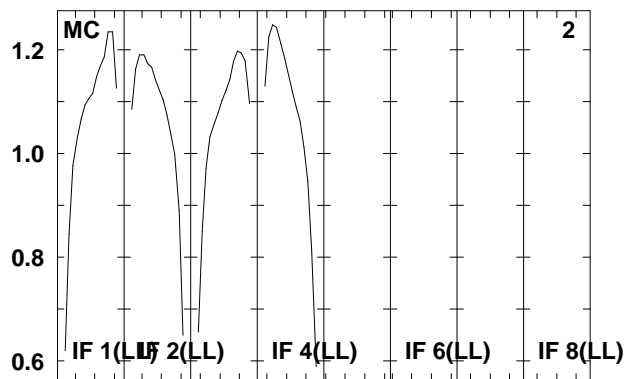
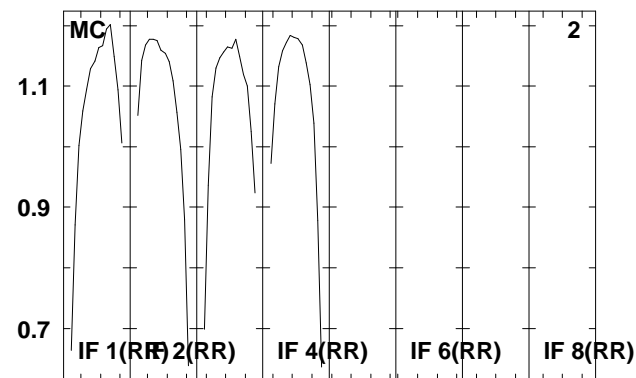
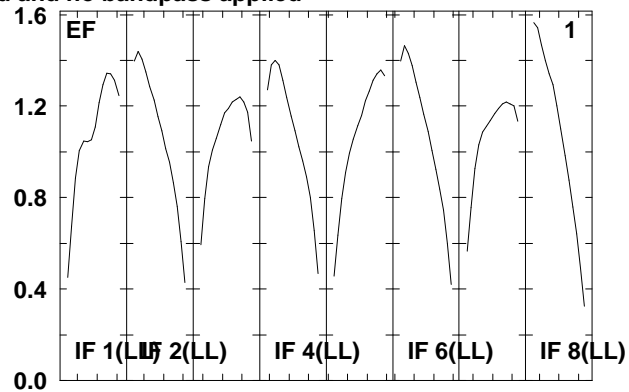
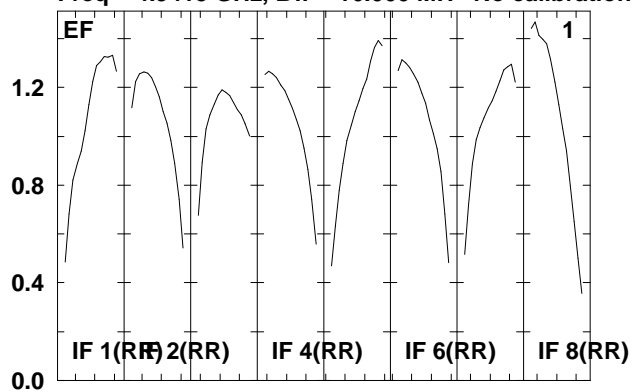

Lower frame: Real Jy

Total-power spectrum Antenna: \*

Timerange: 00/16:08:20 to 00/16:14:16

Plot file version 186 created 07-DEC-2009 16:06:13

J2002+47 RT006C.UVDATA.1

Freq = 4.9415 GHz, Bw = 16.000 MH No calibration applied and no bandpass applied

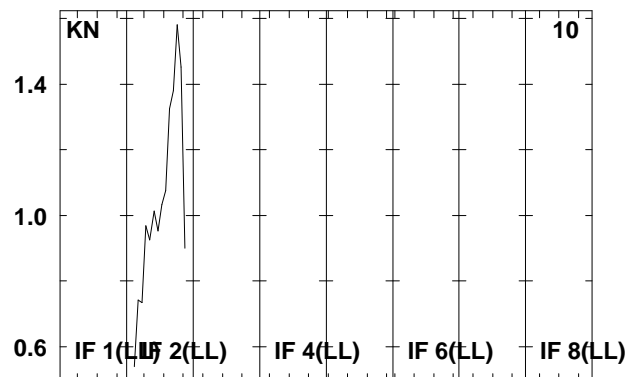
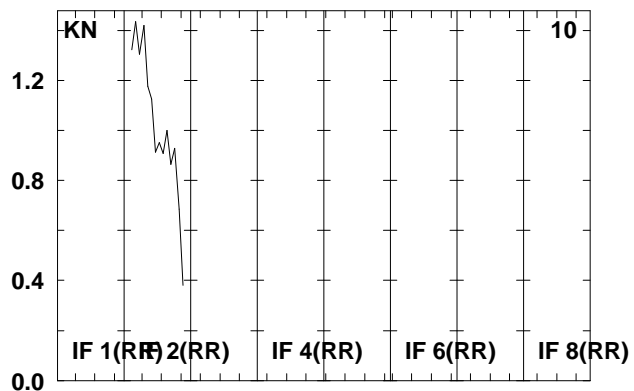
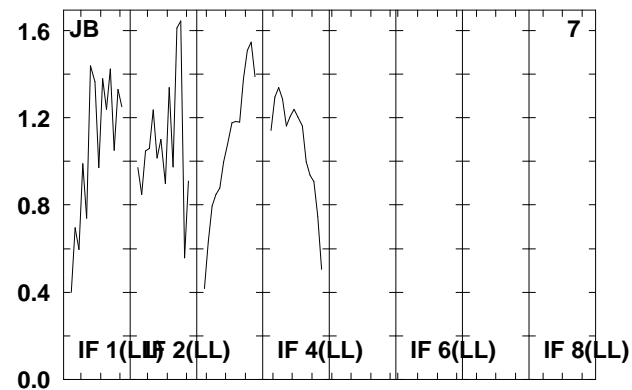
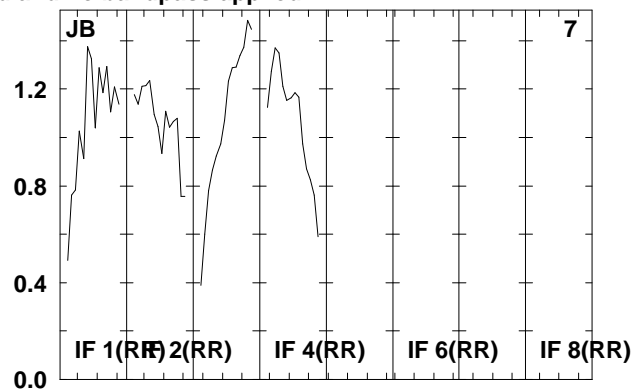
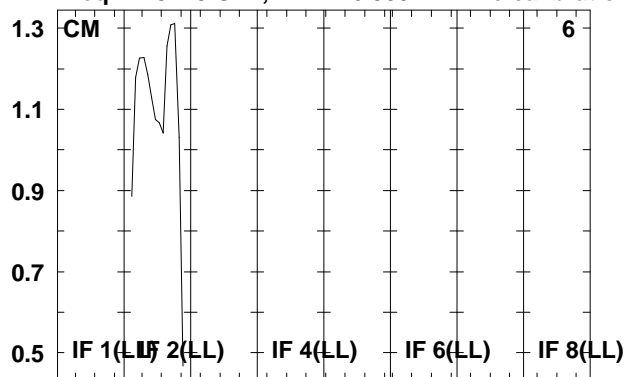

Lower frame: Real Jy  
Total-power spectrum Antenna: \*  
Timerange: 00/16:08:20 to 00/16:14:16

Plot file version 187 created 07-DEC-2009 16:06:14

J1912+05 RT006C.UVDATA.1

Freq = 4.9415 GHz, Bw = 16.000 MH No calibration applied and no bandpass applied

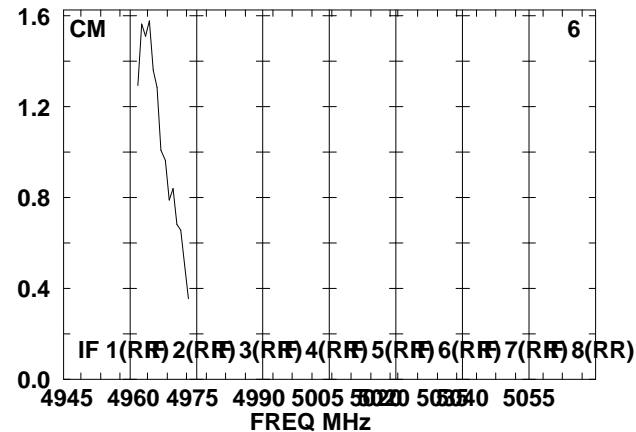
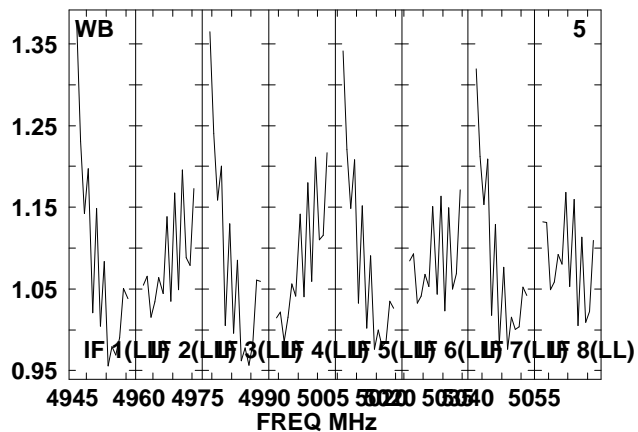
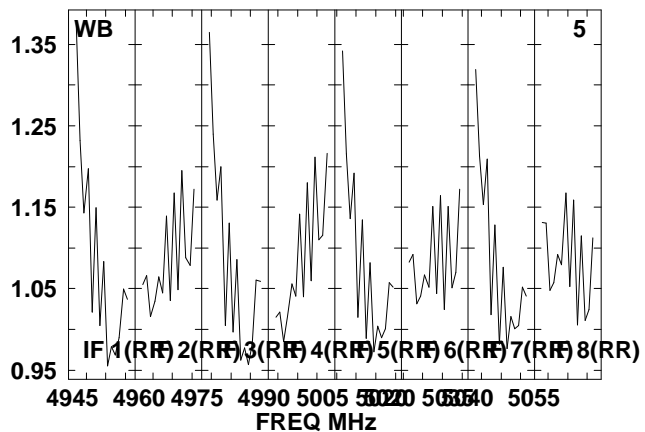
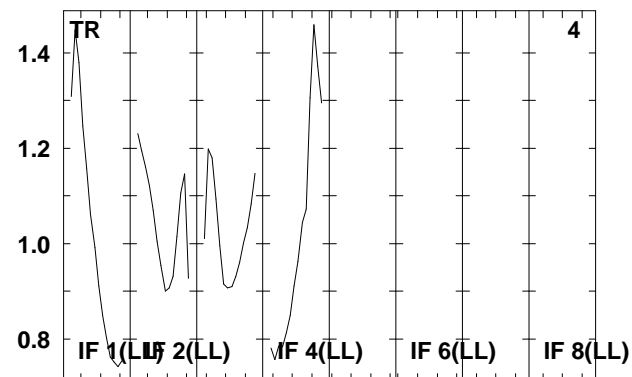
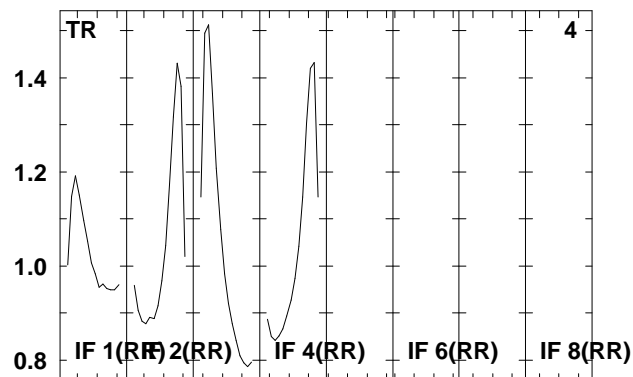
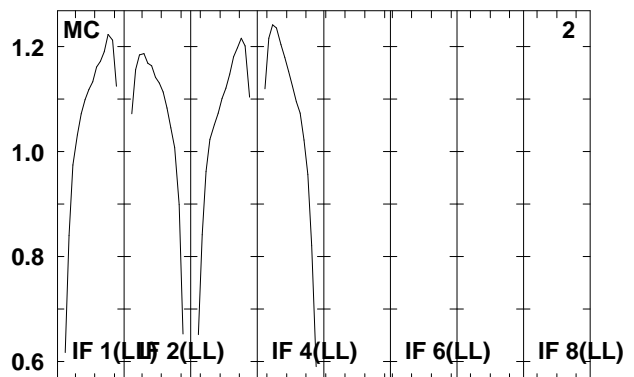
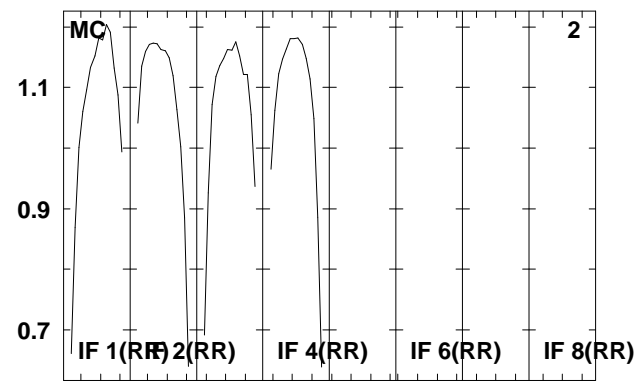
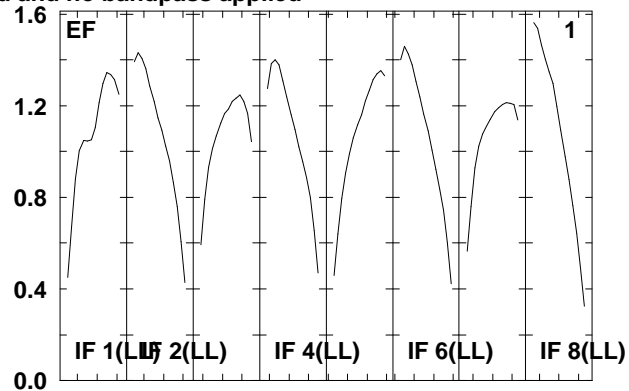
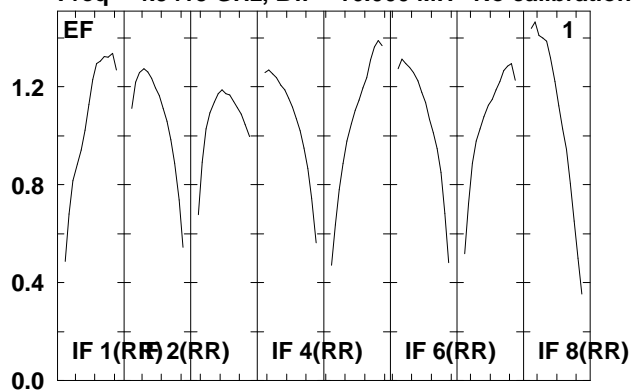

Lower frame: Real Jy  
Total-power spectrum Antenna: \*  
Timerange: 00/16:17:20 to 00/16:20:20

Plot file version 188 created 07-DEC-2009 16:06:14

J1912+05 RT006C.UVDATA.1

Freq = 4.9415 GHz, Bw = 16.000 MH No calibration applied and no bandpass applied

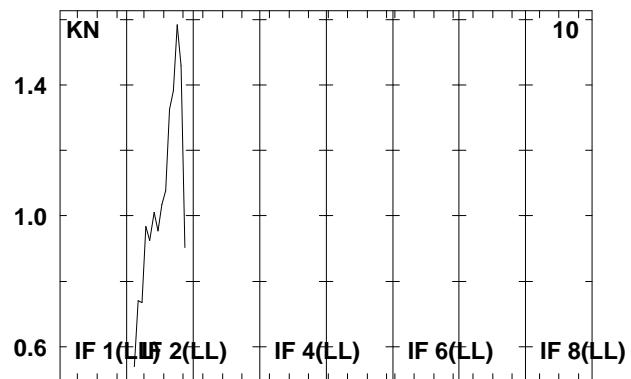
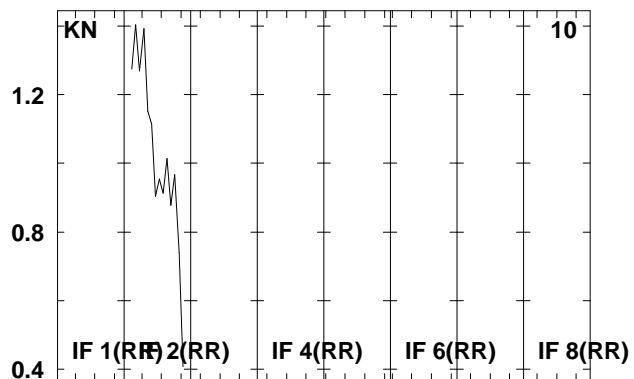
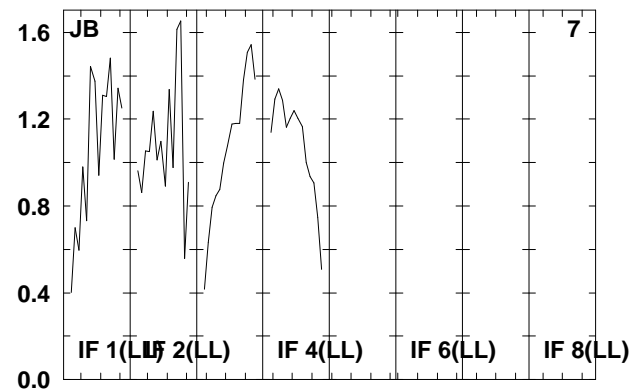
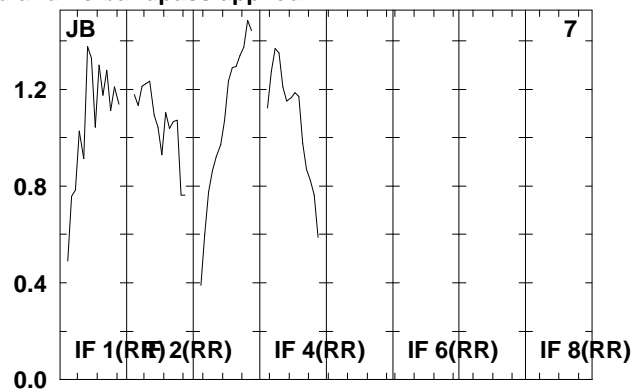
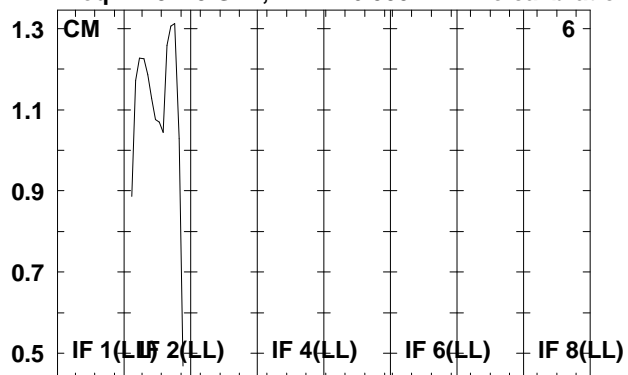

Lower frame: Real Jy  
Total-power spectrum Antenna: \*  
Timerange: 00/16:17:20 to 00/16:20:20

Plot file version 189 created 07-DEC-2009 16:06:14

SS433 RT006C.UVDATA.1

Freq = 4.9415 GHz, Bw = 16.000 MH No calibration applied and no bandpass applied

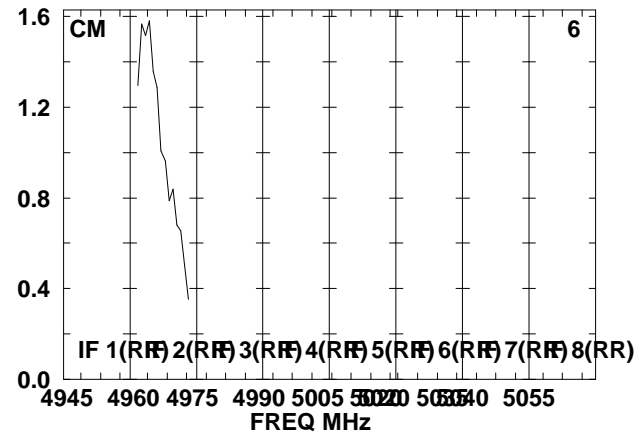
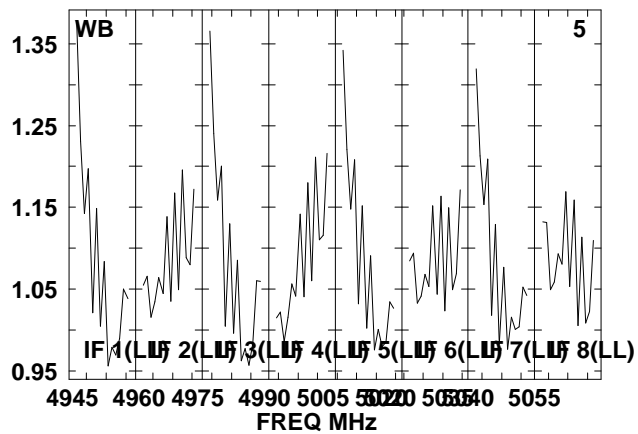
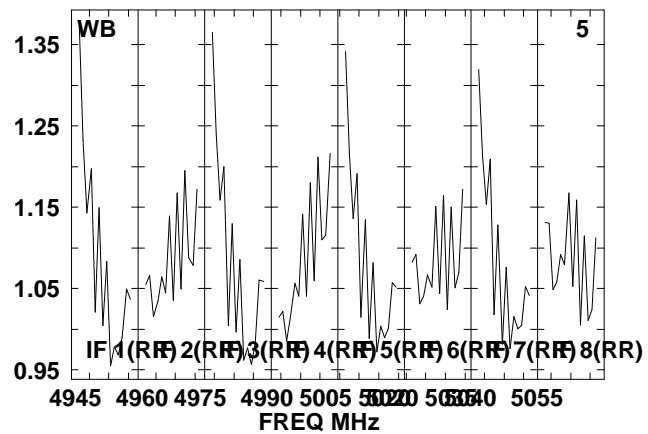
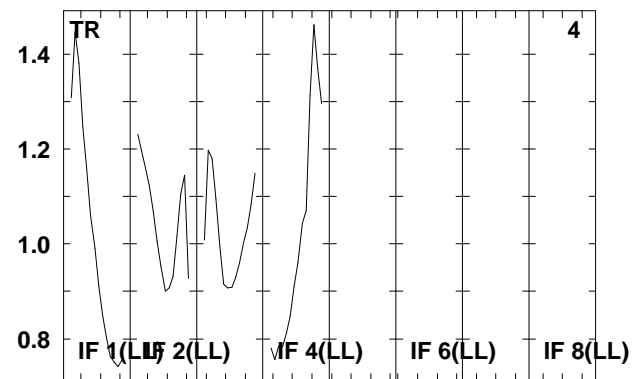
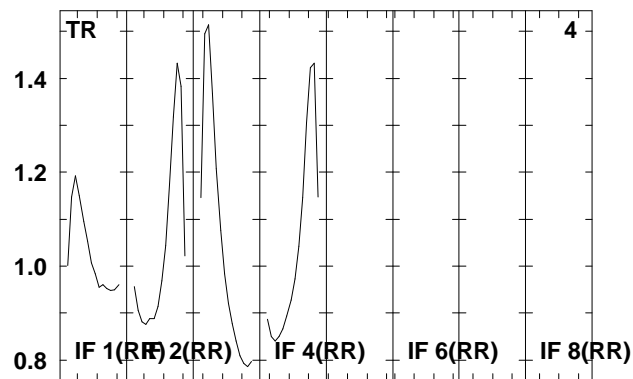
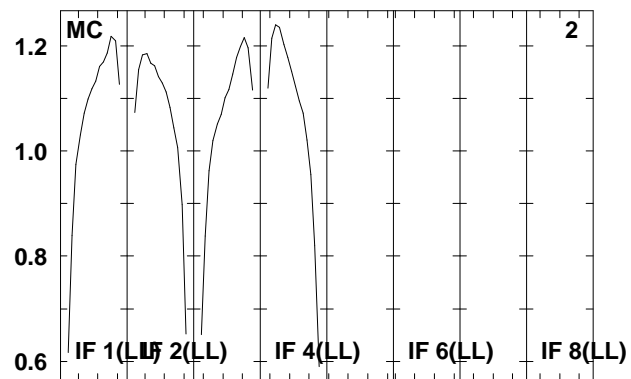
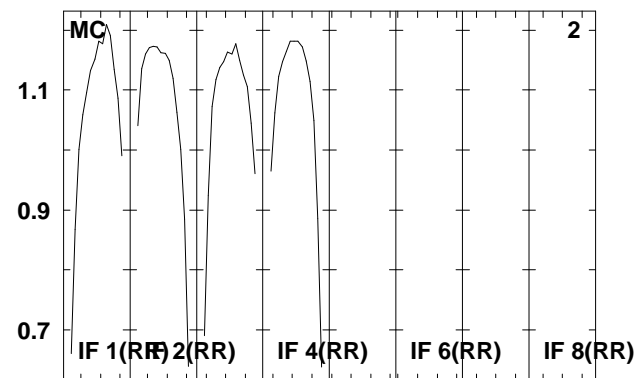
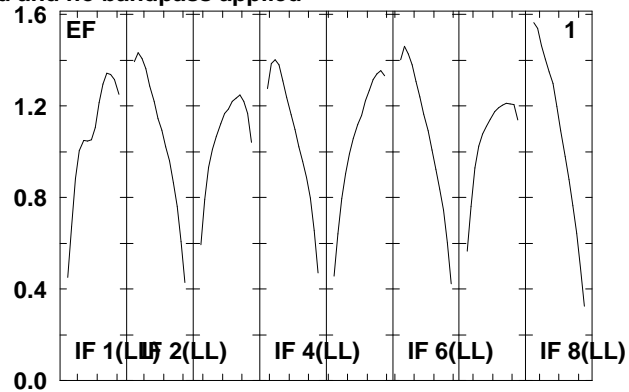
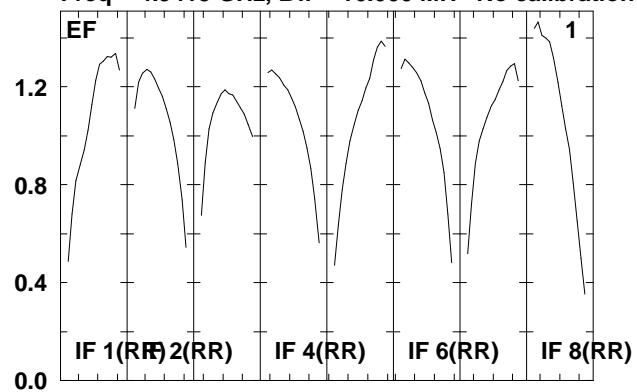

Lower frame: Real Jy  
Total-power spectrum Antenna: \*  
Timerange: 00/16:20:24 to 00/16:22:40

Plot file version 190 created 07-DEC-2009 16:06:14

SS433 RT006C.UVDATA.1

Freq = 4.9415 GHz, Bw = 16.000 MH No calibration applied and no bandpass applied

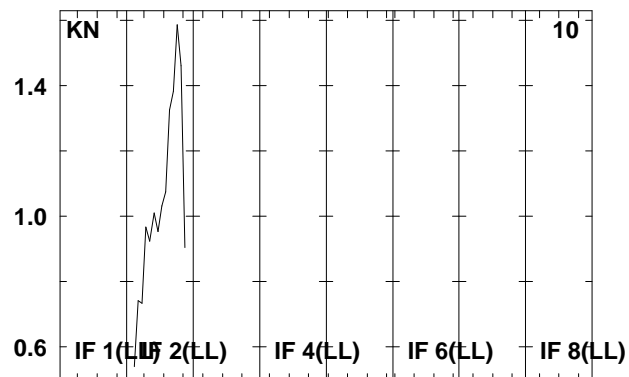
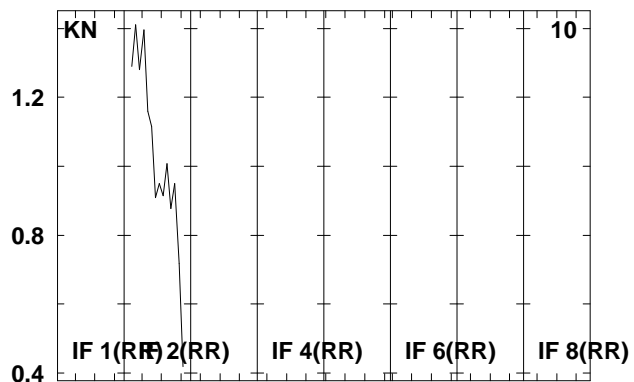
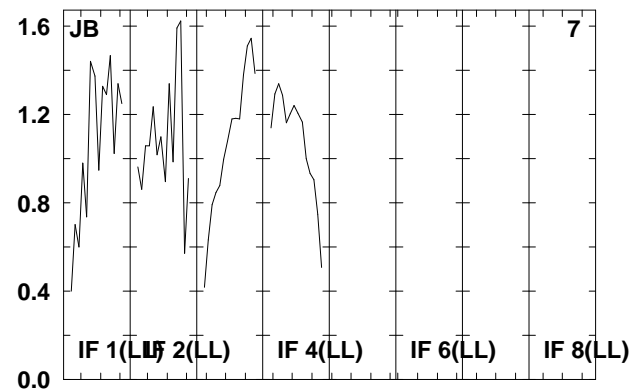
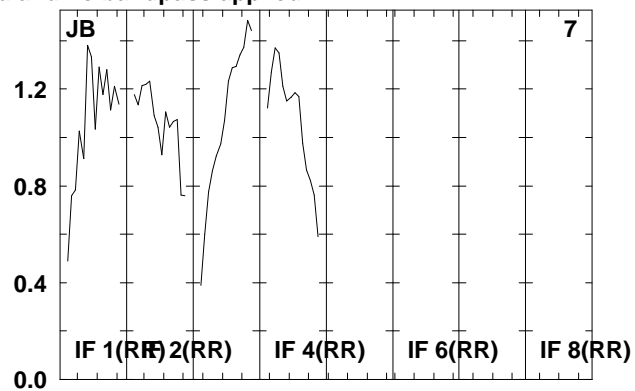
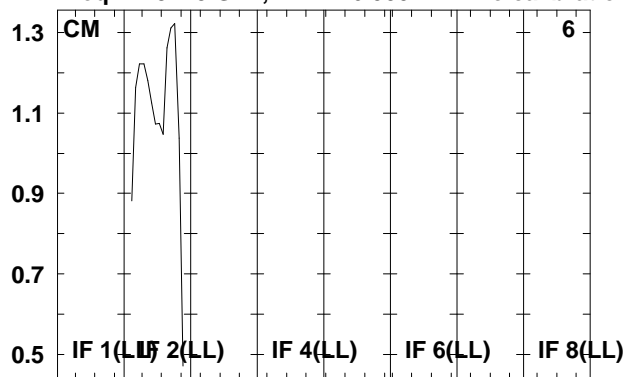

Lower frame: Real Jy  
Total-power spectrum Antenna: \*  
Timerange: 00/16:20:24 to 00/16:22:40

Plot file version 191 created 07-DEC-2009 16:06:15

J1912+05 RT006C.UVDATA.1

Freq = 4.9415 GHz, Bw = 16.000 MH No calibration applied and no bandpass applied

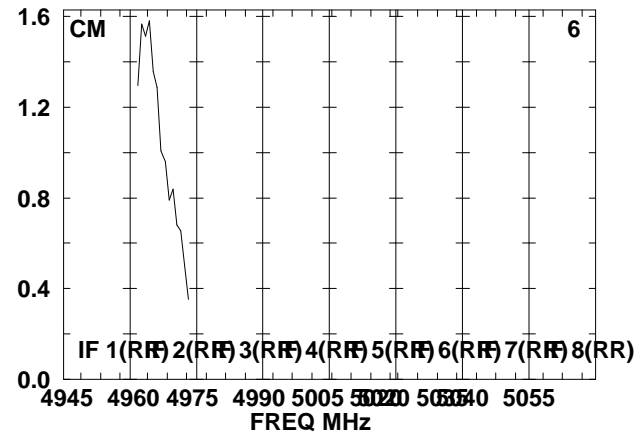
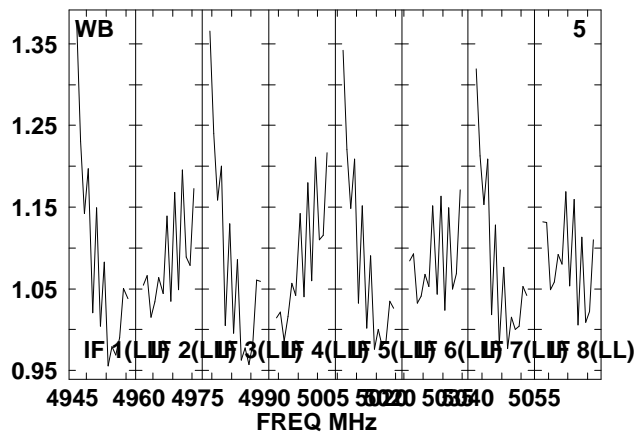
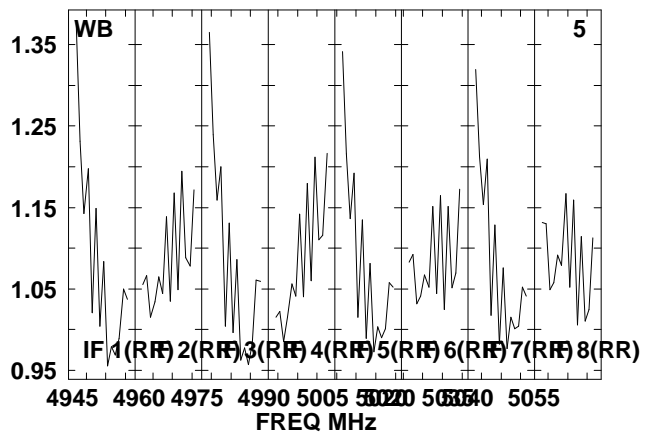
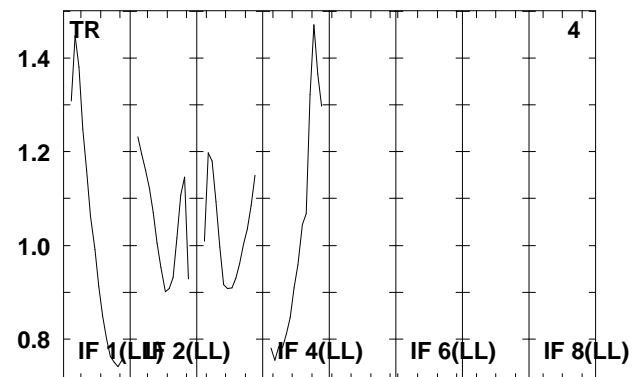
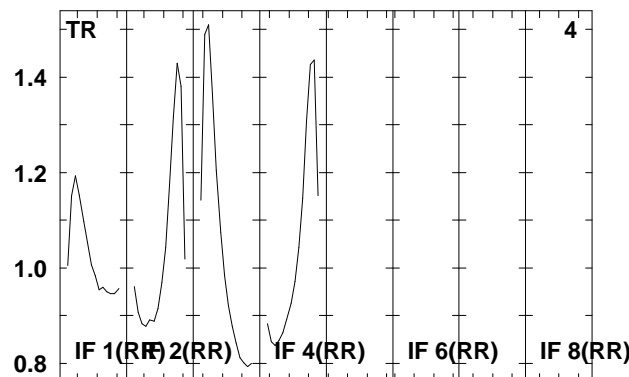
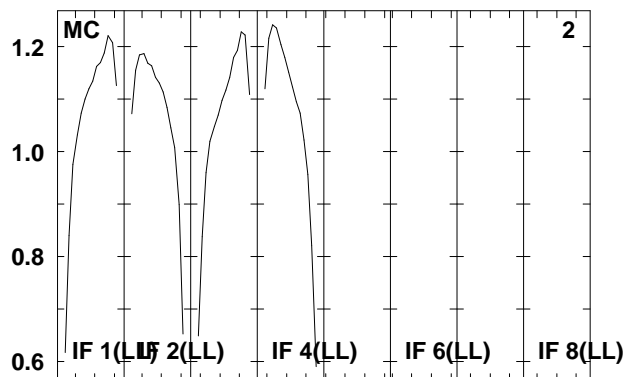
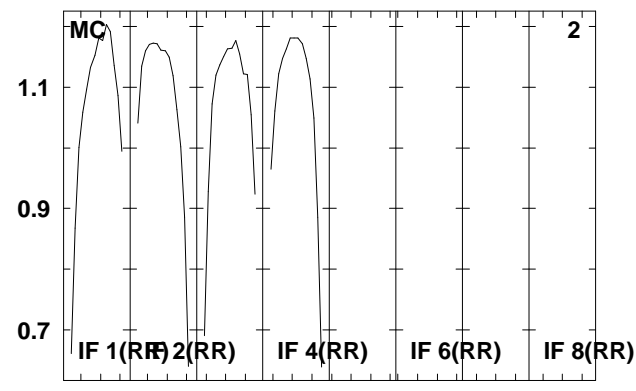
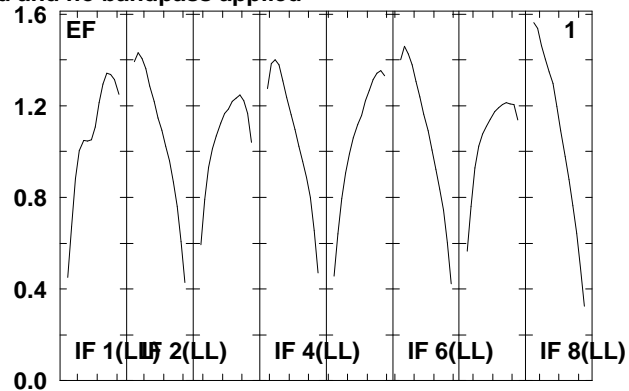
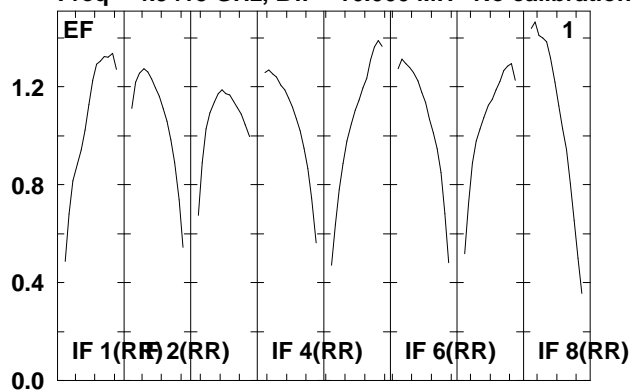

Lower frame: Real Jy  
Total-power spectrum Antenna: \*  
Timerange: 00/16:22:44 to 00/16:23:56

Plot file version 192 created 07-DEC-2009 16:06:15

J1912+05 RT006C.UVDATA.1

Freq = 4.9415 GHz, Bw = 16.000 MH No calibration applied and no bandpass applied

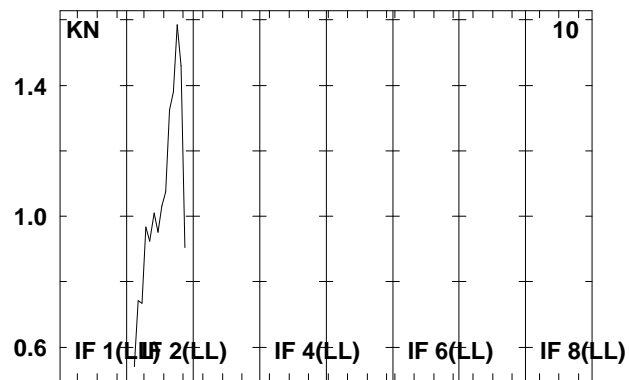
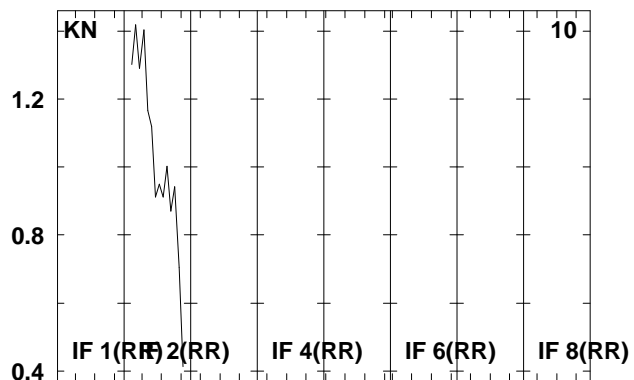
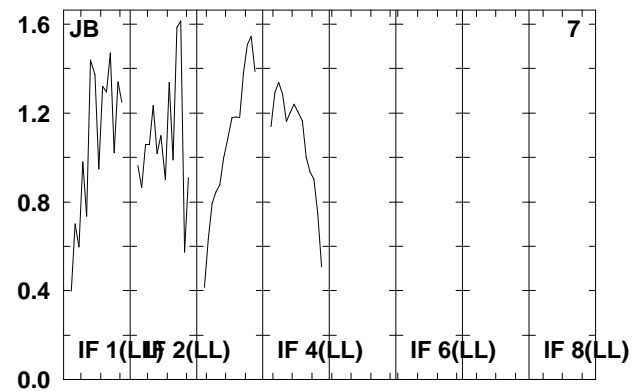
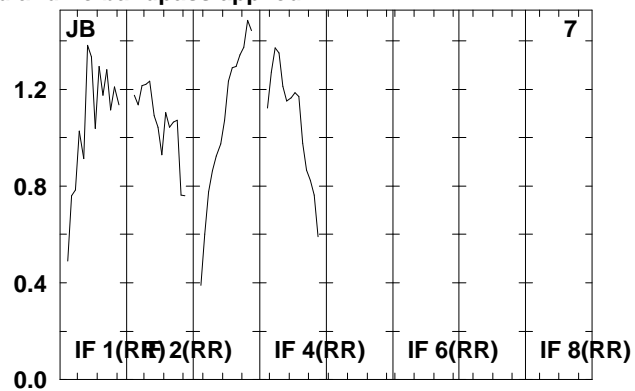
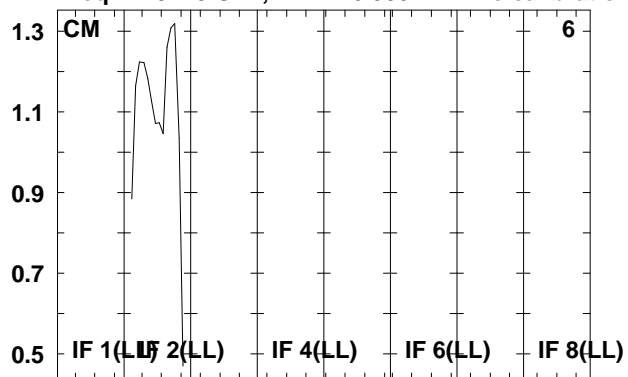

Lower frame: Real Jy  
Total-power spectrum Antenna: \*  
Timerange: 00/16:22:44 to 00/16:23:56



Plot file version 193 created 07-DEC-2009 16:06:15  
 SS433 RT006C.UVDATA.1  
 Freq = 4.9415 GHz, Bw = 16.000 MH No calibration applied and no bandpass applied

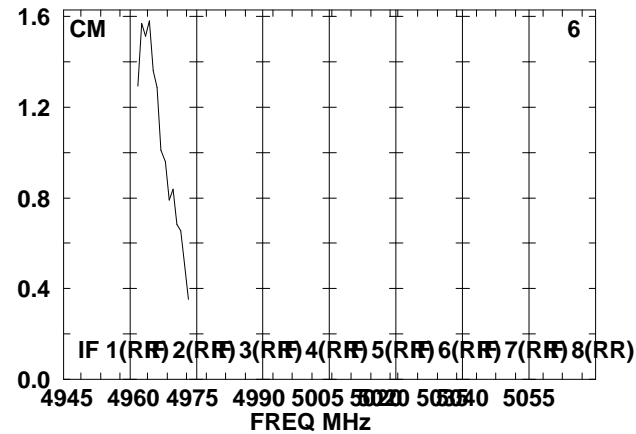
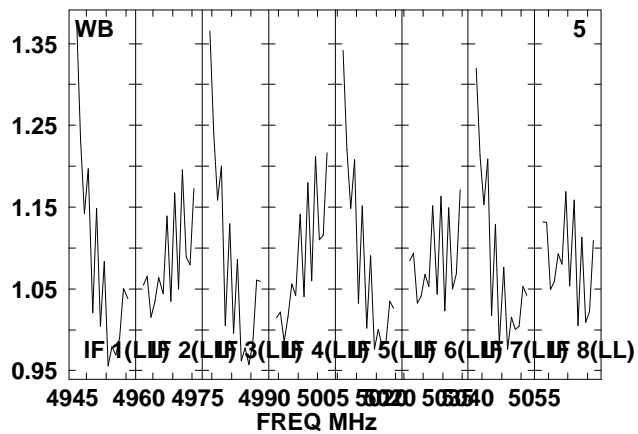
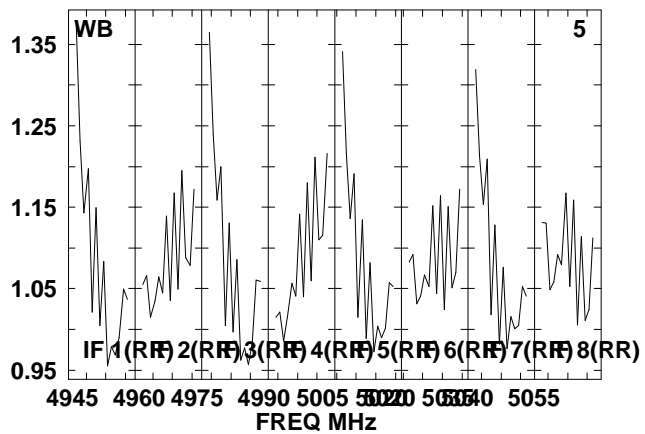
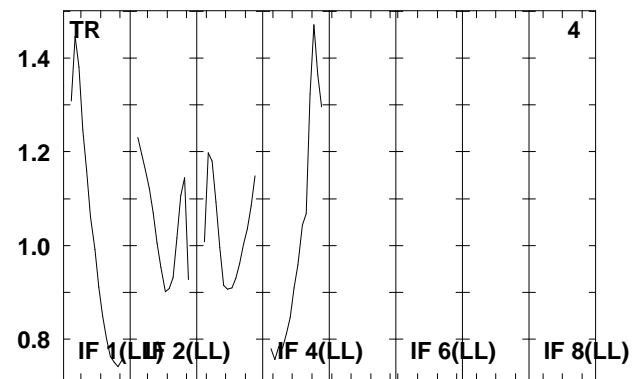
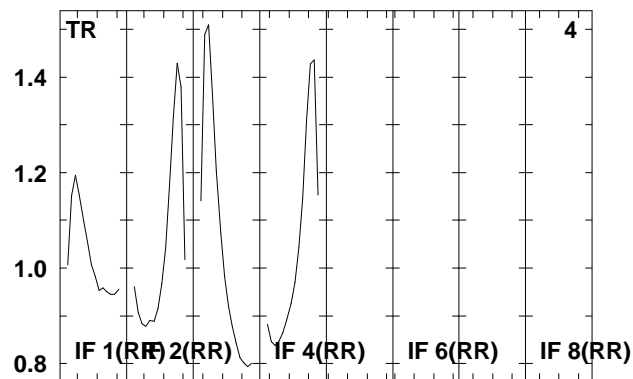
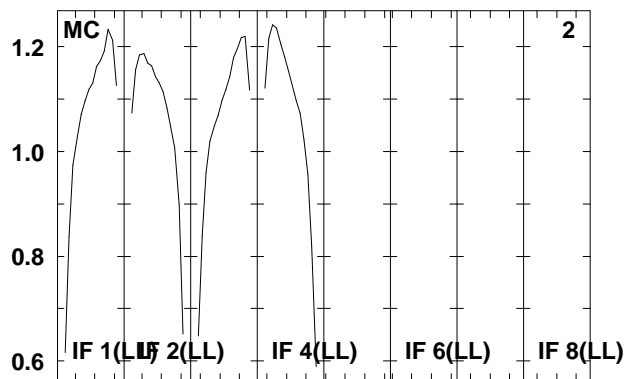
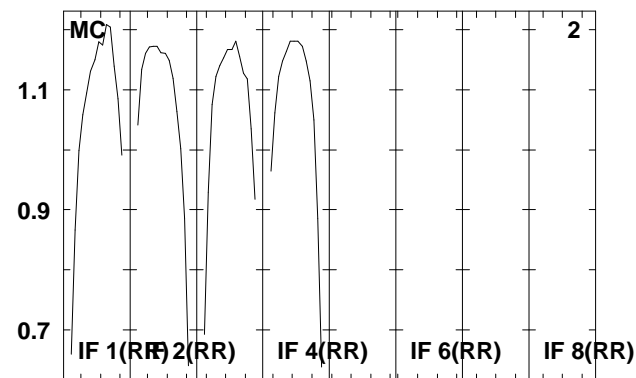
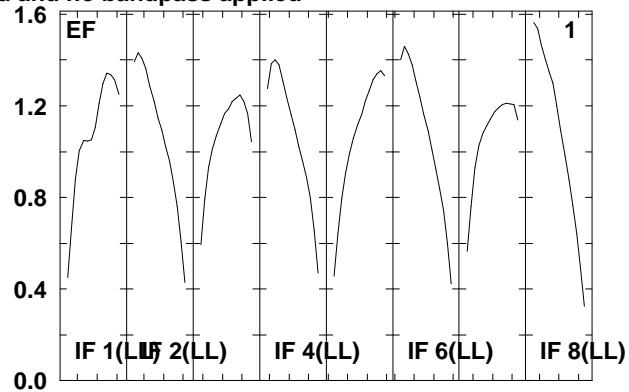
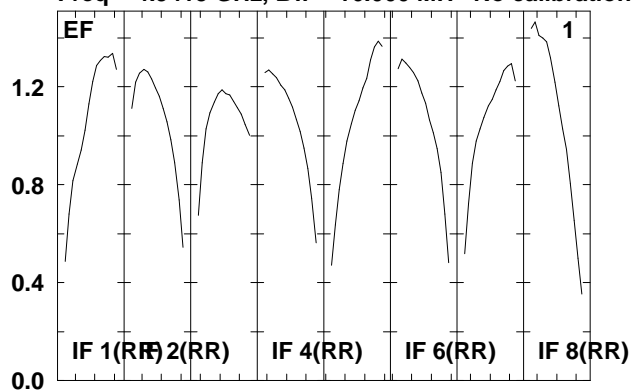

Lower frame: Real Jy  
 Total-power spectrum Antenna: \*  
 Timerange: 00/16:24:00 to 00/16:26:16

Plot file version 194 created 07-DEC-2009 16:06:15

SS433 RT006C.UVDATA.1

Freq = 4.9415 GHz, Bw = 16.000 MH No calibration applied and no bandpass applied

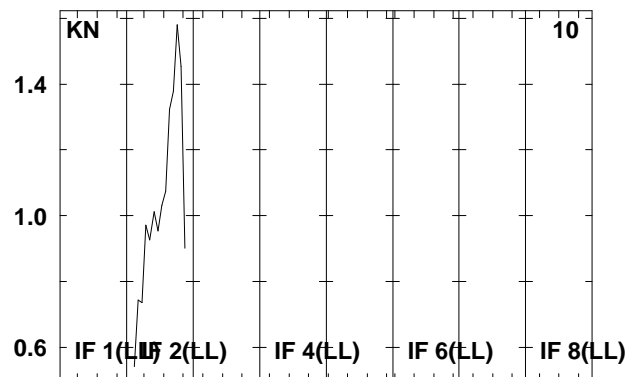
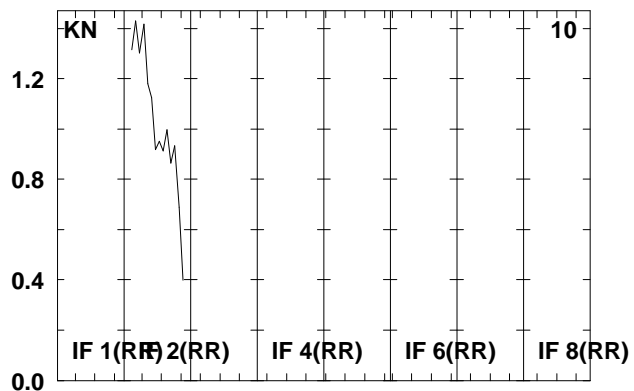
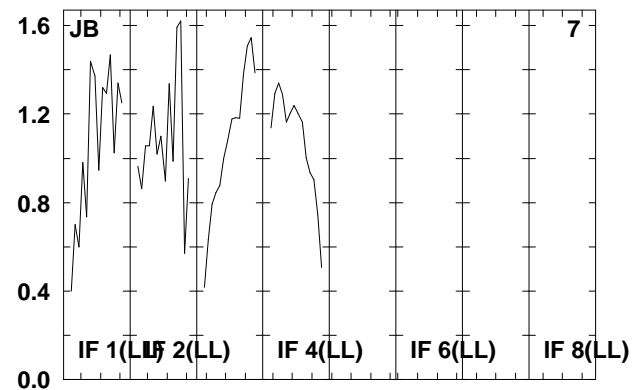
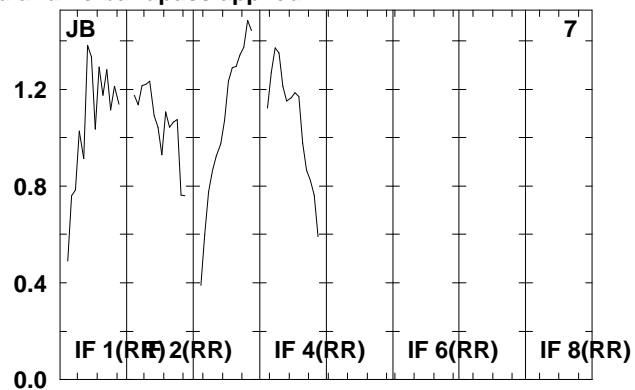
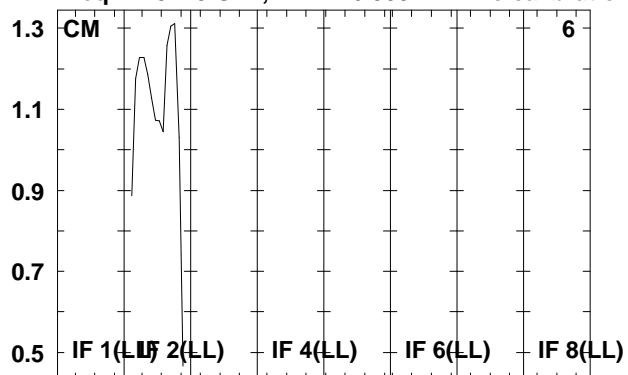

Lower frame: Real Jy  
Total-power spectrum Antenna: \*  
Timerange: 00/16:24:00 to 00/16:26:16

Plot file version 195 created 07-DEC-2009 16:06:15

J1912+05 RT006C.UVDATA.1

Freq = 4.9415 GHz, Bw = 16.000 MH No calibration applied and no bandpass applied

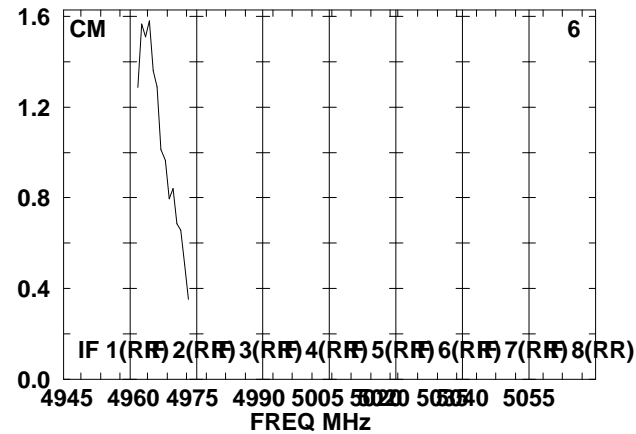
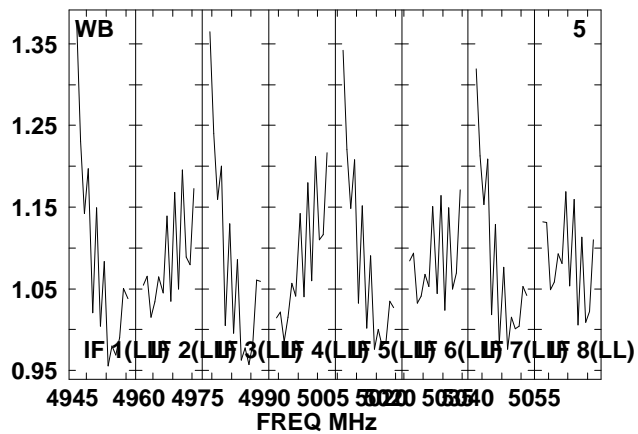
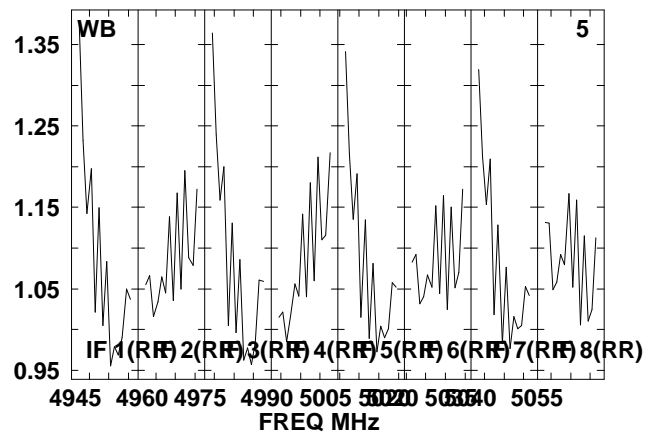
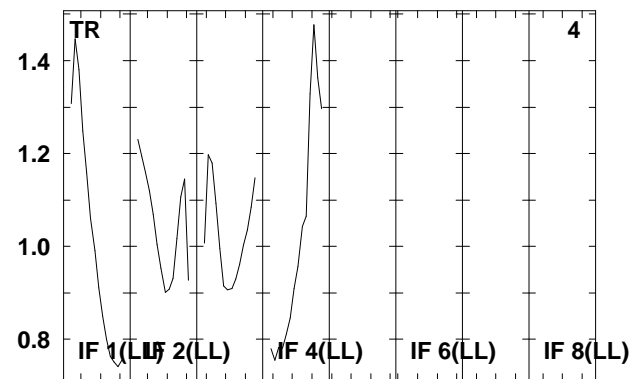
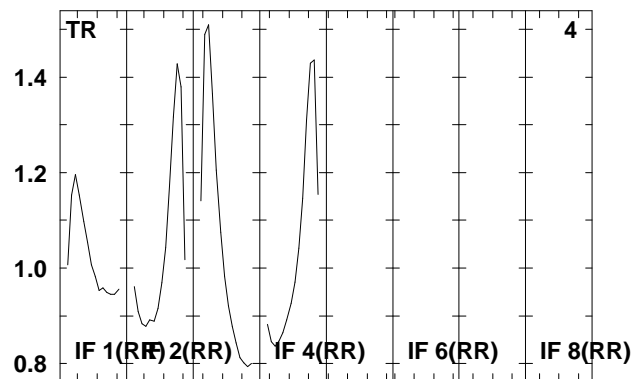
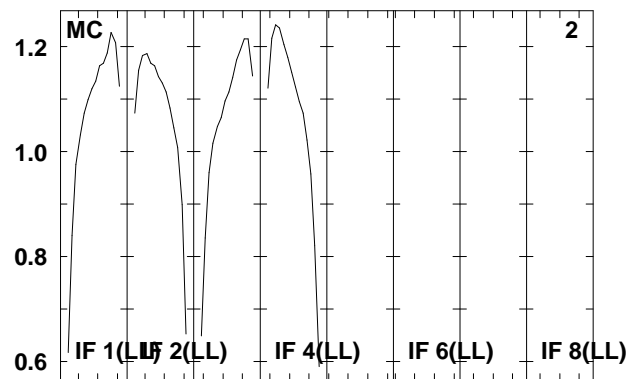
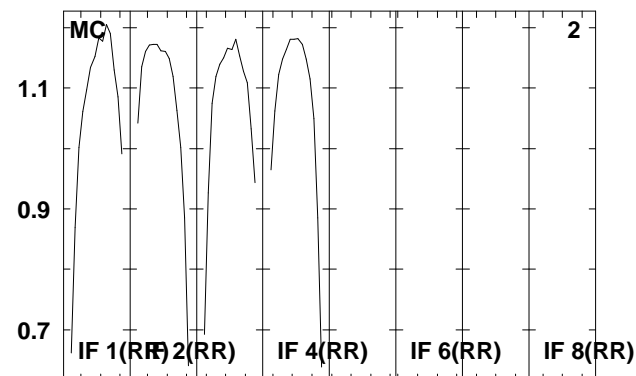
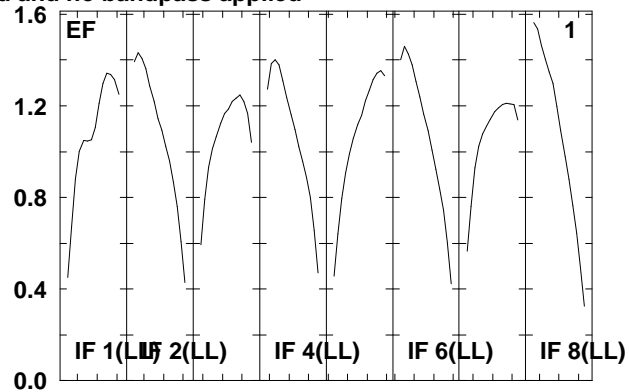
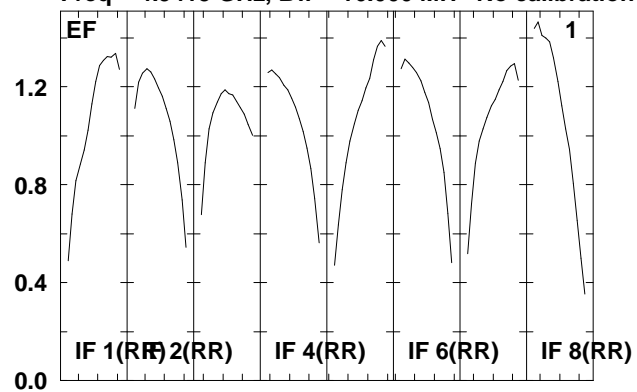

Lower frame: Real Jy  
Total-power spectrum Antenna: \*  
Timerange: 00/16:26:20 to 00/16:27:40

Plot file version 196 created 07-DEC-2009 16:06:15

J1912+05 RT006C.UVDATA.1

Freq = 4.9415 GHz, Bw = 16.000 MH No calibration applied and no bandpass applied

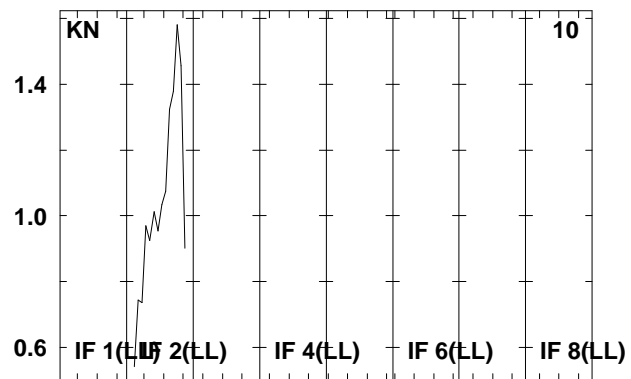
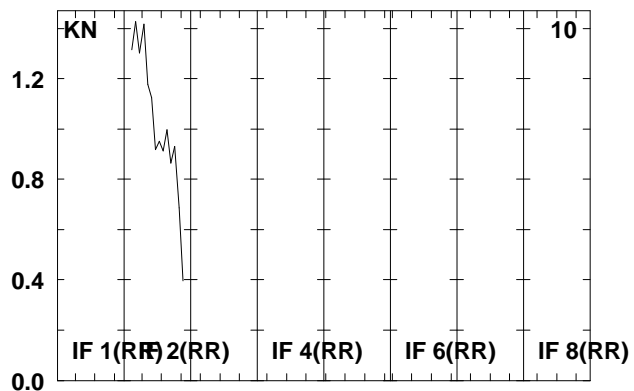
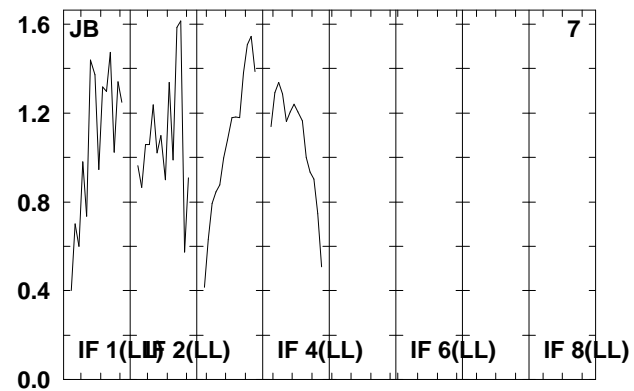
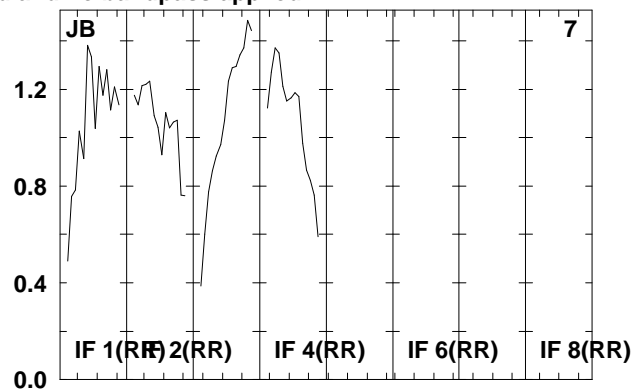
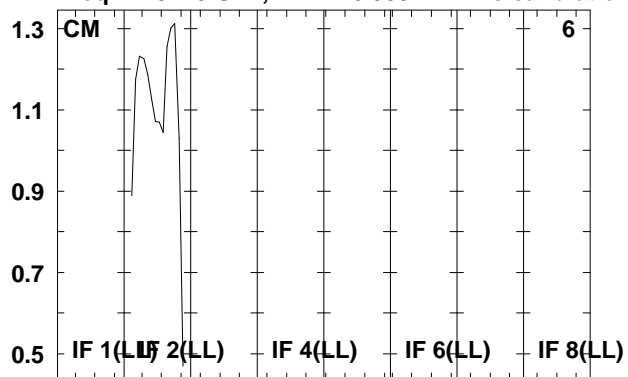

Lower frame: Real Jy  
Total-power spectrum Antenna: \*  
Timerange: 00/16:26:20 to 00/16:27:40

Plot file version 197 created 07-DEC-2009 16:06:16

SS433 RT006C.UVDATA.1

Freq = 4.9415 GHz, Bw = 16.000 MH No calibration applied and no bandpass applied

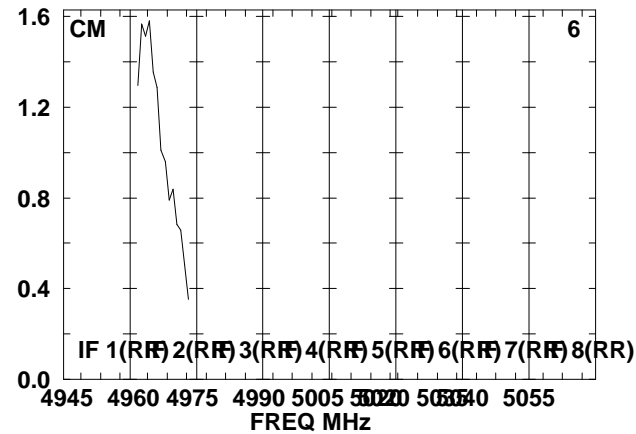
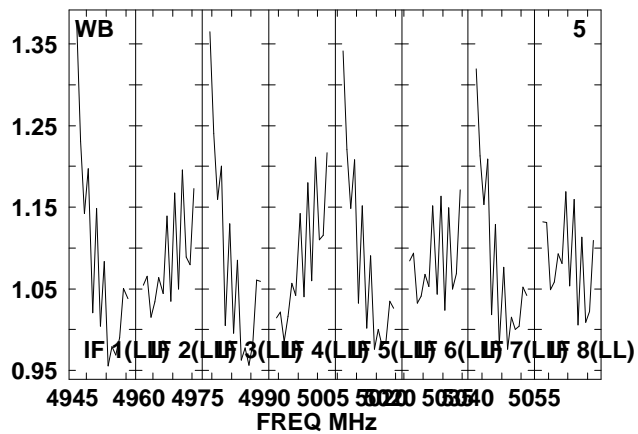
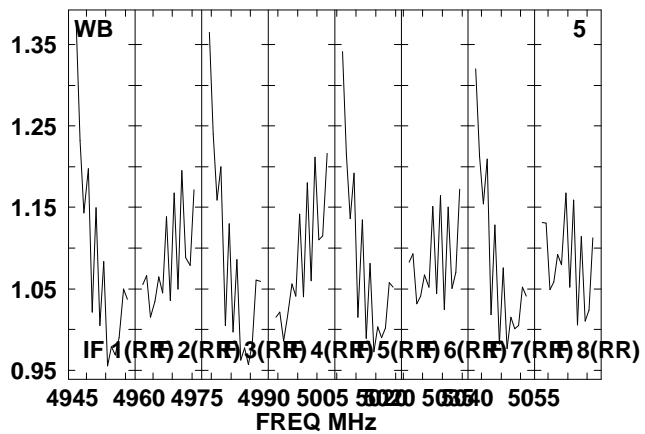
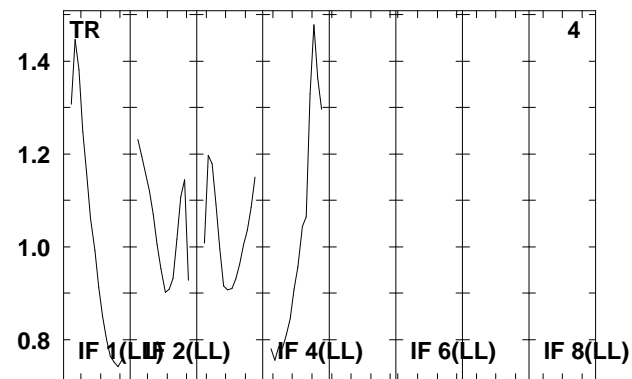
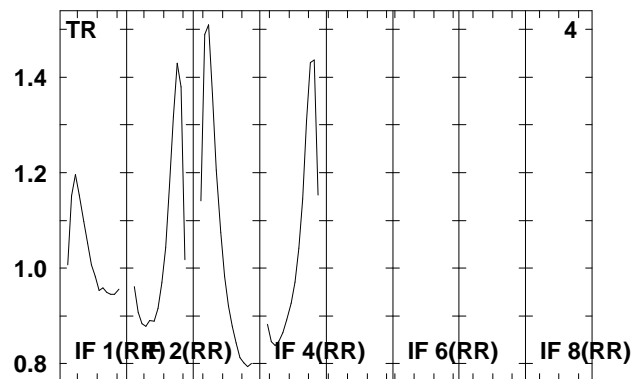
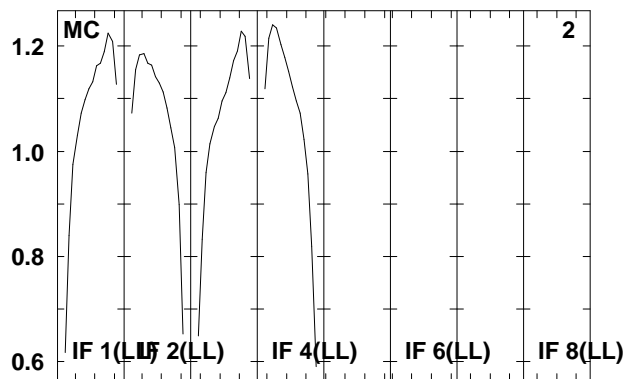
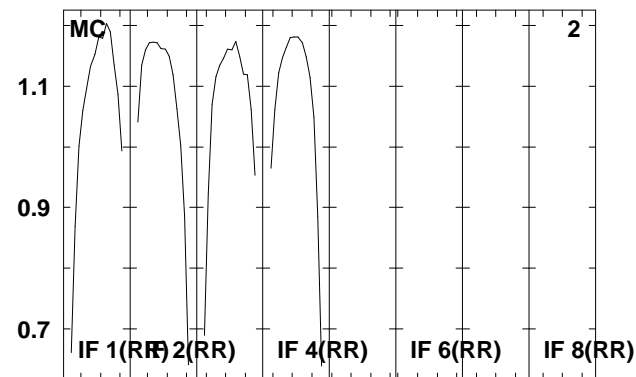
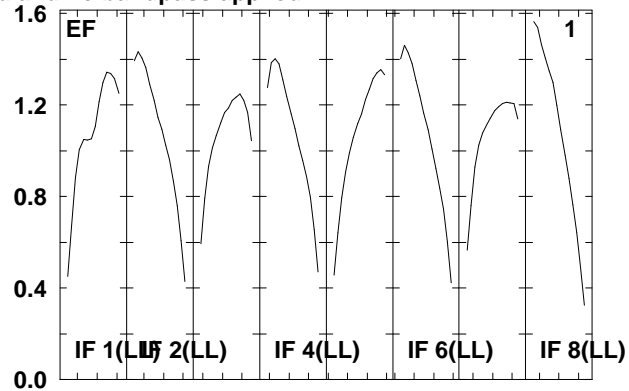
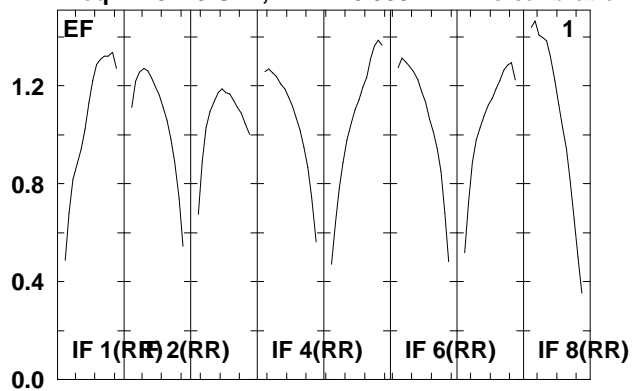

Lower frame: Real Jy  
Total-power spectrum Antenna: \*  
Timerange: 00/16:27:44 to 00/16:29:56

Plot file version 198 created 07-DEC-2009 16:06:16

SS433 RT006C.UVDATA.1

Freq = 4.9415 GHz, Bw = 16.000 MH No calibration applied and no bandpass applied

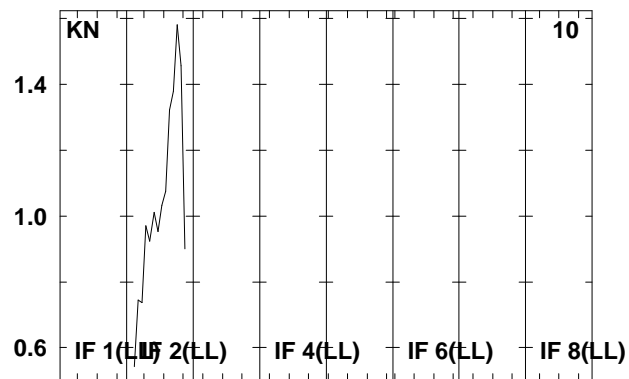
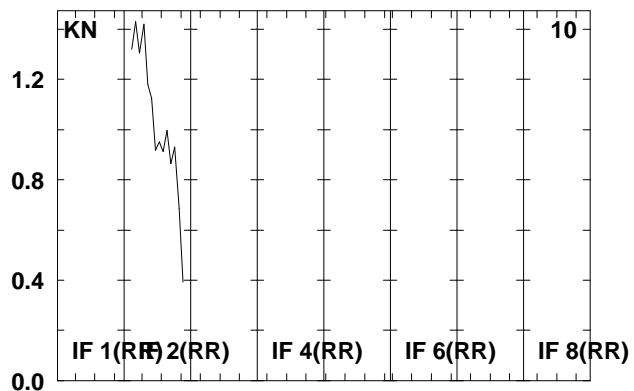
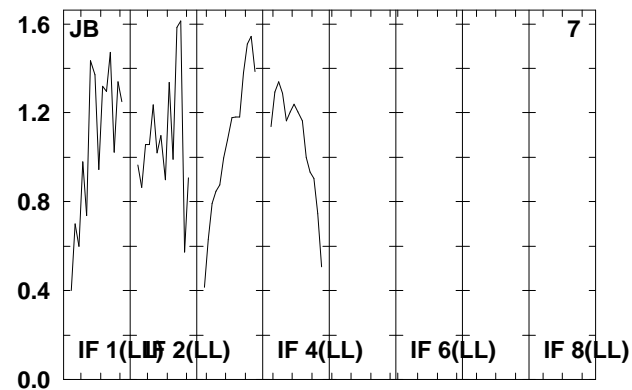
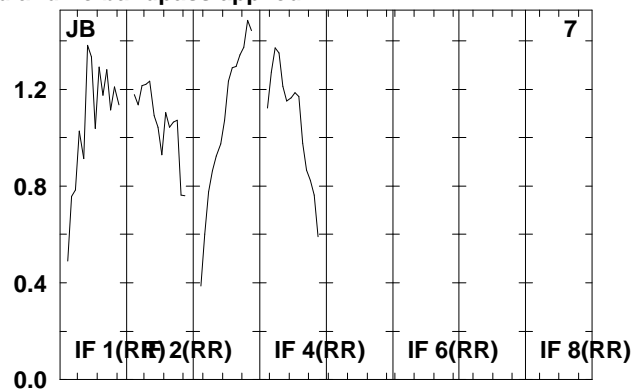
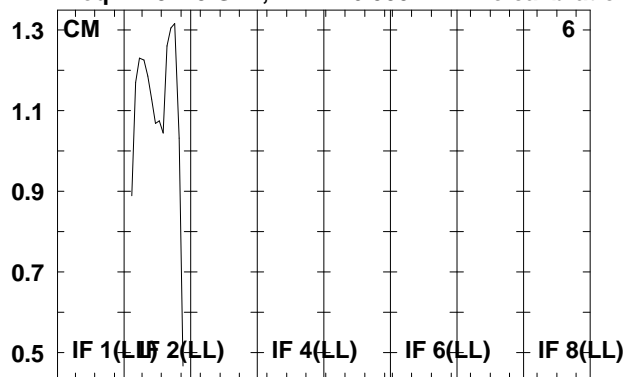

Lower frame: Real Jy  
Total-power spectrum Antenna: \*  
Timerange: 00/16:27:44 to 00/16:29:56

Plot file version 199 created 07-DEC-2009 16:06:16

J1912+05 RT006C.UVDATA.1

Freq = 4.9415 GHz, Bw = 16.000 MH No calibration applied and no bandpass applied

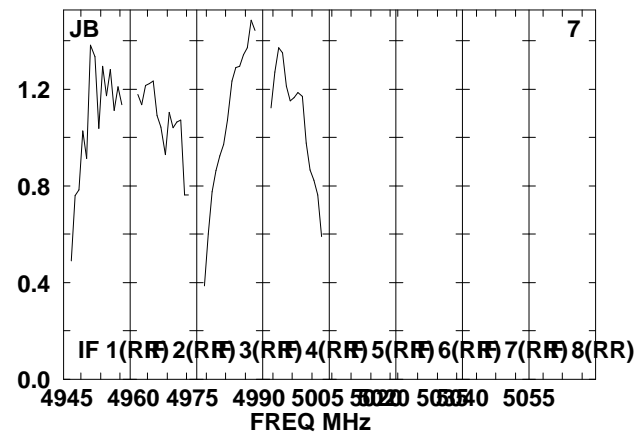
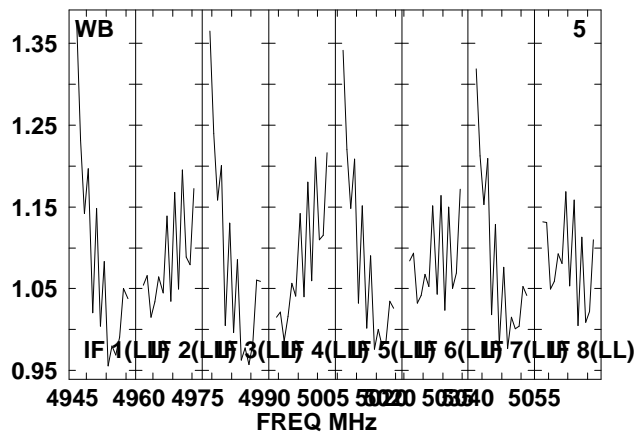
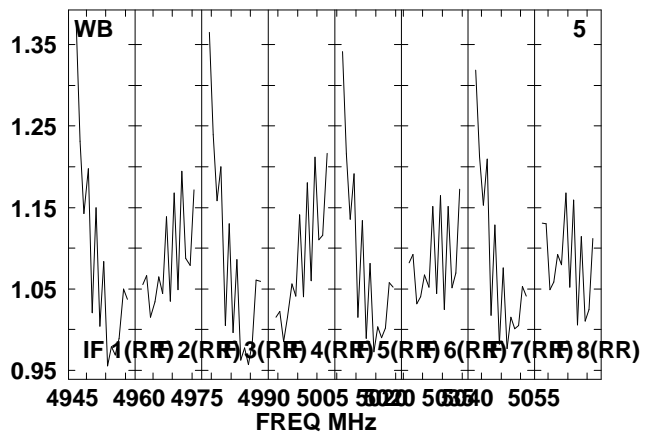
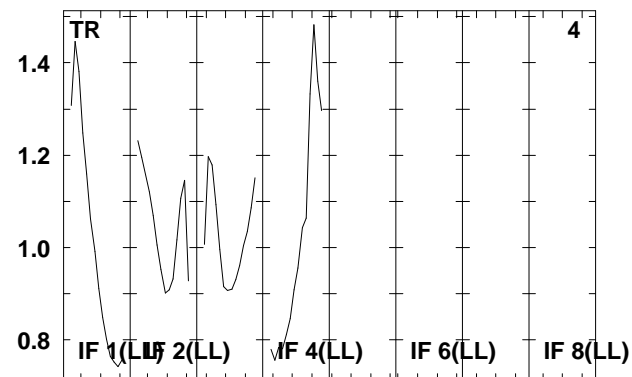
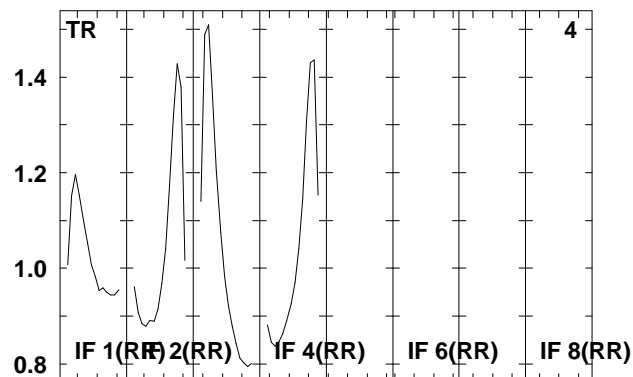
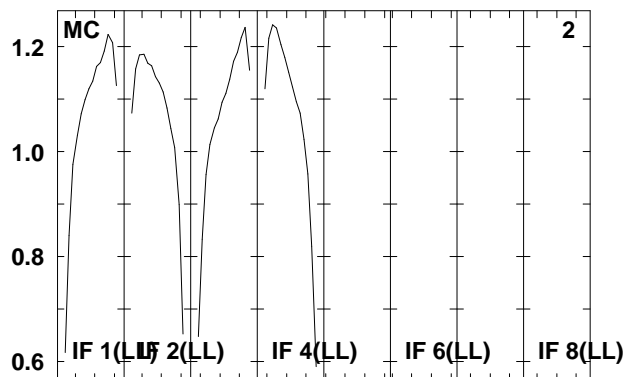
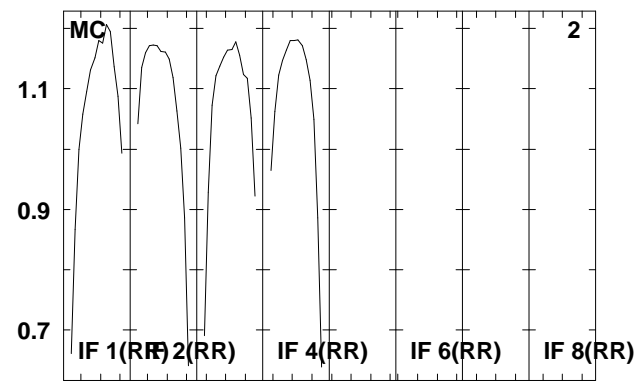
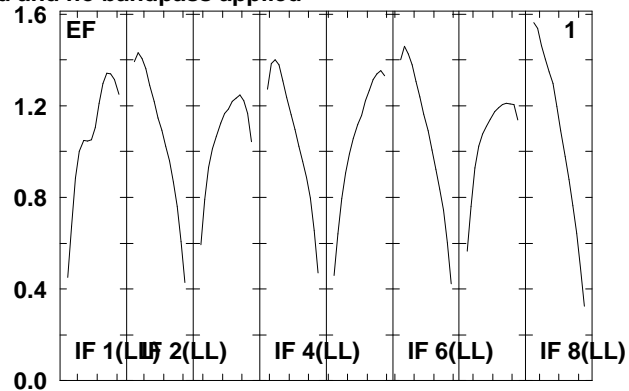
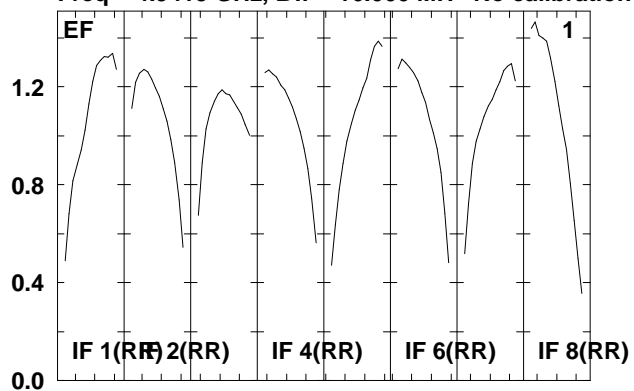

Lower frame: Real Jy

Total-power spectrum Antenna: \*

Timerange: 00/16:30:04 to 00/16:31:20

Plot file version 200 created 07-DEC-2009 16:06:16  
J1912+05 RT006C.UVDATA.1  
Freq = 4.9415 GHz, Bw = 16.000 MH No calibration applied and no bandpass applied

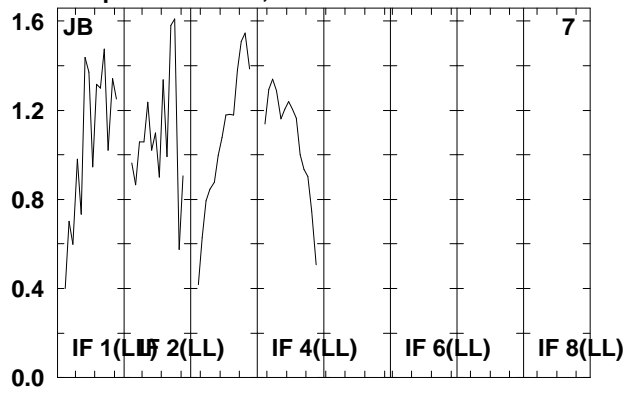

Lower frame: Real Jy  
Total-power spectrum Antenna: \*  
Timerange: 00/16:30:04 to 00/16:31:20



Plot file version 201 created 07-DEC-2009 16:06:16

SS433 RT006C.UVDATA.1

Freq = 4.9415 GHz, Bw = 16.000 MH No calibration applied and no bandpass applied

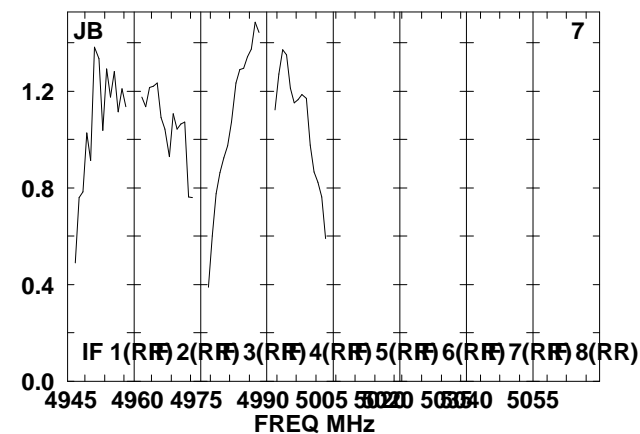
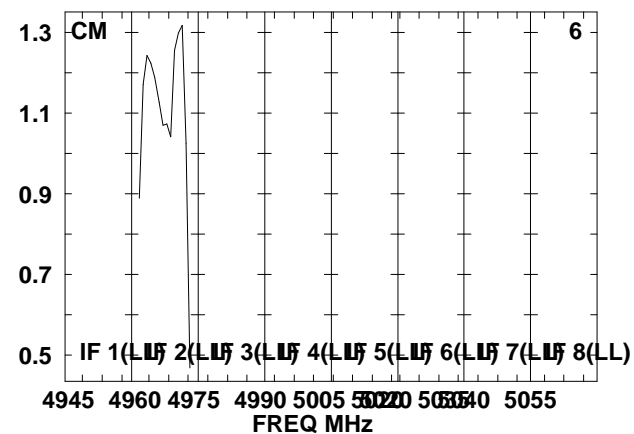
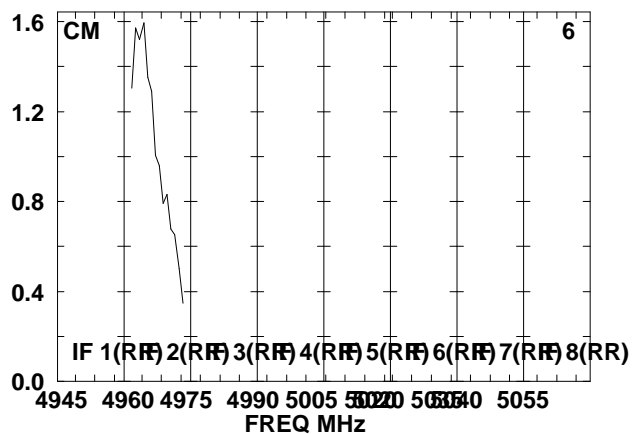
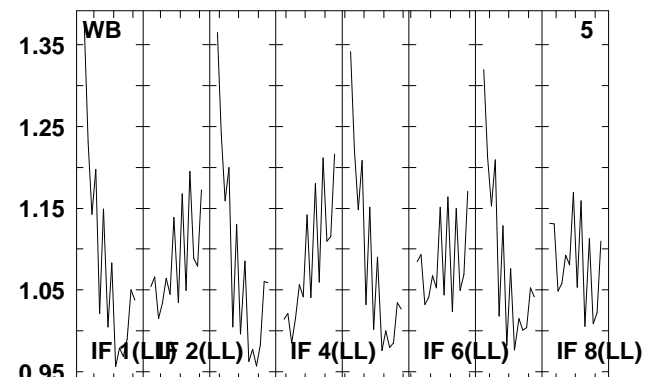
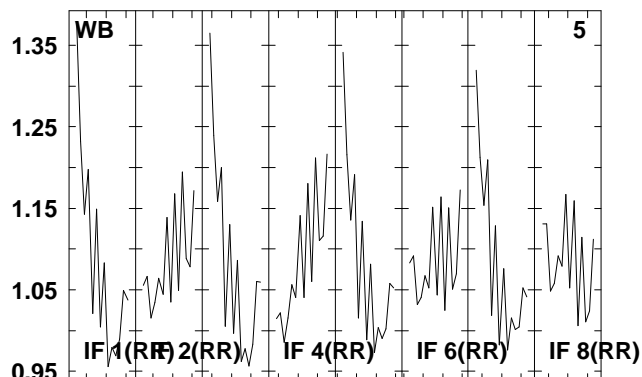
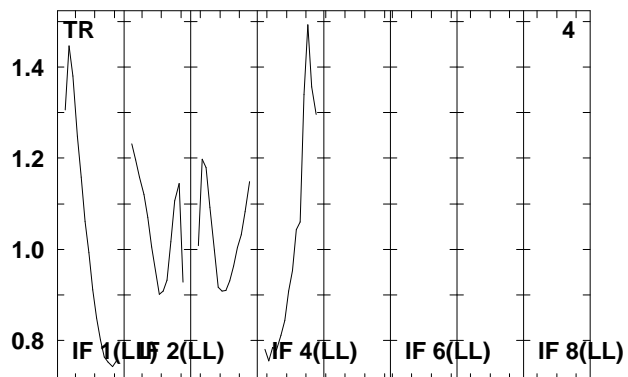
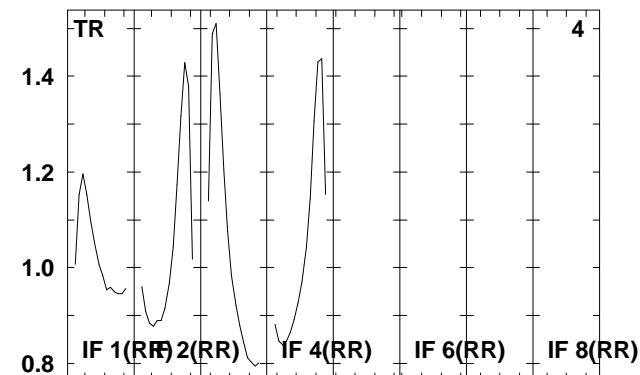
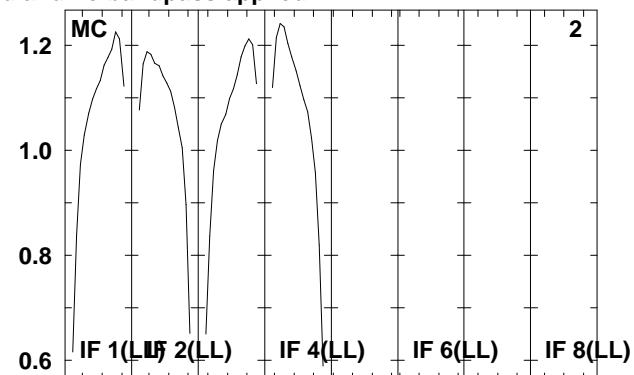
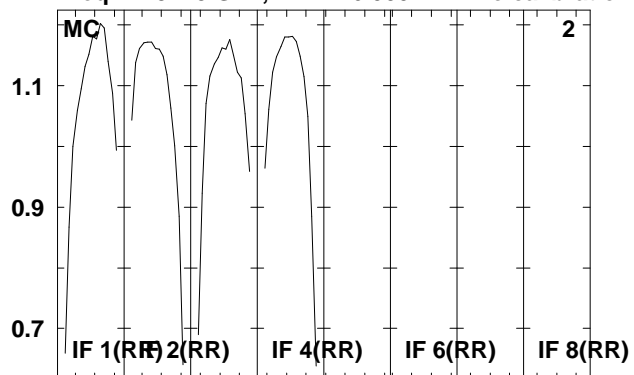

Lower frame: Real Jy

Total-power spectrum Antenna: \*

Timerange: 00/16:31:24 to 00/16:33:36

Plot file version 202 created 07-DEC-2009 16:06:16

SS433 RT006C.UVDATA.1

Freq = 4.9415 GHz, Bw = 16.000 MH No calibration applied and no bandpass applied

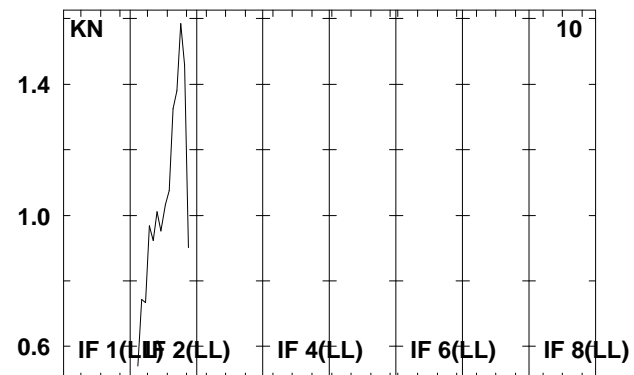
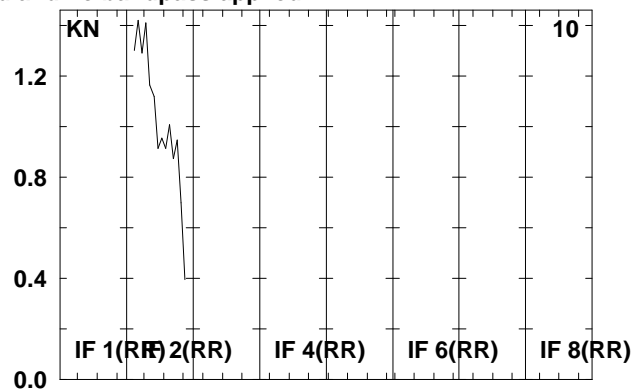
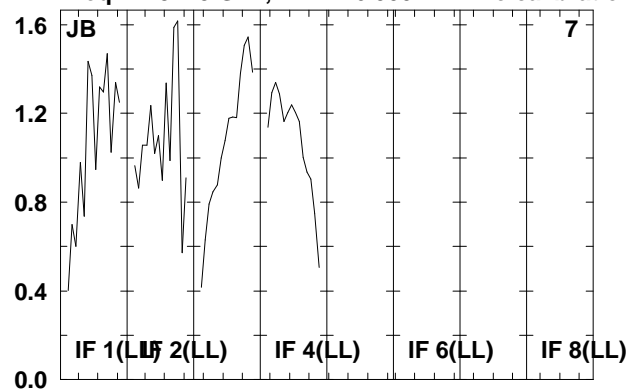

Lower frame: Real Jy  
Total-power spectrum Antenna: \*  
Timerange: 00/16:31:24 to 00/16:33:36

Plot file version 203 created 07-DEC-2009 16:06:17

J1911+16 RT006C.UVDATA.1

Freq = 4.9415 GHz, Bw = 16.000 MH No calibration applied and no bandpass applied

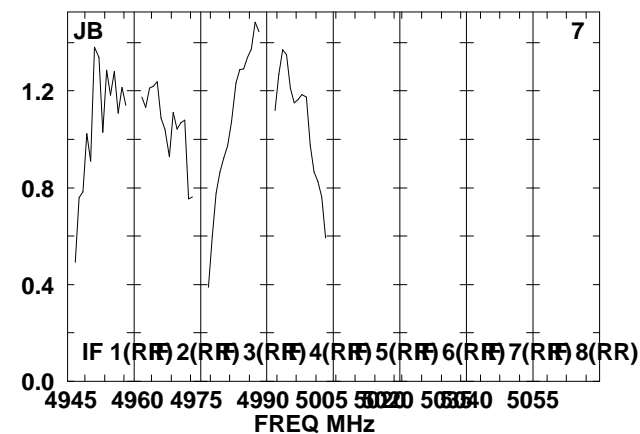
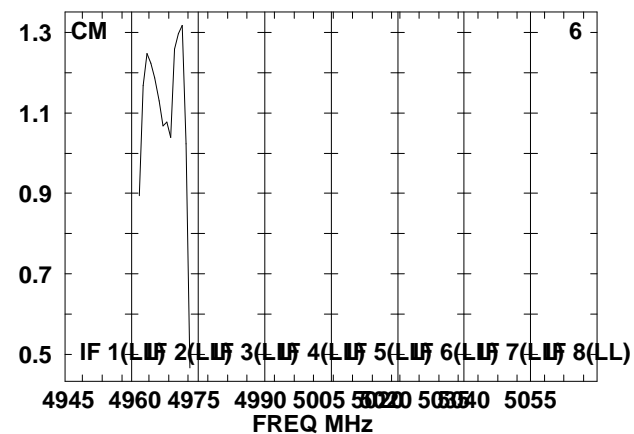
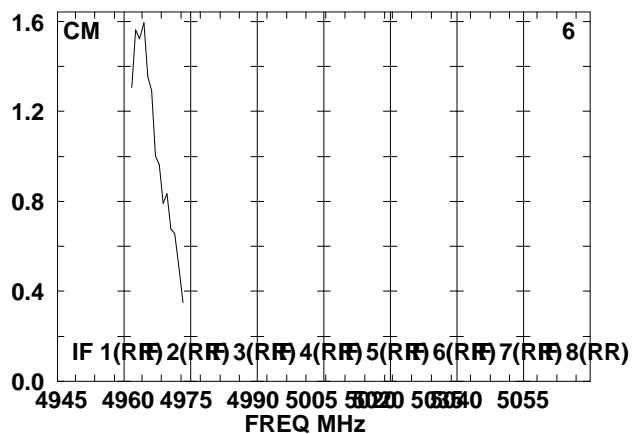
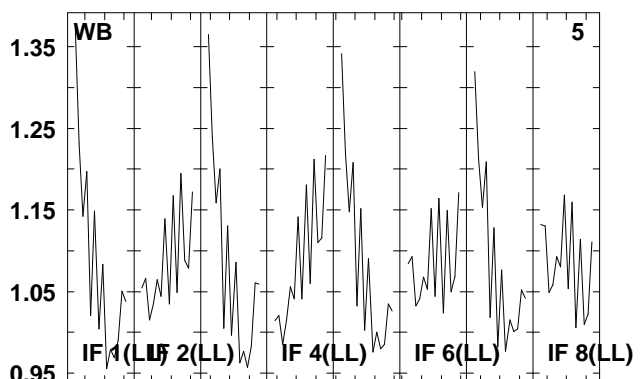
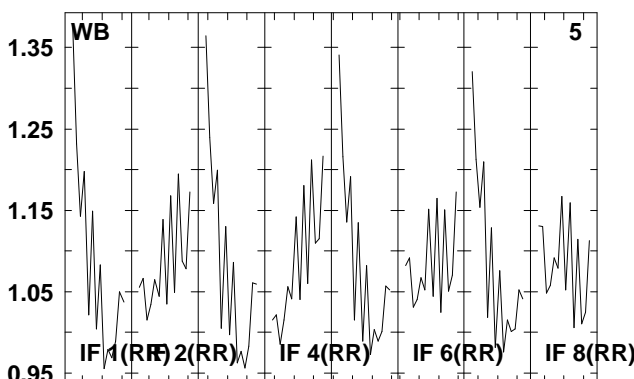
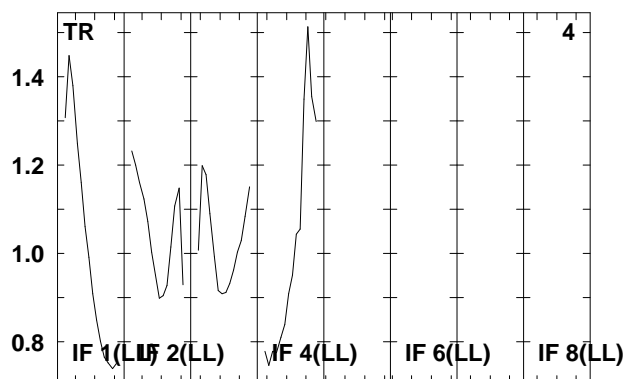
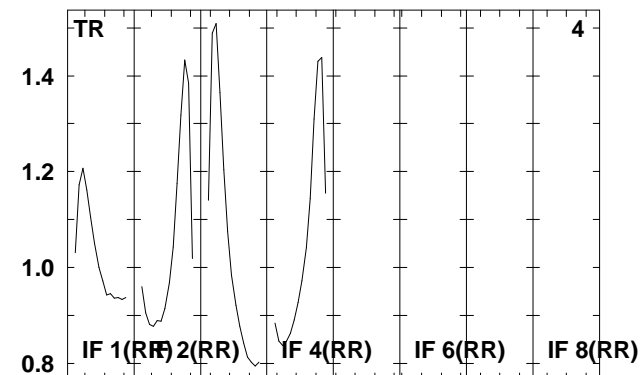
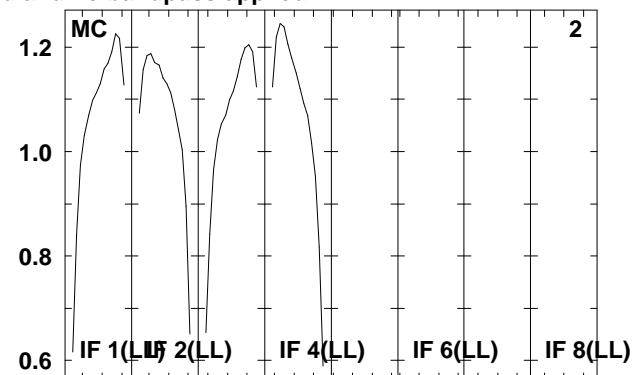
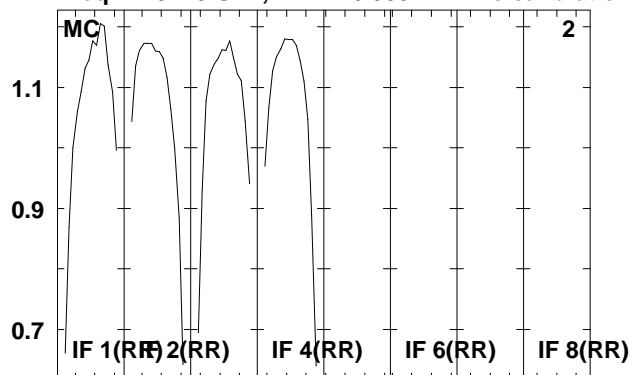

Lower frame: Real Jy  
Total-power spectrum Antenna: \*  
Timerange: 00/16:34:44 to 00/16:35:36

Plot file version 204 created 07-DEC-2009 16:06:17

J1911+16 RT006C.UVDATA.1

Freq = 4.9415 GHz, Bw = 16.000 MH No calibration applied and no bandpass applied

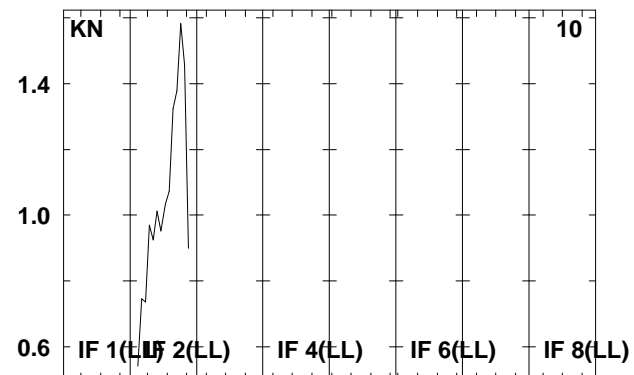
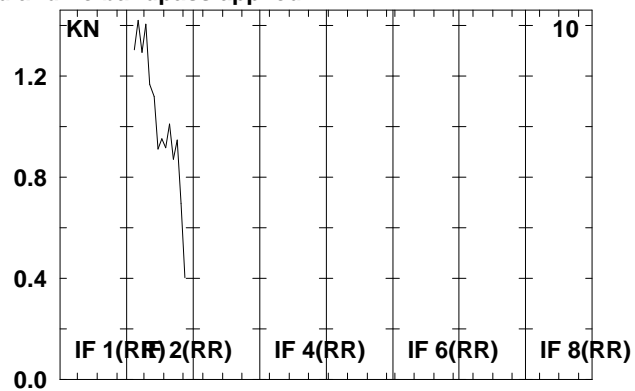
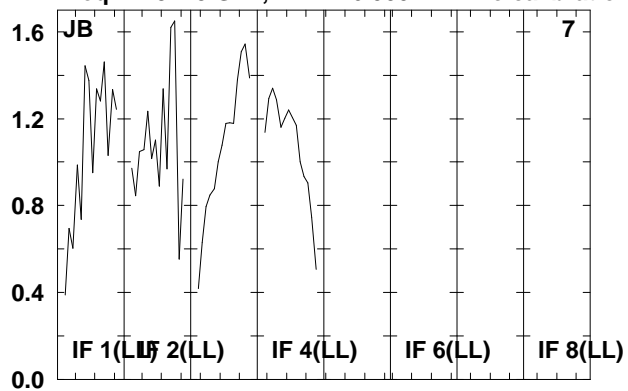

Lower frame: Real Jy  
Total-power spectrum Antenna: \*  
Timerange: 00/16:34:44 to 00/16:35:36

Plot file version 205 created 07-DEC-2009 16:06:17

J1912+05 RT006C.UVDATA.1

Freq = 4.9415 GHz, Bw = 16.000 MH No calibration applied and no bandpass applied

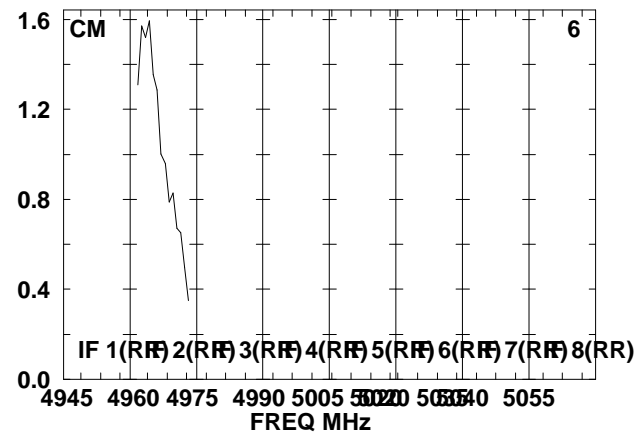
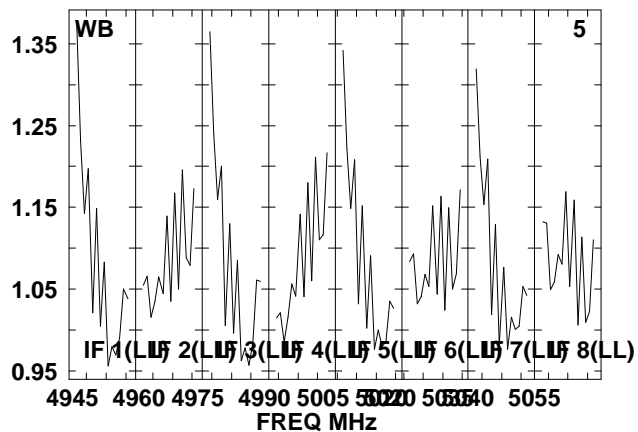
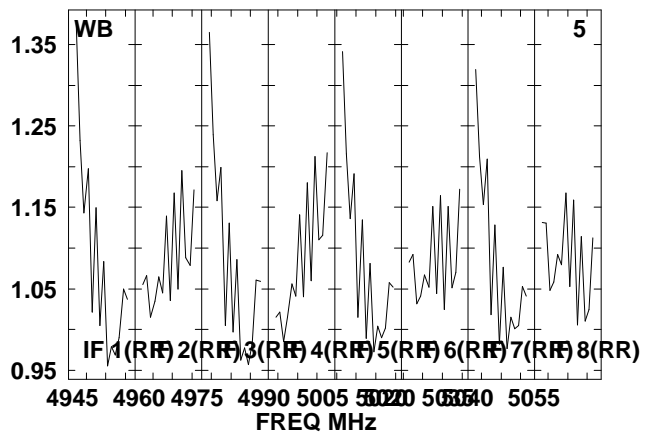
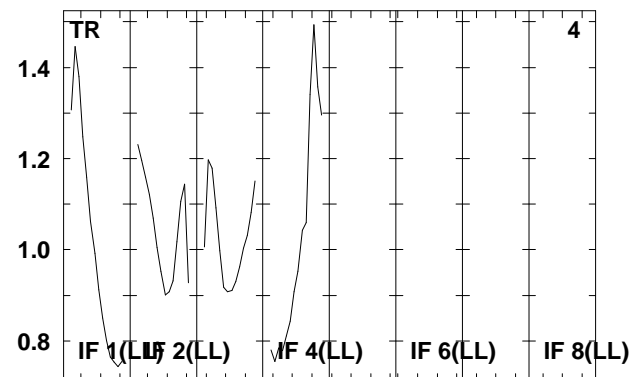
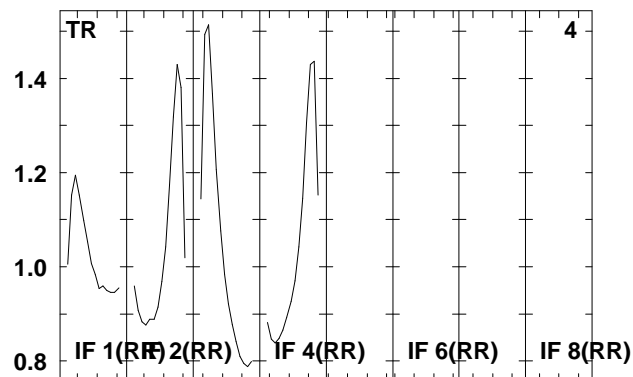
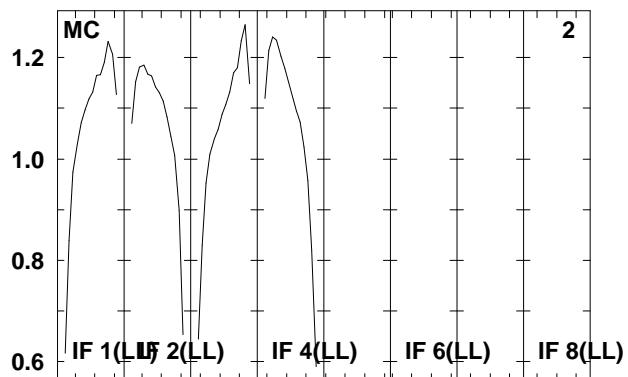
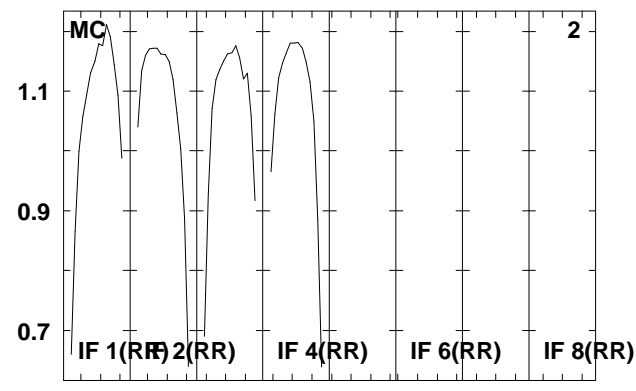
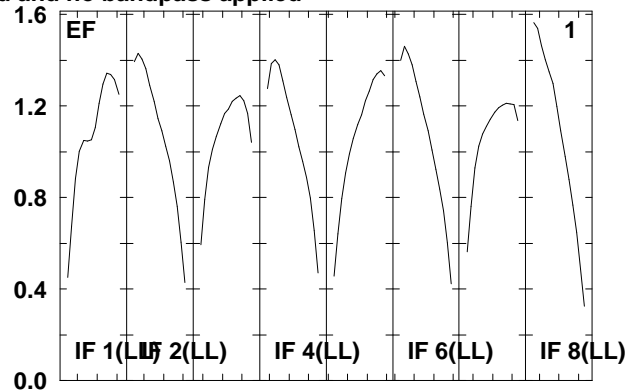
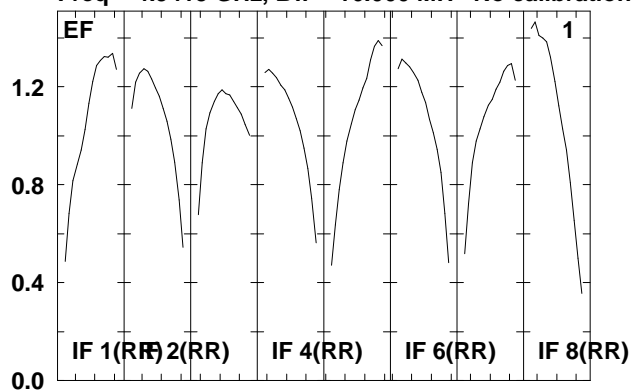

Lower frame: Real Jy

Total-power spectrum Antenna: \*

Timerange: 00/16:36:44 to 00/16:37:36

Plot file version 206 created 07-DEC-2009 16:06:17

J1912+05 RT006C.UVDATA.1

Freq = 4.9415 GHz, Bw = 16.000 MH No calibration applied and no bandpass applied

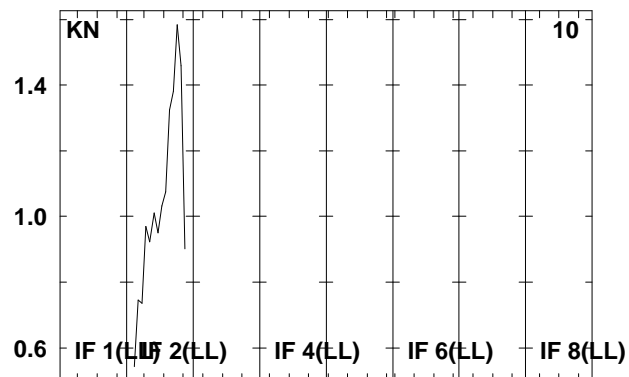
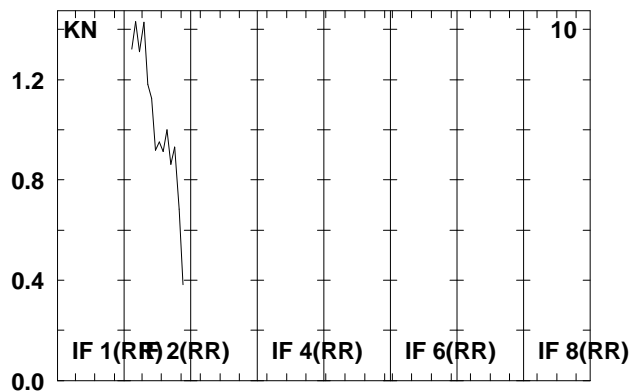
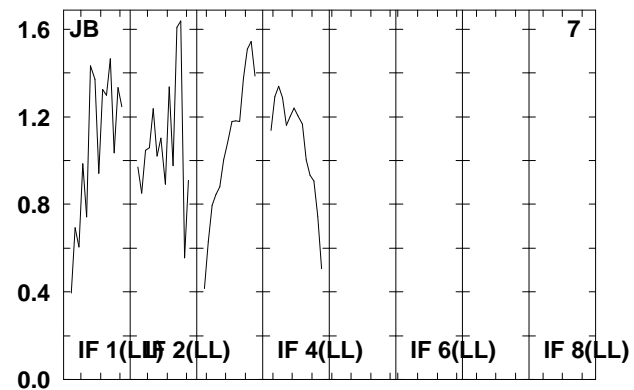
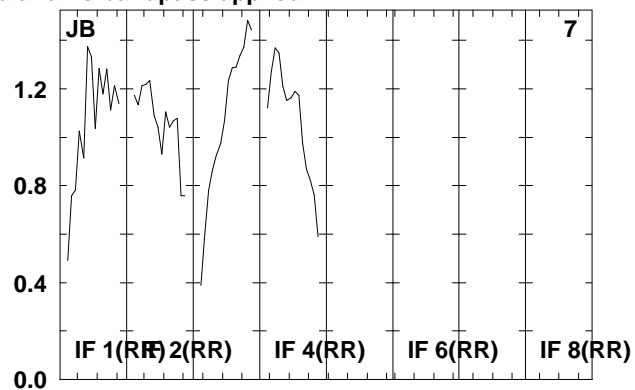
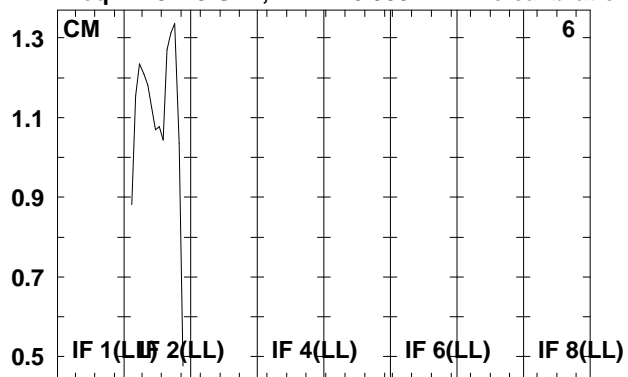

Lower frame: Real Jy  
Total-power spectrum Antenna: \*  
Timerange: 00/16:36:44 to 00/16:37:36

Plot file version 207 created 07-DEC-2009 16:06:17

SS433 RT006C.UVDATA.1

Freq = 4.9415 GHz, Bw = 16.000 MH No calibration applied and no bandpass applied

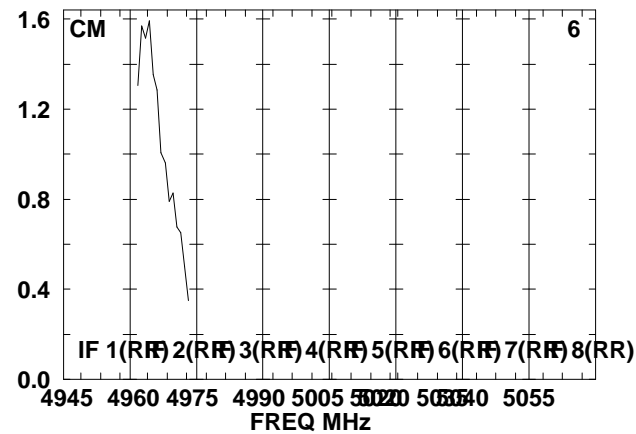
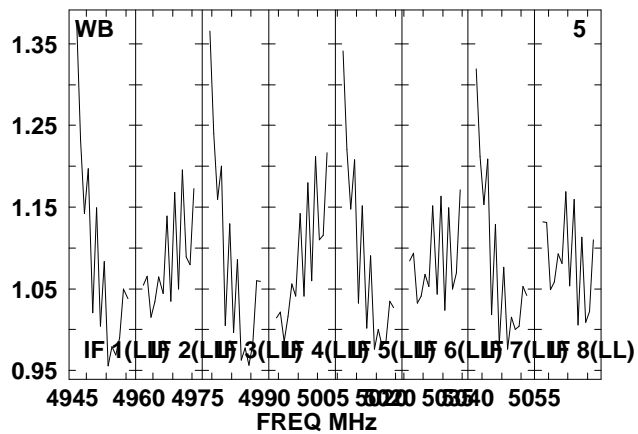
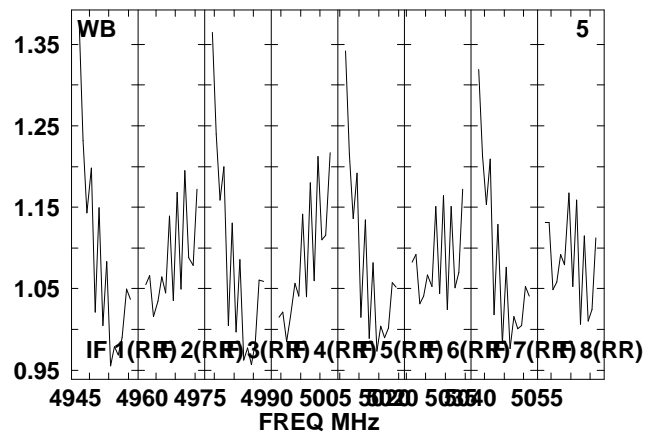
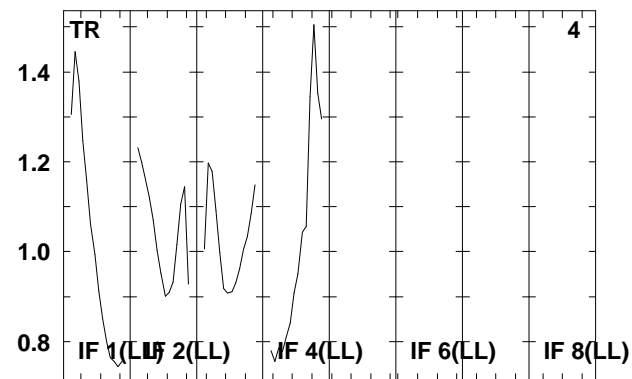
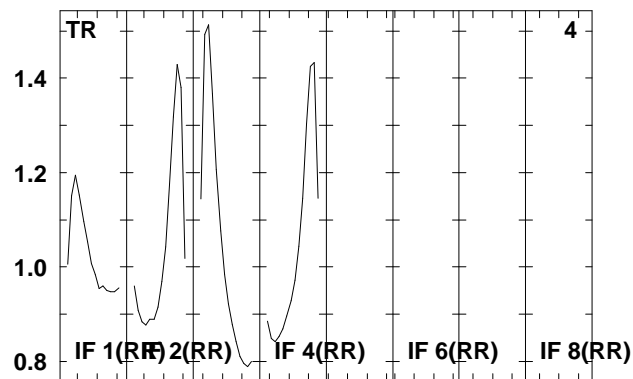
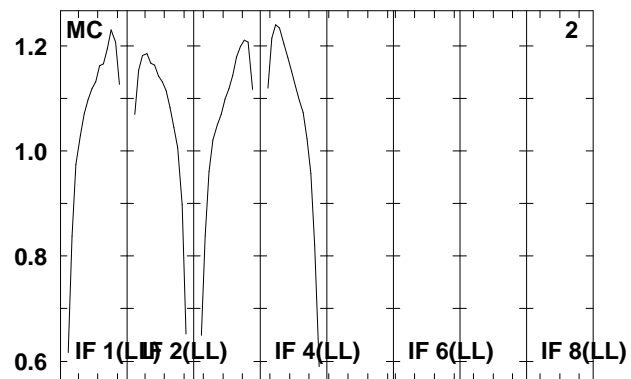
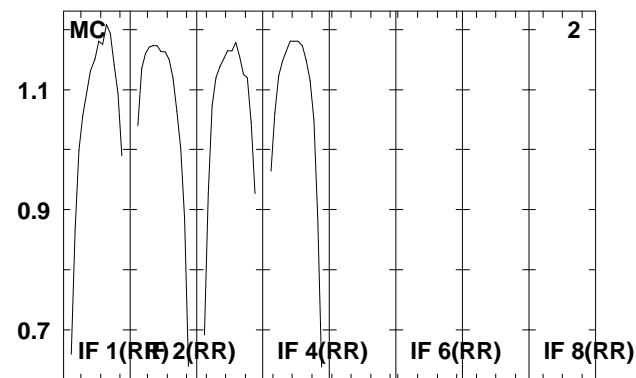
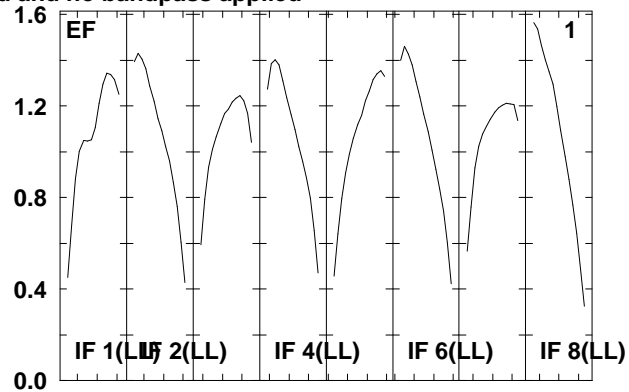
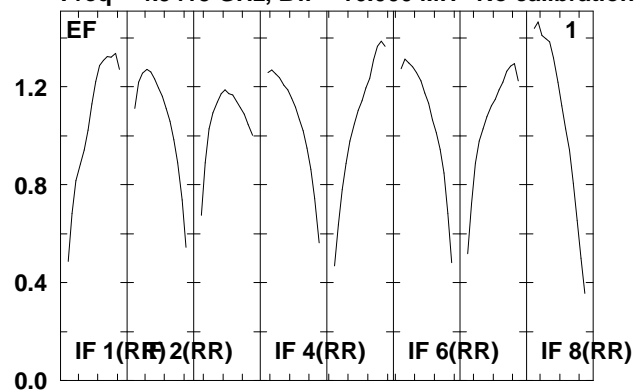

Lower frame: Real Jy  
Total-power spectrum Antenna: \*  
Timerange: 00/16:37:40 to 00/16:39:56

Plot file version 208 created 07-DEC-2009 16:06:17

SS433 RT006C.UVDATA.1

Freq = 4.9415 GHz, Bw = 16.000 MH No calibration applied and no bandpass applied

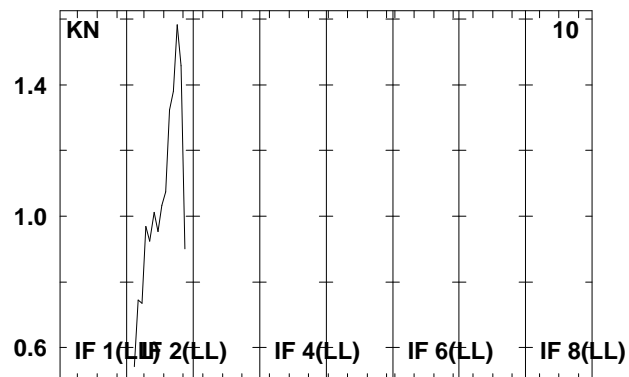
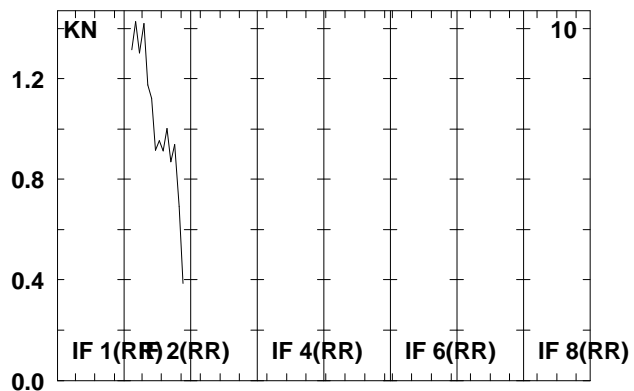
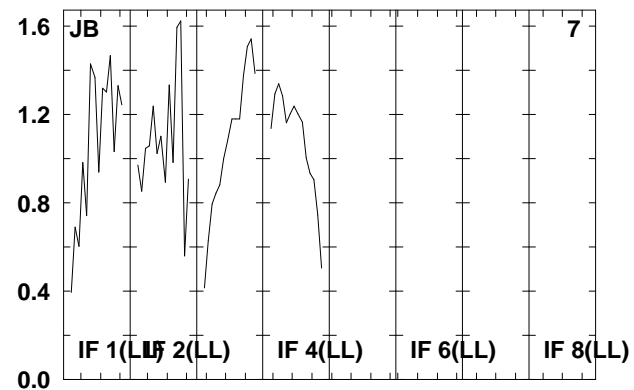
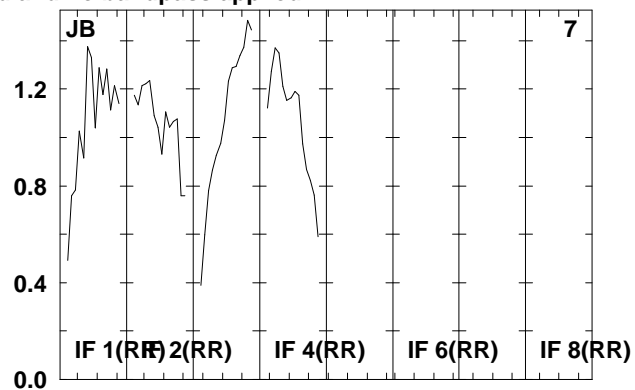
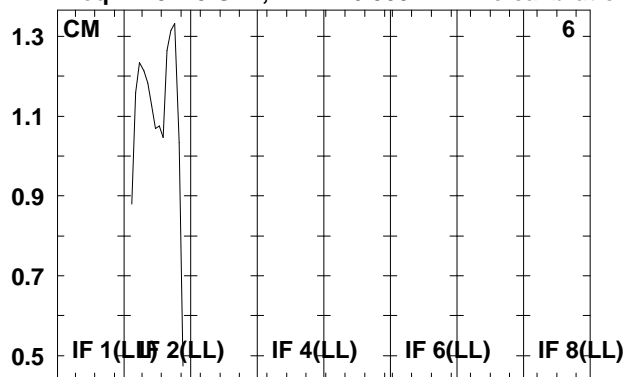

Lower frame: Real Jy  
Total-power spectrum Antenna: \*  
Timerange: 00/16:37:40 to 00/16:39:56



Plot file version 209 created 07-DEC-2009 16:06:17

J1912+05 RT006C.UVDATA.1

Freq = 4.9415 GHz, Bw = 16.000 MH No calibration applied and no bandpass applied

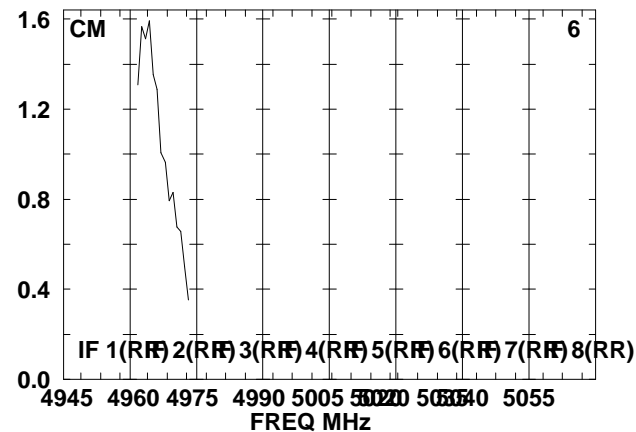
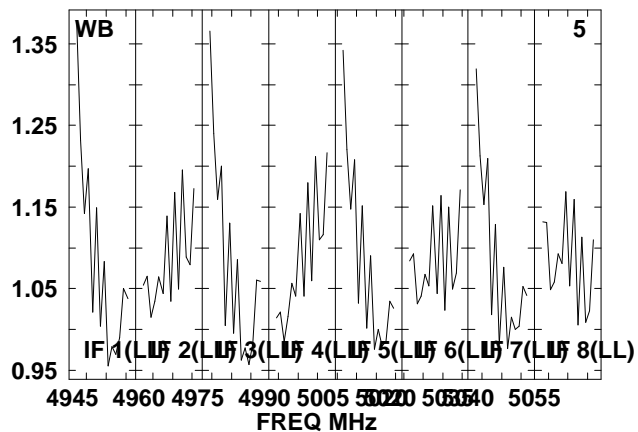
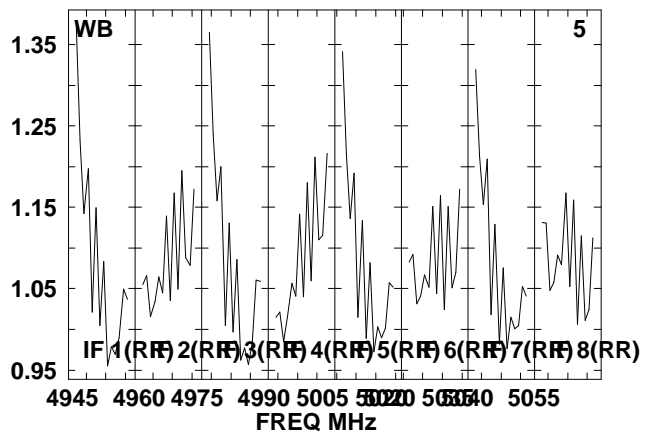
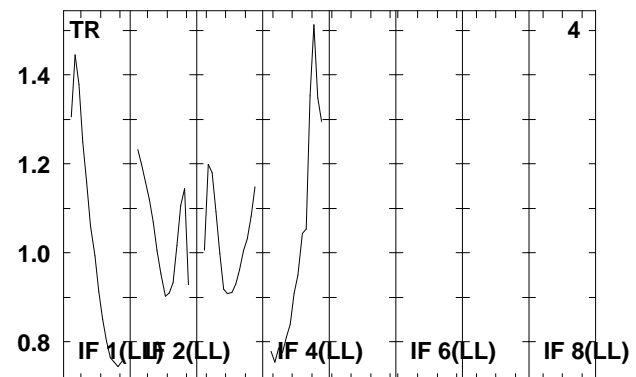
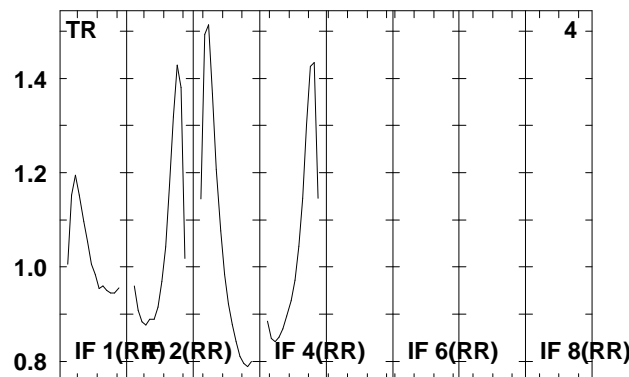
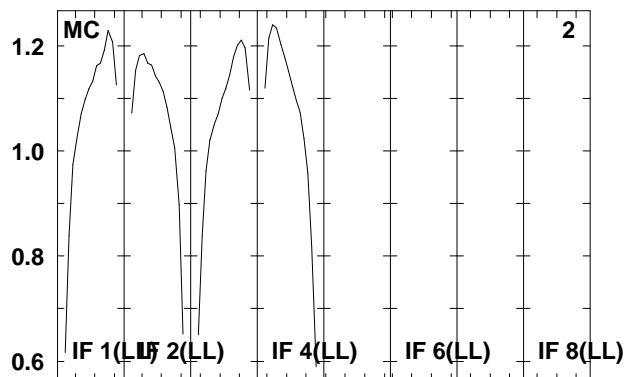
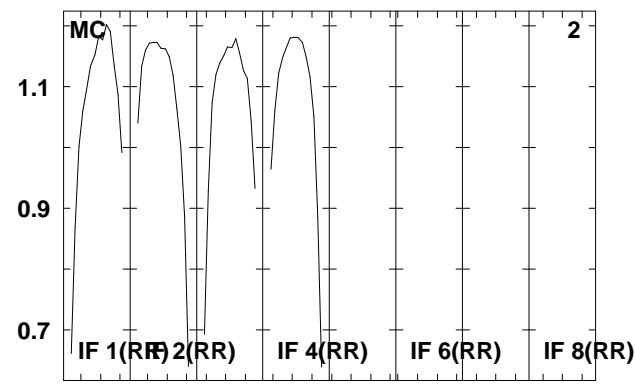
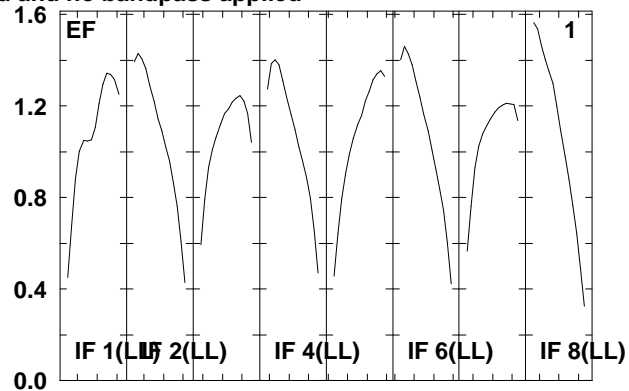
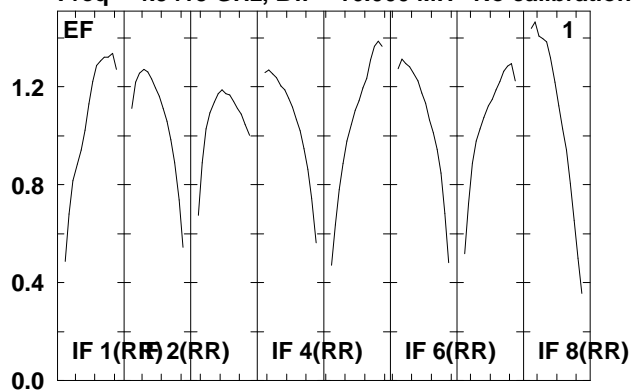

Lower frame: Real Jy  
Total-power spectrum Antenna: \*  
Timerange: 00/16:40:00 to 00/16:41:16

Plot file version 210 created 07-DEC-2009 16:06:18

J1912+05 RT006C.UVDATA.1

Freq = 4.9415 GHz, Bw = 16.000 MH No calibration applied and no bandpass applied

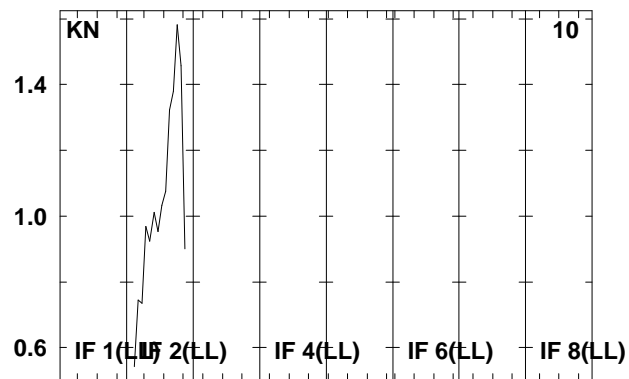
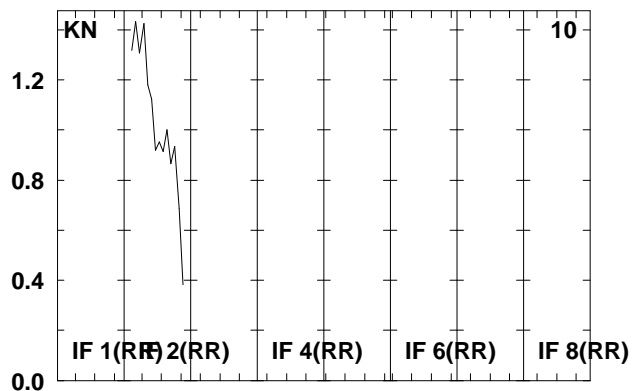
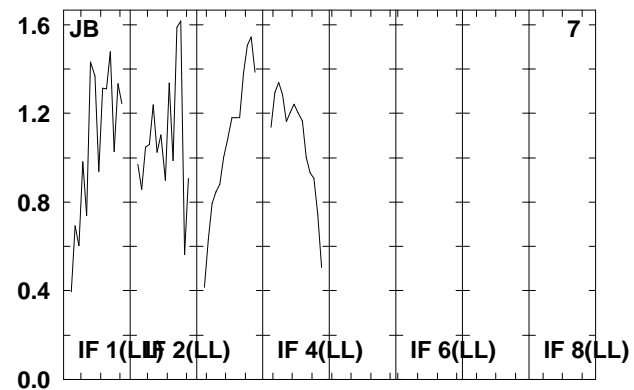
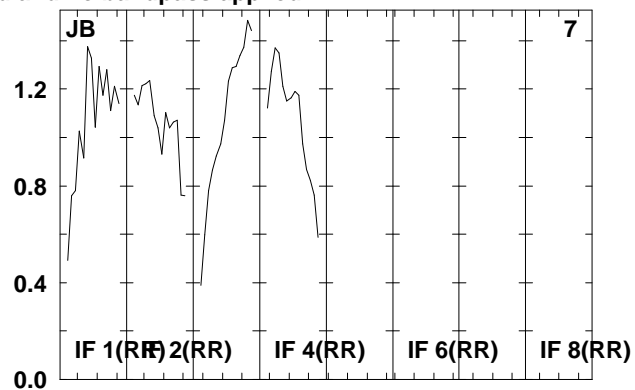
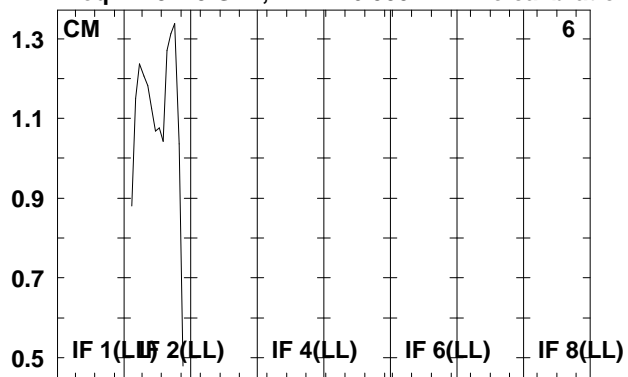

Lower frame: Real Jy  
Total-power spectrum Antenna: \*  
Timerange: 00/16:40:00 to 00/16:41:16

Plot file version 211 created 07-DEC-2009 16:06:18

SS433 RT006C.UVDATA.1

Freq = 4.9415 GHz, Bw = 16.000 MH No calibration applied and no bandpass applied

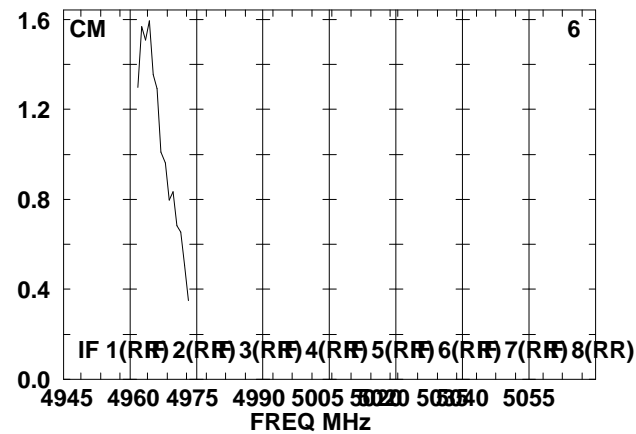
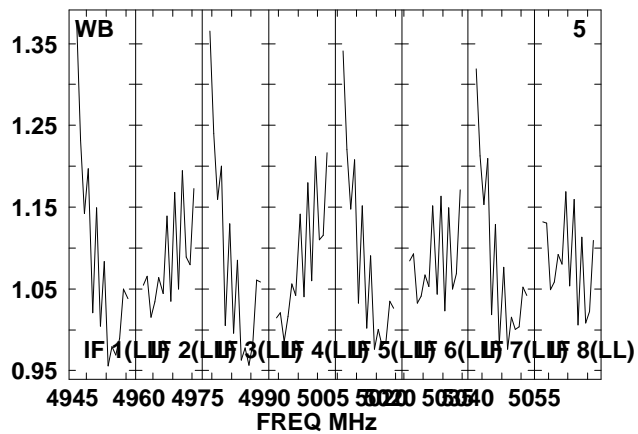
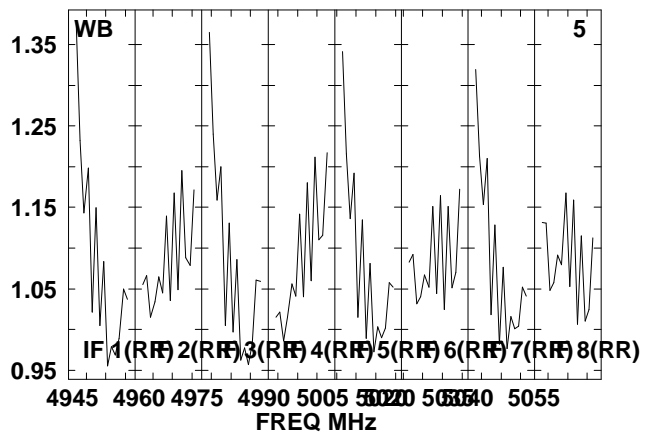
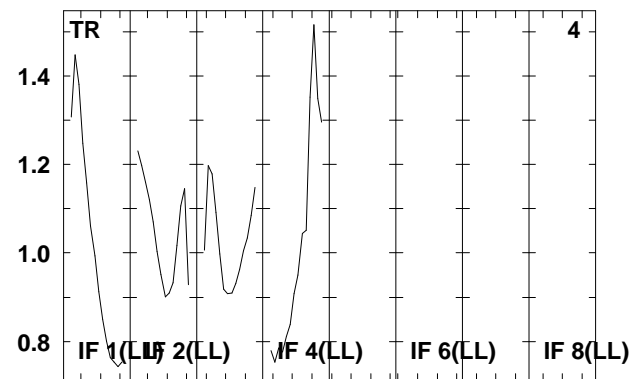
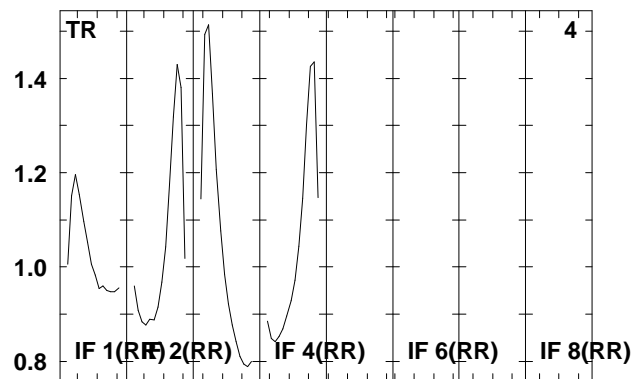
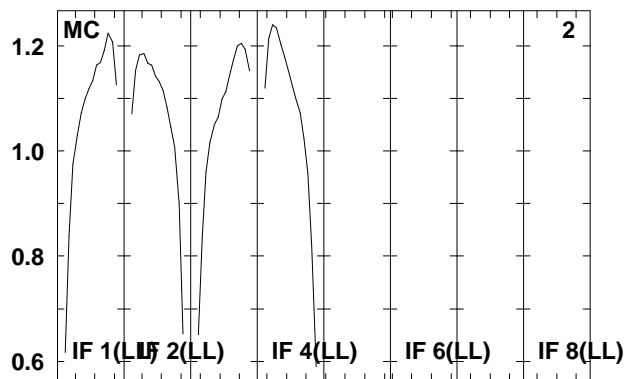
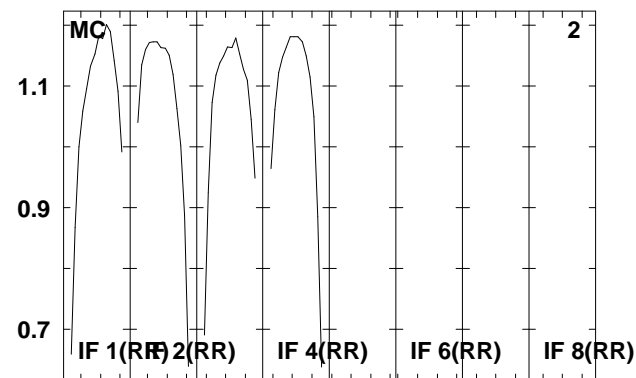
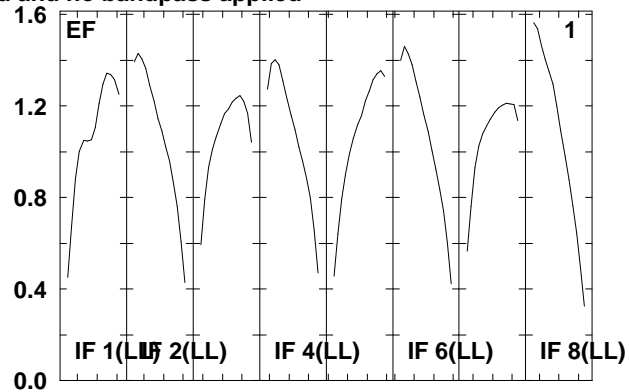
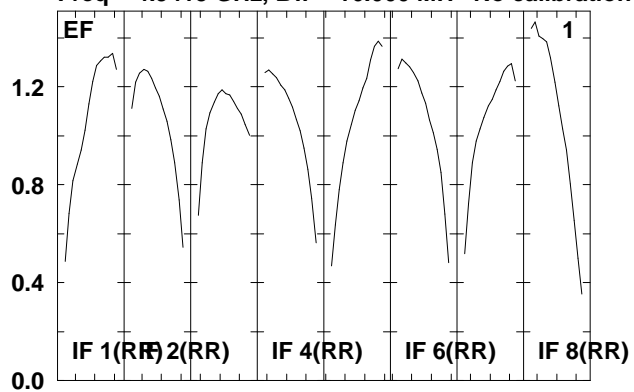

Lower frame: Real Jy  
Total-power spectrum Antenna: \*  
Timerange: 00/16:41:20 to 00/16:43:36

Plot file version 212 created 07-DEC-2009 16:06:18

SS433 RT006C.UVDATA.1

Freq = 4.9415 GHz, Bw = 16.000 MH No calibration applied and no bandpass applied

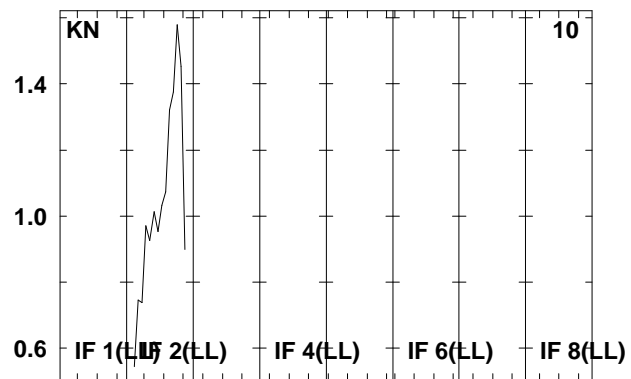
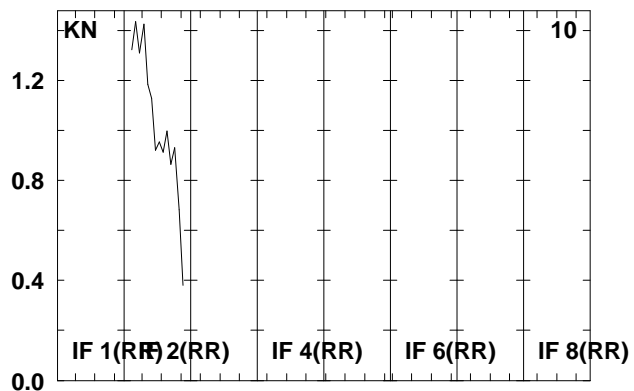
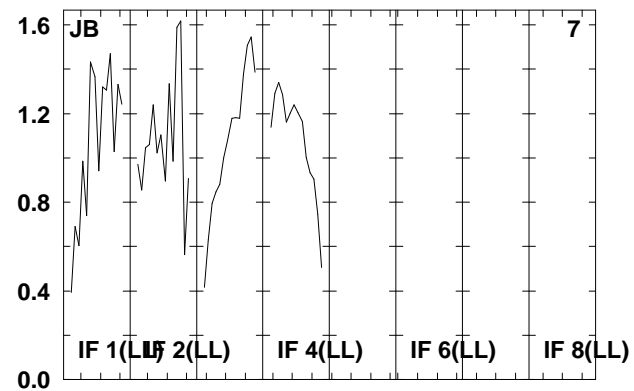
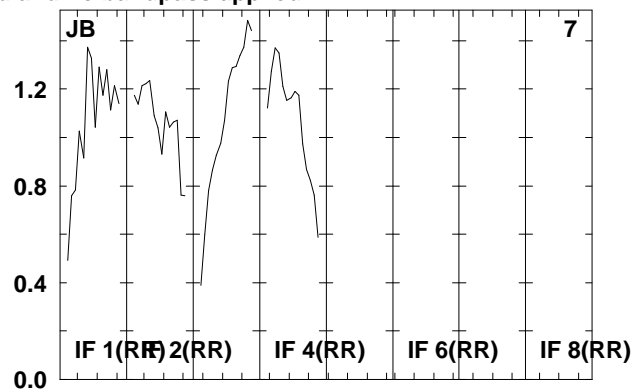
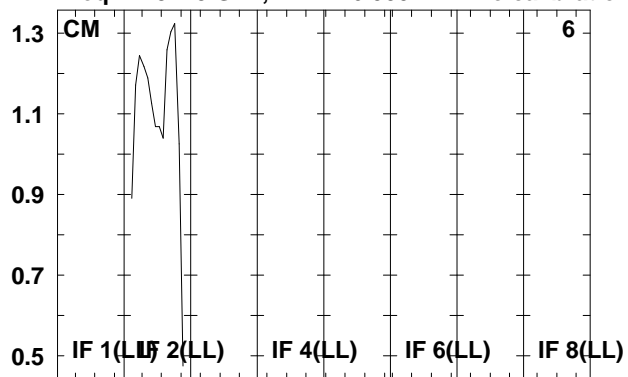

Lower frame: Real Jy  
Total-power spectrum Antenna: \*  
Timerange: 00/16:41:20 to 00/16:43:36

Plot file version 213 created 07-DEC-2009 16:06:18

J1912+05 RT006C.UVDATA.1

Freq = 4.9415 GHz, Bw = 16.000 MH No calibration applied and no bandpass applied

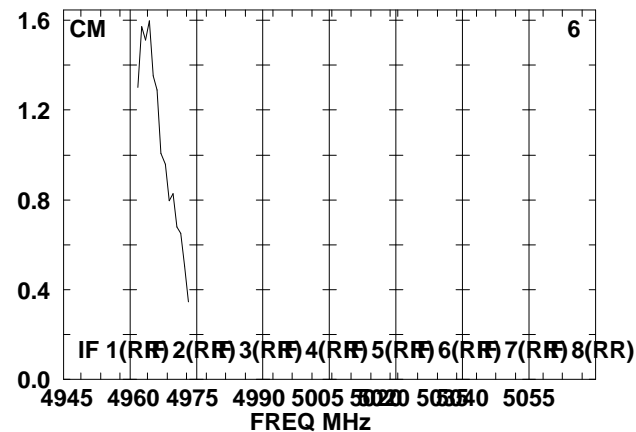
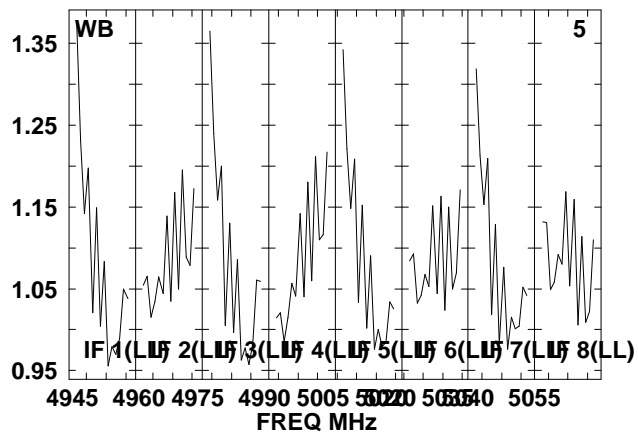
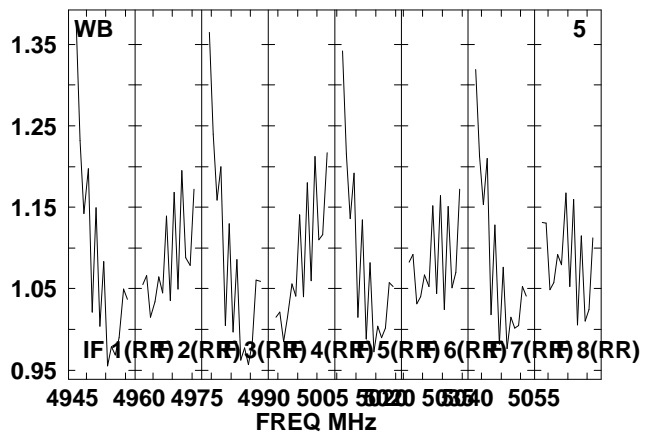
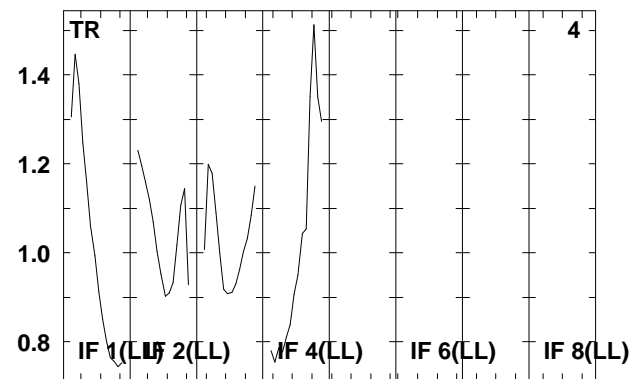
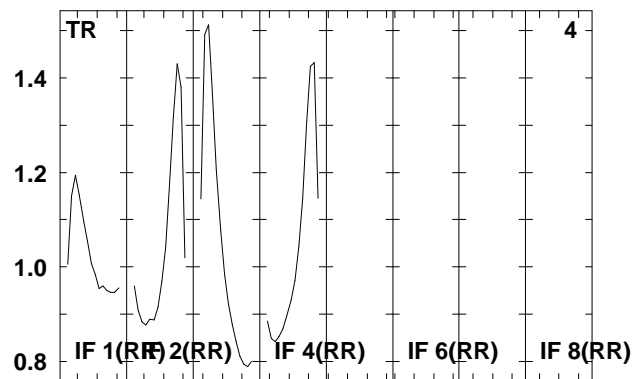
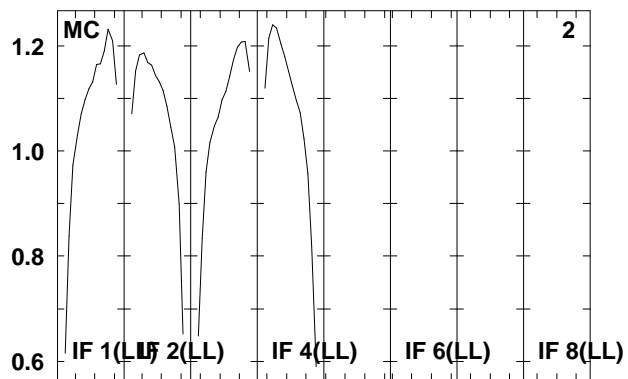
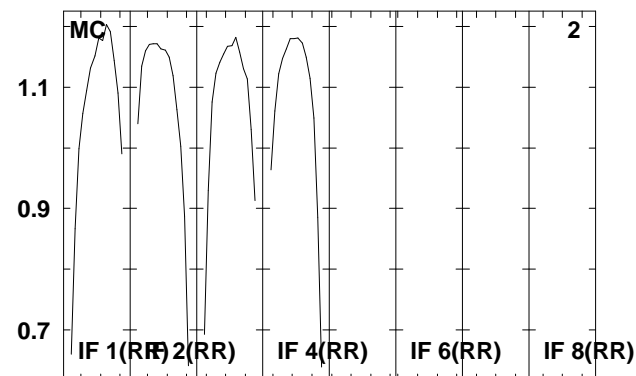
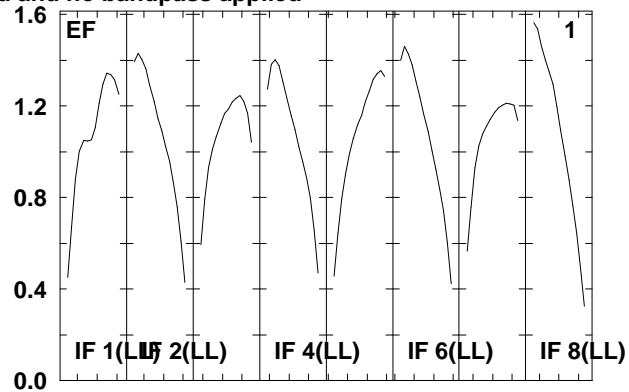
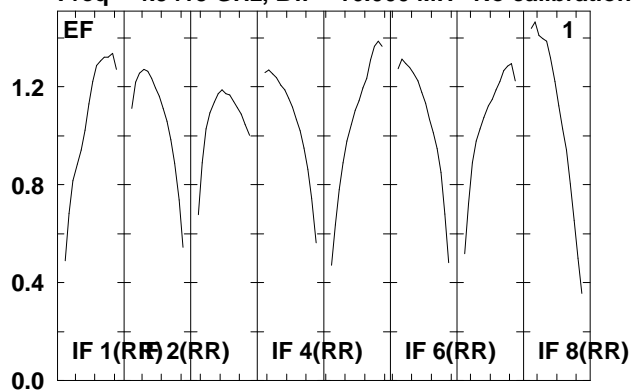

Lower frame: Real Jy

Total-power spectrum Antenna: \*

Timerange: 00/16:43:40 to 00/16:45:00

Plot file version 214 created 07-DEC-2009 16:06:18

J1912+05 RT006C.UVDATA.1

Freq = 4.9415 GHz, Bw = 16.000 MH No calibration applied and no bandpass applied

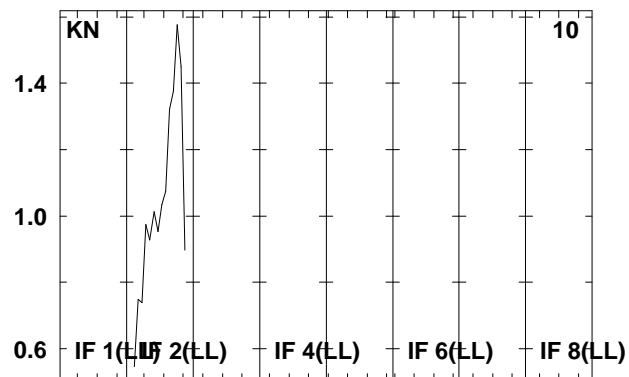
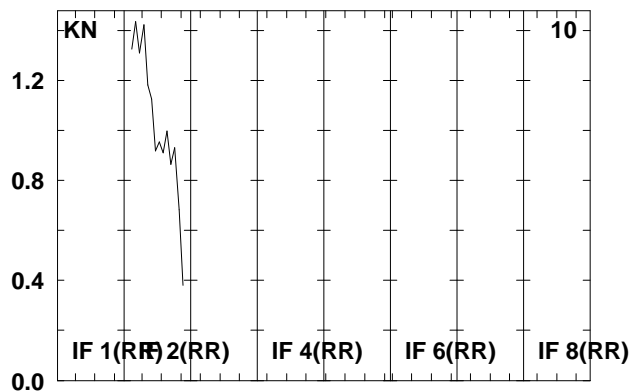
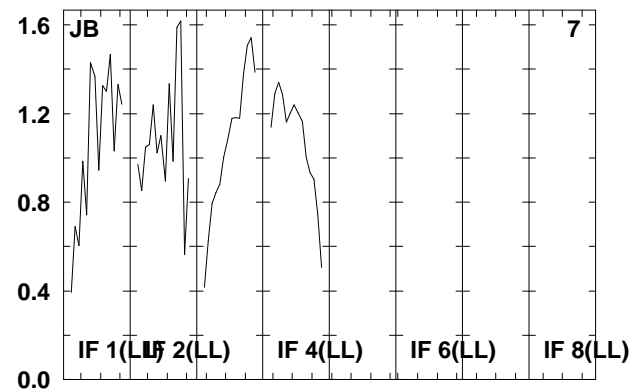
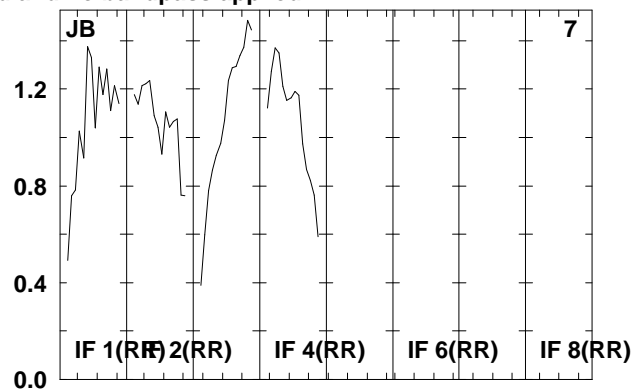
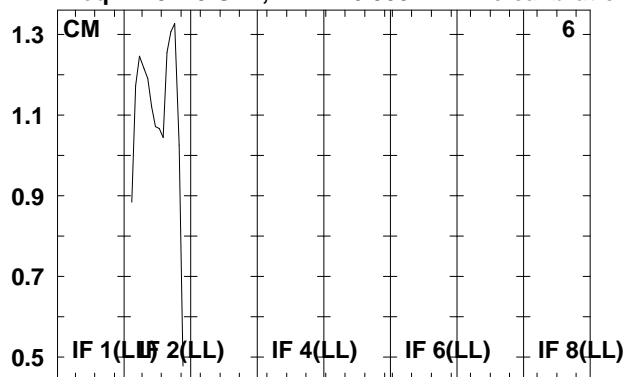

Lower frame: Real Jy  
Total-power spectrum Antenna: \*  
Timerange: 00/16:43:40 to 00/16:45:00

Plot file version 215 created 07-DEC-2009 16:06:19

SS433 RT006C.UVDATA.1

Freq = 4.9415 GHz, Bw = 16.000 MH No calibration applied and no bandpass applied

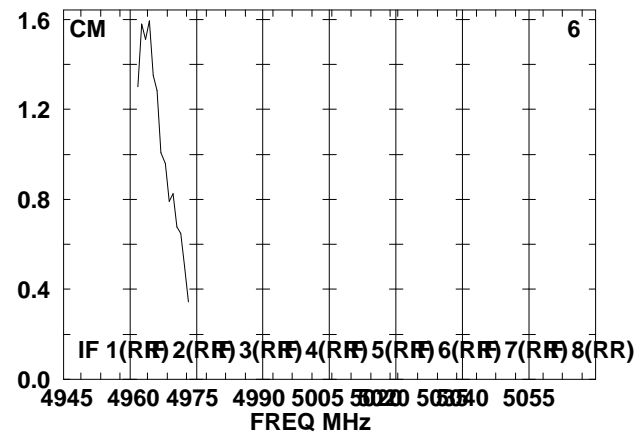
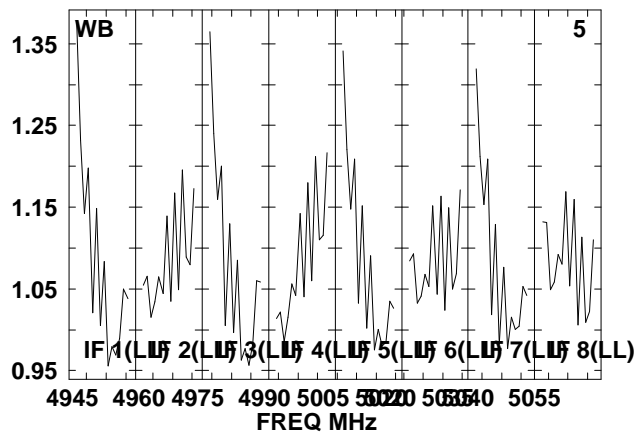
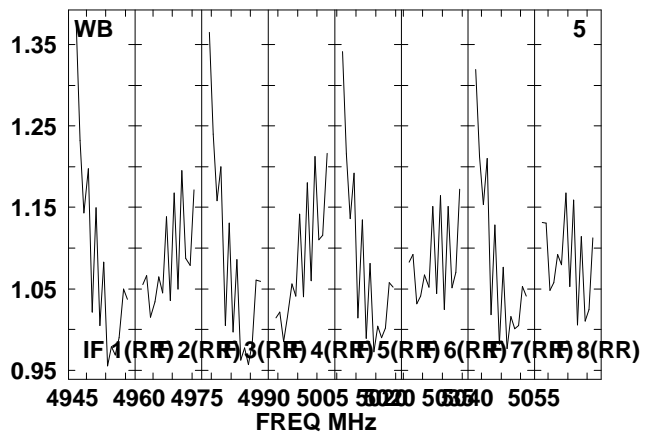
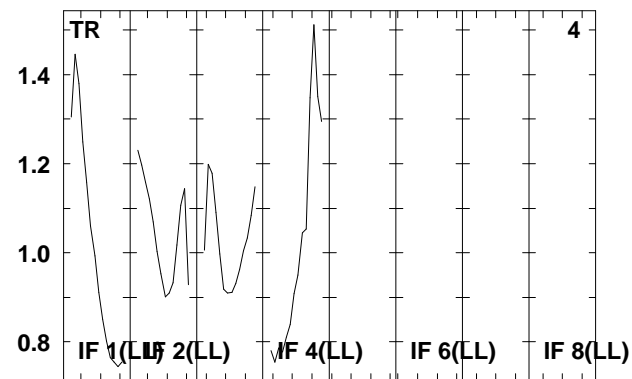
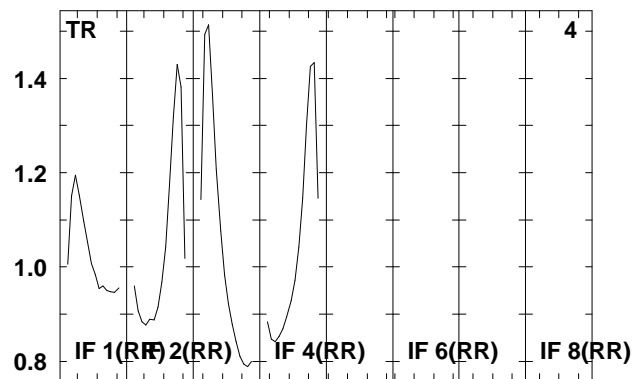
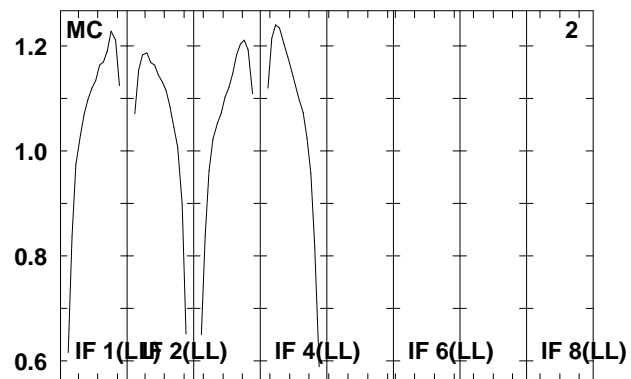
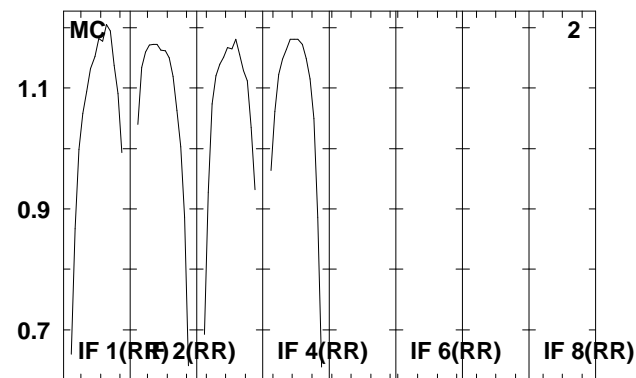
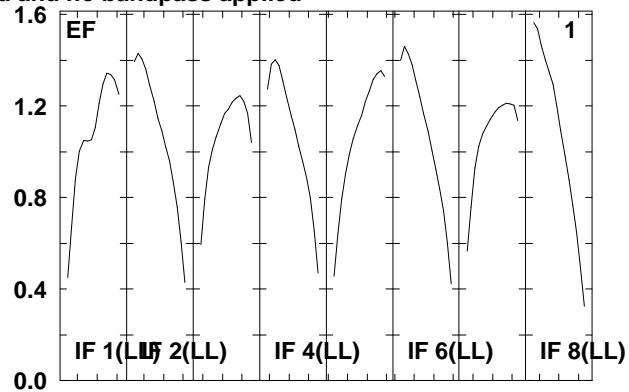
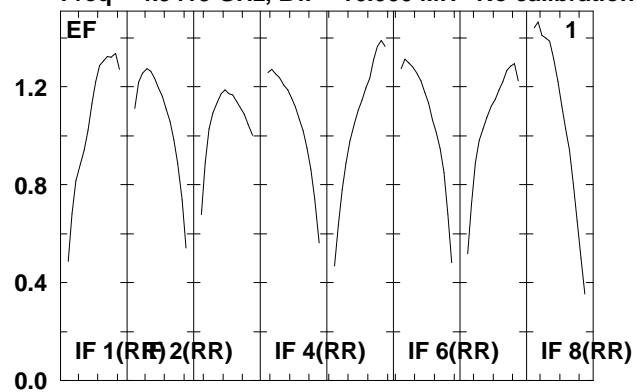

Lower frame: Real Jy  
Total-power spectrum Antenna: \*  
Timerange: 00/16:45:04 to 00/16:47:20

Plot file version 216 created 07-DEC-2009 16:06:19

SS433 RT006C.UVDATA.1

Freq = 4.9415 GHz, Bw = 16.000 MH No calibration applied and no bandpass applied

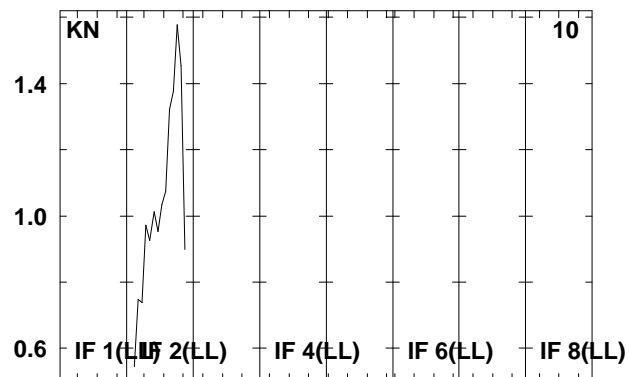
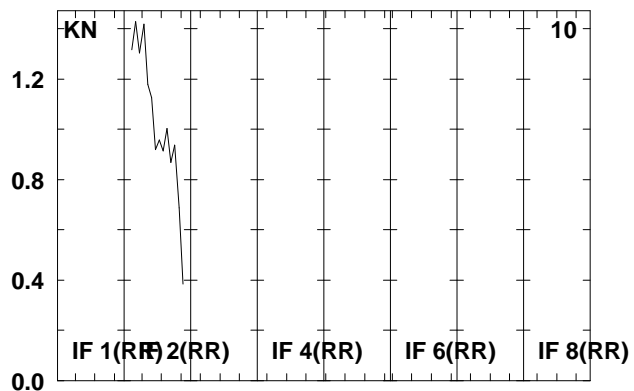
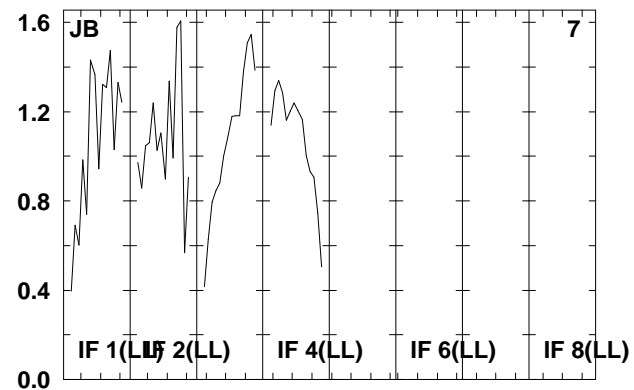
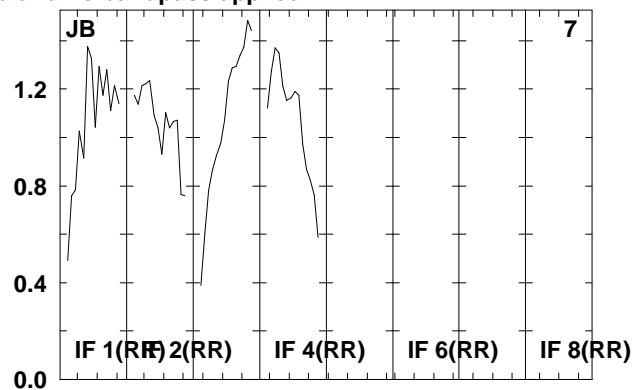
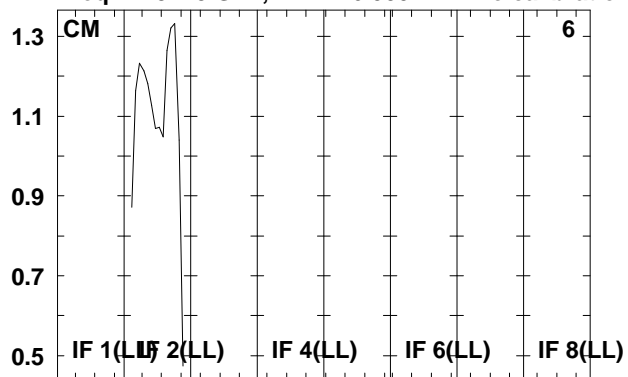

Lower frame: Real Jy  
Total-power spectrum Antenna: \*  
Timerange: 00/16:45:04 to 00/16:47:20



Plot file version 217 created 07-DEC-2009 16:06:19

J1912+05 RT006C.UVDATA.1

Freq = 4.9415 GHz, Bw = 16.000 MH No calibration applied and no bandpass applied

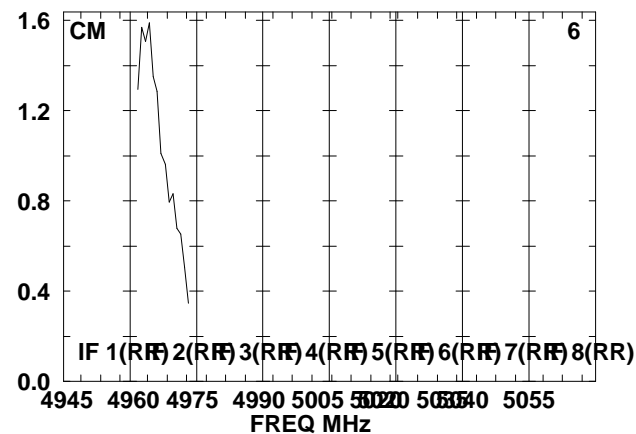
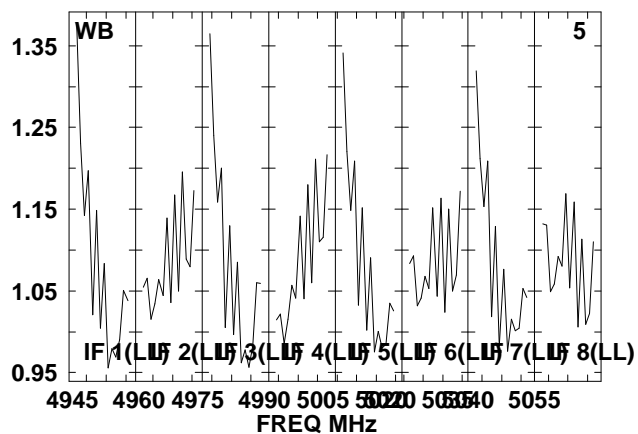
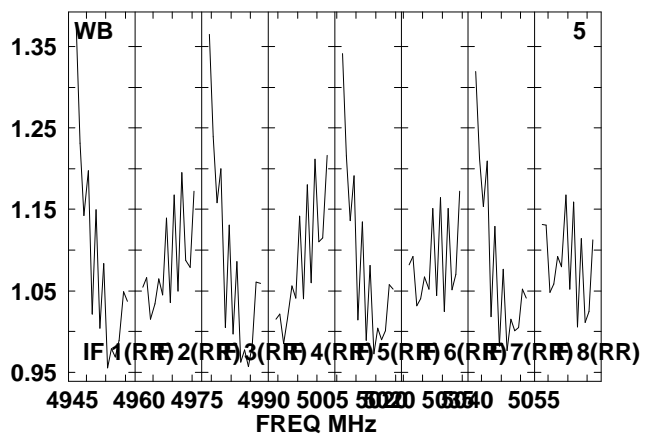
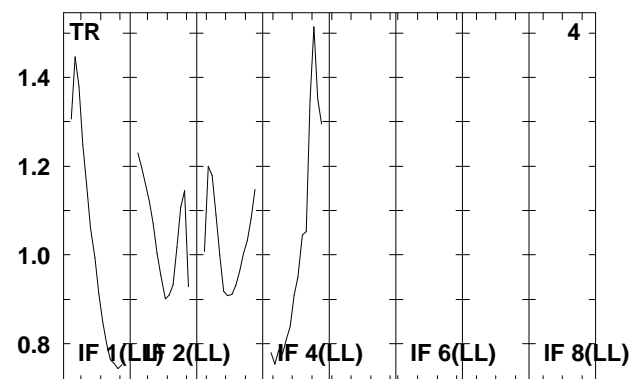
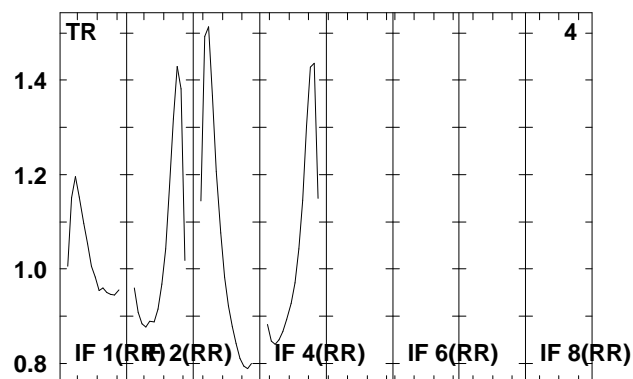
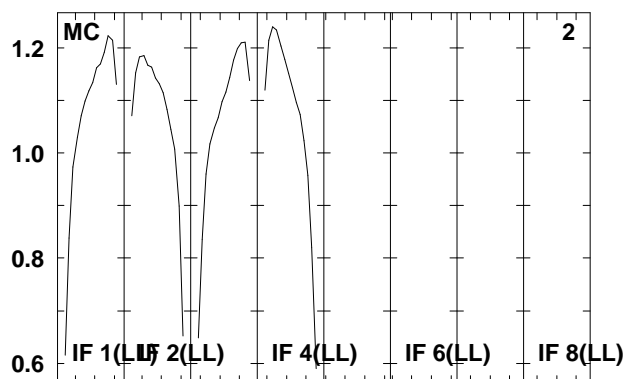
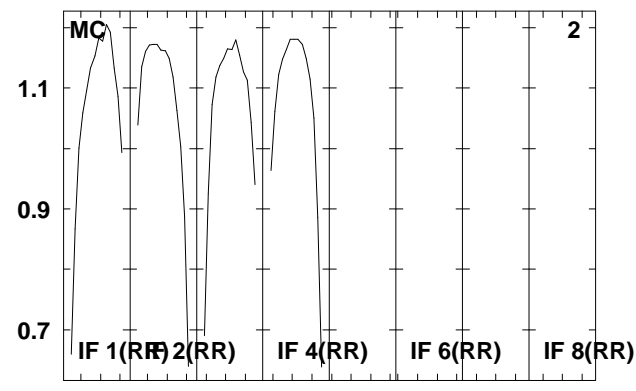
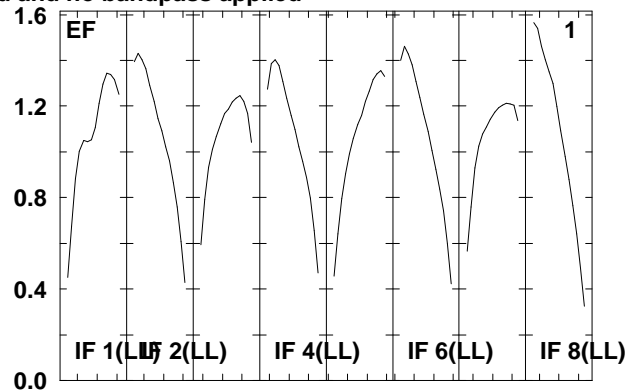
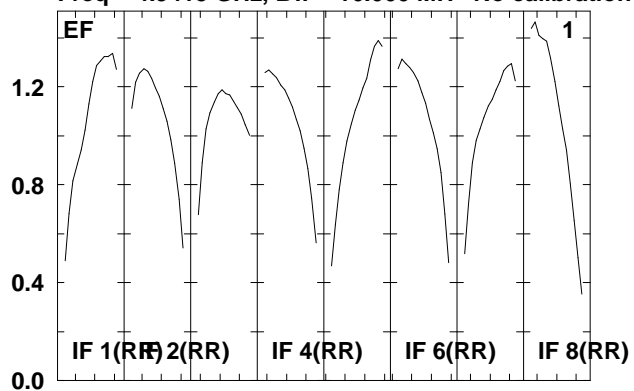

Lower frame: Real Jy  
Total-power spectrum Antenna: \*  
Timerange: 00/16:47:24 to 00/16:48:36

Plot file version 218 created 07-DEC-2009 16:06:19

J1912+05 RT006C.UVDATA.1

Freq = 4.9415 GHz, Bw = 16.000 MH No calibration applied and no bandpass applied

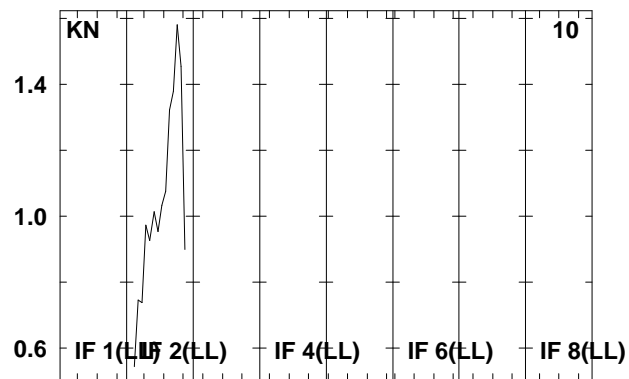
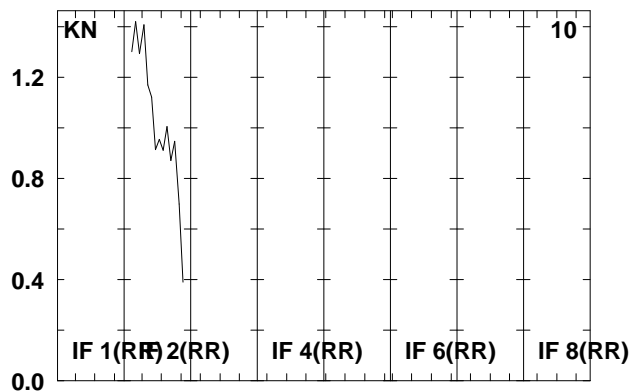
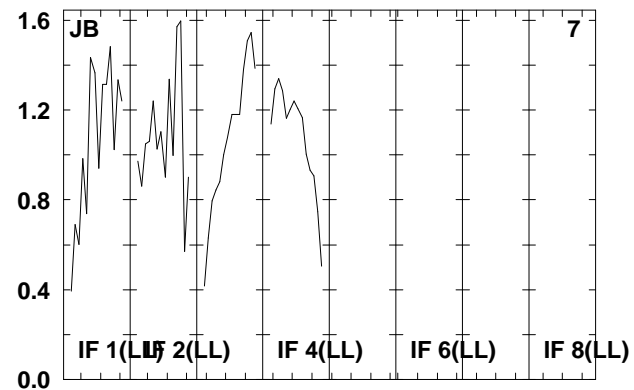
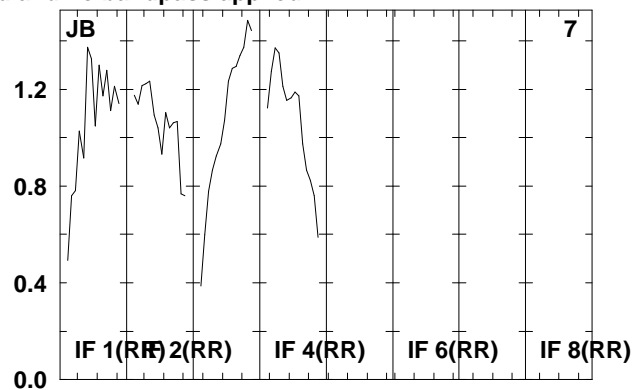
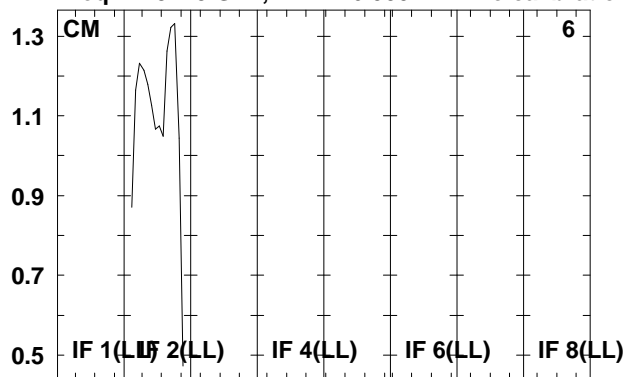

Lower frame: Real Jy  
Total-power spectrum Antenna: \*  
Timerange: 00/16:47:24 to 00/16:48:36

Plot file version 219 created 07-DEC-2009 16:06:19

SS433 RT006C.UVDATA.1

Freq = 4.9415 GHz, Bw = 16.000 MH No calibration applied and no bandpass applied

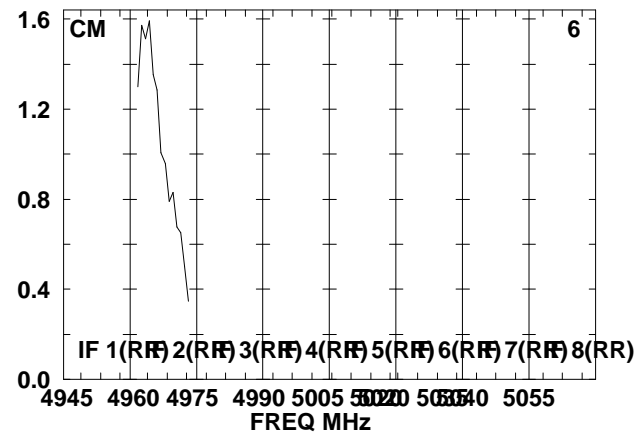
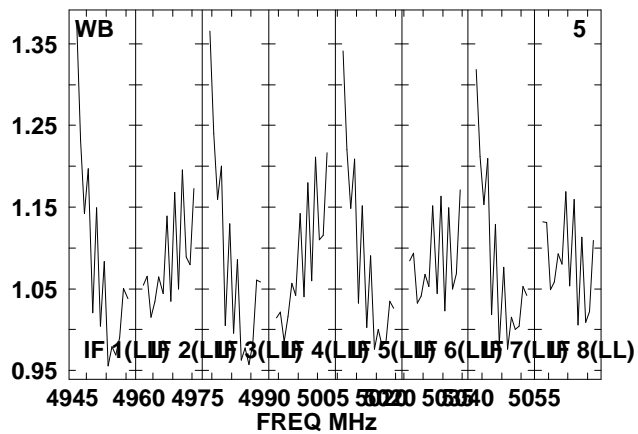
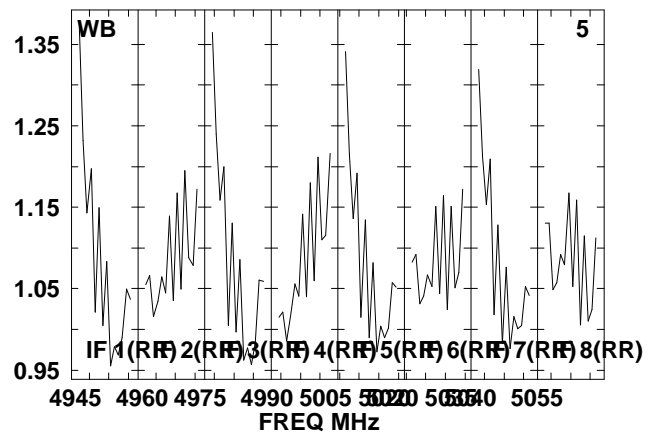
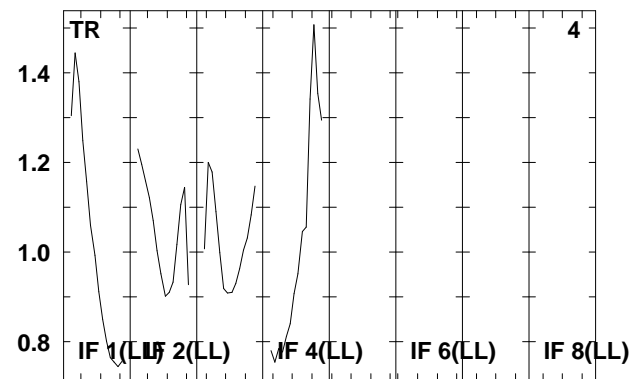
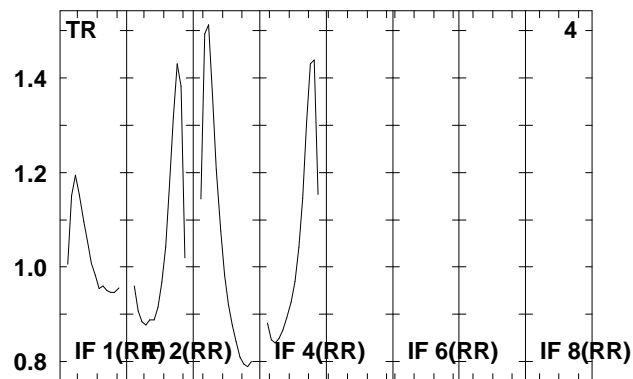
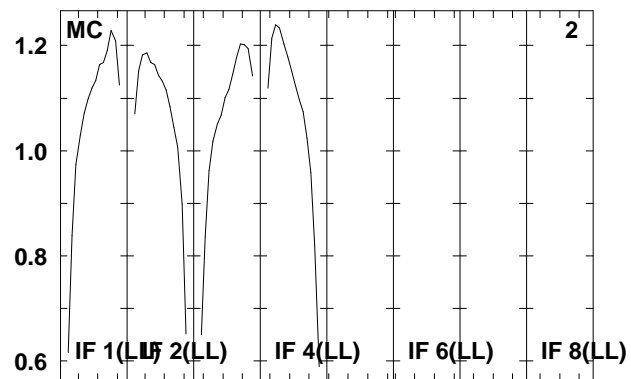
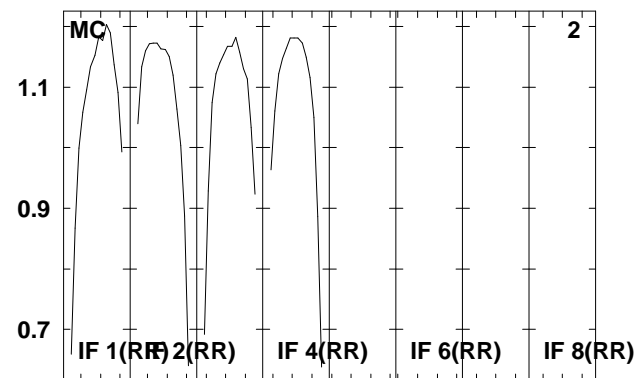
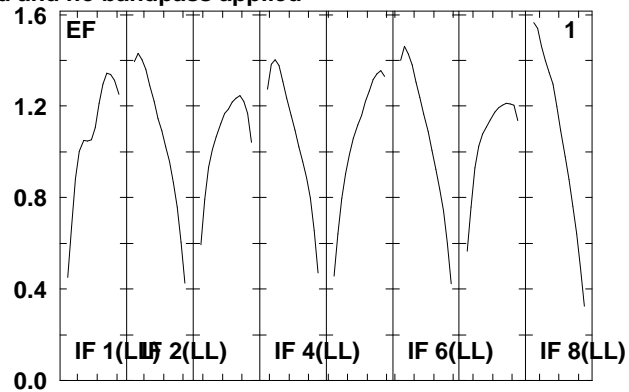
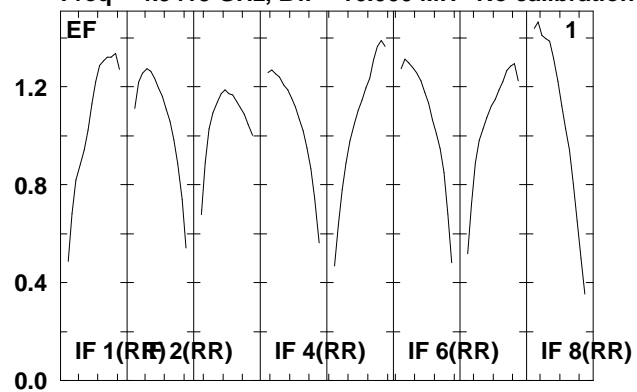

Lower frame: Real Jy

Total-power spectrum Antenna: \*

Timerange: 00/16:48:40 to 00/16:50:56

Plot file version 220 created 07-DEC-2009 16:06:19

SS433 RT006C.UVDATA.1

Freq = 4.9415 GHz, Bw = 16.000 MH No calibration applied and no bandpass applied

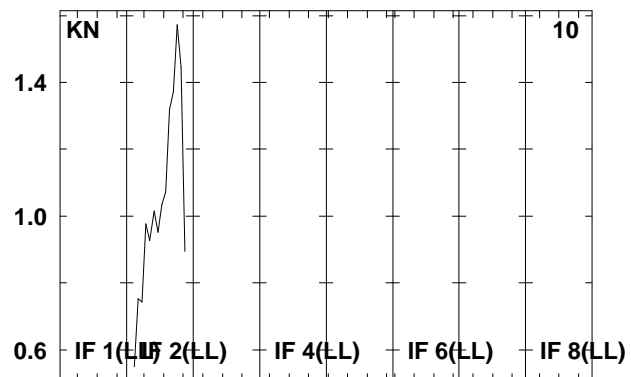
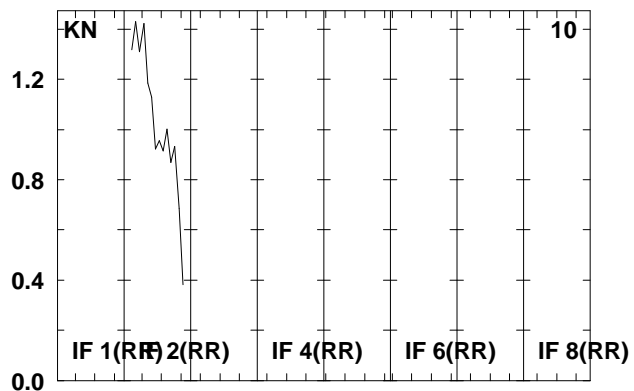
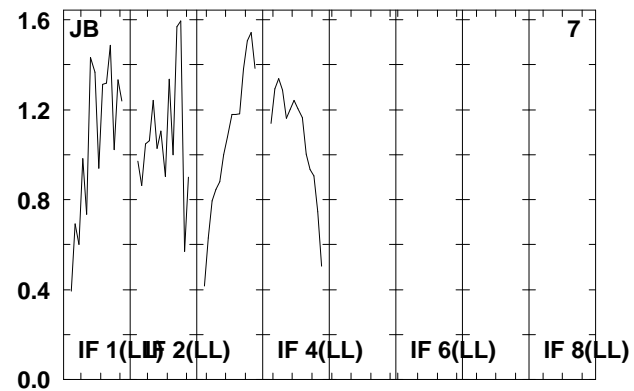
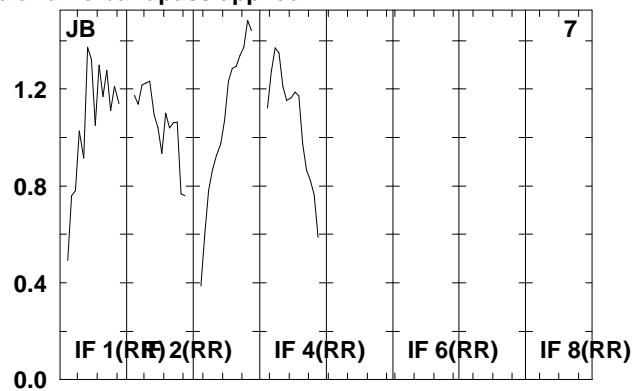
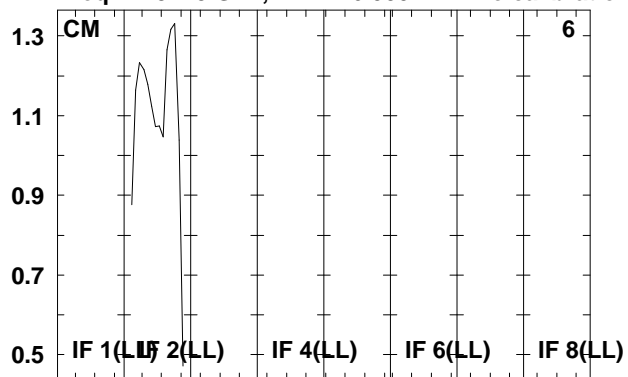

Lower frame: Real Jy  
Total-power spectrum Antenna: \*  
Timerange: 00/16:48:40 to 00/16:50:56

Plot file version 221 created 07-DEC-2009 16:06:20

J1911+16 RT006C.UVDATA.1

Freq = 4.9415 GHz, Bw = 16.000 MH No calibration applied and no bandpass applied

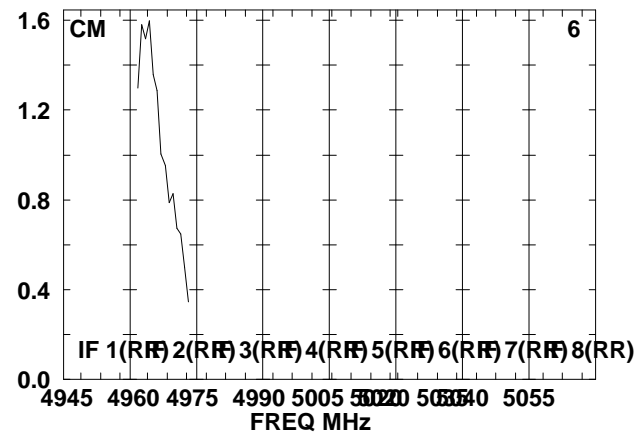
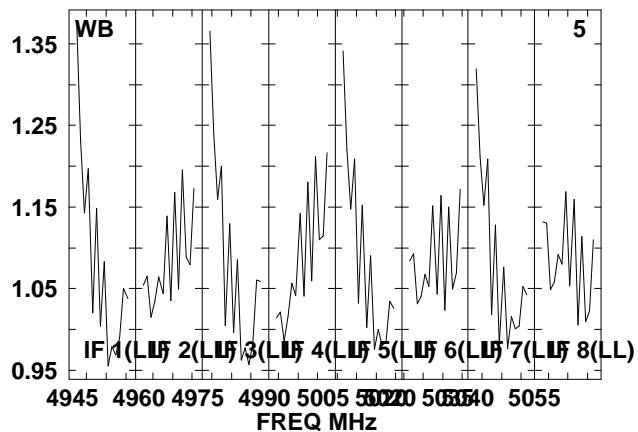
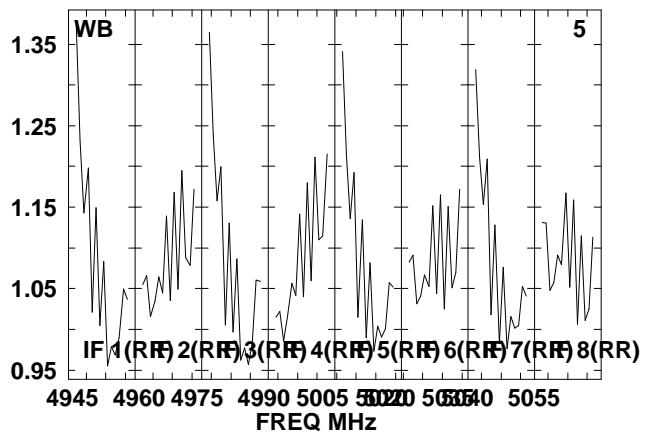
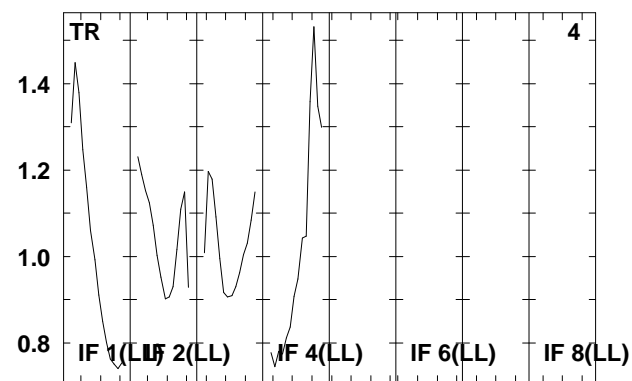
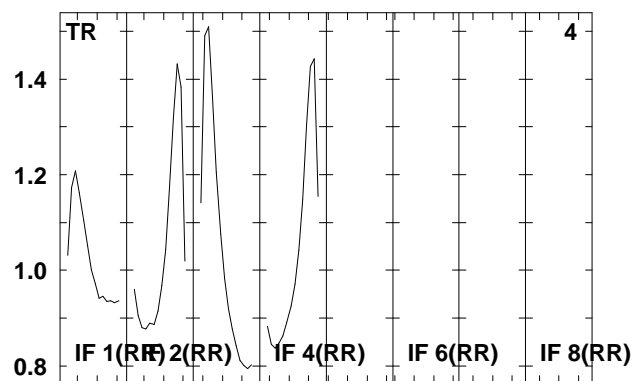
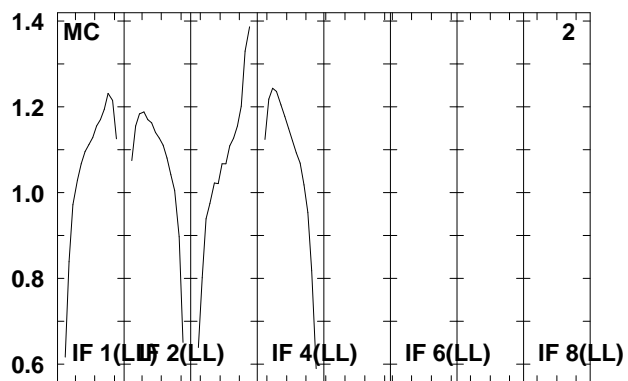
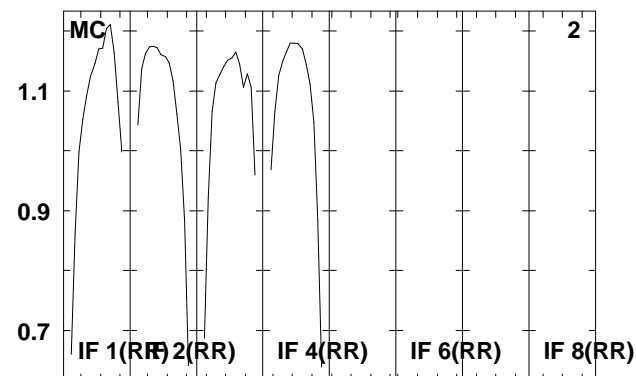
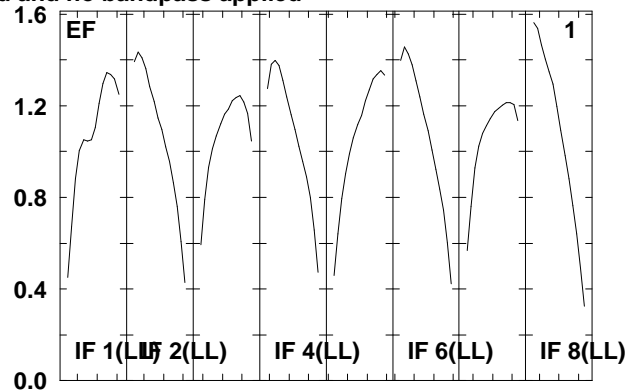
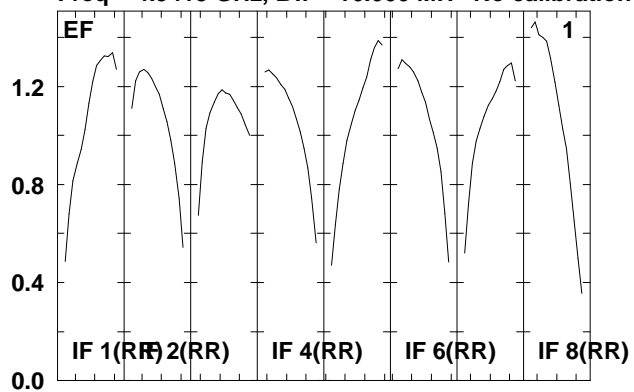

Lower frame: Real Jy  
Total-power spectrum Antenna: \*  
Timerange: 00/16:52:04 to 00/16:52:56

Plot file version 222 created 07-DEC-2009 16:06:20

J1911+16 RT006C.UVDATA.1

Freq = 4.9415 GHz, Bw = 16.000 MH No calibration applied and no bandpass applied

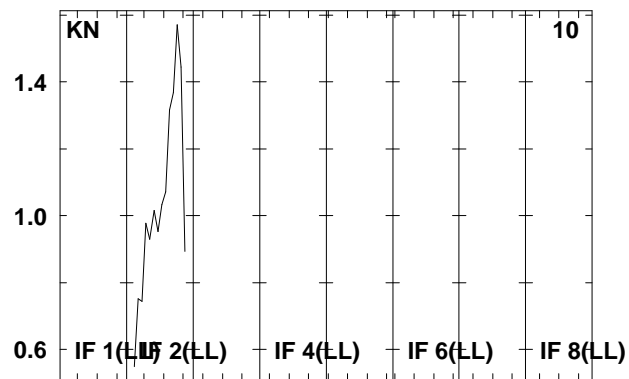
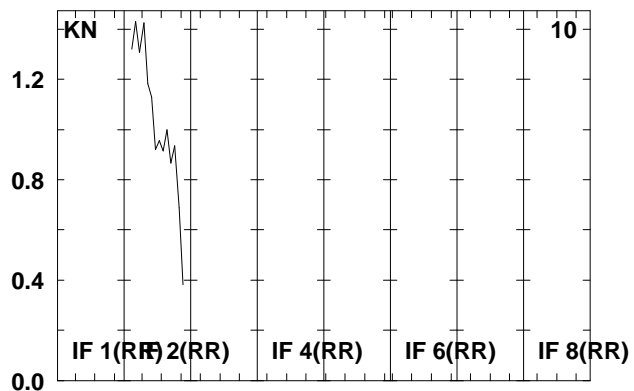
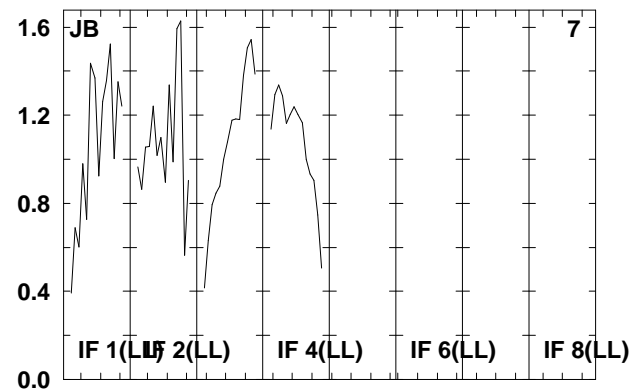
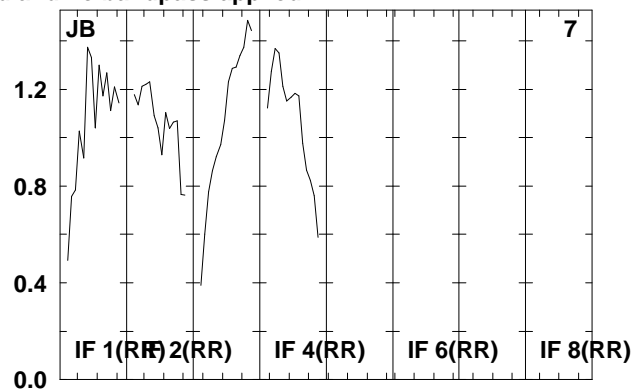
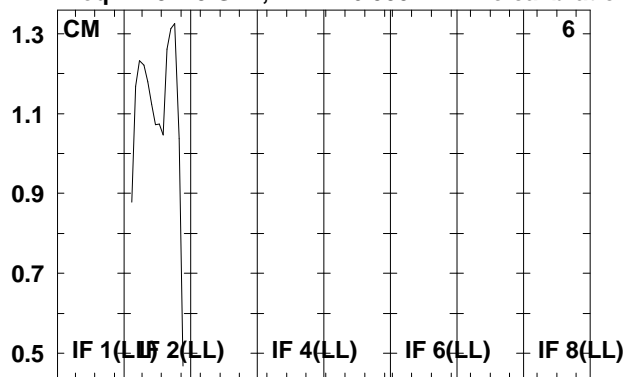

Lower frame: Real Jy  
Total-power spectrum Antenna: \*  
Timerange: 00/16:52:04 to 00/16:52:56

Plot file version 223 created 07-DEC-2009 16:06:20

J1912+05 RT006C.UVDATA.1

Freq = 4.9415 GHz, Bw = 16.000 MH No calibration applied and no bandpass applied

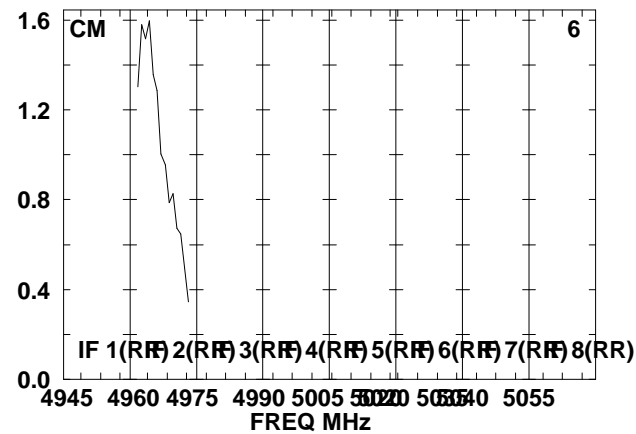
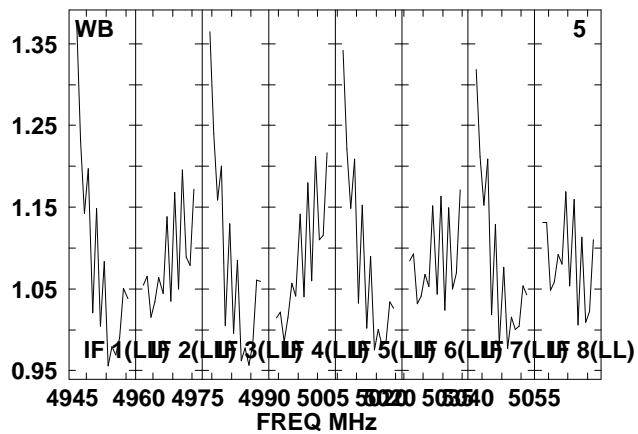
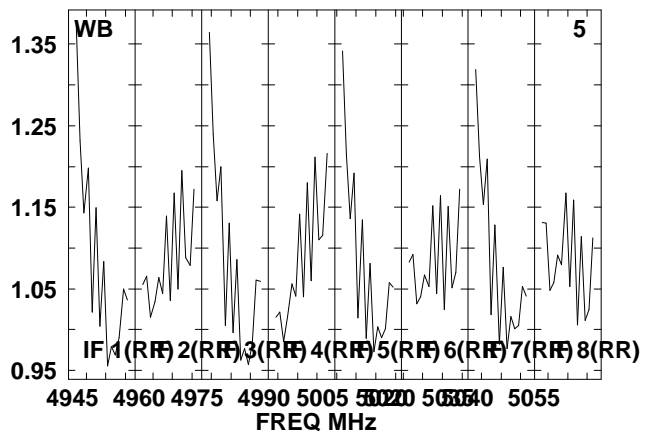
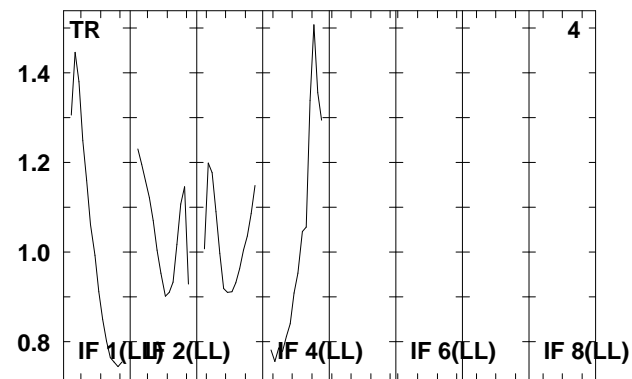
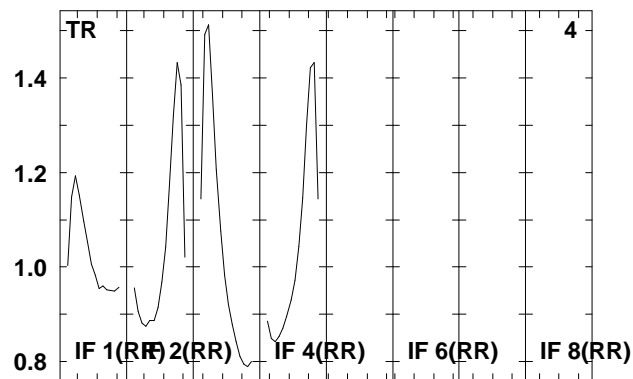
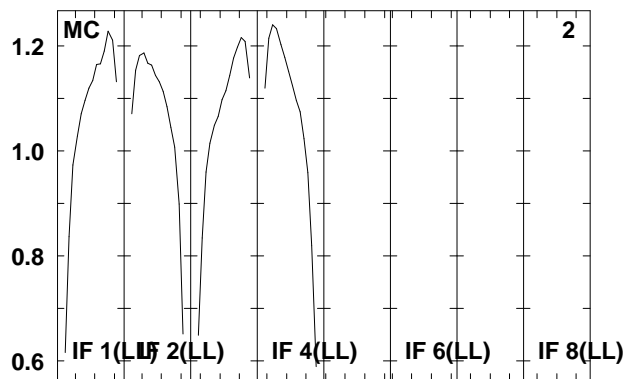
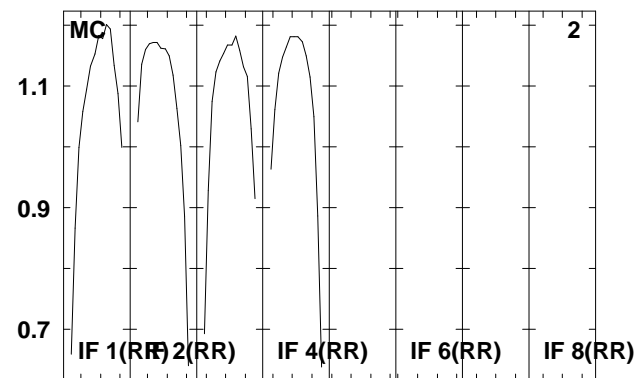
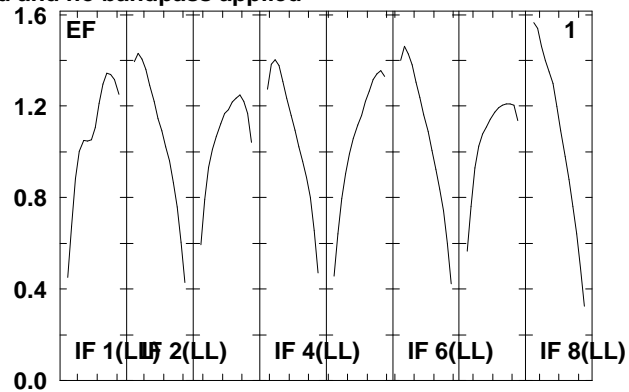
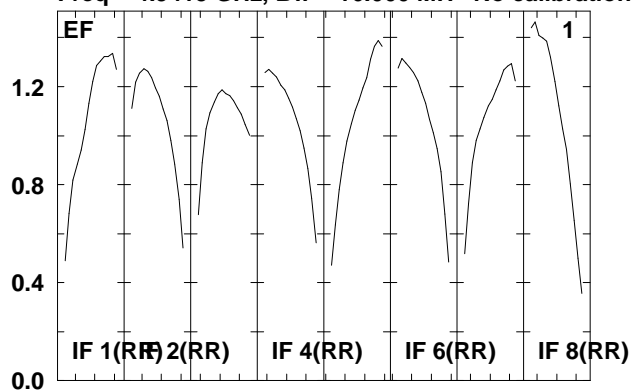

Lower frame: Real Jy  
Total-power spectrum Antenna: \*  
Timerange: 00/16:54:04 to 00/16:54:56

Plot file version 224 created 07-DEC-2009 16:06:20

J1912+05 RT006C.UVDATA.1

Freq = 4.9415 GHz, Bw = 16.000 MH No calibration applied and no bandpass applied

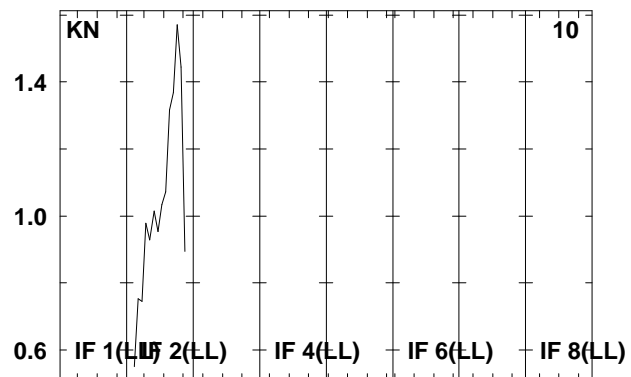
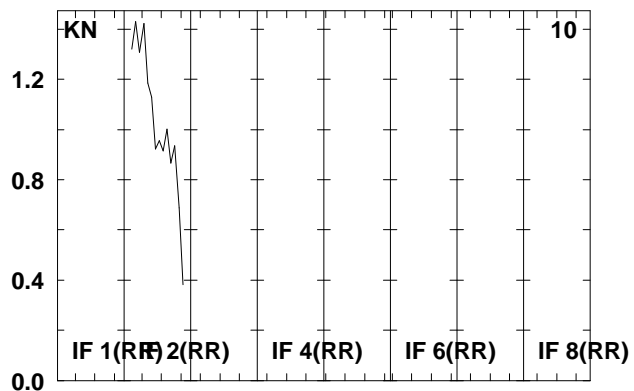
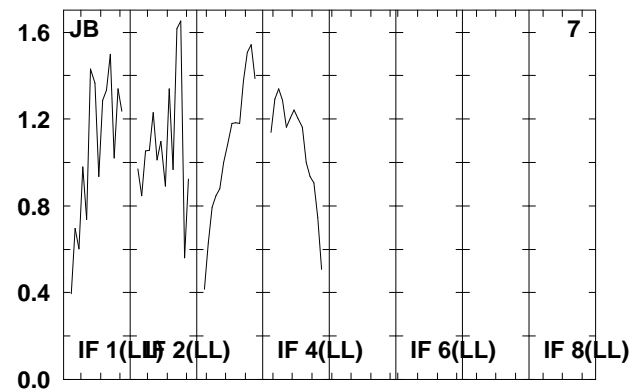
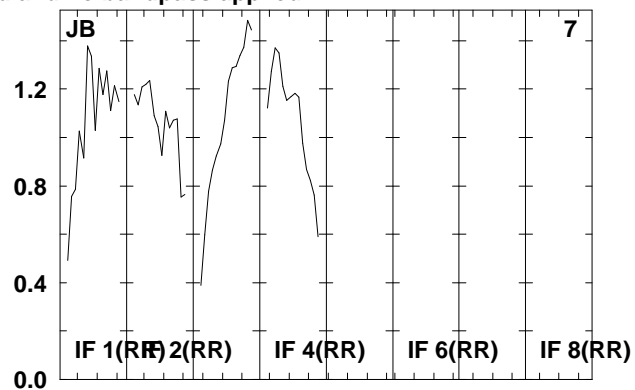
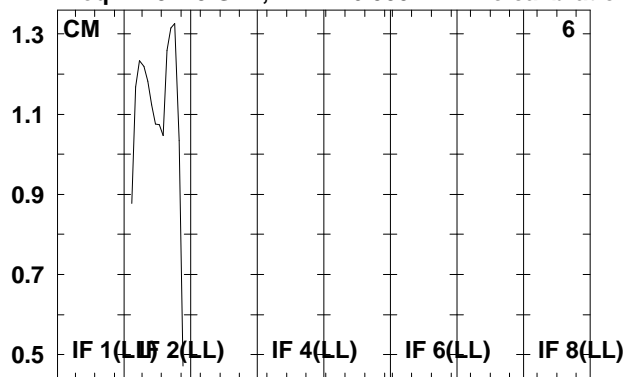

Lower frame: Real Jy  
Total-power spectrum Antenna: \*  
Timerange: 00/16:54:04 to 00/16:54:56



Plot file version 225 created 07-DEC-2009 16:06:20

SS433 RT006C.UVDATA.1

Freq = 4.9415 GHz, Bw = 16.000 MH No calibration applied and no bandpass applied

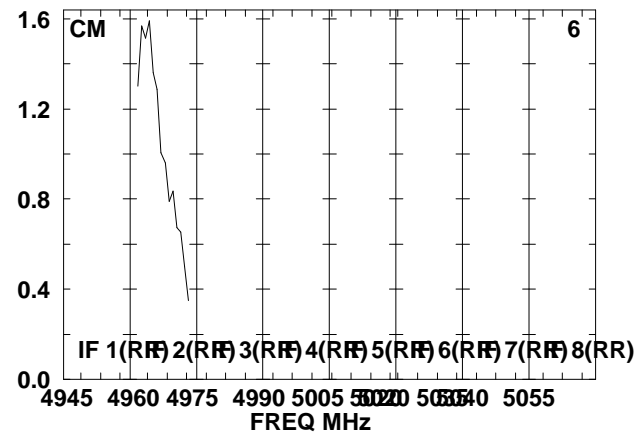
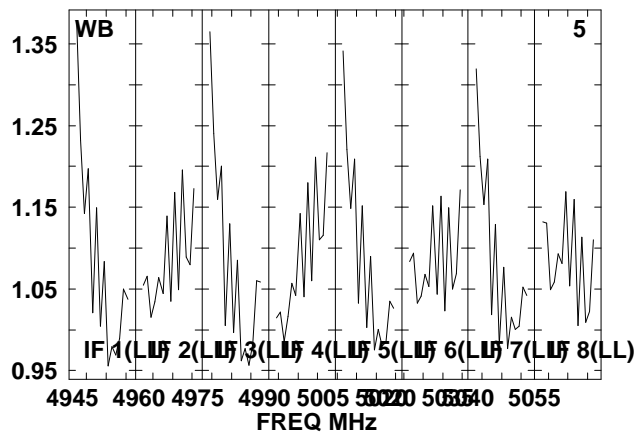
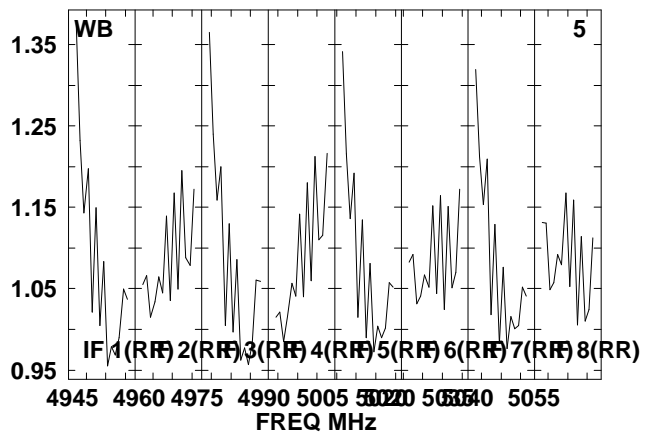
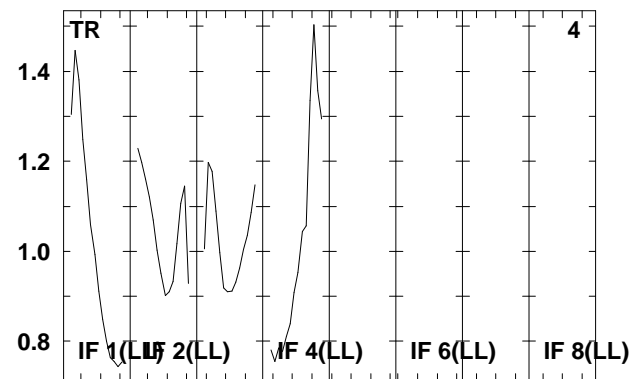
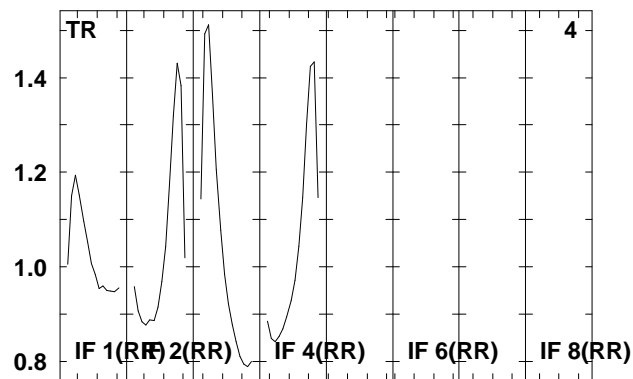
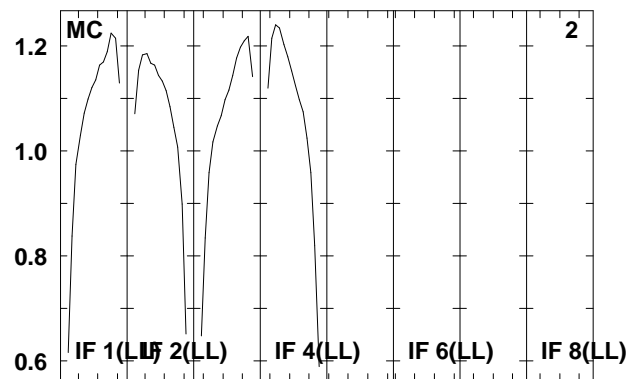
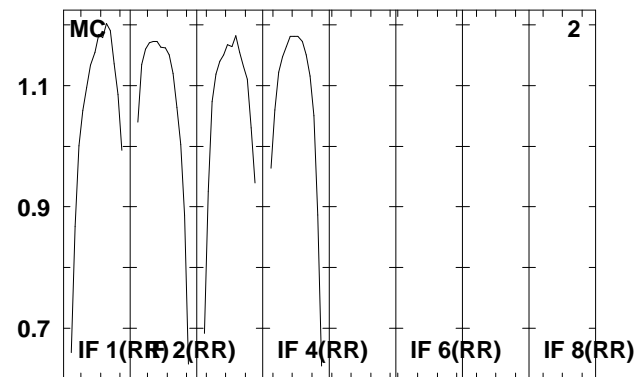
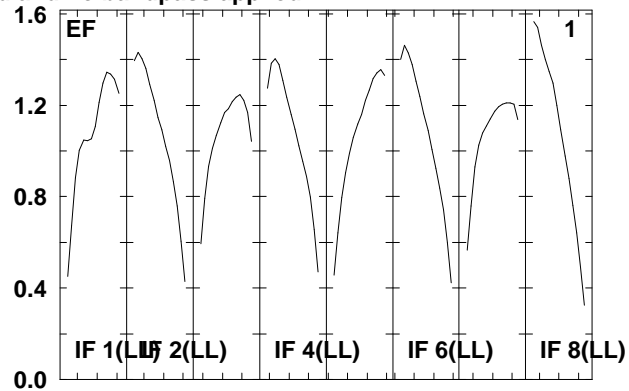
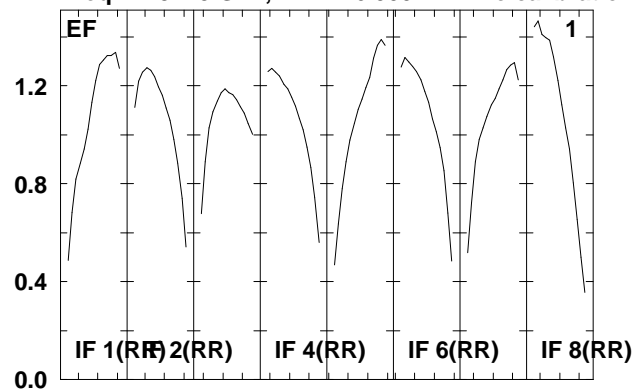

Lower frame: Real Jy  
Total-power spectrum Antenna: \*  
Timerange: 00/16:55:00 to 00/16:57:16

Plot file version 226 created 07-DEC-2009 16:06:20

SS433 RT006C.UVDATA.1

Freq = 4.9415 GHz, Bw = 16.000 MH No calibration applied and no bandpass applied

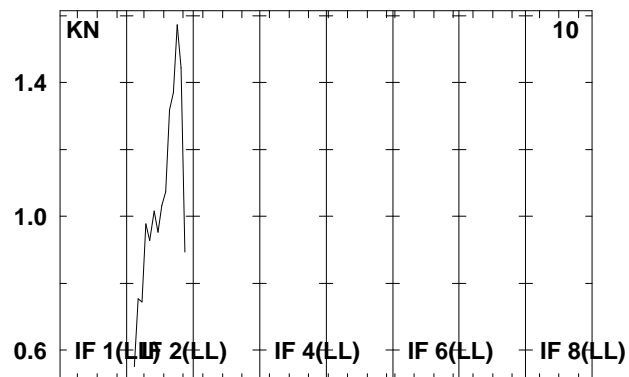
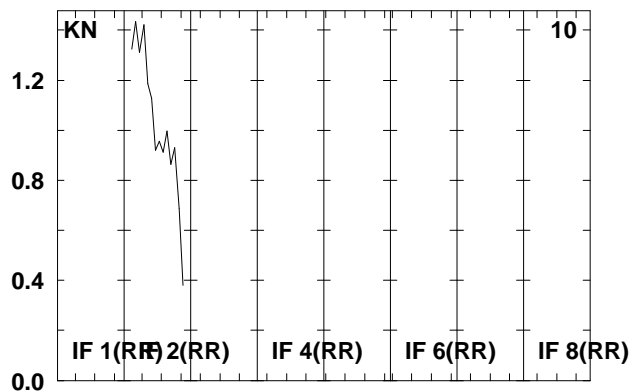
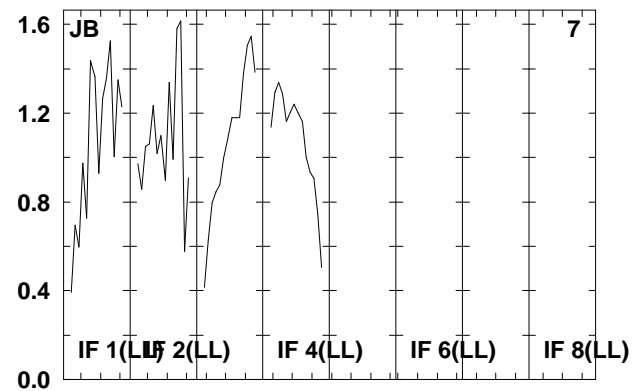
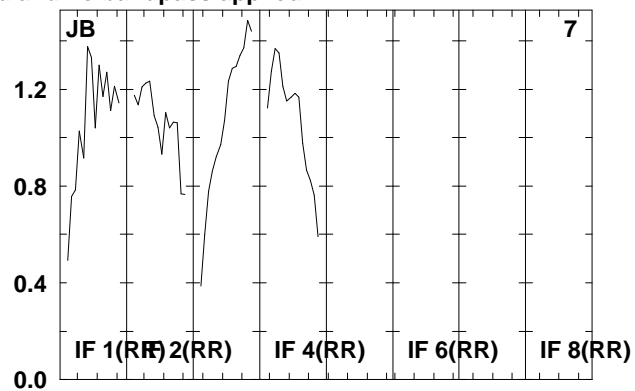
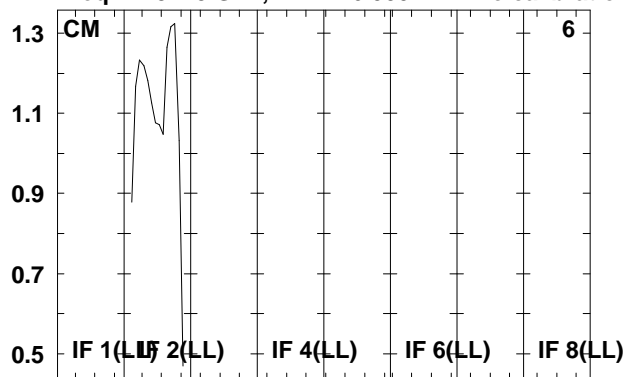

Lower frame: Real Jy  
Total-power spectrum Antenna: \*  
Timerange: 00/16:55:00 to 00/16:57:16

Plot file version 227 created 07-DEC-2009 16:06:21

J1912+05 RT006C.UVDATA.1

Freq = 4.9415 GHz, Bw = 16.000 MH No calibration applied and no bandpass applied

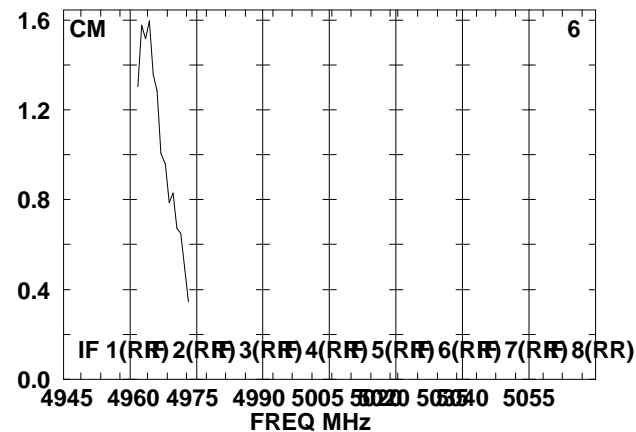
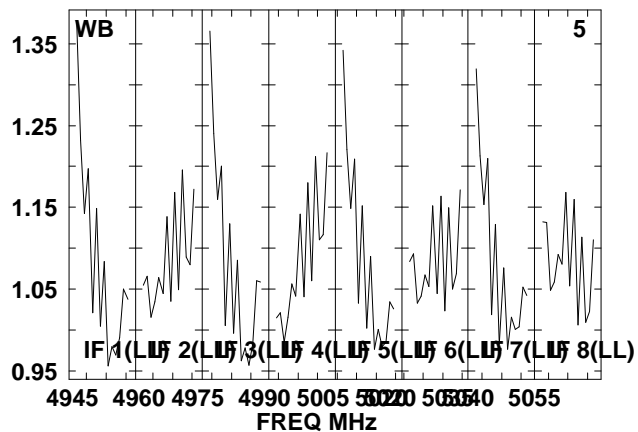
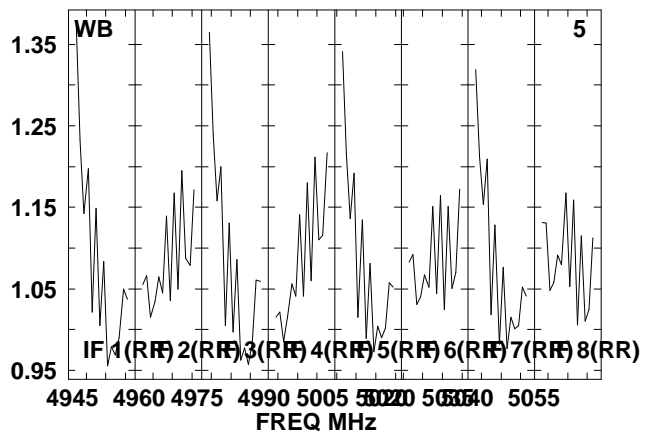
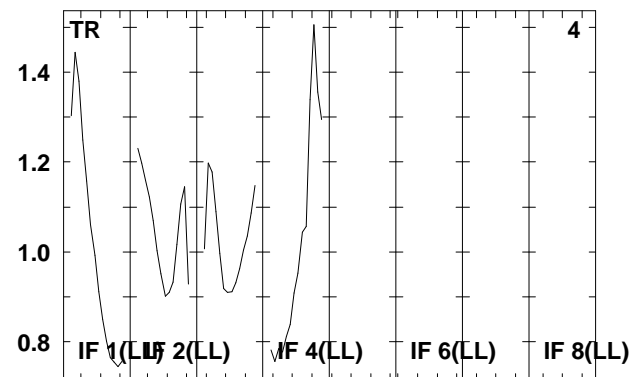
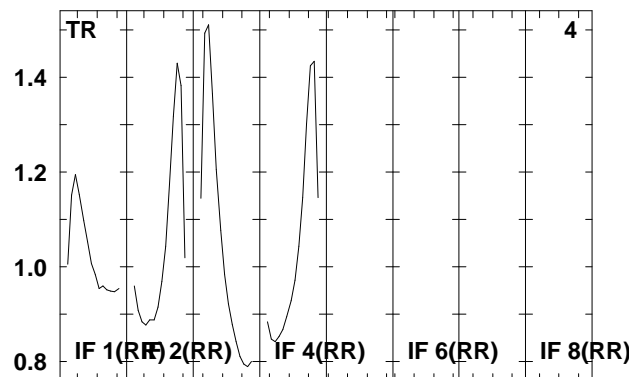
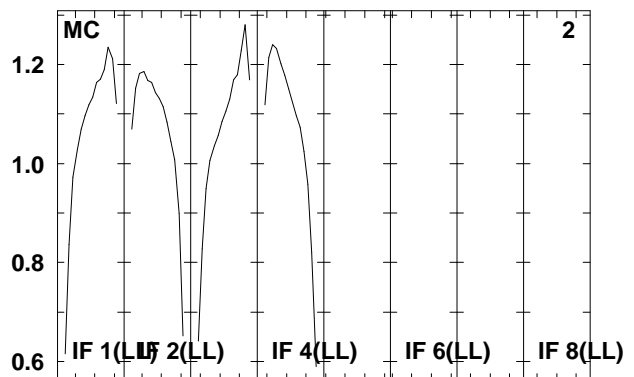
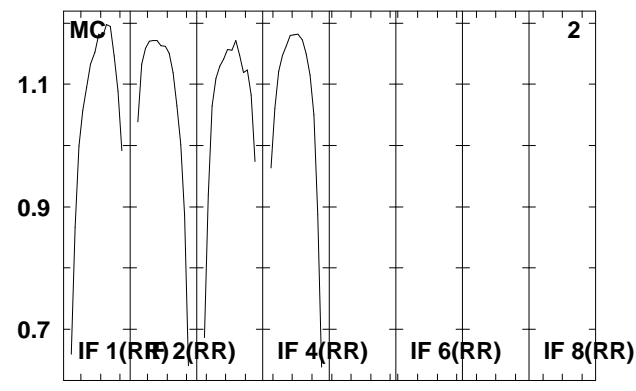
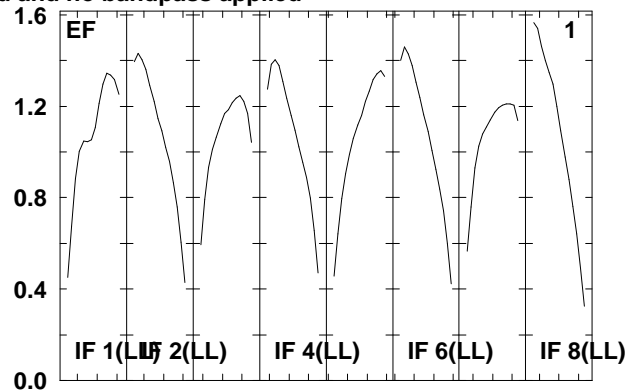
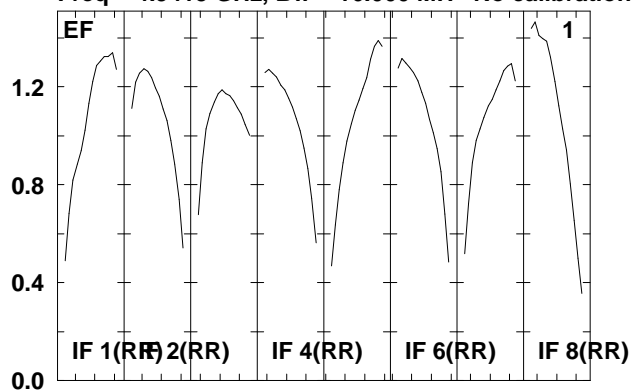

Lower frame: Real Jy  
Total-power spectrum Antenna: \*  
Timerange: 00/16:57:20 to 00/16:58:40

Plot file version 228 created 07-DEC-2009 16:06:21

J1912+05 RT006C.UVDATA.1

Freq = 4.9415 GHz, Bw = 16.000 MH No calibration applied and no bandpass applied

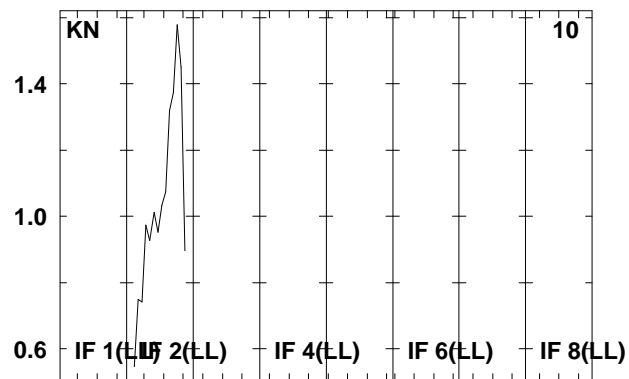
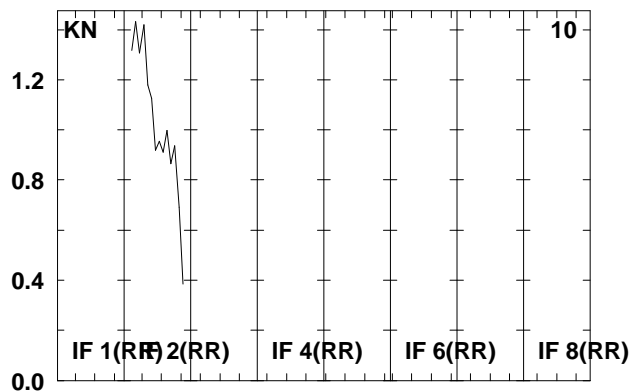
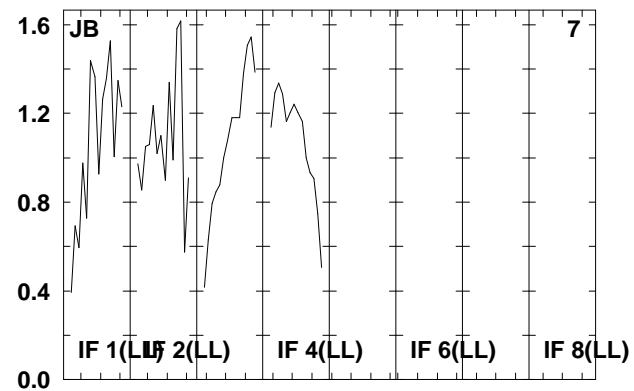
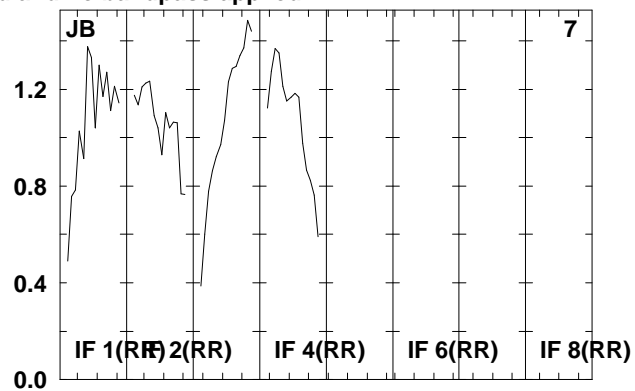
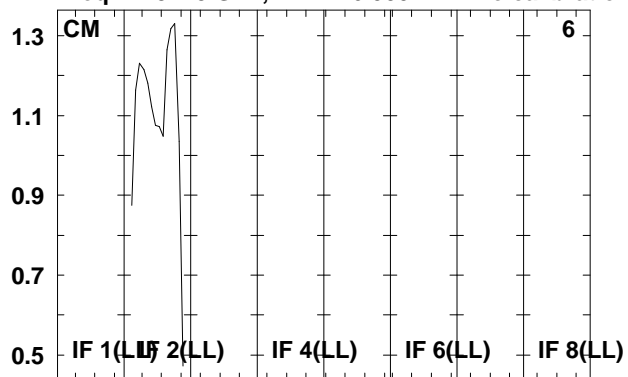

Lower frame: Real Jy  
Total-power spectrum Antenna: \*  
Timerange: 00/16:57:20 to 00/16:58:40

Plot file version 229 created 07-DEC-2009 16:06:21

SS433 RT006C.UVDATA.1

Freq = 4.9415 GHz, Bw = 16.000 MH No calibration applied and no bandpass applied

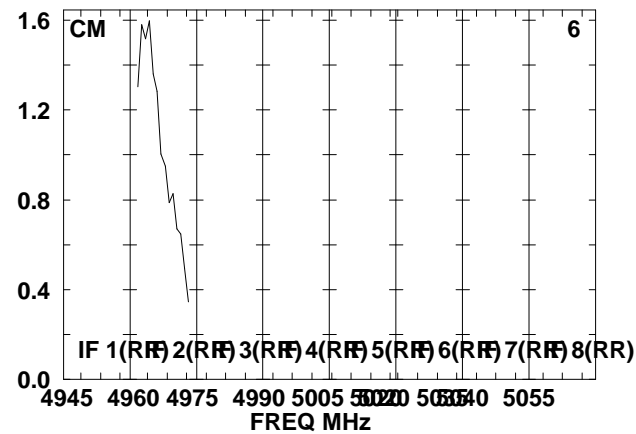
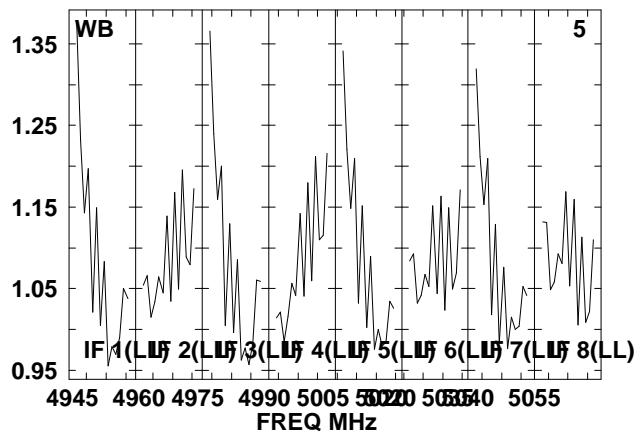
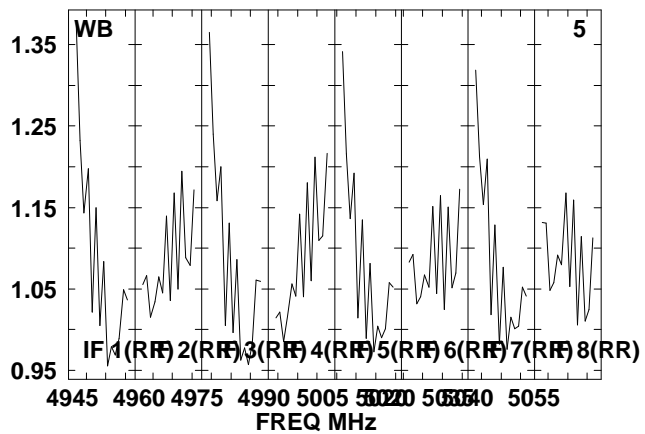
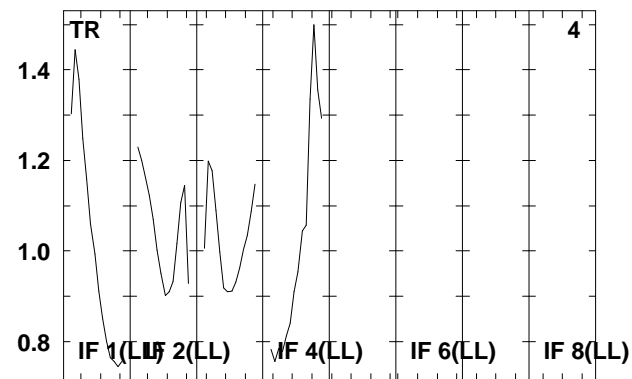
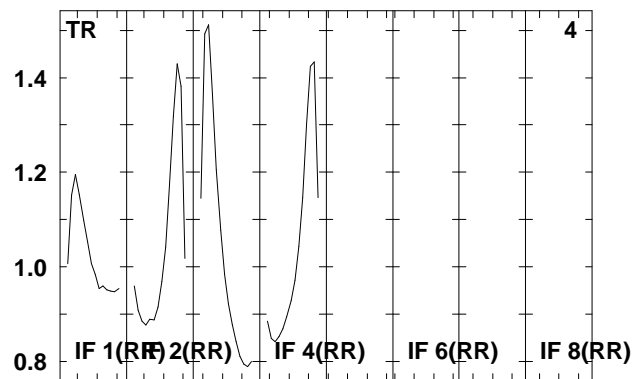
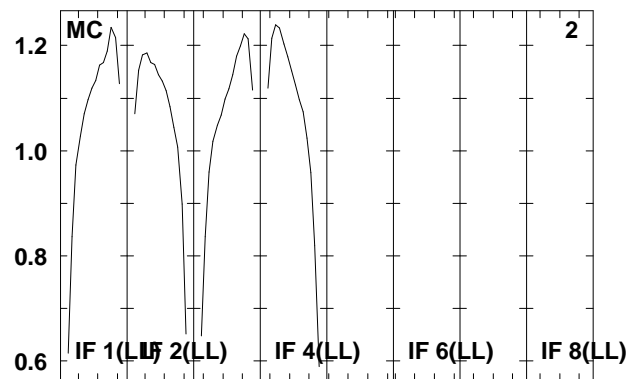
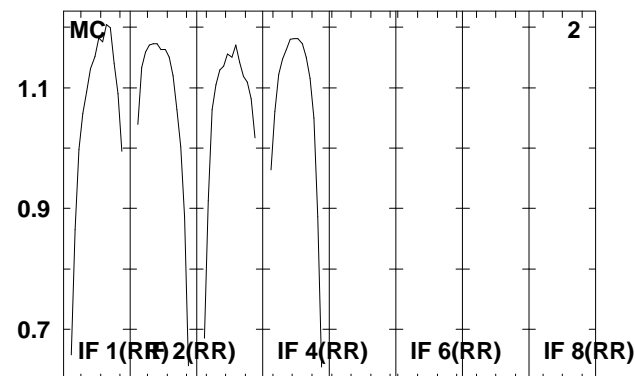
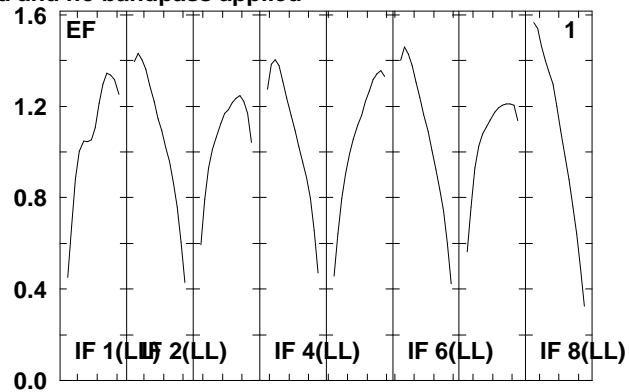
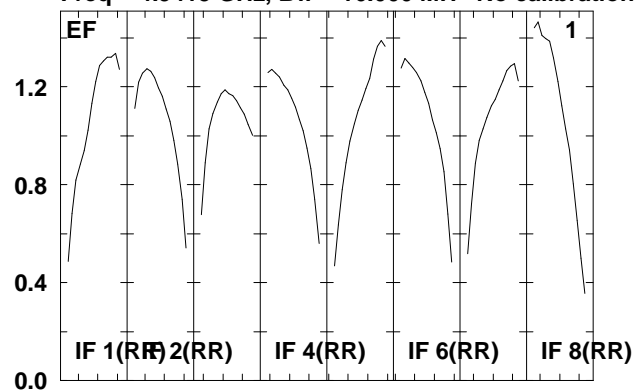

Lower frame: Real Jy  
Total-power spectrum Antenna: \*  
Timerange: 00/16:58:44 to 00/17:01:00

Plot file version 230 created 07-DEC-2009 16:06:21

SS433 RT006C.UVDATA.1

Freq = 4.9415 GHz, Bw = 16.000 MH No calibration applied and no bandpass applied

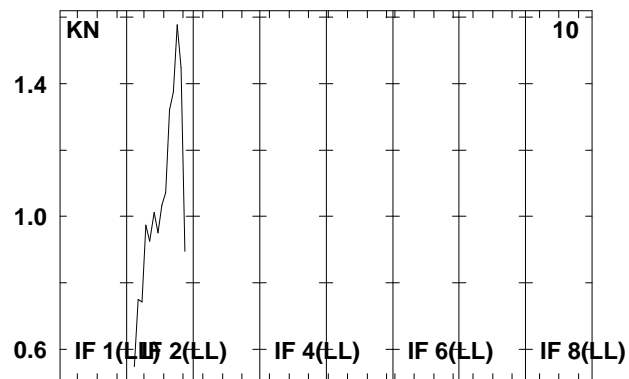
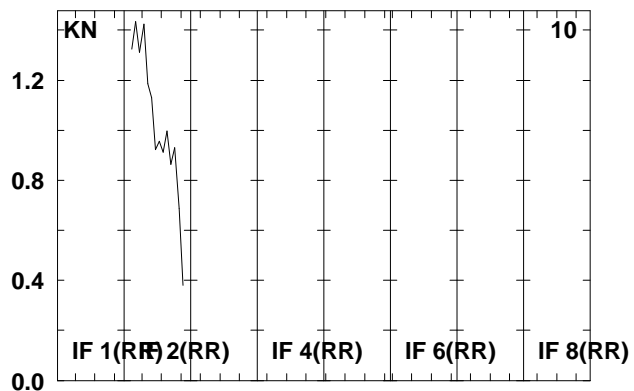
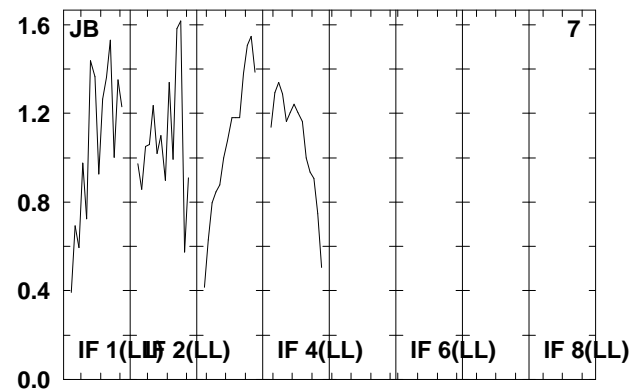
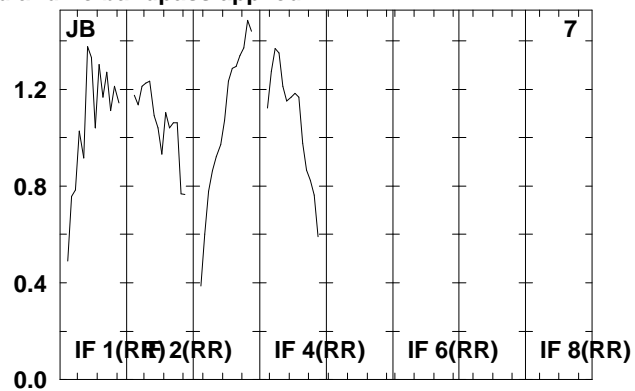
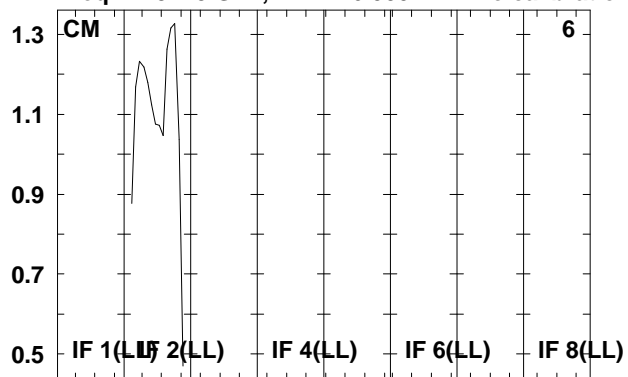

Lower frame: Real Jy  
Total-power spectrum Antenna: \*  
Timerange: 00/16:58:44 to 00/17:01:00

Plot file version 231 created 07-DEC-2009 16:06:21

J1912+05 RT006C.UVDATA.1

Freq = 4.9415 GHz, Bw = 16.000 MH No calibration applied and no bandpass applied

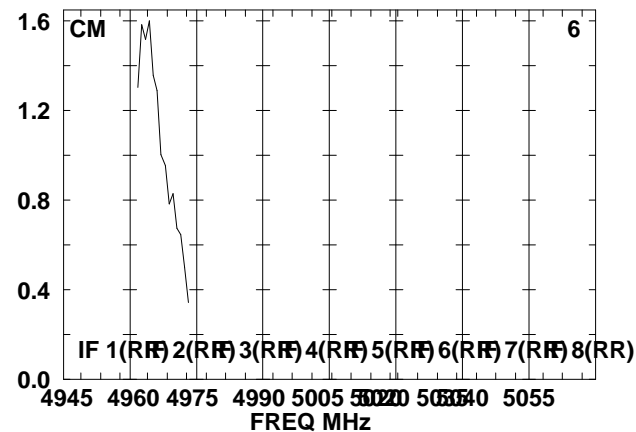
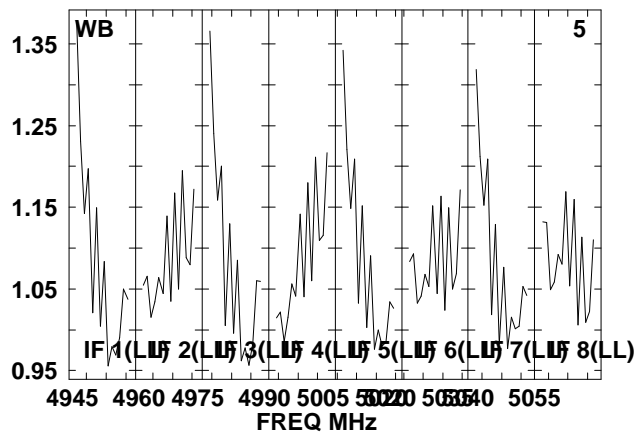
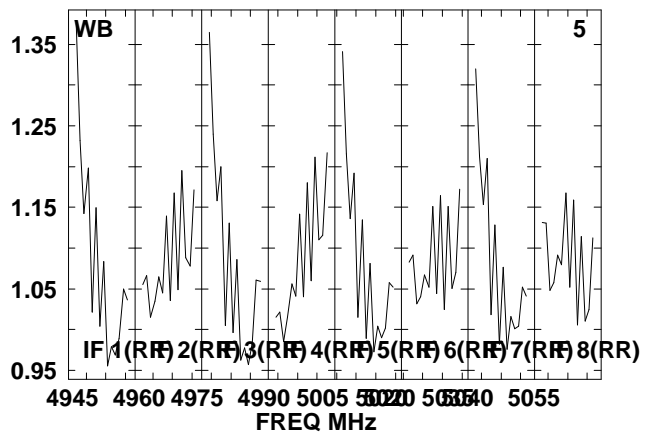
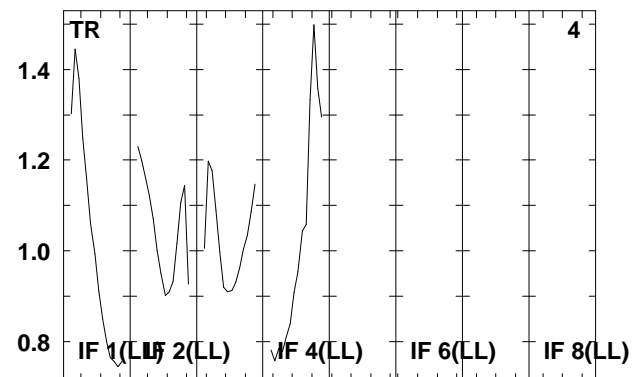
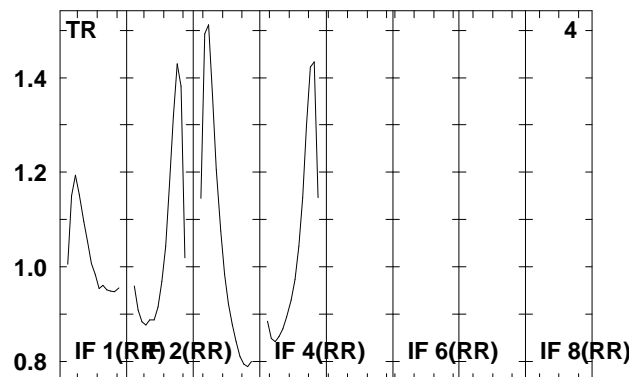
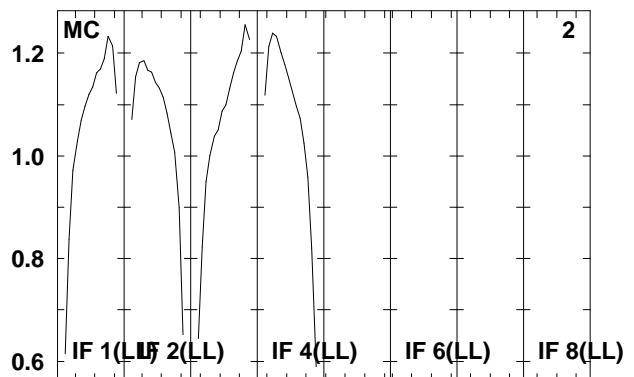
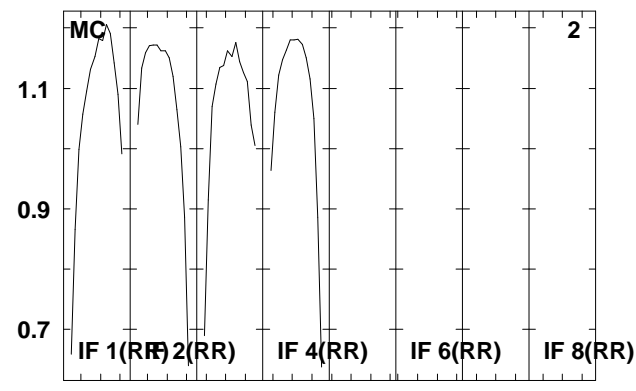
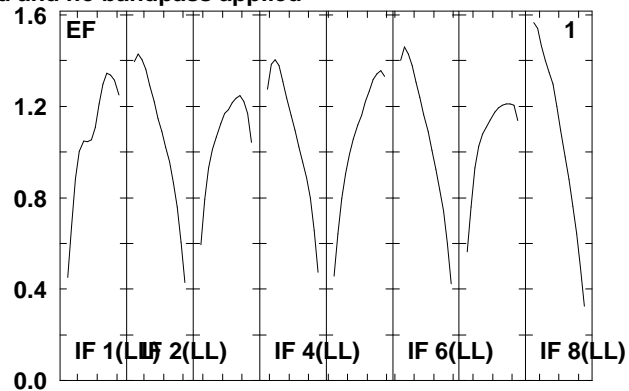
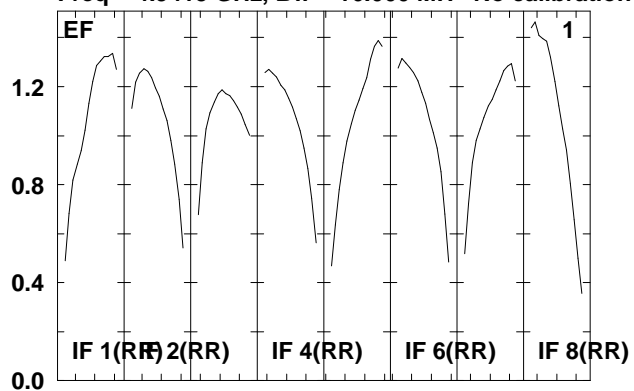

Lower frame: Real Jy  
Total-power spectrum Antenna: \*  
Timerange: 00/17:01:04 to 00/17:02:16

Plot file version 232 created 07-DEC-2009 16:06:21

J1912+05 RT006C.UVDATA.1

Freq = 4.9415 GHz, Bw = 16.000 MH No calibration applied and no bandpass applied

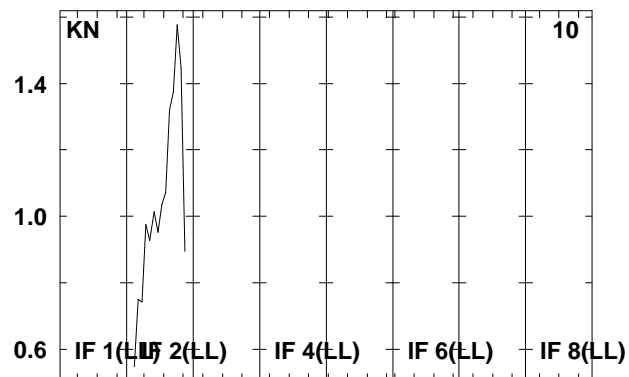
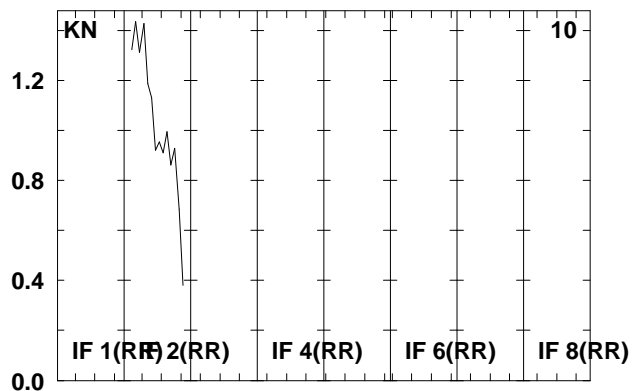
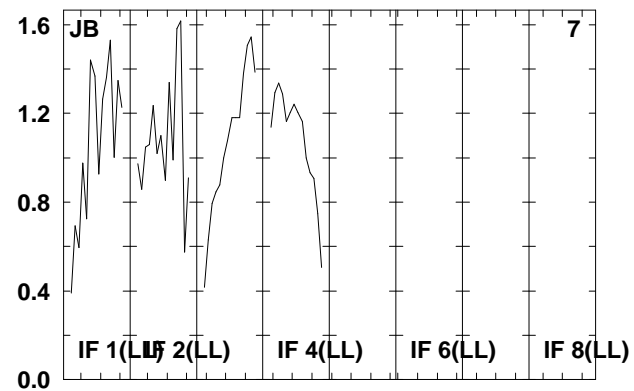
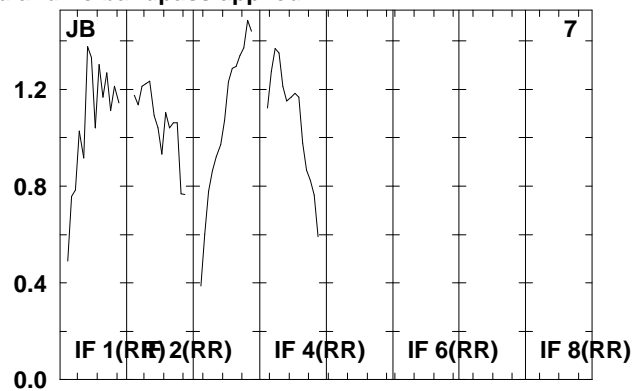
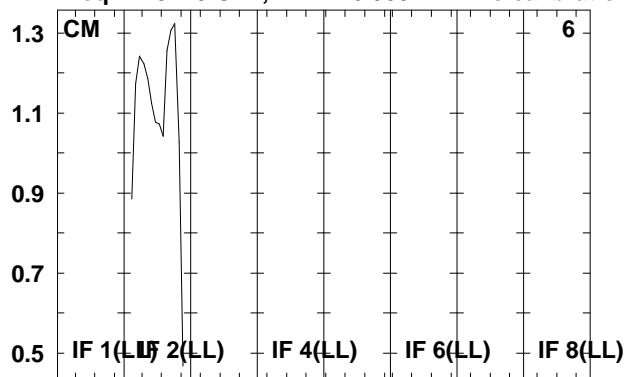

Lower frame: Real Jy  
Total-power spectrum Antenna: \*  
Timerange: 00/17:01:04 to 00/17:02:16



Plot file version 233 created 07-DEC-2009 16:06:22

SS433 RT006C.UVDATA.1

Freq = 4.9415 GHz, Bw = 16.000 MH No calibration applied and no bandpass applied

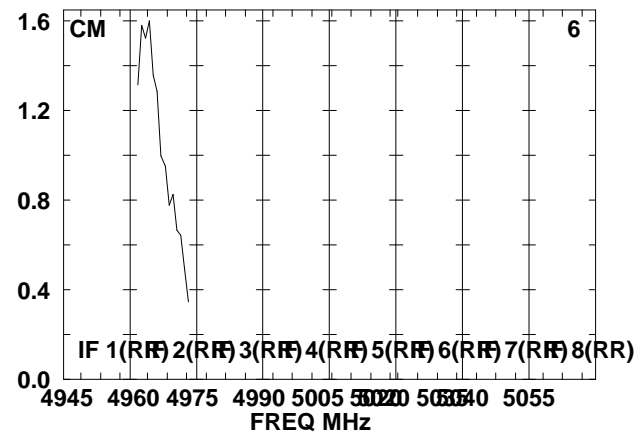
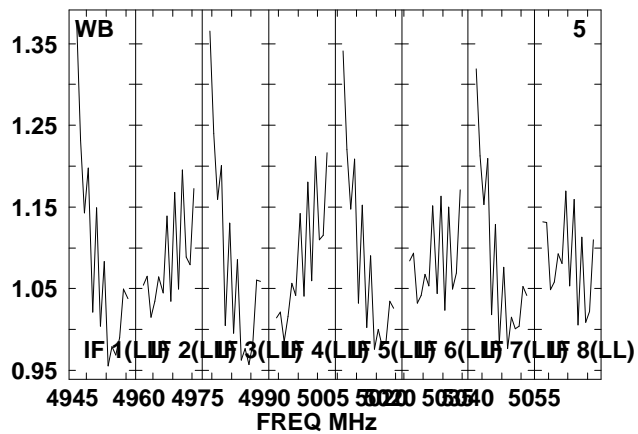
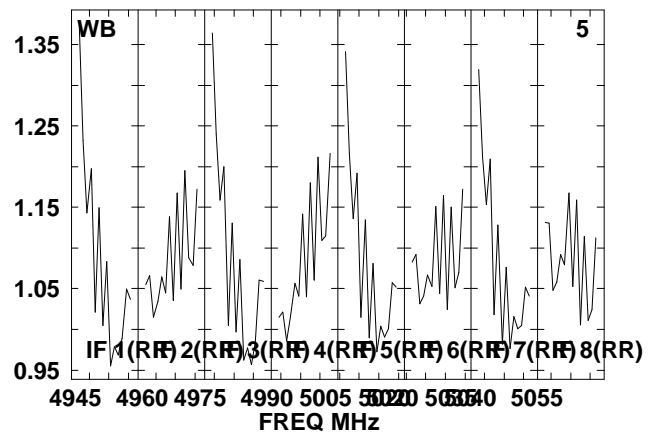
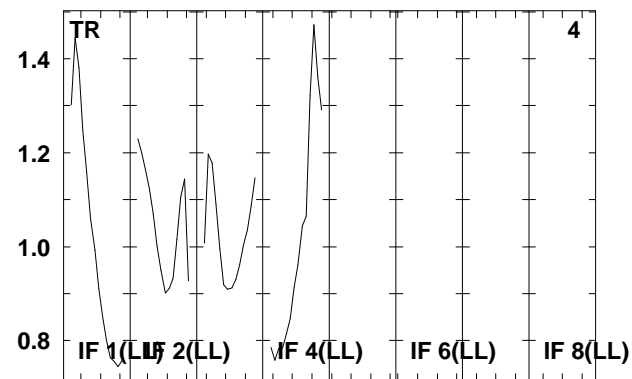
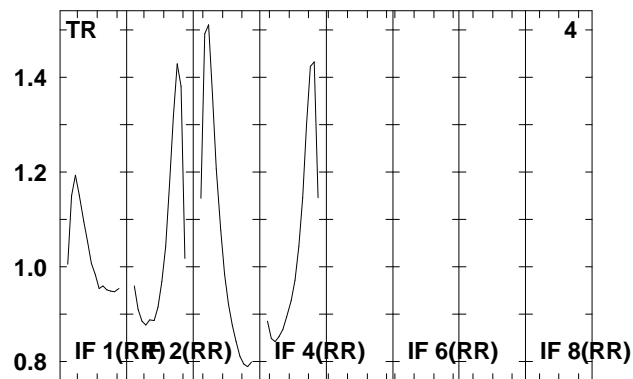
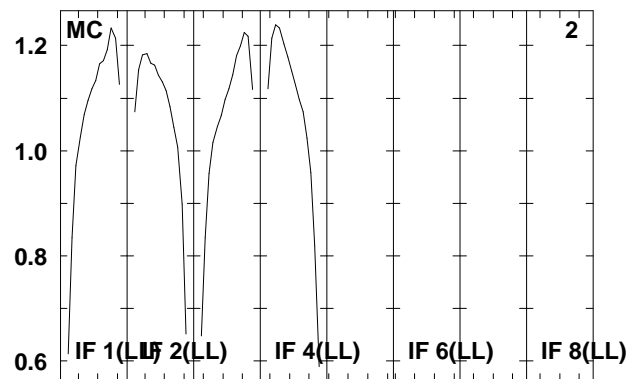
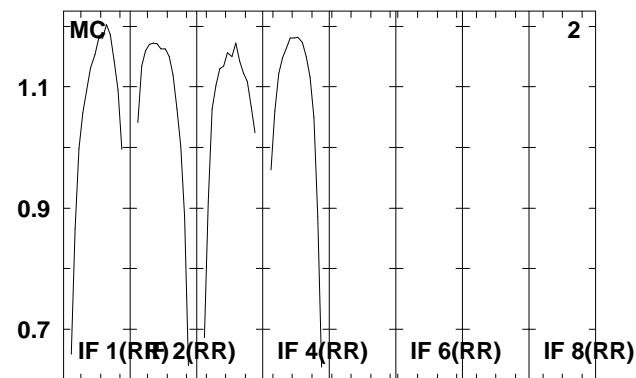
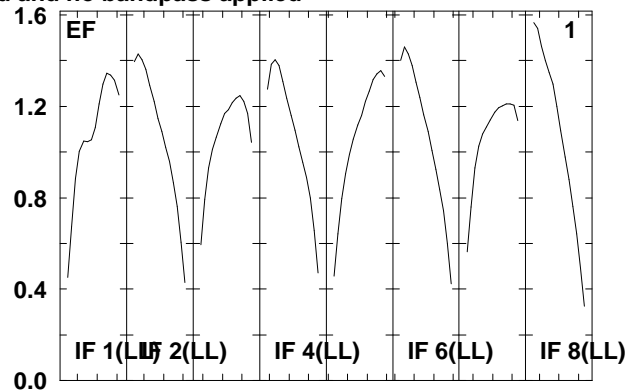
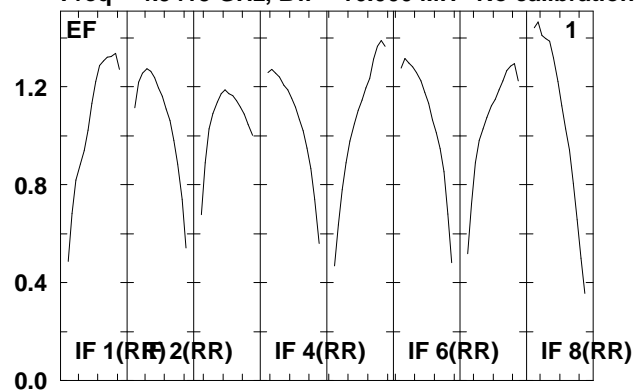

Lower frame: Real Jy  
Total-power spectrum Antenna: \*  
Timerange: 00/17:02:20 to 00/17:04:36

Plot file version 234 created 07-DEC-2009 16:06:22

SS433 RT006C.UVDATA.1

Freq = 4.9415 GHz, Bw = 16.000 MH No calibration applied and no bandpass applied

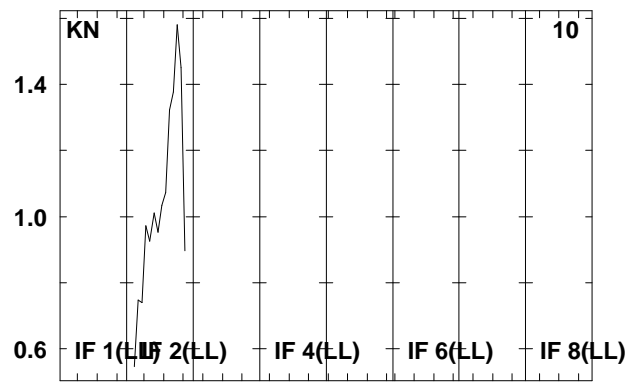
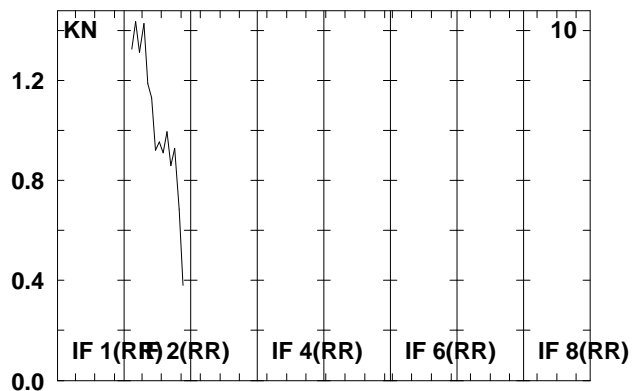
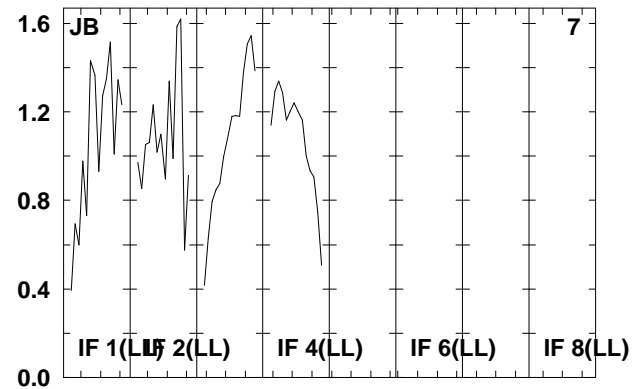
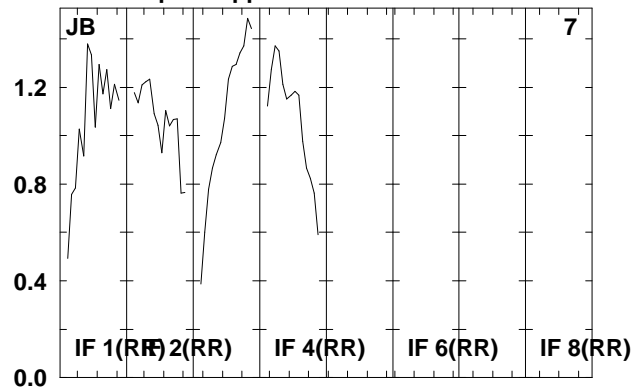
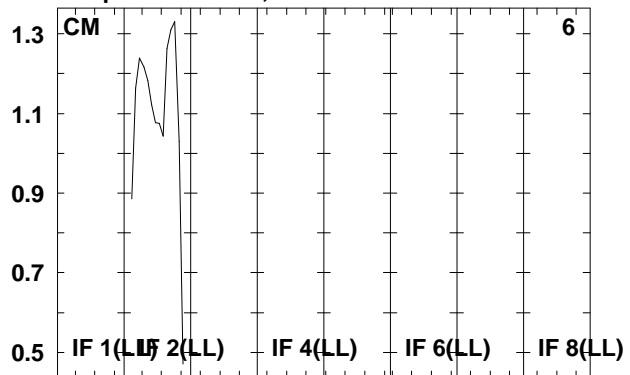

Lower frame: Real Jy  
Total-power spectrum Antenna: \*  
Timerange: 00/17:02:20 to 00/17:04:36

Plot file version 235 created 07-DEC-2009 16:06:22

J1912+05 RT006C.UVDATA.1

Freq = 4.9415 GHz, Bw = 16.000 MH No calibration applied and no bandpass applied

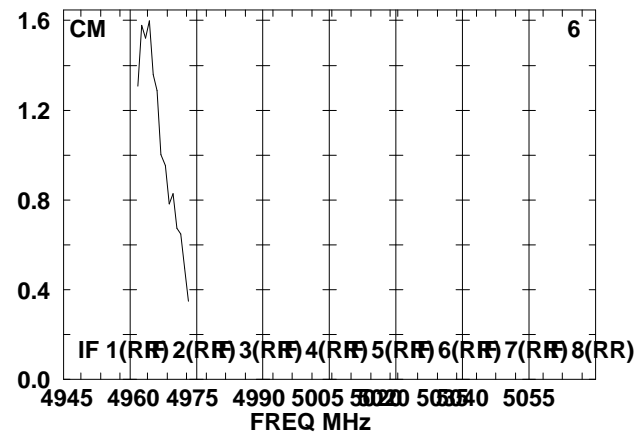
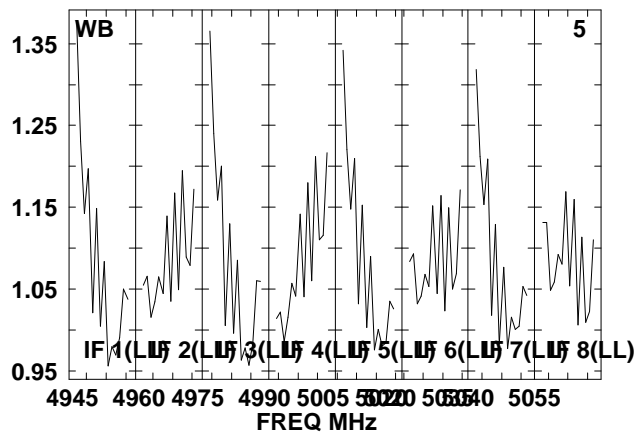
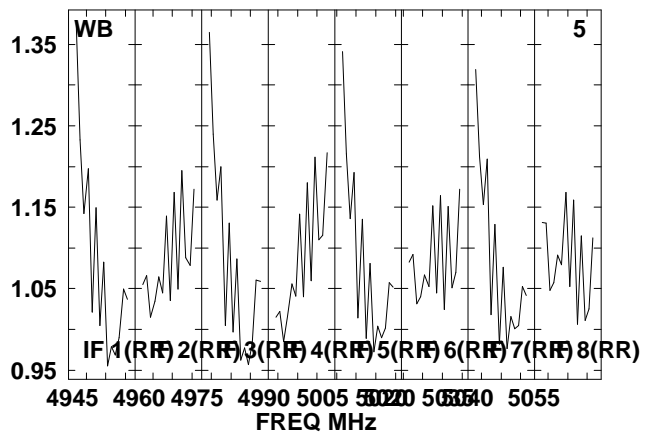
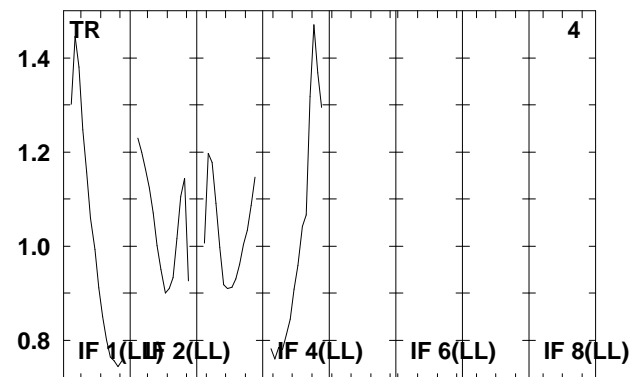
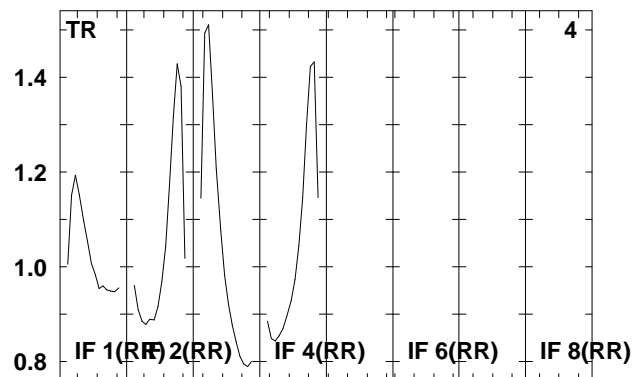
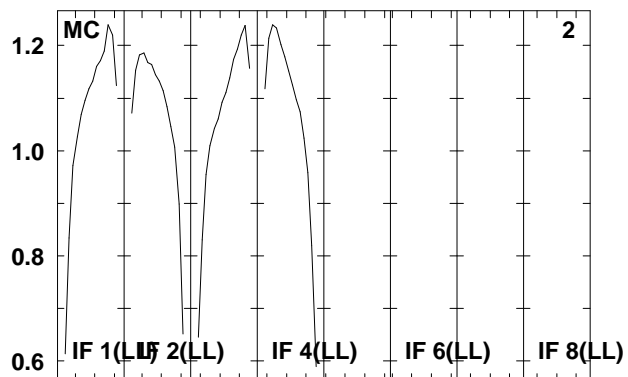
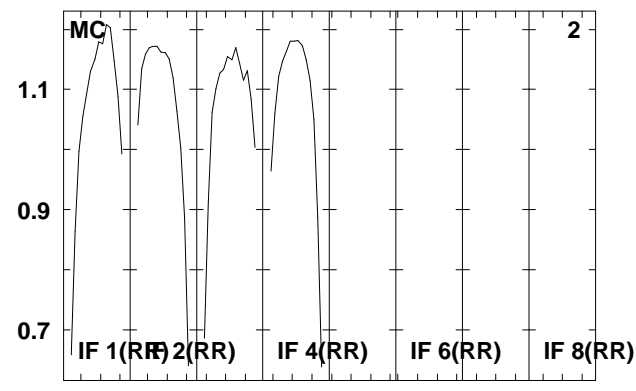
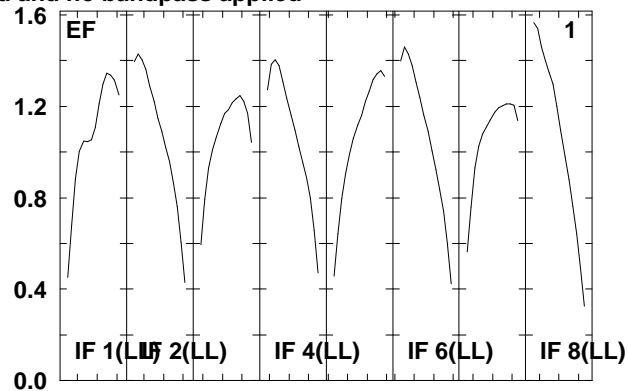
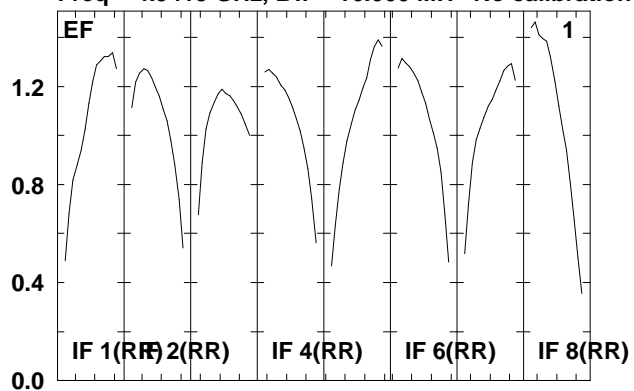

Lower frame: Real Jy  
Total-power spectrum Antenna: \*  
Timerange: 00/17:04:40 to 00/17:05:56

Plot file version 236 created 07-DEC-2009 16:06:22

J1912+05 RT006C.UVDATA.1

Freq = 4.9415 GHz, Bw = 16.000 MH No calibration applied and no bandpass applied

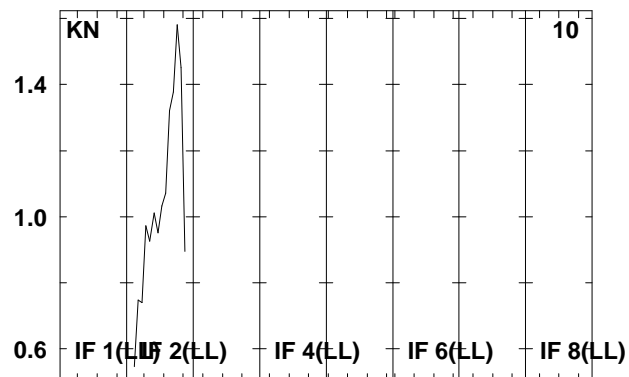
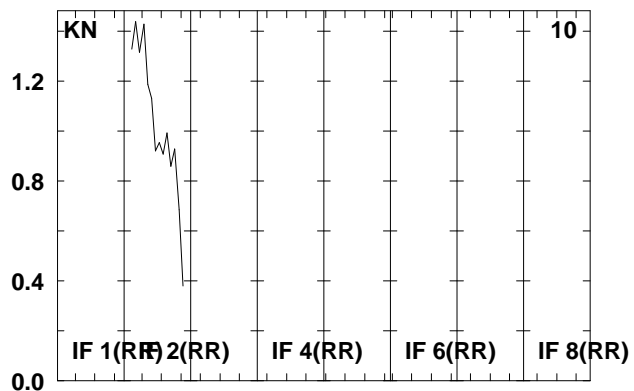
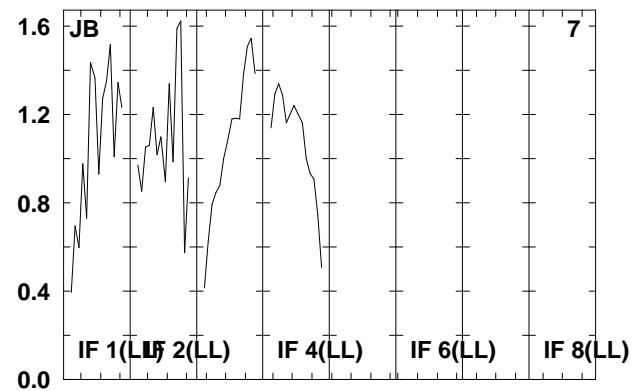
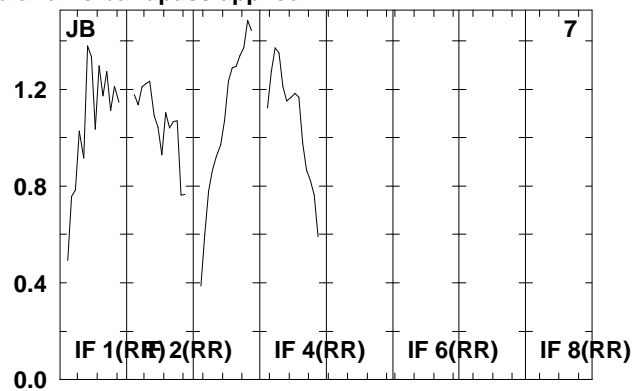
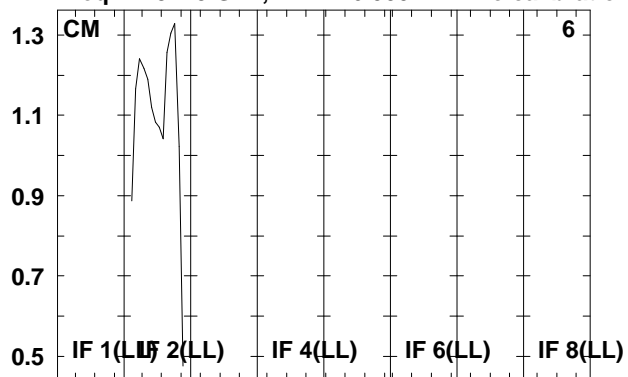

Lower frame: Real Jy  
Total-power spectrum Antenna: \*  
Timerange: 00/17:04:40 to 00/17:05:56

Plot file version 237 created 07-DEC-2009 16:06:22

SS433 RT006C.UVDATA.1

Freq = 4.9415 GHz, Bw = 16.000 MH No calibration applied and no bandpass applied

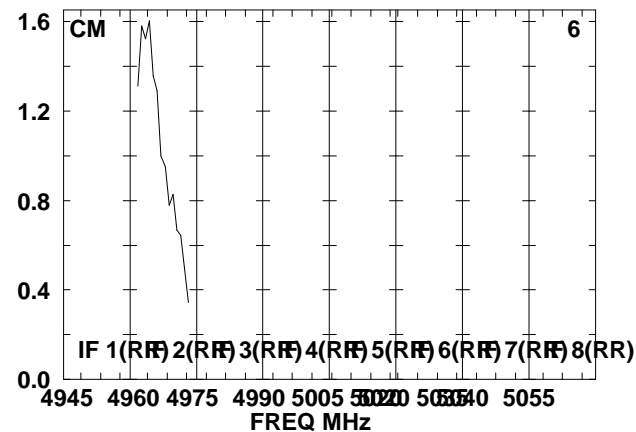
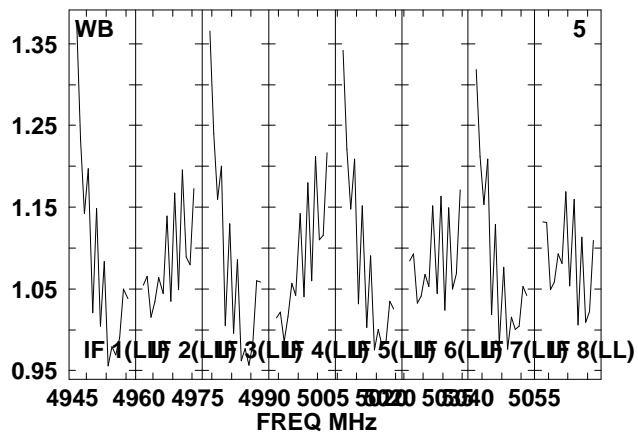
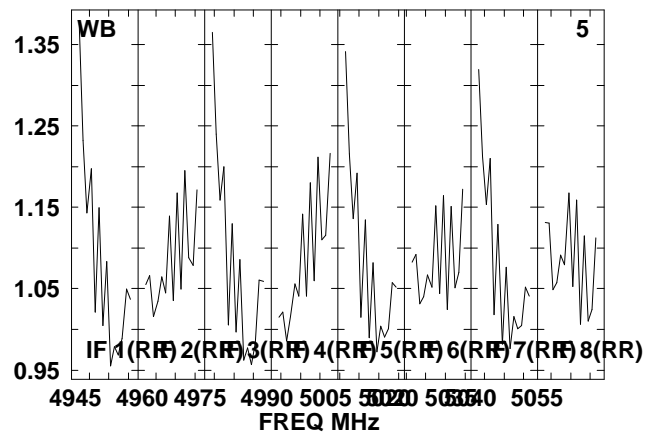
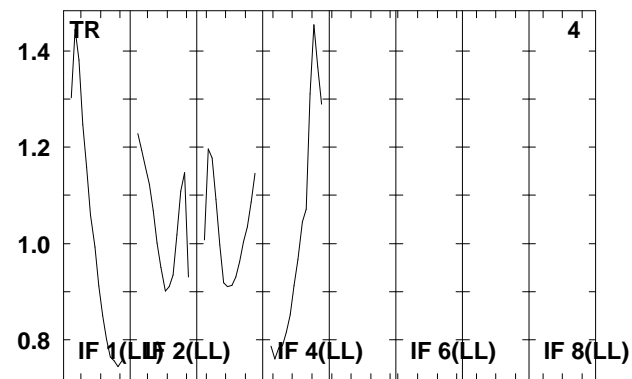
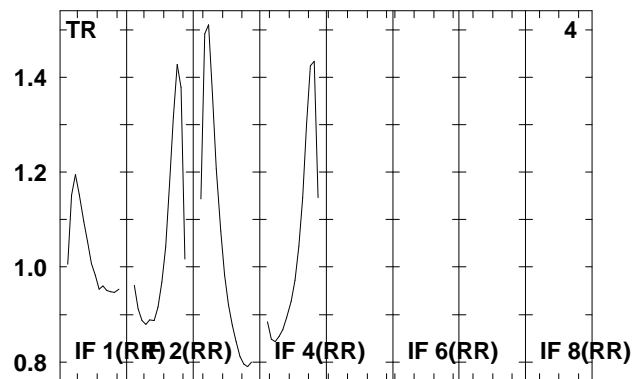
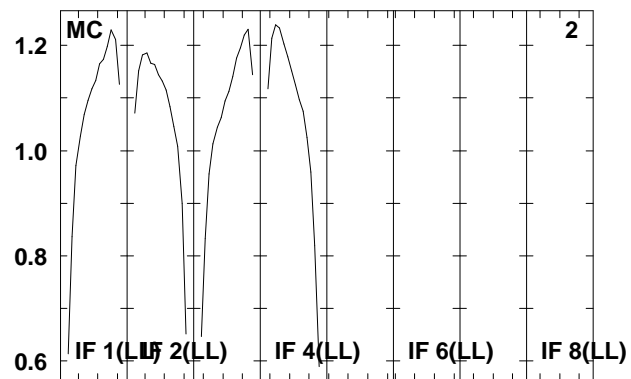
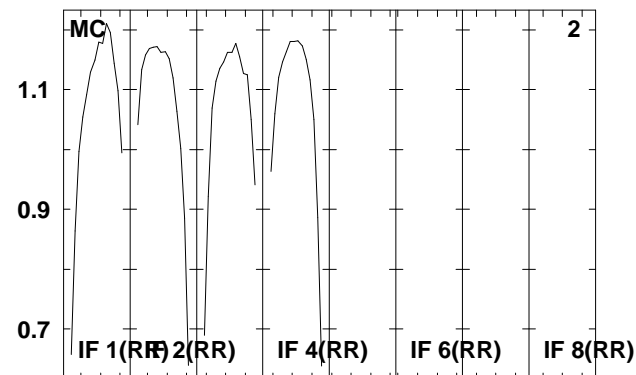
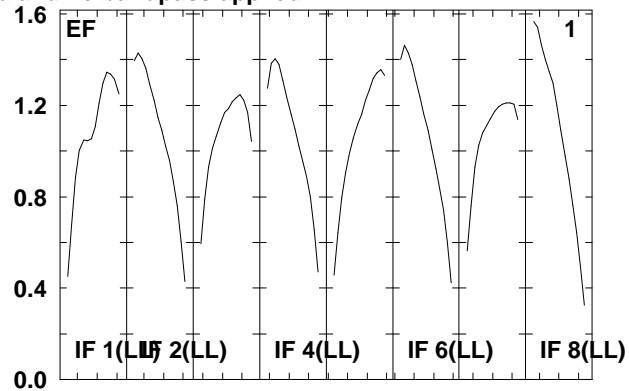
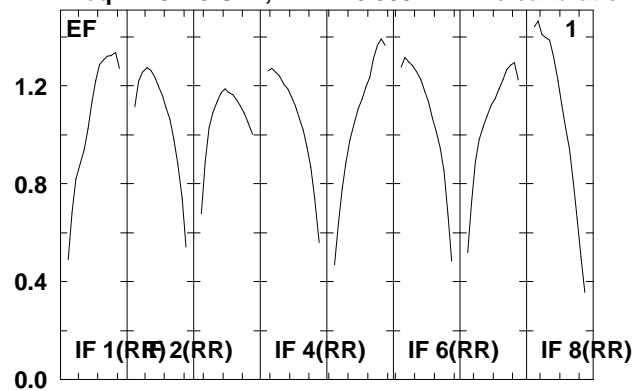

Lower frame: Real Jy  
Total-power spectrum Antenna: \*  
Timerange: 00/17:06:04 to 00/17:08:16

Plot file version 238 created 07-DEC-2009 16:06:23

SS433 RT006C.UVDATA.1

Freq = 4.9415 GHz, Bw = 16.000 MH No calibration applied and no bandpass applied

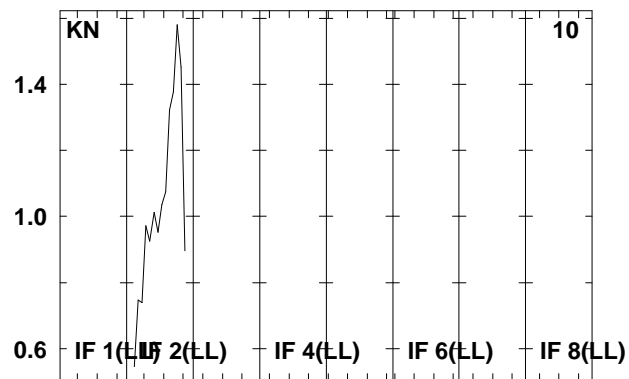
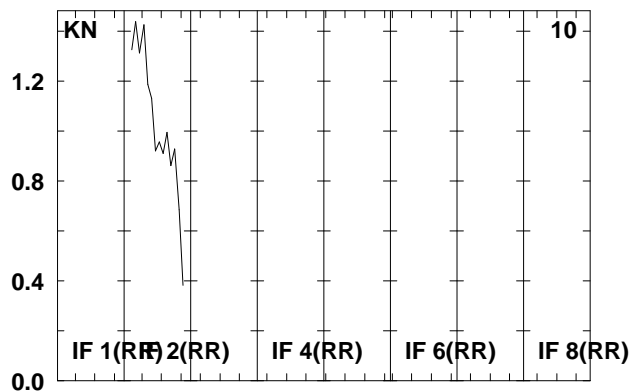
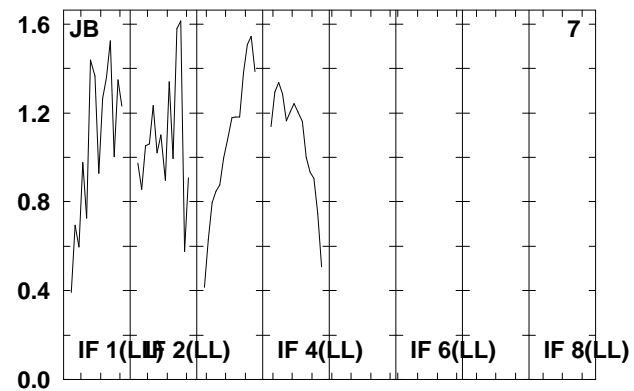
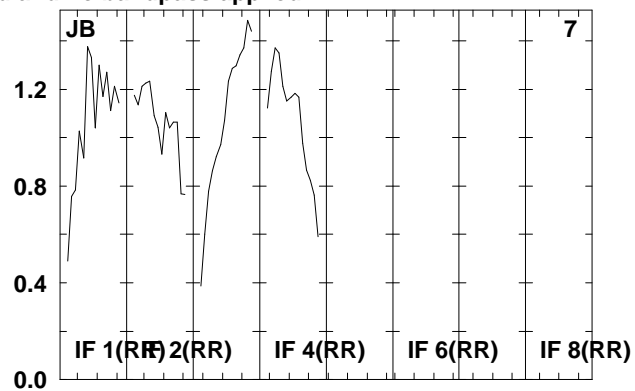
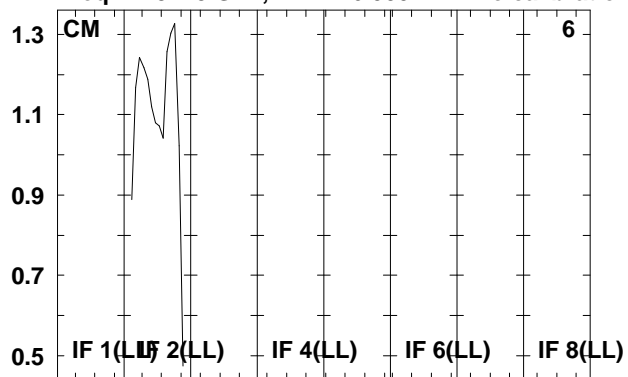

Lower frame: Real Jy  
Total-power spectrum Antenna: \*  
Timerange: 00/17:06:04 to 00/17:08:16

Plot file version 239 created 07-DEC-2009 16:06:23

J1911+16 RT006C.UVDATA.1

Freq = 4.9415 GHz, Bw = 16.000 MH No calibration applied and no bandpass applied

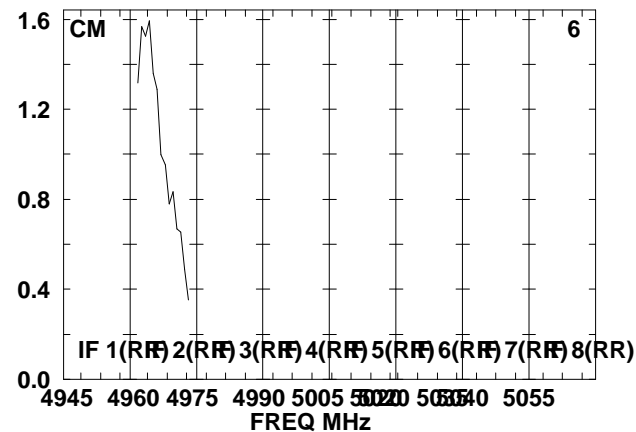
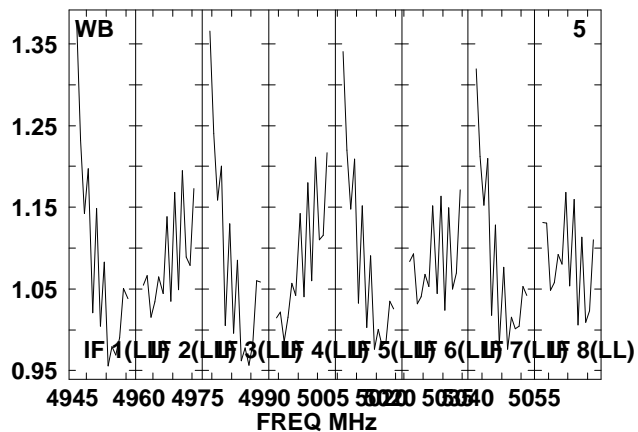
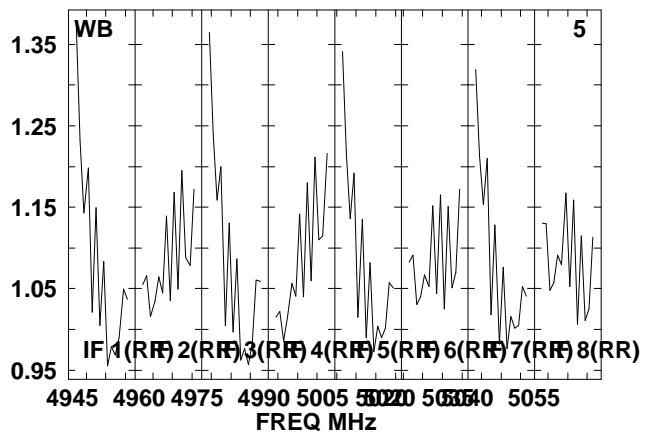
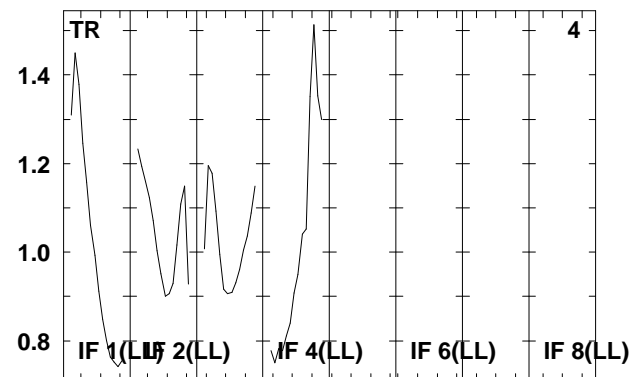
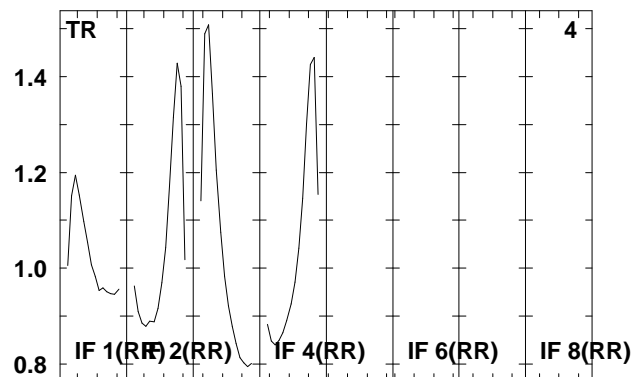
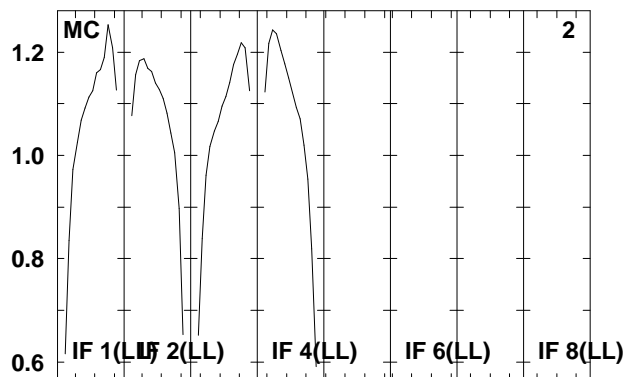
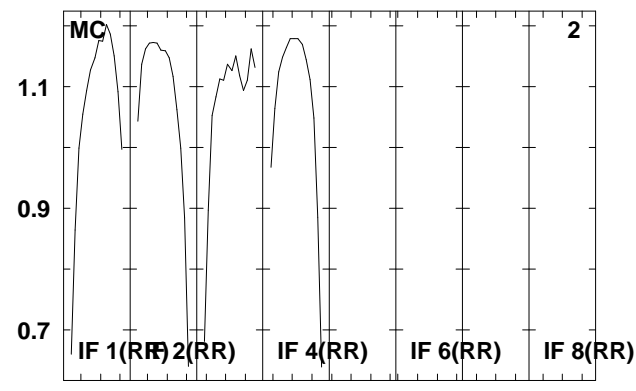
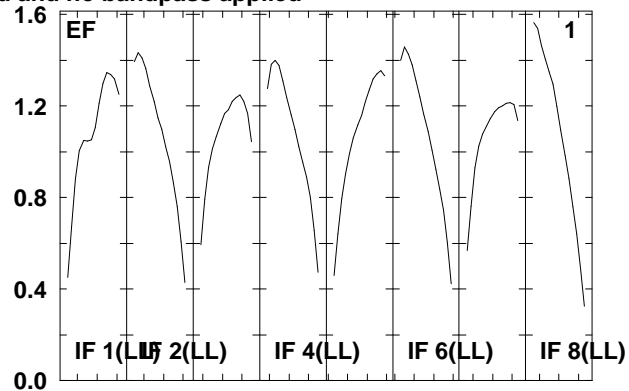
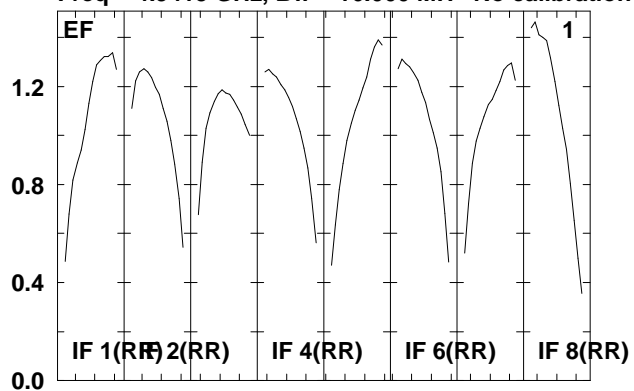

Lower frame: Real Jy  
Total-power spectrum Antenna: \*  
Timerange: 00/17:09:20 to 00/17:10:16

Plot file version 240 created 07-DEC-2009 16:06:23

J1911+16 RT006C.UVDATA.1

Freq = 4.9415 GHz, Bw = 16.000 MH No calibration applied and no bandpass applied

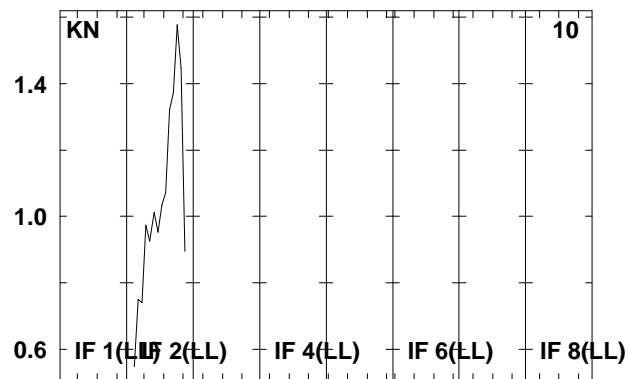
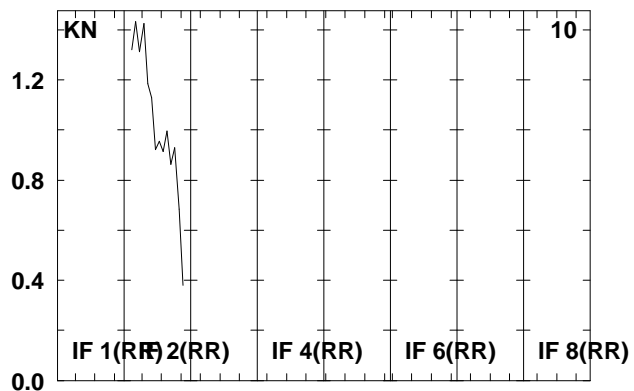
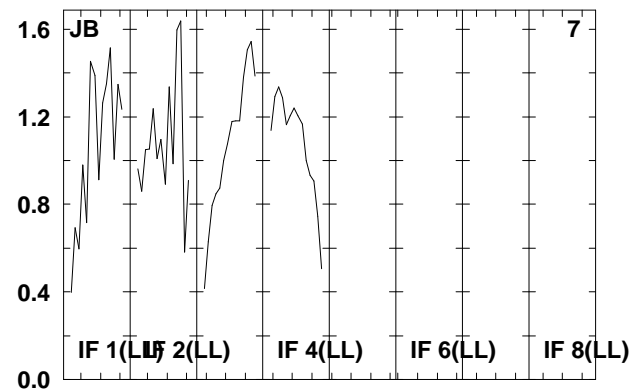
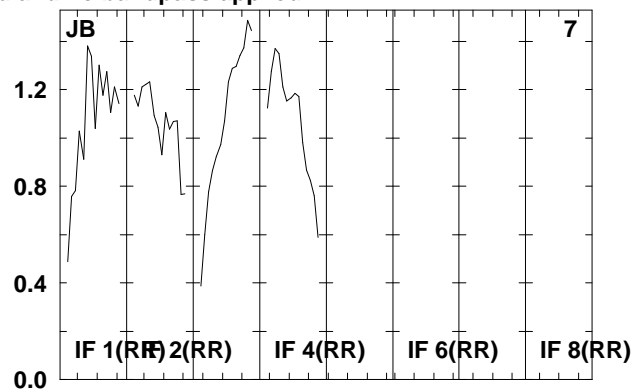
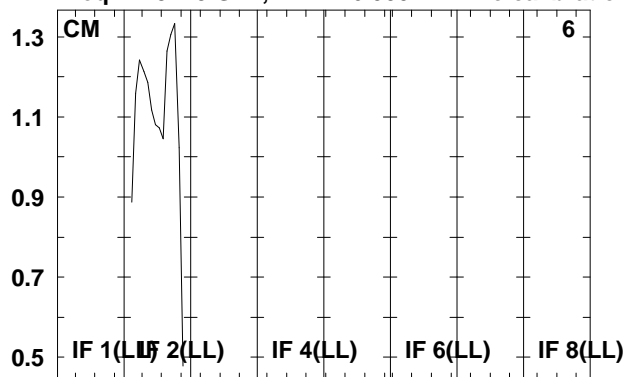

Lower frame: Real Jy  
Total-power spectrum Antenna: \*  
Timerange: 00/17:09:20 to 00/17:10:16



Plot file version 241 created 07-DEC-2009 16:06:23

J1912+05 RT006C.UVDATA.1

Freq = 4.9415 GHz, Bw = 16.000 MH No calibration applied and no bandpass applied

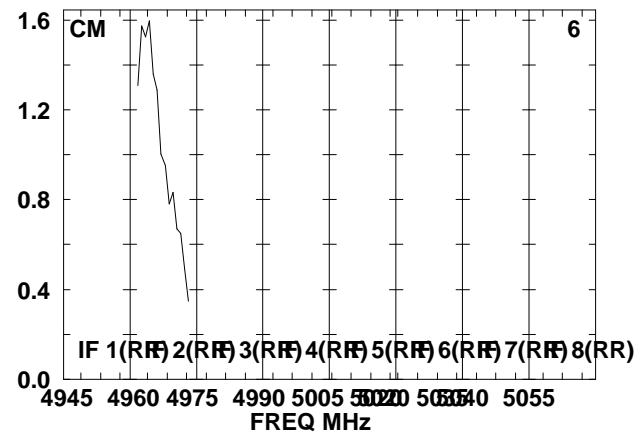
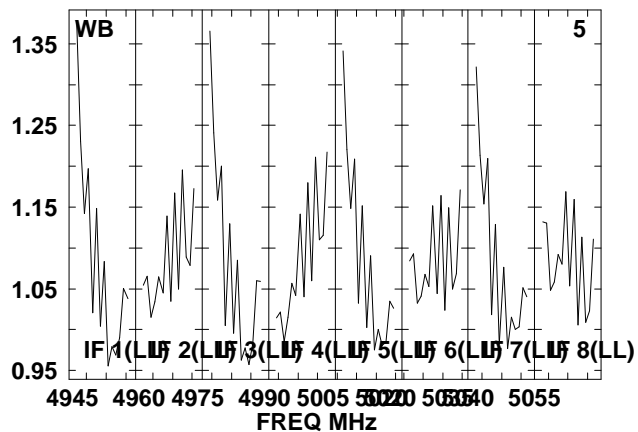
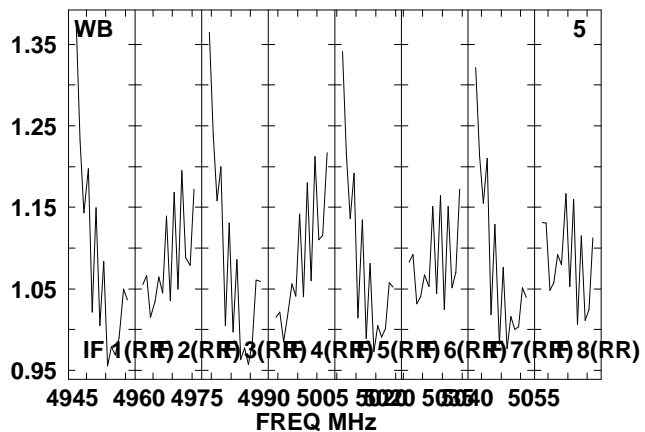
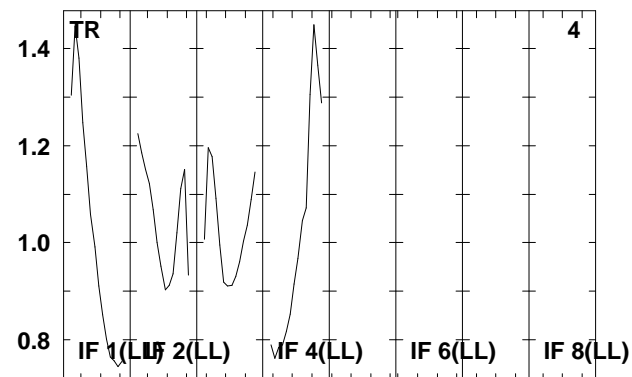
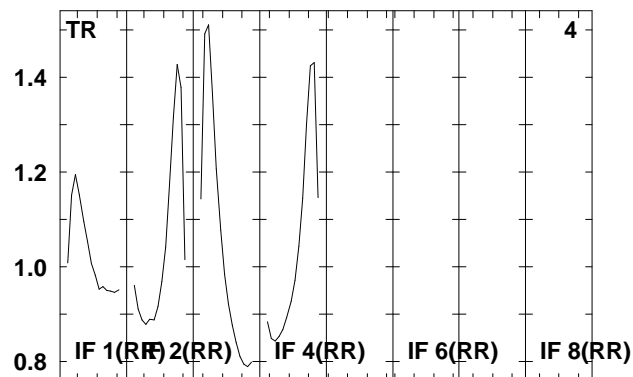
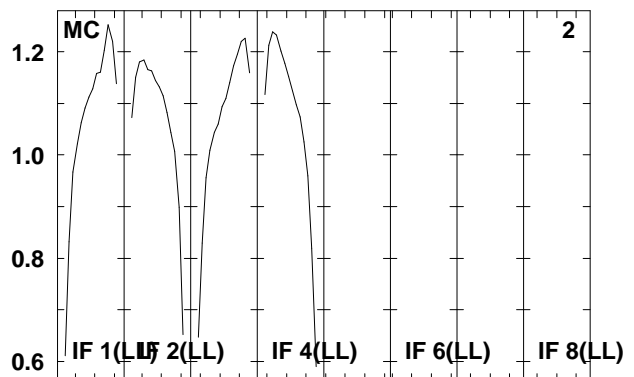
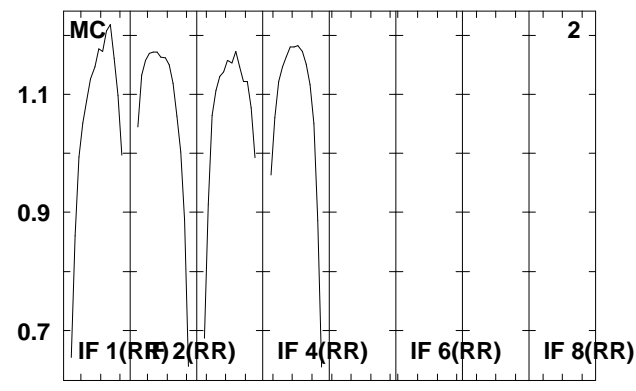
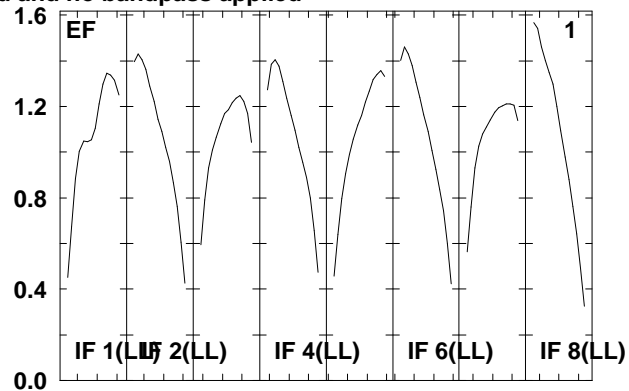
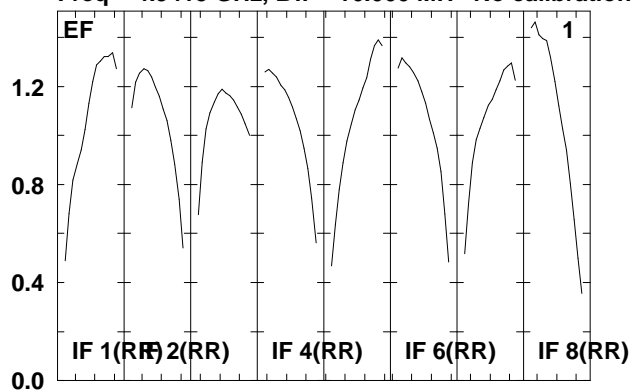

Lower frame: Real Jy  
Total-power spectrum Antenna: \*  
Timerange: 00/17:11:20 to 00/17:12:20

Plot file version 242 created 07-DEC-2009 16:06:24

J1912+05 RT006C.UVDATA.1

Freq = 4.9415 GHz, Bw = 16.000 MH No calibration applied and no bandpass applied

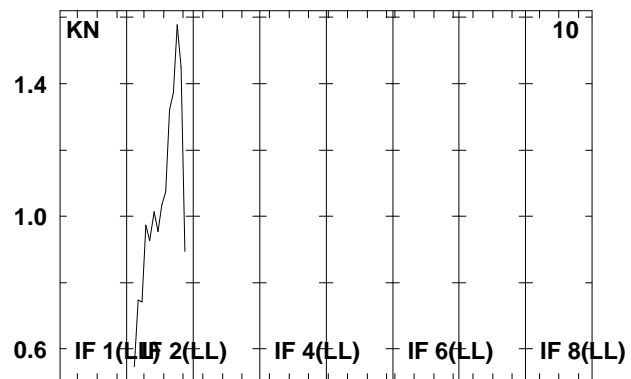
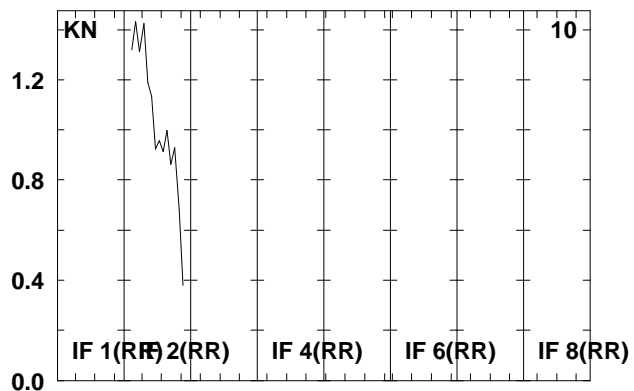
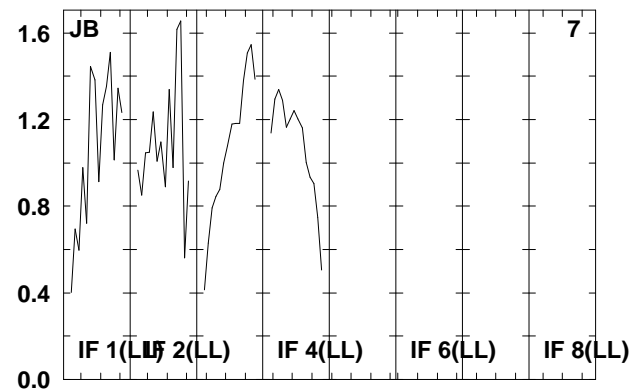
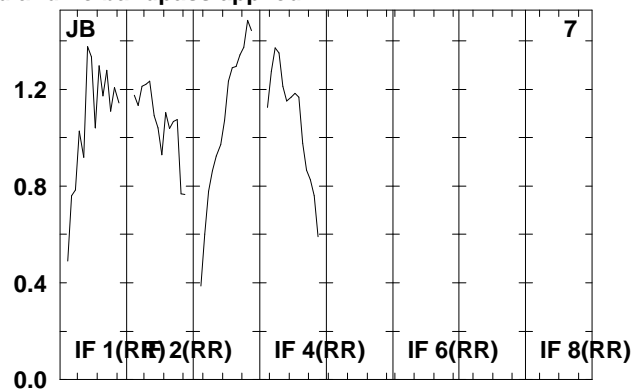
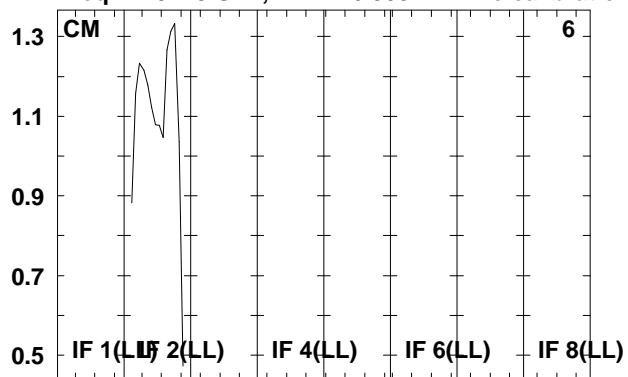

Lower frame: Real Jy  
Total-power spectrum Antenna: \*  
Timerange: 00/17:11:20 to 00/17:12:20

Plot file version 243 created 07-DEC-2009 16:06:24

SS433 RT006C.UVDATA.1

Freq = 4.9415 GHz, Bw = 16.000 MH No calibration applied and no bandpass applied

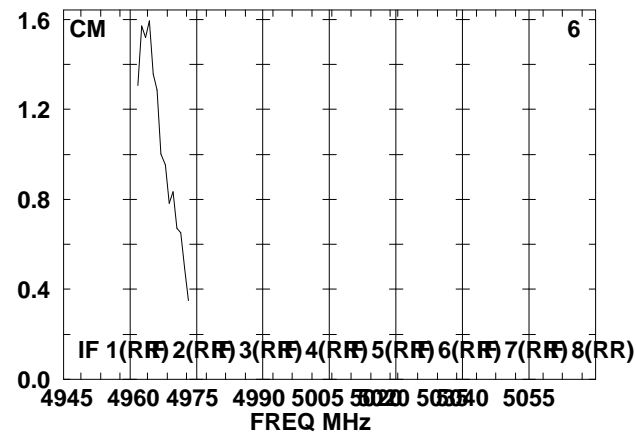
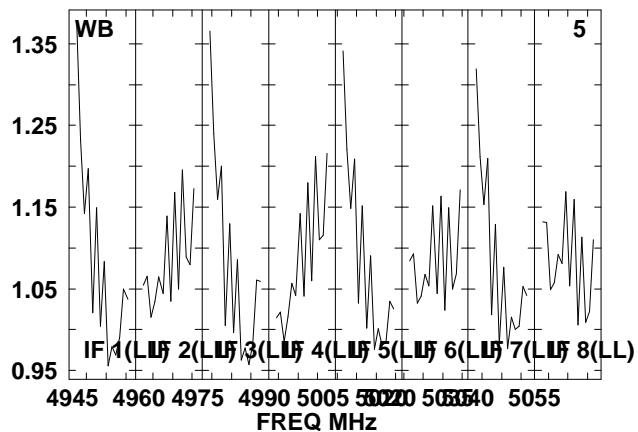
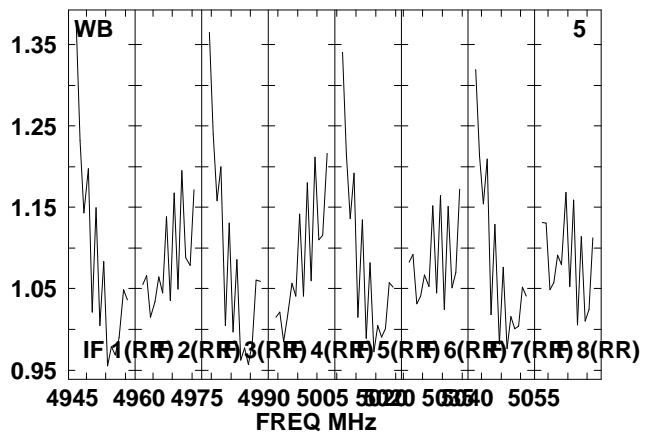
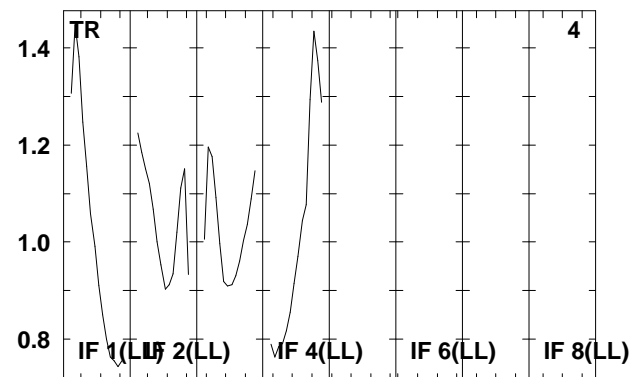
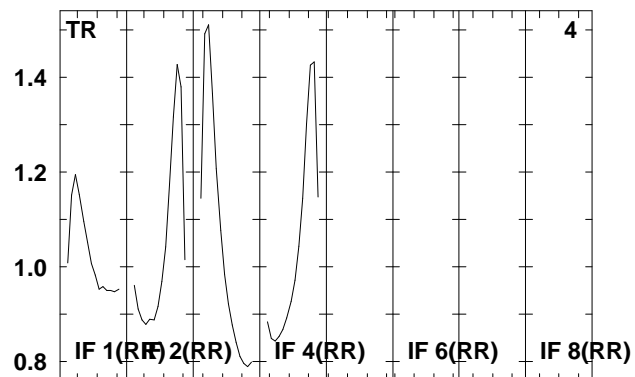
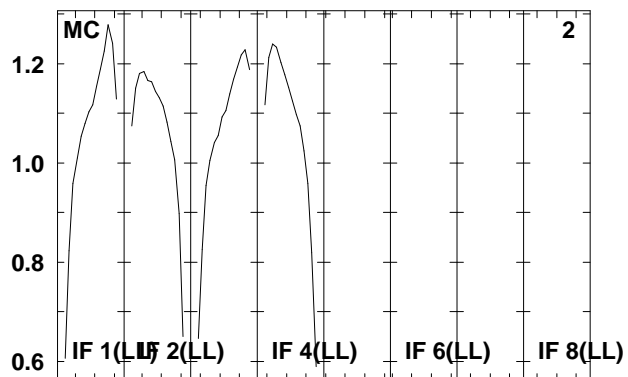
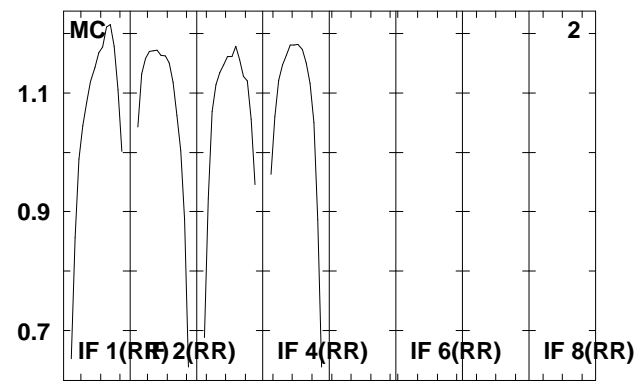
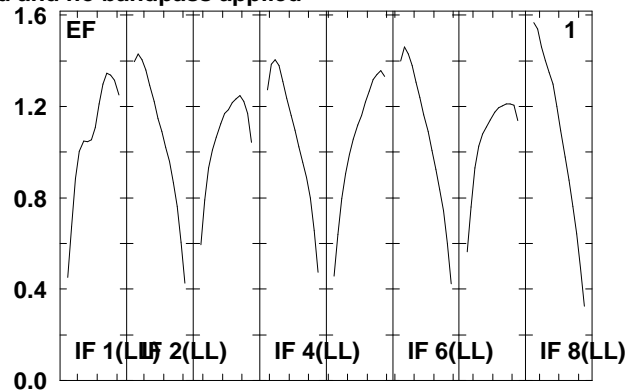
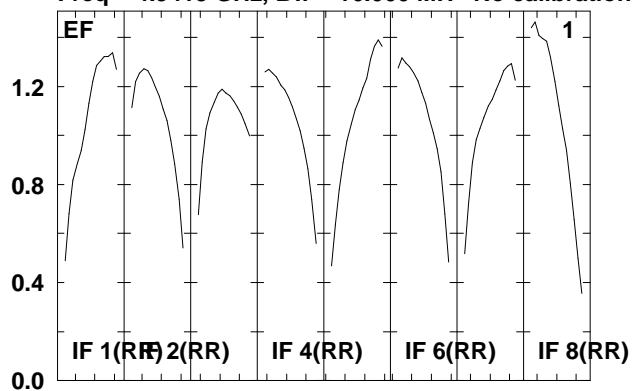

Lower frame: Real Jy

Total-power spectrum Antenna: \*

Timerange: 00/17:12:24 to 00/17:14:40

Plot file version 244 created 07-DEC-2009 16:06:24

SS433 RT006C.UVDATA.1

Freq = 4.9415 GHz, Bw = 16.000 MH No calibration applied and no bandpass applied

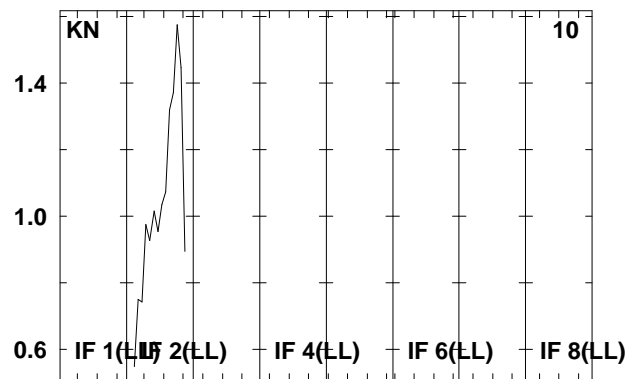
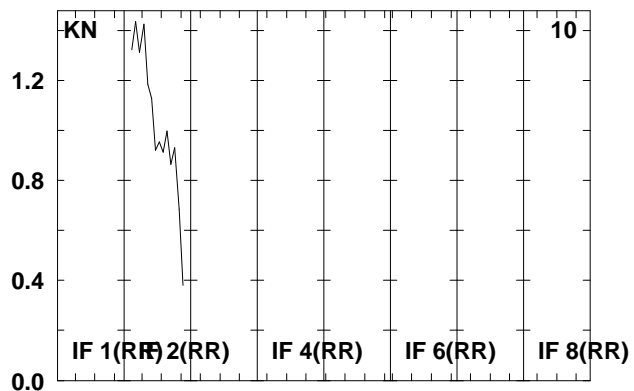
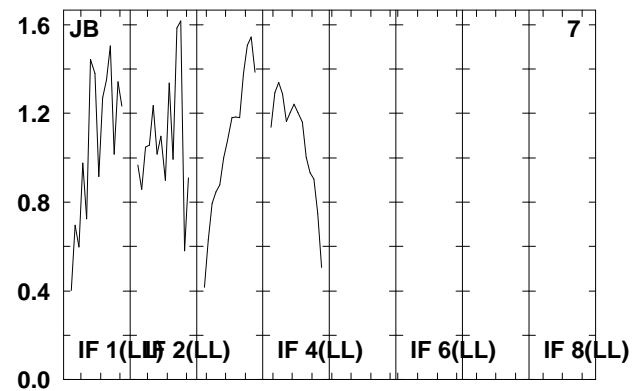
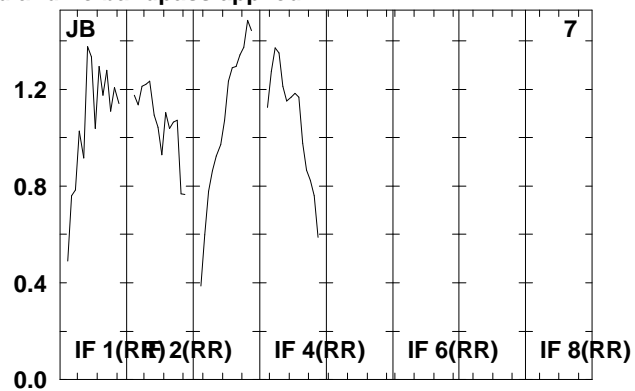
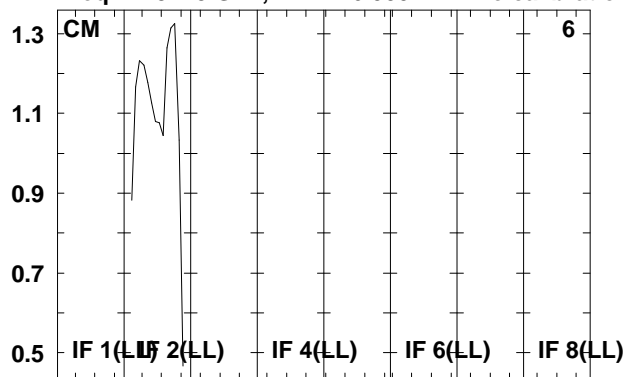

Lower frame: Real Jy  
Total-power spectrum Antenna: \*  
Timerange: 00/17:12:24 to 00/17:14:40

Plot file version 245 created 07-DEC-2009 16:06:24

J1912+05 RT006C.UVDATA.1

Freq = 4.9415 GHz, Bw = 16.000 MH No calibration applied and no bandpass applied

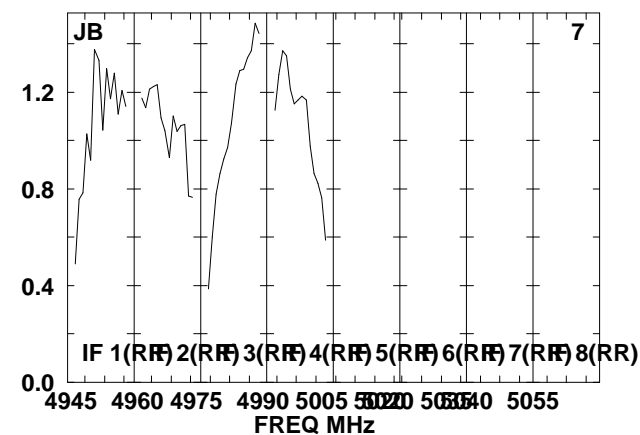
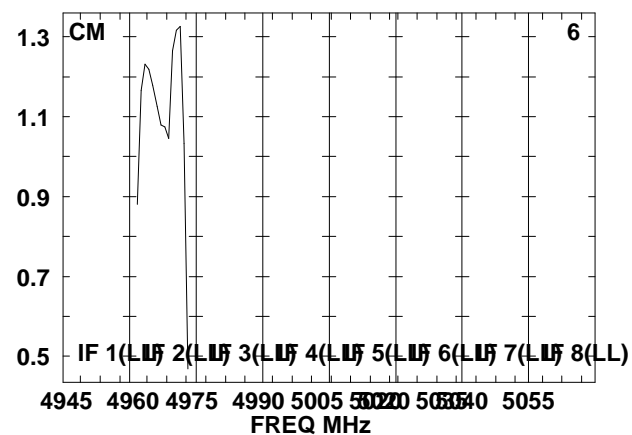
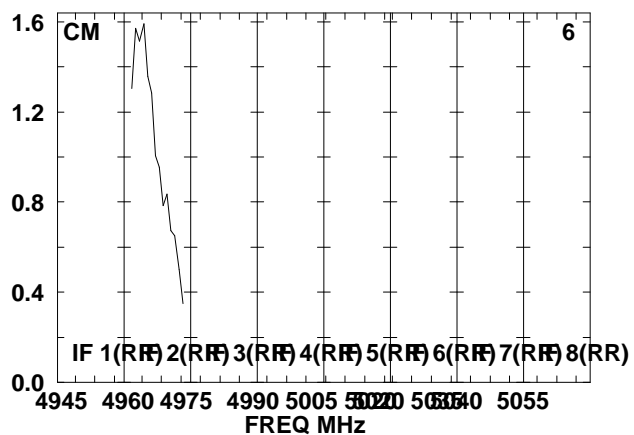
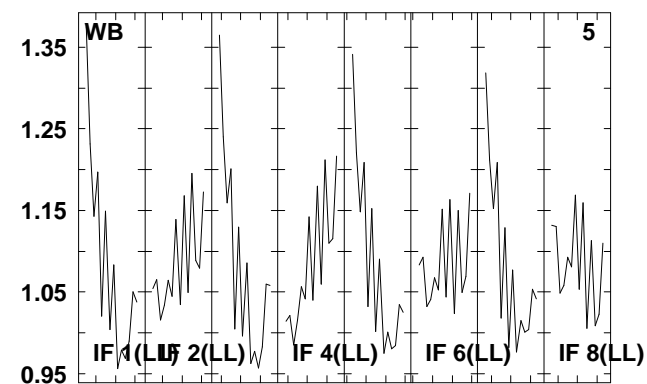
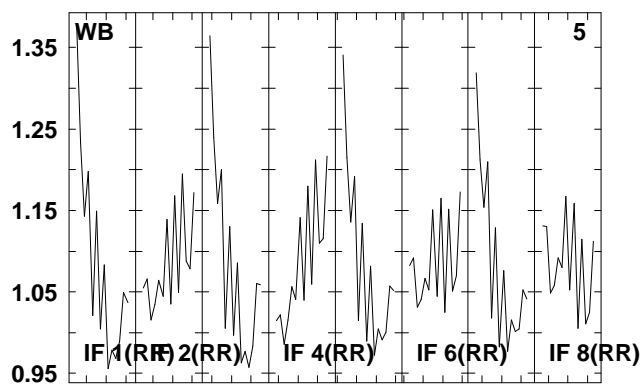
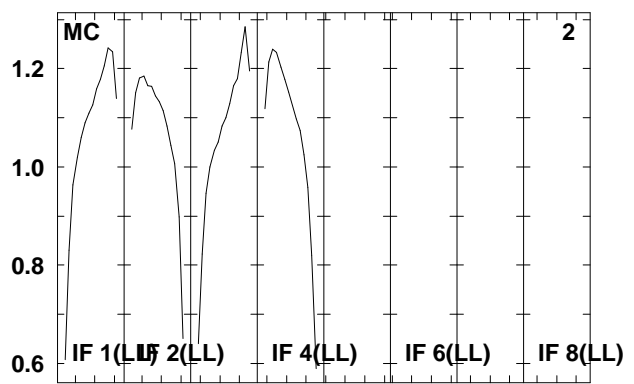
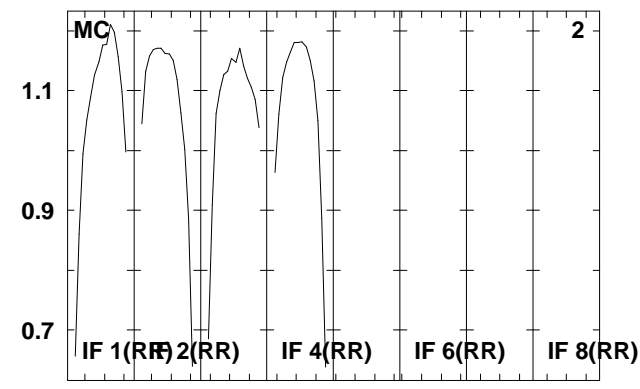
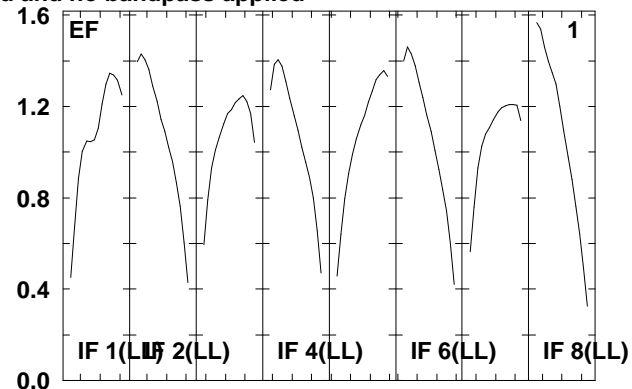
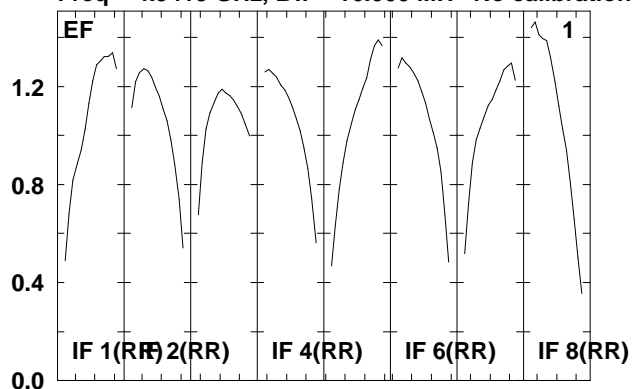

Lower frame: Real Jy  
Total-power spectrum Antenna: \*  
Timerange: 00/17:14:44 to 00/17:15:56

Plot file version 246 created 07-DEC-2009 16:06:24

J1912+05 RT006C.UVDATA.1

Freq = 4.9415 GHz, Bw = 16.000 MH No calibration applied and no bandpass applied

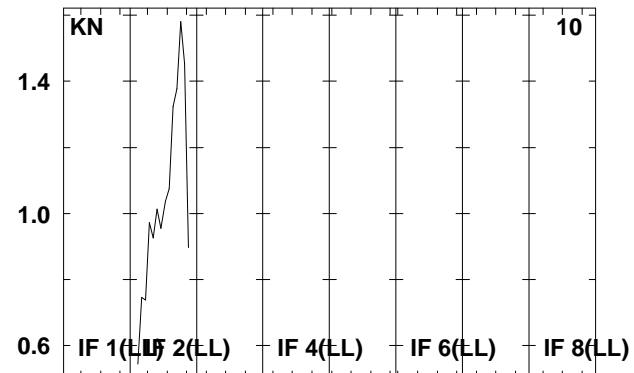
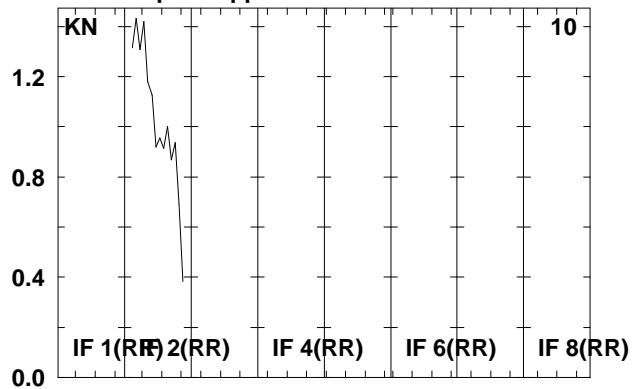
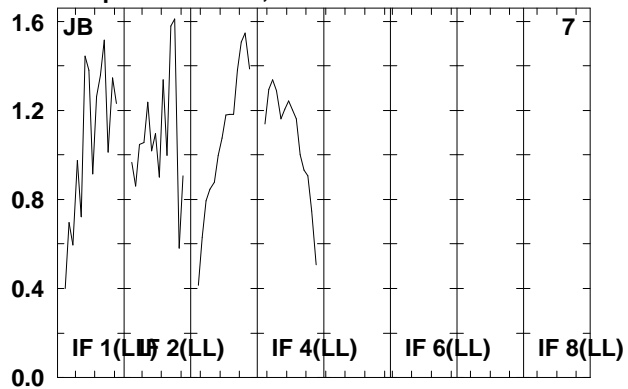

Lower frame: Real Jy  
Total-power spectrum Antenna: \*  
Timerange: 00/17:14:44 to 00/17:15:56

Plot file version 247 created 07-DEC-2009 16:06:24

SS433 RT006C.UVDATA.1

Freq = 4.9415 GHz, Bw = 16.000 MH No calibration applied and no bandpass applied

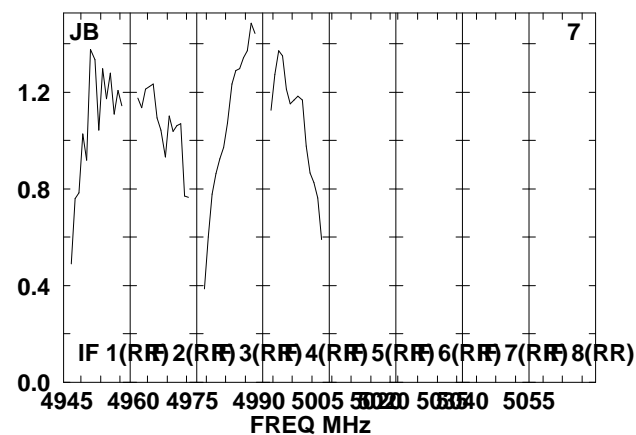
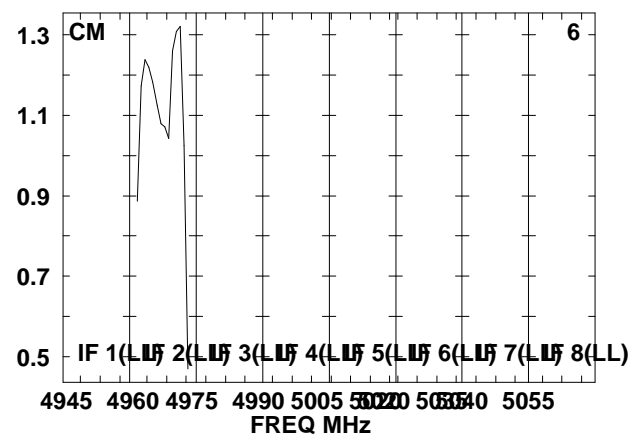
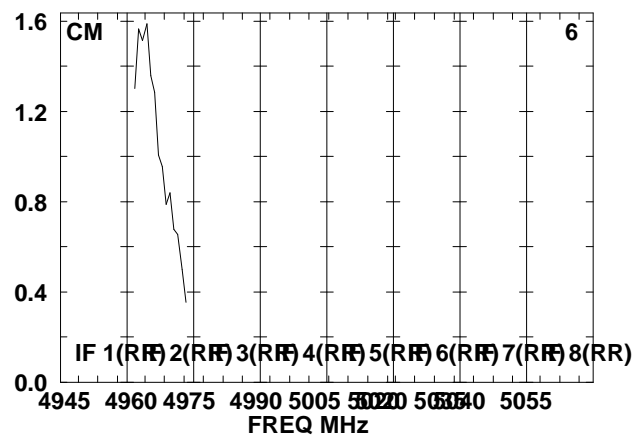
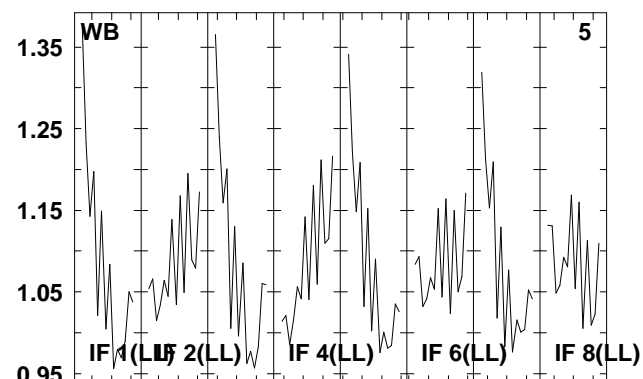
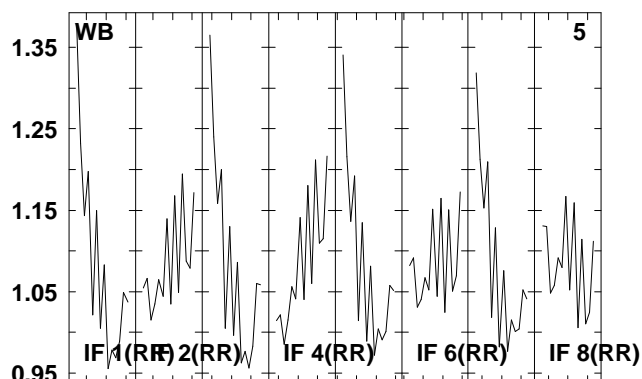
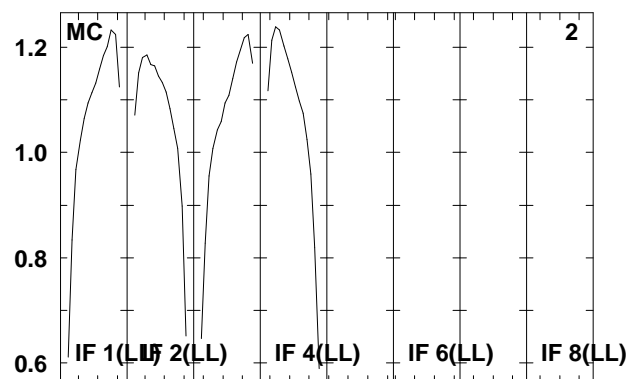
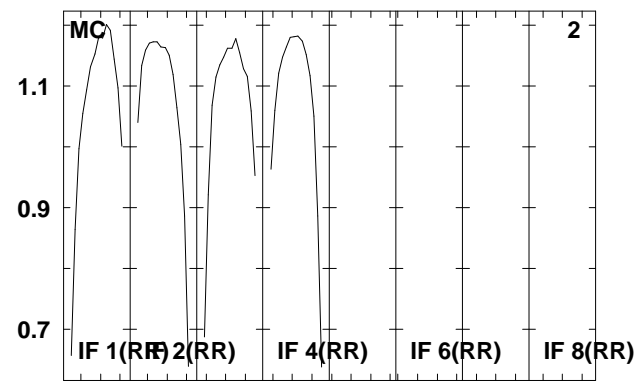
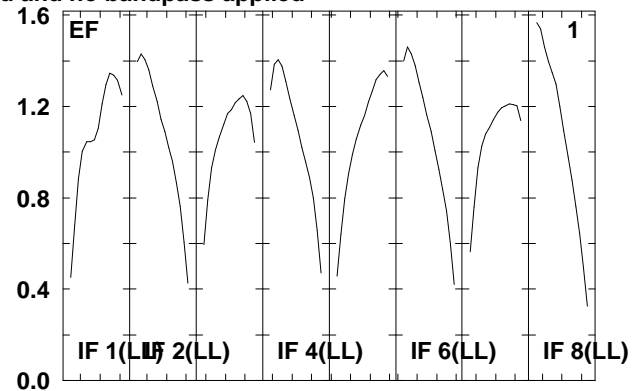
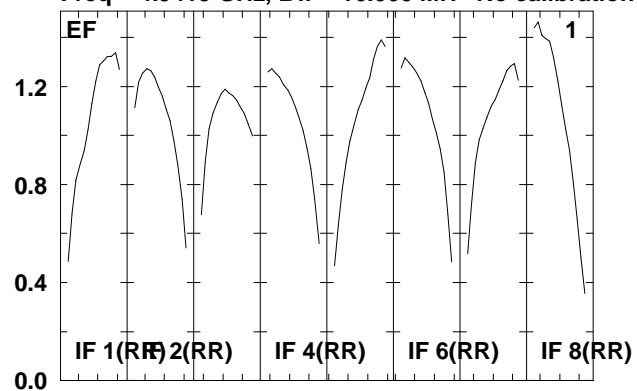

Lower frame: Real Jy  
Total-power spectrum Antenna: \*  
Timerange: 00/17:16:00 to 00/17:18:16

Plot file version 248 created 07-DEC-2009 16:06:25

SS433 RT006C.UVDATA.1

Freq = 4.9415 GHz, Bw = 16.000 MH No calibration applied and no bandpass applied

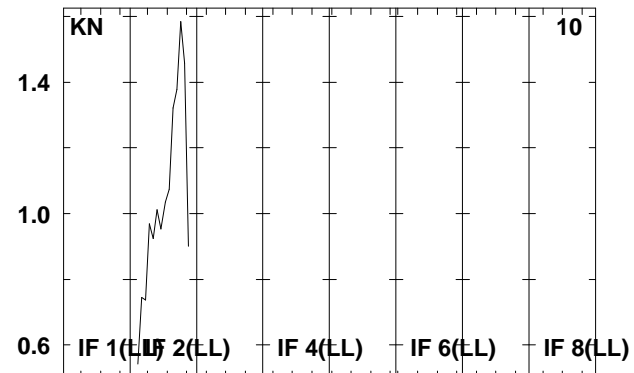
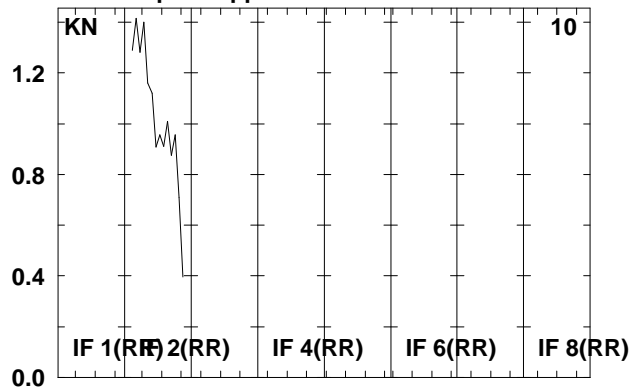
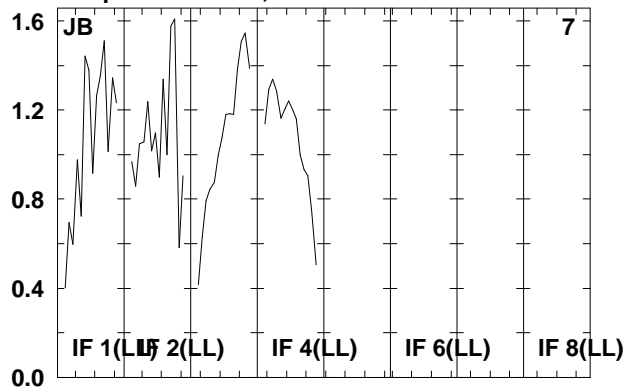

Lower frame: Real Jy  
Total-power spectrum Antenna: \*  
Timerange: 00/17:16:00 to 00/17:18:16



Plot file version 249 created 07-DEC-2009 16:06:25

J1912+05 RT006C.UVDATA.1

Freq = 4.9415 GHz, Bw = 16.000 MH No calibration applied and no bandpass applied

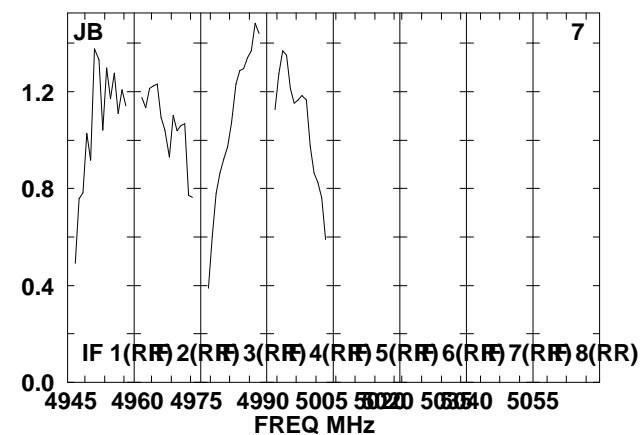
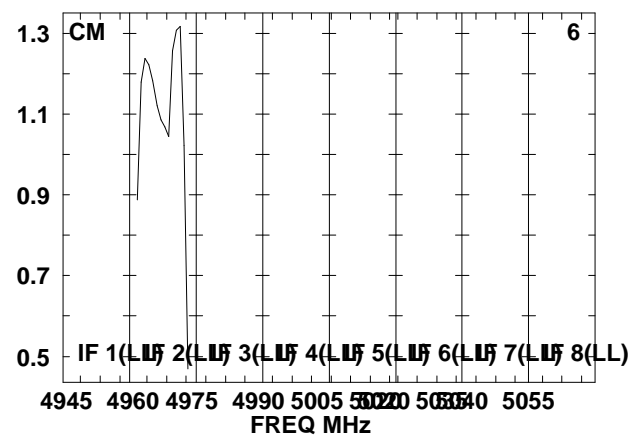
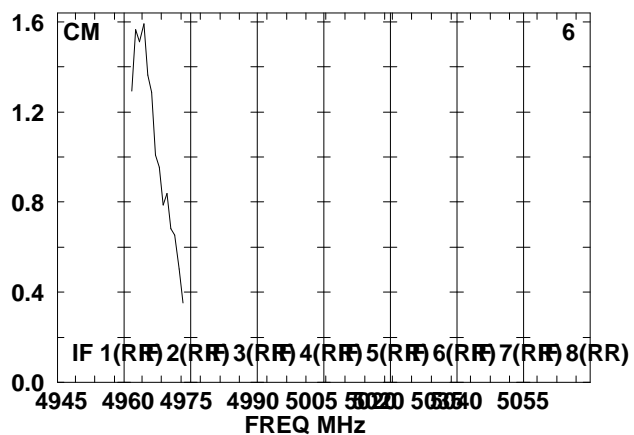
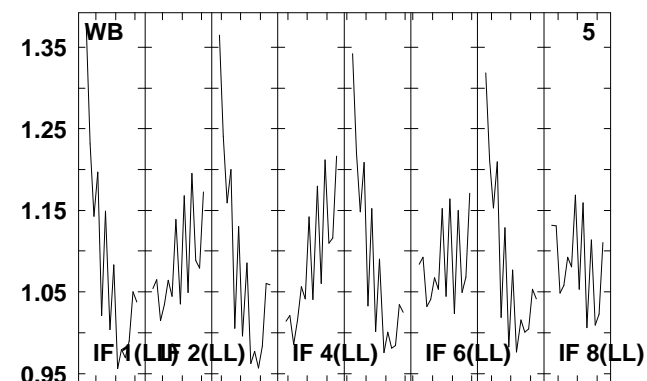
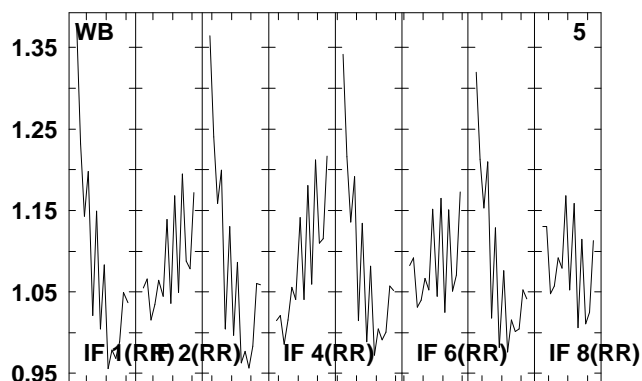
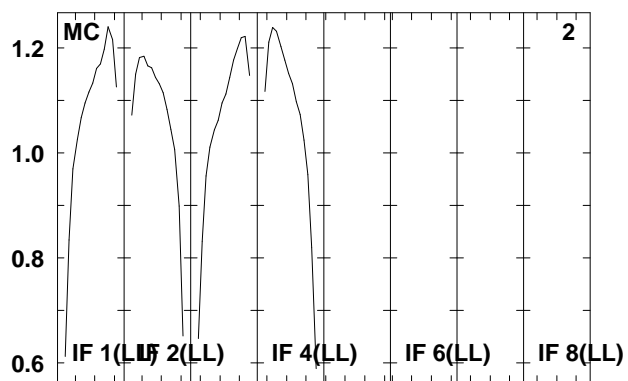
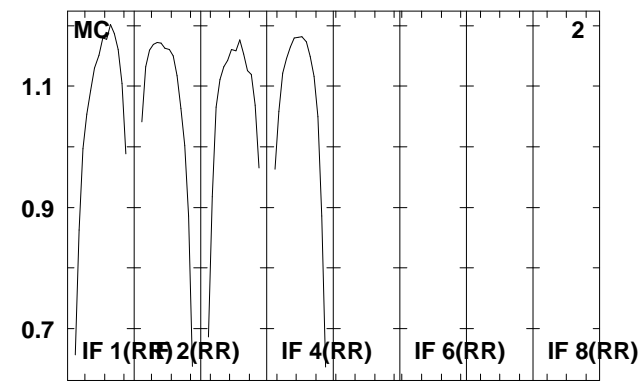
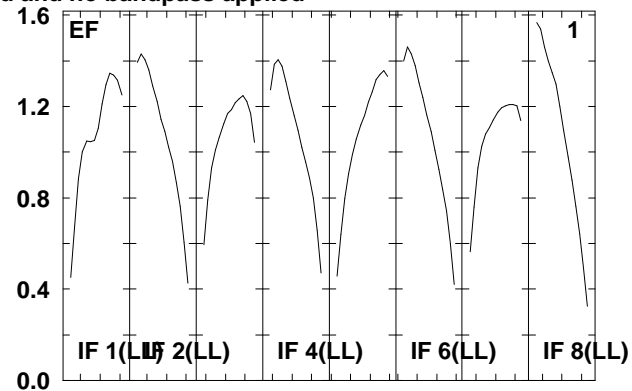
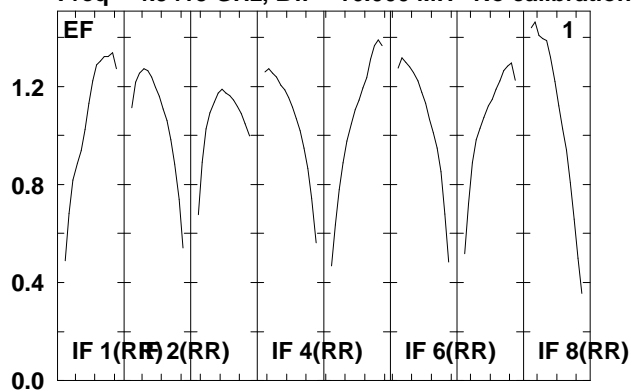

Lower frame: Real Jy  
Total-power spectrum Antenna: \*  
Timerange: 00/17:18:20 to 00/17:19:36

Plot file version 250 created 07-DEC-2009 16:06:25

J1912+05 RT006C.UVDATA.1

Freq = 4.9415 GHz, Bw = 16.000 MH No calibration applied and no bandpass applied

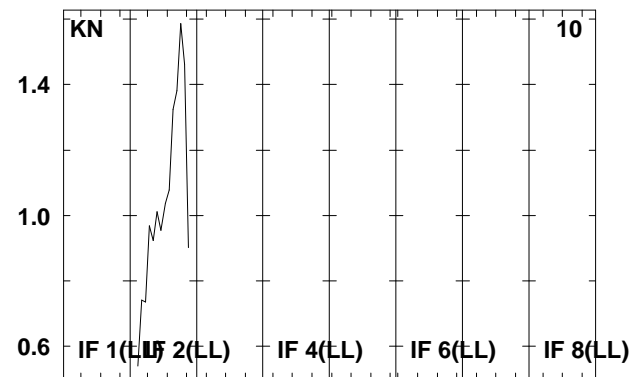
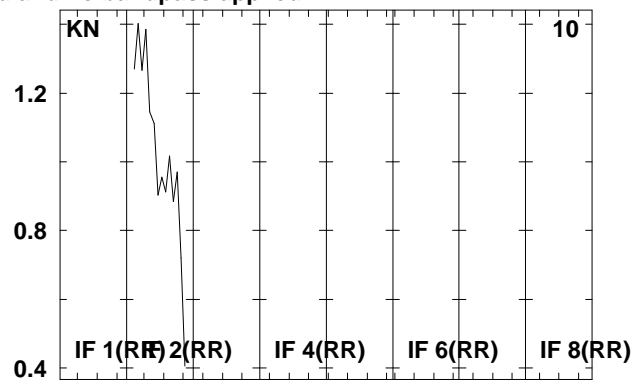
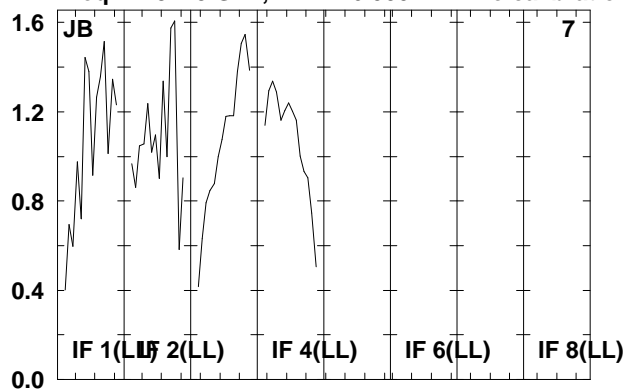

Lower frame: Real Jy  
Total-power spectrum Antenna: \*  
Timerange: 00/17:18:20 to 00/17:19:36

Plot file version 251 created 07-DEC-2009 16:06:25  
 SS433 RT006C.UVDATA.1  
 Freq = 4.9415 GHz, Bw = 16.000 MH No calibration applied and no bandpass applied

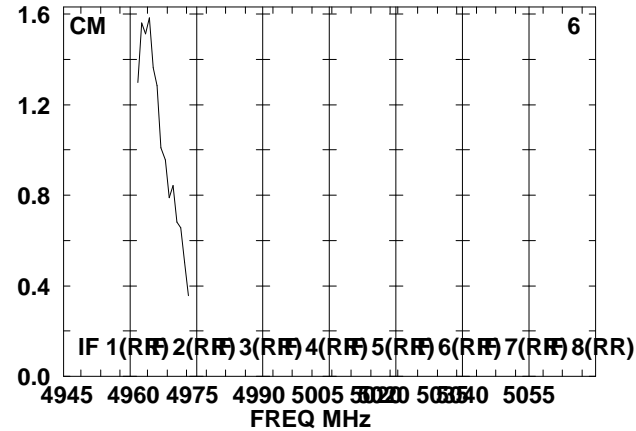
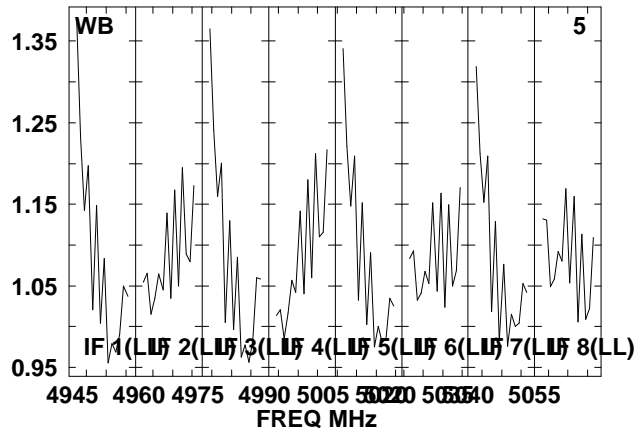
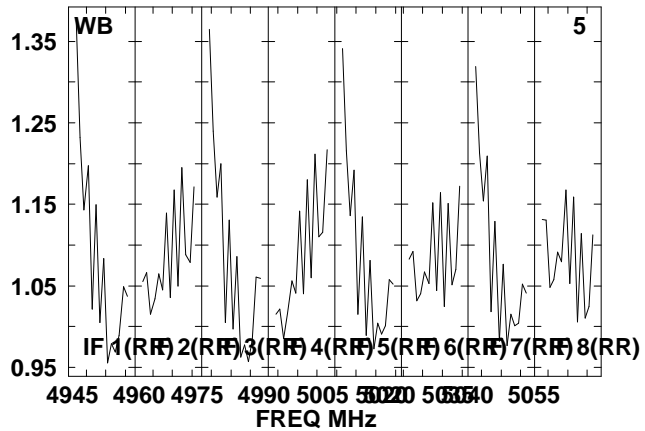
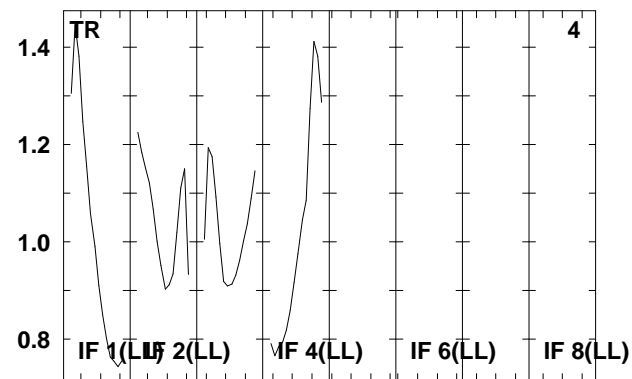
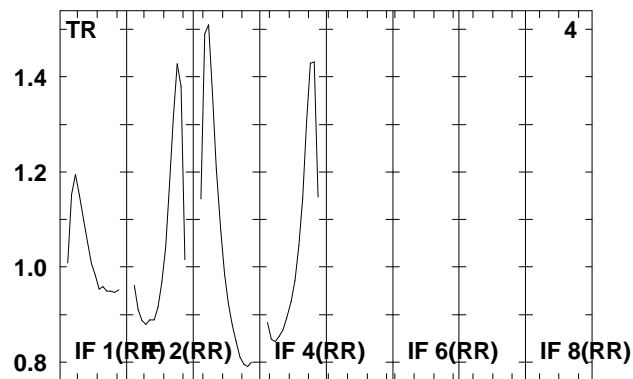
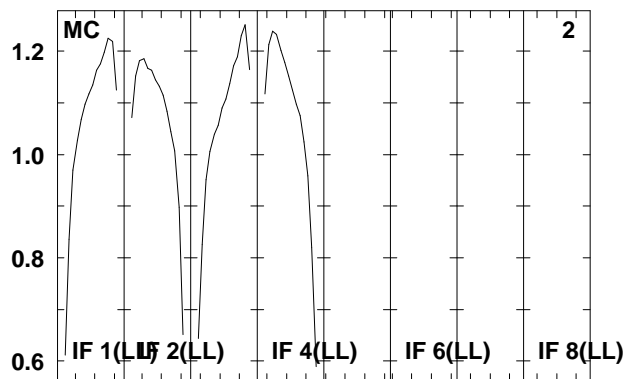
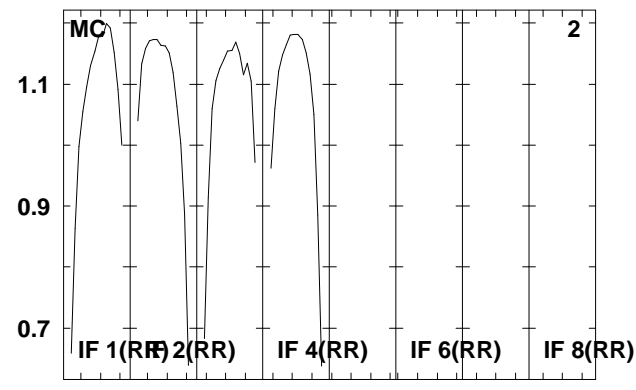
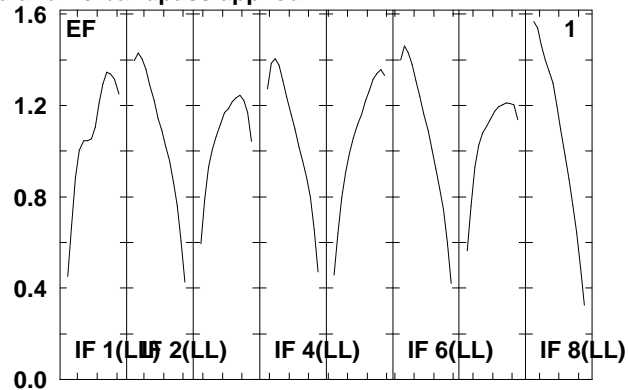
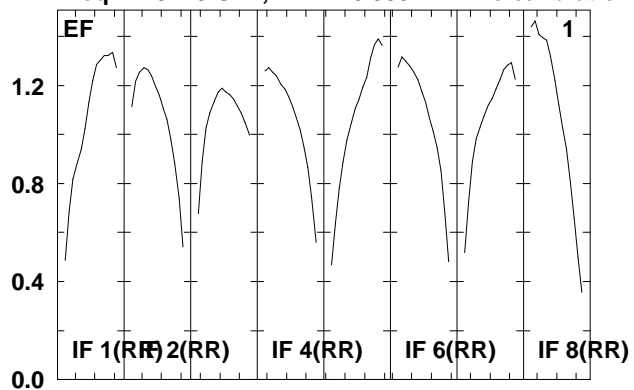

Lower frame: Real Jy  
 Total-power spectrum Antenna: \*  
 Timerange: 00/17:19:40 to 00/17:21:56

Plot file version 252 created 07-DEC-2009 16:06:25

SS433 RT006C.UVDATA.1

Freq = 4.9415 GHz, Bw = 16.000 MH No calibration applied and no bandpass applied

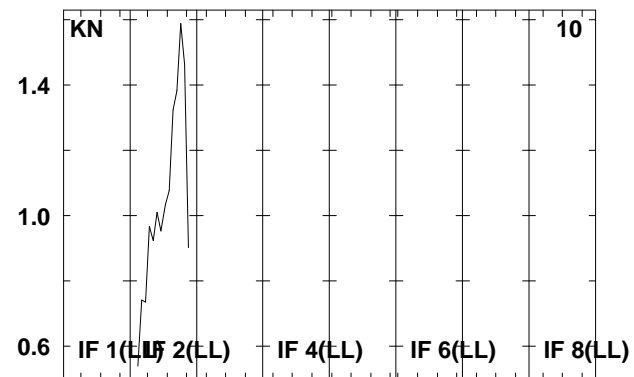
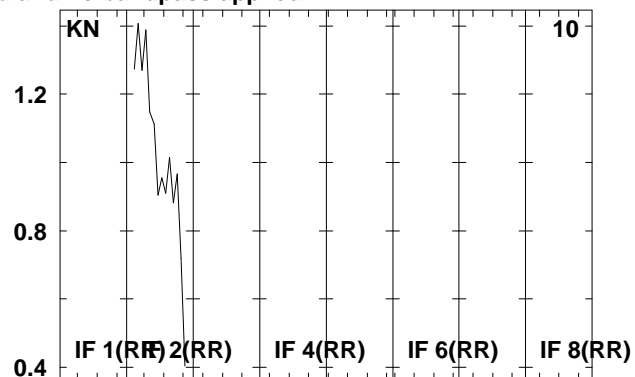
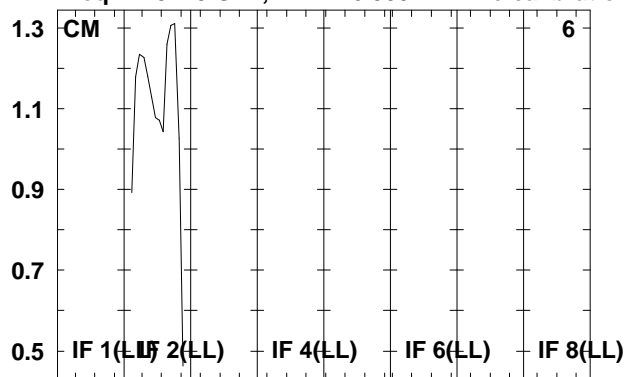

Lower frame: Real Jy  
Total-power spectrum Antenna: \*  
Timerange: 00/17:19:40 to 00/17:21:56

Plot file version 253 created 07-DEC-2009 16:06:25

J1912+05 RT006C.UVDATA.1

Freq = 4.9415 GHz, Bw = 16.000 MH No calibration applied and no bandpass applied

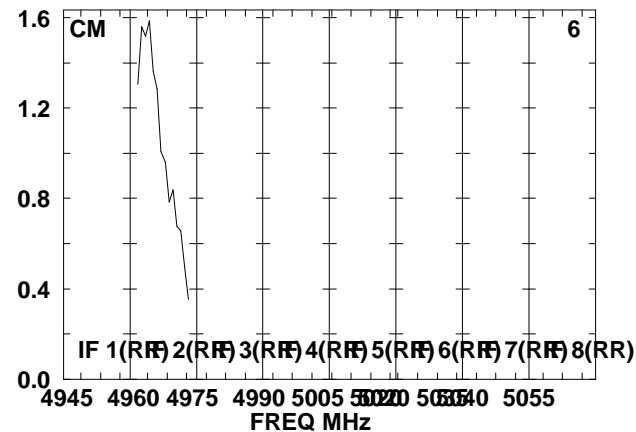
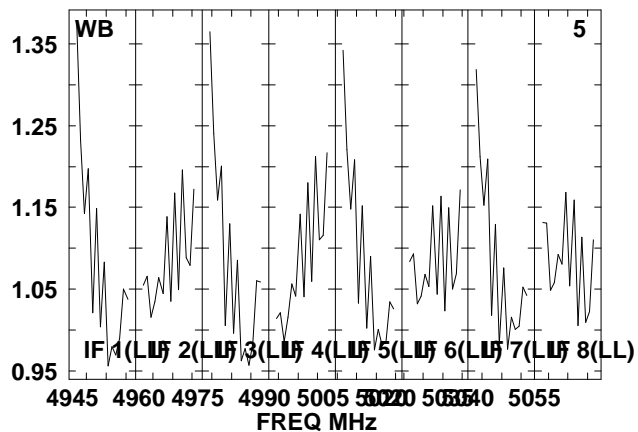
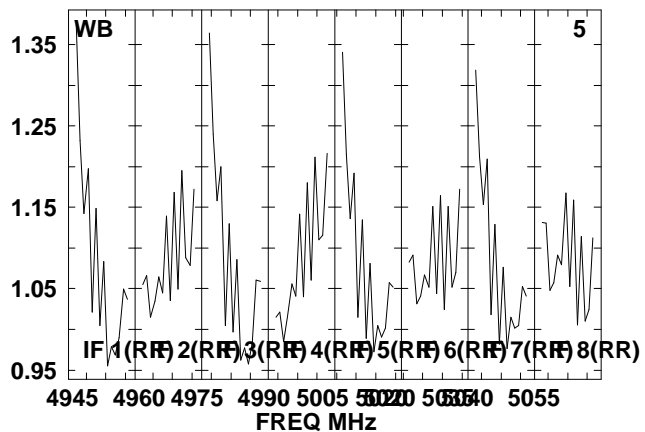
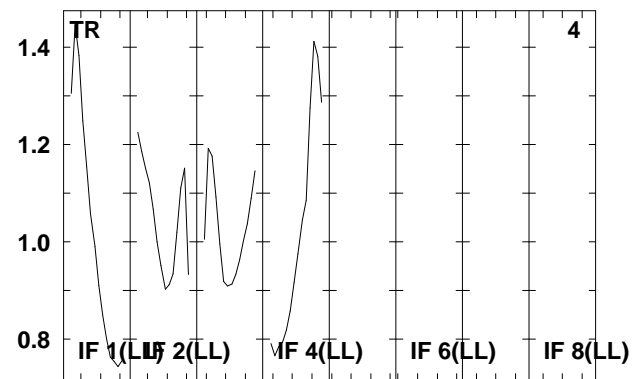
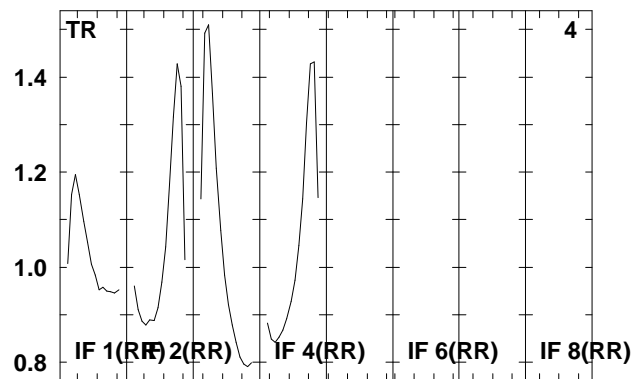
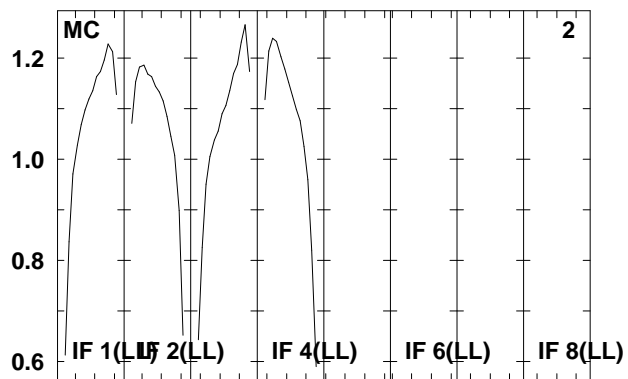
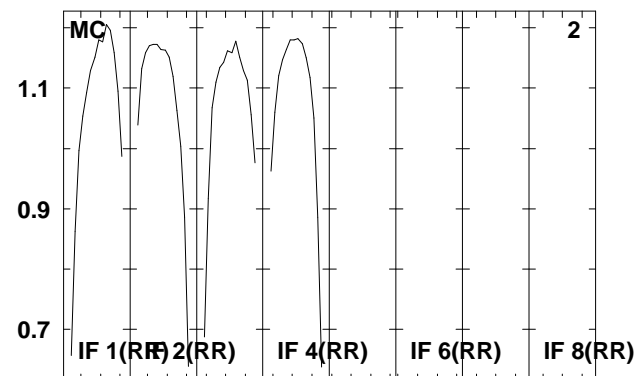
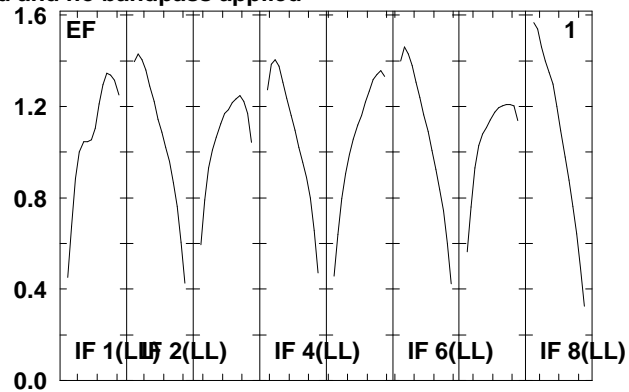
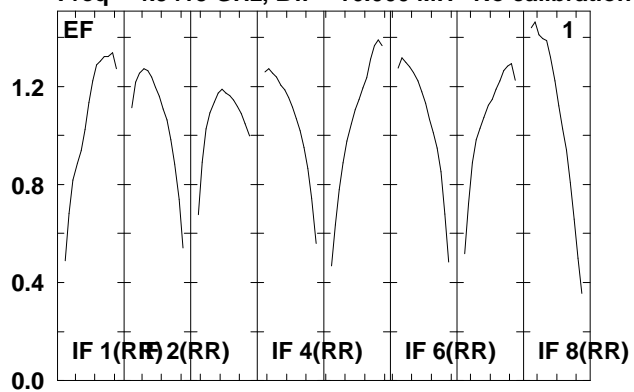

Lower frame: Real Jy  
Total-power spectrum Antenna: \*  
Timerange: 00/17:22:00 to 00/17:23:20

Plot file version 254 created 07-DEC-2009 16:06:26

J1912+05 RT006C.UVDATA.1

Freq = 4.9415 GHz, Bw = 16.000 MH No calibration applied and no bandpass applied

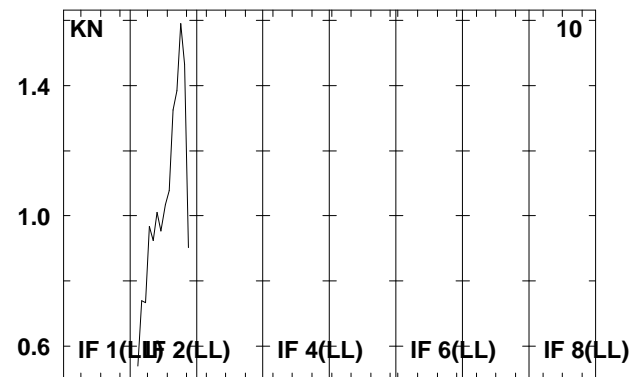
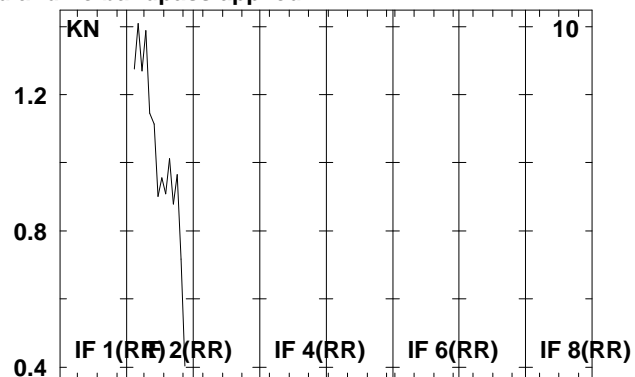
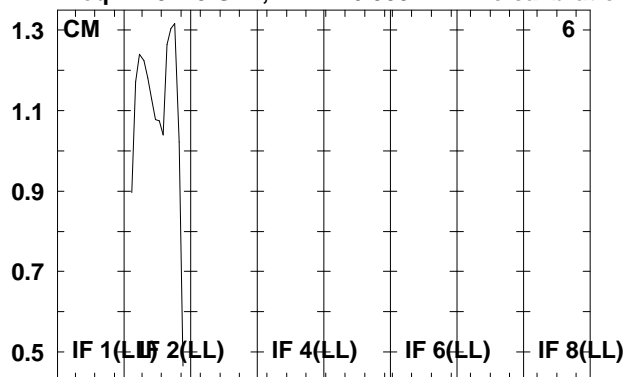

Lower frame: Real Jy  
Total-power spectrum Antenna: \*  
Timerange: 00/17:22:00 to 00/17:23:20

Plot file version 255 created 07-DEC-2009 16:06:26

SS433 RT006C.UVDATA.1

Freq = 4.9415 GHz, Bw = 16.000 MH No calibration applied and no bandpass applied

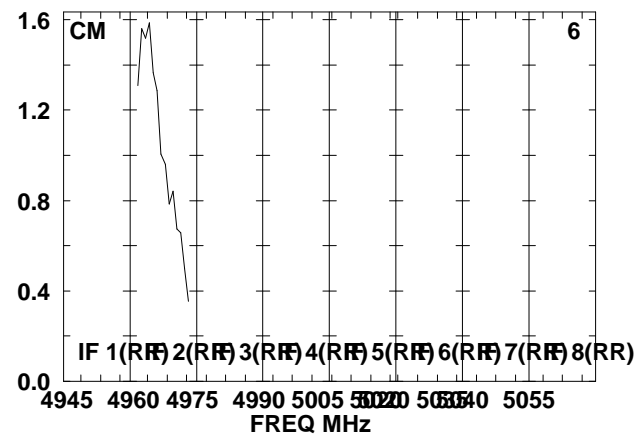
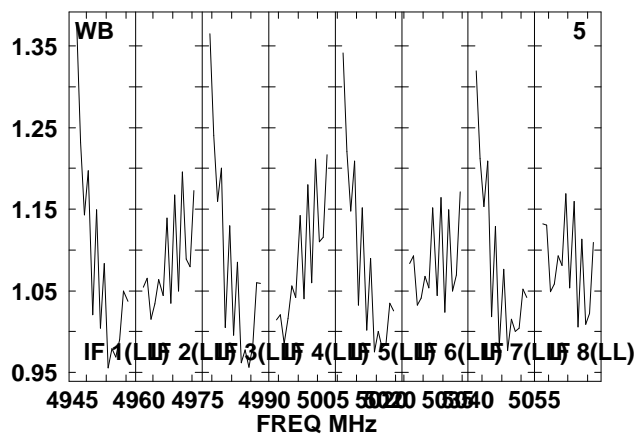
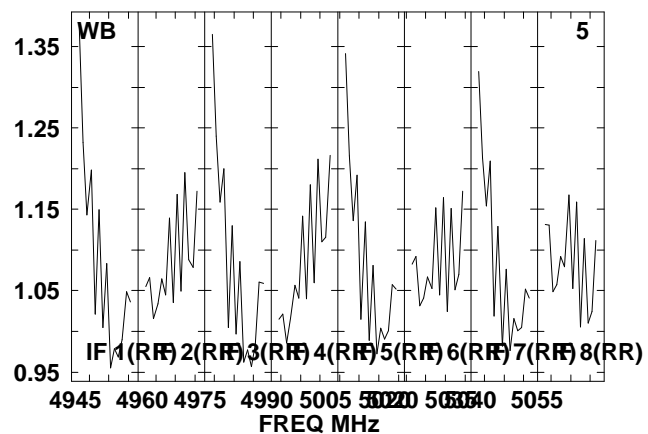
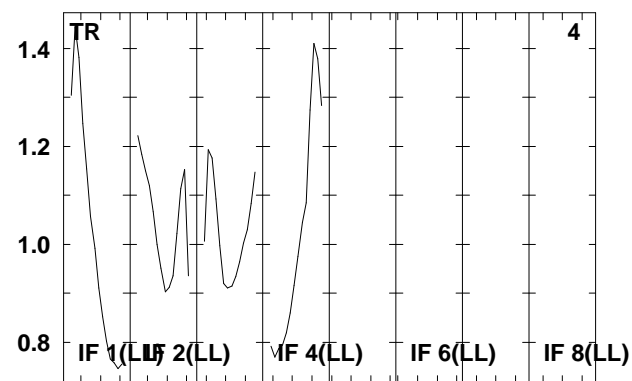
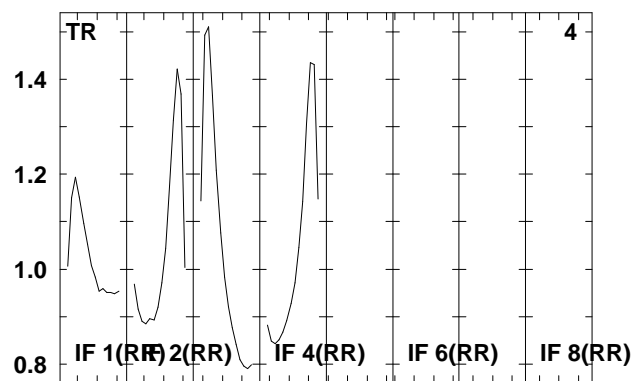
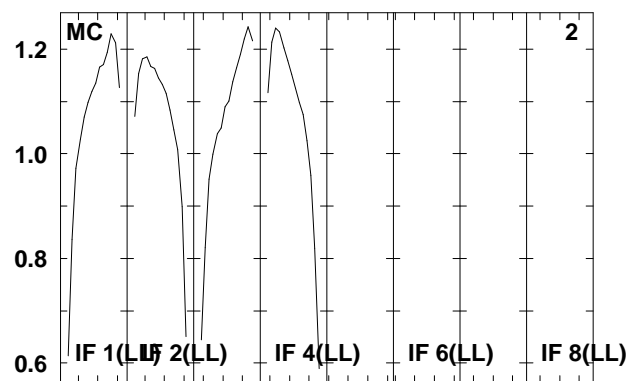
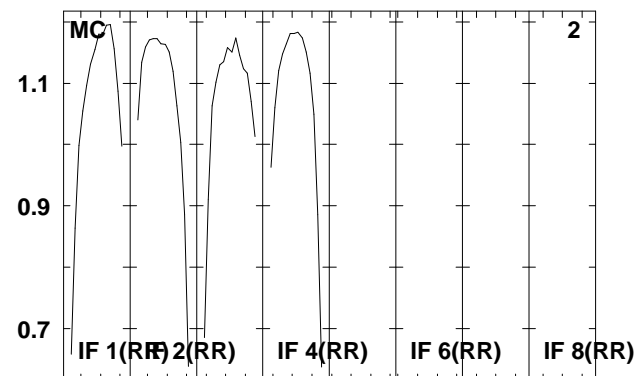
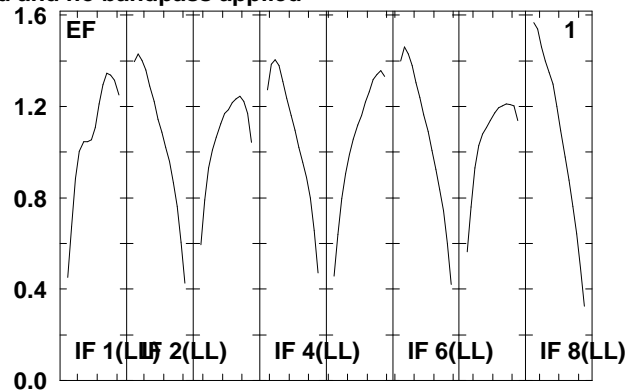
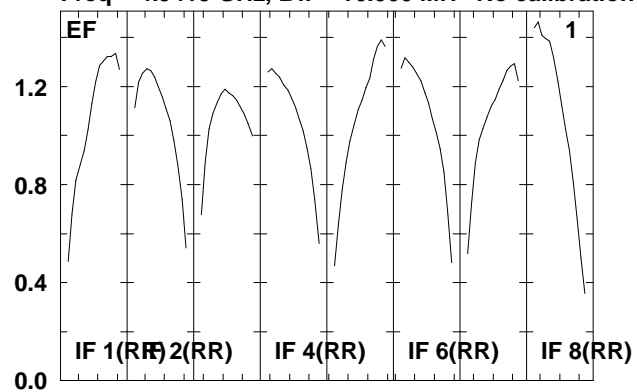

Lower frame: Real Jy  
Total-power spectrum Antenna: \*  
Timerange: 00/17:23:24 to 00/17:25:36

Plot file version 256 created 07-DEC-2009 16:06:26

SS433 RT006C.UVDATA.1

Freq = 4.9415 GHz, Bw = 16.000 MH No calibration applied and no bandpass applied

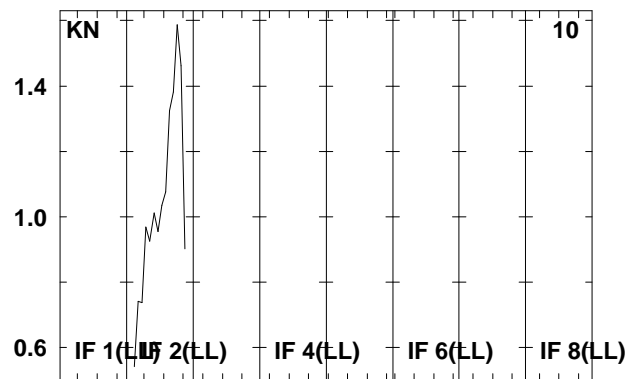
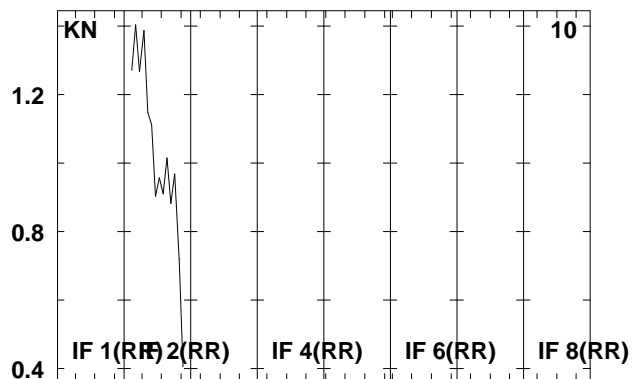
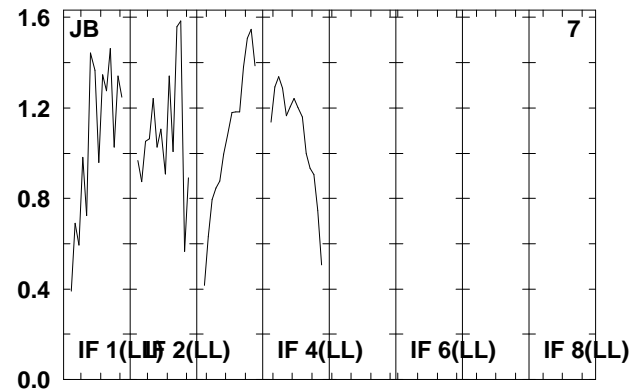
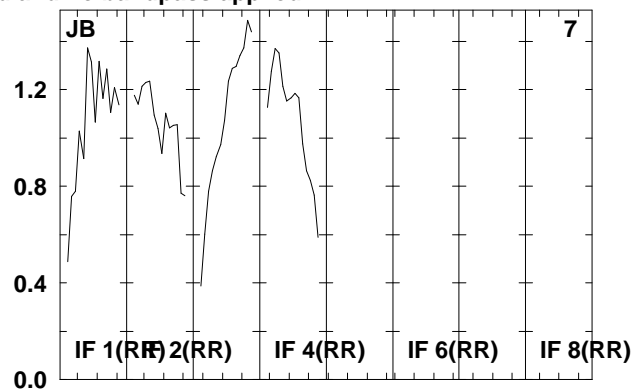
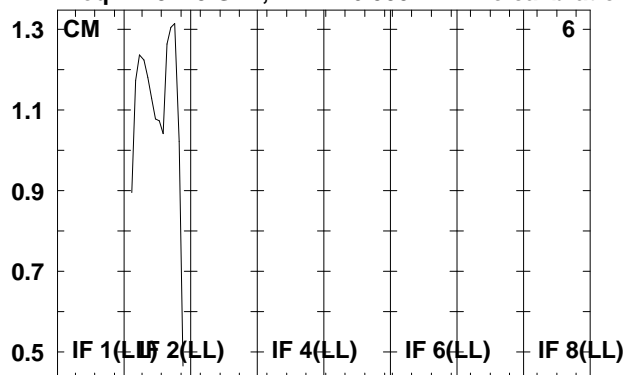

Lower frame: Real Jy  
Total-power spectrum Antenna: \*  
Timerange: 00/17:23:24 to 00/17:25:36



Plot file version 257 created 07-DEC-2009 16:06:26

J1911+16 RT006C.UVDATA.1

Freq = 4.9415 GHz, Bw = 16.000 MH No calibration applied and no bandpass applied

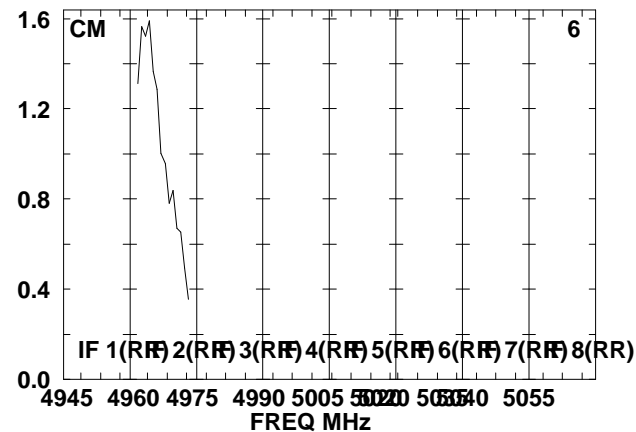
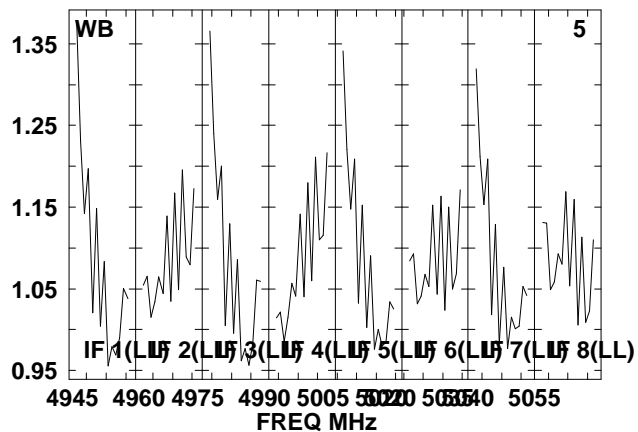
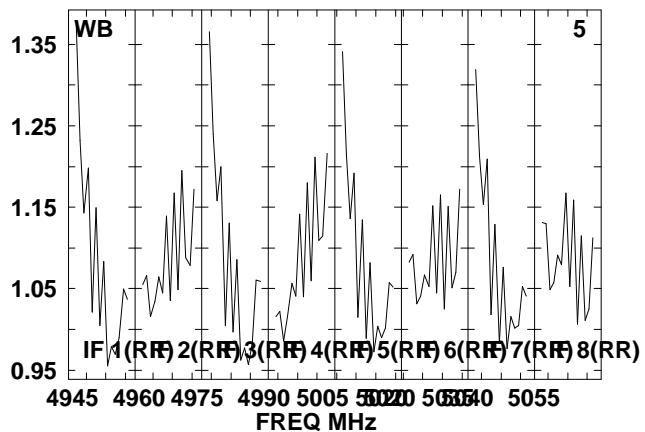
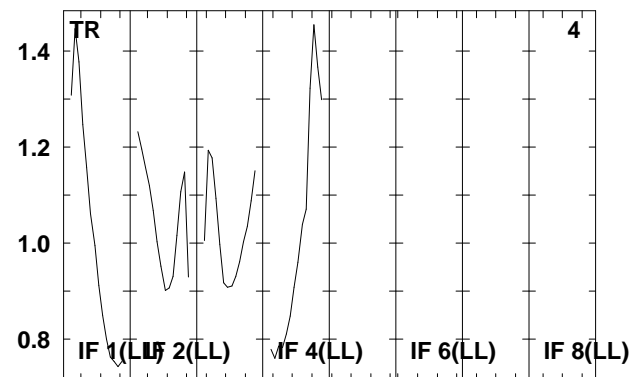
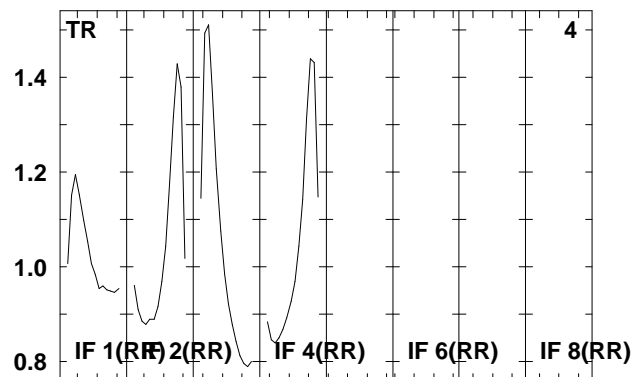
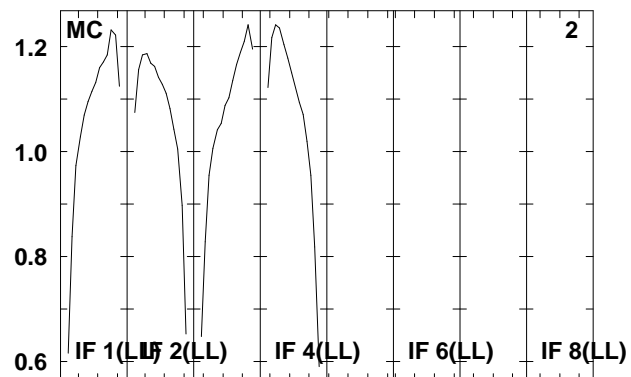
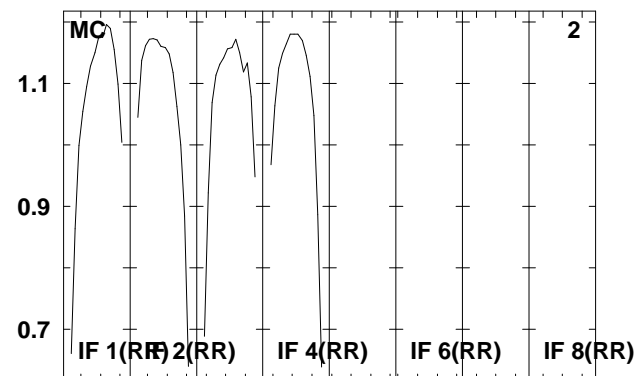
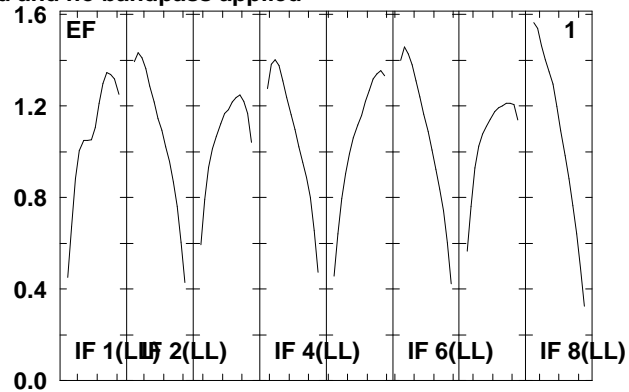
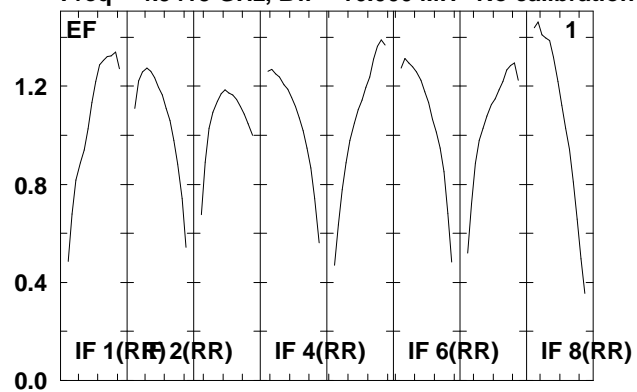

Lower frame: Real Jy  
Total-power spectrum Antenna: \*  
Timerange: 00/17:26:40 to 00/17:27:40

Plot file version 258 created 07-DEC-2009 16:06:26

J1911+16 RT006C.UVDATA.1

Freq = 4.9415 GHz, Bw = 16.000 MH No calibration applied and no bandpass applied

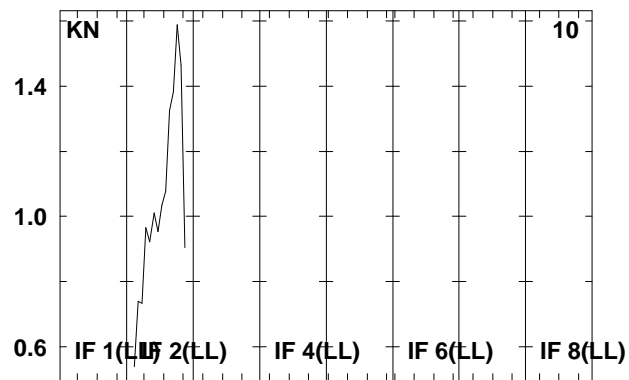
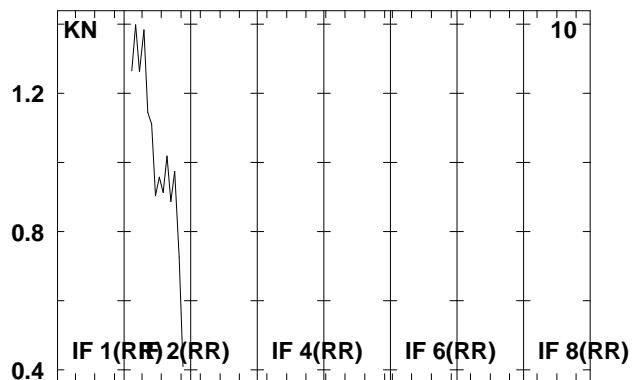
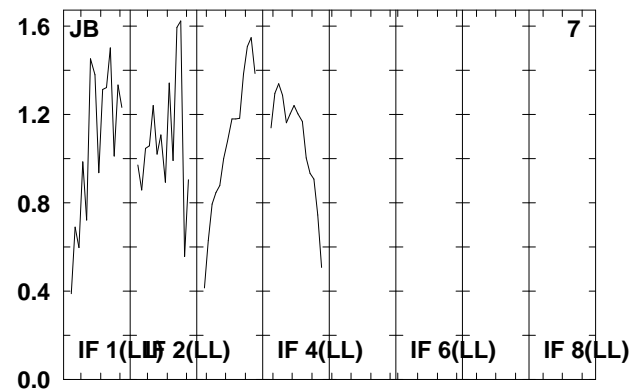
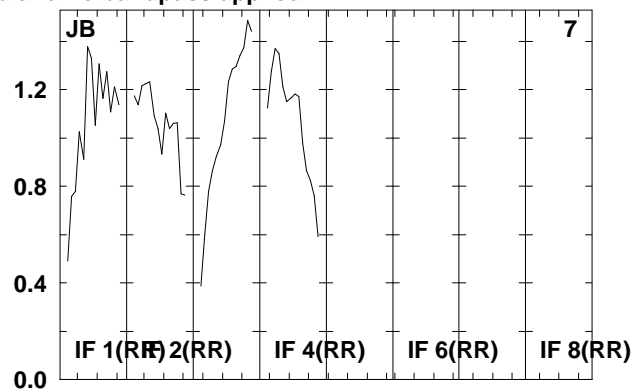
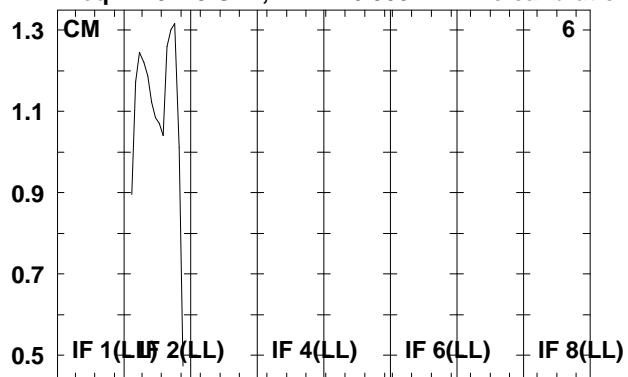

Lower frame: Real Jy  
Total-power spectrum Antenna: \*  
Timerange: 00/17:26:40 to 00/17:27:40

Plot file version 259 created 07-DEC-2009 16:06:26

J1912+05 RT006C.UVDATA.1

Freq = 4.9415 GHz, Bw = 16.000 MH No calibration applied and no bandpass applied

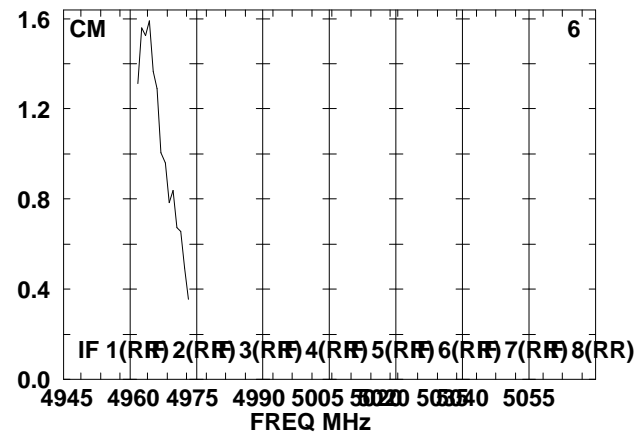
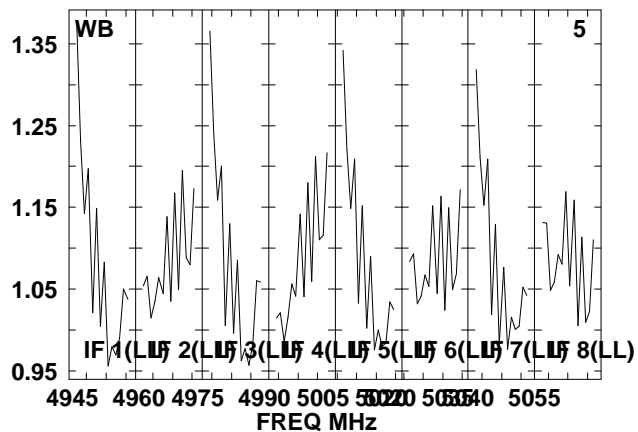
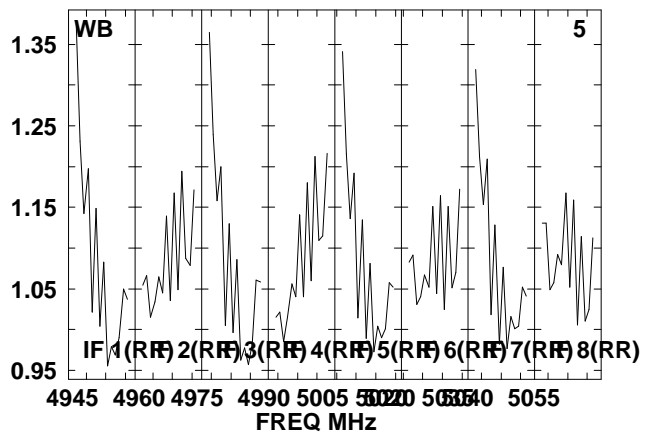
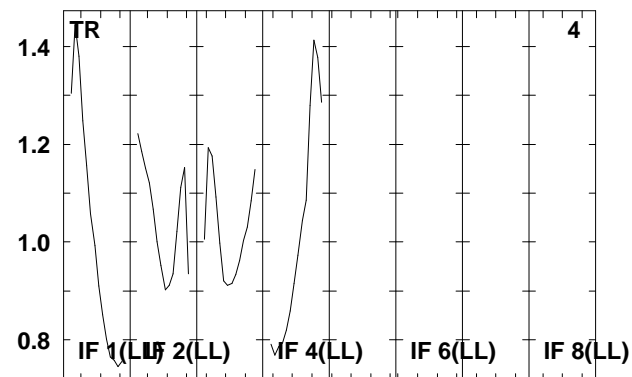
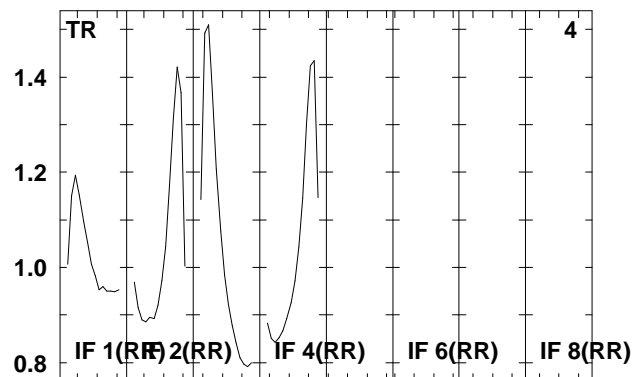
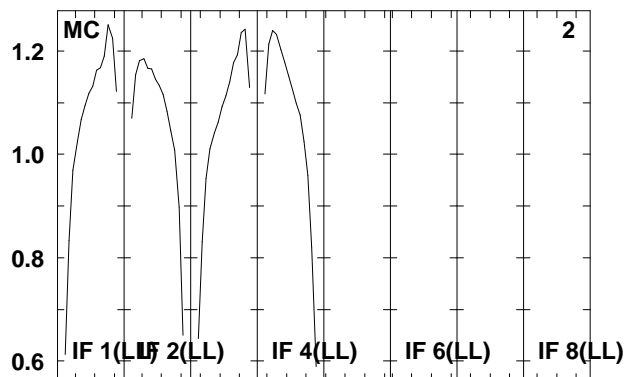
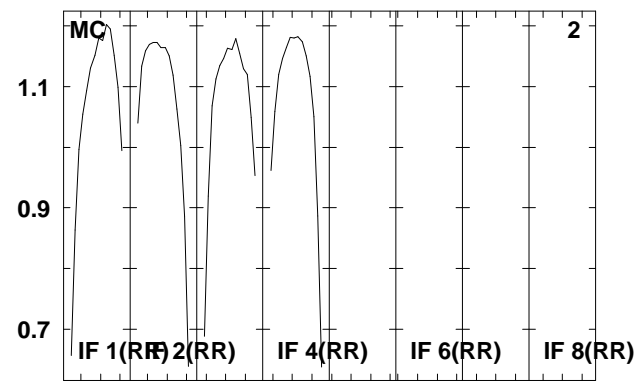
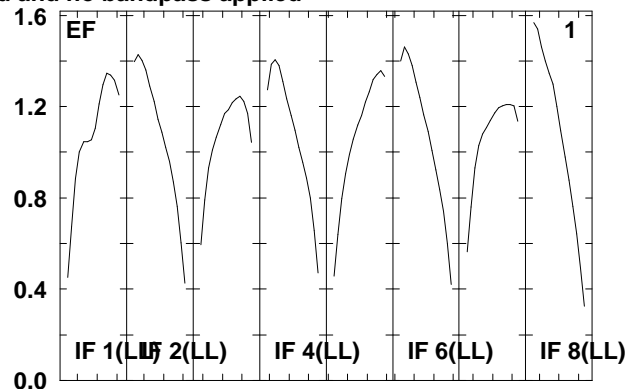
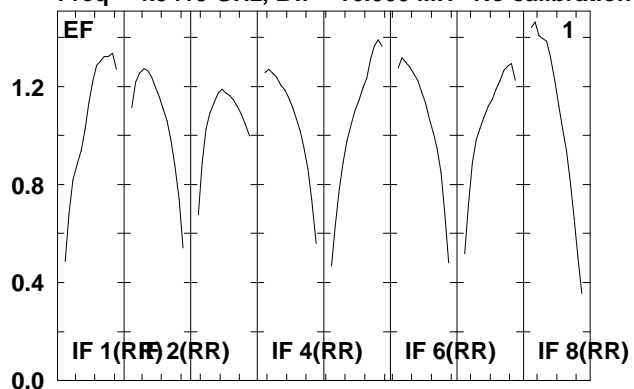

Lower frame: Real Jy

Total-power spectrum Antenna: \*

Timerange: 00/17:28:40 to 00/17:29:40

Plot file version 260 created 07-DEC-2009 16:06:26

J1912+05 RT006C.UVDATA.1

Freq = 4.9415 GHz, Bw = 16.000 MH No calibration applied and no bandpass applied

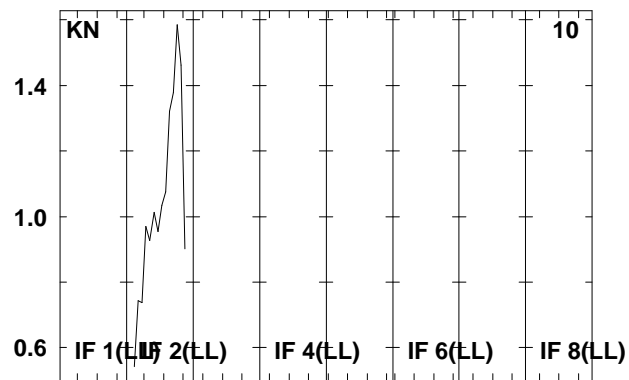
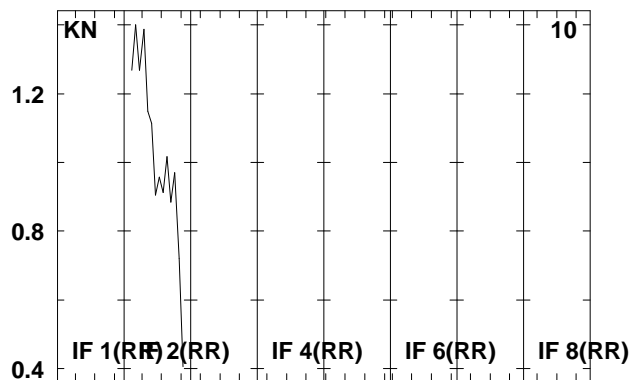
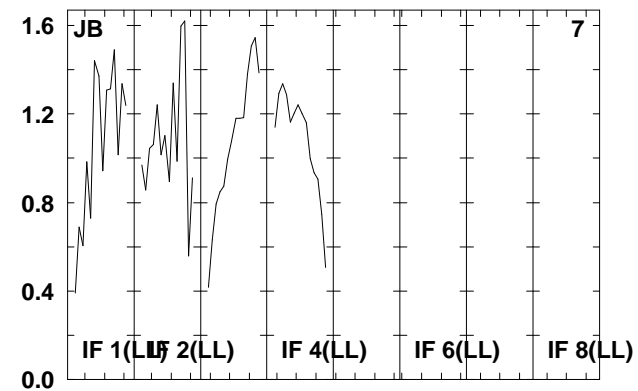
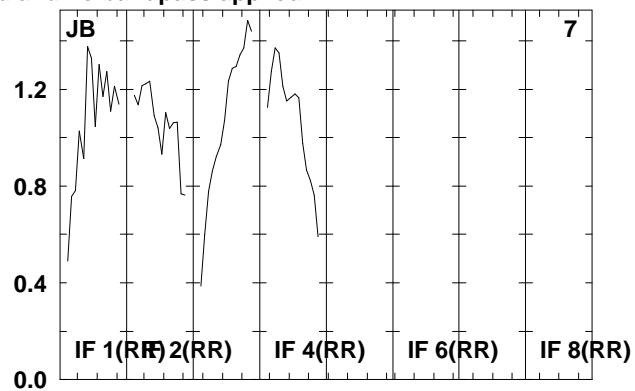
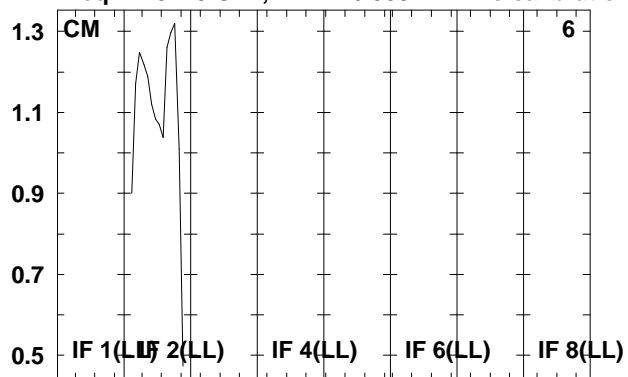

Lower frame: Real Jy  
Total-power spectrum Antenna: \*  
Timerange: 00/17:28:40 to 00/17:29:40

Plot file version 261 created 07-DEC-2009 16:06:27

SS433 RT006C.UVDATA.1

Freq = 4.9415 GHz, Bw = 16.000 MH No calibration applied and no bandpass applied

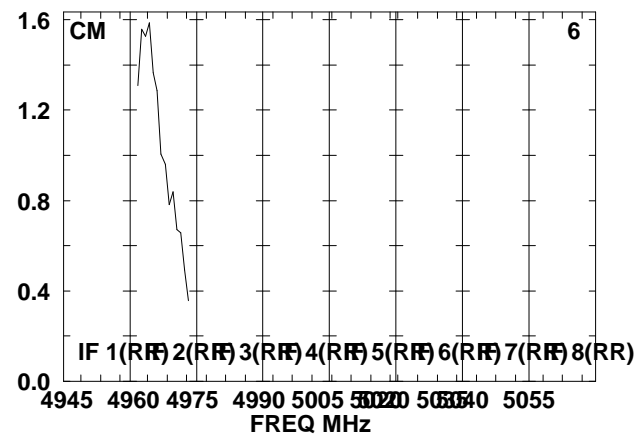
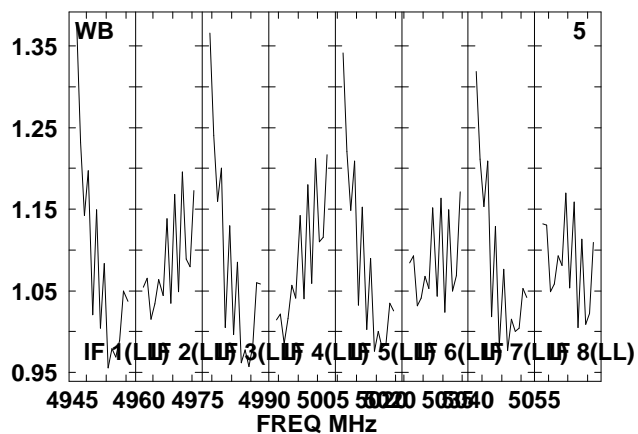
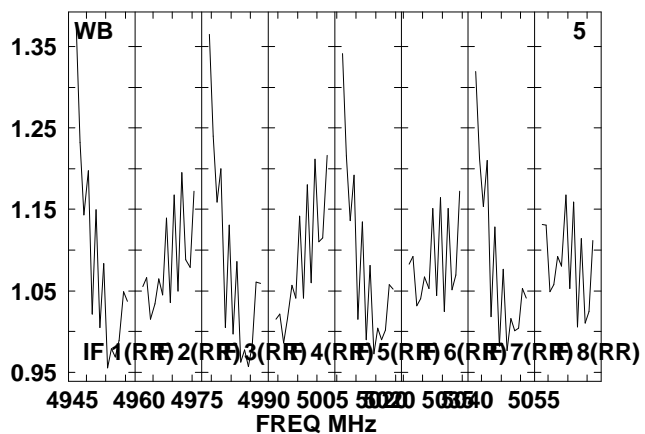
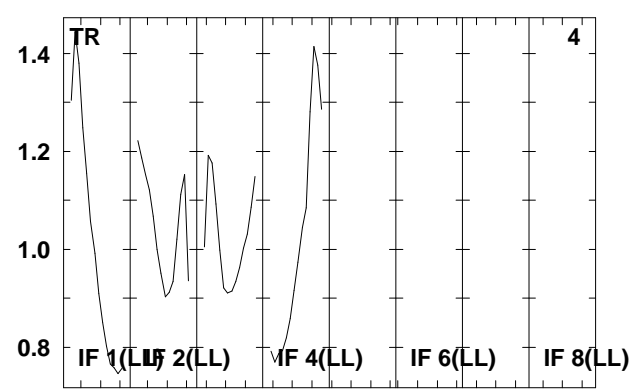
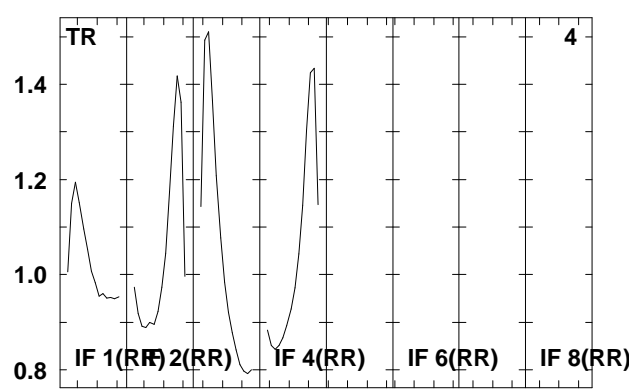
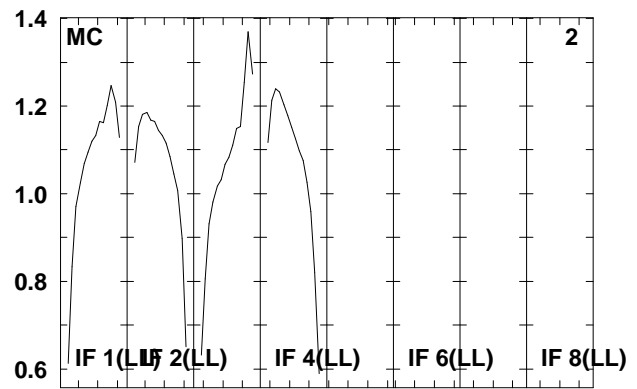
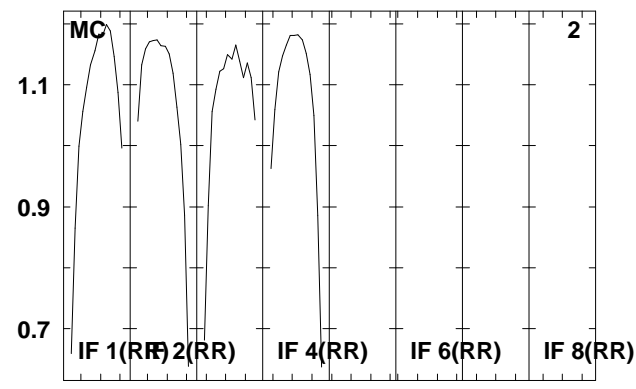
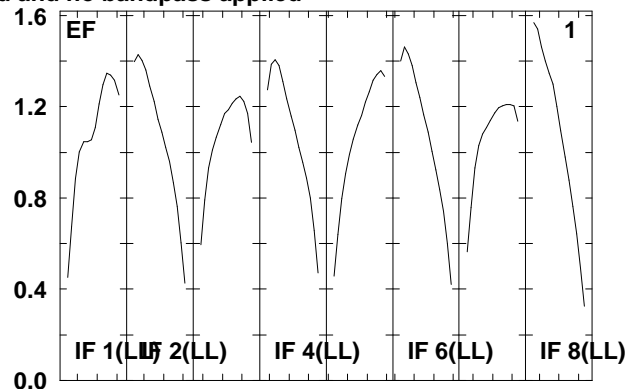
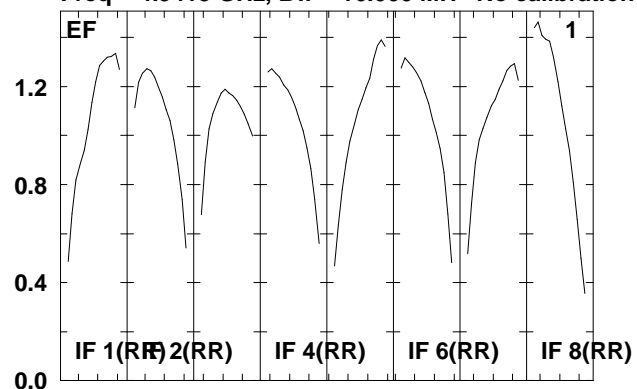

Lower frame: Real Jy  
Total-power spectrum Antenna: \*  
Timerange: 00/17:29:44 to 00/17:32:00

Plot file version 262 created 07-DEC-2009 16:06:27

SS433 RT006C.UVDATA.1

Freq = 4.9415 GHz, Bw = 16.000 MH No calibration applied and no bandpass applied

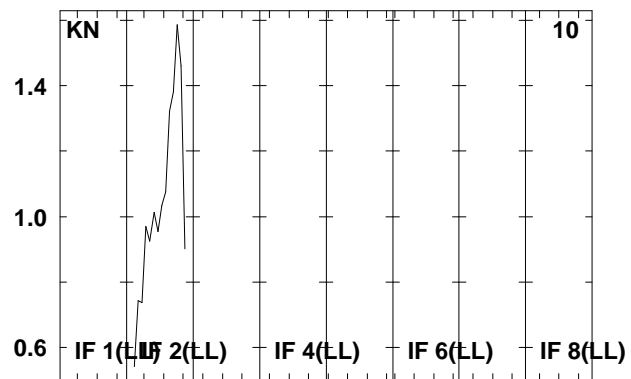
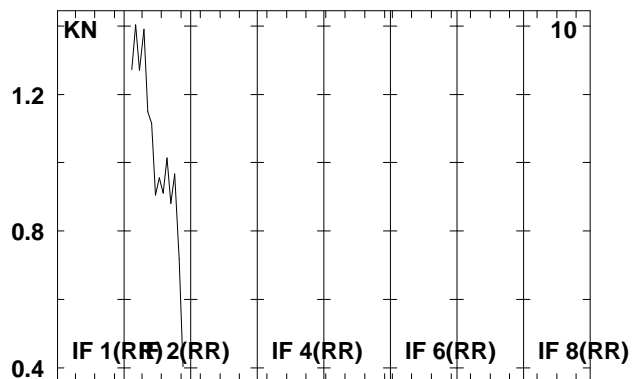
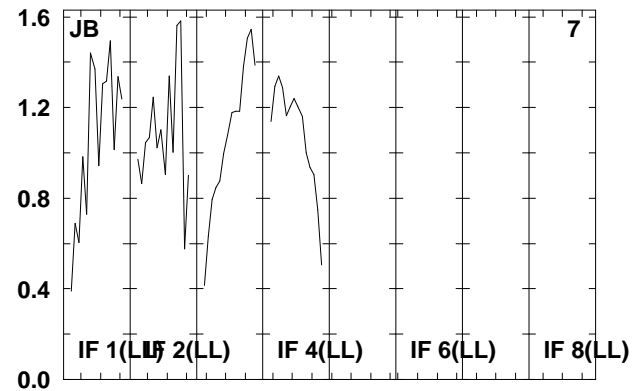
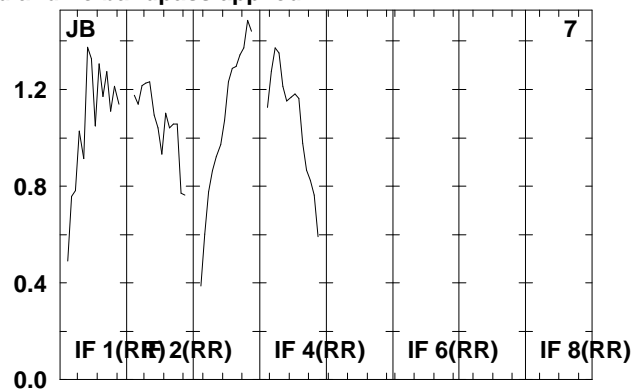
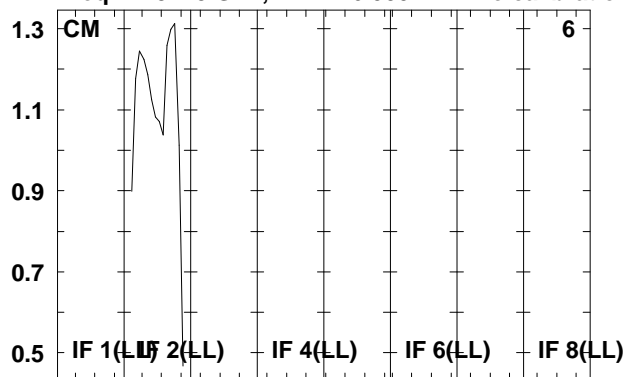

Lower frame: Real Jy  
Total-power spectrum Antenna: \*  
Timerange: 00/17:29:44 to 00/17:32:00

Plot file version 263 created 07-DEC-2009 16:06:27

J1912+05 RT006C.UVDATA.1

Freq = 4.9415 GHz, Bw = 16.000 MH No calibration applied and no bandpass applied

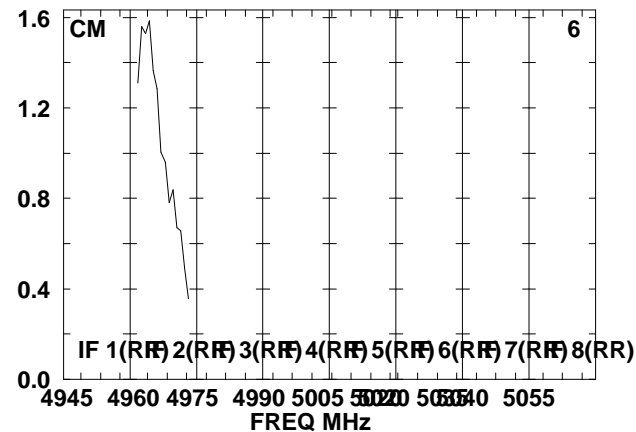
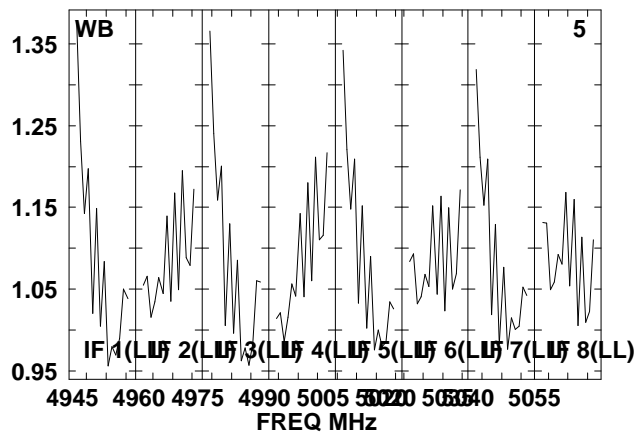
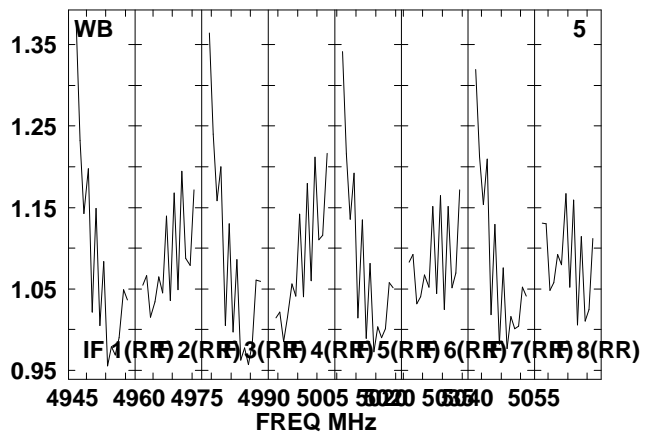
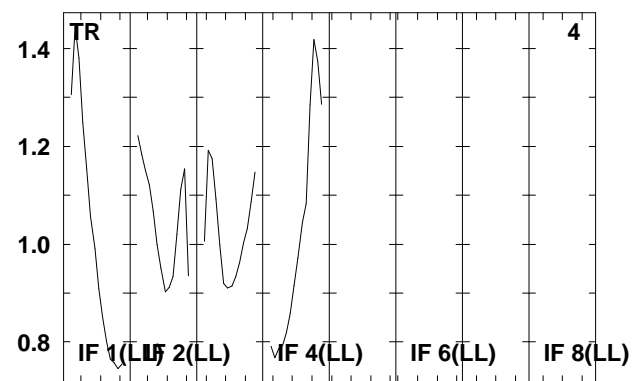
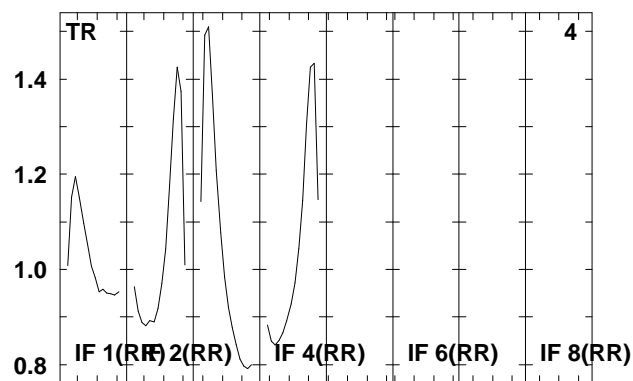
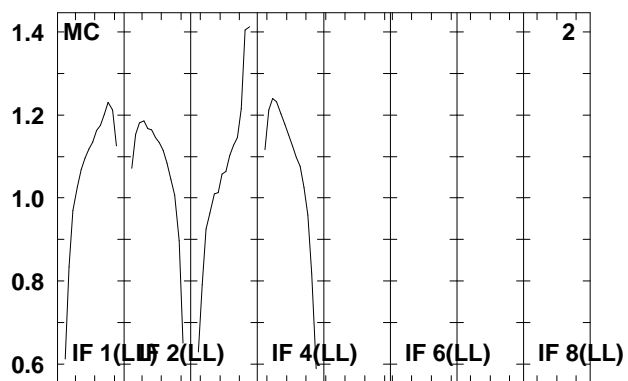
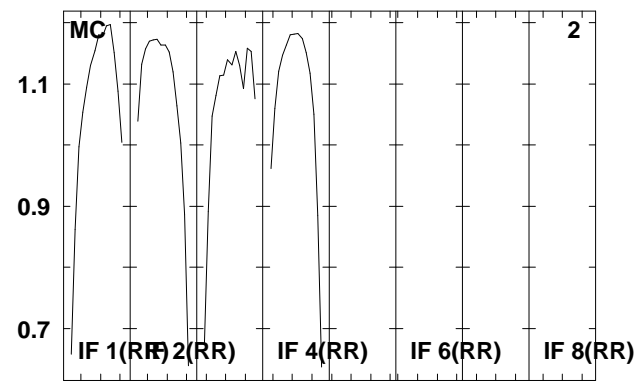
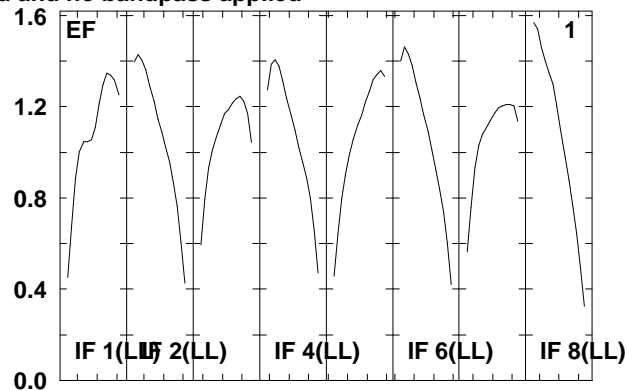
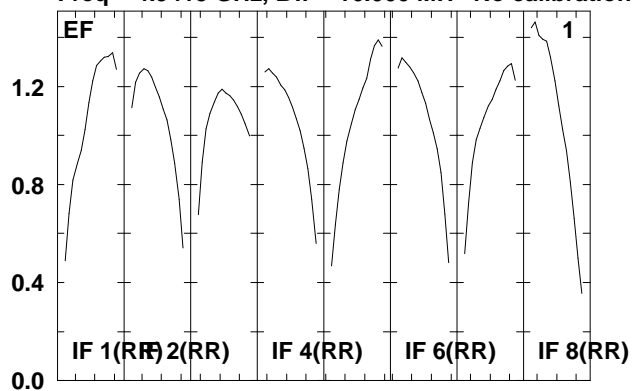

Lower frame: Real Jy  
Total-power spectrum Antenna: \*  
Timerange: 00/17:32:04 to 00/17:33:16

Plot file version 264 created 07-DEC-2009 16:06:27

J1912+05 RT006C.UVDATA.1

Freq = 4.9415 GHz, Bw = 16.000 MH No calibration applied and no bandpass applied

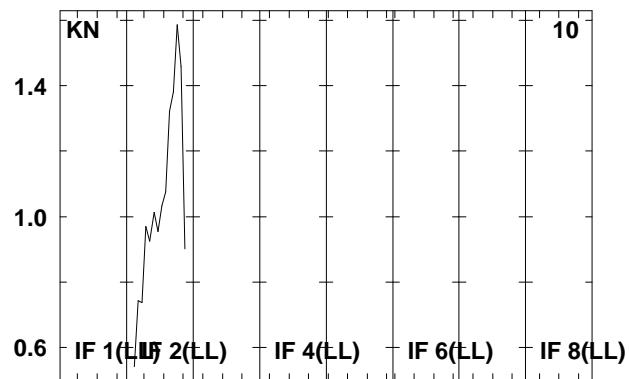
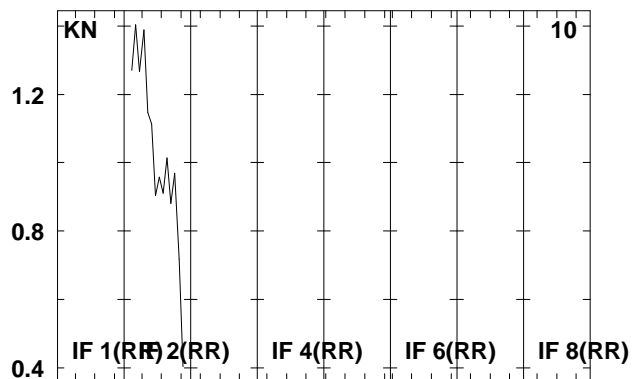
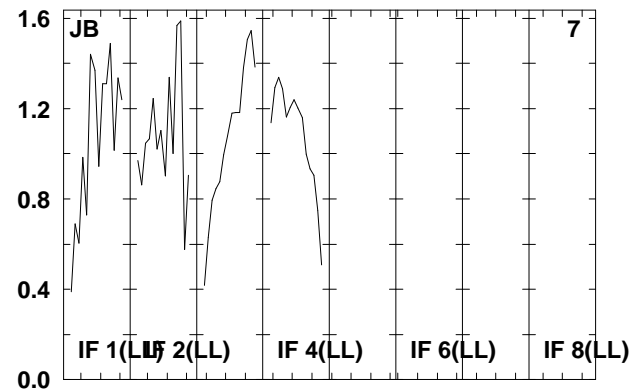
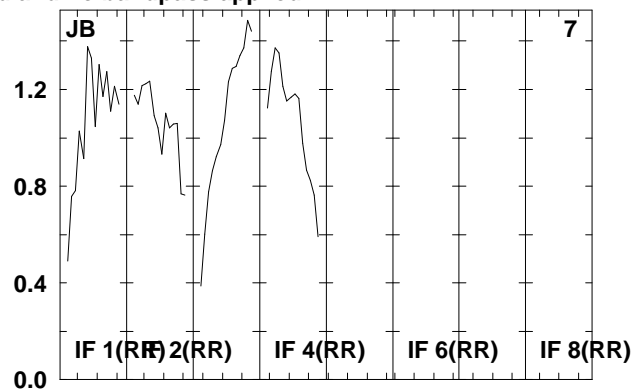
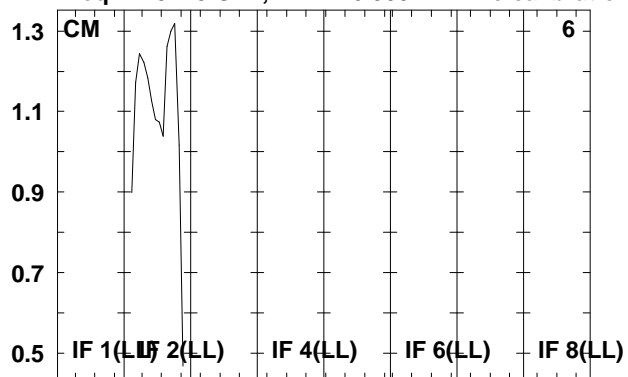

Lower frame: Real Jy  
Total-power spectrum Antenna: \*  
Timerange: 00/17:32:04 to 00/17:33:16



Plot file version 265 created 07-DEC-2009 16:06:27

SS433 RT006C.UVDATA.1

Freq = 4.9415 GHz, Bw = 16.000 MH No calibration applied and no bandpass applied

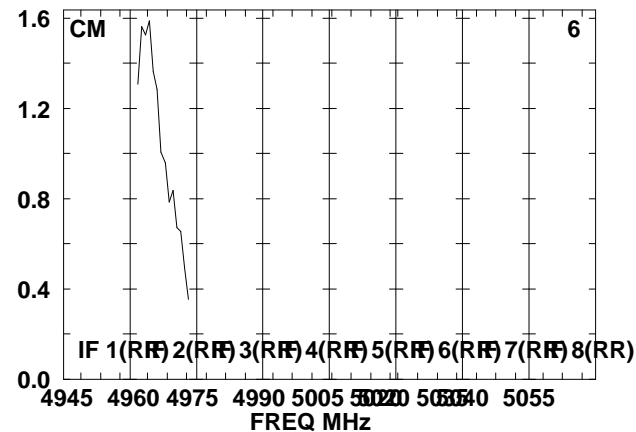
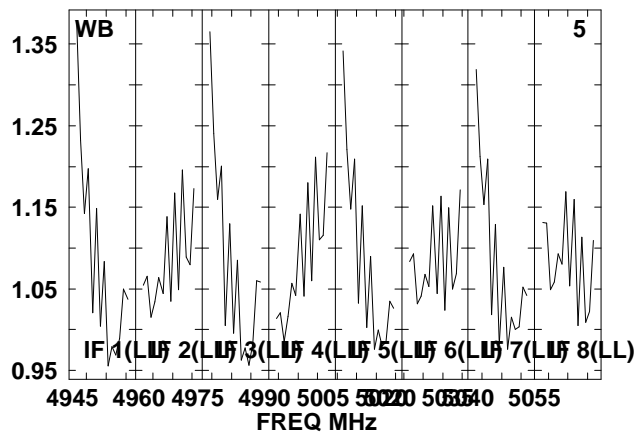
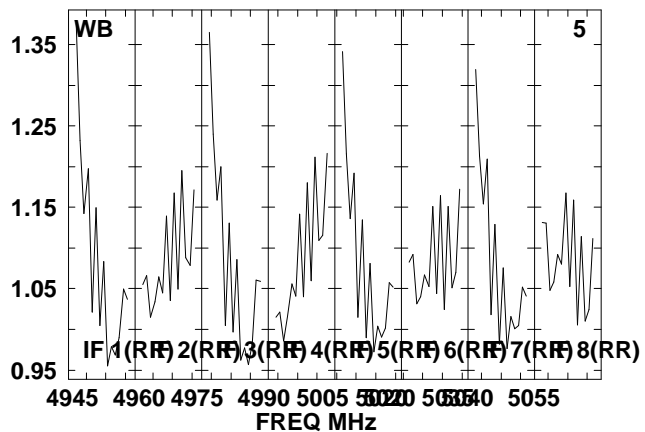
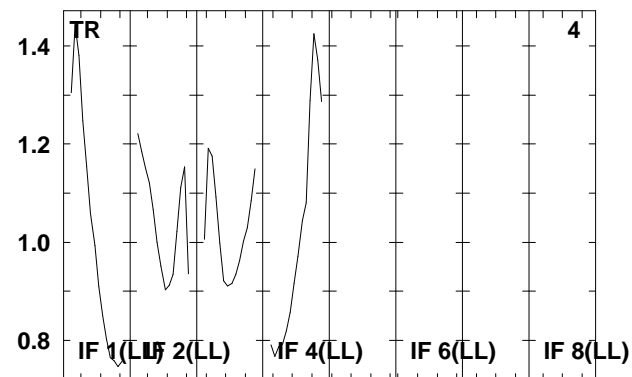
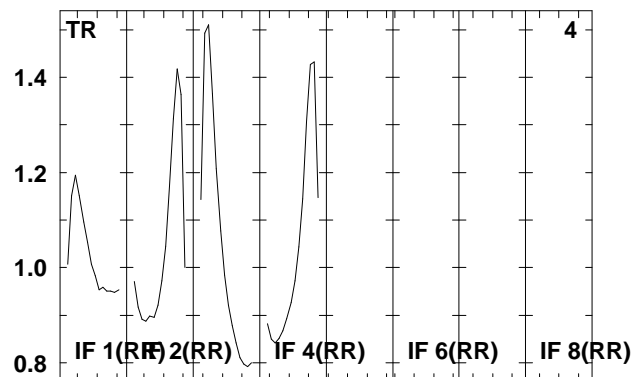
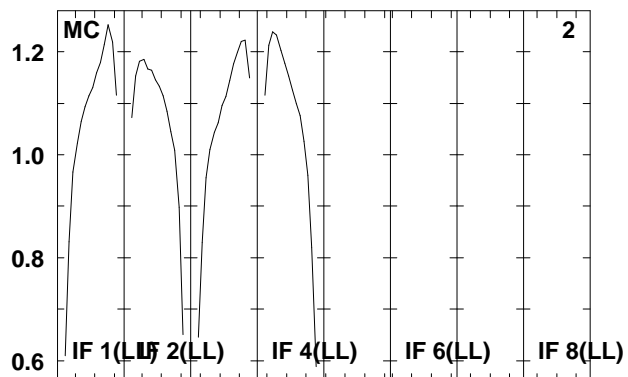
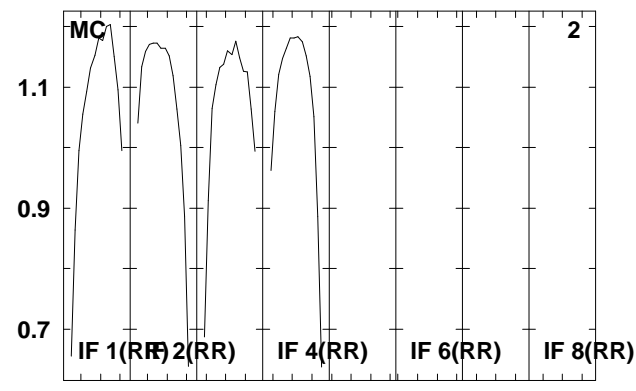
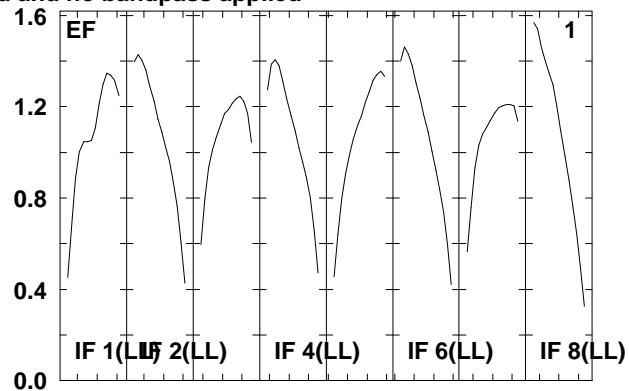
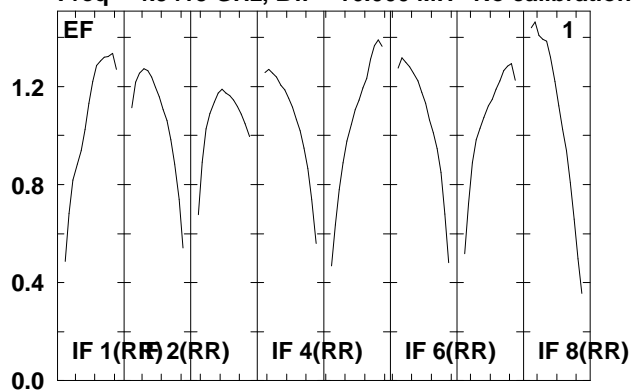

Lower frame: Real Jy

Total-power spectrum Antenna: \*

Timerange: 00/17:33:20 to 00/17:35:36

Plot file version 266 created 07-DEC-2009 16:06:27

SS433 RT006C.UVDATA.1

Freq = 4.9415 GHz, Bw = 16.000 MH No calibration applied and no bandpass applied

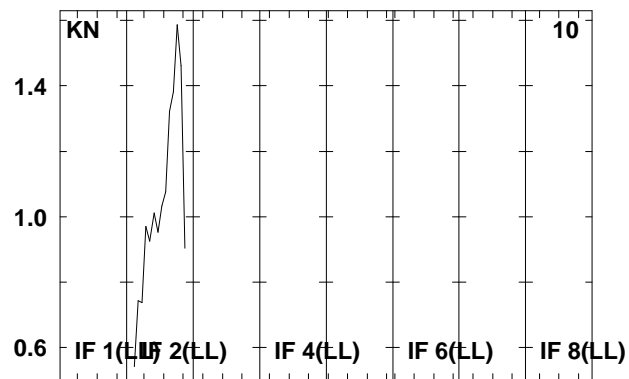
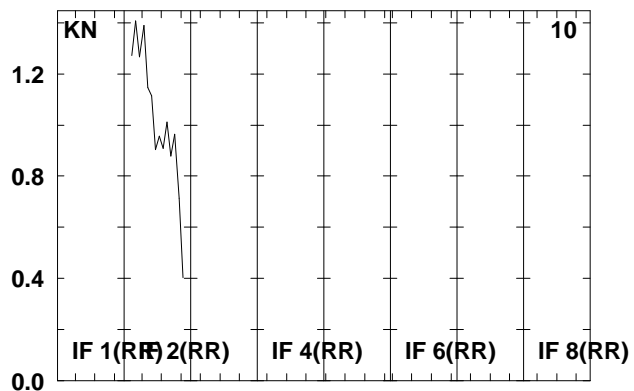
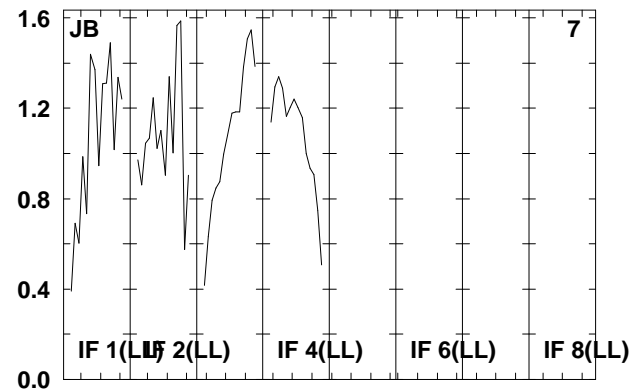
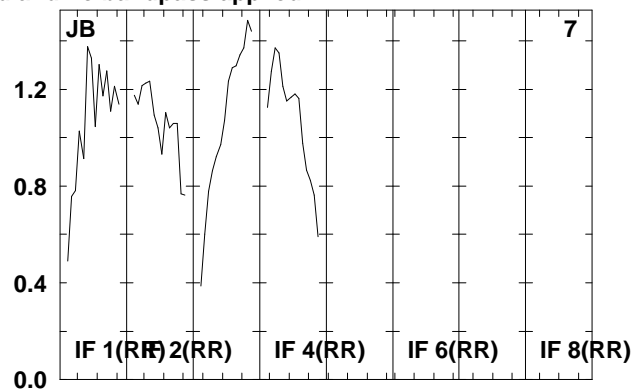
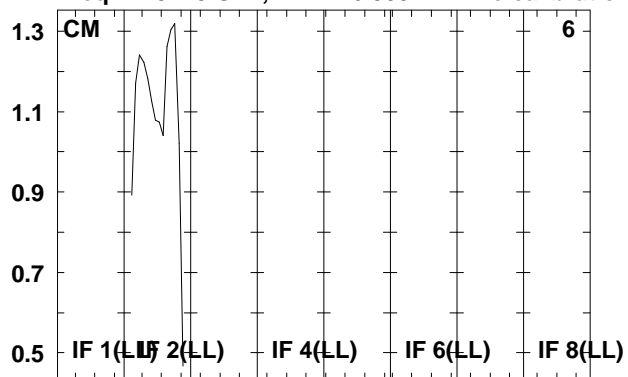

Lower frame: Real Jy  
Total-power spectrum Antenna: \*  
Timerange: 00/17:33:20 to 00/17:35:36

Plot file version 267 created 07-DEC-2009 16:06:28

J1912+05 RT006C.UVDATA.1

Freq = 4.9415 GHz, Bw = 16.000 MH No calibration applied and no bandpass applied

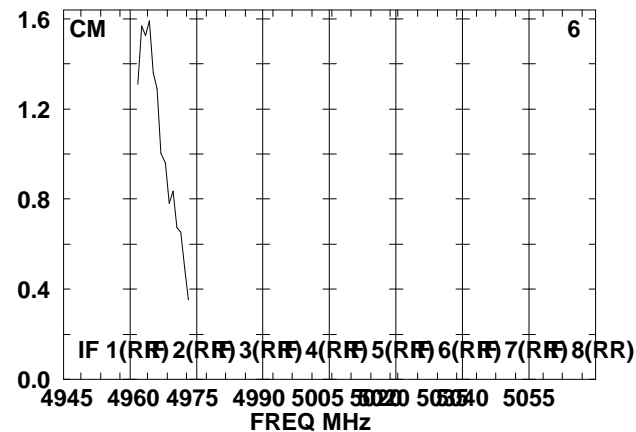
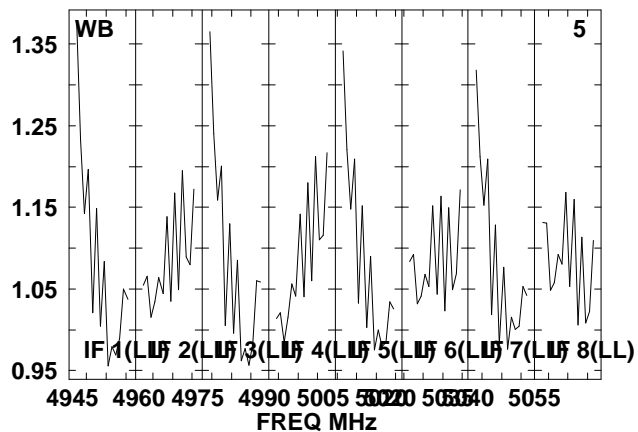
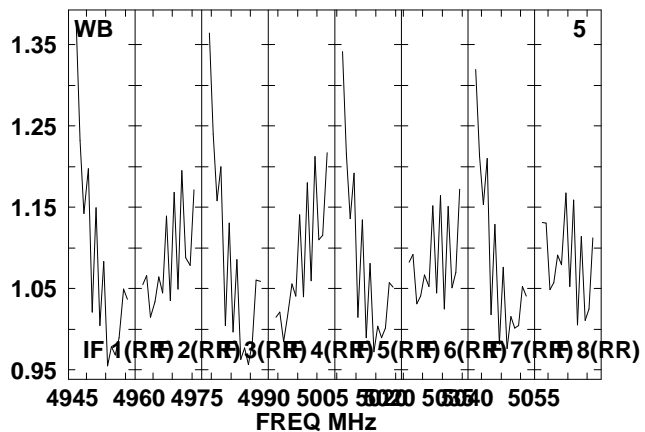
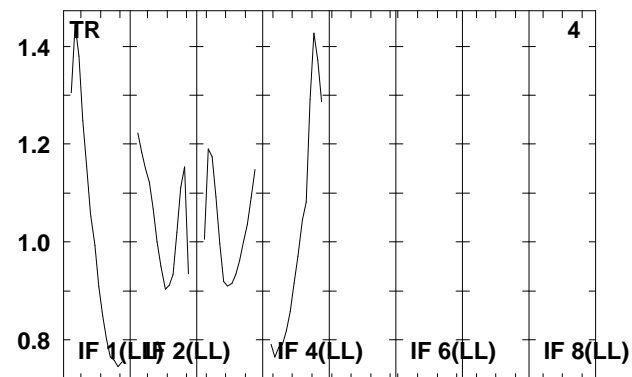
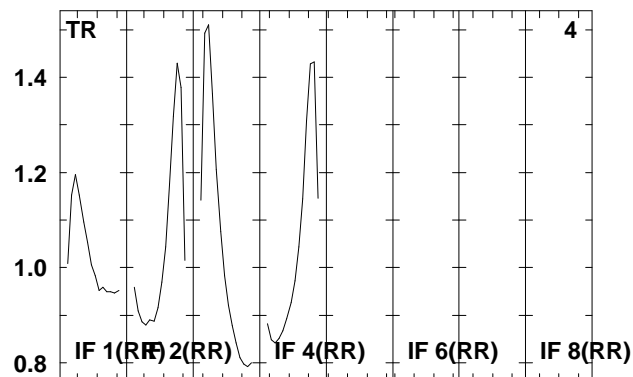
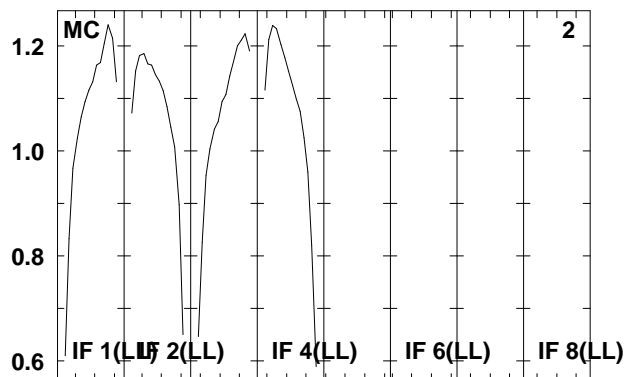
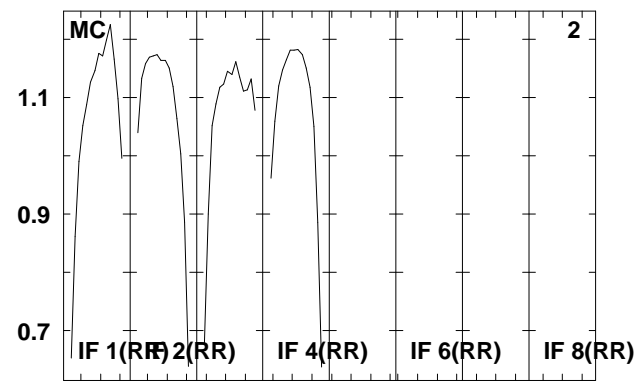
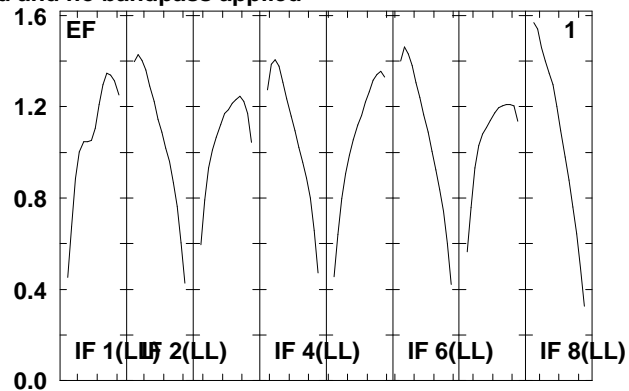
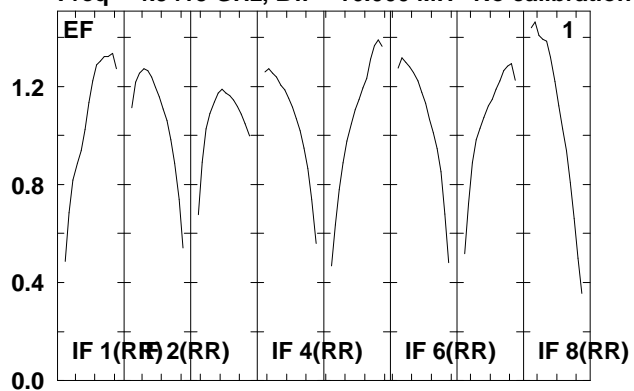

Lower frame: Real Jy  
Total-power spectrum Antenna: \*  
Timerange: 00/17:35:40 to 00/17:37:00

Plot file version 268 created 07-DEC-2009 16:06:28

J1912+05 RT006C.UVDATA.1

Freq = 4.9415 GHz, Bw = 16.000 MH No calibration applied and no bandpass applied

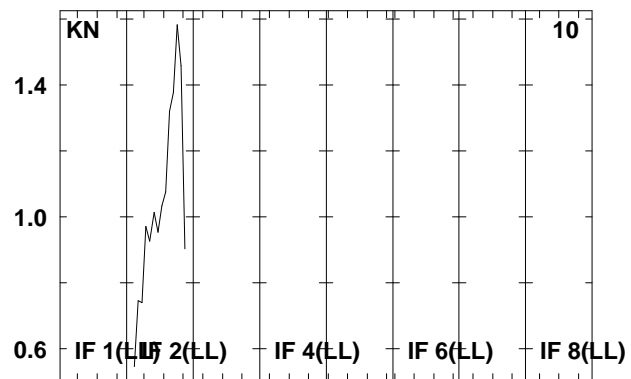
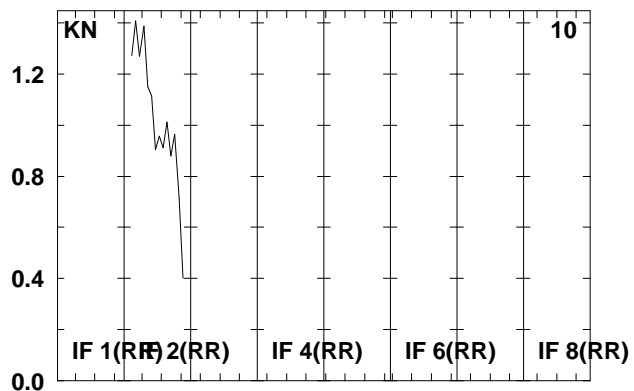
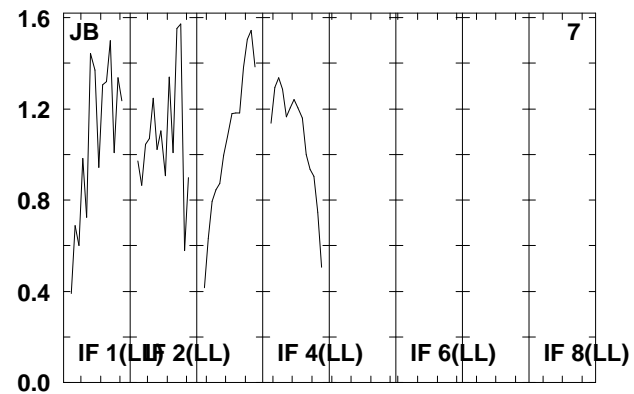
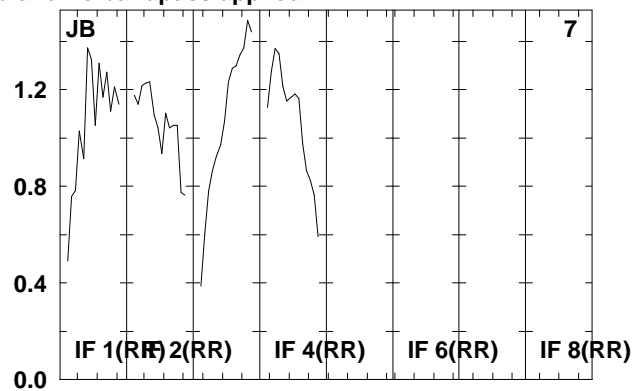
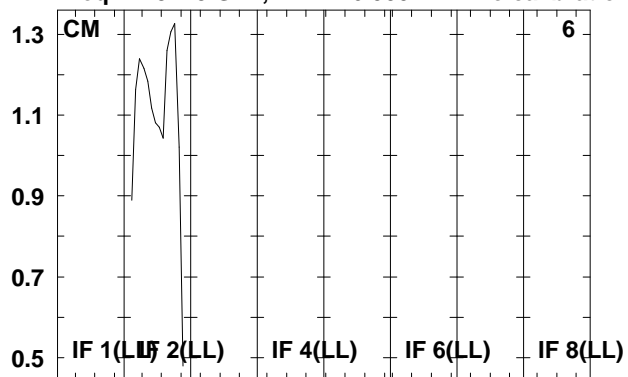

Lower frame: Real Jy  
Total-power spectrum Antenna: \*  
Timerange: 00/17:35:40 to 00/17:37:00

Plot file version 269 created 07-DEC-2009 16:06:28

SS433 RT006C.UVDATA.1

Freq = 4.9415 GHz, Bw = 16.000 MH No calibration applied and no bandpass applied

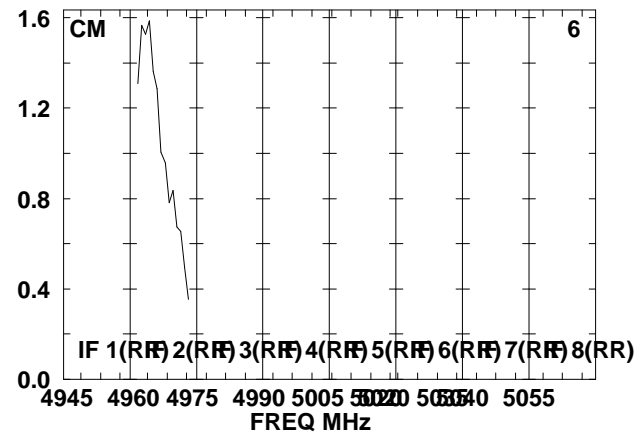
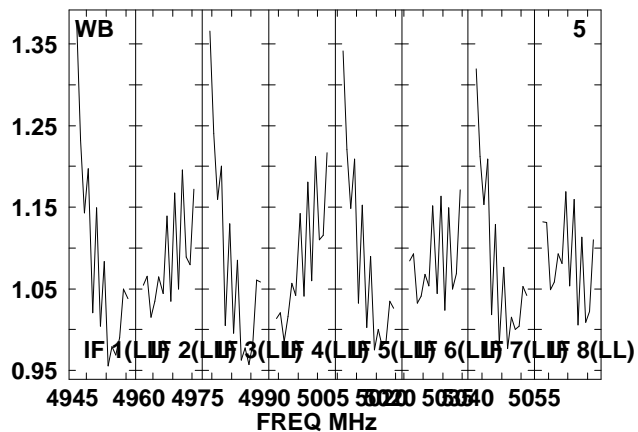
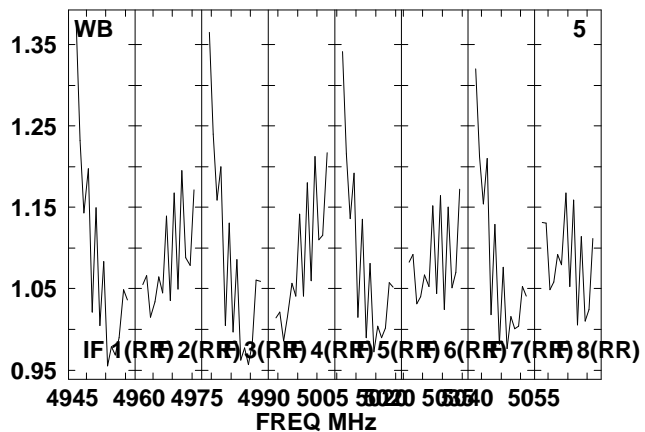
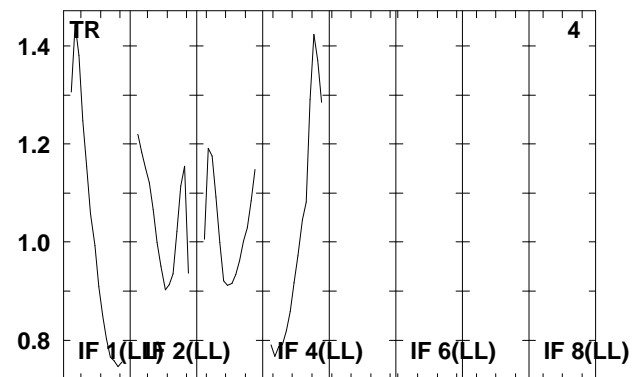
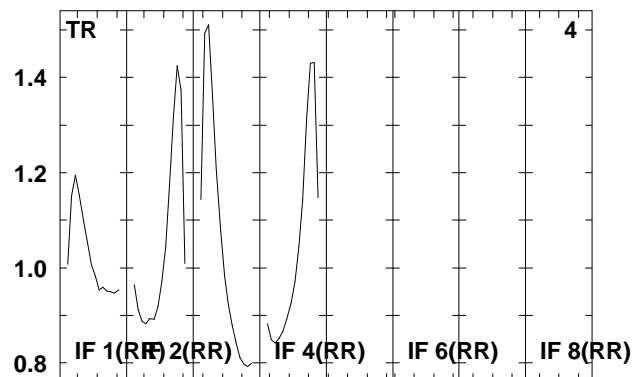
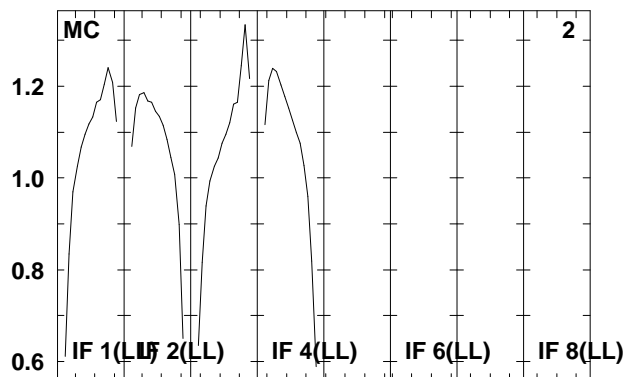
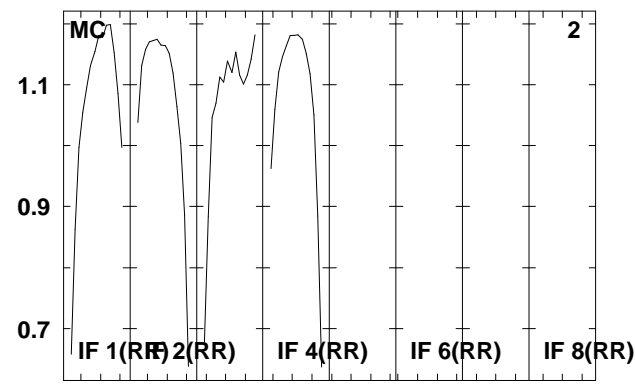
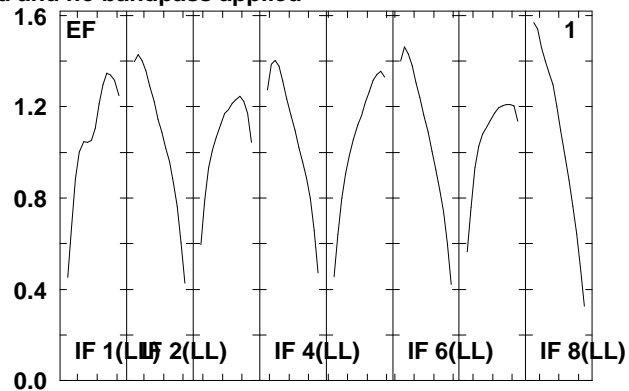
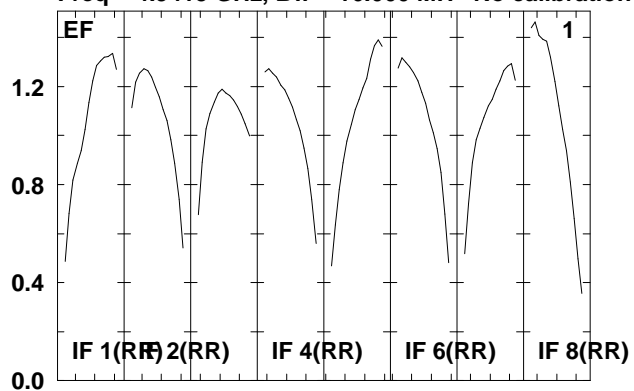

Lower frame: Real Jy  
Total-power spectrum Antenna: \*  
Timerange: 00/17:37:04 to 00/17:39:20

Plot file version 270 created 07-DEC-2009 16:06:28

SS433 RT006C.UVDATA.1

Freq = 4.9415 GHz, Bw = 16.000 MH No calibration applied and no bandpass applied

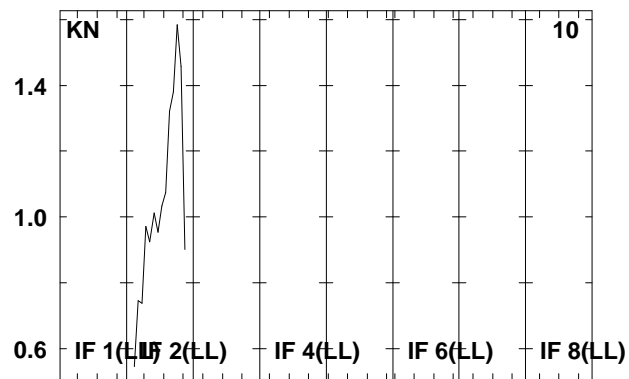
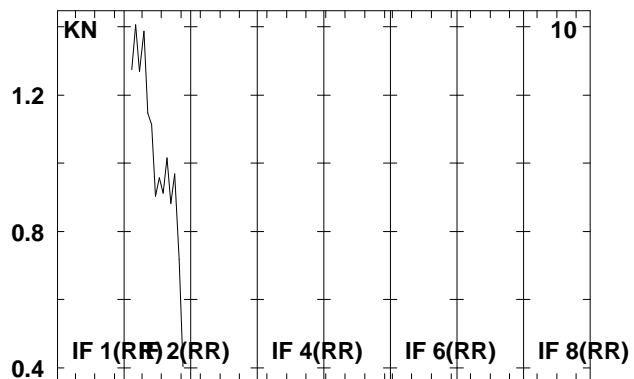
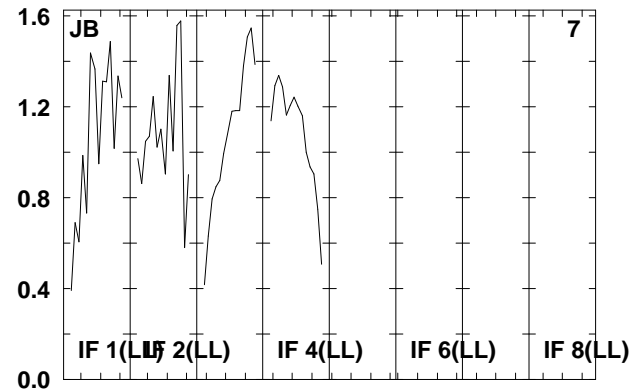
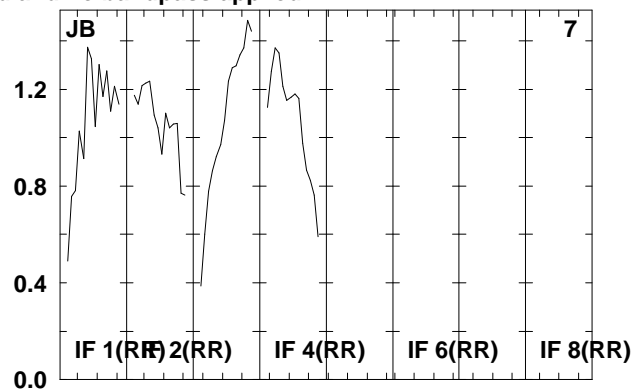
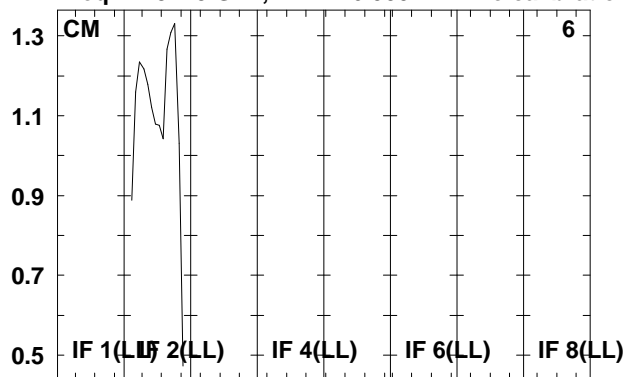

Lower frame: Real Jy  
Total-power spectrum Antenna: \*  
Timerange: 00/17:37:04 to 00/17:39:20

Plot file version 271 created 07-DEC-2009 16:06:29

J1912+05 RT006C.UVDATA.1

Freq = 4.9415 GHz, Bw = 16.000 MH No calibration applied and no bandpass applied

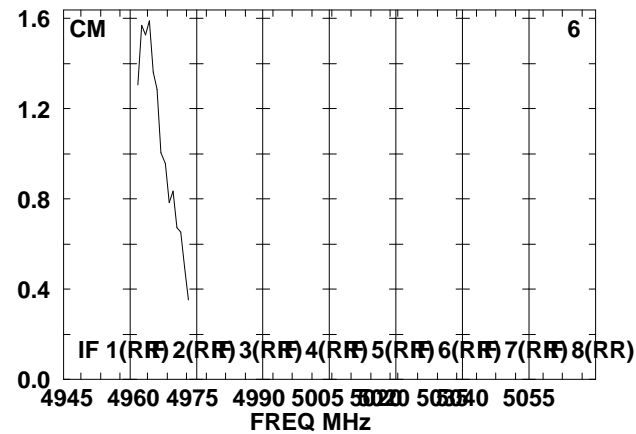
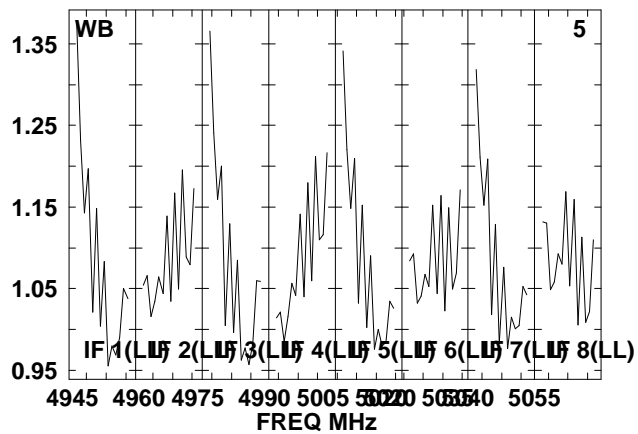
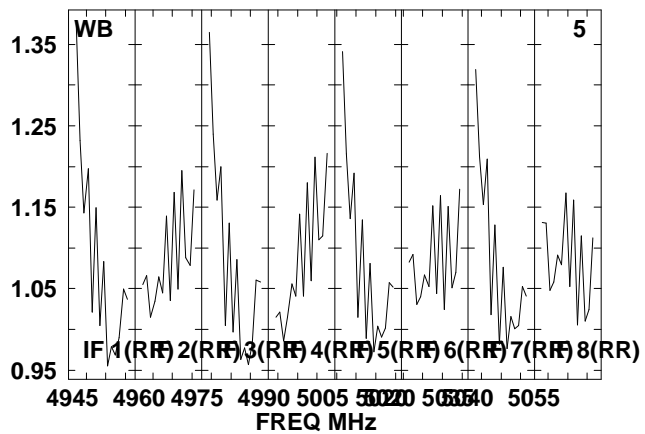
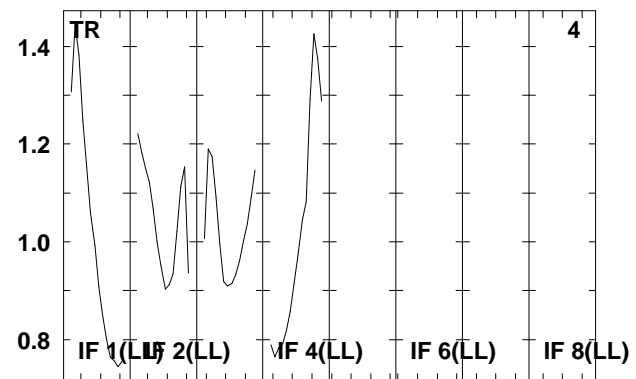
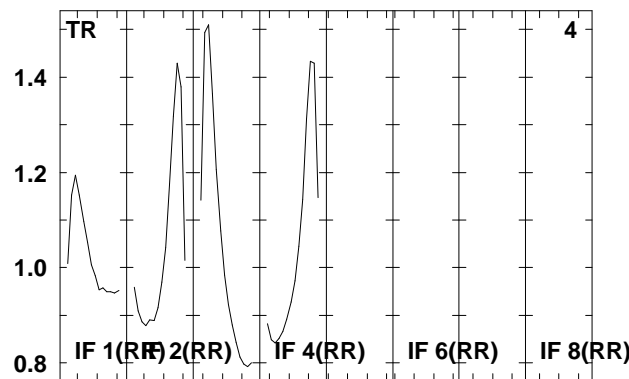
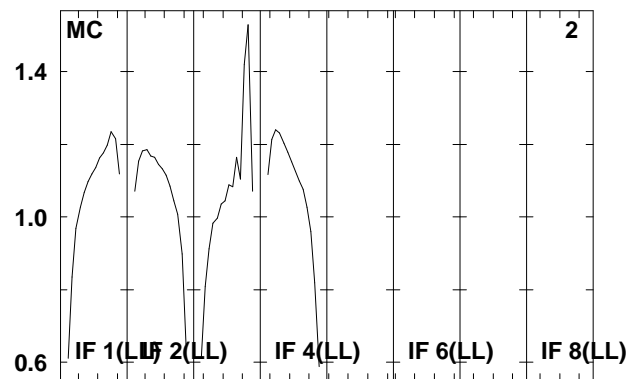
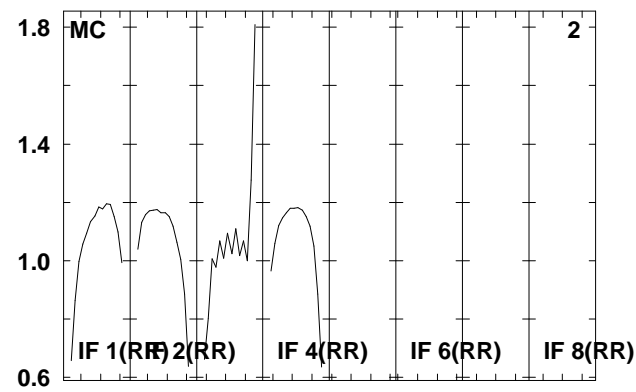
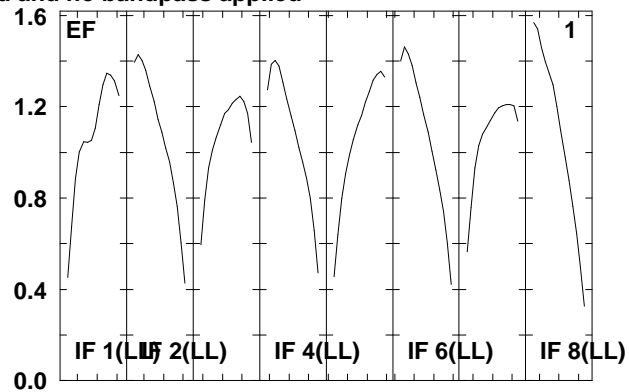
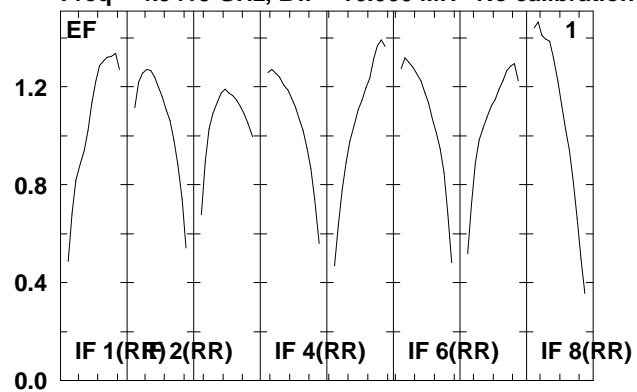

Lower frame: Real Jy  
Total-power spectrum Antenna: \*  
Timerange: 00/17:39:24 to 00/17:40:36

Plot file version 272 created 07-DEC-2009 16:06:29

J1912+05 RT006C.UVDATA.1

Freq = 4.9415 GHz, Bw = 16.000 MH No calibration applied and no bandpass applied

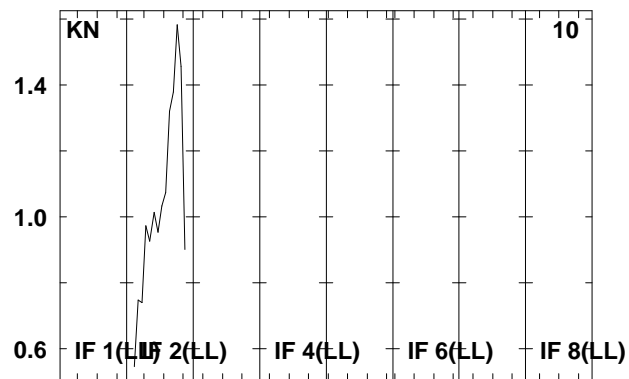
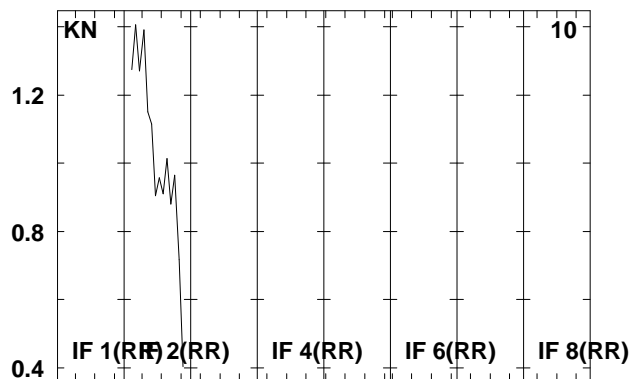
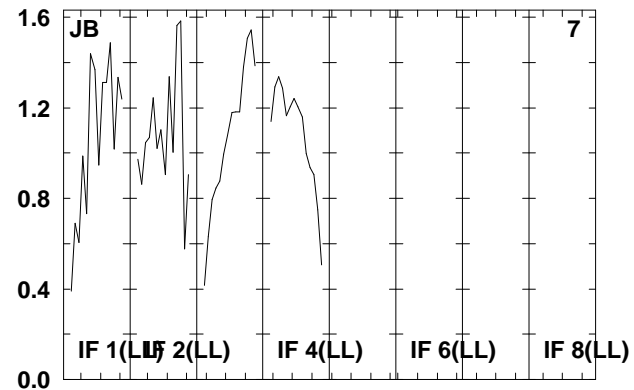
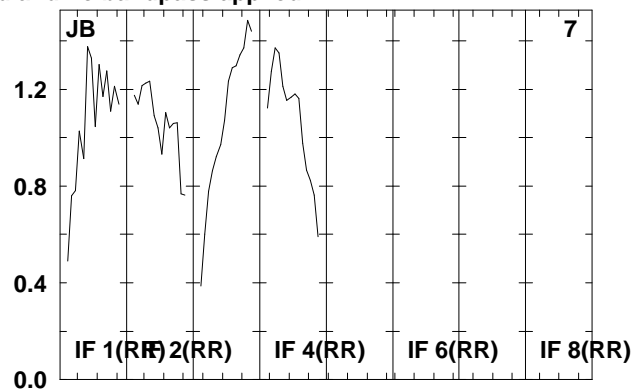
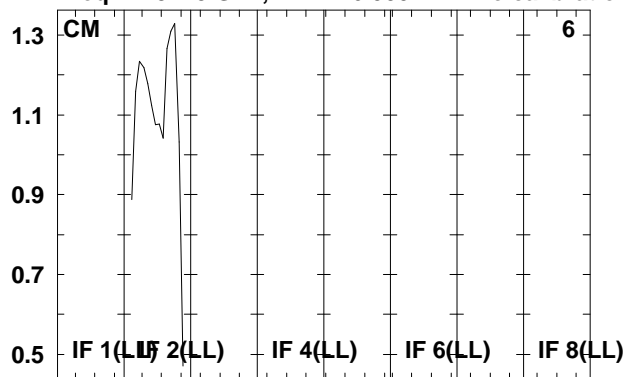

Lower frame: Real Jy  
Total-power spectrum Antenna: \*  
Timerange: 00/17:39:24 to 00/17:40:36



Plot file version 273 created 07-DEC-2009 16:06:29

SS433 RT006C.UVDATA.1

Freq = 4.9415 GHz, Bw = 16.000 MH No calibration applied and no bandpass applied

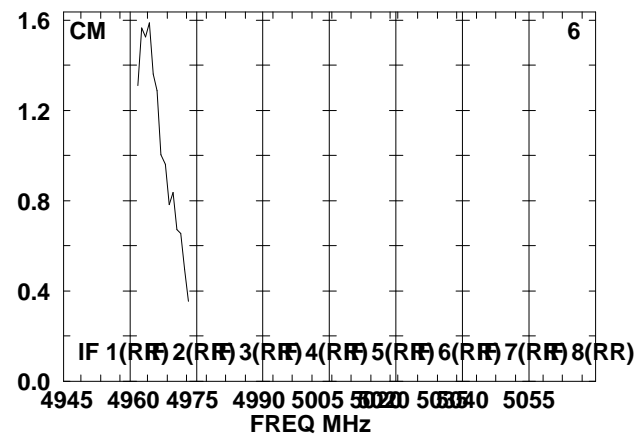
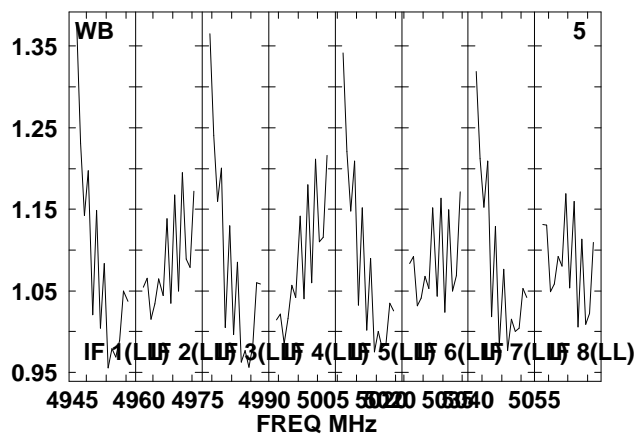
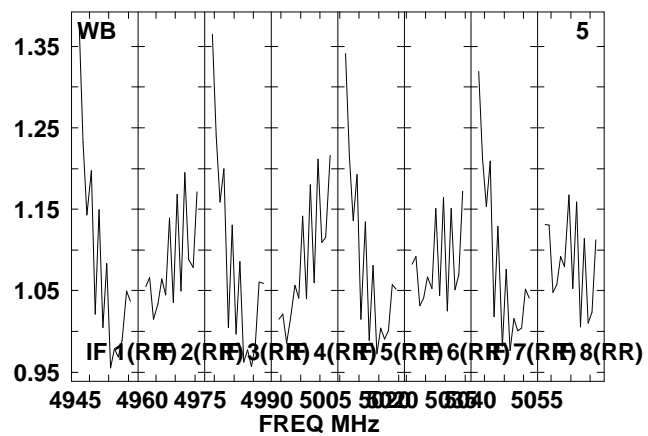
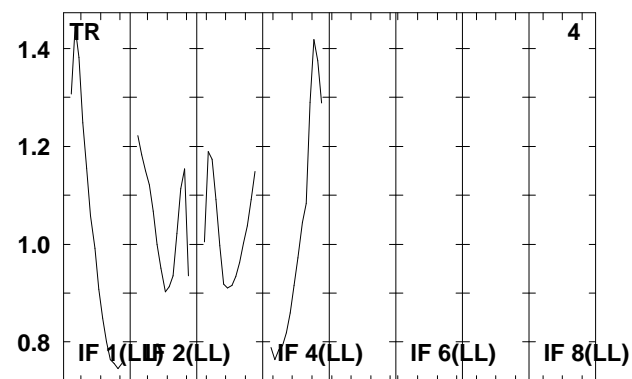
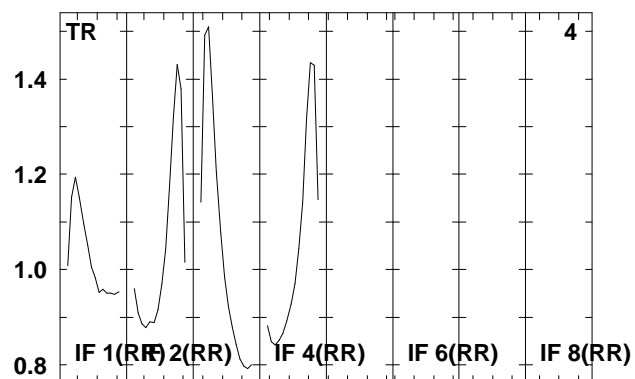
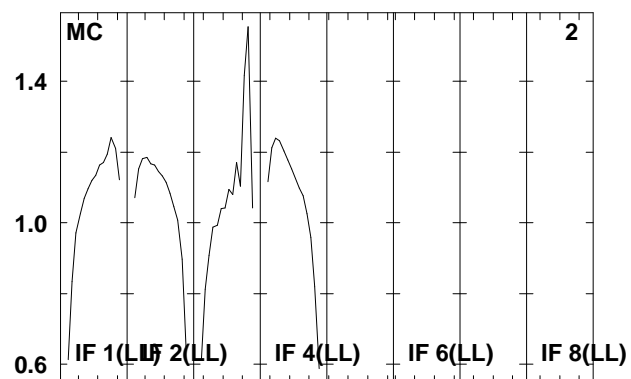
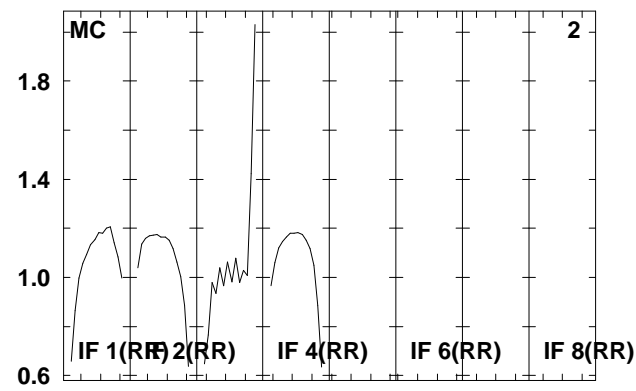
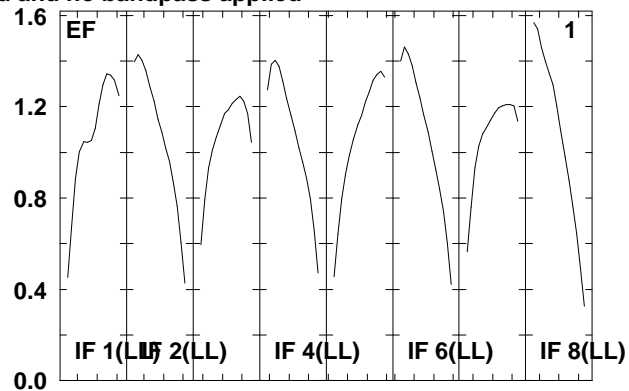
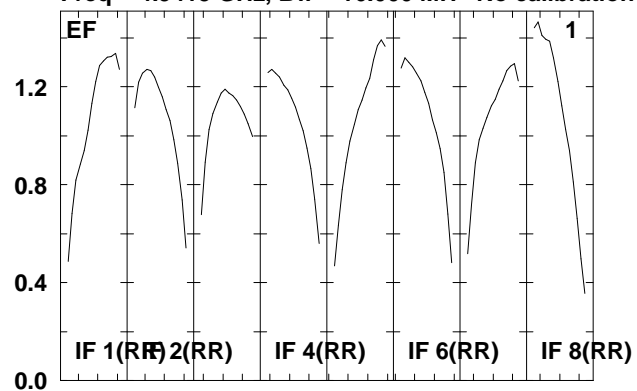

Lower frame: Real Jy  
Total-power spectrum Antenna: \*  
Timerange: 00/17:40:40 to 00/17:42:56

Plot file version 274 created 07-DEC-2009 16:06:29

SS433 RT006C.UVDATA.1

Freq = 4.9415 GHz, Bw = 16.000 MH No calibration applied and no bandpass applied

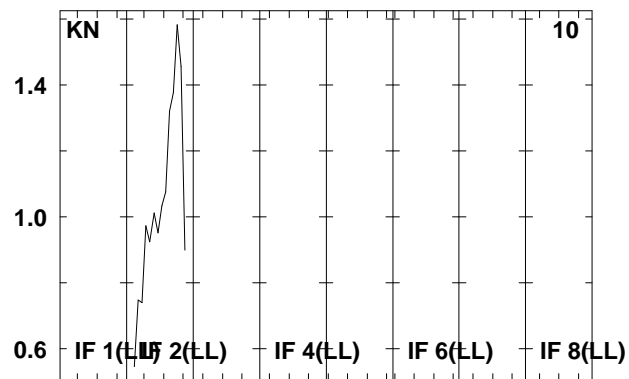
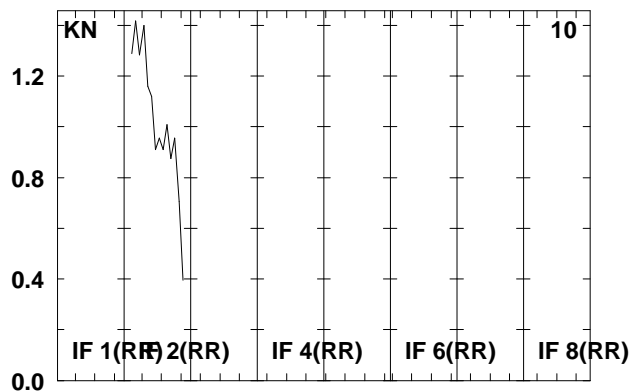
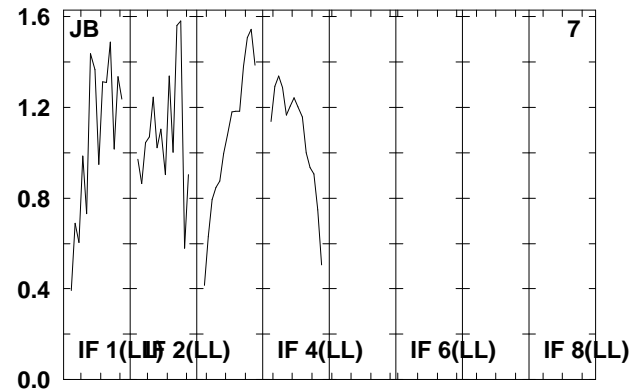
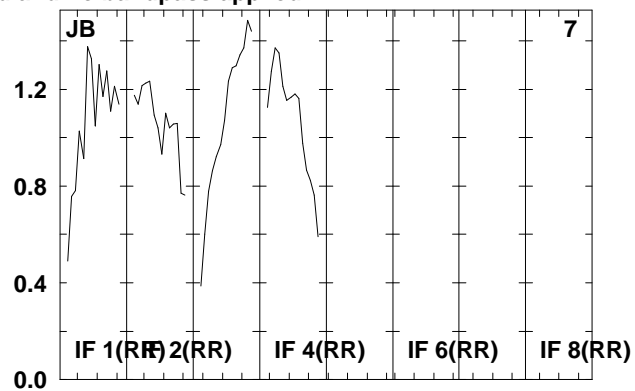
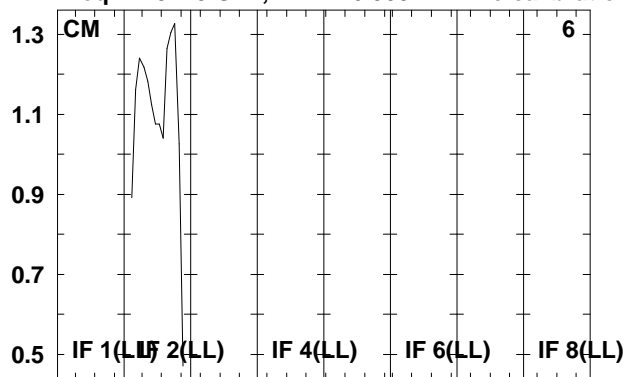

Lower frame: Real Jy  
Total-power spectrum Antenna: \*  
Timerange: 00/17:40:40 to 00/17:42:56

Plot file version 275 created 07-DEC-2009 16:06:29

J1911+16 RT006C.UVDATA.1

Freq = 4.9415 GHz, Bw = 16.000 MH No calibration applied and no bandpass applied

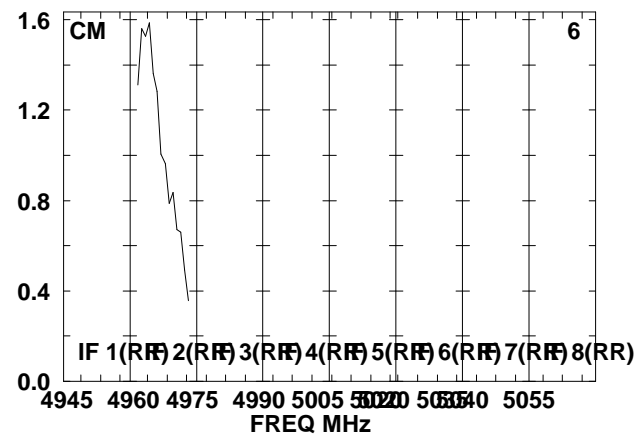
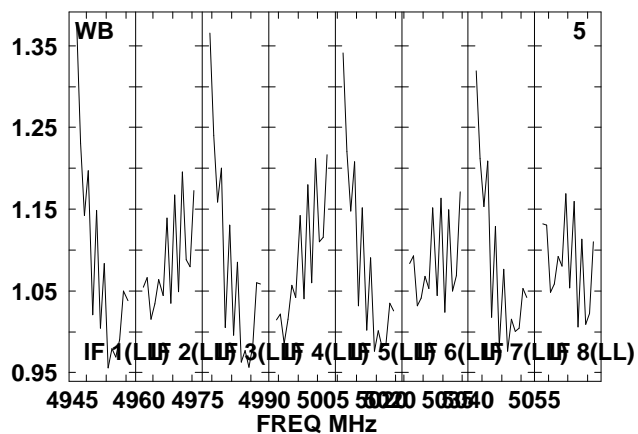
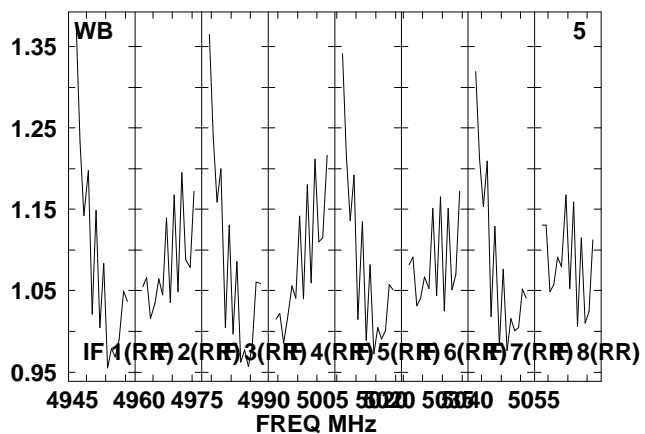
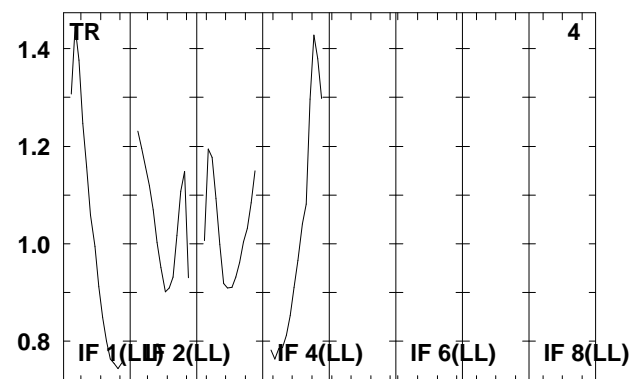
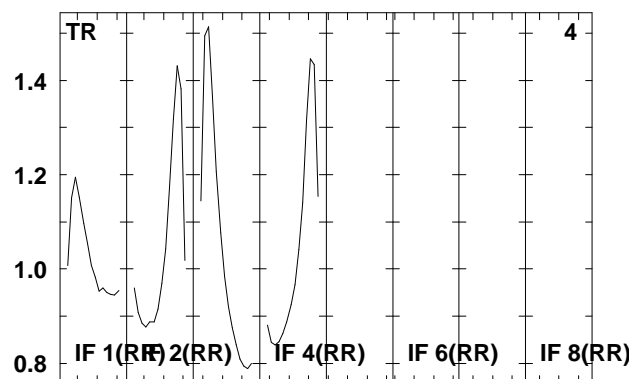
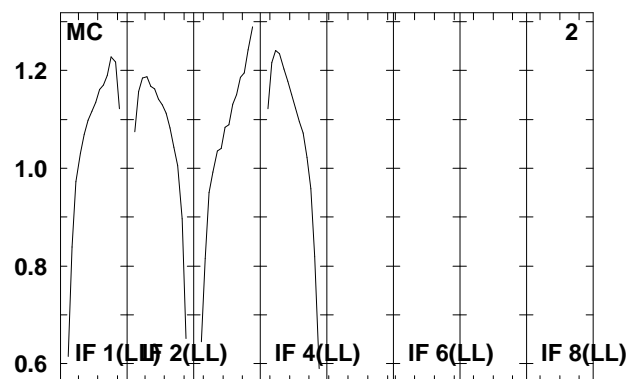
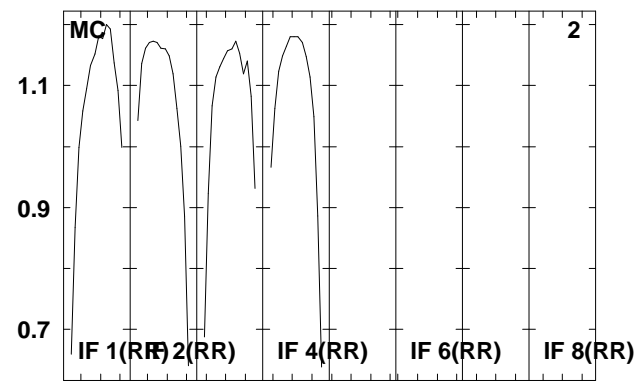
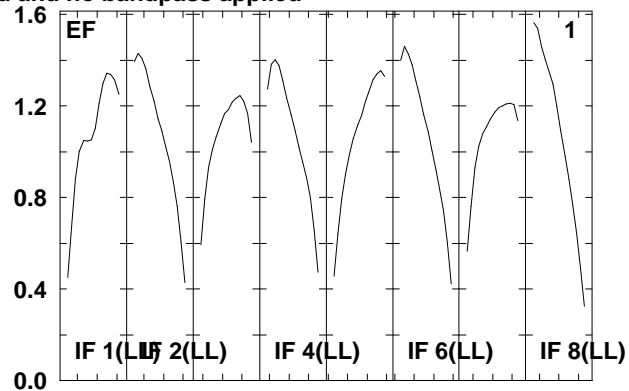
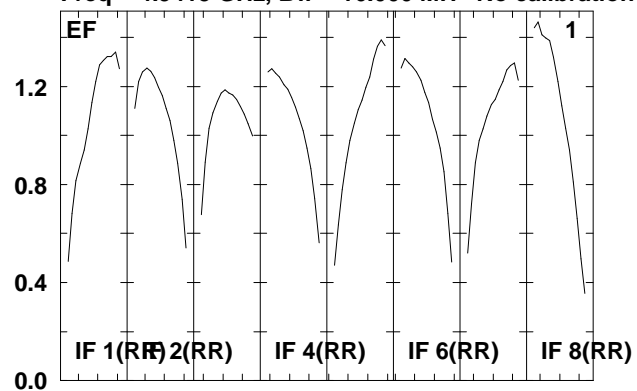

Lower frame: Real Jy  
Total-power spectrum Antenna: \*  
Timerange: 00/17:44:04 to 00/17:44:56

Plot file version 276 created 07-DEC-2009 16:06:29

J1911+16 RT006C.UVDATA.1

Freq = 4.9415 GHz, Bw = 16.000 MH No calibration applied and no bandpass applied

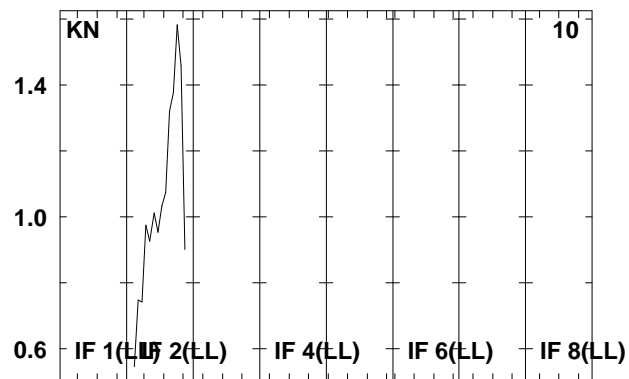
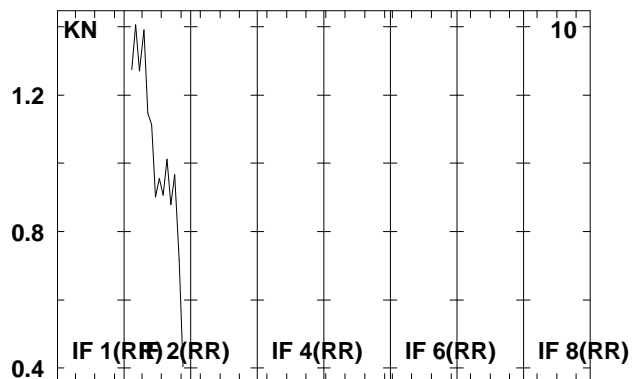
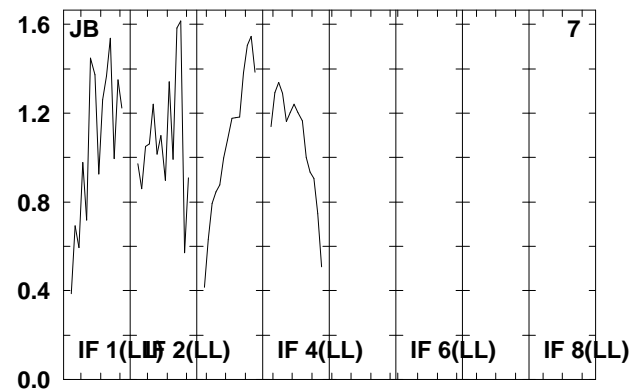
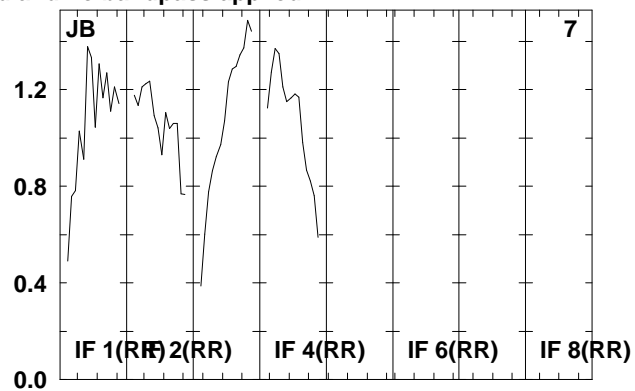
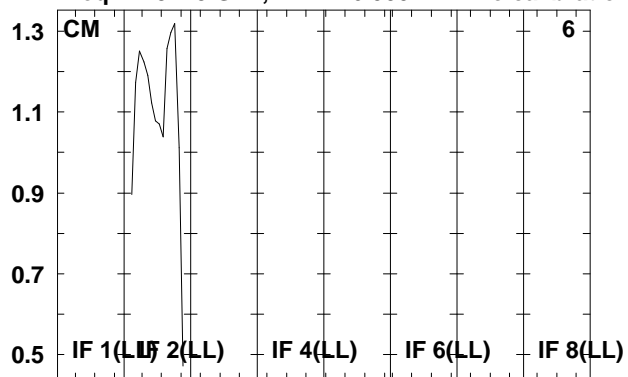

Lower frame: Real Jy  
Total-power spectrum Antenna: \*  
Timerange: 00/17:44:04 to 00/17:44:56

Plot file version 277 created 07-DEC-2009 16:06:30

J2002+47 RT006C.UVDATA.1

Freq = 4.9415 GHz, Bw = 16.000 MH No calibration applied and no bandpass applied

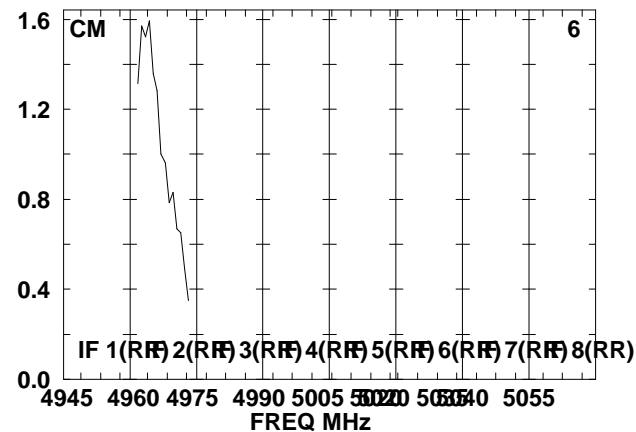
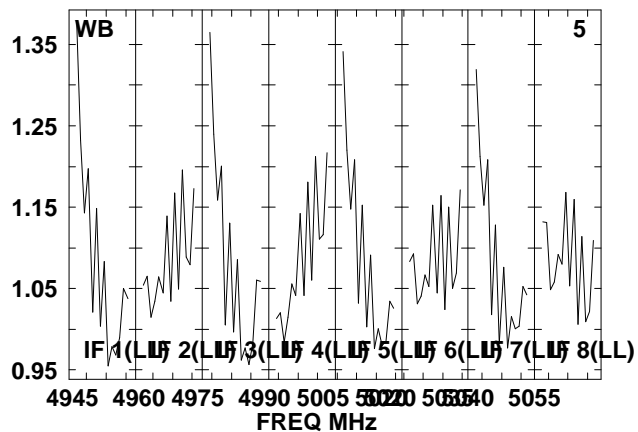
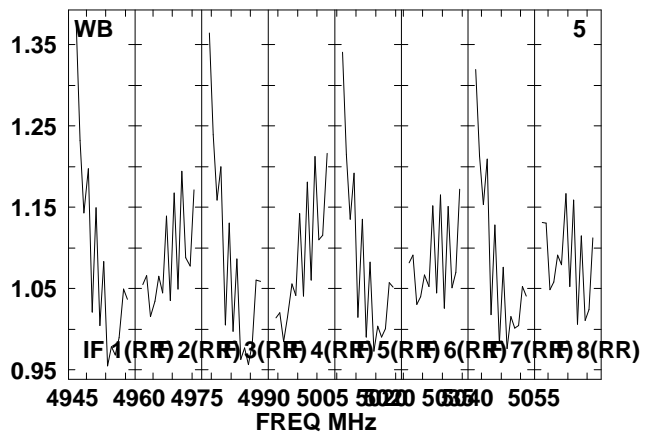
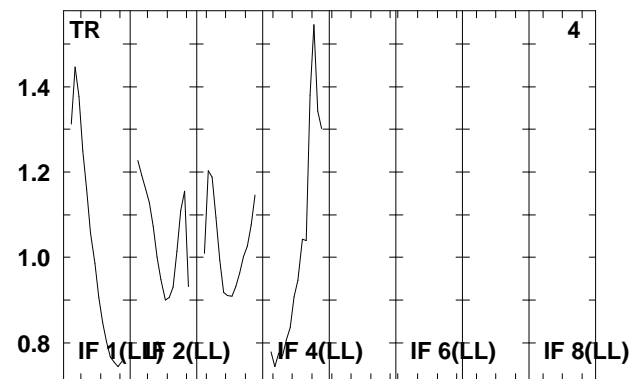
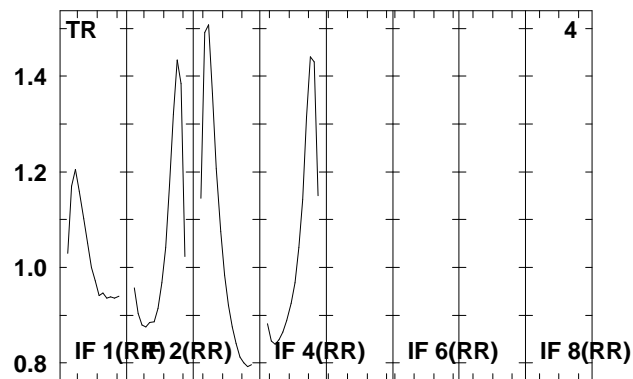
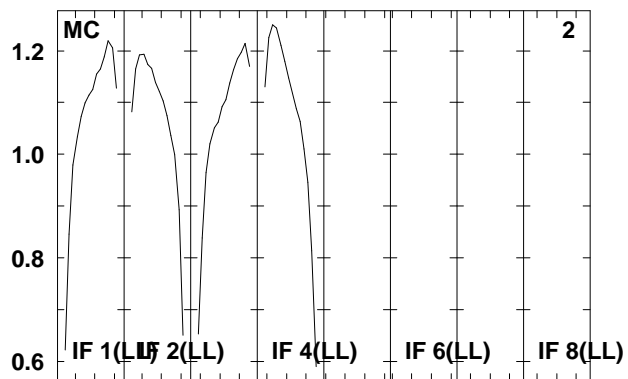
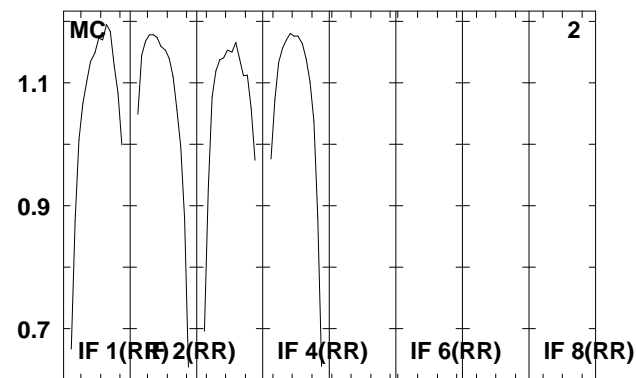
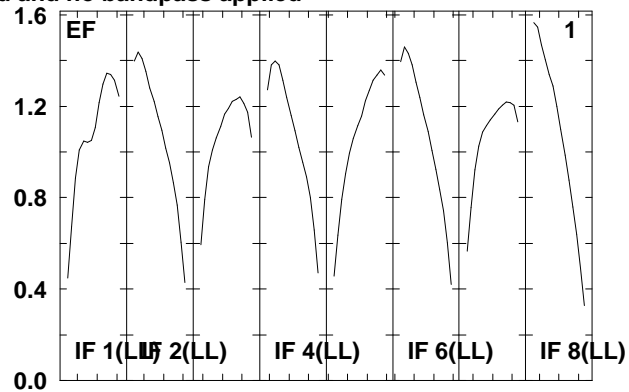
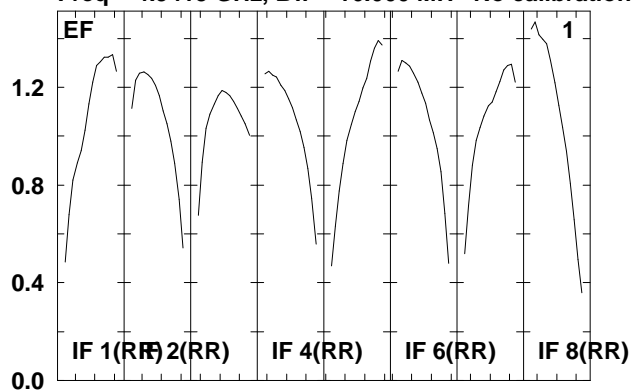

Lower frame: Real Jy

Total-power spectrum Antenna: \*

Timerange: 00/17:49:00 to 00/17:54:52

Plot file version 278 created 07-DEC-2009 16:06:30

J2002+47 RT006C.UVDATA.1

Freq = 4.9415 GHz, Bw = 16.000 MH No calibration applied and no bandpass applied

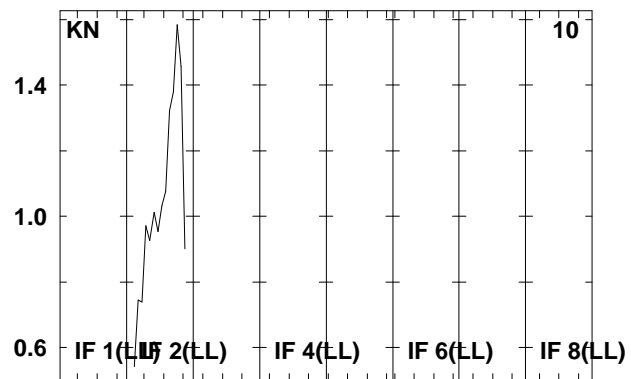
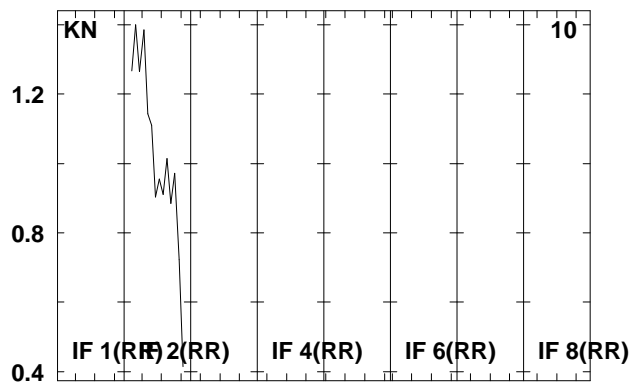
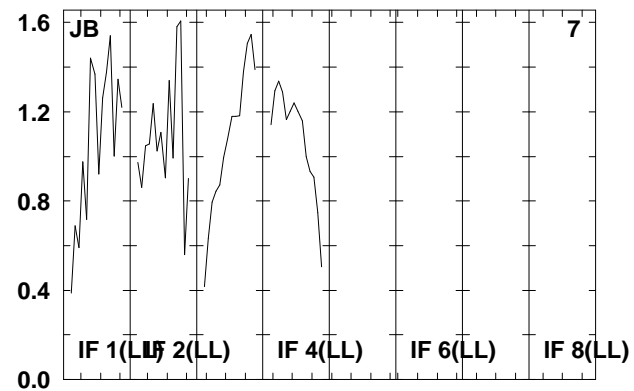
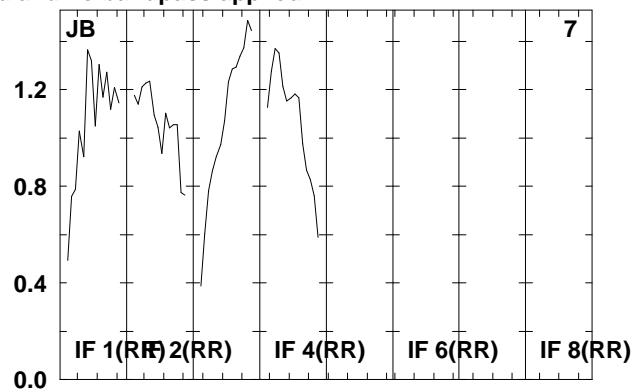
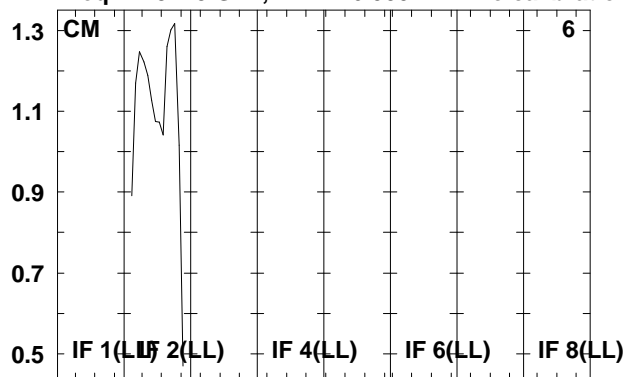

Lower frame: Real Jy  
Total-power spectrum Antenna: \*  
Timerange: 00/17:49:00 to 00/17:54:52

Plot file version 279 created 07-DEC-2009 16:06:31

J1832+28 RT006C.UVDATA.1

Freq = 4.9415 GHz, Bw = 16.000 MH No calibration applied and no bandpass applied

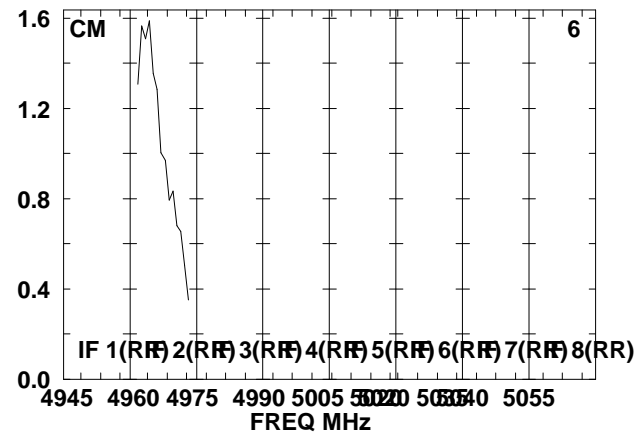
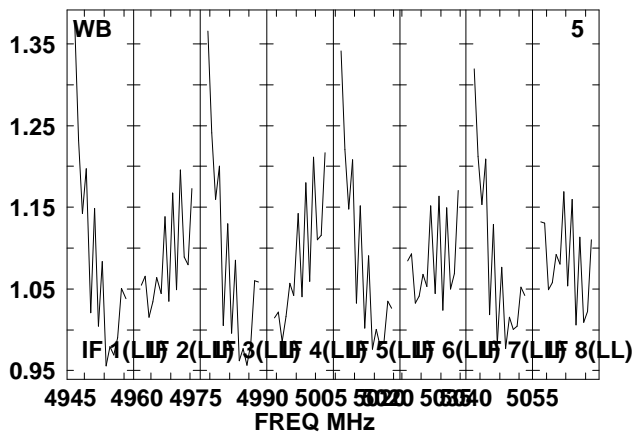
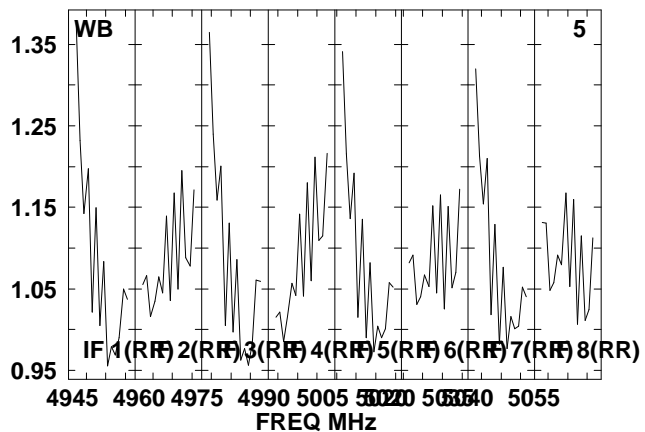
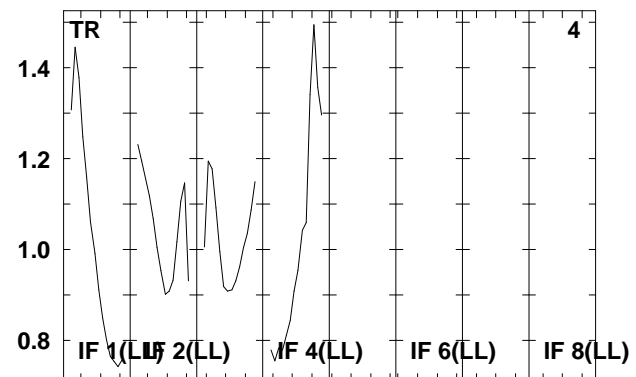
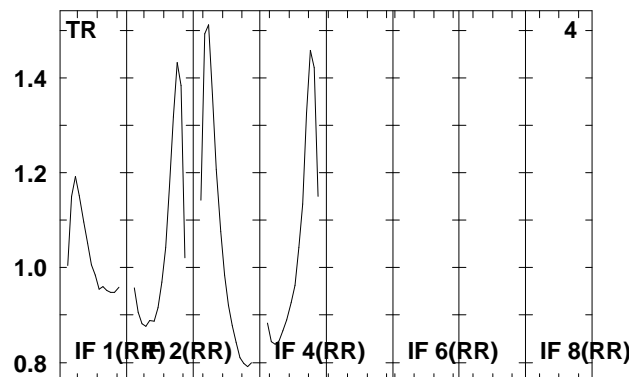
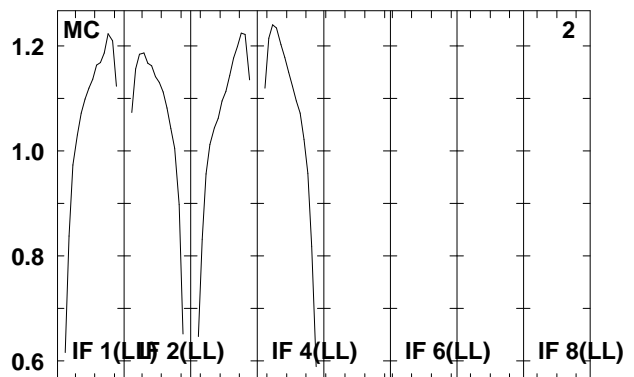
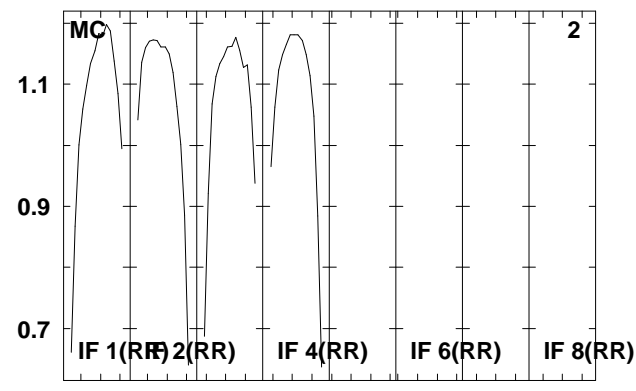
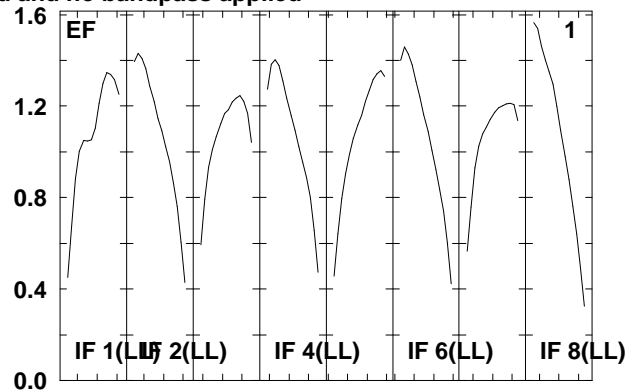
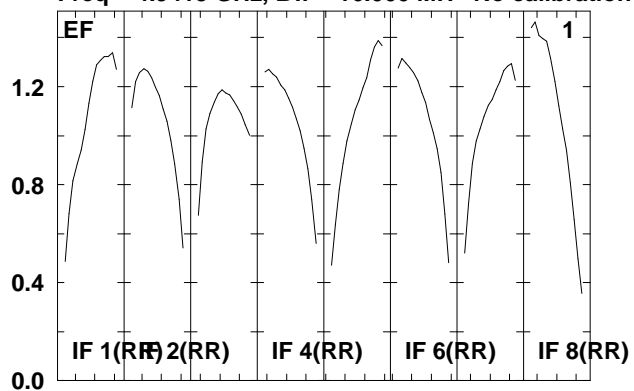

Lower frame: Real Jy  
Total-power spectrum Antenna: \*  
Timerange: 00/17:58:58 to 00/18:18:58

Plot file version 280 created 07-DEC-2009 16:06:32

J1832+28 RT006C.UVDATA.1

Freq = 4.9415 GHz, Bw = 16.000 MH No calibration applied and no bandpass applied

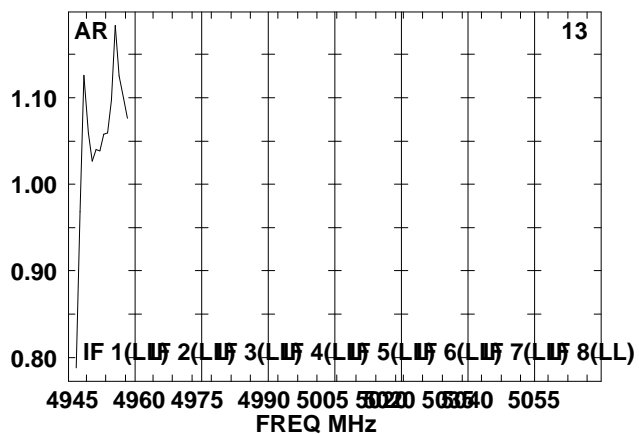
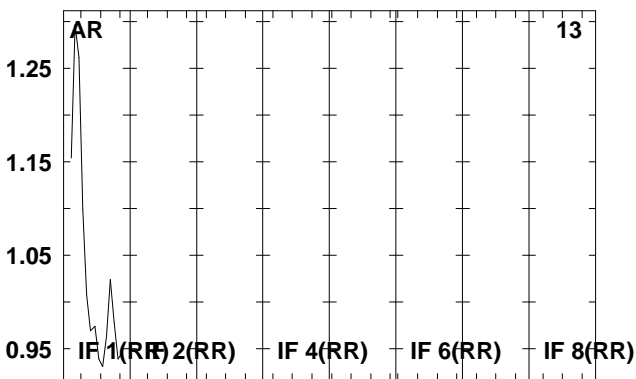
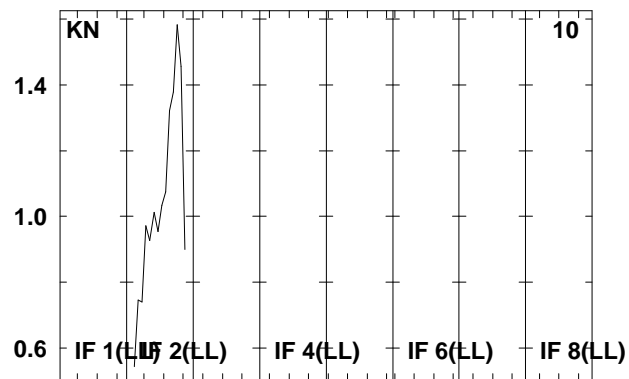
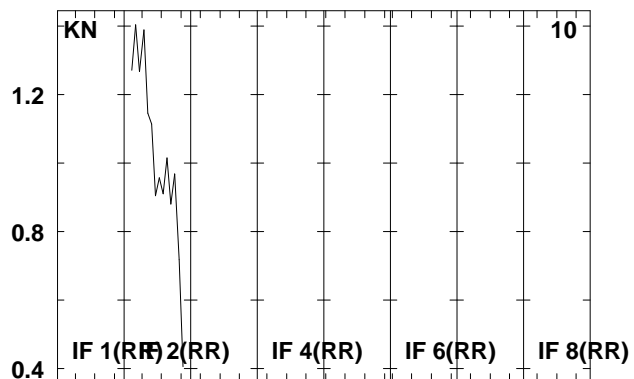
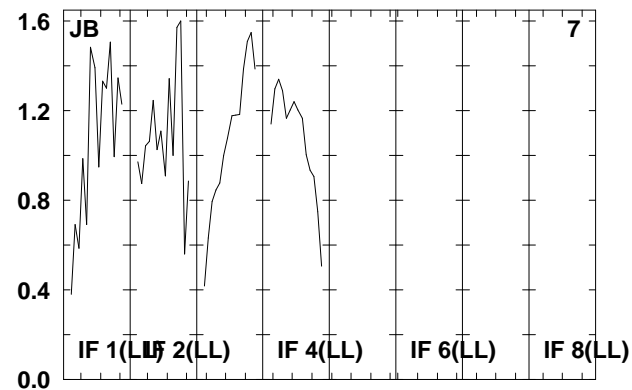
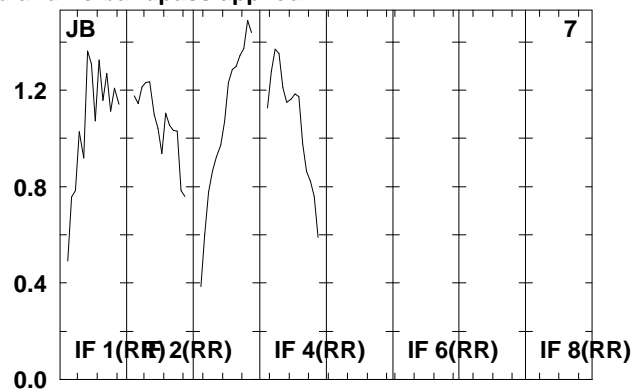
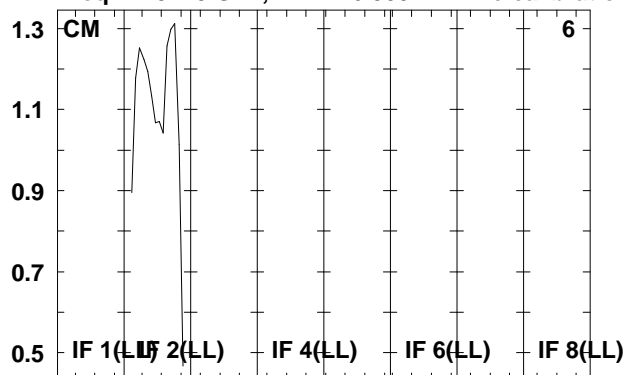

Lower frame: Real Jy

Total-power spectrum Antenna: \*

Timerange: 00/17:58:58 to 00/18:18:58



Plot file version 281 created 07-DEC-2009 16:06:34

J1832+28 RT006C.UVDATA.1

Freq = 4.9415 GHz, Bw = 16.000 MH No calibration applied and no bandpass applied

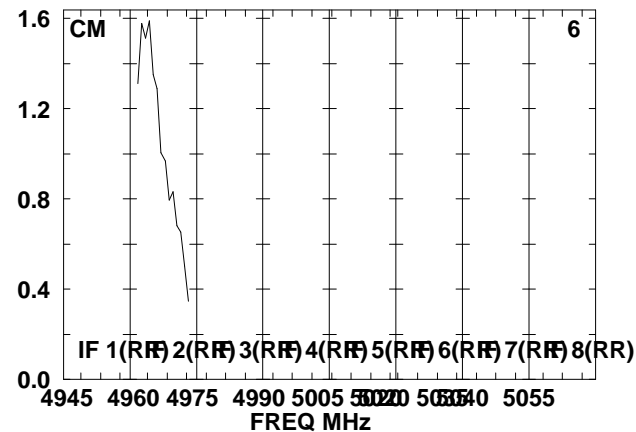
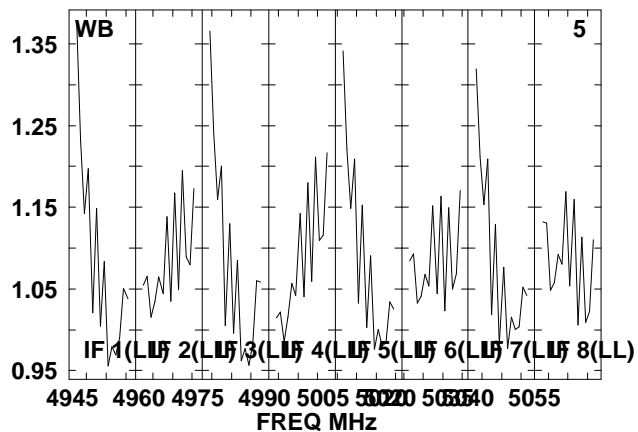
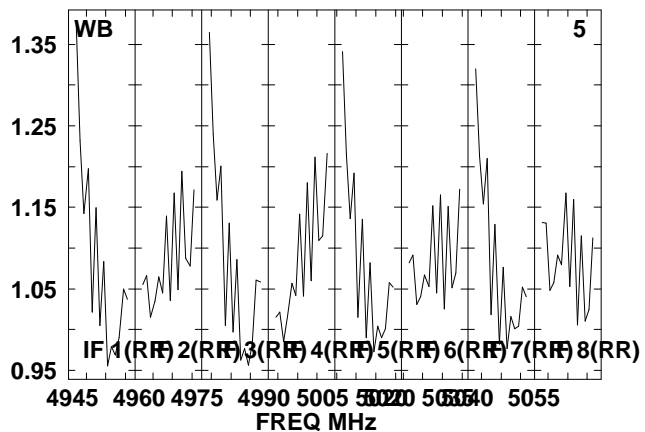
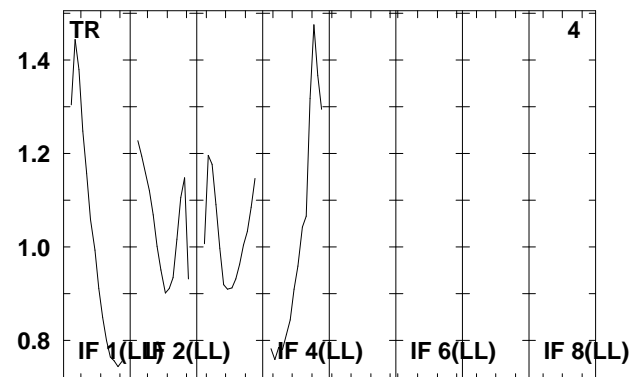
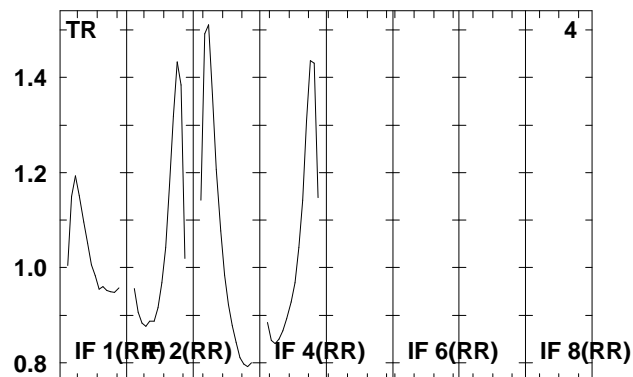
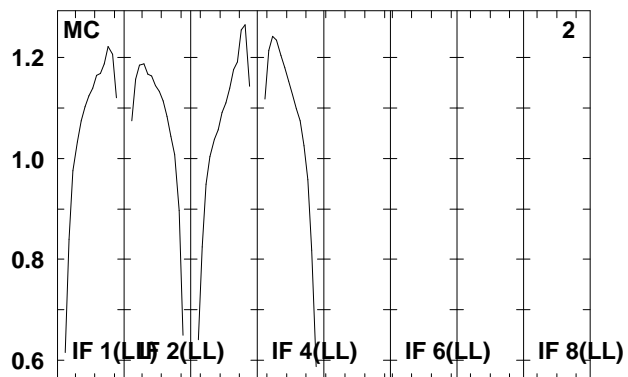
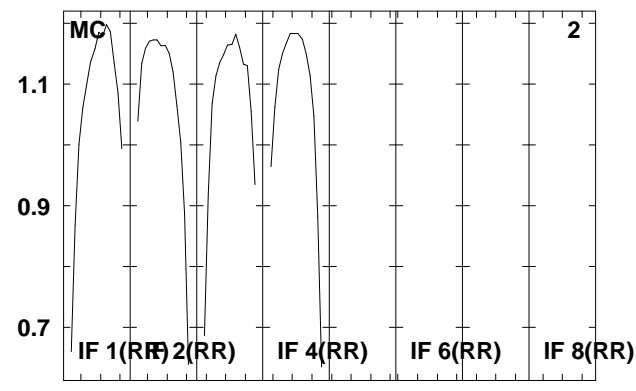
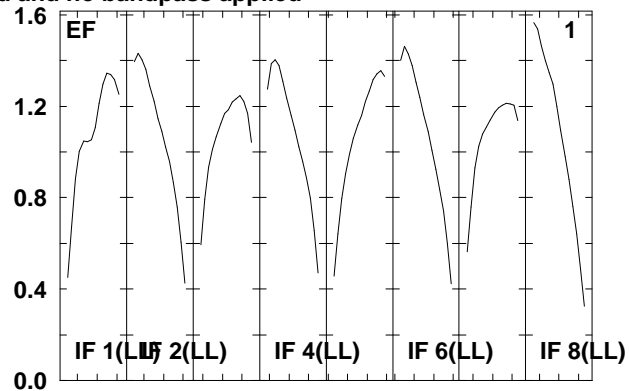
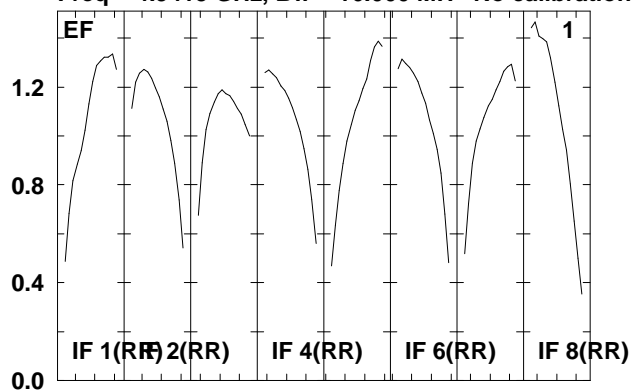

Lower frame: Real Jy  
Total-power spectrum Antenna: \*  
Timerange: 00/18:22:02 to 00/18:38:58

Plot file version 282 created 07-DEC-2009 16:06:35

J1832+28 RT006C.UVDATA.1

Freq = 4.9415 GHz, Bw = 16.000 MH No calibration applied and no bandpass applied

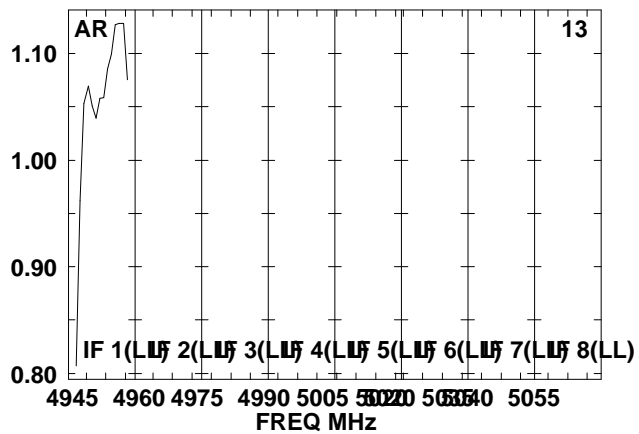
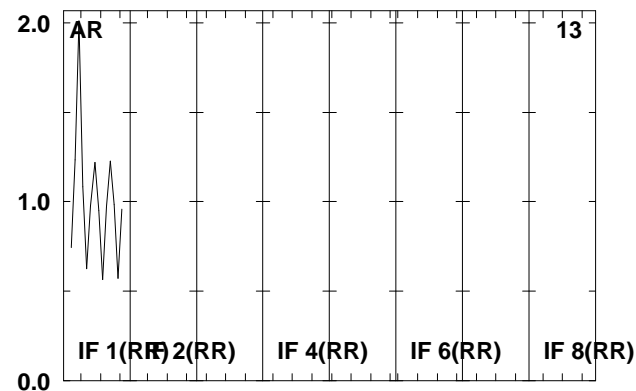
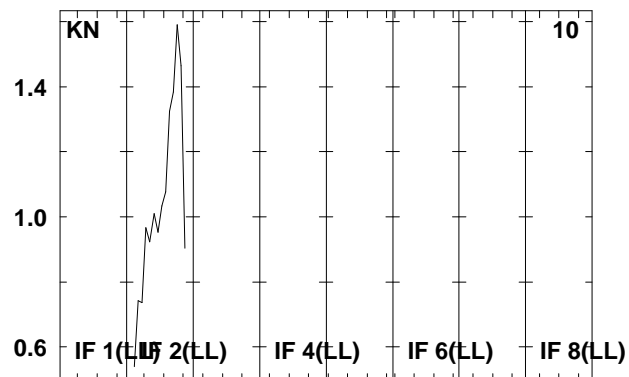
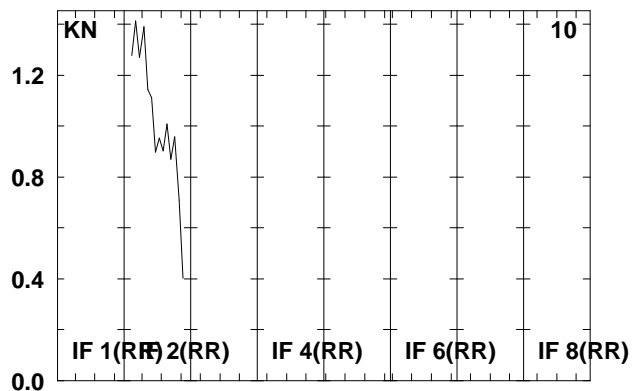
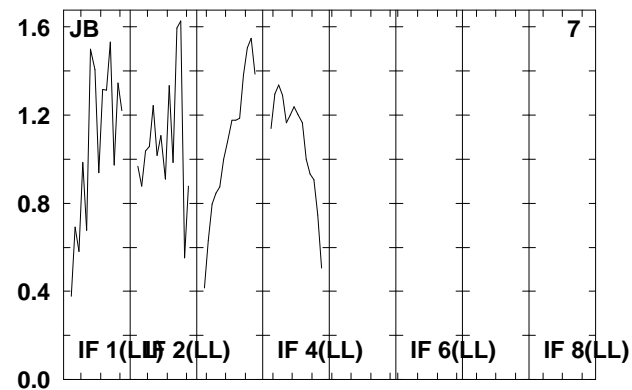
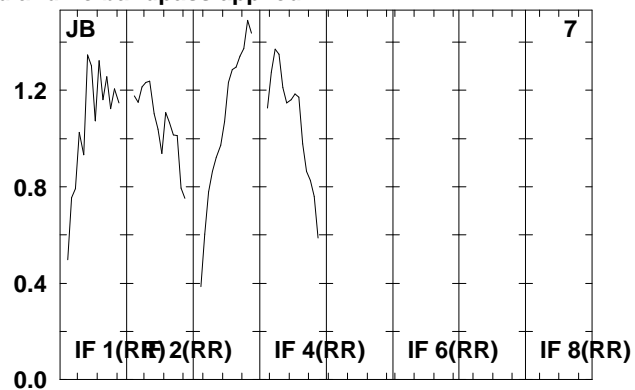
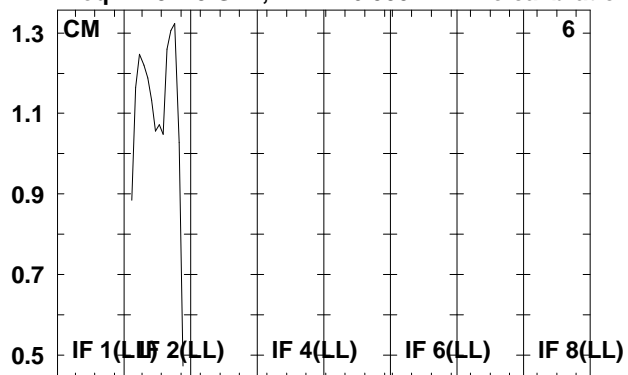

Lower frame: Real Jy

Total-power spectrum Antenna: \*

Timerange: 00/18:22:02 to 00/18:38:58

Plot file version 283 created 07-DEC-2009 16:06:37

J1912+05 RT006C.UVDATA.1

Freq = 4.9415 GHz, Bw = 16.000 MH No calibration applied and no bandpass applied

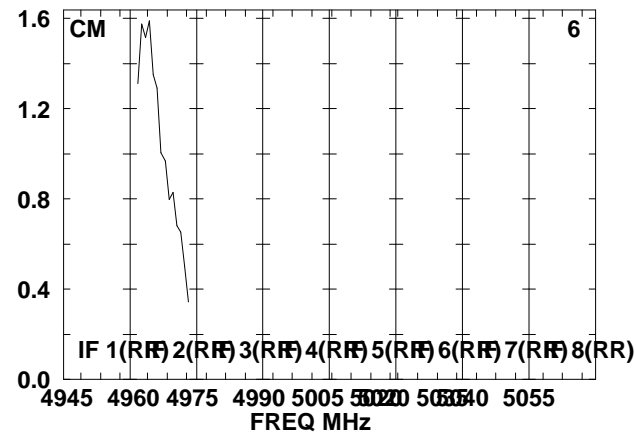
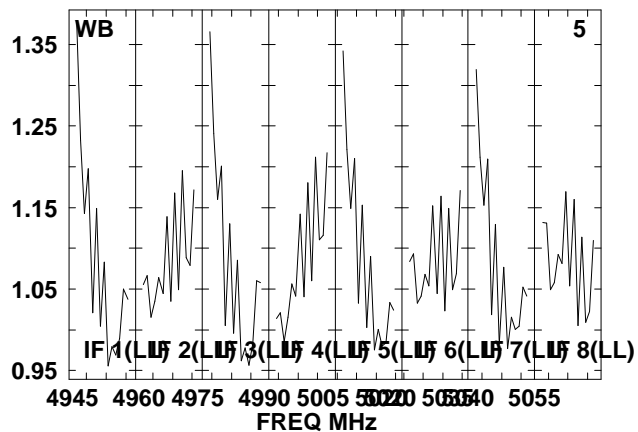
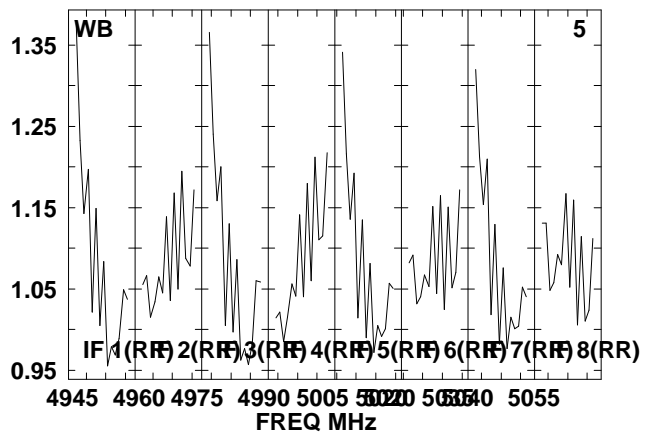
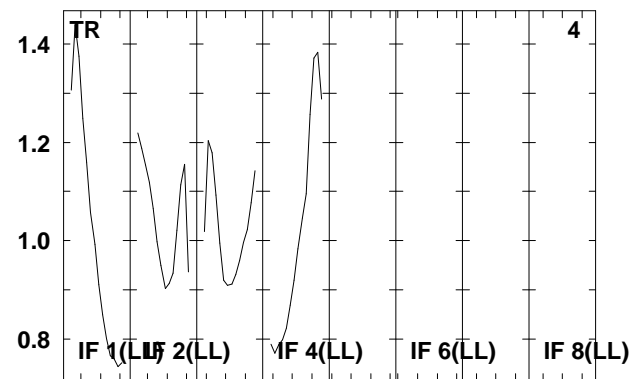
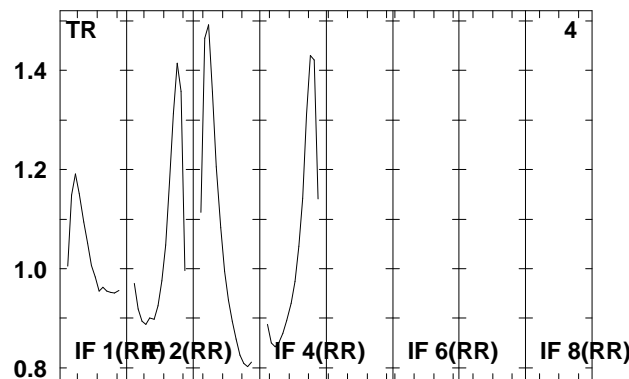
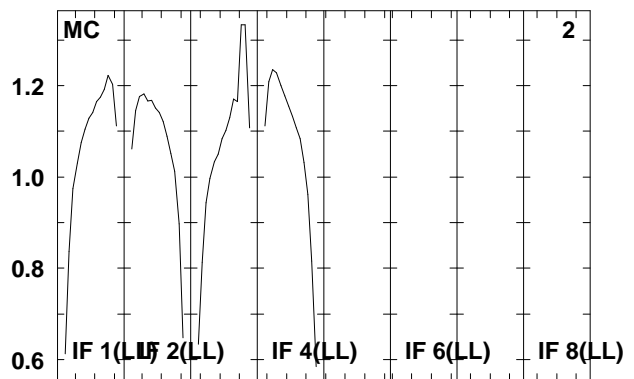
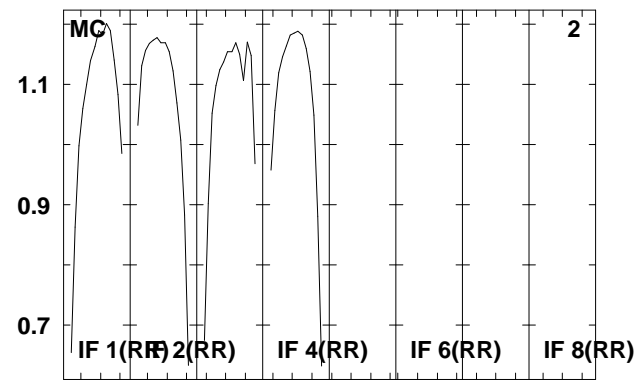
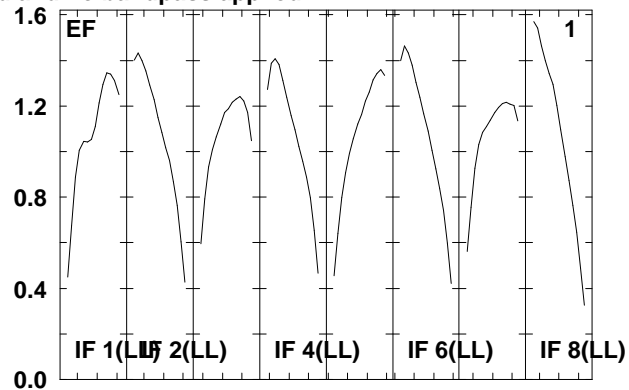
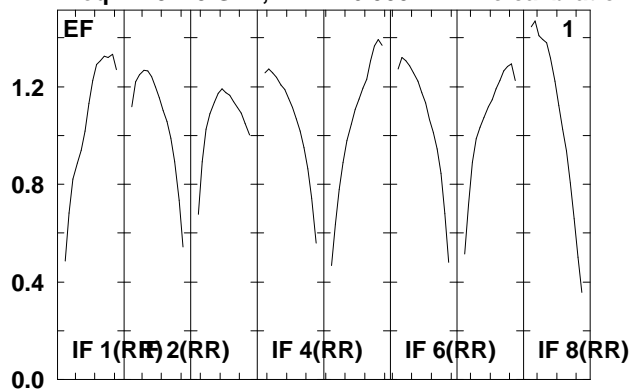

Lower frame: Real Jy  
Total-power spectrum Antenna: \*  
Timerange: 00/18:42:02 to 00/18:44:58

Plot file version 284 created 07-DEC-2009 16:06:37

J1912+05 RT006C.UVDATA.1

Freq = 4.9415 GHz, Bw = 16.000 MH No calibration applied and no bandpass applied

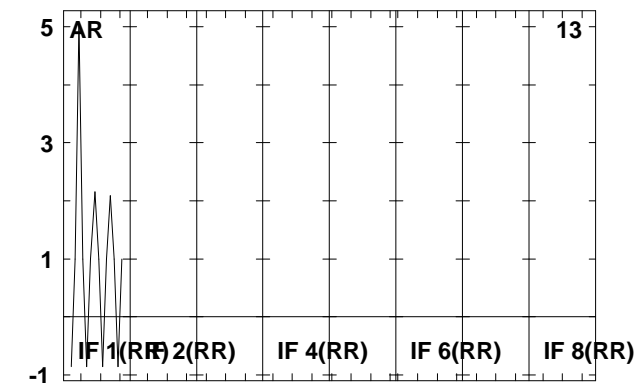
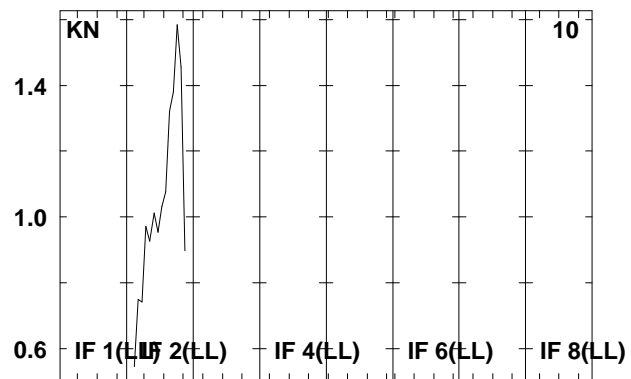
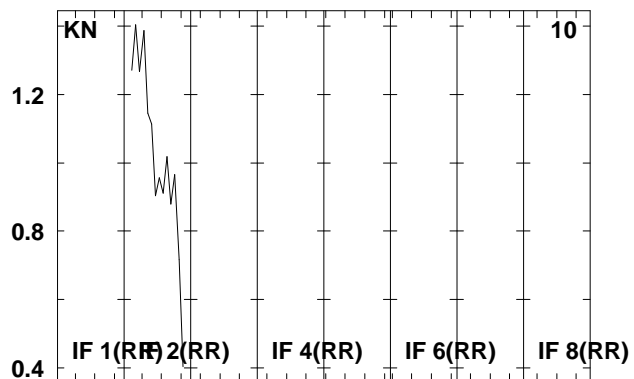
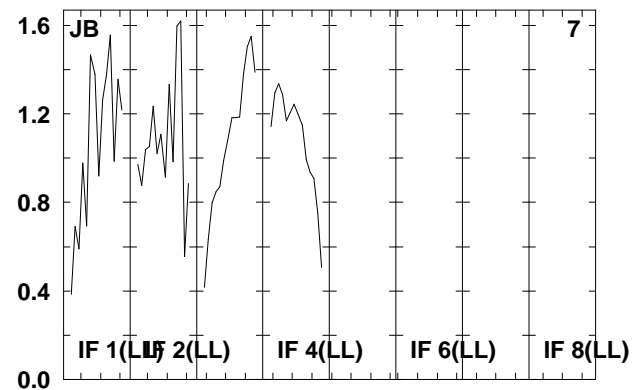
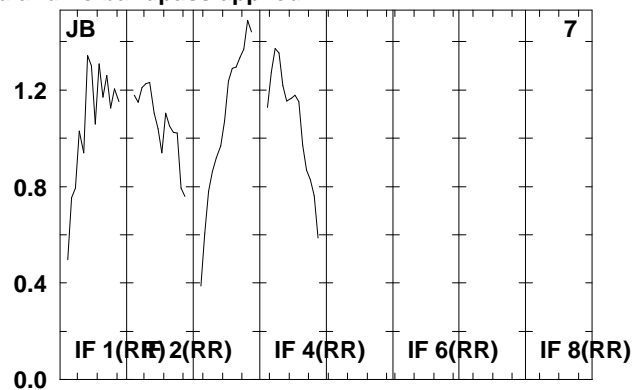
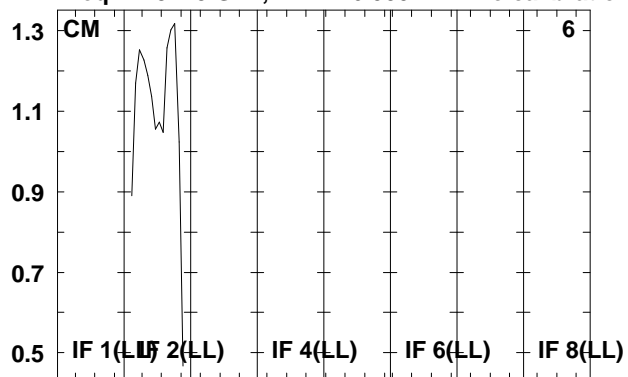

Lower frame: Real Jy  
Total-power spectrum Antenna: \*  
Timerange: 00/18:42:02 to 00/18:44:58

Plot file version 285 created 07-DEC-2009 16:06:37

SS433 RT006C.UVDATA.1

Freq = 4.9415 GHz, Bw = 16.000 MH No calibration applied and no bandpass applied

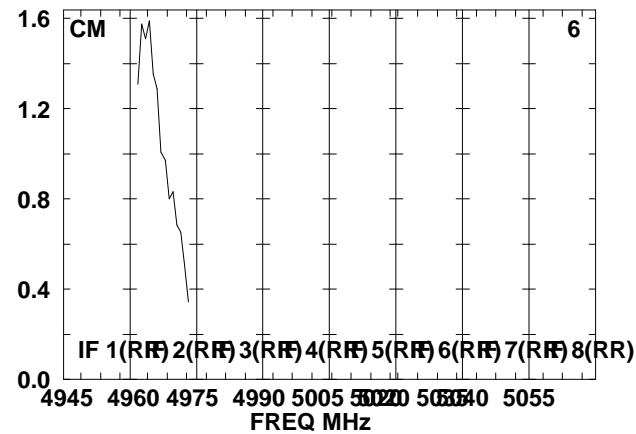
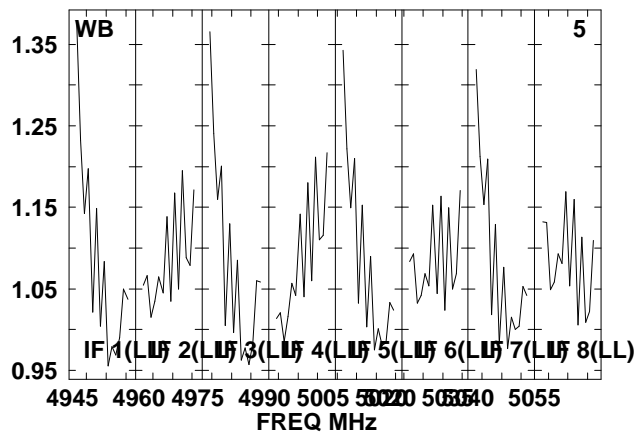
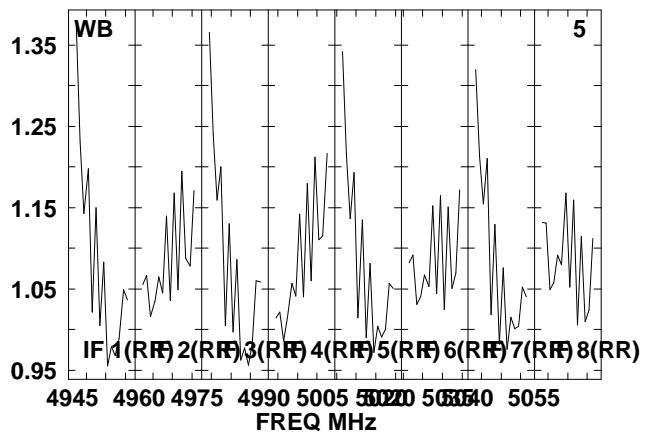
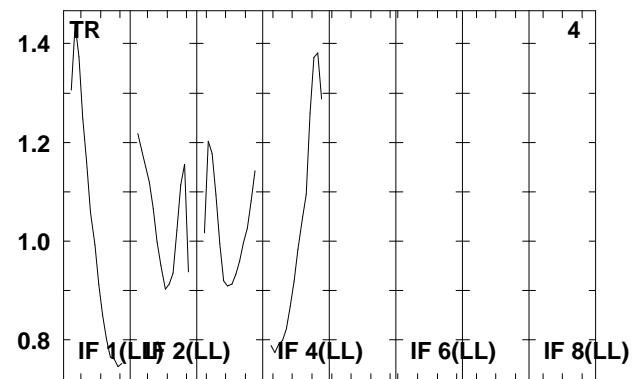
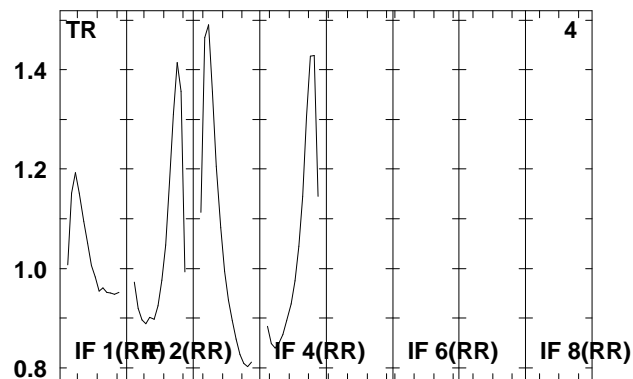
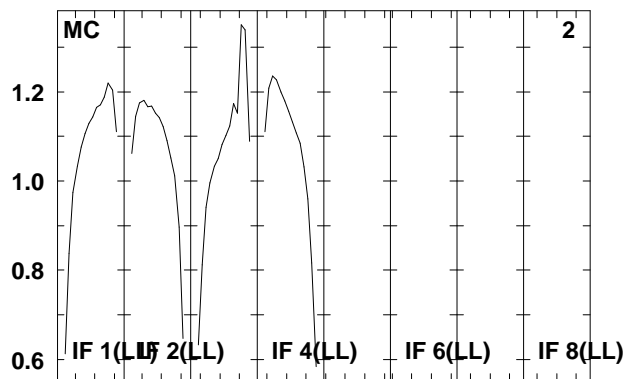
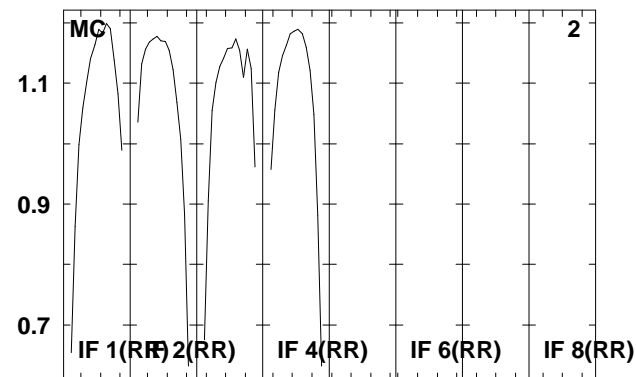
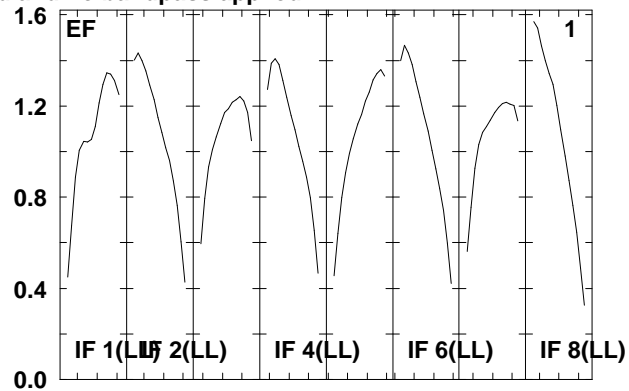
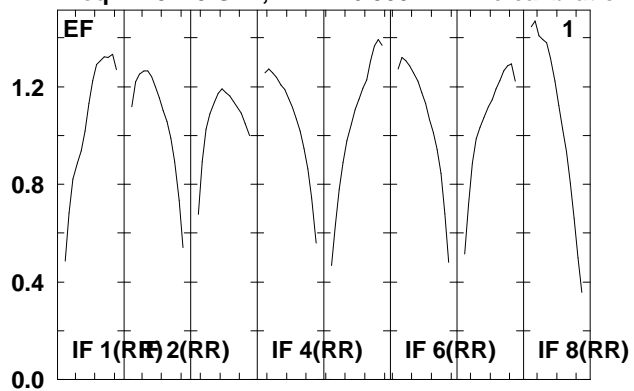

Lower frame: Real Jy  
Total-power spectrum Antenna: \*  
Timerange: 00/18:45:02 to 00/18:47:18

Plot file version 286 created 07-DEC-2009 16:06:37

SS433 RT006C.UVDATA.1

Freq = 4.9415 GHz, Bw = 16.000 MH No calibration applied and no bandpass applied

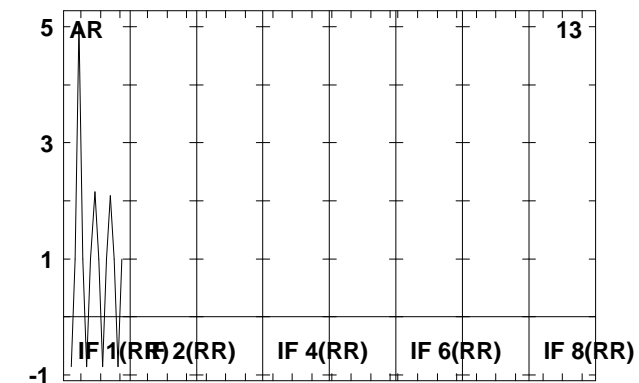
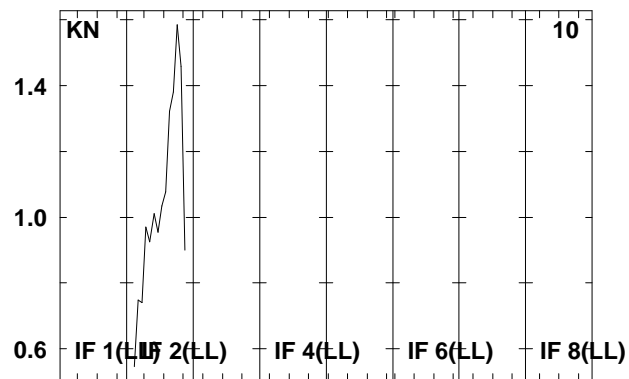
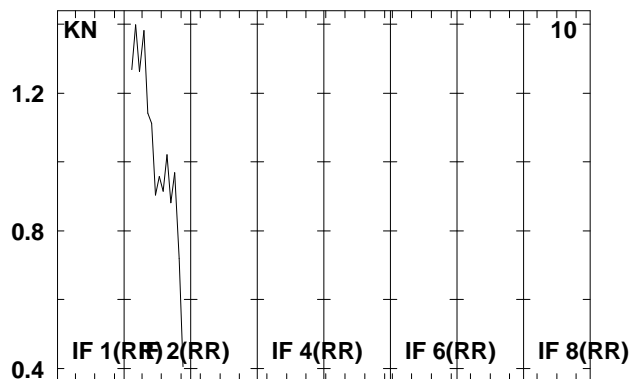
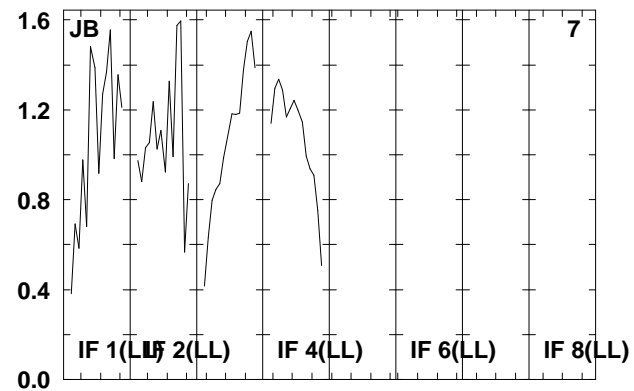
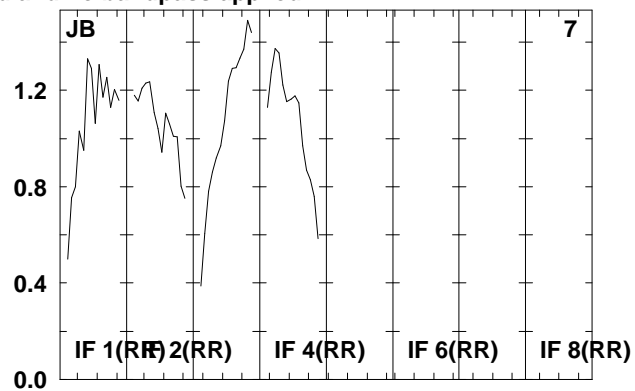
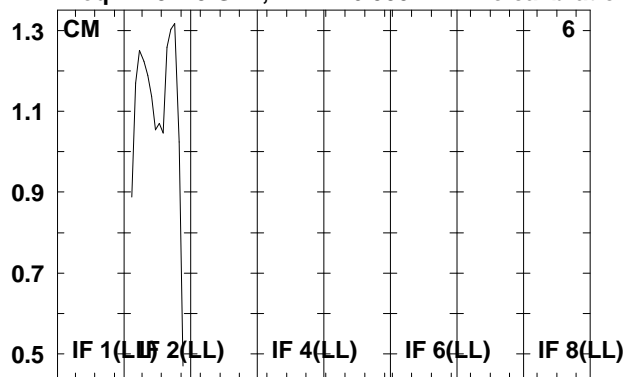

Lower frame: Real Jy  
Total-power spectrum Antenna: \*  
Timerange: 00/18:45:02 to 00/18:47:18

Plot file version 287 created 07-DEC-2009 16:06:37

J1912+05 RT006C.UVDATA.1

Freq = 4.9415 GHz, Bw = 16.000 MH No calibration applied and no bandpass applied

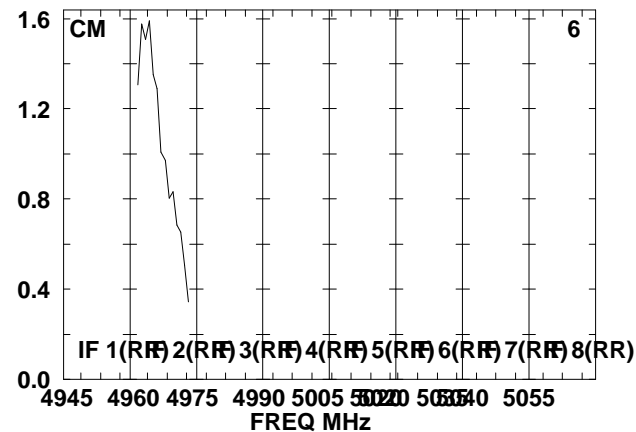
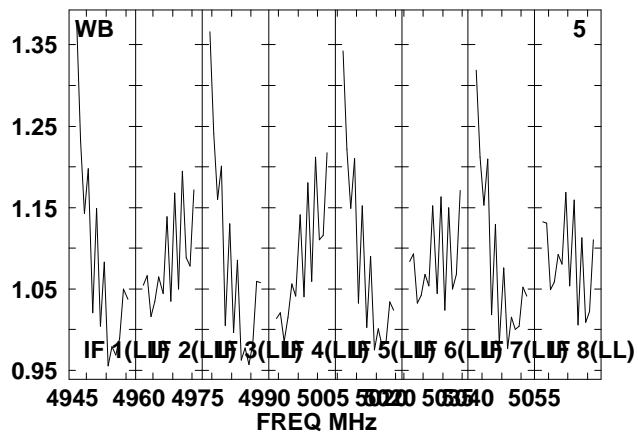
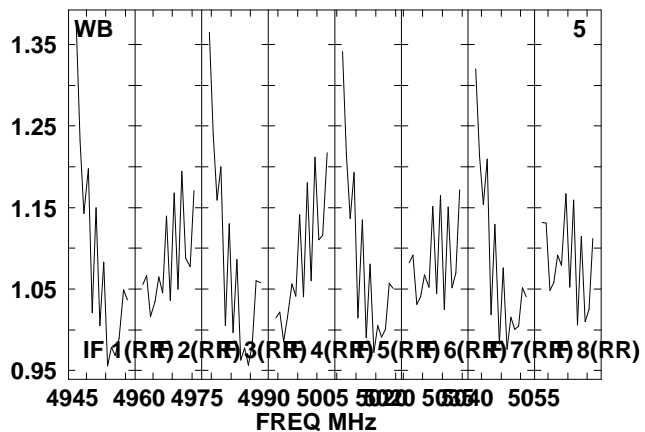
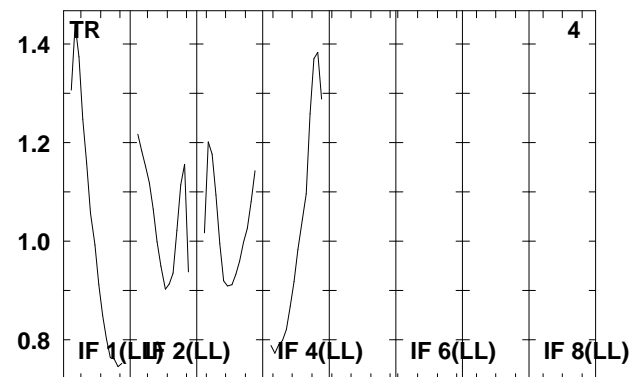
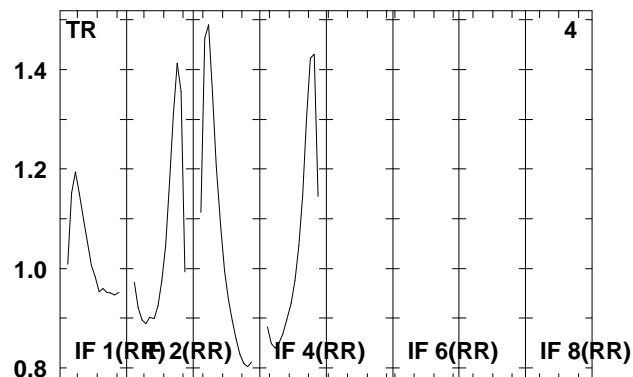
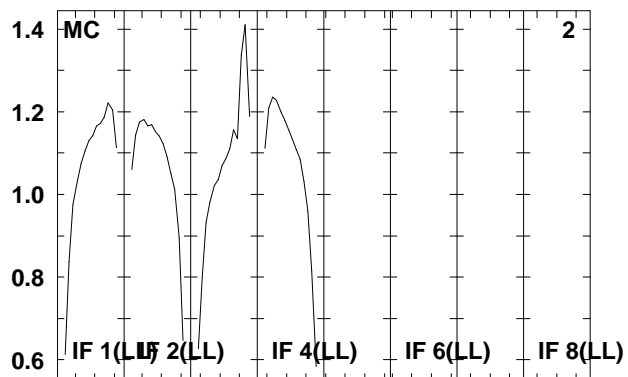
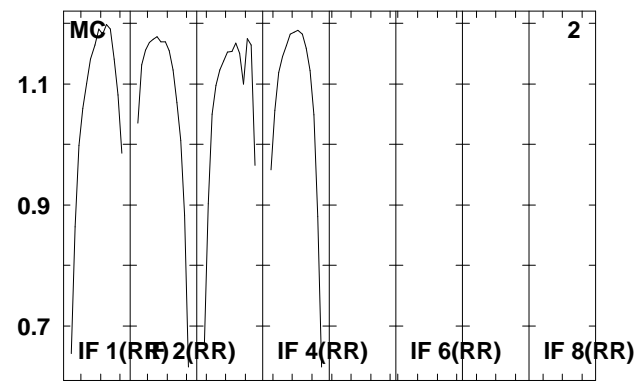
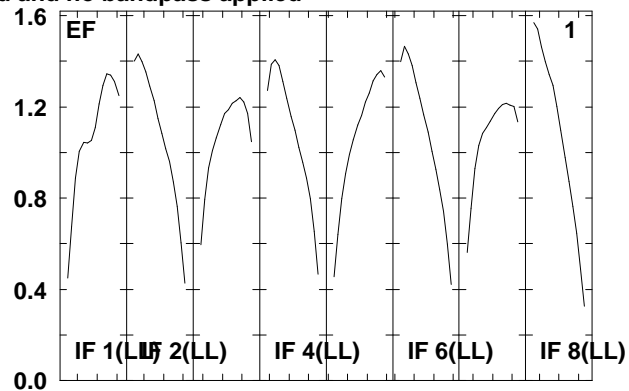
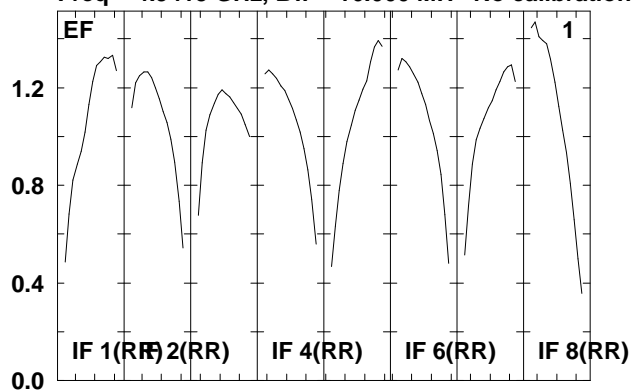

Lower frame: Real Jy

Total-power spectrum Antenna: \*

Timerange: 00/18:47:22 to 00/18:48:38

Plot file version 288 created 07-DEC-2009 16:06:38

J1912+05 RT006C.UVDATA.1

Freq = 4.9415 GHz, Bw = 16.000 MH No calibration applied and no bandpass applied

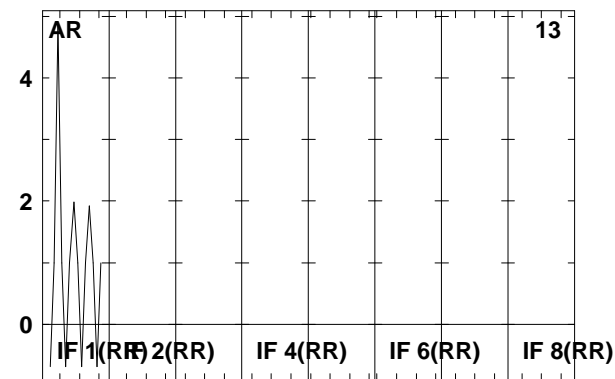
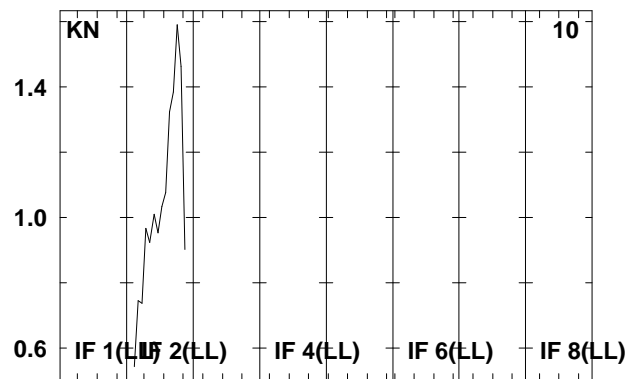
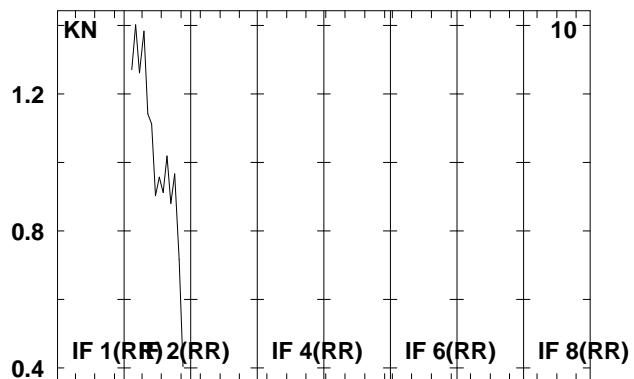
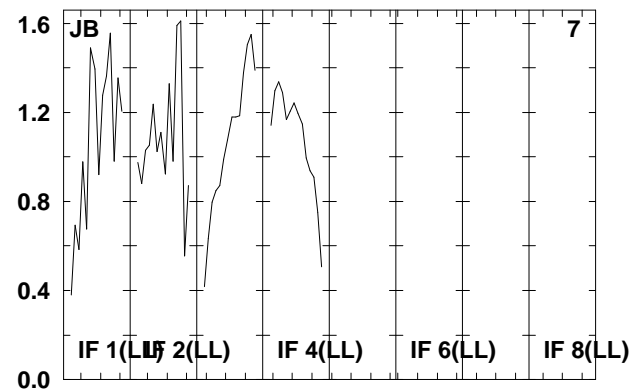
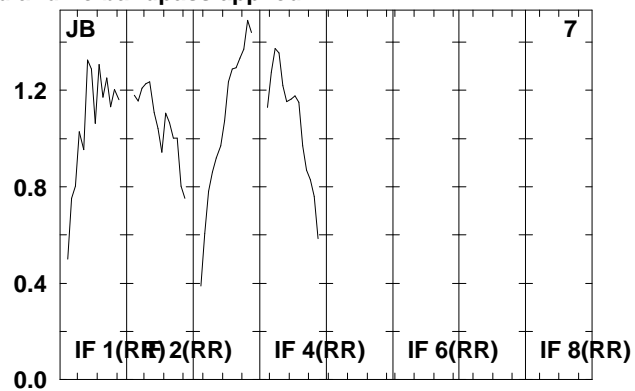
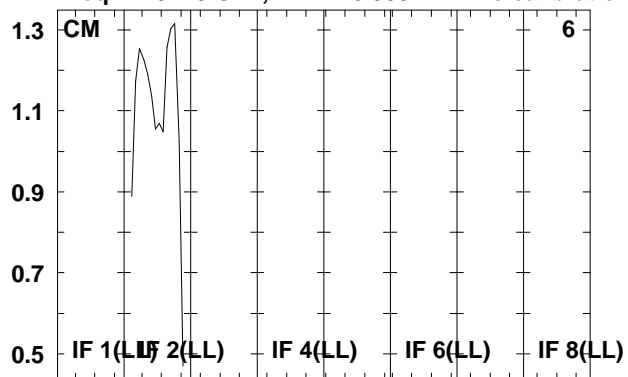

Lower frame: Real Jy  
Total-power spectrum Antenna: \*  
Timerange: 00/18:47:22 to 00/18:48:38



Plot file version 289 created 07-DEC-2009 16:06:38

SS433 RT006C.UVDATA.1

Freq = 4.9415 GHz, Bw = 16.000 MH No calibration applied and no bandpass applied

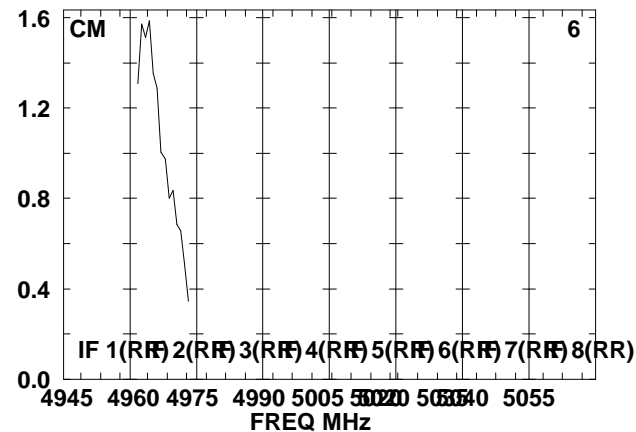
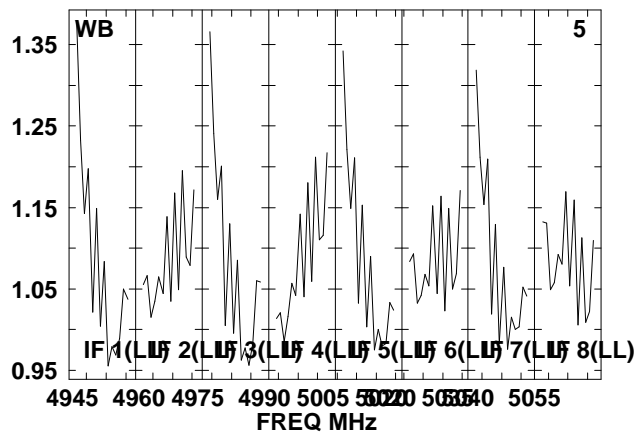
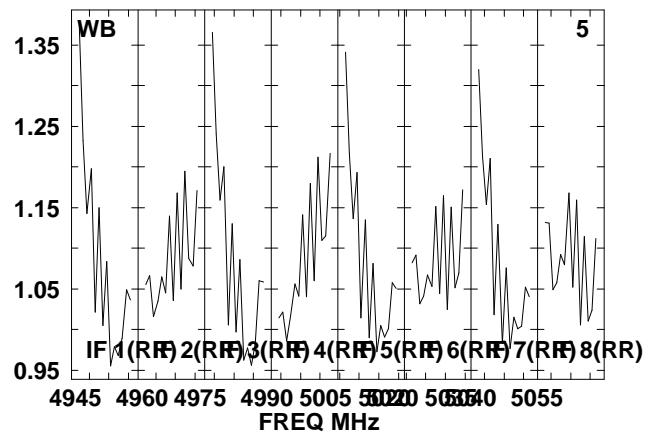
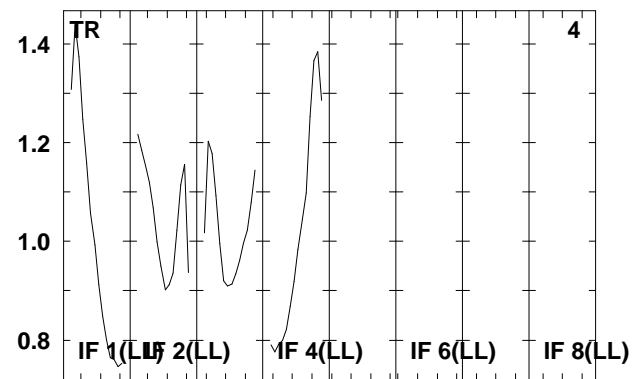
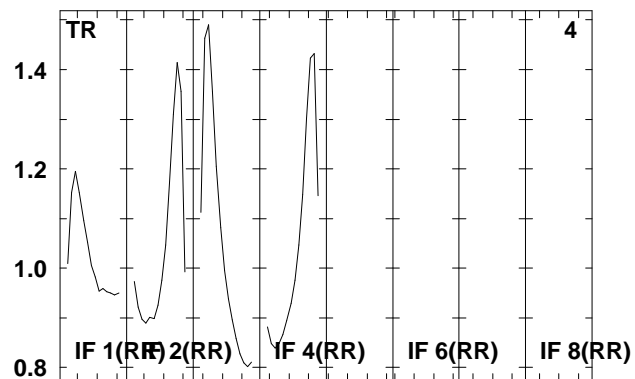
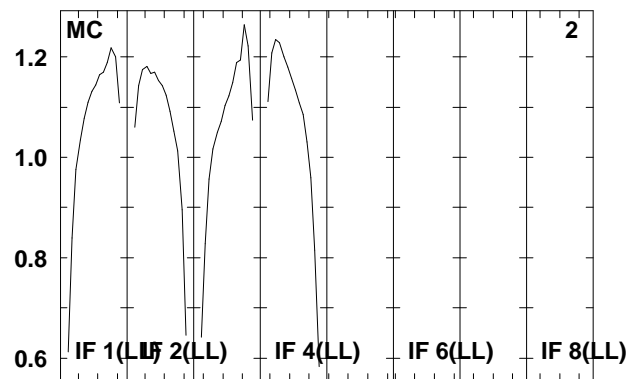
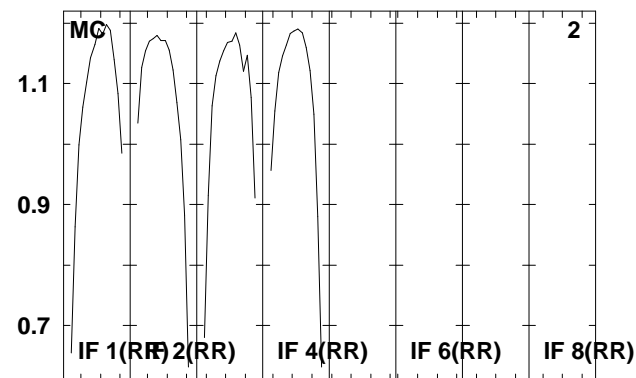
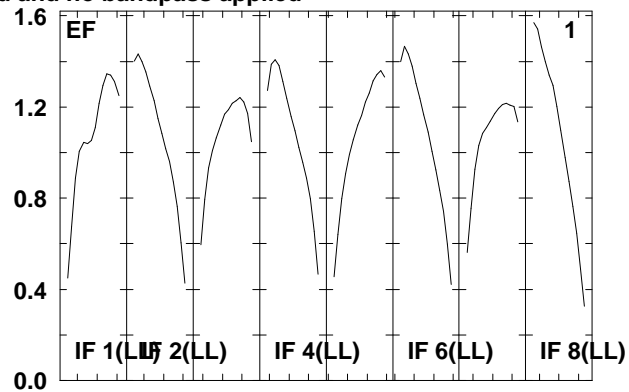
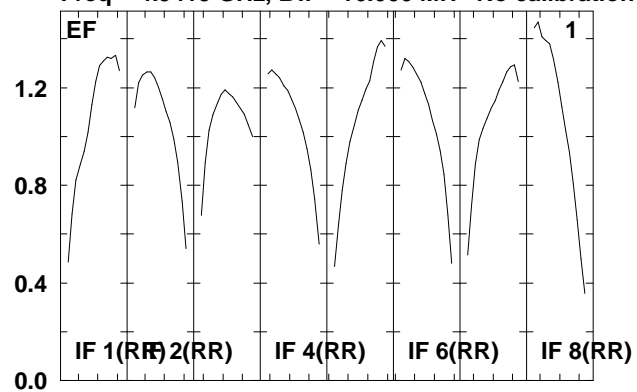

Lower frame: Real Jy

Total-power spectrum Antenna: \*

Timerange: 00/18:48:42 to 00/18:50:58

Plot file version 290 created 07-DEC-2009 16:06:39

SS433 RT006C.UVDATA.1

Freq = 4.9415 GHz, Bw = 16.000 MH No calibration applied and no bandpass applied

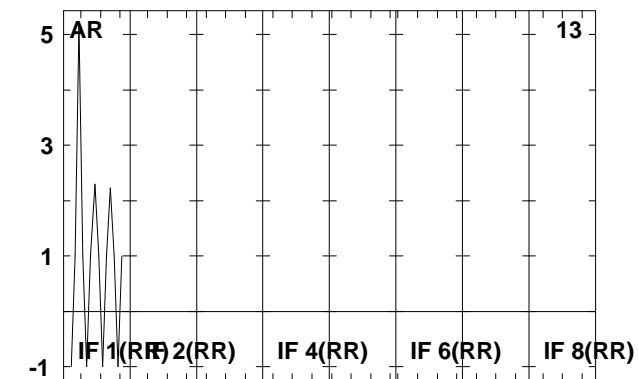
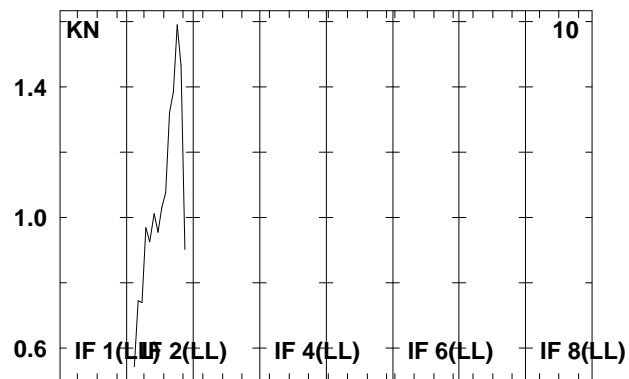
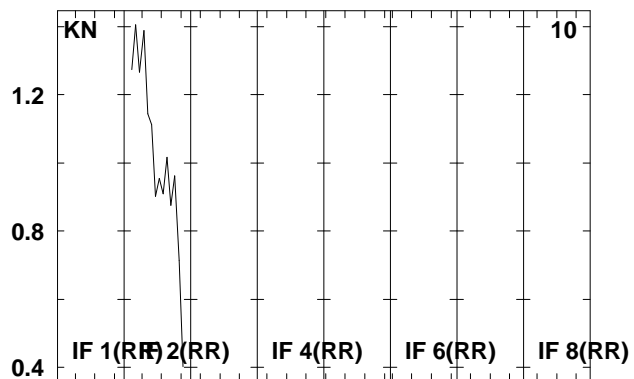
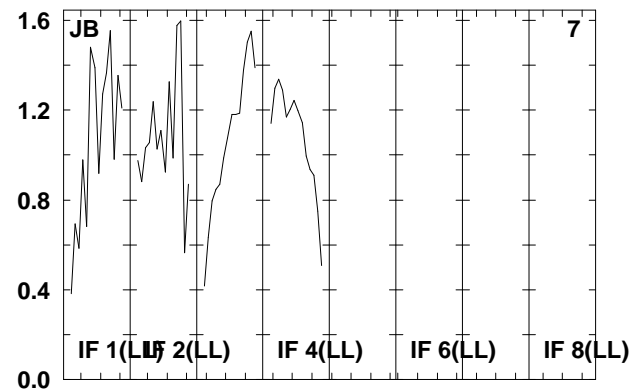
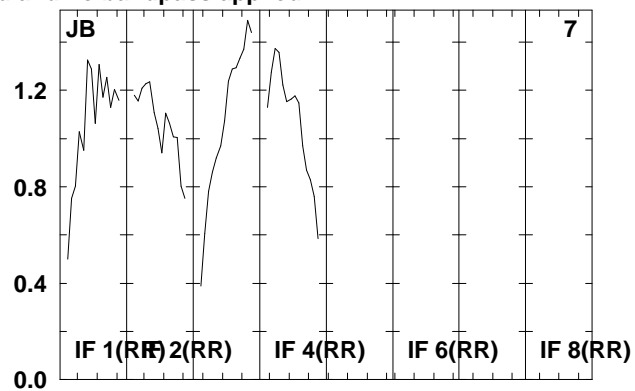
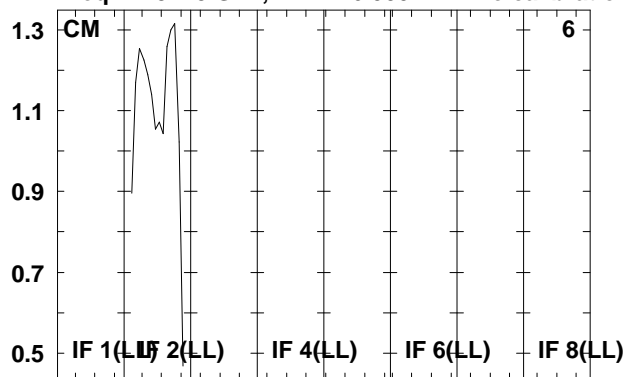

Lower frame: Real Jy  
Total-power spectrum Antenna: \*  
Timerange: 00/18:48:42 to 00/18:50:58

Plot file version 291 created 07-DEC-2009 16:06:39

J1912+05 RT006C.UVDATA.1

Freq = 4.9415 GHz, Bw = 16.000 MH No calibration applied and no bandpass applied

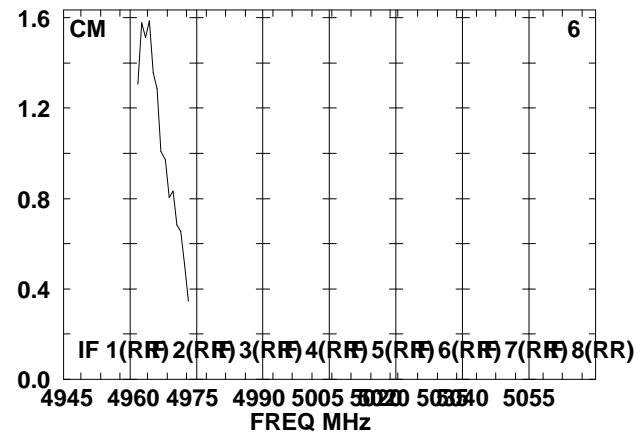
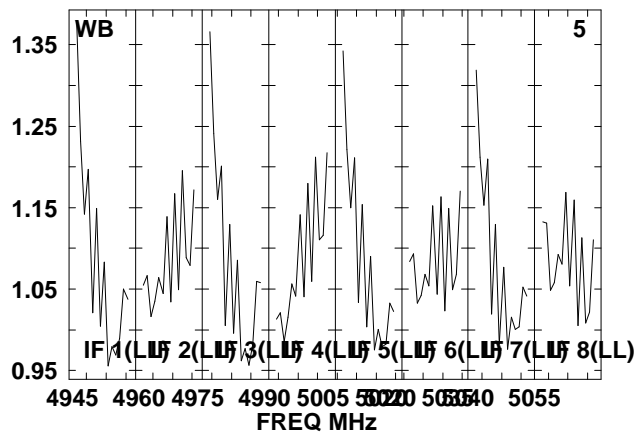
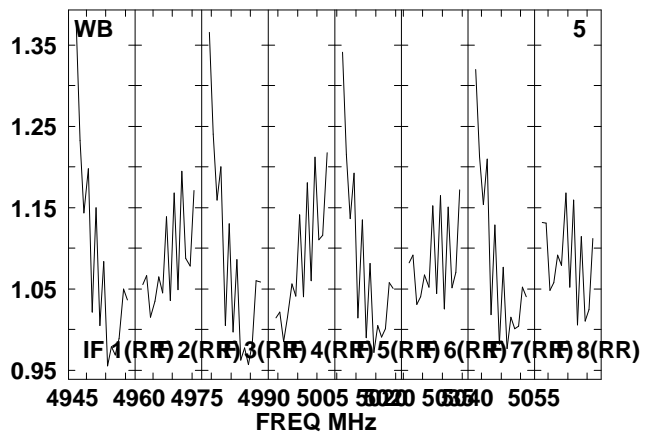
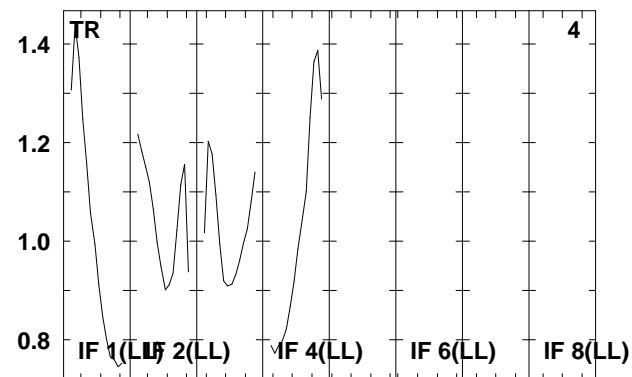
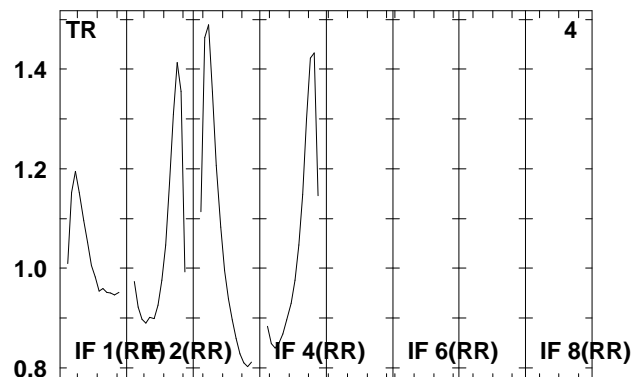
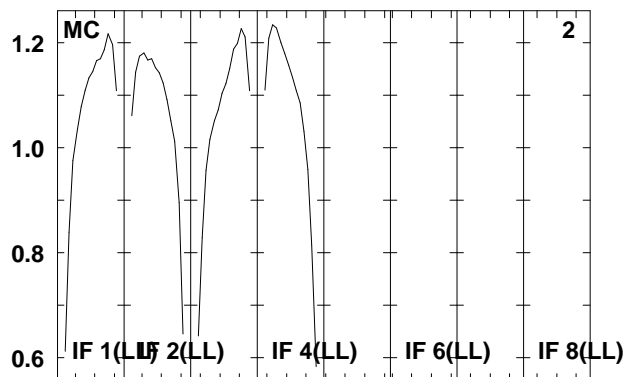
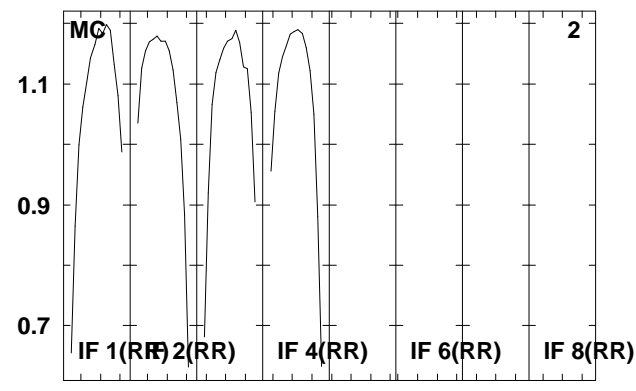
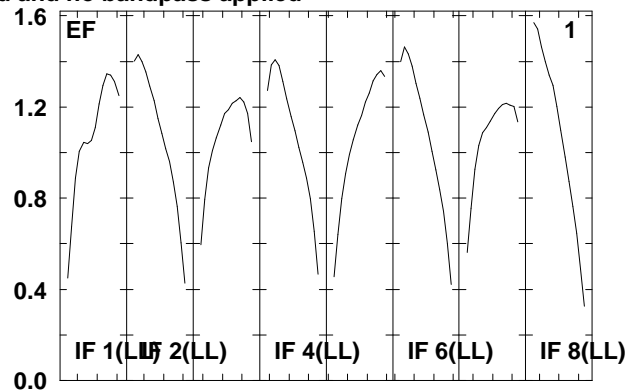
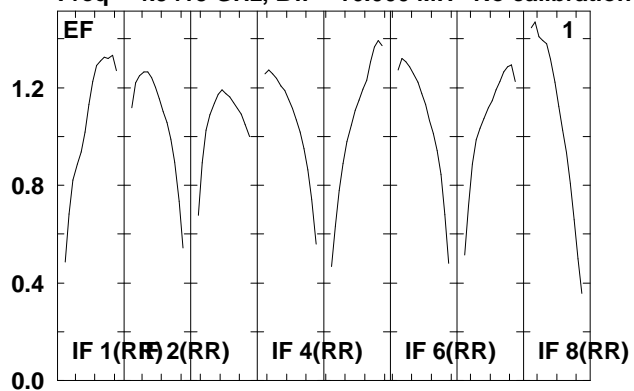

Lower frame: Real Jy  
Total-power spectrum Antenna: \*  
Timerange: 00/18:51:02 to 00/18:52:18

Plot file version 292 created 07-DEC-2009 16:06:39

J1912+05 RT006C.UVDATA.1

Freq = 4.9415 GHz, Bw = 16.000 MH No calibration applied and no bandpass applied

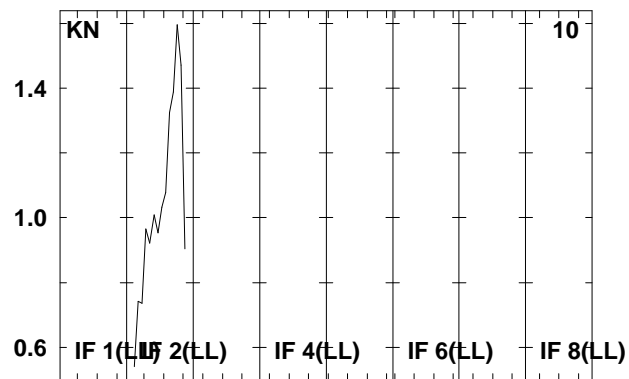
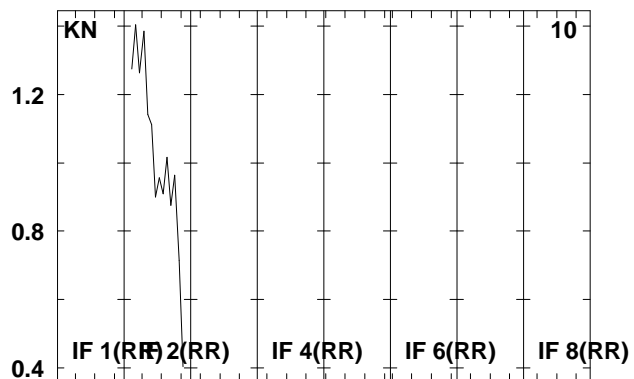
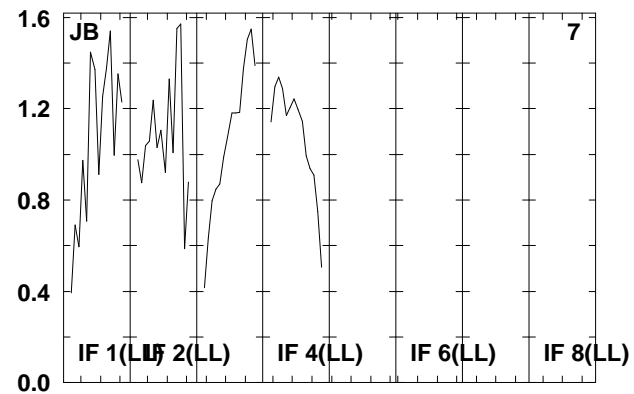
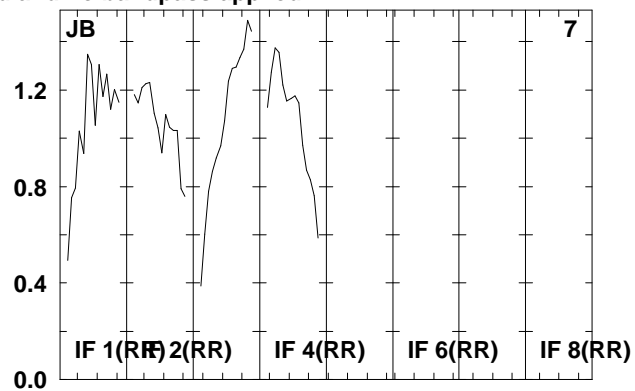
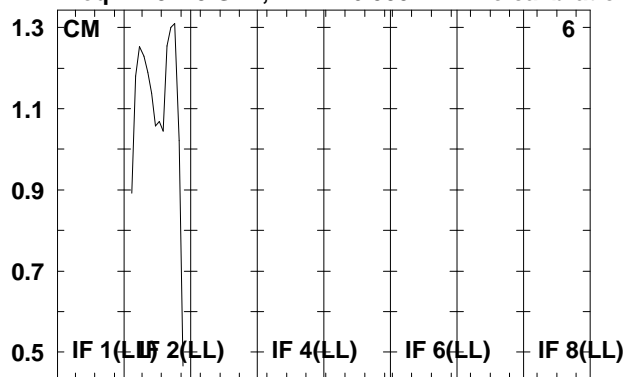

Lower frame: Real Jy  
Total-power spectrum Antenna: \*  
Timerange: 00/18:51:02 to 00/18:52:18

Plot file version 293 created 07-DEC-2009 16:06:39

SS433 RT006C.UVDATA.1

Freq = 4.9415 GHz, Bw = 16.000 MH No calibration applied and no bandpass applied

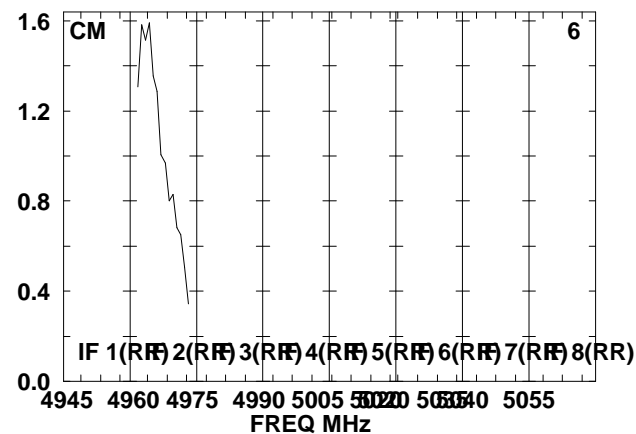
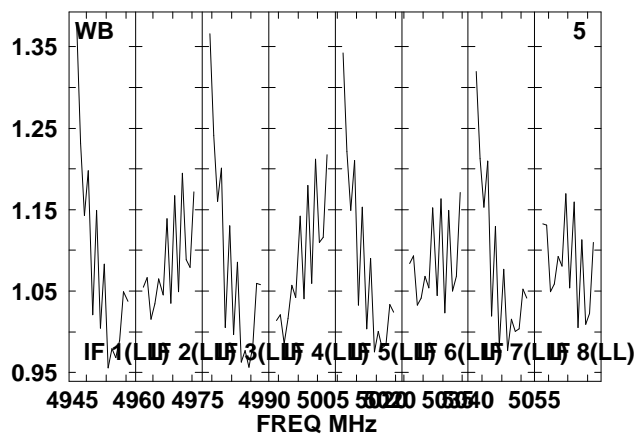
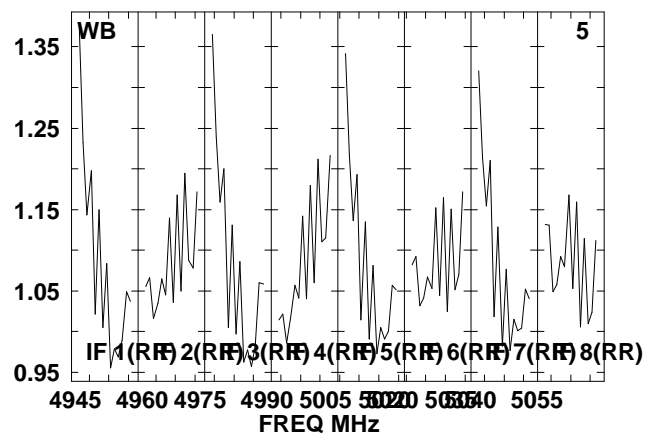
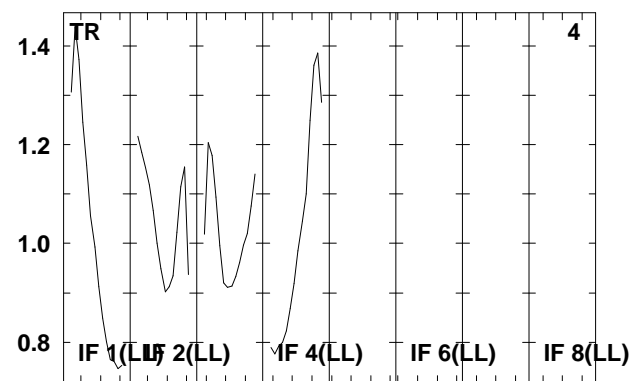
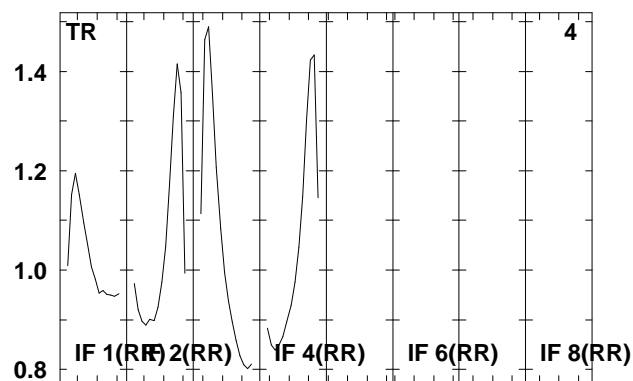
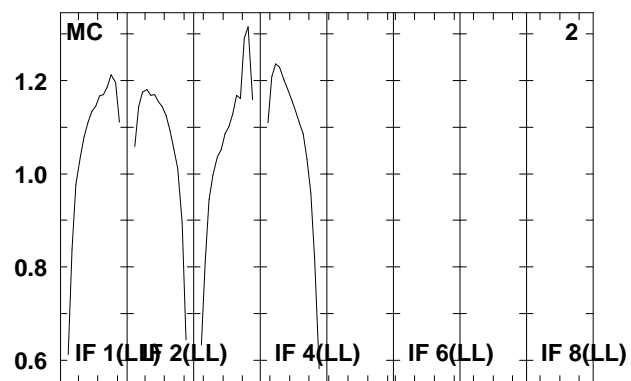
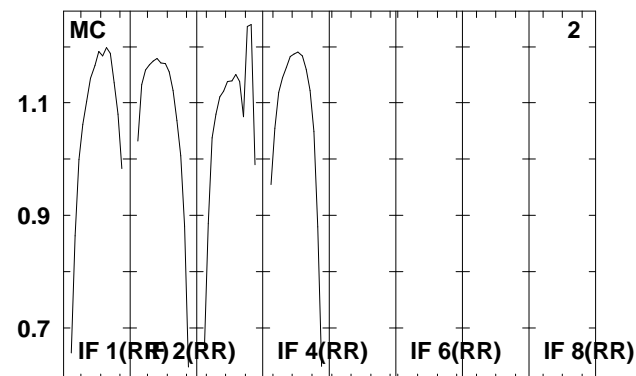
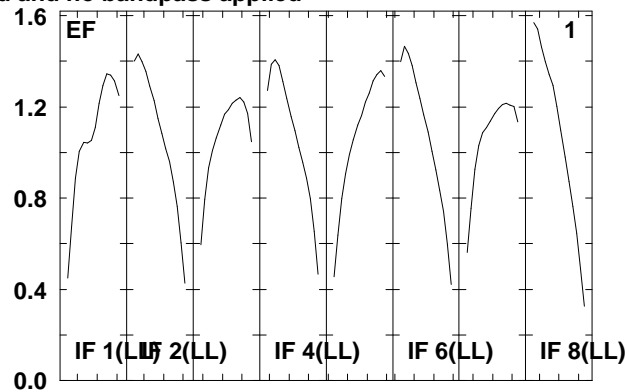
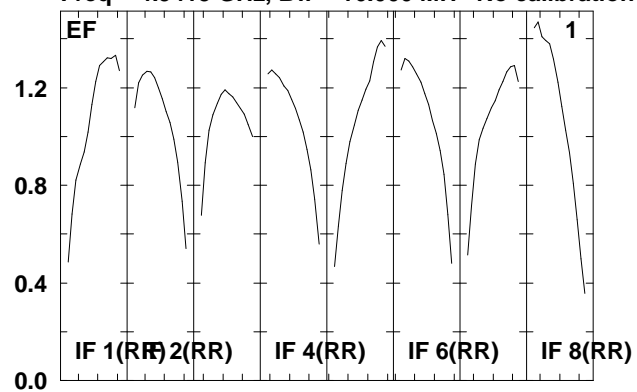

Lower frame: Real Jy

Total-power spectrum Antenna: \*

Timerange: 00/18:52:22 to 00/18:54:38

Plot file version 294 created 07-DEC-2009 16:06:40

SS433 RT006C.UVDATA.1

Freq = 4.9415 GHz, Bw = 16.000 MH No calibration applied and no bandpass applied

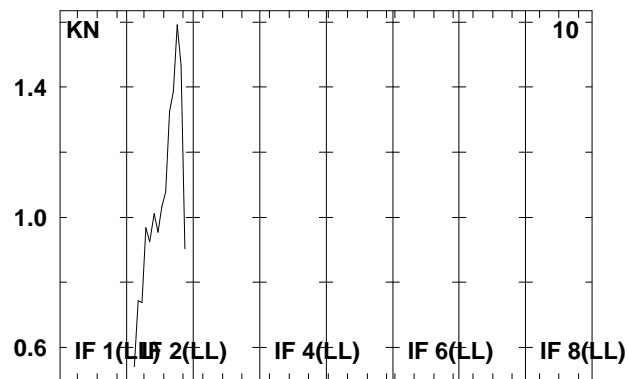
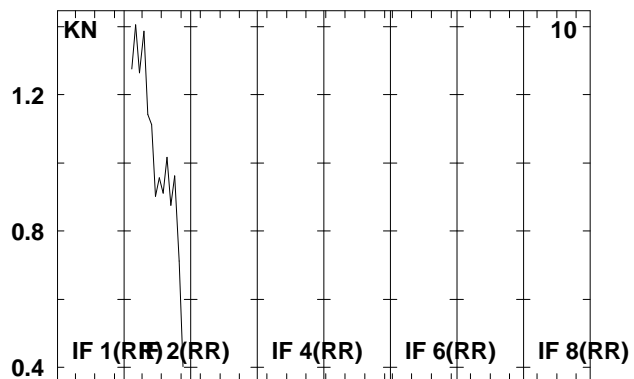
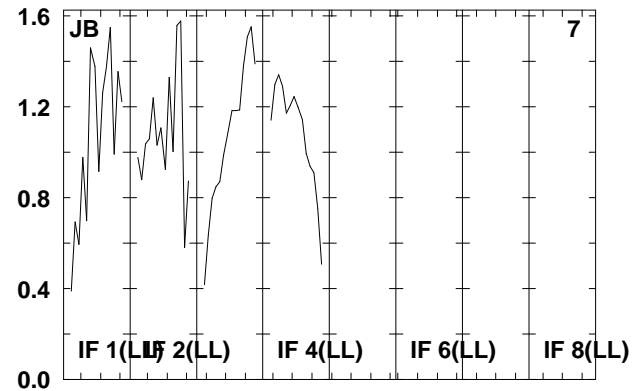
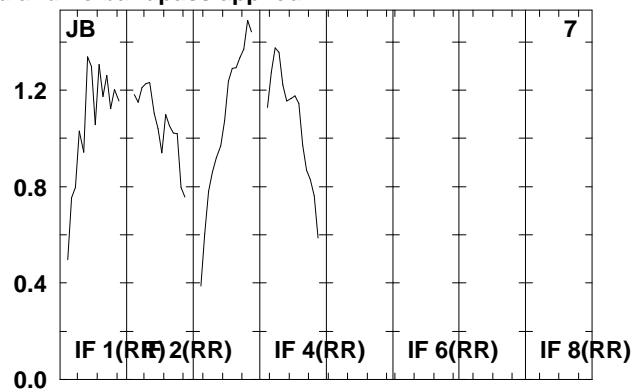
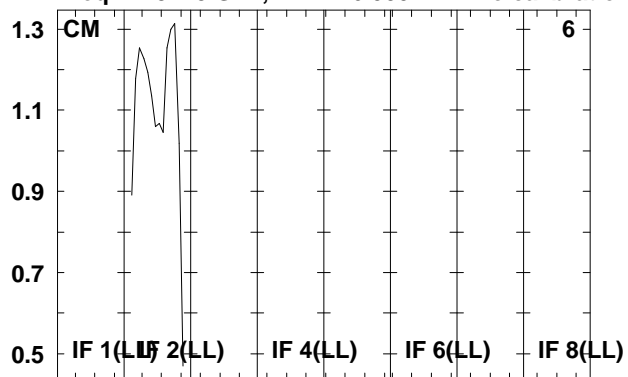

Lower frame: Real Jy  
Total-power spectrum Antenna: \*  
Timerange: 00/18:52:22 to 00/18:54:38

Plot file version 295 created 07-DEC-2009 16:06:40

J1912+05 RT006C.UVDATA.1

Freq = 4.9415 GHz, Bw = 16.000 MH No calibration applied and no bandpass applied

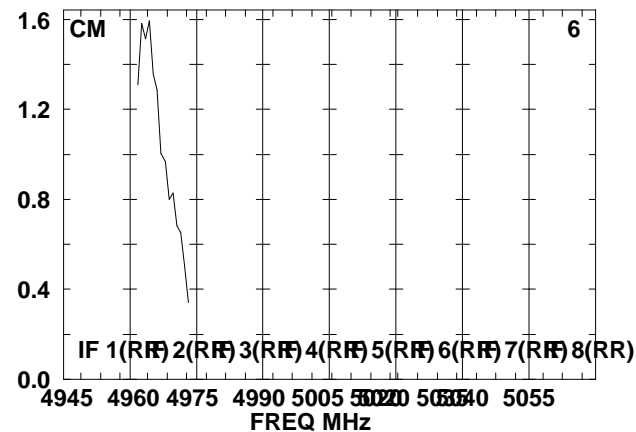
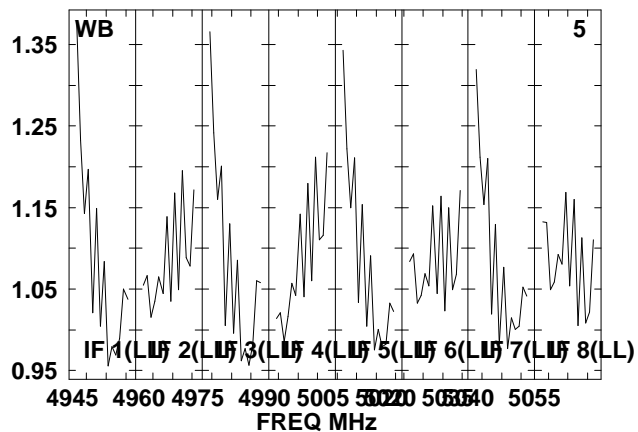
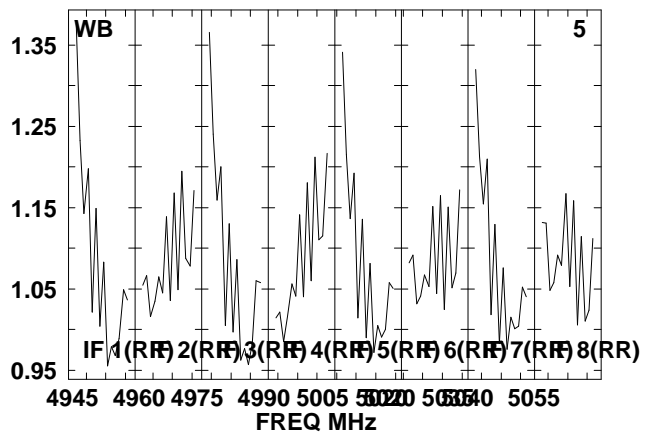
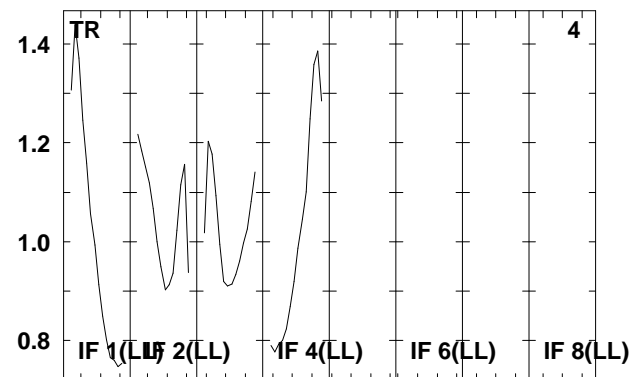
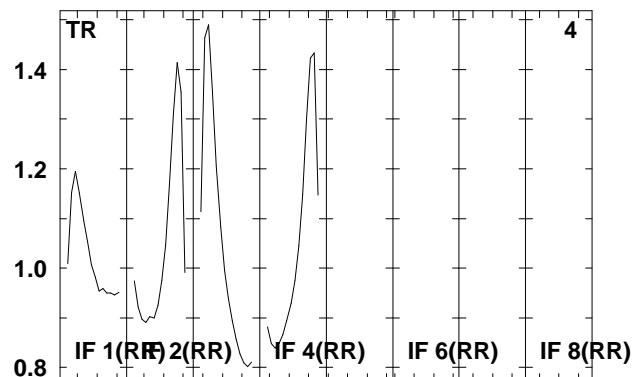
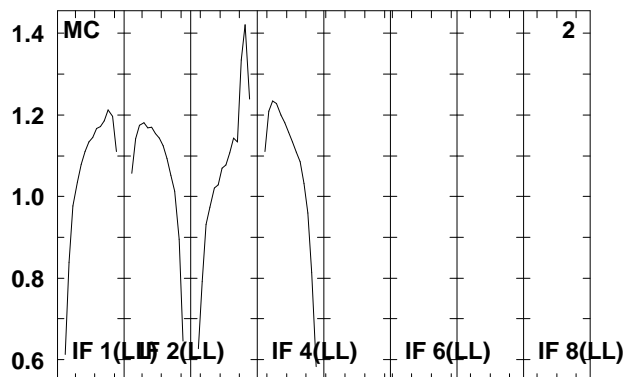
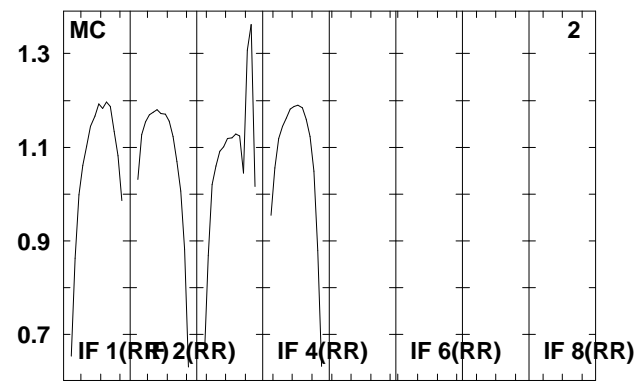
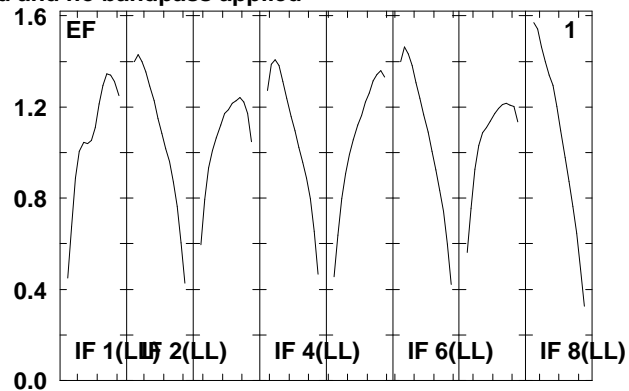
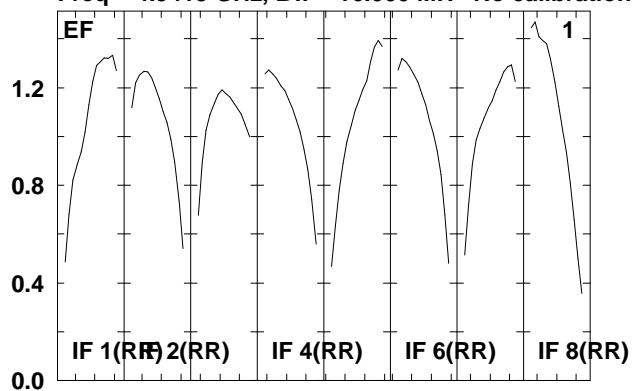

Lower frame: Real Jy  
Total-power spectrum Antenna: \*  
Timerange: 00/18:54:42 to 00/18:55:58

Plot file version 296 created 07-DEC-2009 16:06:40

J1912+05 RT006C.UVDATA.1

Freq = 4.9415 GHz, Bw = 16.000 MH No calibration applied and no bandpass applied

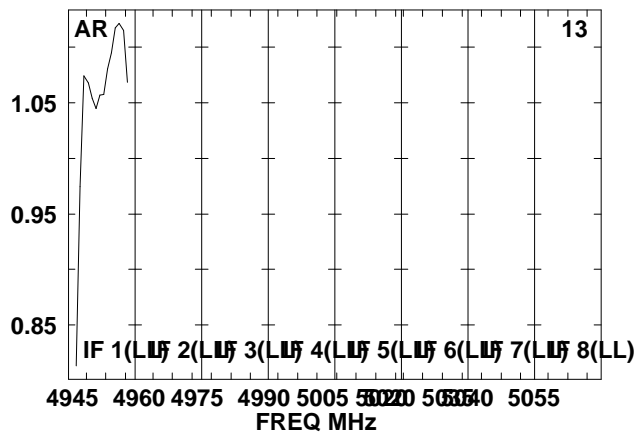
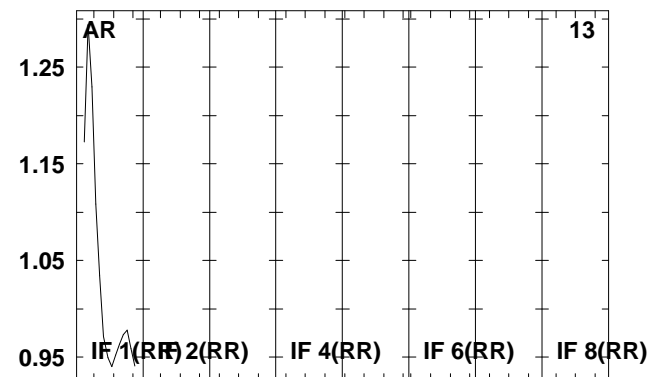
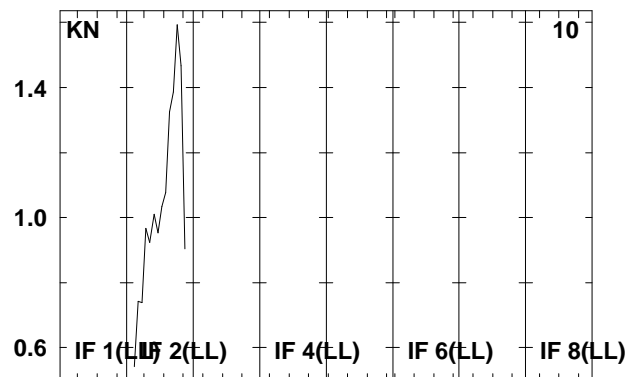
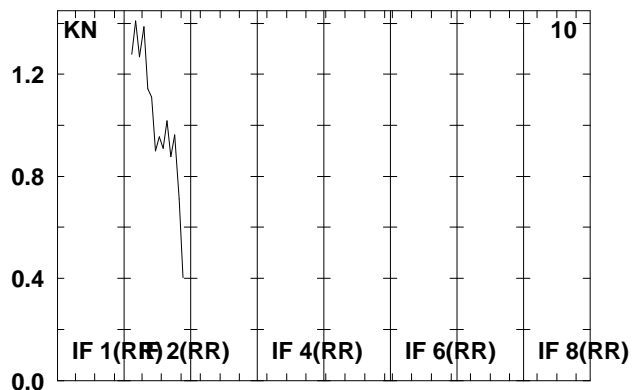
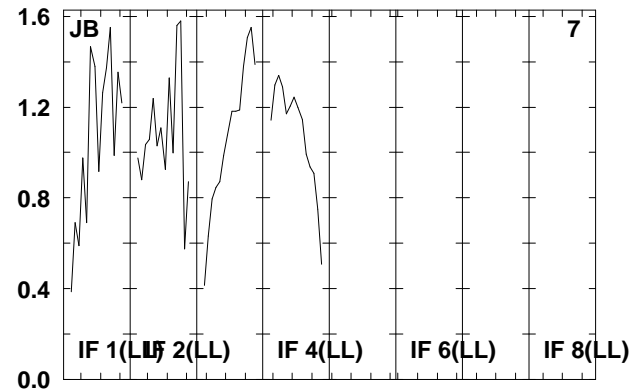
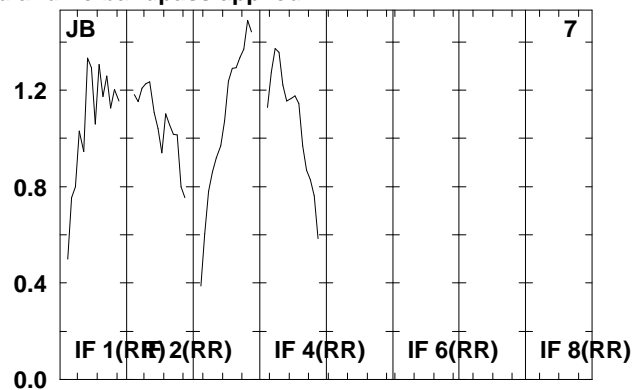
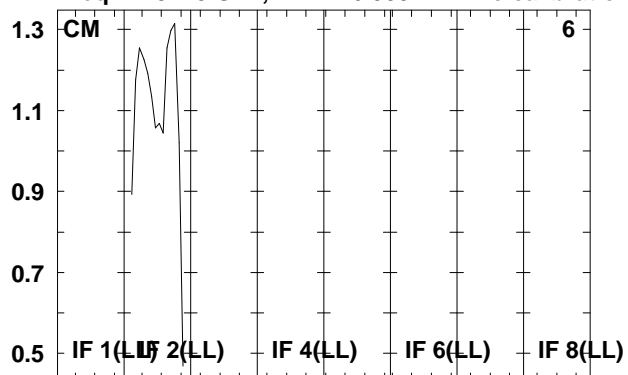

Lower frame: Real Jy

Total-power spectrum Antenna: \*

Timerange: 00/18:54:42 to 00/18:55:58



Plot file version 297 created 07-DEC-2009 16:06:40

SS433 RT006C.UVDATA.1

Freq = 4.9415 GHz, Bw = 16.000 MH No calibration applied and no bandpass applied

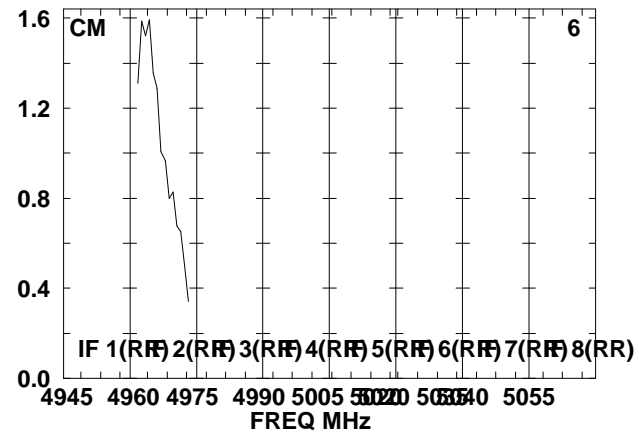
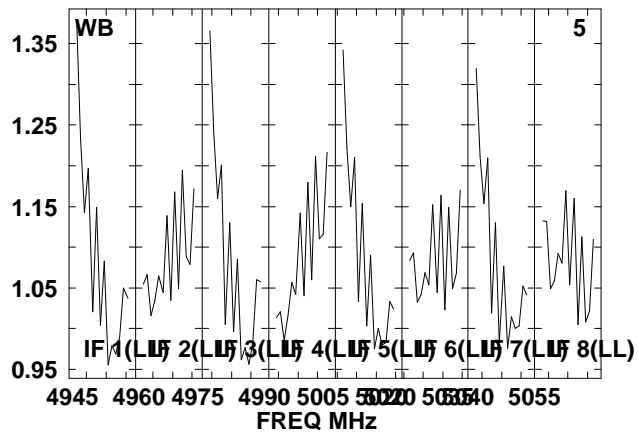
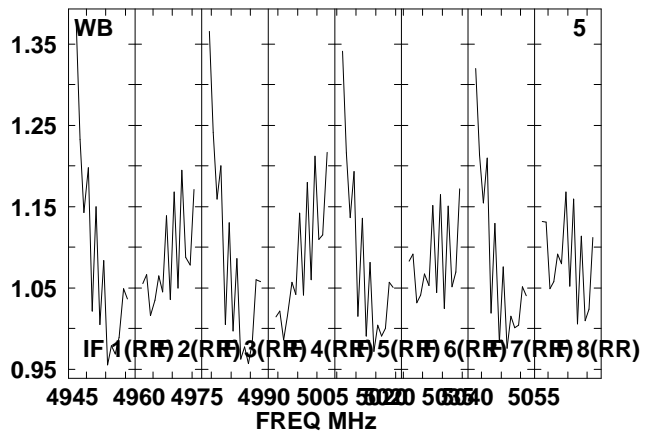
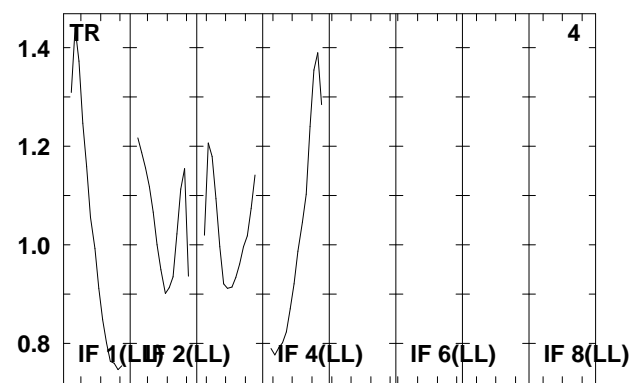
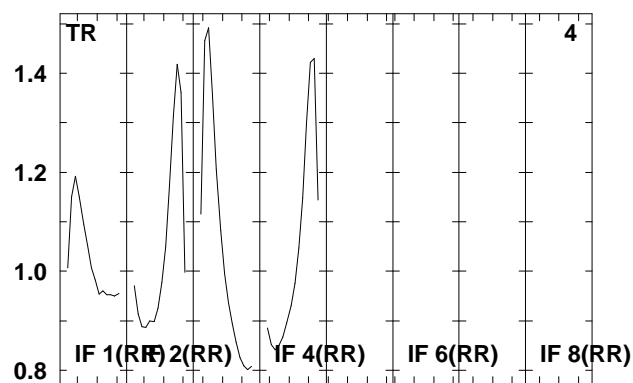
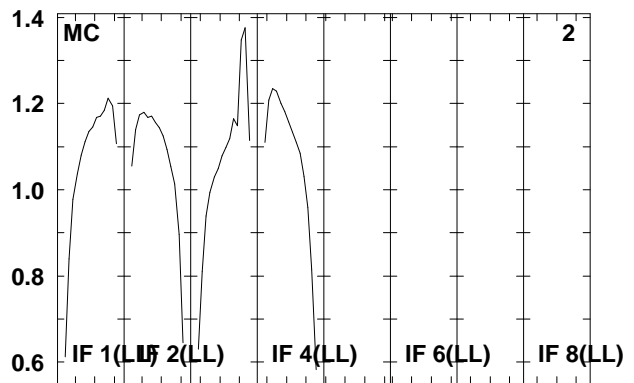
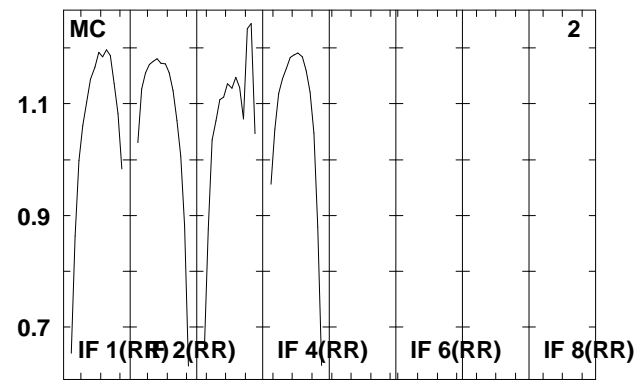
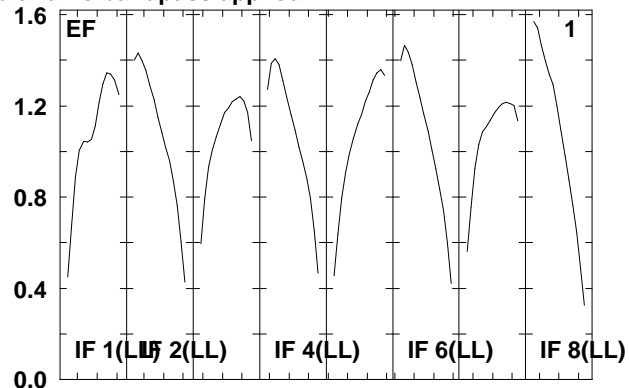
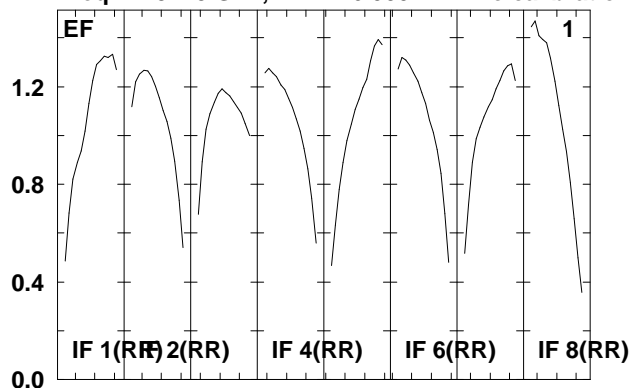

Lower frame: Real Jy  
Total-power spectrum Antenna: \*  
Timerange: 00/18:56:02 to 00/18:58:18

Plot file version 298 created 07-DEC-2009 16:06:40

SS433 RT006C.UVDATA.1

Freq = 4.9415 GHz, Bw = 16.000 MH No calibration applied and no bandpass applied

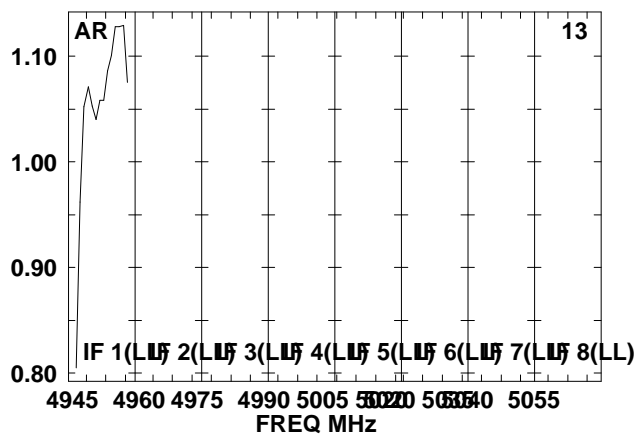
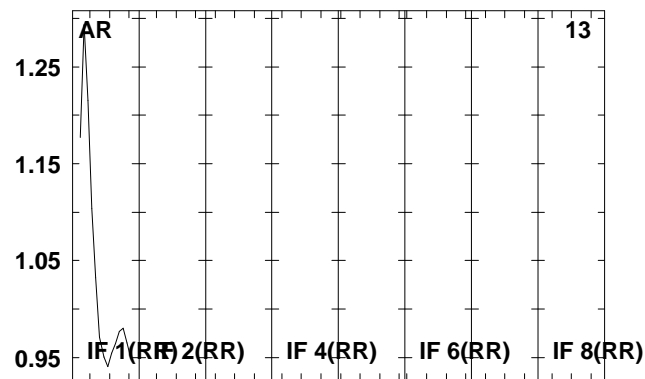
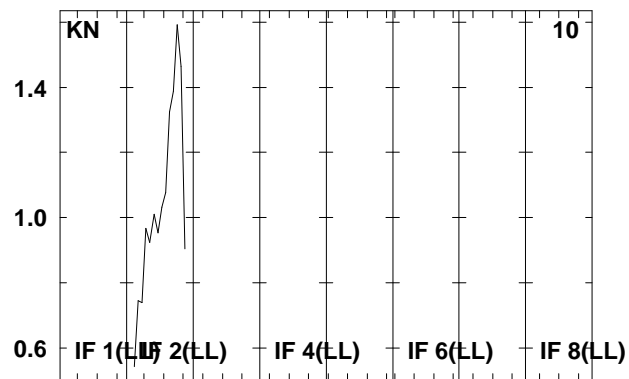
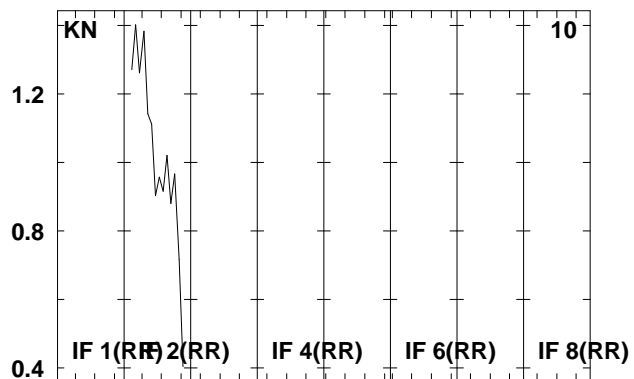
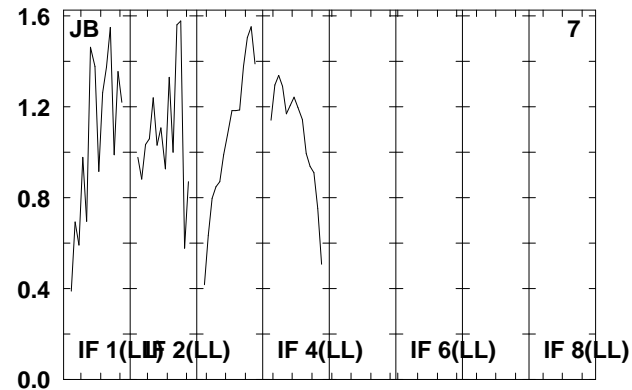
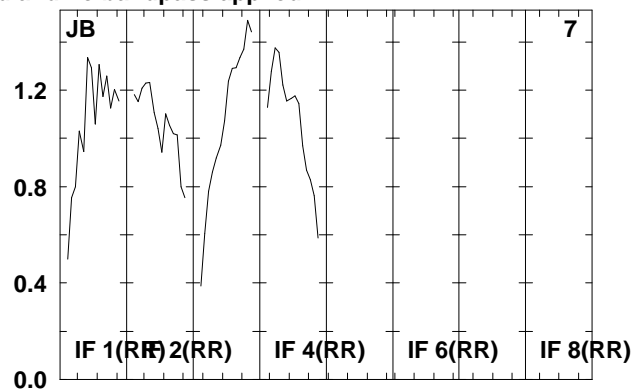
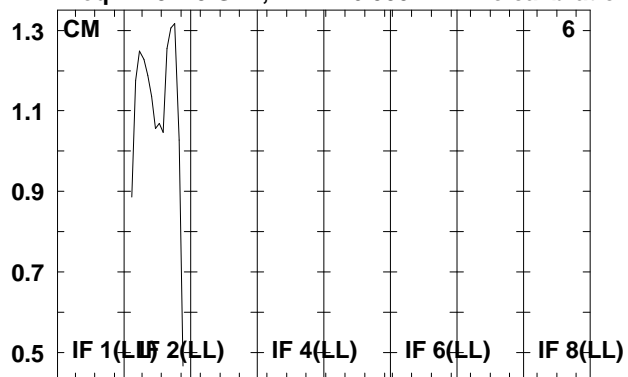

Lower frame: Real Jy

Total-power spectrum Antenna: \*

Timerange: 00/18:56:02 to 00/18:58:18

Plot file version 299 created 07-DEC-2009 16:06:41

J1912+05 RT006C.UVDATA.1

Freq = 4.9415 GHz, Bw = 16.000 MH No calibration applied and no bandpass applied

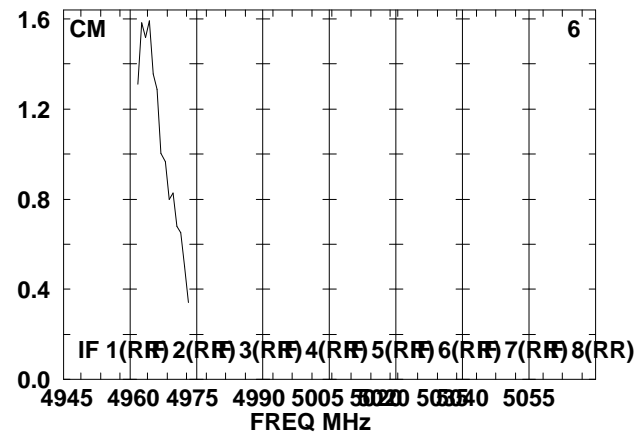
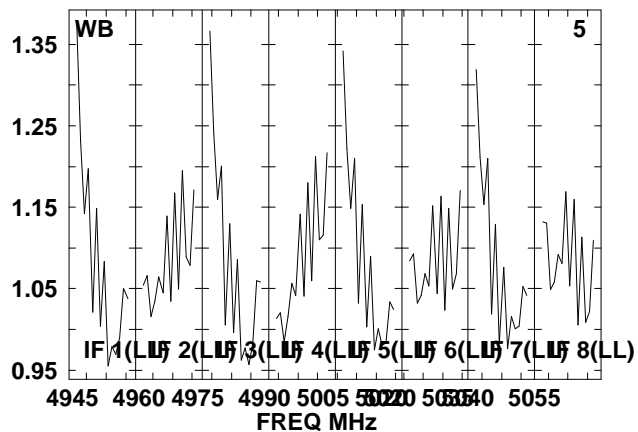
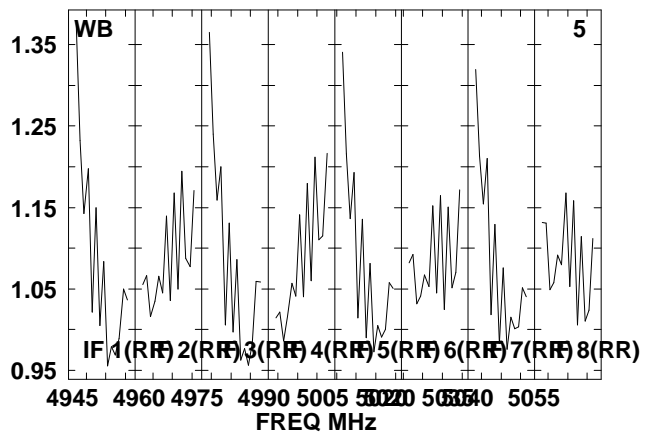
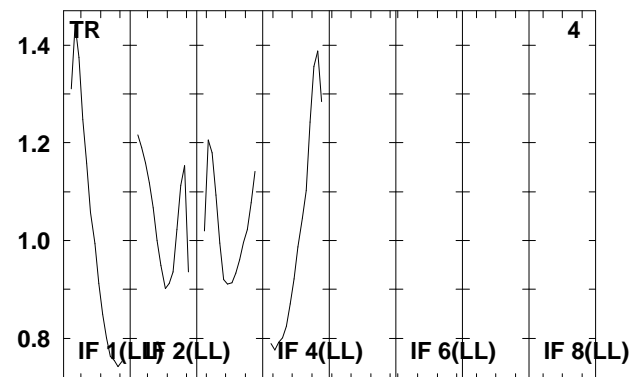
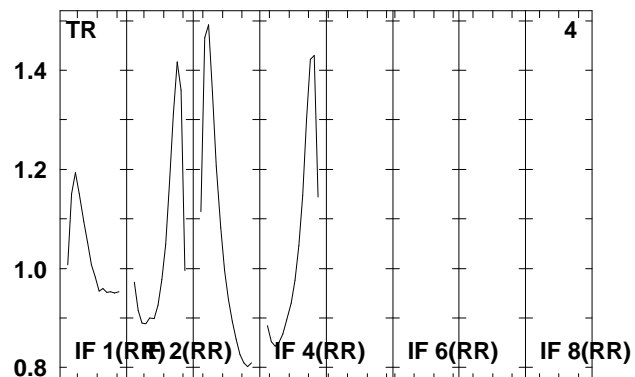
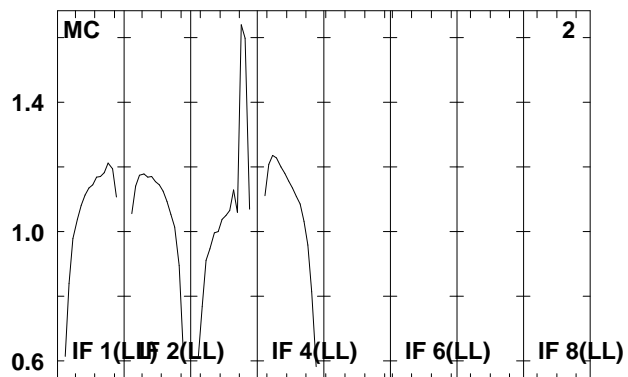
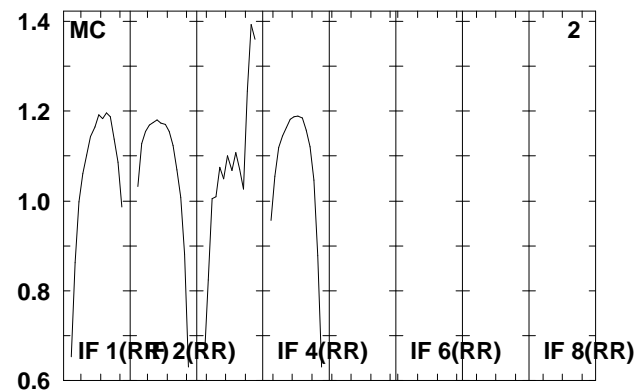
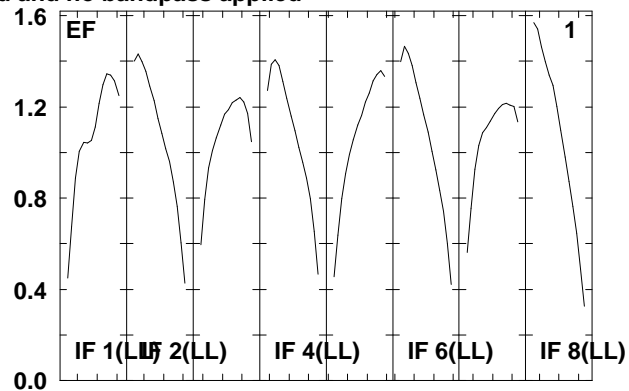
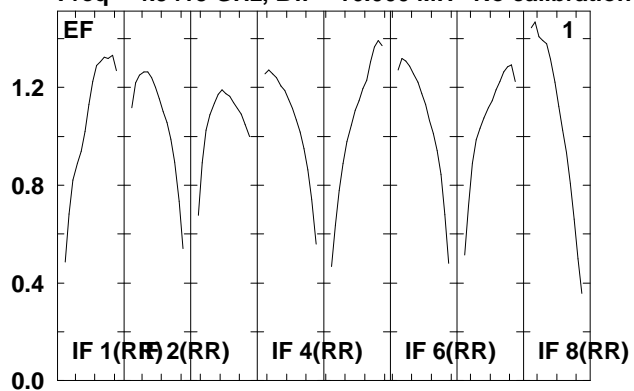

Lower frame: Real Jy  
Total-power spectrum Antenna: \*  
Timerange: 00/18:59:22 to 00/19:00:18

Plot file version 300 created 07-DEC-2009 16:06:41

J1912+05 RT006C.UVDATA.1

Freq = 4.9415 GHz, Bw = 16.000 MH No calibration applied and no bandpass applied

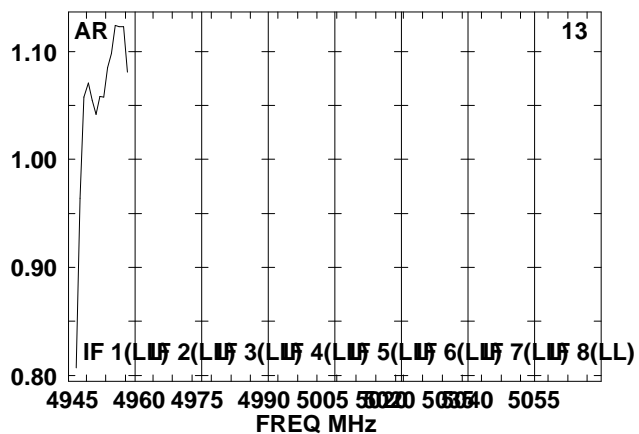
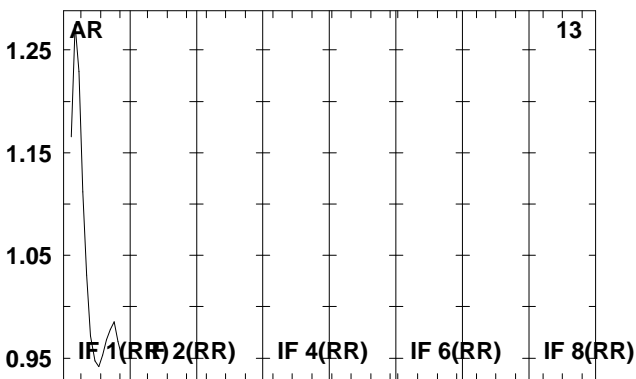
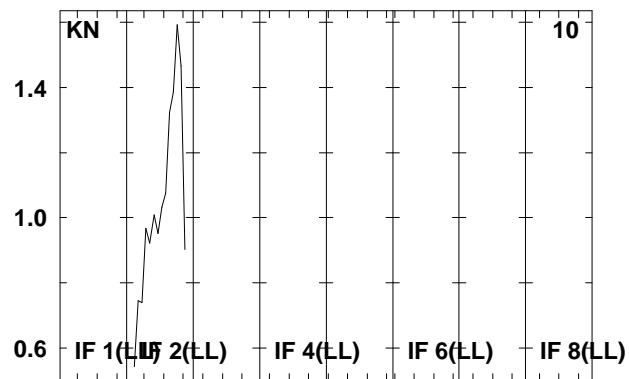
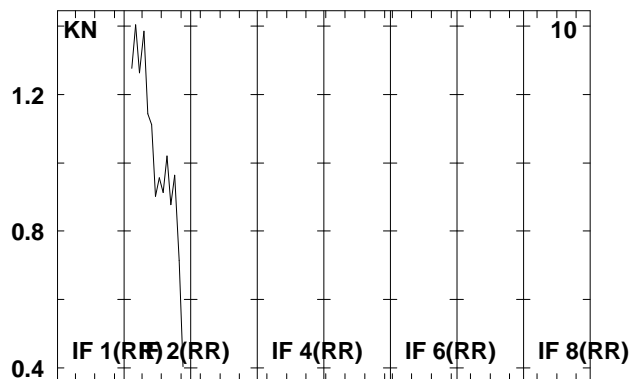
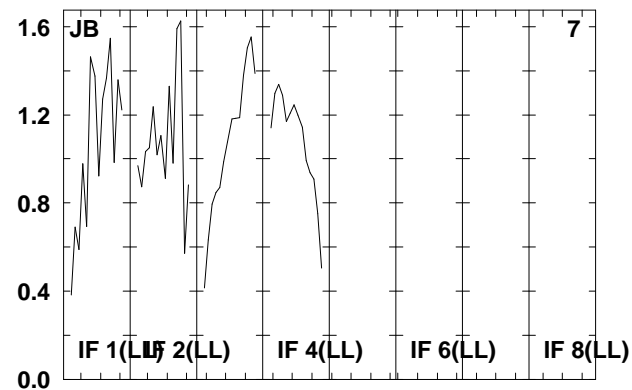
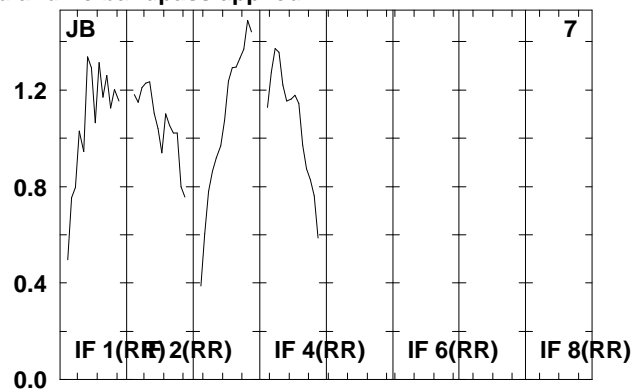
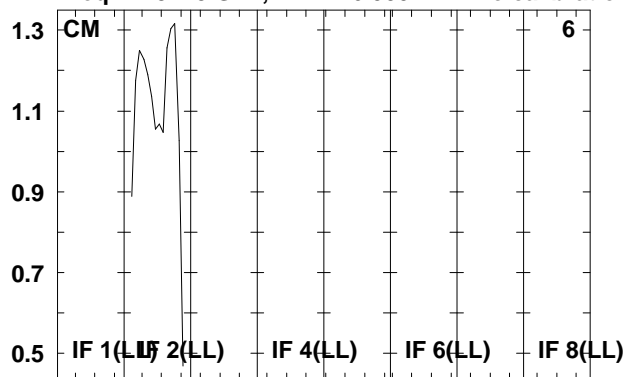

Lower frame: Real Jy

Total-power spectrum Antenna: \*

Timerange: 00/18:59:22 to 00/19:00:18

Plot file version 301 created 07-DEC-2009 16:06:41

SS433 RT006C.UVDATA.1

Freq = 4.9415 GHz, Bw = 16.000 MH No calibration applied and no bandpass applied

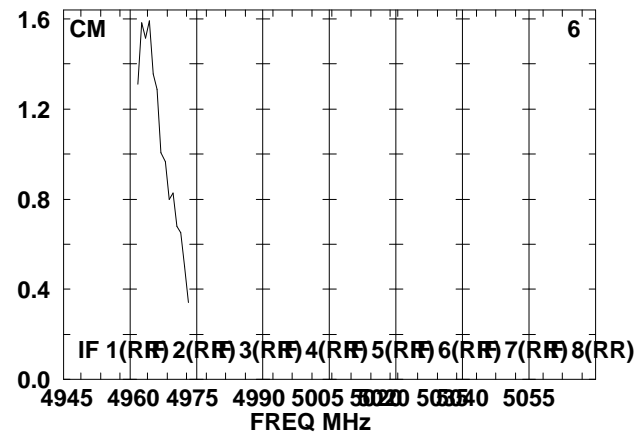
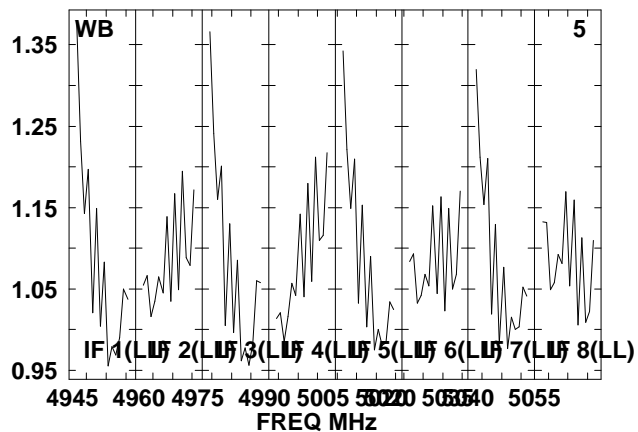
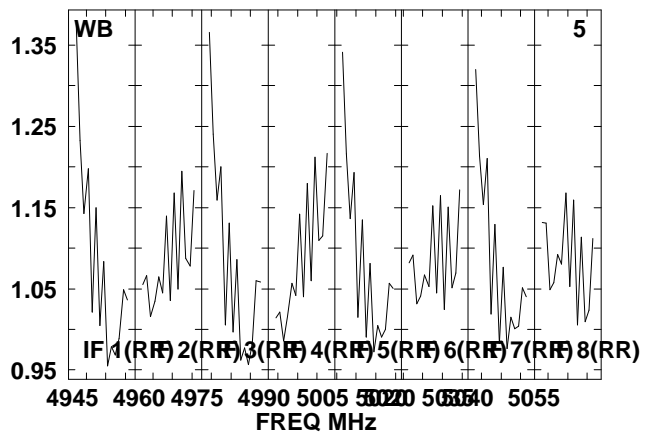
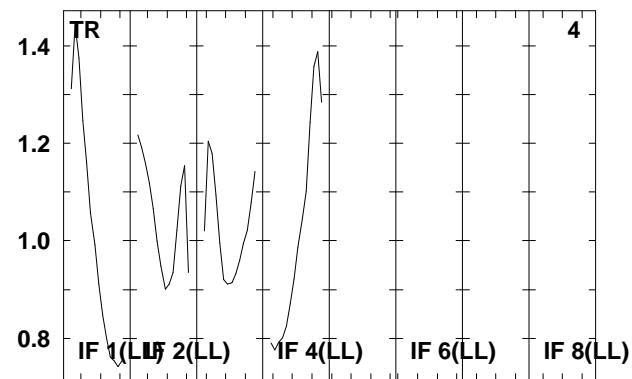
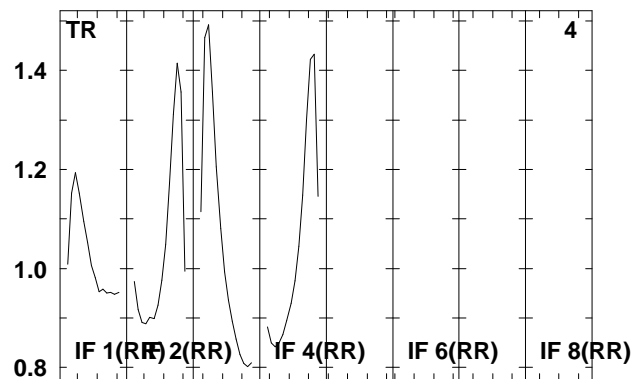
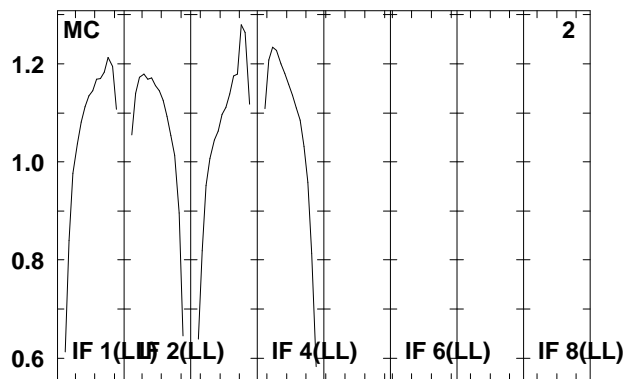
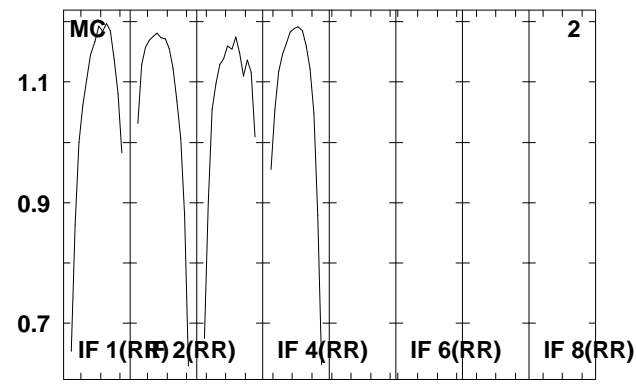
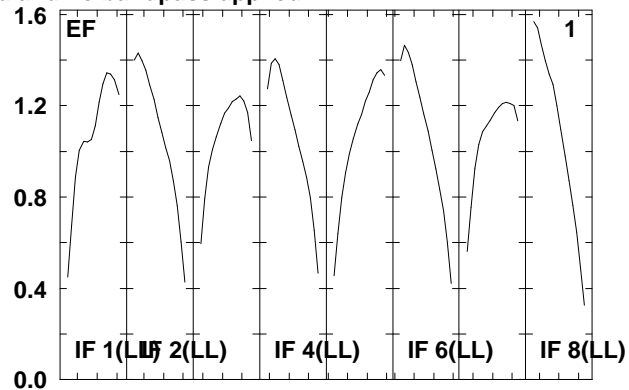
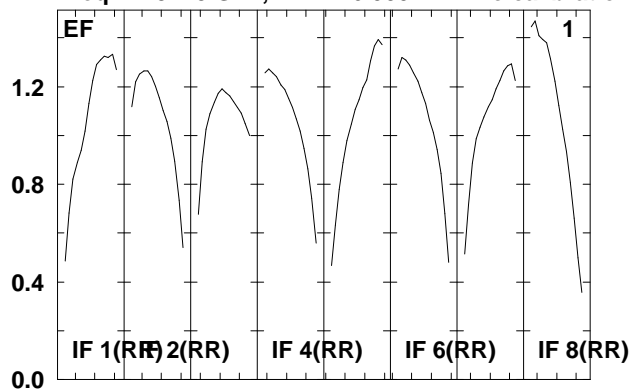

Lower frame: Real Jy

Total-power spectrum Antenna: \*

Timerange: 00/19:00:22 to 00/19:02:38

Plot file version 302 created 07-DEC-2009 16:06:41

SS433 RT006C.UVDATA.1

Freq = 4.9415 GHz, Bw = 16.000 MH No calibration applied and no bandpass applied

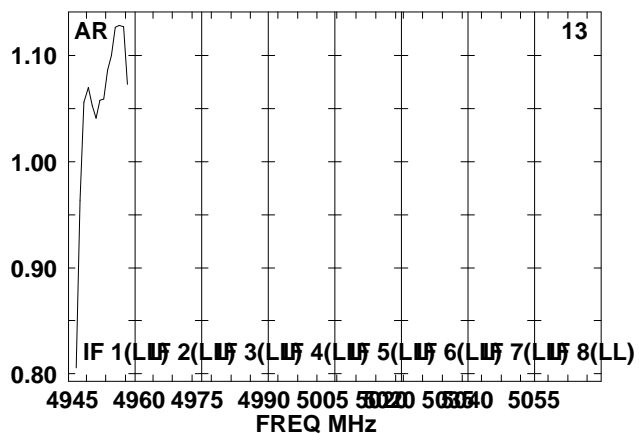
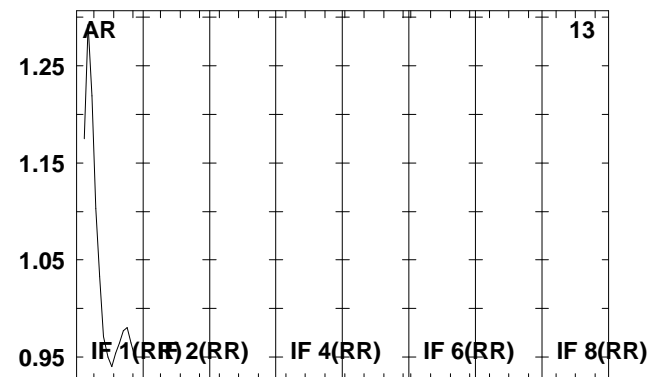
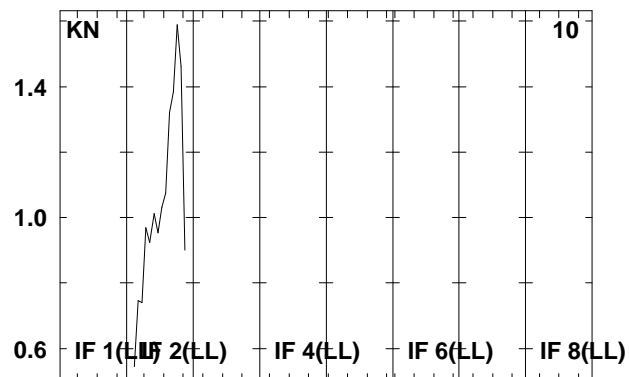
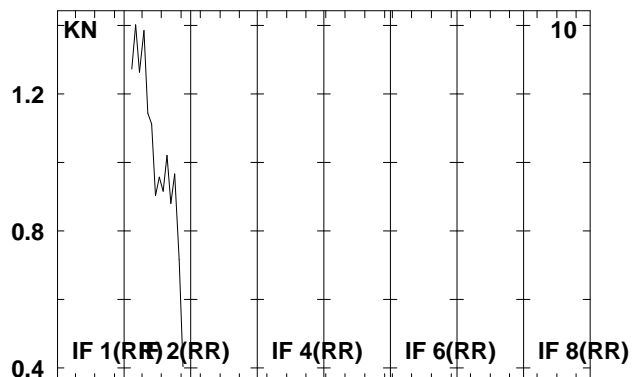
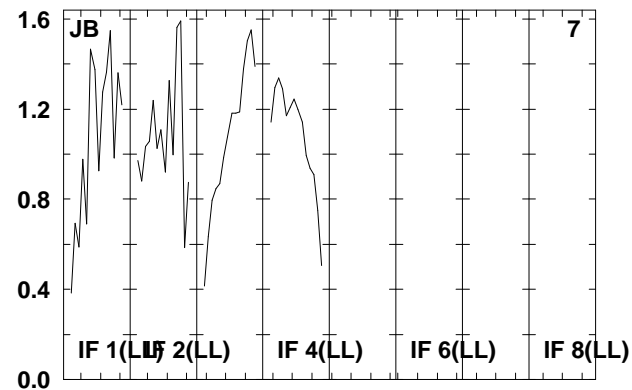
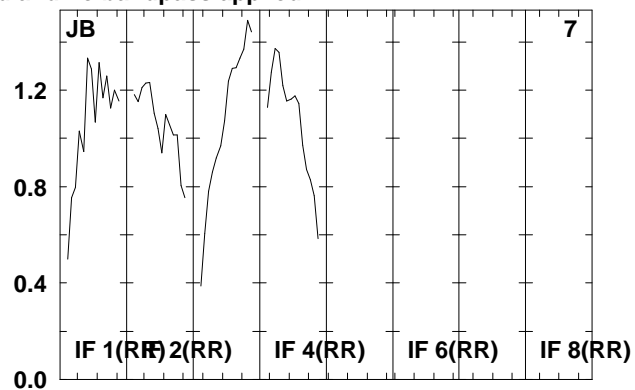
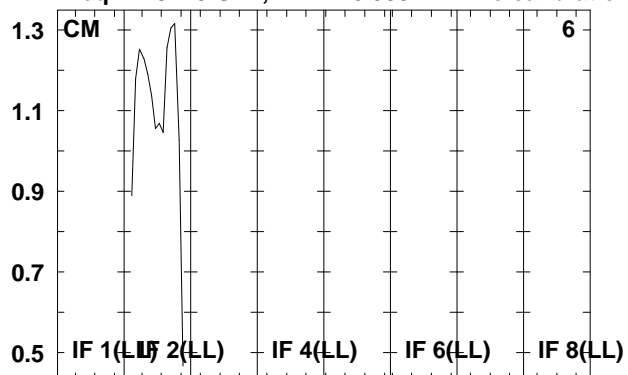

Lower frame: Real Jy

Total-power spectrum Antenna: \*

Timerange: 00/19:00:22 to 00/19:02:38

Plot file version 303 created 07-DEC-2009 16:06:41

J1912+05 RT006C.UVDATA.1

Freq = 4.9415 GHz, Bw = 16.000 MH No calibration applied and no bandpass applied

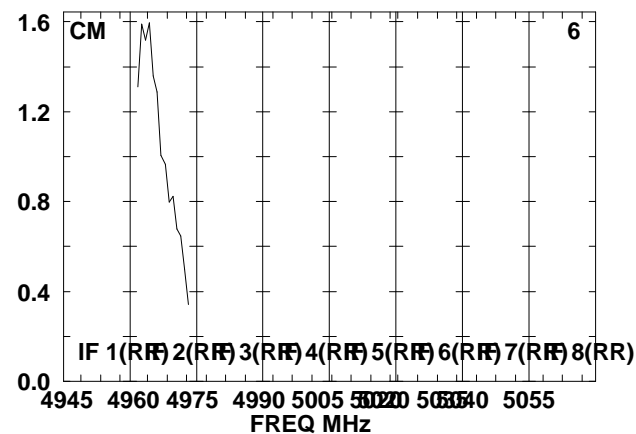
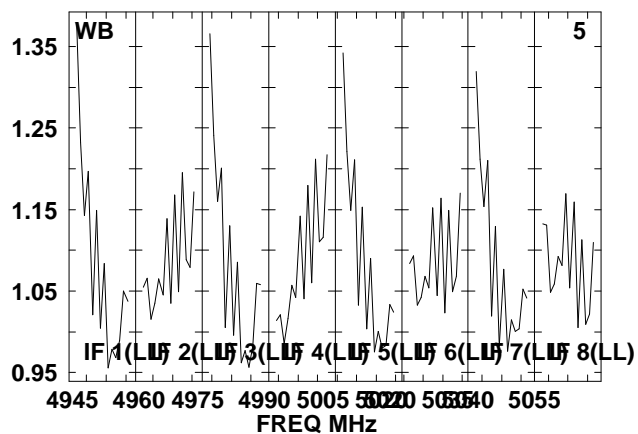
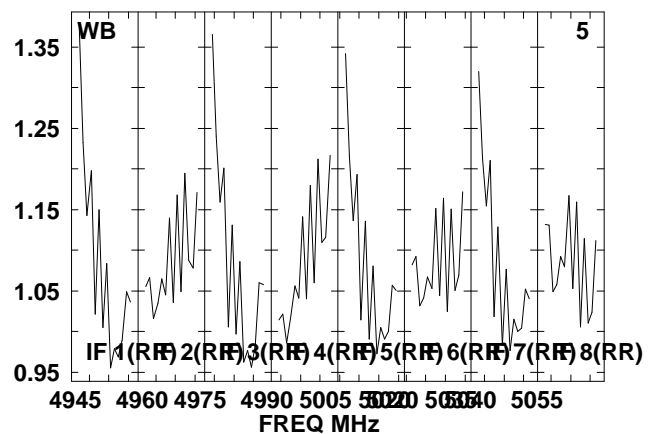
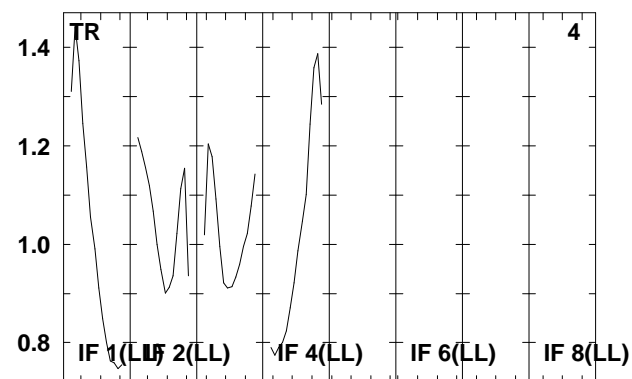
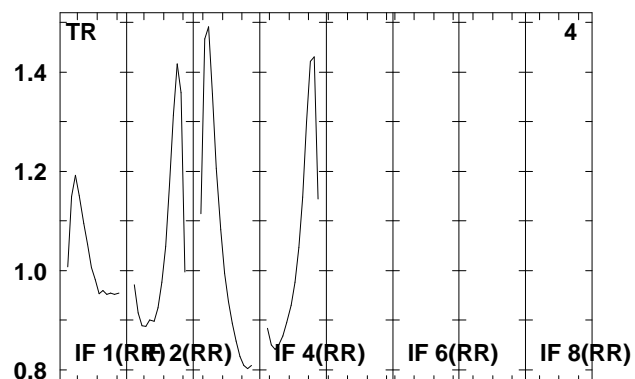
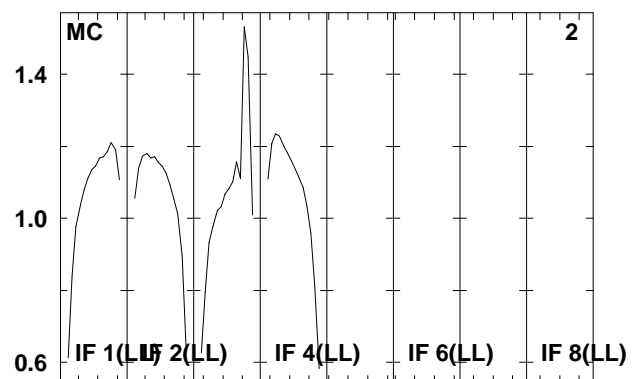
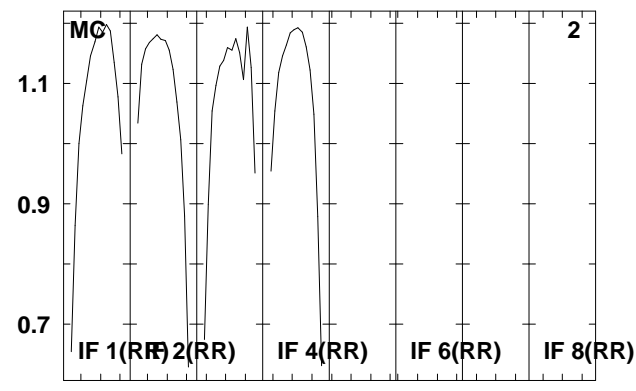
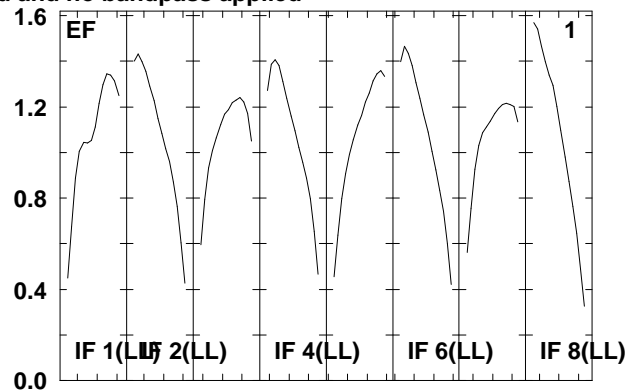
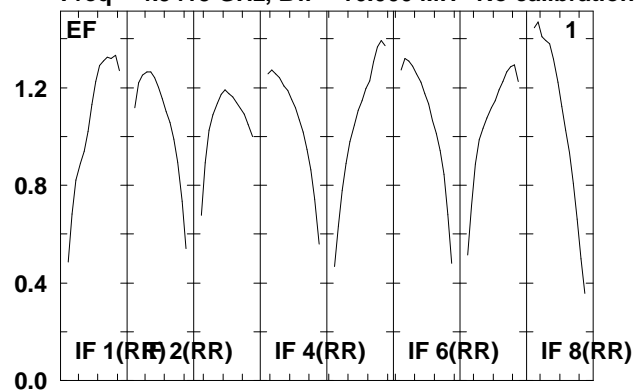

Lower frame: Real Jy  
Total-power spectrum Antenna: \*  
Timerange: 00/19:02:42 to 00/19:03:58

Plot file version 304 created 07-DEC-2009 16:06:41

J1912+05 RT006C.UVDATA.1

Freq = 4.9415 GHz, Bw = 16.000 MH No calibration applied and no bandpass applied

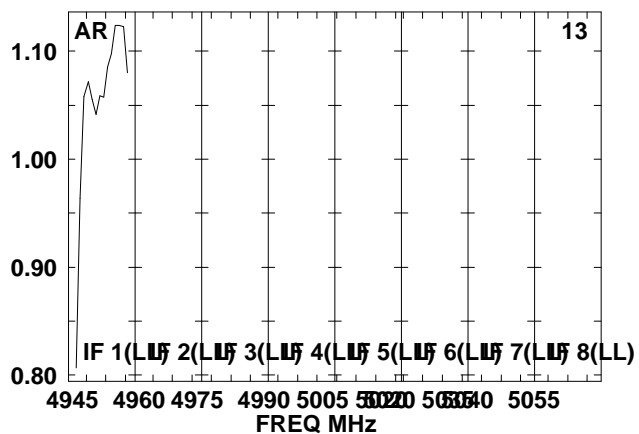
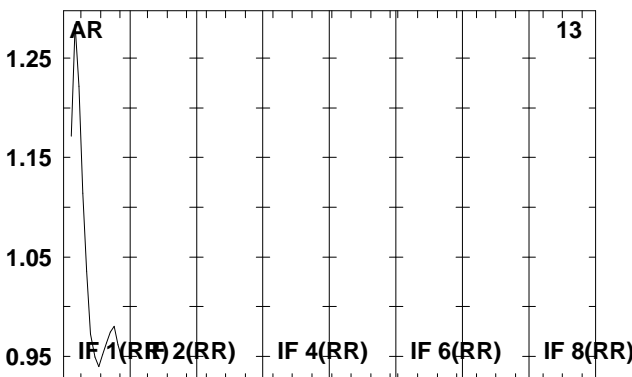
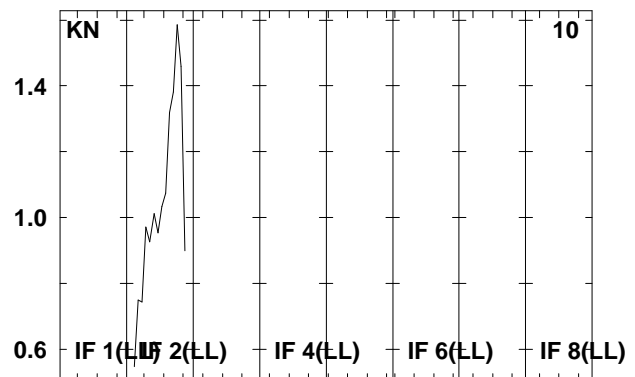
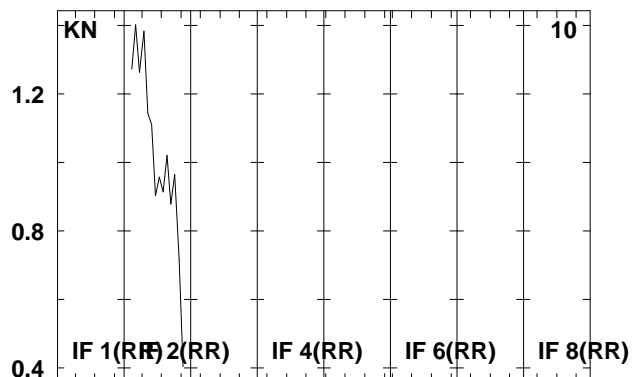
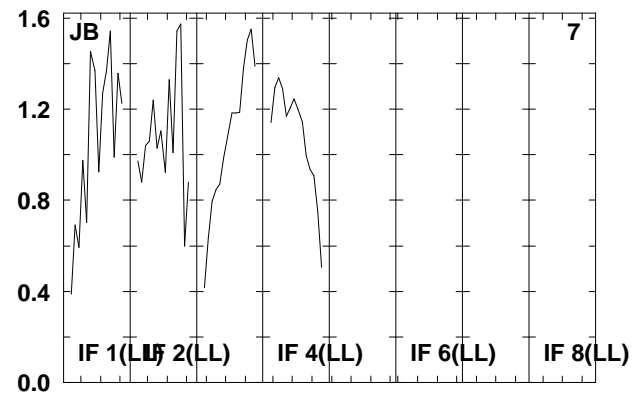
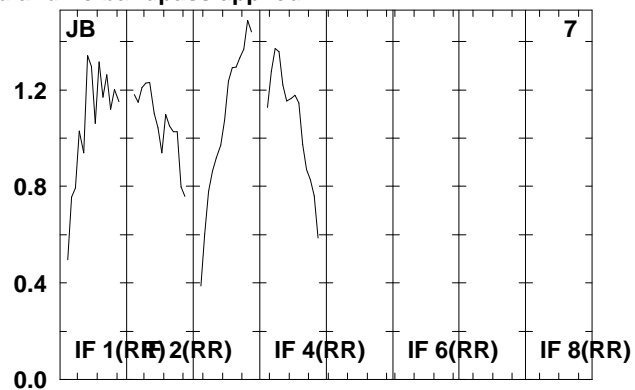
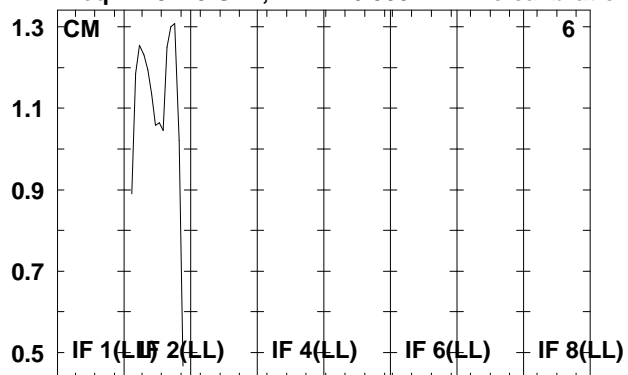

Lower frame: Real Jy

Total-power spectrum Antenna: \*

Timerange: 00/19:02:42 to 00/19:03:58



Plot file version 305 created 07-DEC-2009 16:06:42

SS433 RT006C.UVDATA.1

Freq = 4.9415 GHz, Bw = 16.000 MH No calibration applied and no bandpass applied

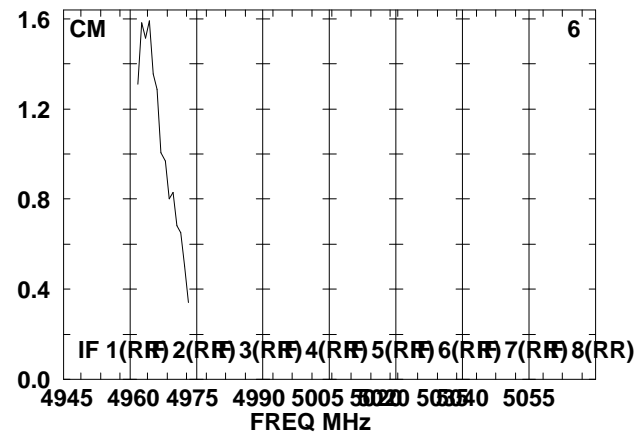
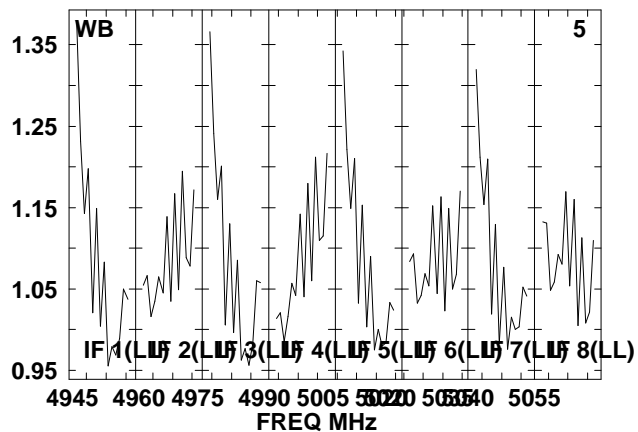
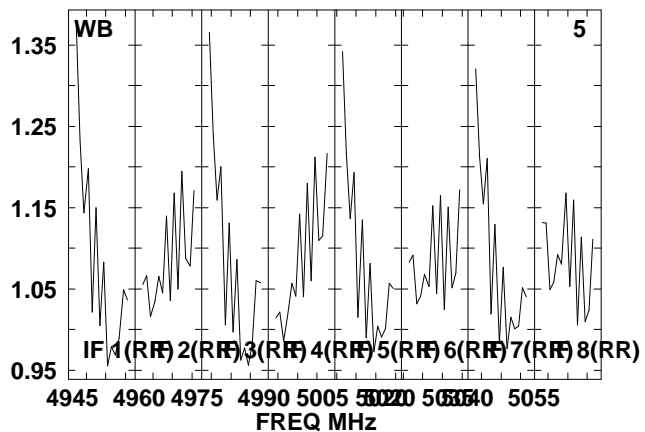
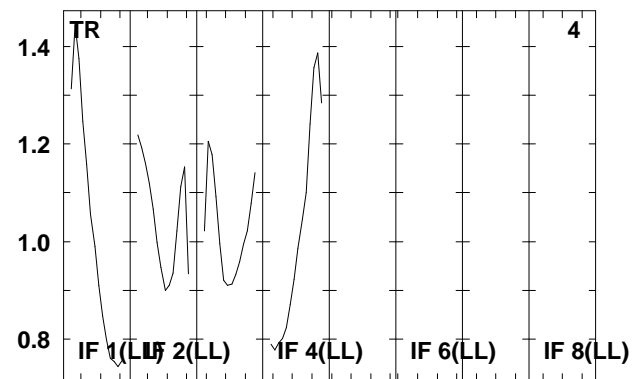
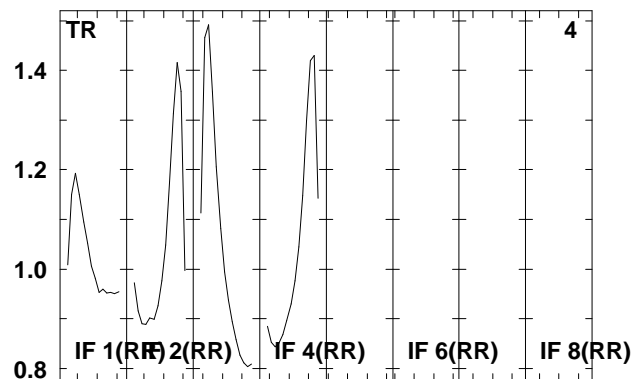
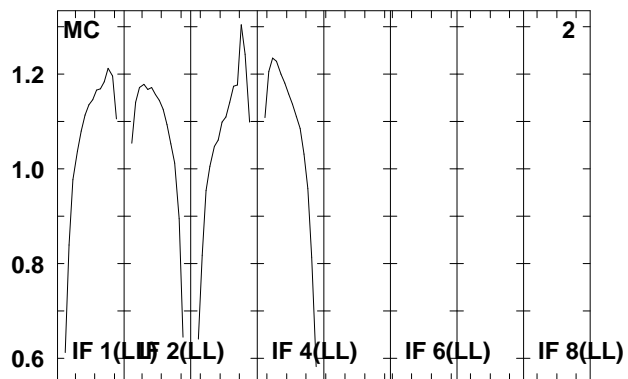
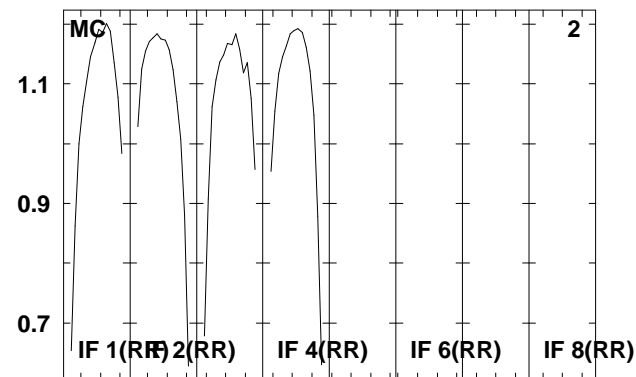
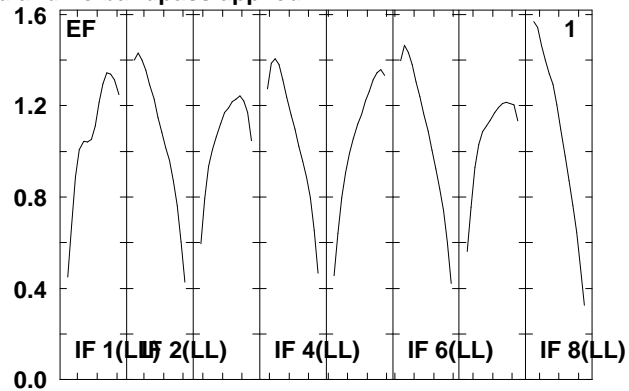
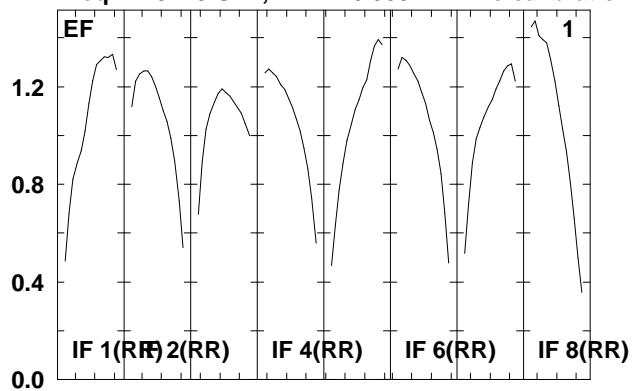

Lower frame: Real Jy

Total-power spectrum Antenna: \*

Timerange: 00/19:04:02 to 00/19:06:18

Plot file version 306 created 07-DEC-2009 16:06:42

SS433 RT006C.UVDATA.1

Freq = 4.9415 GHz, Bw = 16.000 MH No calibration applied and no bandpass applied

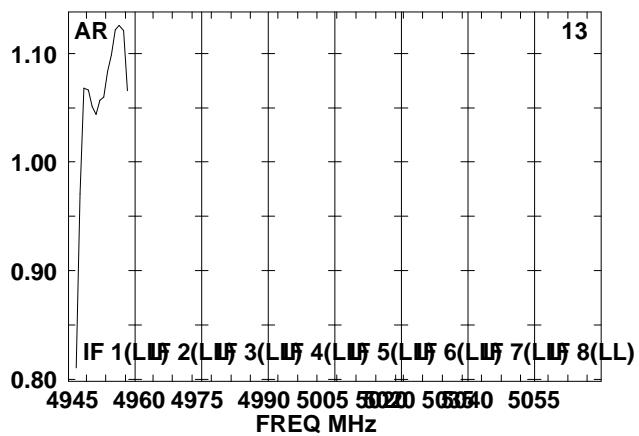
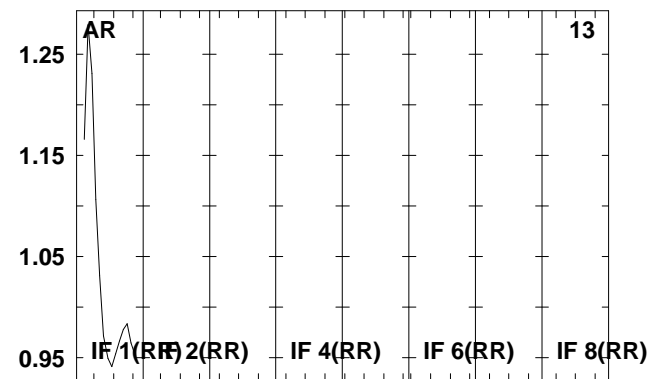
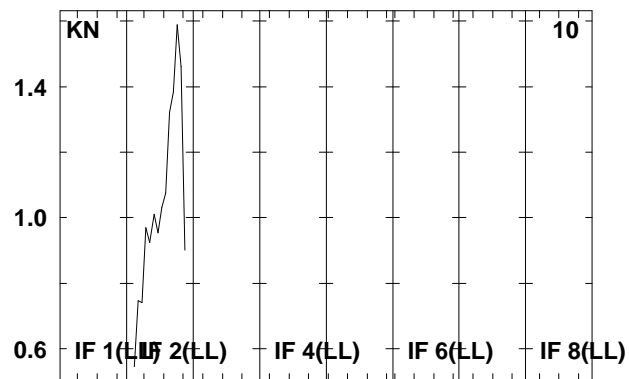
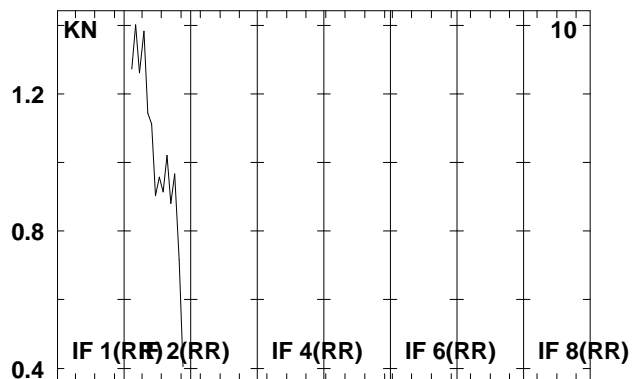
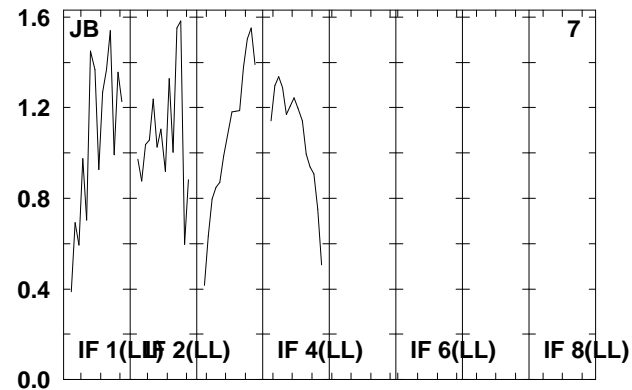
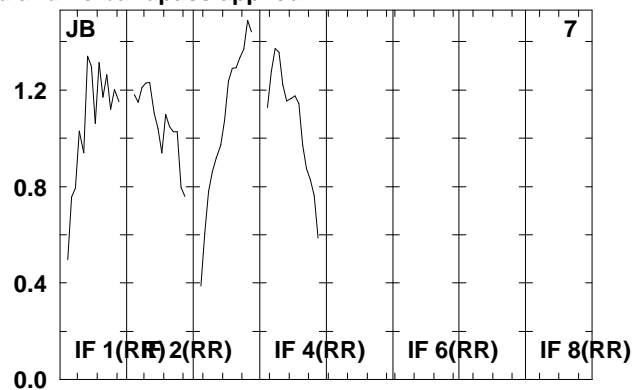
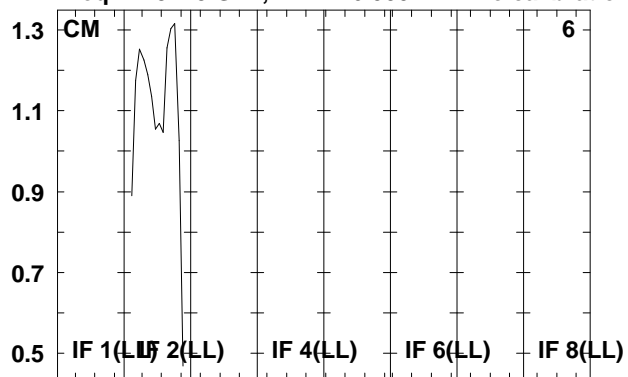

Lower frame: Real Jy

Total-power spectrum Antenna: \*

Timerange: 00/19:04:02 to 00/19:06:18

Plot file version 307 created 07-DEC-2009 16:06:42

J1912+05 RT006C.UVDATA.1

Freq = 4.9415 GHz, Bw = 16.000 MH No calibration applied and no bandpass applied

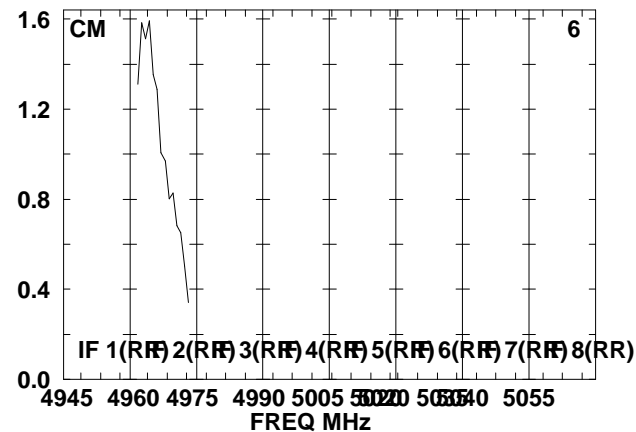
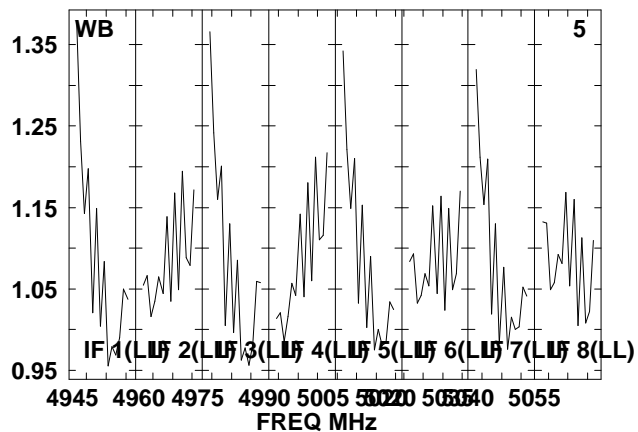
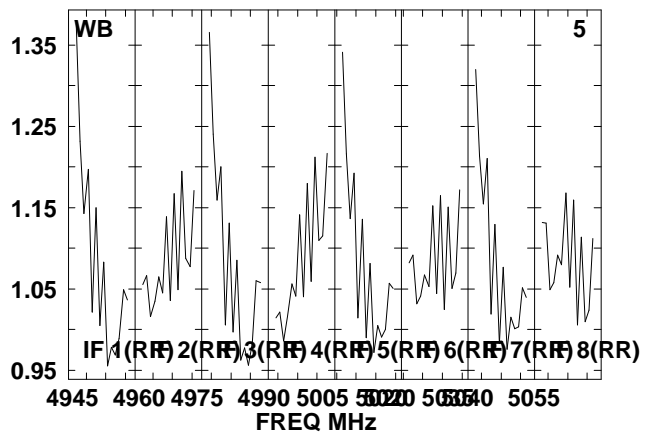
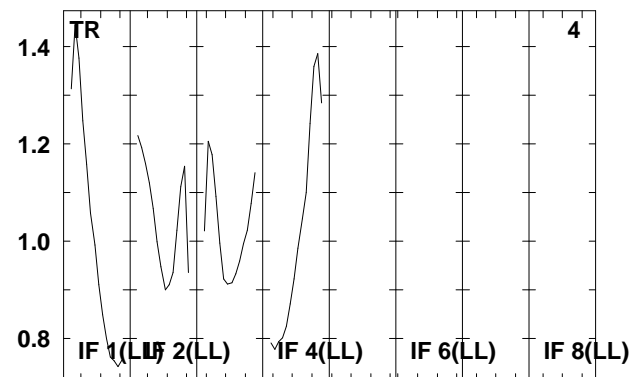
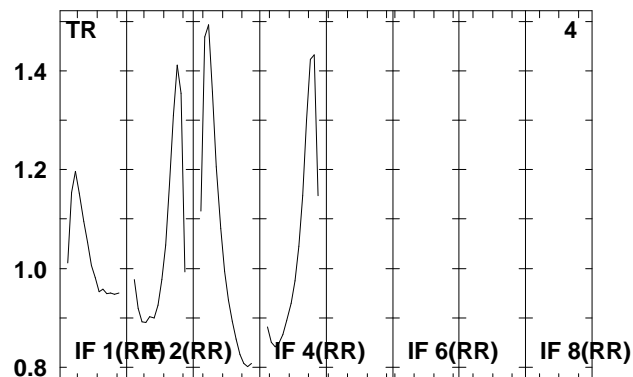
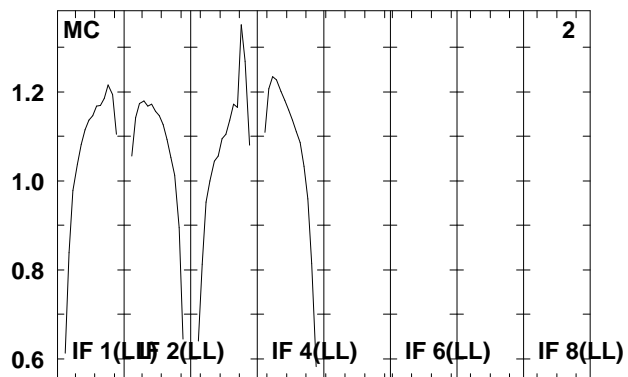
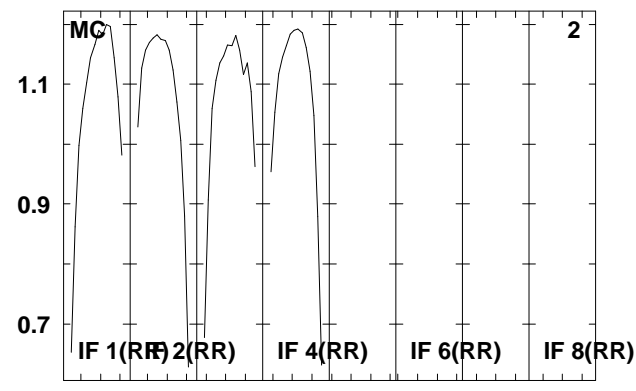
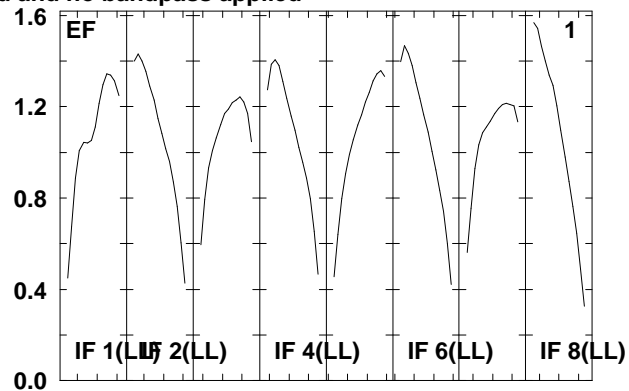
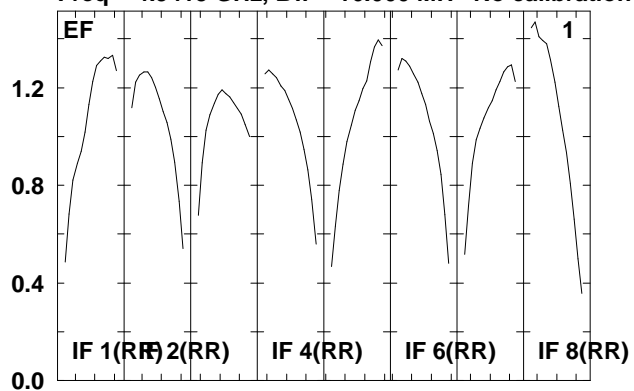

Lower frame: Real Jy  
Total-power spectrum Antenna: \*  
Timerange: 00/19:06:22 to 00/19:07:38

Plot file version 308 created 07-DEC-2009 16:06:42

J1912+05 RT006C.UVDATA.1

Freq = 4.9415 GHz, Bw = 16.000 MH No calibration applied and no bandpass applied

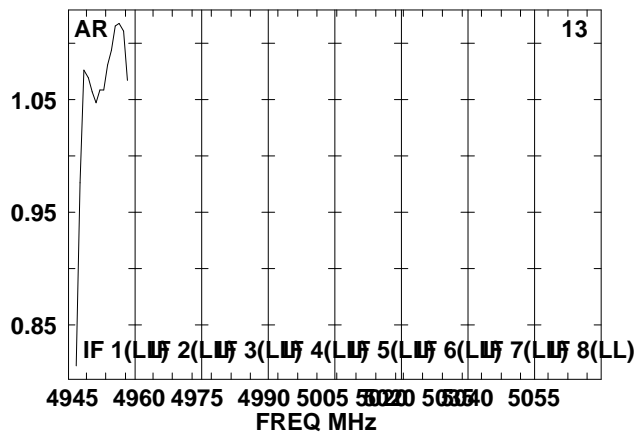
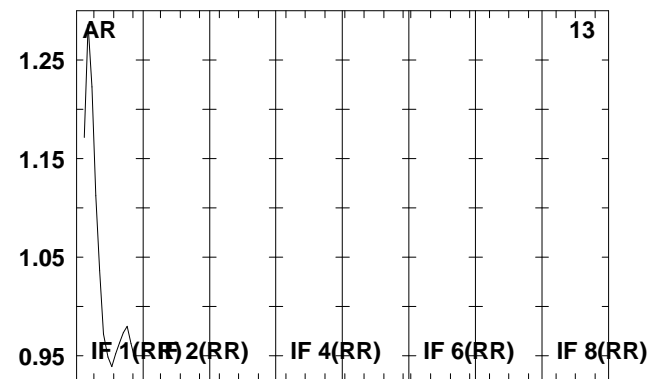
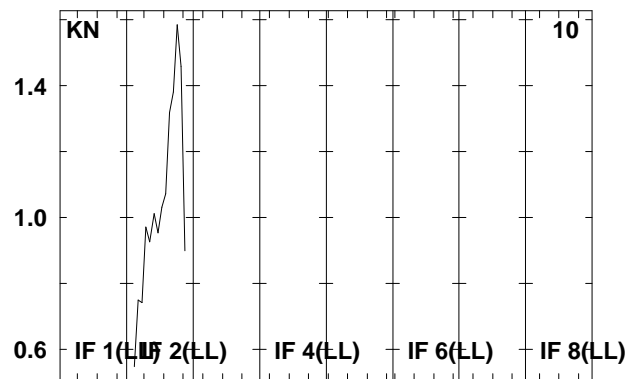
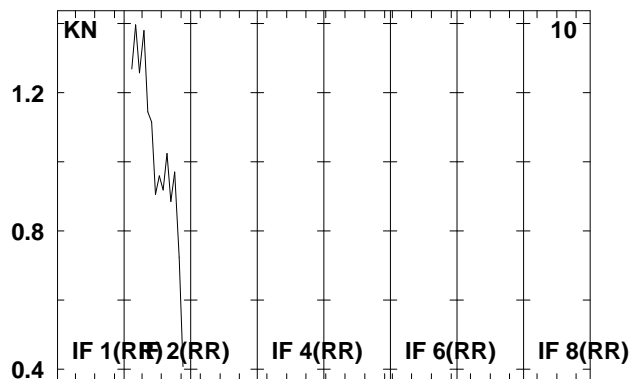
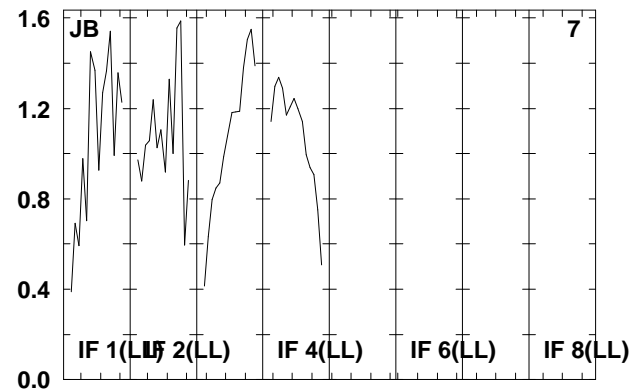
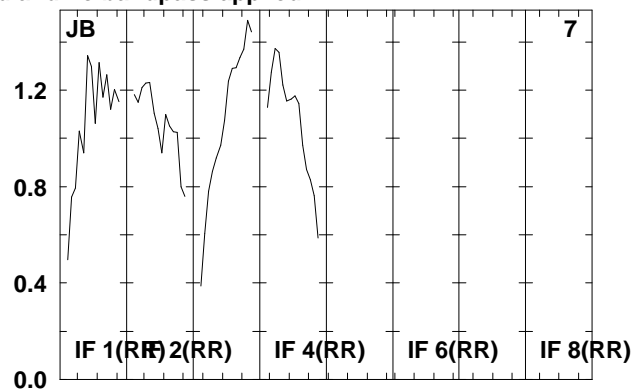
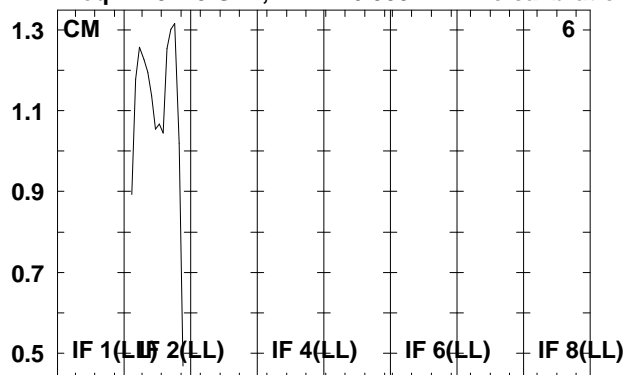

Lower frame: Real Jy

Total-power spectrum Antenna: \*

Timerange: 00/19:06:22 to 00/19:07:38

Plot file version 309 created 07-DEC-2009 16:06:43

SS433 RT006C.UVDATA.1

Freq = 4.9415 GHz, Bw = 16.000 MH No calibration applied and no bandpass applied

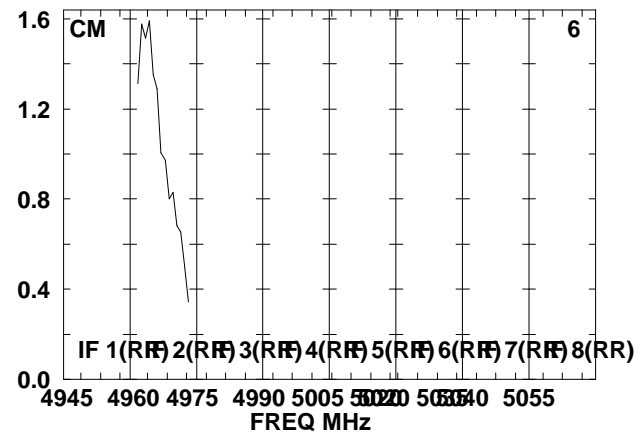
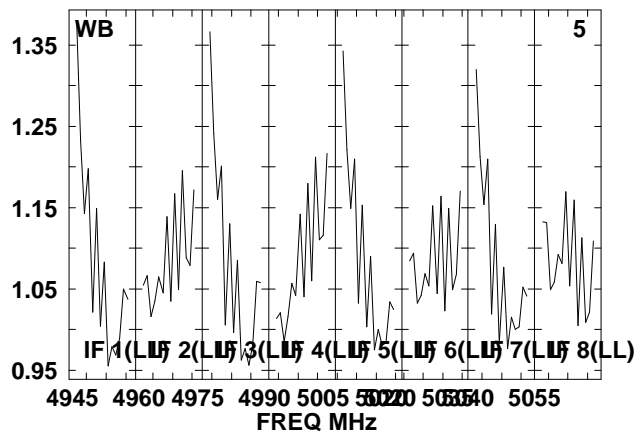
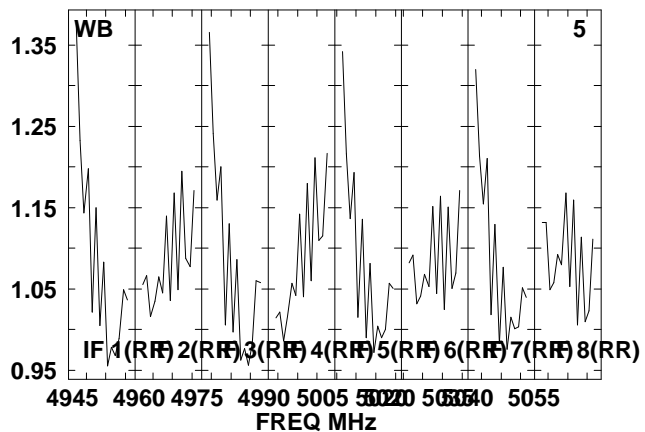
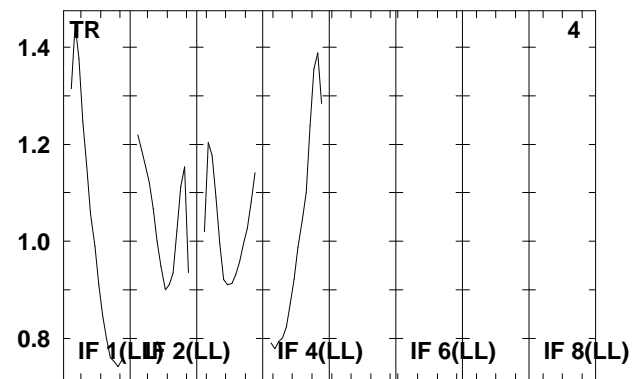
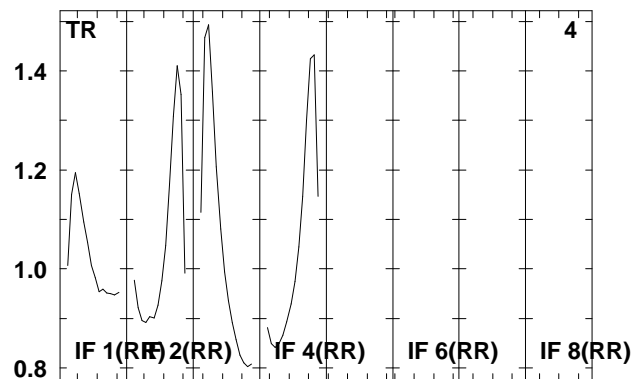
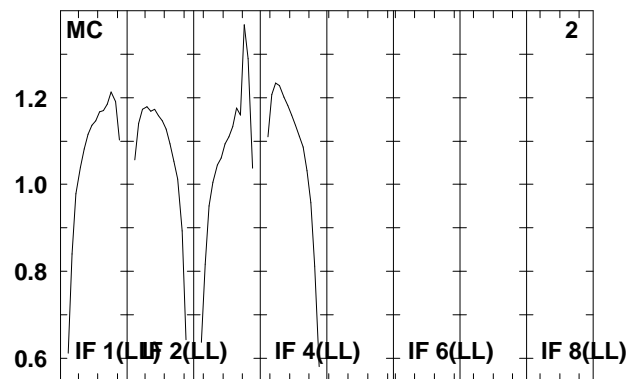
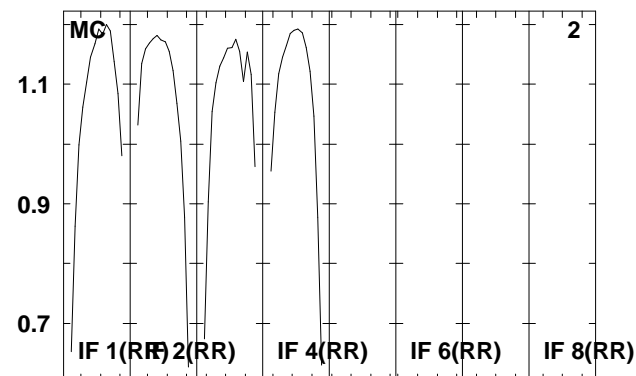
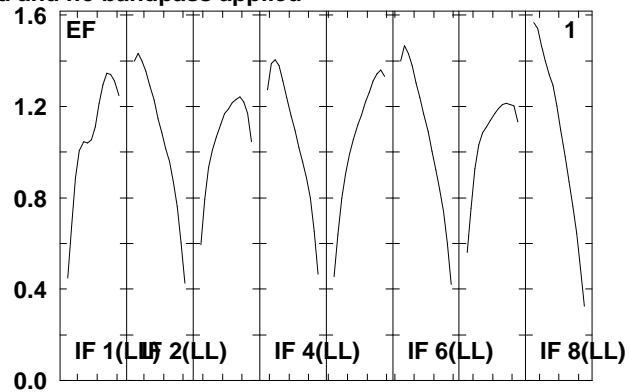
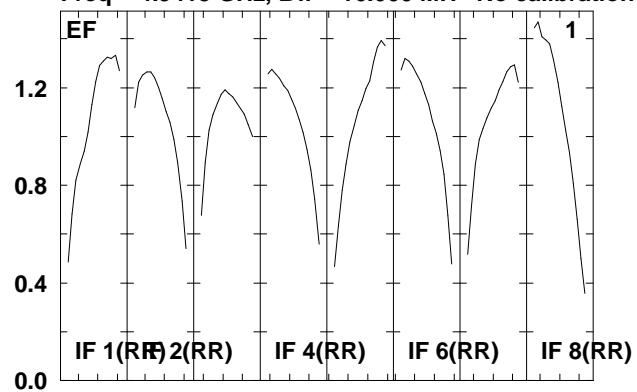

Lower frame: Real Jy  
Total-power spectrum Antenna: \*  
Timerange: 00/19:07:42 to 00/19:09:58

Plot file version 310 created 07-DEC-2009 16:06:43

SS433 RT006C.UVDATA.1

Freq = 4.9415 GHz, Bw = 16.000 MH No calibration applied and no bandpass applied

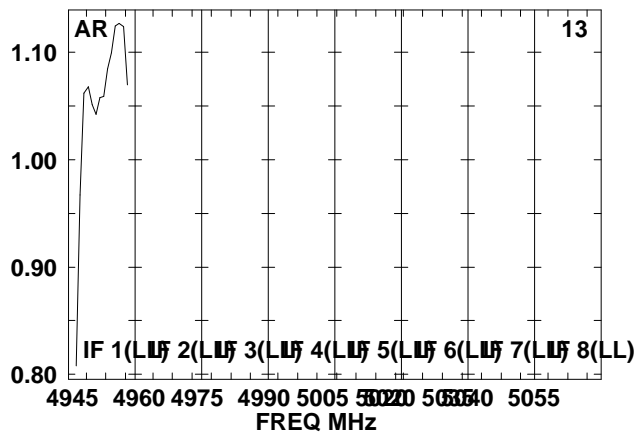
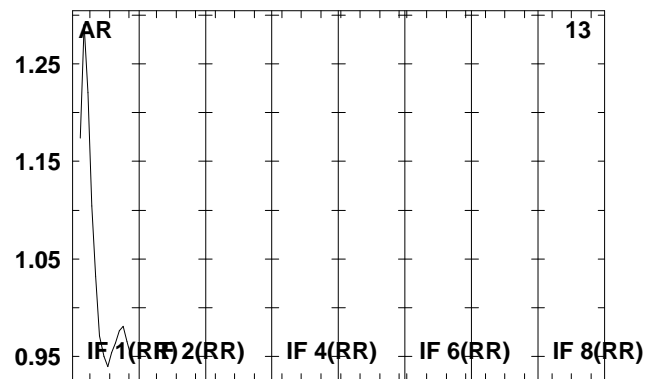
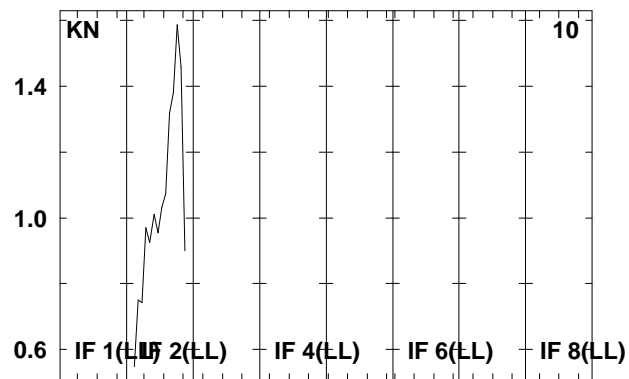
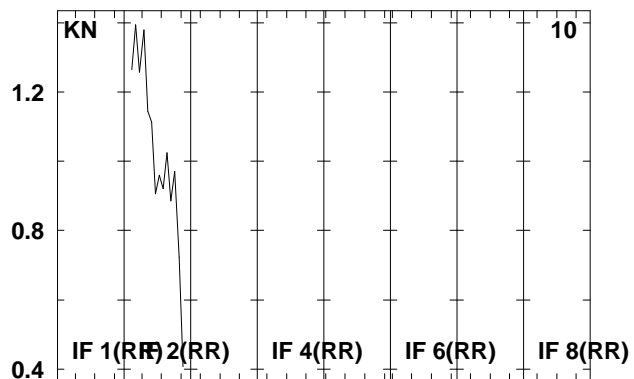
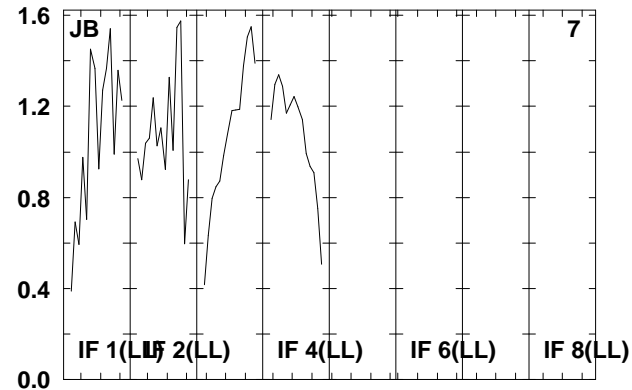
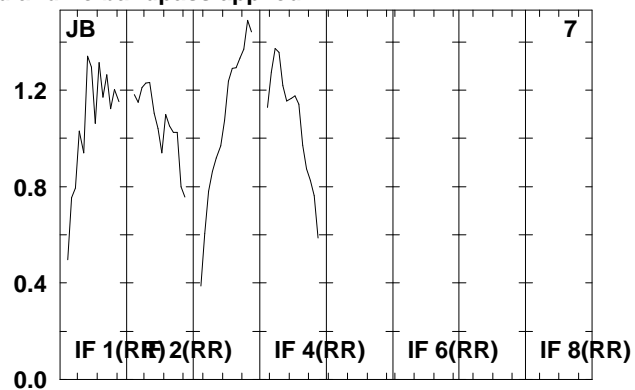
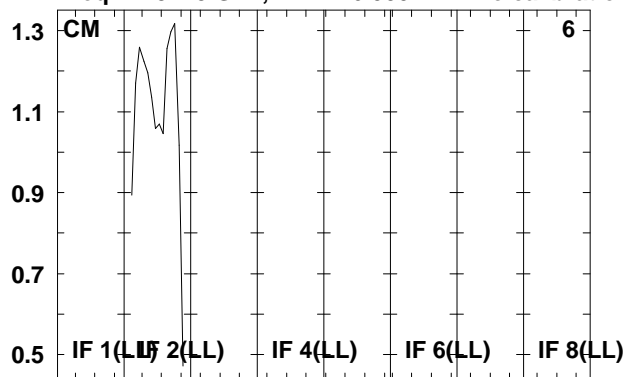

Lower frame: Real Jy

Total-power spectrum Antenna: \*

Timerange: 00/19:07:42 to 00/19:09:58

Plot file version 311 created 07-DEC-2009 16:06:43

J1912+05 RT006C.UVDATA.1

Freq = 4.9415 GHz, Bw = 16.000 MH No calibration applied and no bandpass applied

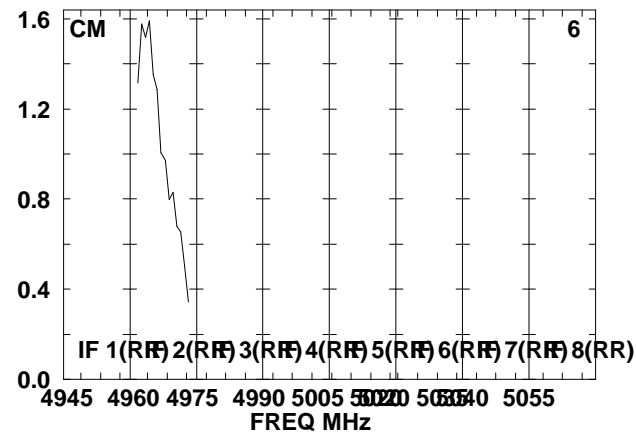
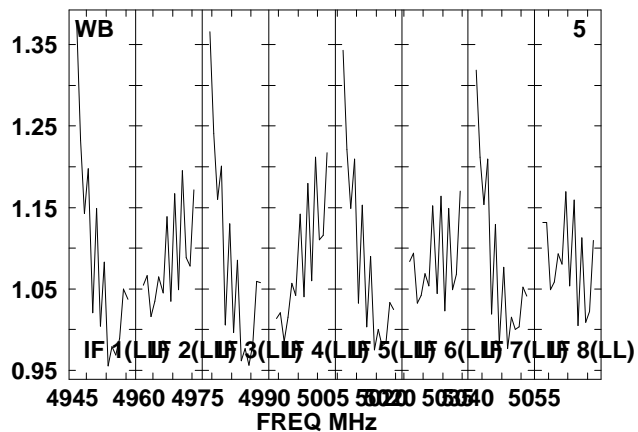
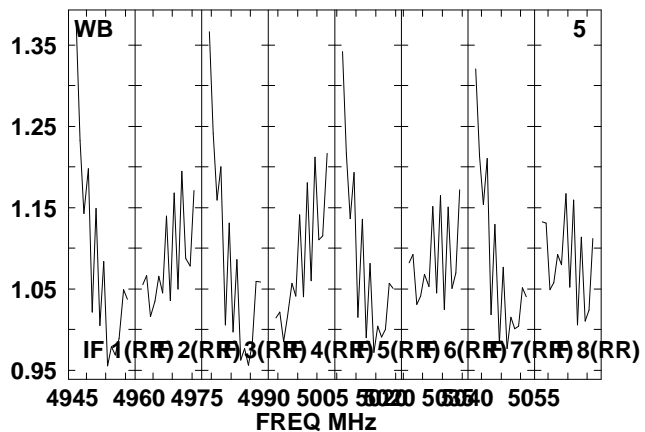
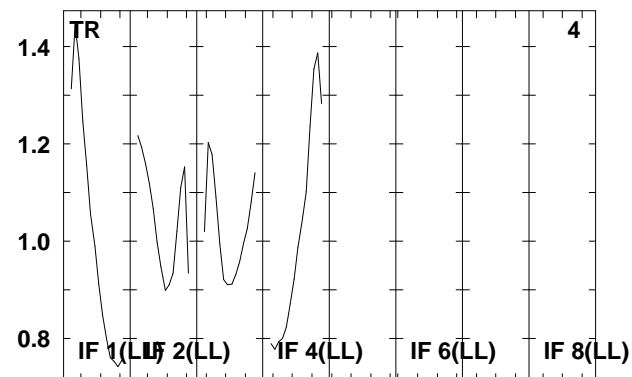
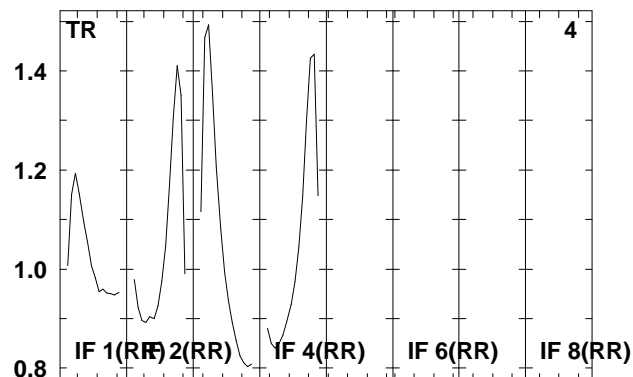
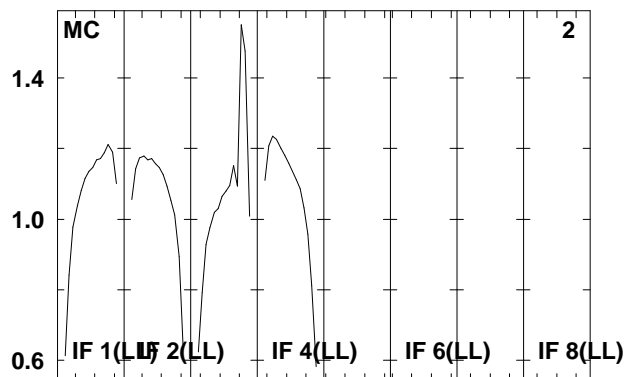
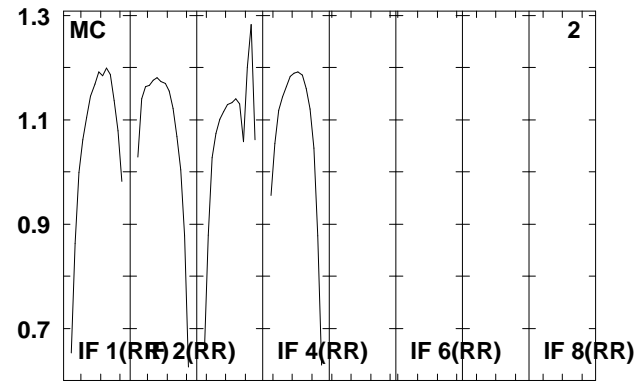
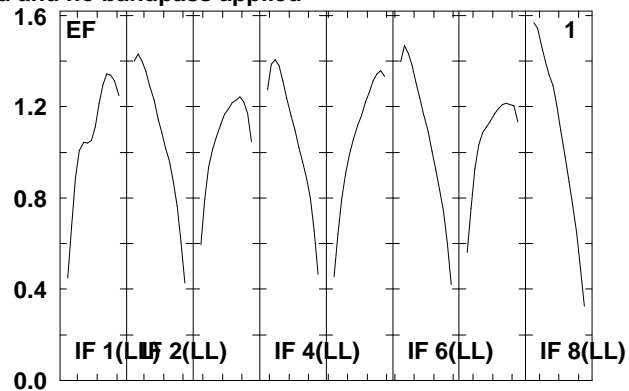
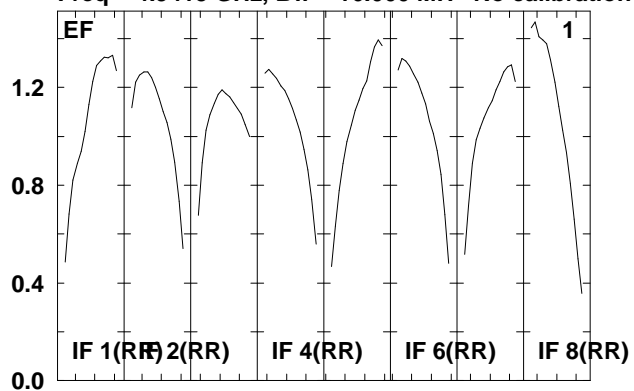

Lower frame: Real Jy  
Total-power spectrum Antenna: \*  
Timerange: 00/19:10:02 to 00/19:11:18

Plot file version 312 created 07-DEC-2009 16:06:43

J1912+05 RT006C.UVDATA.1

Freq = 4.9415 GHz, Bw = 16.000 MH No calibration applied and no bandpass applied

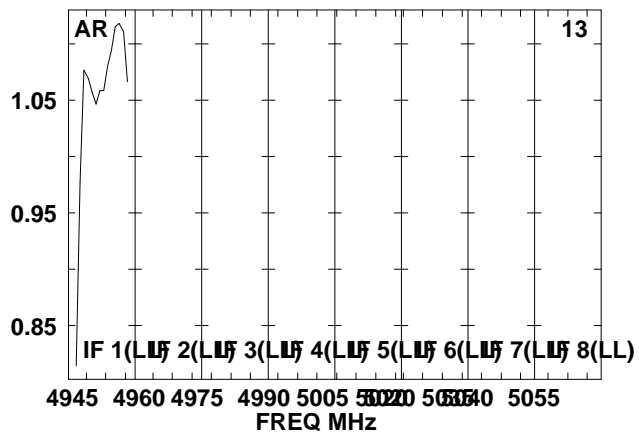
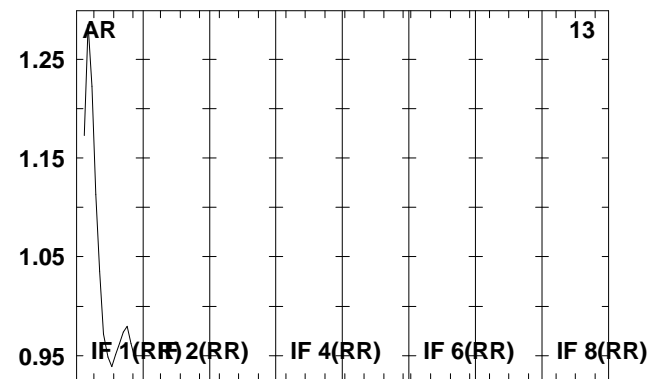
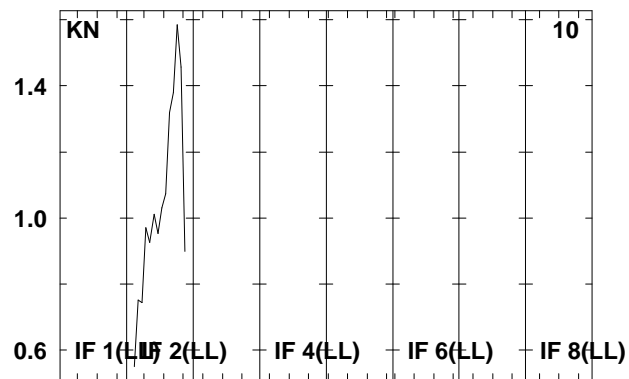
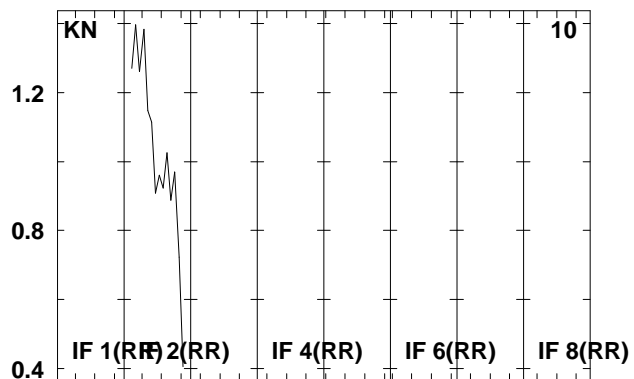
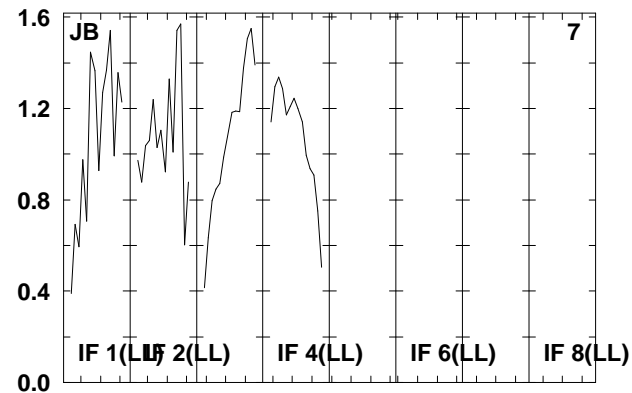
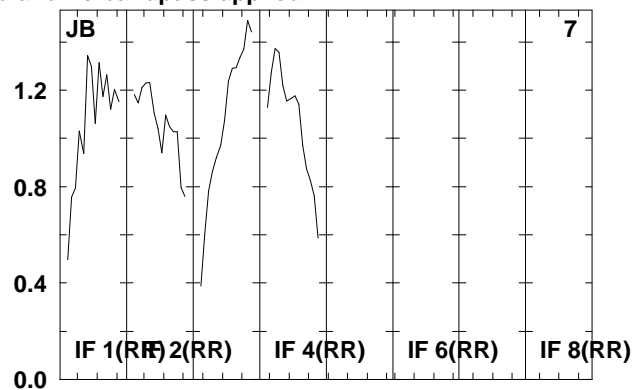
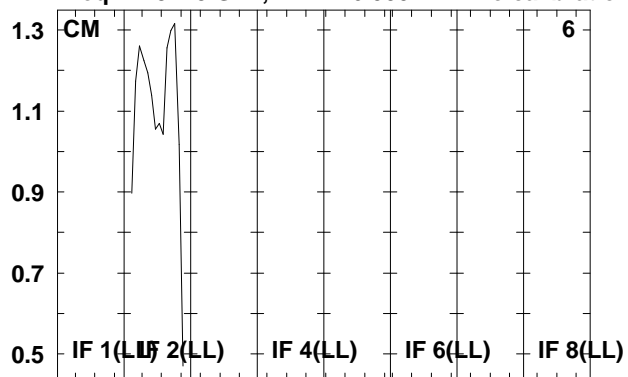

Lower frame: Real Jy

Total-power spectrum Antenna: \*

Timerange: 00/19:10:02 to 00/19:11:18



Plot file version 313 created 07-DEC-2009 16:06:44

SS433 RT006C.UVDATA.1

Freq = 4.9415 GHz, Bw = 16.000 MH No calibration applied and no bandpass applied

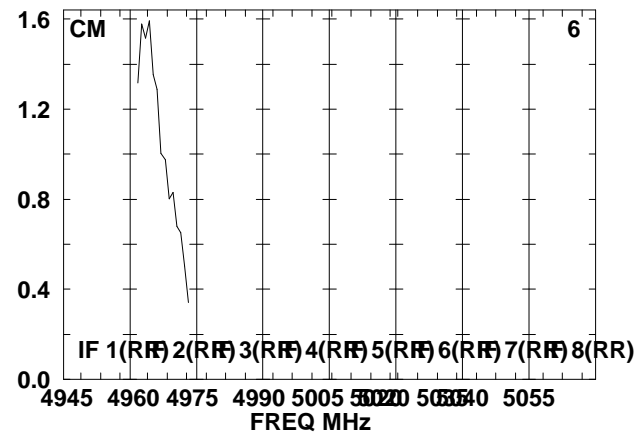
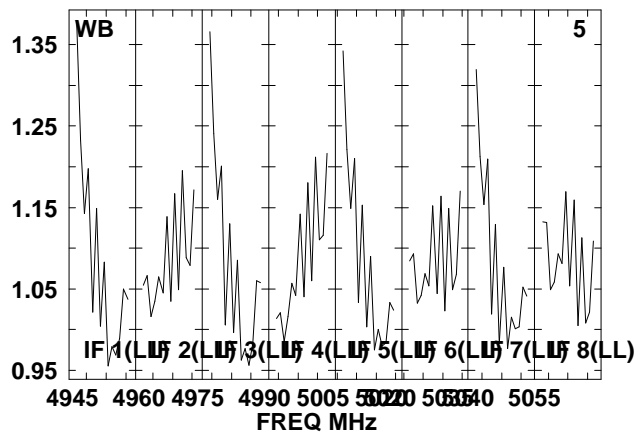
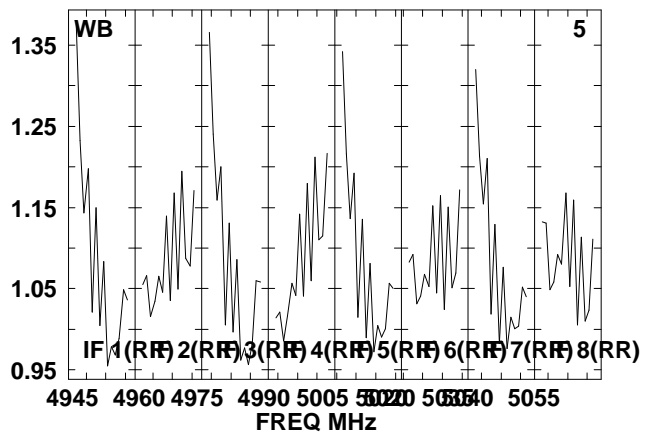
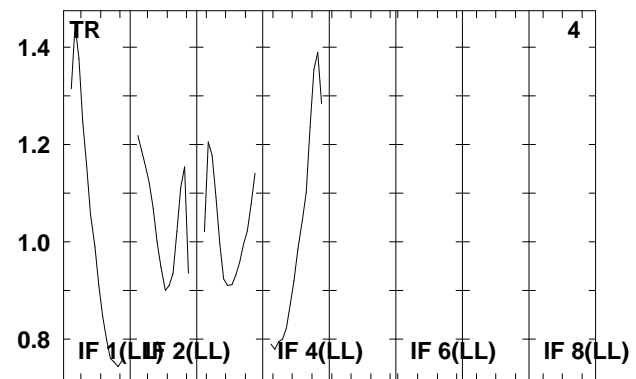
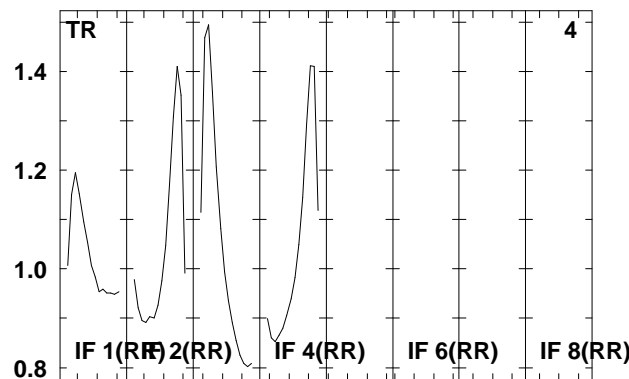
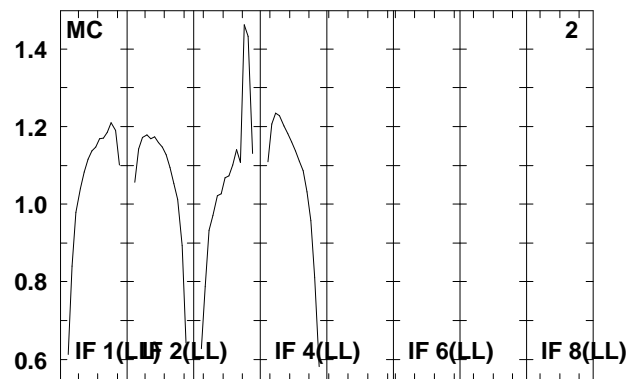
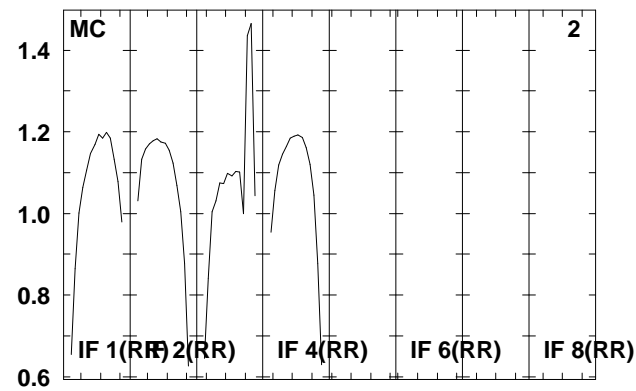
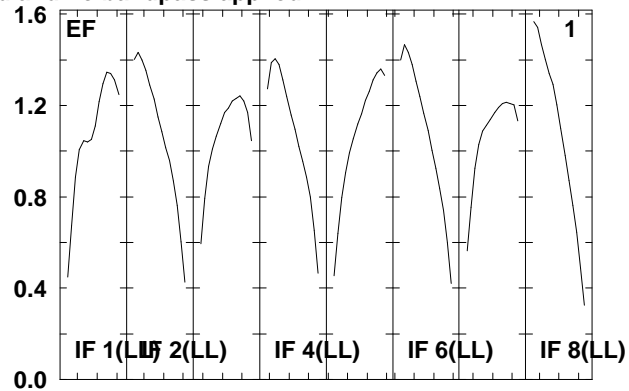
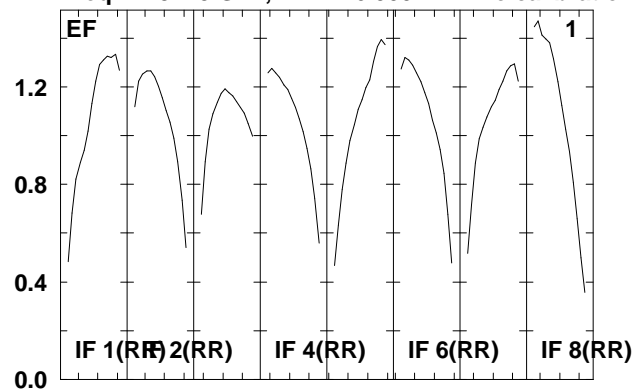

Lower frame: Real Jy  
Total-power spectrum Antenna: \*  
Timerange: 00/19:11:22 to 00/19:13:38

Plot file version 314 created 07-DEC-2009 16:06:44

SS433 RT006C.UVDATA.1

Freq = 4.9415 GHz, Bw = 16.000 MH No calibration applied and no bandpass applied

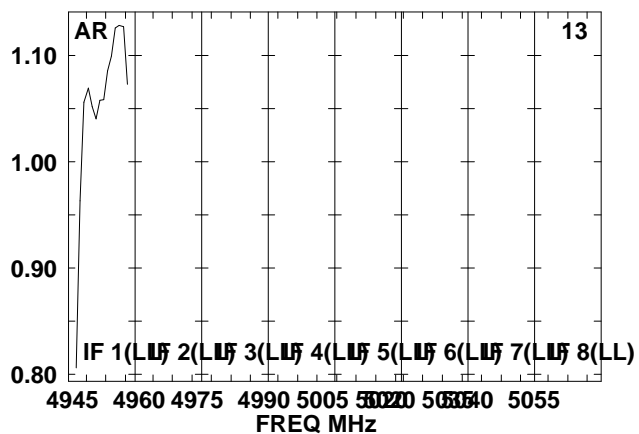
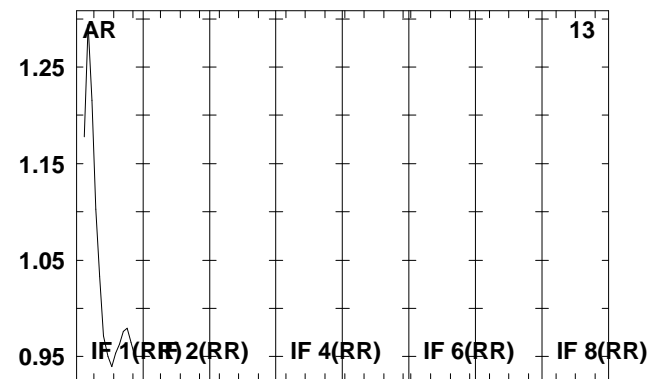
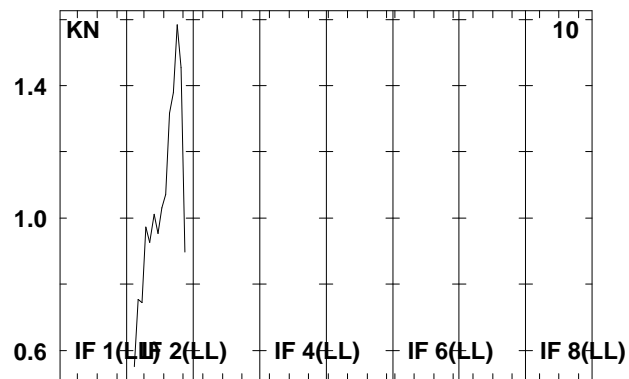
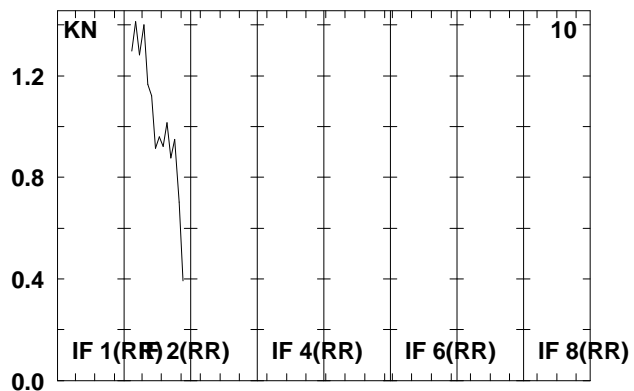
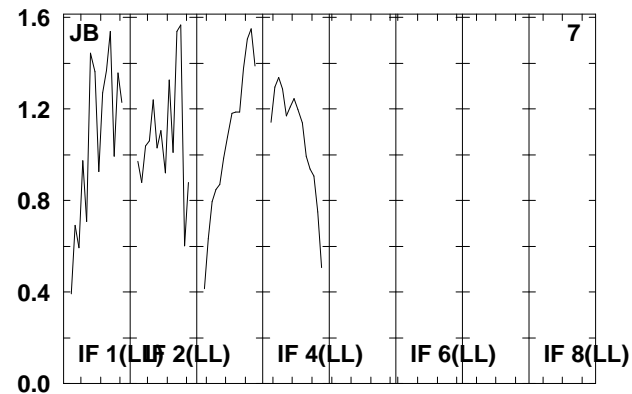
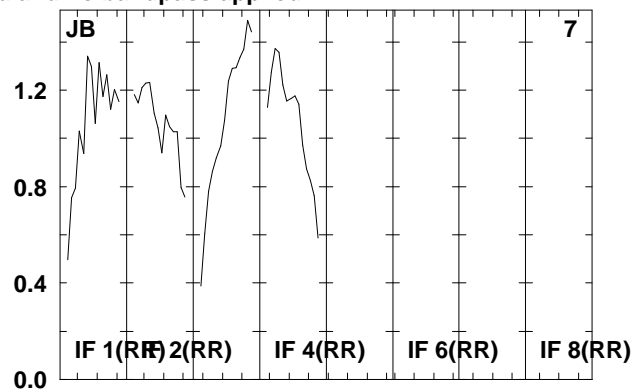
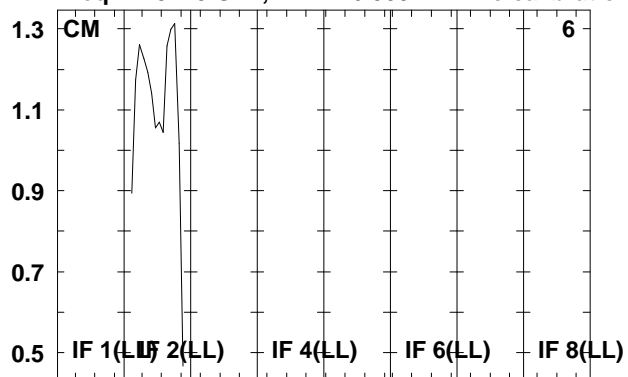

Lower frame: Real Jy

Total-power spectrum Antenna: \*

Timerange: 00/19:11:22 to 00/19:13:38

Plot file version 315 created 07-DEC-2009 16:06:44

J1912+05 RT006C.UVDATA.1

Freq = 4.9415 GHz, Bw = 16.000 MH No calibration applied and no bandpass applied

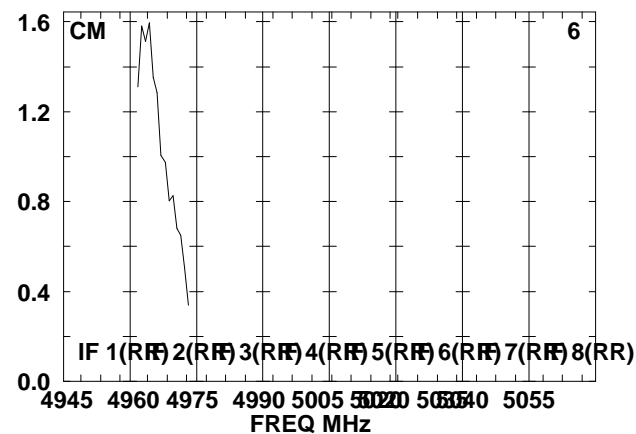
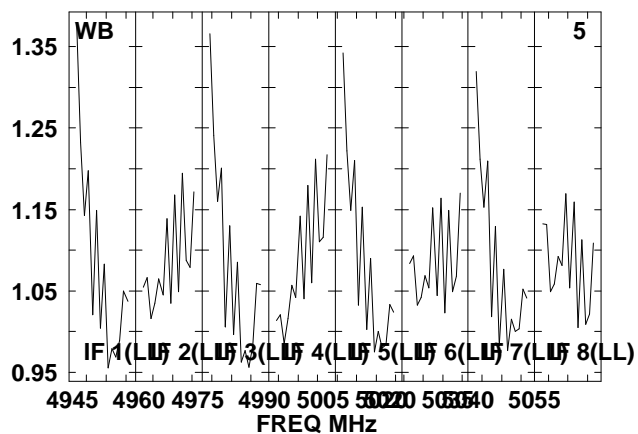
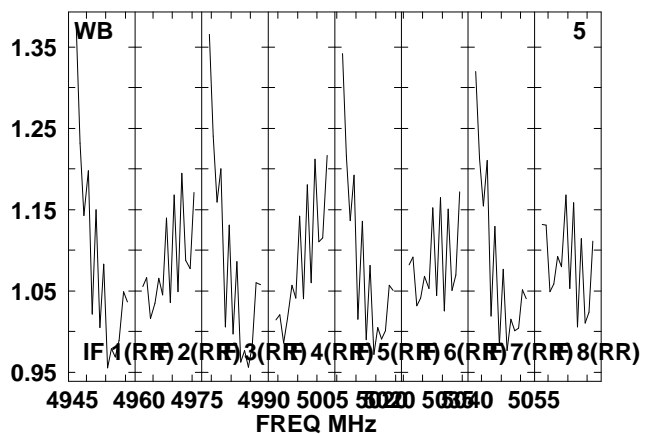
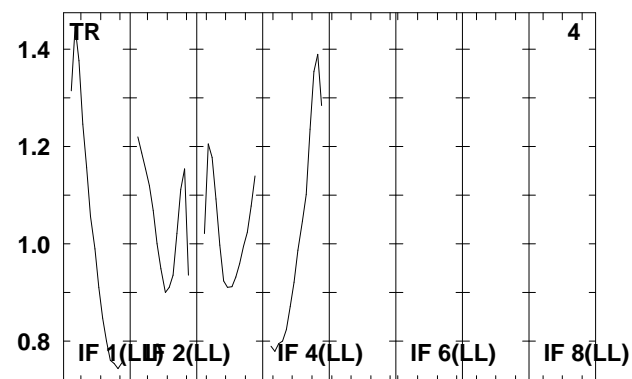
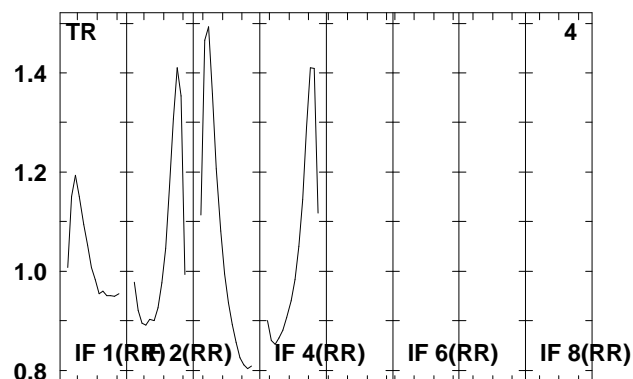
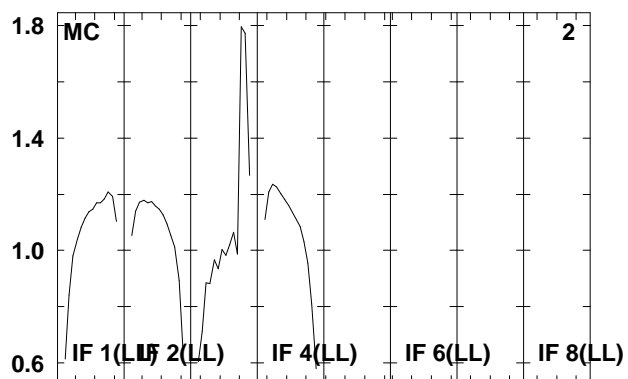
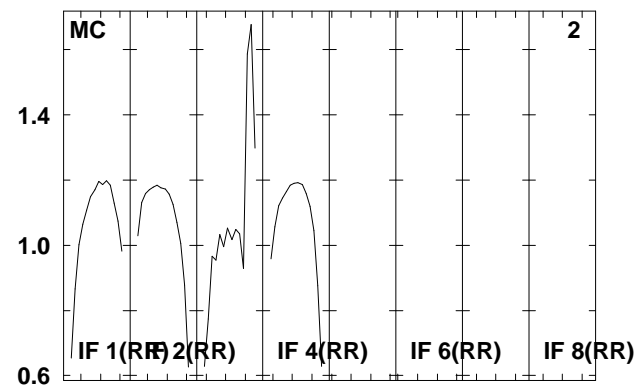
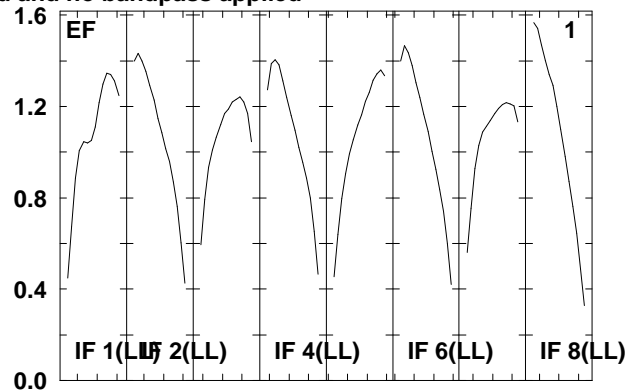
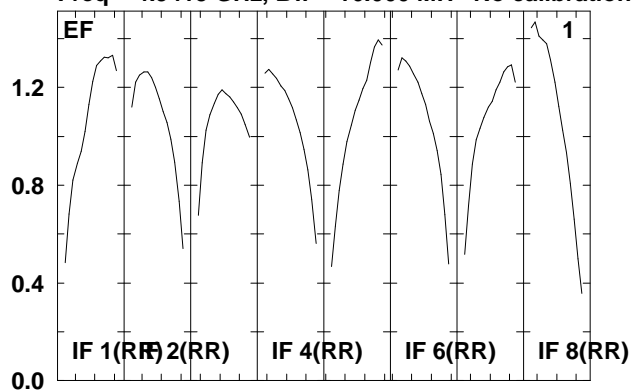

Lower frame: Real Jy

Total-power spectrum Antenna: \*

Timerange: 00/19:14:42 to 00/19:15:38

Plot file version 316 created 07-DEC-2009 16:06:44

J1912+05 RT006C.UVDATA.1

Freq = 4.9415 GHz, Bw = 16.000 MH No calibration applied and no bandpass applied

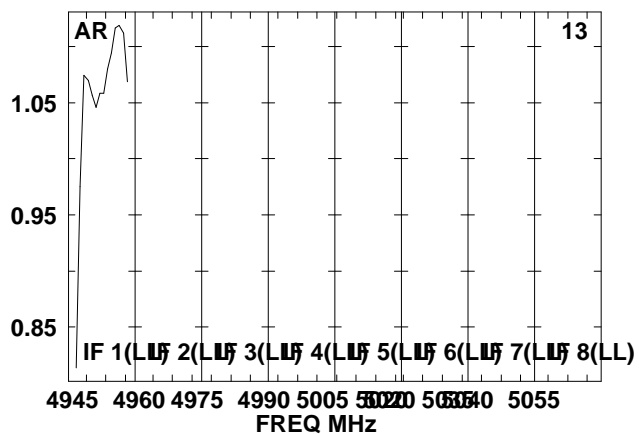
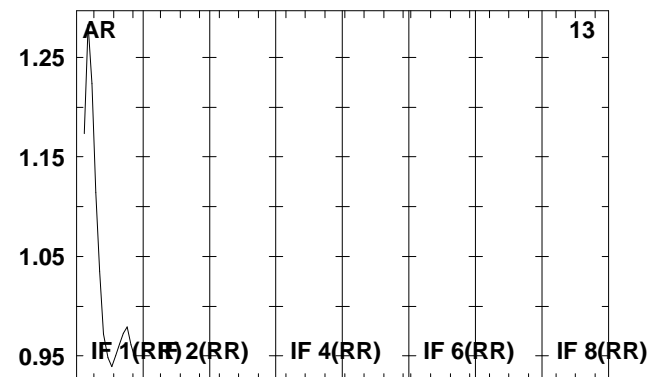
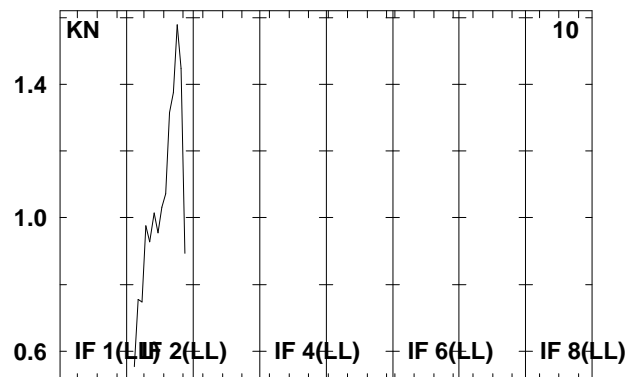
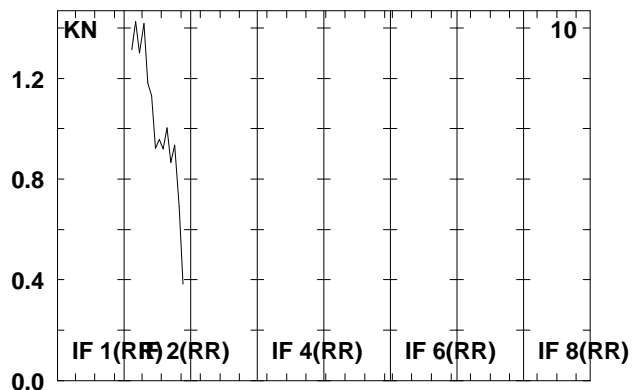
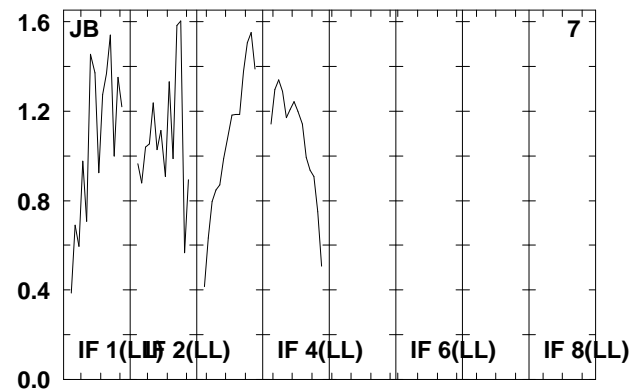
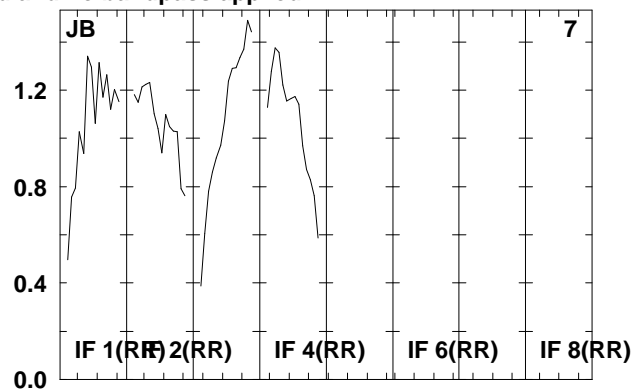
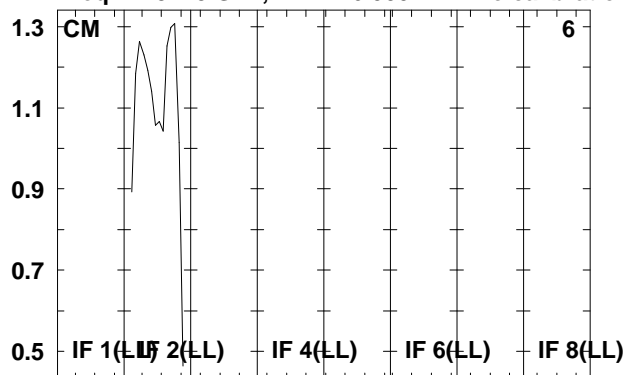

Lower frame: Real Jy

Total-power spectrum Antenna: \*

Timerange: 00/19:14:42 to 00/19:15:38

Plot file version 317 created 07-DEC-2009 16:06:44

SS433 RT006C.UVDATA.1

Freq = 4.9415 GHz, Bw = 16.000 MH No calibration applied and no bandpass applied

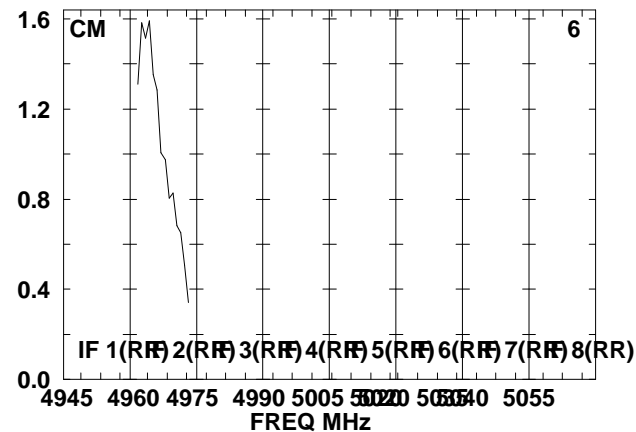
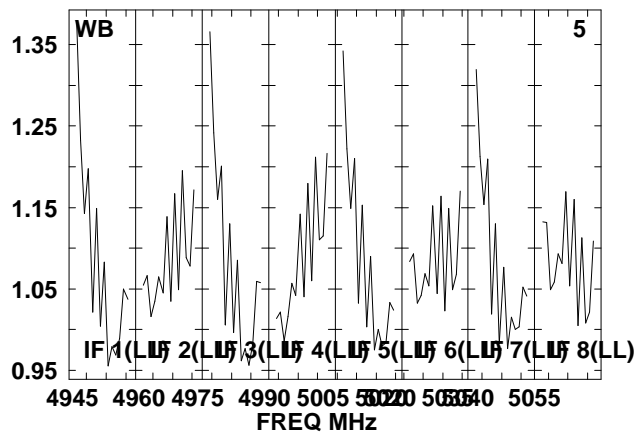
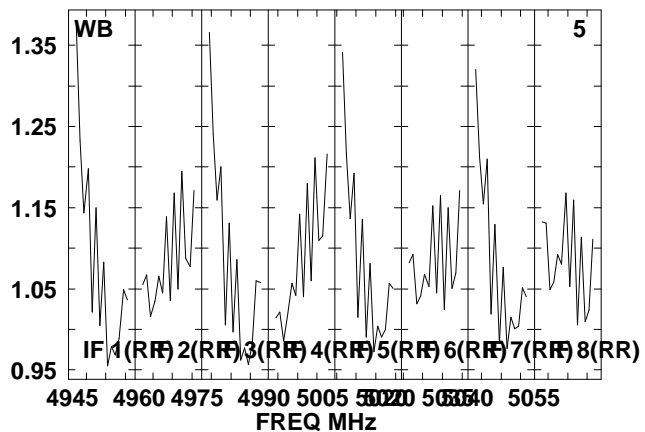
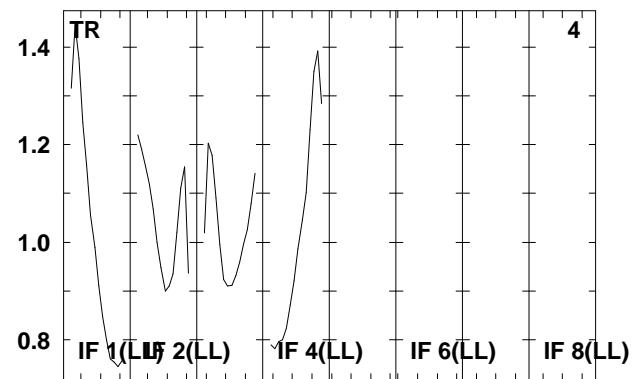
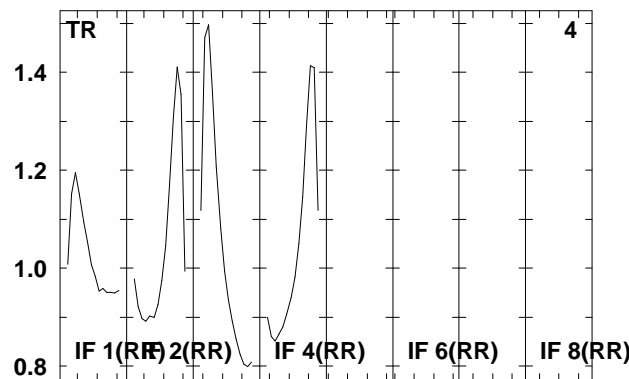
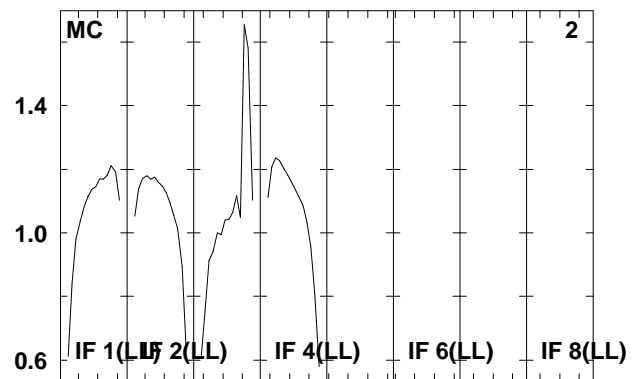
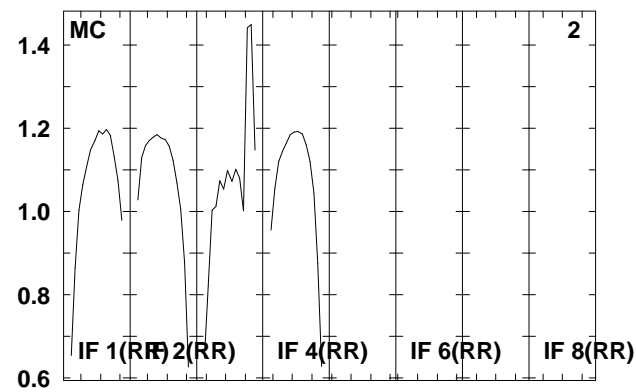
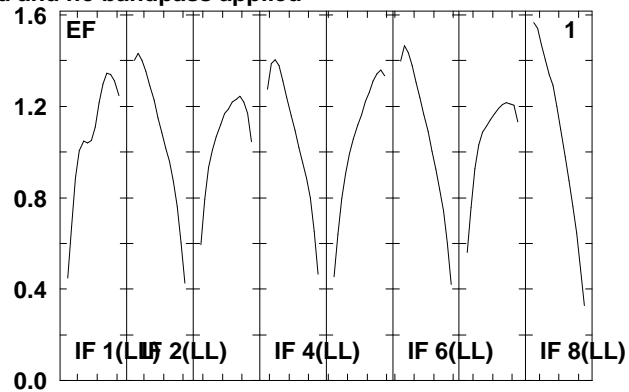
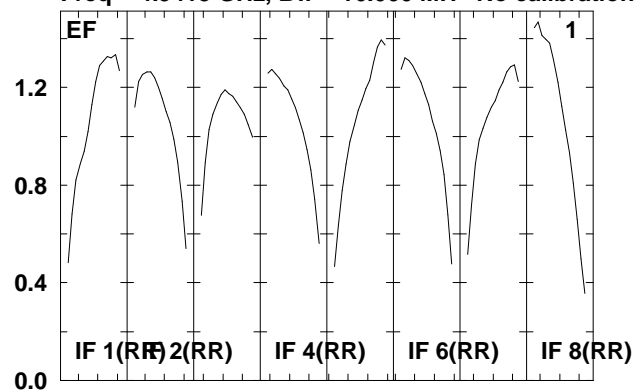

Lower frame: Real Jy  
Total-power spectrum Antenna: \*  
Timerange: 00/19:15:42 to 00/19:17:58

Plot file version 318 created 07-DEC-2009 16:06:45

SS433 RT006C.UVDATA.1

Freq = 4.9415 GHz, Bw = 16.000 MH No calibration applied and no bandpass applied

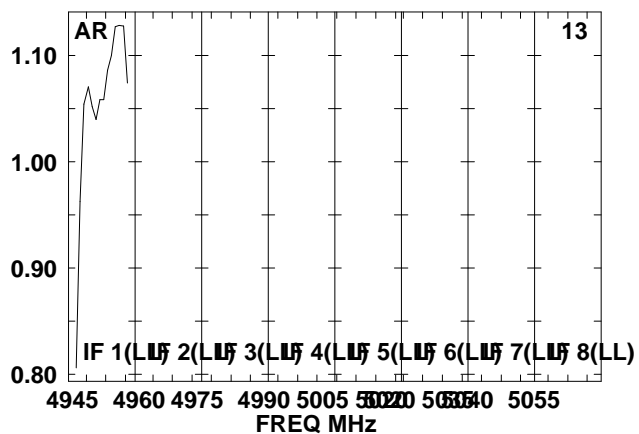
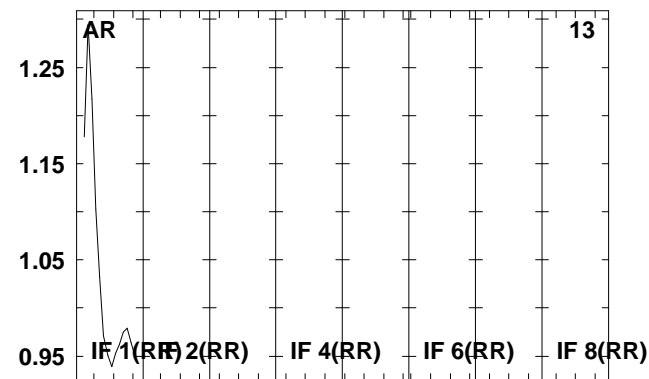
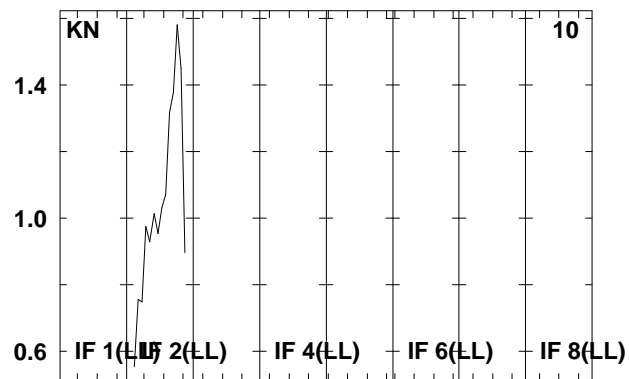
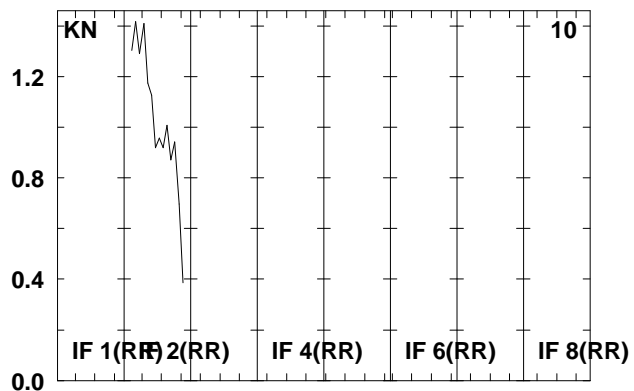
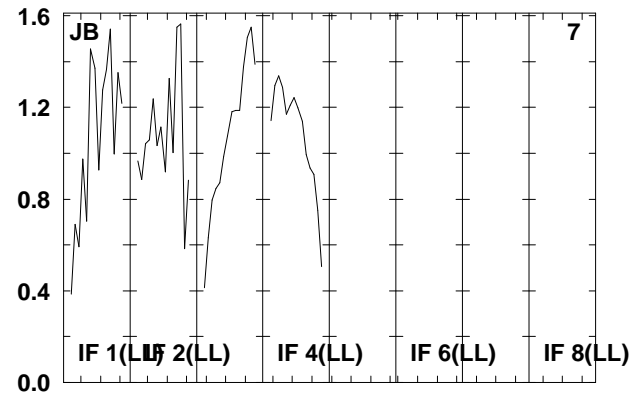
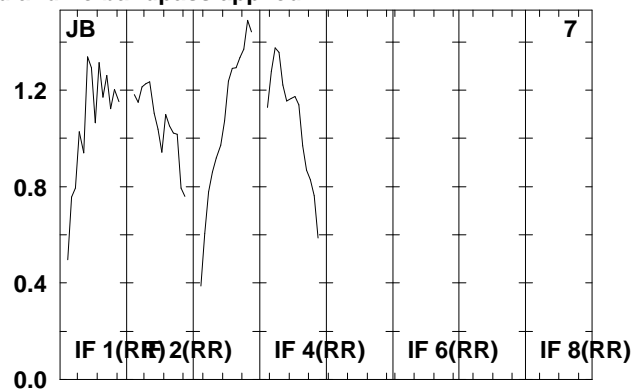
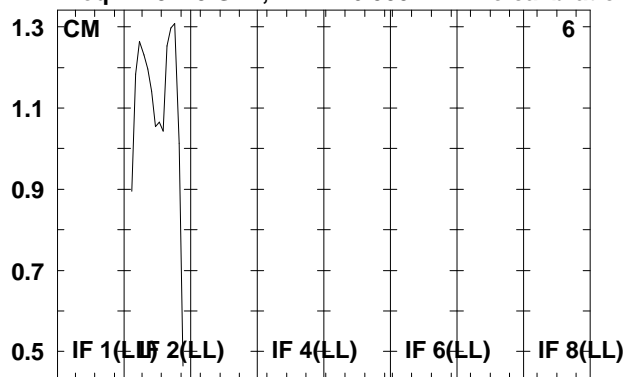

Lower frame: Real Jy

Total-power spectrum Antenna: \*

Timerange: 00/19:15:42 to 00/19:17:58

Plot file version 319 created 07-DEC-2009 16:06:45

J1912+05 RT006C.UVDATA.1

Freq = 4.9415 GHz, Bw = 16.000 MH No calibration applied and no bandpass applied

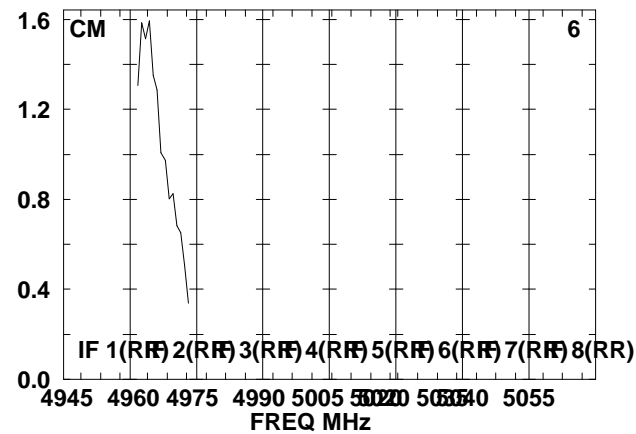
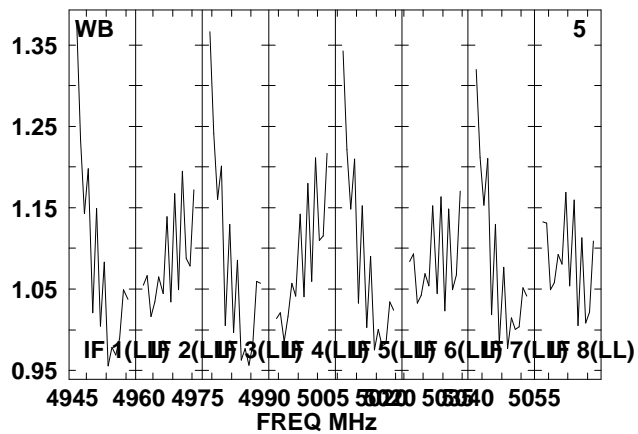
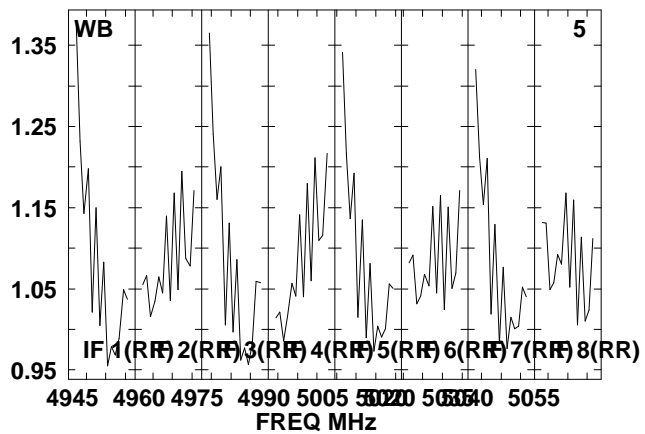
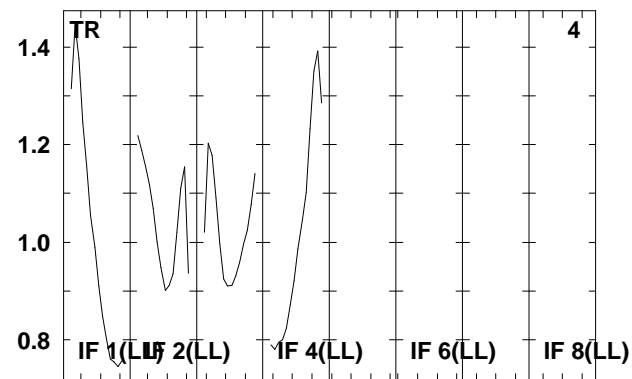
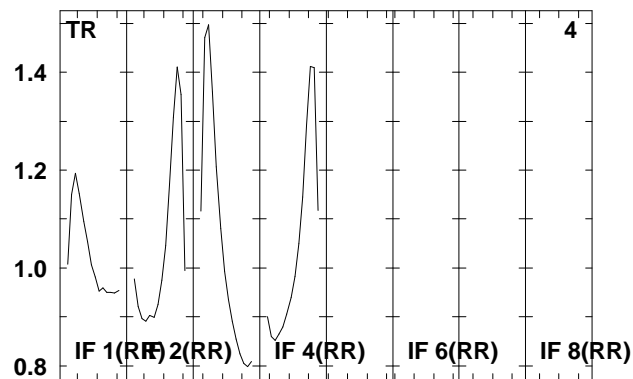
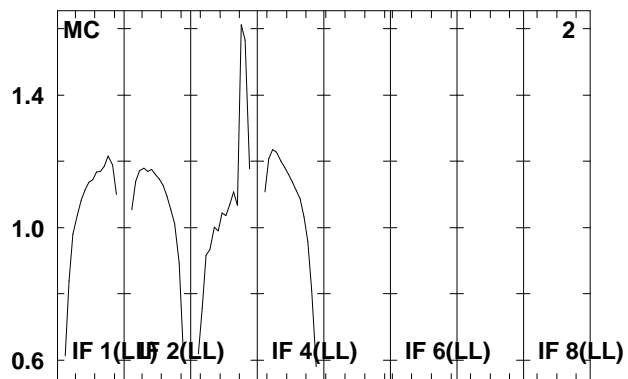
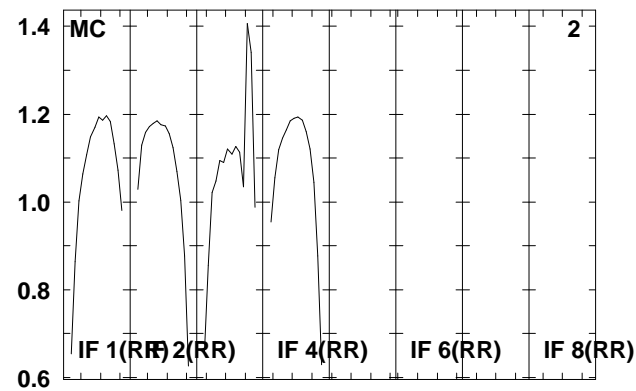
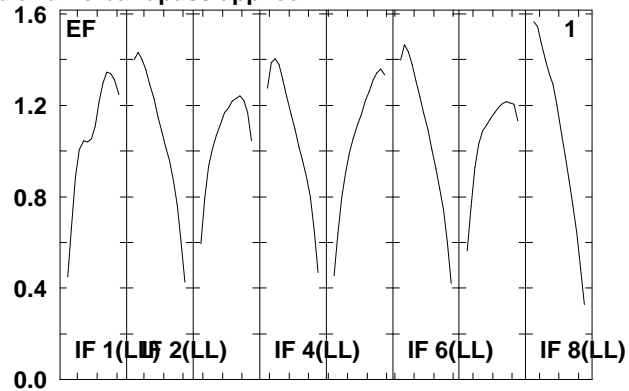
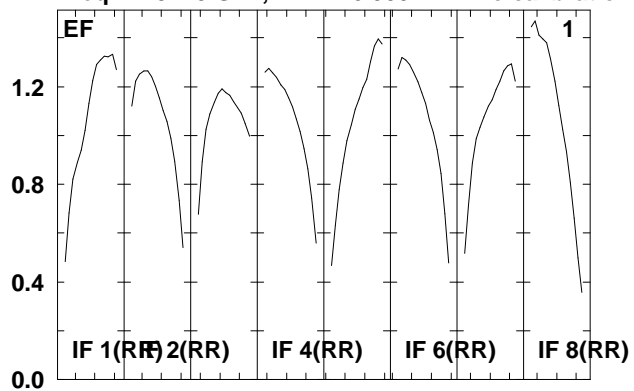

Lower frame: Real Jy

Total-power spectrum Antenna: \*

Timerange: 00/19:18:02 to 00/19:19:18

Plot file version 320 created 07-DEC-2009 16:06:45

J1912+05 RT006C.UVDATA.1

Freq = 4.9415 GHz, Bw = 16.000 MH No calibration applied and no bandpass applied

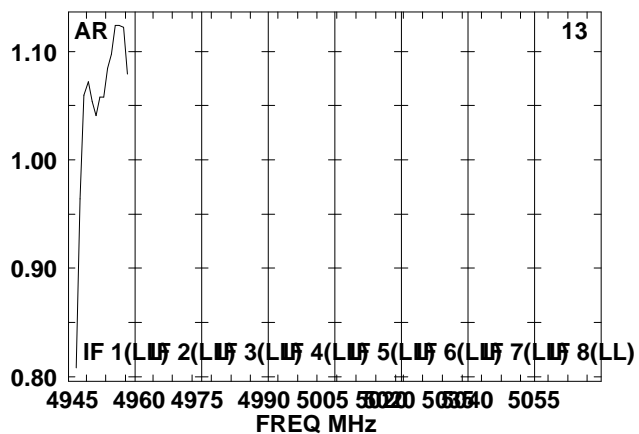
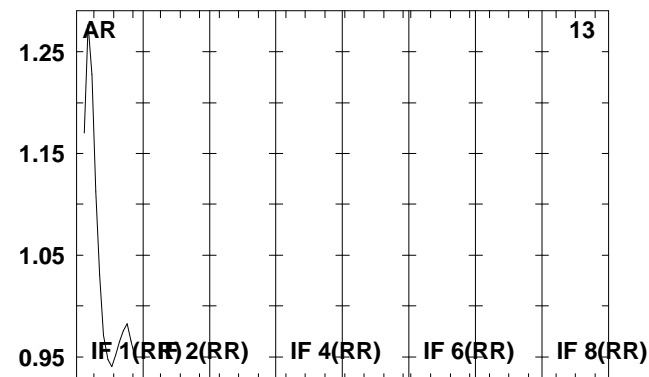
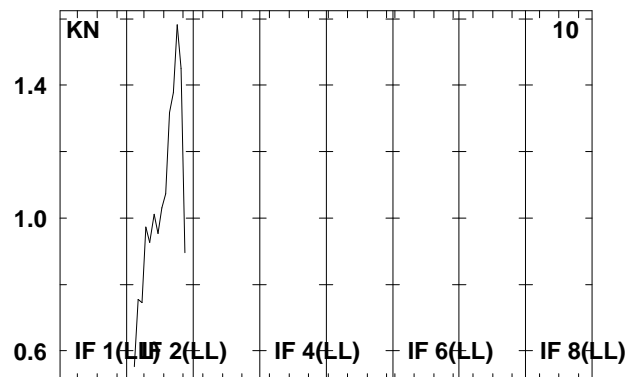
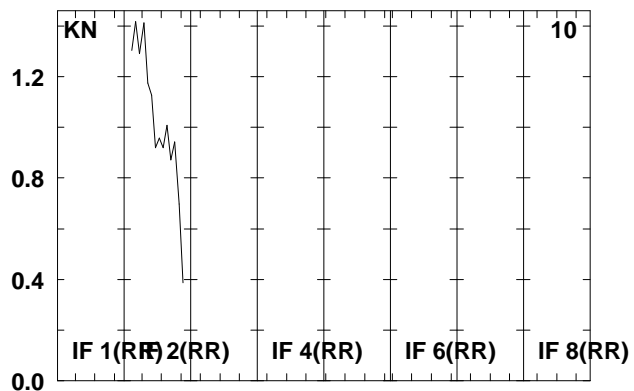
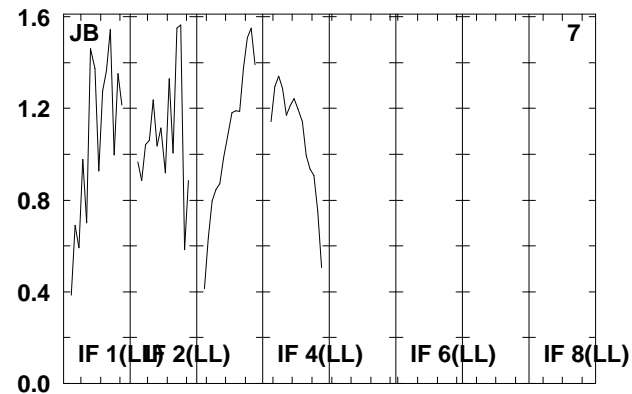
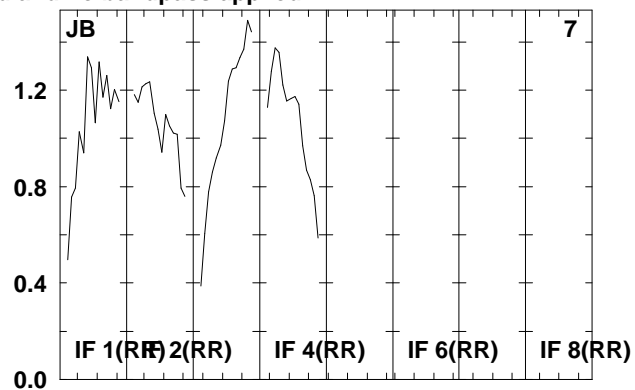
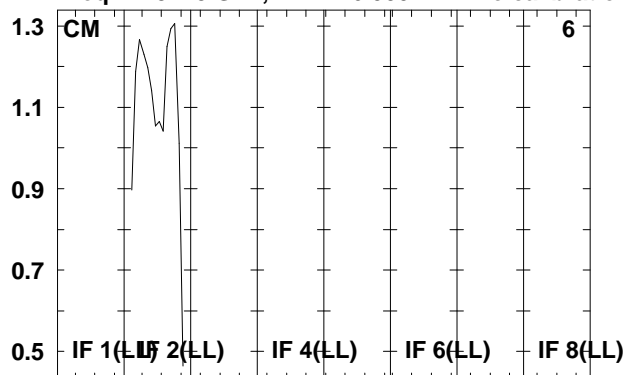

Lower frame: Real Jy

Total-power spectrum Antenna: \*

Timerange: 00/19:18:02 to 00/19:19:18



Plot file version 321 created 07-DEC-2009 16:06:45  
 SS433 RT006C.UVDATA.1  
 Freq = 4.9415 GHz, Bw = 16.000 MH No calibration applied and no bandpass applied

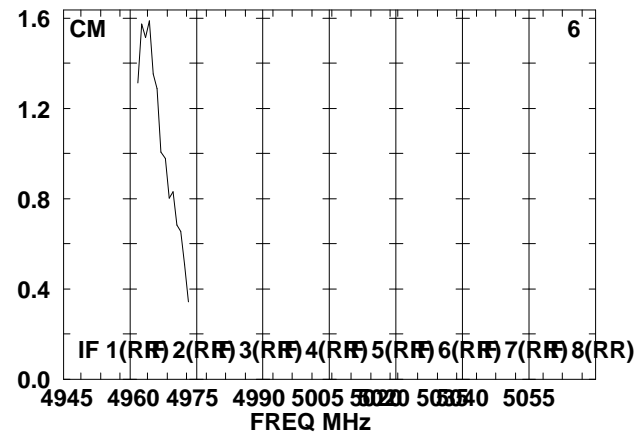
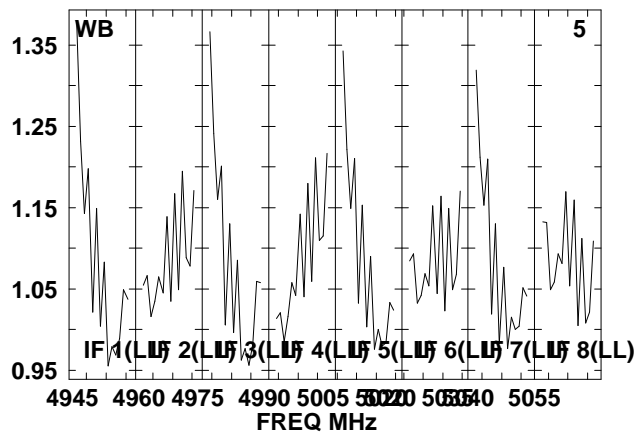
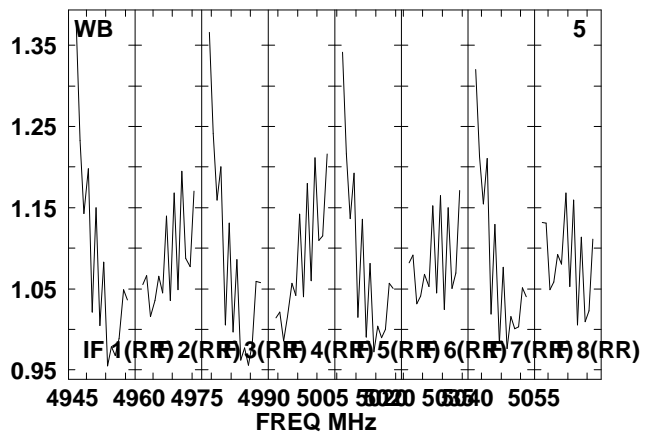
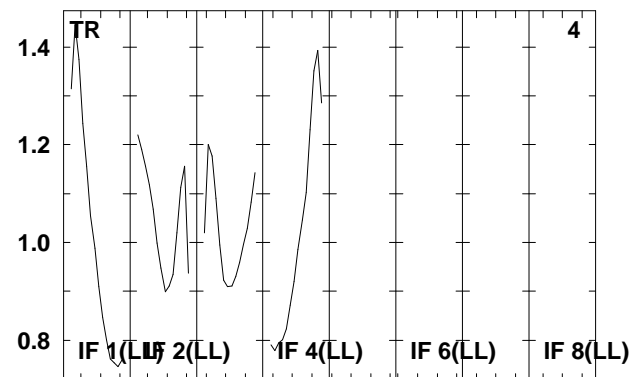
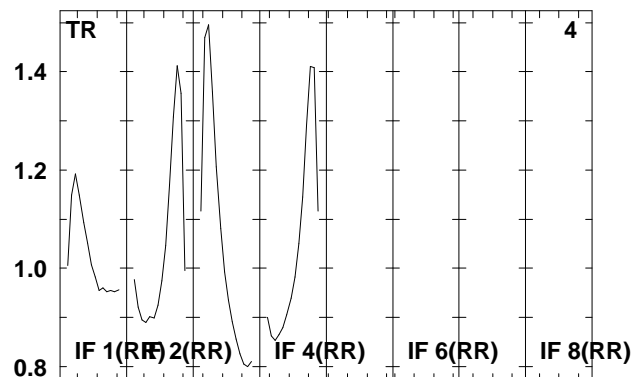
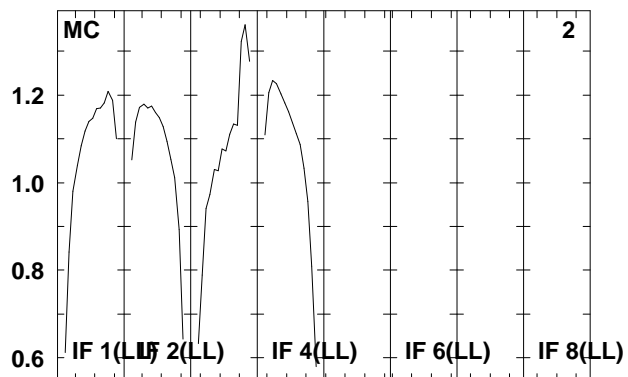
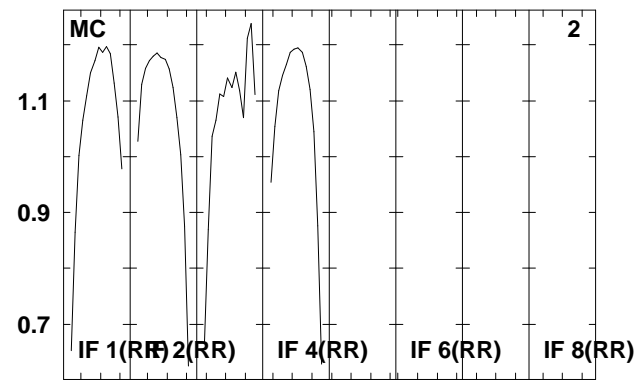
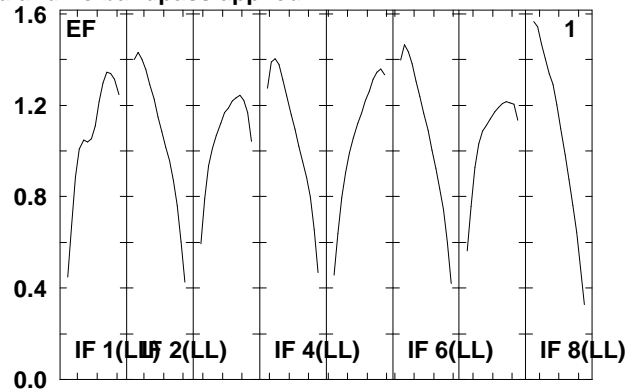
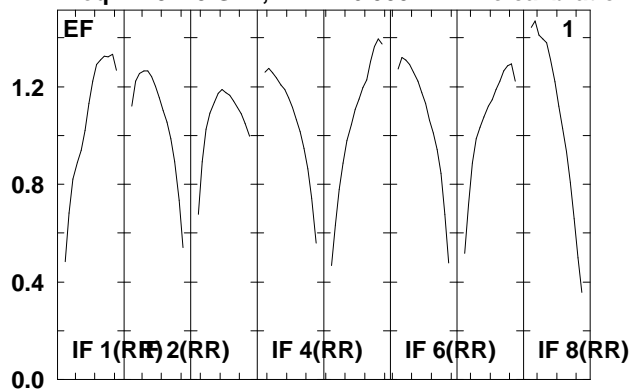

Lower frame: Real Jy  
 Total-power spectrum Antenna: \*  
 Timerange: 00/19:19:22 to 00/19:21:38

Plot file version 322 created 07-DEC-2009 16:06:45

SS433 RT006C.UVDATA.1

Freq = 4.9415 GHz, Bw = 16.000 MH No calibration applied and no bandpass applied

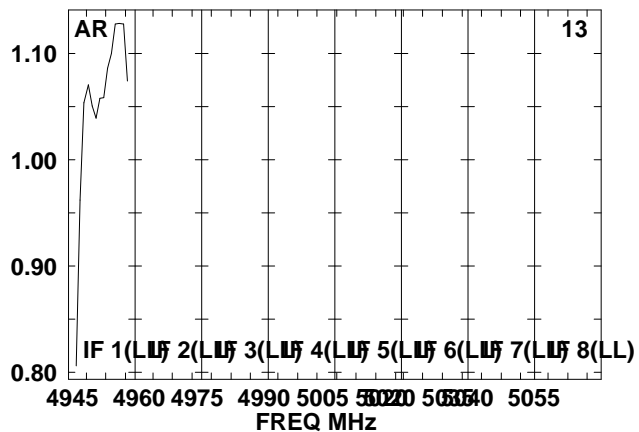
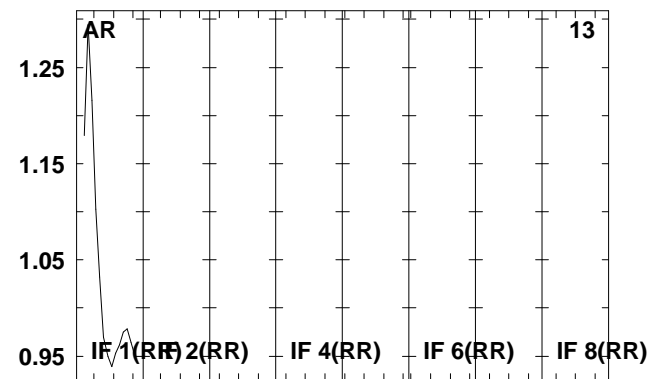
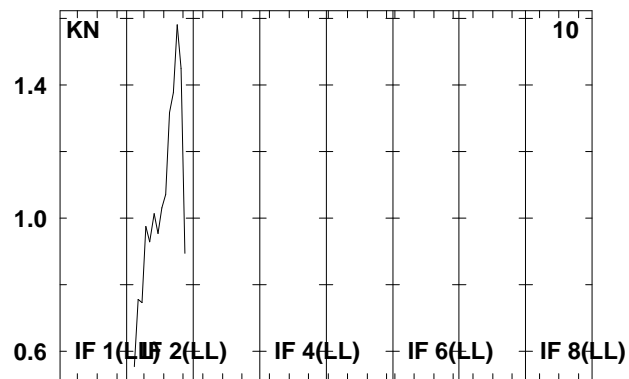
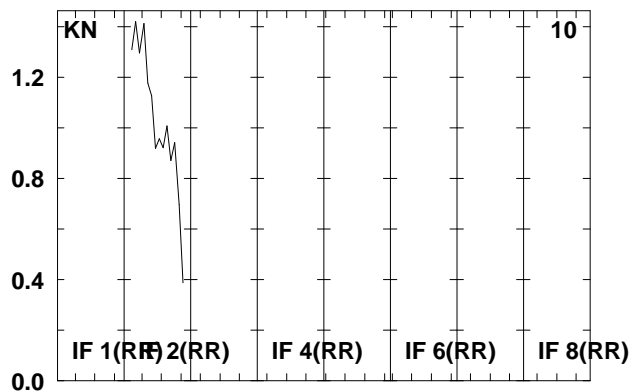
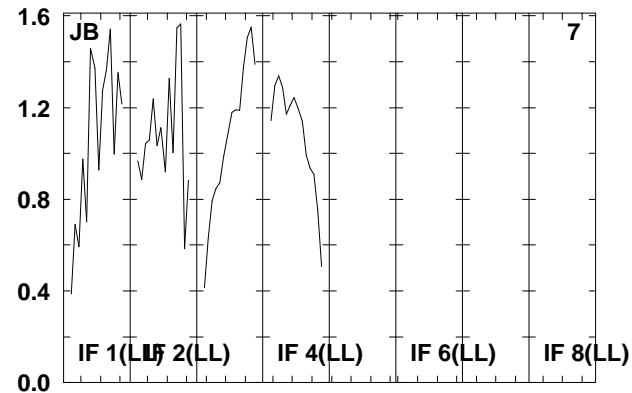
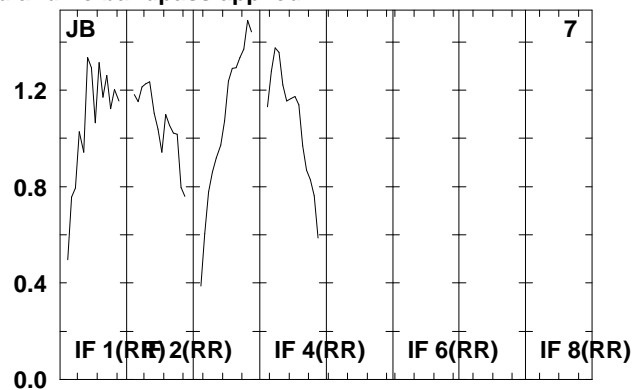
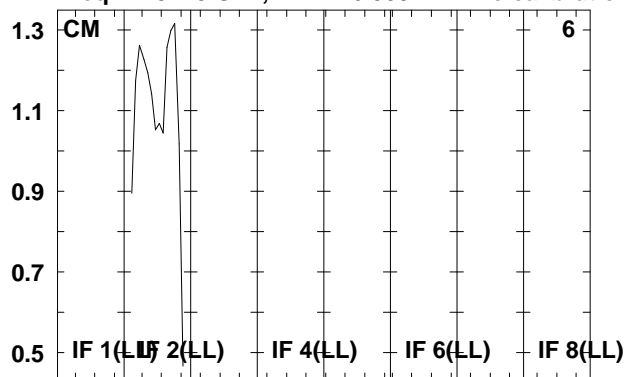

Lower frame: Real Jy

Total-power spectrum Antenna: \*

Timerange: 00/19:19:22 to 00/19:21:38

Plot file version 323 created 07-DEC-2009 16:06:46

J1912+05 RT006C.UVDATA.1

Freq = 4.9415 GHz, Bw = 16.000 MH No calibration applied and no bandpass applied

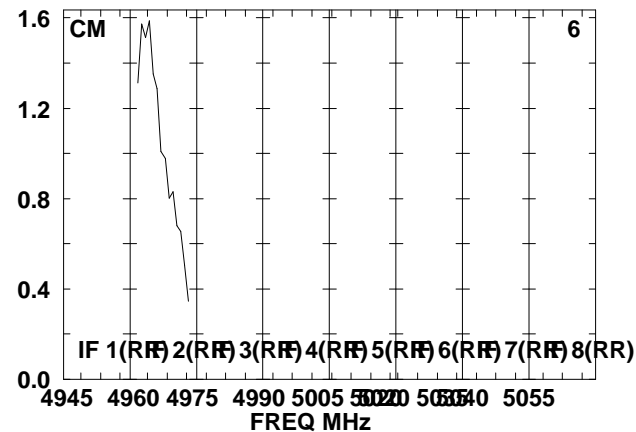
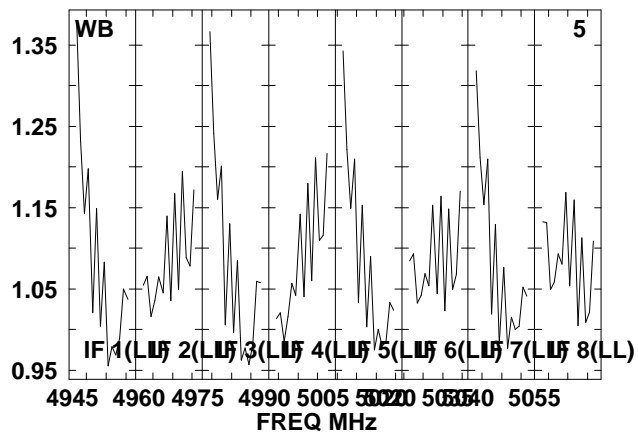
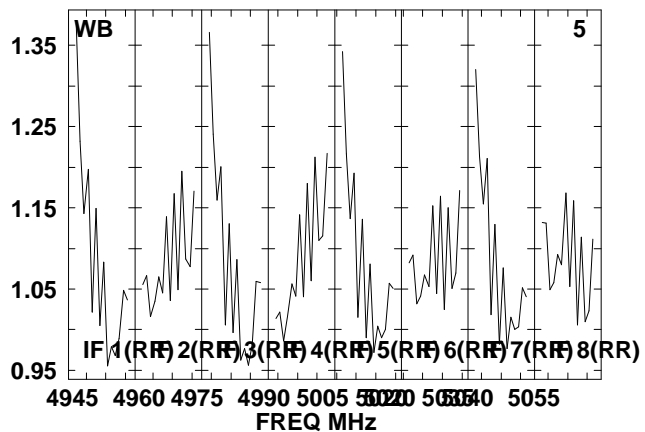
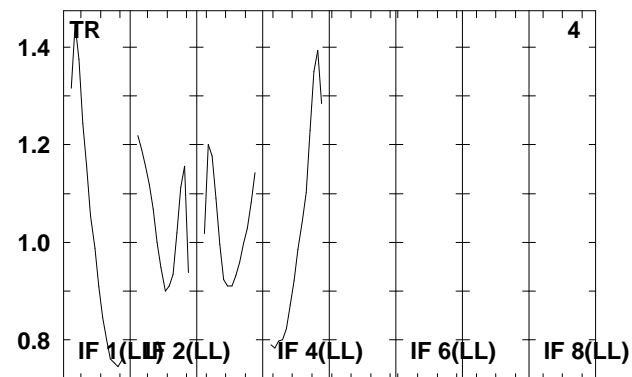
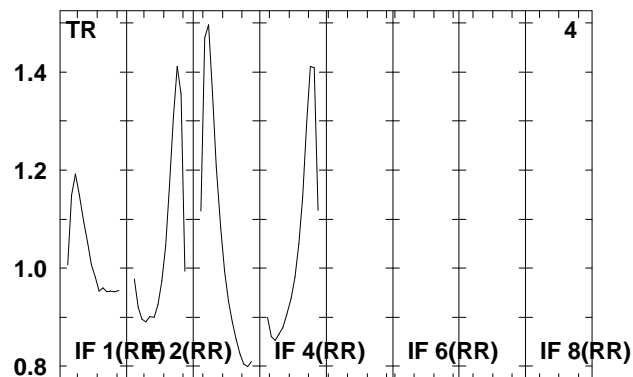
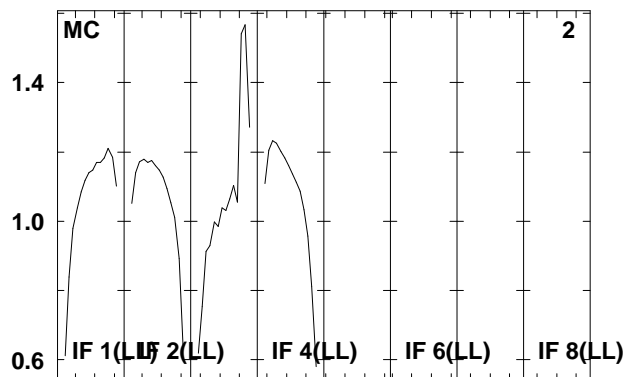
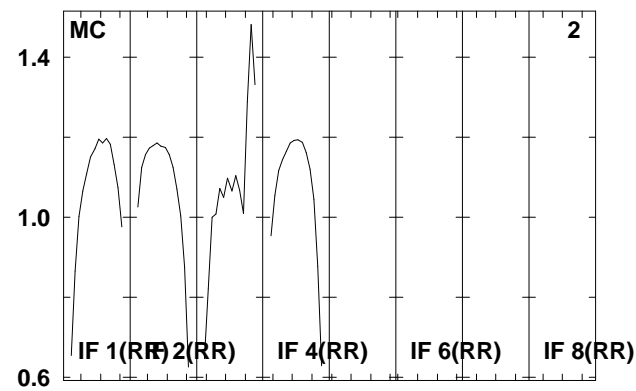
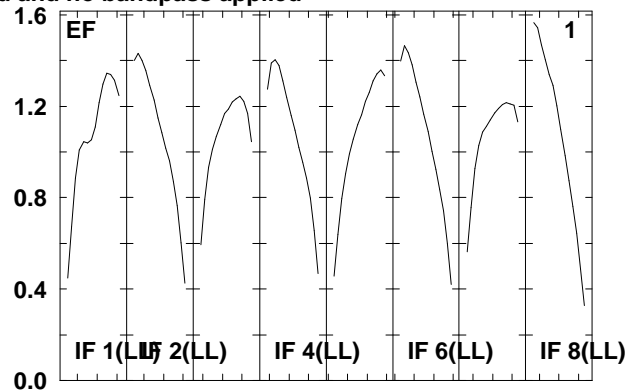
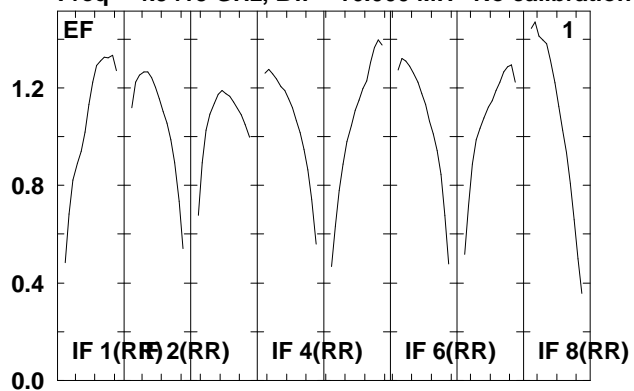

Lower frame: Real Jy

Total-power spectrum Antenna: \*

Timerange: 00/19:21:42 to 00/19:22:58

Plot file version 324 created 07-DEC-2009 16:06:46

J1912+05 RT006C.UVDATA.1

Freq = 4.9415 GHz, Bw = 16.000 MH No calibration applied and no bandpass applied

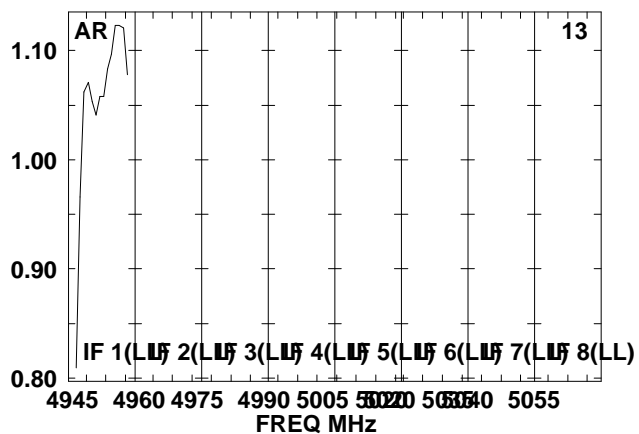
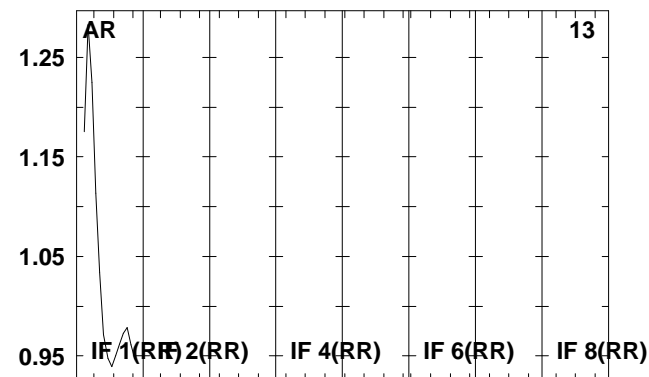
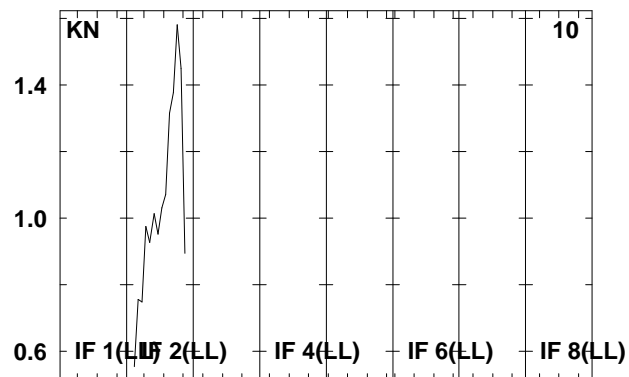
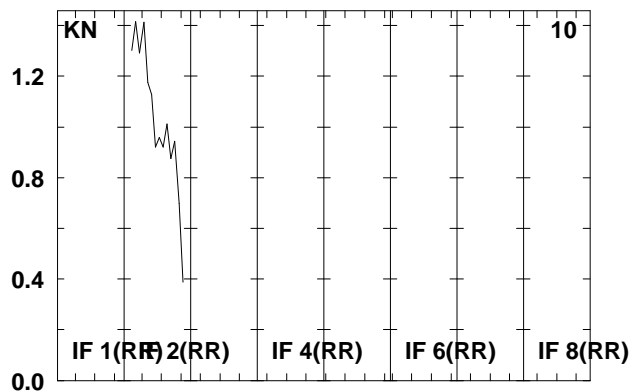
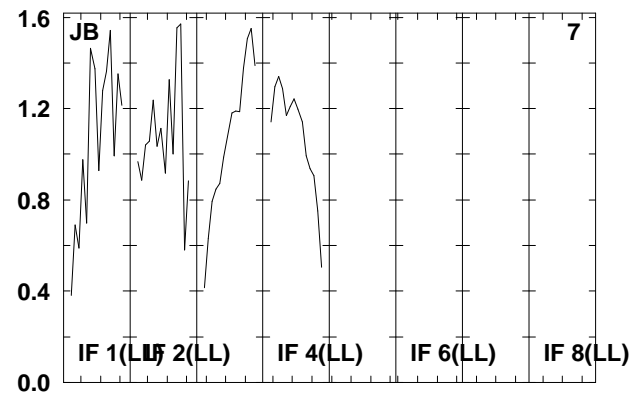
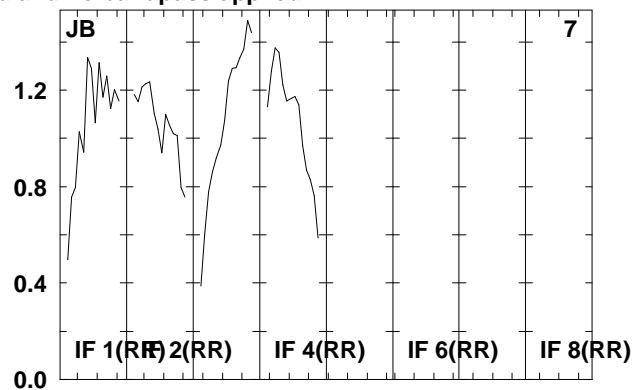
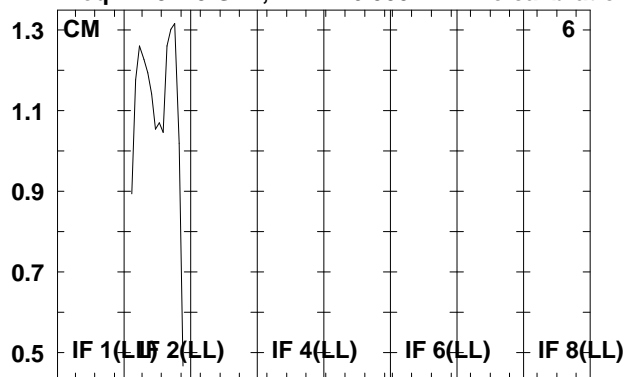

Lower frame: Real Jy

Total-power spectrum Antenna: \*

Timerange: 00/19:21:42 to 00/19:22:58

Plot file version 325 created 07-DEC-2009 16:06:46

SS433 RT006C.UVDATA.1

Freq = 4.9415 GHz, Bw = 16.000 MH No calibration applied and no bandpass applied

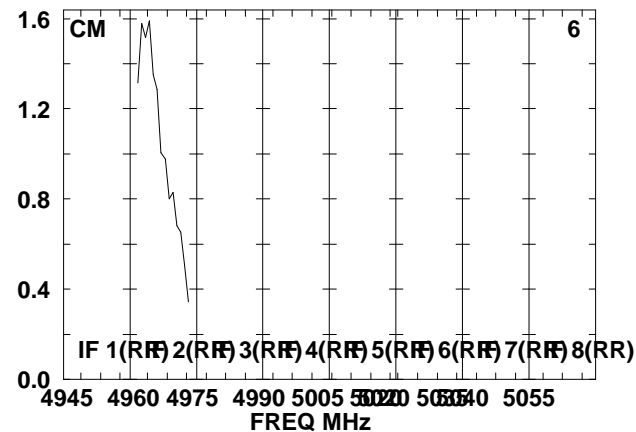
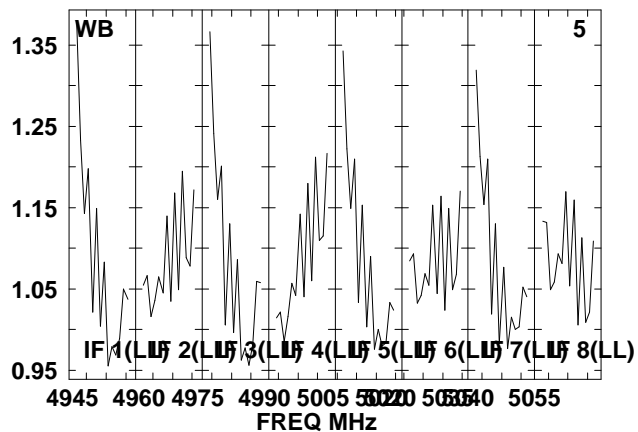
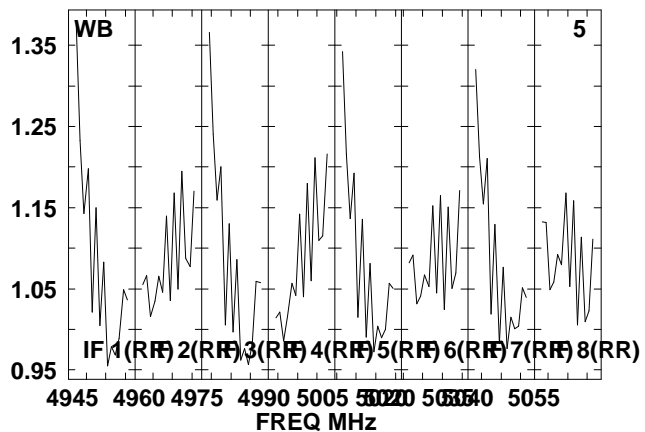
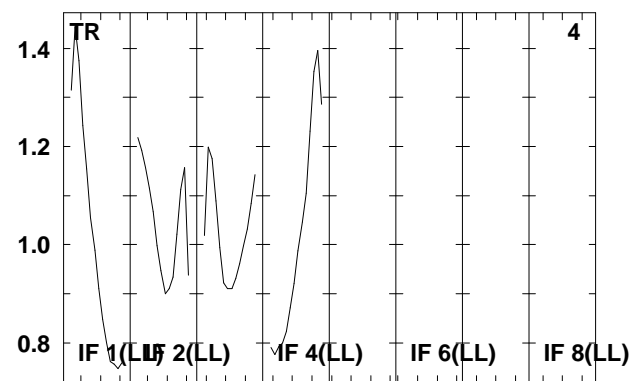
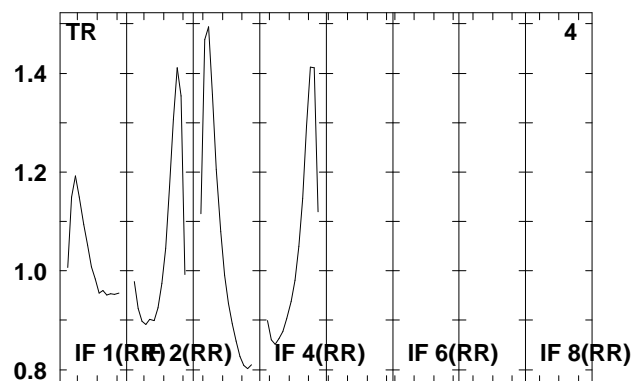
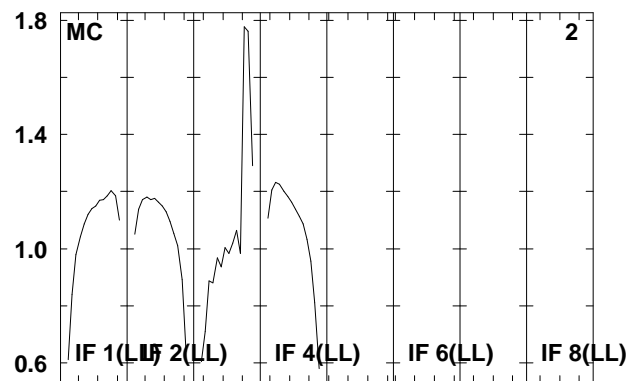
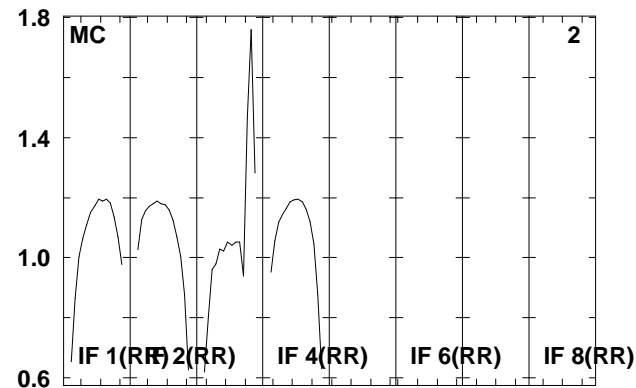
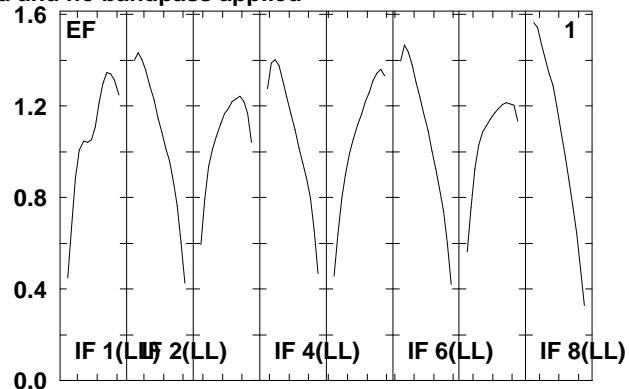
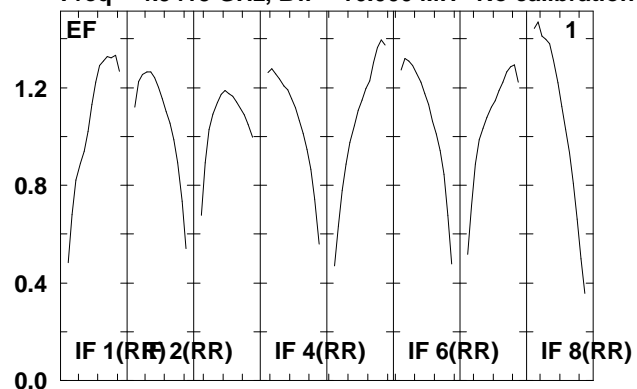

Lower frame: Real Jy  
Total-power spectrum Antenna: \*  
Timerange: 00/19:23:02 to 00/19:25:18

Plot file version 326 created 07-DEC-2009 16:06:46

SS433 RT006C.UVDATA.1

Freq = 4.9415 GHz, Bw = 16.000 MH No calibration applied and no bandpass applied

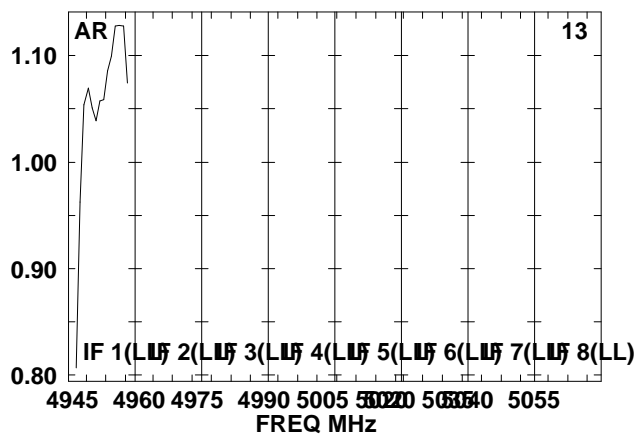
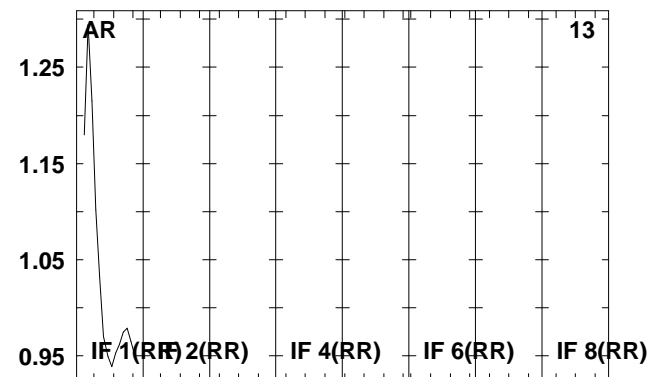
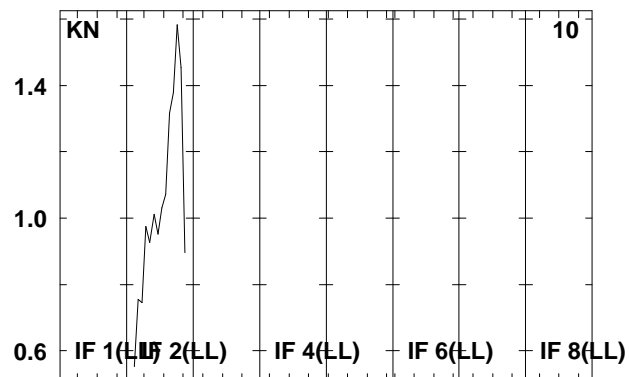
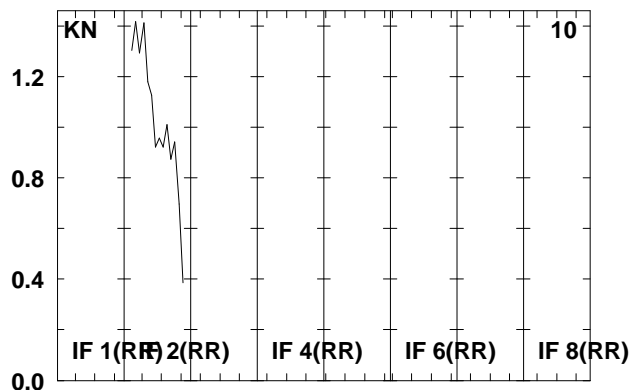
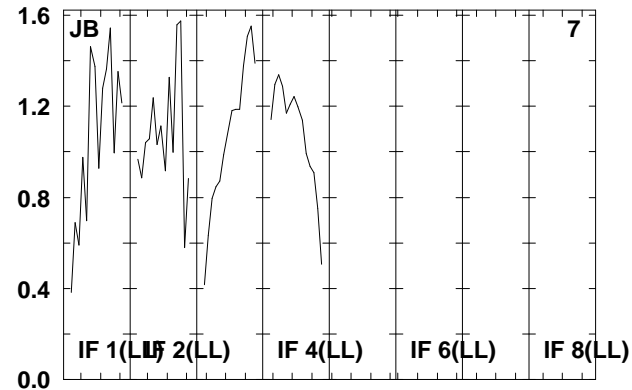
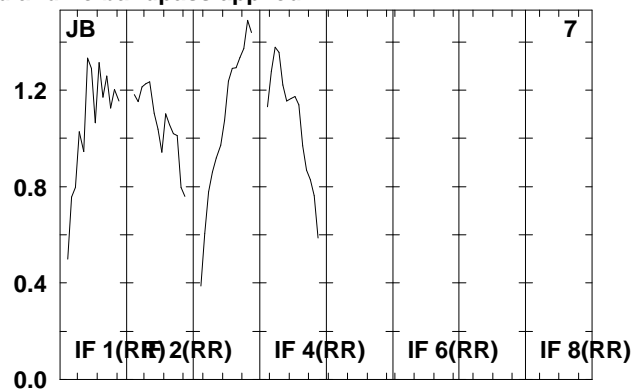
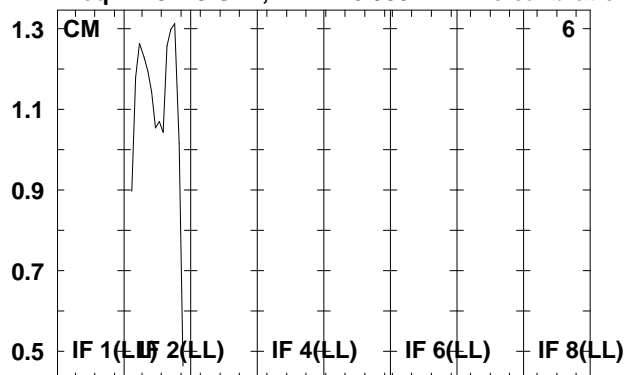

Lower frame: Real Jy

Total-power spectrum Antenna: \*

Timerange: 00/19:23:02 to 00/19:25:18

Plot file version 327 created 07-DEC-2009 16:06:46

J1912+05 RT006C.UVDATA.1

Freq = 4.9415 GHz, Bw = 16.000 MH No calibration applied and no bandpass applied

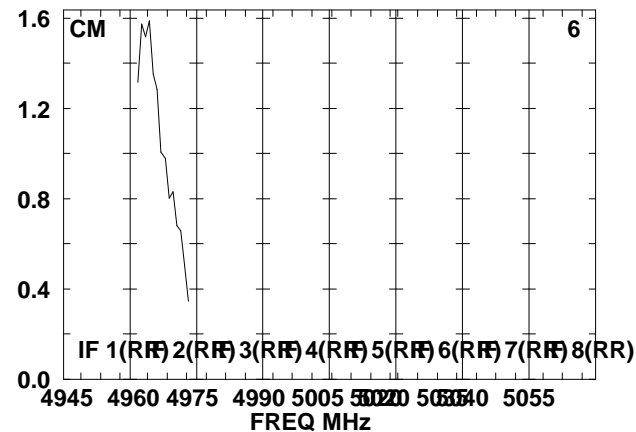
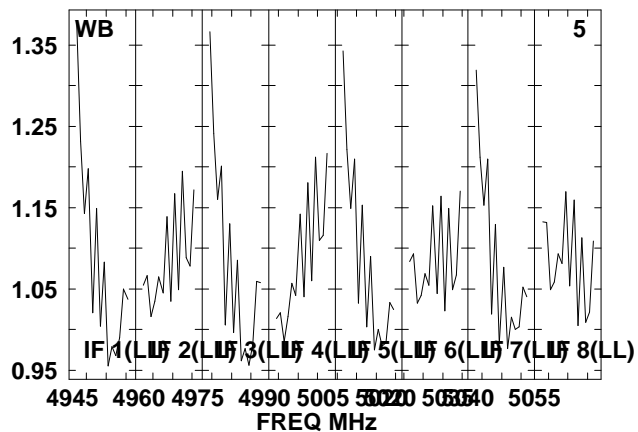
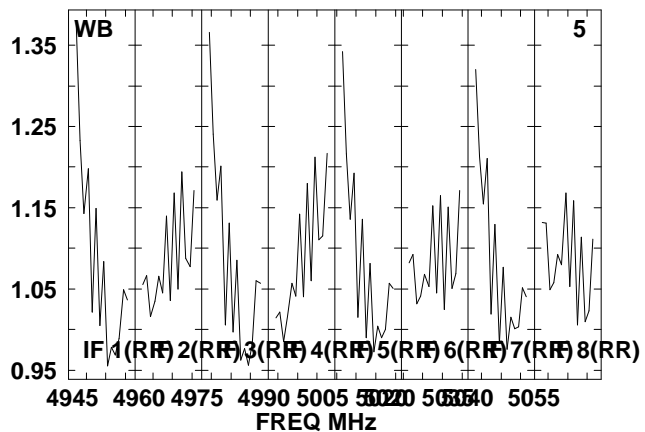
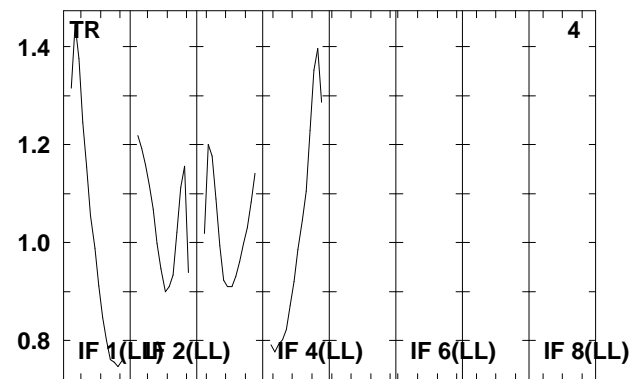
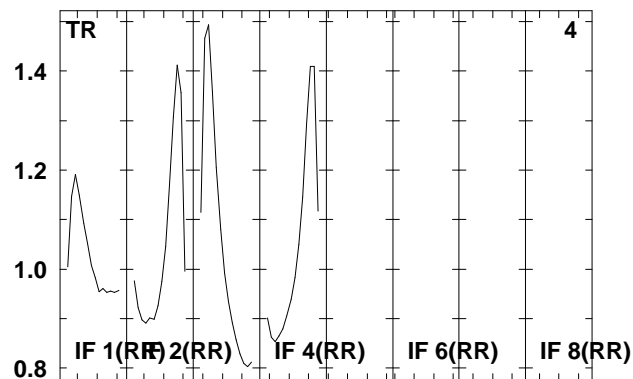
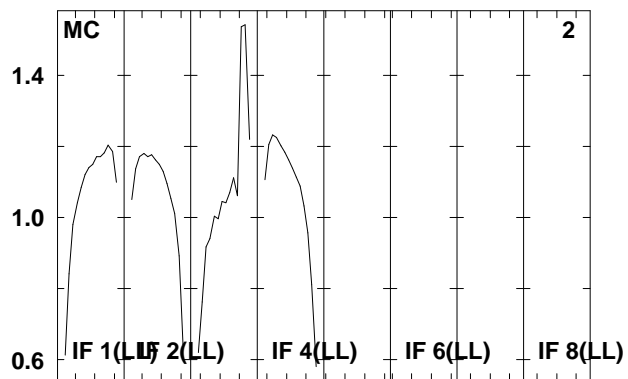
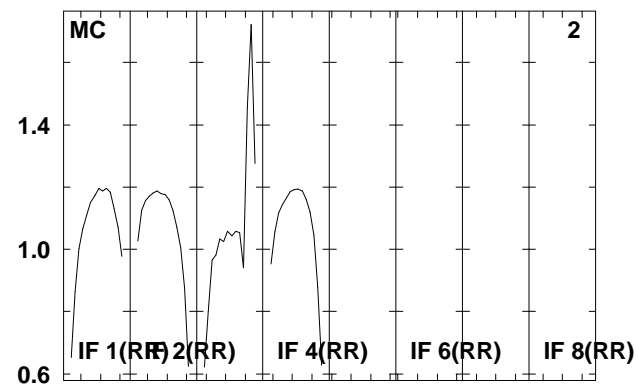
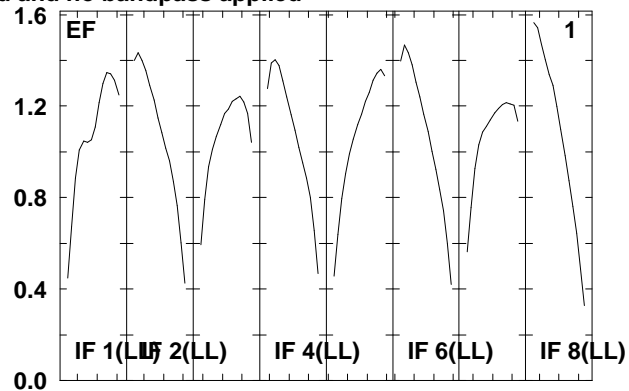
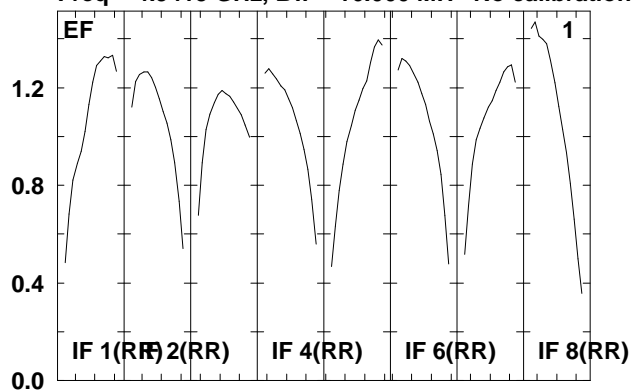

Lower frame: Real Jy

Total-power spectrum Antenna: \*

Timerange: 00/19:25:22 to 00/19:26:38

Plot file version 328 created 07-DEC-2009 16:06:47

J1912+05 RT006C.UVDATA.1

Freq = 4.9415 GHz, Bw = 16.000 MH No calibration applied and no bandpass applied

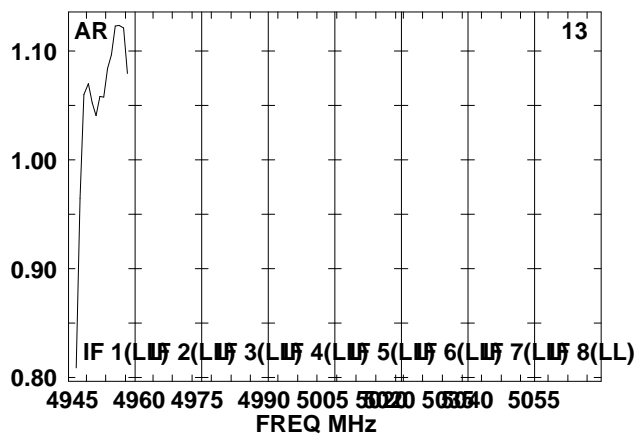
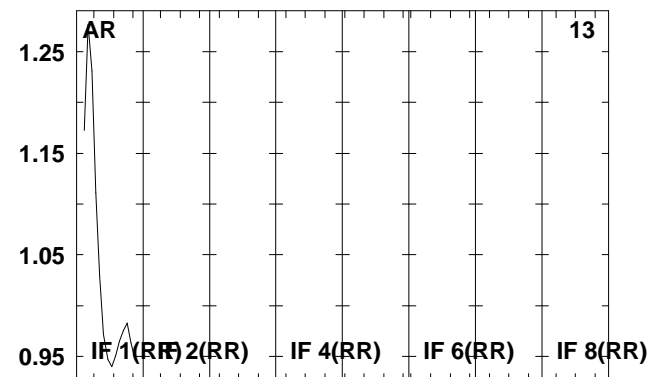
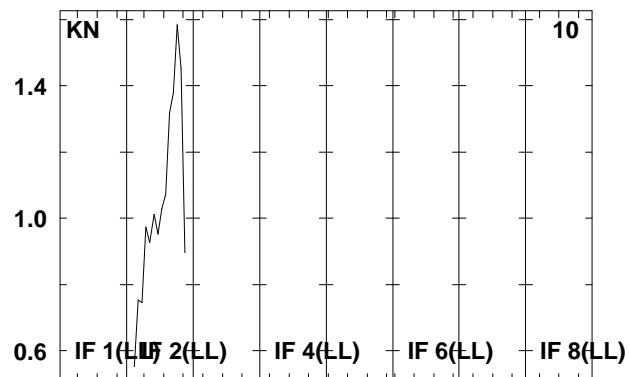
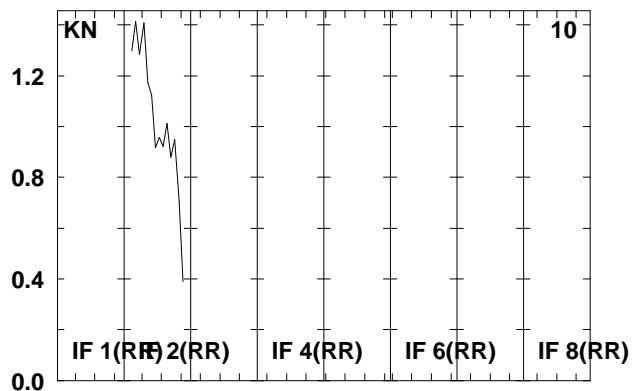
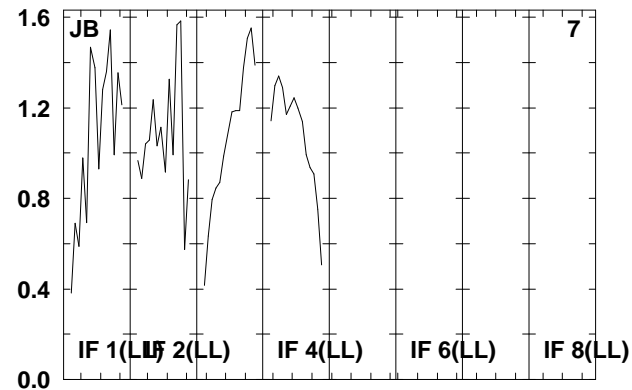
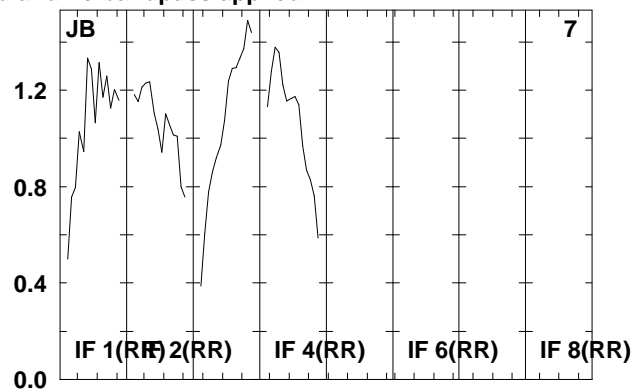
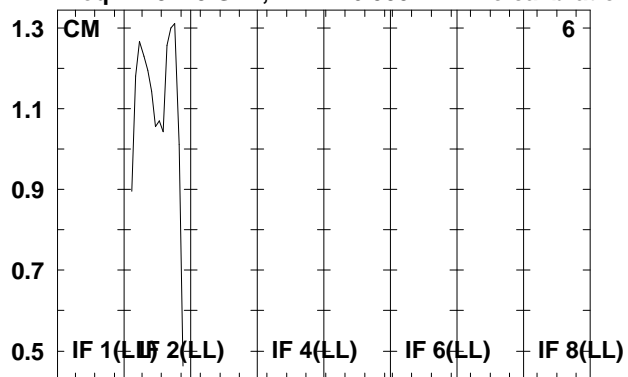

Lower frame: Real Jy

Total-power spectrum Antenna: \*

Timerange: 00/19:25:22 to 00/19:26:38



Plot file version 329 created 07-DEC-2009 16:06:47

SS433 RT006C.UVDATA.1

Freq = 4.9415 GHz, Bw = 16.000 MH No calibration applied and no bandpass applied

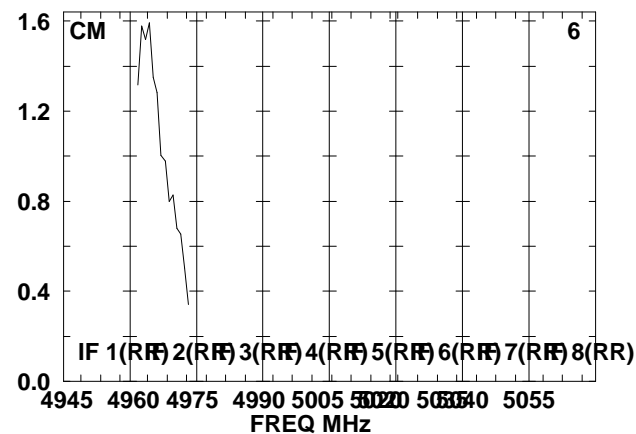
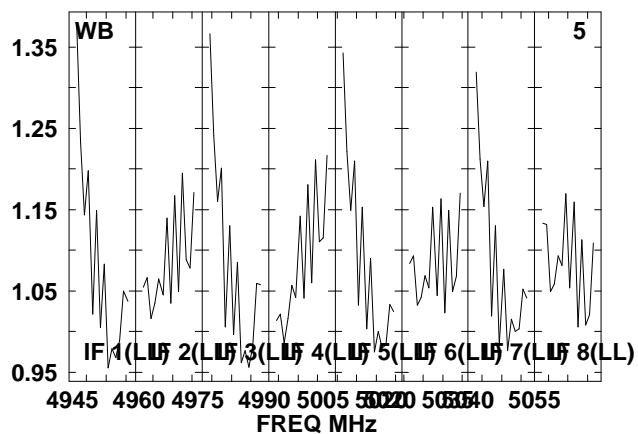
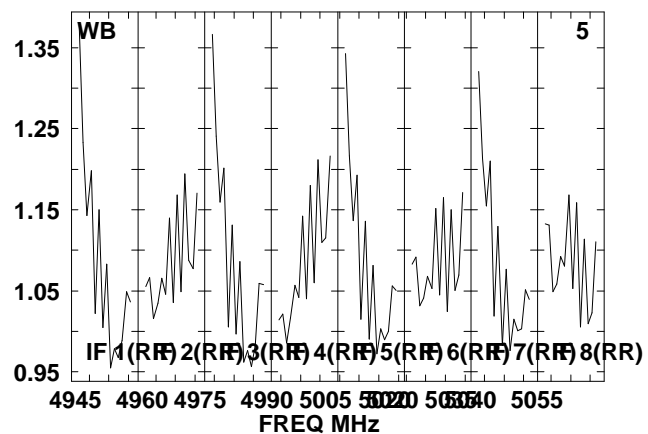
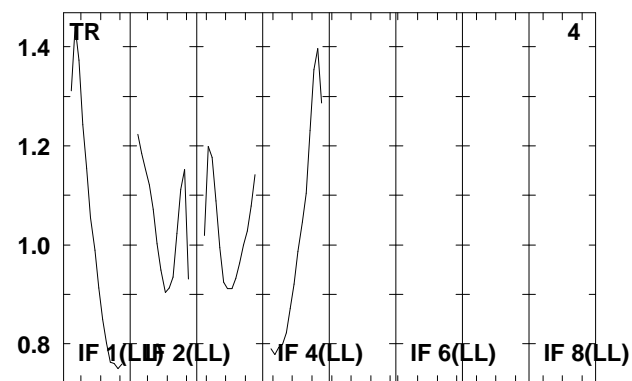
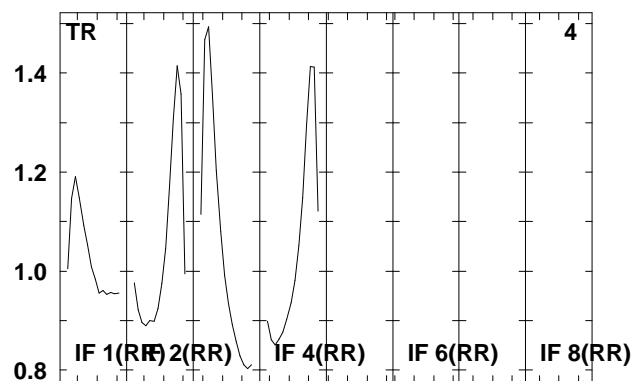
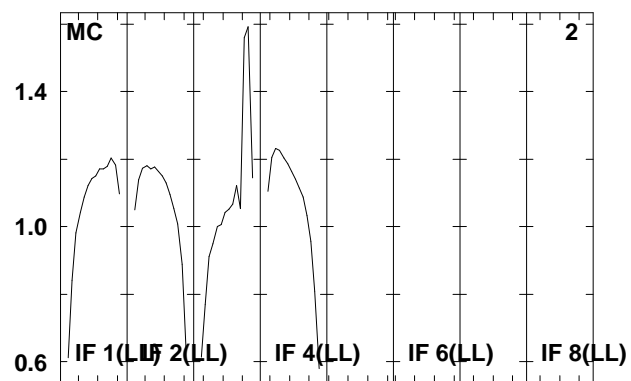
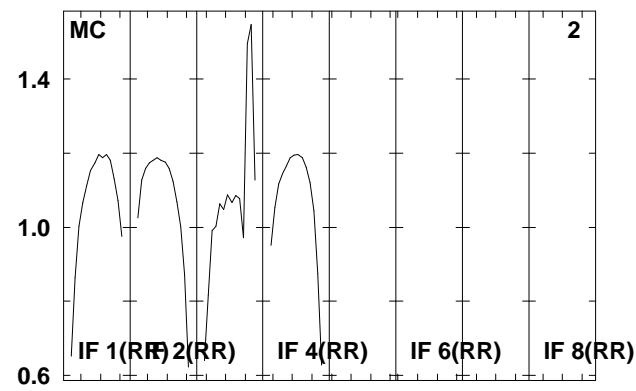
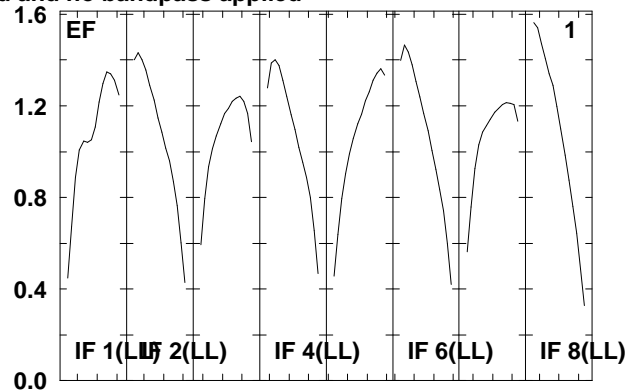
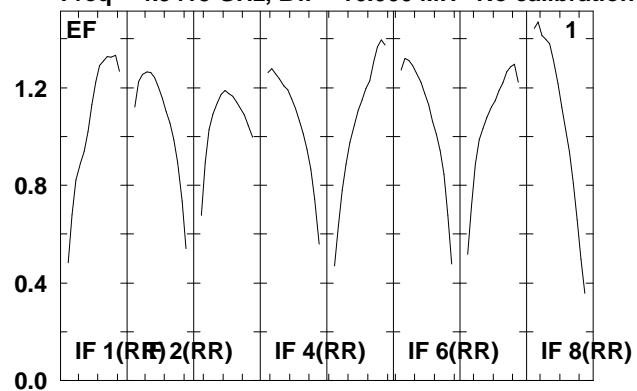

Lower frame: Real Jy

Total-power spectrum Antenna: \*

Timerange: 00/19:26:42 to 00/19:28:58

Plot file version 330 created 07-DEC-2009 16:06:47

SS433 RT006C.UVDATA.1

Freq = 4.9415 GHz, Bw = 16.000 MH No calibration applied and no bandpass applied

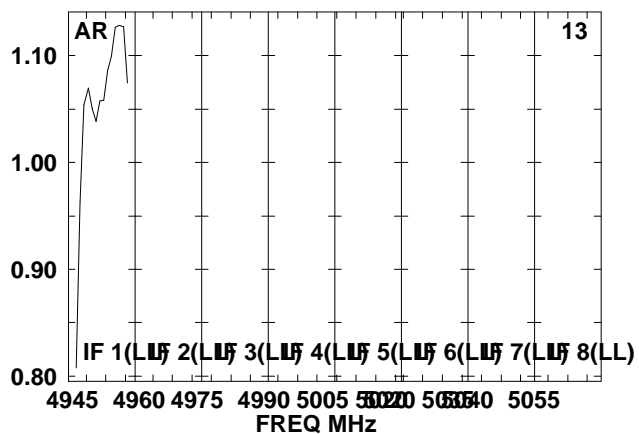
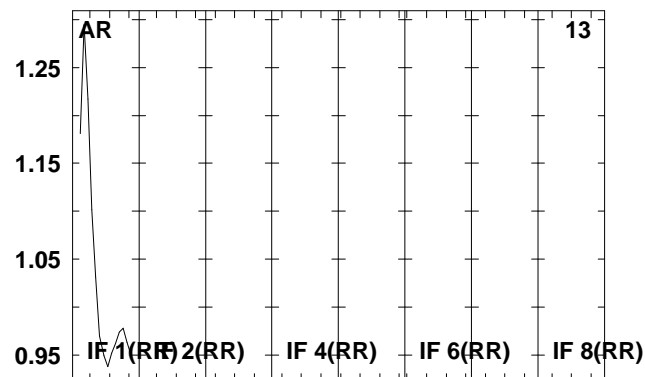
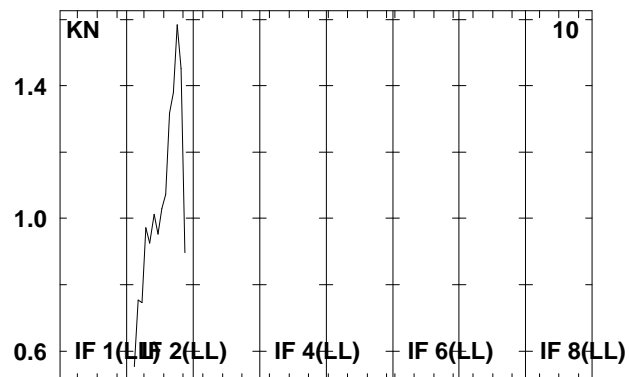
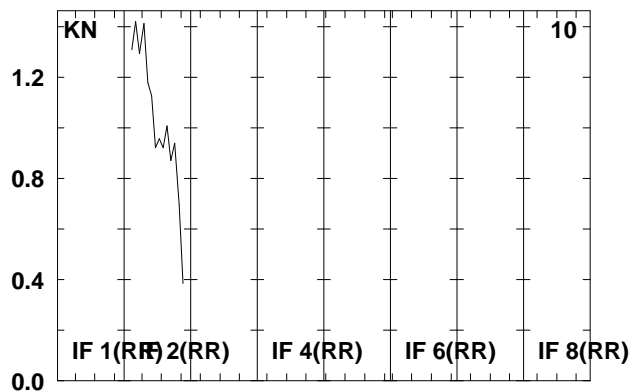
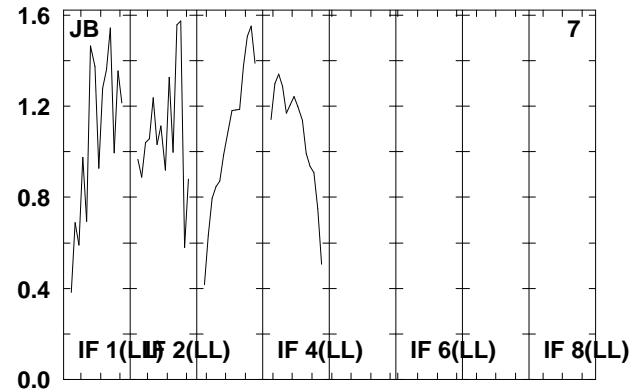
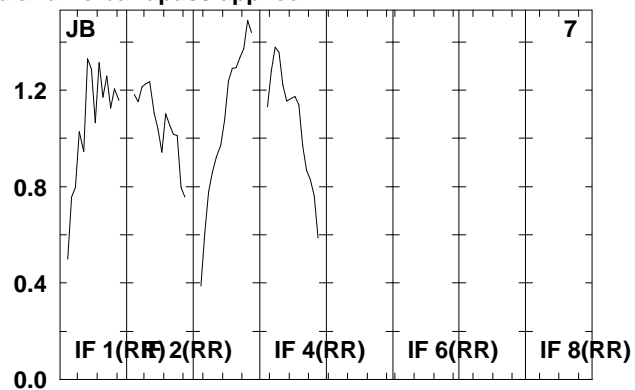
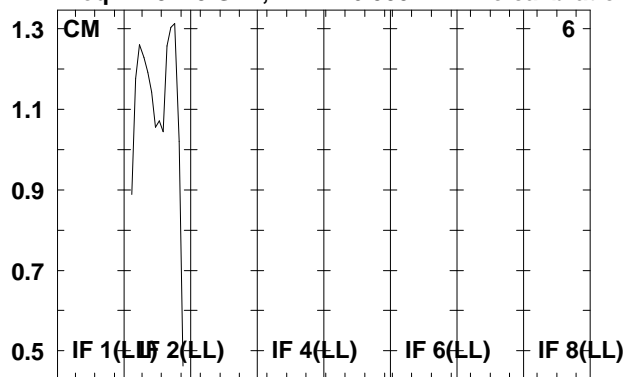

Lower frame: Real Jy

Total-power spectrum Antenna: \*

Timerange: 00/19:26:42 to 00/19:28:58

Plot file version 331 created 07-DEC-2009 16:06:47

J1912+05 RT006C.UVDATA.1

Freq = 4.9415 GHz, Bw = 16.000 MH No calibration applied and no bandpass applied

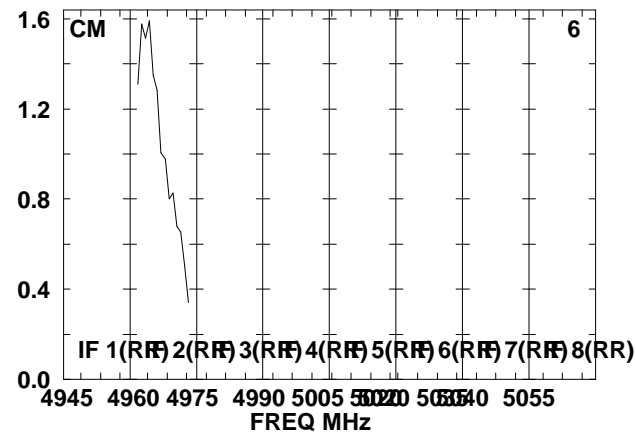
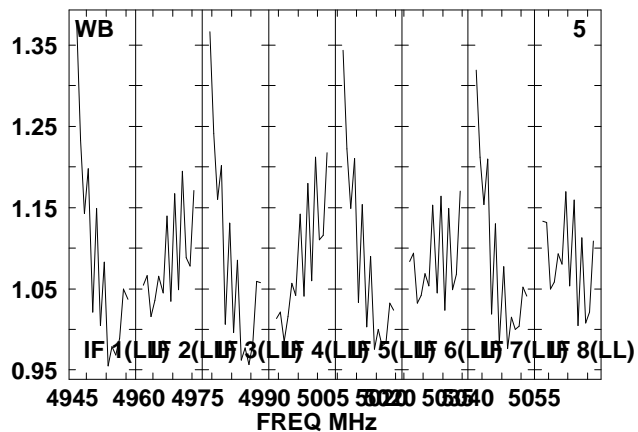
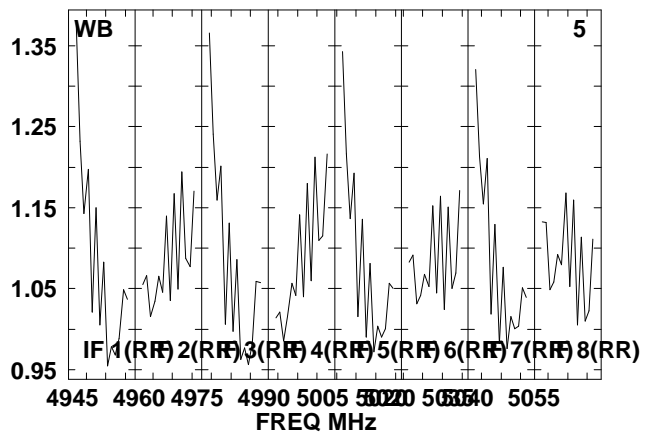
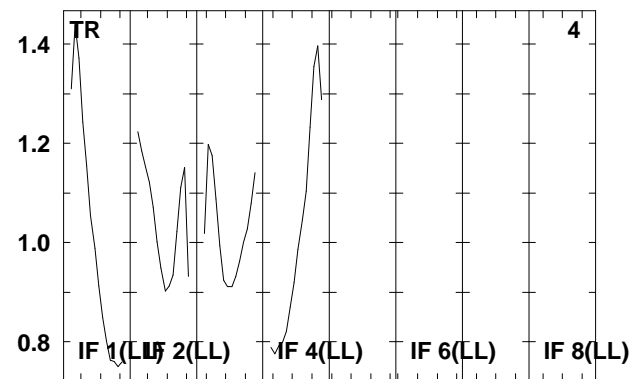
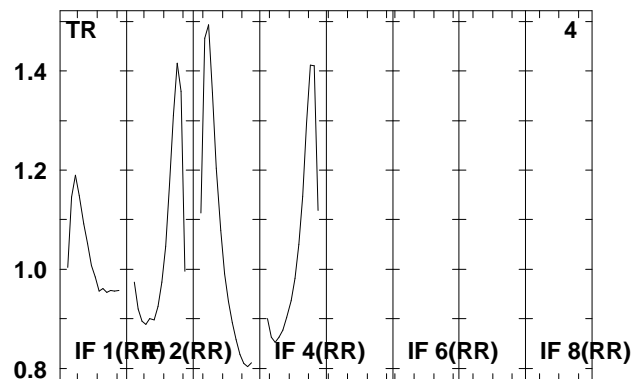
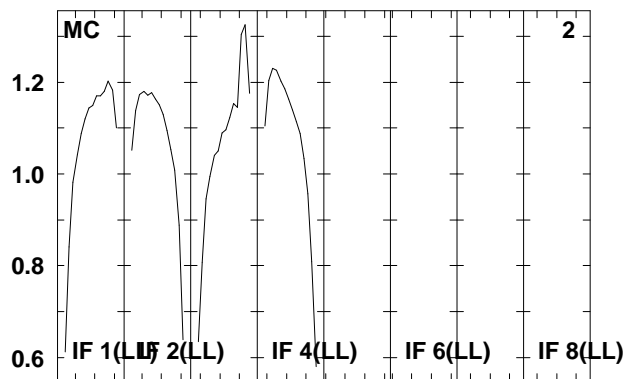
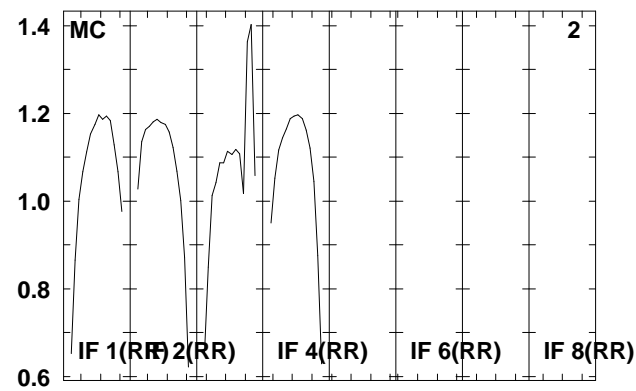
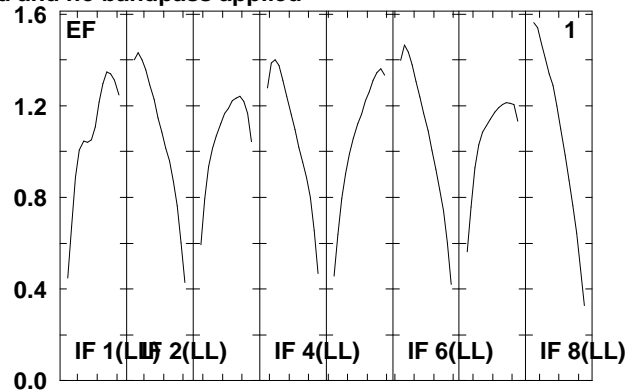
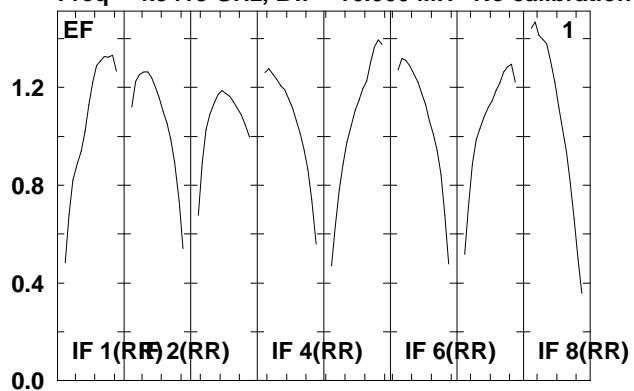

Lower frame: Real Jy  
Total-power spectrum Antenna: \*  
Timerange: 00/19:30:02 to 00/19:30:58

Plot file version 332 created 07-DEC-2009 16:06:47

J1912+05 RT006C.UVDATA.1

Freq = 4.9415 GHz, Bw = 16.000 MH No calibration applied and no bandpass applied

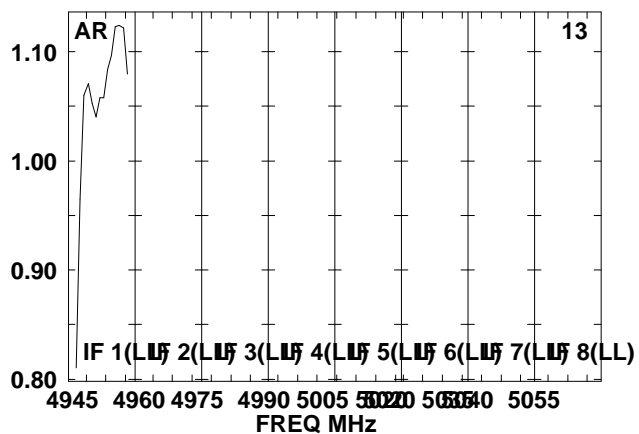
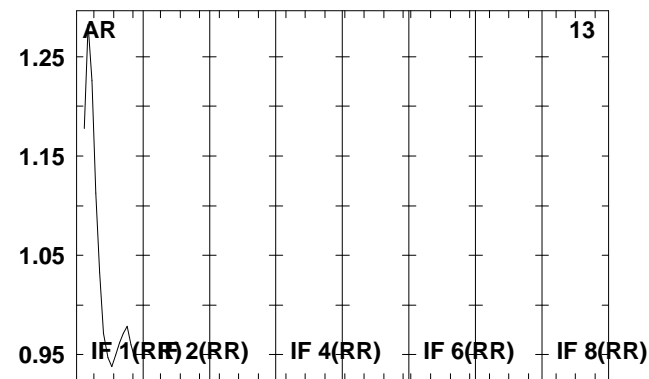
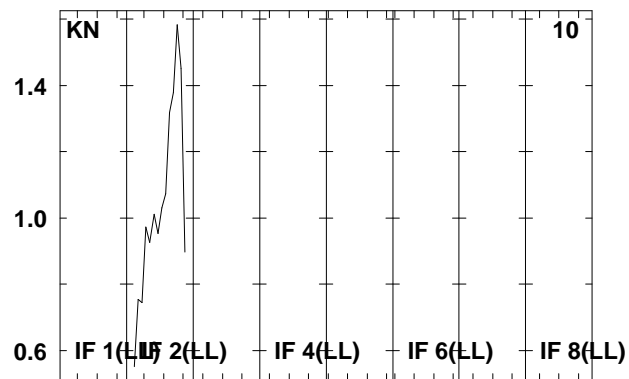
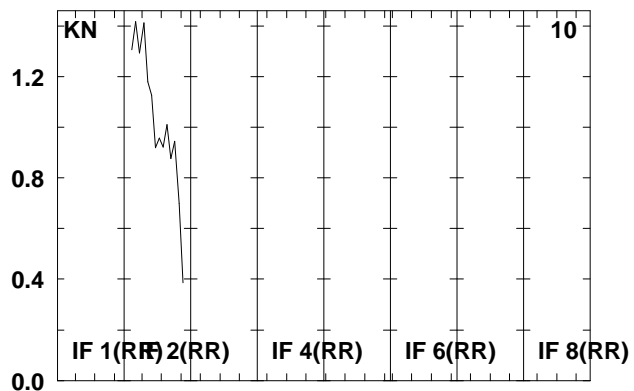
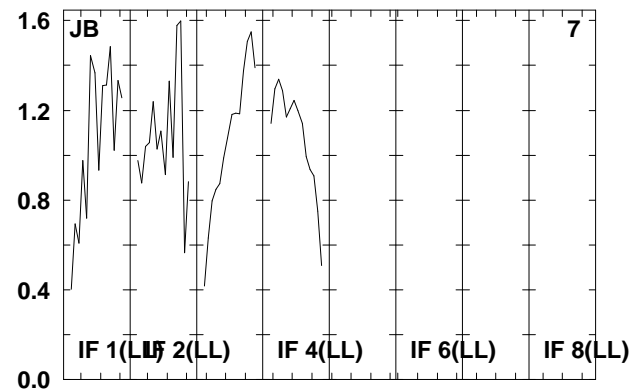
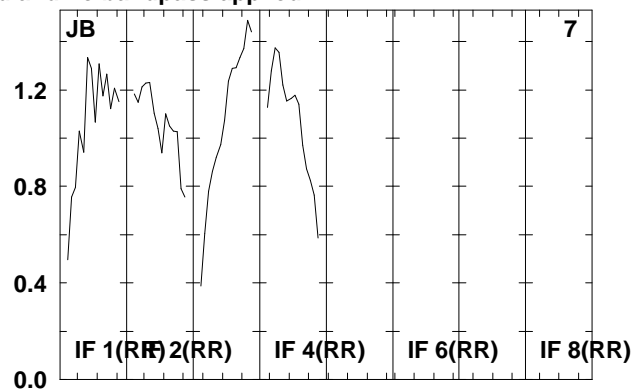
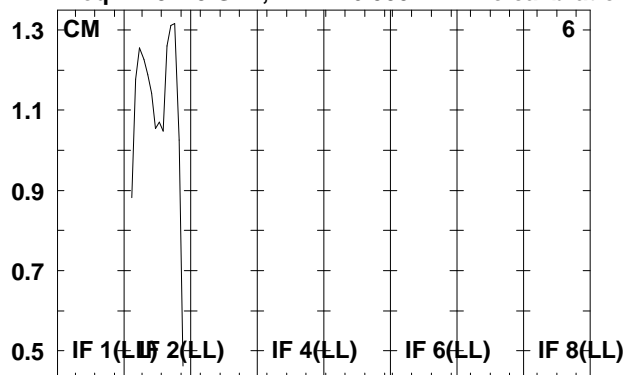

Lower frame: Real Jy

Total-power spectrum Antenna: \*

Timerange: 00/19:30:02 to 00/19:30:58

Plot file version 333 created 07-DEC-2009 16:06:47

SS433 RT006C.UVDATA.1

Freq = 4.9415 GHz, Bw = 16.000 MH No calibration applied and no bandpass applied

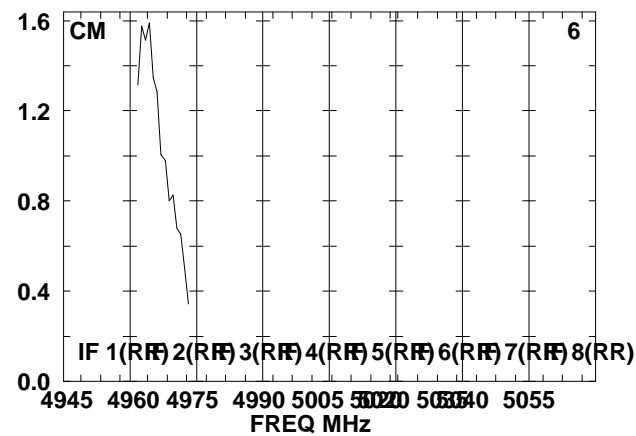
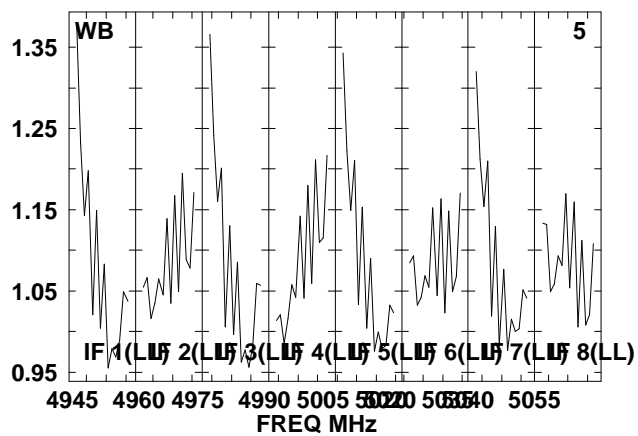
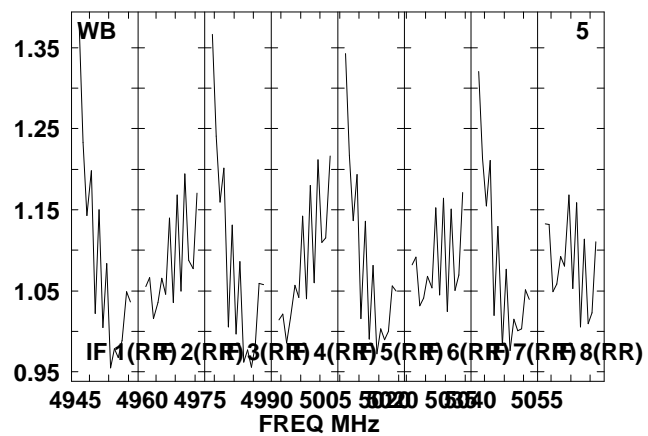
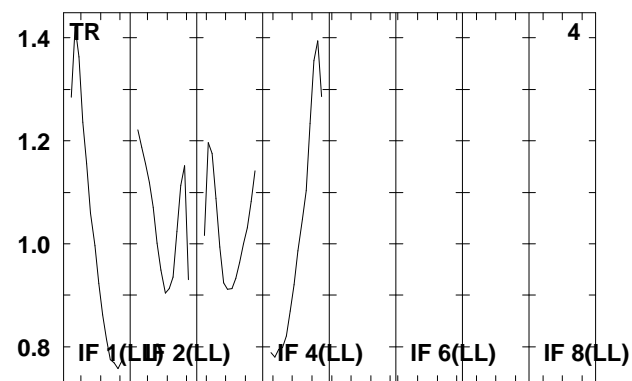
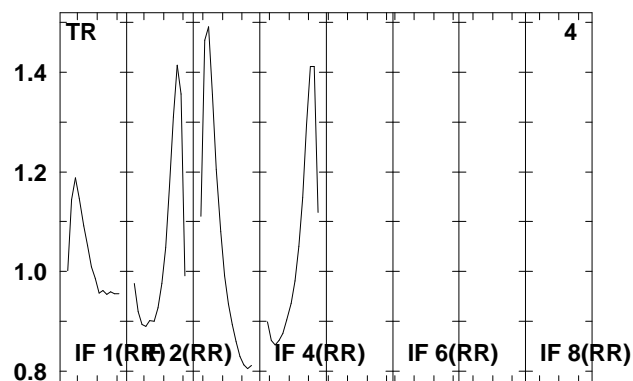
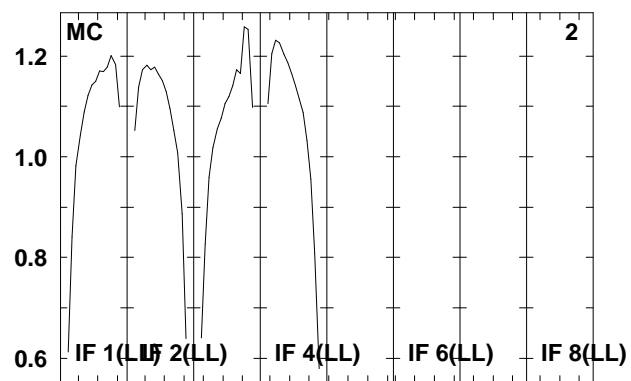
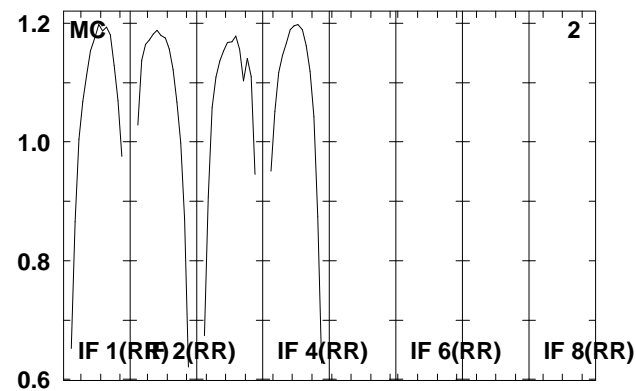
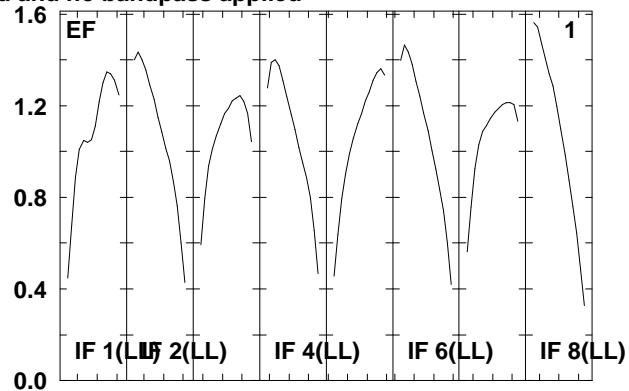
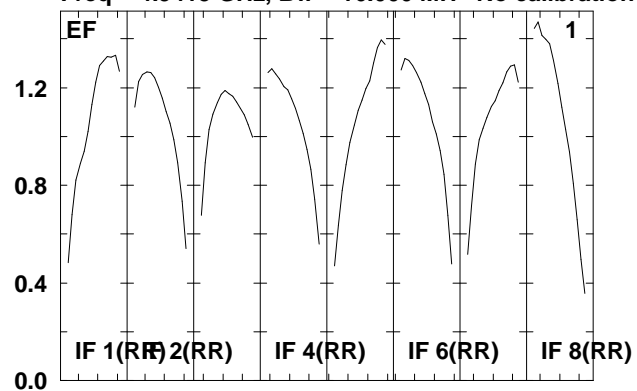

Lower frame: Real Jy

Total-power spectrum Antenna: \*

Timerange: 00/19:31:02 to 00/19:33:18

Plot file version 334 created 07-DEC-2009 16:06:48

SS433 RT006C.UVDATA.1

Freq = 4.9415 GHz, Bw = 16.000 MH No calibration applied and no bandpass applied

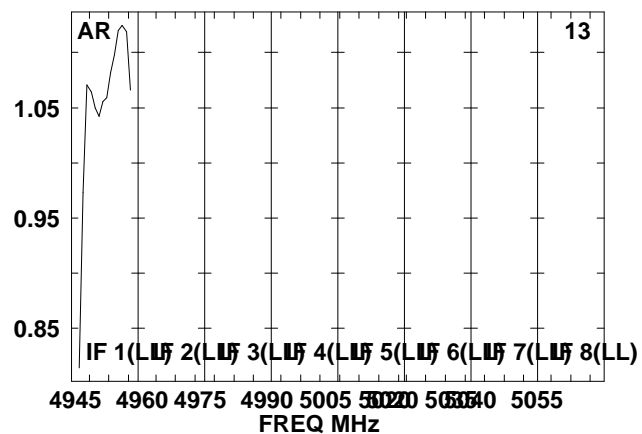
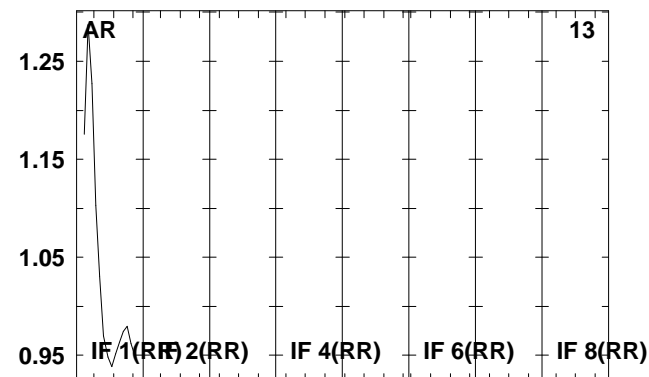
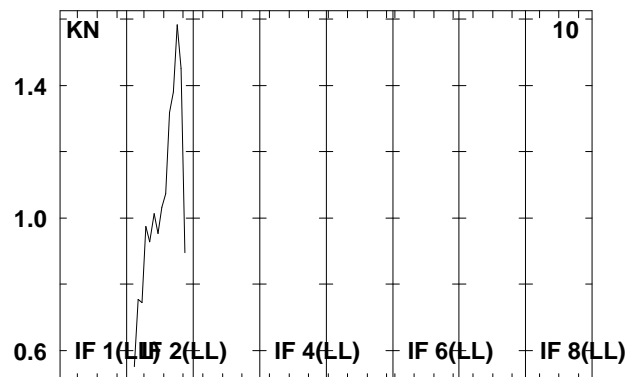
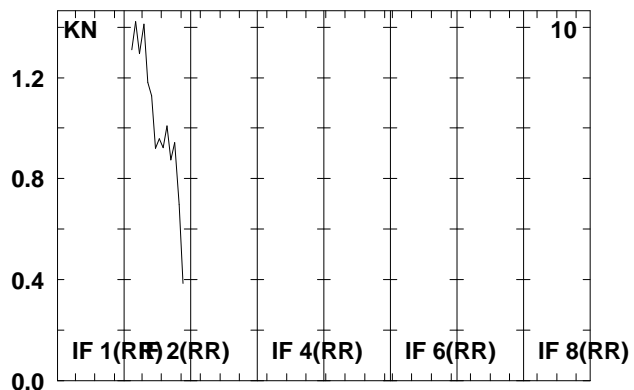
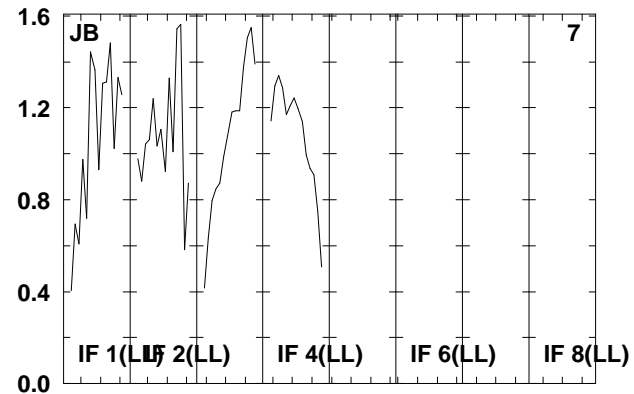
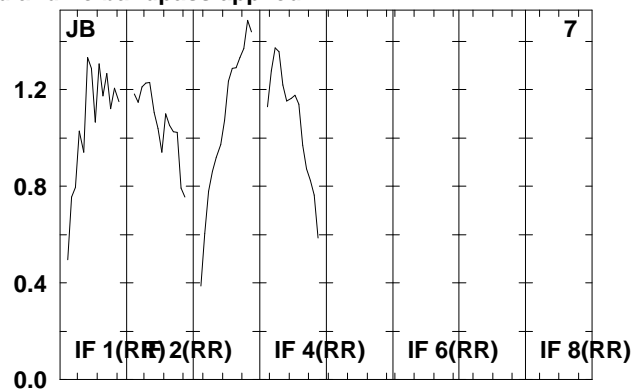
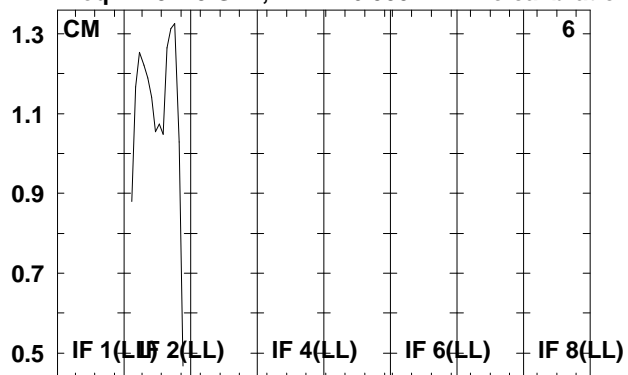

Lower frame: Real Jy

Total-power spectrum Antenna: \*

Timerange: 00/19:31:02 to 00/19:33:18

Plot file version 335 created 07-DEC-2009 16:06:48

J1912+05 RT006C.UVDATA.1

Freq = 4.9415 GHz, Bw = 16.000 MH No calibration applied and no bandpass applied

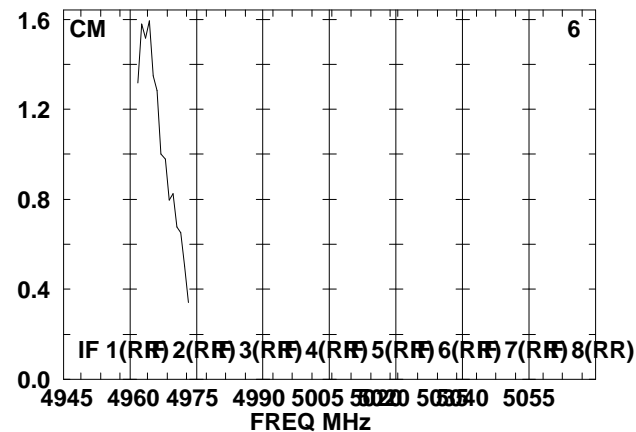
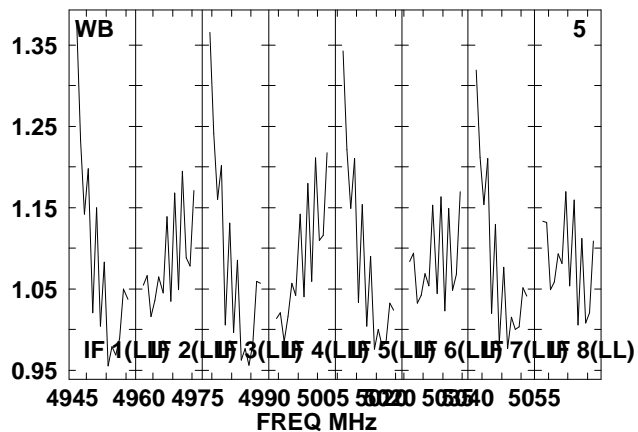
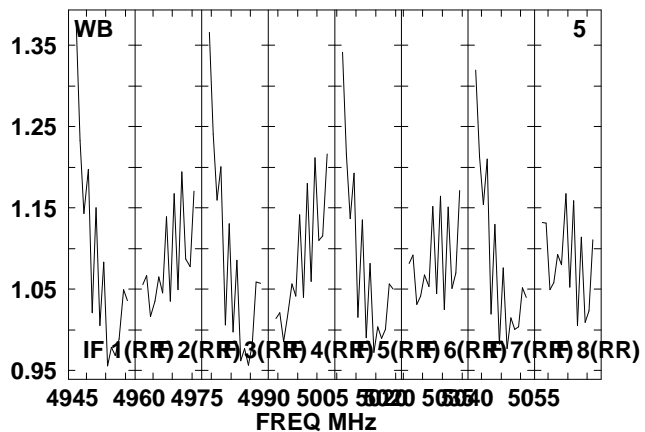
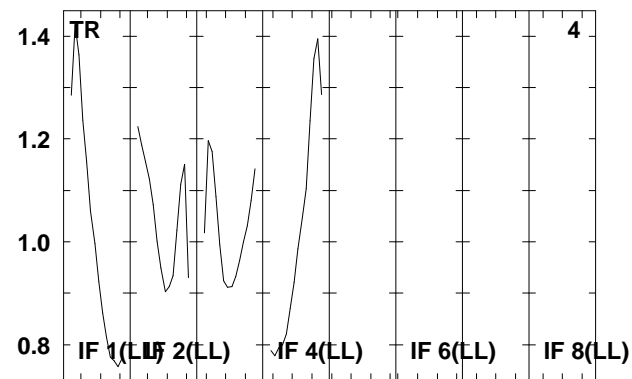
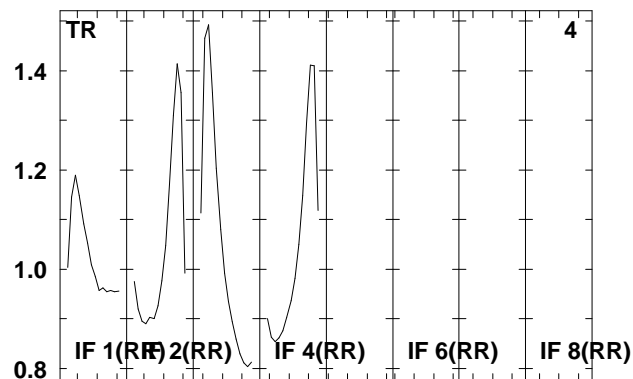
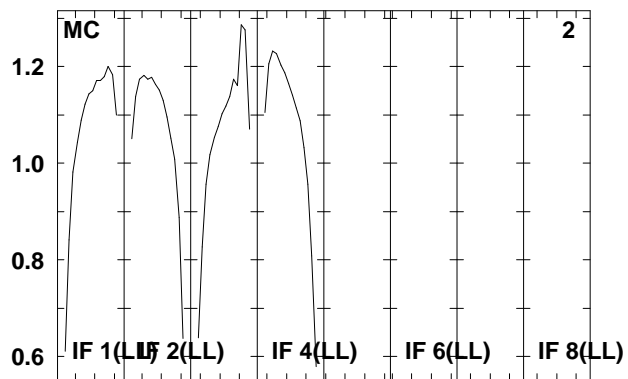
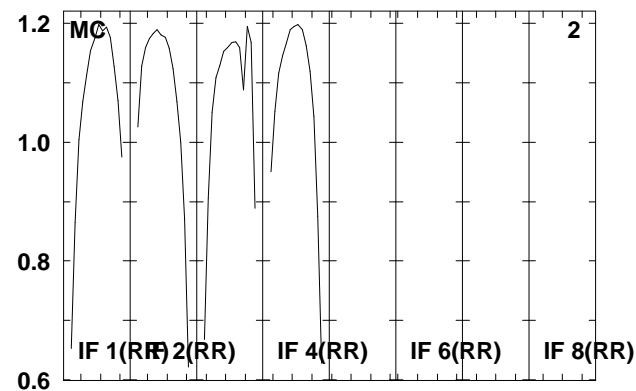
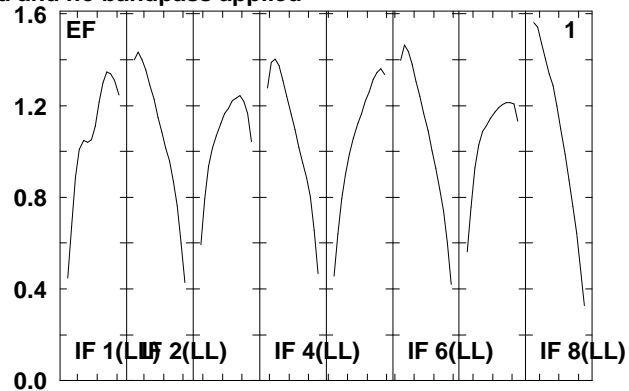
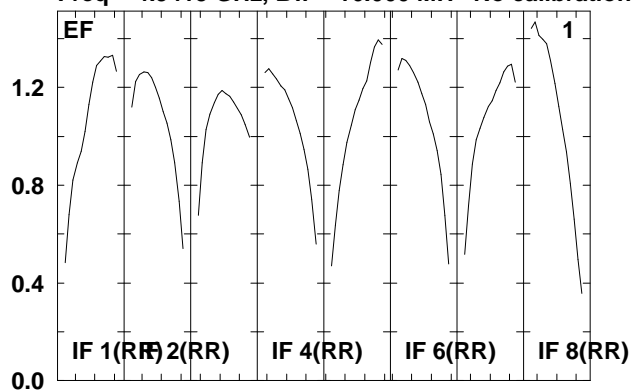

Lower frame: Real Jy

Total-power spectrum Antenna: \*

Timerange: 00/19:33:22 to 00/19:34:38

Plot file version 336 created 07-DEC-2009 16:06:48

J1912+05 RT006C.UVDATA.1

Freq = 4.9415 GHz, Bw = 16.000 MH No calibration applied and no bandpass applied

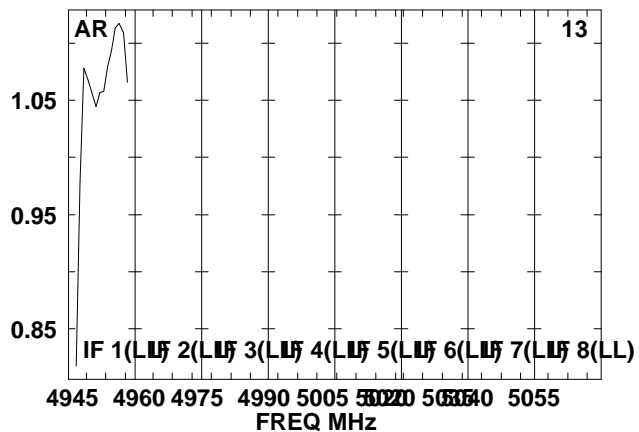
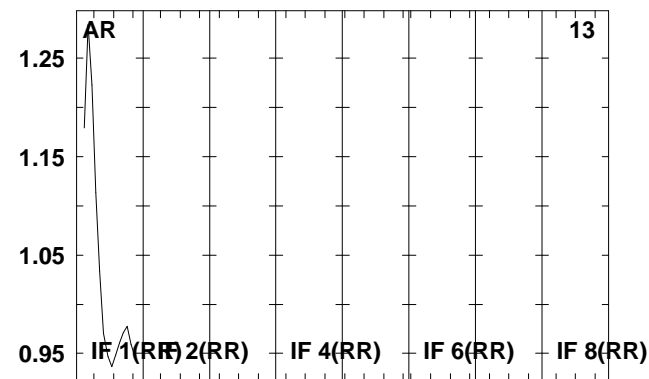
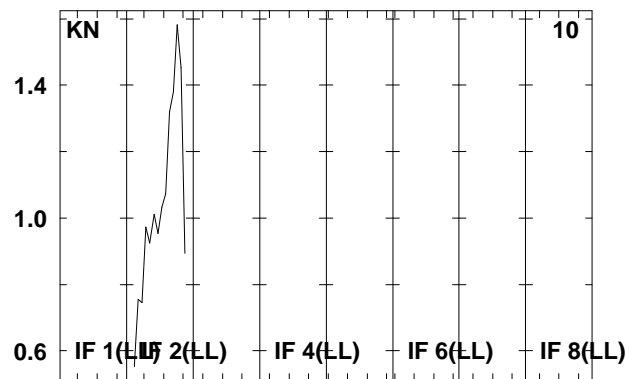
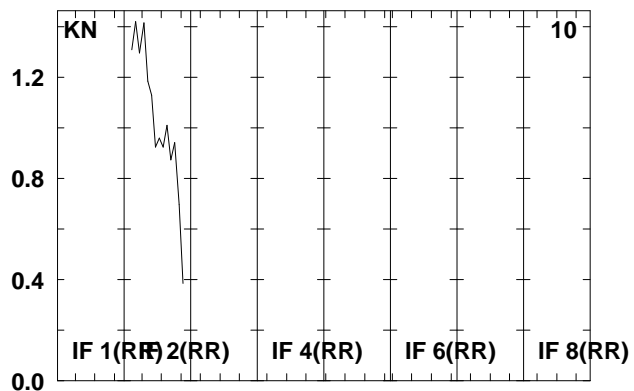
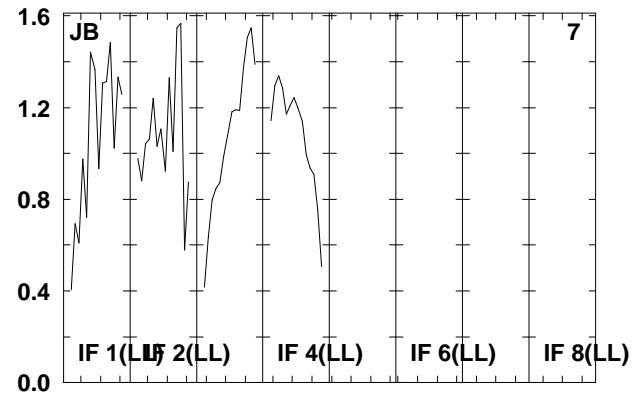
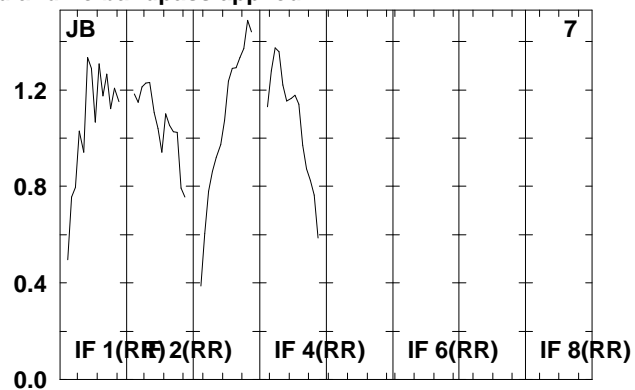
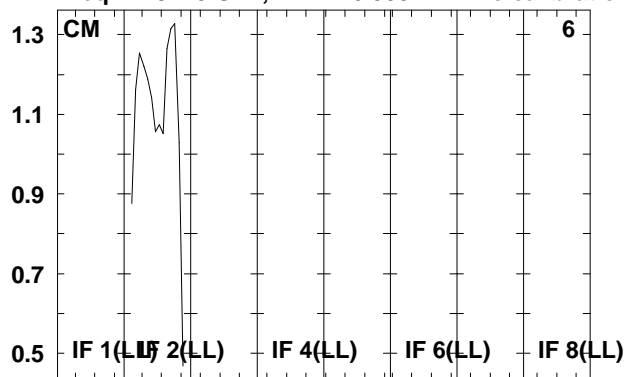

Lower frame: Real Jy

Total-power spectrum Antenna: \*

Timerange: 00/19:33:22 to 00/19:34:38



Plot file version 337 created 07-DEC-2009 16:06:49

SS433 RT006C.UVDATA.1

Freq = 4.9415 GHz, Bw = 16.000 MH No calibration applied and no bandpass applied

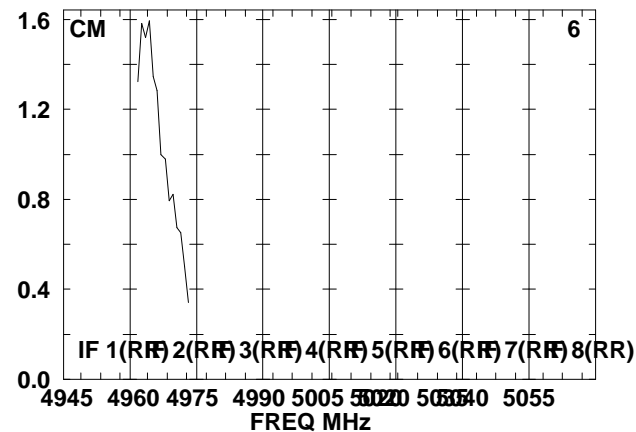
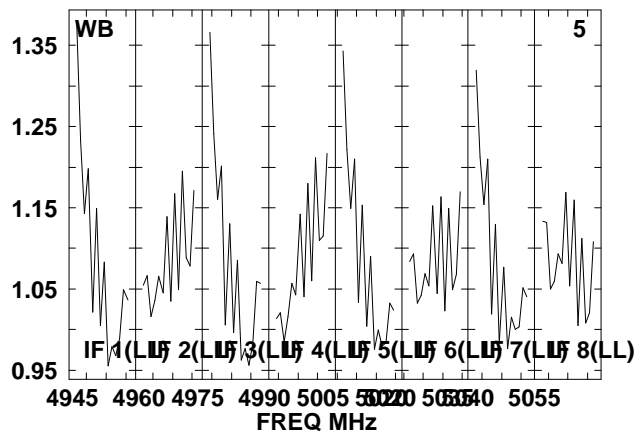
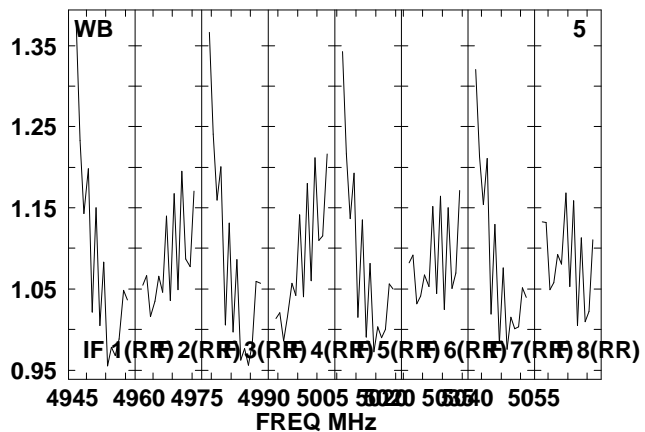
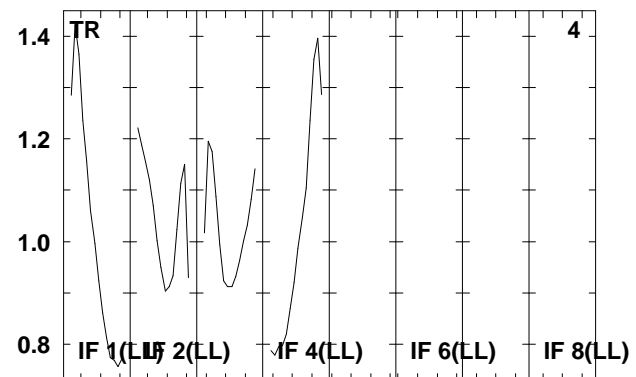
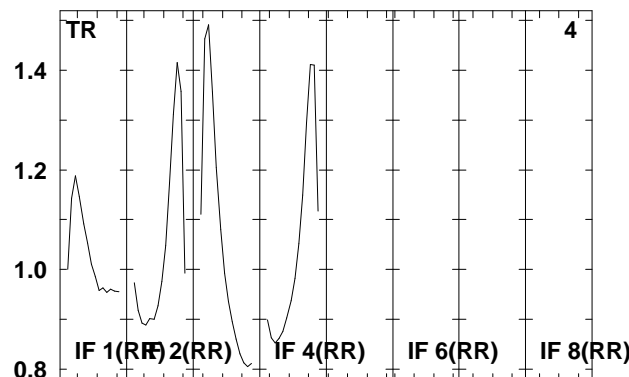
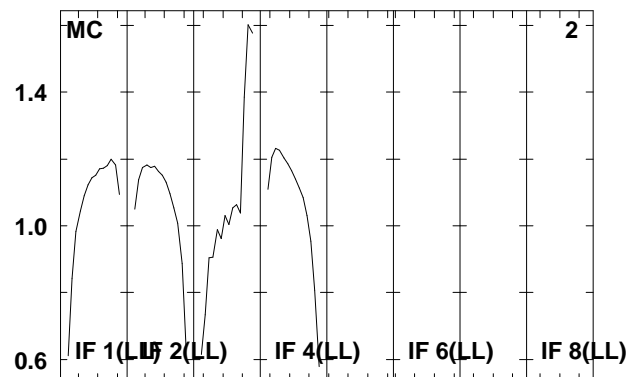
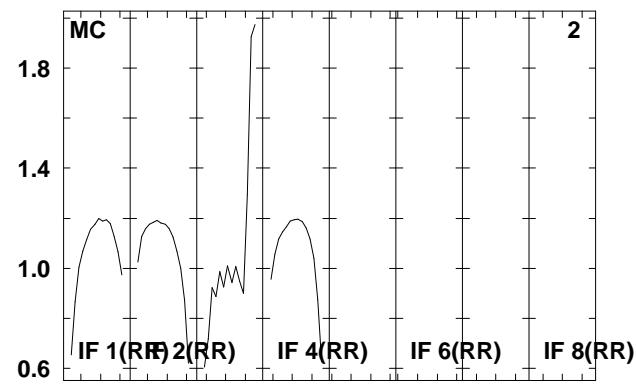
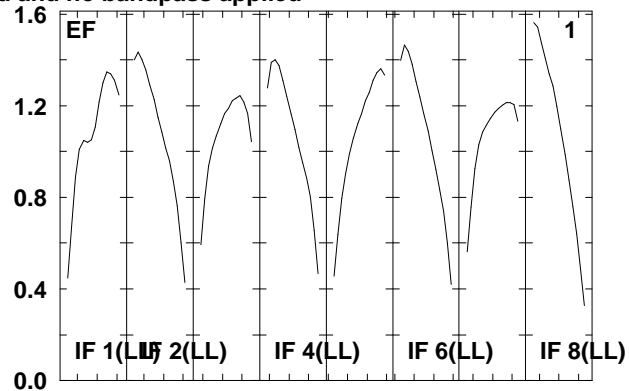
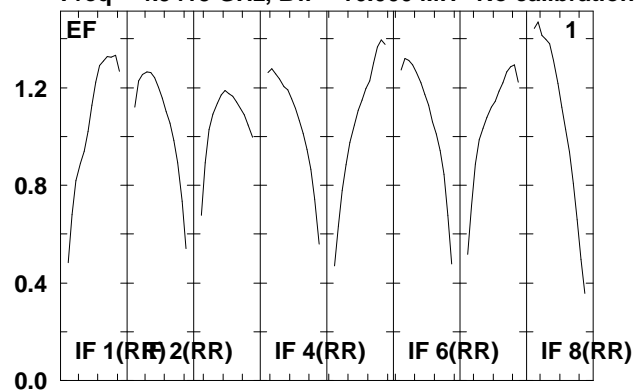

Lower frame: Real Jy  
Total-power spectrum Antenna: \*  
Timerange: 00/19:34:42 to 00/19:36:58

Plot file version 338 created 07-DEC-2009 16:06:49

SS433 RT006C.UVDATA.1

Freq = 4.9415 GHz, Bw = 16.000 MH No calibration applied and no bandpass applied

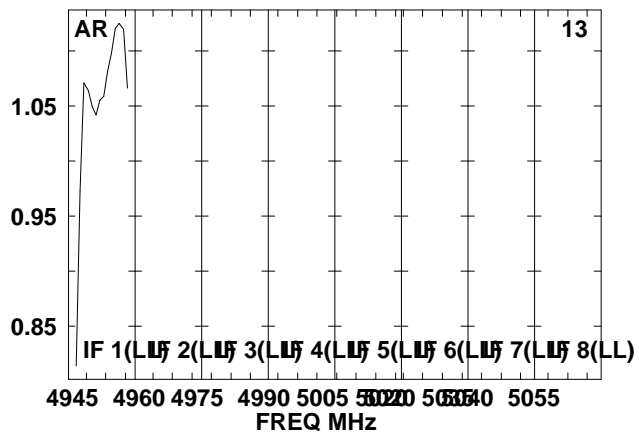
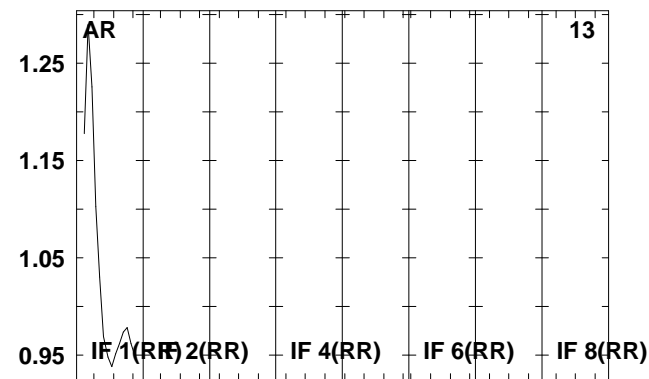
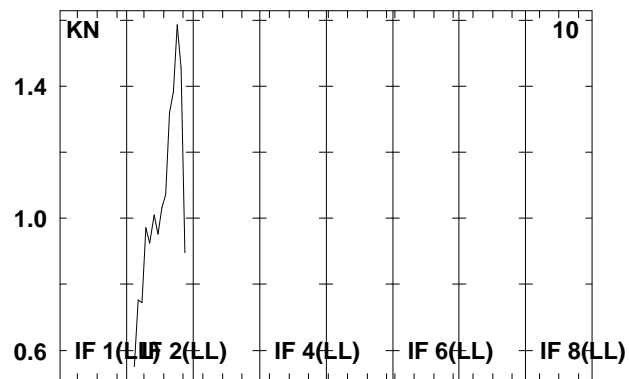
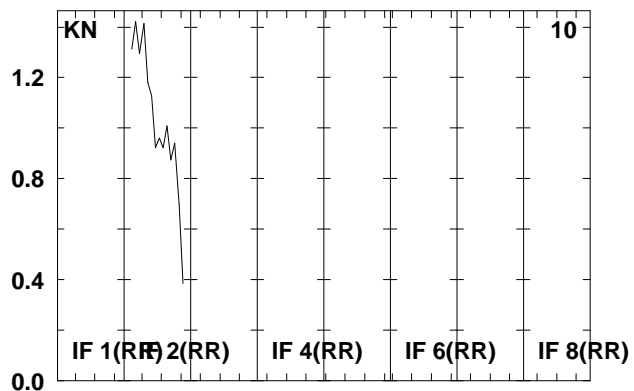
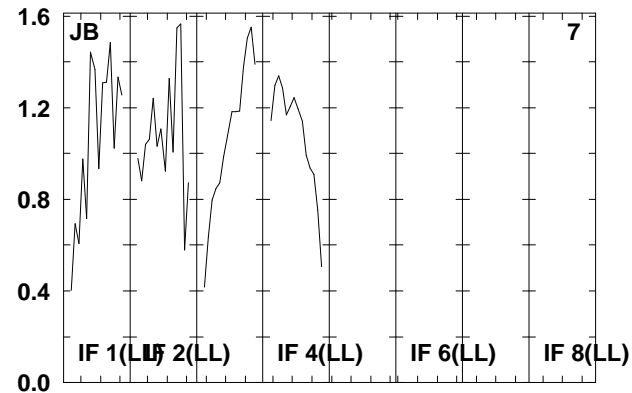
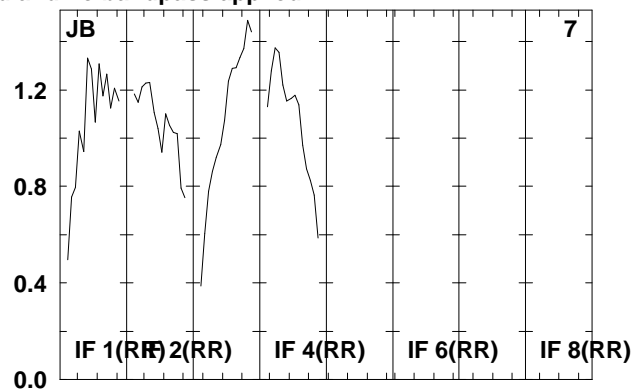
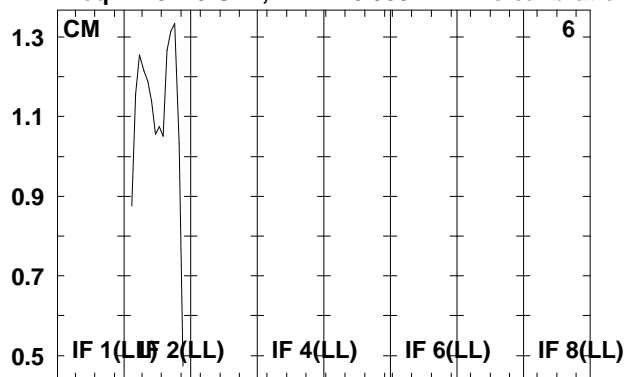

4945 4960 4975 4990 5005 5020 5035 5050 5055  
FREQ MHz

Lower frame: Real Jy

Total-power spectrum Antenna: \*

Timerange: 00/19:34:42 to 00/19:36:58

Plot file version 339 created 07-DEC-2009 16:06:49

J1912+05 RT006C.UVDATA.1

Freq = 4.9415 GHz, Bw = 16.000 MH No calibration applied and no bandpass applied

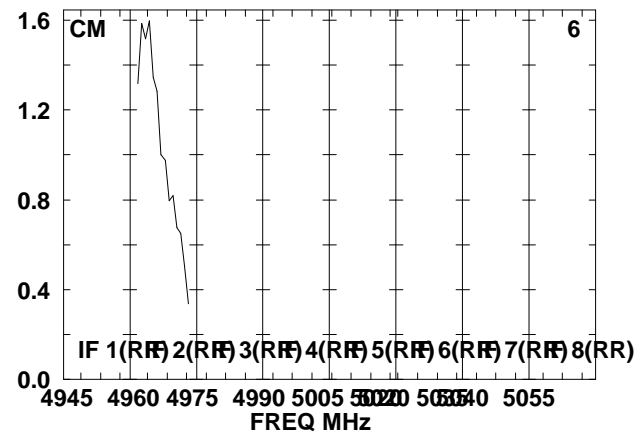
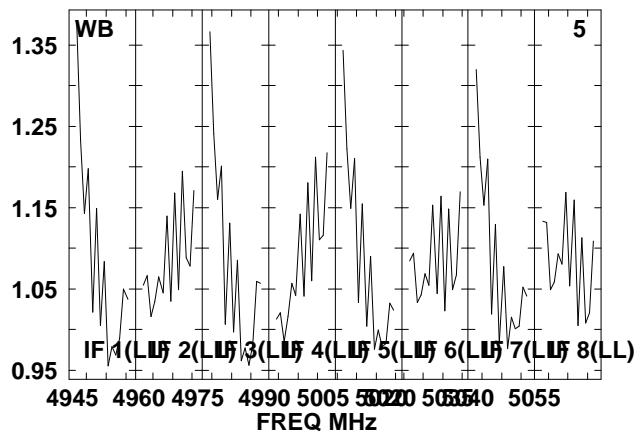
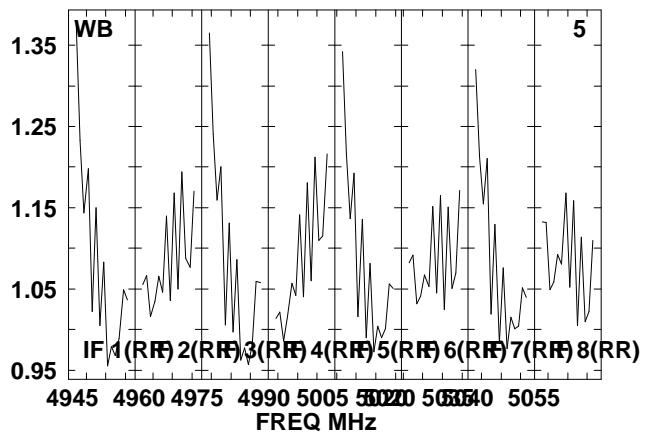
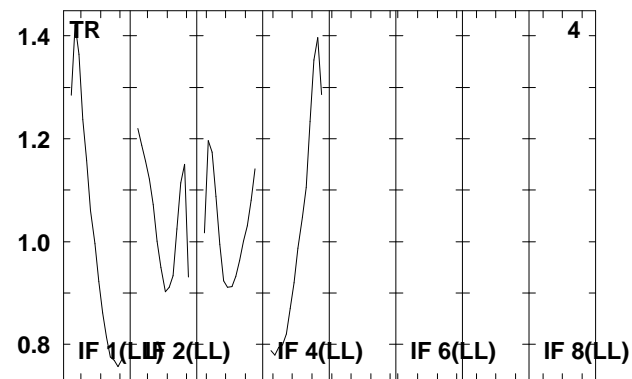
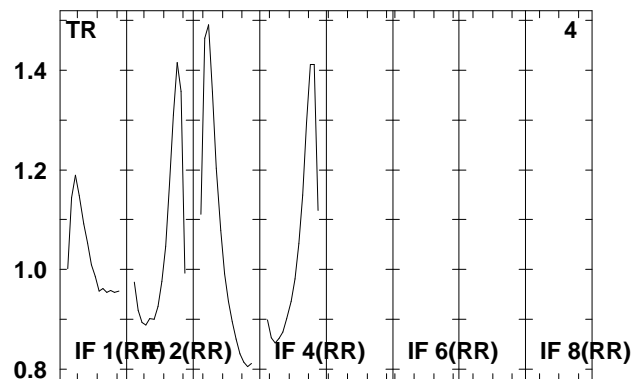
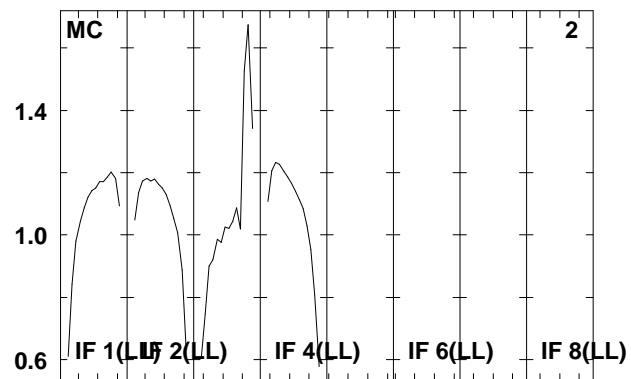
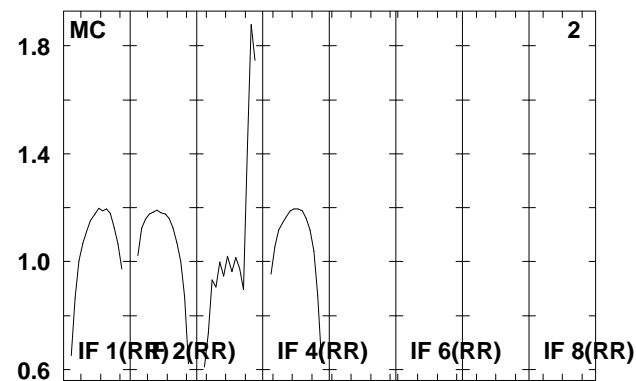
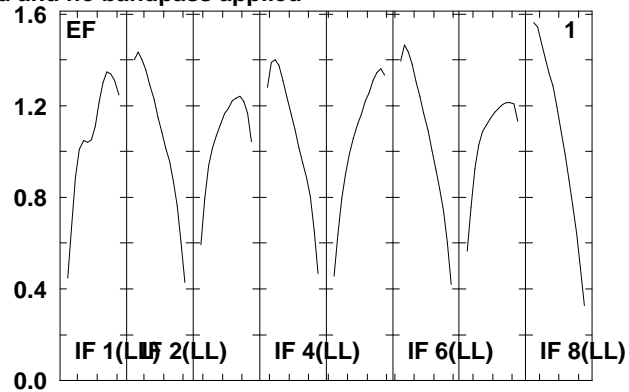
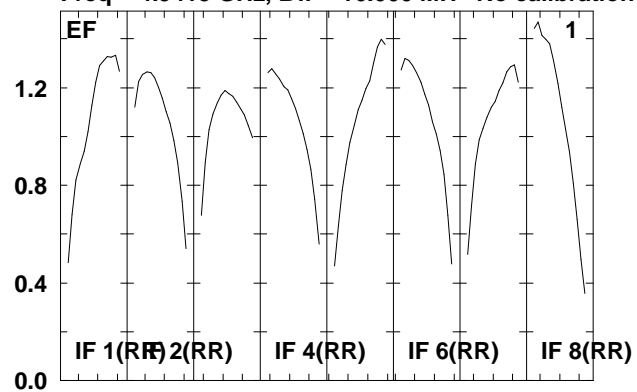

Lower frame: Real Jy  
Total-power spectrum Antenna: \*  
Timerange: 00/19:37:02 to 00/19:38:18

Plot file version 340 created 07-DEC-2009 16:06:49

J1912+05 RT006C.UVDATA.1

Freq = 4.9415 GHz, Bw = 16.000 MH No calibration applied and no bandpass applied

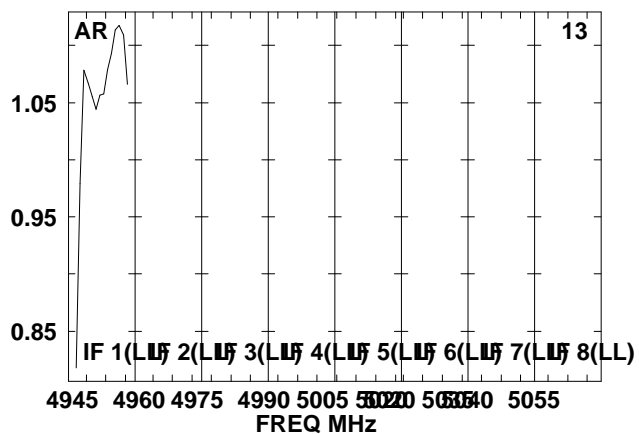
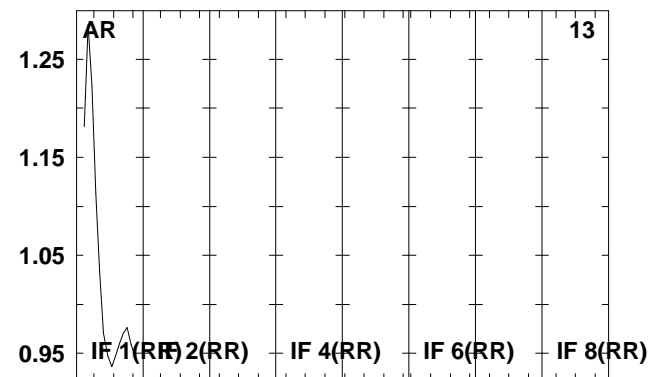
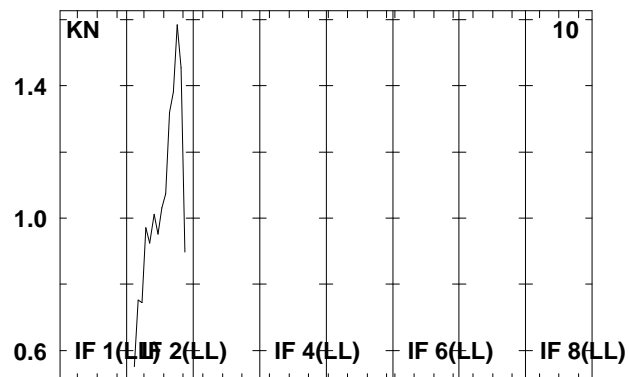
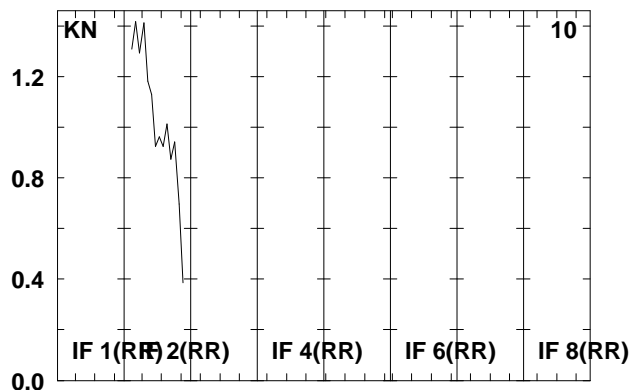
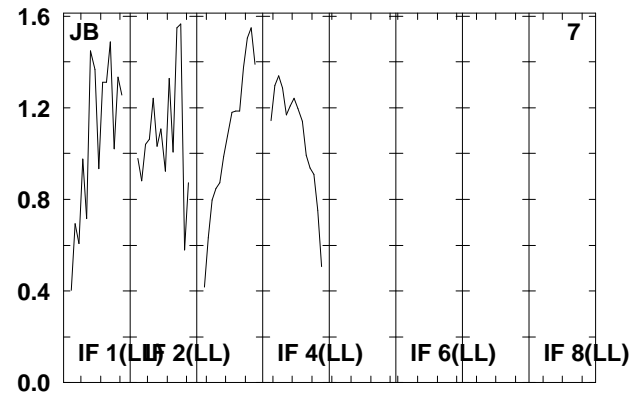
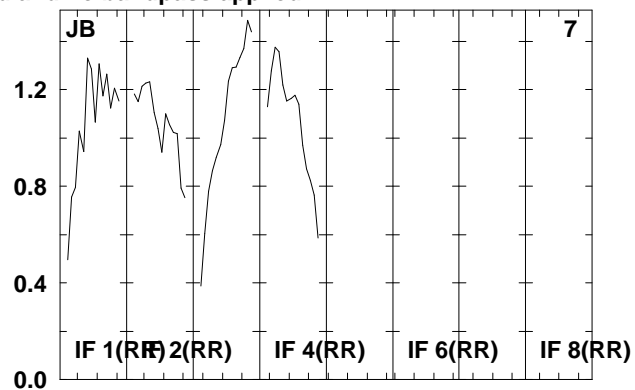
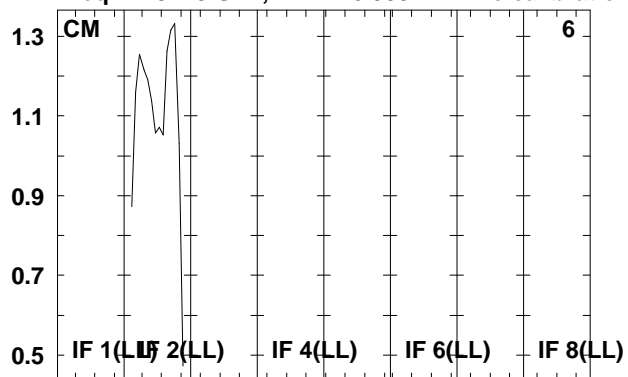

Lower frame: Real Jy

Total-power spectrum Antenna: \*

Timerange: 00/19:37:02 to 00/19:38:18

Plot file version 341 created 07-DEC-2009 16:06:49

SS433 RT006C.UVDATA.1

Freq = 4.9415 GHz, Bw = 16.000 MH No calibration applied and no bandpass applied

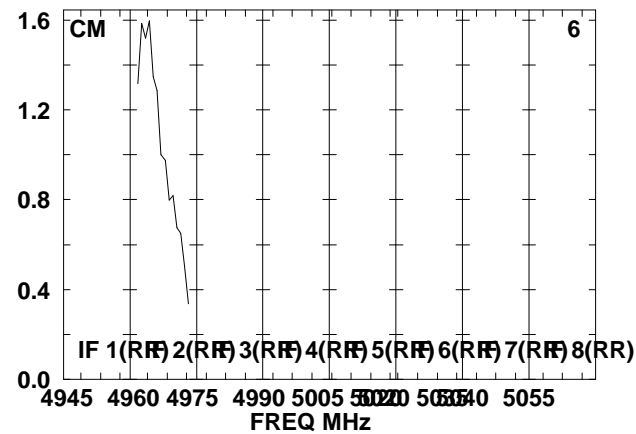
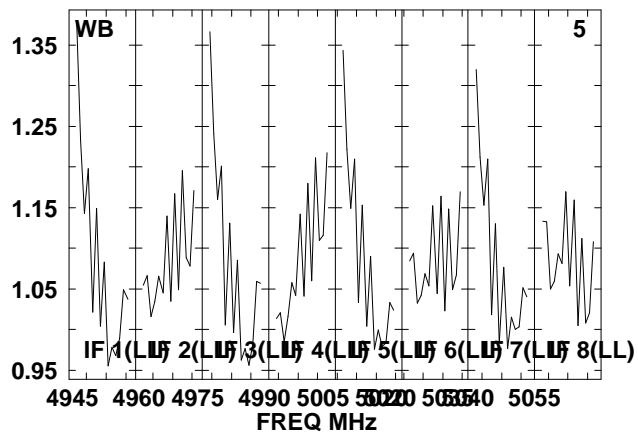
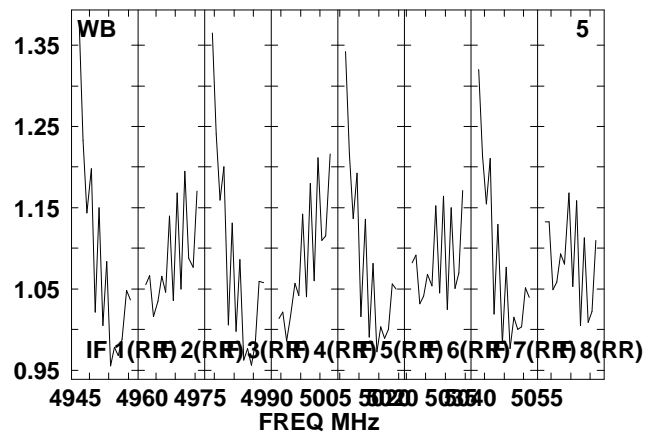
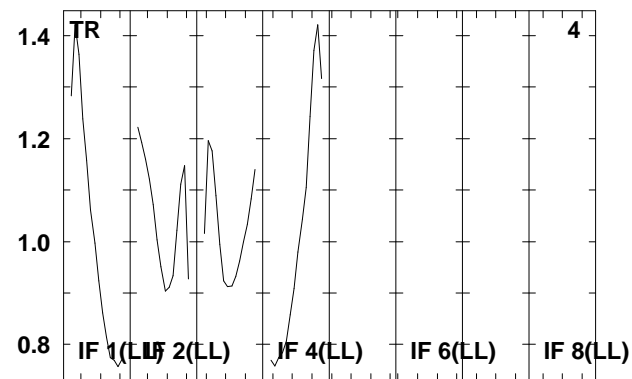
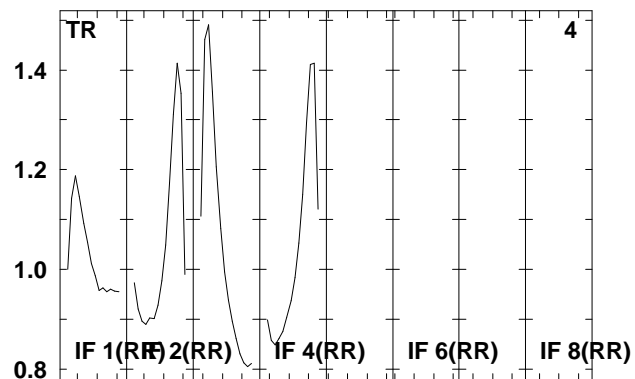
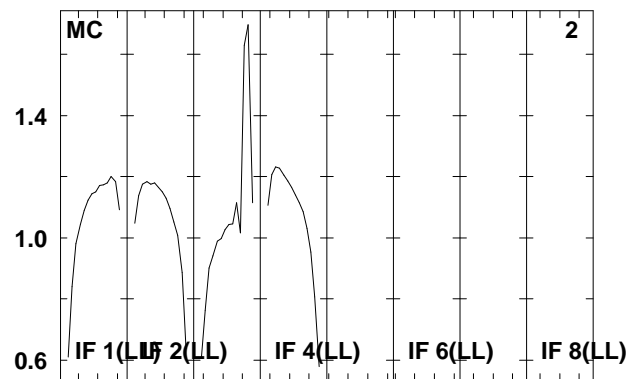
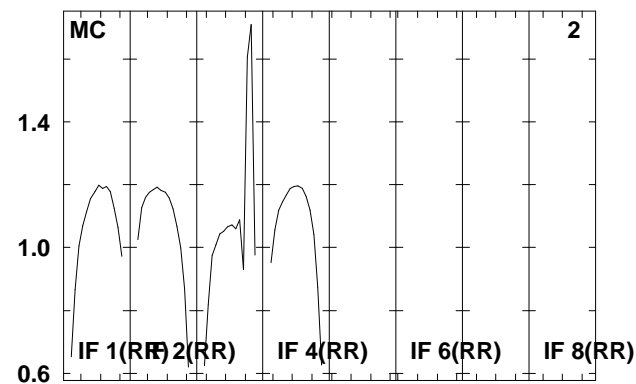
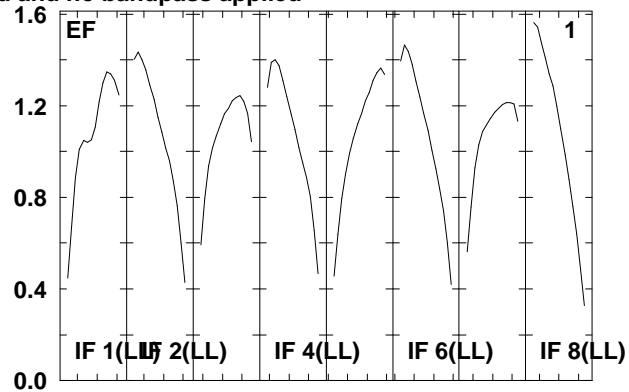
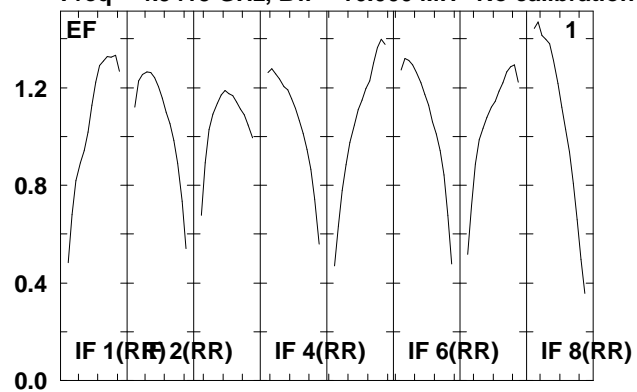

Lower frame: Real Jy  
Total-power spectrum Antenna: \*  
Timerange: 00/19:38:22 to 00/19:40:38

Plot file version 342 created 07-DEC-2009 16:06:50

SS433 RT006C.UVDATA.1

Freq = 4.9415 GHz, Bw = 16.000 MH No calibration applied and no bandpass applied

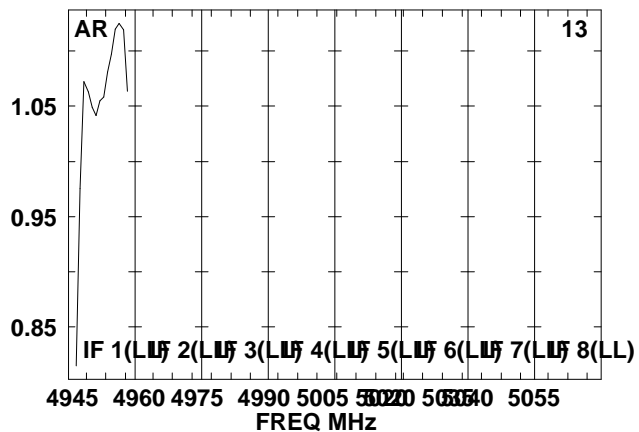
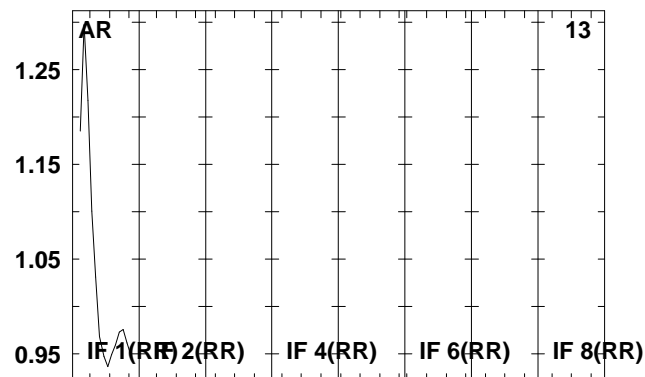
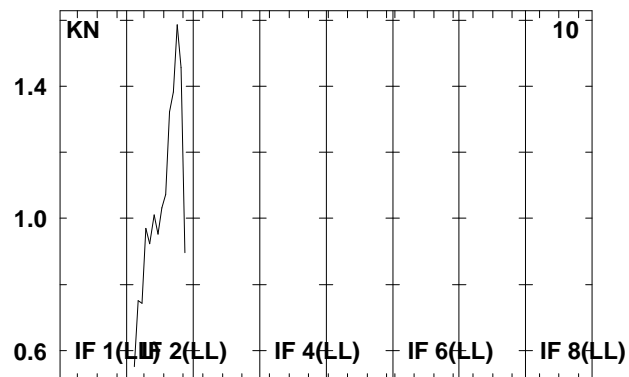
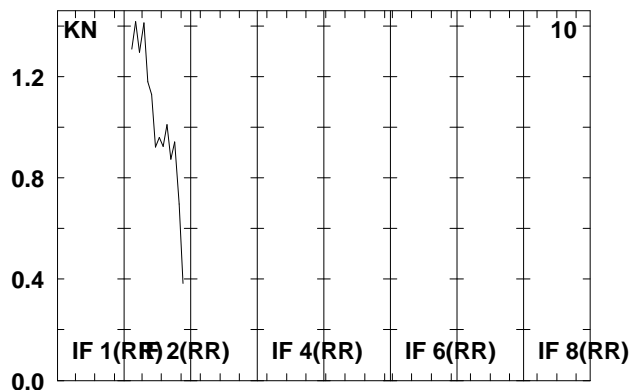
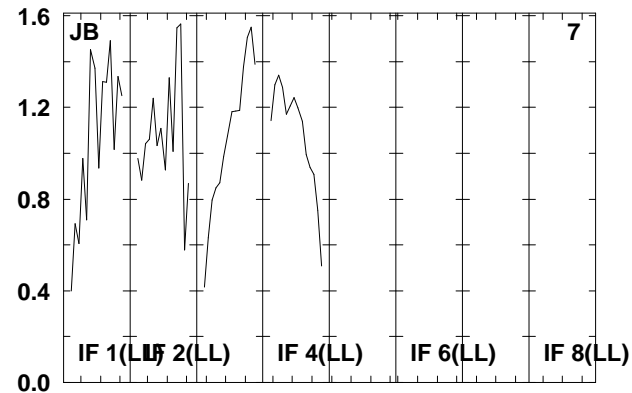
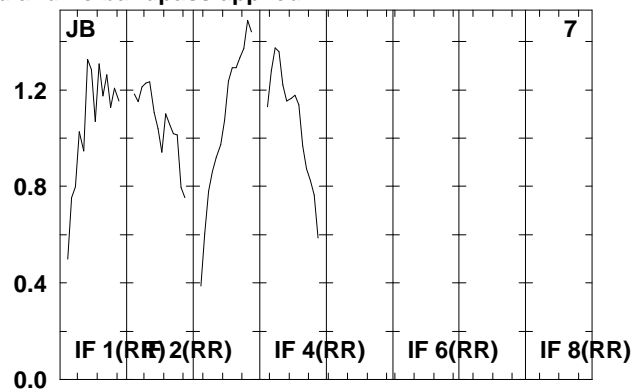
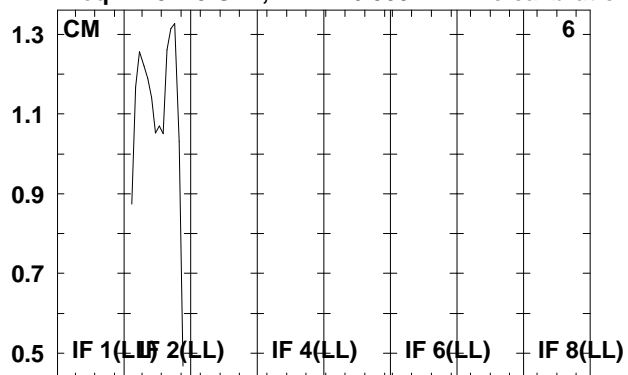

Lower frame: Real Jy

Total-power spectrum Antenna: \*

Timerange: 00/19:38:22 to 00/19:40:38

Plot file version 343 created 07-DEC-2009 16:06:50

J1912+05 RT006C.UVDATA.1

Freq = 4.9415 GHz, Bw = 16.000 MH No calibration applied and no bandpass applied

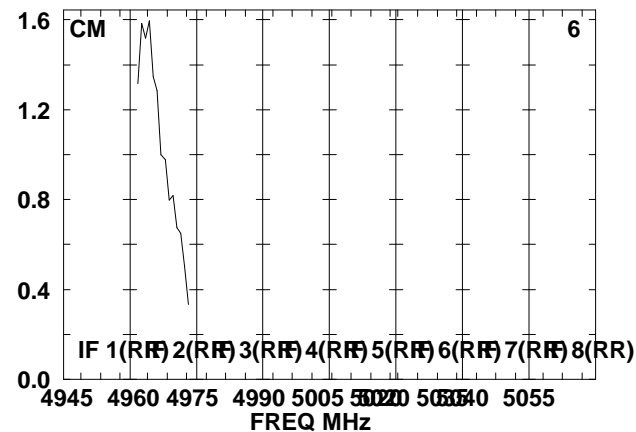
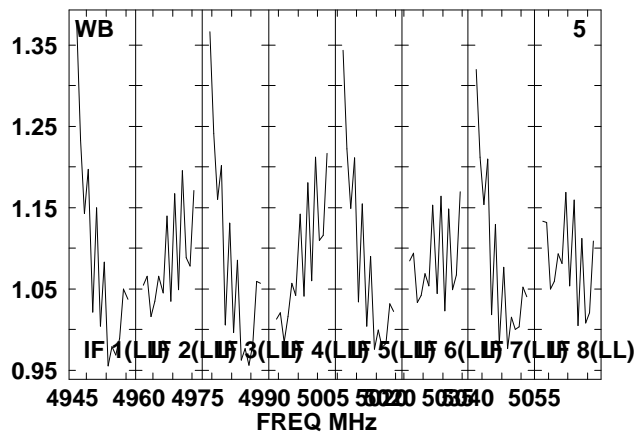
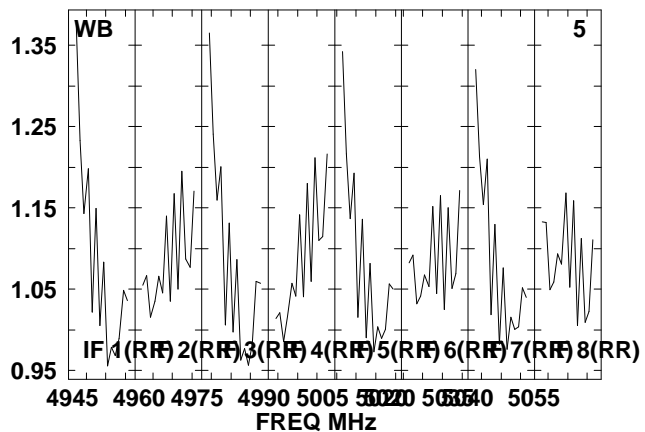
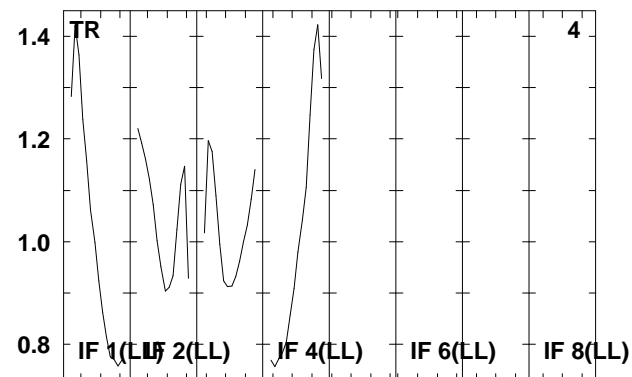
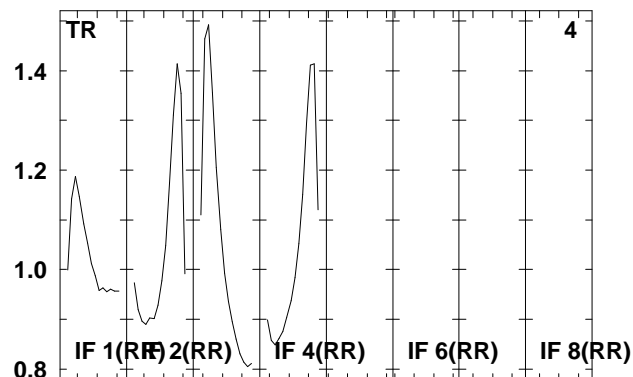
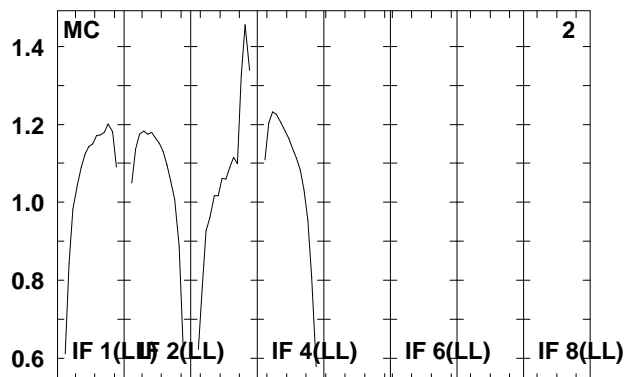
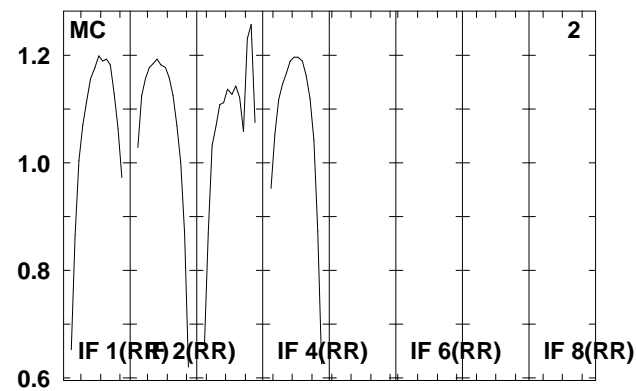
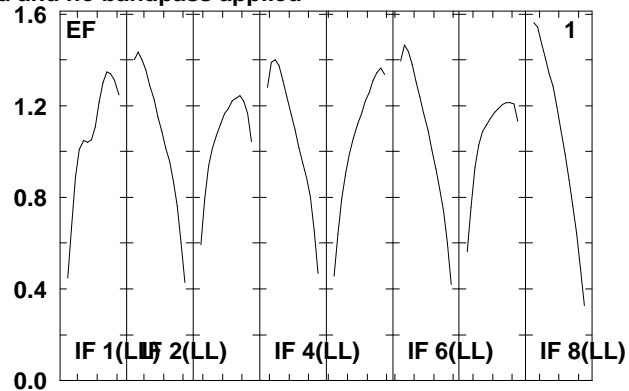
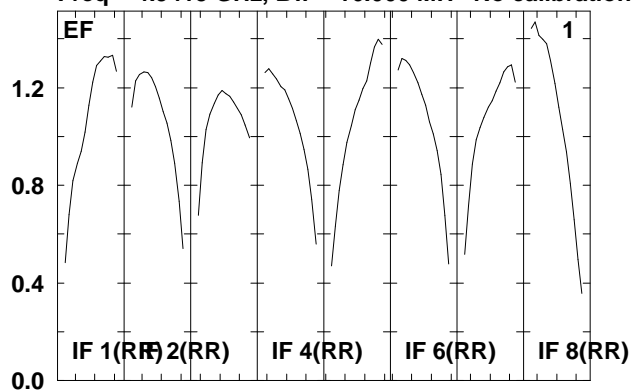

Lower frame: Real Jy

Total-power spectrum Antenna: \*

Timerange: 00/19:40:42 to 00/19:41:58

Plot file version 344 created 07-DEC-2009 16:06:50

J1912+05 RT006C.UVDATA.1

Freq = 4.9415 GHz, Bw = 16.000 MH No calibration applied and no bandpass applied

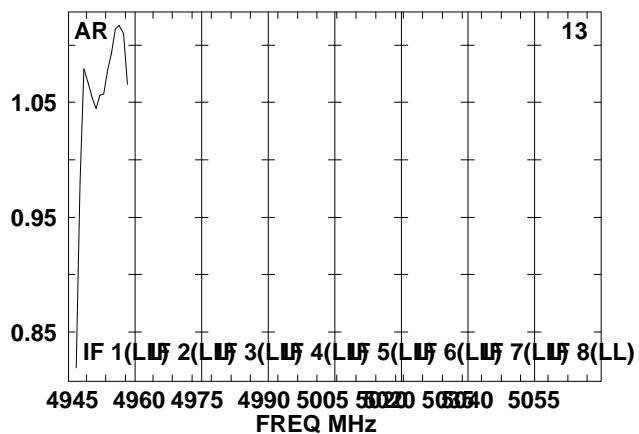
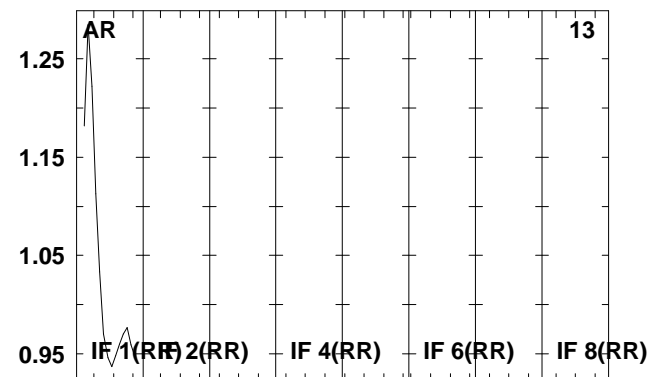
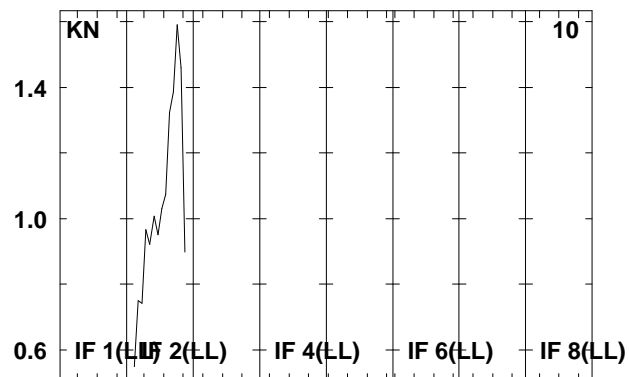
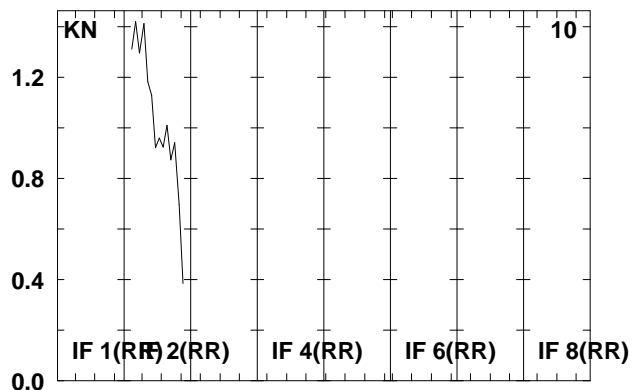
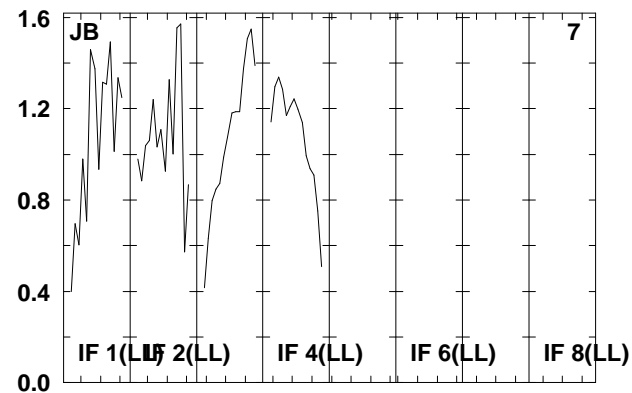
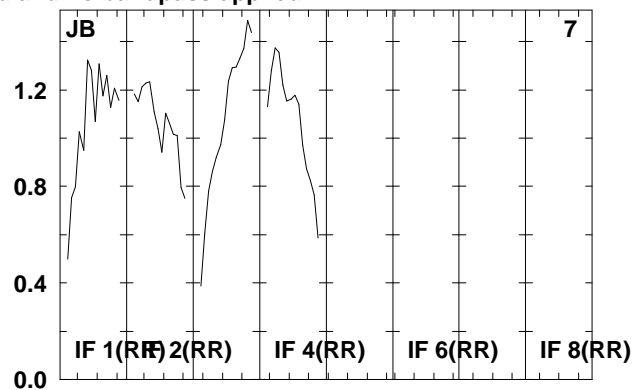
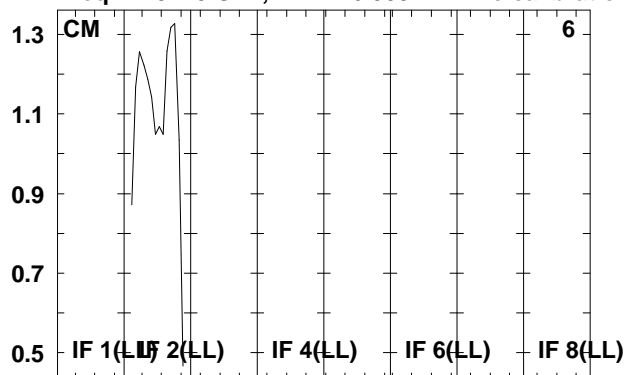

Lower frame: Real Jy

Total-power spectrum Antenna: \*

Timerange: 00/19:40:42 to 00/19:41:58



Plot file version 345 created 07-DEC-2009 16:06:50

SS433 RT006C.UVDATA.1

Freq = 4.9415 GHz, Bw = 16.000 MH No calibration applied and no bandpass applied

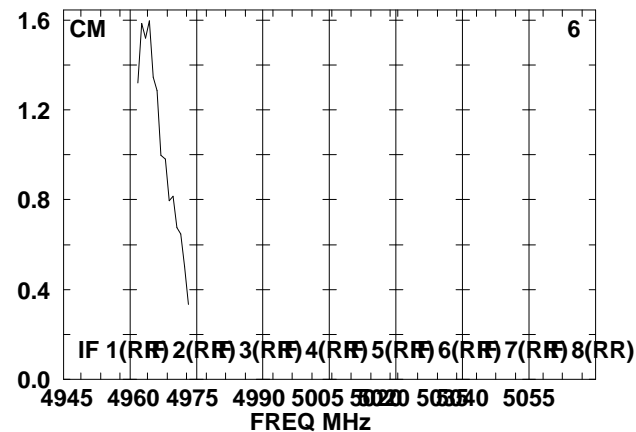
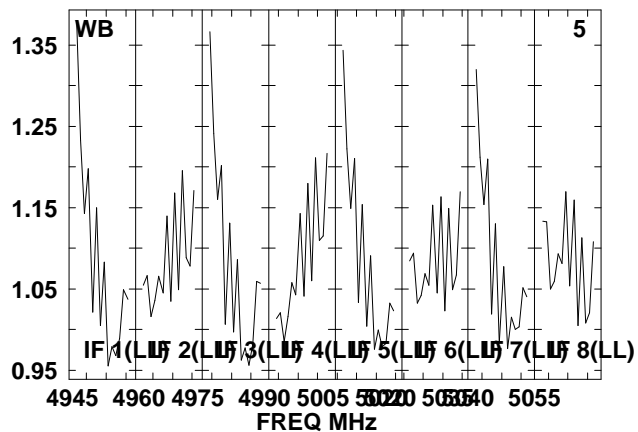
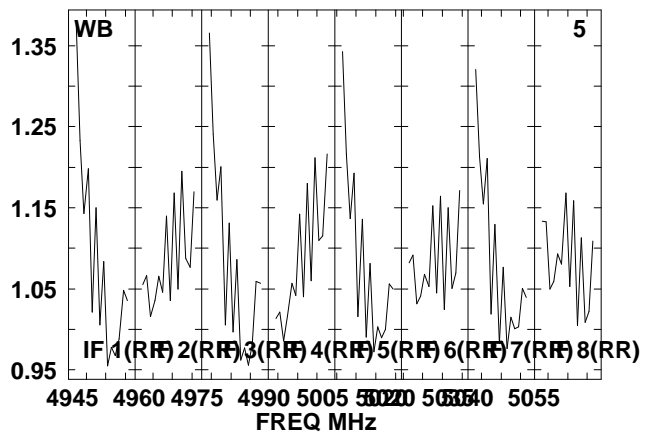
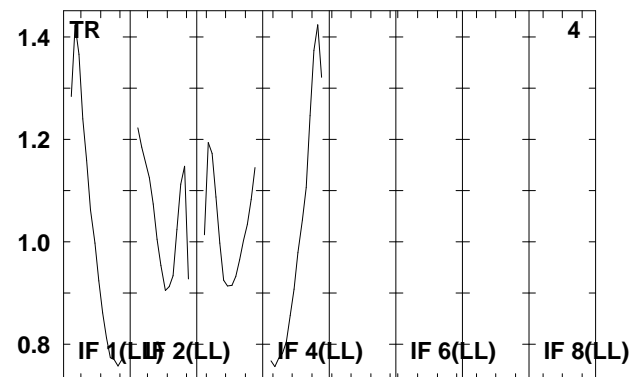
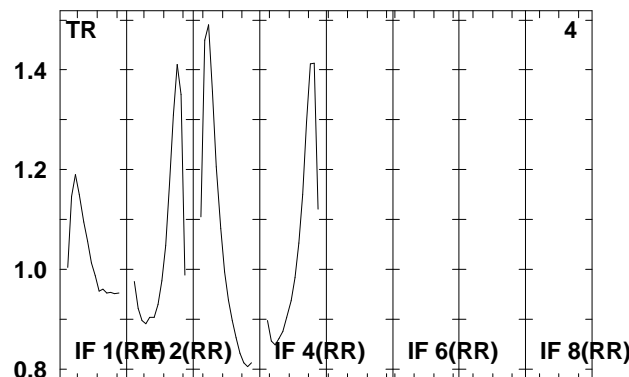
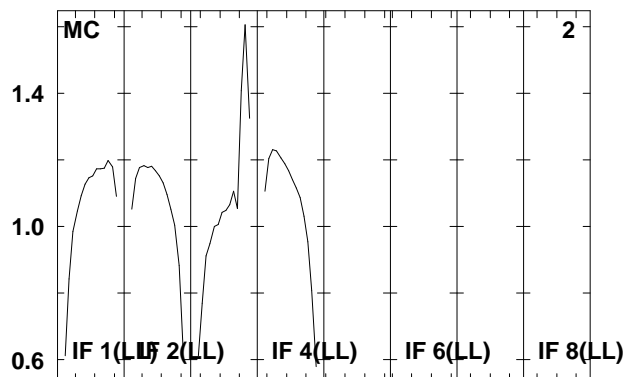
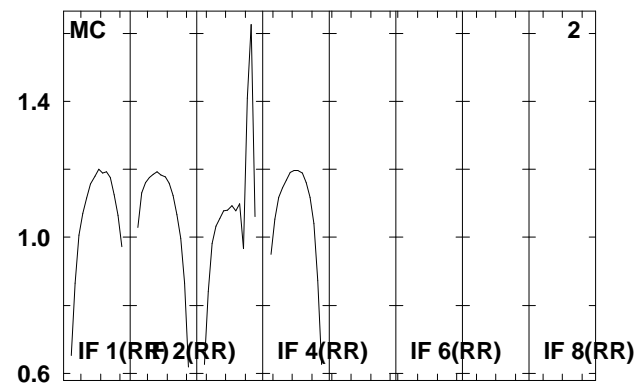
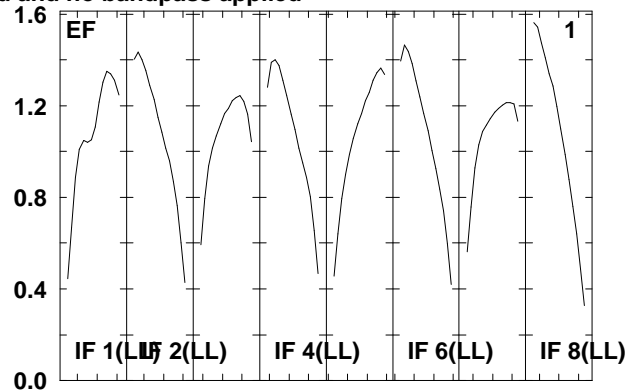
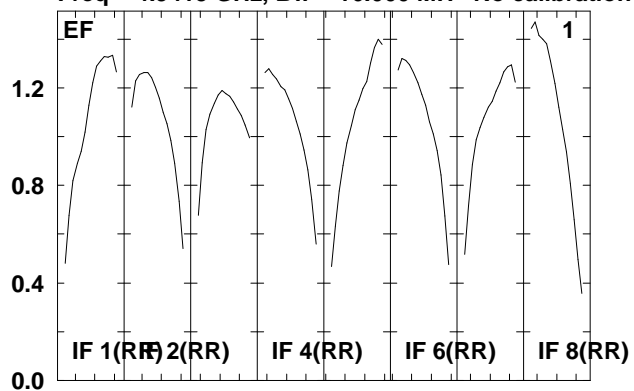

Lower frame: Real Jy

Total-power spectrum Antenna: \*

Timerange: 00/19:42:02 to 00/19:44:18

Plot file version 346 created 07-DEC-2009 16:06:50

SS433 RT006C.UVDATA.1

Freq = 4.9415 GHz, Bw = 16.000 MH No calibration applied and no bandpass applied

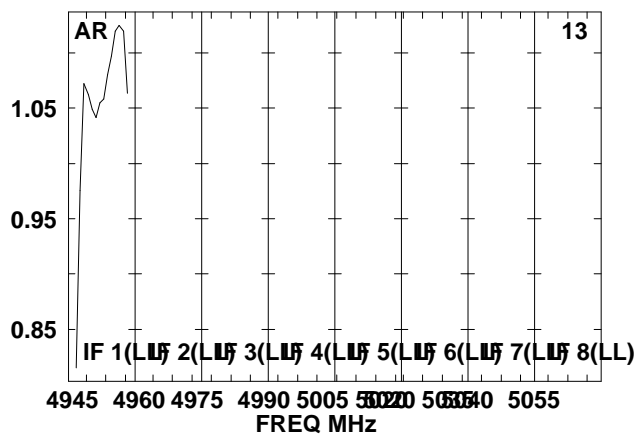
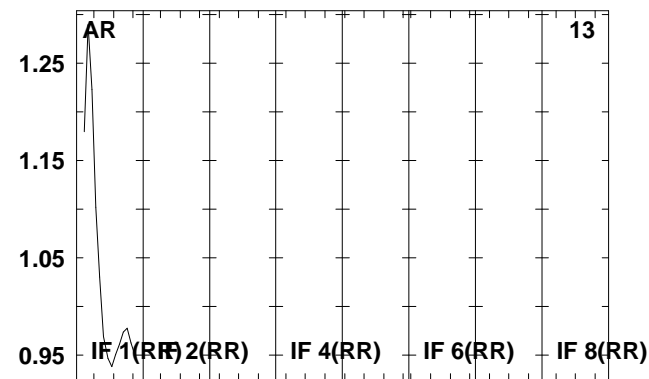
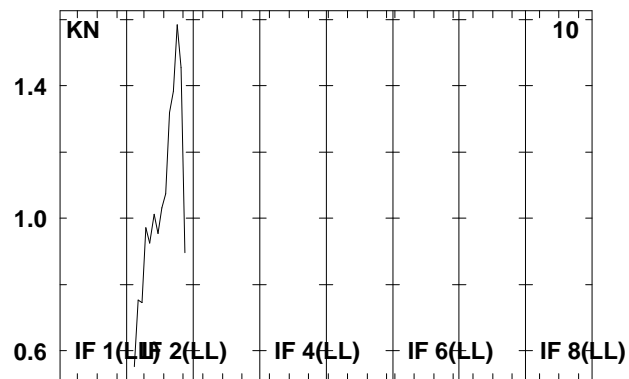
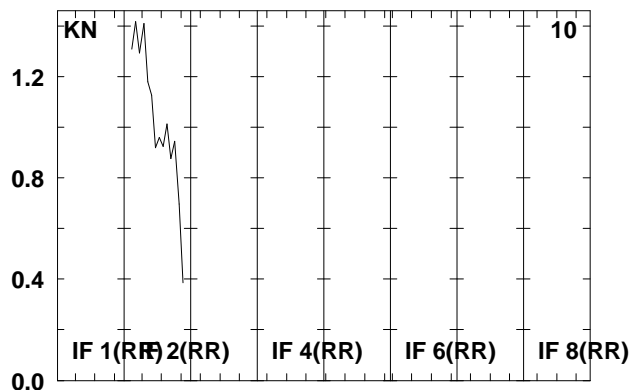
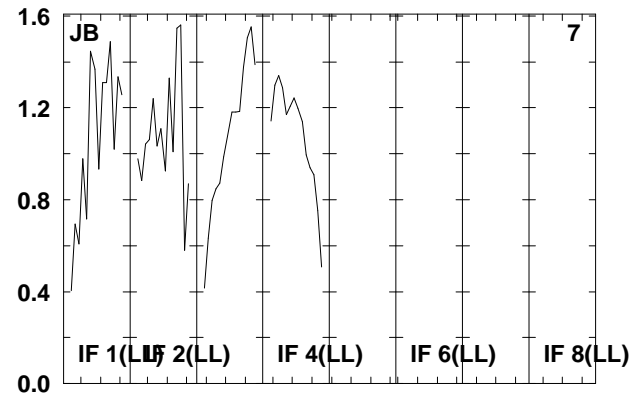
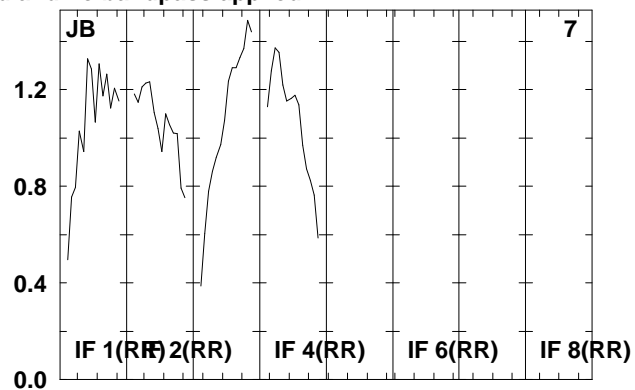
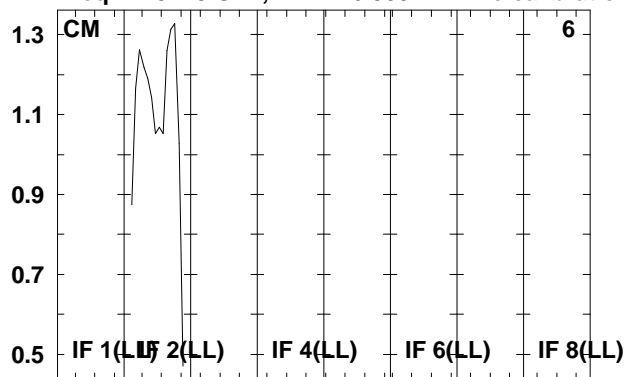

Lower frame: Real Jy

Total-power spectrum Antenna: \*

Timerange: 00/19:42:02 to 00/19:44:18

Plot file version 347 created 07-DEC-2009 16:06:51

J1912+05 RT006C.UVDATA.1

Freq = 4.9415 GHz, Bw = 16.000 MH No calibration applied and no bandpass applied

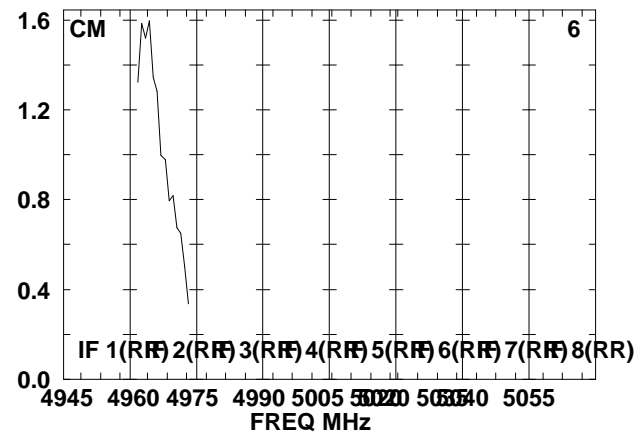
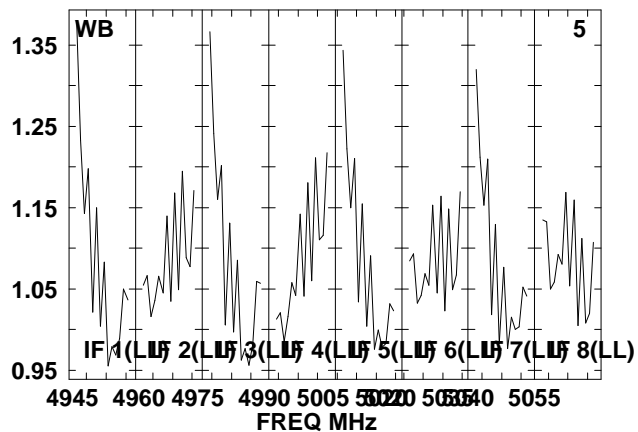
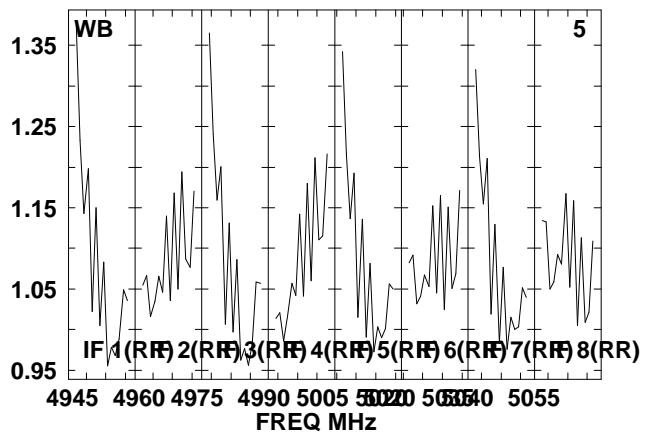
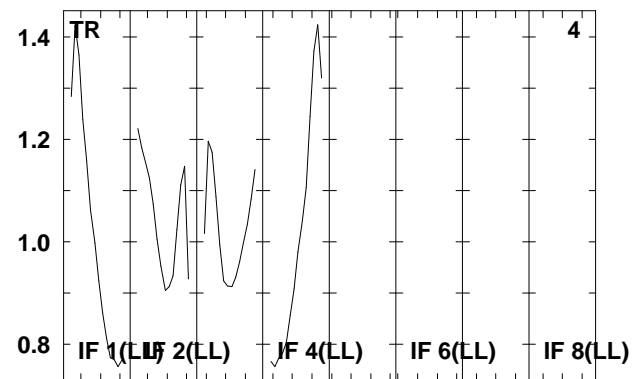
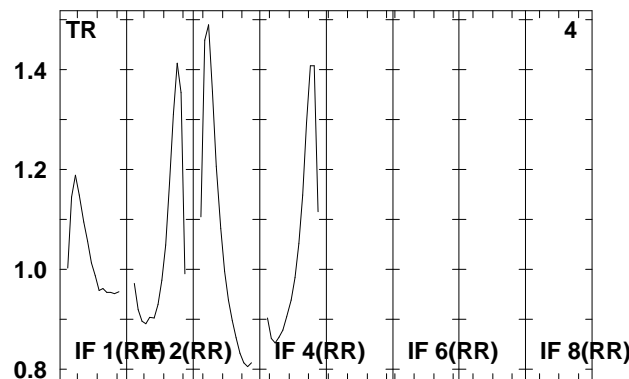
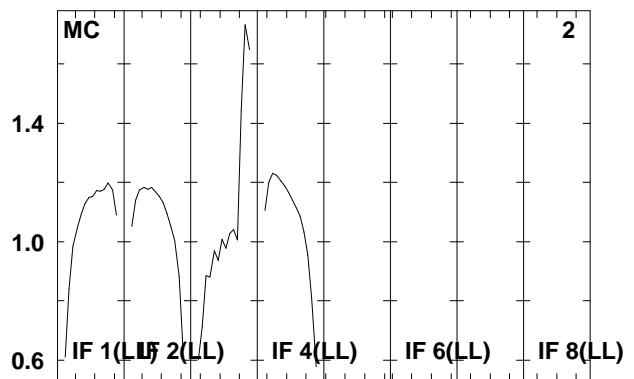
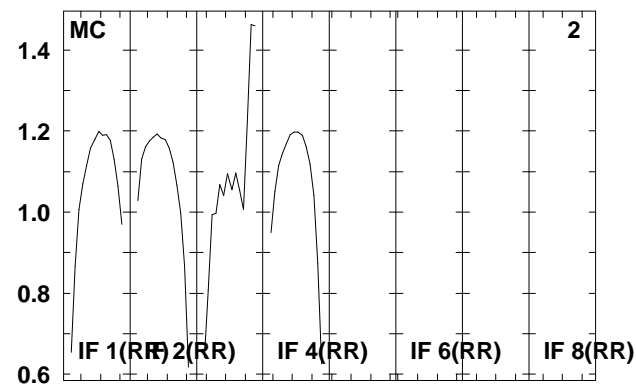
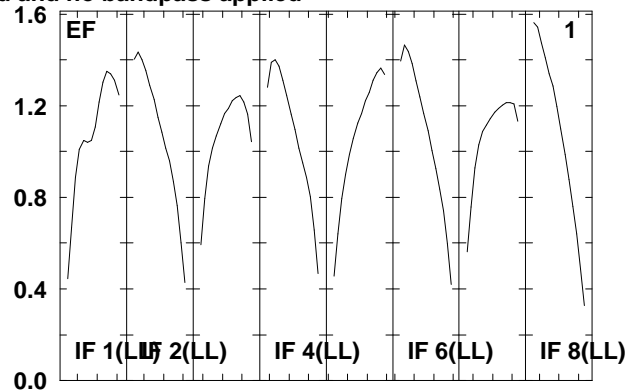
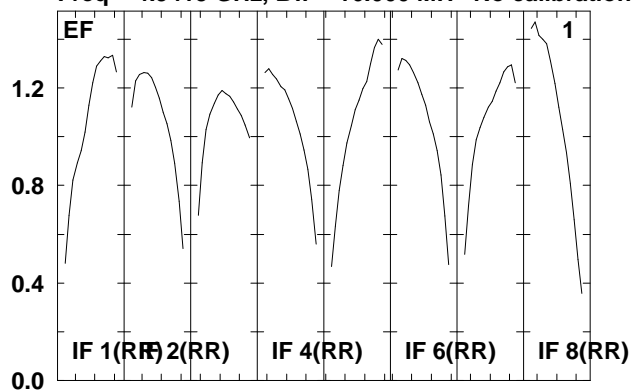

Lower frame: Real Jy  
Total-power spectrum Antenna: \*  
Timerange: 00/19:45:22 to 00/19:46:18

Plot file version 348 created 07-DEC-2009 16:06:51

J1912+05 RT006C.UVDATA.1

Freq = 4.9415 GHz, Bw = 16.000 MH No calibration applied and no bandpass applied

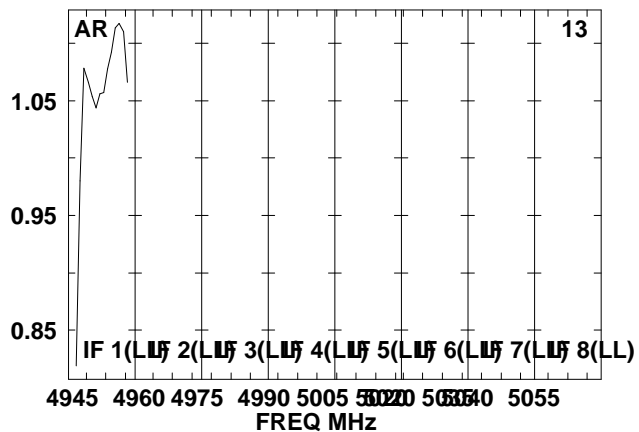
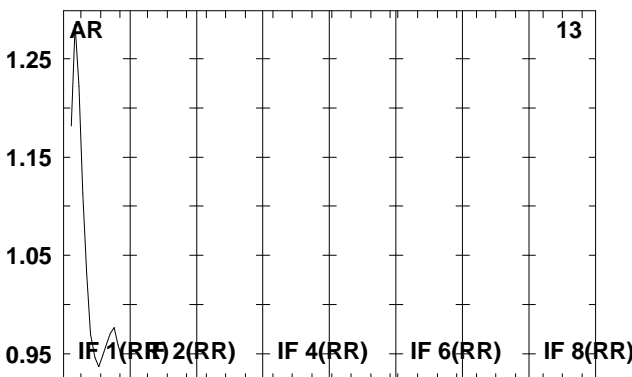
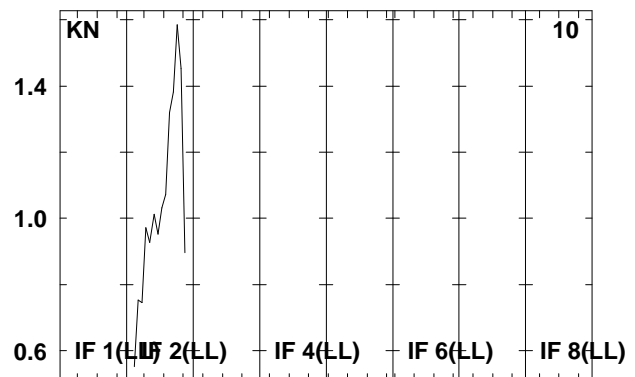
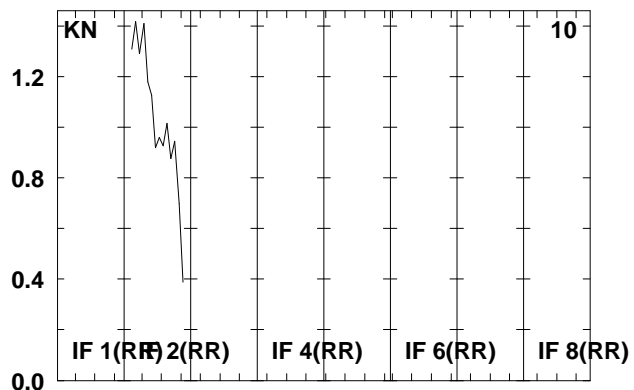
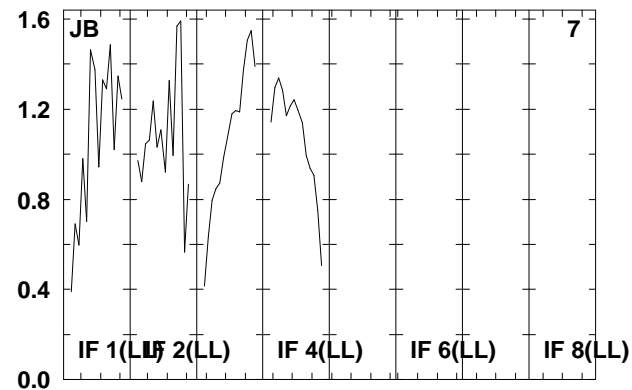
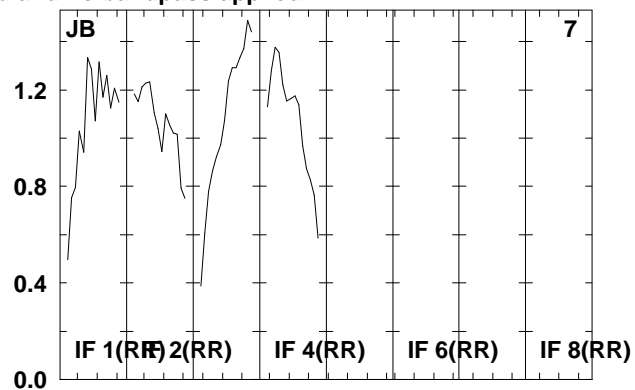
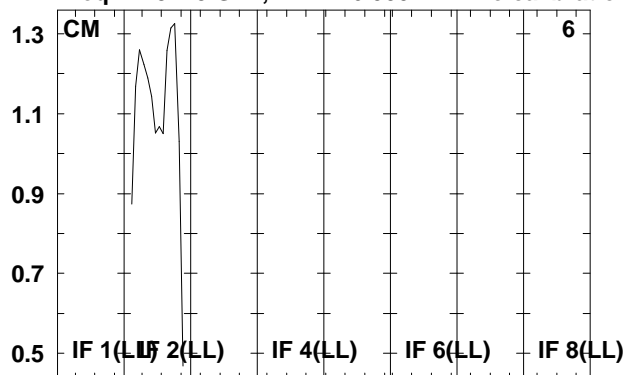

Lower frame: Real Jy

Total-power spectrum Antenna: \*

Timerange: 00/19:45:22 to 00/19:46:18

Plot file version 349 created 07-DEC-2009 16:06:51

SS433 RT006C.UVDATA.1

Freq = 4.9415 GHz, Bw = 16.000 MH No calibration applied and no bandpass applied

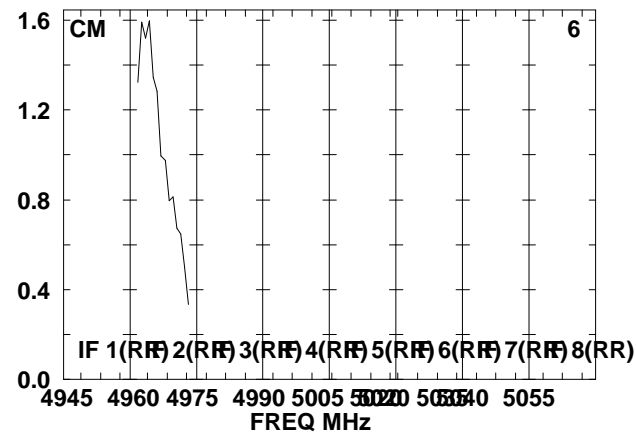
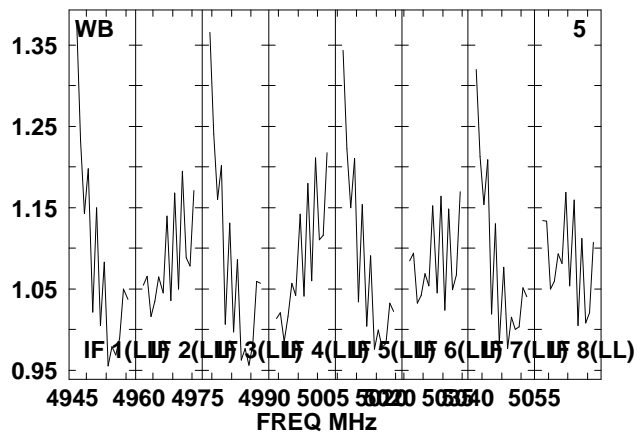
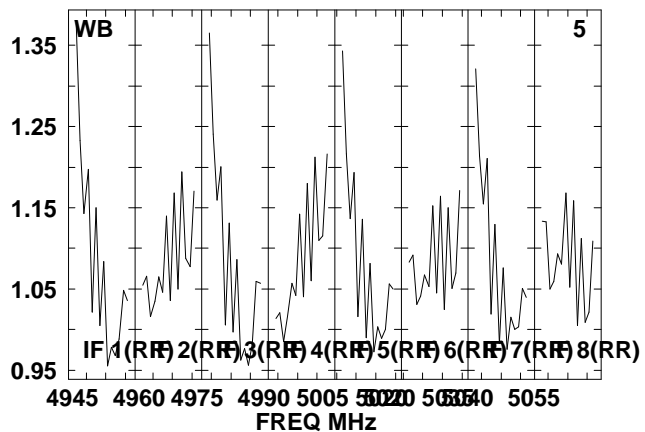
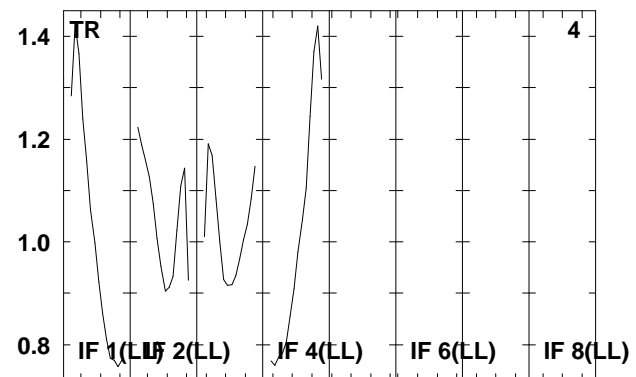
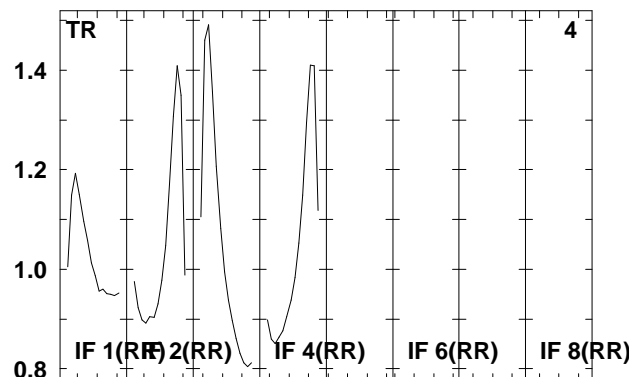
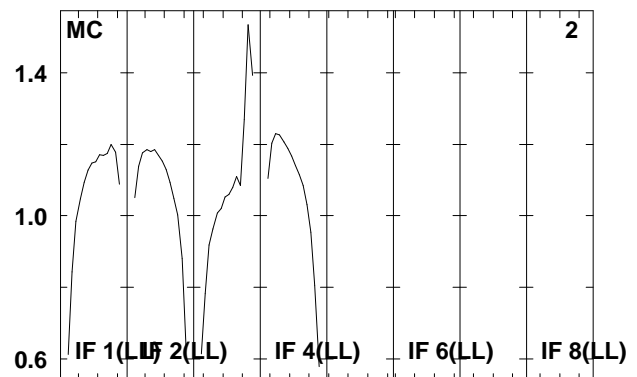
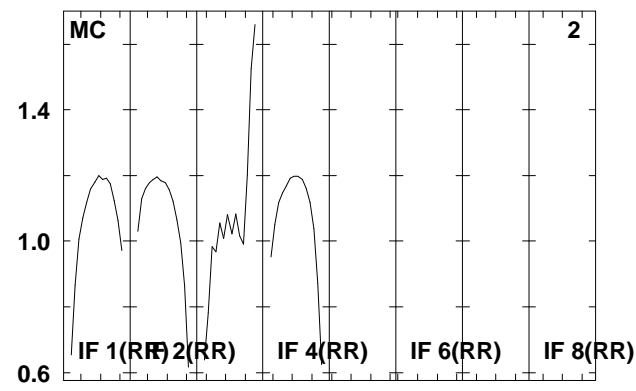
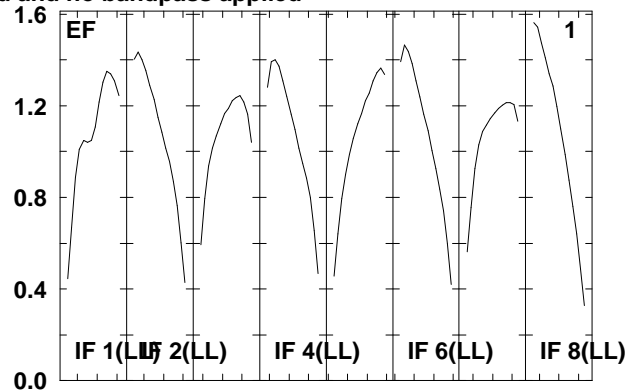
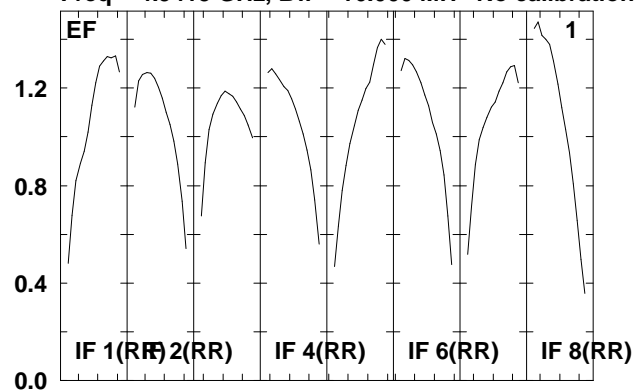

Lower frame: Real Jy

Total-power spectrum Antenna: \*

Timerange: 00/19:46:22 to 00/19:48:38

Plot file version 350 created 07-DEC-2009 16:06:51

SS433 RT006C.UVDATA.1

Freq = 4.9415 GHz, Bw = 16.000 MH No calibration applied and no bandpass applied

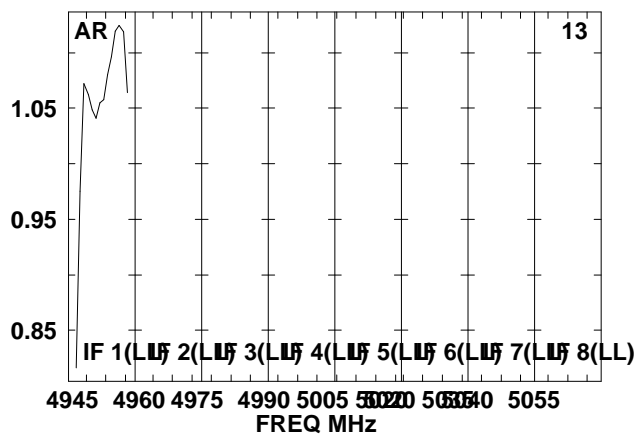
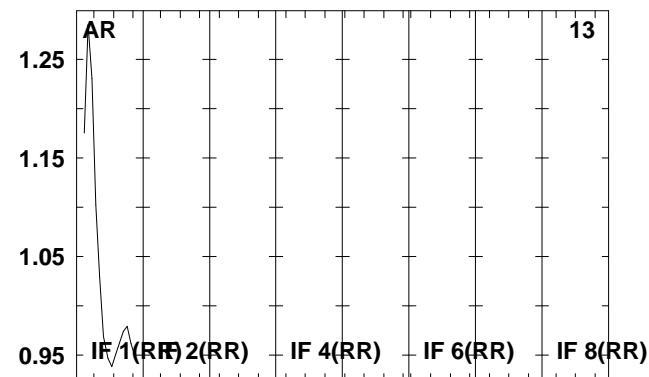
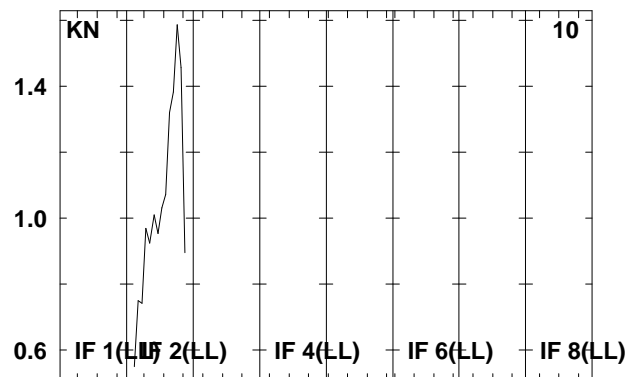
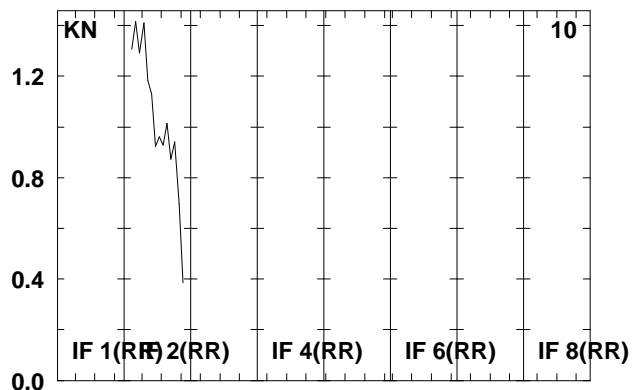
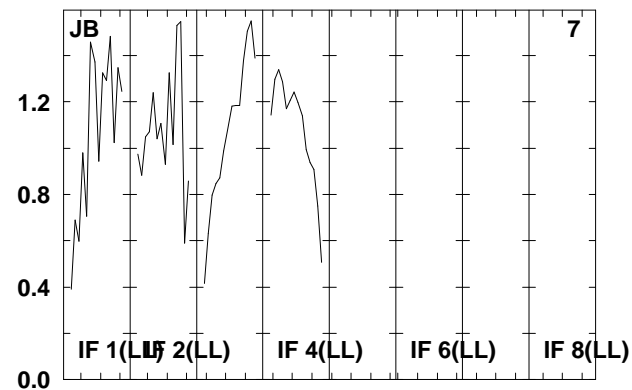
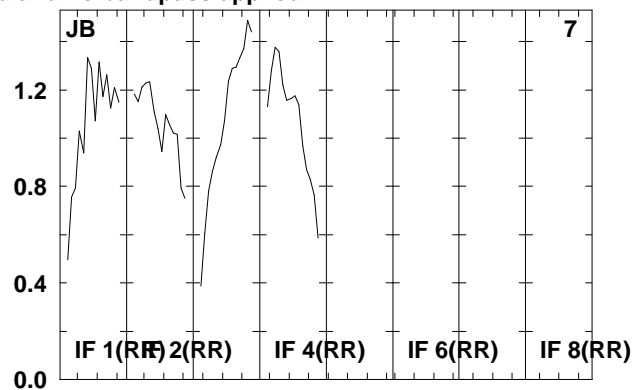
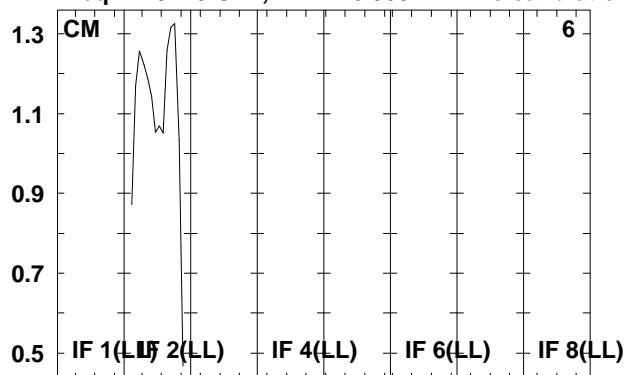

Lower frame: Real Jy

Total-power spectrum Antenna: \*

Timerange: 00/19:46:22 to 00/19:48:38

Plot file version 351 created 07-DEC-2009 16:06:51

J1912+05 RT006C.UVDATA.1

Freq = 4.9415 GHz, Bw = 16.000 MH No calibration applied and no bandpass applied

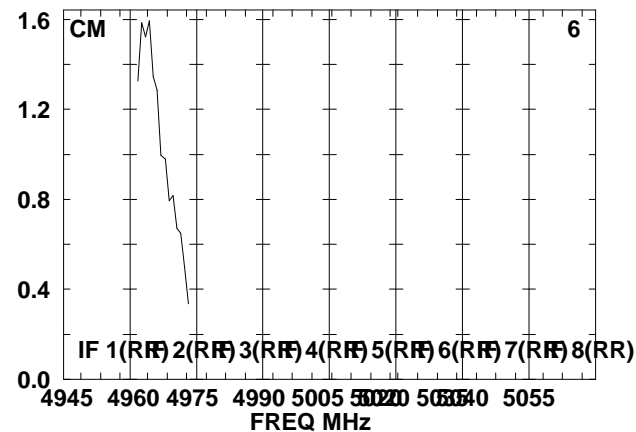
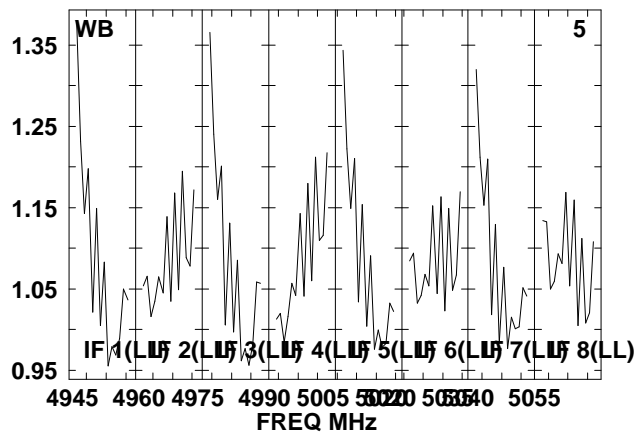
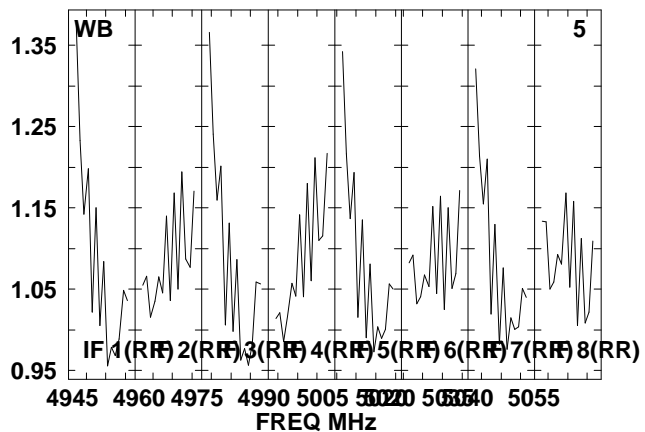
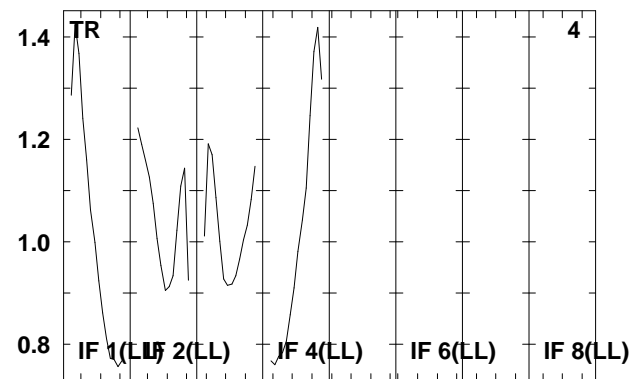
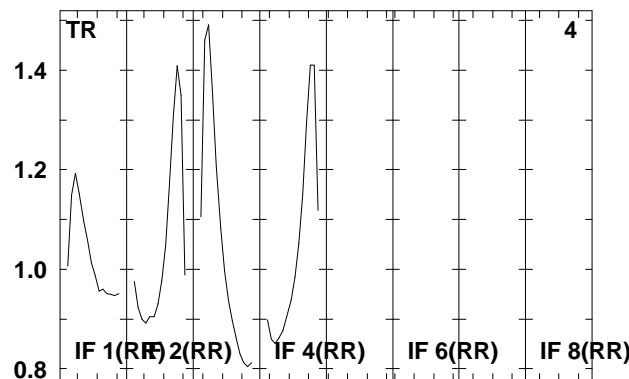
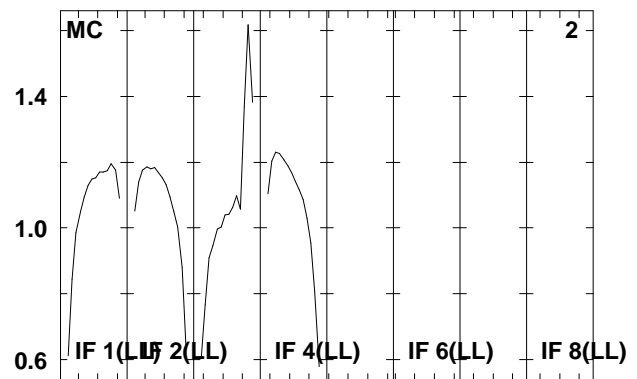
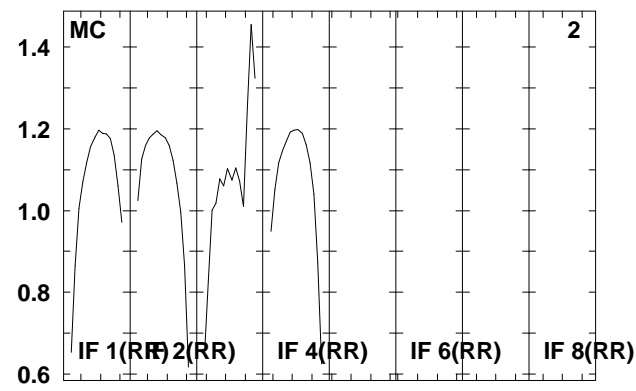
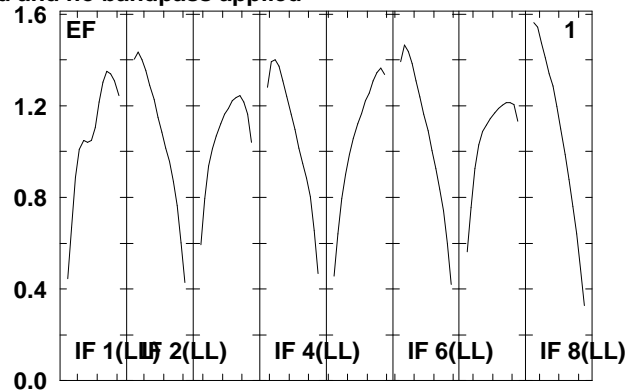
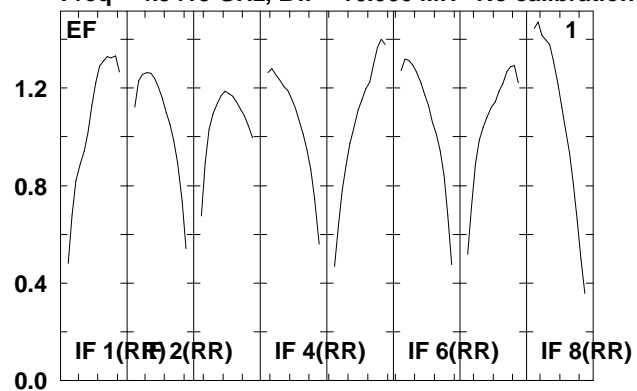

Lower frame: Real Jy  
Total-power spectrum Antenna: \*  
Timerange: 00/19:48:42 to 00/19:49:58

Plot file version 352 created 07-DEC-2009 16:06:52

J1912+05 RT006C.UVDATA.1

Freq = 4.9415 GHz, Bw = 16.000 MH No calibration applied and no bandpass applied

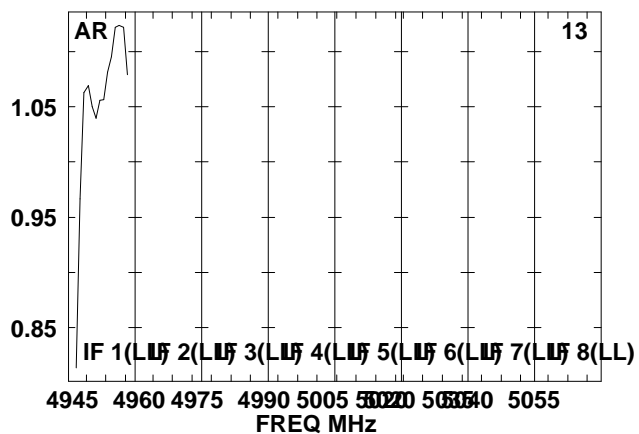
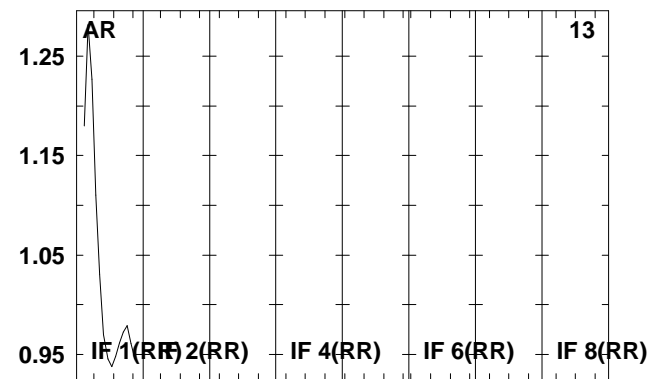
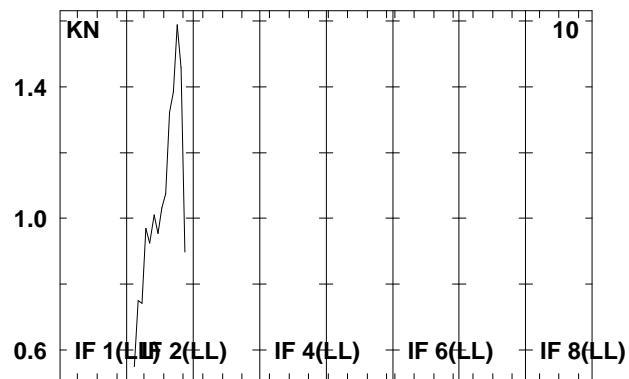
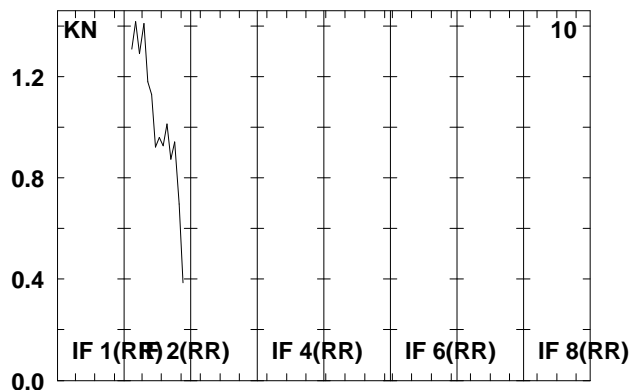
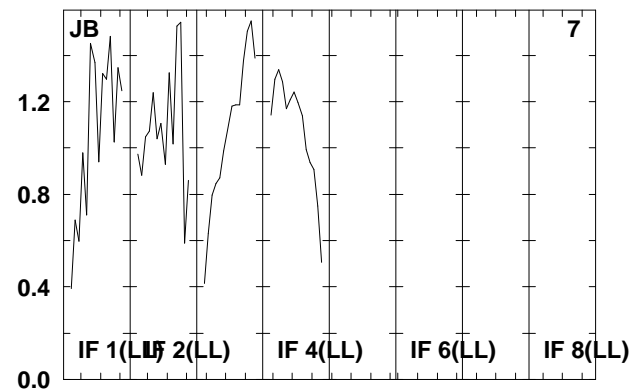
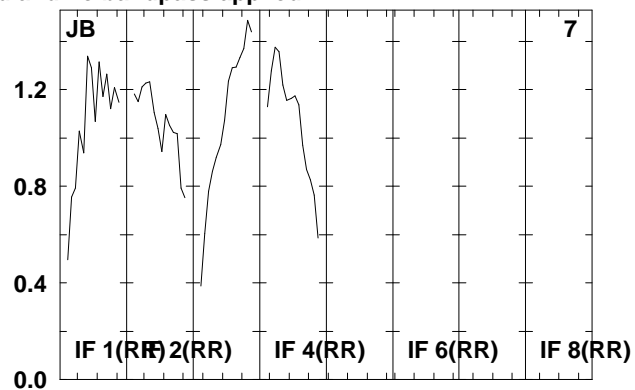
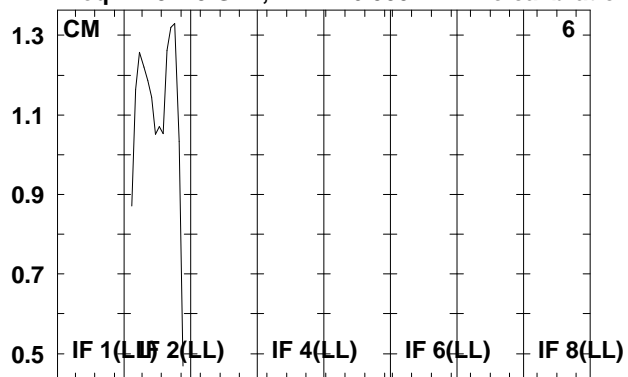

Lower frame: Real Jy

Total-power spectrum Antenna: \*

Timerange: 00/19:48:42 to 00/19:49:58



Plot file version 353 created 07-DEC-2009 16:06:52

SS433 RT006C.UVDATA.1

Freq = 4.9415 GHz, Bw = 16.000 MH No calibration applied and no bandpass applied

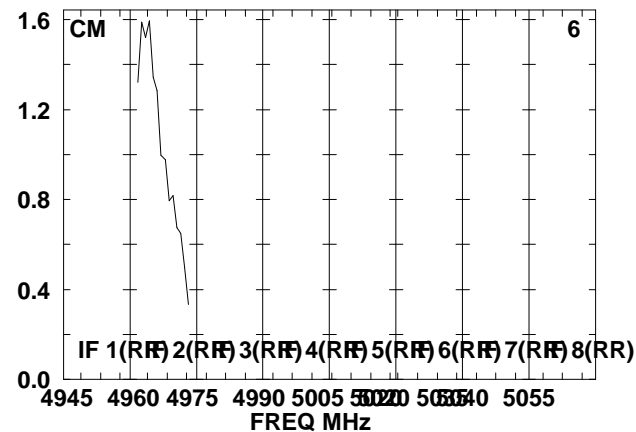
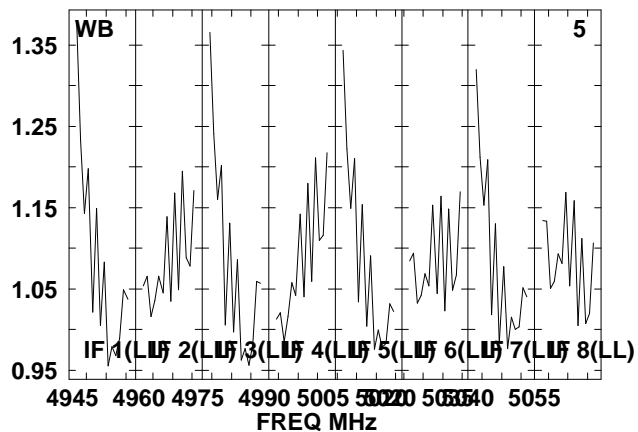
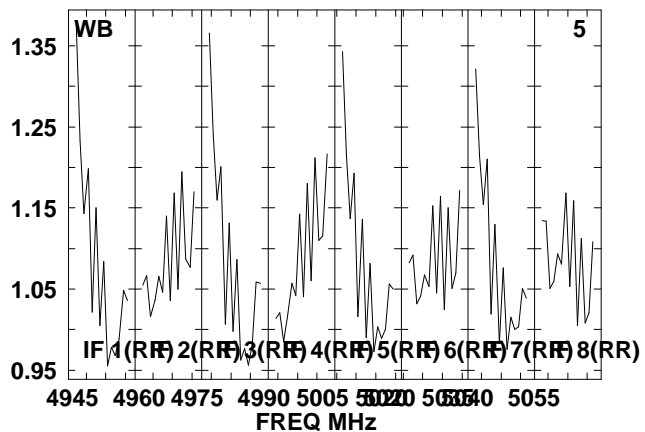
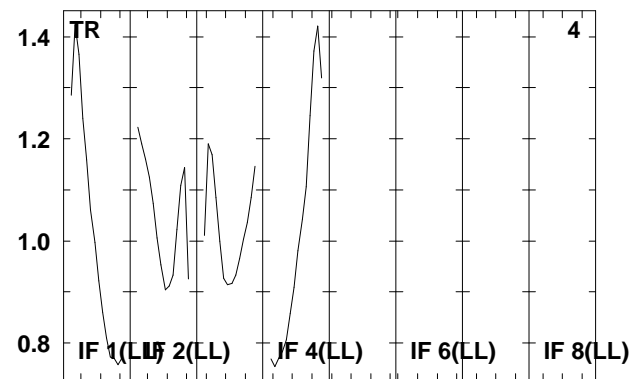
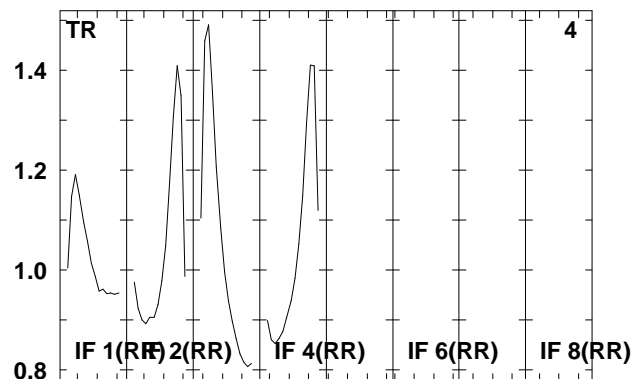
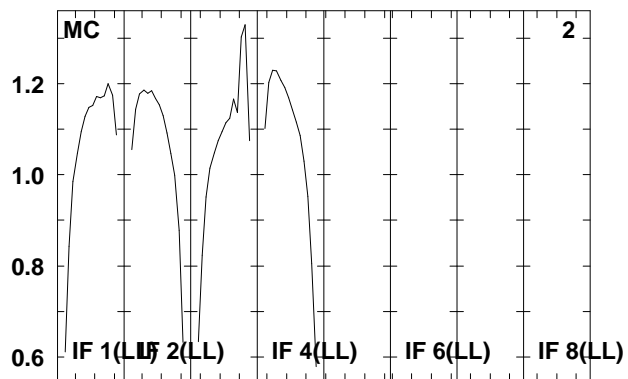
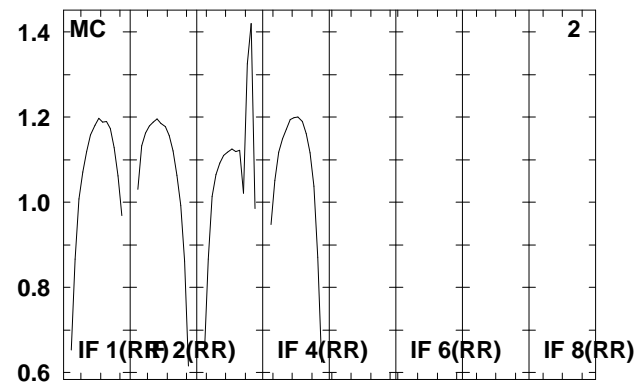
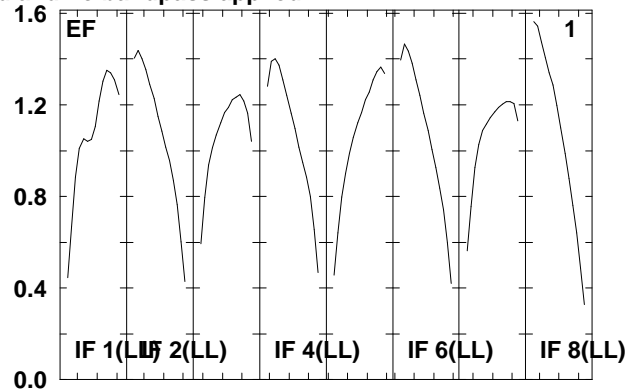
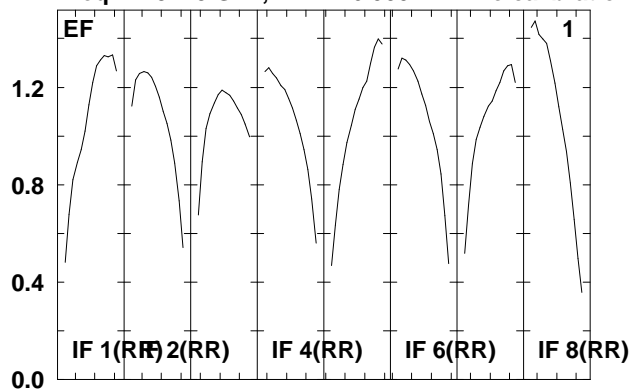

Lower frame: Real Jy

Total-power spectrum Antenna: \*

Timerange: 00/19:50:02 to 00/19:52:14

Plot file version 354 created 07-DEC-2009 16:06:52

SS433 RT006C.UVDATA.1

Freq = 4.9415 GHz, Bw = 16.000 MH No calibration applied and no bandpass applied

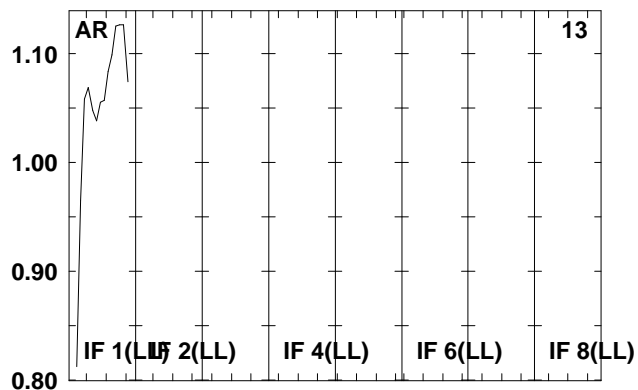
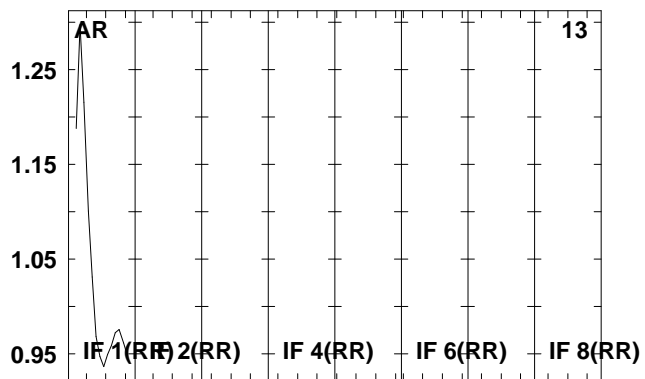
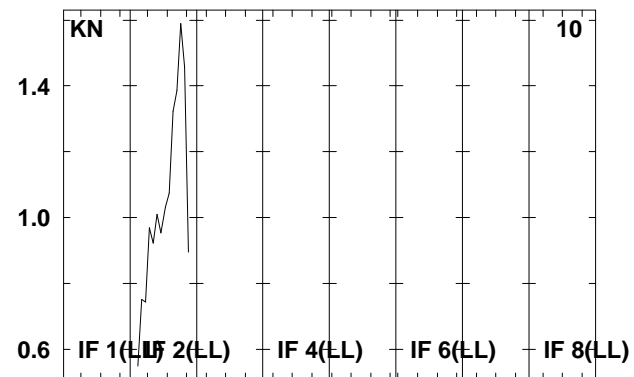
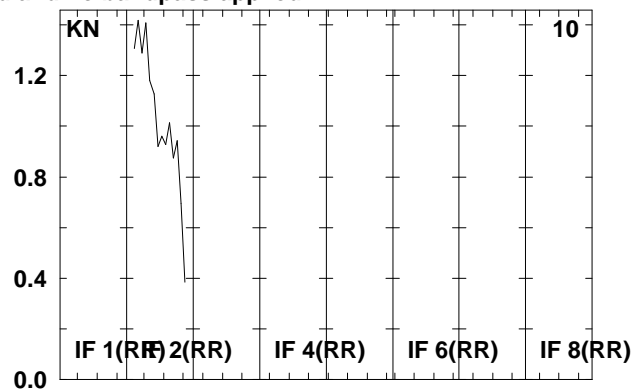
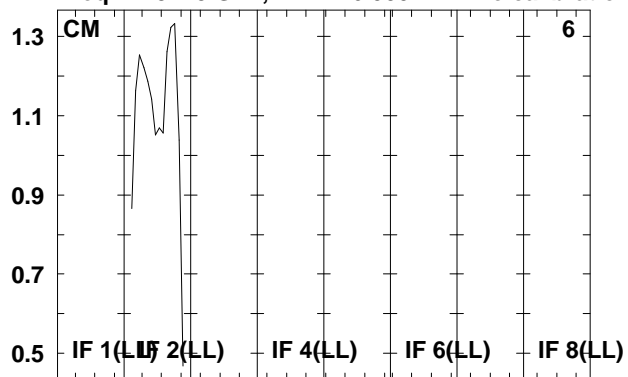

Lower frame: Real Jy  
Total-power spectrum Antenna: \*  
Timerange: 00/19:50:02 to 00/19:52:14

Plot file version 355 created 07-DEC-2009 16:06:52

J1912+05 RT006C.UVDATA.1

Freq = 4.9415 GHz, Bw = 16.000 MH No calibration applied and no bandpass applied

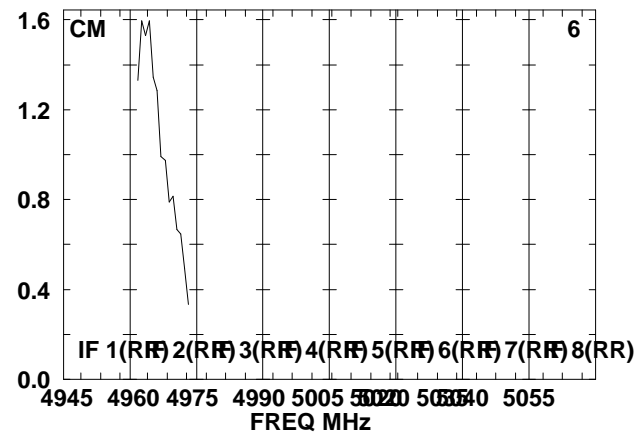
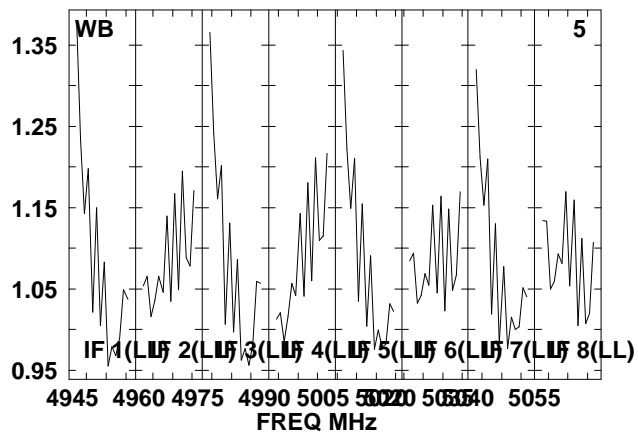
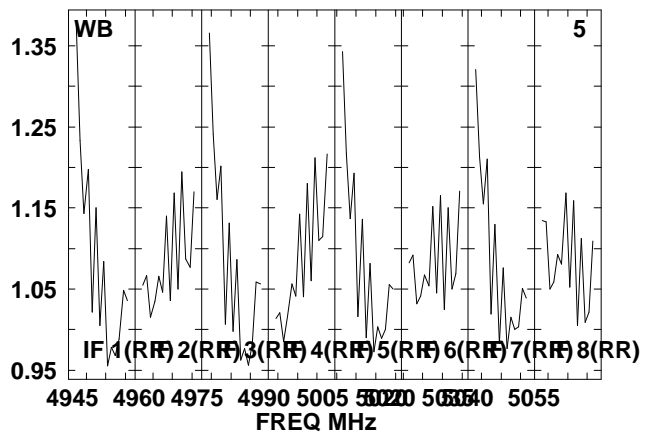
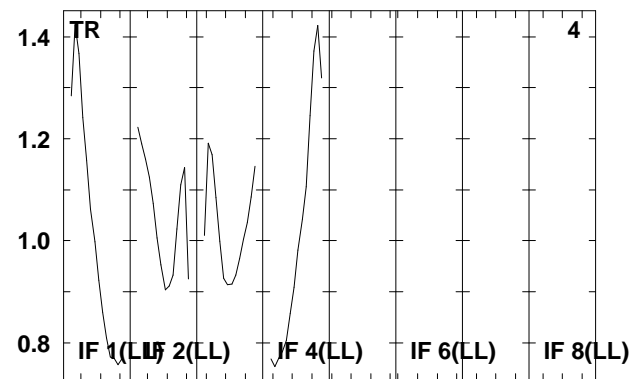
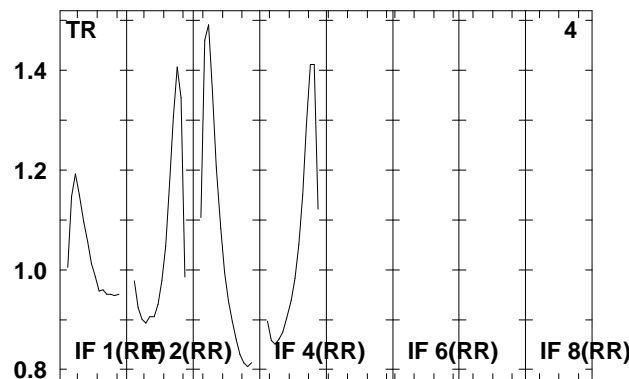
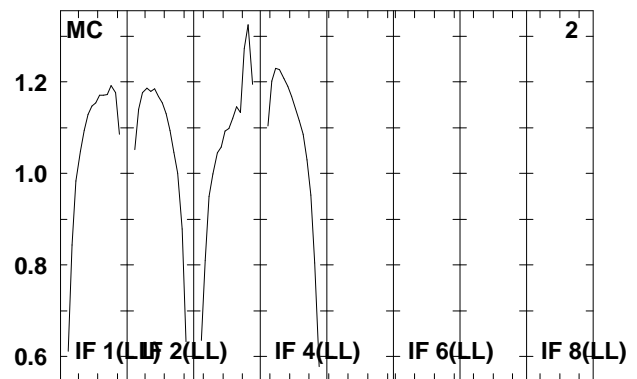
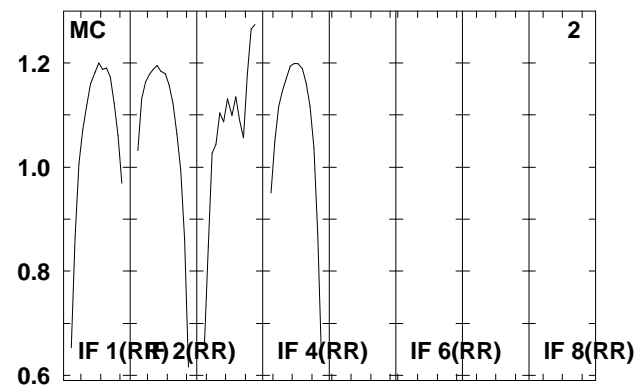
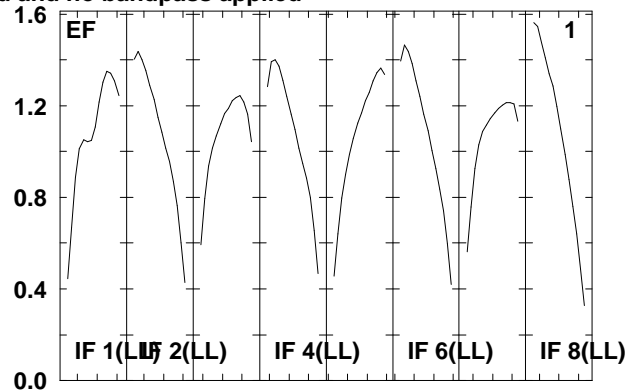
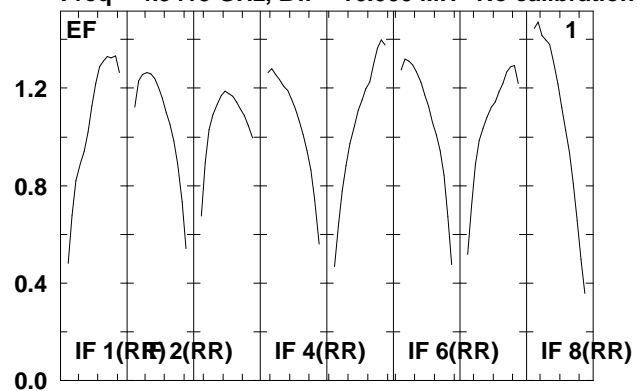

Lower frame: Real Jy  
Total-power spectrum Antenna: \*  
Timerange: 00/19:52:22 to 00/19:53:34

Plot file version 356 created 07-DEC-2009 16:06:52

J1912+05 RT006C.UVDATA.1

Freq = 4.9415 GHz, Bw = 16.000 MH No calibration applied and no bandpass applied

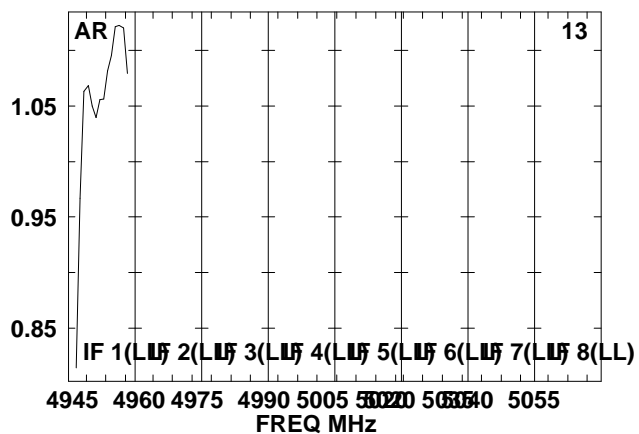
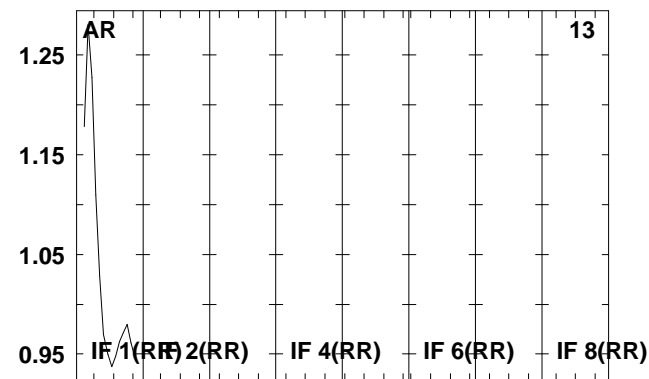
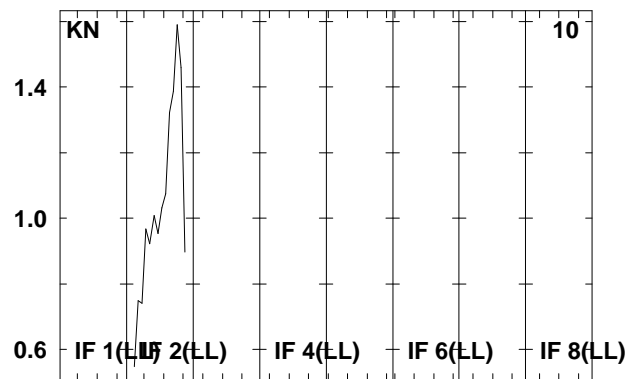
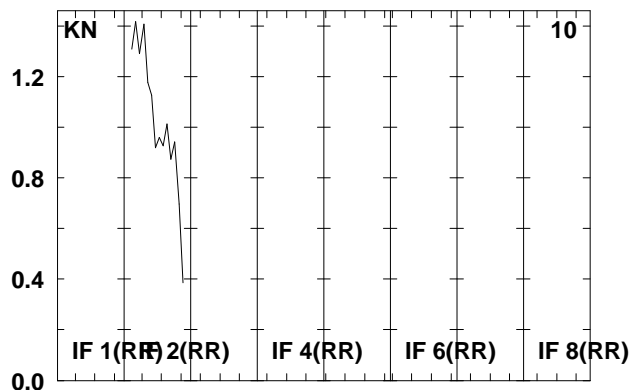
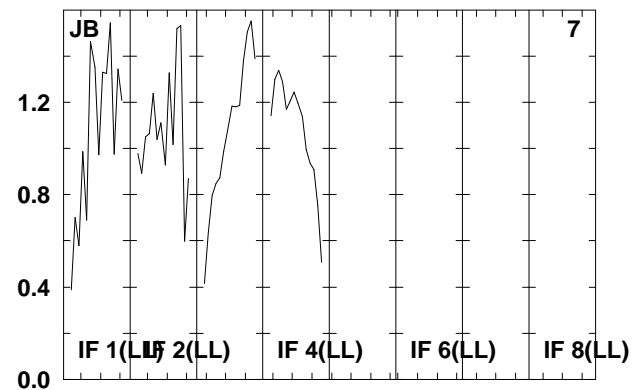
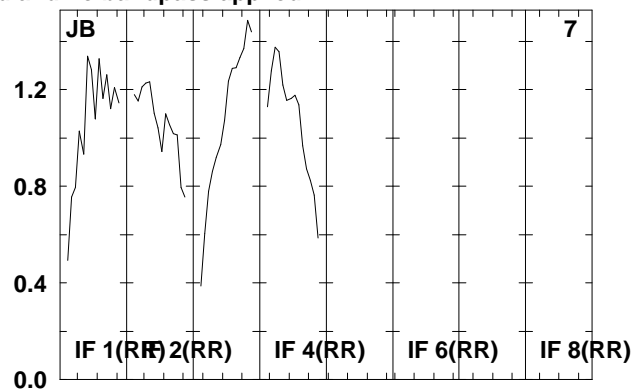
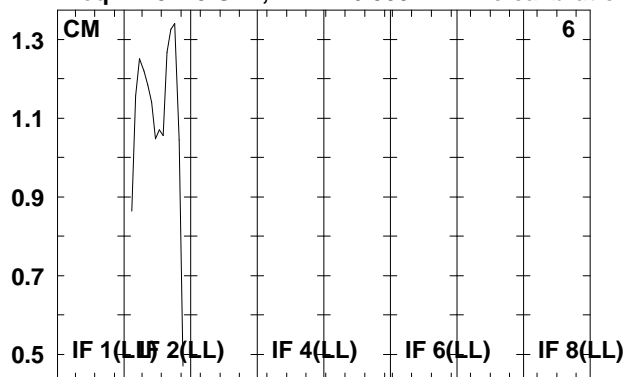

Lower frame: Real Jy

Total-power spectrum Antenna: \*

Timerange: 00/19:52:22 to 00/19:53:34

Plot file version 357 created 07-DEC-2009 16:06:52

SS433 RT006C.UVDATA.1

Freq = 4.9415 GHz, Bw = 16.000 MH No calibration applied and no bandpass applied

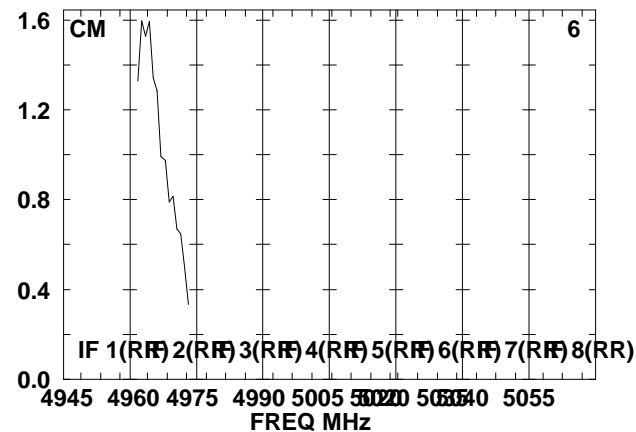
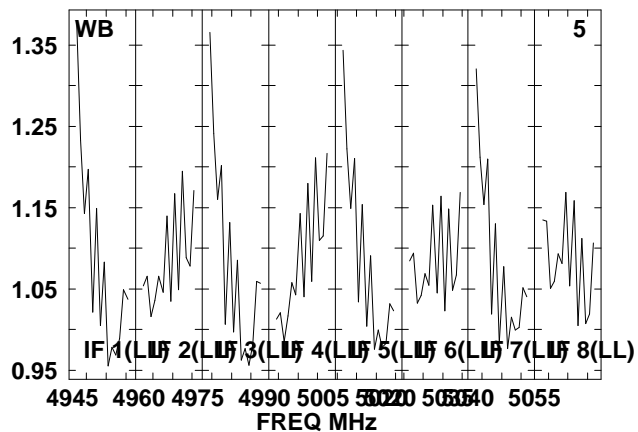
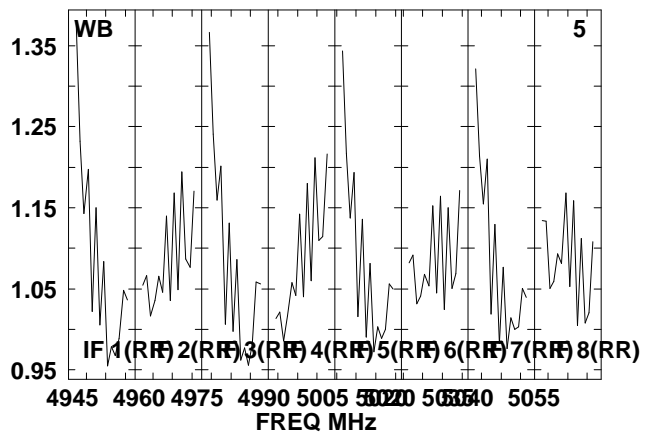
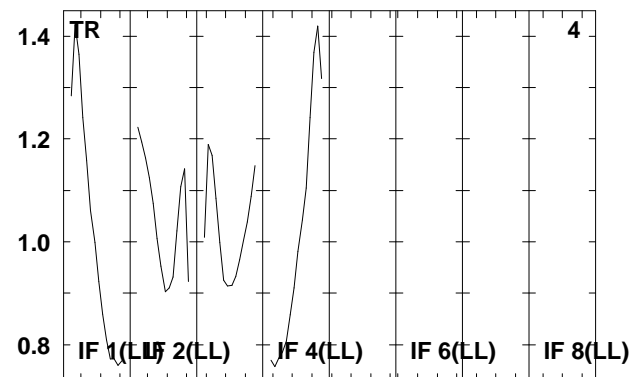
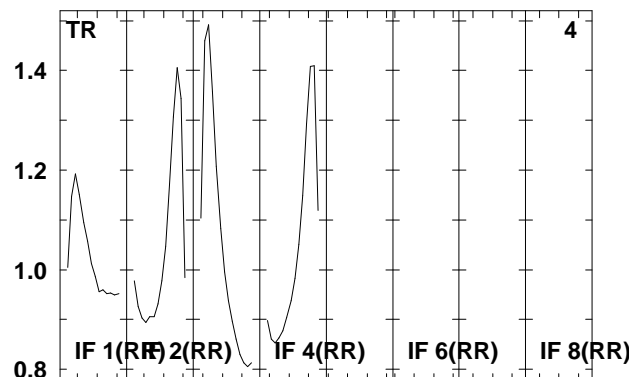
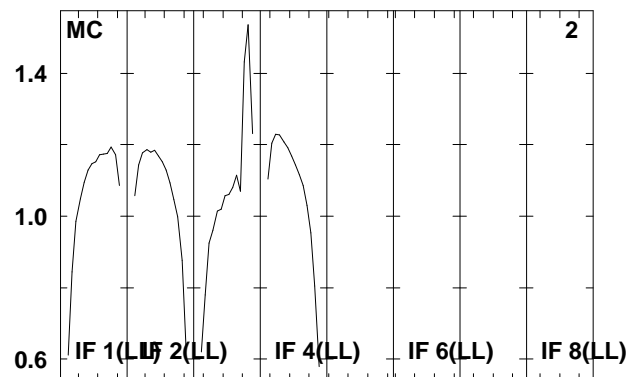
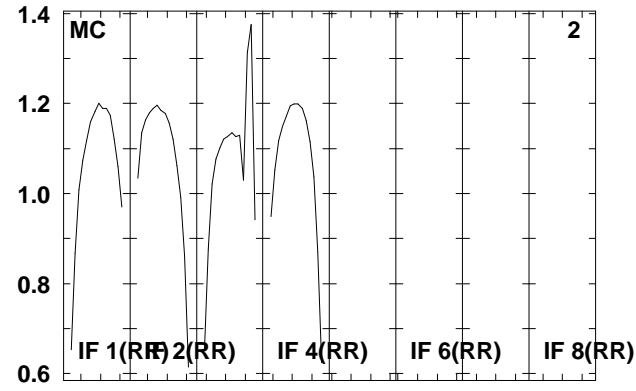
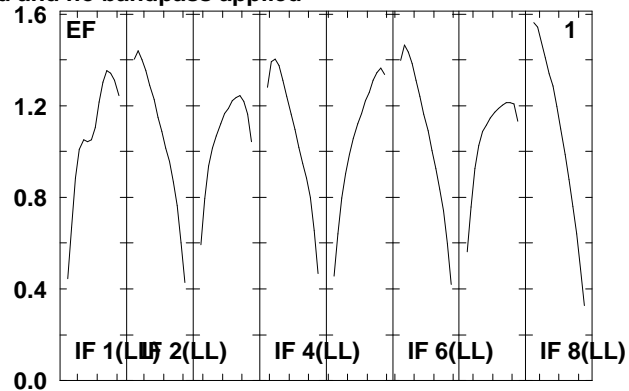
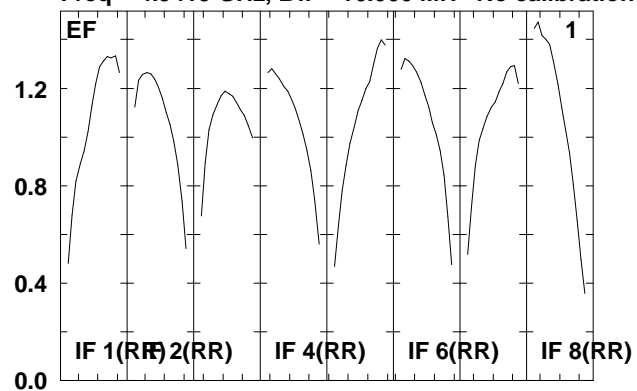

Lower frame: Real Jy  
Total-power spectrum Antenna: \*  
Timerange: 00/19:53:50 to 00/19:55:58

Plot file version 358 created 07-DEC-2009 16:06:53

SS433 RT006C.UVDATA.1

Freq = 4.9415 GHz, Bw = 16.000 MH No calibration applied and no bandpass applied

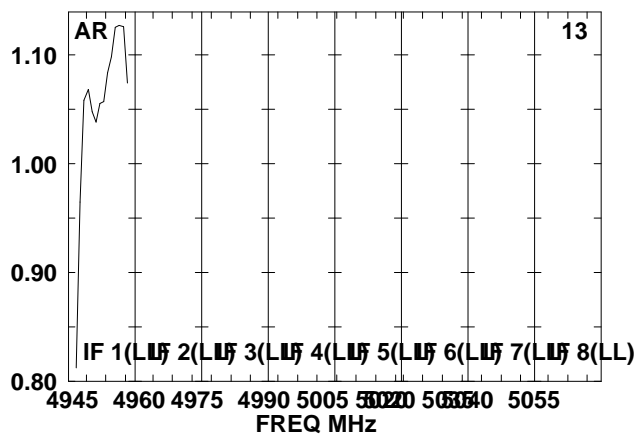
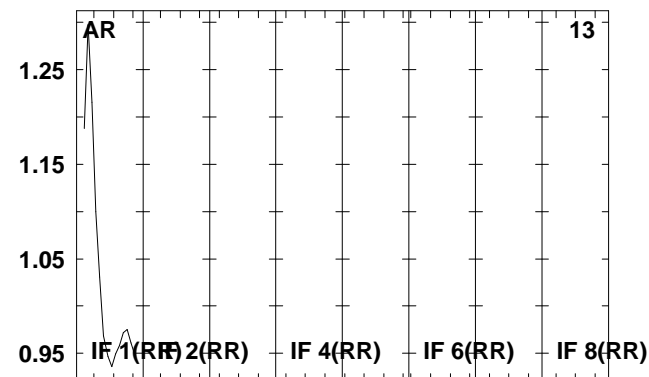
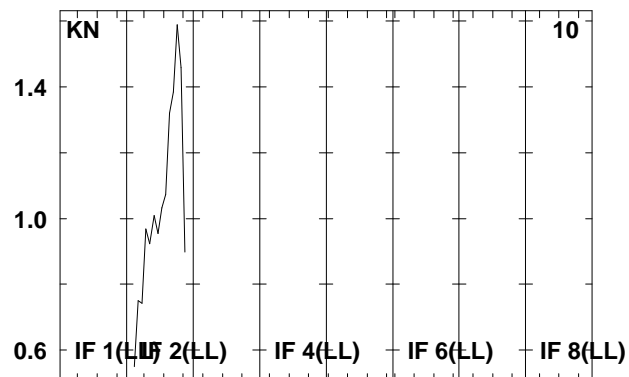
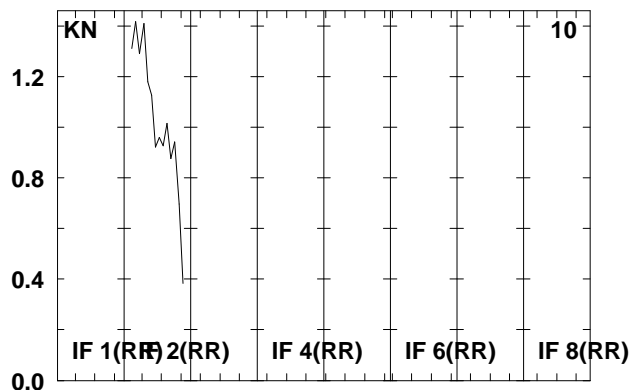
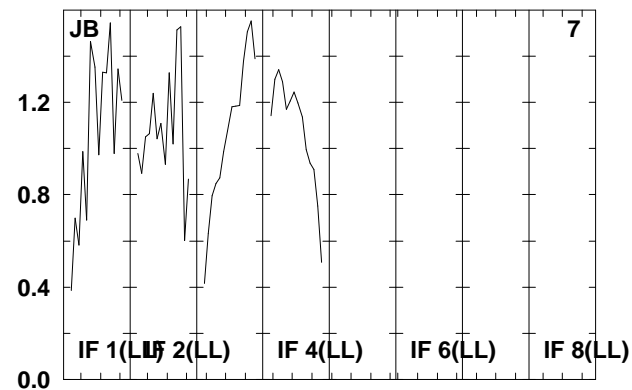
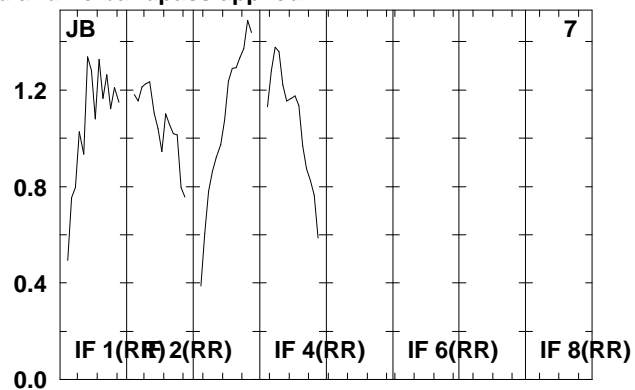
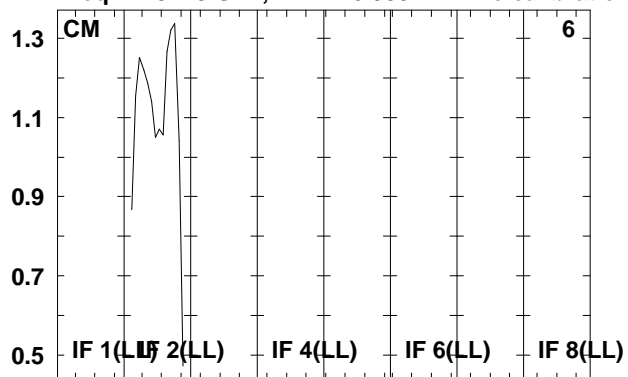

Lower frame: Real Jy

Total-power spectrum Antenna: \*

Timerange: 00/19:53:50 to 00/19:55:58

Plot file version 359 created 07-DEC-2009 16:06:53

J1912+05 RT006C.UVDATA.1

Freq = 4.9415 GHz, Bw = 16.000 MH No calibration applied and no bandpass applied

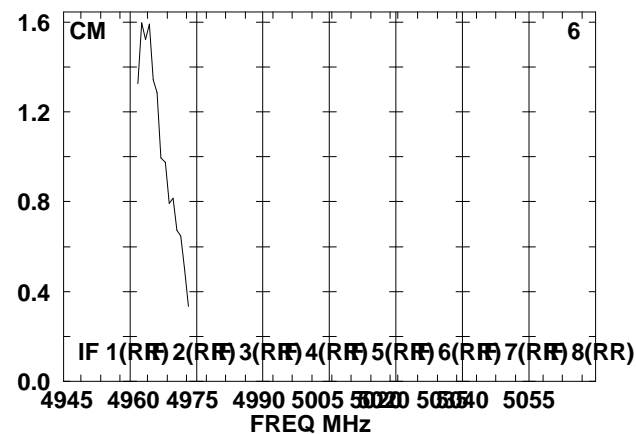
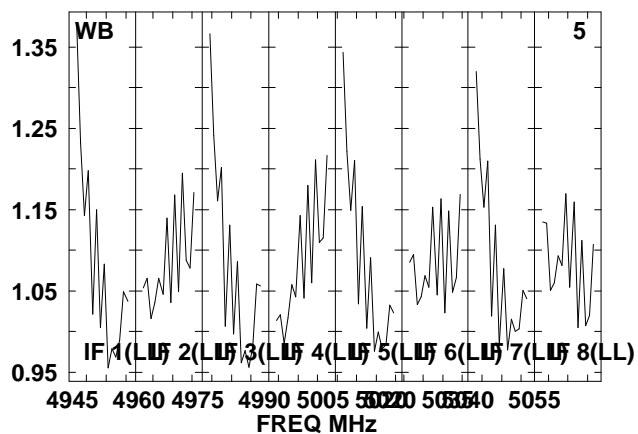
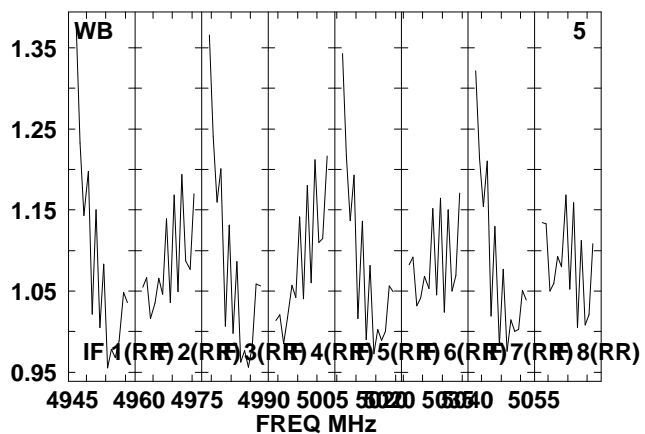
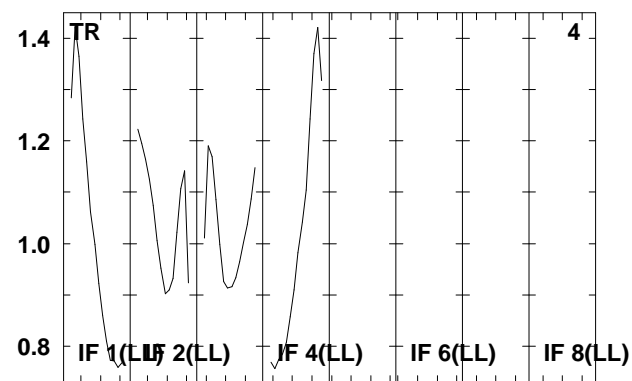
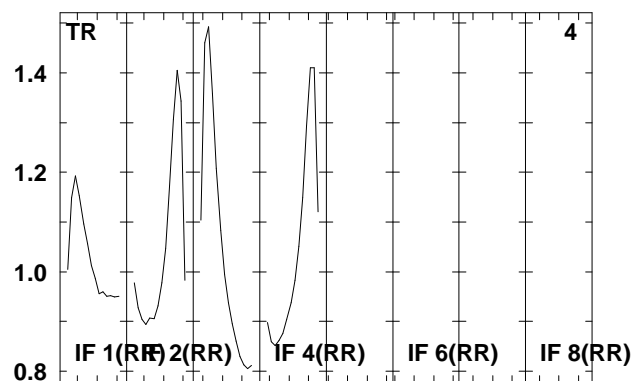
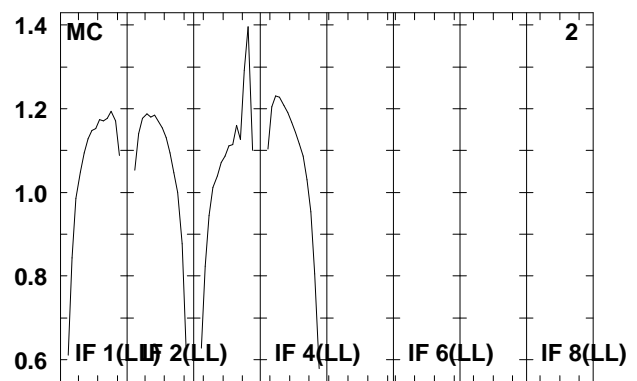
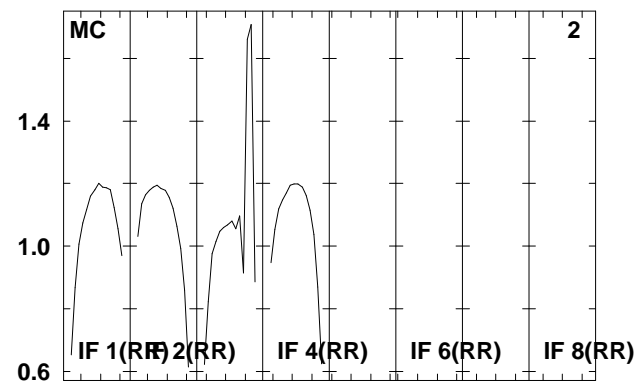
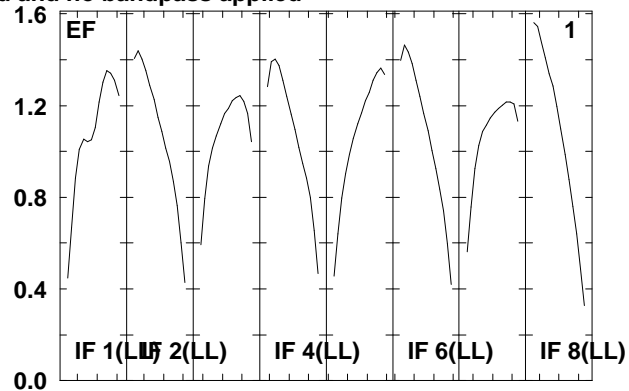
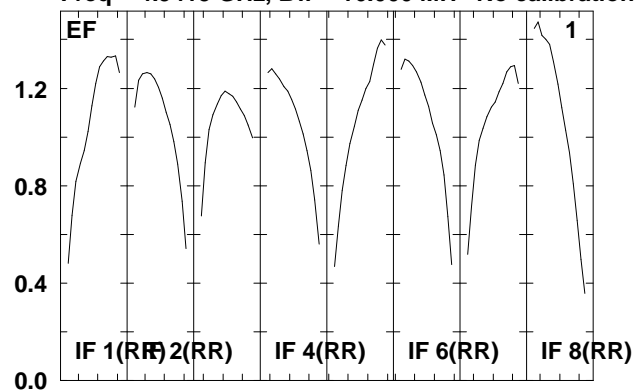

Lower frame: Real Jy

Total-power spectrum Antenna: \*

Timerange: 00/19:56:02 to 00/19:57:18

Plot file version 360 created 07-DEC-2009 16:06:53

J1912+05 RT006C.UVDATA.1

Freq = 4.9415 GHz, Bw = 16.000 MH No calibration applied and no bandpass applied

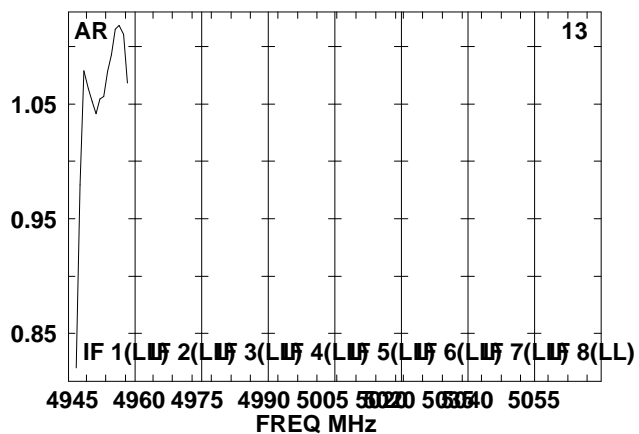
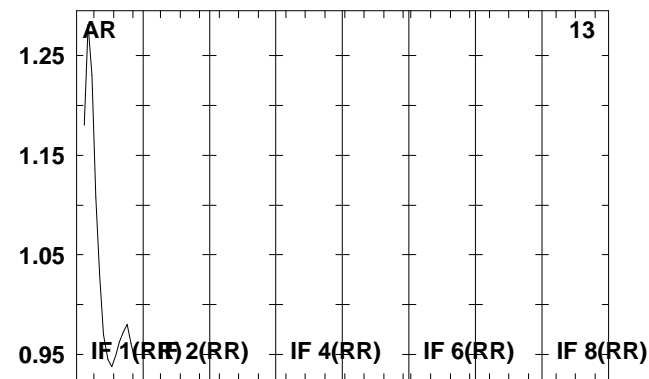
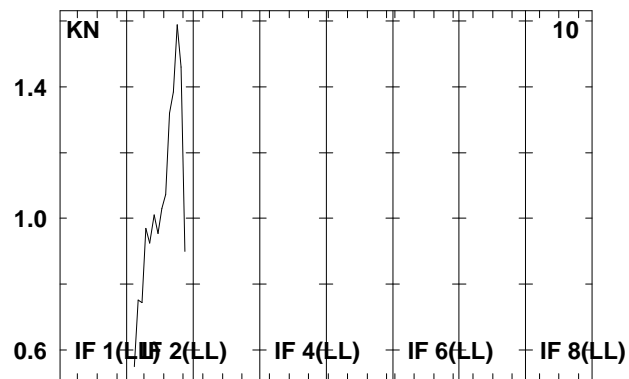
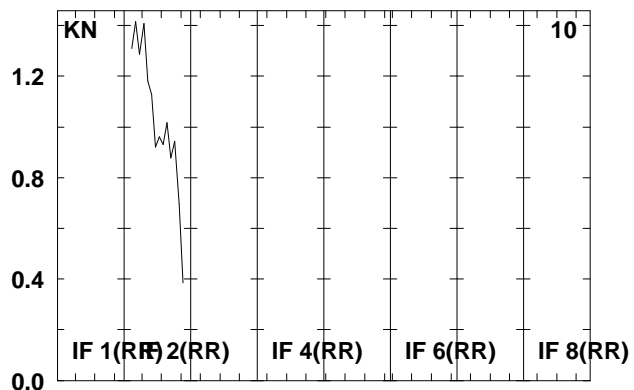
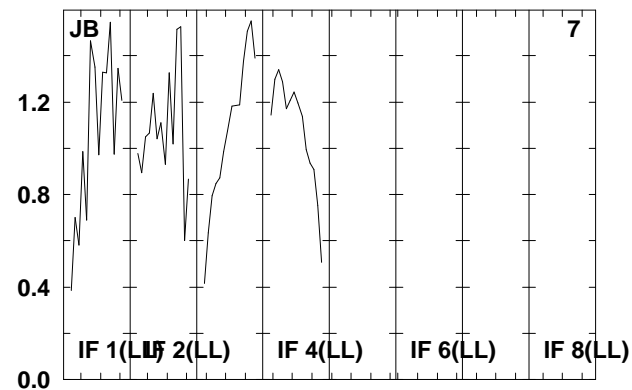
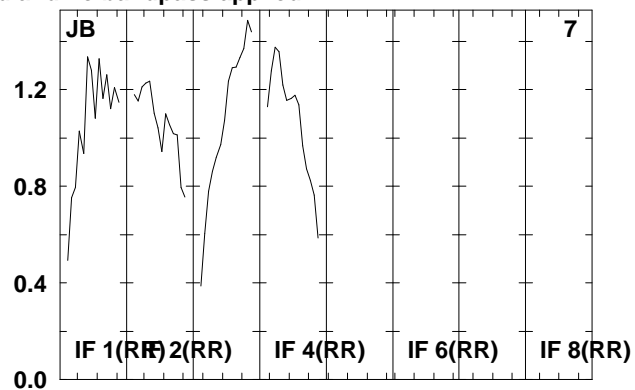
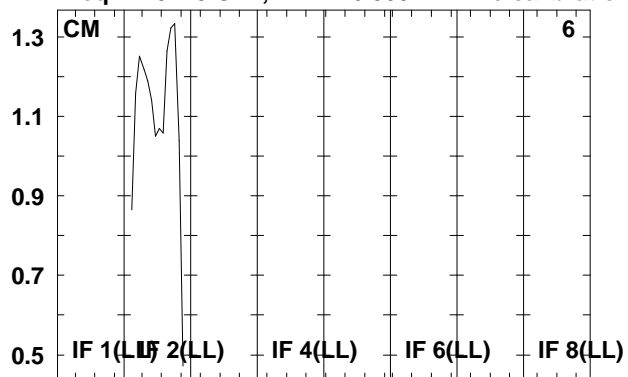

Lower frame: Real Jy

Total-power spectrum Antenna: \*

Timerange: 00/19:56:02 to 00/19:57:18



Plot file version 361 created 07-DEC-2009 16:06:54

SS433 RT006C.UVDATA.1

Freq = 4.9415 GHz, Bw = 16.000 MH No calibration applied and no bandpass applied

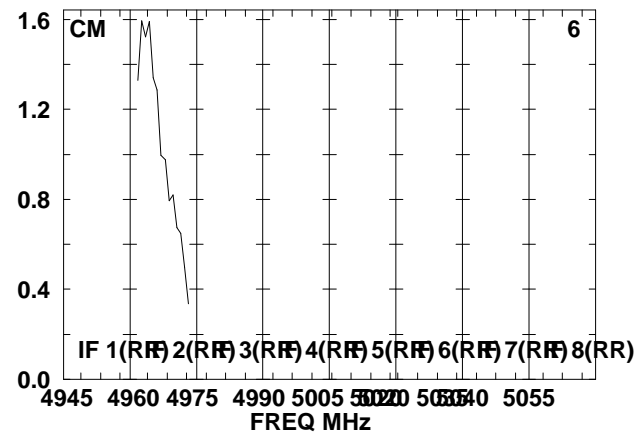
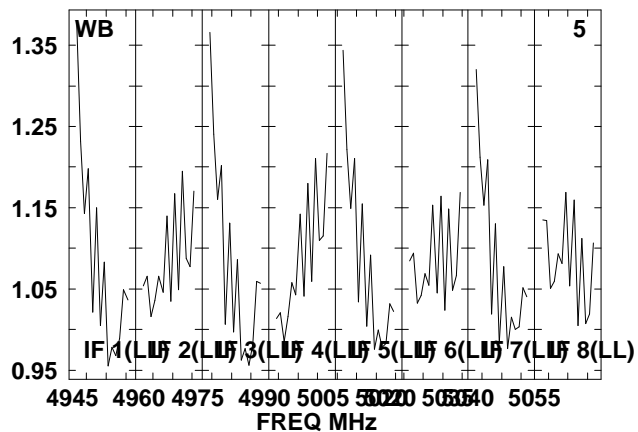
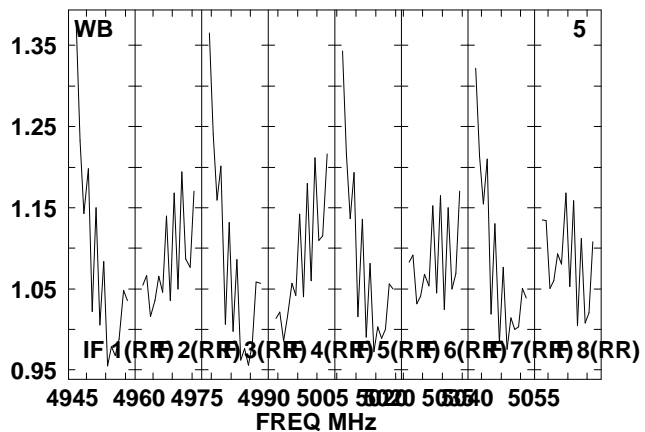
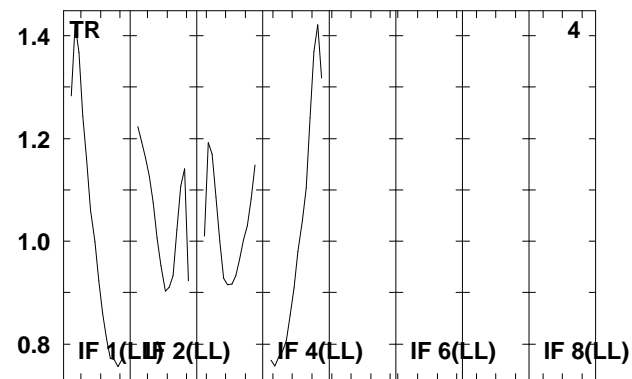
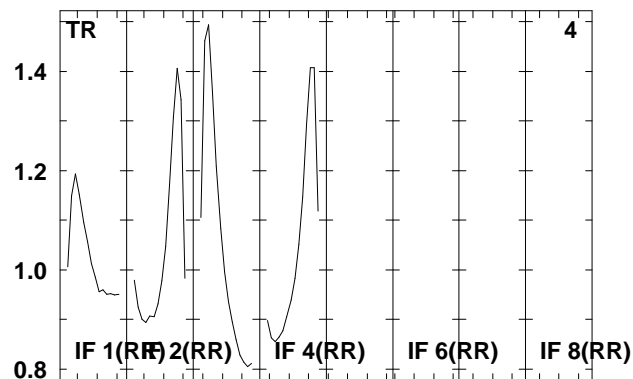
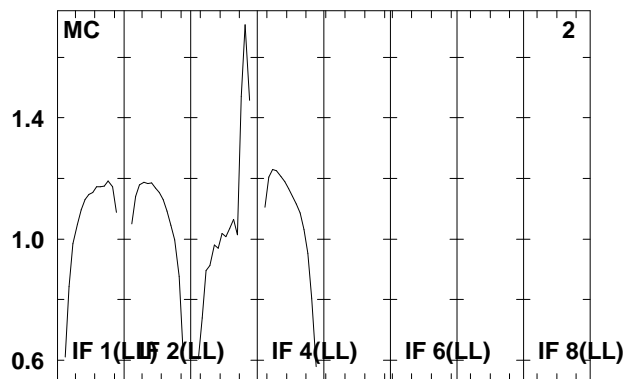
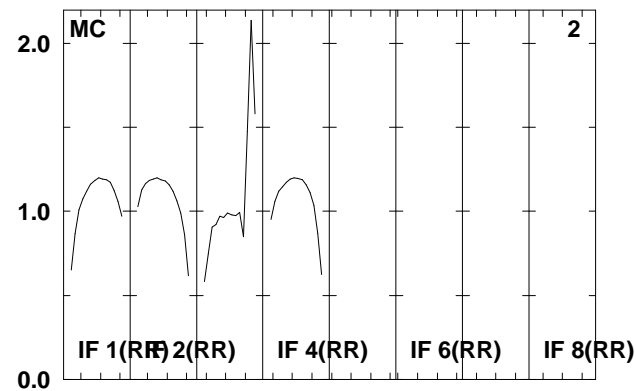
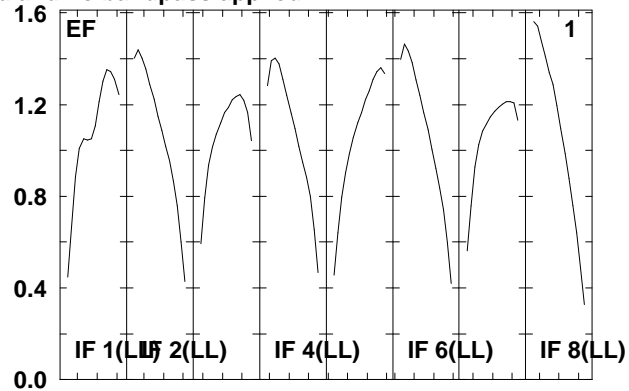
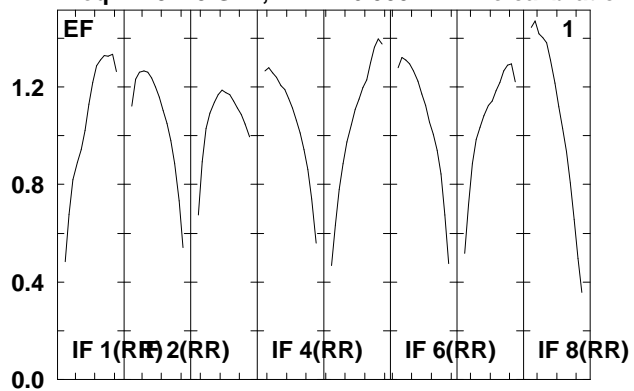

Lower frame: Real Jy  
Total-power spectrum Antenna: \*  
Timerange: 00/19:57:22 to 00/19:59:38

Plot file version 362 created 07-DEC-2009 16:06:54

SS433 RT006C.UVDATA.1

Freq = 4.9415 GHz, Bw = 16.000 MH No calibration applied and no bandpass applied

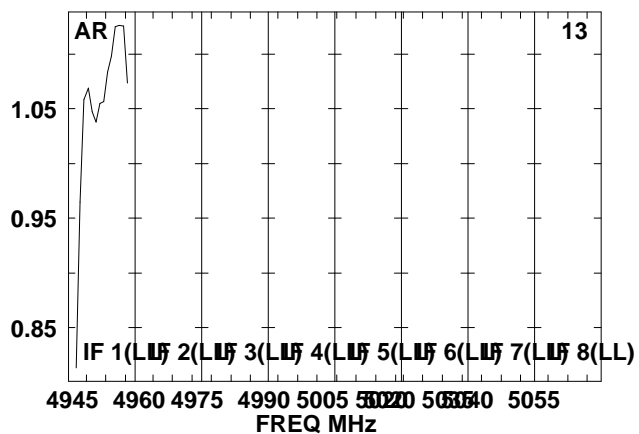
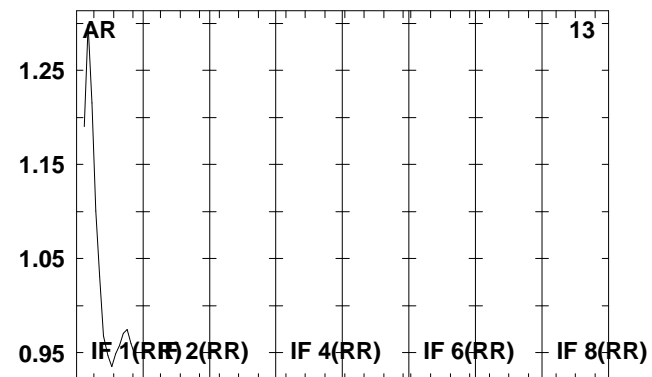
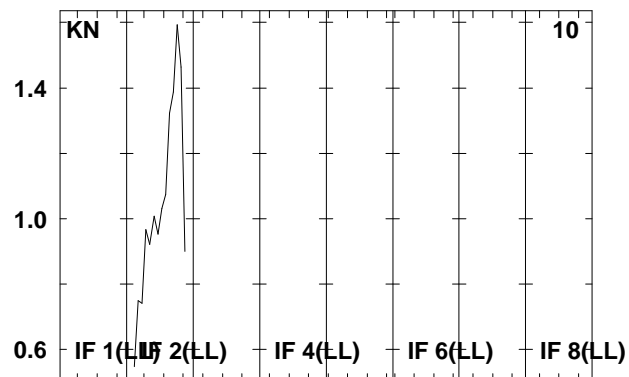
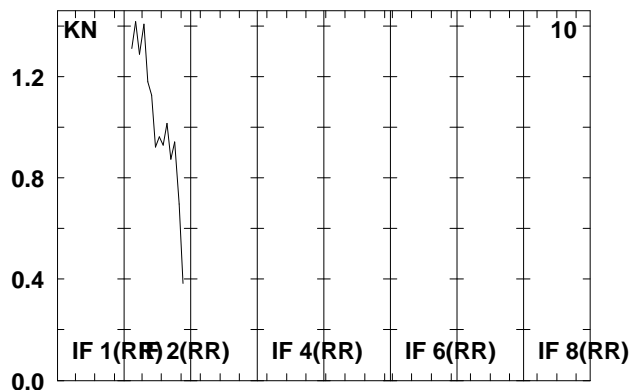
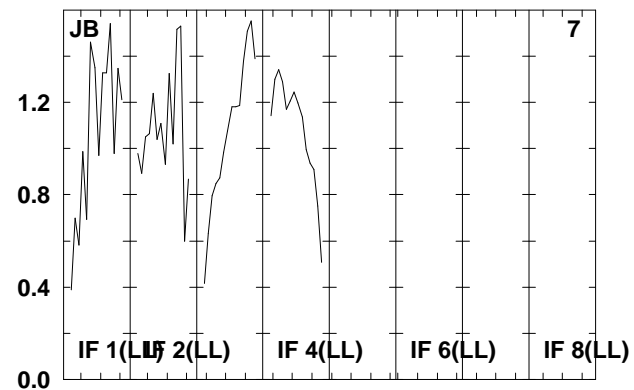
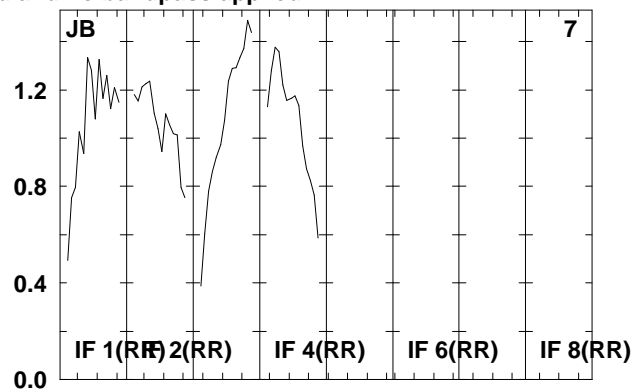
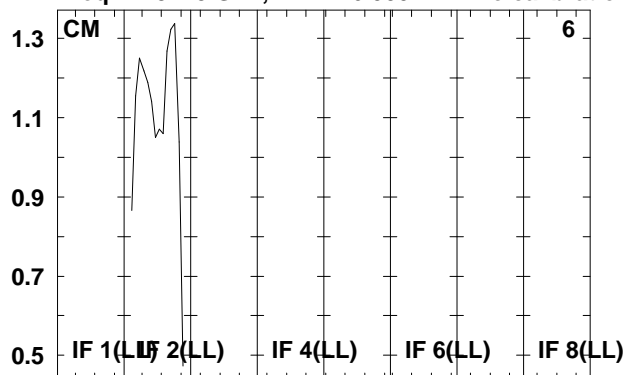

Lower frame: Real Jy

Total-power spectrum Antenna: \*

Timerange: 00/19:57:22 to 00/19:59:38

Plot file version 363 created 07-DEC-2009 16:06:54

J1912+05 RT006C.UVDATA.1

Freq = 4.9415 GHz, Bw = 16.000 MH No calibration applied and no bandpass applied

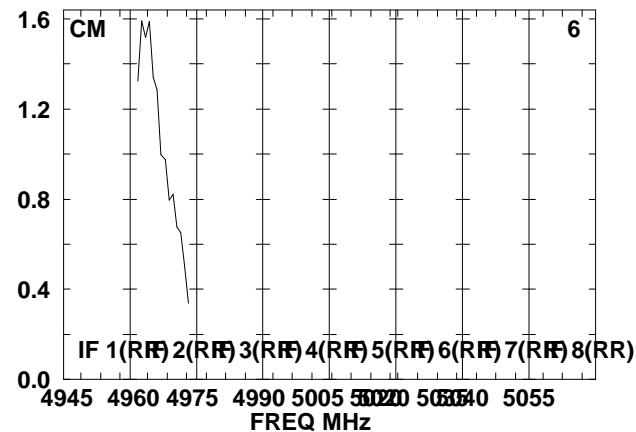
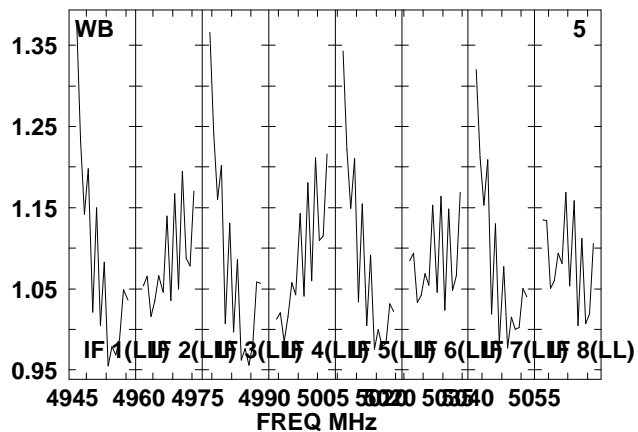
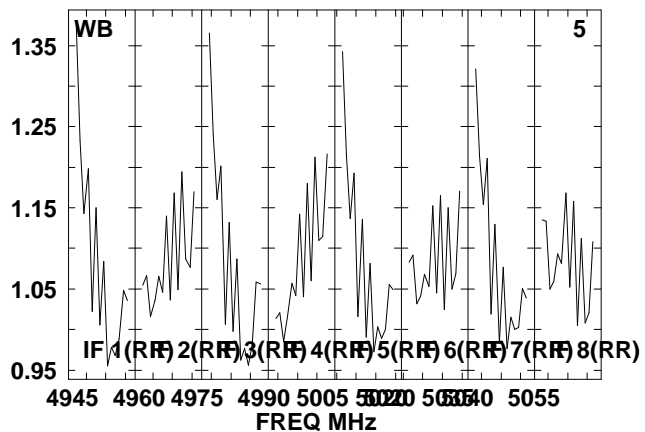
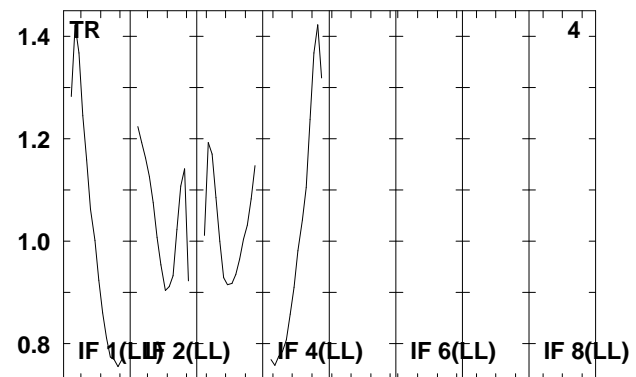
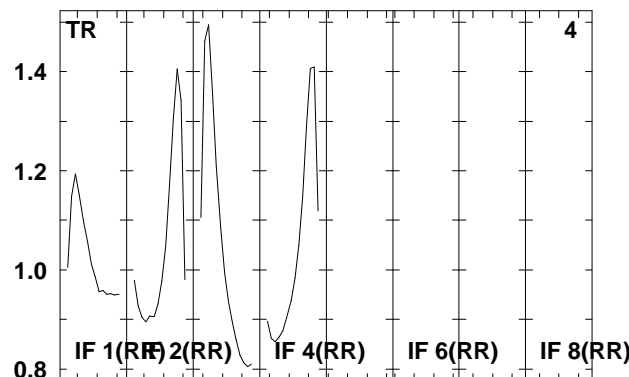
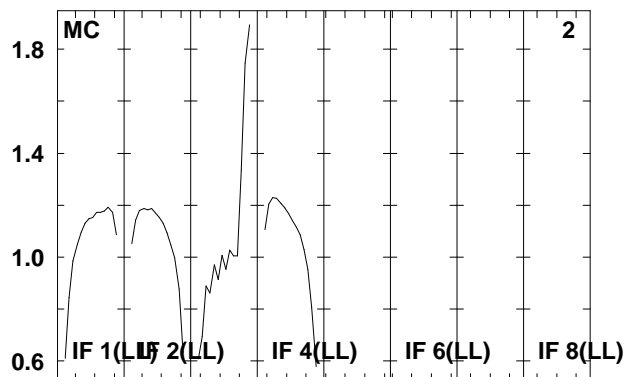
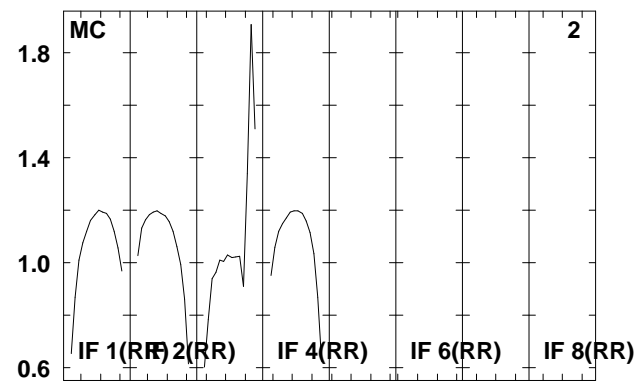
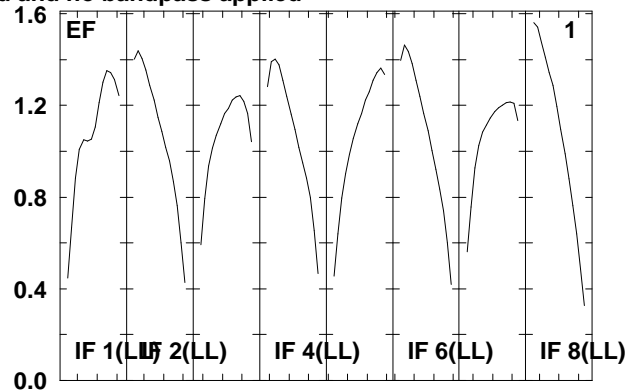
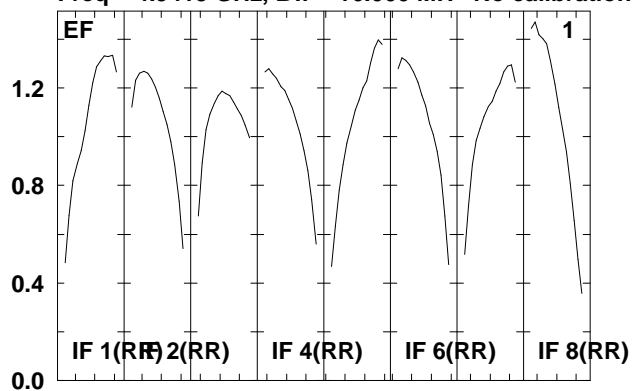

Lower frame: Real Jy  
Total-power spectrum Antenna: \*  
Timerange: 00/20:00:42 to 00/20:01:38

Plot file version 364 created 07-DEC-2009 16:06:54

J1912+05 RT006C.UVDATA.1

Freq = 4.9415 GHz, Bw = 16.000 MH No calibration applied and no bandpass applied

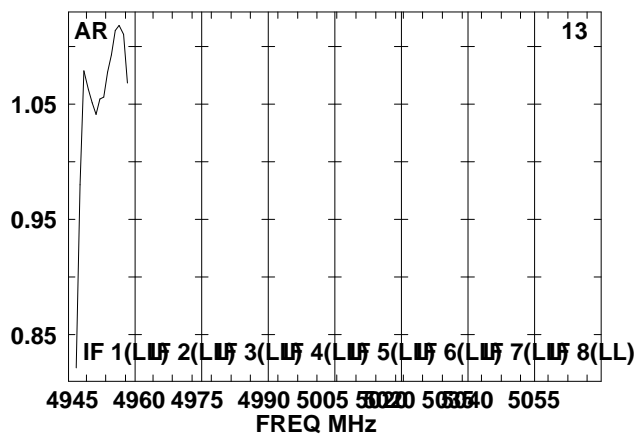
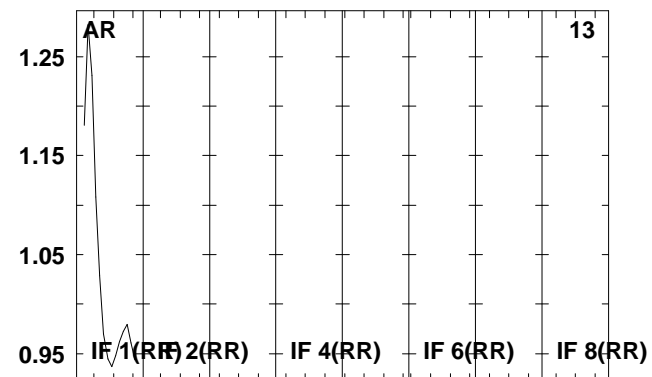
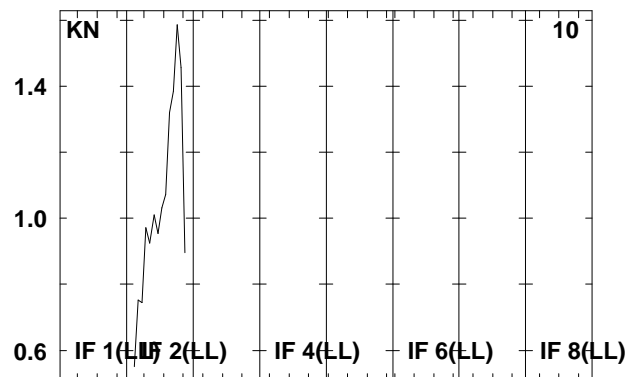
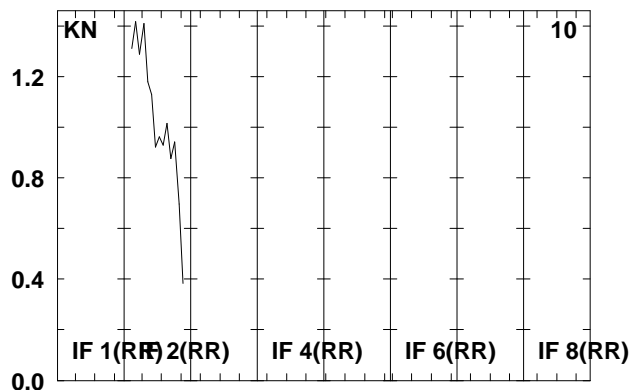
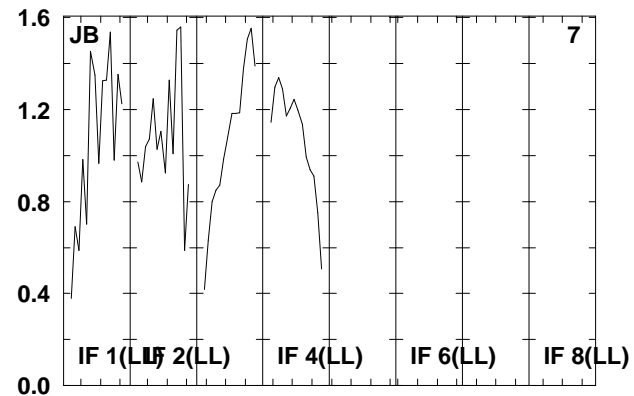
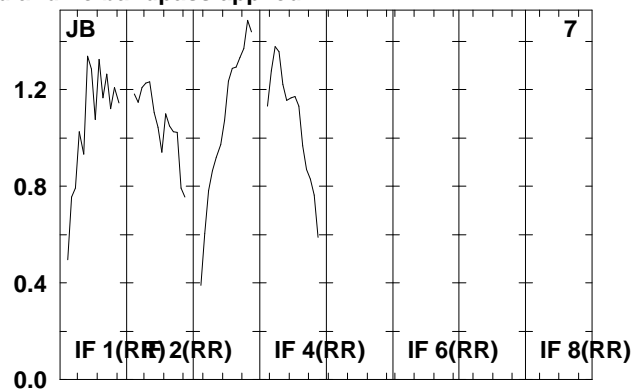
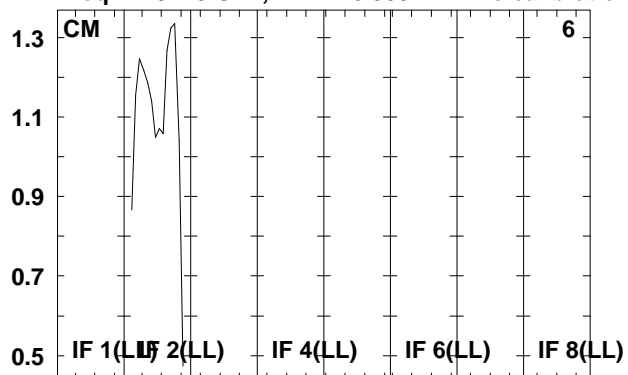

Lower frame: Real Jy

Total-power spectrum Antenna: \*

Timerange: 00/20:00:42 to 00/20:01:38

Plot file version 365 created 07-DEC-2009 16:06:54

SS433 RT006C.UVDATA.1

Freq = 4.9415 GHz, Bw = 16.000 MH No calibration applied and no bandpass applied

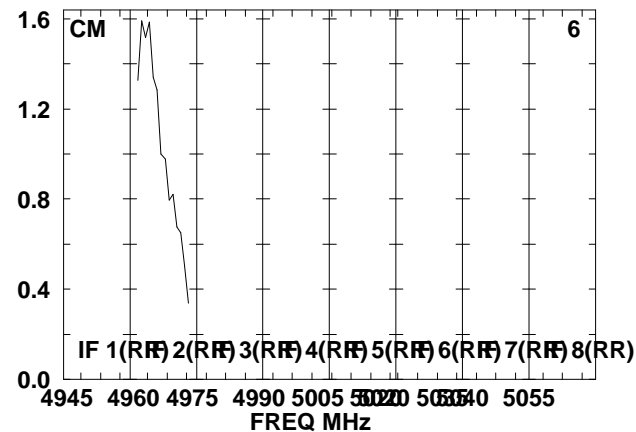
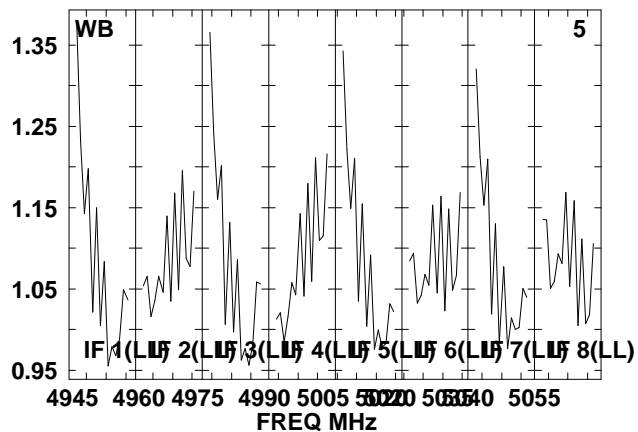
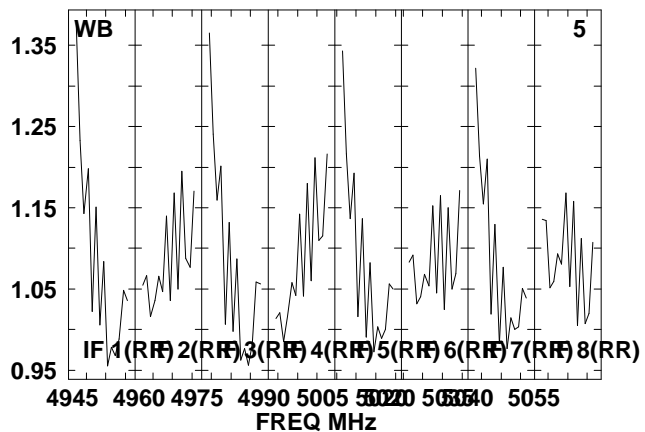
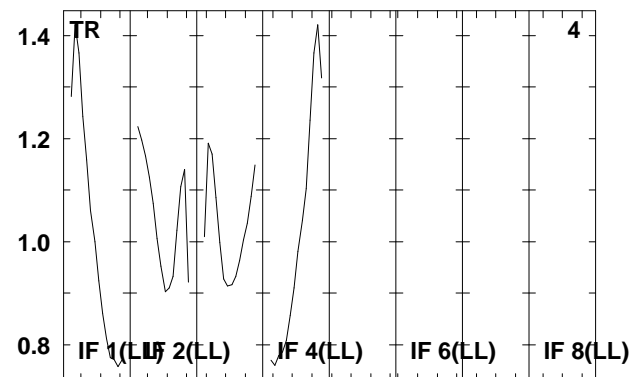
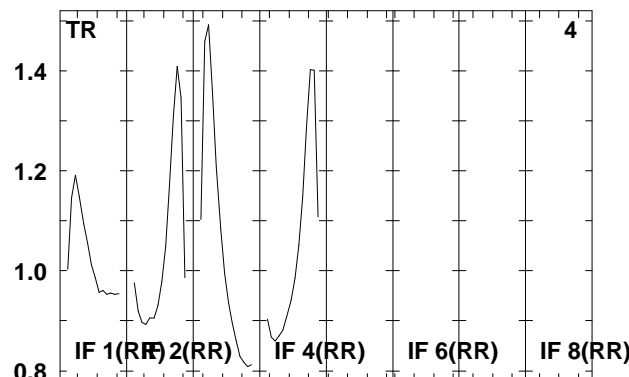
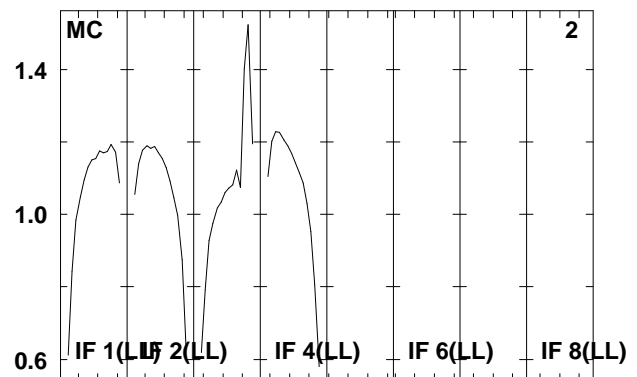
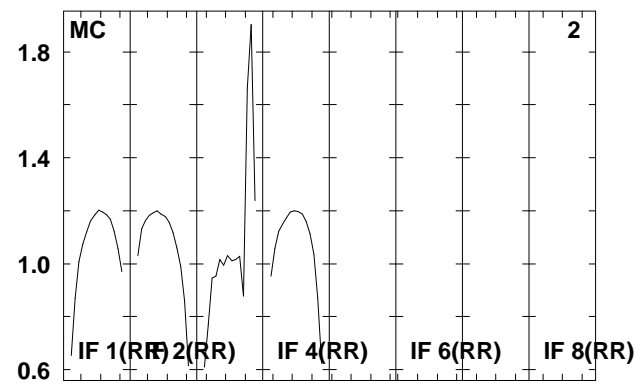
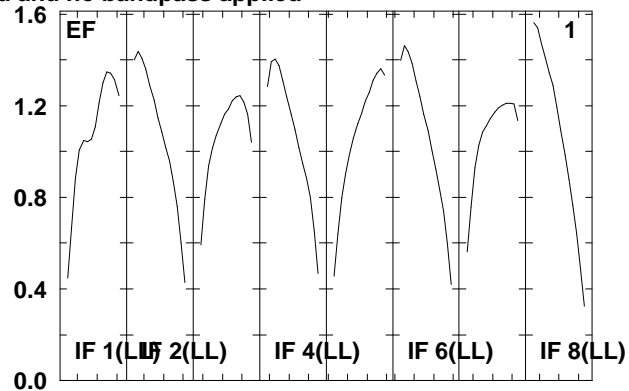
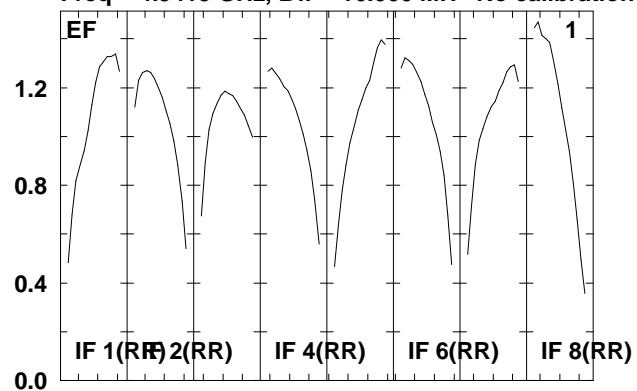

Lower frame: Real Jy

Total-power spectrum Antenna: \*

Timerange: 00/20:01:42 to 00/20:03:58

Plot file version 366 created 07-DEC-2009 16:06:55

SS433 RT006C.UVDATA.1

Freq = 4.9415 GHz, Bw = 16.000 MH No calibration applied and no bandpass applied

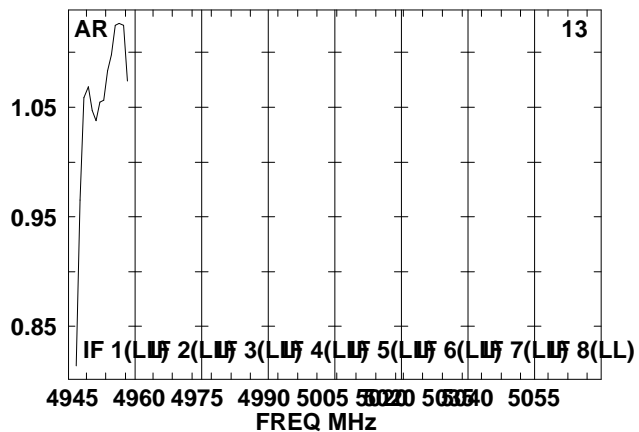
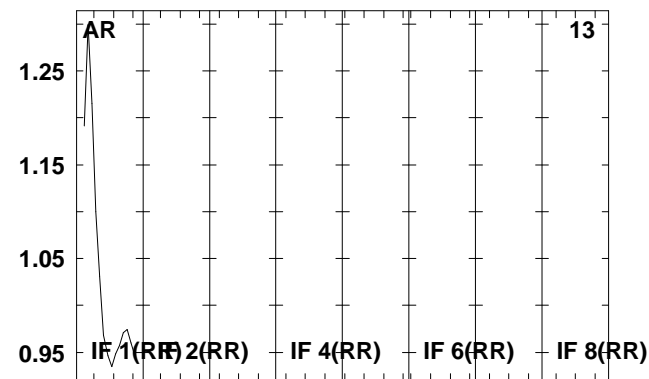
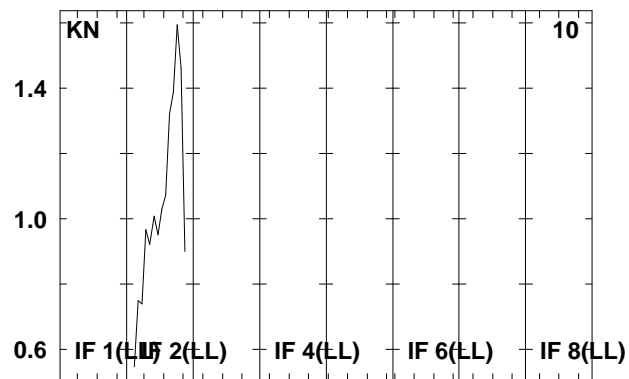
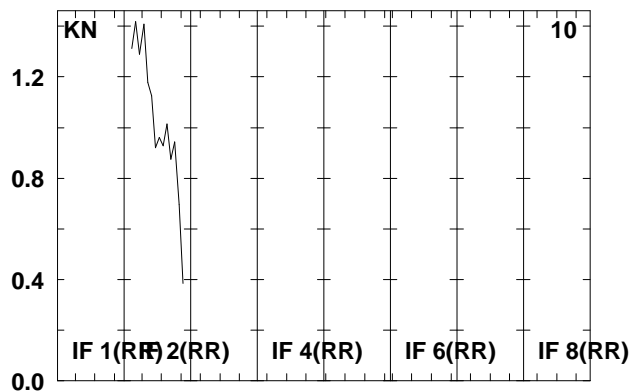
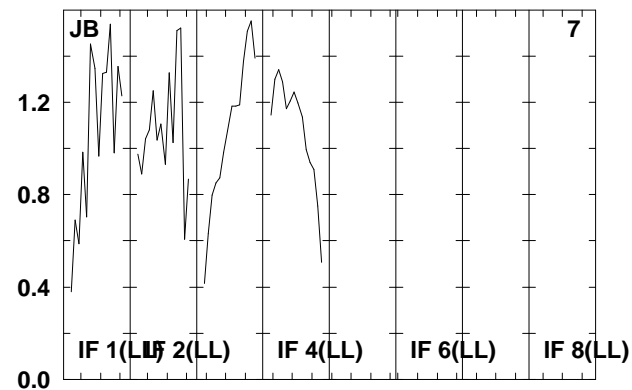
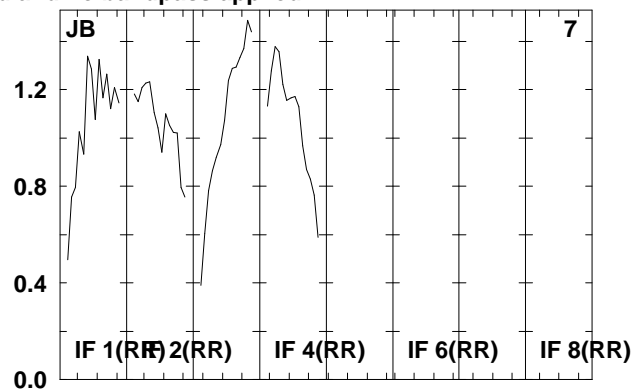
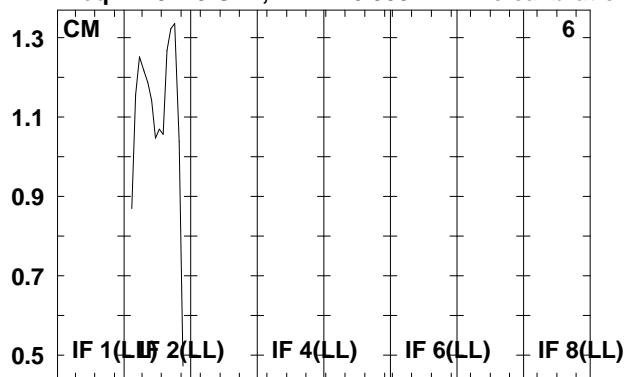

Lower frame: Real Jy

Total-power spectrum Antenna: \*

Timerange: 00/20:01:42 to 00/20:03:58

Plot file version 367 created 07-DEC-2009 16:06:55

J1912+05 RT006C.UVDATA.1

Freq = 4.9415 GHz, Bw = 16.000 MH No calibration applied and no bandpass applied

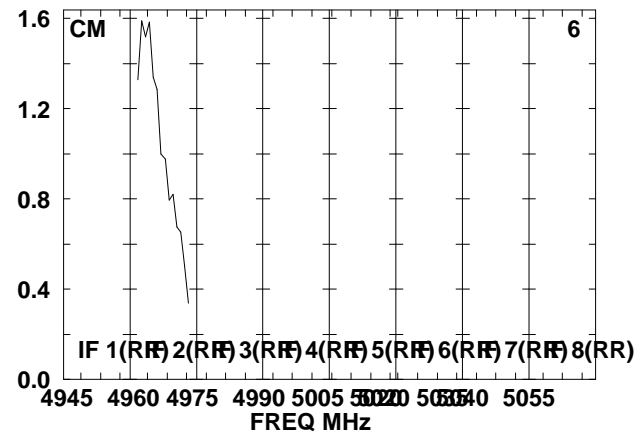
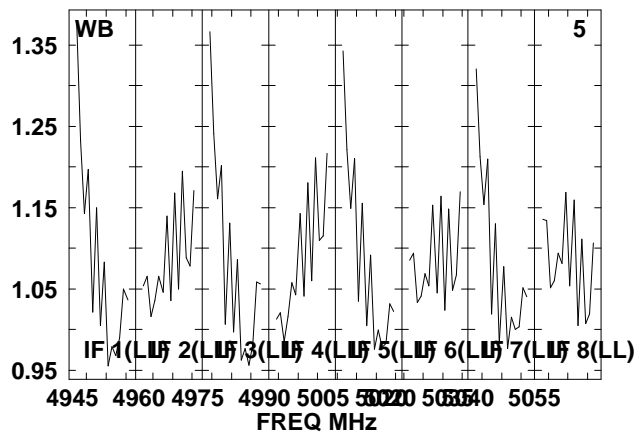
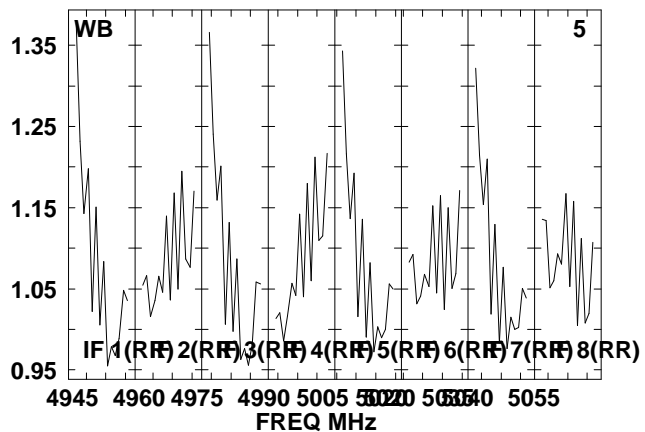
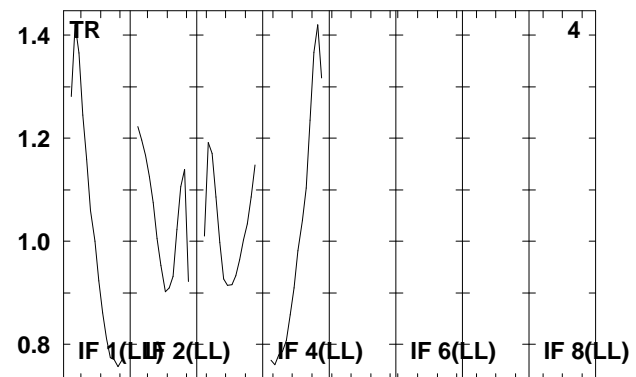
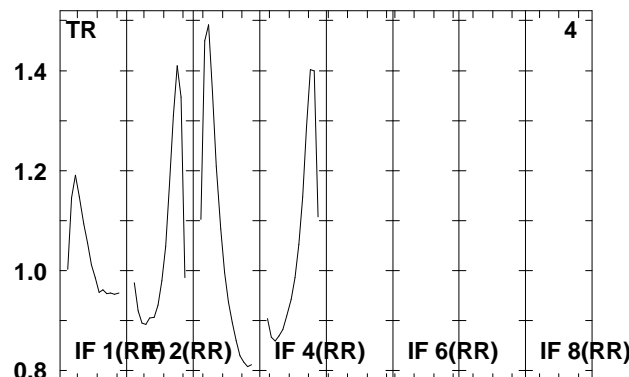
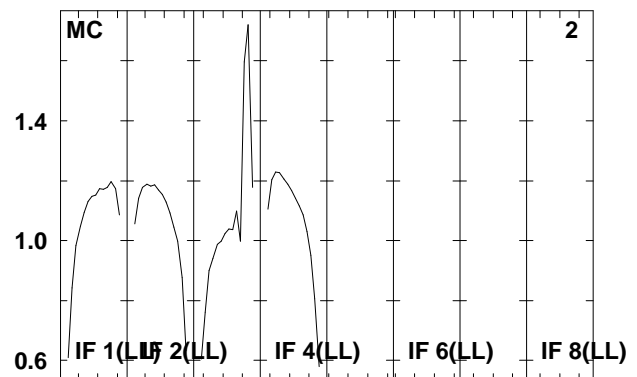
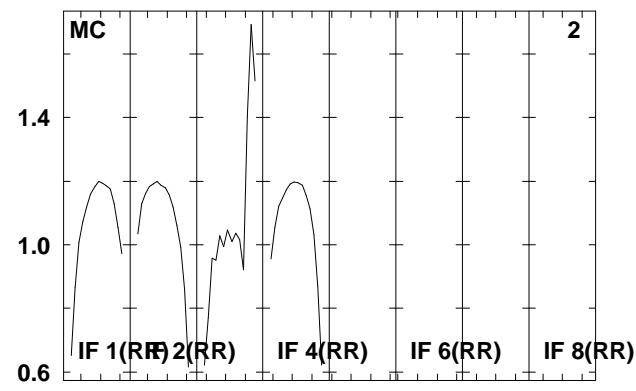
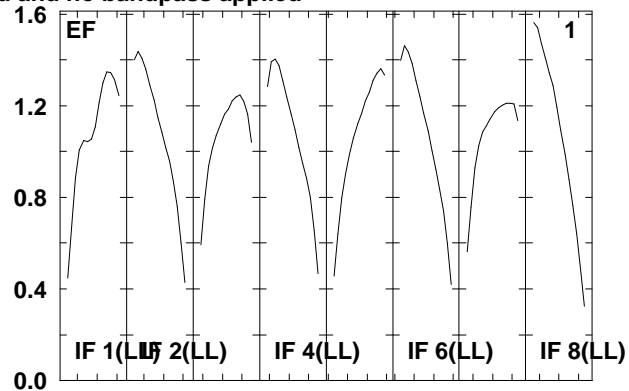
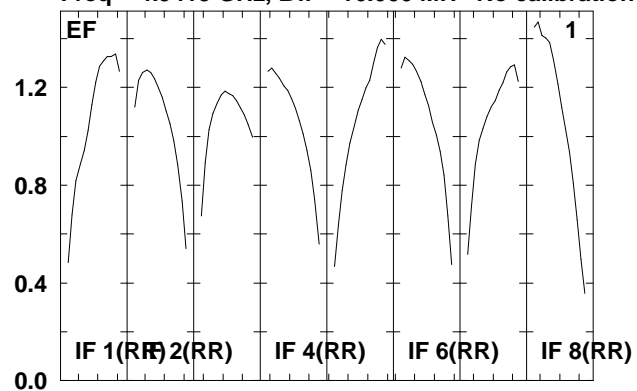

Lower frame: Real Jy  
Total-power spectrum Antenna: \*  
Timerange: 00/20:04:02 to 00/20:05:18

Plot file version 368 created 07-DEC-2009 16:06:55

J1912+05 RT006C.UVDATA.1

Freq = 4.9415 GHz, Bw = 16.000 MH No calibration applied and no bandpass applied

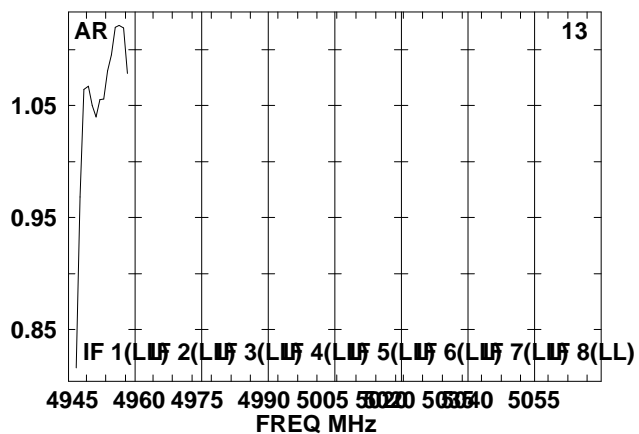
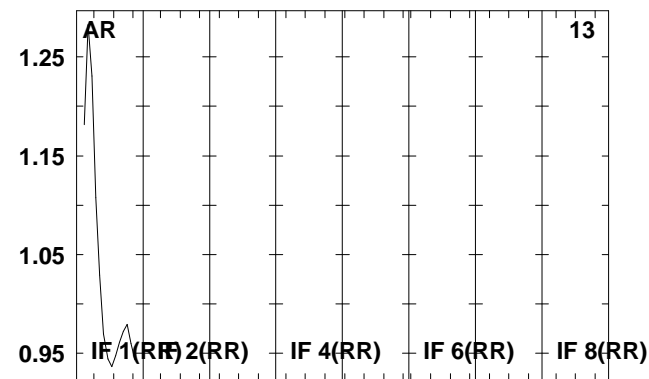
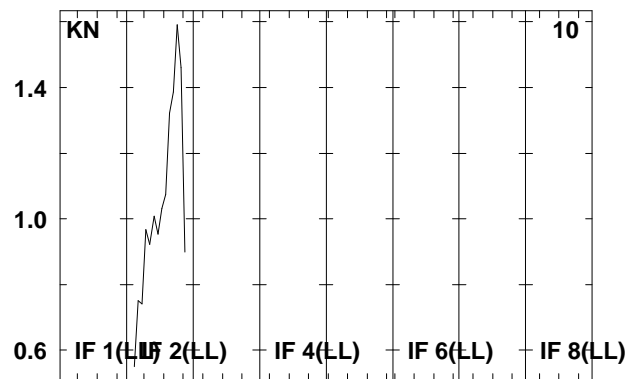
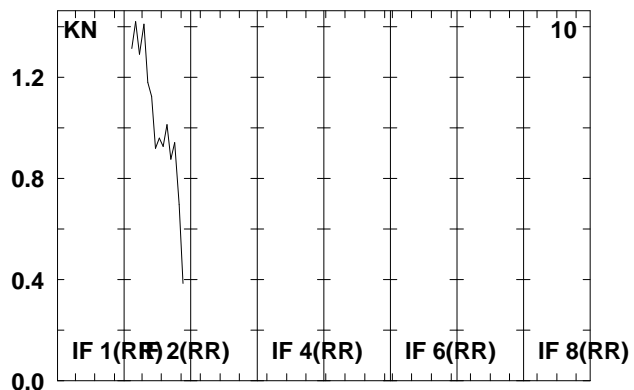
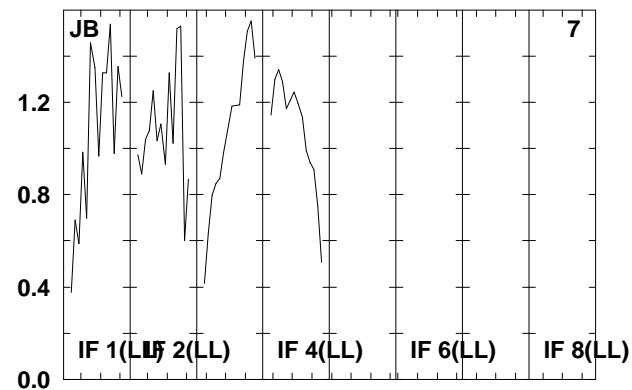
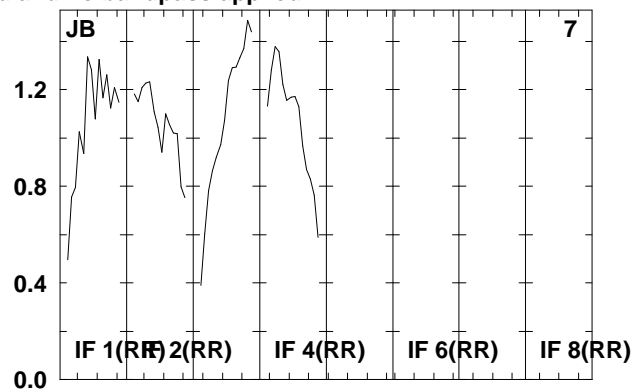
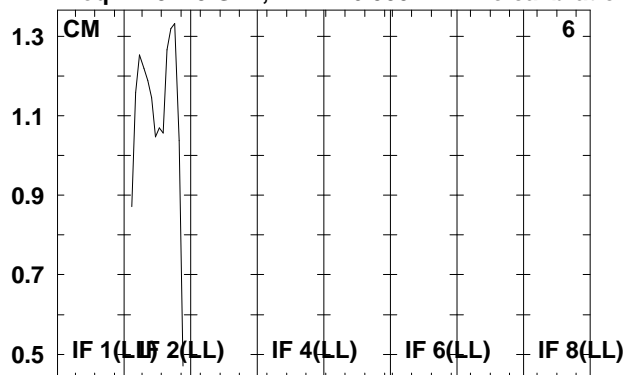

Lower frame: Real Jy

Total-power spectrum Antenna: \*

Timerange: 00/20:04:02 to 00/20:05:18



Plot file version 369 created 07-DEC-2009 16:06:55

SS433 RT006C.UVDATA.1

Freq = 4.9415 GHz, Bw = 16.000 MH No calibration applied and no bandpass applied

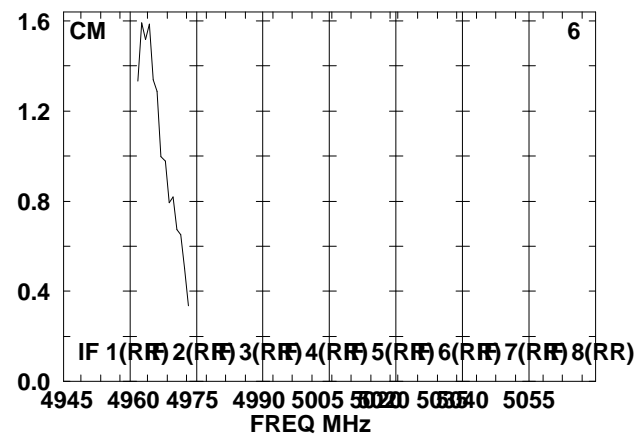
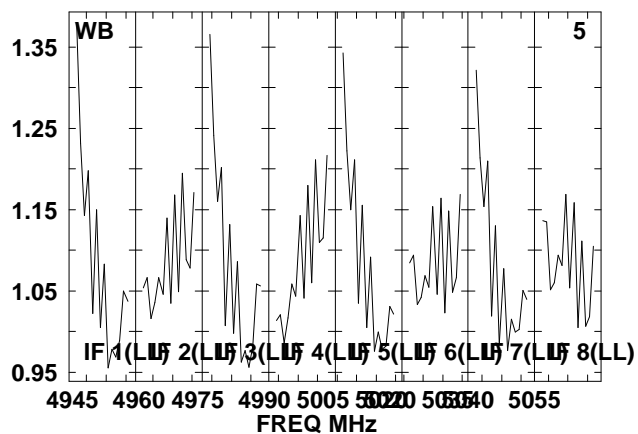
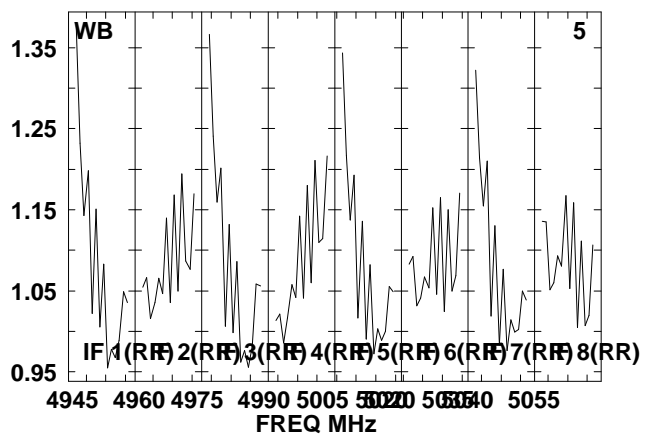
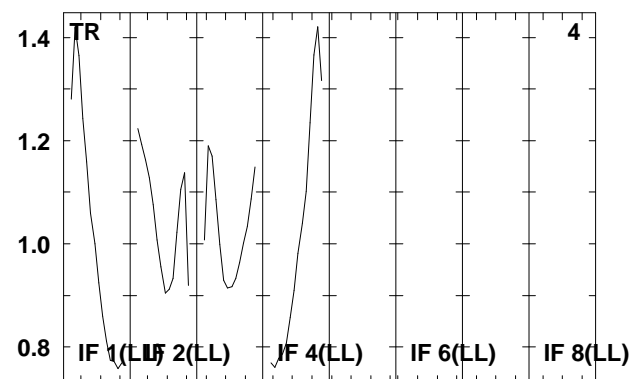
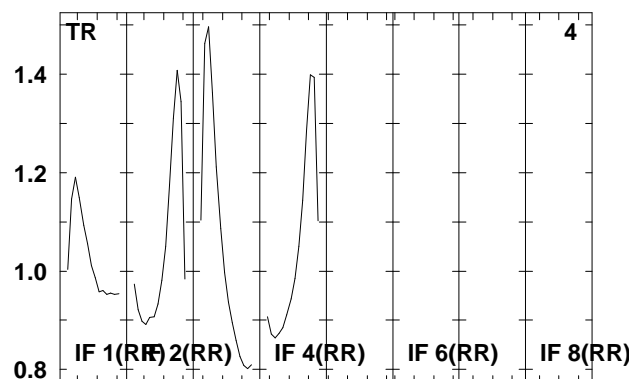
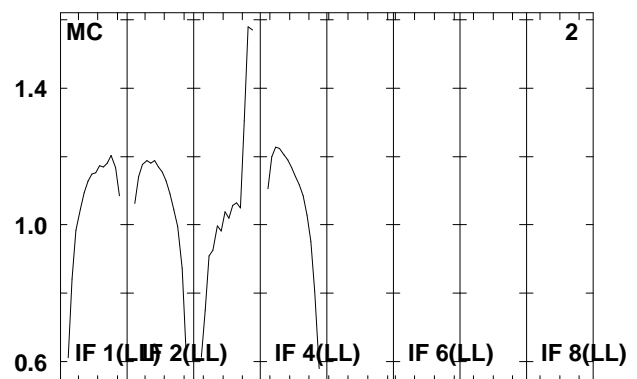
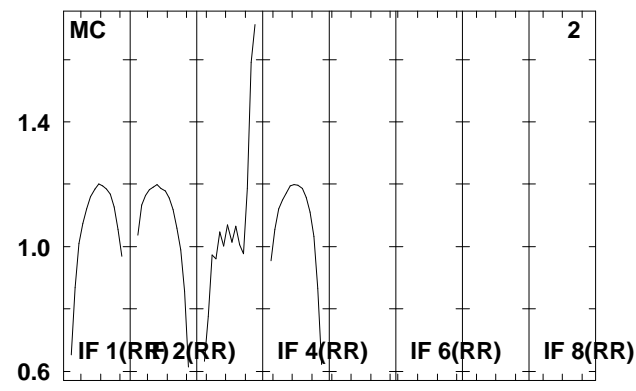
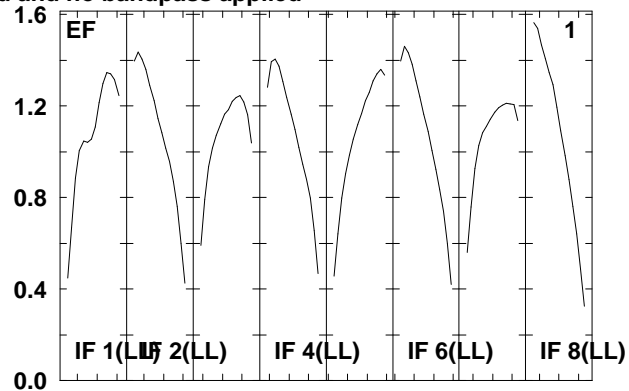
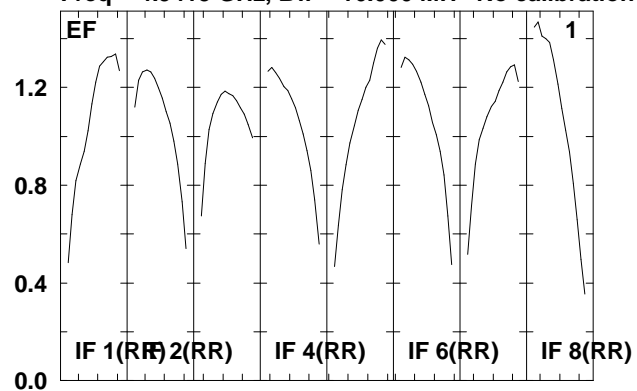

Lower frame: Real Jy

Total-power spectrum Antenna: \*

Timerange: 00/20:05:22 to 00/20:07:38

Plot file version 370 created 07-DEC-2009 16:06:55

SS433 RT006C.UVDATA.1

Freq = 4.9415 GHz, Bw = 16.000 MH No calibration applied and no bandpass applied

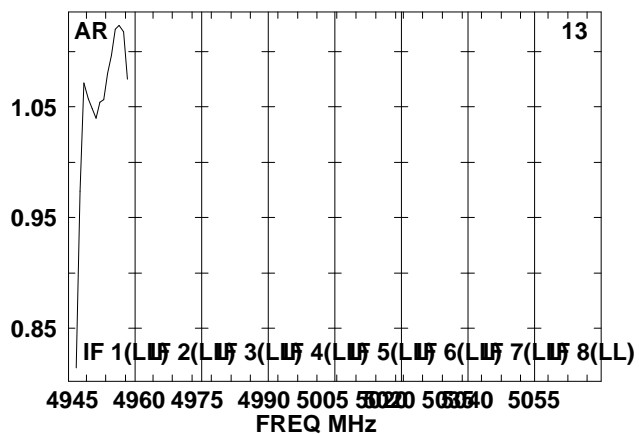
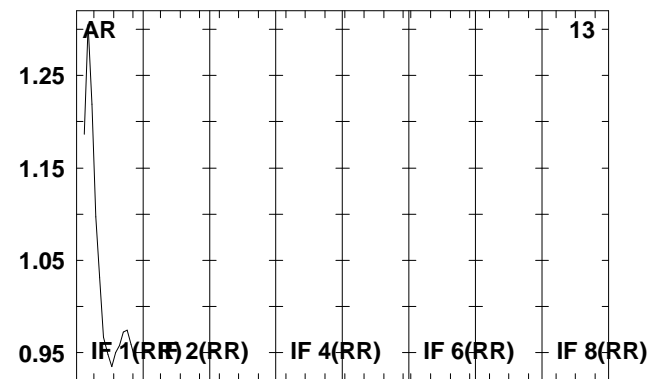
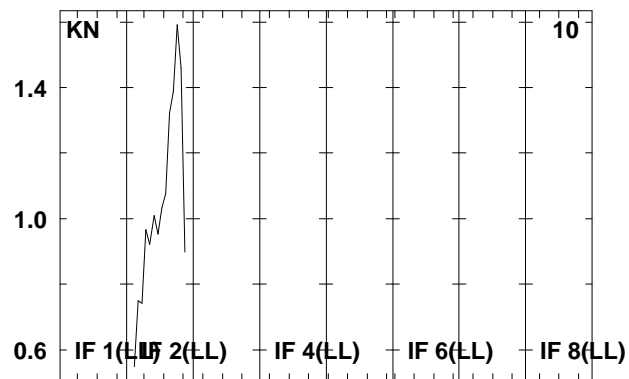
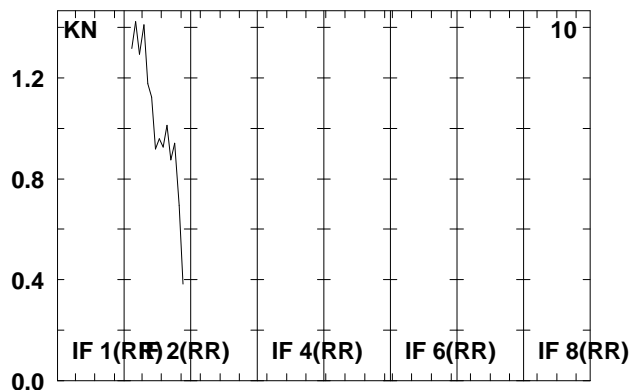
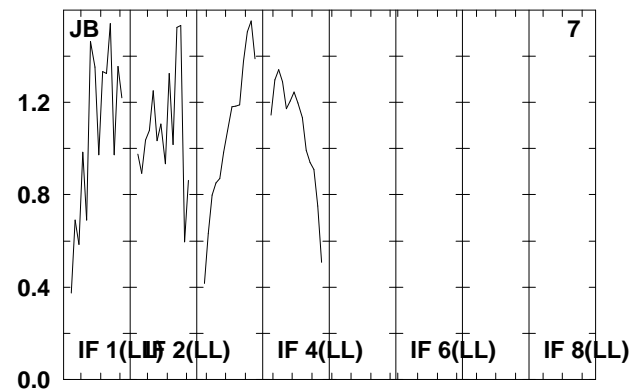
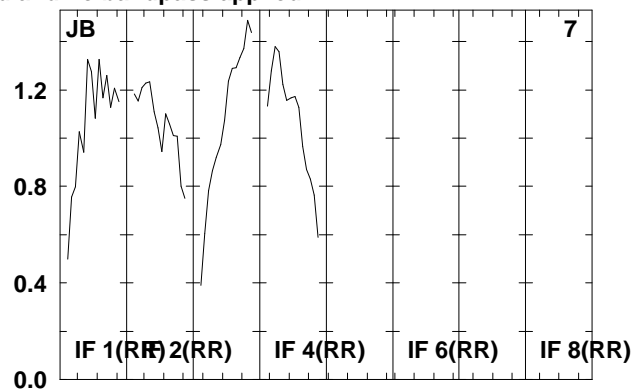
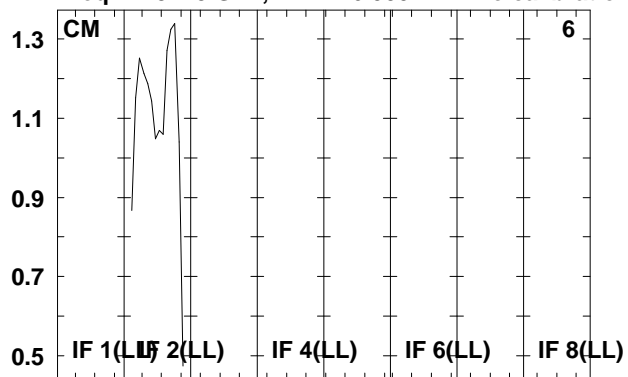

Lower frame: Real Jy

Total-power spectrum Antenna: \*

Timerange: 00/20:05:22 to 00/20:07:38

Plot file version 371 created 07-DEC-2009 16:06:56

J1912+05 RT006C.UVDATA.1

Freq = 4.9415 GHz, Bw = 16.000 MH No calibration applied and no bandpass applied

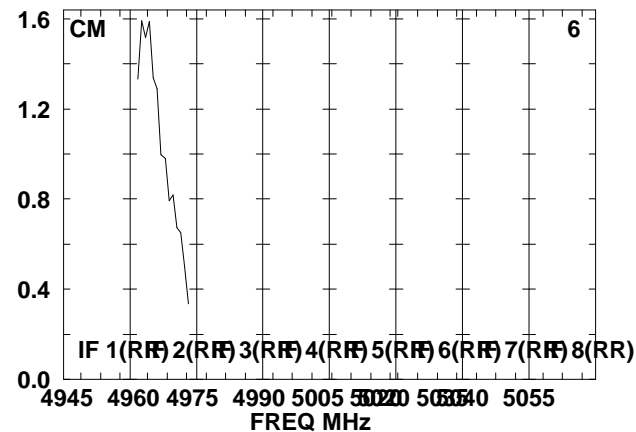
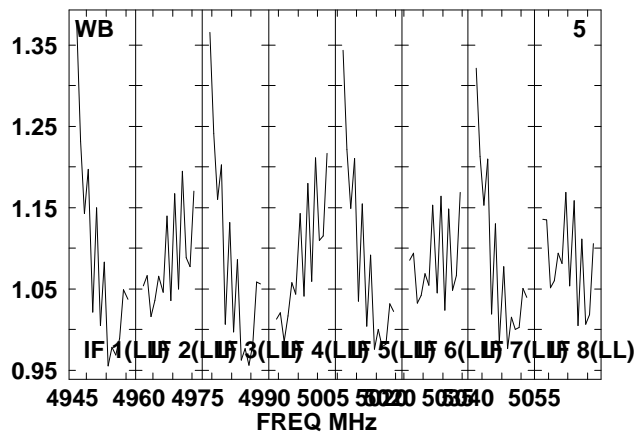
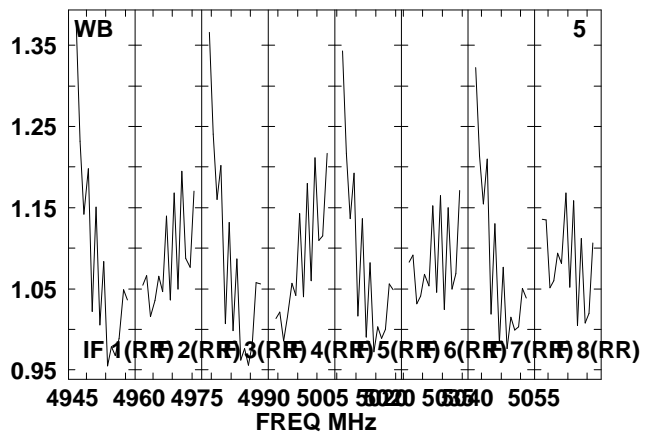
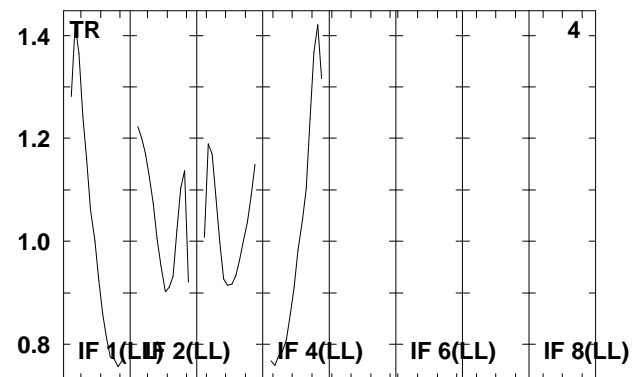
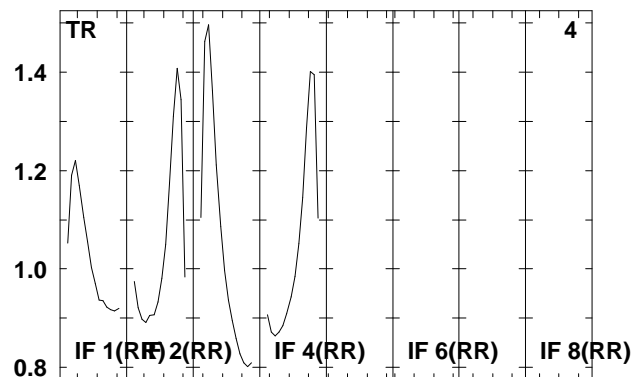
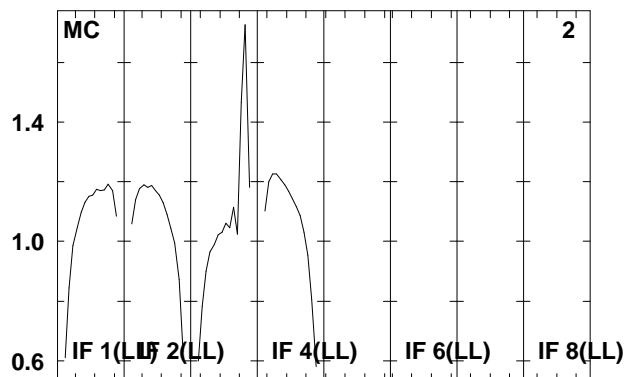
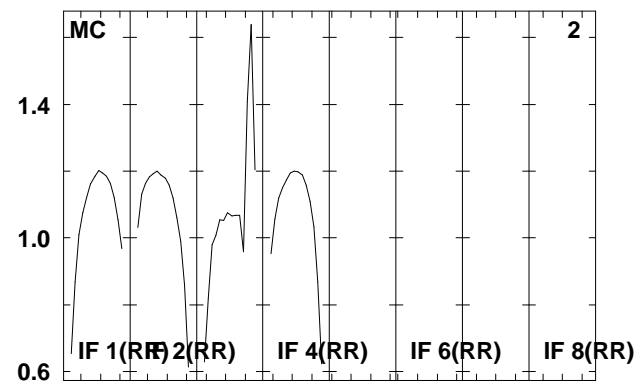
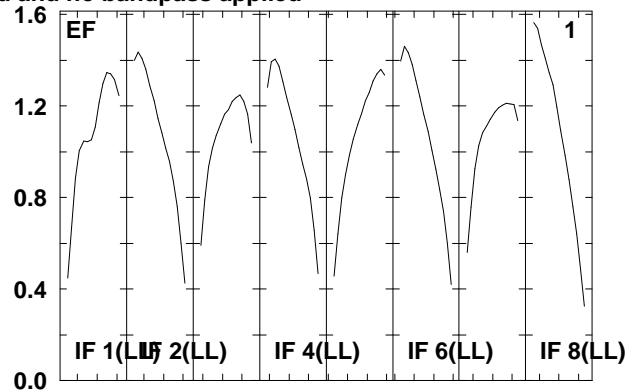
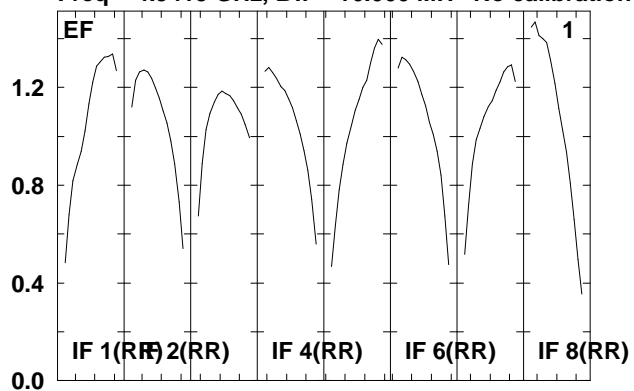

Lower frame: Real Jy

Total-power spectrum Antenna: \*

Timerange: 00/20:07:42 to 00/20:08:58

Plot file version 372 created 07-DEC-2009 16:06:56

J1912+05 RT006C.UVDATA.1

Freq = 4.9415 GHz, Bw = 16.000 MH No calibration applied and no bandpass applied

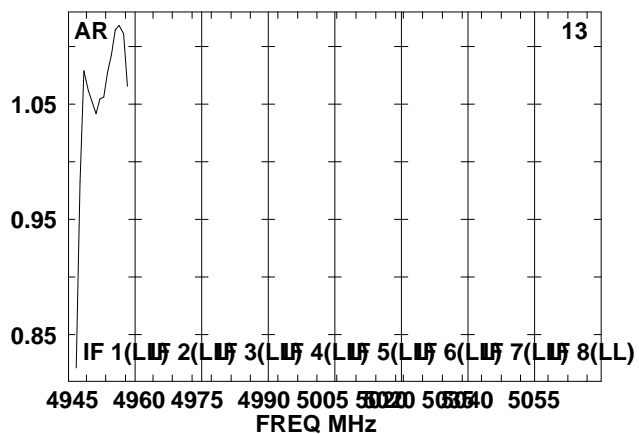
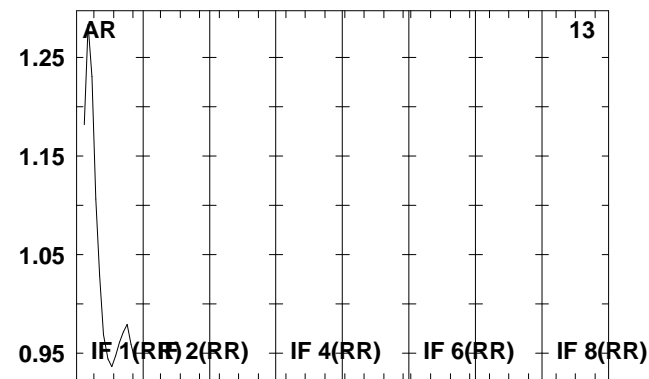
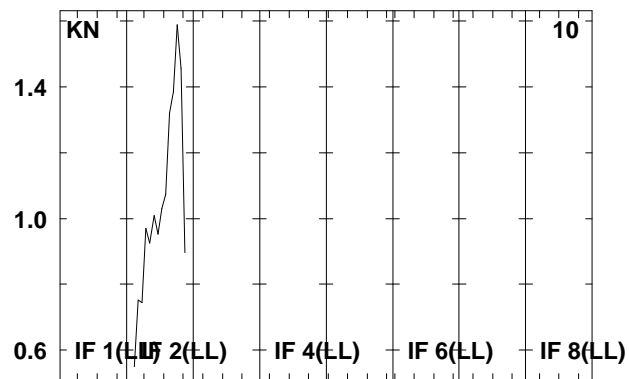
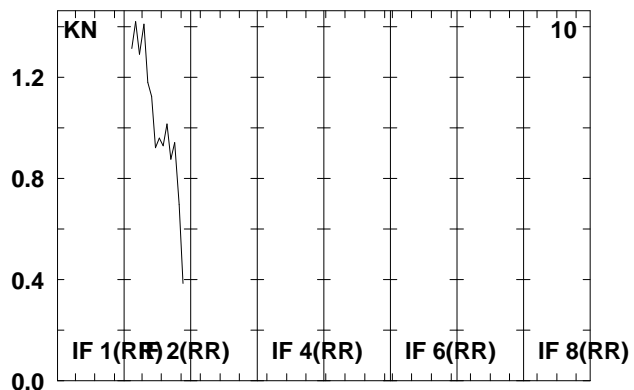
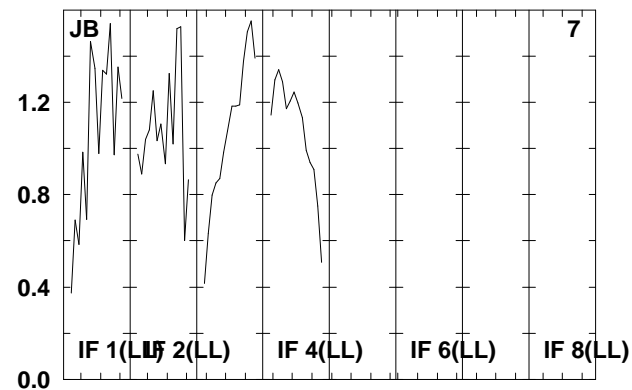
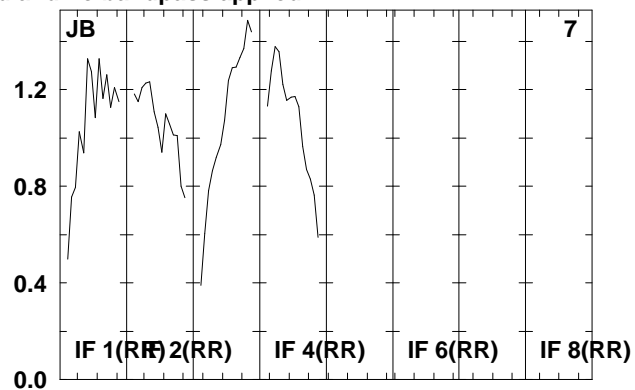
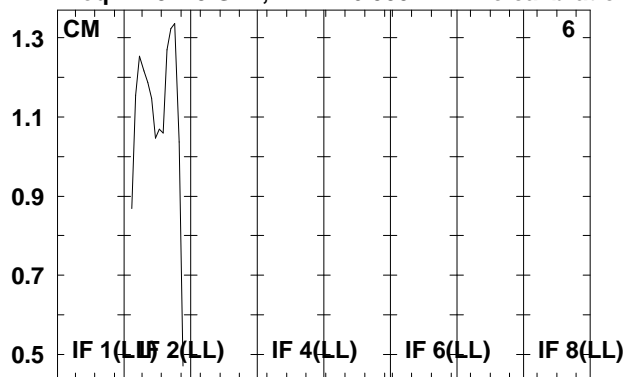

Lower frame: Real Jy

Total-power spectrum Antenna: \*

Timerange: 00/20:07:42 to 00/20:08:58

Plot file version 373 created 07-DEC-2009 16:06:56

SS433 RT006C.UVDATA.1

Freq = 4.9415 GHz, Bw = 16.000 MH No calibration applied and no bandpass applied

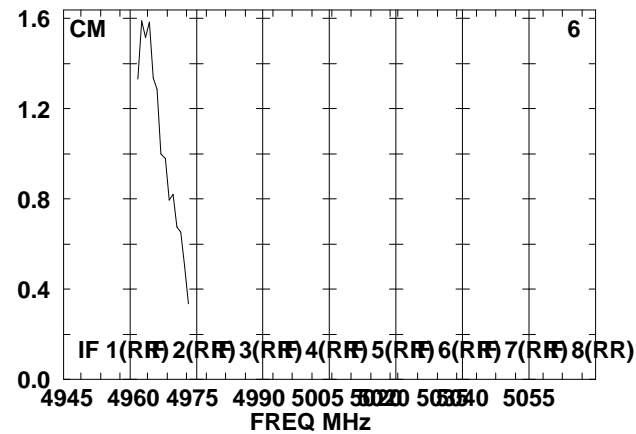
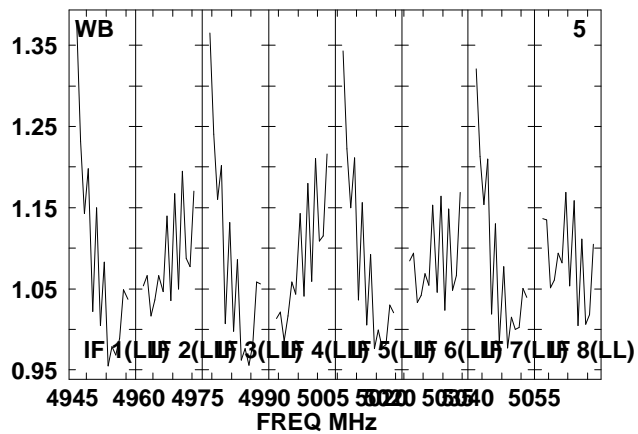
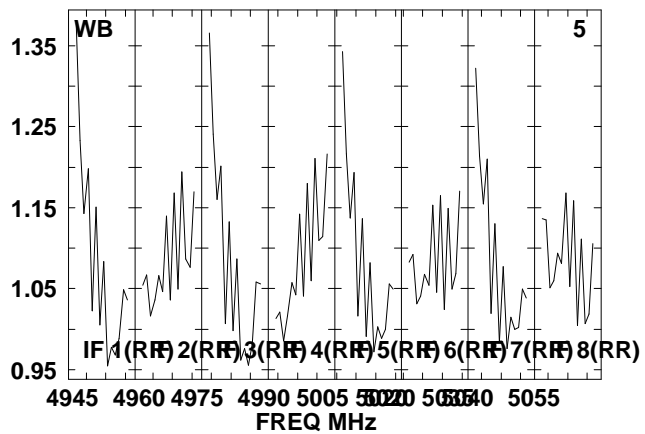
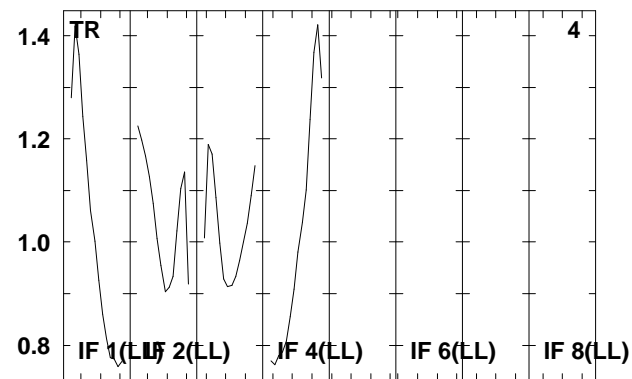
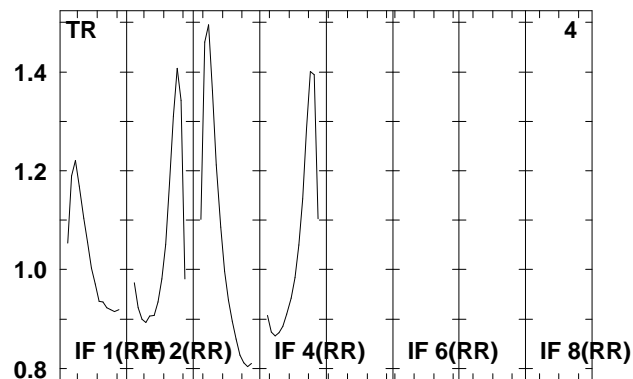
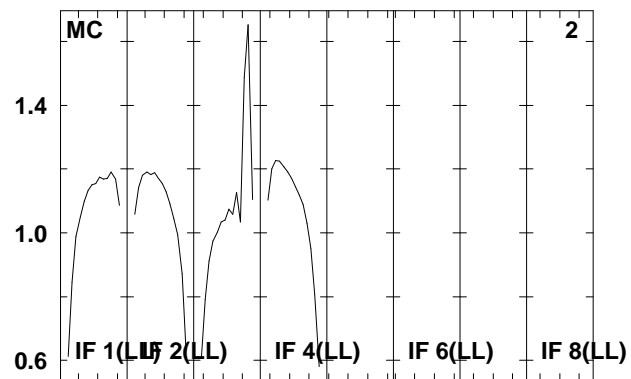
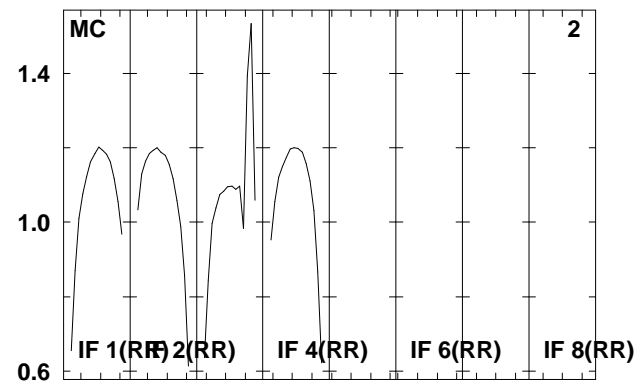
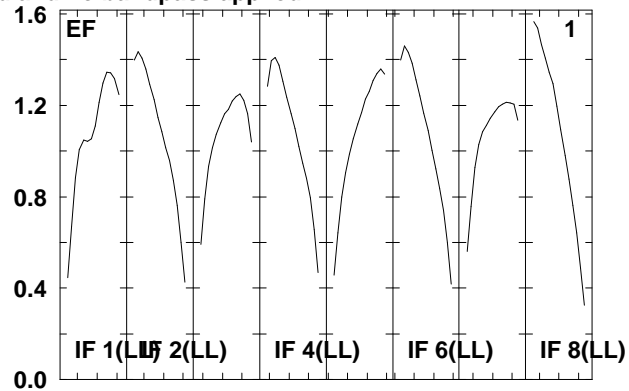
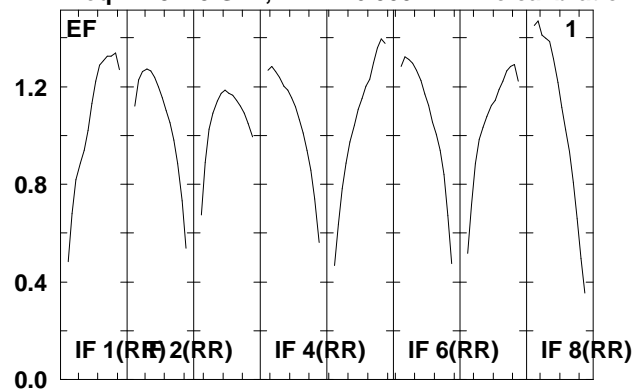

Lower frame: Real Jy  
Total-power spectrum Antenna: \*  
Timerange: 00/20:09:02 to 00/20:11:18

Plot file version 374 created 07-DEC-2009 16:06:56

SS433 RT006C.UVDATA.1

Freq = 4.9415 GHz, Bw = 16.000 MH No calibration applied and no bandpass applied

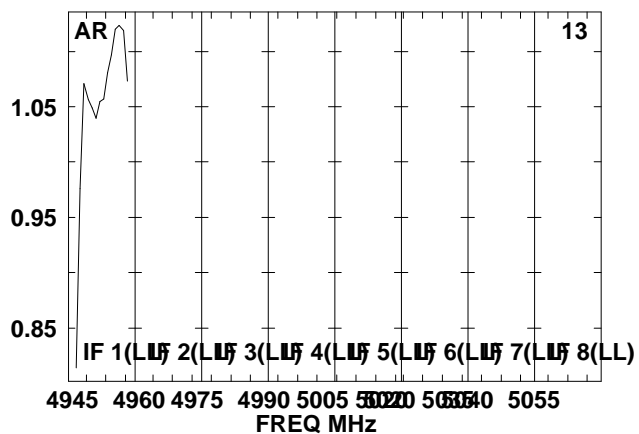
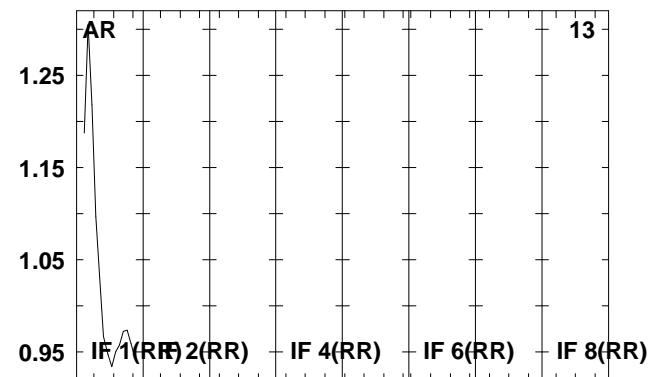
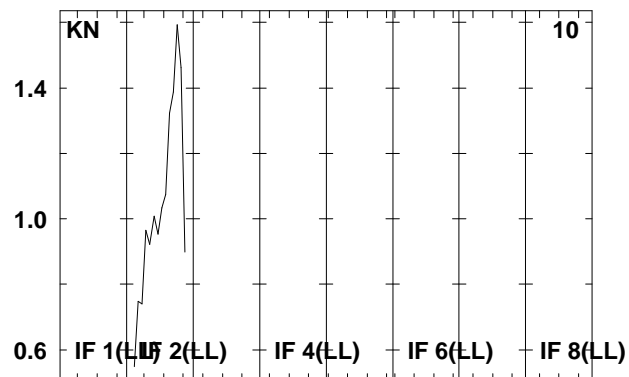
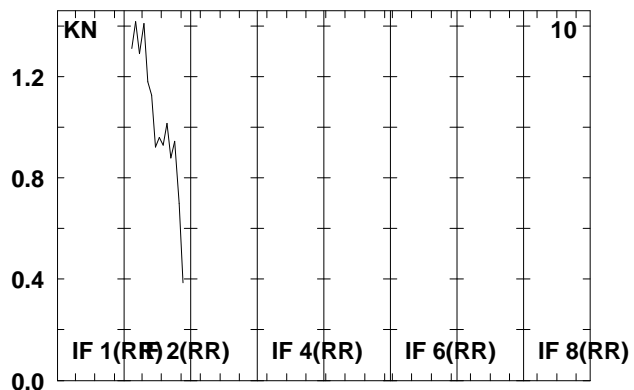
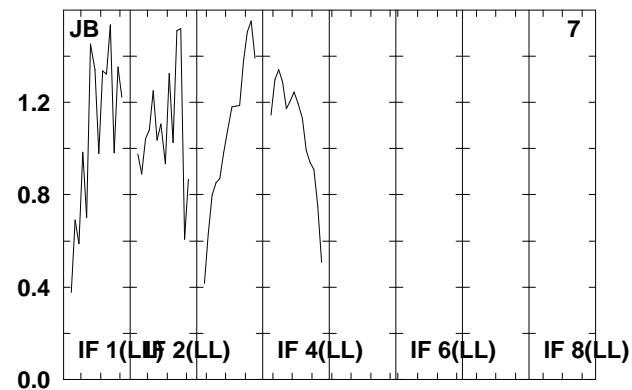
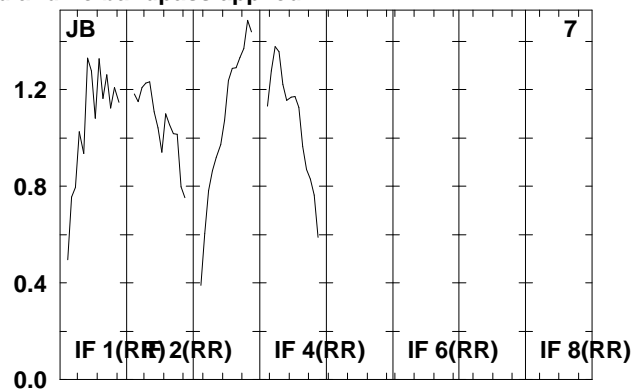
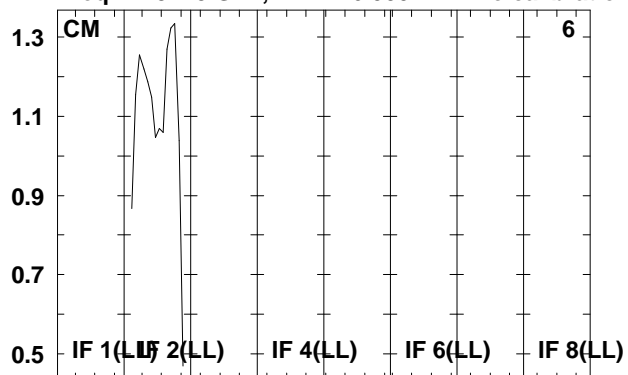

Lower frame: Real Jy

Total-power spectrum Antenna: \*

Timerange: 00/20:09:02 to 00/20:11:18

Plot file version 375 created 07-DEC-2009 16:06:57

J1912+05 RT006C.UVDATA.1

Freq = 4.9415 GHz, Bw = 16.000 MH No calibration applied and no bandpass applied

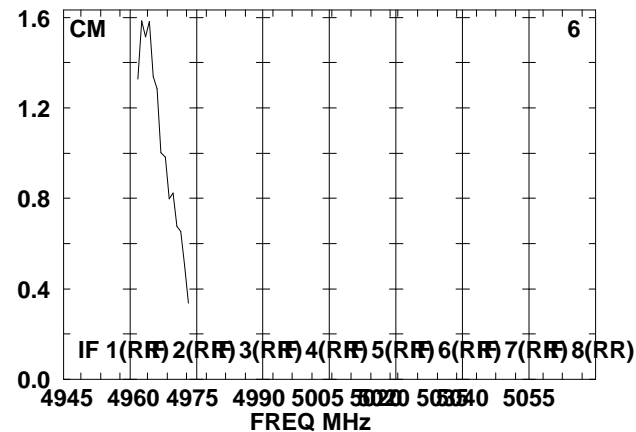
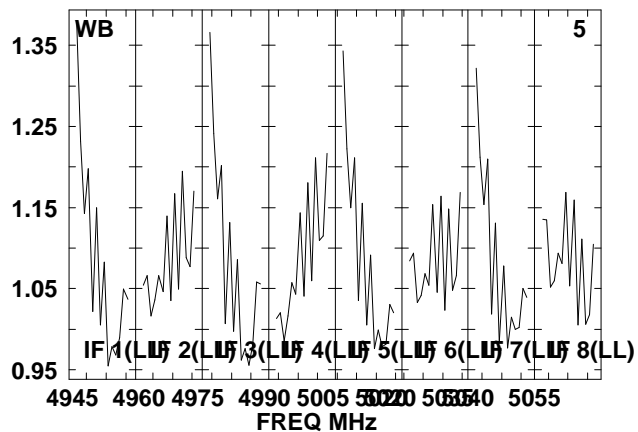
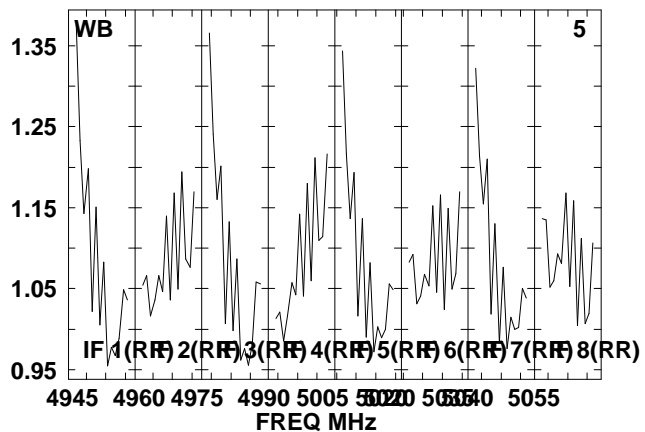
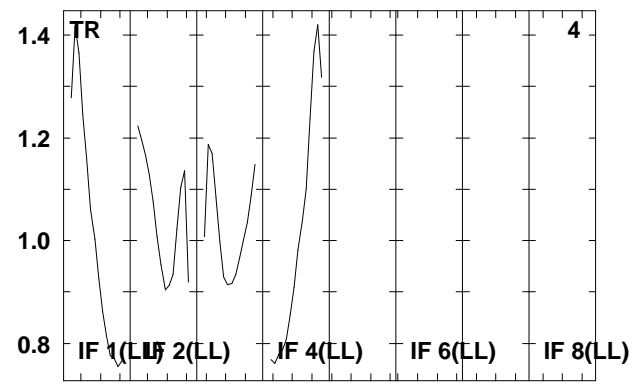
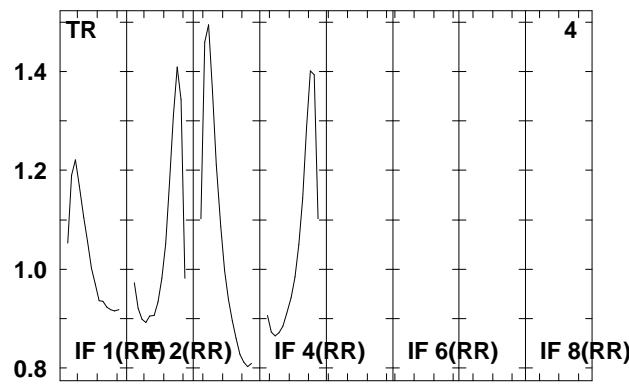
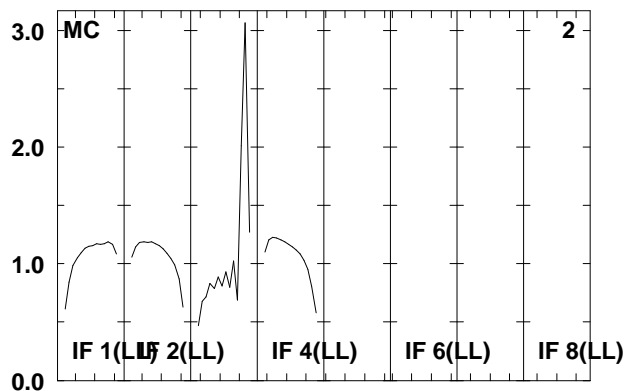
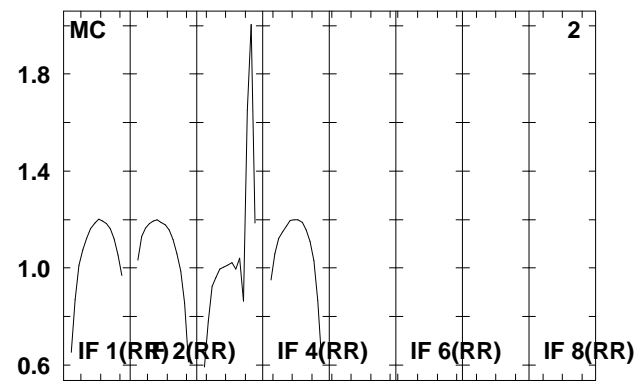
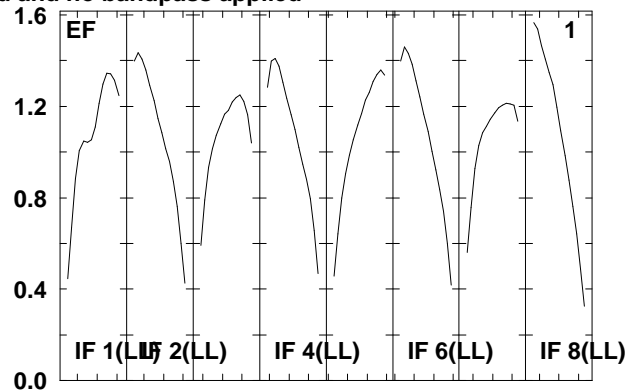
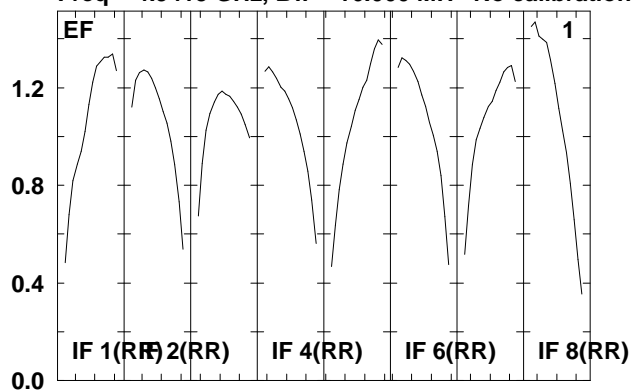

Lower frame: Real Jy  
Total-power spectrum Antenna: \*  
Timerange: 00/20:11:22 to 00/20:12:38

Plot file version 376 created 07-DEC-2009 16:06:57

J1912+05 RT006C.UVDATA.1

Freq = 4.9415 GHz, Bw = 16.000 MH No calibration applied and no bandpass applied

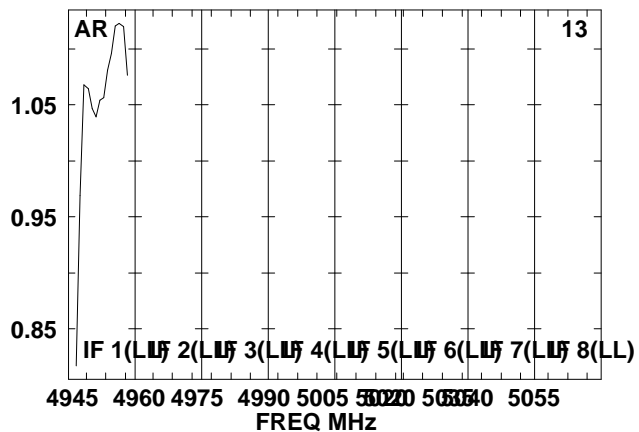
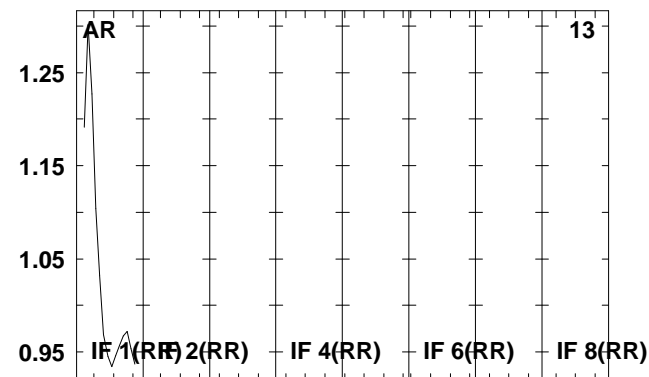
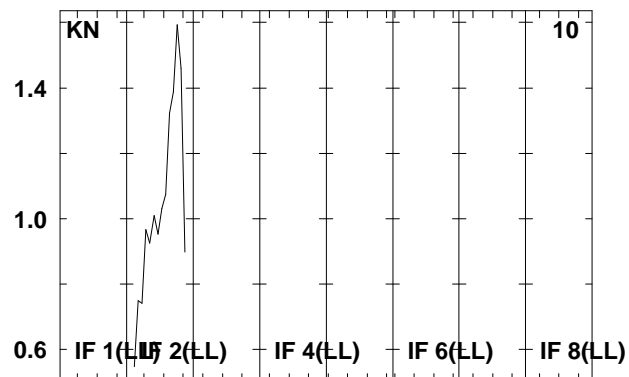
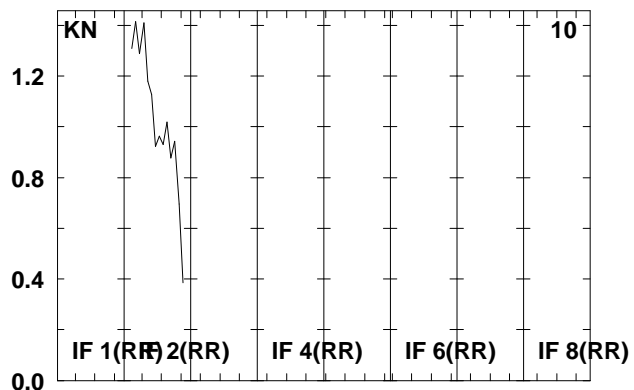
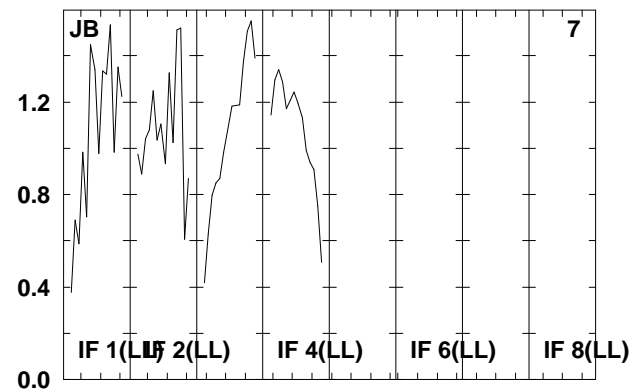
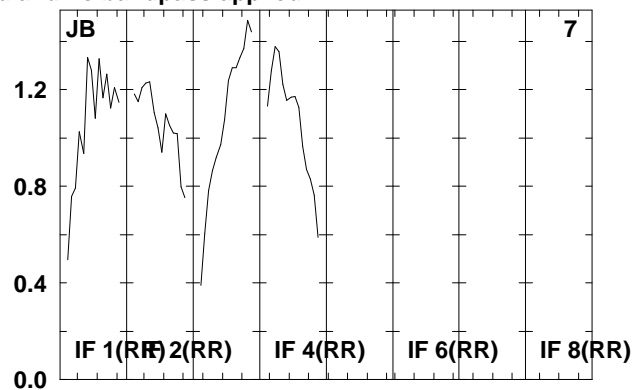
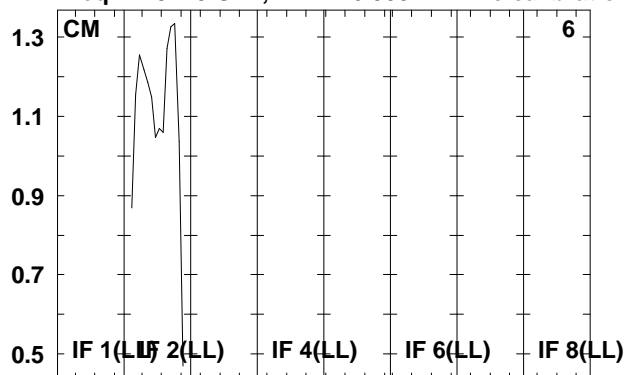

Lower frame: Real Jy

Total-power spectrum Antenna: \*

Timerange: 00/20:11:22 to 00/20:12:38



Plot file version 377 created 07-DEC-2009 16:06:57

SS433 RT006C.UVDATA.1

Freq = 4.9415 GHz, Bw = 16.000 MH No calibration applied and no bandpass applied

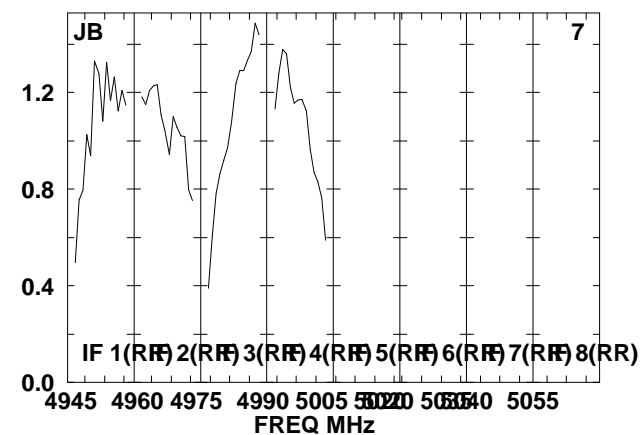
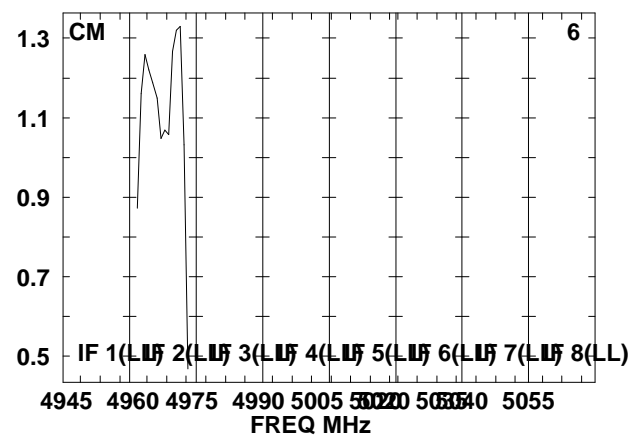
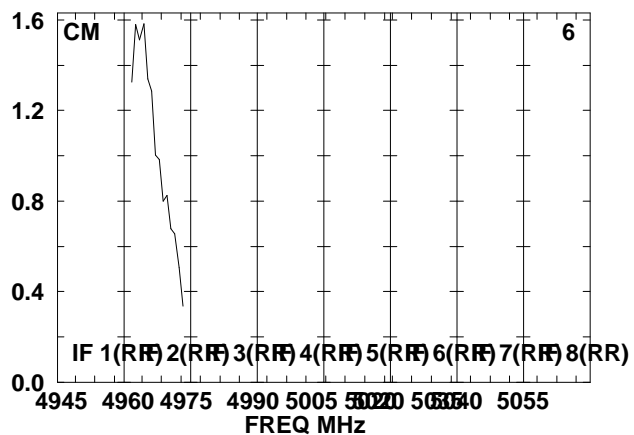
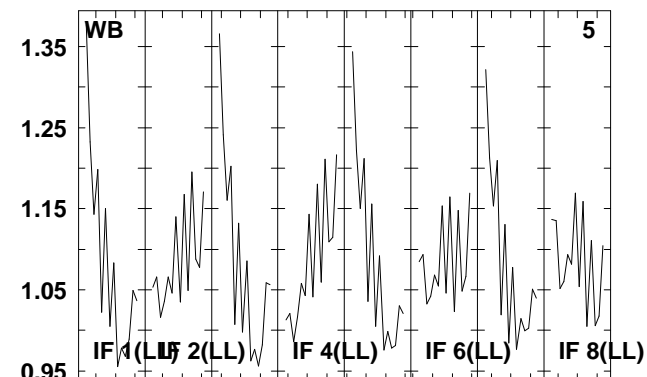
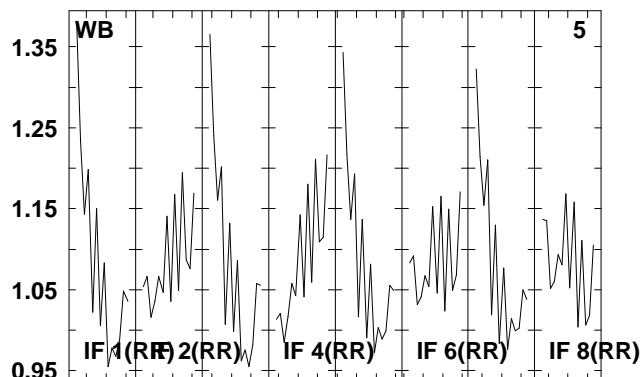
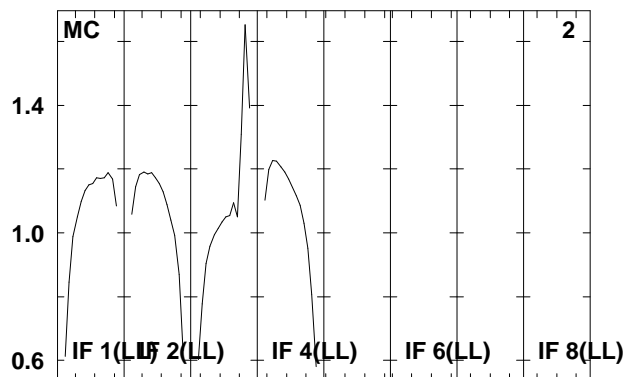
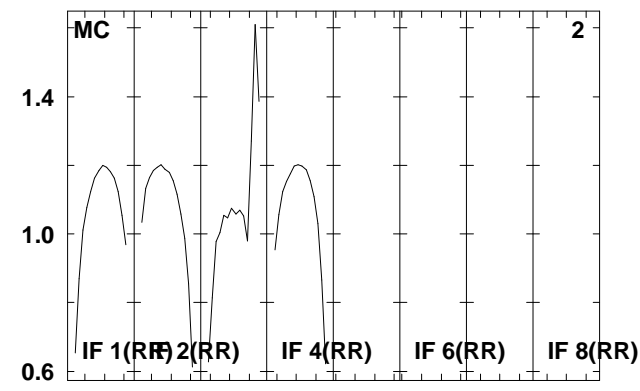
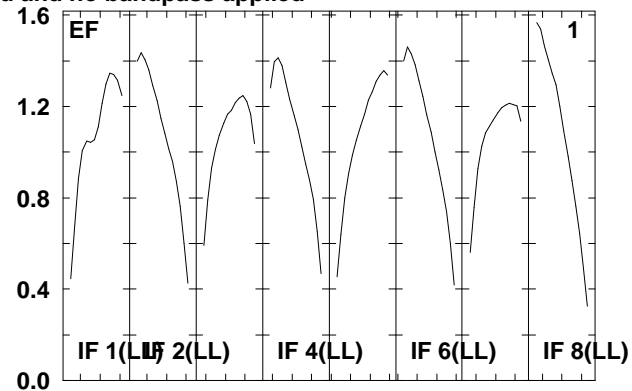
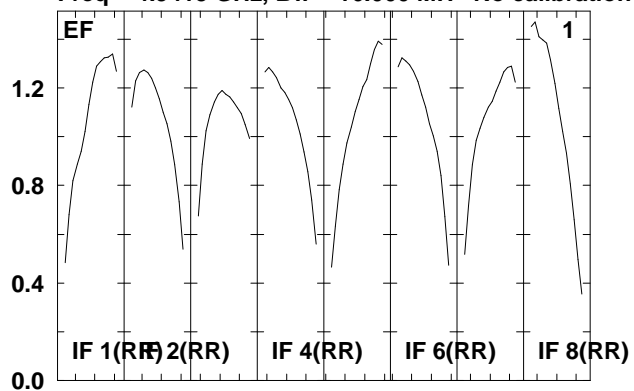

Lower frame: Real Jy  
Total-power spectrum Antenna: \*  
Timerange: 00/20:12:42 to 00/20:14:58

Plot file version 378 created 07-DEC-2009 16:06:57

SS433 RT006C.UVDATA.1

Freq = 4.9415 GHz, Bw = 16.000 MH No calibration applied and no bandpass applied

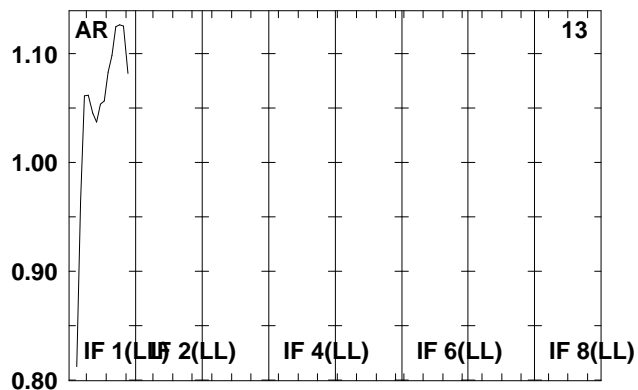
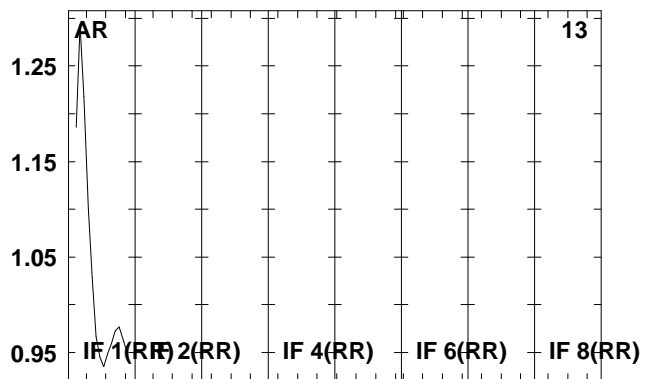
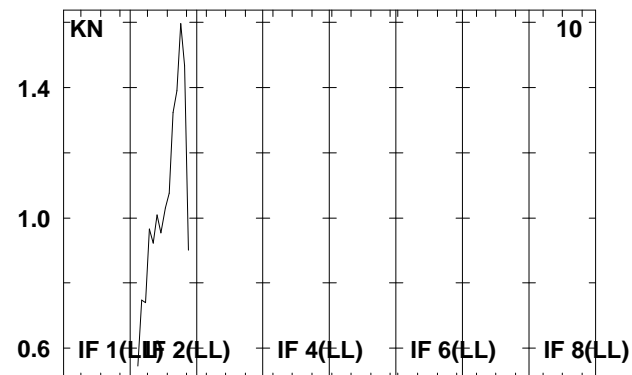
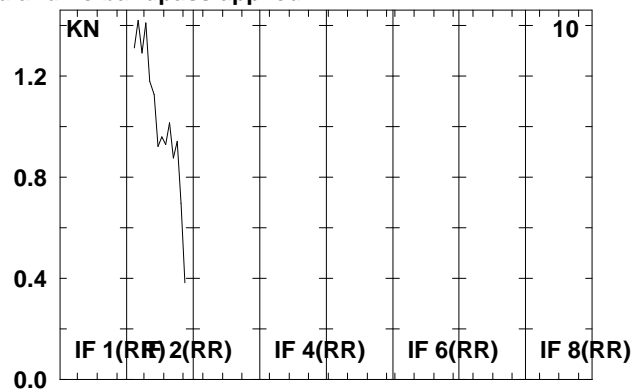
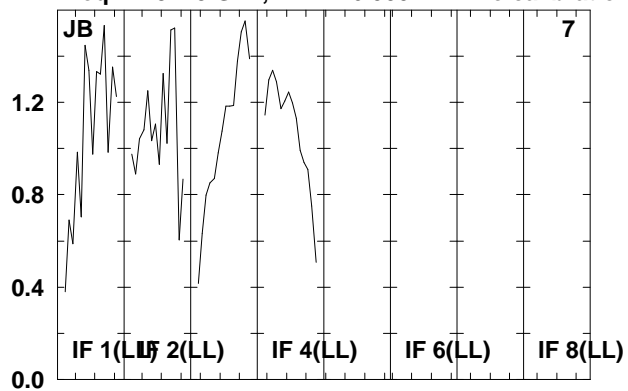

Lower frame: Real Jy  
Total-power spectrum Antenna: \*  
Timerange: 00/20:12:42 to 00/20:14:58

Plot file version 379 created 07-DEC-2009 16:06:58

J1911+16 RT006C.UVDATA.1

Freq = 4.9415 GHz, Bw = 16.000 MH No calibration applied and no bandpass applied

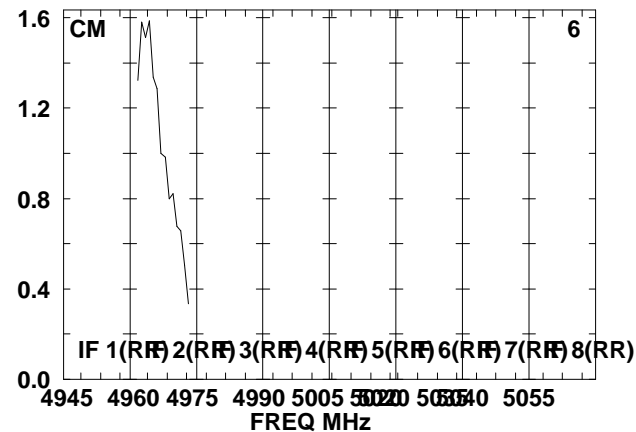
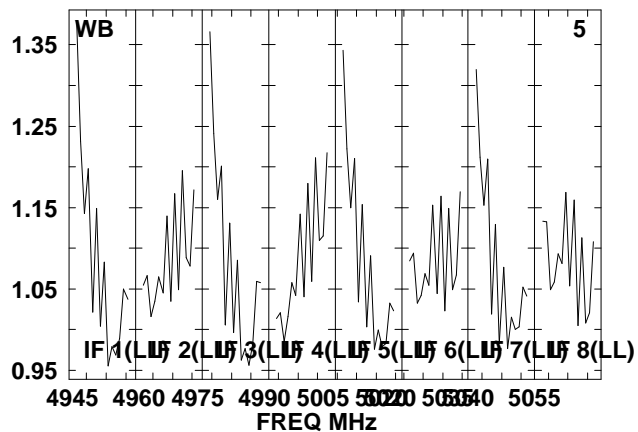
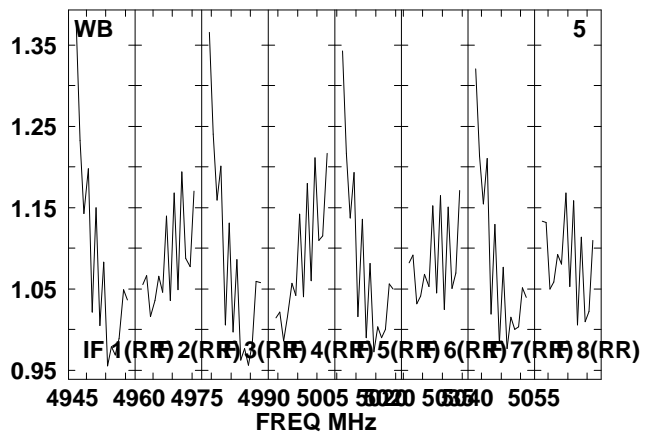
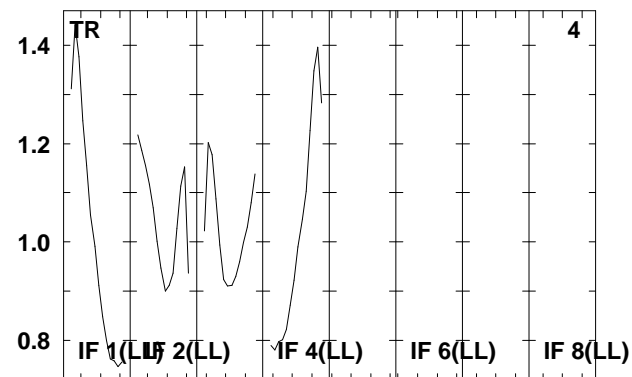
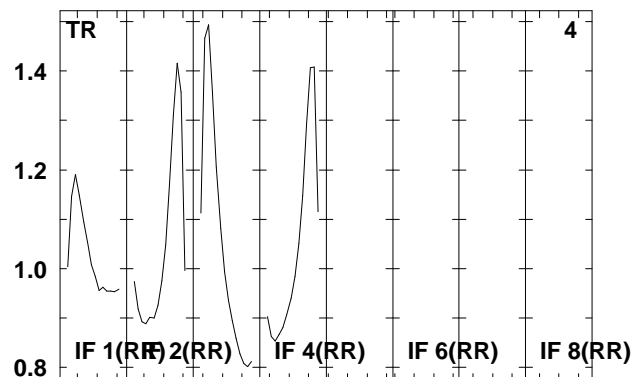
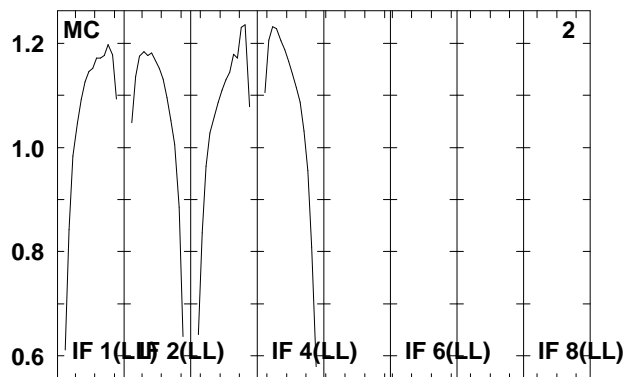
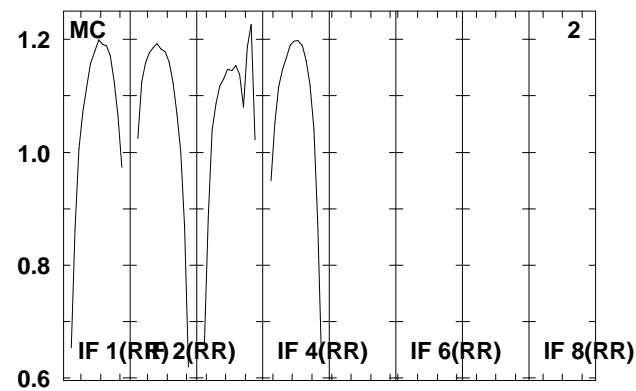
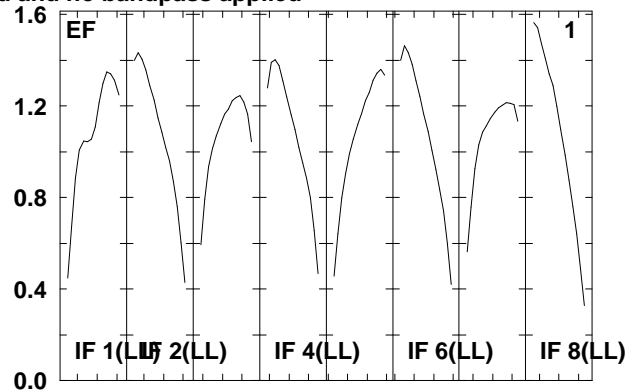
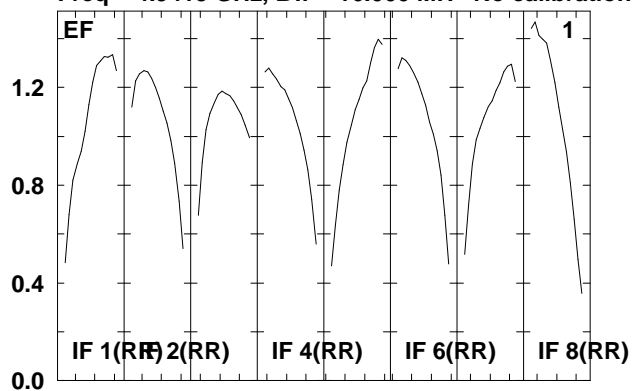

Lower frame: Real Jy

Total-power spectrum Antenna: \*

Timerange: 00/20:19:02 to 00/20:28:54

Plot file version 380 created 07-DEC-2009 16:06:58

J1911+16 RT006C.UVDATA.1

Freq = 4.9415 GHz, Bw = 16.000 MH No calibration applied and no bandpass applied

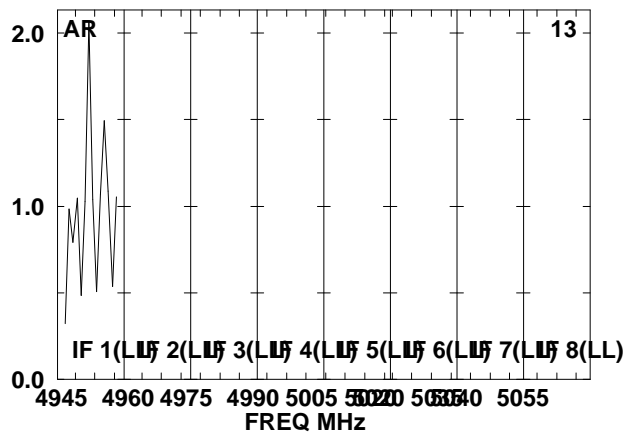
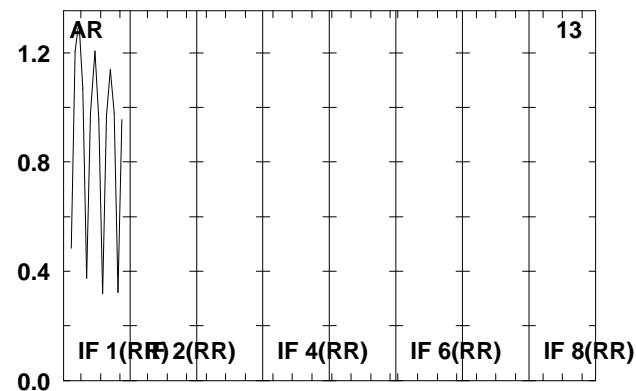
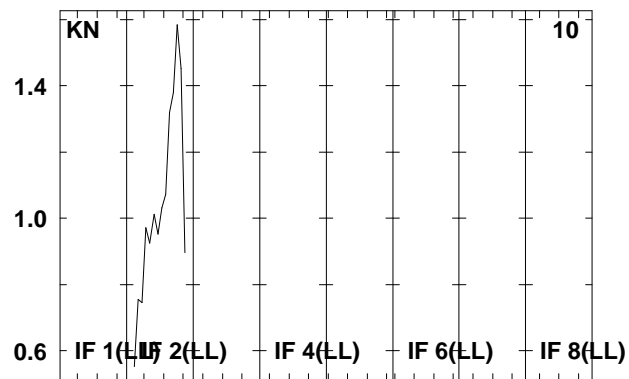
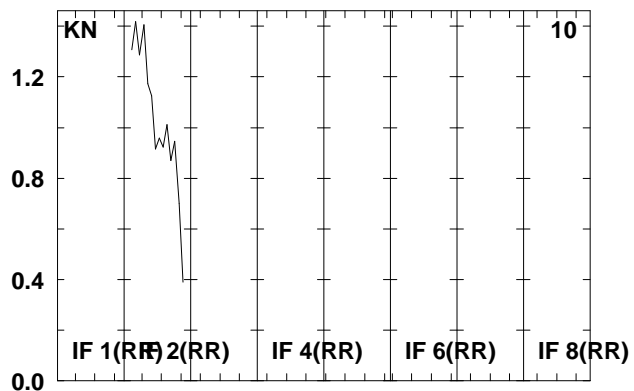
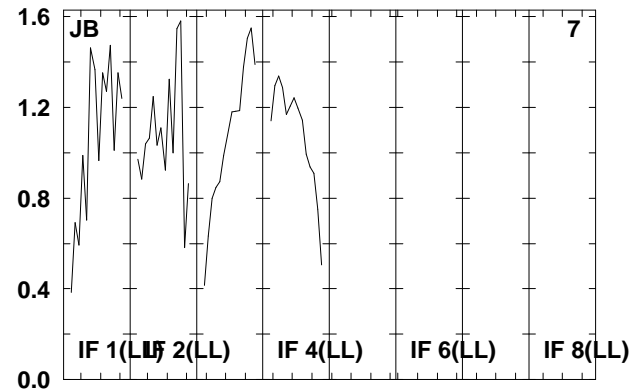
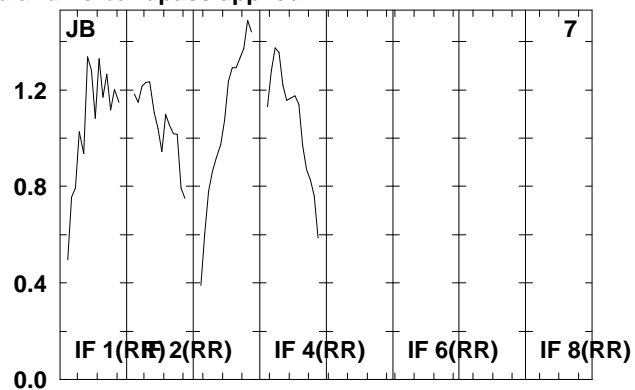
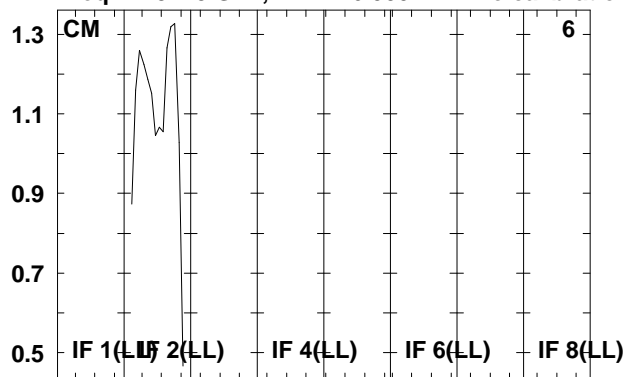

Lower frame: Real Jy

Total-power spectrum Antenna: \*

Timerange: 00/20:19:02 to 00/20:28:54