

Plot file version 1 created 10-JUN-2016 17:21:47

OQ208 RT013A.UVDATA.1

Freq = 4.9270 GHz, Bw = 16.000 MH No calibration applied and no bandpass applied

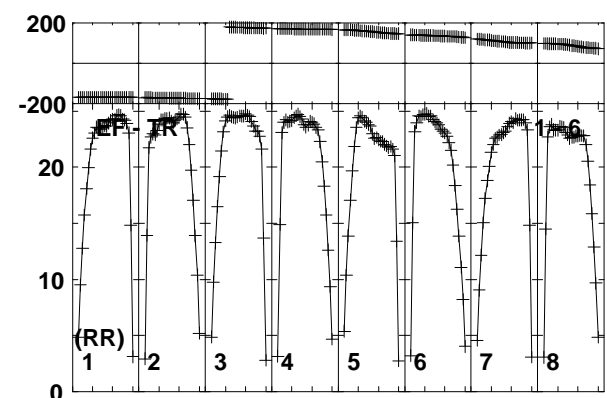
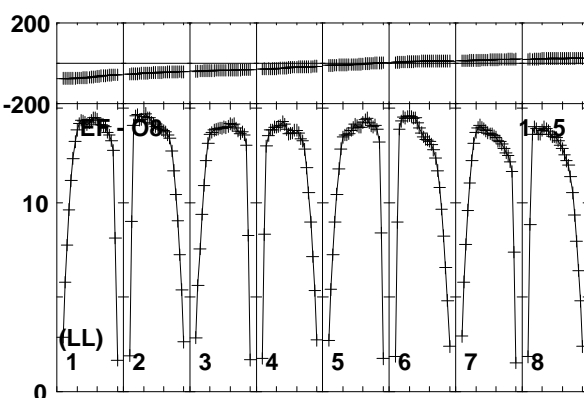
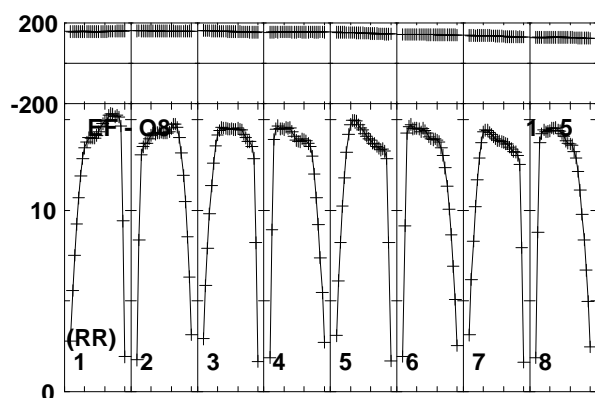
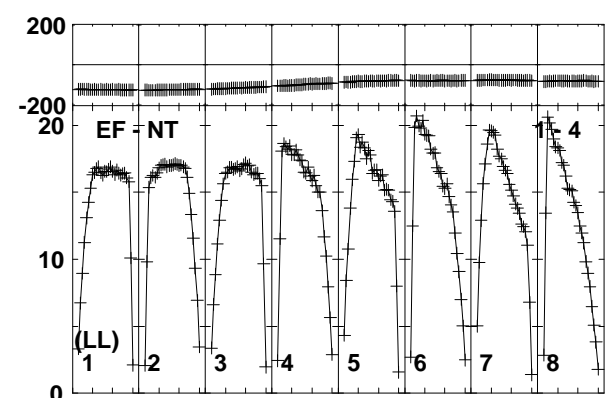
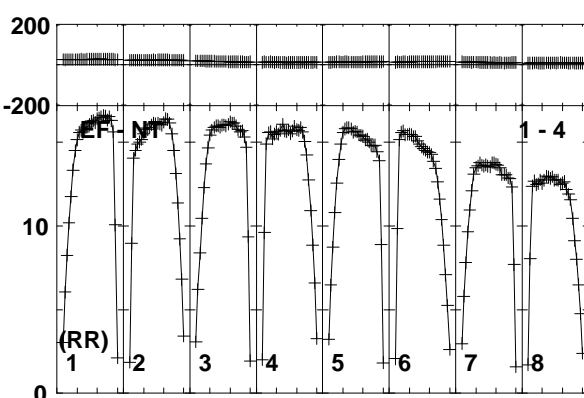
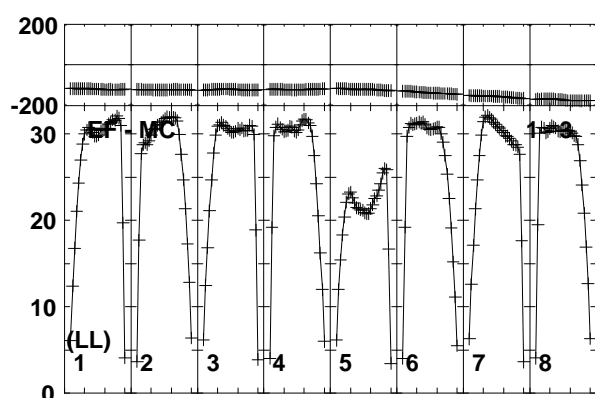
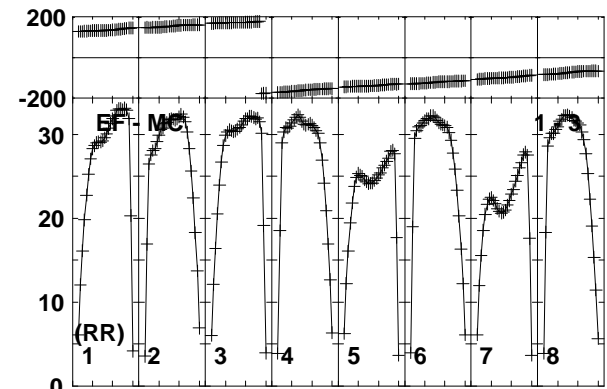
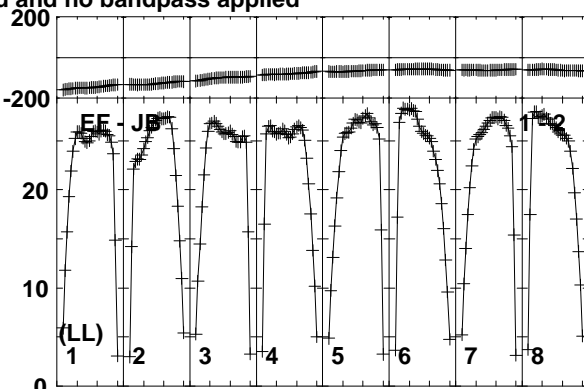
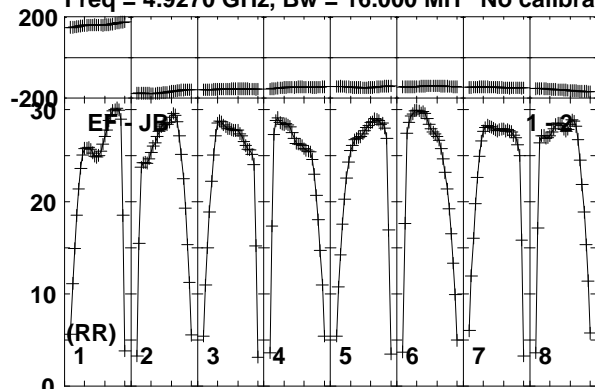

Lower frame: Milli Ampl Jy Top frame: Phas deg  
Vector averaged cross-power spectrum Baseline: EF (01) - JB (02)  
Timerange: 00/17:30:32 to 00/17:43:09

Plot file version 2 created 10-JUN-2016 17:21:48

OQ208 RT013A.UVDATA.1

Freq = 4.9270 GHz, Bw = 16.000 MH No calibration applied and no bandpass applied

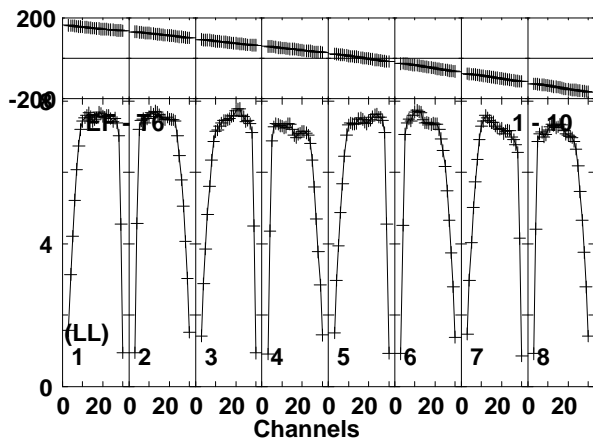
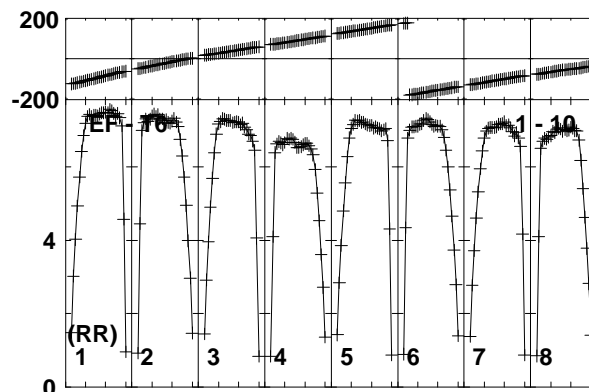
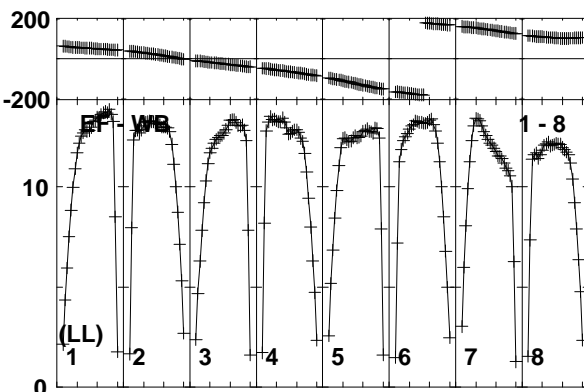
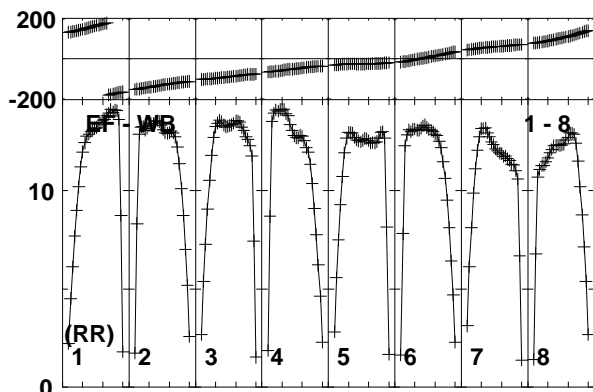
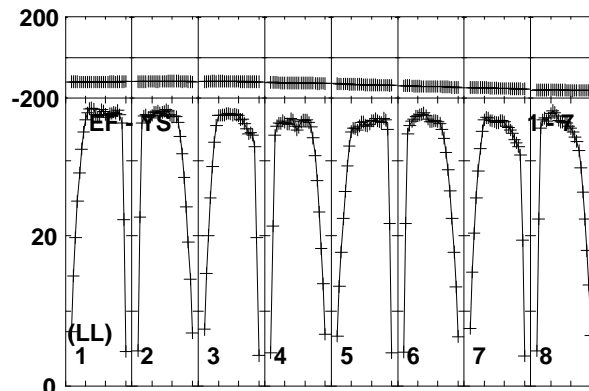
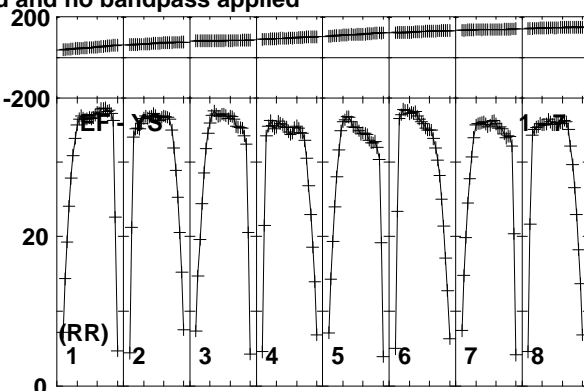
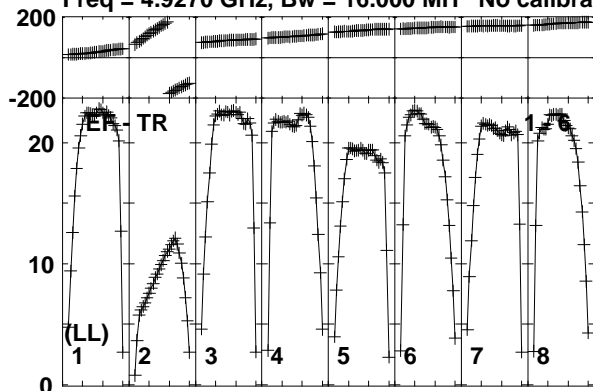

Lower frame: Milli Ampl Jy Top frame: Phas deg  
Vector averaged cross-power spectrum Baseline: EF (01) - TR (06)  
Timerange: 00/17:30:32 to 00/17:43:09



Plot file version 3 created 10-JUN-2016 17:21:49  
 OQ208 RT013A.UVDATA.1

Freq = 4.9270 GHz, Bw = 16.000 MH No calibration applied and no bandpass applied

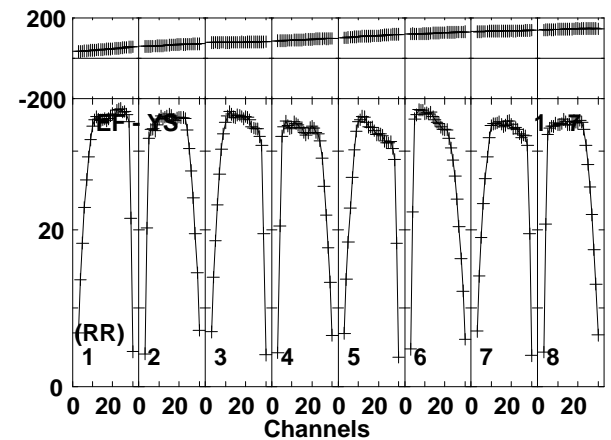
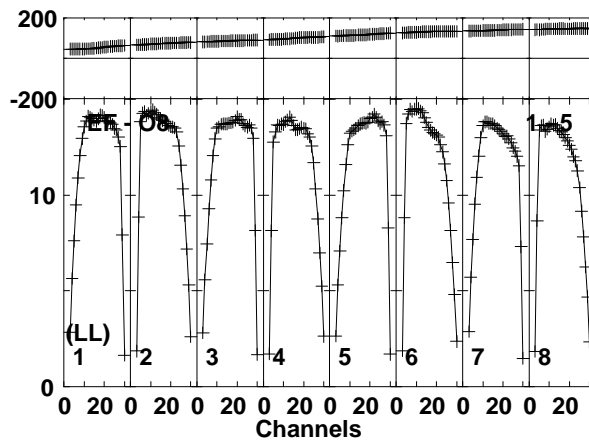
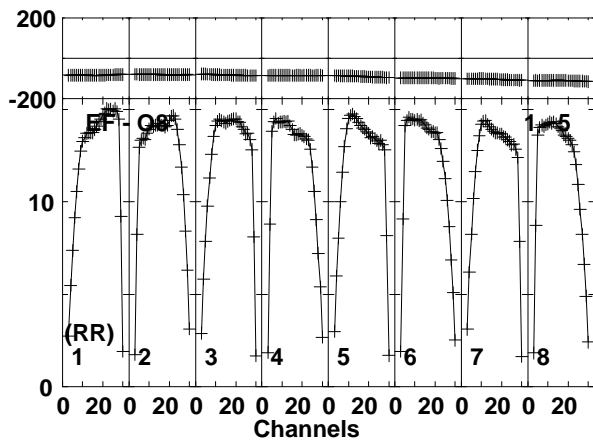
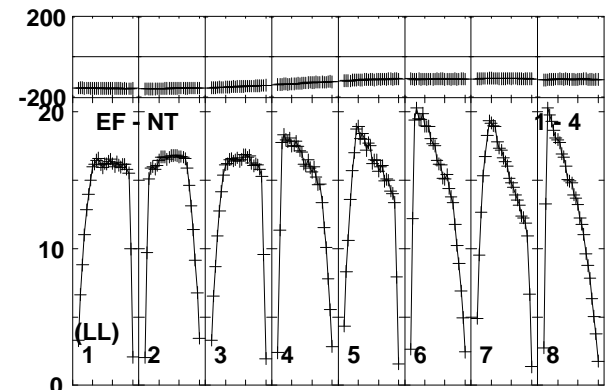
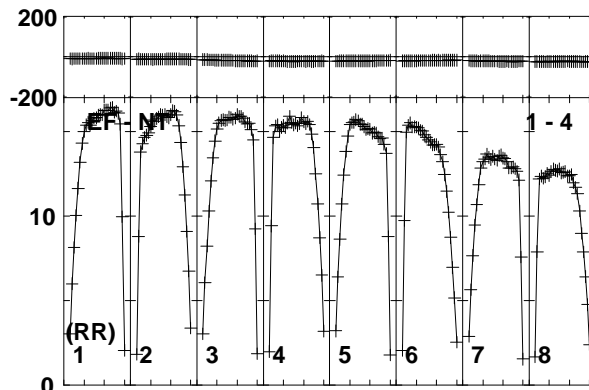
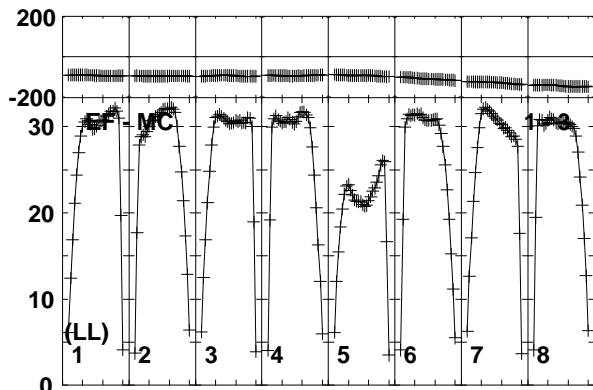
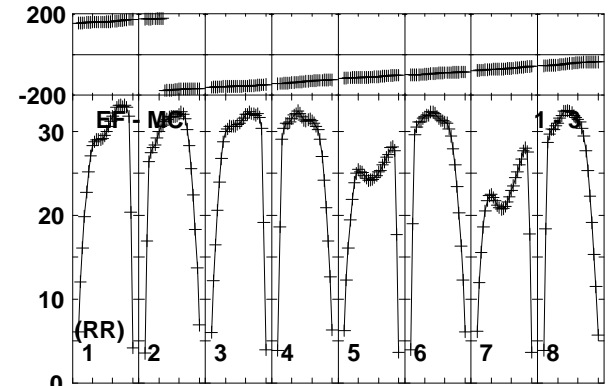
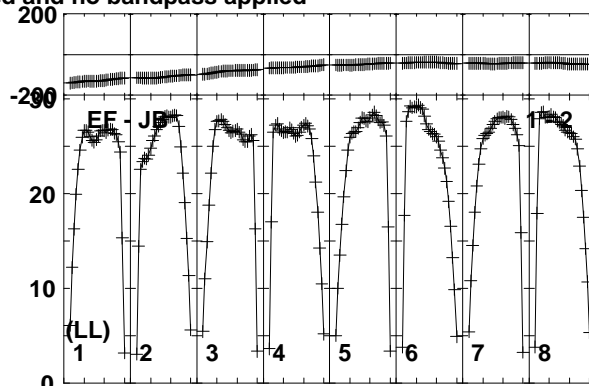
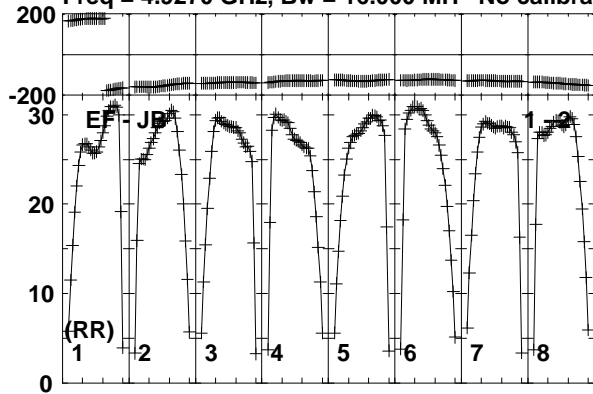

Lower frame: Milli Ampl Jy Top frame: Phas deg  
 Vector averaged cross-power spectrum Baseline: EF (01) - JB (02)  
 Timerange: 00/17:43:50 to 00/17:58:09

Plot file version 4 created 10-JUN-2016 17:21:50

OQ208 RT013A.UVDATA.1

Freq = 4.9270 GHz, Bw = 16.000 MH No calibration applied and no bandpass applied

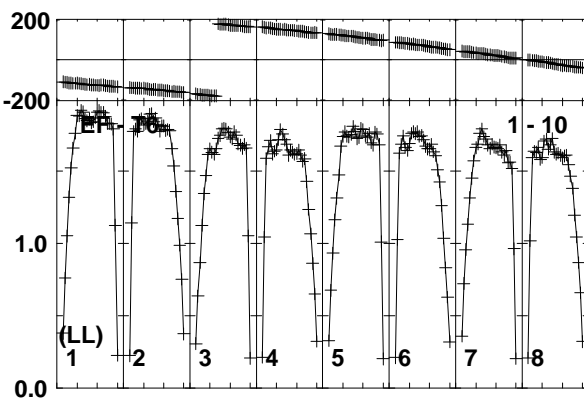
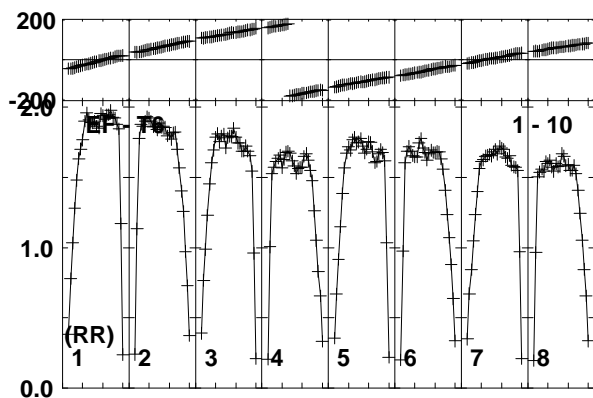
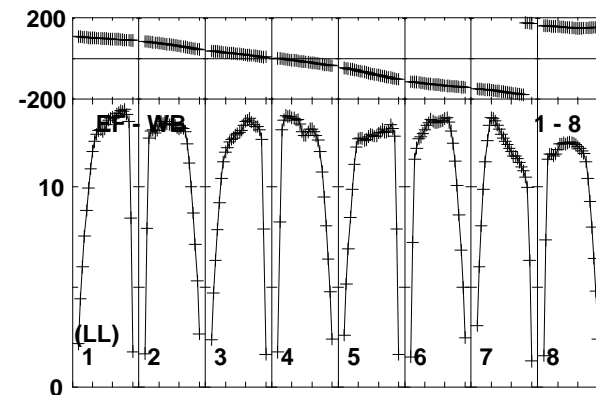
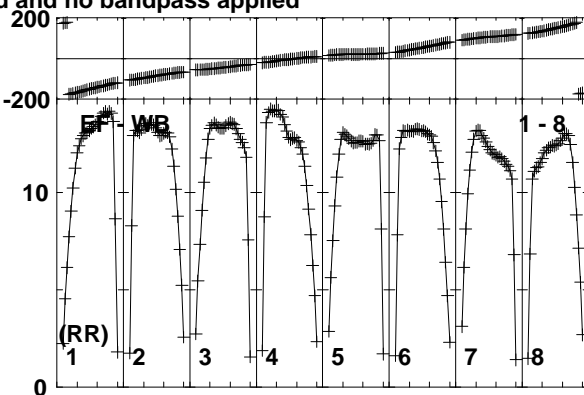
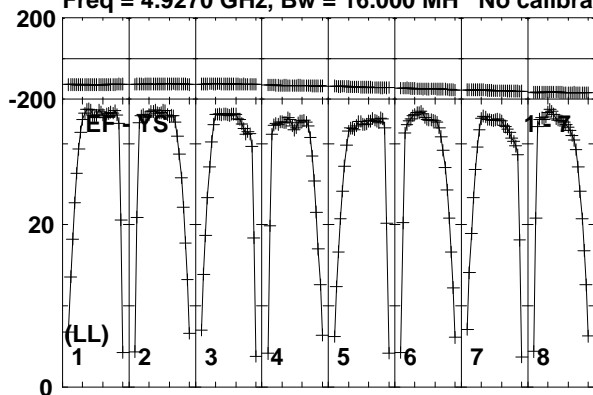

Lower frame: Milli Ampl Jy Top frame: Phas deg  
Vector averaged cross-power spectrum Baseline: EF (01) - YS (07)  
Timerange: 00:17:43:50 to 00:17:58:09

Plot file version 5 created 10-JUN-2016 17:21:50

OQ208 RT013A.UVDATA.1

Freq = 4.9270 GHz, Bw = 16.000 MH No calibration applied and no bandpass applied

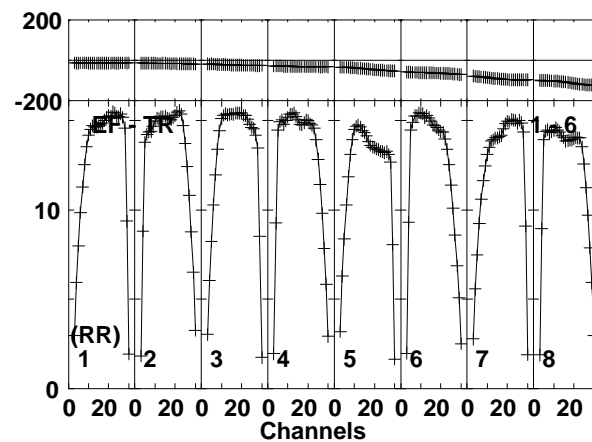
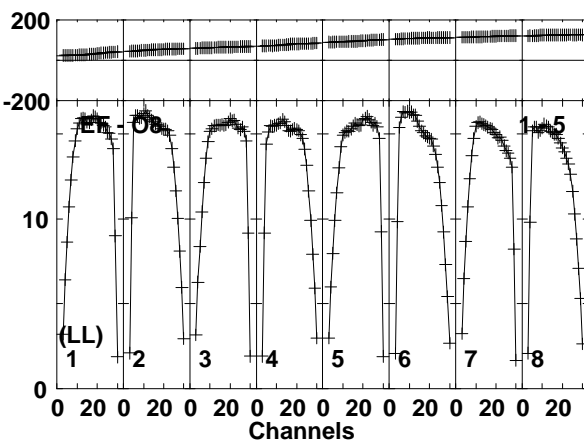
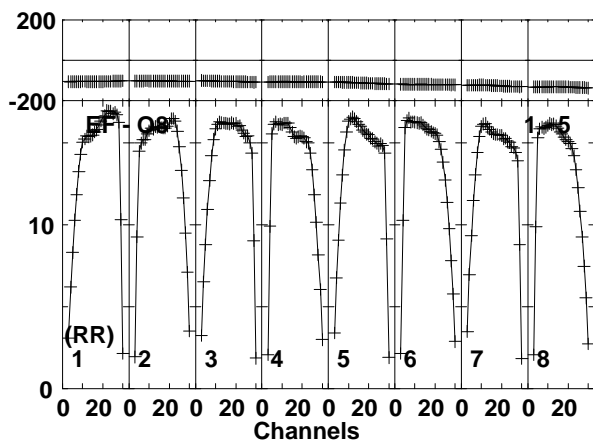
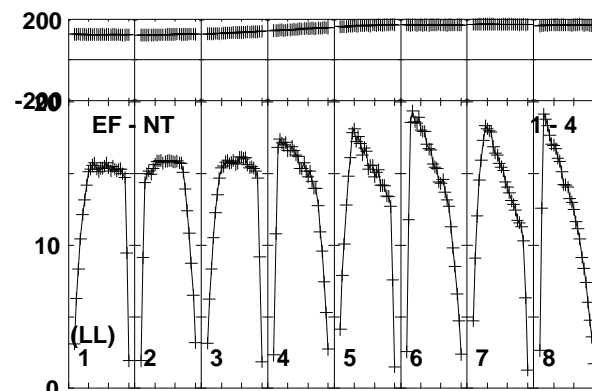
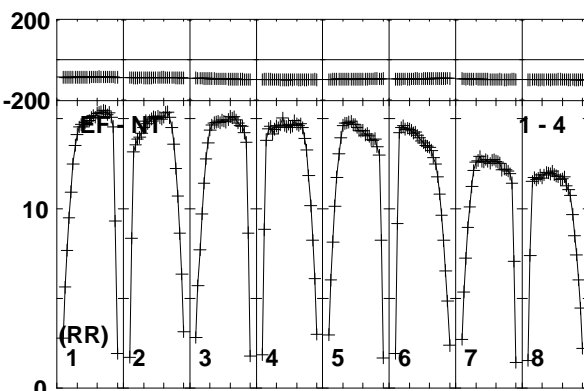
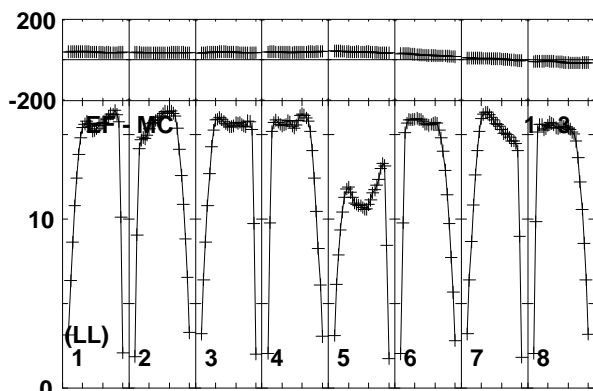
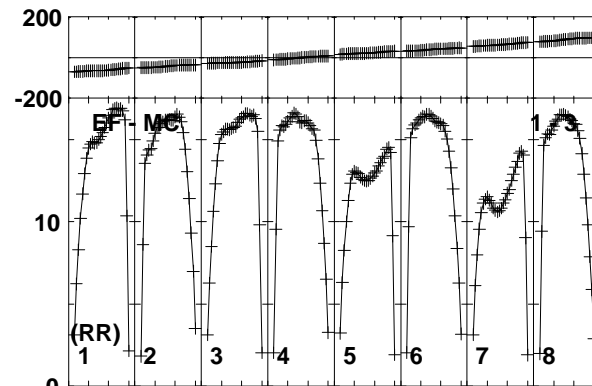
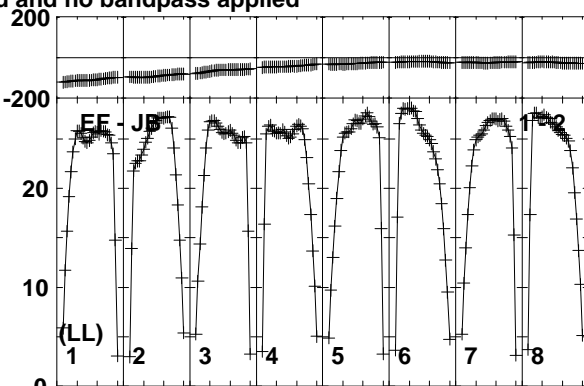
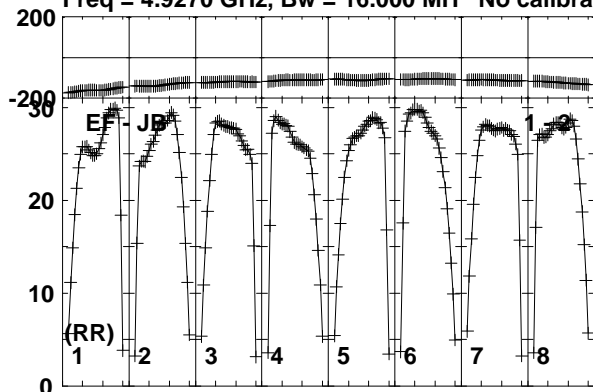

Lower frame: Milli Ampl Jy Top frame: Phas deg  
Vector averaged cross-power spectrum Baseline: EF (01) - JB (02)  
Timerange: 00/17:58:50 to 00/18:13:10

Plot file version 6 created 10-JUN-2016 17:21:51

OQ208 RT013A.UVDATA.1

Freq = 4.9270 GHz, Bw = 16.000 MH No calibration applied and no bandpass applied

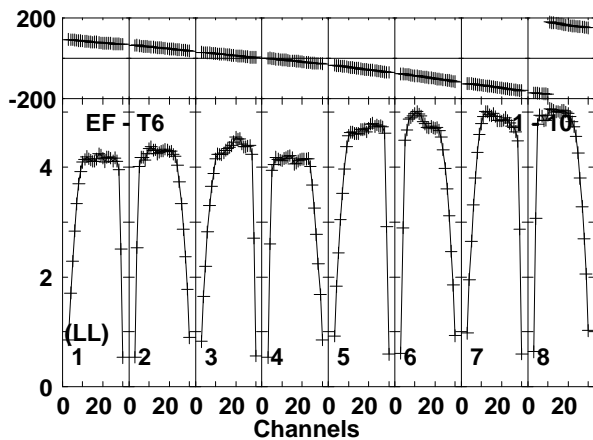
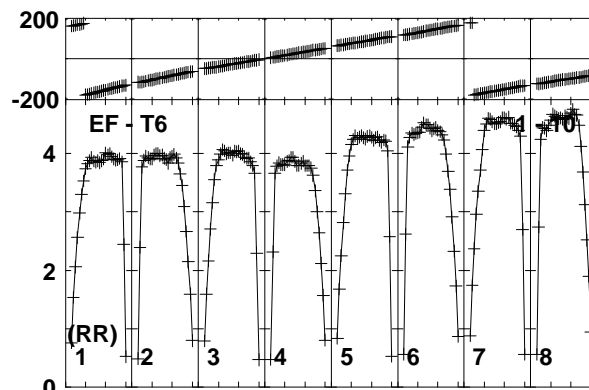
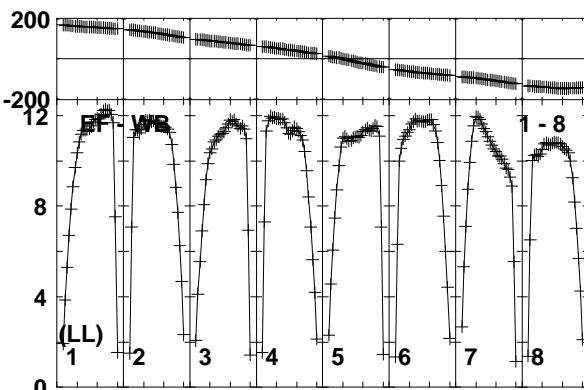
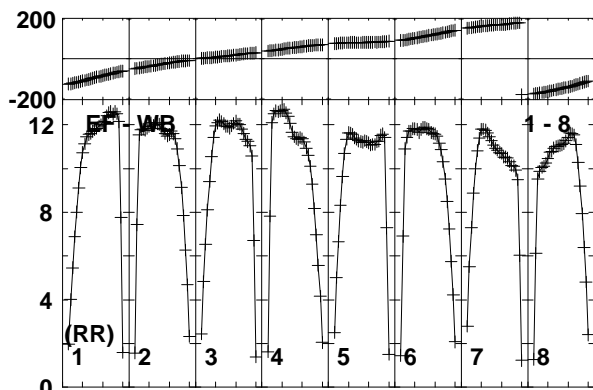
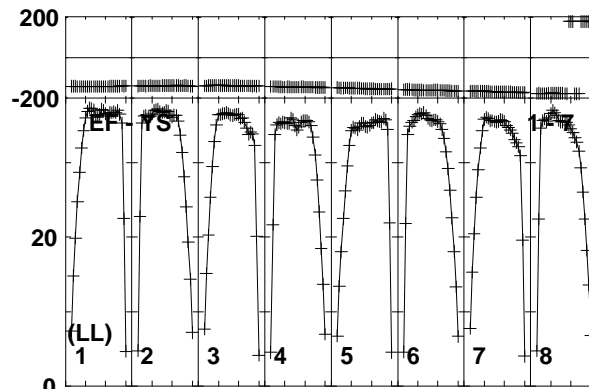
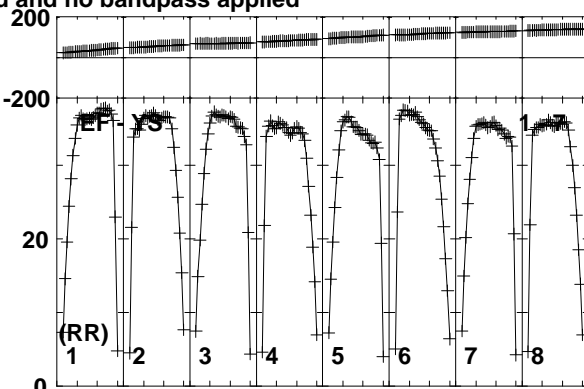
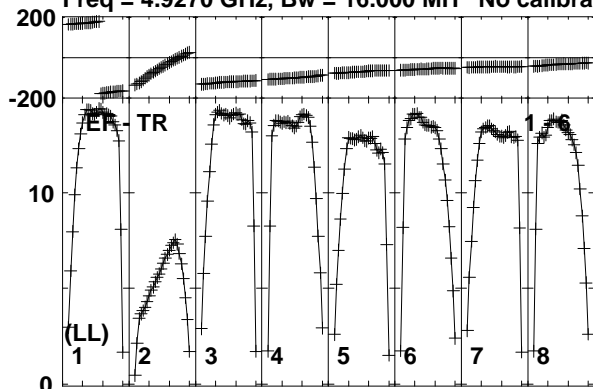

Lower frame: Milli Ampl Jy Top frame: Phas deg  
Vector averaged cross-power spectrum Baseline: EF (01) - TR (06)  
Timerange: 00/17:58:50 to 00/18:13:10

Plot file version 7 created 10-JUN-2016 17:21:51

OQ208 RT013A.UVDATA.1

Freq = 4.9270 GHz, Bw = 16.000 MH No calibration applied and no bandpass applied

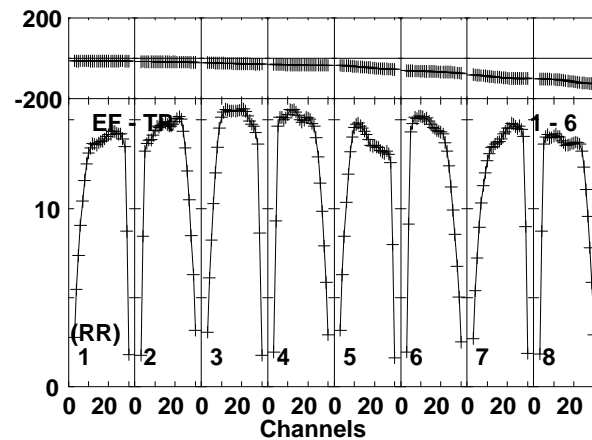
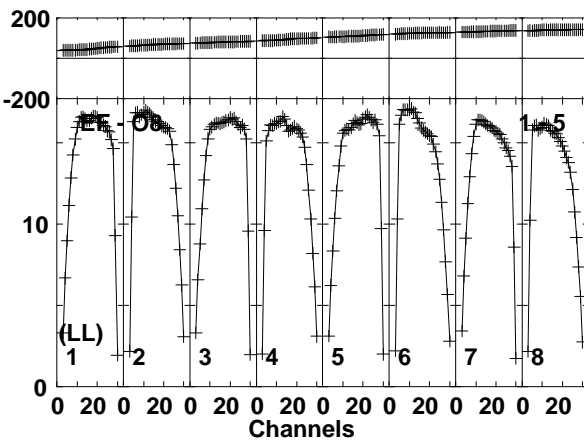
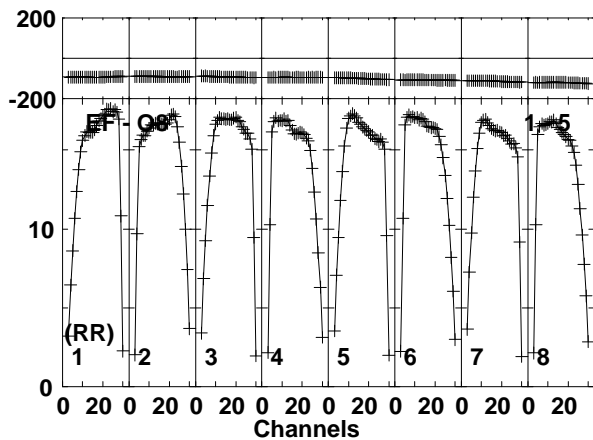
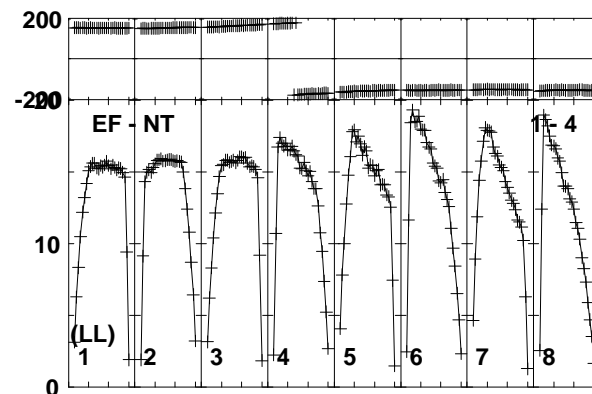
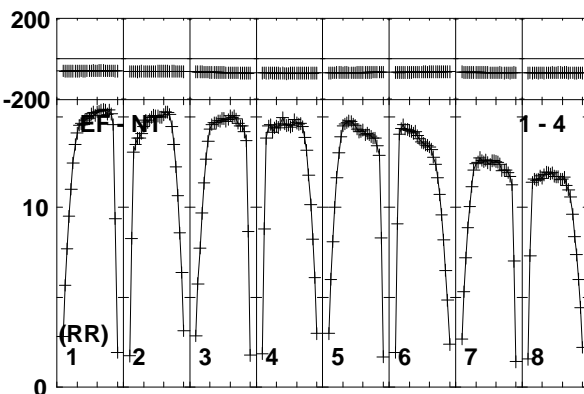
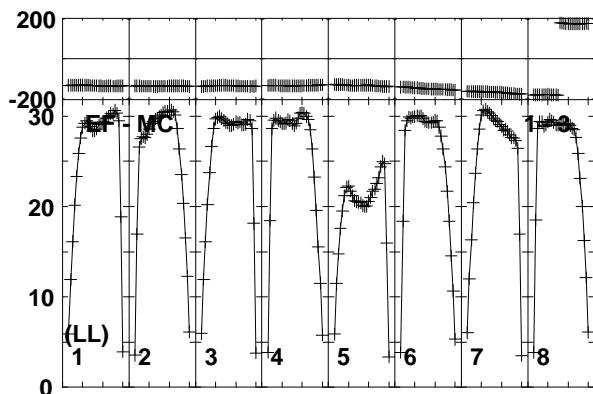
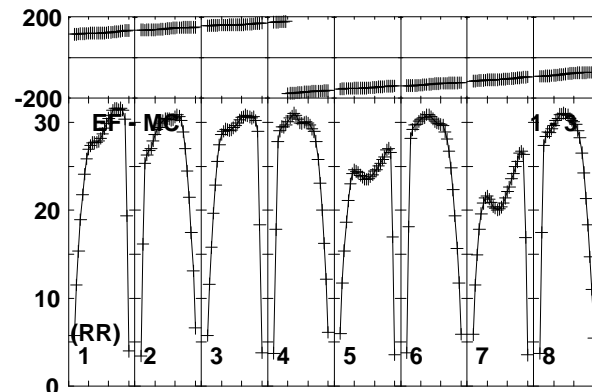
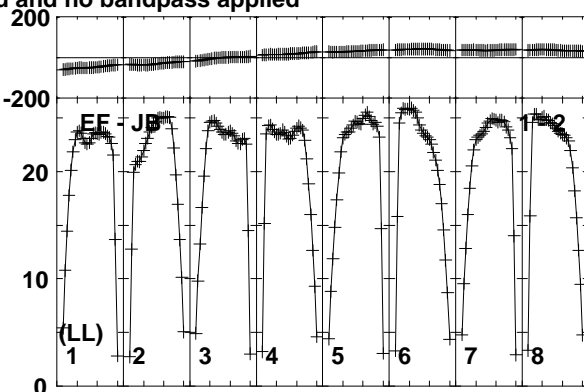
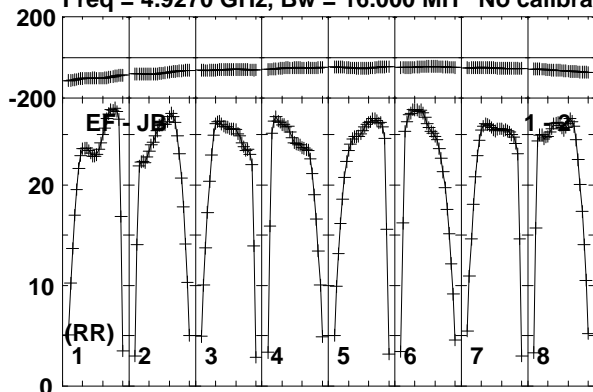

Lower frame: Milli Ampl Jy Top frame: Phas deg  
Vector averaged cross-power spectrum Baseline: EF (01) - JB (02)  
Timerange: 00/18:13:51 to 00/18:28:09

Plot file version 8 created 10-JUN-2016 17:21:52

OQ208 RT013A.UVDATA.1

Freq = 4.9270 GHz, Bw = 16.000 MH No calibration applied and no bandpass applied

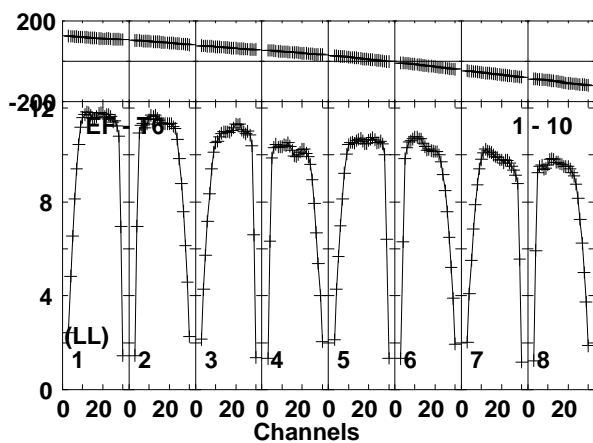
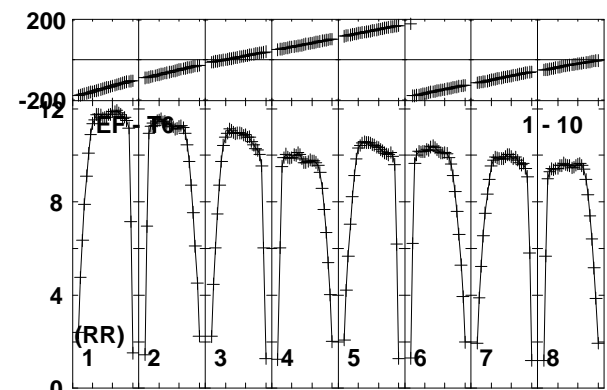
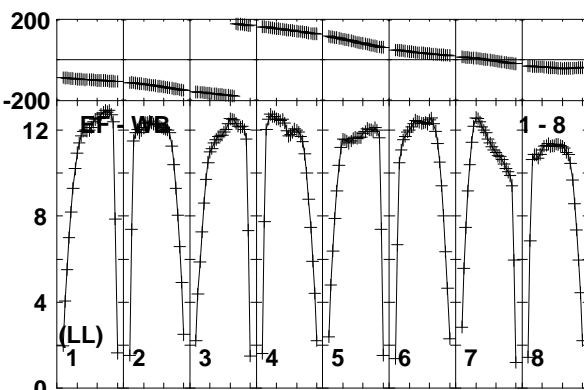
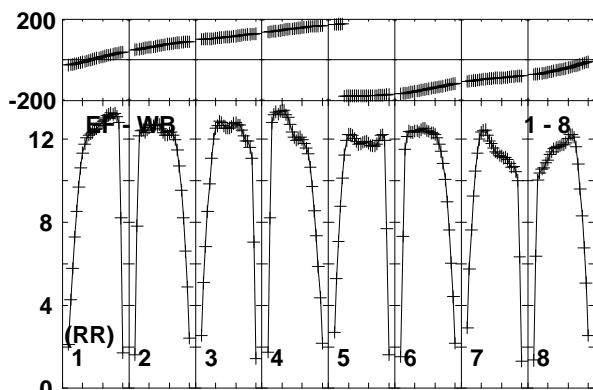
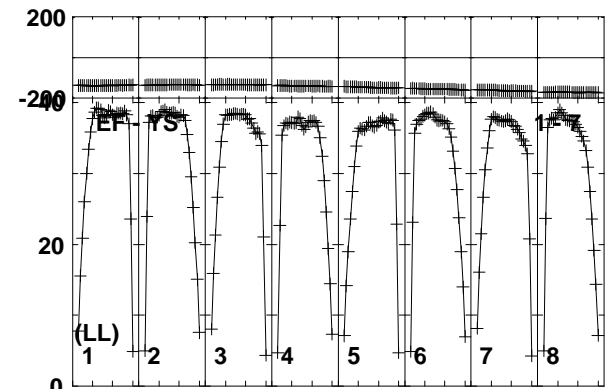
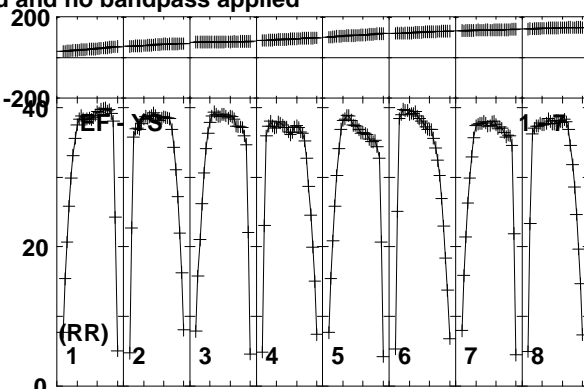
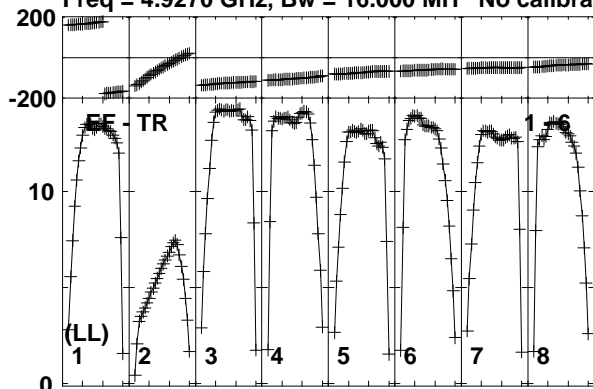

Lower frame: Milli Ampl Jy Top frame: Phas deg  
Vector averaged cross-power spectrum Baseline: EF (01) - TR (06)  
Timerange: 00/18:13:51 to 00/18:28:09

Plot file version 9 created 10-JUN-2016 17:21:53  
 3C345 RT013A.UVDATA.1  
 Freq = 4.9270 GHz, Bw = 16.000 MH No calibration applied and no bandpass applied

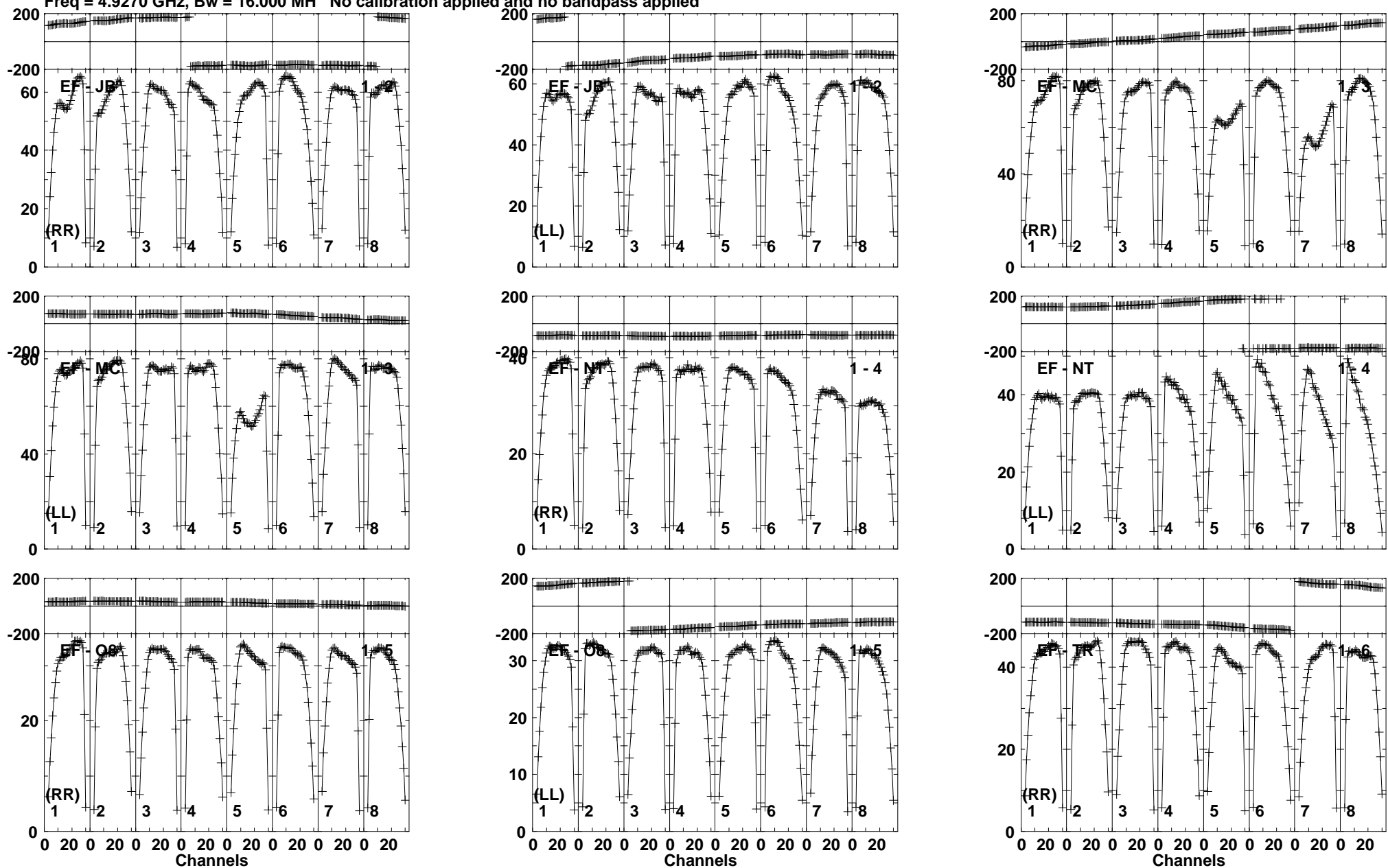

Lower frame: Milli Ampl Jy Top frame: Phas deg  
 Vector averaged cross-power spectrum Baseline: EF (01) - JB (02)  
 Timerange: 00:18:30:40 to 00:18:43:09

Plot file version 10 created 10-JUN-2016 17:21:53

3C345 RT013A.UVDATA.1

Freq = 4.9270 GHz, Bw = 16.000 MH No calibration applied and no bandpass applied

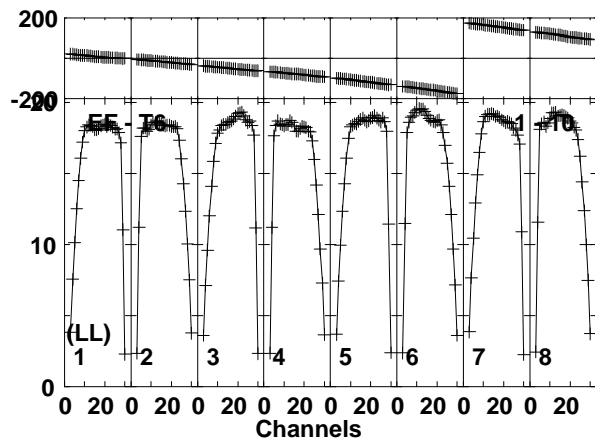
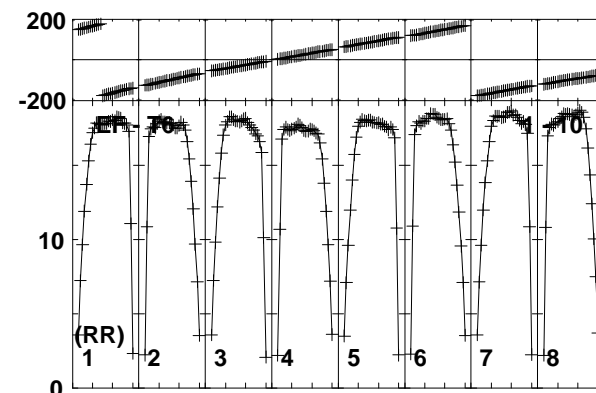
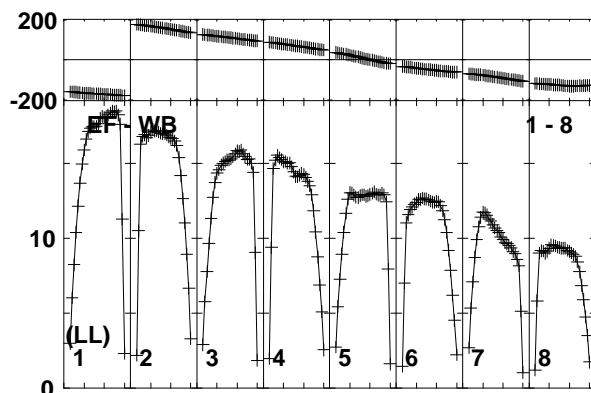
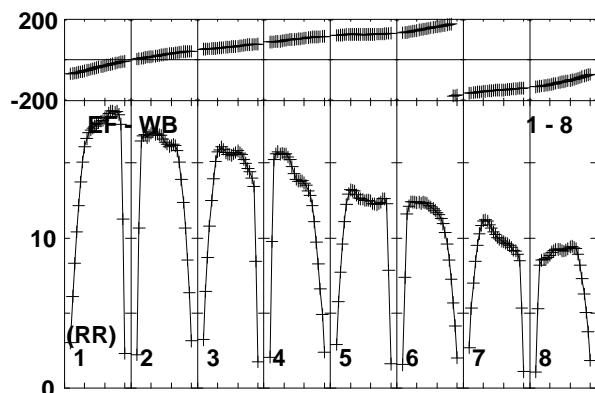
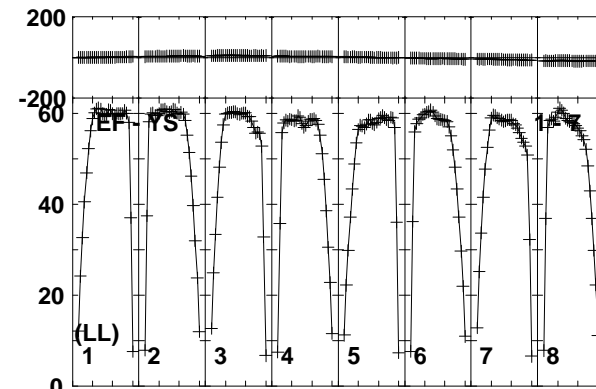
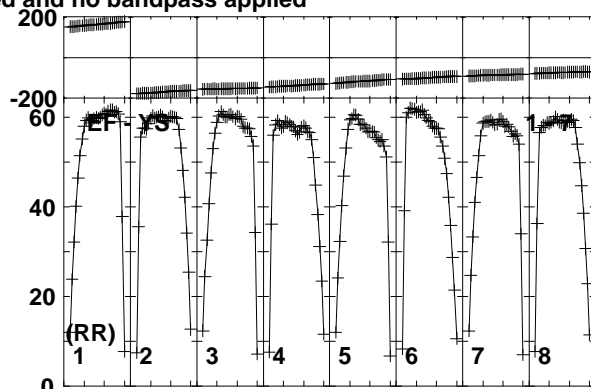
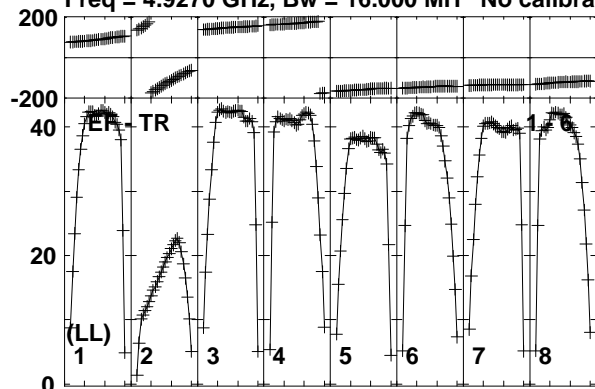

Lower frame: Milli Ampl Jy Top frame: Phas deg  
Vector averaged cross-power spectrum Baseline: EF (01) - TR (06)  
Timerange: 00/18:30:40 to 00/18:43:09



Plot file version 11 created 10-JUN-2016 17:21:54

3C345 RT013A.UVDATA.1

Freq = 4.9270 GHz, Bw = 16.000 MH No calibration applied and no bandpass applied

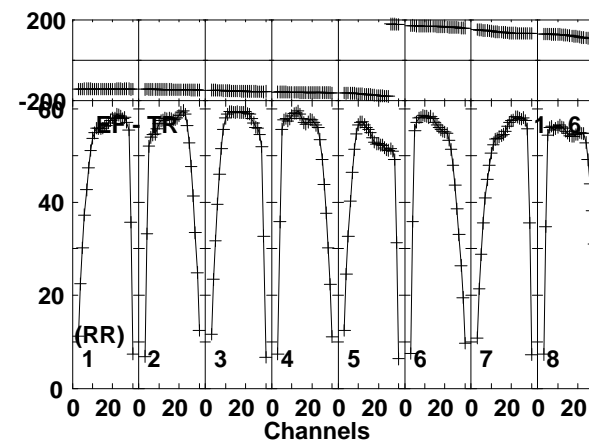
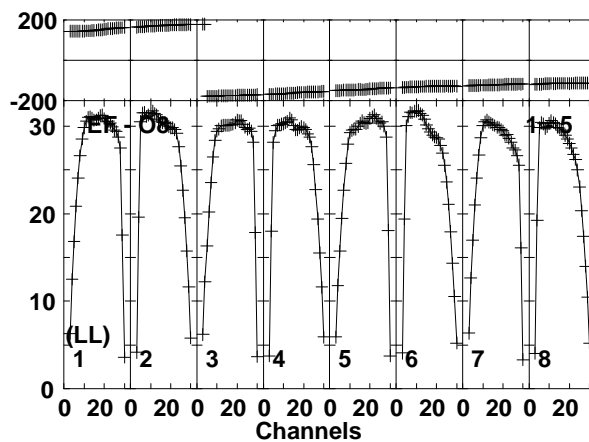
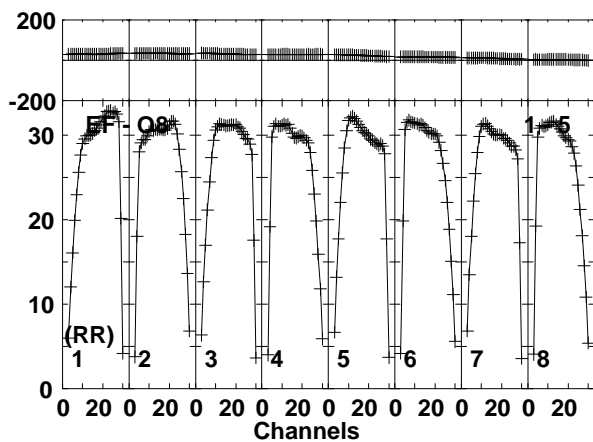
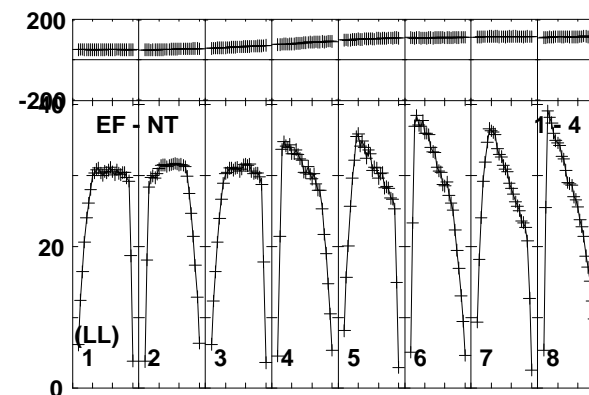
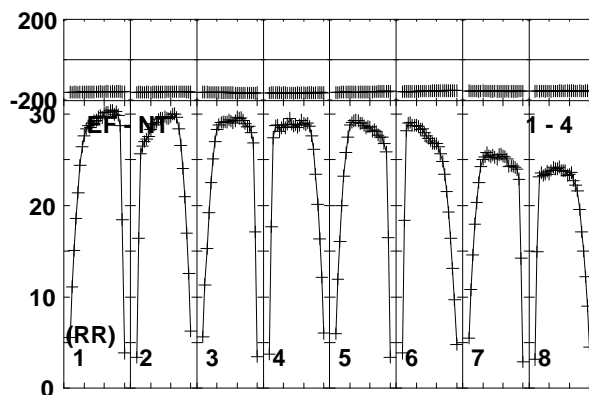
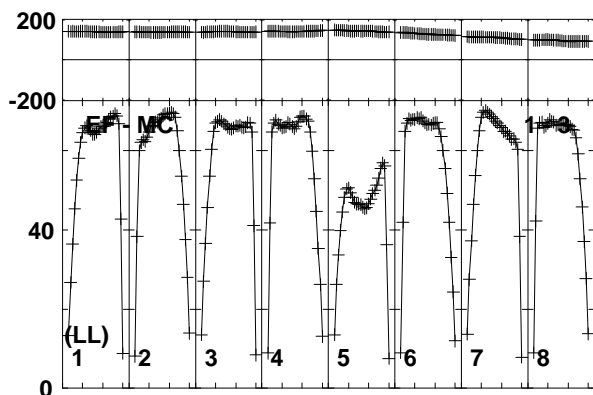
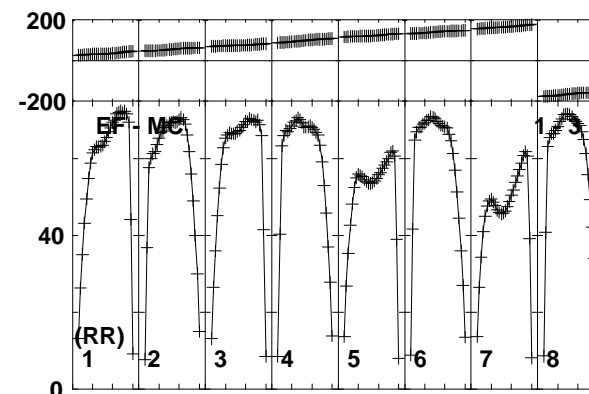
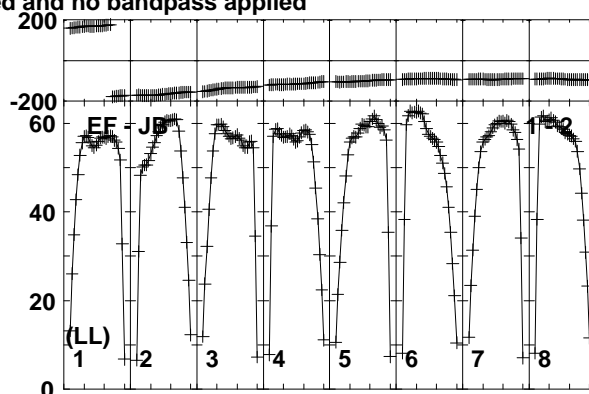
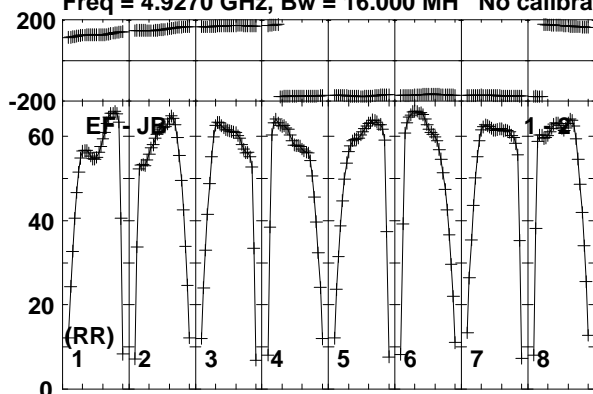

Lower frame: Milli Ampl Jy Top frame: Phas deg  
Vector averaged cross-power spectrum Baseline: EF (01) - JB (02)  
Timerange: 00:18:43:50 to 00:18:58:10

Plot file version 12 created 10-JUN-2016 17:21:55

3C345 RT013A.UVDATA.1

Freq = 4.9270 GHz, Bw = 16.000 MH No calibration applied and no bandpass applied

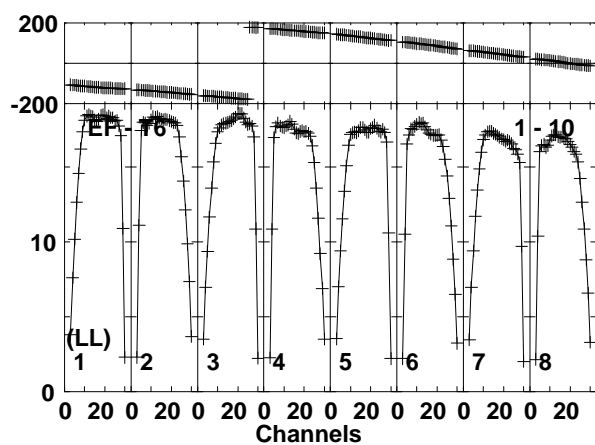
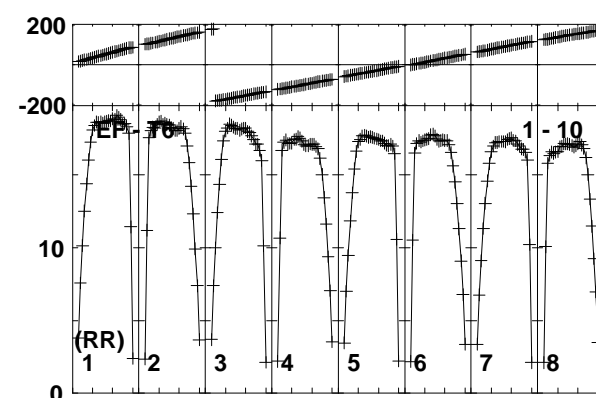
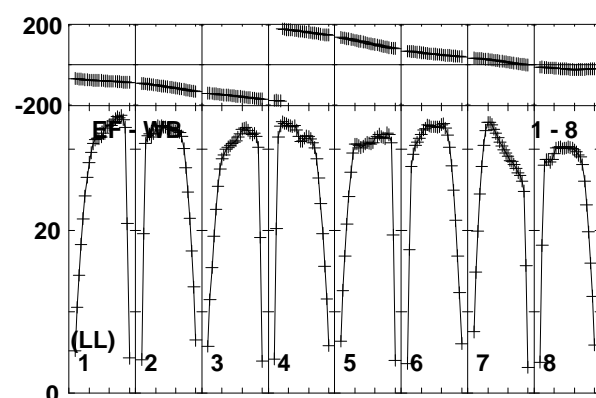
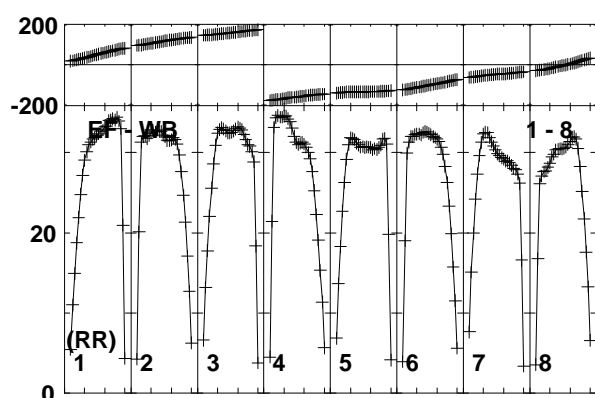
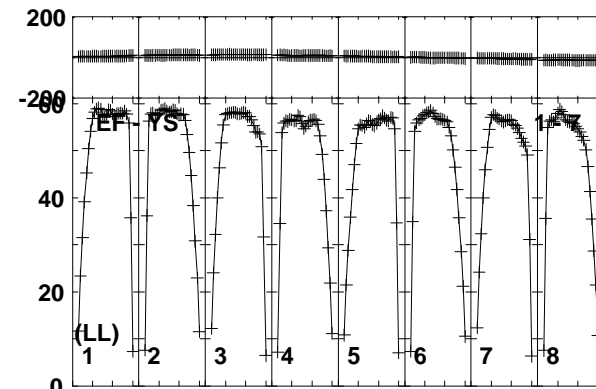
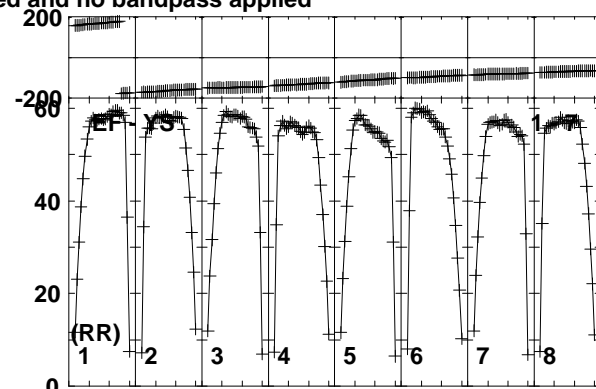
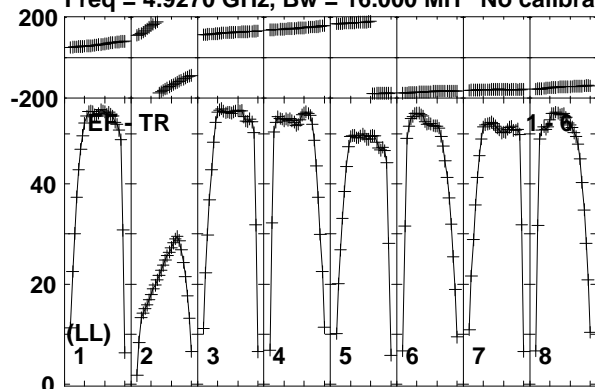

Lower frame: Milli Ampl Jy Top frame: Phas deg  
Vector averaged cross-power spectrum Baseline: EF (01) - TR (06)  
Timerange: 00/18:43:50 to 00/18:58:10

Plot file version 13 created 10-JUN-2016 17:21:55

3C345 RT013A.UVDATA.1

Freq = 4.9270 GHz, Bw = 16.000 MH No calibration applied and no bandpass applied

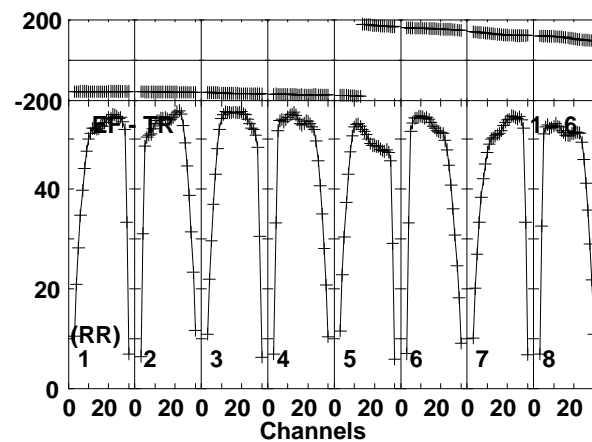
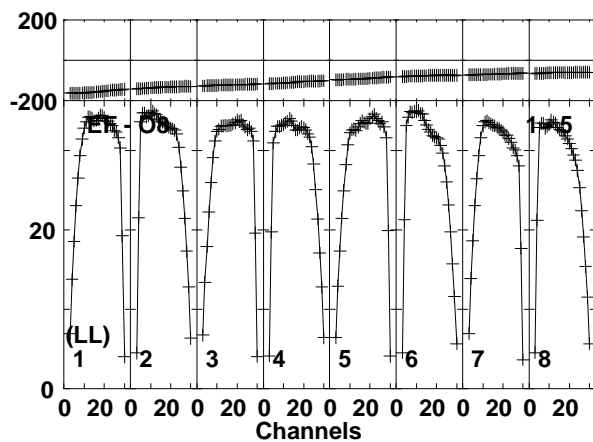
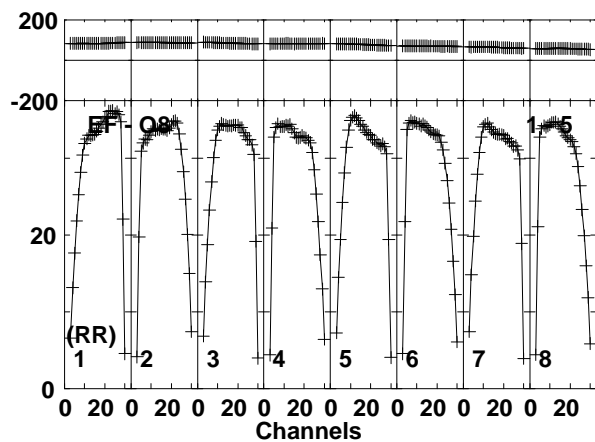
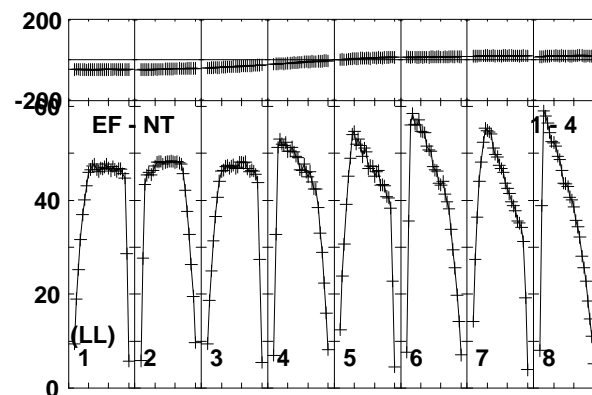
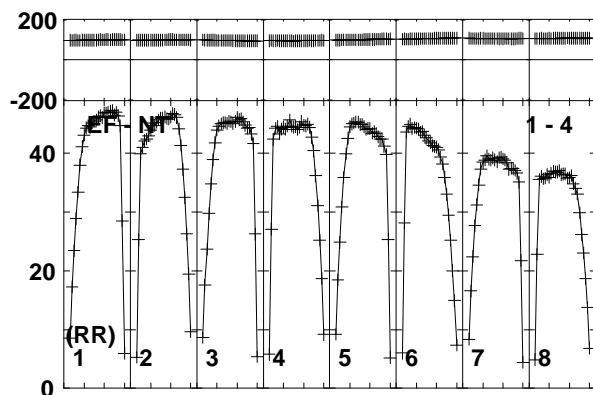
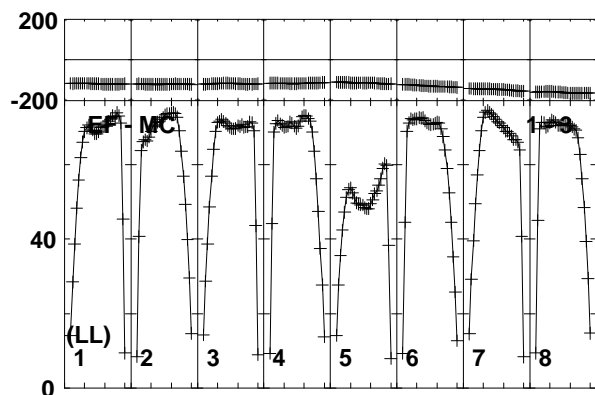
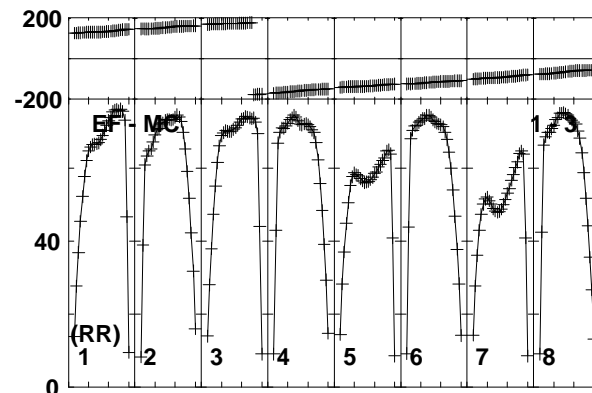
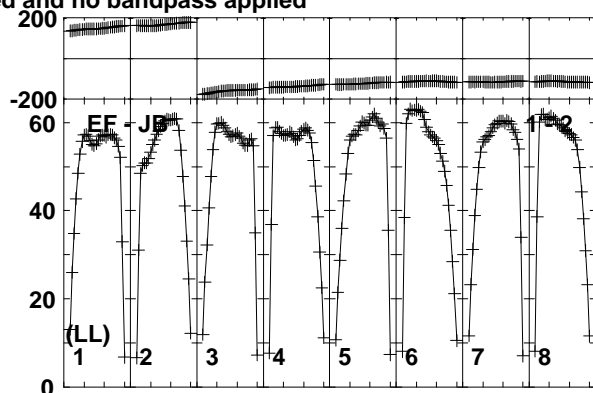
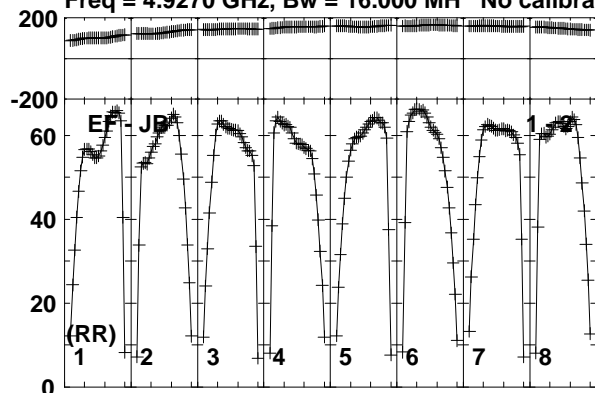

Lower frame: Milli Ampl Jy Top frame: Phas deg  
Vector averaged cross-power spectrum Baseline: EF (01) - JB (02)  
Timerange: 00/19:00:15 to 00/19:13:09

Plot file version 14 created 10-JUN-2016 17:21:56

3C345 RT013A.UVDATA.1

Freq = 4.9270 GHz, Bw = 16.000 MH No calibration applied and no bandpass applied

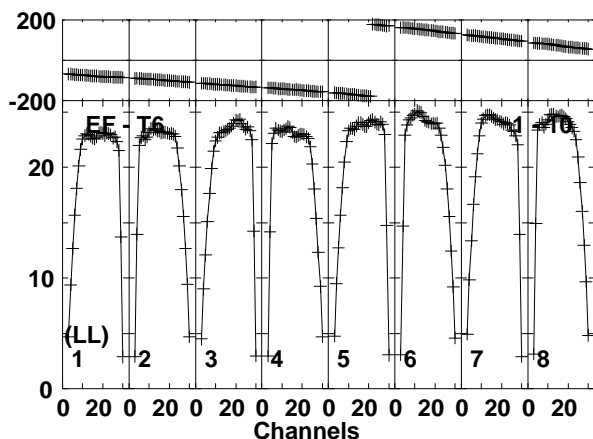
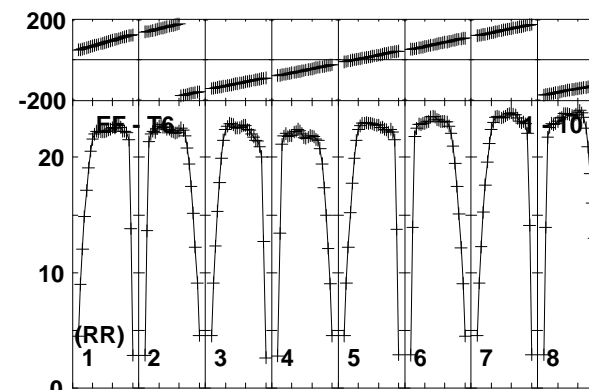
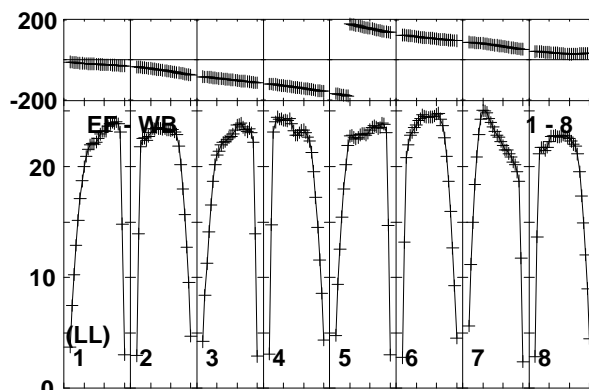
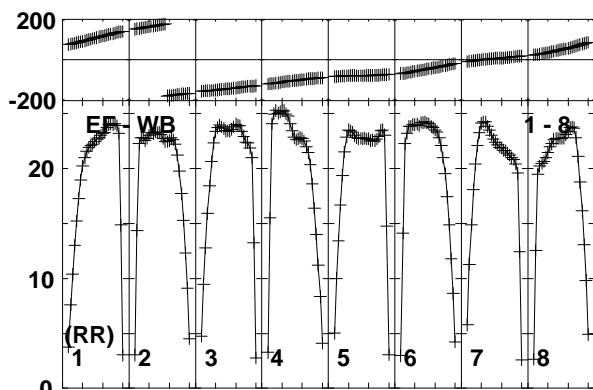
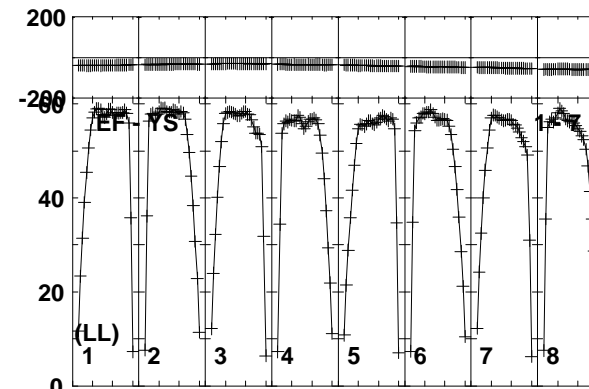
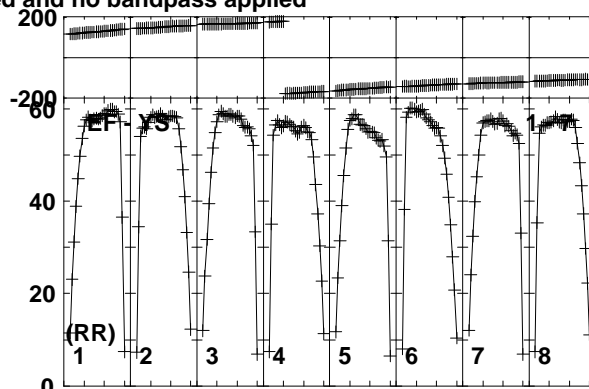
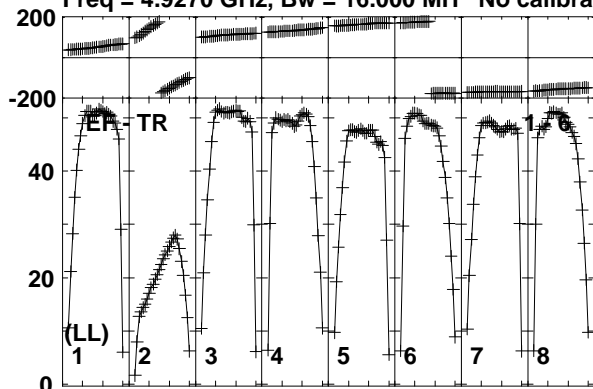

Lower frame: Milli Ampl Jy Top frame: Phas deg  
Vector averaged cross-power spectrum Baseline: EF (01) - TR (06)  
Timerange: 00/19:00:15 to 00/19:13:09

Plot file version 15 created 10-JUN-2016 17:21:57

3C345 RT013A.UVDATA.1

Freq = 4.9270 GHz, Bw = 16.000 MH No calibration applied and no bandpass applied

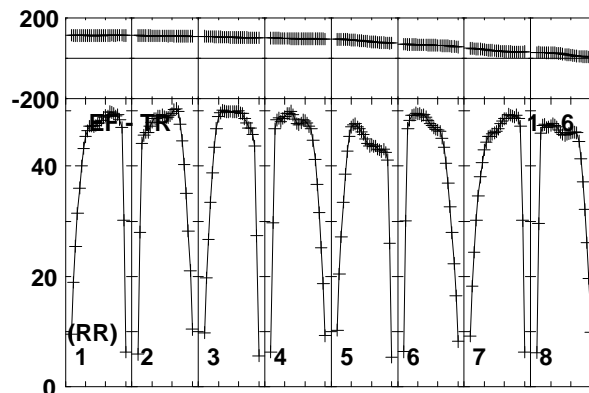
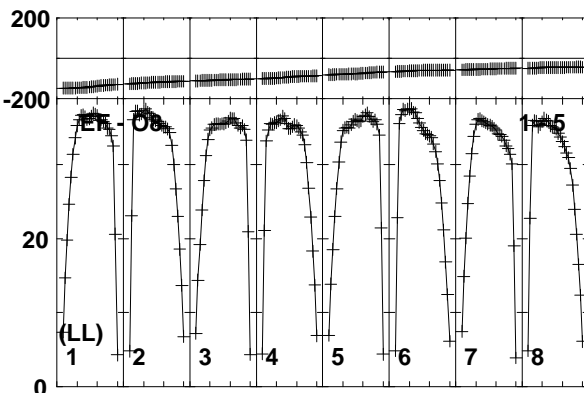
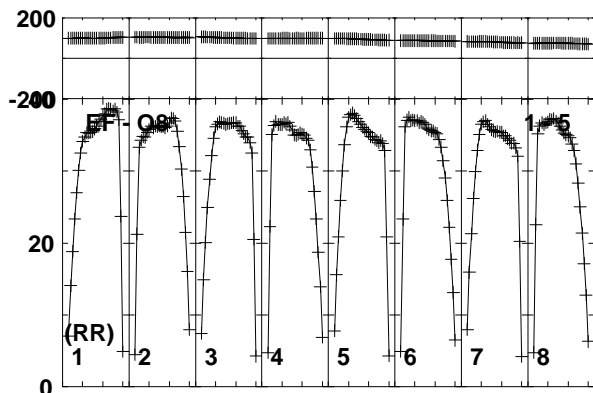
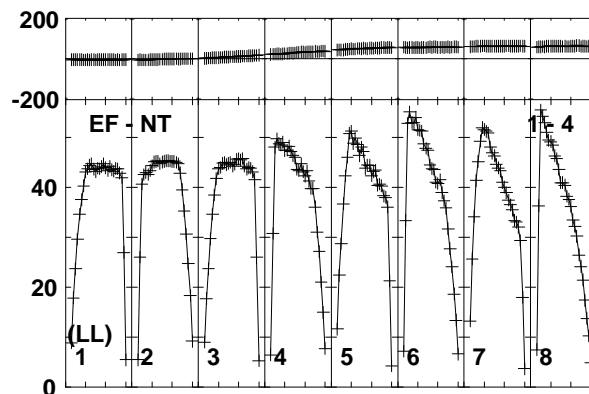
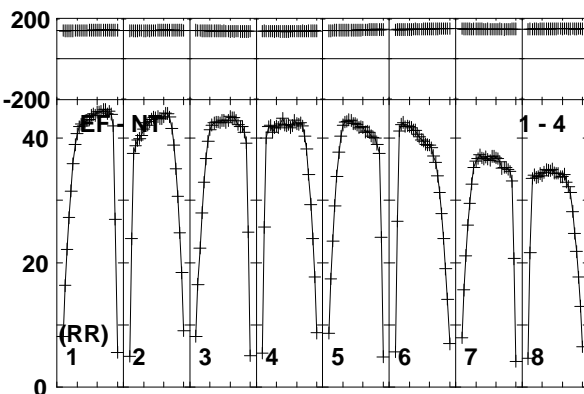
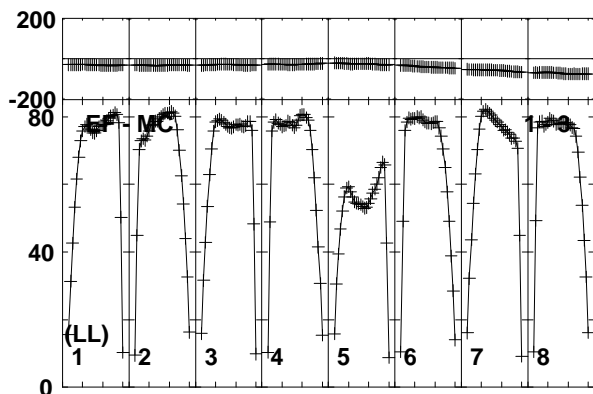
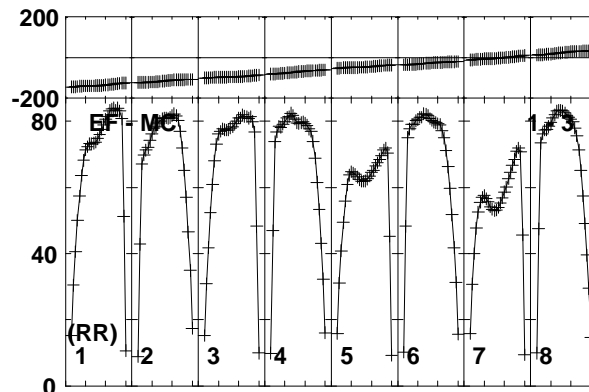
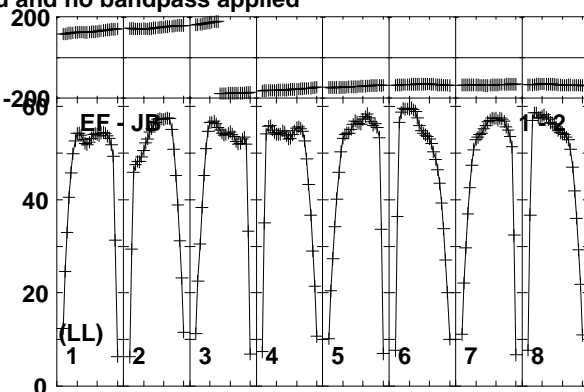
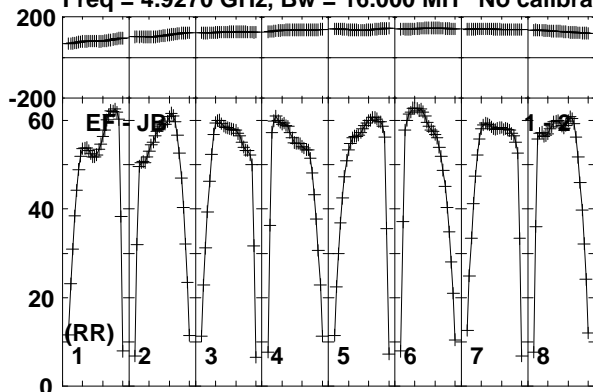

Lower frame: Milli Ampl Jy Top frame: Phas deg  
Vector averaged cross-power spectrum Baseline: EF (01) - JB (02)  
Timerange: 00/19:13:50 to 00/19:28:09

Plot file version 16 created 10-JUN-2016 17:21:57

3C345 RT013A.UVDATA.1

Freq = 4.9270 GHz, Bw = 16.000 MH No calibration applied and no bandpass applied

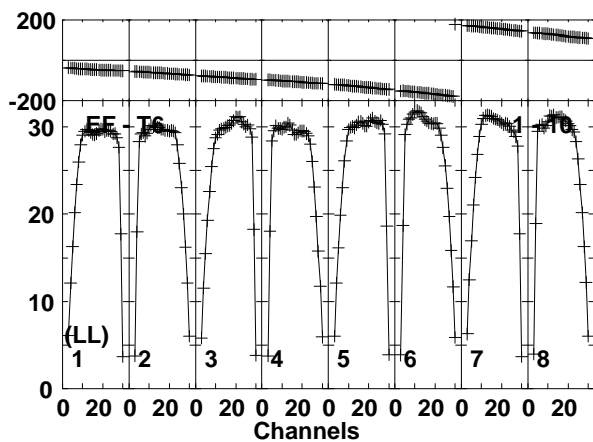
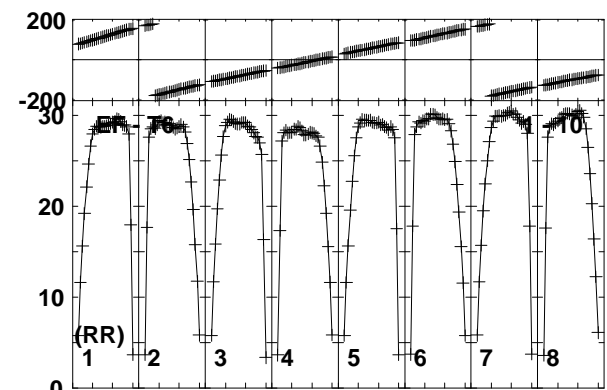
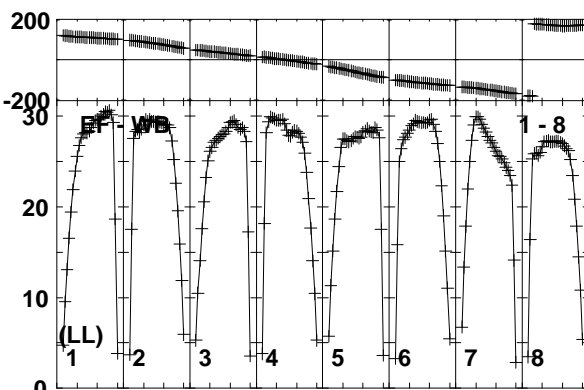
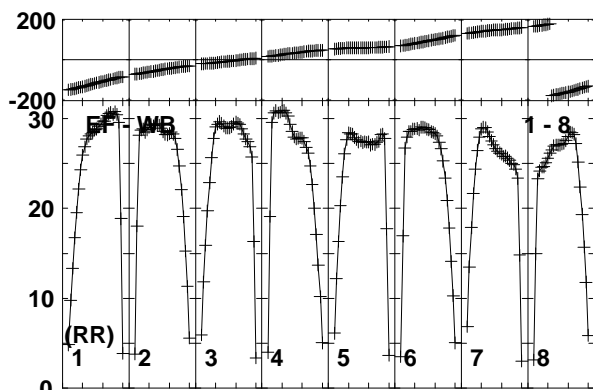
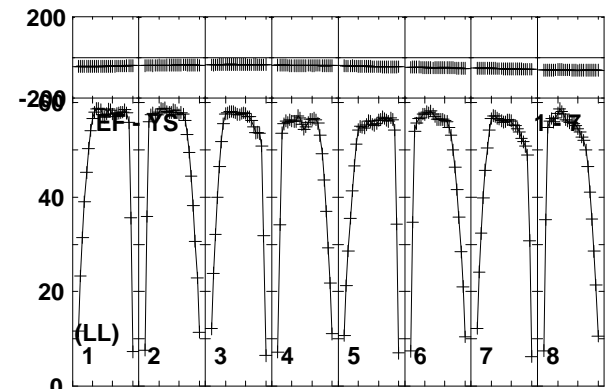
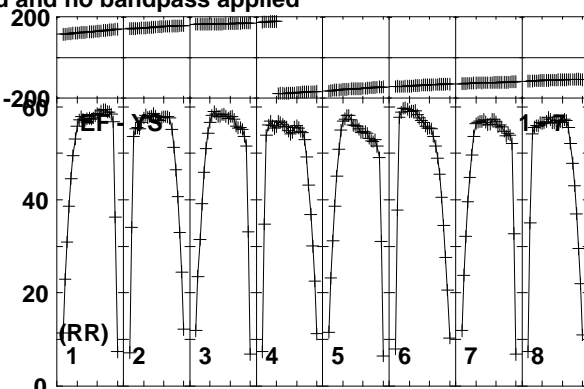
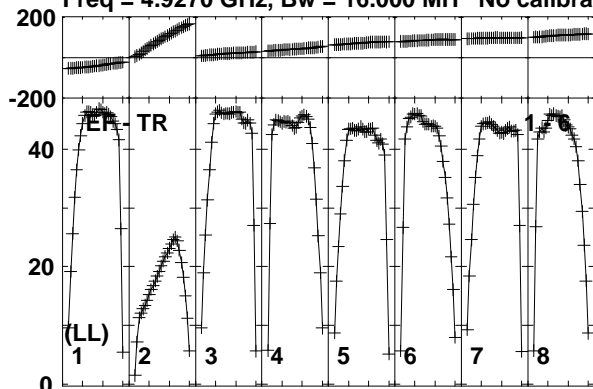

Lower frame: Milli Ampl Jy Top frame: Phas deg  
Vector averaged cross-power spectrum Baseline: EF (01) - TR (06)  
Timerange: 00/19:13:50 to 00/19:28:09

Plot file version 17 created 10-JUN-2016 17:21:58

3C345 RT013A.UVDATA.1

Freq = 4.9270 GHz, Bw = 16.000 MH No calibration applied and no bandpass applied

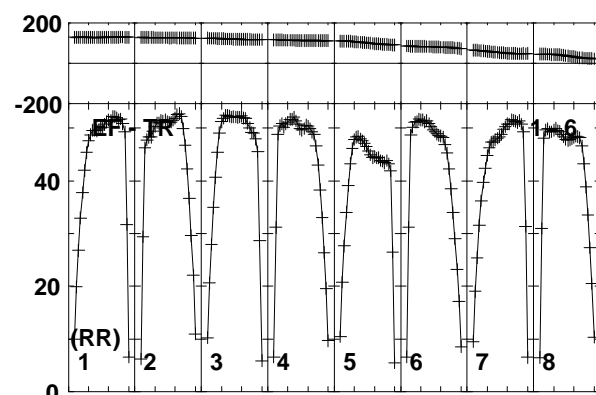
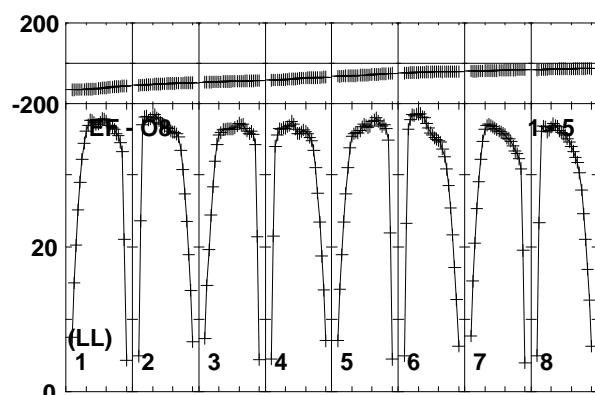
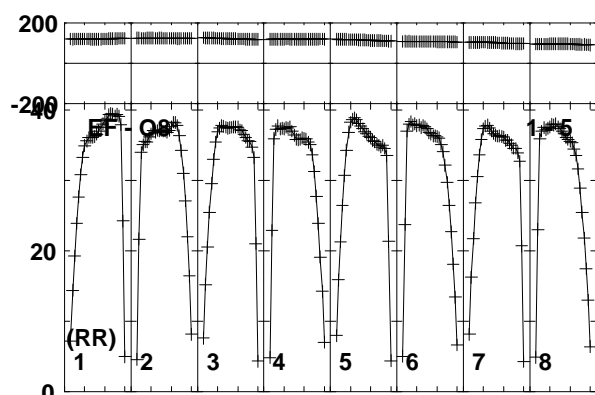
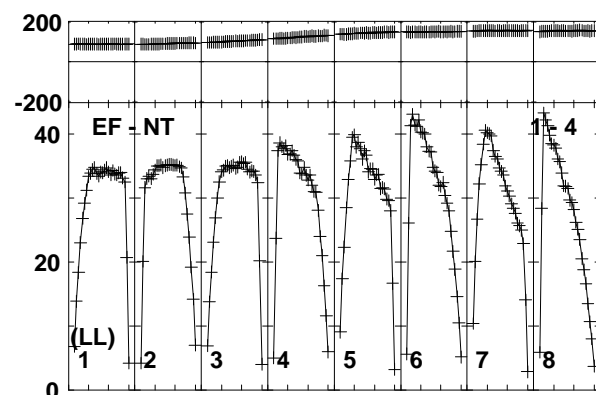
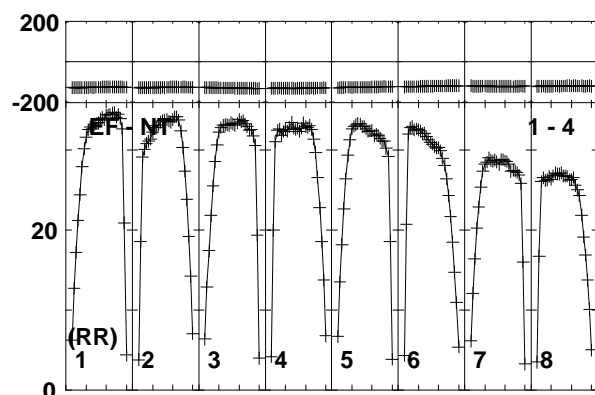
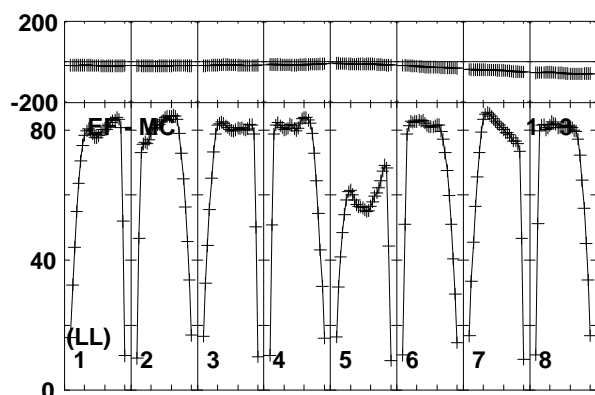
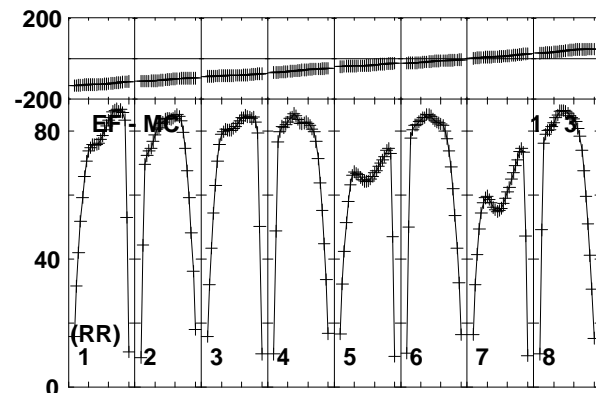
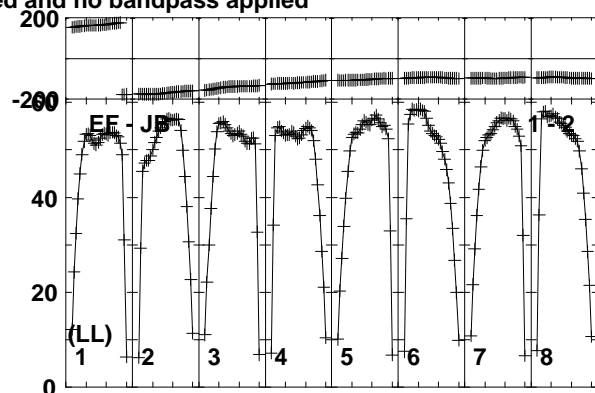
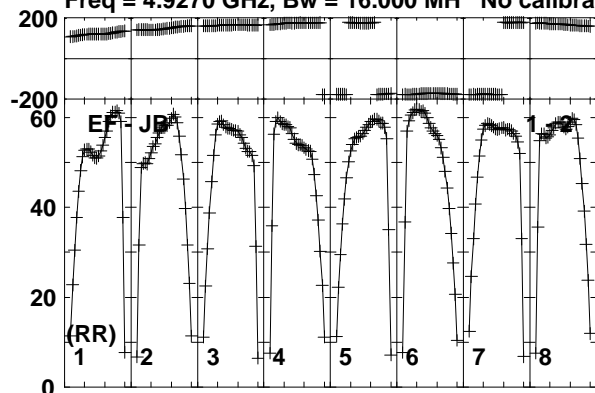

Lower frame: Milli Ampl Jy Top frame: Phas deg  
Vector averaged cross-power spectrum Baseline: EF (01) - JB (02)  
Timerange: 00/19:28:50 to 00/19:43:10

Plot file version 18 created 10-JUN-2016 17:21:59

3C345 RT013A.UVDATA.1

Freq = 4.9270 GHz, Bw = 16.000 MH No calibration applied and no bandpass applied

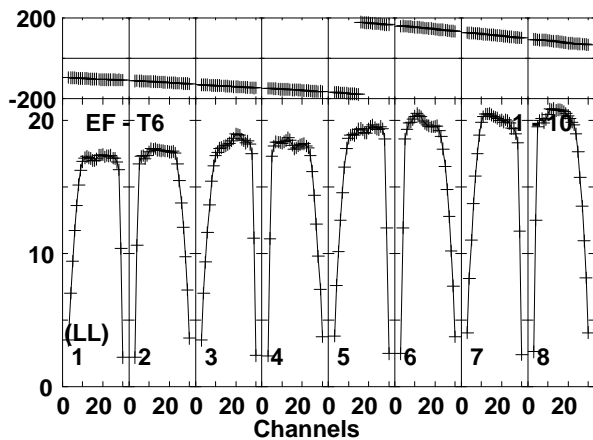
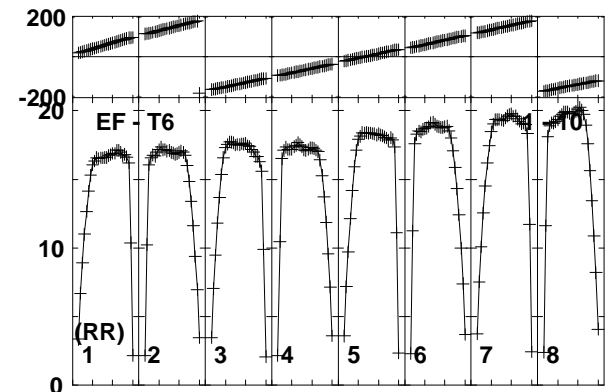
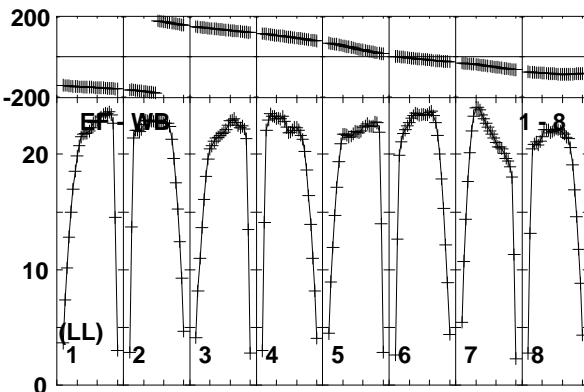
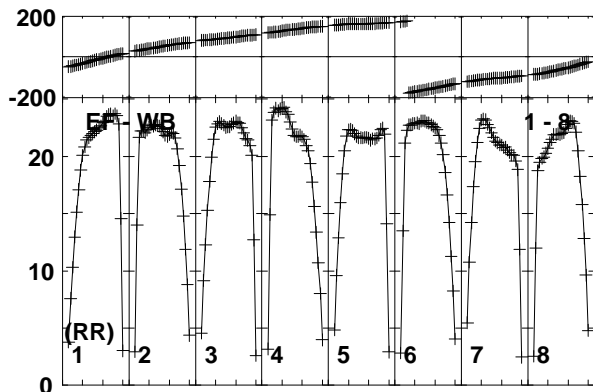
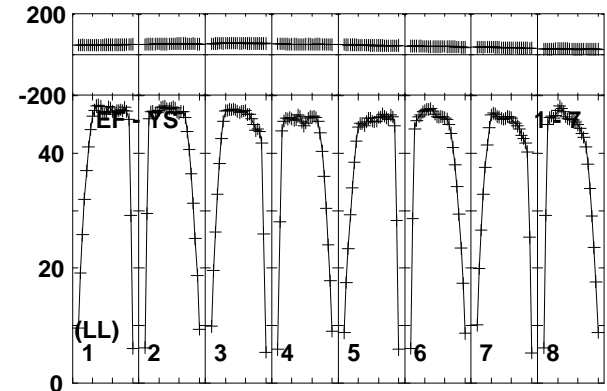
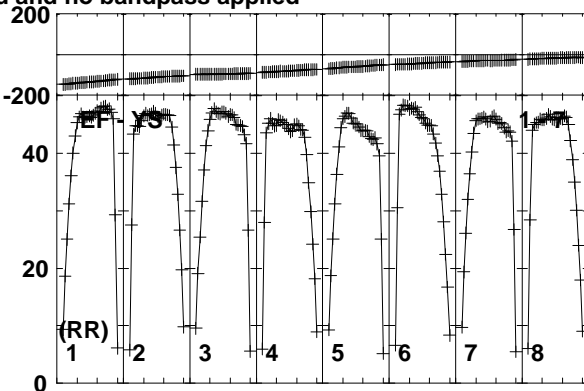
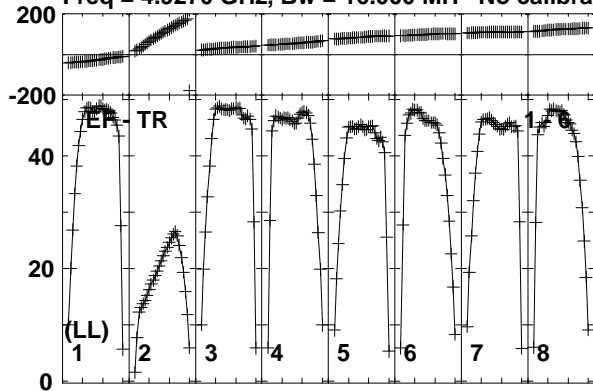

Lower frame: Milli Ampl Jy Top frame: Phas deg  
Vector averaged cross-power spectrum Baseline: EF (01) - TR (06)  
Timerange: 00/19:28:50 to 00/19:43:10



Plot file version 19 created 10-JUN-2016 17:21:59

3C345 RT013A.UVDATA.1

Freq = 4.9270 GHz, Bw = 16.000 MH No calibration applied and no bandpass applied

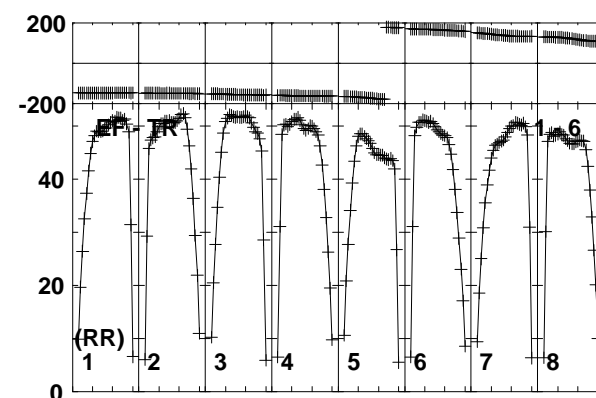
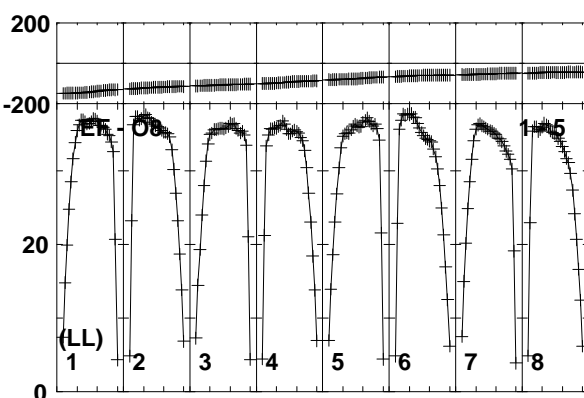
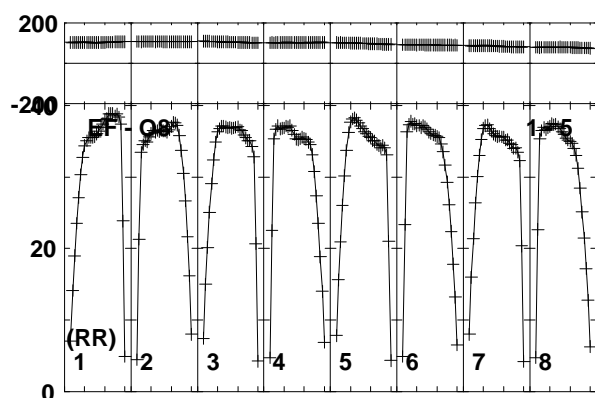
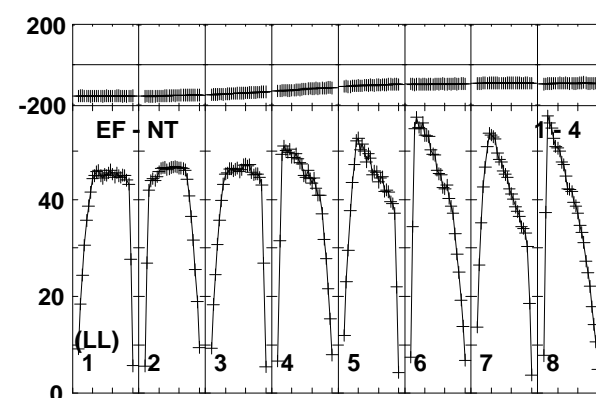
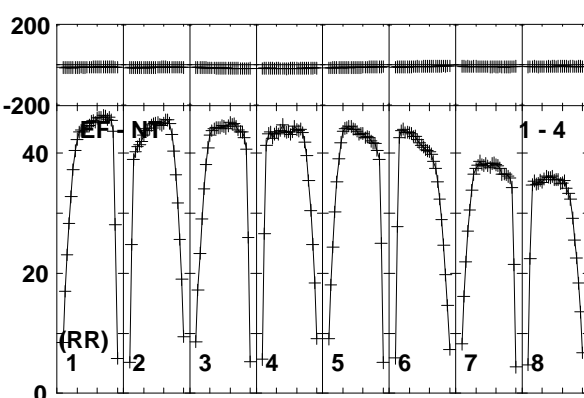
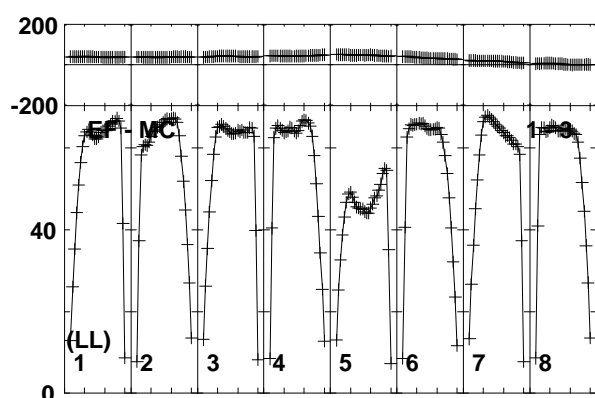
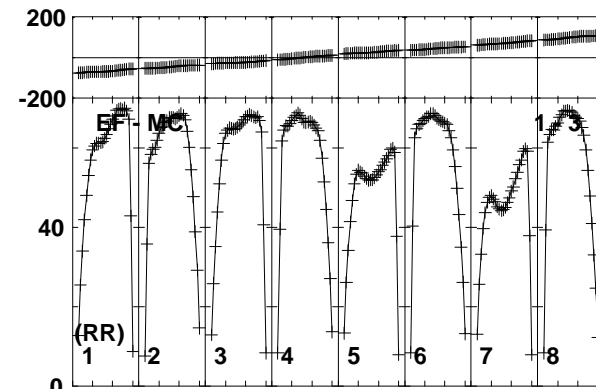
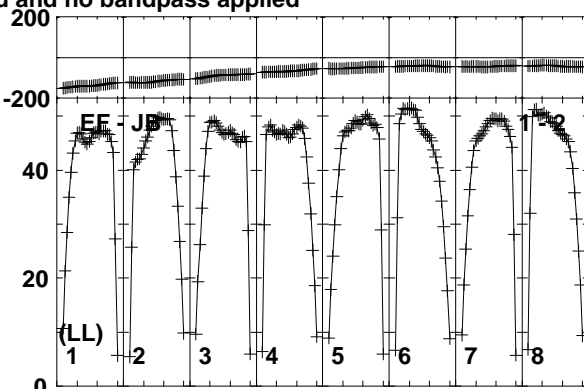
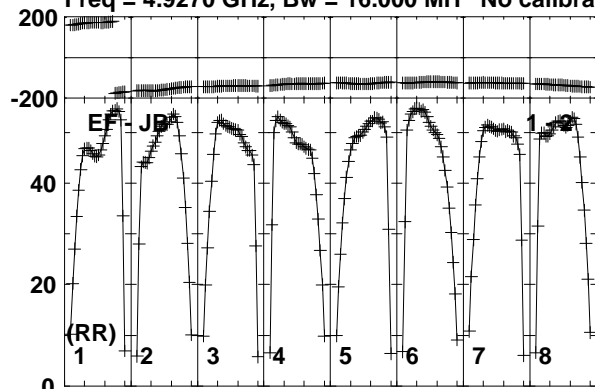

Lower frame: Milli Ampl Jy Top frame: Phas deg  
Vector averaged cross-power spectrum Baseline: EF (01) - JB (02)  
Timerange: 00/19:43:51 to 00/19:58:09

Plot file version 20 created 10-JUN-2016 17:22:00

3C345 RT013A.UVDATA.1

Freq = 4.9270 GHz, Bw = 16.000 MH No calibration applied and no bandpass applied

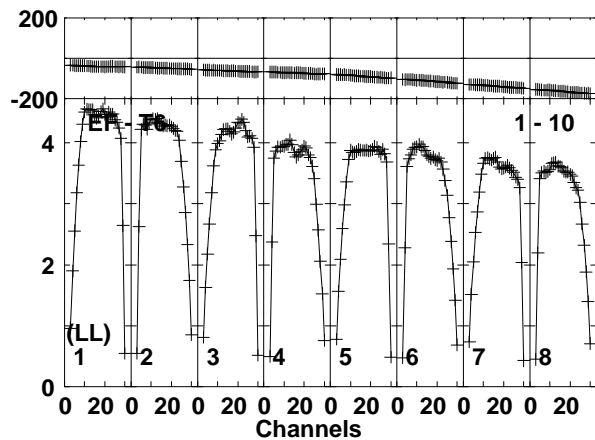
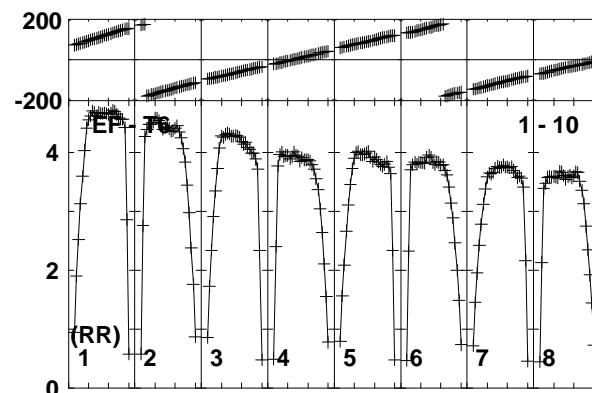
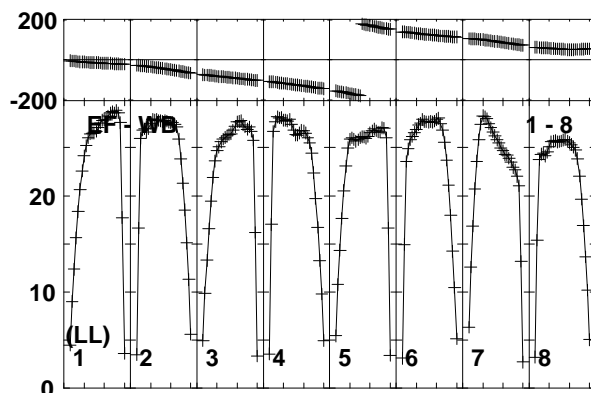
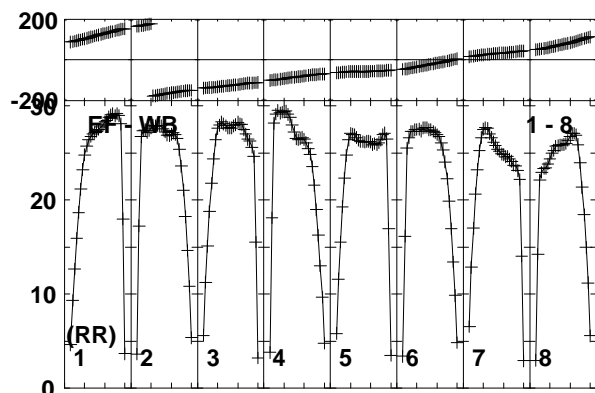
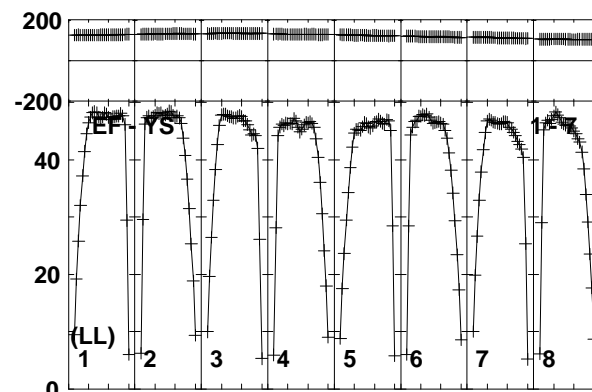
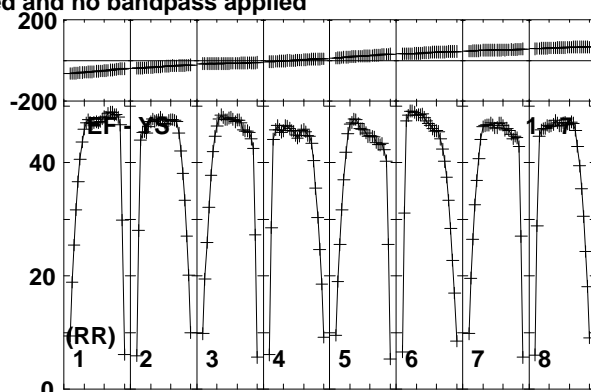
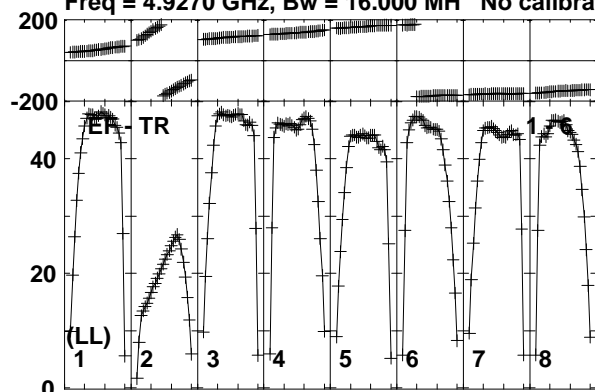

Lower frame: Milli Ampl Jy Top frame: Phas deg  
Vector averaged cross-power spectrum Baseline: EF (01) - TR (06)  
Timerange: 00/19:43:51 to 00/19:58:09

Plot file version 21 created 10-JUN-2016 17:22:01

3C345 RT013A.UVDATA.1

Freq = 4.9270 GHz, Bw = 16.000 MH No calibration applied and no bandpass applied

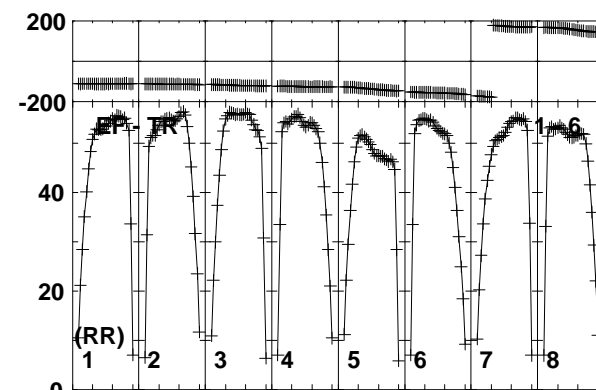
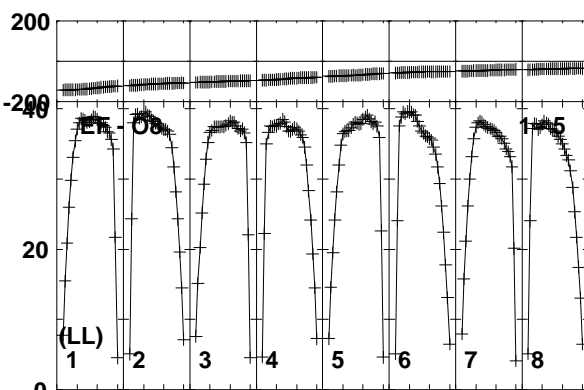
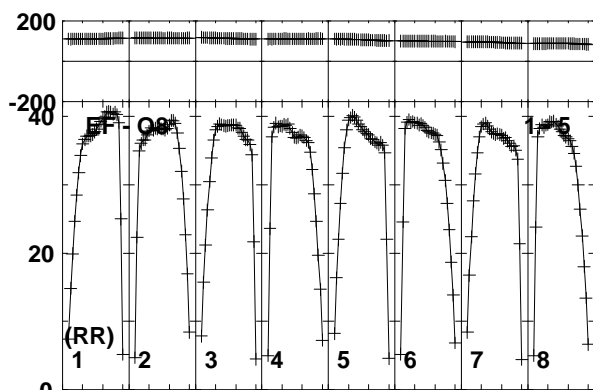
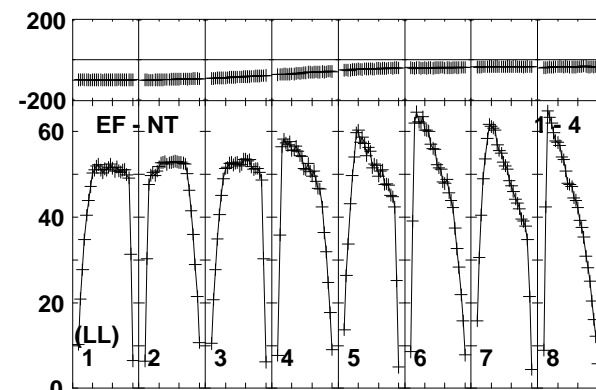
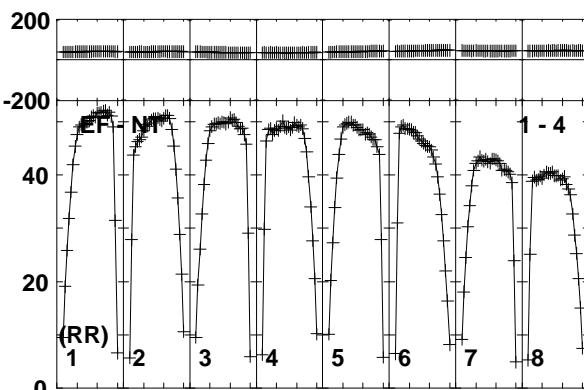
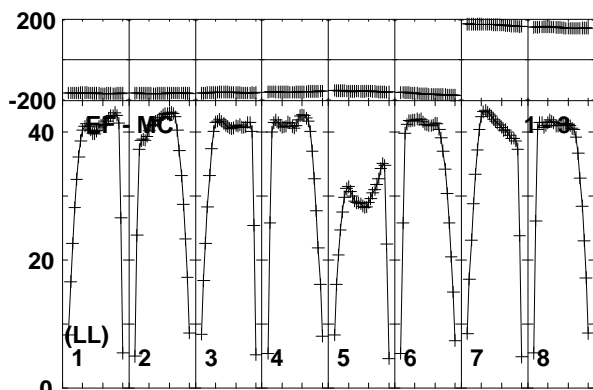
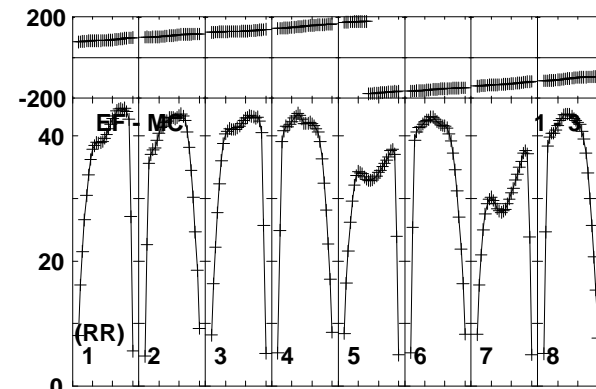
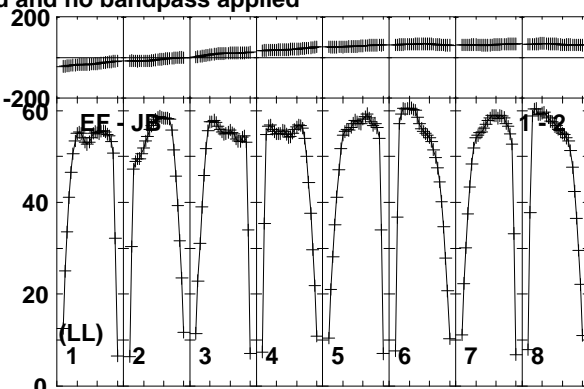
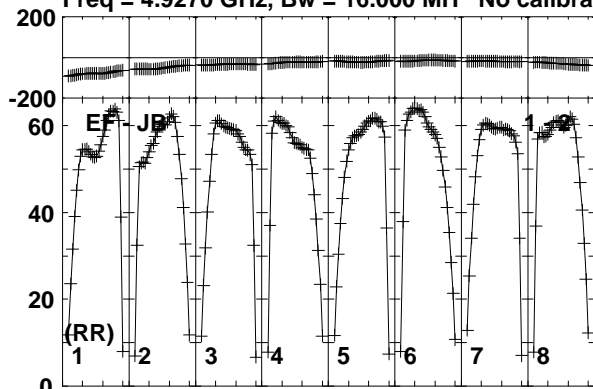

Lower frame: Milli Ampl Jy Top frame: Phas deg  
Vector averaged cross-power spectrum Baseline: EF (01) - JB (02)  
Timerange: 00/19:58:50 to 00/20:13:09

Plot file version 22 created 10-JUN-2016 17:22:01

3C345 RT013A.UVDATA.1

Freq = 4.9270 GHz, Bw = 16.000 MH No calibration applied and no bandpass applied

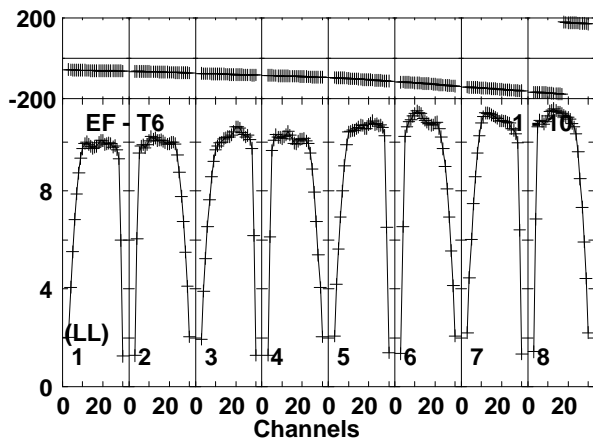
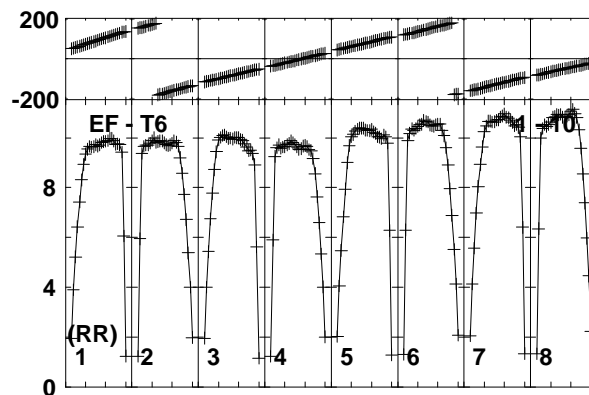
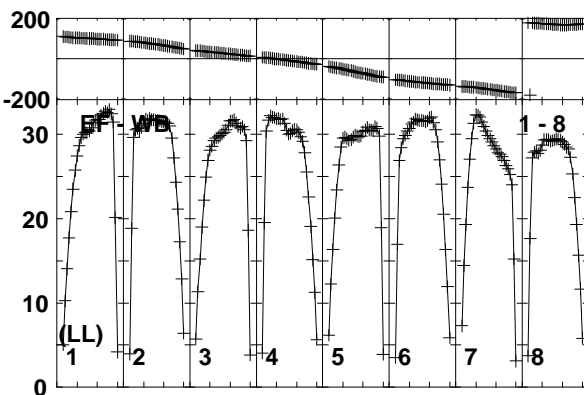
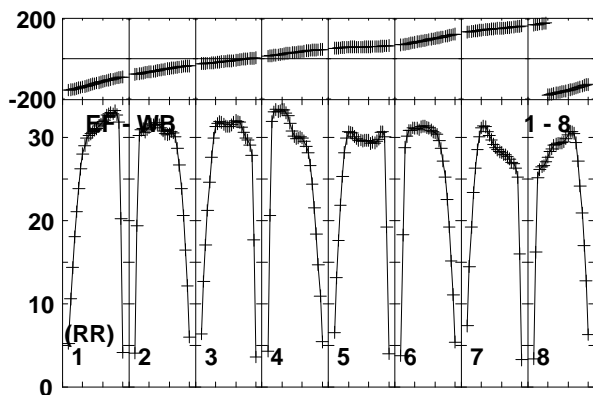
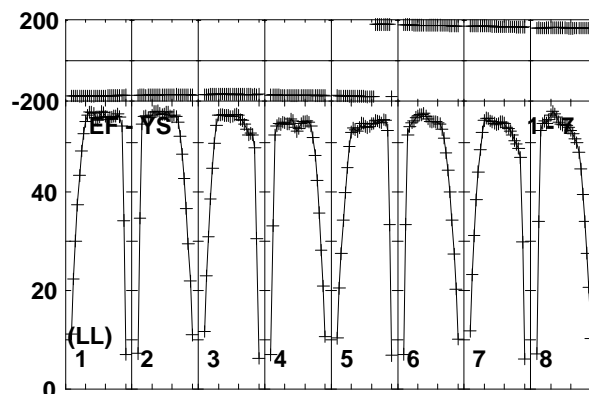
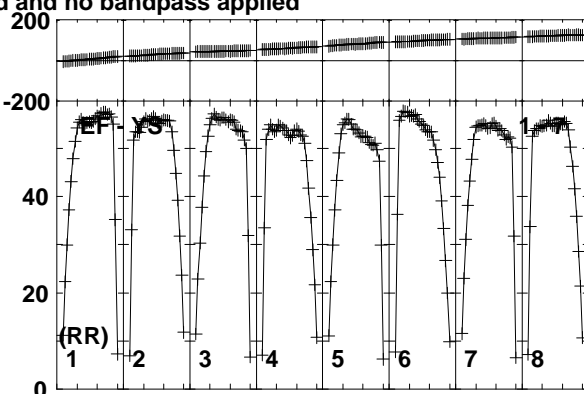
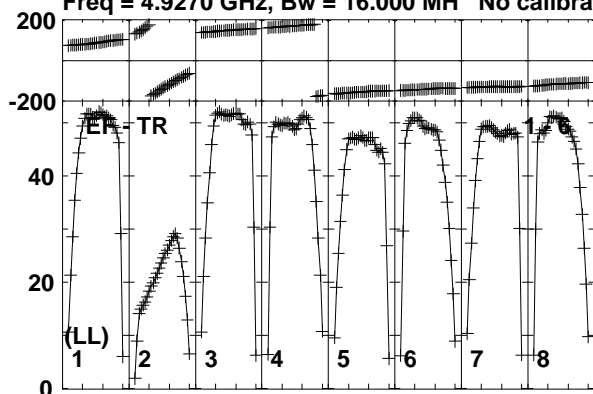

Lower frame: Milli Ampl Jy Top frame: Phas deg  
Vector averaged cross-power spectrum Baseline: EF (01) - TR (06)  
Timerange: 00/19:58:50 to 00/20:13:09

Plot file version 23 created 10-JUN-2016 17:22:02

3C345 RT013A.UVDATA.1

Freq = 4.9270 GHz, Bw = 16.000 MH No calibration applied and no bandpass applied

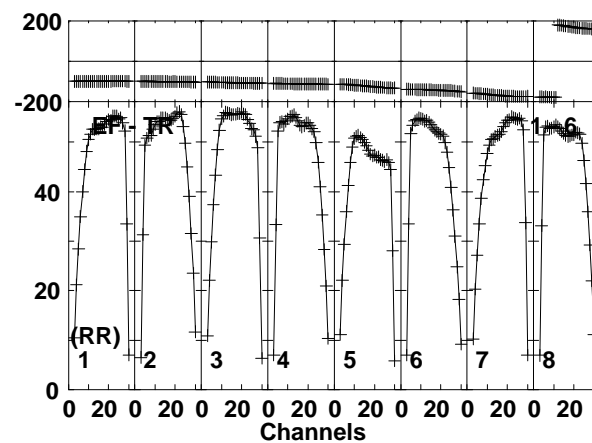
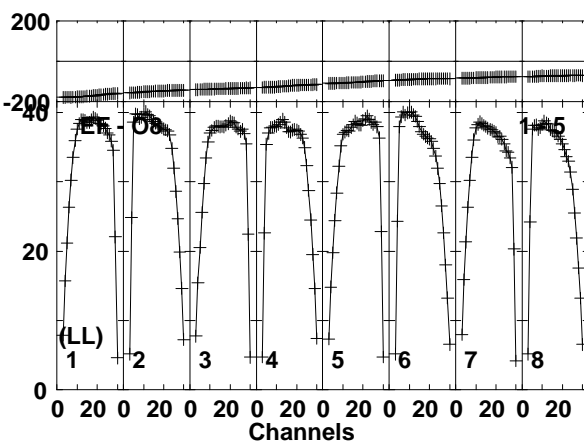
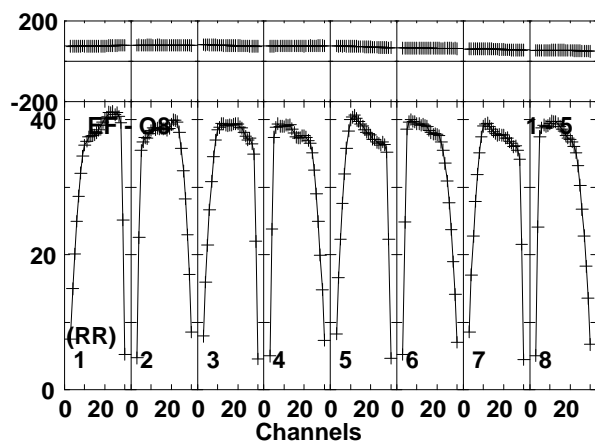
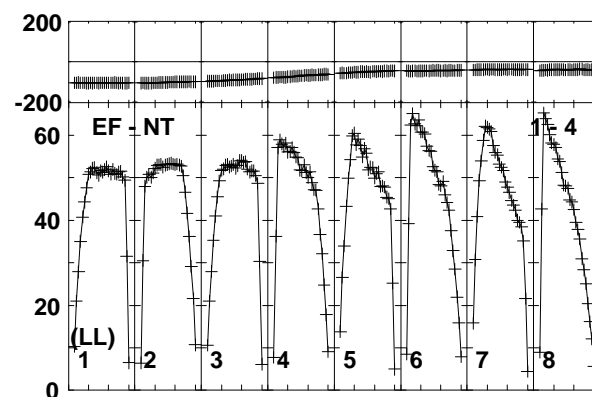
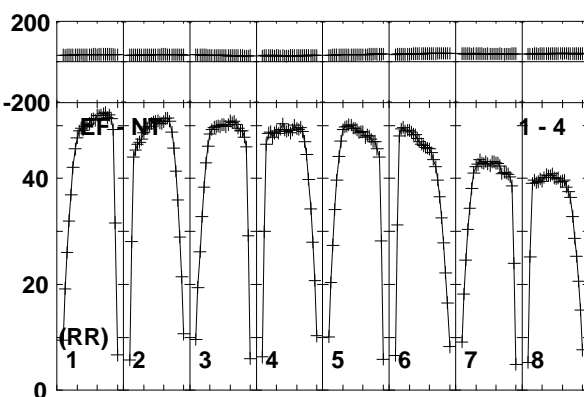
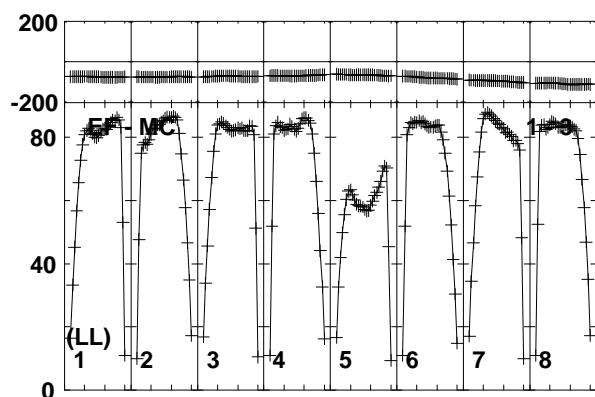
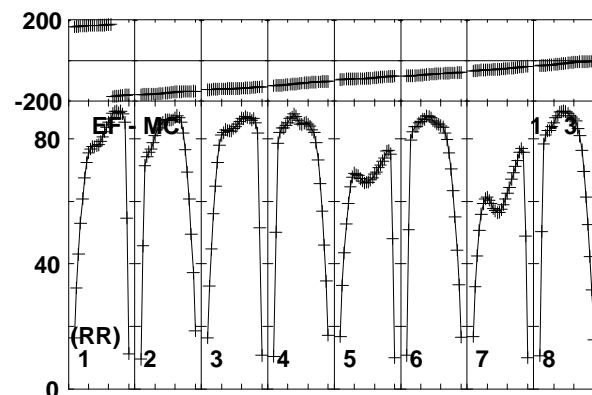
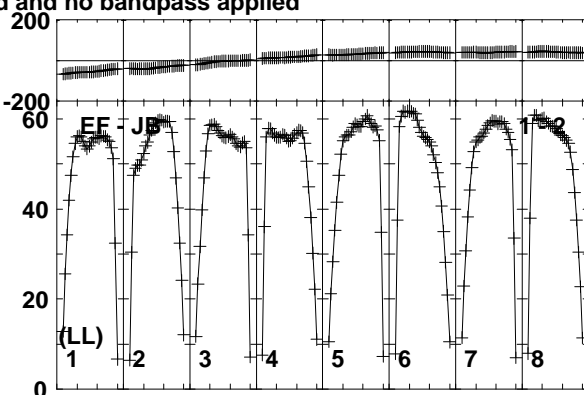
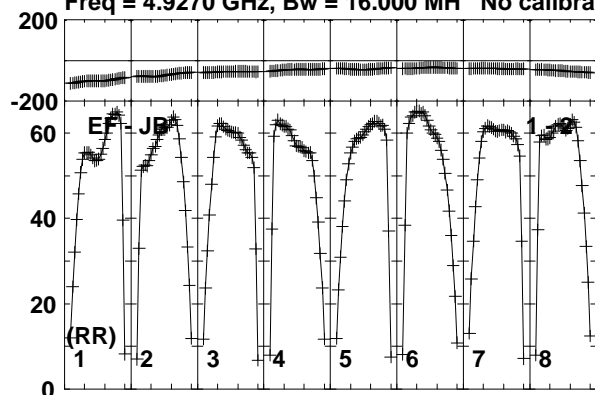

Lower frame: Milli Ampl Jy Top frame: Phas deg  
Vector averaged cross-power spectrum Baseline: EF (01) - JB (02)  
Timerange: 00/20:13:50 to 00/20:17:19

Plot file version 24 created 10-JUN-2016 17:22:02

3C345 RT013A.UVDATA.1

Freq = 4.9270 GHz, Bw = 16.000 MH No calibration applied and no bandpass applied

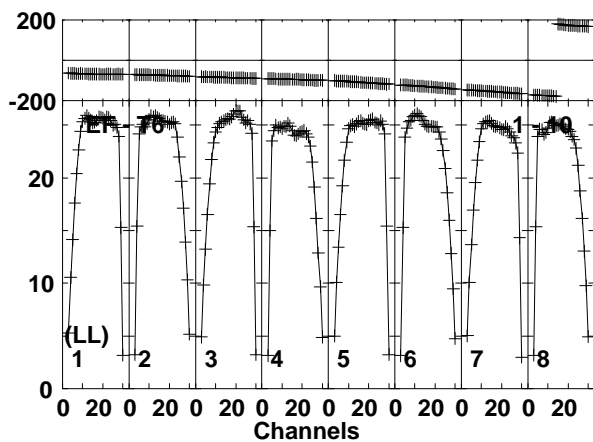
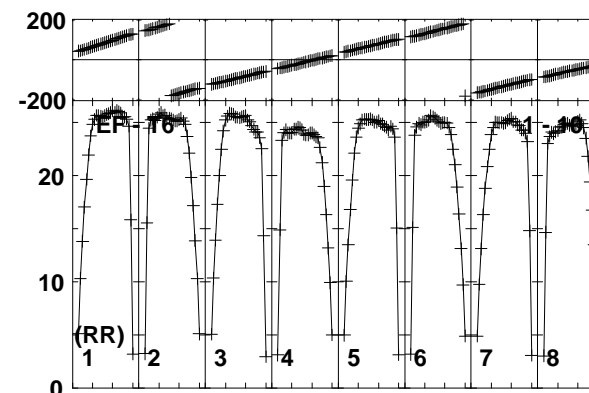
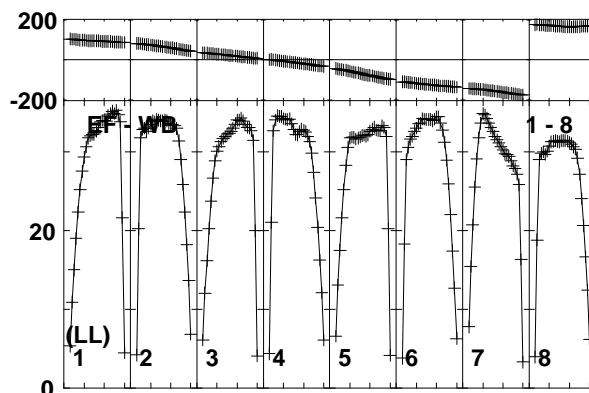
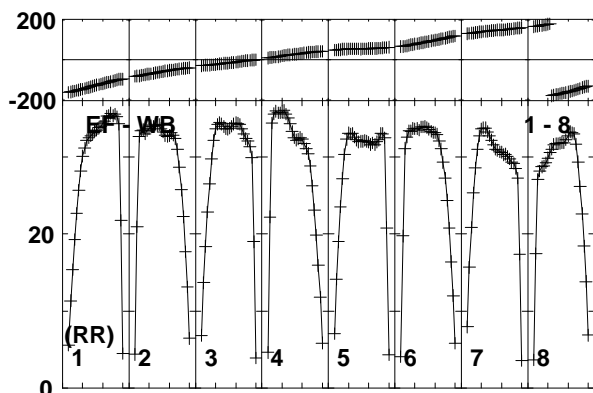
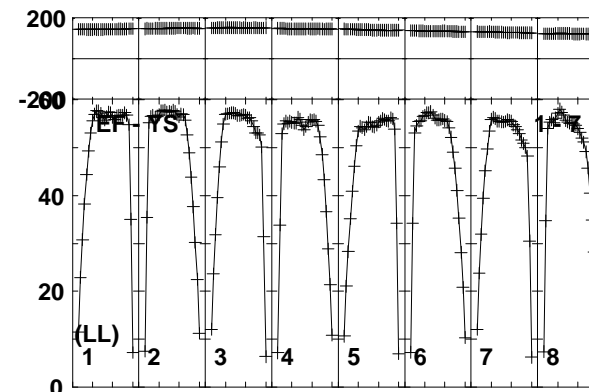
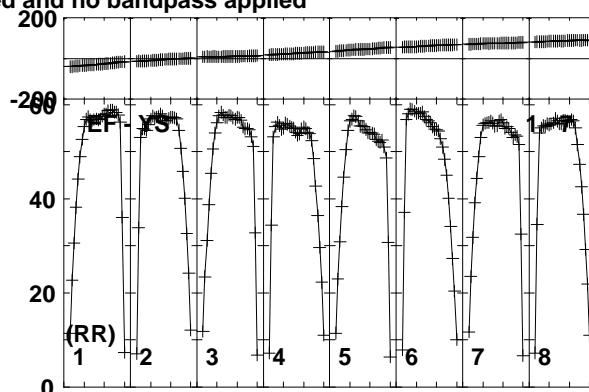
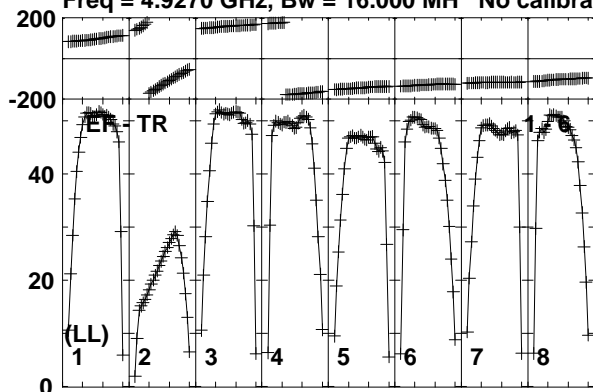

Lower frame: Milli Ampl Jy Top frame: Phas deg  
Vector averaged cross-power spectrum Baseline: EF (01) - TR (06)  
Timerange: 00/20:13:50 to 00/20:17:19

Plot file version 25 created 10-JUN-2016 17:22:02

J1957+3338 RT013A.UVDATA.1

Freq = 4.9270 GHz, Bw = 16.000 MH No calibration applied and no bandpass applied

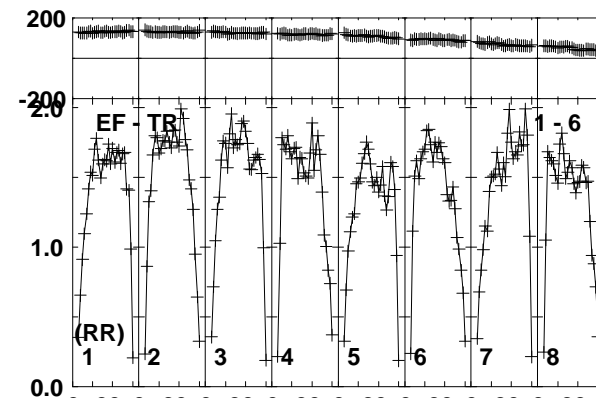
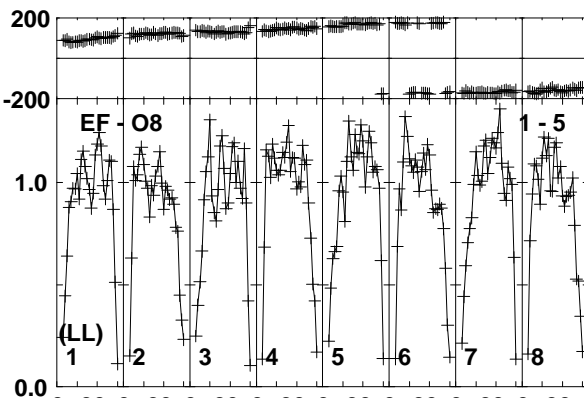
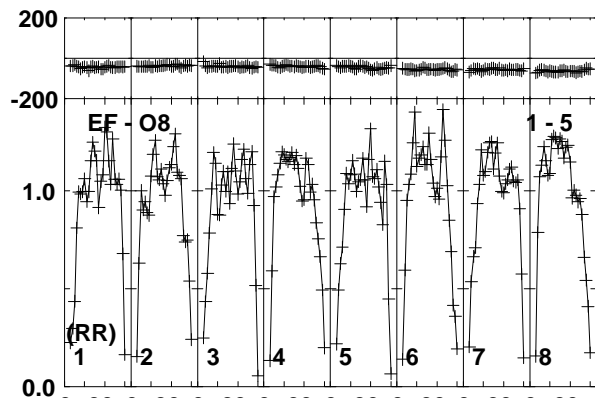
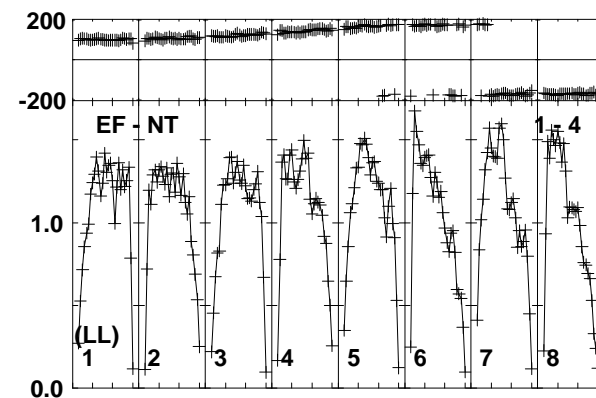
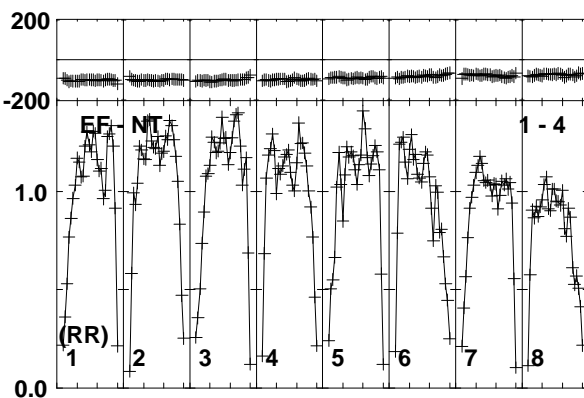
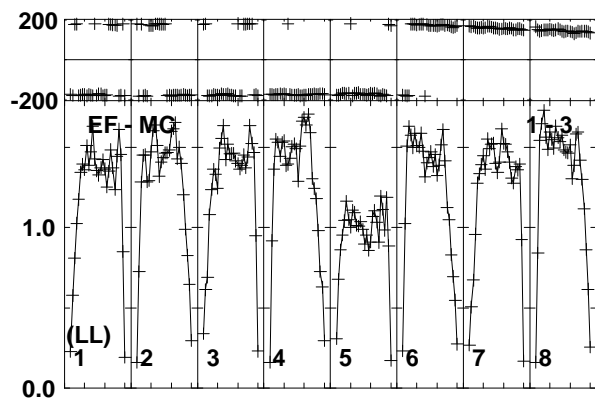
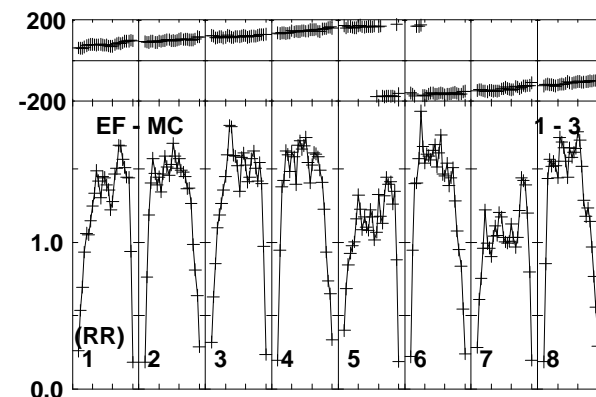
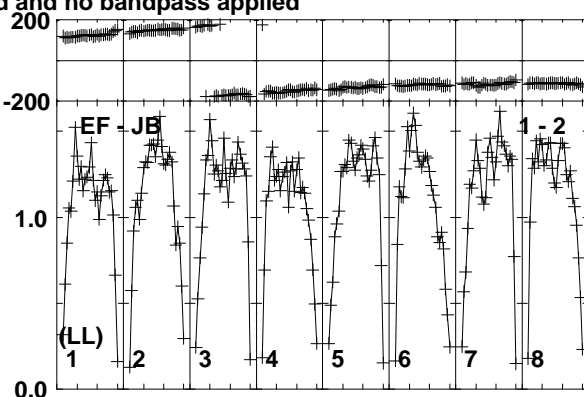
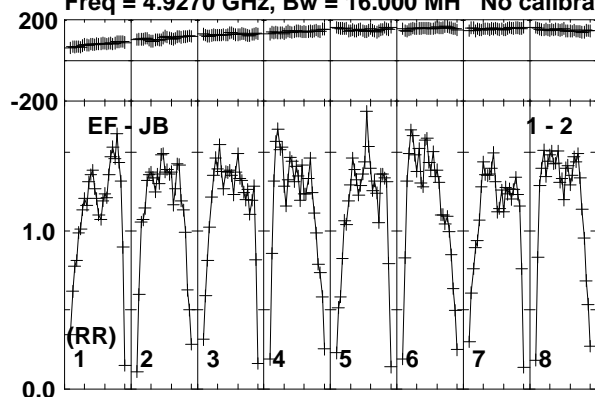

Lower frame: Milli Ampl Jy Top frame: Phas deg  
Vector averaged cross-power spectrum Baseline: EF (01) - JB (02)  
Timerange: 00/20:20:31 to 00/20:21:59

Plot file version 26 created 10-JUN-2016 17:22:02

J1957+3338 RT013A.UVDATA.1

Freq = 4.9270 GHz, Bw = 16.000 MH No calibration applied and no bandpass applied

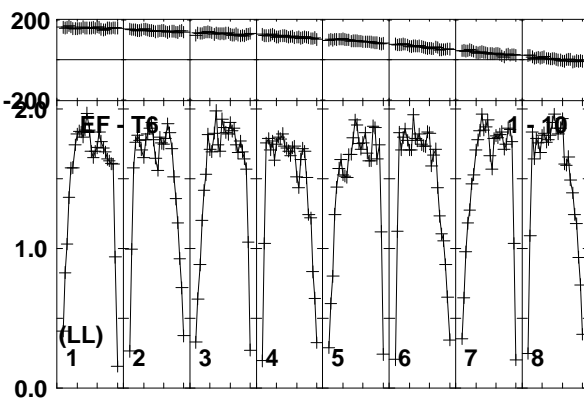
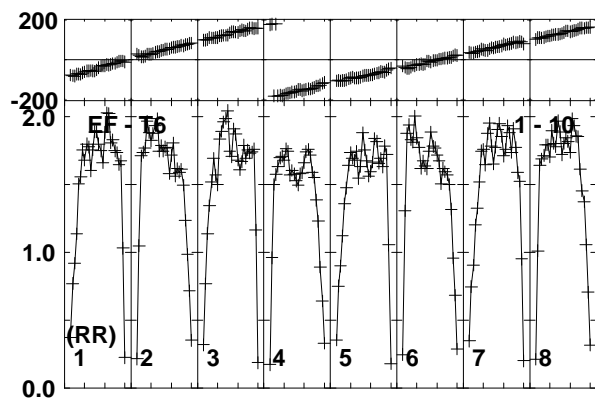
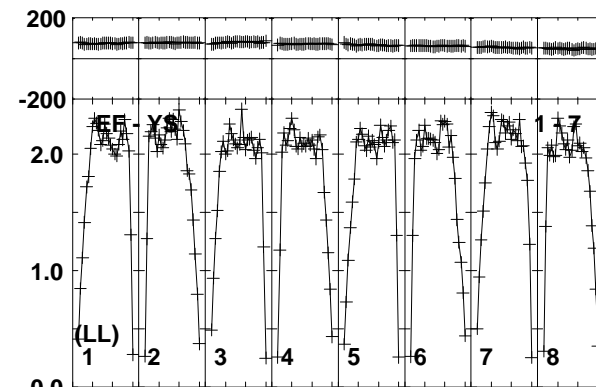
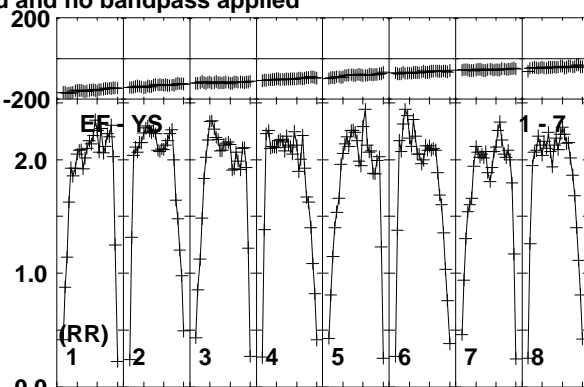
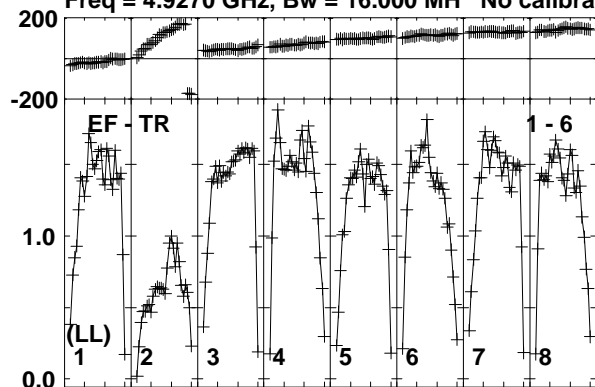

Lower frame: Milli Ampl Jy Top frame: Phas deg  
Vector averaged cross-power spectrum Baseline: EF (01) - TR (06)  
Timerange: 00/20:20:31 to 00/20:21:59



Plot file version 27 created 10-JUN-2016 17:22:02

CHECK RT013A.UVDATA.1

Freq = 4.9270 GHz, Bw = 16.000 MH No calibration applied and no bandpass applied

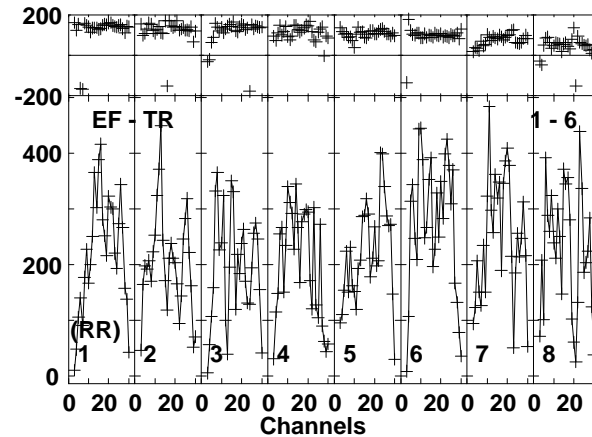
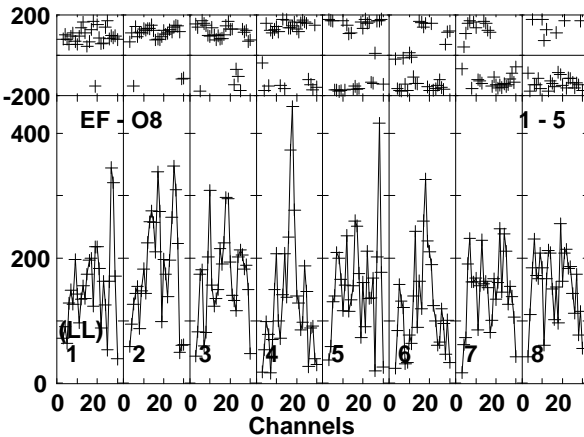
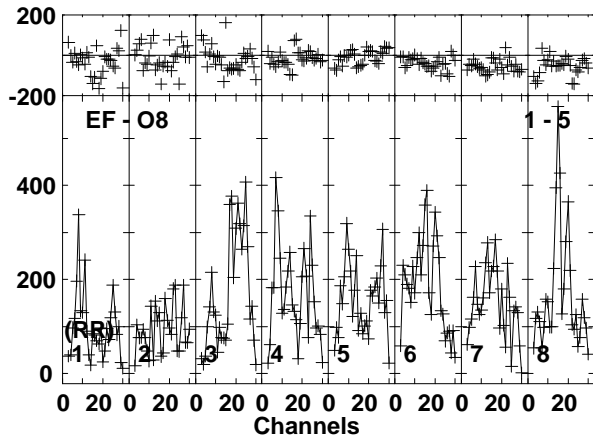
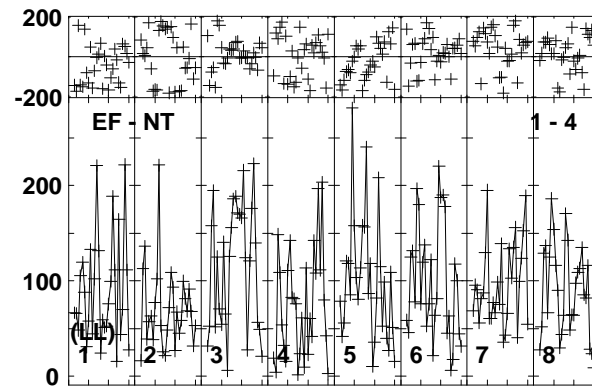
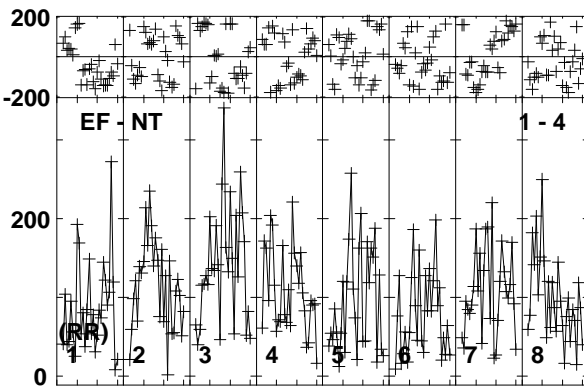
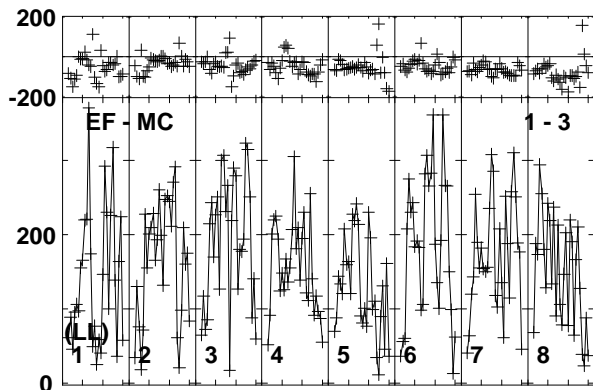
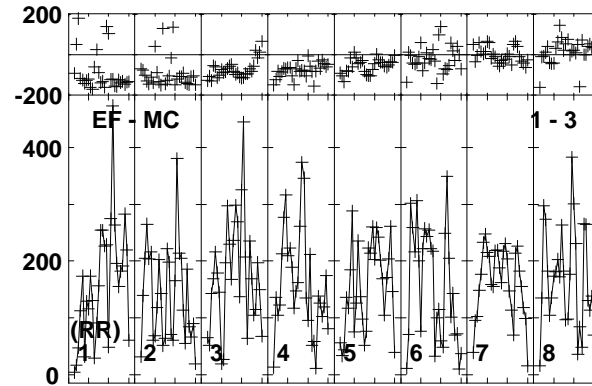
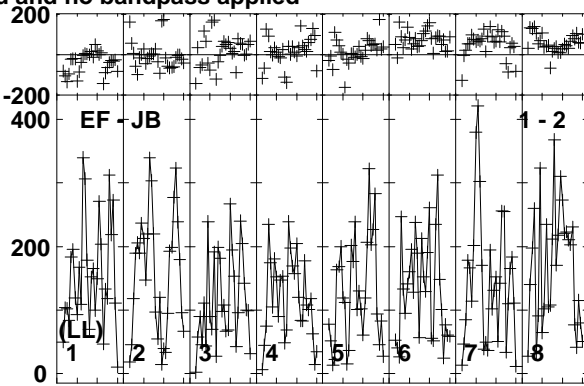
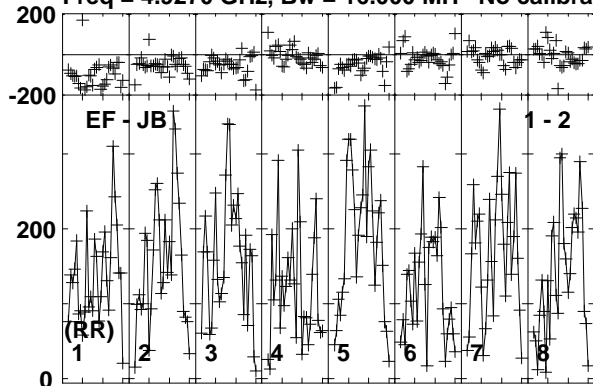

Lower frame: Micro Ampl Jy Top frame: Phas deg  
Vector averaged cross-power spectrum Baseline: EF (01) - JB (02)  
Timerange: 00/20:22:40 to 00/20:24:40

Plot file version 28 created 10-JUN-2016 17:22:02

CHECK RT013A.UVDATA.1

Freq = 4.9270 GHz, Bw = 16.000 MH No calibration applied and no bandpass applied

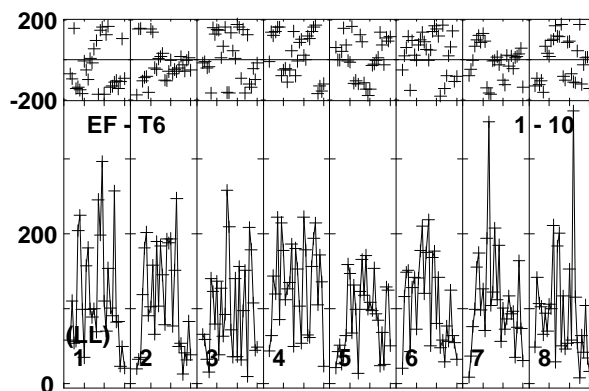
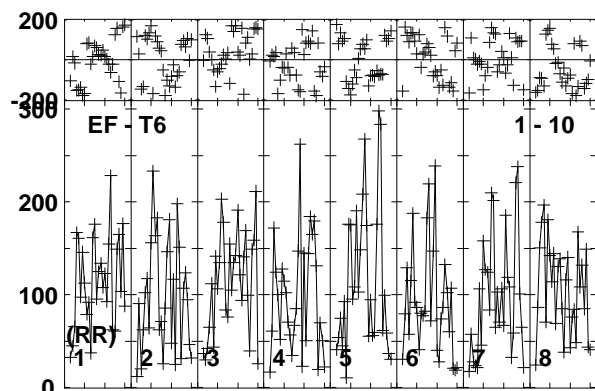
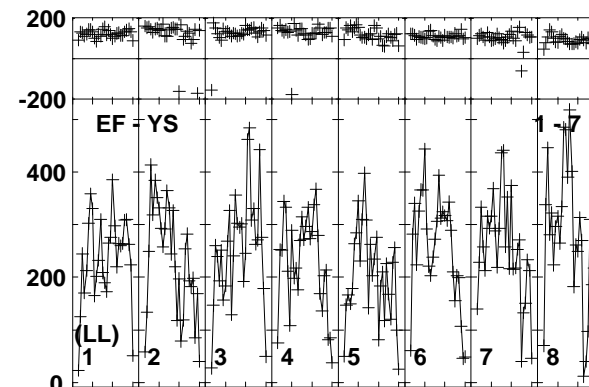
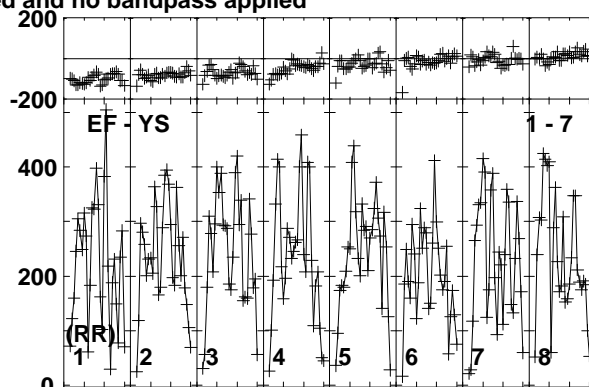
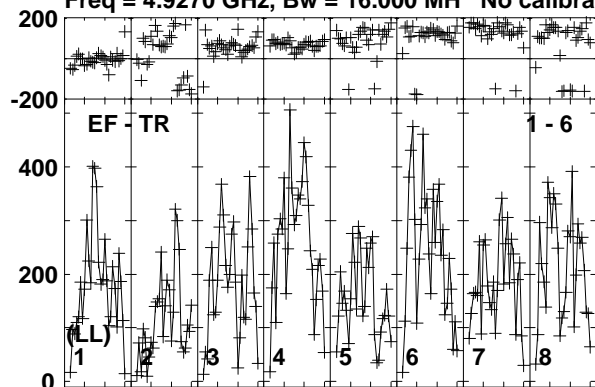

Lower frame: Micro Ampl Jy Top frame: Phas deg  
Vector averaged cross-power spectrum Baseline: EF (01) - TR (06)  
Timerange: 00/20:22:40 to 00/20:24:40

Plot file version 29 created 10-JUN-2016 17:22:02

CYGX1 RT013A.UVDATA.1

Freq = 4.9270 GHz, Bw = 16.000 MH No calibration applied and no bandpass applied

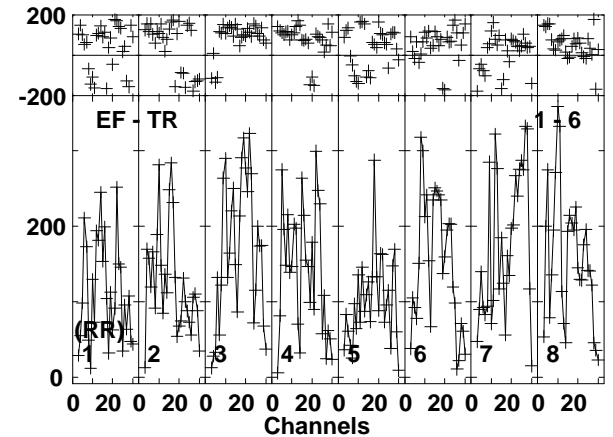
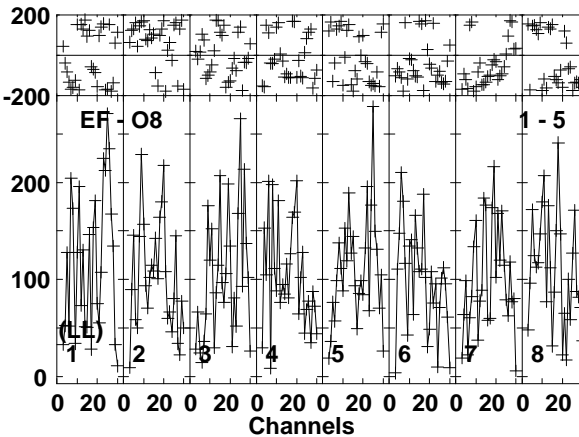
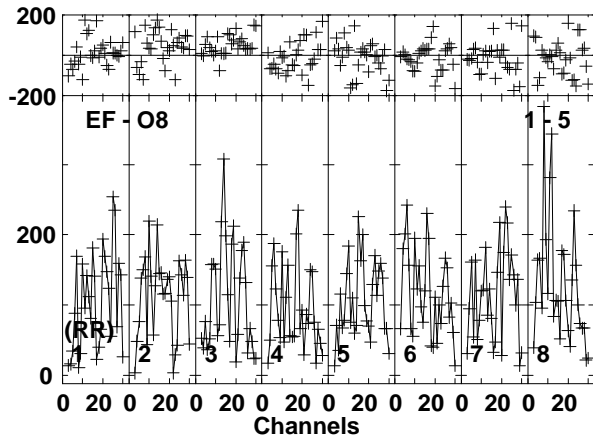
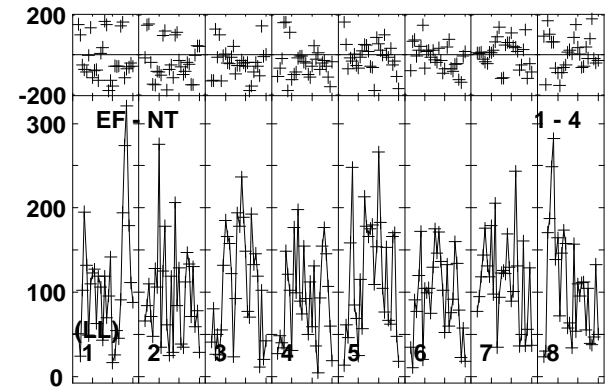
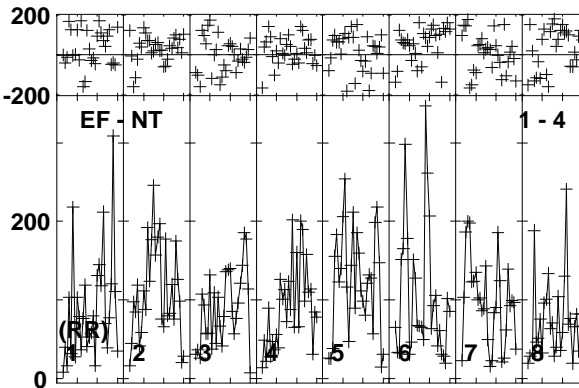
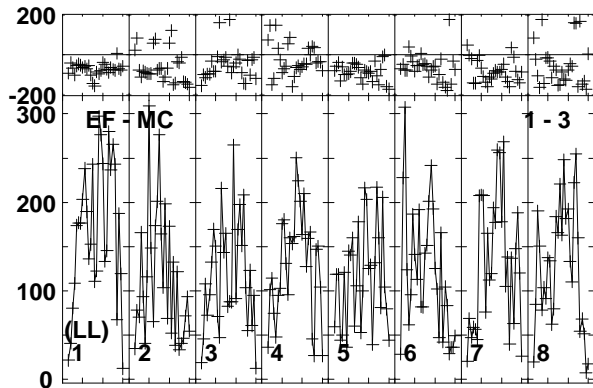
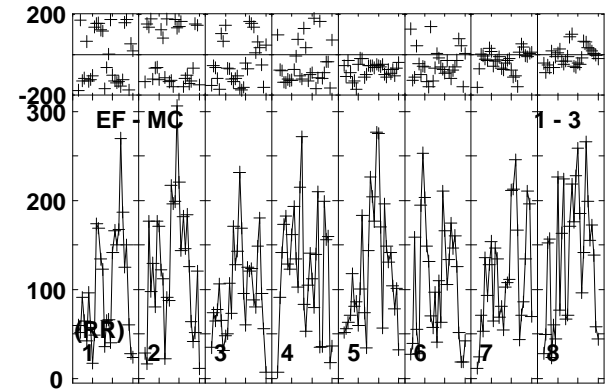
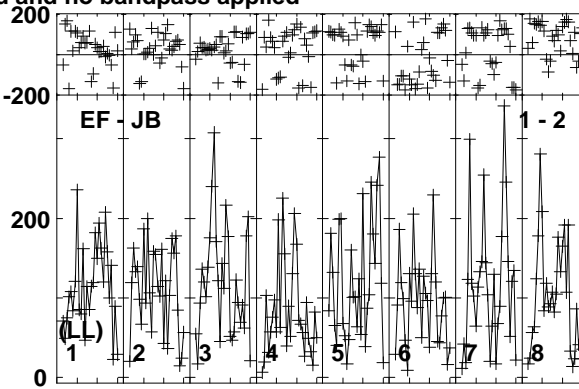
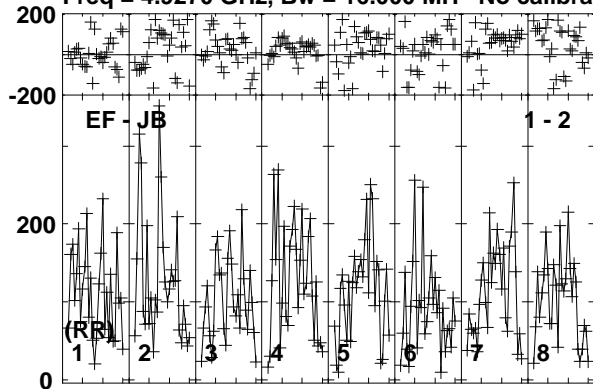

Lower frame: Micro Ampl Jy Top frame: Phas deg  
Vector averaged cross-power spectrum Baseline: EF (01) - JB (02)  
Timerange: 00/20:24:41 to 00/20:27:09

Plot file version 30 created 10-JUN-2016 17:22:02

CYGX1 RT013A.UVDATA.1

Freq = 4.9270 GHz, Bw = 16.000 MH No calibration applied and no bandpass applied

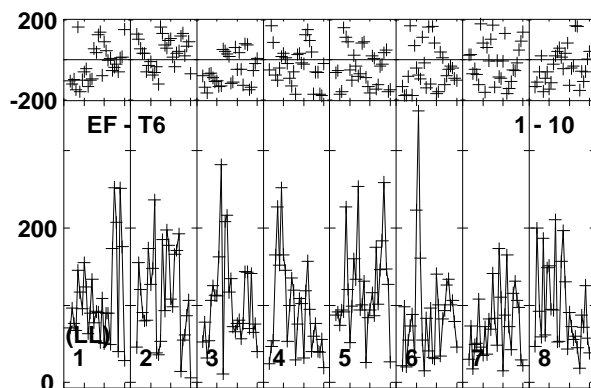
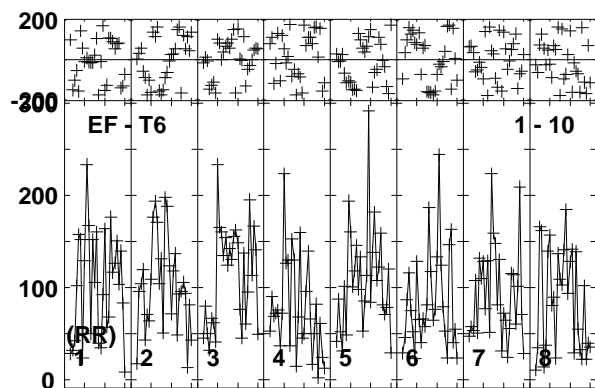
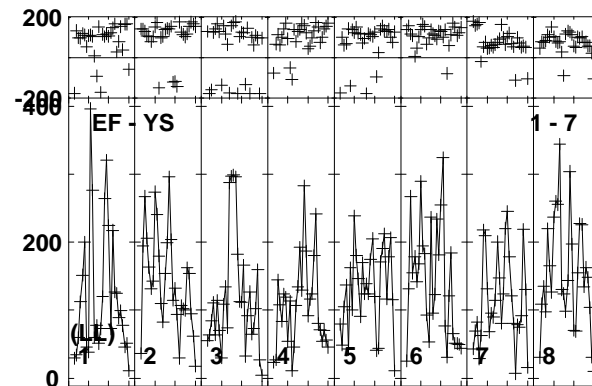
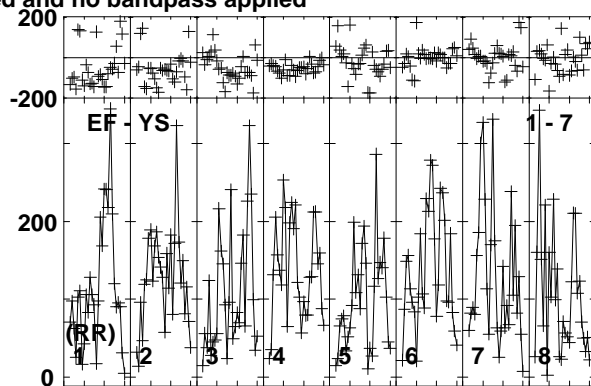
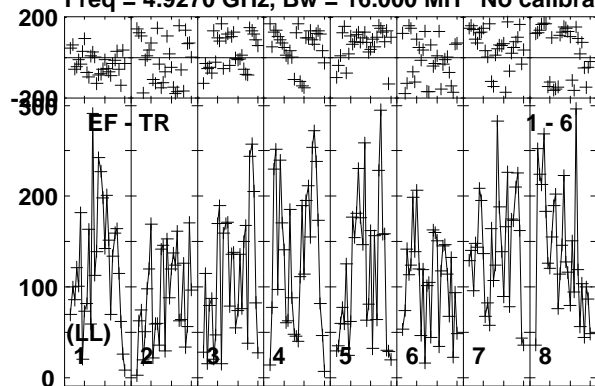

Lower frame: Micro Ampl Jy Top frame: Phas deg  
Vector averaged cross-power spectrum Baseline: EF (01) - TR (06)  
Timerange: 00/20:24:41 to 00/20:27:09

Plot file version 31 created 10-JUN-2016 17:22:02

J1957+3338 RT013A.UVDATA.1

Freq = 4.9270 GHz, Bw = 16.000 MH No calibration applied and no bandpass applied

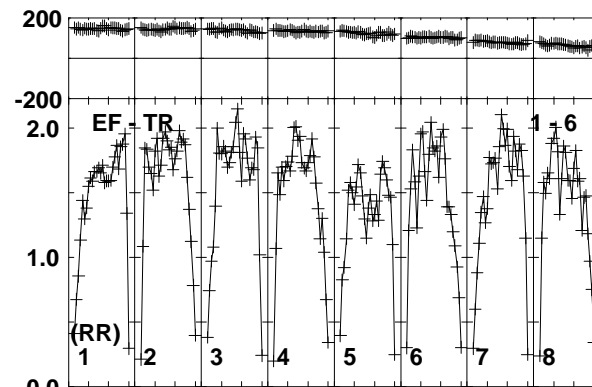
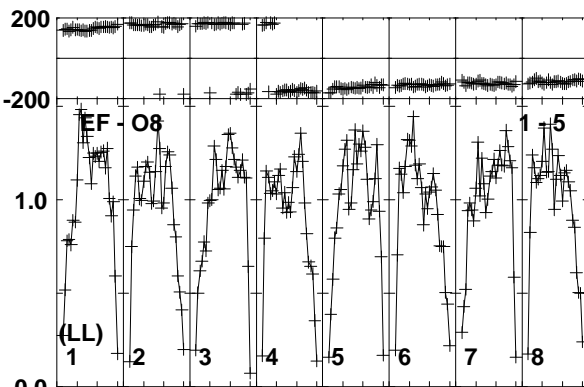
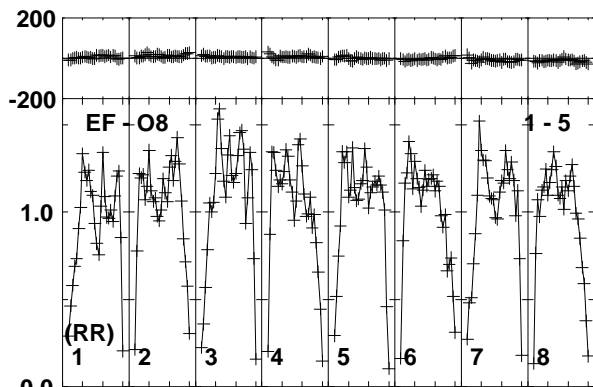
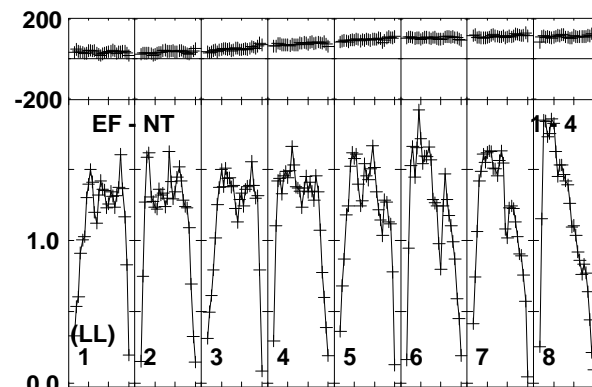
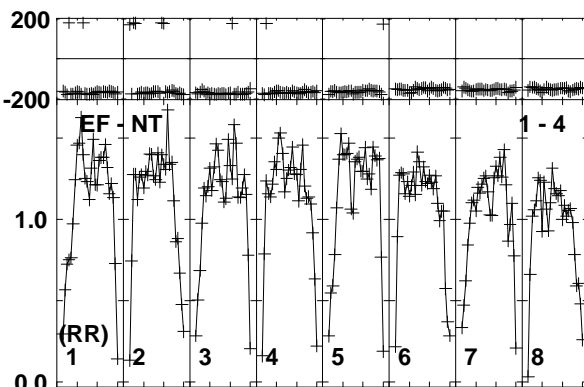
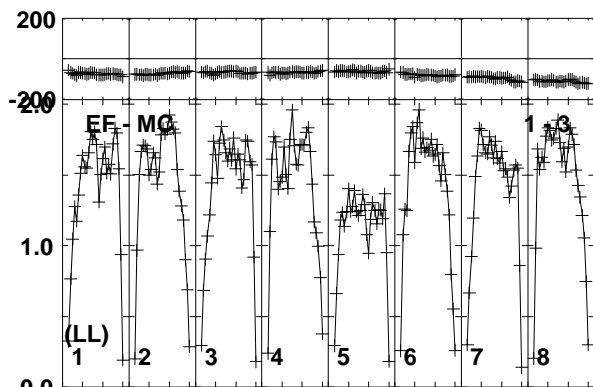
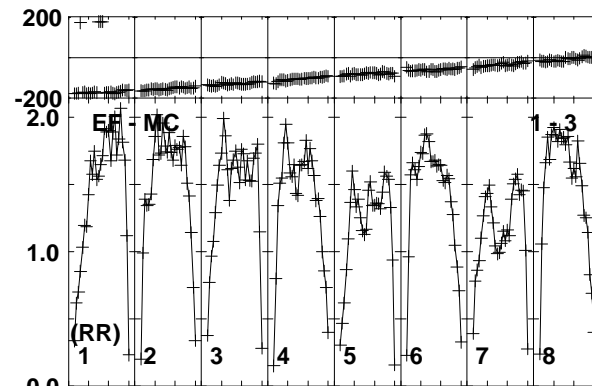
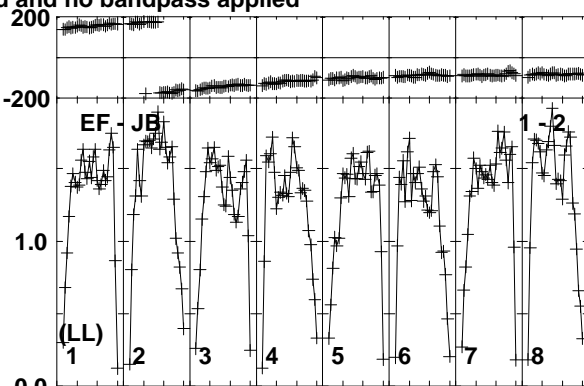
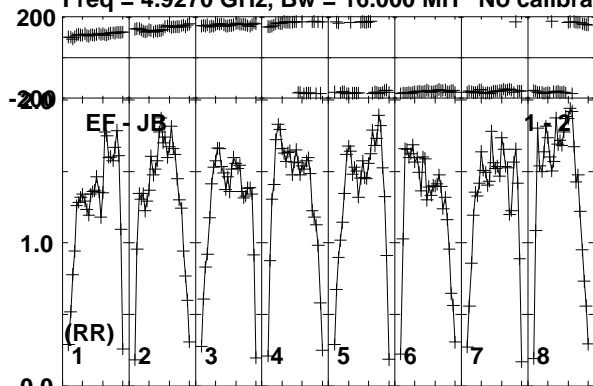

Lower frame: Milli Ampl Jy Top frame: Phas deg  
Vector averaged cross-power spectrum Baseline: EF (01) - JB (02)  
Timerange: 00/20:27:11 to 00/20:28:39

Plot file version 32 created 10-JUN-2016 17:22:03

J1957+3338 RT013A.UVDATA.1

Freq = 4.9270 GHz, Bw = 16.000 MH No calibration applied and no bandpass applied

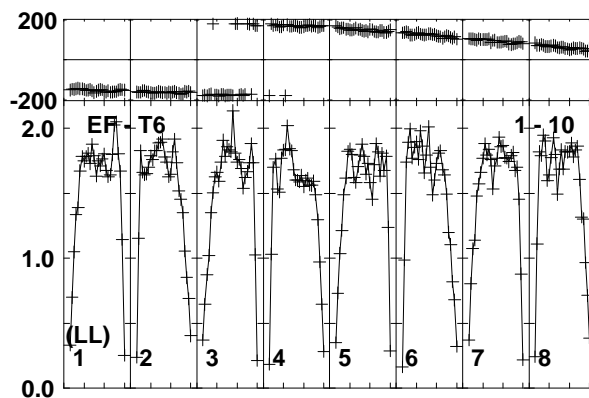
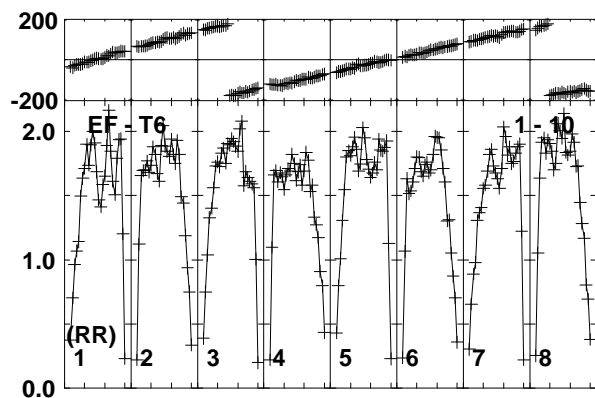
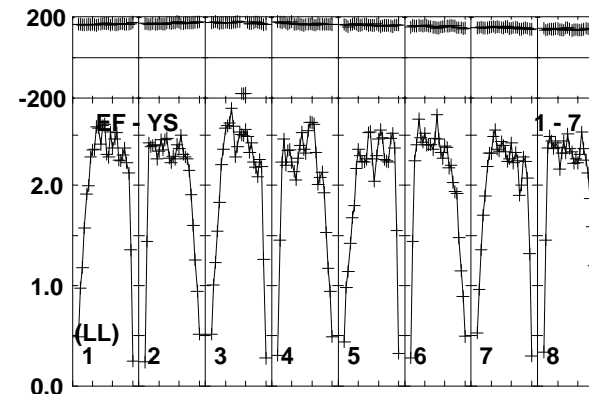
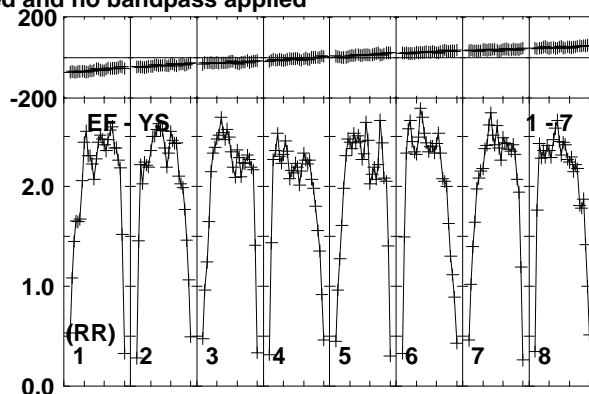
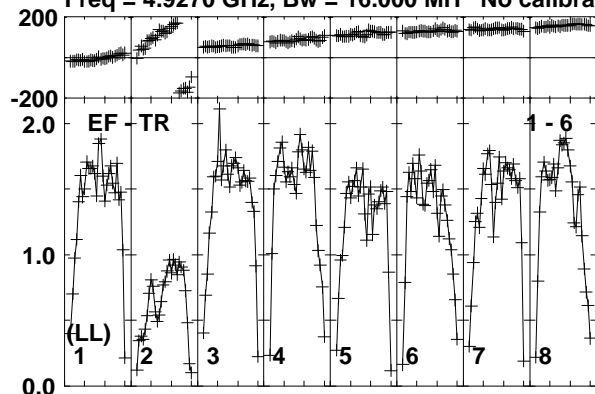

Lower frame: Milli Ampl Jy Top frame: Phas deg  
Vector averaged cross-power spectrum Baseline: EF (01) - TR (06)  
Timerange: 00/20:27:11 to 00/20:28:39

Plot file version 33 created 10-JUN-2016 17:22:03

CHECK RT013A.UVDATA.1

Freq = 4.9270 GHz, Bw = 16.000 MH No calibration applied and no bandpass applied

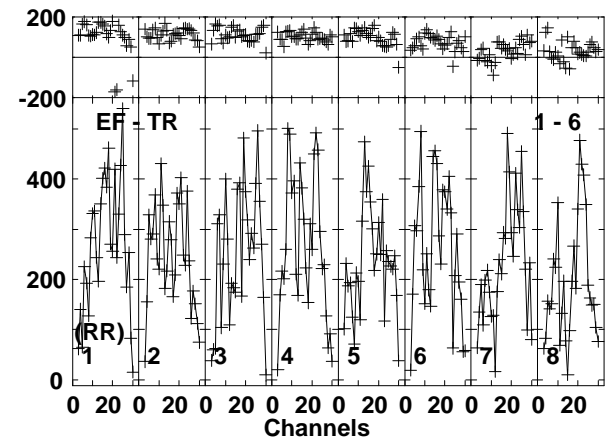
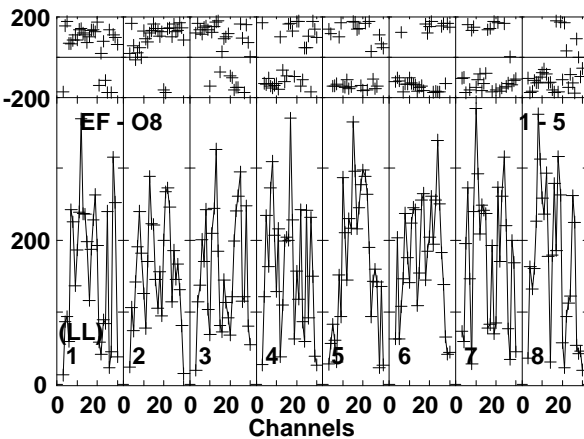
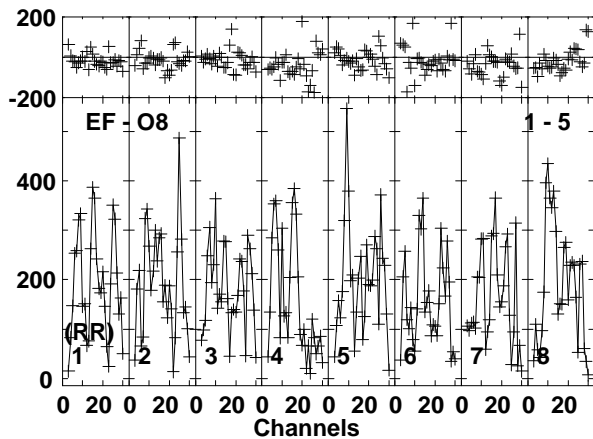
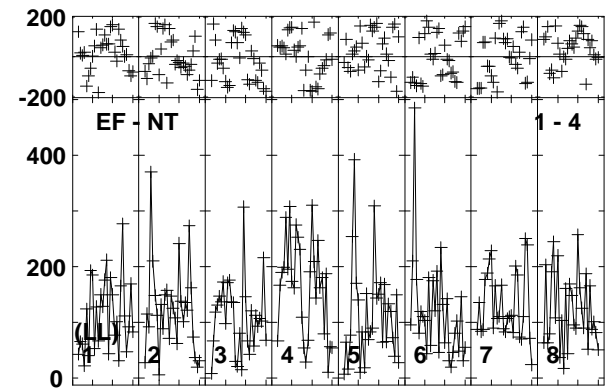
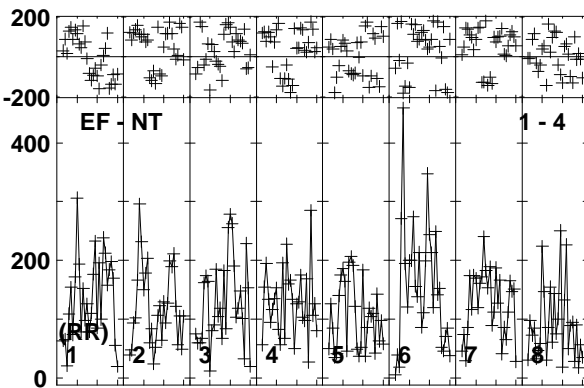
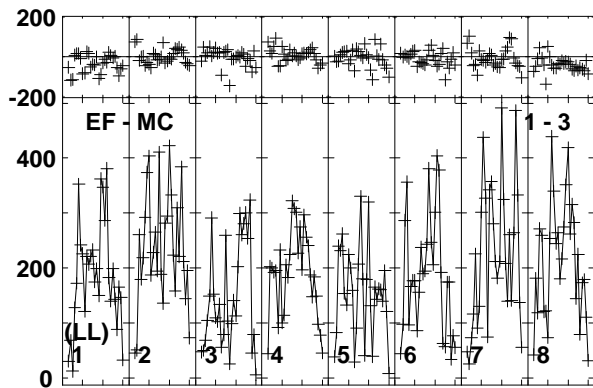
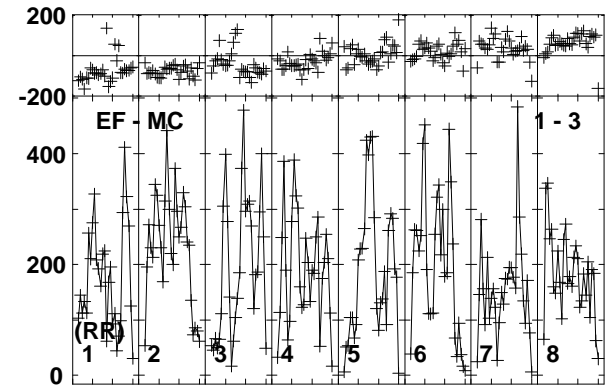
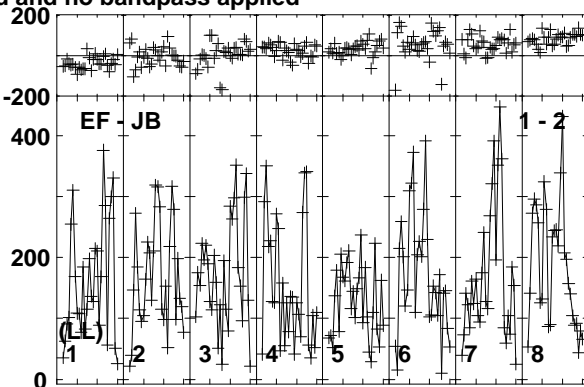
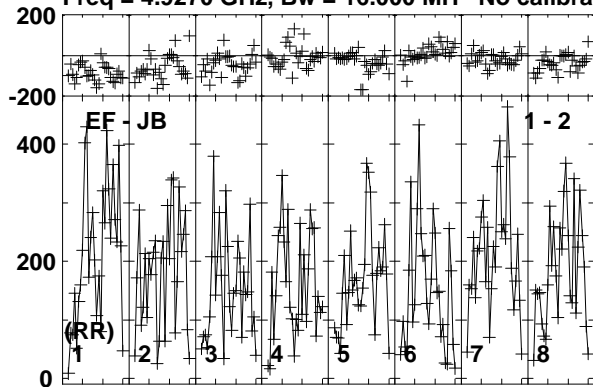

Lower frame: Micro Ampl Jy Top frame: Phas deg  
Vector averaged cross-power spectrum Baseline: EF (01) - JB (02)  
Timerange: 00/20:28:41 to 00/20:30:40

Plot file version 34 created 10-JUN-2016 17:22:03

CHECK RT013A.UVDATA.1

Freq = 4.9270 GHz, Bw = 16.000 MH No calibration applied and no bandpass applied

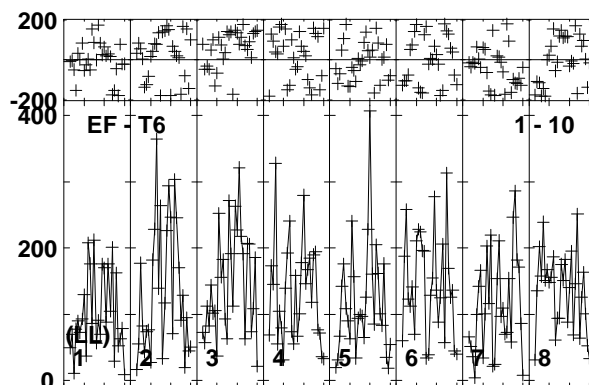
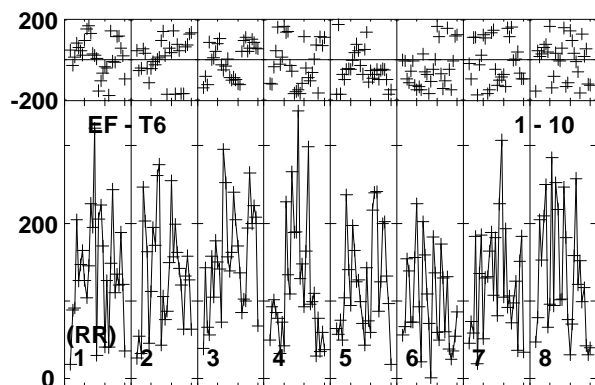
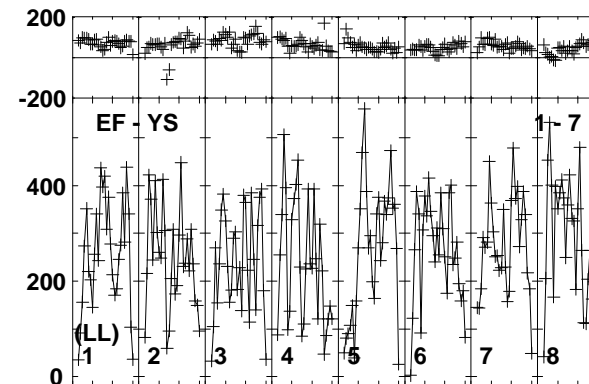
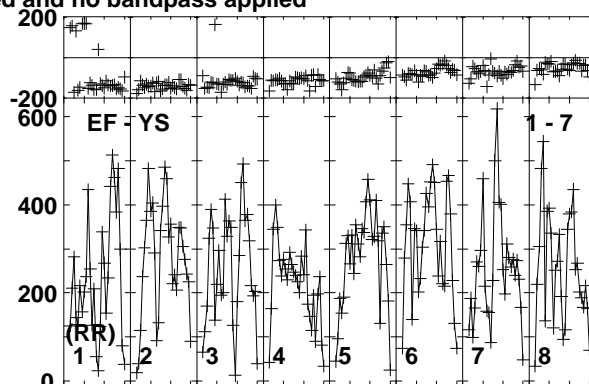
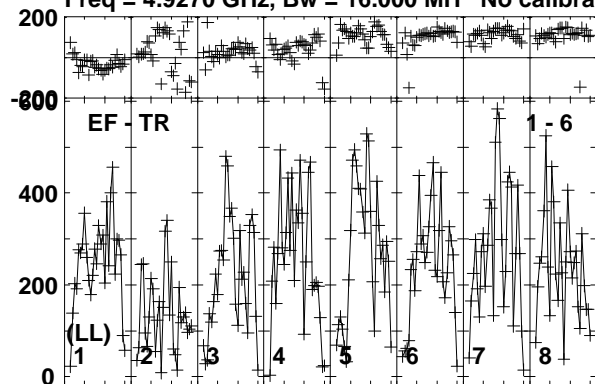

Lower frame: Micro Ampl Jy Top frame: Phas deg  
Vector averaged cross-power spectrum Baseline: EF (01) - TR (06)  
Timerange: 00/20:28:41 to 00/20:30:40



Plot file version 35 created 10-JUN-2016 17:22:03

CYGX1 RT013A.UVDATA.1

Freq = 4.9270 GHz, Bw = 16.000 MH No calibration applied and no bandpass applied

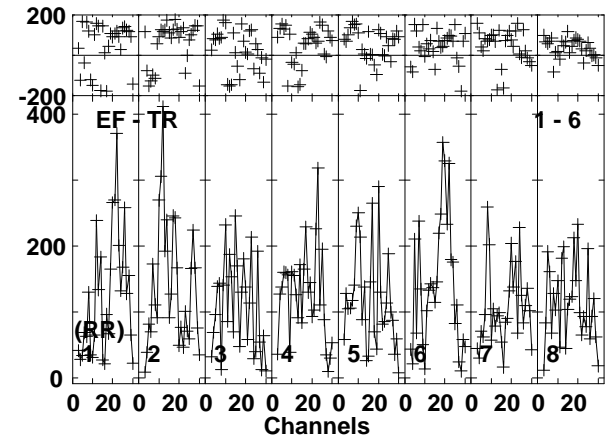
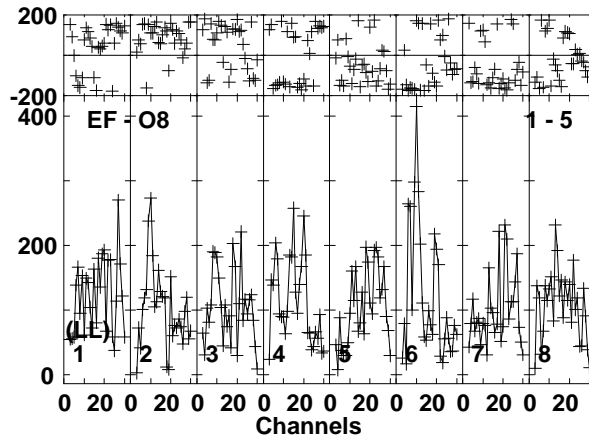
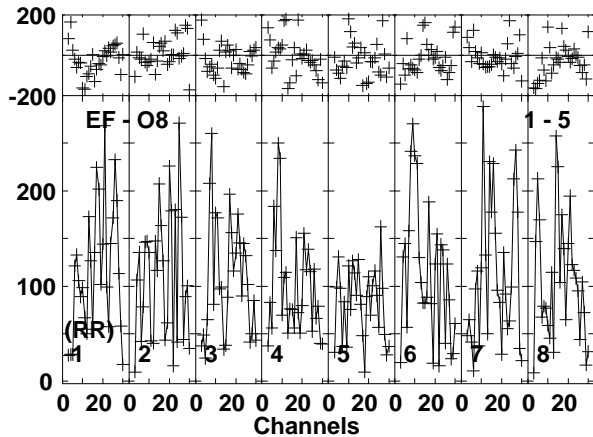
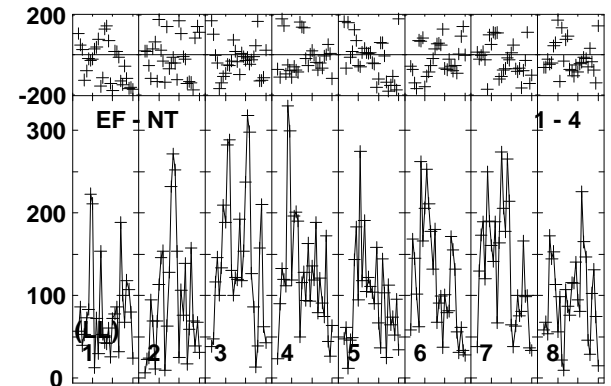
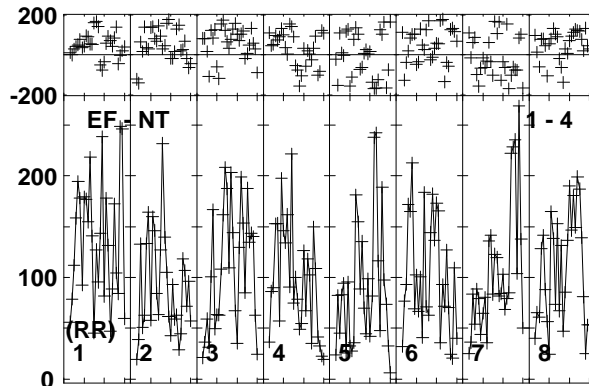
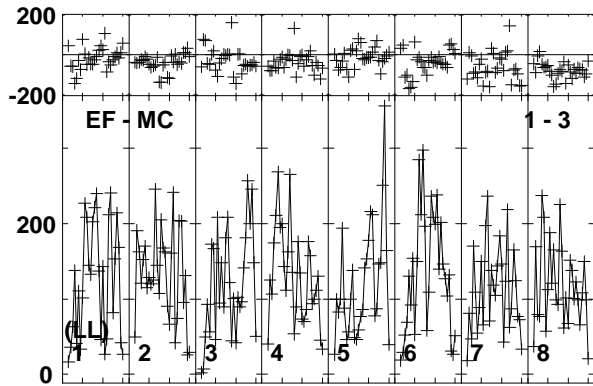
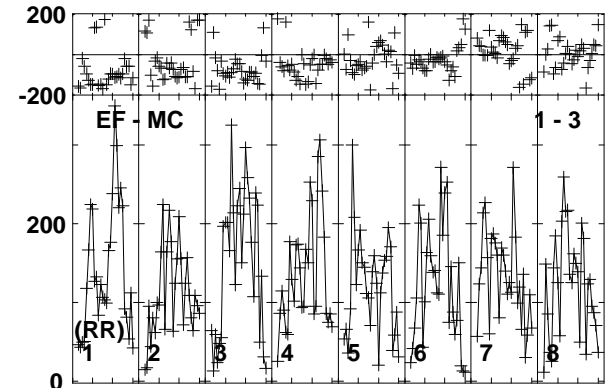
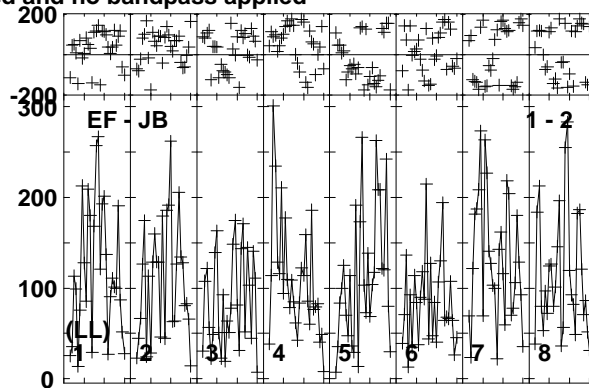
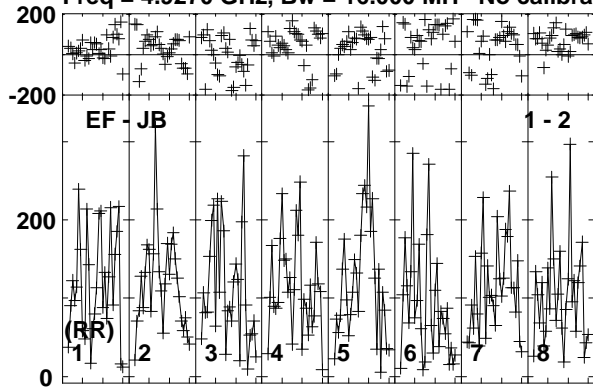

Lower frame: Micro Ampl Jy Top frame: Phas deg  
Vector averaged cross-power spectrum Baseline: EF (01) - JB (02)  
Timerange: 00/20:30:41 to 00/20:33:10

Plot file version 36 created 10-JUN-2016 17:22:03

CYGX1 RT013A.UVDATA.1

Freq = 4.9270 GHz, Bw = 16.000 MH No calibration applied and no bandpass applied

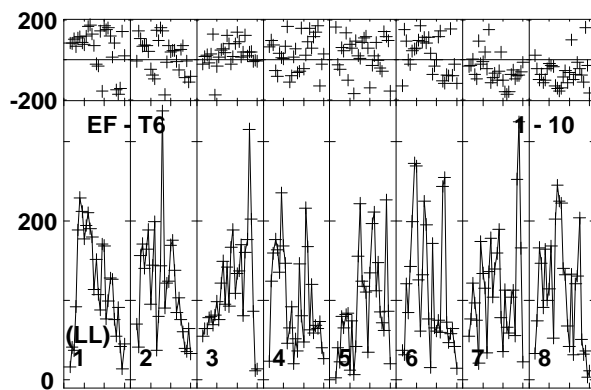
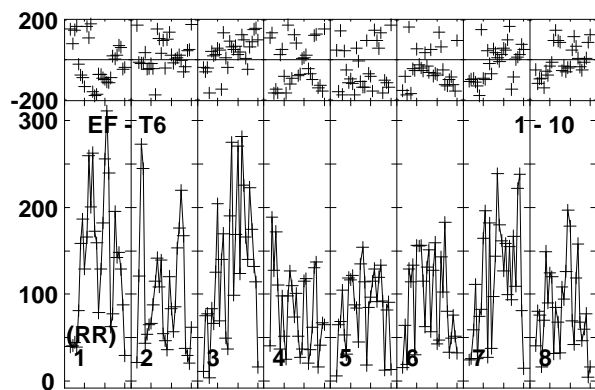
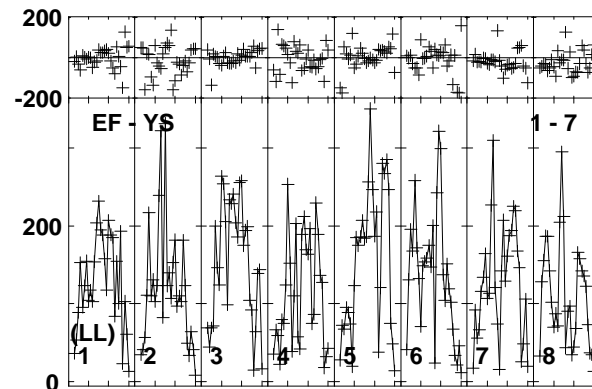
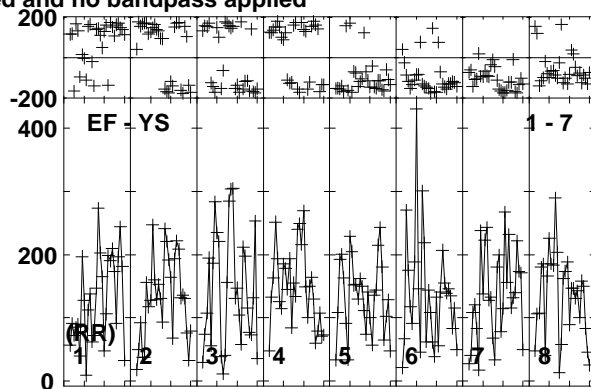
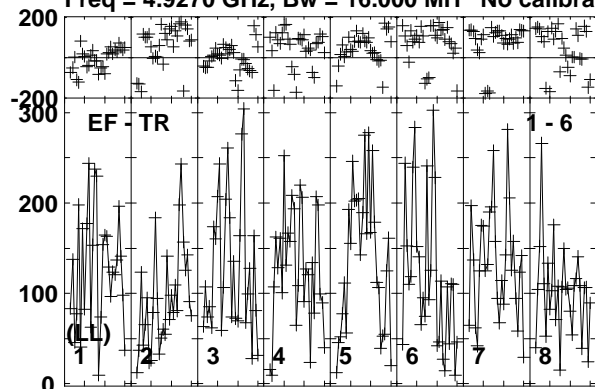

Lower frame: Micro Ampl Jy Top frame: Phas deg  
Vector averaged cross-power spectrum Baseline: EF (01) - TR (06)  
Timerange: 00/20:30:41 to 00/20:33:10

Plot file version 37 created 10-JUN-2016 17:22:03

J1957+3338 RT013A.UVDATA.1

Freq = 4.9270 GHz, Bw = 16.000 MH No calibration applied and no bandpass applied

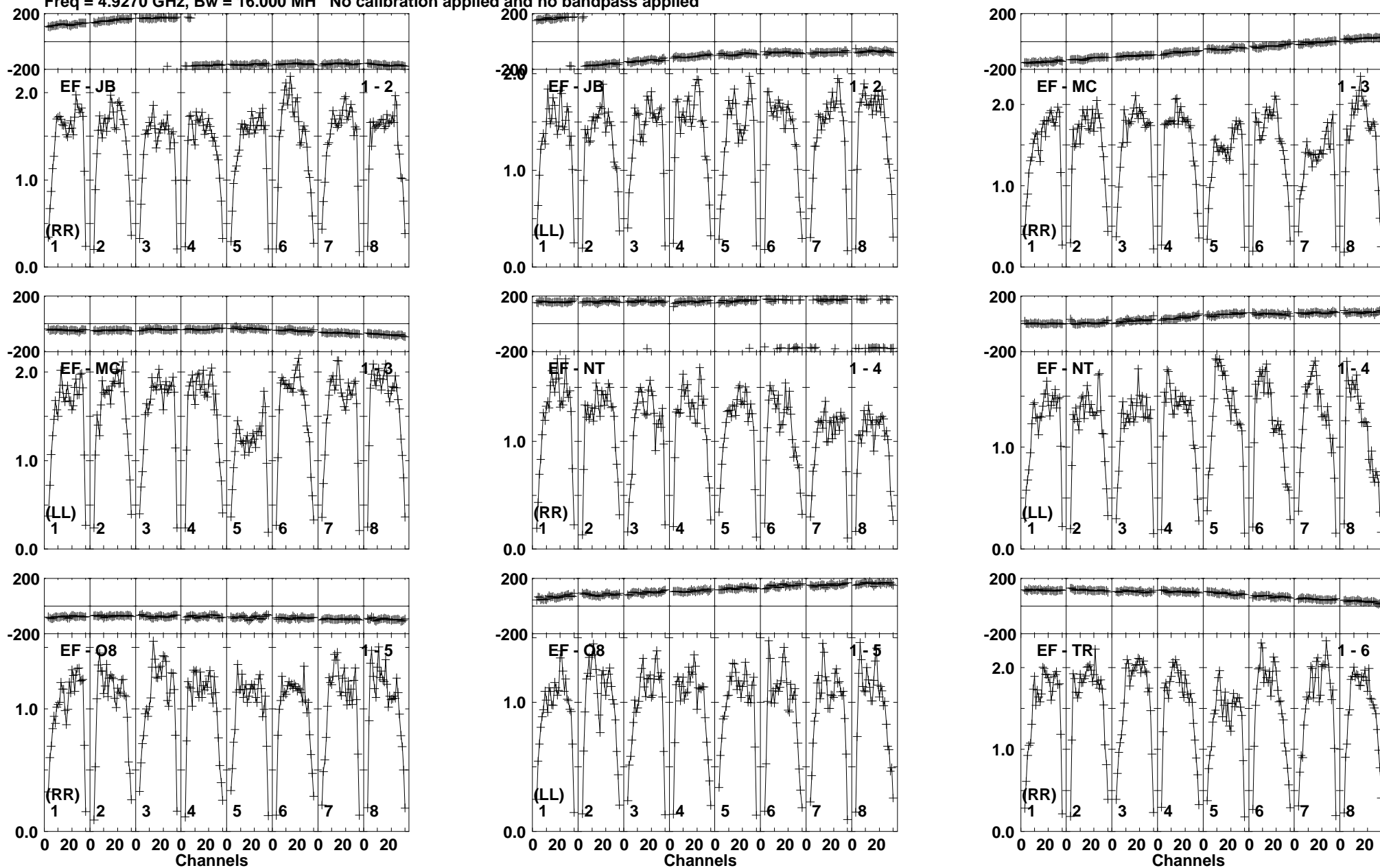

Lower frame: Milli Ampl Jy Top frame: Phas deg  
Vector averaged cross-power spectrum Baseline: EF (01) - JB (02)  
Timerange: 00/20:33:11 to 00/20:34:39

Plot file version 38 created 10-JUN-2016 17:22:03

J1957+3338 RT013A.UVDATA.1

Freq = 4.9270 GHz, Bw = 16.000 MH No calibration applied and no bandpass applied

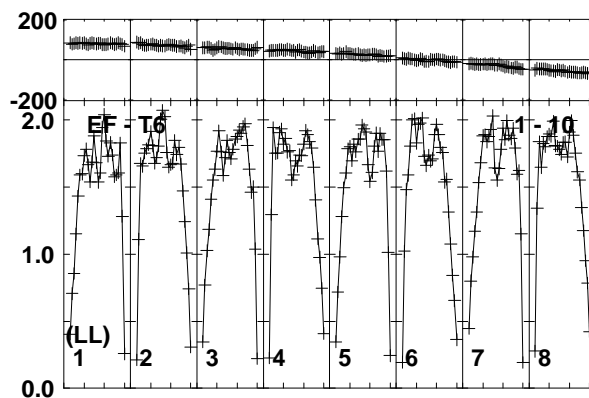
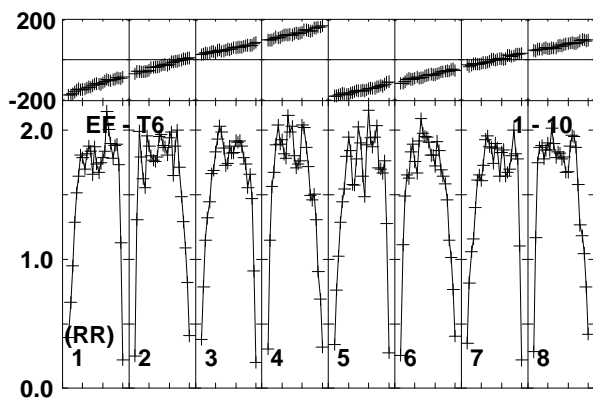
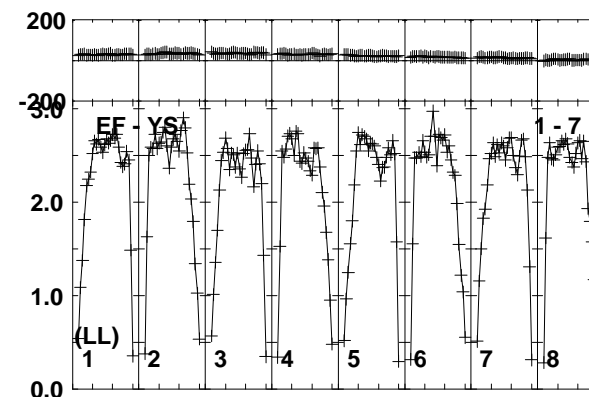
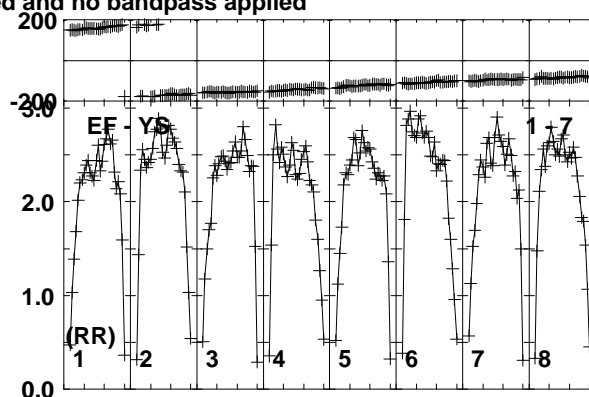
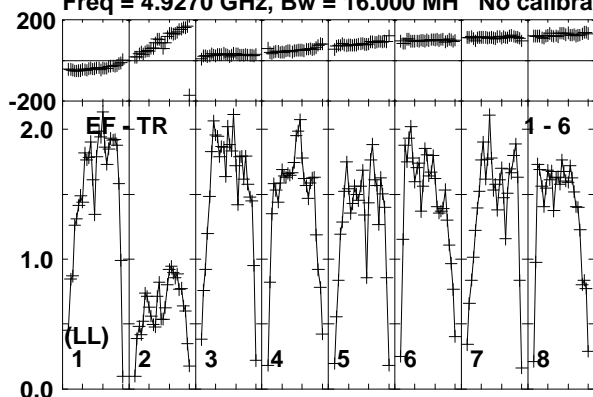

Lower frame: Milli Ampl Jy Top frame: Phas deg  
Vector averaged cross-power spectrum Baseline: EF (01) - TR (06)  
Timerange: 00/20:33:11 to 00/20:34:39

Plot file version 39 created 10-JUN-2016 17:22:03

CHECK RT013A.UVDATA.1

Freq = 4.9270 GHz, Bw = 16.000 MH No calibration applied and no bandpass applied

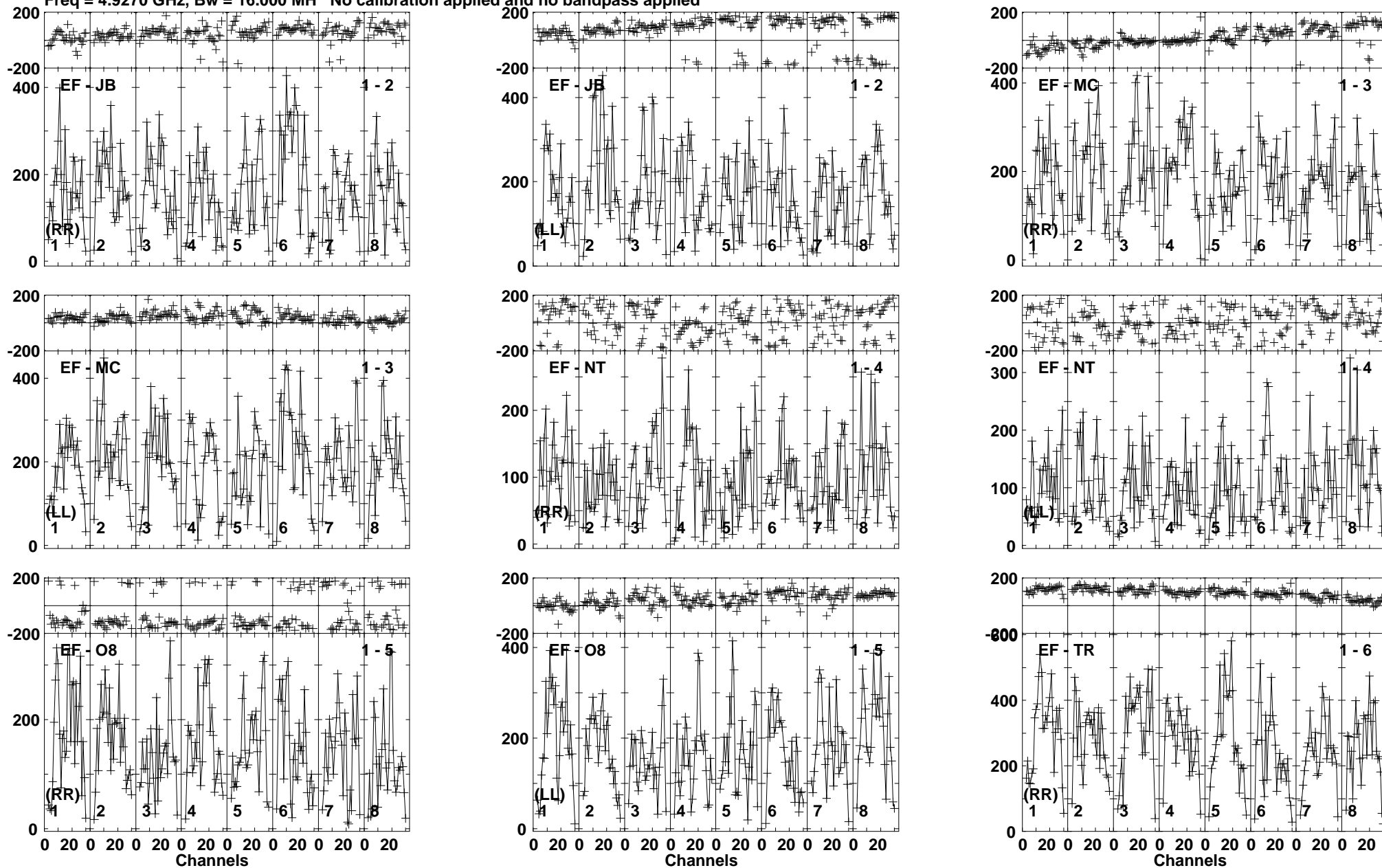

Lower frame: Micro Ampl Jy Top frame: Phas deg  
Vector averaged cross-power spectrum Baseline: EF (01) - JB (02)  
Timerange: 00/20:35:20 to 00/20:37:20

Plot file version 40 created 10-JUN-2016 17:22:03

CHECK RT013A.UVDATA.1

Freq = 4.9270 GHz, Bw = 16.000 MH No calibration applied and no bandpass applied

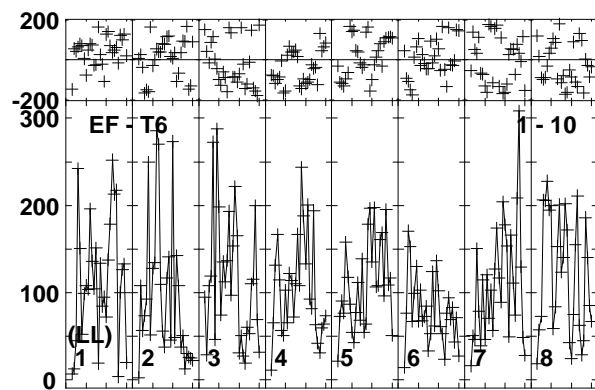
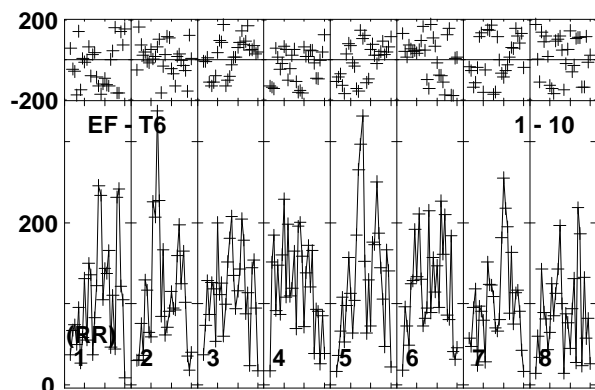
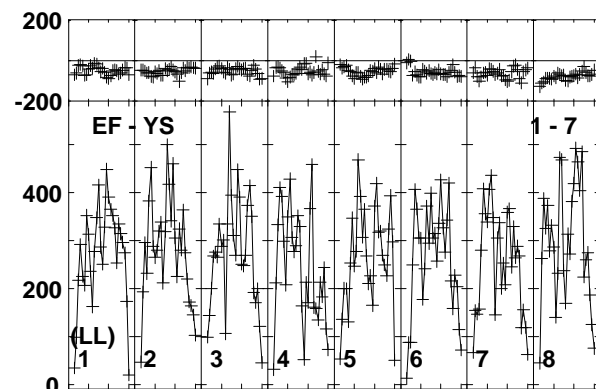
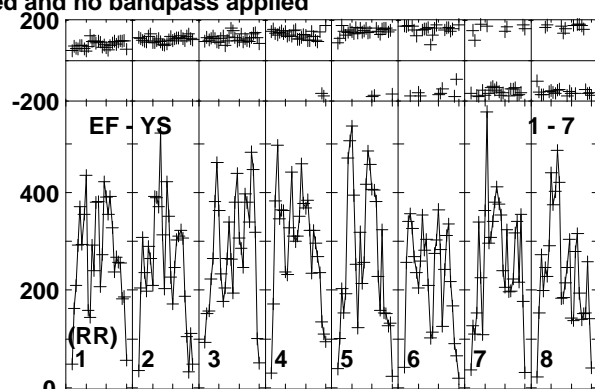
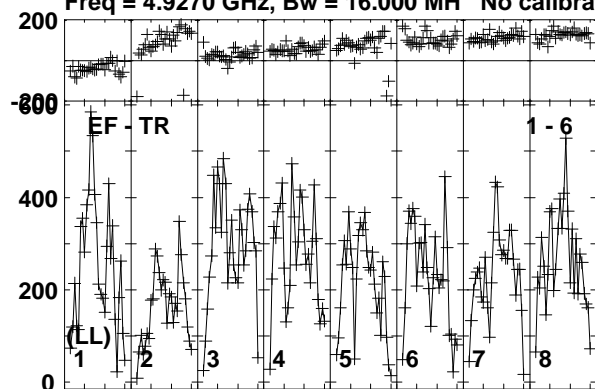

Lower frame: Micro Ampl Jy Top frame: Phas deg  
Vector averaged cross-power spectrum Baseline: EF (01) - TR (06)  
Timerange: 00/20:35:20 to 00/20:37:20

Plot file version 41 created 10-JUN-2016 17:22:03

CYGX1 RT013A.UVDATA.1

Freq = 4.9270 GHz, Bw = 16.000 MH No calibration applied and no bandpass applied

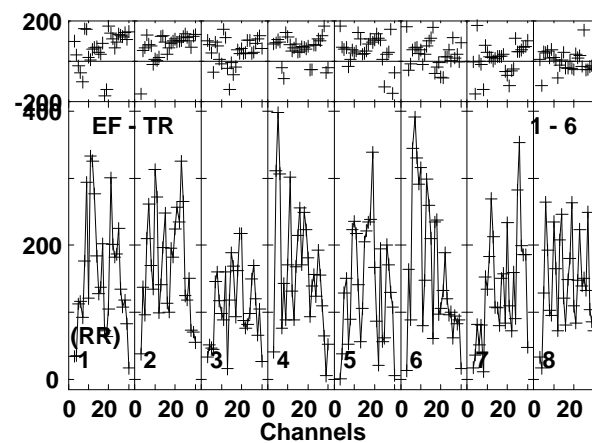
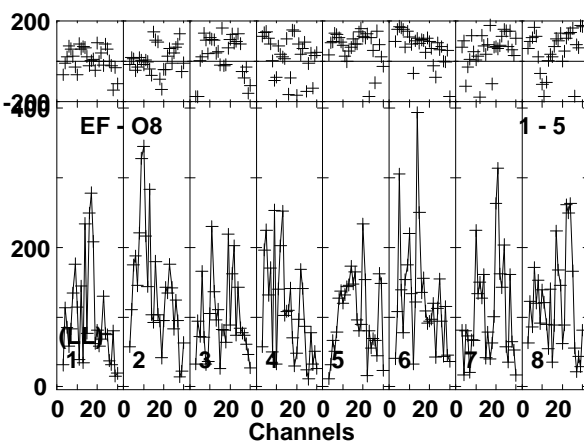
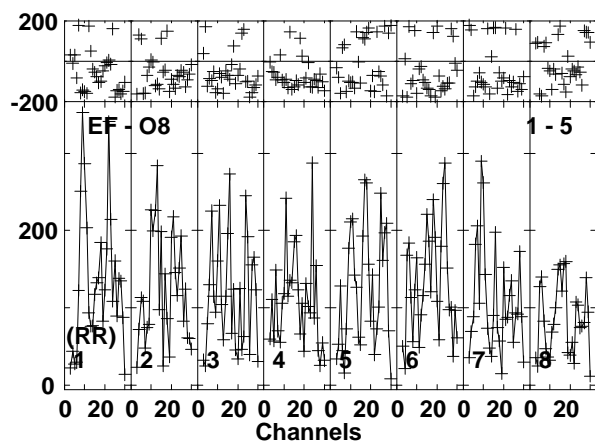
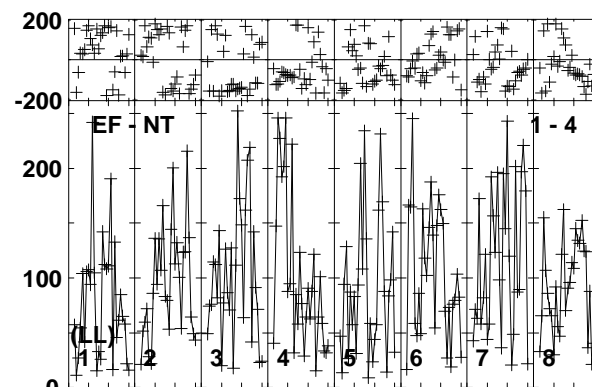
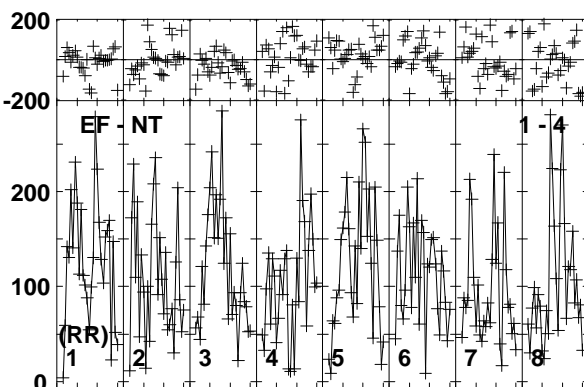
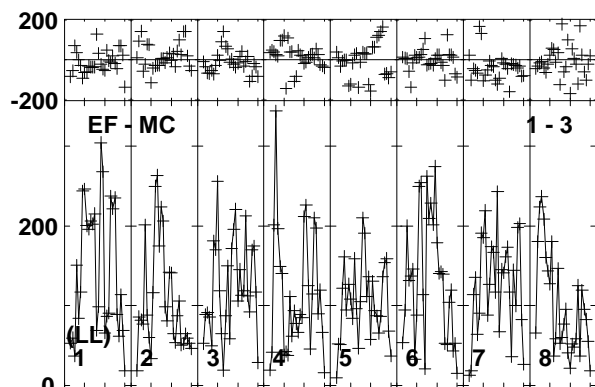
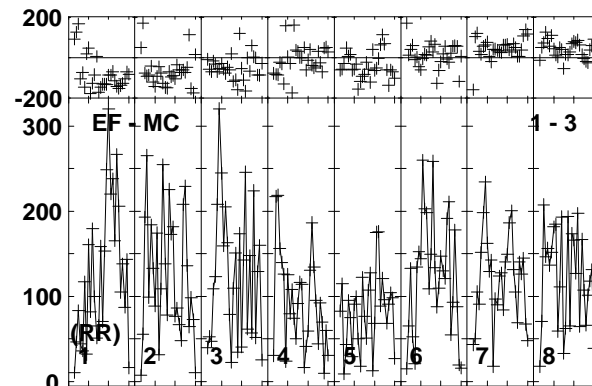
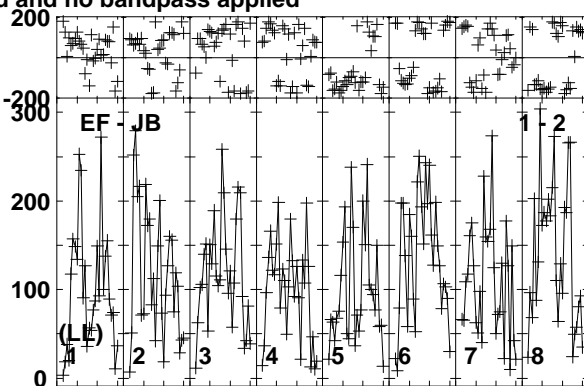
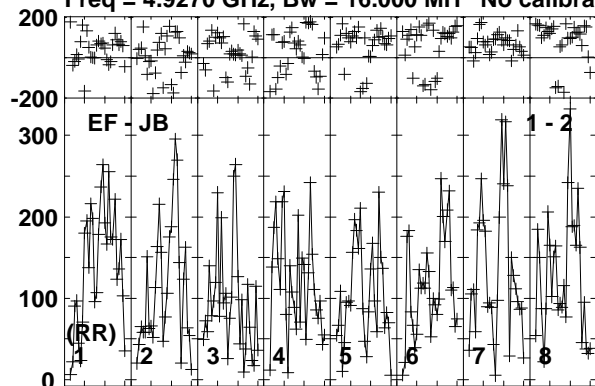

Lower frame: Micro Ampl Jy Top frame: Phas deg  
Vector averaged cross-power spectrum Baseline: EF (01) - JB (02)  
Timerange: 00/20:37:21 to 00/20:39:49

Plot file version 42 created 10-JUN-2016 17:22:03

CYGX1 RT013A.UVDATA.1

Freq = 4.9270 GHz, Bw = 16.000 MH No calibration applied and no bandpass applied

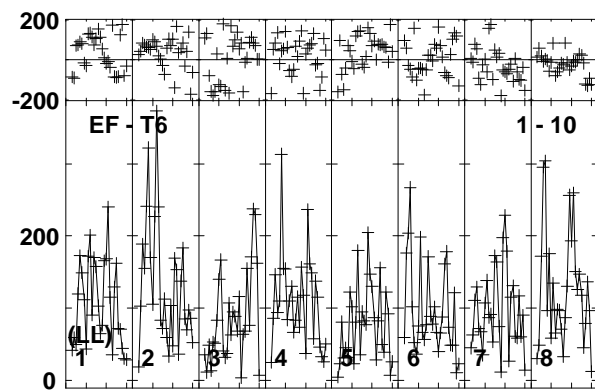
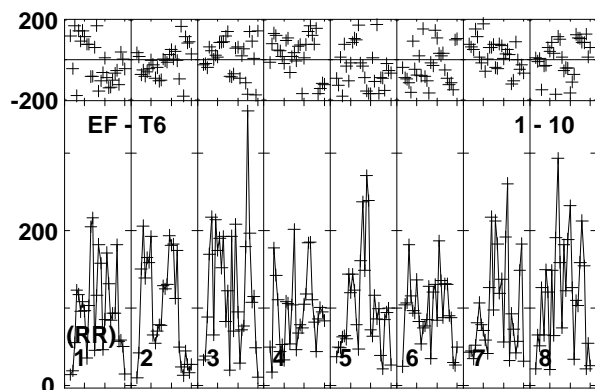
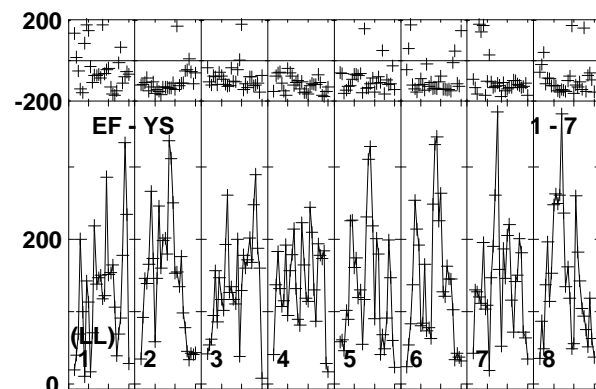
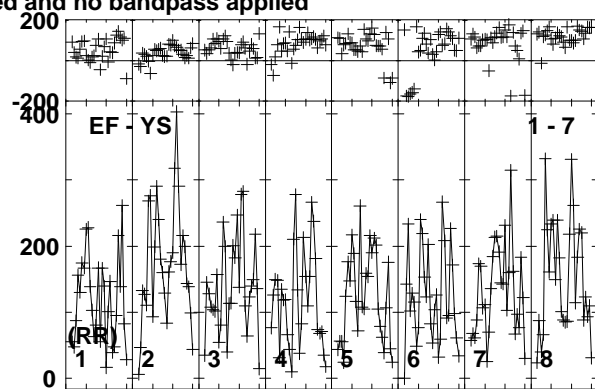
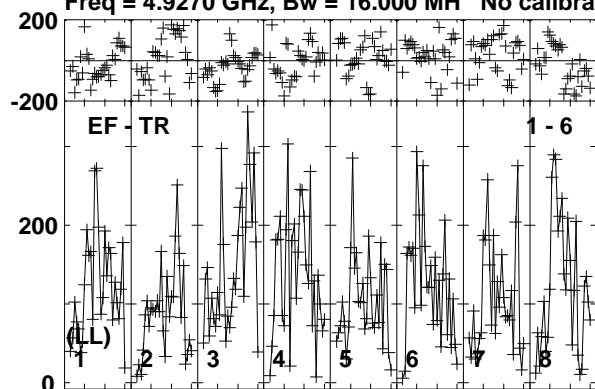

Lower frame: Micro Ampl Jy Top frame: Phas deg  
Vector averaged cross-power spectrum Baseline: EF (01) - TR (06)  
Timerange: 00/20:37:21 to 00/20:39:49



Plot file version 43 created 10-JUN-2016 17:22:04

J1957+3338 RT013A.UVDATA.1

Freq = 4.9270 GHz, Bw = 16.000 MH No calibration applied and no bandpass applied

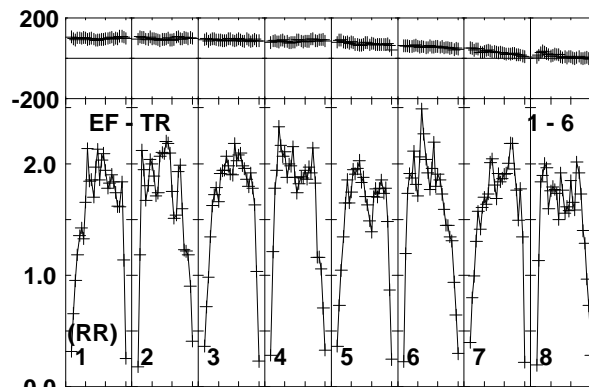
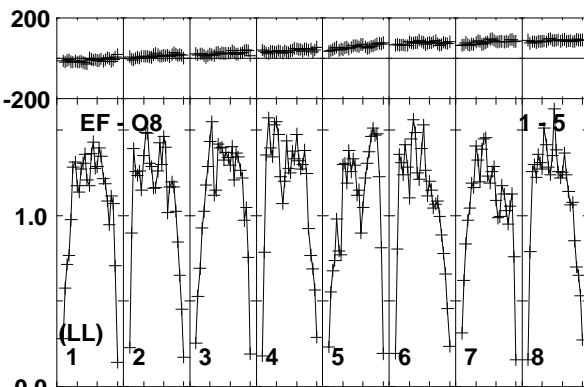
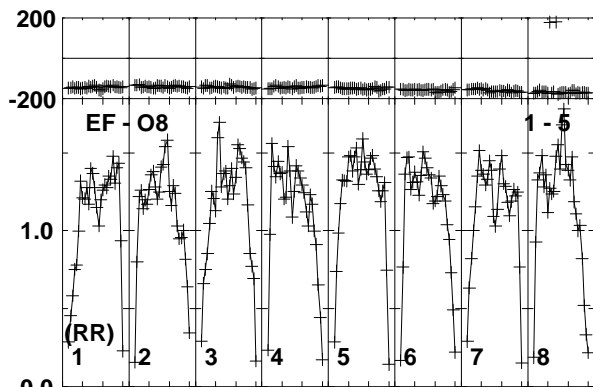
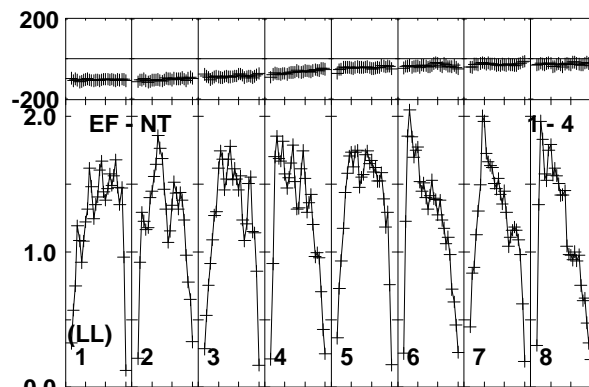
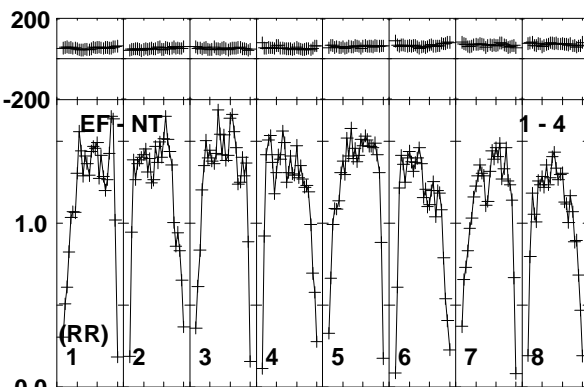
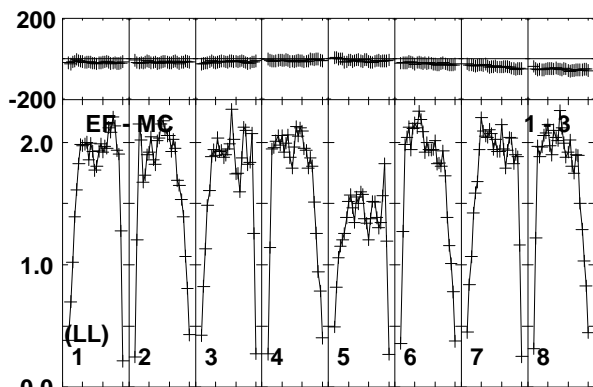
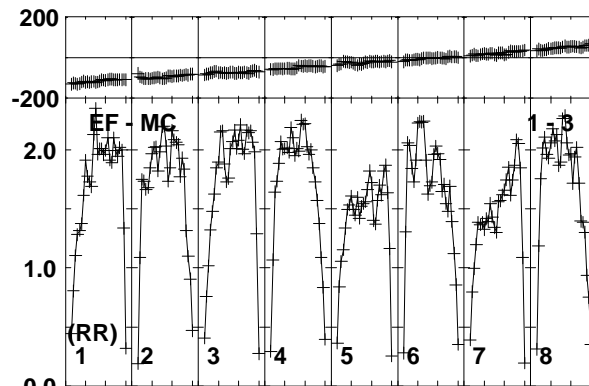
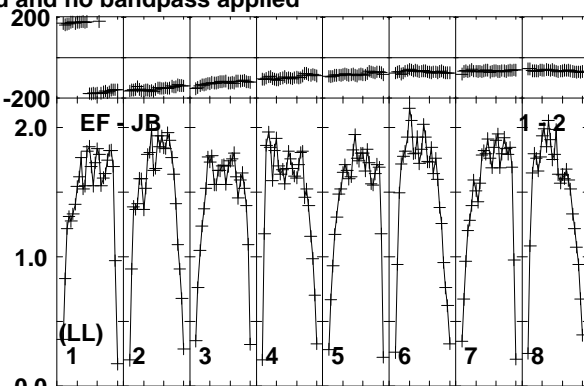
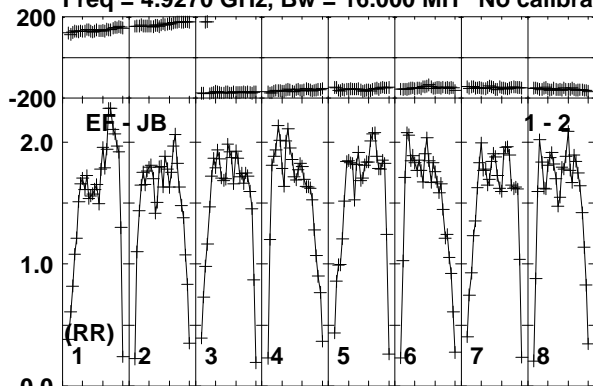

Lower frame: Milli Ampl Jy Top frame: Phas deg  
Vector averaged cross-power spectrum Baseline: EF (01) - JB (02)  
Timerange: 00/20:39:51 to 00/20:41:19

Plot file version 44 created 10-JUN-2016 17:22:04

J1957+3338 RT013A.UVDATA.1

Freq = 4.9270 GHz, Bw = 16.000 MH No calibration applied and no bandpass applied

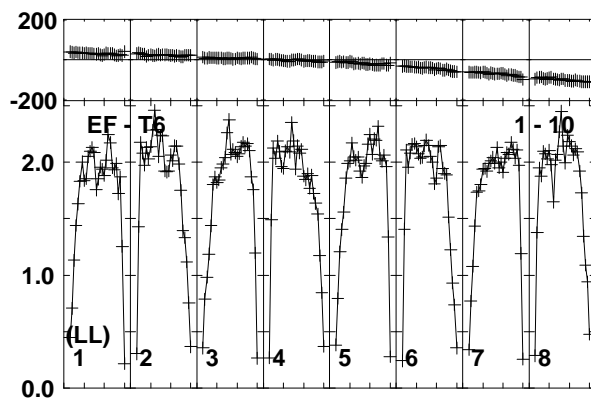
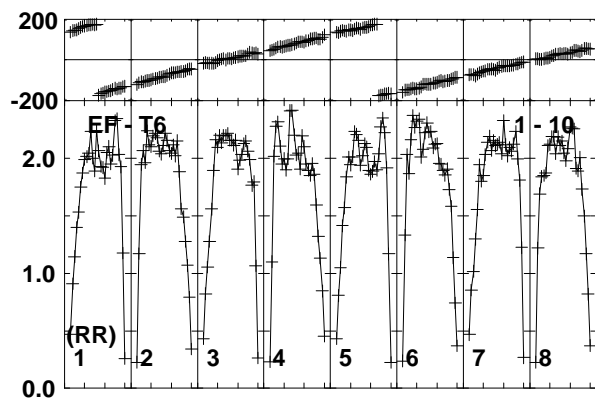
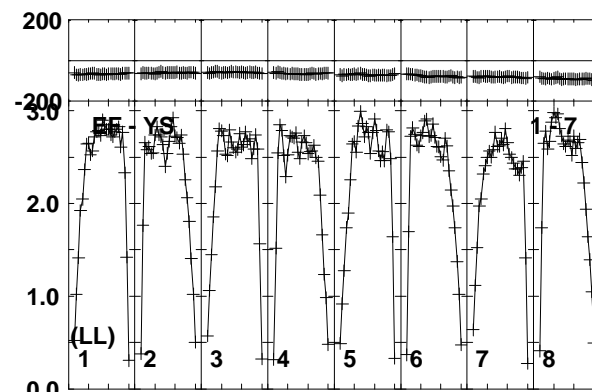
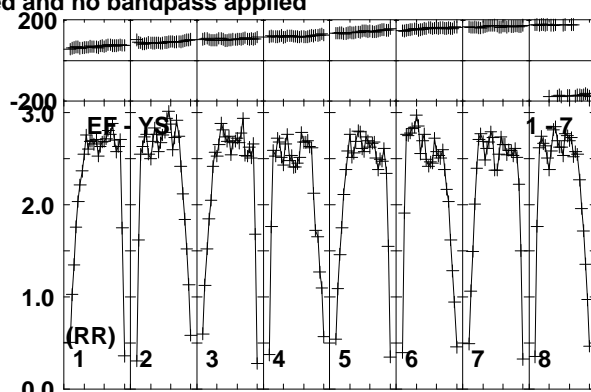
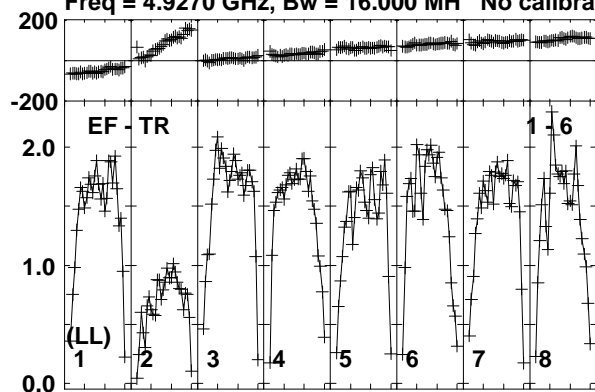

Lower frame: Milli Ampl Jy Top frame: Phas deg  
Vector averaged cross-power spectrum Baseline: EF (01) - TR (06)  
Timerange: 00/20:39:51 to 00/20:41:19

Plot file version 45 created 10-JUN-2016 17:22:04

CHECK RT013A.UVDATA.1

Freq = 4.9270 GHz, Bw = 16.000 MH No calibration applied and no bandpass applied

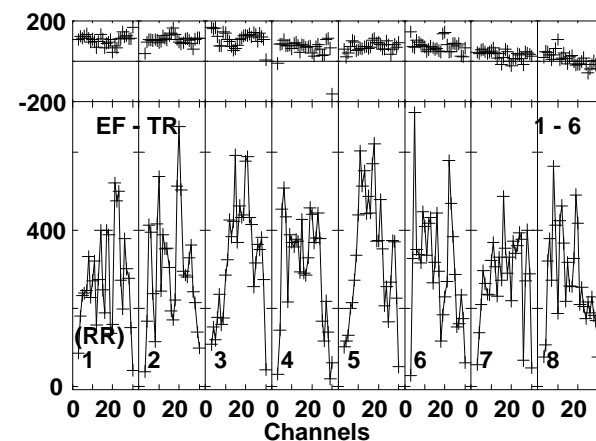
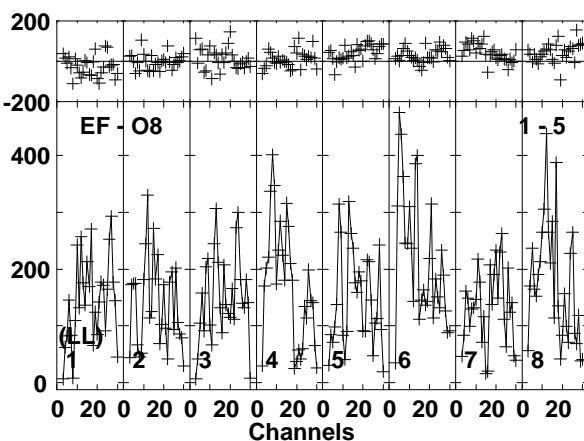
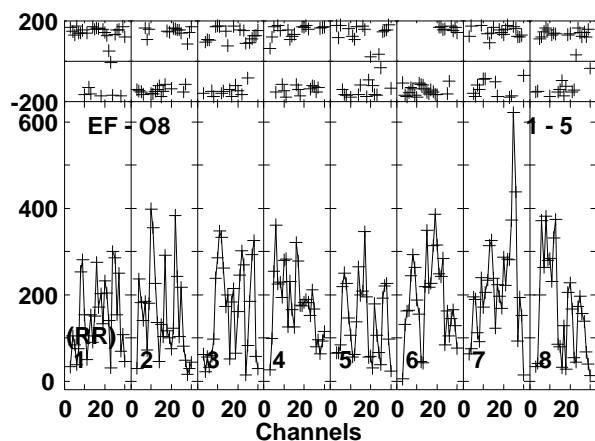
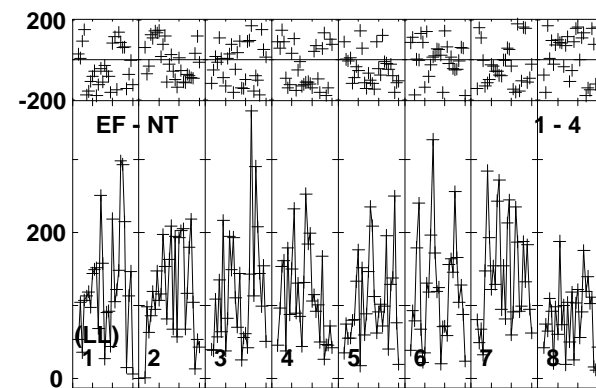
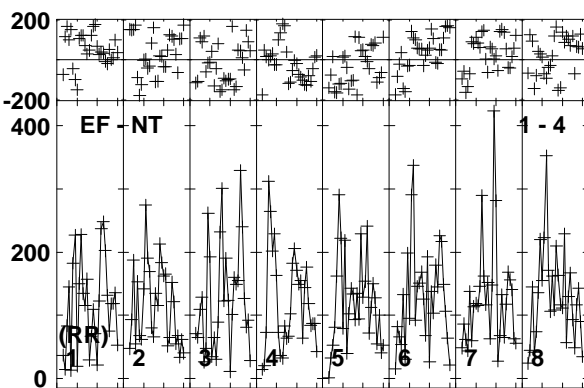
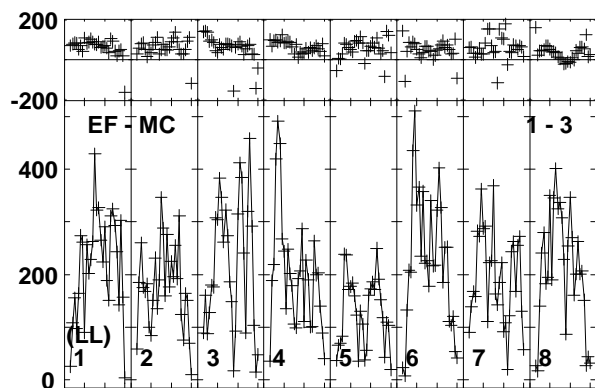
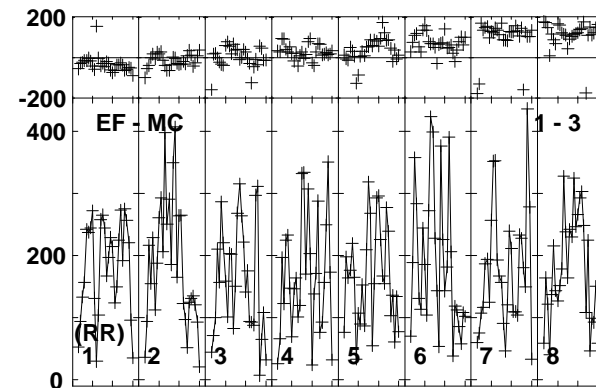
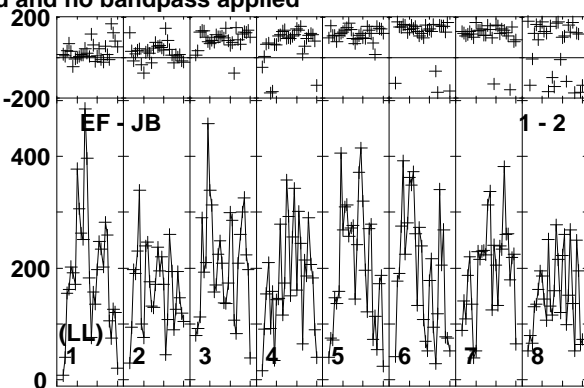
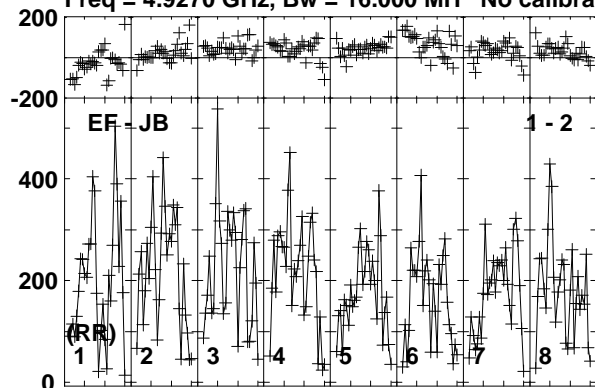

Lower frame: Micro Ampl Jy Top frame: Phas deg  
Vector averaged cross-power spectrum Baseline: EF (01) - JB (02)  
Timerange: 00/20:41:20 to 00/20:43:20

Plot file version 46 created 10-JUN-2016 17:22:04

CHECK RT013A.UVDATA.1

Freq = 4.9270 GHz, Bw = 16.000 MH No calibration applied and no bandpass applied

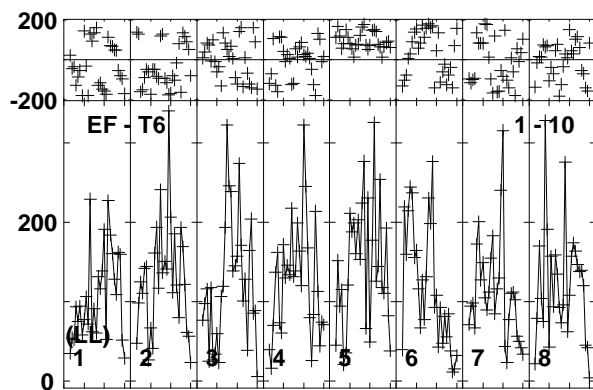
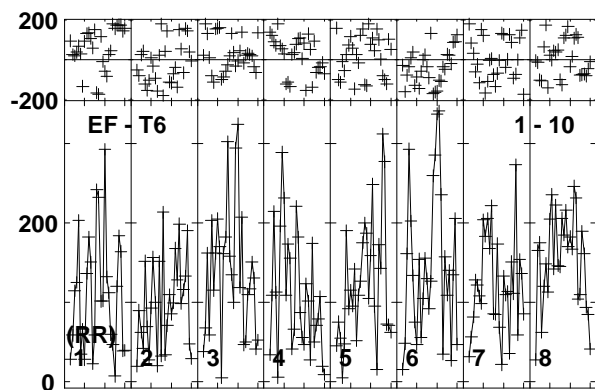
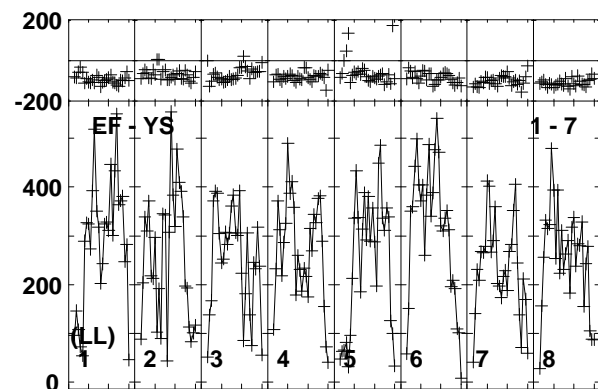
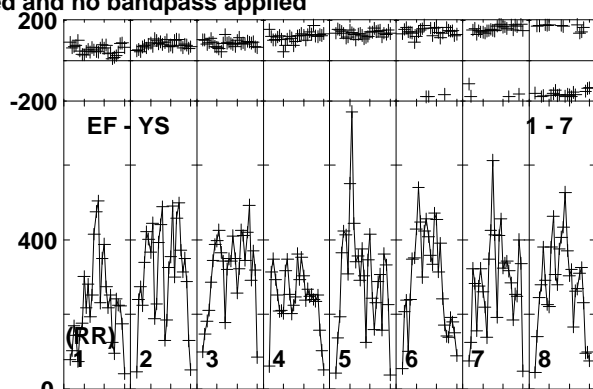
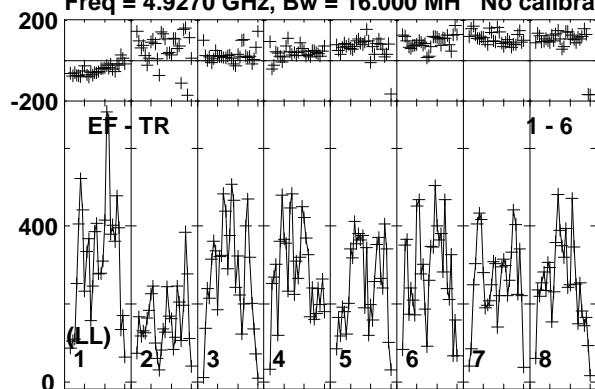

Lower frame: Micro Ampl Jy Top frame: Phas deg  
Vector averaged cross-power spectrum Baseline: EF (01) - TR (06)  
Timerange: 00/20:41:20 to 00/20:43:20

Plot file version 47 created 10-JUN-2016 17:22:04

CYGX1 RT013A.UVDATA.1

Freq = 4.9270 GHz, Bw = 16.000 MH No calibration applied and no bandpass applied

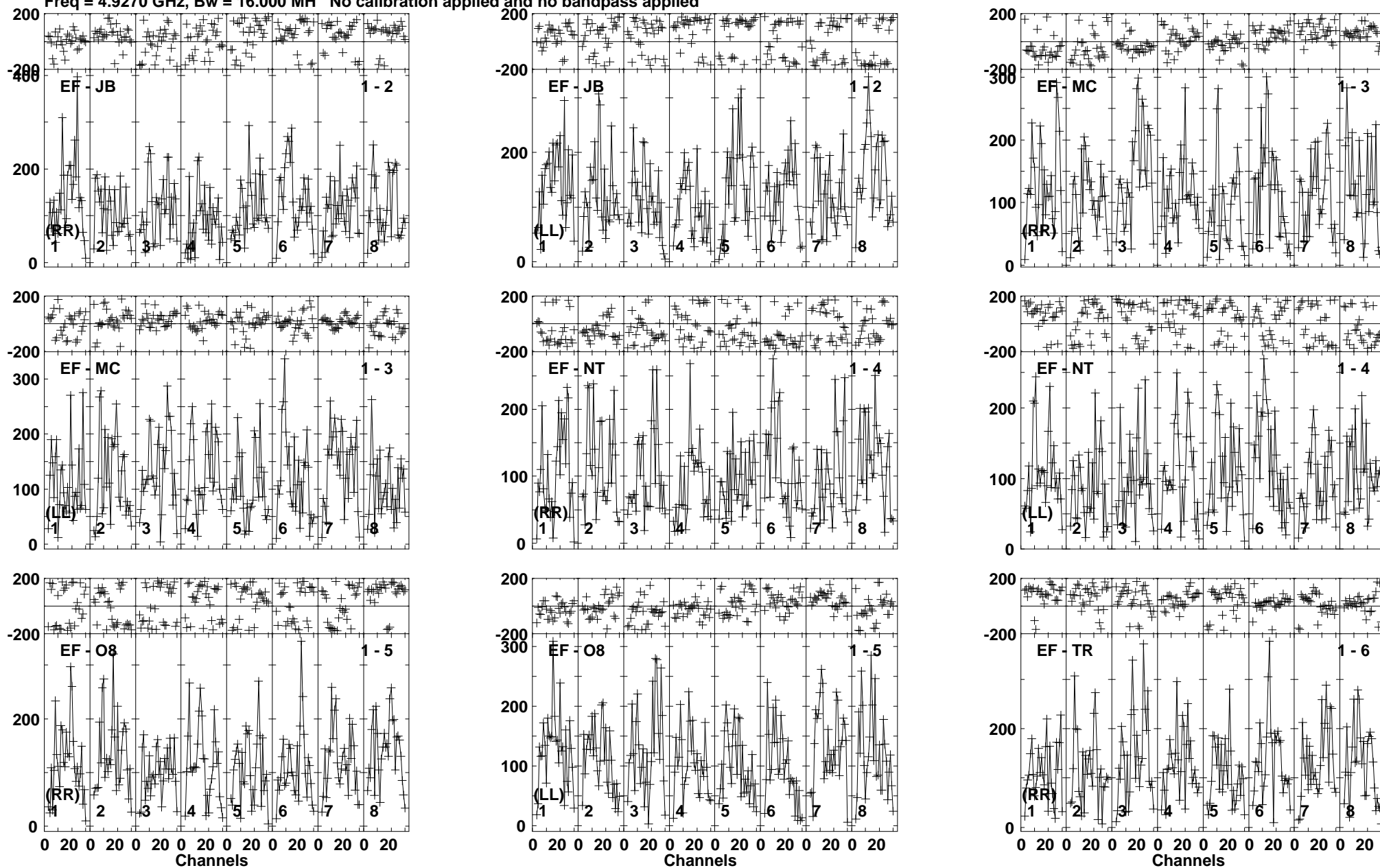

Lower frame: Micro Ampl Jy Top frame: Phas deg  
Vector averaged cross-power spectrum Baseline: EF (01) - JB (02)  
Timerange: 00/20:43:20 to 00/20:45:49

Plot file version 48 created 10-JUN-2016 17:22:04

CYGX1 RT013A.UVDATA.1

Freq = 4.9270 GHz, Bw = 16.000 MH No calibration applied and no bandpass applied

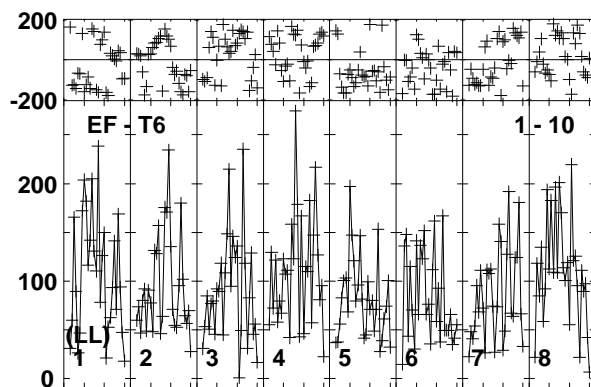
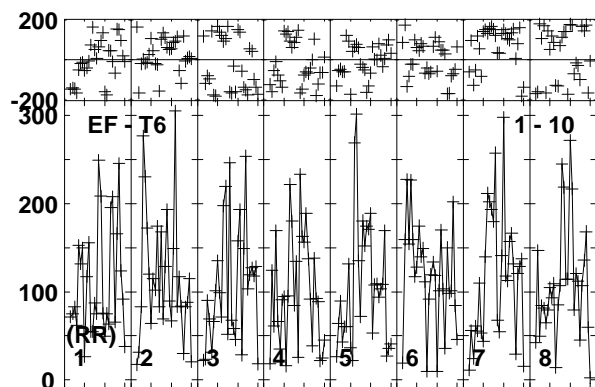
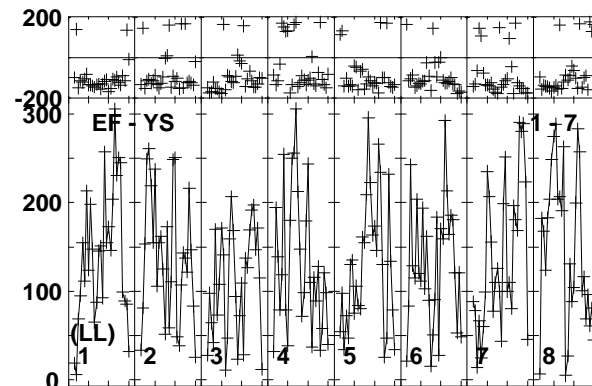
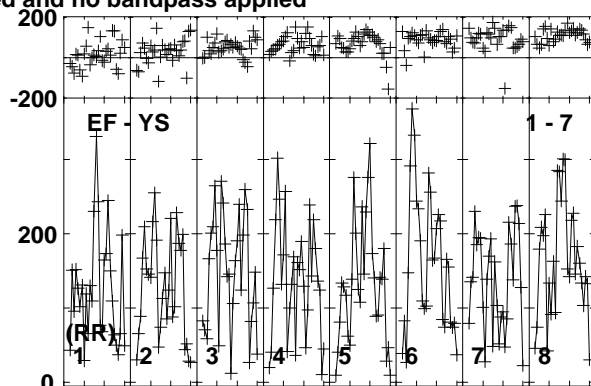
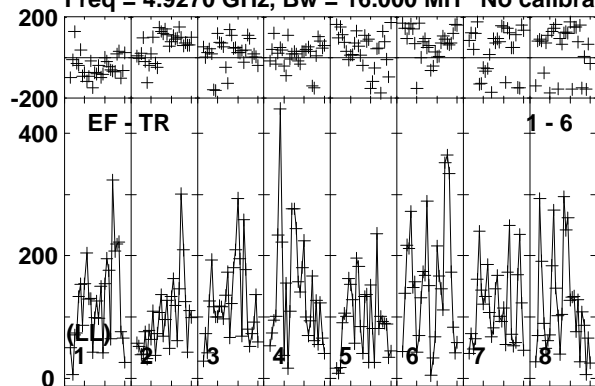

Lower frame: Micro Ampl Jy Top frame: Phas deg  
Vector averaged cross-power spectrum Baseline: EF (01) - TR (06)  
Timerange: 00/20:43:20 to 00/20:45:49

Plot file version 49 created 10-JUN-2016 17:22:04

J1957+3338 RT013A.UVDATA.1

Freq = 4.9270 GHz, Bw = 16.000 MH No calibration applied and no bandpass applied

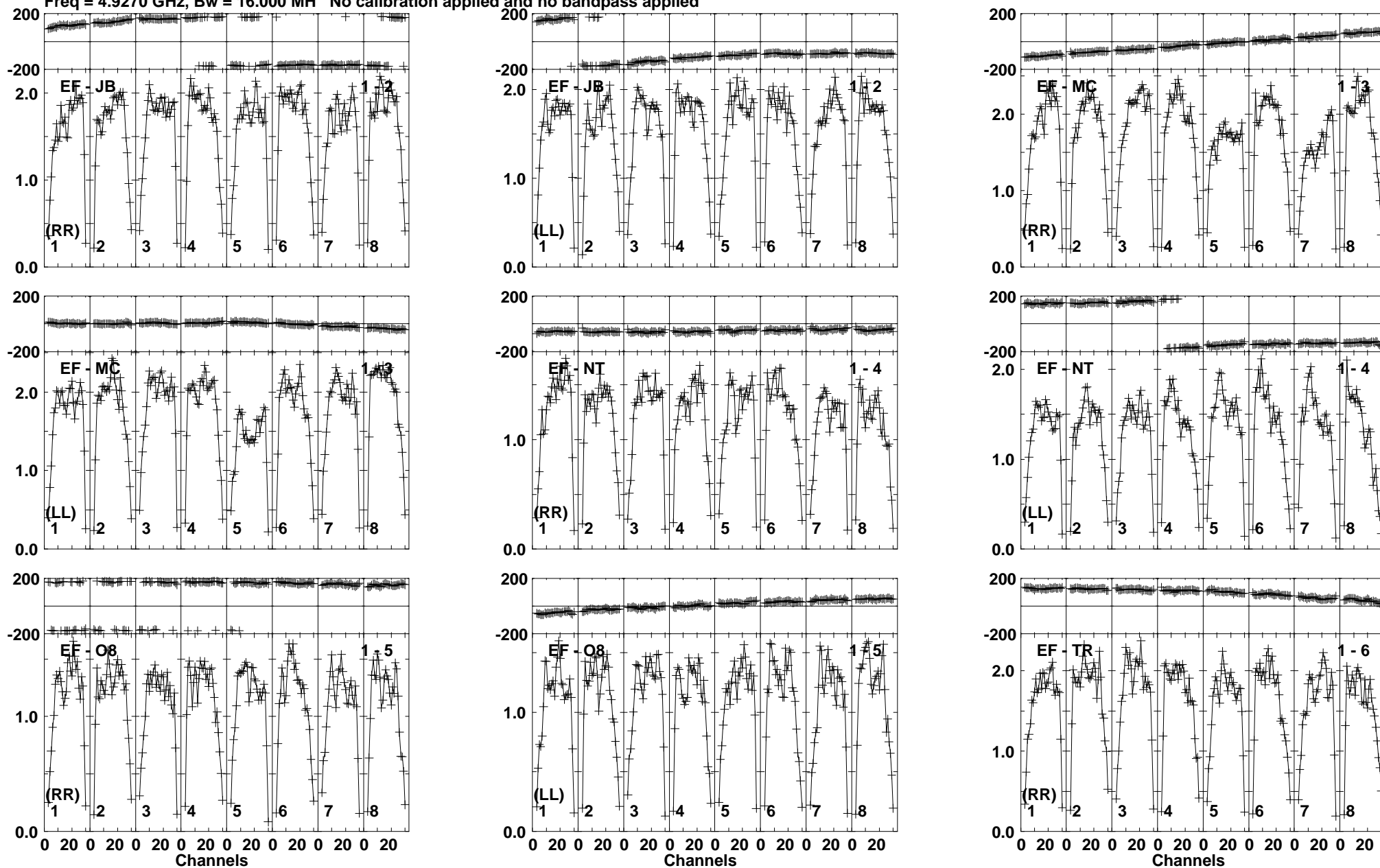

Lower frame: Milli Ampl Jy Top frame: Phas deg  
Vector averaged cross-power spectrum Baseline: EF (01) - JB (02)  
Timerange: 00/20:45:50 to 00/20:47:19

Plot file version 50 created 10-JUN-2016 17:22:04

J1957+3338 RT013A.UVDATA.1

Freq = 4.9270 GHz, Bw = 16.000 MH No calibration applied and no bandpass applied

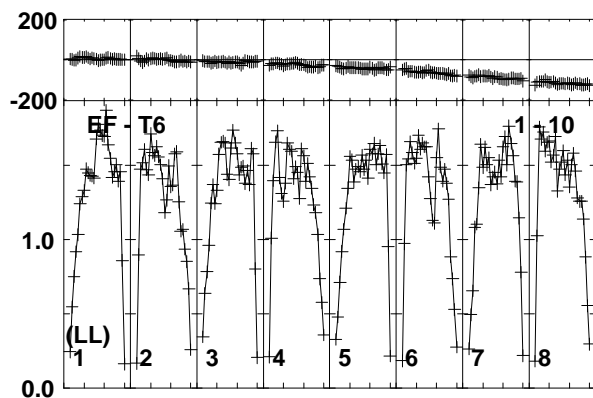
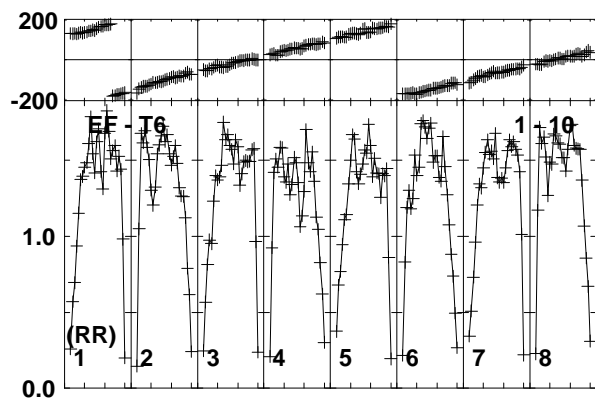
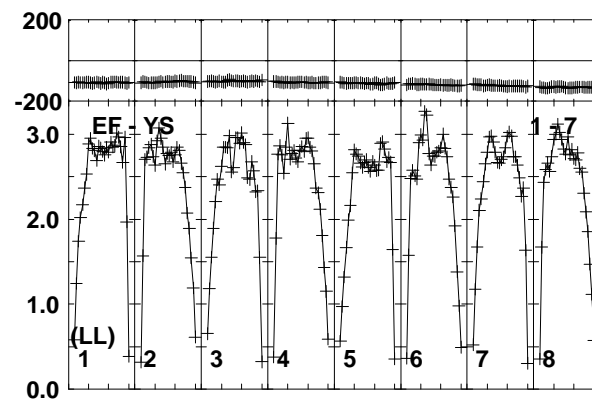
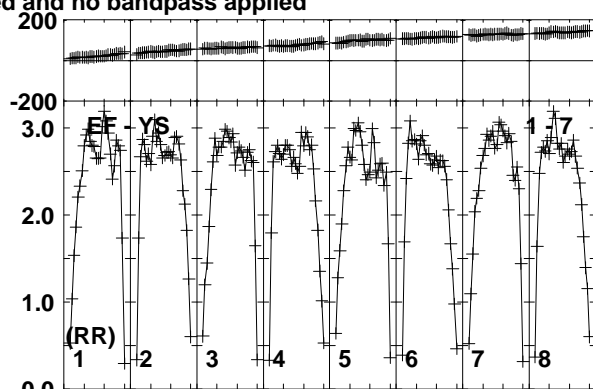
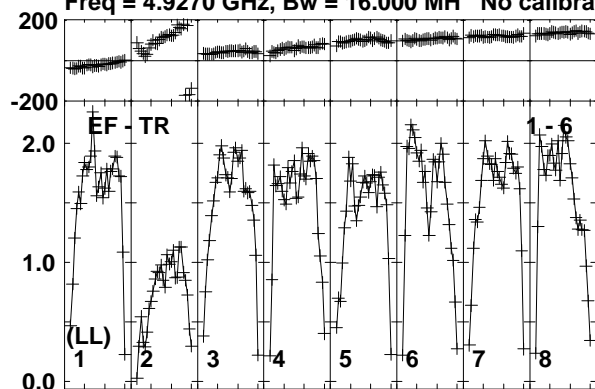

Lower frame: Milli Ampl Jy Top frame: Phas deg  
Vector averaged cross-power spectrum Baseline: EF (01) - TR (06)  
Timerange: 00/20:45:50 to 00/20:47:19



Plot file version 51 created 10-JUN-2016 17:22:04

CHECK RT013A.UVDATA.1

Freq = 4.9270 GHz, Bw = 16.000 MH No calibration applied and no bandpass applied

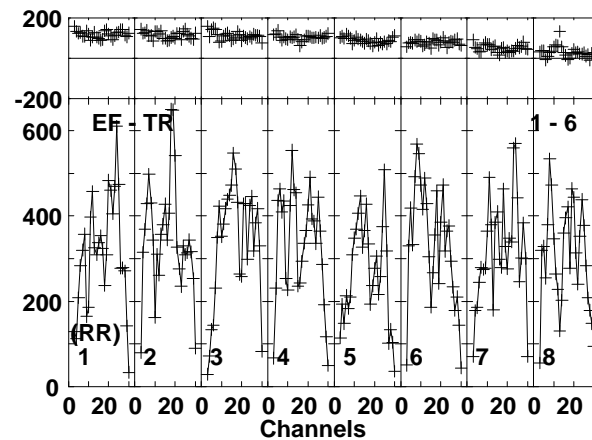
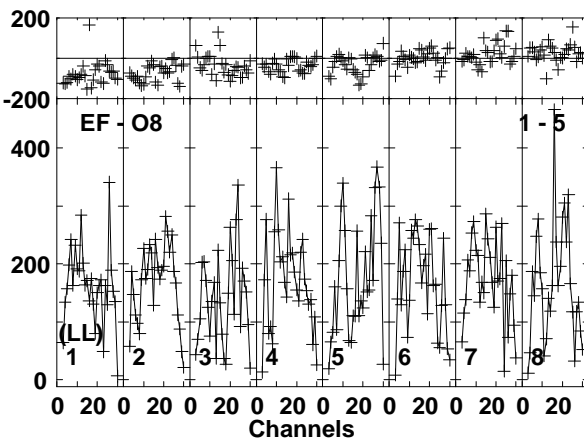
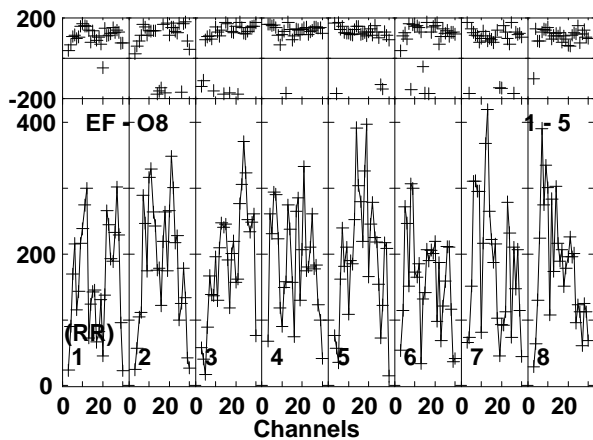
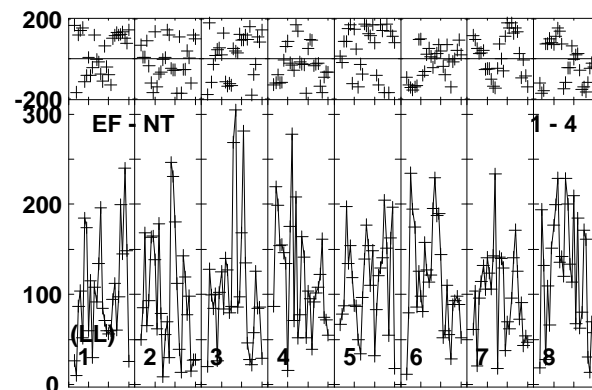
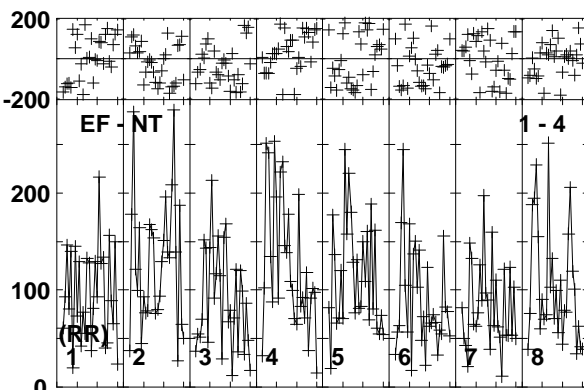
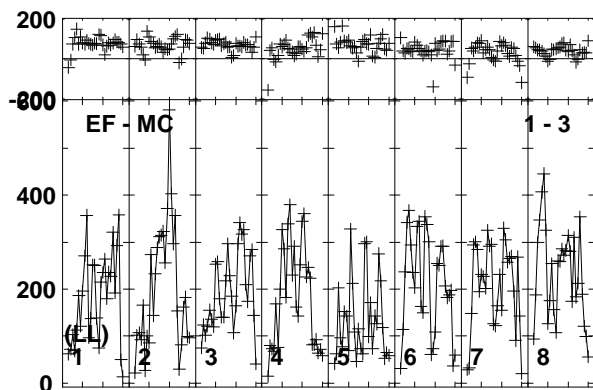
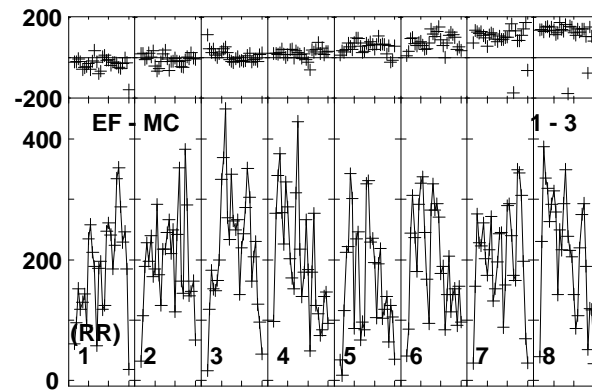
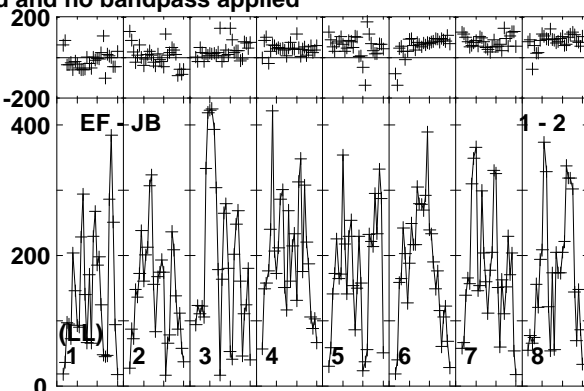
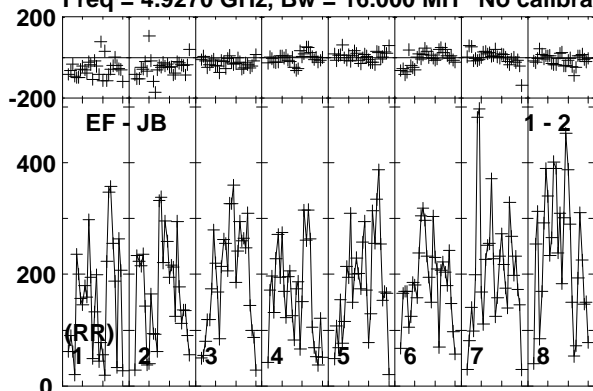

Lower frame: Micro Ampl Jy Top frame: Phas deg  
Vector averaged cross-power spectrum Baseline: EF (01) - JB (02)  
Timerange: 00/20:48:00 to 00/20:50:00

Plot file version 52 created 10-JUN-2016 17:22:04

CHECK RT013A.UVDATA.1

Freq = 4.9270 GHz, Bw = 16.000 MH No calibration applied and no bandpass applied

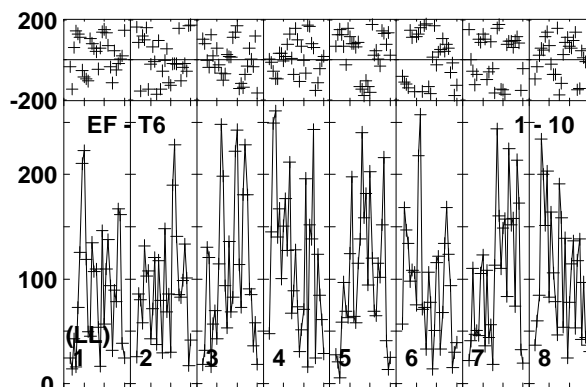
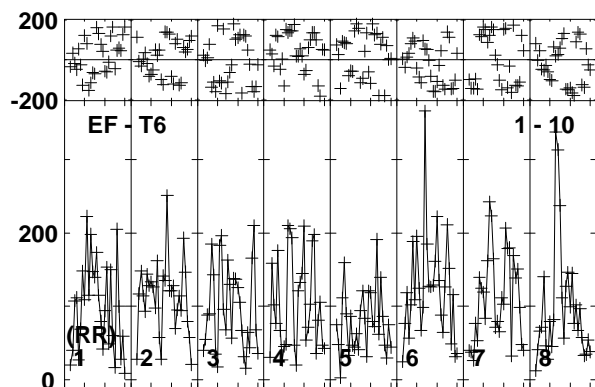
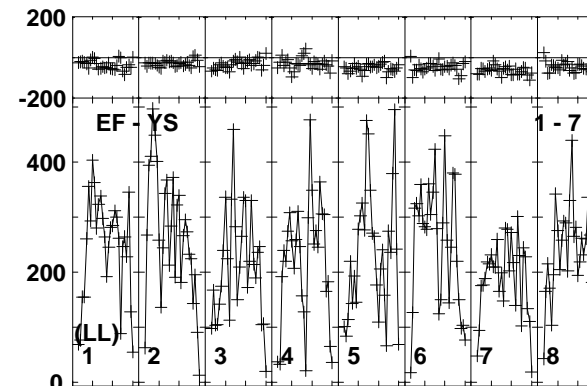
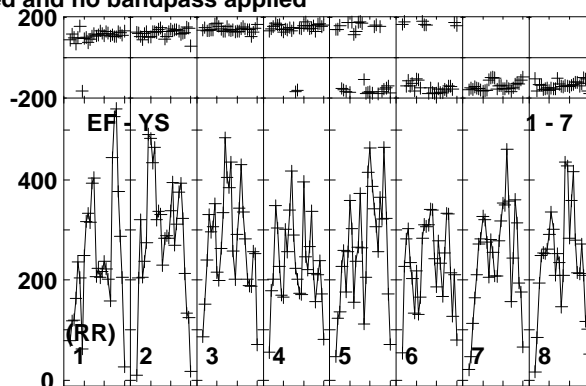
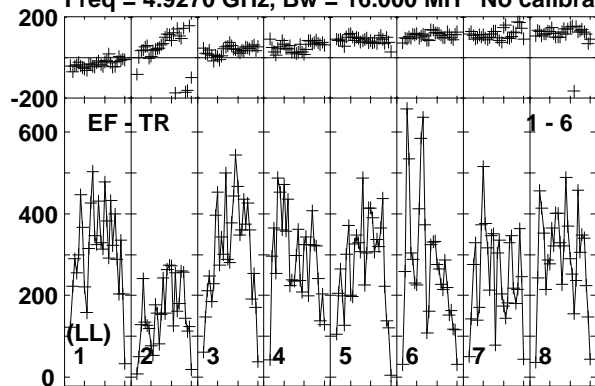

Lower frame: Micro Ampl Jy Top frame: Phas deg  
Vector averaged cross-power spectrum Baseline: EF (01) - TR (06)  
Timerange: 00/20:48:00 to 00/20:50:00

Plot file version 53 created 10-JUN-2016 17:22:04

CYGX1 RT013A.UVDATA.1

Freq = 4.9270 GHz, Bw = 16.000 MH No calibration applied and no bandpass applied

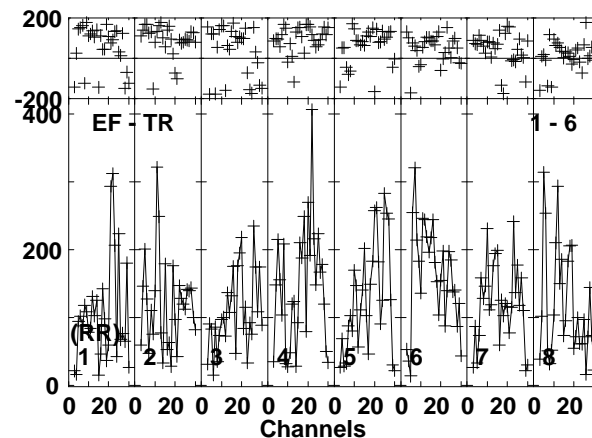
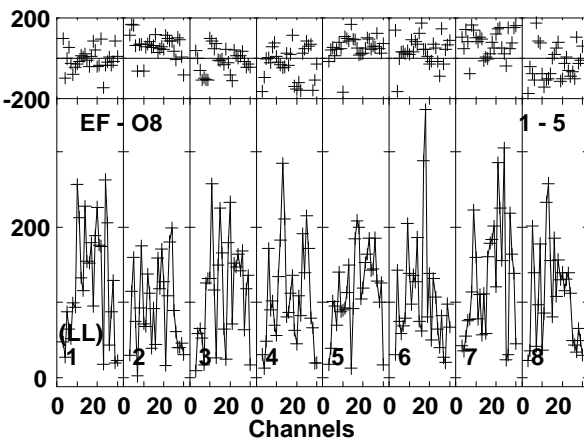
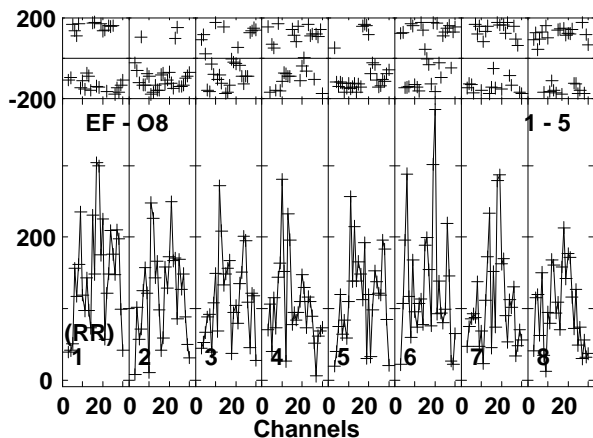
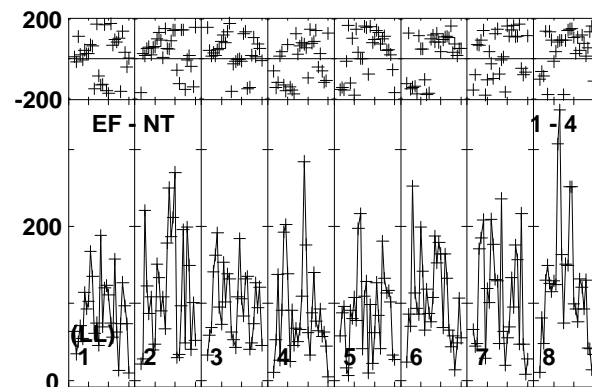
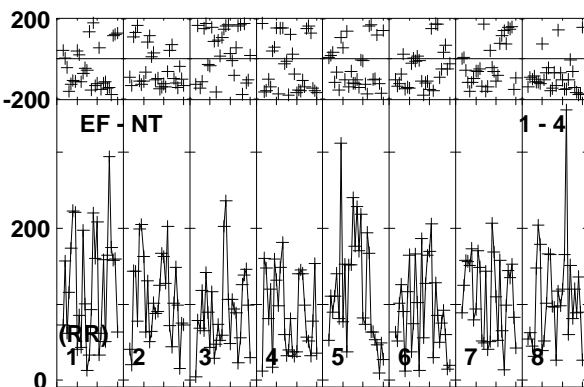
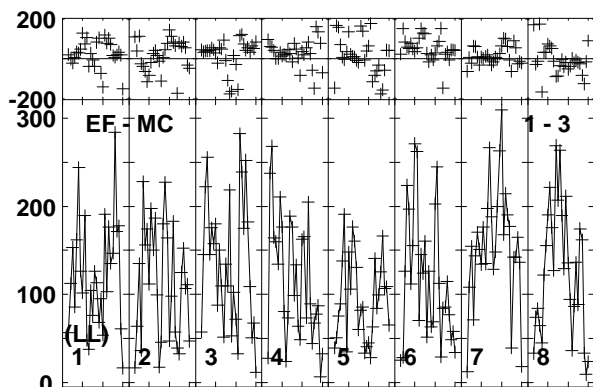
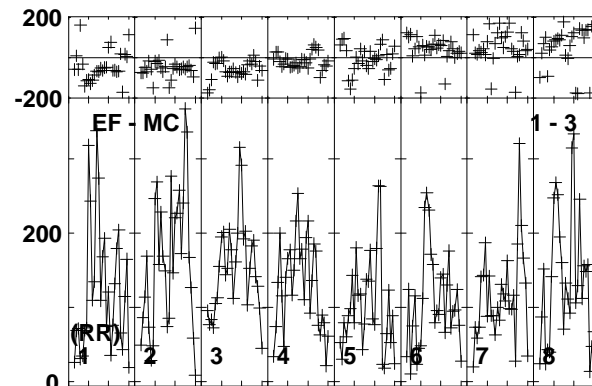
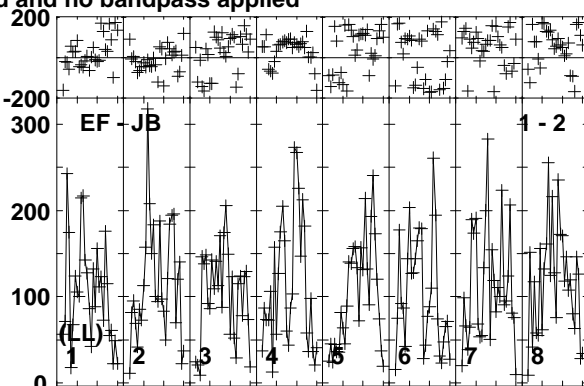
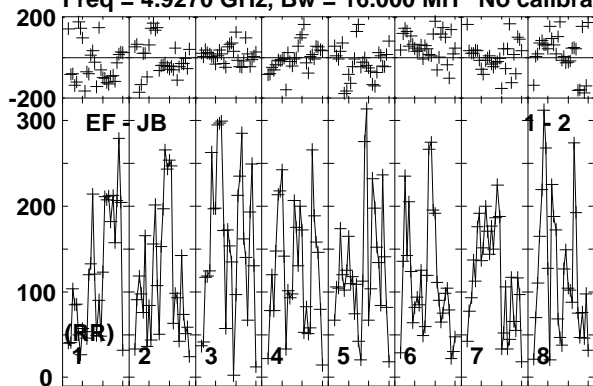

Lower frame: Micro Ampl Jy Top frame: Phas deg  
Vector averaged cross-power spectrum Baseline: EF (01) - JB (02)  
Timerange: 00/20:50:01 to 00/20:52:30

Plot file version 54 created 10-JUN-2016 17:22:05

CYGX1 RT013A.UVDATA.1

Freq = 4.9270 GHz, Bw = 16.000 MH No calibration applied and no bandpass applied

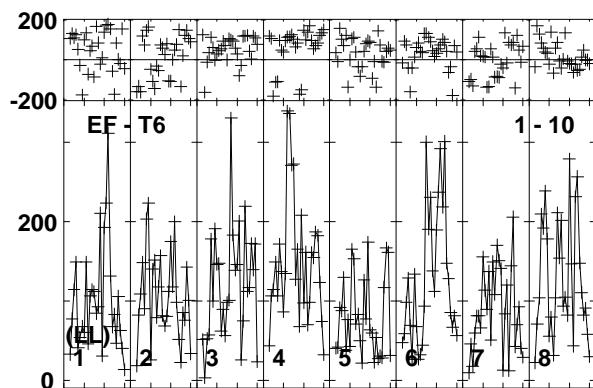
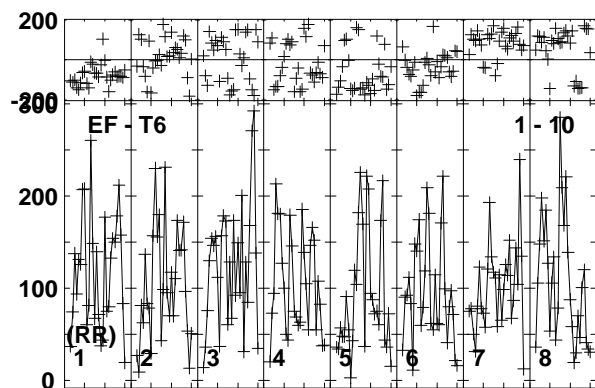
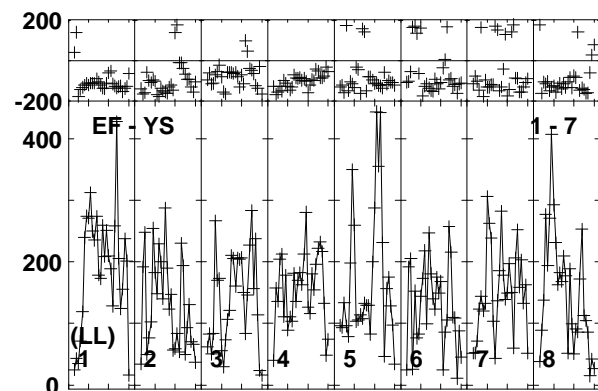
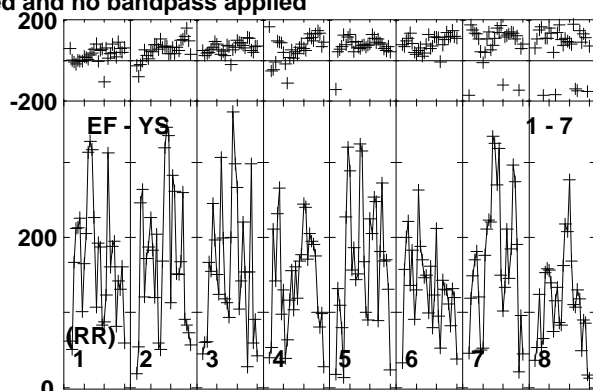
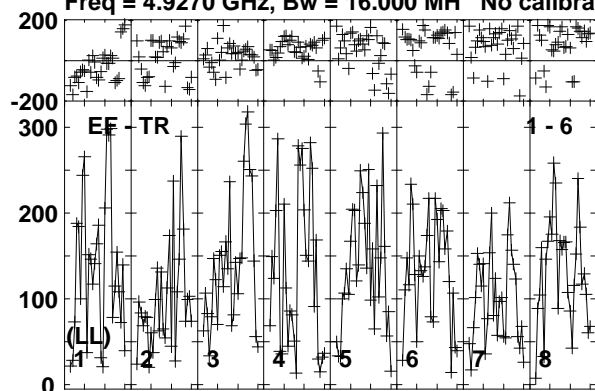

Lower frame: Micro Ampl Jy Top frame: Phas deg  
Vector averaged cross-power spectrum Baseline: EF (01) - TR (06)  
Timerange: 00/20:50:01 to 00/20:52:30

Plot file version 55 created 10-JUN-2016 17:22:05

J1957+3338 RT013A.UVDATA.1

Freq = 4.9270 GHz, Bw = 16.000 MH No calibration applied and no bandpass applied

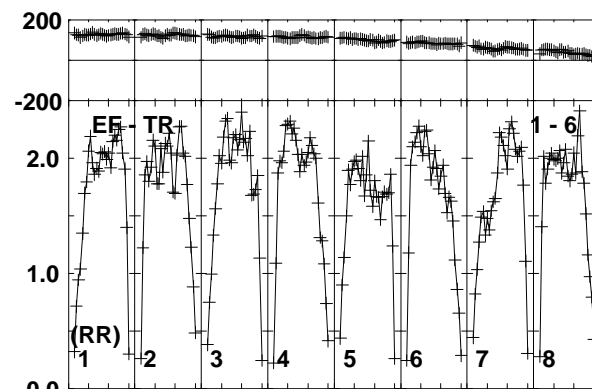
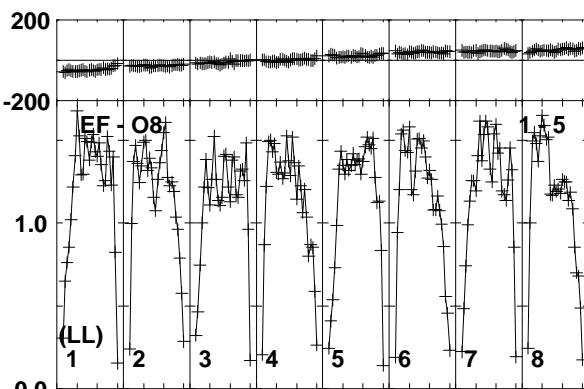
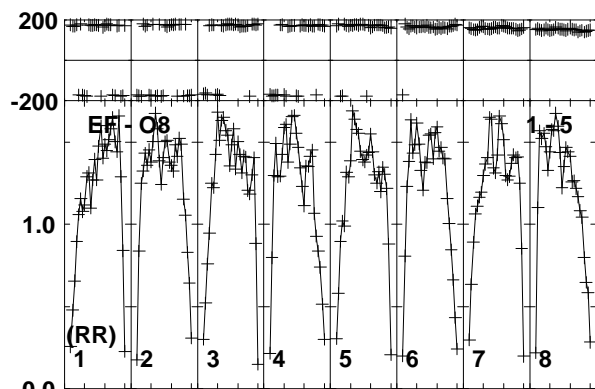
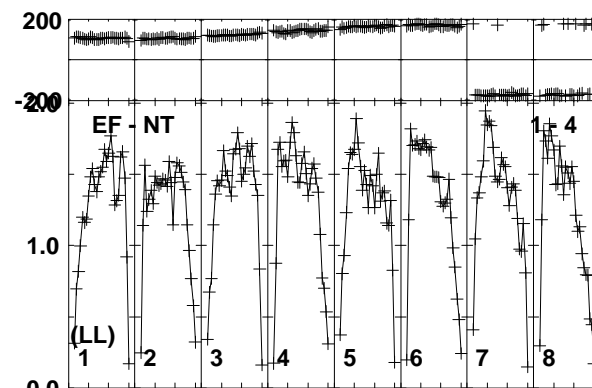
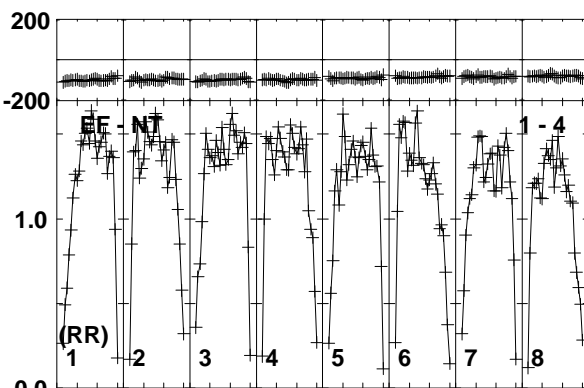
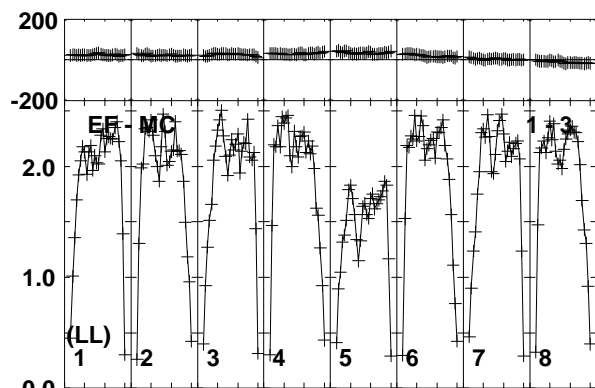
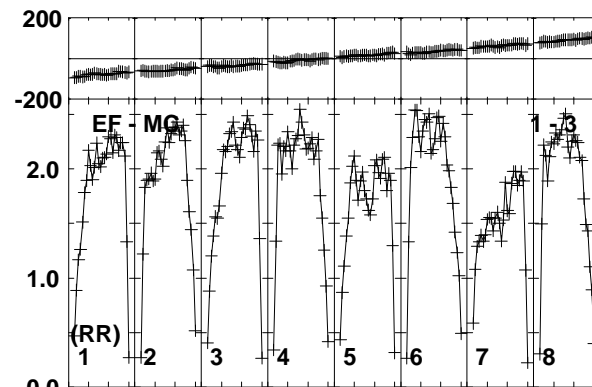
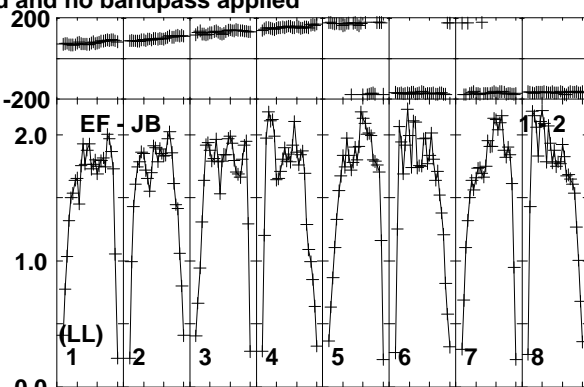
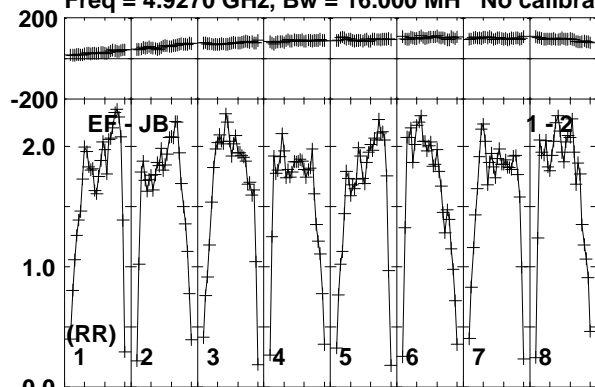

Lower frame: Milli Ampl Jy Top frame: Phas deg

Vector averaged cross-power spectrum Baseline: EF (01) - JB (02)

Timerange: 00/20:52:31 to 00/20:53:59

Plot file version 56 created 10-JUN-2016 17:22:05

J1957+3338 RT013A.UVDATA.1

Freq = 4.9270 GHz, Bw = 16.000 MH No calibration applied and no bandpass applied

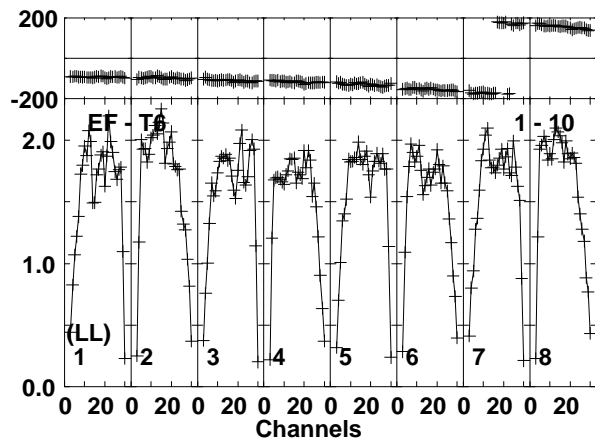
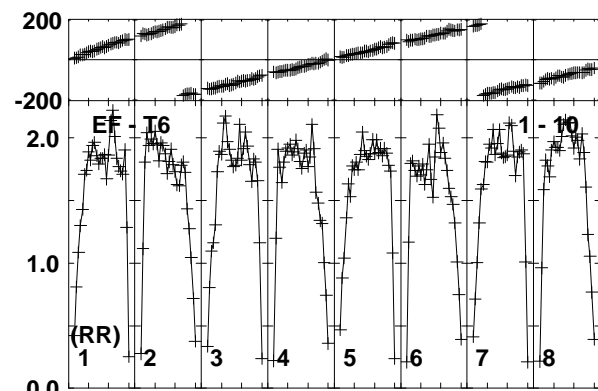
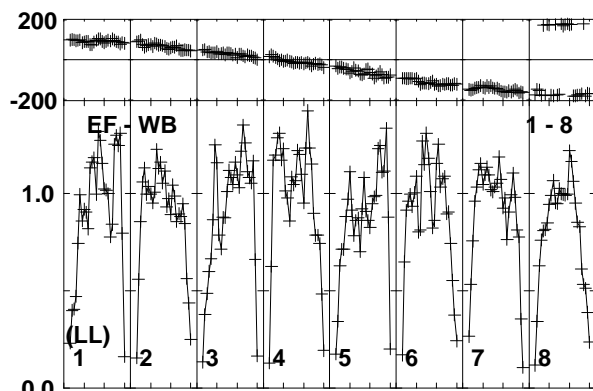
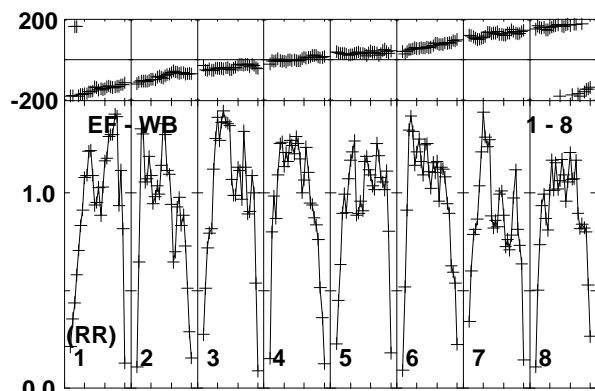
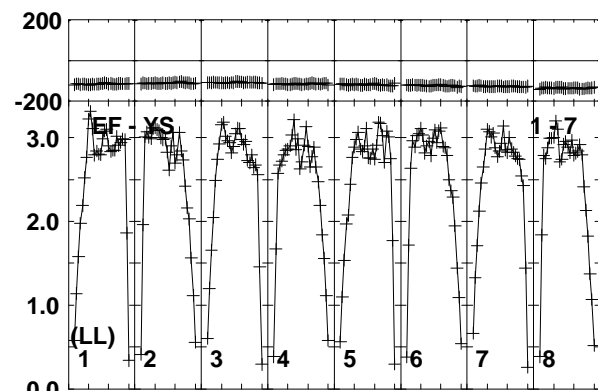
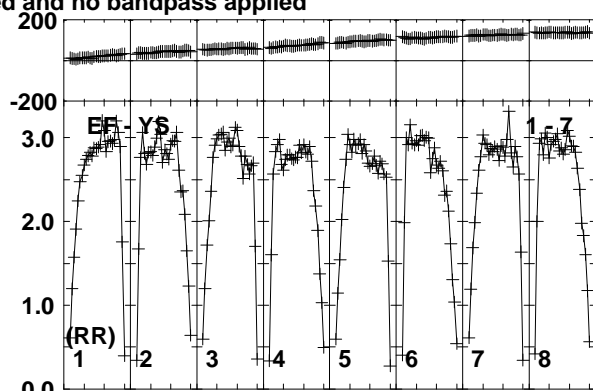
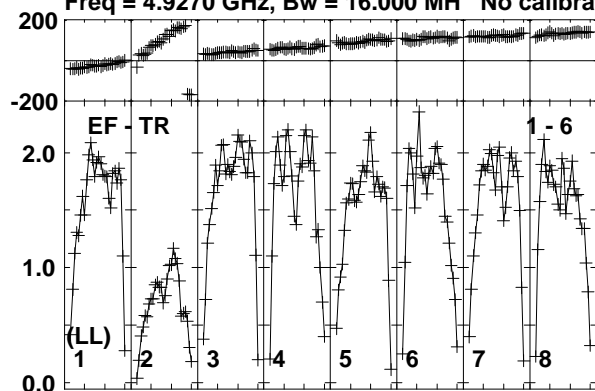

Lower frame: Milli Ampl Jy Top frame: Phas deg  
Vector averaged cross-power spectrum Baseline: EF (01) - TR (06)  
Timerange: 00/20:52:31 to 00/20:53:59

Plot file version 57 created 10-JUN-2016 17:22:05

CHECK RT013A.UVDATA.1

Freq = 4.9270 GHz, Bw = 16.000 MH No calibration applied and no bandpass applied

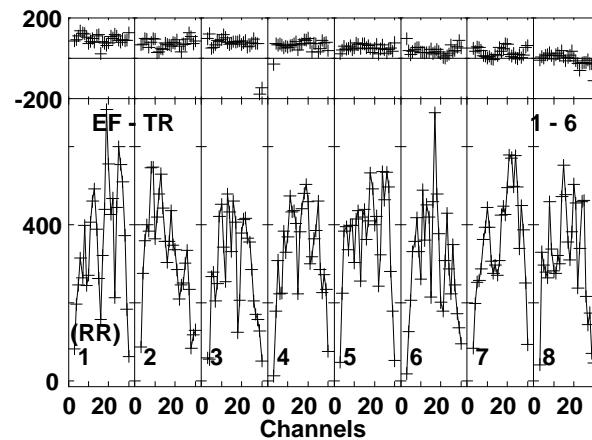
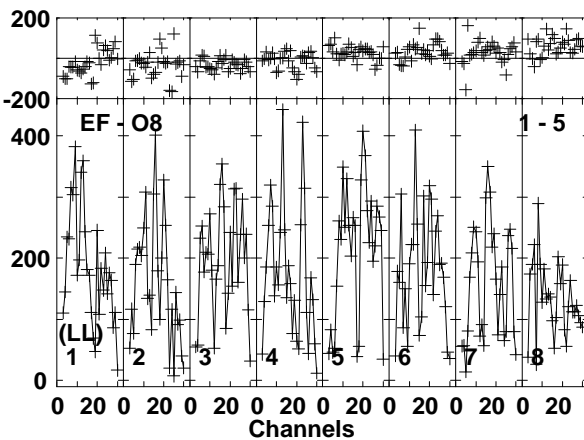
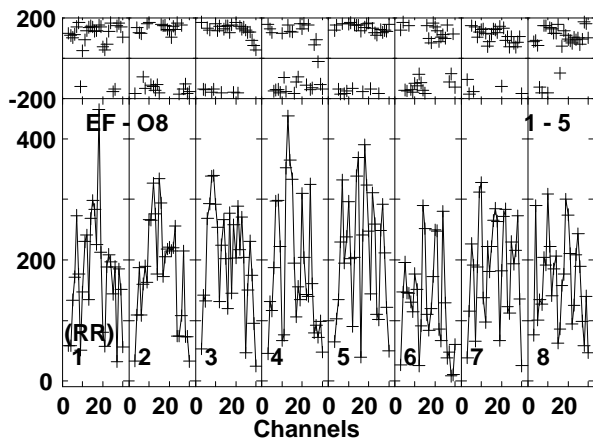
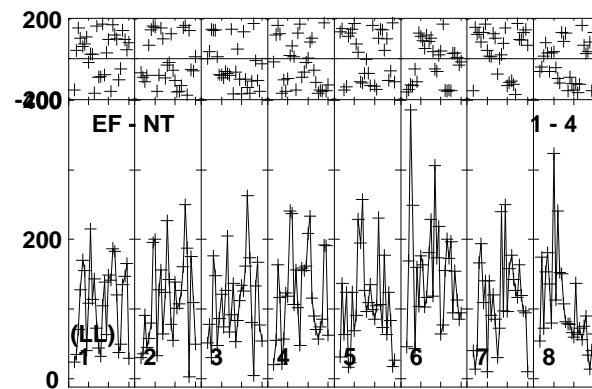
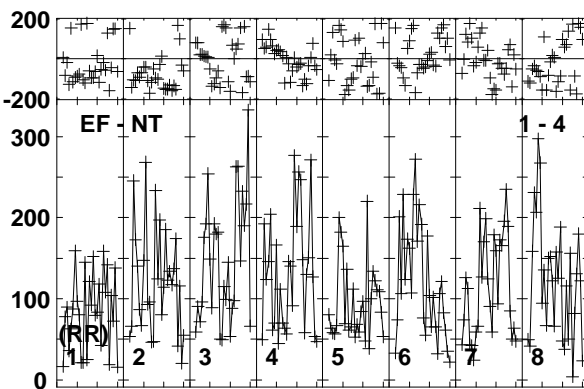
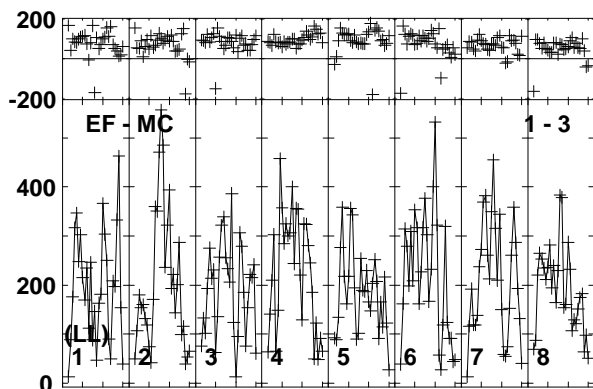
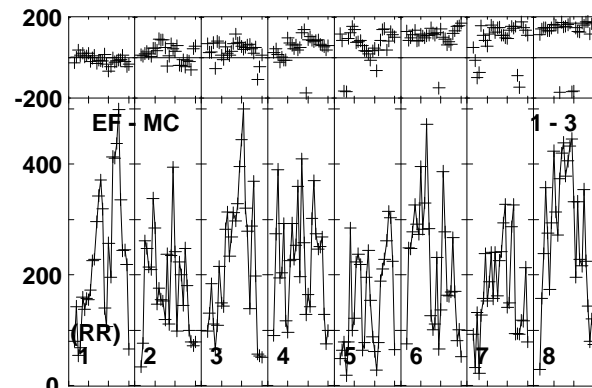
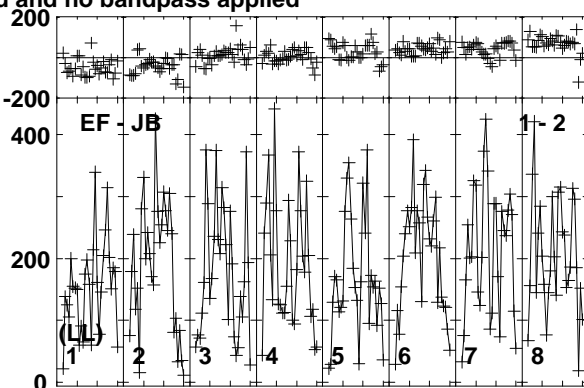
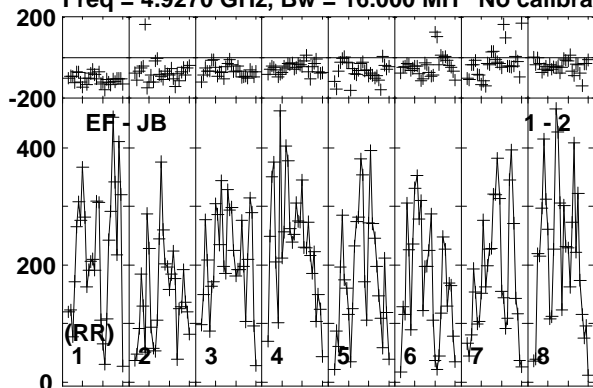

Lower frame: Micro Ampl Jy Top frame: Phas deg  
Vector averaged cross-power spectrum Baseline: EF (01) - JB (02)  
Timerange: 00/20:54:00 to 00/20:56:00

Plot file version 58 created 10-JUN-2016 17:22:05

CHECK RT013A.UVDATA.1

Freq = 4.9270 GHz, Bw = 16.000 MH No calibration applied and no bandpass applied

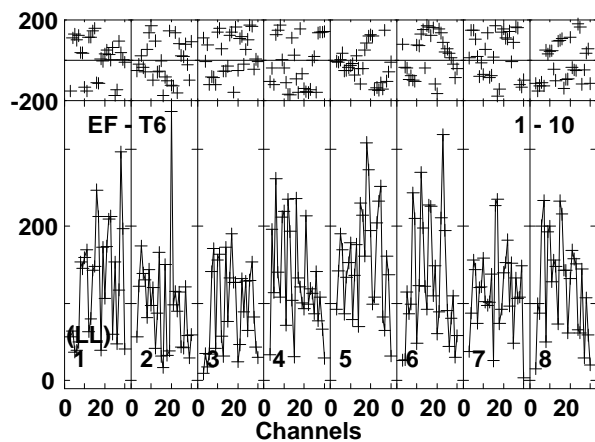
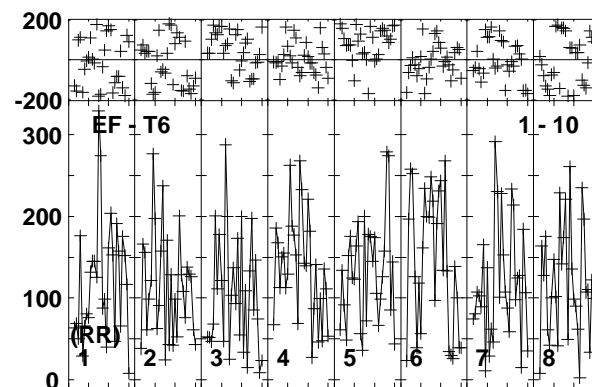
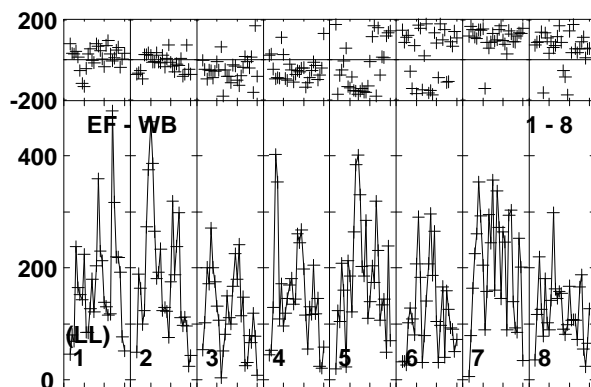
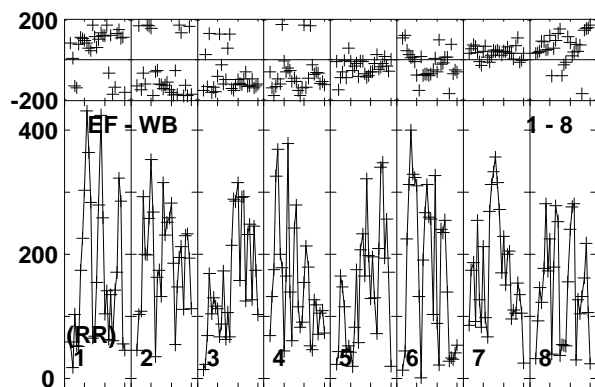
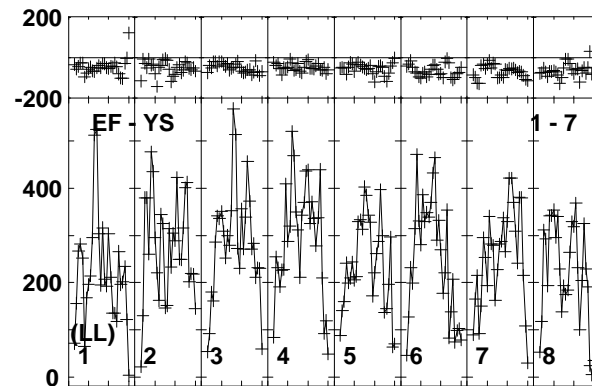
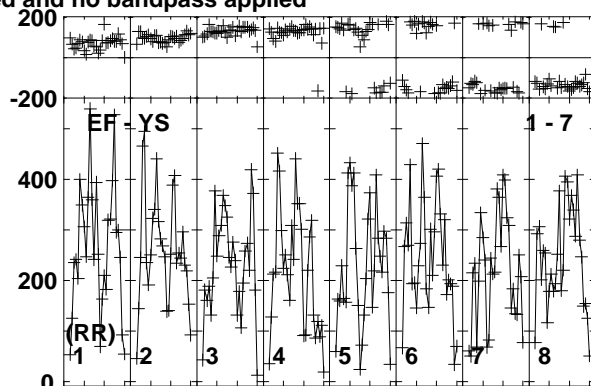
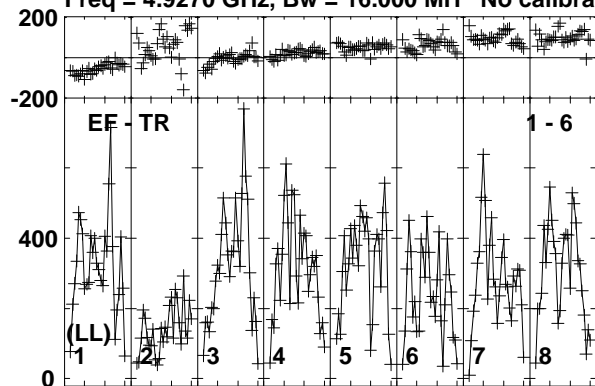

Lower frame: Micro Ampl Jy Top frame: Phas deg  
Vector averaged cross-power spectrum Baseline: EF (01) - TR (06)  
Timerange: 00:20:54:00 to 00:20:56:00



Plot file version 59 created 10-JUN-2016 17:22:05

CYGX1 RT013A.UVDATA.1

Freq = 4.9270 GHz, Bw = 16.000 MH No calibration applied and no bandpass applied

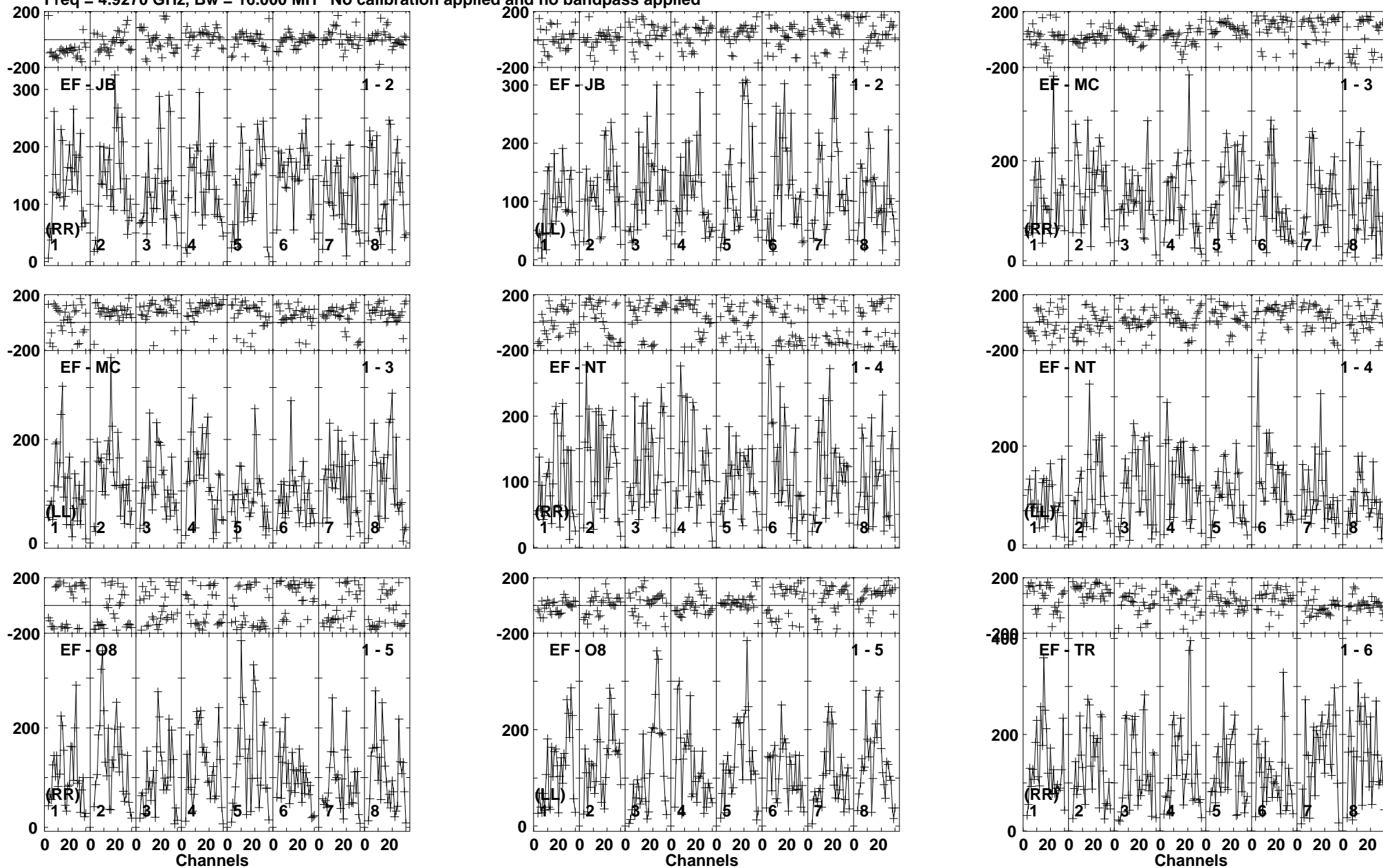

Lower frame: Micro Ampl Jy Top frame: Phas deg  
Vector averaged cross-power spectrum Baseline: EF (01) - JB (02)  
Timerange: 00/20:56:00 to 00/20:58:30

Plot file version 60 created 10-JUN-2016 17:22:05

CYGX1 RT013A.UVDATA.1

Freq = 4.9270 GHz, Bw = 16.000 MH No calibration applied and no bandpass applied

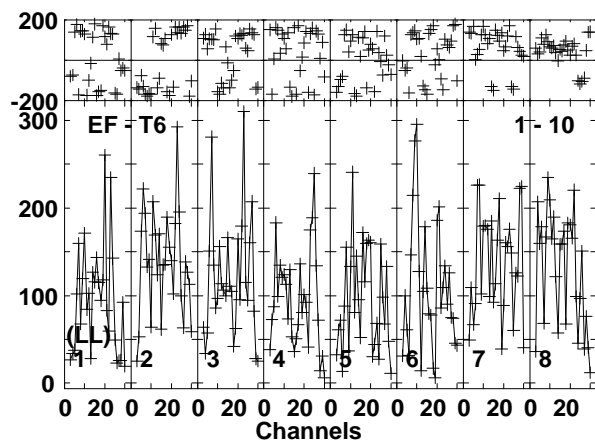
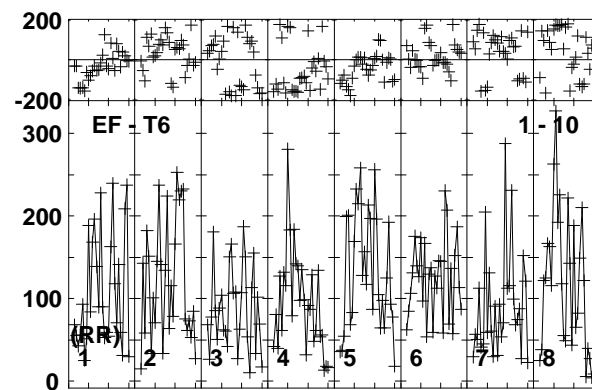
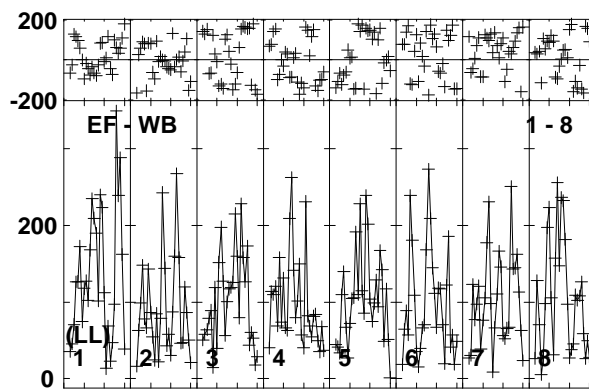
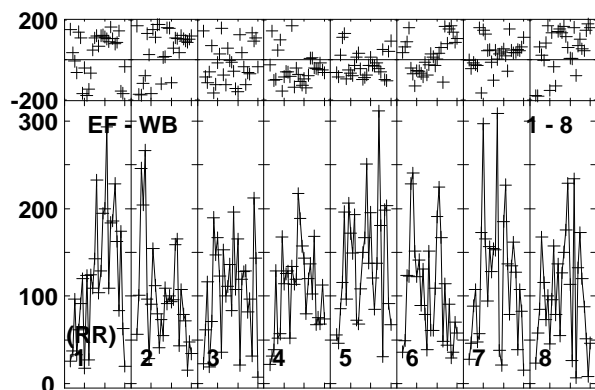
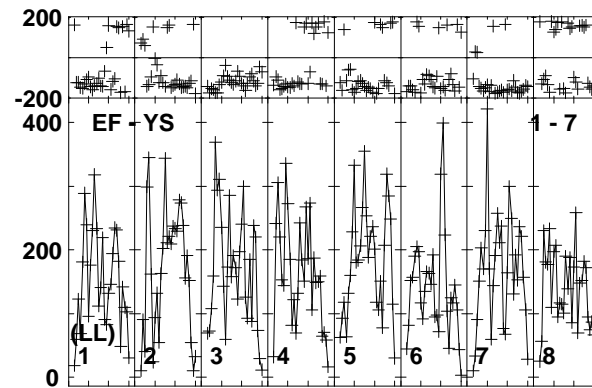
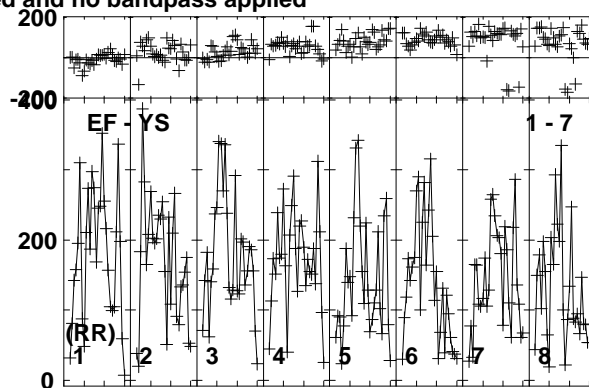
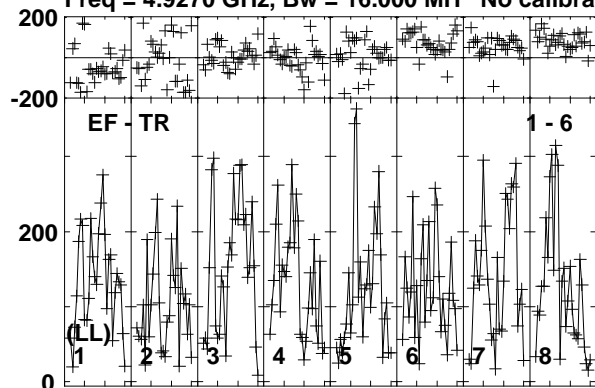

Lower frame: Micro Ampl Jy Top frame: Phas deg  
Vector averaged cross-power spectrum Baseline: EF (01) - TR (06)  
Timerange: 00/20:56:00 to 00/20:58:30

Plot file version 61 created 10-JUN-2016 17:22:05

J1957+3338 RT013A.UVDATA.1

Freq = 4.9270 GHz, Bw = 16.000 MH No calibration applied and no bandpass applied

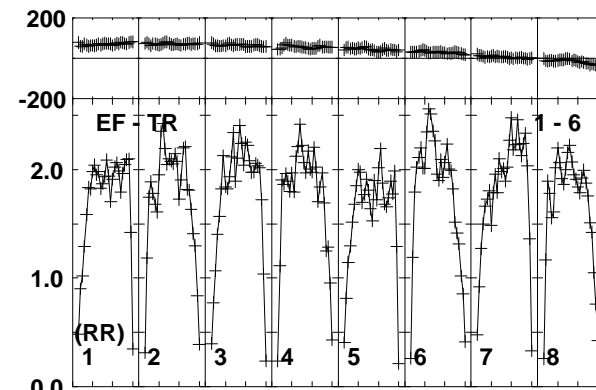
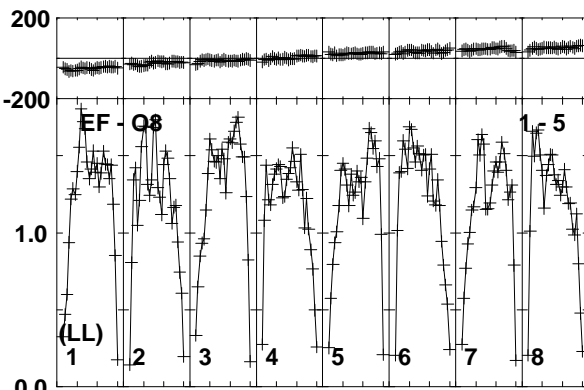
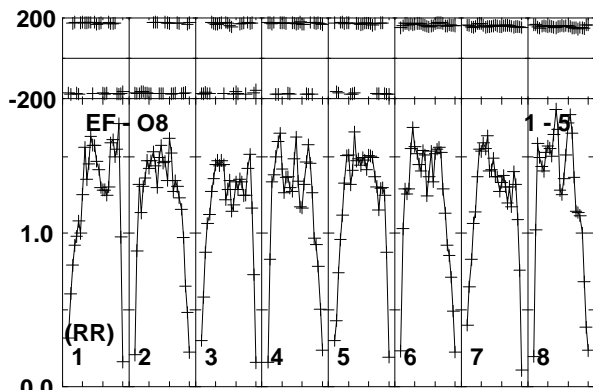
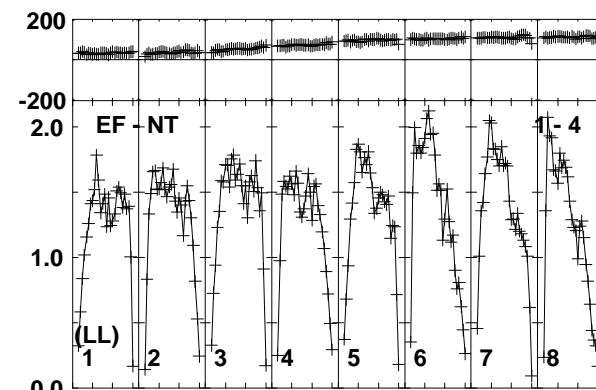
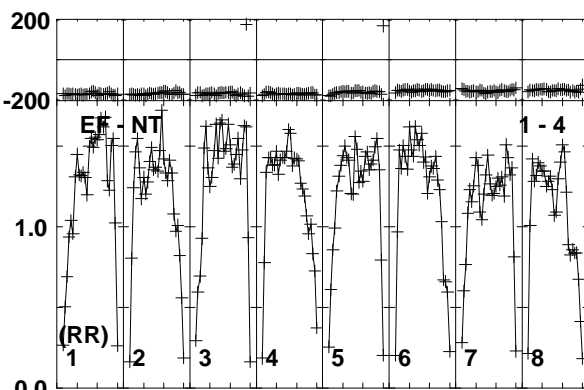
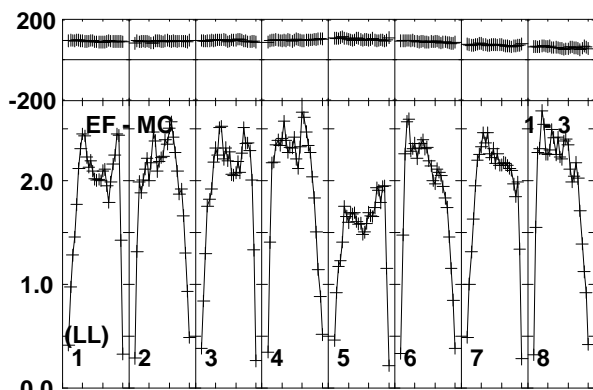
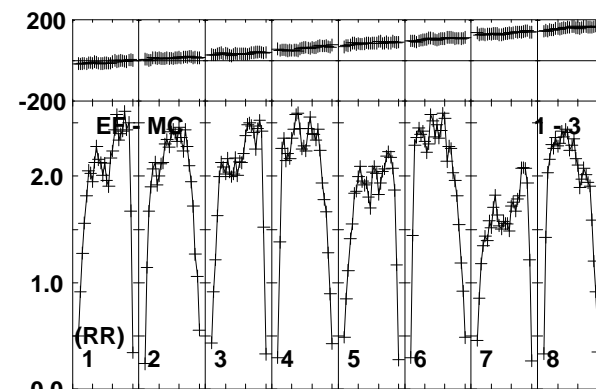
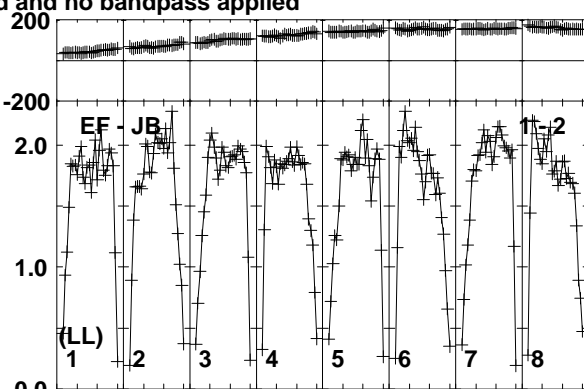
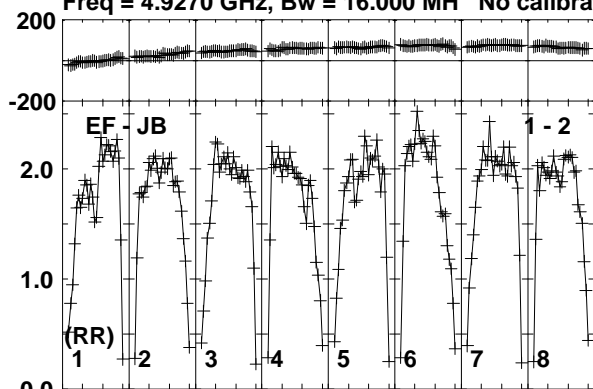

Lower frame: Milli Ampl Jy Top frame: Phas deg  
Vector averaged cross-power spectrum Baseline: EF (01) - JB (02)  
Timerange: 00/20:58:31 to 00/20:59:59

Plot file version 62 created 10-JUN-2016 17:22:05

J1957+3338 RT013A.UVDATA.1

Freq = 4.9270 GHz, Bw = 16.000 MH No calibration applied and no bandpass applied

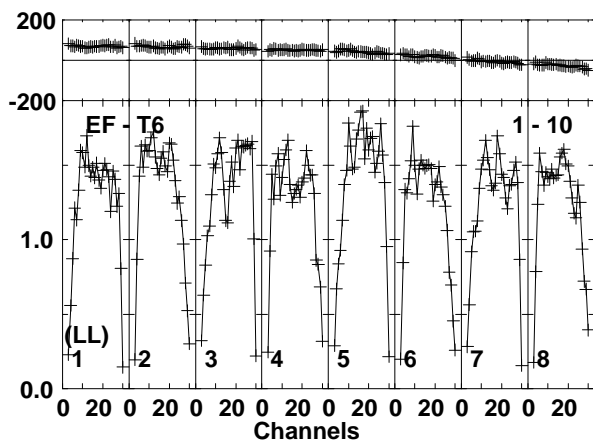
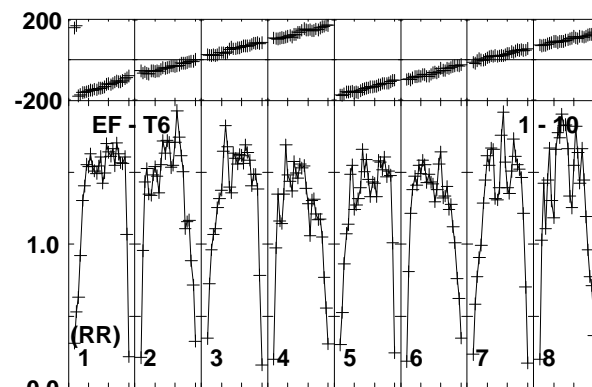
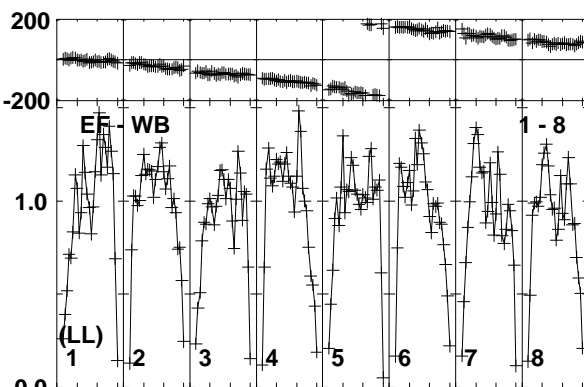
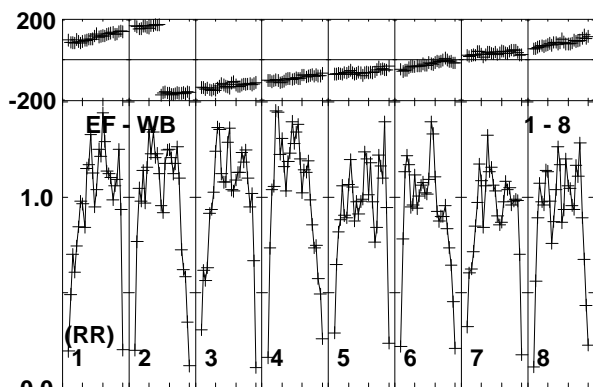
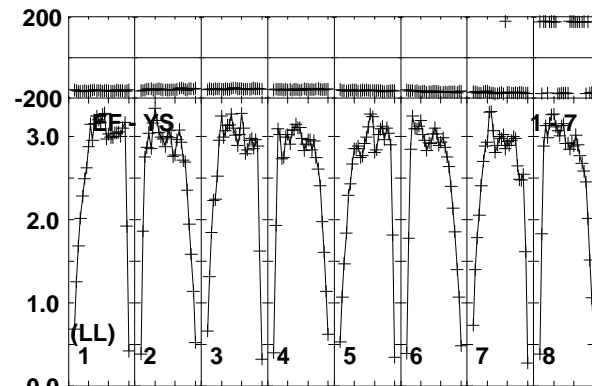
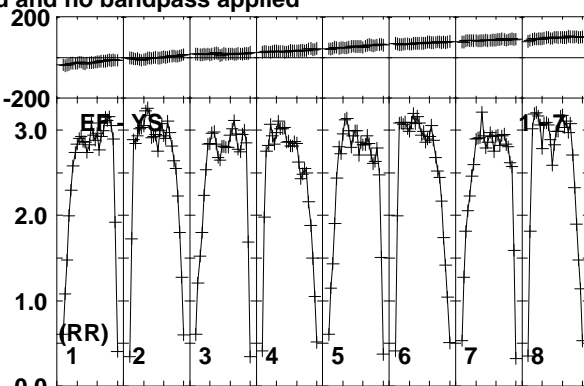
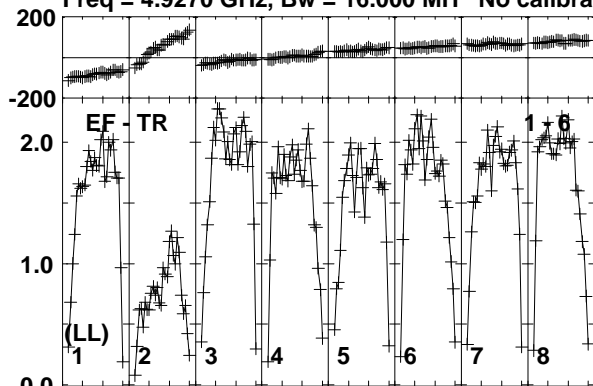

Lower frame: Milli Ampl Jy Top frame: Phas deg  
Vector averaged cross-power spectrum Baseline: EF (01) - TR (06)  
Timerange: 00/20:58:31 to 00/20:59:59

Plot file version 63 created 10-JUN-2016 17:22:06

CHECK RT013A.UVDATA.1

Freq = 4.9270 GHz, Bw = 16.000 MH No calibration applied and no bandpass applied

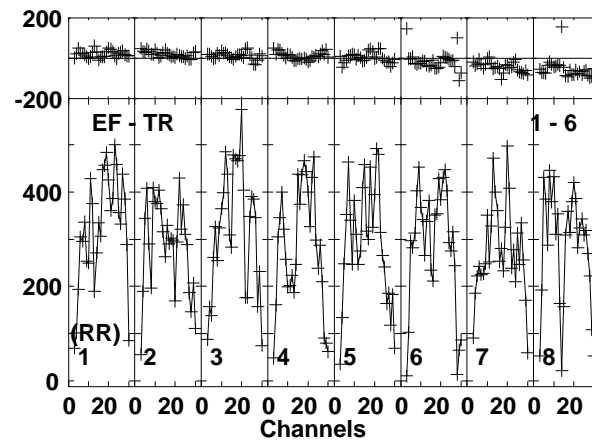
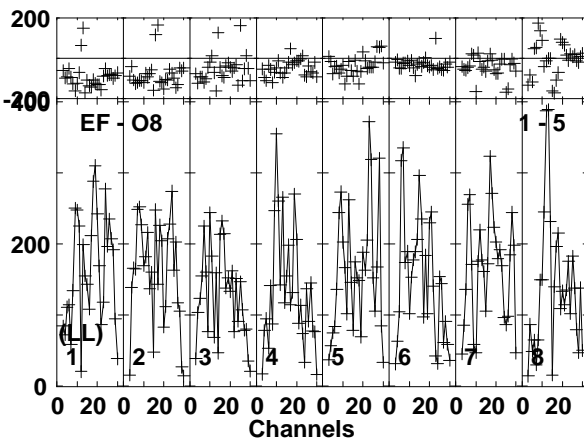
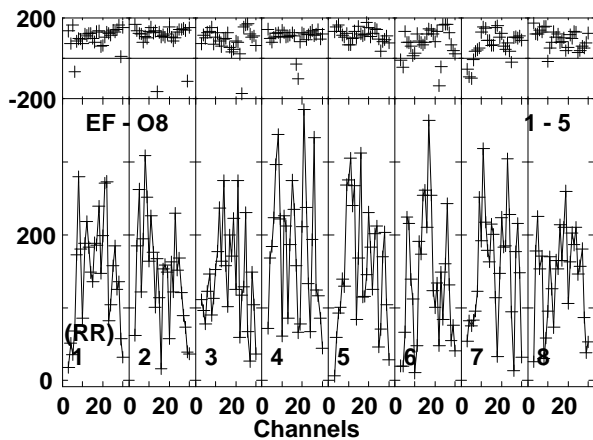
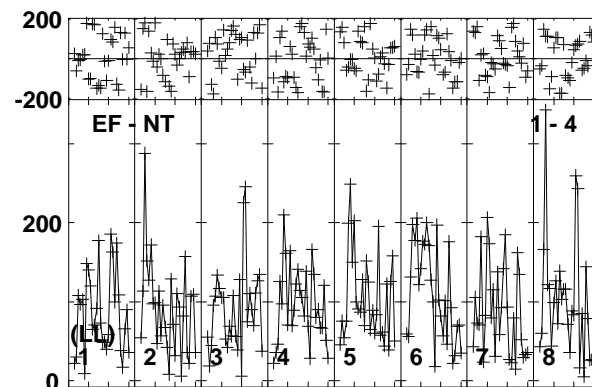
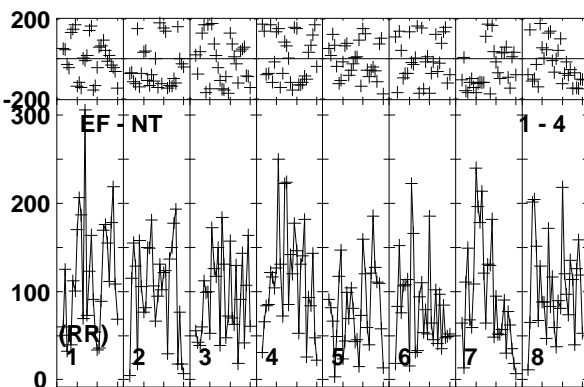
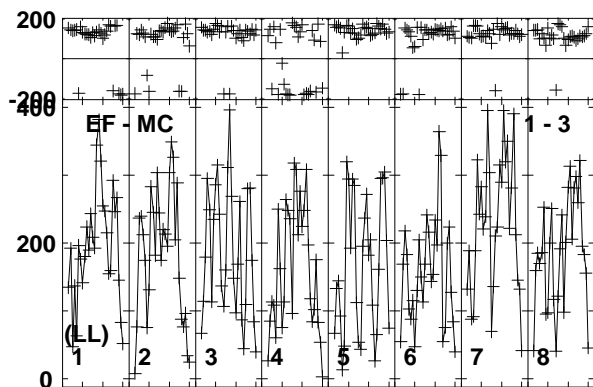
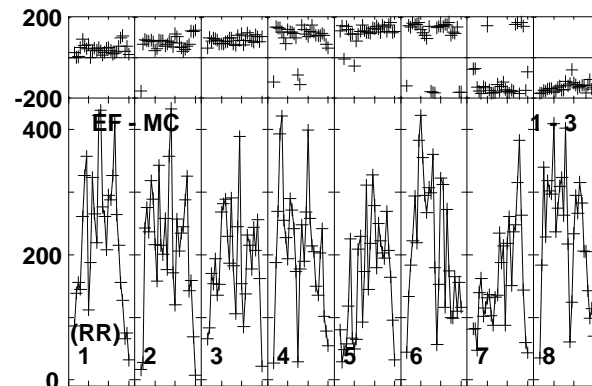
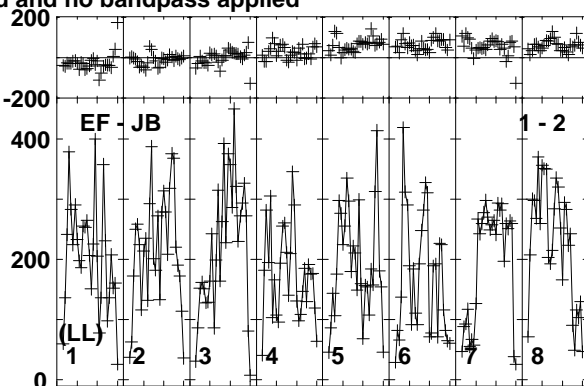
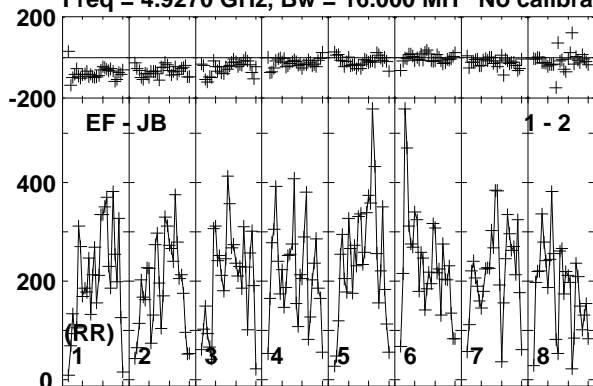

Lower frame: Micro Ampl Jy Top frame: Phas deg  
Vector averaged cross-power spectrum Baseline: EF (01) - JB (02)  
Timerange: 00/21:00:40 to 00/21:02:40

Plot file version 64 created 10-JUN-2016 17:22:06

CHECK RT013A.UVDATA.1

Freq = 4.9270 GHz, Bw = 16.000 MH No calibration applied and no bandpass applied

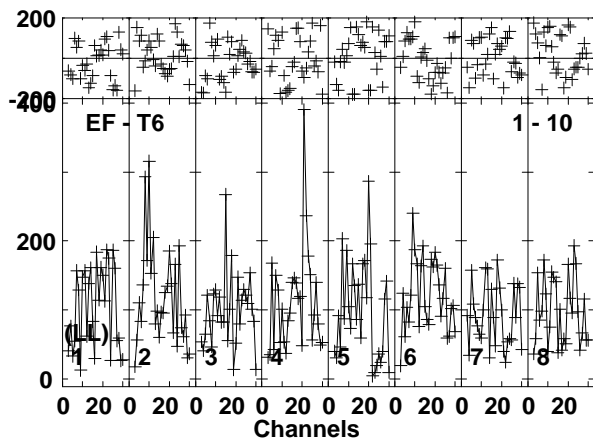
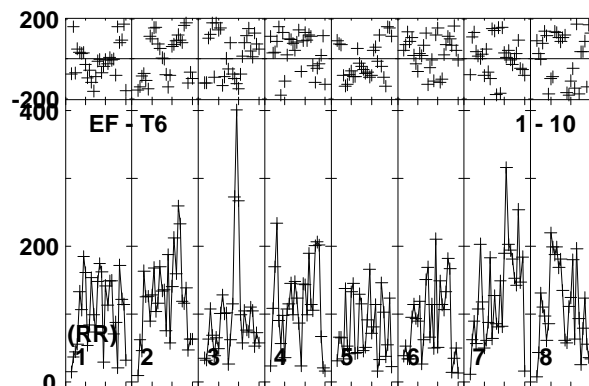
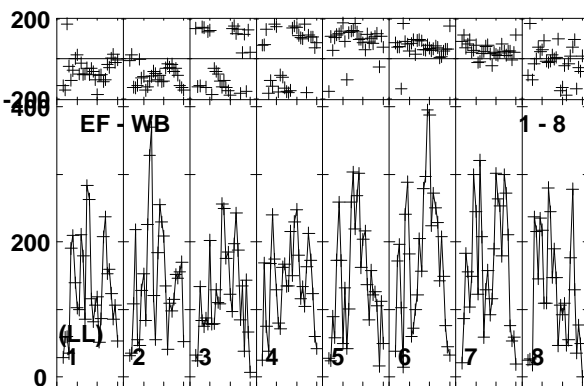
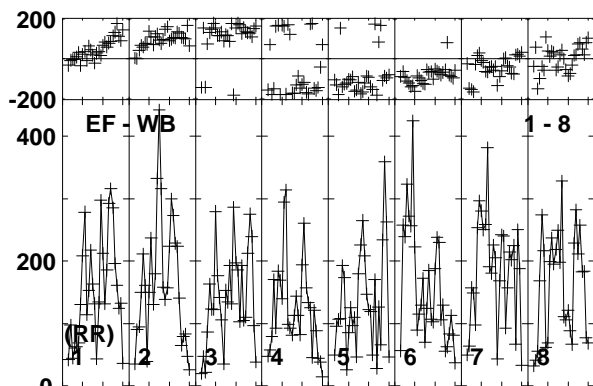
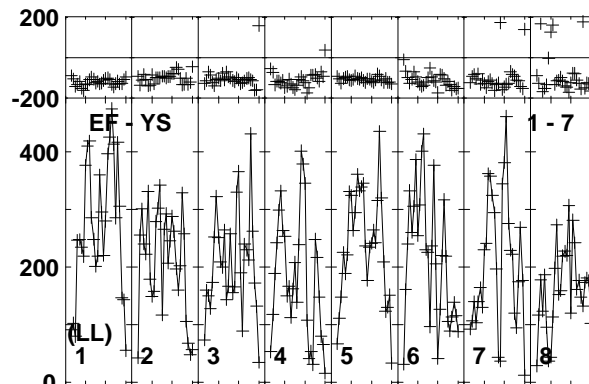
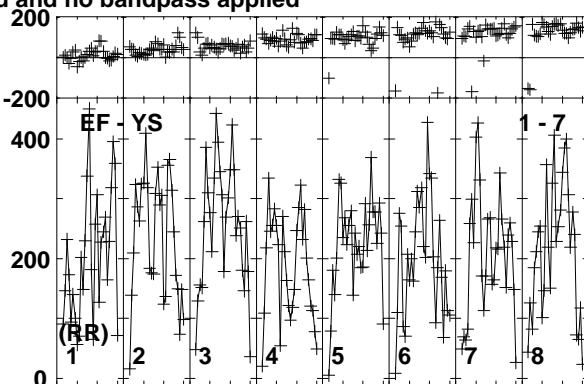
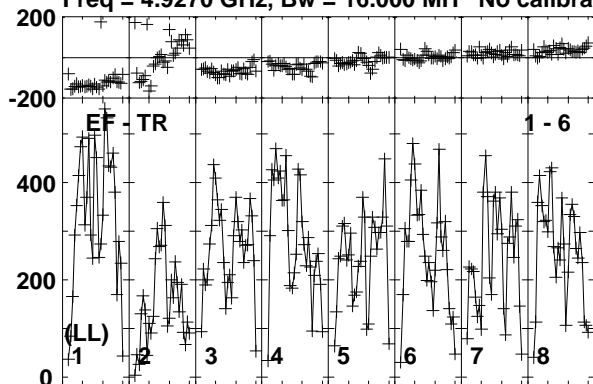

Lower frame: Micro Ampl Jy Top frame: Phas deg  
Vector averaged cross-power spectrum Baseline: EF (01) - TR (06)  
Timerange: 00/21:00:40 to 00/21:02:40

Plot file version 65 created 10-JUN-2016 17:22:06

CYGX1 RT013A.UVDATA.1

Freq = 4.9270 GHz, Bw = 16.000 MH No calibration applied and no bandpass applied

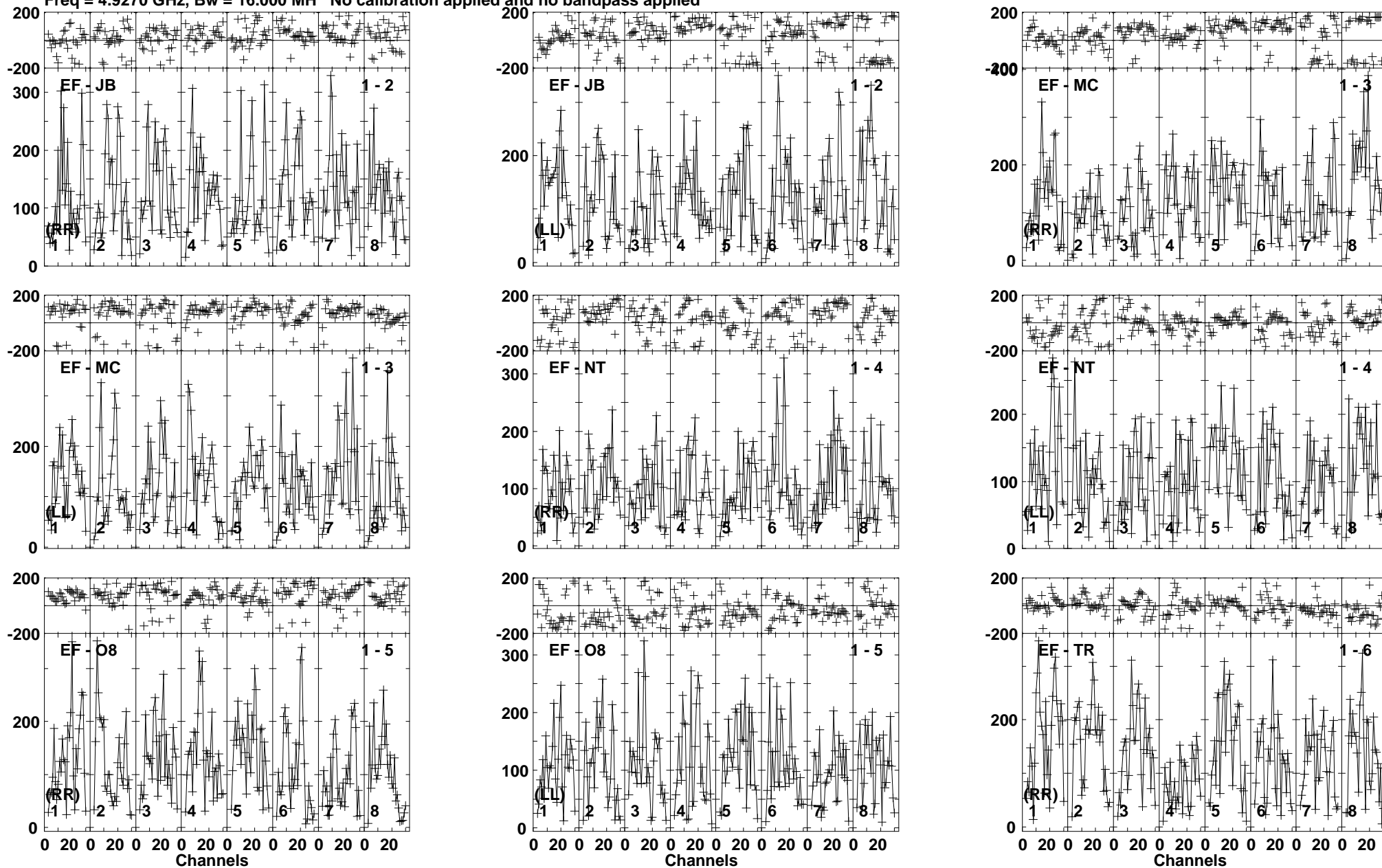

Lower frame: Micro Ampl Jy Top frame: Phas deg  
Vector averaged cross-power spectrum Baseline: EF (01) - JB (02)  
Timerange: 00/21:02:40 to 00/21:05:09

Plot file version 66 created 10-JUN-2016 17:22:06

CYGX1 RT013A.UVDATA.1

Freq = 4.9270 GHz, Bw = 16.000 MH No calibration applied and no bandpass applied

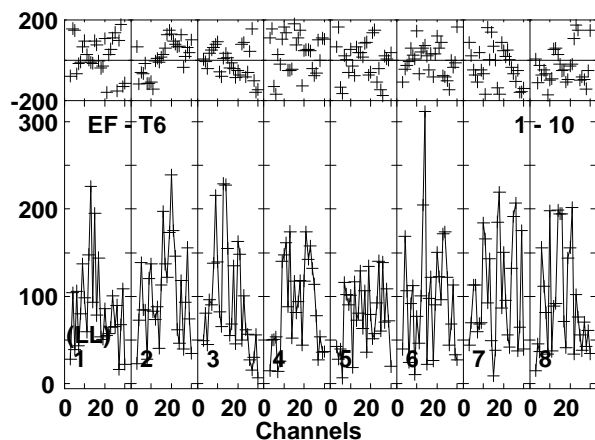
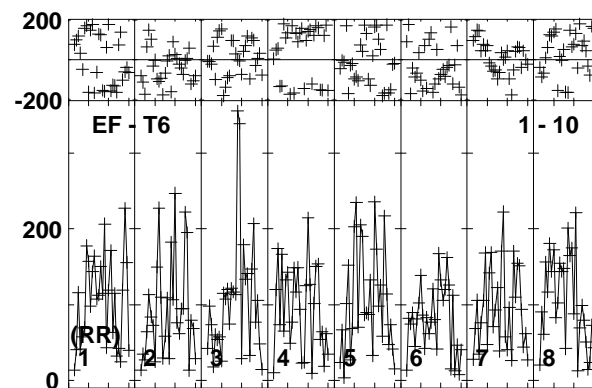
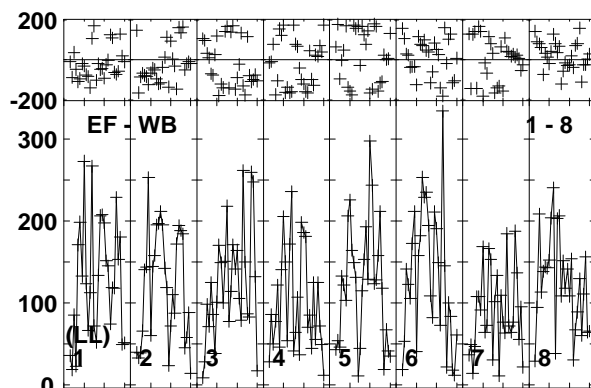
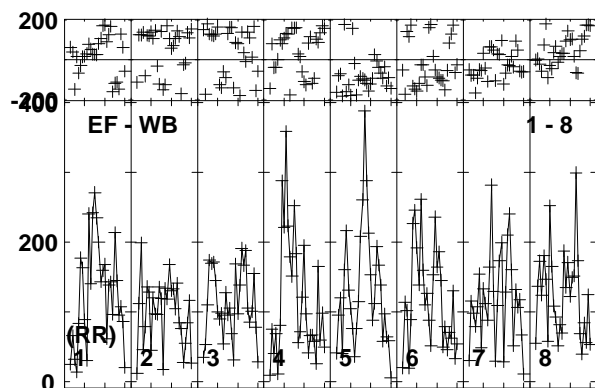
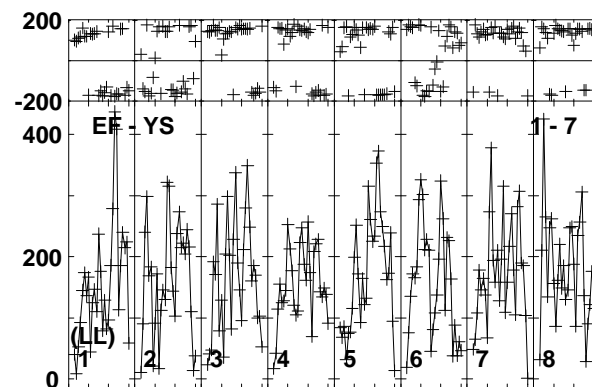
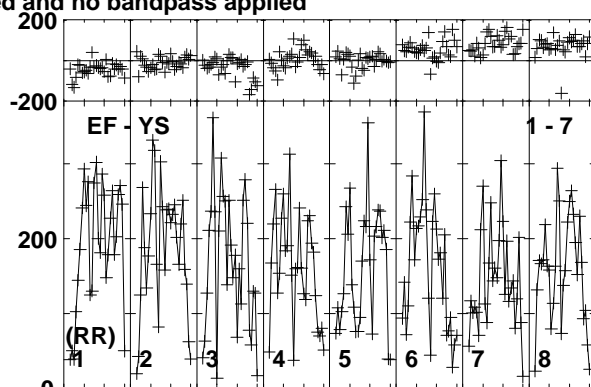
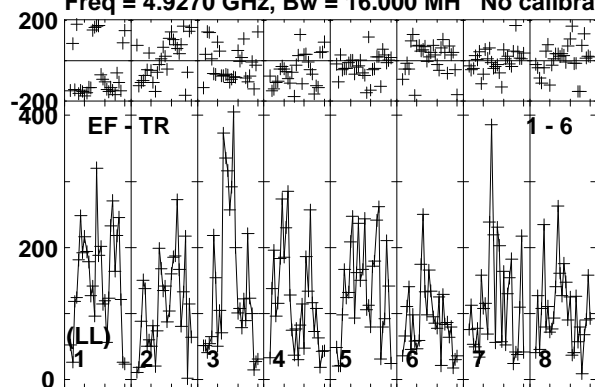

Lower frame: Micro Ampl Jy Top frame: Phas deg  
Vector averaged cross-power spectrum Baseline: EF (01) - TR (06)  
Timerange: 00/21:02:40 to 00/21:05:09



Plot file version 67 created 10-JUN-2016 17:22:06

J1957+3338 RT013A.UVDATA.1

Freq = 4.9270 GHz, Bw = 16.000 MH No calibration applied and no bandpass applied

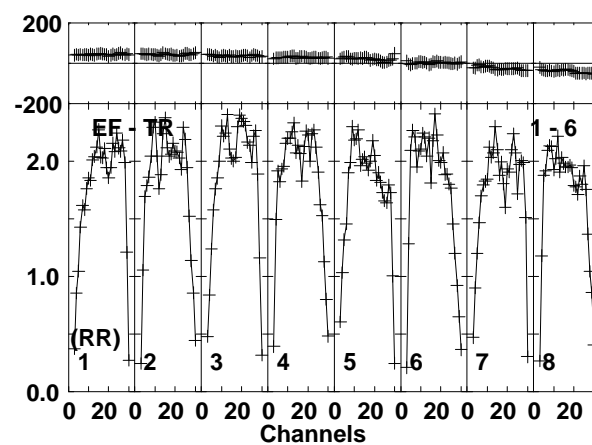
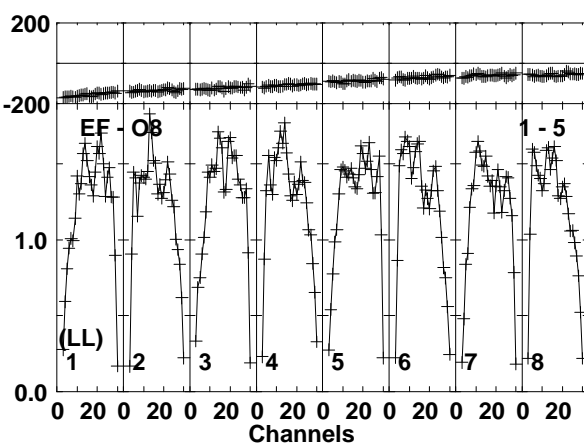
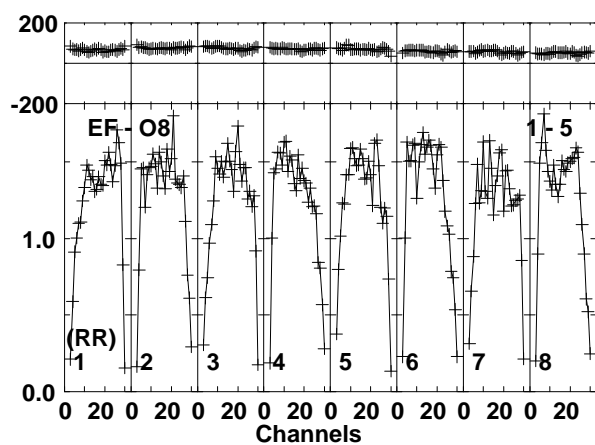
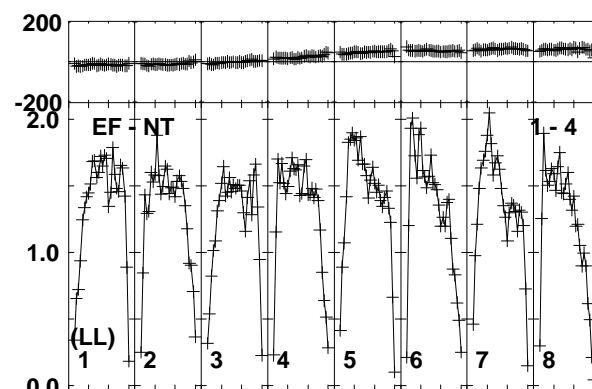
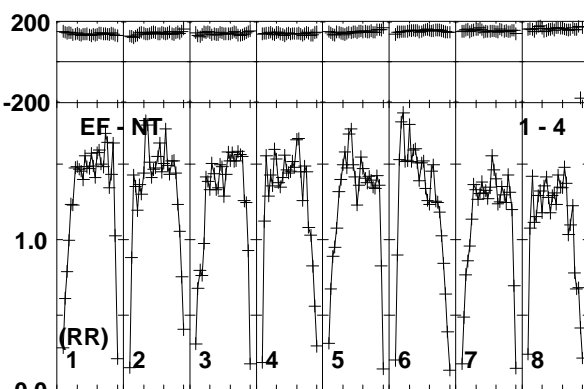
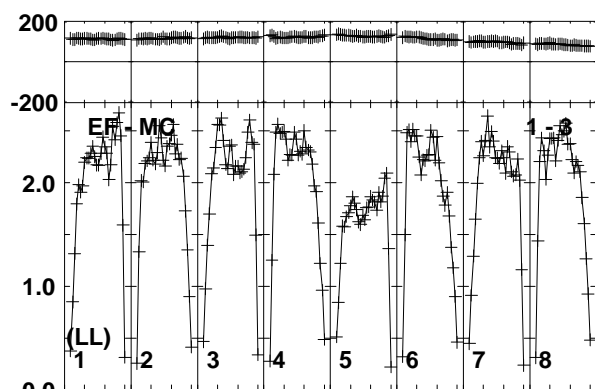
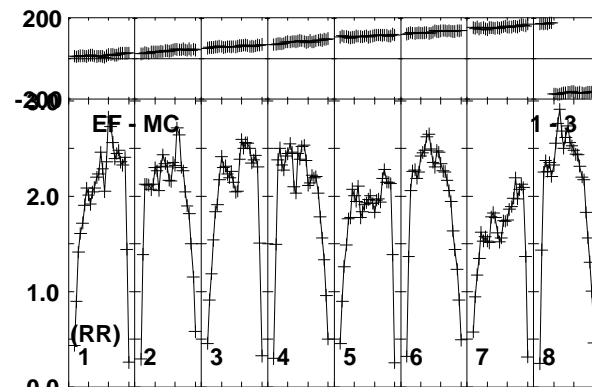
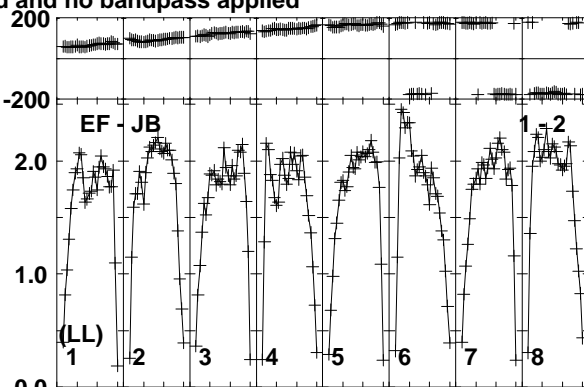
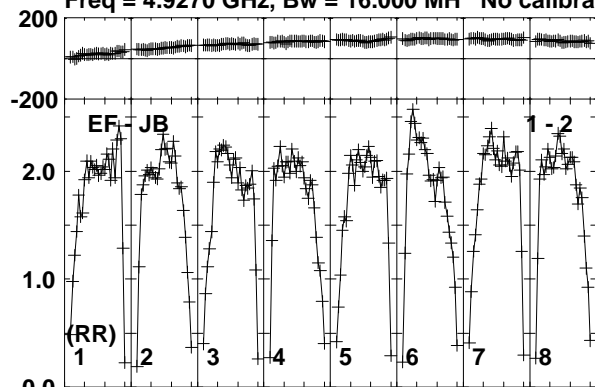

Lower frame: Milli Ampl Jy Top frame: Phas deg  
Vector averaged cross-power spectrum Baseline: EF (01) - JB (02)  
Timerange: 00/21:05:11 to 00/21:06:39

Plot file version 68 created 10-JUN-2016 17:22:06

J1957+3338 RT013A.UVDATA.1

Freq = 4.9270 GHz, Bw = 16.000 MH No calibration applied and no bandpass applied

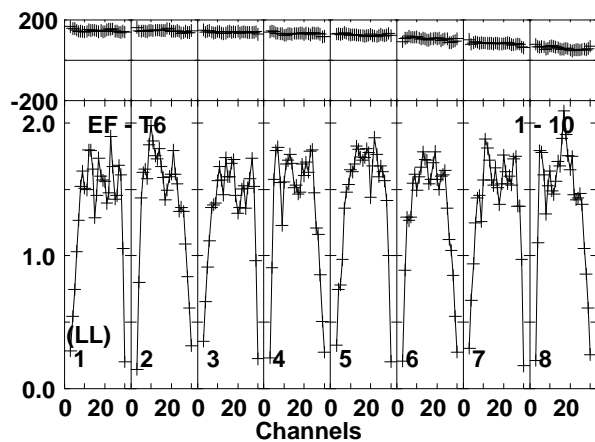
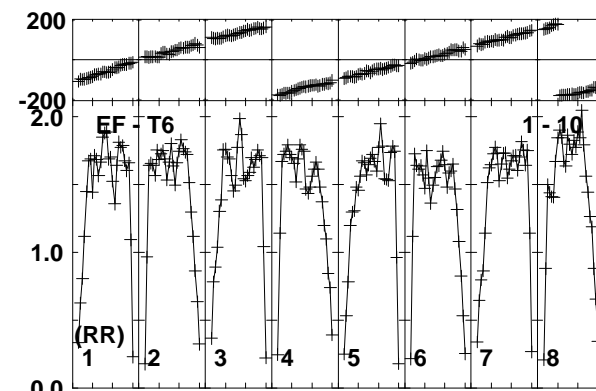
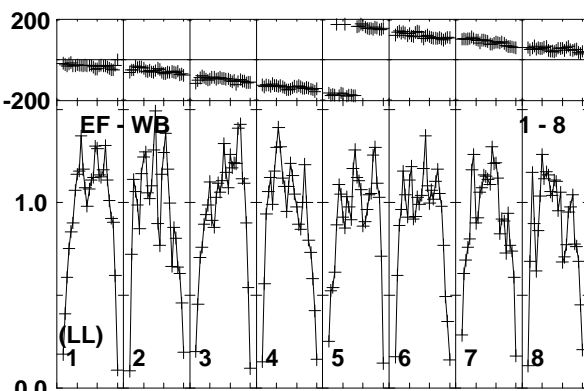
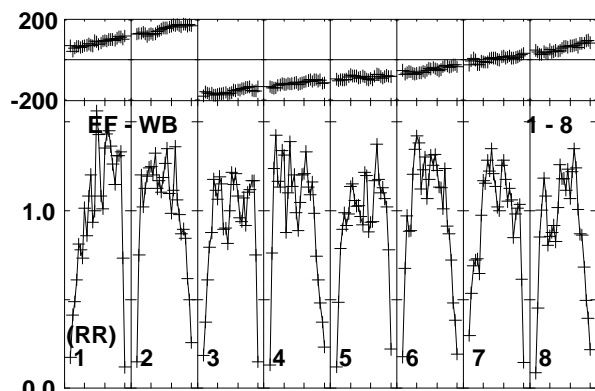
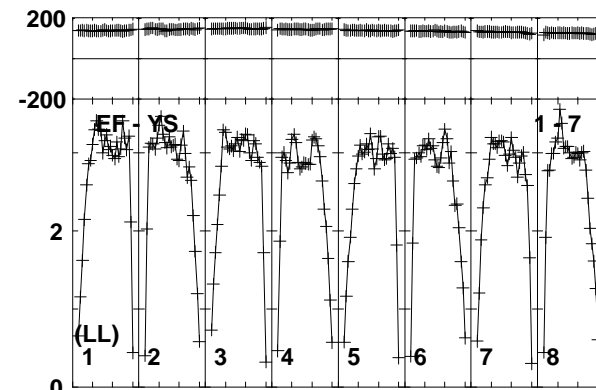
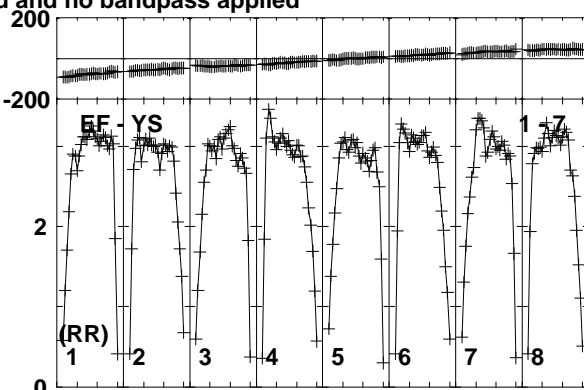
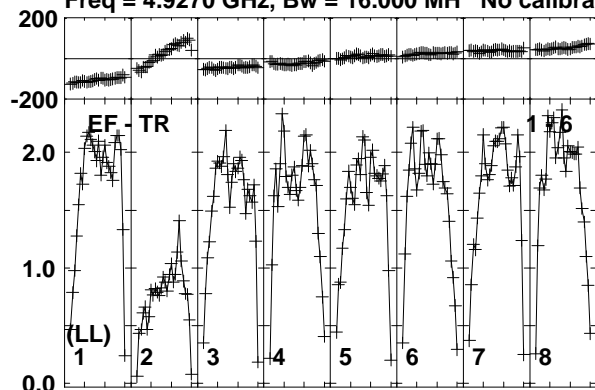

Lower frame: Milli Ampl Jy Top frame: Phas deg  
Vector averaged cross-power spectrum Baseline: EF (01) - TR (06)  
Timerange: 00/21:05:11 to 00/21:06:39

Plot file version 69 created 10-JUN-2016 17:22:06

CHECK RT013A.UVDATA.1

Freq = 4.9270 GHz, Bw = 16.000 MH No calibration applied and no bandpass applied

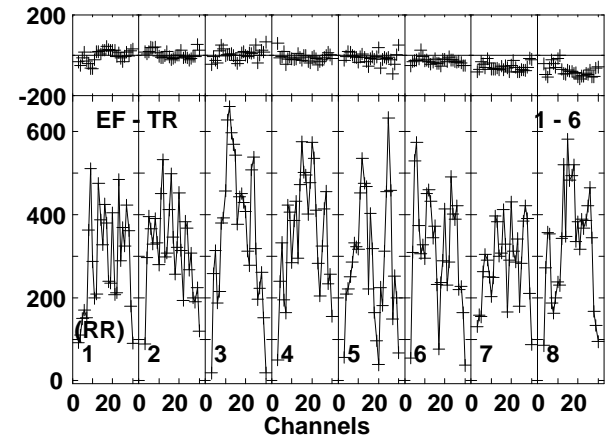
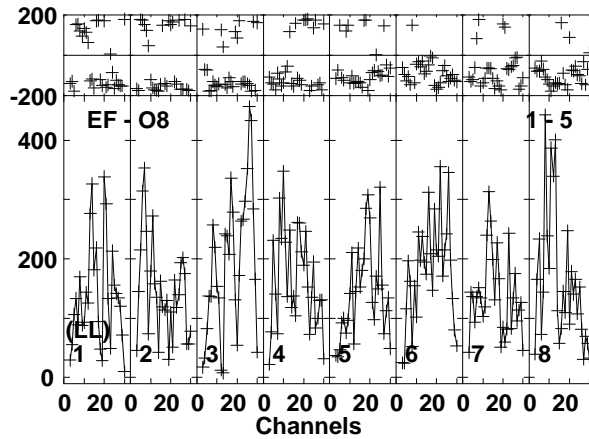
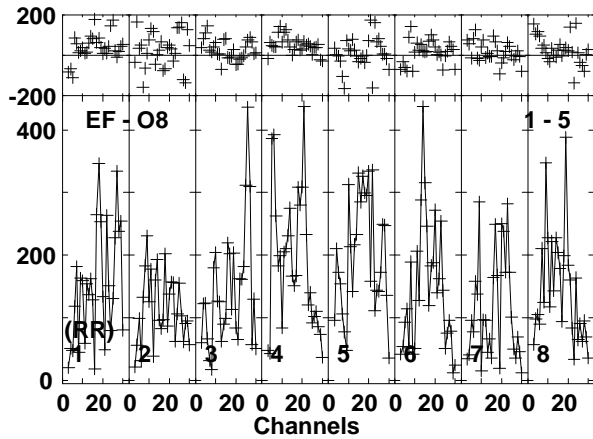
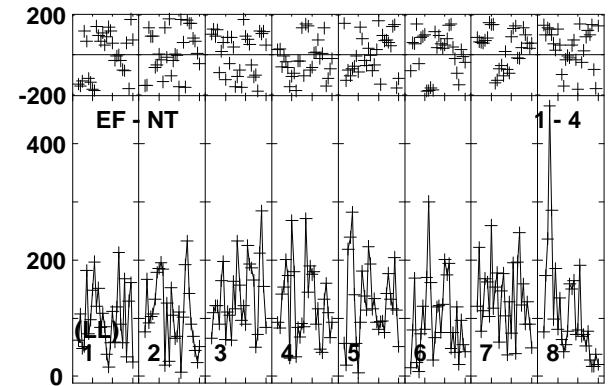
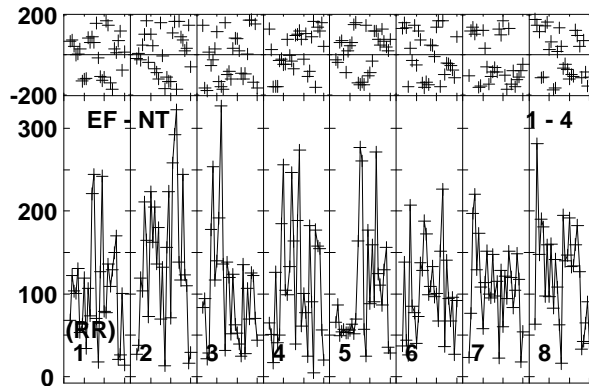
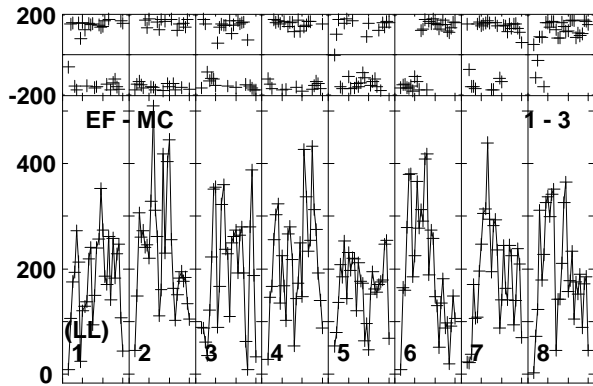
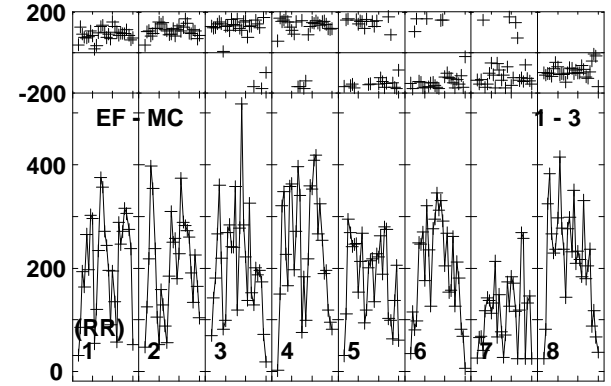
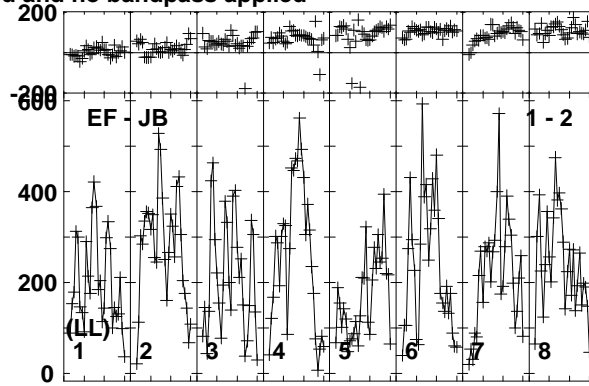
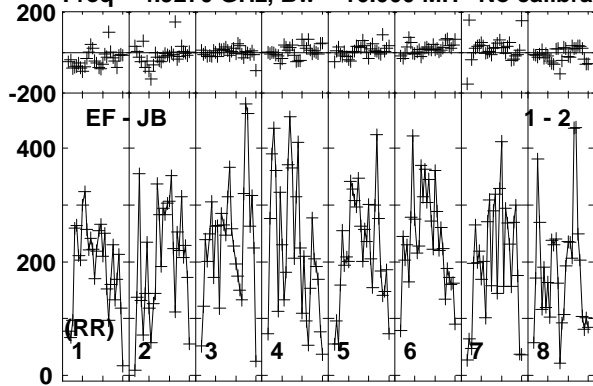

Lower frame: Micro Ampl Jy Top frame: Phas deg  
Vector averaged cross-power spectrum Baseline: EF (01) - JB (02)  
Timerange: 00/21:06:40 to 00/21:08:40

Plot file version 70 created 10-JUN-2016 17:22:06

CHECK RT013A.UVDATA.1

Freq = 4.9270 GHz, Bw = 16.000 MH No calibration applied and no bandpass applied

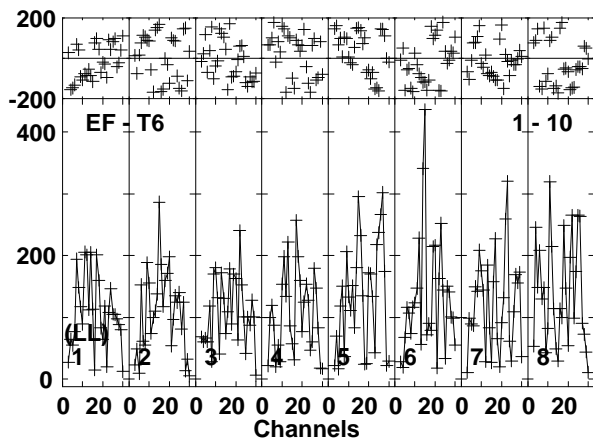
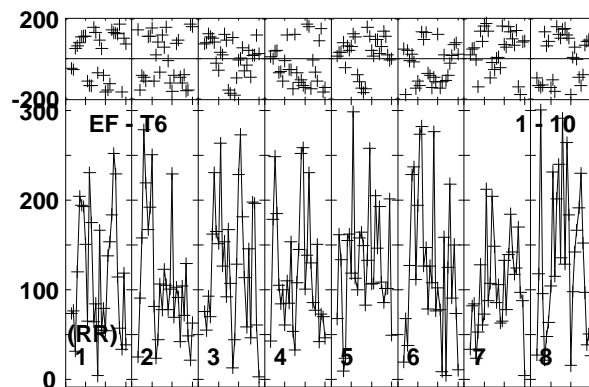
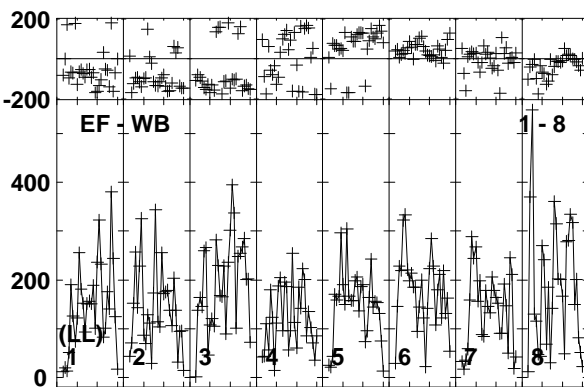
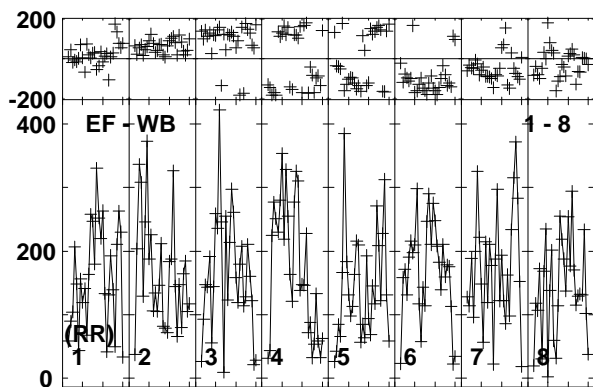
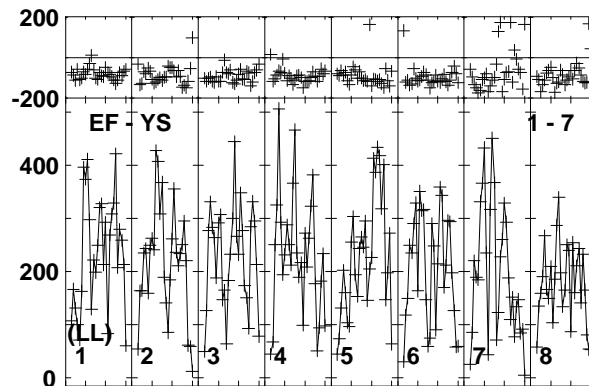
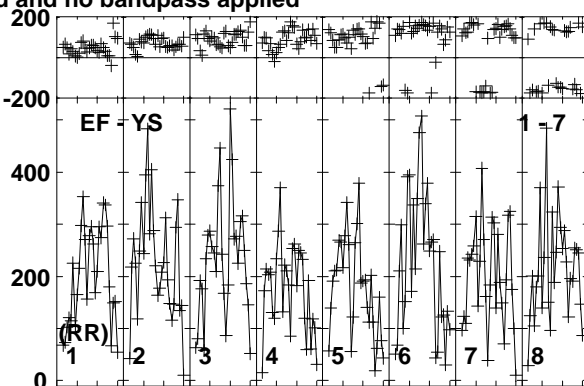
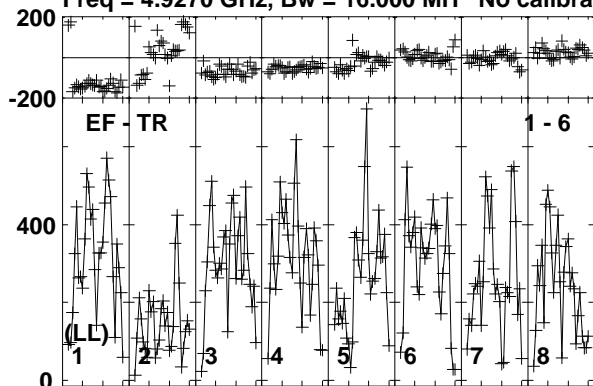

Lower frame: Micro Ampl Jy Top frame: Phas deg  
Vector averaged cross-power spectrum Baseline: EF (01) - TR (06)  
Timerange: 00/21:06:40 to 00/21:08:40

Plot file version 71 created 10-JUN-2016 17:22:06

CYGX1 RT013A.UVDATA.1

Freq = 4.9270 GHz, Bw = 16.000 MH No calibration applied and no bandpass applied

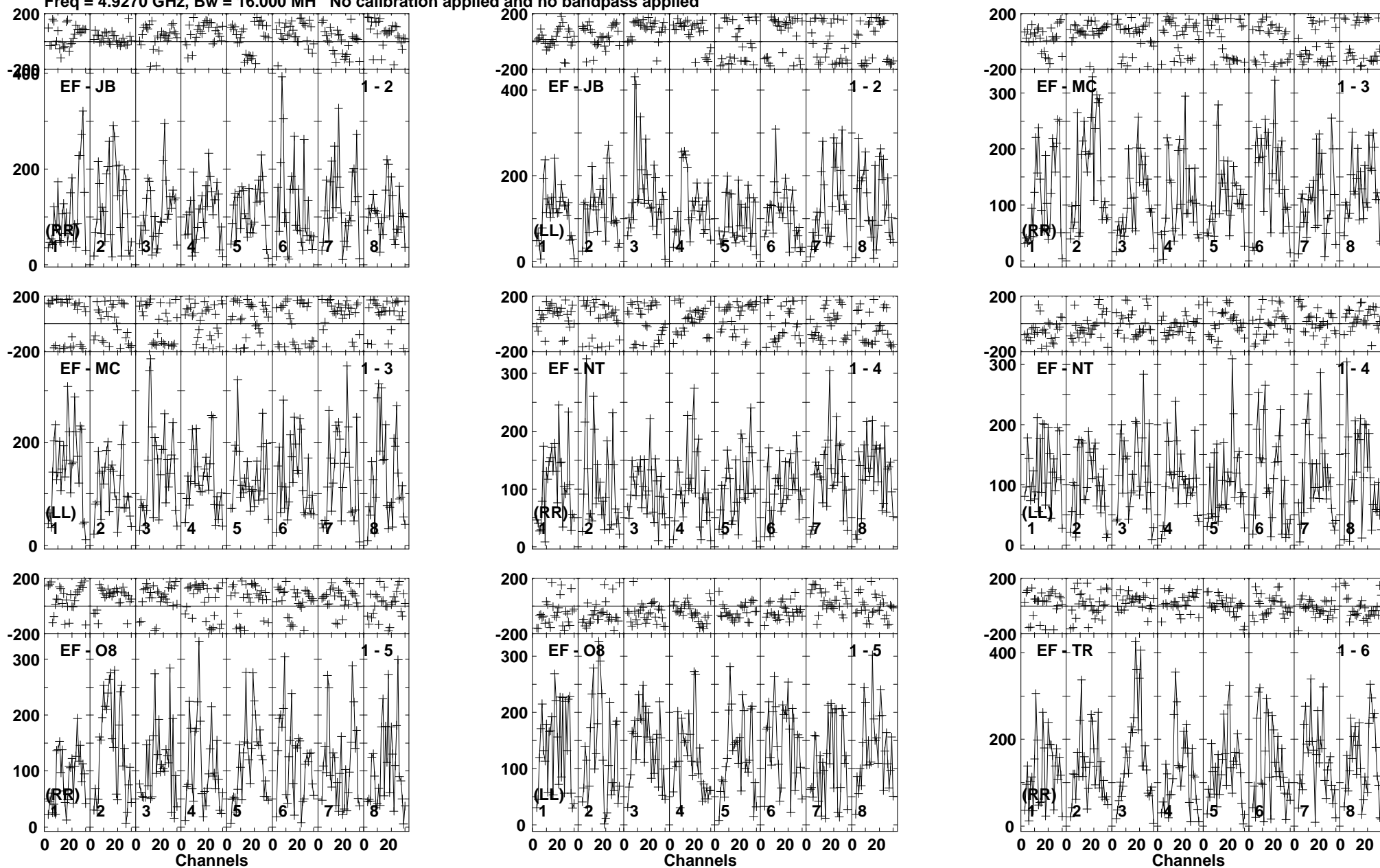

Lower frame: Micro Ampl Jy Top frame: Phas deg  
Vector averaged cross-power spectrum Baseline: EF (01) - JB (02)  
Timerange: 00/21:08:41 to 00/21:11:09

Plot file version 72 created 10-JUN-2016 17:22:06

CYGX1 RT013A.UVDATA.1

Freq = 4.9270 GHz, Bw = 16.000 MH No calibration applied and no bandpass applied

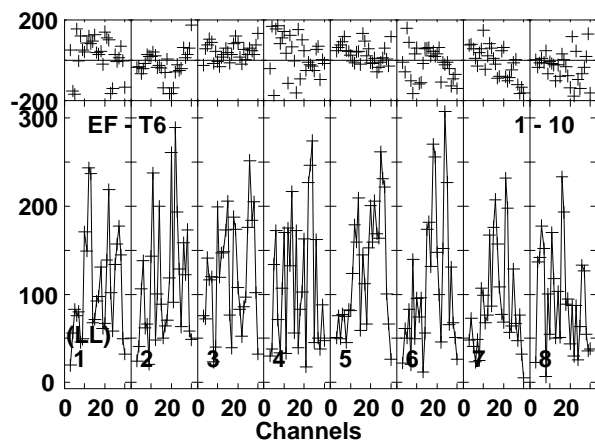
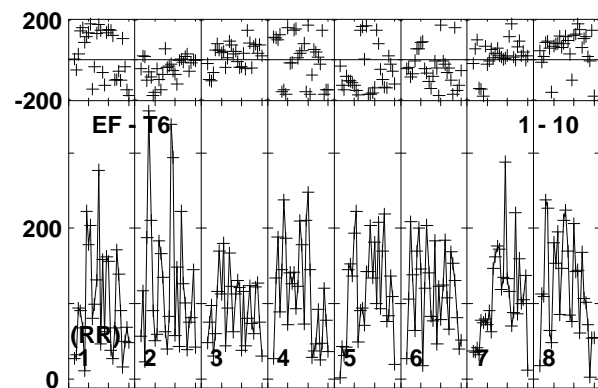
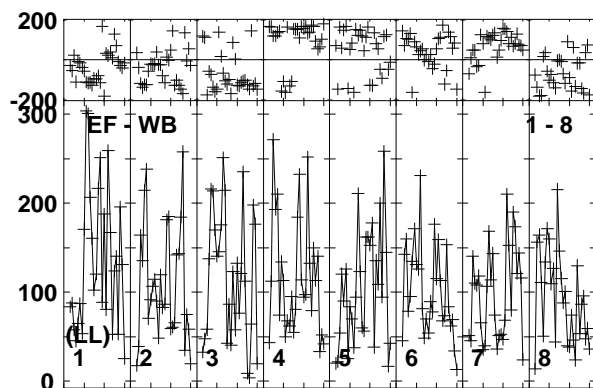
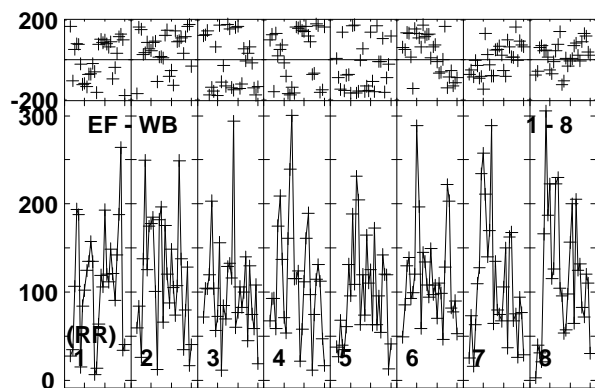
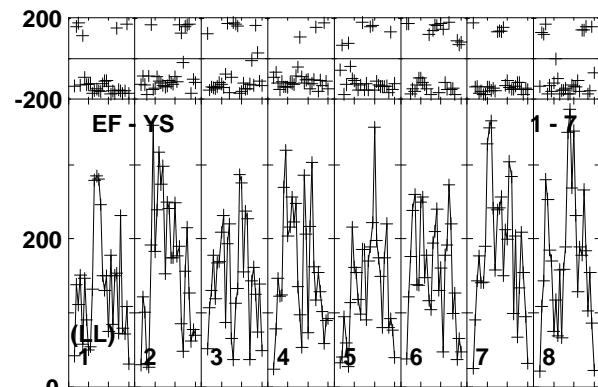
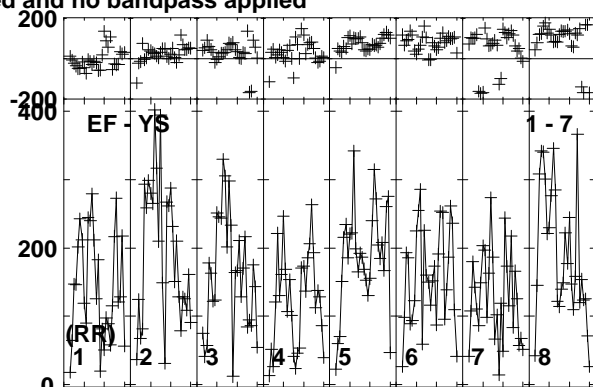
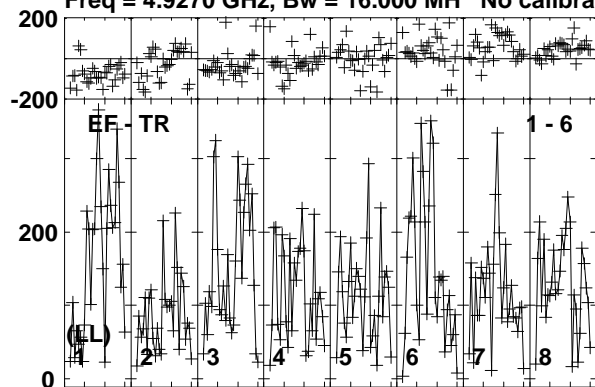

Lower frame: Micro Ampl Jy Top frame: Phas deg  
Vector averaged cross-power spectrum Baseline: EF (01) - TR (06)  
Timerange: 00/21:08:41 to 00/21:11:09

Plot file version 73 created 10-JUN-2016 17:22:07

J1957+3338 RT013A.UVDATA.1

Freq = 4.9270 GHz, Bw = 16.000 MH No calibration applied and no bandpass applied

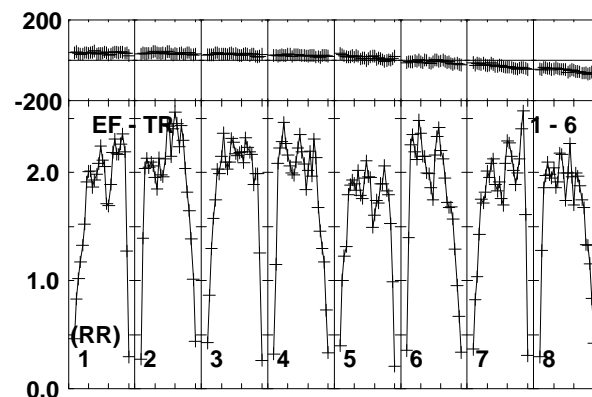
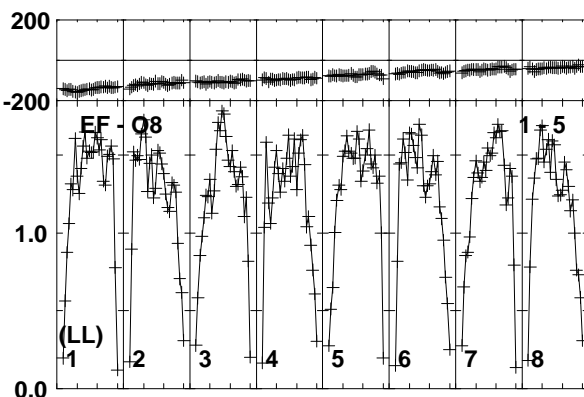
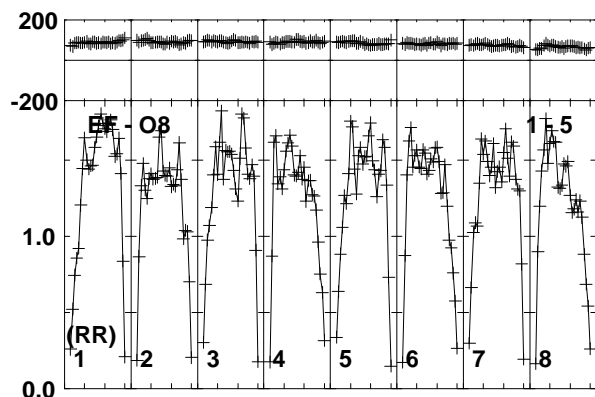
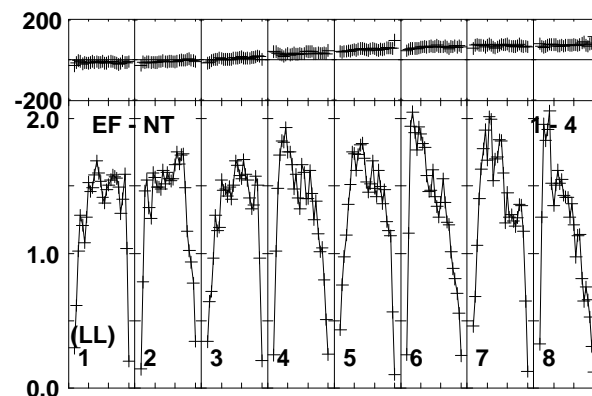
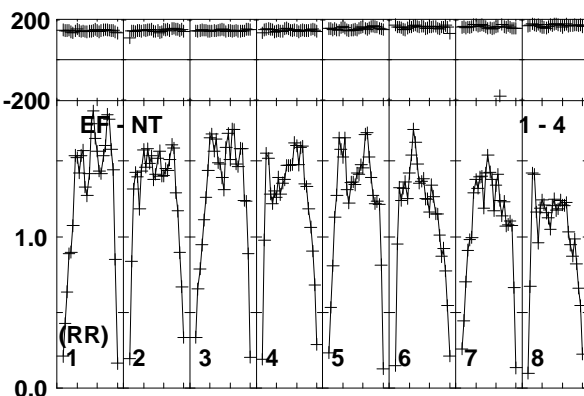
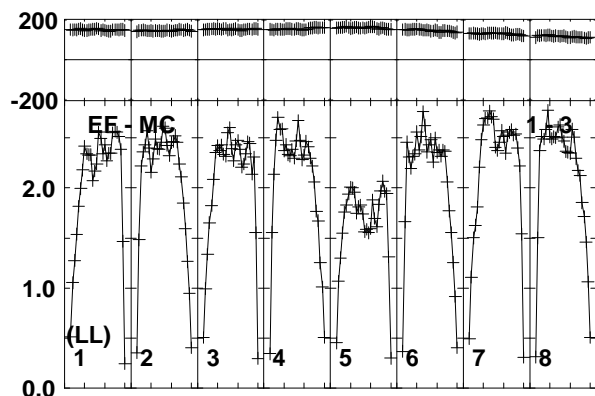
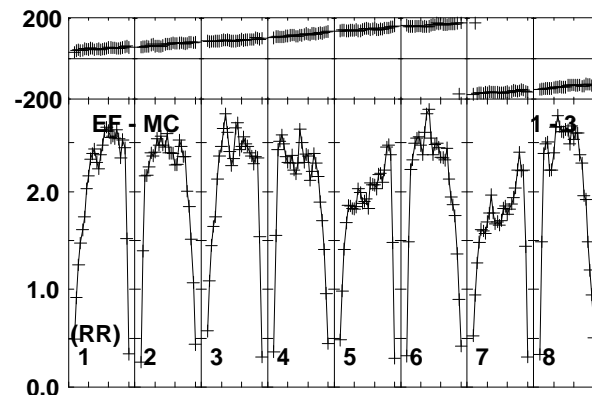
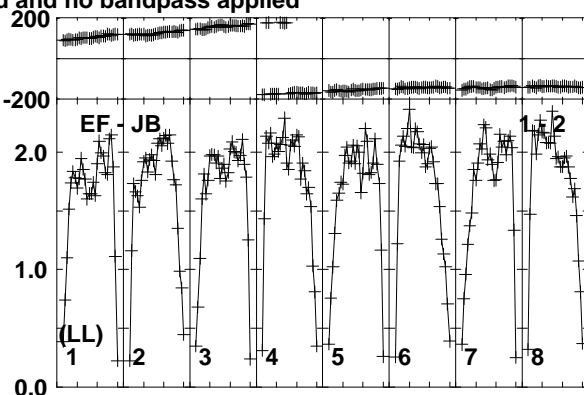
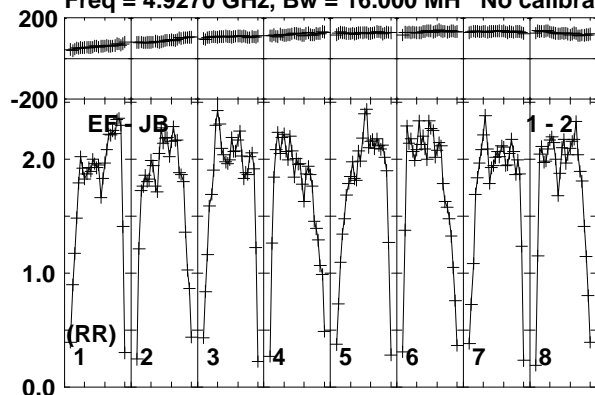

Lower frame: Milli Ampl Jy Top frame: Phas deg  
Vector averaged cross-power spectrum Baseline: EF (01) - JB (02)  
Timerange: 00/21:11:10 to 00/21:12:39

Plot file version 74 created 10-JUN-2016 17:22:07

J1957+3338 RT013A.UVDATA.1

Freq = 4.9270 GHz, Bw = 16.000 MH No calibration applied and no bandpass applied

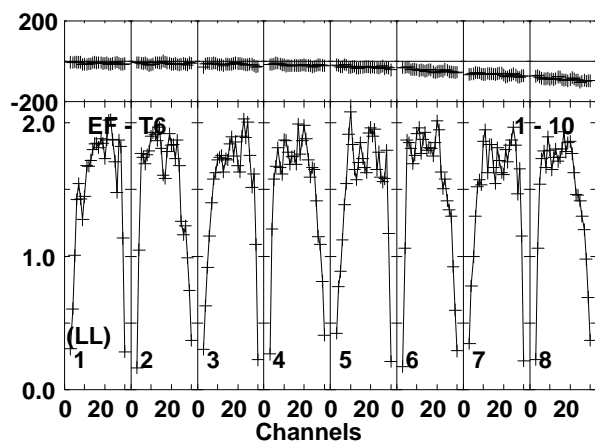
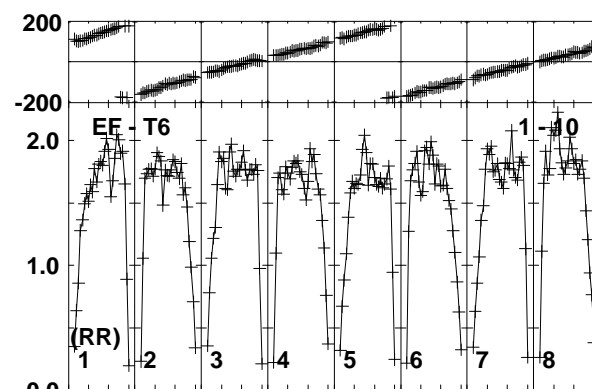
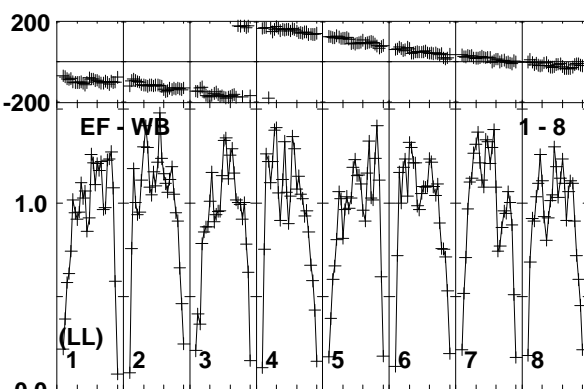
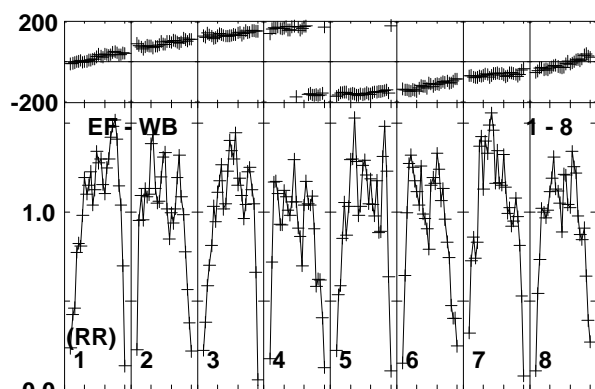
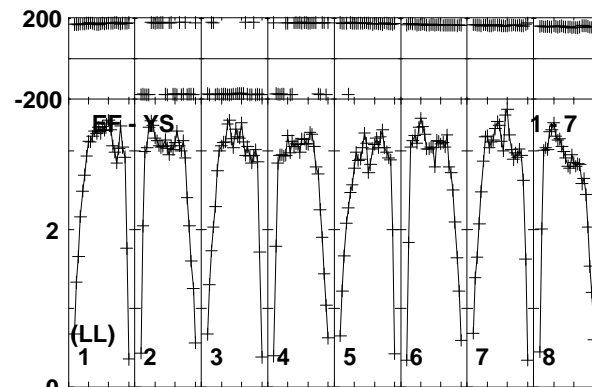
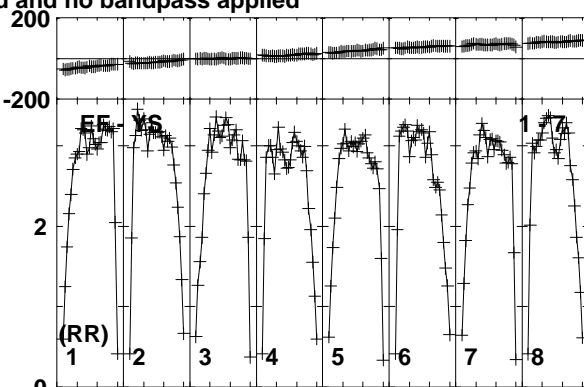
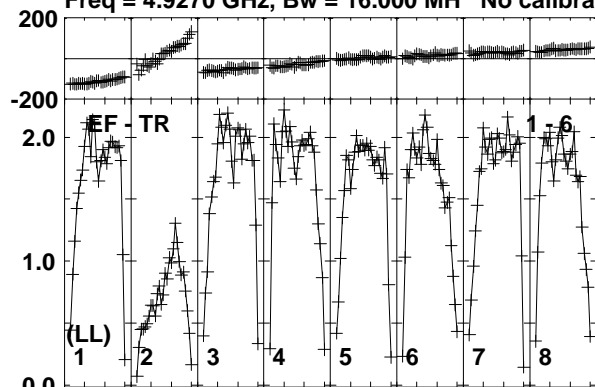

Lower frame: Milli Ampl Jy Top frame: Phas deg  
Vector averaged cross-power spectrum Baseline: EF (01) - TR (06)  
Timerange: 00/21:11:10 to 00/21:12:39



Plot file version 75 created 10-JUN-2016 17:22:07

CHECK RT013A.UVDATA.1

Freq = 4.9270 GHz, Bw = 16.000 MH No calibration applied and no bandpass applied

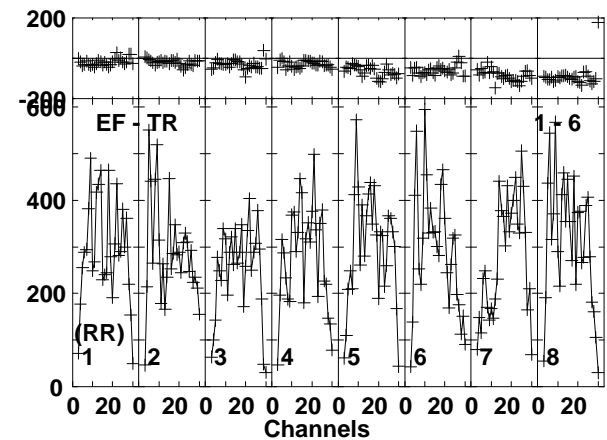
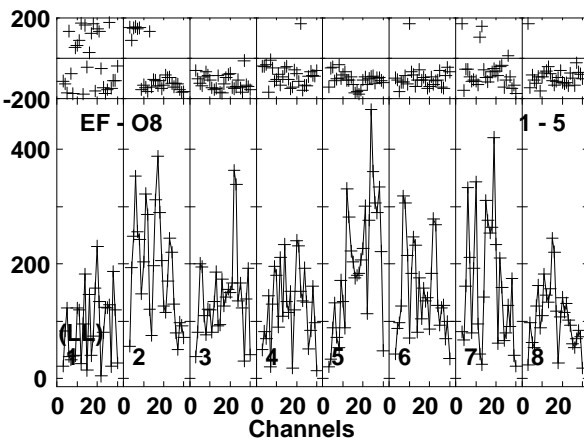
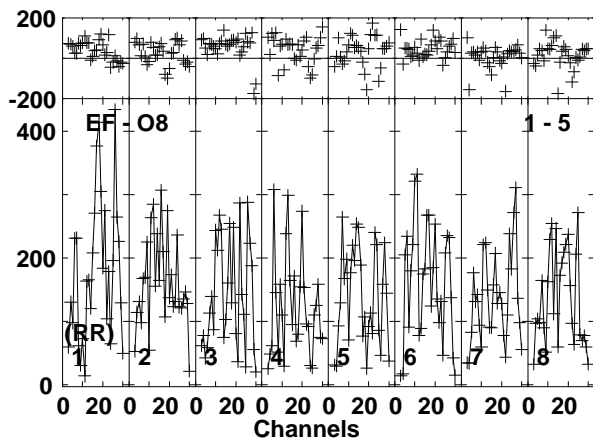
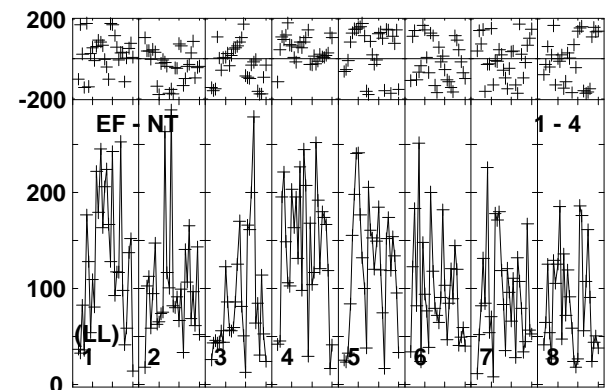
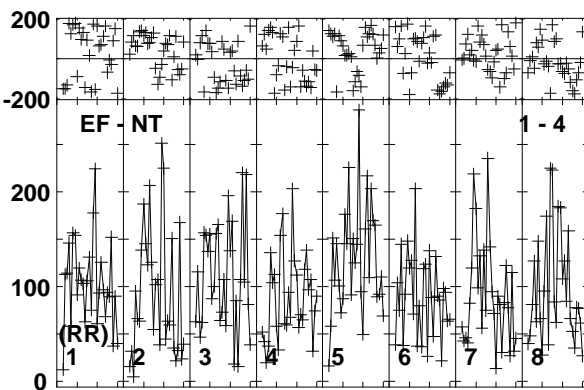
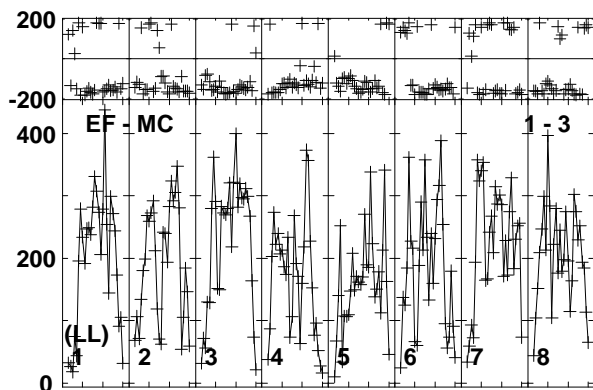
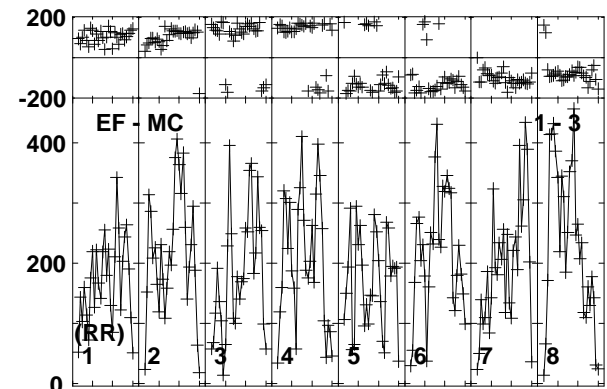
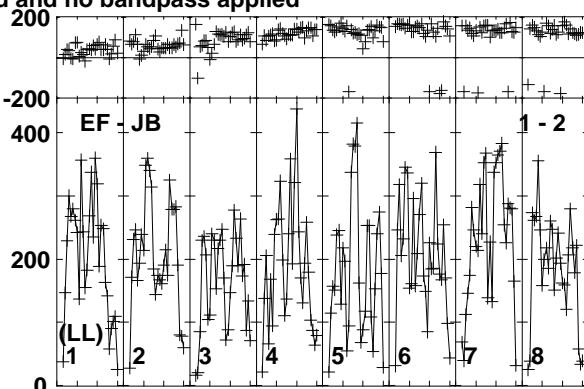
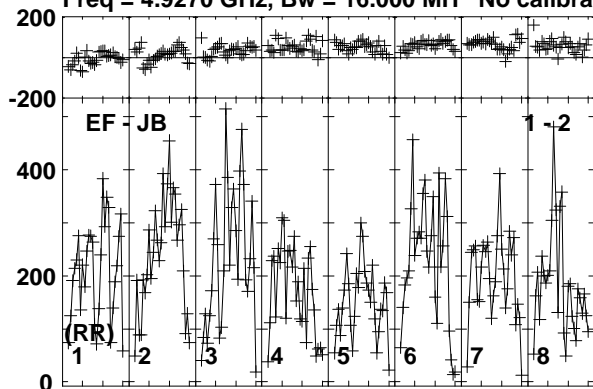

Lower frame: Micro Ampl Jy Top frame: Phas deg  
Vector averaged cross-power spectrum Baseline: EF (01) - JB (02)  
Timerange: 00/21:13:21 to 00/21:15:20

Plot file version 76 created 10-JUN-2016 17:22:07

CHECK RT013A.UVDATA.1

Freq = 4.9270 GHz, Bw = 16.000 MH No calibration applied and no bandpass applied

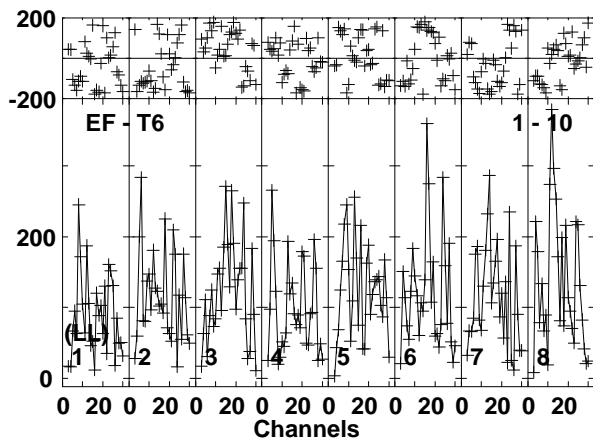
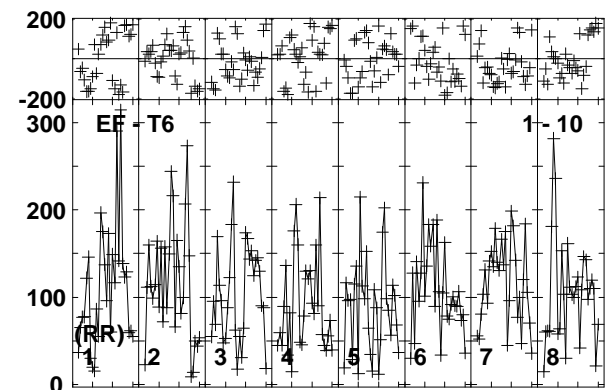
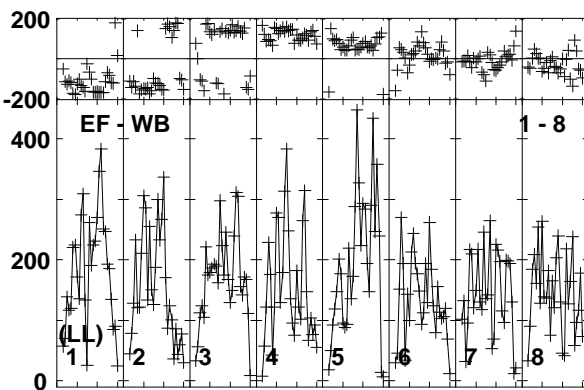
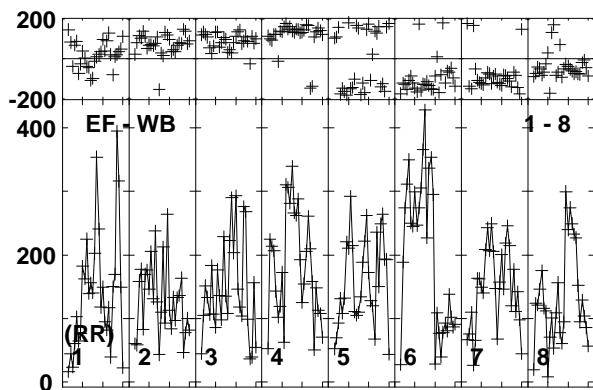
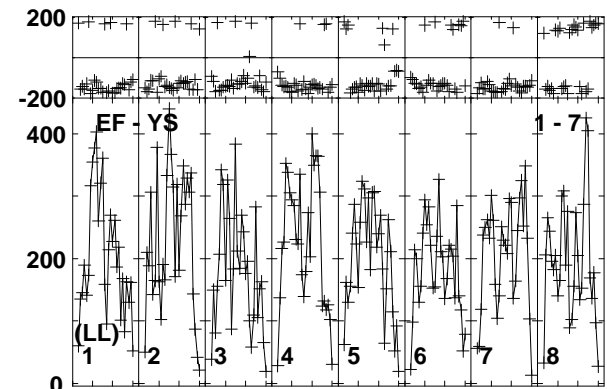
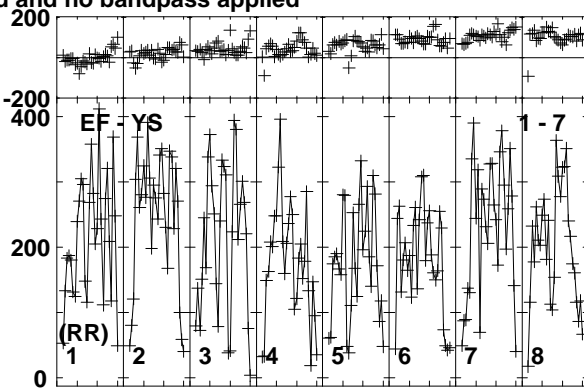
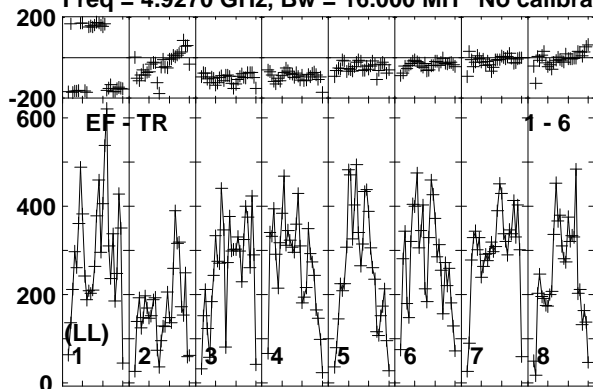

Lower frame: Micro Ampl Jy Top frame: Phas deg  
Vector averaged cross-power spectrum Baseline: EF (01) - TR (06)  
Timerange: 00/21:13:21 to 00/21:15:20

Plot file version 77 created 10-JUN-2016 17:22:07

CYGX1 RT013A.UVDATA.1

Freq = 4.9270 GHz, Bw = 16.000 MH No calibration applied and no bandpass applied

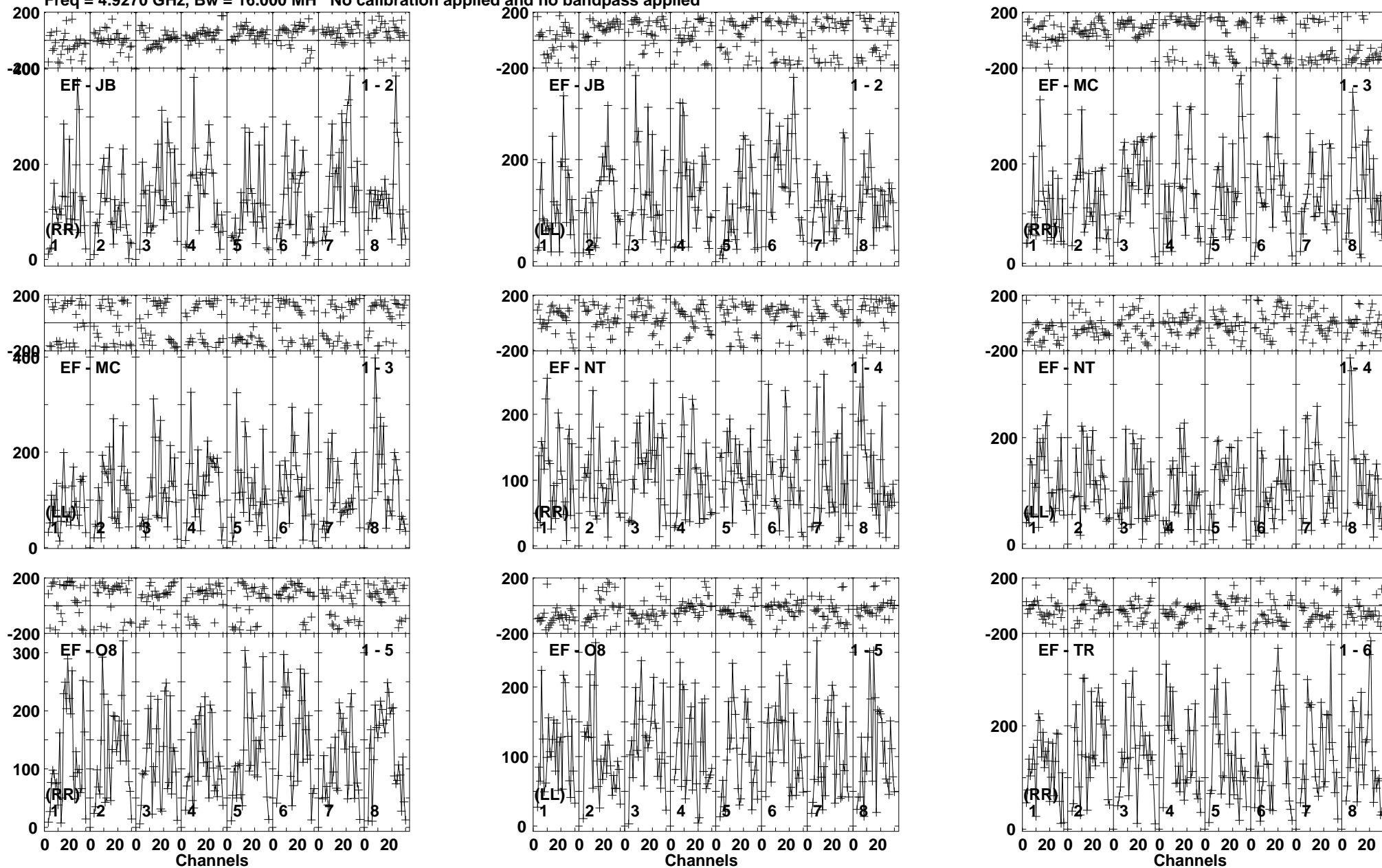

Lower frame: Micro Ampl Jy Top frame: Phas deg  
Vector averaged cross-power spectrum Baseline: EF (01) - JB (02)  
Timerange: 00/21:15:21 to 00/21:17:49

Plot file version 78 created 10-JUN-2016 17:22:07

CYGX1 RT013A.UVDATA.1

Freq = 4.9270 GHz, Bw = 16.000 MH No calibration applied and no bandpass applied

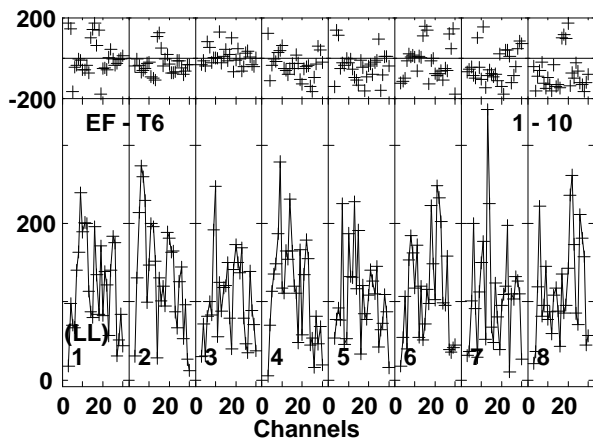
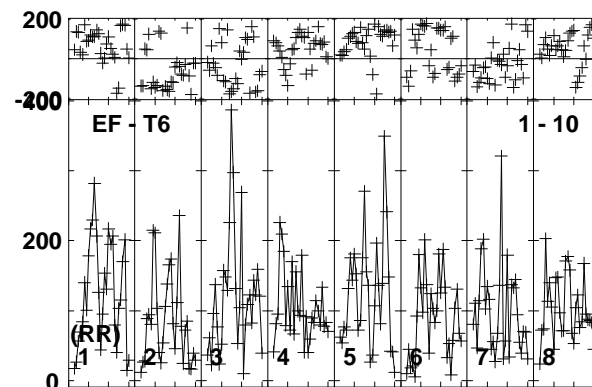
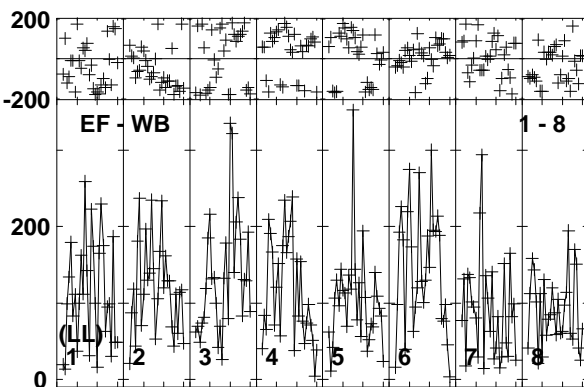
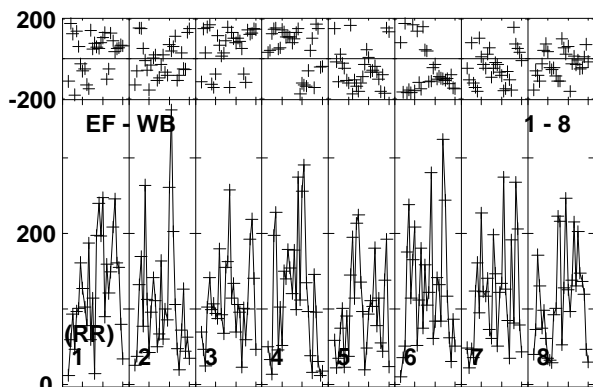
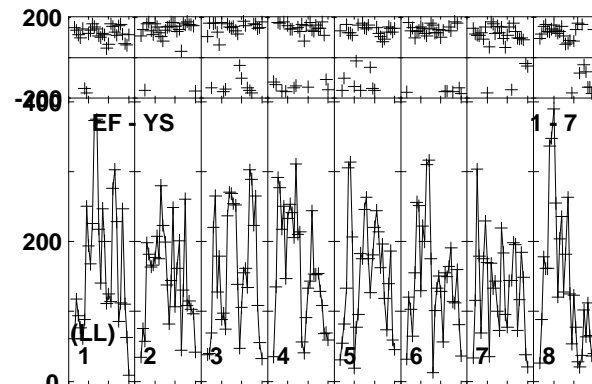
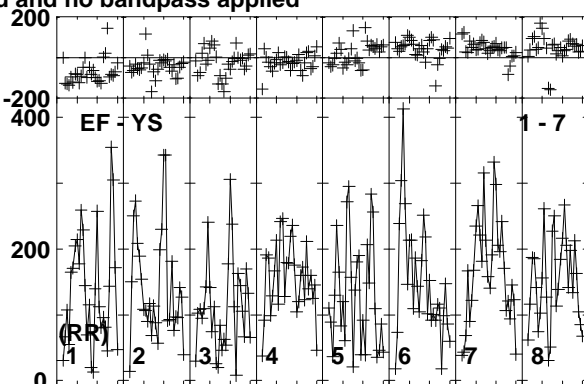
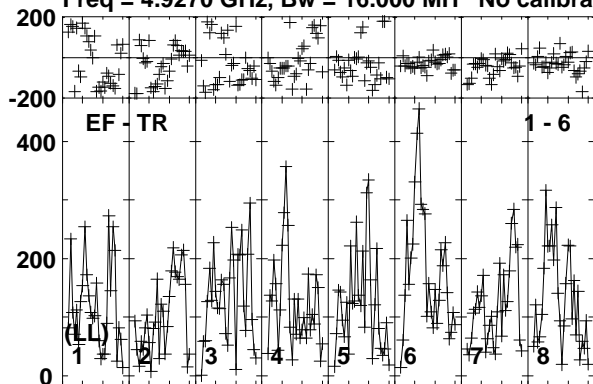

Lower frame: Micro Ampl Jy Top frame: Phas deg  
Vector averaged cross-power spectrum Baseline: EF (01) - TR (06)  
Timerange: 00/21:15:21 to 00/21:17:49

Plot file version 79 created 10-JUN-2016 17:22:07

J1957+3338 RT013A.UVDATA.1

Freq = 4.9270 GHz, Bw = 16.000 MH No calibration applied and no bandpass applied

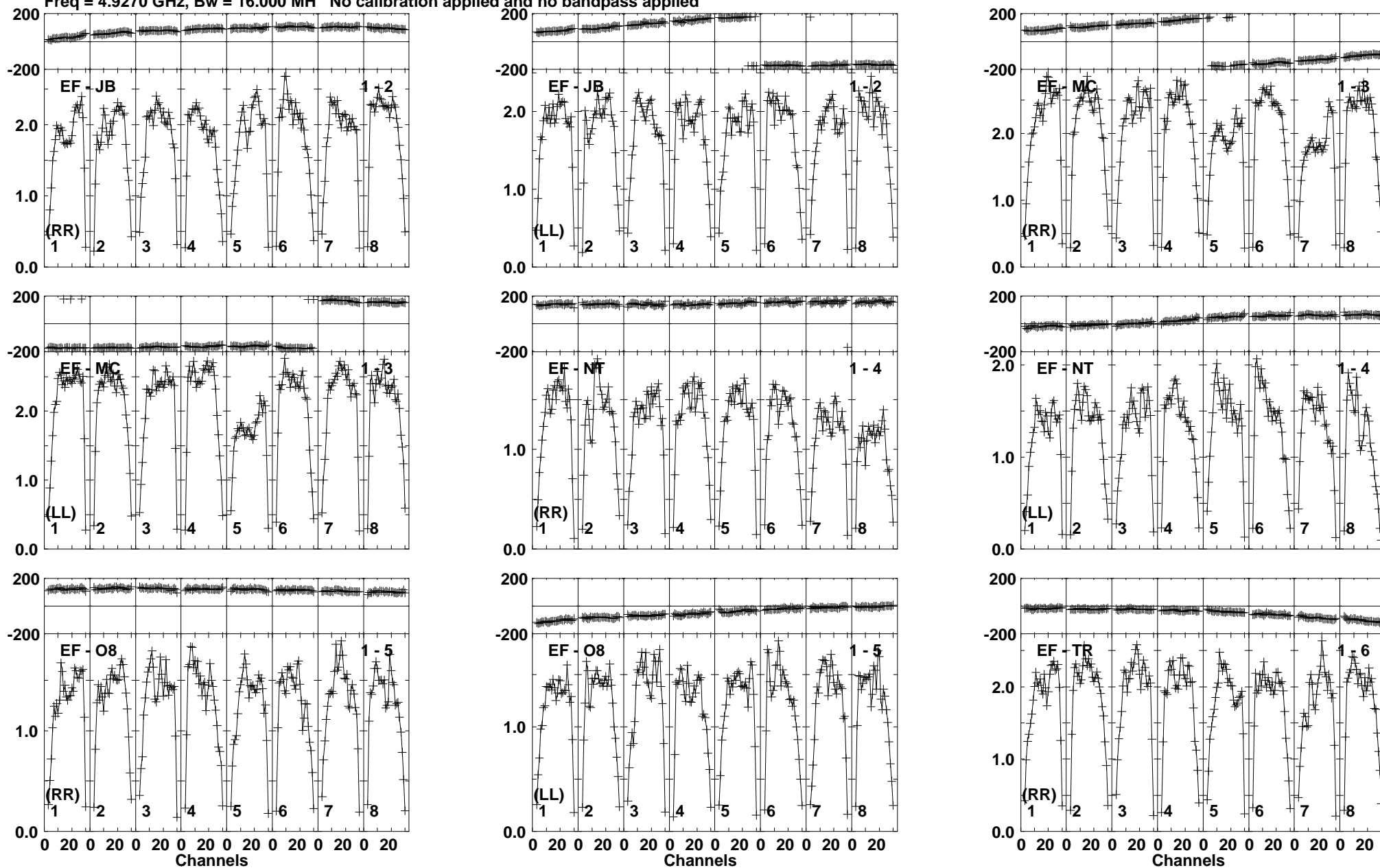

Lower frame: Milli Ampl Jy Top frame: Phas deg  
Vector averaged cross-power spectrum Baseline: EF (01) - JB (02)  
Timerange: 00/21:17:50 to 00/21:19:20

Plot file version 80 created 10-JUN-2016 17:22:07

J1957+3338 RT013A.UVDATA.1

Freq = 4.9270 GHz, Bw = 16.000 MH No calibration applied and no bandpass applied

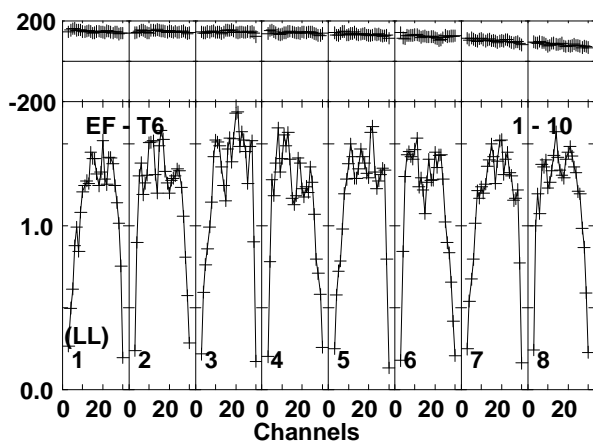
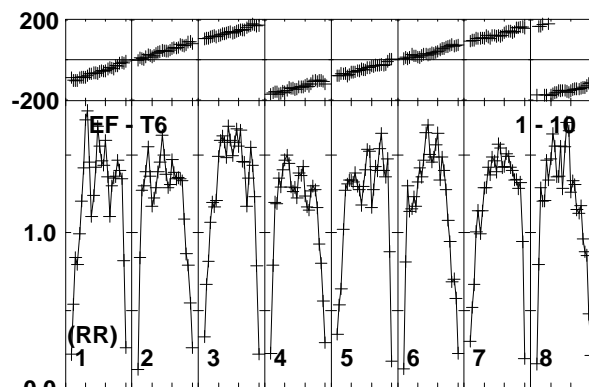
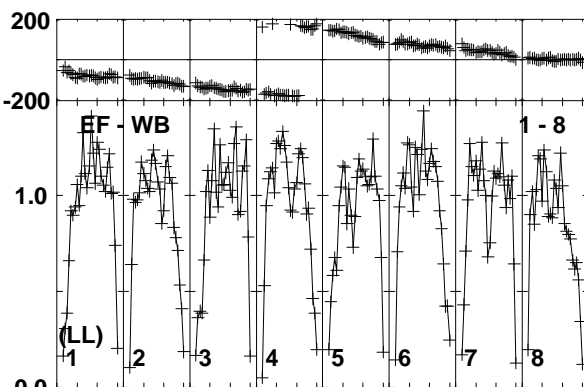
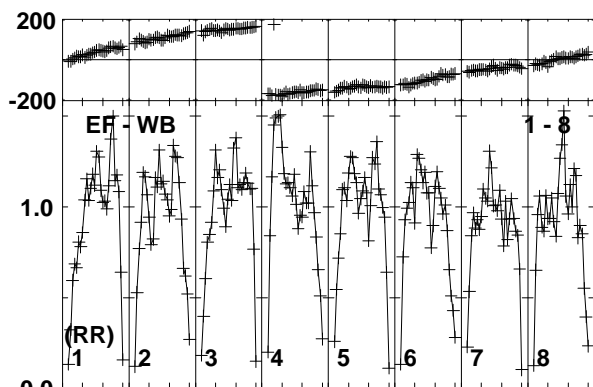
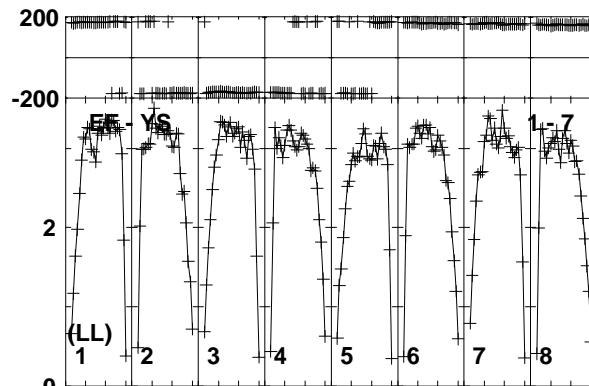
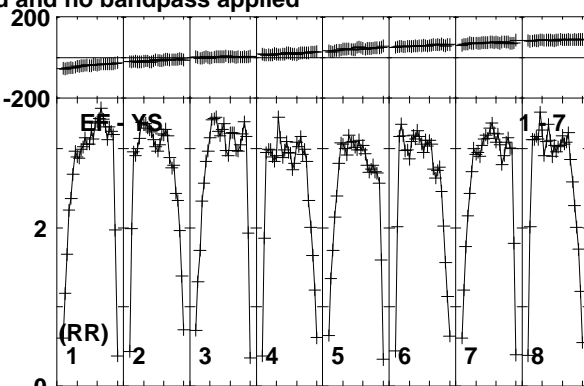
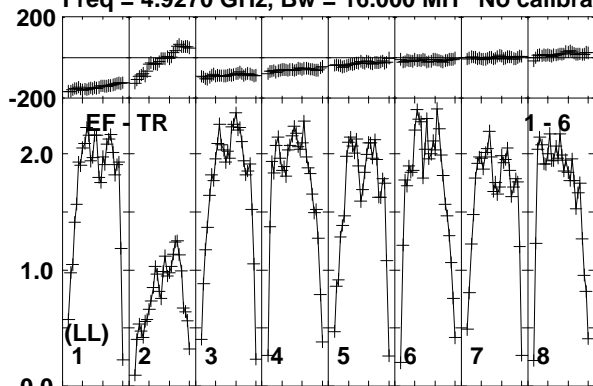

Lower frame: Milli Ampl Jy Top frame: Phas deg  
Vector averaged cross-power spectrum Baseline: EF (01) - TR (06)  
Timerange: 00/21:17:50 to 00/21:19:20

Plot file version 81 created 10-JUN-2016 17:22:07

CHECK RT013A.UVDATA.1

Freq = 4.9270 GHz, Bw = 16.000 MH No calibration applied and no bandpass applied

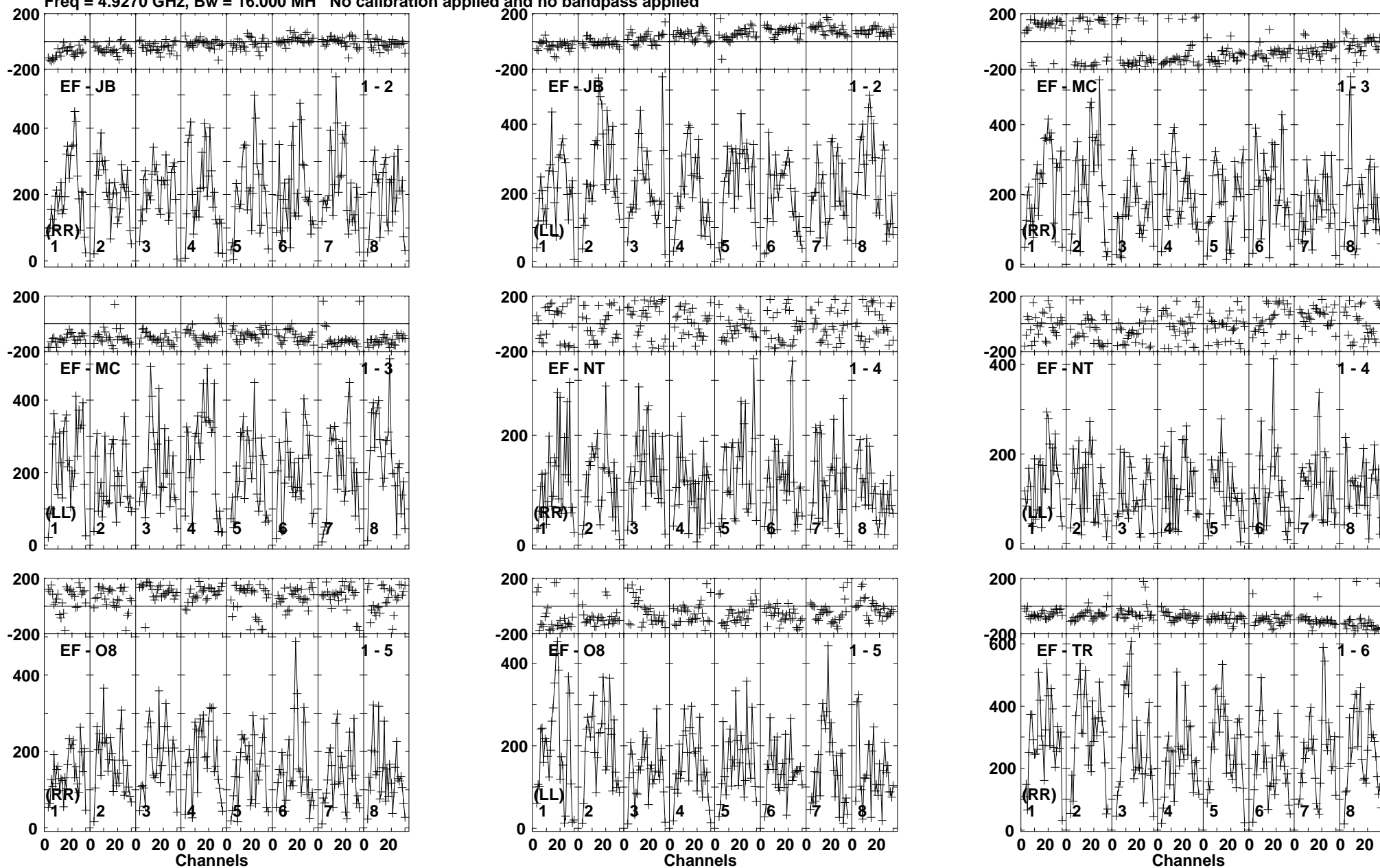

Lower frame: Micro Ampl Jy Top frame: Phas deg  
Vector averaged cross-power spectrum Baseline: EF (01) - JB (02)  
Timerange: 00/21:19:20 to 00/21:21:19

Plot file version 82 created 10-JUN-2016 17:22:08

CHECK RT013A.UVDATA.1

Freq = 4.9270 GHz, Bw = 16.000 MH No calibration applied and no bandpass applied

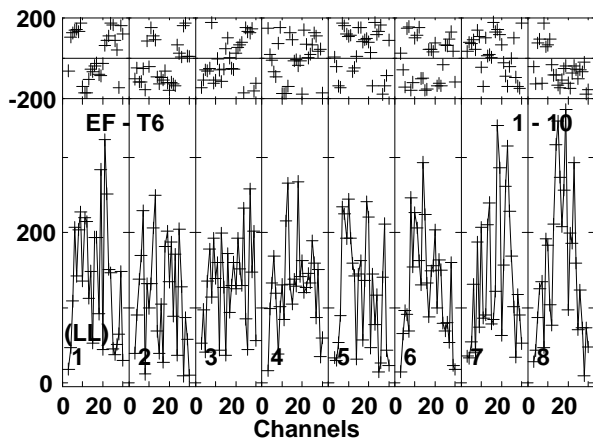
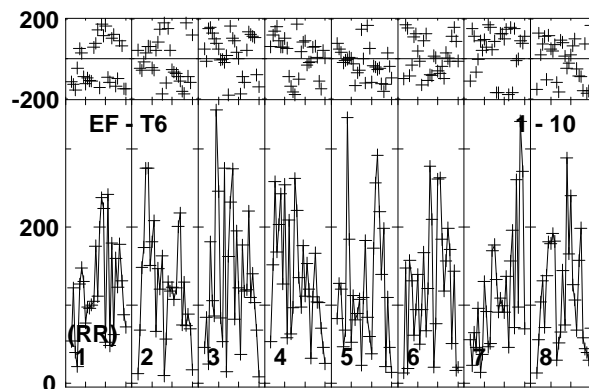
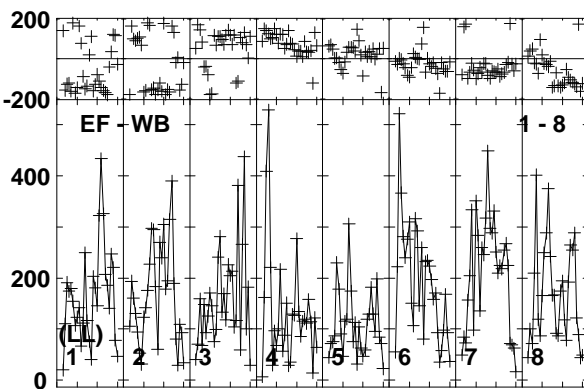
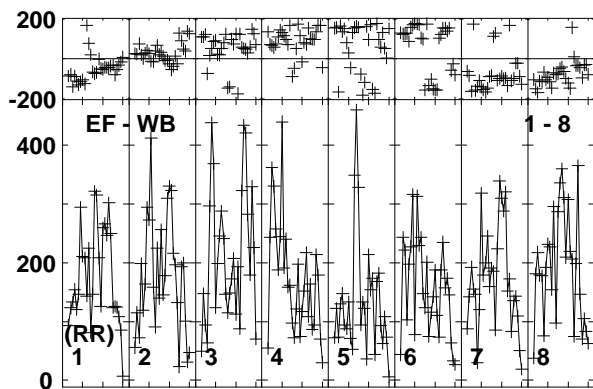
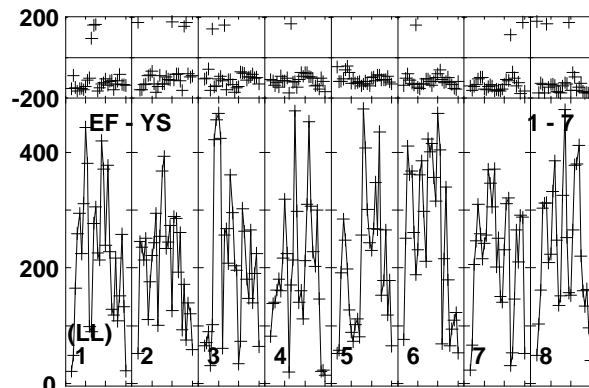
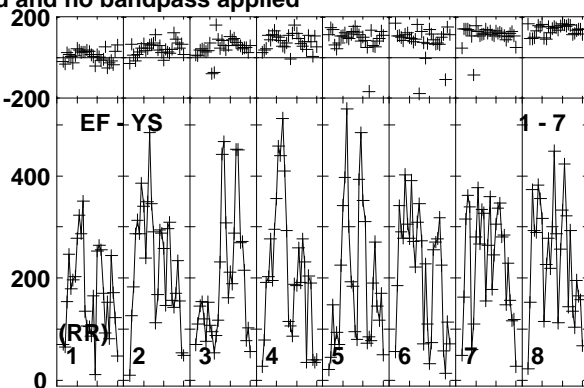
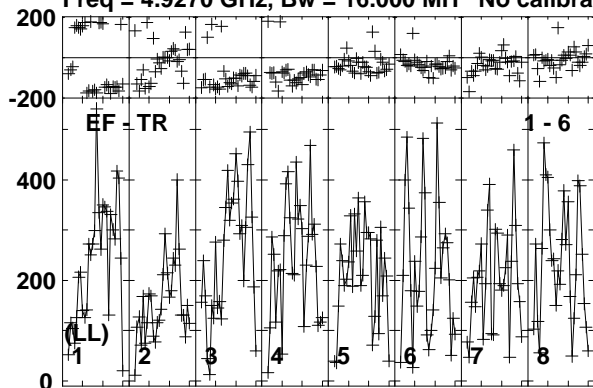

Lower frame: Micro Ampl Jy Top frame: Phas deg  
Vector averaged cross-power spectrum Baseline: EF (01) - TR (06)  
Timerange: 00/21:19:20 to 00/21:21:19



Plot file version 83 created 10-JUN-2016 17:22:08

CYGX1 RT013A.UVDATA.1

Freq = 4.9270 GHz, Bw = 16.000 MH No calibration applied and no bandpass applied

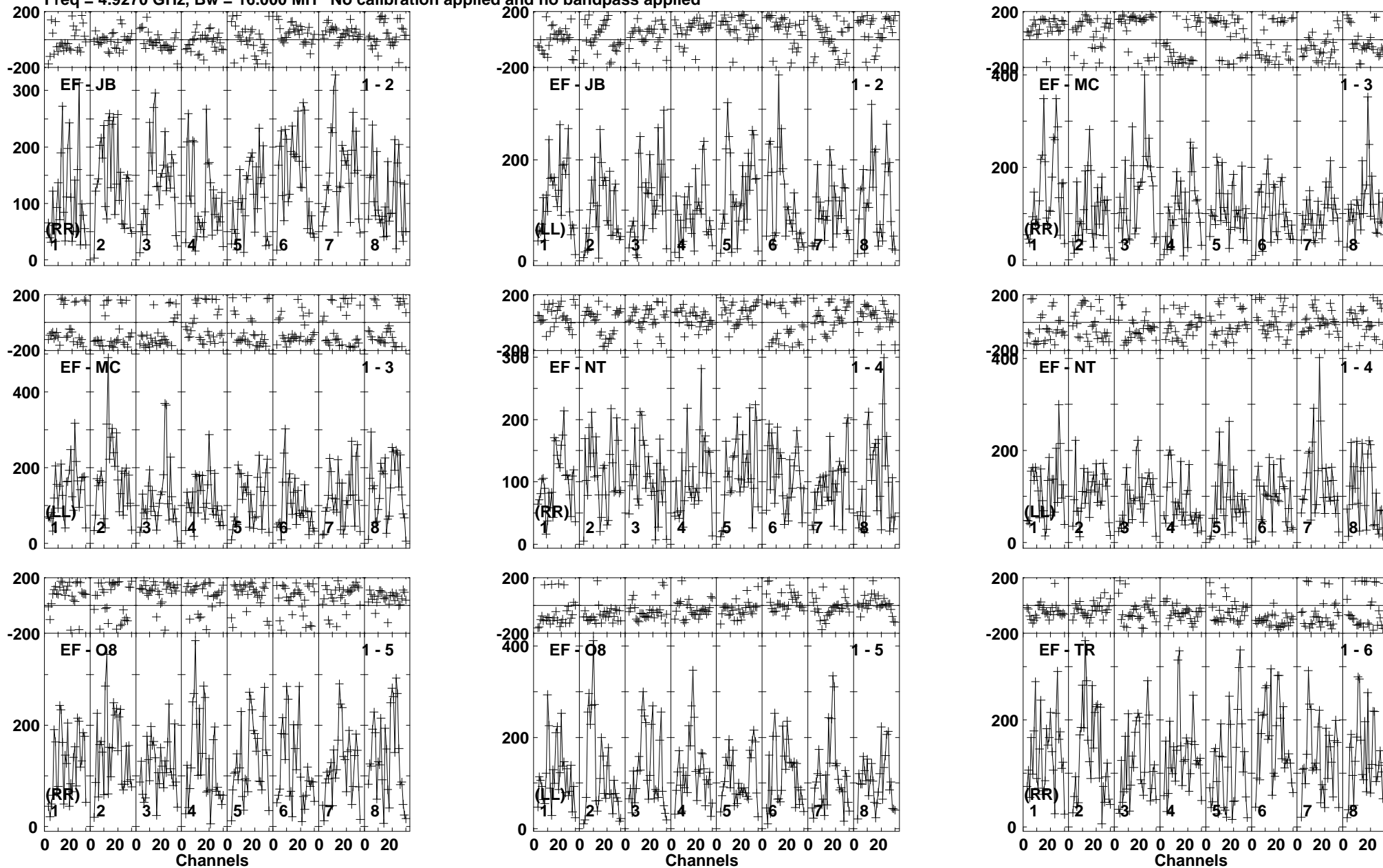

Lower frame: Micro Ampl Jy Top frame: Phas deg  
Vector averaged cross-power spectrum Baseline: EF (01) - JB (02)  
Timerange: 00/21:21:20 to 00/21:23:49

Plot file version 84 created 10-JUN-2016 17:22:08

CYGX1 RT013A.UVDATA.1

Freq = 4.9270 GHz, Bw = 16.000 MH No calibration applied and no bandpass applied

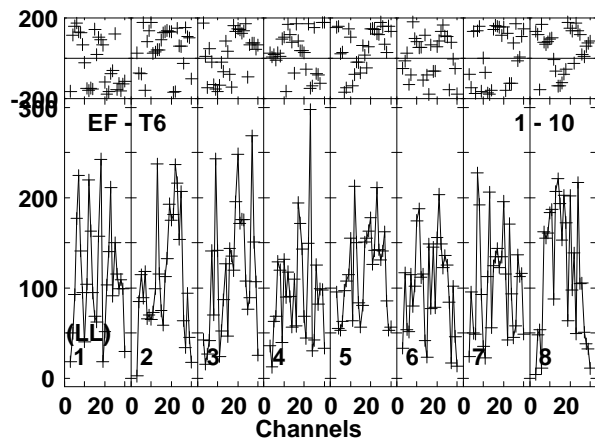
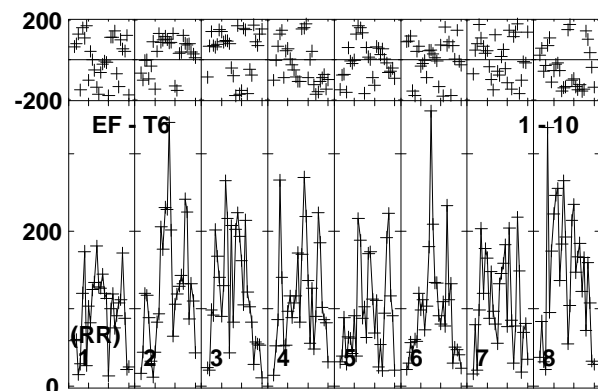
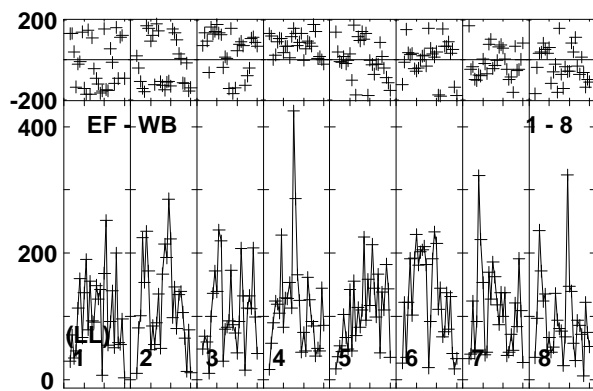
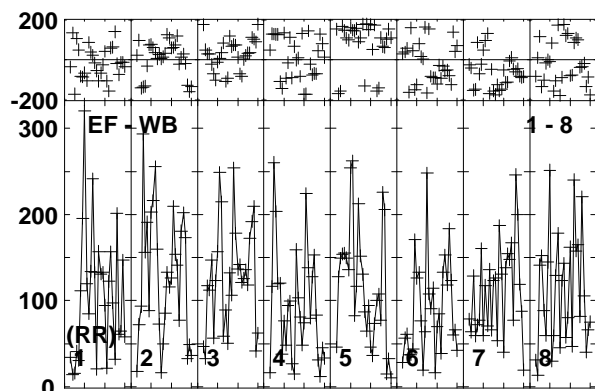
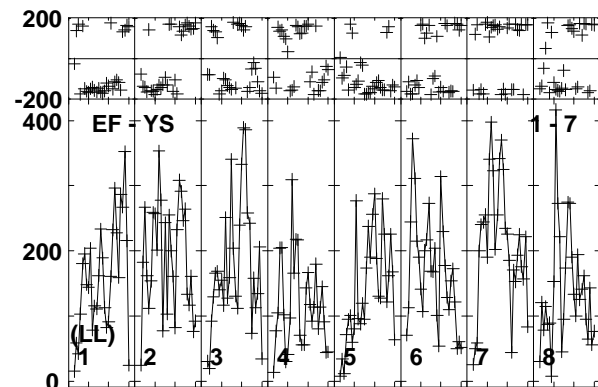
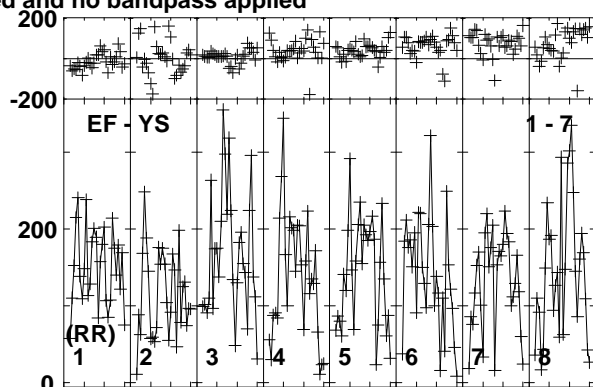
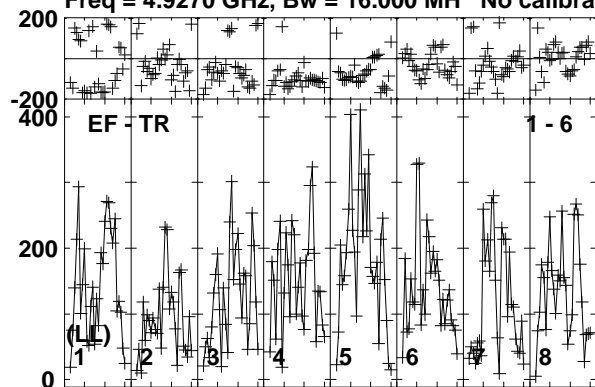

Lower frame: Micro Ampl Jy Top frame: Phas deg  
Vector averaged cross-power spectrum Baseline: EF (01) - TR (06)  
Timerange: 00/21:21:20 to 00/21:23:49

Plot file version 85 created 10-JUN-2016 17:22:08

J1957+3338 RT013A.UVDATA.1

Freq = 4.9270 GHz, Bw = 16.000 MH No calibration applied and no bandpass applied

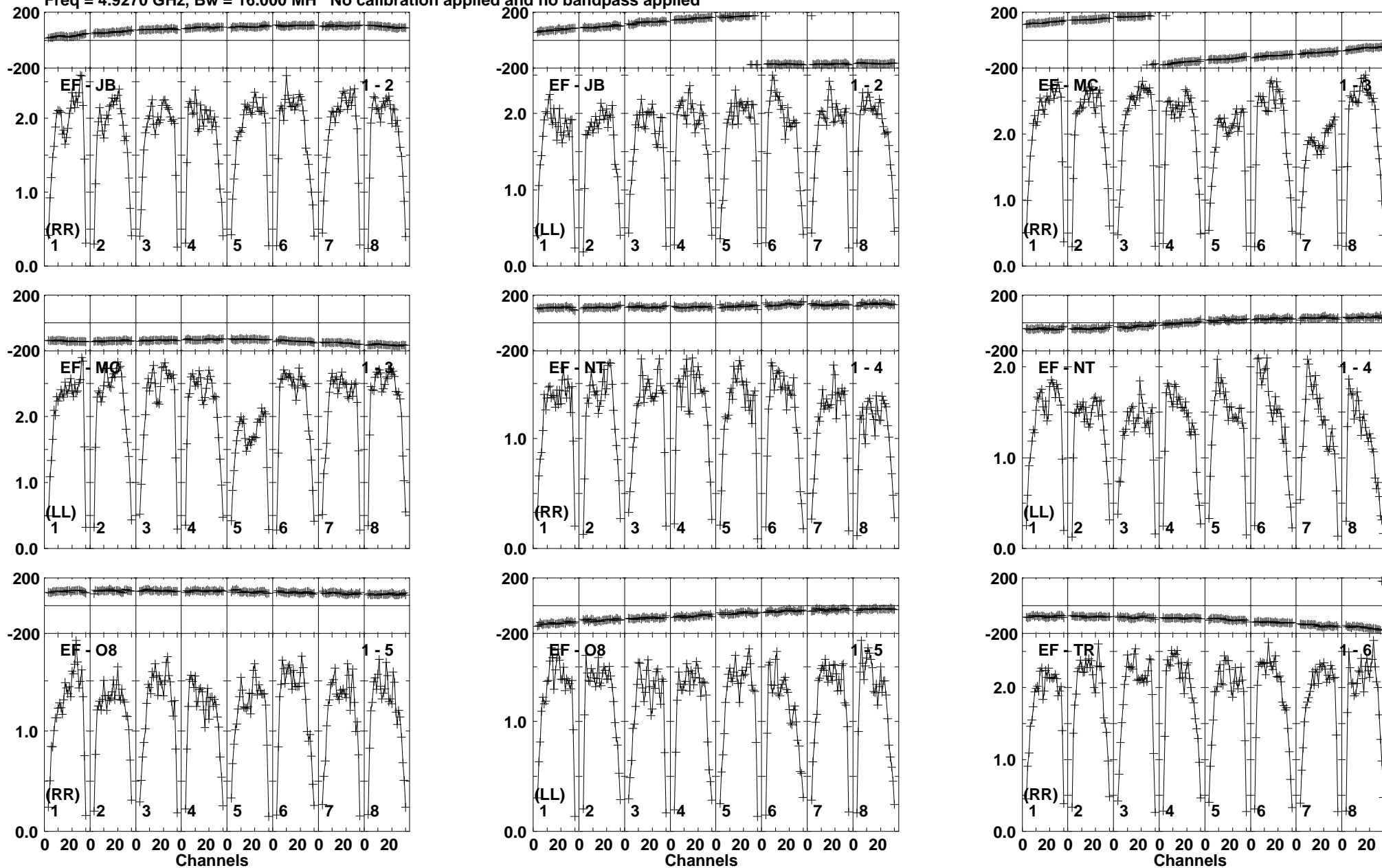

Lower frame: Milli Ampl Jy Top frame: Phas deg  
Vector averaged cross-power spectrum Baseline: EF (01) - JB (02)  
Timerange: 00/21:23:51 to 00/21:25:20

Plot file version 86 created 10-JUN-2016 17:22:08

J1957+3338 RT013A.UVDATA.1

Freq = 4.9270 GHz, Bw = 16.000 MH No calibration applied and no bandpass applied

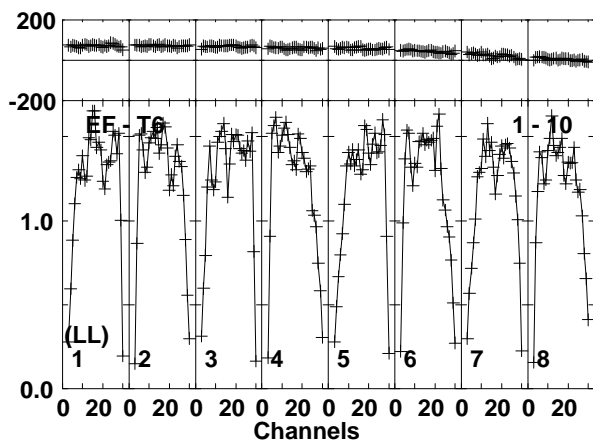
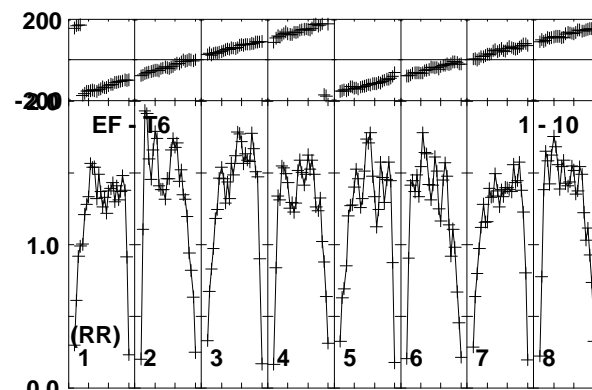
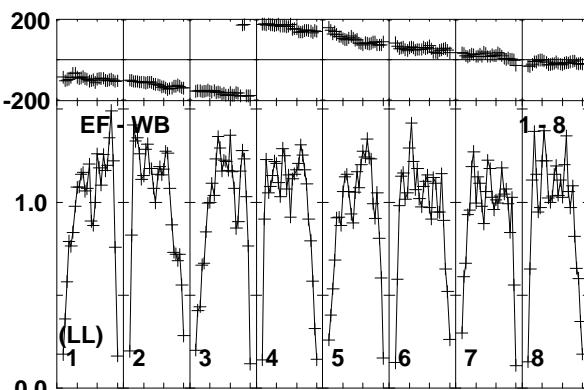
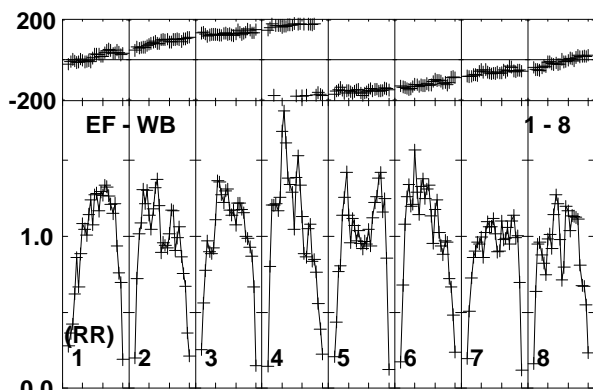
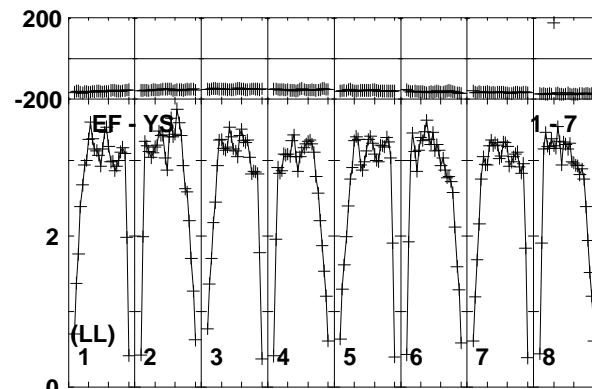
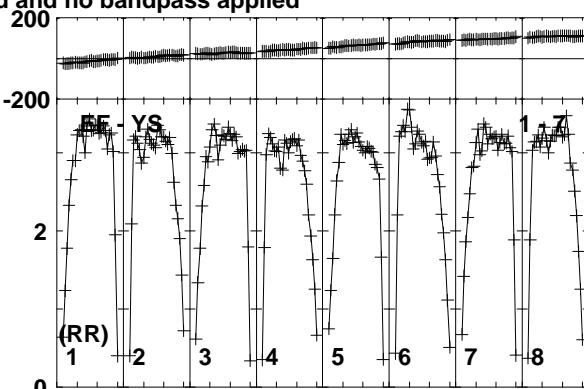
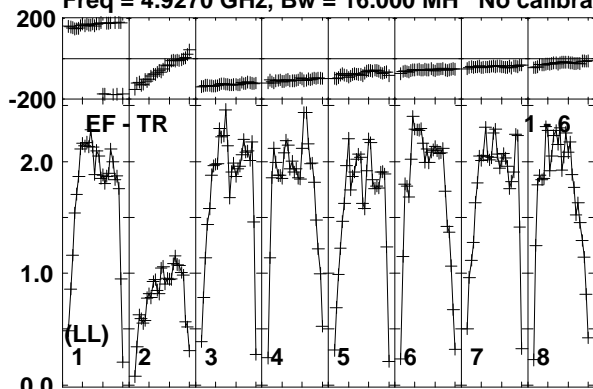

Lower frame: Milli Ampl Jy Top frame: Phas deg  
Vector averaged cross-power spectrum Baseline: EF (01) - TR (06)  
Timerange: 00/21:23:51 to 00/21:25:20

Plot file version 87 created 10-JUN-2016 17:22:08

CHECK RT013A.UVDATA.1

Freq = 4.9270 GHz, Bw = 16.000 MH No calibration applied and no bandpass applied

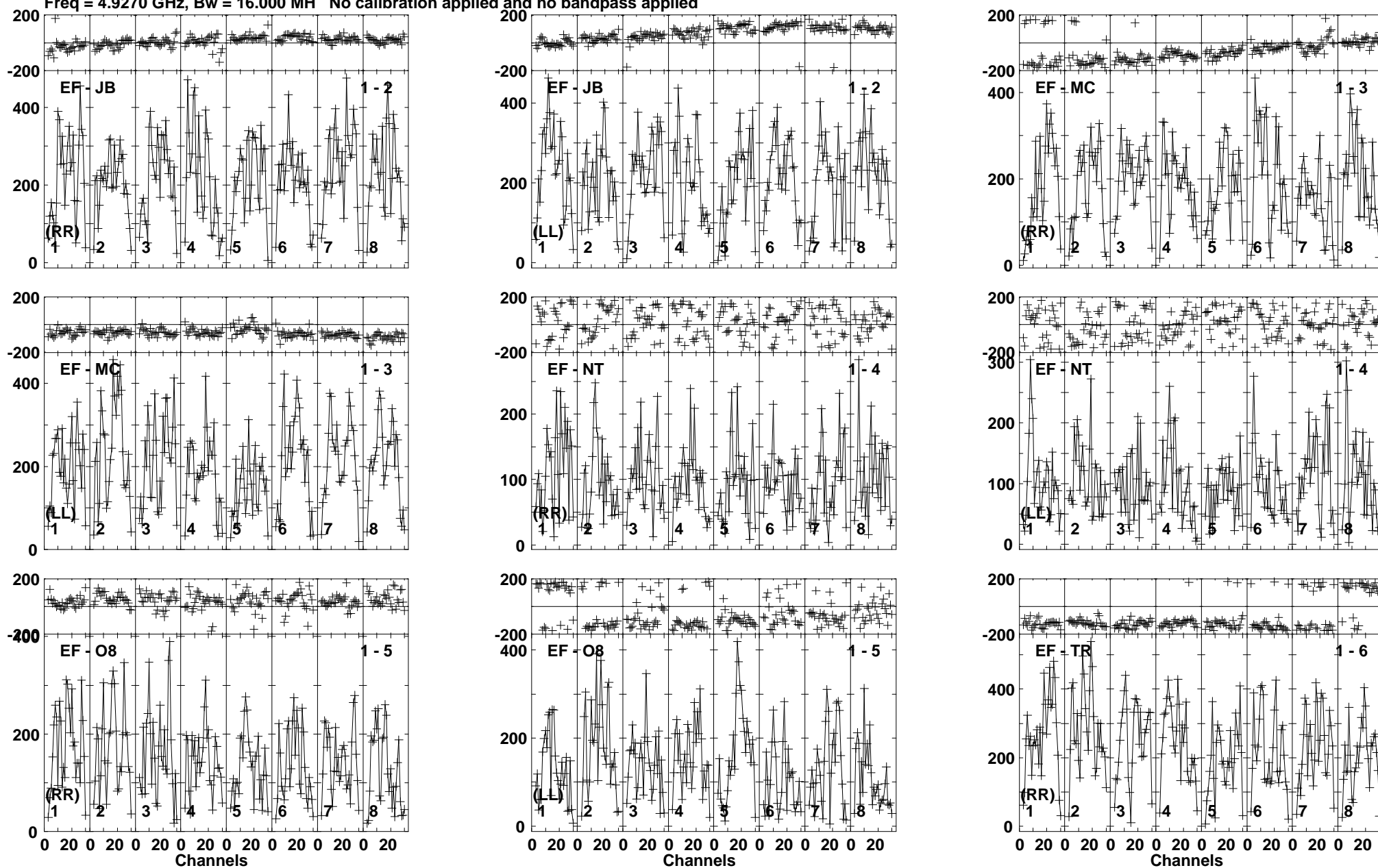

Lower frame: Micro Ampl Jy Top frame: Phas deg  
Vector averaged cross-power spectrum Baseline: EF (01) - JB (02)  
Timerange: 00/21:26:00 to 00/21:28:00

Plot file version 88 created 10-JUN-2016 17:22:08

CHECK RT013A.UVDATA.1

Freq = 4.9270 GHz, Bw = 16.000 MH No calibration applied and no bandpass applied

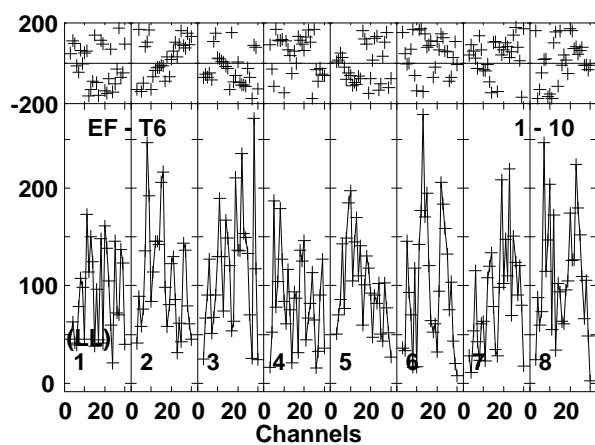
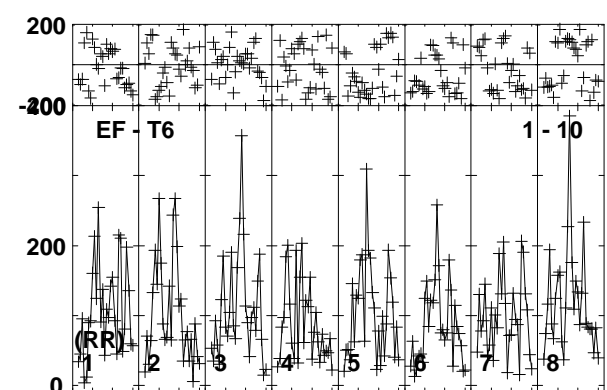
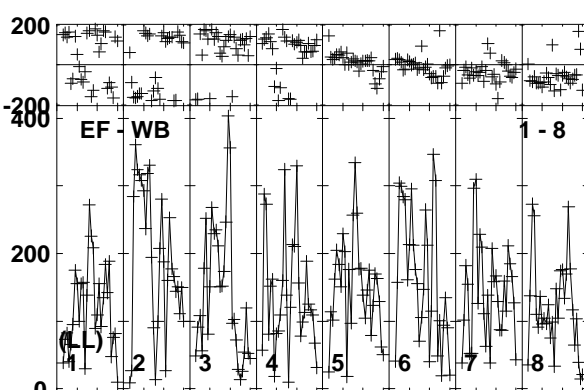
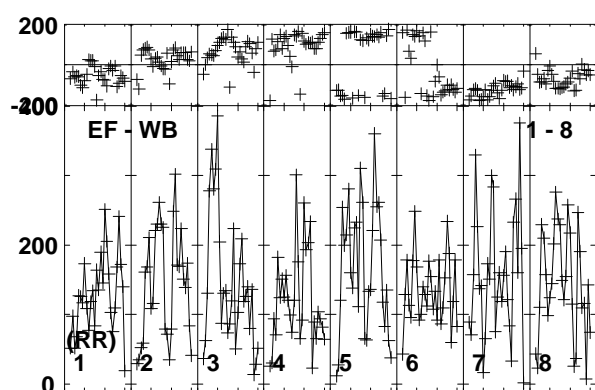
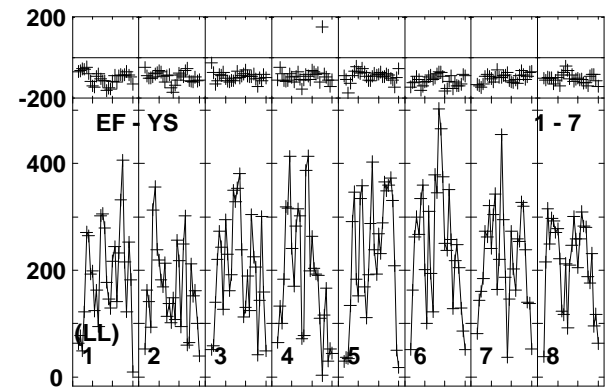
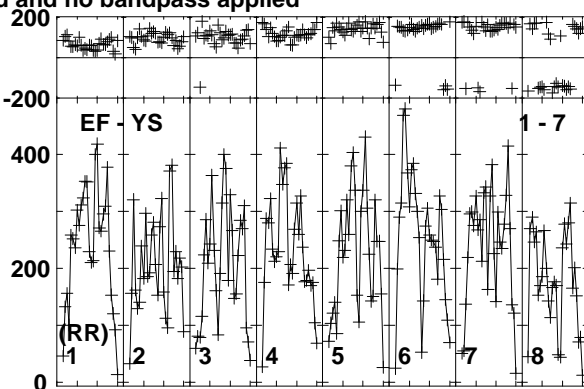
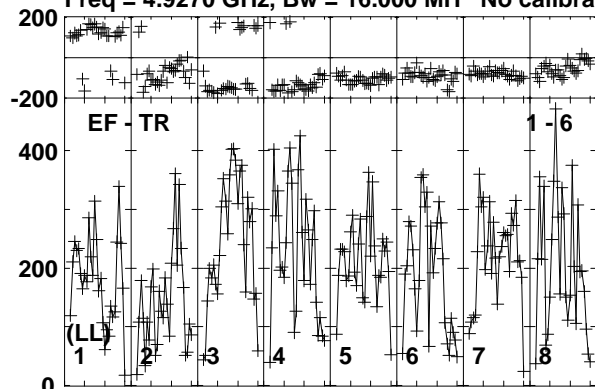

Lower frame: Micro Ampl Jy Top frame: Phas deg  
Vector averaged cross-power spectrum Baseline: EF (01) - TR (06)  
Timerange: 00/21:26:00 to 00/21:28:00

Plot file version 89 created 10-JUN-2016 17:22:08

CYGX1 RT013A.UVDATA.1

Freq = 4.9270 GHz, Bw = 16.000 MH No calibration applied and no bandpass applied

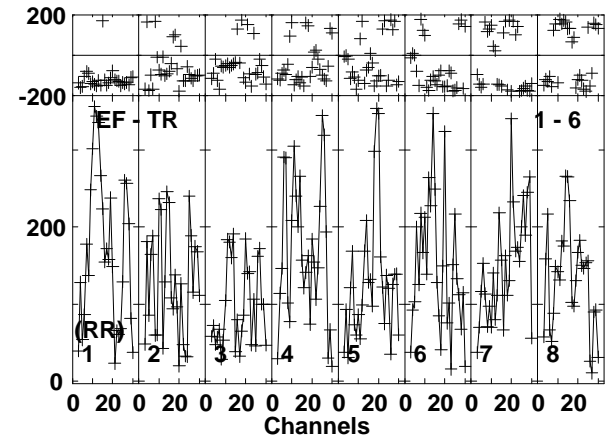
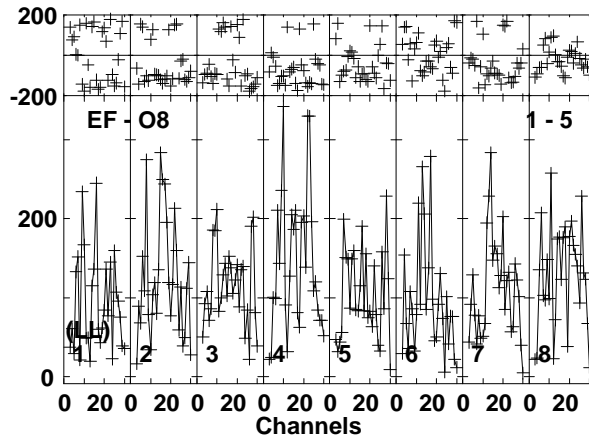
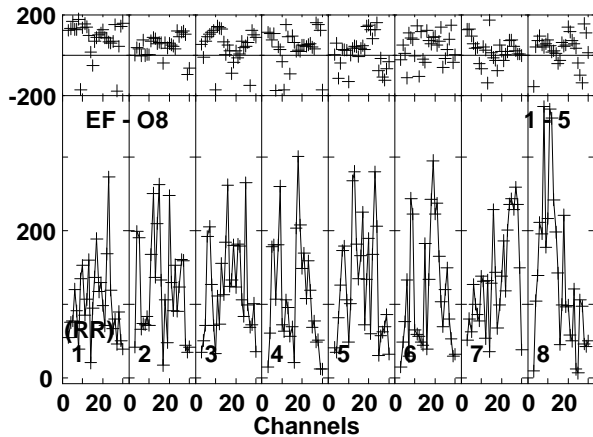
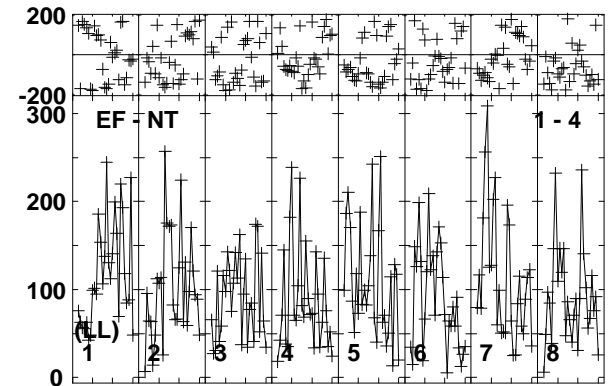
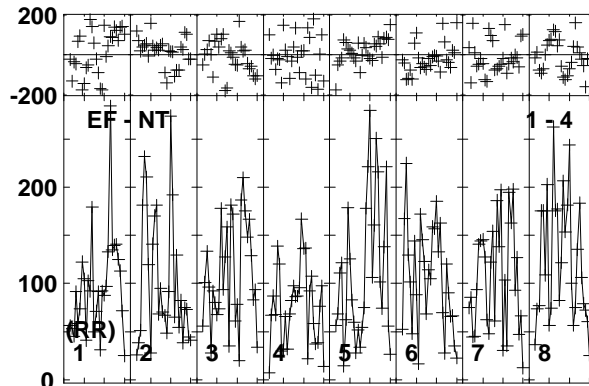
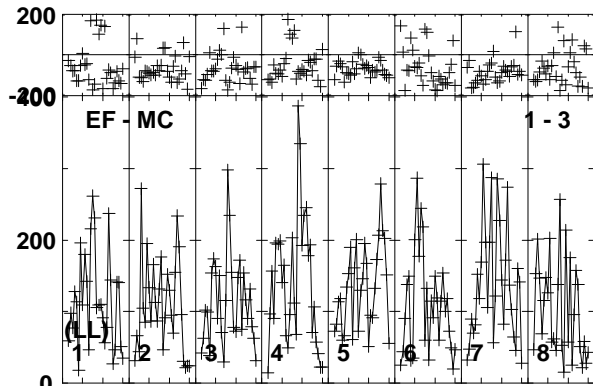
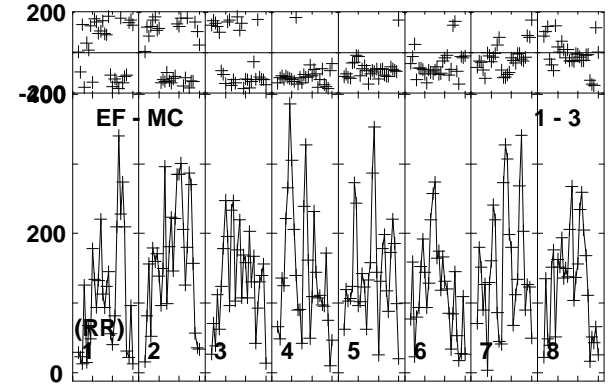
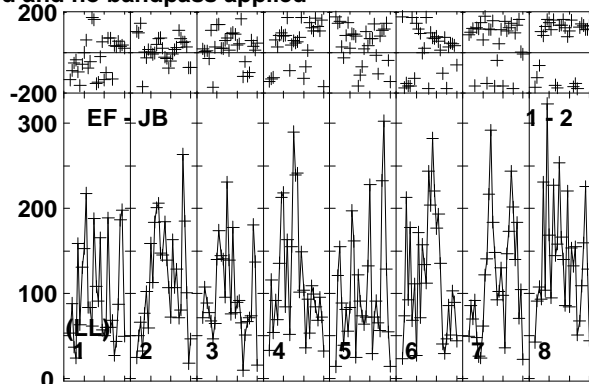
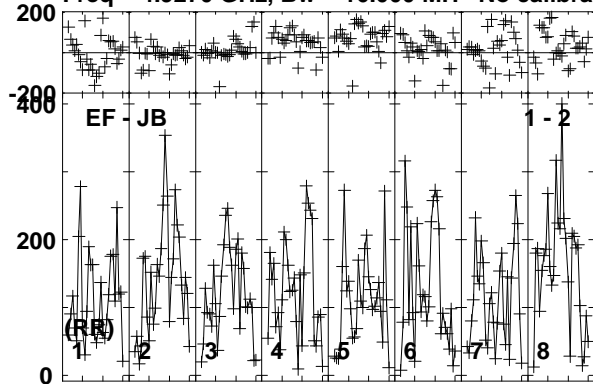

Lower frame: Micro Ampl Jy Top frame: Phas deg  
Vector averaged cross-power spectrum Baseline: EF (01) - JB (02)  
Timerange: 00/21:28:01 to 00/21:30:29

Plot file version 90 created 10-JUN-2016 17:22:08

CYGX1 RT013A.UVDATA.1

Freq = 4.9270 GHz, Bw = 16.000 MH No calibration applied and no bandpass applied

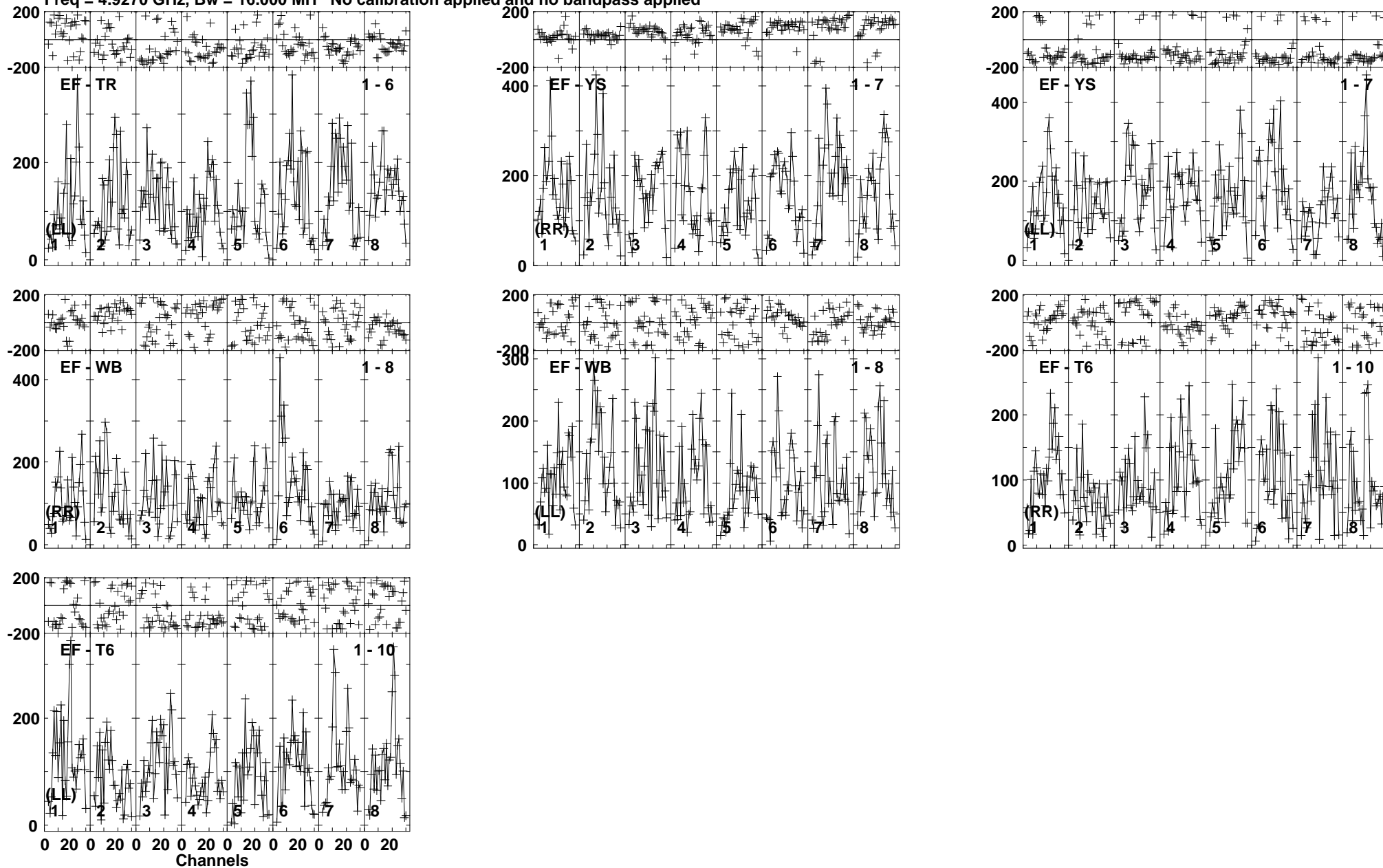

Lower frame: Micro Ampl Jy Top frame: Phas deg  
Vector averaged cross-power spectrum Baseline: EF (01) - TR (06)  
Timerange: 00/21:28:01 to 00/21:30:29



Plot file version 91 created 10-JUN-2016 17:22:09

J1957+3338 RT013A.UVDATA.1

Freq = 4.9270 GHz, Bw = 16.000 MH No calibration applied and no bandpass applied

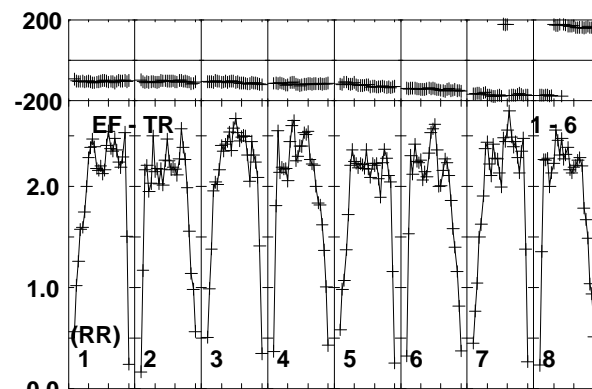
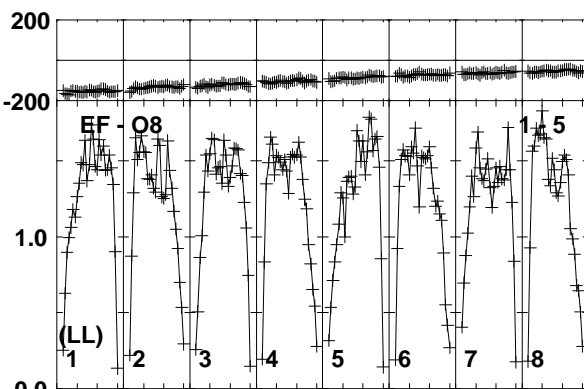
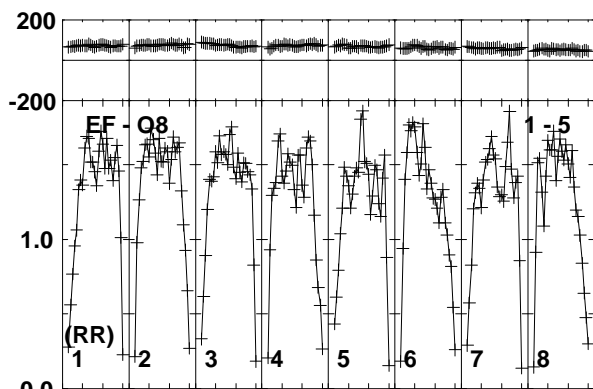
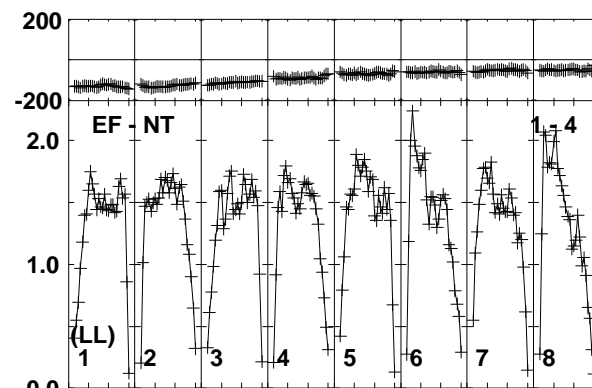
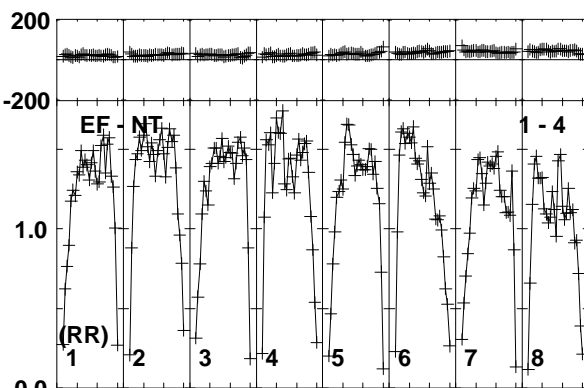
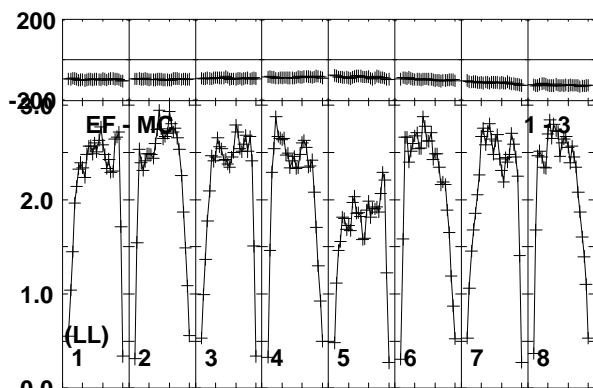
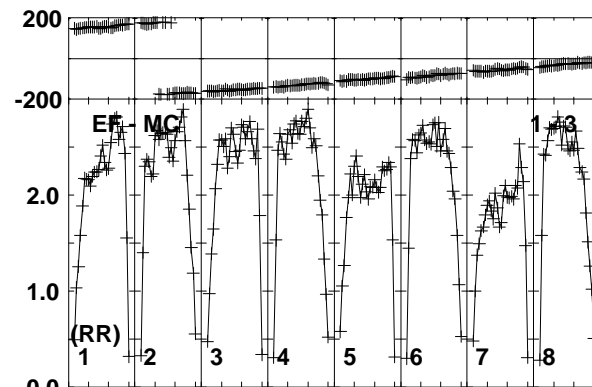
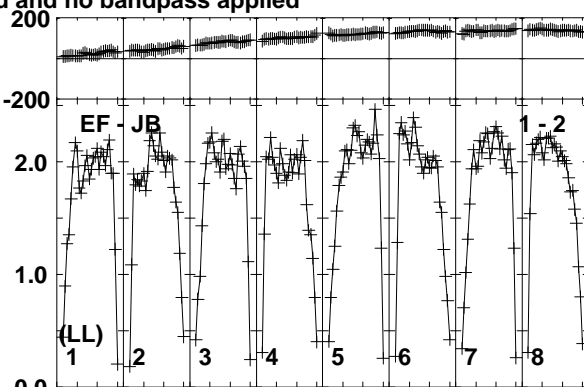
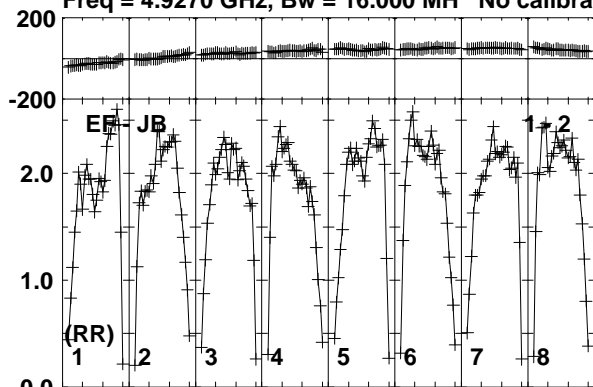

Lower frame: Milli Ampl Jy Top frame: Phas deg  
Vector averaged cross-power spectrum Baseline: EF (01) - JB (02)  
Timerange: 00/21:30:31 to 00/21:32:00

Plot file version 92 created 10-JUN-2016 17:22:09

J1957+3338 RT013A.UVDATA.1

Freq = 4.9270 GHz, Bw = 16.000 MH No calibration applied and no bandpass applied

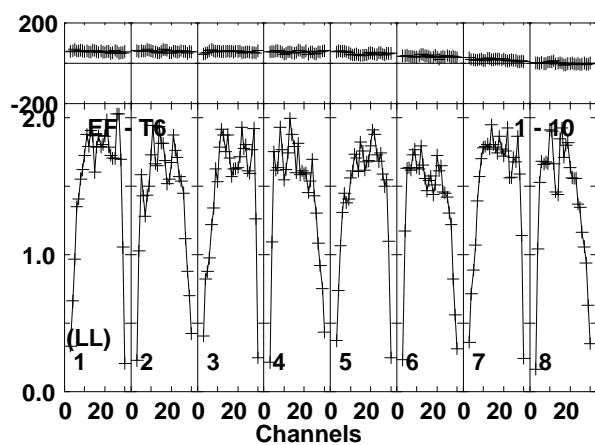
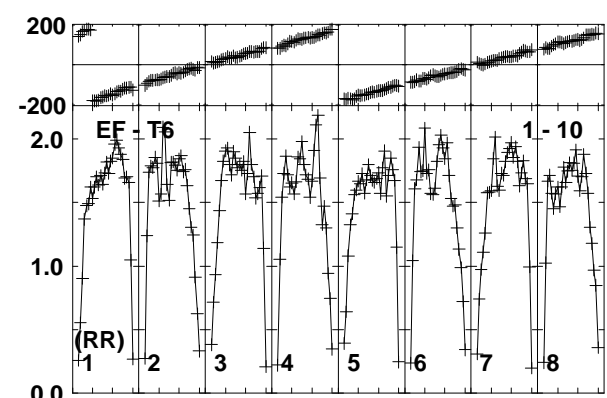
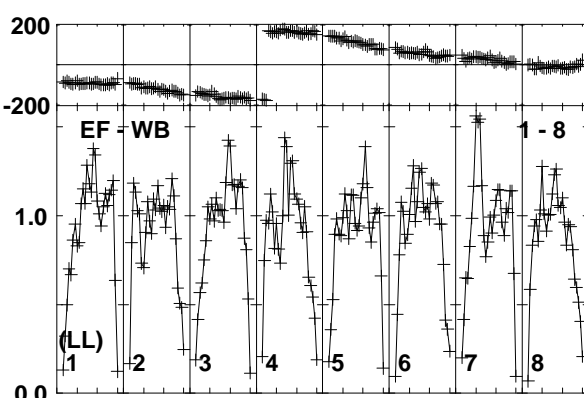
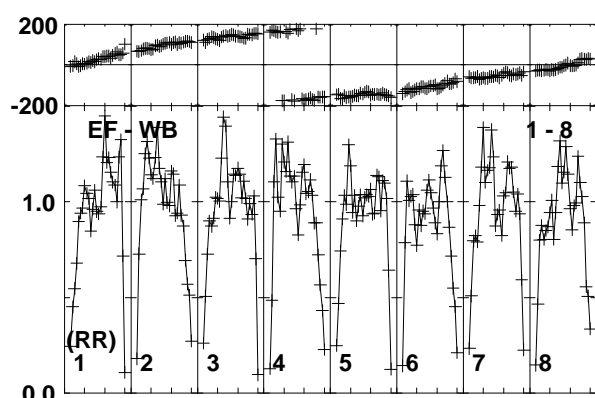
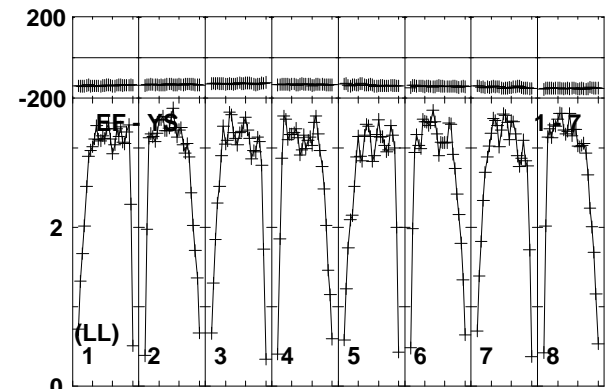
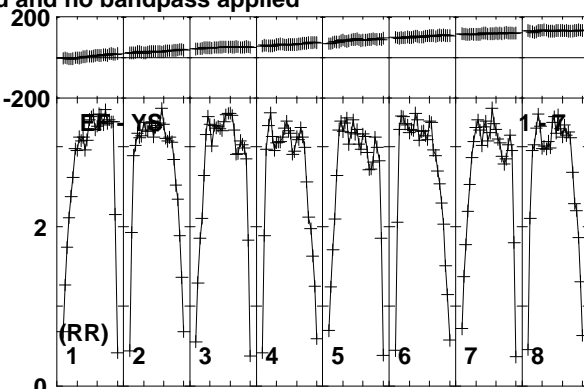
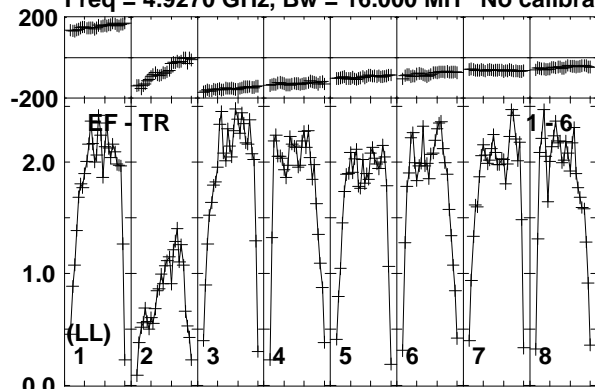

Lower frame: Milli Ampl Jy Top frame: Phas deg  
Vector averaged cross-power spectrum Baseline: EF (01) - TR (06)  
Timerange: 00/21:30:31 to 00/21:32:00

Plot file version 93 created 10-JUN-2016 17:22:09

CHECK RT013A.UVDATA.1

Freq = 4.9270 GHz, Bw = 16.000 MH No calibration applied and no bandpass applied

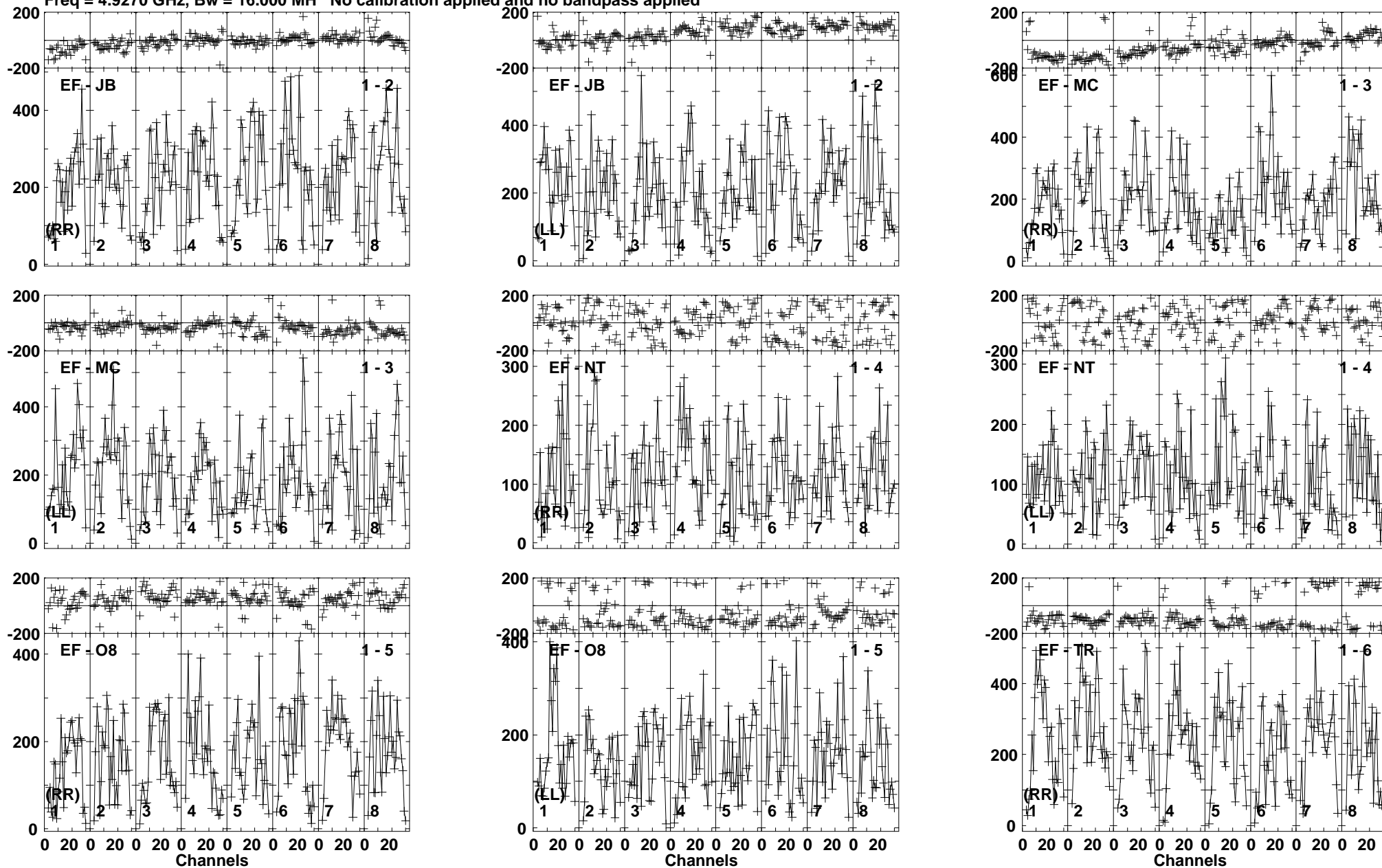

Lower frame: Micro Ampl Jy Top frame: Phas deg  
Vector averaged cross-power spectrum Baseline: EF (01) - JB (02)  
Timerange: 00/21:32:00 to 00/21:34:00

Plot file version 94 created 10-JUN-2016 17:22:09

CHECK RT013A.UVDATA.1

Freq = 4.9270 GHz, Bw = 16.000 MH No calibration applied and no bandpass applied

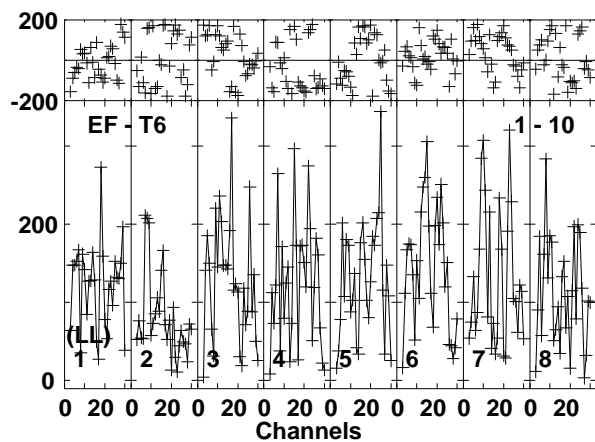
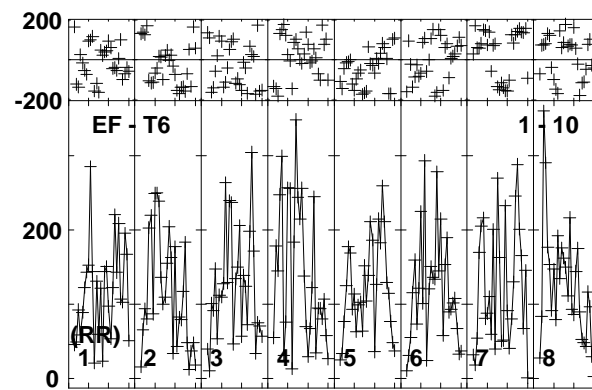
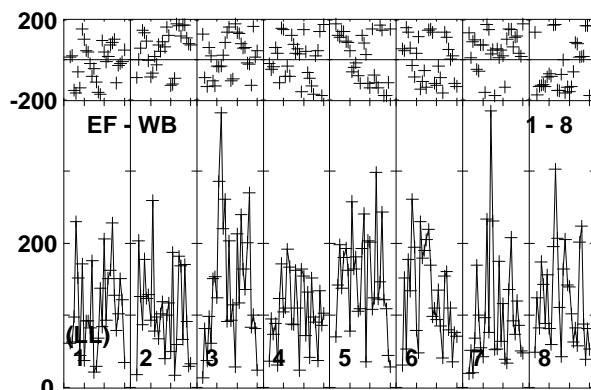
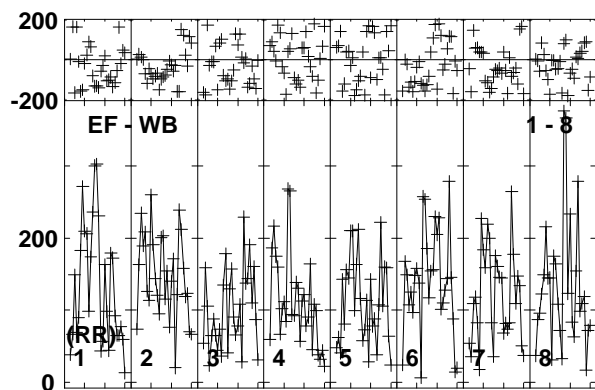
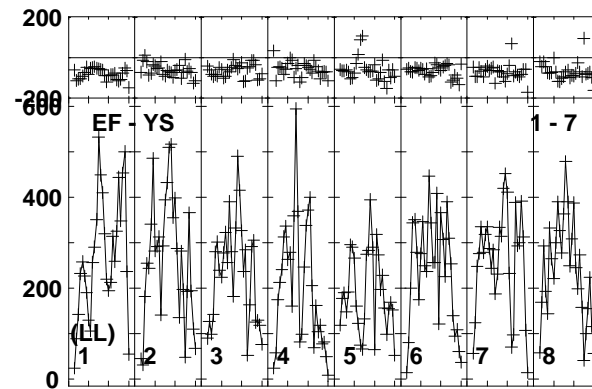
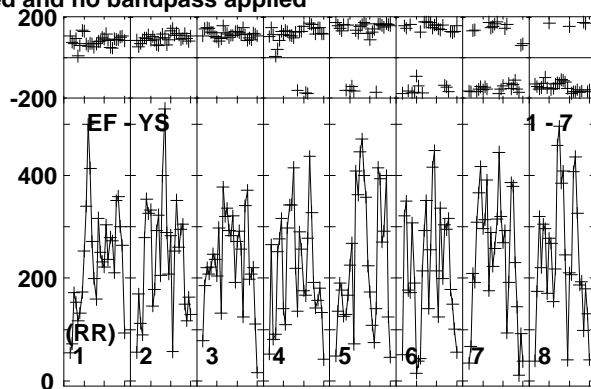
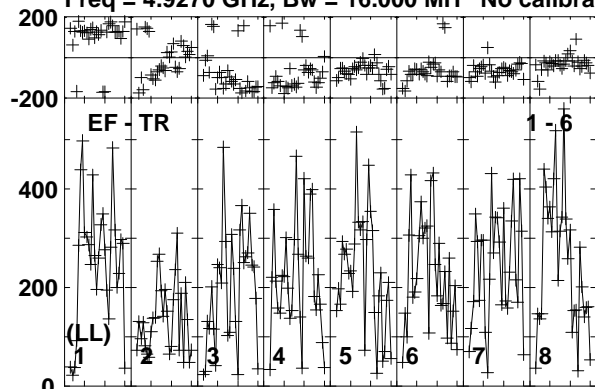

Lower frame: Micro Ampl Jy Top frame: Phas deg  
Vector averaged cross-power spectrum Baseline: EF (01) - TR (06)  
Timerange: 00/21:32:00 to 00/21:34:00

Plot file version 95 created 10-JUN-2016 17:22:09

CYGX1 RT013A.UVDATA.1

Freq = 4.9270 GHz, Bw = 16.000 MH No calibration applied and no bandpass applied

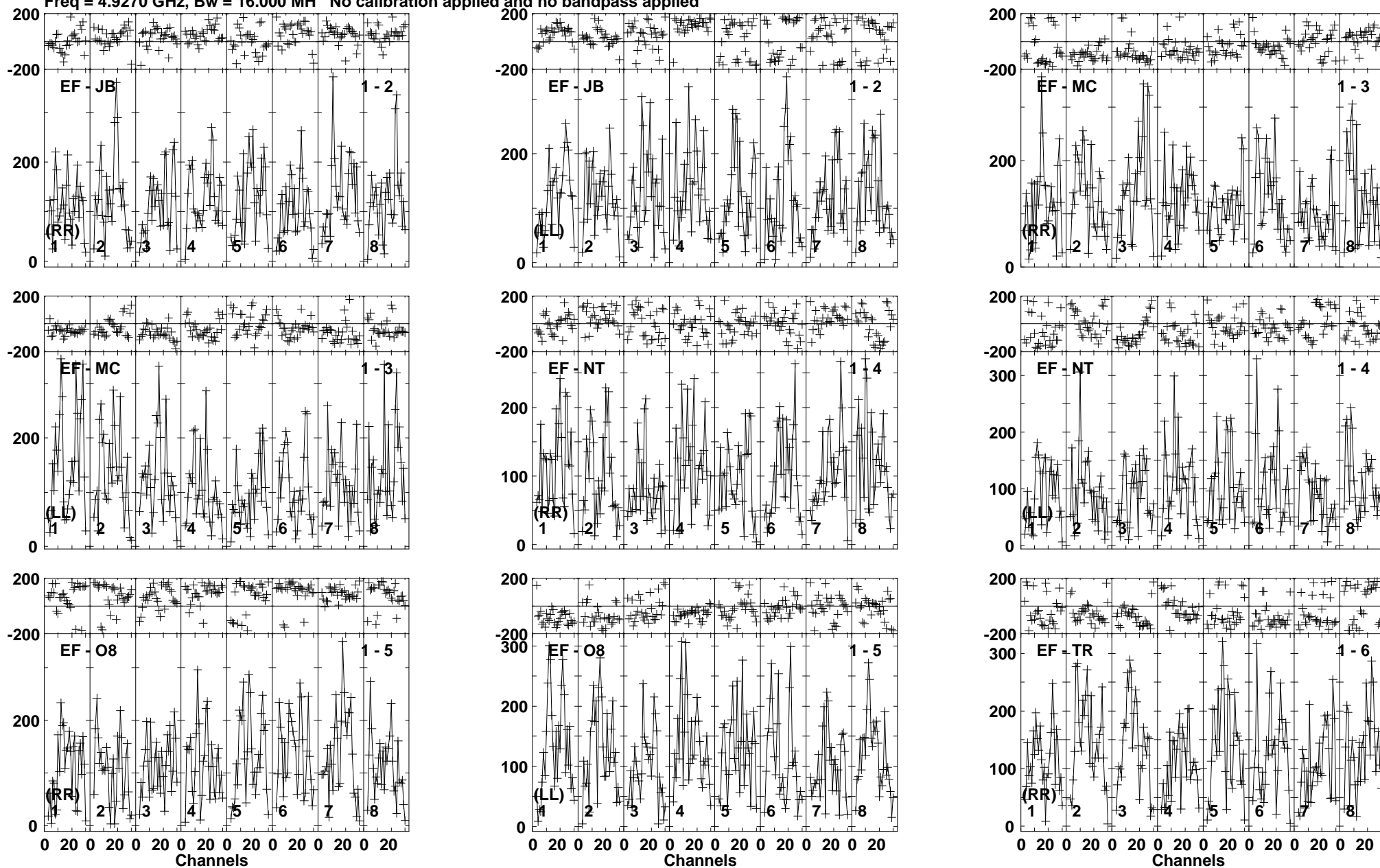

Lower frame: Micro Ampl Jy Top frame: Phas deg  
Vector averaged cross-power spectrum Baseline: EF (01) - JB (02)  
Timerange: 00/21:34:01 to 00/21:36:29

Plot file version 96 created 10-JUN-2016 17:22:09

CYGX1 RT013A.UVDATA.1

Freq = 4.9270 GHz, Bw = 16.000 MH No calibration applied and no bandpass applied

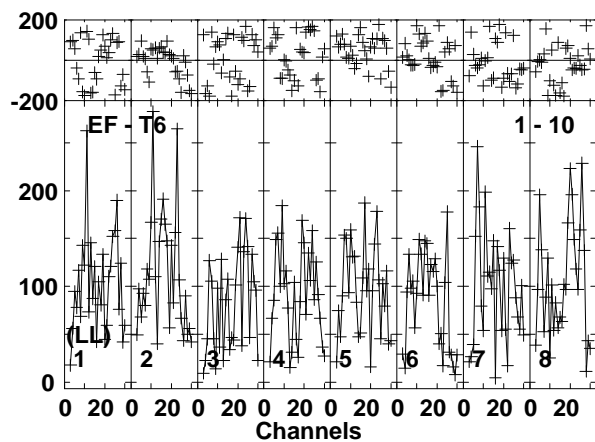
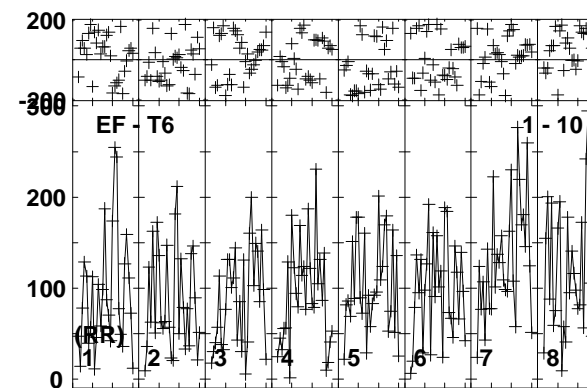
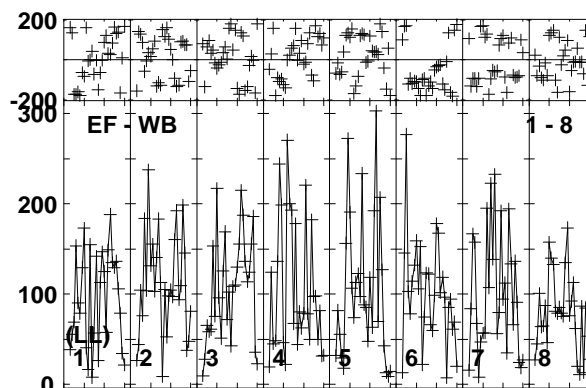
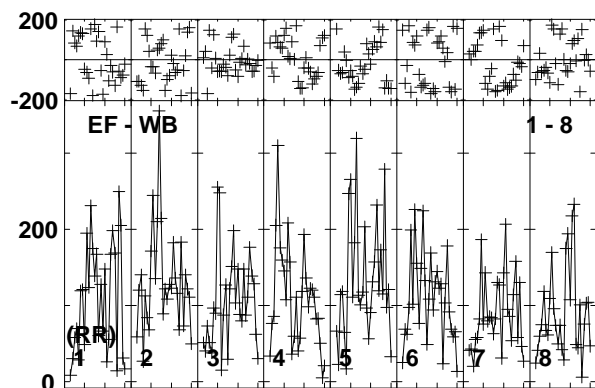
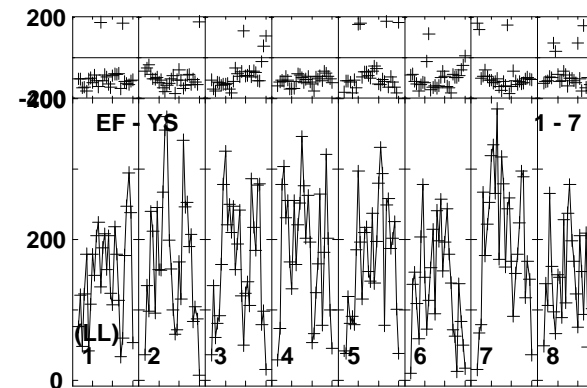
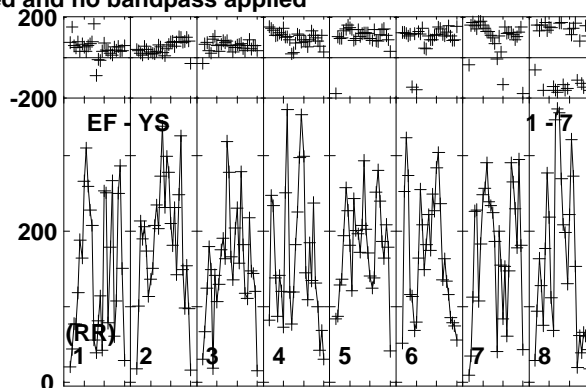
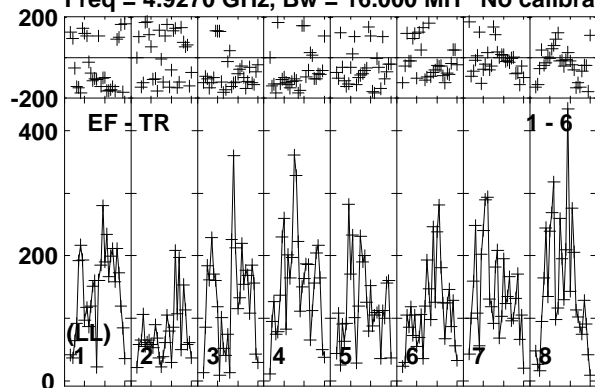

Lower frame: Micro Ampl Jy Top frame: Phas deg  
Vector averaged cross-power spectrum Baseline: EF (01) - TR (06)  
Timerange: 00/21:34:01 to 00/21:36:29

Plot file version 97 created 10-JUN-2016 17:22:09

J1957+3338 RT013A.UVDATA.1

Freq = 4.9270 GHz, Bw = 16.000 MH No calibration applied and no bandpass applied

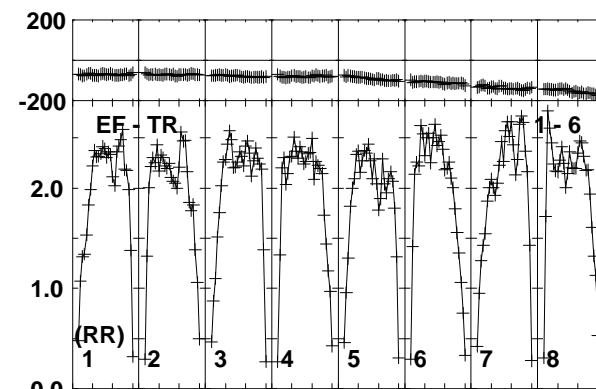
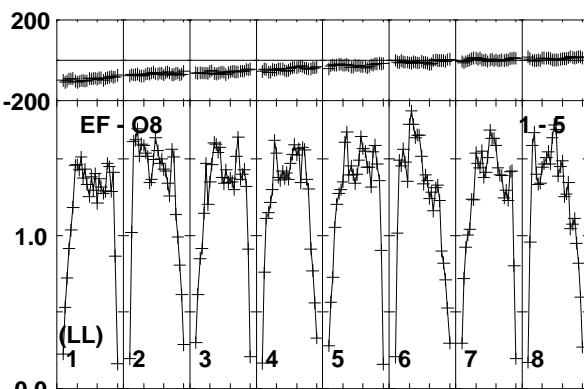
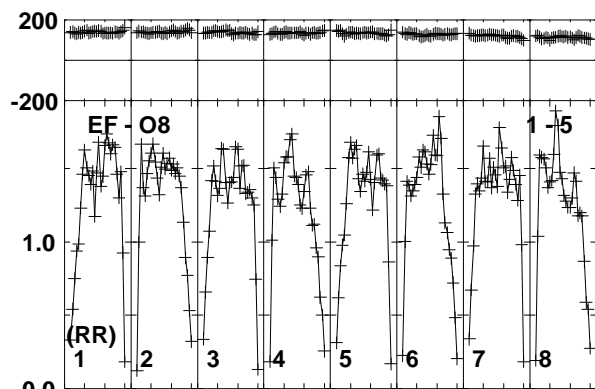
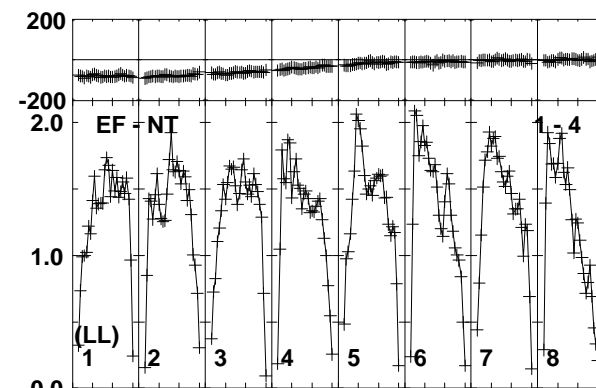
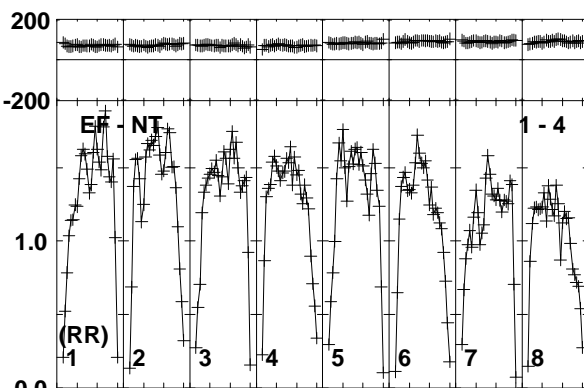
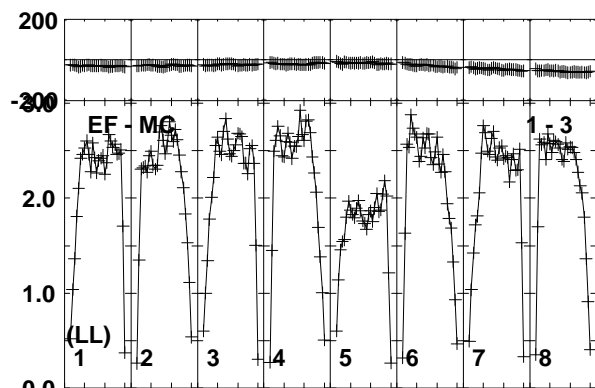
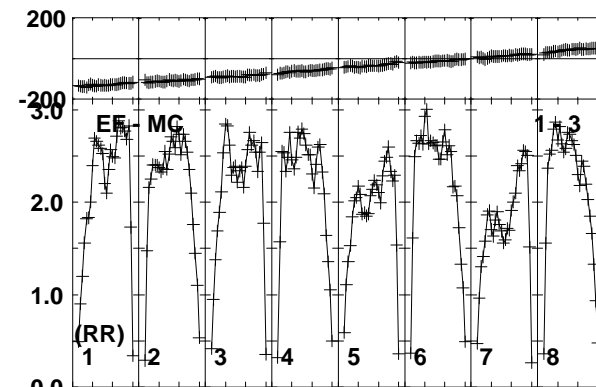
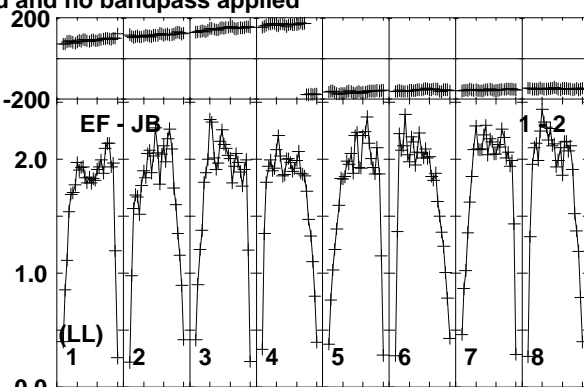
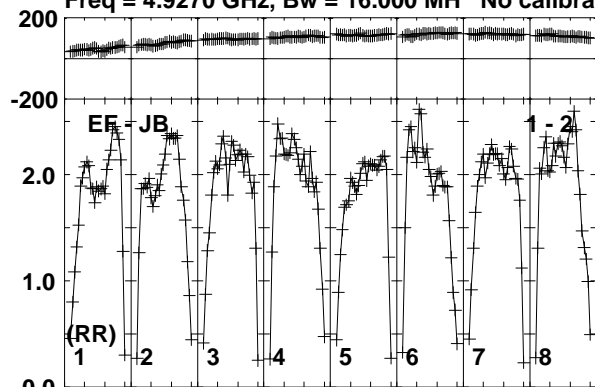

Lower frame: Milli Ampl Jy Top frame: Phas deg  
Vector averaged cross-power spectrum Baseline: EF (01) - JB (02)  
Timerange: 00/21:36:31 to 00/21:37:59

Plot file version 98 created 10-JUN-2016 17:22:09

J1957+3338 RT013A.UVDATA.1

Freq = 4.9270 GHz, Bw = 16.000 MH No calibration applied and no bandpass applied

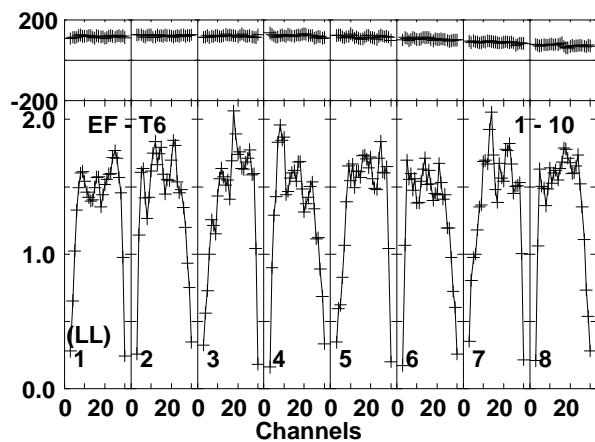
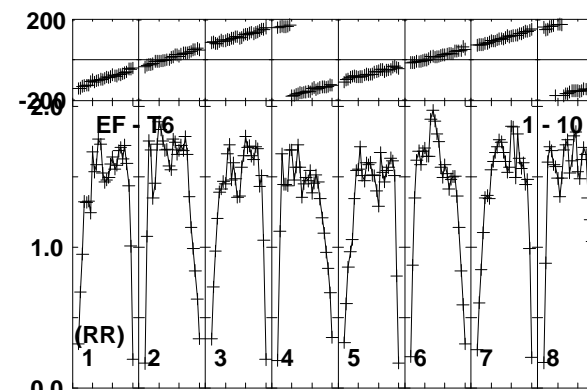
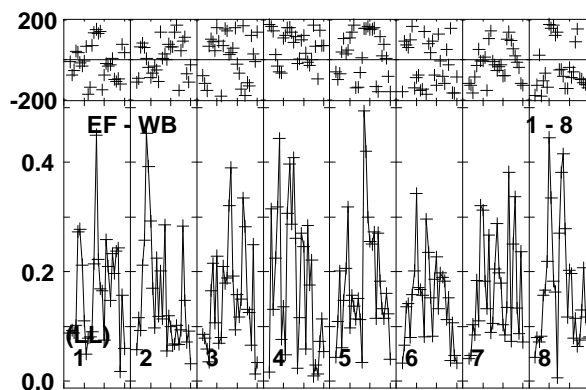
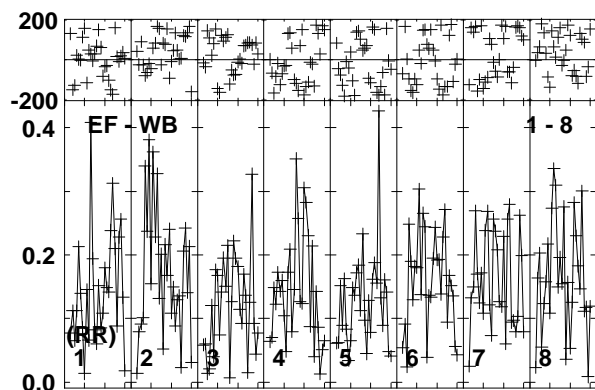
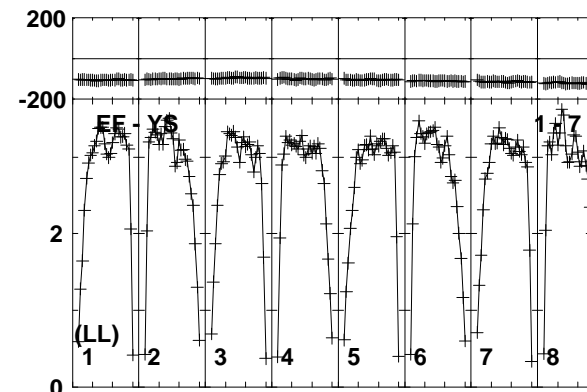
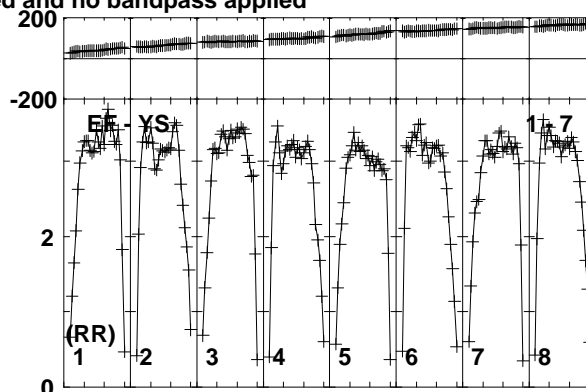
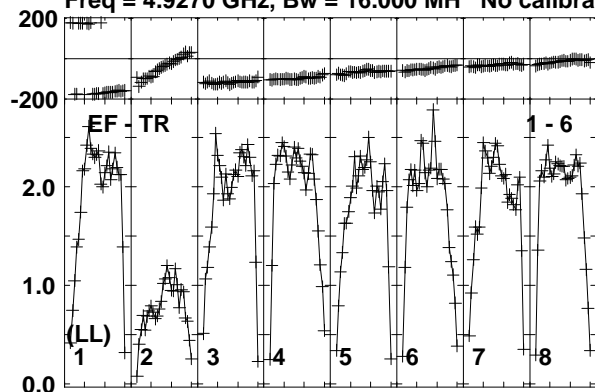

Lower frame: Milli Ampl Jy Top frame: Phas deg  
Vector averaged cross-power spectrum Baseline: EF (01) - TR (06)  
Timerange: 00/21:36:31 to 00/21:37:59



Plot file version 99 created 10-JUN-2016 17:22:09

CHECK RT013A.UVDATA.1

Freq = 4.9270 GHz, Bw = 16.000 MH No calibration applied and no bandpass applied

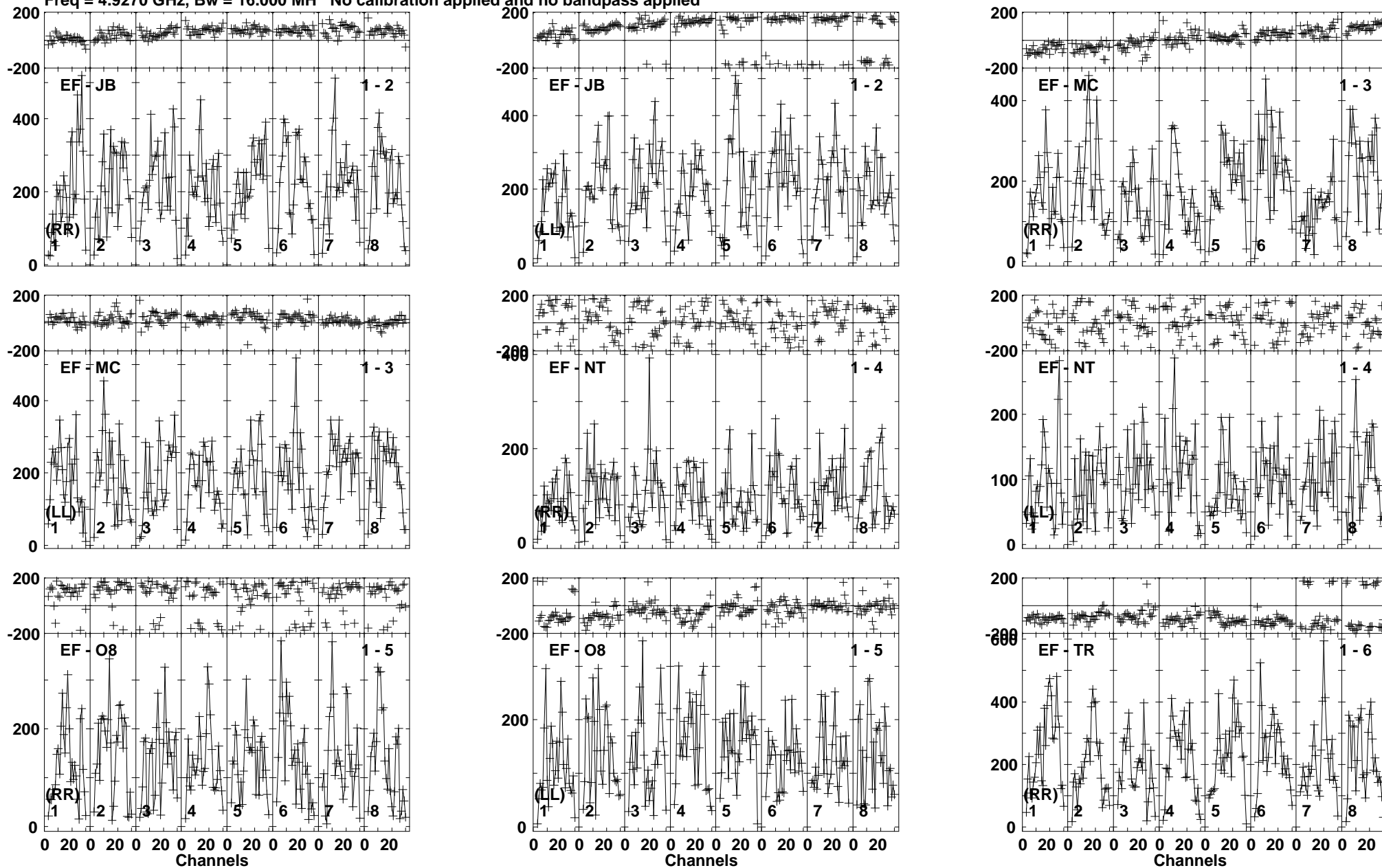

Lower frame: Micro Ampl Jy Top frame: Phas deg  
Vector averaged cross-power spectrum Baseline: EF (01) - JB (02)  
Timerange: 00/21:38:40 to 00/21:40:40

Plot file version 100 created 10-JUN-2016 17:22:10

CHECK RT013A.UVDATA.1

Freq = 4.9270 GHz, Bw = 16.000 MH No calibration applied and no bandpass applied

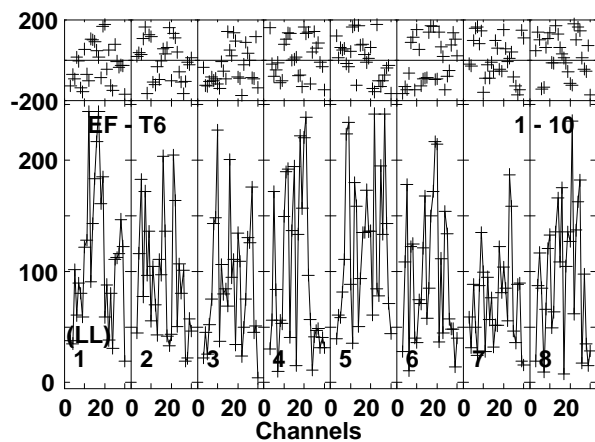
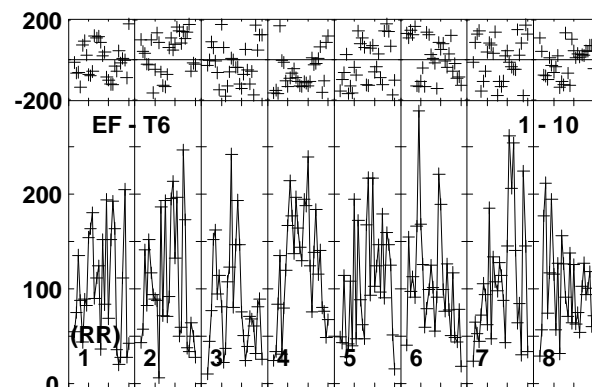
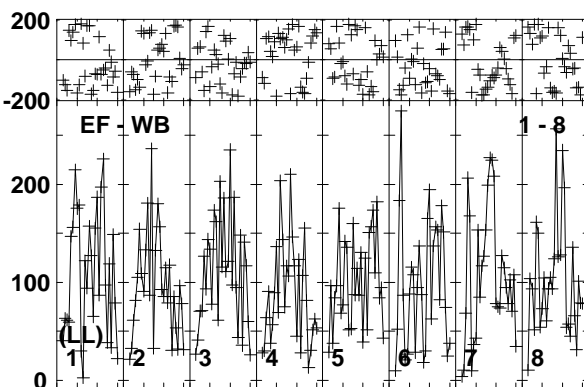
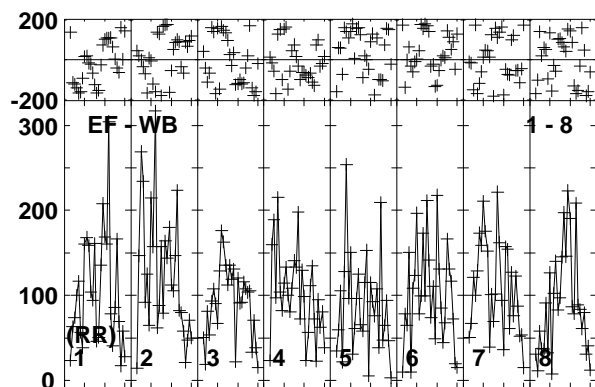
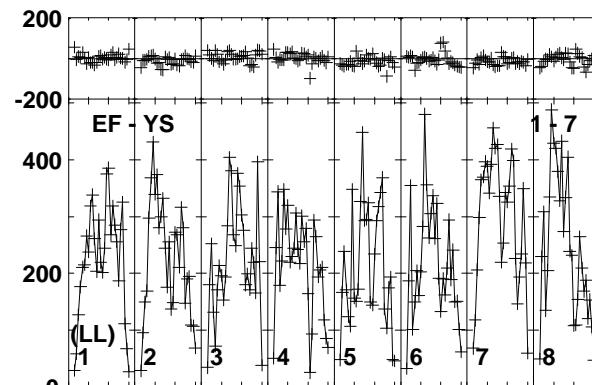
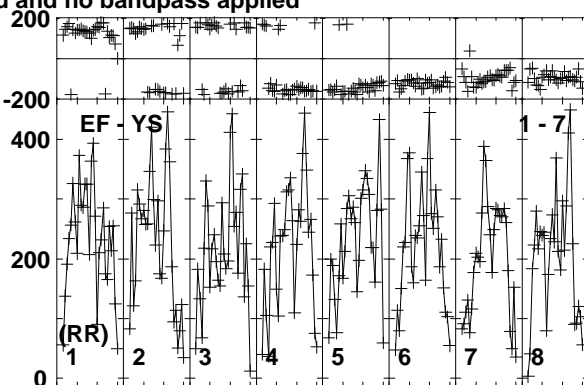
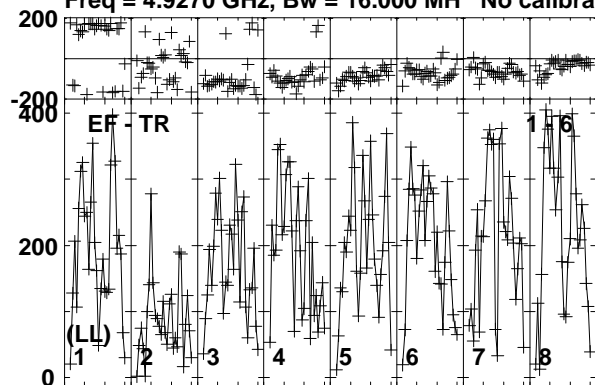

Lower frame: Micro Ampl Jy Top frame: Phas deg  
Vector averaged cross-power spectrum Baseline: EF (01) - TR (06)  
Timerange: 00/21:38:40 to 00/21:40:40

Plot file version 101 created 10-JUN-2016 17:22:10

CYGX1 RT013A.UVDATA.1

Freq = 4.9270 GHz, Bw = 16.000 MH No calibration applied and no bandpass applied

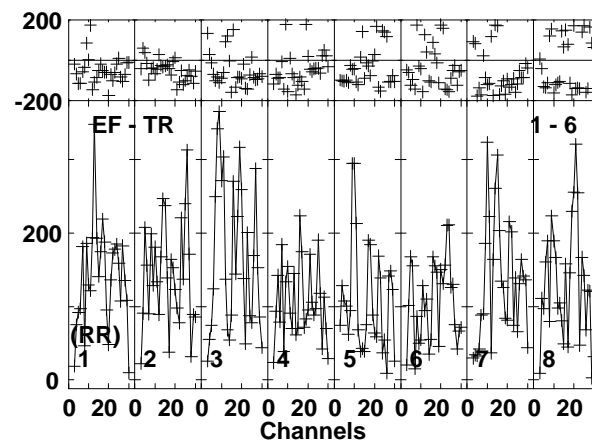
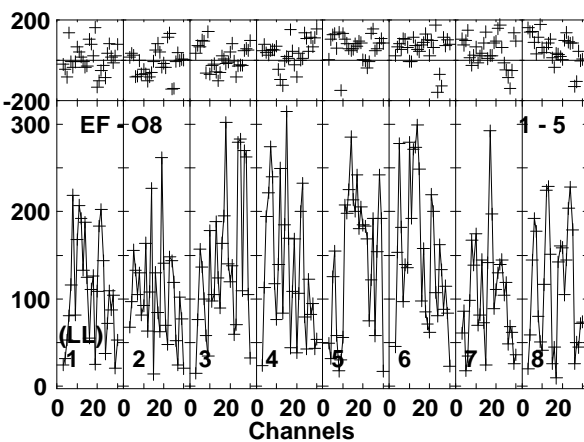
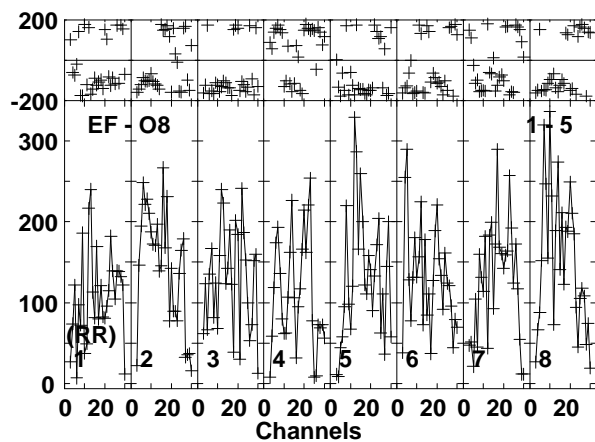
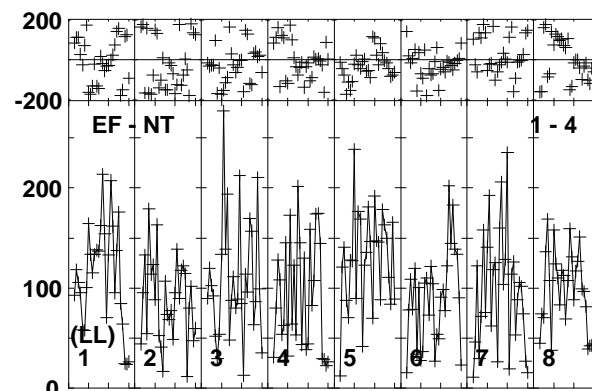
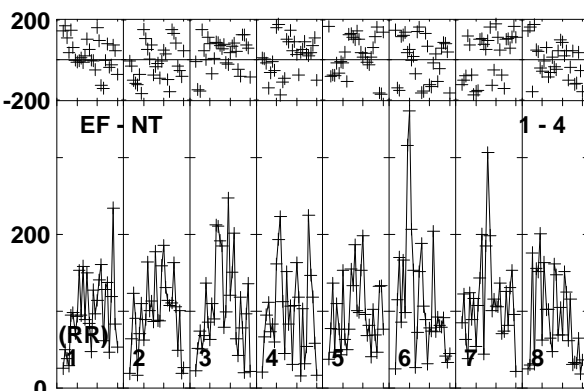
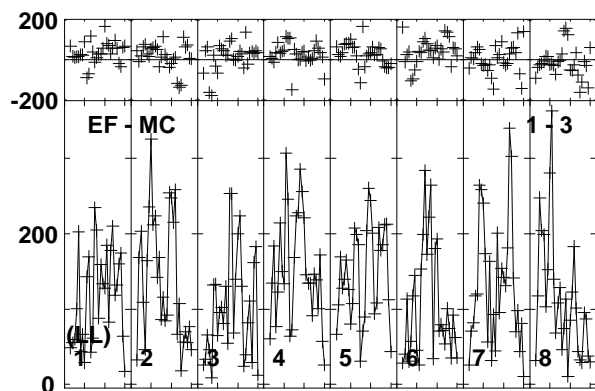
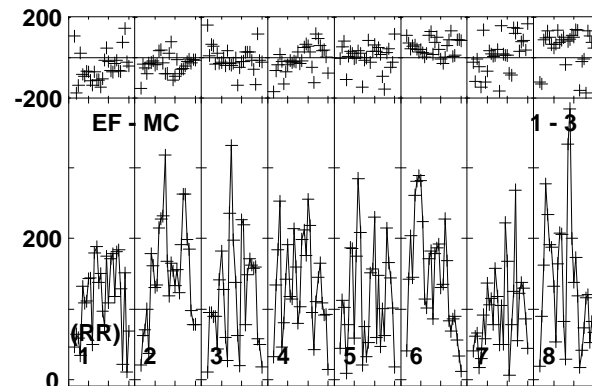
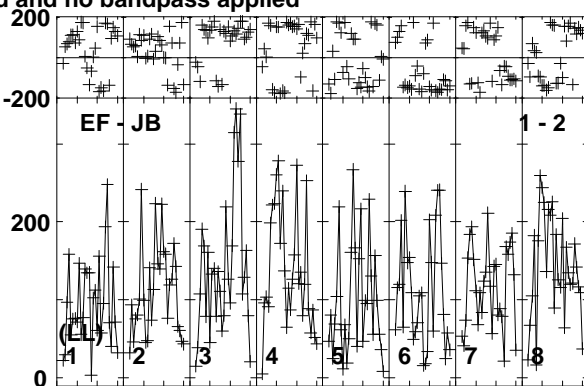
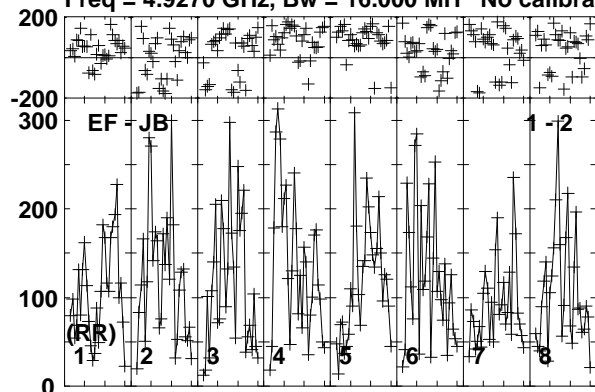

Lower frame: Micro Ampl Jy Top frame: Phas deg  
Vector averaged cross-power spectrum Baseline: EF (01) - JB (02)  
Timerange: 00/21:40:41 to 00/21:43:09

Plot file version 102 created 10-JUN-2016 17:22:10

CYGX1 RT013A.UVDATA.1

Freq = 4.9270 GHz, Bw = 16.000 MH No calibration applied and no bandpass applied

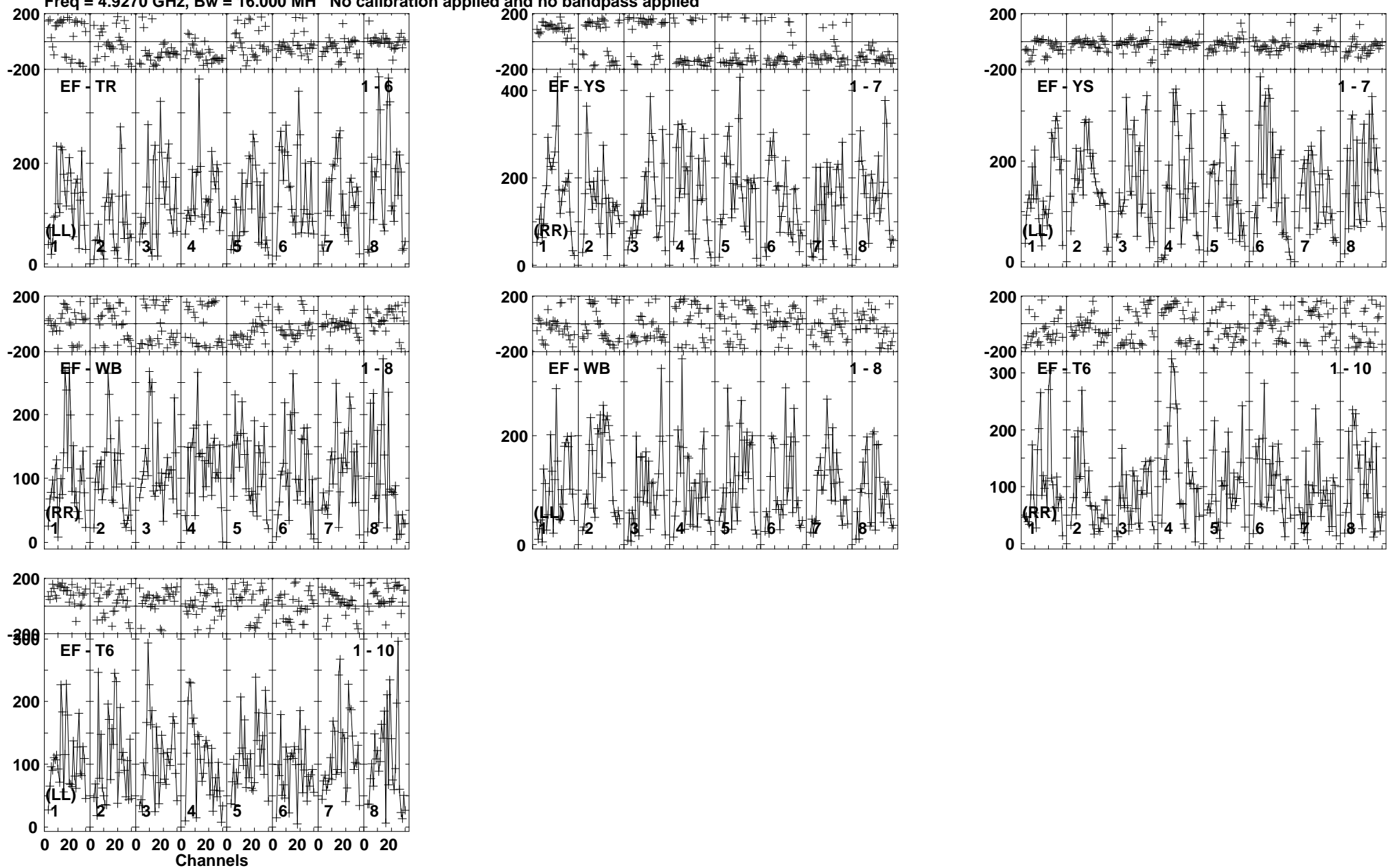

Lower frame: Micro Ampl Jy Top frame: Phas deg  
Vector averaged cross-power spectrum Baseline: EF (01) - TR (06)  
Timerange: 00/21:40:41 to 00/21:43:09

Plot file version 103 created 10-JUN-2016 17:22:10

J1957+3338 RT013A.UVDATA.1

Freq = 4.9270 GHz, Bw = 16.000 MH No calibration applied and no bandpass applied

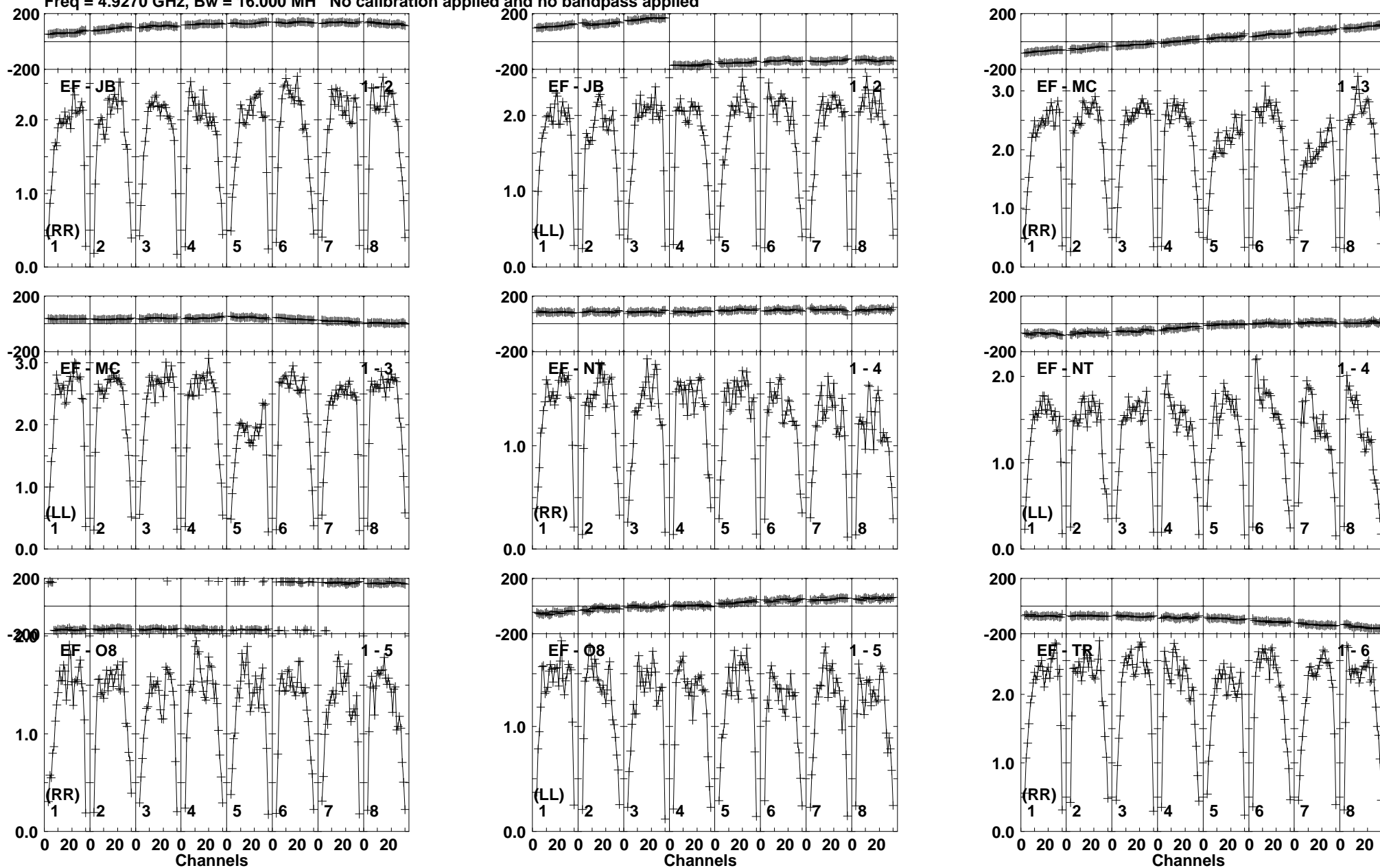

Lower frame: Milli Ampl Jy Top frame: Phas deg  
Vector averaged cross-power spectrum Baseline: EF (01) - JB (02)  
Timerange: 00/21:43:11 to 00/21:44:39

Plot file version 104 created 10-JUN-2016 17:22:10

J1957+3338 RT013A.UVDATA.1

Freq = 4.9270 GHz, Bw = 16.000 MH No calibration applied and no bandpass applied

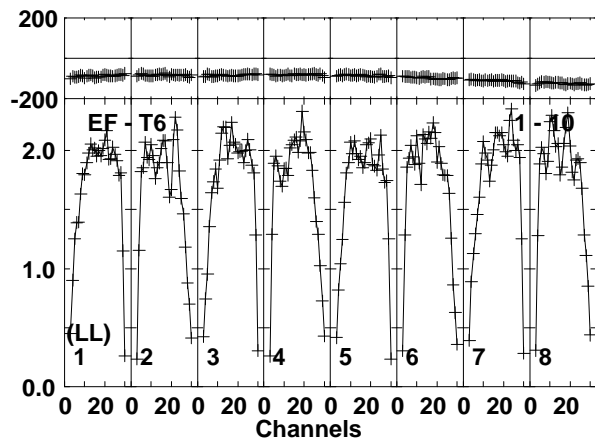
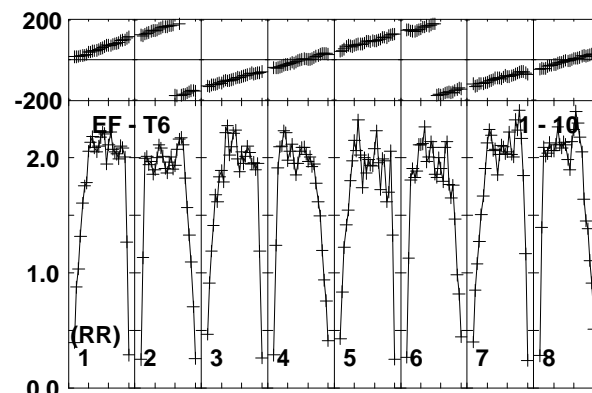
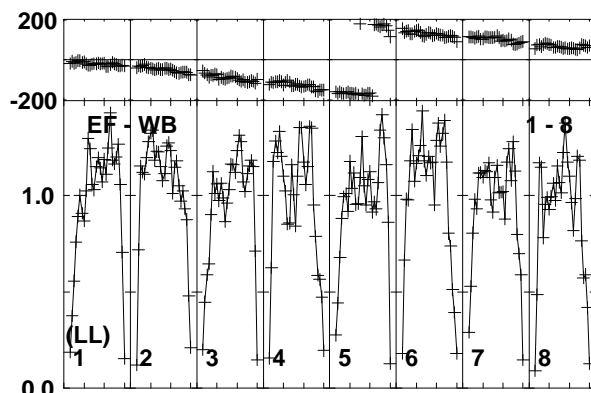
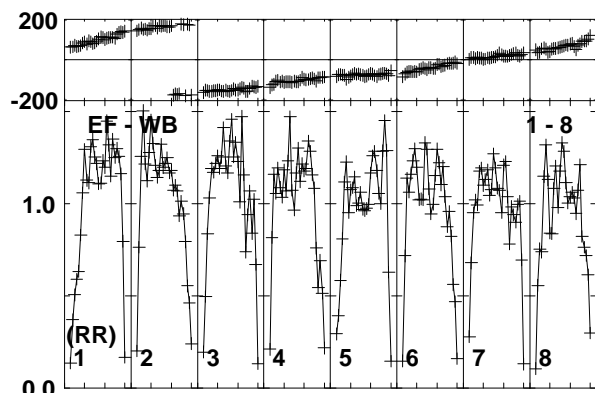
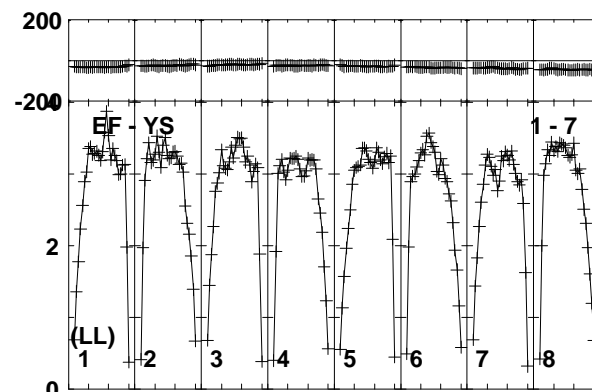
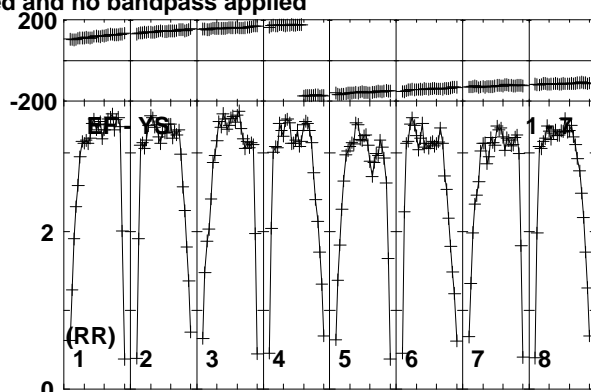
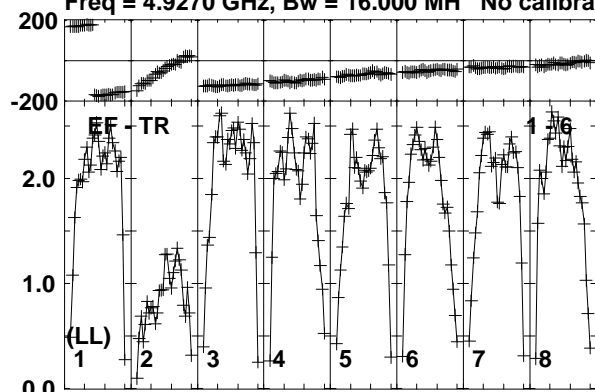

Lower frame: Milli Ampl Jy Top frame: Phas deg  
Vector averaged cross-power spectrum Baseline: EF (01) - TR (06)  
Timerange: 00/21:43:11 to 00/21:44:39

Plot file version 105 created 10-JUN-2016 17:22:10

CHECK RT013A.UVDATA.1

Freq = 4.9270 GHz, Bw = 16.000 MH No calibration applied and no bandpass applied

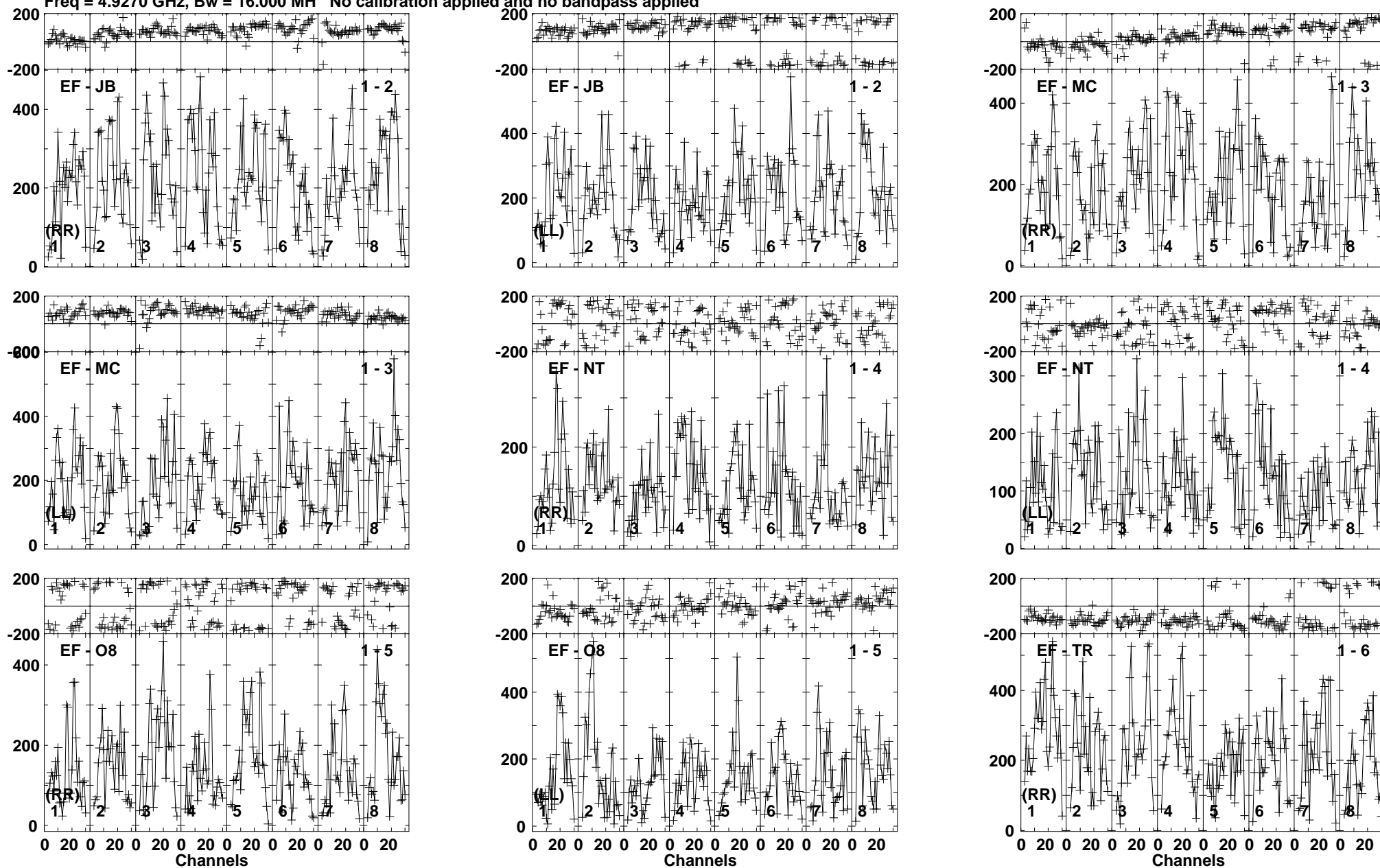

Lower frame: Micro Ampl Jy Top frame: Phas deg  
Vector averaged cross-power spectrum Baseline: EF (01) - JB (02)  
Timerange: 00/21:44:40 to 00/21:46:40

Plot file version 106 created 10-JUN-2016 17:22:10

CHECK RT013A.UVDATA.1

Freq = 4.9270 GHz, Bw = 16.000 MH No calibration applied and no bandpass applied

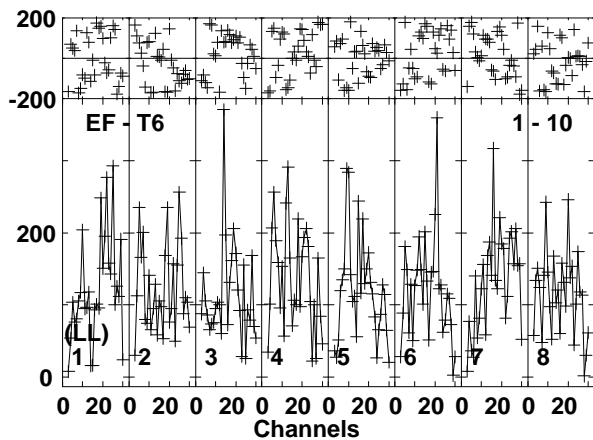
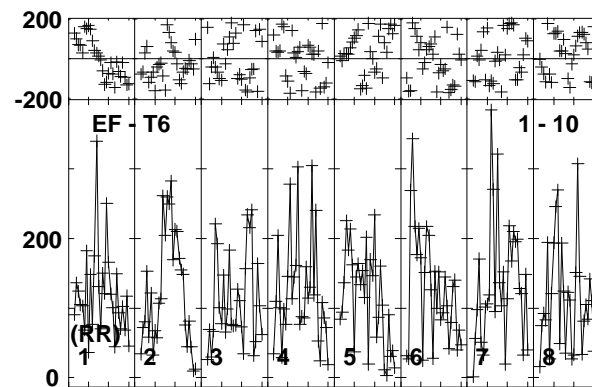
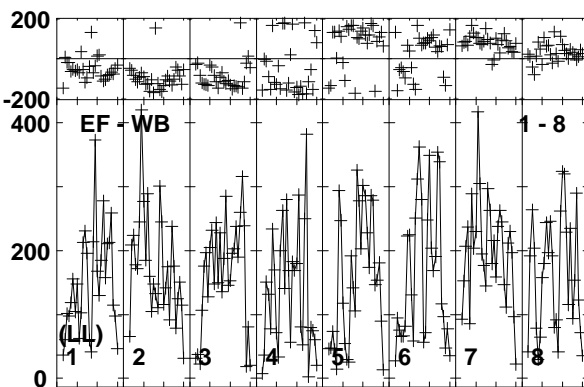
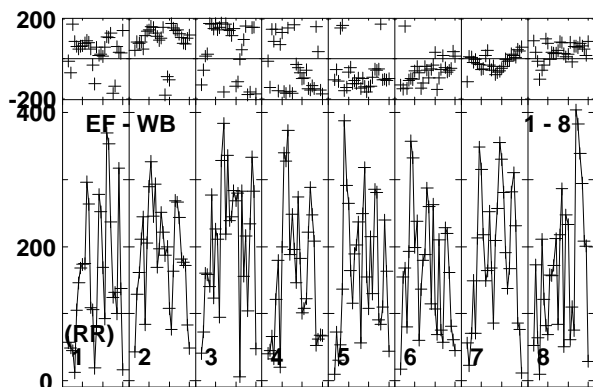
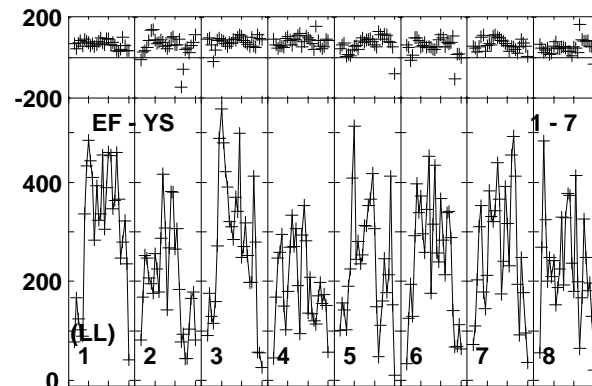
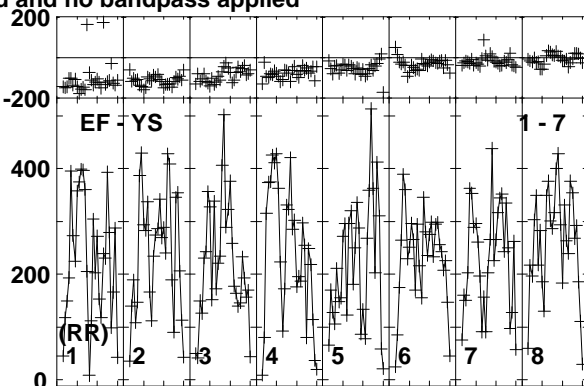
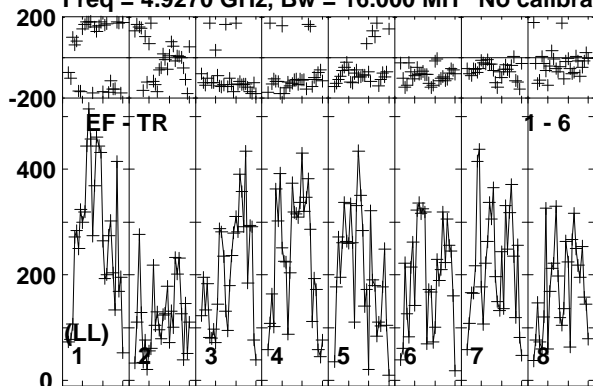

Lower frame: Micro Ampl Jy Top frame: Phas deg  
Vector averaged cross-power spectrum Baseline: EF (01) - TR (06)  
Timerange: 00/21:44:40 to 00/21:46:40



Plot file version 107 created 10-JUN-2016 17:22:10

CYGX1 RT013A.UVDATA.1

Freq = 4.9270 GHz, Bw = 16.000 MH No calibration applied and no bandpass applied

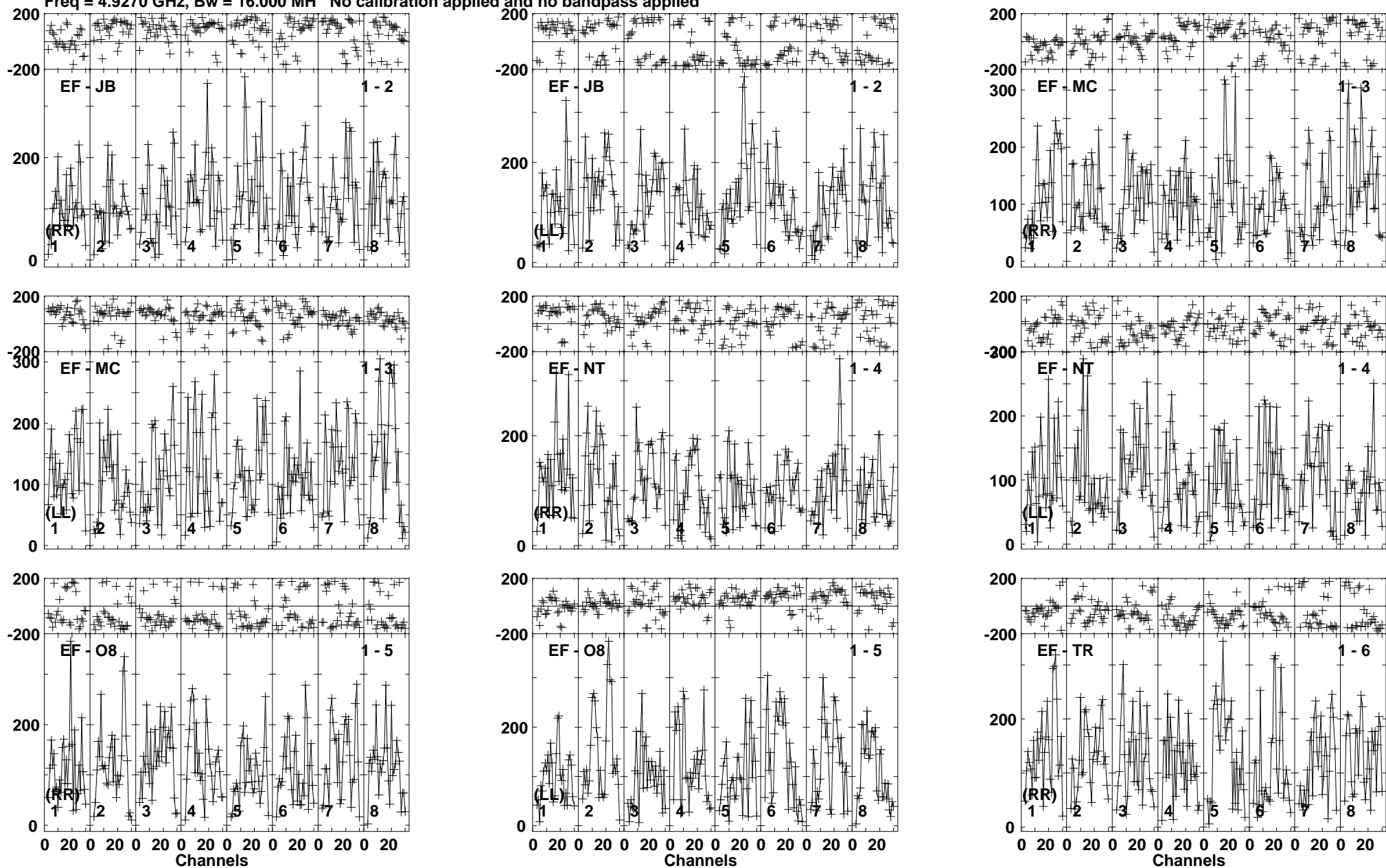

Lower frame: Micro Ampl Jy Top frame: Phas deg  
Vector averaged cross-power spectrum Baseline: EF (01) - JB (02)  
Timerange: 00/21:46:41 to 00/21:49:09

Plot file version 108 created 10-JUN-2016 17:22:10

CYGX1 RT013A.UVDATA.1

Freq = 4.9270 GHz, Bw = 16.000 MH No calibration applied and no bandpass applied

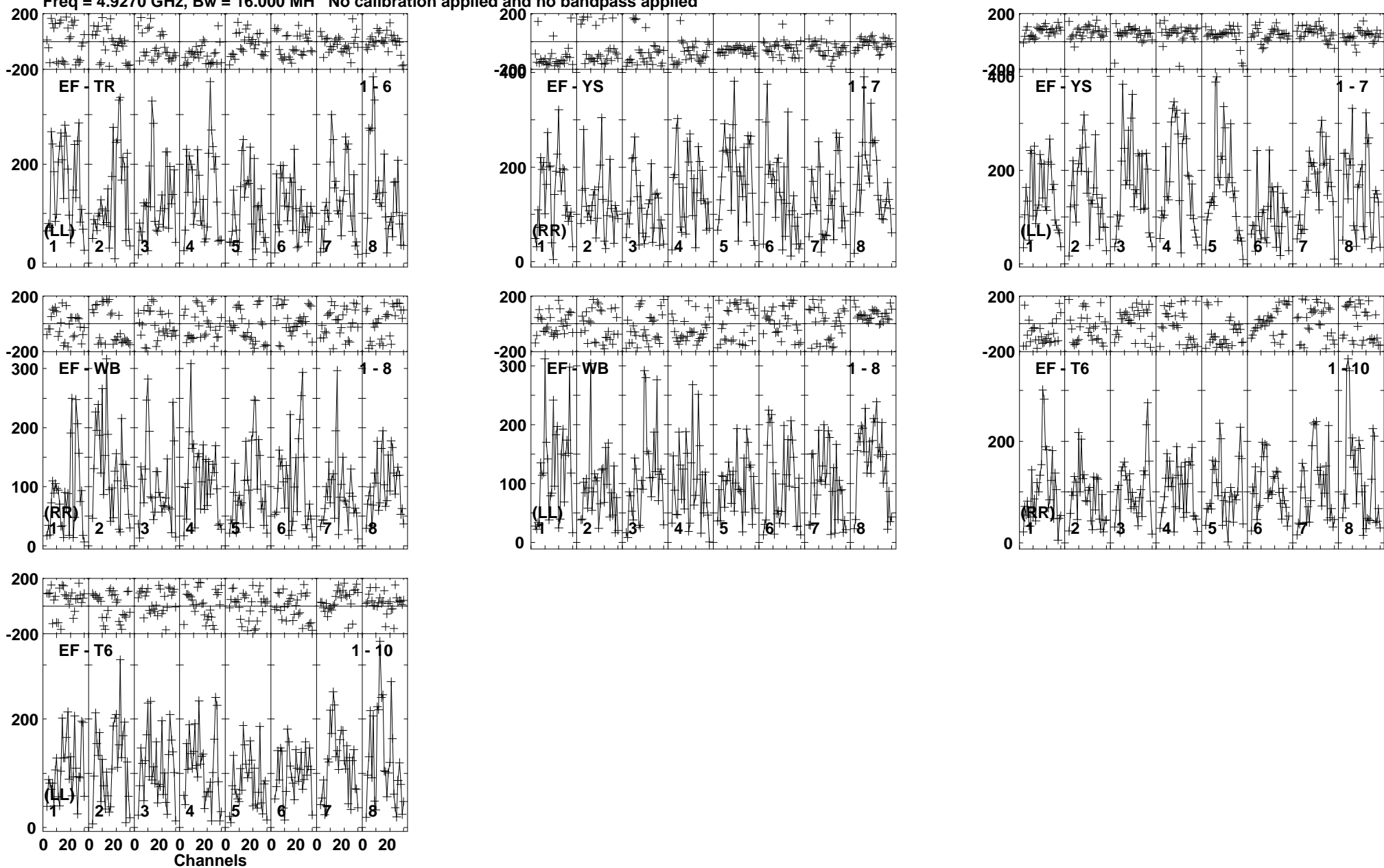

Lower frame: Micro Ampl Jy Top frame: Phas deg  
Vector averaged cross-power spectrum Baseline: EF (01) - TR (06)  
Timerange: 00:21:46:41 to 00:21:49:09

Plot file version 109 created 10-JUN-2016 17:22:11

J1957+3338 RT013A.UVDATA.1

Freq = 4.9270 GHz, Bw = 16.000 MH No calibration applied and no bandpass applied

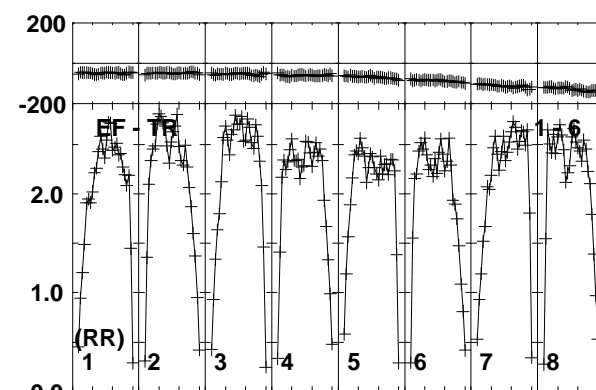
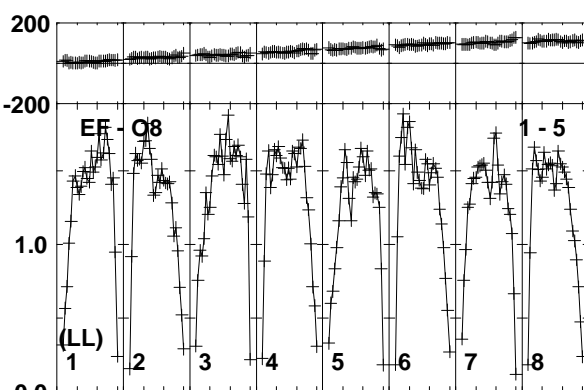
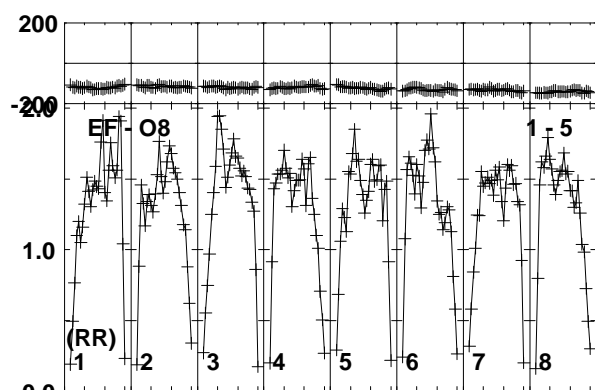
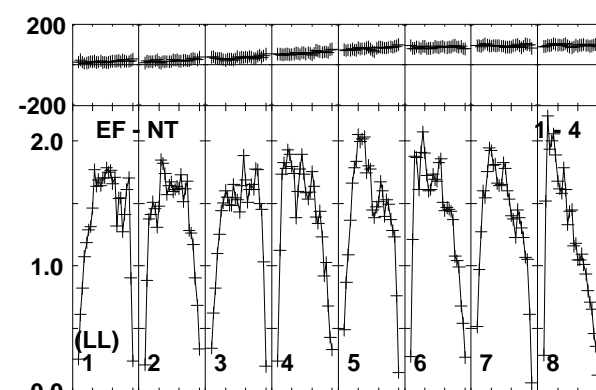
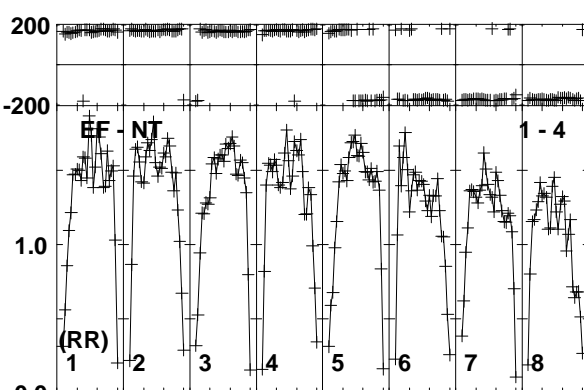
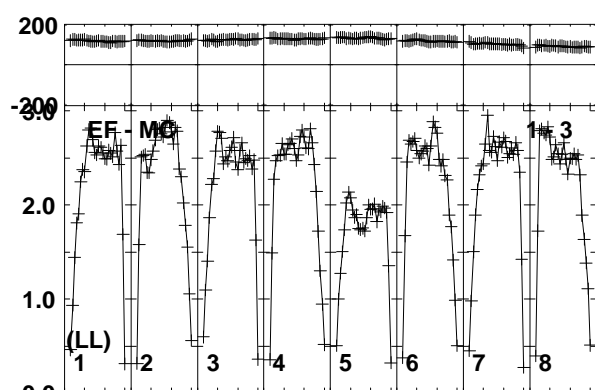
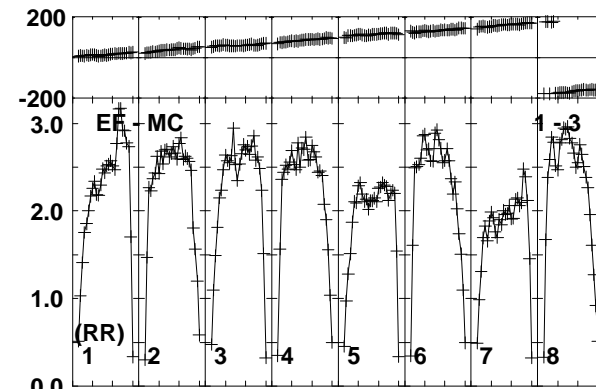
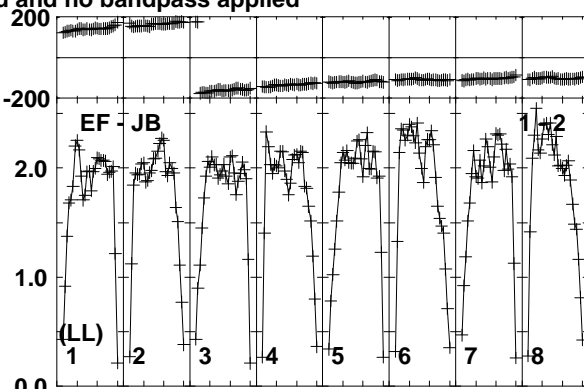
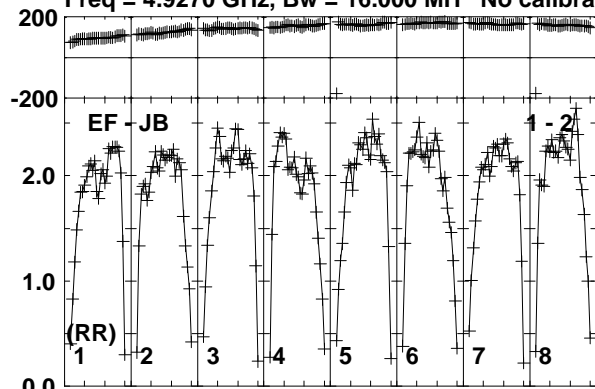

Lower frame: Milli Ampl Jy Top frame: Phas deg  
Vector averaged cross-power spectrum Baseline: EF (01) - JB (02)  
Timerange: 00:21:49:11 to 00:21:50:39

Plot file version 110 created 10-JUN-2016 17:22:11

J1957+3338 RT013A.UVDATA.1

Freq = 4.9270 GHz, Bw = 16.000 MH No calibration applied and no bandpass applied

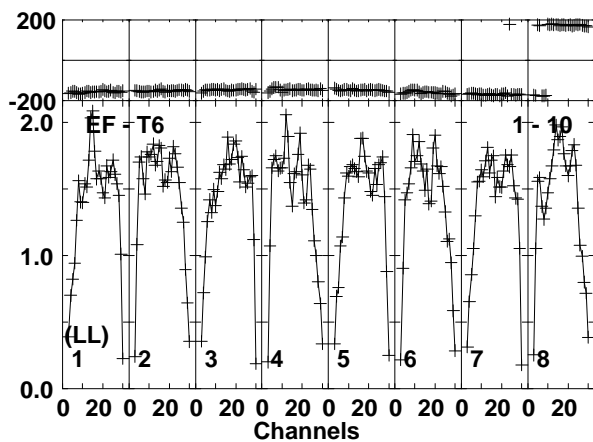
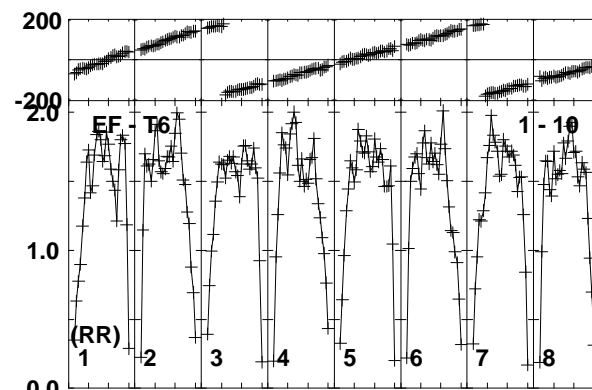
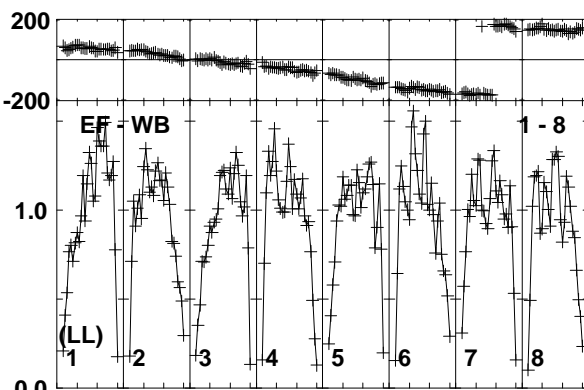
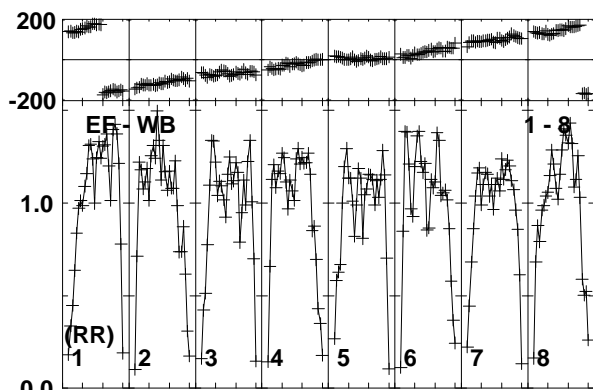
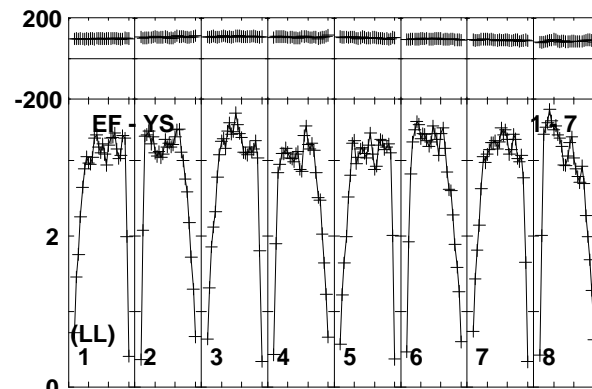
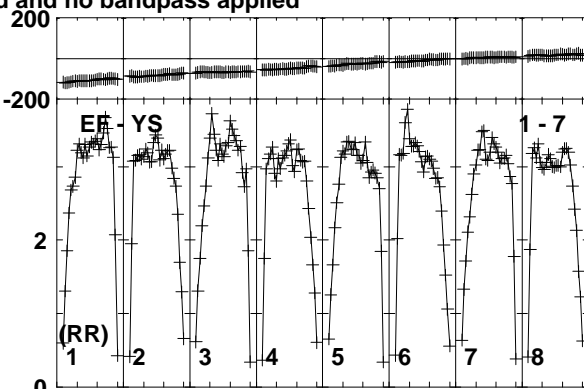
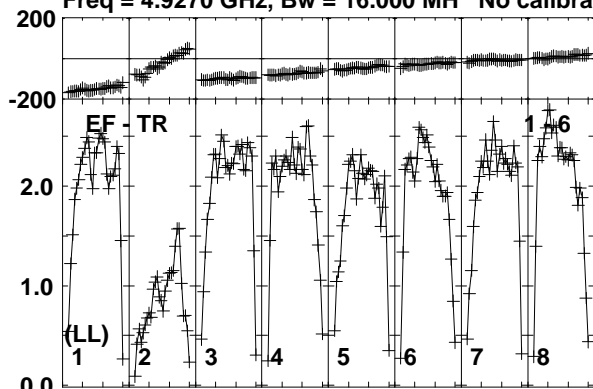

Lower frame: Milli Ampl Jy Top frame: Phas deg  
Vector averaged cross-power spectrum Baseline: EF (01) - TR (06)  
Timerange: 00/21:49:11 to 00/21:50:39

Plot file version 111 created 10-JUN-2016 17:22:11

CHECK RT013A.UVDATA.1

Freq = 4.9270 GHz, Bw = 16.000 MH No calibration applied and no bandpass applied

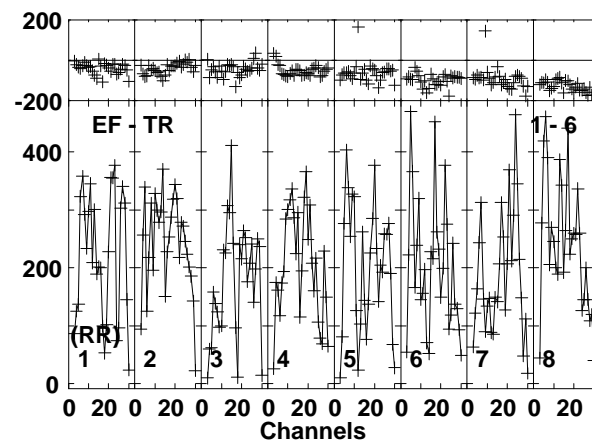
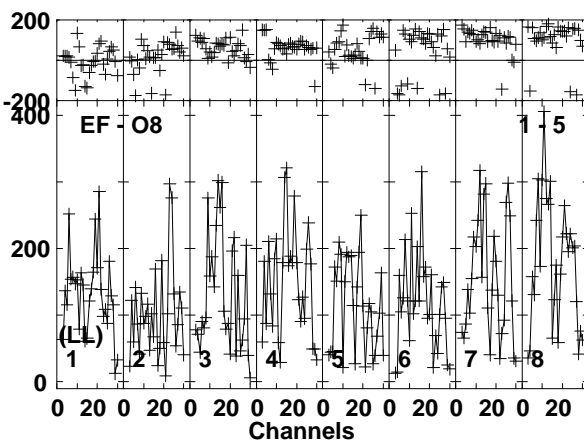
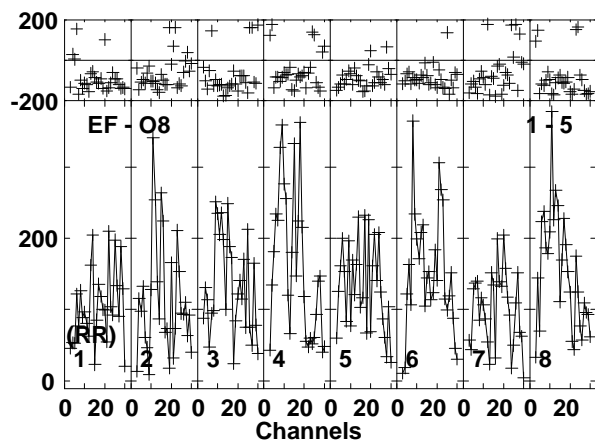
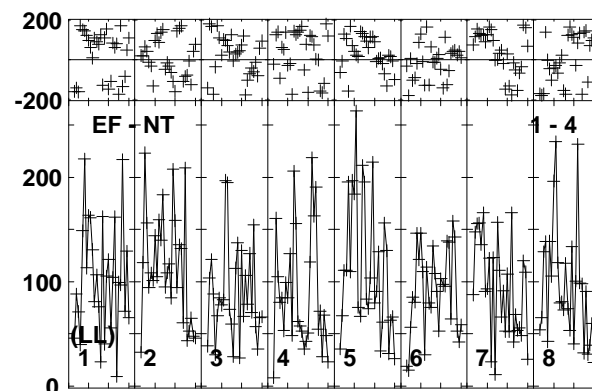
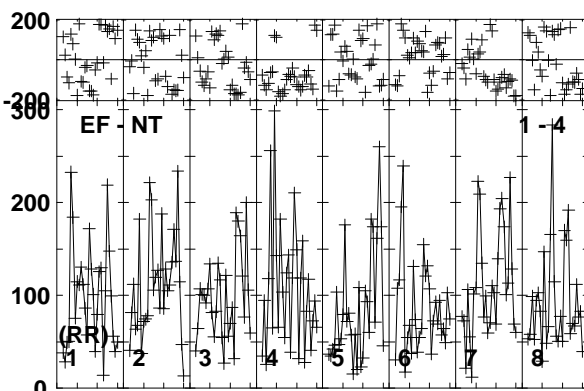
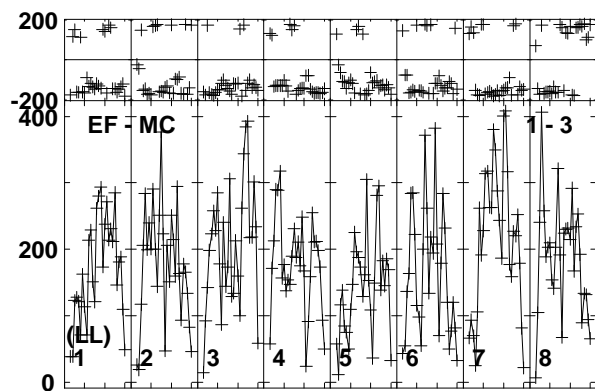
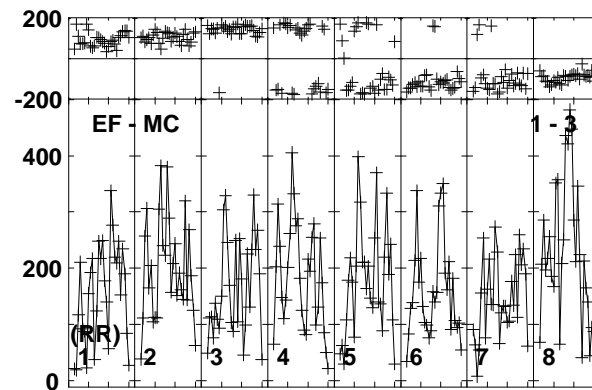
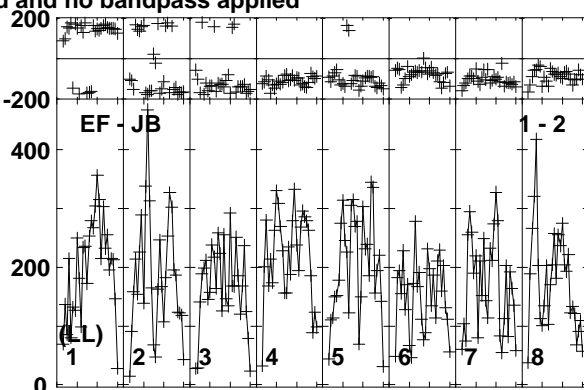
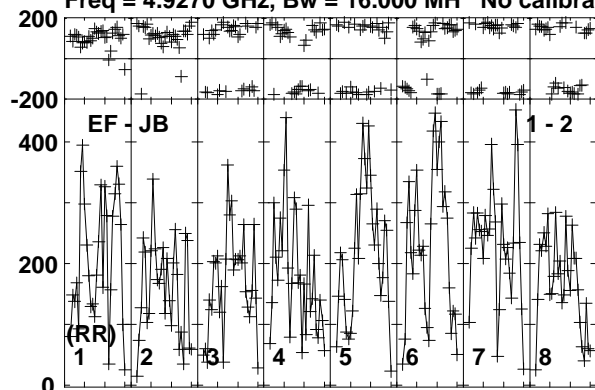

Lower frame: Micro Ampl Jy Top frame: Phas deg  
Vector averaged cross-power spectrum Baseline: EF (01) - JB (02)  
Timerange: 00/21:51:20 to 00/21:53:20

Plot file version 112 created 10-JUN-2016 17:22:11

CHECK RT013A.UVDATA.1

Freq = 4.9270 GHz, Bw = 16.000 MH No calibration applied and no bandpass applied

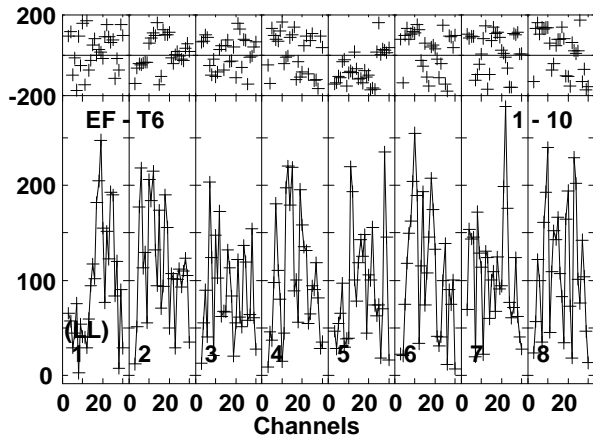
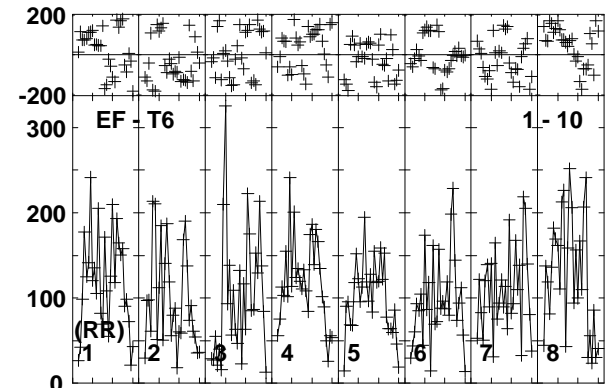
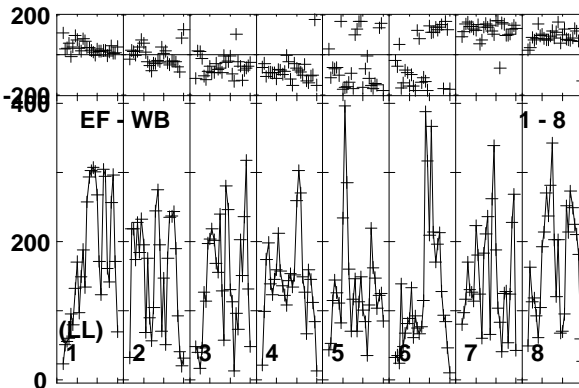
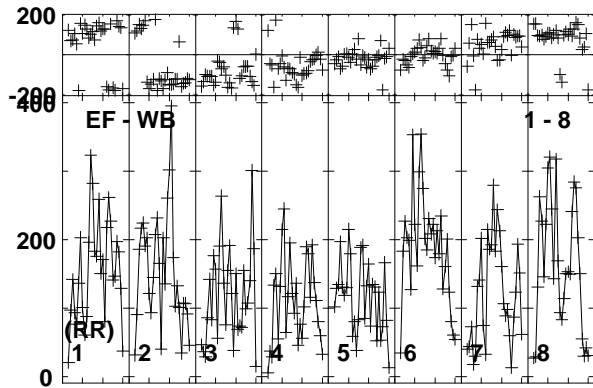
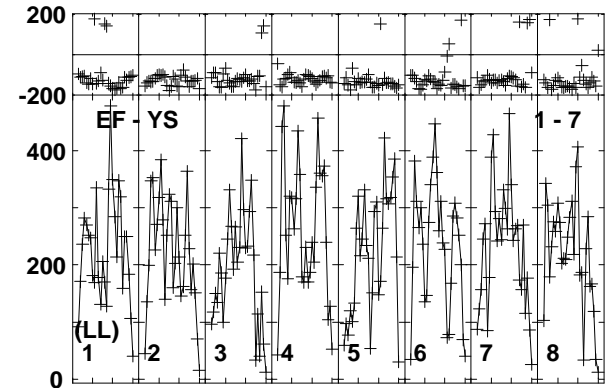
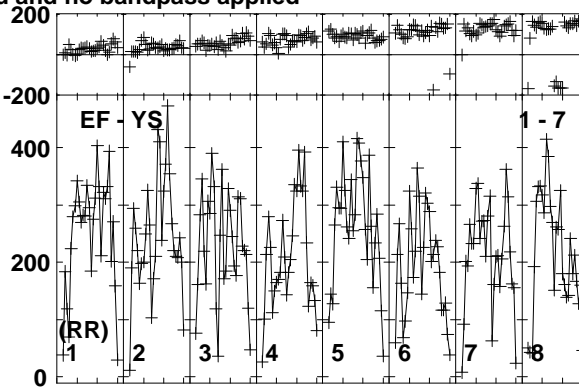
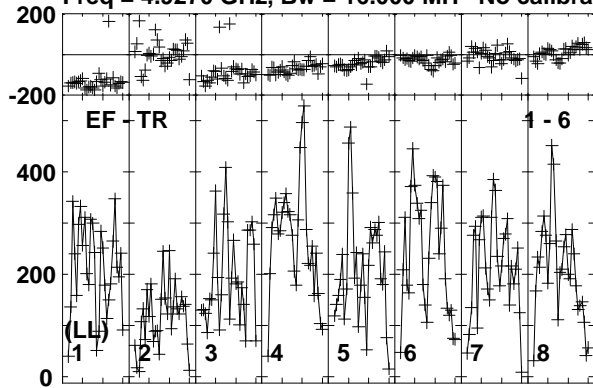

Lower frame: Micro Ampl Jy Top frame: Phas deg  
Vector averaged cross-power spectrum Baseline: EF (01) - TR (06)  
Timerange: 00/21:51:20 to 00/21:53:20

Plot file version 113 created 10-JUN-2016 17:22:11

CYGX1 RT013A.UVDATA.1

Freq = 4.9270 GHz, Bw = 16.000 MH No calibration applied and no bandpass applied

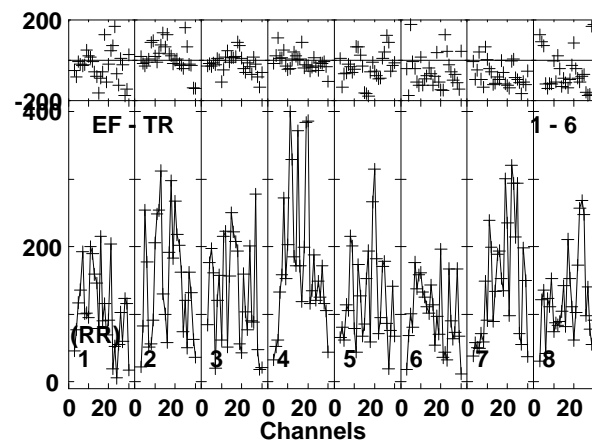
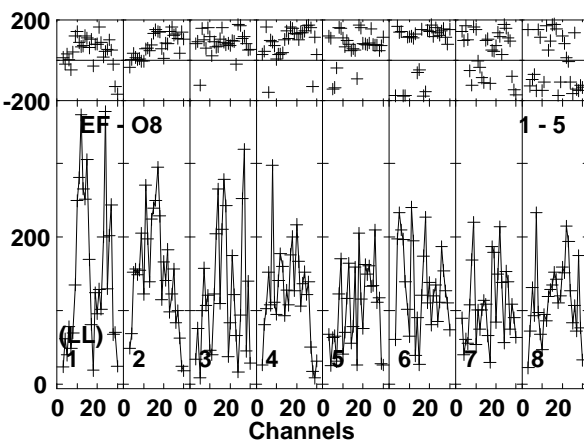
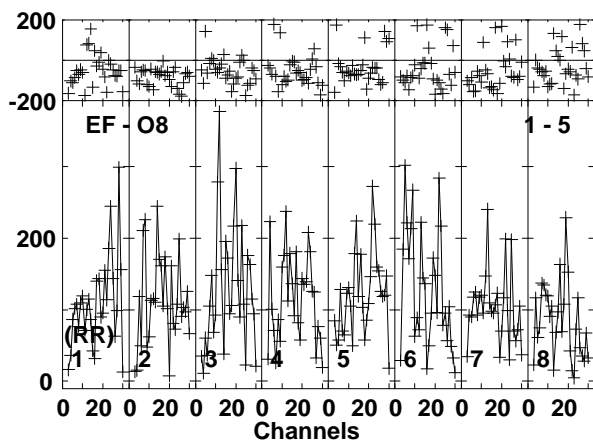
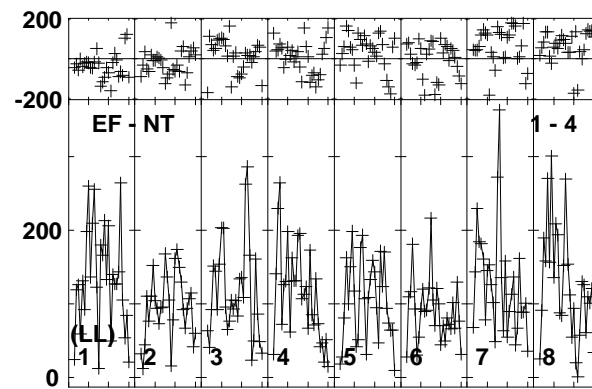
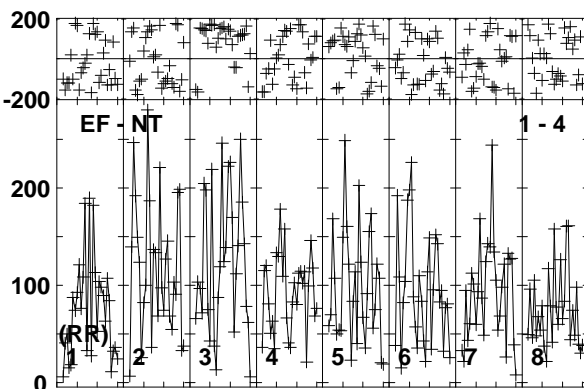
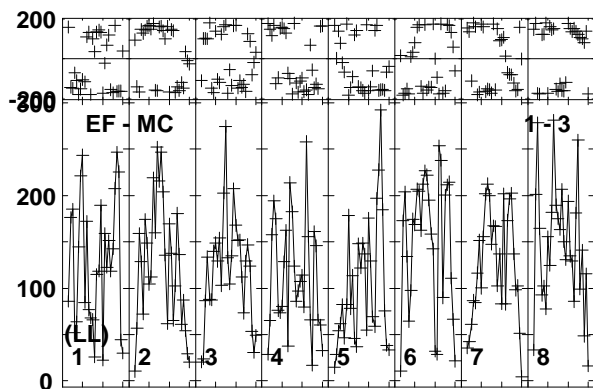
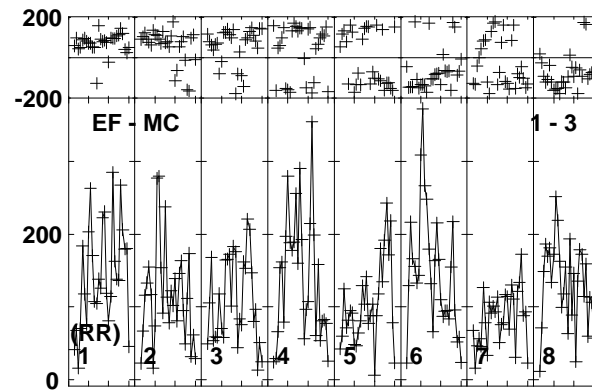
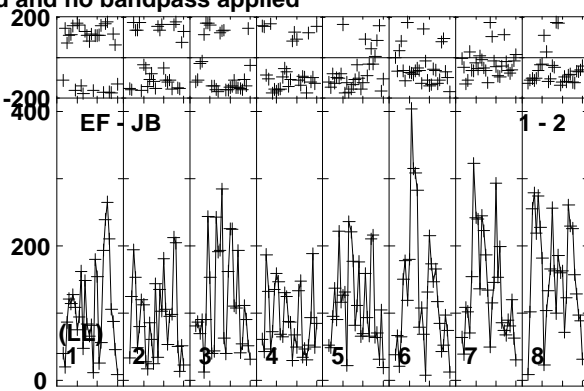
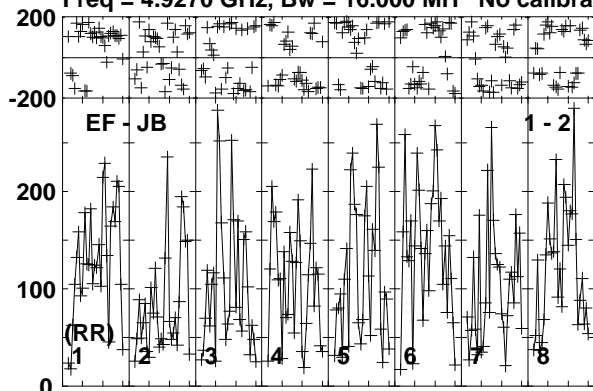

Lower frame: Micro Ampl Jy Top frame: Phas deg  
Vector averaged cross-power spectrum Baseline: EF (01) - JB (02)  
Timerange: 00/21:53:21 to 00/21:55:49

Plot file version 114 created 10-JUN-2016 17:22:11

CYGX1 RT013A.UVDATA.1

Freq = 4.9270 GHz, Bw = 16.000 MH No calibration applied and no bandpass applied

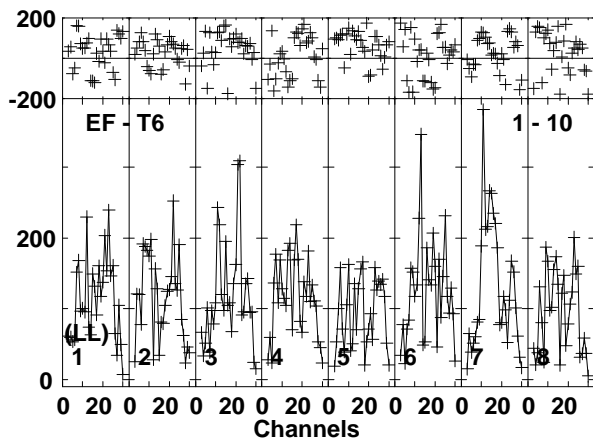
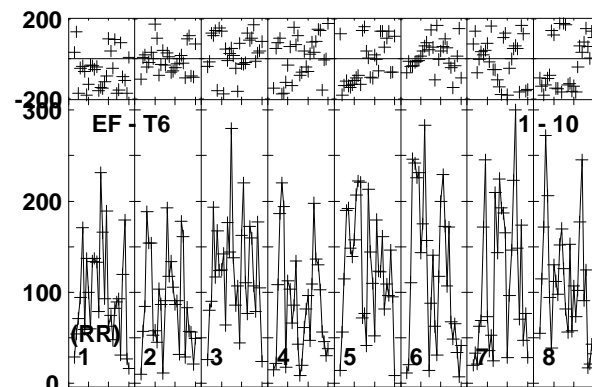
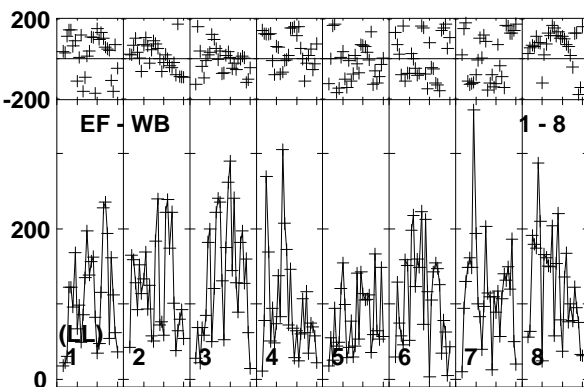
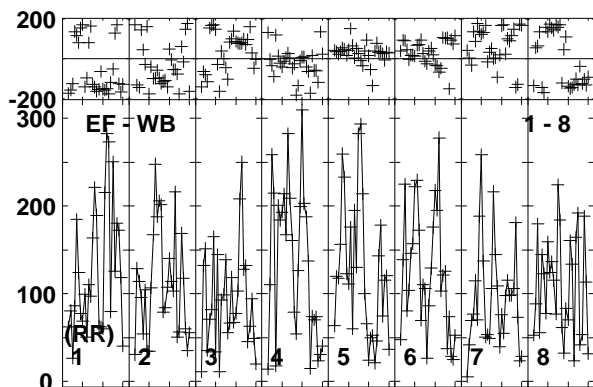
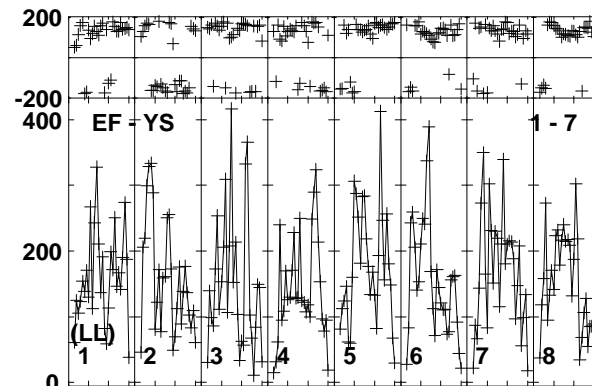
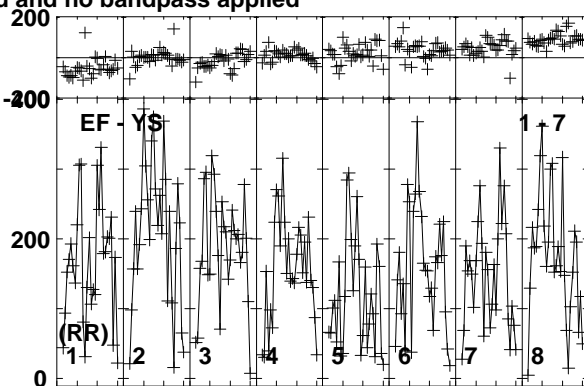
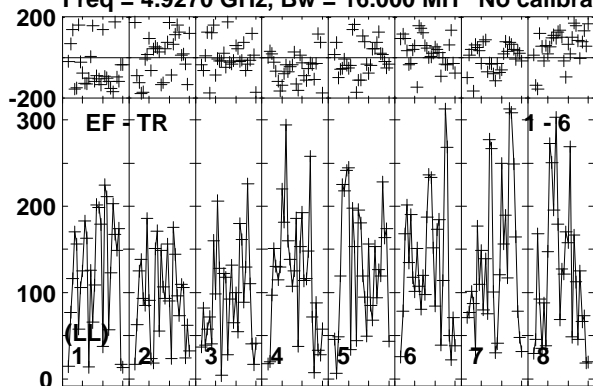

Lower frame: Micro Ampl Jy Top frame: Phas deg  
Vector averaged cross-power spectrum Baseline: EF (01) - TR (06)  
Timerange: 00/21:53:21 to 00/21:55:49



Plot file version 115 created 10-JUN-2016 17:22:11

J1957+3338 RT013A.UVDATA.1

Freq = 4.9270 GHz, Bw = 16.000 MH No calibration applied and no bandpass applied

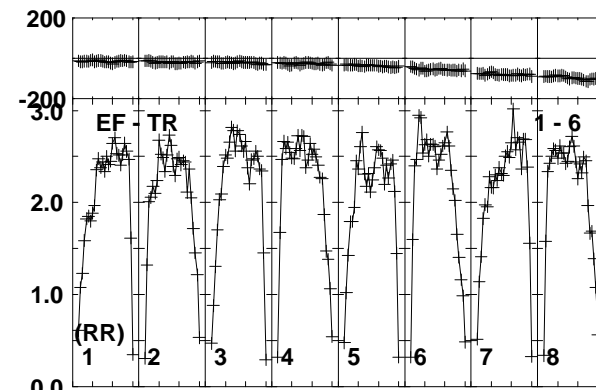
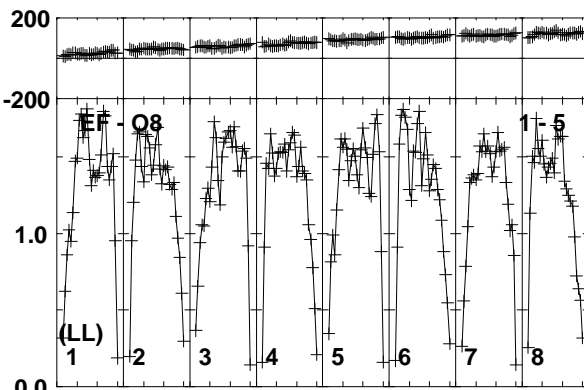
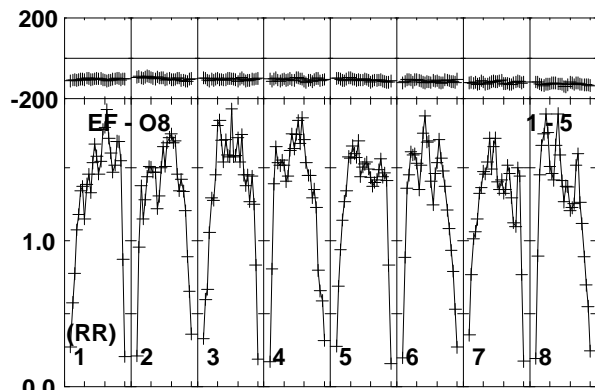
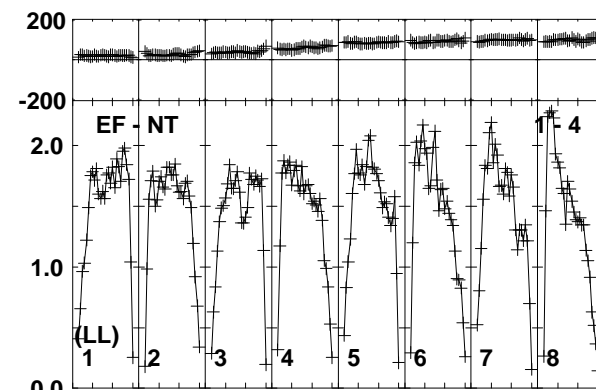
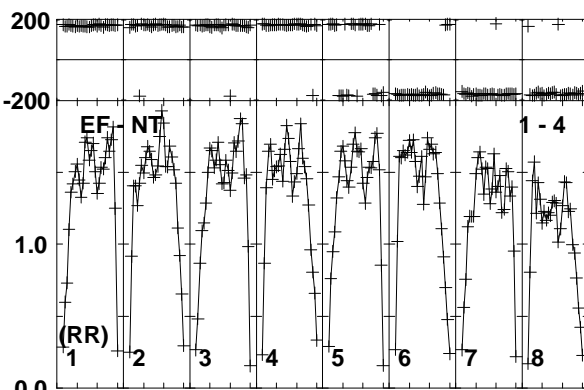
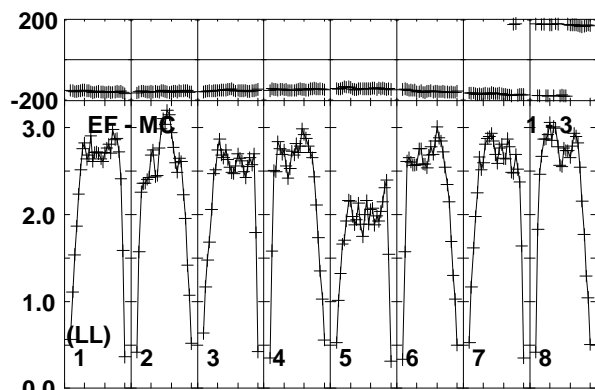
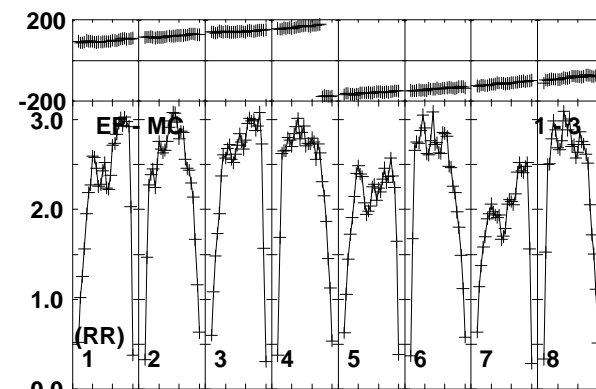
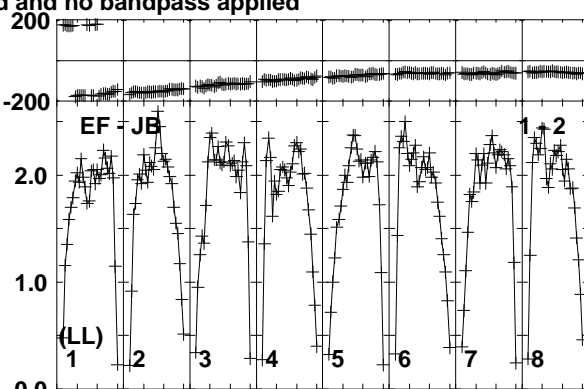
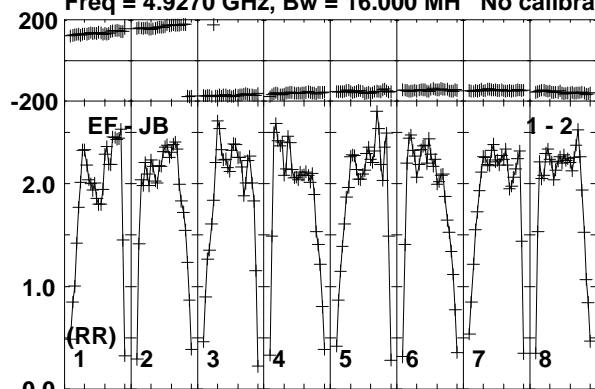

Lower frame: Milli Ampl Jy Top frame: Phas deg

Vector averaged cross-power spectrum Baseline: EF (01) - JB (02)

Timerange: 00/21:55:51 to 00/21:57:20

Plot file version 116 created 10-JUN-2016 17:22:11

J1957+3338 RT013A.UVDATA.1

Freq = 4.9270 GHz, Bw = 16.000 MH No calibration applied and no bandpass applied

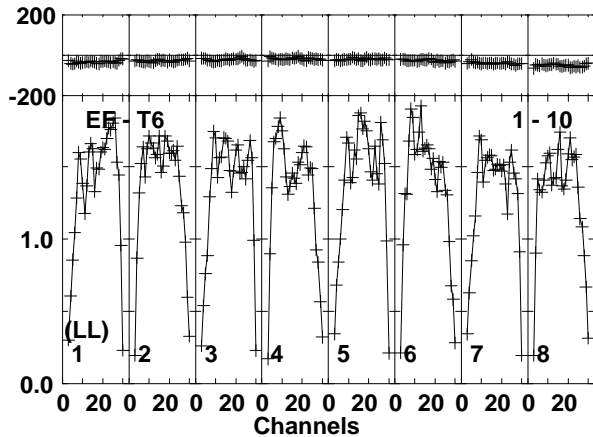
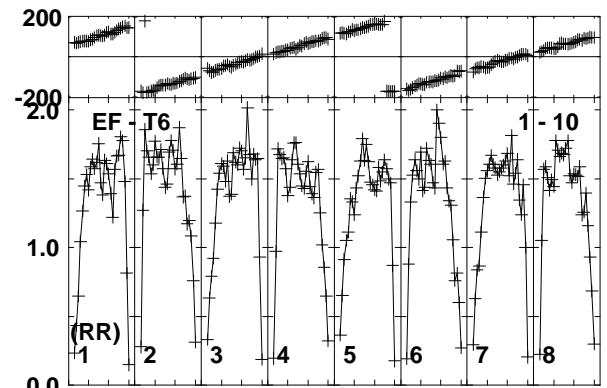
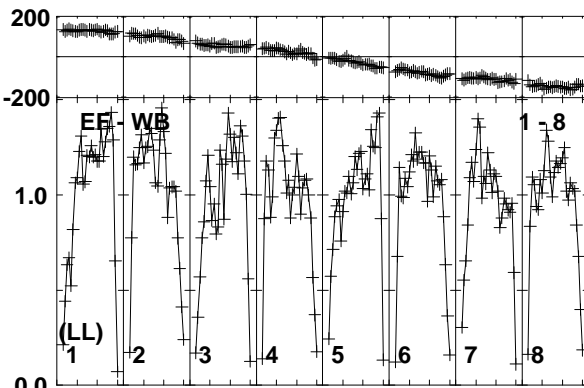
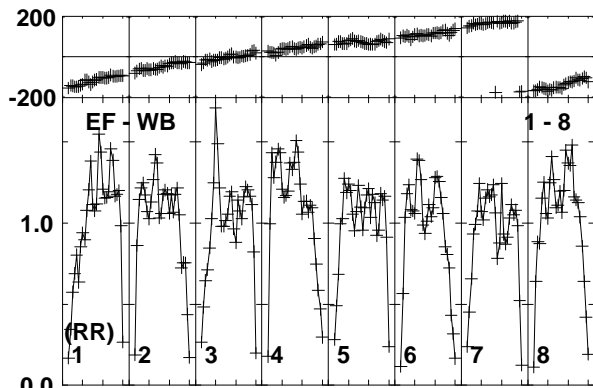
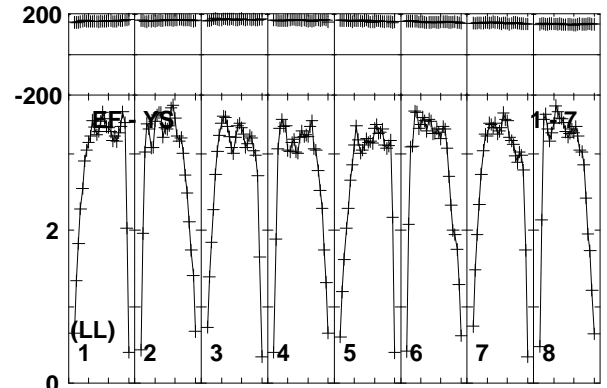
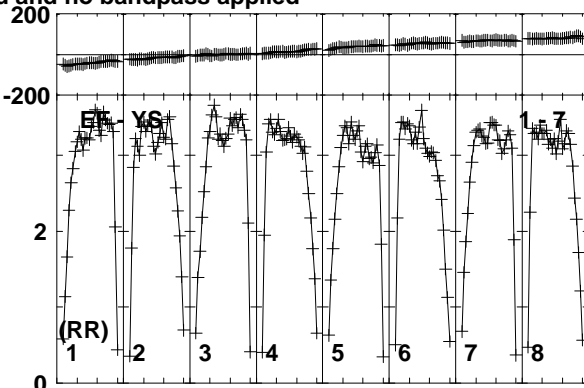
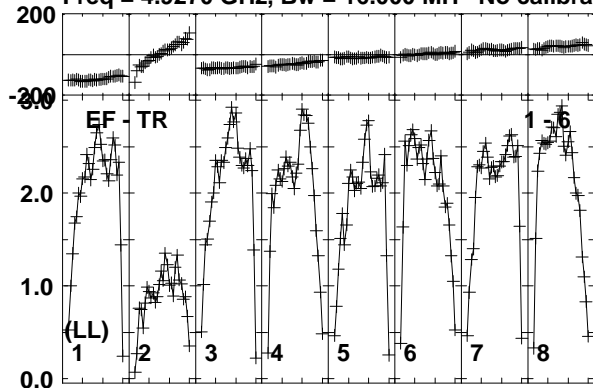

Lower frame: Milli Ampl Jy Top frame: Phas deg  
Vector averaged cross-power spectrum Baseline: EF (01) - TR (06)  
Timerange: 00/21:55:51 to 00/21:57:20

Plot file version 117 created 10-JUN-2016 17:22:11

CHECK RT013A.UVDATA.1

Freq = 4.9270 GHz, Bw = 16.000 MH No calibration applied and no bandpass applied

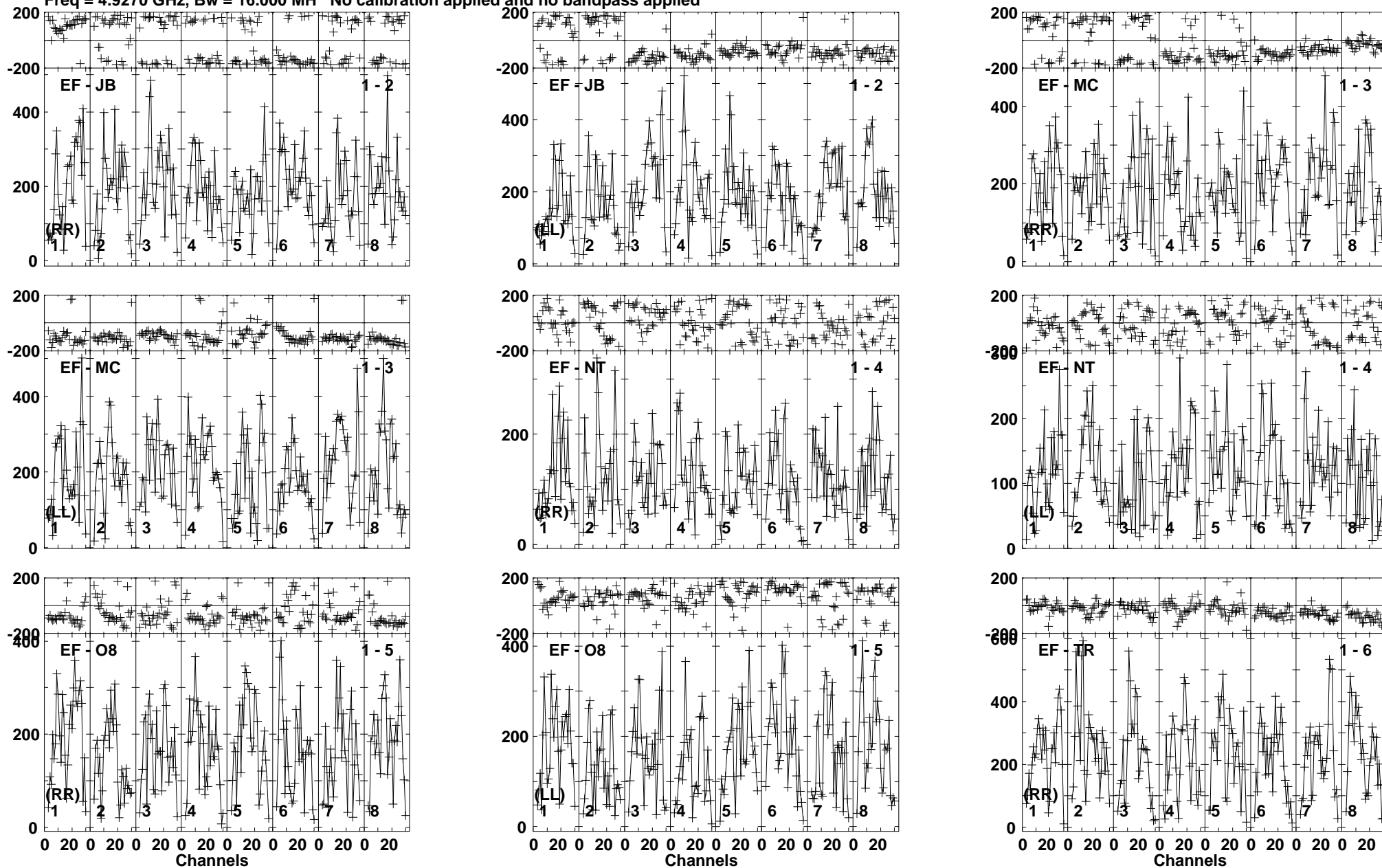

Lower frame: Micro Ampl Jy Top frame: Phas deg  
Vector averaged cross-power spectrum Baseline: EF (01) - JB (02)  
Timerange: 00/21:57:20 to 00/21:59:20

Plot file version 118 created 10-JUN-2016 17:22:12

CHECK RT013A.UVDATA.1

Freq = 4.9270 GHz, Bw = 16.000 MH No calibration applied and no bandpass applied

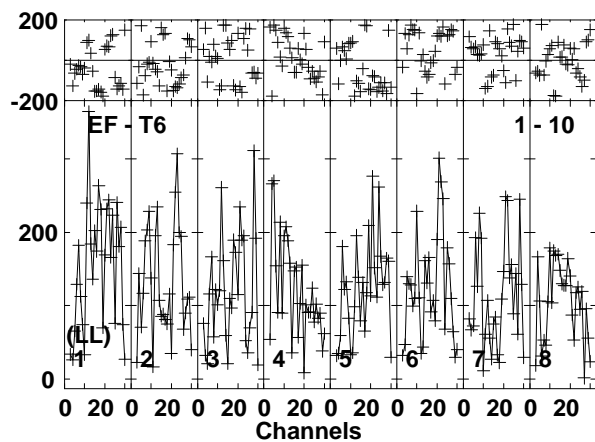
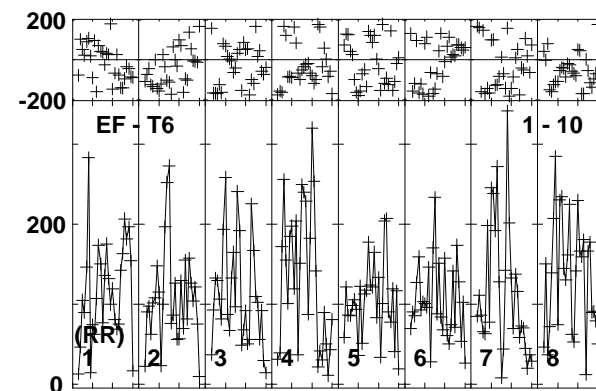
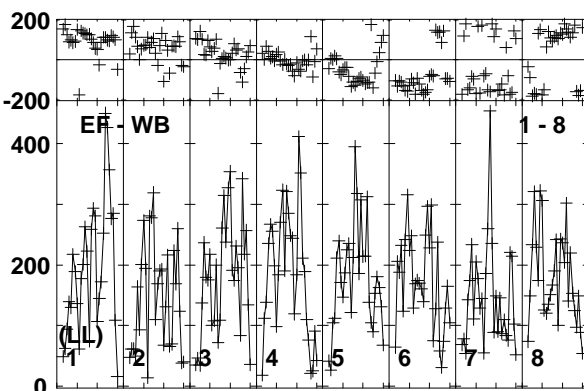
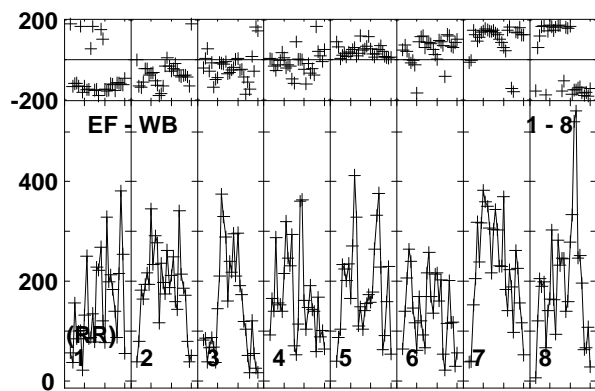
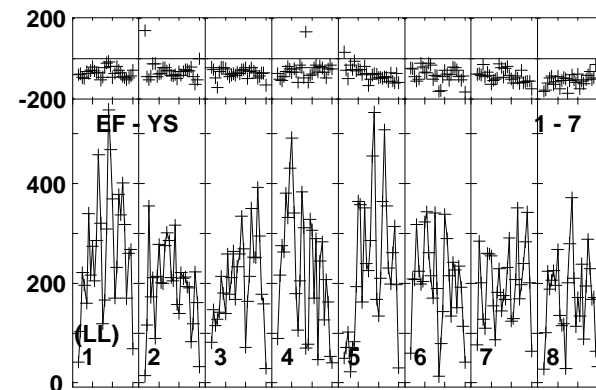
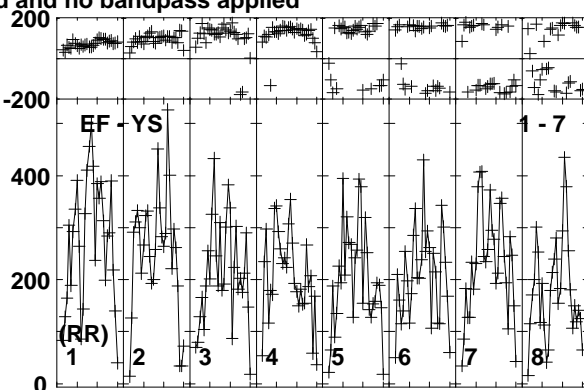
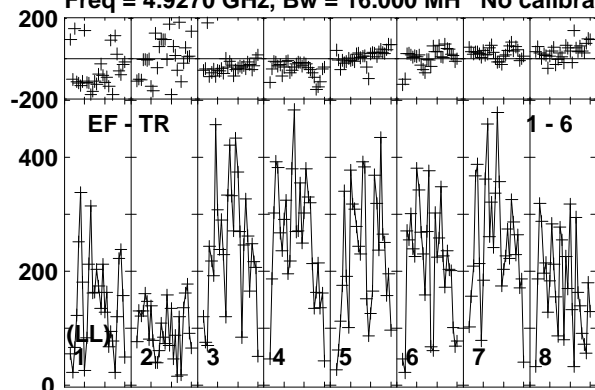

Lower frame: Micro Ampl Jy Top frame: Phas deg  
Vector averaged cross-power spectrum Baseline: EF (01) - TR (06)  
Timerange: 00/21:57:20 to 00/21:59:20

Plot file version 119 created 10-JUN-2016 17:22:12

CYGX1 RT013A.UVDATA.1

Freq = 4.9270 GHz, Bw = 16.000 MH No calibration applied and no bandpass applied

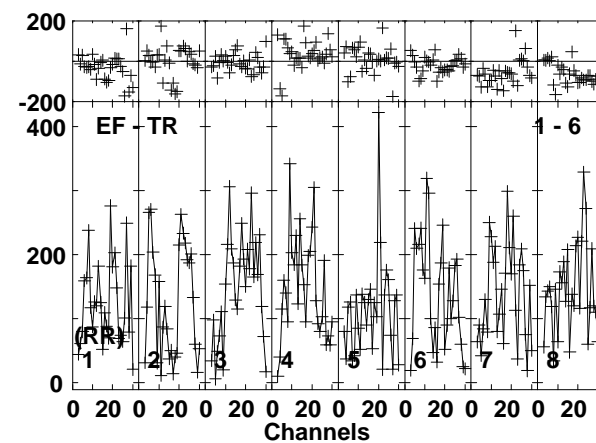
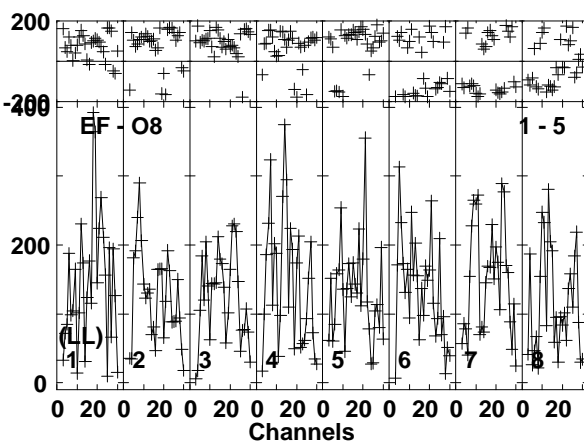
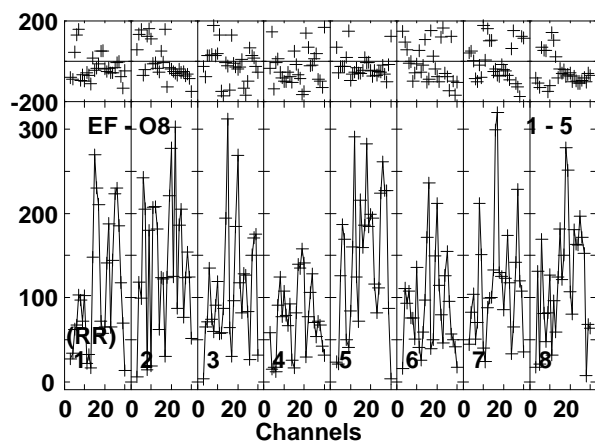
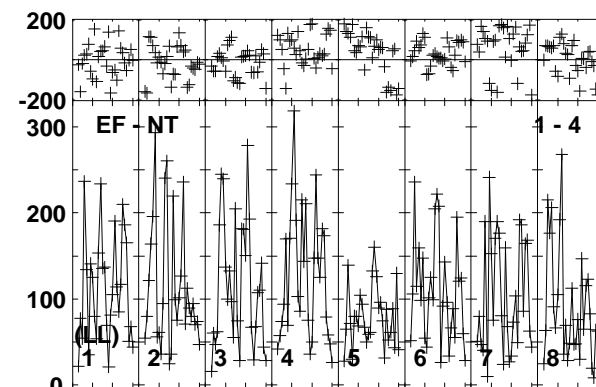
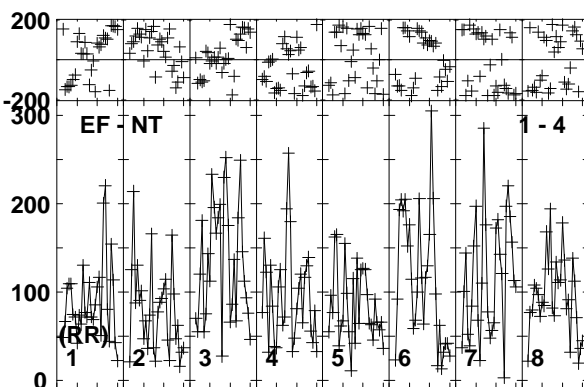
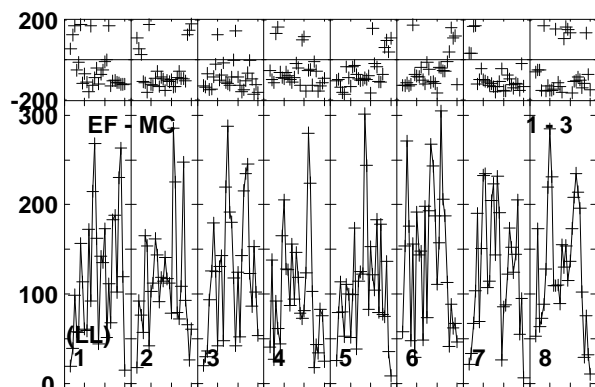
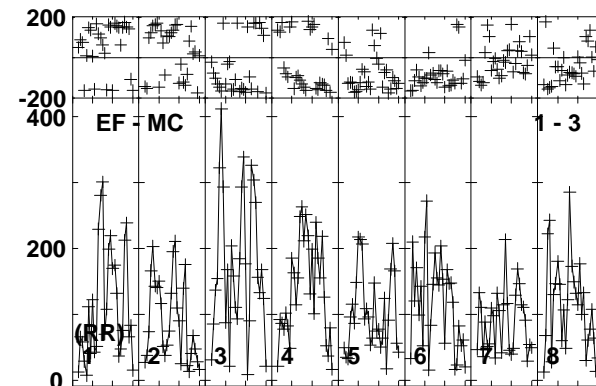
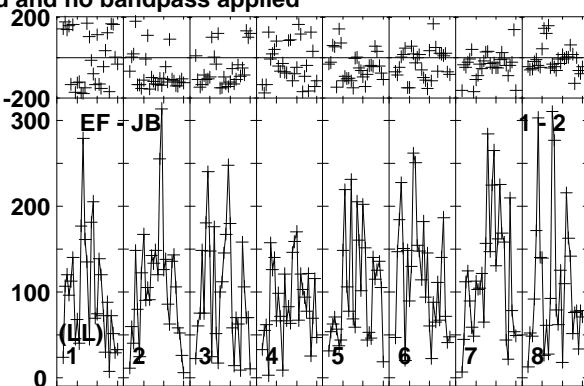
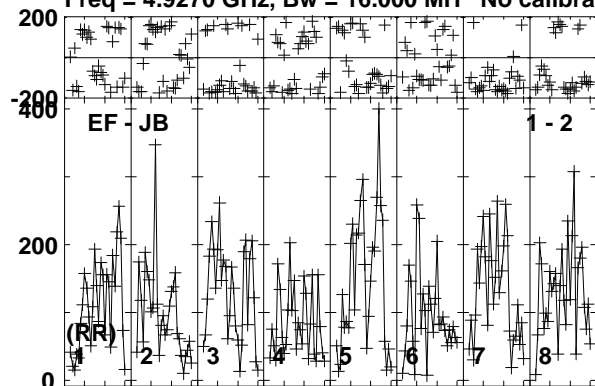

Lower frame: Micro Ampl Jy Top frame: Phas deg  
Vector averaged cross-power spectrum Baseline: EF (01) - JB (02)  
Timerange: 00/21:59:21 to 00/22:01:49

Plot file version 120 created 10-JUN-2016 17:22:12

CYGX1 RT013A.UVDATA.1

Freq = 4.9270 GHz, Bw = 16.000 MH No calibration applied and no bandpass applied

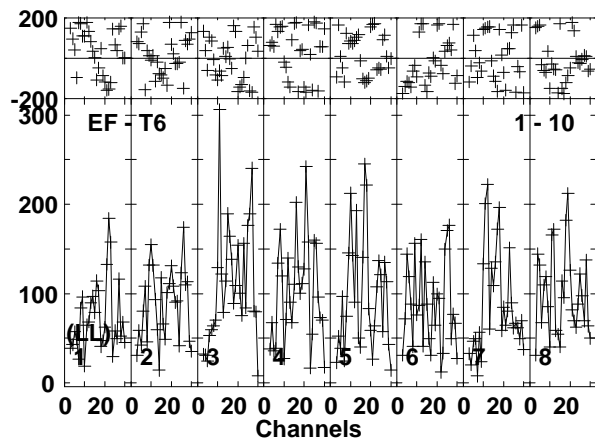
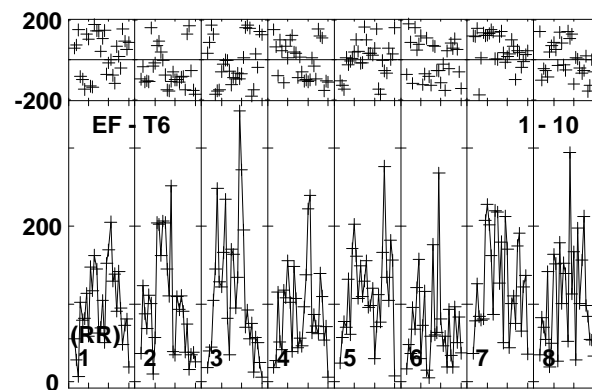
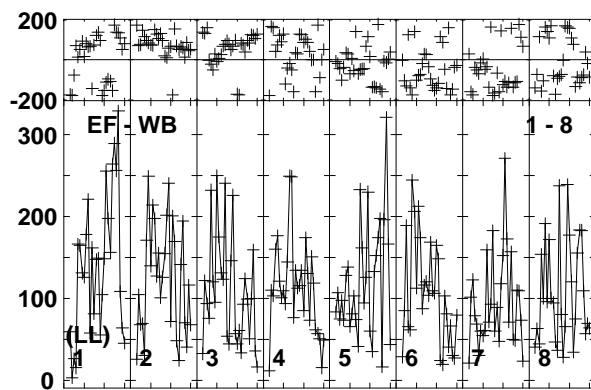
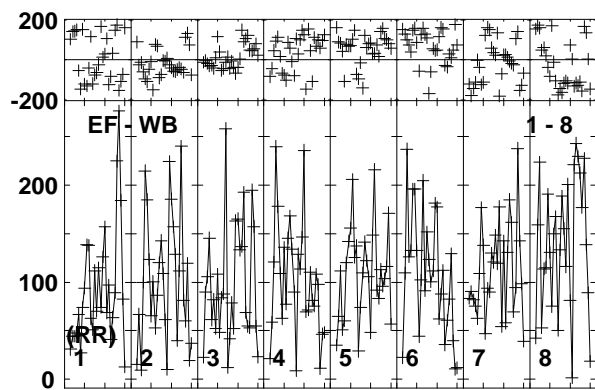
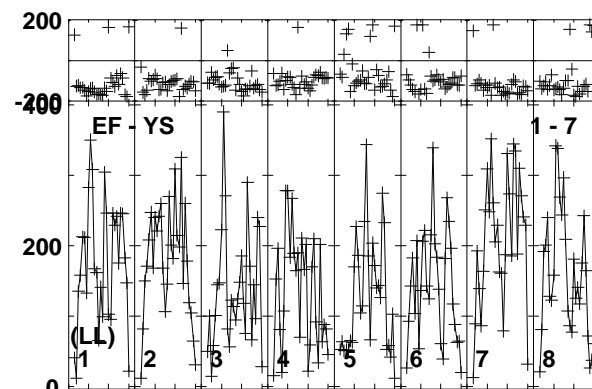
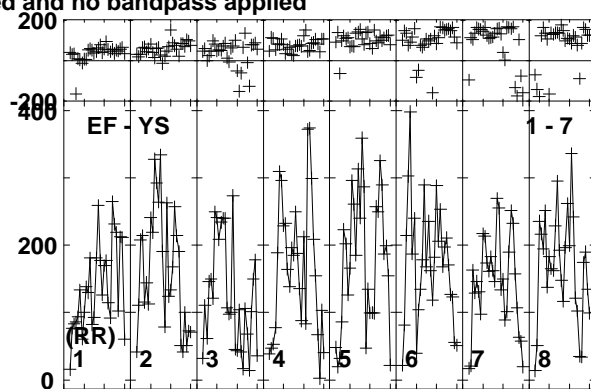
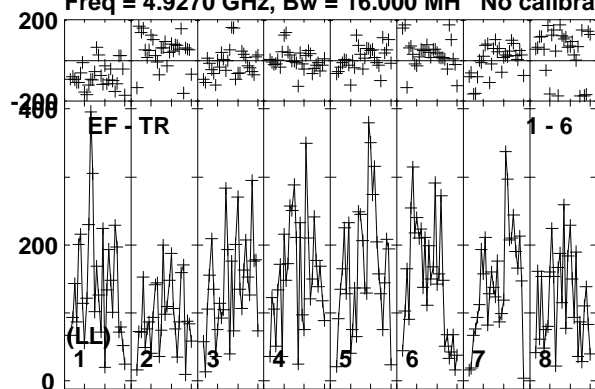

Lower frame: Micro Ampl Jy Top frame: Phas deg  
Vector averaged cross-power spectrum Baseline: EF (01) - TR (06)  
Timerange: 00/21:59:21 to 00/22:01:49

Plot file version 121 created 10-JUN-2016 17:22:12

J1957+3338 RT013A.UVDATA.1

Freq = 4.9270 GHz, Bw = 16.000 MH No calibration applied and no bandpass applied

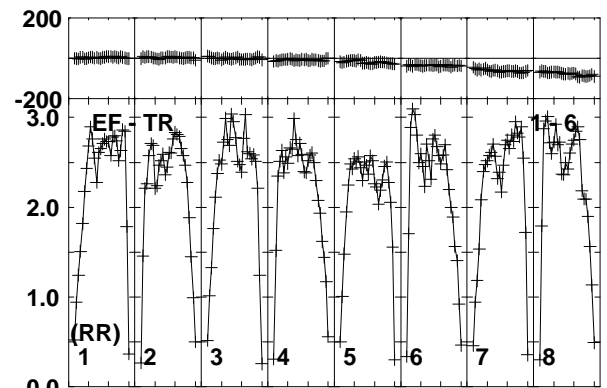
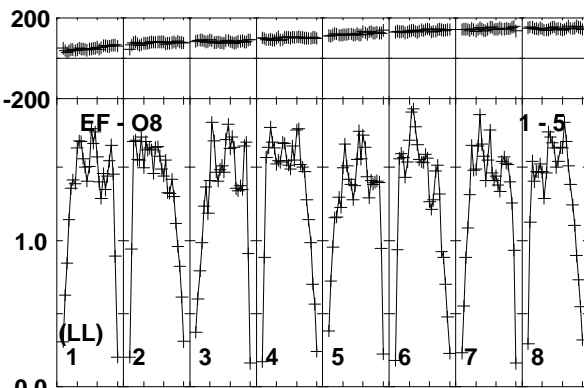
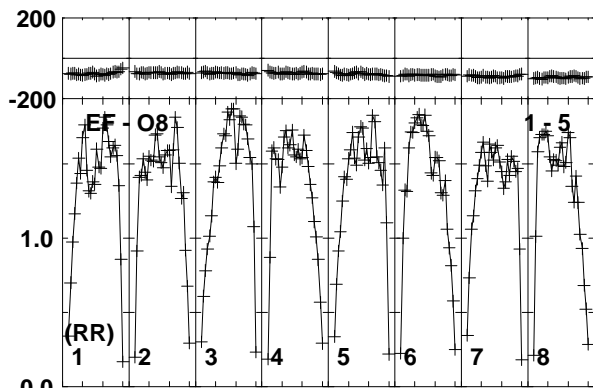
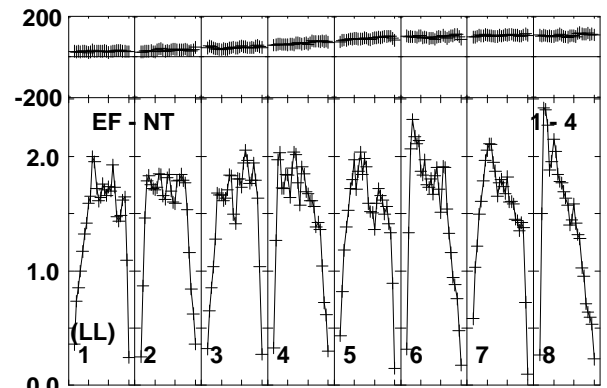
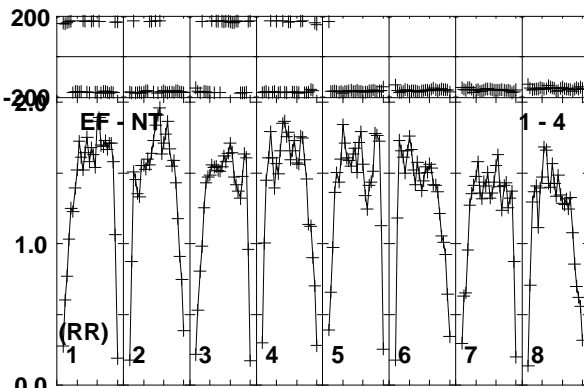
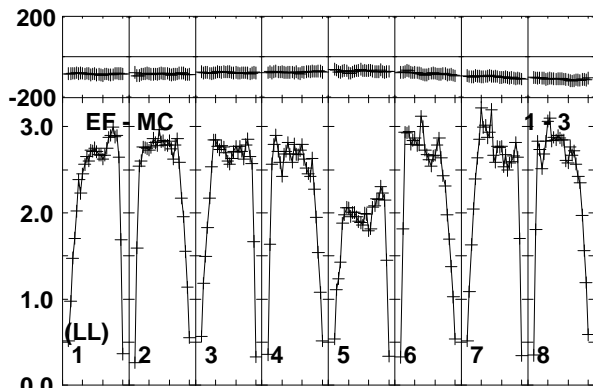
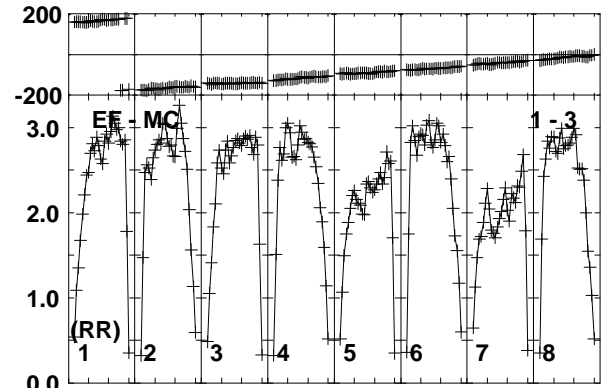
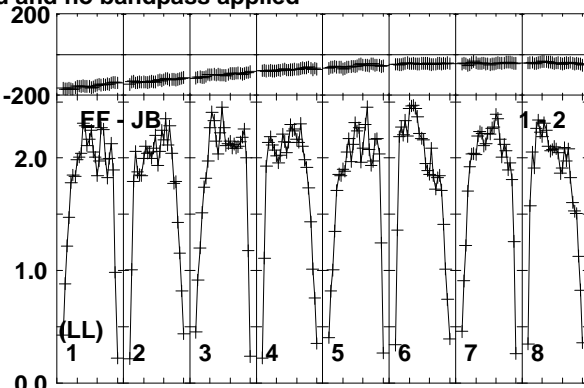
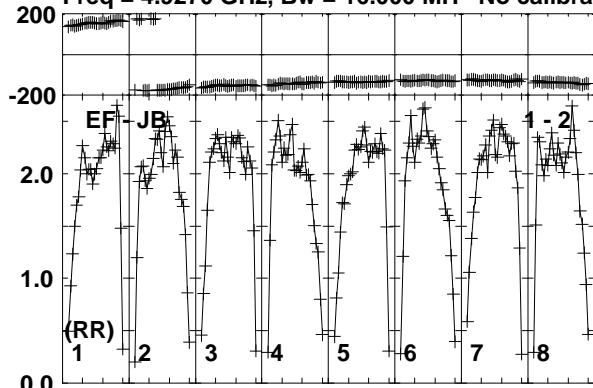

Lower frame: Milli Ampl Jy Top frame: Phas deg  
Vector averaged cross-power spectrum Baseline: EF (01) - JB (02)  
Timerange: 00:22:01:51 to 00:22:03:19

Plot file version 122 created 10-JUN-2016 17:22:12

J1957+3338 RT013A.UVDATA.1

Freq = 4.9270 GHz, Bw = 16.000 MH No calibration applied and no bandpass applied

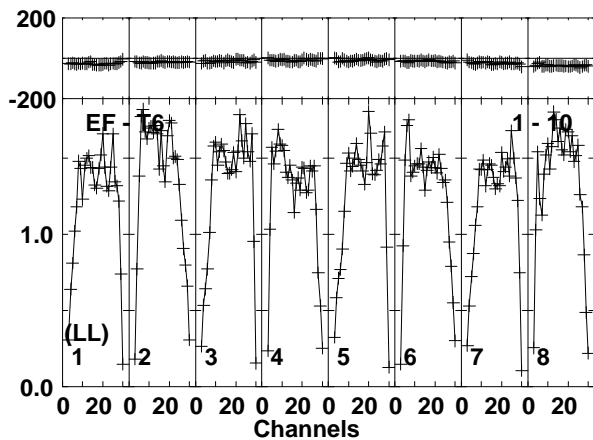
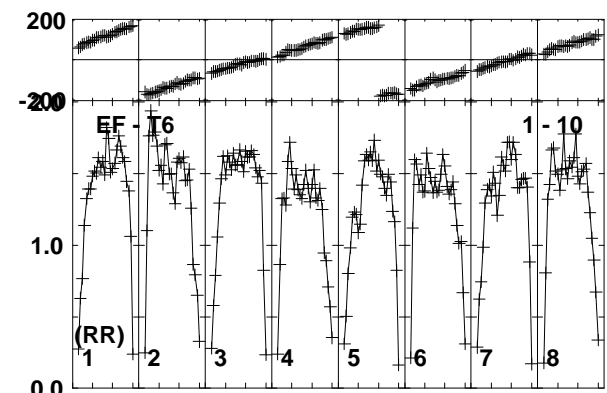
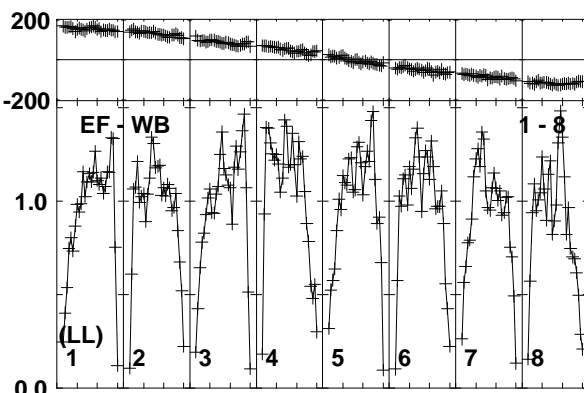
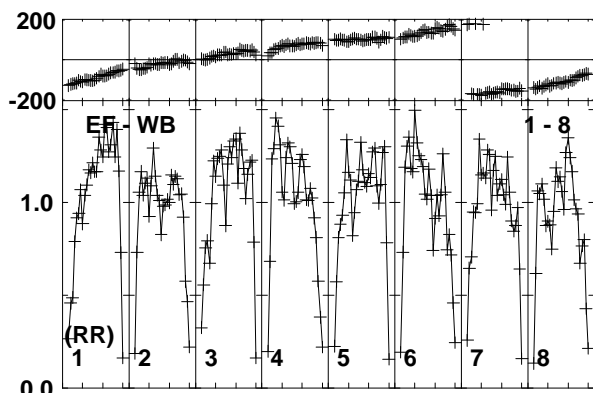
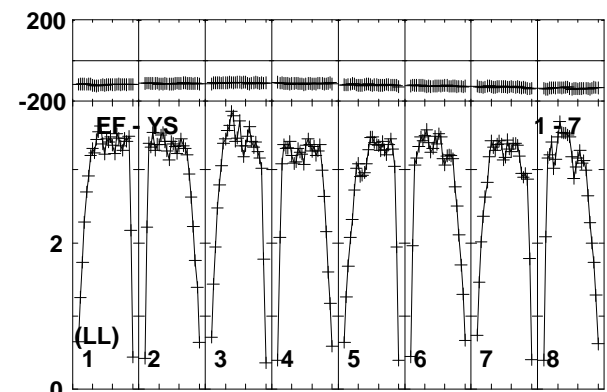
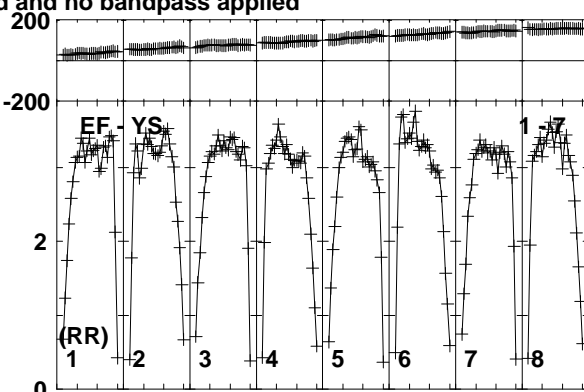
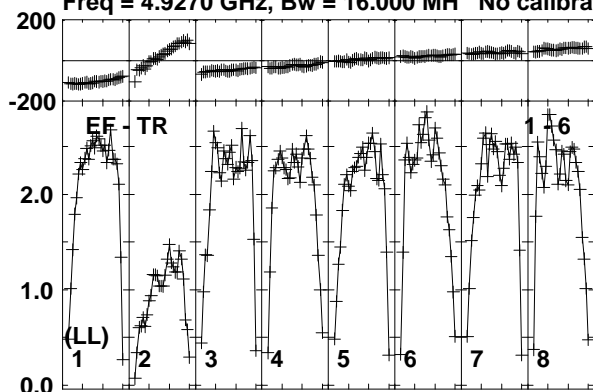

Lower frame: Milli Ampl Jy Top frame: Phas deg  
Vector averaged cross-power spectrum Baseline: EF (01) - TR (06)  
Timerange: 00/22:01:51 to 00/22:03:19



Plot file version 123 created 10-JUN-2016 17:22:12

CHECK RT013A.UVDATA.1

Freq = 4.9270 GHz, Bw = 16.000 MH No calibration applied and no bandpass applied

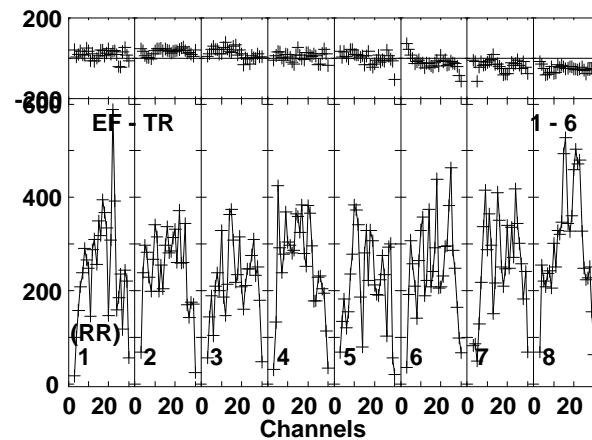
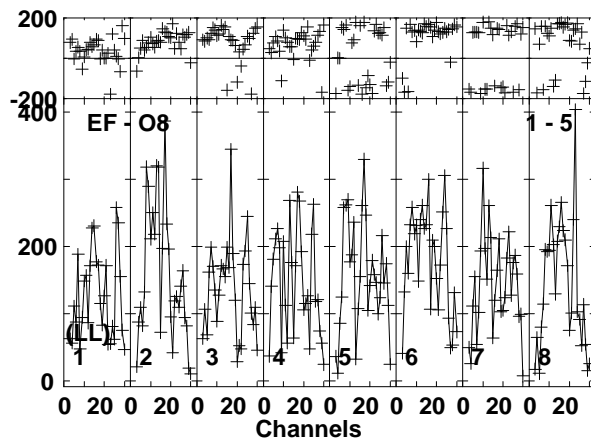
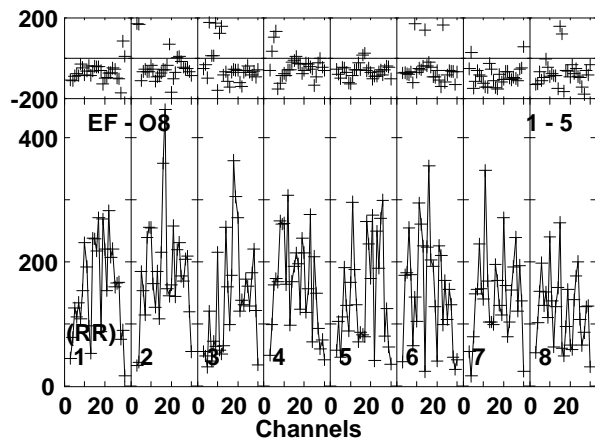
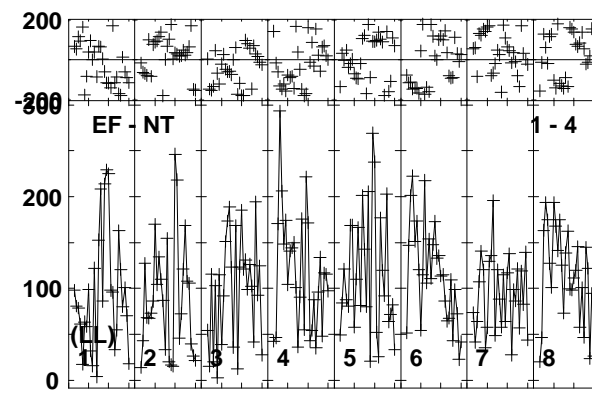
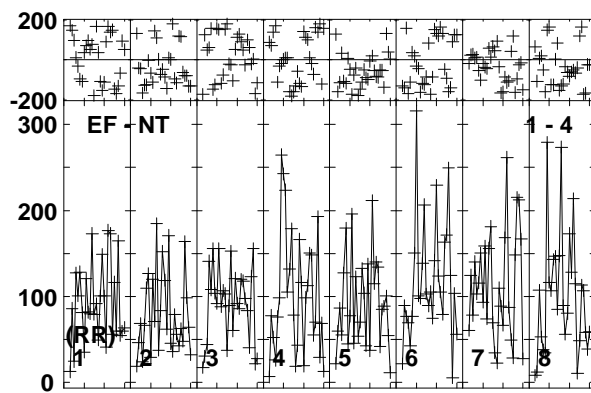
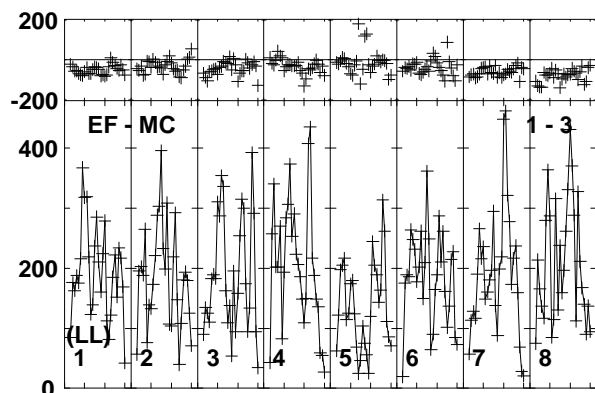
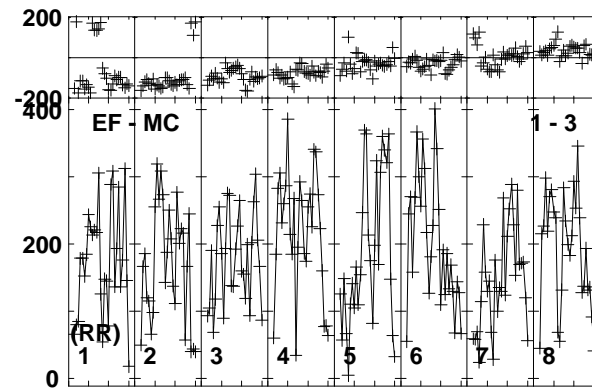
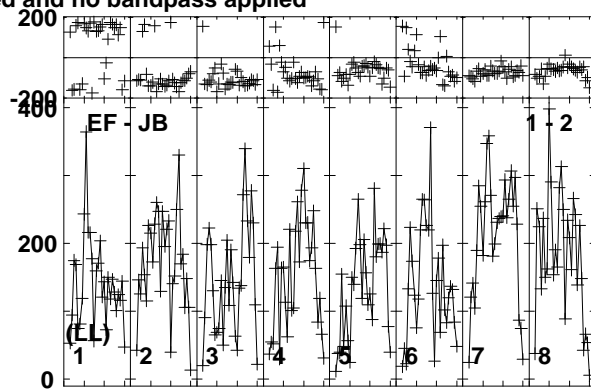
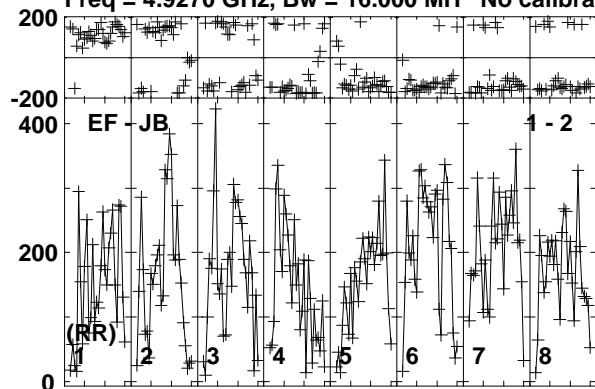

Lower frame: Micro Ampl Jy Top frame: Phas deg  
Vector averaged cross-power spectrum Baseline: EF (01) - JB (02)  
Timerange: 00:22:04:00 to 00:22:06:00

Plot file version 124 created 10-JUN-2016 17:22:12

CHECK RT013A.UVDATA.1

Freq = 4.9270 GHz, Bw = 16.000 MH No calibration applied and no bandpass applied

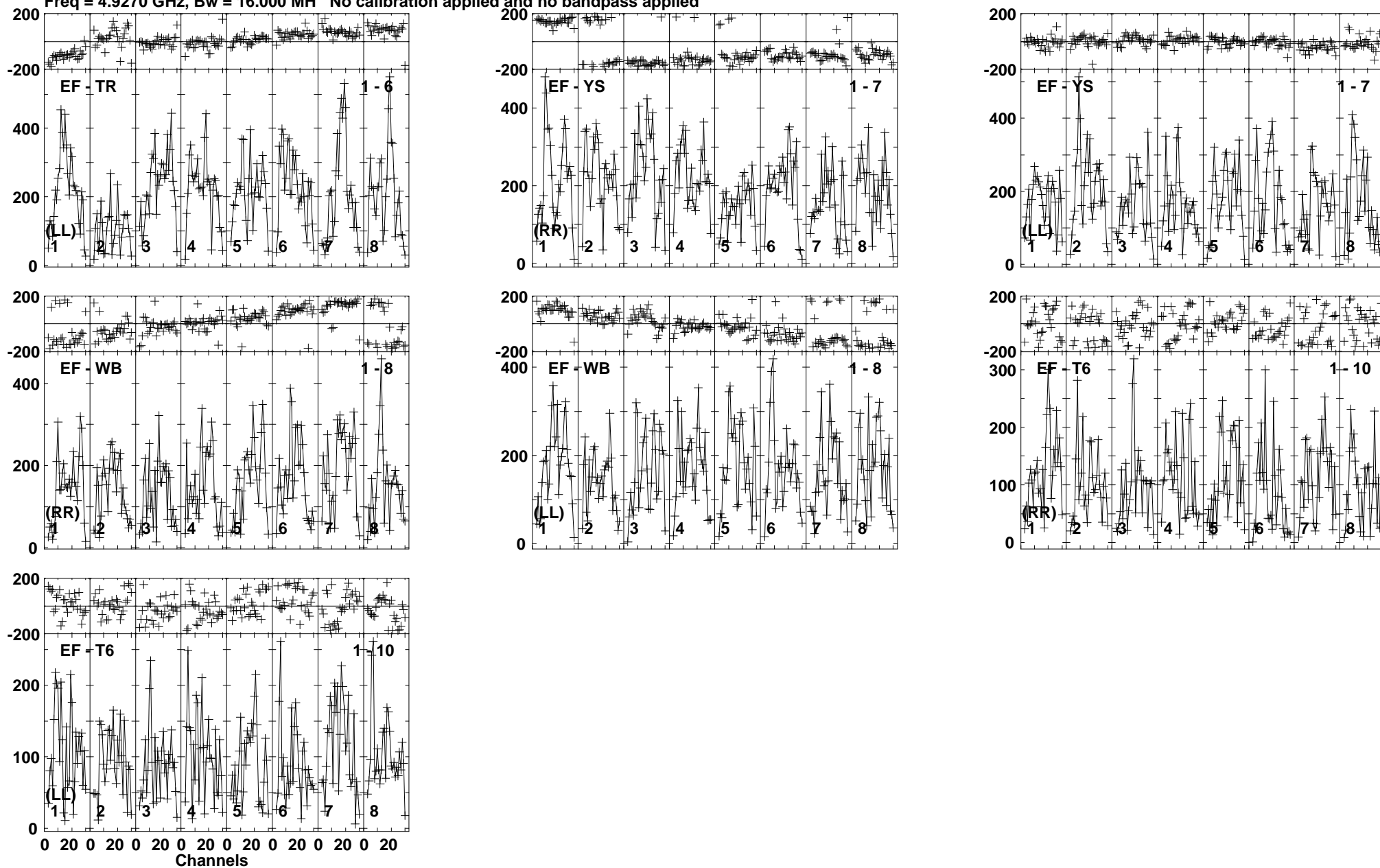

Lower frame: Micro Ampl Jy Top frame: Phas deg  
Vector averaged cross-power spectrum Baseline: EF (01) - TR (06)  
Timerange: 00:22:04:00 to 00:22:06:00

Plot file version 125 created 10-JUN-2016 17:22:12

CYGX1 RT013A.UVDATA.1

Freq = 4.9270 GHz, Bw = 16.000 MH No calibration applied and no bandpass applied

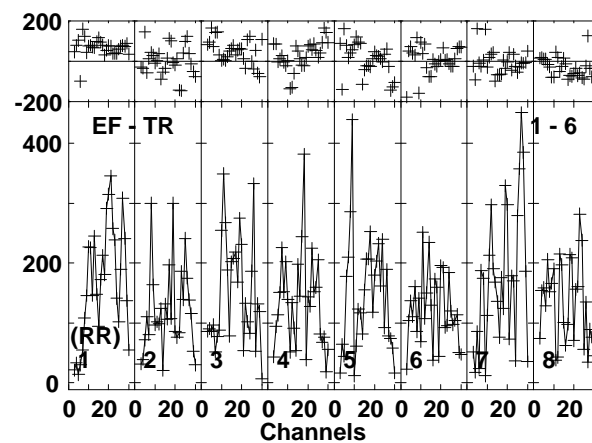
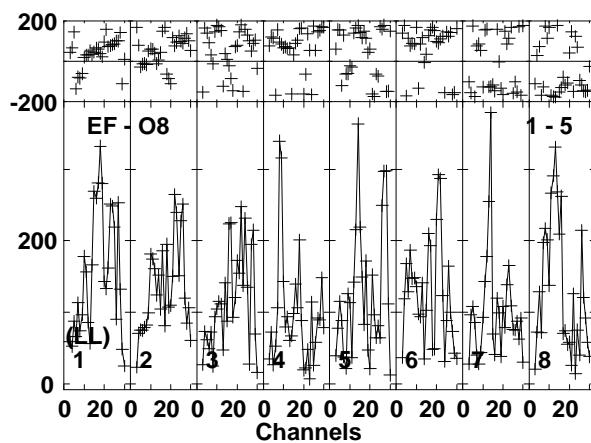
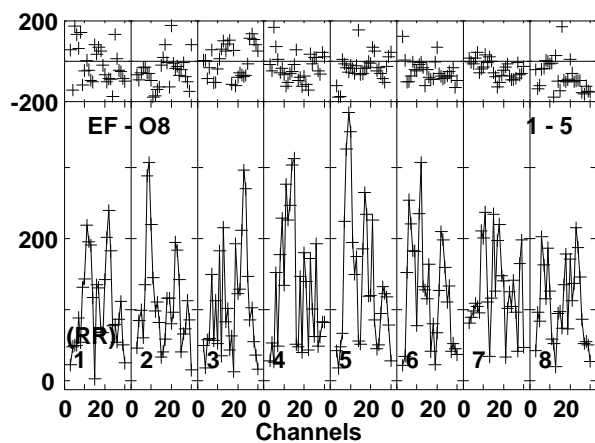
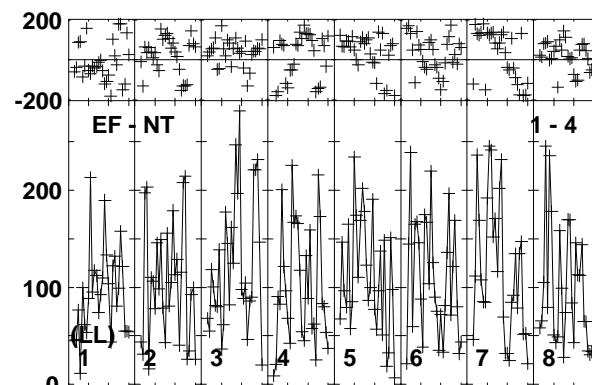
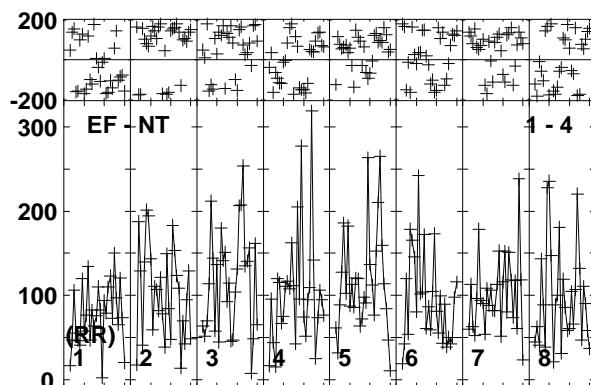
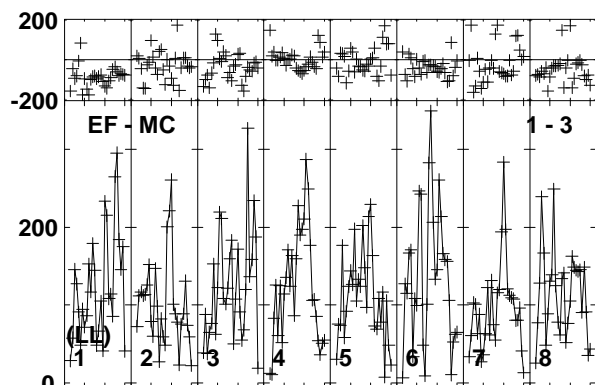
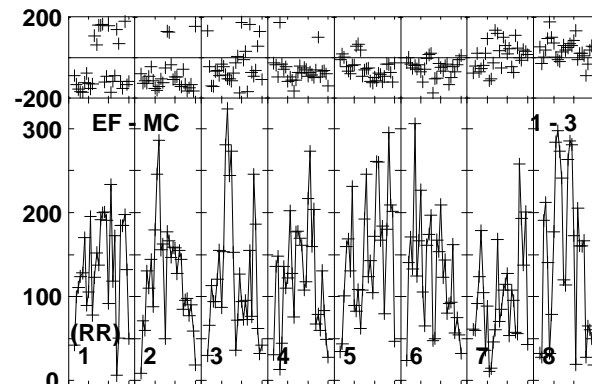
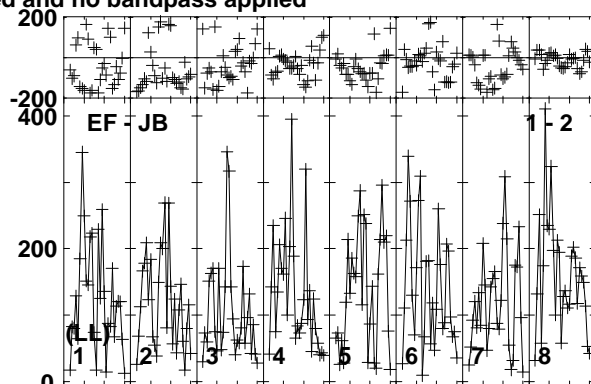
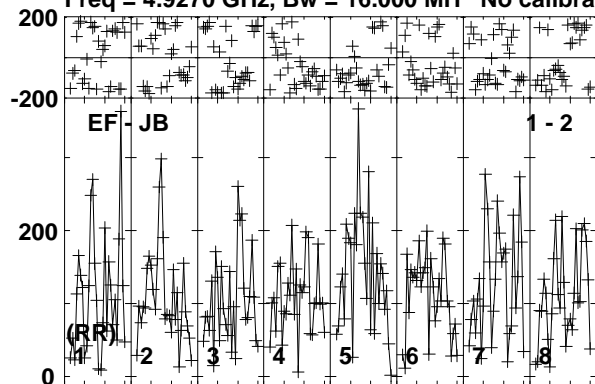

Lower frame: Micro Ampl Jy Top frame: Phas deg  
Vector averaged cross-power spectrum Baseline: EF (01) - JB (02)  
Timerange: 00/22:06:01 to 00/22:08:30

Plot file version 126 created 10-JUN-2016 17:22:12

CYGX1 RT013A.UVDATA.1

Freq = 4.9270 GHz, Bw = 16.000 MH No calibration applied and no bandpass applied

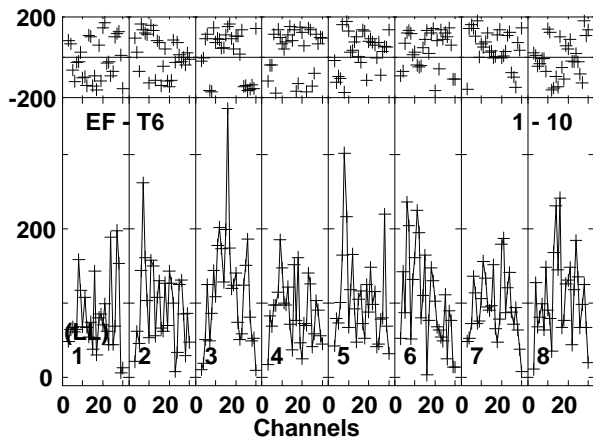
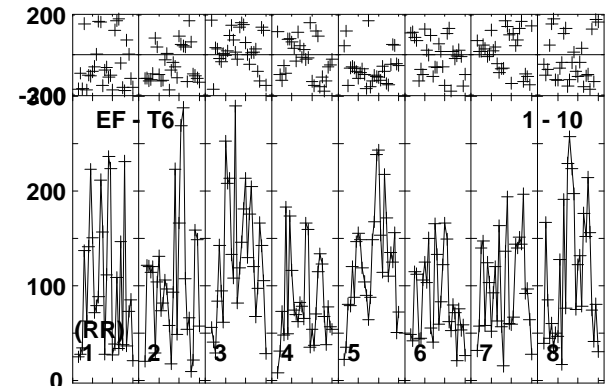
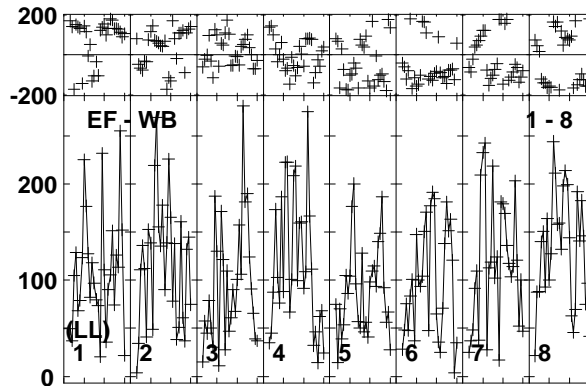
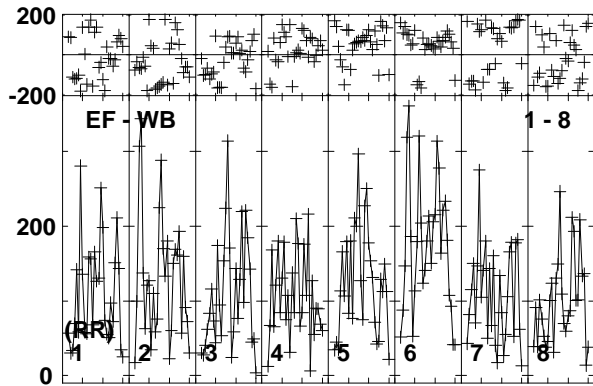
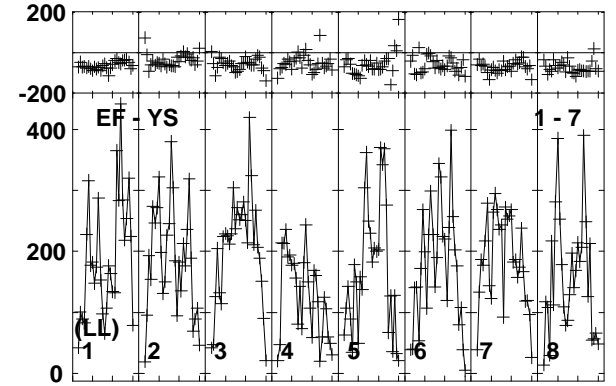
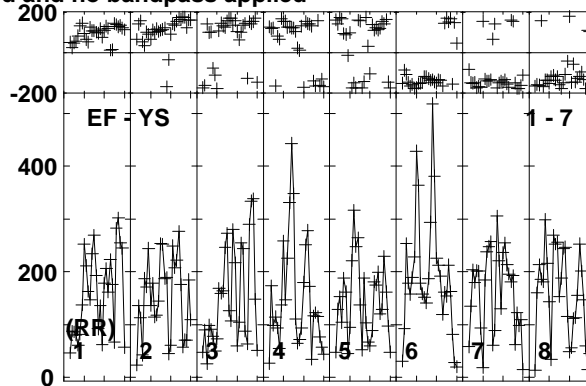
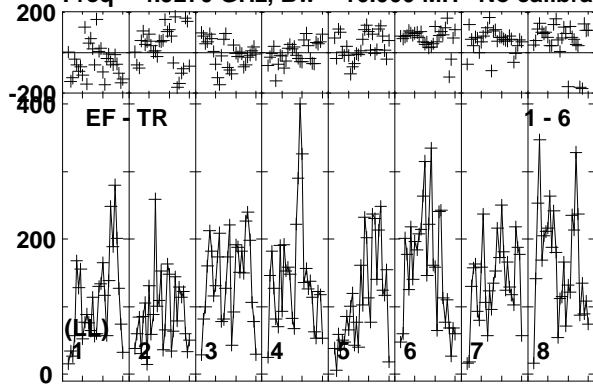

Lower frame: Micro Ampl Jy Top frame: Phas deg  
Vector averaged cross-power spectrum Baseline: EF (01) - TR (06)  
Timerange: 00:22:06:01 to 00:22:08:30

Plot file version 127 created 10-JUN-2016 17:22:13

J1957+3338 RT013A.UVDATA.1

Freq = 4.9270 GHz, Bw = 16.000 MH No calibration applied and no bandpass applied

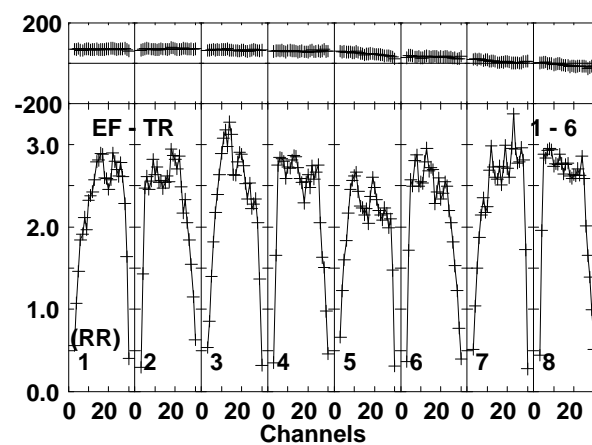
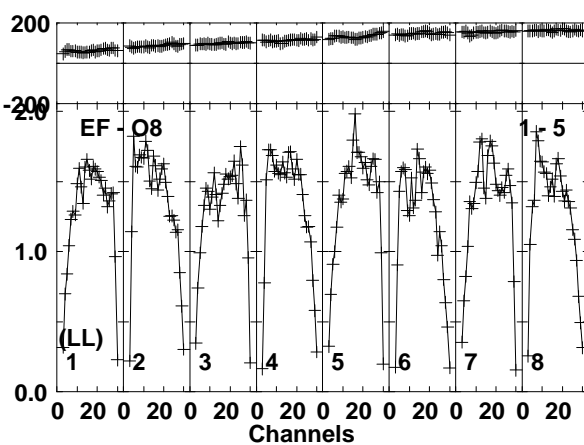
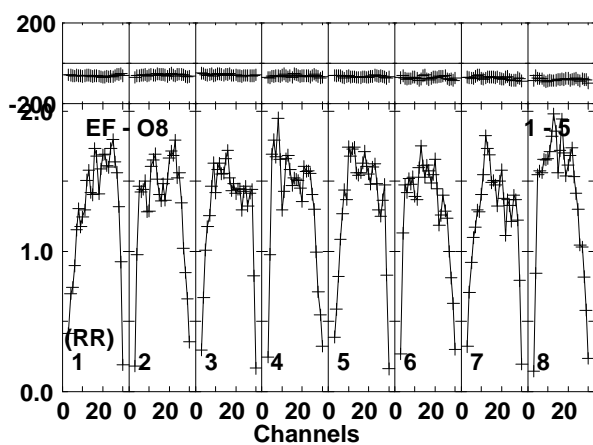
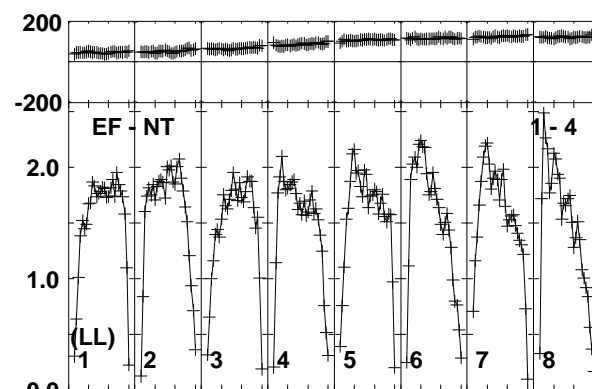
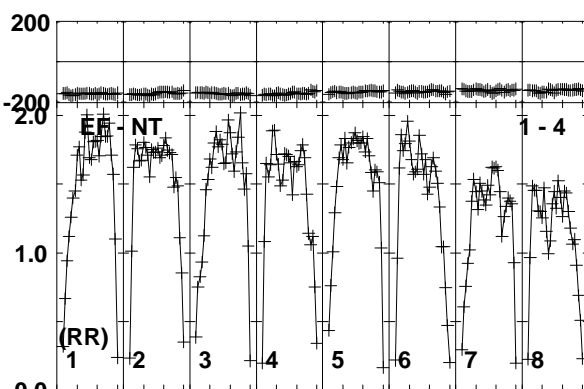
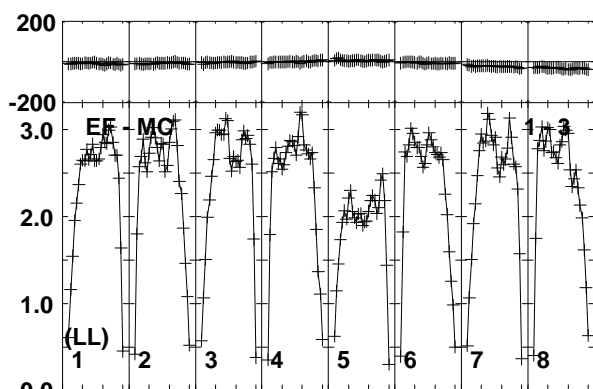
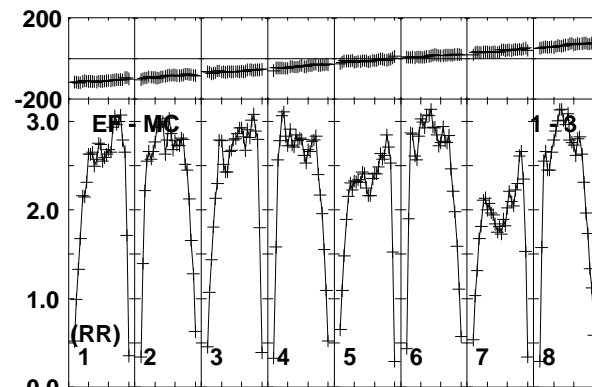
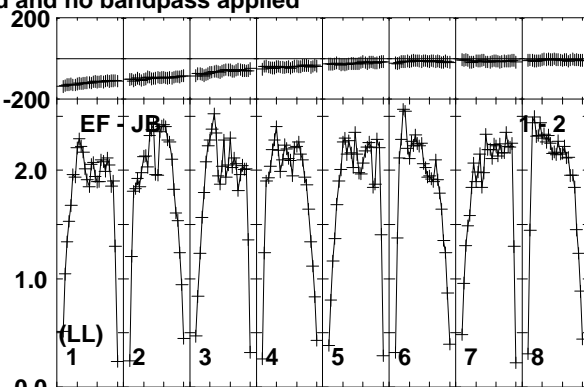
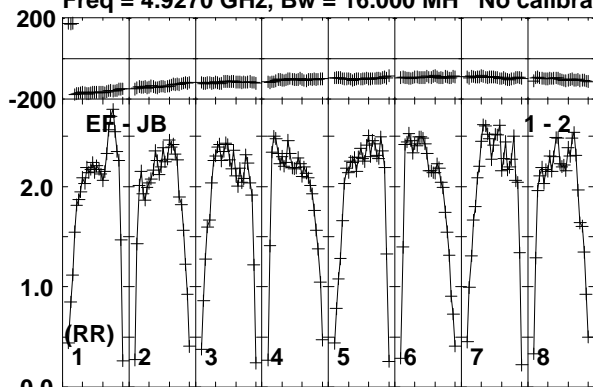

Lower frame: Milli Ampl Jy Top frame: Phas deg  
Vector averaged cross-power spectrum Baseline: EF (01) - JB (02)  
Timerange: 00/22:08:31 to 00/22:09:59

Plot file version 128 created 10-JUN-2016 17:22:13

J1957+3338 RT013A.UVDATA.1

Freq = 4.9270 GHz, Bw = 16.000 MH No calibration applied and no bandpass applied

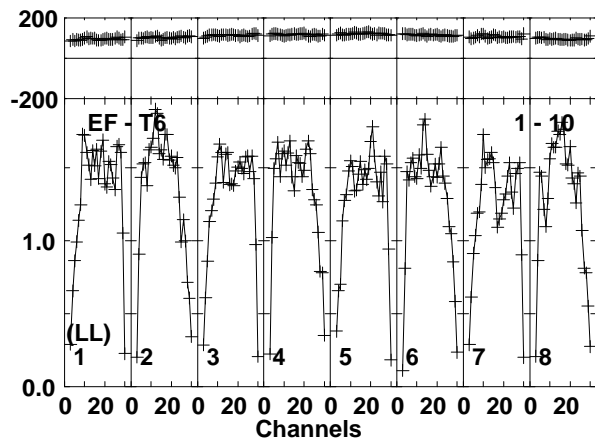
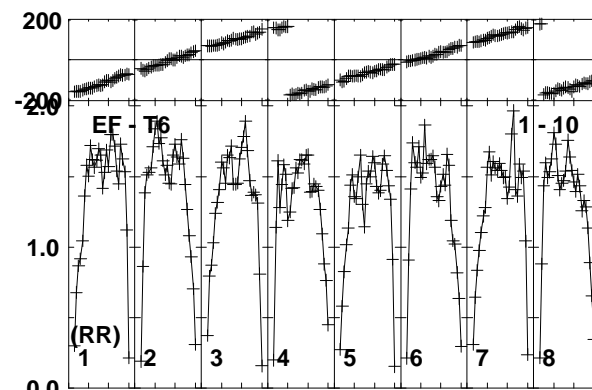
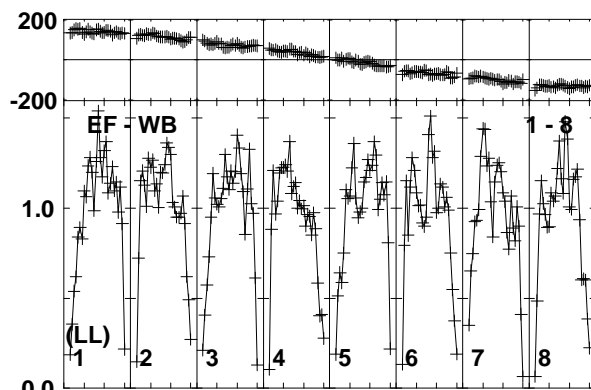
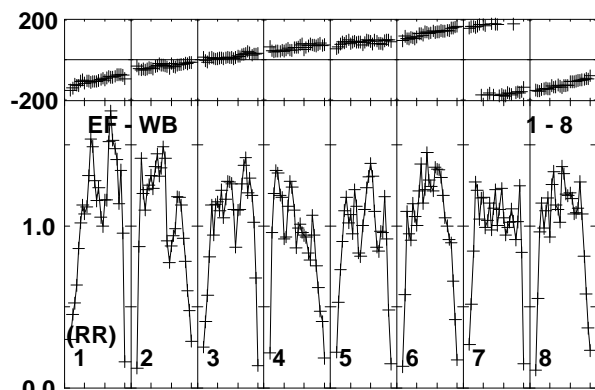
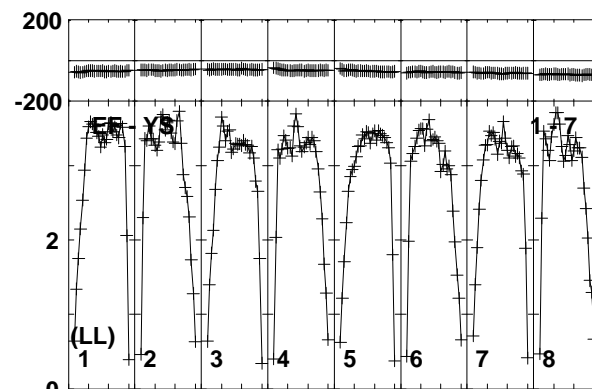
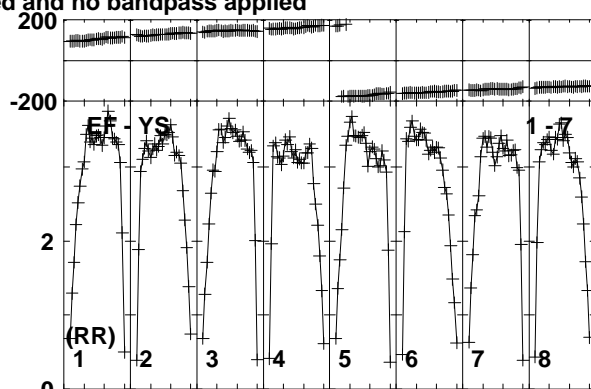
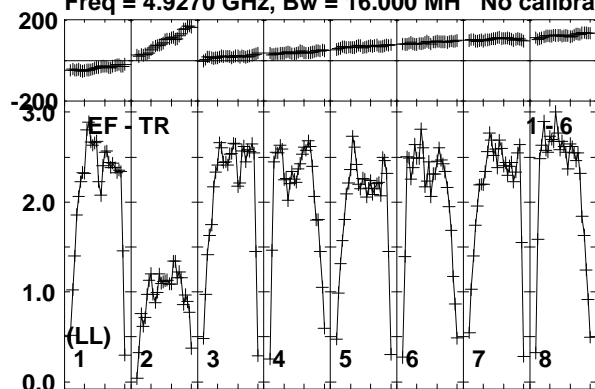

Lower frame: Milli Ampl Jy Top frame: Phas deg  
Vector averaged cross-power spectrum Baseline: EF (01) - TR (06)  
Timerange: 00/22:08:31 to 00/22:09:59

Plot file version 129 created 10-JUN-2016 17:22:13

CHECK RT013A.UVDATA.1

Freq = 4.9270 GHz, Bw = 16.000 MH No calibration applied and no bandpass applied

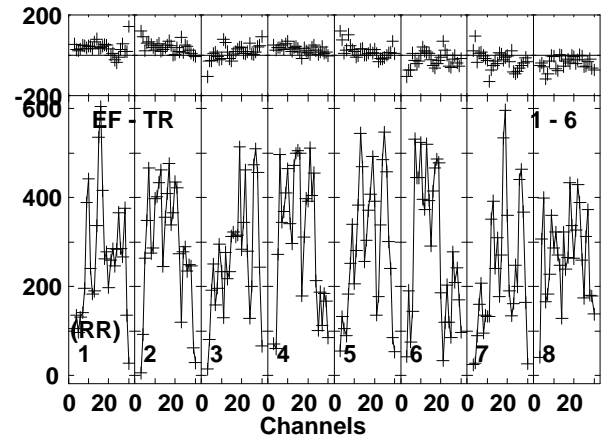
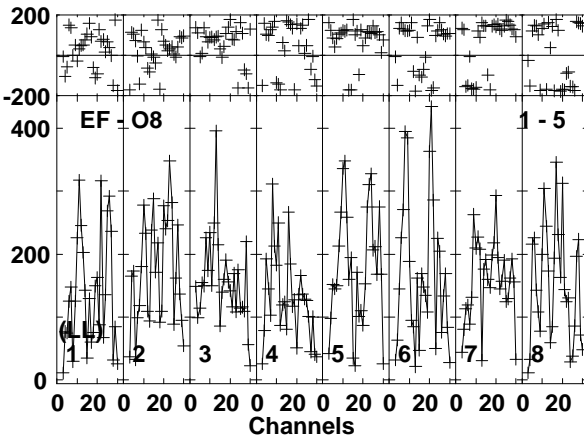
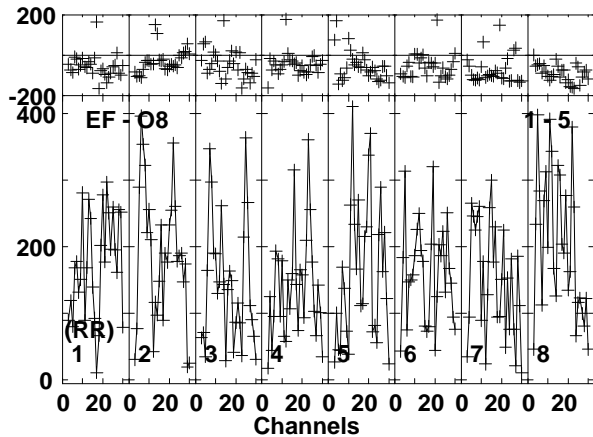
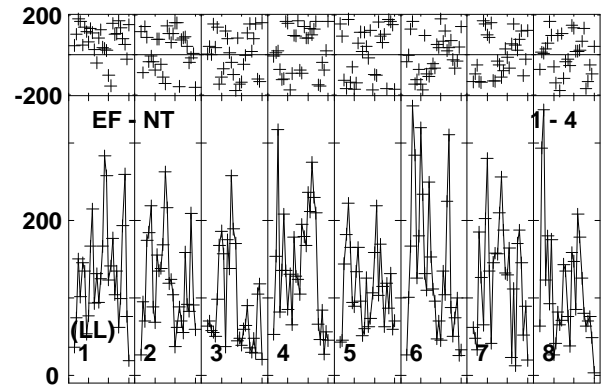
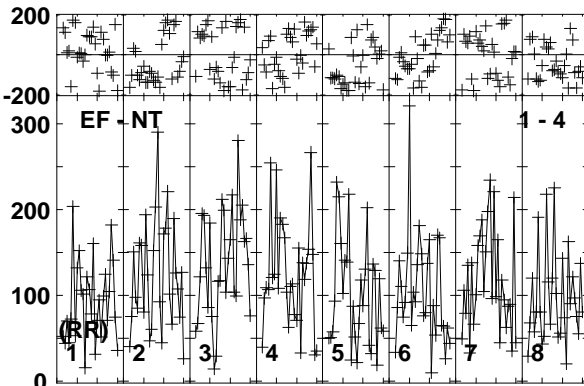
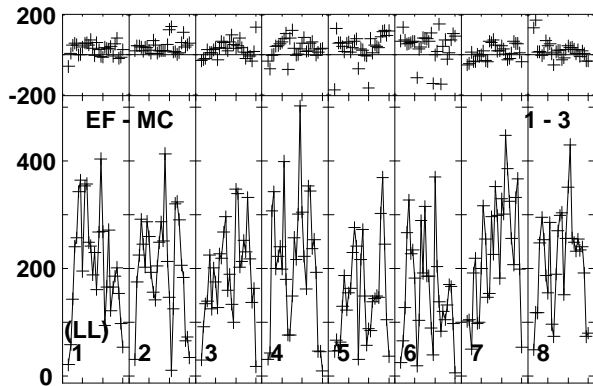
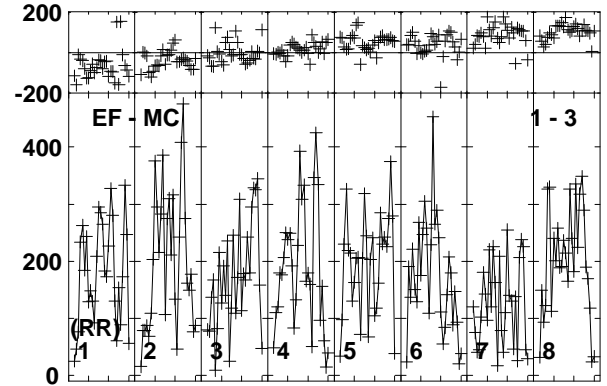
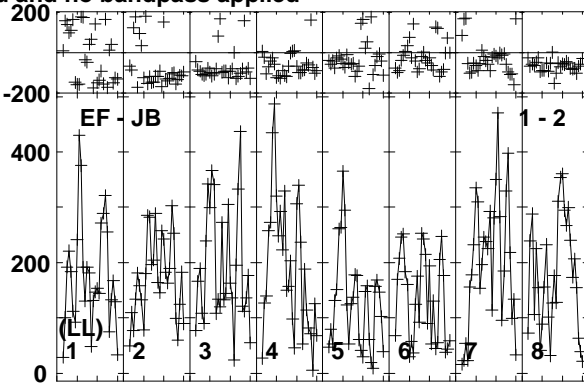
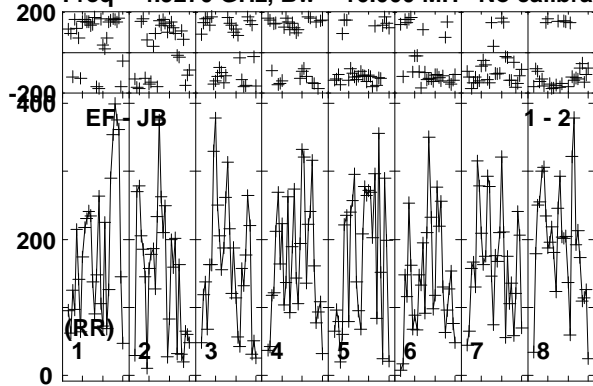

Lower frame: Micro Ampl Jy Top frame: Phas deg  
Vector averaged cross-power spectrum Baseline: EF (01) - JB (02)  
Timerange: 00/22:10:00 to 00/22:12:00

Plot file version 130 created 10-JUN-2016 17:22:13

CHECK RT013A.UVDATA.1

Freq = 4.9270 GHz, Bw = 16.000 MH No calibration applied and no bandpass applied

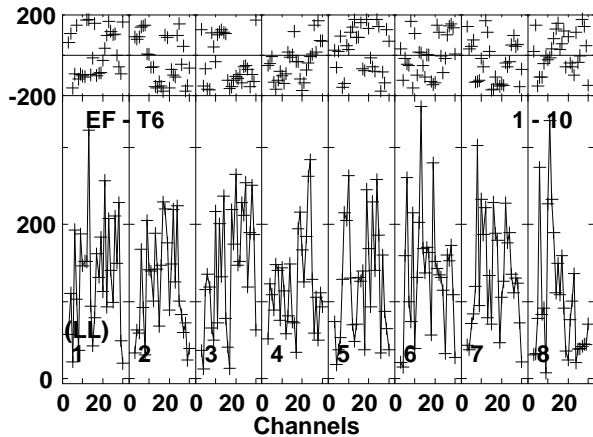
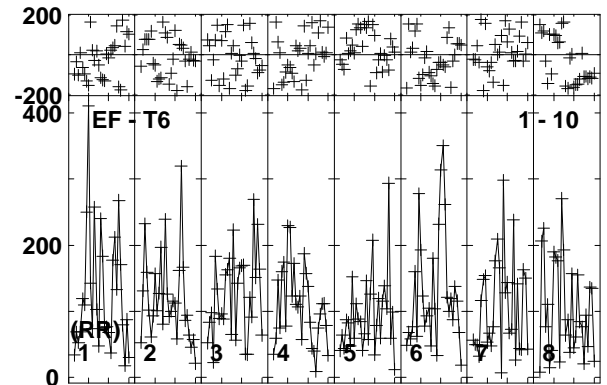
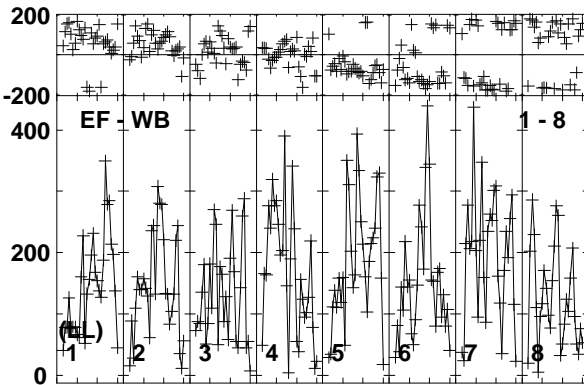
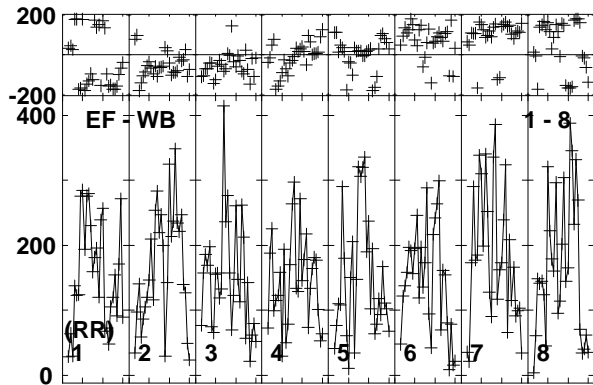
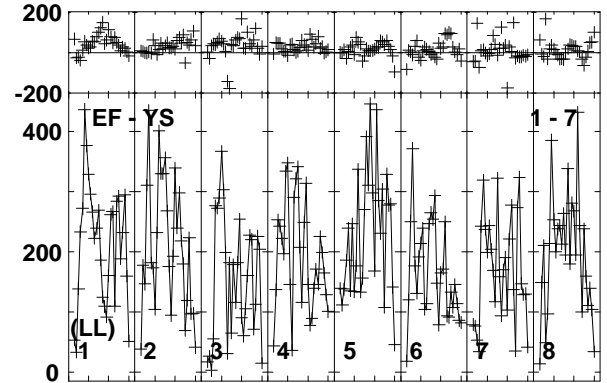
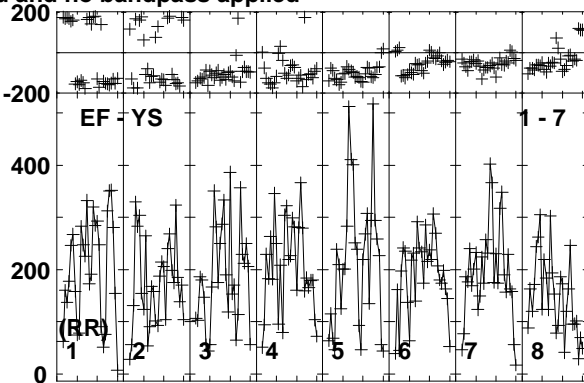
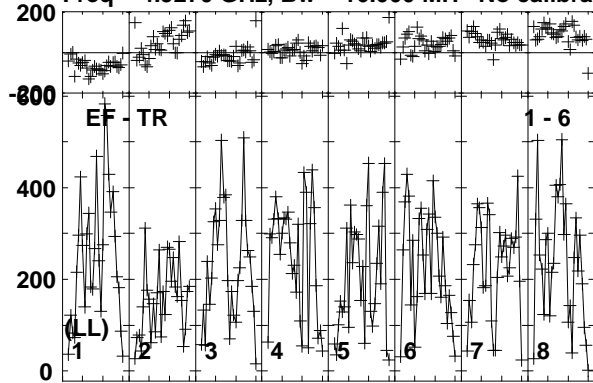

Lower frame: Micro Ampl Jy Top frame: Phas deg  
Vector averaged cross-power spectrum Baseline: EF (01) - TR (06)  
Timerange: 00:22:10:00 to 00:22:12:00



Plot file version 131 created 10-JUN-2016 17:22:13

CYGX1 RT013A.UVDATA.1

Freq = 4.9270 GHz, Bw = 16.000 MH No calibration applied and no bandpass applied

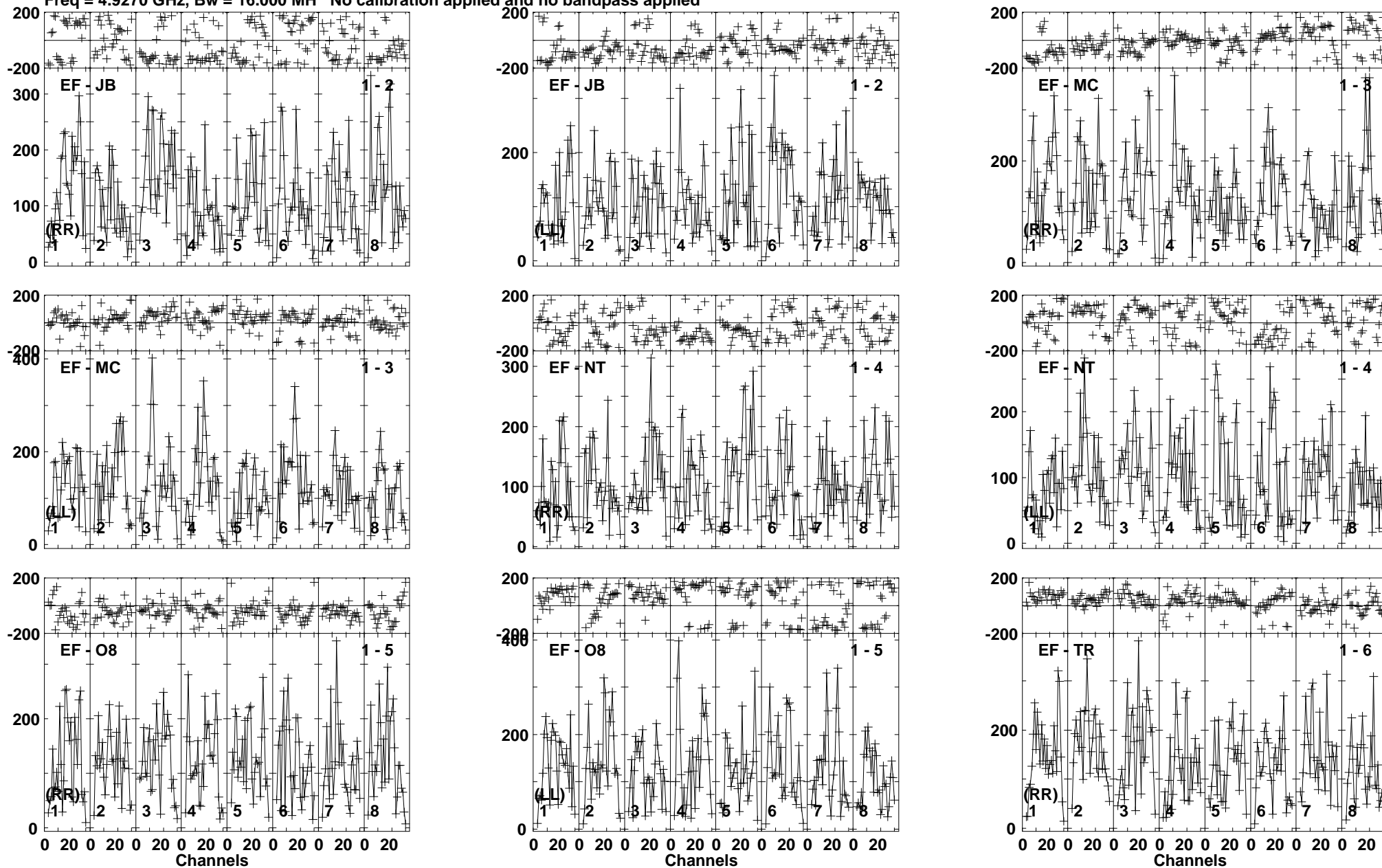

Lower frame: Micro Ampl Jy Top frame: Phas deg  
Vector averaged cross-power spectrum Baseline: EF (01) - JB (02)  
Timerange: 00:22:12:00 to 00:22:14:29

Plot file version 132 created 10-JUN-2016 17:22:13

CYGX1 RT013A.UVDATA.1

Freq = 4.9270 GHz, Bw = 16.000 MH No calibration applied and no bandpass applied

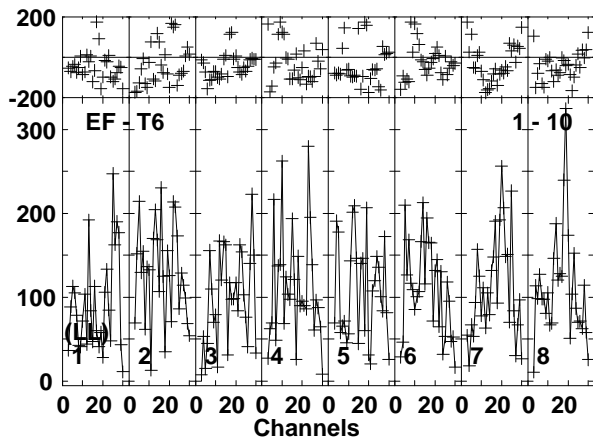
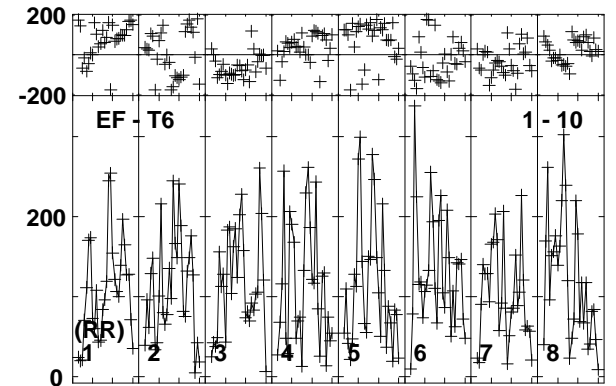
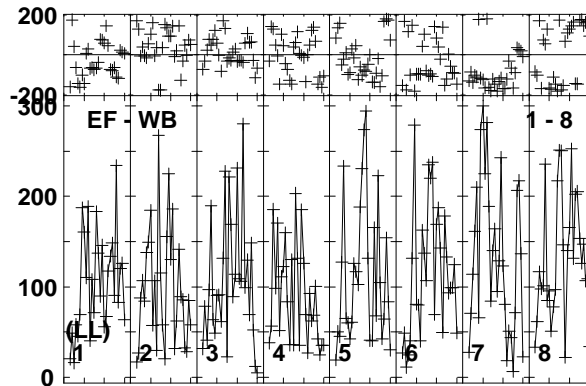
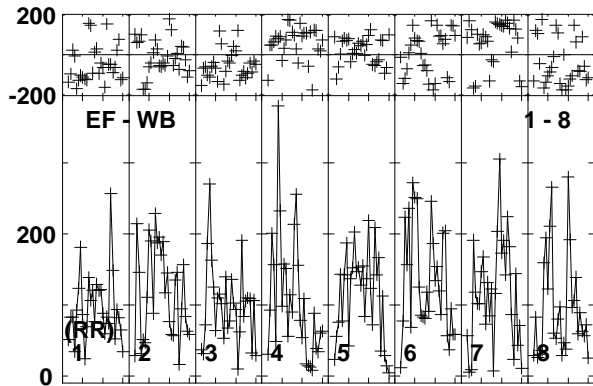
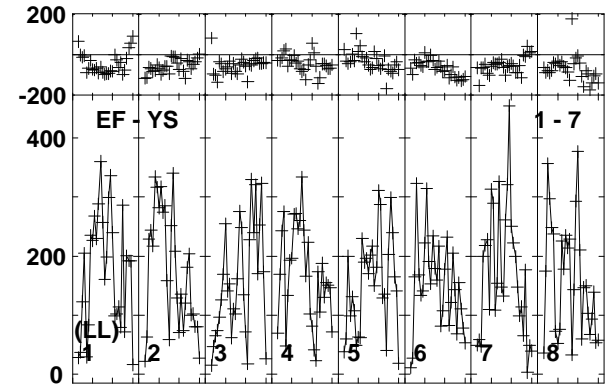
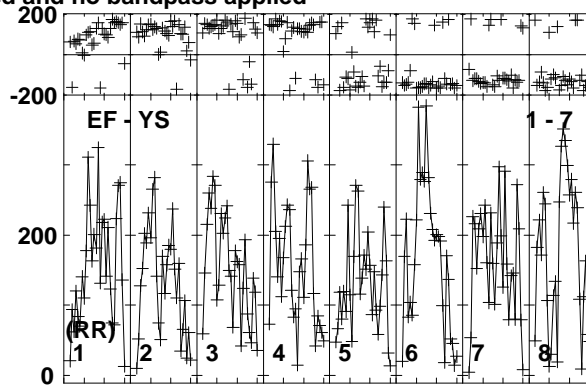
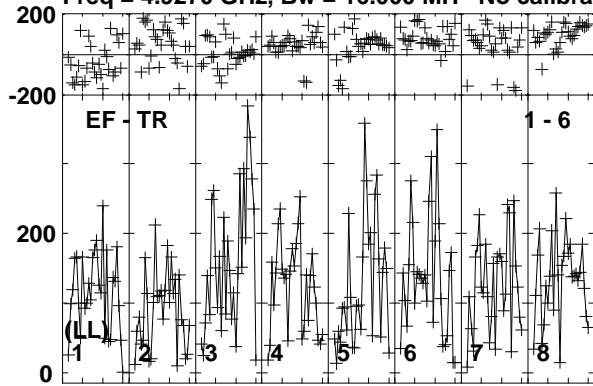

Lower frame: Micro Ampl Jy Top frame: Phas deg  
Vector averaged cross-power spectrum Baseline: EF (01) - TR (06)  
Timerange: 00:22:12:00 to 00:22:14:29

Plot file version 133 created 10-JUN-2016 17:22:13

J1957+3338 RT013A.UVDATA.1

Freq = 4.9270 GHz, Bw = 16.000 MH No calibration applied and no bandpass applied

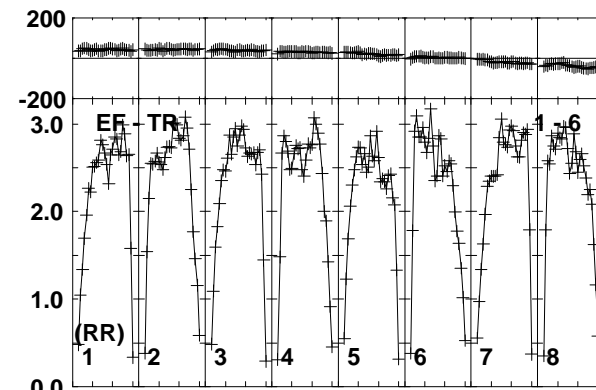
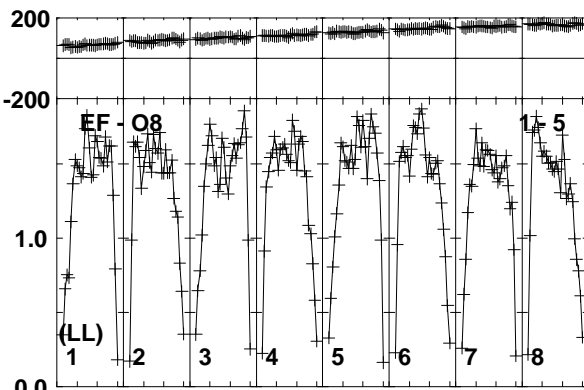
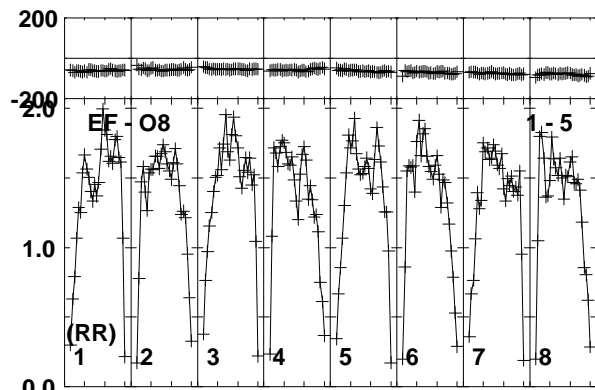
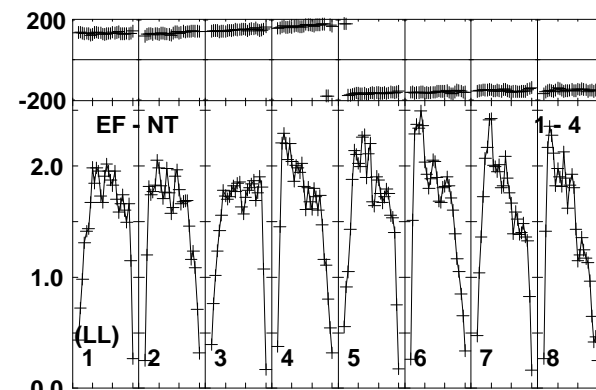
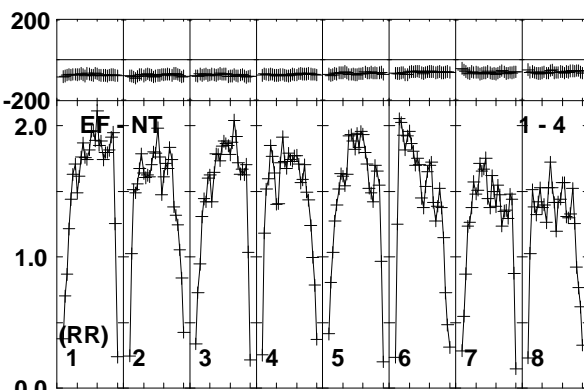
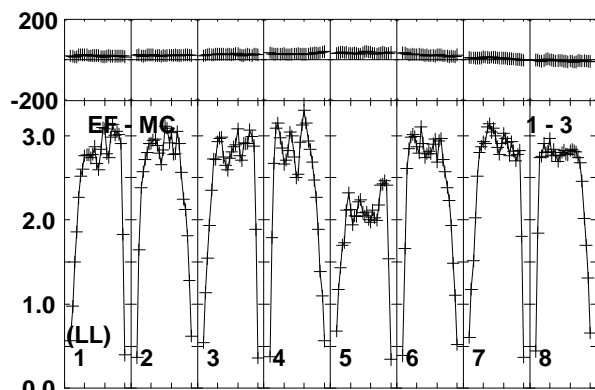
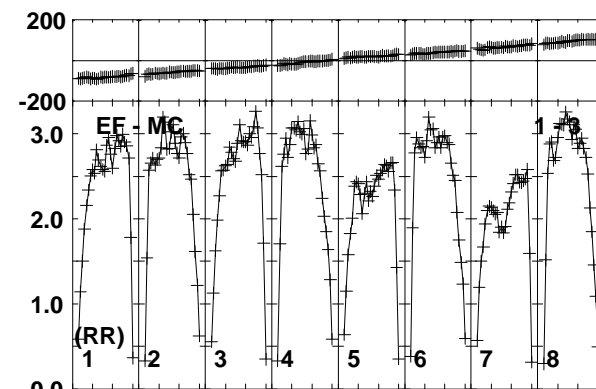
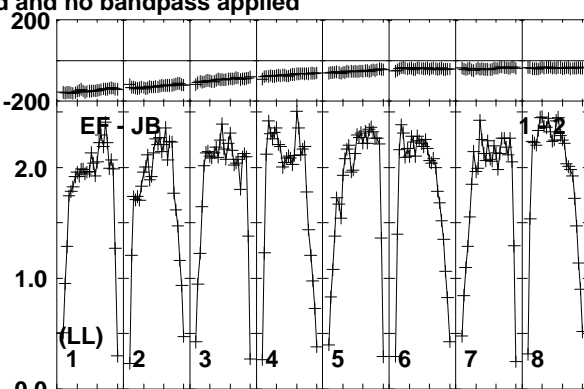
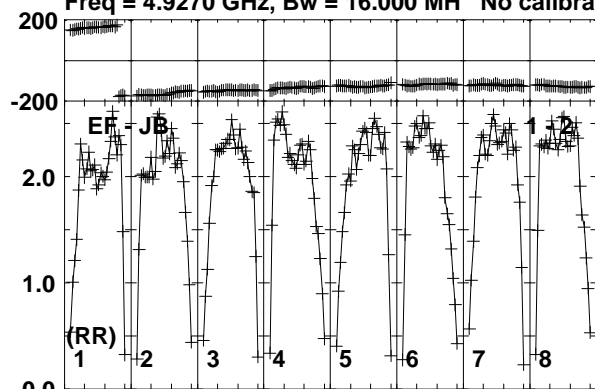

Lower frame: Milli Ampl Jy Top frame: Phas deg  
Vector averaged cross-power spectrum Baseline: EF (01) - JB (02)  
Timerange: 00:22:14:31 to 00:22:15:59

Plot file version 134 created 10-JUN-2016 17:22:13

J1957+3338 RT013A.UVDATA.1

Freq = 4.9270 GHz, Bw = 16.000 MH No calibration applied and no bandpass applied

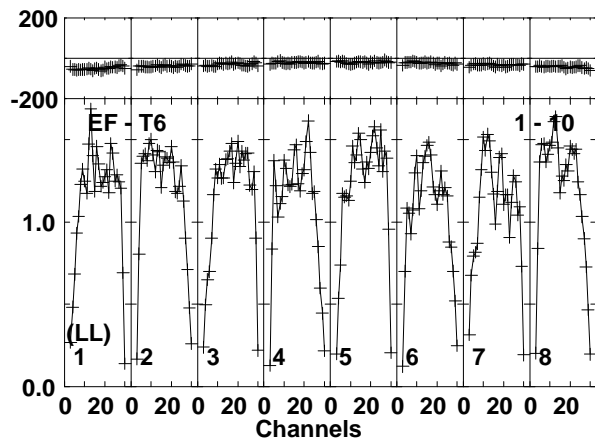
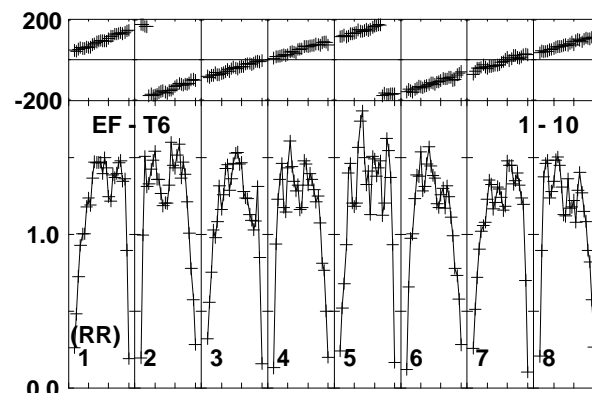
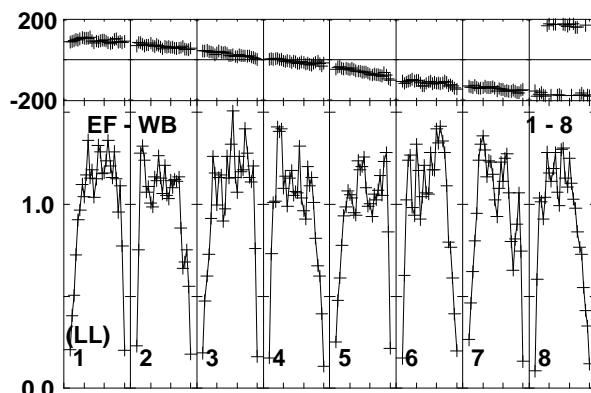
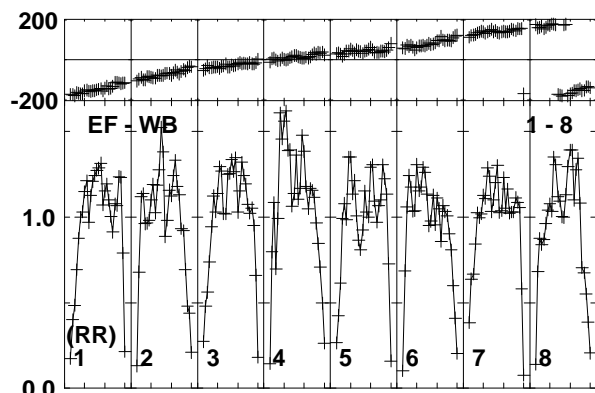
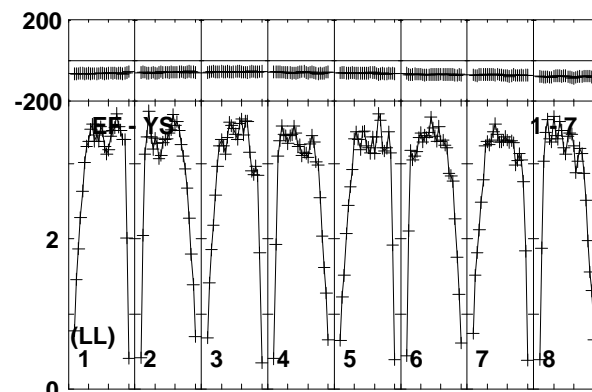
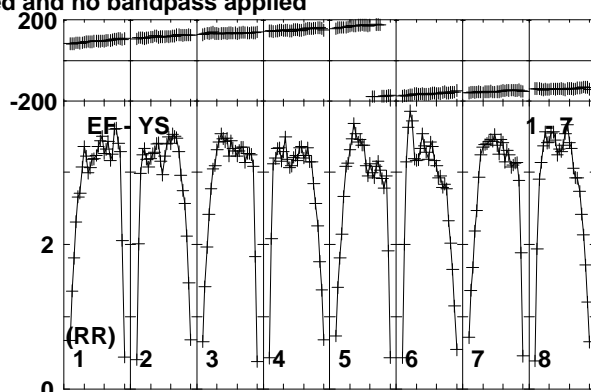
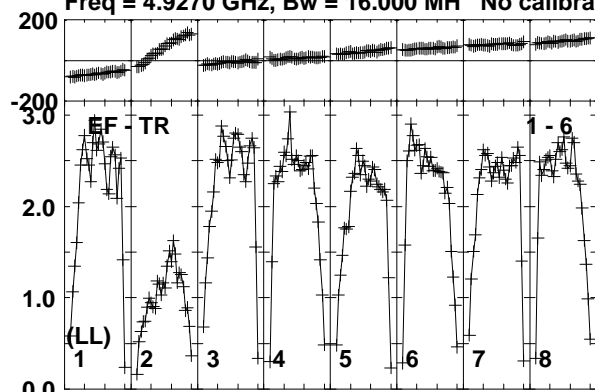

Lower frame: Milli Ampl Jy Top frame: Phas deg  
Vector averaged cross-power spectrum Baseline: EF (01) - TR (06)  
Timerange: 00/22:14:31 to 00/22:15:59

Plot file version 135 created 10-JUN-2016 17:22:13

CHECK RT013A.UVDATA.1

Freq = 4.9270 GHz, Bw = 16.000 MH No calibration applied and no bandpass applied

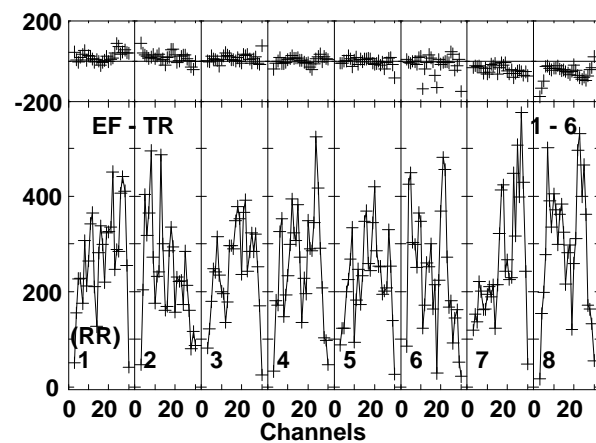
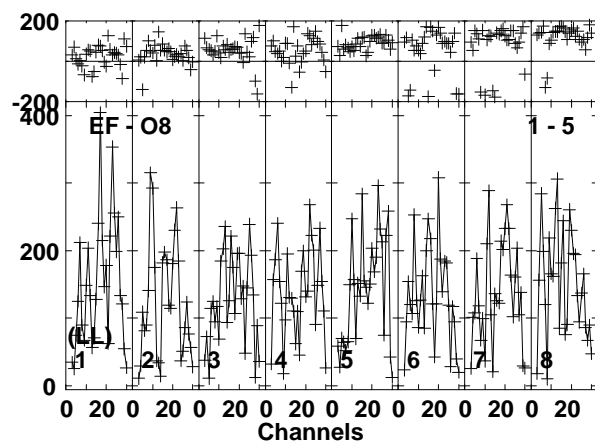
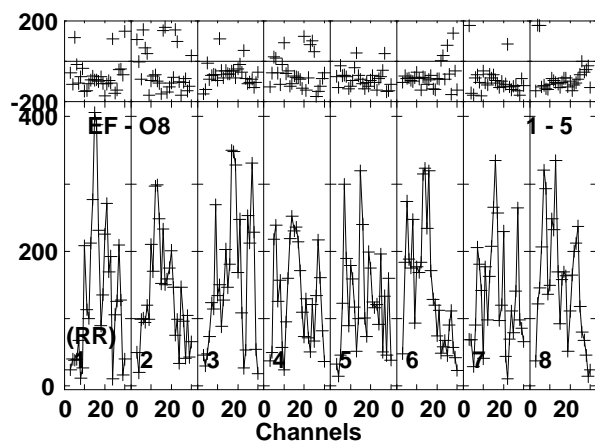
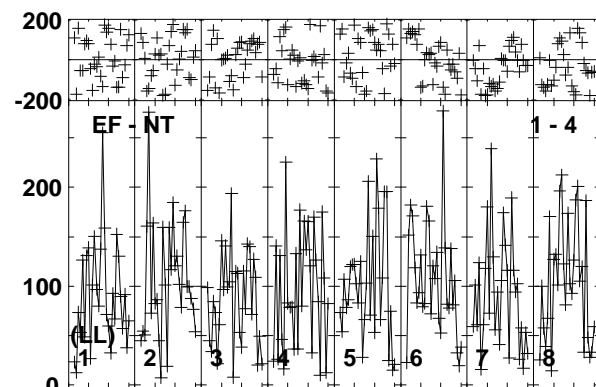
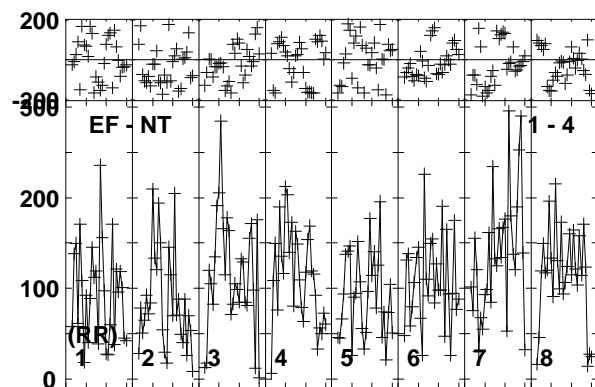
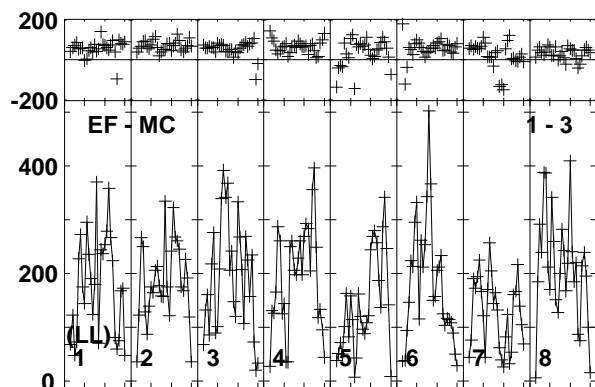
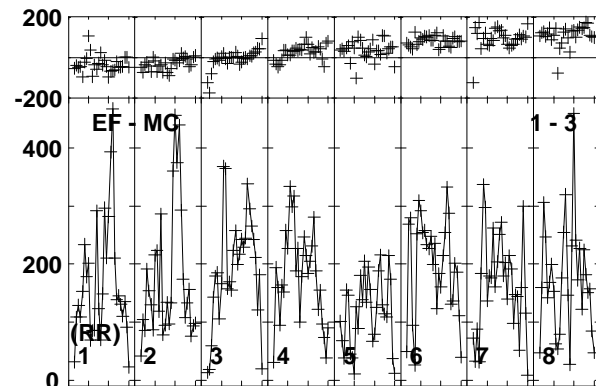
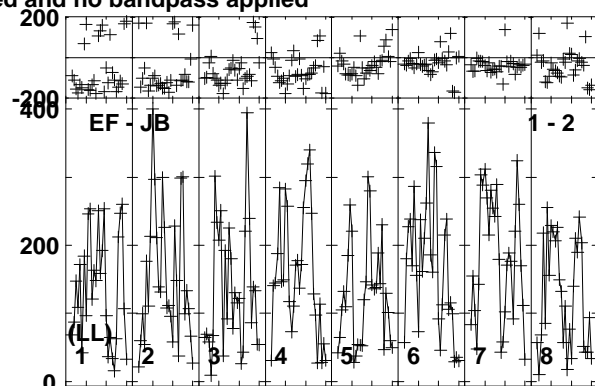
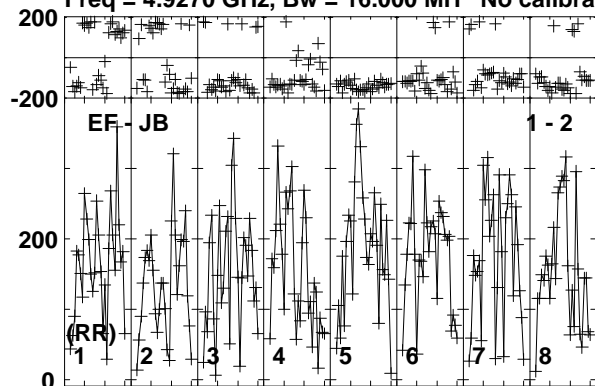

Lower frame: Micro Ampl Jy Top frame: Phas deg  
Vector averaged cross-power spectrum Baseline: EF (01) - JB (02)  
Timerange: 00/22:16:40 to 00/22:18:39

Plot file version 136 created 10-JUN-2016 17:22:14

CHECK RT013A.UVDATA.1

Freq = 4.9270 GHz, Bw = 16.000 MH No calibration applied and no bandpass applied

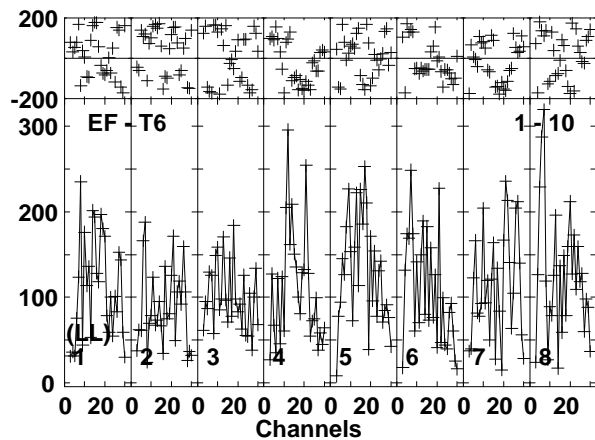
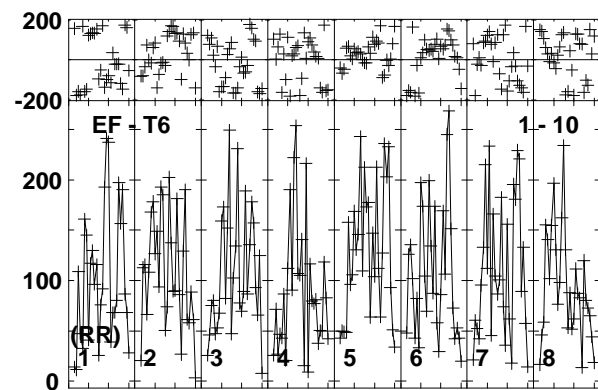
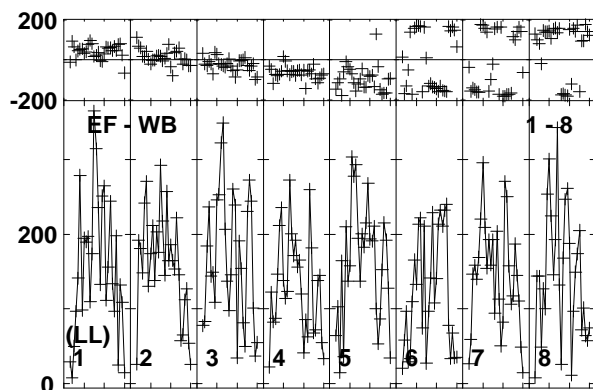
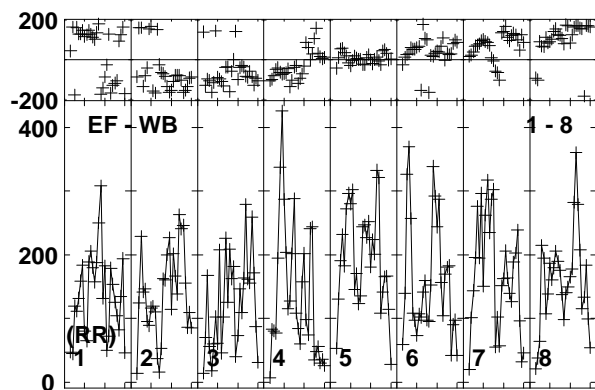
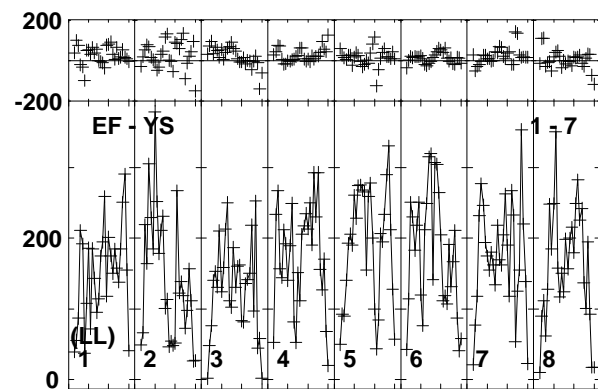
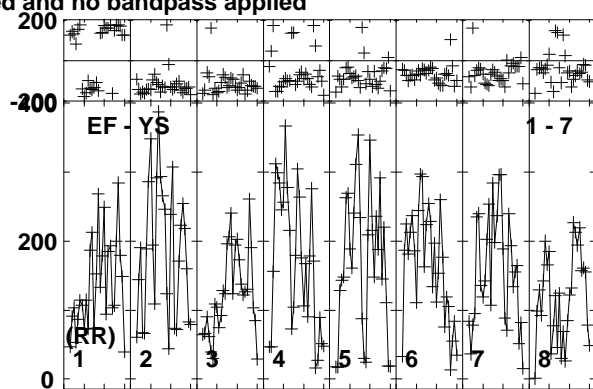
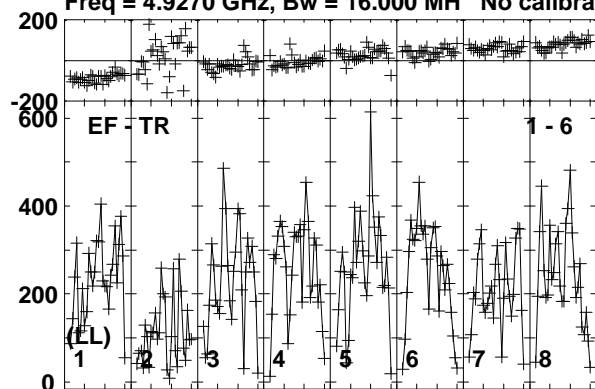

Lower frame: Micro Ampl Jy Top frame: Phas deg  
Vector averaged cross-power spectrum Baseline: EF (01) - TR (06)  
Timerange: 00/22:16:40 to 00/22:18:39

Plot file version 137 created 10-JUN-2016 17:22:14

CYGX1 RT013A.UVDATA.1

Freq = 4.9270 GHz, Bw = 16.000 MH No calibration applied and no bandpass applied

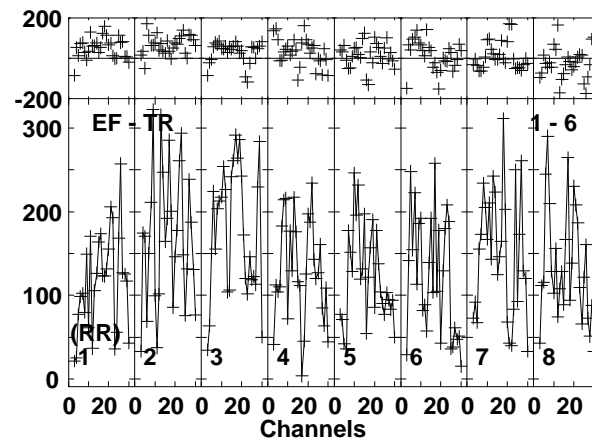
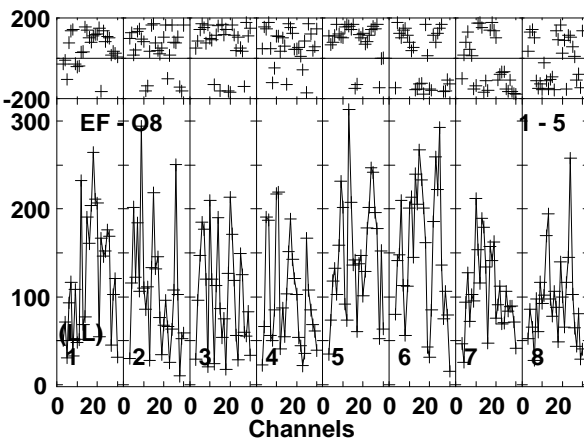
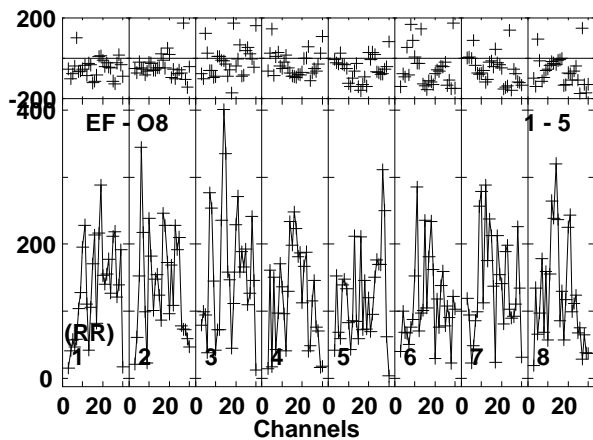
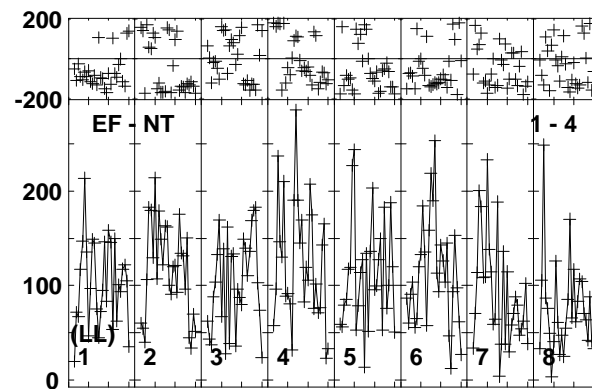
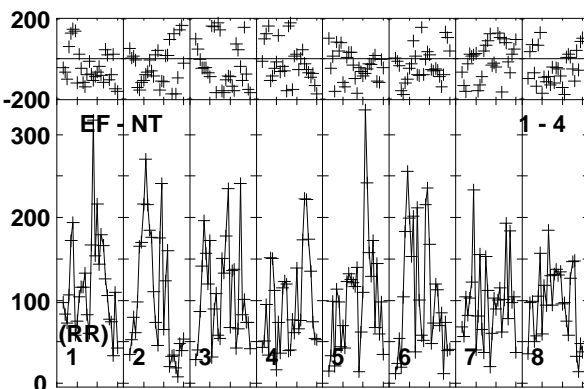
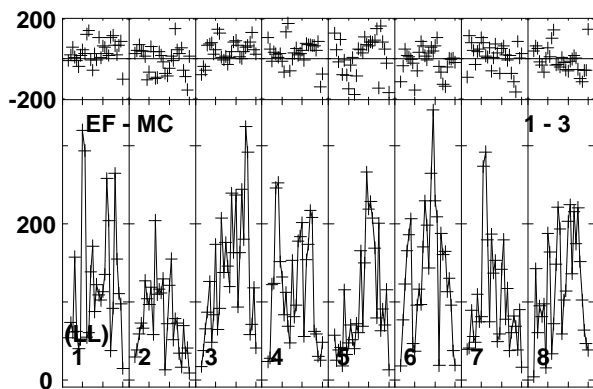
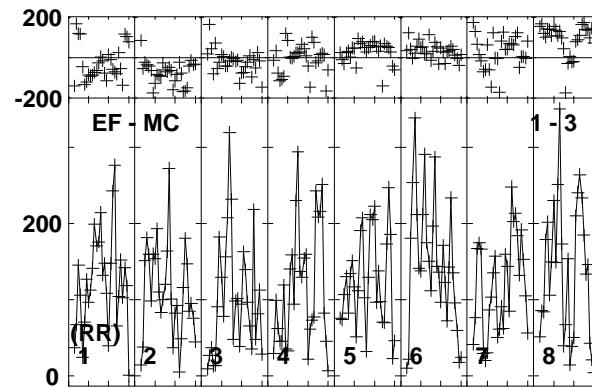
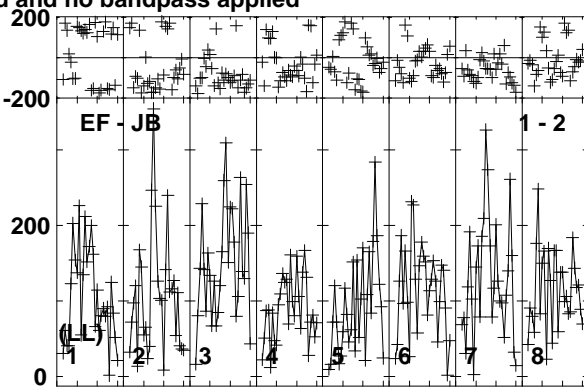
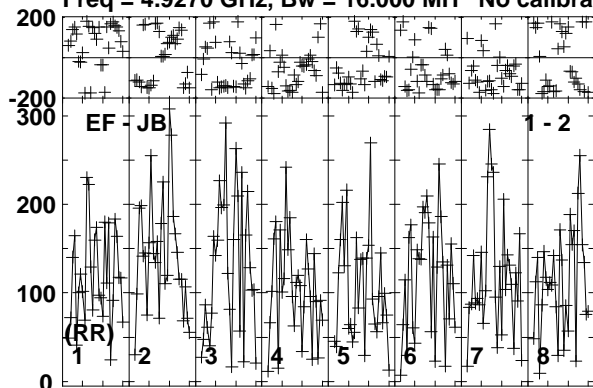

Lower frame: Micro Ampl Jy Top frame: Phas deg  
Vector averaged cross-power spectrum Baseline: EF (01) - JB (02)  
Timerange: 00/22:18:40 to 00/22:21:09

Plot file version 138 created 10-JUN-2016 17:22:14  
CYGX1 RT013A.UVDATA.1

Freq = 4.9270 GHz, Bw = 16.000 MH No calibration applied and no bandpass applied

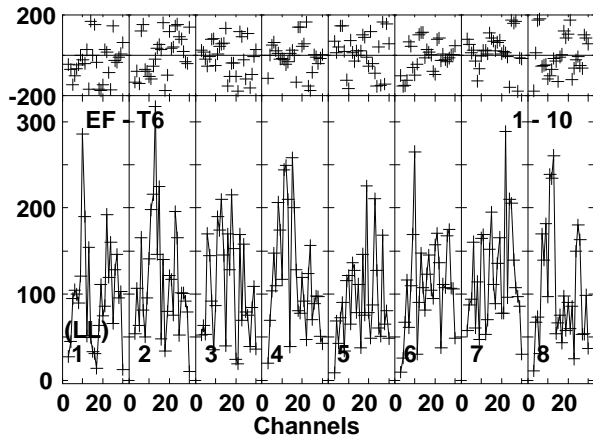
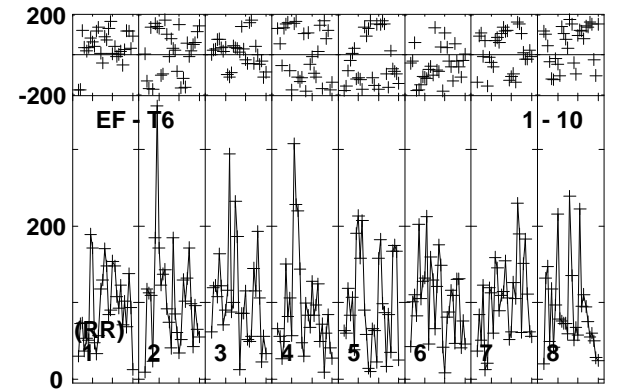
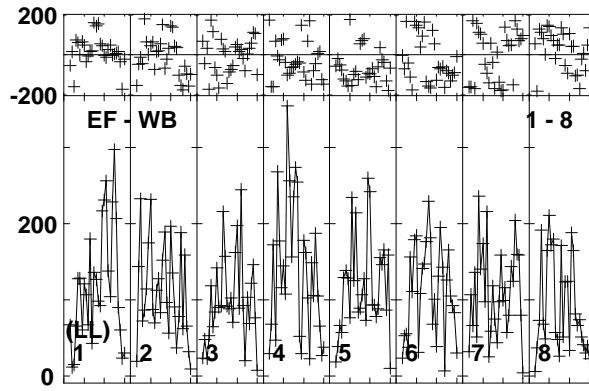
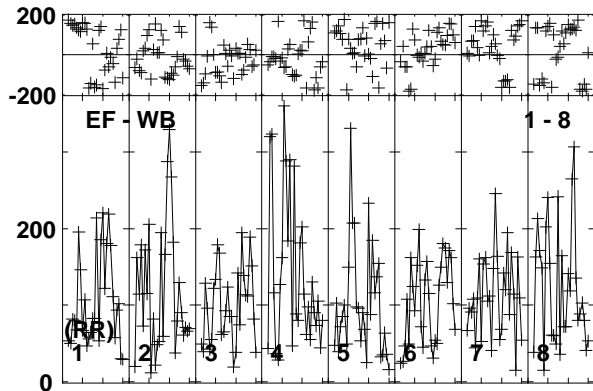
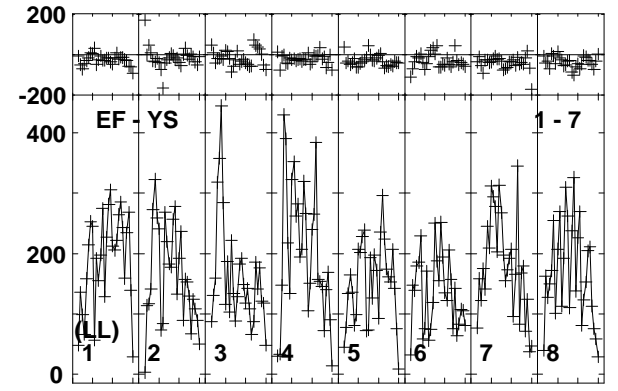
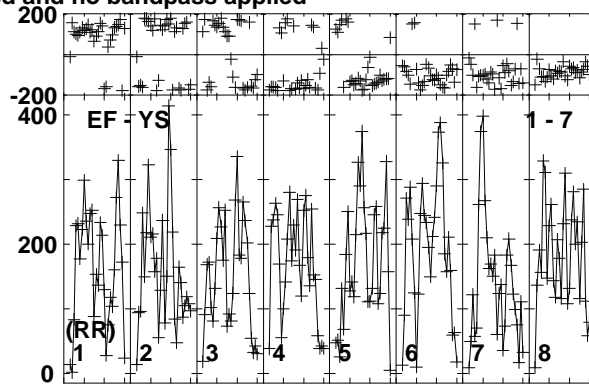
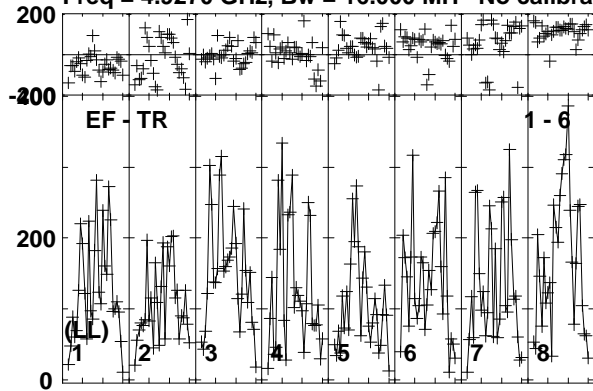

Lower frame: Micro Ampl Jy Top frame: Phas deg  
Vector averaged cross-power spectrum Baseline: EF (01) - TR (06)  
Timerange: 00/22:18:40 to 00/22:21:09



Plot file version 139 created 10-JUN-2016 17:22:14

J1957+3338 RT013A.UVDATA.1

Freq = 4.9270 GHz, Bw = 16.000 MH No calibration applied and no bandpass applied

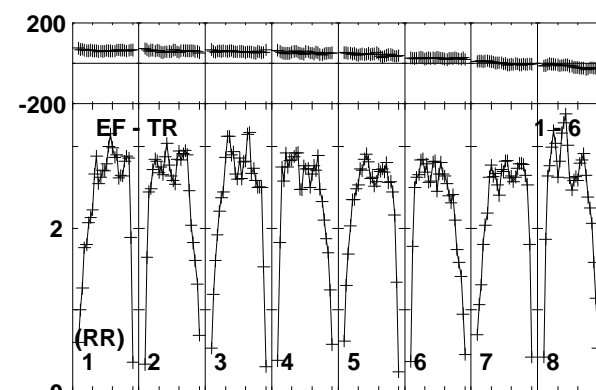
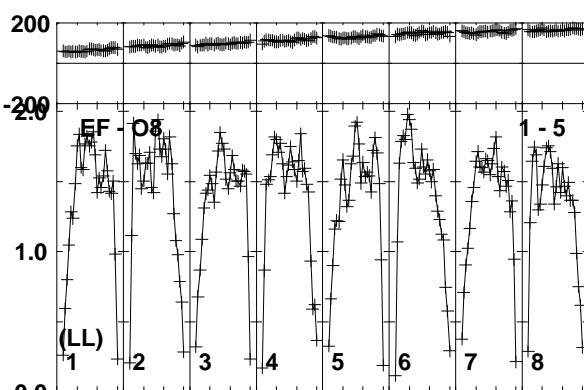
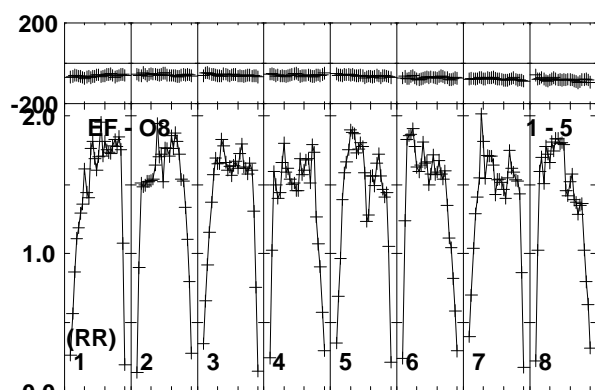
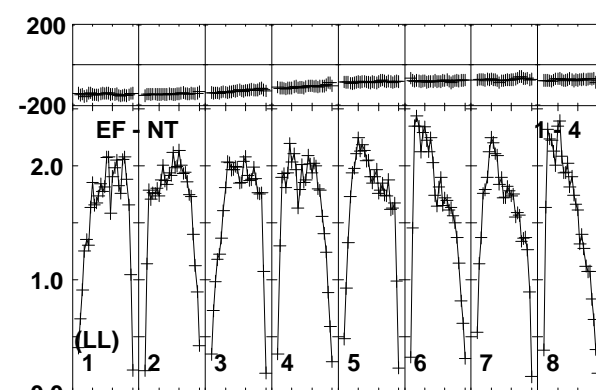
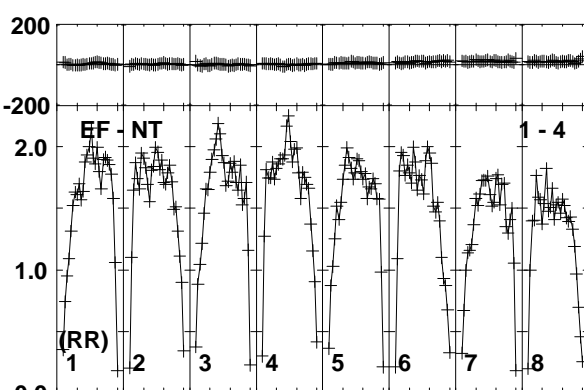
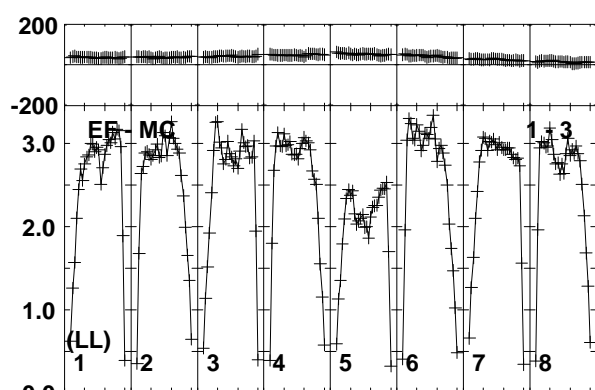
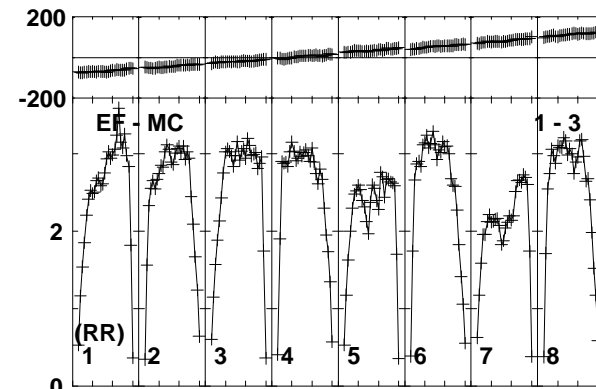
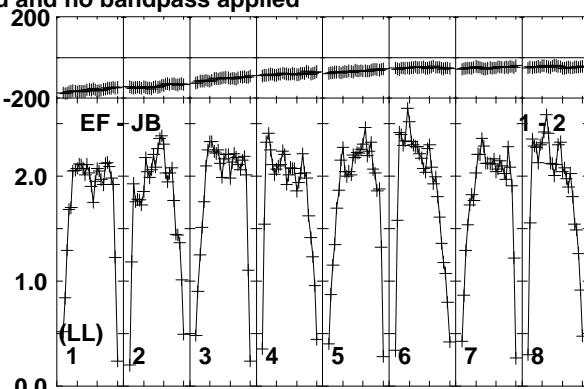
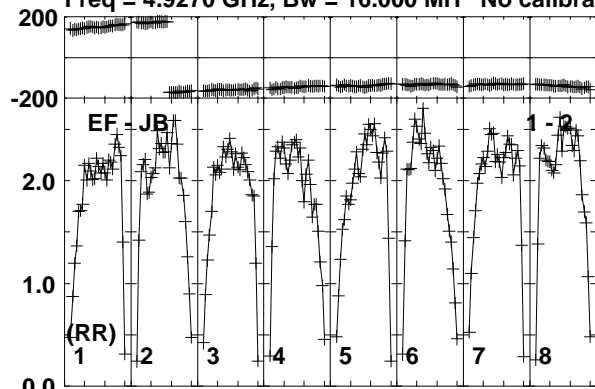

Lower frame: Milli Ampl Jy Top frame: Phas deg  
Vector averaged cross-power spectrum Baseline: EF (01) - JB (02)  
Timerange: 00/22:21:11 to 00/22:22:39

Plot file version 140 created 10-JUN-2016 17:22:14

J1957+3338 RT013A.UVDATA.1

Freq = 4.9270 GHz, Bw = 16.000 MH No calibration applied and no bandpass applied

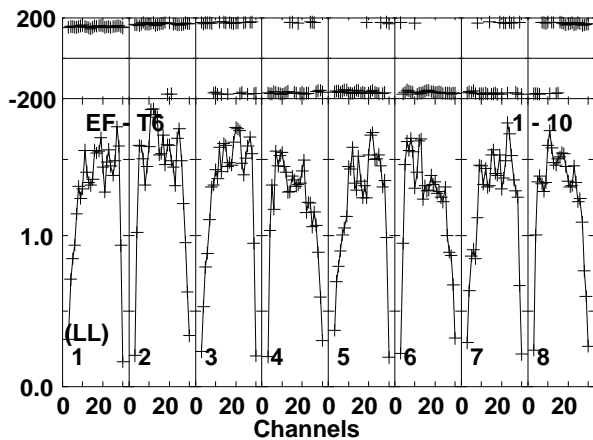
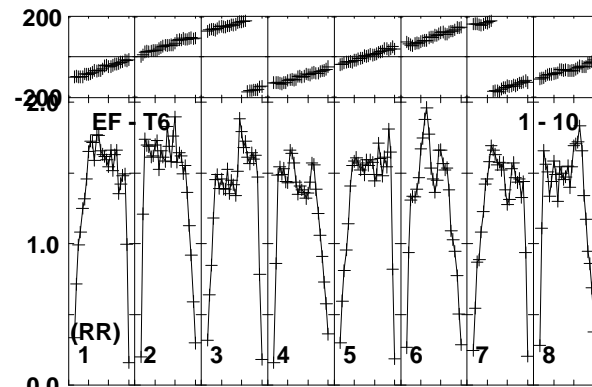
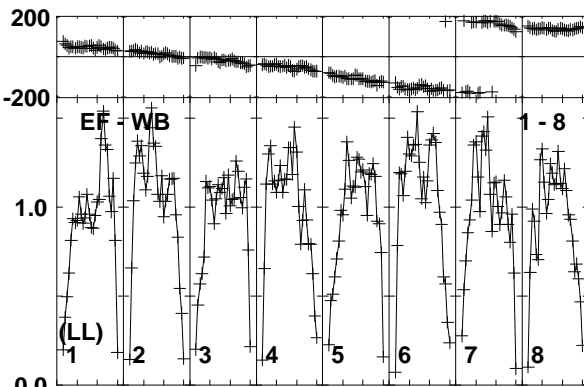
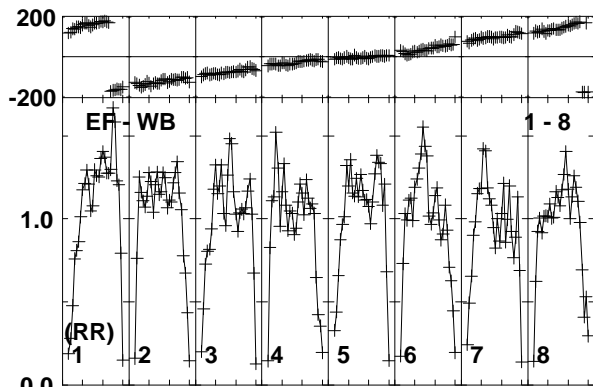
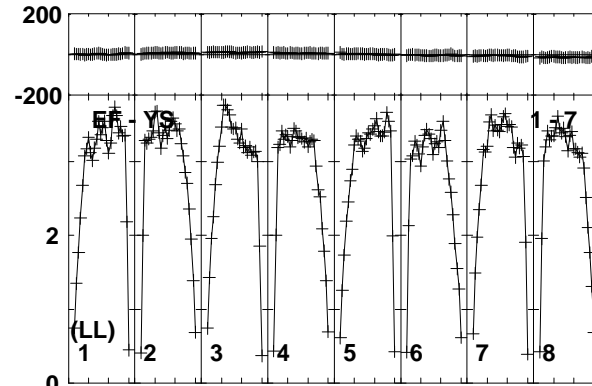
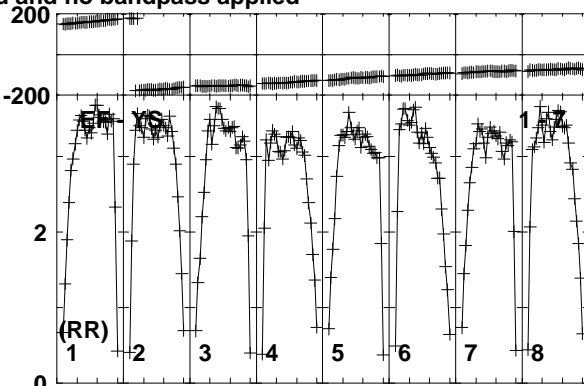
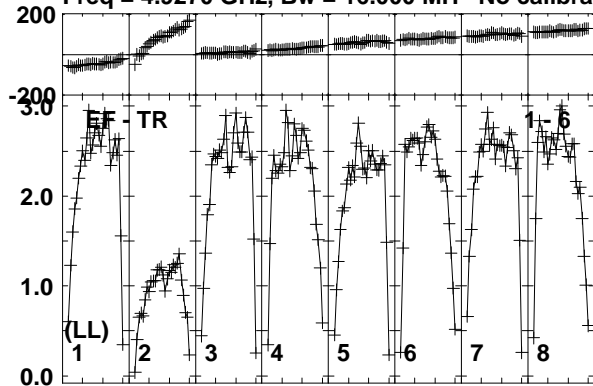

Lower frame: Milli Ampl Jy Top frame: Phas deg  
Vector averaged cross-power spectrum Baseline: EF (01) - TR (06)  
Timerange: 00/22:21:11 to 00/22:22:39

Plot file version 141 created 10-JUN-2016 17:22:14

CHECK RT013A.UVDATA.1

Freq = 4.9270 GHz, Bw = 16.000 MH No calibration applied and no bandpass applied

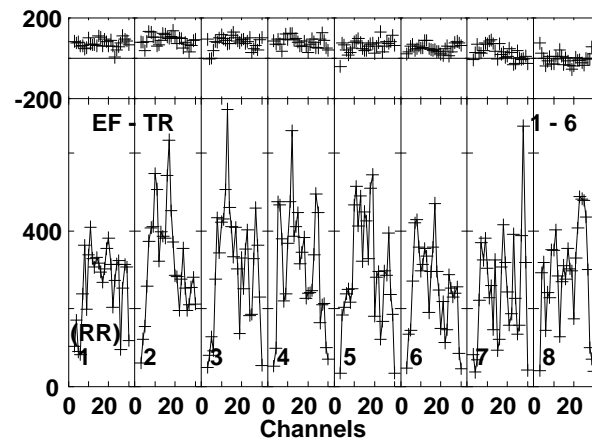
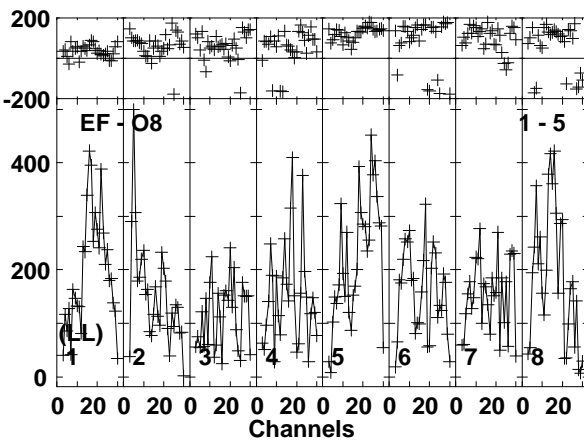
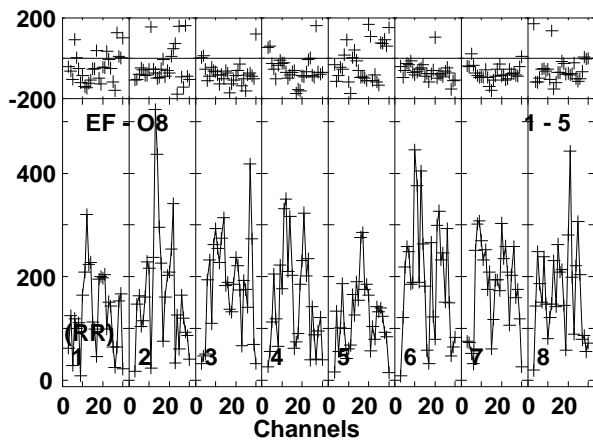
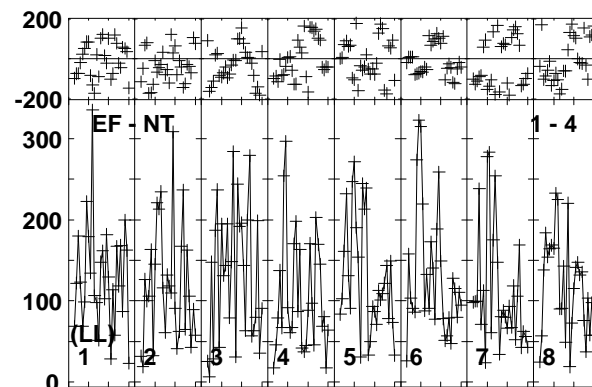
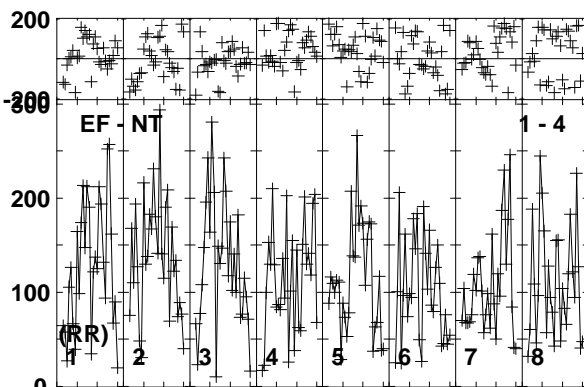
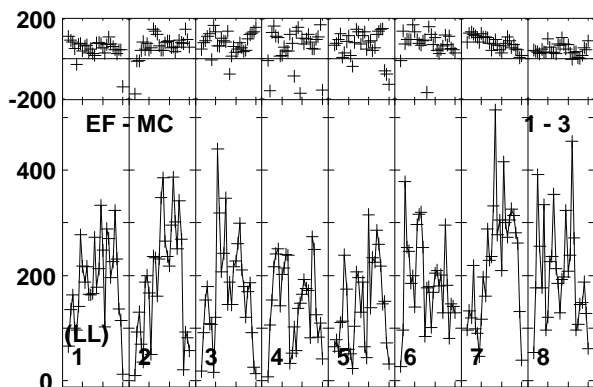
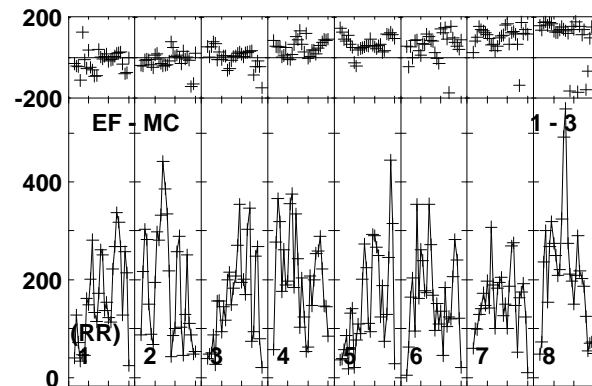
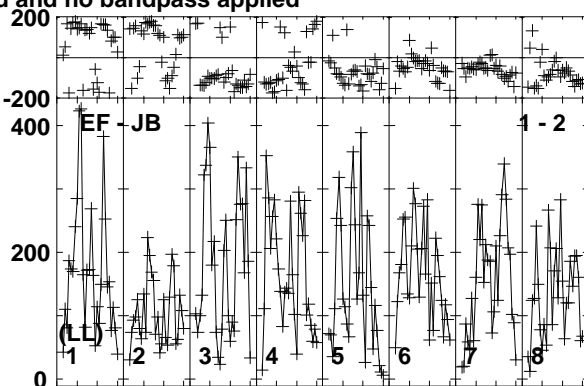
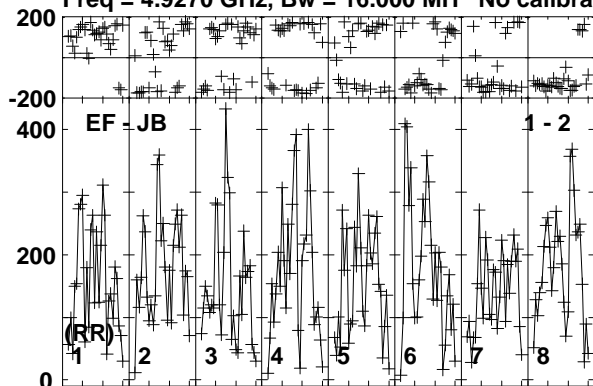

Lower frame: Micro Ampl Jy Top frame: Phas deg  
Vector averaged cross-power spectrum Baseline: EF (01) - JB (02)  
Timerange: 00/22:22:41 to 00/22:24:40

Plot file version 142 created 10-JUN-2016 17:22:14

CHECK RT013A.UVDATA.1

Freq = 4.9270 GHz, Bw = 16.000 MH No calibration applied and no bandpass applied

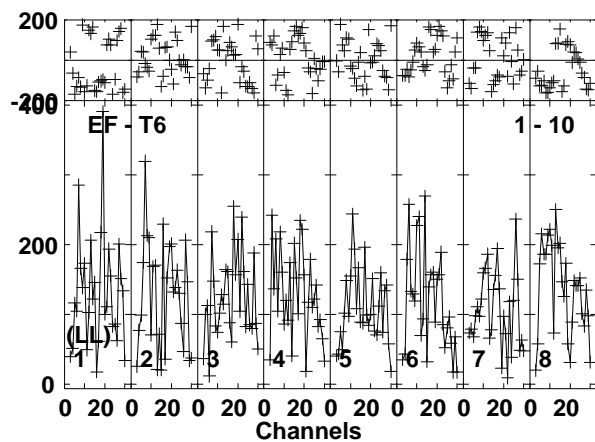
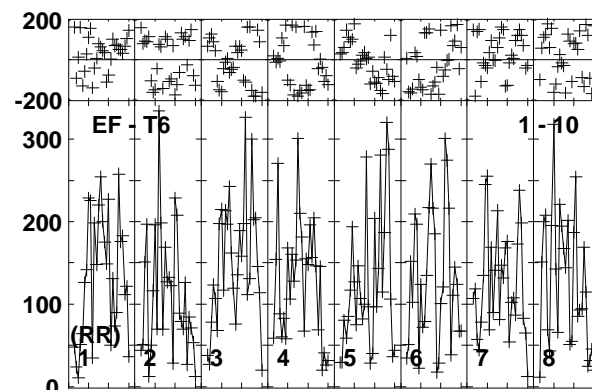
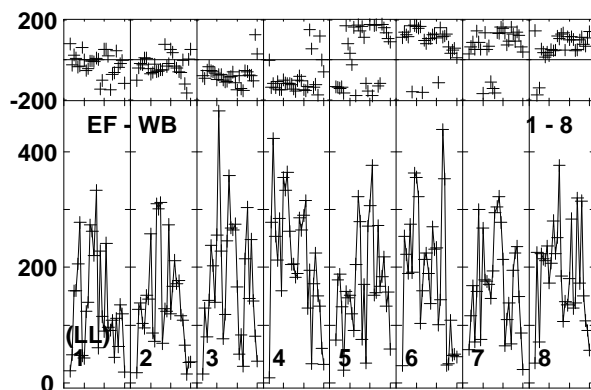
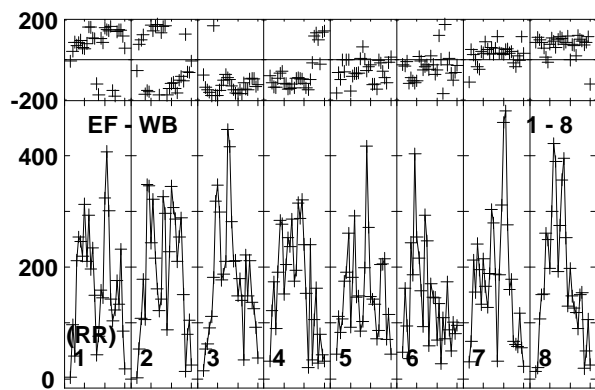
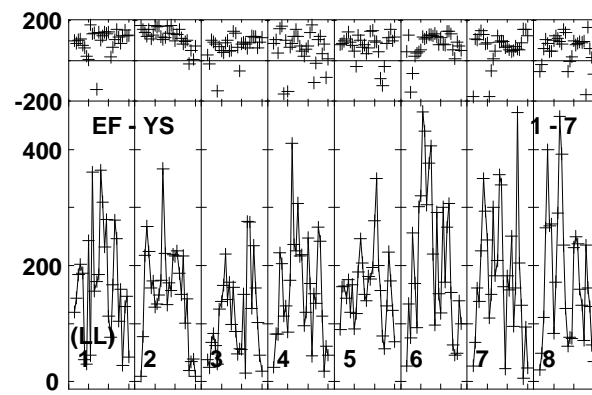
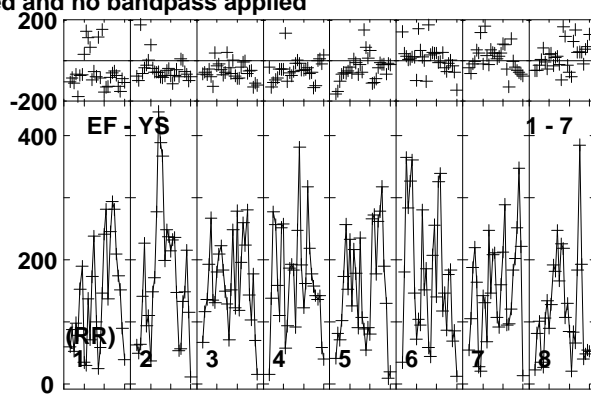
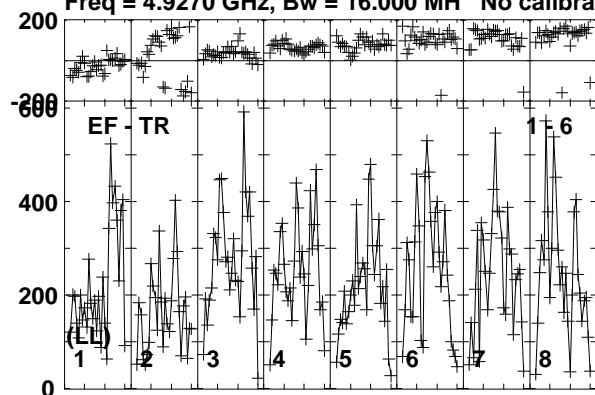

Lower frame: Micro Ampl Jy Top frame: Phas deg  
Vector averaged cross-power spectrum Baseline: EF (01) - TR (06)  
Timerange: 00/22:22:41 to 00/22:24:40

Plot file version 143 created 10-JUN-2016 17:22:14

CYGX1 RT013A.UVDATA.1

Freq = 4.9270 GHz, Bw = 16.000 MH No calibration applied and no bandpass applied

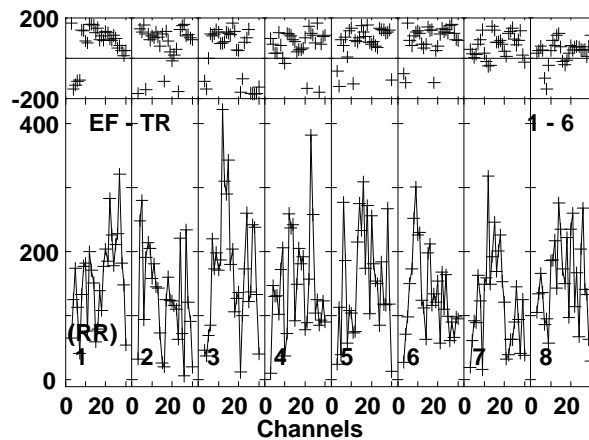
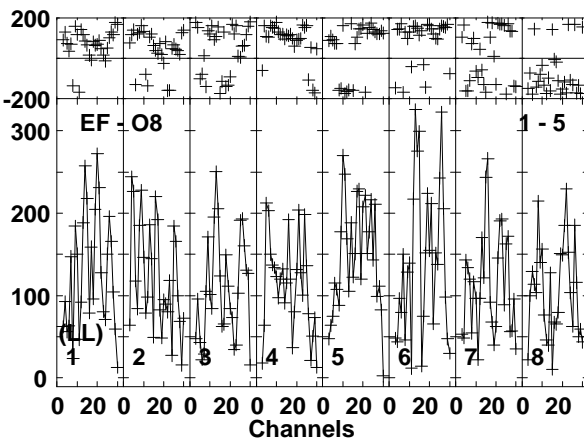
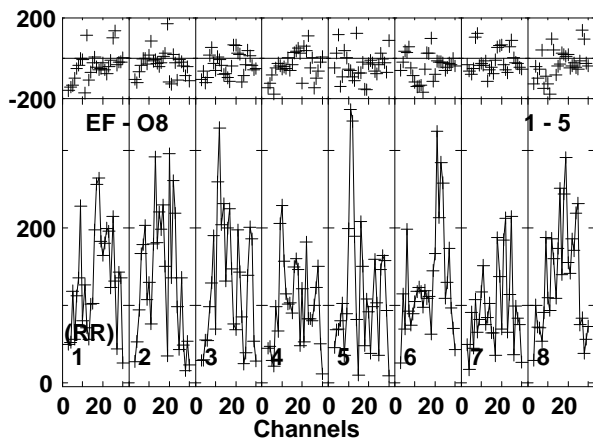
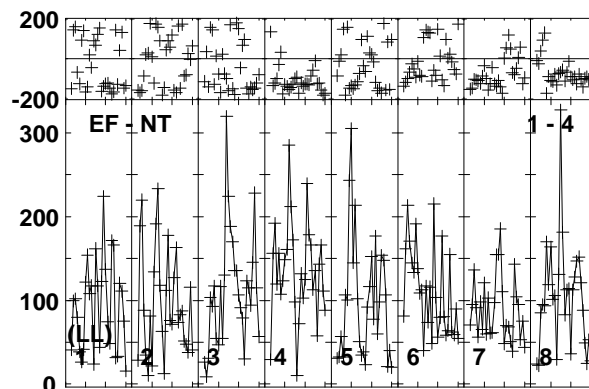
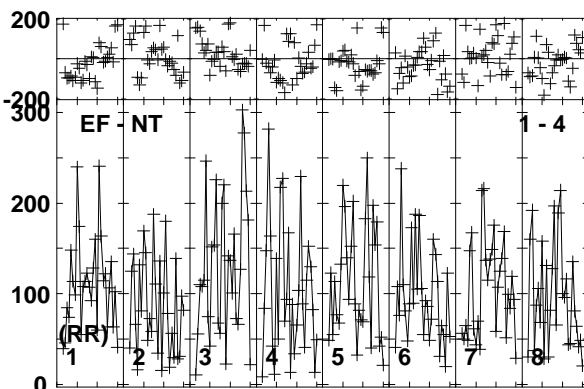
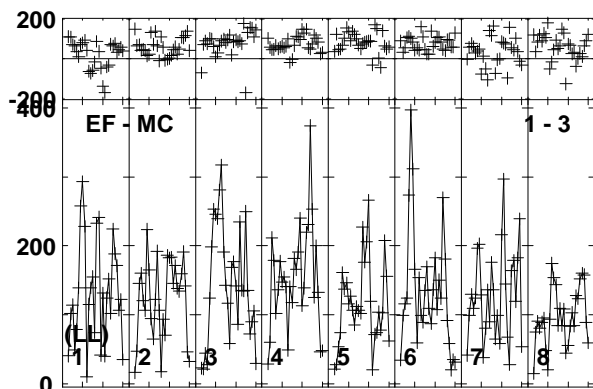
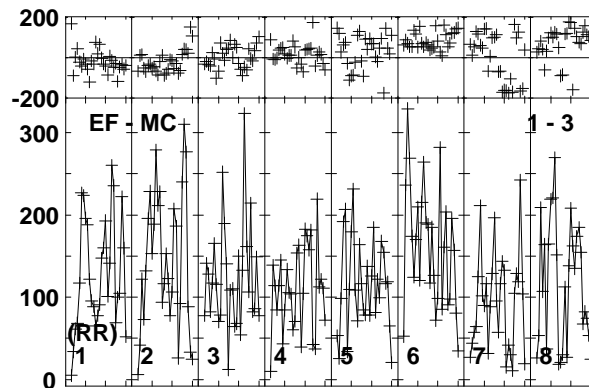
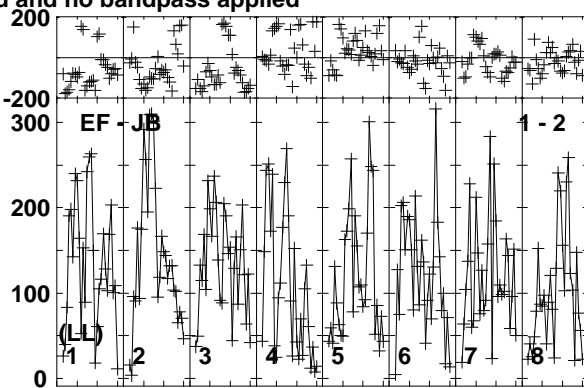
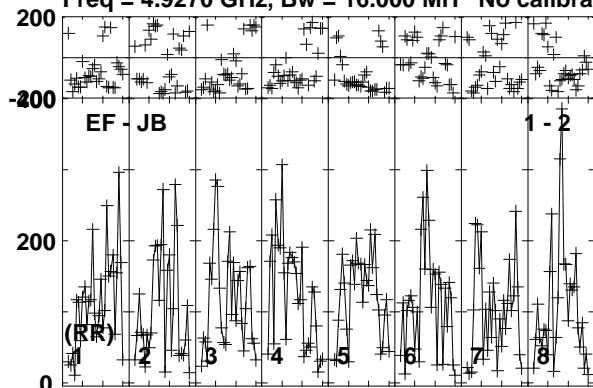

Lower frame: Micro Ampl Jy Top frame: Phas deg  
Vector averaged cross-power spectrum Baseline: EF (01) - JB (02)  
Timerange: 00/22:24:41 to 00/22:27:09

Plot file version 144 created 10-JUN-2016 17:22:14

CYGX1 RT013A.UVDATA.1

Freq = 4.9270 GHz, Bw = 16.000 MH No calibration applied and no bandpass applied

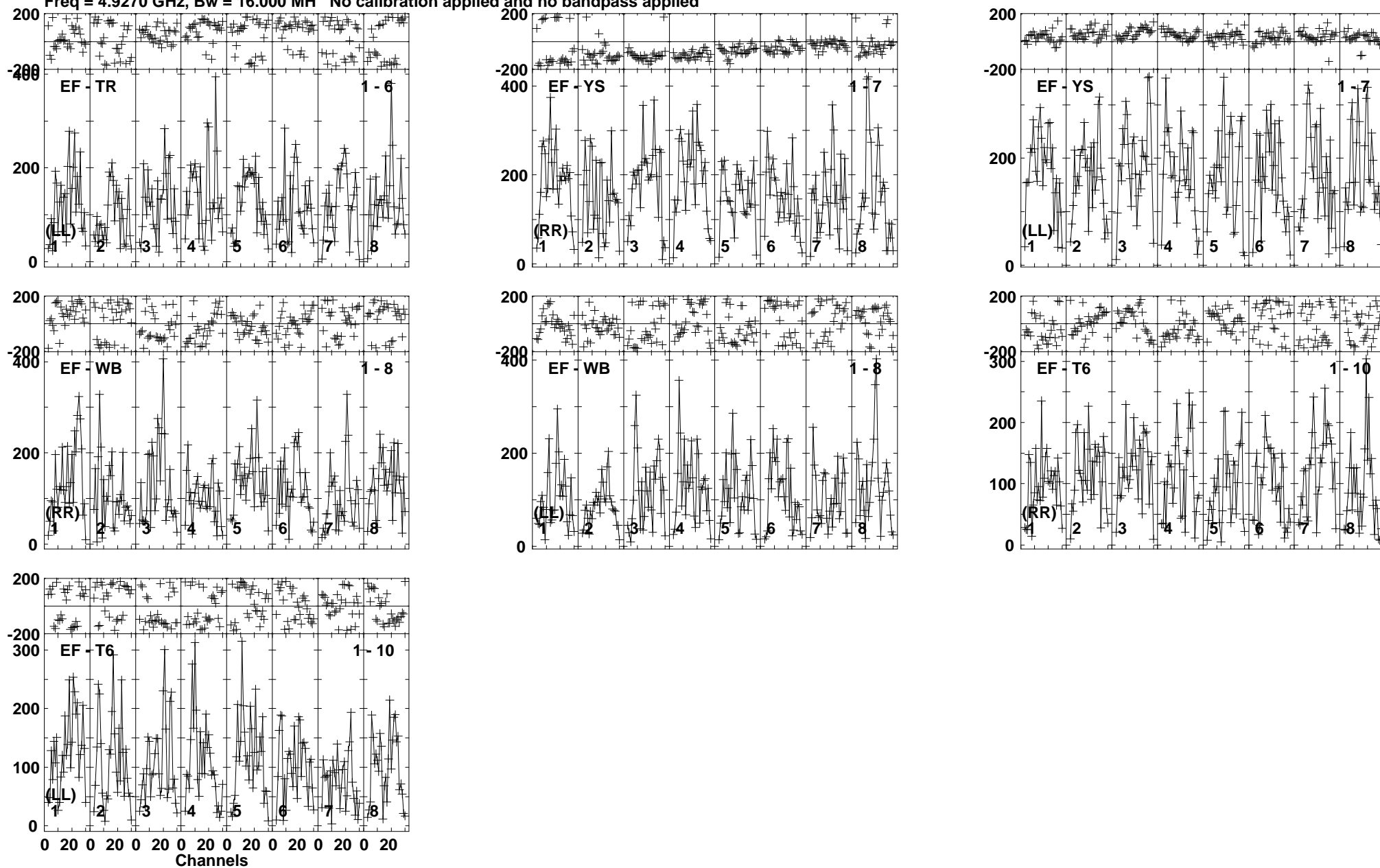

Lower frame: Micro Ampl Jy Top frame: Phas deg  
Vector averaged cross-power spectrum Baseline: EF (01) - TR (06)  
Timerange: 00/22:24:41 to 00/22:27:09

Plot file version 145 created 10-JUN-2016 17:22:15

J1957+3338 RT013A.UVDATA.1

Freq = 4.9270 GHz, Bw = 16.000 MH No calibration applied and no bandpass applied

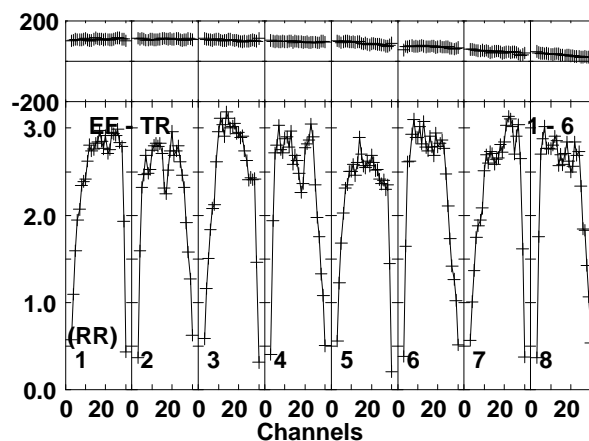
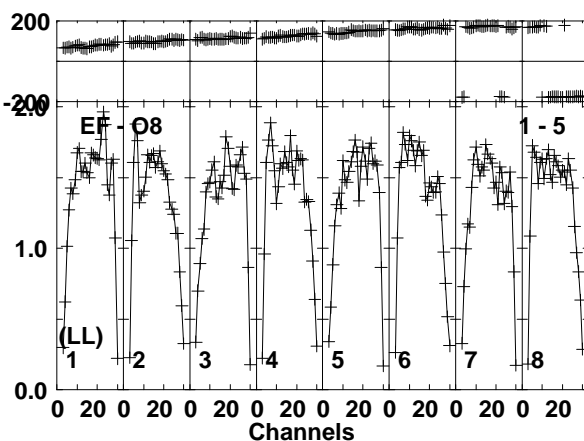
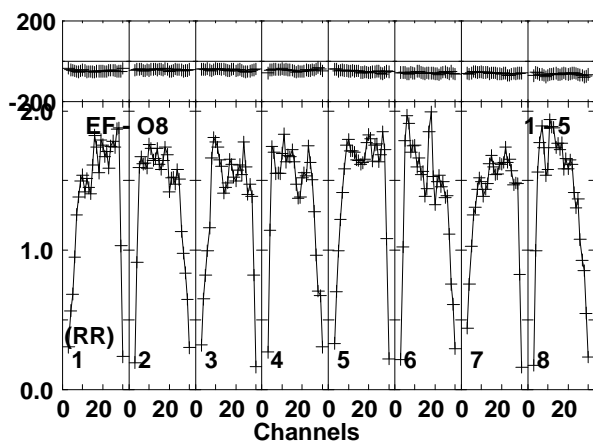
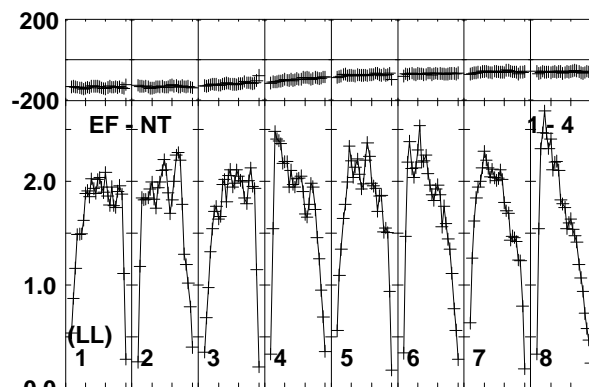
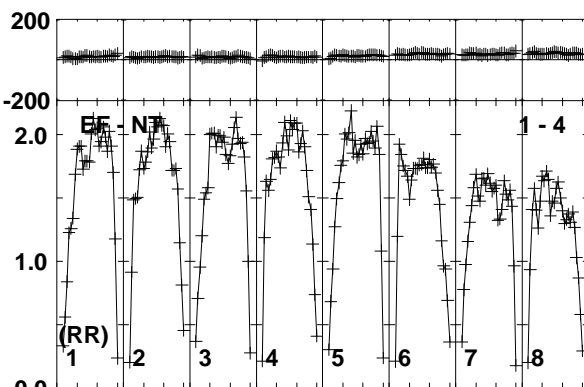
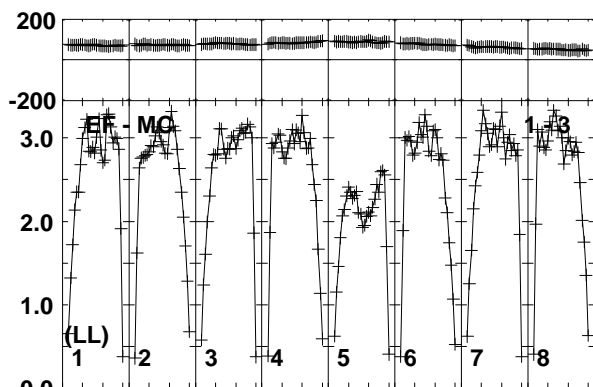
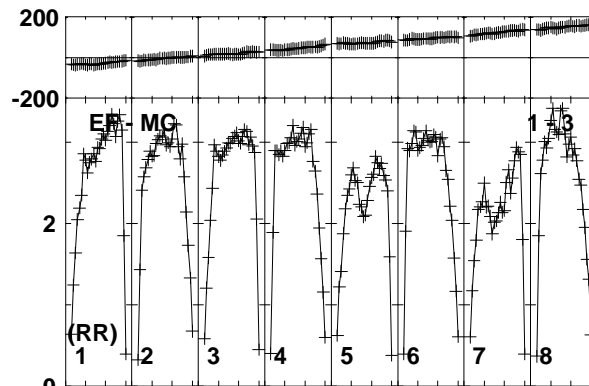
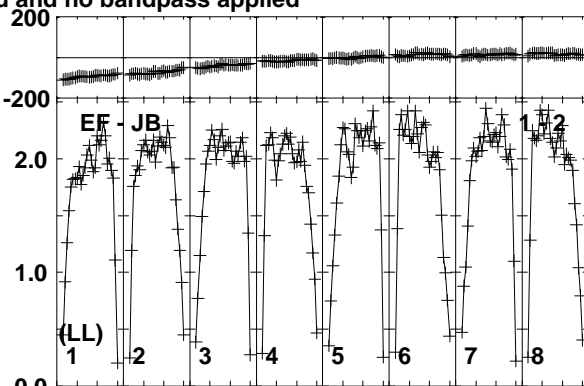
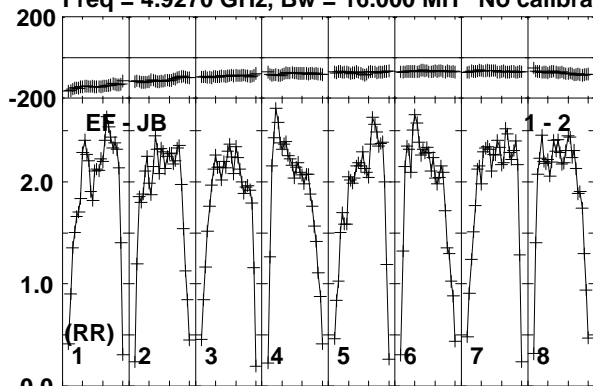

Lower frame: Milli Ampl Jy Top frame: Phas deg  
Vector averaged cross-power spectrum Baseline: EF (01) - JB (02)  
Timerange: 00/22:27:10 to 00/22:28:39

Plot file version 146 created 10-JUN-2016 17:22:15

J1957+3338 RT013A.UVDATA.1

Freq = 4.9270 GHz, Bw = 16.000 MH No calibration applied and no bandpass applied

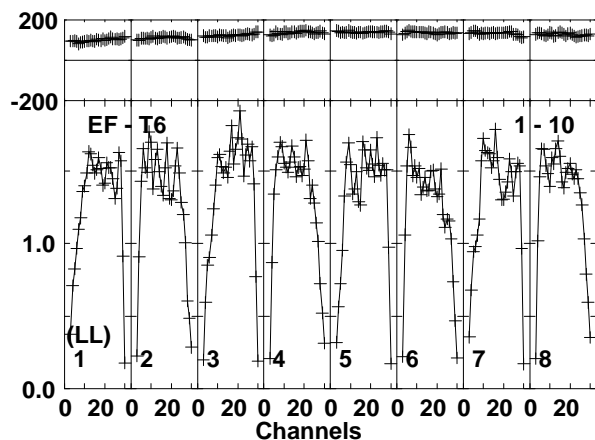
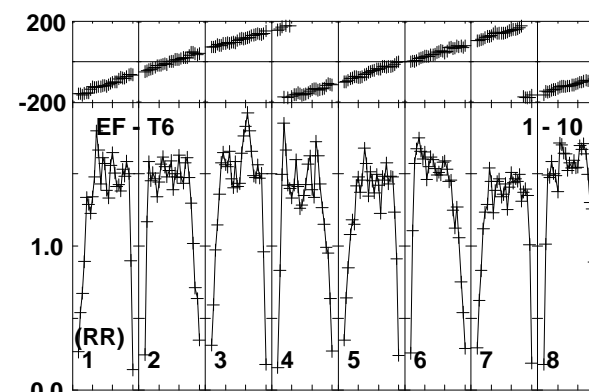
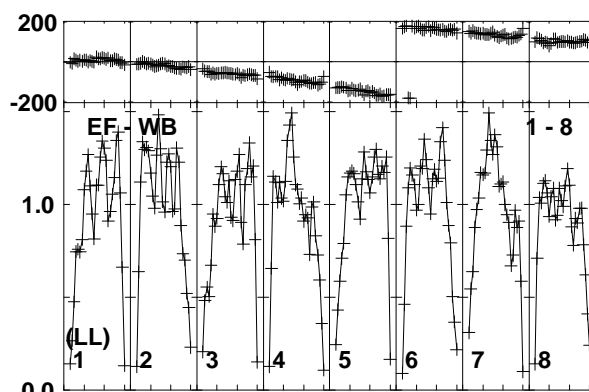
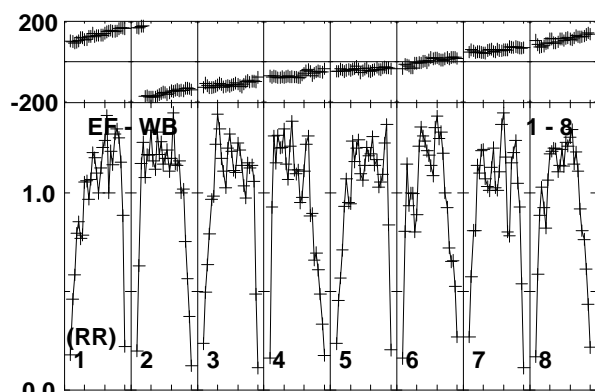
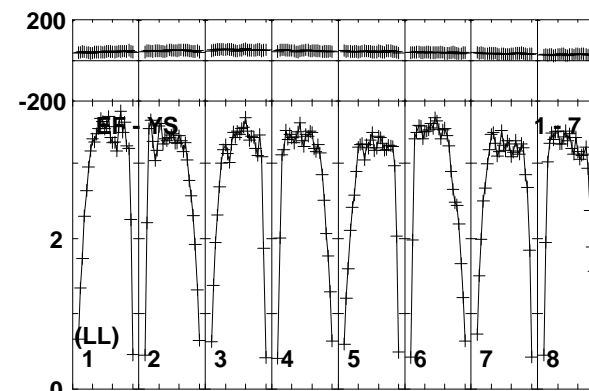
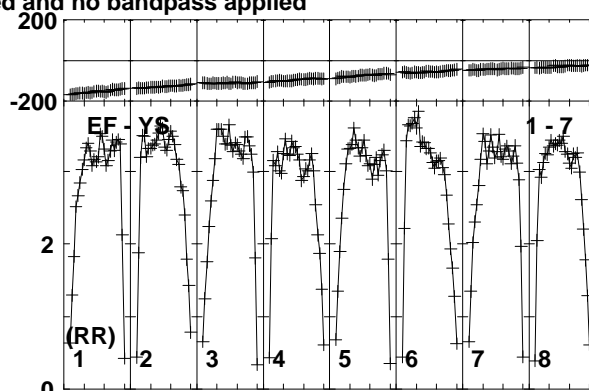
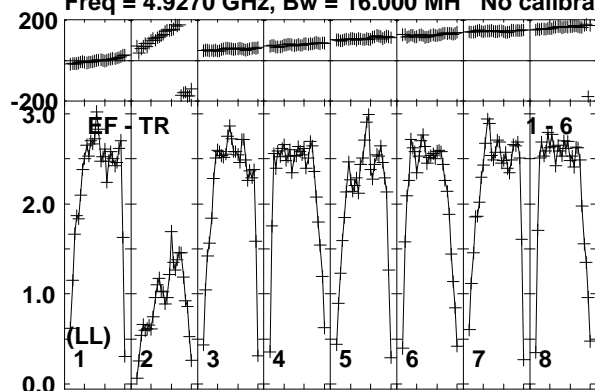

Lower frame: Milli Ampl Jy Top frame: Phas deg  
Vector averaged cross-power spectrum Baseline: EF (01) - TR (06)  
Timerange: 00:22:27:10 to 00:22:28:39



Plot file version 147 created 10-JUN-2016 17:22:15

CHECK RT013A.UVDATA.1

Freq = 4.9270 GHz, Bw = 16.000 MH No calibration applied and no bandpass applied

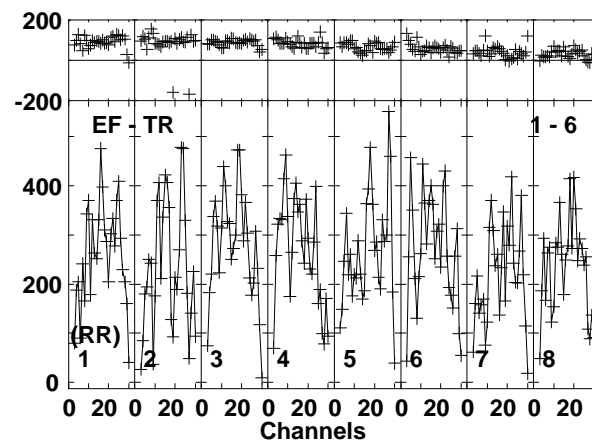
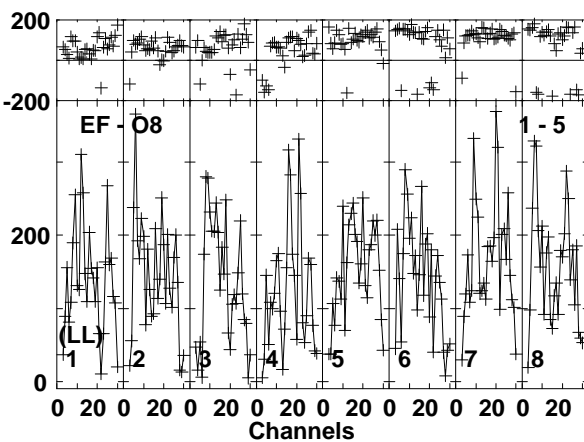
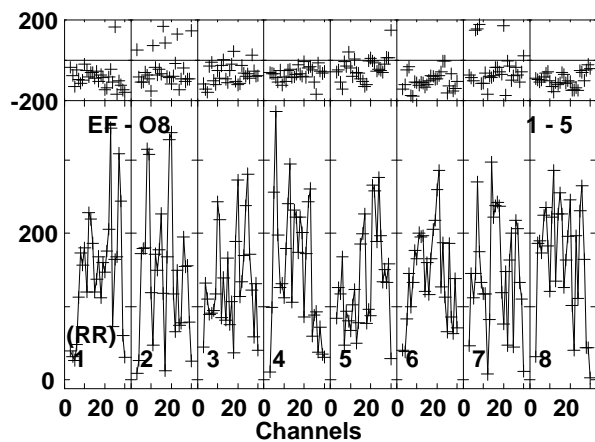
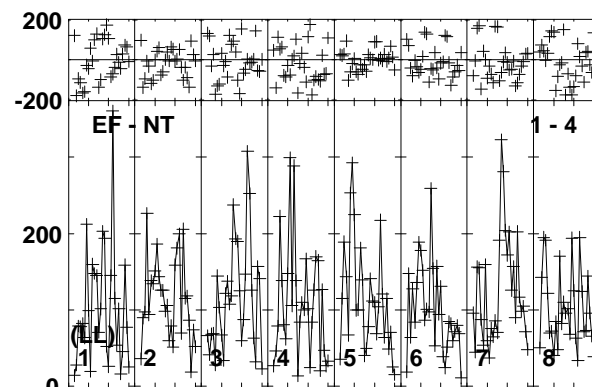
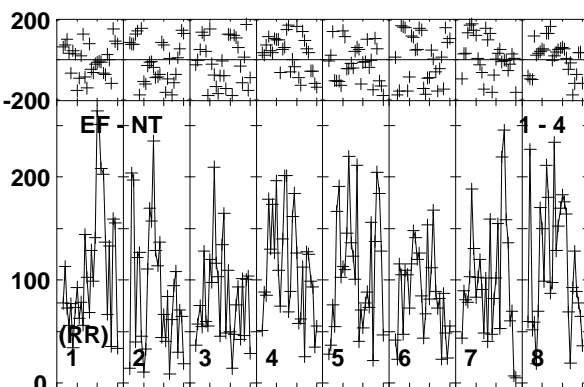
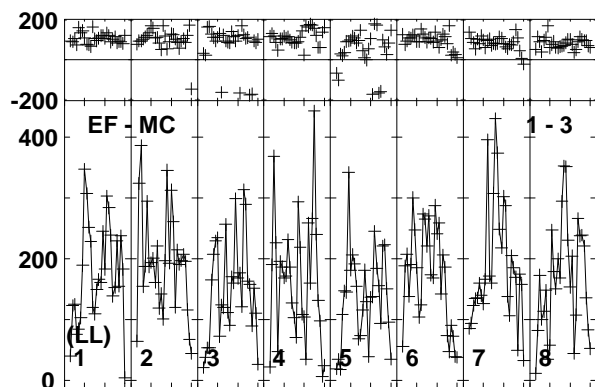
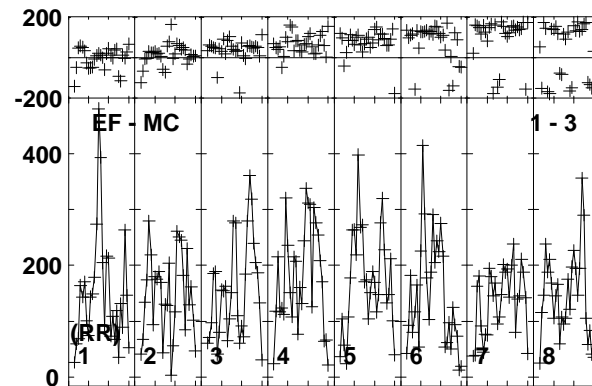
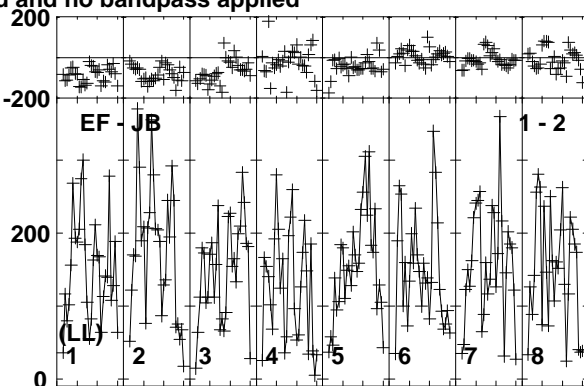
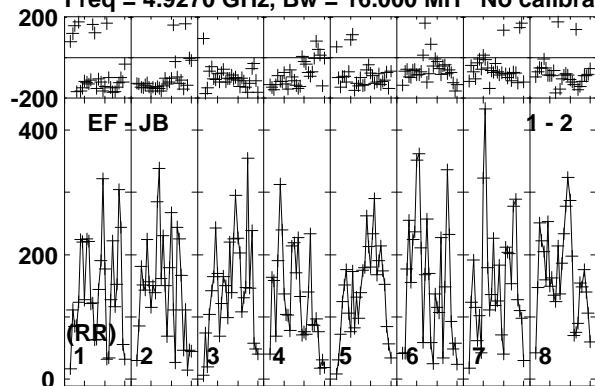

Lower frame: Micro Ampl Jy Top frame: Phas deg  
Vector averaged cross-power spectrum Baseline: EF (01) - JB (02)  
Timerange: 00:22:29:21 to 00:22:31:19

Plot file version 148 created 10-JUN-2016 17:22:15

CHECK RT013A.UVDATA.1

Freq = 4.9270 GHz, Bw = 16.000 MH No calibration applied and no bandpass applied

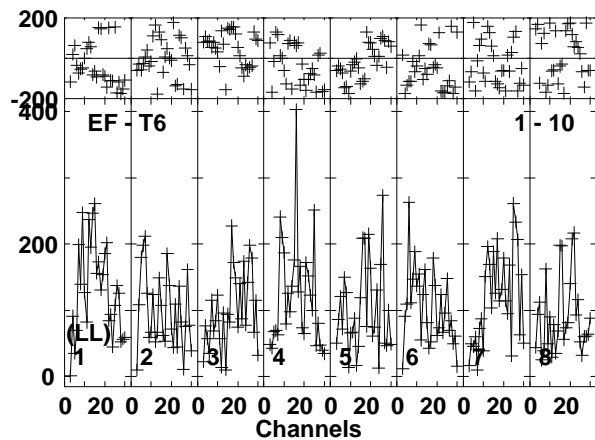
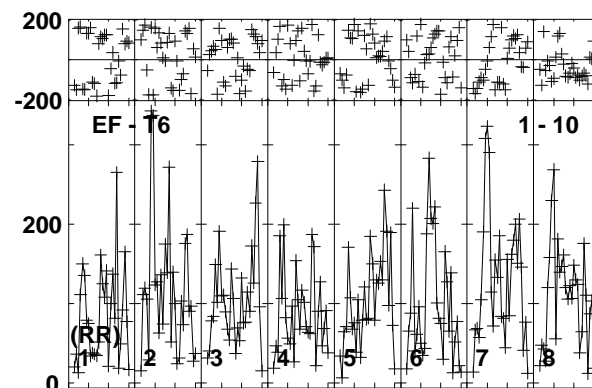
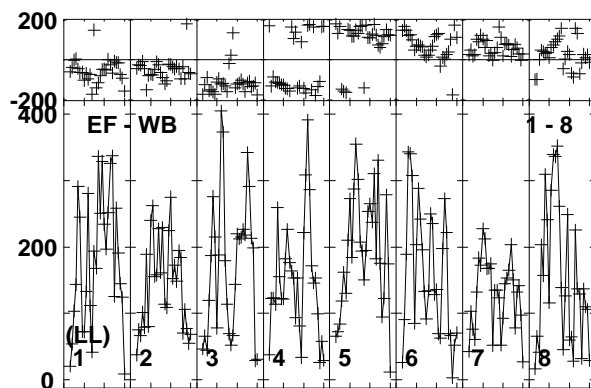
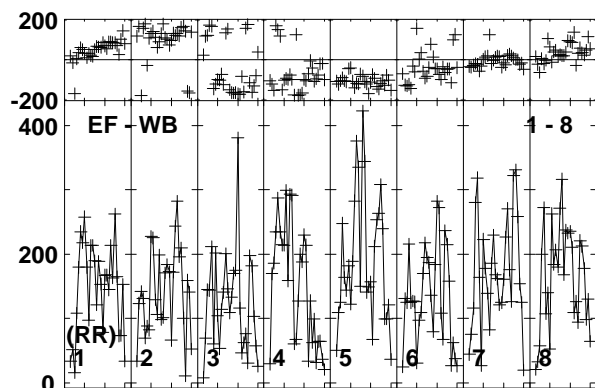
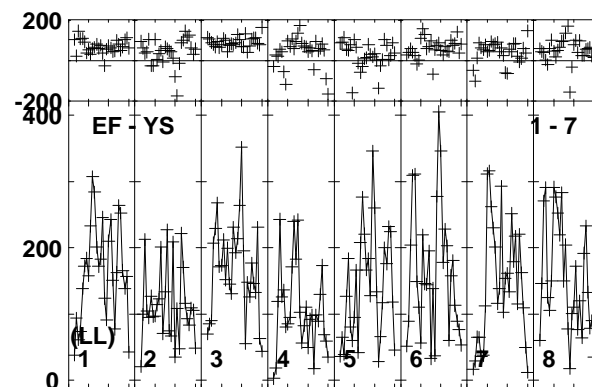
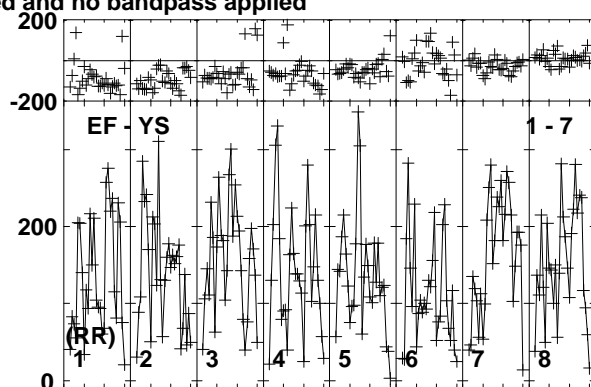
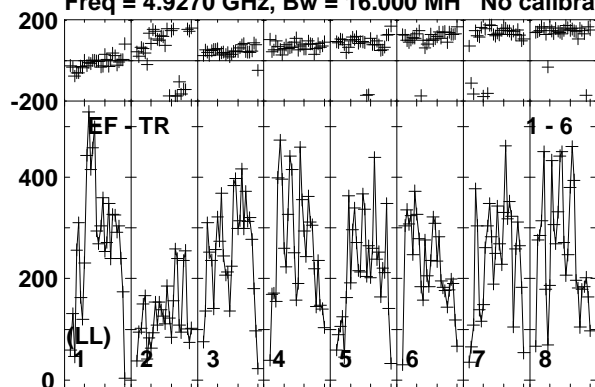

Lower frame: Micro Ampl Jy Top frame: Phas deg  
Vector averaged cross-power spectrum Baseline: EF (01) - TR (06)  
Timerange: 00:22:29:21 to 00:22:31:19

Plot file version 149 created 10-JUN-2016 17:22:15

CYGX1 RT013A.UVDATA.1

Freq = 4.9270 GHz, Bw = 16.000 MH No calibration applied and no bandpass applied

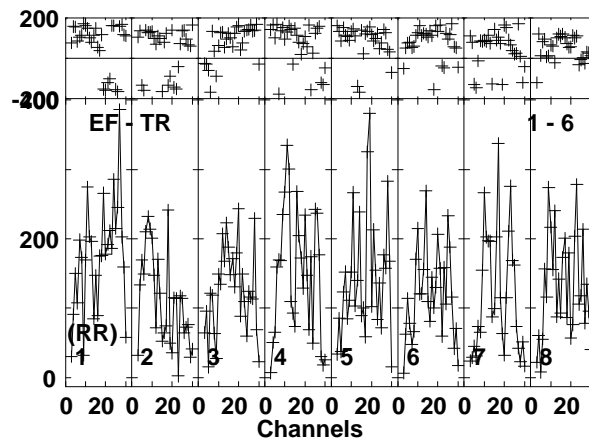
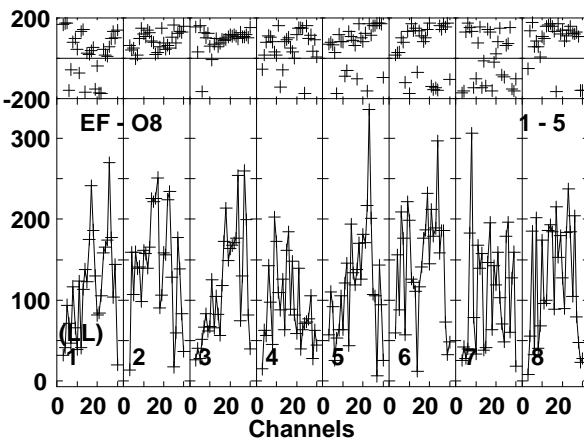
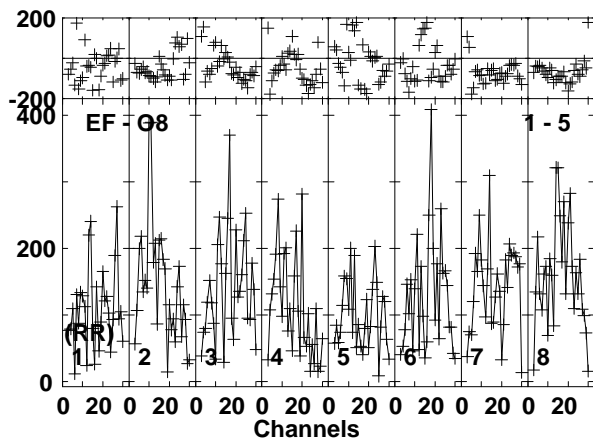
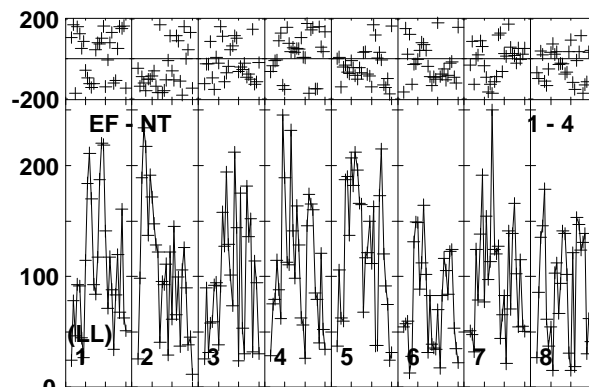
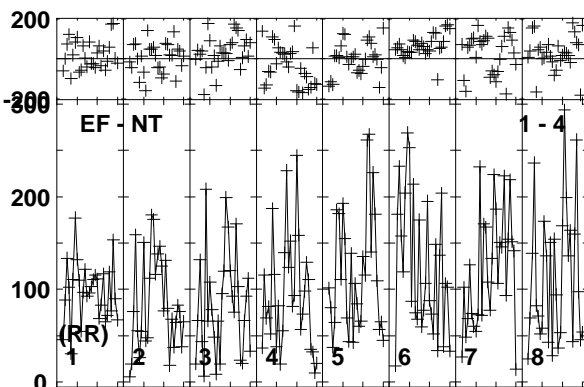
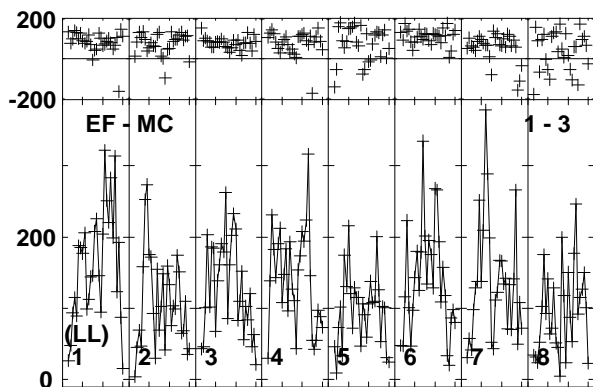
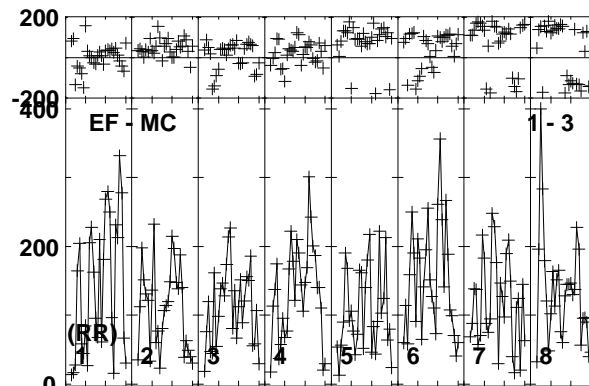
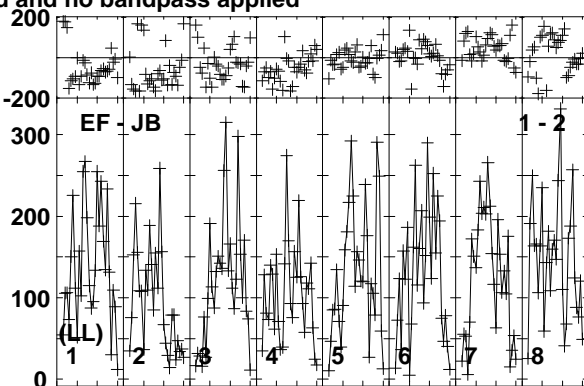
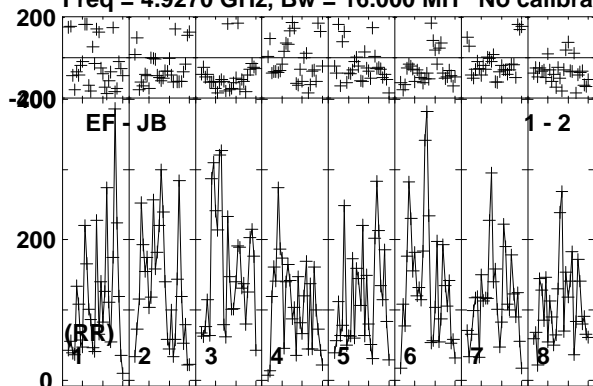

Lower frame: Micro Ampl Jy Top frame: Phas deg  
Vector averaged cross-power spectrum Baseline: EF (01) - JB (02)  
Timerange: 00:22:31:21 to 00:22:33:49

Plot file version 150 created 10-JUN-2016 17:22:15

CYGX1 RT013A.UVDATA.1

Freq = 4.9270 GHz, Bw = 16.000 MH No calibration applied and no bandpass applied

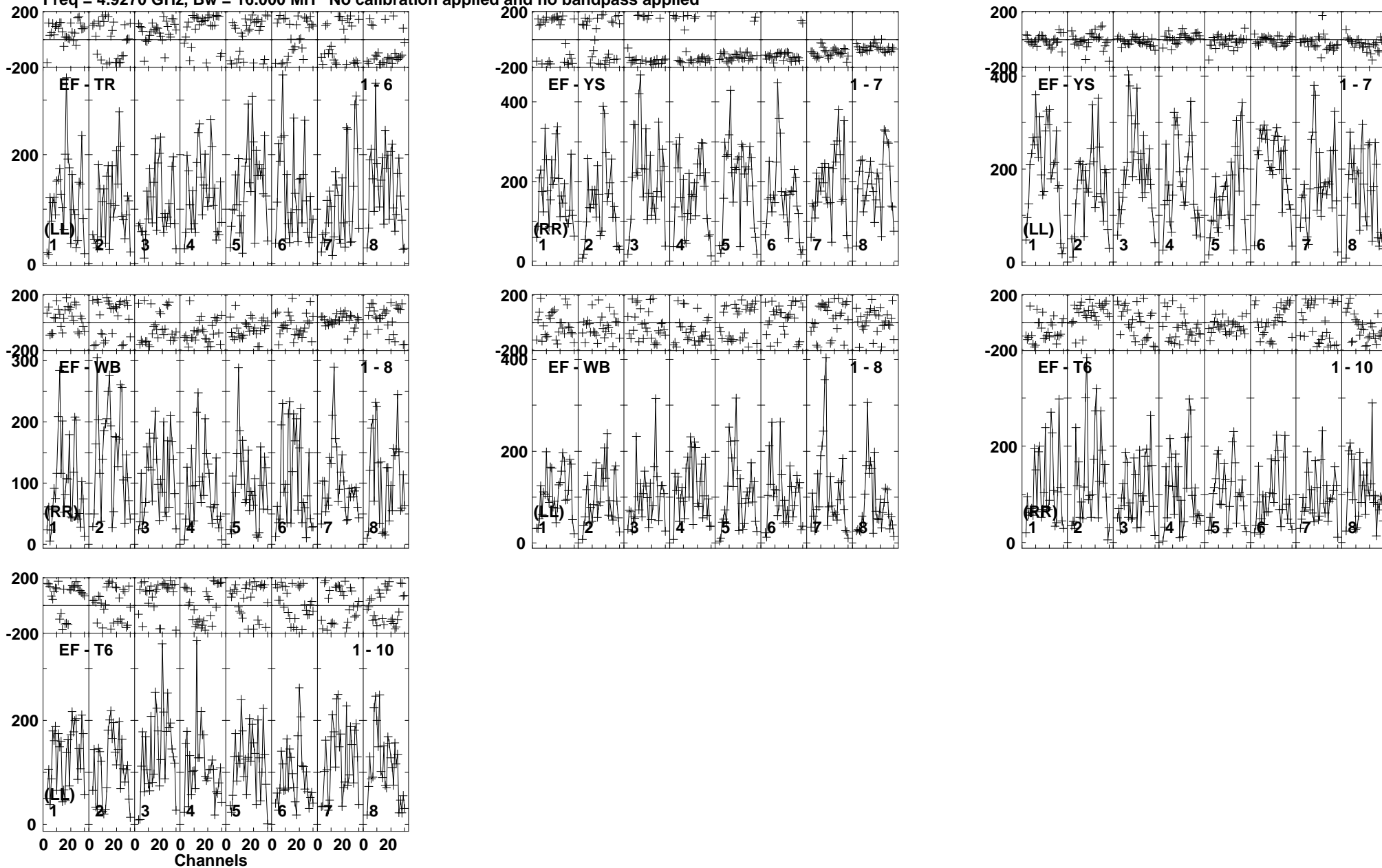

Lower frame: Micro Ampl Jy Top frame: Phas deg  
Vector averaged cross-power spectrum Baseline: EF (01) - TR (06)  
Timerange: 00/22:31:21 to 00/22:33:49

Plot file version 151 created 10-JUN-2016 17:22:15

J1957+3338 RT013A.UVDATA.1

Freq = 4.9270 GHz, Bw = 16.000 MH No calibration applied and no bandpass applied

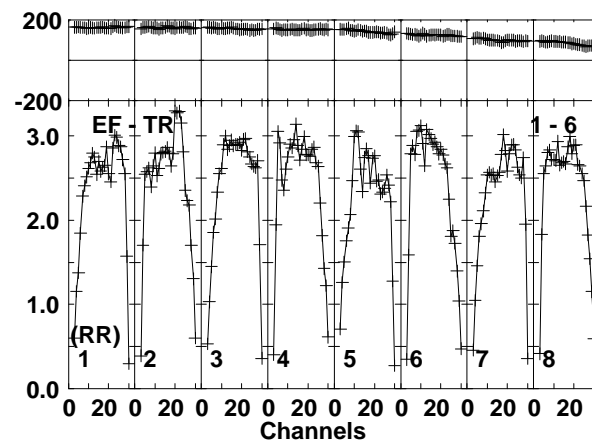
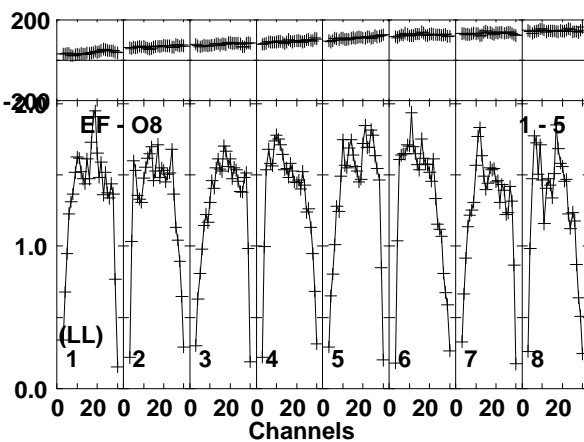
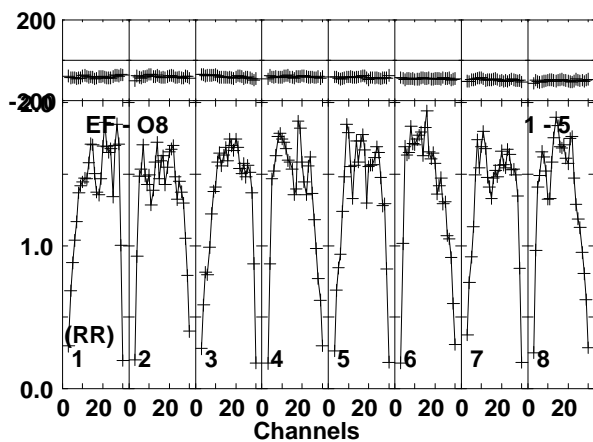
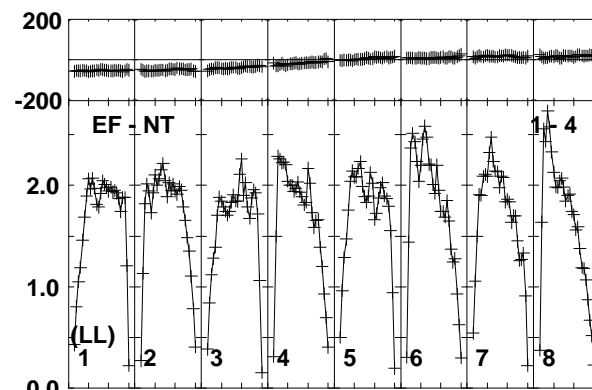
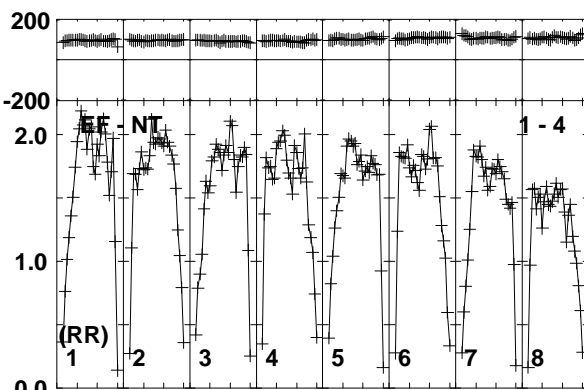
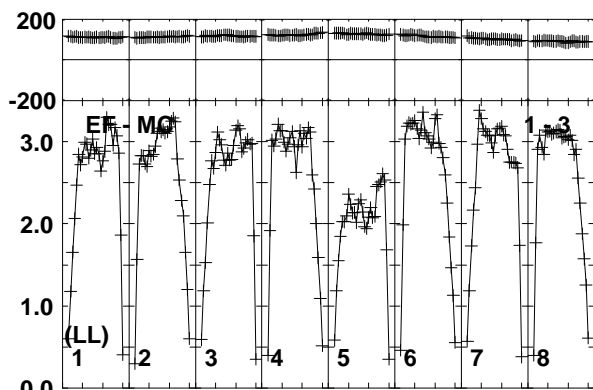
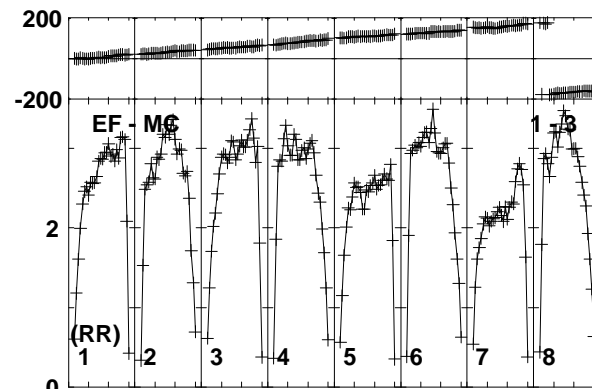
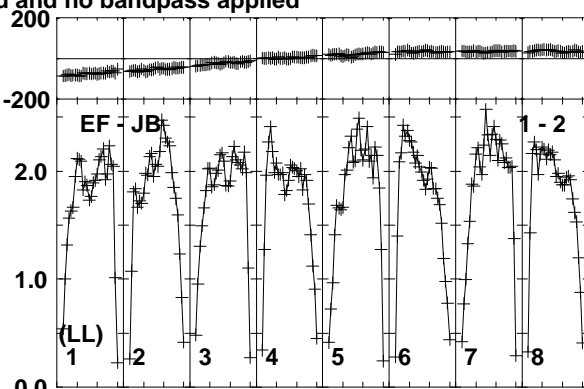
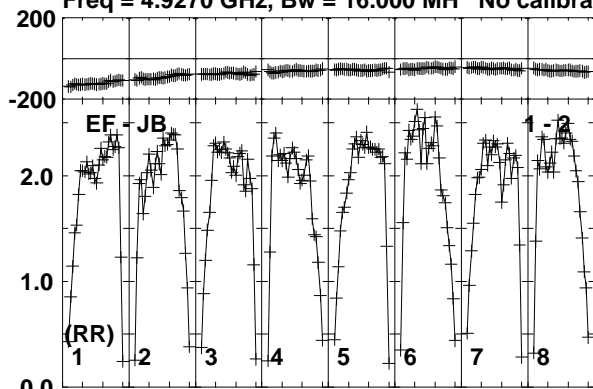

Lower frame: Milli Ampl Jy Top frame: Phas deg  
Vector averaged cross-power spectrum Baseline: EF (01) - JB (02)  
Timerange: 00/22:33:51 to 00/22:35:20

Plot file version 152 created 10-JUN-2016 17:22:15

J1957+3338 RT013A.UVDATA.1

Freq = 4.9270 GHz, Bw = 16.000 MH No calibration applied and no bandpass applied

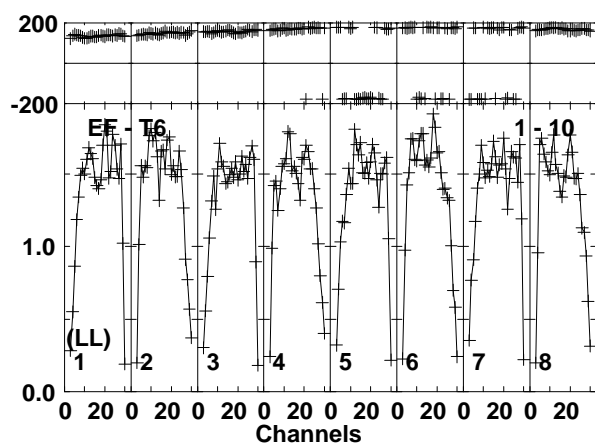
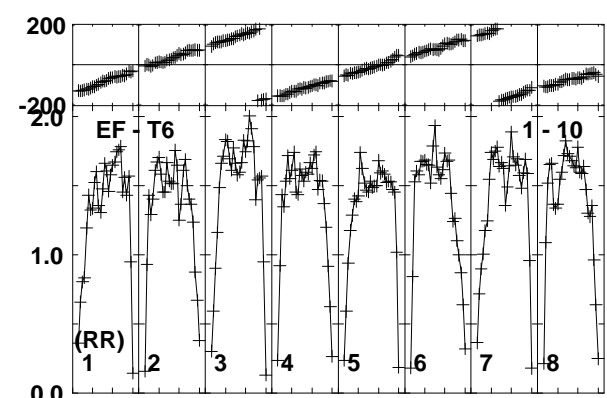
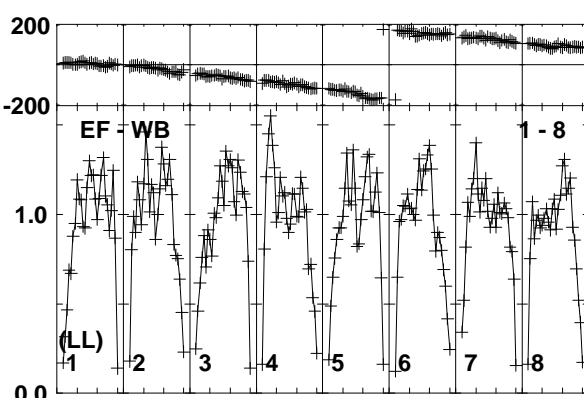
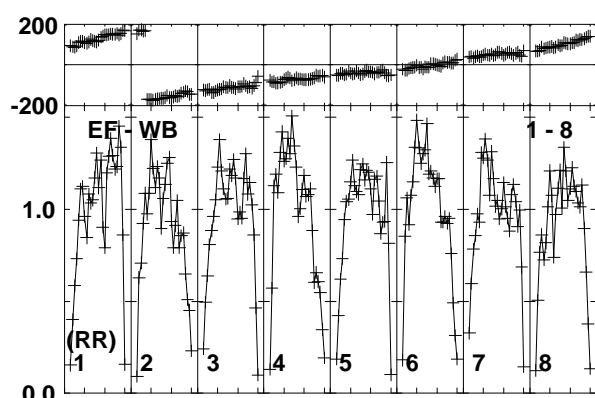
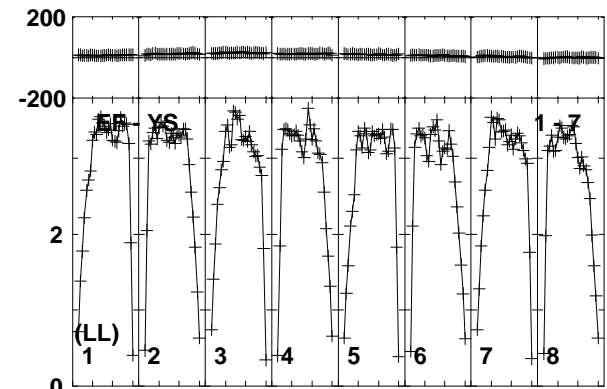
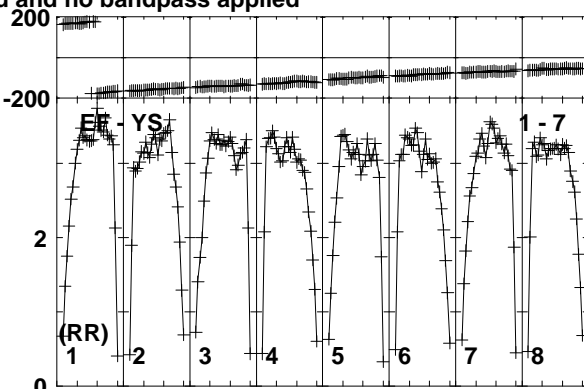
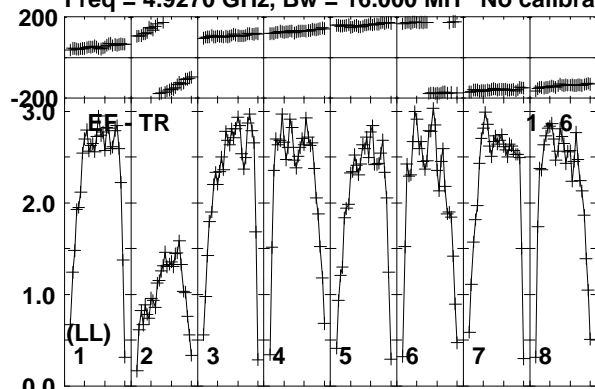

Lower frame: Milli Ampl Jy Top frame: Phas deg  
Vector averaged cross-power spectrum Baseline: EF (01) - TR (06)  
Timerange: 00/22:33:51 to 00/22:35:20

Plot file version 153 created 10-JUN-2016 17:22:15

CHECK RT013A.UVDATA.1

Freq = 4.9270 GHz, Bw = 16.000 MH No calibration applied and no bandpass applied

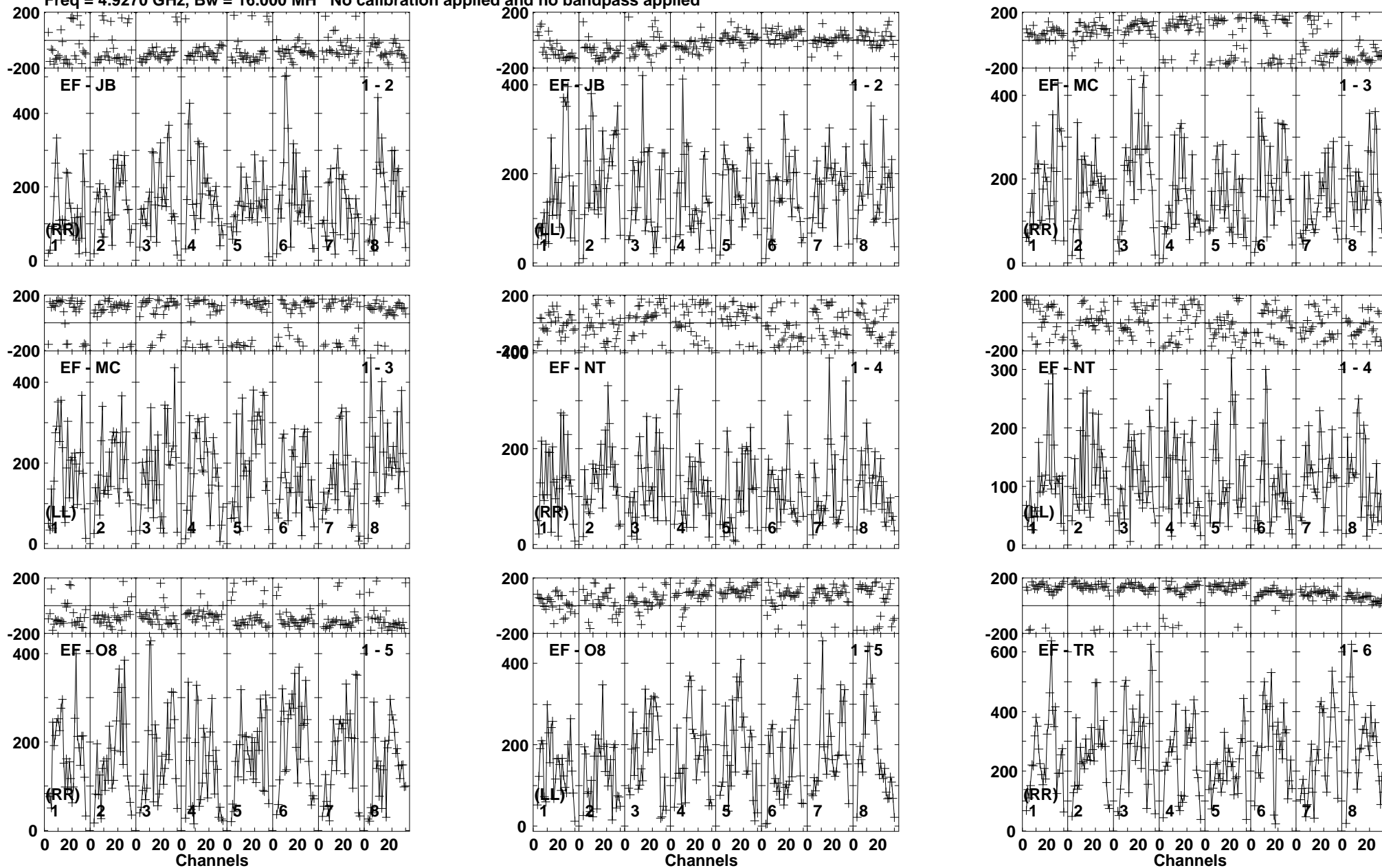

Plot file version 154 created 10-JUN-2016 17:22:16

CHECK RT013A.UVDATA.1

Freq = 4.9270 GHz, Bw = 16.000 MH No calibration applied and no bandpass applied

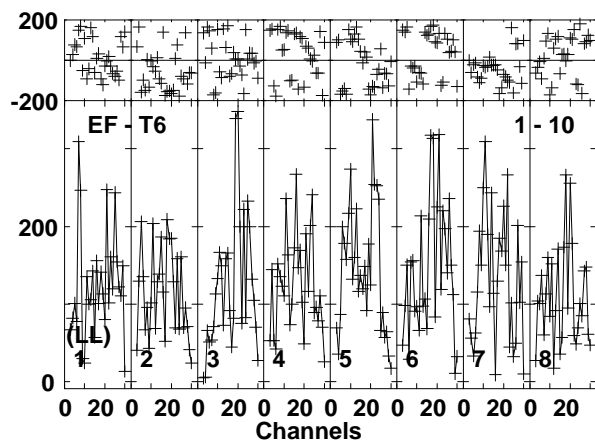
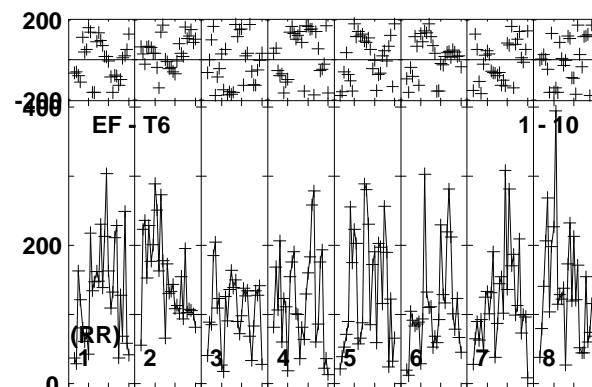
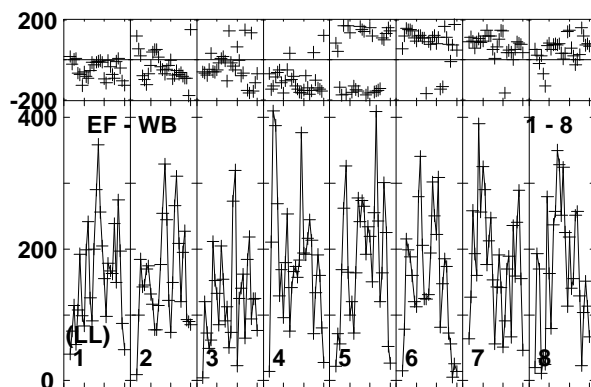
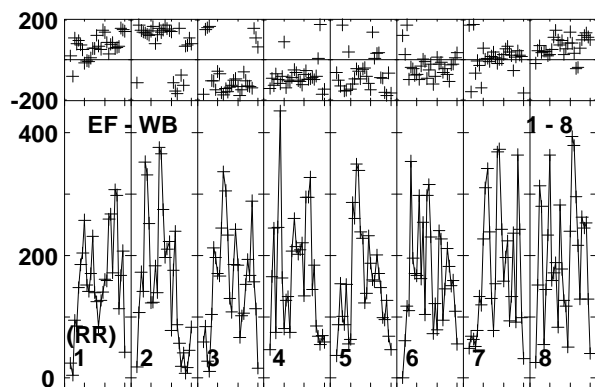
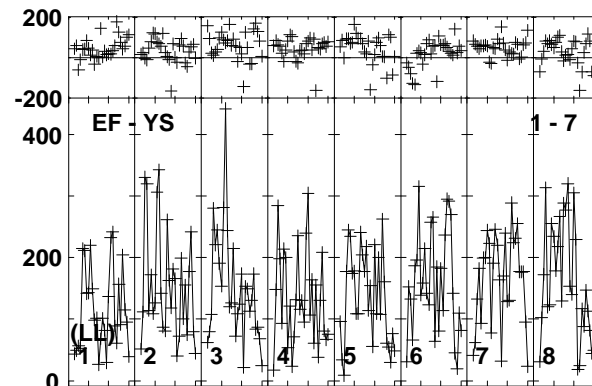
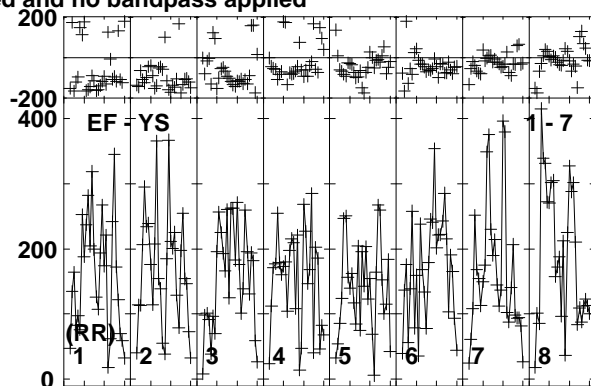
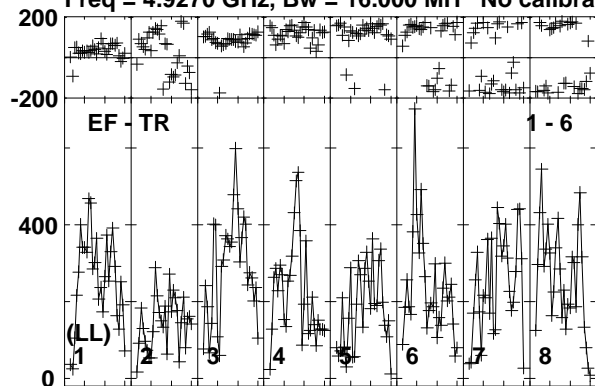

Lower frame: Micro Ampl Jy Top frame: Phas deg  
Vector averaged cross-power spectrum Baseline: EF (01) - TR (06)  
Timerange: 00:22:35:20 to 00:22:37:19





Plot file version 156 created 10-JUN-2016 17:22:16

CYGX1 RT013A.UVDATA.1

Freq = 4.9270 GHz, Bw = 16.000 MH No calibration applied and no bandpass applied

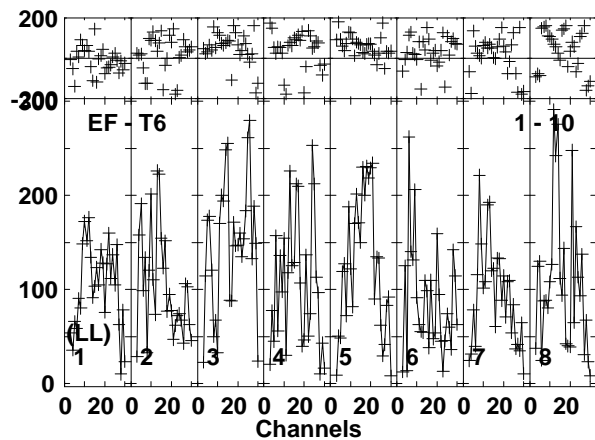
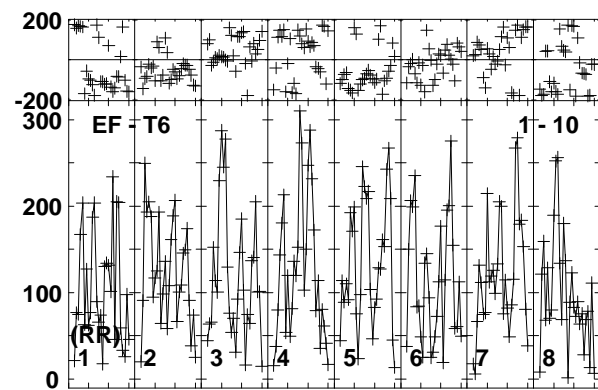
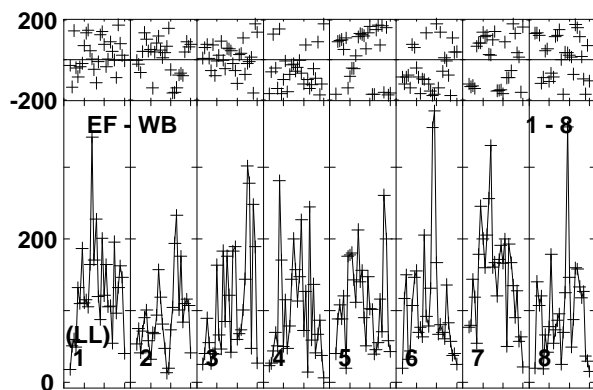
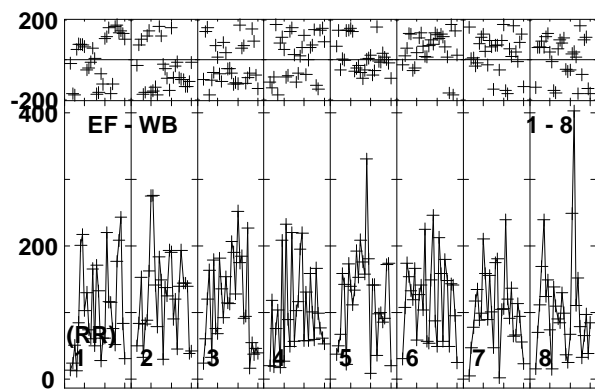
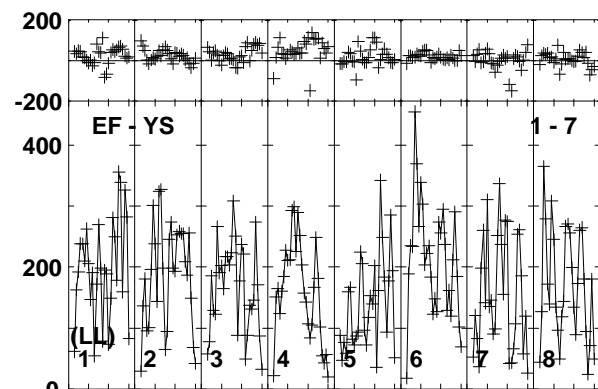
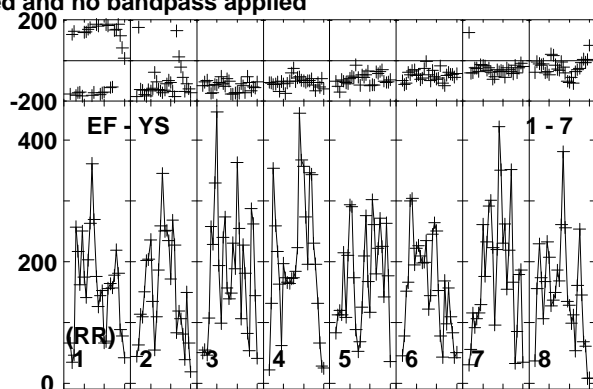
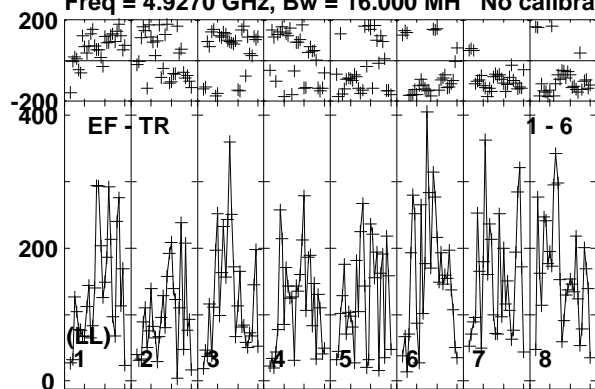

Lower frame: Micro Ampl Jy Top frame: Phas deg  
Vector averaged cross-power spectrum Baseline: EF (01) - TR (06)  
Timerange: 00/22:37:21 to 00/22:39:49

Plot file version 157 created 10-JUN-2016 17:22:16

J1957+3338 RT013A.UVDATA.1

Freq = 4.9270 GHz, Bw = 16.000 MH No calibration applied and no bandpass applied

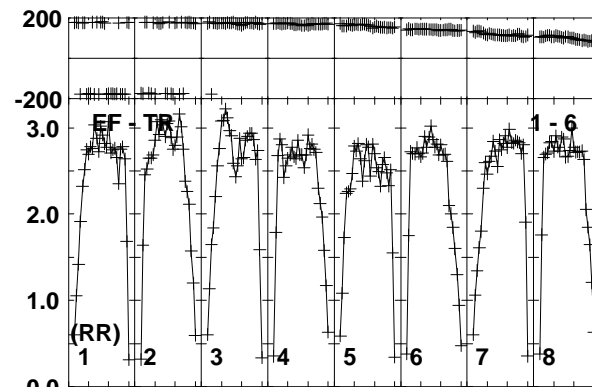
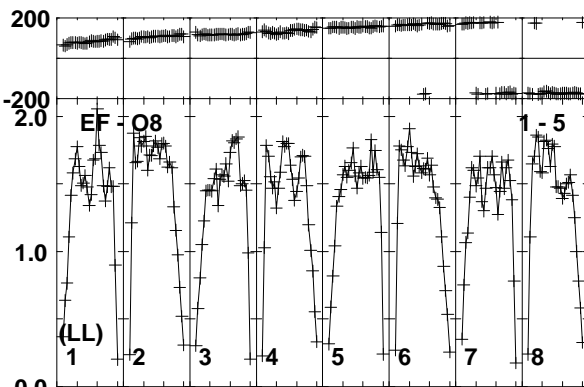
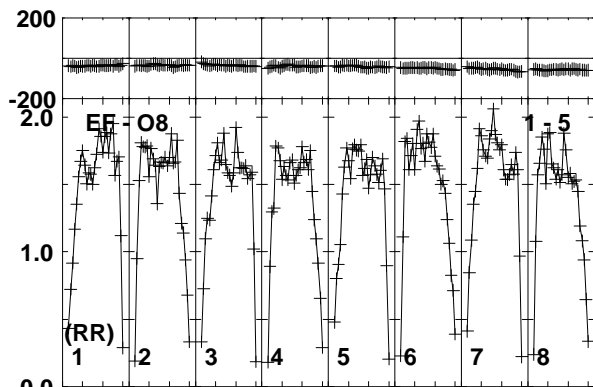
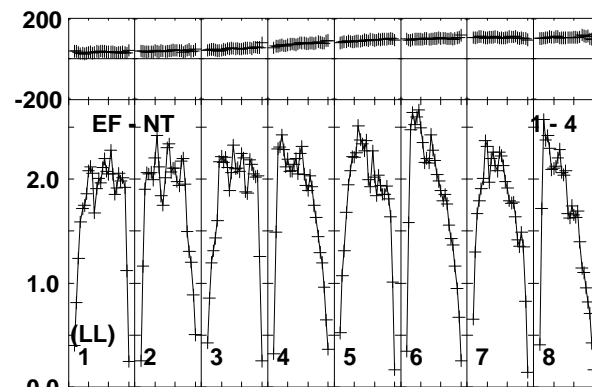
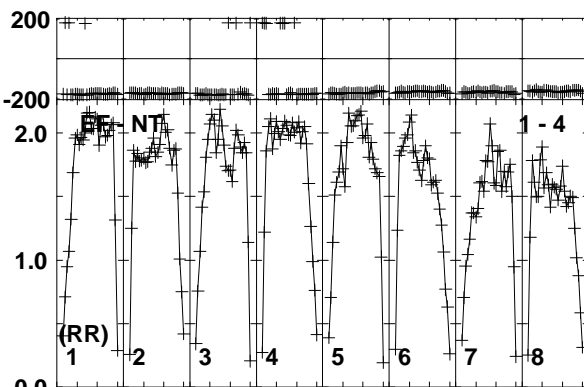
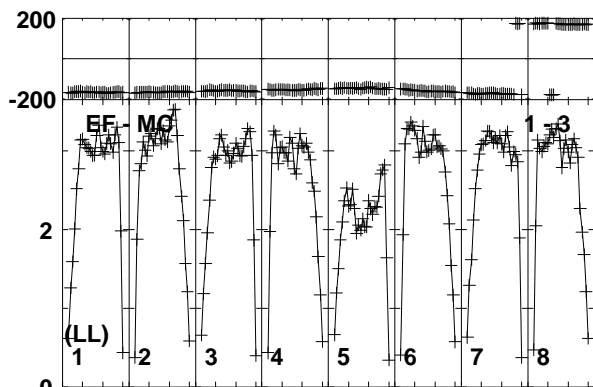
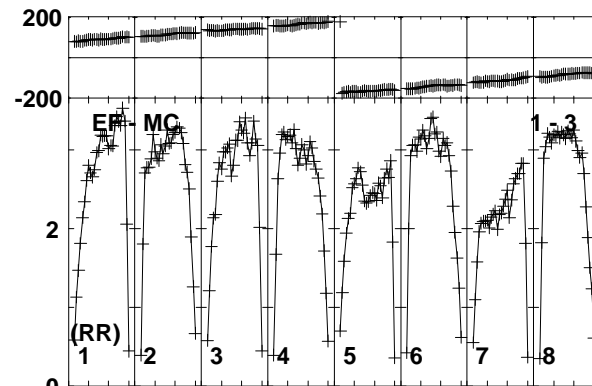
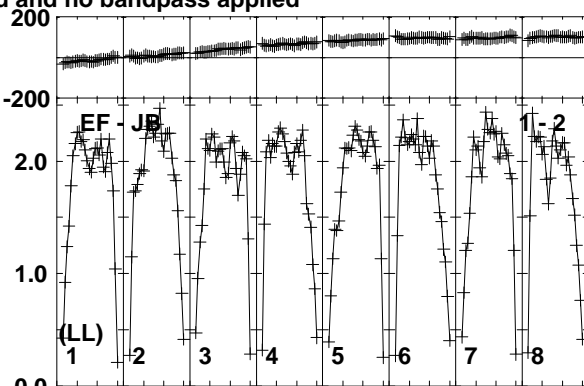
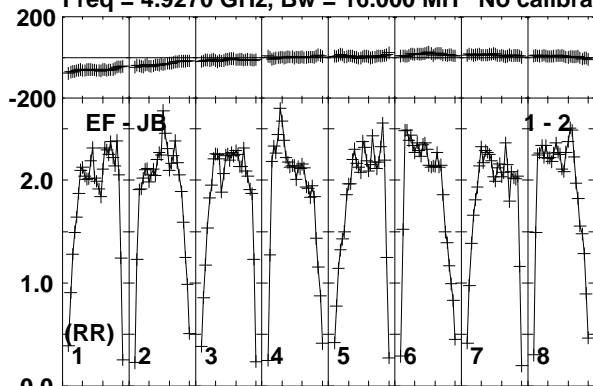

Lower frame: Milli Ampl Jy Top frame: Phas deg  
Vector averaged cross-power spectrum Baseline: EF (01) - JB (02)  
Timerange: 00:22:39:51 to 00:22:41:20

Plot file version 158 created 10-JUN-2016 17:22:16

J1957+3338 RT013A.UVDATA.1

Freq = 4.9270 GHz, Bw = 16.000 MH No calibration applied and no bandpass applied

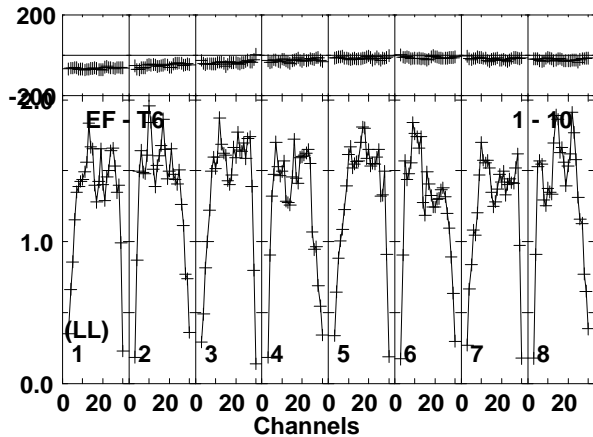
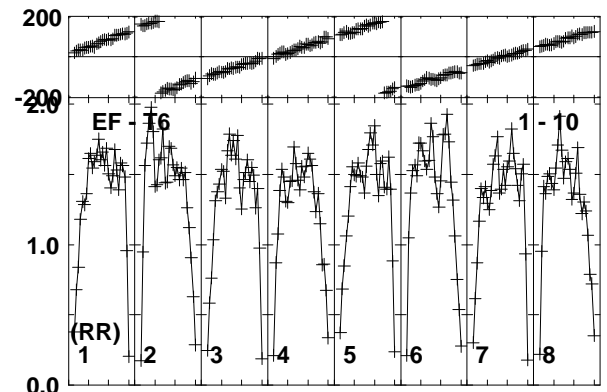
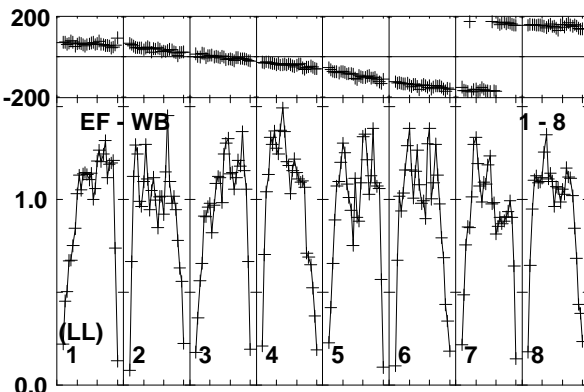
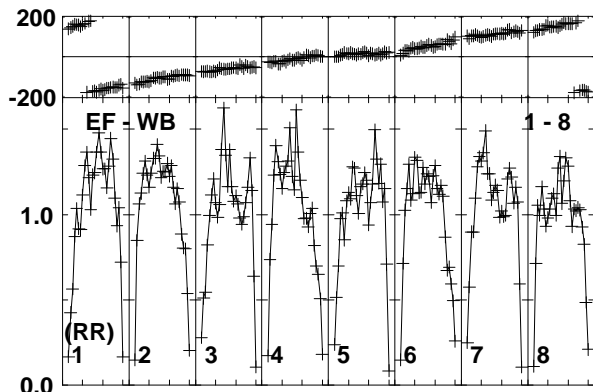
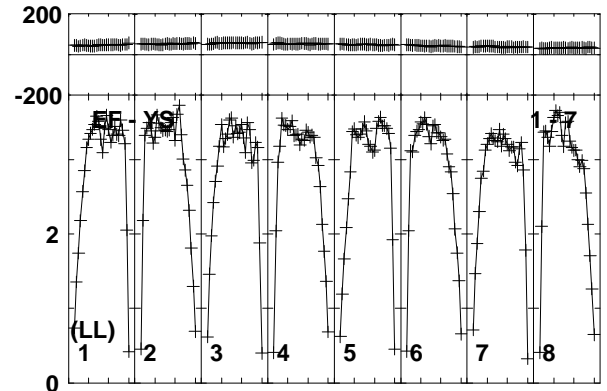
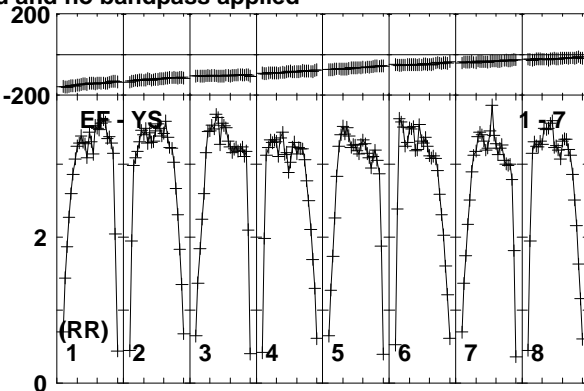
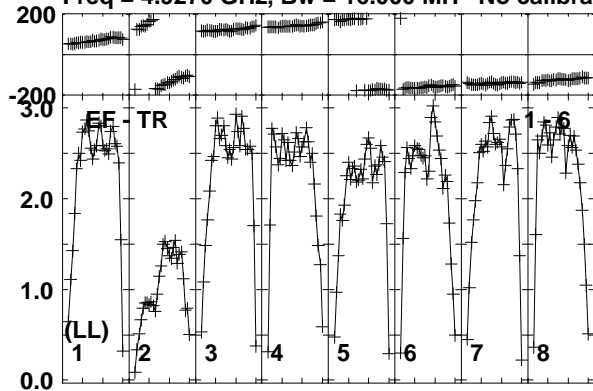

Lower frame: Milli Ampl Jy Top frame: Phas deg  
Vector averaged cross-power spectrum Baseline: EF (01) - TR (06)  
Timerange: 00/22:39:51 to 00/22:41:20

Plot file version 159 created 10-JUN-2016 17:22:16

CHECK RT013A.UVDATA.1

Freq = 4.9270 GHz, Bw = 16.000 MH No calibration applied and no bandpass applied

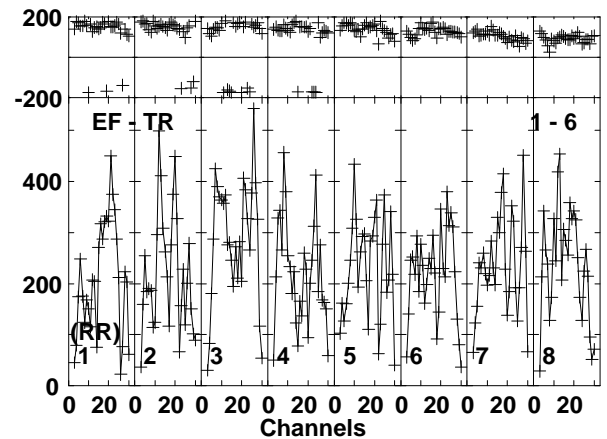
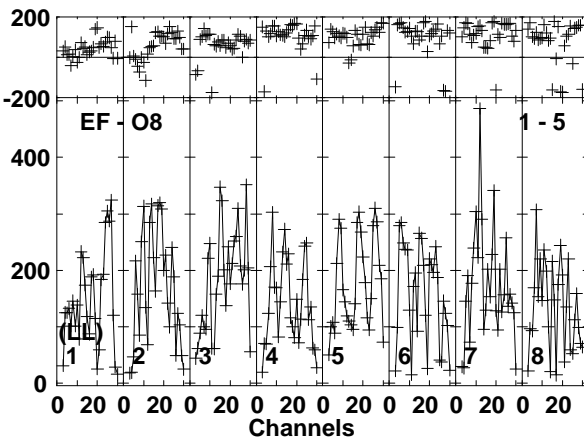
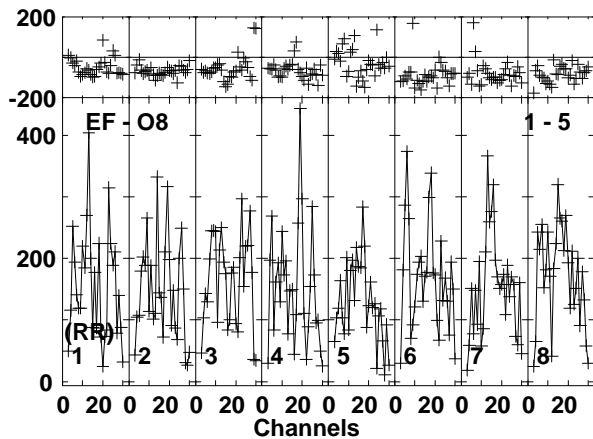
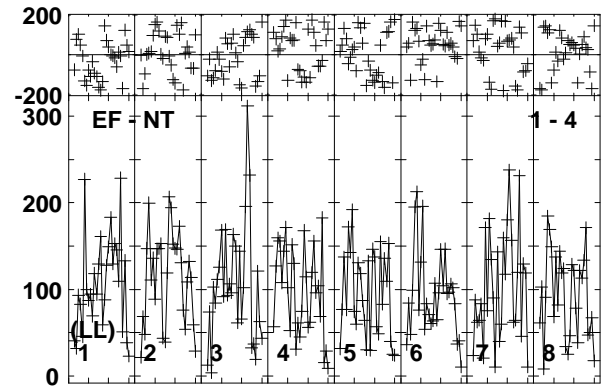
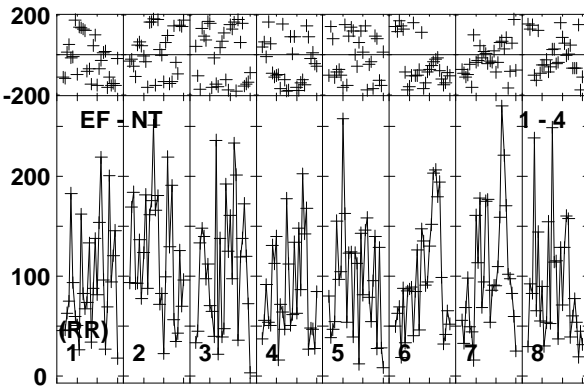
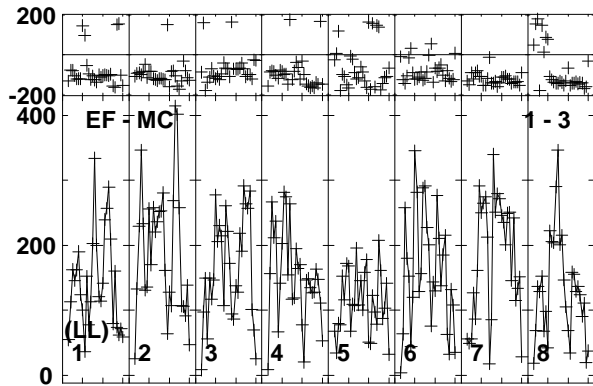
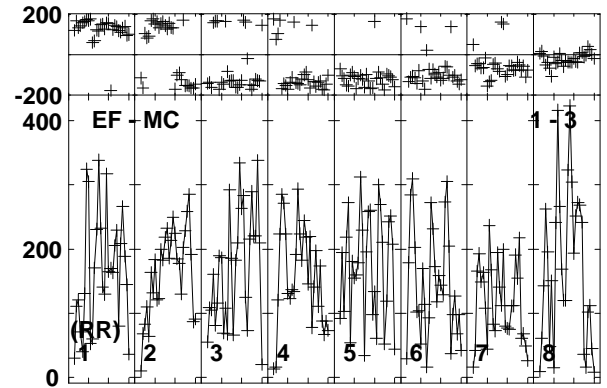
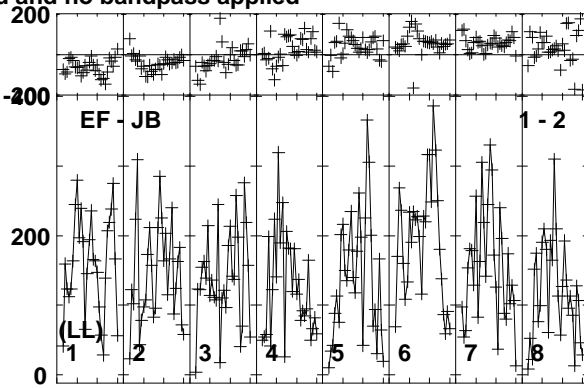
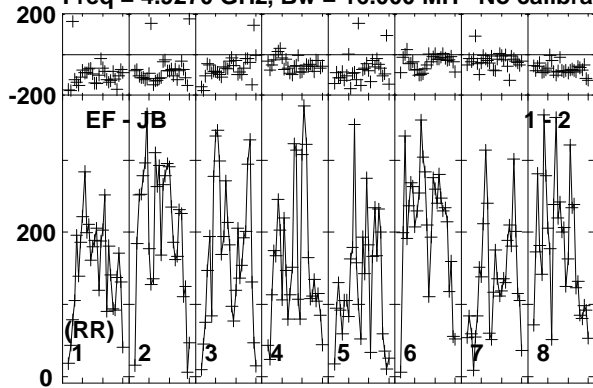

Lower frame: Micro Ampl Jy Top frame: Phas deg  
Vector averaged cross-power spectrum Baseline: EF (01) - JB (02)  
Timerange: 00:22:42:00 to 00:22:43:59

Plot file version 160 created 10-JUN-2016 17:22:16

CHECK RT013A.UVDATA.1

Freq = 4.9270 GHz, Bw = 16.000 MH No calibration applied and no bandpass applied

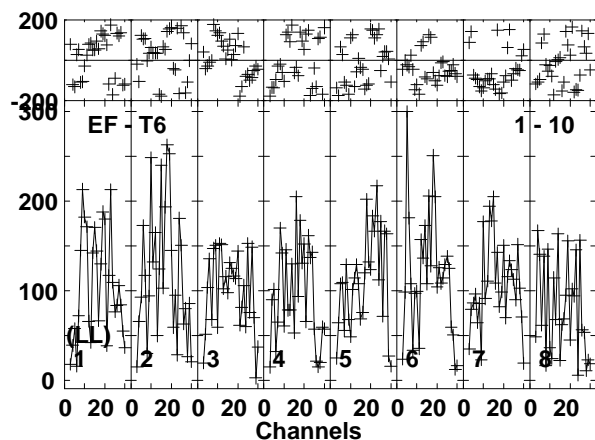
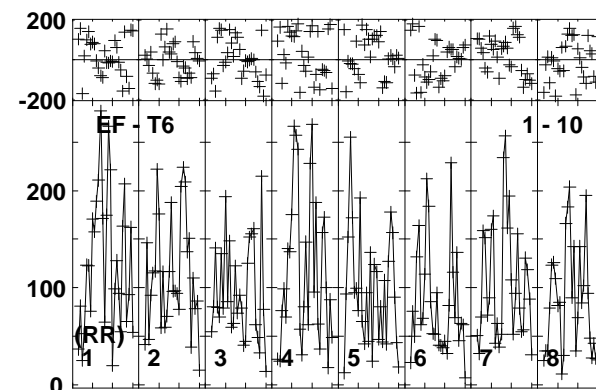
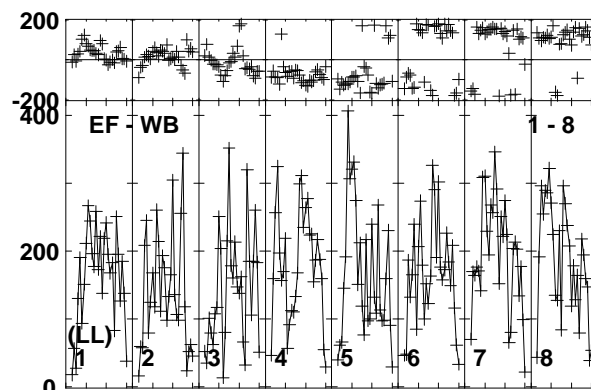
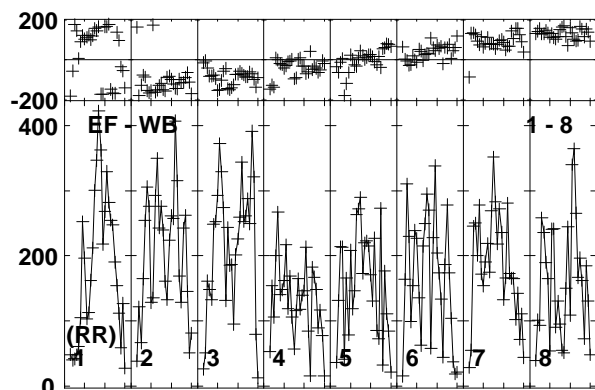
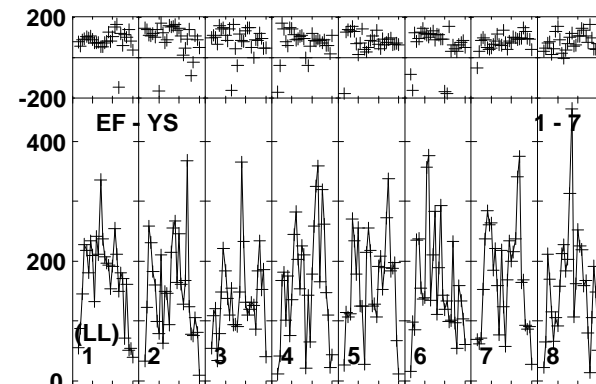
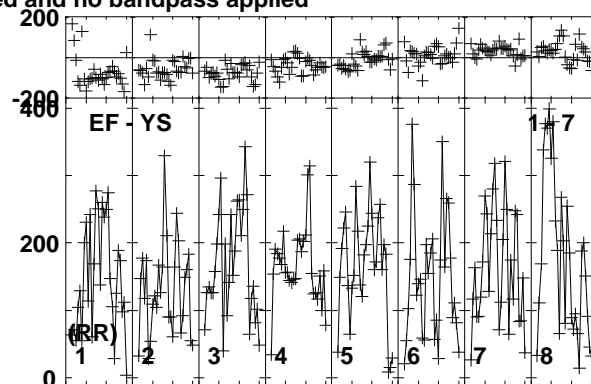
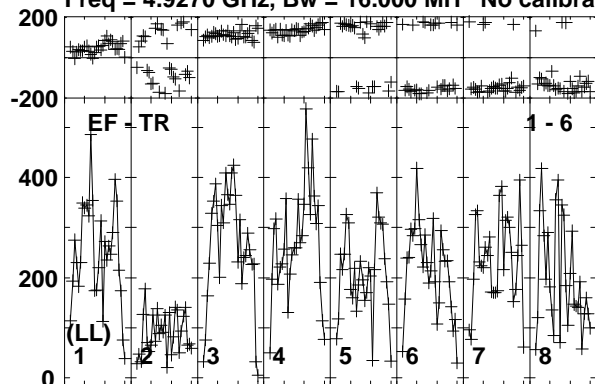

Lower frame: Micro Ampl Jy Top frame: Phas deg  
Vector averaged cross-power spectrum Baseline: EF (01) - TR (06)  
Timerange: 00:22:42:00 to 00:22:43:59

Plot file version 161 created 10-JUN-2016 17:22:16

CYGX1 RT013A.UVDATA.1

Freq = 4.9270 GHz, Bw = 16.000 MH No calibration applied and no bandpass applied

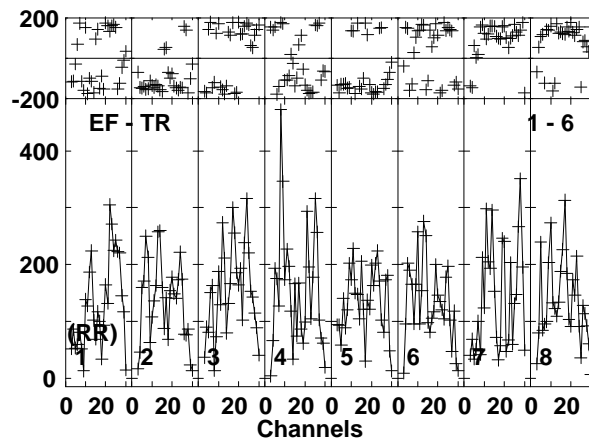
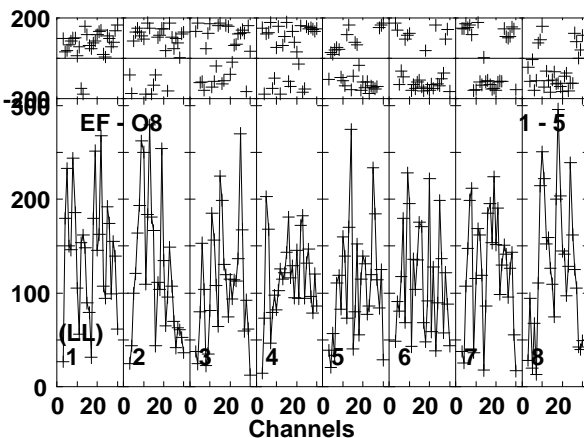
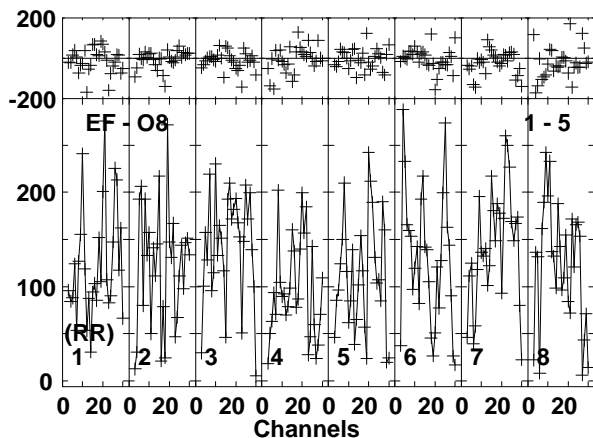
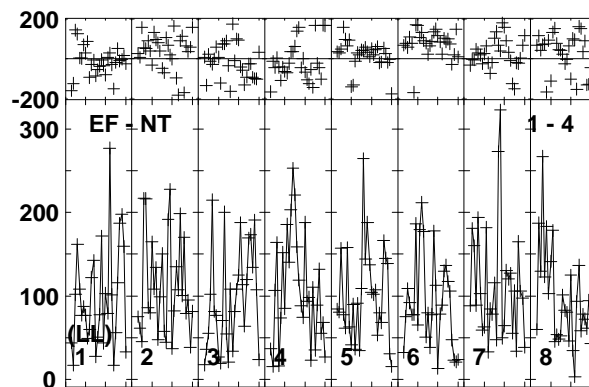
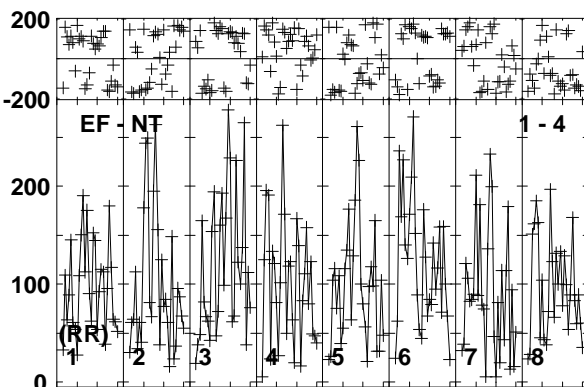
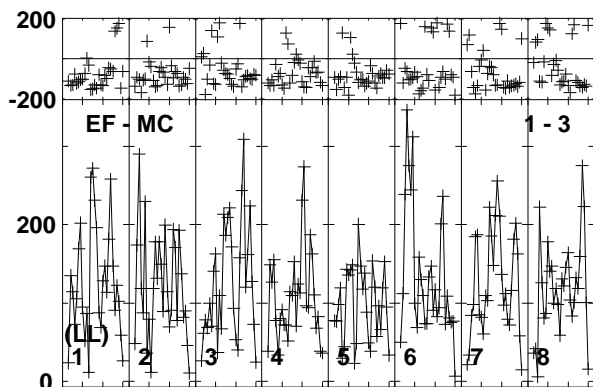
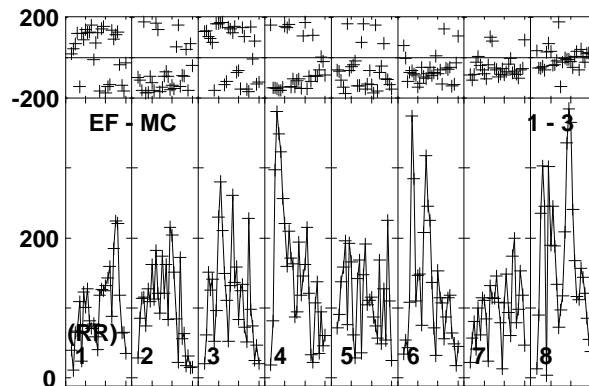
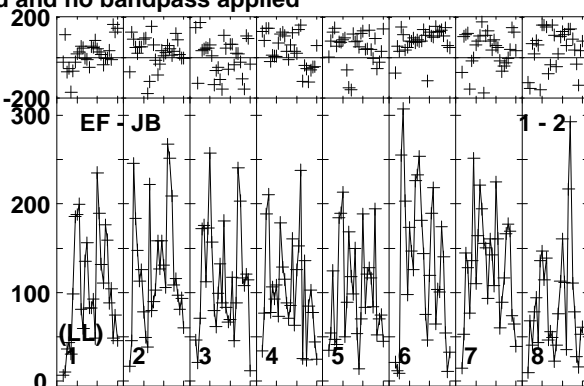
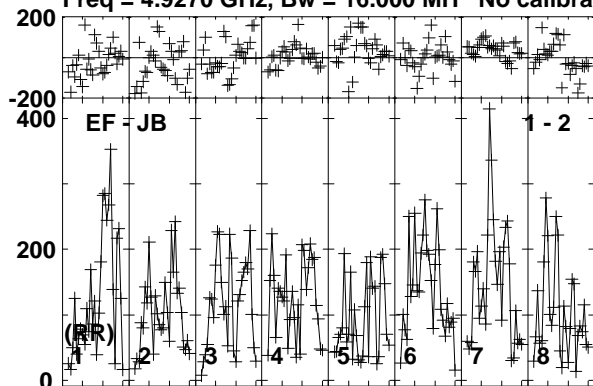

Lower frame: Micro Ampl Jy Top frame: Phas deg  
Vector averaged cross-power spectrum Baseline: EF (01) - JB (02)  
Timerange: 00/22:44:01 to 00/22:46:29

Plot file version 162 created 10-JUN-2016 17:22:16

CYGX1 RT013A.UVDATA.1

Freq = 4.9270 GHz, Bw = 16.000 MH No calibration applied and no bandpass applied

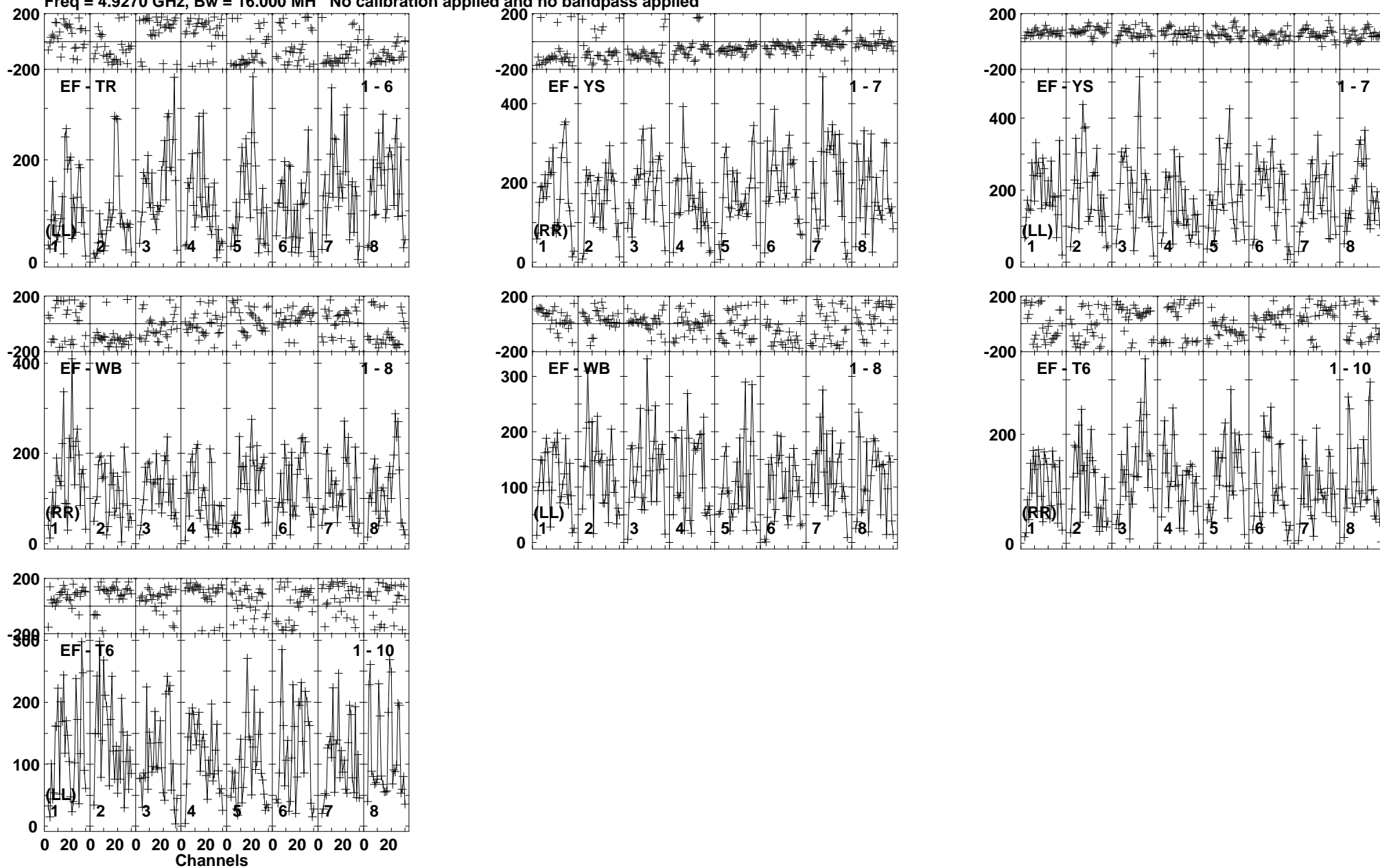

Lower frame: Micro Ampl Jy Top frame: Phas deg  
Vector averaged cross-power spectrum Baseline: EF (01) - TR (06)  
Timerange: 00/22:44:01 to 00/22:46:29



Plot file version 163 created 10-JUN-2016 17:22:17

J1957+3338 RT013A.UVDATA.1

Freq = 4.9270 GHz, Bw = 16.000 MH No calibration applied and no bandpass applied

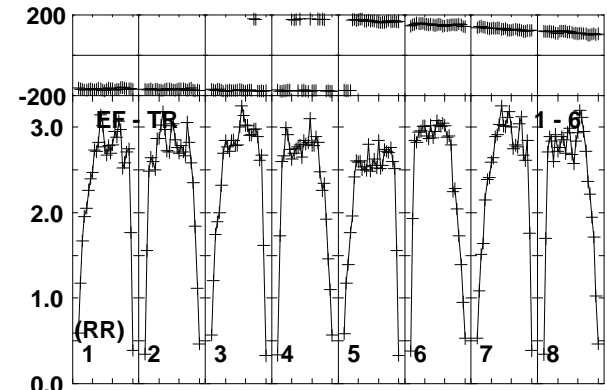
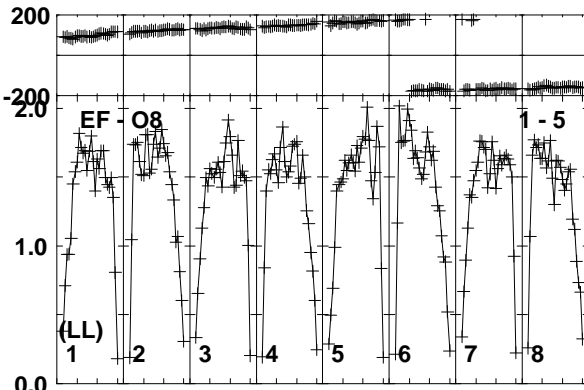
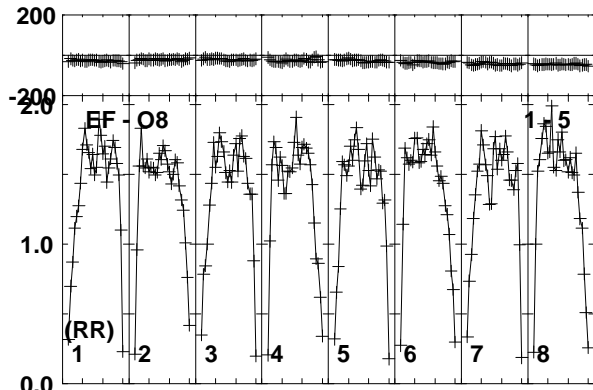
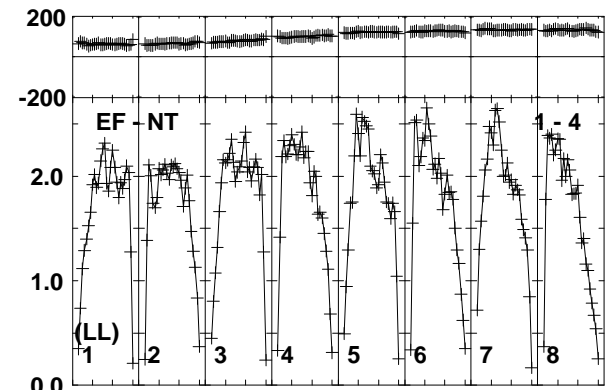
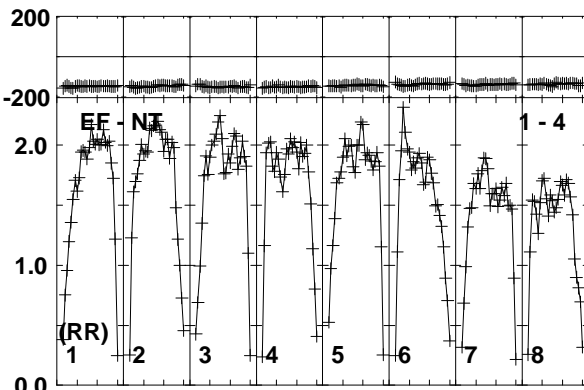
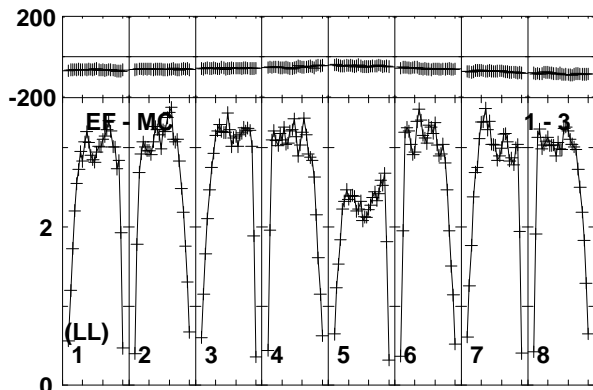
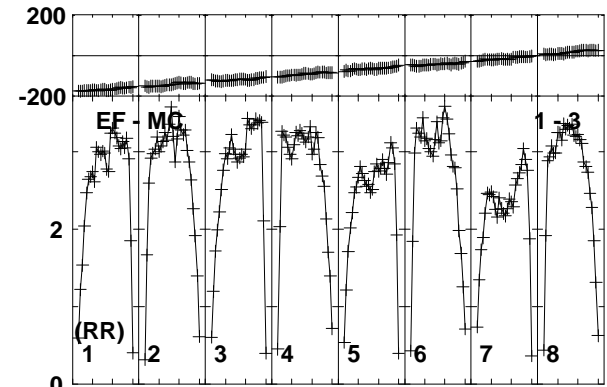
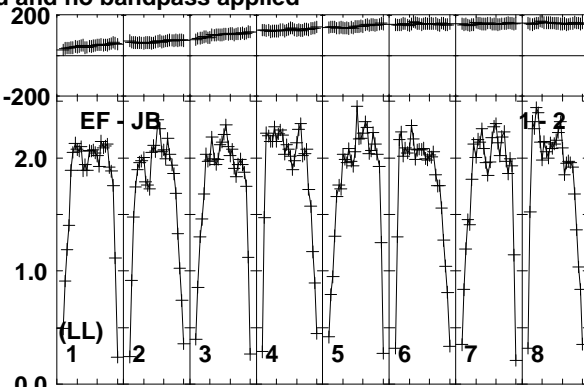
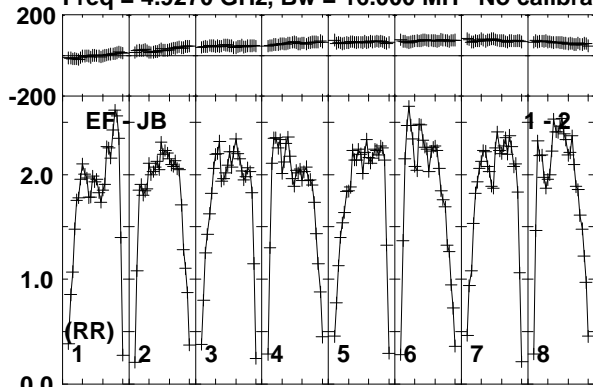

Lower frame: Milli Ampl Jy Top frame: Phas deg  
Vector averaged cross-power spectrum Baseline: EF (01) - JB (02)  
Timerange: 00/22:46:30 to 00/22:48:00

Plot file version 164 created 10-JUN-2016 17:22:17

J1957+3338 RT013A.UVDATA.1

Freq = 4.9270 GHz, Bw = 16.000 MH No calibration applied and no bandpass applied

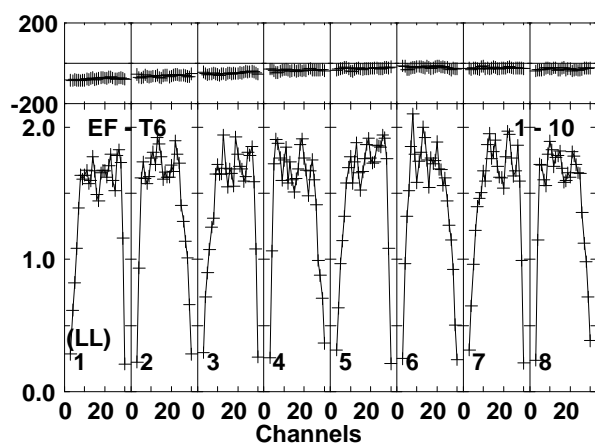
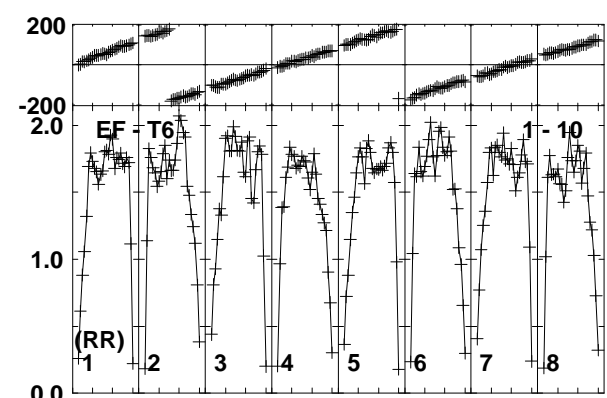
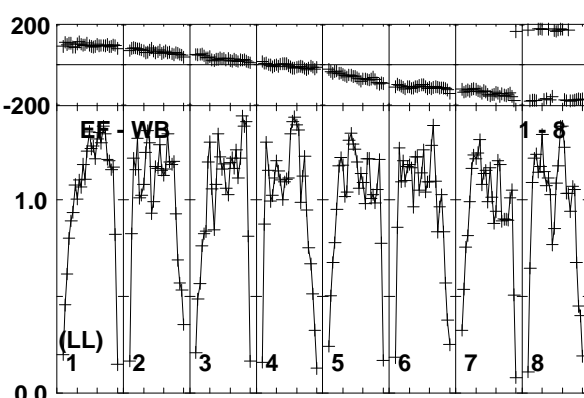
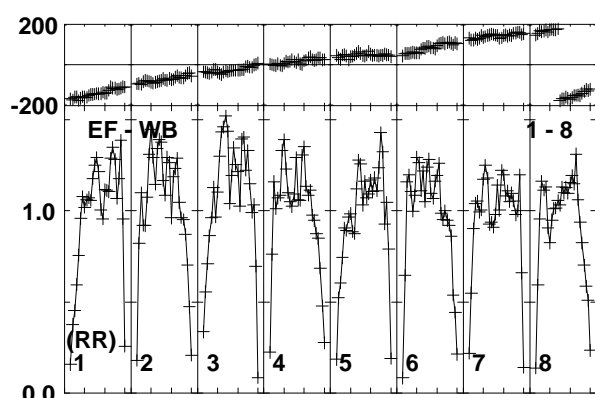
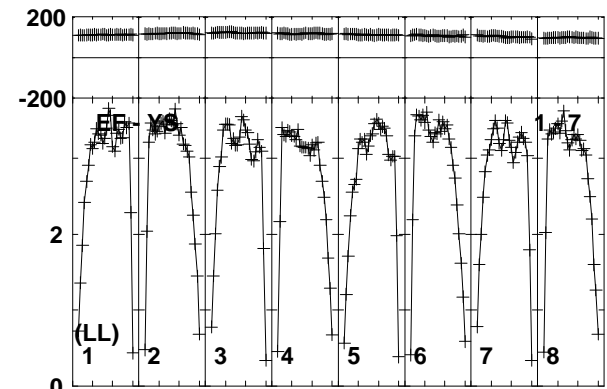
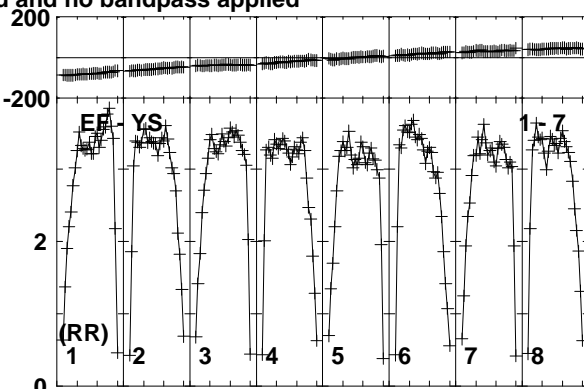
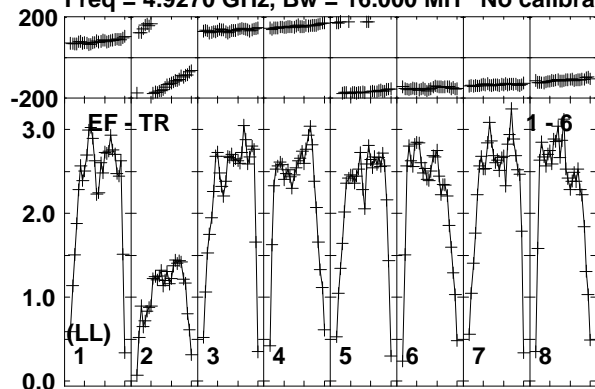

Lower frame: Milli Ampl Jy Top frame: Phas deg  
Vector averaged cross-power spectrum Baseline: EF (01) - TR (06)  
Timerange: 00/22:46:30 to 00/22:48:00

Plot file version 165 created 10-JUN-2016 17:22:17

CHECK RT013A.UVDATA.1

Freq = 4.9270 GHz, Bw = 16.000 MH No calibration applied and no bandpass applied

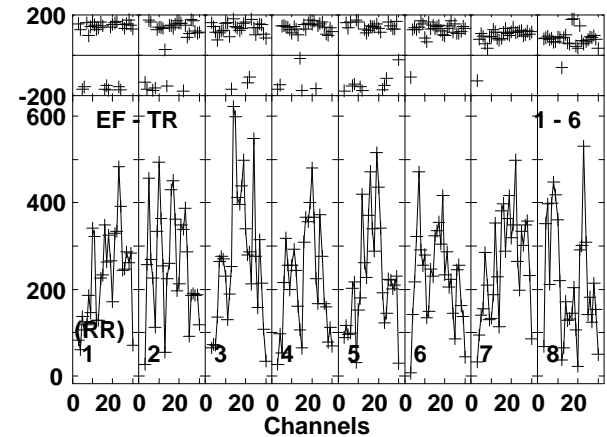
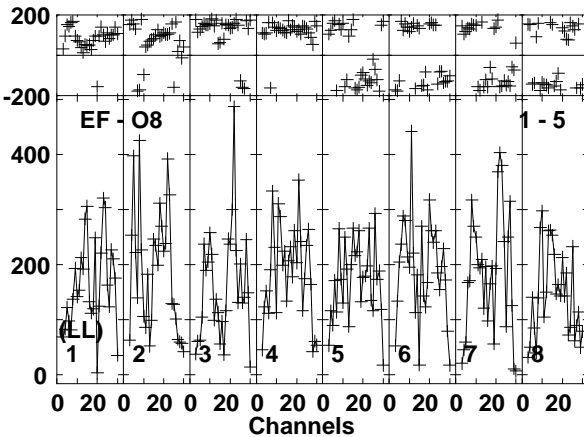
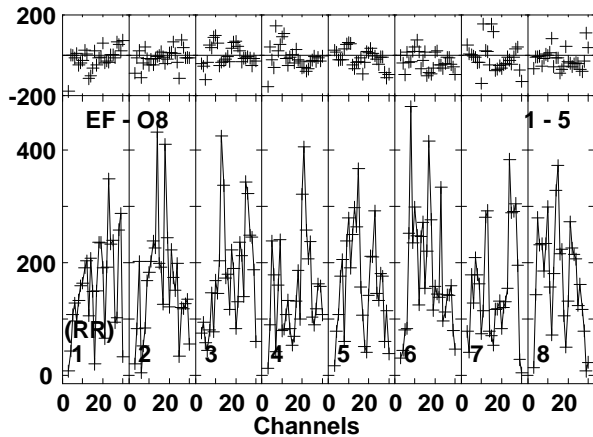
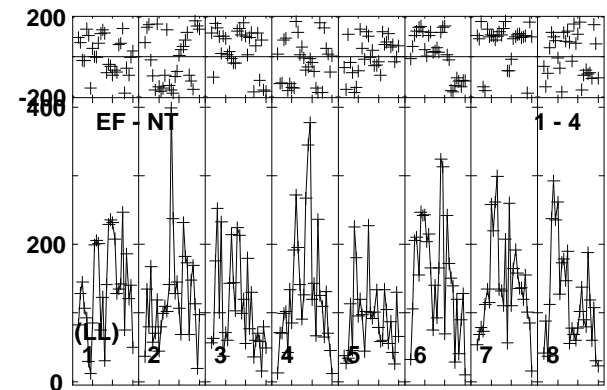
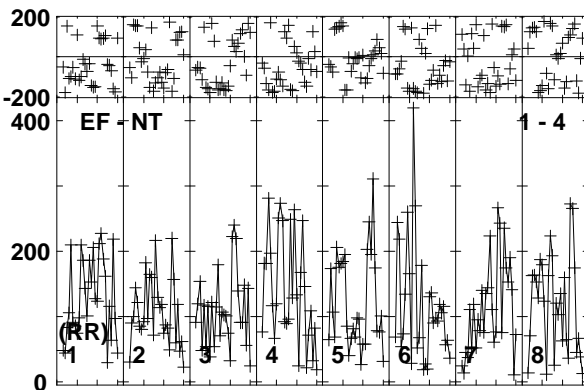
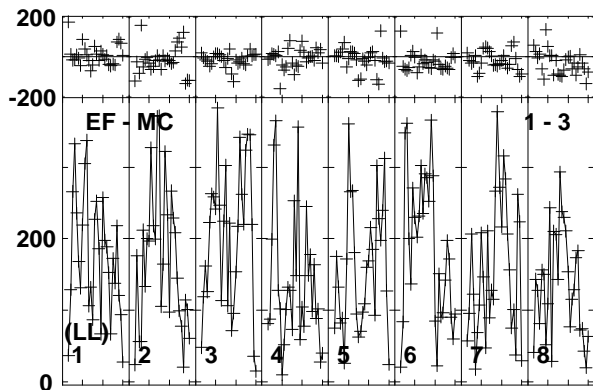
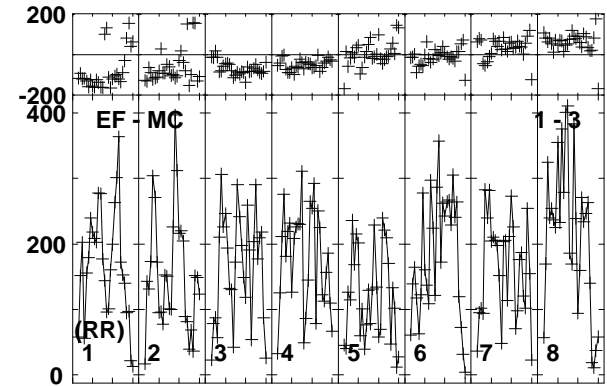
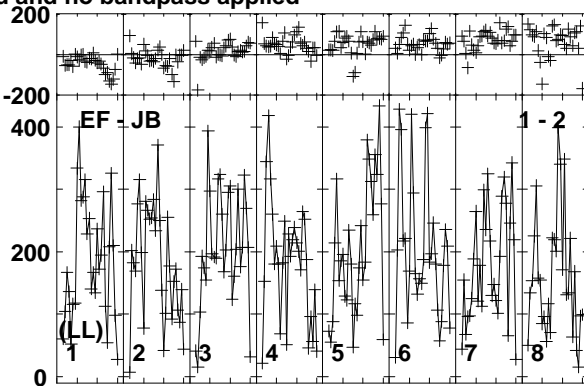
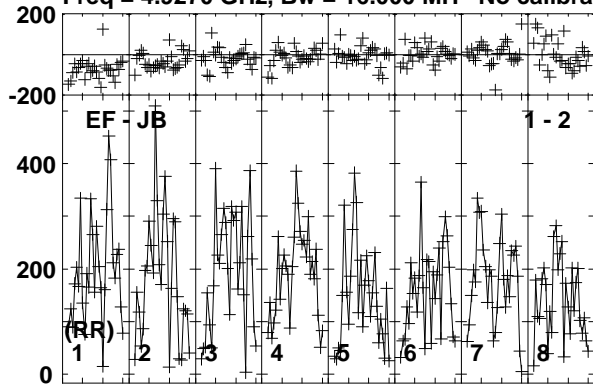

Lower frame: Micro Ampl Jy Top frame: Phas deg  
Vector averaged cross-power spectrum Baseline: EF (01) - JB (02)  
Timerange: 00:22:48:00 to 00:22:50:00

Plot file version 166 created 10-JUN-2016 17:22:17

CHECK RT013A.UVDATA.1

Freq = 4.9270 GHz, Bw = 16.000 MH No calibration applied and no bandpass applied

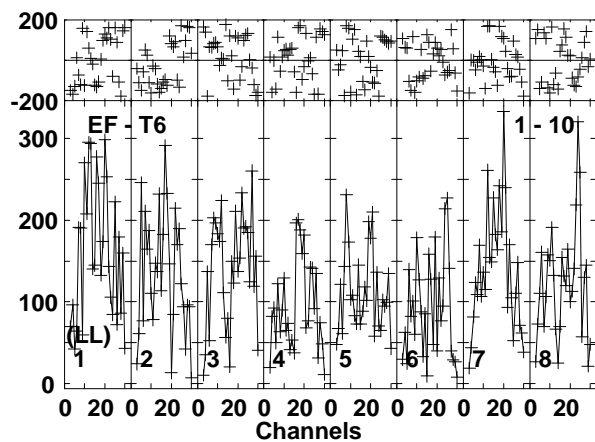
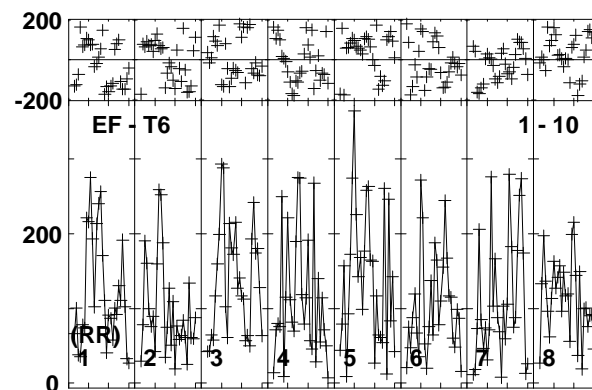
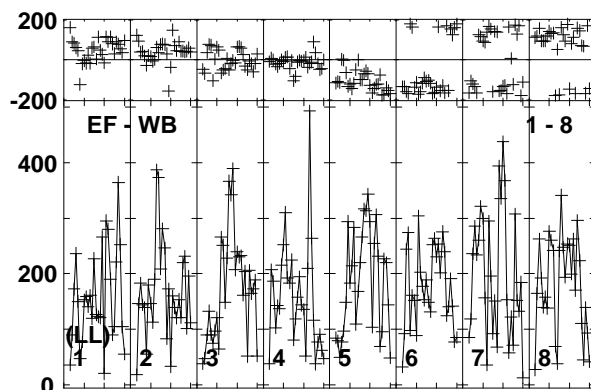
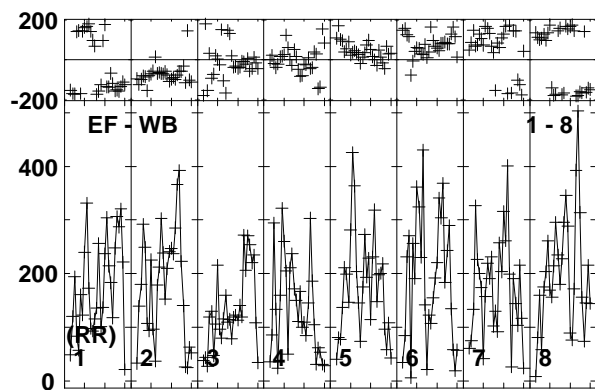
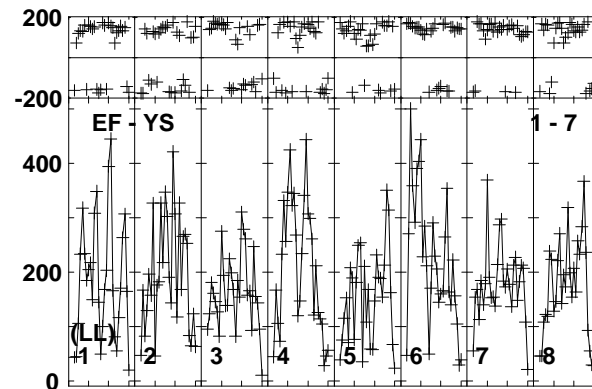
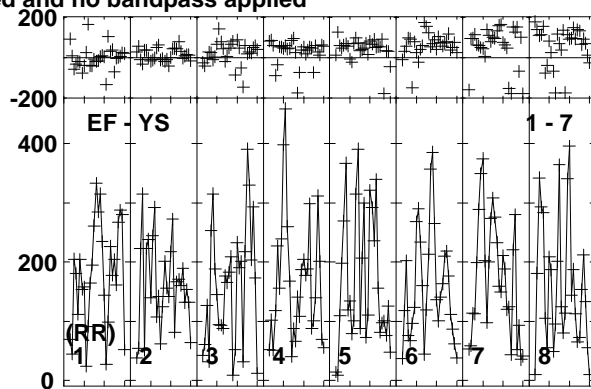
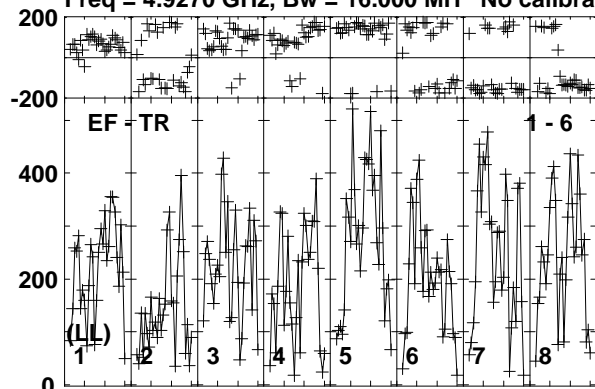

Lower frame: Micro Ampl Jy Top frame: Phas deg  
Vector averaged cross-power spectrum Baseline: EF (01) - TR (06)  
Timerange: 00:22:48:00 to 00:22:50:00

Plot file version 167 created 10-JUN-2016 17:22:17

CYGX1 RT013A.UVDATA.1

Freq = 4.9270 GHz, Bw = 16.000 MH No calibration applied and no bandpass applied

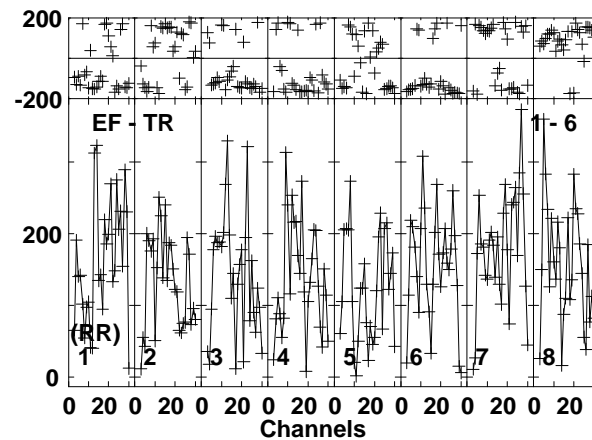
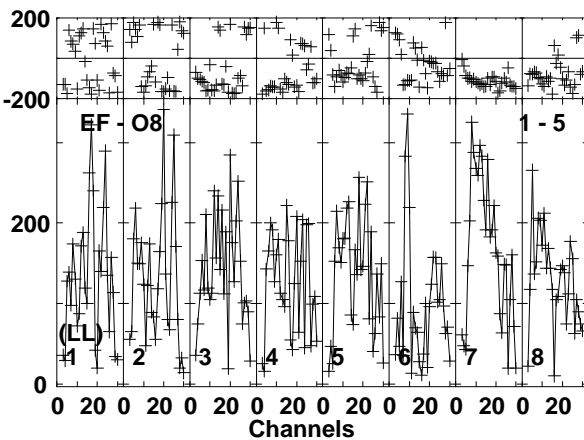
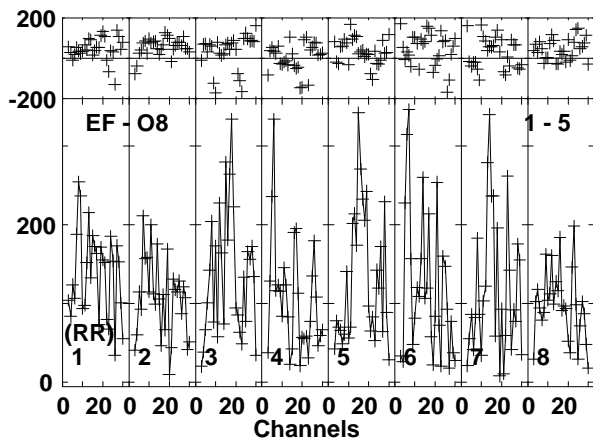
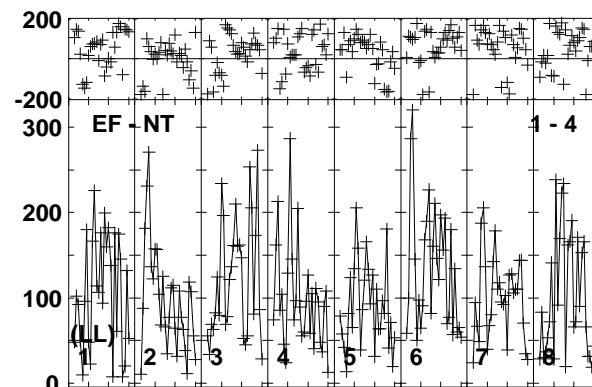
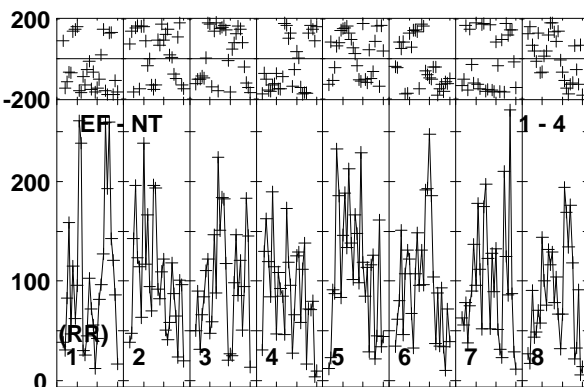
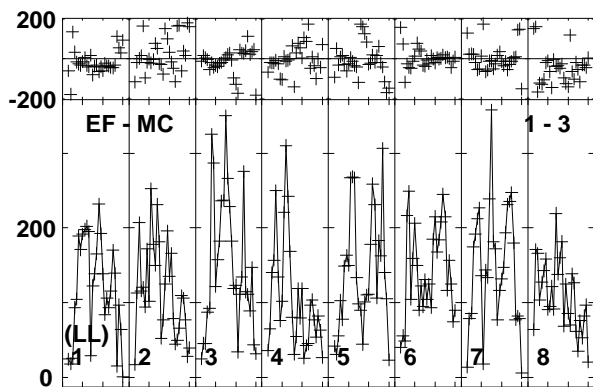
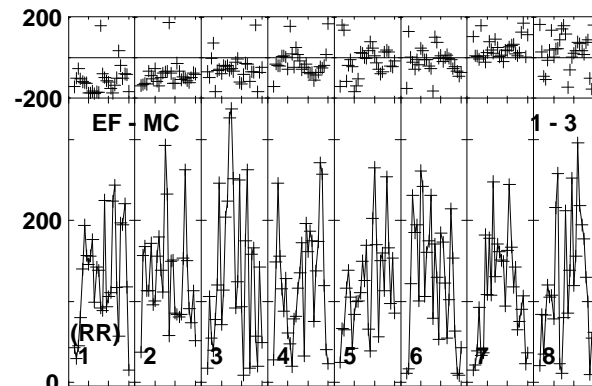
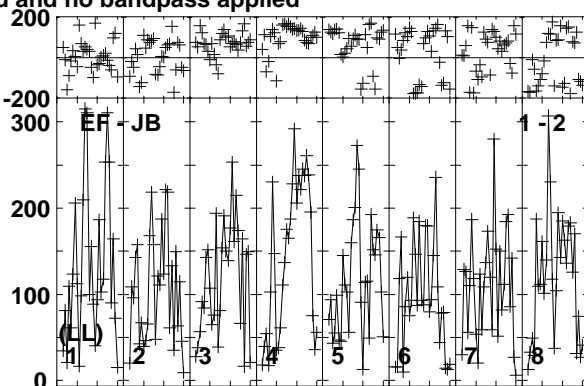
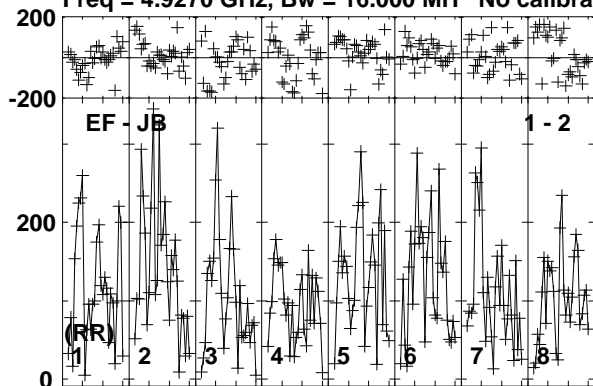

Lower frame: Micro Ampl Jy Top frame: Phas deg  
Vector averaged cross-power spectrum Baseline: EF (01) - JB (02)  
Timerange: 00:22:50:01 to 00:22:52:29

Plot file version 168 created 10-JUN-2016 17:22:17

CYGX1 RT013A.UVDATA.1

Freq = 4.9270 GHz, Bw = 16.000 MH No calibration applied and no bandpass applied

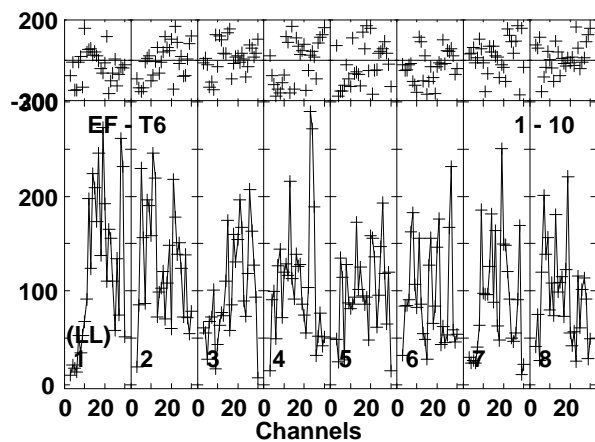
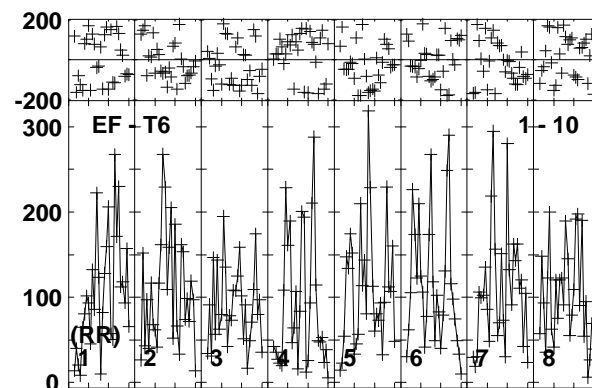
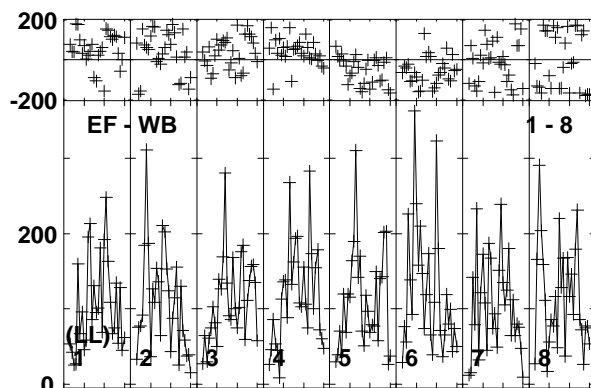
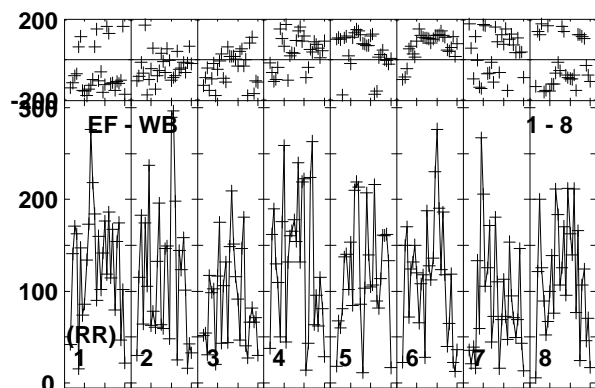
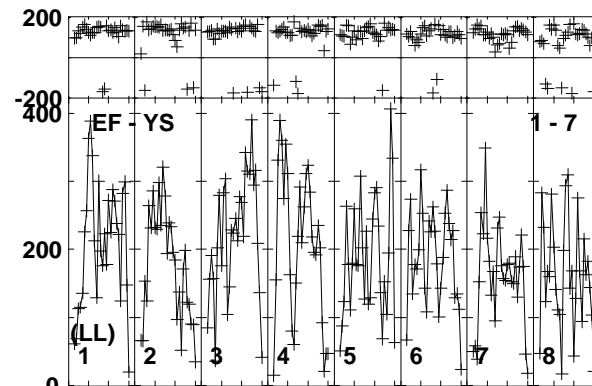
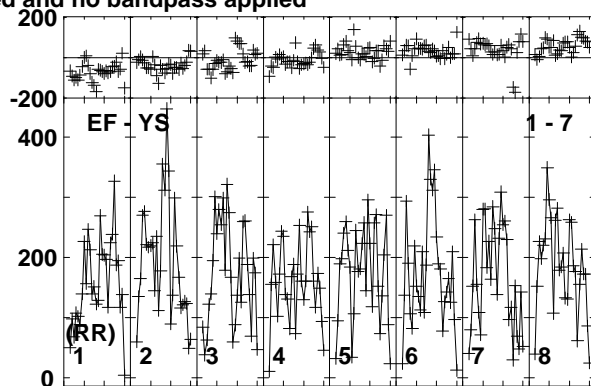
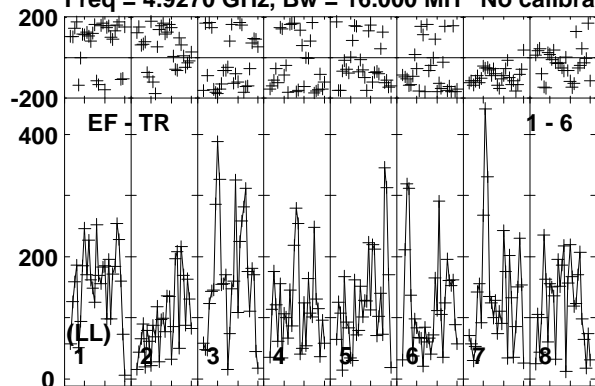

Lower frame: Micro Ampl Jy Top frame: Phas deg  
Vector averaged cross-power spectrum Baseline: EF (01) - TR (06)  
Timerange: 00/22:50:01 to 00/22:52:29

Plot file version 169 created 10-JUN-2016 17:22:17

J1957+3338 RT013A.UVDATA.1

Freq = 4.9270 GHz, Bw = 16.000 MH No calibration applied and no bandpass applied

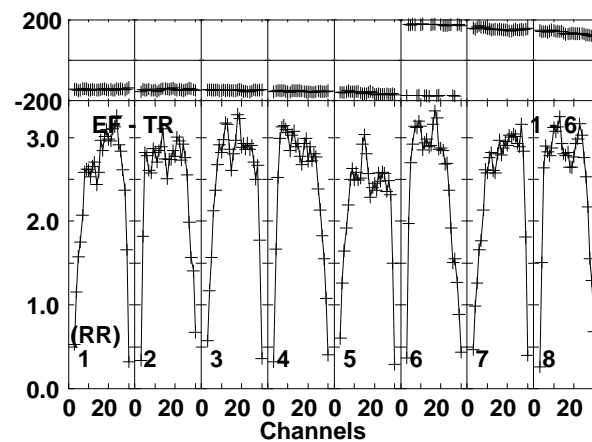
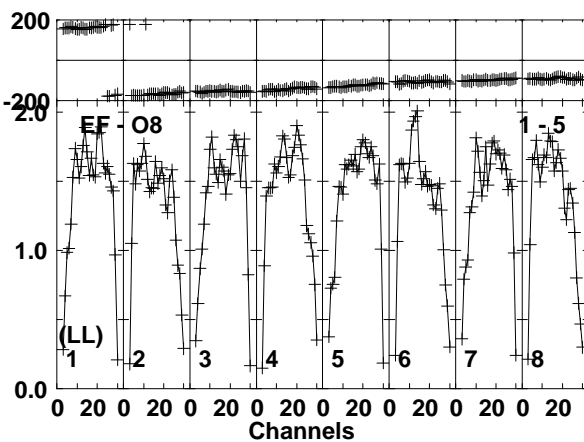
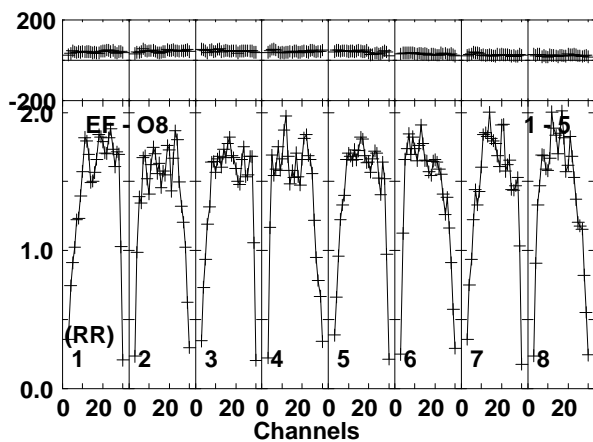
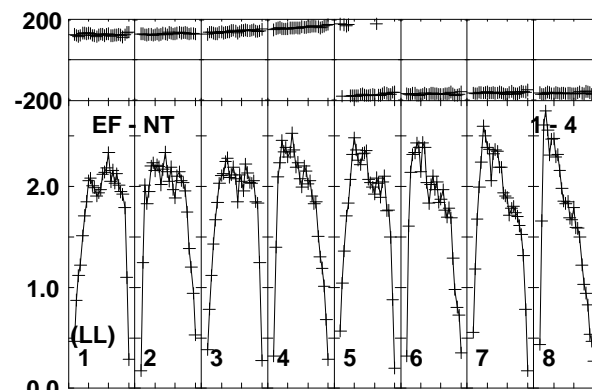
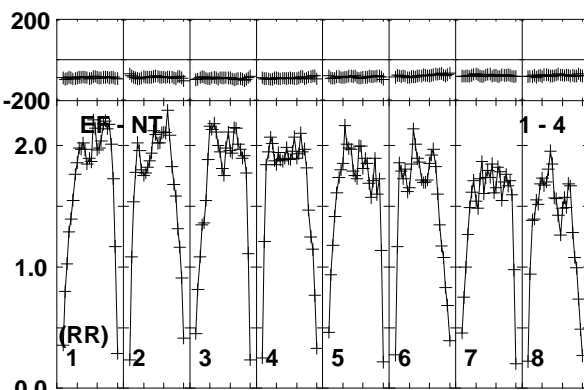
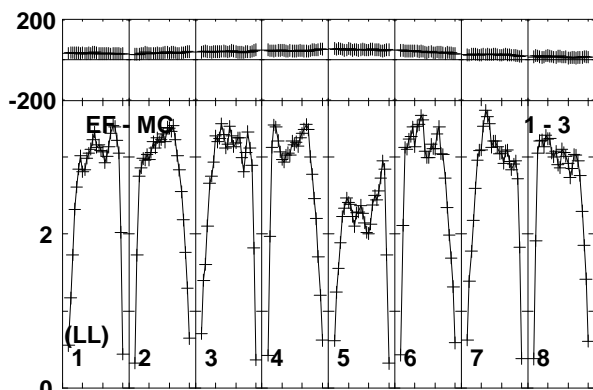
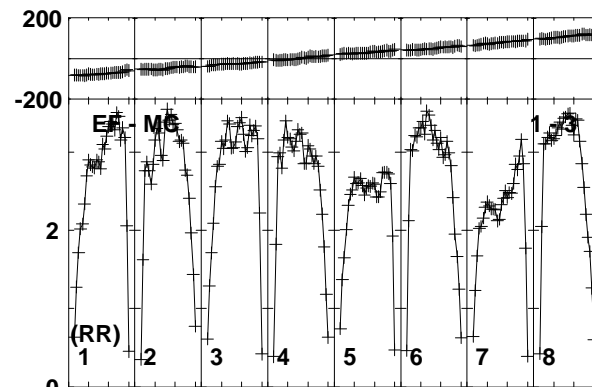
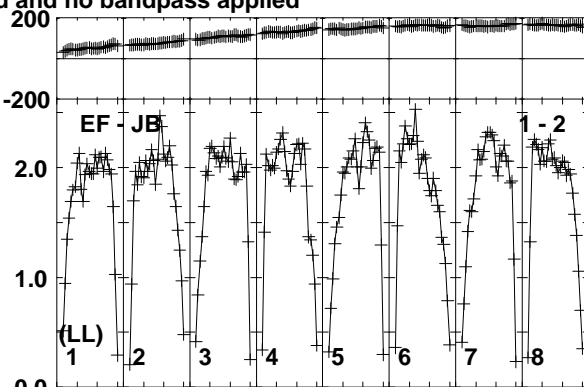
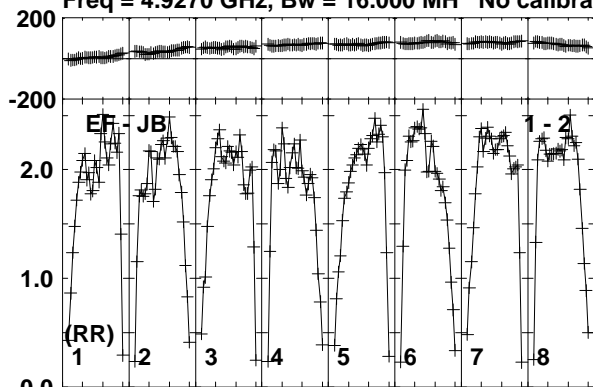

Lower frame: Milli Ampl Jy Top frame: Phas deg  
Vector averaged cross-power spectrum Baseline: EF (01) - JB (02)  
Timerange: 00/22:52:31 to 00/22:53:59

Plot file version 170 created 10-JUN-2016 17:22:17

J1957+3338 RT013A.UVDATA.1

Freq = 4.9270 GHz, Bw = 16.000 MH No calibration applied and no bandpass applied

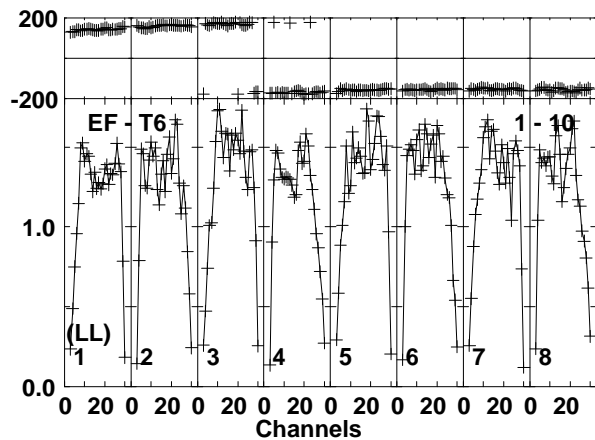
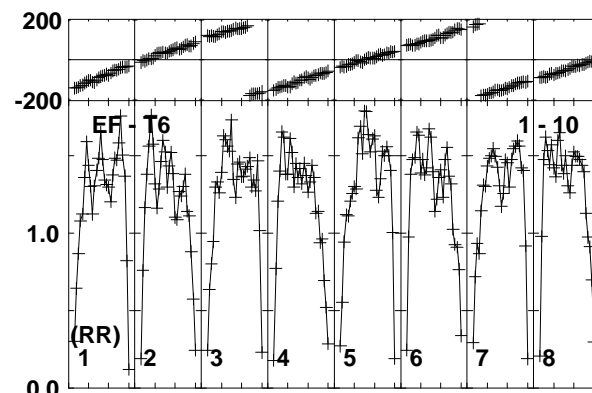
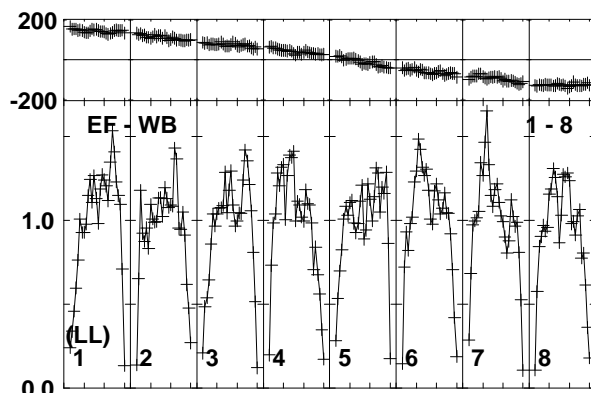
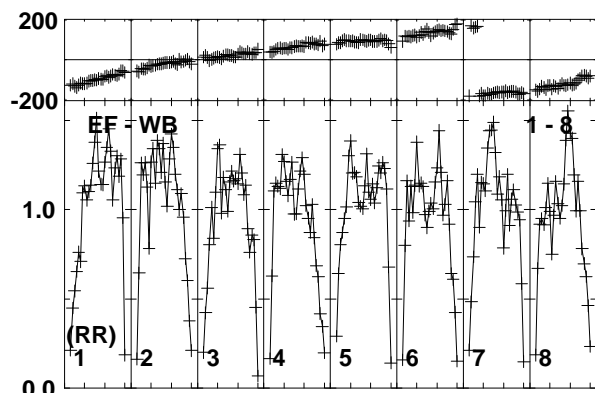
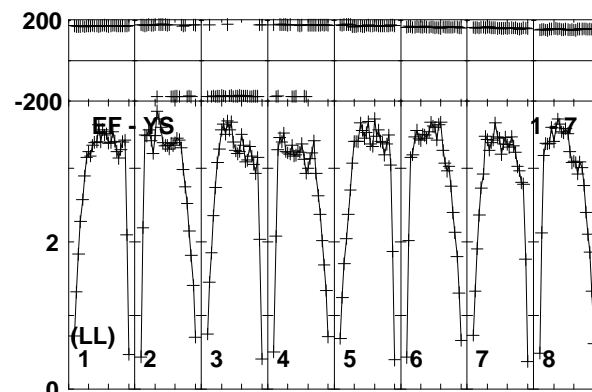
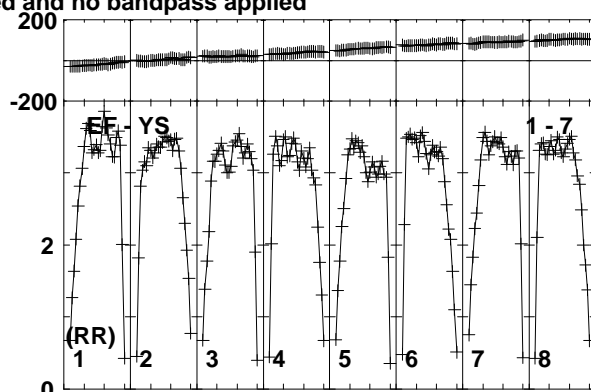
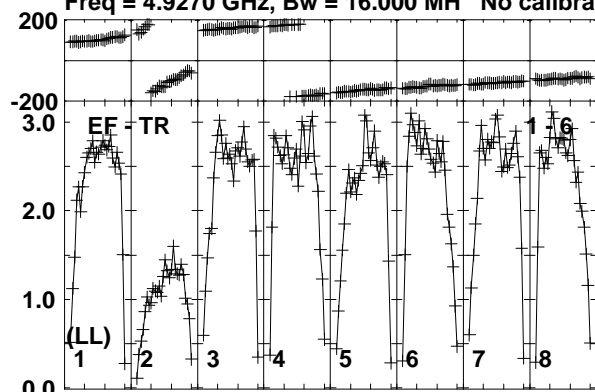

Lower frame: Milli Ampl Jy Top frame: Phas deg  
Vector averaged cross-power spectrum Baseline: EF (01) - TR (06)  
Timerange: 00/22:52:31 to 00/22:53:59



Plot file version 171 created 10-JUN-2016 17:22:18

CHECK RT013A.UVDATA.1

Freq = 4.9270 GHz, Bw = 16.000 MH No calibration applied and no bandpass applied

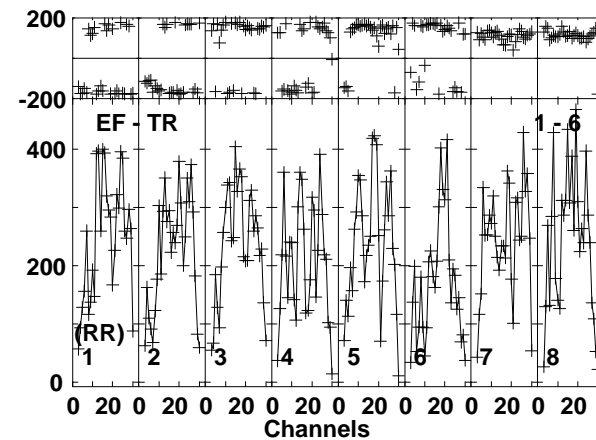
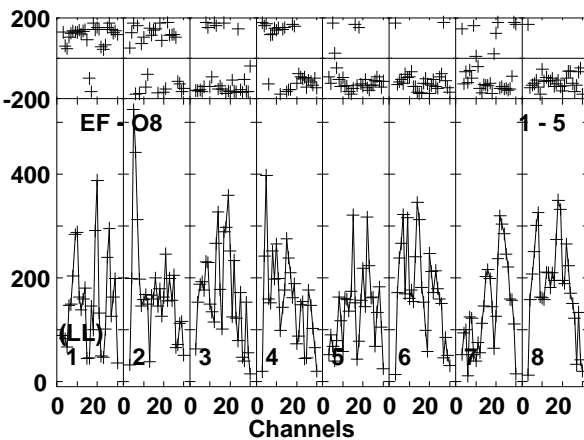
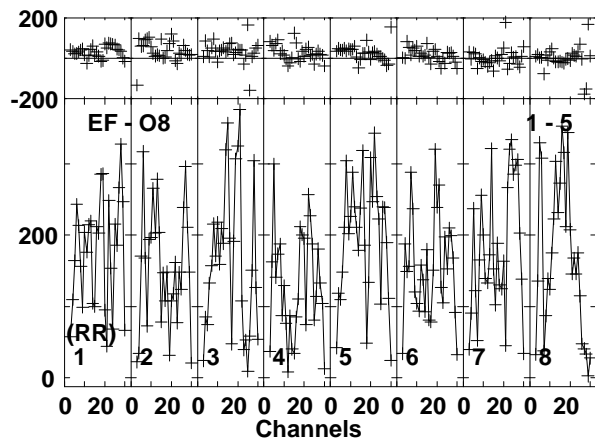
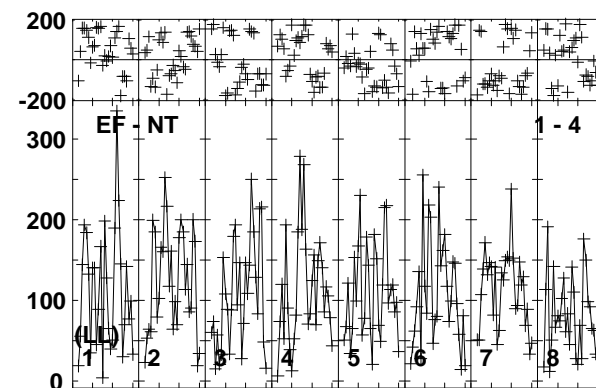
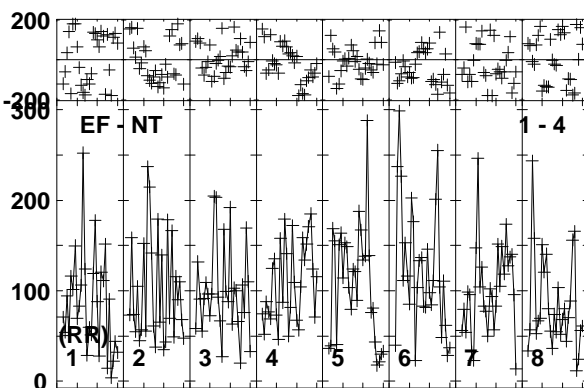
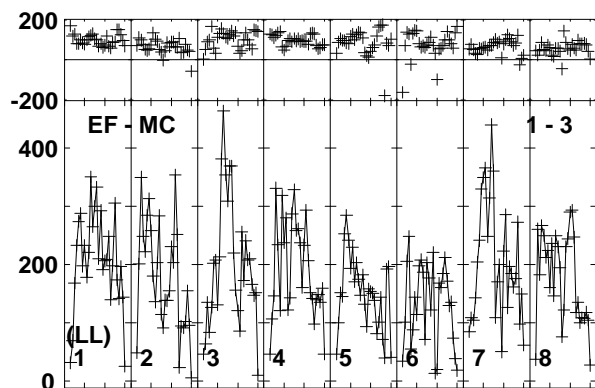
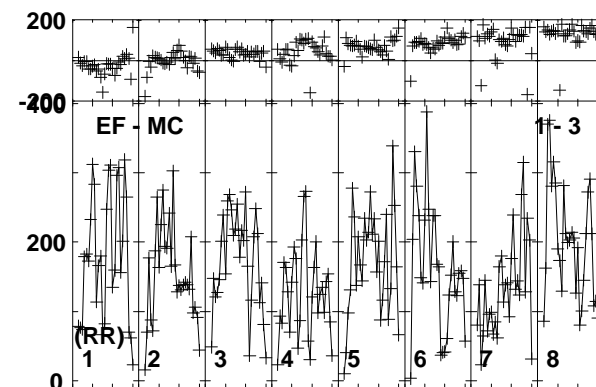
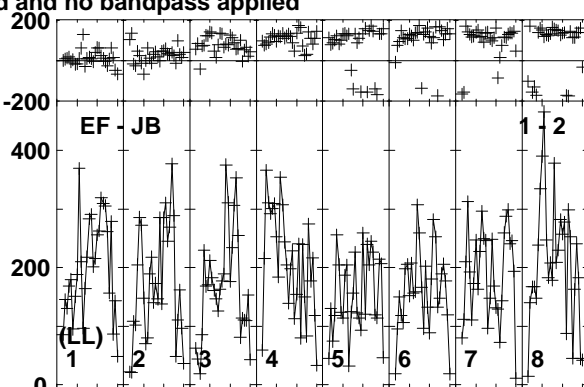
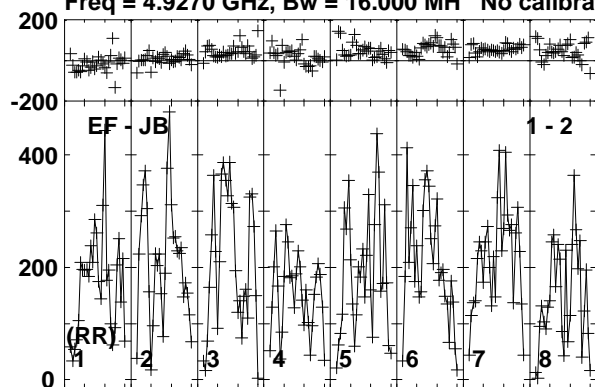

Lower frame: Micro Ampl Jy Top frame: Phas deg  
Vector averaged cross-power spectrum Baseline: EF (01) - JB (02)  
Timerange: 00:22:54:40 to 00:22:56:39

Plot file version 172 created 10-JUN-2016 17:22:18

CHECK RT013A.UVDATA.1

Freq = 4.9270 GHz, Bw = 16.000 MH No calibration applied and no bandpass applied

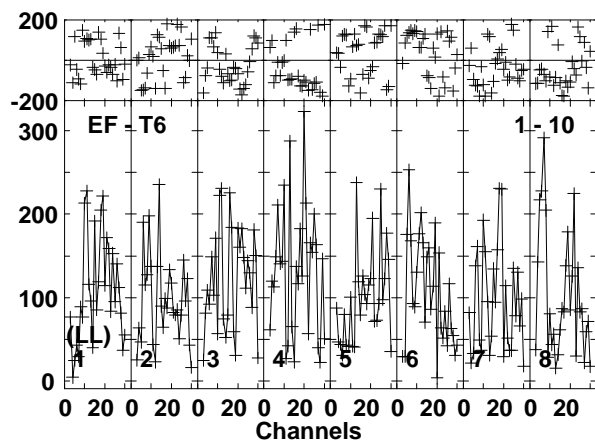
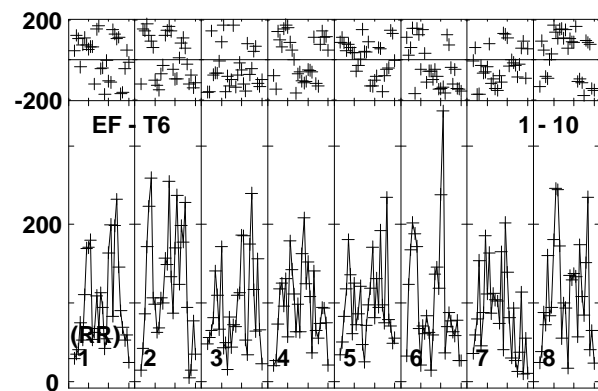
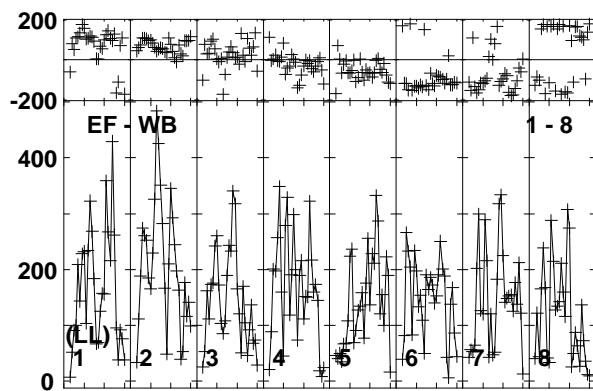
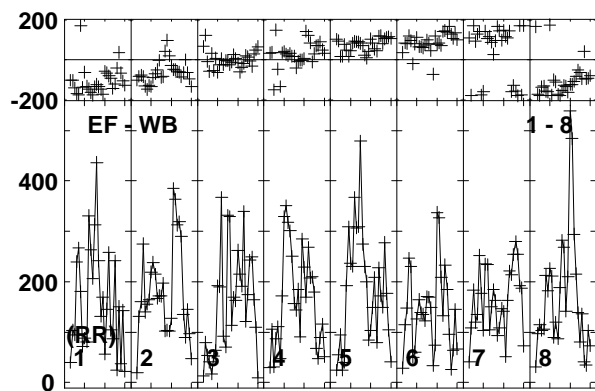
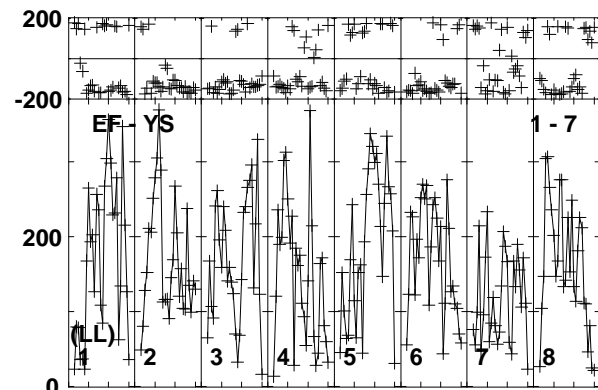
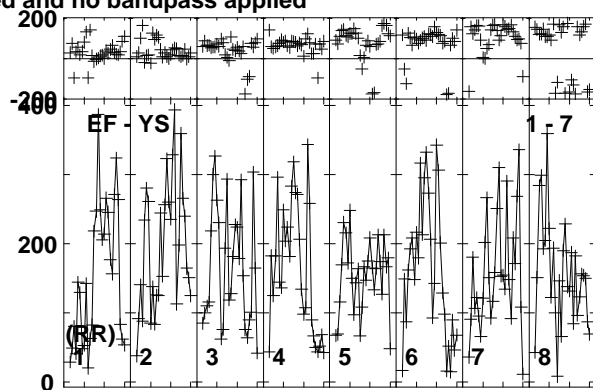
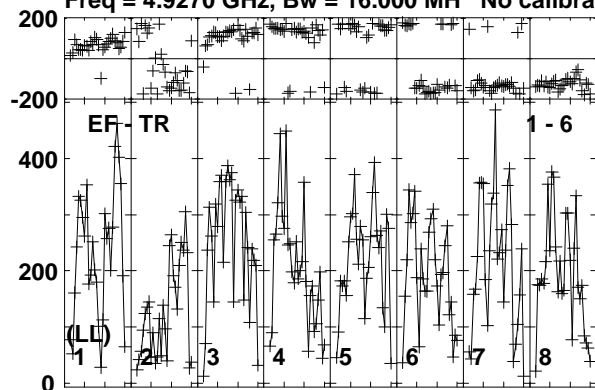

Lower frame: Micro Ampl Jy Top frame: Phas deg  
Vector averaged cross-power spectrum Baseline: EF (01) - TR (06)  
Timerange: 00/22:54:40 to 00/22:56:39

Plot file version 173 created 10-JUN-2016 17:22:18

CYGX1 RT013A.UVDATA.1

Freq = 4.9270 GHz, Bw = 16.000 MH No calibration applied and no bandpass applied

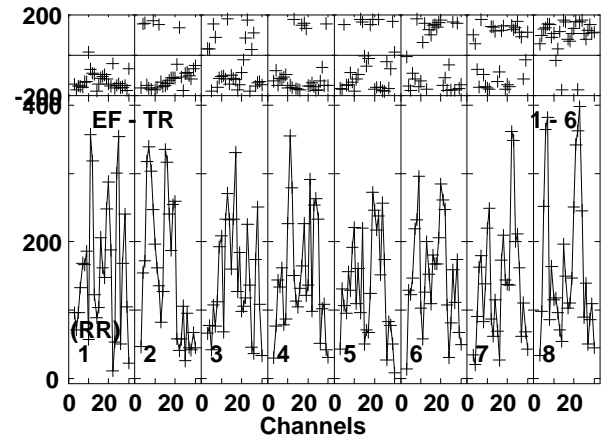
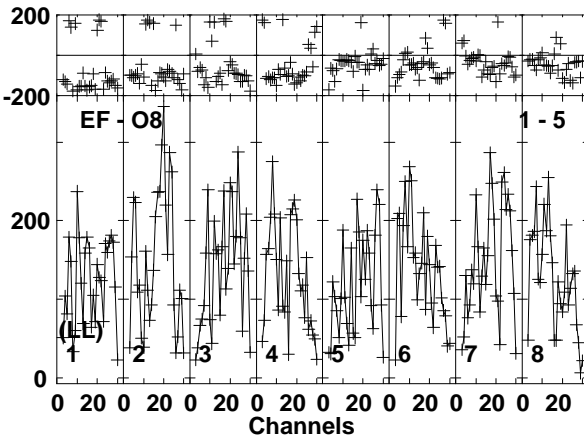
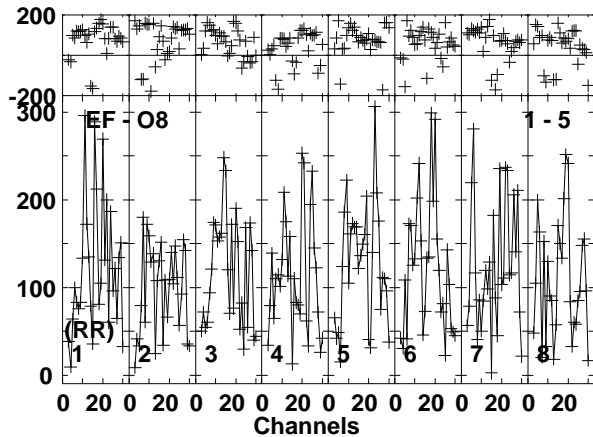
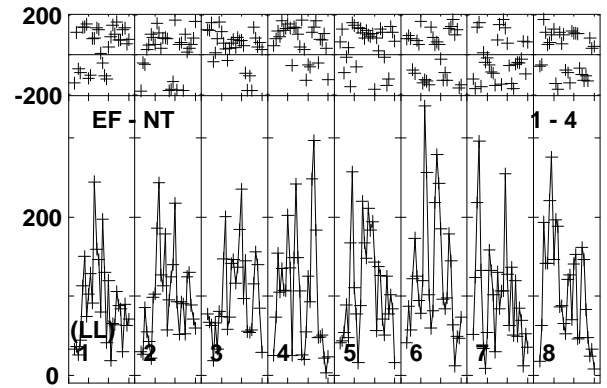
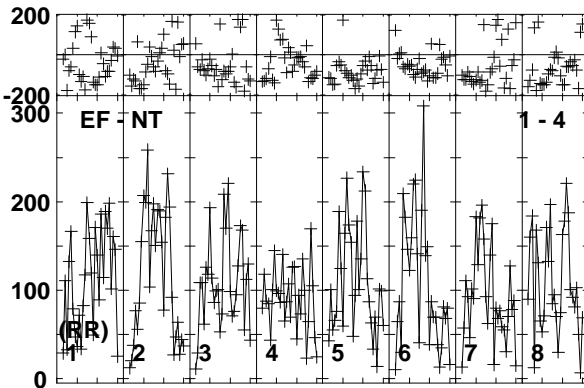
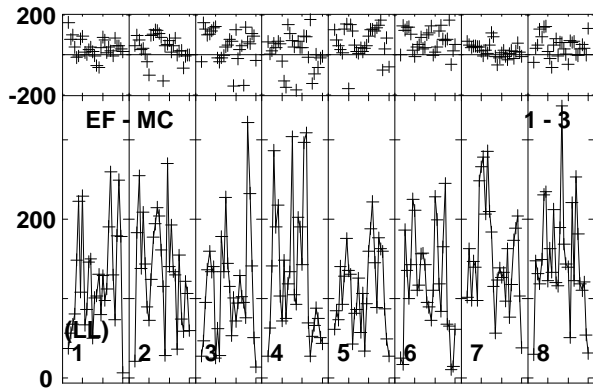
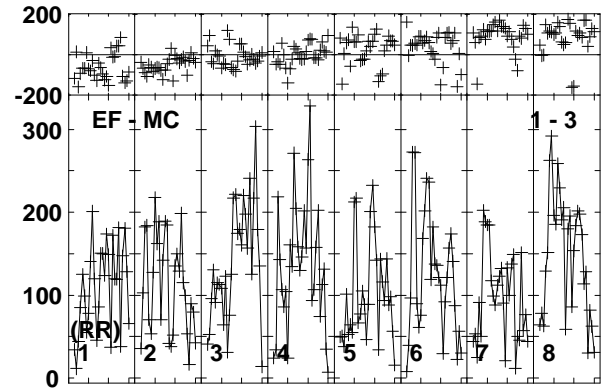
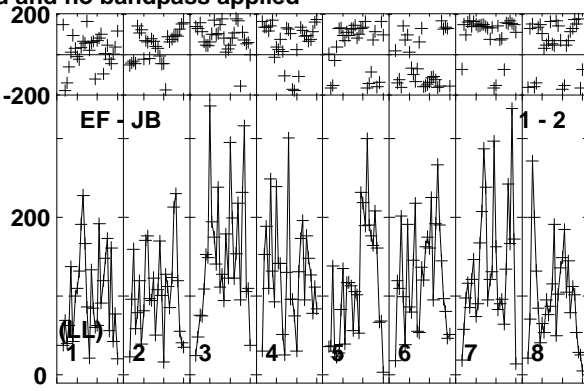
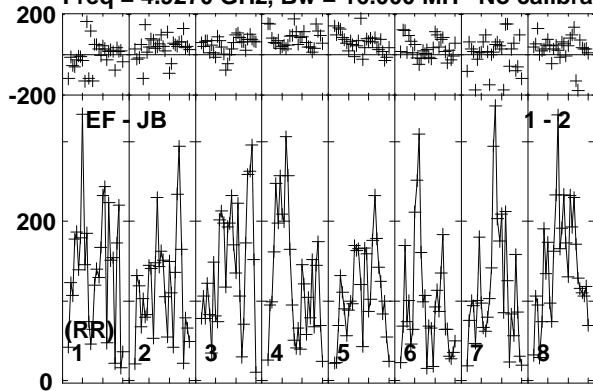

Lower frame: Micro Ampl Jy Top frame: Phas deg  
Vector averaged cross-power spectrum Baseline: EF (01) - JB (02)  
Timerange: 00/22:56:41 to 00/22:59:09

Plot file version 174 created 10-JUN-2016 17:22:18

CYGX1 RT013A.UVDATA.1

Freq = 4.9270 GHz, Bw = 16.000 MH No calibration applied and no bandpass applied

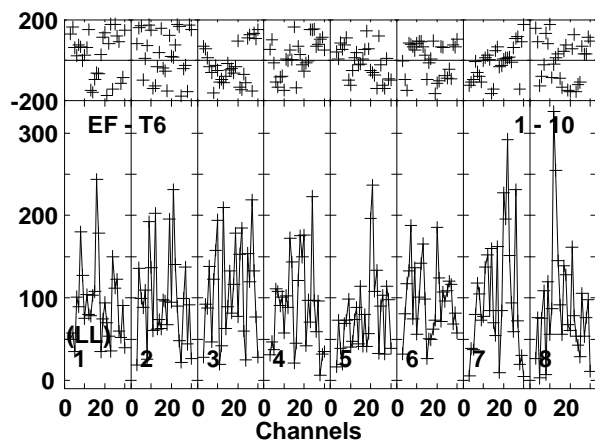
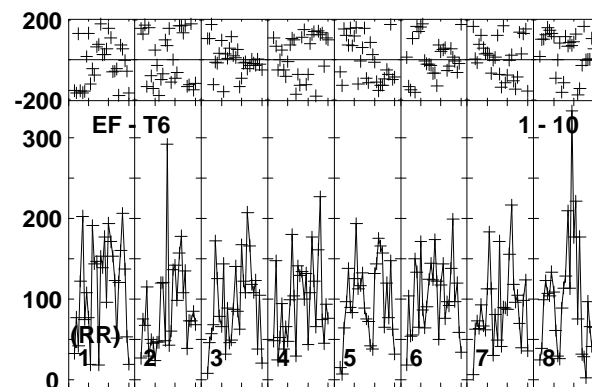
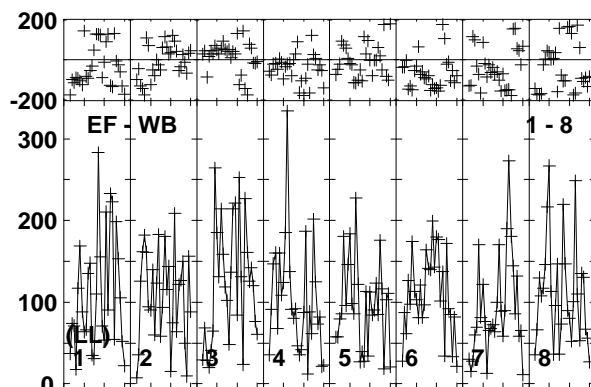
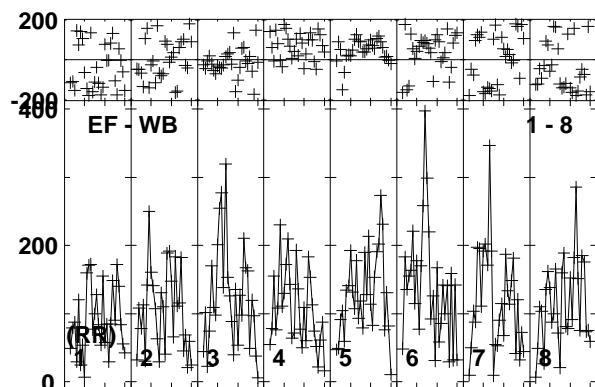
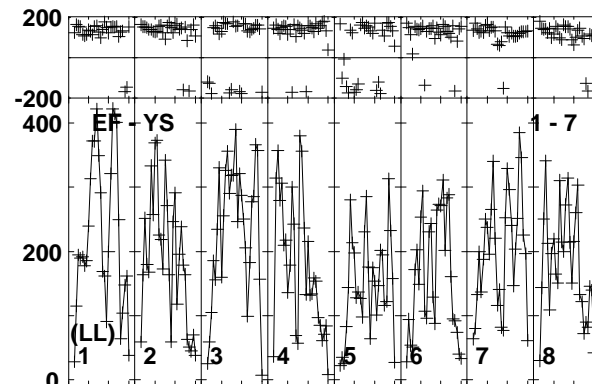
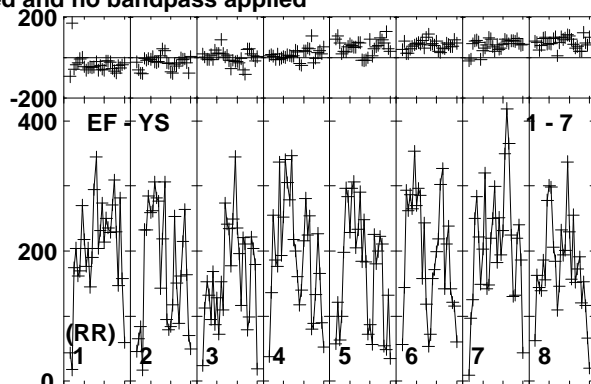
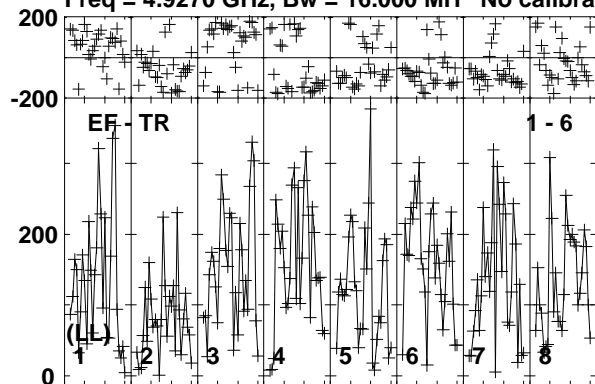

Lower frame: Micro Ampl Jy Top frame: Phas deg  
Vector averaged cross-power spectrum Baseline: EF (01) - TR (06)  
Timerange: 00/22:56:41 to 00/22:59:09

Plot file version 175 created 10-JUN-2016 17:22:18

J1957+3338 RT013A.UVDATA.1

Freq = 4.9270 GHz, Bw = 16.000 MH No calibration applied and no bandpass applied

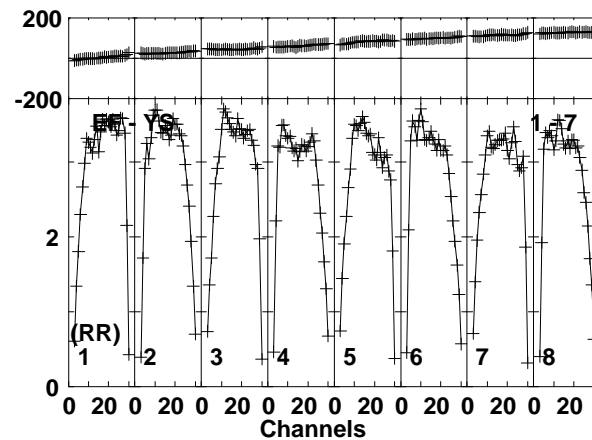
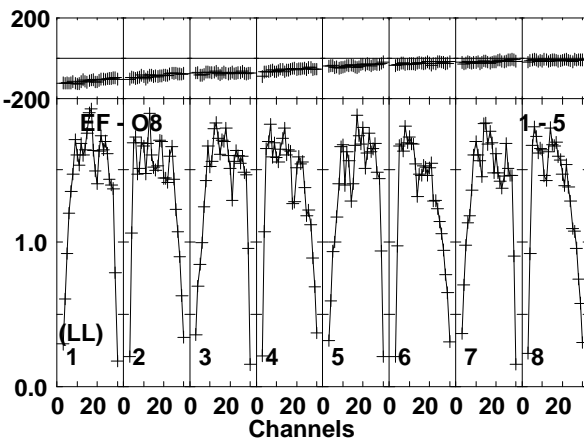
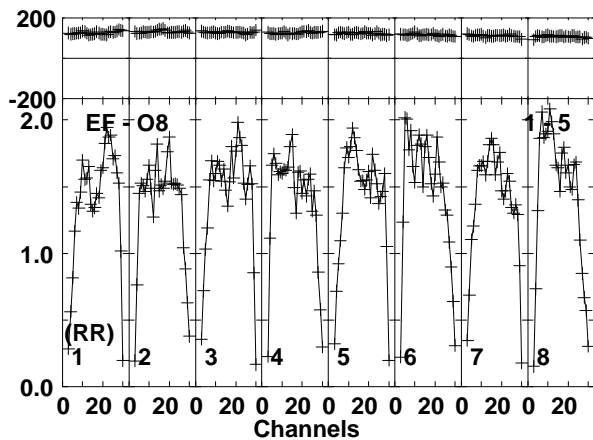
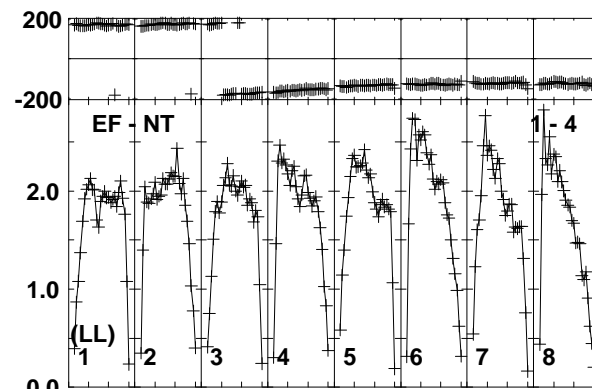
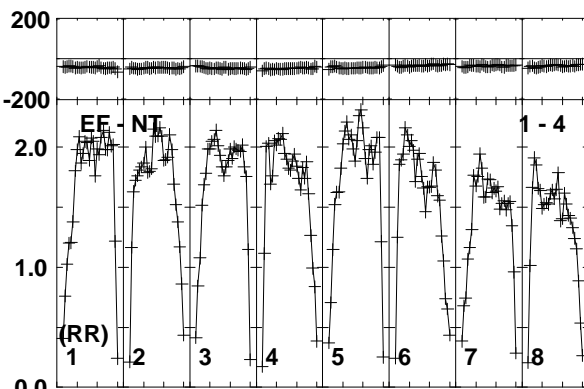
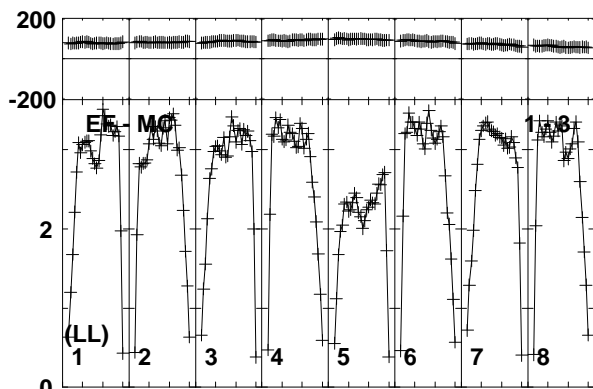
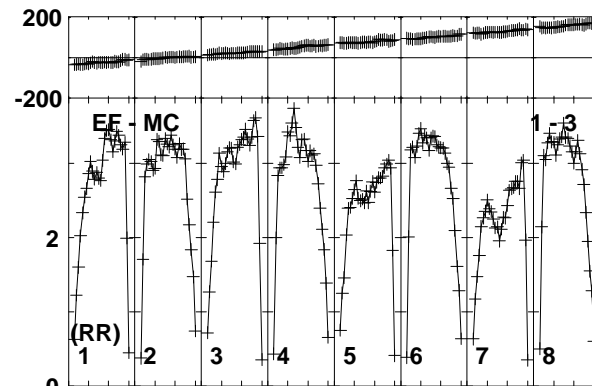
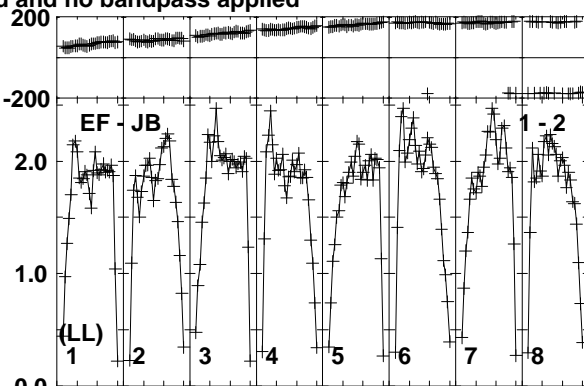
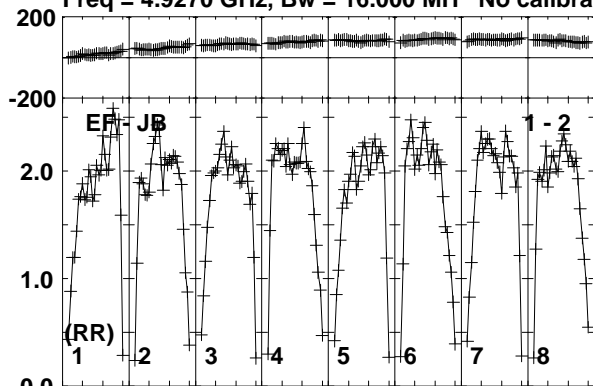

Lower frame: Milli Ampl Jy Top frame: Phas deg  
Vector averaged cross-power spectrum Baseline: EF (01) - JB (02)  
Timerange: 00/22:59:10 to 00/23:00:39

Plot file version 176 created 10-JUN-2016 17:22:18

J1957+3338 RT013A.UVDATA.1

Freq = 4.9270 GHz, Bw = 16.000 MH No calibration applied and no bandpass applied

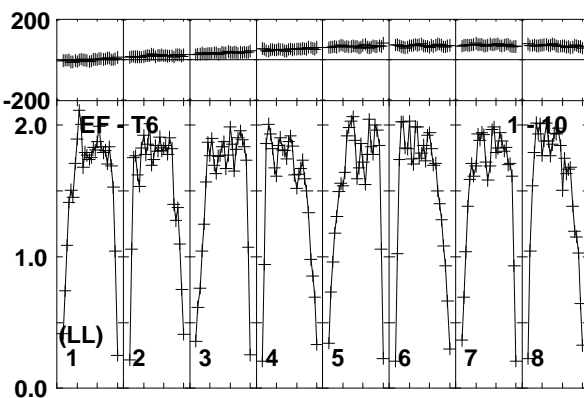
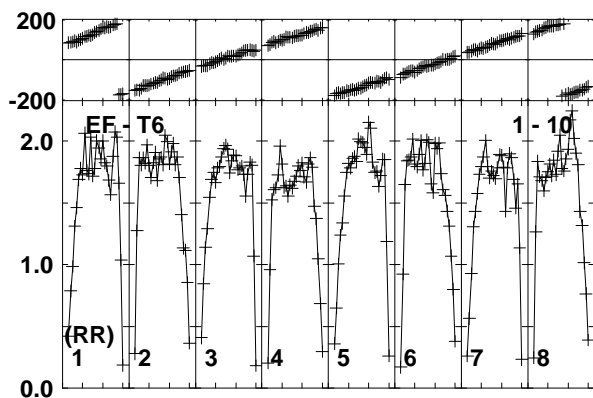
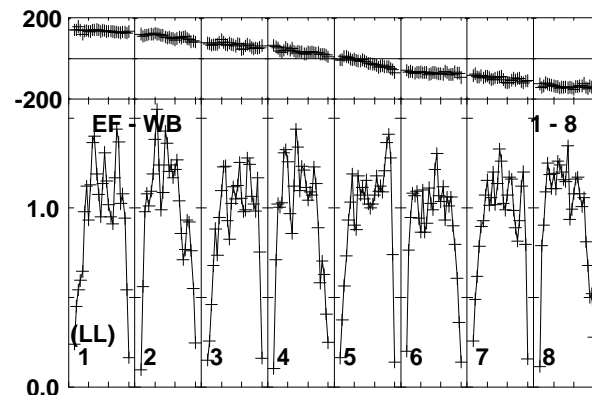
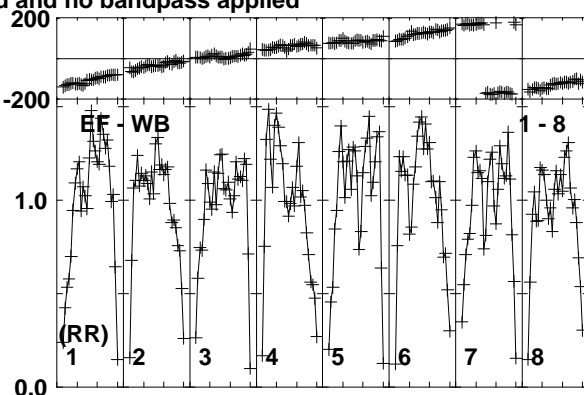
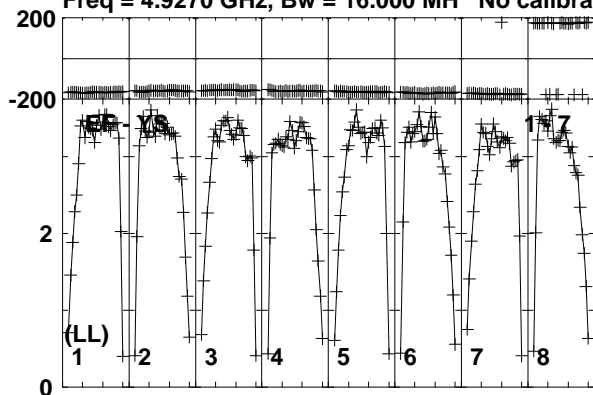

Lower frame: Milli Ampl Jy Top frame: Phas deg  
Vector averaged cross-power spectrum Baseline: EF (01) - YS (07)  
Timerange: 00/22:59:10 to 00/23:00:39

Plot file version 177 created 10-JUN-2016 17:22:18

CHECK RT013A.UVDATA.1

Freq = 4.9270 GHz, Bw = 16.000 MH No calibration applied and no bandpass applied

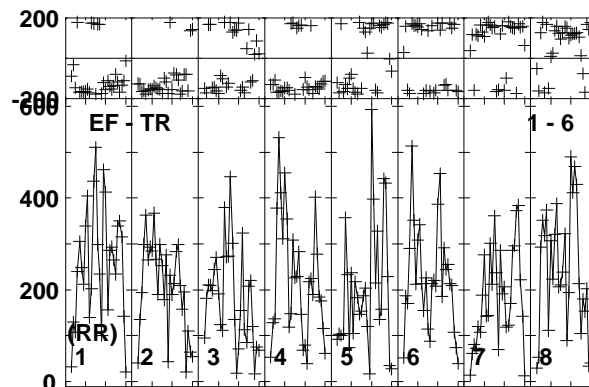
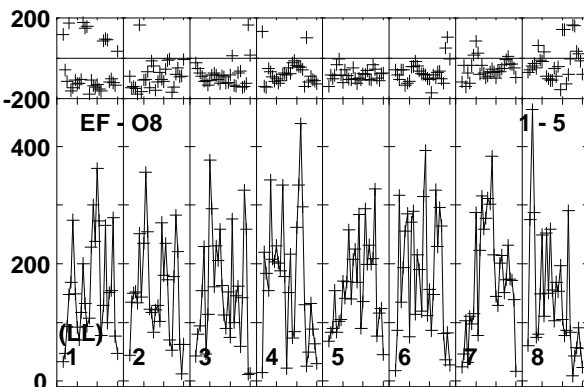
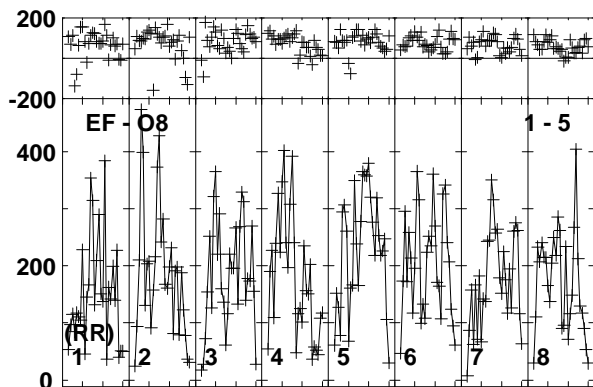
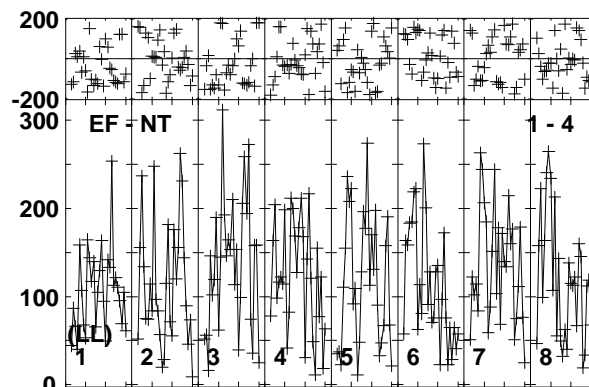
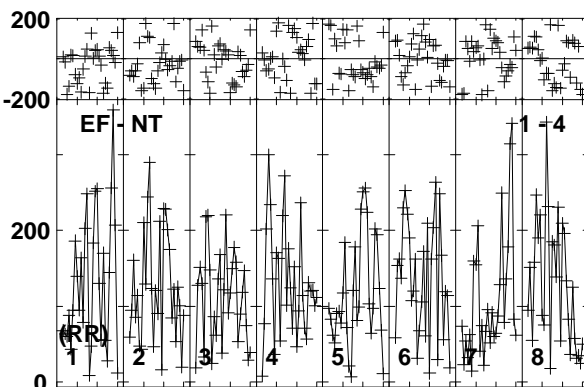
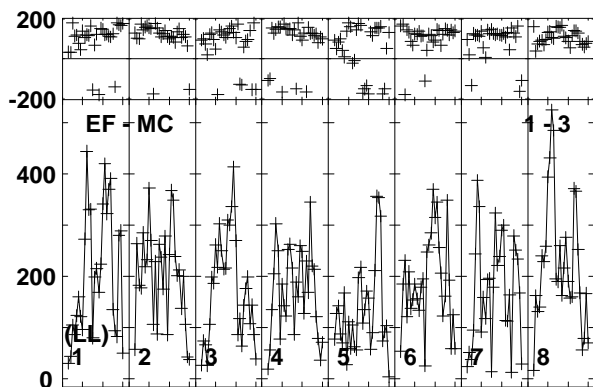
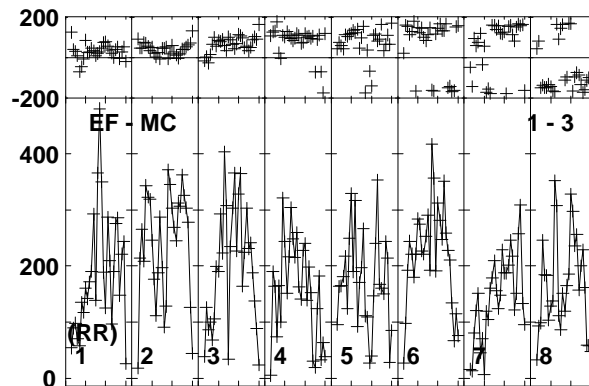
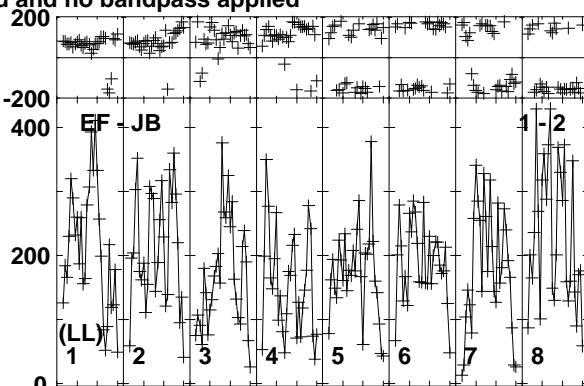
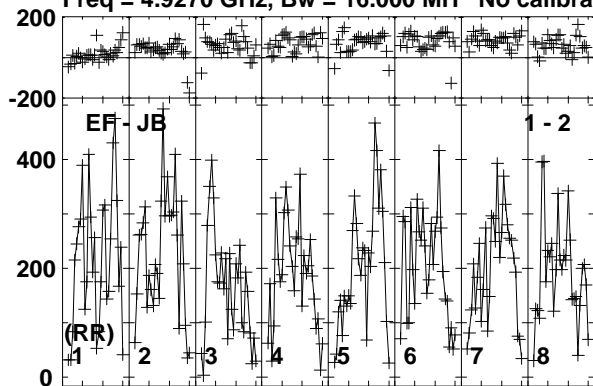

Lower frame: Micro Ampl Jy Top frame: Phas deg  
Vector averaged cross-power spectrum Baseline: EF (01) - JB (02)  
Timerange: 00/23:00:40 to 00/23:02:40

Plot file version 178 created 10-JUN-2016 17:22:18

CHECK RT013A.UVDATA.1

Freq = 4.9270 GHz, Bw = 16.000 MH No calibration applied and no bandpass applied

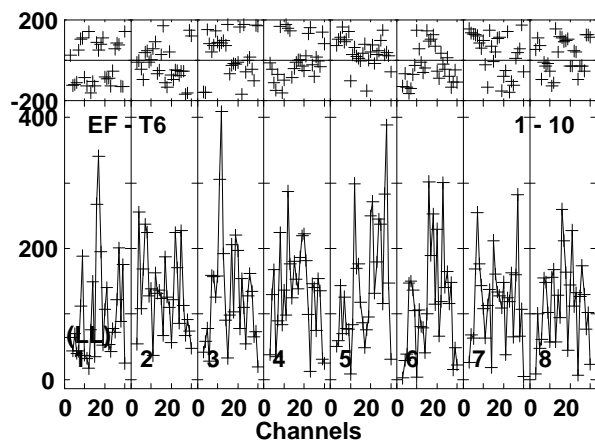
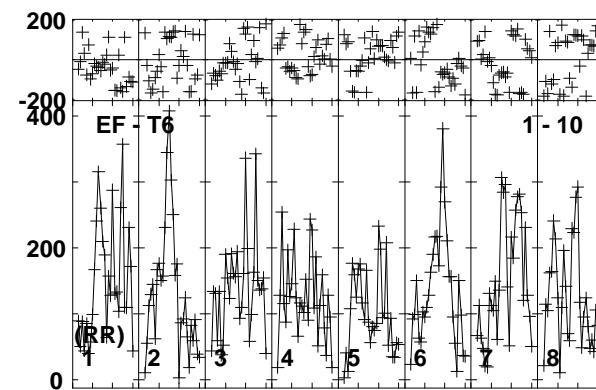
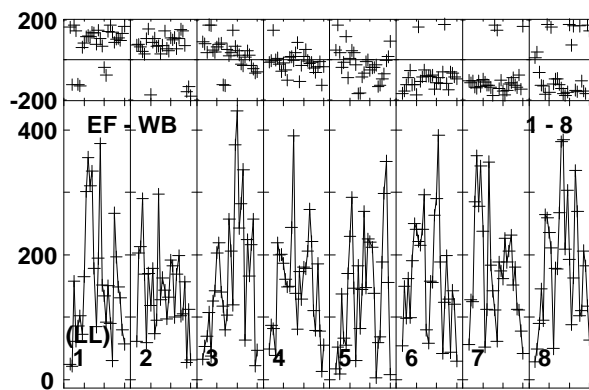
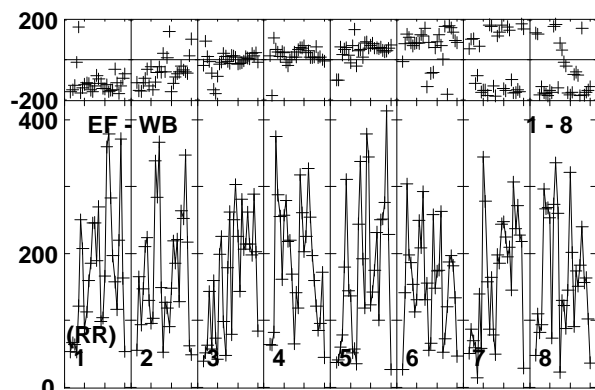
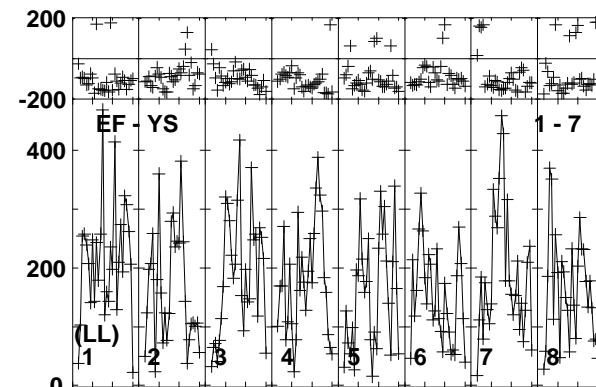
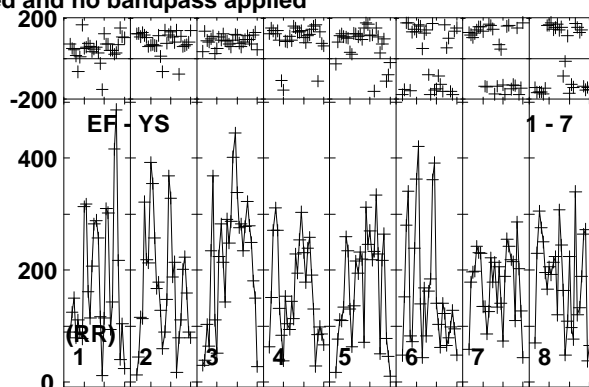
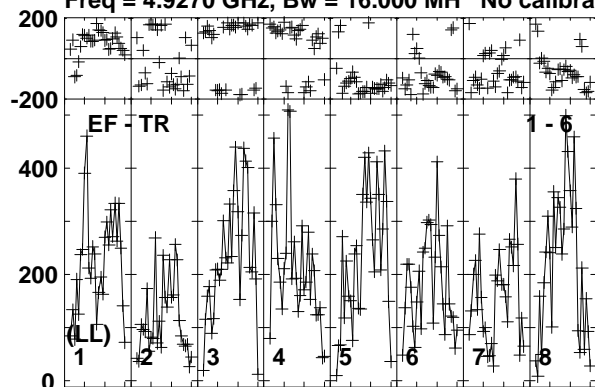

Lower frame: Micro Ampl Jy Top frame: Phas deg  
Vector averaged cross-power spectrum Baseline: EF (01) - TR (06)  
Timerange: 00/23:00:40 to 00/23:02:40



Plot file version 179 created 10-JUN-2016 17:22:19

CYGX1 RT013A.UVDATA.1

Freq = 4.9270 GHz, Bw = 16.000 MH No calibration applied and no bandpass applied

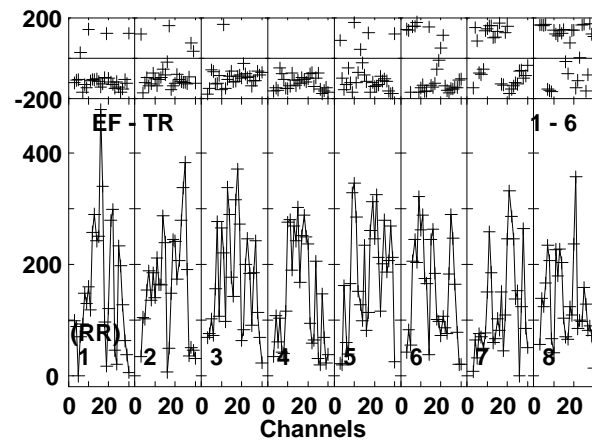
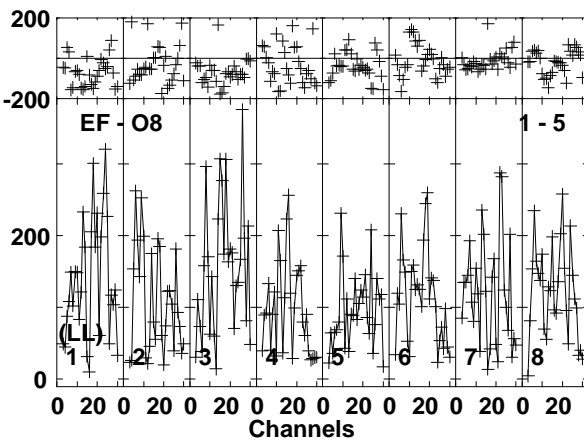
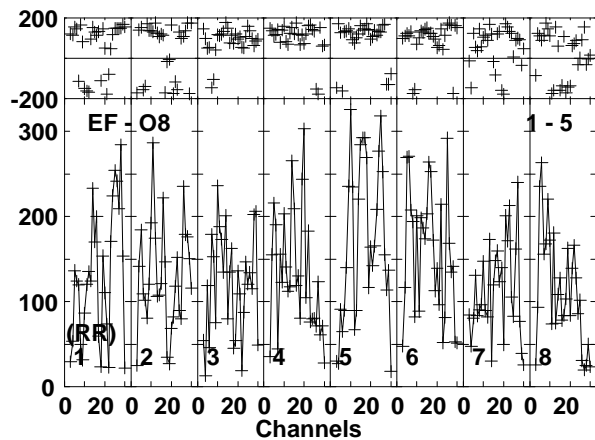
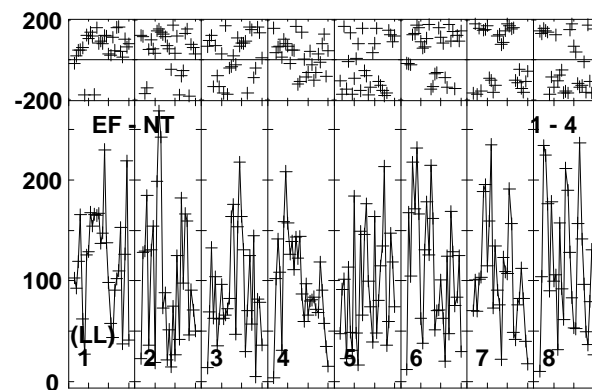
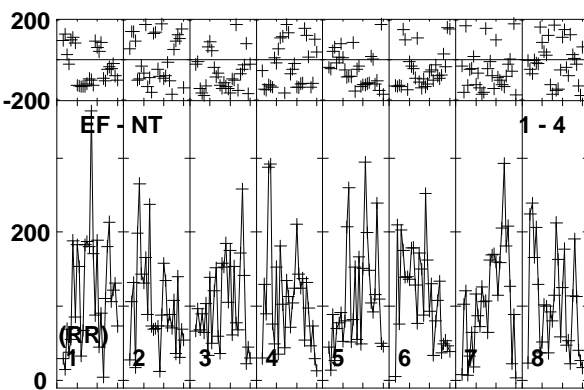
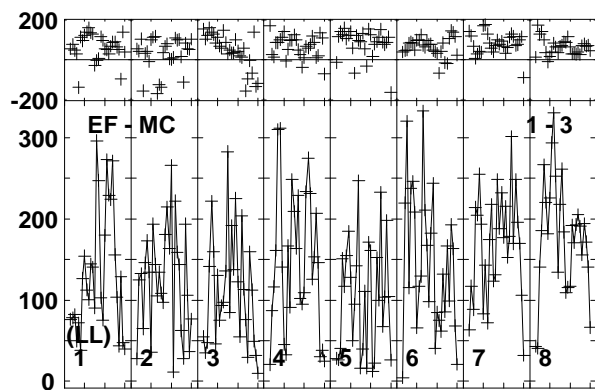
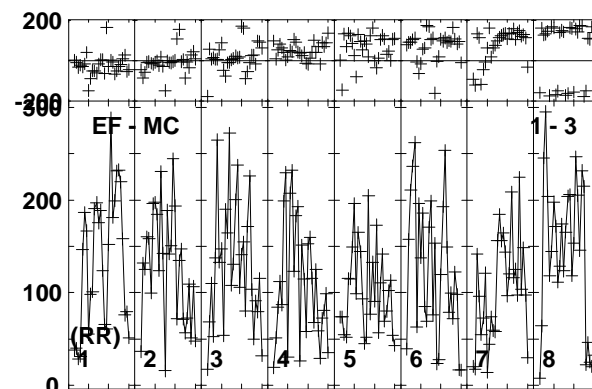
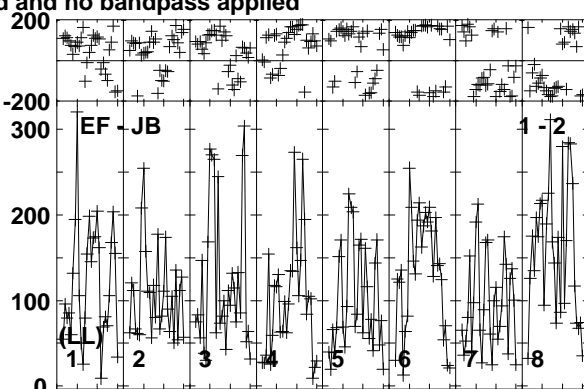
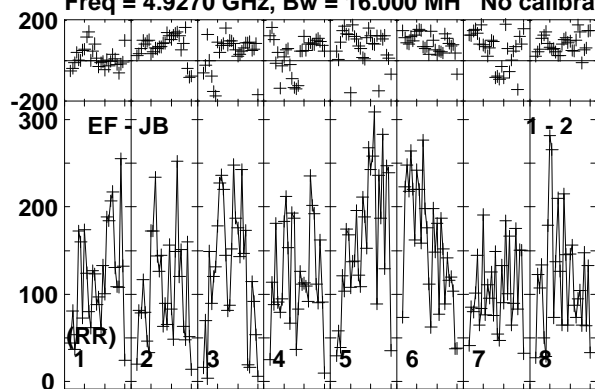

Lower frame: Micro Ampl Jy Top frame: Phas deg  
Vector averaged cross-power spectrum Baseline: EF (01) - JB (02)  
Timerange: 00/23:02:41 to 00/23:05:09

Plot file version 180 created 10-JUN-2016 17:22:19

CYGX1 RT013A.UVDATA.1

Freq = 4.9270 GHz, Bw = 16.000 MH No calibration applied and no bandpass applied

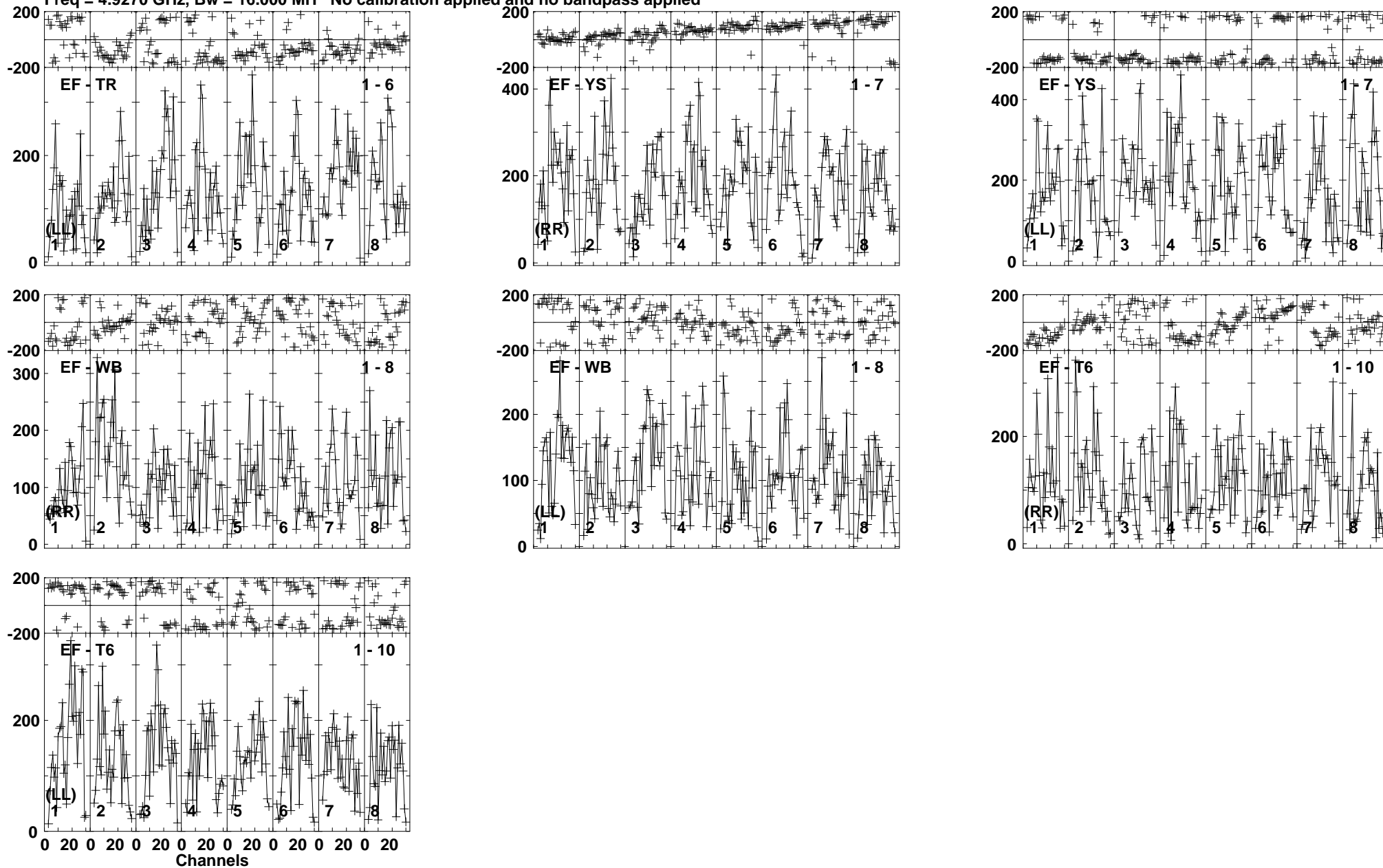

Lower frame: Micro Ampl Jy Top frame: Phas deg  
Vector averaged cross-power spectrum Baseline: EF (01) - TR (06)  
Timerange: 00/23:02:41 to 00/23:05:09

Plot file version 181 created 10-JUN-2016 17:22:19

J1957+3338 RT013A.UVDATA.1

Freq = 4.9270 GHz, Bw = 16.000 MH No calibration applied and no bandpass applied

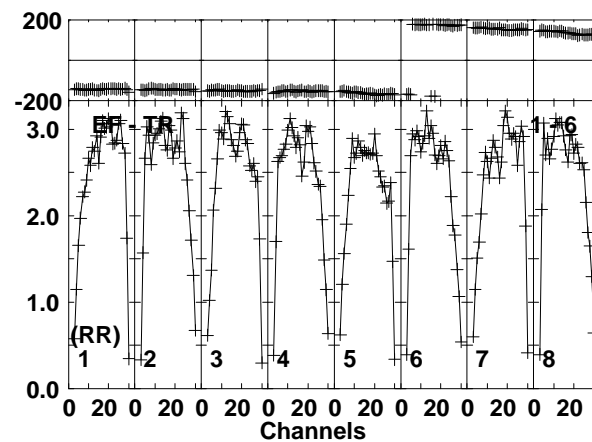
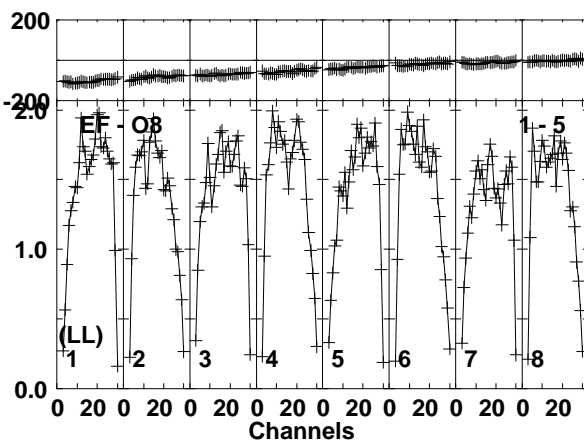
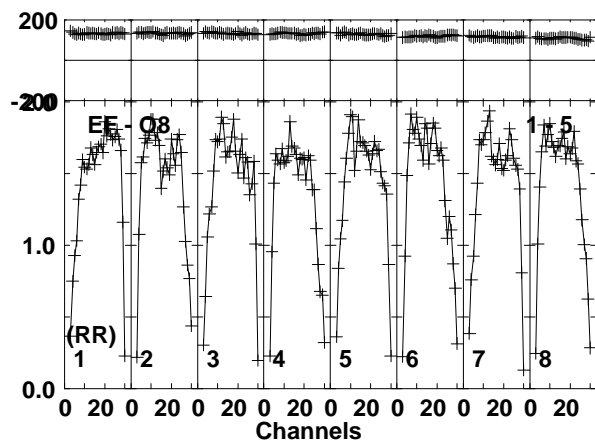
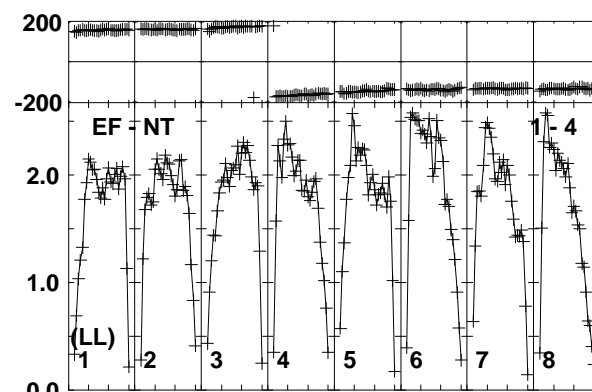
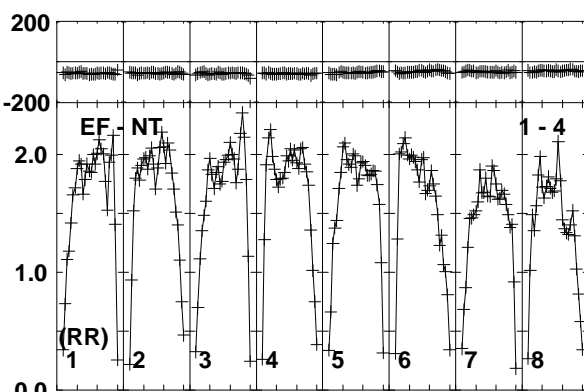
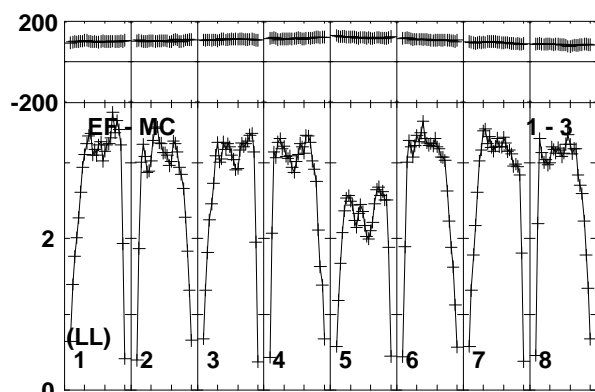
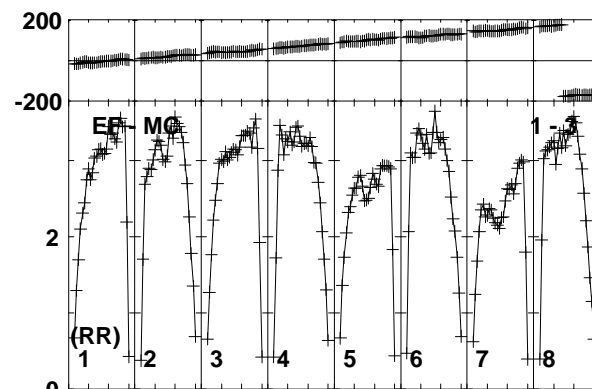
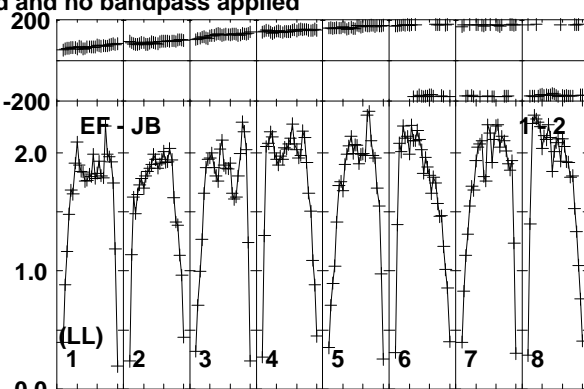
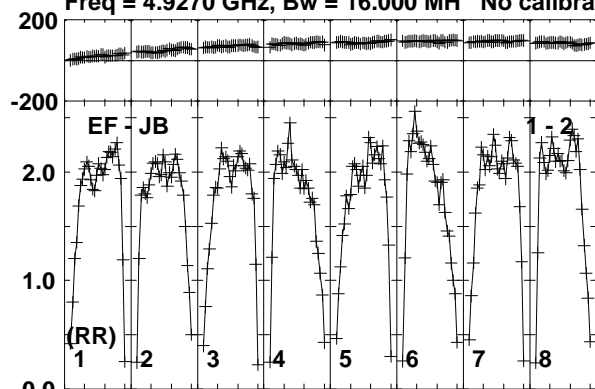

Lower frame: Milli Ampl Jy Top frame: Phas deg  
Vector averaged cross-power spectrum Baseline: EF (01) - JB (02)  
Timerange: 00/23:05:11 to 00/23:06:40

Plot file version 182 created 10-JUN-2016 17:22:19

J1957+3338 RT013A.UVDATA.1

Freq = 4.9270 GHz, Bw = 16.000 MH No calibration applied and no bandpass applied

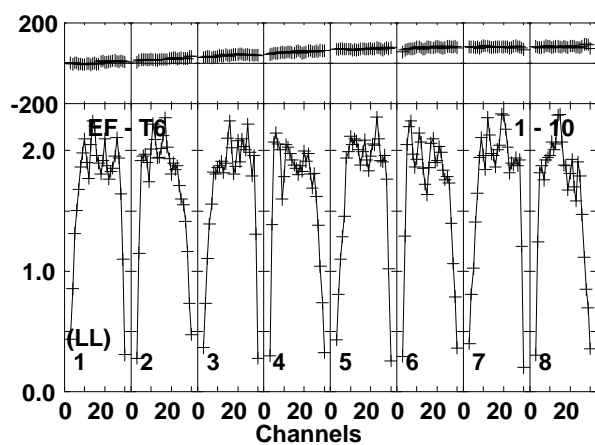
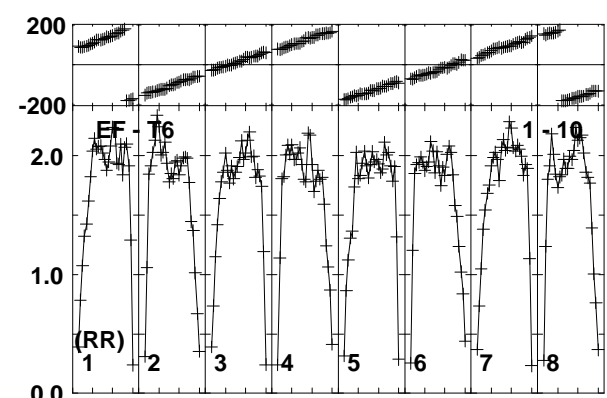
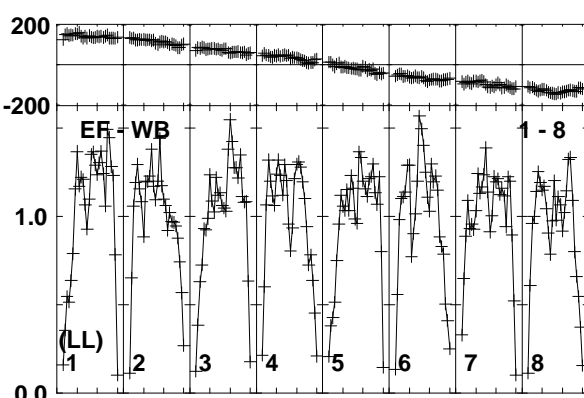
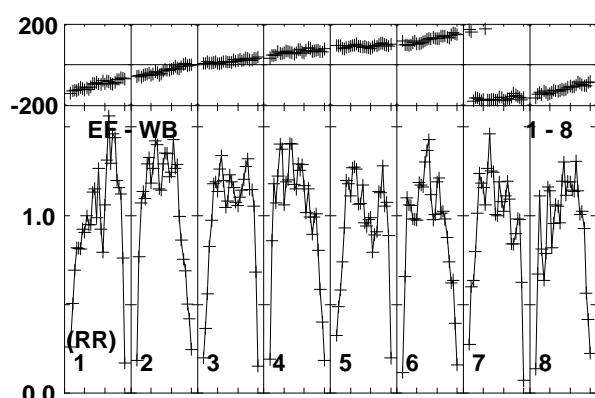
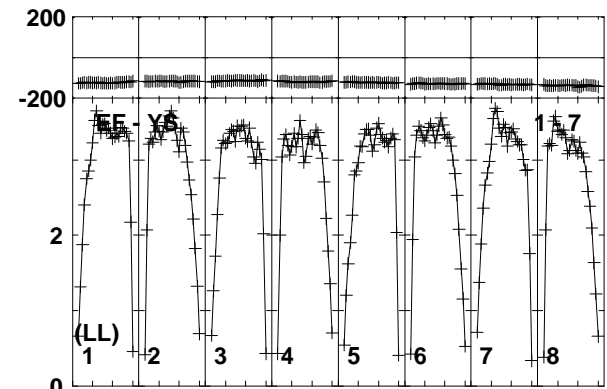
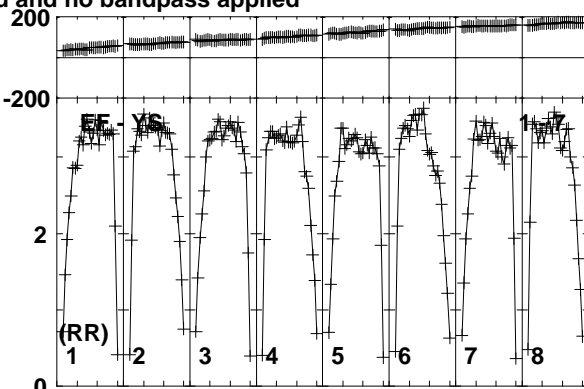
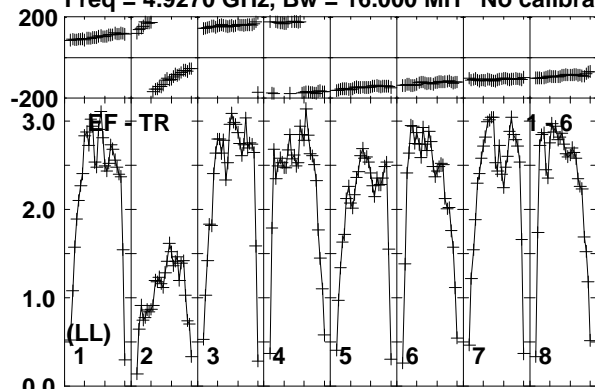

Lower frame: Milli Ampl Jy Top frame: Phas deg  
Vector averaged cross-power spectrum Baseline: EF (01) - TR (06)  
Timerange: 00/23:05:11 to 00/23:06:40

Plot file version 183 created 10-JUN-2016 17:22:19

CHECK RT013A.UVDATA.1

Freq = 4.9270 GHz, Bw = 16.000 MH No calibration applied and no bandpass applied

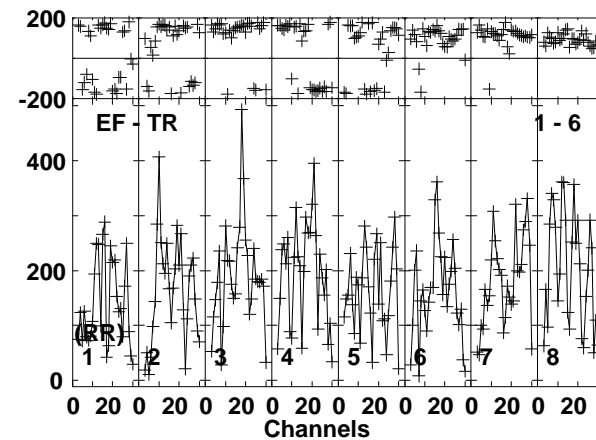
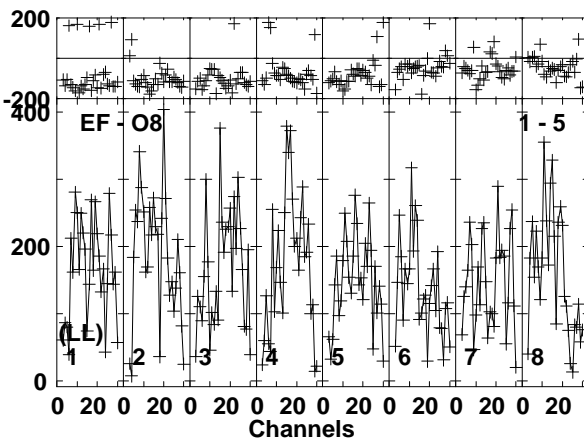
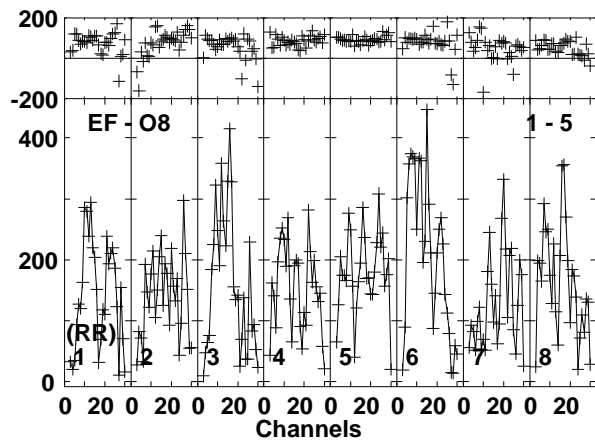
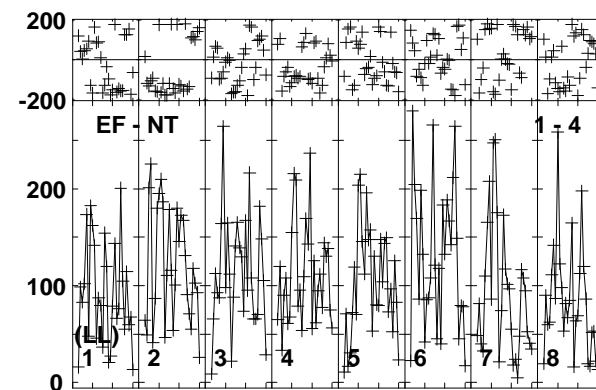
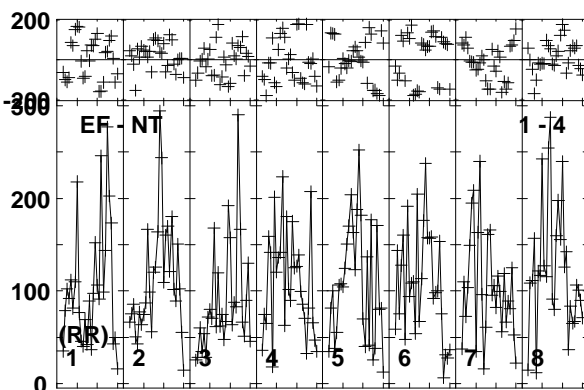
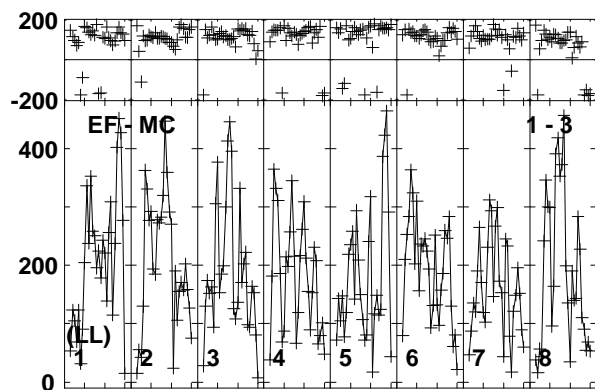
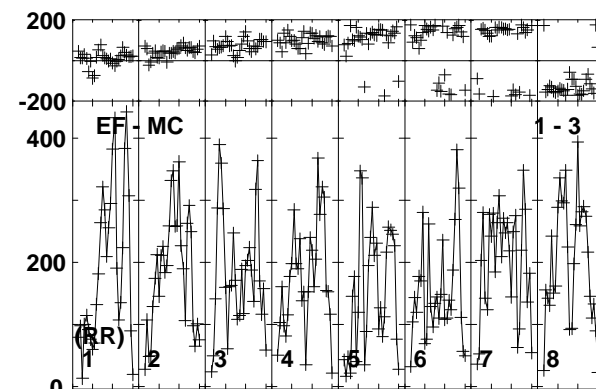
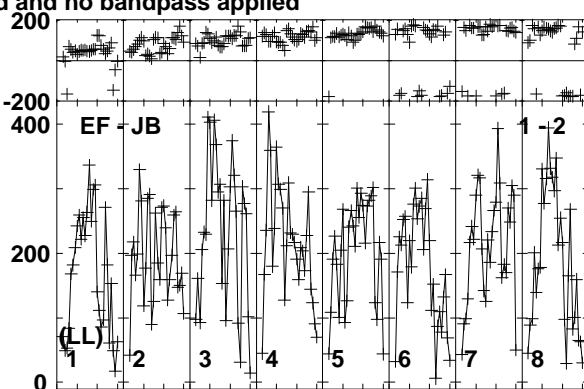
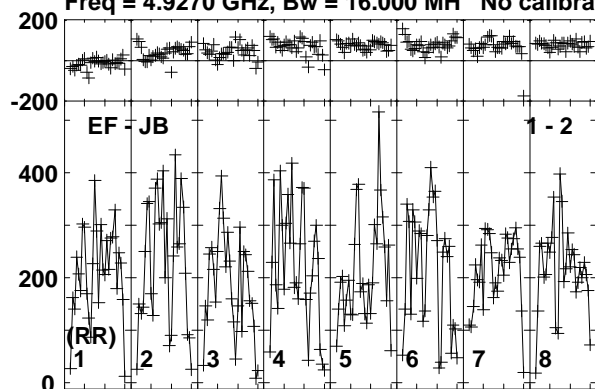

Lower frame: Micro Ampl Jy Top frame: Phas deg  
Vector averaged cross-power spectrum Baseline: EF (01) - JB (02)  
Timerange: 00/23:07:20 to 00/23:09:20

Plot file version 184 created 10-JUN-2016 17:22:19

CHECK RT013A.UVDATA.1

Freq = 4.9270 GHz, Bw = 16.000 MH No calibration applied and no bandpass applied

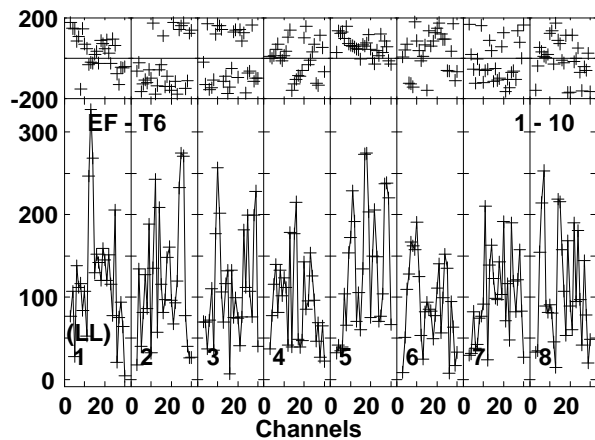
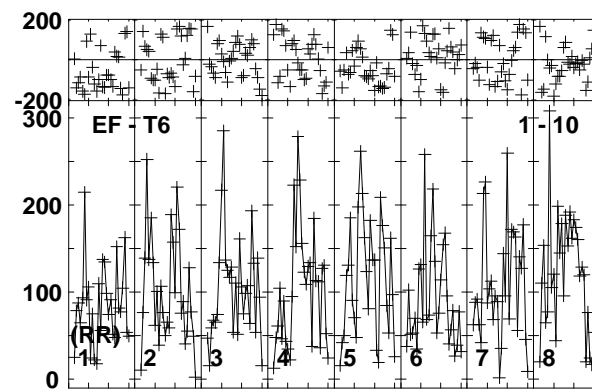
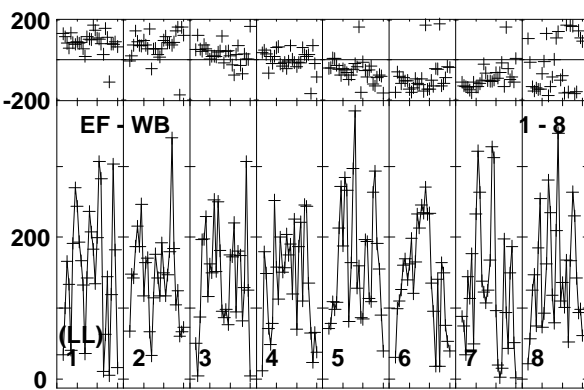
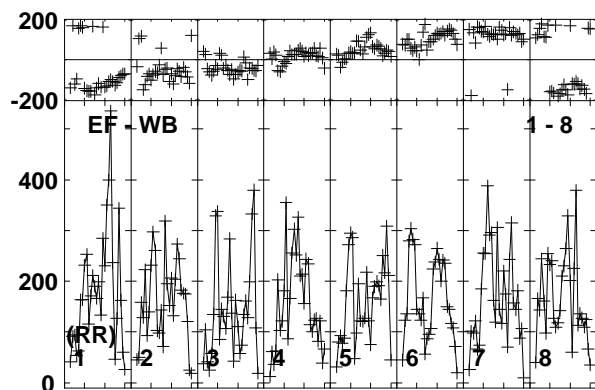
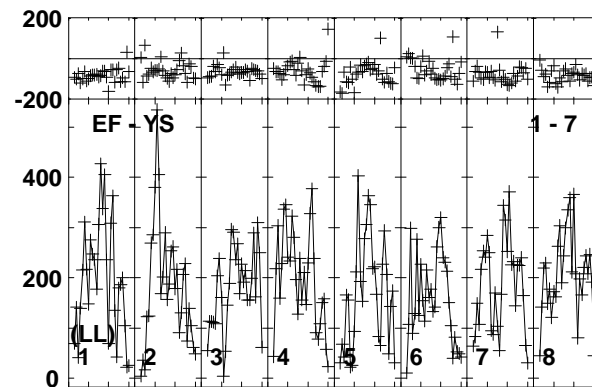
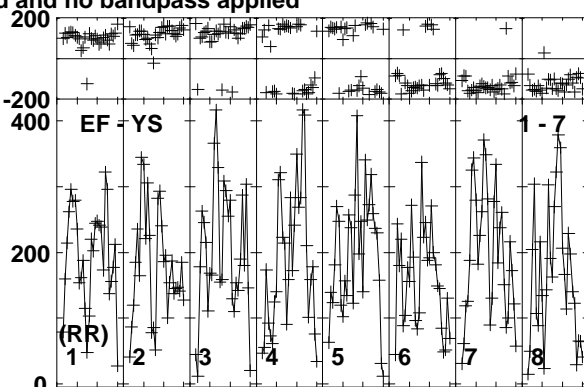
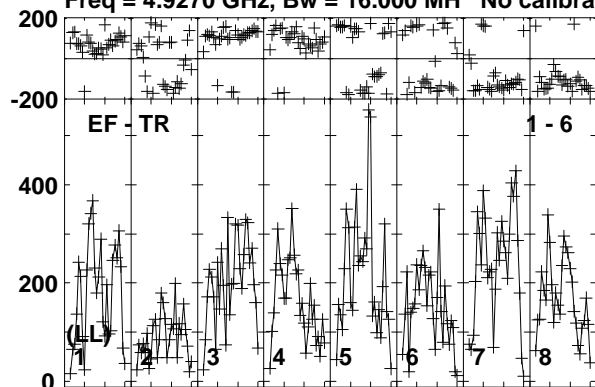

Lower frame: Micro Ampl Jy Top frame: Phas deg  
Vector averaged cross-power spectrum Baseline: EF (01) - TR (06)  
Timerange: 00/23:07:20 to 00/23:09:20

Plot file version 185 created 10-JUN-2016 17:22:19

CYGX1 RT013A.UVDATA.1

Freq = 4.9270 GHz, Bw = 16.000 MH No calibration applied and no bandpass applied

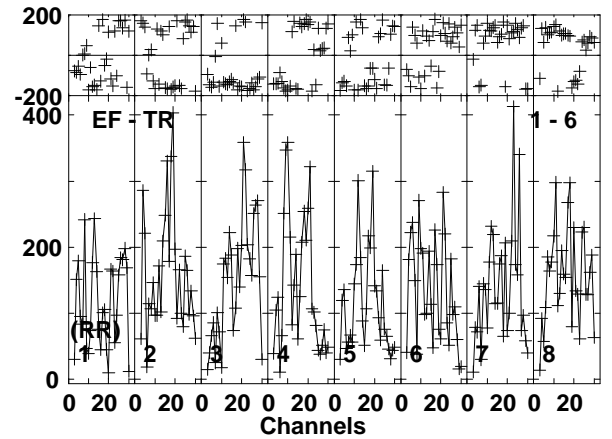
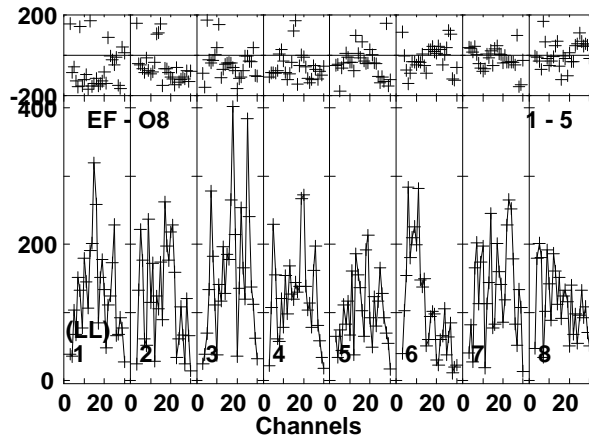
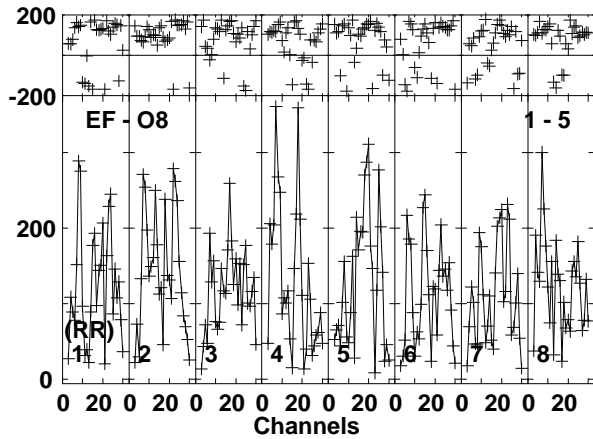
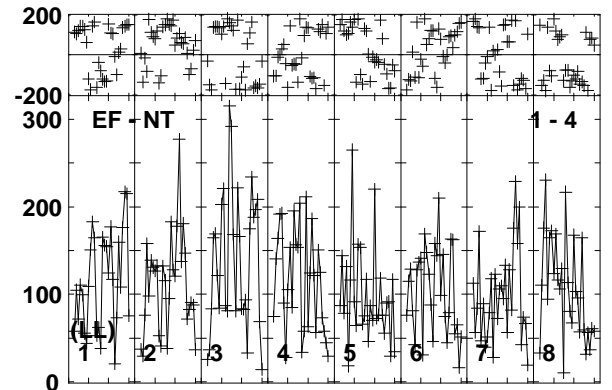
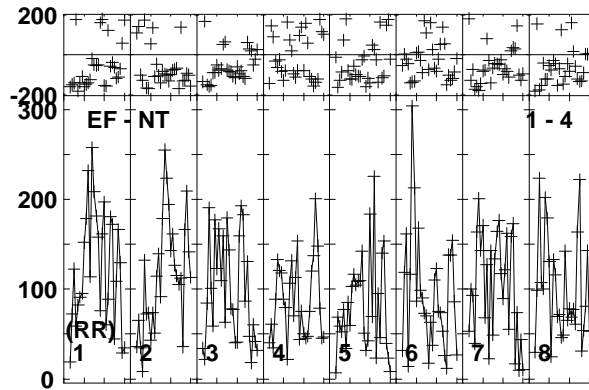
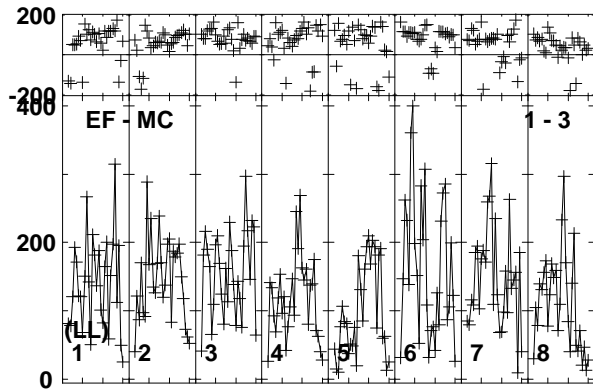
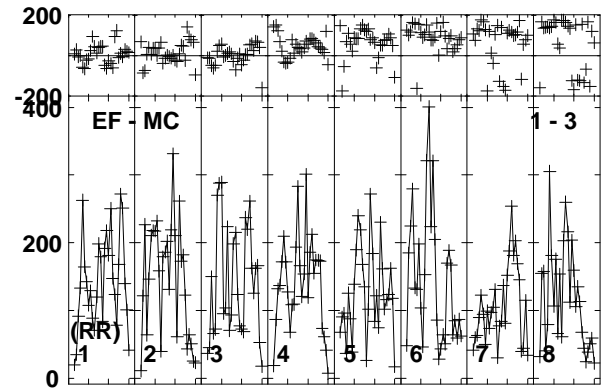
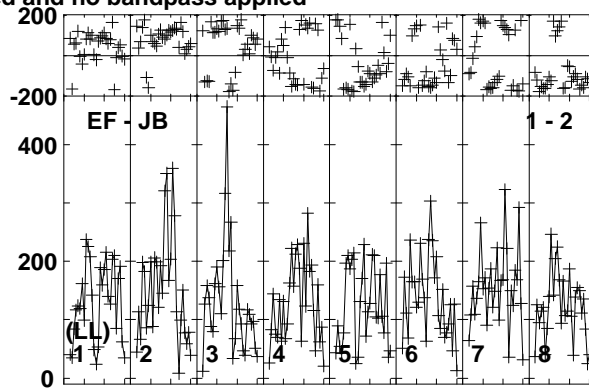
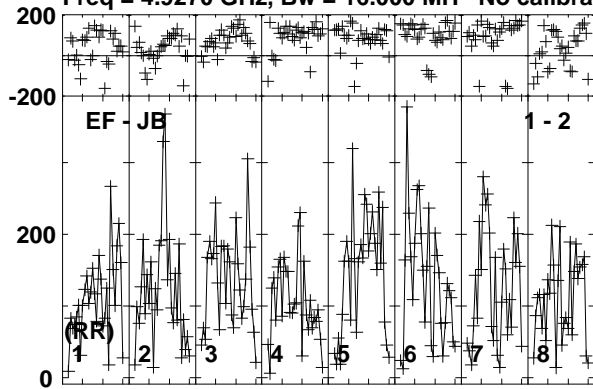

Lower frame: Micro Ampl Jy Top frame: Phas deg  
Vector averaged cross-power spectrum Baseline: EF (01) - JB (02)  
Timerange: 00/23:09:21 to 00/23:11:49

Plot file version 186 created 10-JUN-2016 17:22:19

CYGX1 RT013A.UVDATA.1

Freq = 4.9270 GHz, Bw = 16.000 MH No calibration applied and no bandpass applied

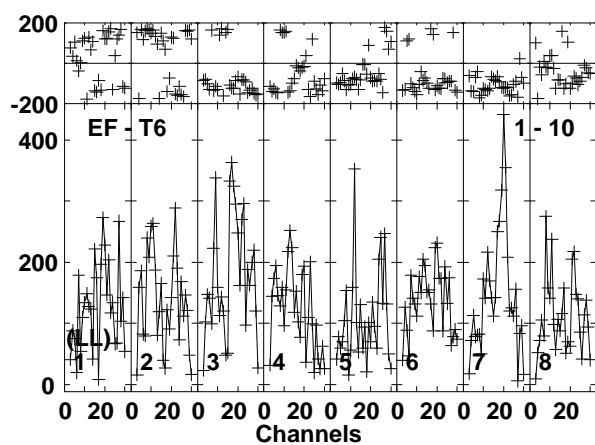
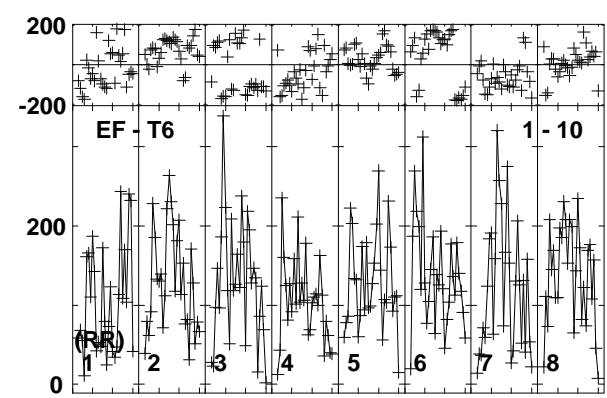
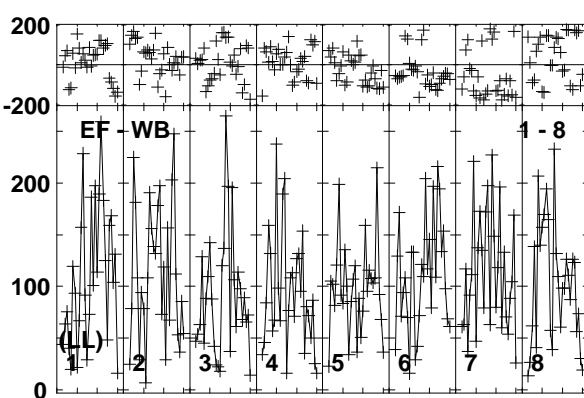
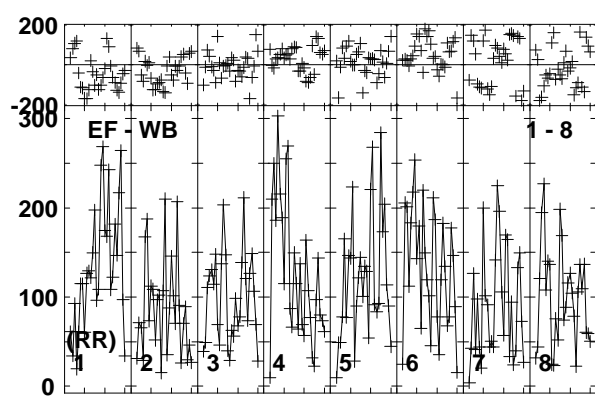
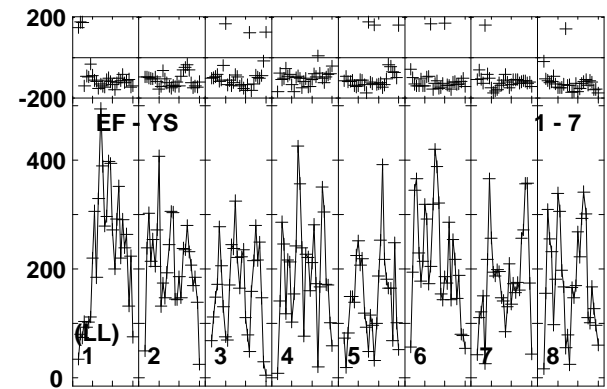
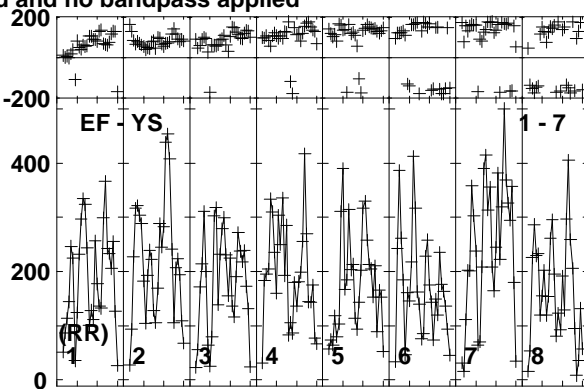
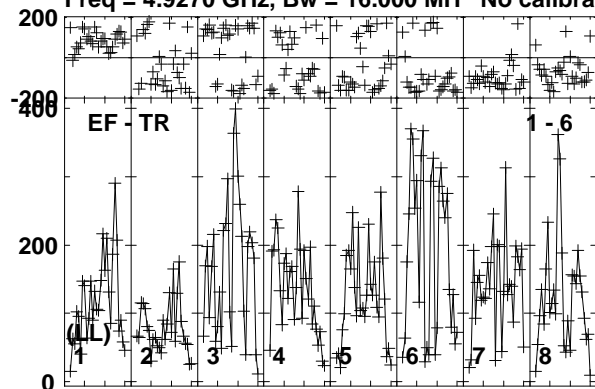

Lower frame: Micro Ampl Jy Top frame: Phas deg  
Vector averaged cross-power spectrum Baseline: EF (01) - TR (06)  
Timerange: 00/23:09:21 to 00/23:11:49



Plot file version 187 created 10-JUN-2016 17:22:20

J1957+3338 RT013A.UVDATA.1

Freq = 4.9270 GHz, Bw = 16.000 MH No calibration applied and no bandpass applied

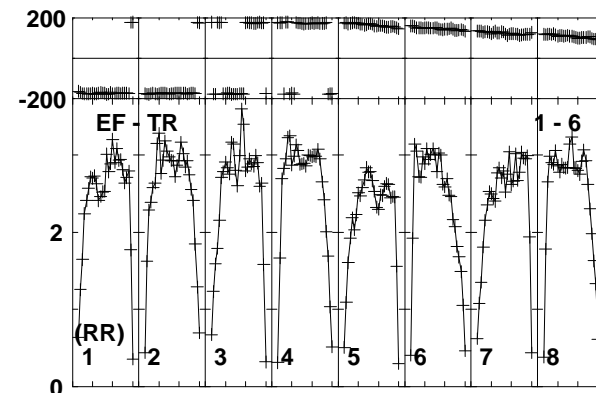
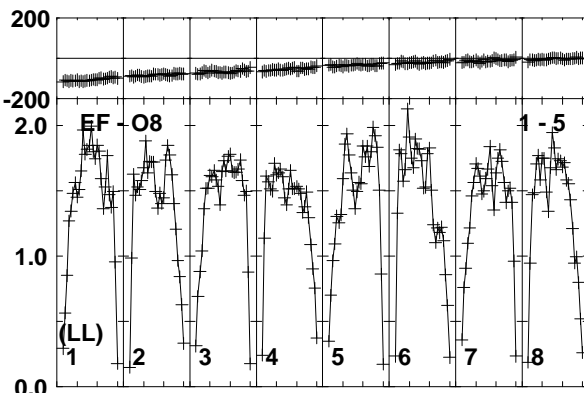
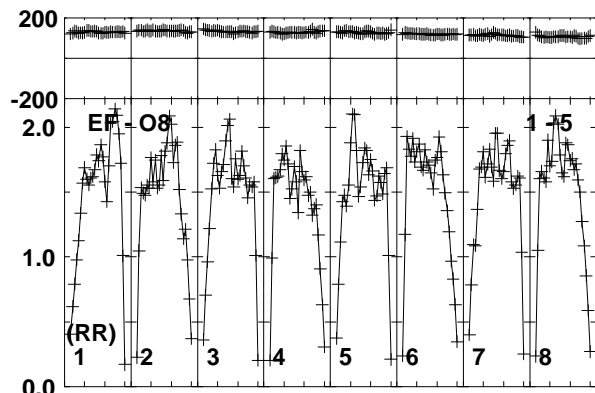
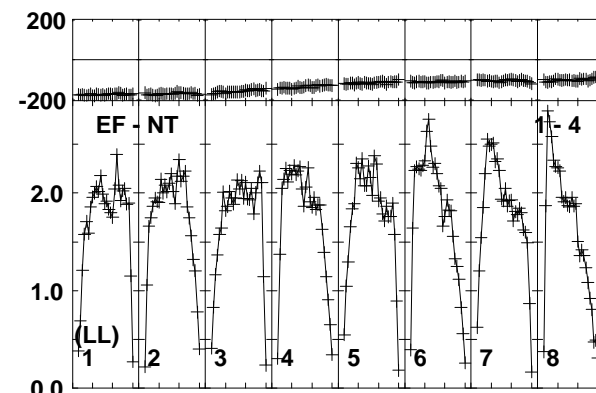
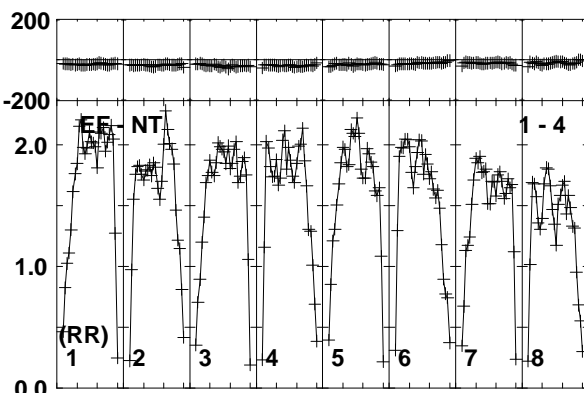
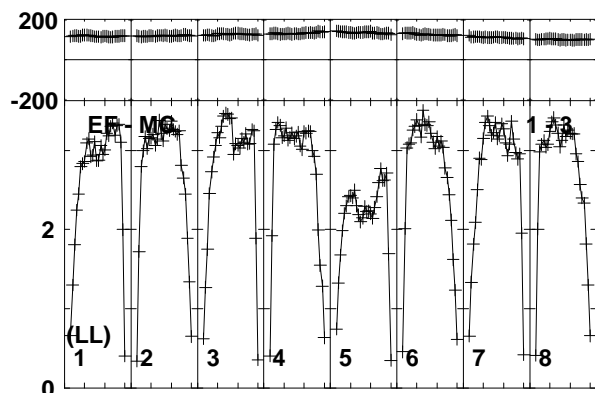
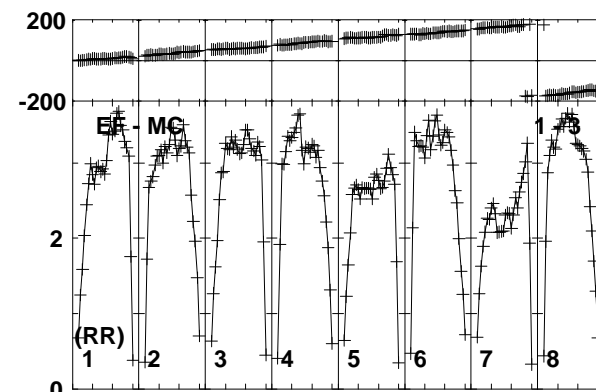
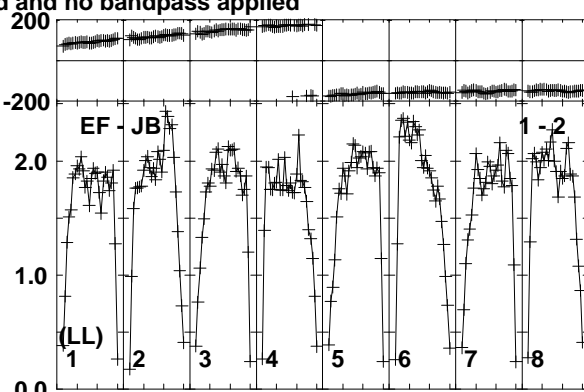
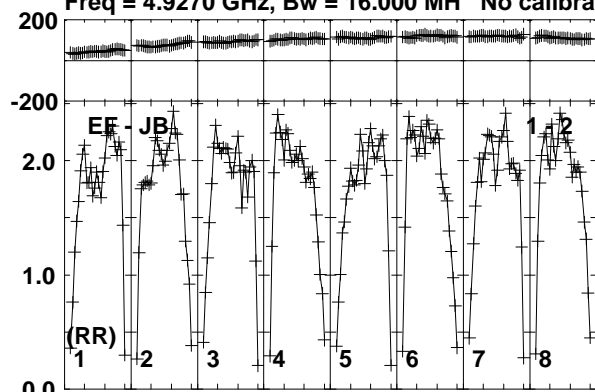

Lower frame: Milli Ampl Jy Top frame: Phas deg  
Vector averaged cross-power spectrum Baseline: EF (01) - JB (02)  
Timerange: 00/23:11:50 to 00/23:13:20

Plot file version 188 created 10-JUN-2016 17:22:20

J1957+3338 RT013A.UVDATA.1

Freq = 4.9270 GHz, Bw = 16.000 MH No calibration applied and no bandpass applied

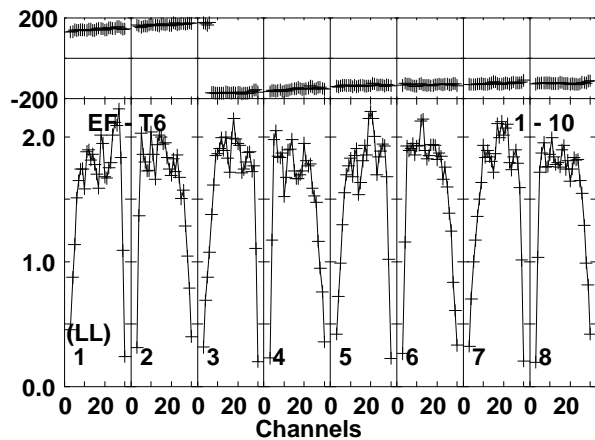
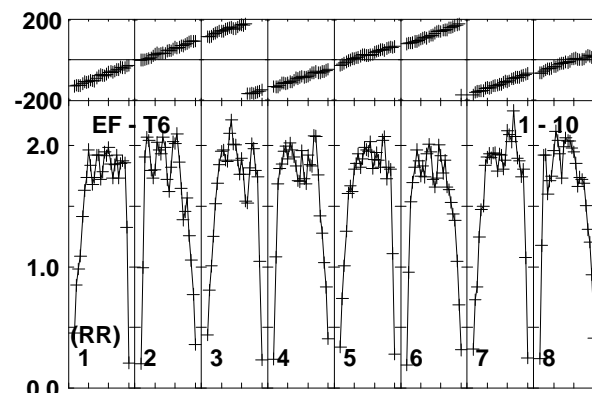
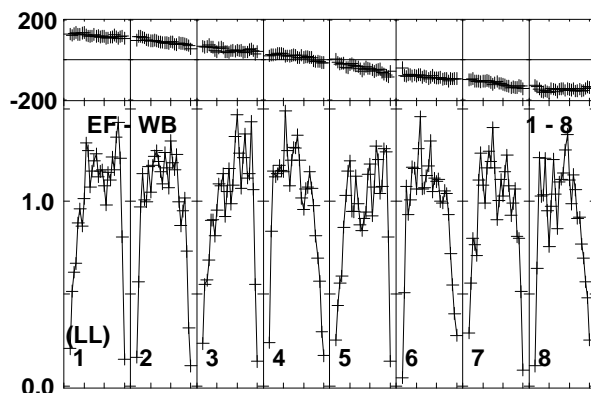
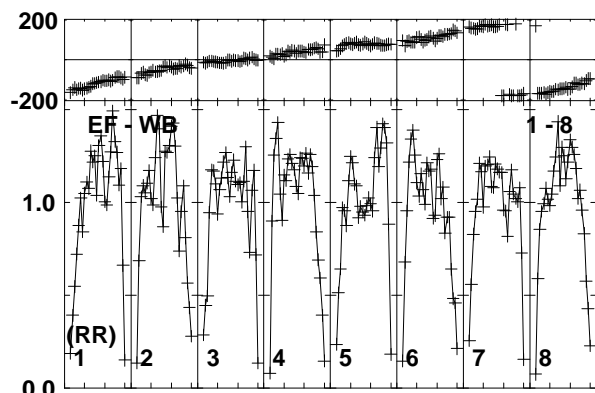
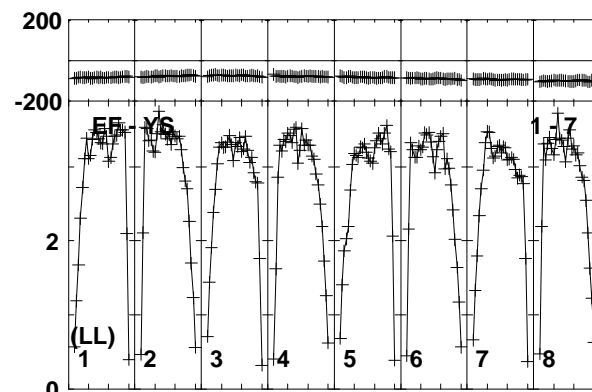
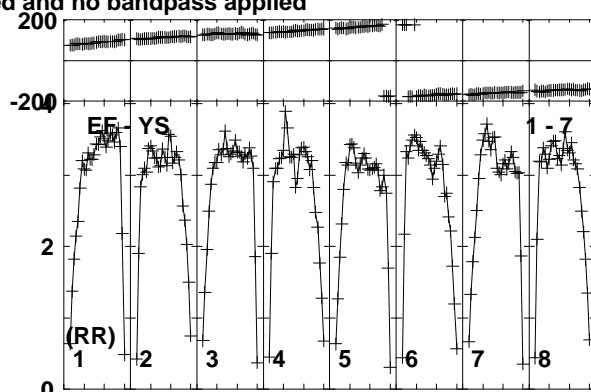
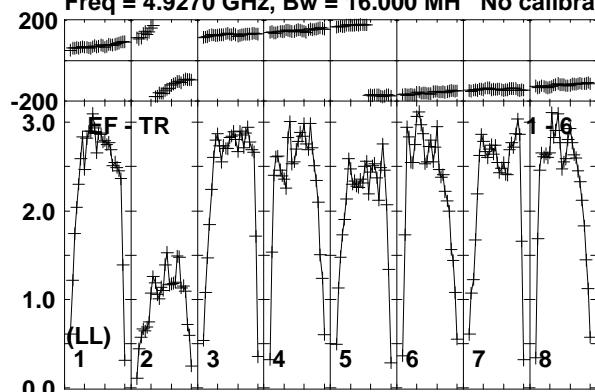

Lower frame: Milli Ampl Jy Top frame: Phas deg  
Vector averaged cross-power spectrum Baseline: EF (01) - TR (06)  
Timerange: 00/23:11:50 to 00/23:13:20

Plot file version 189 created 10-JUN-2016 17:22:20

CHECK RT013A.UVDATA.1

Freq = 4.9270 GHz, Bw = 16.000 MH No calibration applied and no bandpass applied

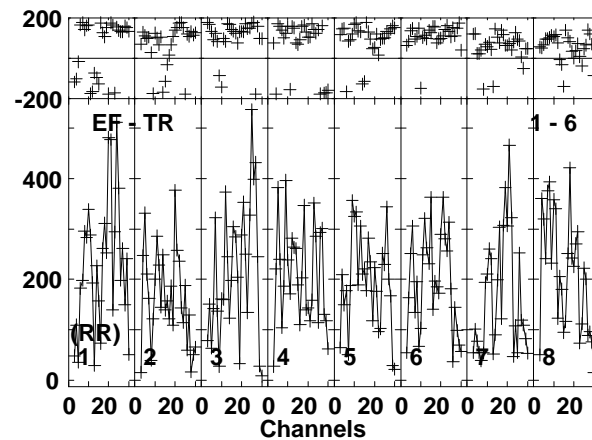
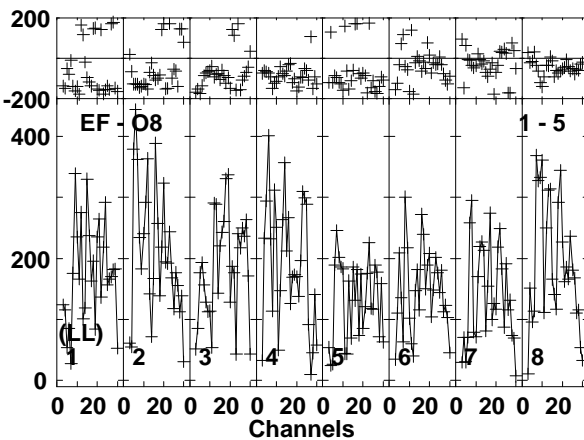
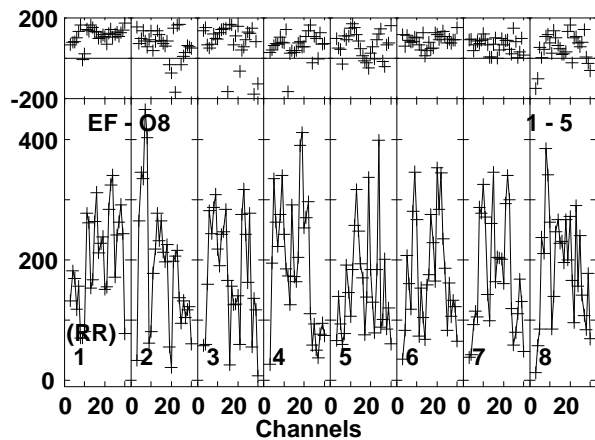
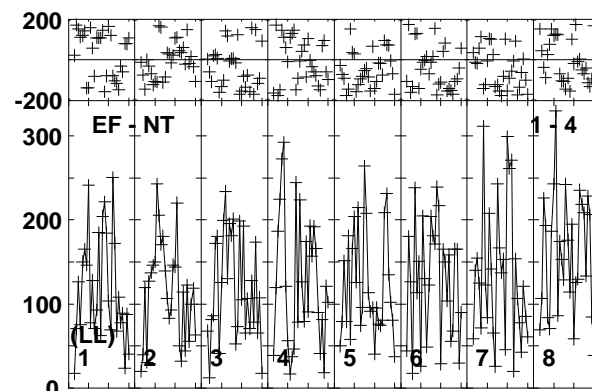
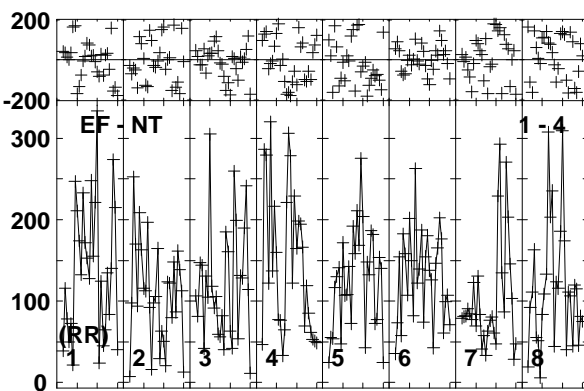
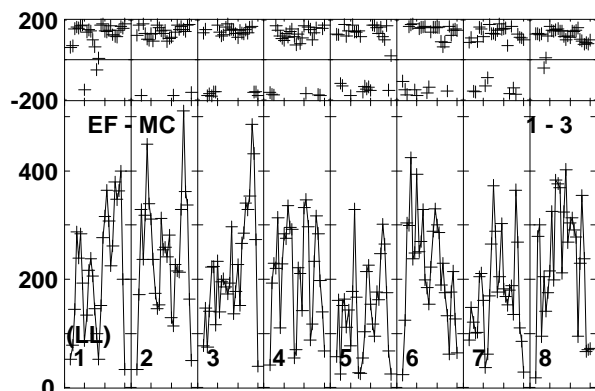
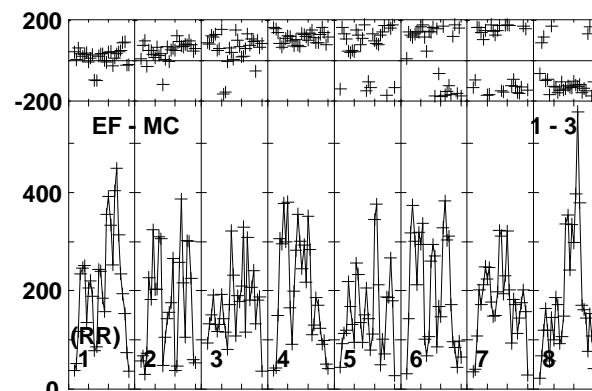
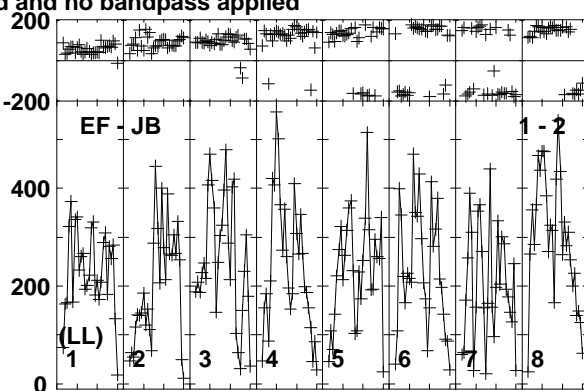
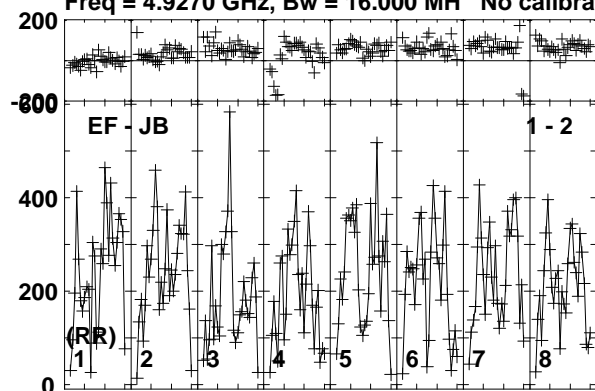

Lower frame: Micro Ampl Jy Top frame: Phas deg  
Vector averaged cross-power spectrum Baseline: EF (01) - JB (02)  
Timerange: 00/23:13:20 to 00/23:15:20

Plot file version 190 created 10-JUN-2016 17:22:20

CHECK RT013A.UVDATA.1

Freq = 4.9270 GHz, Bw = 16.000 MH No calibration applied and no bandpass applied

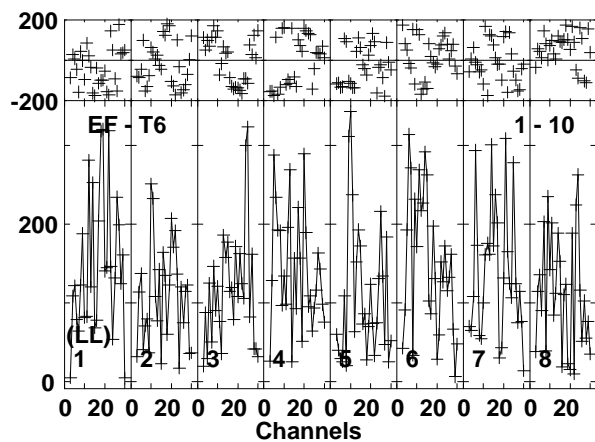
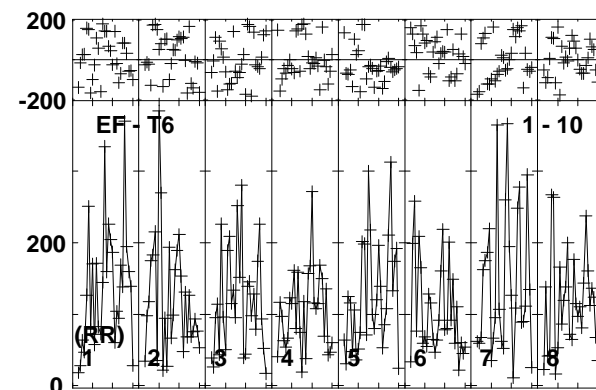
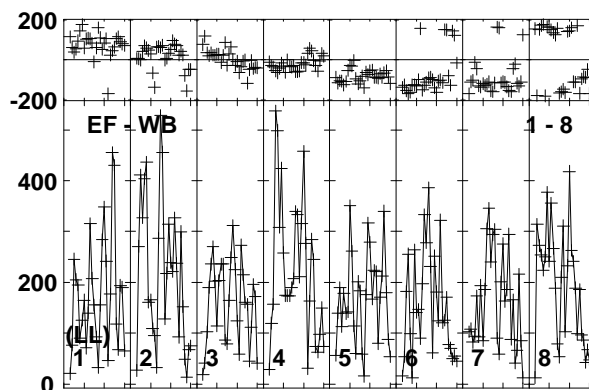
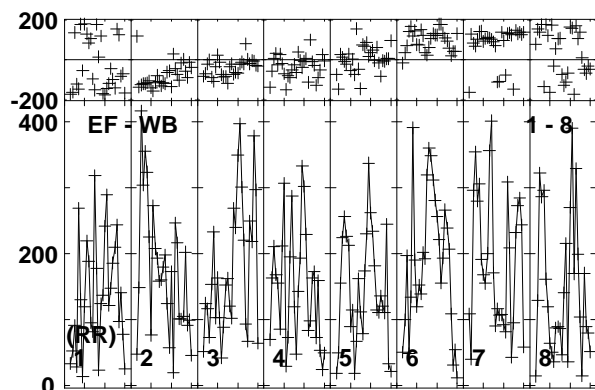
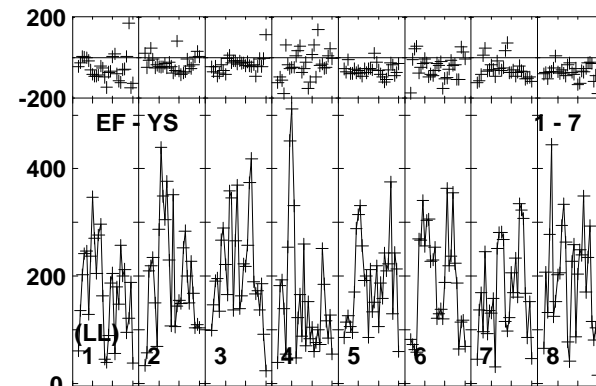
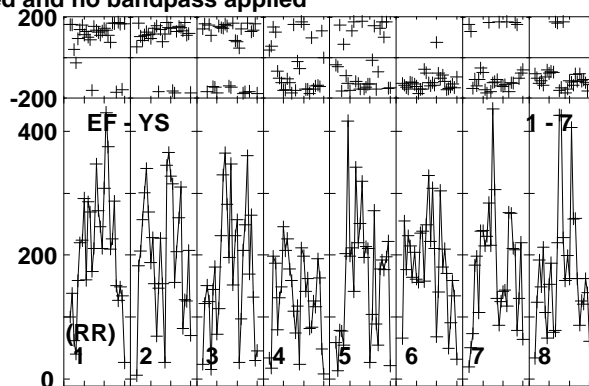
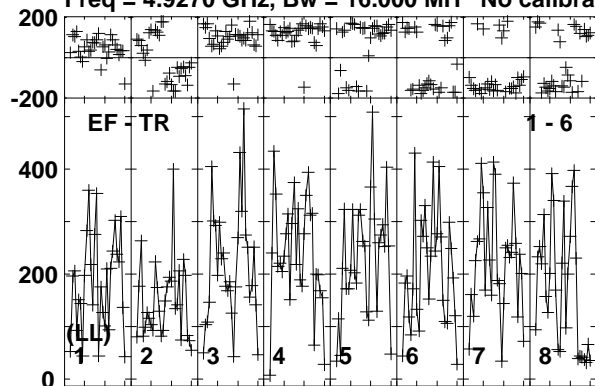

Lower frame: Micro Ampl Jy Top frame: Phas deg  
Vector averaged cross-power spectrum Baseline: EF (01) - TR (06)  
Timerange: 00/23:13:20 to 00/23:15:20

Plot file version 191 created 10-JUN-2016 17:22:20

CYGX1 RT013A.UVDATA.1

Freq = 4.9270 GHz, Bw = 16.000 MH No calibration applied and no bandpass applied

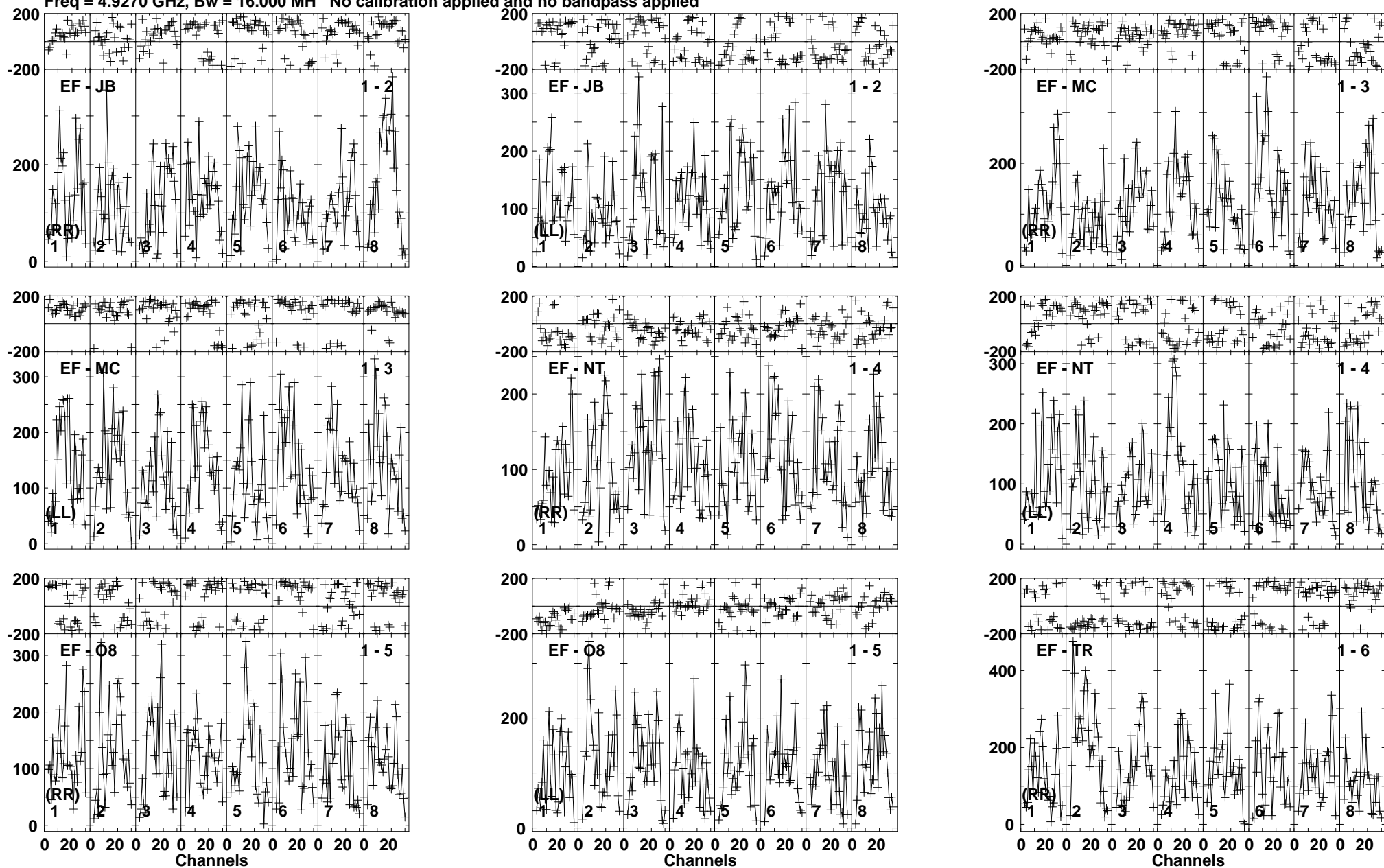

Lower frame: Micro Ampl Jy Top frame: Phas deg  
Vector averaged cross-power spectrum Baseline: EF (01) - JB (02)  
Timerange: 00/23:15:21 to 00/23:17:50

Plot file version 192 created 10-JUN-2016 17:22:20

CYGX1 RT013A.UVDATA.1

Freq = 4.9270 GHz, Bw = 16.000 MH No calibration applied and no bandpass applied

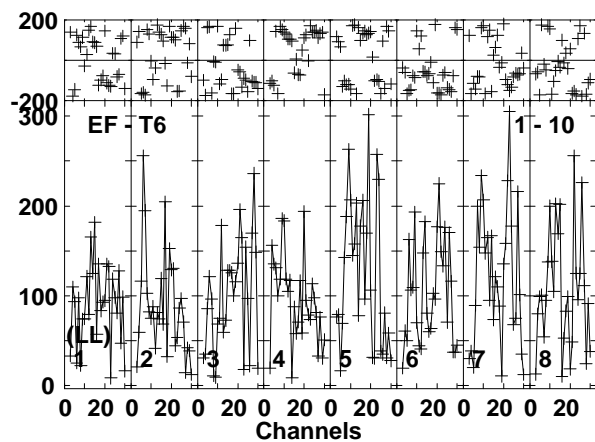
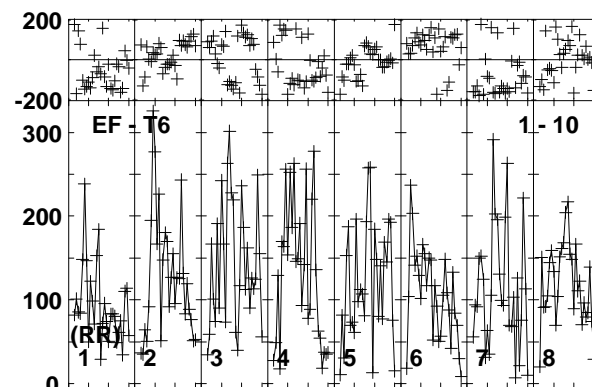
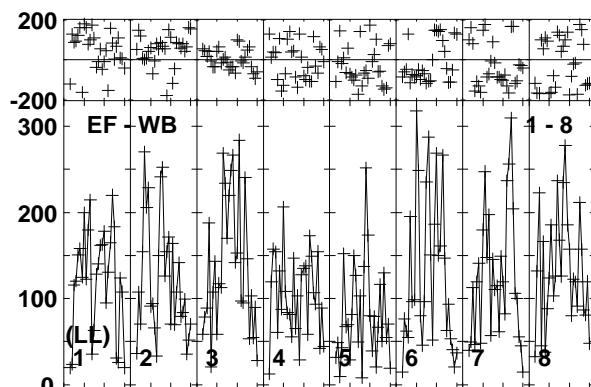
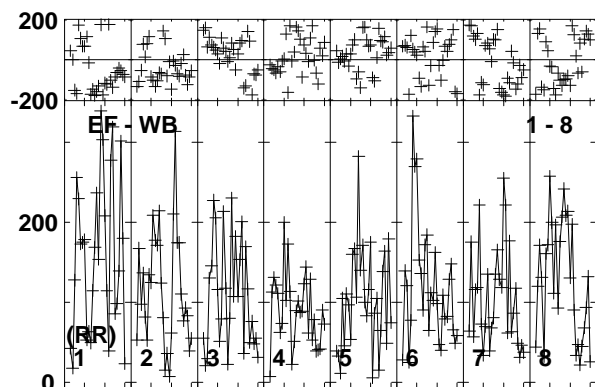
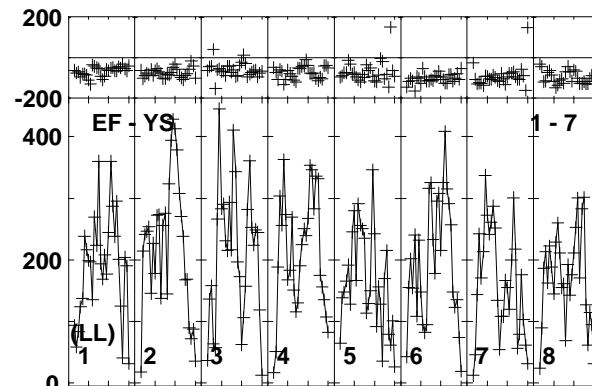
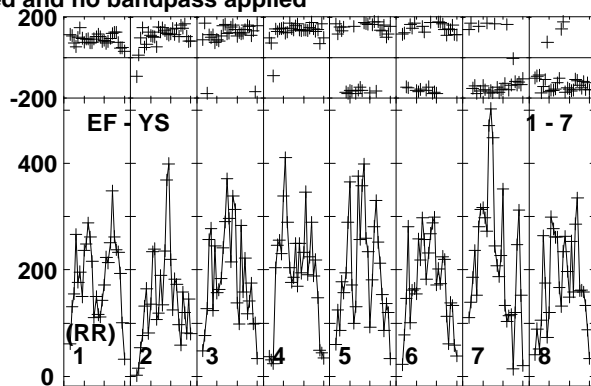
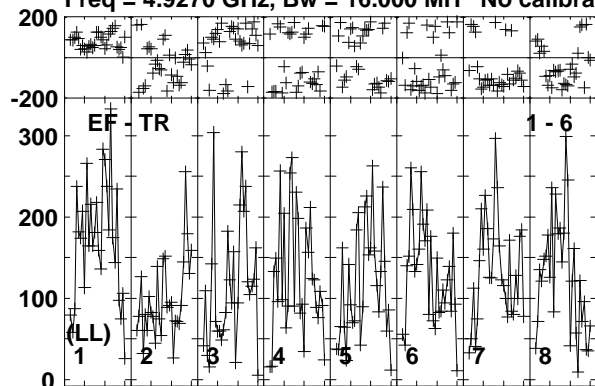

Lower frame: Micro Ampl Jy Top frame: Phas deg  
Vector averaged cross-power spectrum Baseline: EF (01) - TR (06)  
Timerange: 00/23:15:21 to 00/23:17:50

Plot file version 193 created 10-JUN-2016 17:22:20

J1957+3338 RT013A.UVDATA.1

Freq = 4.9270 GHz, Bw = 16.000 MH No calibration applied and no bandpass applied

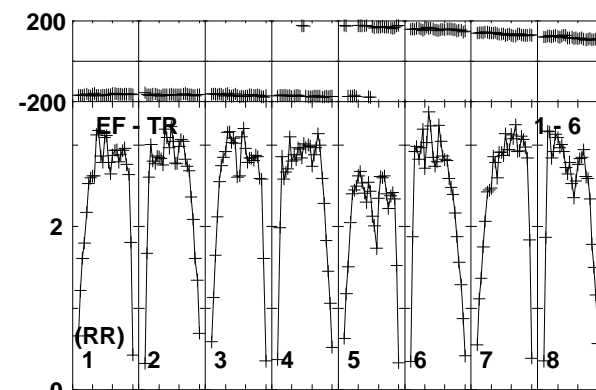
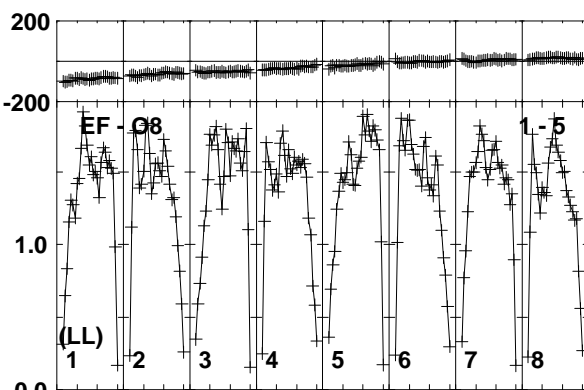
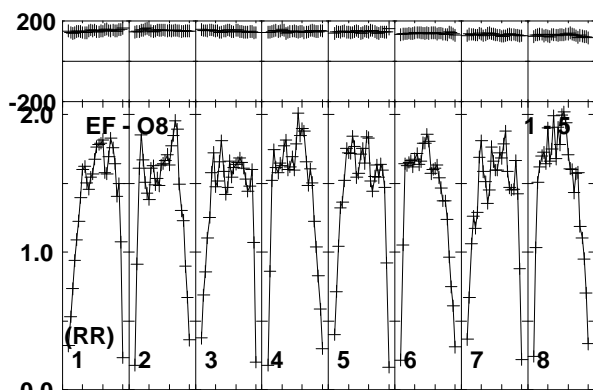
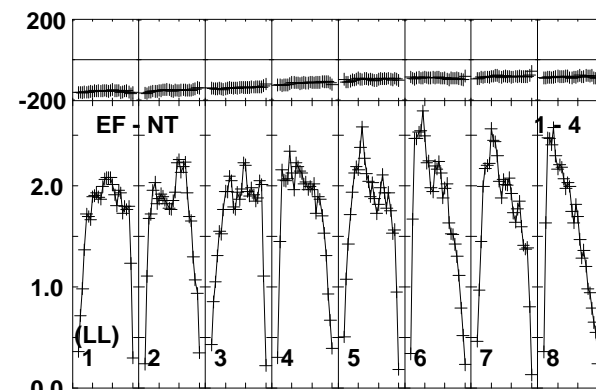
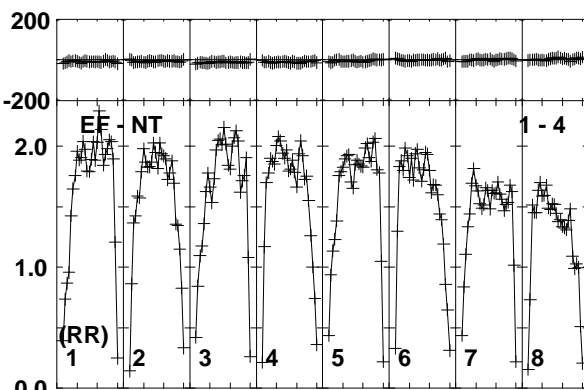
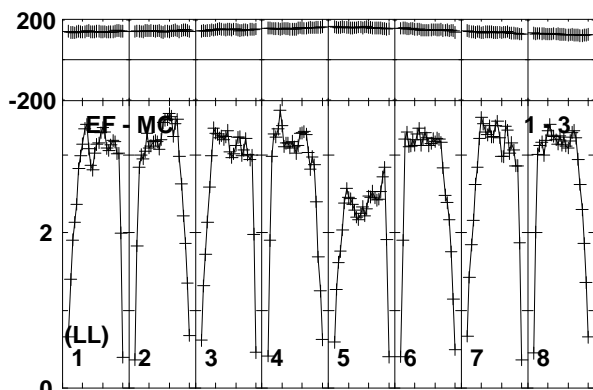
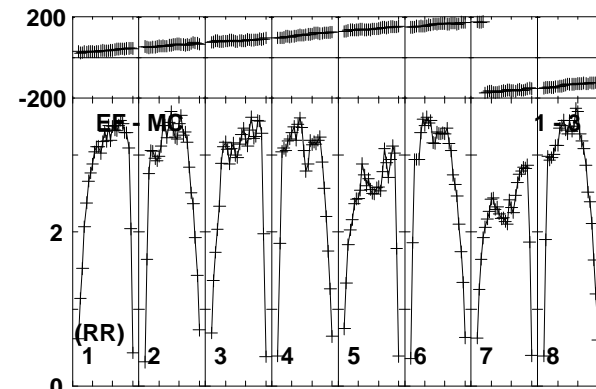
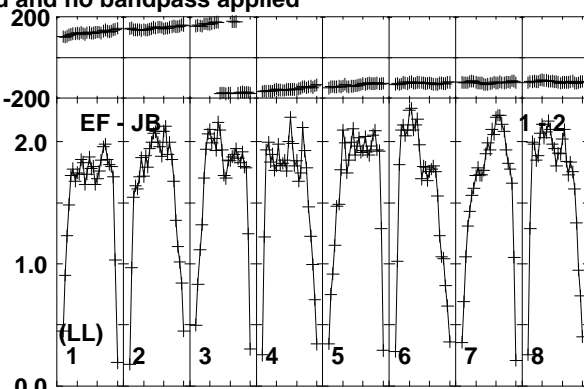
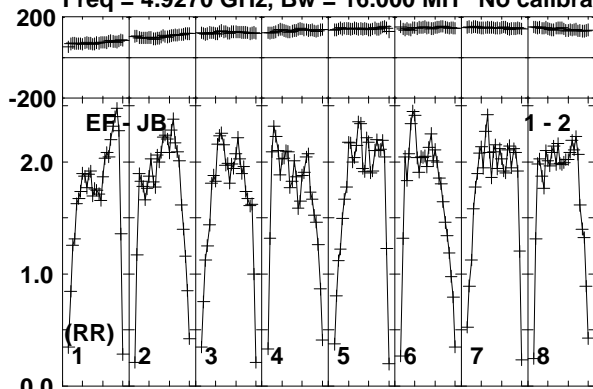

Lower frame: Milli Ampl Jy Top frame: Phas deg  
Vector averaged cross-power spectrum Baseline: EF (01) - JB (02)  
Timerange: 00/23:17:51 to 00/23:19:19

Plot file version 194 created 10-JUN-2016 17:22:20

J1957+3338 RT013A.UVDATA.1

Freq = 4.9270 GHz, Bw = 16.000 MH No calibration applied and no bandpass applied

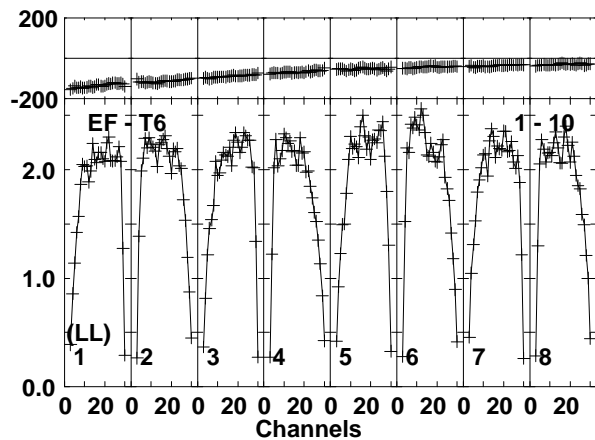
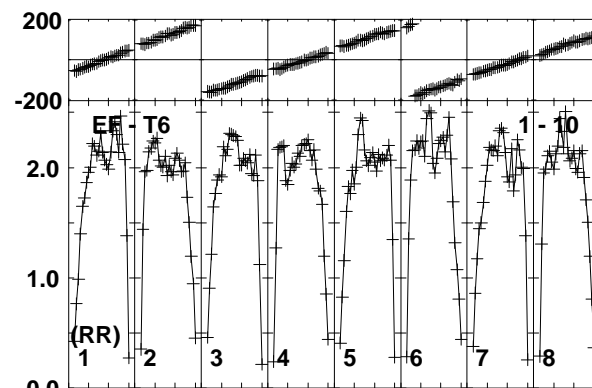
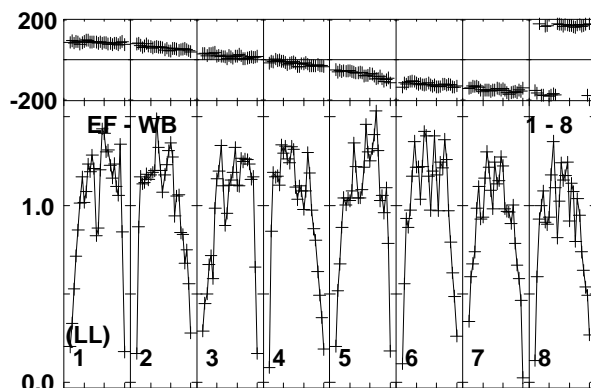
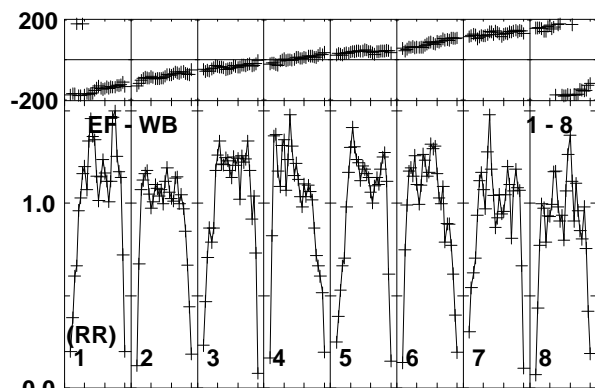
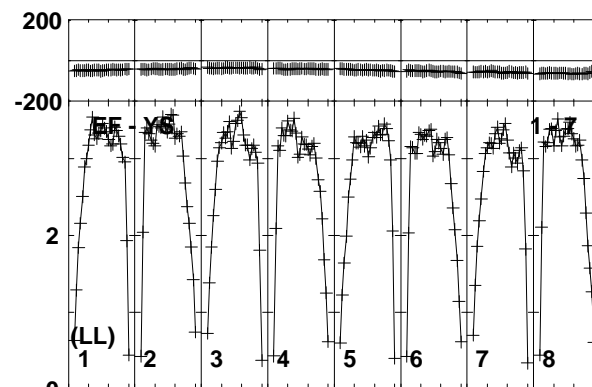
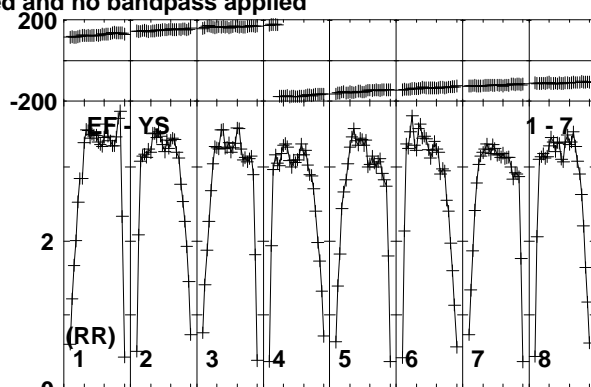
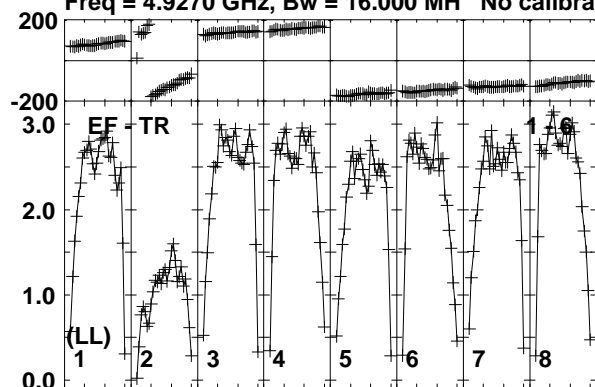

Lower frame: Milli Ampl Jy Top frame: Phas deg  
Vector averaged cross-power spectrum Baseline: EF (01) - TR (06)  
Timerange: 00/23:17:51 to 00/23:19:19



Plot file version 195 created 10-JUN-2016 17:22:20

CHECK RT013A.UVDATA.1

Freq = 4.9270 GHz, Bw = 16.000 MH No calibration applied and no bandpass applied

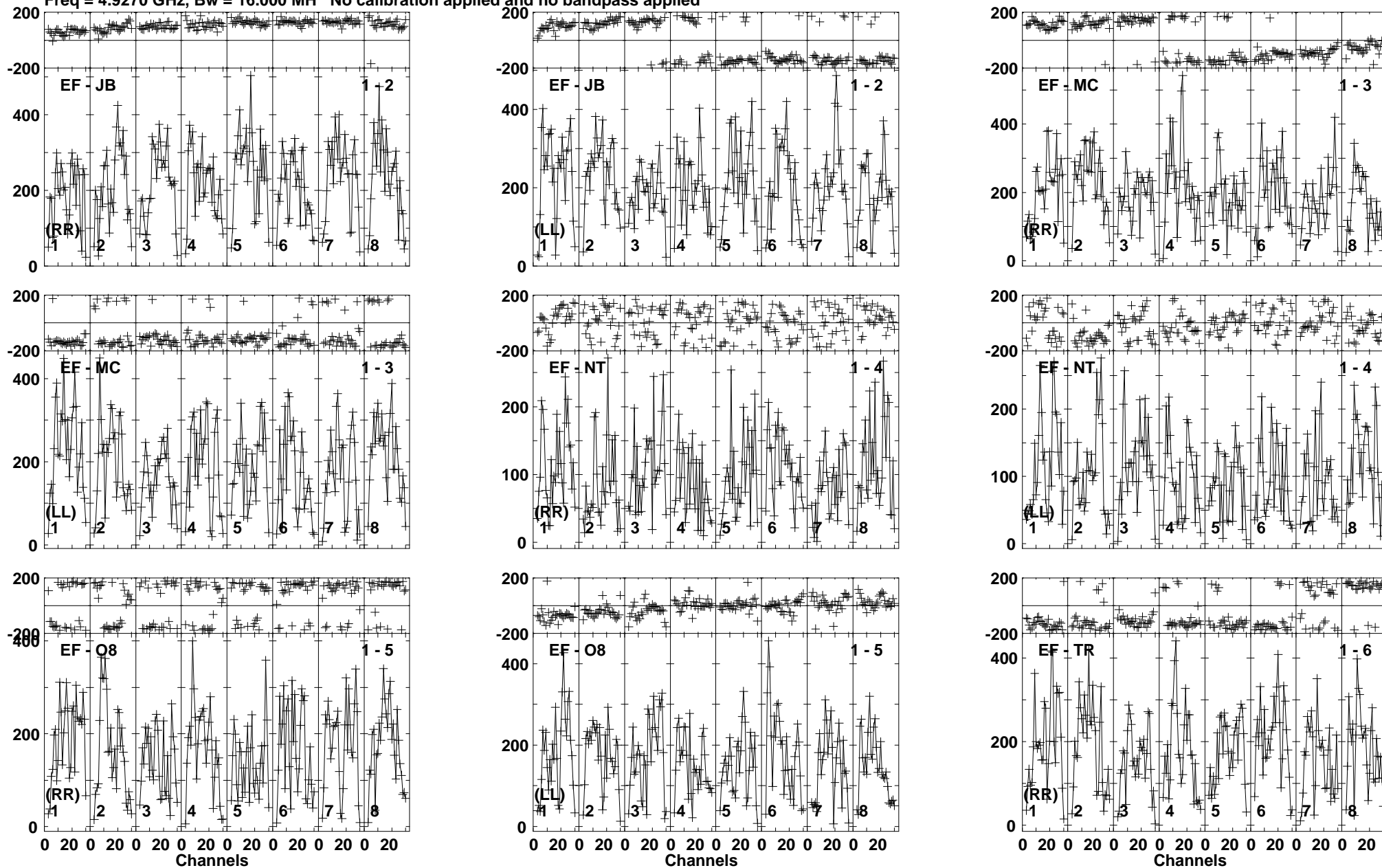

Lower frame: Micro Ampl Jy Top frame: Phas deg  
Vector averaged cross-power spectrum Baseline: EF (01) - JB (02)  
Timerange: 00/23:20:00 to 00/23:21:59

Plot file version 196 created 10-JUN-2016 17:22:21

CHECK RT013A.UVDATA.1

Freq = 4.9270 GHz, Bw = 16.000 MH No calibration applied and no bandpass applied

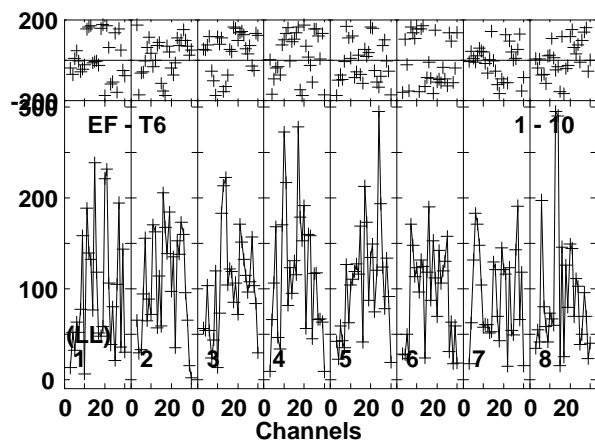
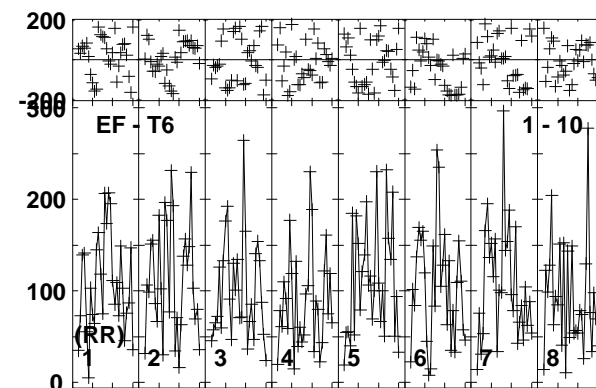
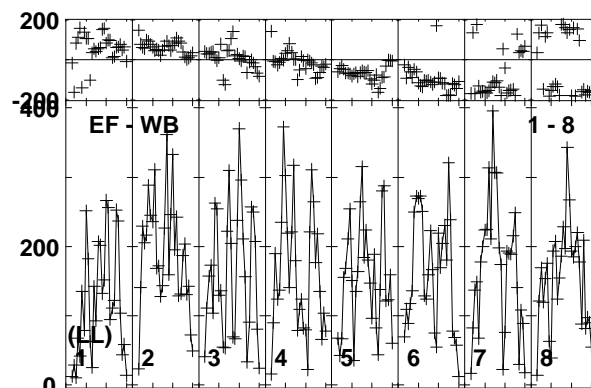
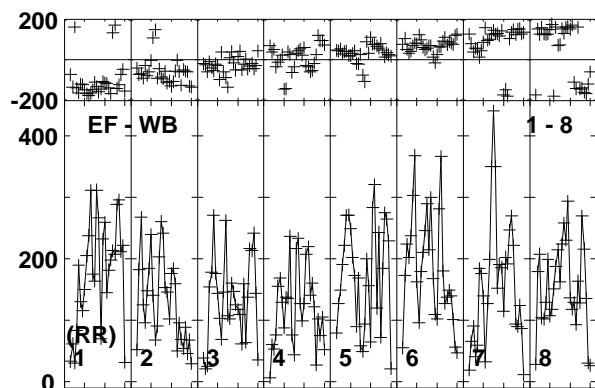
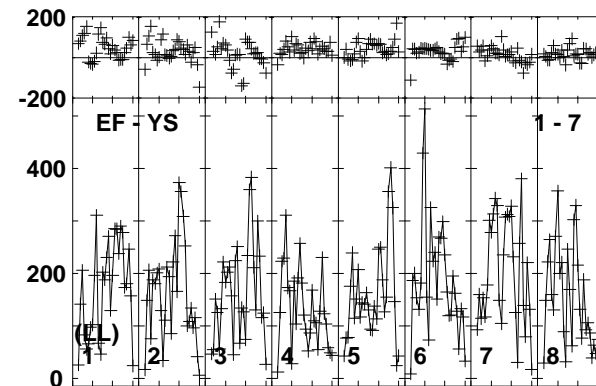
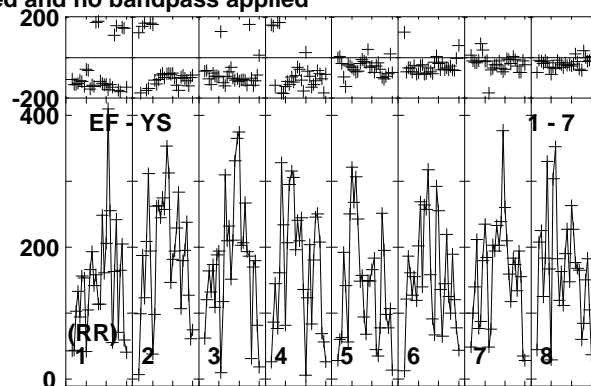
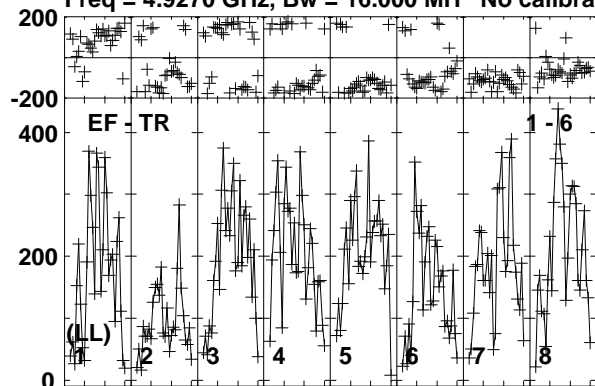

Lower frame: Micro Ampl Jy Top frame: Phas deg  
Vector averaged cross-power spectrum Baseline: EF (01) - TR (06)  
Timerange: 00/23:20:00 to 00/23:21:59

Plot file version 197 created 10-JUN-2016 17:22:21

CYGX1 RT013A.UVDATA.1

Freq = 4.9270 GHz, Bw = 16.000 MH No calibration applied and no bandpass applied

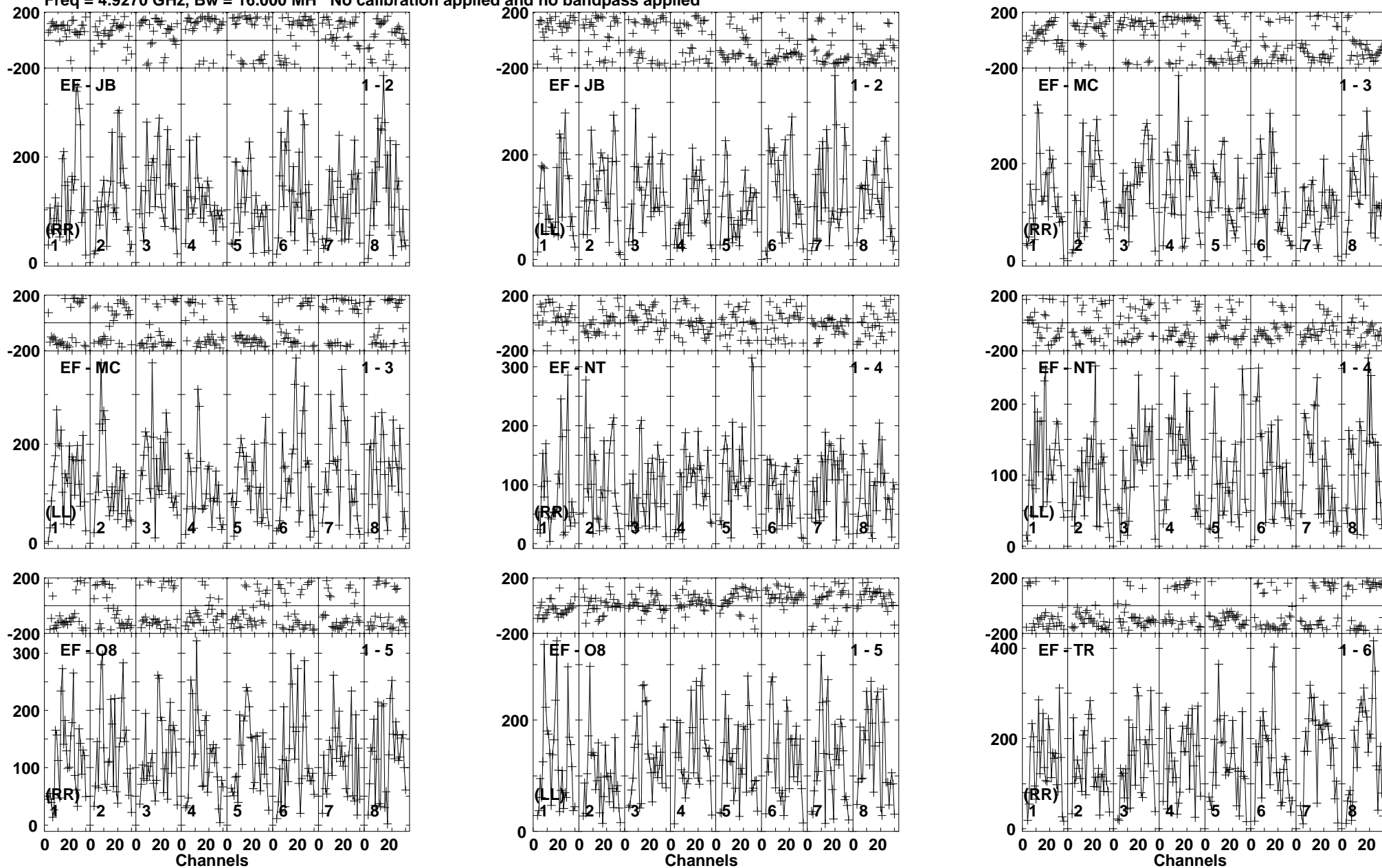

Lower frame: Micro Ampl Jy Top frame: Phas deg  
Vector averaged cross-power spectrum Baseline: EF (01) - JB (02)  
Timerange: 00/23:22:01 to 00/23:24:30

Plot file version 198 created 10-JUN-2016 17:22:21

CYGX1 RT013A.UVDATA.1

Freq = 4.9270 GHz, Bw = 16.000 MH No calibration applied and no bandpass applied

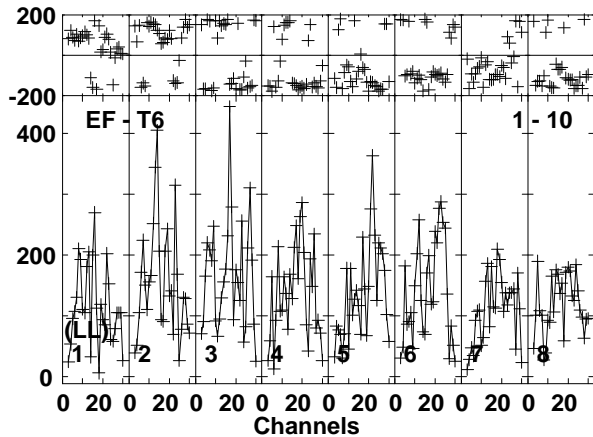
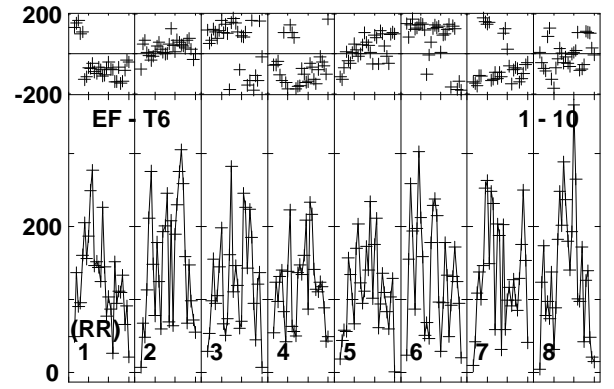
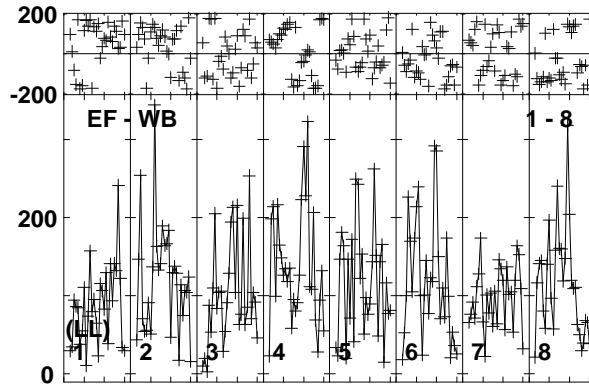
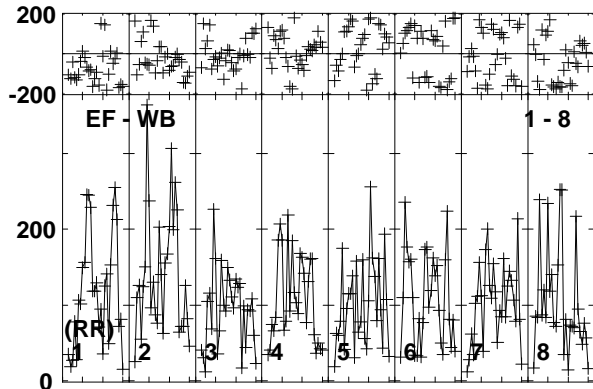
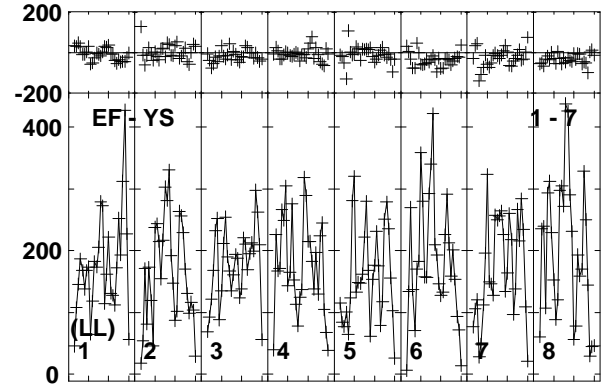
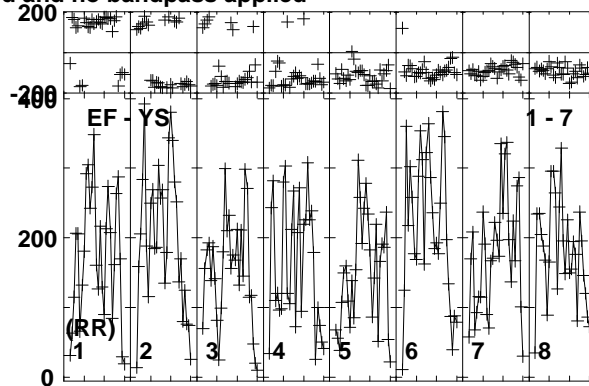
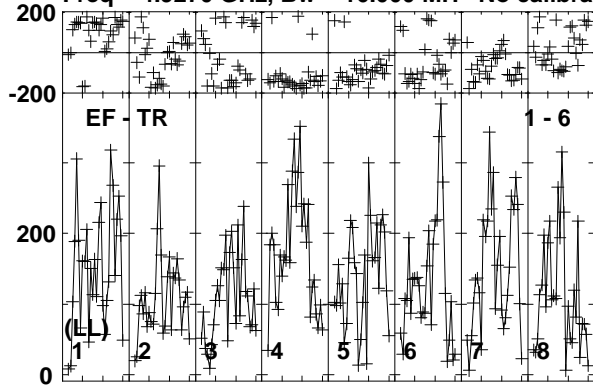

Lower frame: Micro Ampl Jy Top frame: Phas deg  
Vector averaged cross-power spectrum Baseline: EF (01) - TR (06)  
Timerange: 00/23:22:01 to 00/23:24:30

Plot file version 199 created 10-JUN-2016 17:22:21

J1957+3338 RT013A.UVDATA.1

Freq = 4.9270 GHz, Bw = 16.000 MH No calibration applied and no bandpass applied

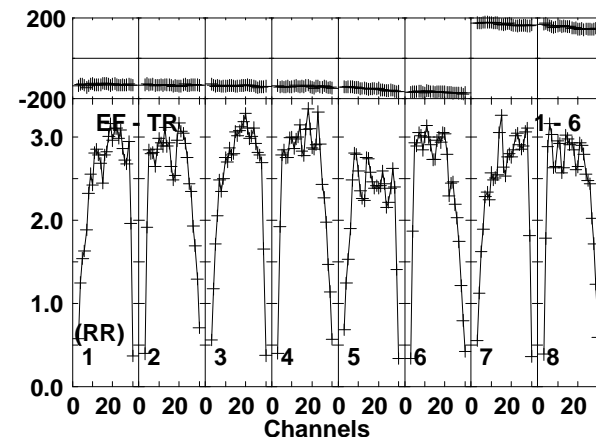
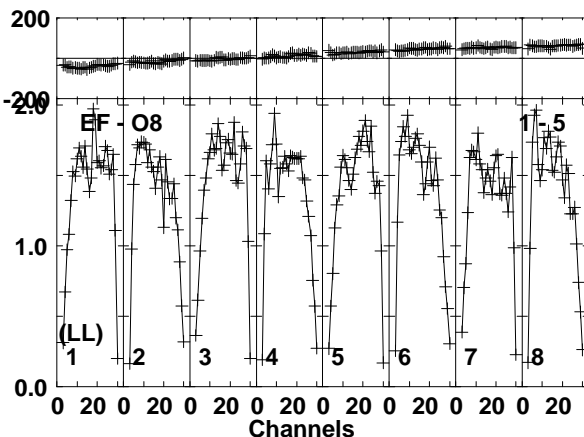
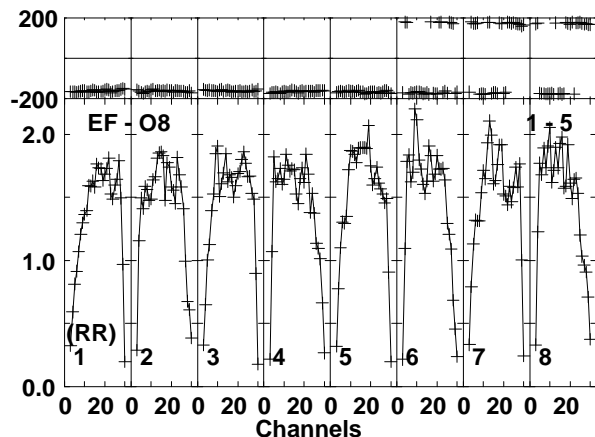
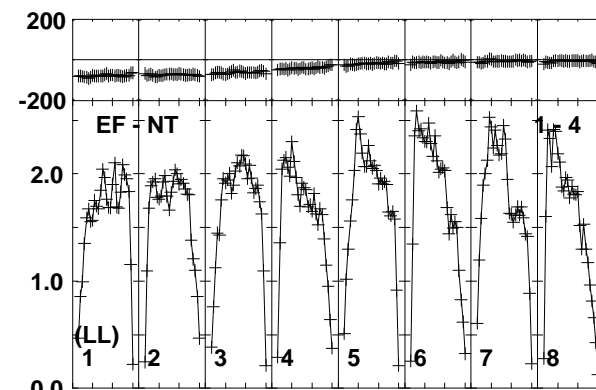
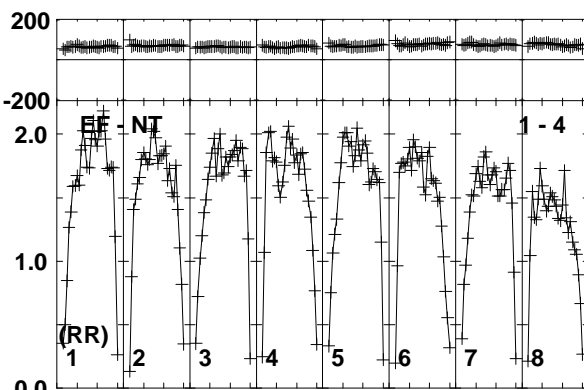
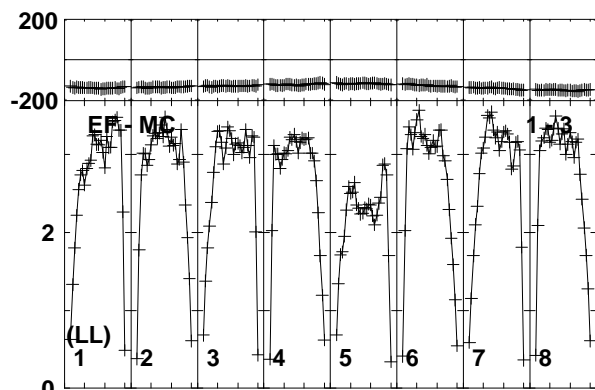
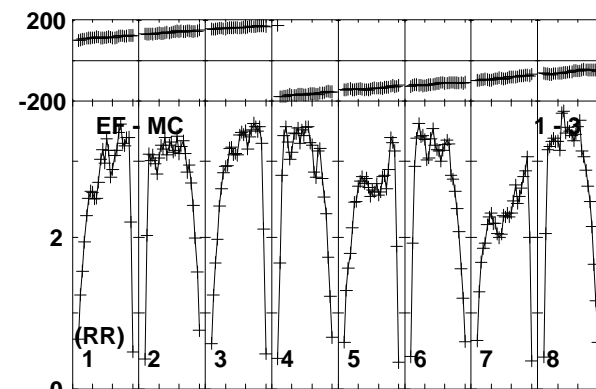
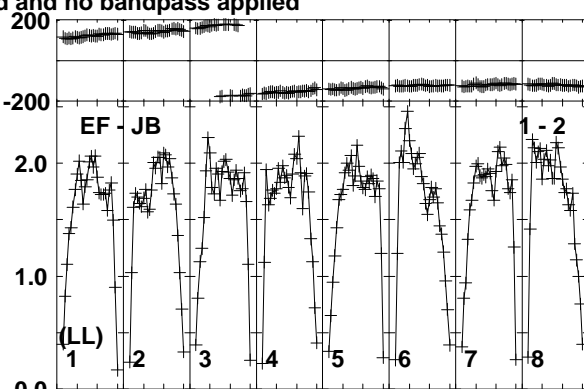
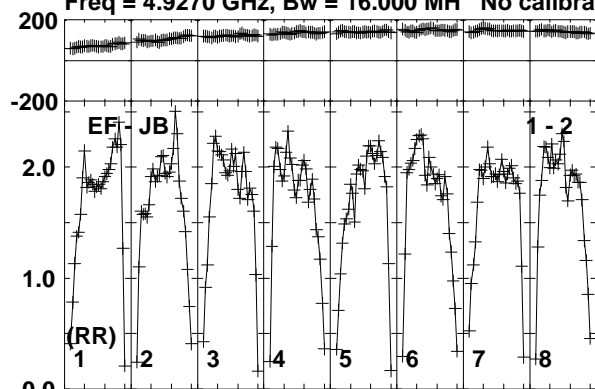

Lower frame: Milli Ampl Jy Top frame: Phas deg  
Vector averaged cross-power spectrum Baseline: EF (01) - JB (02)  
Timerange: 00/23:24:30 to 00/23:25:59

Plot file version 200 created 10-JUN-2016 17:22:21

J1957+3338 RT013A.UVDATA.1

Freq = 4.9270 GHz, Bw = 16.000 MH No calibration applied and no bandpass applied

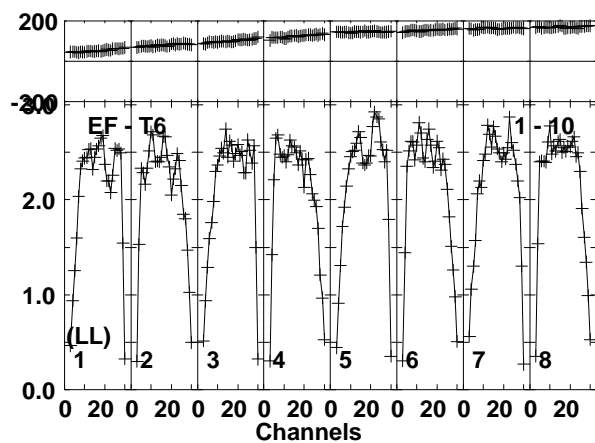
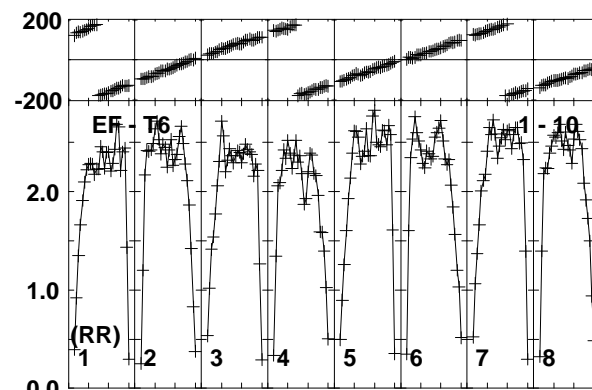
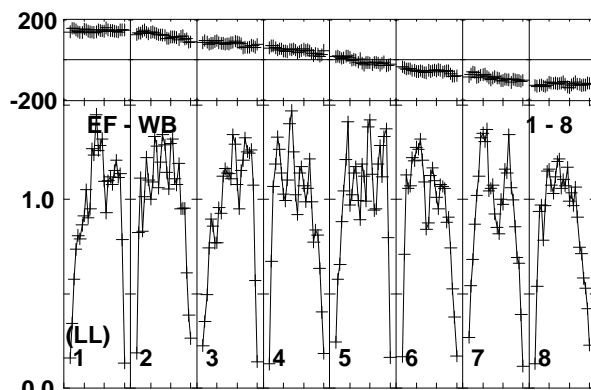
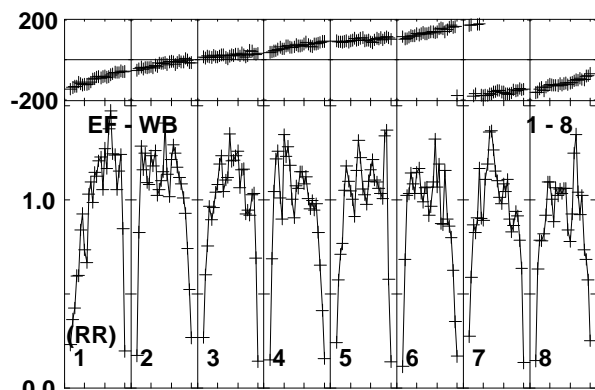
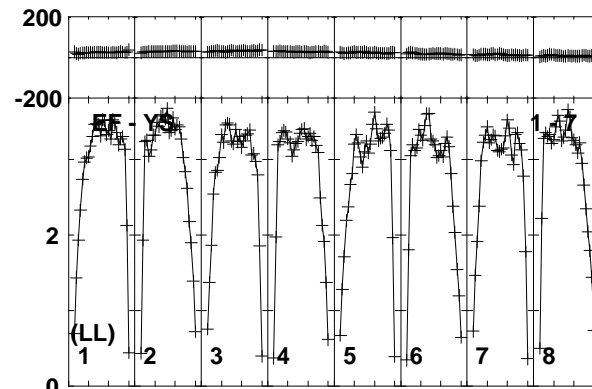
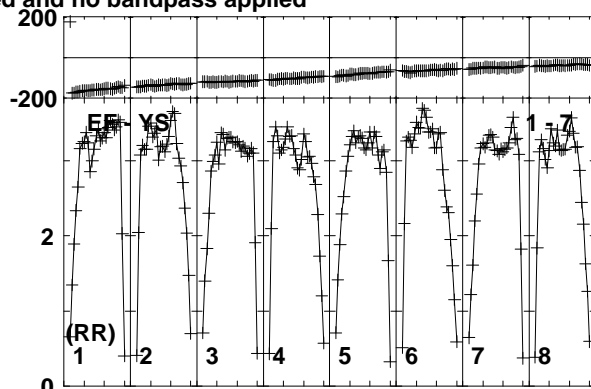
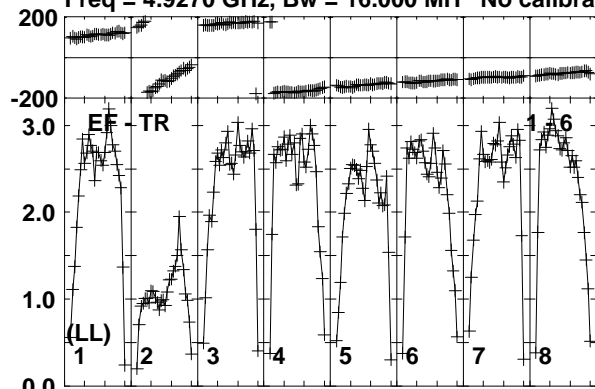

Lower frame: Milli Ampl Jy Top frame: Phas deg  
Vector averaged cross-power spectrum Baseline: EF (01) - TR (06)  
Timerange: 00/23:24:30 to 00/23:25:59

Plot file version 201 created 10-JUN-2016 17:22:21

CHECK RT013A.UVDATA.1

Freq = 4.9270 GHz, Bw = 16.000 MH No calibration applied and no bandpass applied

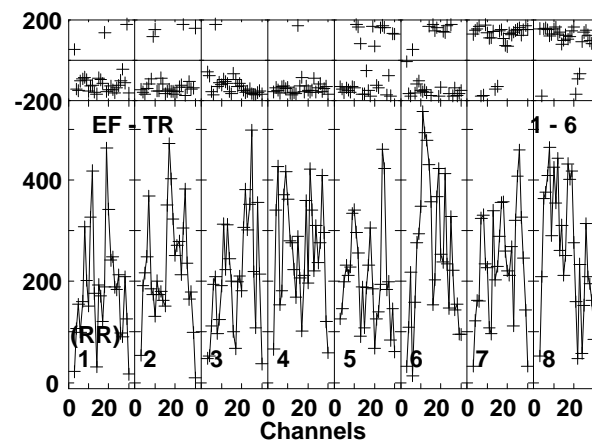
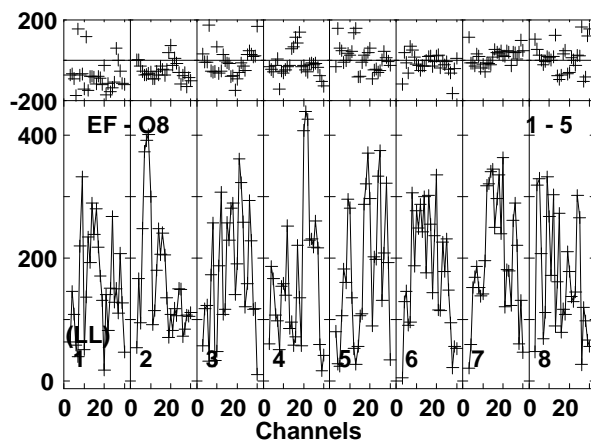
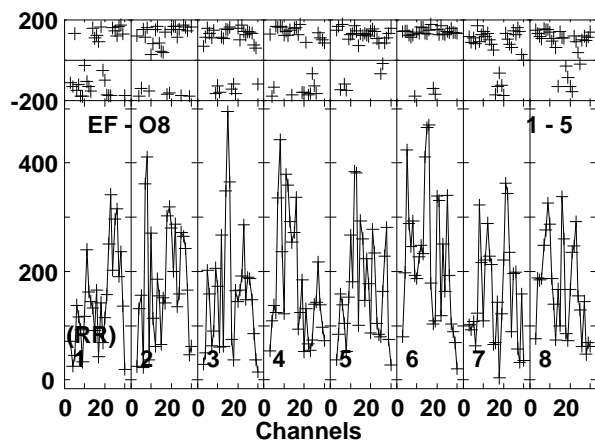
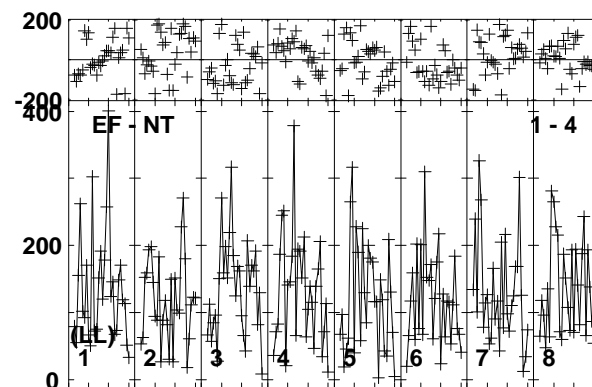
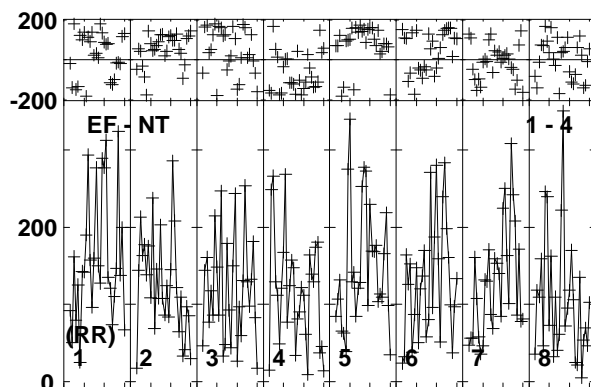
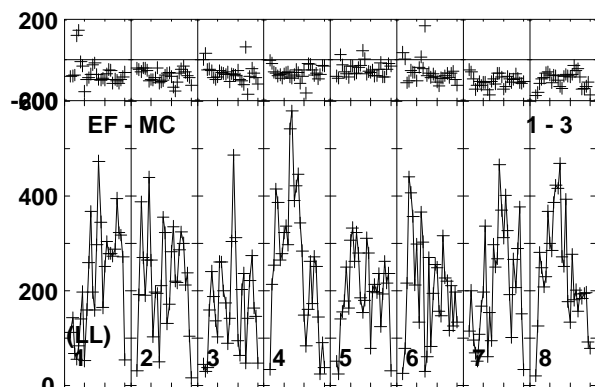
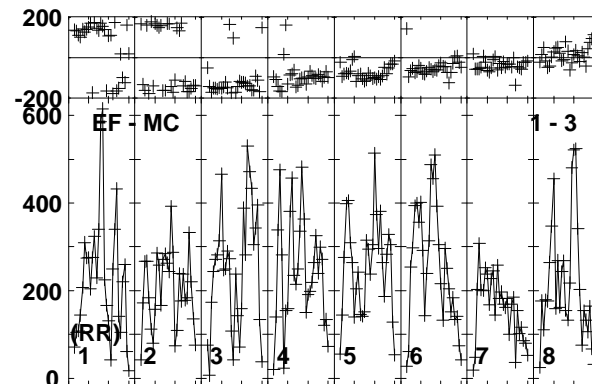
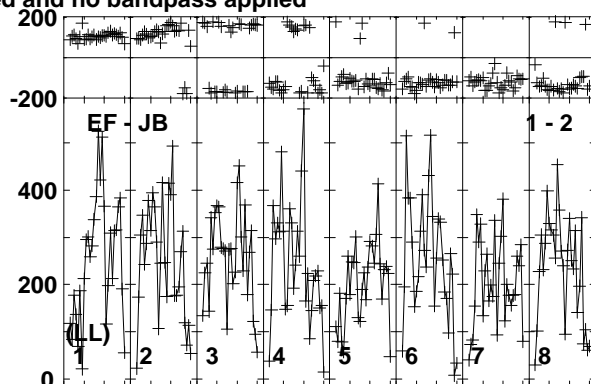
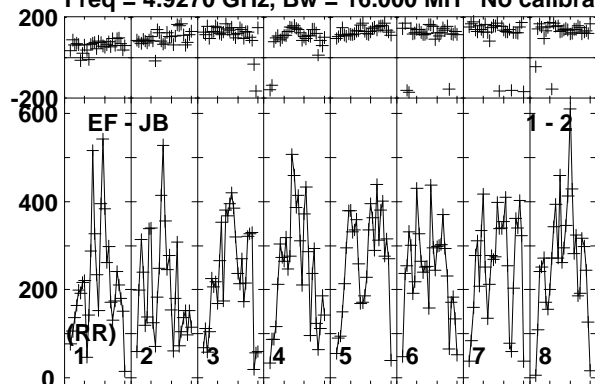

Lower frame: Micro Ampl Jy Top frame: Phas deg  
Vector averaged cross-power spectrum Baseline: EF (01) - JB (02)  
Timerange: 00/23:26:00 to 00/23:28:00

Plot file version 202 created 10-JUN-2016 17:22:21

CHECK RT013A.UVDATA.1

Freq = 4.9270 GHz, Bw = 16.000 MH No calibration applied and no bandpass applied

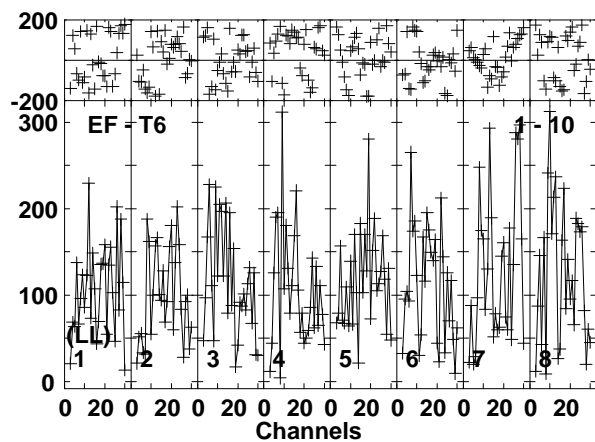
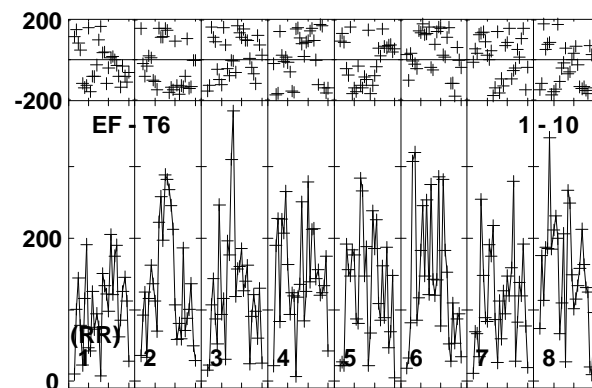
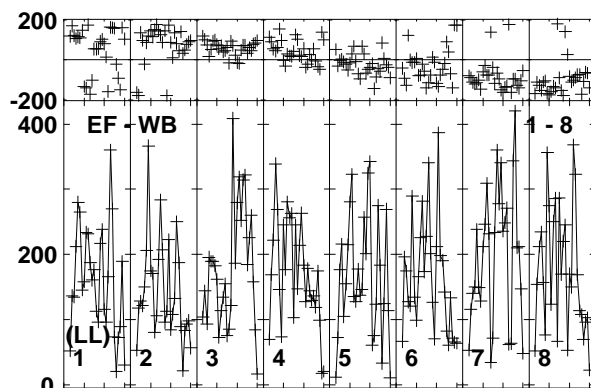
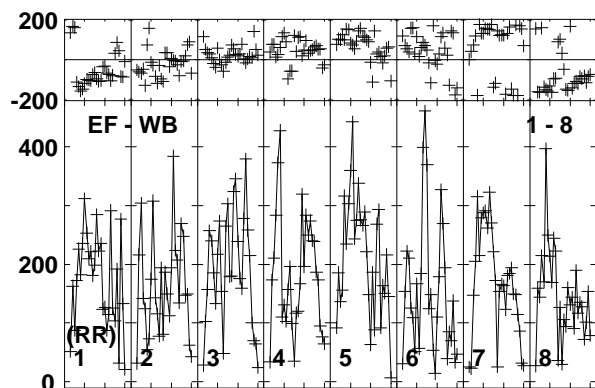
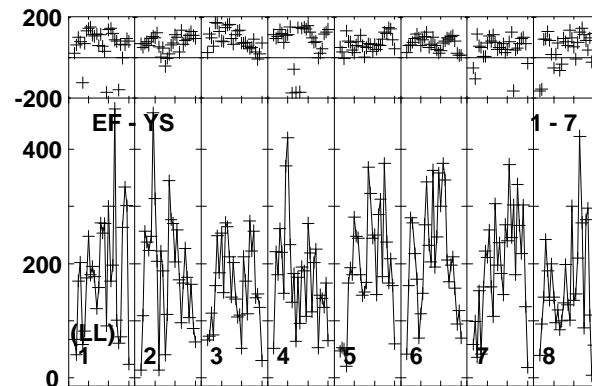
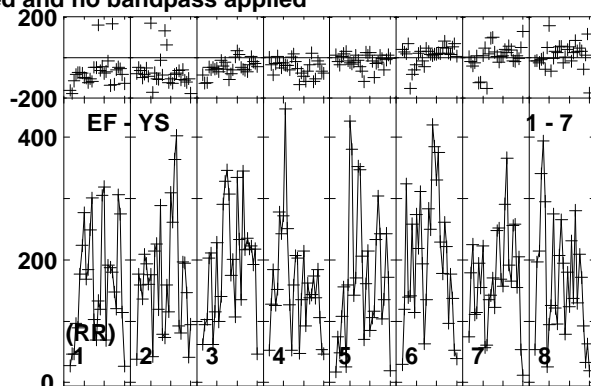
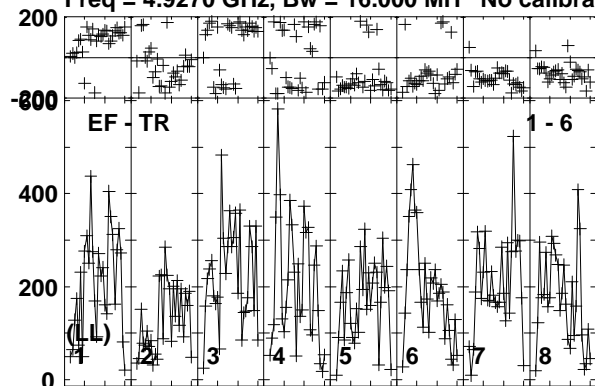

Lower frame: Micro Ampl Jy Top frame: Phas deg  
Vector averaged cross-power spectrum Baseline: EF (01) - TR (06)  
Timerange: 00/23:26:00 to 00/23:28:00



Plot file version 203 created 10-JUN-2016 17:22:21

CYGX1 RT013A.UVDATA.1

Freq = 4.9270 GHz, Bw = 16.000 MH No calibration applied and no bandpass applied

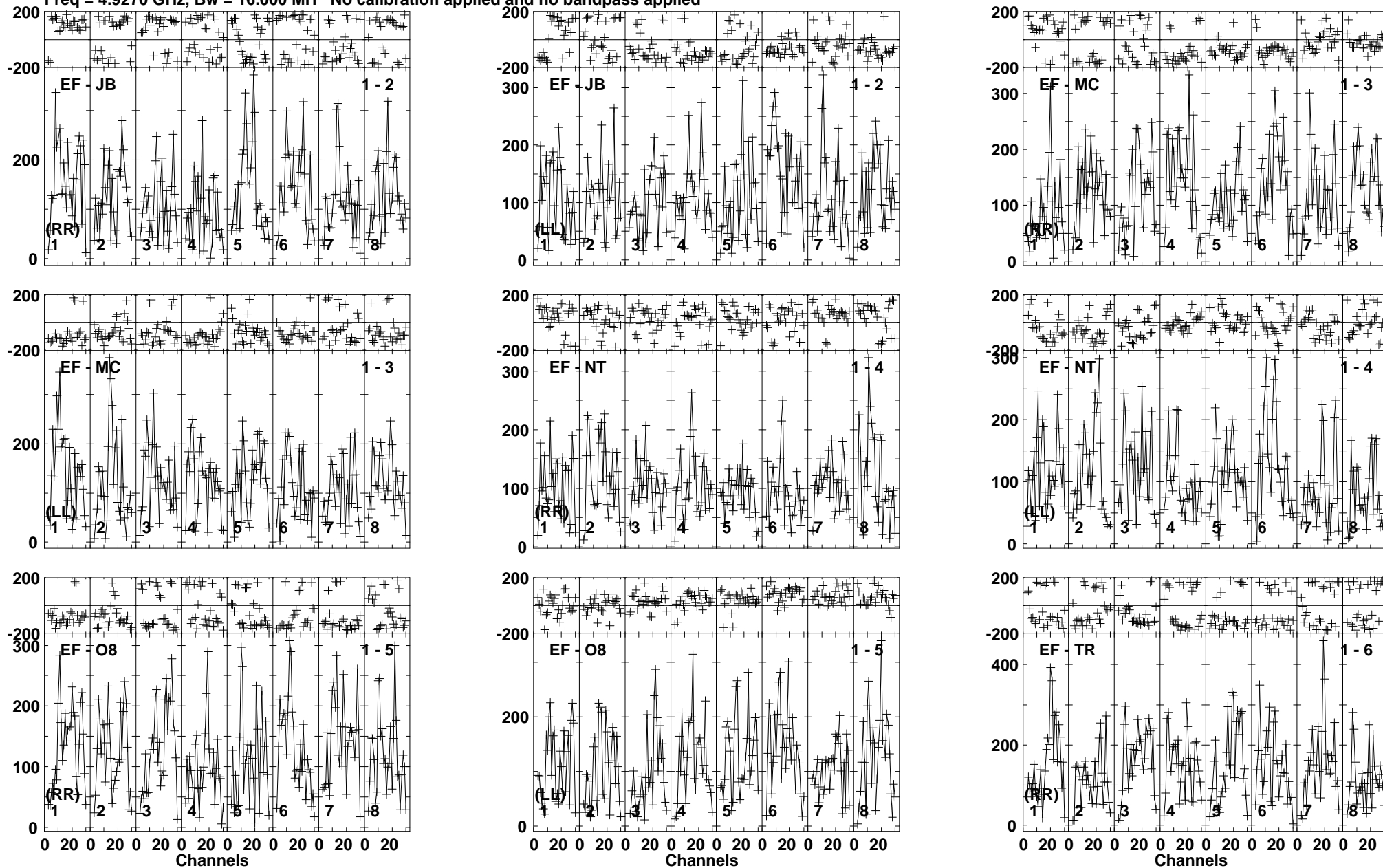

Lower frame: Micro Ampl Jy Top frame: Phas deg  
Vector averaged cross-power spectrum Baseline: EF (01) - JB (02)  
Timerange: 00/23:28:00 to 00/23:30:29

Plot file version 204 created 10-JUN-2016 17:22:22

CYGX1 RT013A.UVDATA.1

Freq = 4.9270 GHz, Bw = 16.000 MH No calibration applied and no bandpass applied

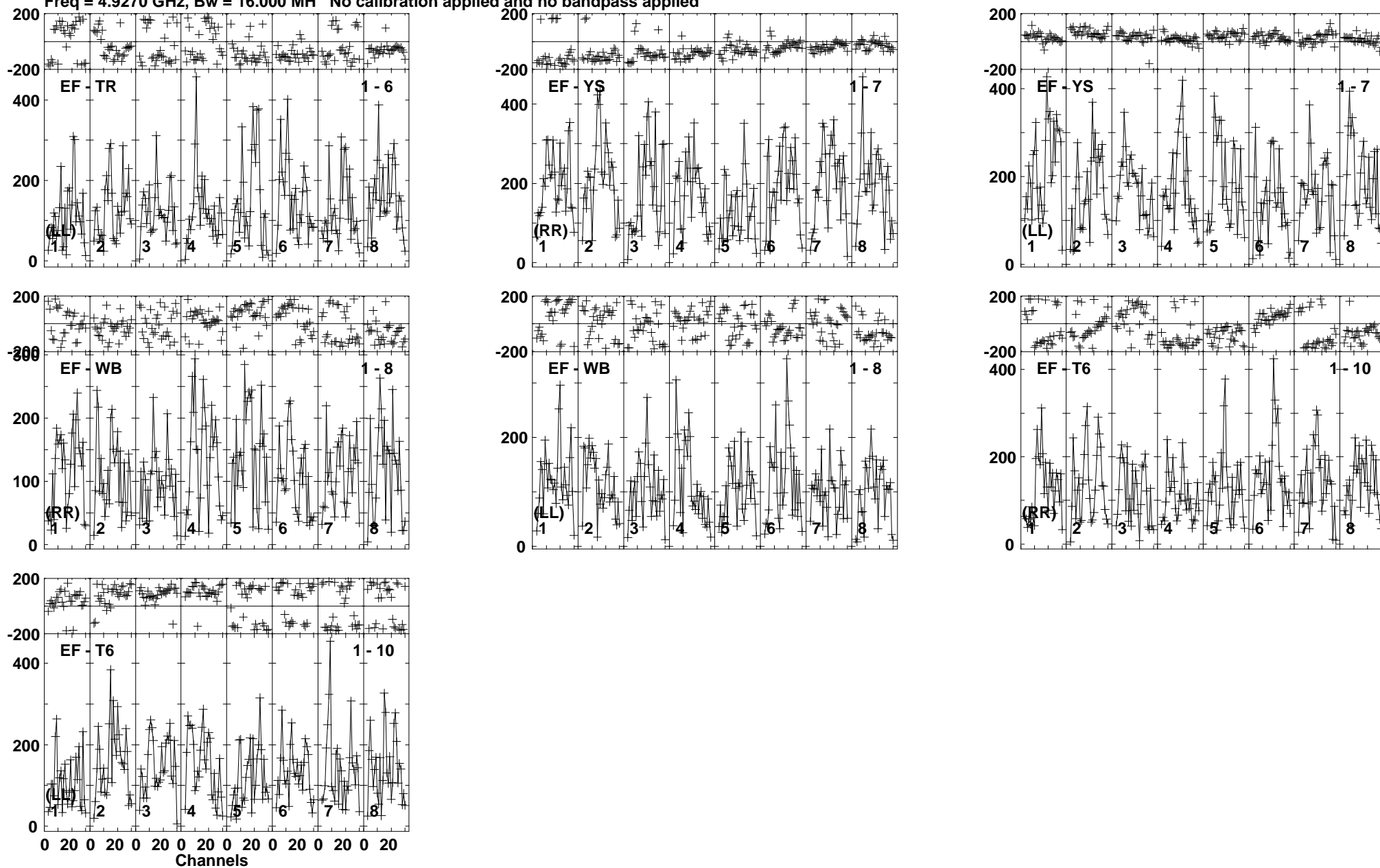

Lower frame: Micro Ampl Jy Top frame: Phas deg  
Vector averaged cross-power spectrum Baseline: EF (01) - TR (06)  
Timerange: 00/23:28:00 to 00/23:30:29

Plot file version 205 created 10-JUN-2016 17:22:22

J1957+3338 RT013A.UVDATA.1

Freq = 4.9270 GHz, Bw = 16.000 MH No calibration applied and no bandpass applied

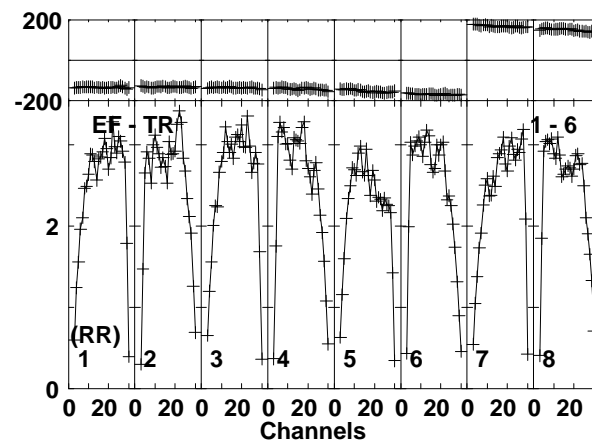
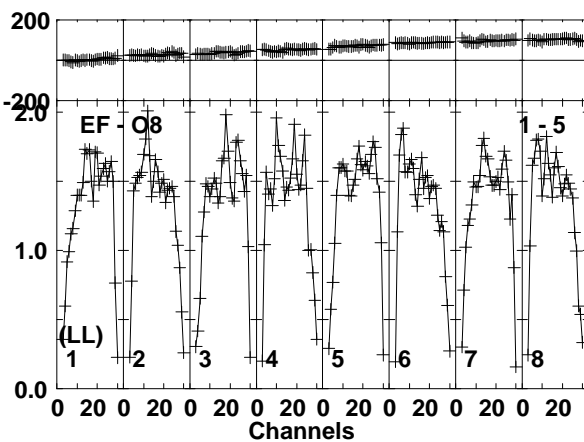
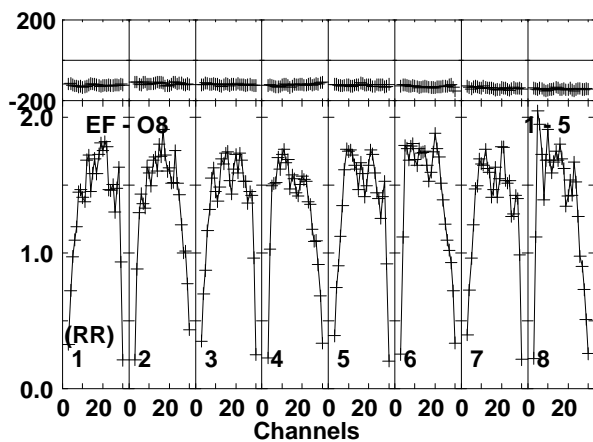
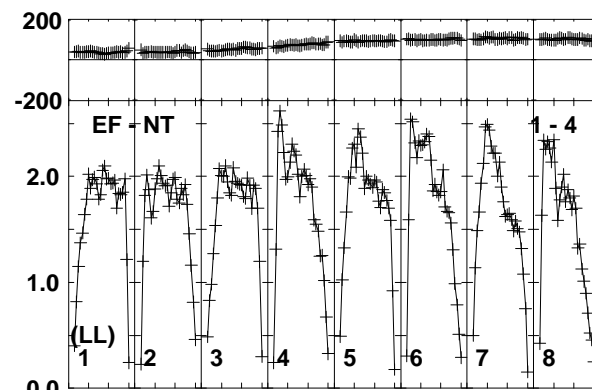
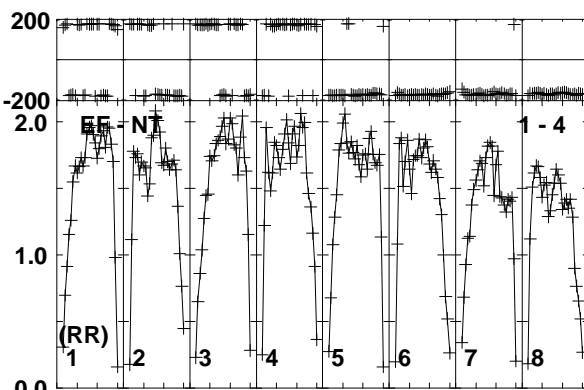
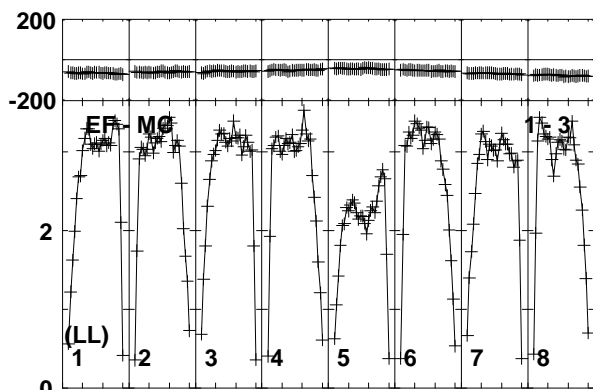
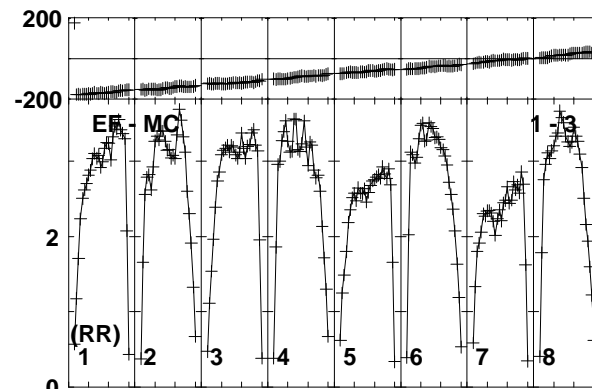
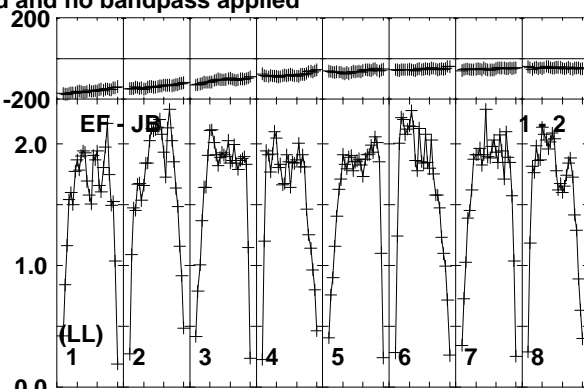
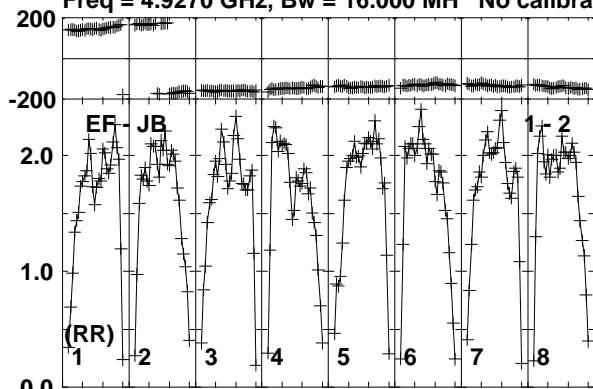

Lower frame: Milli Ampl Jy Top frame: Phas deg  
Vector averaged cross-power spectrum Baseline: EF (01) - JB (02)  
Timerange: 00/23:30:31 to 00/23:31:59

Plot file version 206 created 10-JUN-2016 17:22:22

J1957+3338 RT013A.UVDATA.1

Freq = 4.9270 GHz, Bw = 16.000 MH No calibration applied and no bandpass applied

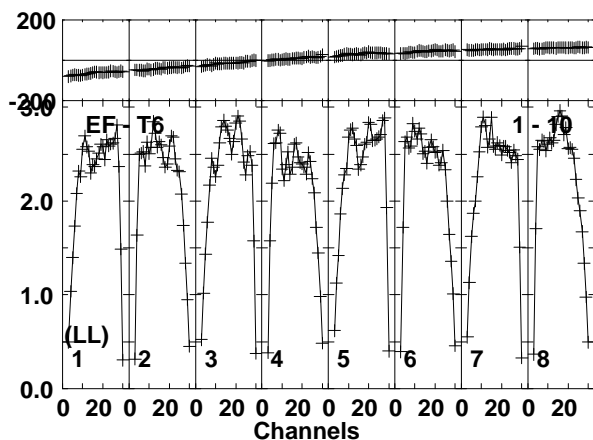
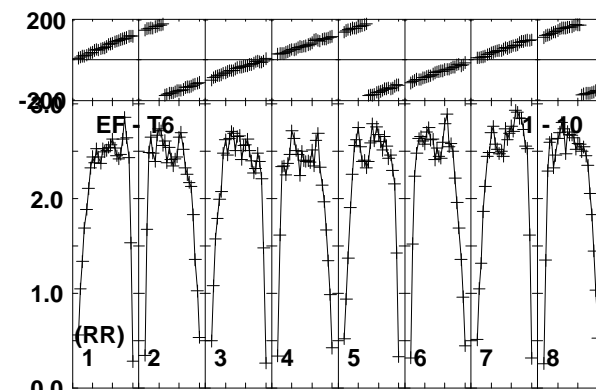
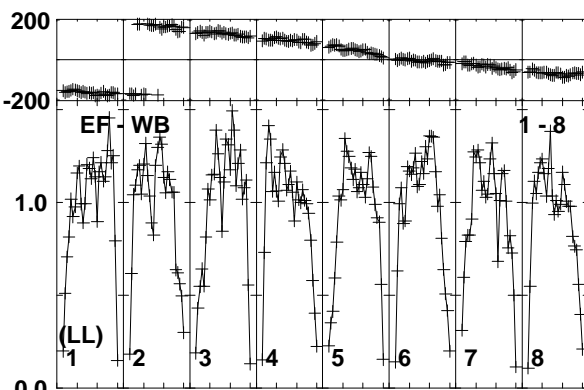
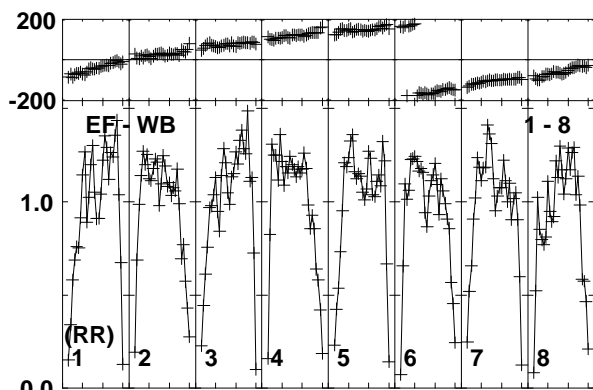
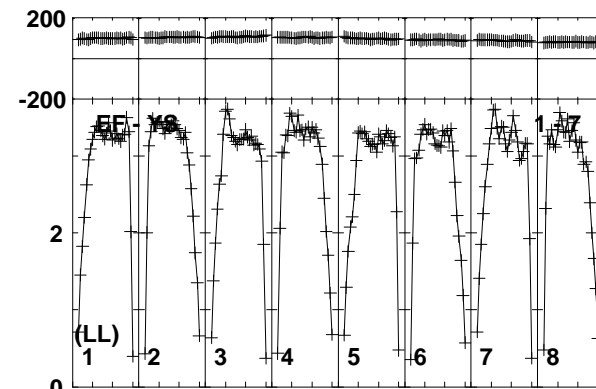
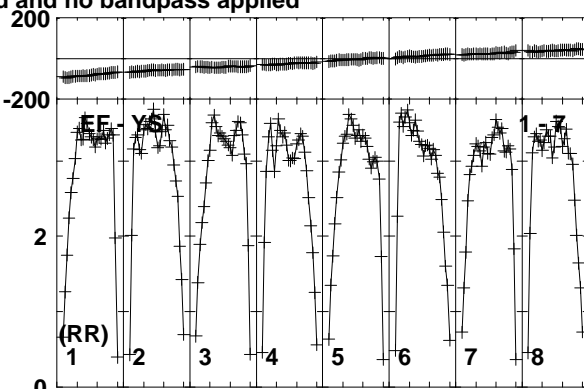
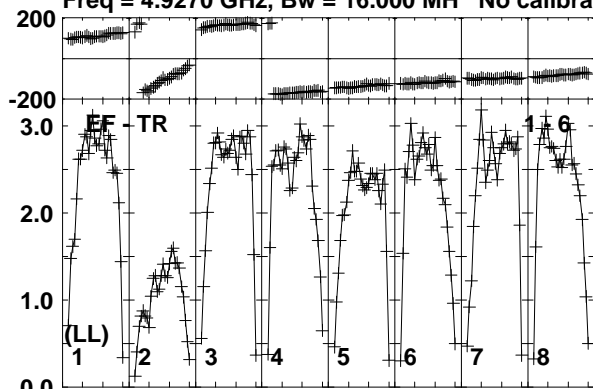

Lower frame: Milli Ampl Jy Top frame: Phas deg  
Vector averaged cross-power spectrum Baseline: EF (01) - TR (06)  
Timerange: 00/23:30:31 to 00/23:31:59

Plot file version 207 created 10-JUN-2016 17:22:22

CHECK RT013A.UVDATA.1

Freq = 4.9270 GHz, Bw = 16.000 MH No calibration applied and no bandpass applied

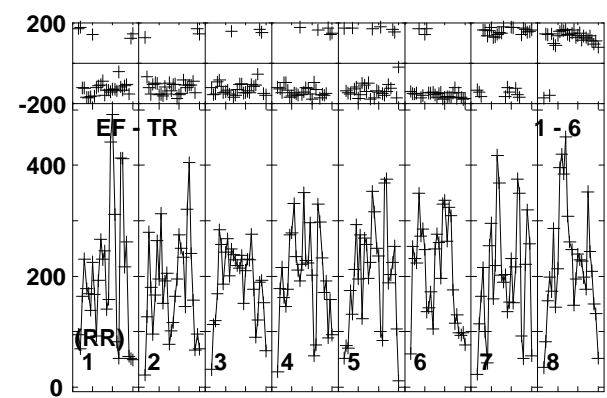
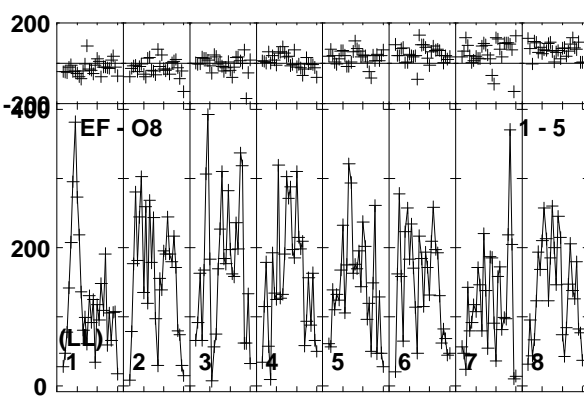
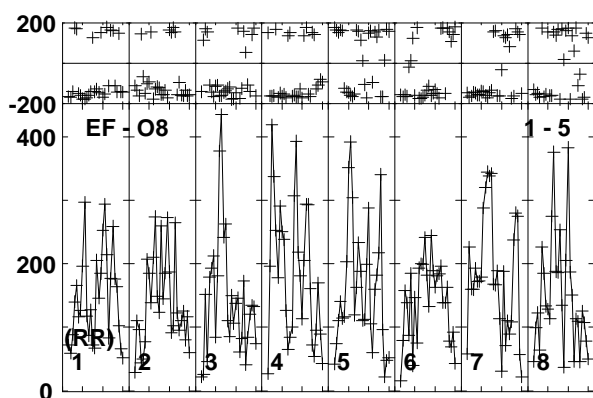
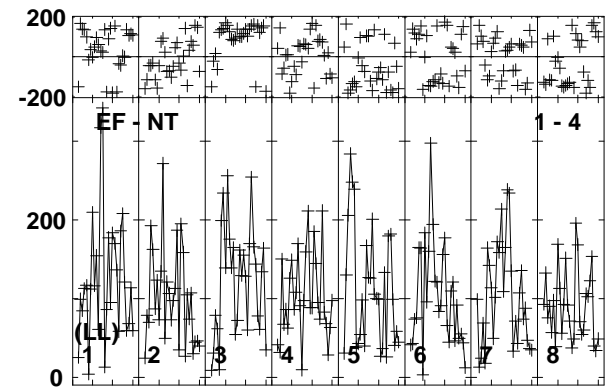
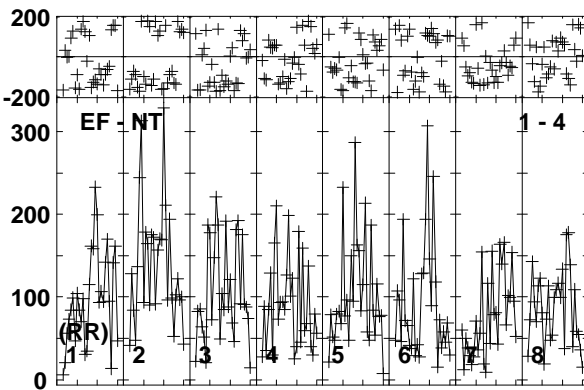
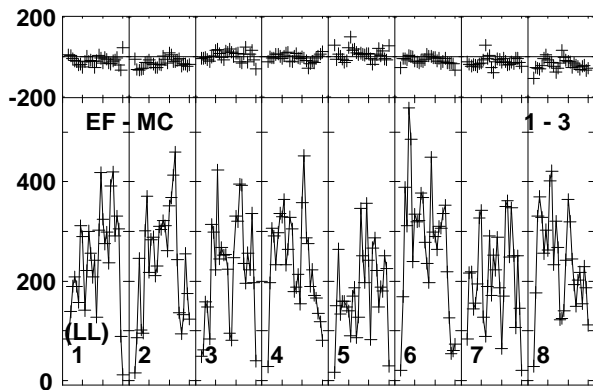
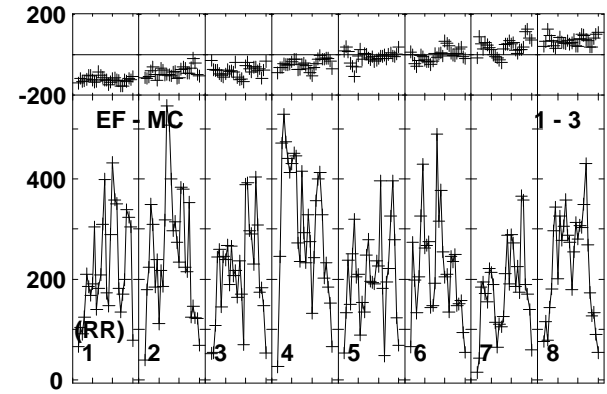
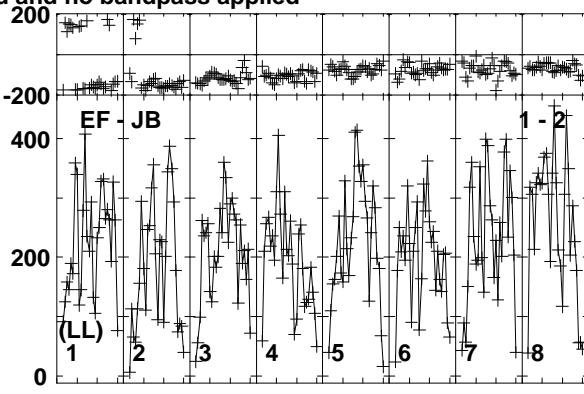
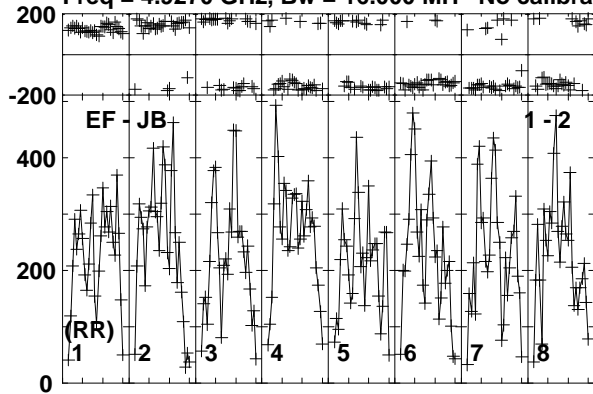

Lower frame: Micro Ampl Jy Top frame: Phas deg  
Vector averaged cross-power spectrum Baseline: EF (01) - JB (02)  
Timerange: 00/23:32:40 to 00/23:34:39

Plot file version 208 created 10-JUN-2016 17:22:22

CHECK RT013A.UVDATA.1

Freq = 4.9270 GHz, Bw = 16.000 MH No calibration applied and no bandpass applied

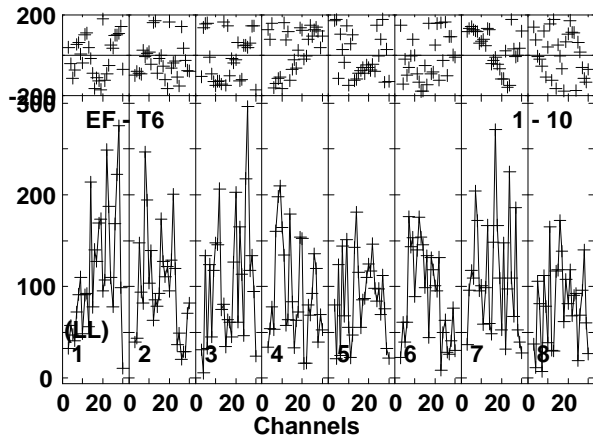
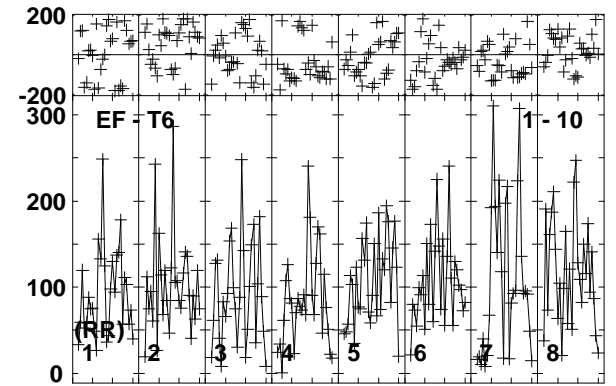
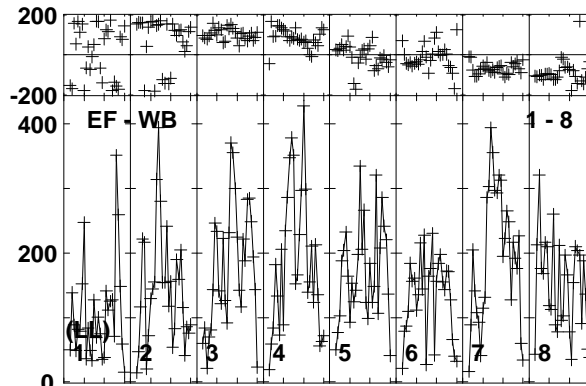
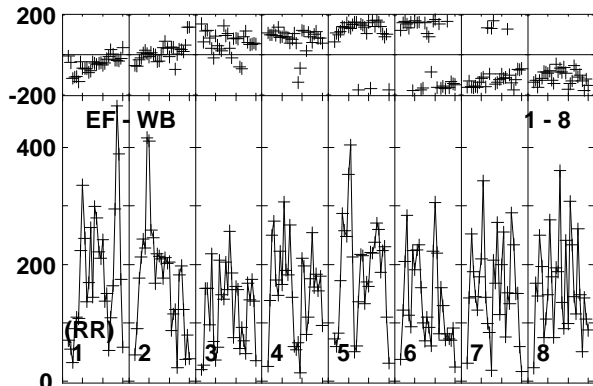
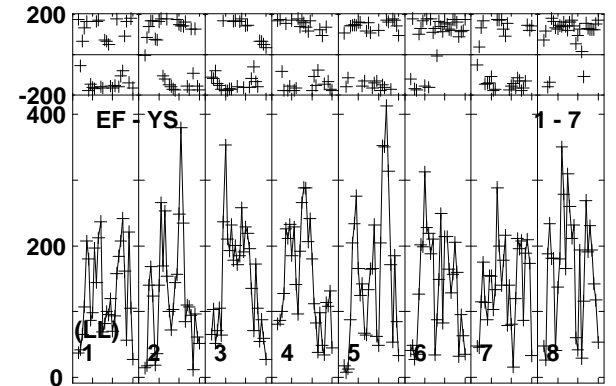
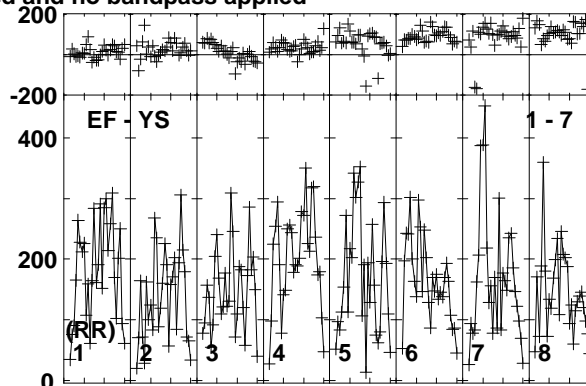
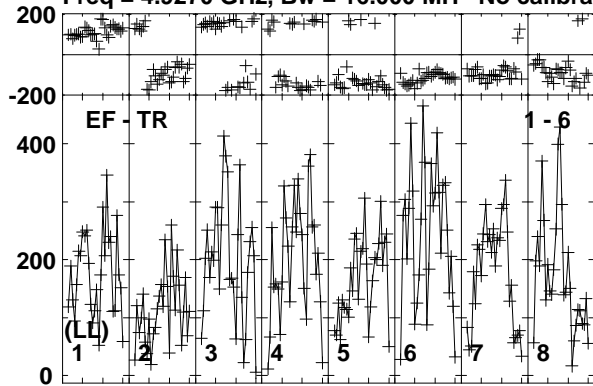

Lower frame: Micro Ampl Jy Top frame: Phas deg  
Vector averaged cross-power spectrum Baseline: EF (01) - TR (06)  
Timerange: 00/23:32:40 to 00/23:34:39

Plot file version 209 created 10-JUN-2016 17:22:22

CYGX1 RT013A.UVDATA.1

Freq = 4.9270 GHz, Bw = 16.000 MH No calibration applied and no bandpass applied

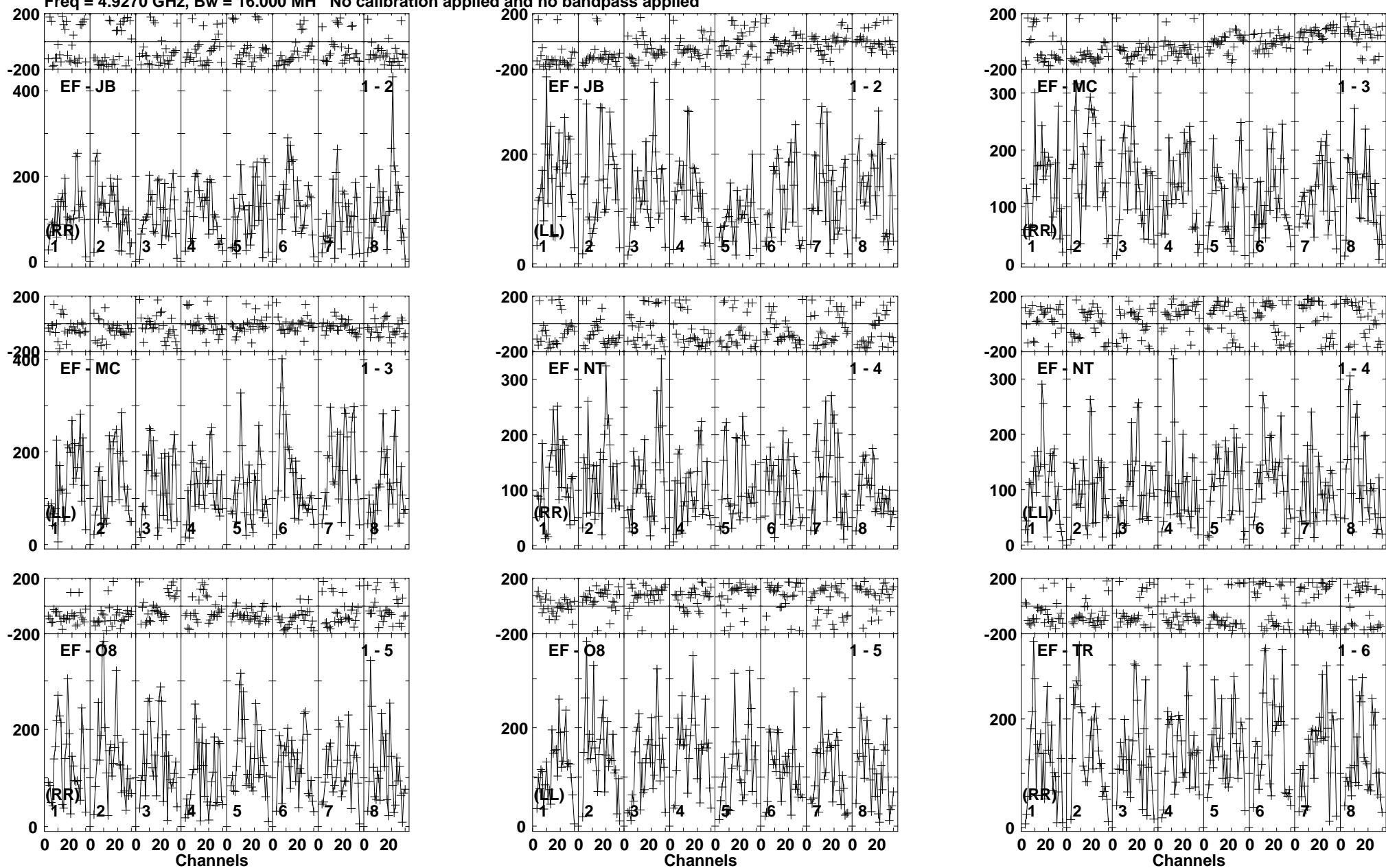

Lower frame: Micro Ampl Jy Top frame: Phas deg  
Vector averaged cross-power spectrum Baseline: EF (01) - JB (02)  
Timerange: 00/23:34:40 to 00/23:37:09

Plot file version 210 created 10-JUN-2016 17:22:22

CYGX1 RT013A.UVDATA.1

Freq = 4.9270 GHz, Bw = 16.000 MH No calibration applied and no bandpass applied

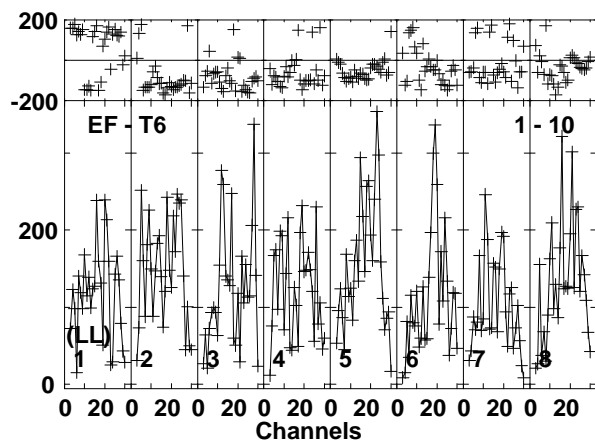
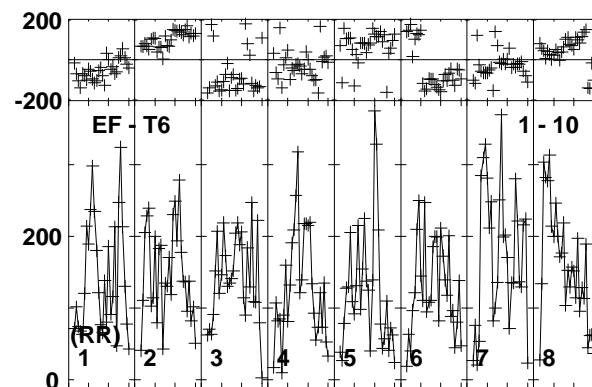
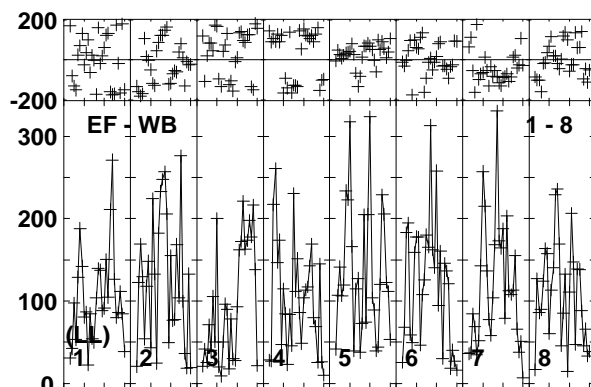
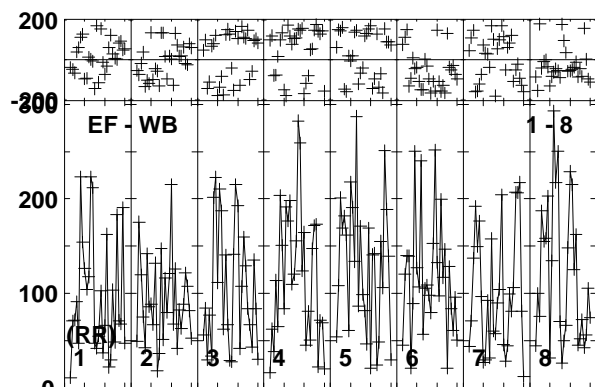
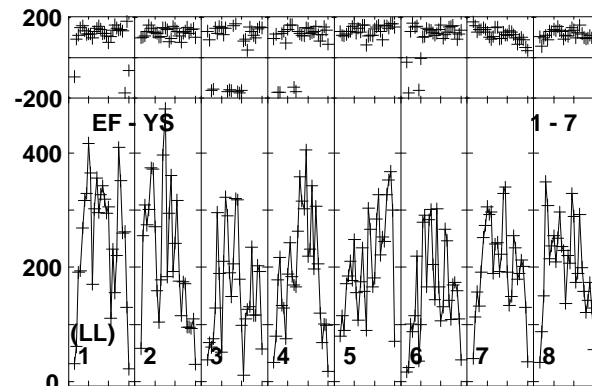
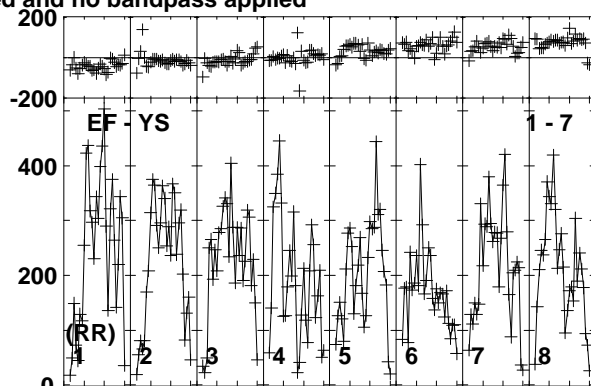
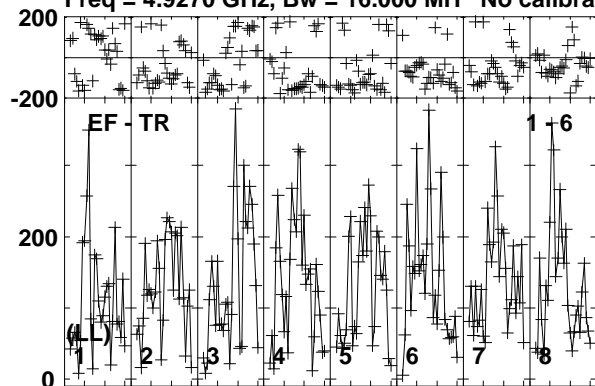

Lower frame: Micro Ampl Jy Top frame: Phas deg  
Vector averaged cross-power spectrum Baseline: EF (01) - TR (06)  
Timerange: 00/23:34:40 to 00/23:37:09



Plot file version 211 created 10-JUN-2016 17:22:22

J1957+3338 RT013A.UVDATA.1

Freq = 4.9270 GHz, Bw = 16.000 MH No calibration applied and no bandpass applied

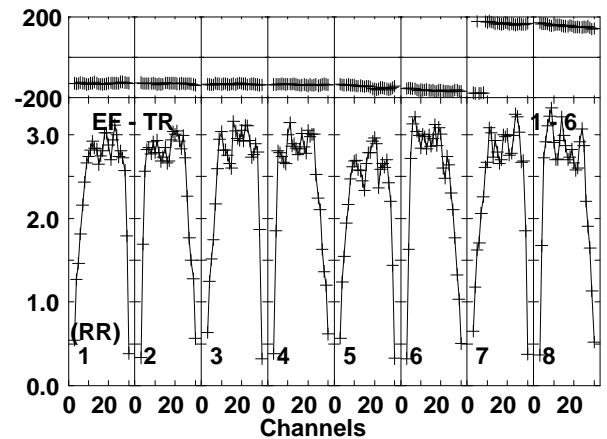
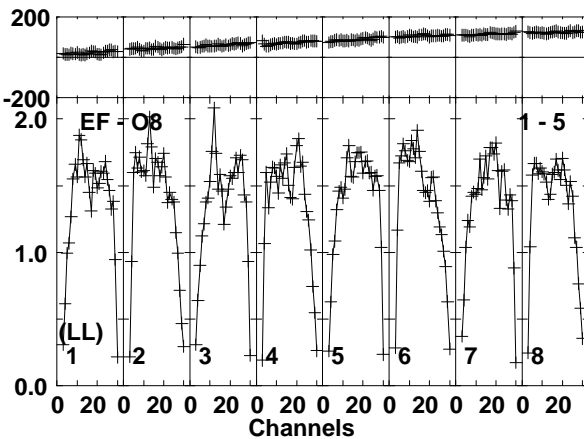
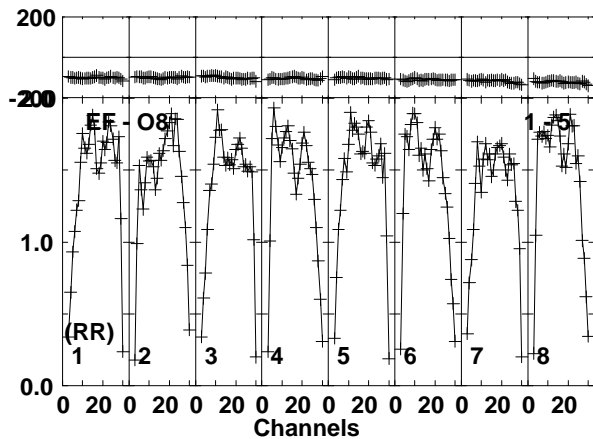
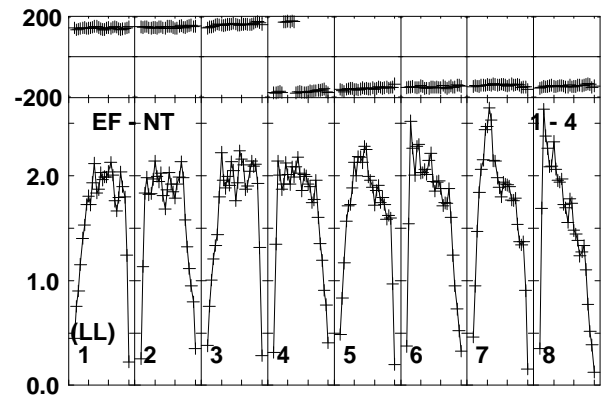
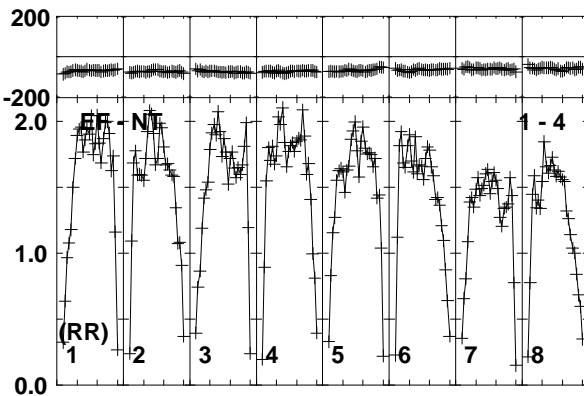
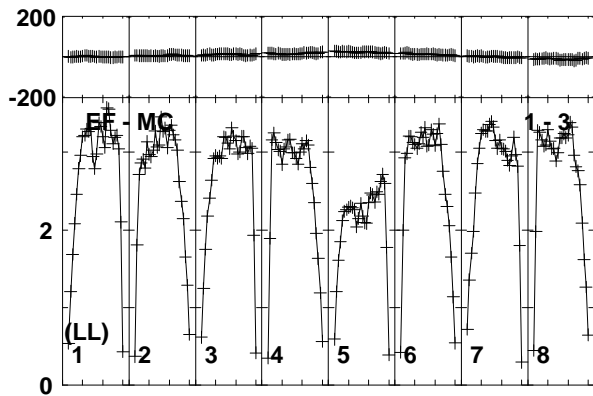
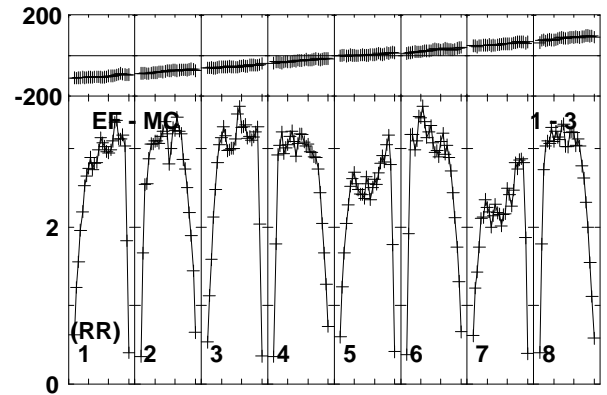
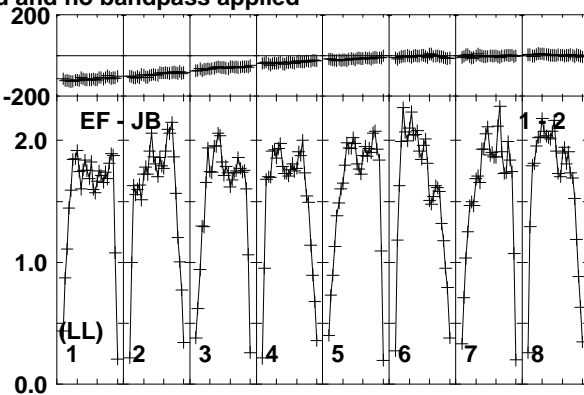
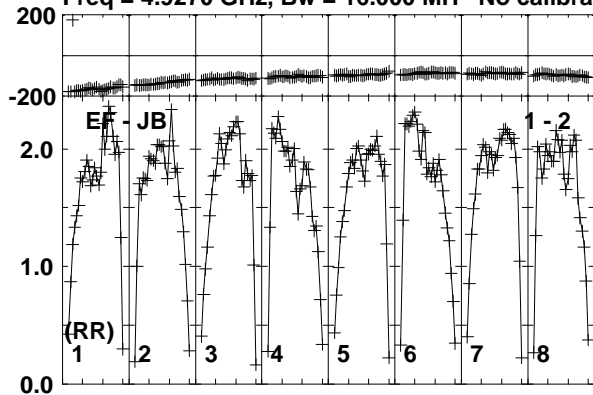

Lower frame: Milli Ampl Jy Top frame: Phas deg

Vector averaged cross-power spectrum Baseline: EF (01) - JB (02)

Timerange: 00/23:37:10 to 00/23:38:40

Plot file version 212 created 10-JUN-2016 17:22:22

J1957+3338 RT013A.UVDATA.1

Freq = 4.9270 GHz, Bw = 16.000 MH No calibration applied and no bandpass applied

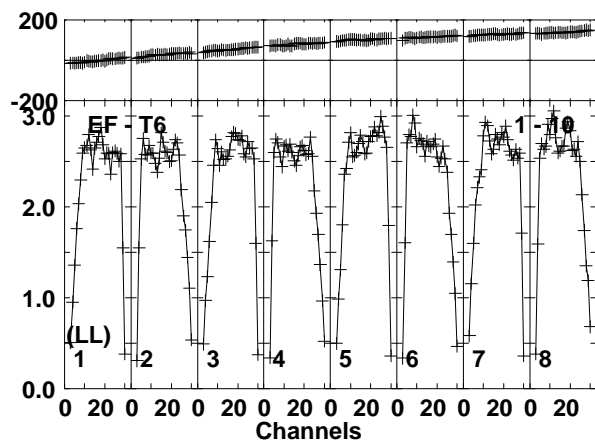
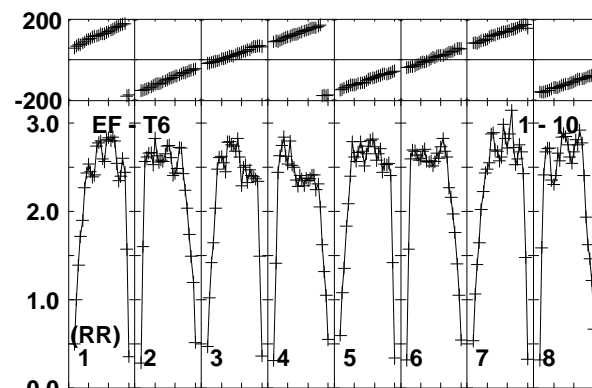
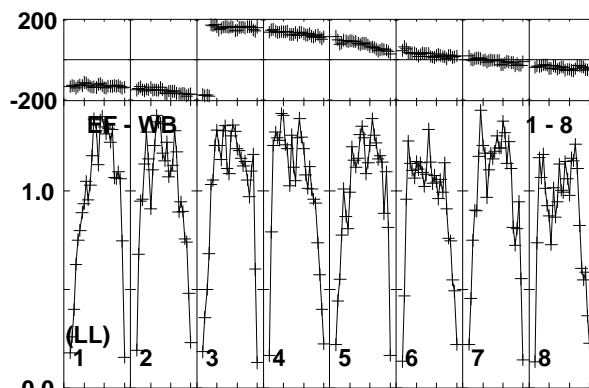
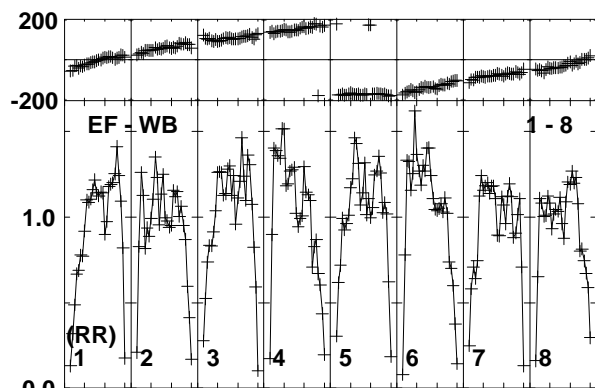
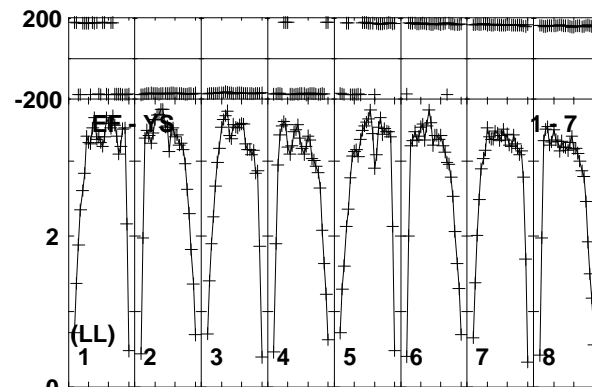
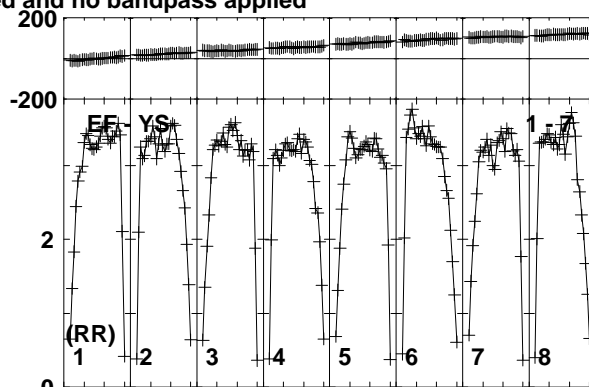
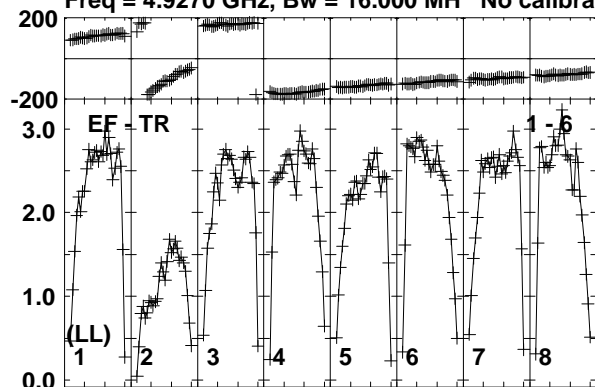

Lower frame: Milli Ampl Jy Top frame: Phas deg  
Vector averaged cross-power spectrum Baseline: EF (01) - TR (06)  
Timerange: 00/23:37:10 to 00/23:38:40

Plot file version 213 created 10-JUN-2016 17:22:23

CHECK RT013A.UVDATA.1

Freq = 4.9270 GHz, Bw = 16.000 MH No calibration applied and no bandpass applied

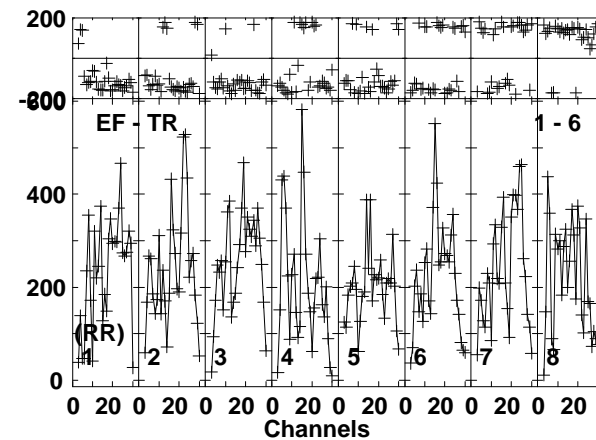
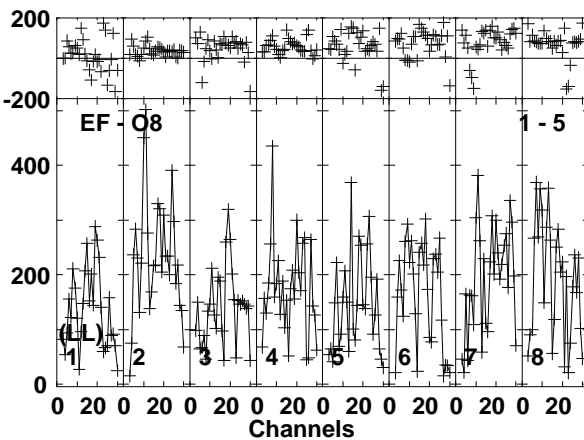
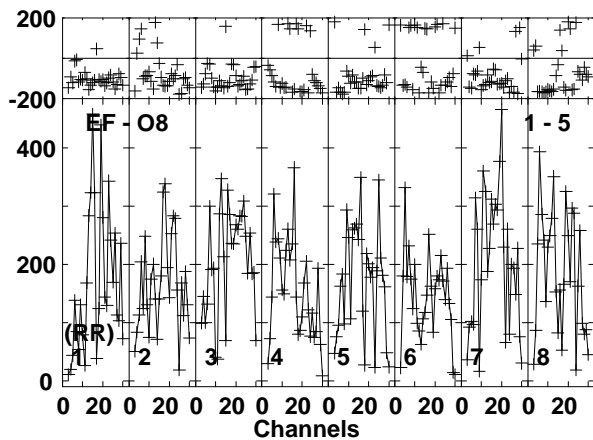
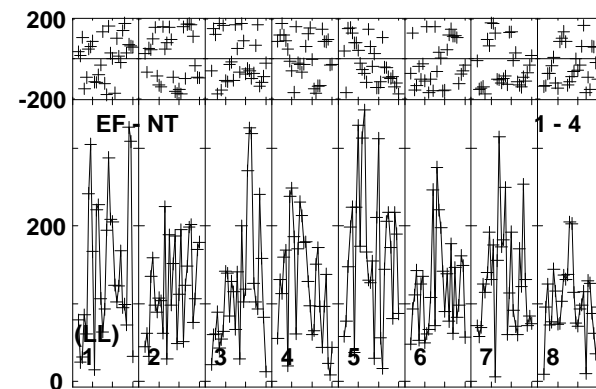
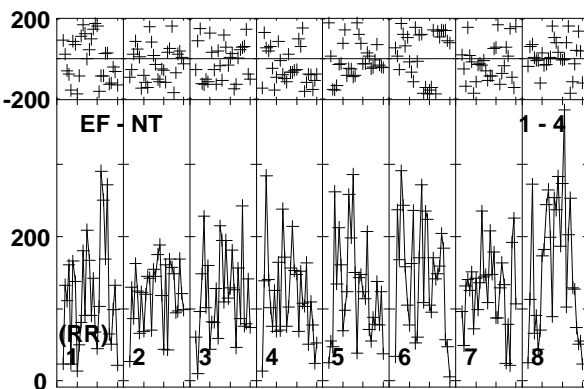
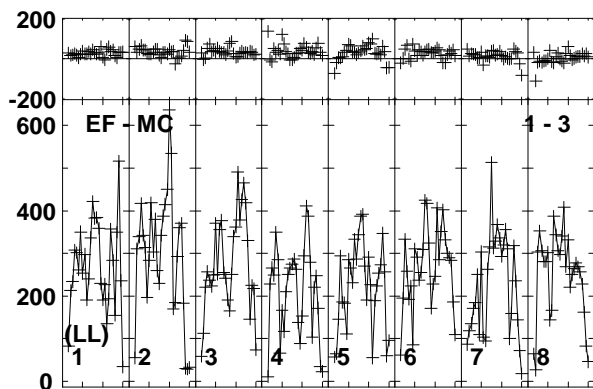
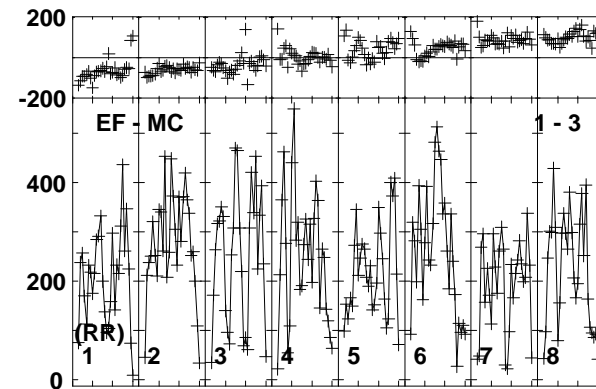
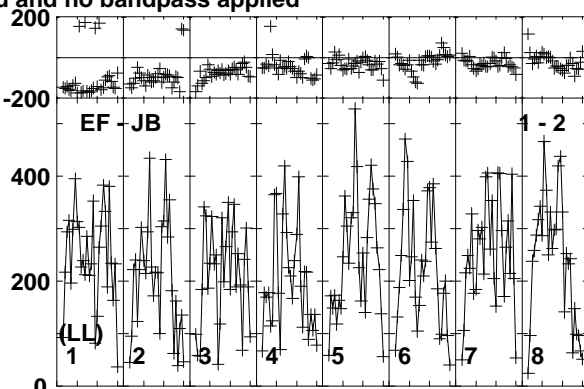
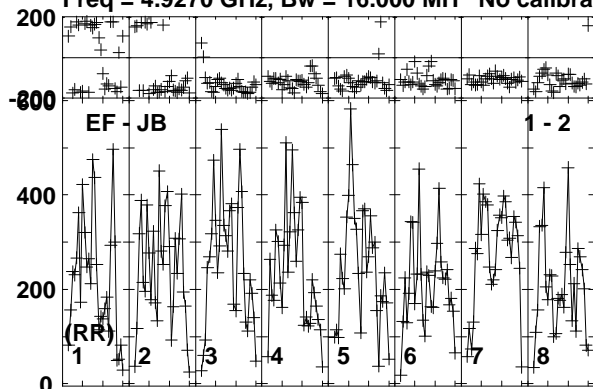

Lower frame: Micro Ampl Jy Top frame: Phas deg  
Vector averaged cross-power spectrum Baseline: EF (01) - JB (02)  
Timerange: 00/23:38:41 to 00/23:40:40

Plot file version 214 created 10-JUN-2016 17:22:23

CHECK RT013A.UVDATA.1

Freq = 4.9270 GHz, Bw = 16.000 MH No calibration applied and no bandpass applied

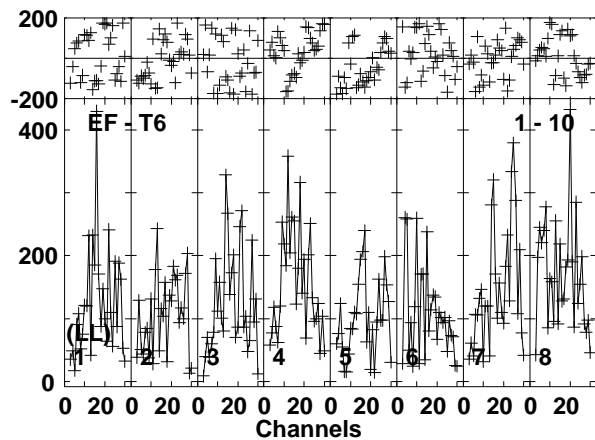
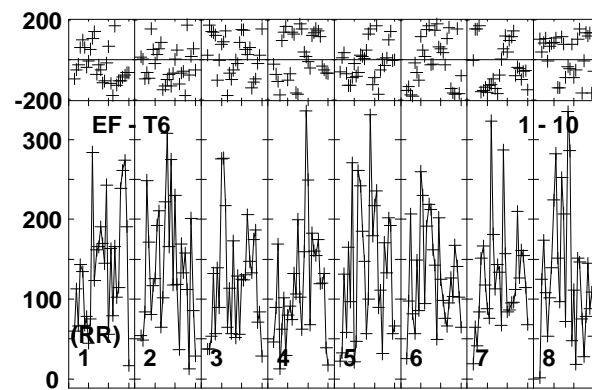
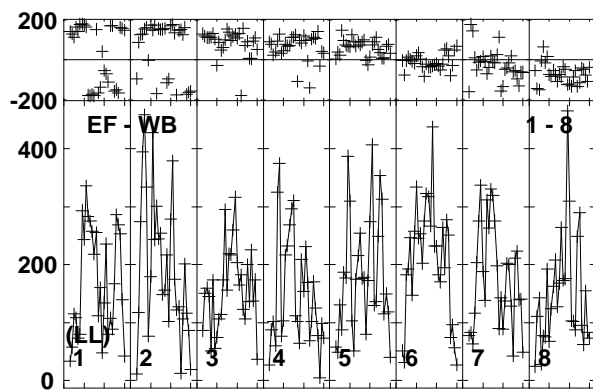
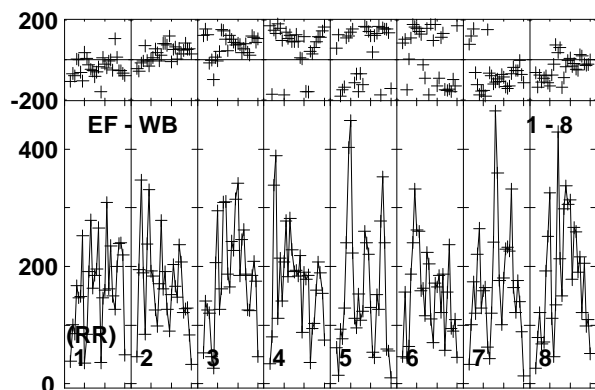
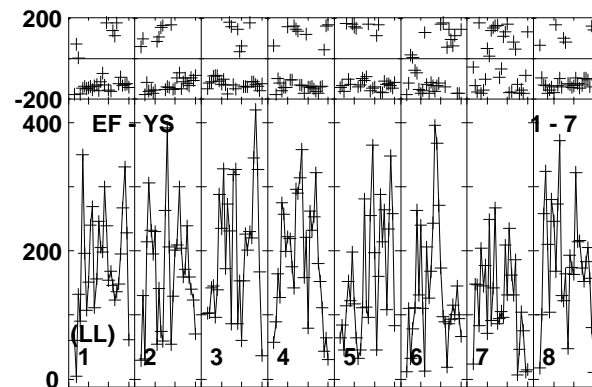
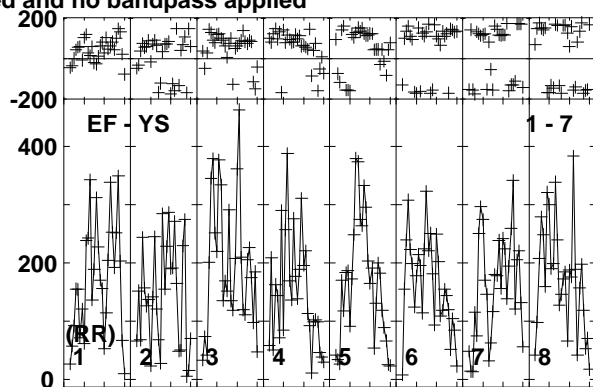
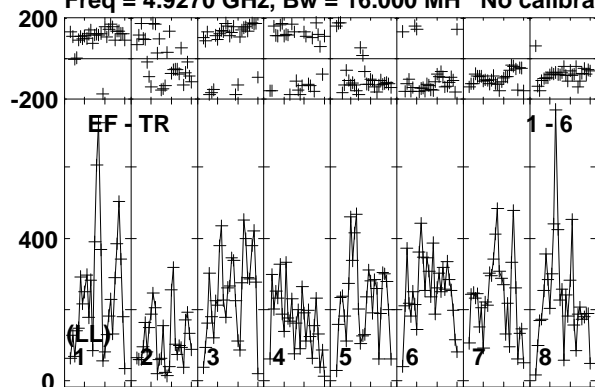

Lower frame: Micro Ampl Jy Top frame: Phas deg  
Vector averaged cross-power spectrum Baseline: EF (01) - TR (06)  
Timerange: 00/23:38:41 to 00/23:40:40

Plot file version 215 created 10-JUN-2016 17:22:23

CYGX1 RT013A.UVDATA.1

Freq = 4.9270 GHz, Bw = 16.000 MH No calibration applied and no bandpass applied

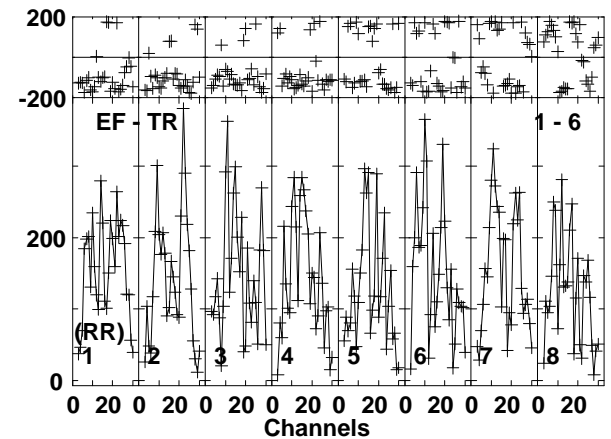
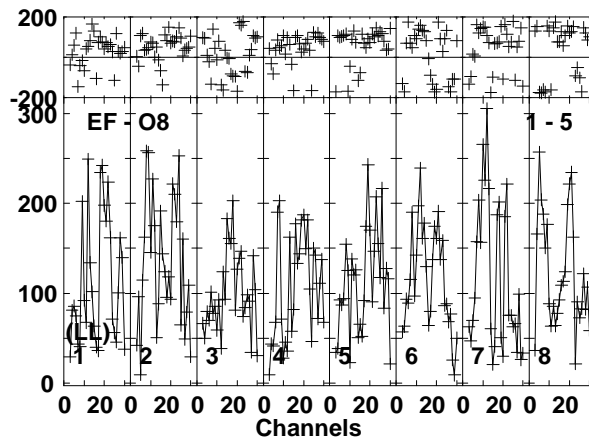
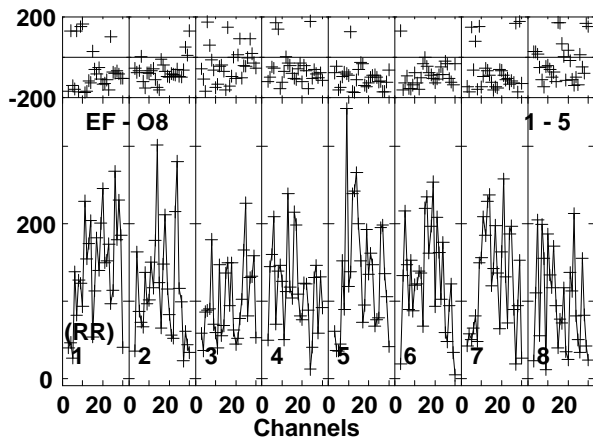
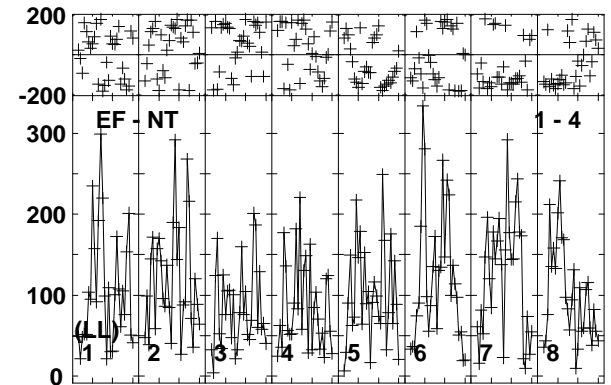
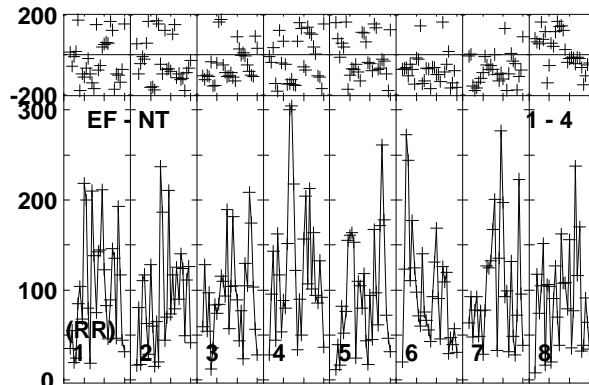
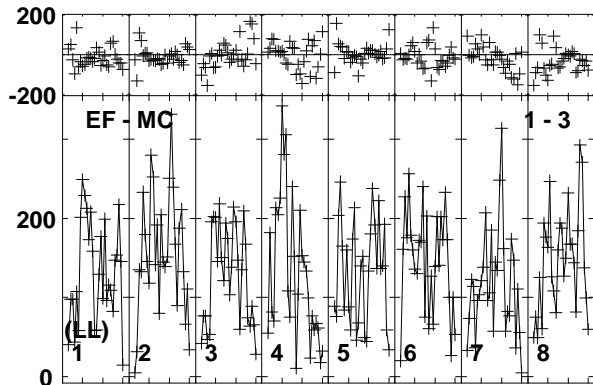
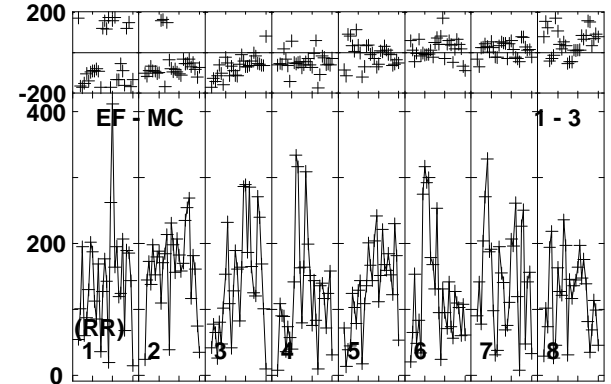
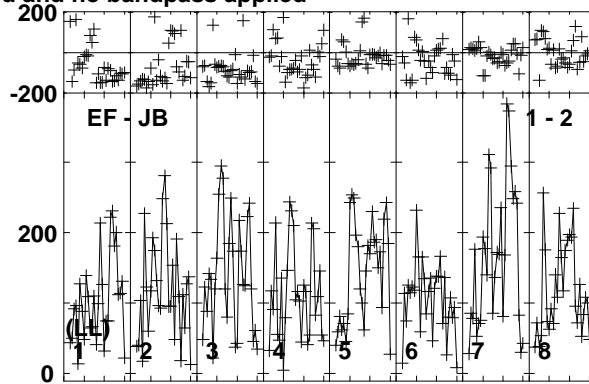
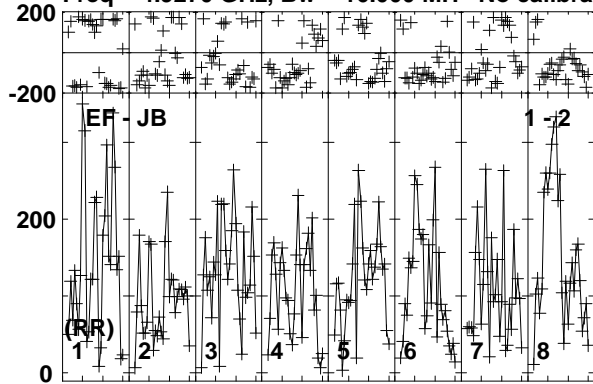

Lower frame: Micro Ampl Jy Top frame: Phas deg  
Vector averaged cross-power spectrum Baseline: EF (01) - JB (02)  
Timerange: 00/23:40:41 to 00/23:43:09

Plot file version 216 created 10-JUN-2016 17:22:23

CYGX1 RT013A.UVDATA.1

Freq = 4.9270 GHz, Bw = 16.000 MH No calibration applied and no bandpass applied

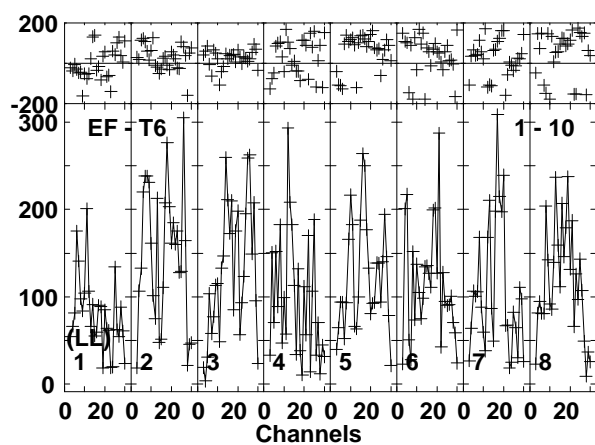
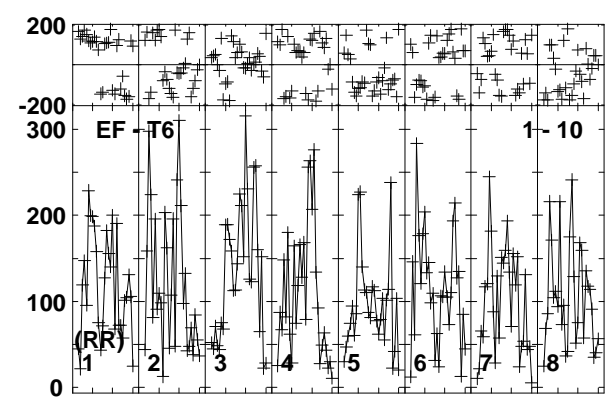
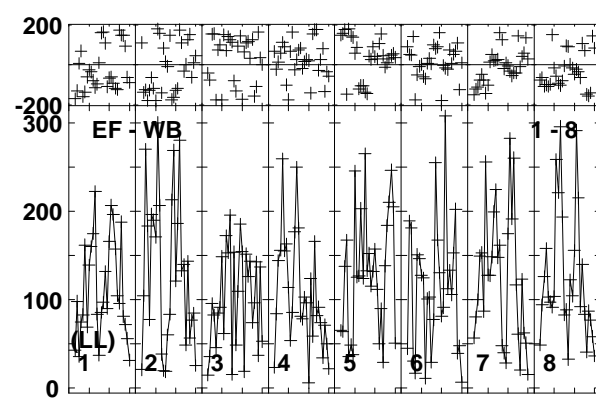
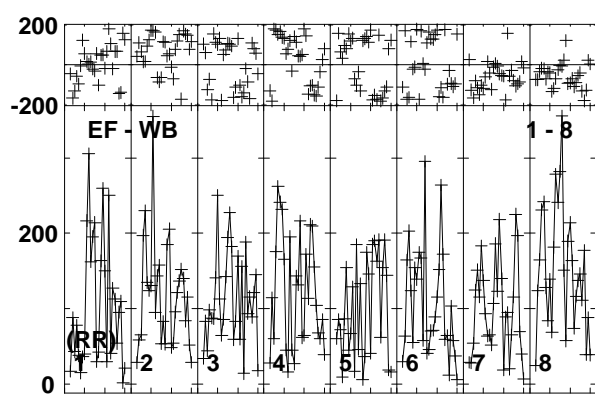
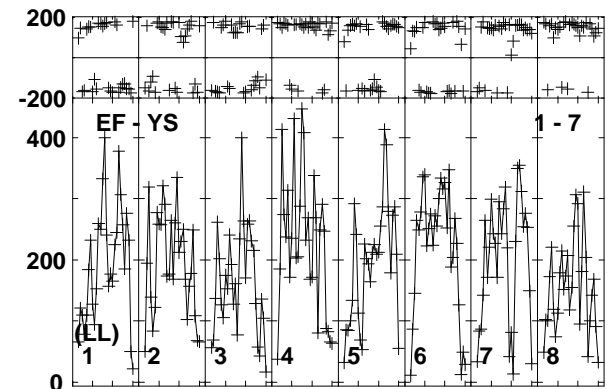
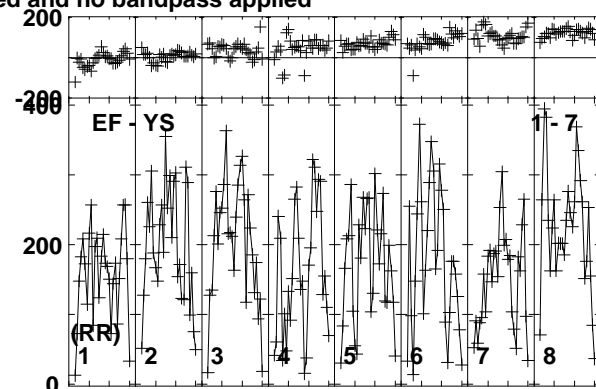
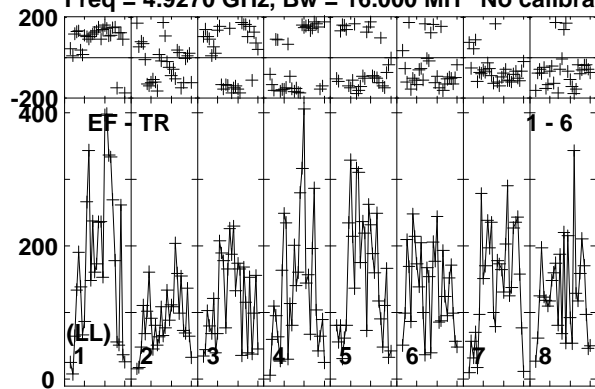

Lower frame: Micro Ampl Jy Top frame: Phas deg  
Vector averaged cross-power spectrum Baseline: EF (01) - TR (06)  
Timerange: 00/23:40:41 to 00/23:43:09

Plot file version 217 created 10-JUN-2016 17:22:23

J1957+3338 RT013A.UVDATA.1

Freq = 4.9270 GHz, Bw = 16.000 MH No calibration applied and no bandpass applied

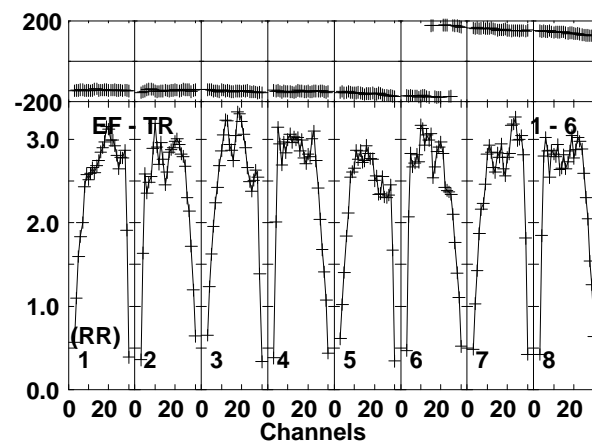
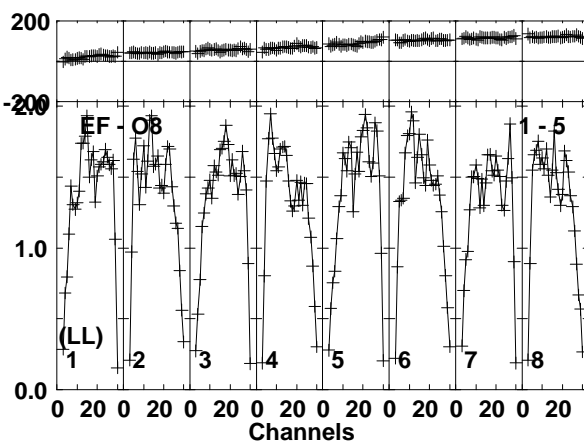
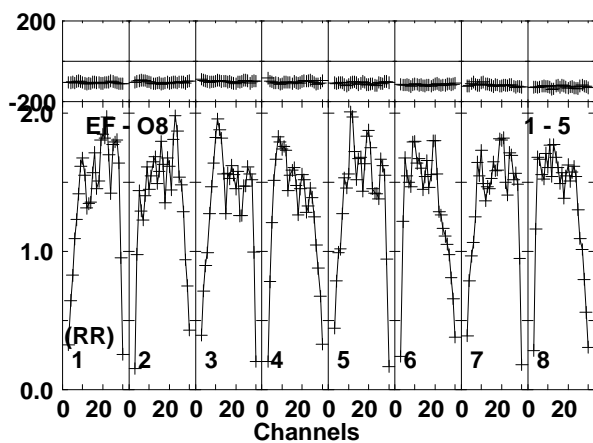
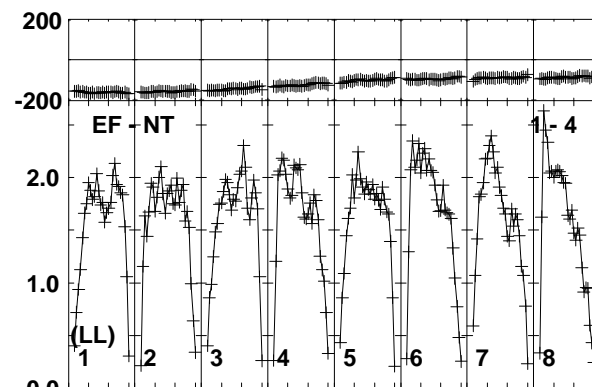
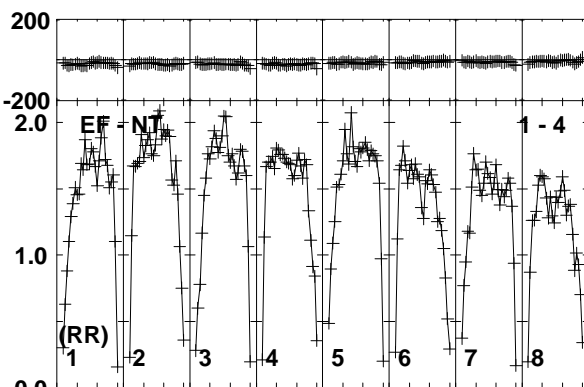
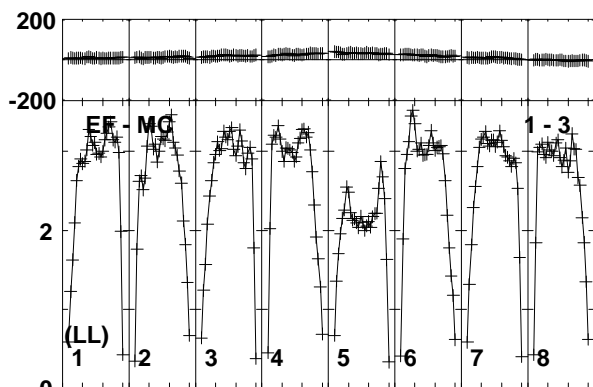
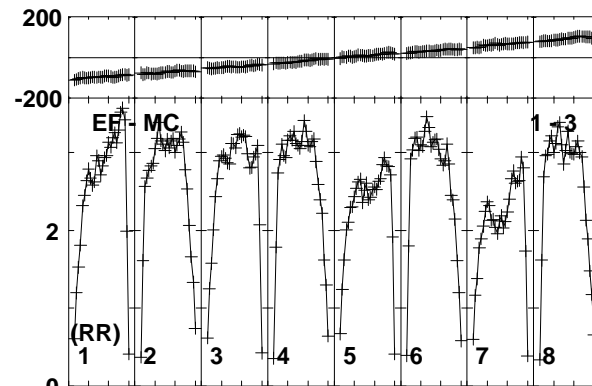
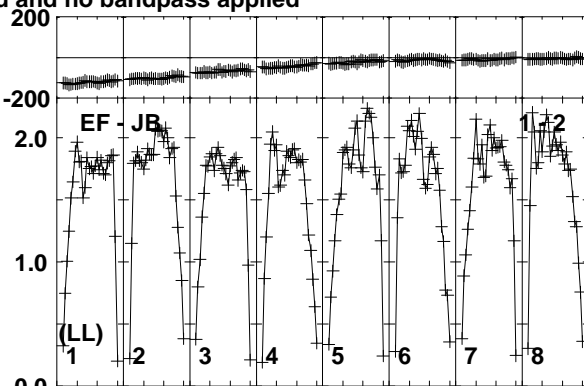
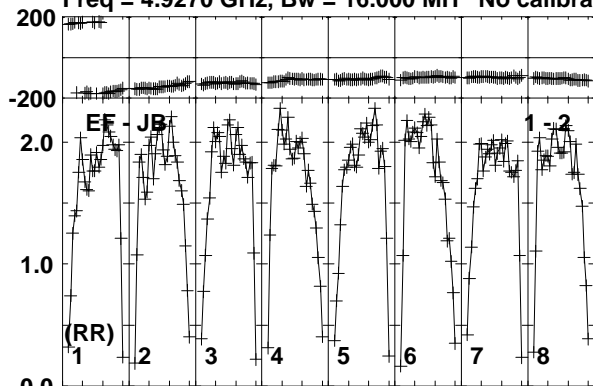

Lower frame: Milli Ampl Jy Top frame: Phas deg  
Vector averaged cross-power spectrum Baseline: EF (01) - JB (02)  
Timerange: 00/23:43:11 to 00/23:44:40

Plot file version 218 created 10-JUN-2016 17:22:23

J1957+3338 RT013A.UVDATA.1

Freq = 4.9270 GHz, Bw = 16.000 MH No calibration applied and no bandpass applied

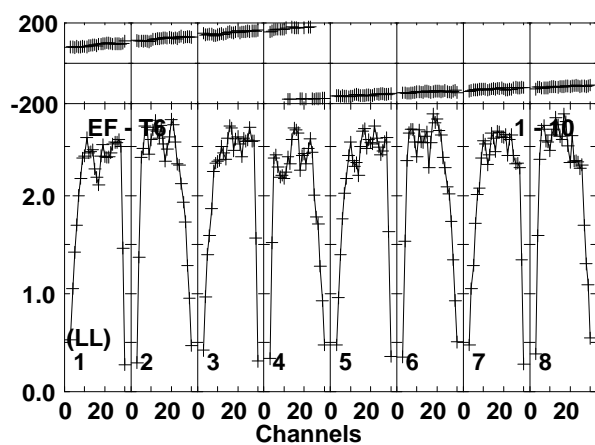
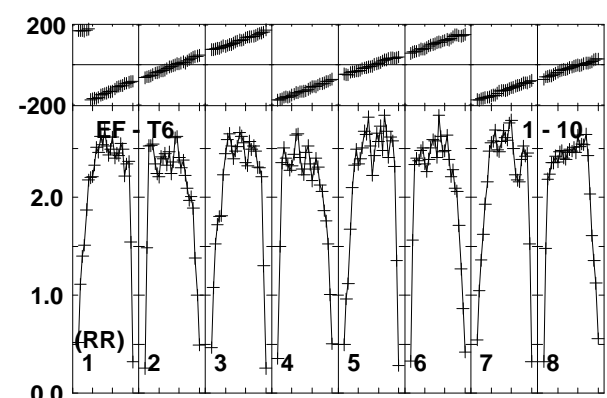
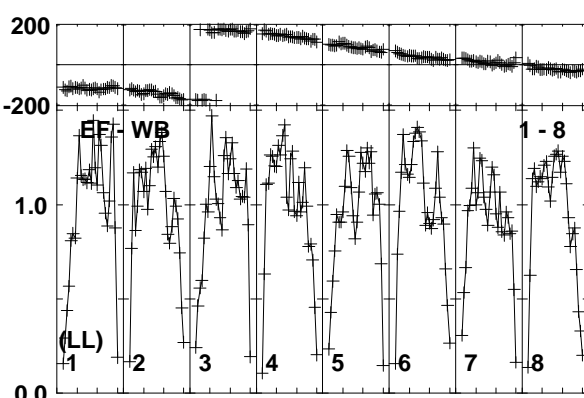
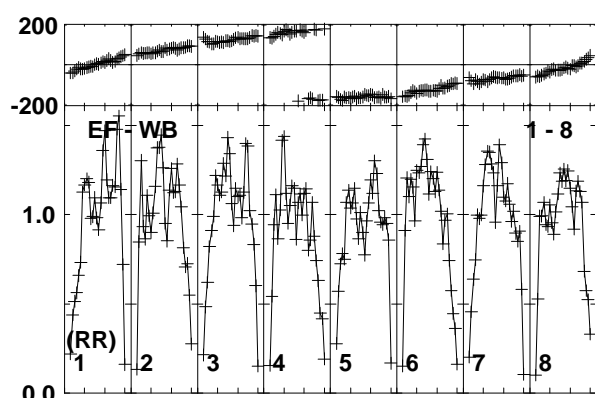
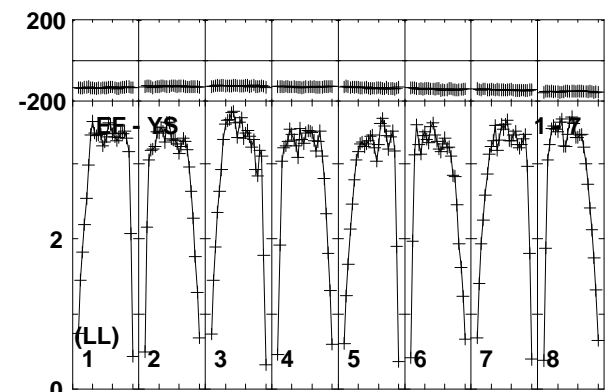
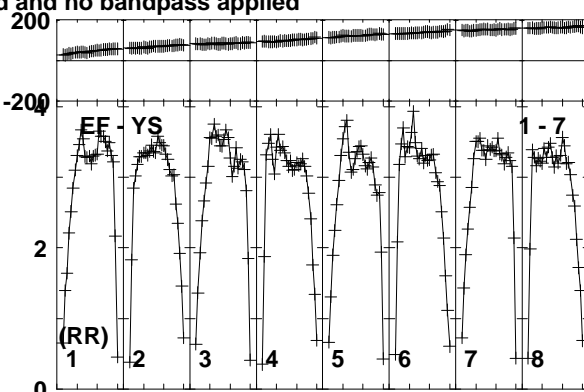
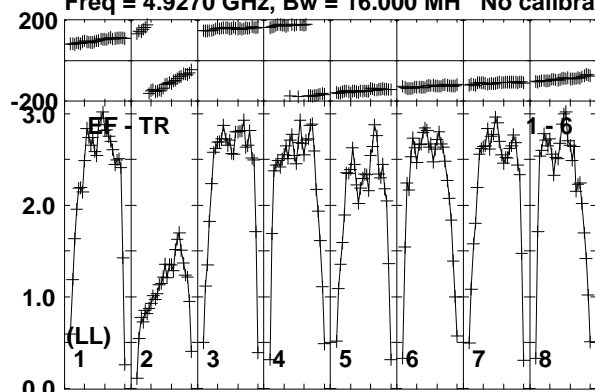

Lower frame: Milli Ampl Jy Top frame: Phas deg  
Vector averaged cross-power spectrum Baseline: EF (01) - TR (06)  
Timerange: 00/23:43:11 to 00/23:44:40



Plot file version 219 created 10-JUN-2016 17:22:23

CHECK RT013A.UVDATA.1

Freq = 4.9270 GHz, Bw = 16.000 MH No calibration applied and no bandpass applied

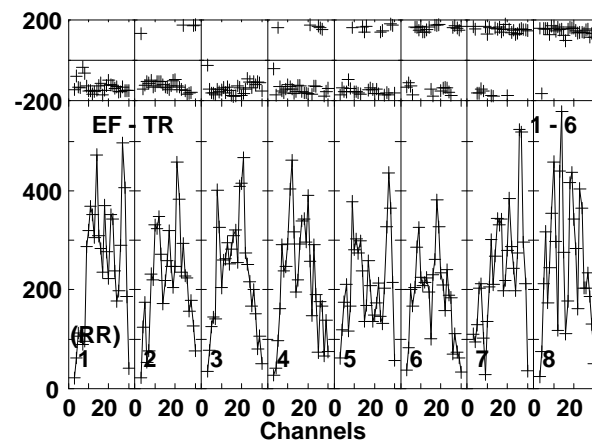
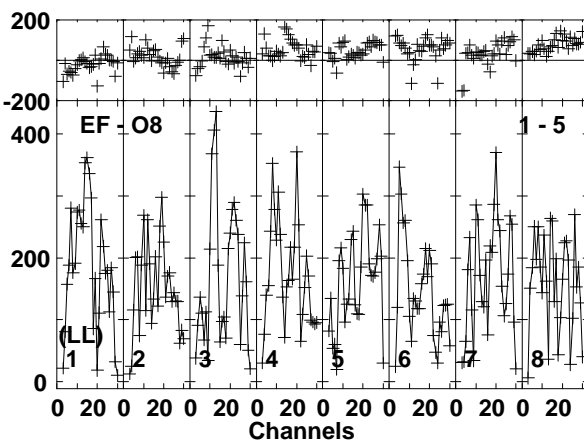
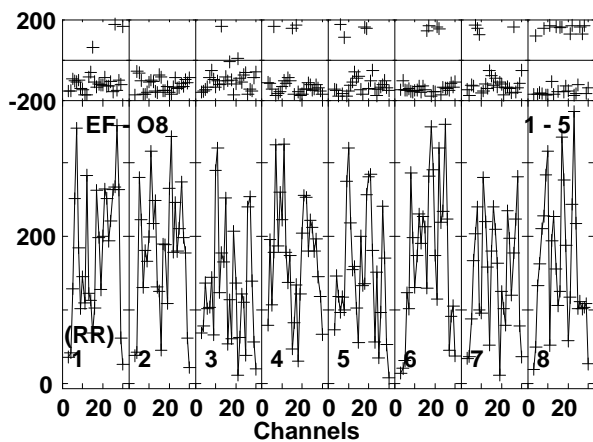
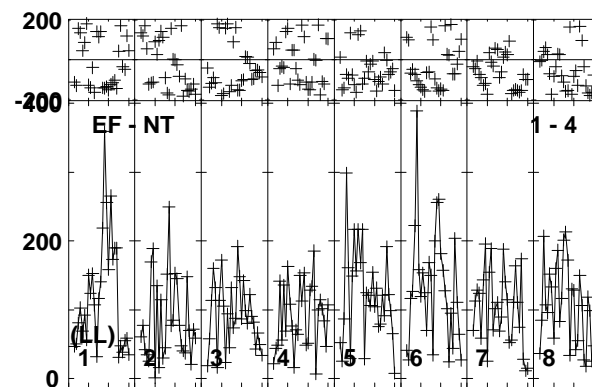
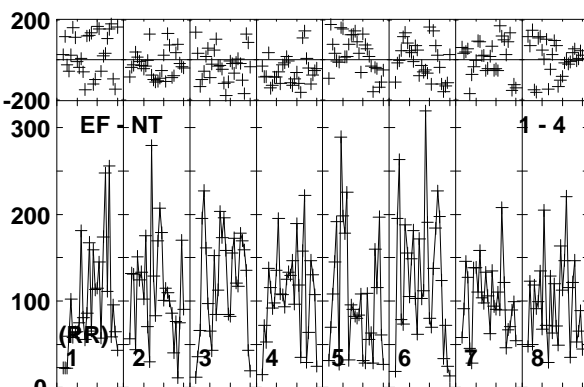
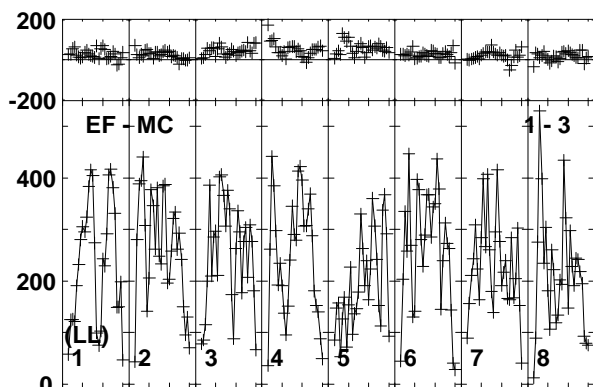
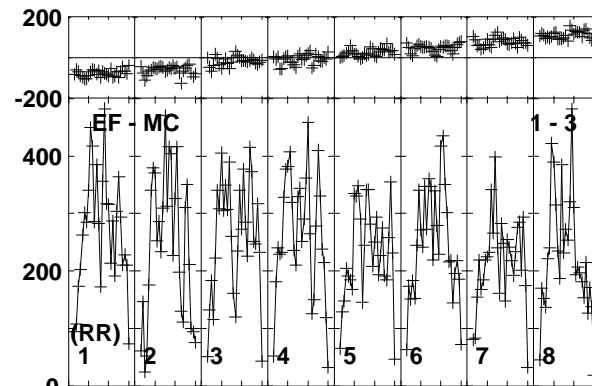
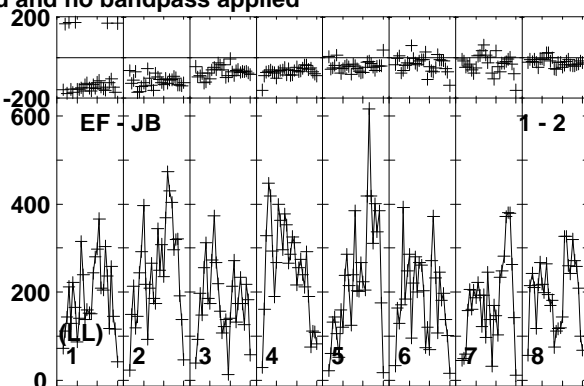
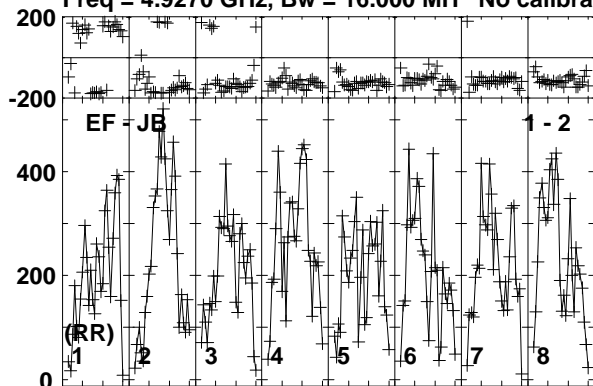

Lower frame: Micro Ampl Jy Top frame: Phas deg  
Vector averaged cross-power spectrum Baseline: EF (01) - JB (02)  
Timerange: 00/23:45:21 to 00/23:47:19

Plot file version 220 created 10-JUN-2016 17:22:23

CHECK RT013A.UVDATA.1

Freq = 4.9270 GHz, Bw = 16.000 MH No calibration applied and no bandpass applied

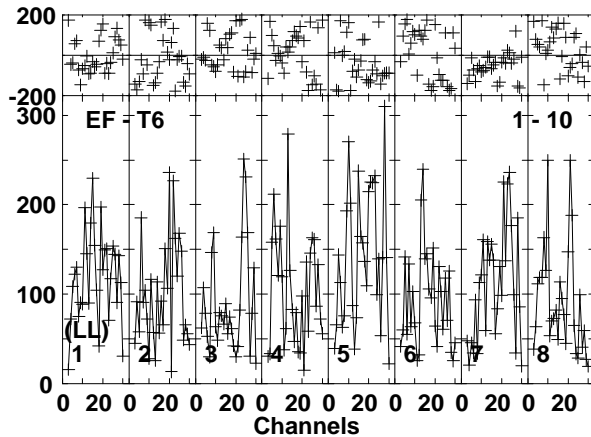
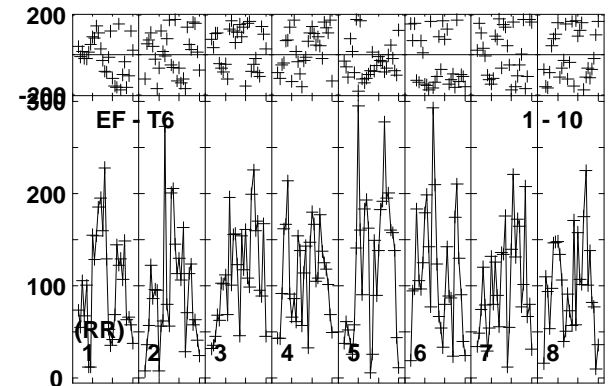
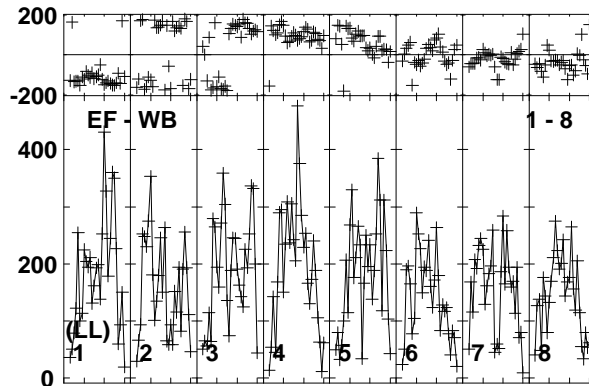
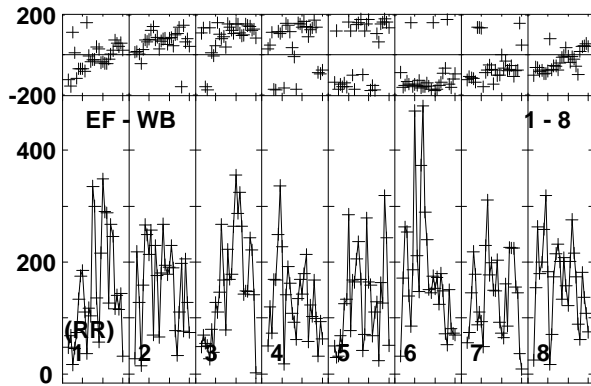
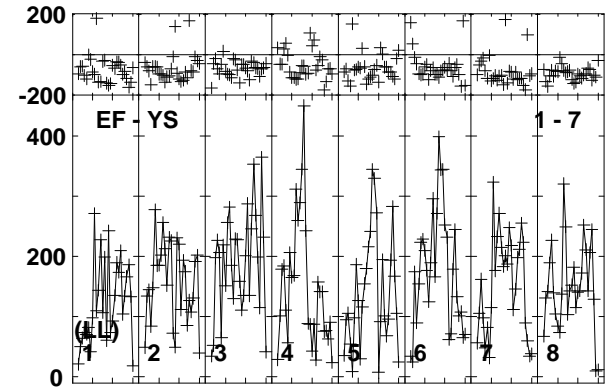
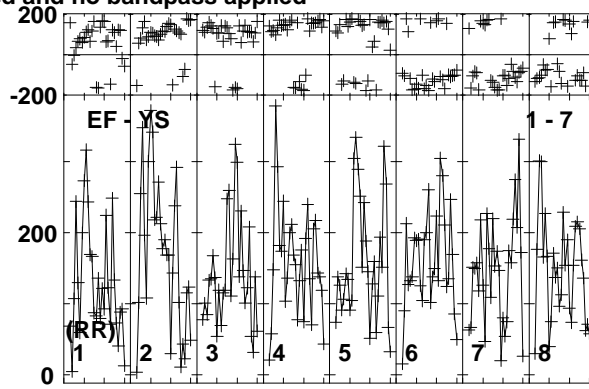
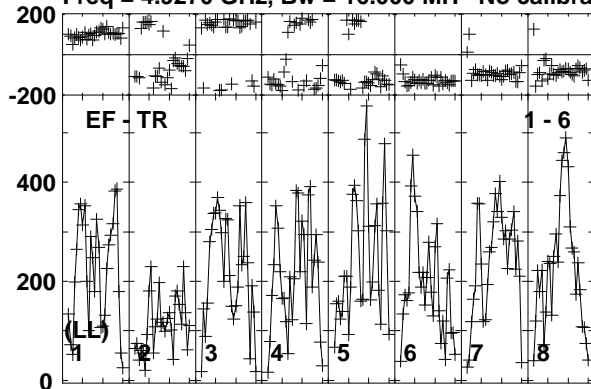

Lower frame: Micro Ampl Jy Top frame: Phas deg  
Vector averaged cross-power spectrum Baseline: EF (01) - TR (06)  
Timerange: 00/23:45:21 to 00/23:47:19

Plot file version 221 created 10-JUN-2016 17:22:24

CYGX1 RT013A.UVDATA.1

Freq = 4.9270 GHz, Bw = 16.000 MH No calibration applied and no bandpass applied

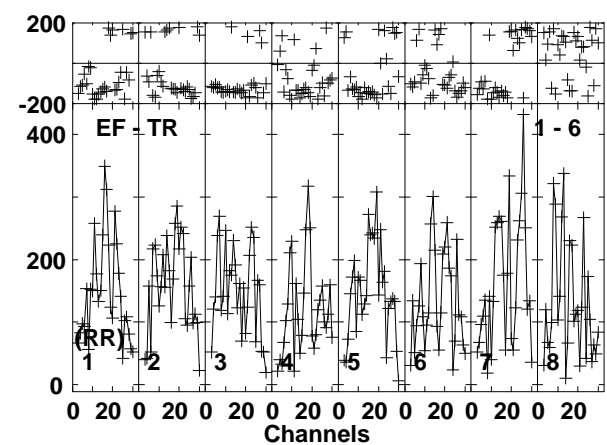
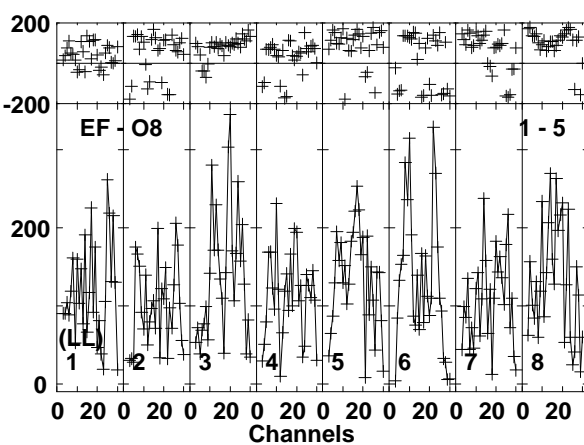
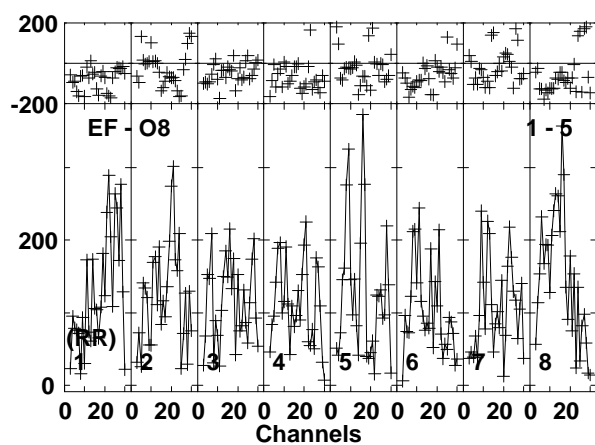
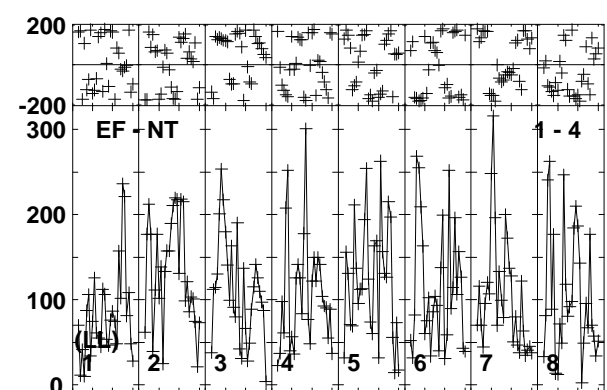
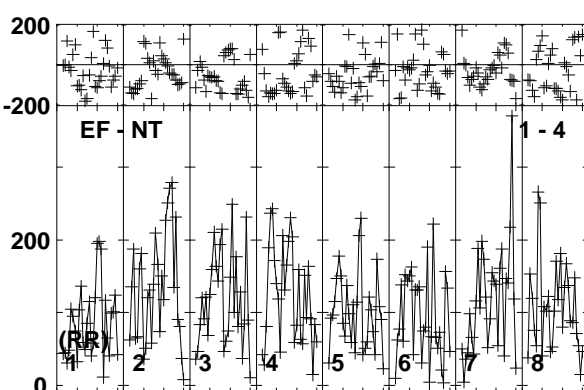
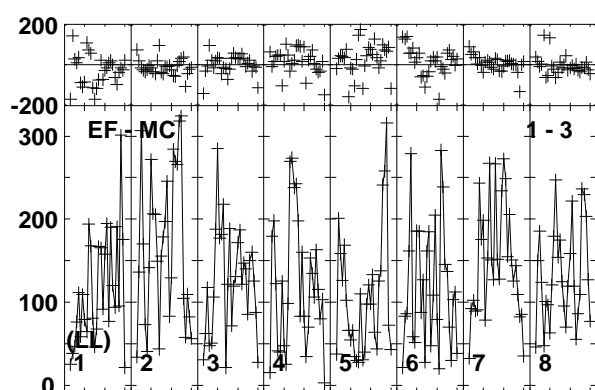
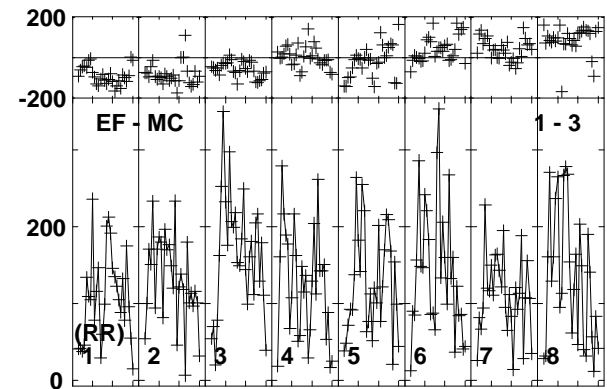
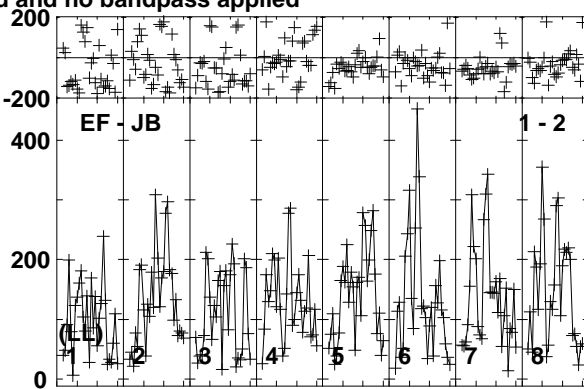
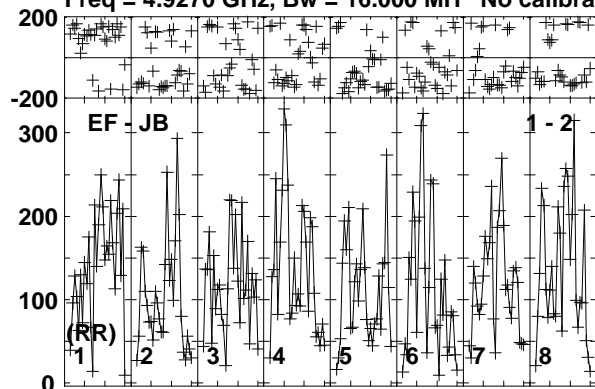

Lower frame: Micro Ampl Jy Top frame: Phas deg  
Vector averaged cross-power spectrum Baseline: EF (01) - JB (02)  
Timerange: 00/23:47:21 to 00/23:49:49

Plot file version 222 created 10-JUN-2016 17:22:24

CYGX1 RT013A.UVDATA.1

Freq = 4.9270 GHz, Bw = 16.000 MH No calibration applied and no bandpass applied

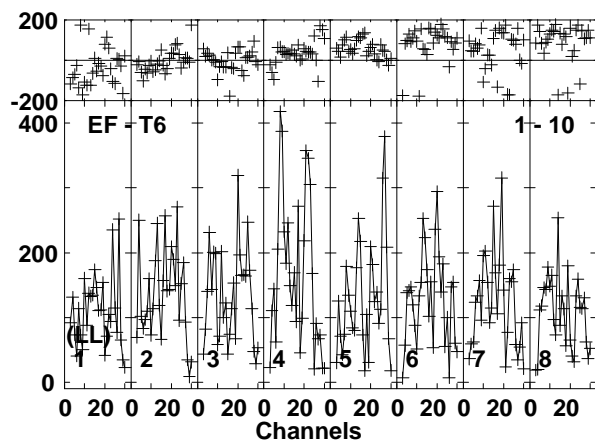
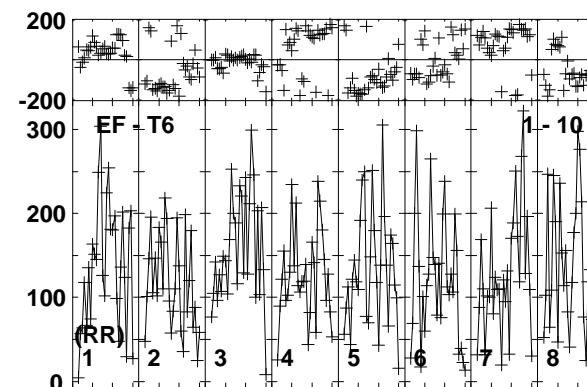
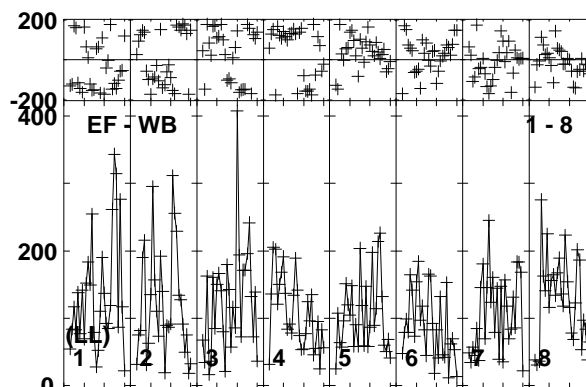
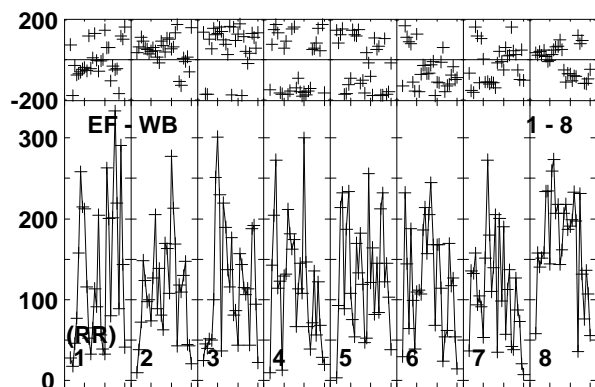
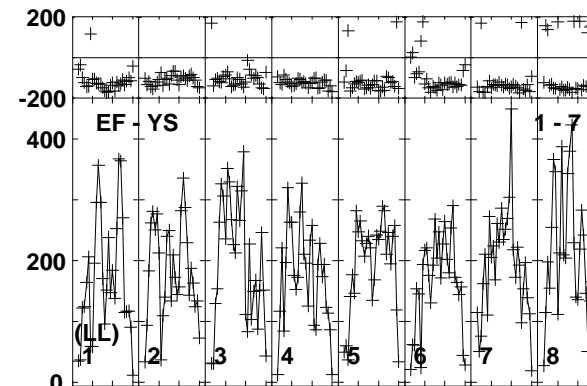
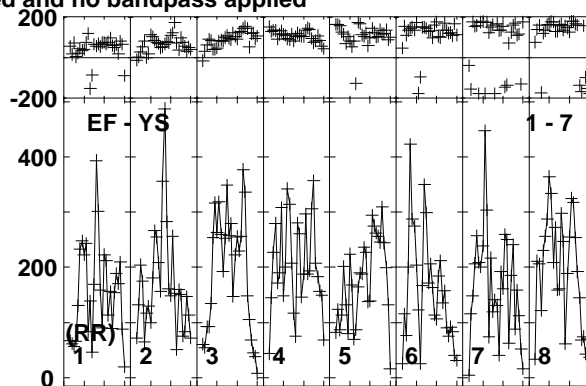
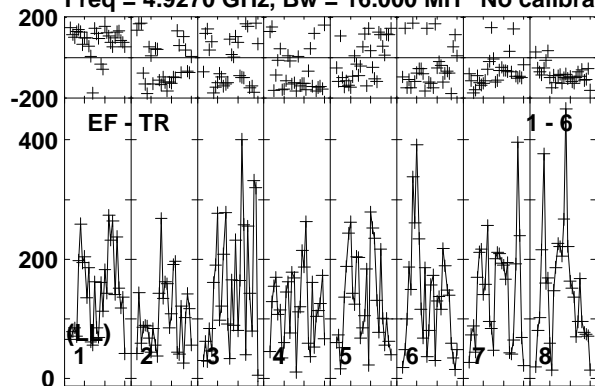

Lower frame: Micro Ampl Jy Top frame: Phas deg  
Vector averaged cross-power spectrum Baseline: EF (01) - TR (06)  
Timerange: 00/23:47:21 to 00/23:49:49

Plot file version 223 created 10-JUN-2016 17:22:24

J1957+3338 RT013A.UVDATA.1

Freq = 4.9270 GHz, Bw = 16.000 MH No calibration applied and no bandpass applied

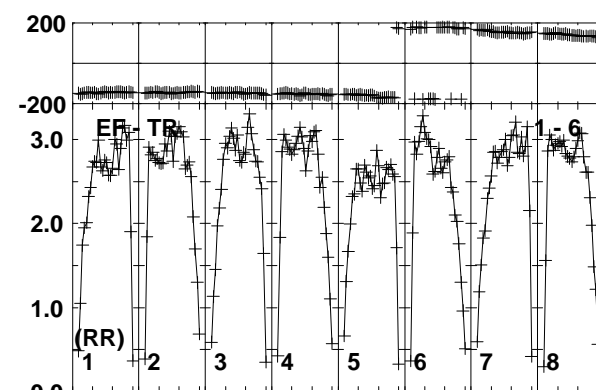
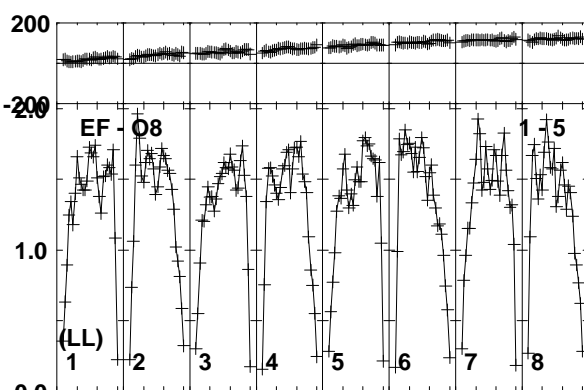
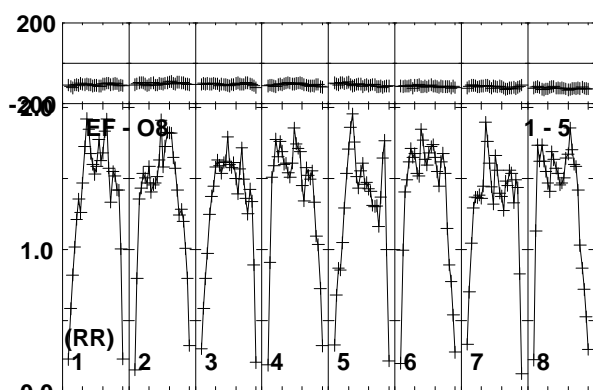
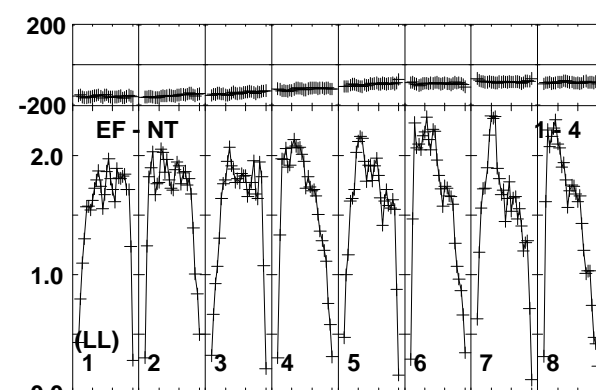
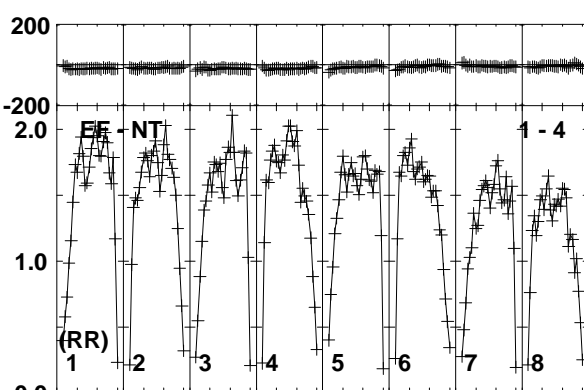
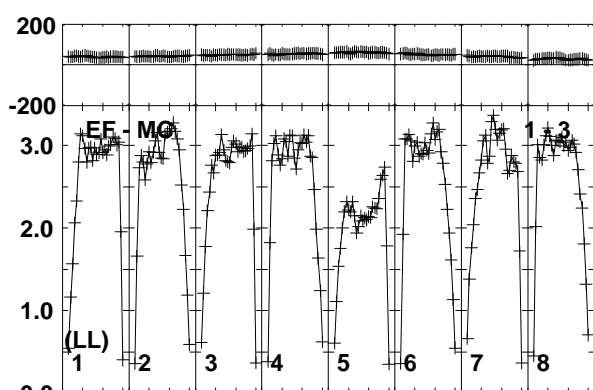
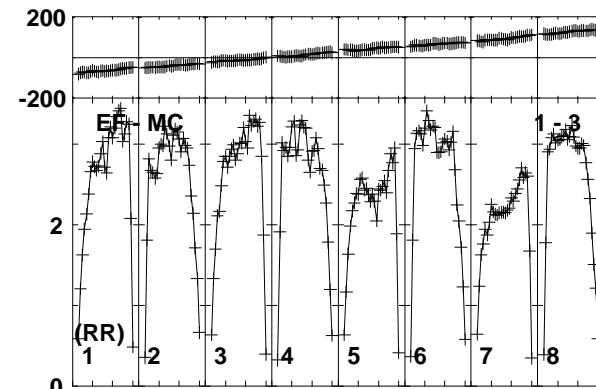
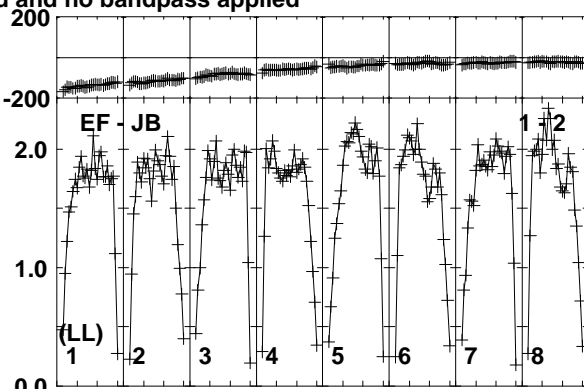
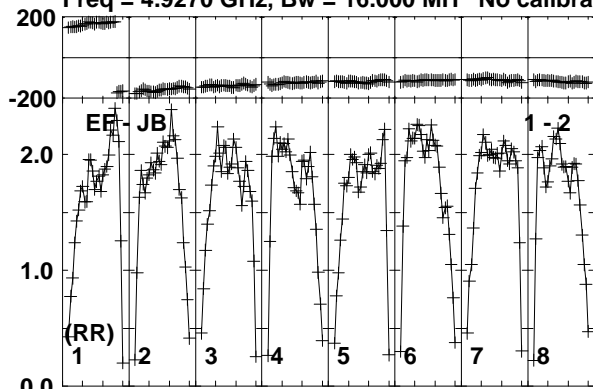

Lower frame: Milli Ampl Jy Top frame: Phas deg  
Vector averaged cross-power spectrum Baseline: EF (01) - JB (02)  
Timerange: 00/23:49:50 to 00/23:51:20

Plot file version 224 created 10-JUN-2016 17:22:24

J1957+3338 RT013A.UVDATA.1

Freq = 4.9270 GHz, Bw = 16.000 MH No calibration applied and no bandpass applied

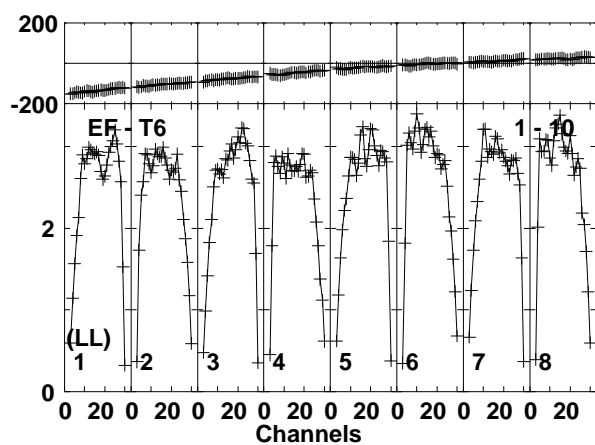
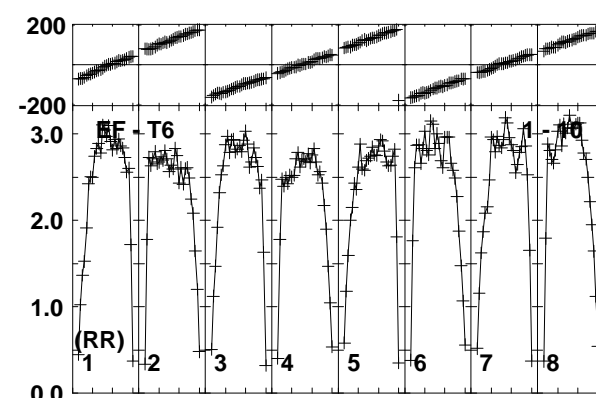
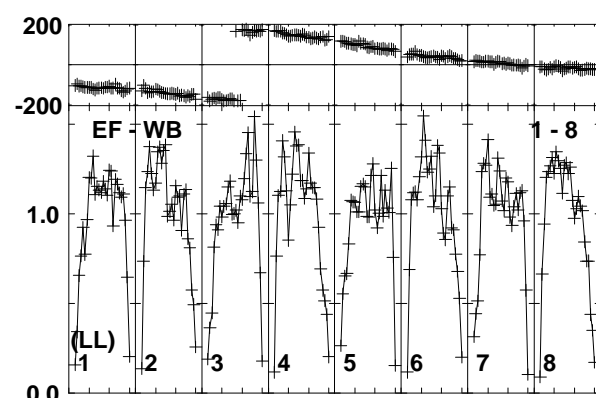
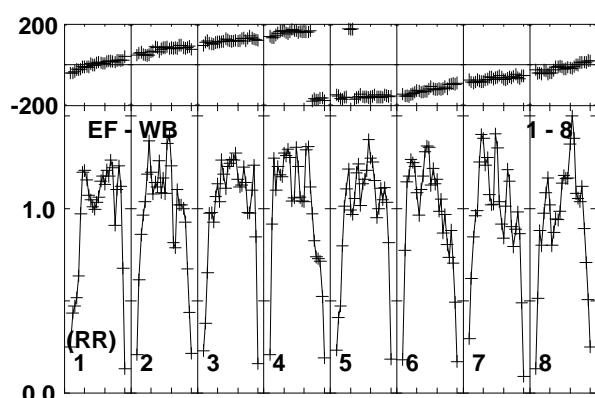
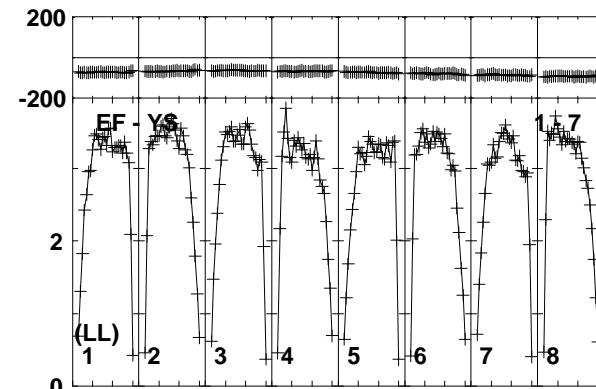
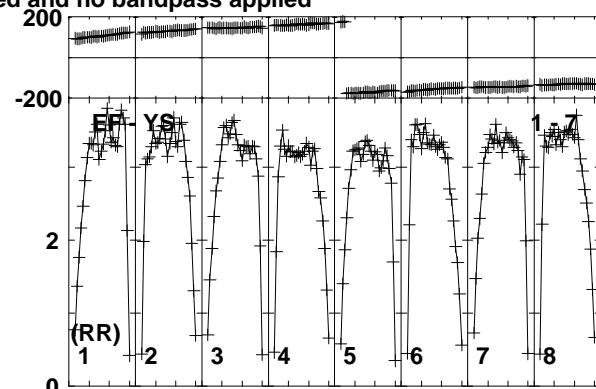
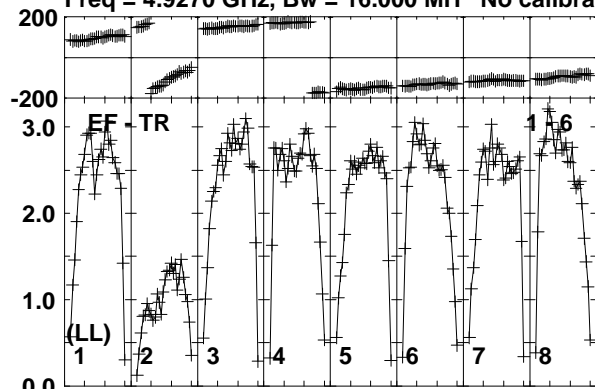

Lower frame: Milli Ampl Jy Top frame: Phas deg  
Vector averaged cross-power spectrum Baseline: EF (01) - TR (06)  
Timerange: 00/23:49:50 to 00/23:51:20

Plot file version 225 created 10-JUN-2016 17:22:24

CHECK RT013A.UVDATA.1

Freq = 4.9270 GHz, Bw = 16.000 MH No calibration applied and no bandpass applied

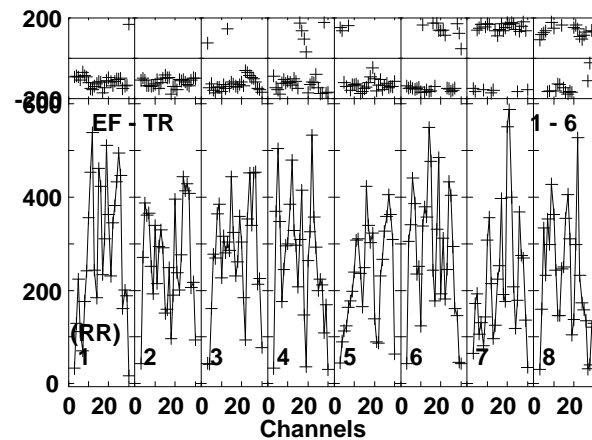
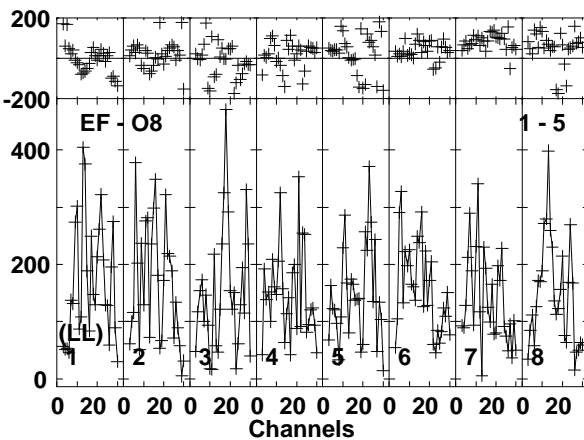
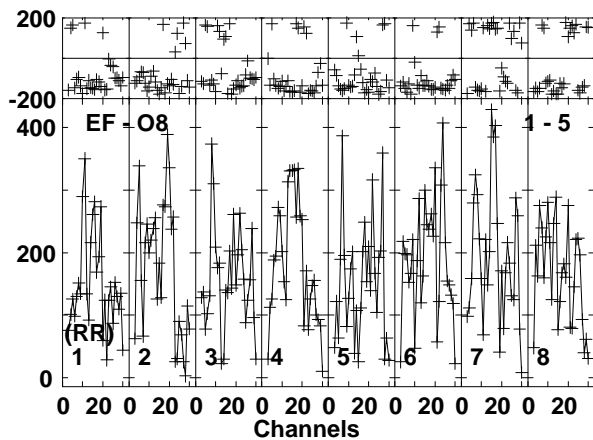
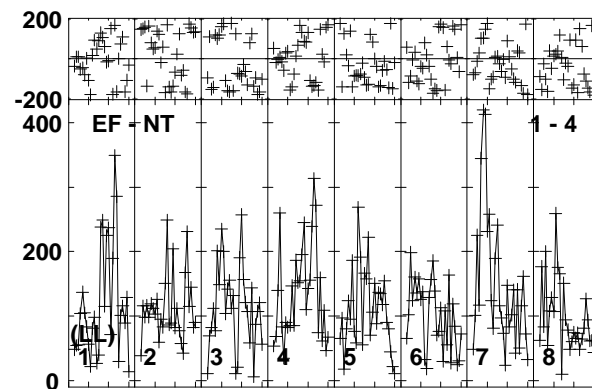
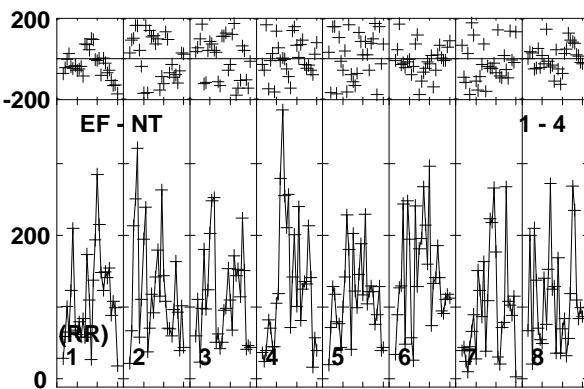
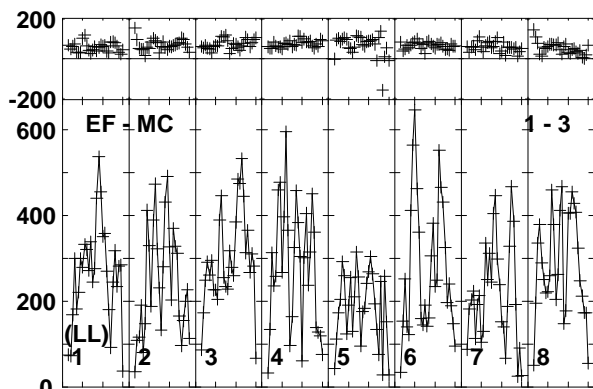
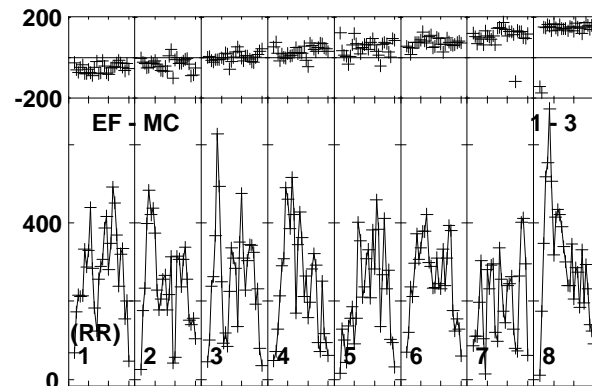
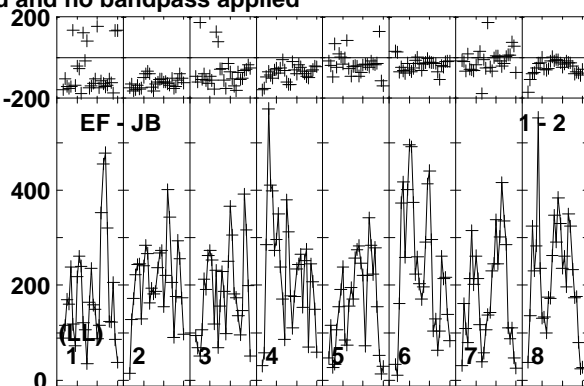
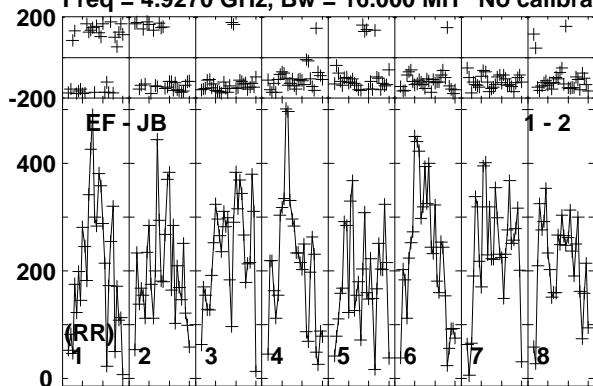

Lower frame: Micro Ampl Jy Top frame: Phas deg  
Vector averaged cross-power spectrum Baseline: EF (01) - JB (02)  
Timerange: 00/23:51:20 to 00/23:53:20

Plot file version 226 created 10-JUN-2016 17:22:24

CHECK RT013A.UVDATA.1

Freq = 4.9270 GHz, Bw = 16.000 MH No calibration applied and no bandpass applied

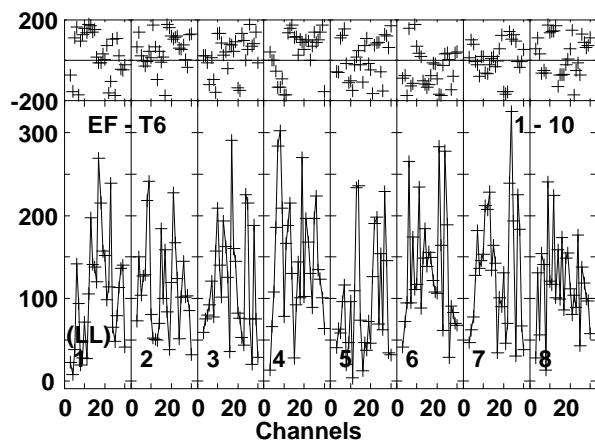
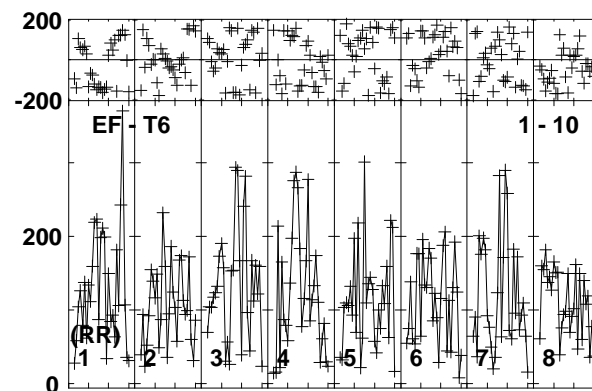
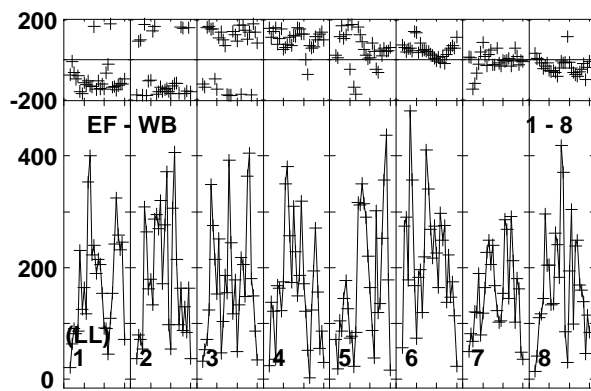
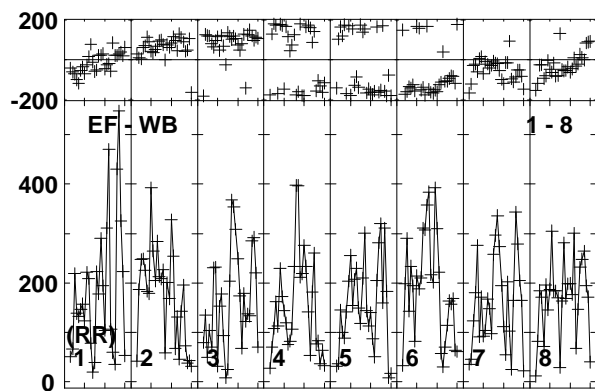
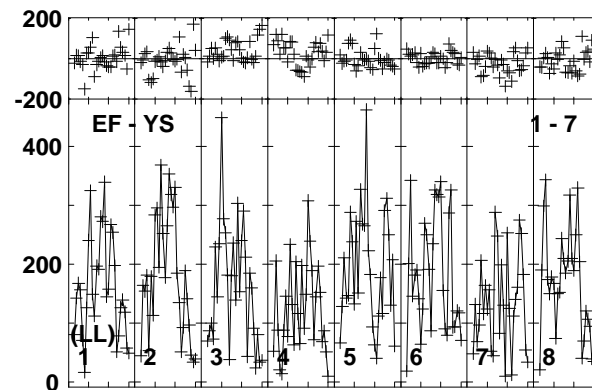
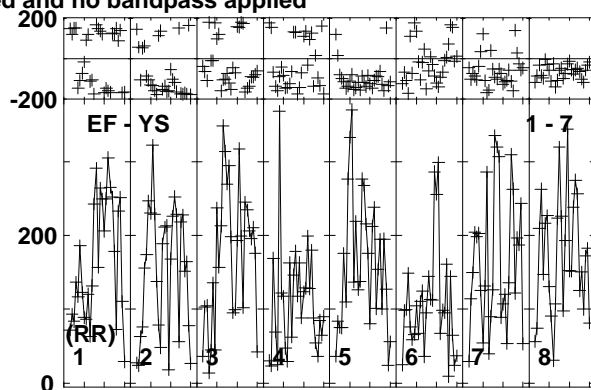
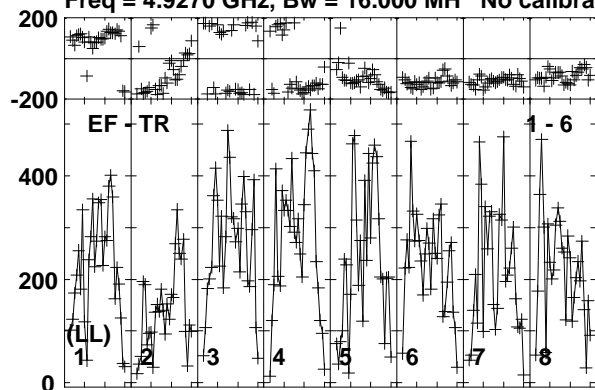

Lower frame: Micro Ampl Jy Top frame: Phas deg  
Vector averaged cross-power spectrum Baseline: EF (01) - TR (06)  
Timerange: 00/23:51:20 to 00/23:53:20



Plot file version 227 created 10-JUN-2016 17:22:24  
CYGX1 RT013A.UVDATA.1

Freq = 4.9270 GHz, Bw = 16.000 MH No calibration applied and no bandpass applied

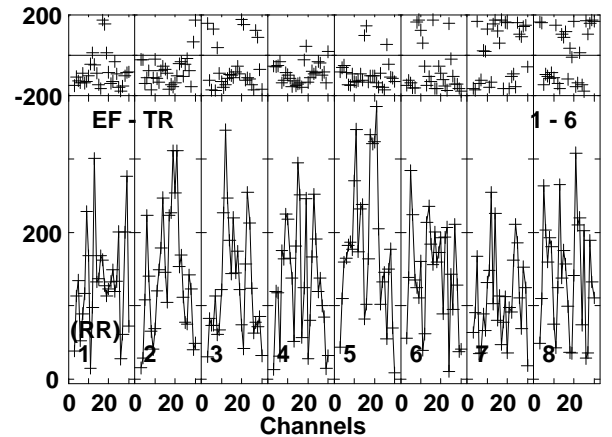
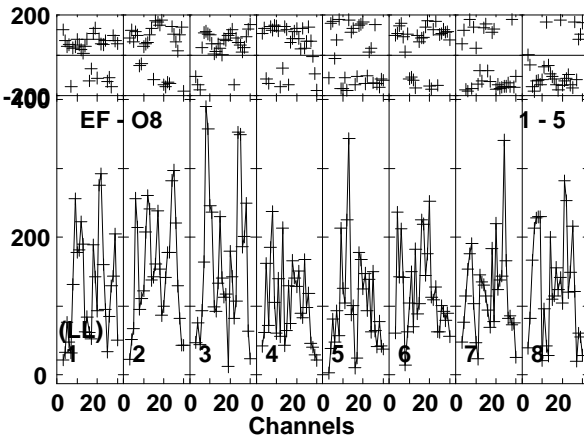
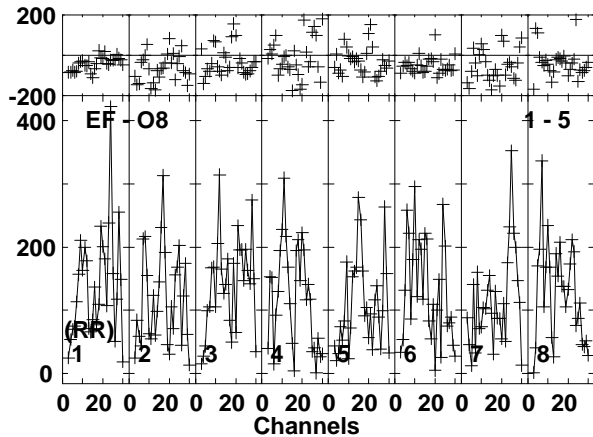
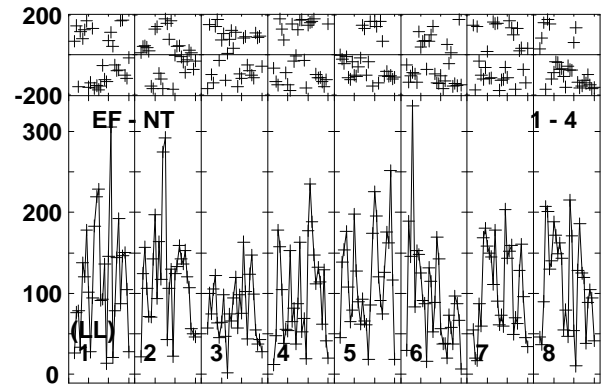
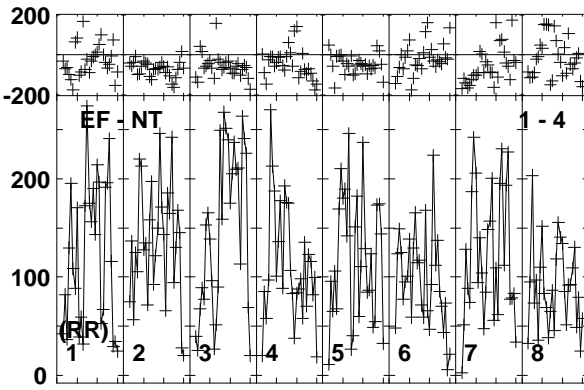
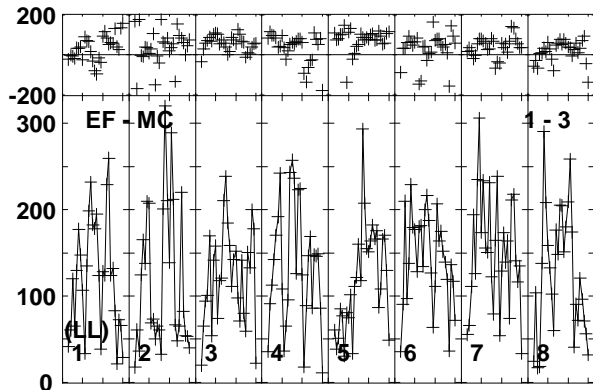
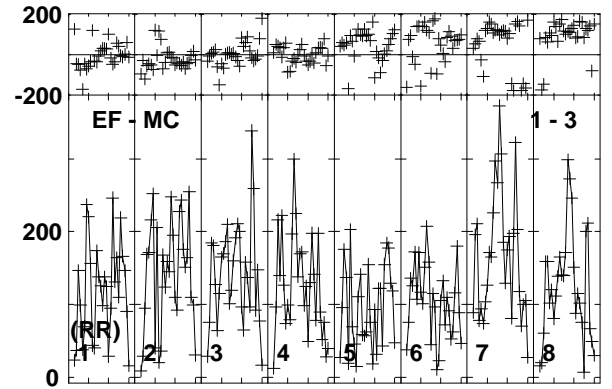
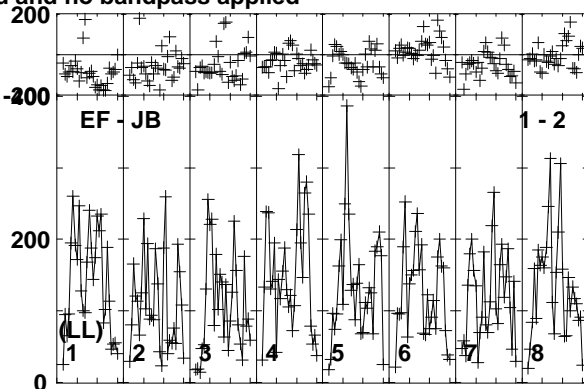
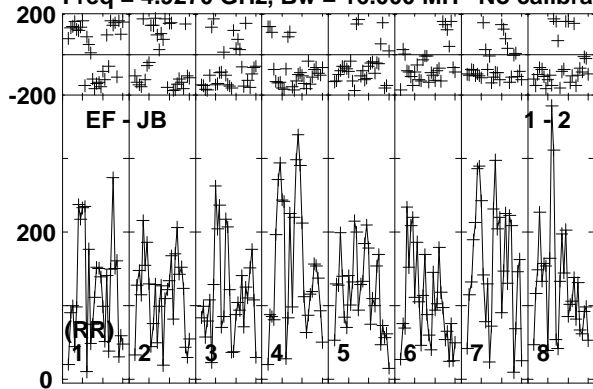

Lower frame: Micro Ampl Jy Top frame: Phas deg  
Vector averaged cross-power spectrum Baseline: EF (01) - JB (02)  
Timerange: 00/23:53:21 to 00/23:55:49

Plot file version 228 created 10-JUN-2016 17:22:24

CYGX1 RT013A.UVDATA.1

Freq = 4.9270 GHz, Bw = 16.000 MH No calibration applied and no bandpass applied

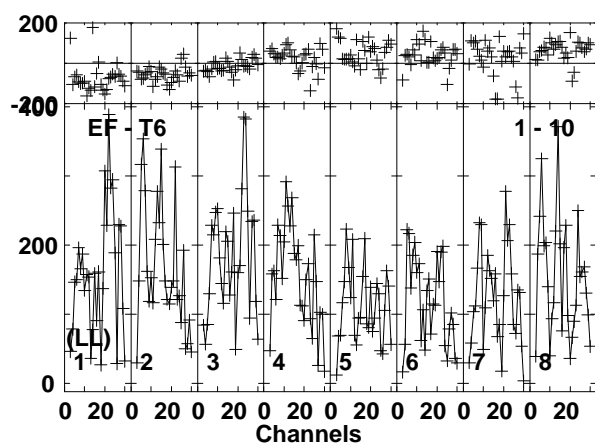
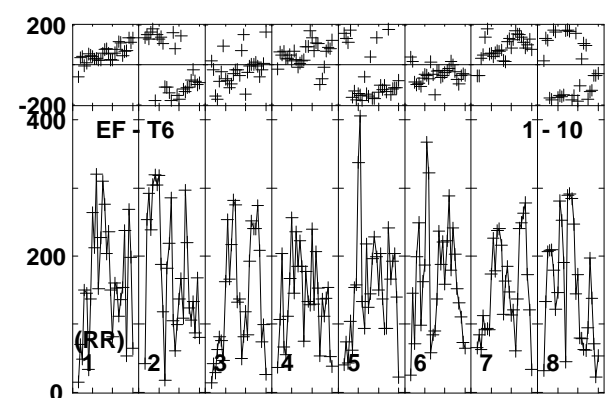
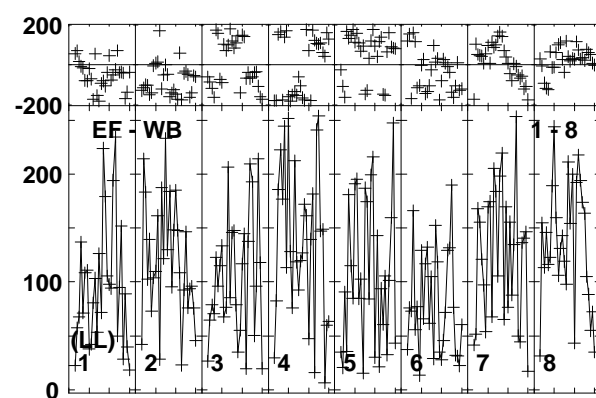
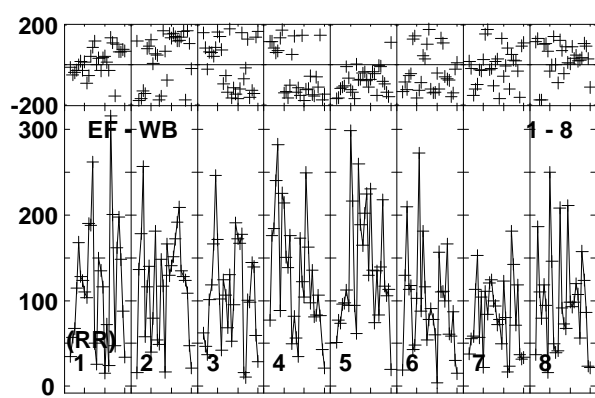
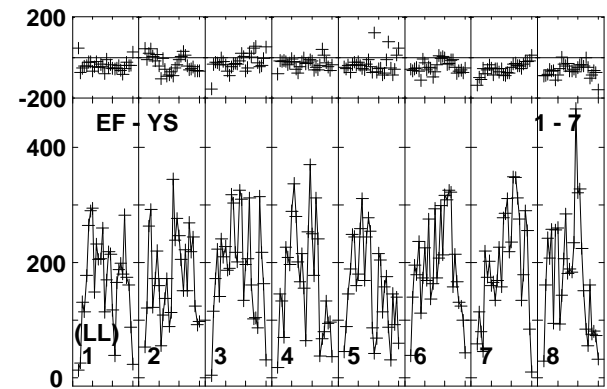
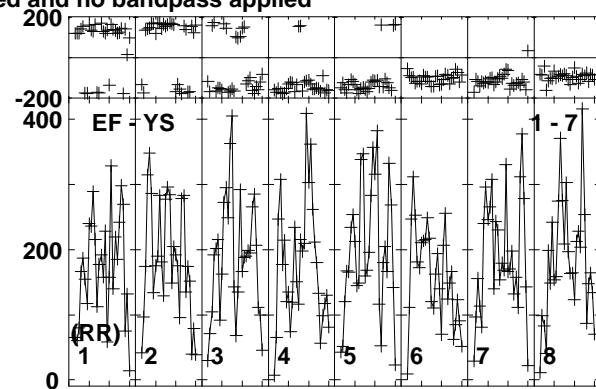
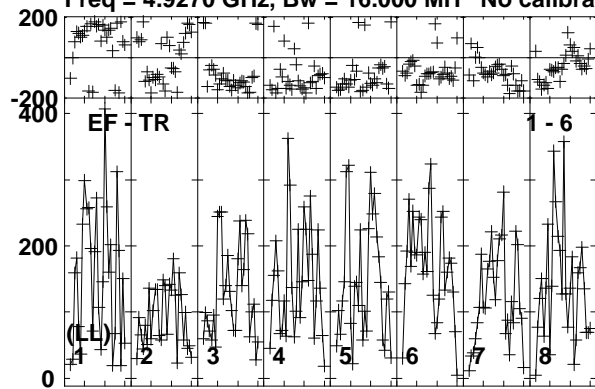

Lower frame: Micro Ampl Jy Top frame: Phas deg  
Vector averaged cross-power spectrum Baseline: EF (01) - TR (06)  
Timerange: 00/23:53:21 to 00/23:55:49

Plot file version 229 created 10-JUN-2016 17:22:24

J1957+3338 RT013A.UVDATA.1

Freq = 4.9270 GHz, Bw = 16.000 MH No calibration applied and no bandpass applied

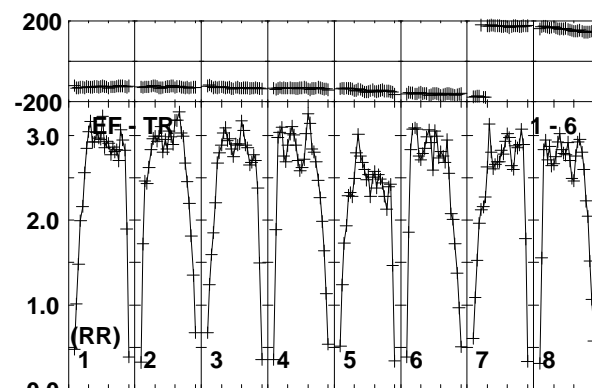
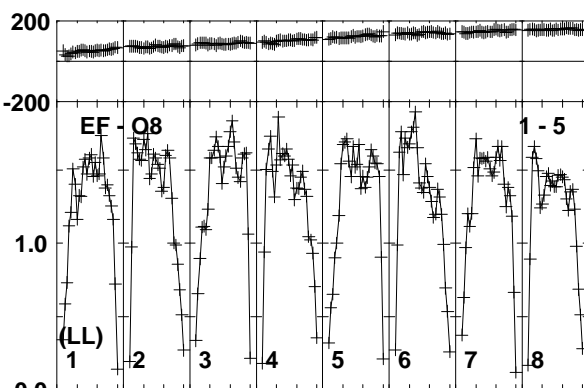
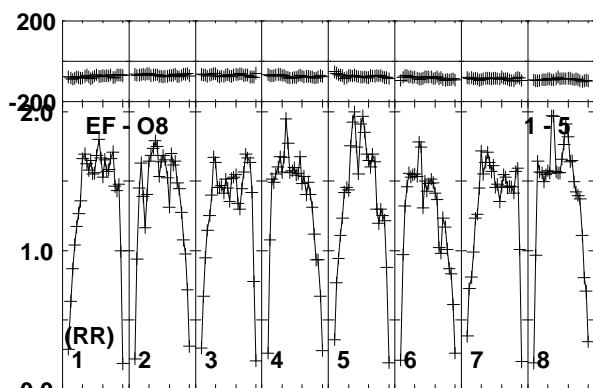
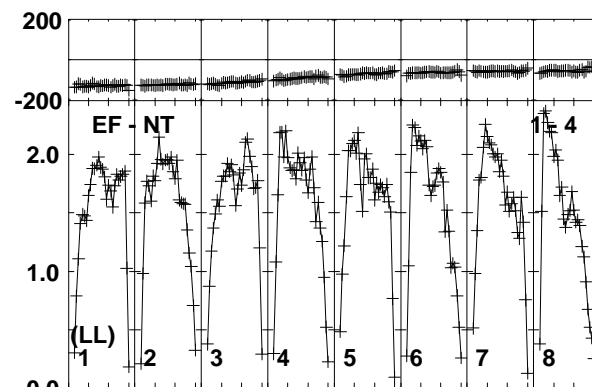
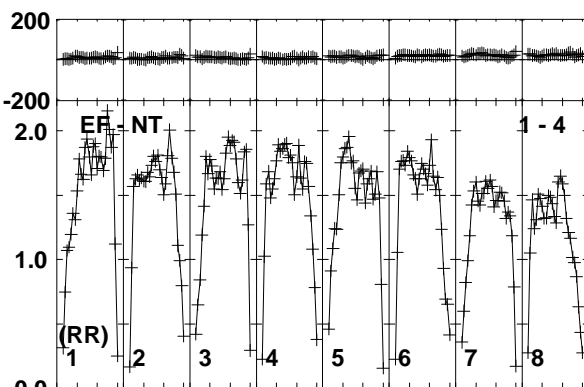
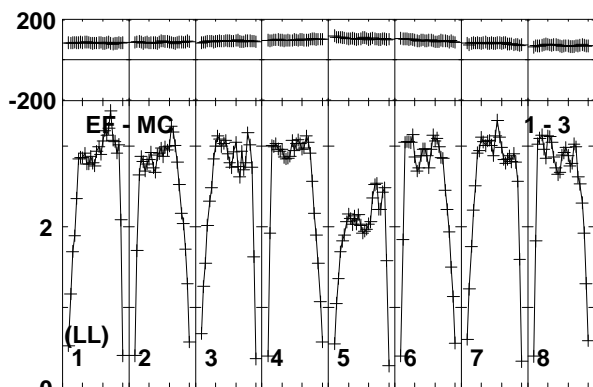
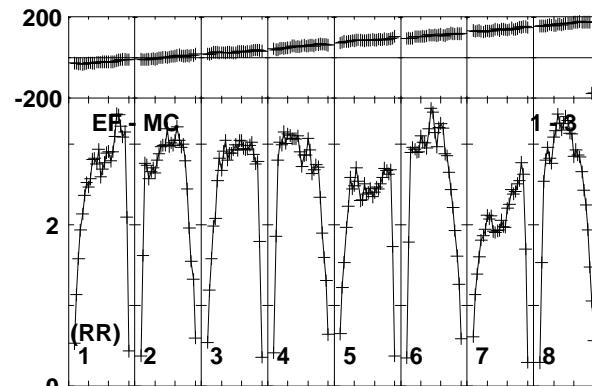
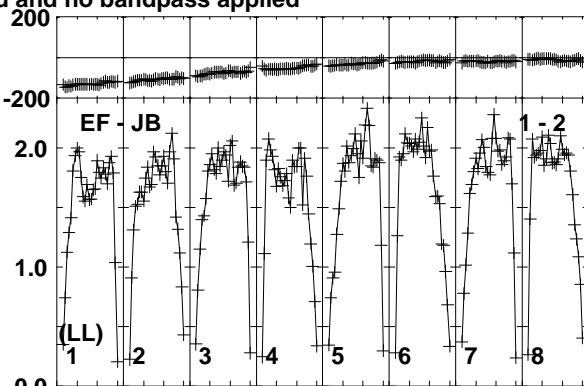
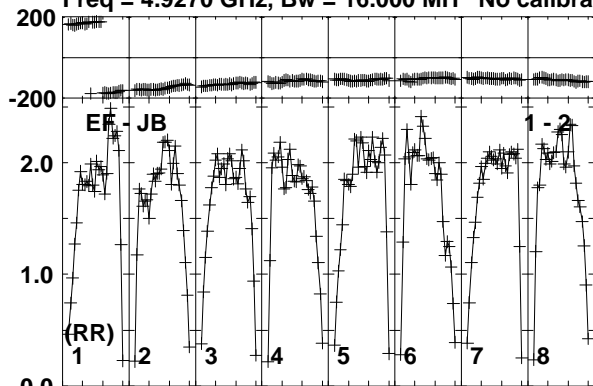

Lower frame: Milli Ampl Jy Top frame: Phas deg  
Vector averaged cross-power spectrum Baseline: EF (01) - JB (02)  
Timerange: 00/23:55:51 to 00/23:57:20

Plot file version 230 created 10-JUN-2016 17:22:25

J1957+3338 RT013A.UVDATA.1

Freq = 4.9270 GHz, Bw = 16.000 MH No calibration applied and no bandpass applied

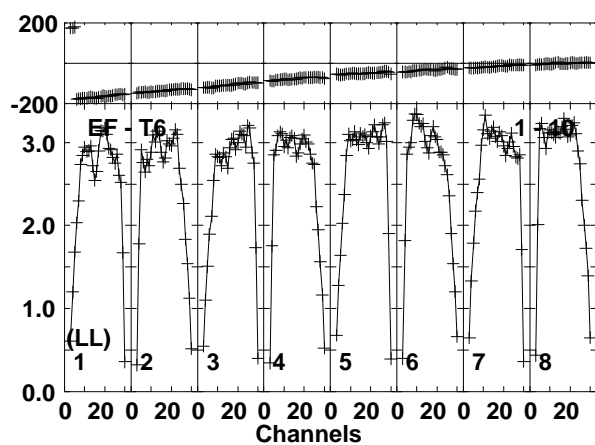
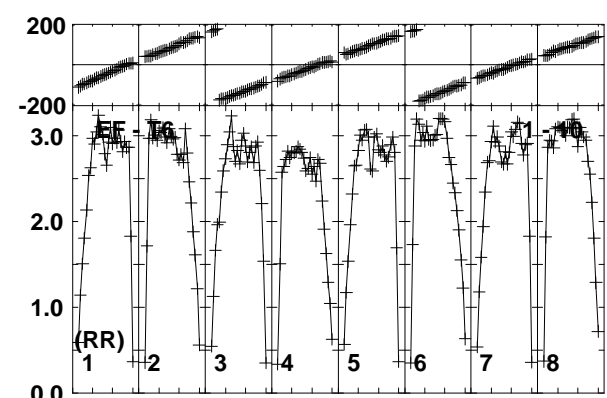
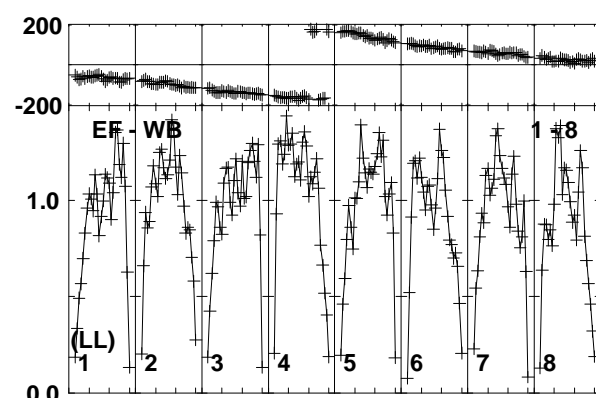
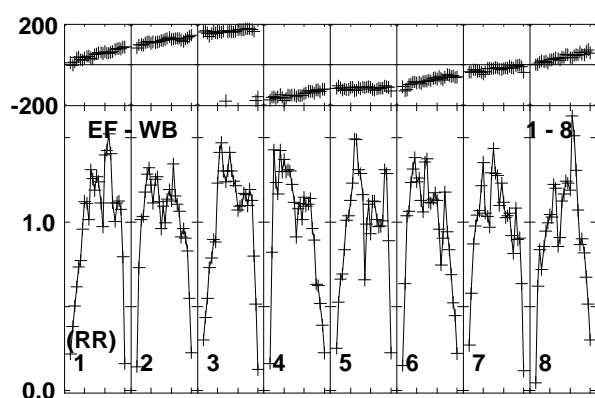
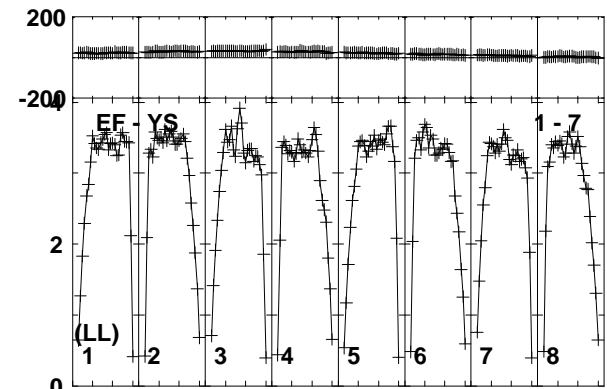
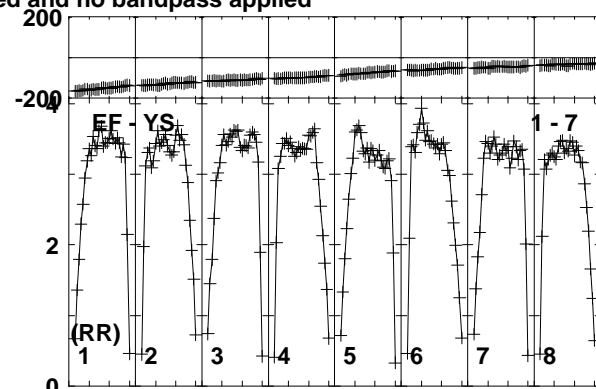
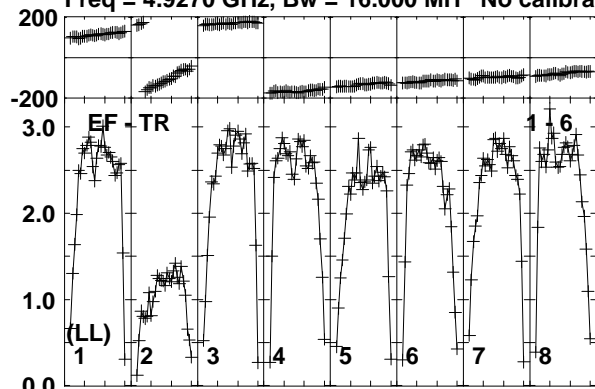

Lower frame: Milli Ampl Jy Top frame: Phas deg  
Vector averaged cross-power spectrum Baseline: EF (01) - TR (06)  
Timerange: 00/23:55:51 to 00/23:57:20

Plot file version 231 created 10-JUN-2016 17:22:25

CHECK RT013A.UVDATA.1

Freq = 4.9270 GHz, Bw = 16.000 MH No calibration applied and no bandpass applied

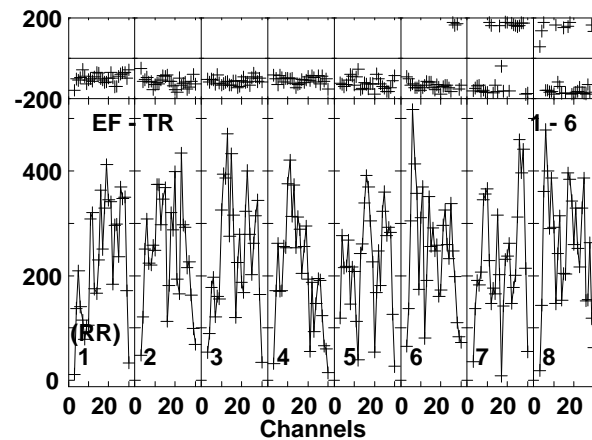
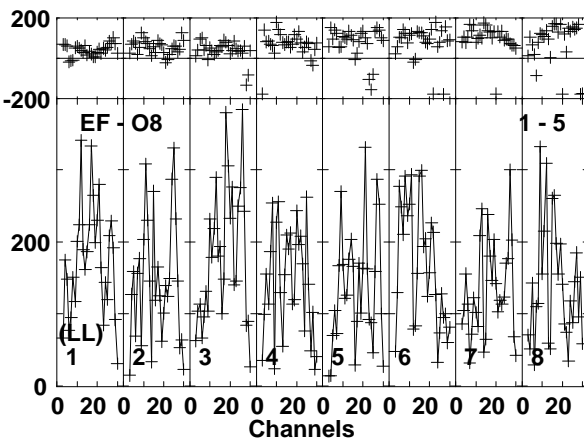
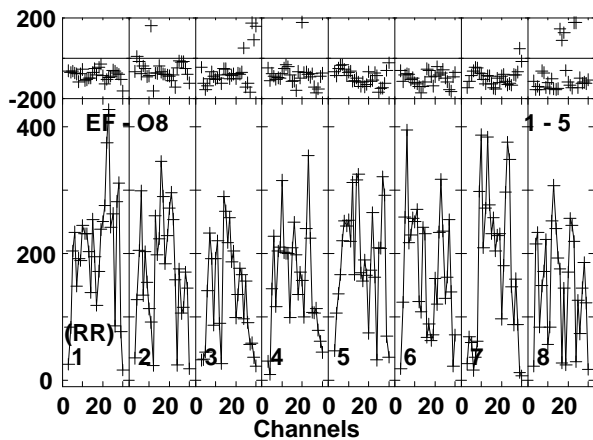
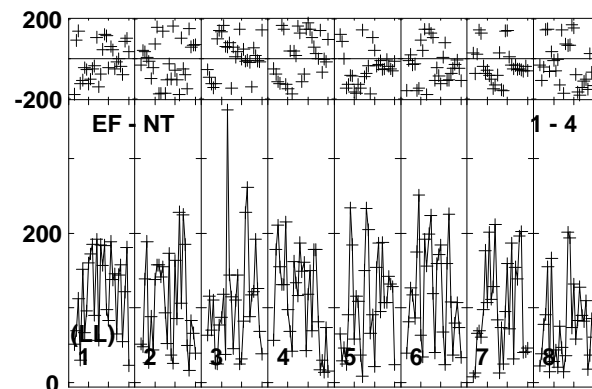
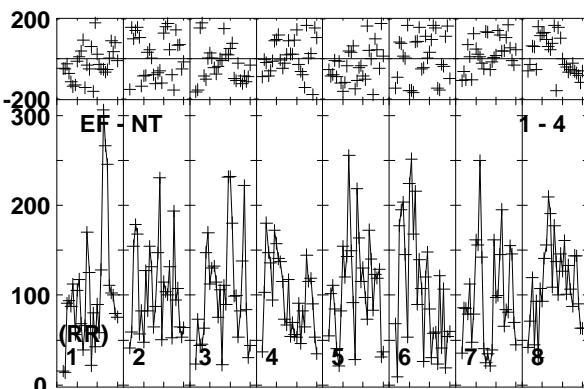
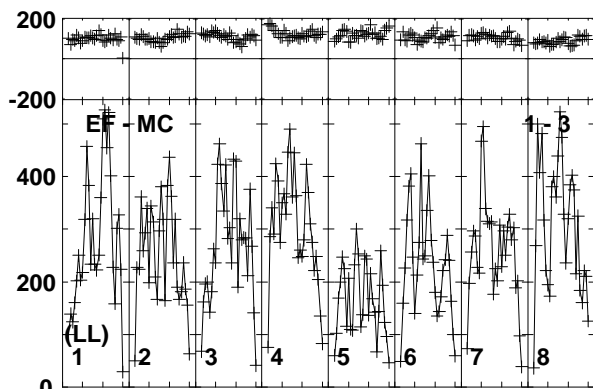
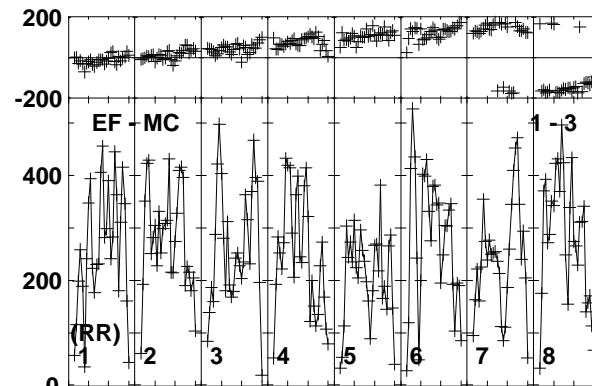
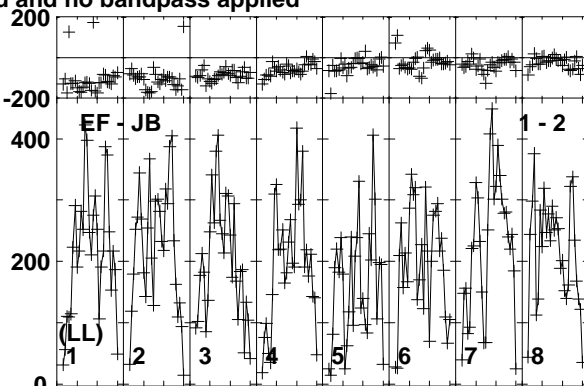
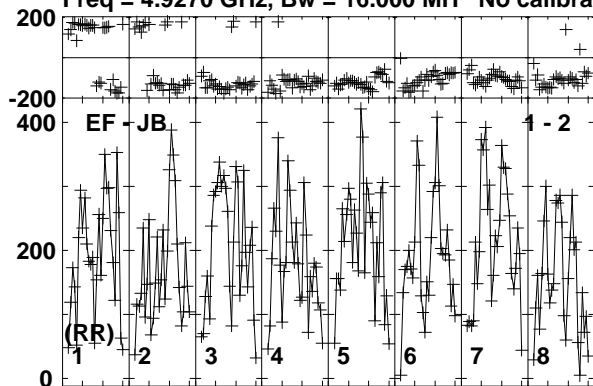

Lower frame: Micro Ampl Jy Top frame: Phas deg  
Vector averaged cross-power spectrum Baseline: EF (01) - JB (02)  
Timerange: 00/23:58:00 to 00/23:59:59

Plot file version 232 created 10-JUN-2016 17:22:25

CHECK RT013A.UVDATA.1

Freq = 4.9270 GHz, Bw = 16.000 MH No calibration applied and no bandpass applied

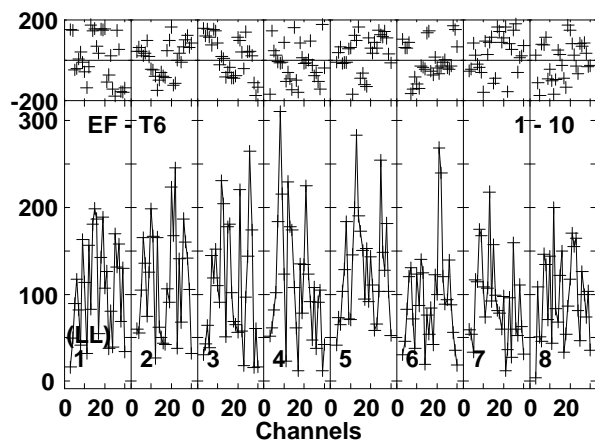
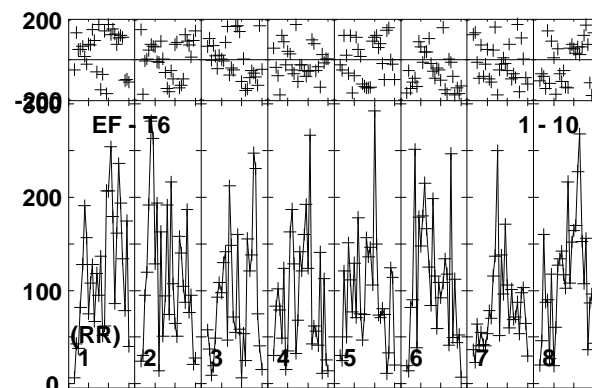
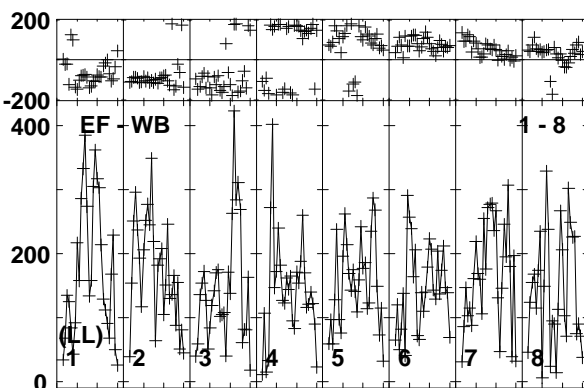
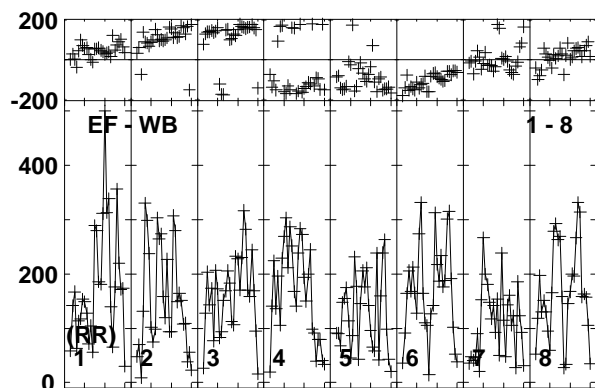
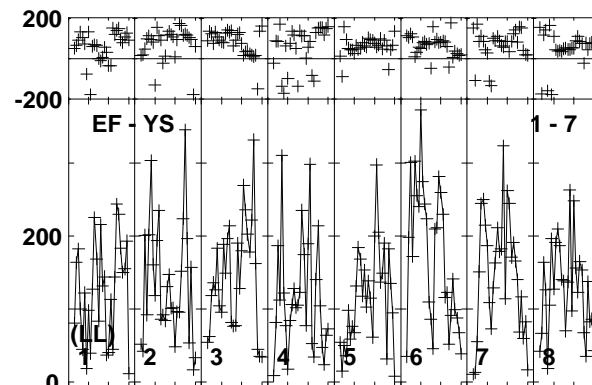
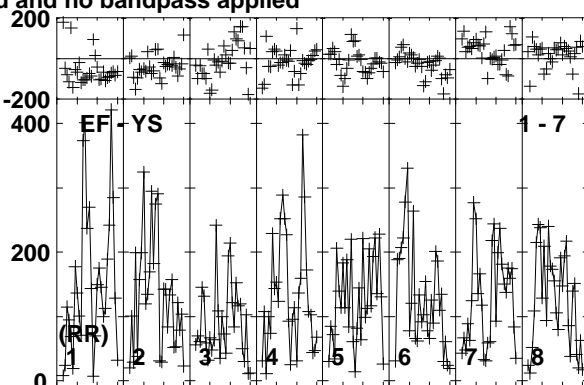
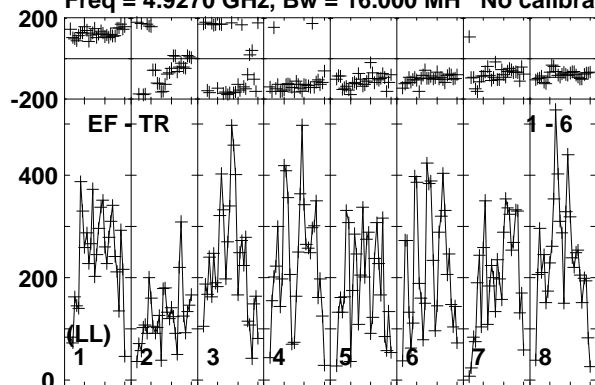

Lower frame: Micro Ampl Jy Top frame: Phas deg  
Vector averaged cross-power spectrum Baseline: EF (01) - TR (06)  
Timerange: 00/23:58:00 to 00/23:59:59

Plot file version 233 created 10-JUN-2016 17:22:25

CYGX1 RT013A.UVDATA.1

Freq = 4.9270 GHz, Bw = 16.000 MH No calibration applied and no bandpass applied

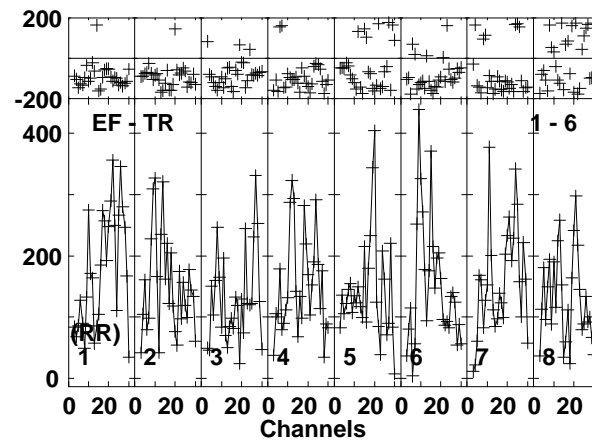
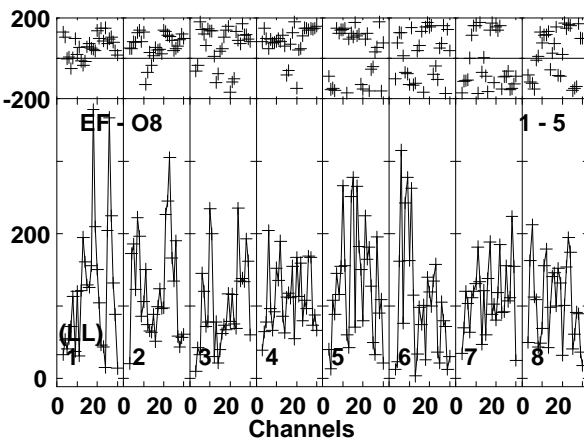
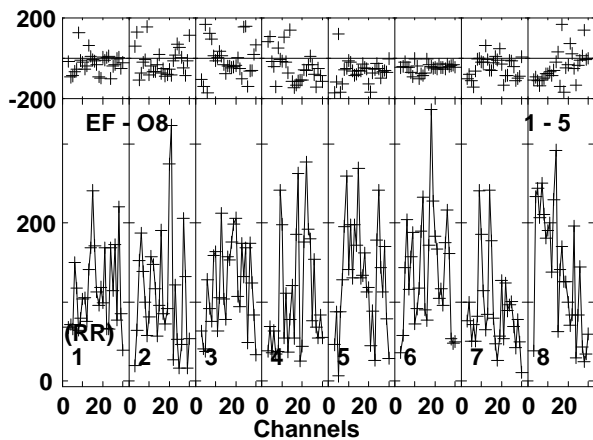
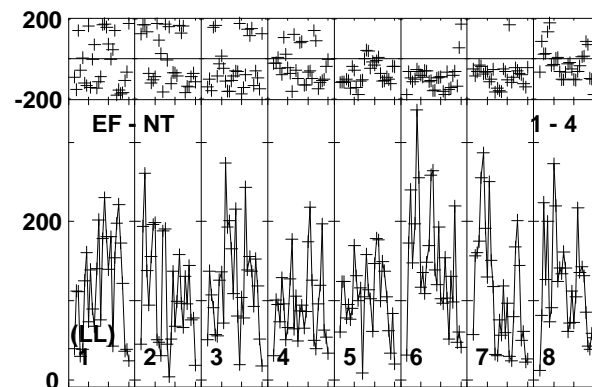
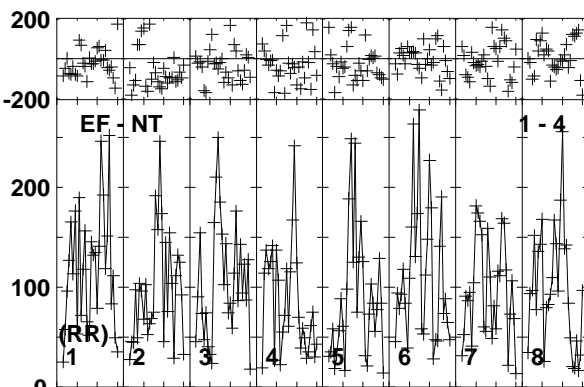
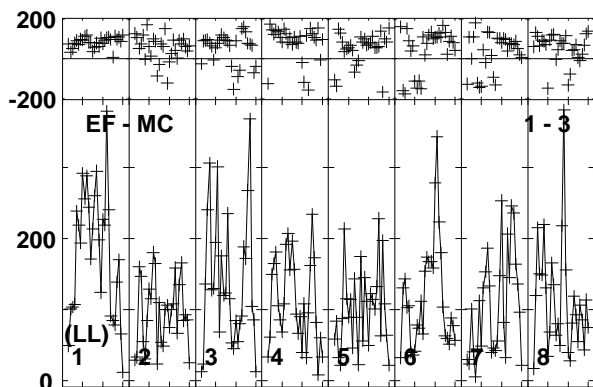
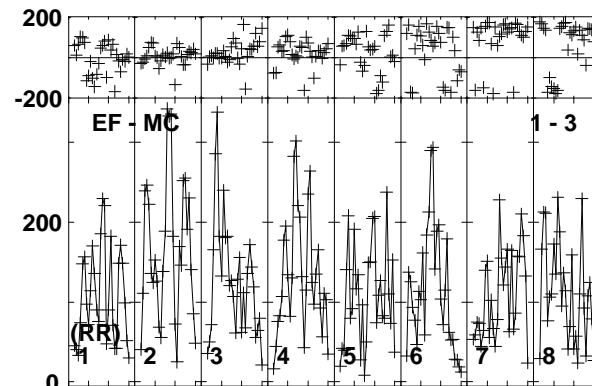
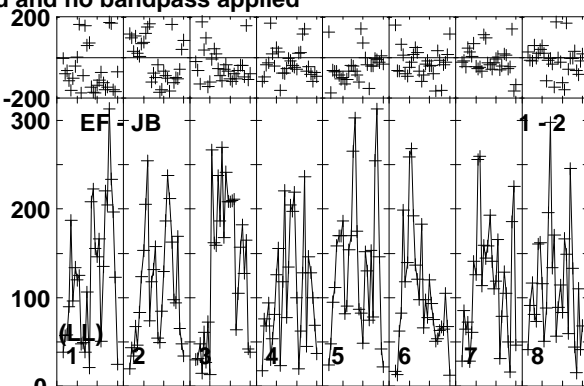
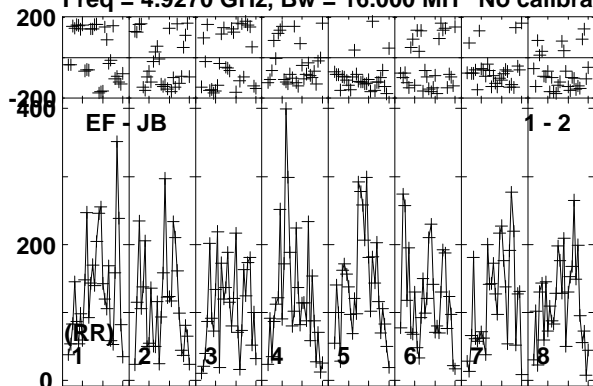

Lower frame: Micro Ampl Jy Top frame: Phas deg  
Vector averaged cross-power spectrum Baseline: EF (01) - JB (02)  
Timerange: 00/23:59:59 to 01/00:02:29

Plot file version 234 created 10-JUN-2016 17:22:25

CYGX1 RT013A.UVDATA.1

Freq = 4.9270 GHz, Bw = 16.000 MH No calibration applied and no bandpass applied

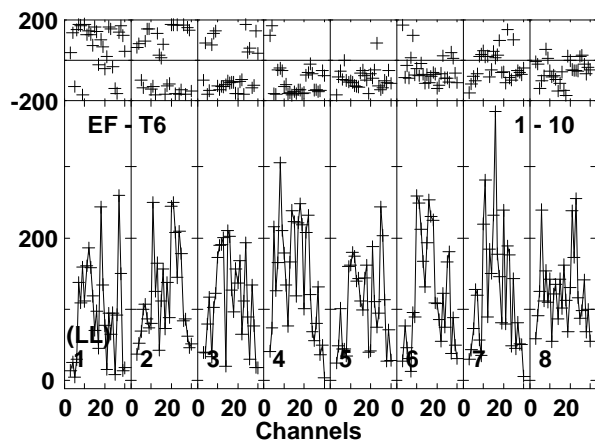
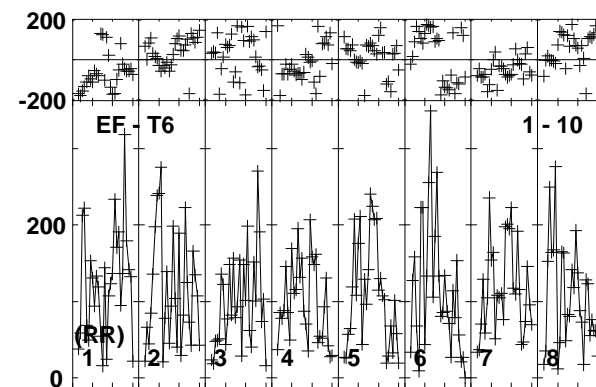
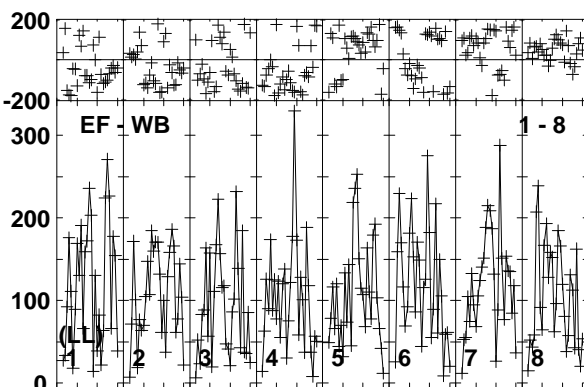
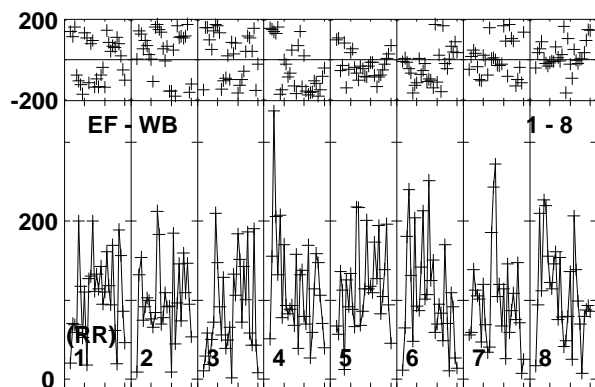
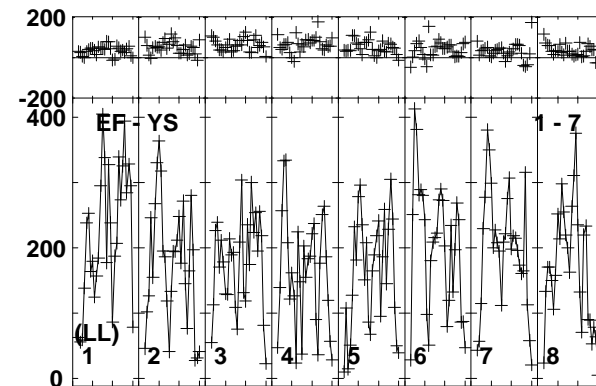
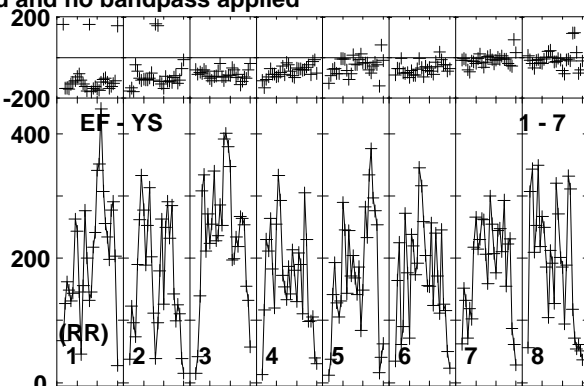
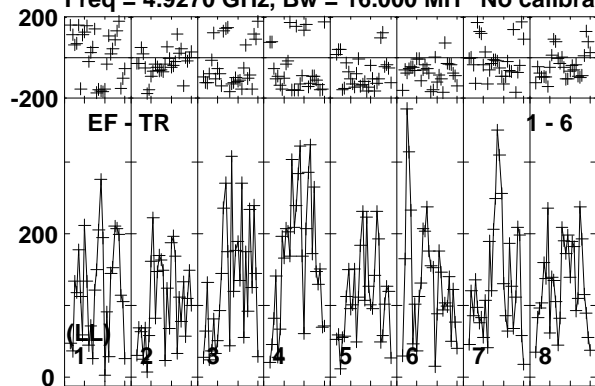

Lower frame: Micro Ampl Jy Top frame: Phas deg  
Vector averaged cross-power spectrum Baseline: EF (01) - TR (06)  
Timerange: 00/23:59:59 to 01/00:02:29



Plot file version 235 created 10-JUN-2016 17:22:25

J1957+3338 RT013A.UVDATA.1

Freq = 4.9270 GHz, Bw = 16.000 MH No calibration applied and no bandpass applied

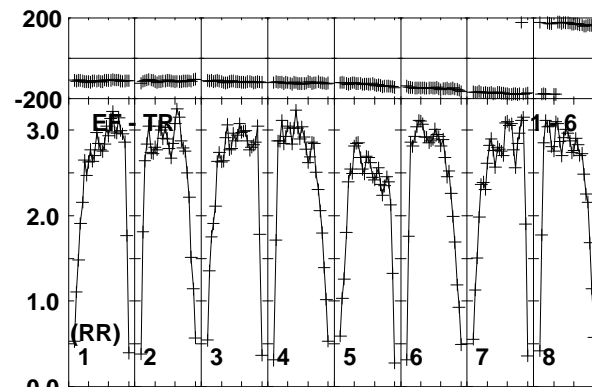
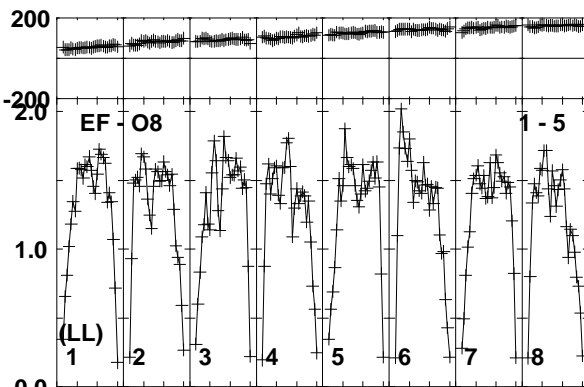
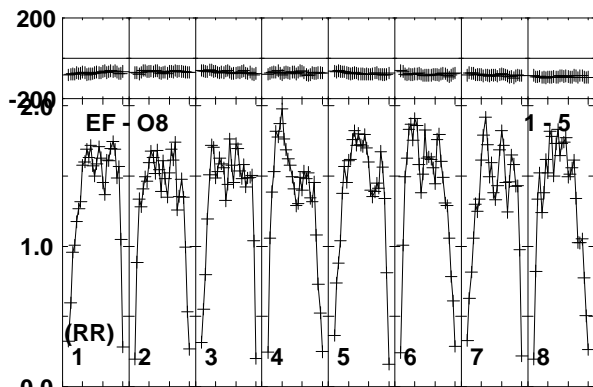
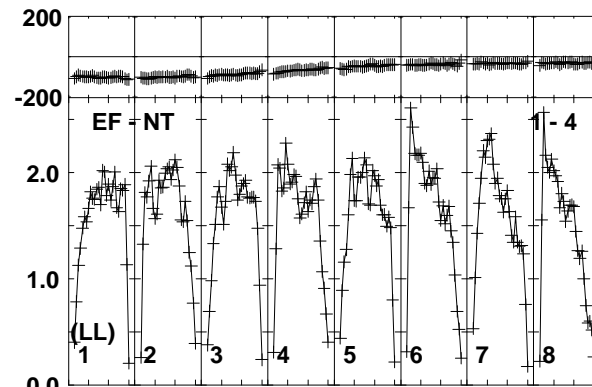
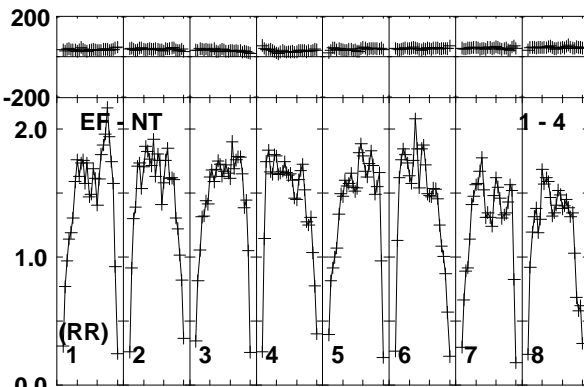
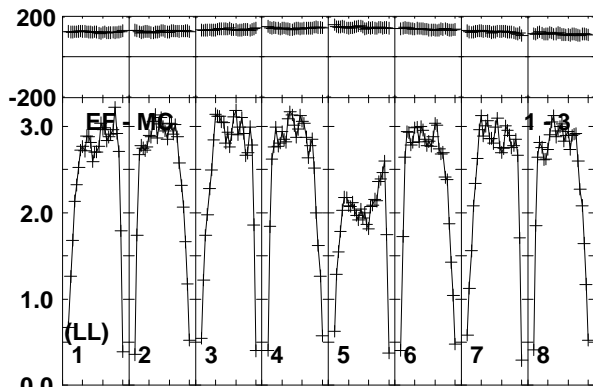
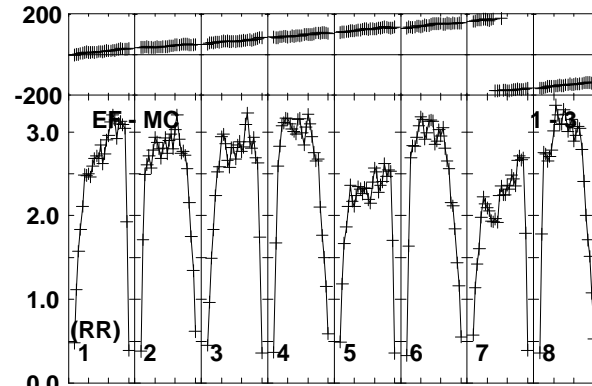
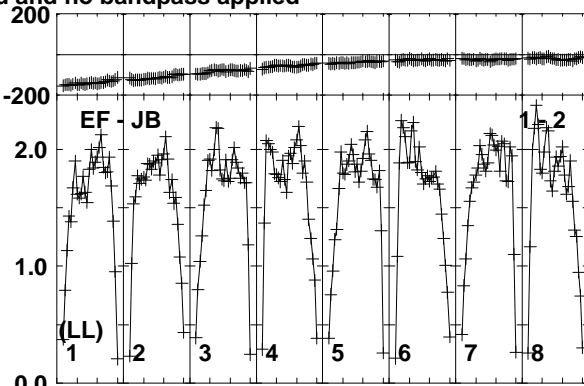
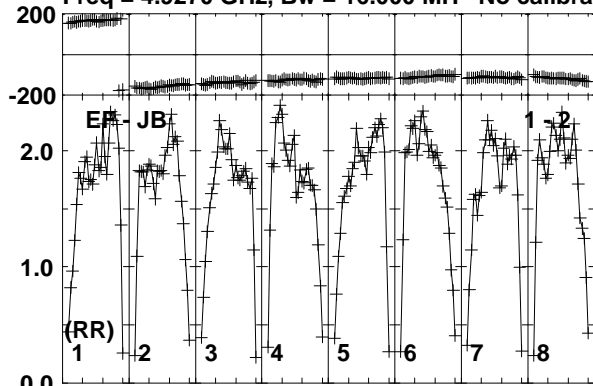

Lower frame: Milli Ampl Jy Top frame: Phas deg

Vector averaged cross-power spectrum Baseline: EF (01) - JB (02)

Timerange: 01/00:02:30 to 01/00:03:59

Plot file version 236 created 10-JUN-2016 17:22:25

J1957+3338 RT013A.UVDATA.1

Freq = 4.9270 GHz, Bw = 16.000 MH No calibration applied and no bandpass applied

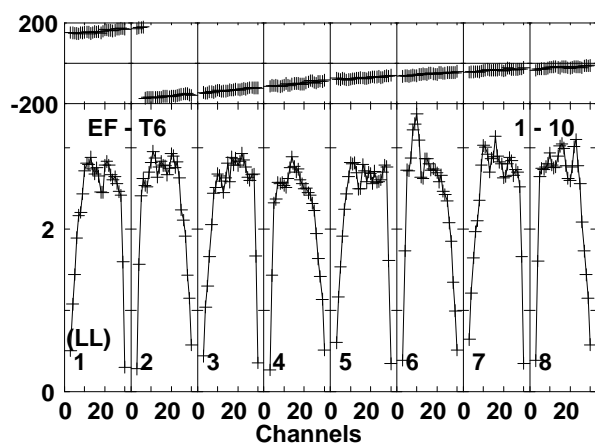
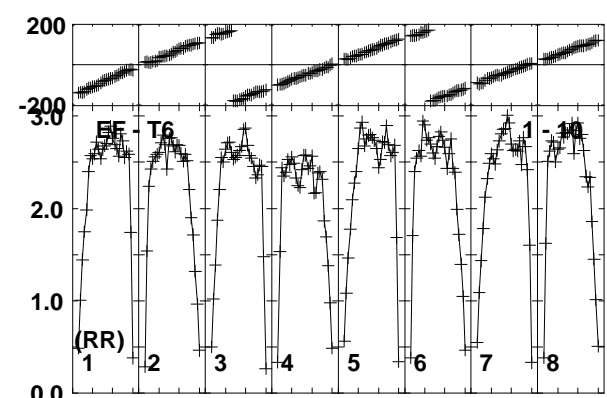
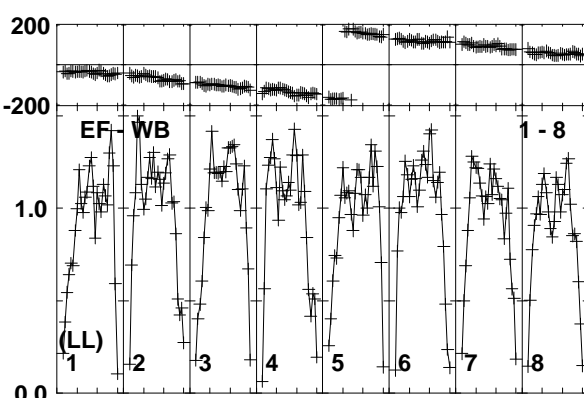
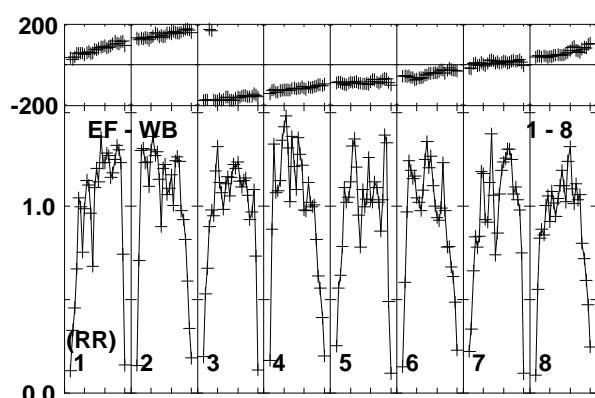
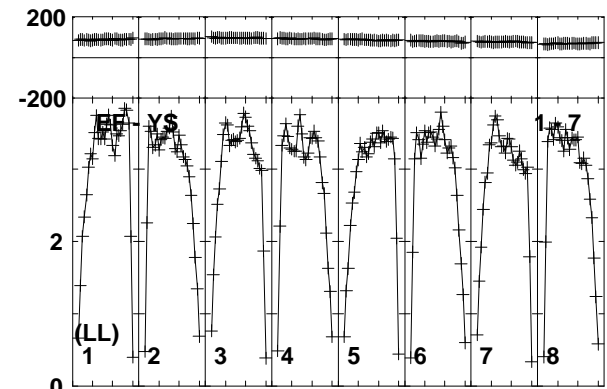
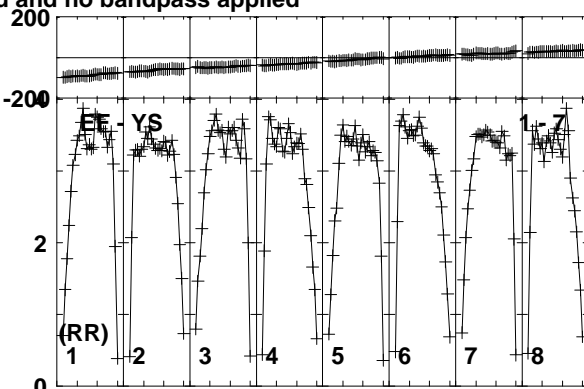
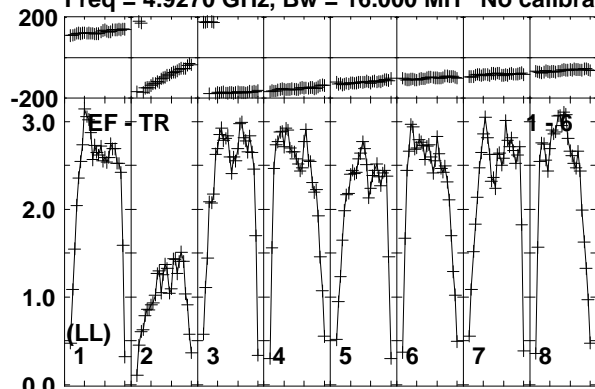

Lower frame: Milli Ampl Jy Top frame: Phas deg  
Vector averaged cross-power spectrum Baseline: EF (01) - TR (06)  
Timerange: 01/00:02:30 to 01/00:03:59

Plot file version 237 created 10-JUN-2016 17:22:25

CHECK RT013A.UVDATA.1

Freq = 4.9270 GHz, Bw = 16.000 MH No calibration applied and no bandpass applied

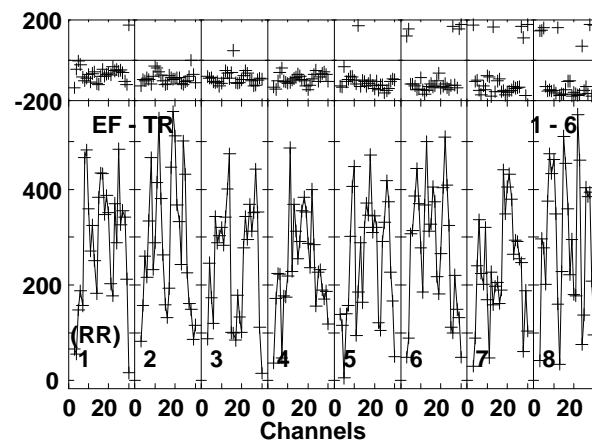
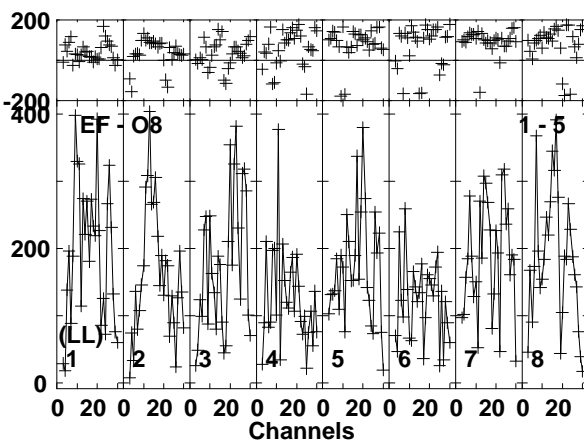
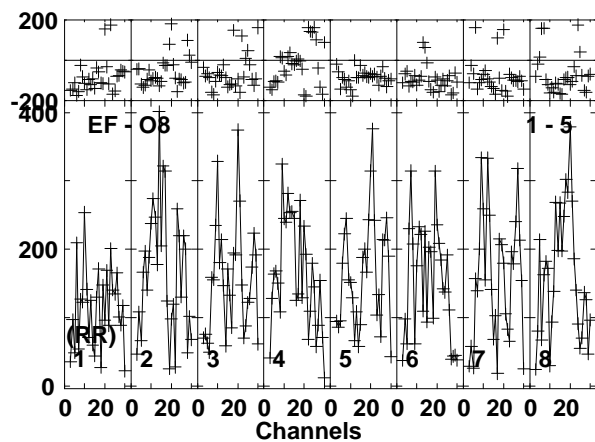
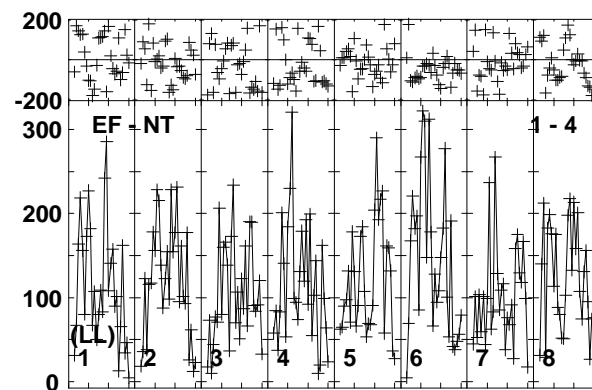
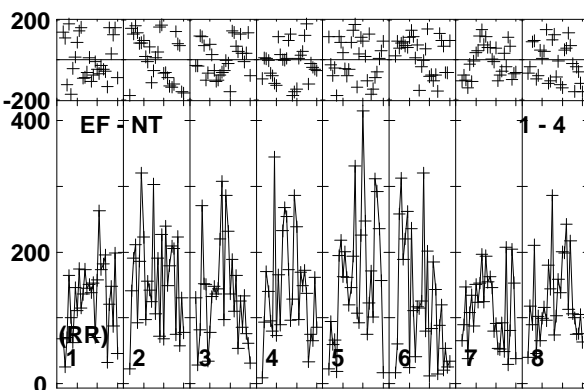
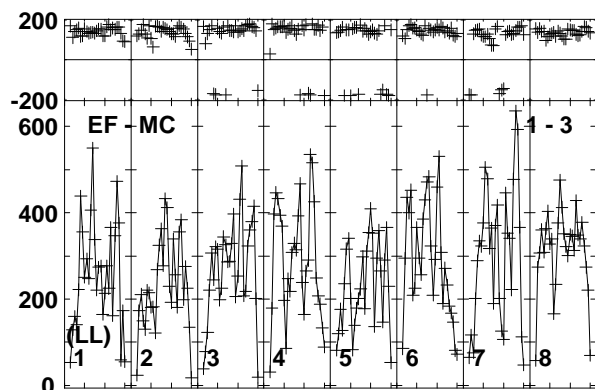
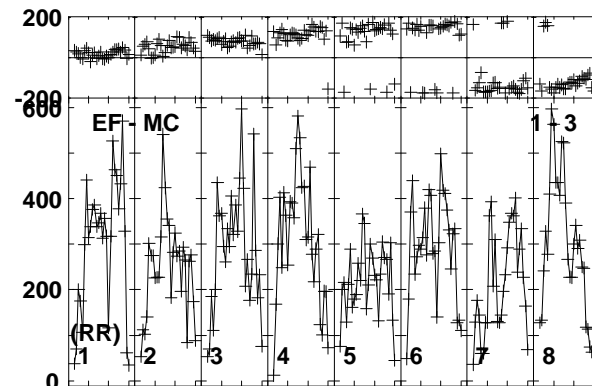
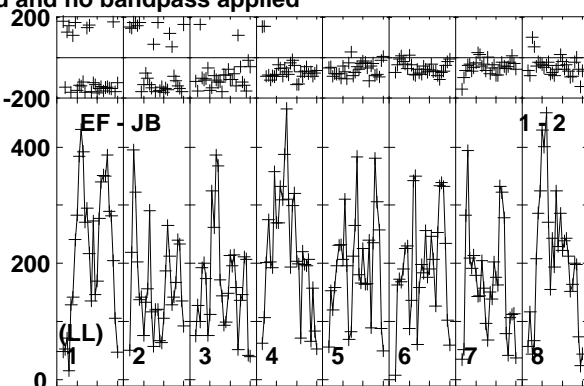
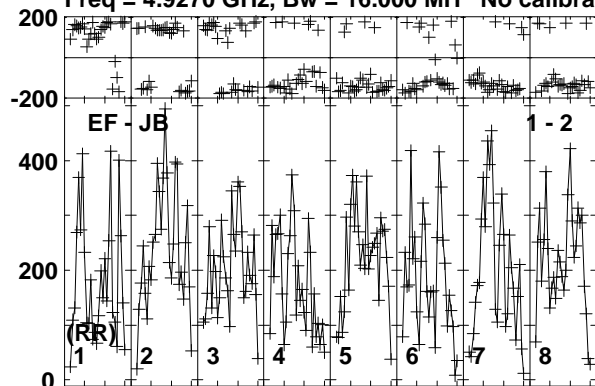

Lower frame: Micro Ampl Jy Top frame: Phas deg  
Vector averaged cross-power spectrum Baseline: EF (01) - JB (02)  
Timerange: 01/00:04:00 to 01/00:06:00

Plot file version 238 created 10-JUN-2016 17:22:25

CHECK RT013A.UVDATA.1

Freq = 4.9270 GHz, Bw = 16.000 MH No calibration applied and no bandpass applied

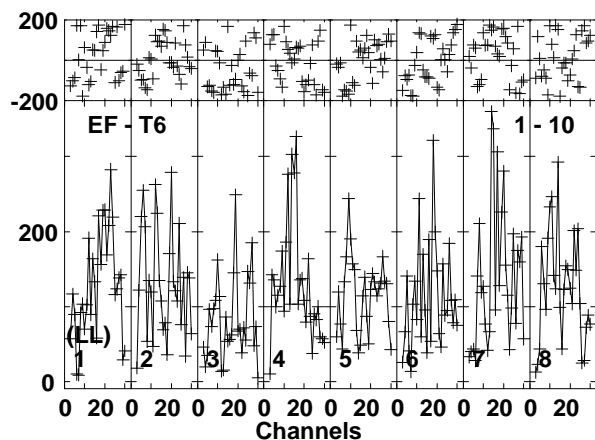
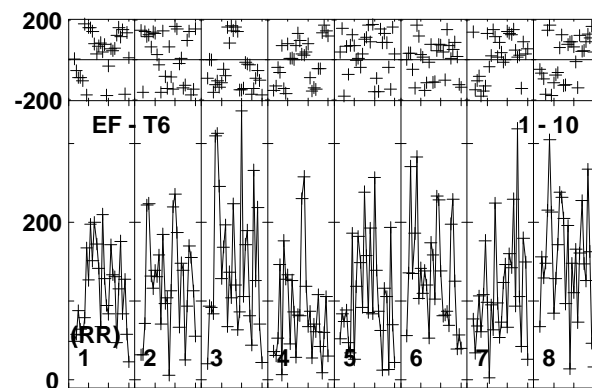
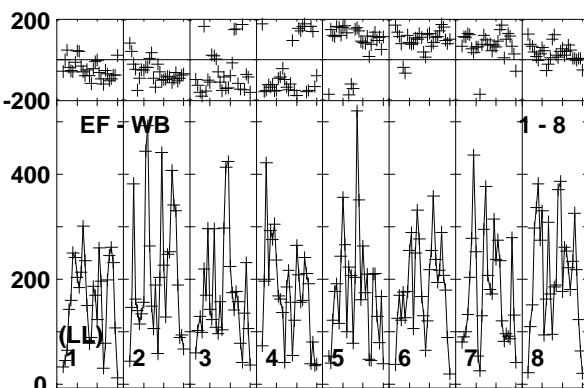
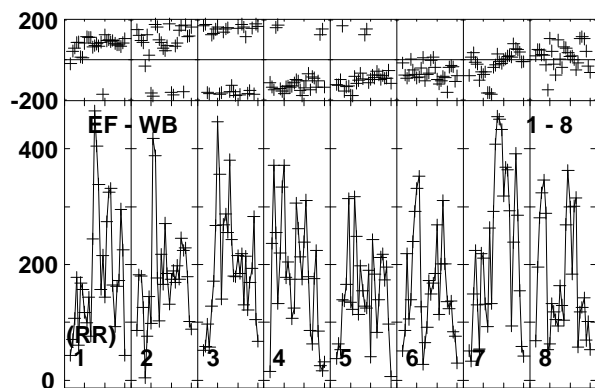
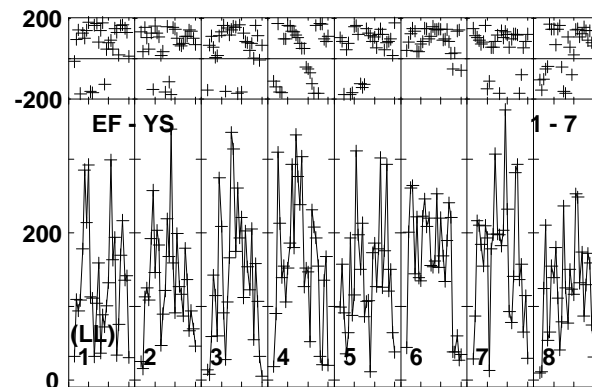
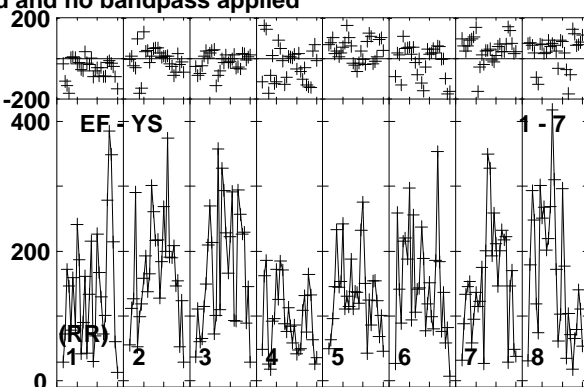
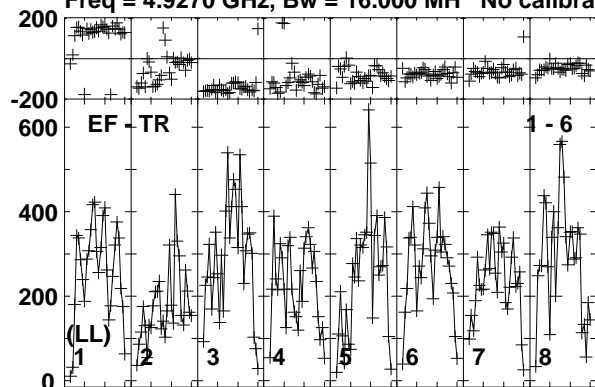

Lower frame: Micro Ampl Jy Top frame: Phas deg  
Vector averaged cross-power spectrum Baseline: EF (01) - TR (06)  
Timerange: 01/00:04:00 to 01/00:06:00

Plot file version 239 created 10-JUN-2016 17:22:26

CYGX1 RT013A.UVDATA.1

Freq = 4.9270 GHz, Bw = 16.000 MH No calibration applied and no bandpass applied

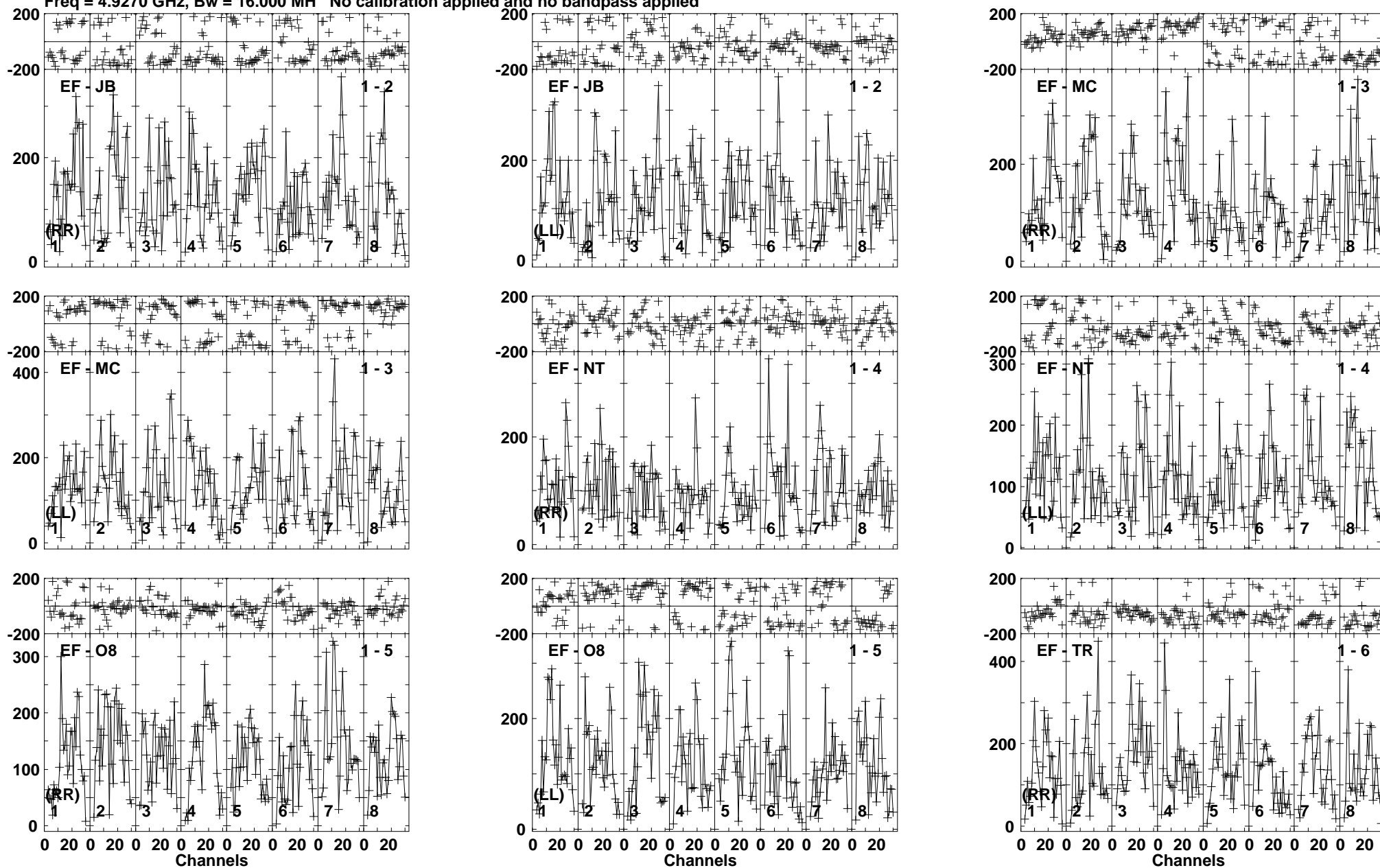

Lower frame: Micro Ampl Jy Top frame: Phas deg  
Vector averaged cross-power spectrum Baseline: EF (01) - JB (02)  
Timerange: 01/00:06:00 to 01/00:08:30

Plot file version 240 created 10-JUN-2016 17:22:26

CYGX1 RT013A.UVDATA.1

Freq = 4.9270 GHz, Bw = 16.000 MH No calibration applied and no bandpass applied

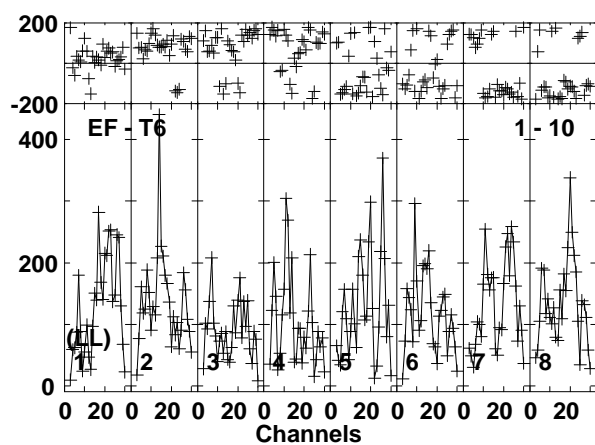
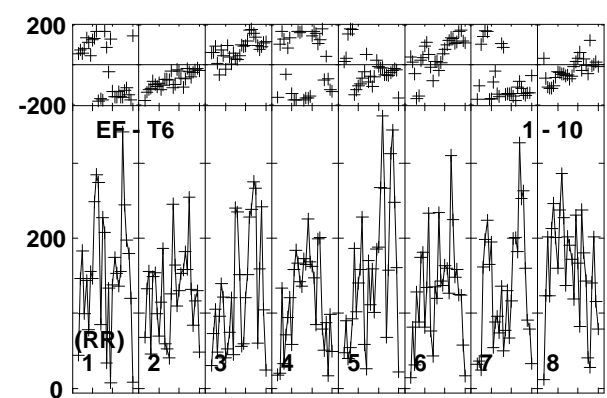
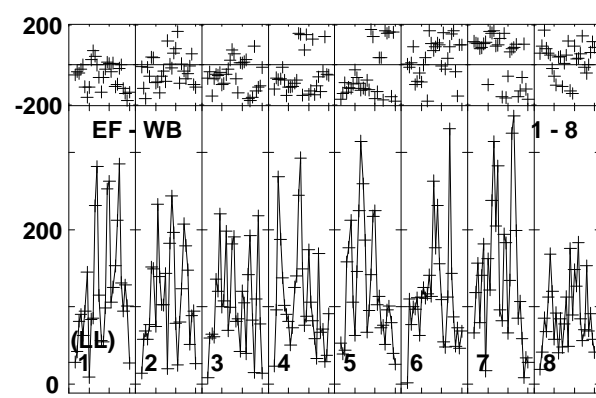
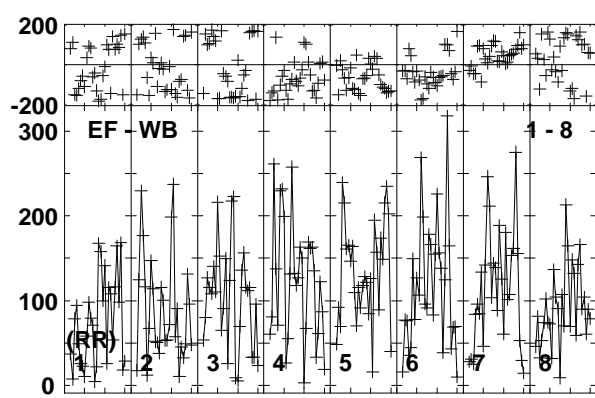
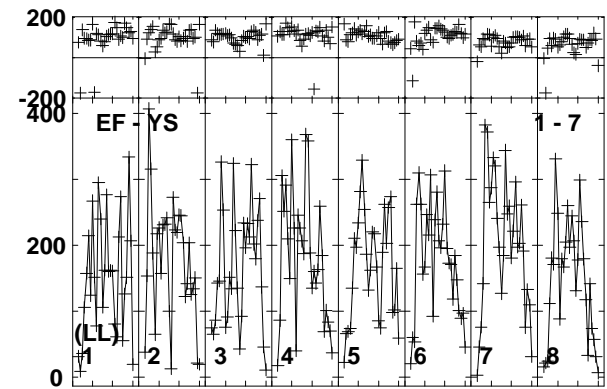
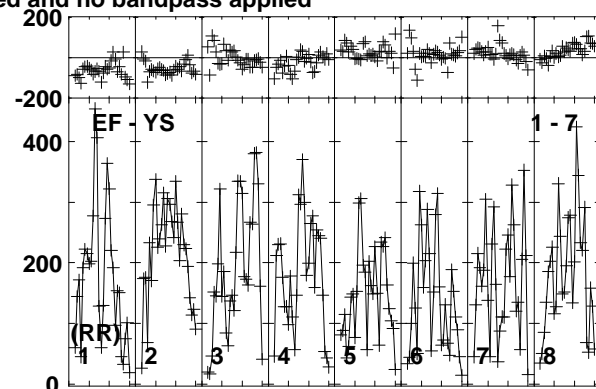
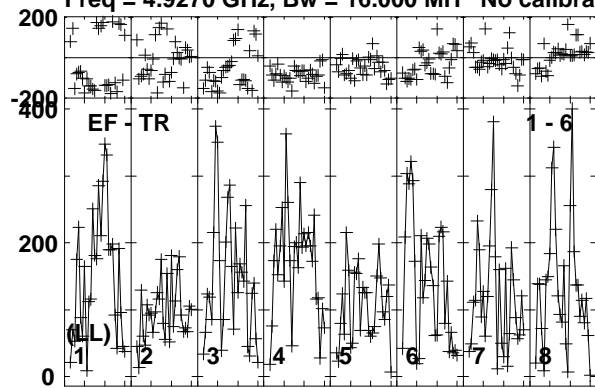

Lower frame: Micro Ampl Jy Top frame: Phas deg  
Vector averaged cross-power spectrum Baseline: EF (01) - TR (06)  
Timerange: 01/00:06:00 to 01/00:08:30

Plot file version 241 created 10-JUN-2016 17:22:26

J1957+3338 RT013A.UVDATA.1

Freq = 4.9270 GHz, Bw = 16.000 MH No calibration applied and no bandpass applied

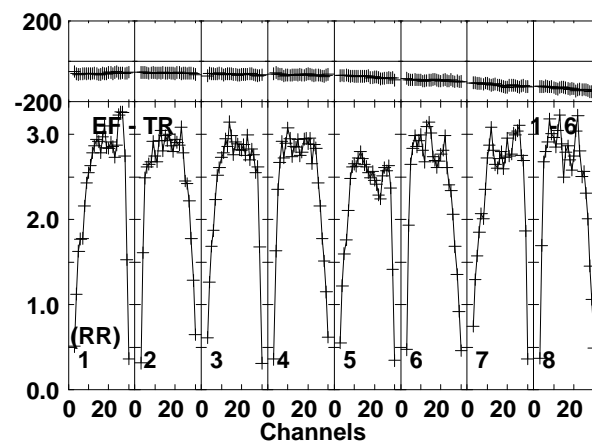
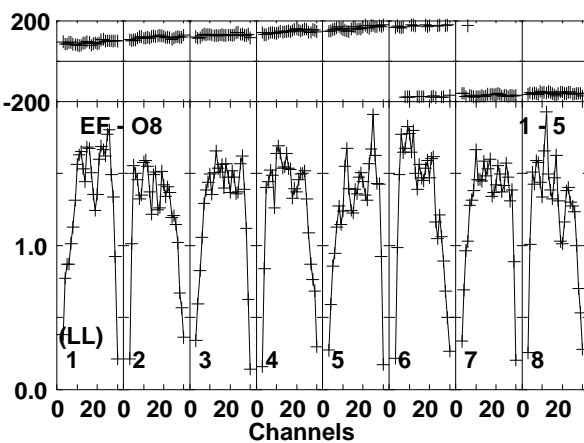
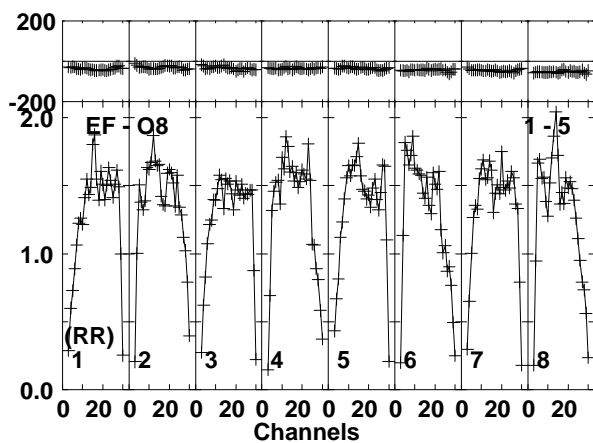
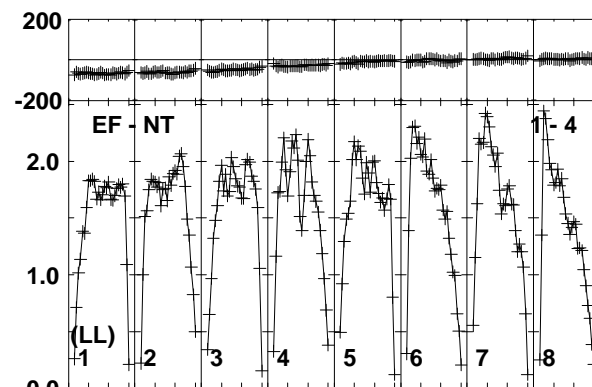
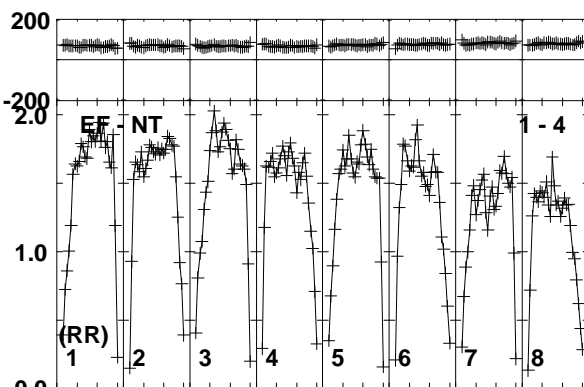
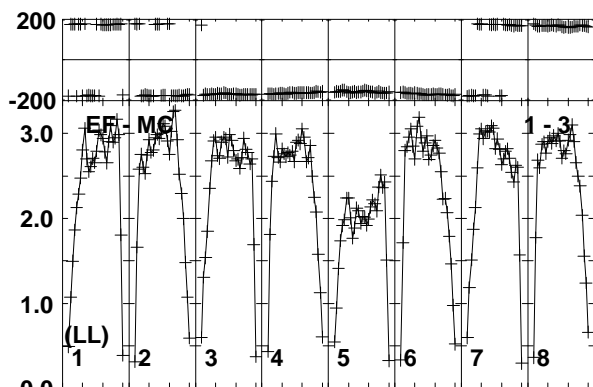
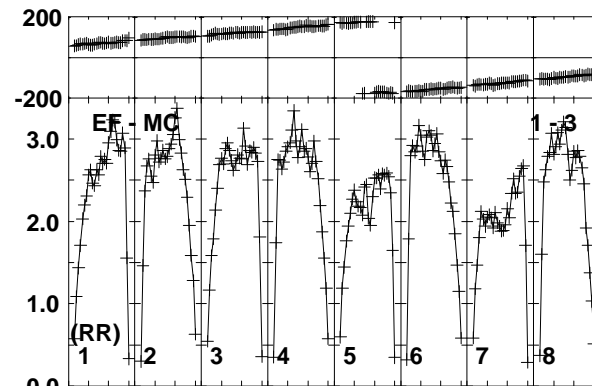
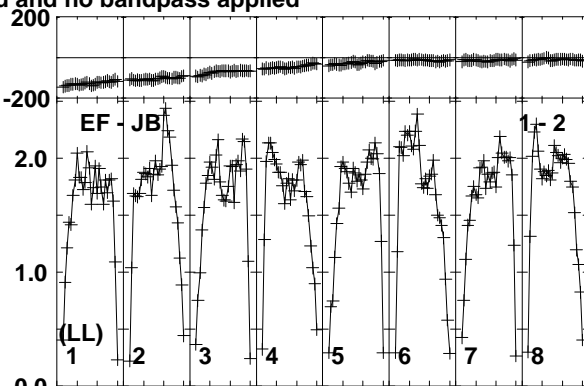
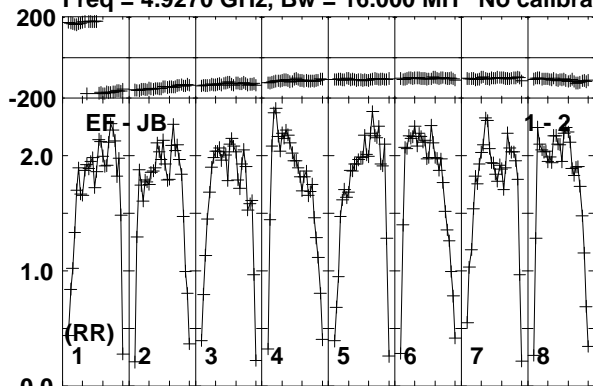

Lower frame: Milli Ampl Jy Top frame: Phas deg  
Vector averaged cross-power spectrum Baseline: EF (01) - JB (02)  
Timerange: 01/00:08:31 to 01/00:10:00

Plot file version 242 created 10-JUN-2016 17:22:26

J1957+3338 RT013A.UVDATA.1

Freq = 4.9270 GHz, Bw = 16.000 MH No calibration applied and no bandpass applied

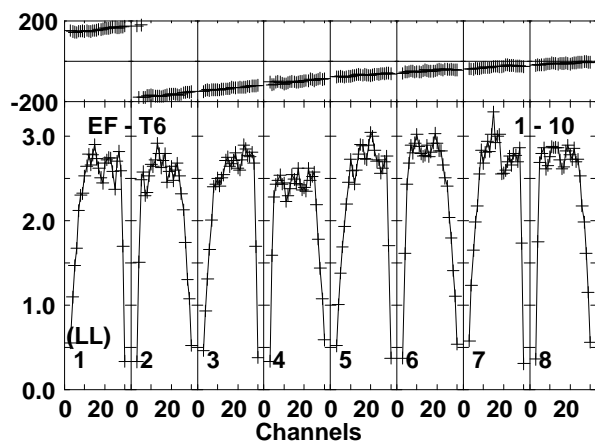
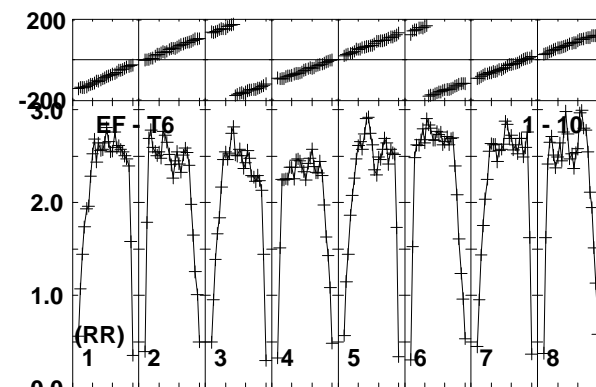
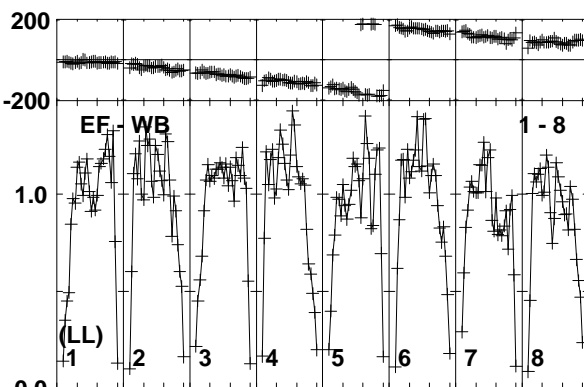
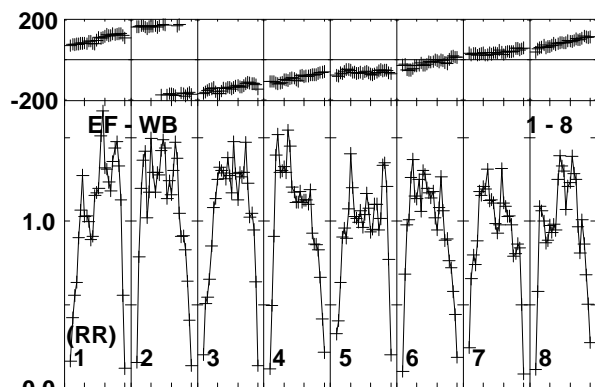
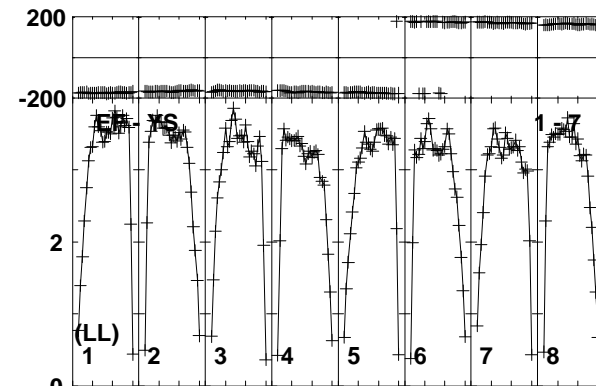
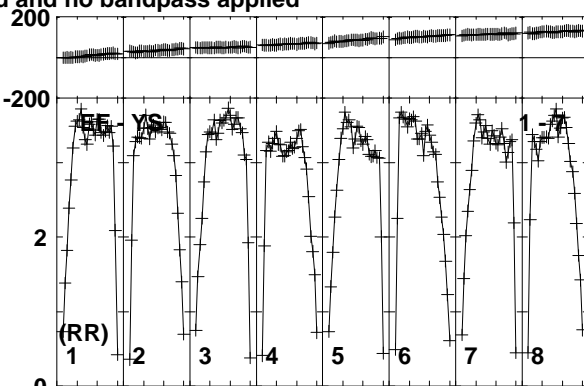
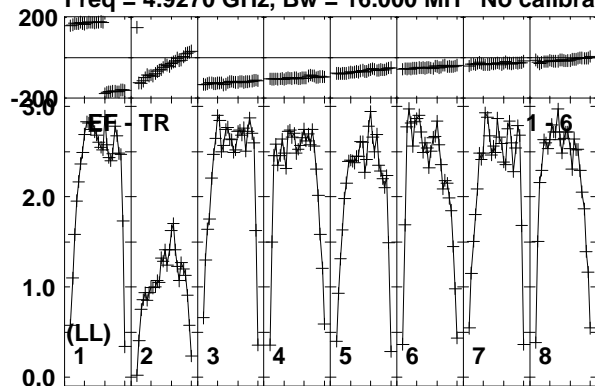

Lower frame: Milli Ampl Jy Top frame: Phas deg  
Vector averaged cross-power spectrum Baseline: EF (01) - TR (06)  
Timerange: 01/00:08:31 to 01/00:10:00



Plot file version 243 created 10-JUN-2016 17:22:26

CHECK RT013A.UVDATA.1

Freq = 4.9270 GHz, Bw = 16.000 MH No calibration applied and no bandpass applied

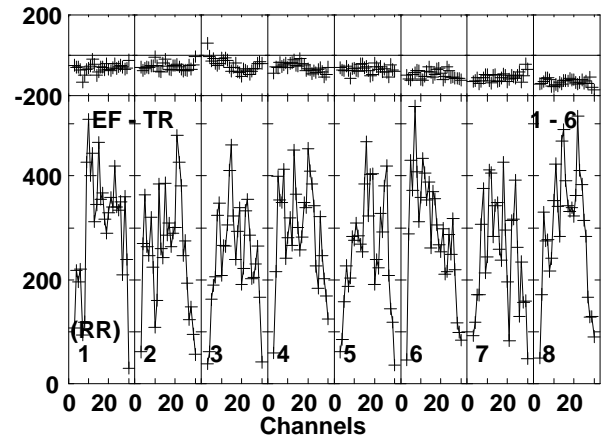
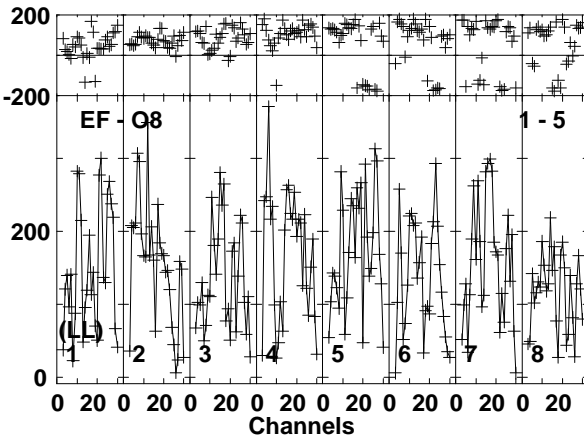
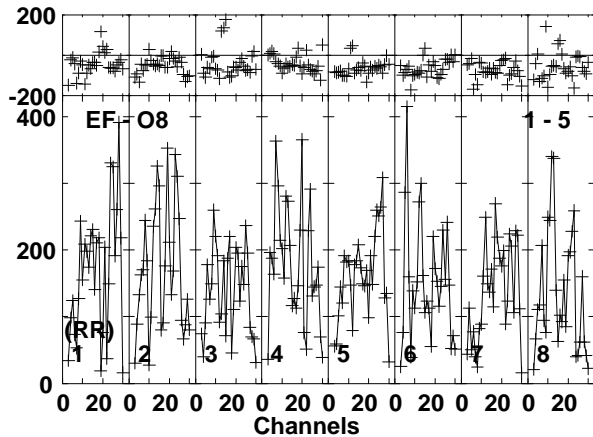
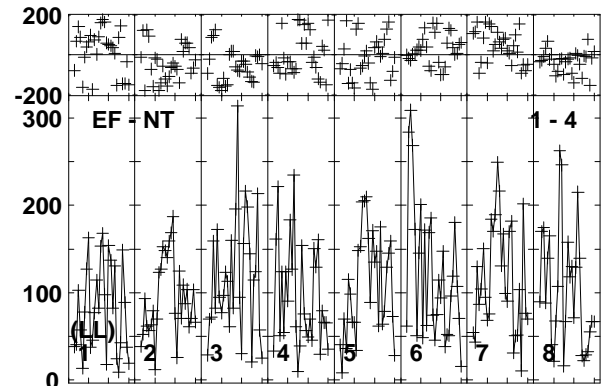
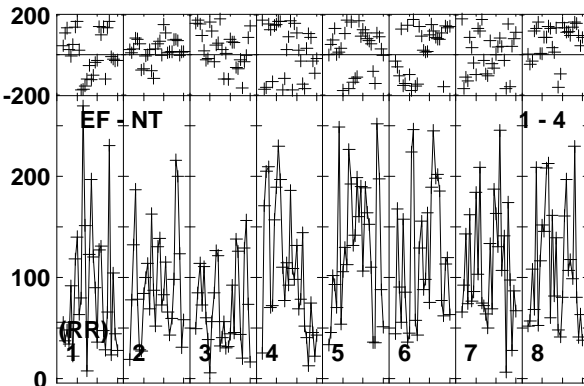
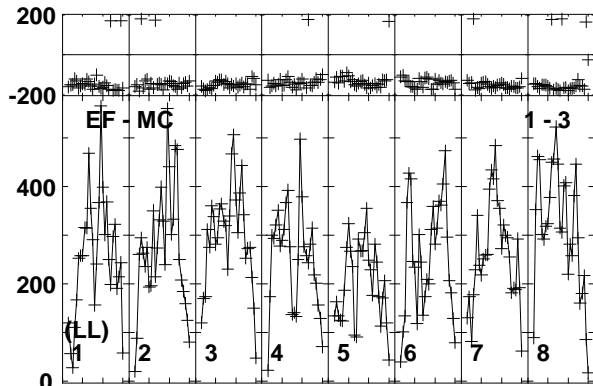
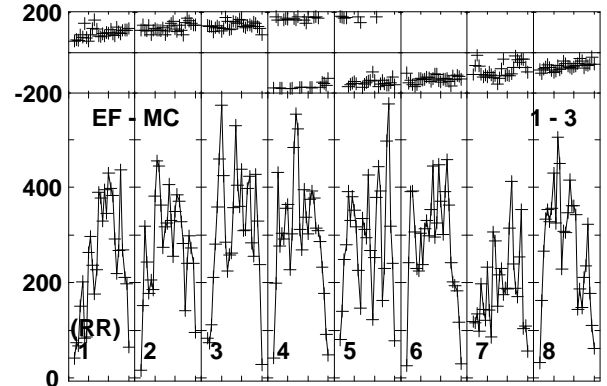
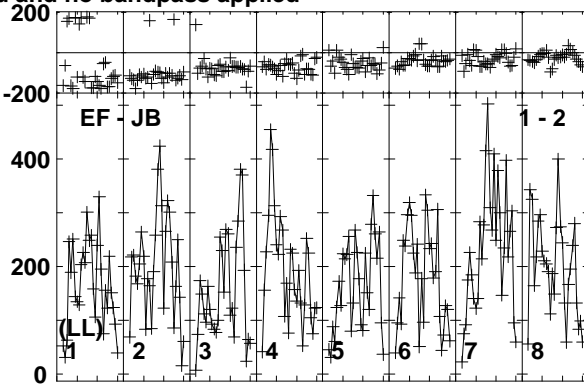
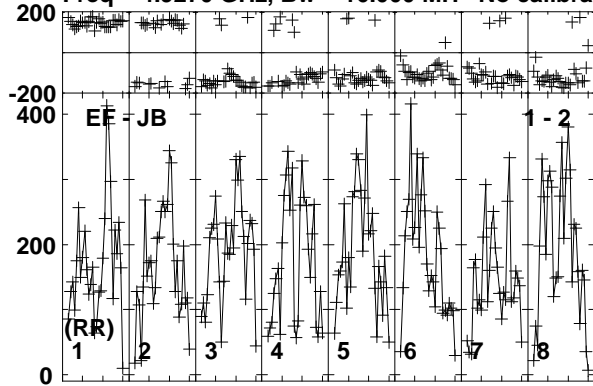

Lower frame: Micro Ampl Jy Top frame: Phas deg  
Vector averaged cross-power spectrum Baseline: EF (01) - JB (02)  
Timerange: 01/00:10:40 to 01/00:12:39

Plot file version 244 created 10-JUN-2016 17:22:26

CHECK RT013A.UVDATA.1

Freq = 4.9270 GHz, Bw = 16.000 MH No calibration applied and no bandpass applied

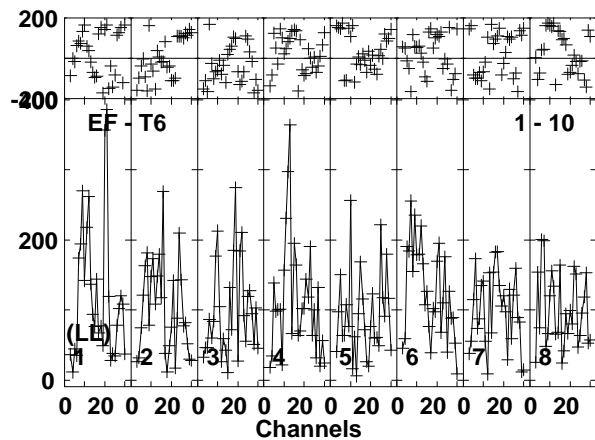
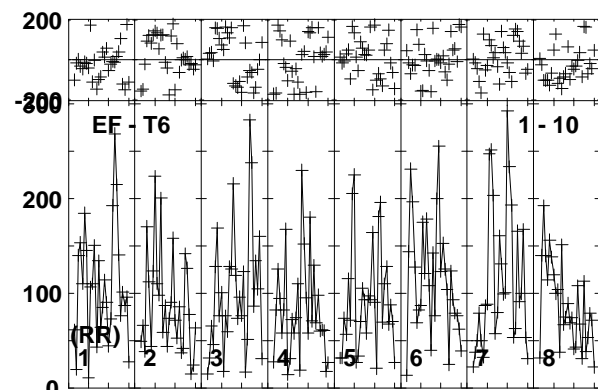
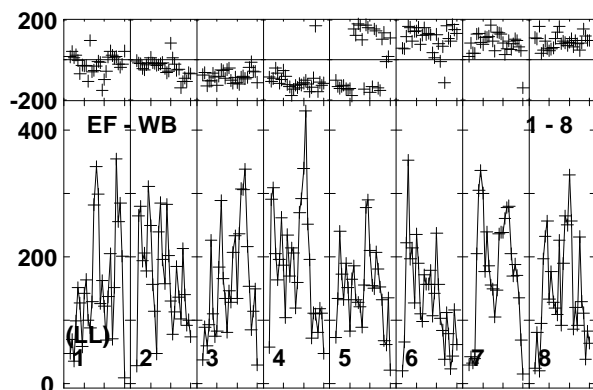
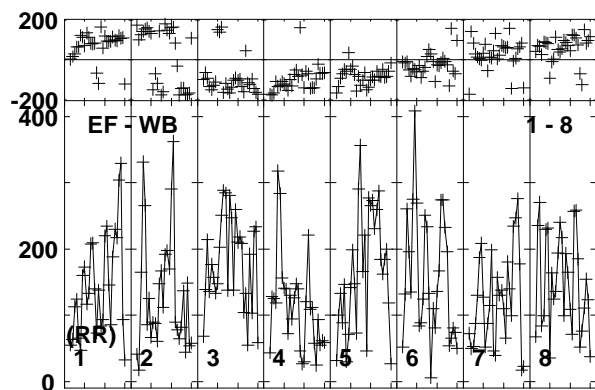
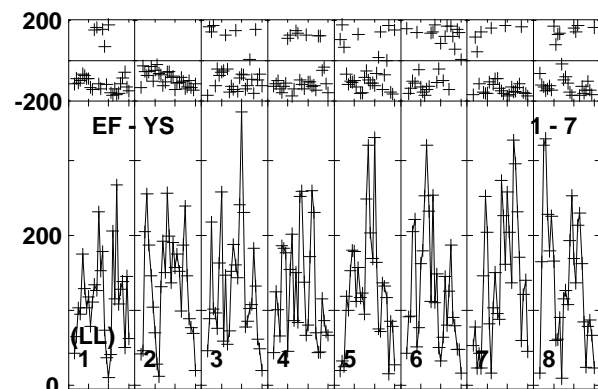
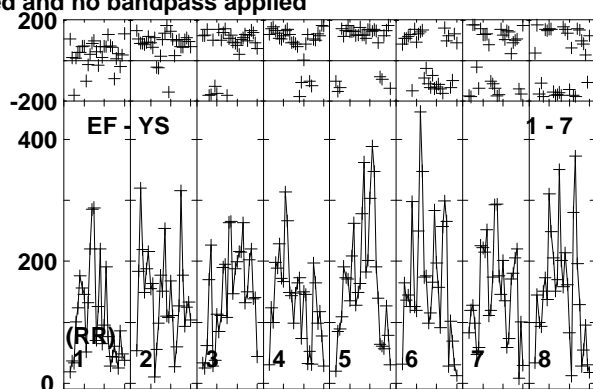
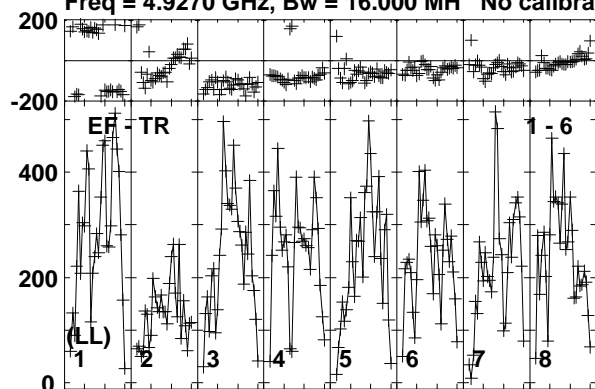

Lower frame: Micro Ampl Jy Top frame: Phas deg  
Vector averaged cross-power spectrum Baseline: EF (01) - TR (06)  
Timerange: 01/00:10:40 to 01/00:12:39

Plot file version 245 created 10-JUN-2016 17:22:26

CYGX1 RT013A.UVDATA.1

Freq = 4.9270 GHz, Bw = 16.000 MH No calibration applied and no bandpass applied

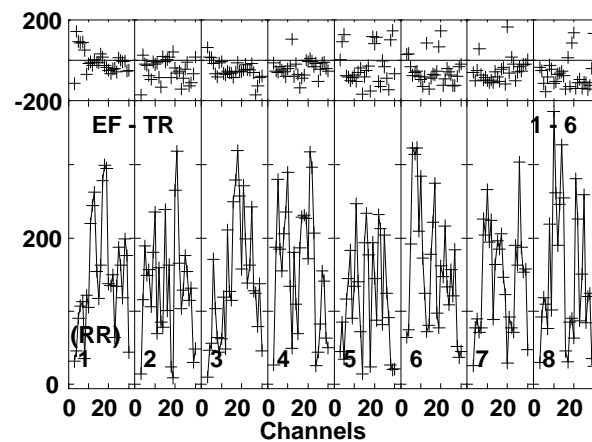
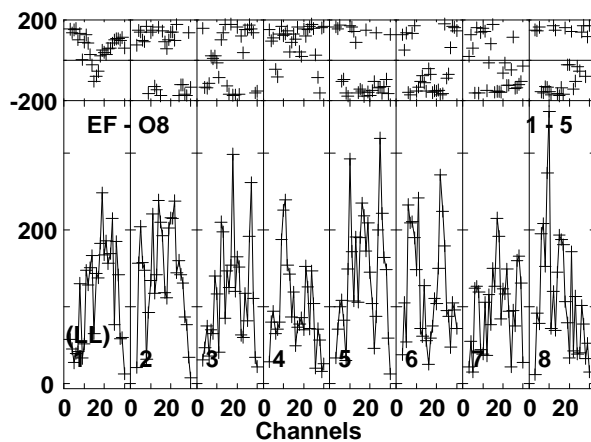
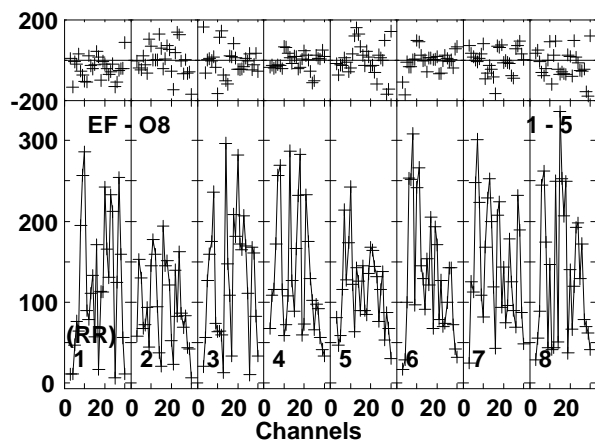
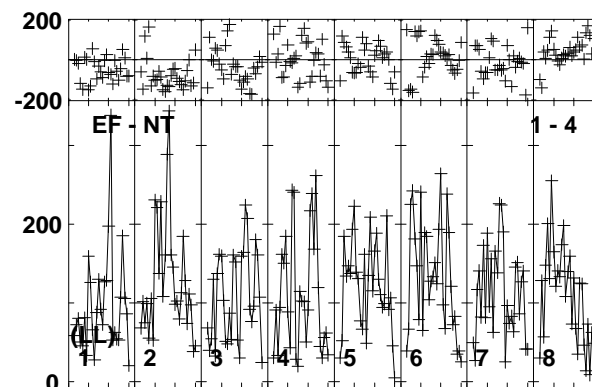
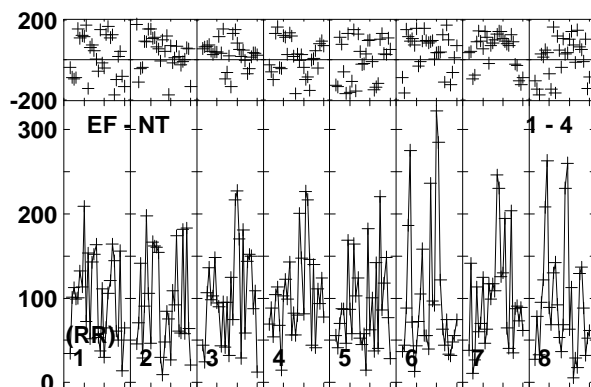
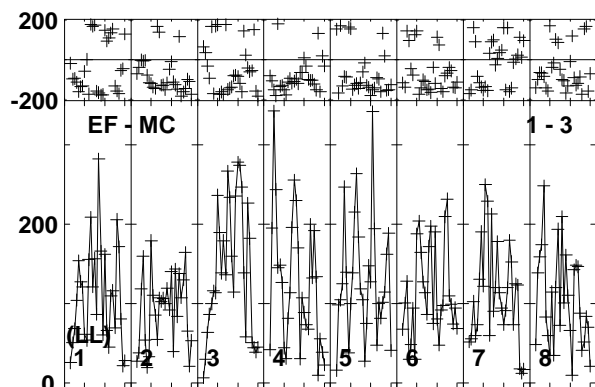
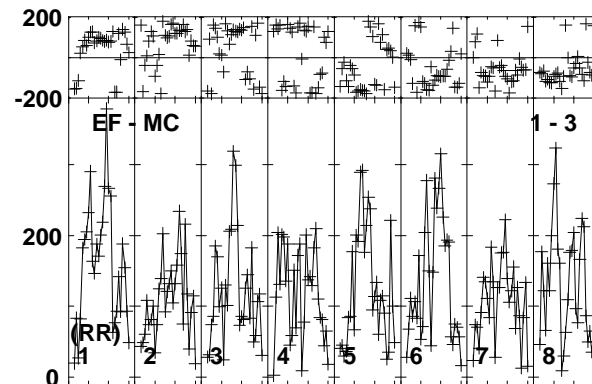
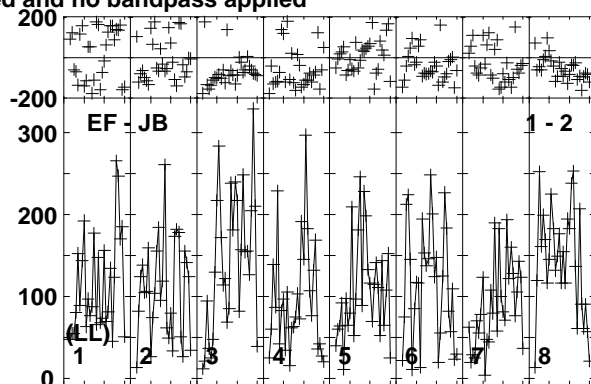
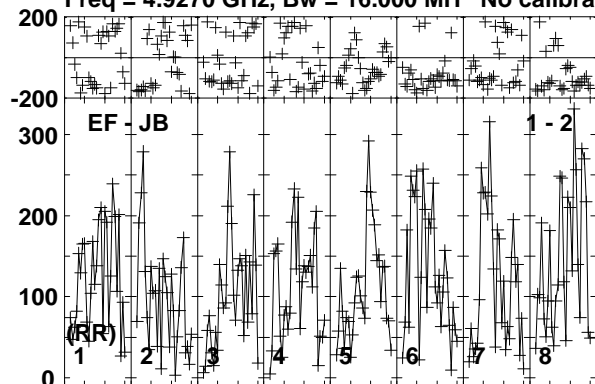

Lower frame: Micro Ampl Jy Top frame: Phas deg  
Vector averaged cross-power spectrum Baseline: EF (01) - JB (02)  
Timerange: 01/00:12:40 to 01/00:15:10

Plot file version 246 created 10-JUN-2016 17:22:26

CYGX1 RT013A.UVDATA.1

Freq = 4.9270 GHz, Bw = 16.000 MH No calibration applied and no bandpass applied

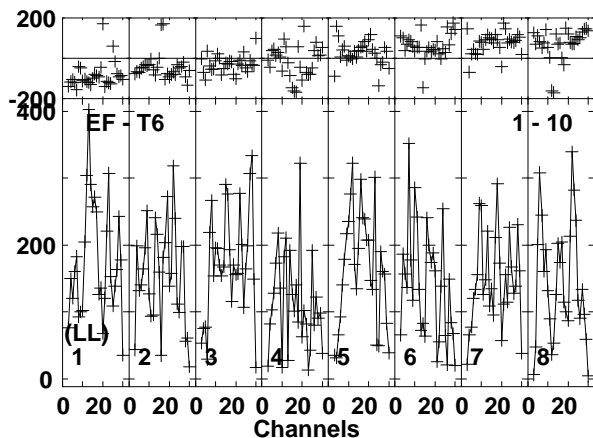
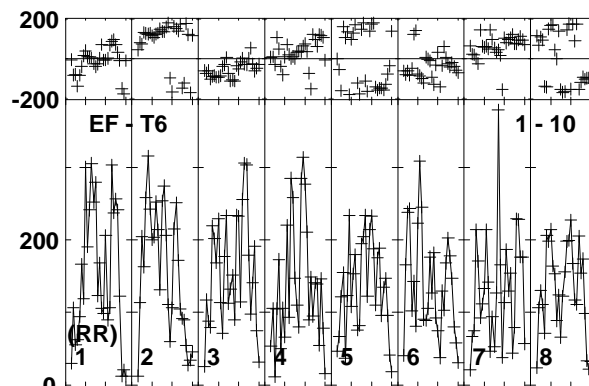
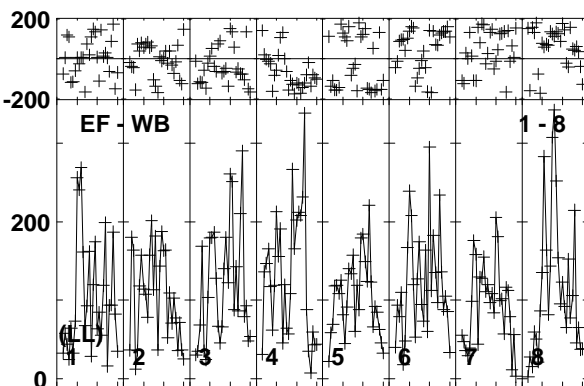
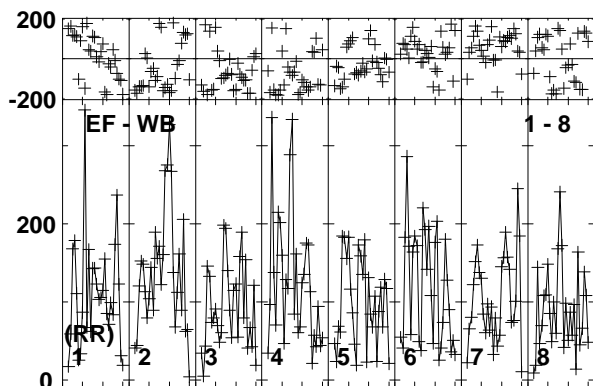
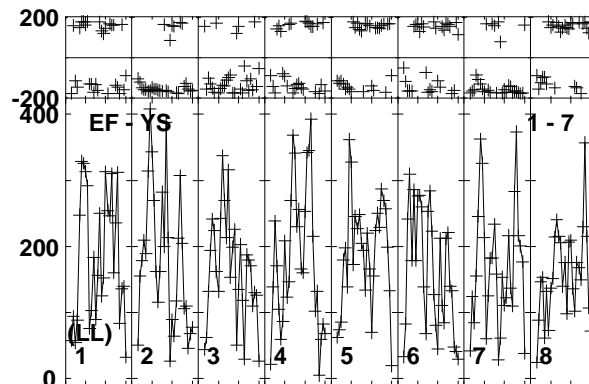
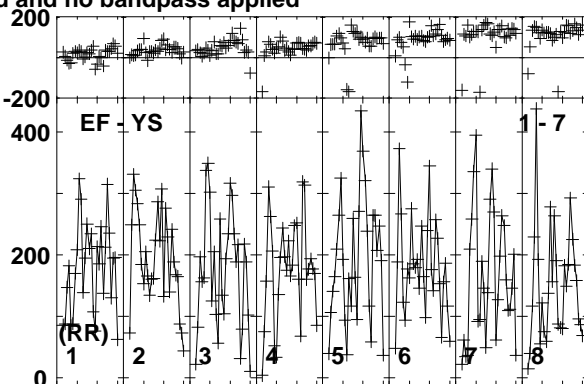
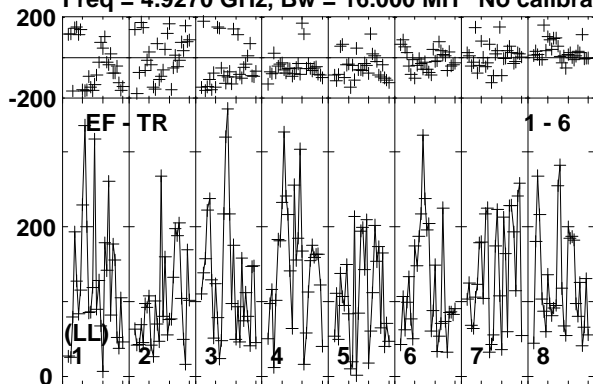

Lower frame: Micro Ampl Jy Top frame: Phas deg  
Vector averaged cross-power spectrum Baseline: EF (01) - TR (06)  
Timerange: 01/00:12:40 to 01/00:15:10

Plot file version 247 created 10-JUN-2016 17:22:26

J1957+3338 RT013A.UVDATA.1

Freq = 4.9270 GHz, Bw = 16.000 MH No calibration applied and no bandpass applied

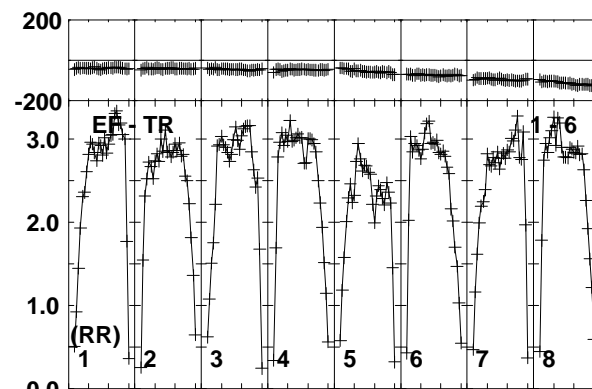
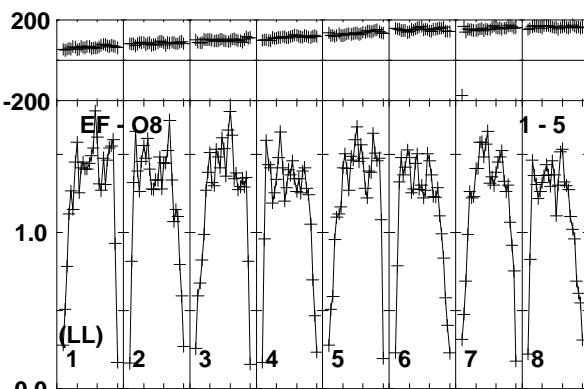
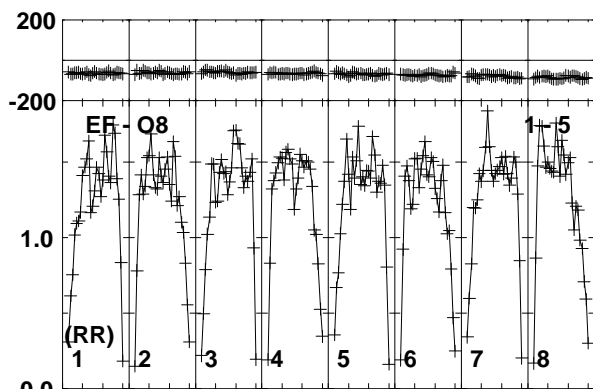
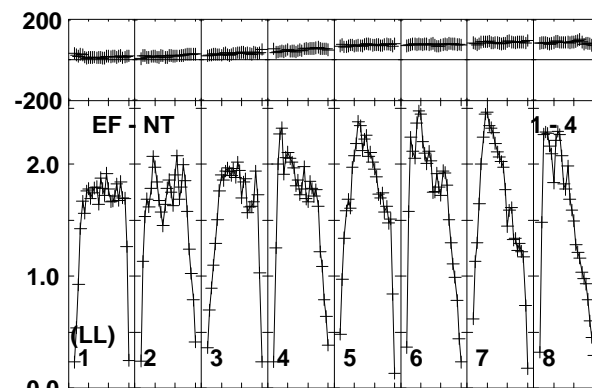
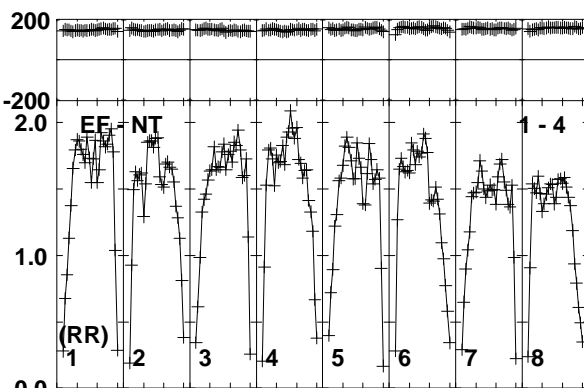
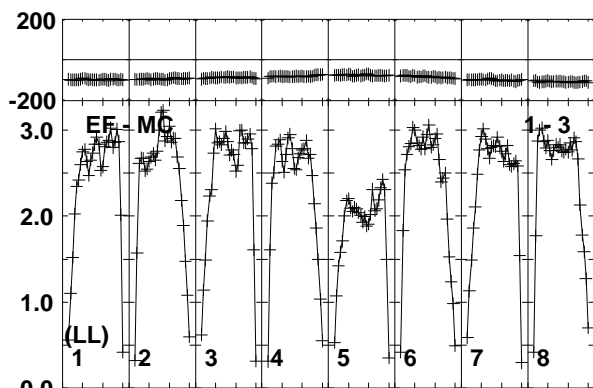
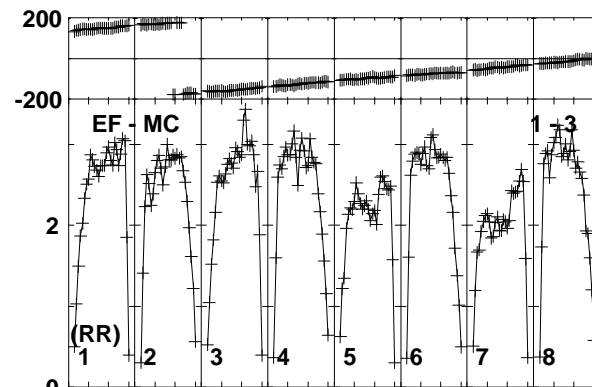
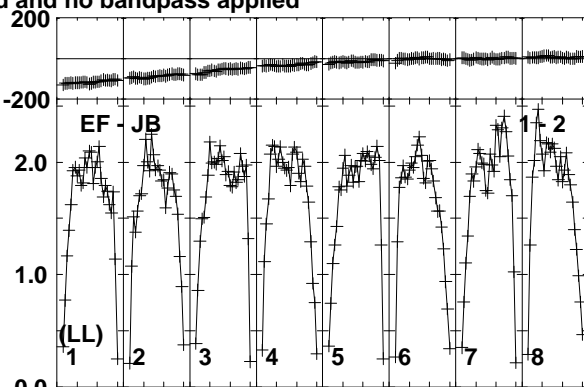
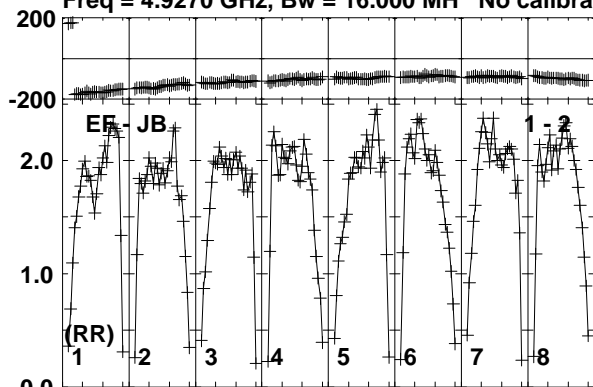

Lower frame: Milli Ampl Jy Top frame: Phas deg  
Vector averaged cross-power spectrum Baseline: EF (01) - JB (02)  
Timerange: 01/00:15:11 to 01/00:16:40

Plot file version 248 created 10-JUN-2016 17:22:26

J1957+3338 RT013A.UVDATA.1

Freq = 4.9270 GHz, Bw = 16.000 MH No calibration applied and no bandpass applied

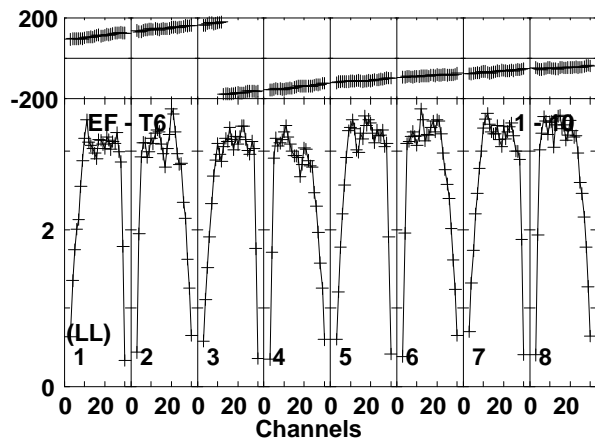
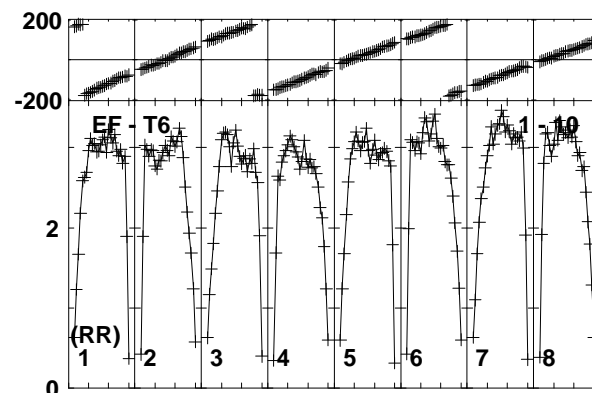
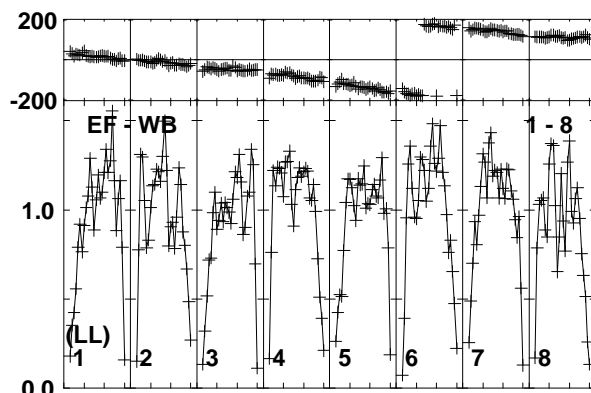
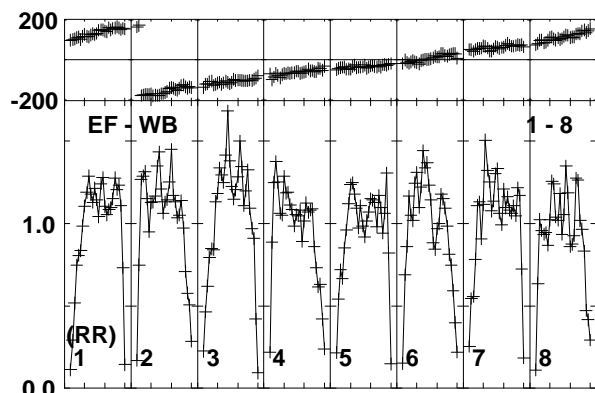
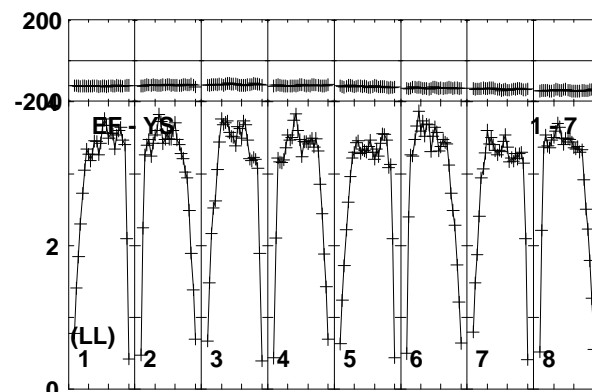
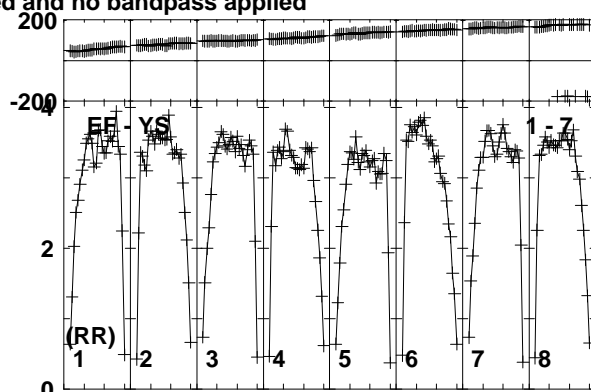
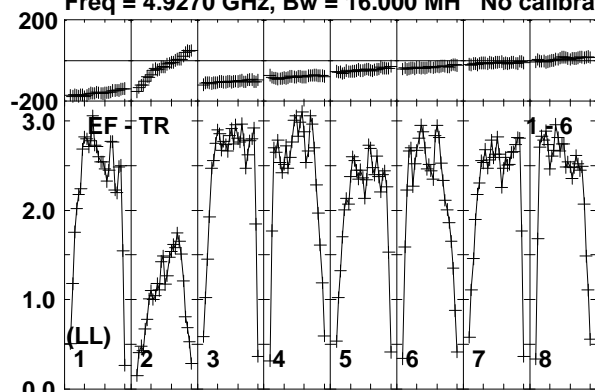

Lower frame: Milli Ampl Jy Top frame: Phas deg  
Vector averaged cross-power spectrum Baseline: EF (01) - TR (06)  
Timerange: 01/00:15:11 to 01/00:16:40

Plot file version 249 created 10-JUN-2016 17:22:27

CHECK RT013A.UVDATA.1

Freq = 4.9270 GHz, Bw = 16.000 MH No calibration applied and no bandpass applied

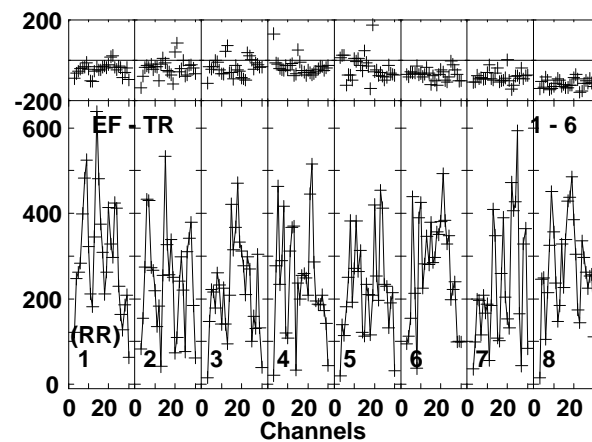
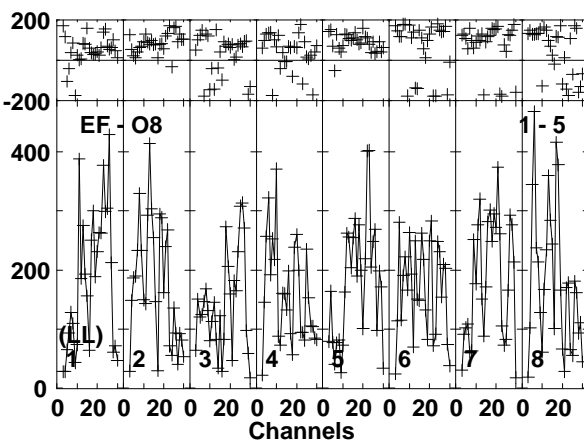
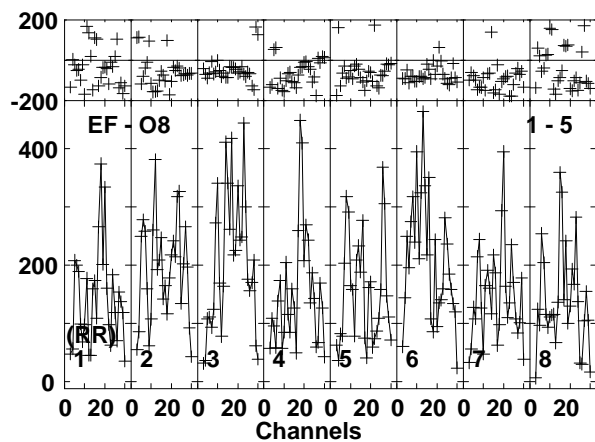
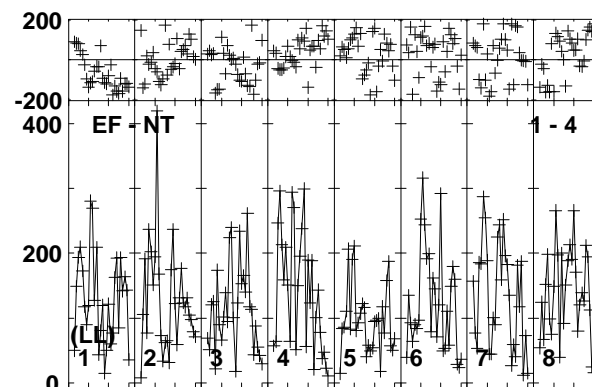
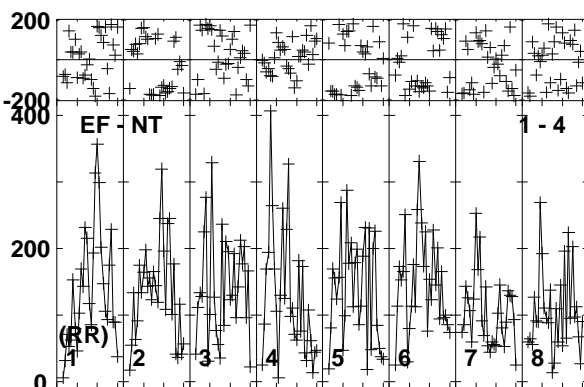
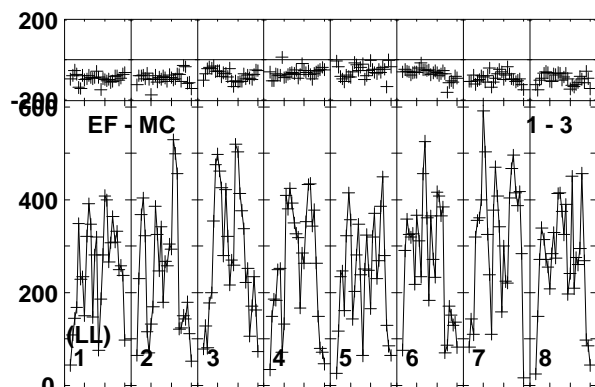
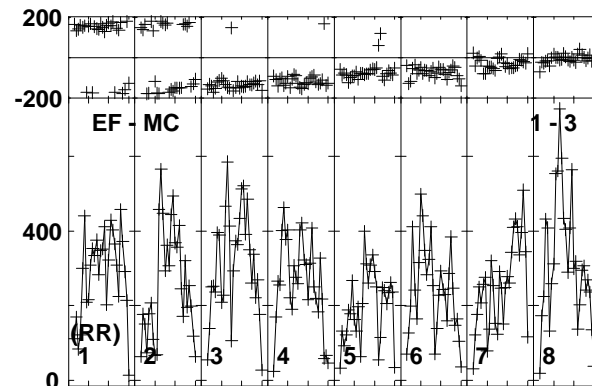
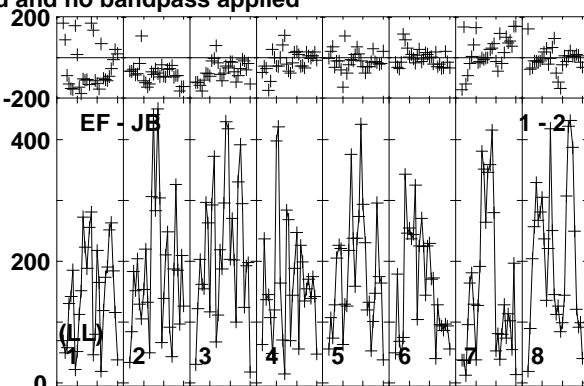
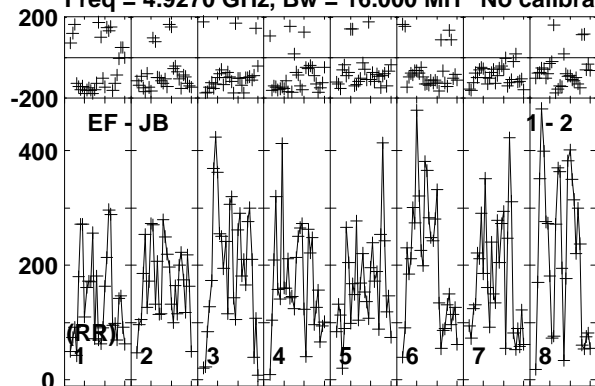

Lower frame: Micro Ampl Jy Top frame: Phas deg  
Vector averaged cross-power spectrum Baseline: EF (01) - JB (02)  
Timerange: 01/00:16:41 to 01/00:18:40

Plot file version 250 created 10-JUN-2016 17:22:27

CHECK RT013A.UVDATA.1

Freq = 4.9270 GHz, Bw = 16.000 MH No calibration applied and no bandpass applied

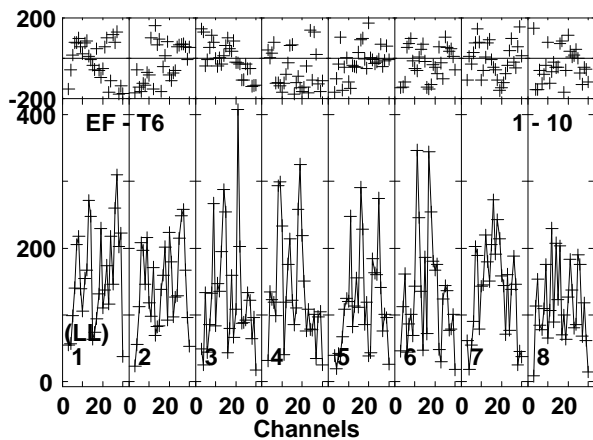
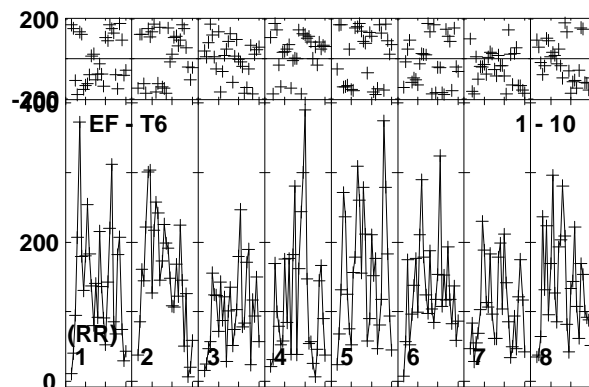
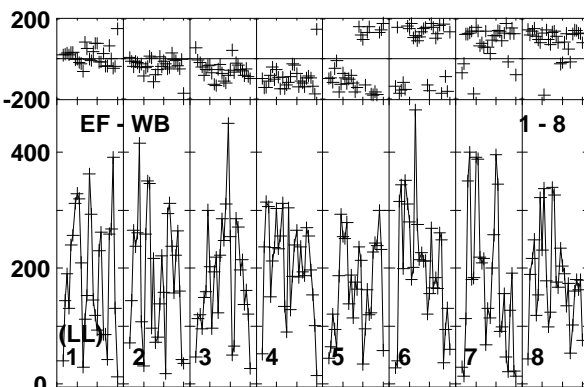
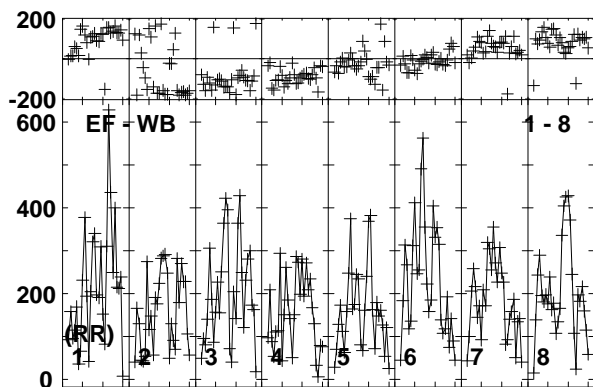
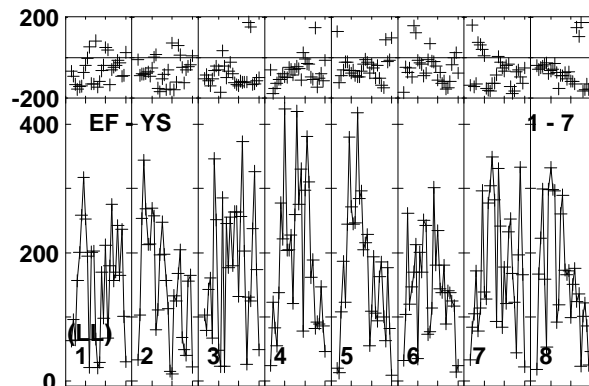
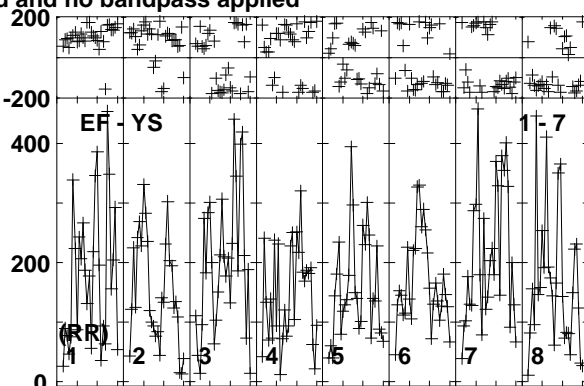
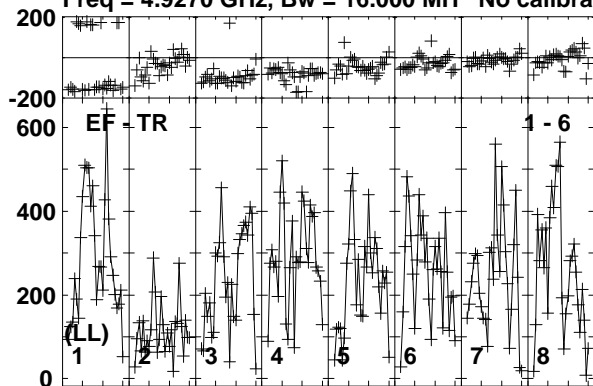

Lower frame: Micro Ampl Jy Top frame: Phas deg  
Vector averaged cross-power spectrum Baseline: EF (01) - TR (06)  
Timerange: 01/00:16:41 to 01/00:18:40



Plot file version 251 created 10-JUN-2016 17:22:27

CYGX1 RT013A.UVDATA.1

Freq = 4.9270 GHz, Bw = 16.000 MH No calibration applied and no bandpass applied

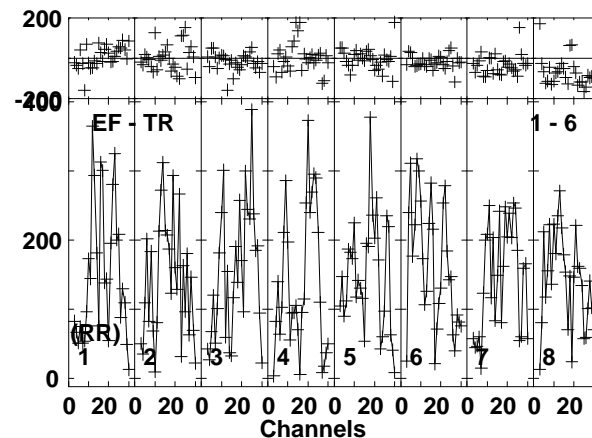
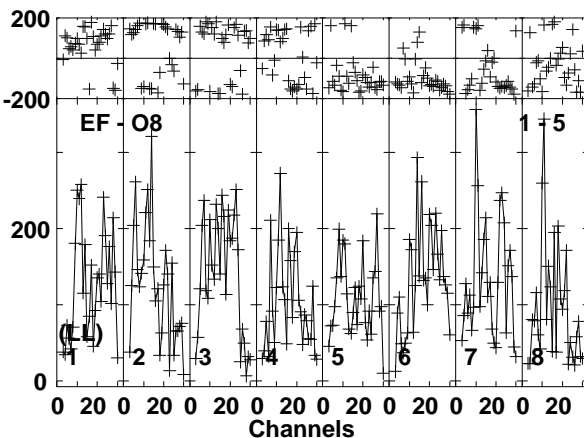
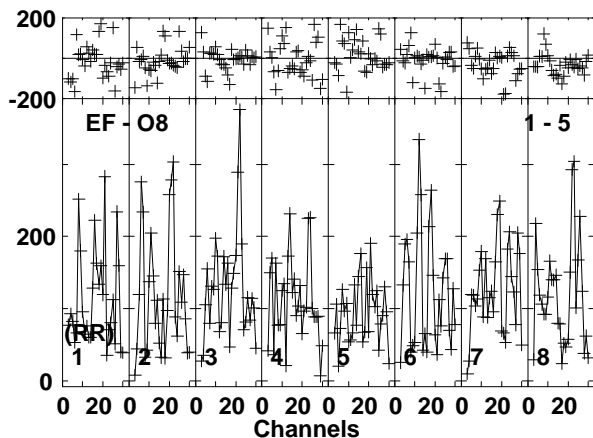
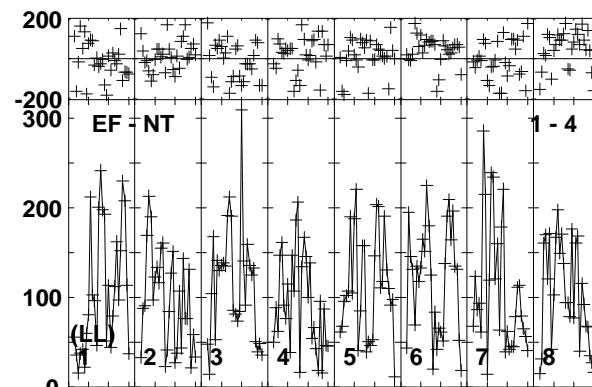
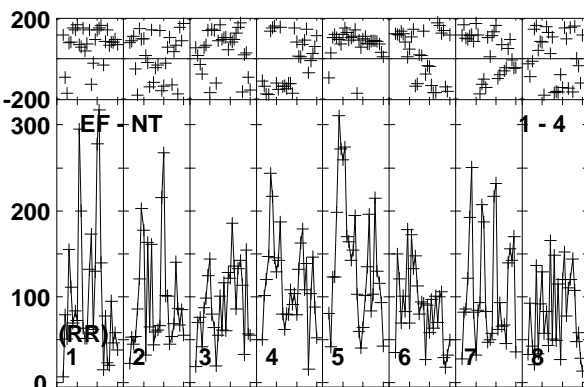
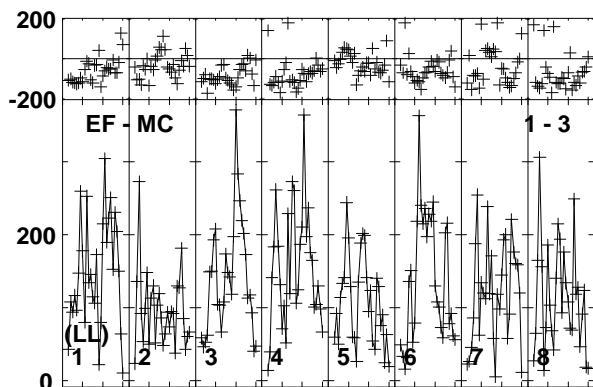
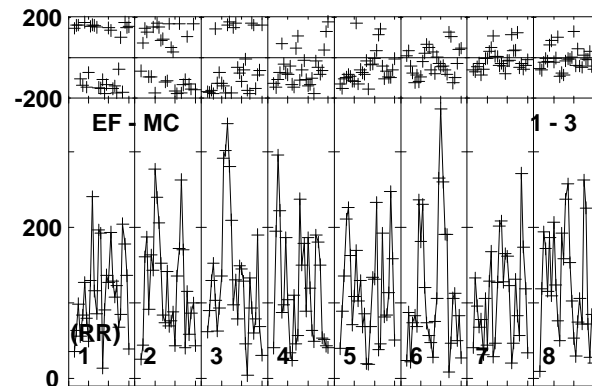
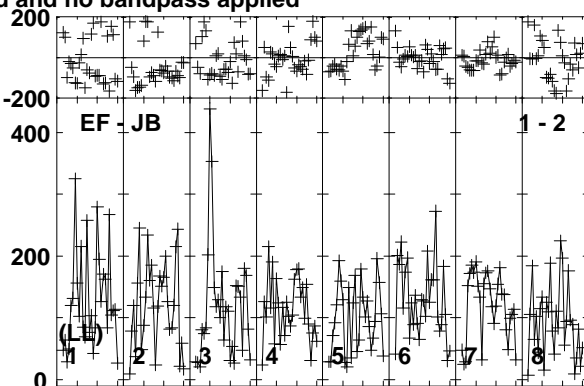
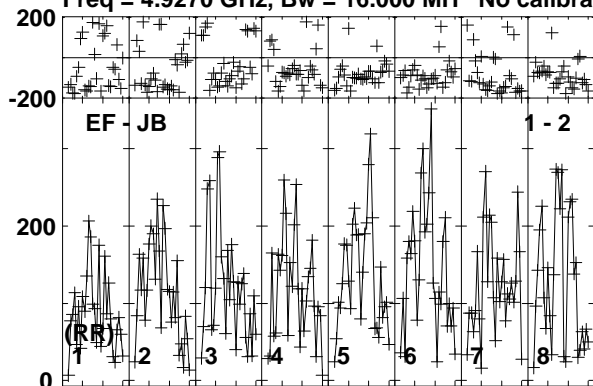

Lower frame: Micro Ampl Jy Top frame: Phas deg  
Vector averaged cross-power spectrum Baseline: EF (01) - JB (02)  
Timerange: 01/00:18:41 to 01/00:21:09

Plot file version 252 created 10-JUN-2016 17:22:27

CYGX1 RT013A.UVDATA.1

Freq = 4.9270 GHz, Bw = 16.000 MH No calibration applied and no bandpass applied

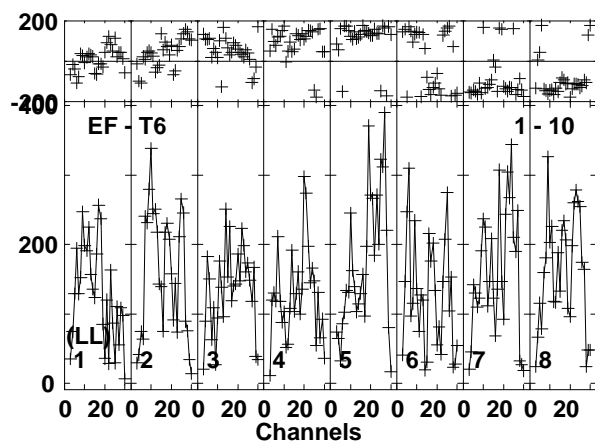
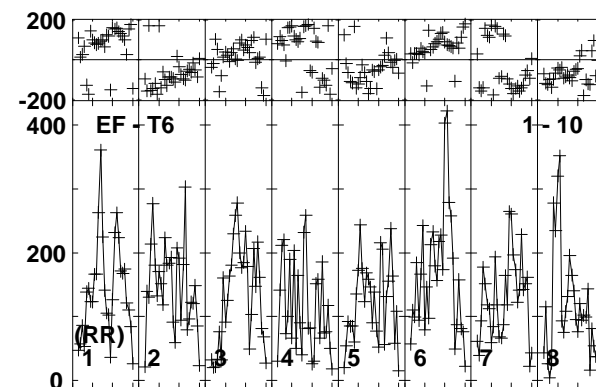
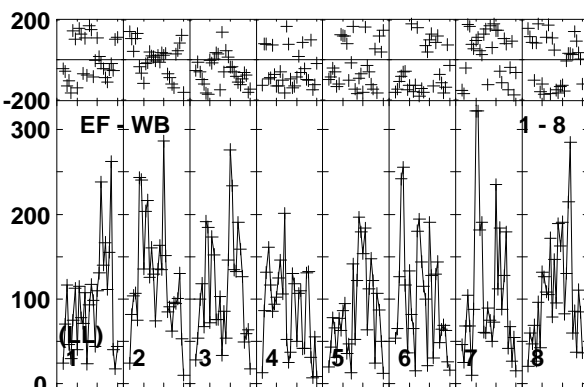
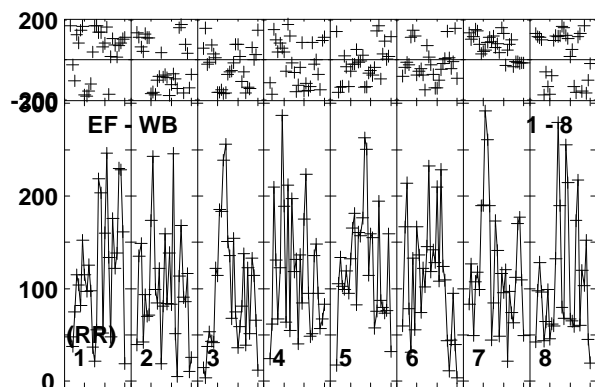
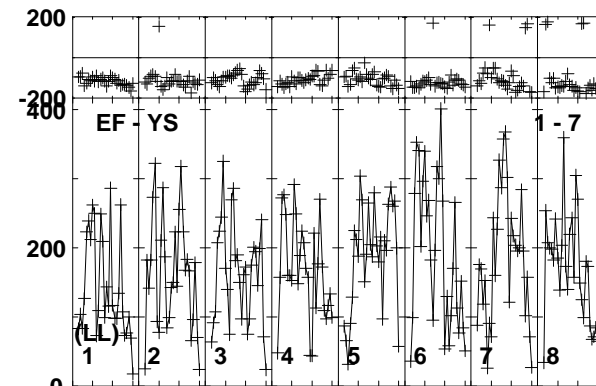
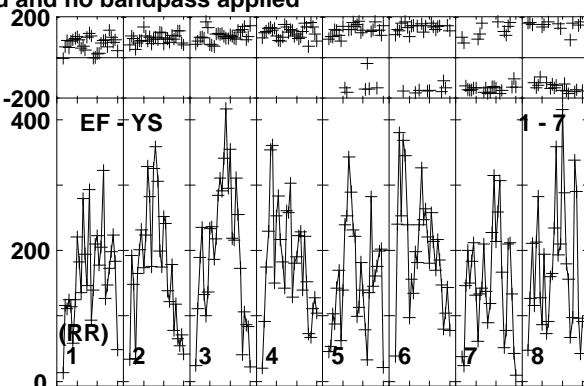
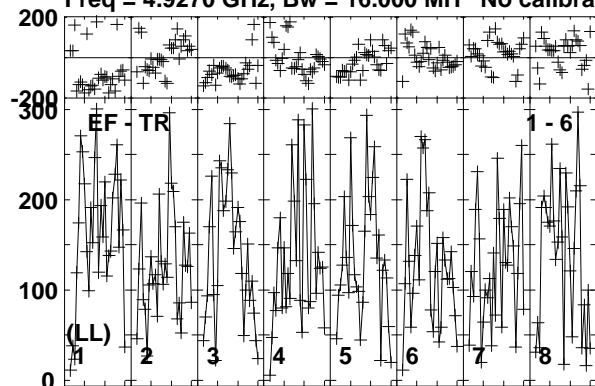

Lower frame: Micro Ampl Jy Top frame: Phas deg  
Vector averaged cross-power spectrum Baseline: EF (01) - TR (06)  
Timerange: 01/00:18:41 to 01/00:21:09

Plot file version 253 created 10-JUN-2016 17:22:27

J1957+3338 RT013A.UVDATA.1

Freq = 4.9270 GHz, Bw = 16.000 MH No calibration applied and no bandpass applied

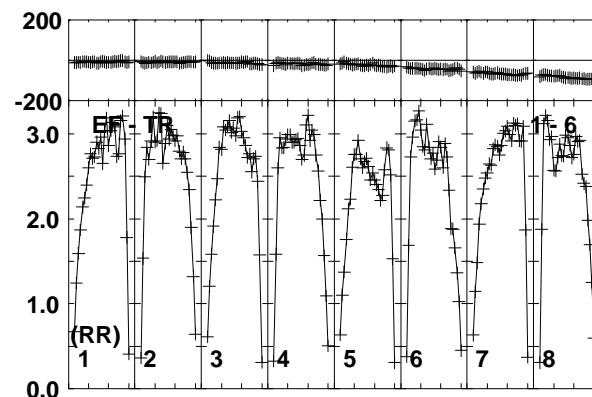
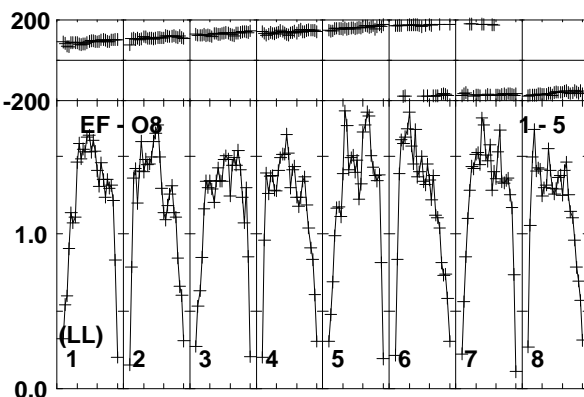
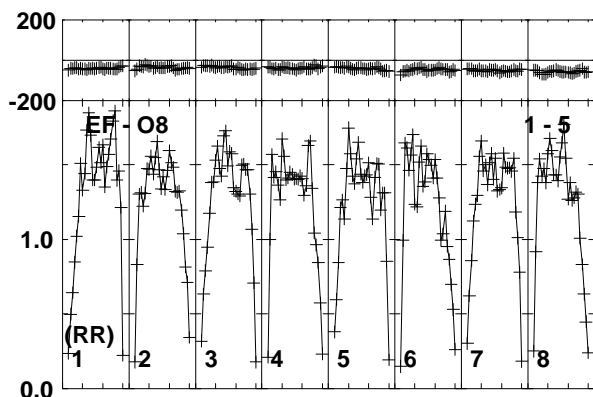
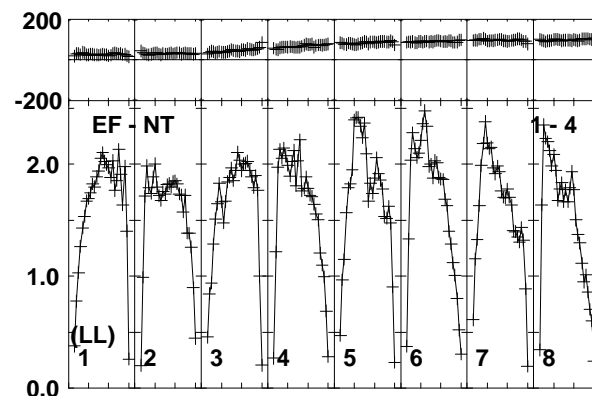
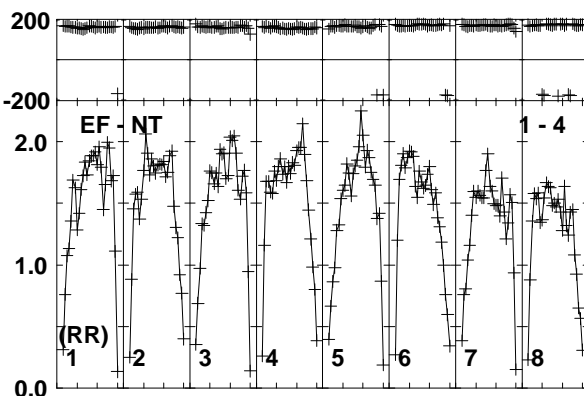
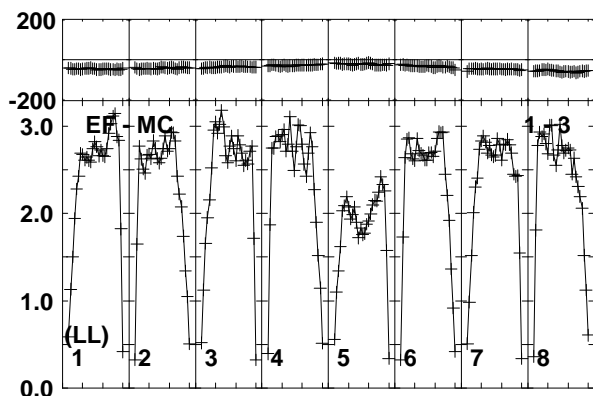
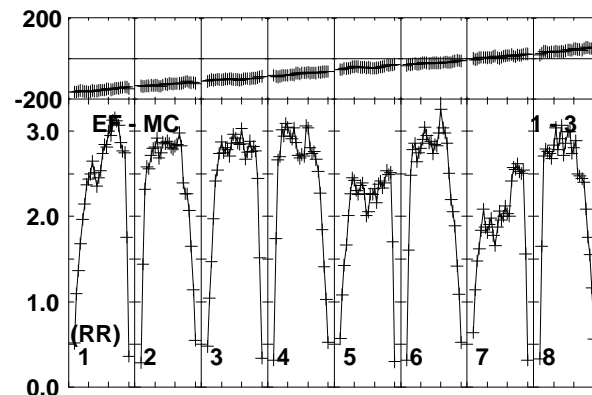
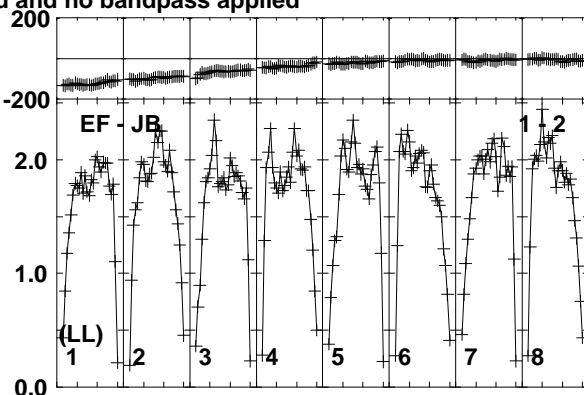
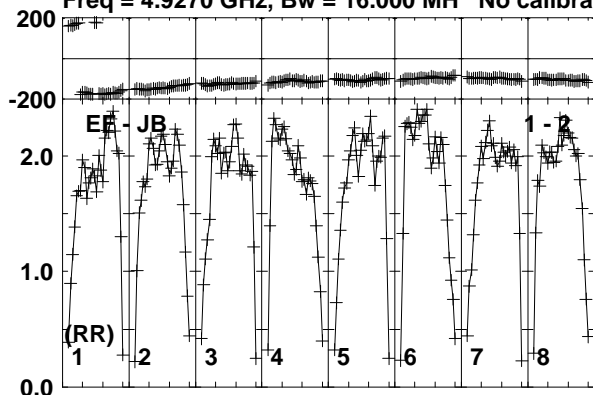

Lower frame: Milli Ampl Jy Top frame: Phas deg  
Vector averaged cross-power spectrum Baseline: EF (01) - JB (02)  
Timerange: 01/00:21:11 to 01/00:22:39

Plot file version 254 created 10-JUN-2016 17:22:27

J1957+3338 RT013A.UVDATA.1

Freq = 4.9270 GHz, Bw = 16.000 MH No calibration applied and no bandpass applied

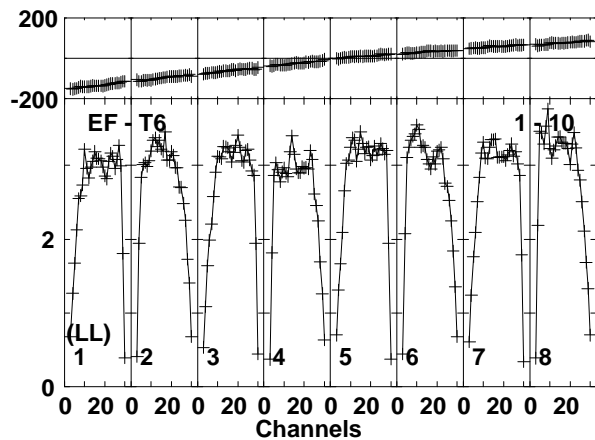
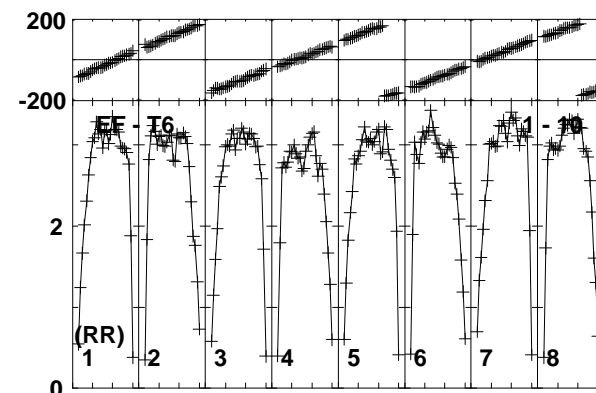
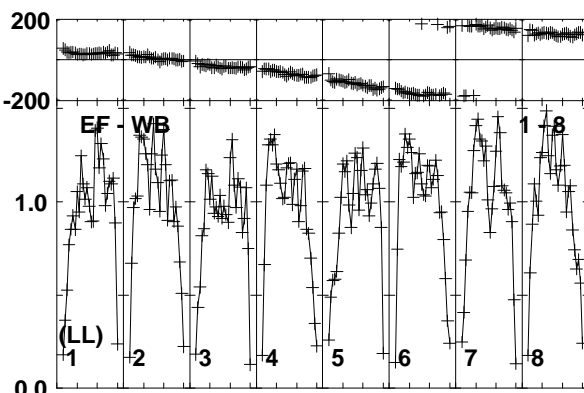
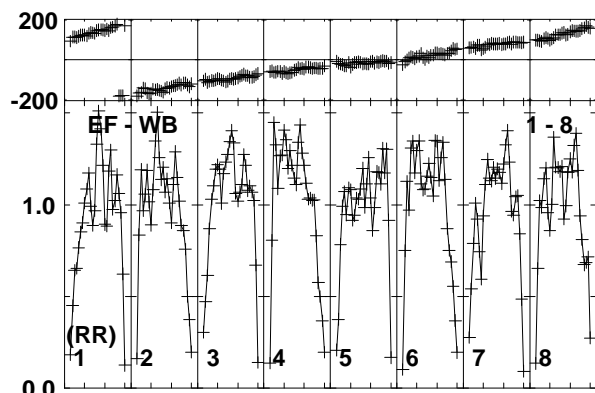
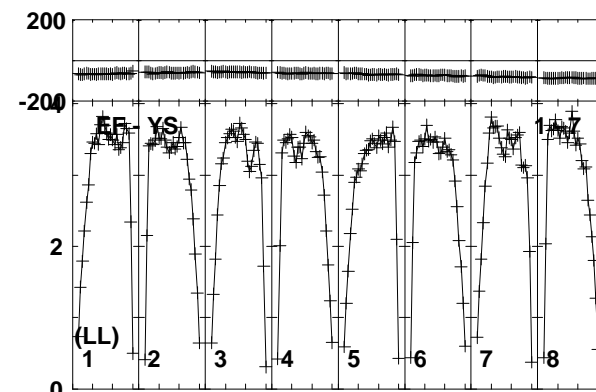
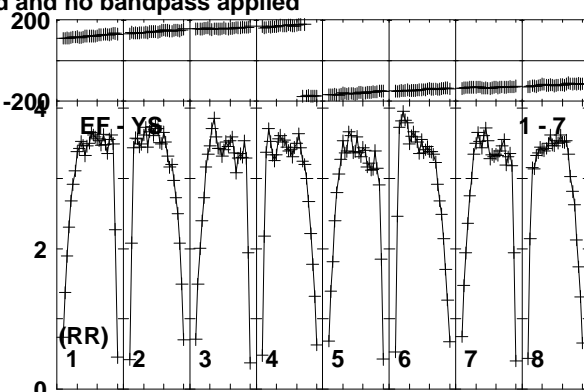
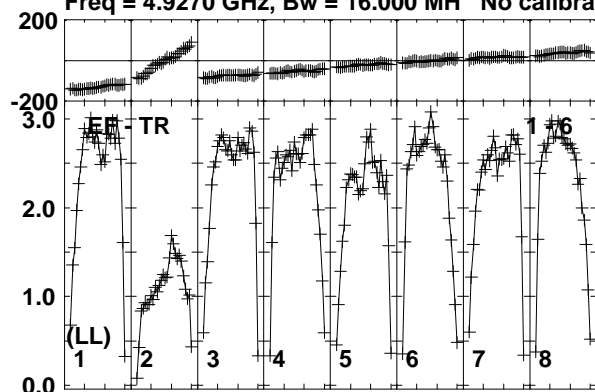

Lower frame: Milli Ampl Jy Top frame: Phas deg  
Vector averaged cross-power spectrum Baseline: EF (01) - TR (06)  
Timerange: 01/00:21:11 to 01/00:22:39

Plot file version 255 created 10-JUN-2016 17:22:27

CHECK RT013A.UVDATA.1

Freq = 4.9270 GHz, Bw = 16.000 MH No calibration applied and no bandpass applied

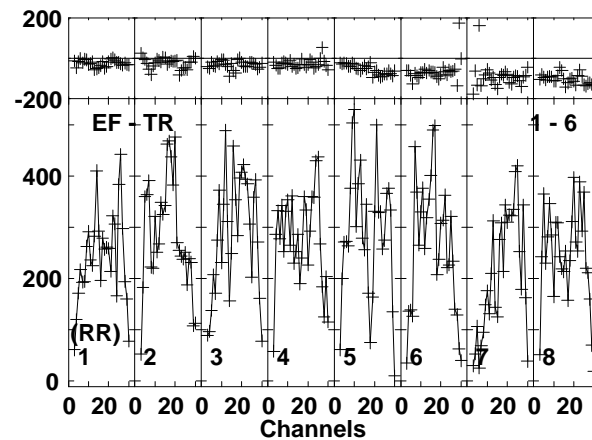
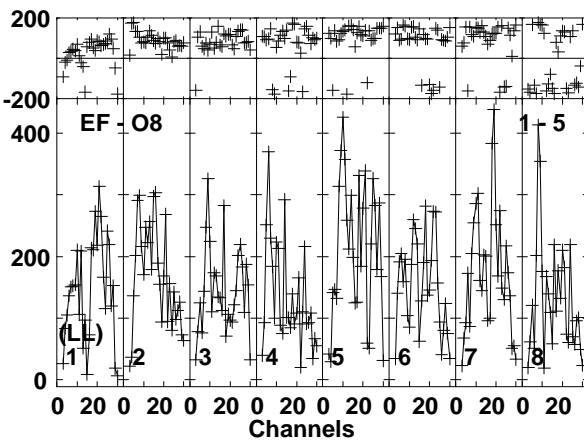
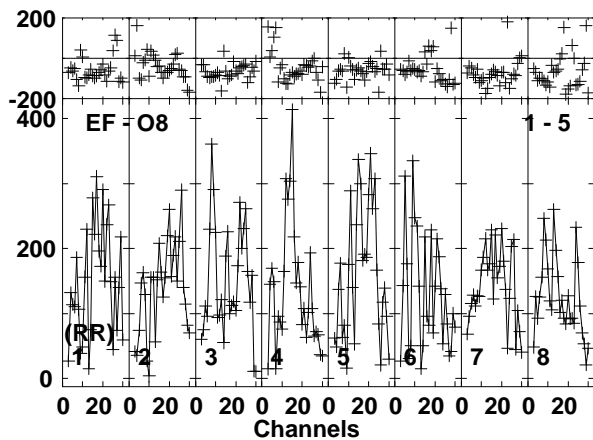
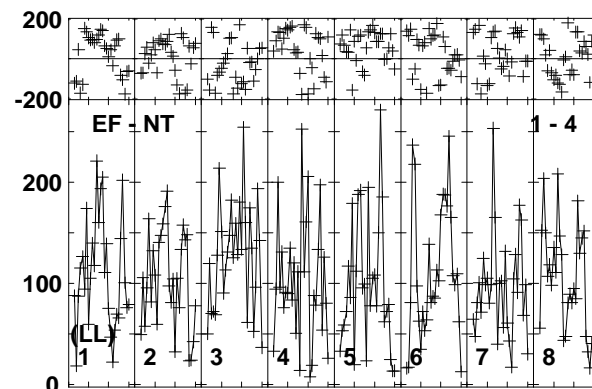
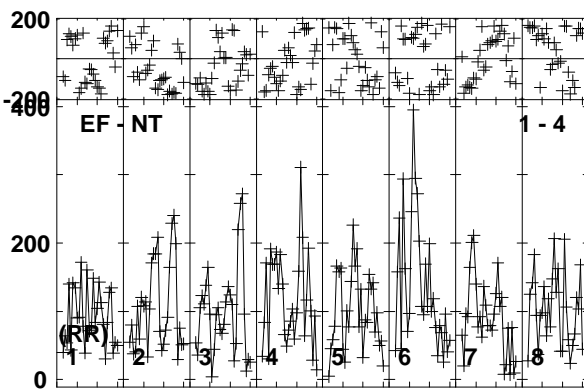
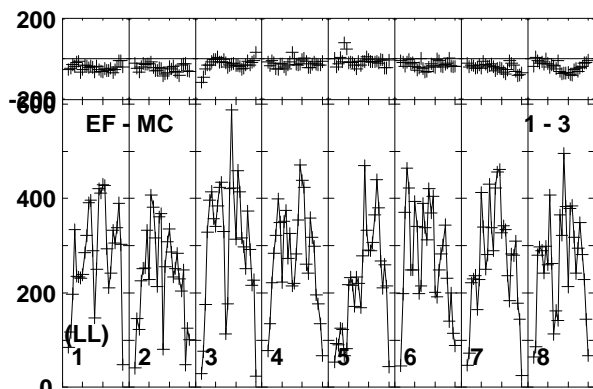
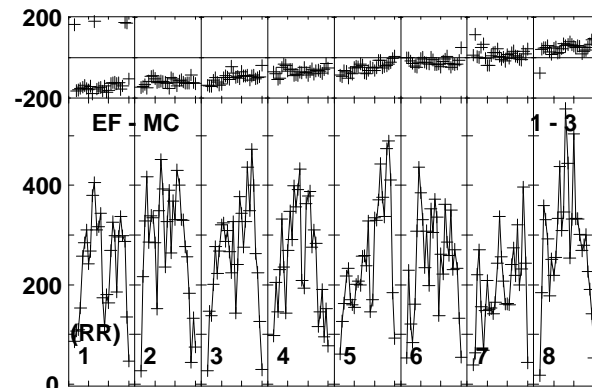
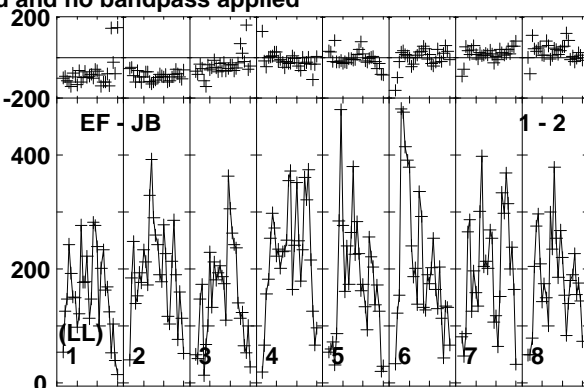
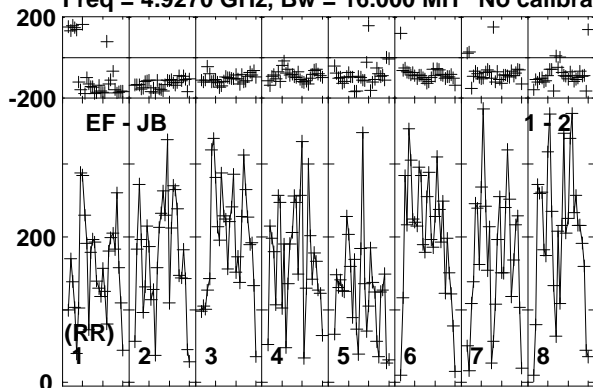

Lower frame: Micro Ampl Jy Top frame: Phas deg  
Vector averaged cross-power spectrum Baseline: EF (01) - JB (02)  
Timerange: 01/00:23:20 to 01/00:25:20

Plot file version 256 created 10-JUN-2016 17:22:27

CHECK RT013A.UVDATA.1

Freq = 4.9270 GHz, Bw = 16.000 MH No calibration applied and no bandpass applied

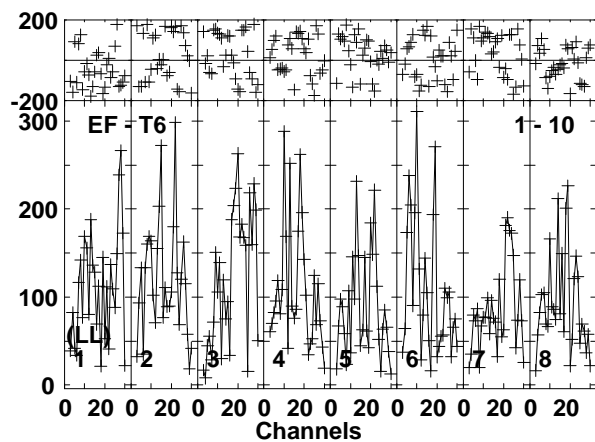
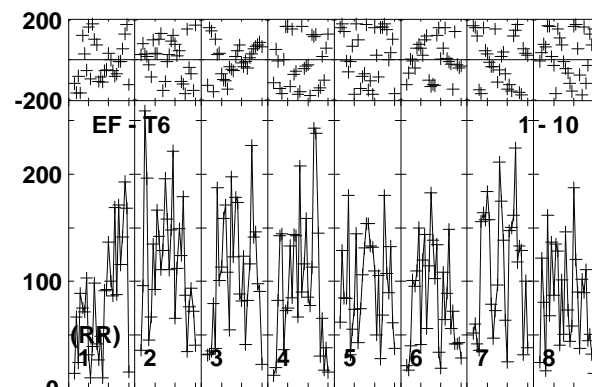
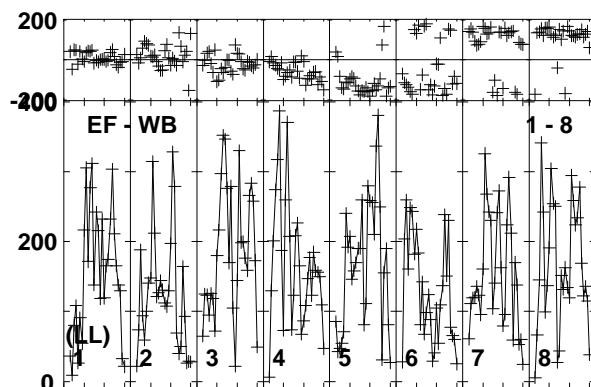
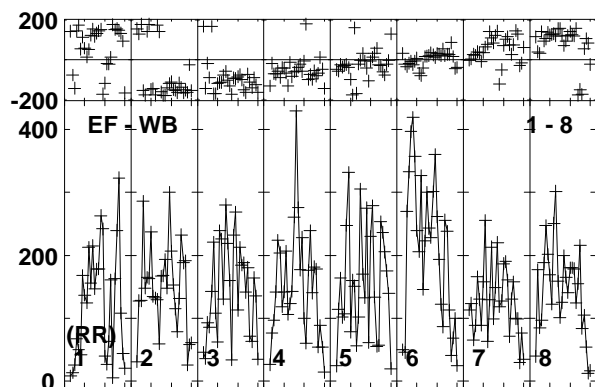
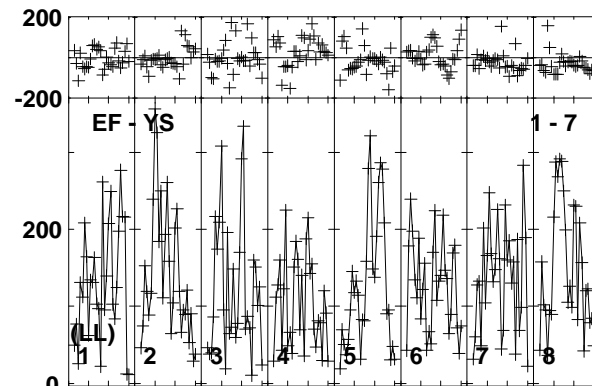
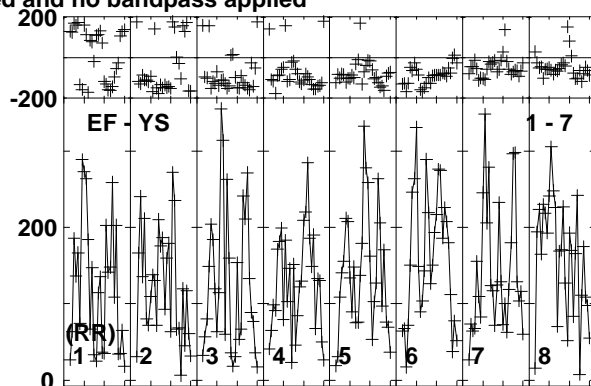
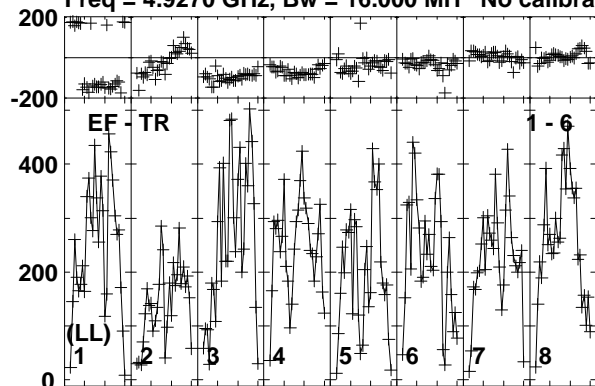

Lower frame: Micro Ampl Jy Top frame: Phas deg  
Vector averaged cross-power spectrum Baseline: EF (01) - TR (06)  
Timerange: 01/00:23:20 to 01/00:25:20

Plot file version 257 created 10-JUN-2016 17:22:27

CYGX1 RT013A.UVDATA.1

Freq = 4.9270 GHz, Bw = 16.000 MH No calibration applied and no bandpass applied

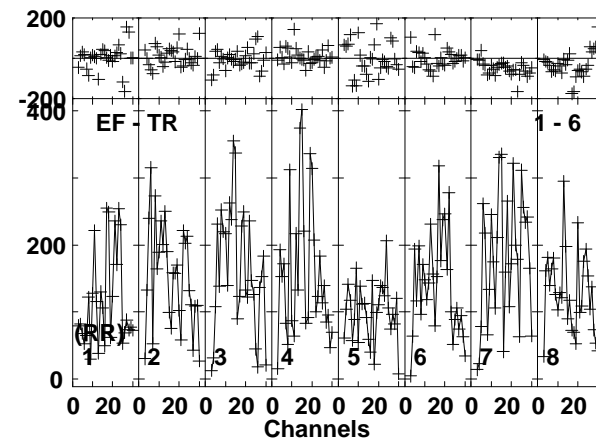
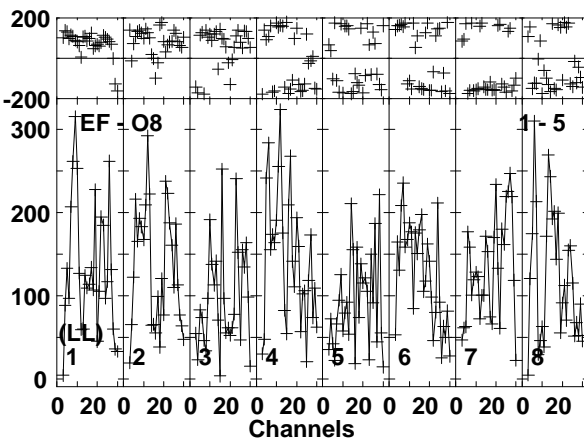
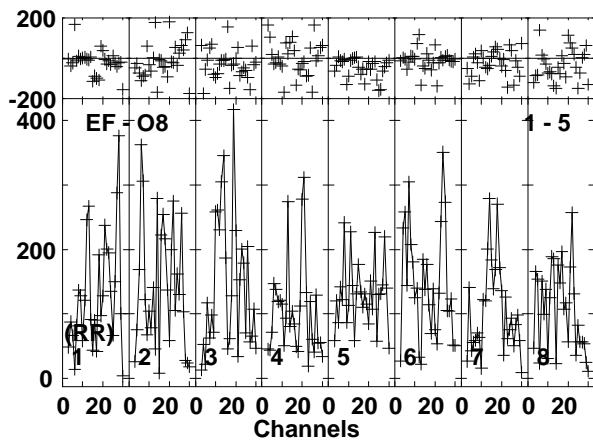
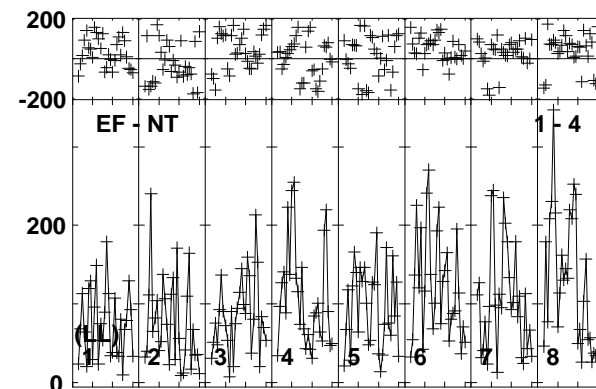
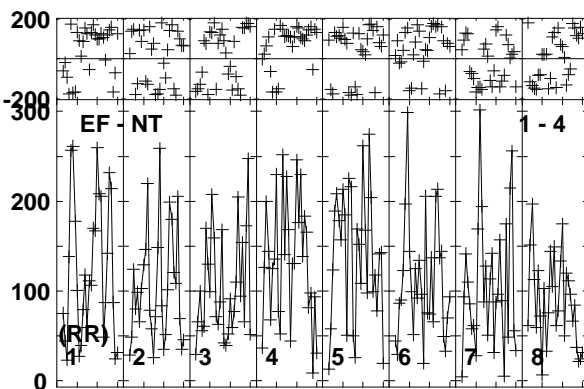
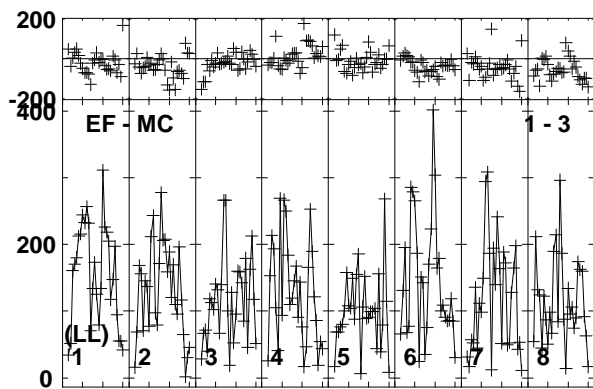
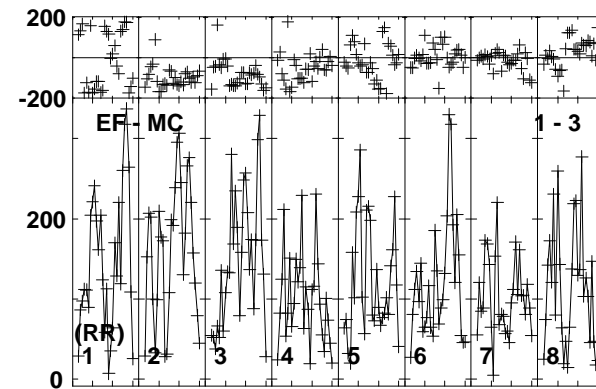
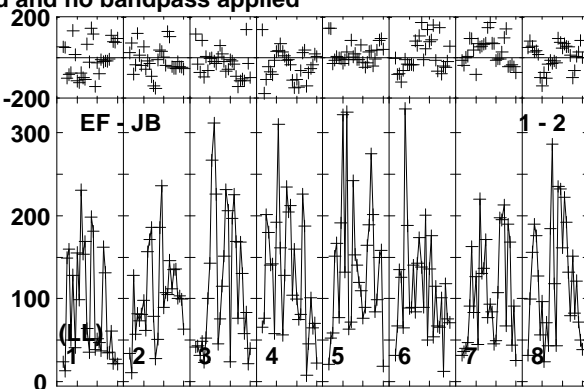
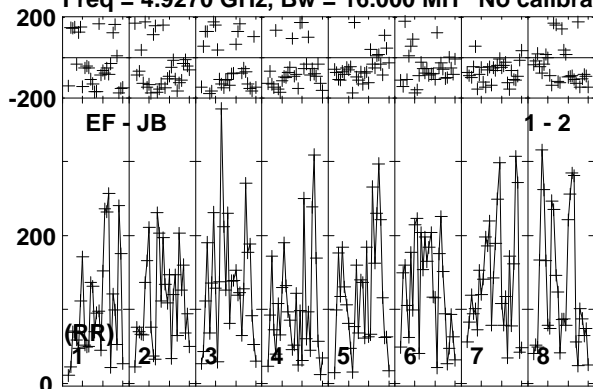

Lower frame: Micro Ampl Jy Top frame: Phas deg  
Vector averaged cross-power spectrum Baseline: EF (01) - JB (02)  
Timerange: 01/00:25:21 to 01/00:27:49

Plot file version 258 created 10-JUN-2016 17:22:28

CYGX1 RT013A.UVDATA.1

Freq = 4.9270 GHz, Bw = 16.000 MH No calibration applied and no bandpass applied

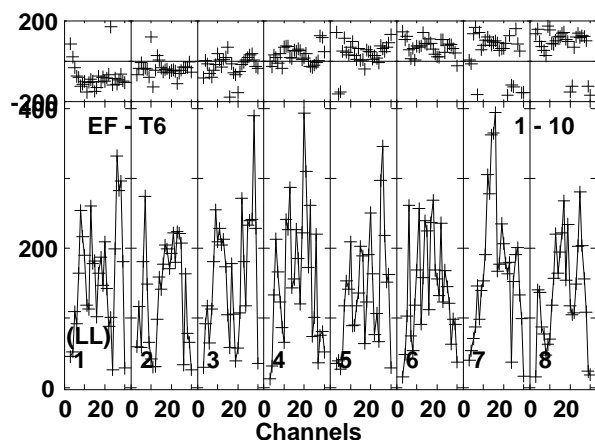
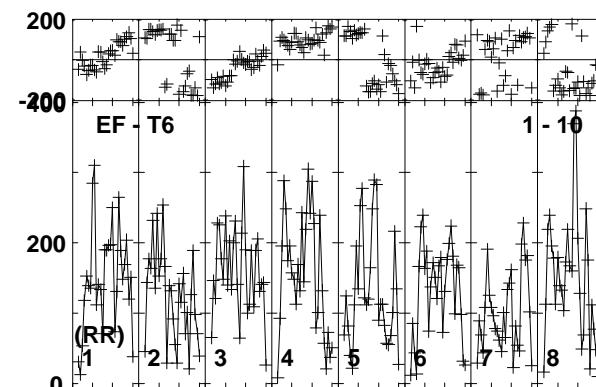
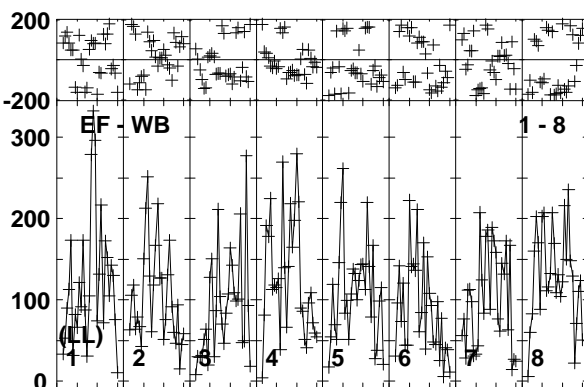
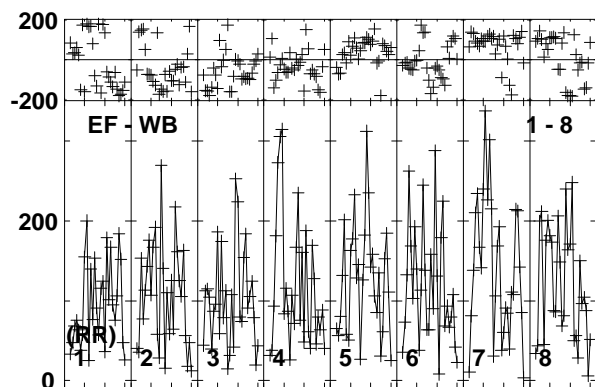
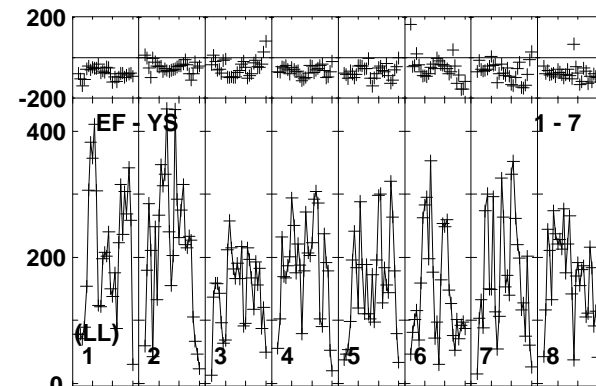
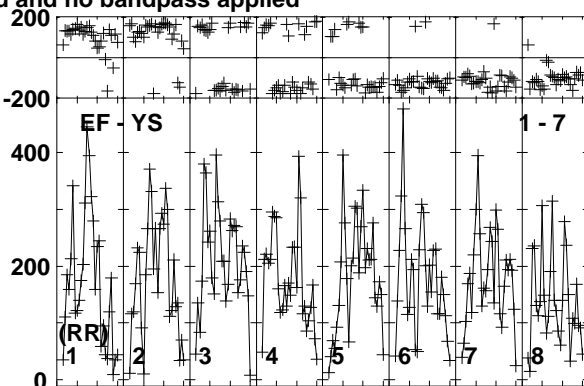
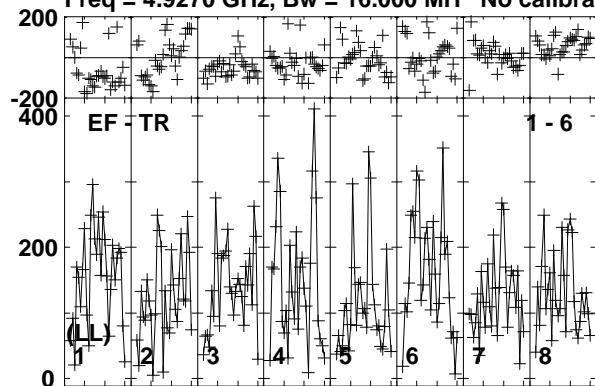

Lower frame: Micro Ampl Jy Top frame: Phas deg  
Vector averaged cross-power spectrum Baseline: EF (01) - TR (06)  
Timerange: 01/00:25:21 to 01/00:27:49



Plot file version 259 created 10-JUN-2016 17:22:28

J1957+3338 RT013A.UVDATA.1

Freq = 4.9270 GHz, Bw = 16.000 MH No calibration applied and no bandpass applied

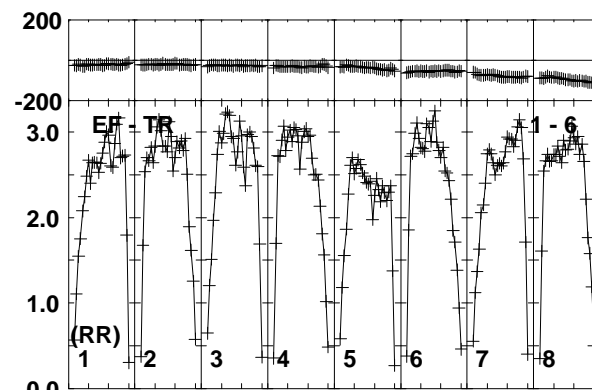
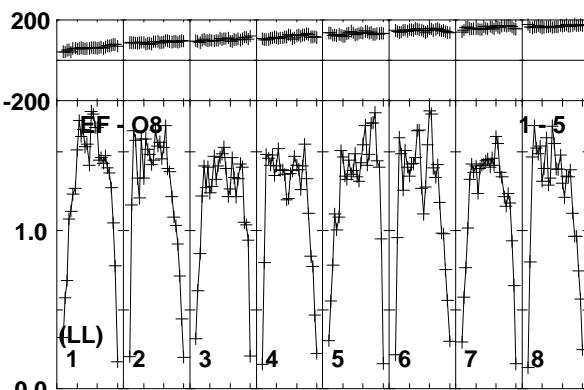
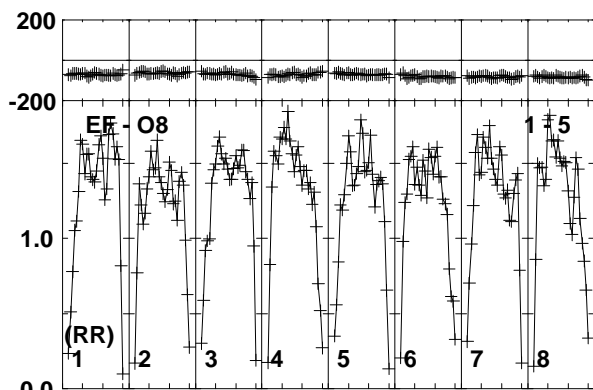
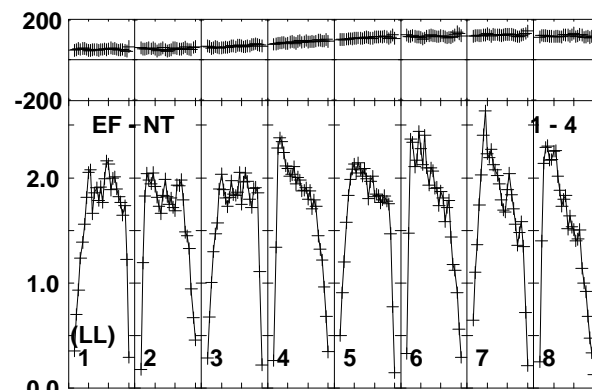
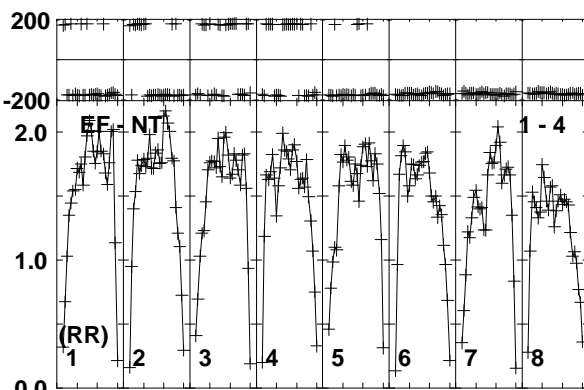
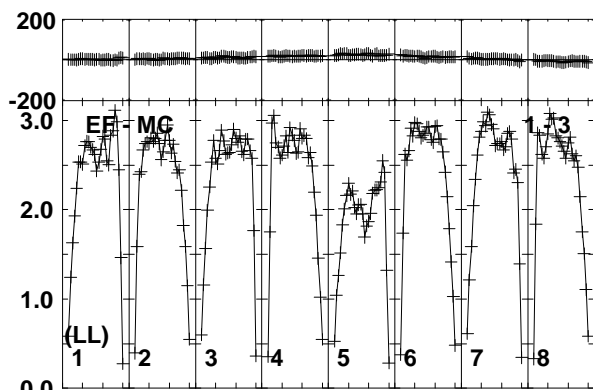
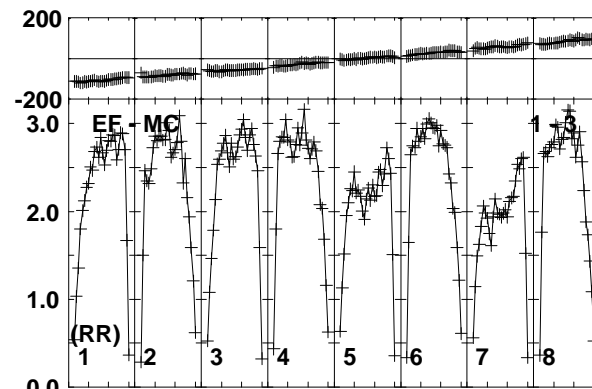
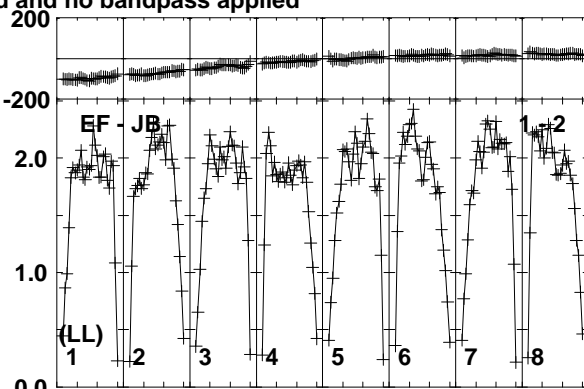
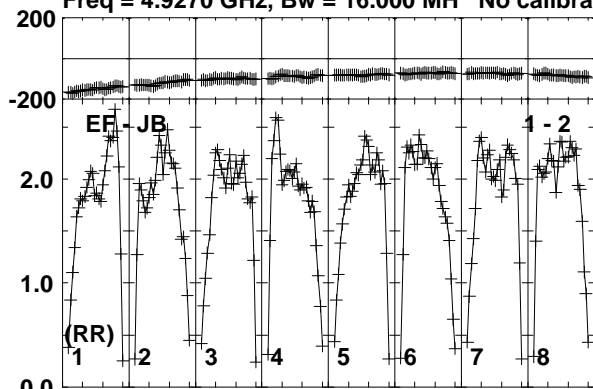

Lower frame: Milli Ampl Jy Top frame: Phas deg  
Vector averaged cross-power spectrum Baseline: EF (01) - JB (02)  
Timerange: 01/00:27:51 to 01/00:29:19

Plot file version 260 created 10-JUN-2016 17:22:28

J1957+3338 RT013A.UVDATA.1

Freq = 4.9270 GHz, Bw = 16.000 MH No calibration applied and no bandpass applied

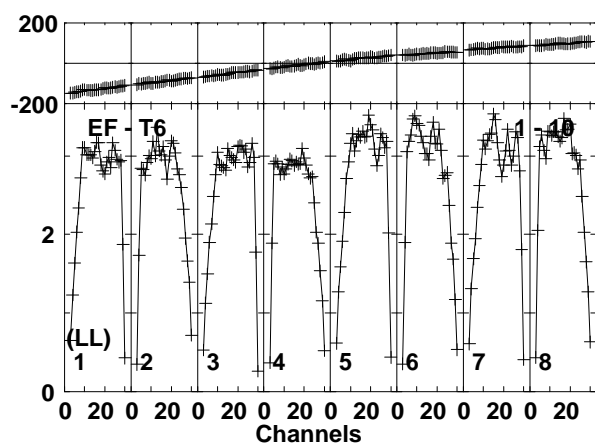
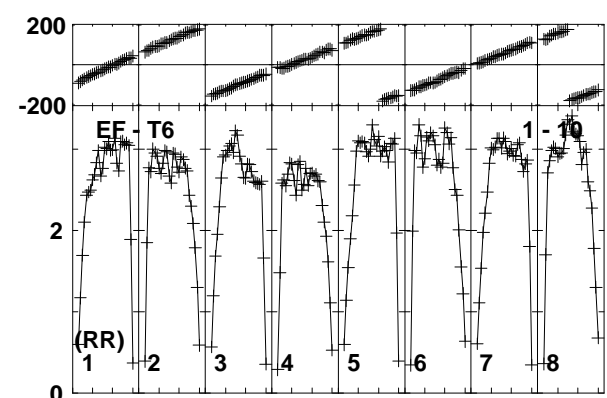
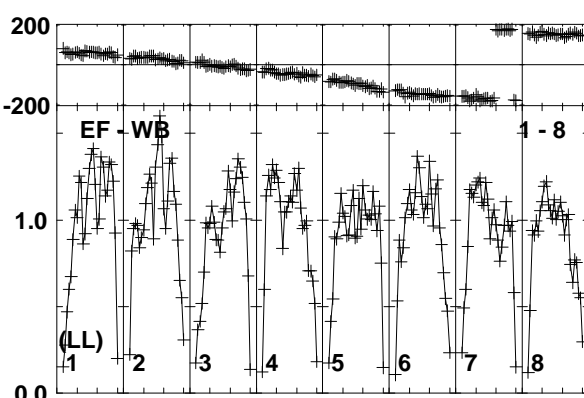
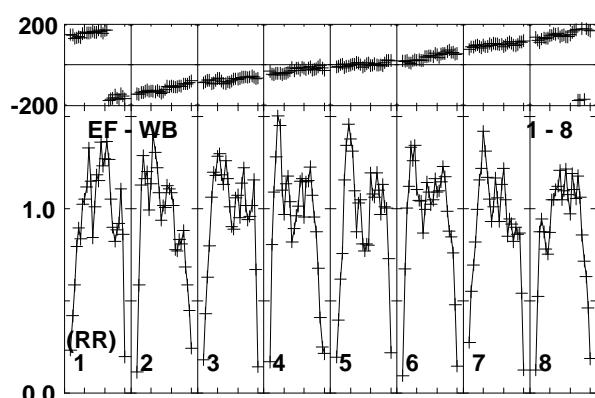
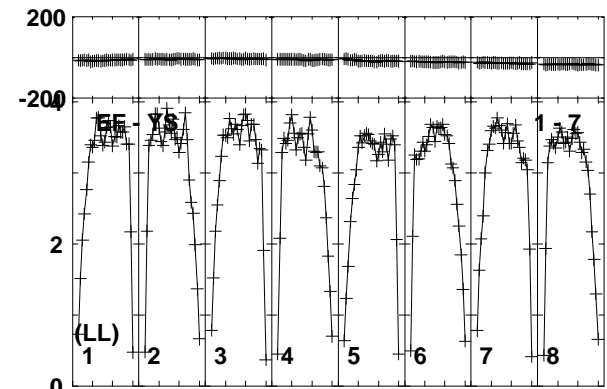
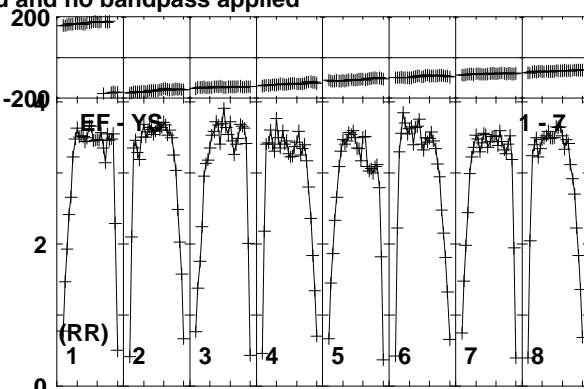
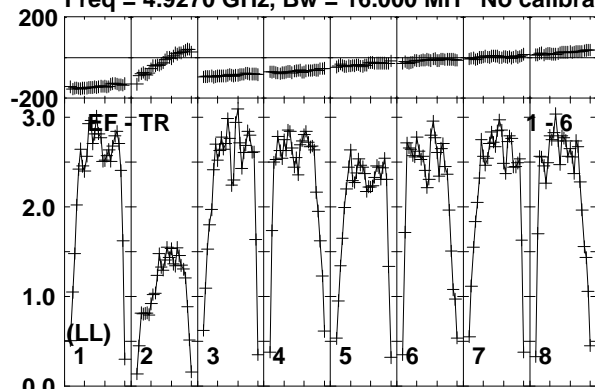

Lower frame: Milli Ampl Jy Top frame: Phas deg  
Vector averaged cross-power spectrum Baseline: EF (01) - TR (06)  
Timerange: 01/00:27:51 to 01/00:29:19

Plot file version 261 created 10-JUN-2016 17:22:28

CHECK RT013A.UVDATA.1

Freq = 4.9270 GHz, Bw = 16.000 MH No calibration applied and no bandpass applied

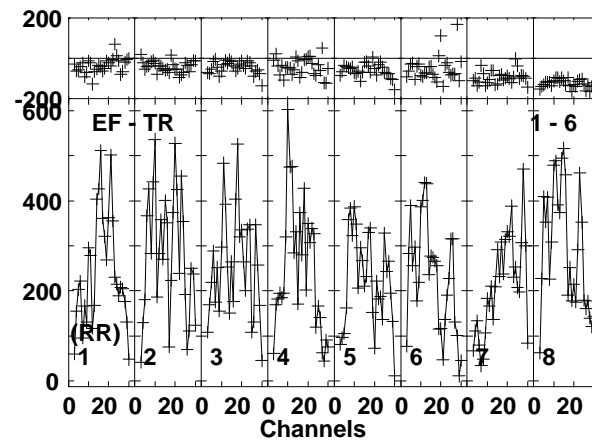
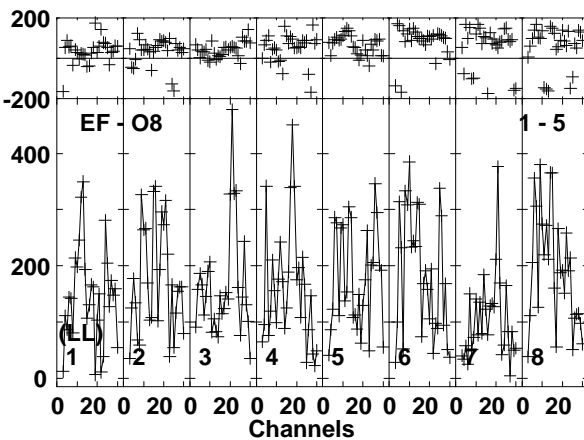
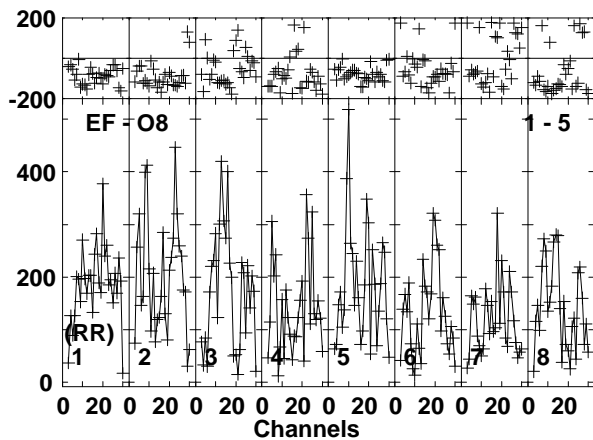
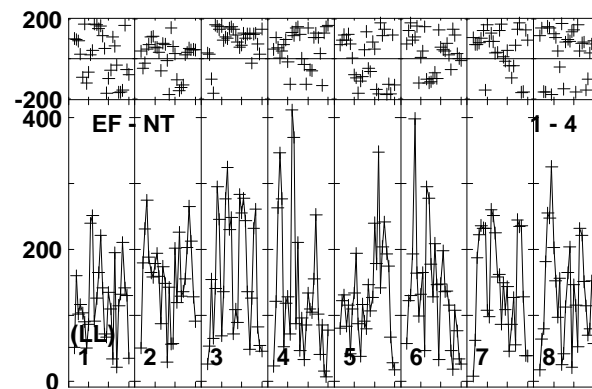
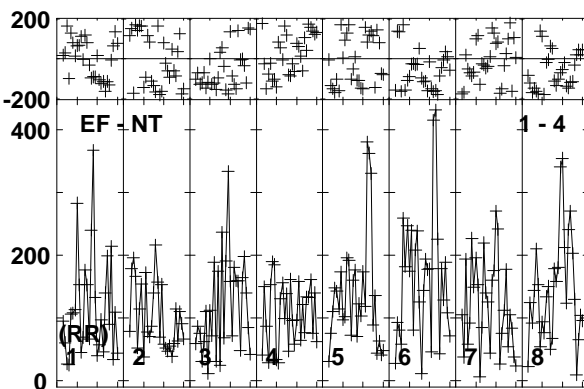
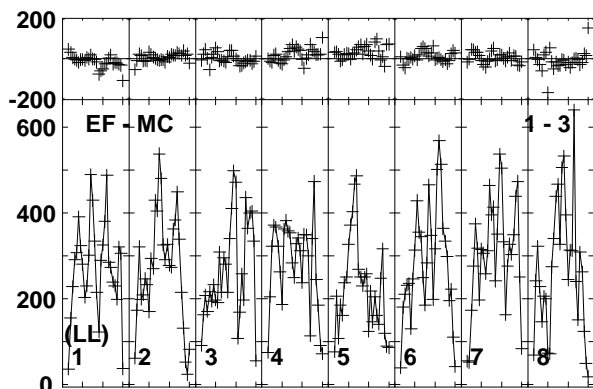
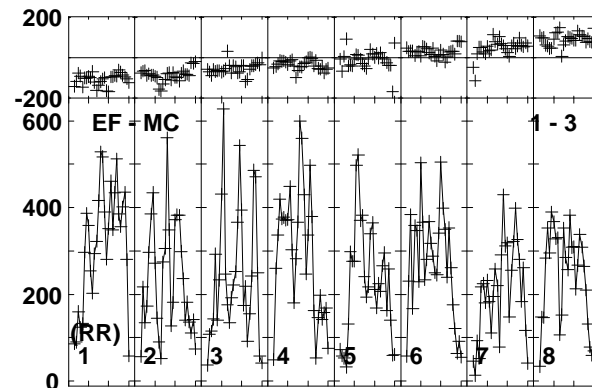
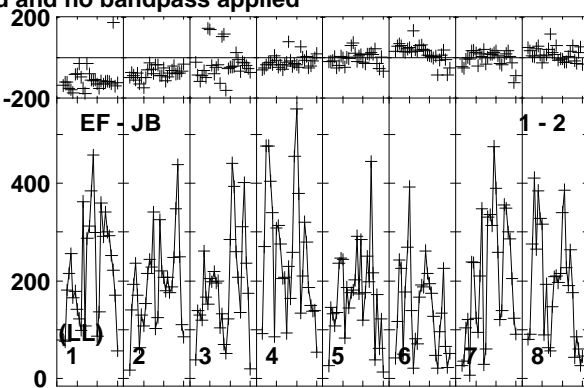
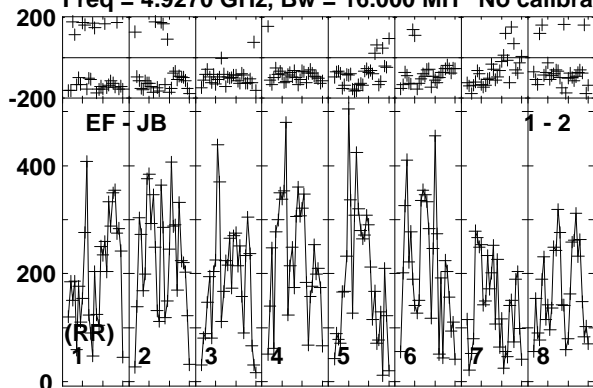

Lower frame: Micro Ampl Jy Top frame: Phas deg  
Vector averaged cross-power spectrum Baseline: EF (01) - JB (02)  
Timerange: 01/00:29:21 to 01/00:31:19

Plot file version 262 created 10-JUN-2016 17:22:28

CHECK RT013A.UVDATA.1

Freq = 4.9270 GHz, Bw = 16.000 MH No calibration applied and no bandpass applied

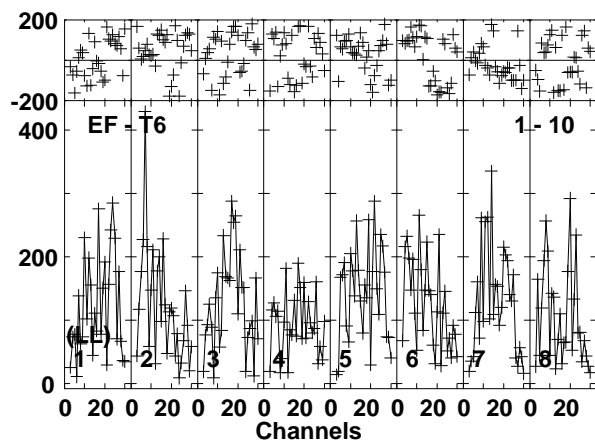
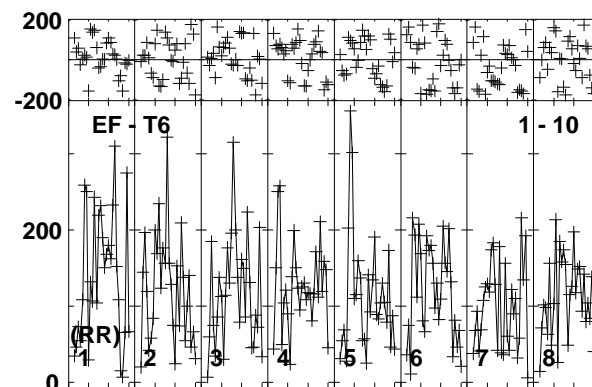
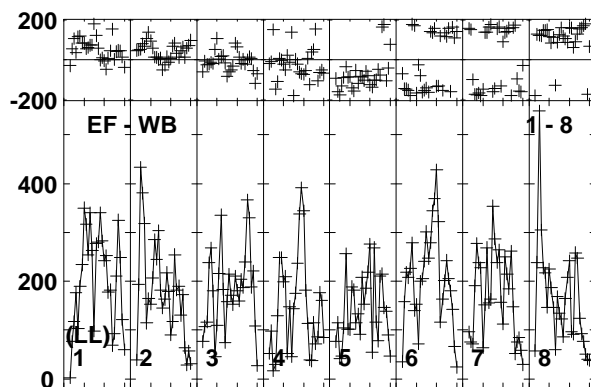
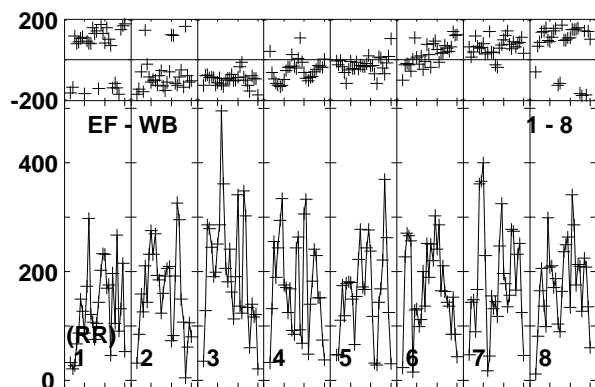
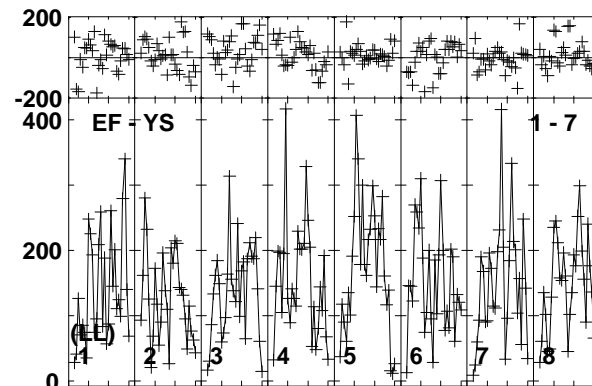
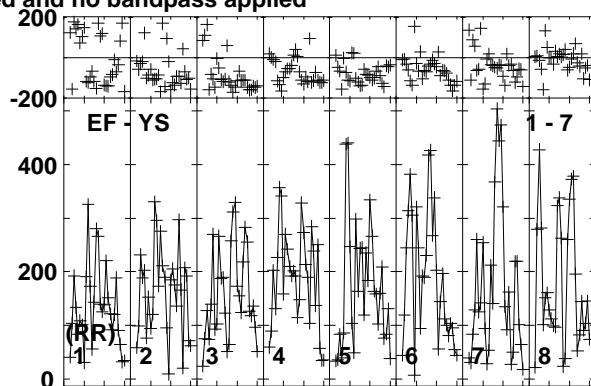
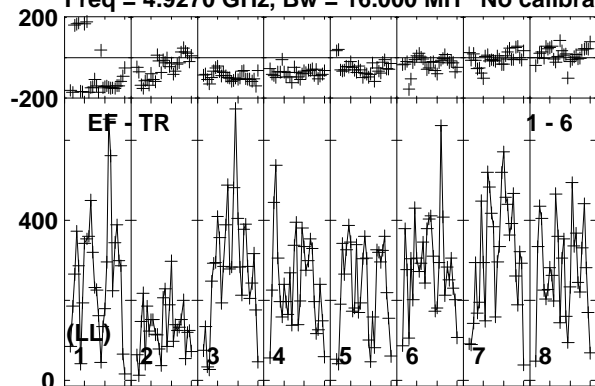

Lower frame: Micro Ampl Jy Top frame: Phas deg  
Vector averaged cross-power spectrum Baseline: EF (01) - TR (06)  
Timerange: 01/00:29:21 to 01/00:31:19

Plot file version 263 created 10-JUN-2016 17:22:28

CYGX1 RT013A.UVDATA.1

Freq = 4.9270 GHz, Bw = 16.000 MHz No calibration applied and no bandpass applied

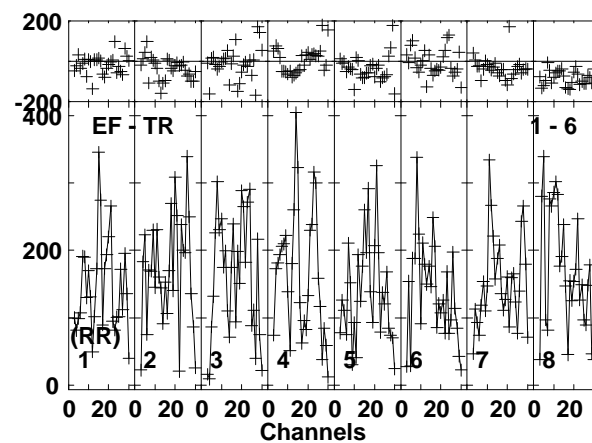
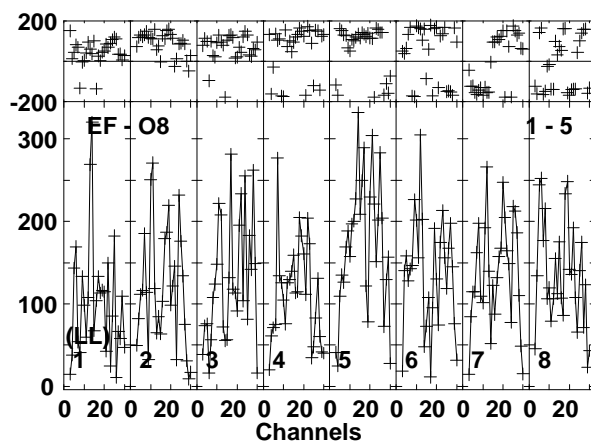
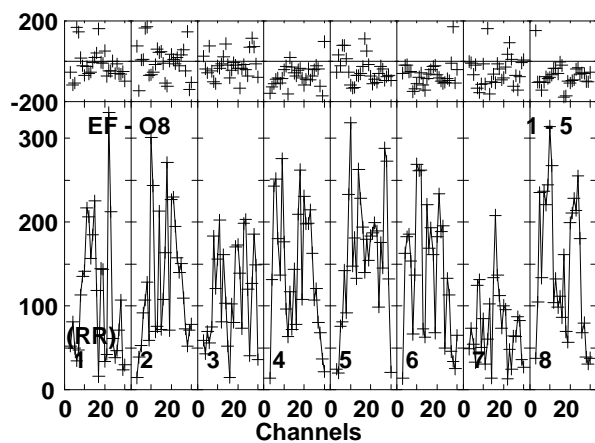
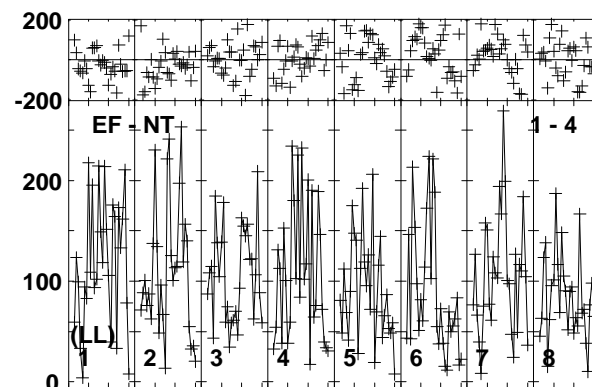
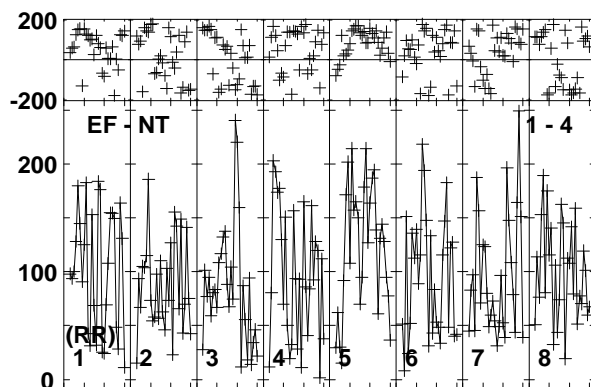
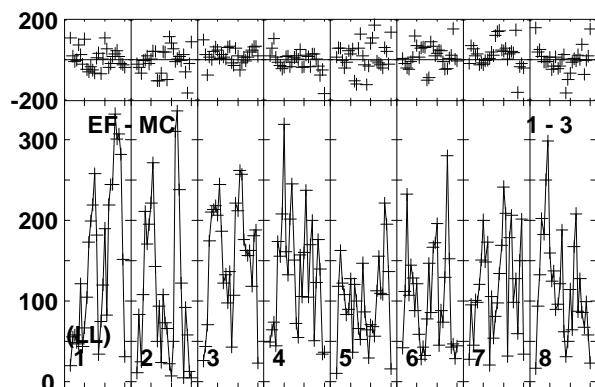
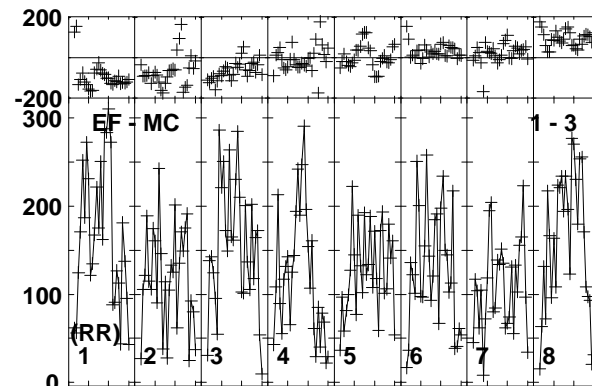
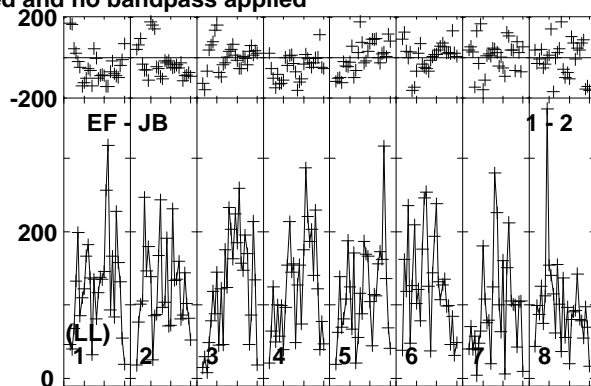
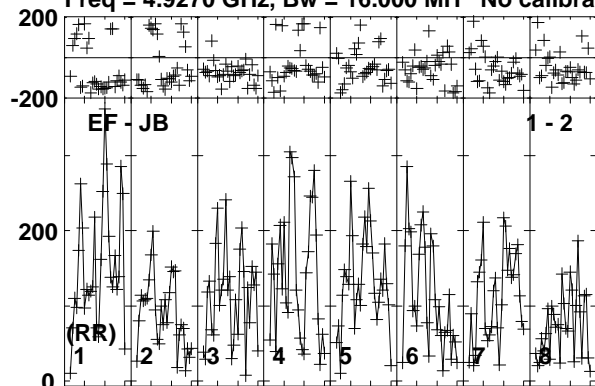

Lower frame: Micro Ampl Jy Top frame: Phas deg  
Vector averaged cross-power spectrum Baseline: EF (01) - JB (02)  
Timerange: 01/00:31:20 to 01/00:33:50

Plot file version 264 created 10-JUN-2016 17:22:28

CYGX1 RT013A.UVDATA.1

Freq = 4.9270 GHz, Bw = 16.000 MH No calibration applied and no bandpass applied

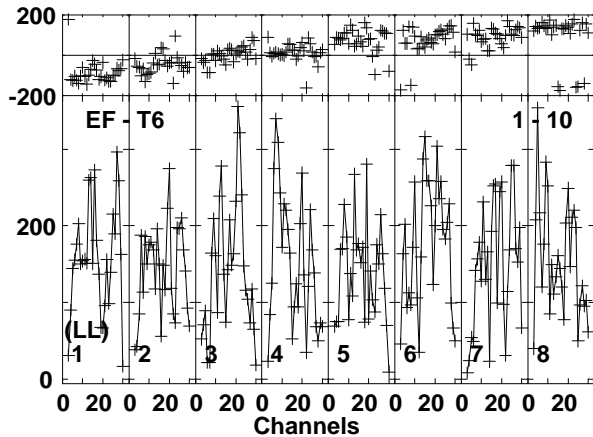
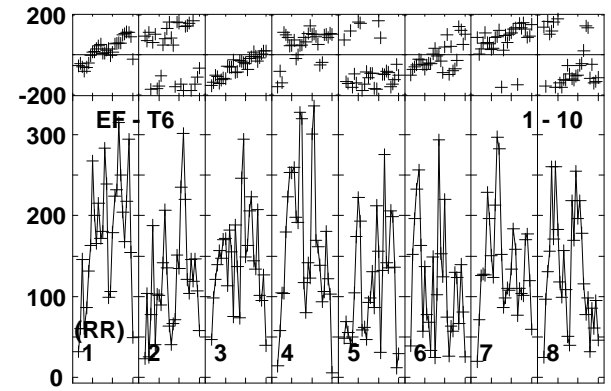
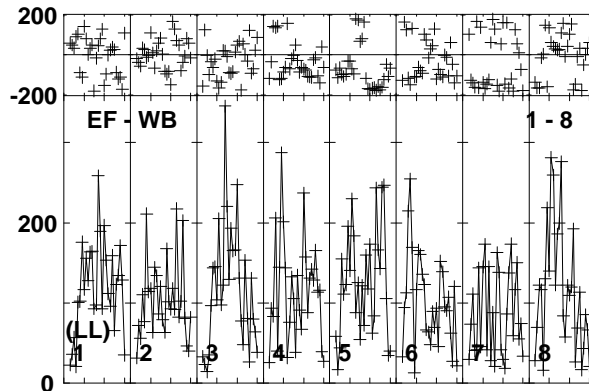
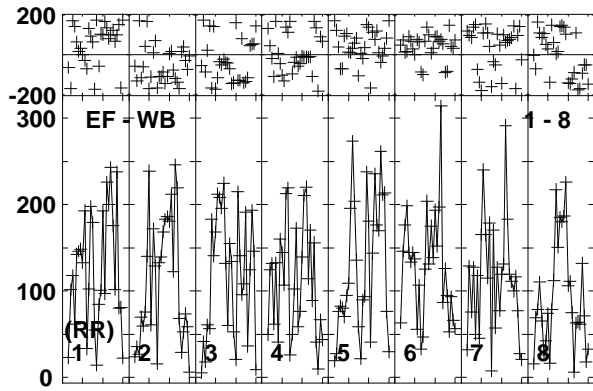
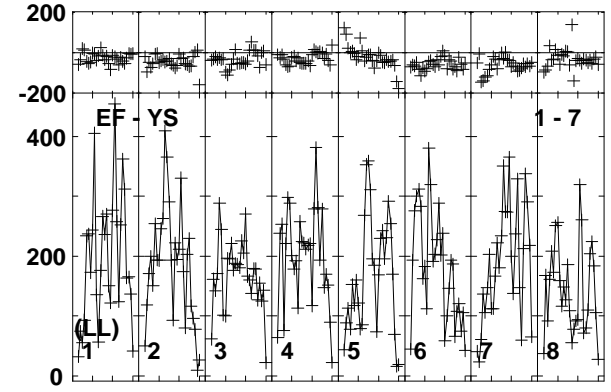
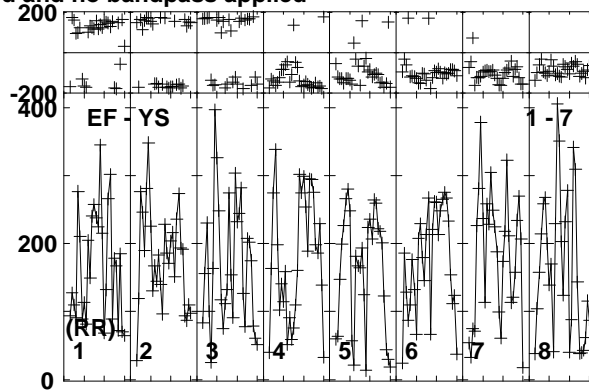
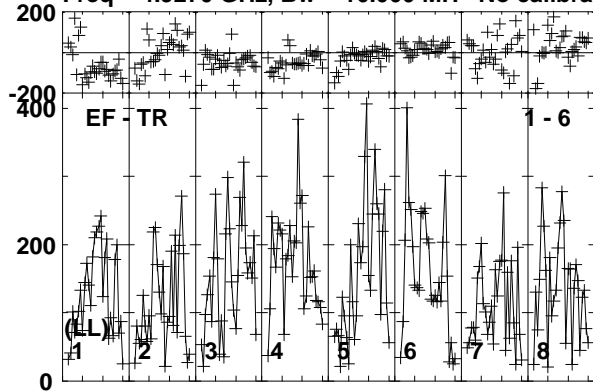

Lower frame: Micro Ampl Jy Top frame: Phas deg  
Vector averaged cross-power spectrum Baseline: EF (01) - TR (06)  
Timerange: 01/00:31:20 to 01/00:33:50

Plot file version 265 created 10-JUN-2016 17:22:28

J1957+3338 RT013A.UVDATA.1

Freq = 4.9270 GHz, Bw = 16.000 MH No calibration applied and no bandpass applied

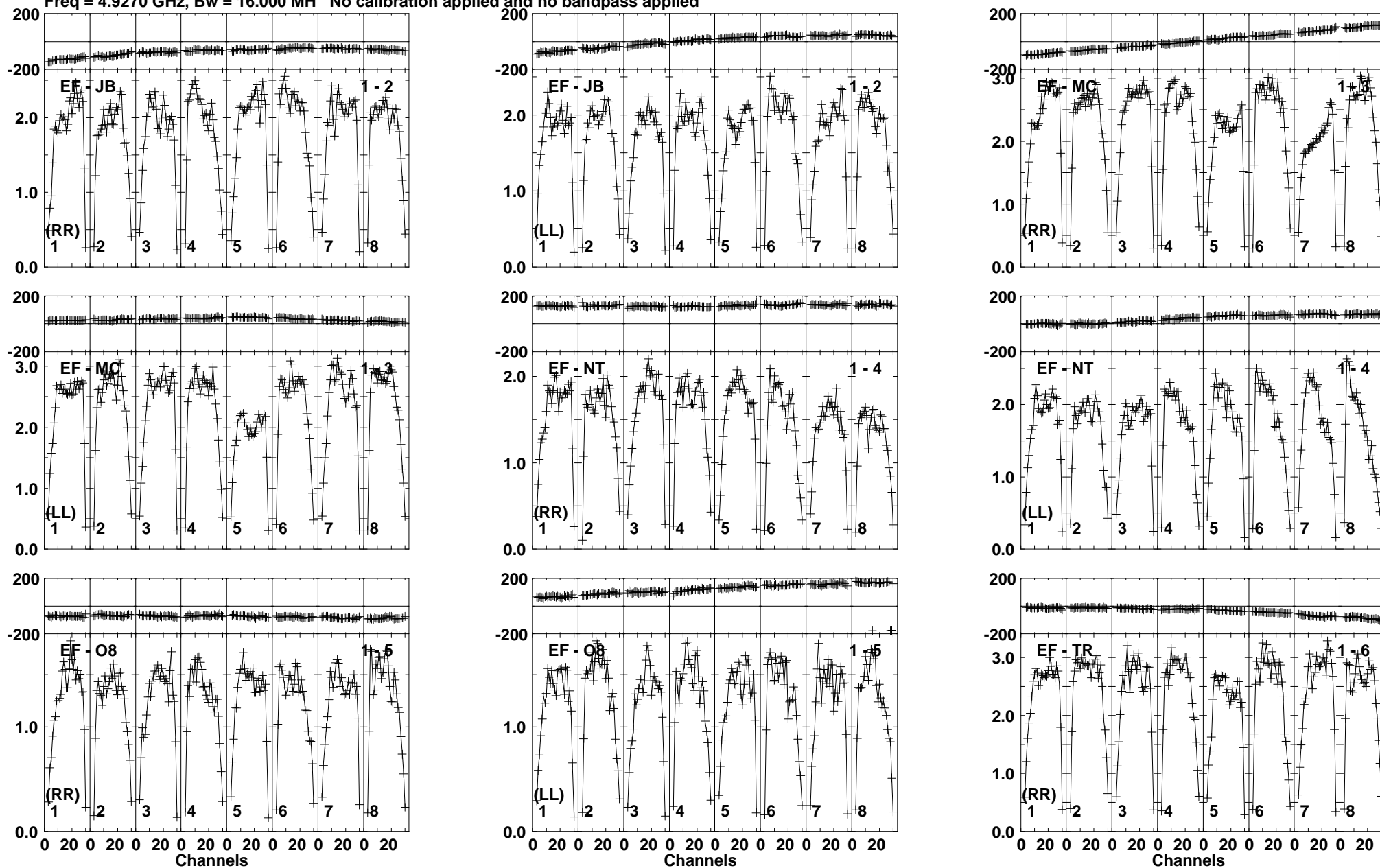

Lower frame: Milli Ampl Jy Top frame: Phas deg  
Vector averaged cross-power spectrum Baseline: EF (01) - JB (02)  
Timerange: 01/00:33:51 to 01/00:35:19

Plot file version 266 created 10-JUN-2016 17:22:28

J1957+3338 RT013A.UVDATA.1

Freq = 4.9270 GHz, Bw = 16.000 MH No calibration applied and no bandpass applied

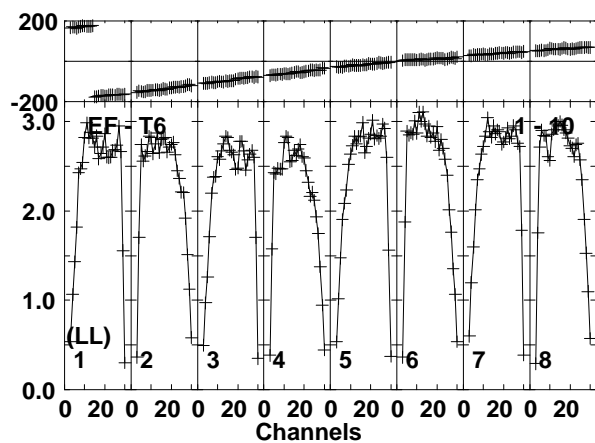
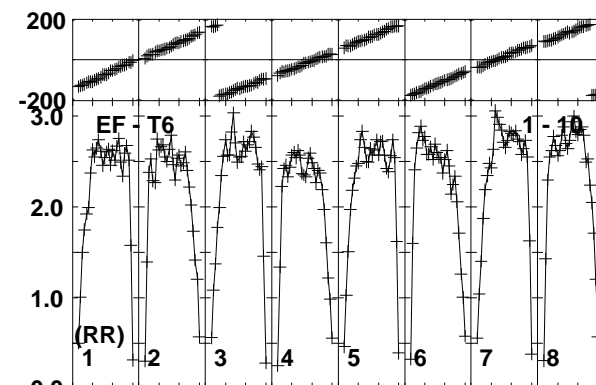
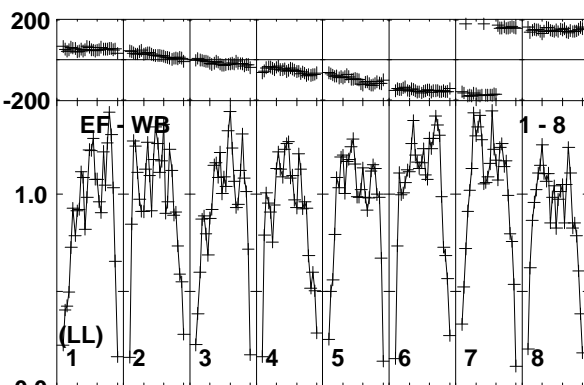
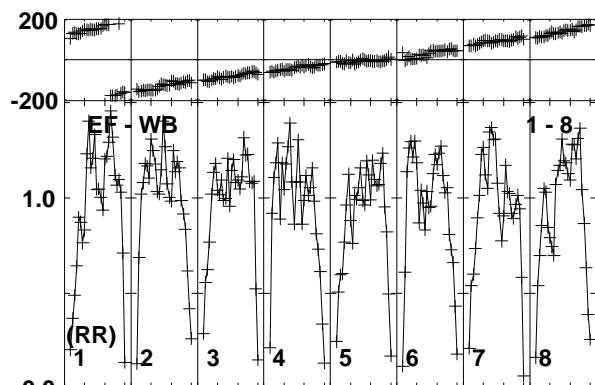
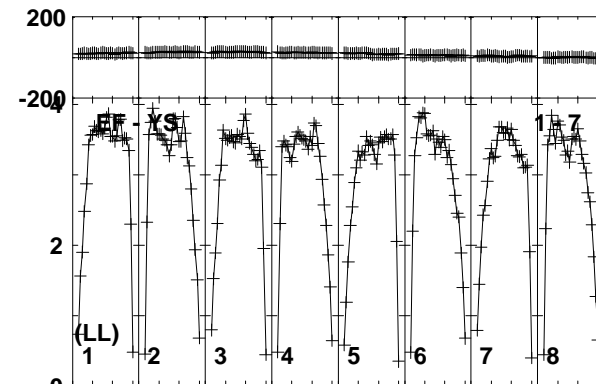
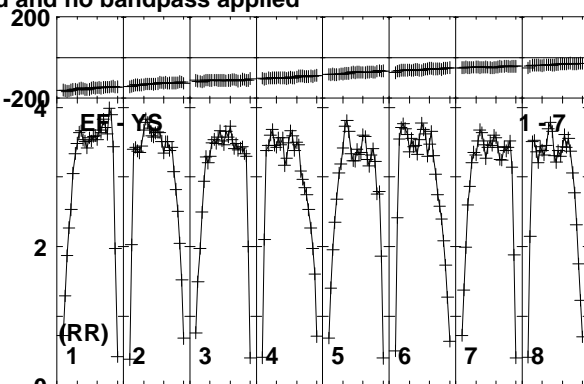
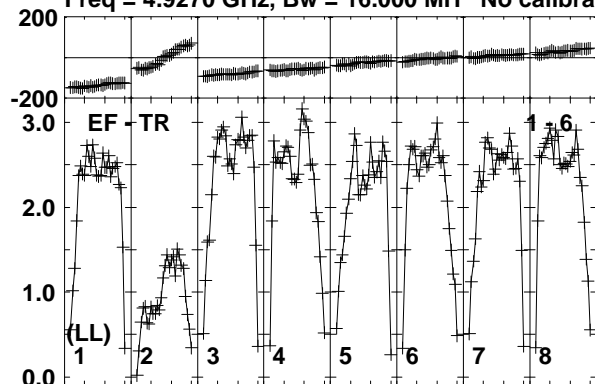

Lower frame: Milli Ampl Jy Top frame: Phas deg  
Vector averaged cross-power spectrum Baseline: EF (01) - TR (06)  
Timerange: 01/00:33:51 to 01/00:35:19



Plot file version 267 created 10-JUN-2016 17:22:29

CHECK RT013A.UVDATA.1

Freq = 4.9270 GHz, Bw = 16.000 MH No calibration applied and no bandpass applied

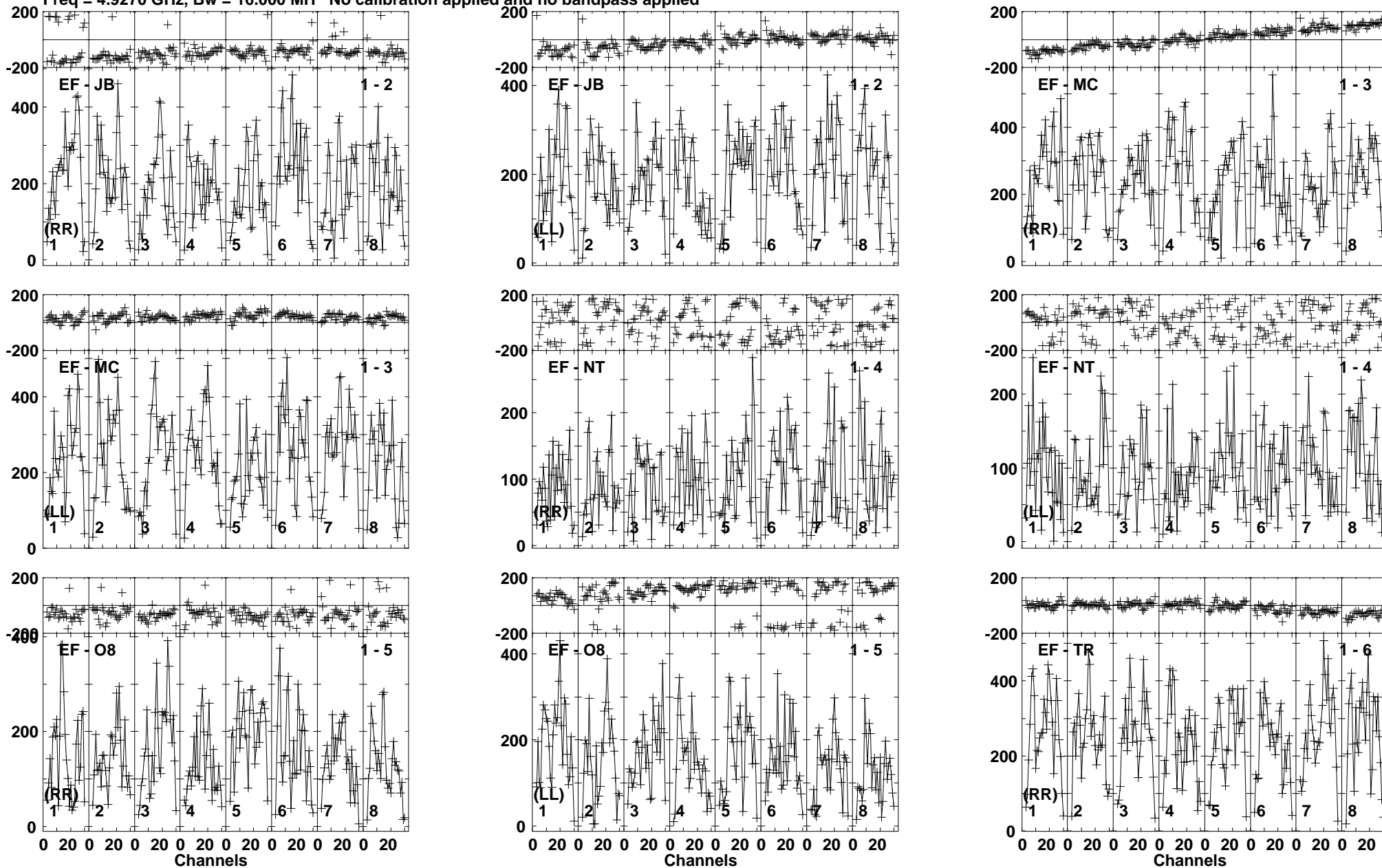

Lower frame: Micro Ampl Jy Top frame: Phas deg  
Vector averaged cross-power spectrum Baseline: EF (01) - JB (02)  
Timerange: 01/00:36:01 to 01/00:38:00

Plot file version 268 created 10-JUN-2016 17:22:29

CHECK RT013A.UVDATA.1

Freq = 4.9270 GHz, Bw = 16.000 MH No calibration applied and no bandpass applied

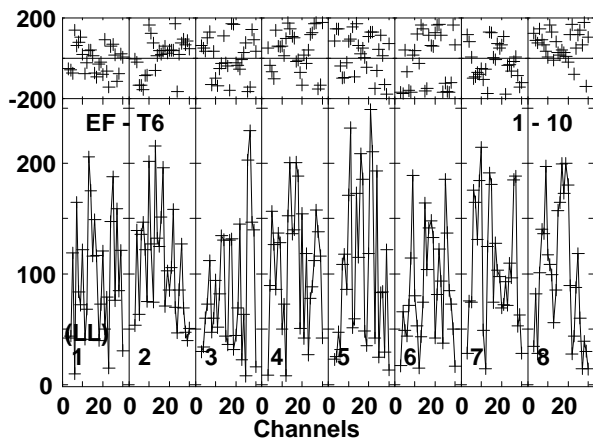
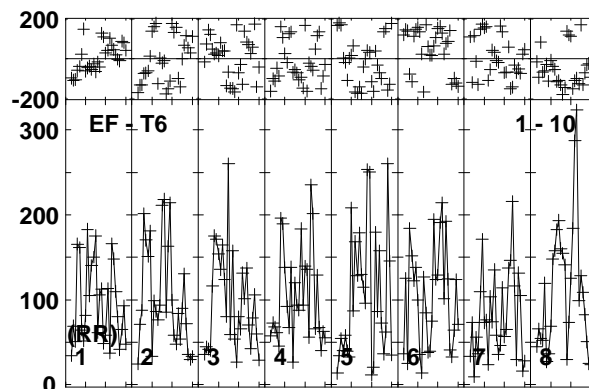
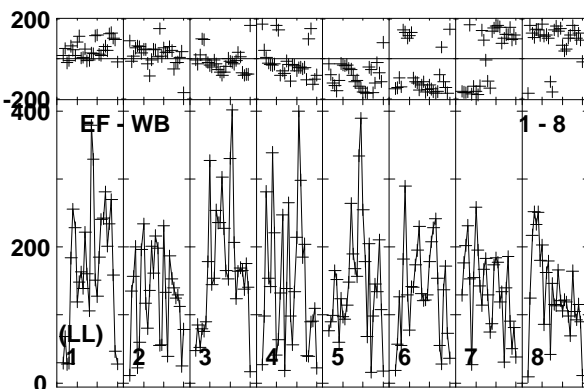
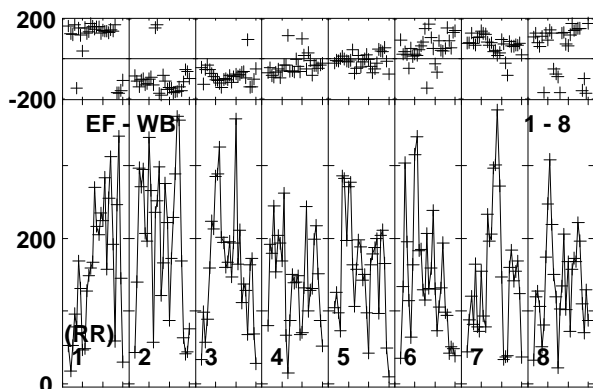
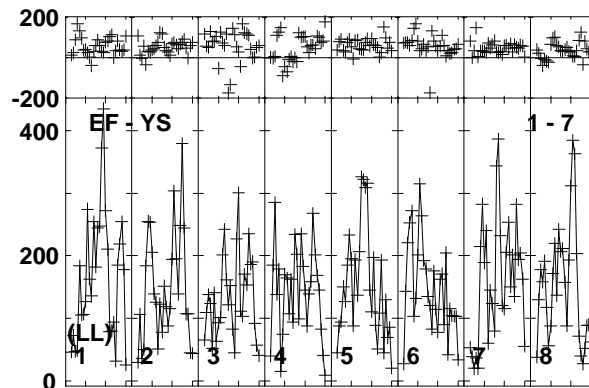
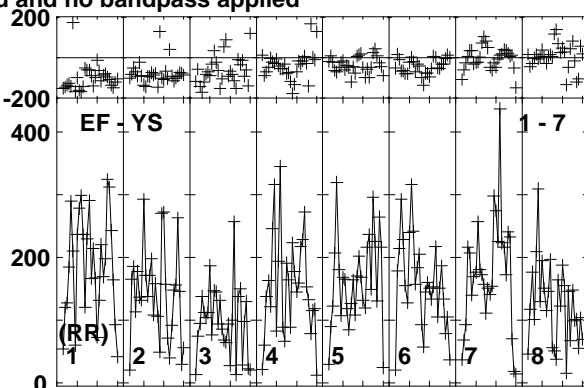
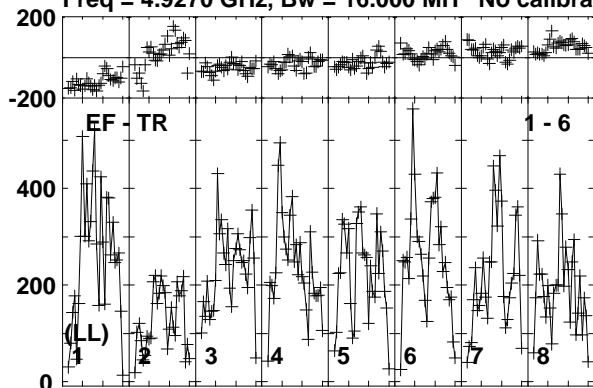

Lower frame: Micro Ampl Jy Top frame: Phas deg  
Vector averaged cross-power spectrum Baseline: EF (01) - TR (06)  
Timerange: 01/00:36:01 to 01/00:38:00

Plot file version 269 created 10-JUN-2016 17:22:29

CYGX1 RT013A.UVDATA.1

Freq = 4.9270 GHz, Bw = 16.000 MH No calibration applied and no bandpass applied

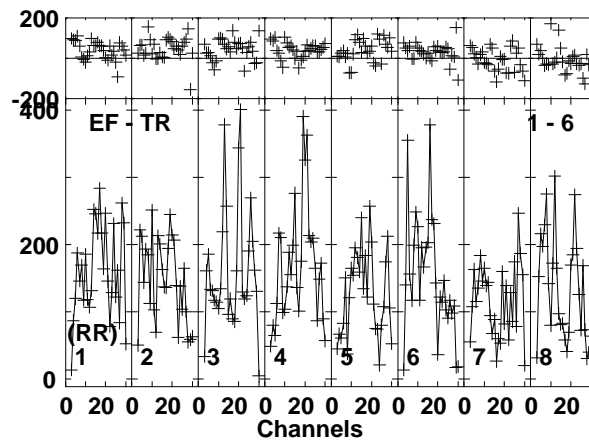
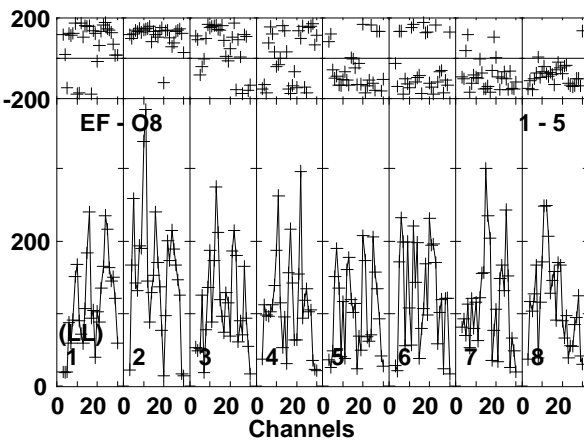
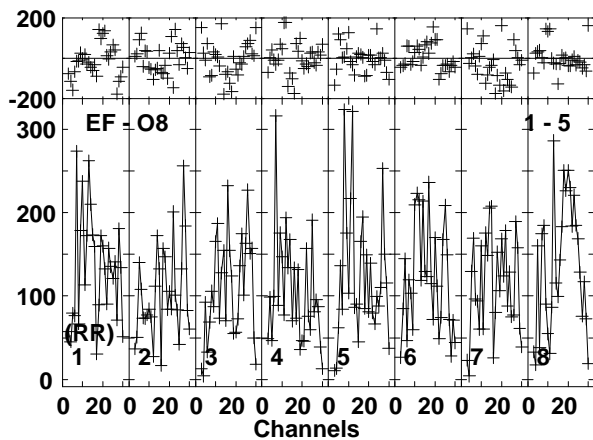
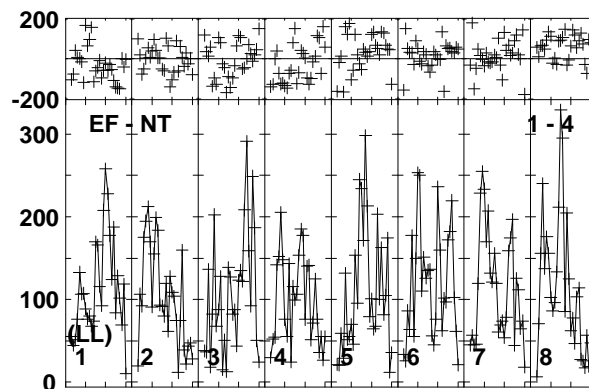
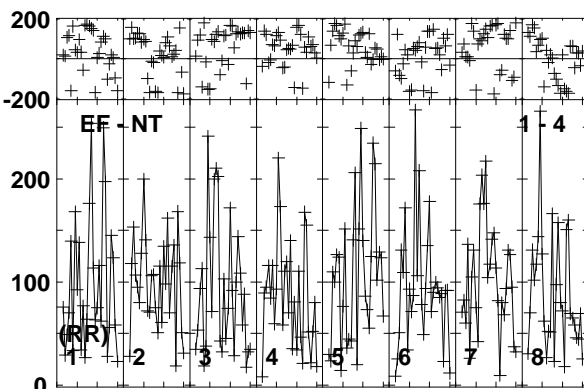
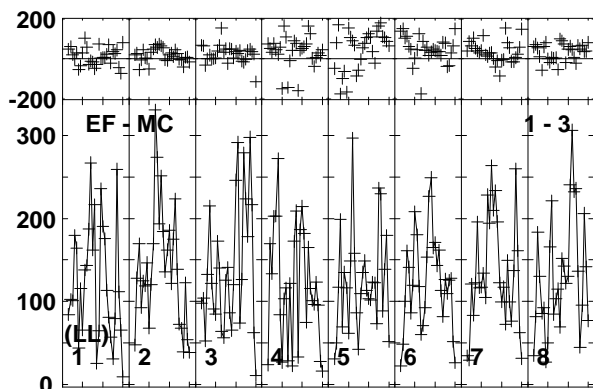
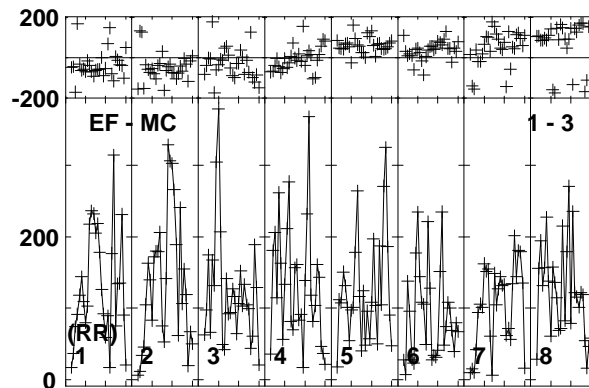
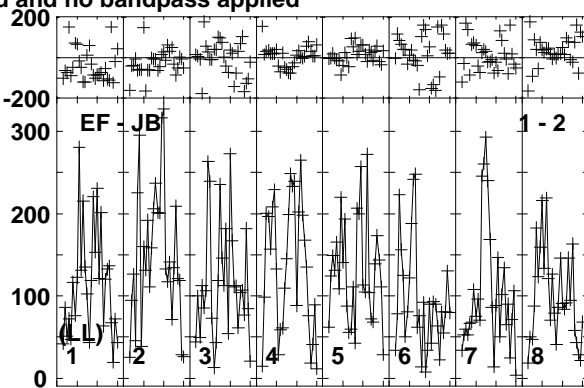
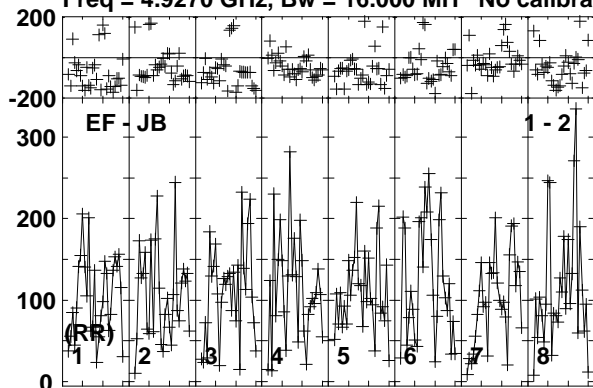

Lower frame: Micro Ampl Jy Top frame: Phas deg  
Vector averaged cross-power spectrum Baseline: EF (01) - JB (02)  
Timerange: 01/00:38:01 to 01/00:40:29

Plot file version 270 created 10-JUN-2016 17:22:29

CYGX1 RT013A.UVDATA.1

Freq = 4.9270 GHz, Bw = 16.000 MH No calibration applied and no bandpass applied

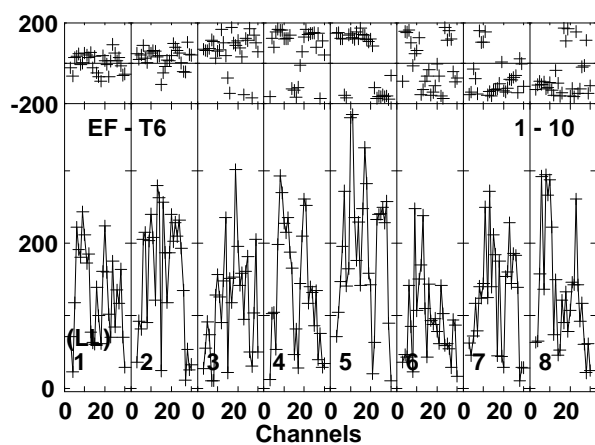
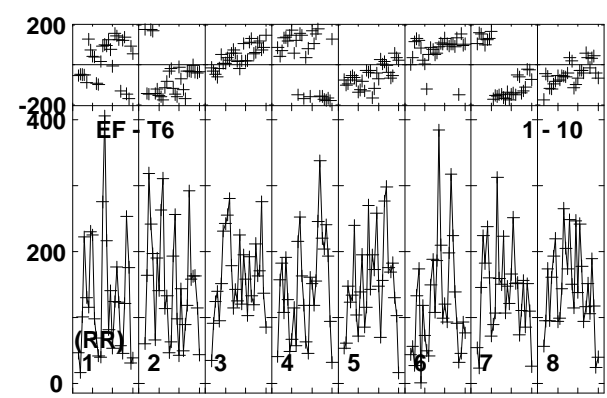
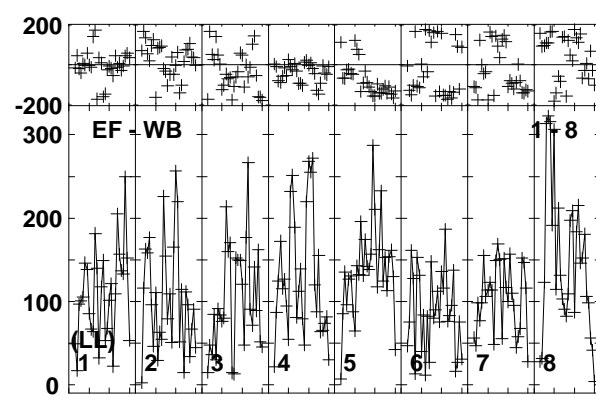
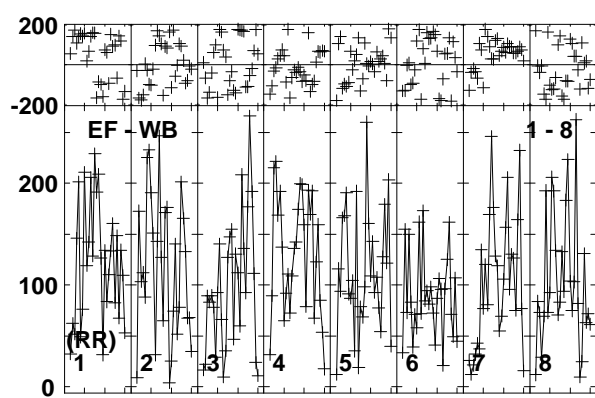
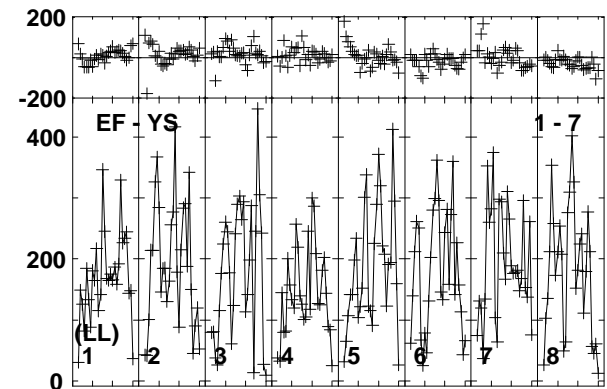
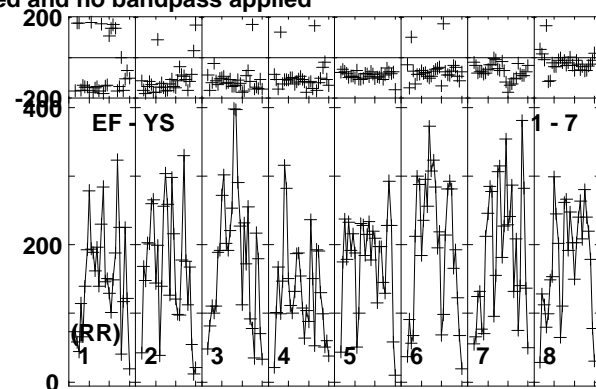
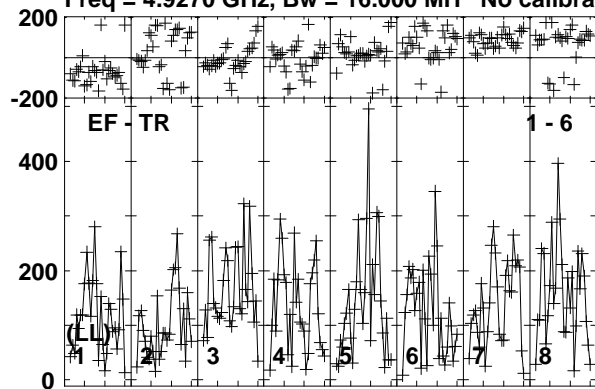

Lower frame: Micro Ampl Jy Top frame: Phas deg  
Vector averaged cross-power spectrum Baseline: EF (01) - TR (06)  
Timerange: 01/00:38:01 to 01/00:40:29

Plot file version 271 created 10-JUN-2016 17:22:29

J1957+3338 RT013A.UVDATA.1

Freq = 4.9270 GHz, Bw = 16.000 MH No calibration applied and no bandpass applied

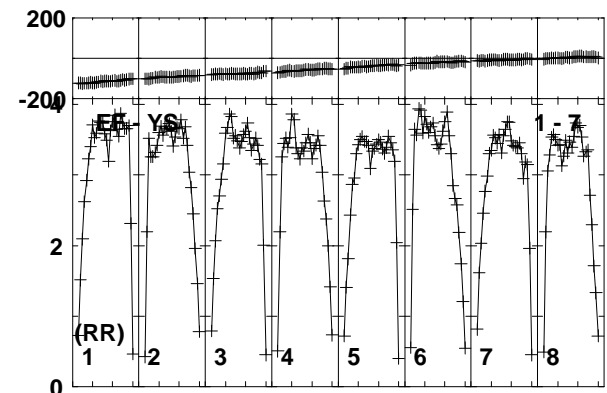
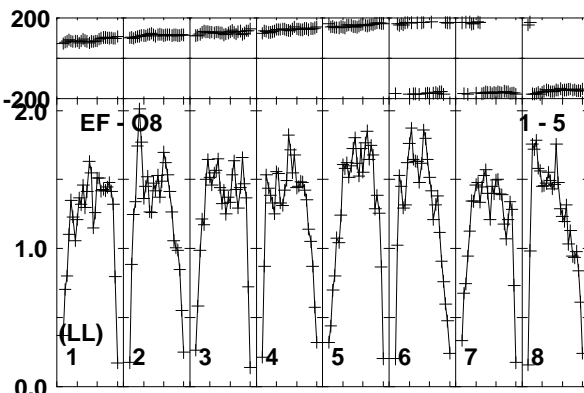
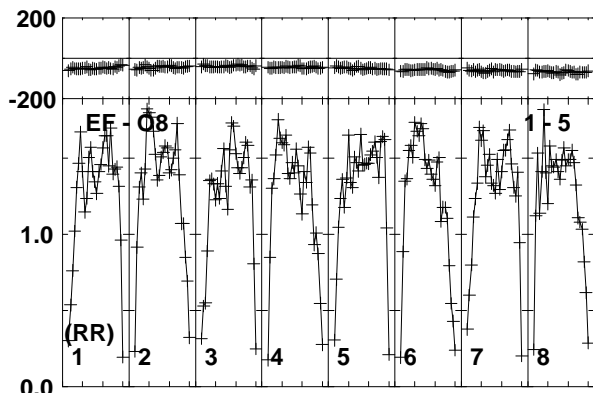
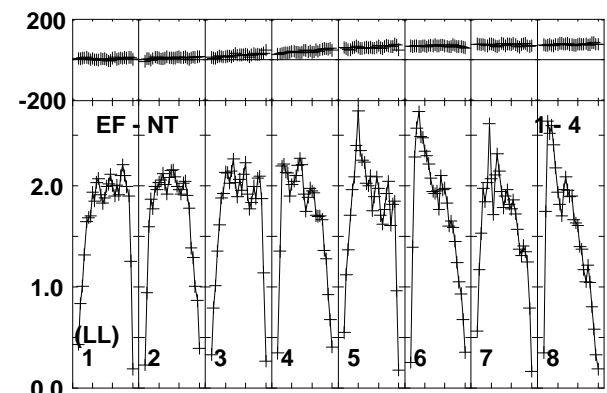
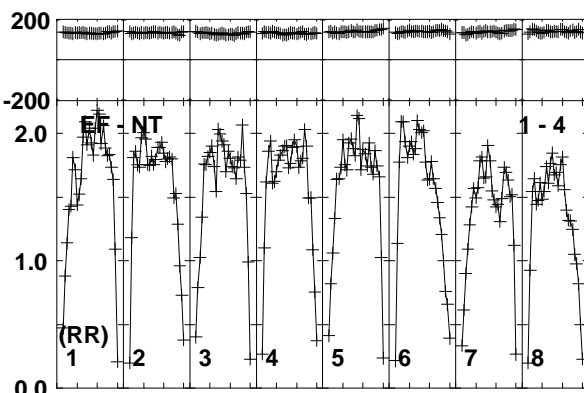
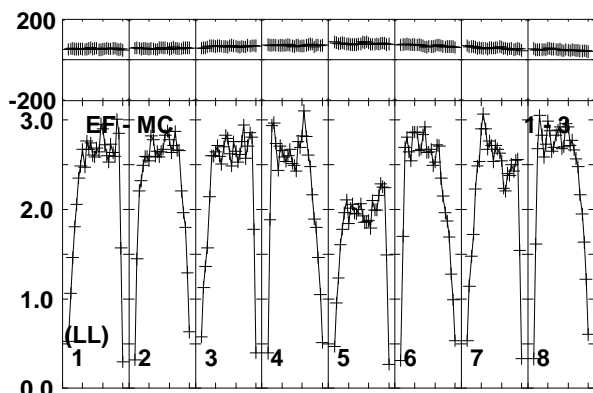
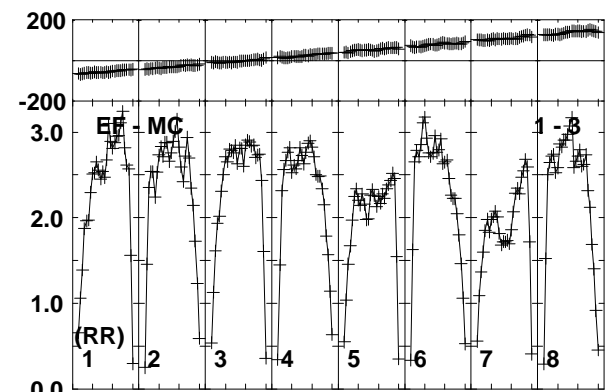
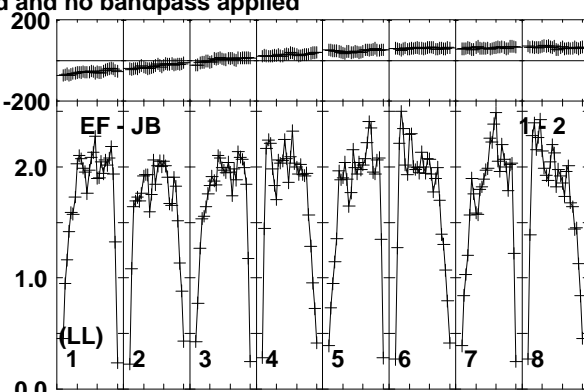
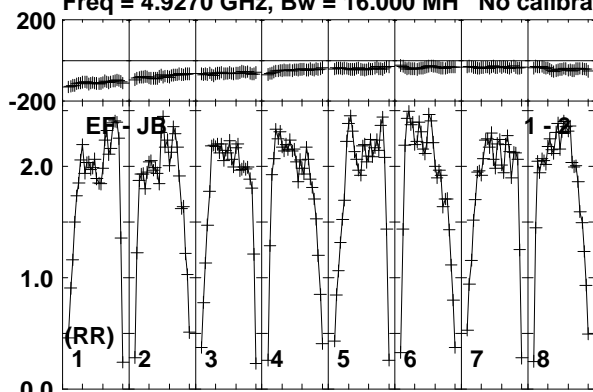

Lower frame: Milli Ampl Jy Top frame: Phas deg  
Vector averaged cross-power spectrum Baseline: EF (01) - JB (02)  
Timerange: 01/00:40:30 to 01/00:41:59

Plot file version 272 created 10-JUN-2016 17:22:29

J1957+3338 RT013A.UVDATA.1

Freq = 4.9270 GHz, Bw = 16.000 MH No calibration applied and no bandpass applied

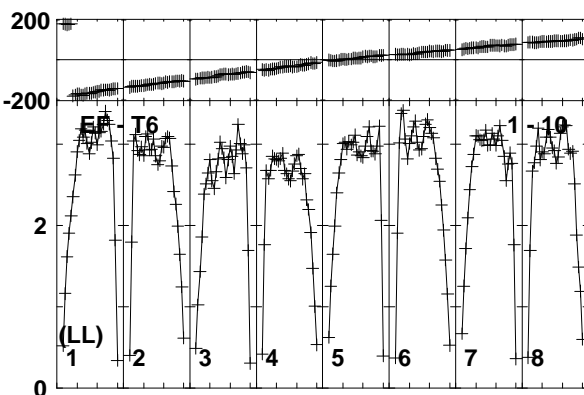
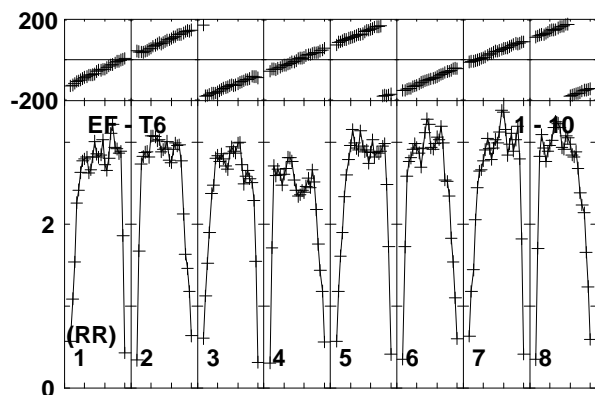
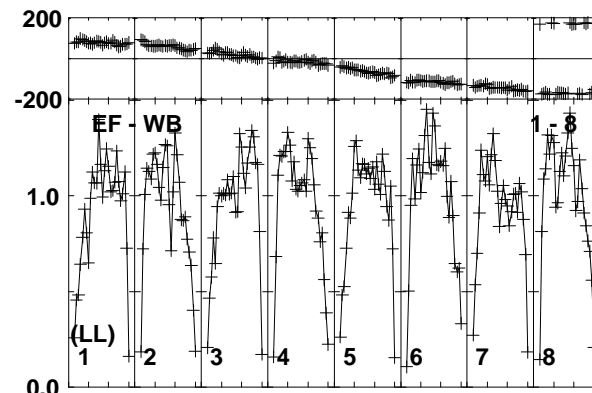
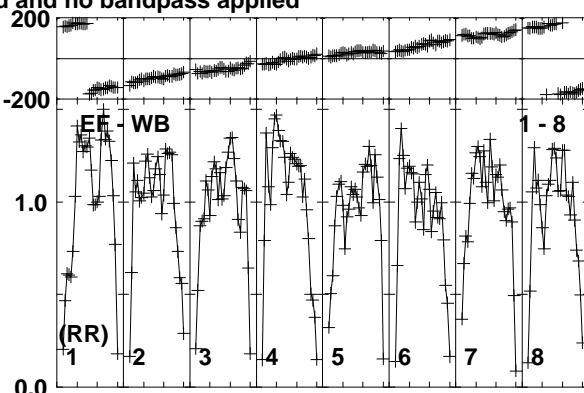
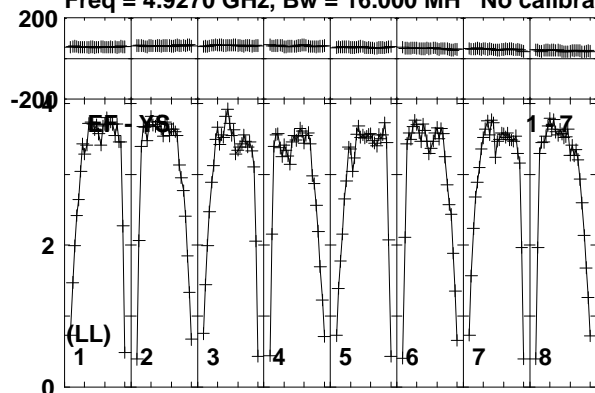

Lower frame: Milli Ampl Jy Top frame: Phas deg  
Vector averaged cross-power spectrum Baseline: EF (01) - YS (07)  
Timerange: 01/00:40:30 to 01/00:41:59

Plot file version 273 created 10-JUN-2016 17:22:29

CHECK RT013A.UVDATA.1

Freq = 4.9270 GHz, Bw = 16.000 MH No calibration applied and no bandpass applied

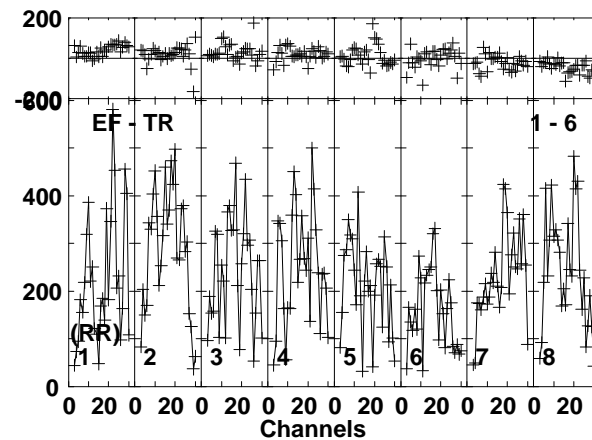
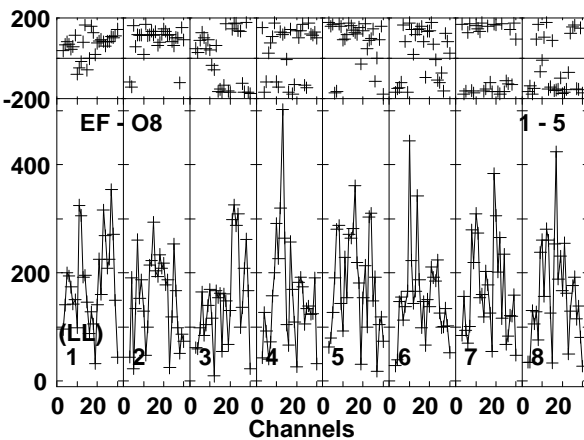
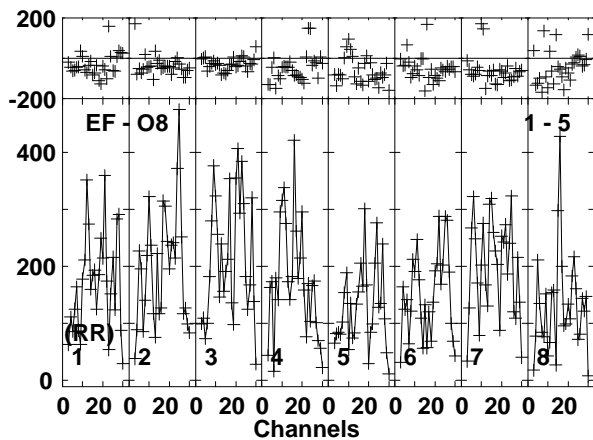
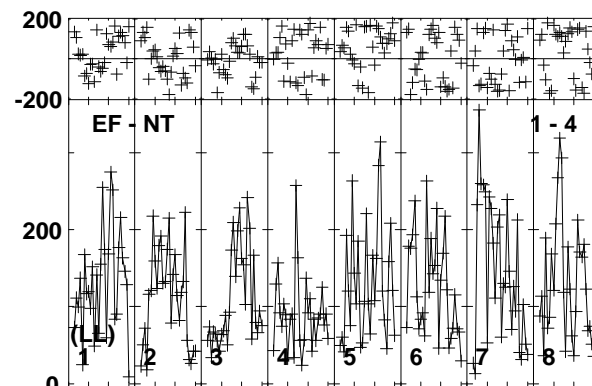
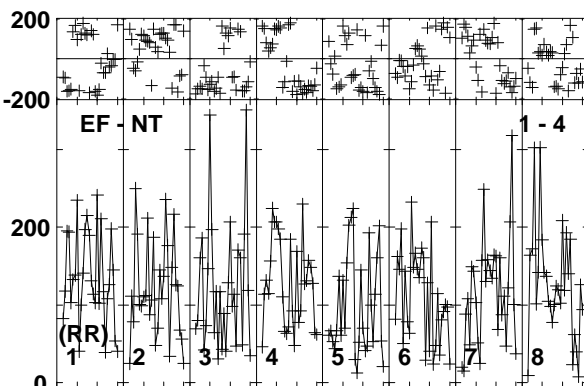
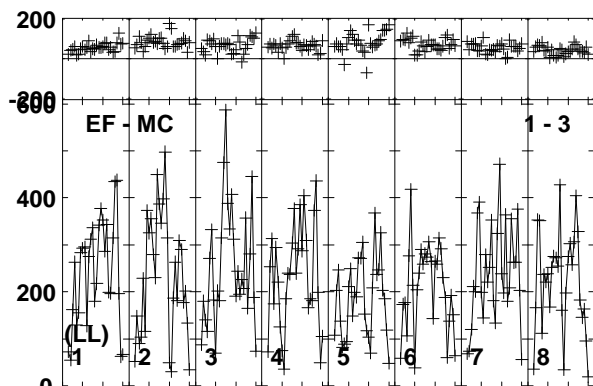
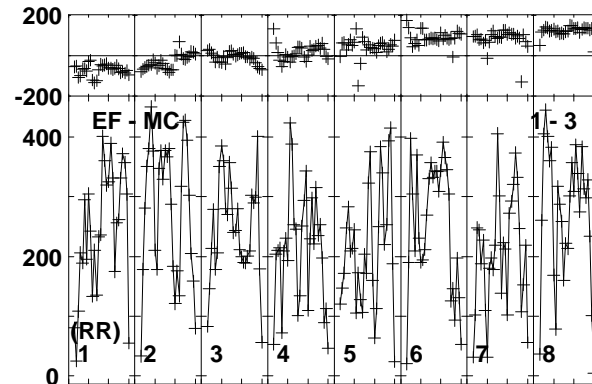
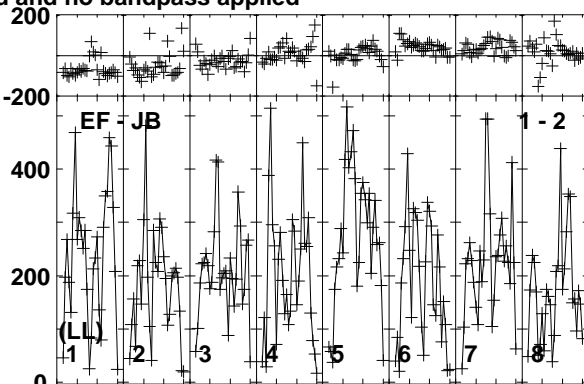
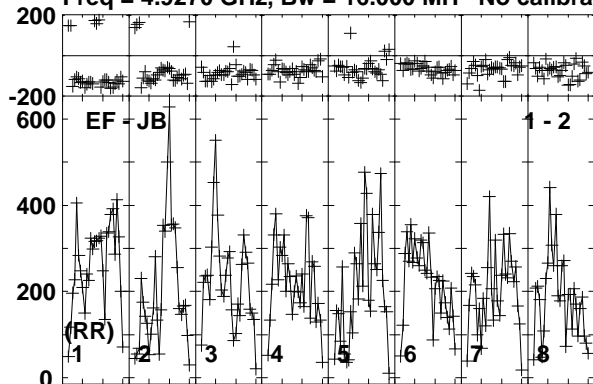

Lower frame: Micro Ampl Jy Top frame: Phas deg  
Vector averaged cross-power spectrum Baseline: EF (01) - JB (02)  
Timerange: 01/00:42:00 to 01/00:43:59

Plot file version 274 created 10-JUN-2016 17:22:29

CHECK RT013A.UVDATA.1

Freq = 4.9270 GHz, Bw = 16.000 MH No calibration applied and no bandpass applied

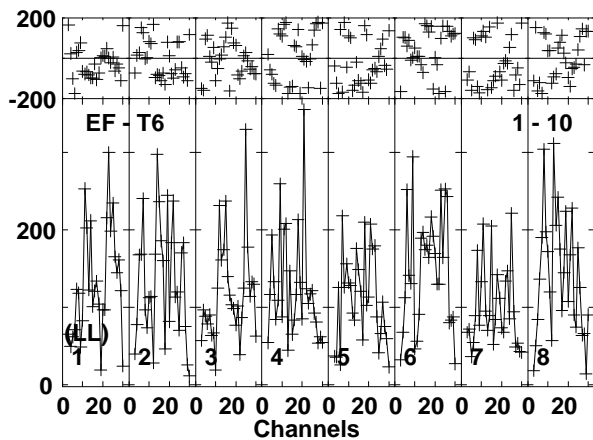
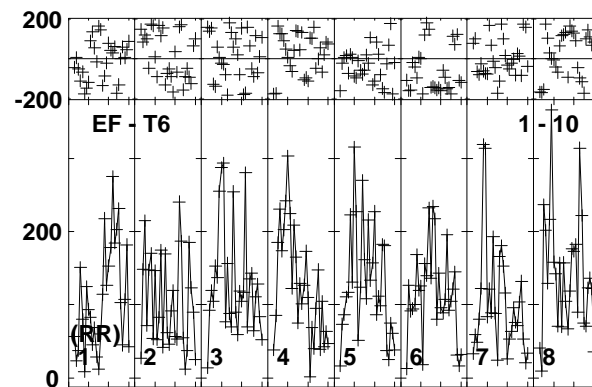
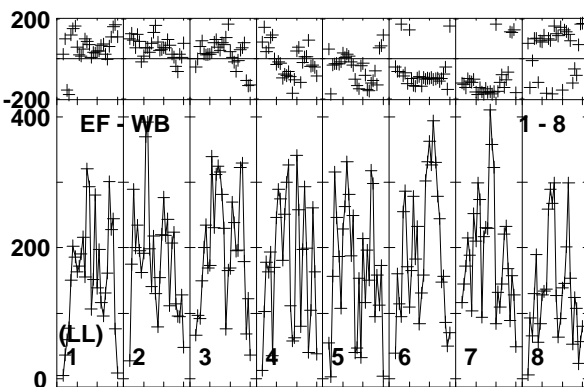
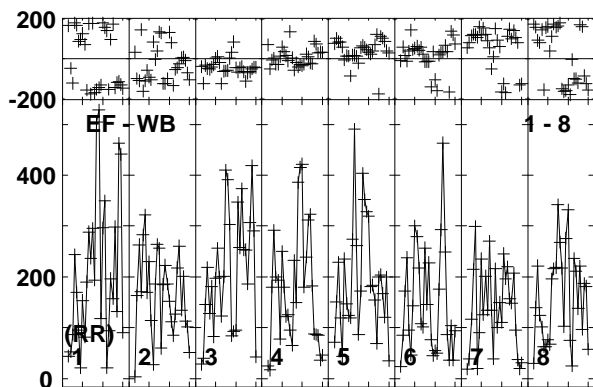
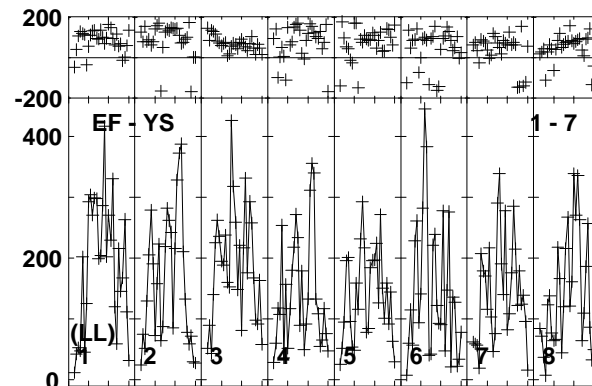
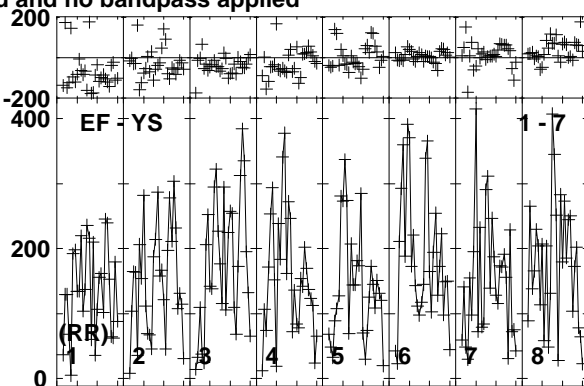
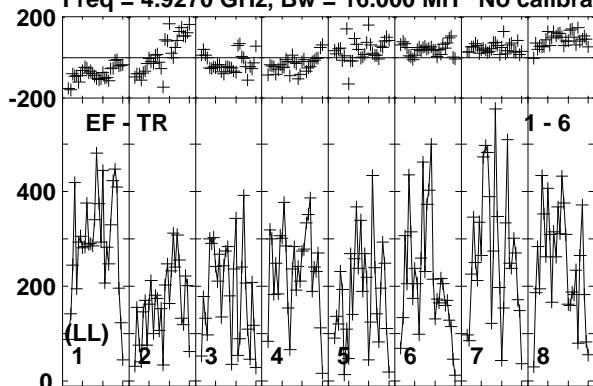

Lower frame: Micro Ampl Jy Top frame: Phas deg  
Vector averaged cross-power spectrum Baseline: EF (01) - TR (06)  
Timerange: 01/00:42:00 to 01/00:43:59



Plot file version 275 created 10-JUN-2016 17:22:29

CYGX1 RT013A.UVDATA.1

Freq = 4.9270 GHz, Bw = 16.000 MH No calibration applied and no bandpass applied

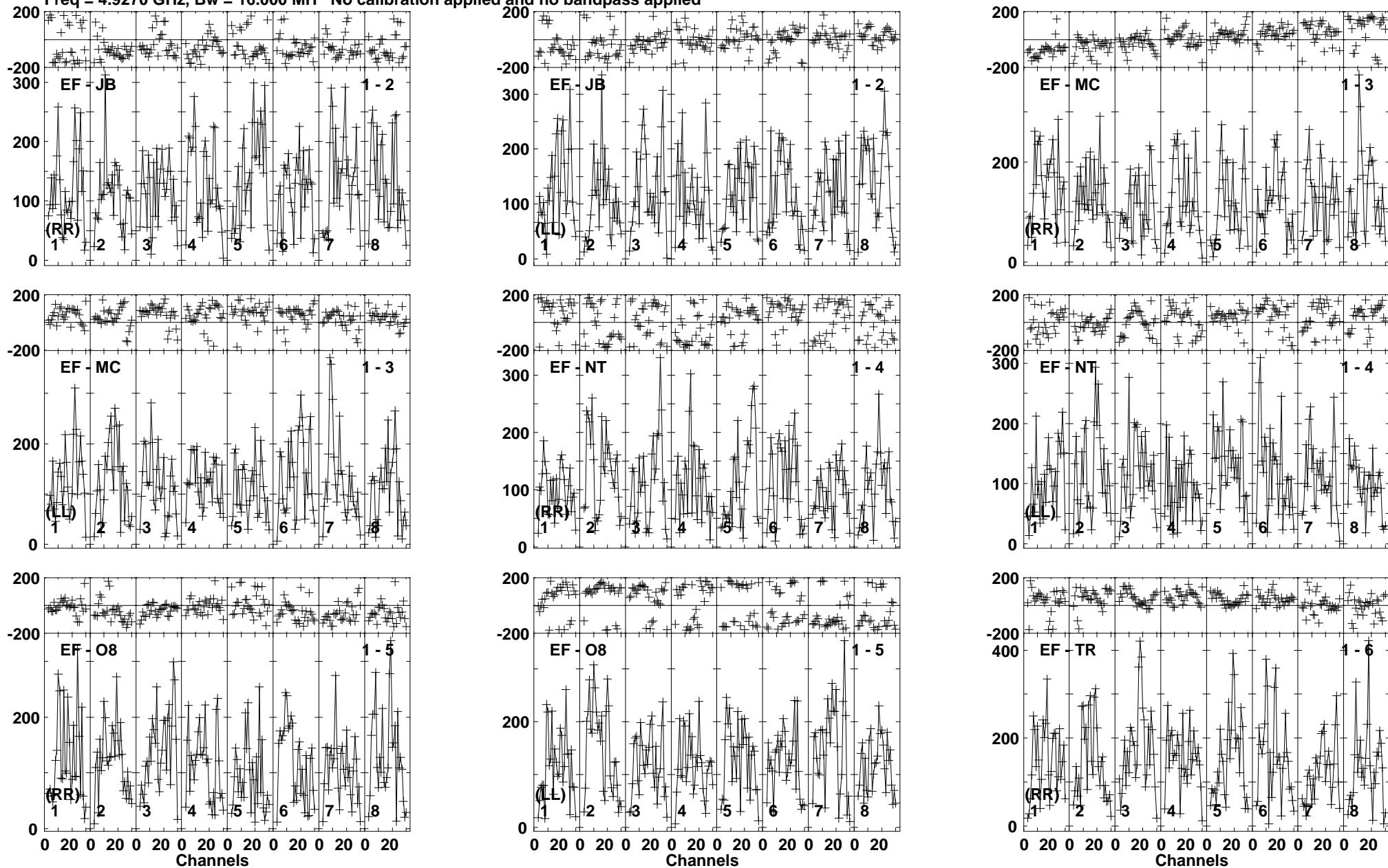

Lower frame: Micro Ampl Jy Top frame: Phas deg  
Vector averaged cross-power spectrum Baseline: EF (01) - JB (02)  
Timerange: 01/00:44:00 to 01/00:46:30

Plot file version 276 created 10-JUN-2016 17:22:30

CYGX1 RT013A.UVDATA.1

Freq = 4.9270 GHz, Bw = 16.000 MH No calibration applied and no bandpass applied

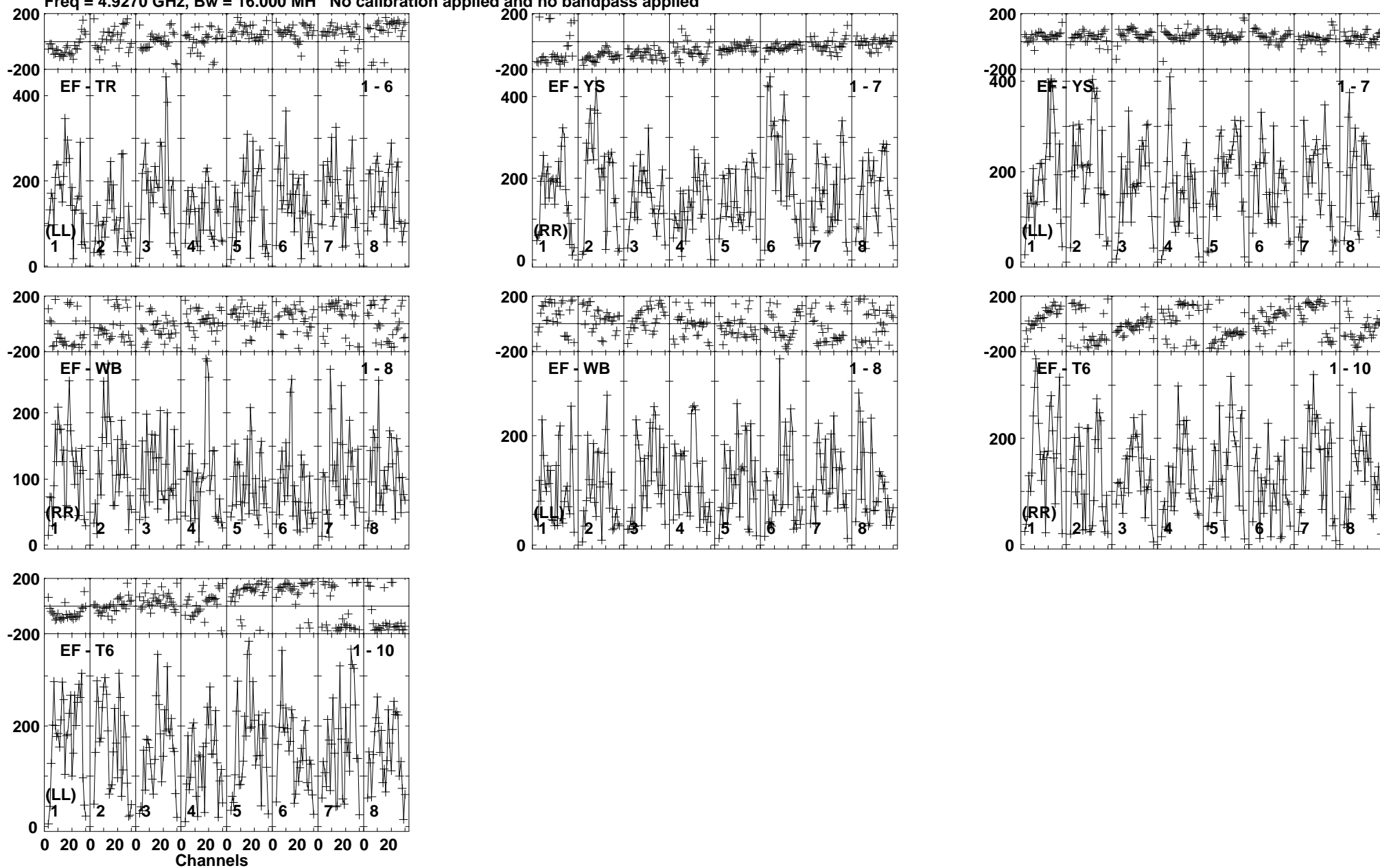

Lower frame: Micro Ampl Jy Top frame: Phas deg  
Vector averaged cross-power spectrum Baseline: EF (01) - TR (06)  
Timerange: 01/00:44:00 to 01/00:46:30

Plot file version 277 created 10-JUN-2016 17:22:30

J1957+3338 RT013A.UVDATA.1

Freq = 4.9270 GHz, Bw = 16.000 MH No calibration applied and no bandpass applied

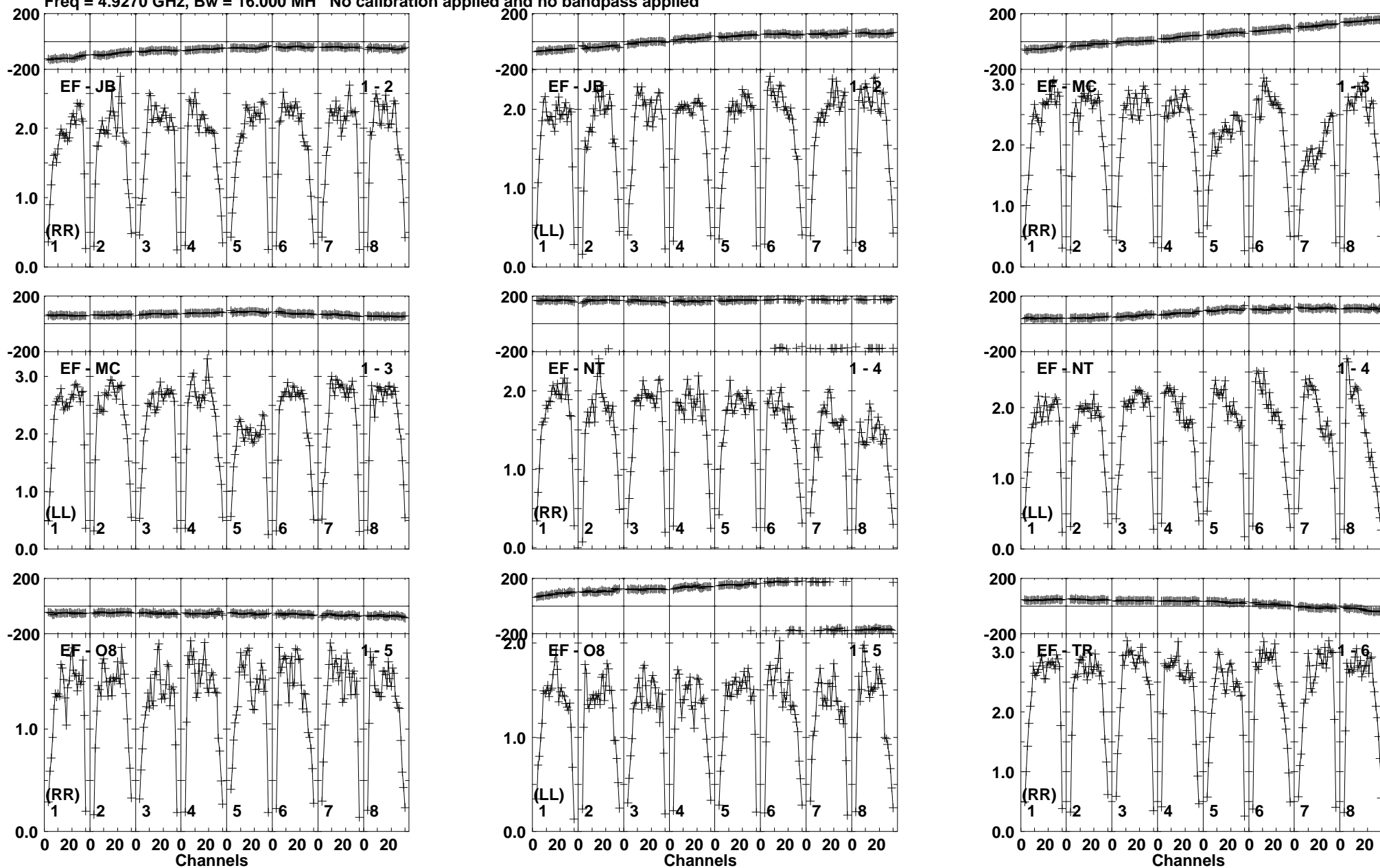

Lower frame: Milli Ampl Jy Top frame: Phas deg  
Vector averaged cross-power spectrum Baseline: EF (01) - JB (02)  
Timerange: 01/00:46:31 to 01/00:48:00

Plot file version 278 created 10-JUN-2016 17:22:30

J1957+3338 RT013A.UVDATA.1

Freq = 4.9270 GHz, Bw = 16.000 MH No calibration applied and no bandpass applied

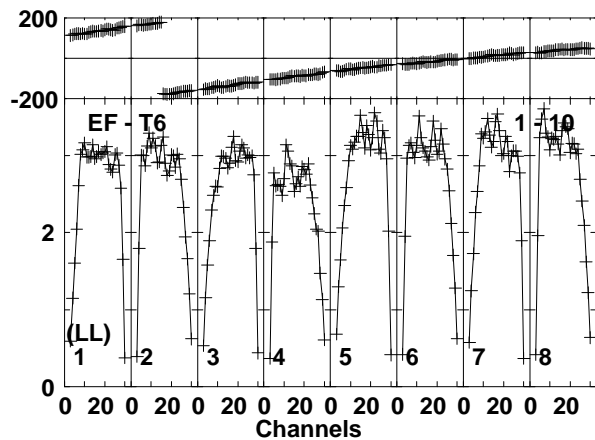
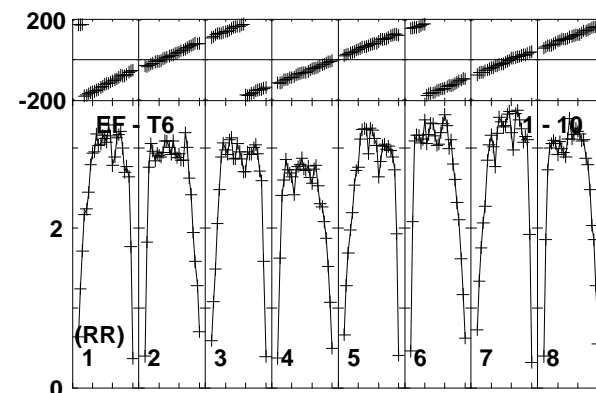
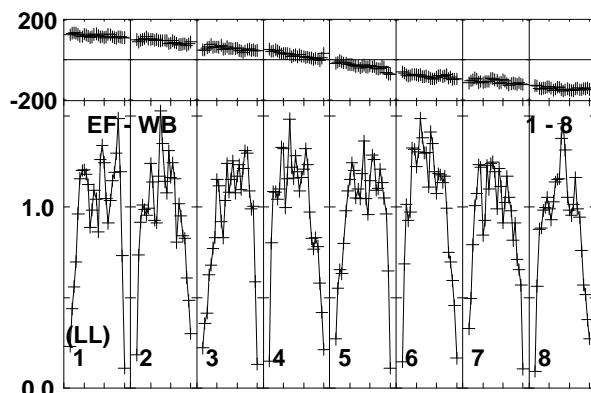
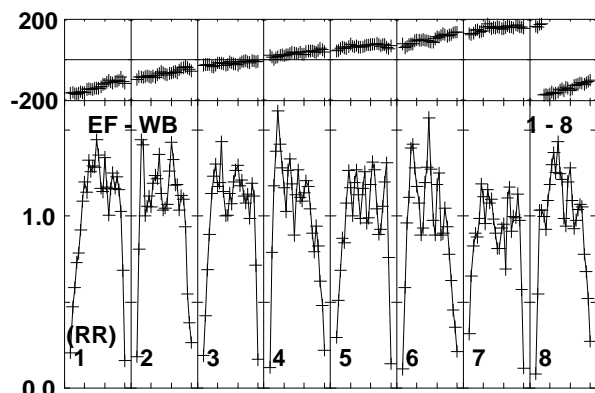
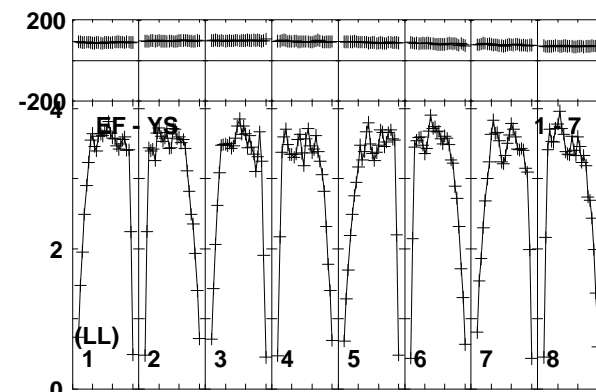
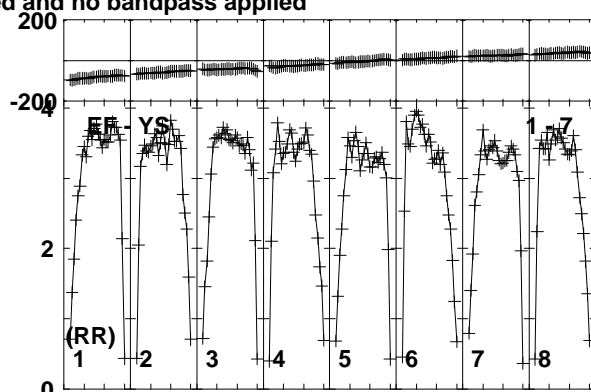
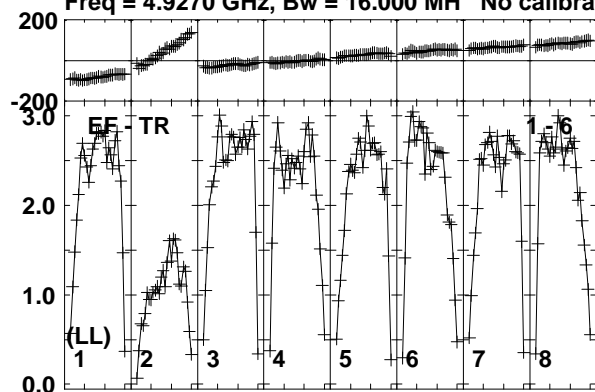

Lower frame: Milli Ampl Jy Top frame: Phas deg  
Vector averaged cross-power spectrum Baseline: EF (01) - TR (06)  
Timerange: 01/00:46:31 to 01/00:48:00

Plot file version 279 created 10-JUN-2016 17:22:30

CHECK RT013A.UVDATA.1

Freq = 4.9270 GHz, Bw = 16.000 MH No calibration applied and no bandpass applied

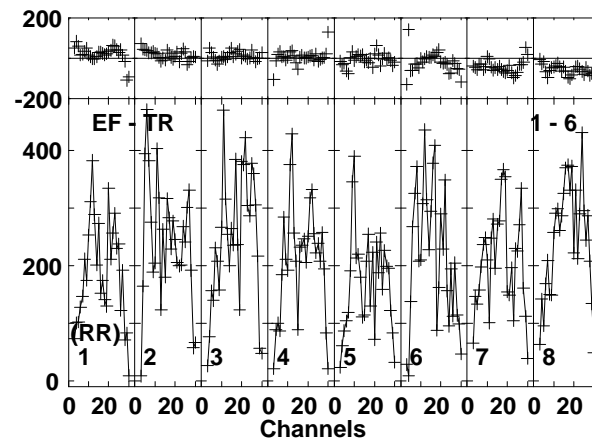
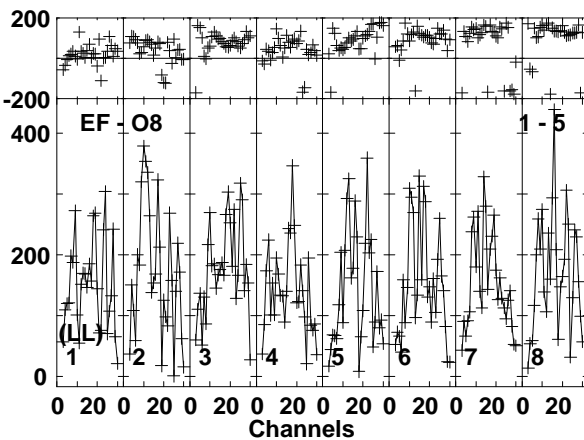
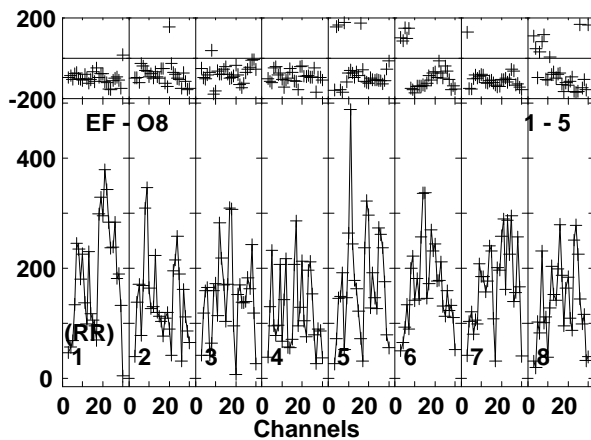
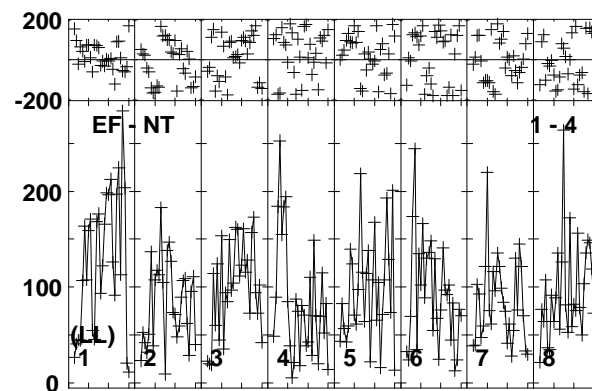
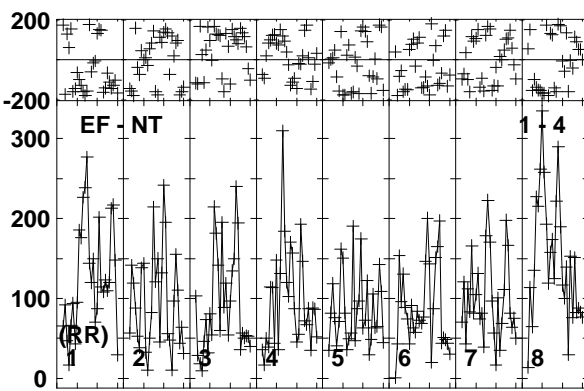
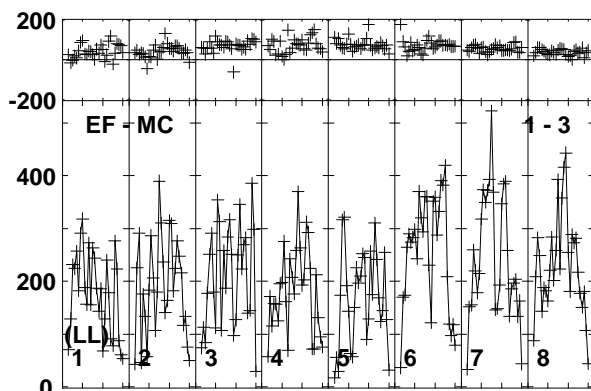
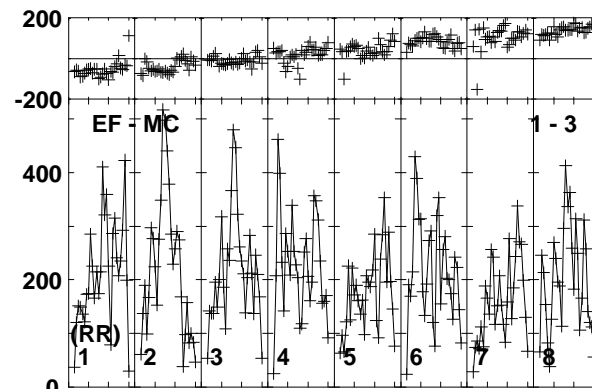
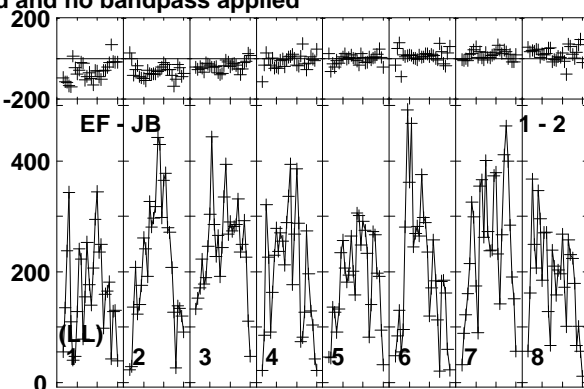
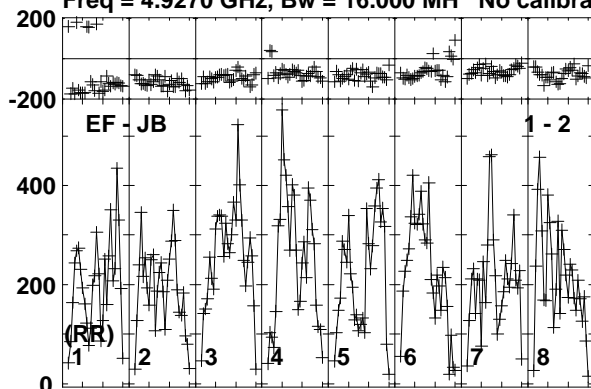

Lower frame: Micro Ampl Jy Top frame: Phas deg  
Vector averaged cross-power spectrum Baseline: EF (01) - JB (02)  
Timerange: 01/00:48:40 to 01/00:50:39

Plot file version 280 created 10-JUN-2016 17:22:30

CHECK RT013A.UVDATA.1

Freq = 4.9270 GHz, Bw = 16.000 MH No calibration applied and no bandpass applied

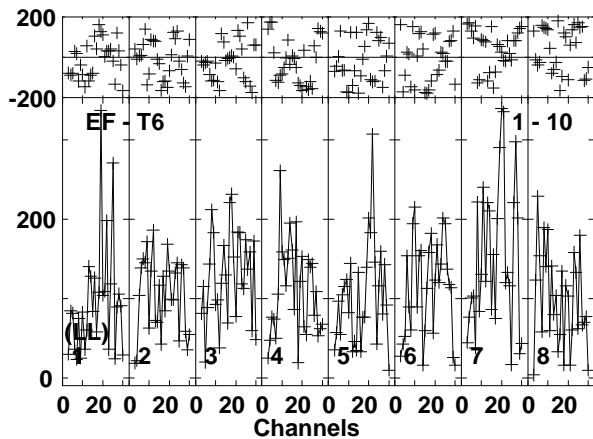
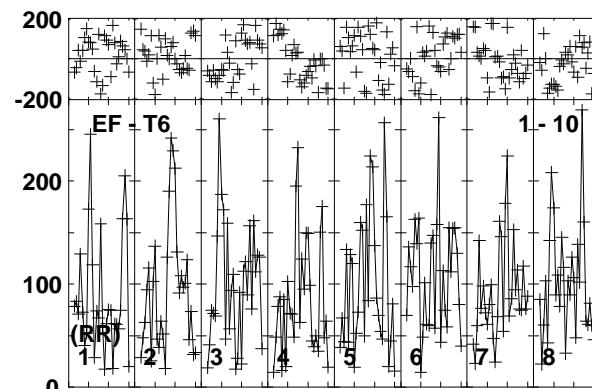
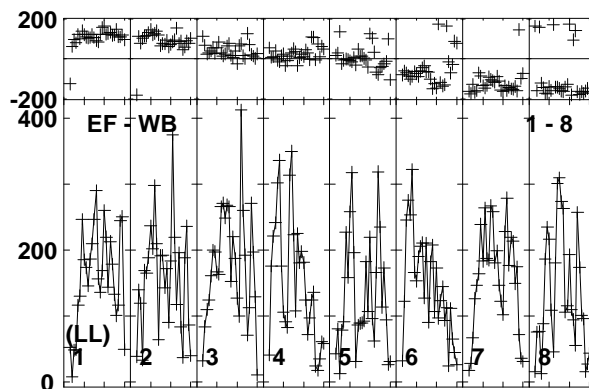
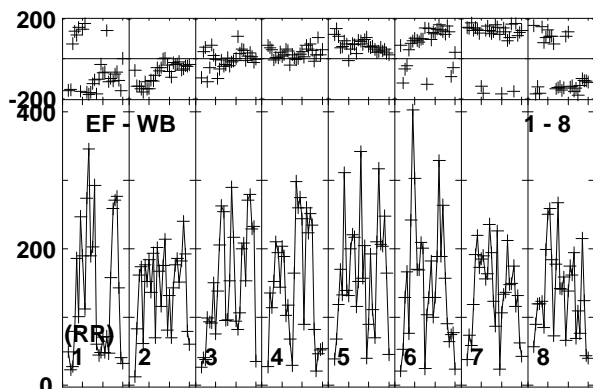
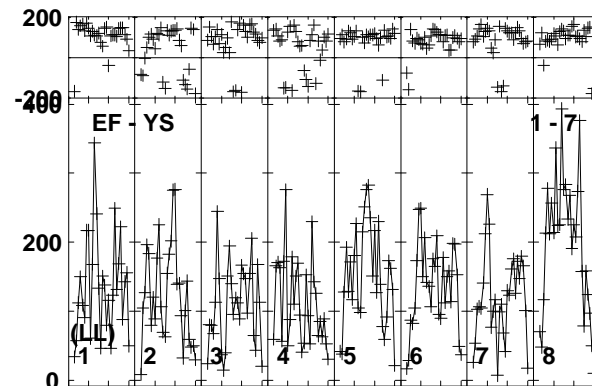
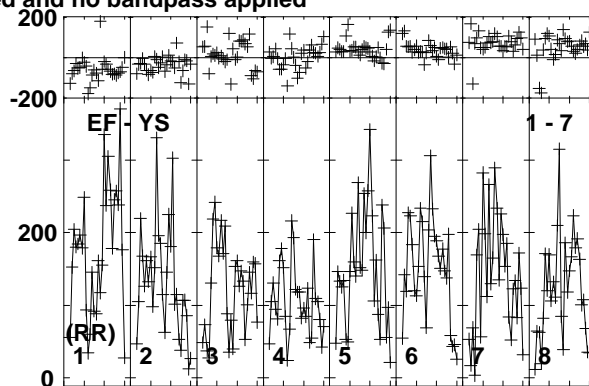
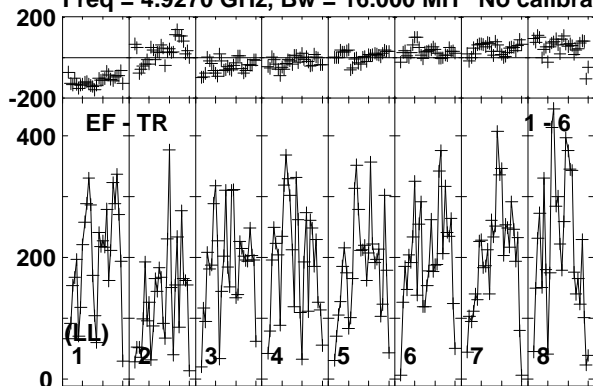

Lower frame: Micro Ampl Jy Top frame: Phas deg  
Vector averaged cross-power spectrum Baseline: EF (01) - TR (06)  
Timerange: 01/00:48:40 to 01/00:50:39

Plot file version 281 created 10-JUN-2016 17:22:30

CYGX1 RT013A.UVDATA.1

Freq = 4.9270 GHz, Bw = 16.000 MH No calibration applied and no bandpass applied

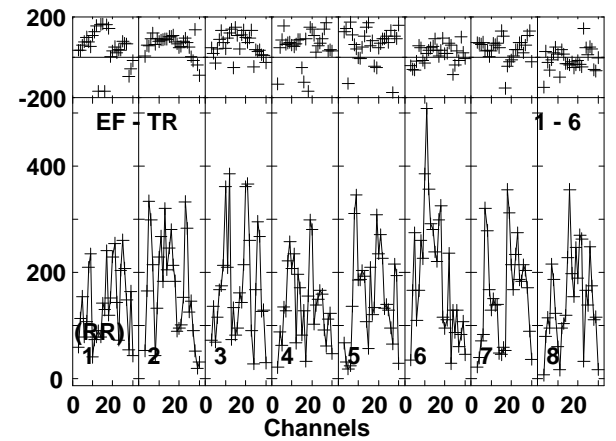
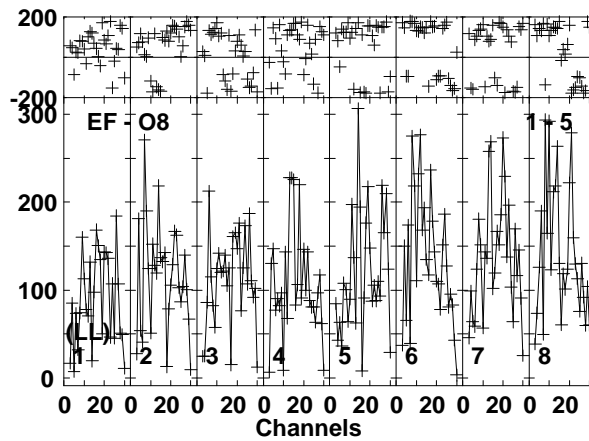
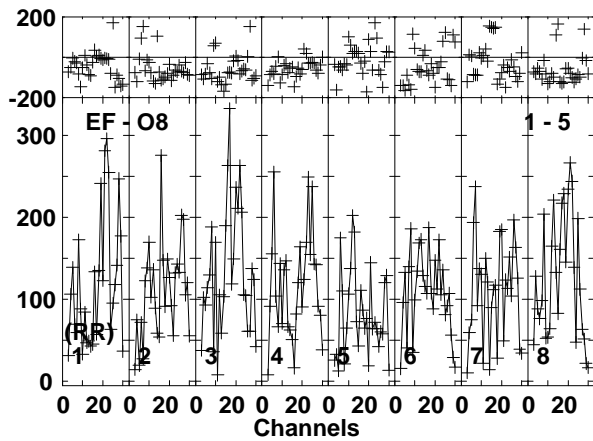
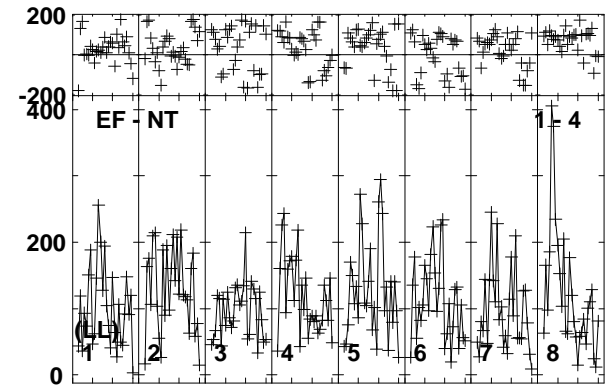
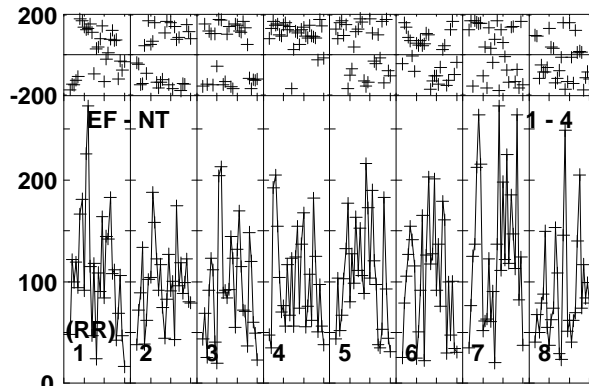
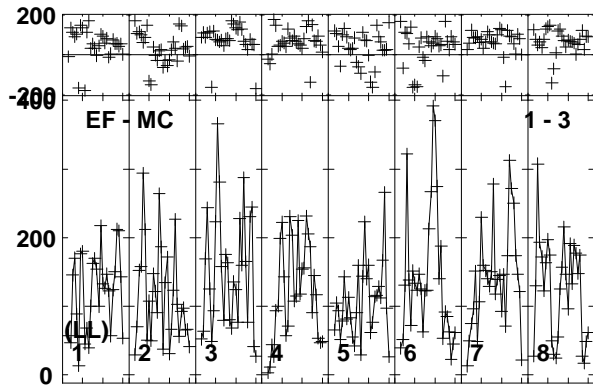
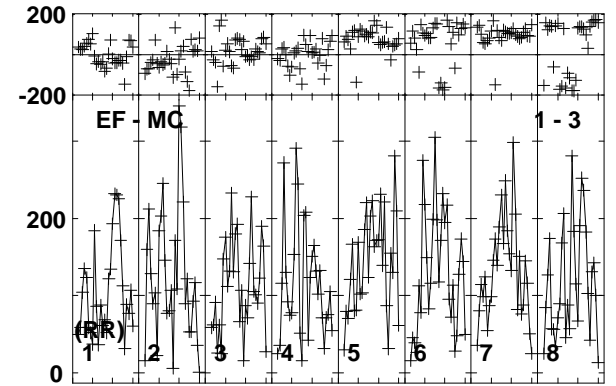
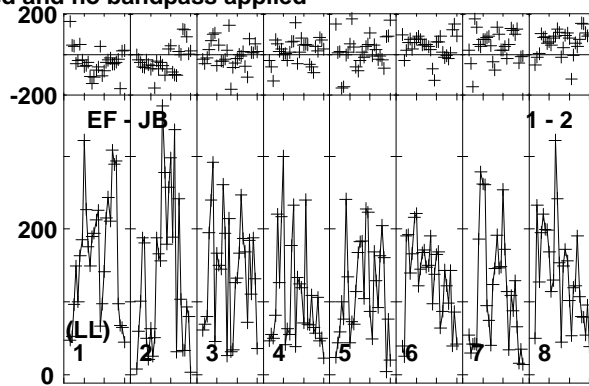
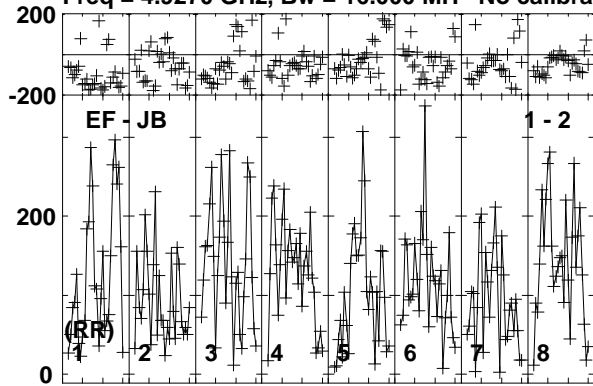

Lower frame: Micro Ampl Jy Top frame: Phas deg  
Vector averaged cross-power spectrum Baseline: EF (01) - JB (02)  
Timerange: 01/00:50:40 to 01/00:53:10

Plot file version 282 created 10-JUN-2016 17:22:30

CYGX1 RT013A.UVDATA.1

Freq = 4.9270 GHz, Bw = 16.000 MH No calibration applied and no bandpass applied

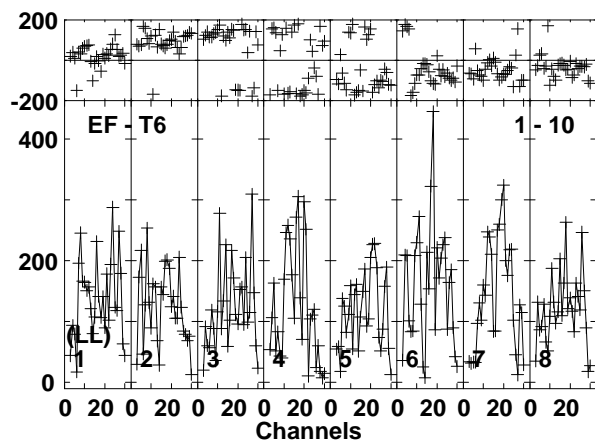
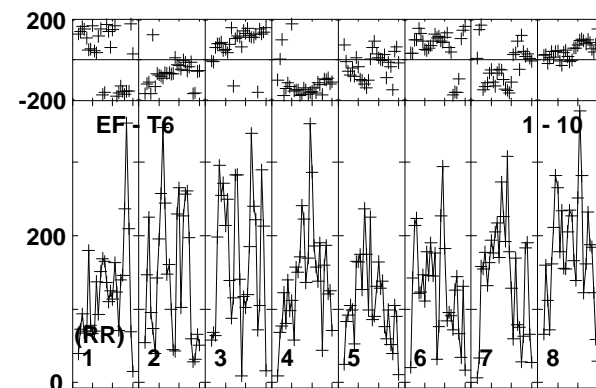
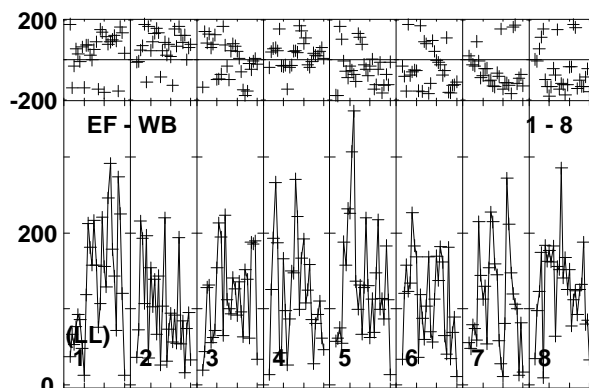
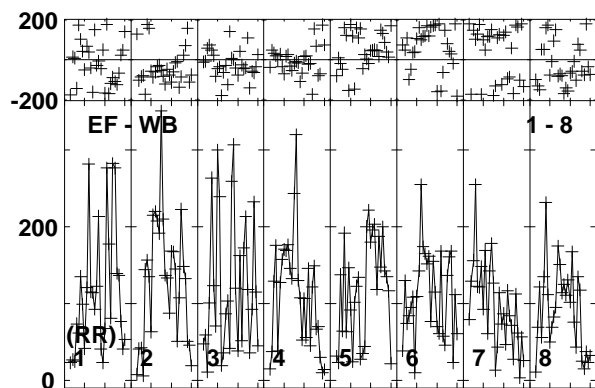
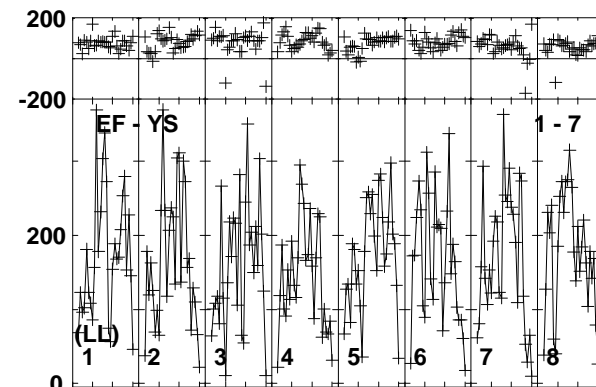
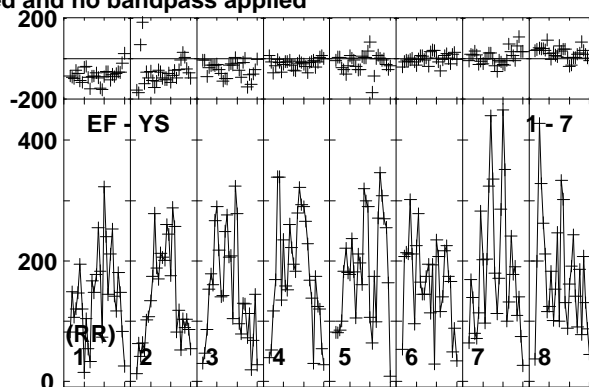
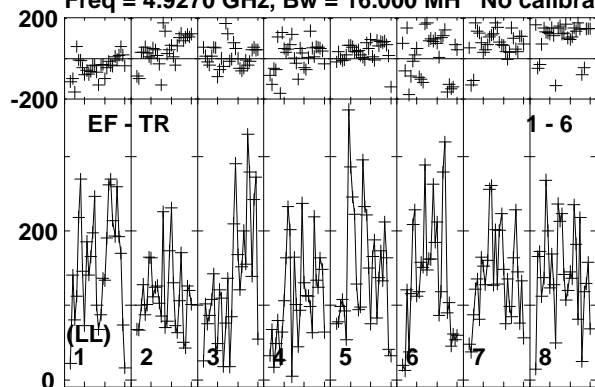

Lower frame: Micro Ampl Jy Top frame: Phas deg  
Vector averaged cross-power spectrum Baseline: EF (01) - TR (06)  
Timerange: 01/00:50:40 to 01/00:53:10



Plot file version 283 created 10-JUN-2016 17:22:30

J1957+3338 RT013A.UVDATA.1

Freq = 4.9270 GHz, Bw = 16.000 MH No calibration applied and no bandpass applied

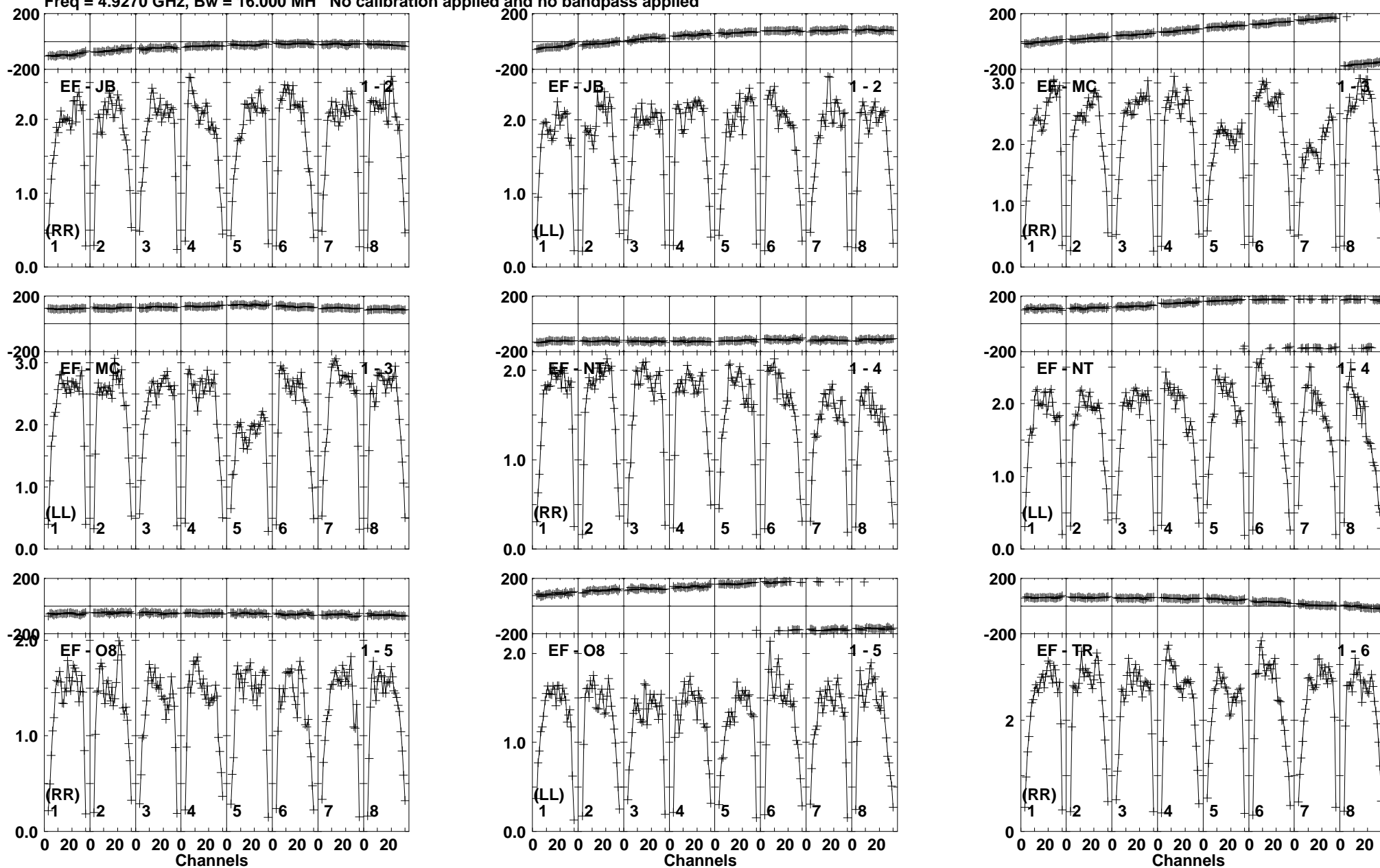

Lower frame: Milli Ampl Jy Top frame: Phas deg  
Vector averaged cross-power spectrum Baseline: EF (01) - JB (02)  
Timerange: 01/00:53:11 to 01/00:54:40

Plot file version 284 created 10-JUN-2016 17:22:30

J1957+3338 RT013A.UVDATA.1

Freq = 4.9270 GHz, Bw = 16.000 MH No calibration applied and no bandpass applied

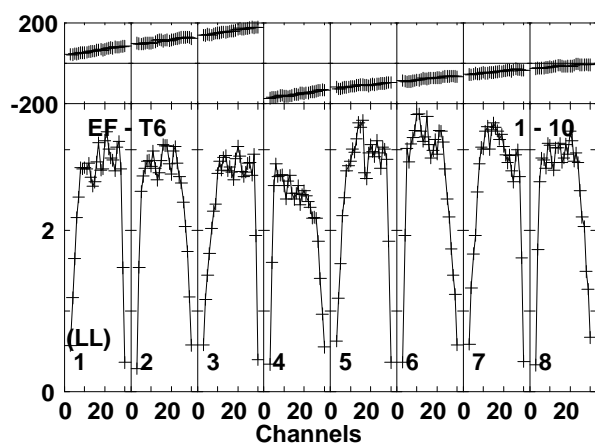
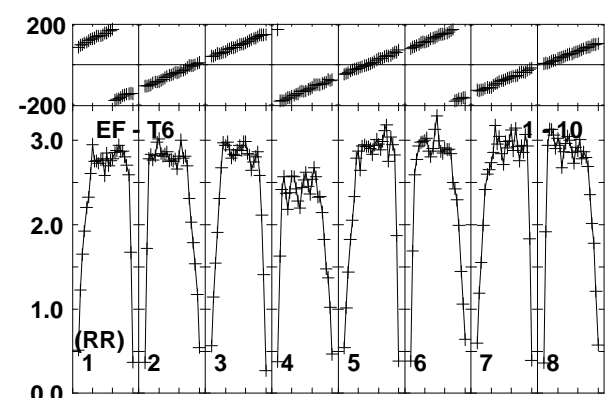
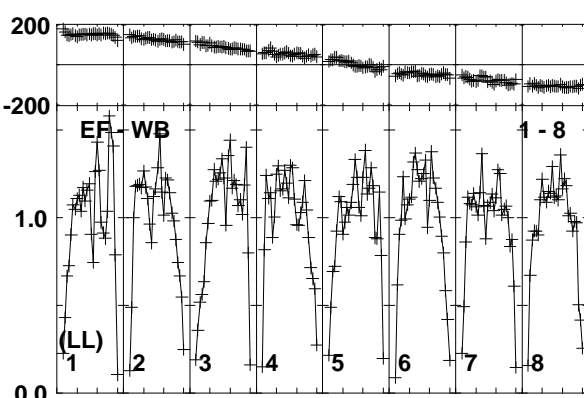
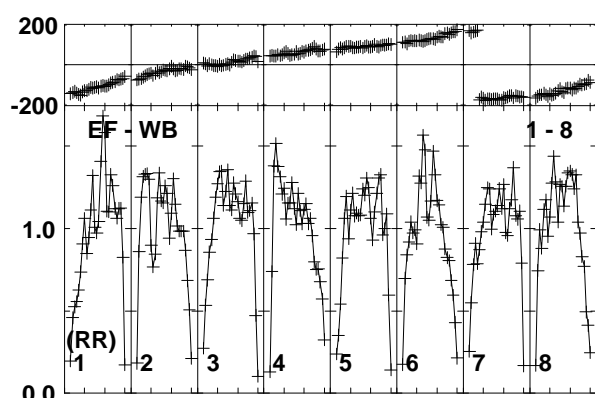
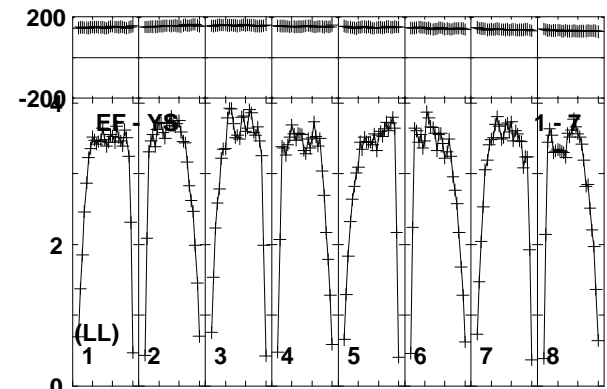
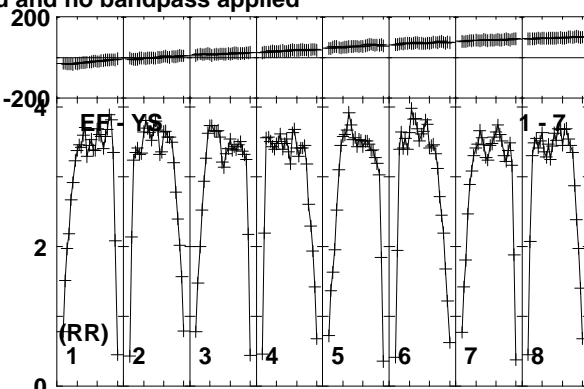
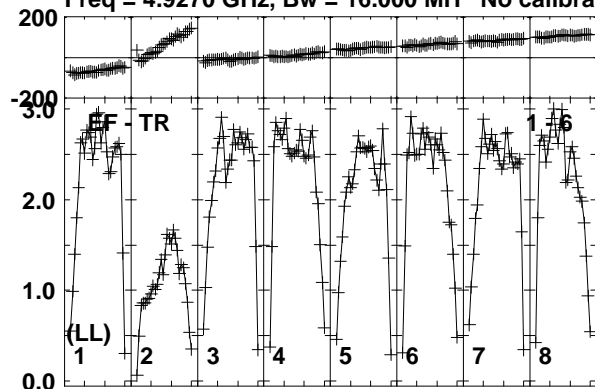

Lower frame: Milli Ampl Jy Top frame: Phas deg  
Vector averaged cross-power spectrum Baseline: EF (01) - TR (06)  
Timerange: 01/00:53:11 to 01/00:54:40

Plot file version 285 created 10-JUN-2016 17:22:31

CHECK RT013A.UVDATA.1

Freq = 4.9270 GHz, Bw = 16.000 MH No calibration applied and no bandpass applied

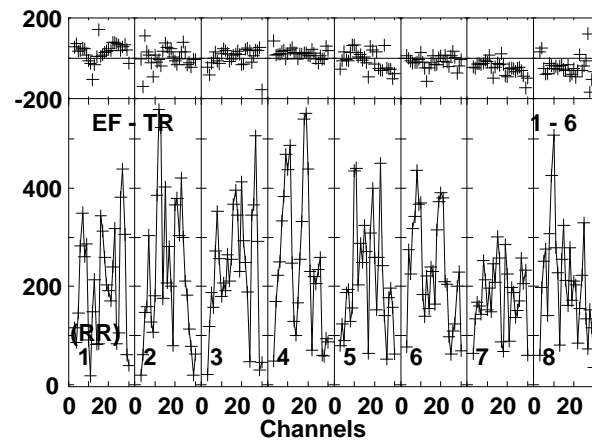
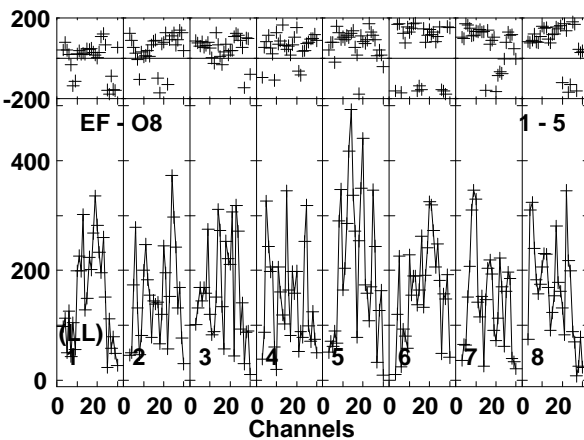
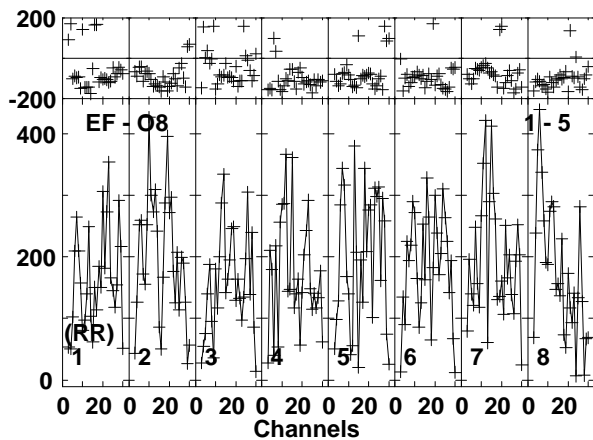
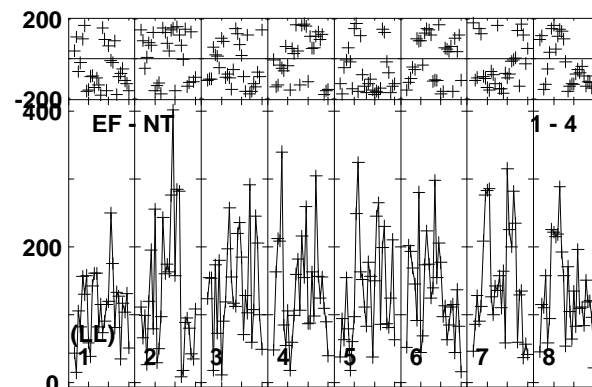
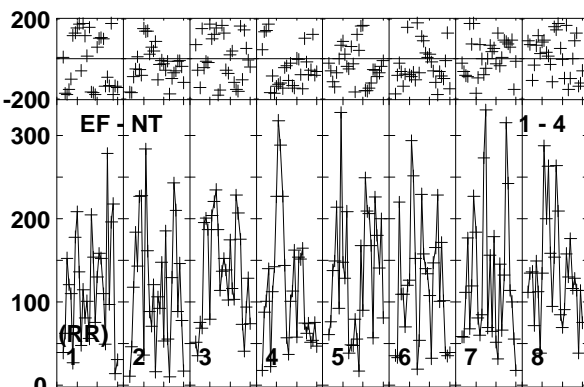
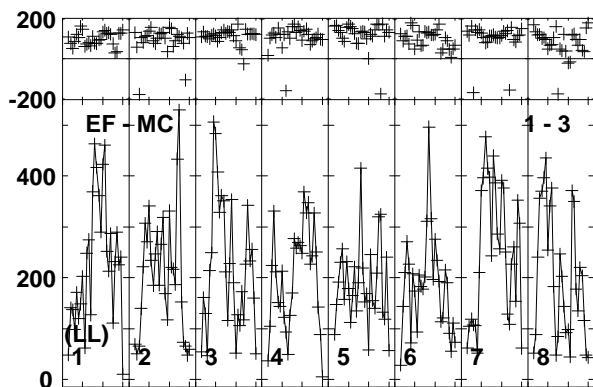
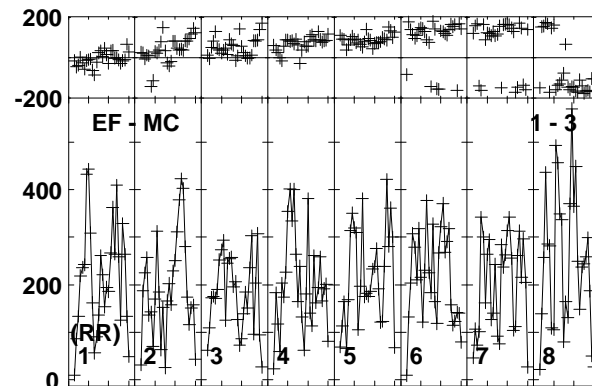
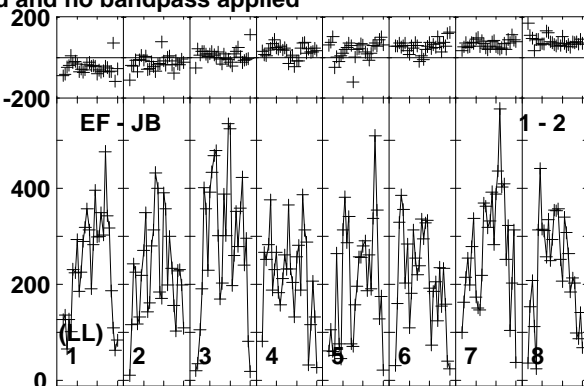
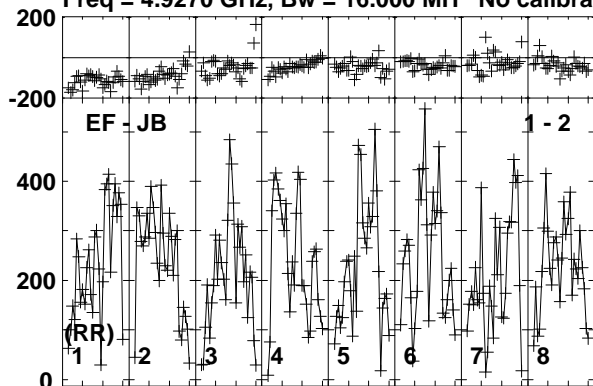

Lower frame: Micro Ampl Jy Top frame: Phas deg  
Vector averaged cross-power spectrum Baseline: EF (01) - JB (02)  
Timerange: 01/00:54:41 to 01/00:56:40

Plot file version 286 created 10-JUN-2016 17:22:31

CHECK RT013A.UVDATA.1

Freq = 4.9270 GHz, Bw = 16.000 MH No calibration applied and no bandpass applied

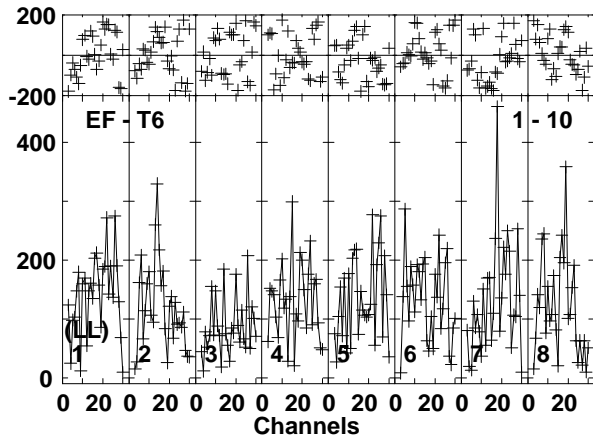
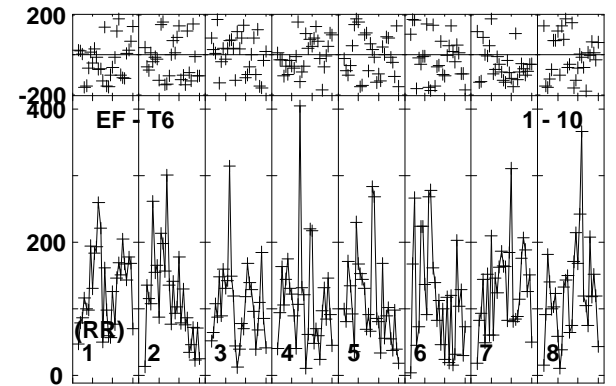
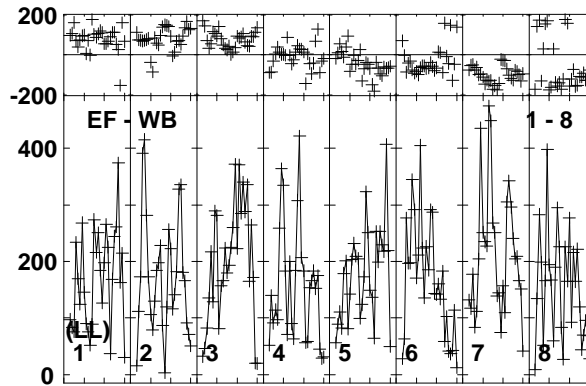
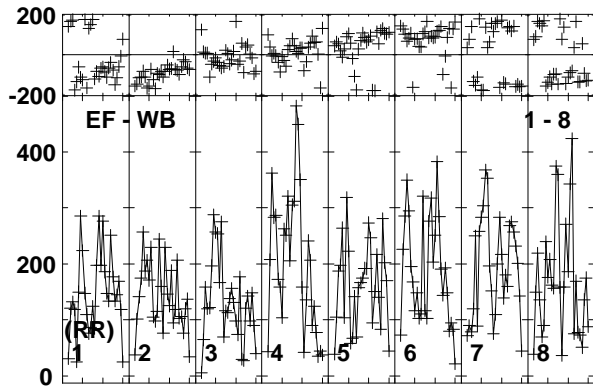
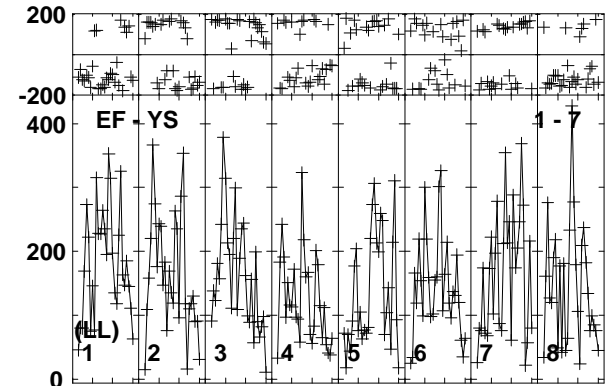
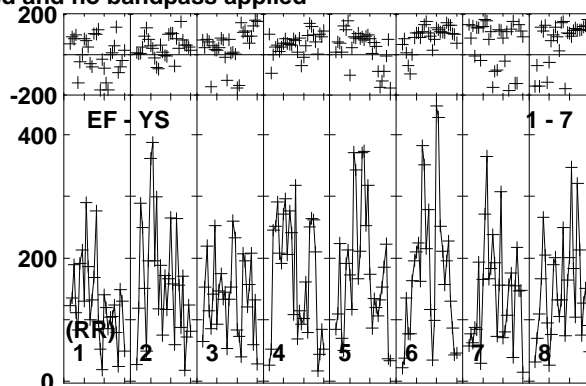
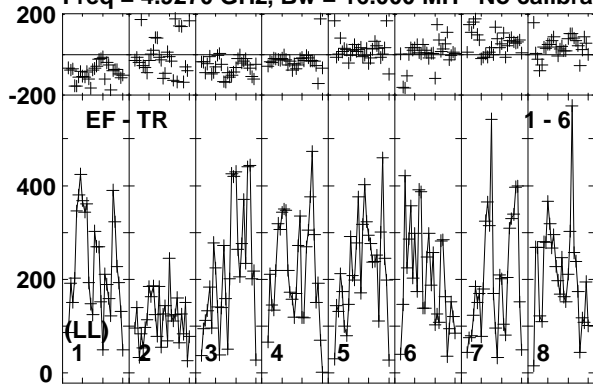

Lower frame: Micro Ampl Jy Top frame: Phas deg  
Vector averaged cross-power spectrum Baseline: EF (01) - TR (06)  
Timerange: 01/00:54:41 to 01/00:56:40

Plot file version 287 created 10-JUN-2016 17:22:31

CYGX1 RT013A.UVDATA.1

Freq = 4.9270 GHz, Bw = 16.000 MH No calibration applied and no bandpass applied

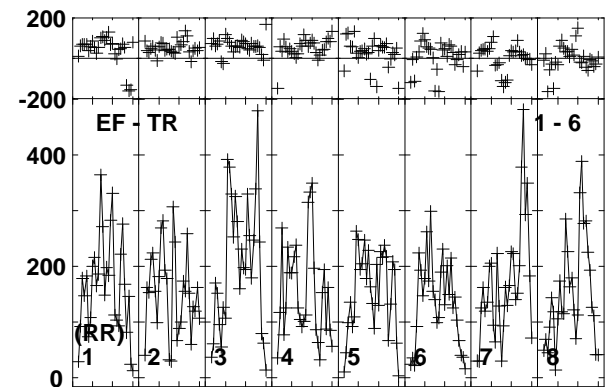
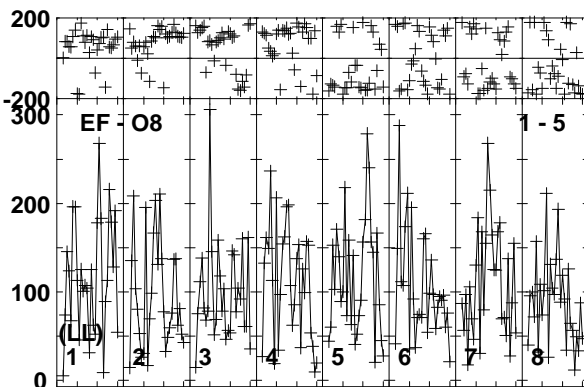
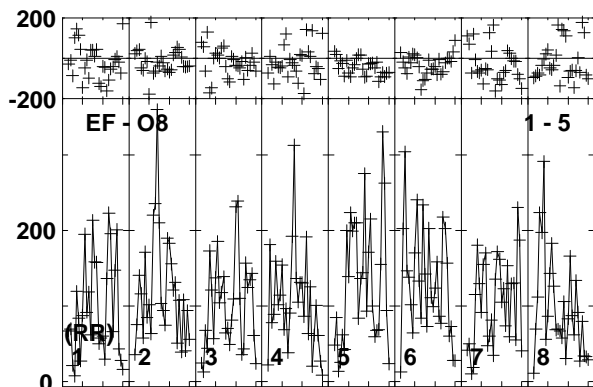
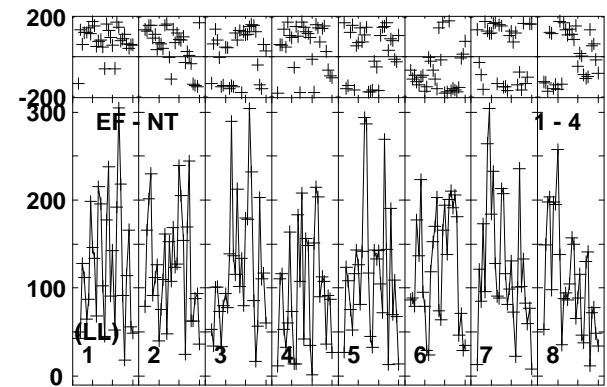
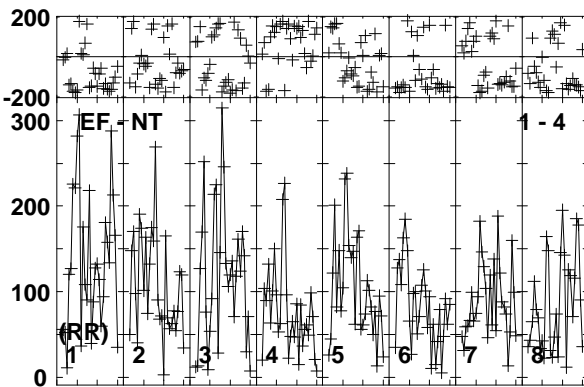
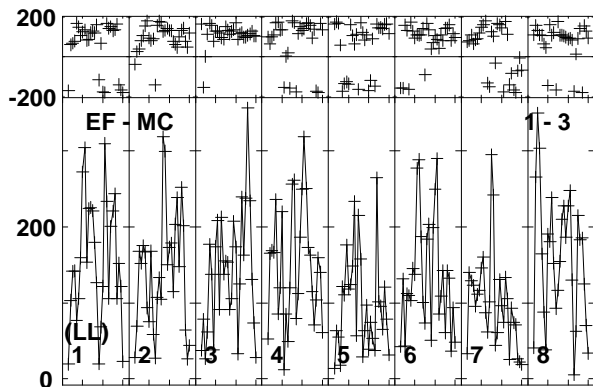
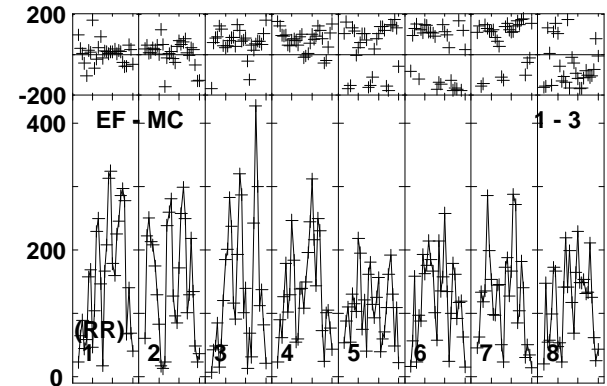
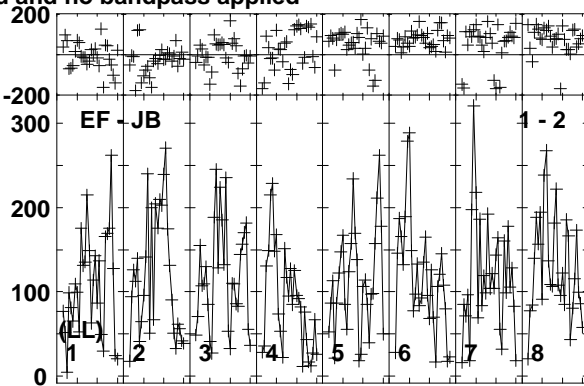
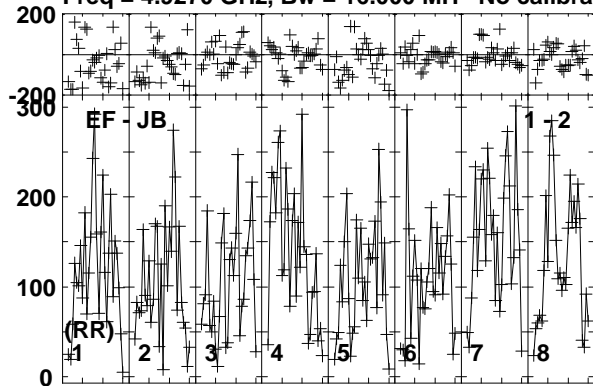

Lower frame: Micro Ampl Jy Top frame: Phas deg  
Vector averaged cross-power spectrum Baseline: EF (01) - JB (02)  
Timerange: 01/00:56:41 to 01/00:59:09

Plot file version 288 created 10-JUN-2016 17:22:31

CYGX1 RT013A.UVDATA.1

Freq = 4.9270 GHz, Bw = 16.000 MH No calibration applied and no bandpass applied

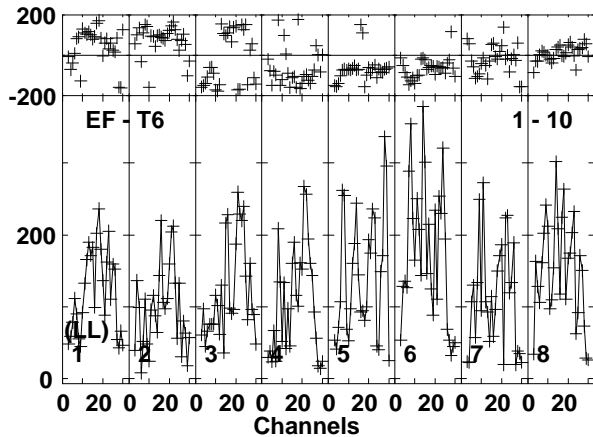
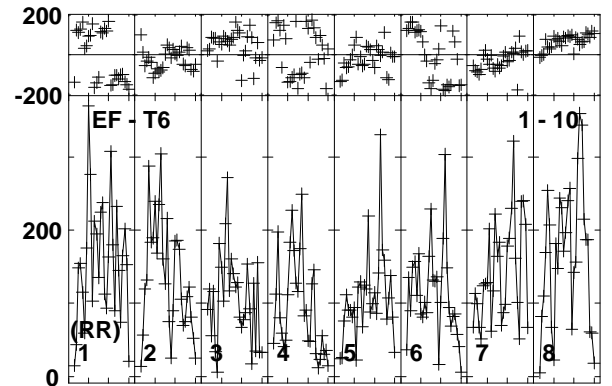
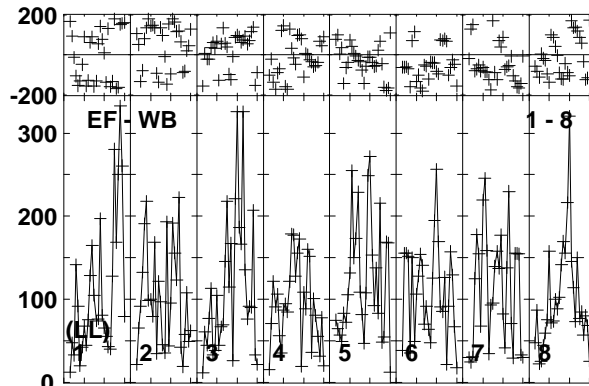
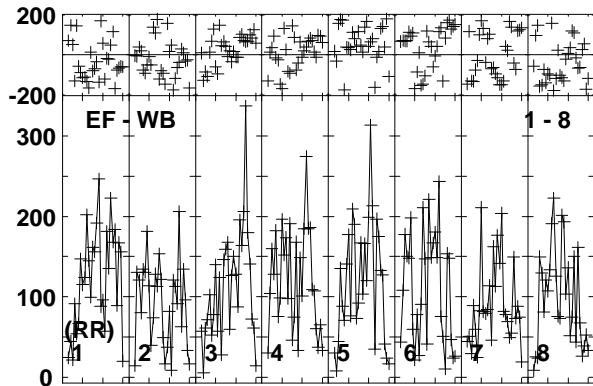
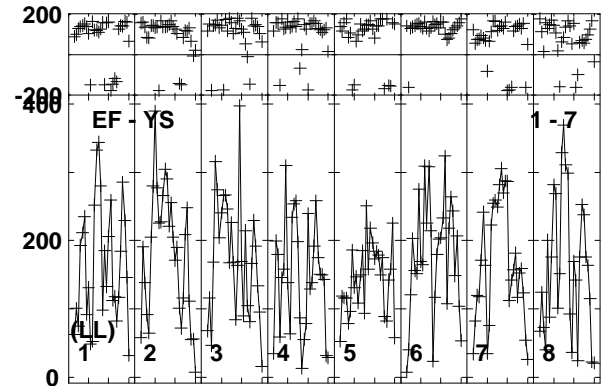
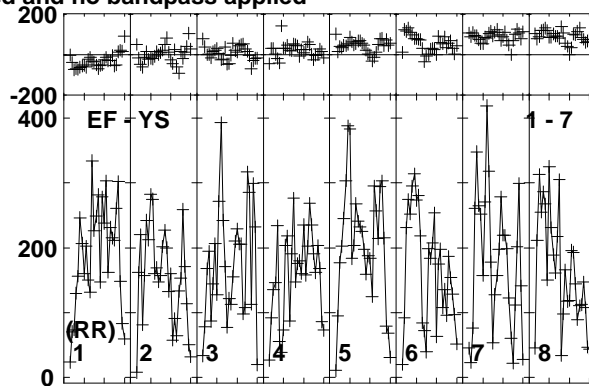
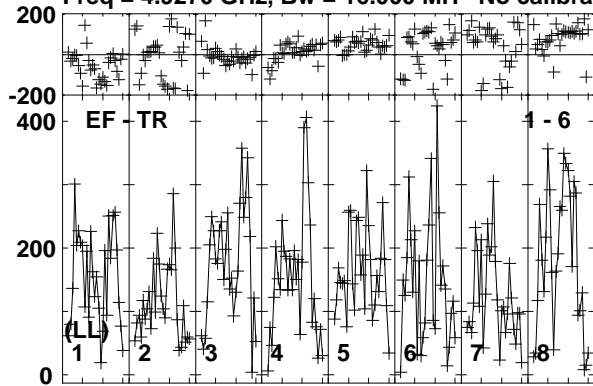

Lower frame: Micro Ampl Jy Top frame: Phas deg  
Vector averaged cross-power spectrum Baseline: EF (01) - TR (06)  
Timerange: 01/00:56:41 to 01/00:59:09

Plot file version 289 created 10-JUN-2016 17:22:31

J1957+3338 RT013A.UVDATA.1

Freq = 4.9270 GHz, Bw = 16.000 MH No calibration applied and no bandpass applied

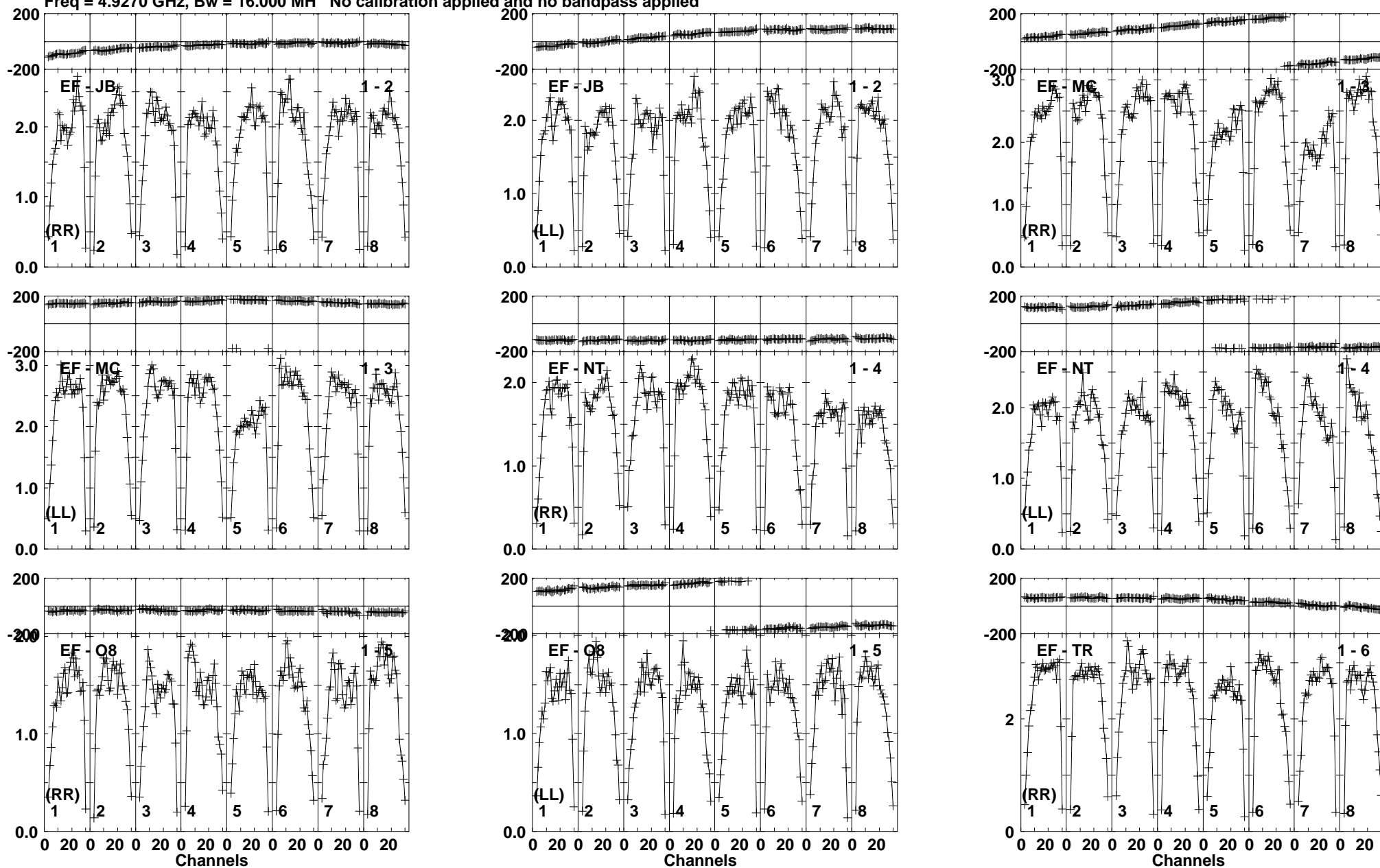

Lower frame: Milli Ampl Jy Top frame: Phas deg  
Vector averaged cross-power spectrum Baseline: EF (01) - JB (02)  
Timerange: 01/00:59:11 to 01/01:00:39

Plot file version 290 created 10-JUN-2016 17:22:31

J1957+3338 RT013A.UVDATA.1

Freq = 4.9270 GHz, Bw = 16.000 MH No calibration applied and no bandpass applied

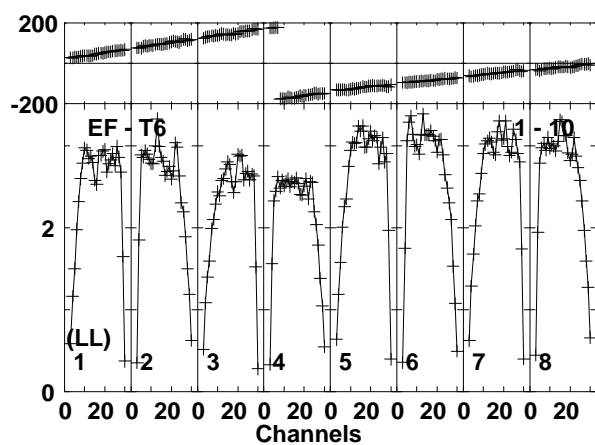
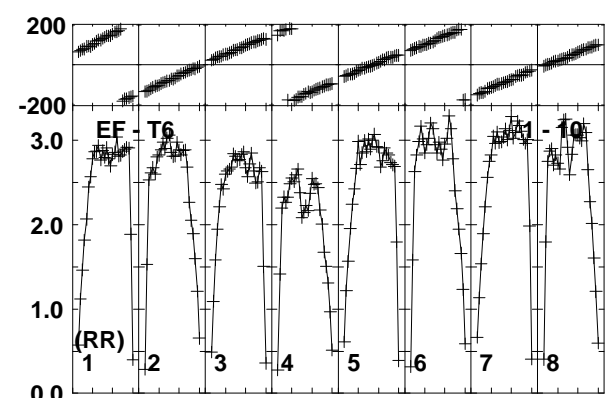
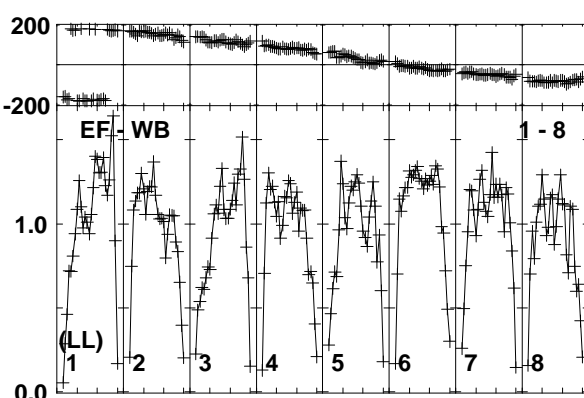
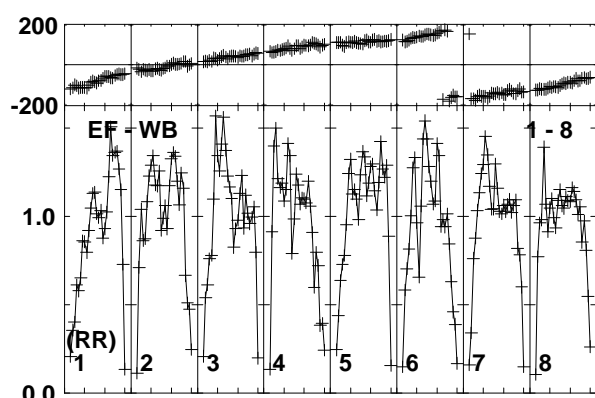
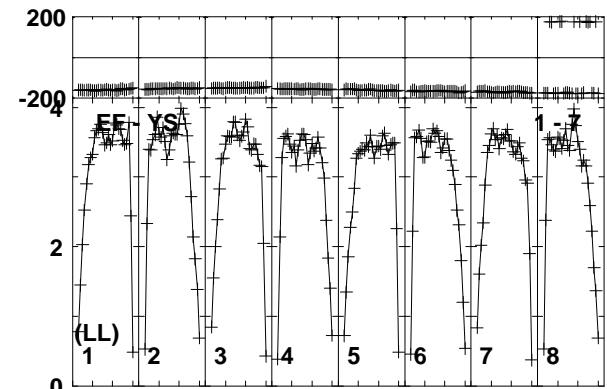
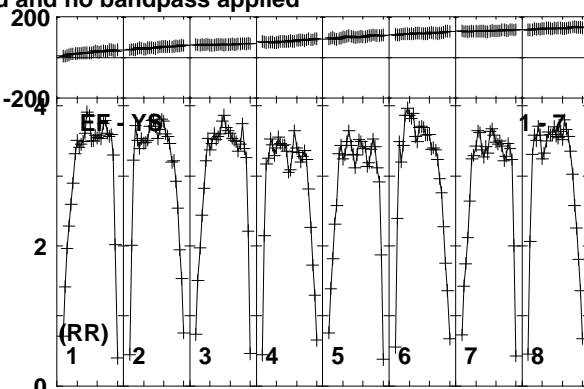
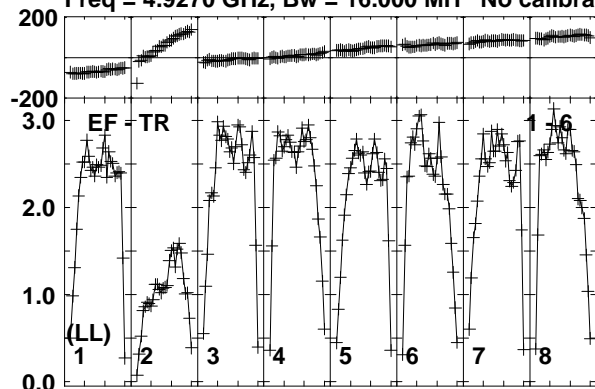

Lower frame: Milli Ampl Jy Top frame: Phas deg  
Vector averaged cross-power spectrum Baseline: EF (01) - TR (06)  
Timerange: 01/00:59:11 to 01/01:00:39



Plot file version 291 created 10-JUN-2016 17:22:31

CHECK RT013A.UVDATA.1

Freq = 4.9270 GHz, Bw = 16.000 MH No calibration applied and no bandpass applied

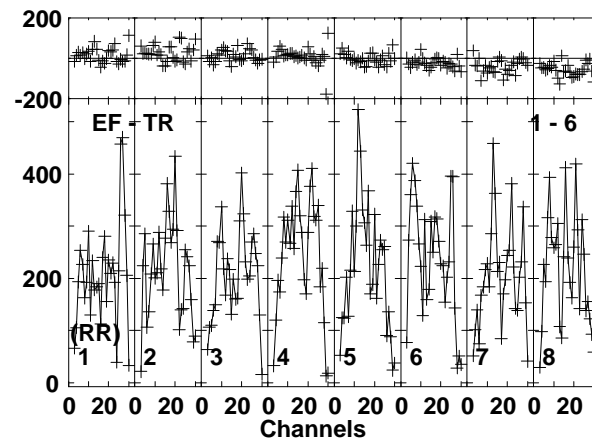
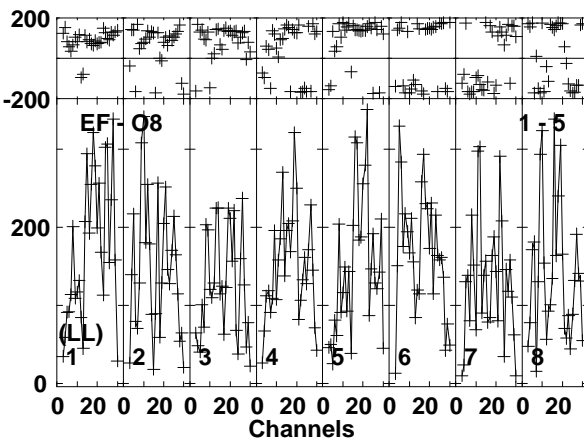
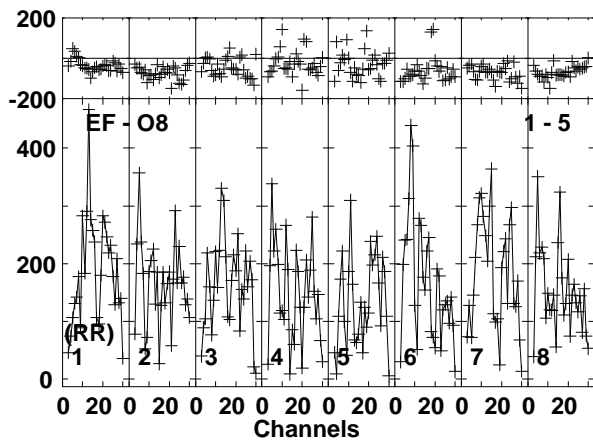
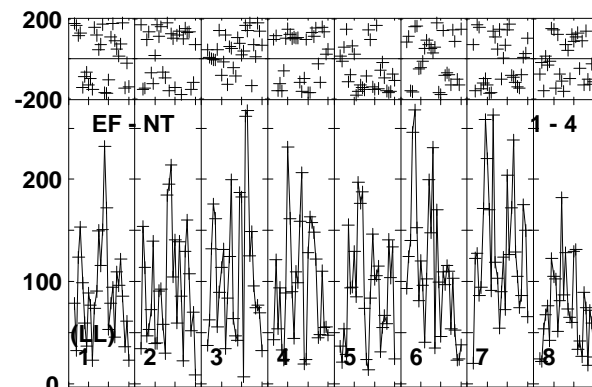
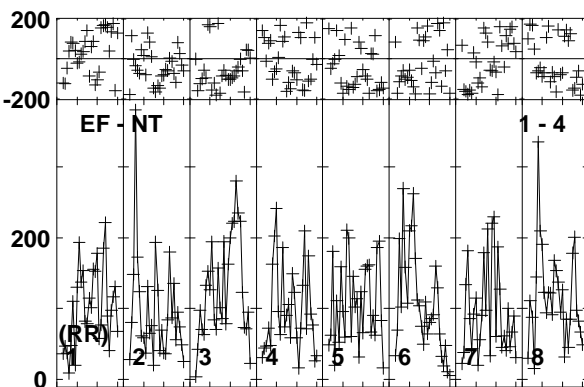
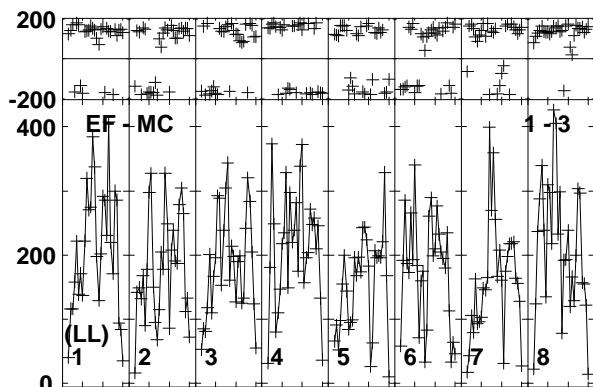
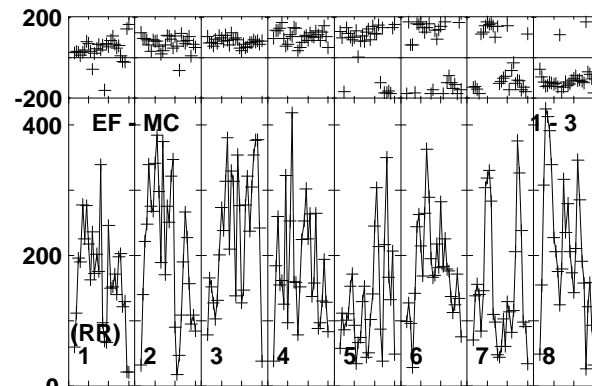
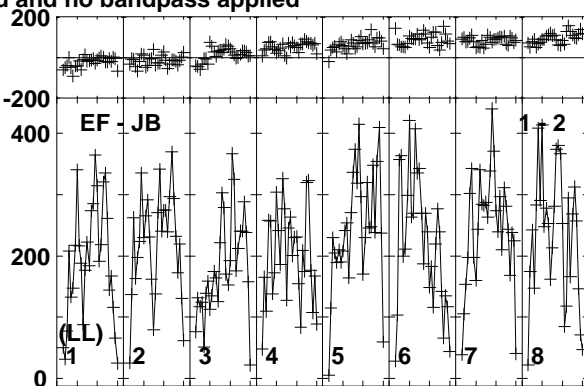
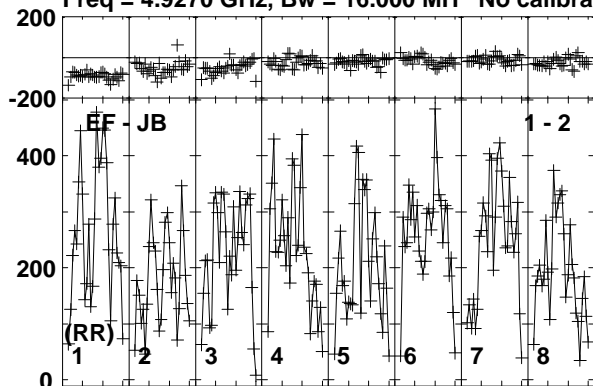

Lower frame: Micro Ampl Jy Top frame: Phas deg  
Vector averaged cross-power spectrum Baseline: EF (01) - JB (02)  
Timerange: 01/01:01:20 to 01/01:03:20

Plot file version 292 created 10-JUN-2016 17:22:31

CHECK RT013A.UVDATA.1

Freq = 4.9270 GHz, Bw = 16.000 MH No calibration applied and no bandpass applied

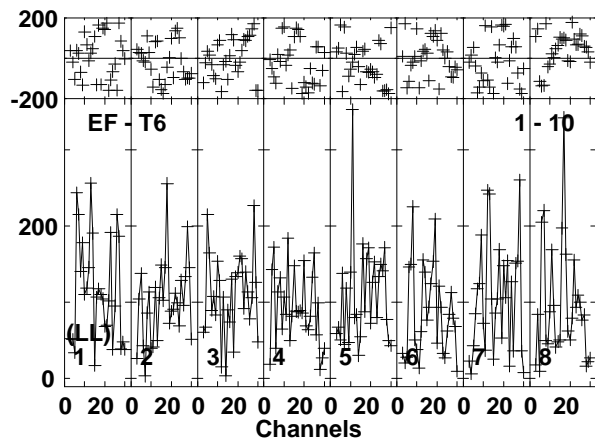
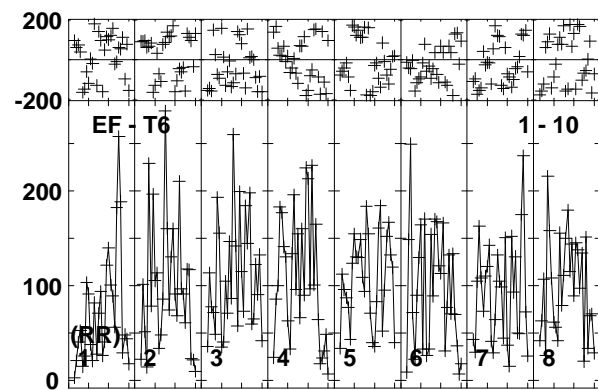
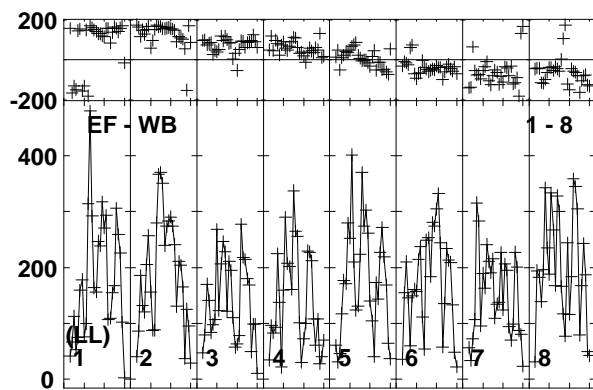
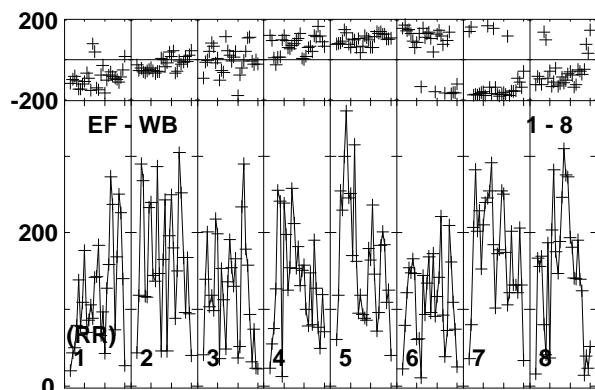
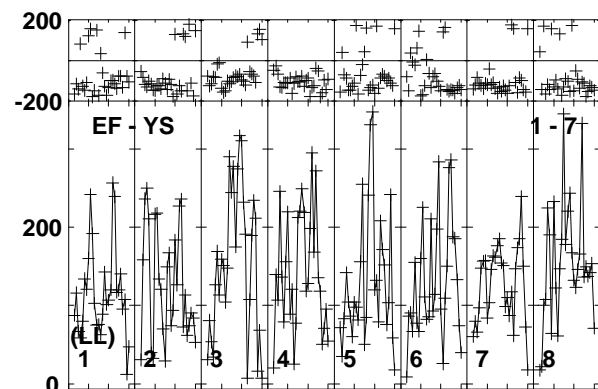
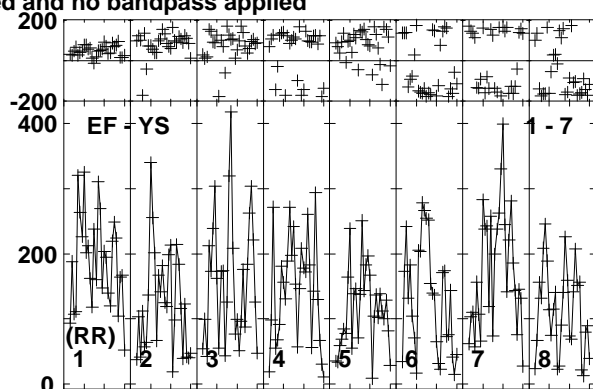
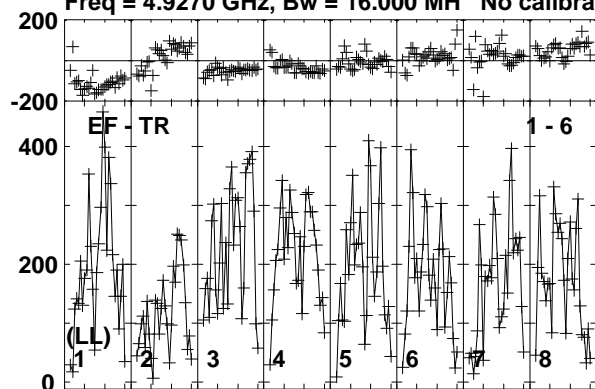

Lower frame: Micro Ampl Jy Top frame: Phas deg  
Vector averaged cross-power spectrum Baseline: EF (01) - TR (06)  
Timerange: 01/01:01:20 to 01/01:03:20

Plot file version 293 created 10-JUN-2016 17:22:32

CYGX1 RT013A.UVDATA.1

Freq = 4.9270 GHz, Bw = 16.000 MH No calibration applied and no bandpass applied

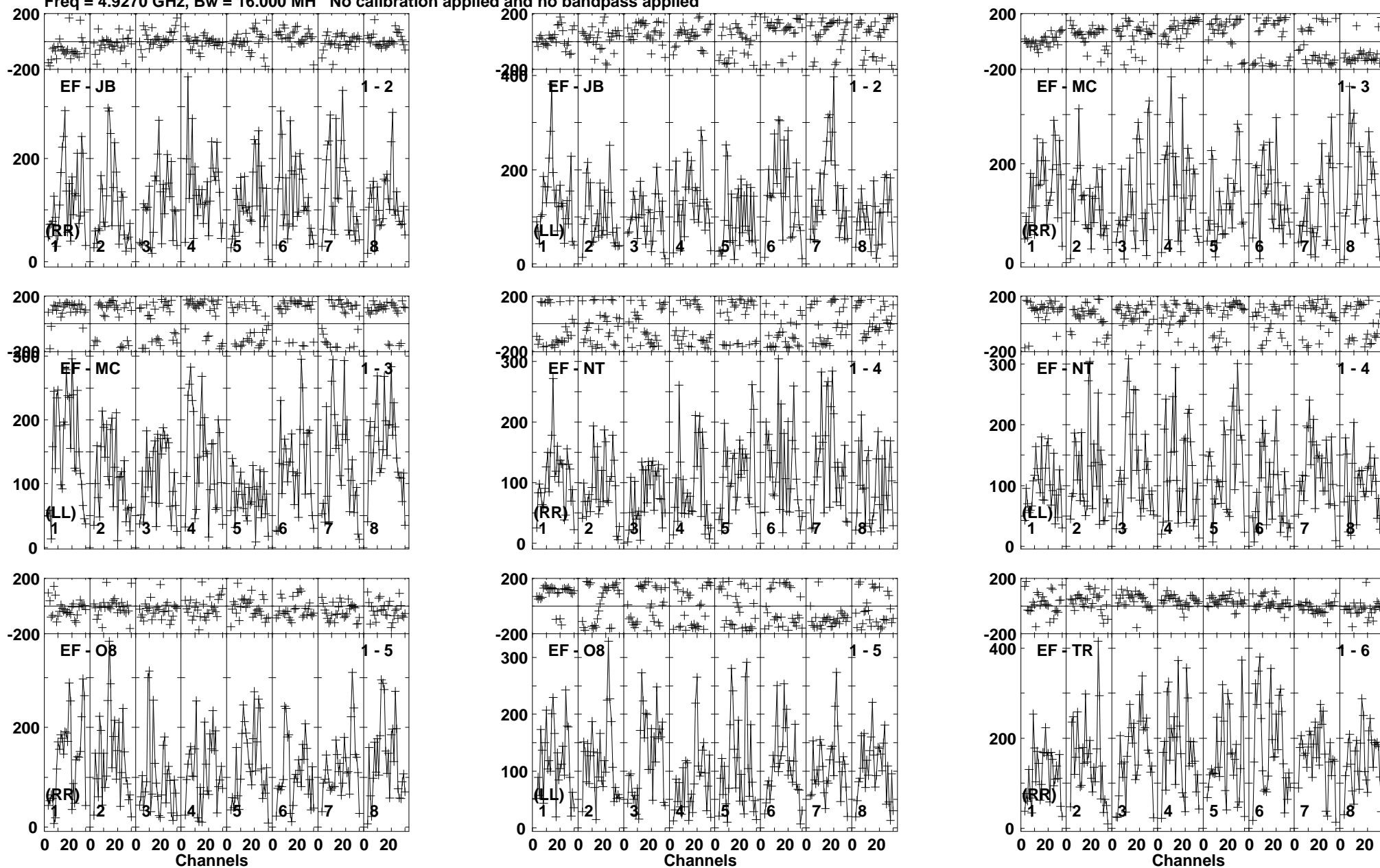

Lower frame: Micro Ampl Jy Top frame: Phas deg  
Vector averaged cross-power spectrum Baseline: EF (01) - JB (02)  
Timerange: 01/01:03:21 to 01/01:05:49

Plot file version 294 created 10-JUN-2016 17:22:32

CYGX1 RT013A.UVDATA.1

Freq = 4.9270 GHz, Bw = 16.000 MH No calibration applied and no bandpass applied

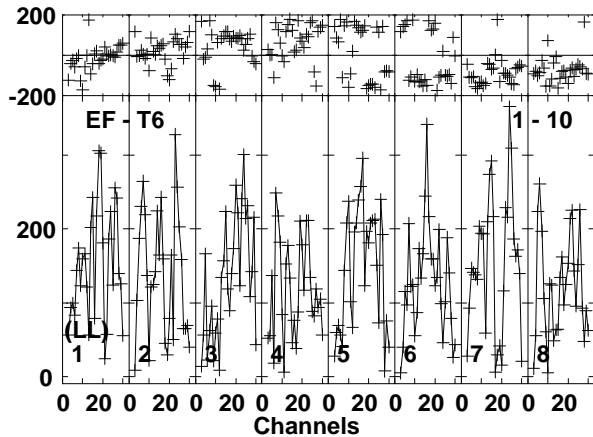
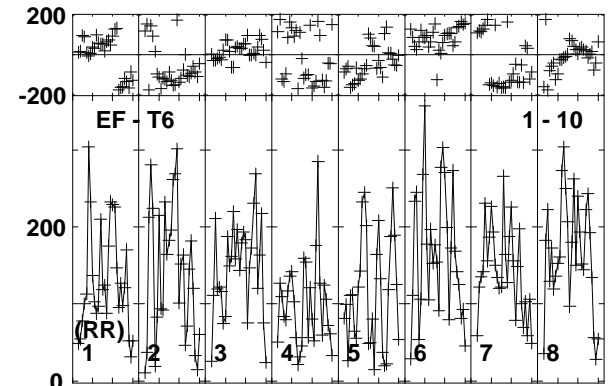
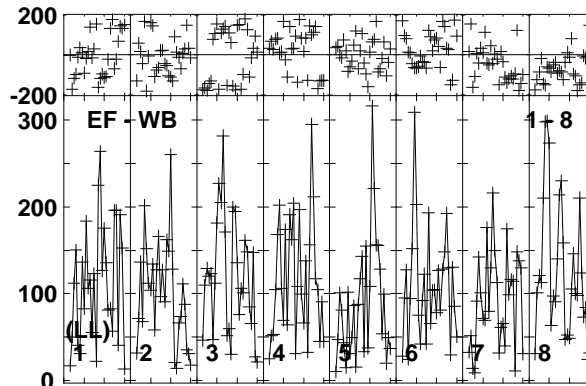
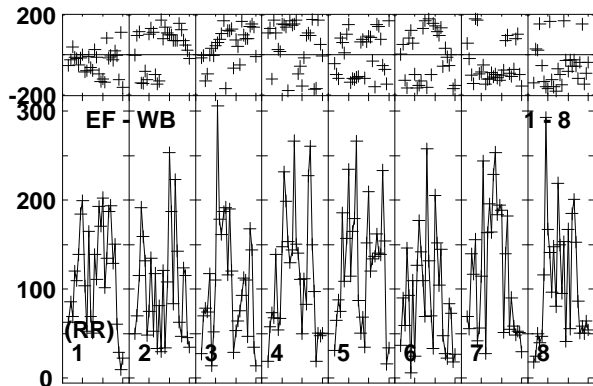
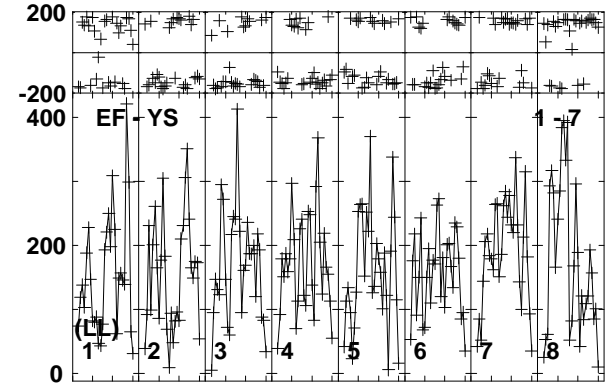
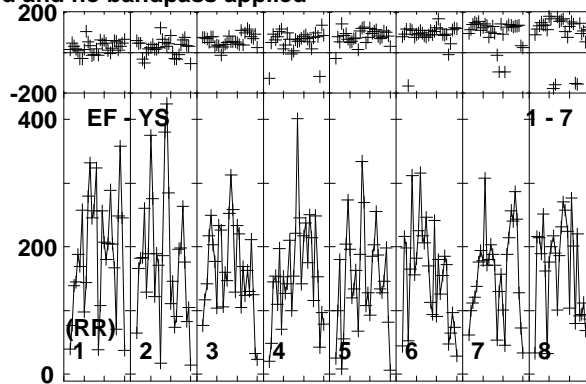
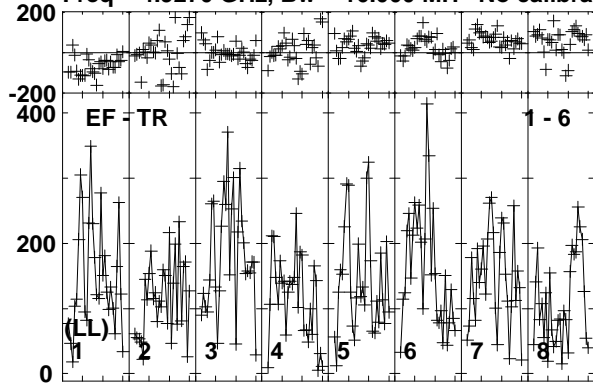

Lower frame: Micro Ampl Jy Top frame: Phas deg  
Vector averaged cross-power spectrum Baseline: EF (01) - TR (06)  
Timerange: 01/01:03:21 to 01/01:05:49

Plot file version 295 created 10-JUN-2016 17:22:32

J1957+3338 RT013A.UVDATA.1

Freq = 4.9270 GHz, Bw = 16.000 MH No calibration applied and no bandpass applied

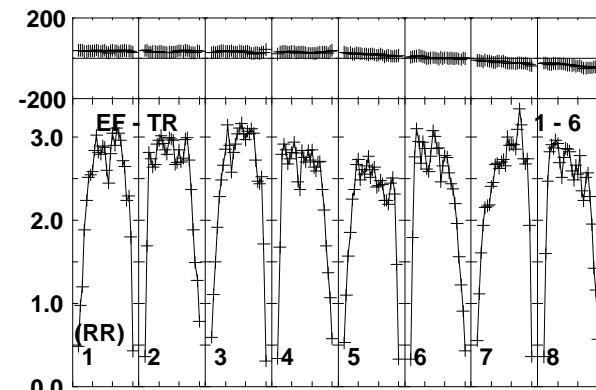
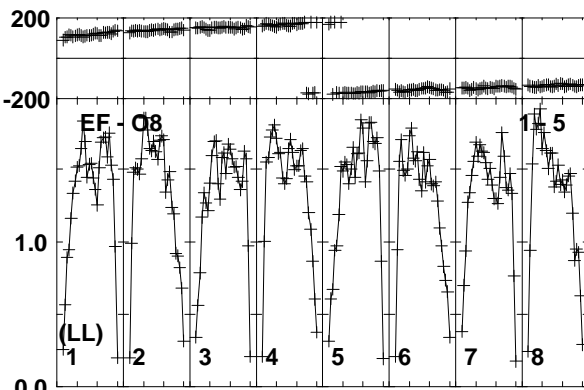
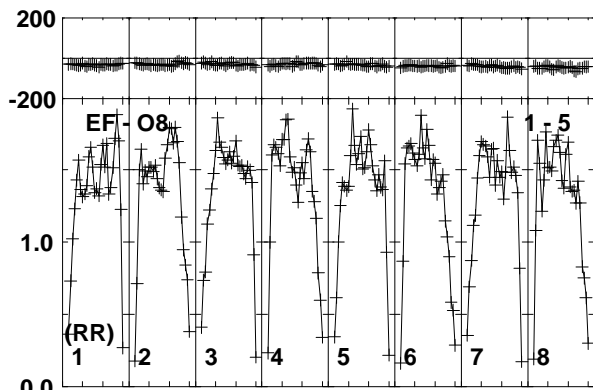
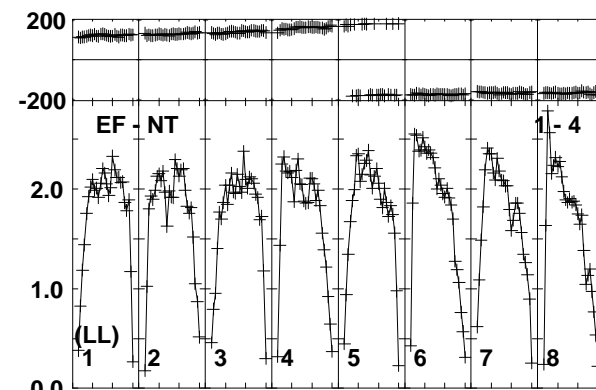
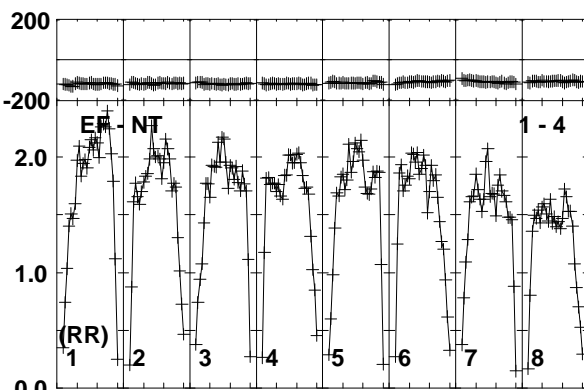
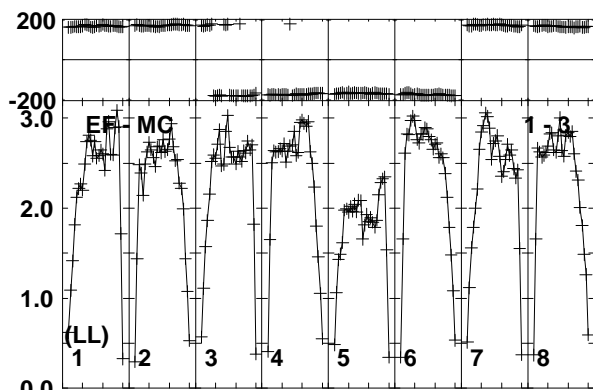
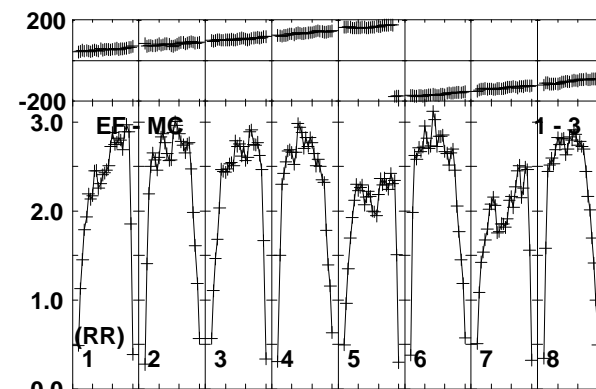
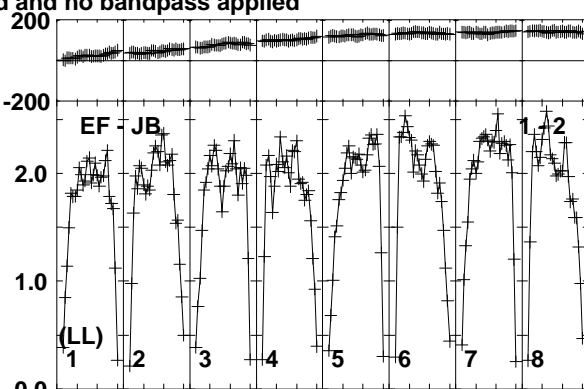
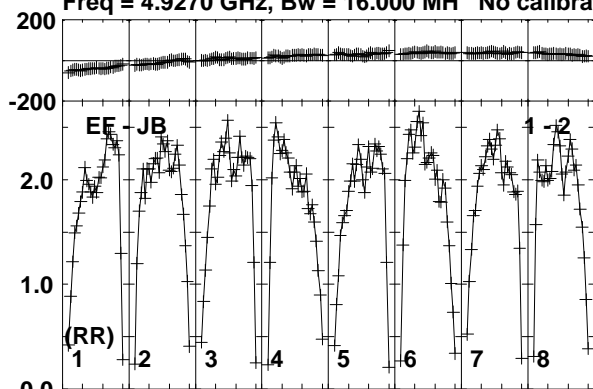

Lower frame: Milli Ampl Jy Top frame: Phas deg  
Vector averaged cross-power spectrum Baseline: EF (01) - JB (02)  
Timerange: 01/01:05:51 to 01/01:07:19

Plot file version 296 created 10-JUN-2016 17:22:32

J1957+3338 RT013A.UVDATA.1

Freq = 4.9270 GHz, Bw = 16.000 MH No calibration applied and no bandpass applied

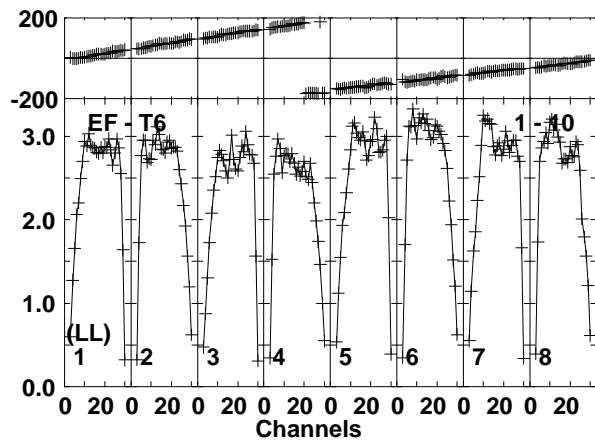
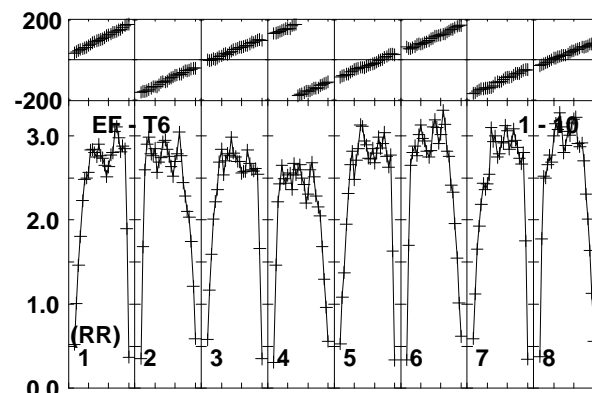
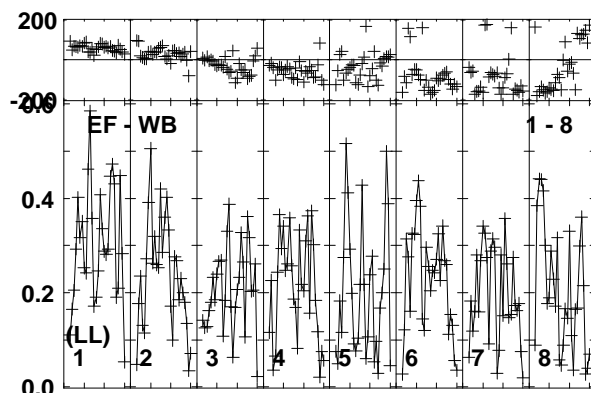
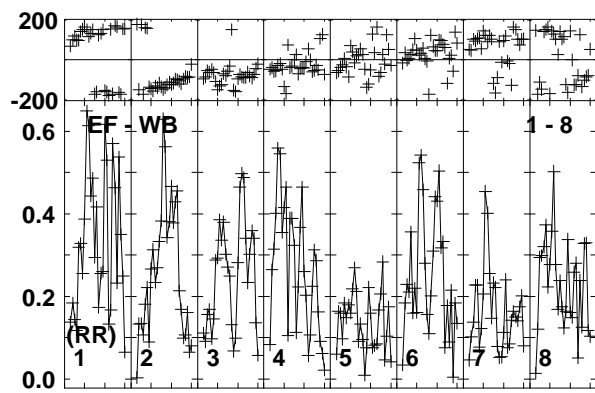
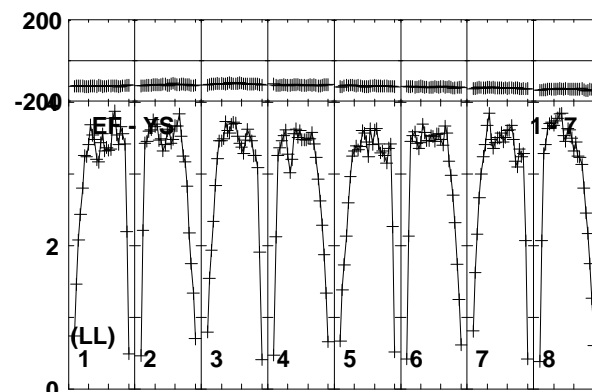
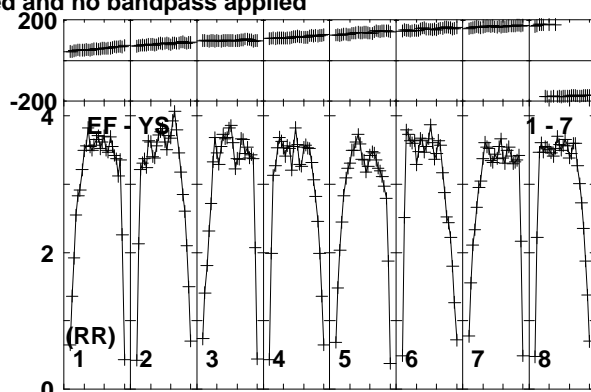
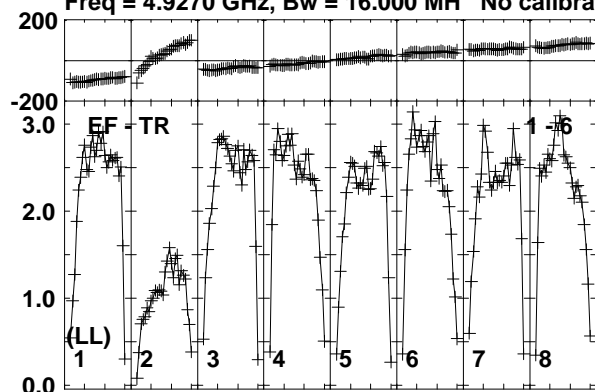

Lower frame: Milli Ampl Jy Top frame: Phas deg  
Vector averaged cross-power spectrum Baseline: EF (01) - TR (06)  
Timerange: 01/01:05:51 to 01/01:07:19

Plot file version 297 created 10-JUN-2016 17:22:32

CHECK RT013A.UVDATA.1

Freq = 4.9270 GHz, Bw = 16.000 MH No calibration applied and no bandpass applied

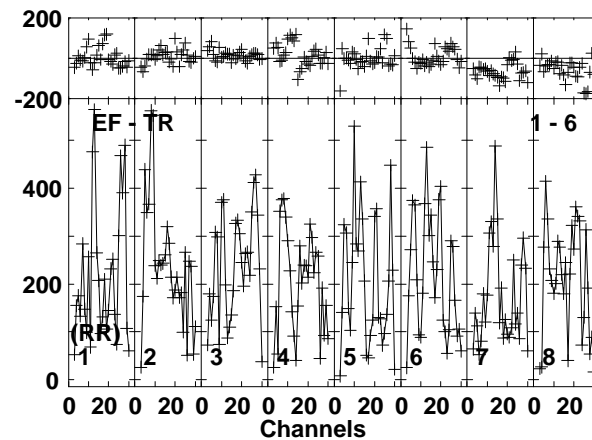
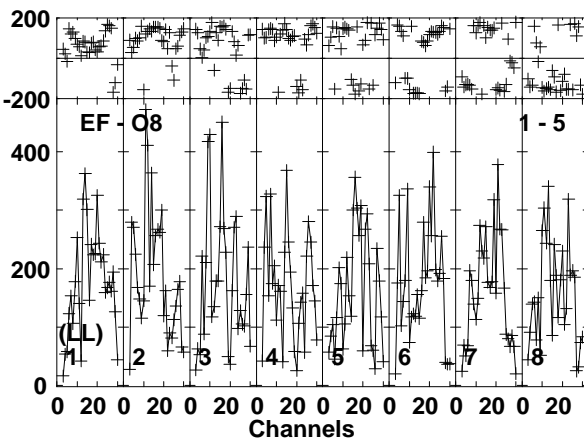
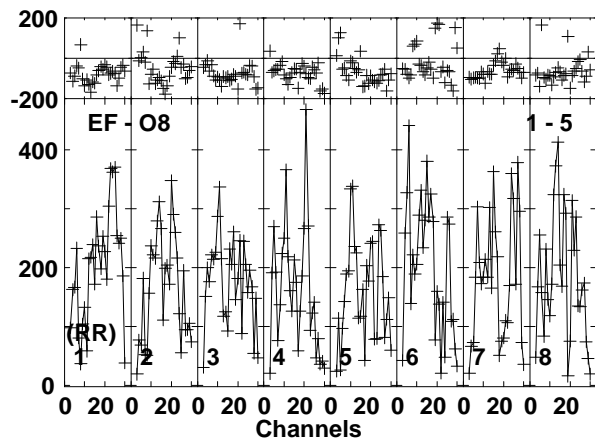
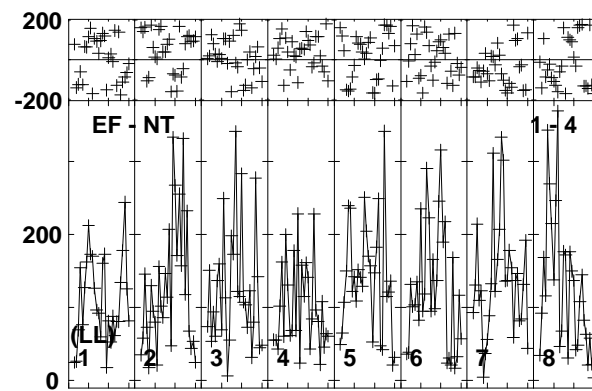
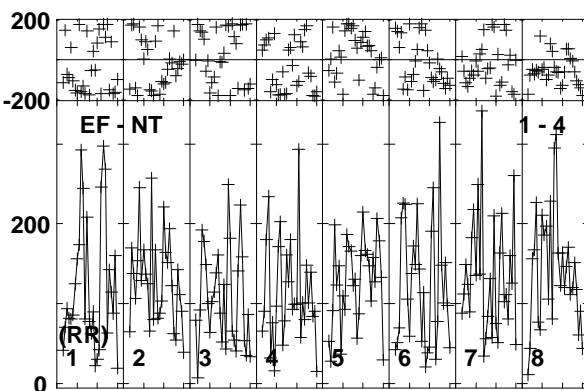
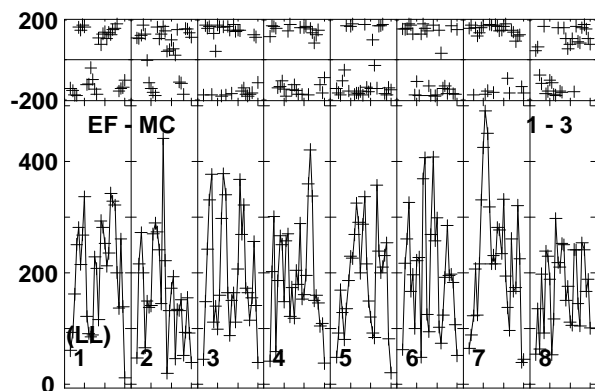
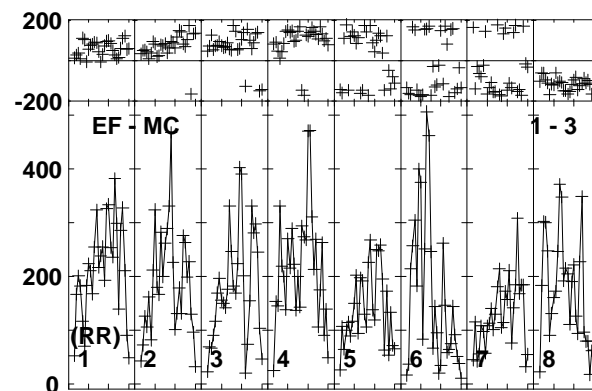
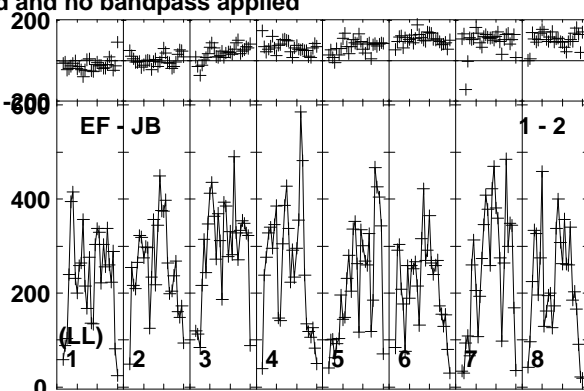
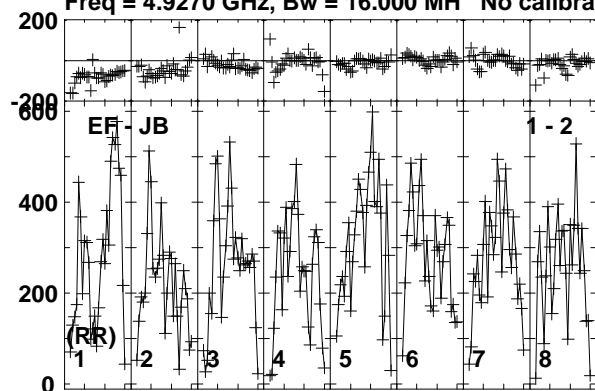

Lower frame: Micro Ampl Jy Top frame: Phas deg  
Vector averaged cross-power spectrum Baseline: EF (01) - JB (02)  
Timerange: 01/01:07:21 to 01/01:09:19

Plot file version 298 created 10-JUN-2016 17:22:32

CHECK RT013A.UVDATA.1

Freq = 4.9270 GHz, Bw = 16.000 MH No calibration applied and no bandpass applied

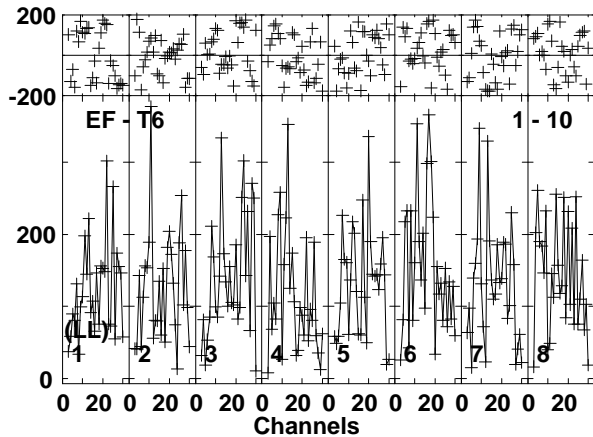
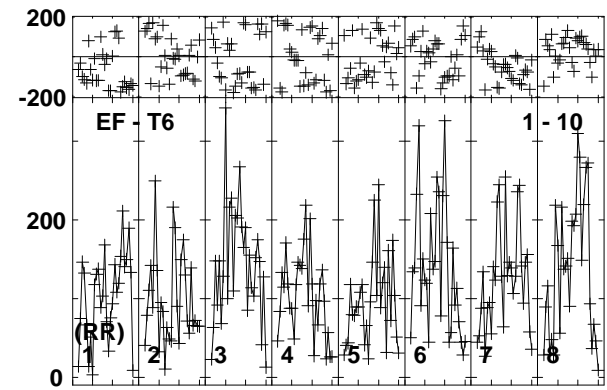
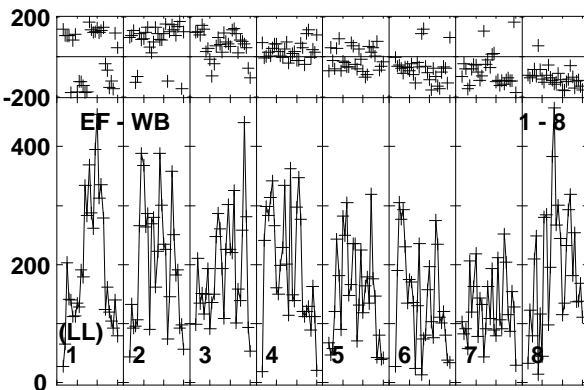
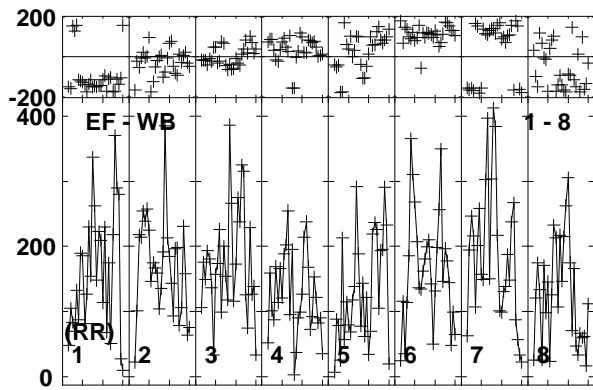
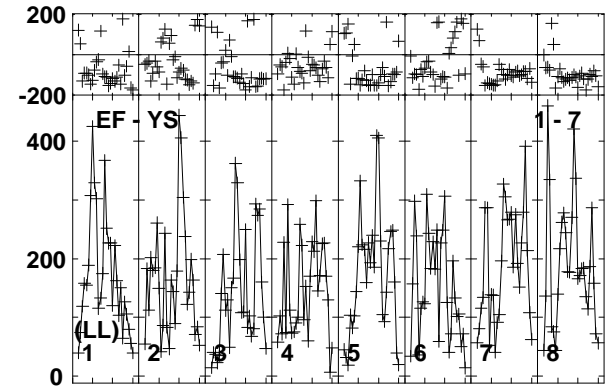
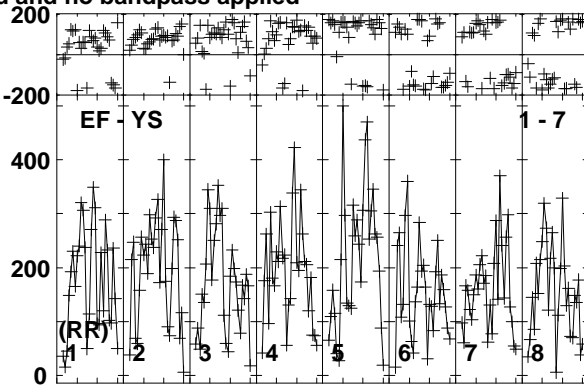
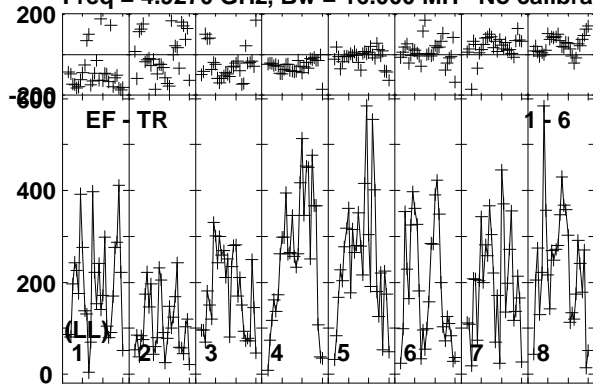

Lower frame: Micro Ampl Jy Top frame: Phas deg  
Vector averaged cross-power spectrum Baseline: EF (01) - TR (06)  
Timerange: 01/01:07:21 to 01/01:09:19



Plot file version 299 created 10-JUN-2016 17:22:32

CYGX1 RT013A.UVDATA.1

Freq = 4.9270 GHz, Bw = 16.000 MH No calibration applied and no bandpass applied

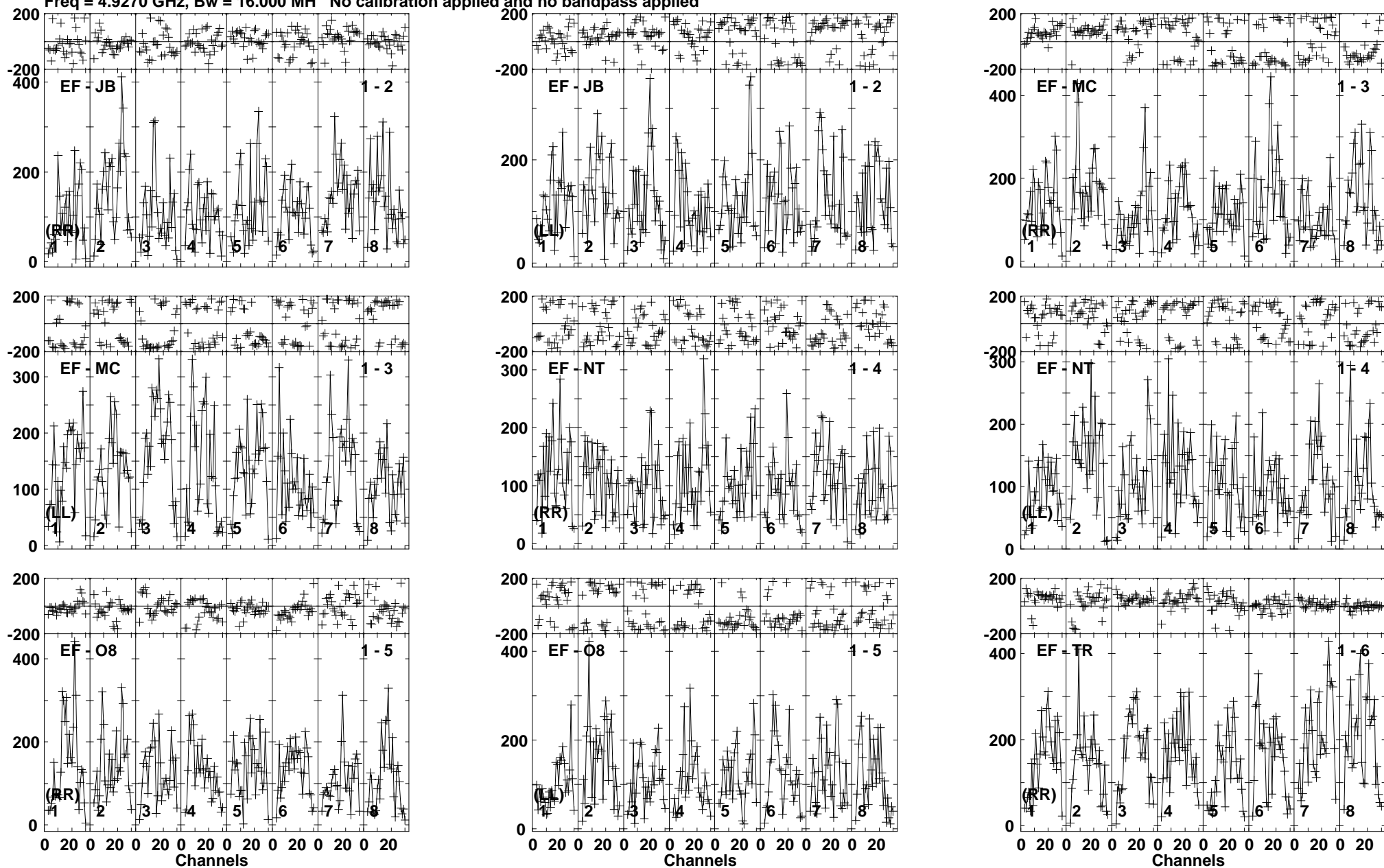

Lower frame: Micro Ampl Jy Top frame: Phas deg  
Vector averaged cross-power spectrum Baseline: EF (01) - JB (02)  
Timerange: 01/01:09:20 to 01/01:11:50

Plot file version 300 created 10-JUN-2016 17:22:32

CYGX1 RT013A.UVDATA.1

Freq = 4.9270 GHz, Bw = 16.000 MH No calibration applied and no bandpass applied

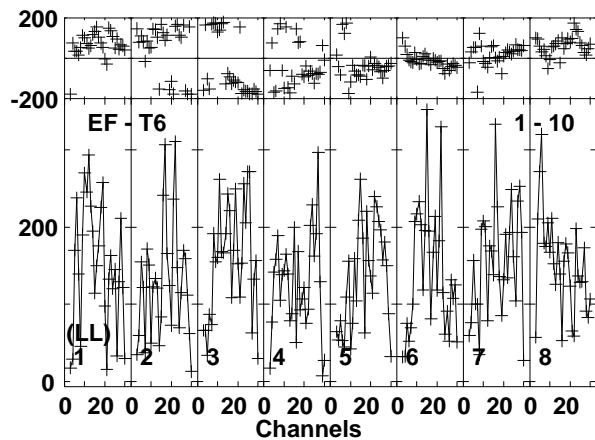
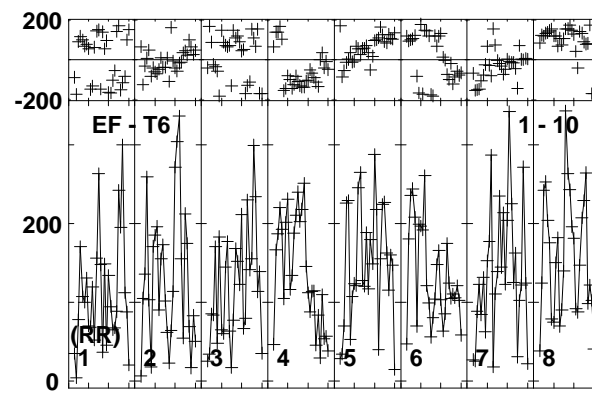
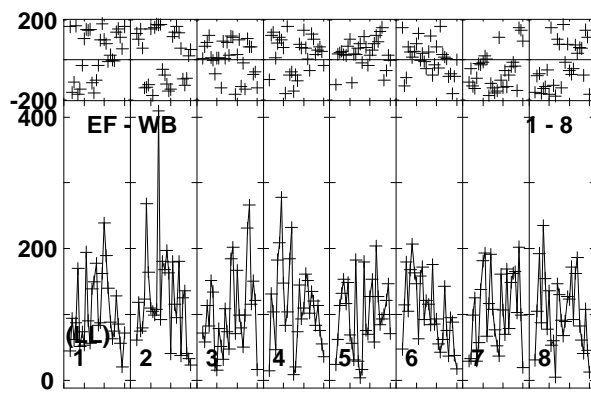
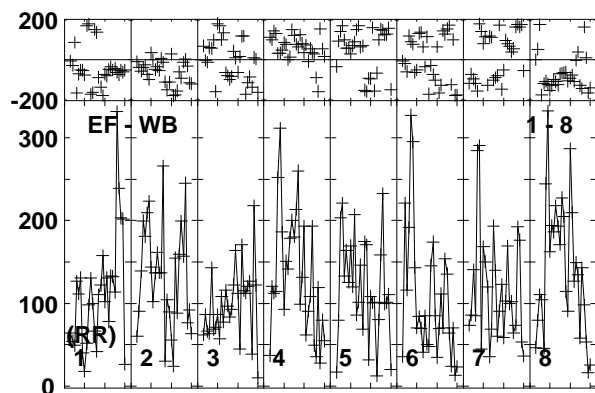
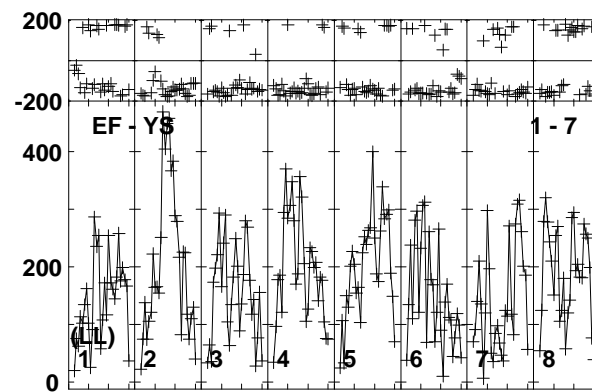
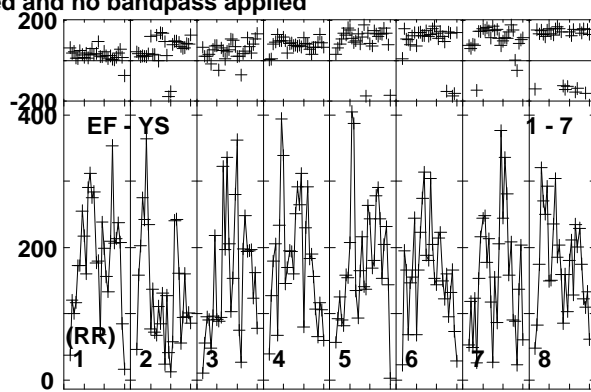
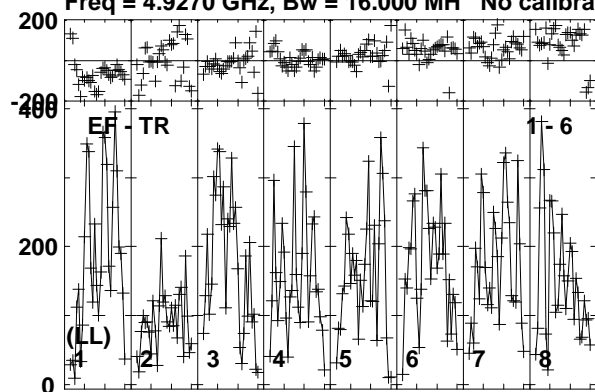

Lower frame: Micro Ampl Jy Top frame: Phas deg  
Vector averaged cross-power spectrum Baseline: EF (01) - TR (06)  
Timerange: 01/01:09:20 to 01/01:11:50

Plot file version 301 created 10-JUN-2016 17:22:32

J1957+3338 RT013A.UVDATA.1

Freq = 4.9270 GHz, Bw = 16.000 MH No calibration applied and no bandpass applied

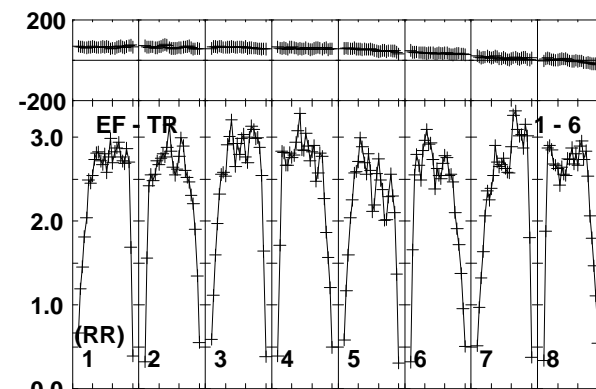
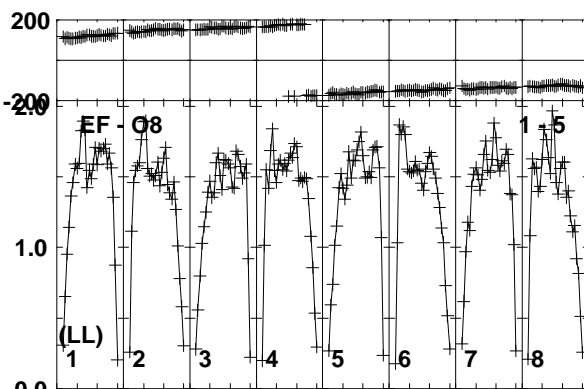
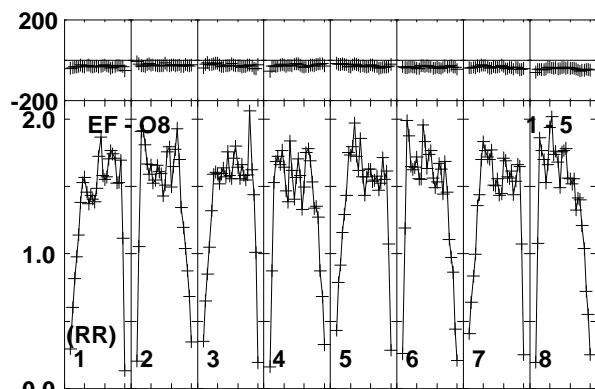
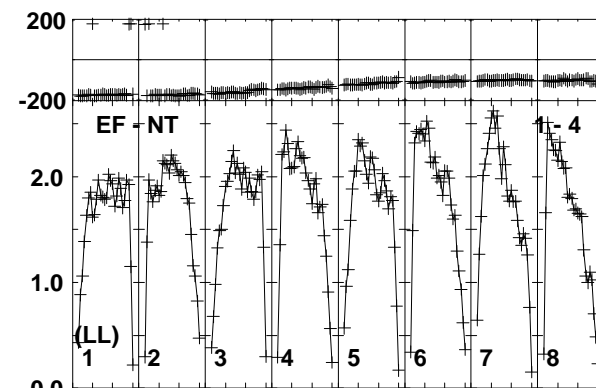
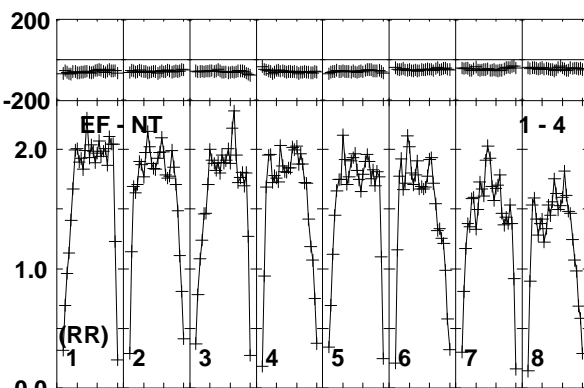
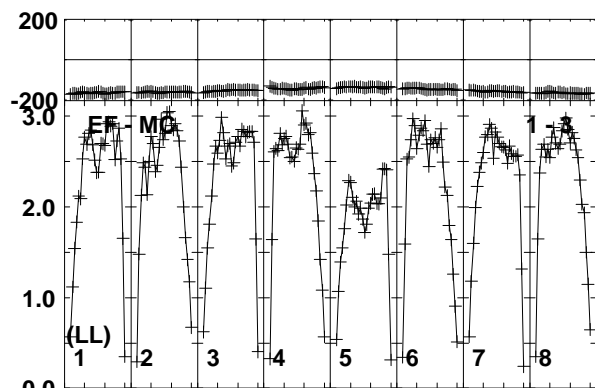
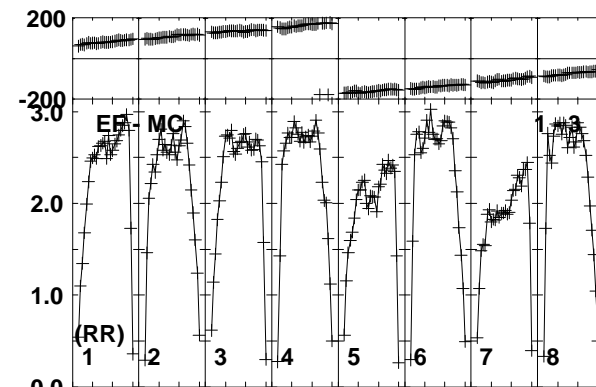
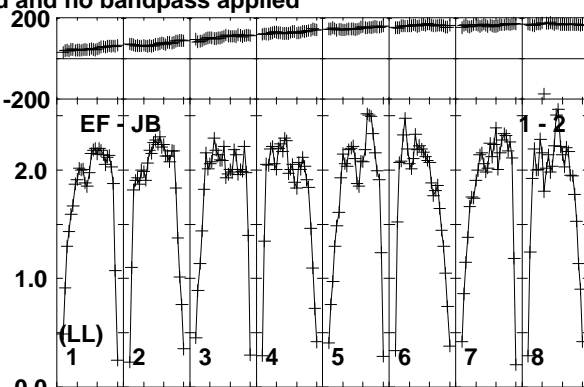
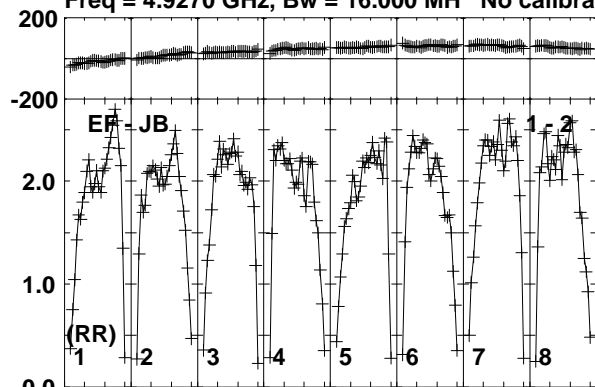

Lower frame: Milli Ampl Jy Top frame: Phas deg  
Vector averaged cross-power spectrum Baseline: EF (01) - JB (02)  
Timerange: 01/01:11:50 to 01/01:13:19

Plot file version 302 created 10-JUN-2016 17:22:33

J1957+3338 RT013A.UVDATA.1

Freq = 4.9270 GHz, Bw = 16.000 MH No calibration applied and no bandpass applied

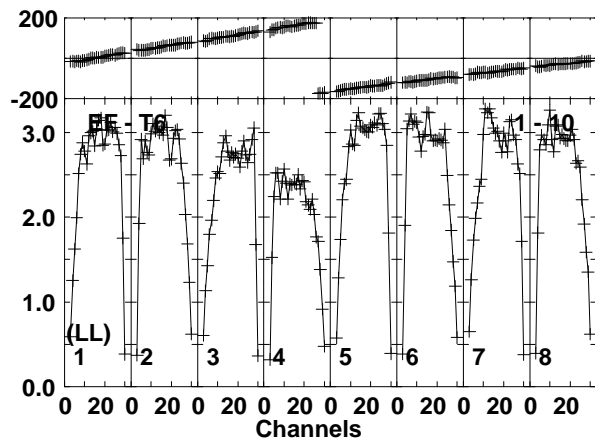
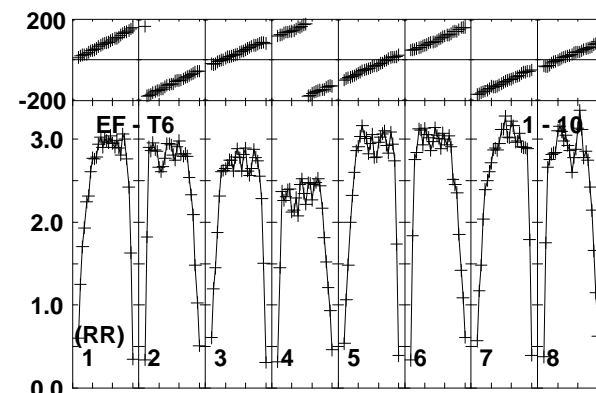
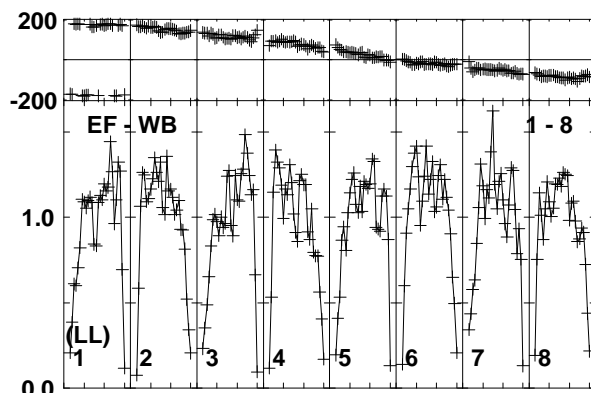
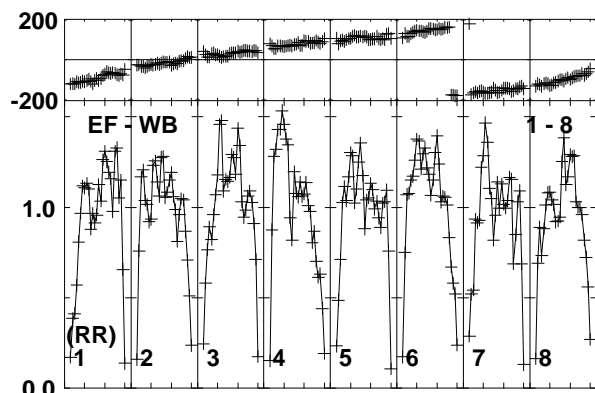
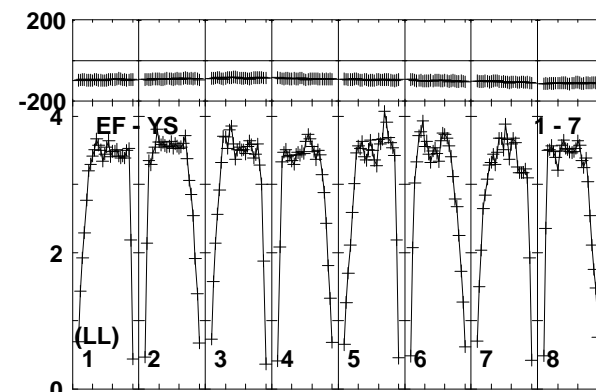
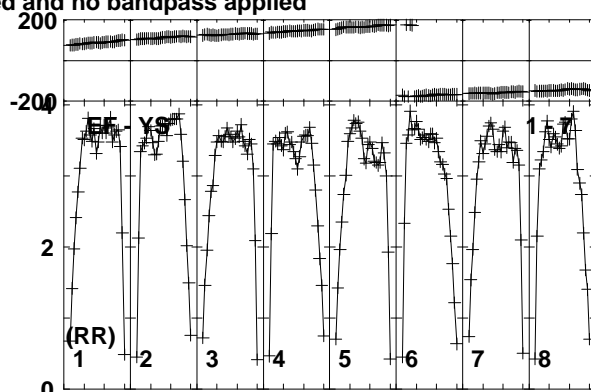
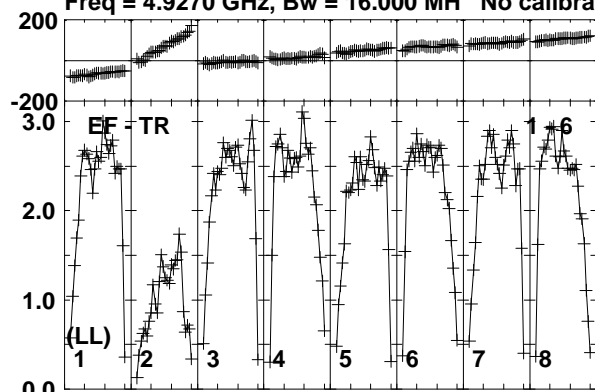

Lower frame: Milli Ampl Jy Top frame: Phas deg  
Vector averaged cross-power spectrum Baseline: EF (01) - TR (06)  
Timerange: 01/01:11:50 to 01/01:13:19

Plot file version 303 created 10-JUN-2016 17:22:33

CHECK RT013A.UVDATA.1

Freq = 4.9270 GHz, Bw = 16.000 MH No calibration applied and no bandpass applied

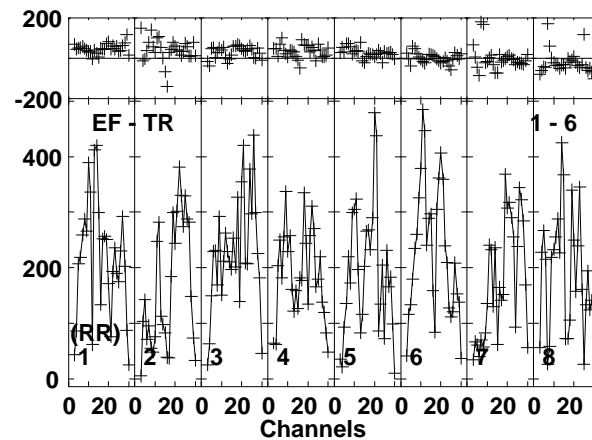
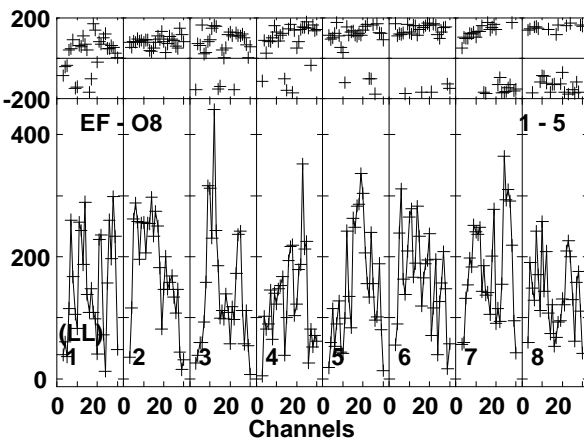
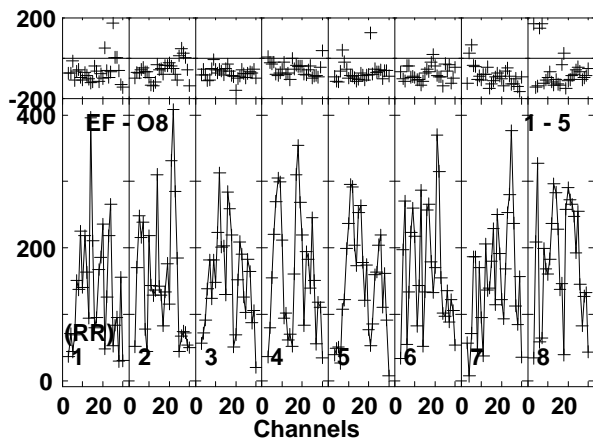
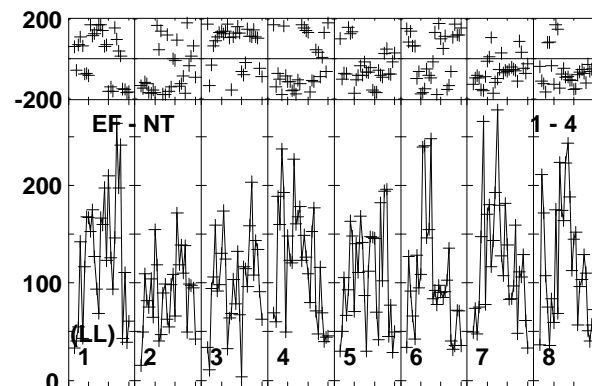
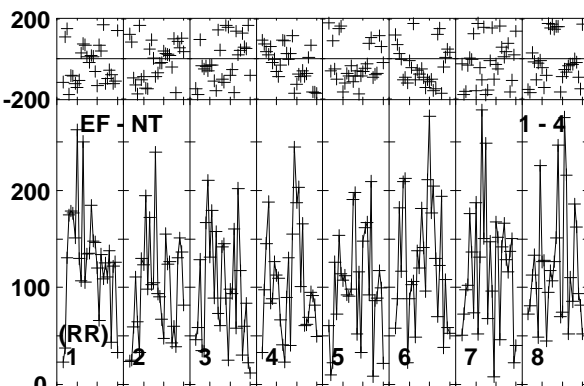
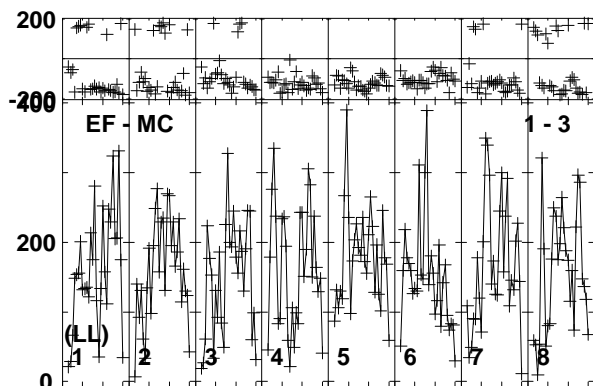
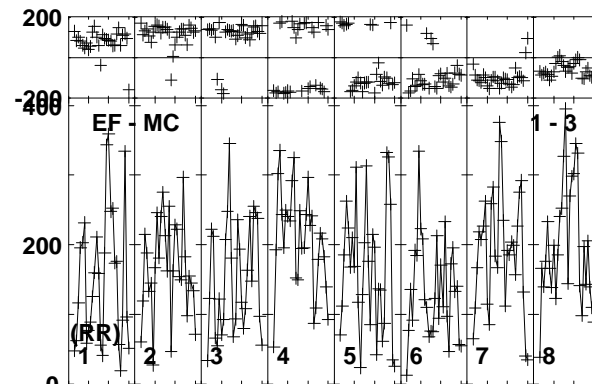
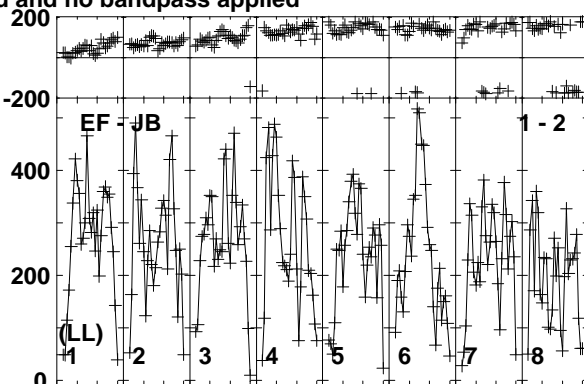
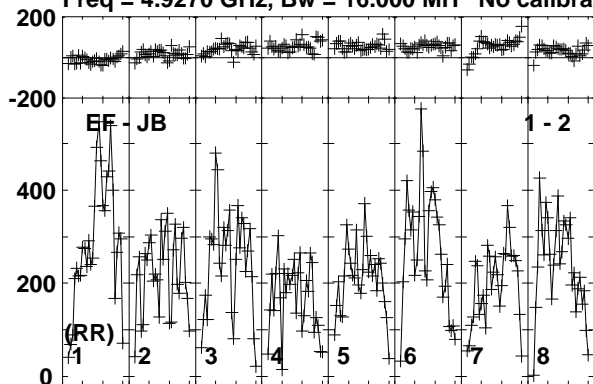

Lower frame: Micro Ampl Jy Top frame: Phas deg  
Vector averaged cross-power spectrum Baseline: EF (01) - JB (02)  
Timerange: 01/01:14:01 to 01/01:16:00

Plot file version 304 created 10-JUN-2016 17:22:33

CHECK RT013A.UVDATA.1

Freq = 4.9270 GHz, Bw = 16.000 MH No calibration applied and no bandpass applied

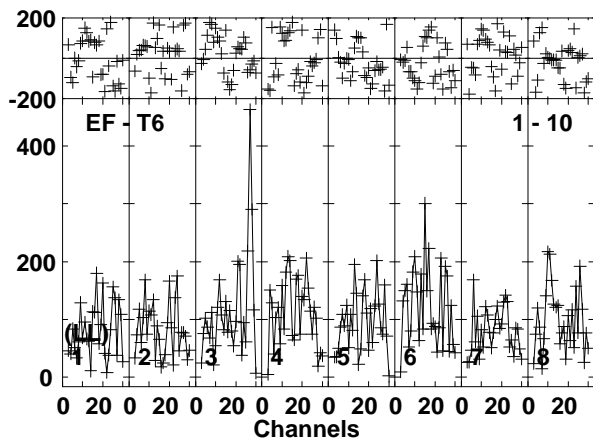
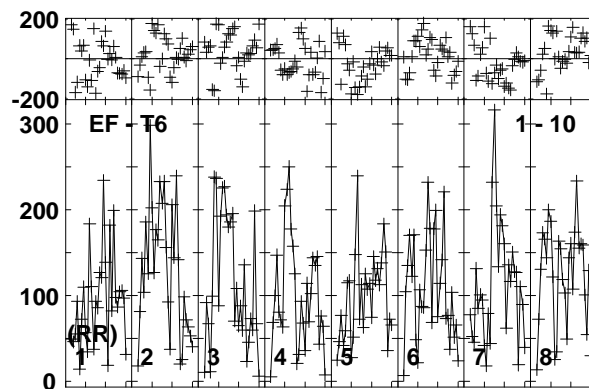
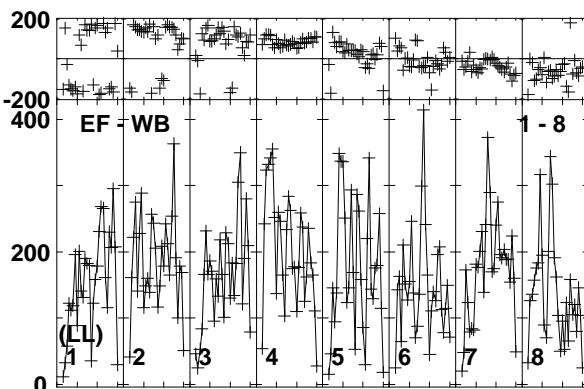
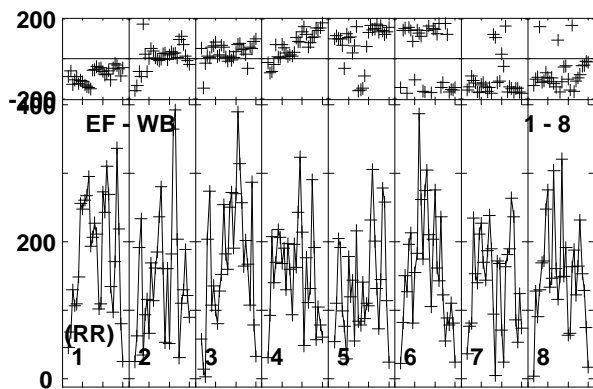
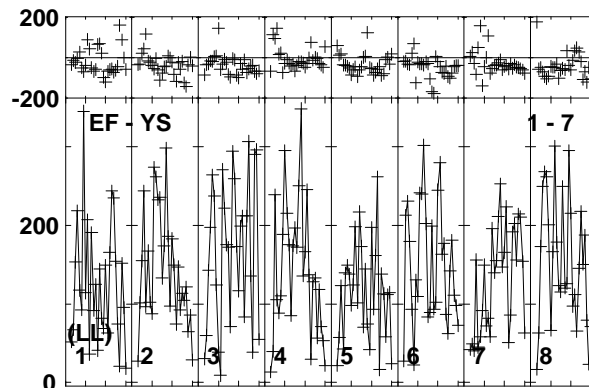
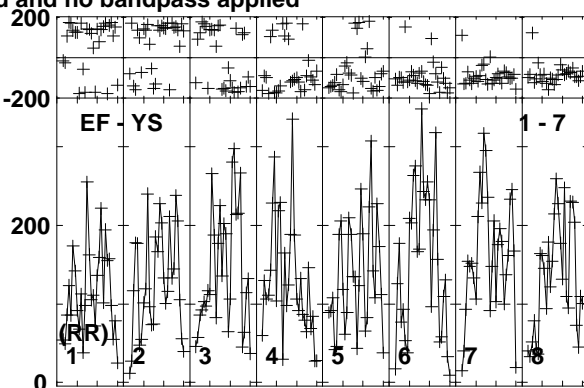
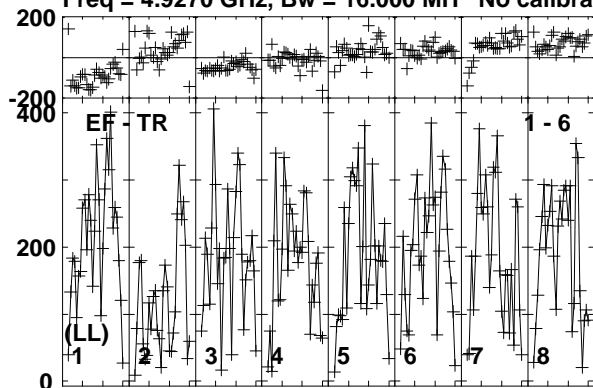

Lower frame: Micro Ampl Jy Top frame: Phas deg  
Vector averaged cross-power spectrum Baseline: EF (01) - TR (06)  
Timerange: 01/01:14:01 to 01/01:16:00

Plot file version 305 created 10-JUN-2016 17:22:33

CYGX1 RT013A.UVDATA.1

Freq = 4.9270 GHz, Bw = 16.000 MH No calibration applied and no bandpass applied

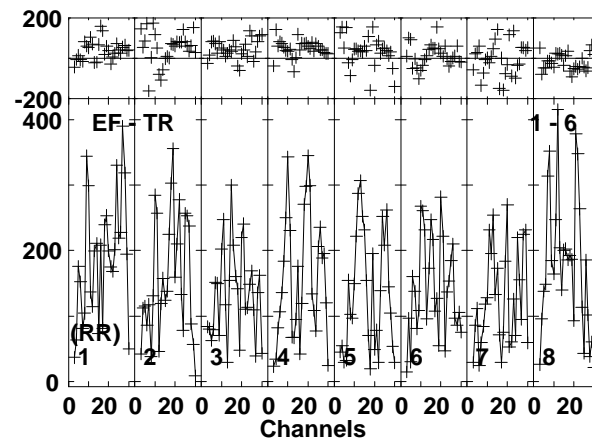
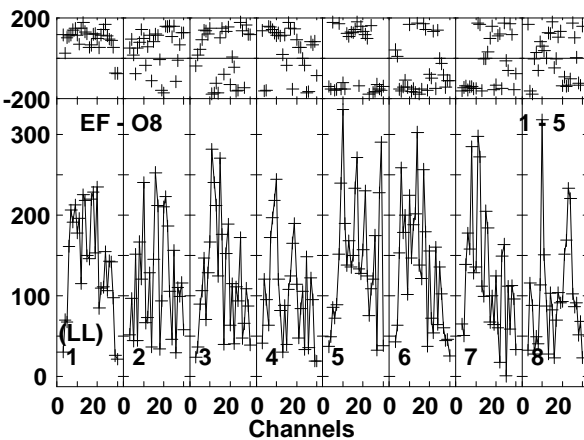
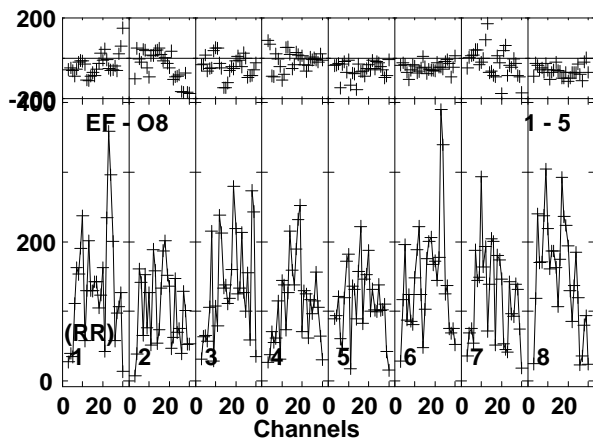
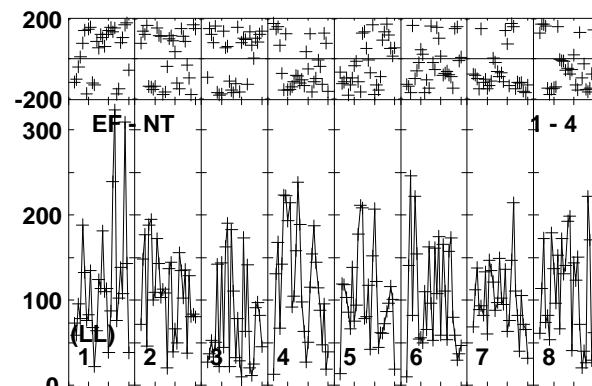
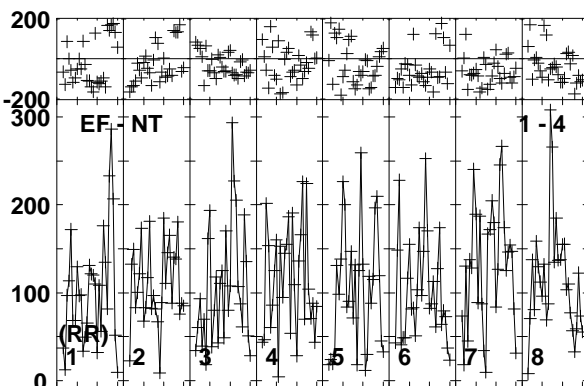
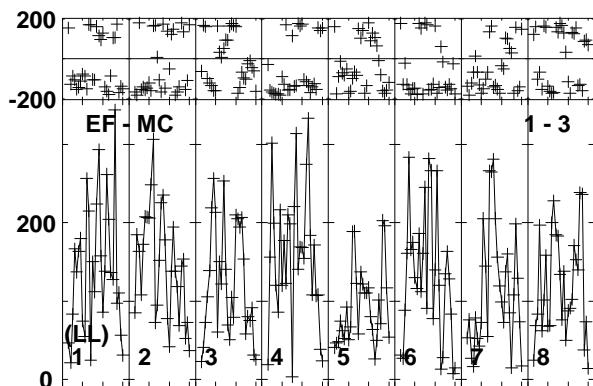
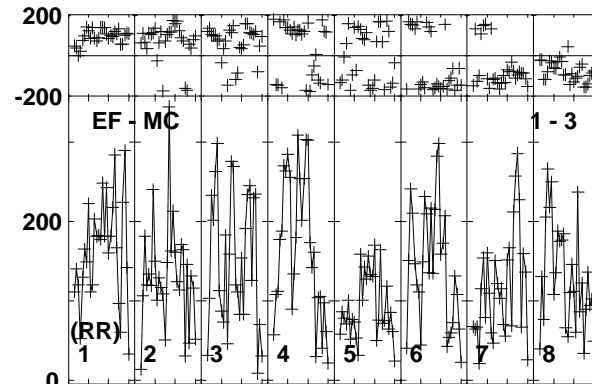
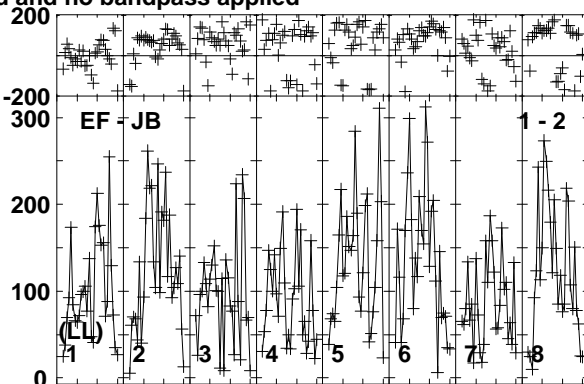
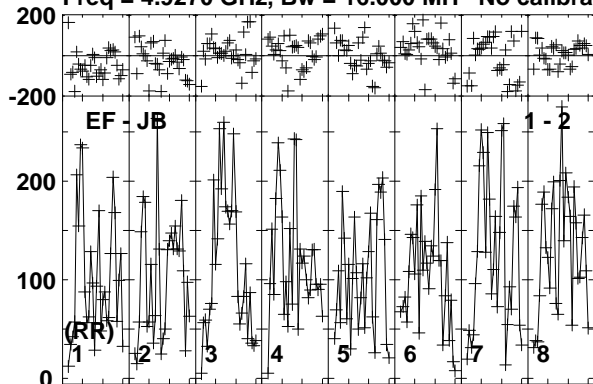

Lower frame: Micro Ampl Jy Top frame: Phas deg  
Vector averaged cross-power spectrum Baseline: EF (01) - JB (02)  
Timerange: 01/01:16:01 to 01/01:18:29

Plot file version 306 created 10-JUN-2016 17:22:33

CYGX1 RT013A.UVDATA.1

Freq = 4.9270 GHz, Bw = 16.000 MH No calibration applied and no bandpass applied

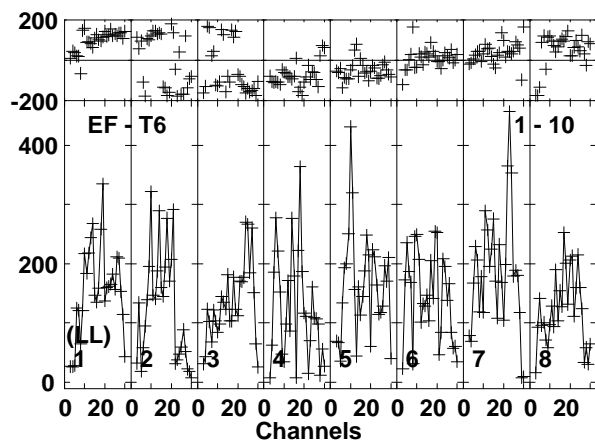
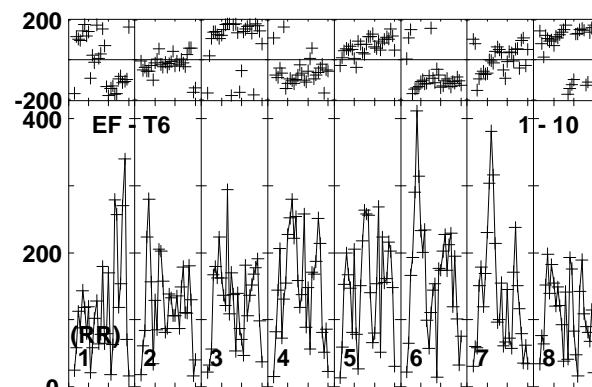
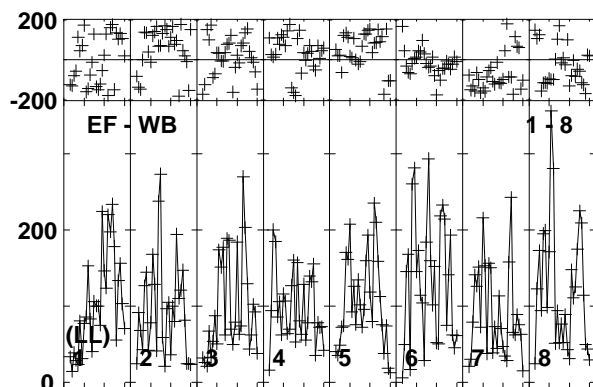
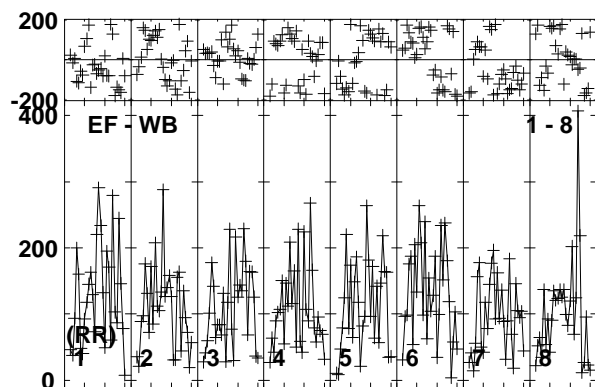
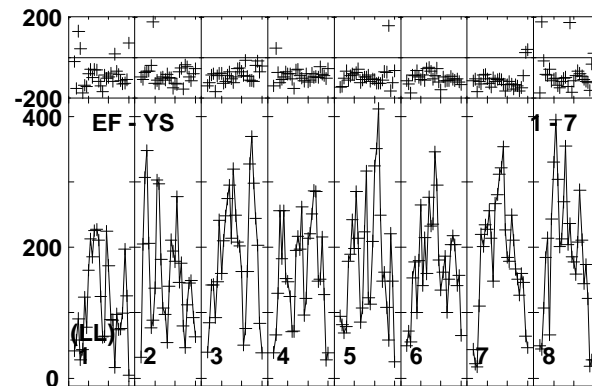
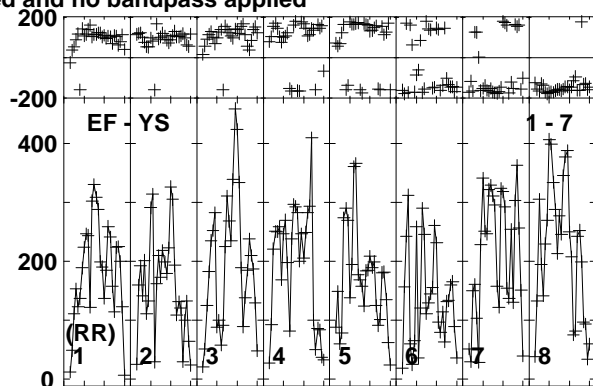
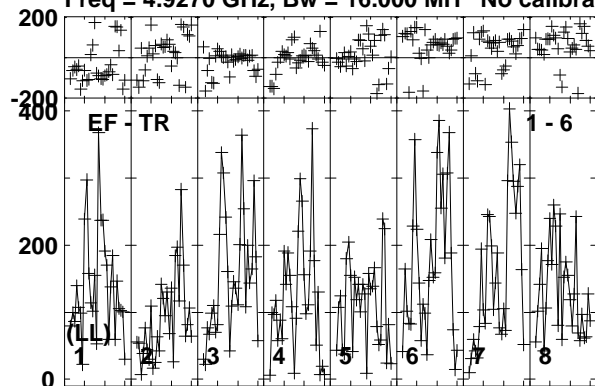

Lower frame: Micro Ampl Jy Top frame: Phas deg  
Vector averaged cross-power spectrum Baseline: EF (01) - TR (06)  
Timerange: 01/01:16:01 to 01/01:18:29



Plot file version 307 created 10-JUN-2016 17:22:33

J1957+3338 RT013A.UVDATA.1

Freq = 4.9270 GHz, Bw = 16.000 MH No calibration applied and no bandpass applied

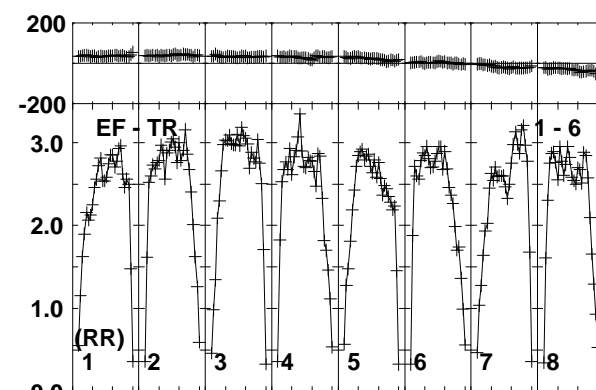
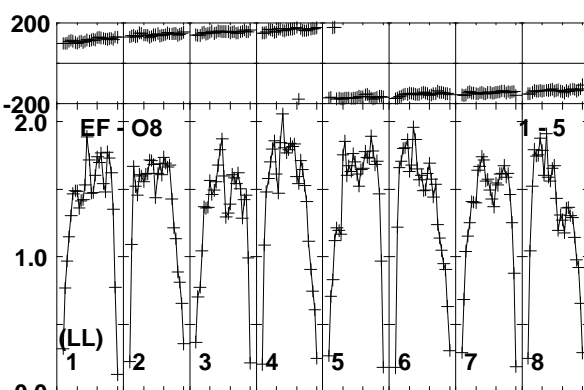
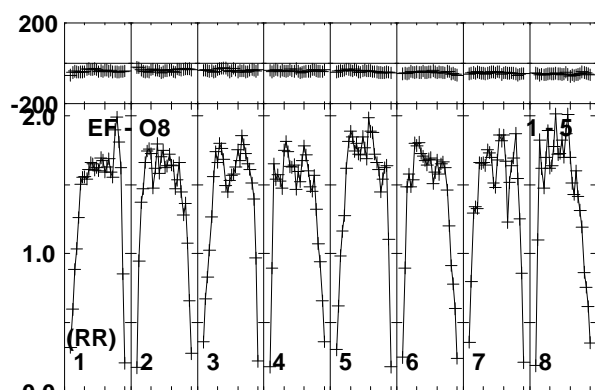
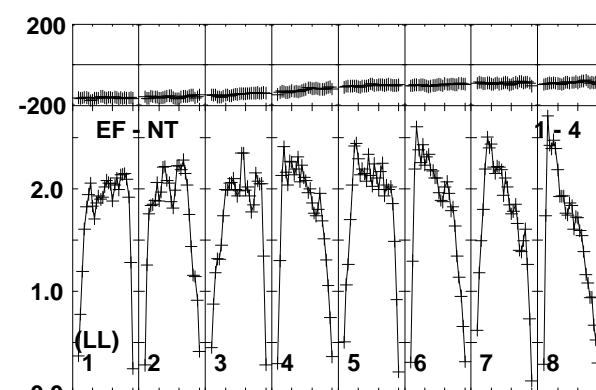
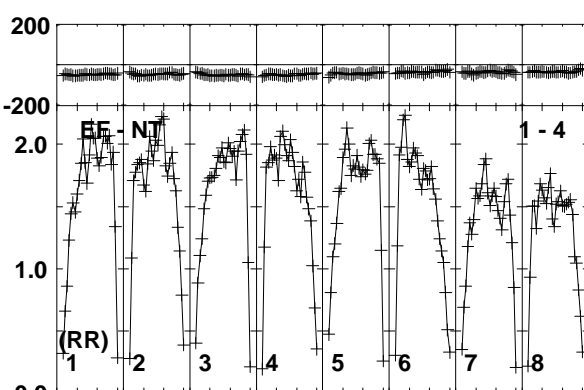
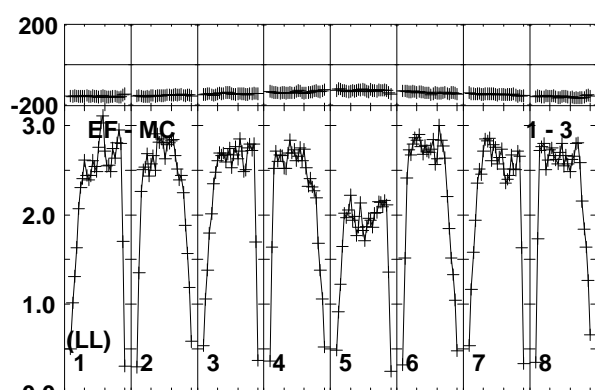
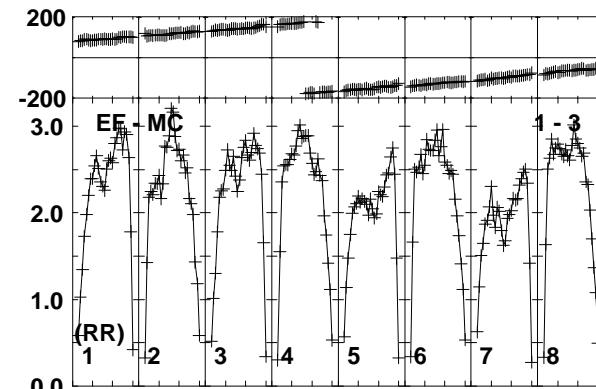
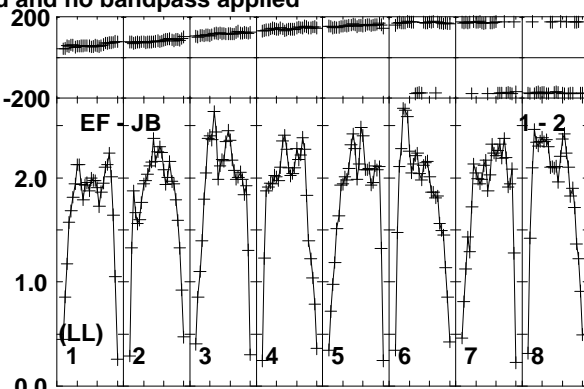
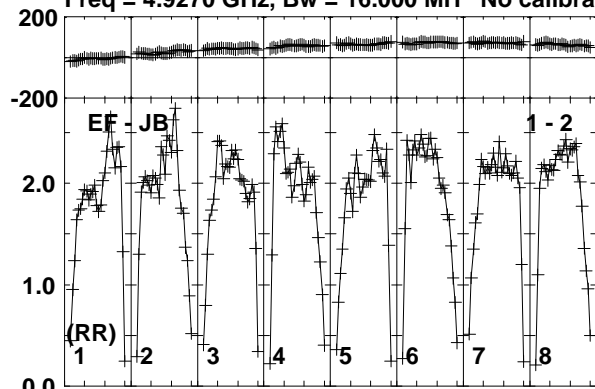

Lower frame: Milli Ampl Jy Top frame: Phas deg  
Vector averaged cross-power spectrum Baseline: EF (01) - JB (02)  
Timerange: 01/01:18:30 to 01/01:19:59

Plot file version 308 created 10-JUN-2016 17:22:33

J1957+3338 RT013A.UVDATA.1

Freq = 4.9270 GHz, Bw = 16.000 MH No calibration applied and no bandpass applied

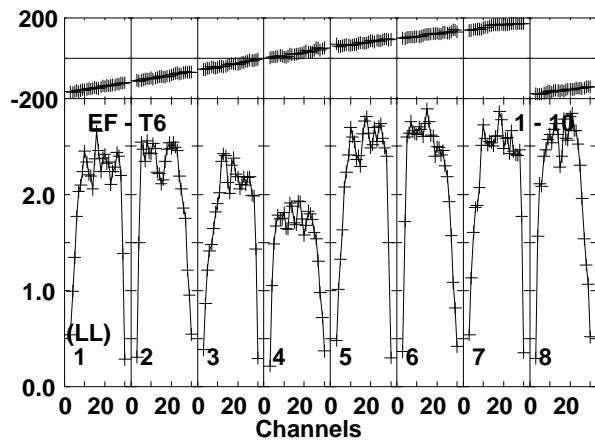
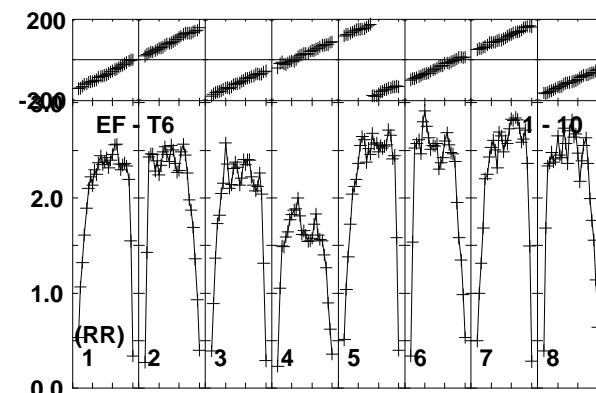
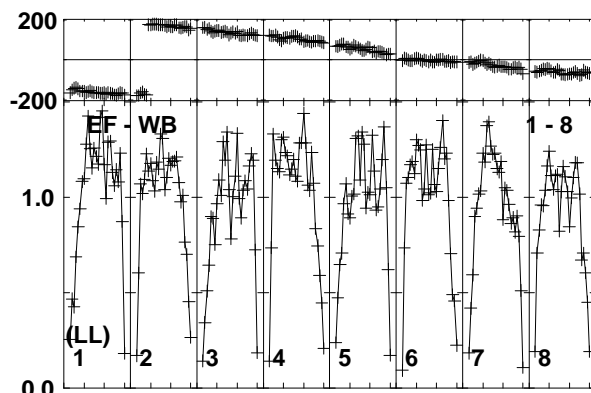
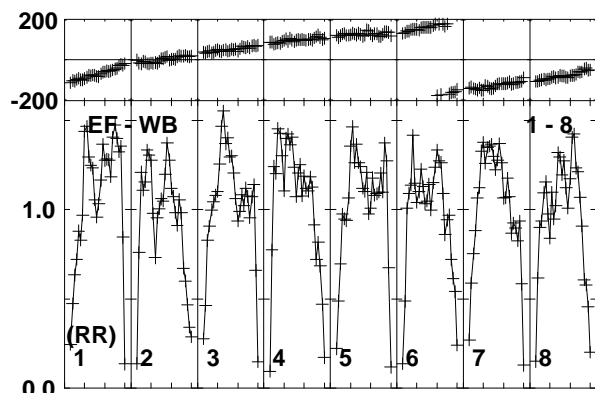
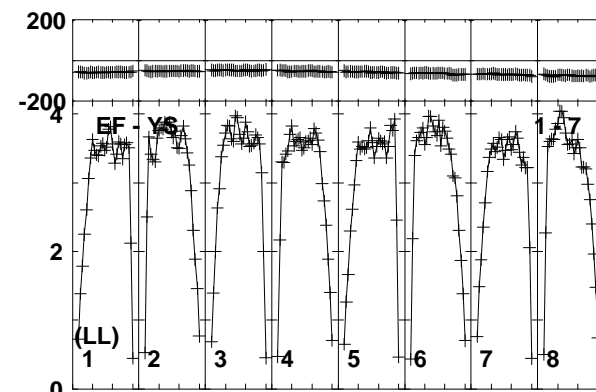
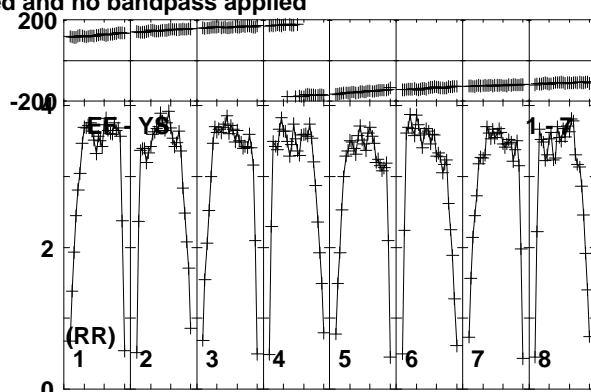
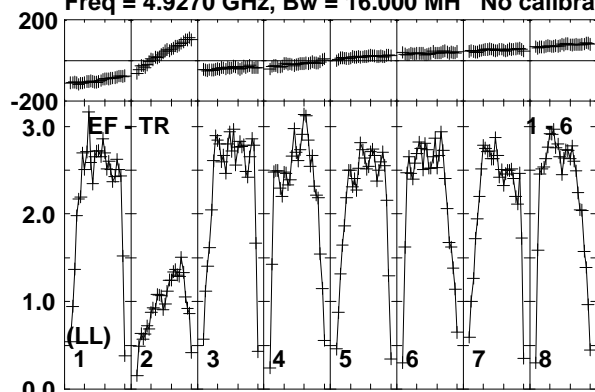

Lower frame: Milli Ampl Jy Top frame: Phas deg  
Vector averaged cross-power spectrum Baseline: EF (01) - TR (06)  
Timerange: 01/01:18:30 to 01/01:19:59

Plot file version 309 created 10-JUN-2016 17:22:33

CHECK RT013A.UVDATA.1

Freq = 4.9270 GHz, Bw = 16.000 MH No calibration applied and no bandpass applied

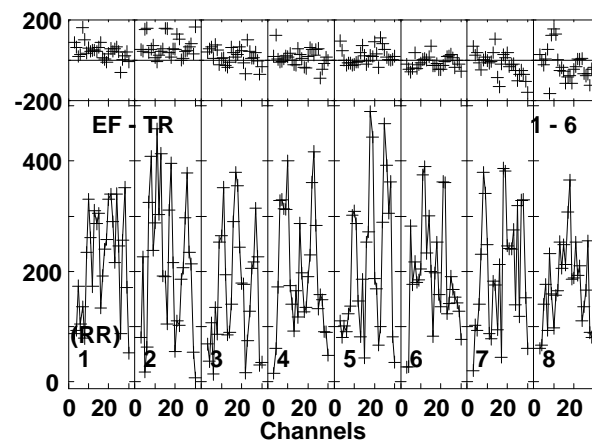
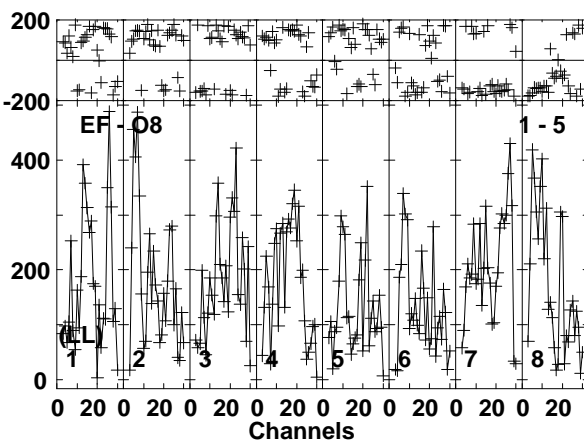
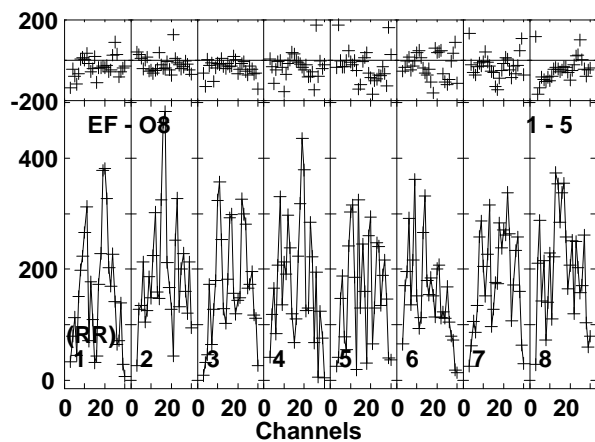
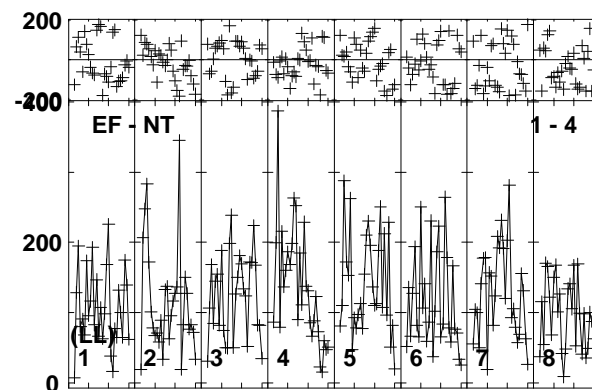
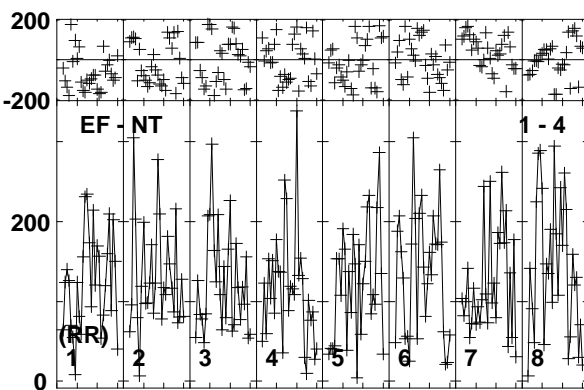
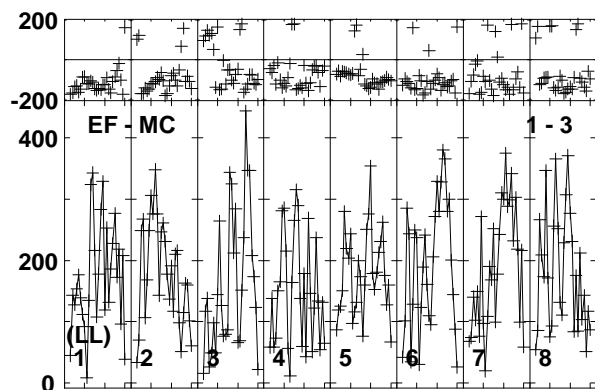
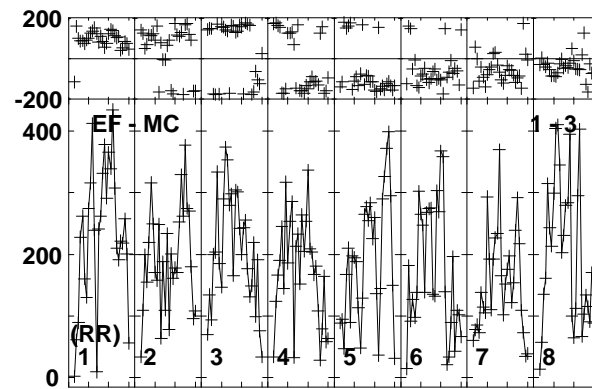
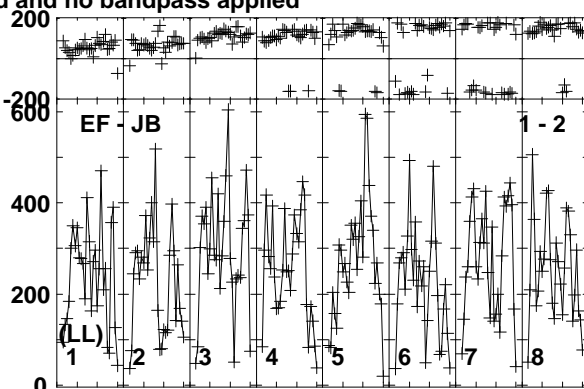
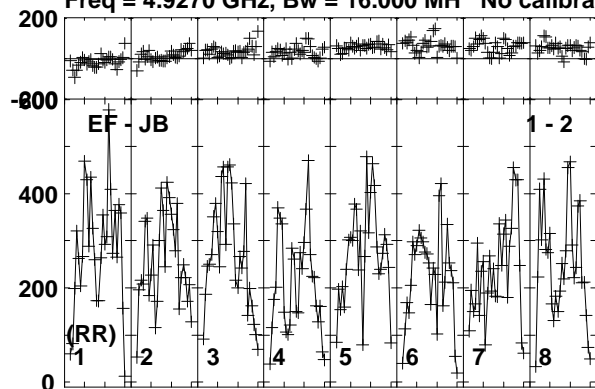

Lower frame: Micro Ampl Jy Top frame: Phas deg  
Vector averaged cross-power spectrum Baseline: EF (01) - JB (02)  
Timerange: 01/01:20:00 to 01/01:21:59

Plot file version 310 created 10-JUN-2016 17:22:33

CHECK RT013A.UVDATA.1

Freq = 4.9270 GHz, Bw = 16.000 MH No calibration applied and no bandpass applied

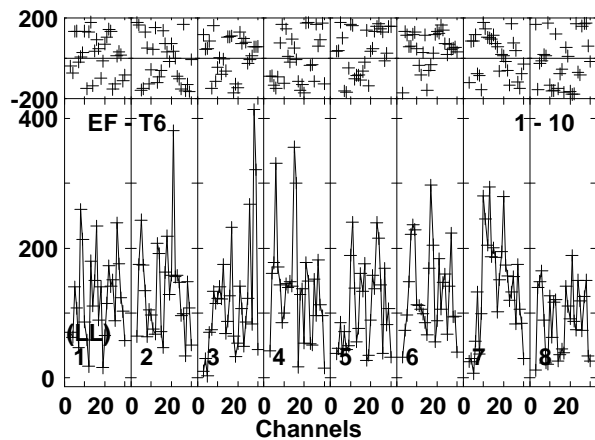
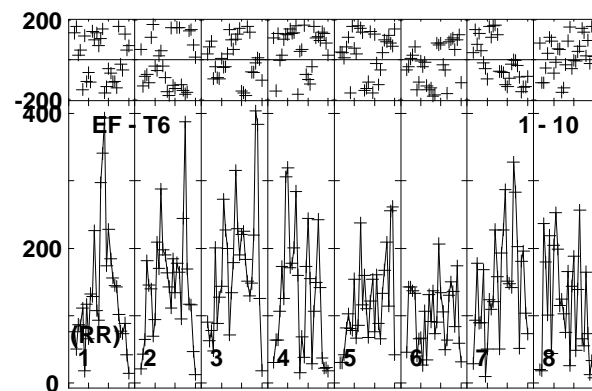
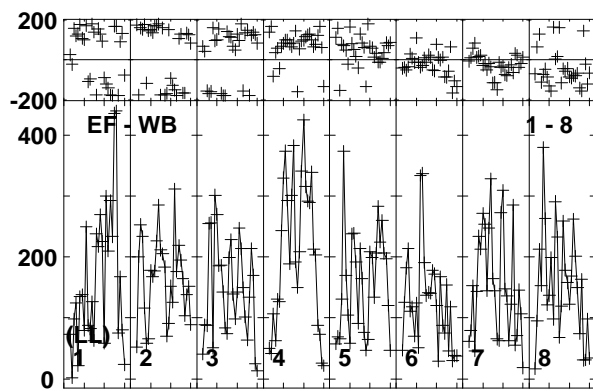
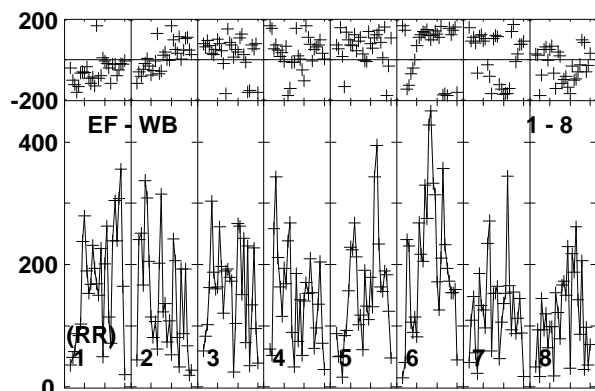
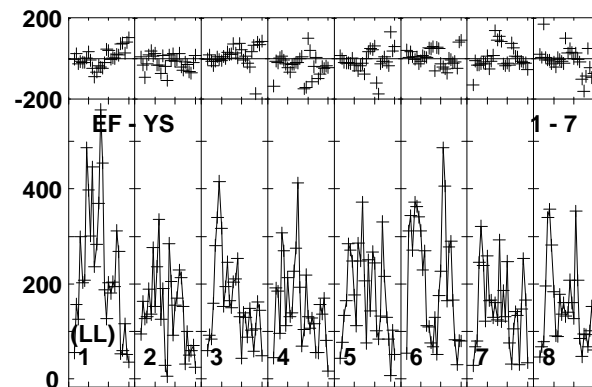
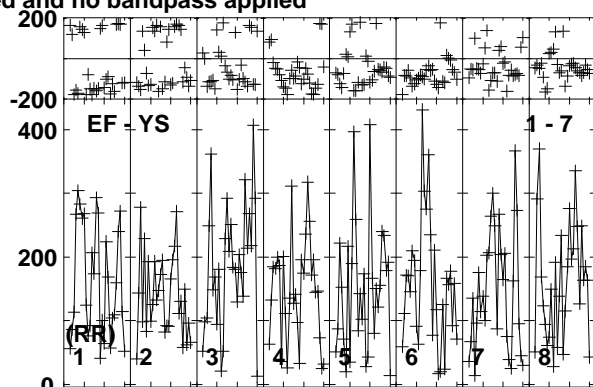
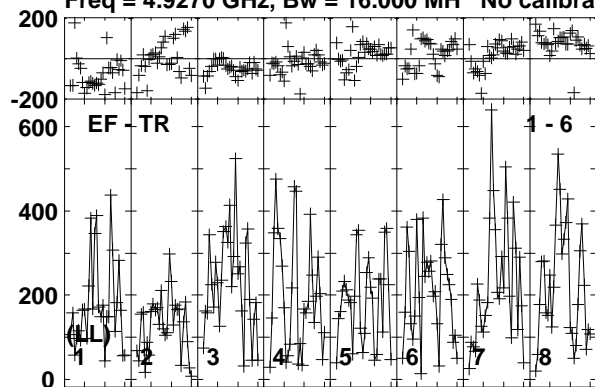

Lower frame: Micro Ampl Jy Top frame: Phas deg  
Vector averaged cross-power spectrum Baseline: EF (01) - TR (06)  
Timerange: 01/01:20:00 to 01/01:21:59

Plot file version 311 created 10-JUN-2016 17:22:34

CYGX1 RT013A.UVDATA.1

Freq = 4.9270 GHz, Bw = 16.000 MH No calibration applied and no bandpass applied

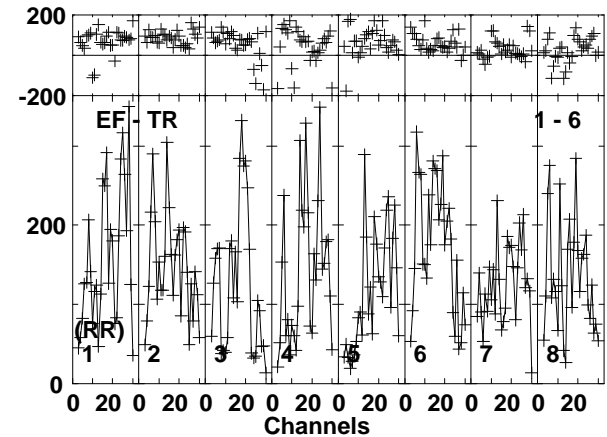
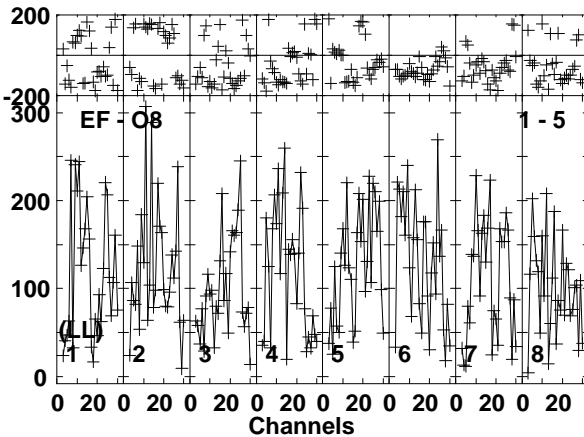
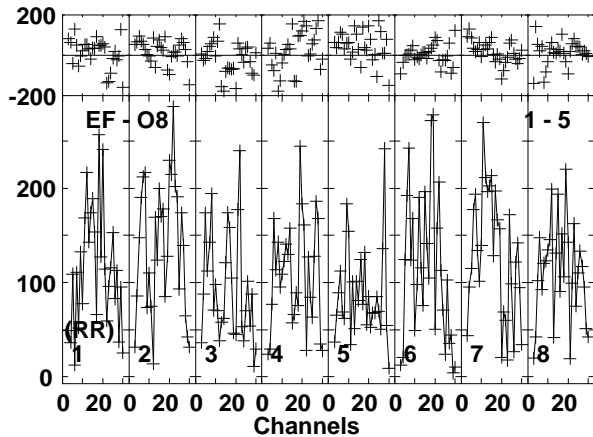
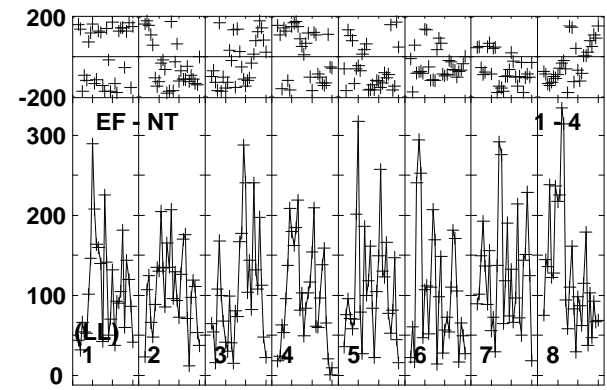
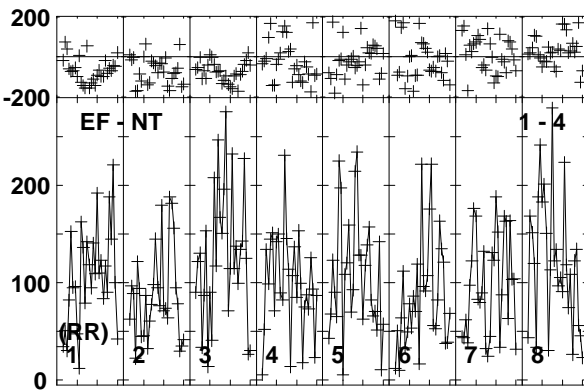
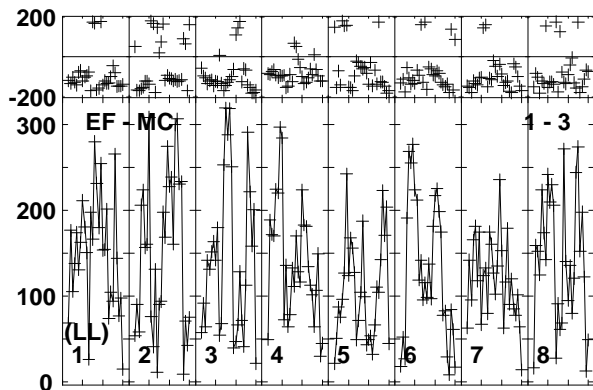
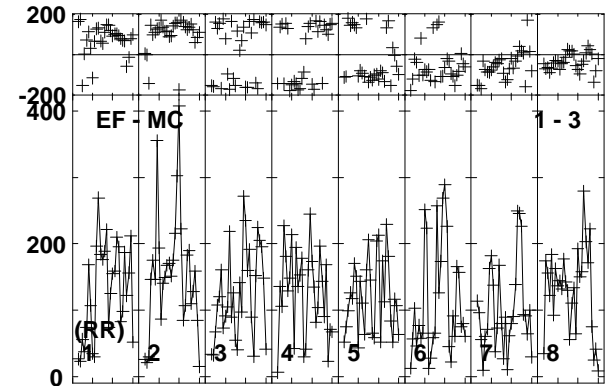
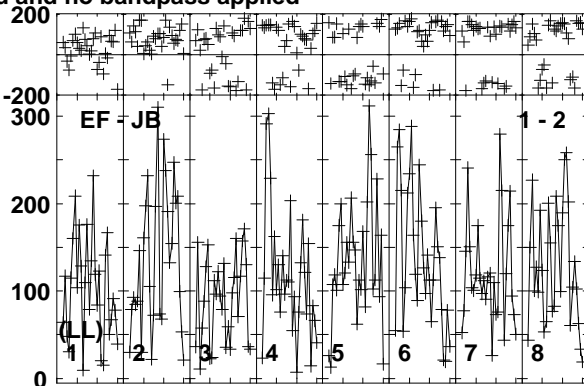
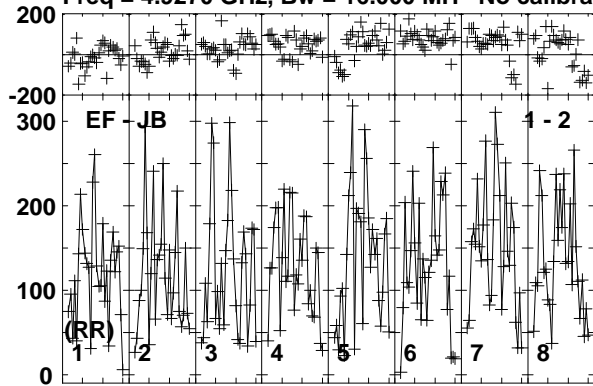

Lower frame: Micro Ampl Jy Top frame: Phas deg  
Vector averaged cross-power spectrum Baseline: EF (01) - JB (02)  
Timerange: 01/01:22:00 to 01/01:24:30

Plot file version 312 created 10-JUN-2016 17:22:34

CYGX1 RT013A.UVDATA.1

Freq = 4.9270 GHz, Bw = 16.000 MH No calibration applied and no bandpass applied

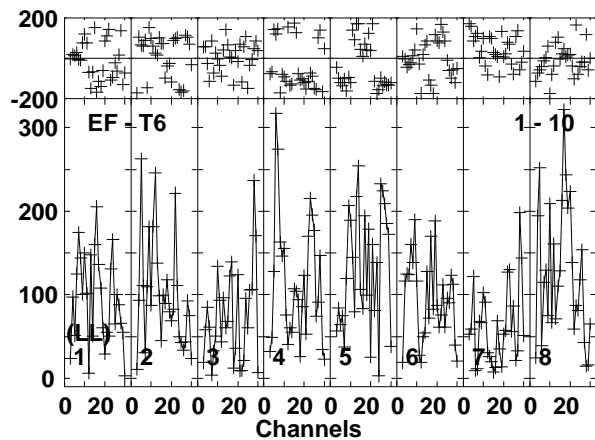
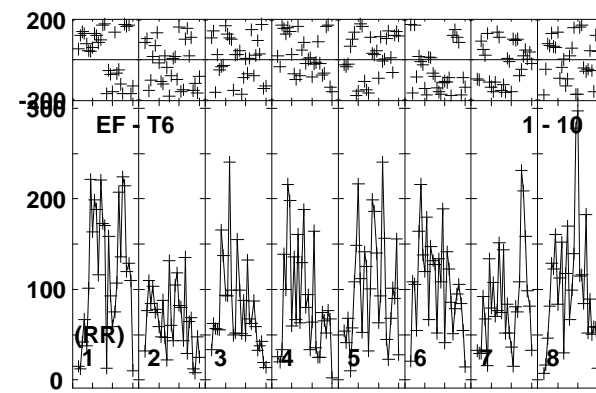
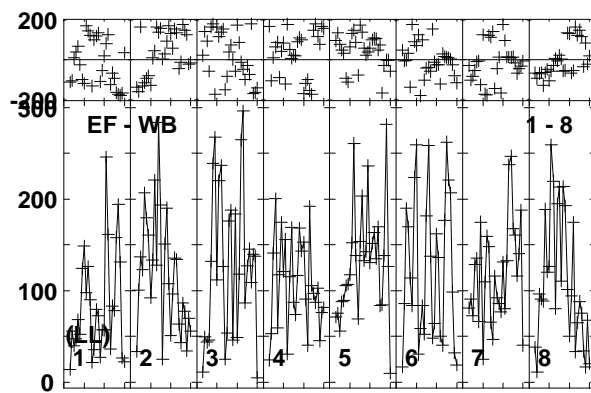
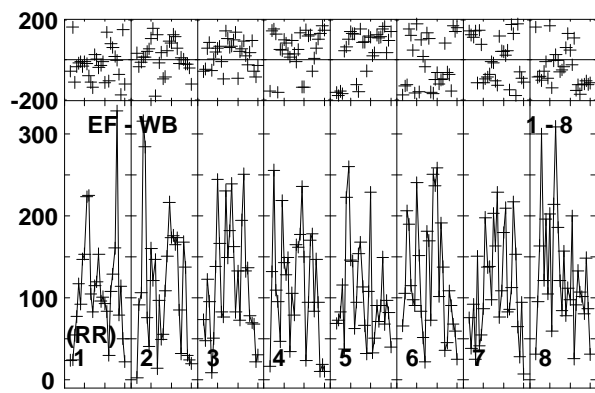
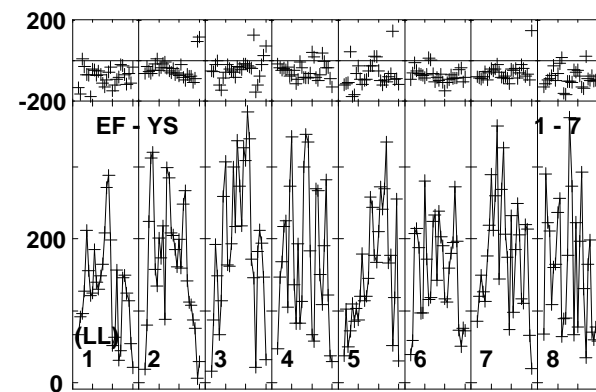
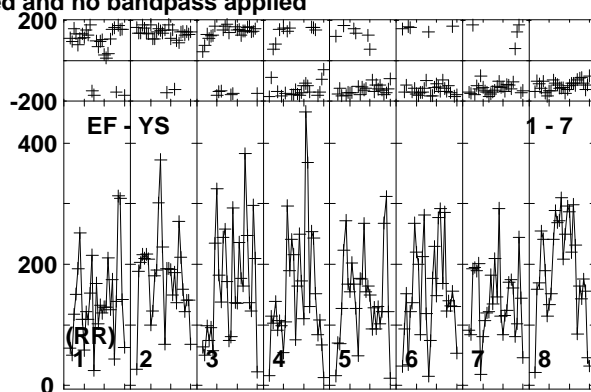
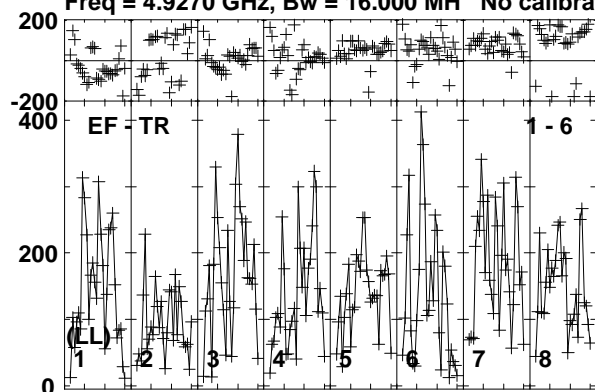

Lower frame: Micro Ampl Jy Top frame: Phas deg  
Vector averaged cross-power spectrum Baseline: EF (01) - TR (06)  
Timerange: 01/01:22:00 to 01/01:24:30

Plot file version 313 created 10-JUN-2016 17:22:34

J1957+3338 RT013A.UVDATA.1

Freq = 4.9270 GHz, Bw = 16.000 MH No calibration applied and no bandpass applied

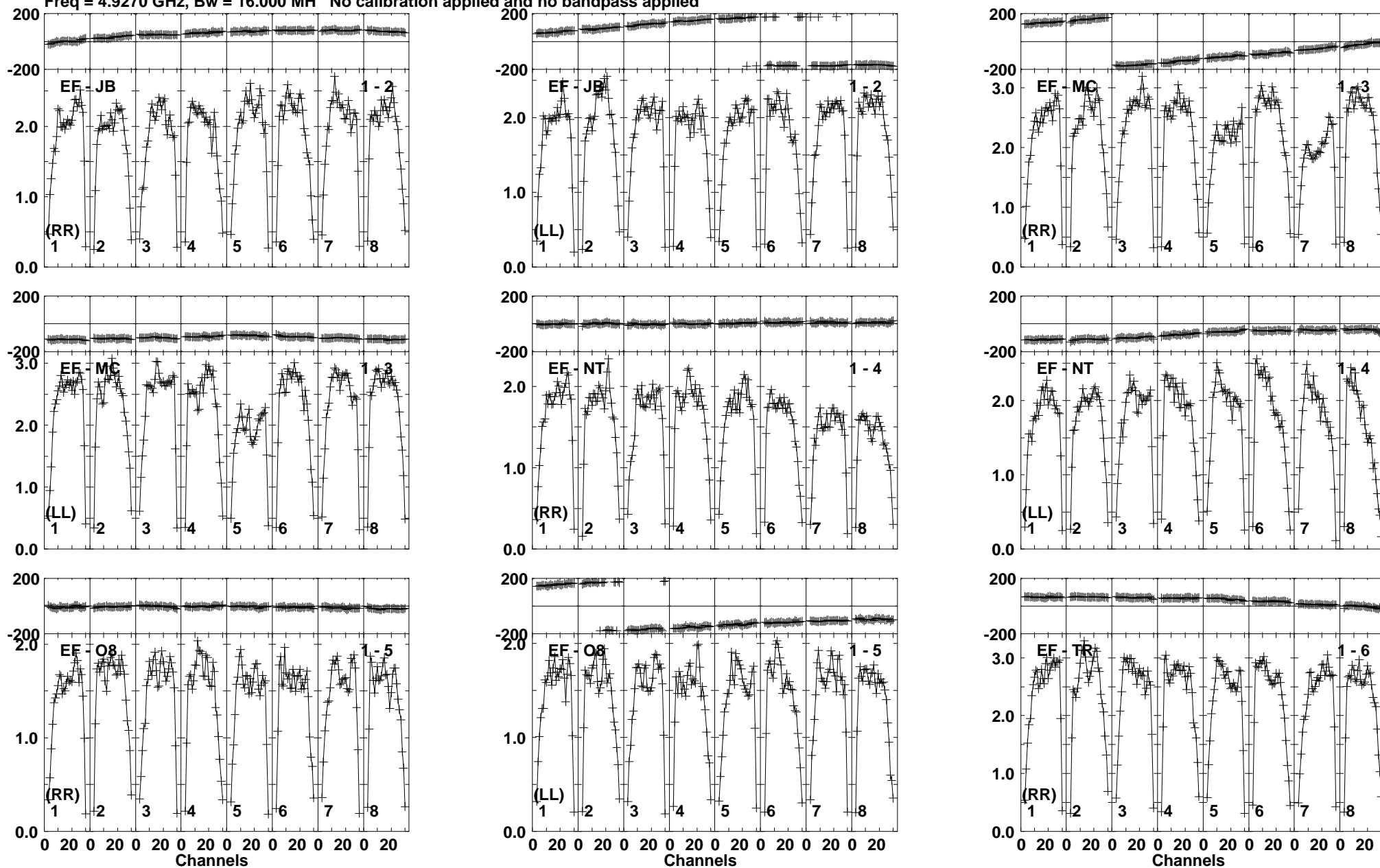

Lower frame: Milli Ampl Jy Top frame: Phas deg  
Vector averaged cross-power spectrum Baseline: EF (01) - JB (02)  
Timerange: 01/01:24:31 to 01/01:26:00

Plot file version 314 created 10-JUN-2016 17:22:34

J1957+3338 RT013A.UVDATA.1

Freq = 4.9270 GHz, Bw = 16.000 MH No calibration applied and no bandpass applied

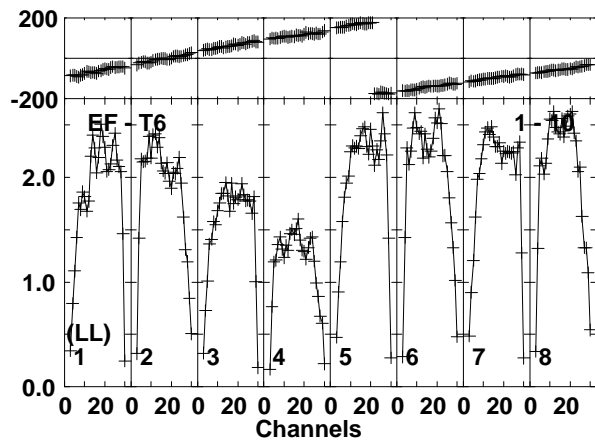
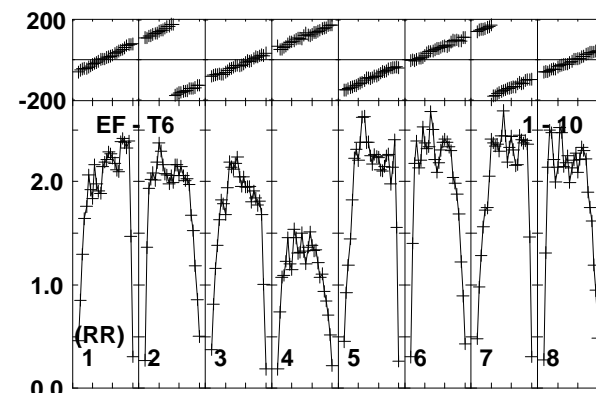
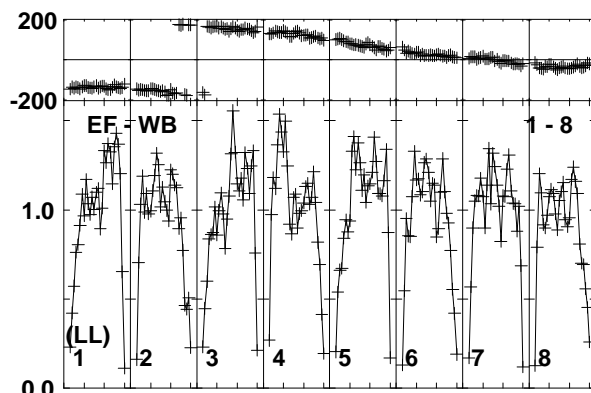
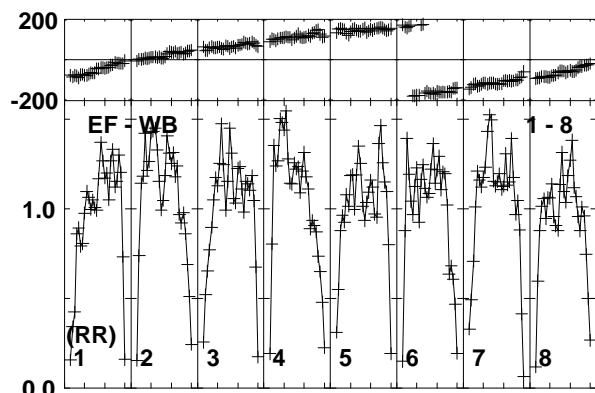
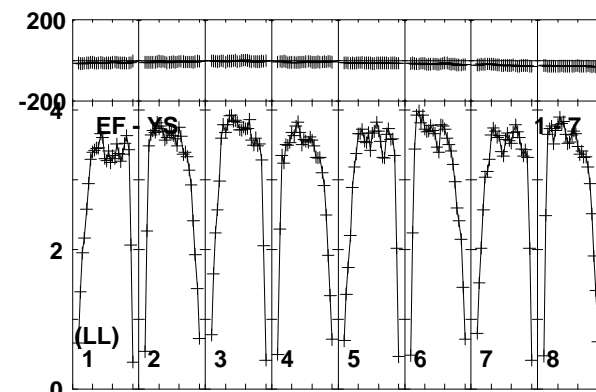
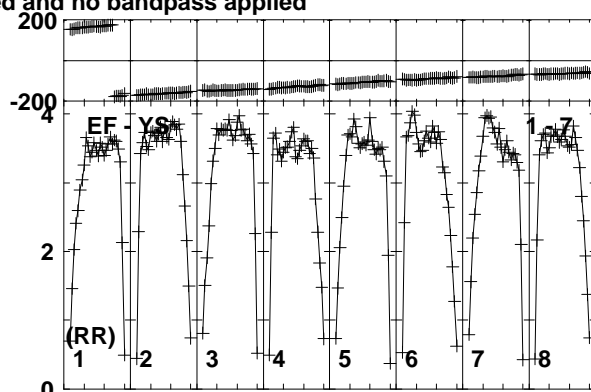
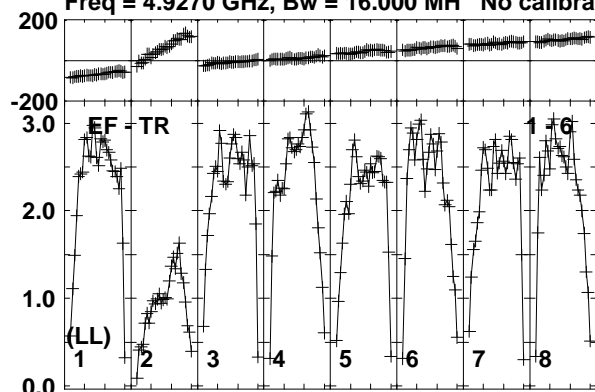

Lower frame: Milli Ampl Jy Top frame: Phas deg  
Vector averaged cross-power spectrum Baseline: EF (01) - TR (06)  
Timerange: 01/01:24:31 to 01/01:26:00



Plot file version 315 created 10-JUN-2016 17:22:34

CHECK RT013A.UVDATA.1

Freq = 4.9270 GHz, Bw = 16.000 MH No calibration applied and no bandpass applied

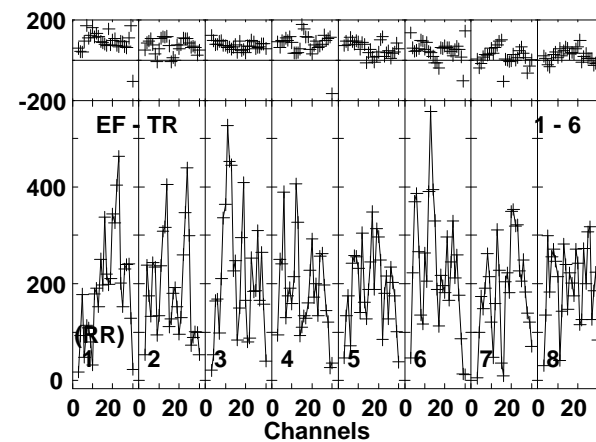
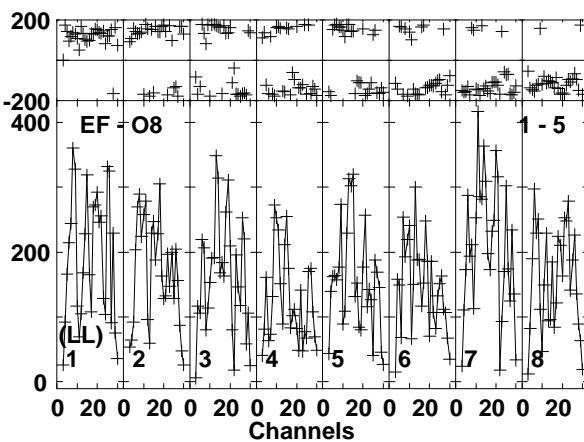
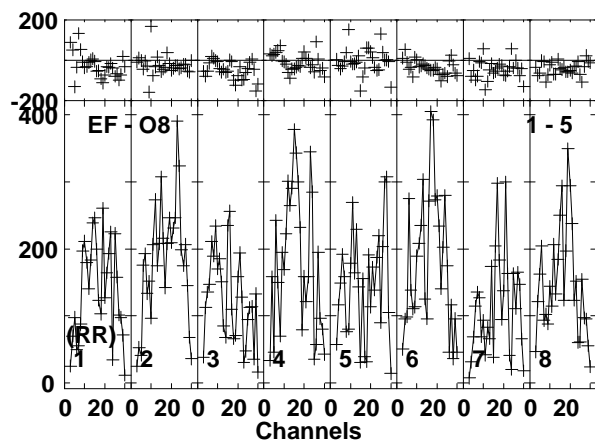
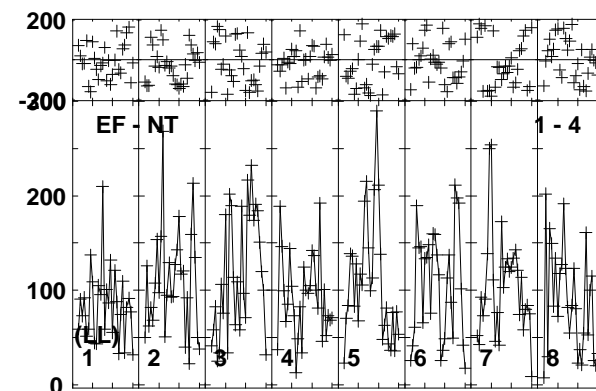
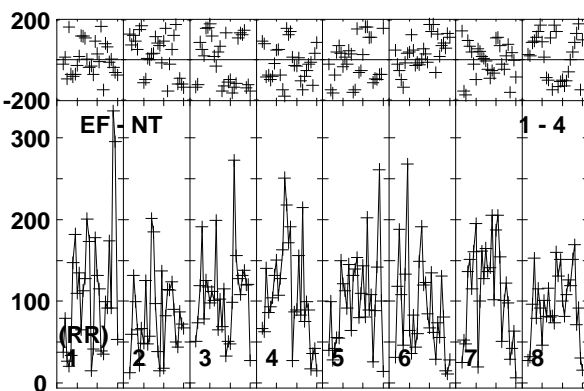
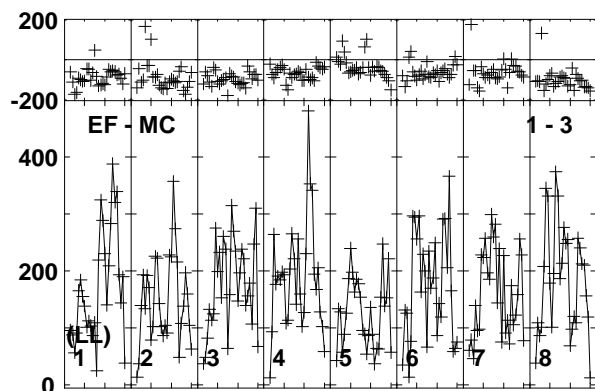
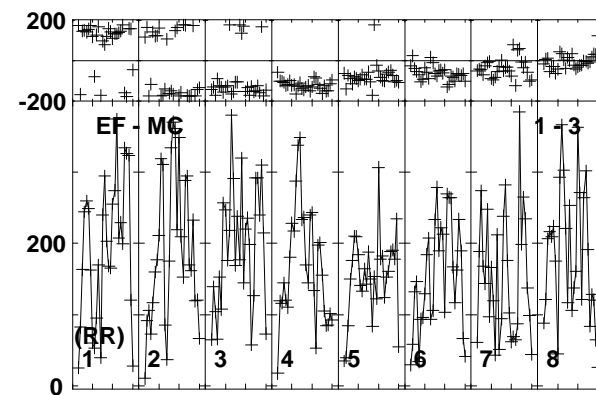
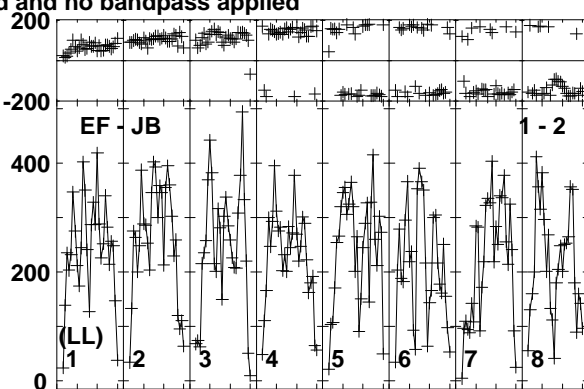
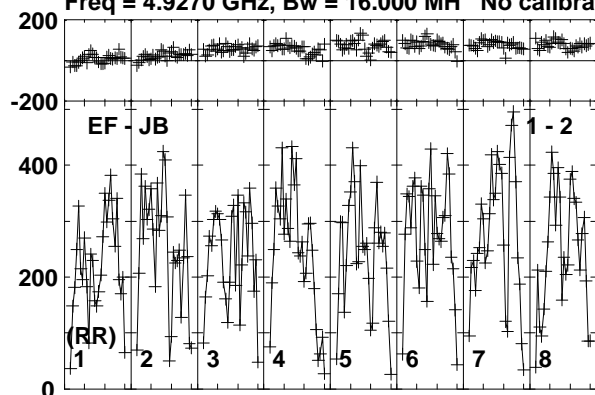

Lower frame: Micro Ampl Jy Top frame: Phas deg  
Vector averaged cross-power spectrum Baseline: EF (01) - JB (02)  
Timerange: 01/01:26:40 to 01/01:28:39

Plot file version 316 created 10-JUN-2016 17:22:34

CHECK RT013A.UVDATA.1

Freq = 4.9270 GHz, Bw = 16.000 MH No calibration applied and no bandpass applied

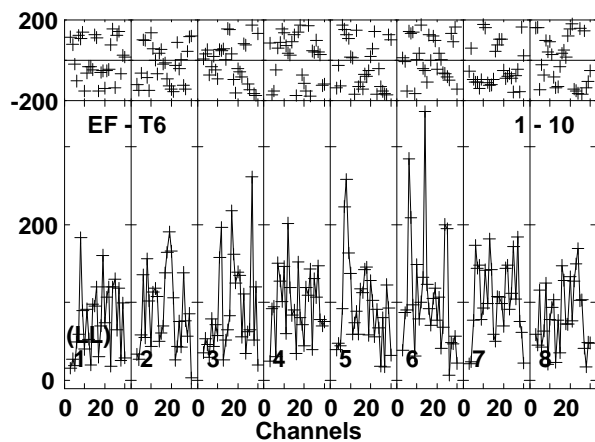
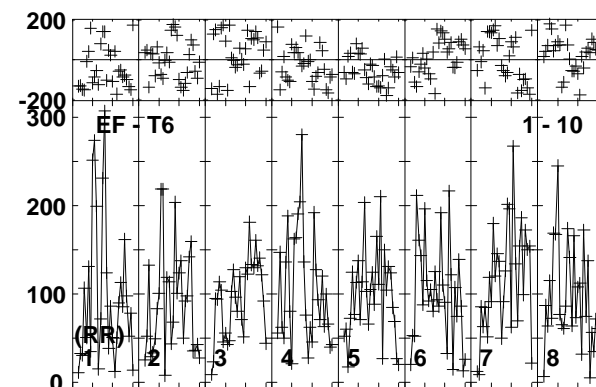
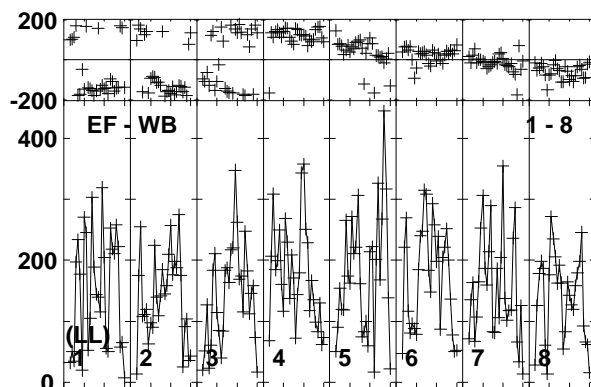
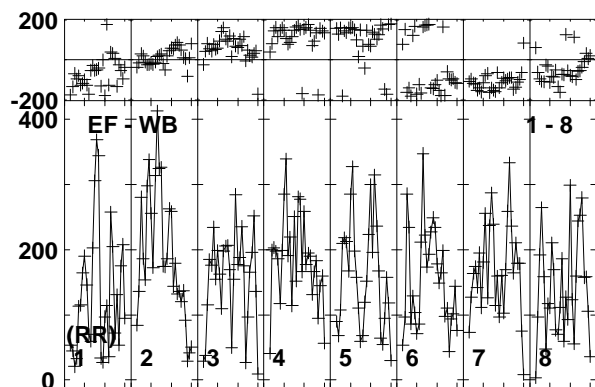
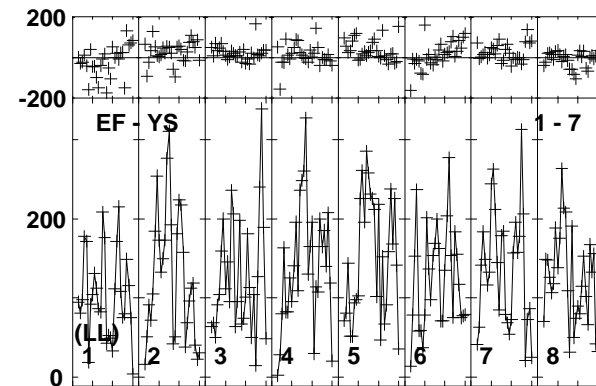
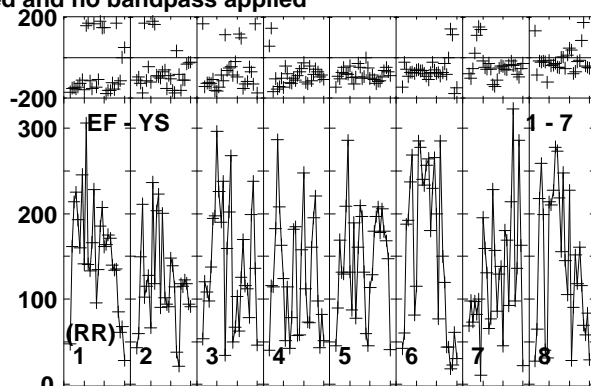
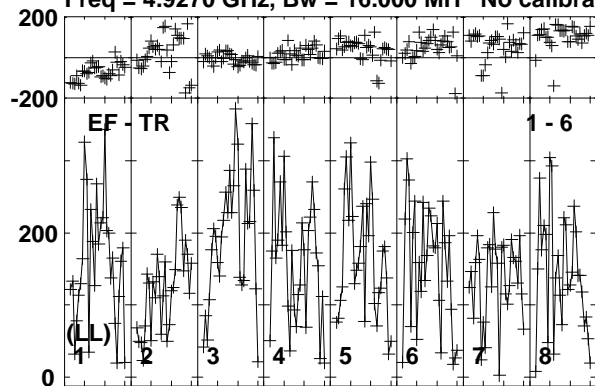

Lower frame: Micro Ampl Jy Top frame: Phas deg  
Vector averaged cross-power spectrum Baseline: EF (01) - TR (06)  
Timerange: 01/01:26:40 to 01/01:28:39

Plot file version 317 created 10-JUN-2016 17:22:34

CYGX1 RT013A.UVDATA.1

Freq = 4.9270 GHz, Bw = 16.000 MH No calibration applied and no bandpass applied

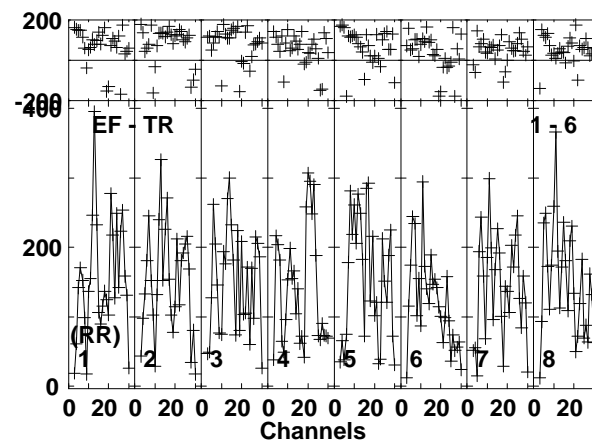
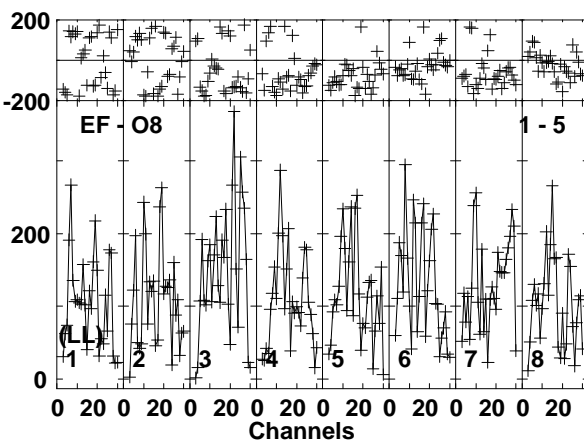
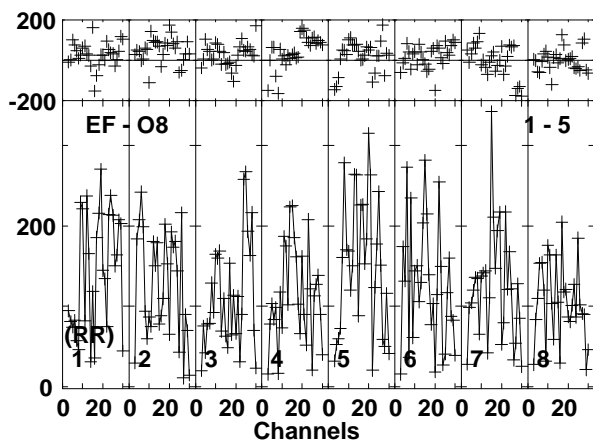
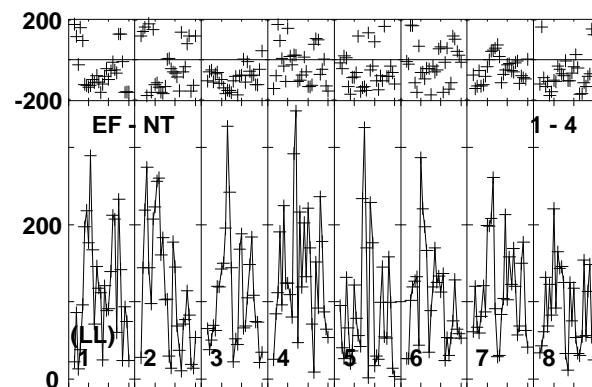
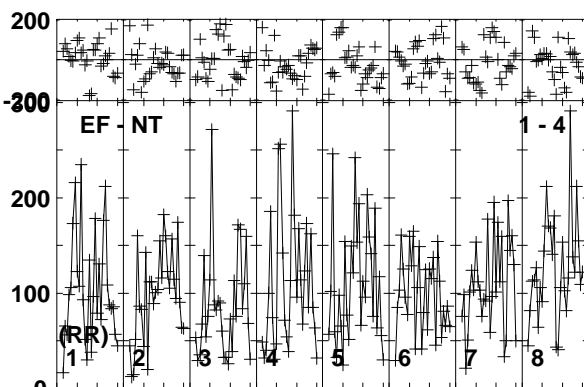
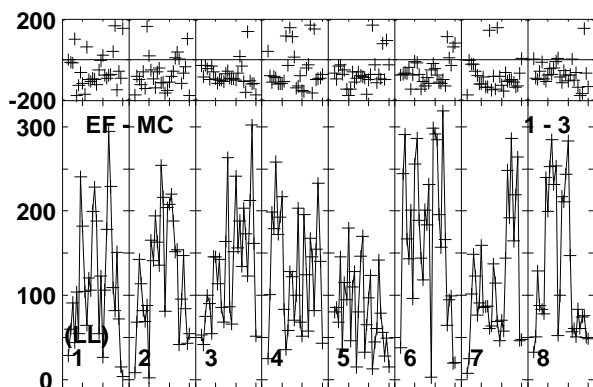
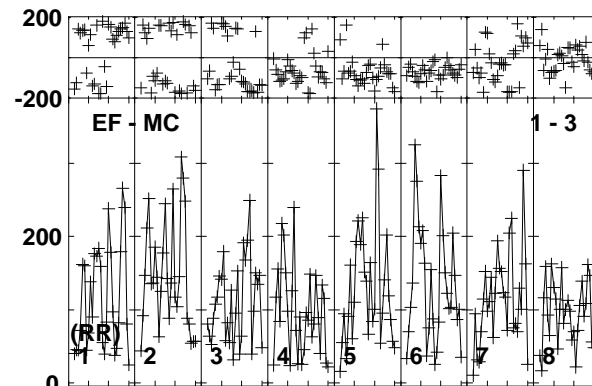
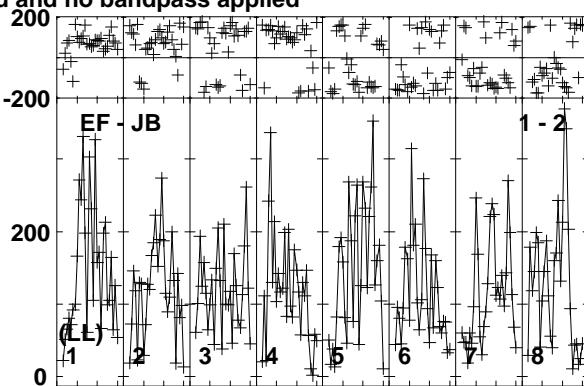
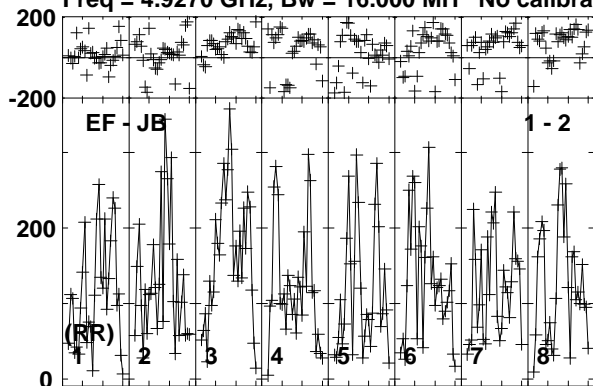

Lower frame: Micro Ampl Jy Top frame: Phas deg  
Vector averaged cross-power spectrum Baseline: EF (01) - JB (02)  
Timerange: 01/01:28:40 to 01/01:31:10

Plot file version 318 created 10-JUN-2016 17:22:34

CYGX1 RT013A.UVDATA.1

Freq = 4.9270 GHz, Bw = 16.000 MH No calibration applied and no bandpass applied

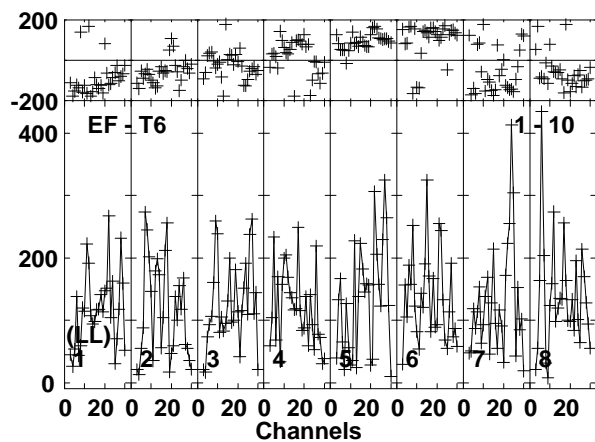
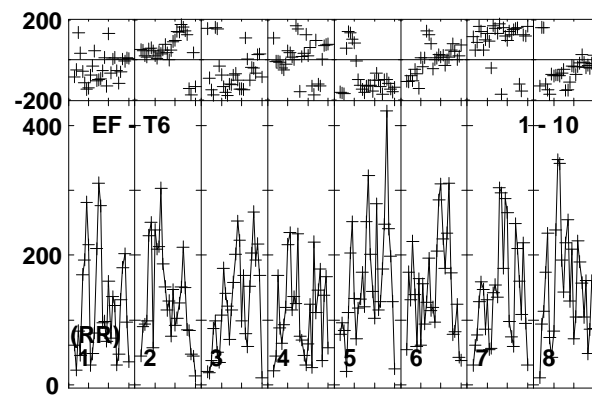
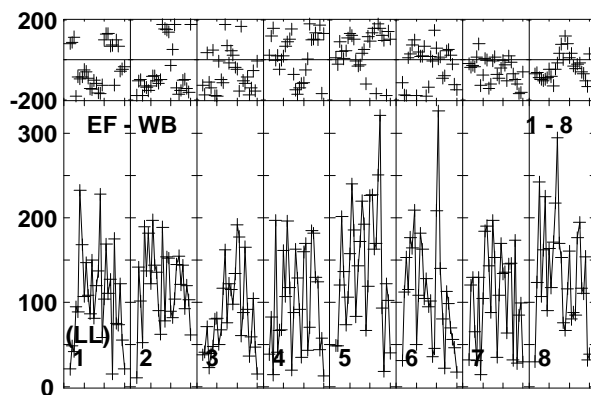
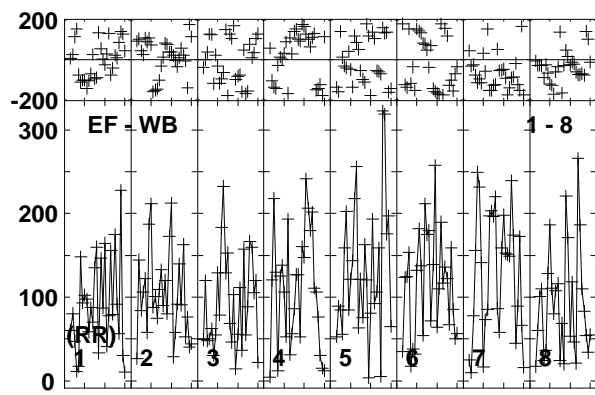
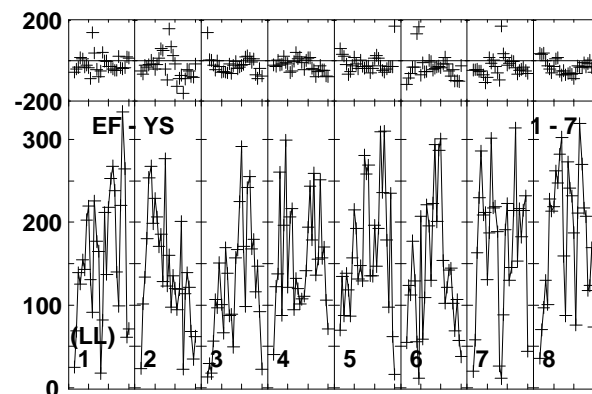
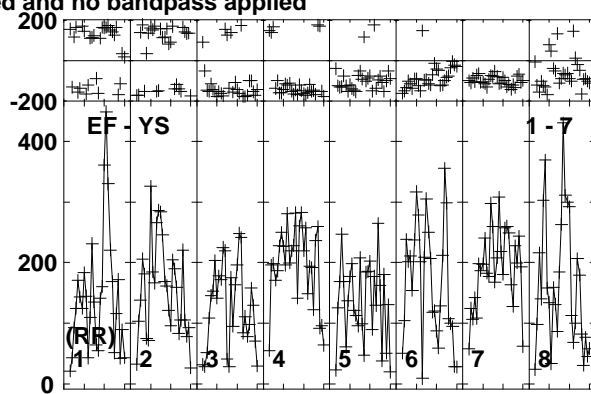
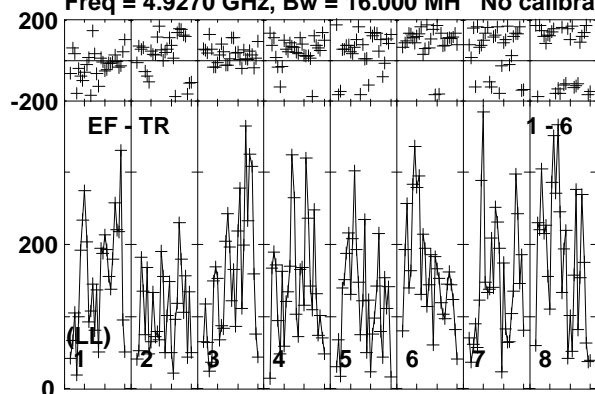

Lower frame: Micro Ampl Jy Top frame: Phas deg  
Vector averaged cross-power spectrum Baseline: EF (01) - TR (06)  
Timerange: 01/01:28:40 to 01/01:31:10

Plot file version 319 created 10-JUN-2016 17:22:34

J1957+3338 RT013A.UVDATA.1

Freq = 4.9270 GHz, Bw = 16.000 MH No calibration applied and no bandpass applied

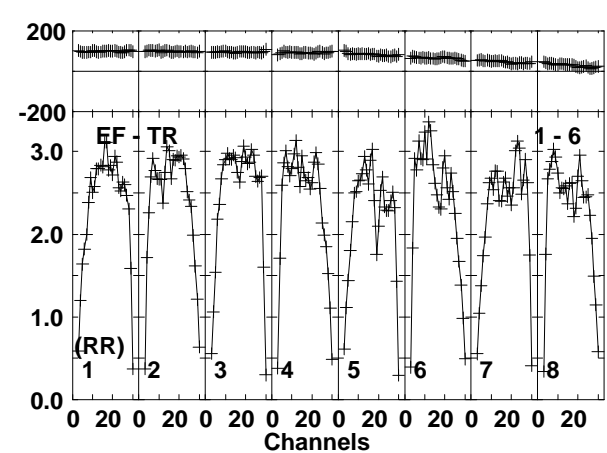
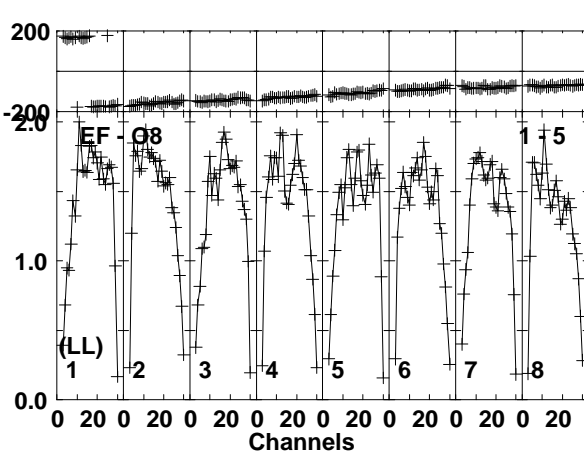
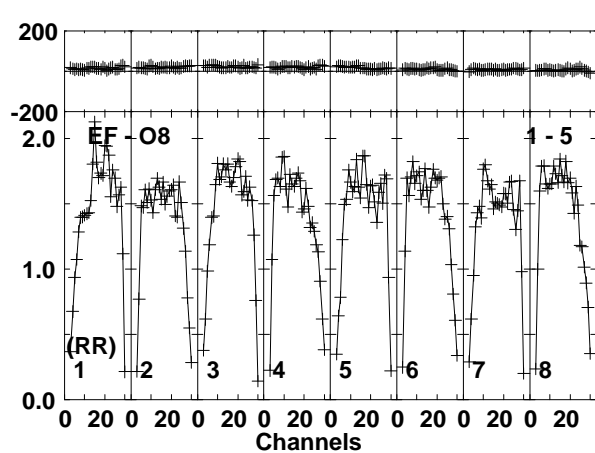
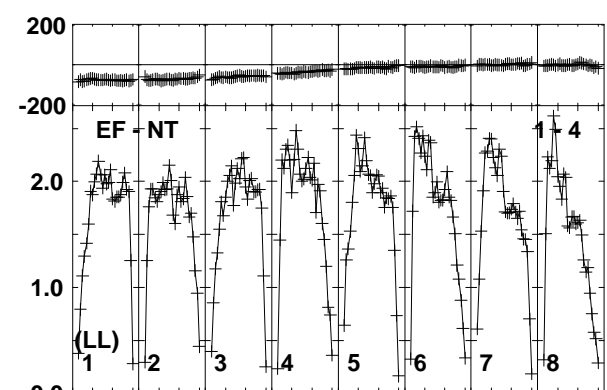
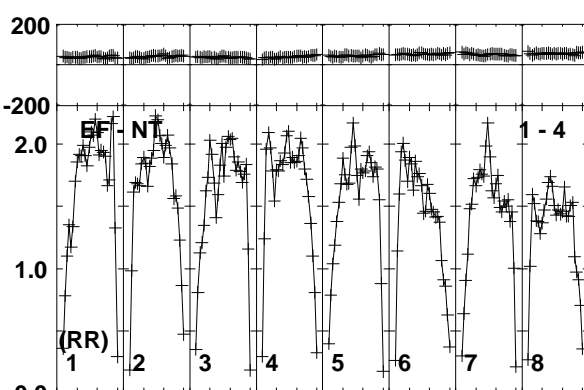
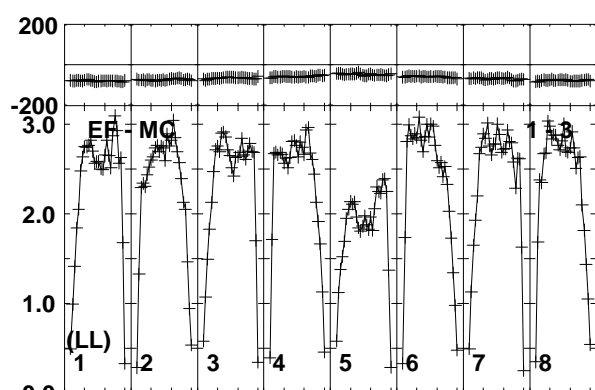
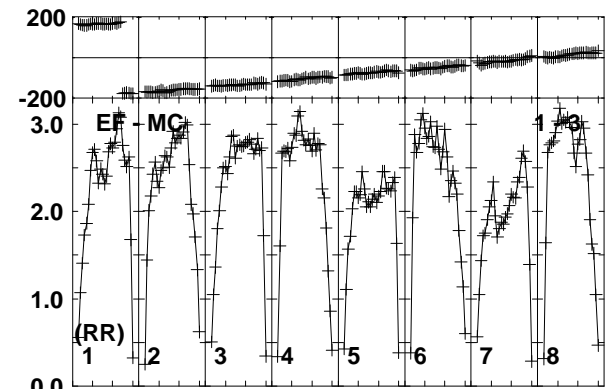
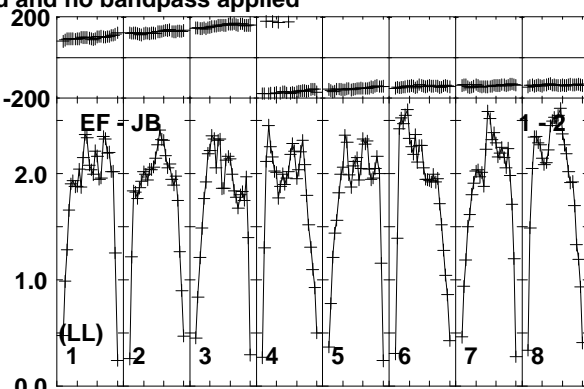
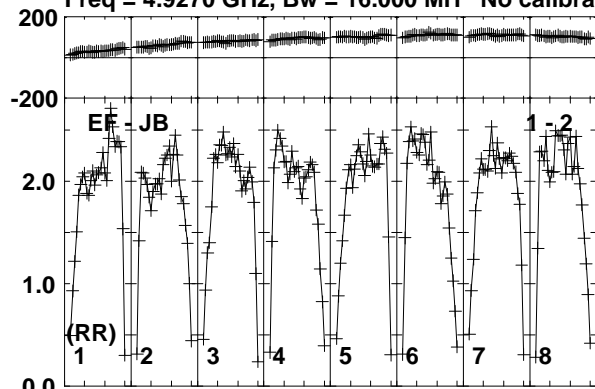

Lower frame: Milli Ampl Jy Top frame: Phas deg  
Vector averaged cross-power spectrum Baseline: EF (01) - JB (02)  
Timerange: 01/01:31:11 to 01/01:32:40

Plot file version 320 created 10-JUN-2016 17:22:34

J1957+3338 RT013A.UVDATA.1

Freq = 4.9270 GHz, Bw = 16.000 MH No calibration applied and no bandpass applied

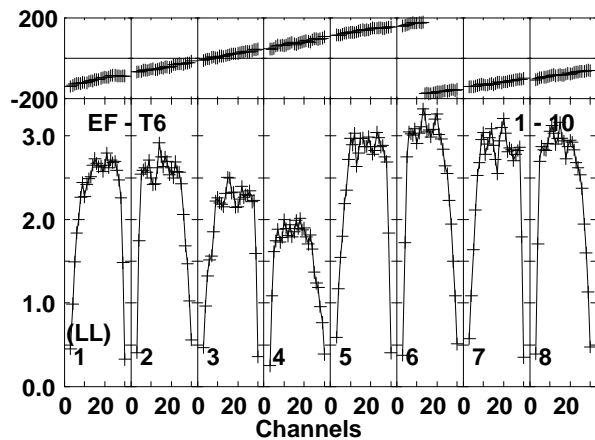
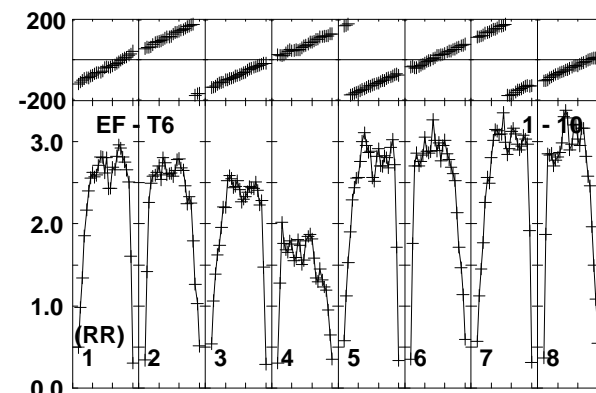
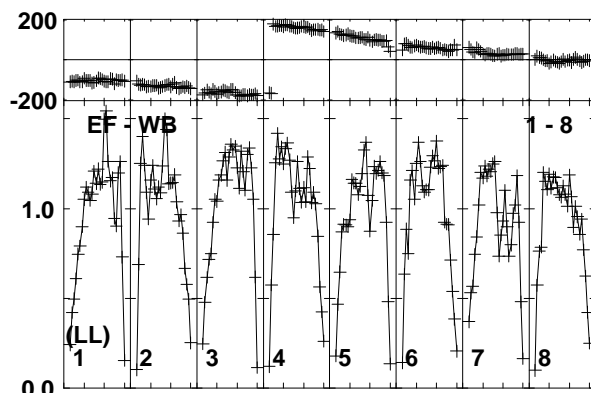
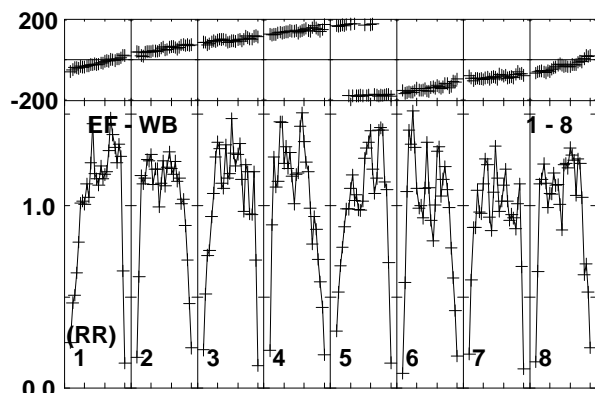
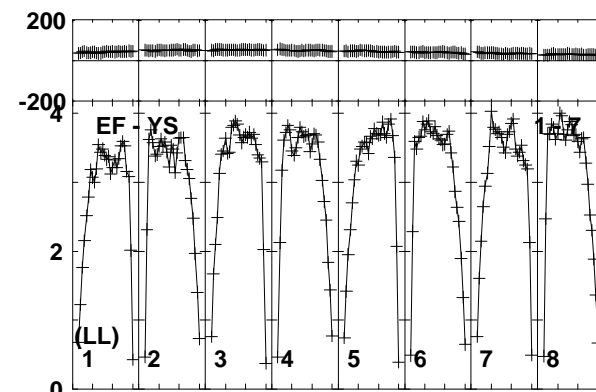
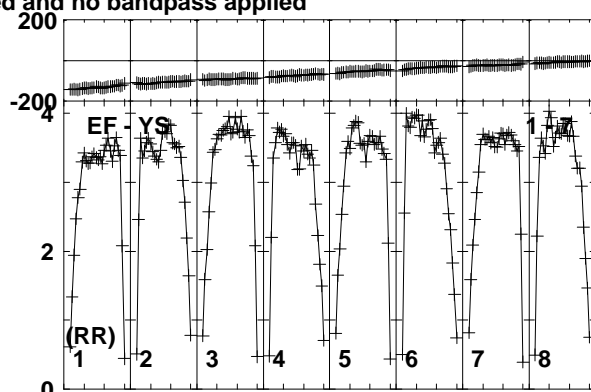
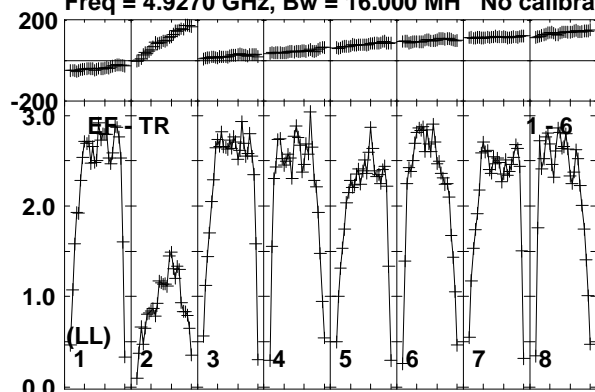

Lower frame: Milli Ampl Jy Top frame: Phas deg  
Vector averaged cross-power spectrum Baseline: EF (01) - TR (06)  
Timerange: 01/01:31:11 to 01/01:32:40

Plot file version 321 created 10-JUN-2016 17:22:35

CHECK RT013A.UVDATA.1

Freq = 4.9270 GHz, Bw = 16.000 MH No calibration applied and no bandpass applied

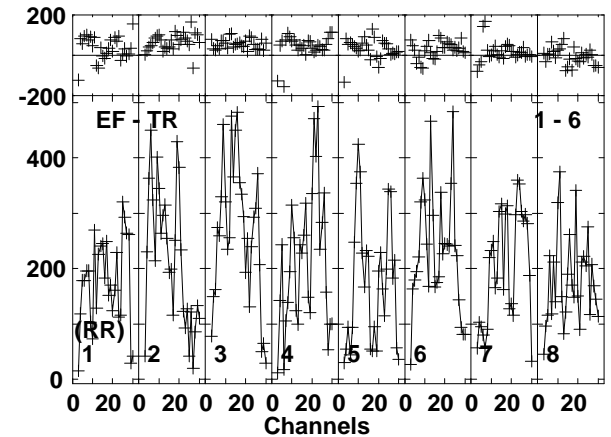
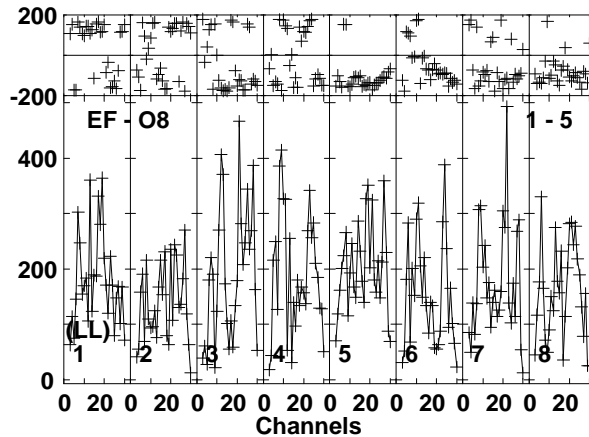
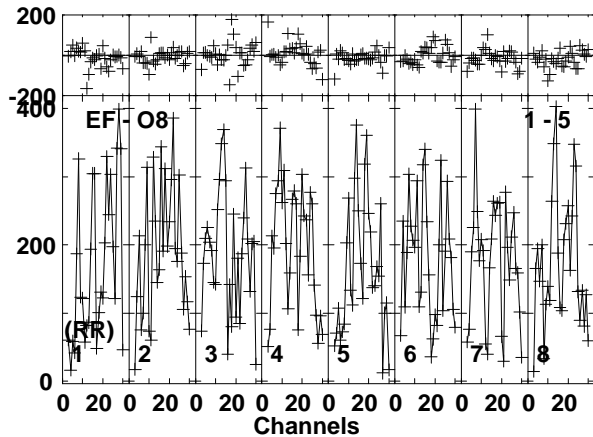
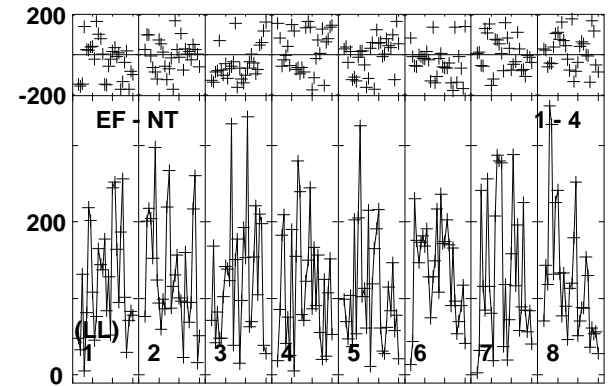
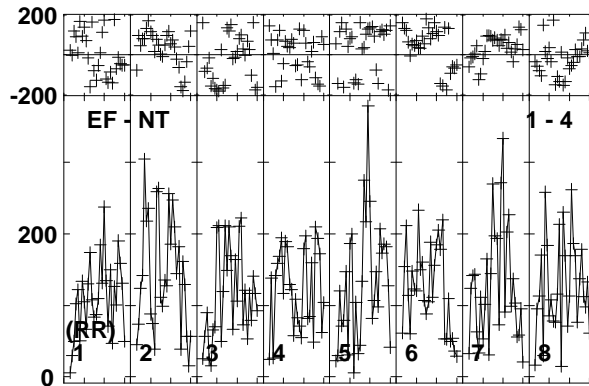
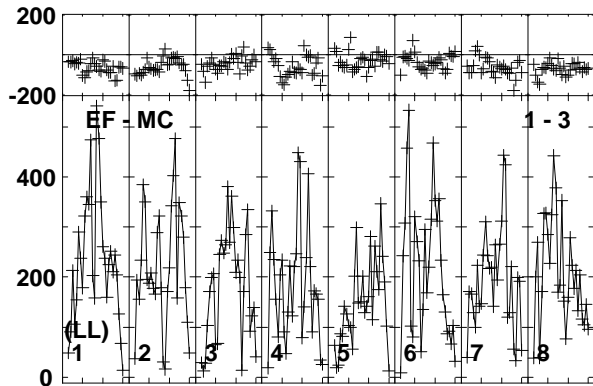
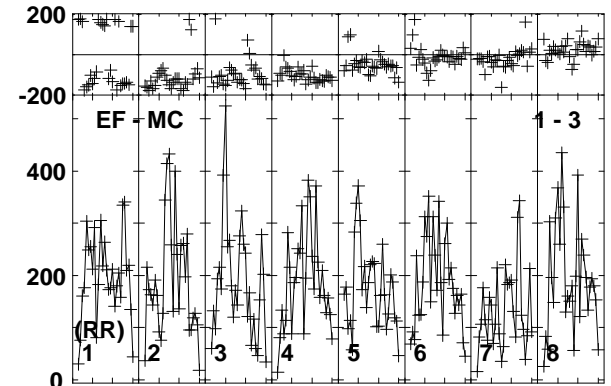
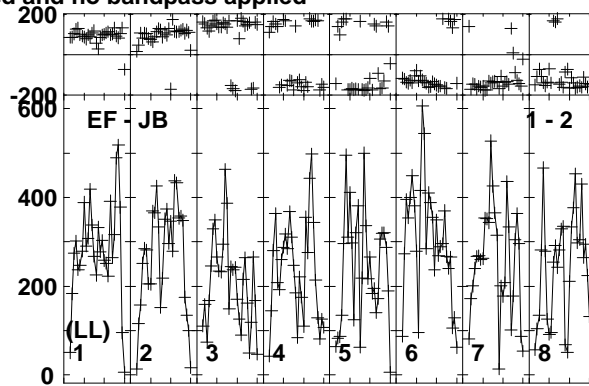
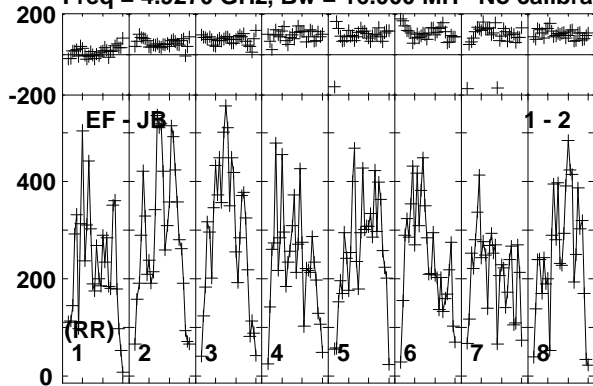

Lower frame: Micro Ampl Jy Top frame: Phas deg  
Vector averaged cross-power spectrum Baseline: EF (01) - JB (02)  
Timerange: 01/01:32:40 to 01/01:34:40

Plot file version 322 created 10-JUN-2016 17:22:35

CHECK RT013A.UVDATA.1

Freq = 4.9270 GHz, Bw = 16.000 MH No calibration applied and no bandpass applied

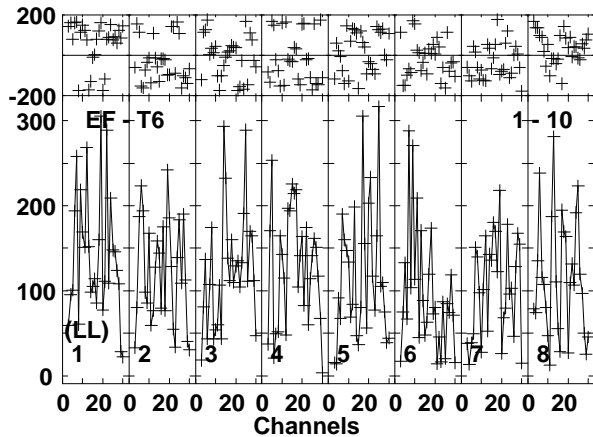
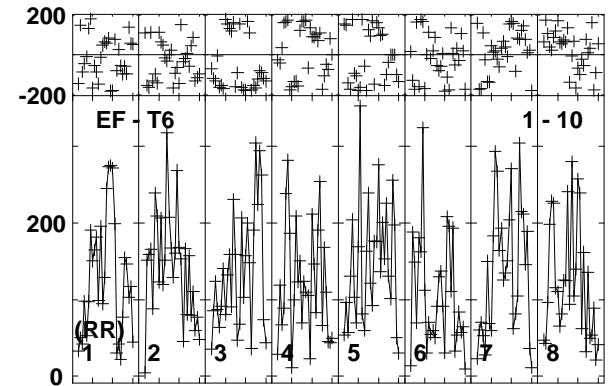
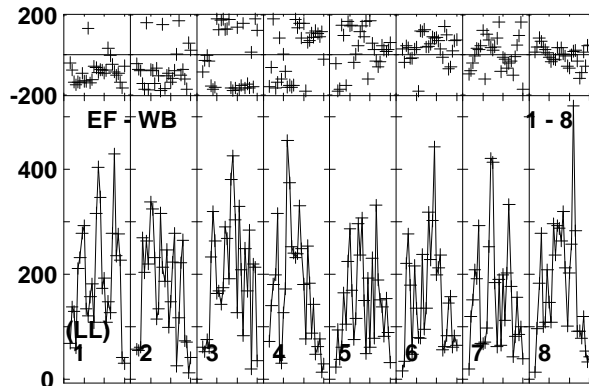
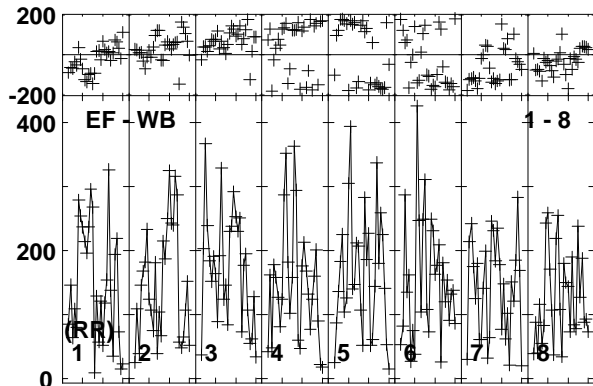
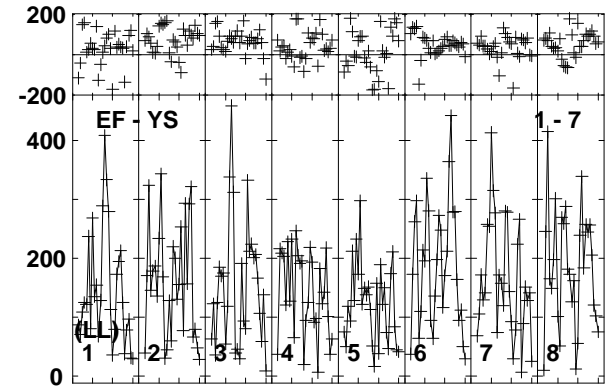
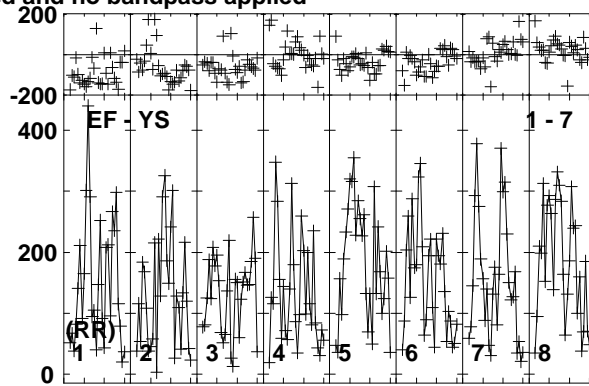
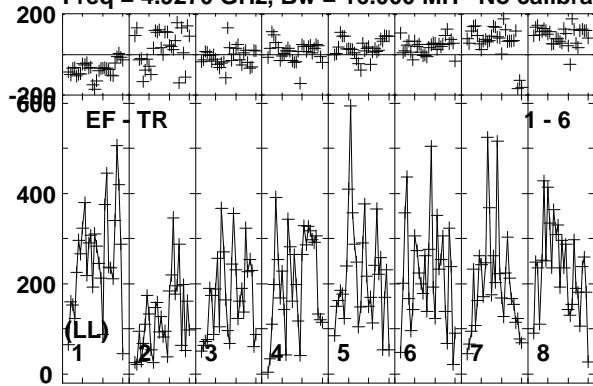

Lower frame: Micro Ampl Jy Top frame: Phas deg  
Vector averaged cross-power spectrum Baseline: EF (01) - TR (06)  
Timerange: 01/01:32:40 to 01/01:34:40



Plot file version 323 created 10-JUN-2016 17:22:35

CYGX1 RT013A.UVDATA.1

Freq = 4.9270 GHz, Bw = 16.000 MH No calibration applied and no bandpass applied

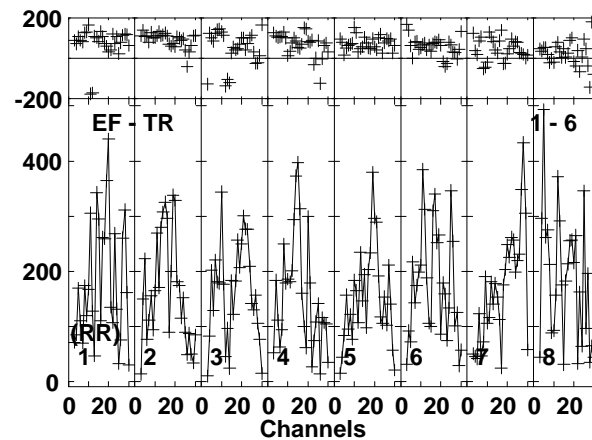
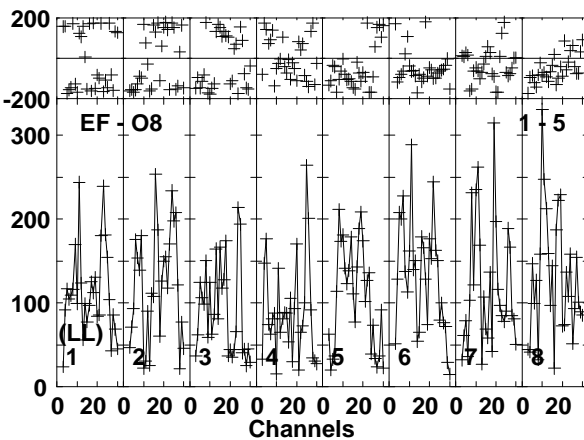
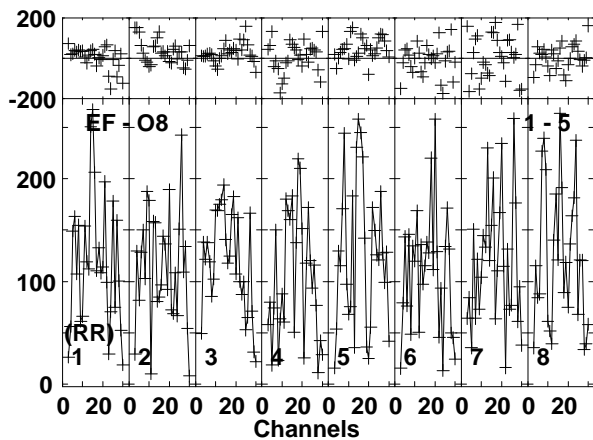
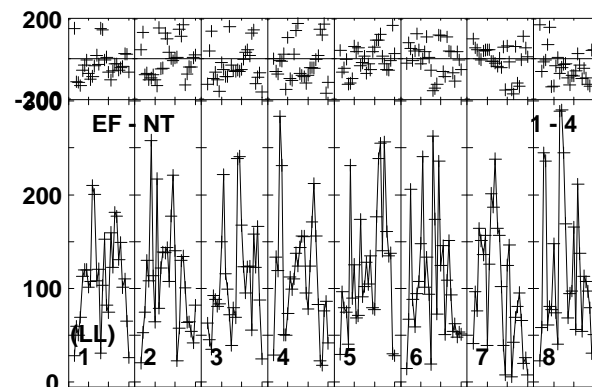
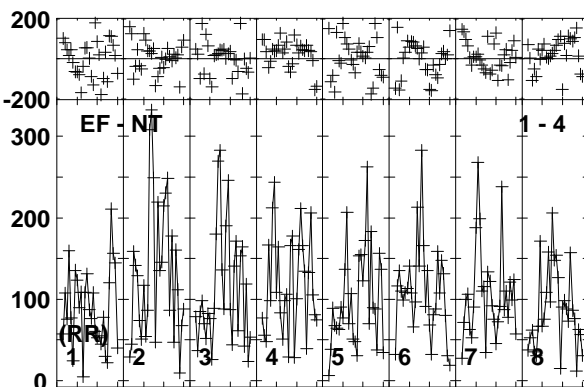
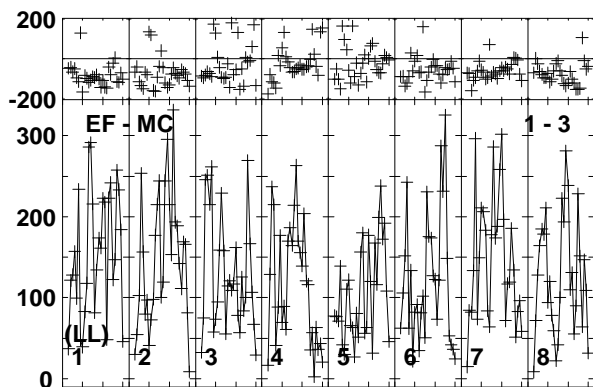
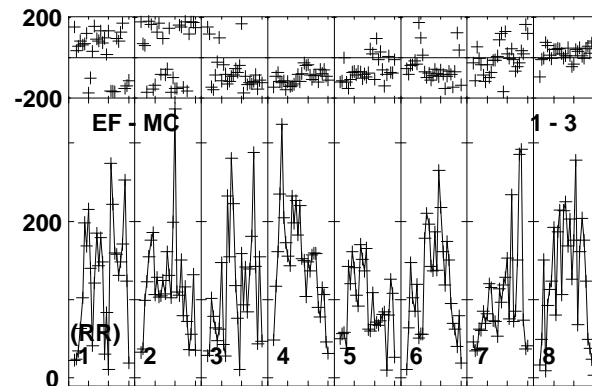
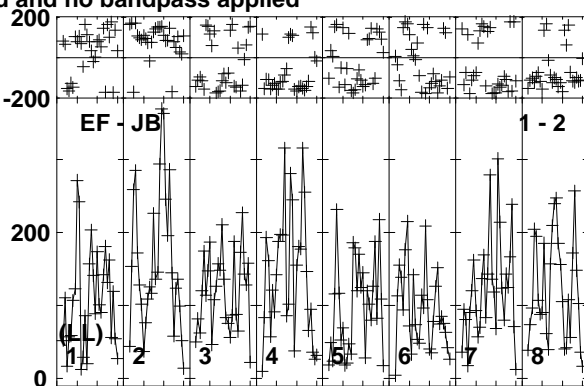
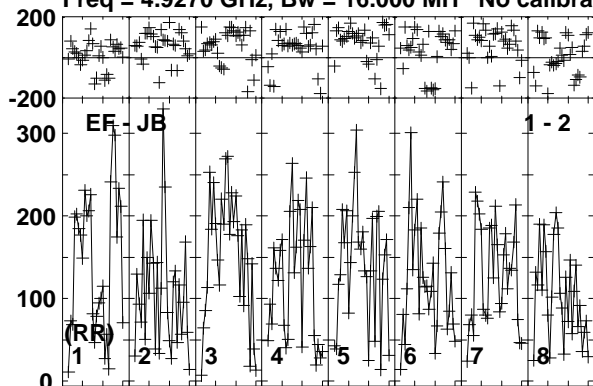

Lower frame: Micro Ampl Jy Top frame: Phas deg  
Vector averaged cross-power spectrum Baseline: EF (01) - JB (02)  
Timerange: 01/01:34:41 to 01/01:37:09

Plot file version 324 created 10-JUN-2016 17:22:35

CYGX1 RT013A.UVDATA.1

Freq = 4.9270 GHz, Bw = 16.000 MH No calibration applied and no bandpass applied

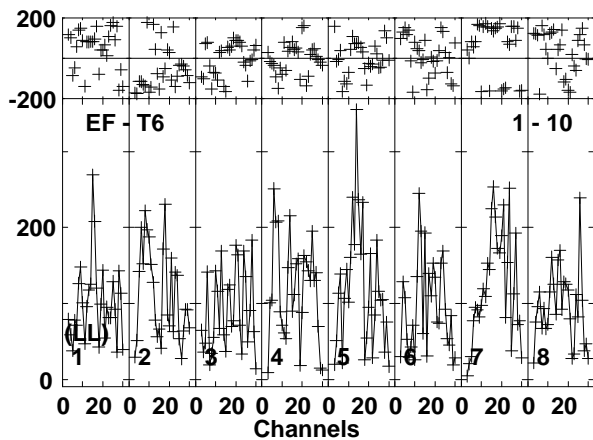
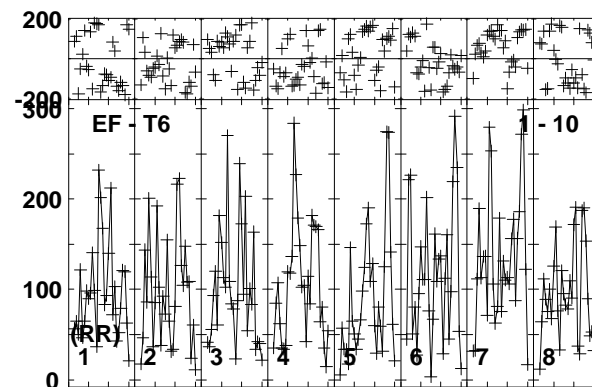
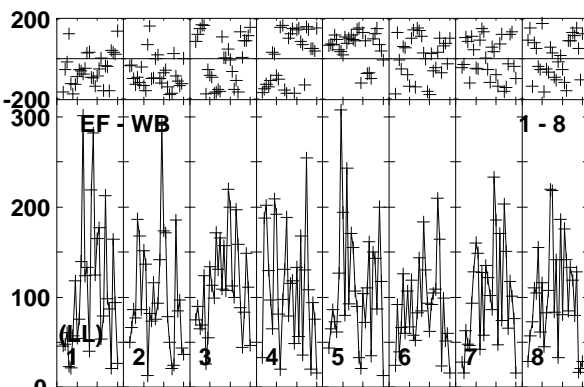
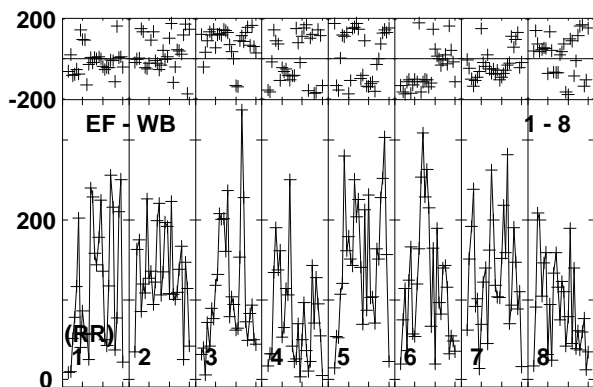
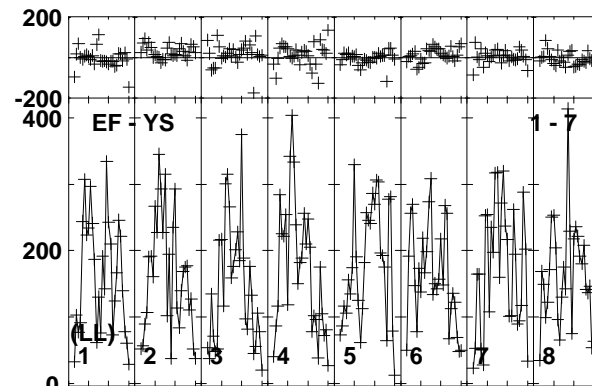
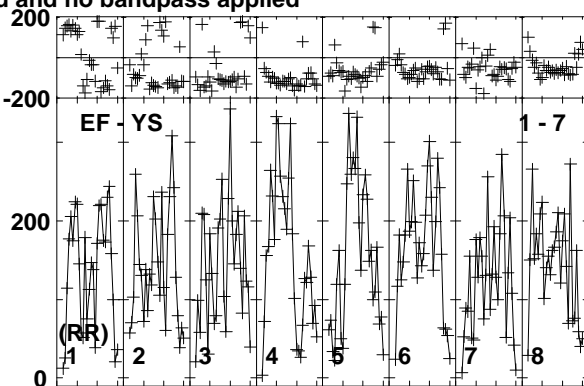
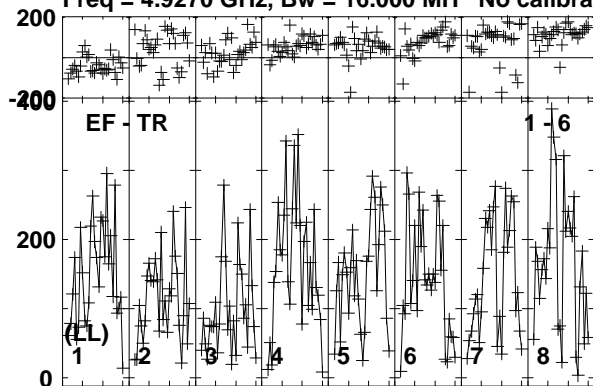

Lower frame: Micro Ampl Jy Top frame: Phas deg  
Vector averaged cross-power spectrum Baseline: EF (01) - TR (06)  
Timerange: 01/01:34:41 to 01/01:37:09

Plot file version 325 created 10-JUN-2016 17:22:35

J1957+3338 RT013A.UVDATA.1

Freq = 4.9270 GHz, Bw = 16.000 MH No calibration applied and no bandpass applied

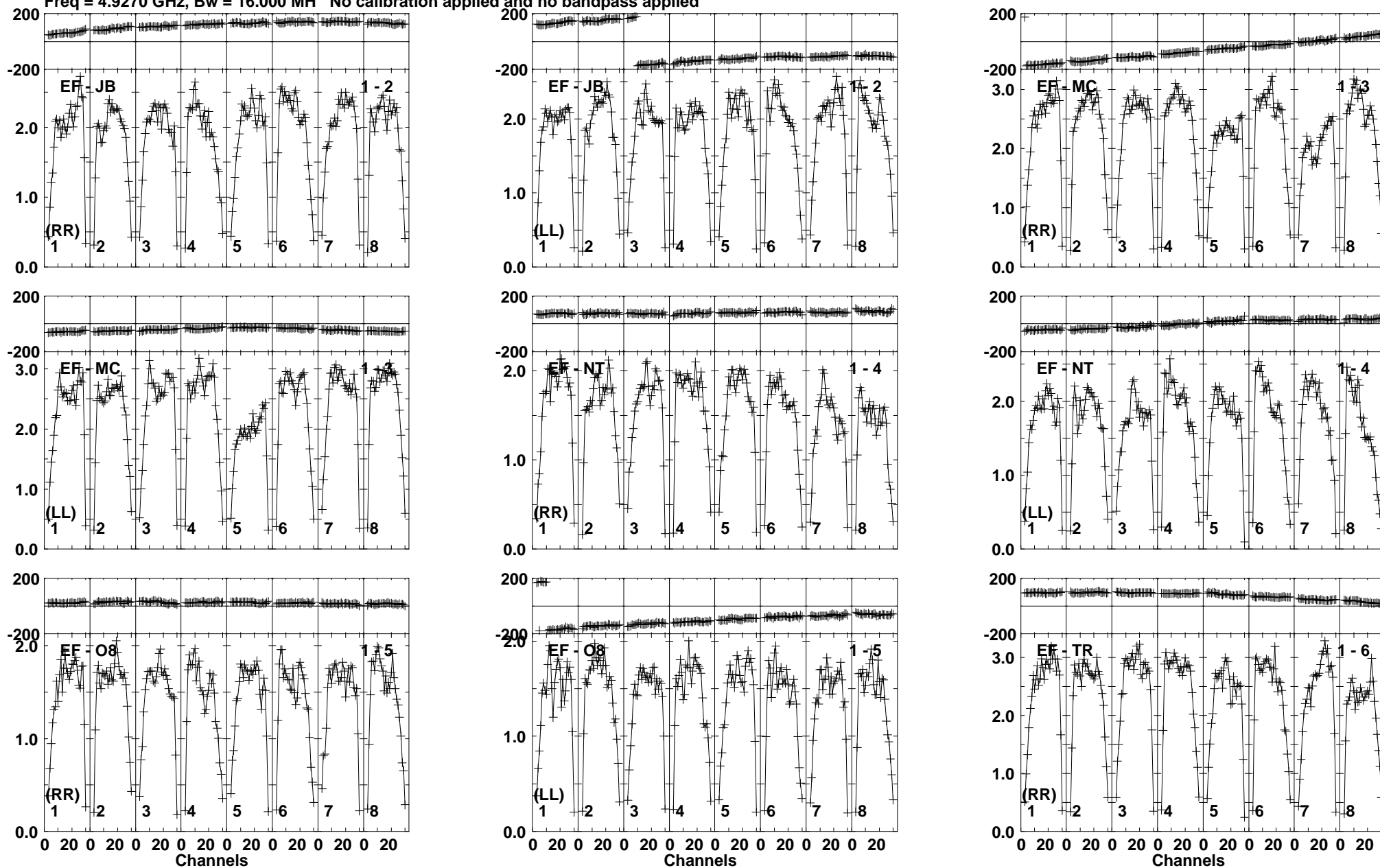

Lower frame: Milli Ampl Jy Top frame: Phas deg  
Vector averaged cross-power spectrum Baseline: EF (01) - JB (02)  
Timerange: 01/01:37:11 to 01/01:38:39

Plot file version 326 created 10-JUN-2016 17:22:35

J1957+3338 RT013A.UVDATA.1

Freq = 4.9270 GHz, Bw = 16.000 MH No calibration applied and no bandpass applied

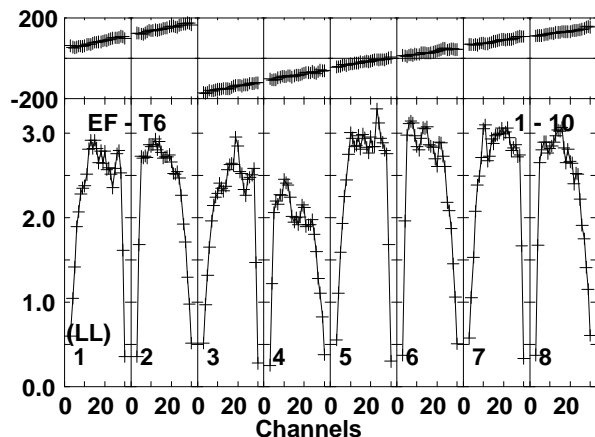
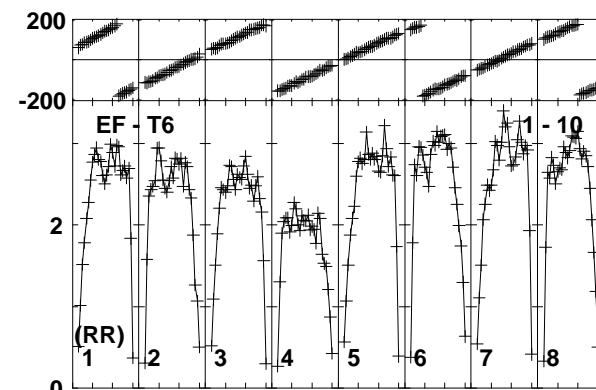
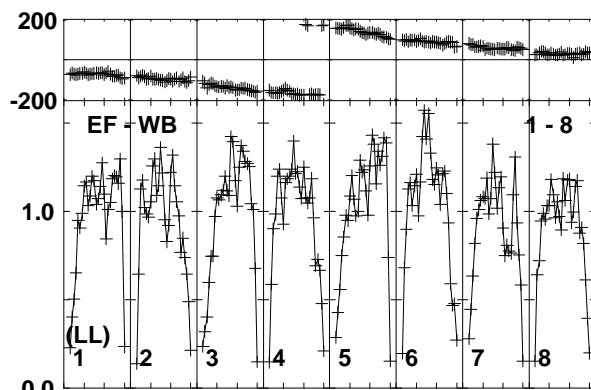
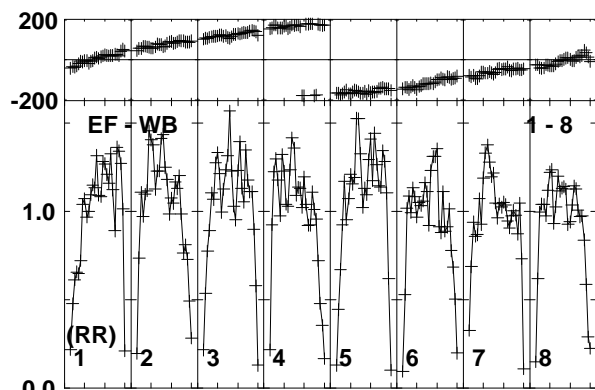
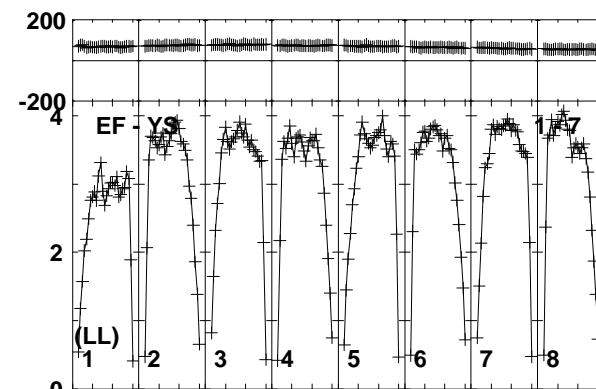
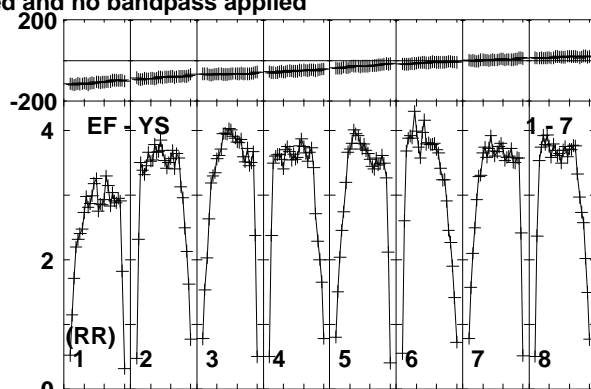
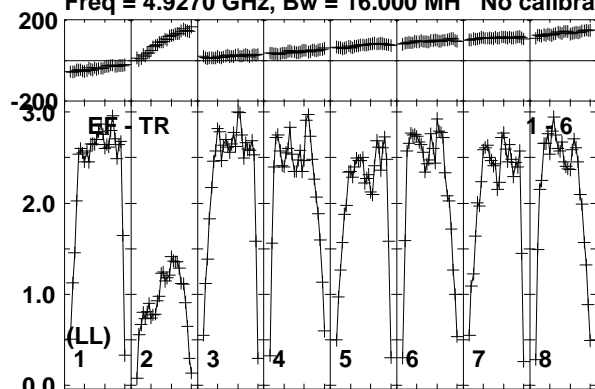

Lower frame: Milli Ampl Jy Top frame: Phas deg  
Vector averaged cross-power spectrum Baseline: EF (01) - TR (06)  
Timerange: 01/01:37:11 to 01/01:38:39

Plot file version 327 created 10-JUN-2016 17:22:35

CHECK RT013A.UVDATA.1

Freq = 4.9270 GHz, Bw = 16.000 MH No calibration applied and no bandpass applied

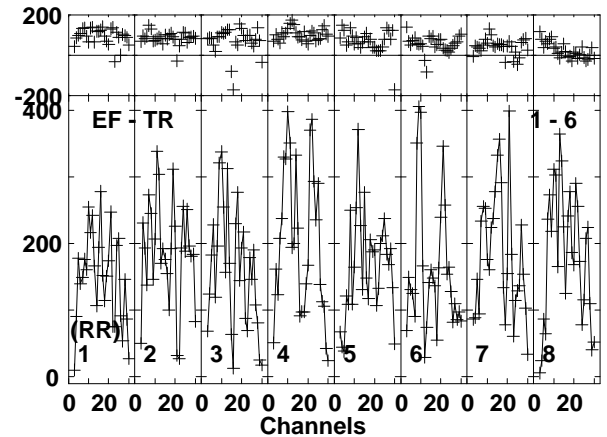
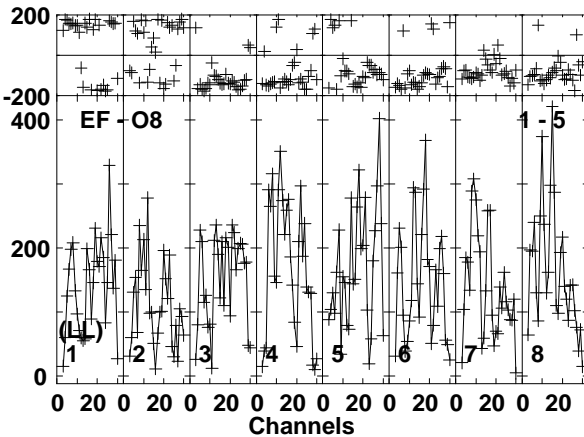
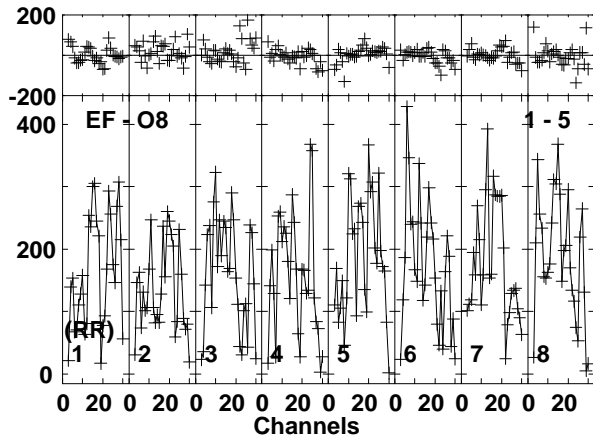
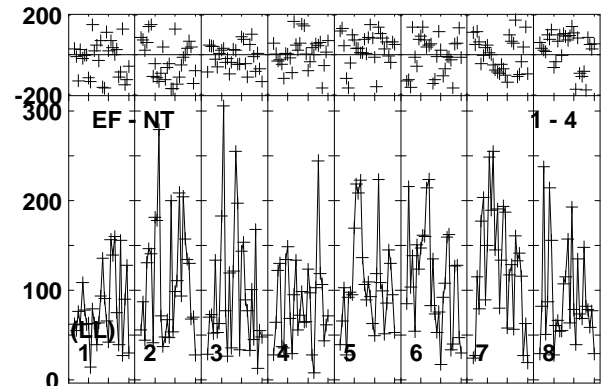
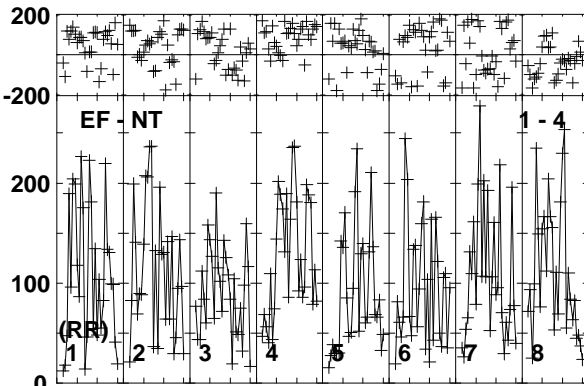
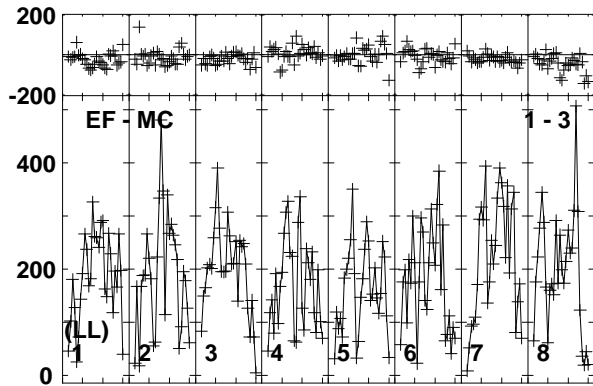
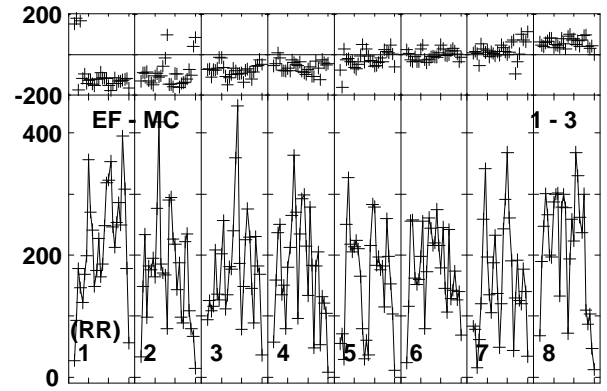
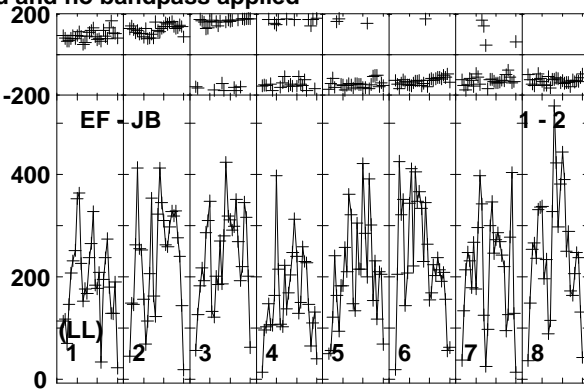
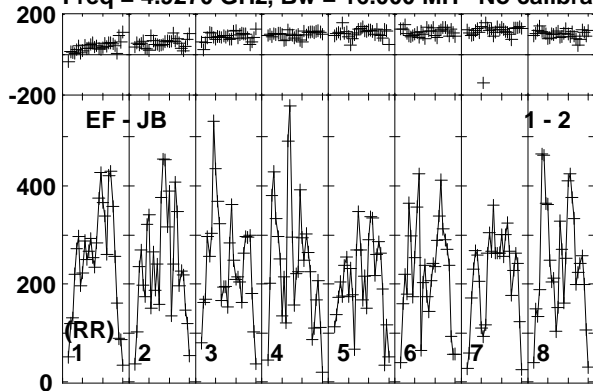

Lower frame: Micro Ampl Jy Top frame: Phas deg  
Vector averaged cross-power spectrum Baseline: EF (01) - JB (02)  
Timerange: 01/01:39:20 to 01/01:41:20

Plot file version 328 created 10-JUN-2016 17:22:35

CHECK RT013A.UVDATA.1

Freq = 4.9270 GHz, Bw = 16.000 MH No calibration applied and no bandpass applied

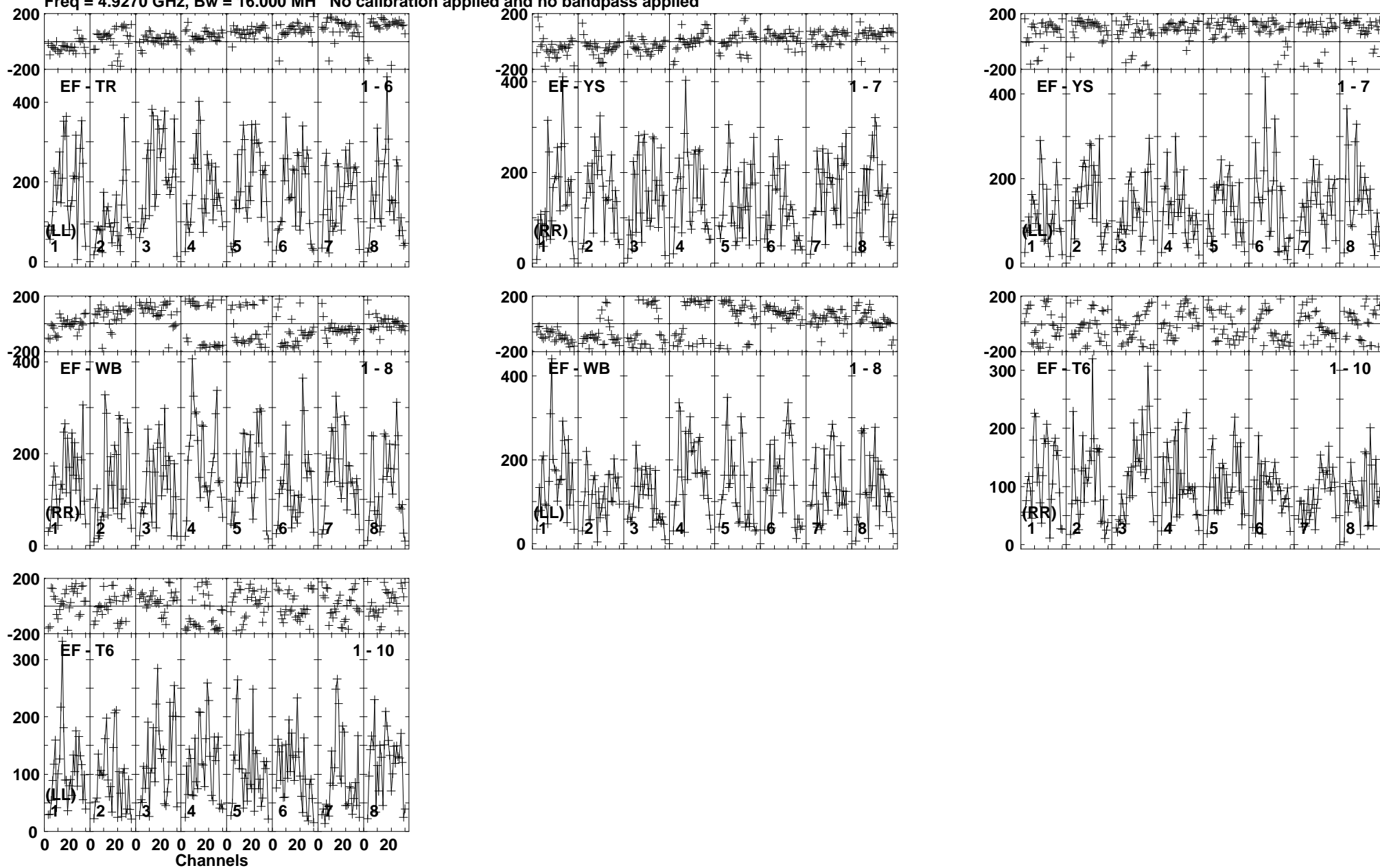

Lower frame: Micro Ampl Jy Top frame: Phas deg  
Vector averaged cross-power spectrum Baseline: EF (01) - TR (06)  
Timerange: 01/01:39:20 to 01/01:41:20

Plot file version 329 created 10-JUN-2016 17:22:35

CYGX1 RT013A.UVDATA.1

Freq = 4.9270 GHz, Bw = 16.000 MH No calibration applied and no bandpass applied

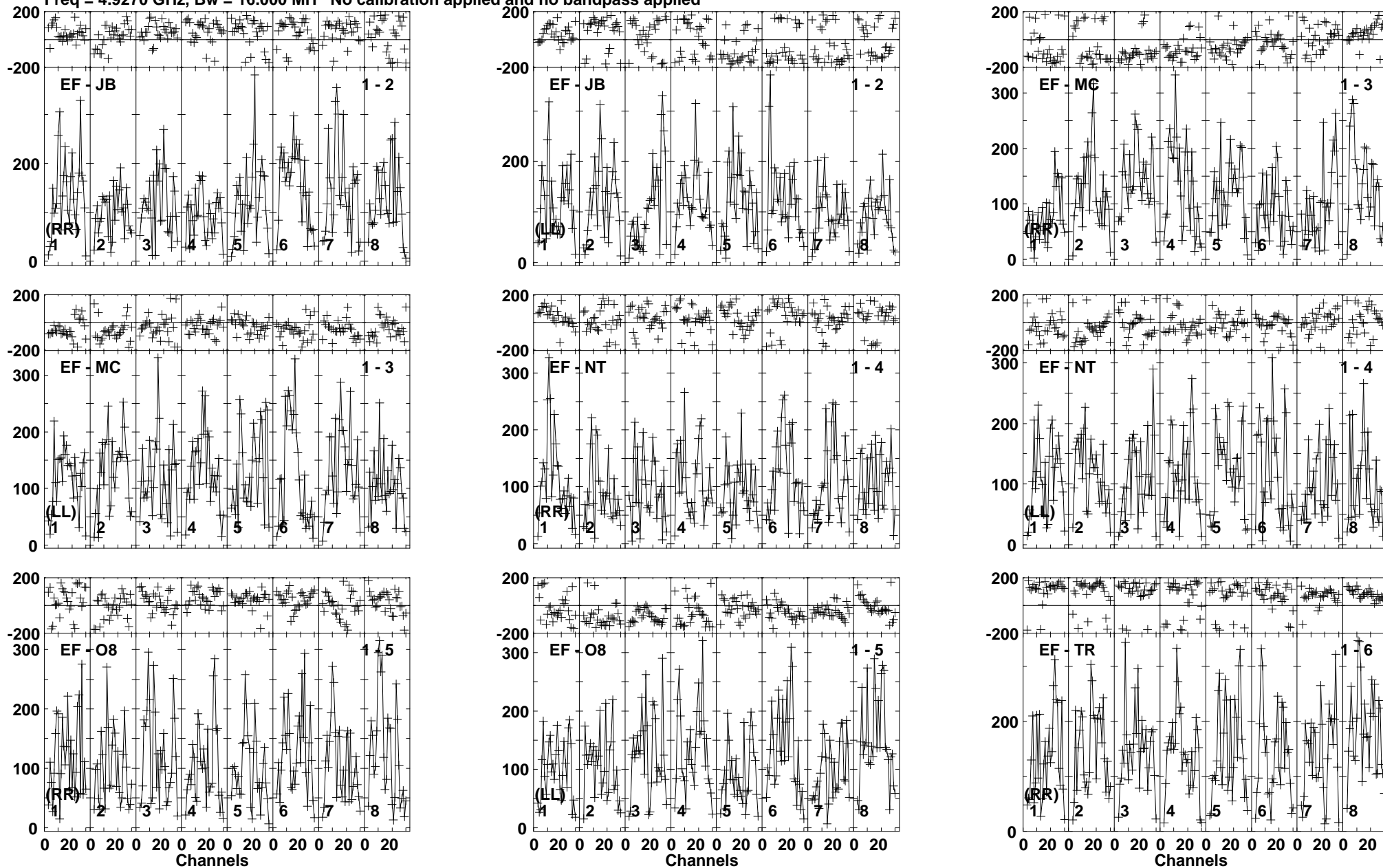

Lower frame: Micro Ampl Jy Top frame: Phas deg  
Vector averaged cross-power spectrum Baseline: EF (01) - JB (02)  
Timerange: 01/01:41:21 to 01/01:43:49

Plot file version 330 created 10-JUN-2016 17:22:36

CYGX1 RT013A.UVDATA.1

Freq = 4.9270 GHz, Bw = 16.000 MH No calibration applied and no bandpass applied

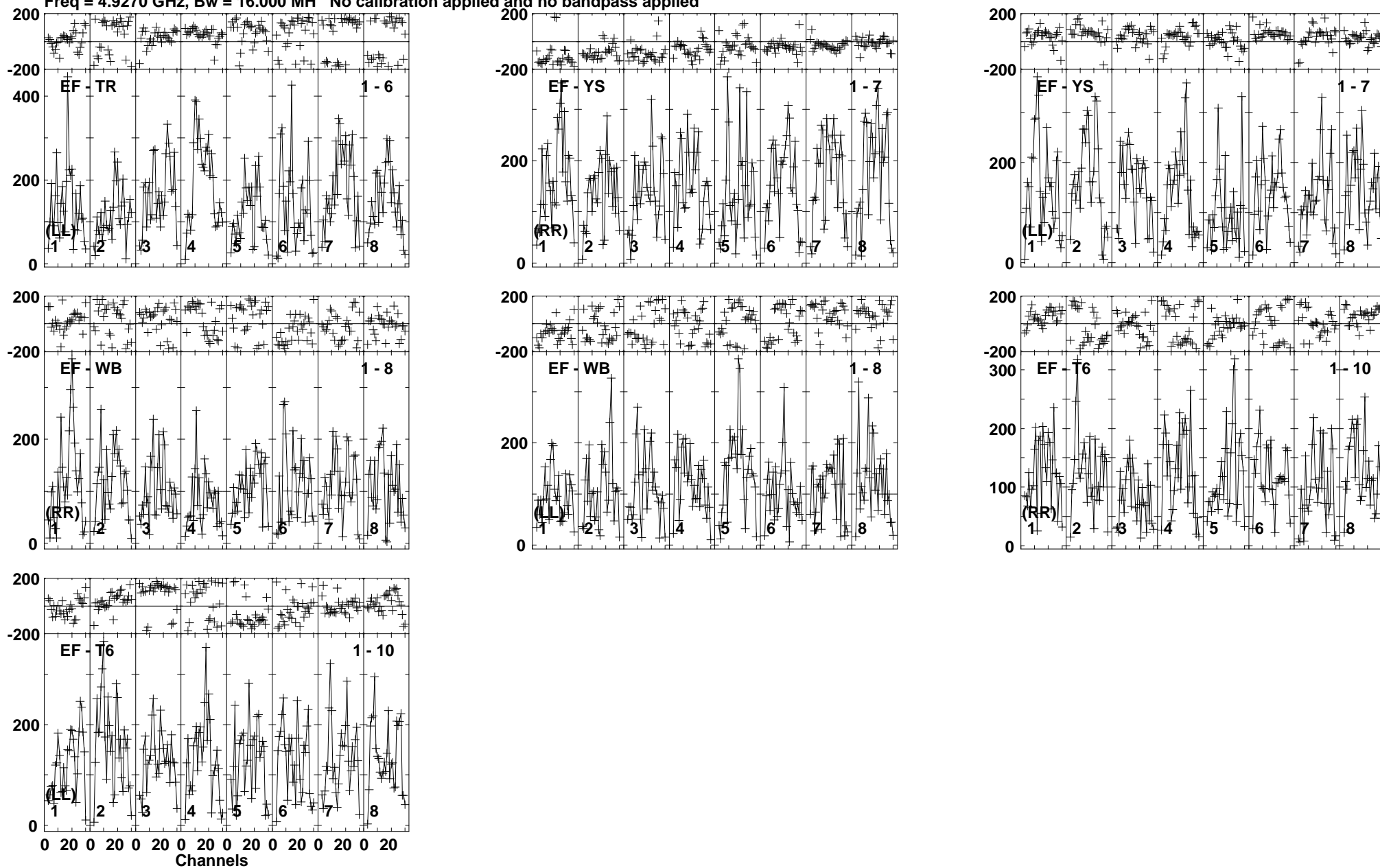

Lower frame: Micro Ampl Jy Top frame: Phas deg  
Vector averaged cross-power spectrum Baseline: EF (01) - TR (06)  
Timerange: 01/01:41:21 to 01/01:43:49



Plot file version 331 created 10-JUN-2016 17:22:36

J1957+3338 RT013A.UVDATA.1

Freq = 4.9270 GHz, Bw = 16.000 MH No calibration applied and no bandpass applied

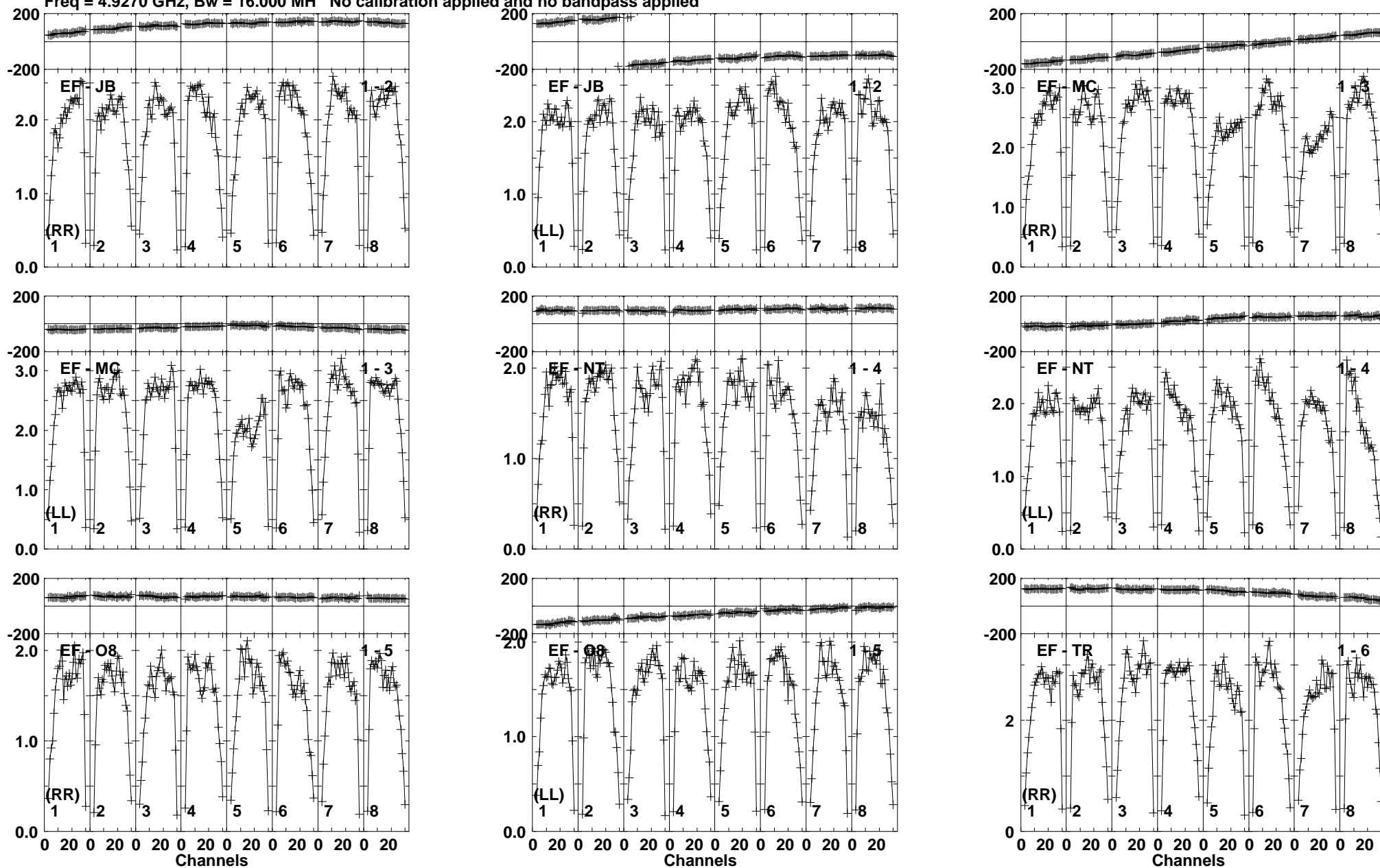

Lower frame: Milli Ampl Jy Top frame: Phas deg  
Vector averaged cross-power spectrum Baseline: EF (01) - JB (02)  
Timerange: 01/01:43:51 to 01/01:45:19

Plot file version 332 created 10-JUN-2016 17:22:36

J1957+3338 RT013A.UVDATA.1

Freq = 4.9270 GHz, Bw = 16.000 MH No calibration applied and no bandpass applied

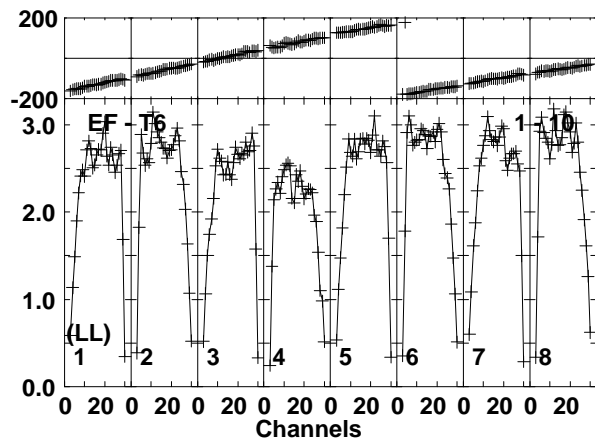
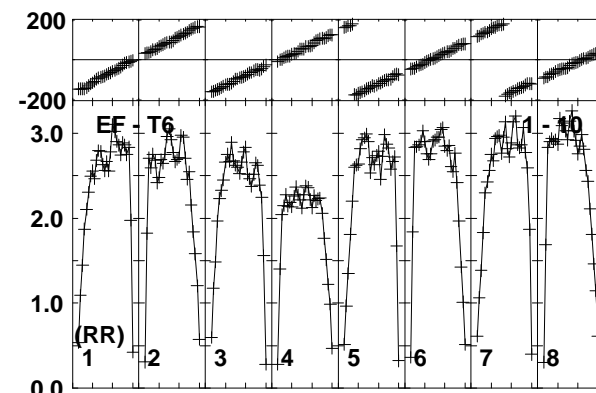
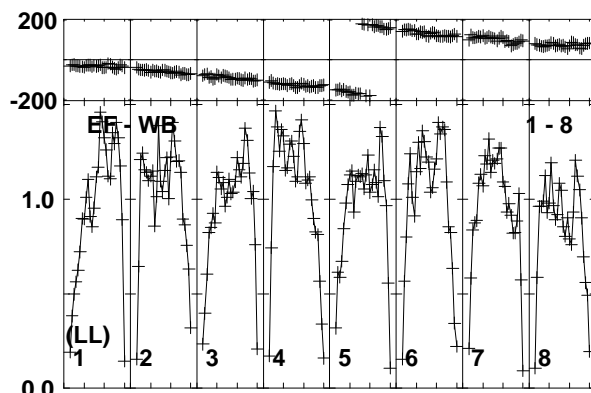
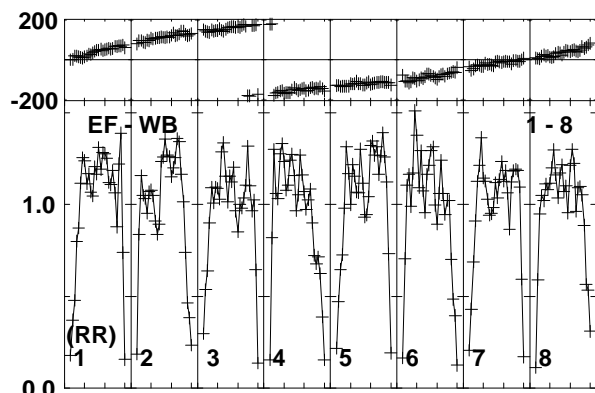
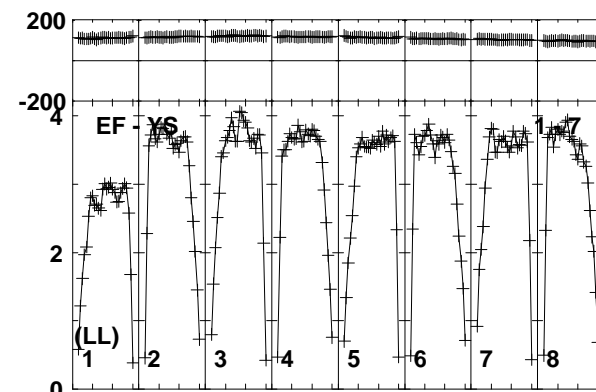
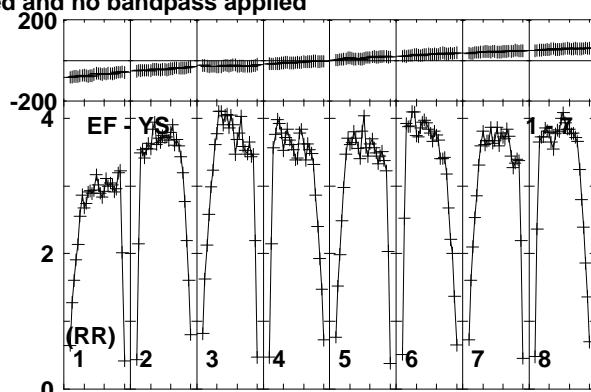
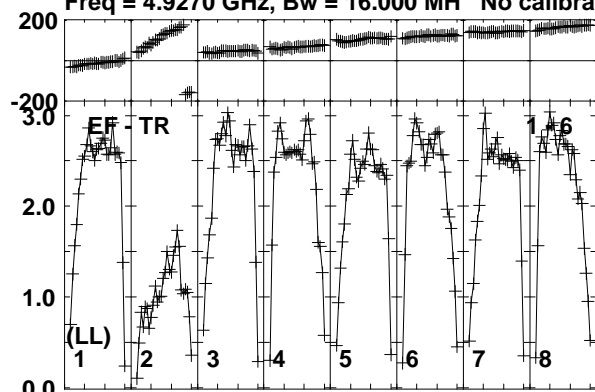

Lower frame: Milli Ampl Jy Top frame: Phas deg  
Vector averaged cross-power spectrum Baseline: EF (01) - TR (06)  
Timerange: 01/01:43:51 to 01/01:45:19

Plot file version 333 created 10-JUN-2016 17:22:36

CHECK RT013A.UVDATA.1

Freq = 4.9270 GHz, Bw = 16.000 MH No calibration applied and no bandpass applied

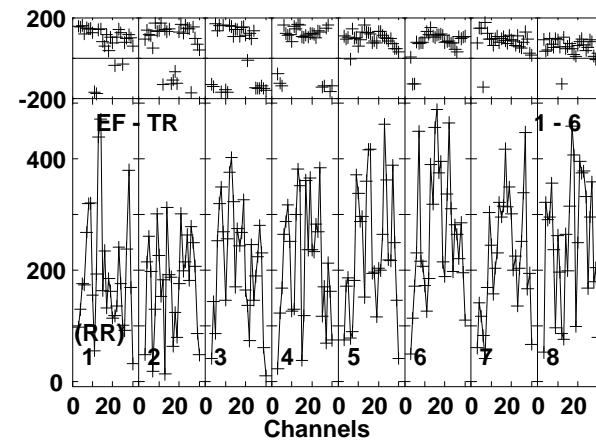
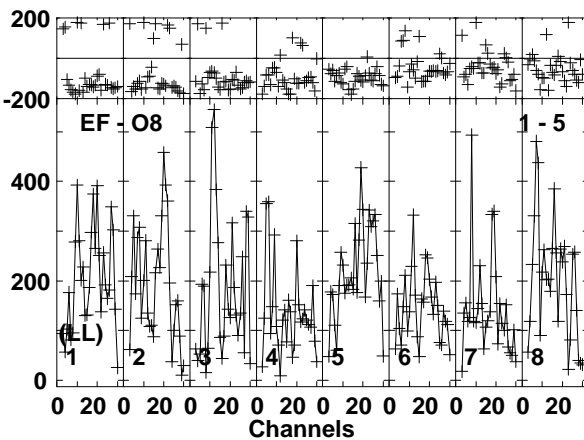
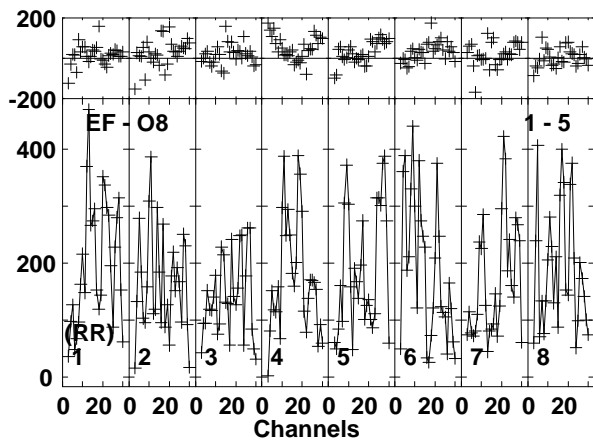
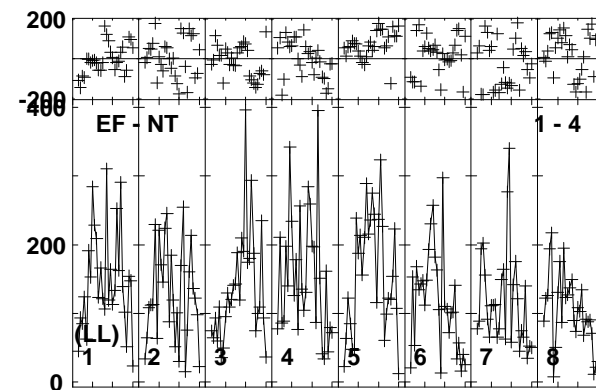
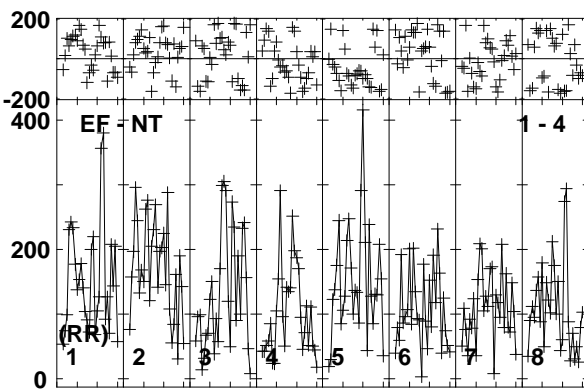
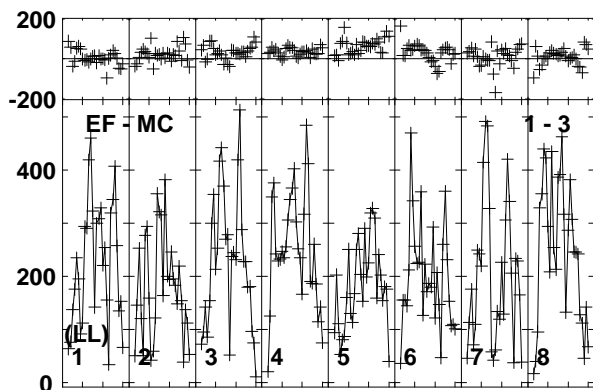
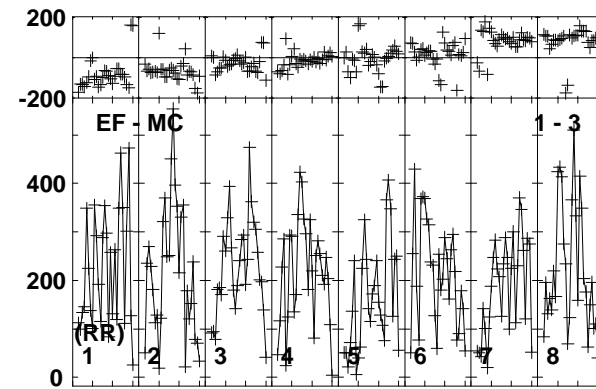
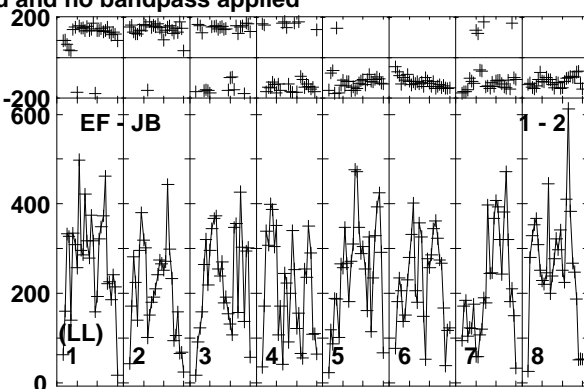
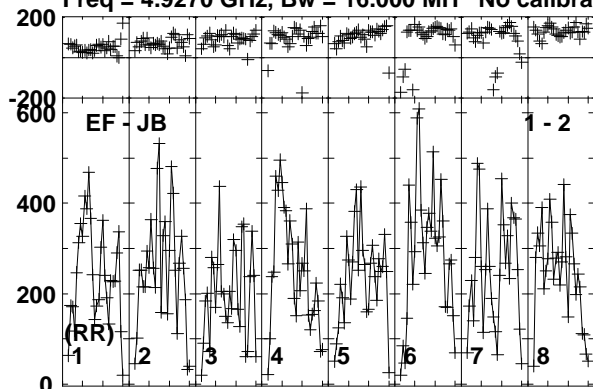

Lower frame: Micro Ampl Jy Top frame: Phas deg  
Vector averaged cross-power spectrum Baseline: EF (01) - JB (02)  
Timerange: 01/01:45:21 to 01/01:47:19

Plot file version 334 created 10-JUN-2016 17:22:36

CHECK RT013A.UVDATA.1

Freq = 4.9270 GHz, Bw = 16.000 MH No calibration applied and no bandpass applied

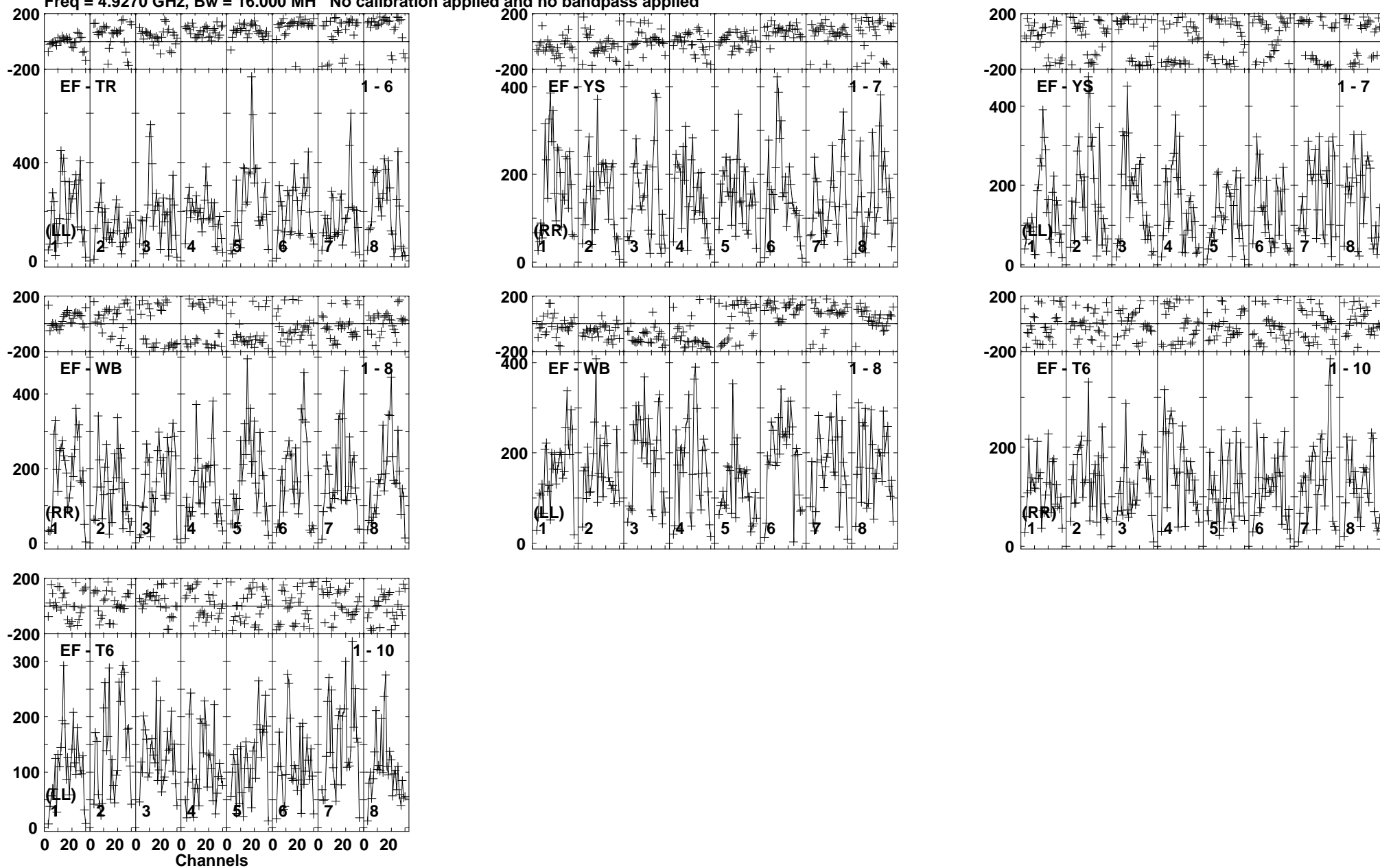

Lower frame: Micro Ampl Jy Top frame: Phas deg  
Vector averaged cross-power spectrum Baseline: EF (01) - TR (06)  
Timerange: 01/01:45:21 to 01/01:47:19

Plot file version 335 created 10-JUN-2016 17:22:36

CYGX1 RT013A.UVDATA.1

Freq = 4.9270 GHz, Bw = 16.000 MH No calibration applied and no bandpass applied

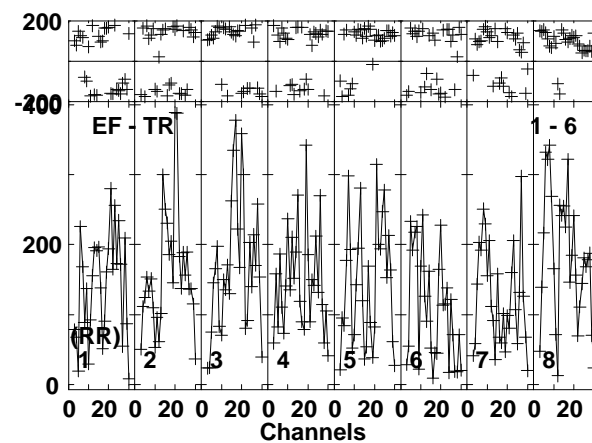
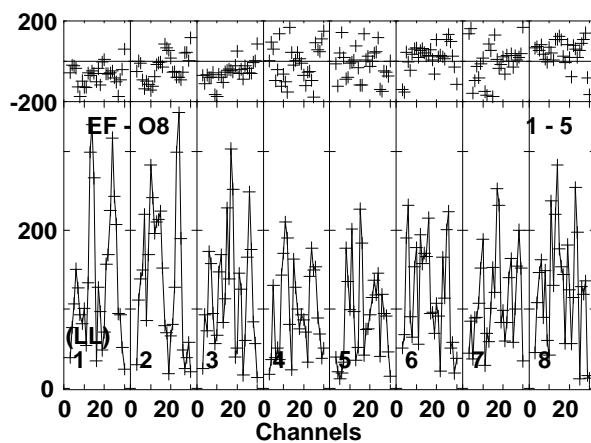
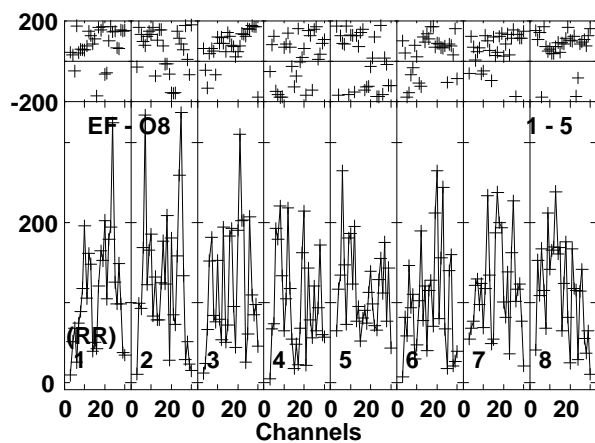
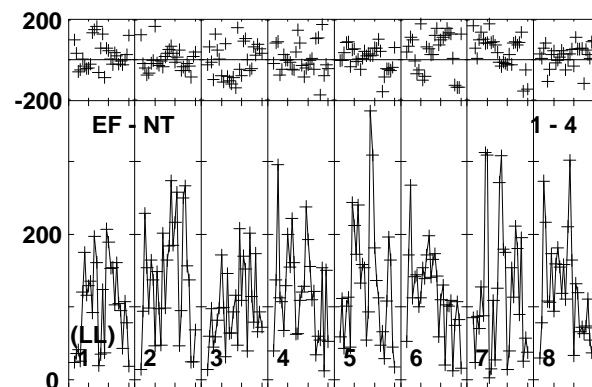
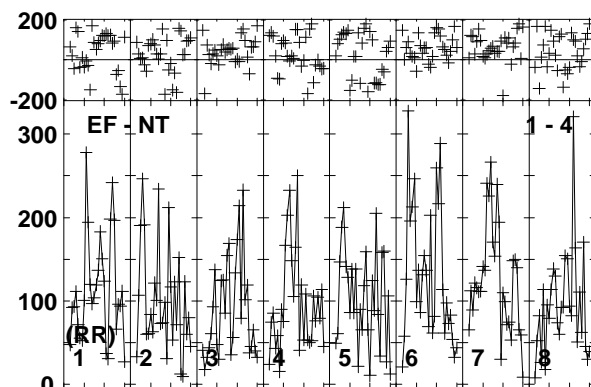
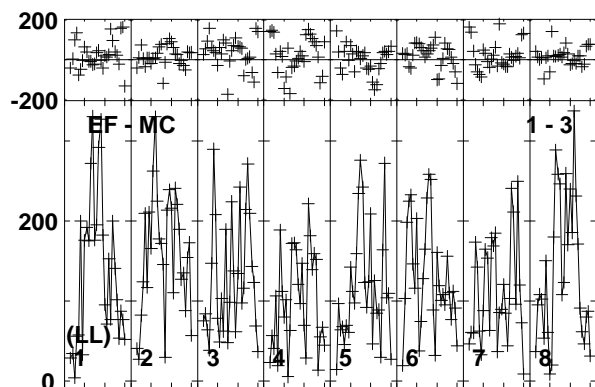
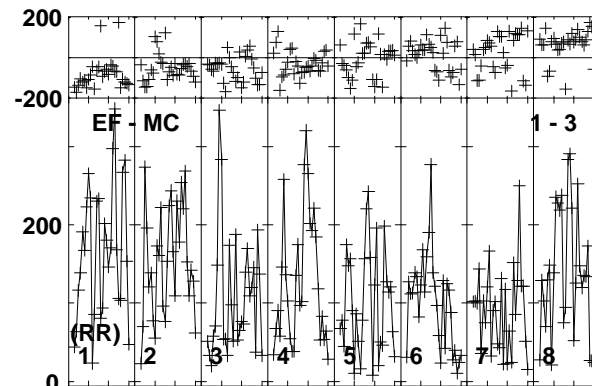
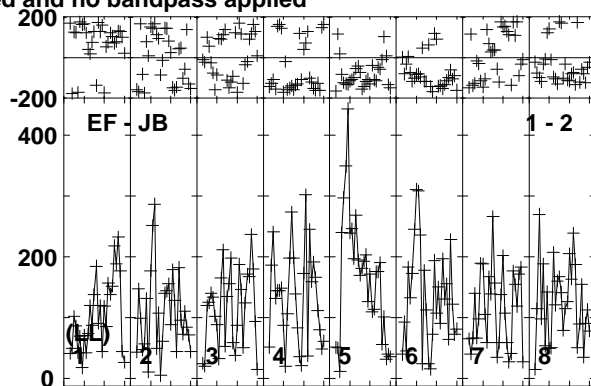
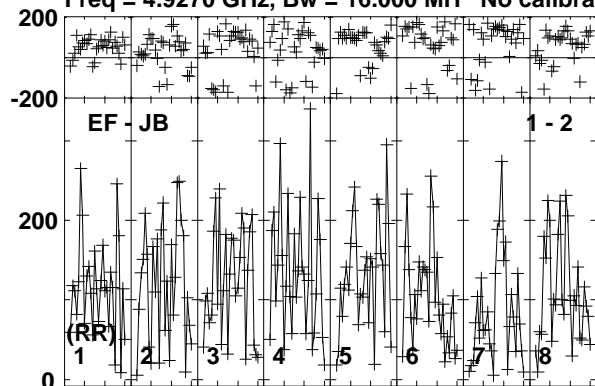

Lower frame: Micro Ampl Jy Top frame: Phas deg  
Vector averaged cross-power spectrum Baseline: EF (01) - JB (02)  
Timerange: 01/01:47:20 to 01/01:49:50

Plot file version 336 created 10-JUN-2016 17:22:36

CYGX1 RT013A.UVDATA.1

Freq = 4.9270 GHz, Bw = 16.000 MH No calibration applied and no bandpass applied

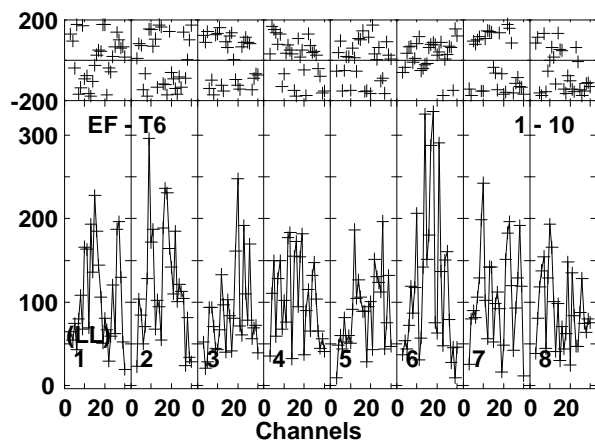
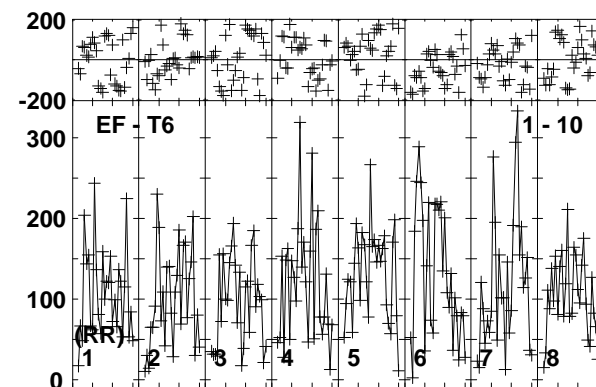
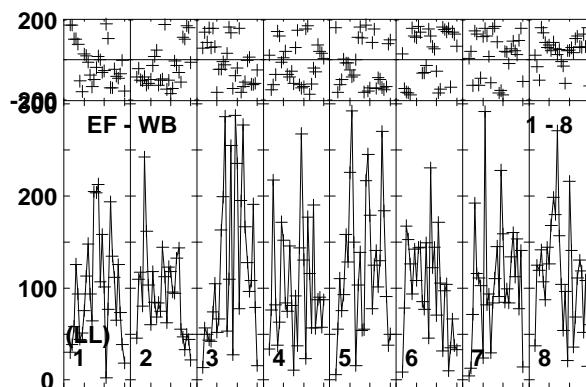
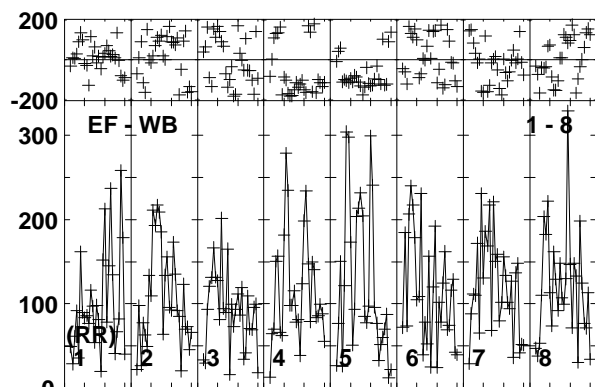
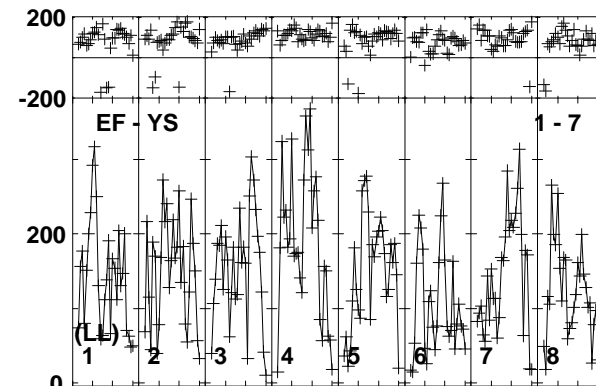
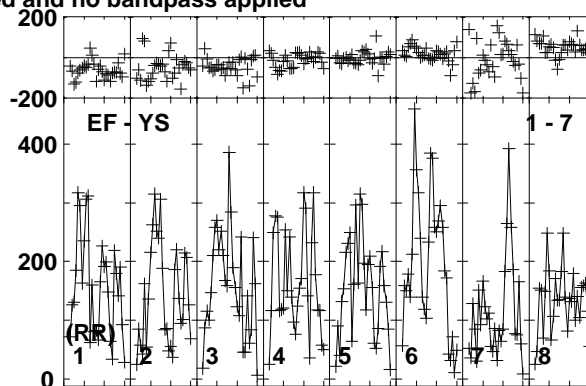
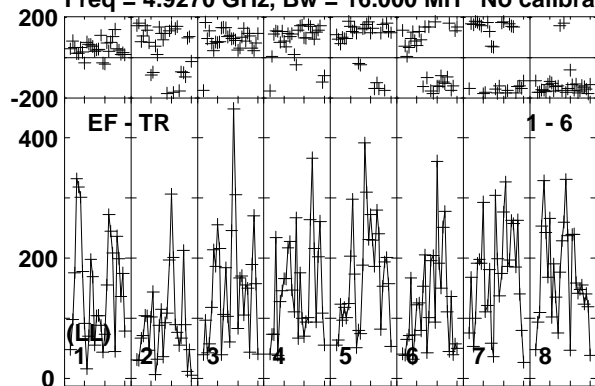

Lower frame: Micro Ampl Jy Top frame: Phas deg  
Vector averaged cross-power spectrum Baseline: EF (01) - TR (06)  
Timerange: 01/01:47:20 to 01/01:49:50

Plot file version 337 created 10-JUN-2016 17:22:36

J1957+3338 RT013A.UVDATA.1

Freq = 4.9270 GHz, Bw = 16.000 MH No calibration applied and no bandpass applied

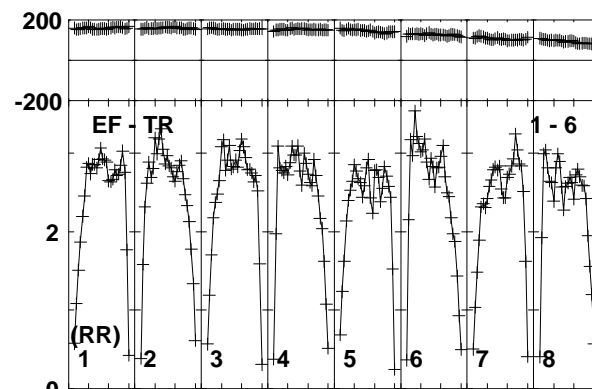
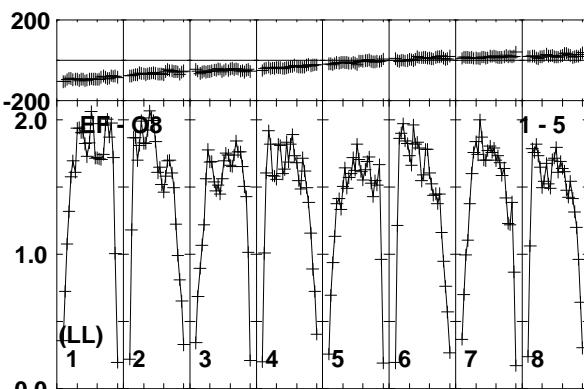
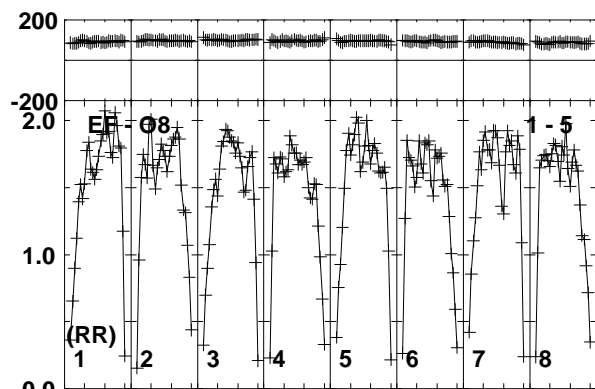
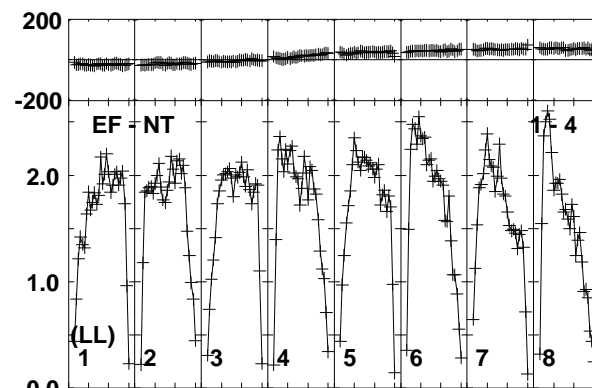
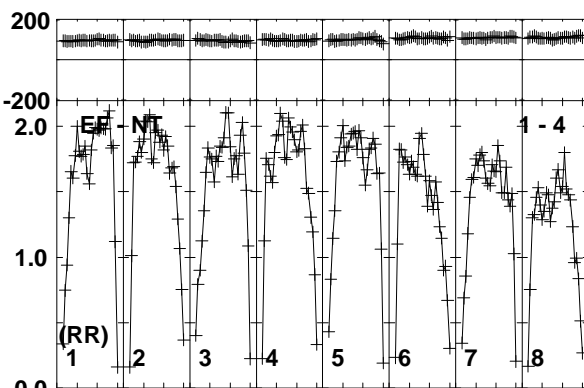
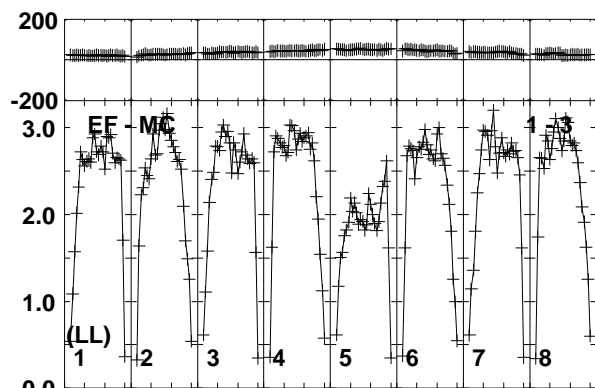
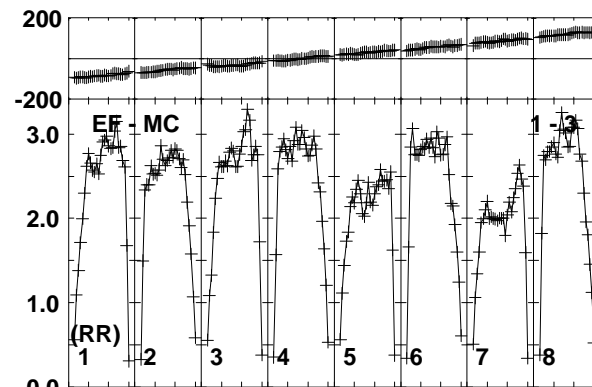
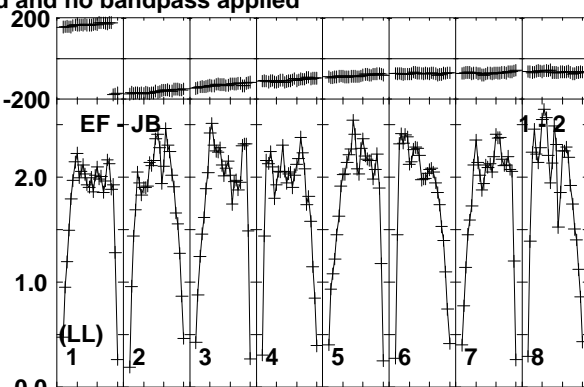
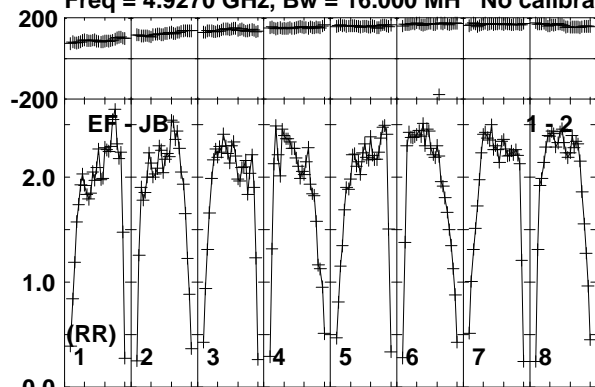

Lower frame: Milli Ampl Jy Top frame: Phas deg  
Vector averaged cross-power spectrum Baseline: EF (01) - JB (02)  
Timerange: 01/01:49:50 to 01/01:51:19

Plot file version 338 created 10-JUN-2016 17:22:36

J1957+3338 RT013A.UVDATA.1

Freq = 4.9270 GHz, Bw = 16.000 MH No calibration applied and no bandpass applied

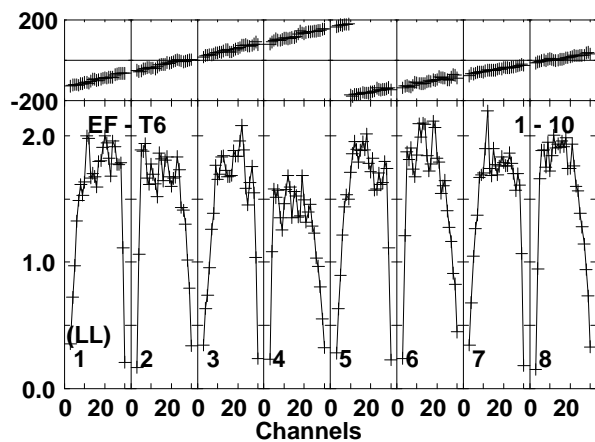
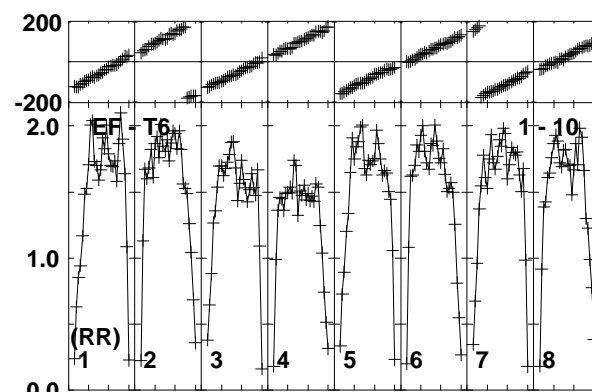
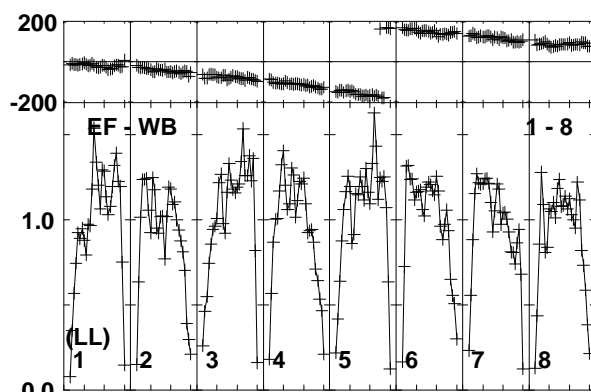
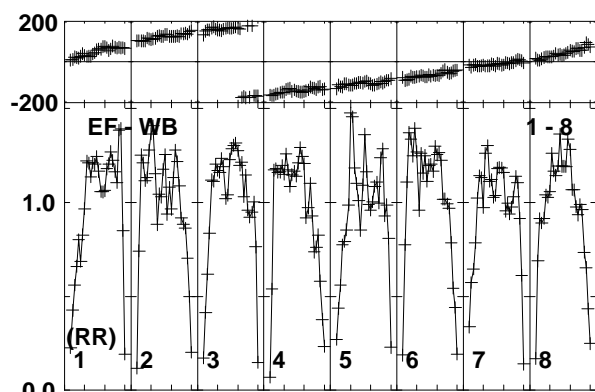
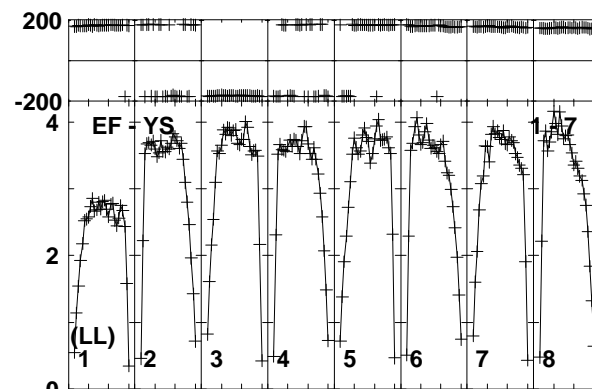
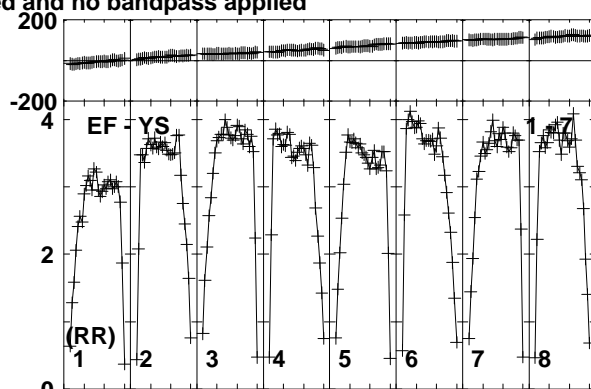
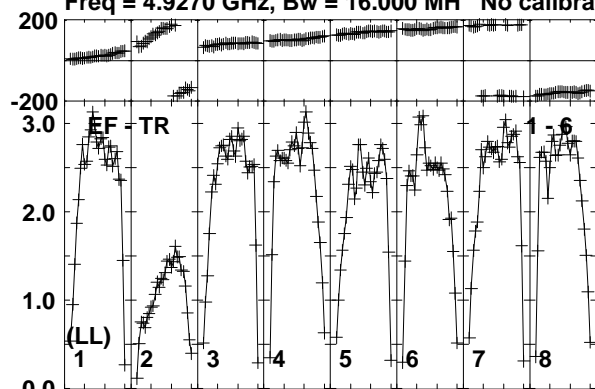

Lower frame: Milli Ampl Jy Top frame: Phas deg  
Vector averaged cross-power spectrum Baseline: EF (01) - TR (06)  
Timerange: 01/01:49:50 to 01/01:51:19



Plot file version 339 created 10-JUN-2016 17:22:37

CHECK RT013A.UVDATA.1

Freq = 4.9270 GHz, Bw = 16.000 MH No calibration applied and no bandpass applied

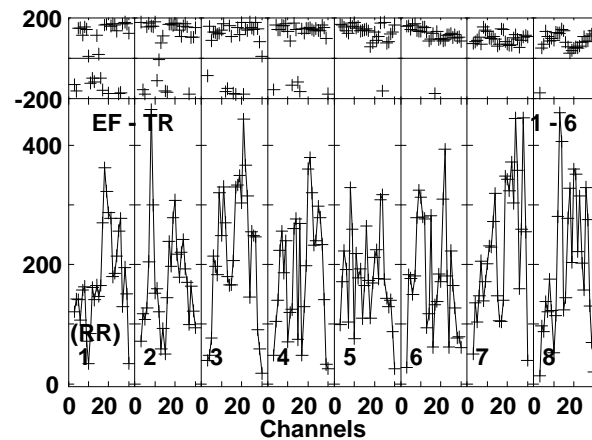
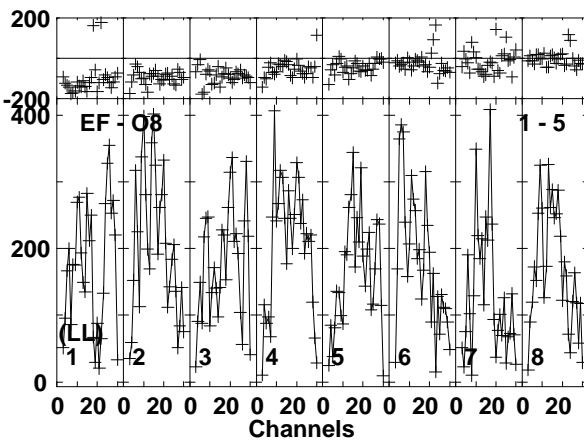
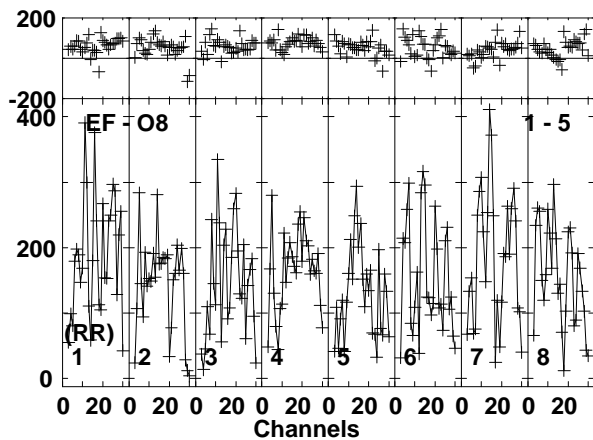
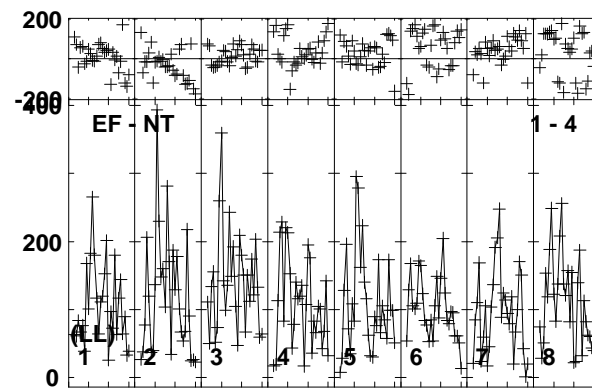
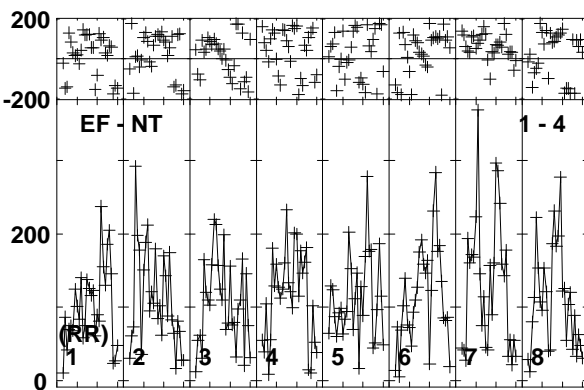
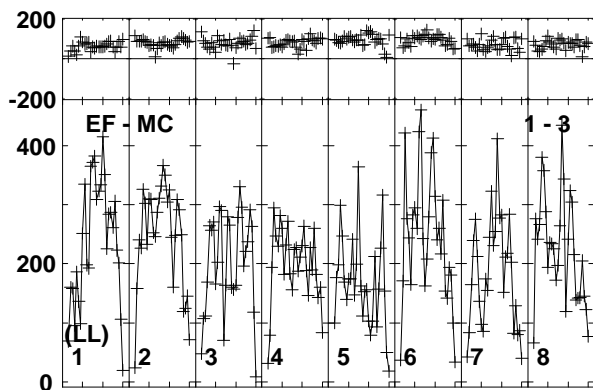
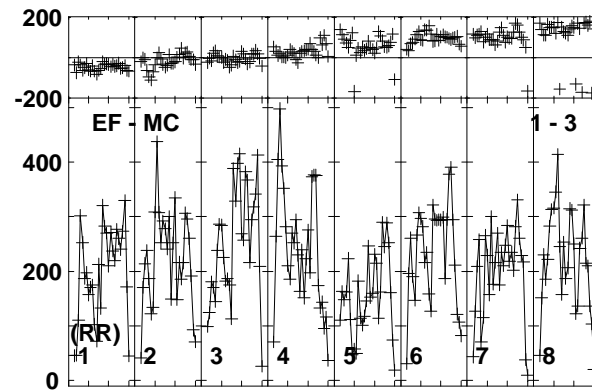
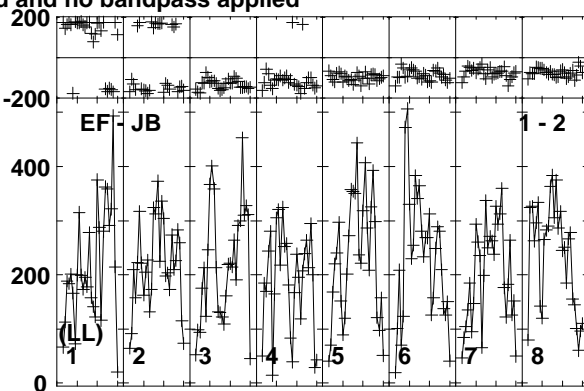
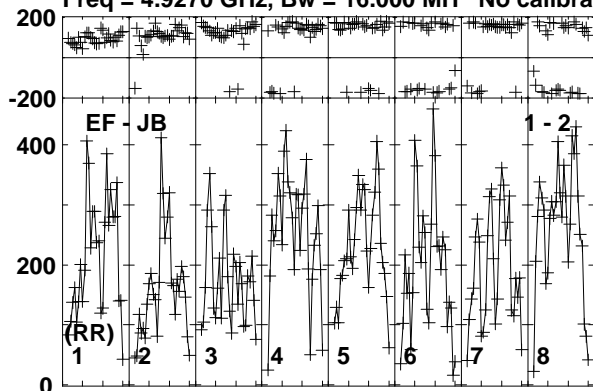

Lower frame: Micro Ampl Jy Top frame: Phas deg  
Vector averaged cross-power spectrum Baseline: EF (01) - JB (02)  
Timerange: 01/01:52:01 to 01/01:54:00

Plot file version 340 created 10-JUN-2016 17:22:37

CHECK RT013A.UVDATA.1

Freq = 4.9270 GHz, Bw = 16.000 MH No calibration applied and no bandpass applied

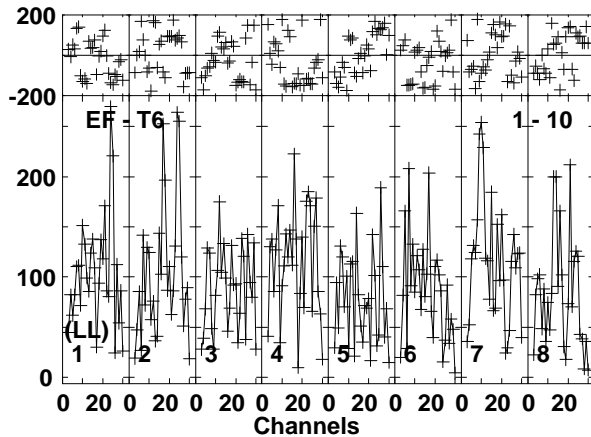
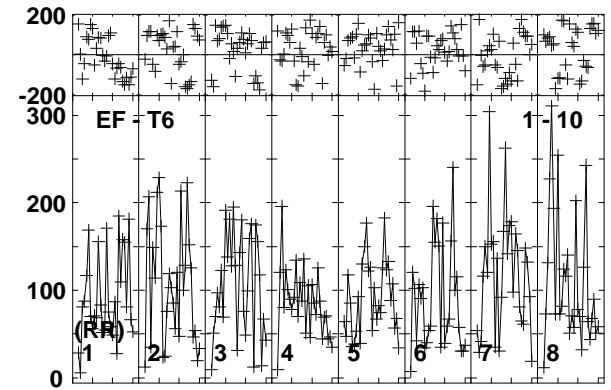
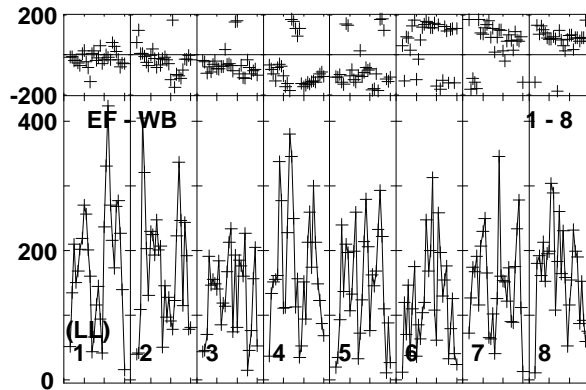
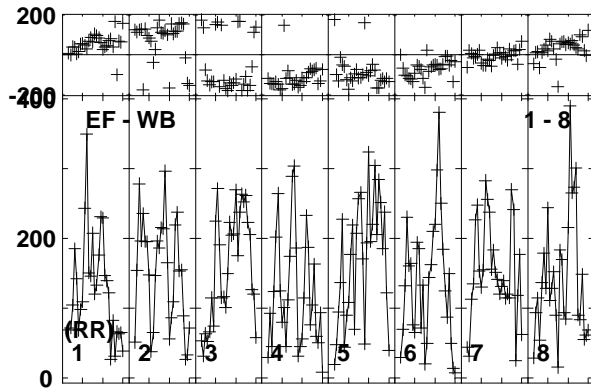
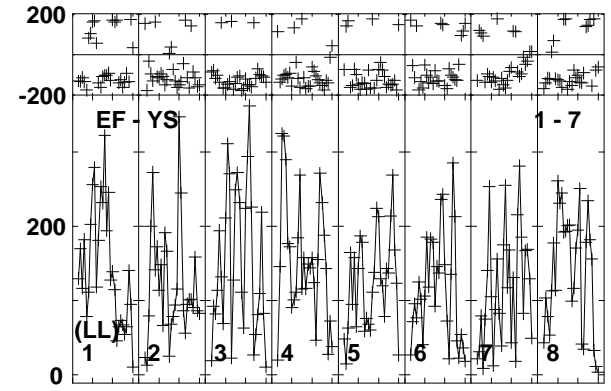
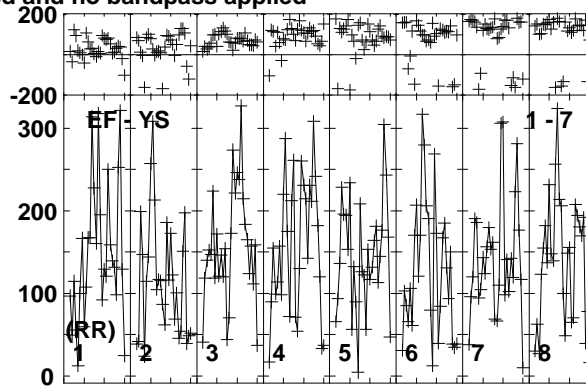
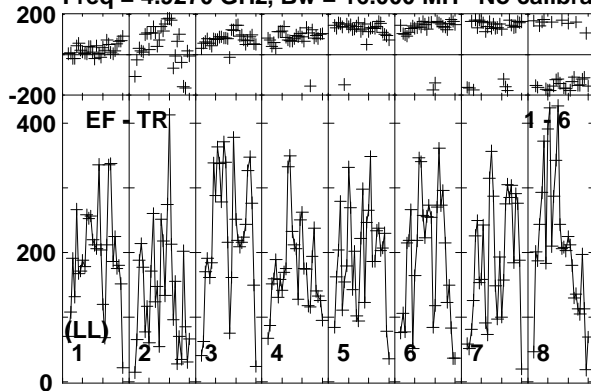

Lower frame: Micro Ampl Jy Top frame: Phas deg  
Vector averaged cross-power spectrum Baseline: EF (01) - TR (06)  
Timerange: 01/01:52:01 to 01/01:54:00

Plot file version 341 created 10-JUN-2016 17:22:37

CYGX1 RT013A.UVDATA.1

Freq = 4.9270 GHz, Bw = 16.000 MH No calibration applied and no bandpass applied

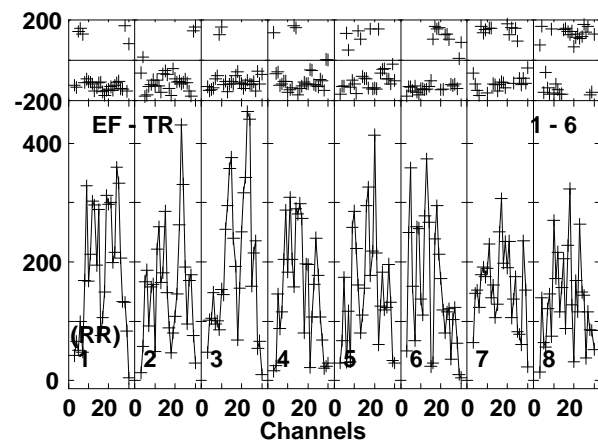
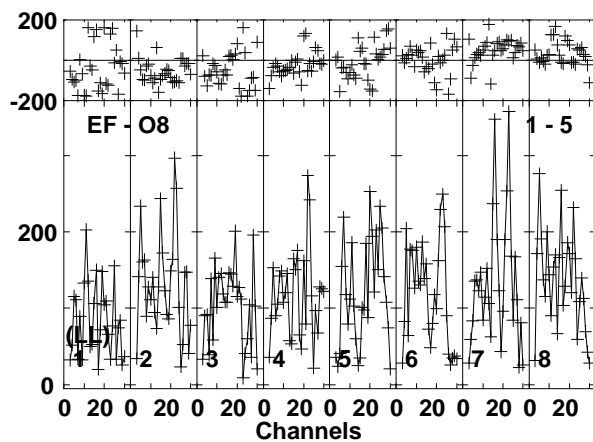
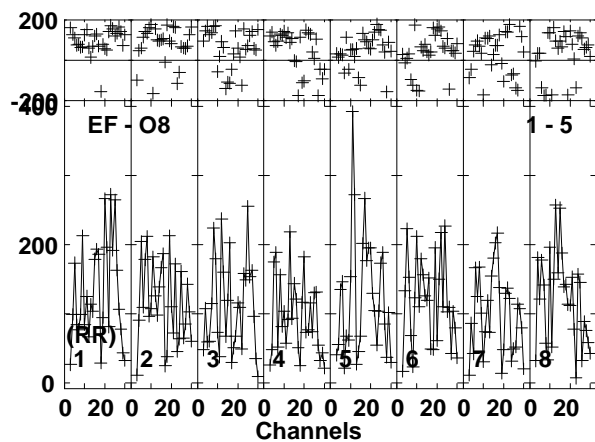
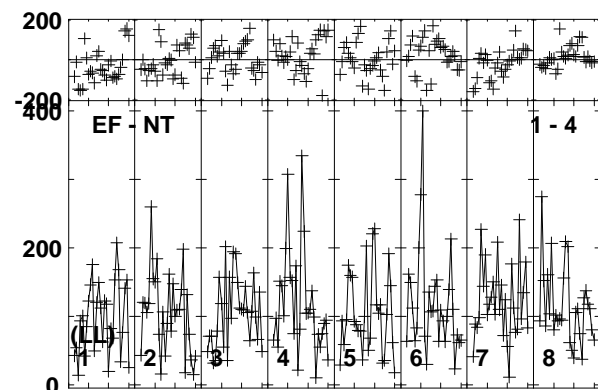
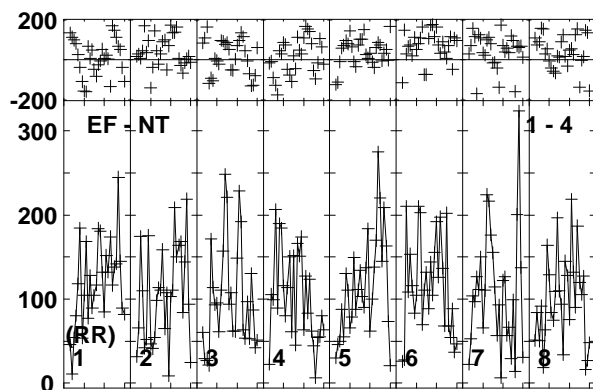
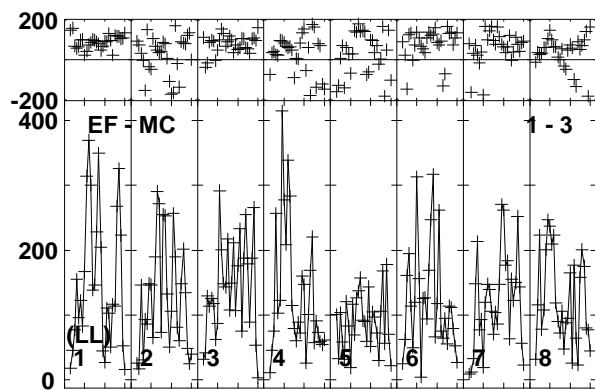
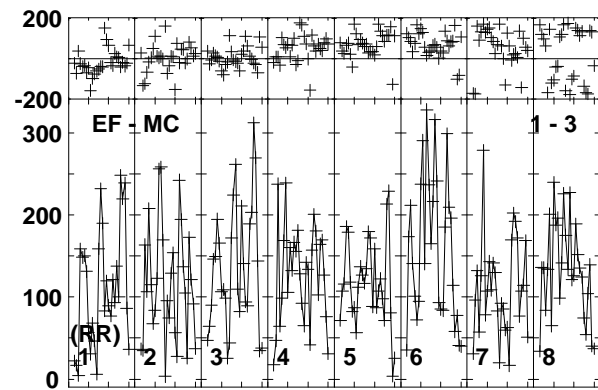
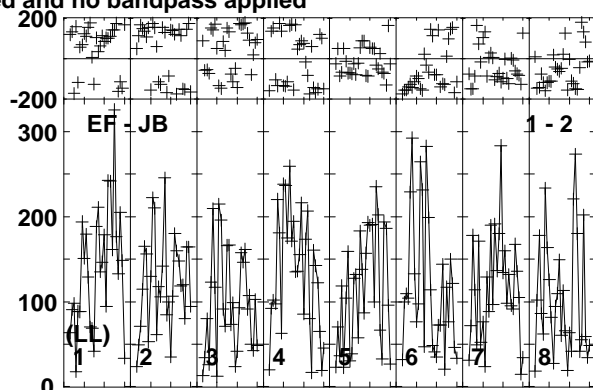
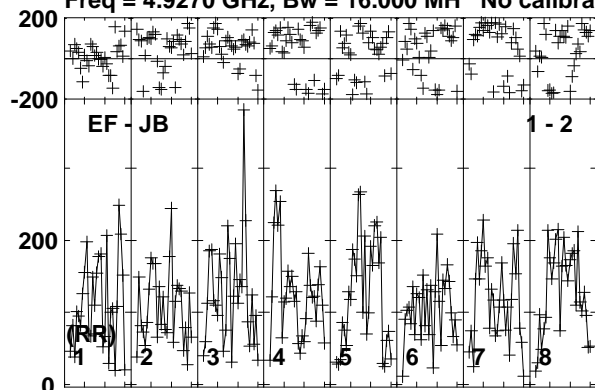

Lower frame: Micro Ampl Jy Top frame: Phas deg  
Vector averaged cross-power spectrum Baseline: EF (01) - JB (02)  
Timerange: 01/01:54:01 to 01/01:56:29

Plot file version 342 created 10-JUN-2016 17:22:37

CYGX1 RT013A.UVDATA.1

Freq = 4.9270 GHz, Bw = 16.000 MH No calibration applied and no bandpass applied

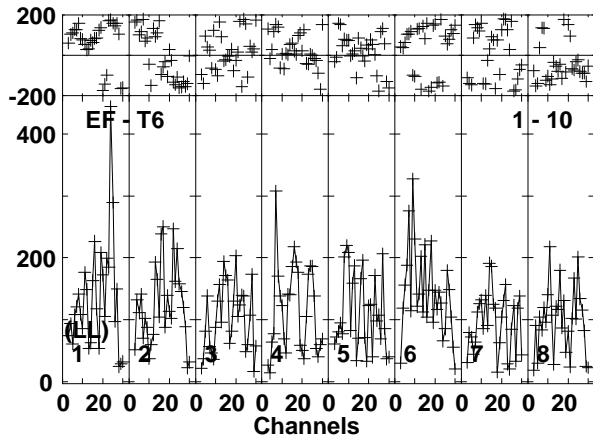
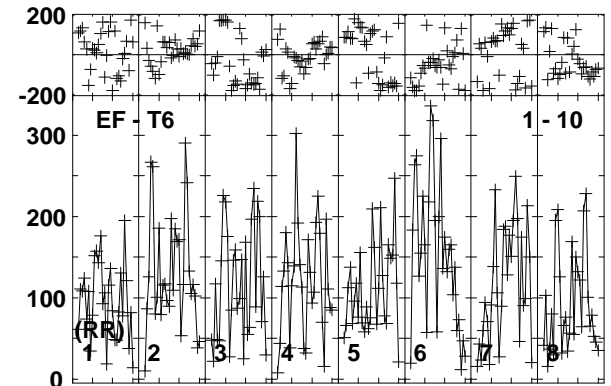
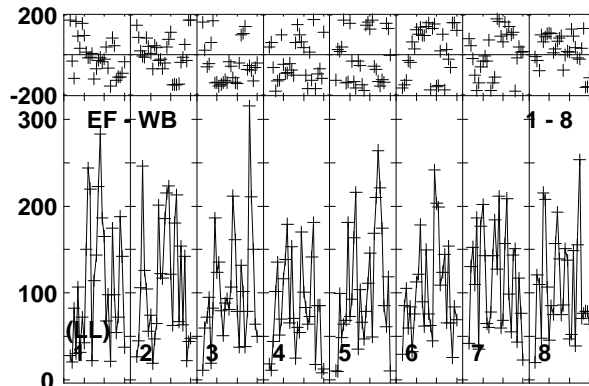
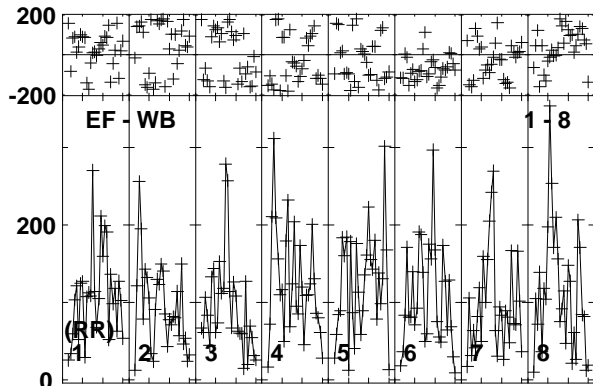
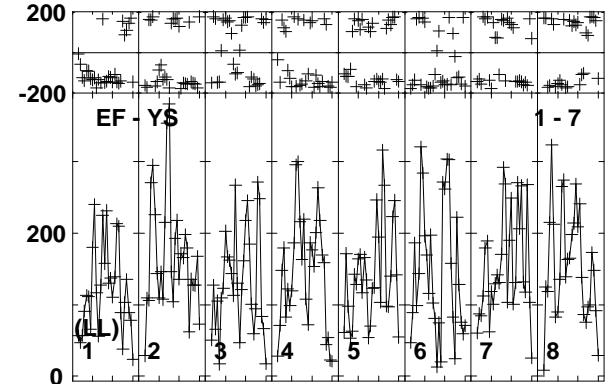
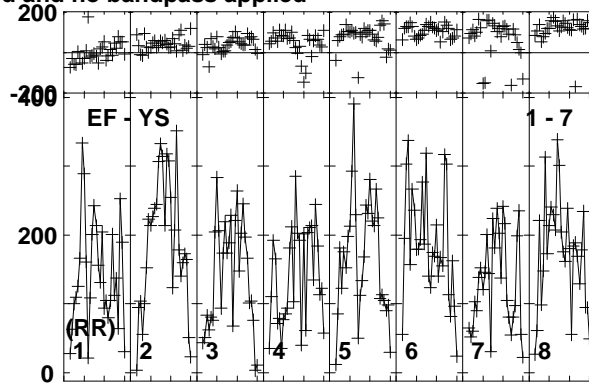
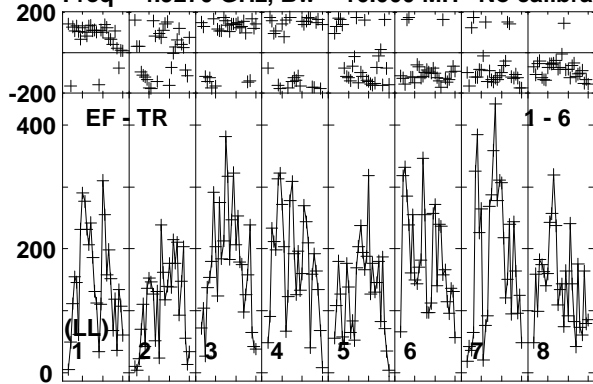

Lower frame: Micro Ampl Jy Top frame: Phas deg  
Vector averaged cross-power spectrum Baseline: EF (01) - TR (06)  
Timerange: 01/01:54:01 to 01/01:56:29

Plot file version 343 created 10-JUN-2016 17:22:37

J1957+3338 RT013A.UVDATA.1

Freq = 4.9270 GHz, Bw = 16.000 MH No calibration applied and no bandpass applied

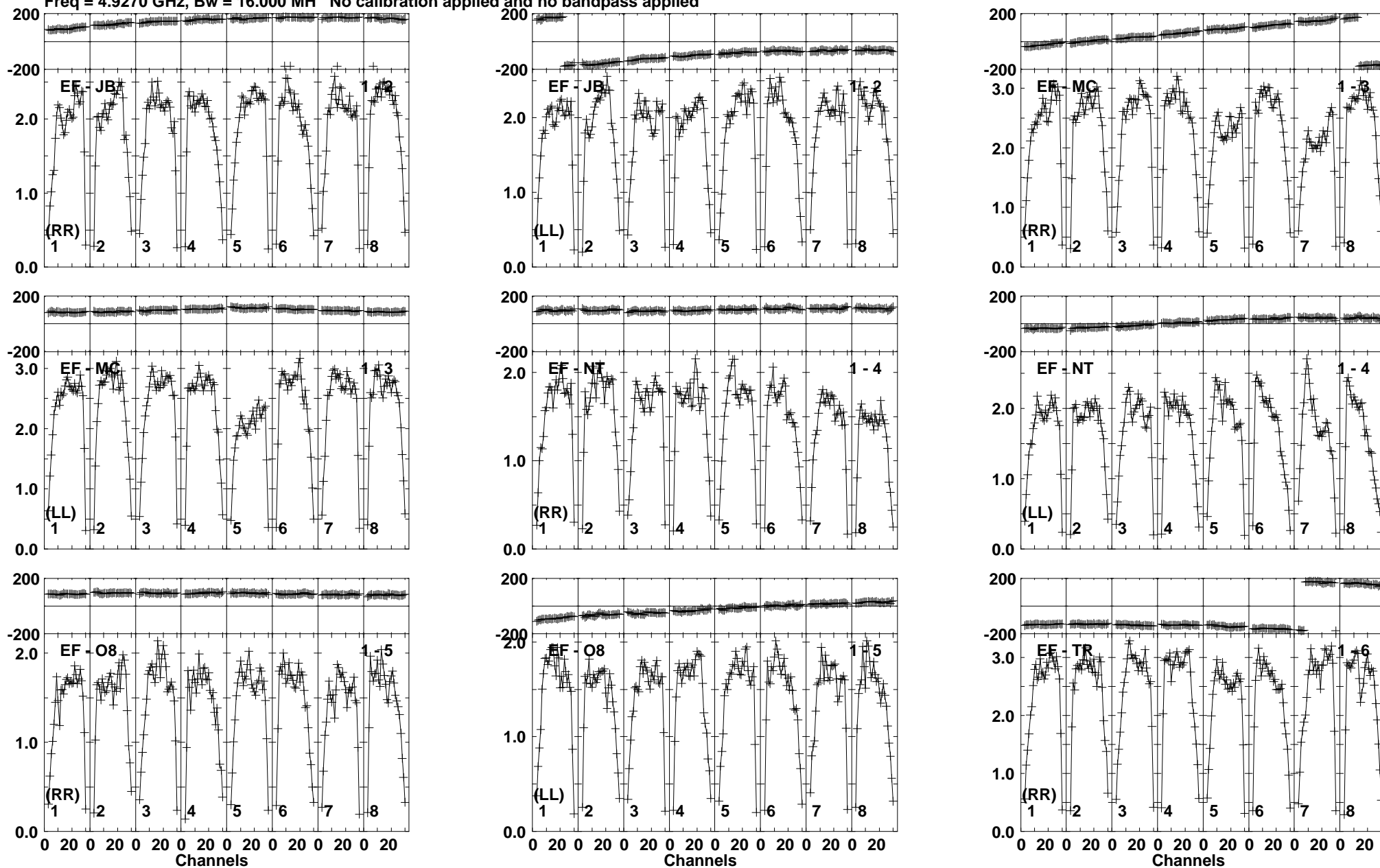

Lower frame: Milli Ampl Jy Top frame: Phas deg  
Vector averaged cross-power spectrum Baseline: EF (01) - JB (02)  
Timerange: 01/01:56:30 to 01/01:57:59

Plot file version 344 created 10-JUN-2016 17:22:37

J1957+3338 RT013A.UVDATA.1

Freq = 4.9270 GHz, Bw = 16.000 MH No calibration applied and no bandpass applied

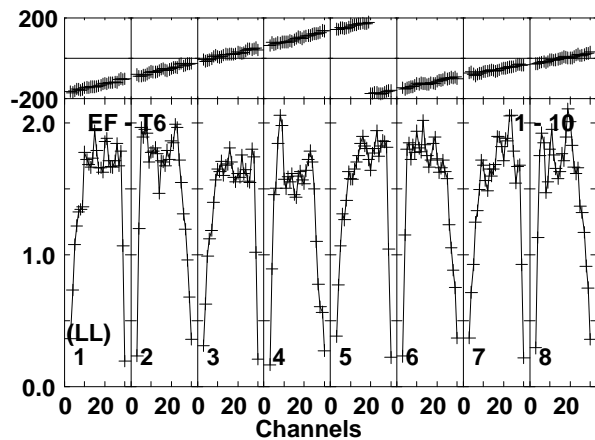
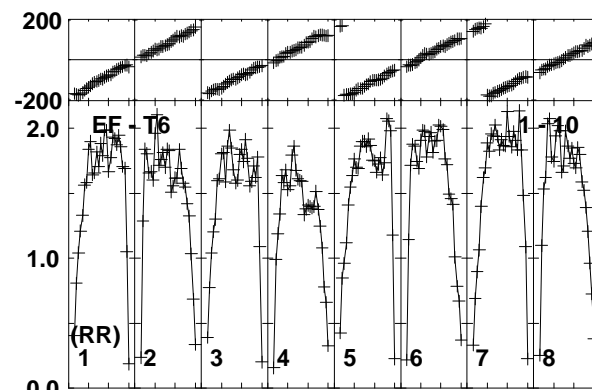
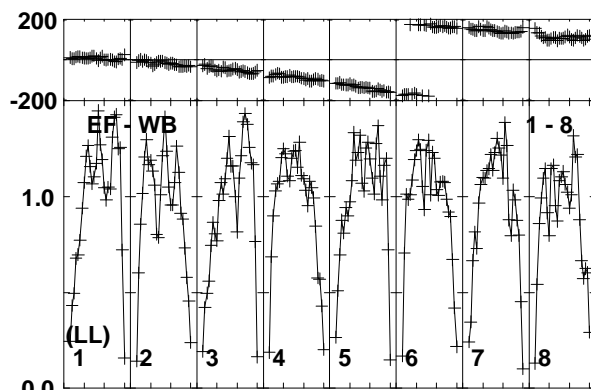
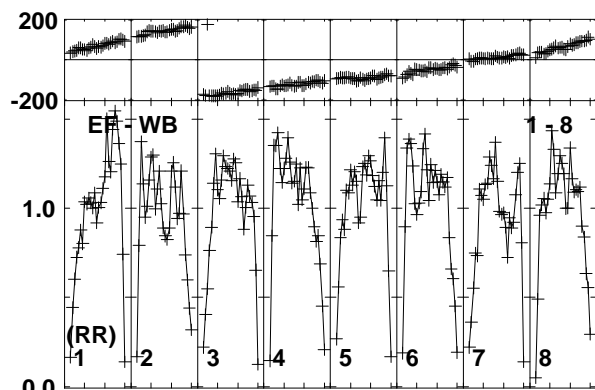
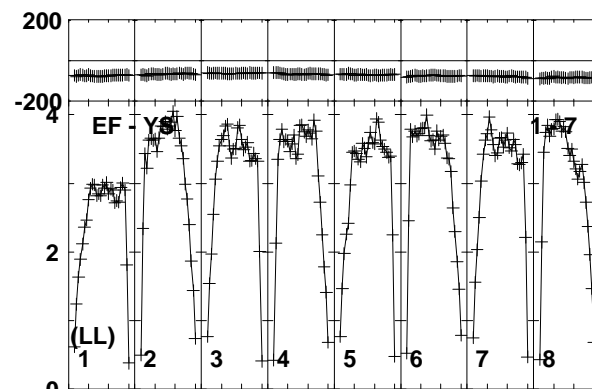
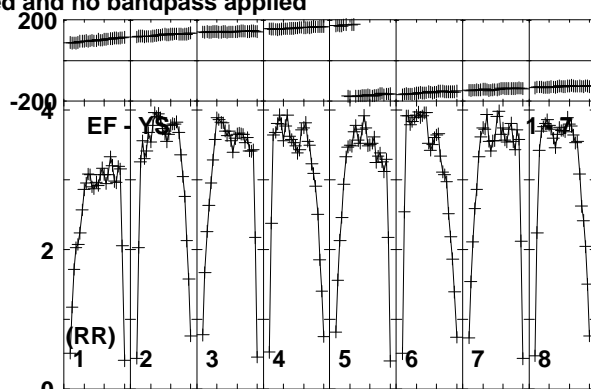
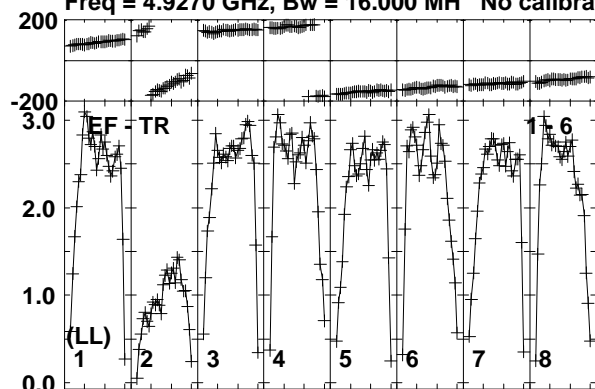

Lower frame: Milli Ampl Jy Top frame: Phas deg  
Vector averaged cross-power spectrum Baseline: EF (01) - TR (06)  
Timerange: 01/01:56:30 to 01/01:57:59

Plot file version 345 created 10-JUN-2016 17:22:37

CHECK RT013A.UVDATA.1

Freq = 4.9270 GHz, Bw = 16.000 MH No calibration applied and no bandpass applied

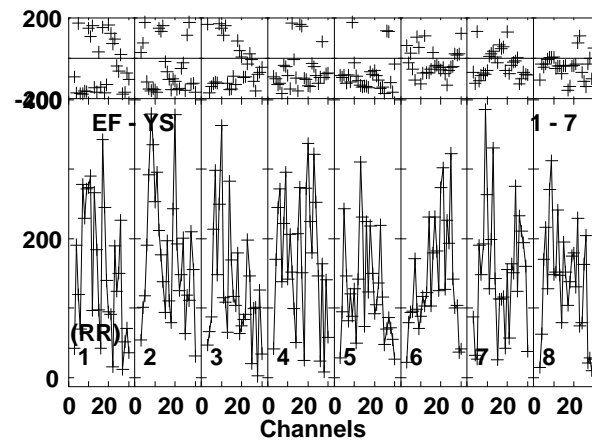
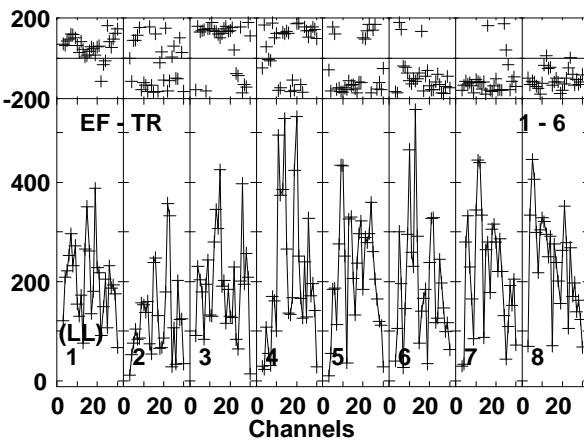
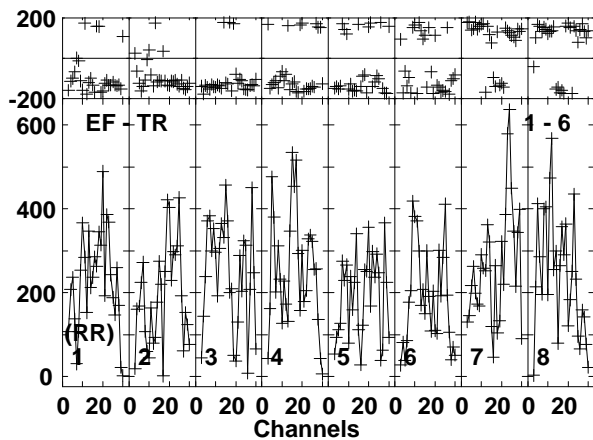
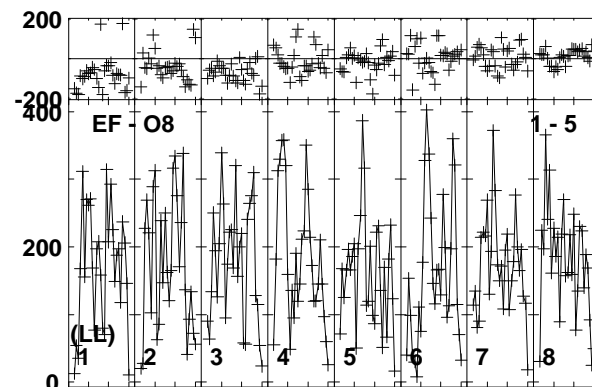
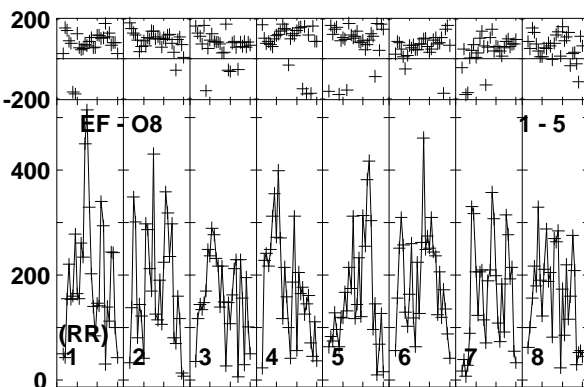
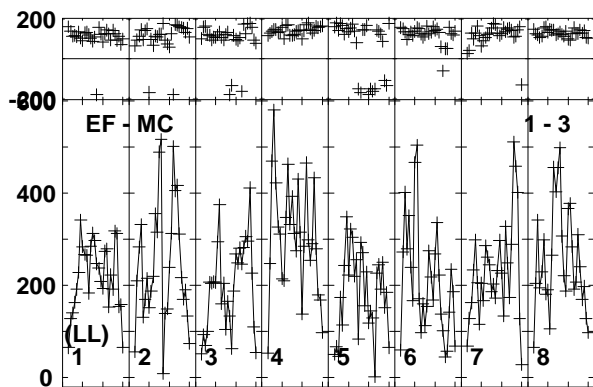
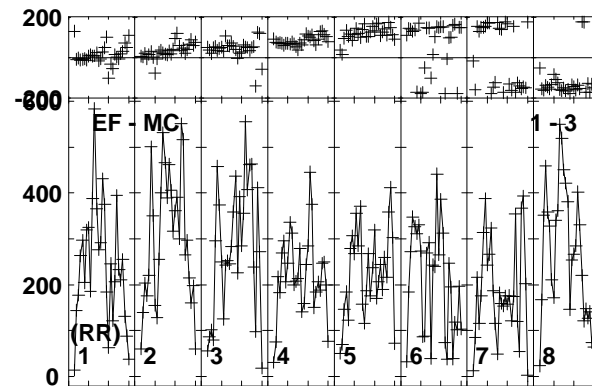
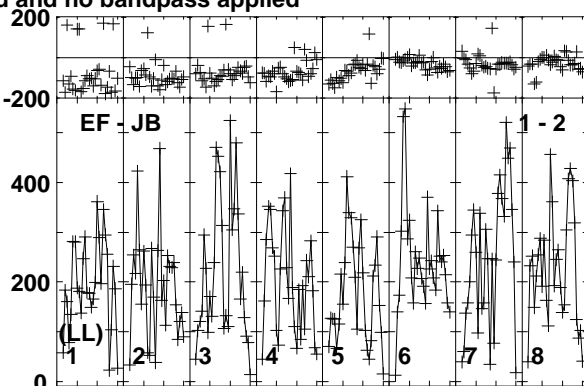
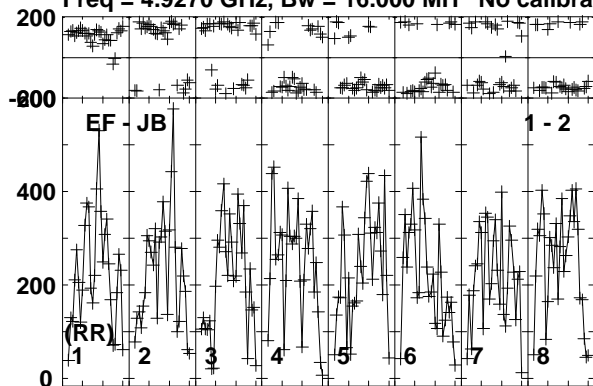

Lower frame: Micro Ampl Jy Top frame: Phas deg  
Vector averaged cross-power spectrum Baseline: EF (01) - JB (02)  
Timerange: 01/01:58:00 to 01/01:59:59

Plot file version 346 created 10-JUN-2016 17:22:37

CHECK RT013A.UVDATA.1

Freq = 4.9270 GHz, Bw = 16.000 MH No calibration applied and no bandpass applied

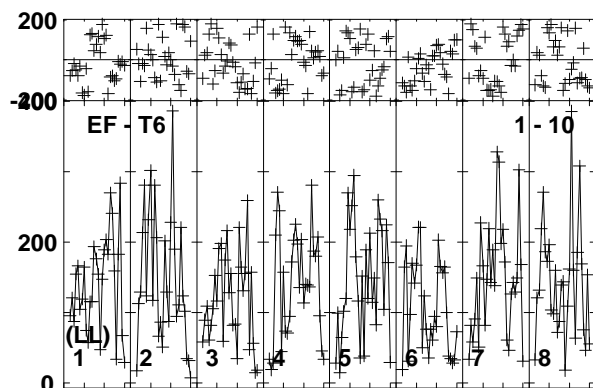
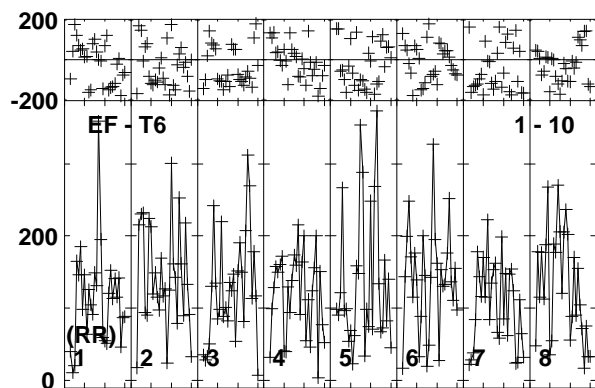
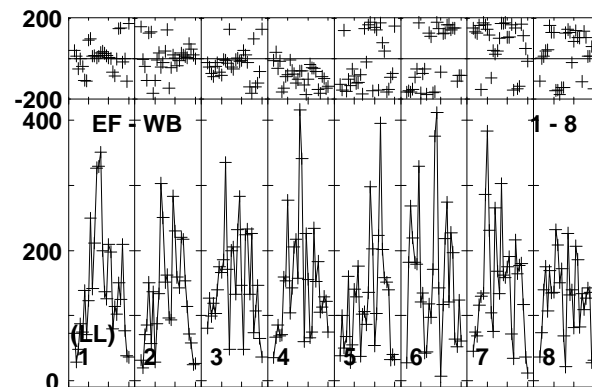
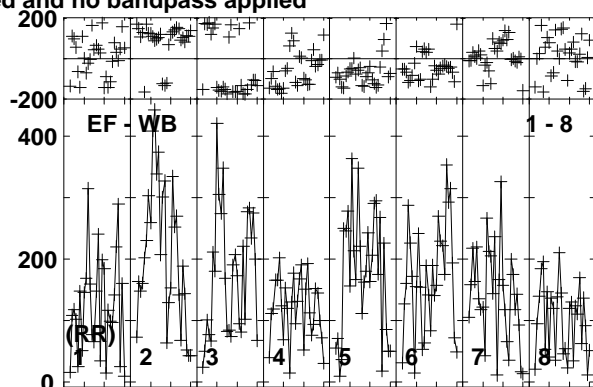
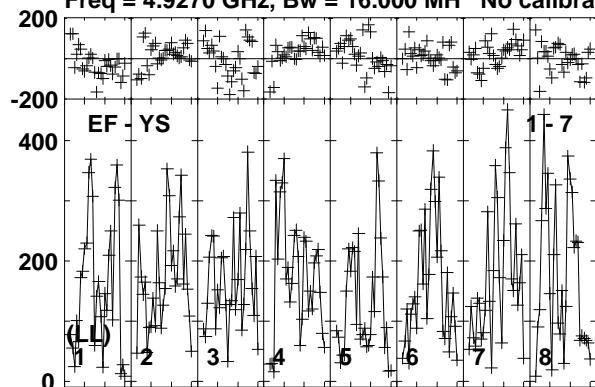

Lower frame: Micro Ampl Jy Top frame: Phas deg  
Vector averaged cross-power spectrum Baseline: EF (01) - YS (07)  
Timerange: 01/01:58:00 to 01/01:59:59



Plot file version 347 created 10-JUN-2016 17:22:37

CYGX1 RT013A.UVDATA.1

Freq = 4.9270 GHz, Bw = 16.000 MH No calibration applied and no bandpass applied

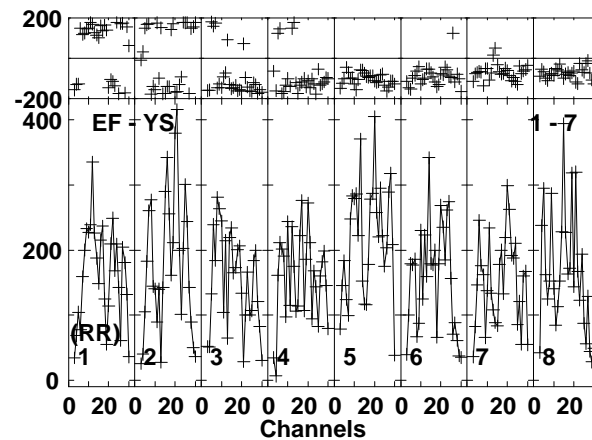
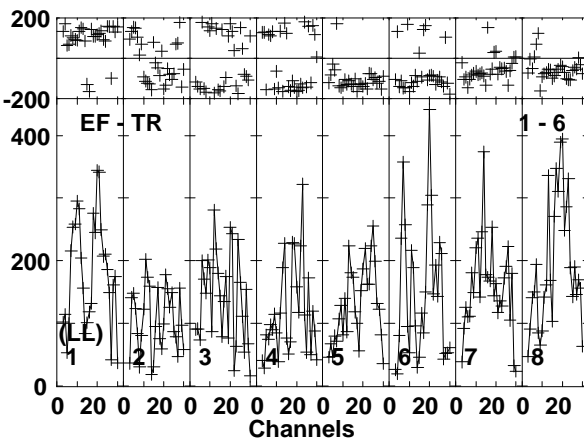
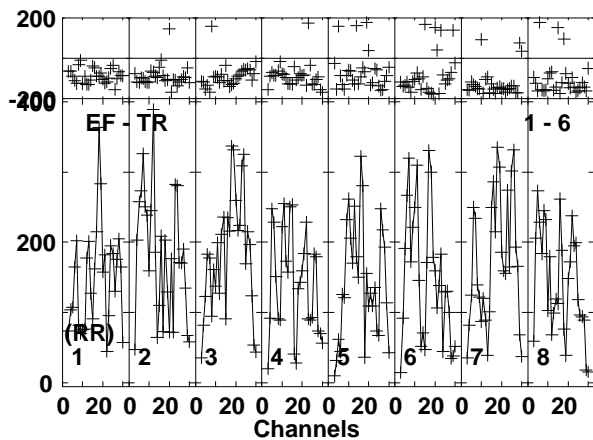
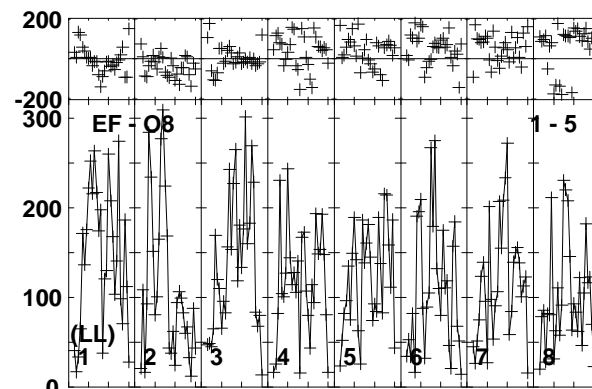
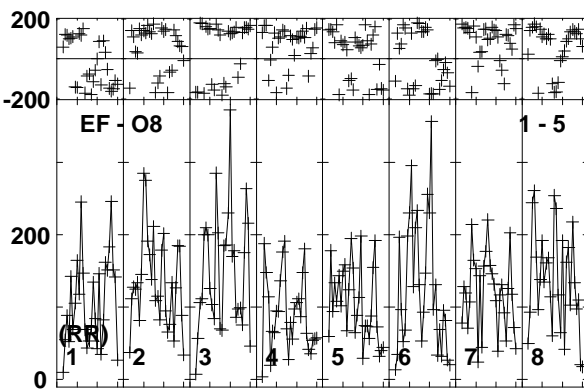
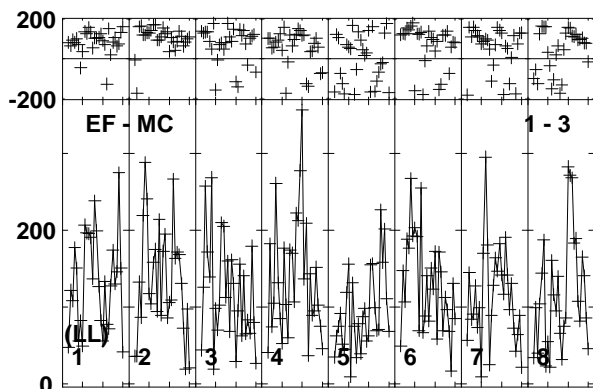
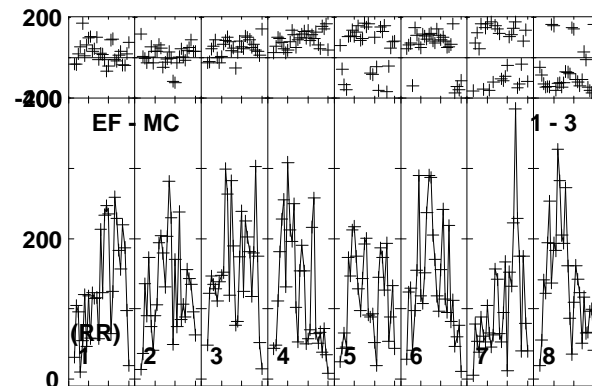
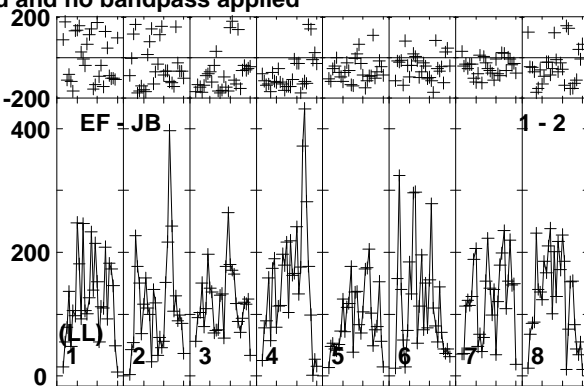
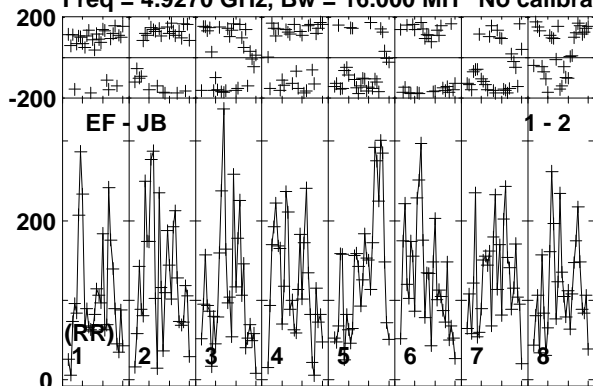

Lower frame: Micro Ampl Jy Top frame: Phas deg  
Vector averaged cross-power spectrum Baseline: EF (01) - JB (02)  
Timerange: 01/02:00:00 to 01/02:02:30

Plot file version 348 created 10-JUN-2016 17:22:38

CYGX1 RT013A.UVDATA.1

Freq = 4.9270 GHz, Bw = 16.000 MH No calibration applied and no bandpass applied

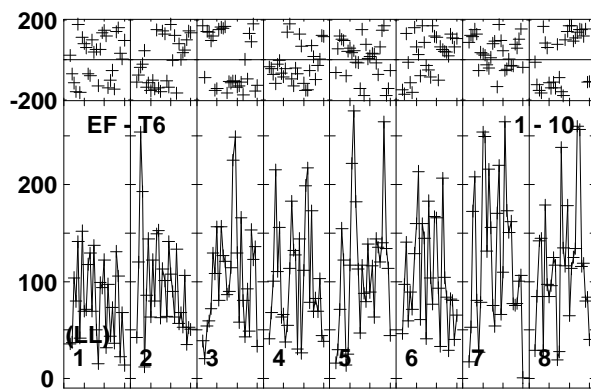
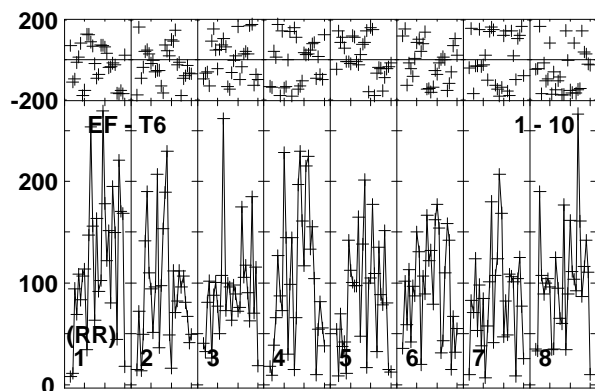
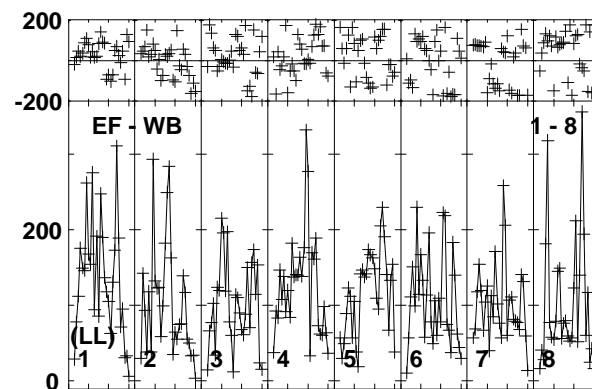
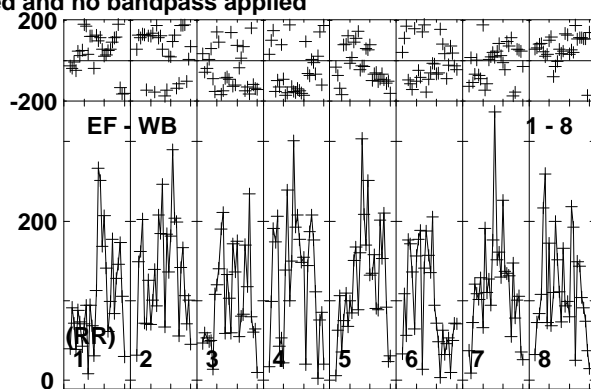
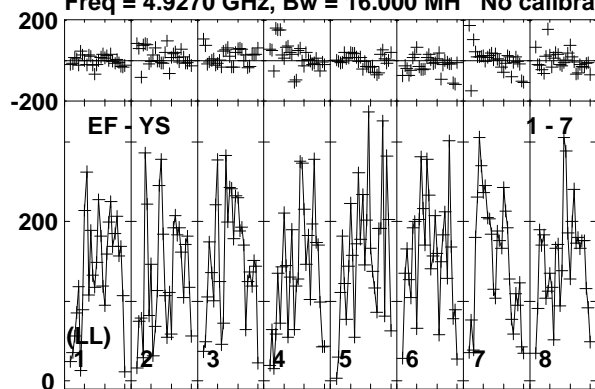

Lower frame: Micro Ampl Jy Top frame: Phas deg  
Vector averaged cross-power spectrum Baseline: EF (01) - YS (07)  
Timerange: 01/02:00:00 to 01/02:02:30

Plot file version 349 created 10-JUN-2016 17:22:38

J1957+3338 RT013A.UVDATA.1

Freq = 4.9270 GHz, Bw = 16.000 MH No calibration applied and no bandpass applied

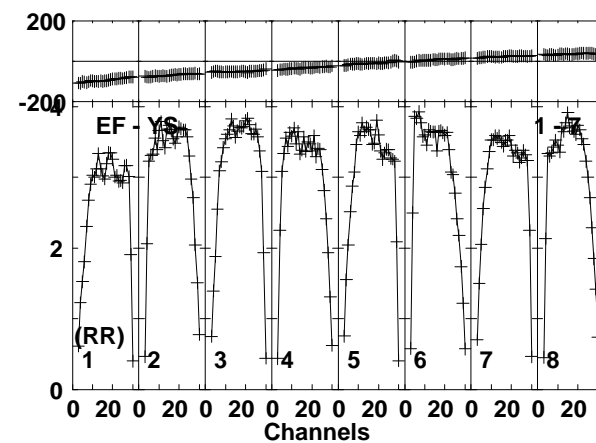
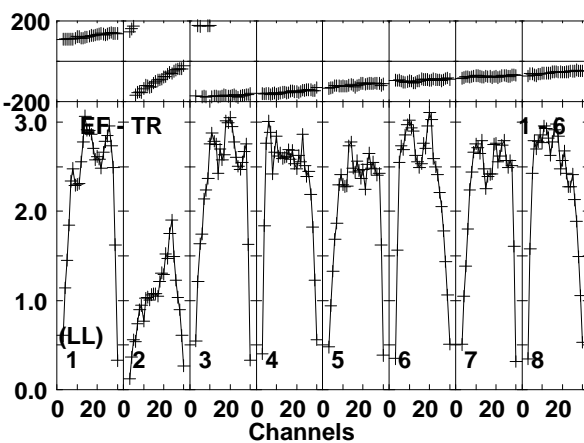
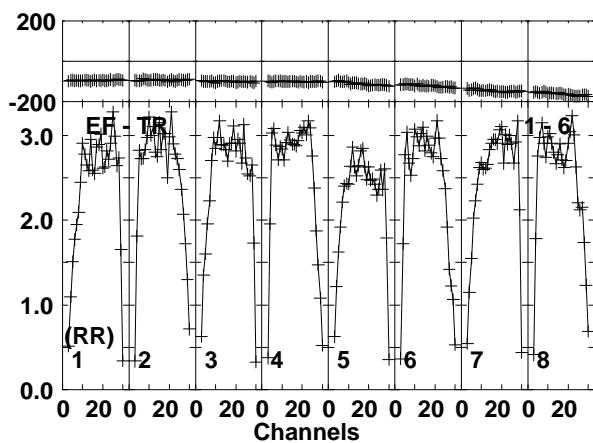
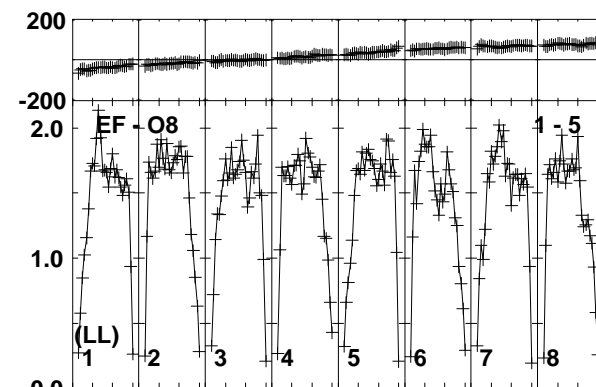
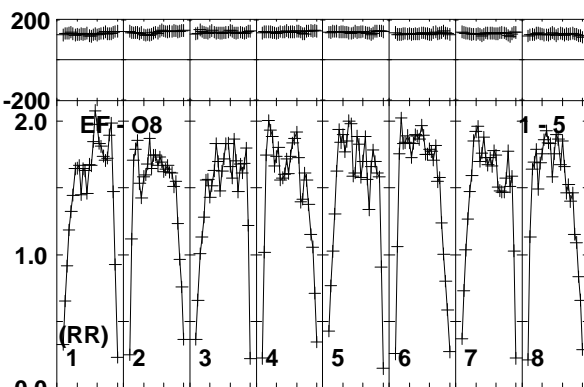
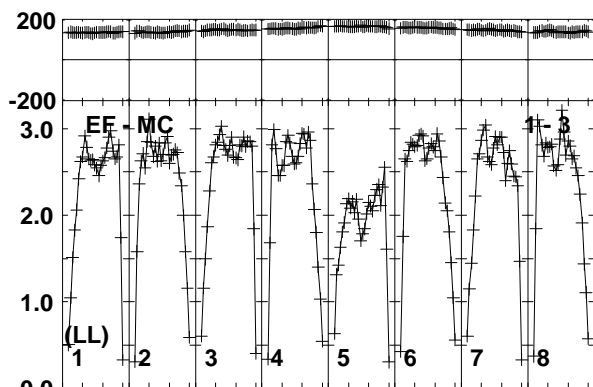
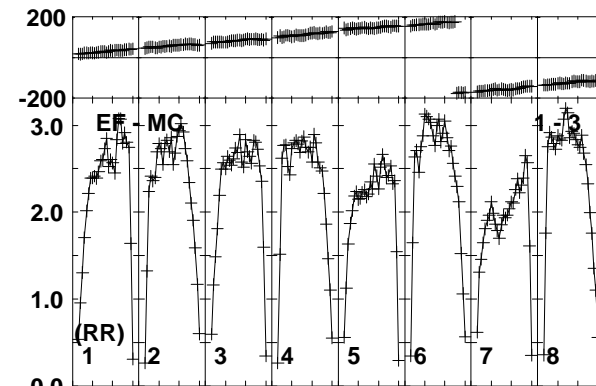
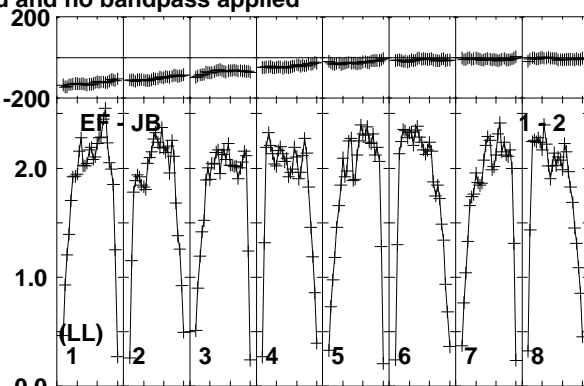
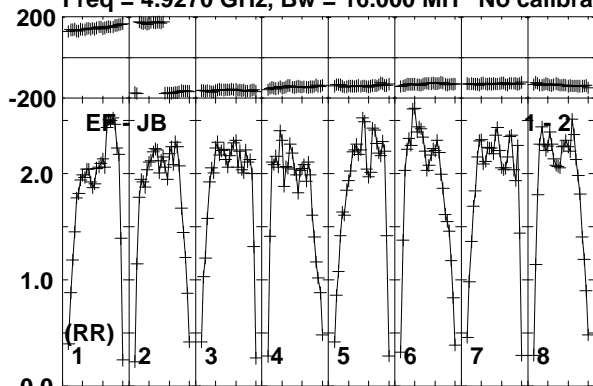

Lower frame: Milli Ampl Jy Top frame: Phas deg  
Vector averaged cross-power spectrum Baseline: EF (01) - JB (02)  
Timerange: 01/02:02:31 to 01/02:04:00

Plot file version 350 created 10-JUN-2016 17:22:38

J1957+3338 RT013A.UVDATA.1

Freq = 4.9270 GHz, Bw = 16.000 MH No calibration applied and no bandpass applied

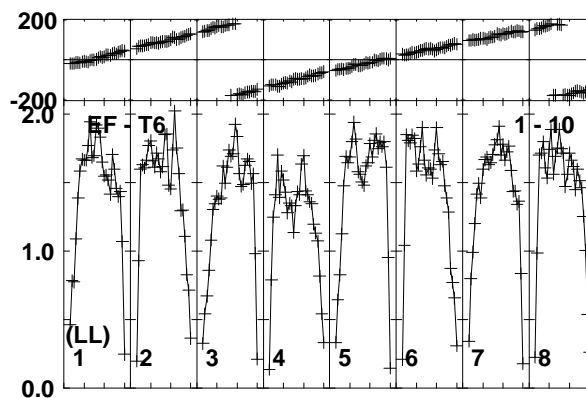
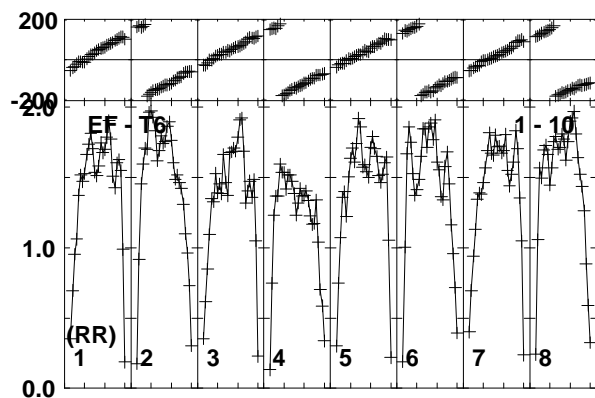
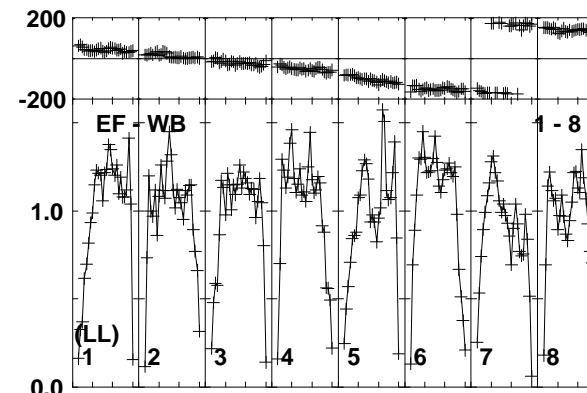
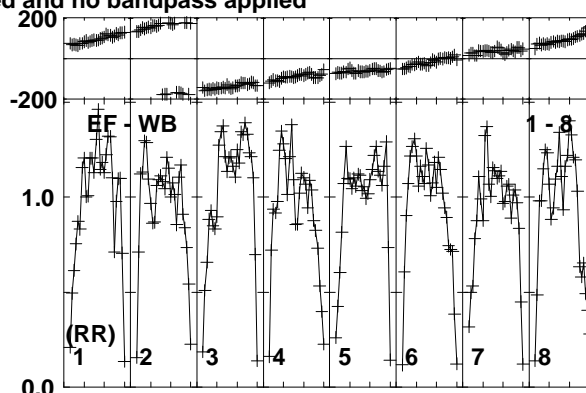
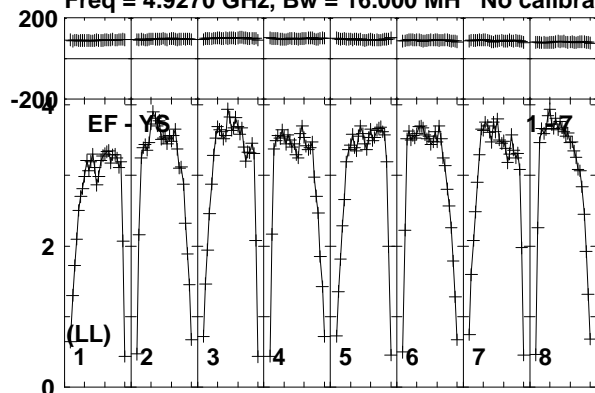

Lower frame: Milli Ampl Jy Top frame: Phas deg  
Vector averaged cross-power spectrum Baseline: EF (01) - YS (07)  
Timerange: 01/02:02:31 to 01/02:04:00

Plot file version 351 created 10-JUN-2016 17:22:38

BLLAC RT013A.UVDATA.1

Freq = 4.9270 GHz, Bw = 16.000 MH No calibration applied and no bandpass applied

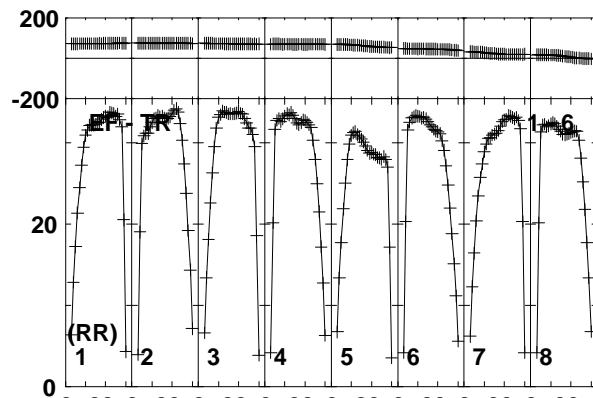
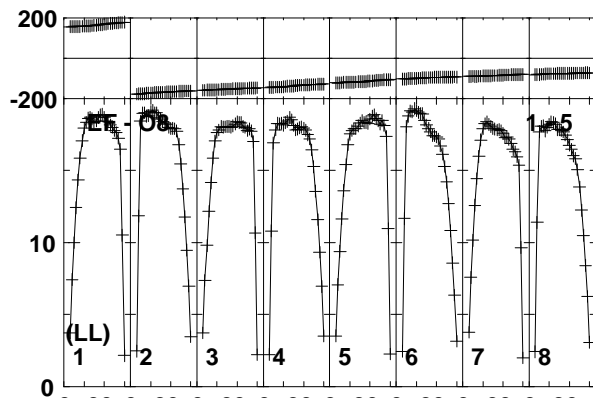
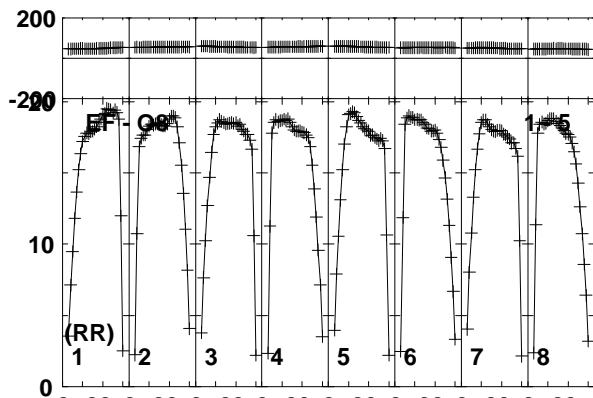
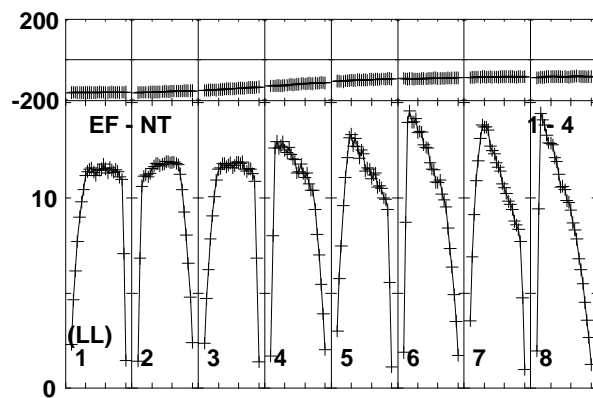
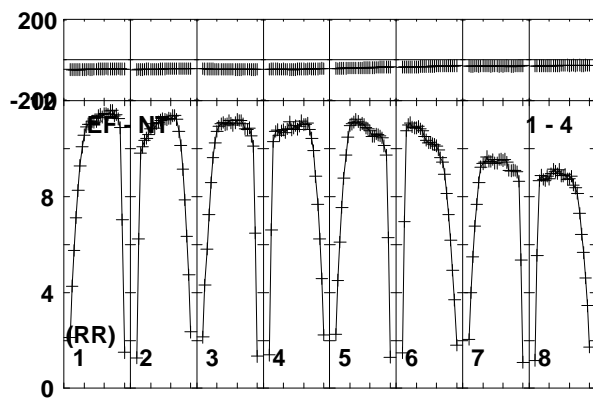
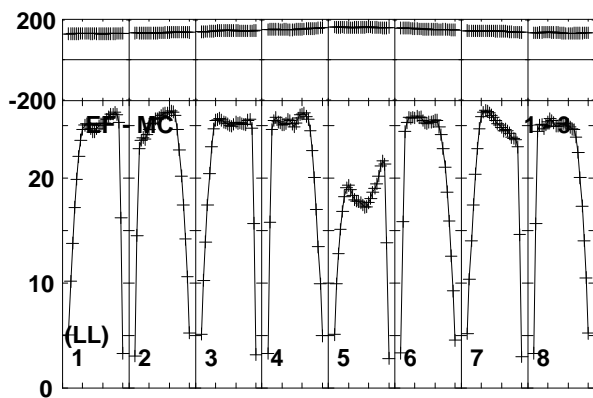
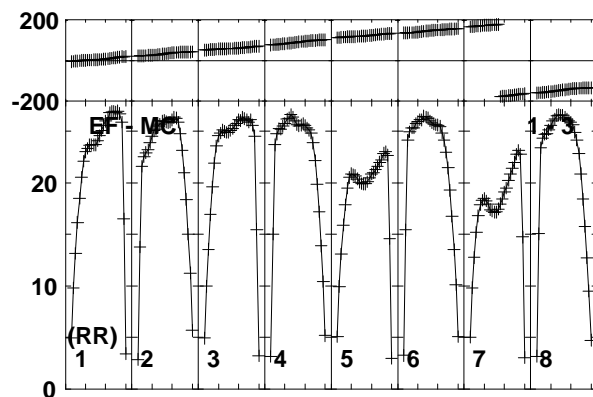
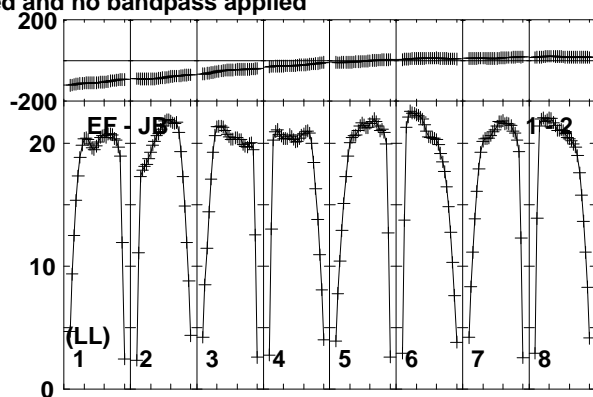
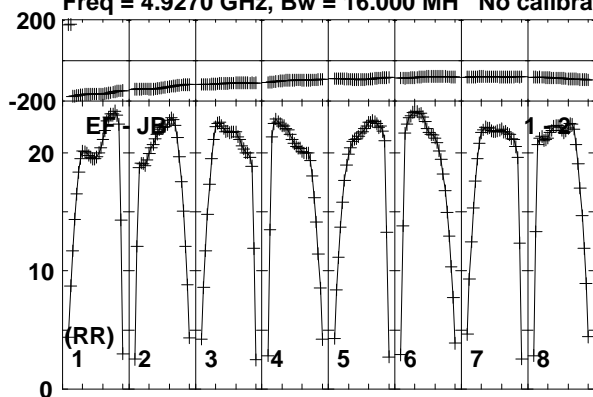

Lower frame: Milli Ampl Jy Top frame: Phas deg  
Vector averaged cross-power spectrum Baseline: EF (01) - JB (02)  
Timerange: 01/02:07:10 to 01/02:13:10

Plot file version 352 created 10-JUN-2016 17:22:38

BLLAC RT013A.UVDATA.1

Freq = 4.9270 GHz, Bw = 16.000 MH No calibration applied and no bandpass applied

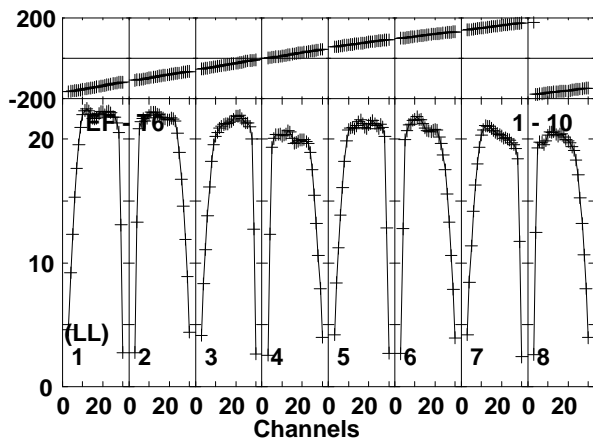
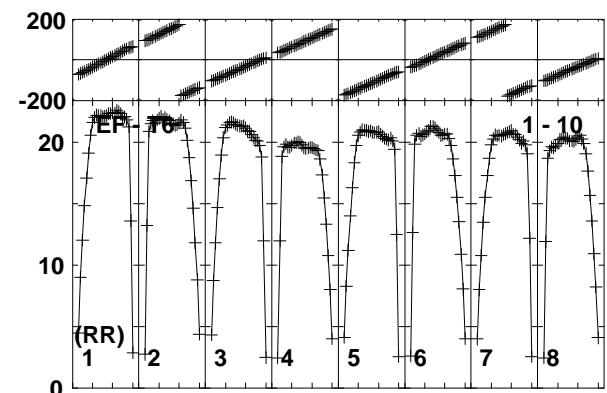
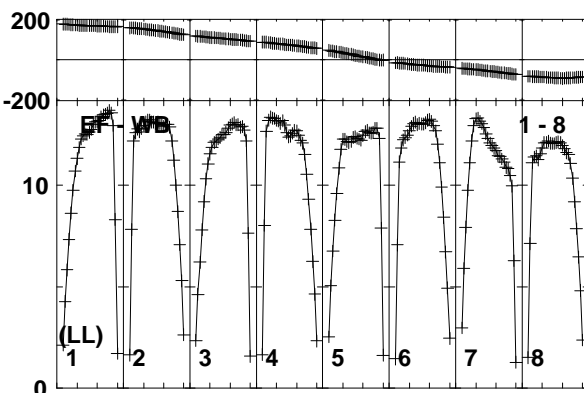
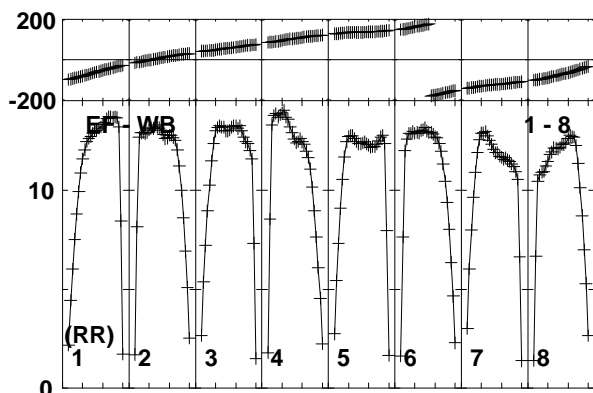
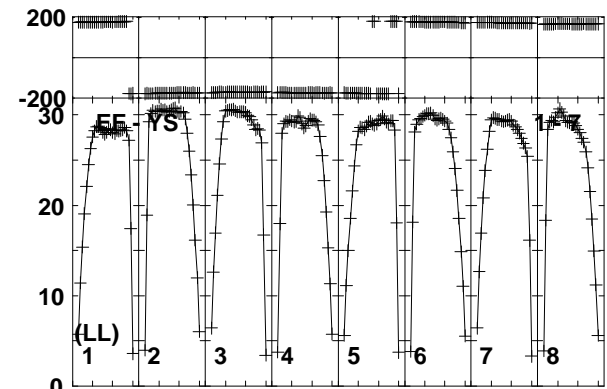
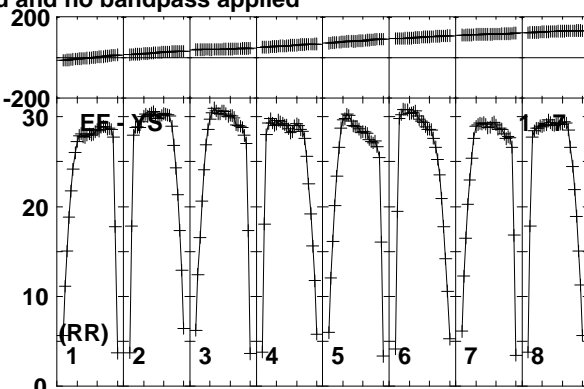
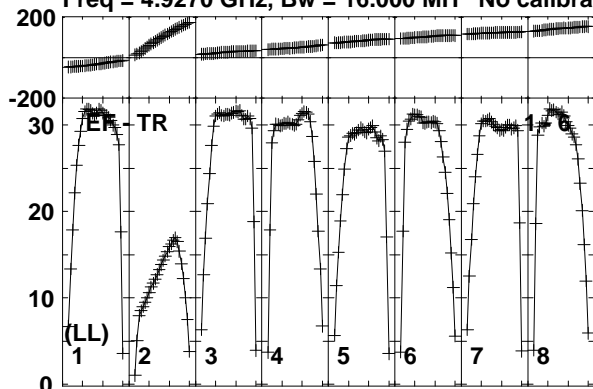

Lower frame: Milli Ampl Jy Top frame: Phas deg  
Vector averaged cross-power spectrum Baseline: EF (01) - TR (06)  
Timerange: 01/02:07:10 to 01/02:13:10

Plot file version 353 created 10-JUN-2016 17:22:38

J1957+3338 RT013A.UVDATA.1

Freq = 4.9270 GHz, Bw = 16.000 MH No calibration applied and no bandpass applied

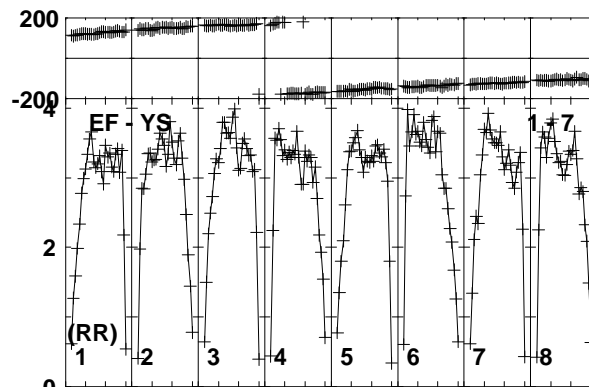
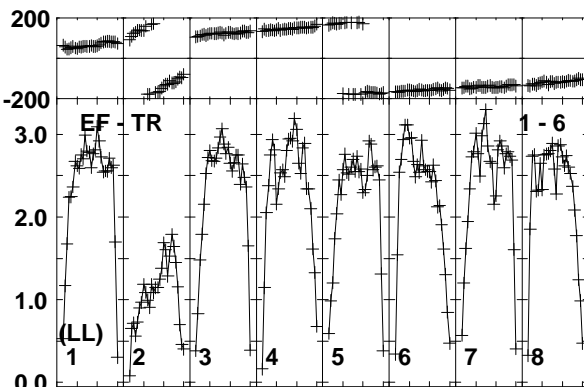
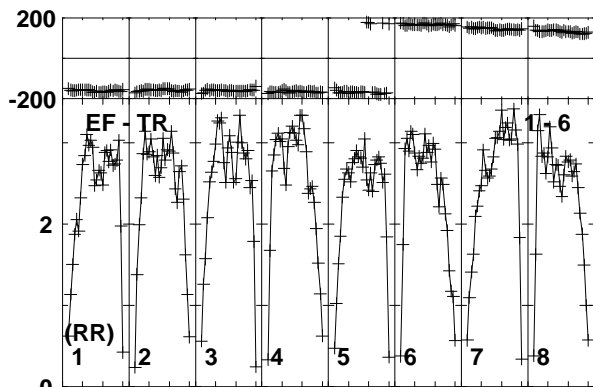
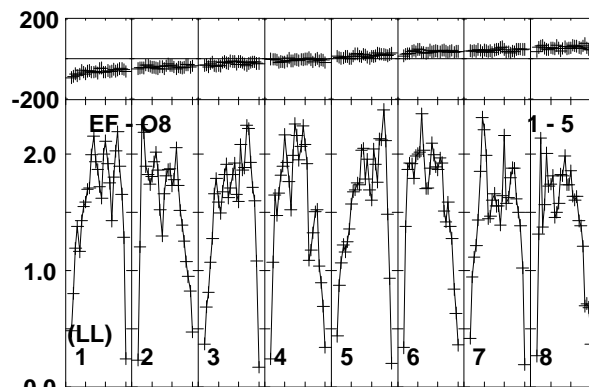
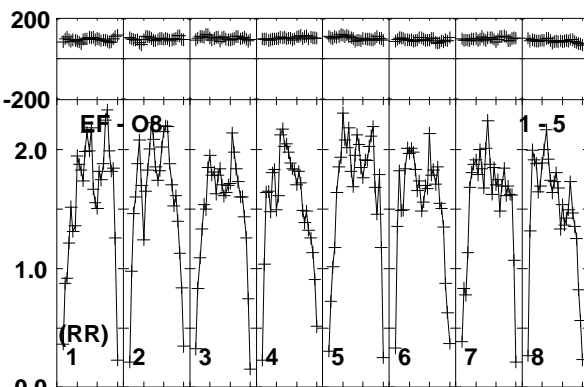
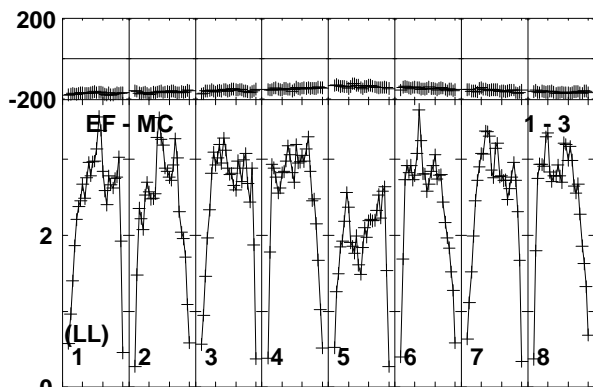
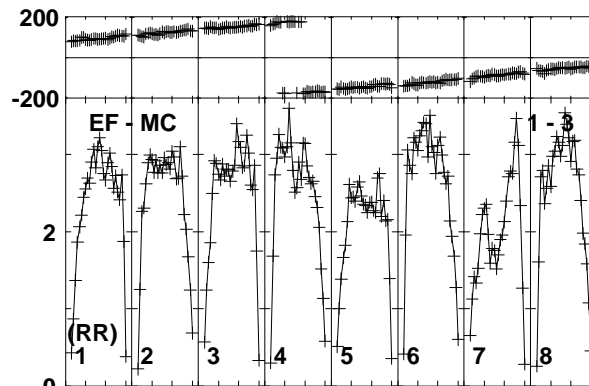
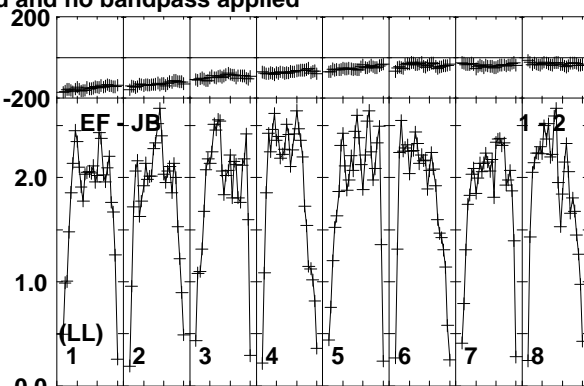
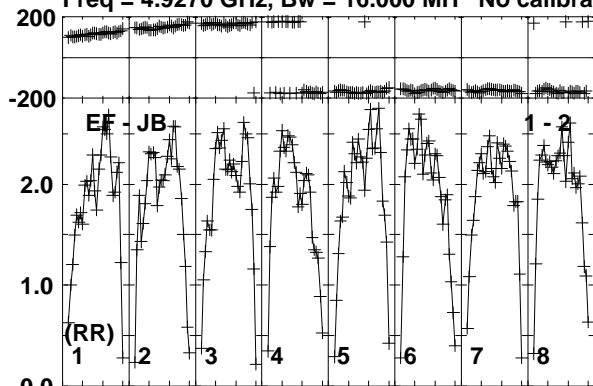

Lower frame: Milli Ampl Jy Top frame: Phas deg  
Vector averaged cross-power spectrum Baseline: EF (01) - JB (02)  
Timerange: 01/02:17:38 to 01/02:18:00

Plot file version 354 created 10-JUN-2016 17:22:38

J1957+3338 RT013A.UVDATA.1

Freq = 4.9270 GHz, Bw = 16.000 MH No calibration applied and no bandpass applied

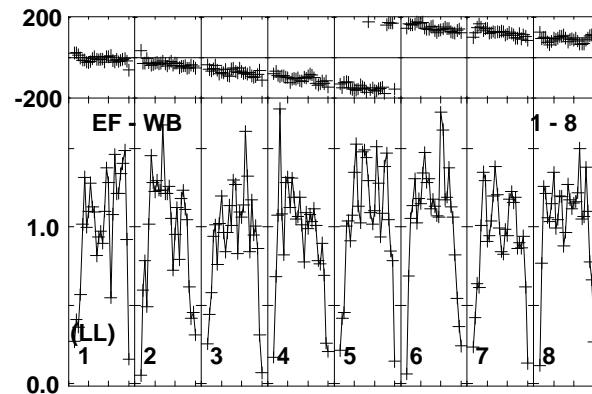
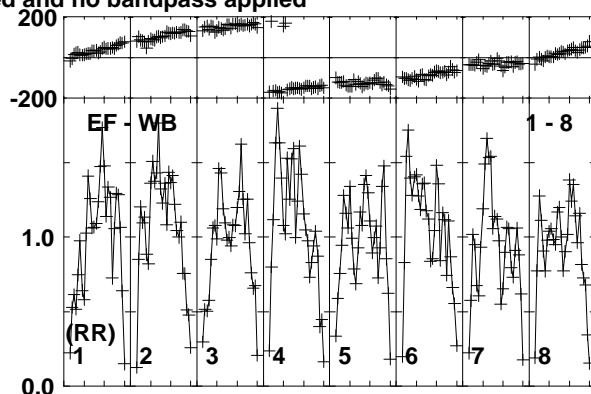
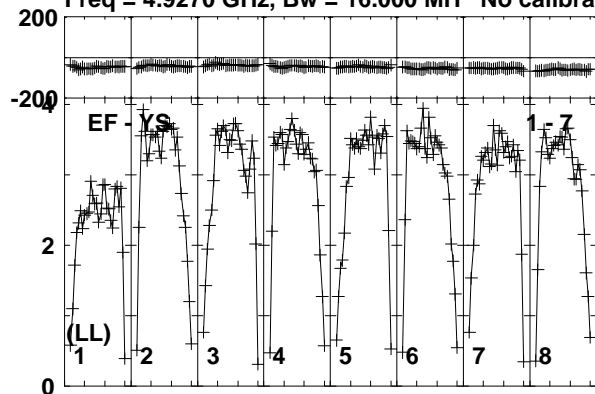

Lower frame: Milli Ampl Jy Top frame: Phas deg  
Vector averaged cross-power spectrum Baseline: EF (01) - YS (07)  
Timerange: 01/02:17:38 to 01/02:18:00



Plot file version 355 created 10-JUN-2016 17:22:38

CHECK RT013A.UVDATA.1

Freq = 4.9270 GHz, Bw = 16.000 MH No calibration applied and no bandpass applied

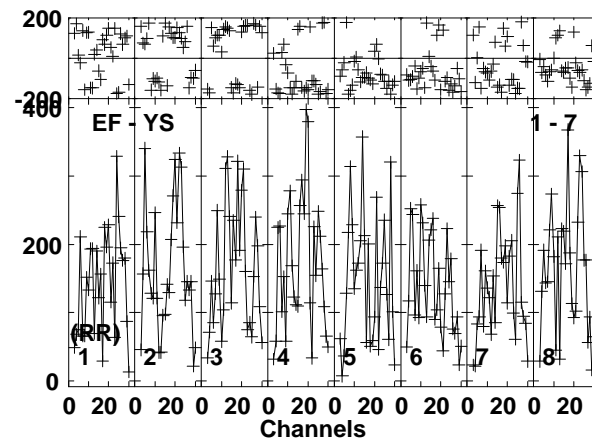
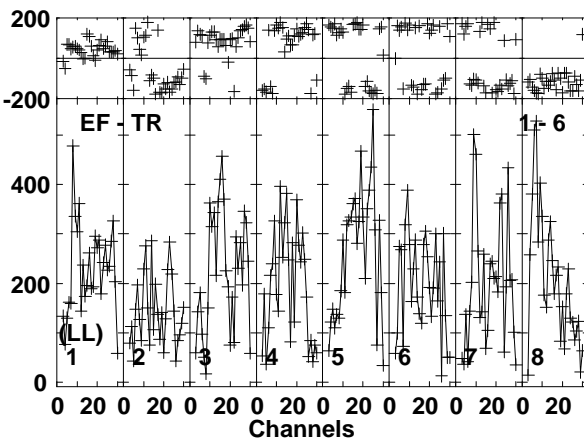
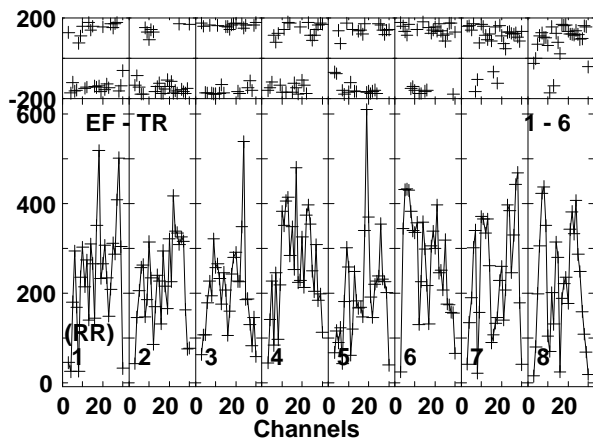
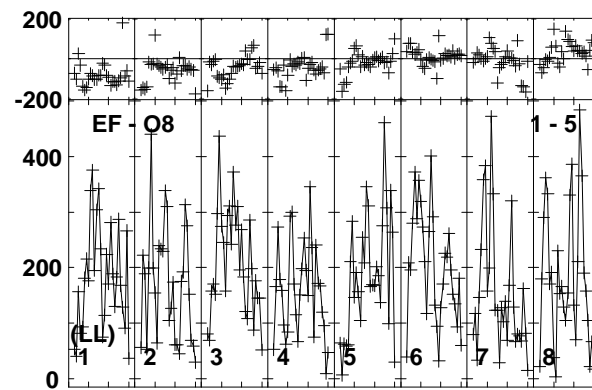
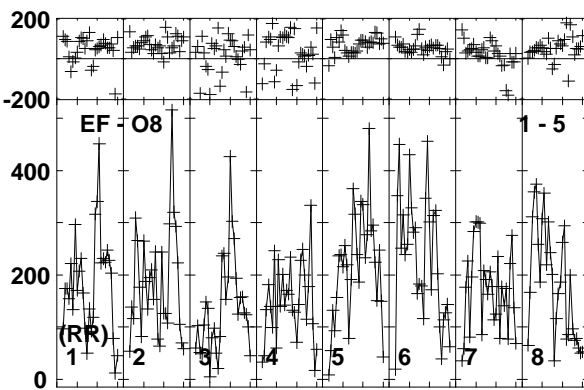
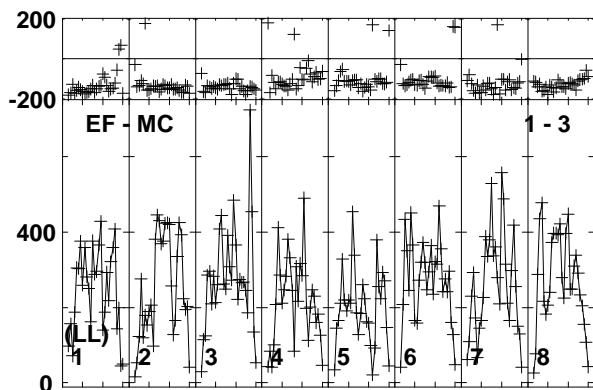
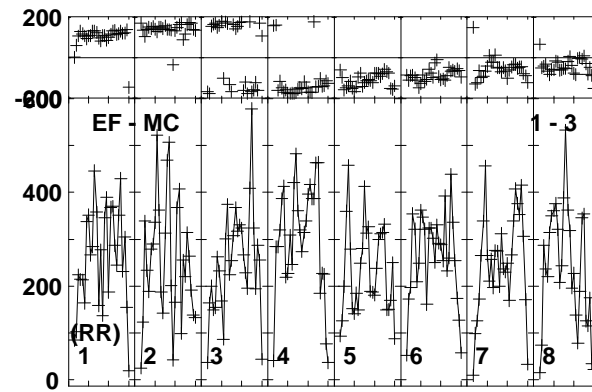
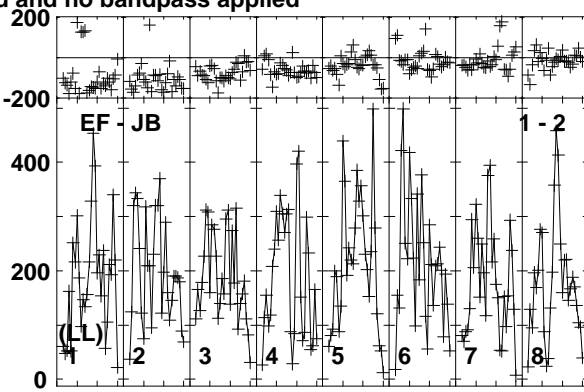
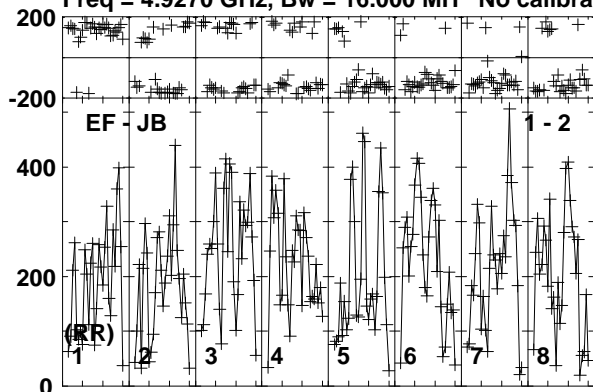

Lower frame: Micro Ampl Jy Top frame: Phas deg  
Vector averaged cross-power spectrum Baseline: EF (01) - JB (02)  
Timerange: 01/02:18:01 to 01/02:20:00

Plot file version 356 created 10-JUN-2016 17:22:38

CHECK RT013A.UVDATA.1

Freq = 4.9270 GHz, Bw = 16.000 MH No calibration applied and no bandpass applied

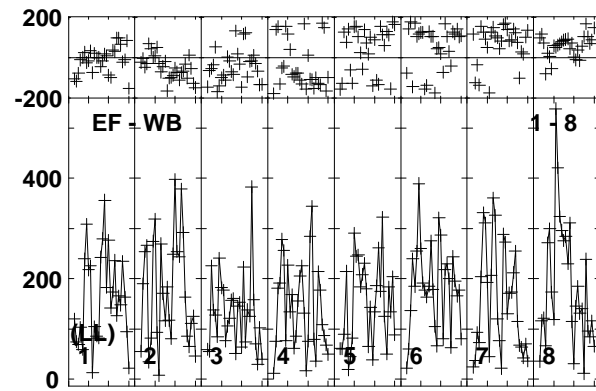
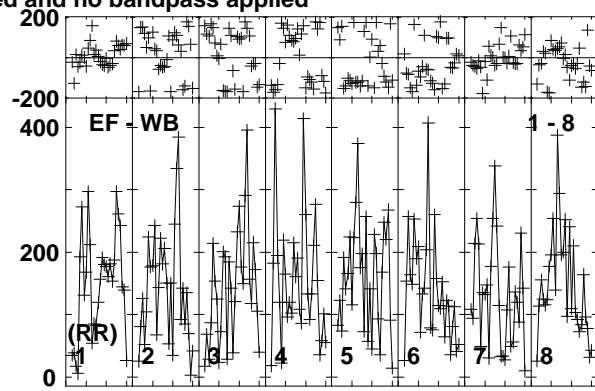
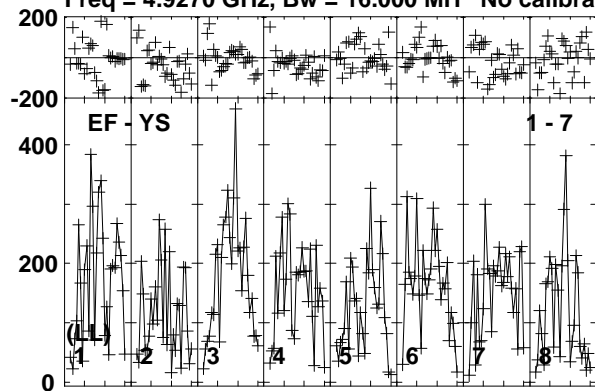

Lower frame: Micro Ampl Jy Top frame: Phas deg  
Vector averaged cross-power spectrum Baseline: EF (01) - YS (07)  
Timerange: 01/02:18:01 to 01/02:20:00



Plot file version 358 created 10-JUN-2016 17:22:39

CYGX1 RT013A.UVDATA.1

Freq = 4.9270 GHz, Bw = 16.000 MH No calibration applied and no bandpass applied

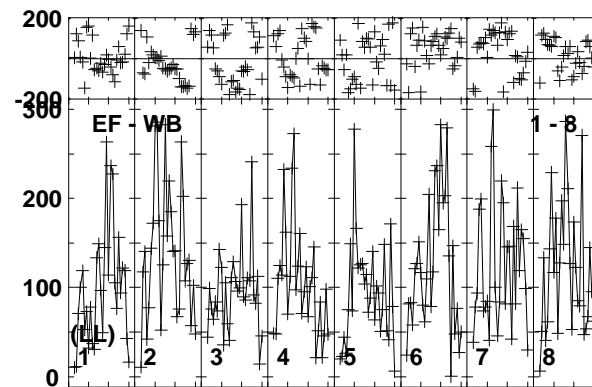
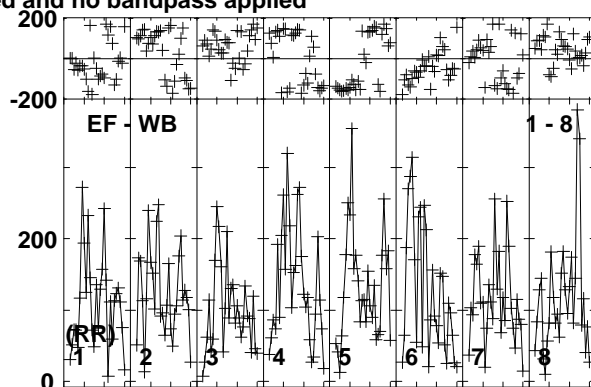
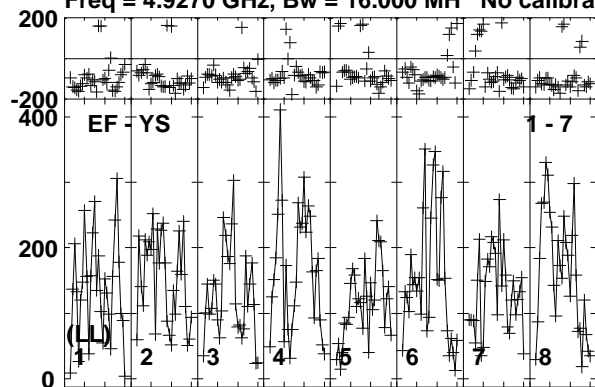

Lower frame: Micro Ampl Jy Top frame: Phas deg  
Vector averaged cross-power spectrum Baseline: EF (01) - YS (07)  
Timerange: 01/02:20:01 to 01/02:22:29

Plot file version 359 created 10-JUN-2016 17:22:39

J1957+3338 RT013A.UVDATA.1

Freq = 4.9270 GHz, Bw = 16.000 MH No calibration applied and no bandpass applied

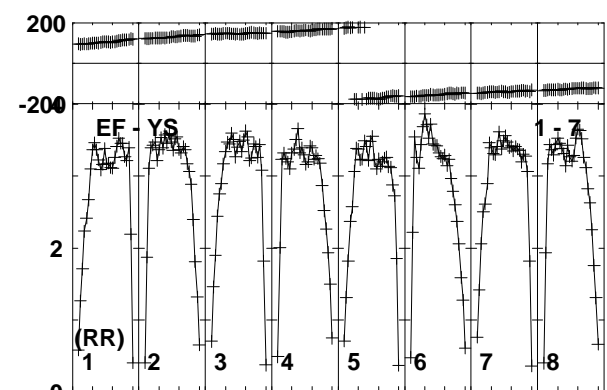
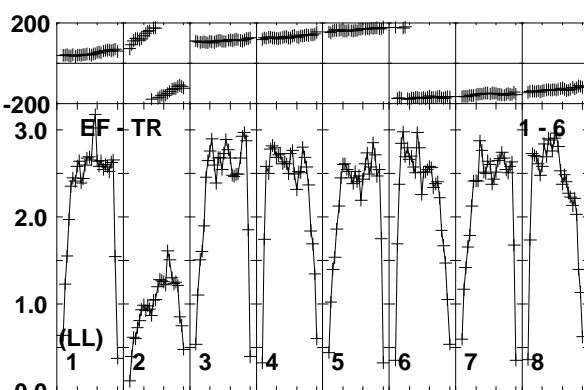
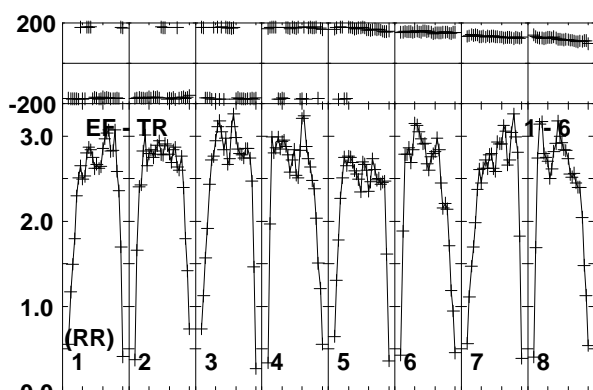
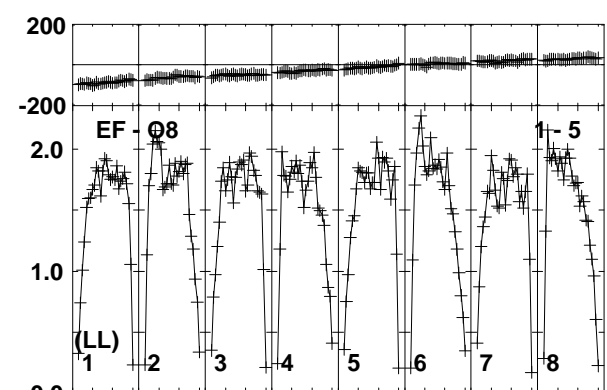
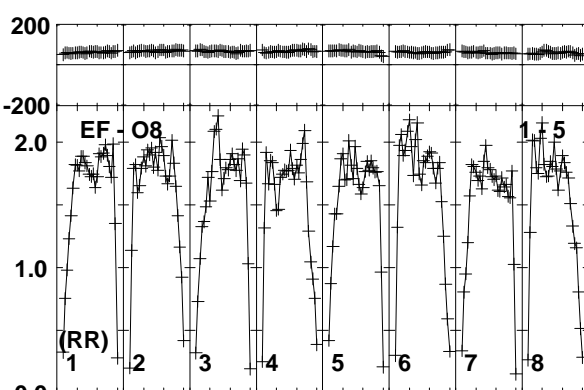
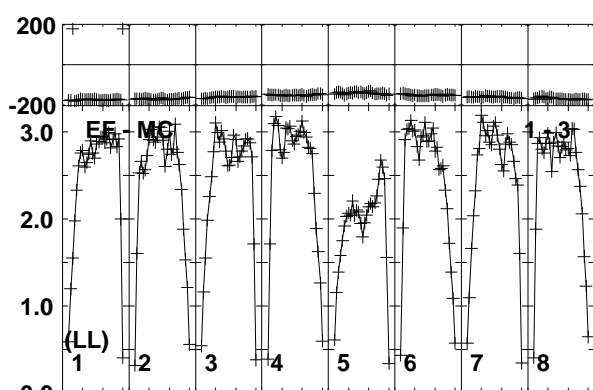
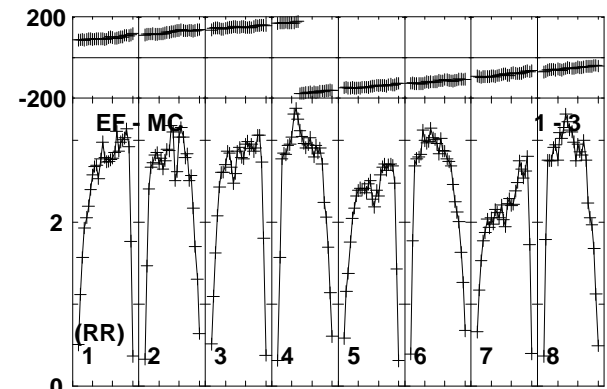
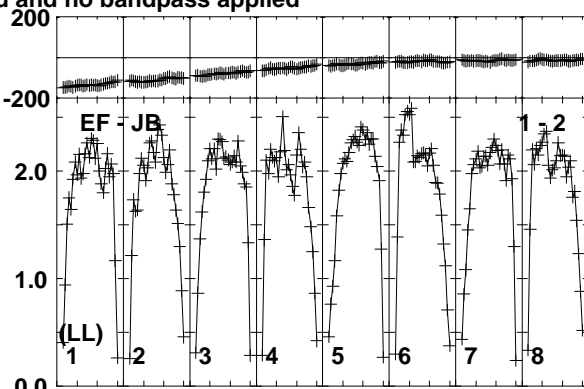
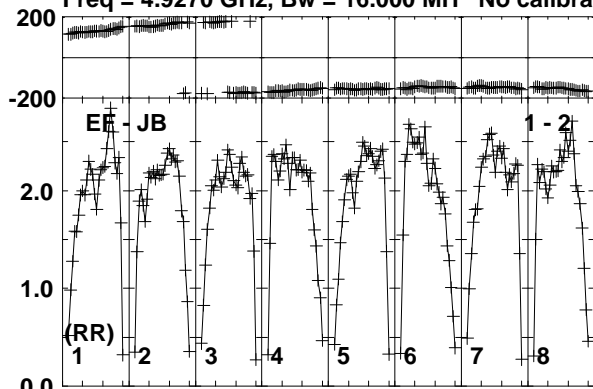

Lower frame: Milli Ampl Jy Top frame: Phas deg  
Vector averaged cross-power spectrum Baseline: EF (01) - JB (02)  
Timerange: 01/02:22:31 to 01/02:23:59

Plot file version 360 created 10-JUN-2016 17:22:39

J1957+3338 RT013A.UVDATA.1

Freq = 4.9270 GHz, Bw = 16.000 MH No calibration applied and no bandpass applied

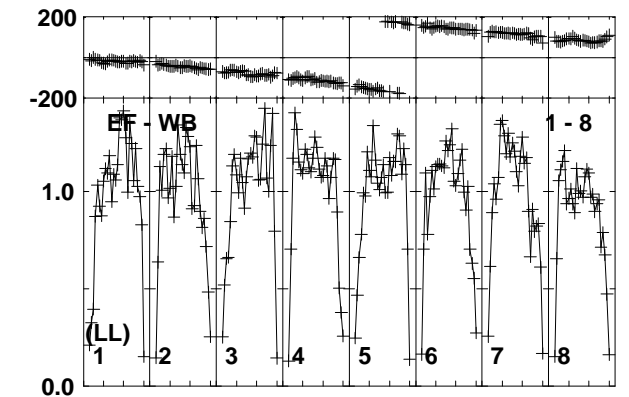
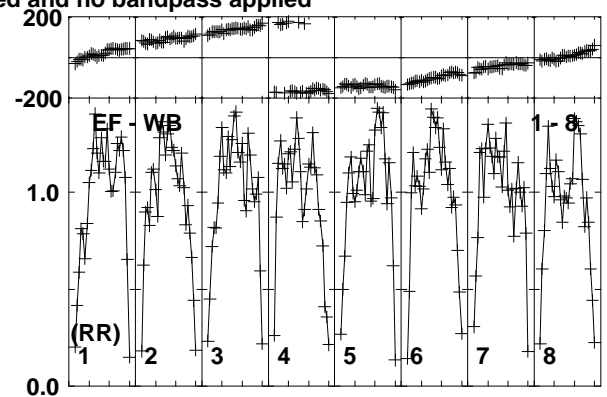
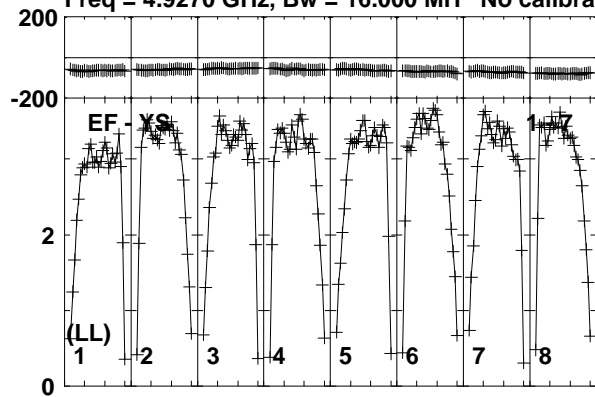

Lower frame: Milli Ampl Jy Top frame: Phas deg  
Vector averaged cross-power spectrum Baseline: EF (01) - YS (07)  
Timerange: 01/02:22:31 to 01/02:23:59

Plot file version 361 created 10-JUN-2016 17:22:39

CHECK RT013A.UVDATA.1

Freq = 4.9270 GHz, Bw = 16.000 MH No calibration applied and no bandpass applied

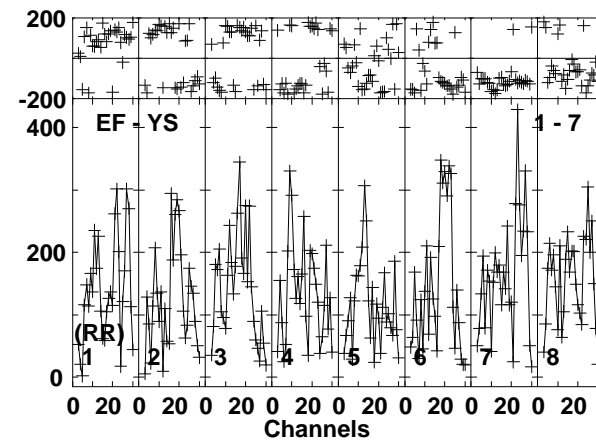
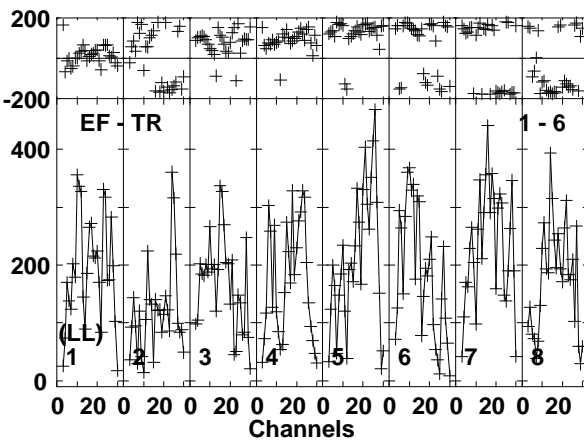
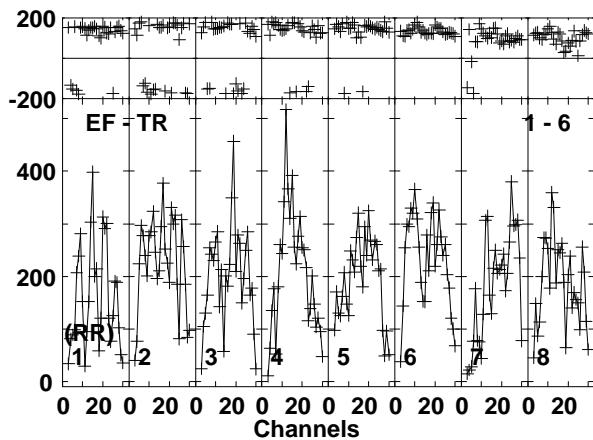
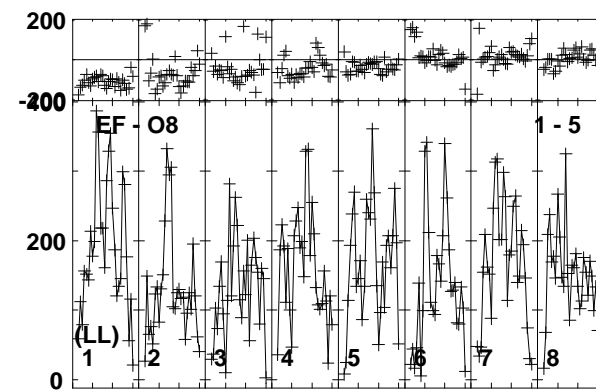
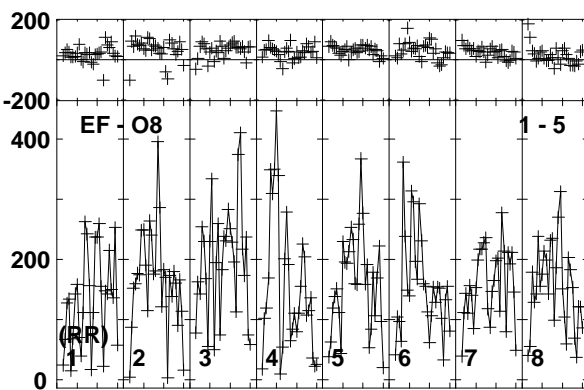
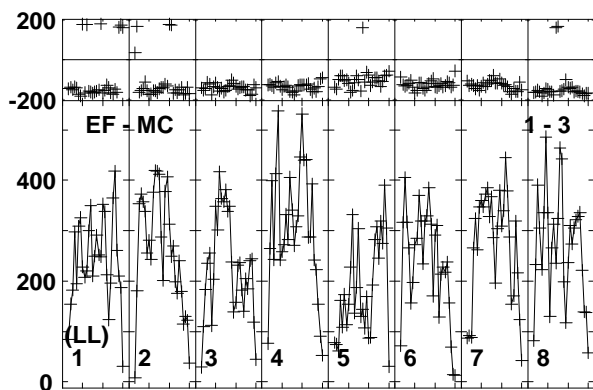
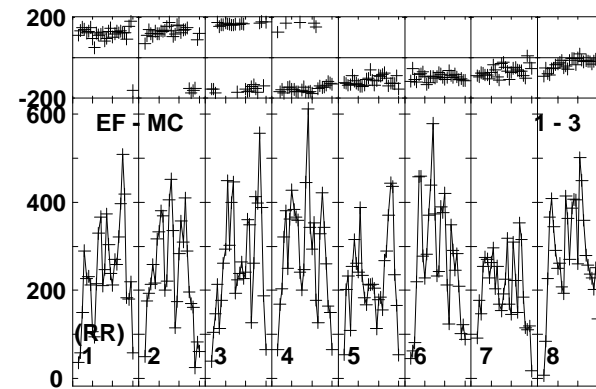
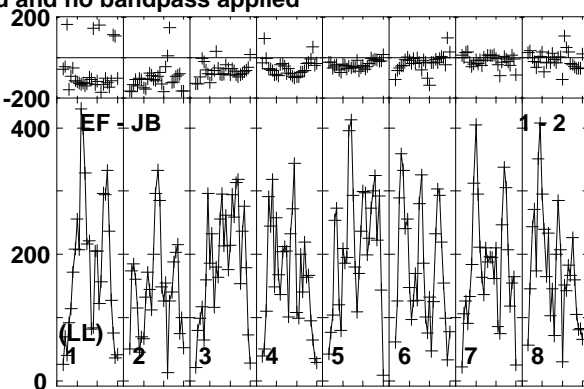
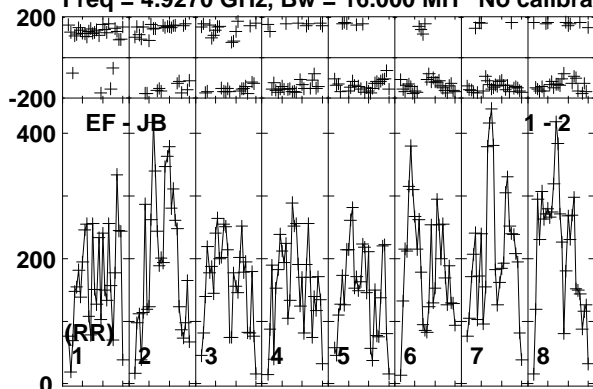

Lower frame: Micro Ampl Jy Top frame: Phas deg  
Vector averaged cross-power spectrum Baseline: EF (01) - JB (02)  
Timerange: 01/02:24:41 to 01/02:26:40

Plot file version 362 created 10-JUN-2016 17:22:39

CHECK RT013A.UVDATA.1

Freq = 4.9270 GHz, Bw = 16.000 MH No calibration applied and no bandpass applied

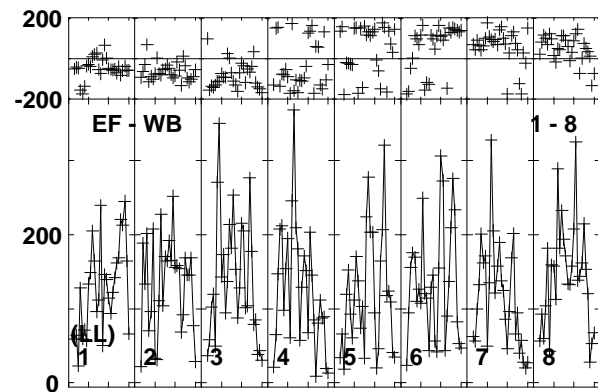
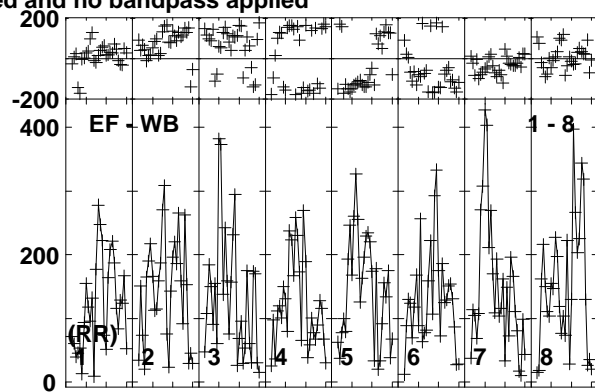
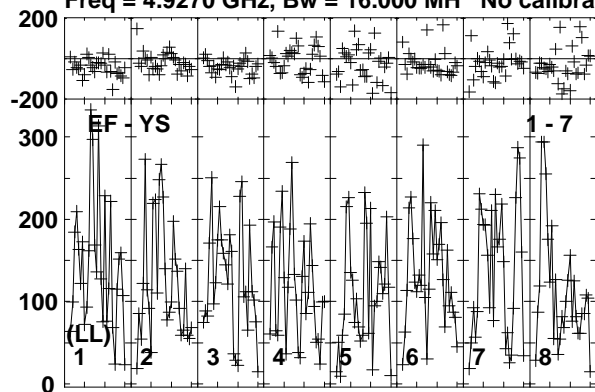

Lower frame: Micro Ampl Jy Top frame: Phas deg  
Vector averaged cross-power spectrum Baseline: EF (01) - YS (07)  
Timerange: 01/02:24:41 to 01/02:26:40



Plot file version 363 created 10-JUN-2016 17:22:39

CYGX1 RT013A.UVDATA.1

Freq = 4.9270 GHz, Bw = 16.000 MH No calibration applied and no bandpass applied

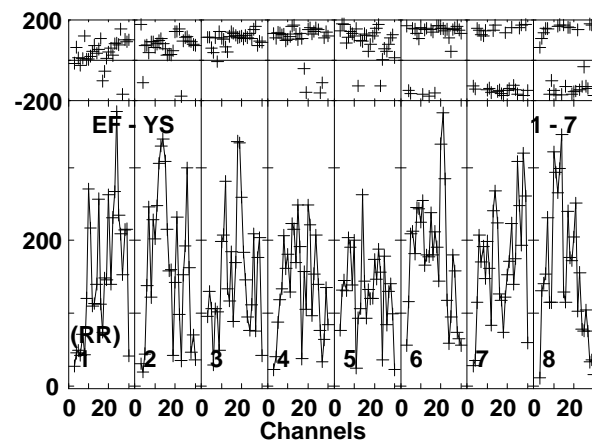
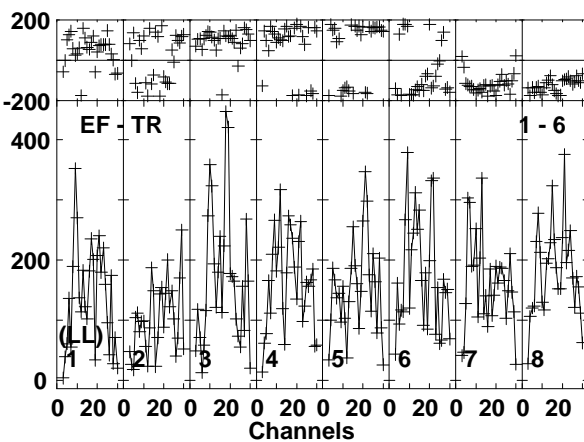
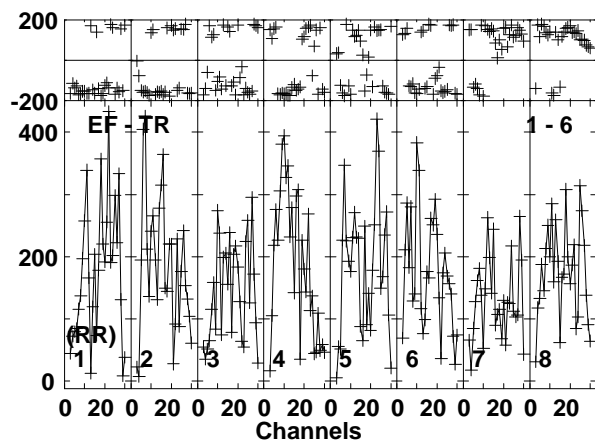
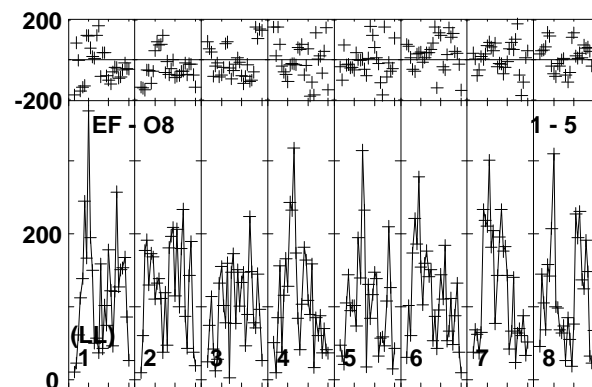
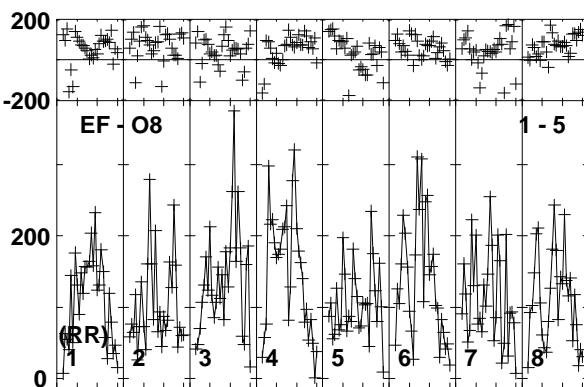
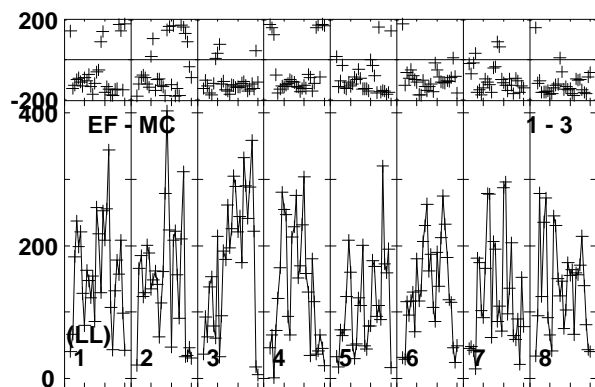
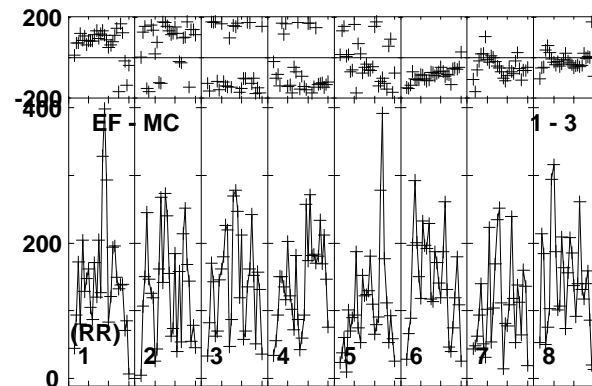
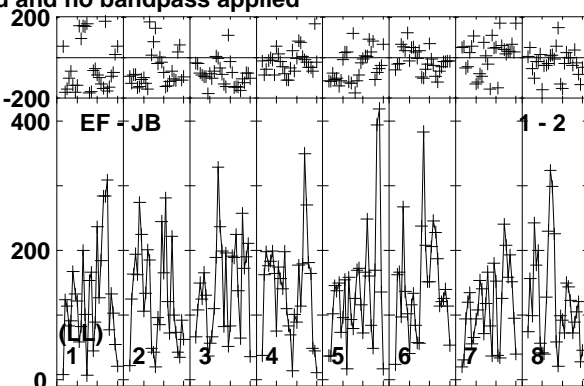
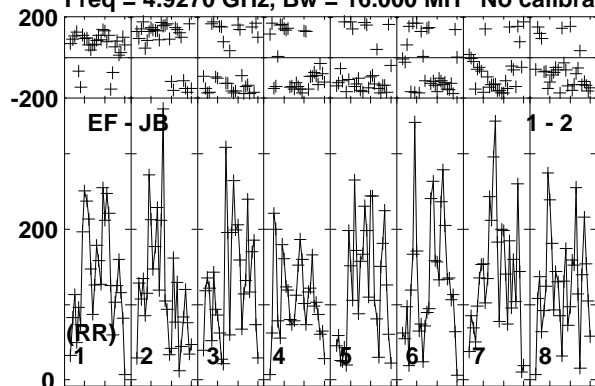

Lower frame: Micro Ampl Jy Top frame: Phas deg  
Vector averaged cross-power spectrum Baseline: EF (01) - JB (02)  
Timerange: 01/02:26:41 to 01/02:29:09

Plot file version 364 created 10-JUN-2016 17:22:39

CYGX1 RT013A.UVDATA.1

Freq = 4.9270 GHz, Bw = 16.000 MH No calibration applied and no bandpass applied

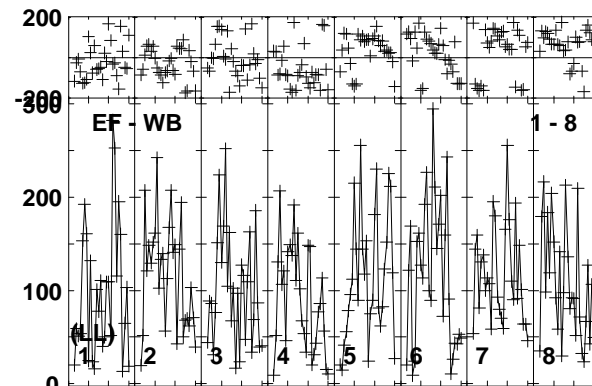
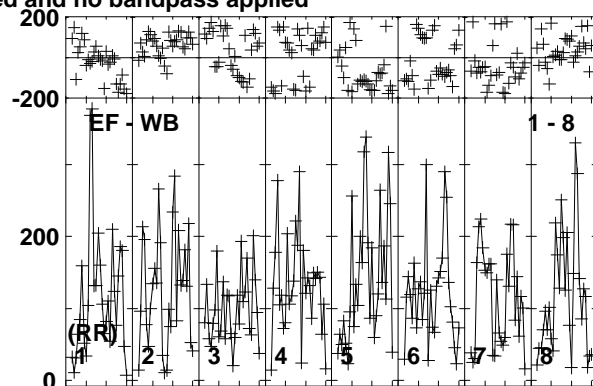
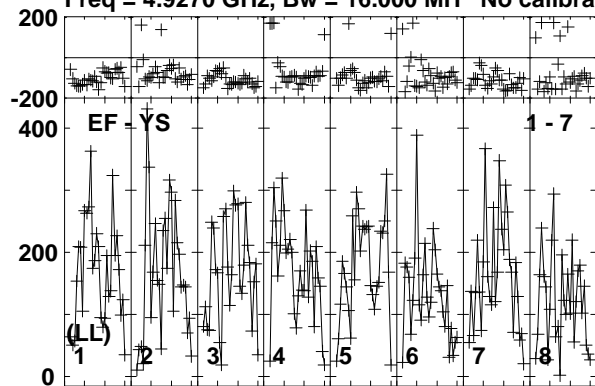

Lower frame: Micro Ampl Jy Top frame: Phas deg  
Vector averaged cross-power spectrum Baseline: EF (01) - YS (07)  
Timerange: 01/02:26:41 to 01/02:29:09

Plot file version 365 created 10-JUN-2016 17:22:39

J1957+3338 RT013A.UVDATA.1

Freq = 4.9270 GHz, Bw = 16.000 MH No calibration applied and no bandpass applied

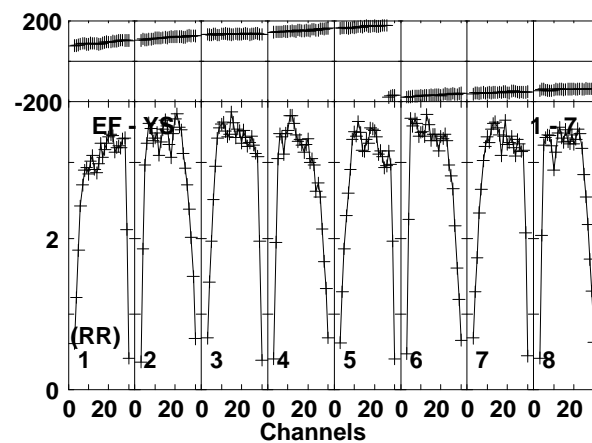
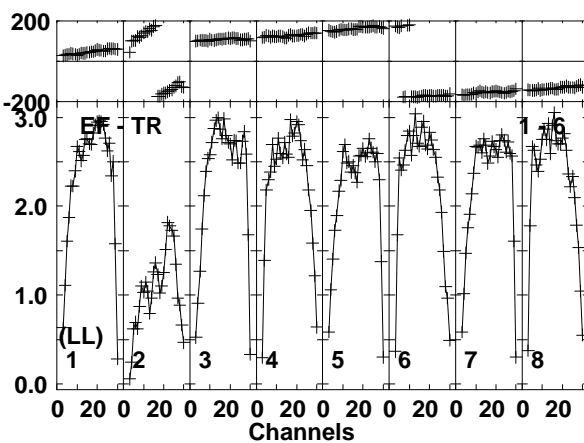
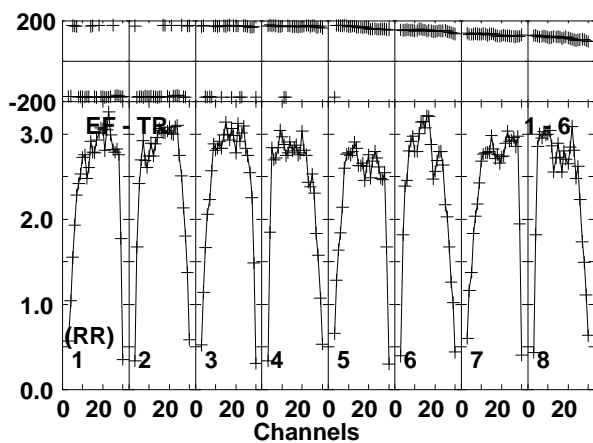
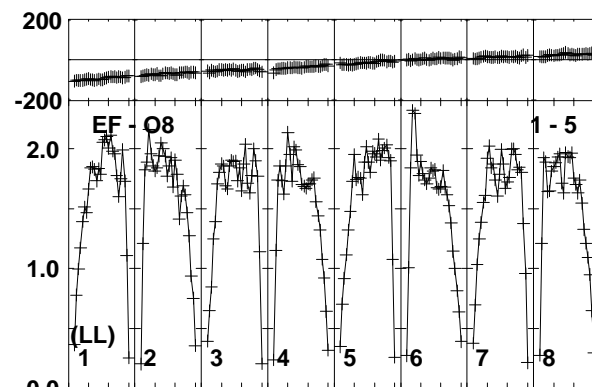
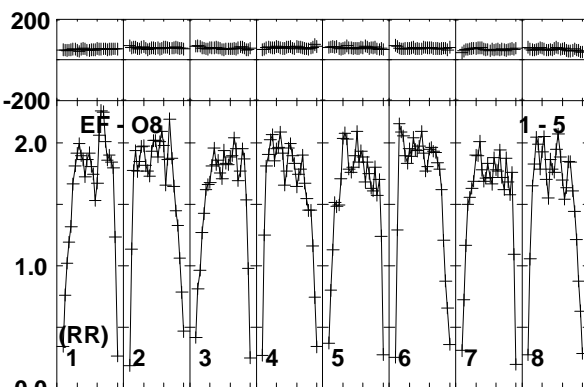
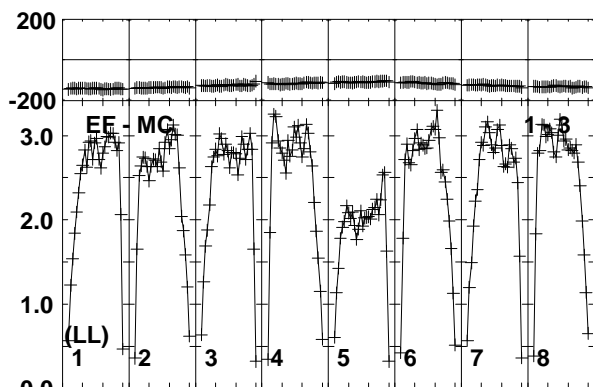
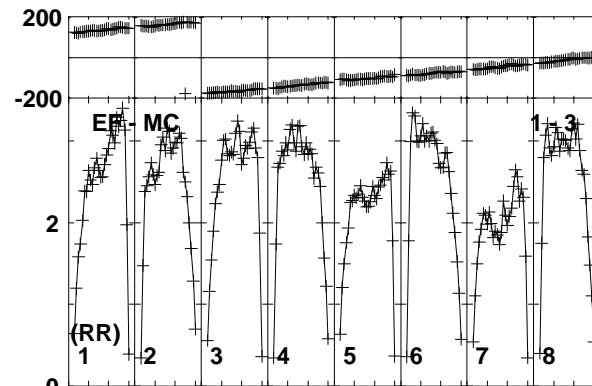
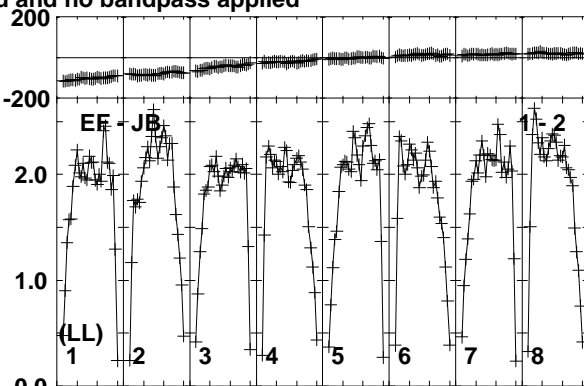
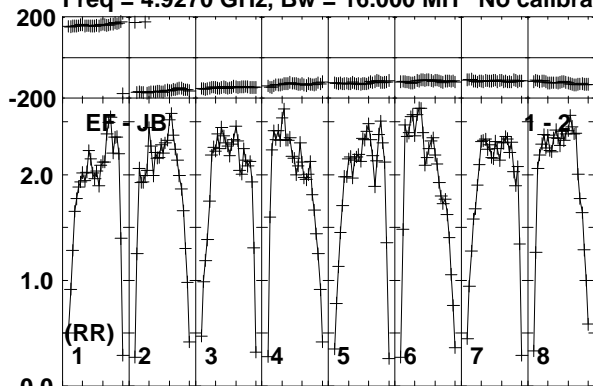

Lower frame: Milli Ampl Jy Top frame: Phas deg  
Vector averaged cross-power spectrum Baseline: EF (01) - JB (02)  
Timerange: 01/02:29:11 to 01/02:30:39

Plot file version 366 created 10-JUN-2016 17:22:39

J1957+3338 RT013A.UVDATA.1

Freq = 4.9270 GHz, Bw = 16.000 MH No calibration applied and no bandpass applied

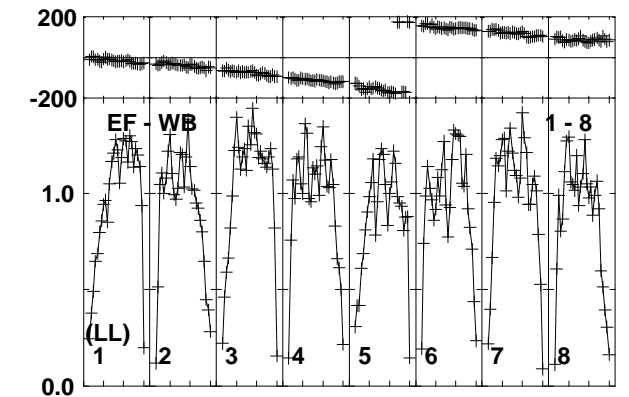
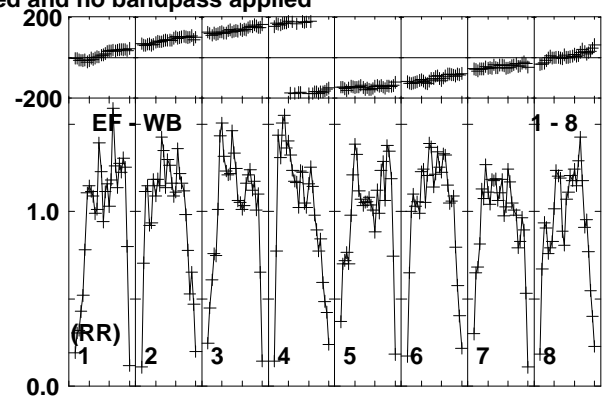
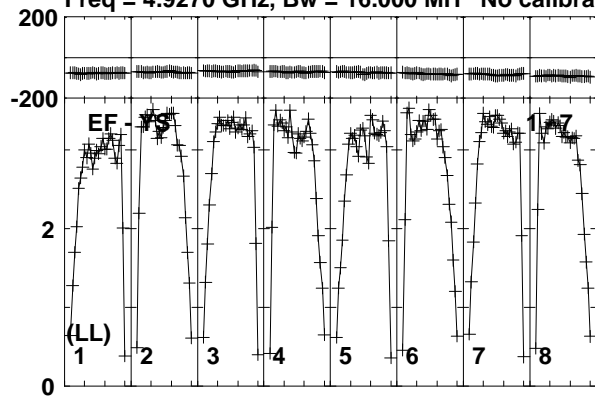

Lower frame: Milli Ampl Jy Top frame: Phas deg  
Vector averaged cross-power spectrum Baseline: EF (01) - YS (07)  
Timerange: 01/02:29:11 to 01/02:30:39

Plot file version 367 created 10-JUN-2016 17:22:39

CHECK RT013A.UVDATA.1

Freq = 4.9270 GHz, Bw = 16.000 MH No calibration applied and no bandpass applied

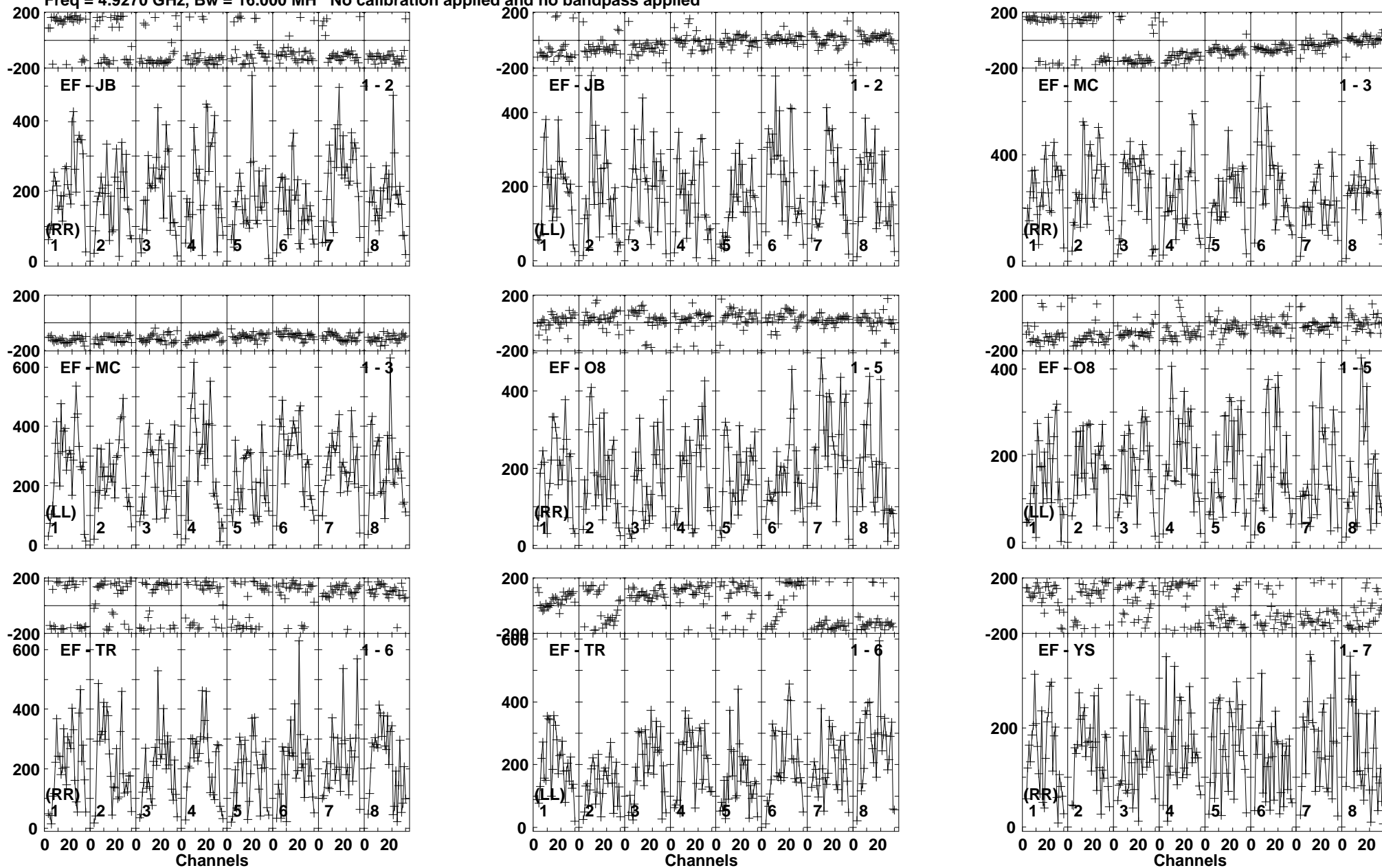

Lower frame: Micro Ampl Jy Top frame: Phas deg  
Vector averaged cross-power spectrum Baseline: EF (01) - JB (02)  
Timerange: 01/02:30:41 to 01/02:32:39

Plot file version 368 created 10-JUN-2016 17:22:39

CHECK RT013A.UVDATA.1

Freq = 4.9270 GHz, Bw = 16.000 MH No calibration applied and no bandpass applied

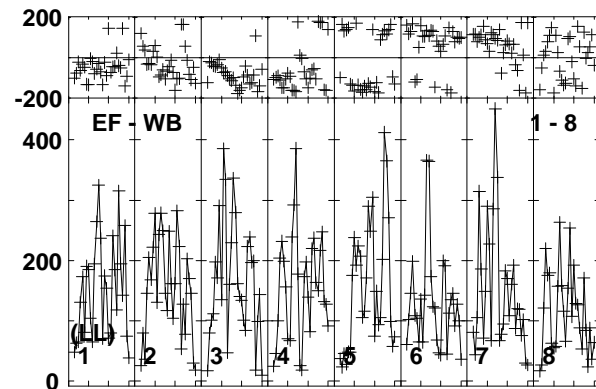
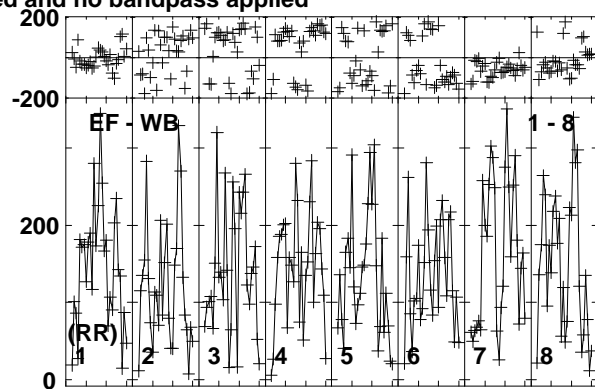
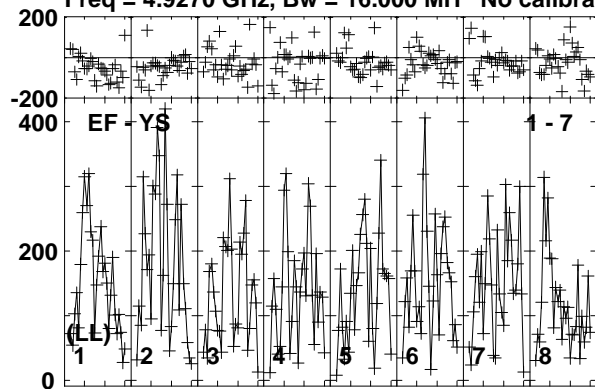

Lower frame: Micro Ampl Jy Top frame: Phas deg  
Vector averaged cross-power spectrum Baseline: EF (01) - YS (07)  
Timerange: 01/02:30:41 to 01/02:32:39

Plot file version 369 created 10-JUN-2016 17:22:39

CYGX1 RT013A.UVDATA.1

Freq = 4.9270 GHz, Bw = 16.000 MH No calibration applied and no bandpass applied

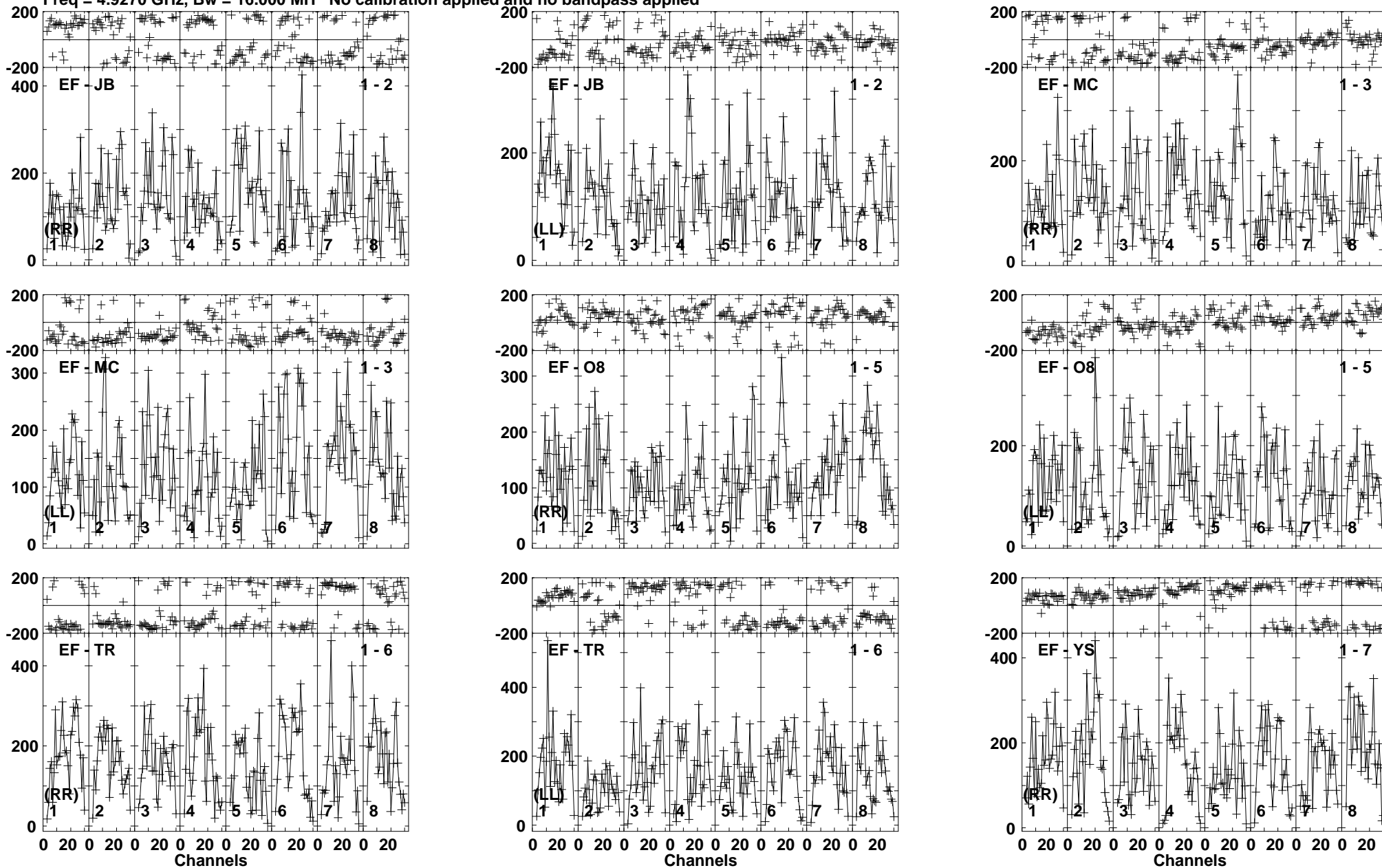

Plot file version 370 created 10-JUN-2016 17:22:40

CYGX1 RT013A.UVDATA.1

Freq = 4.9270 GHz, Bw = 16.000 MH No calibration applied and no bandpass applied

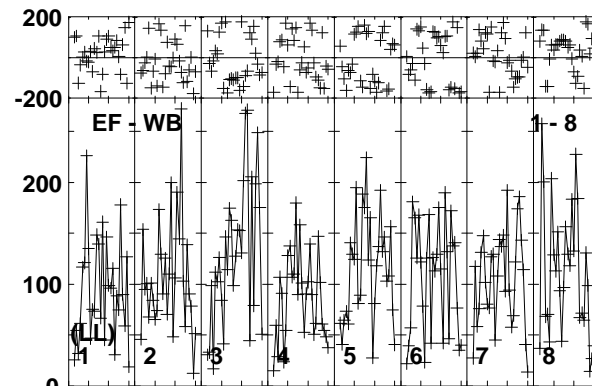
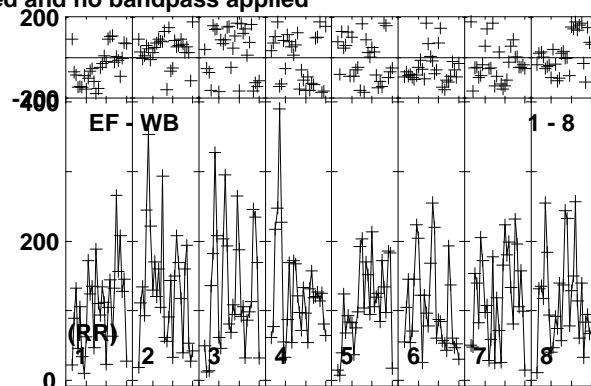
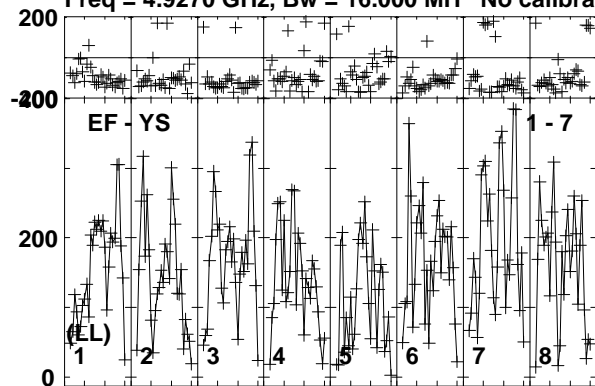

Lower frame: Micro Ampl Jy Top frame: Phas deg  
Vector averaged cross-power spectrum Baseline: EF (01) - YS (07)  
Timerange: 01/02:32:40 to 01/02:35:10



Plot file version 371 created 10-JUN-2016 17:22:40

J1957+3338 RT013A.UVDATA.1

Freq = 4.9270 GHz, Bw = 16.000 MH No calibration applied and no bandpass applied

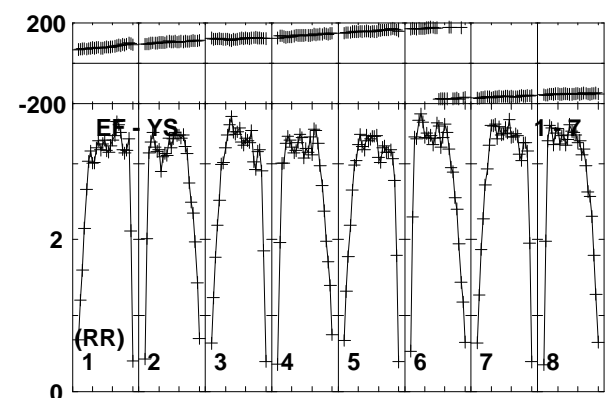
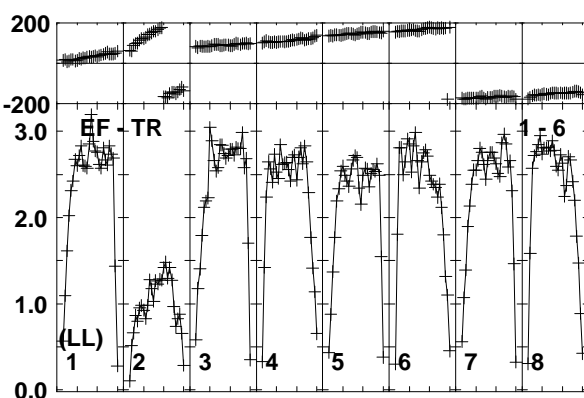
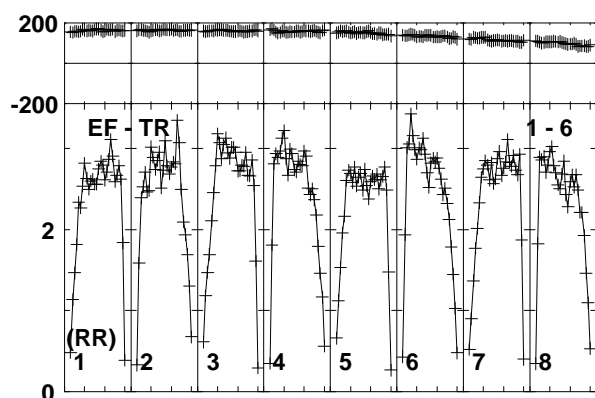
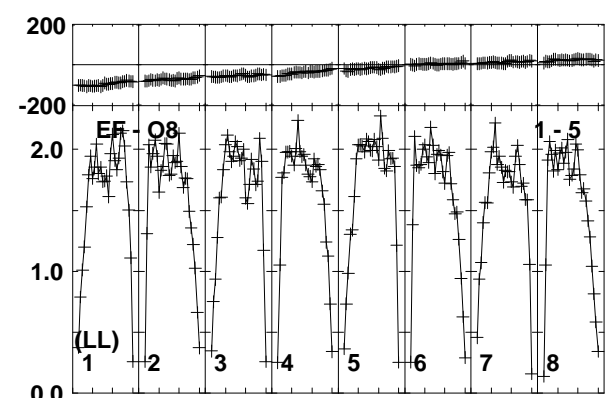
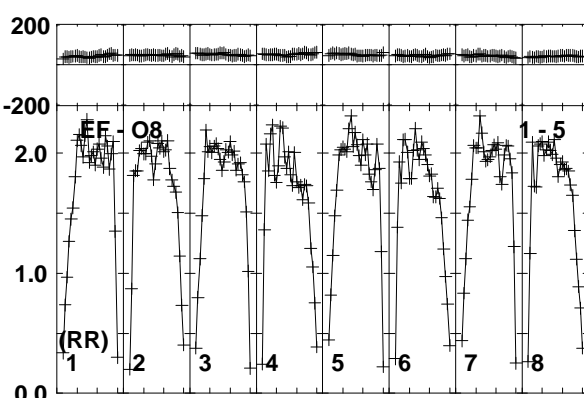
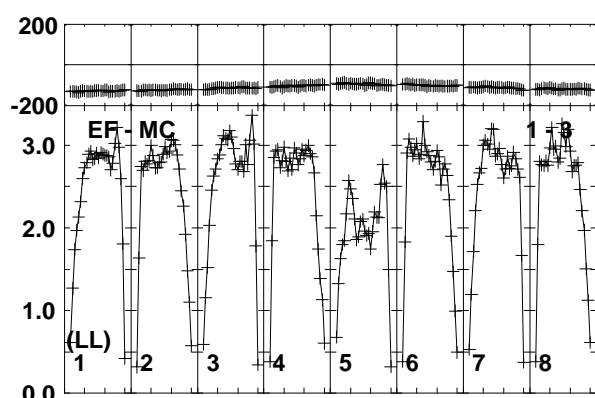
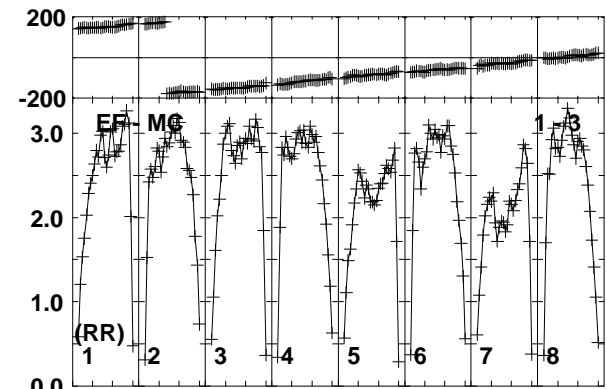
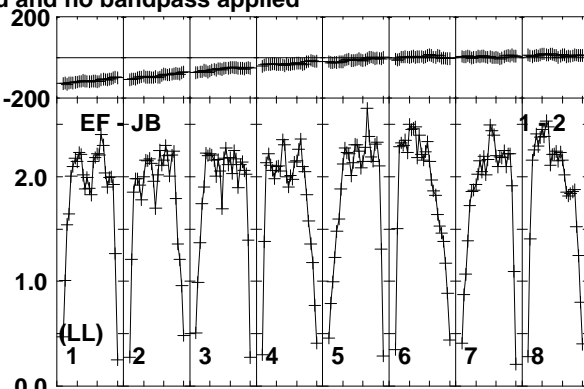
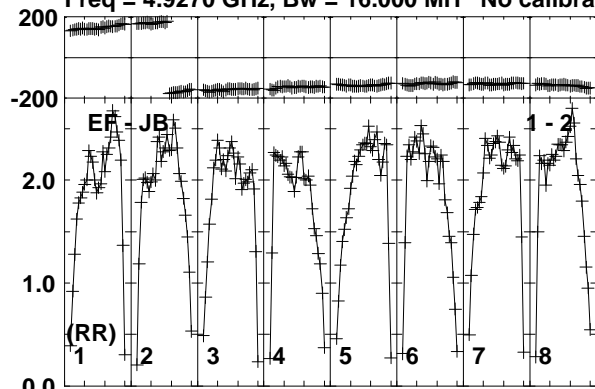

Lower frame: Milli Ampl Jy Top frame: Phas deg  
Vector averaged cross-power spectrum Baseline: EF (01) - JB (02)  
Timerange: 01/02:35:11 to 01/02:36:39

Plot file version 372 created 10-JUN-2016 17:22:40

J1957+3338 RT013A.UVDATA.1

Freq = 4.9270 GHz, Bw = 16.000 MH No calibration applied and no bandpass applied

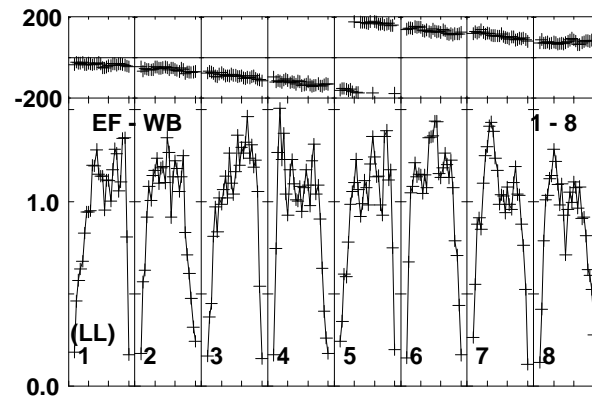
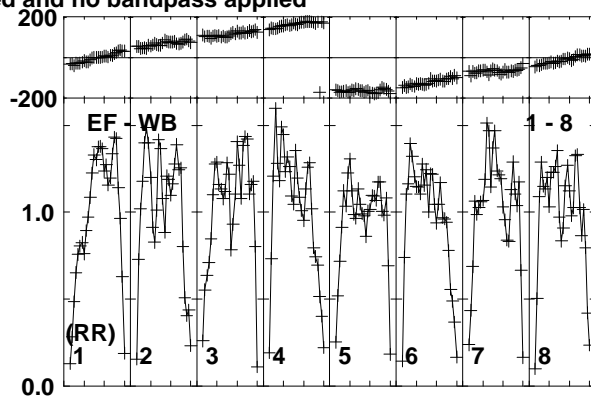
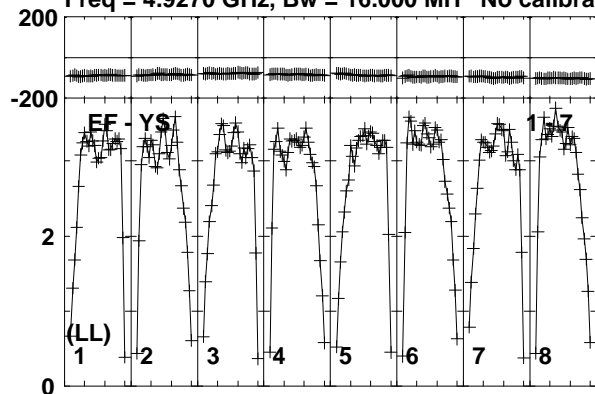

Lower frame: Milli Ampl Jy Top frame: Phas deg  
Vector averaged cross-power spectrum Baseline: EF (01) - YS (07)  
Timerange: 01/02:35:11 to 01/02:36:39

Plot file version 373 created 10-JUN-2016 17:22:40

CHECK RT013A.UVDATA.1

Freq = 4.9270 GHz, Bw = 16.000 MH No calibration applied and no bandpass applied

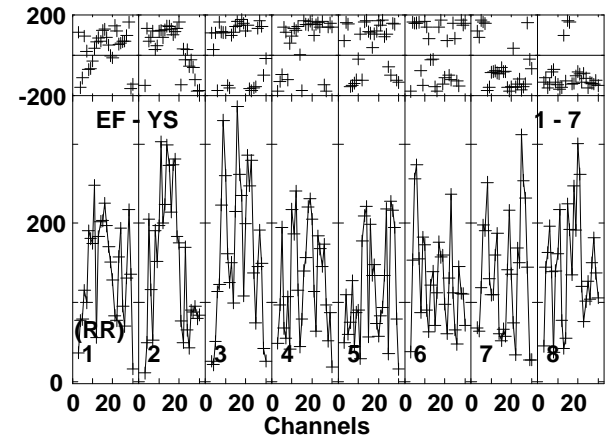
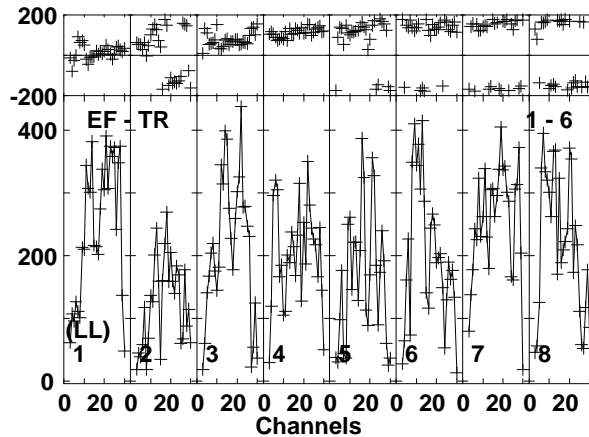
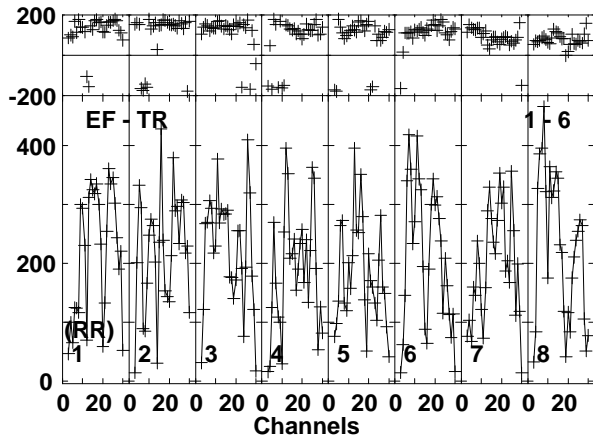
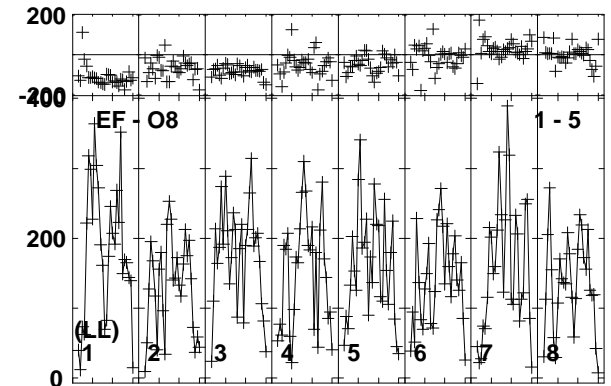
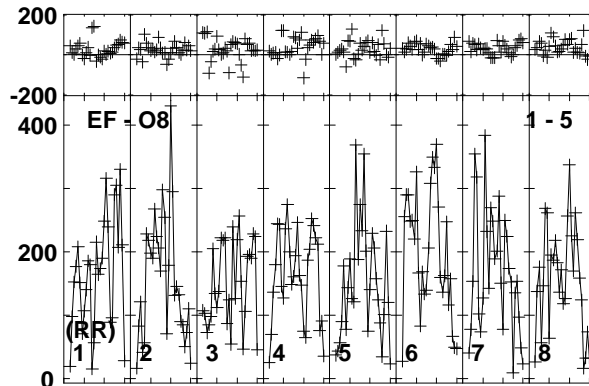
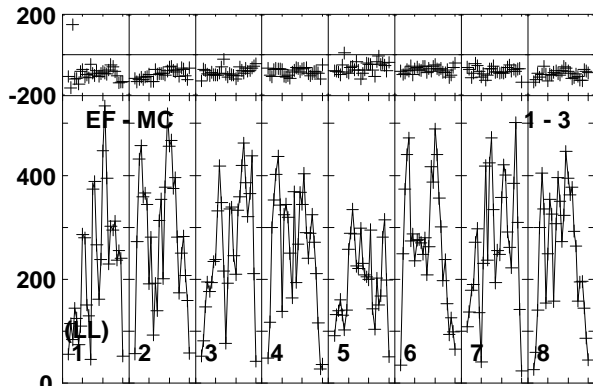
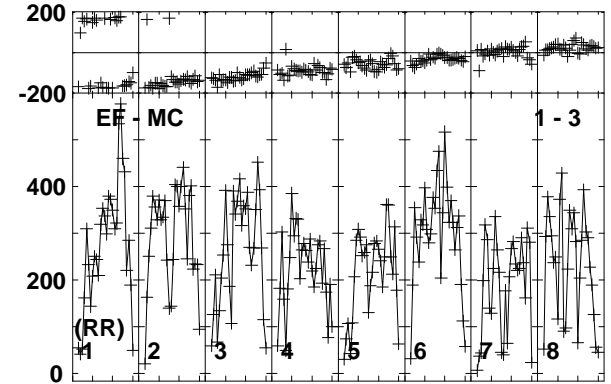
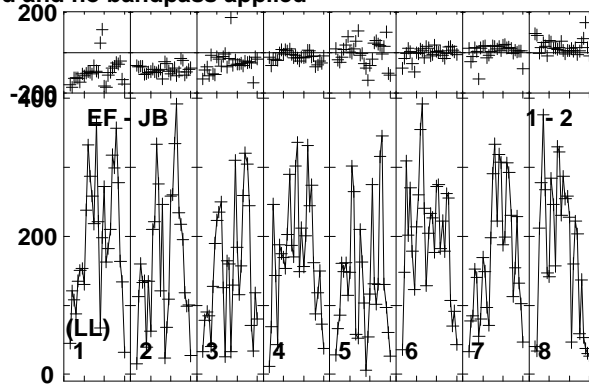
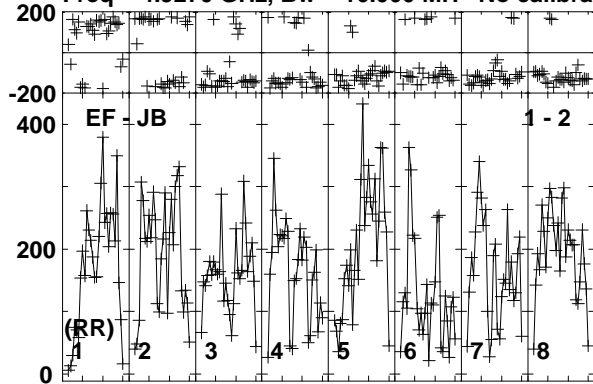

Lower frame: Micro Ampl Jy Top frame: Phas deg  
Vector averaged cross-power spectrum Baseline: EF (01) - JB (02)  
Timerange: 01/02:37:21 to 01/02:39:19

Plot file version 374 created 10-JUN-2016 17:22:40

CHECK RT013A.UVDATA.1

Freq = 4.9270 GHz, Bw = 16.000 MH No calibration applied and no bandpass applied

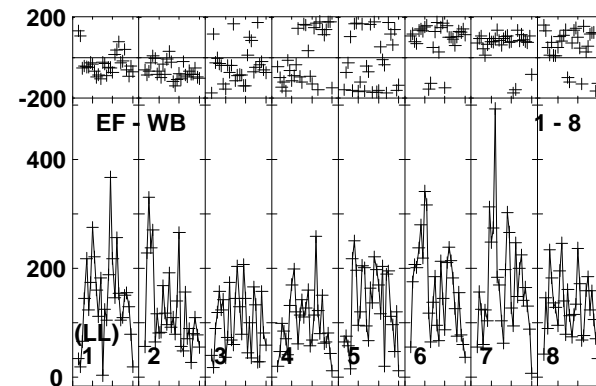
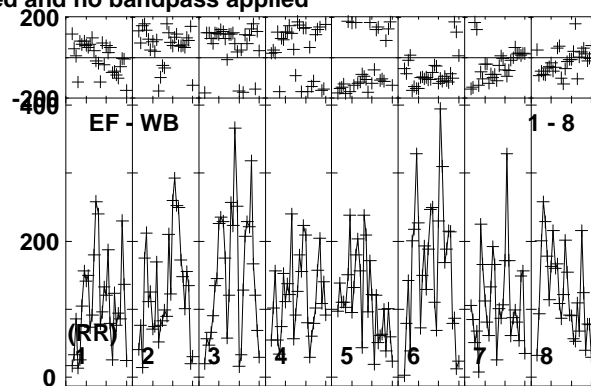
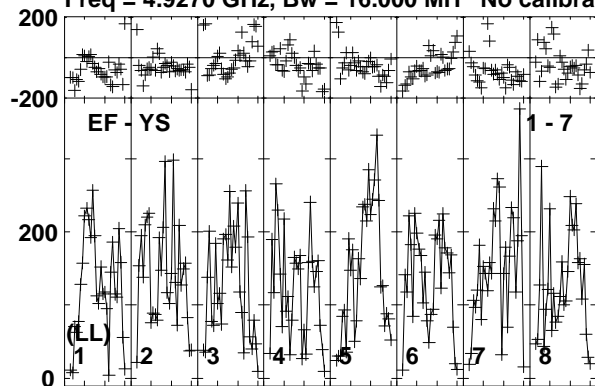

Lower frame: Micro Ampl Jy Top frame: Phas deg  
Vector averaged cross-power spectrum Baseline: EF (01) - YS (07)  
Timerange: 01/02:37:21 to 01/02:39:19

Plot file version 375 created 10-JUN-2016 17:22:40

CYGX1 RT013A.UVDATA.1

Freq = 4.9270 GHz, Bw = 16.000 MH No calibration applied and no bandpass applied

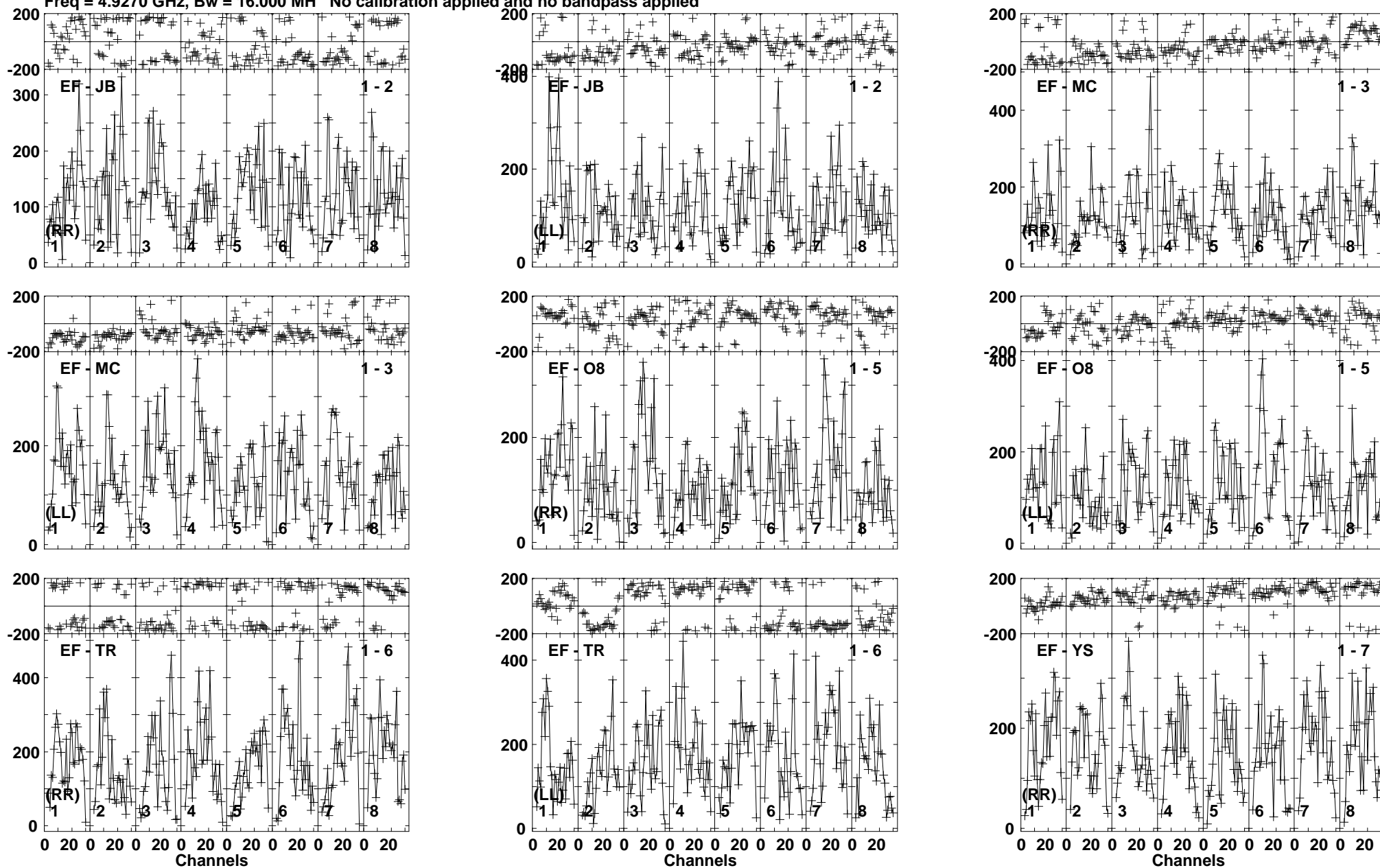

Lower frame: Micro Ampl Jy Top frame: Phas deg  
Vector averaged cross-power spectrum Baseline: EF (01) - JB (02)  
Timerange: 01/02:39:20 to 01/02:41:50

Plot file version 376 created 10-JUN-2016 17:22:40

CYGX1 RT013A.UVDATA.1

Freq = 4.9270 GHz, Bw = 16.000 MH No calibration applied and no bandpass applied

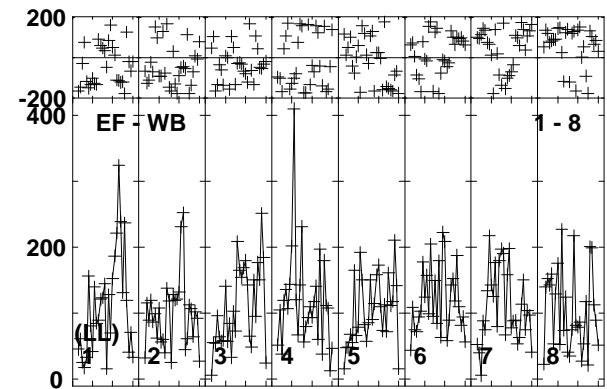
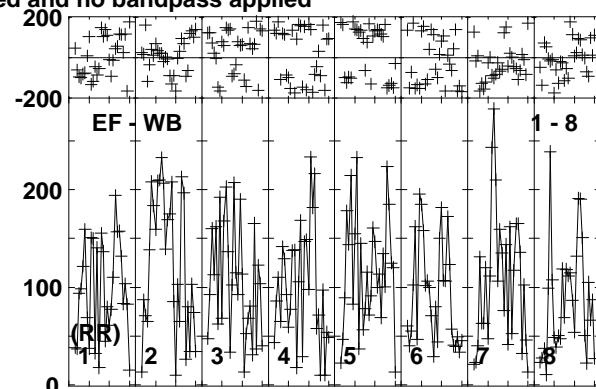
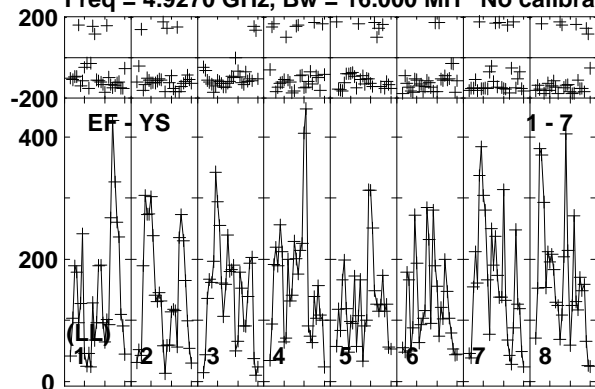

Lower frame: Micro Ampl Jy Top frame: Phas deg  
Vector averaged cross-power spectrum Baseline: EF (01) - YS (07)  
Timerange: 01/02:39:20 to 01/02:41:50

Plot file version 377 created 10-JUN-2016 17:22:40

J1957+3338 RT013A.UVDATA.1

Freq = 4.9270 GHz, Bw = 16.000 MH No calibration applied and no bandpass applied

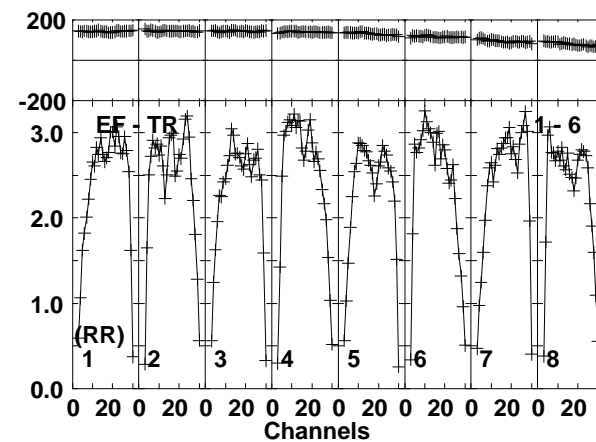
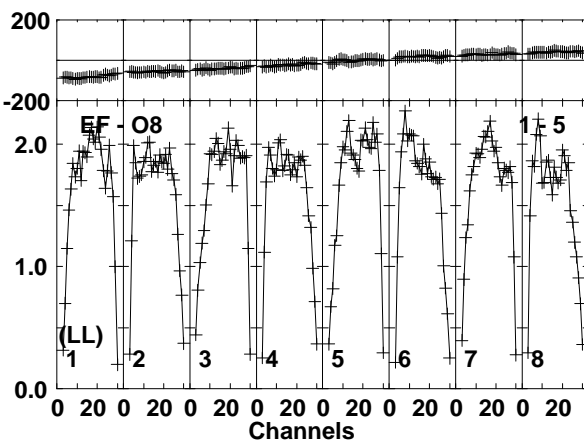
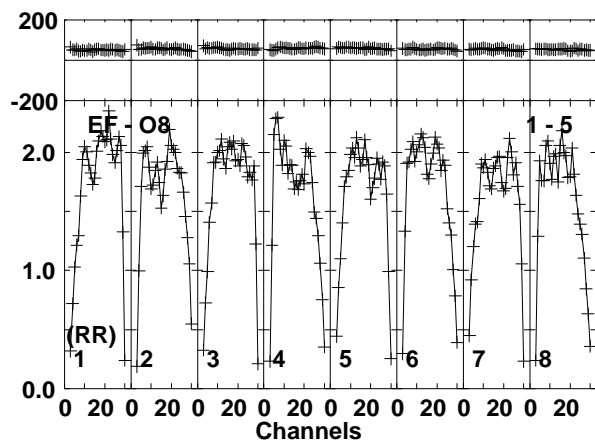
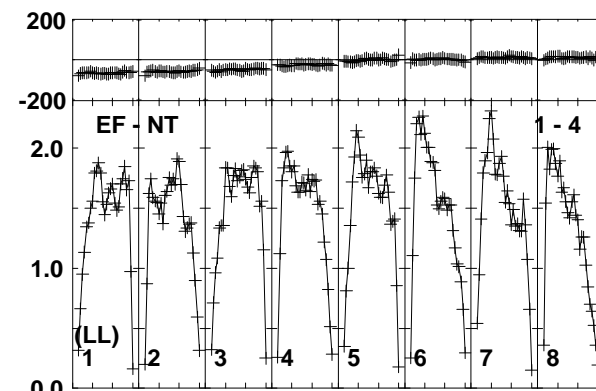
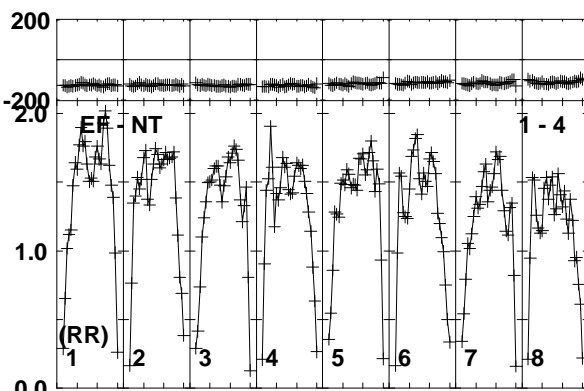
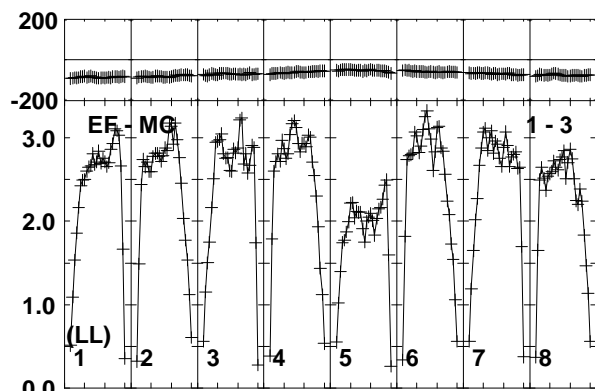
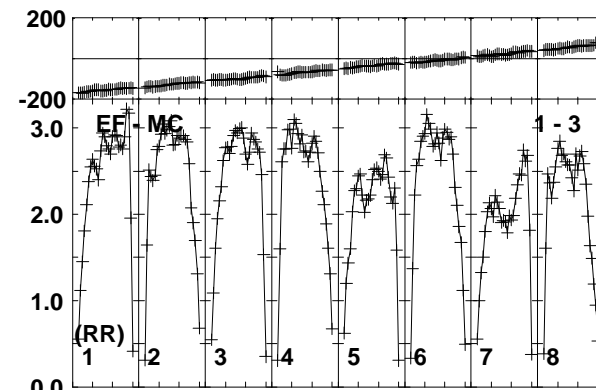
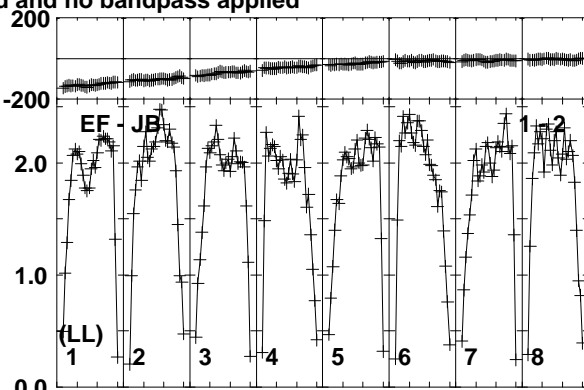
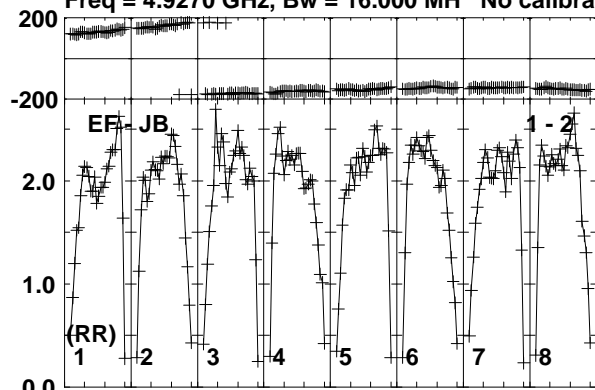

Lower frame: Milli Ampl Jy Top frame: Phas deg  
Vector averaged cross-power spectrum Baseline: EF (01) - JB (02)  
Timerange: 01/02:41:50 to 01/02:43:19

Plot file version 378 created 10-JUN-2016 17:22:40

J1957+3338 RT013A.UVDATA.1

Freq = 4.9270 GHz, Bw = 16.000 MH No calibration applied and no bandpass applied

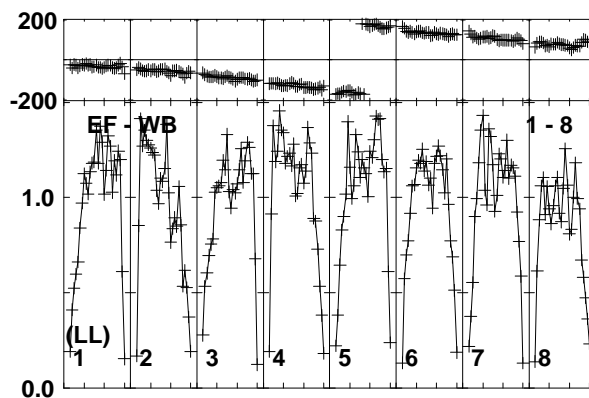
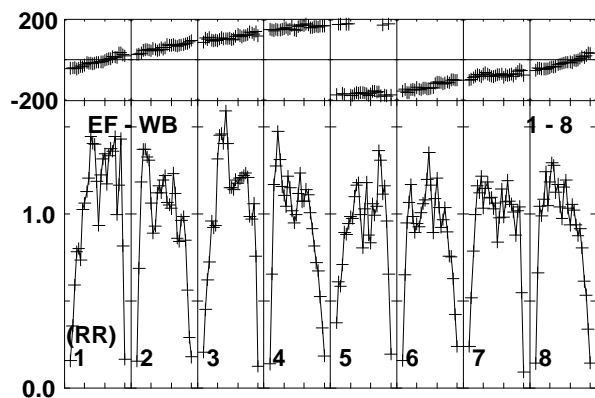
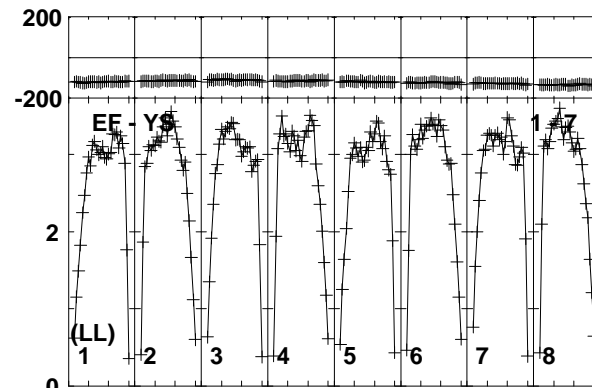
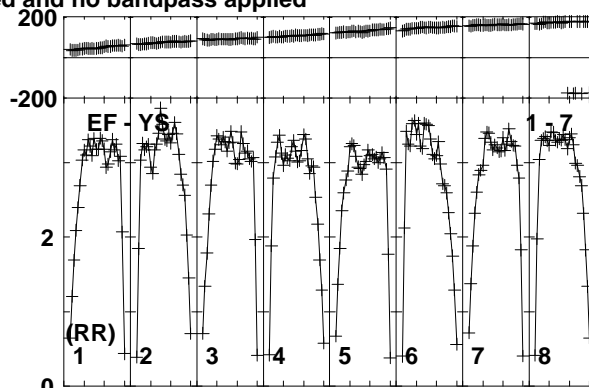
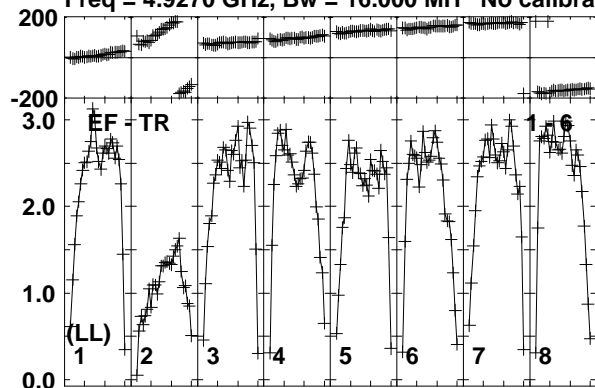

Lower frame: Milli Ampl Jy Top frame: Phas deg  
Vector averaged cross-power spectrum Baseline: EF (01) - TR (06)  
Timerange: 01/02:41:50 to 01/02:43:19



Plot file version 379 created 10-JUN-2016 17:22:40

CHECK RT013A.UVDATA.1

Freq = 4.9270 GHz, Bw = 16.000 MH No calibration applied and no bandpass applied

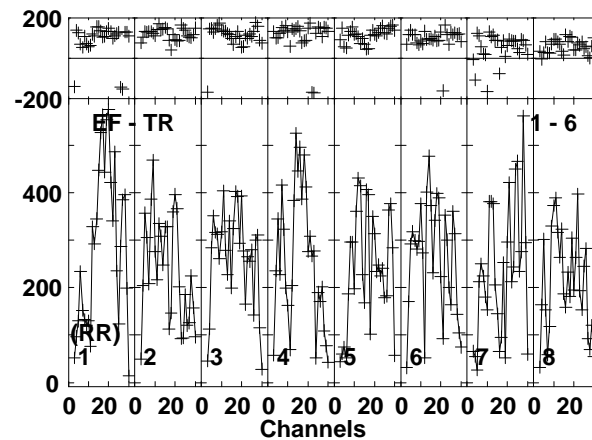
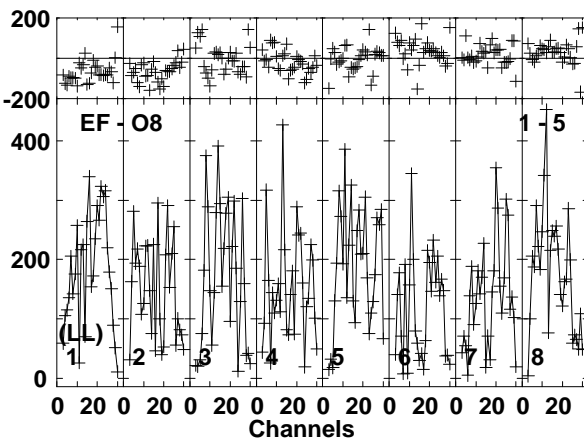
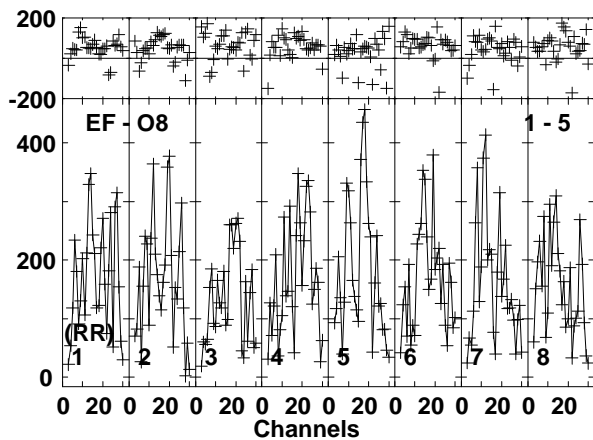
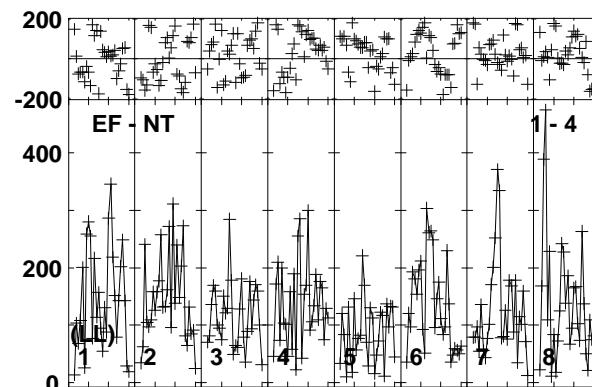
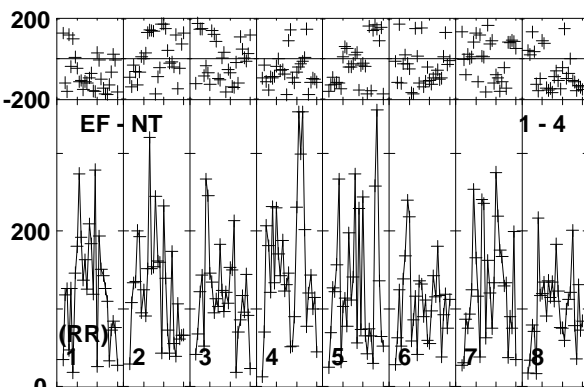
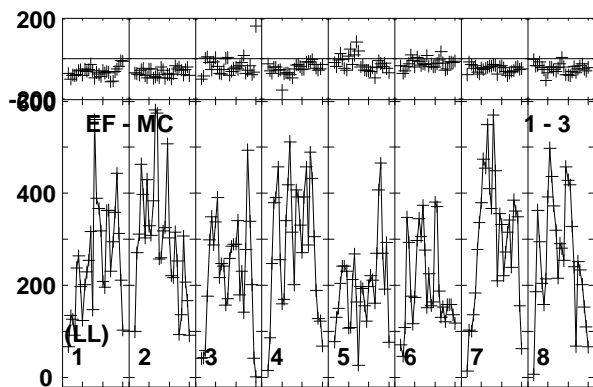
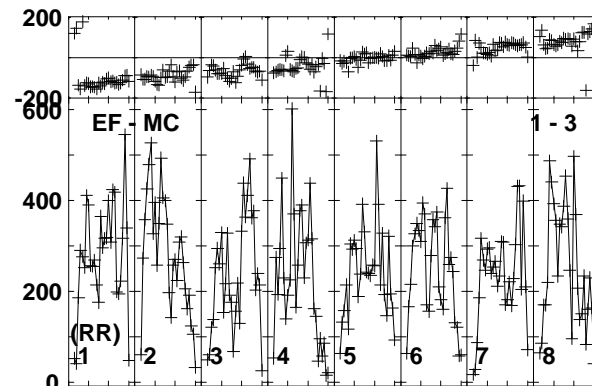
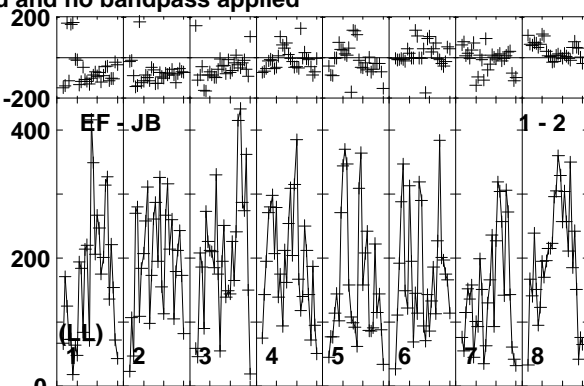
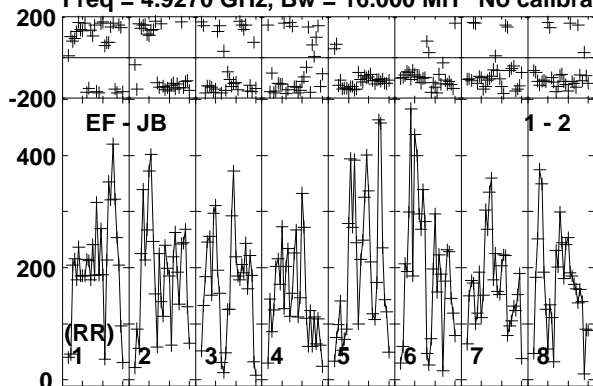

Lower frame: Micro Ampl Jy Top frame: Phas deg  
Vector averaged cross-power spectrum Baseline: EF (01) - JB (02)  
Timerange: 01/02:43:20 to 01/02:45:20

Plot file version 380 created 10-JUN-2016 17:22:40

CHECK RT013A.UVDATA.1

Freq = 4.9270 GHz, Bw = 16.000 MH No calibration applied and no bandpass applied

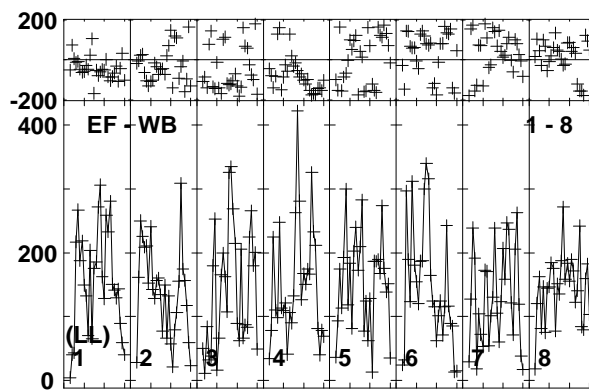
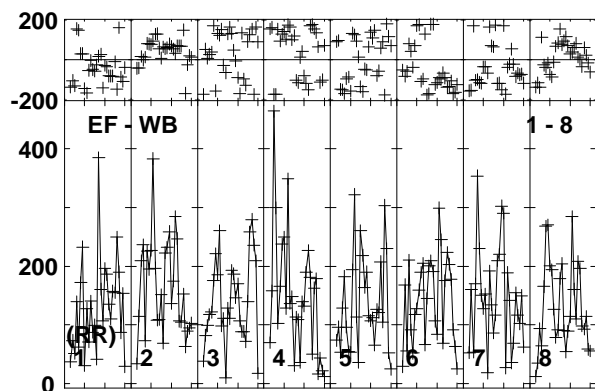
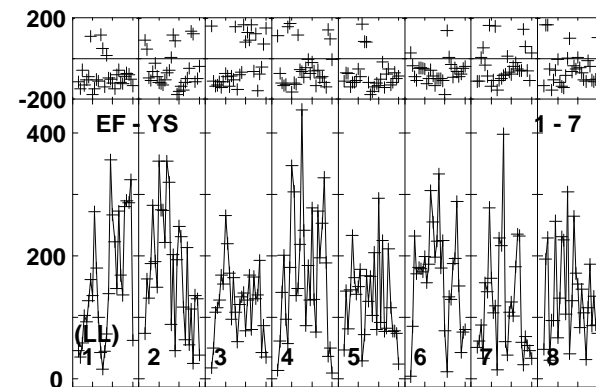
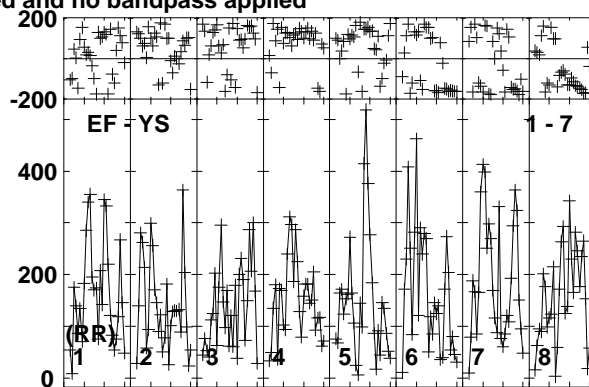
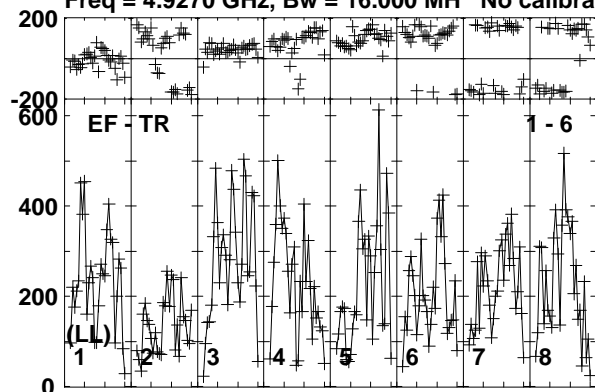

Lower frame: Micro Ampl Jy Top frame: Phas deg  
Vector averaged cross-power spectrum Baseline: EF (01) - TR (06)  
Timerange: 01/02:43:20 to 01/02:45:20

Plot file version 381 created 10-JUN-2016 17:22:40

CYGX1 RT013A.UVDATA.1

Freq = 4.9270 GHz, Bw = 16.000 MH No calibration applied and no bandpass applied

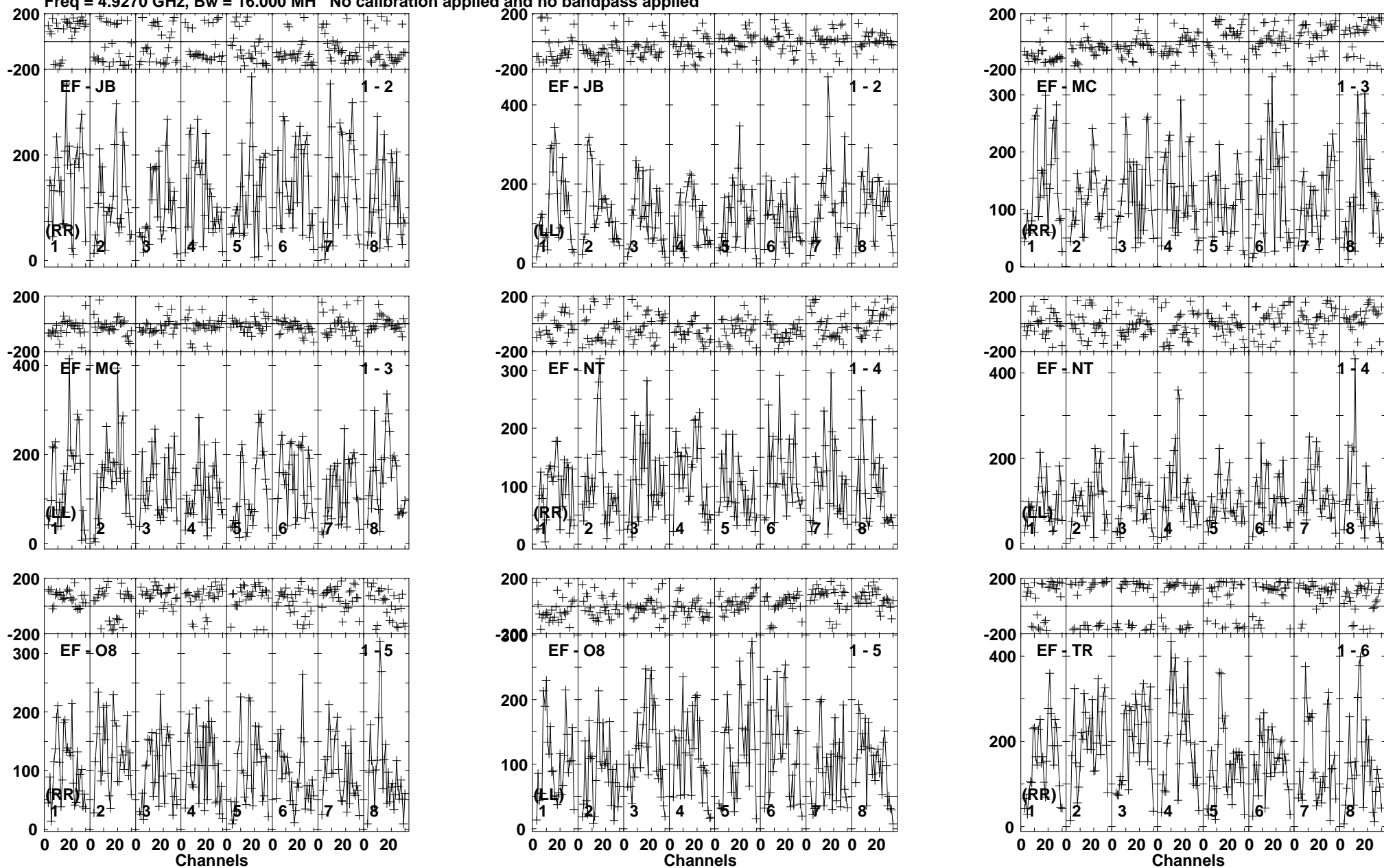

Lower frame: Micro Ampl Jy Top frame: Phas deg  
Vector averaged cross-power spectrum Baseline: EF (01) - JB (02)  
Timerange: 01/02:45:20 to 01/02:47:50

Plot file version 382 created 10-JUN-2016 17:22:41

CYGX1 RT013A.UVDATA.1

Freq = 4.9270 GHz, Bw = 16.000 MH No calibration applied and no bandpass applied

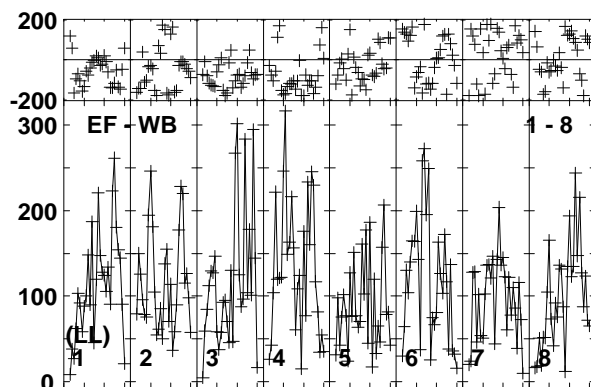
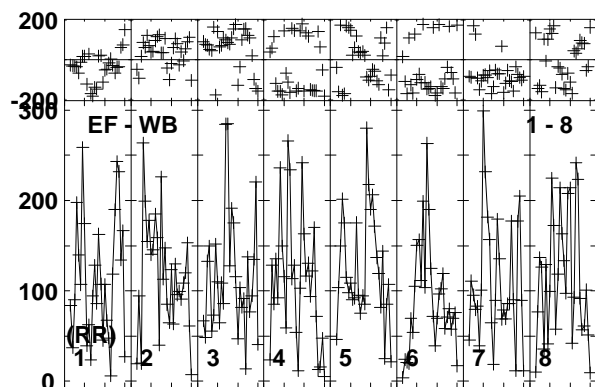
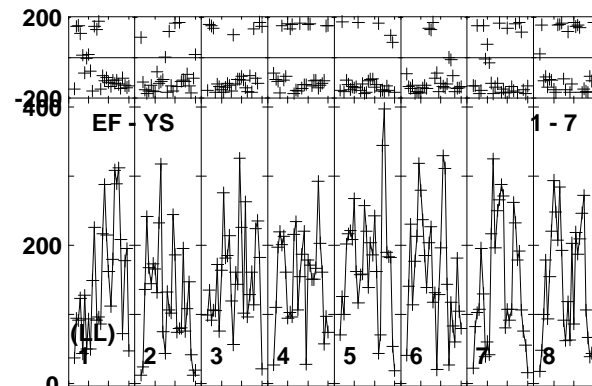
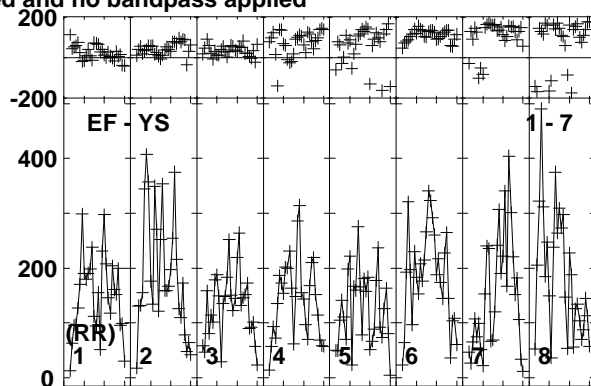
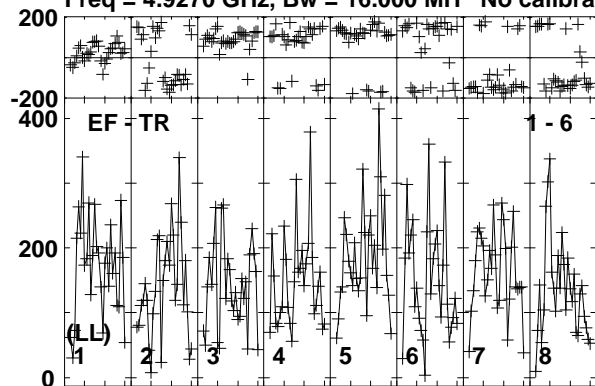

Lower frame: Micro Ampl Jy Top frame: Phas deg  
Vector averaged cross-power spectrum Baseline: EF (01) - TR (06)  
Timerange: 01/02:45:20 to 01/02:47:50

Plot file version 383 created 10-JUN-2016 17:22:41

J1957+3338 RT013A.UVDATA.1

Freq = 4.9270 GHz, Bw = 16.000 MH No calibration applied and no bandpass applied

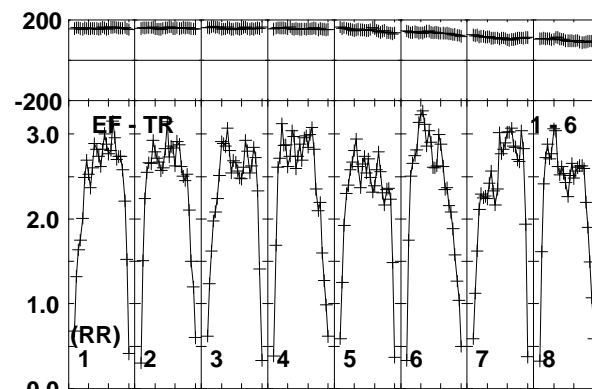
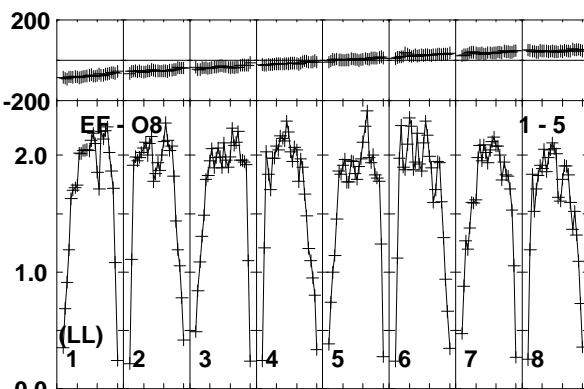
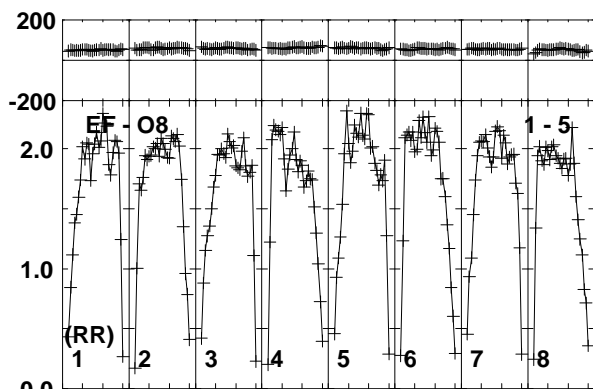
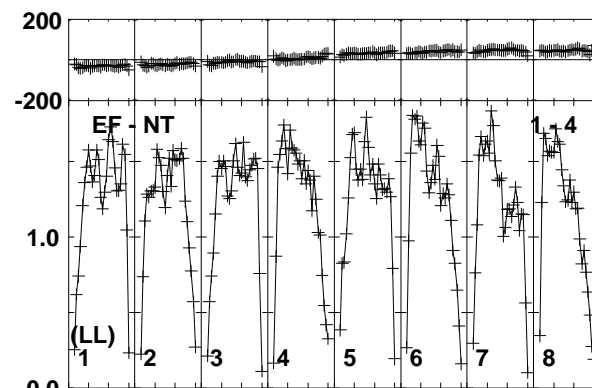
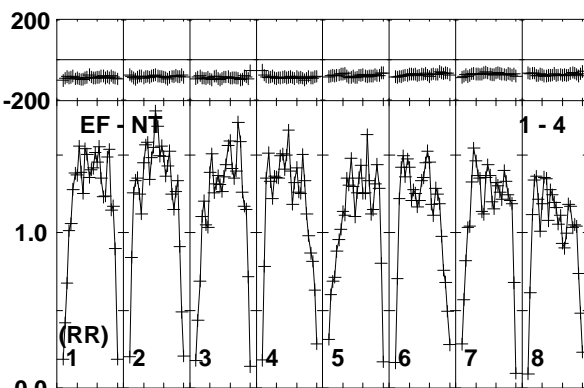
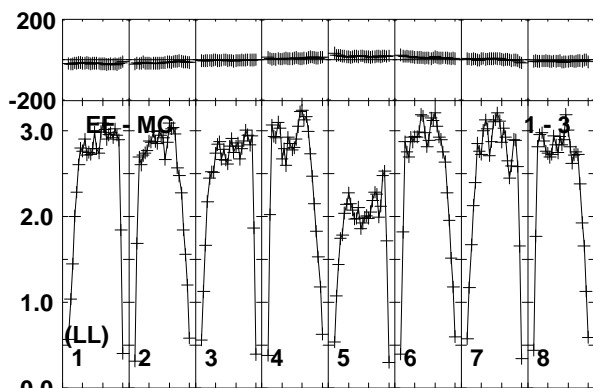
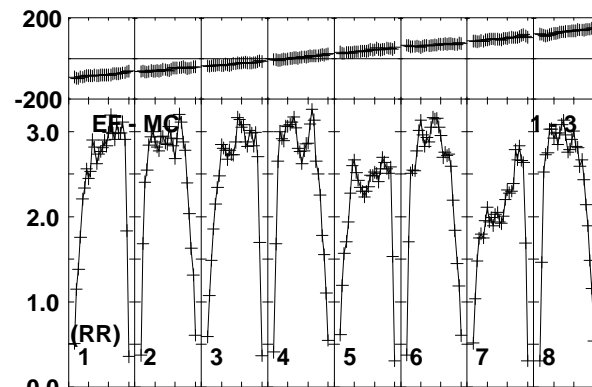
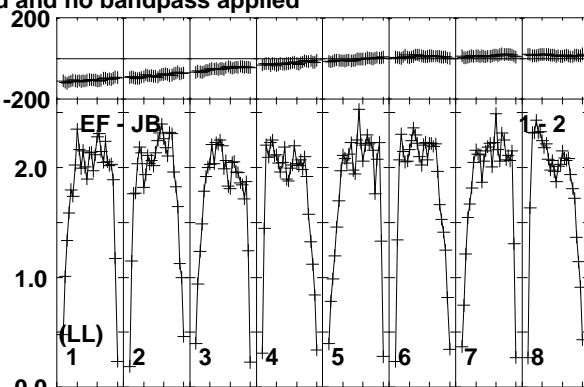
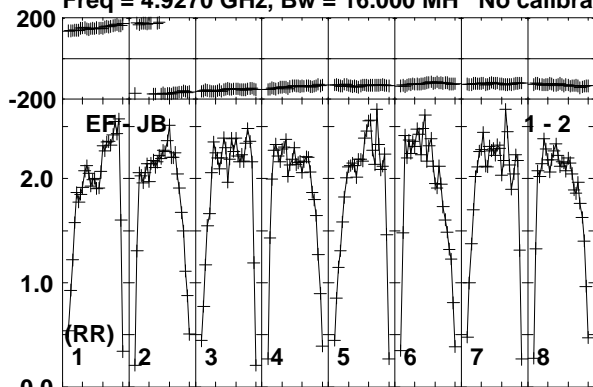

Lower frame: Milli Ampl Jy Top frame: Phas deg

Vector averaged cross-power spectrum Baseline: EF (01) - JB (02)

Timerange: 01/02:47:51 to 01/02:49:20

Plot file version 384 created 10-JUN-2016 17:22:41

J1957+3338 RT013A.UVDATA.1

Freq = 4.9270 GHz, Bw = 16.000 MH No calibration applied and no bandpass applied

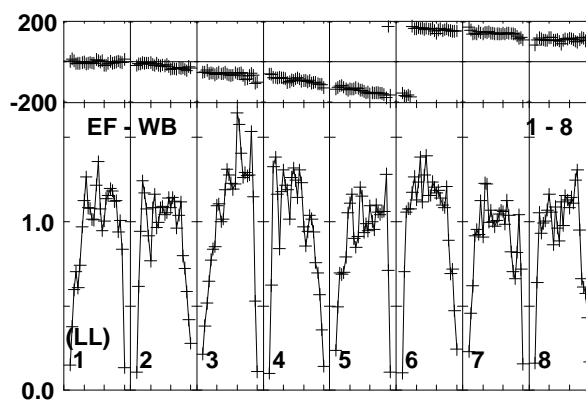
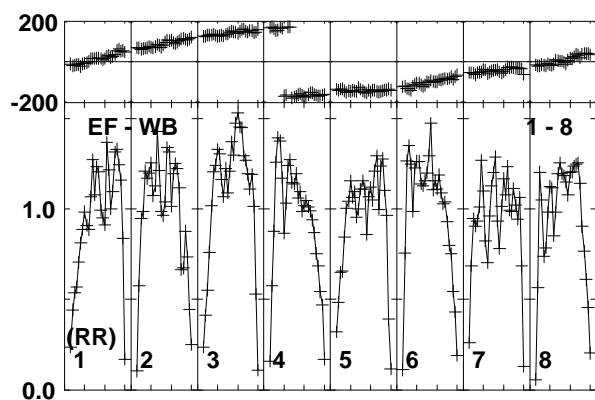
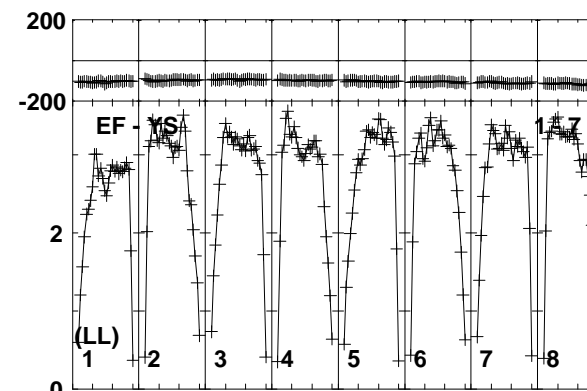
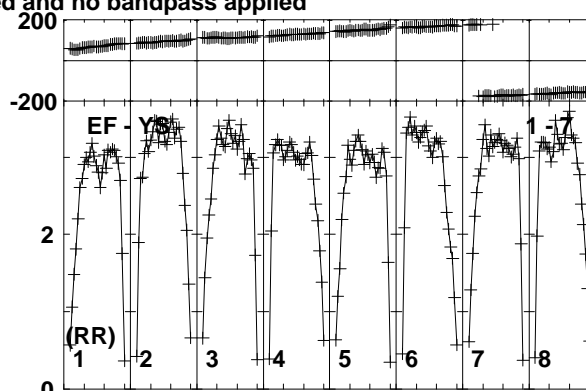
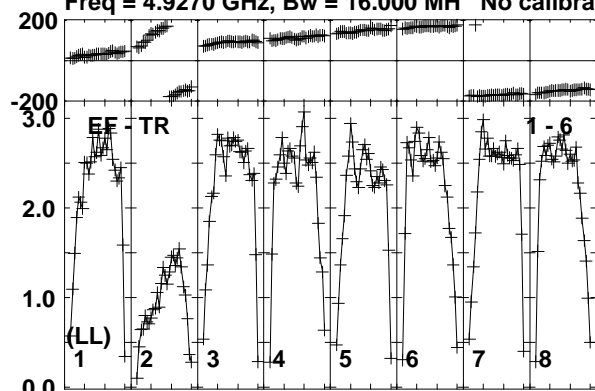

Lower frame: Milli Ampl Jy Top frame: Phas deg  
Vector averaged cross-power spectrum Baseline: EF (01) - TR (06)  
Timerange: 01/02:47:51 to 01/02:49:20

Plot file version 385 created 10-JUN-2016 17:22:41

CHECK RT013A.UVDATA.1

Freq = 4.9270 GHz, Bw = 16.000 MH No calibration applied and no bandpass applied

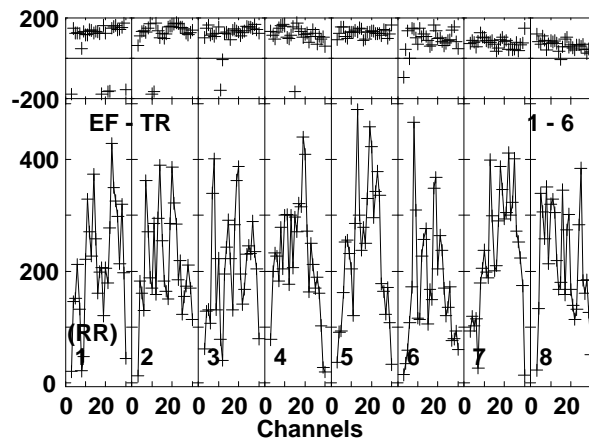
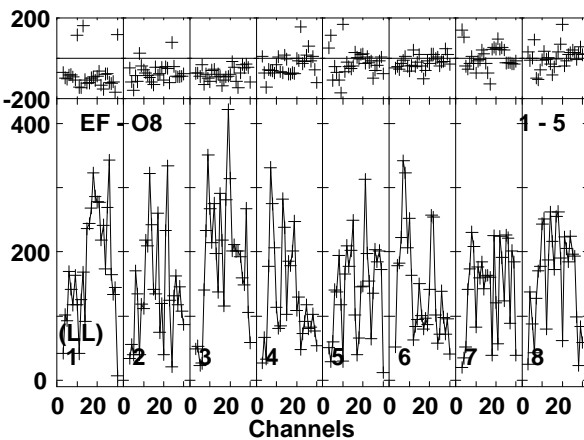
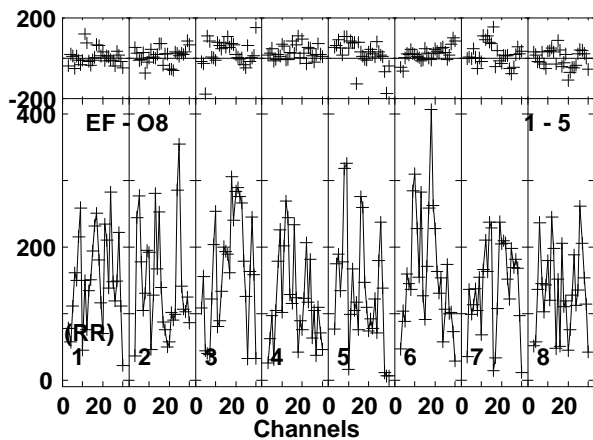
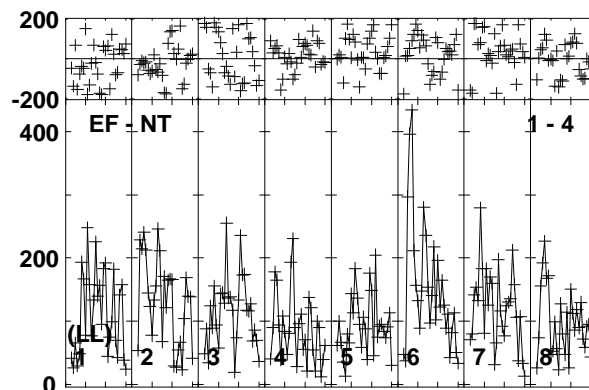
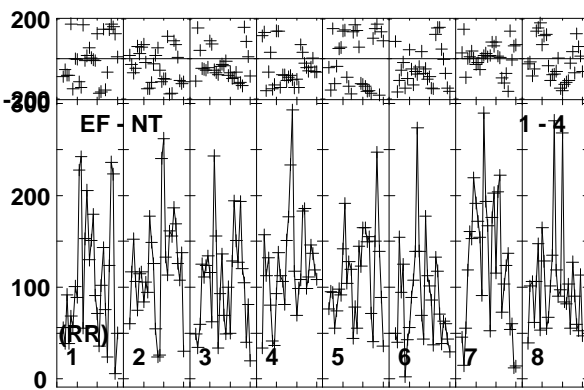
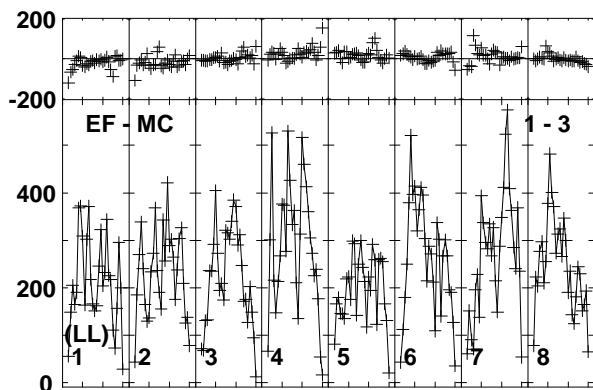
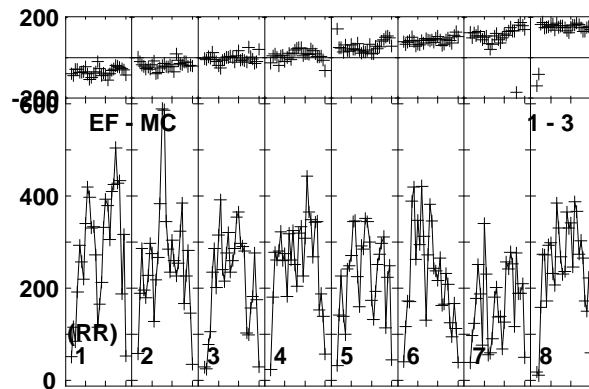
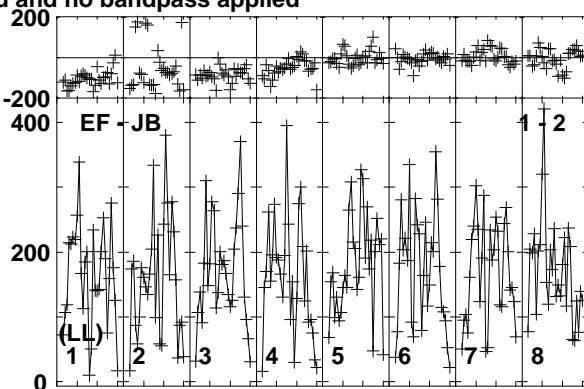
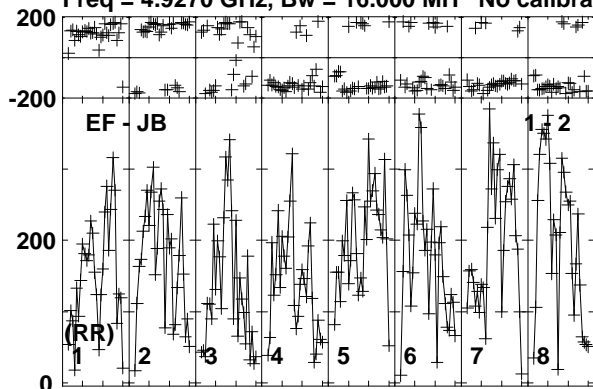

Lower frame: Micro Ampl Jy Top frame: Phas deg  
Vector averaged cross-power spectrum Baseline: EF (01) - JB (02)  
Timerange: 01/02:50:00 to 01/02:51:59

Plot file version 386 created 10-JUN-2016 17:22:41

CHECK RT013A.UVDATA.1

Freq = 4.9270 GHz, Bw = 16.000 MH No calibration applied and no bandpass applied

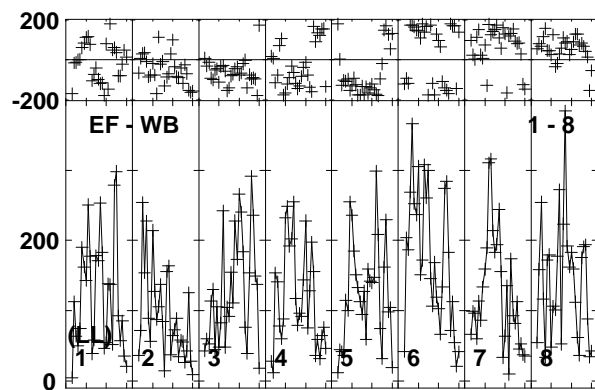
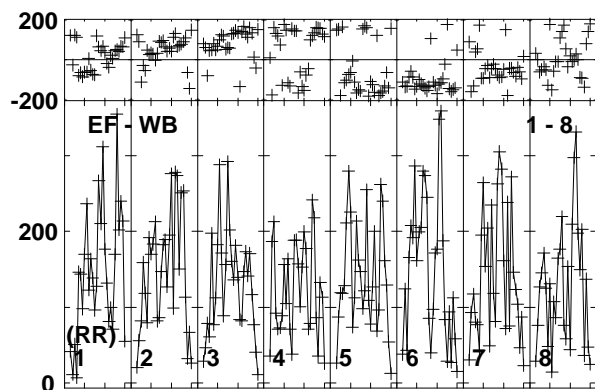
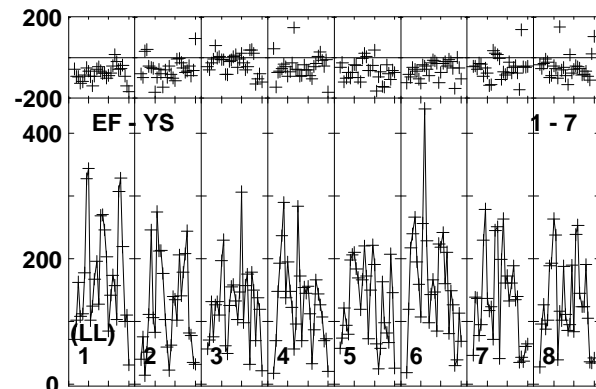
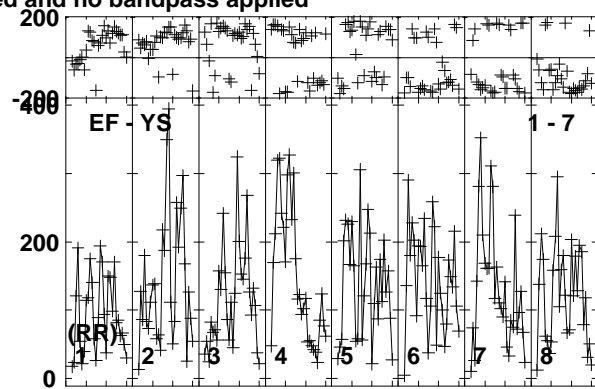
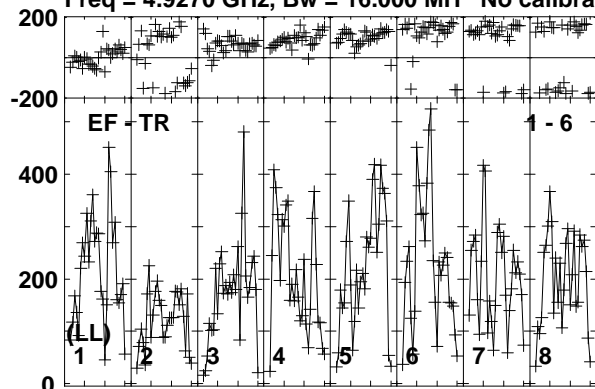

Lower frame: Micro Ampl Jy Top frame: Phas deg  
Vector averaged cross-power spectrum Baseline: EF (01) - TR (06)  
Timerange: 01/02:50:00 to 01/02:51:59



Plot file version 387 created 10-JUN-2016 17:22:41

CYGX1 RT013A.UVDATA.1

Freq = 4.9270 GHz, Bw = 16.000 MH No calibration applied and no bandpass applied

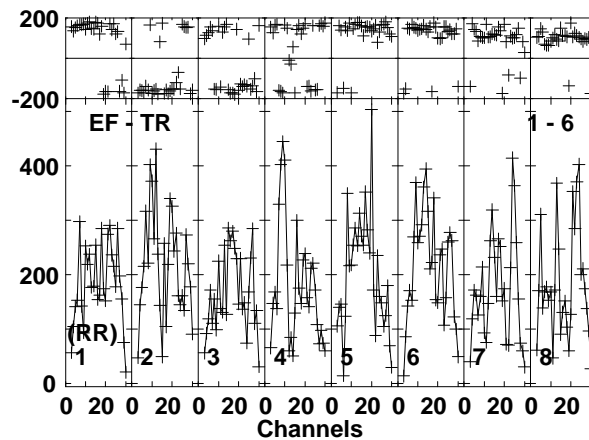
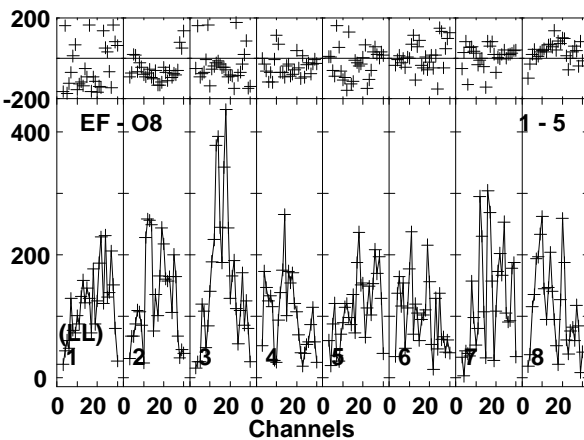
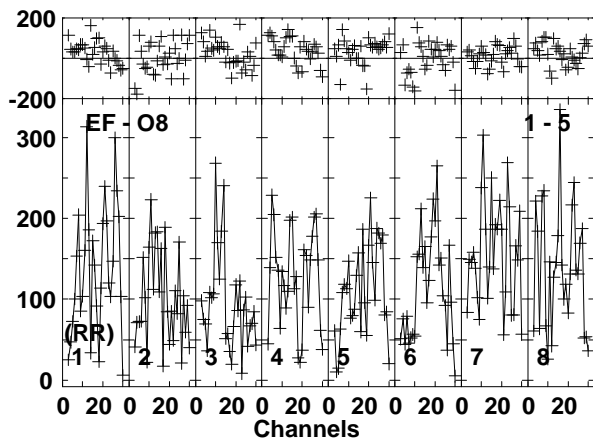
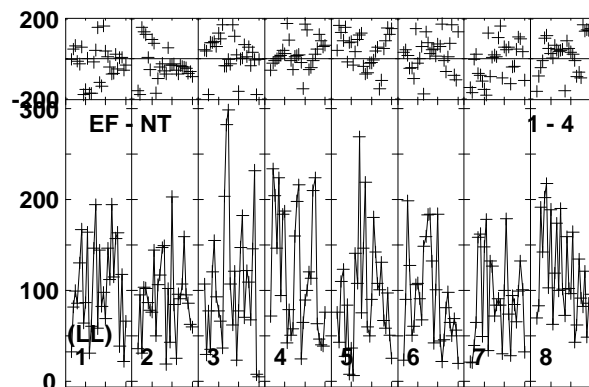
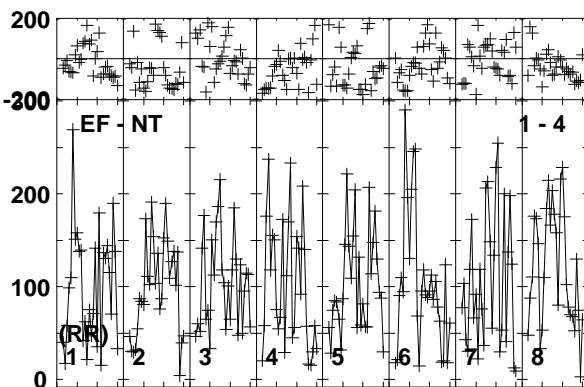
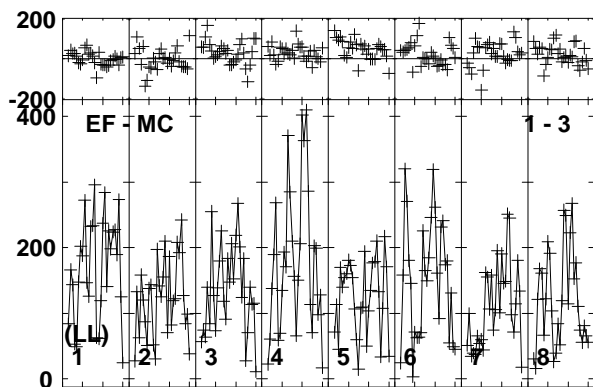
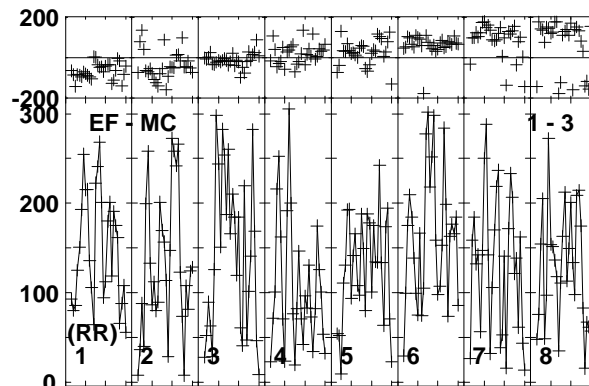
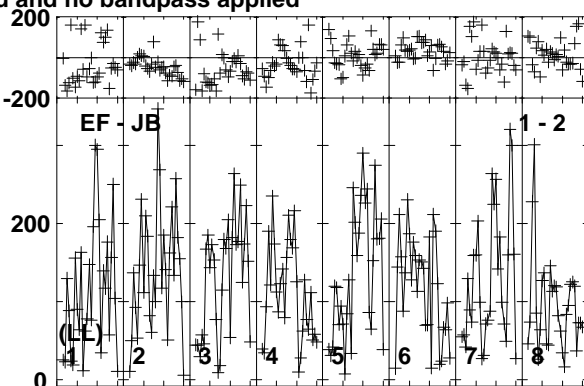
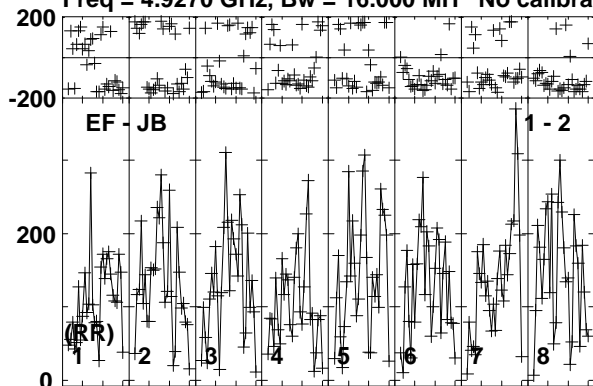

Lower frame: Micro Ampl Jy Top frame: Phas deg  
Vector averaged cross-power spectrum Baseline: EF (01) - JB (02)  
Timerange: 01/02:52:00 to 01/02:54:30

Plot file version 388 created 10-JUN-2016 17:22:41

CYGX1 RT013A.UVDATA.1

Freq = 4.9270 GHz, Bw = 16.000 MH No calibration applied and no bandpass applied

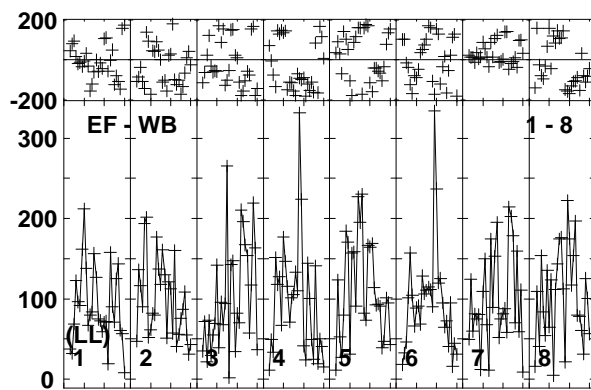
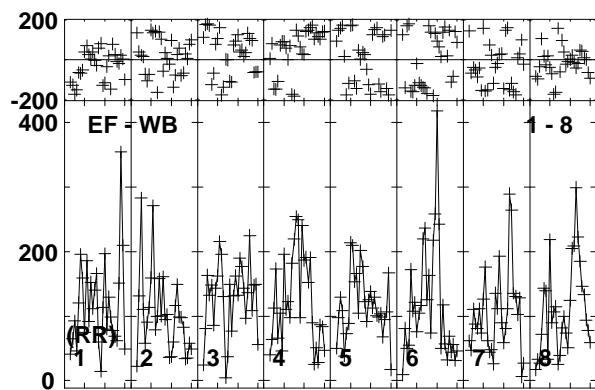
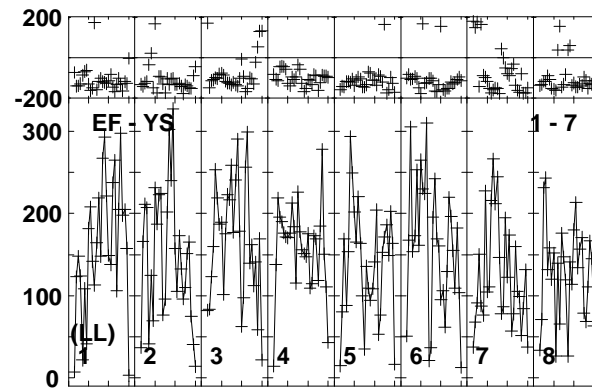
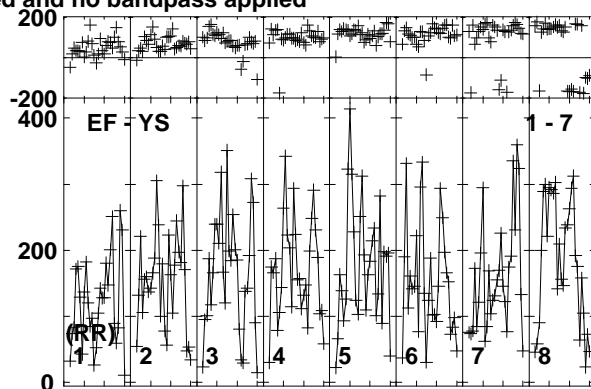
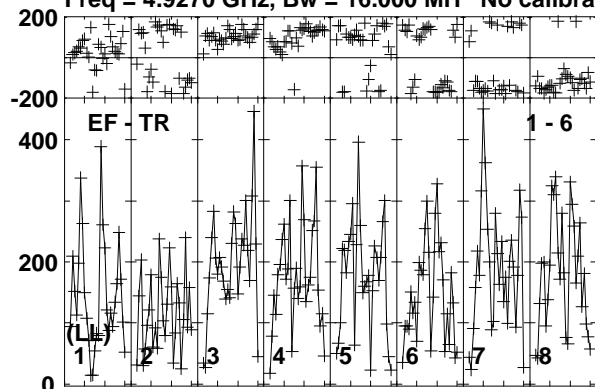

Lower frame: Micro Ampl Jy Top frame: Phas deg  
Vector averaged cross-power spectrum Baseline: EF (01) - TR (06)  
Timerange: 01/02:52:00 to 01/02:54:30

Plot file version 389 created 10-JUN-2016 17:22:41

J1957+3338 RT013A.UVDATA.1

Freq = 4.9270 GHz, Bw = 16.000 MH No calibration applied and no bandpass applied

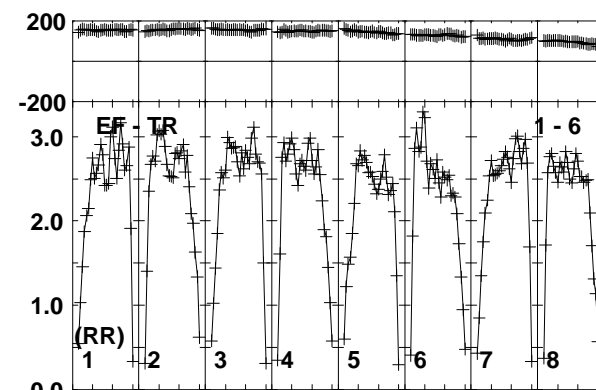
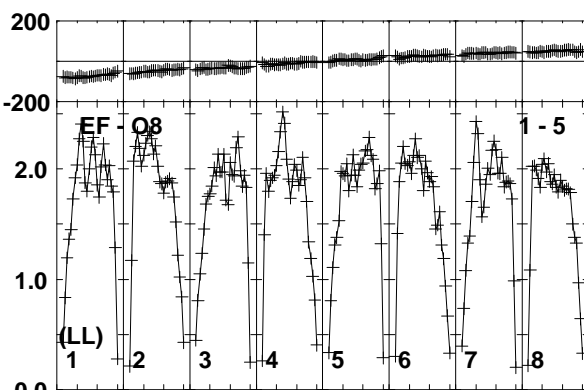
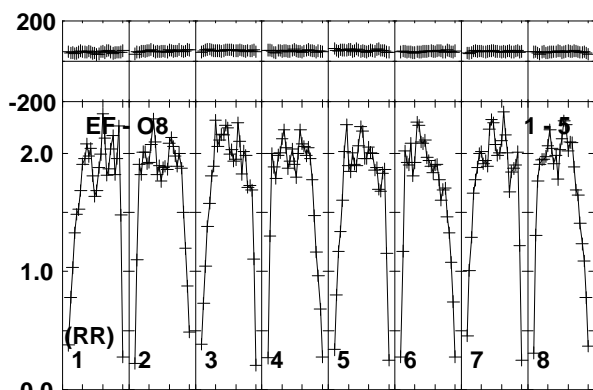
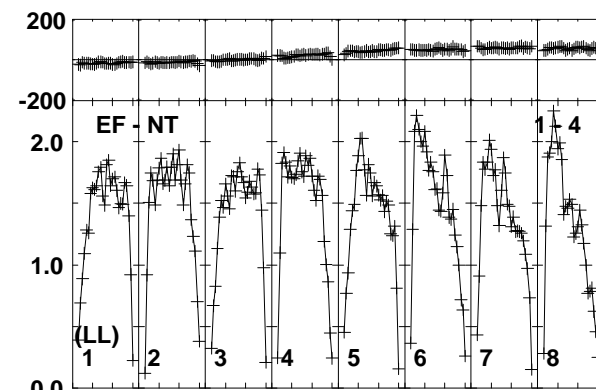
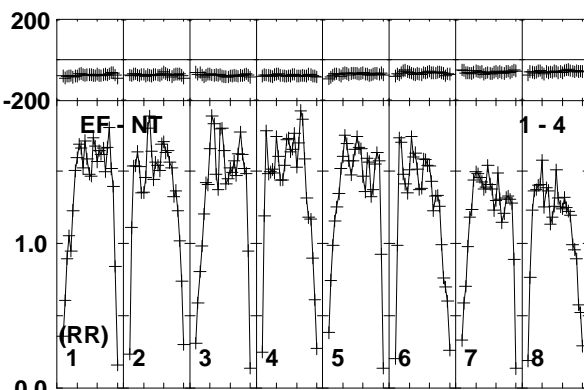
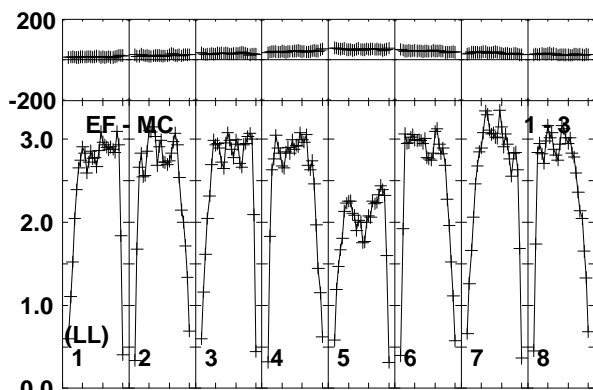
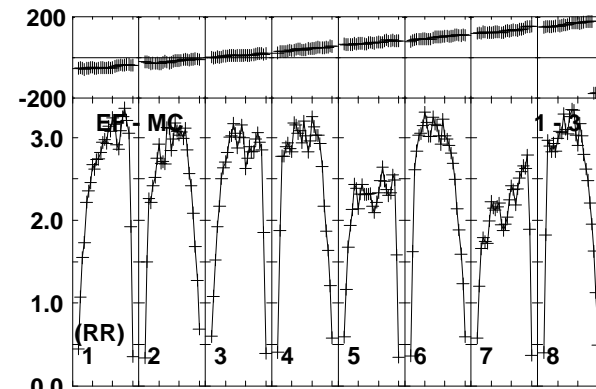
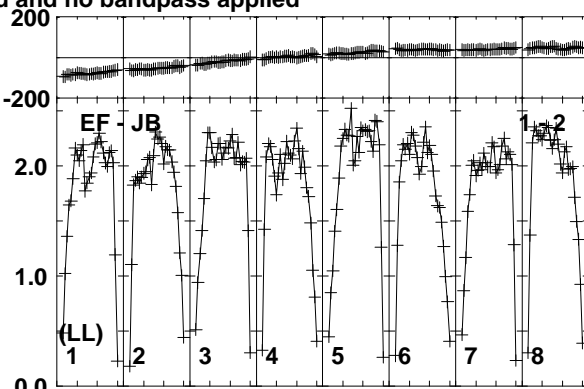
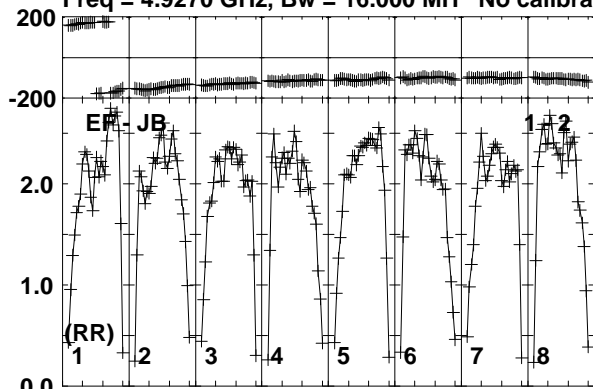

Lower frame: Milli Ampl Jy Top frame: Phas deg  
Vector averaged cross-power spectrum Baseline: EF (01) - JB (02)  
Timerange: 01/02:54:31 to 01/02:56:00

Plot file version 390 created 10-JUN-2016 17:22:41

J1957+3338 RT013A.UVDATA.1

Freq = 4.9270 GHz, Bw = 16.000 MH No calibration applied and no bandpass applied

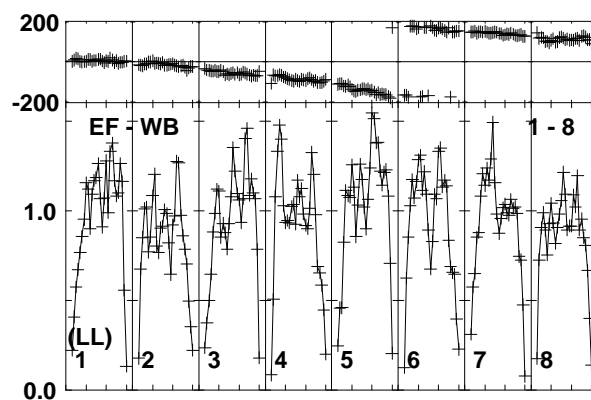
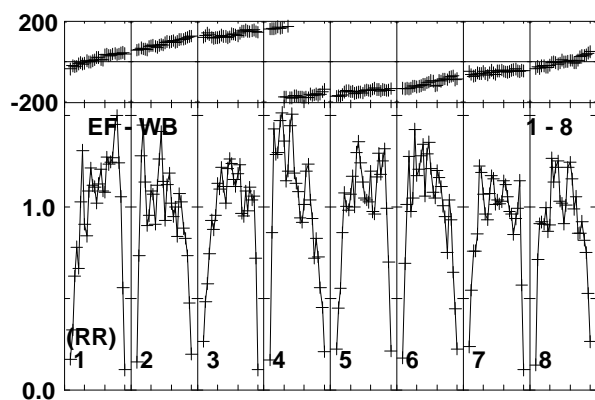
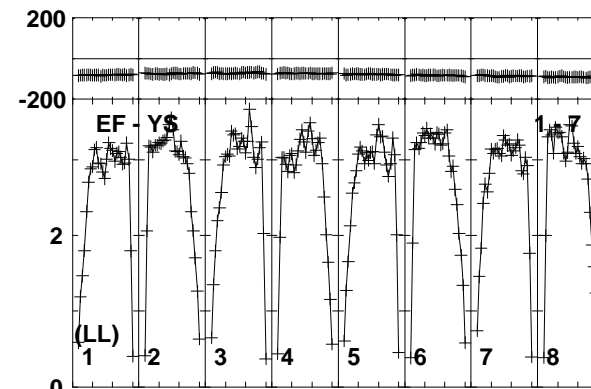
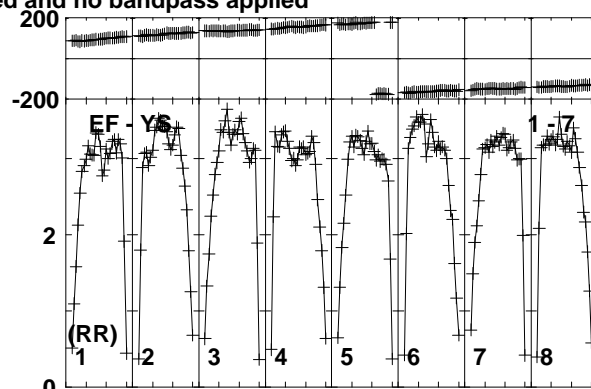
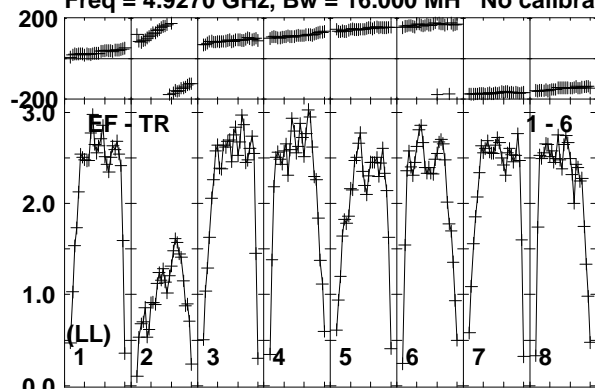

Lower frame: Milli Ampl Jy Top frame: Phas deg  
Vector averaged cross-power spectrum Baseline: EF (01) - TR (06)  
Timerange: 01/02:54:31 to 01/02:56:00

Plot file version 391 created 10-JUN-2016 17:22:41

CHECK RT013A.UVDATA.1

Freq = 4.9270 GHz, Bw = 16.000 MH No calibration applied and no bandpass applied

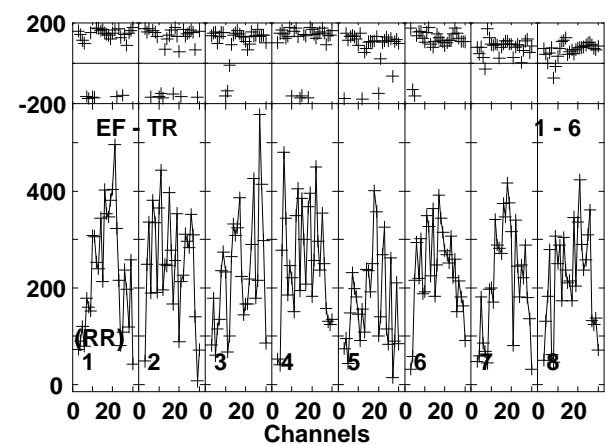
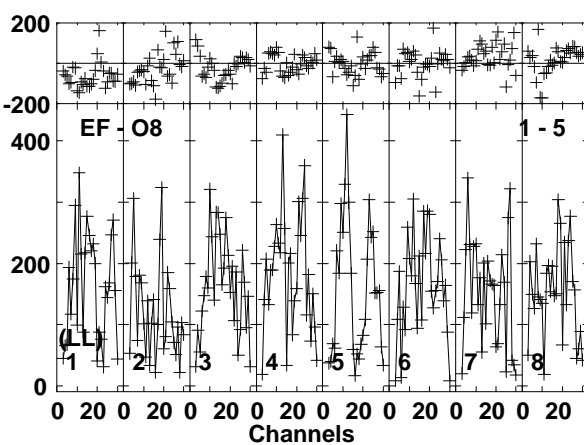
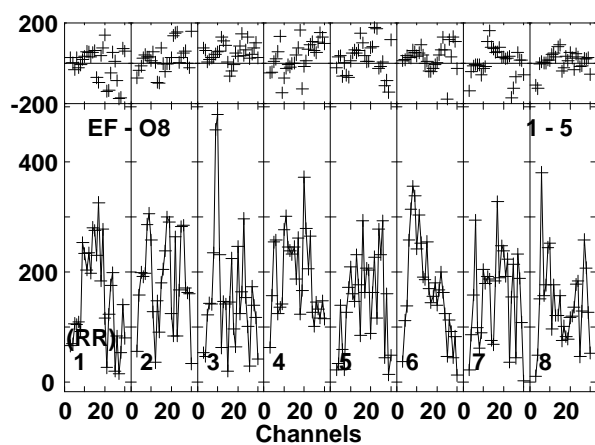
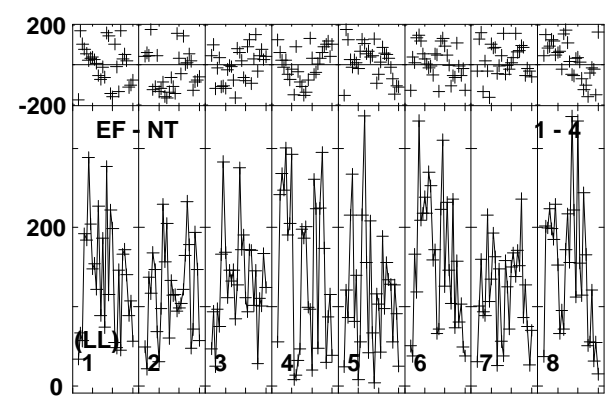
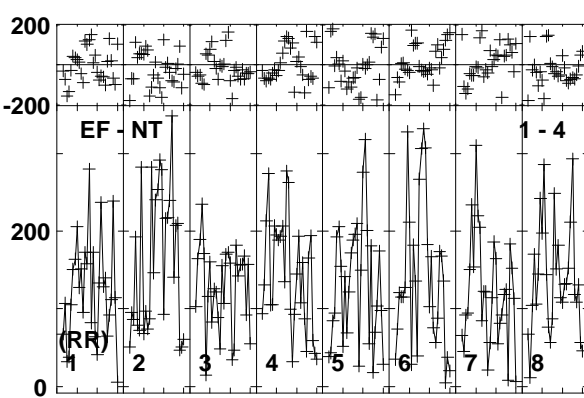
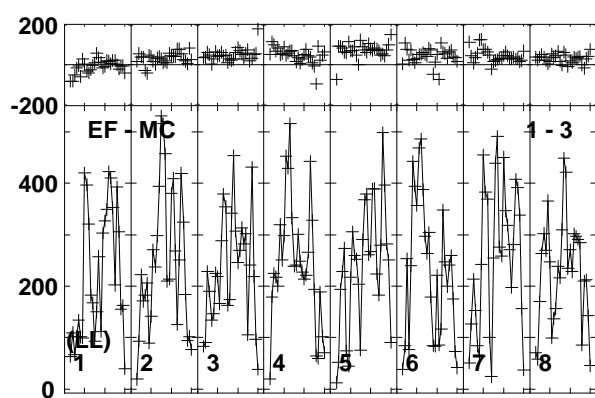
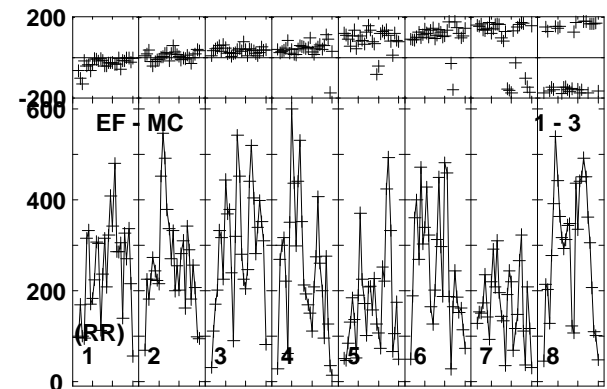
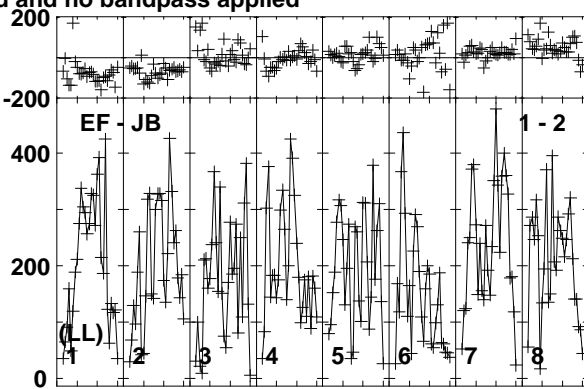
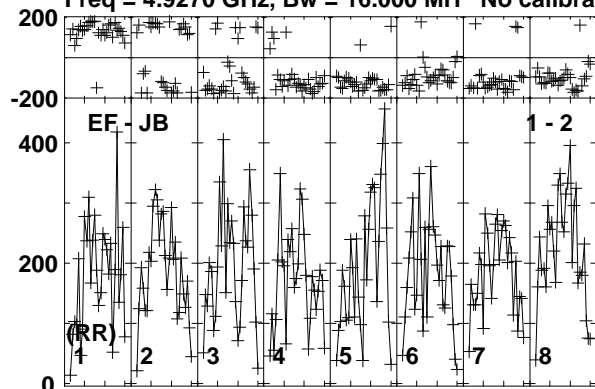

Lower frame: Micro Ampl Jy Top frame: Phas deg  
Vector averaged cross-power spectrum Baseline: EF (01) - JB (02)  
Timerange: 01/02:56:01 to 01/02:58:00

Plot file version 392 created 10-JUN-2016 17:22:42

CHECK RT013A.UVDATA.1

Freq = 4.9270 GHz, Bw = 16.000 MH No calibration applied and no bandpass applied

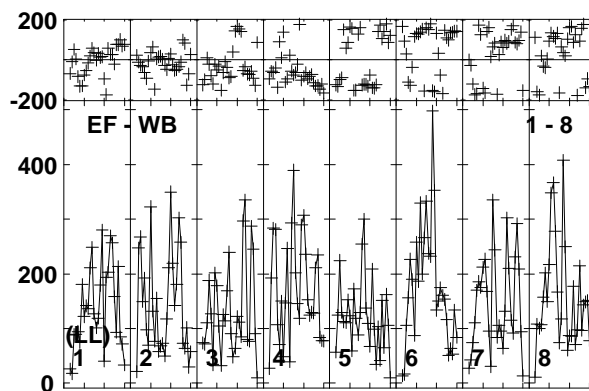
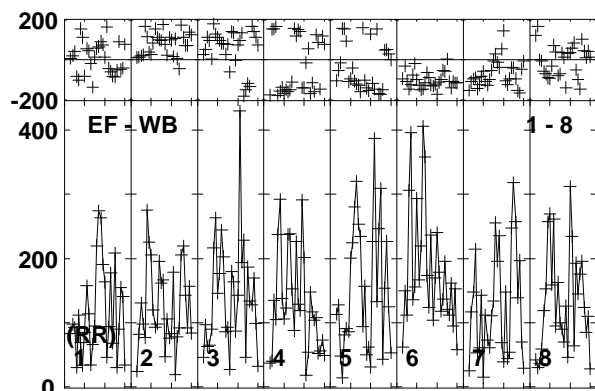
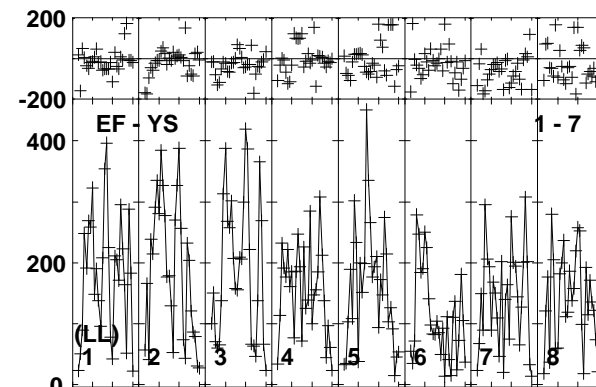
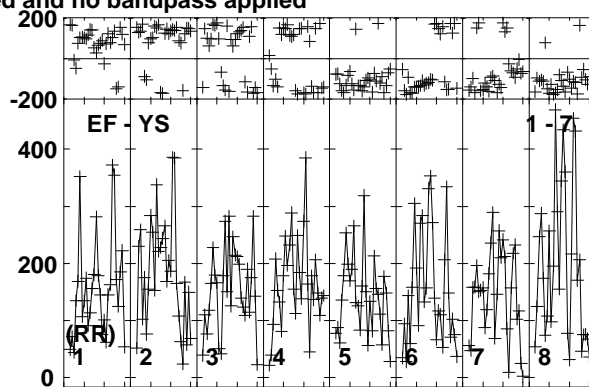
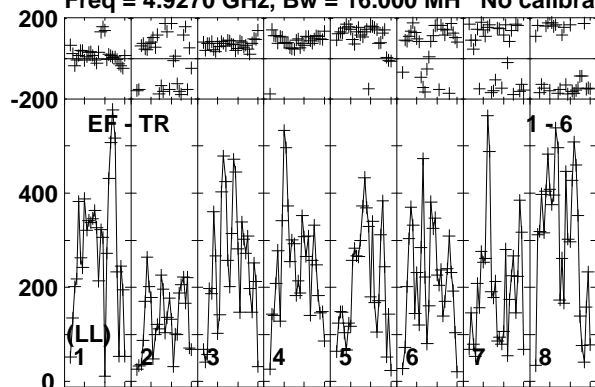

Lower frame: Micro Ampl Jy Top frame: Phas deg  
Vector averaged cross-power spectrum Baseline: EF (01) - TR (06)  
Timerange: 01/02:56:01 to 01/02:58:00

Plot file version 393 created 10-JUN-2016 17:22:42

CYGX1 RT013A.UVDATA.1

Freq = 4.9270 GHz, Bw = 16.000 MH No calibration applied and no bandpass applied

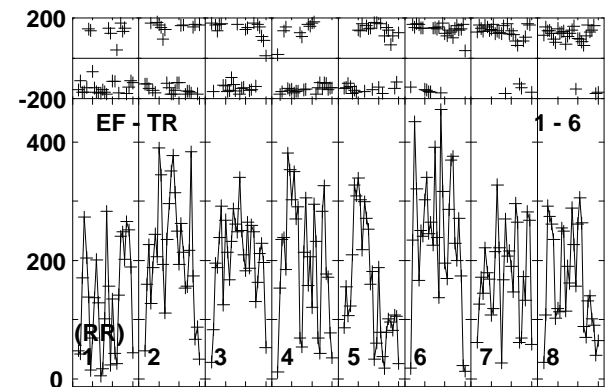
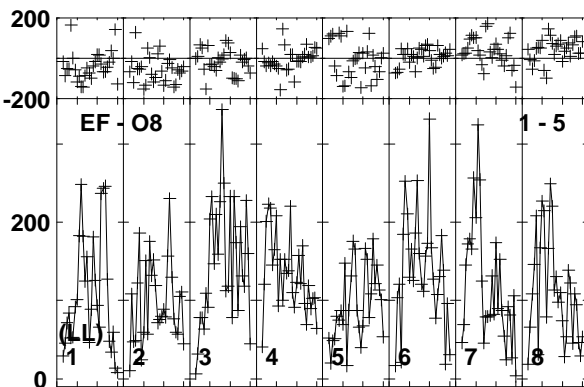
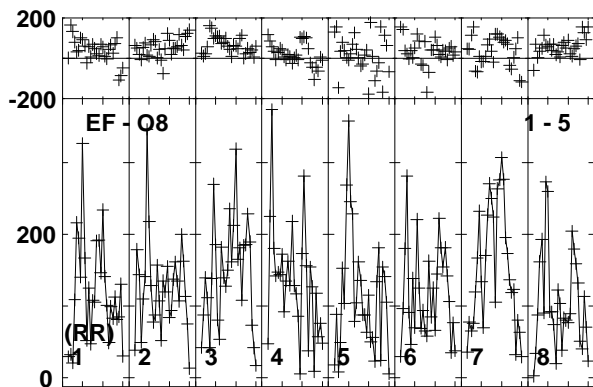
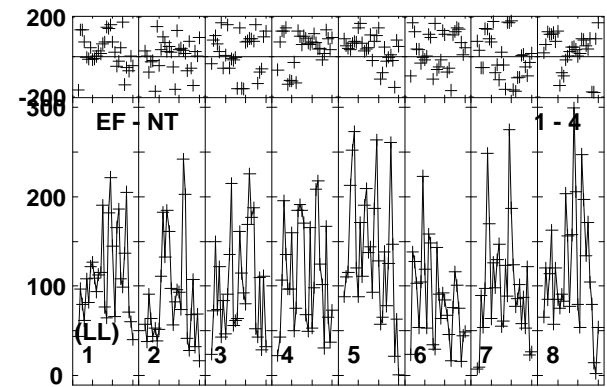
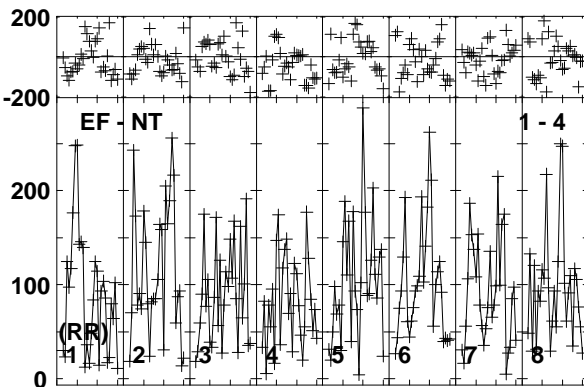
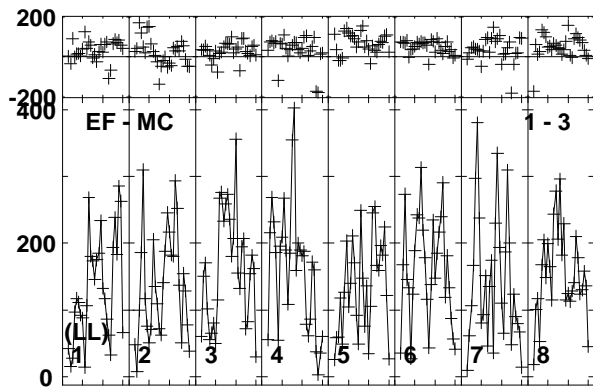
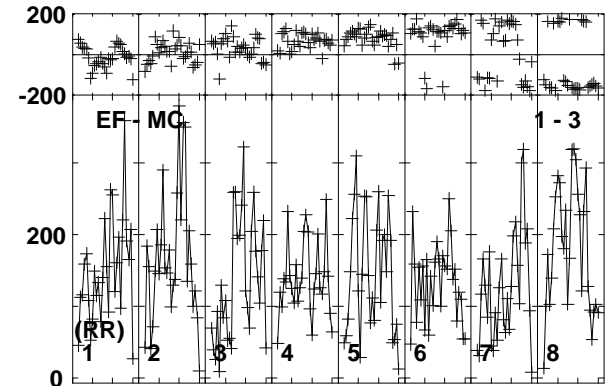
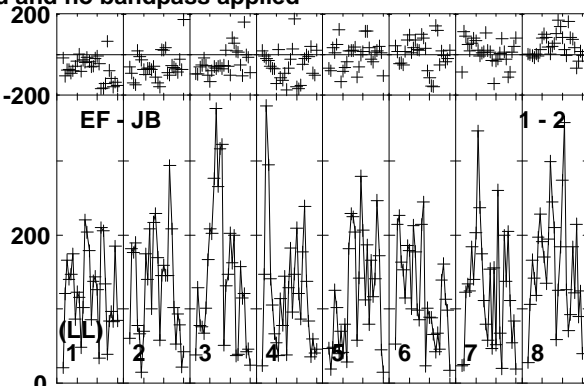
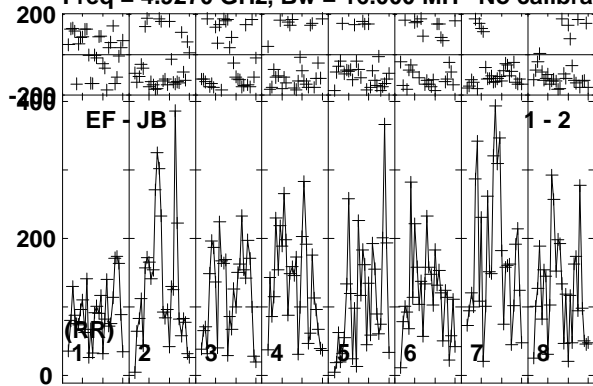

Lower frame: Micro Ampl Jy Top frame: Phas deg  
Vector averaged cross-power spectrum Baseline: EF (01) - JB (02)  
Timerange: 01/02:58:01 to 01/03:00:29

Plot file version 394 created 10-JUN-2016 17:22:42

CYGX1 RT013A.UVDATA.1

Freq = 4.9270 GHz, Bw = 16.000 MH No calibration applied and no bandpass applied

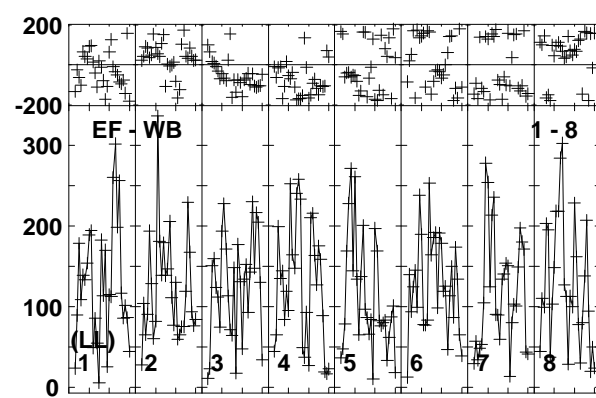
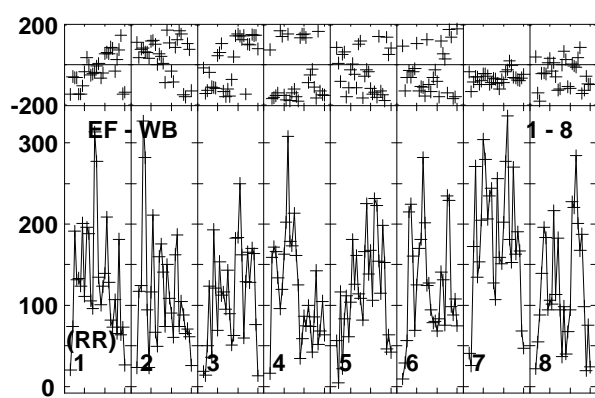
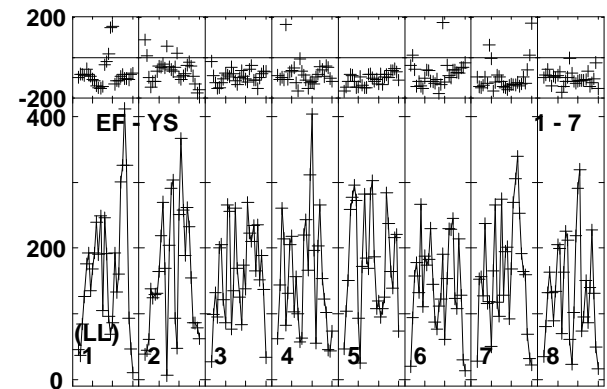
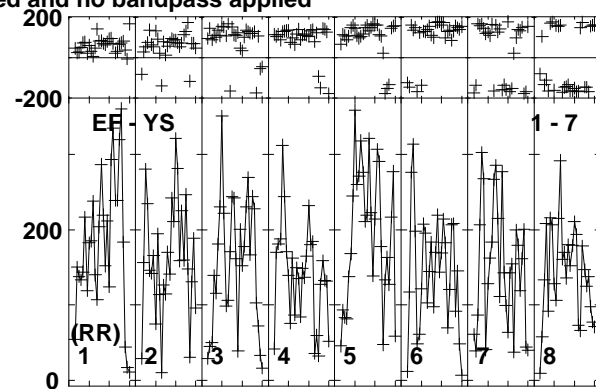
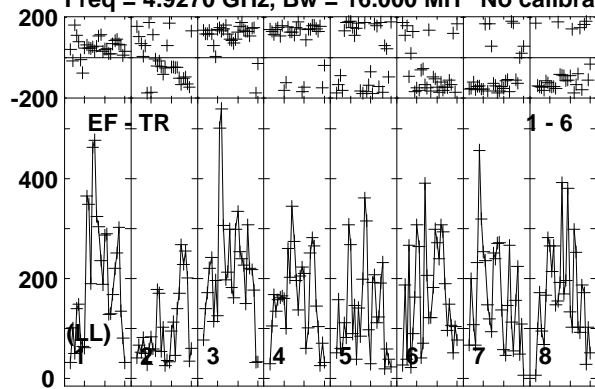

Lower frame: Micro Ampl Jy Top frame: Phas deg  
Vector averaged cross-power spectrum Baseline: EF (01) - TR (06)  
Timerange: 01/02:58:01 to 01/03:00:29



Plot file version 395 created 10-JUN-2016 17:22:42

J1957+3338 RT013A.UVDATA.1

Freq = 4.9270 GHz, Bw = 16.000 MH No calibration applied and no bandpass applied

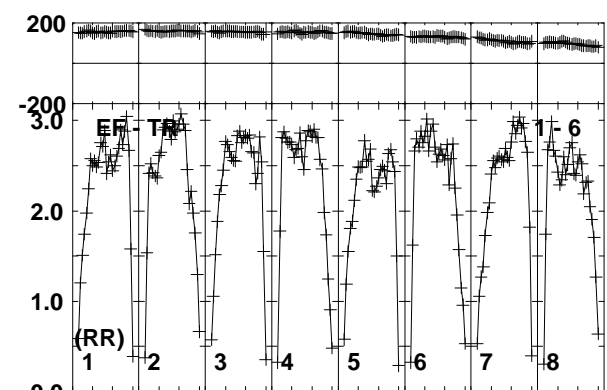
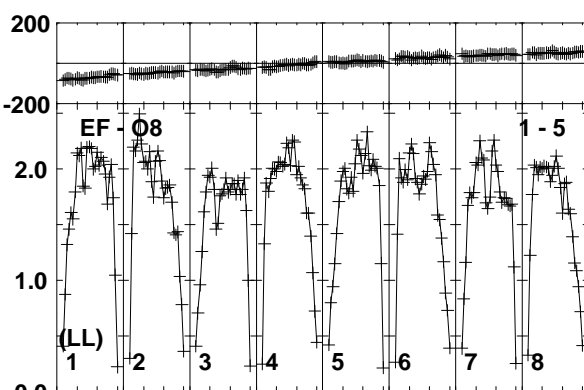
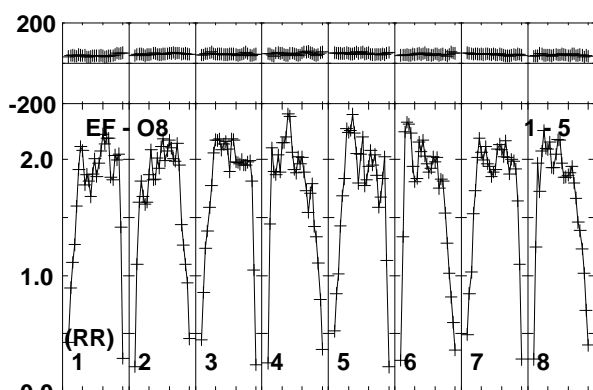
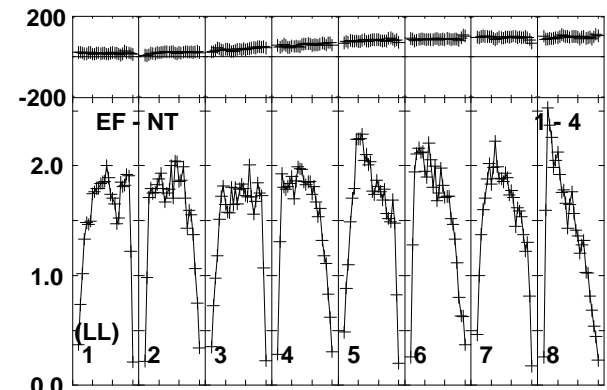
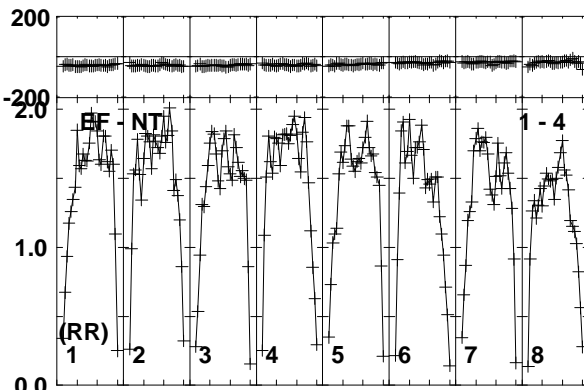
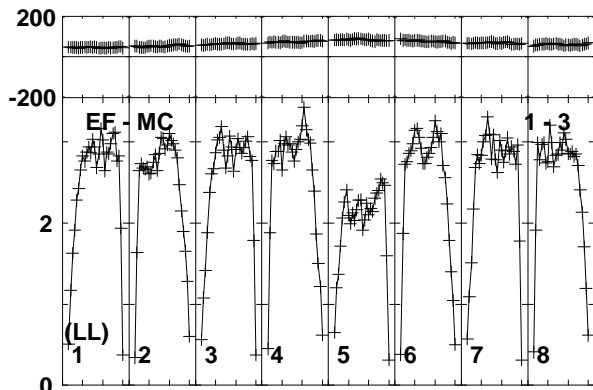
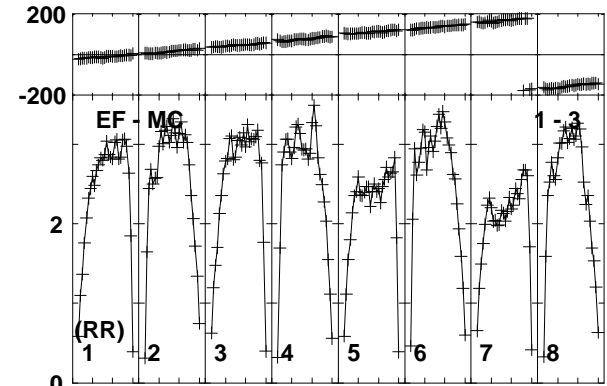
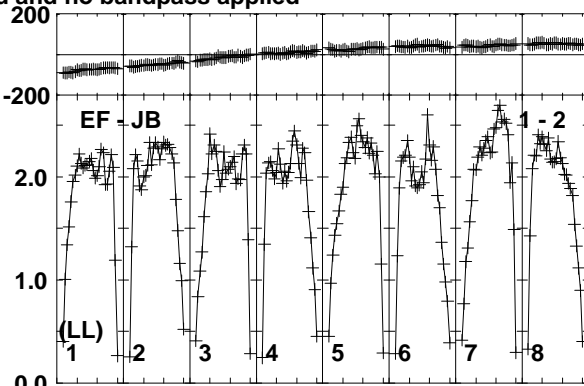
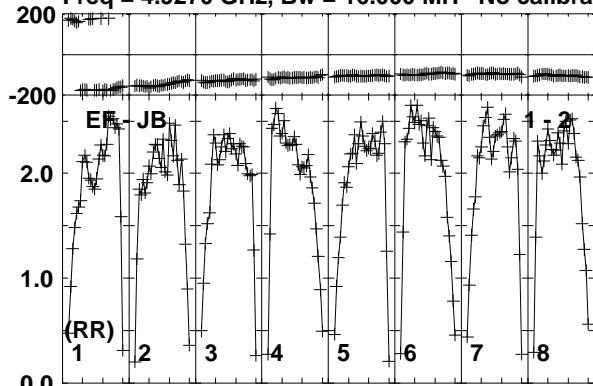

Lower frame: Milli Ampl Jy Top frame: Phas deg

Vector averaged cross-power spectrum Baseline: EF (01) - JB (02)

Timerange: 01/03:00:31 to 01/03:01:59

Plot file version 396 created 10-JUN-2016 17:22:42

J1957+3338 RT013A.UVDATA.1

Freq = 4.9270 GHz, Bw = 16.000 MH No calibration applied and no bandpass applied

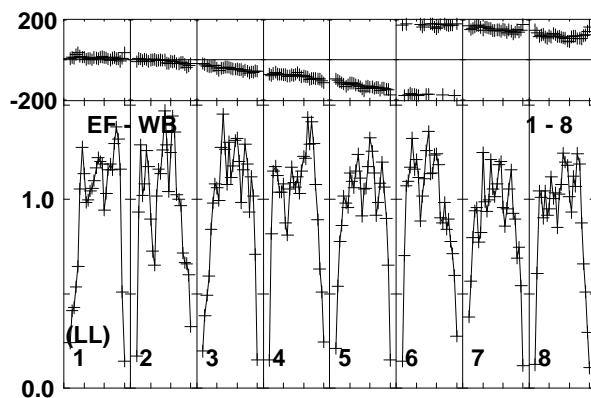
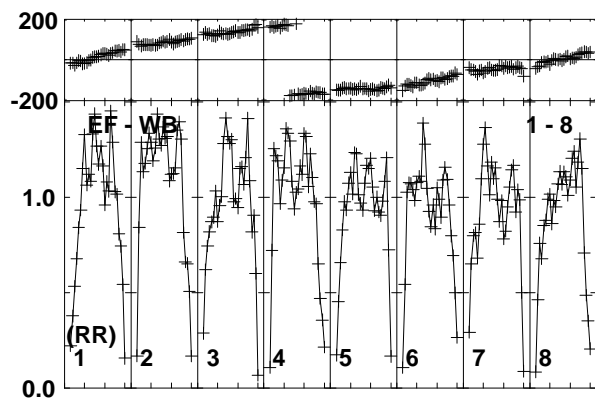
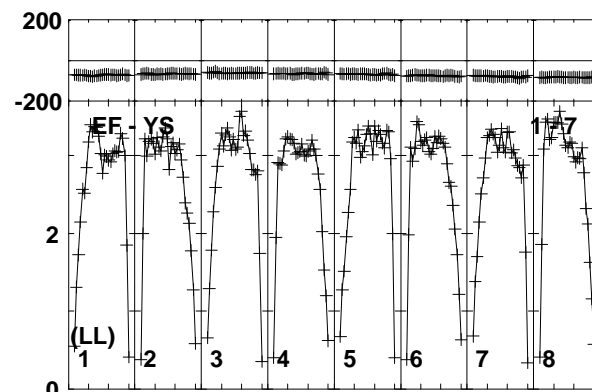
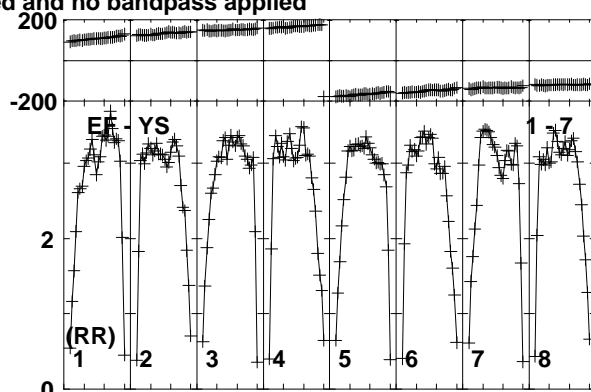
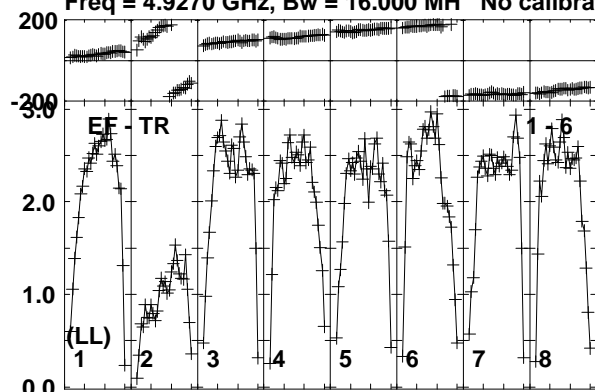

Lower frame: Milli Ampl Jy Top frame: Phas deg  
Vector averaged cross-power spectrum Baseline: EF (01) - TR (06)  
Timerange: 01/03:00:31 to 01/03:01:59

Plot file version 397 created 10-JUN-2016 17:22:42

CHECK RT013A.UVDATA.1

Freq = 4.9270 GHz, Bw = 16.000 MH No calibration applied and no bandpass applied

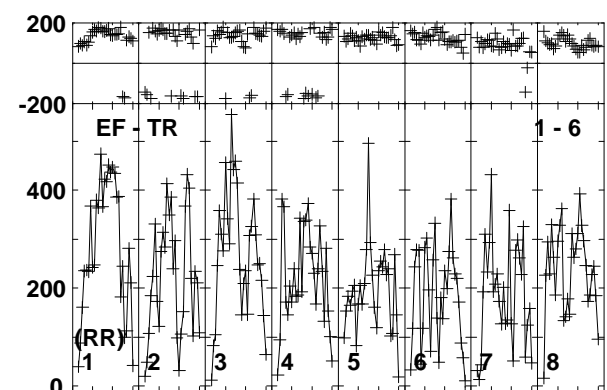
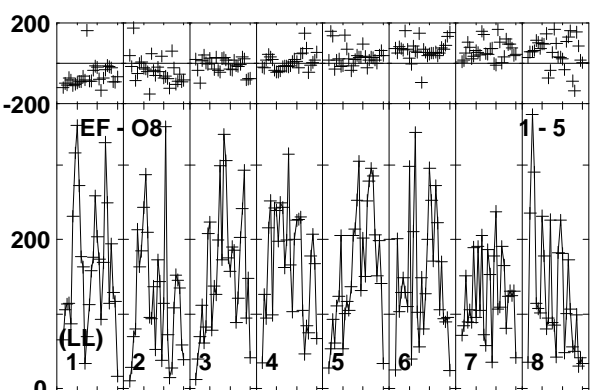
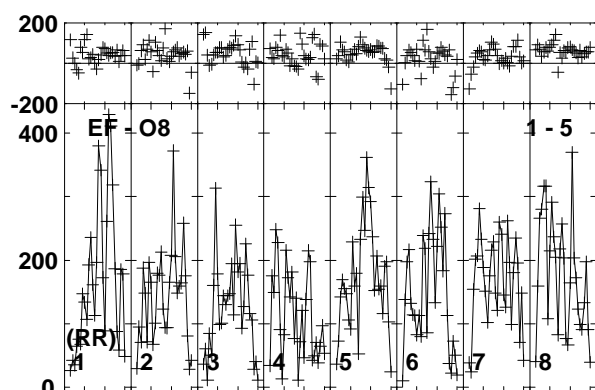
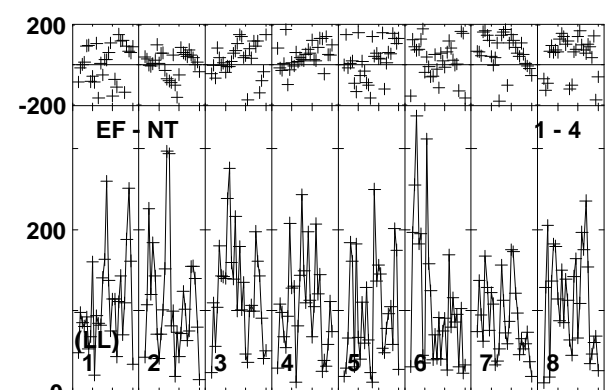
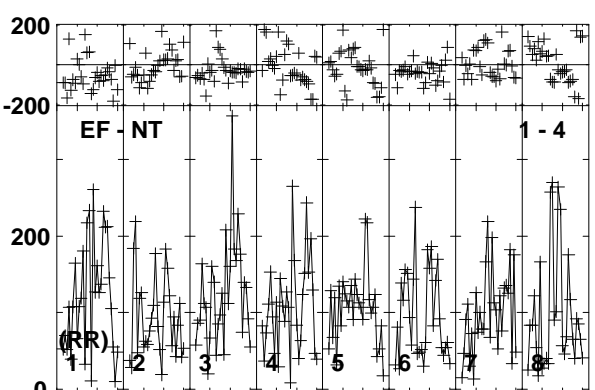
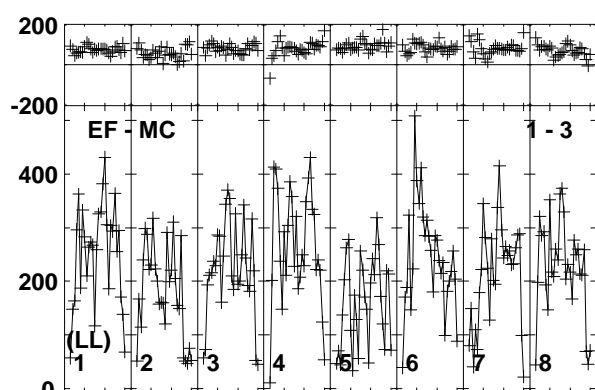
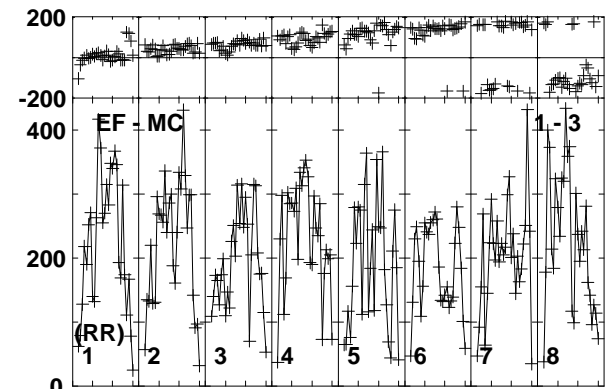
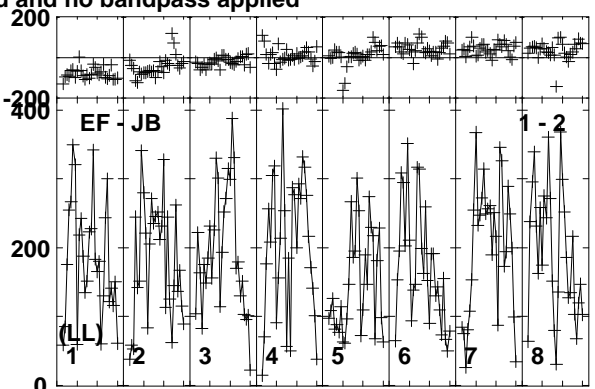
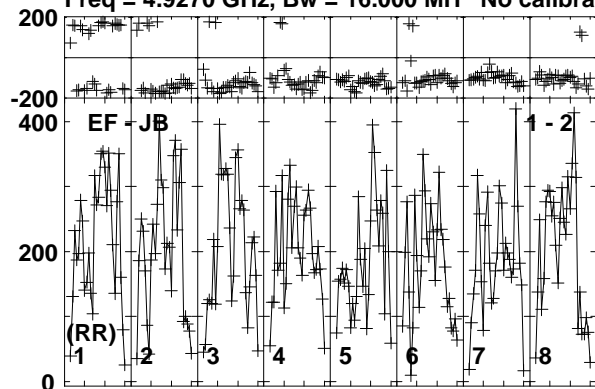

Lower frame: Micro Ampl Jy Top frame: Phas deg  
Vector averaged cross-power spectrum Baseline: EF (01) - JB (02)  
Timerange: 01/03:02:40 to 01/03:04:40

Plot file version 398 created 10-JUN-2016 17:22:42

CHECK RT013A.UVDATA.1

Freq = 4.9270 GHz, Bw = 16.000 MH No calibration applied and no bandpass applied

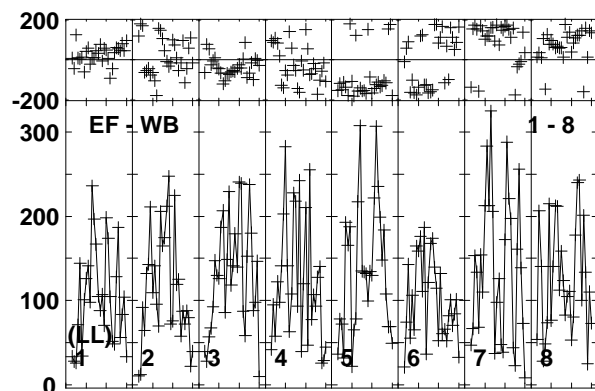
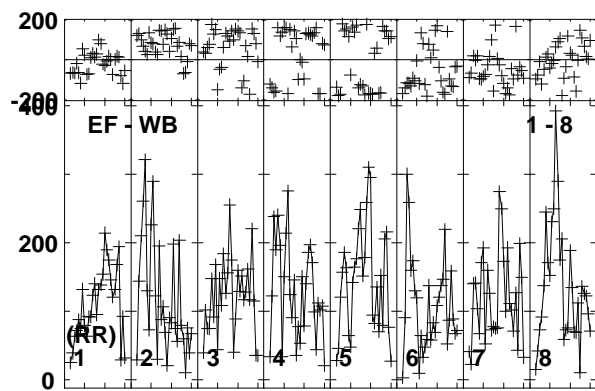
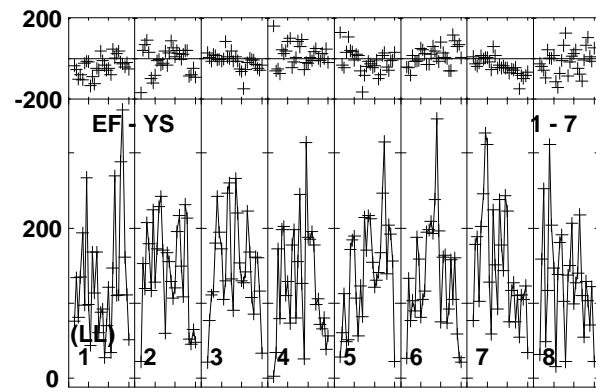
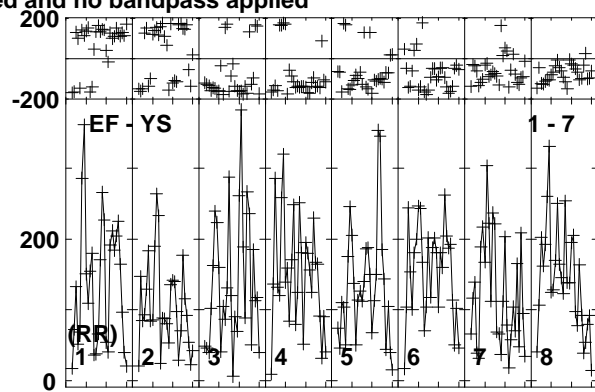
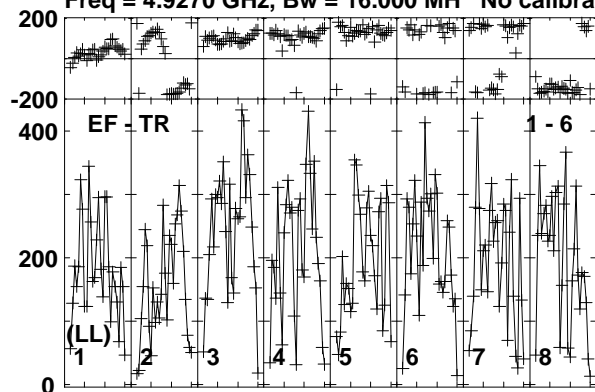

Lower frame: Micro Ampl Jy Top frame: Phas deg  
Vector averaged cross-power spectrum Baseline: EF (01) - TR (06)  
Timerange: 01/03:02:40 to 01/03:04:40

Plot file version 399 created 10-JUN-2016 17:22:42

CYGX1 RT013A.UVDATA.1

Freq = 4.9270 GHz, Bw = 16.000 MH No calibration applied and no bandpass applied

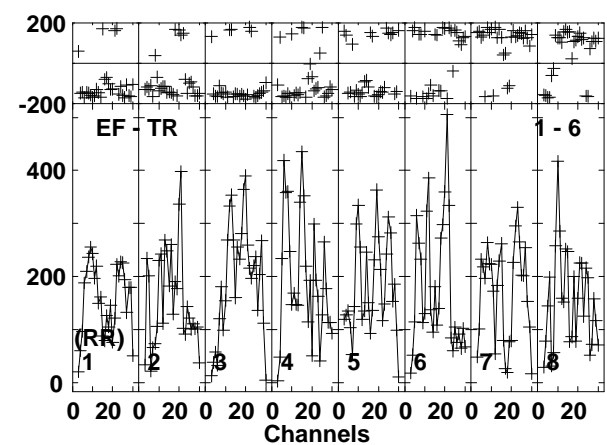
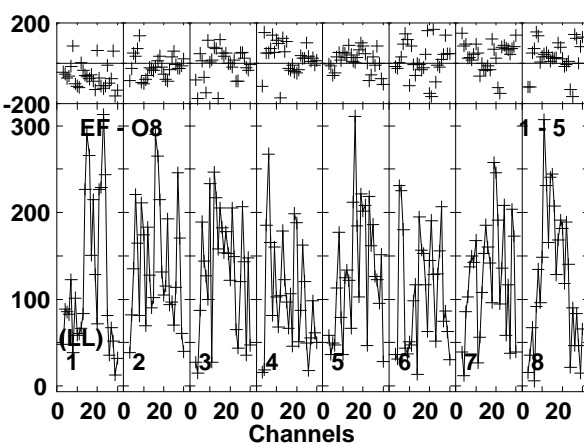
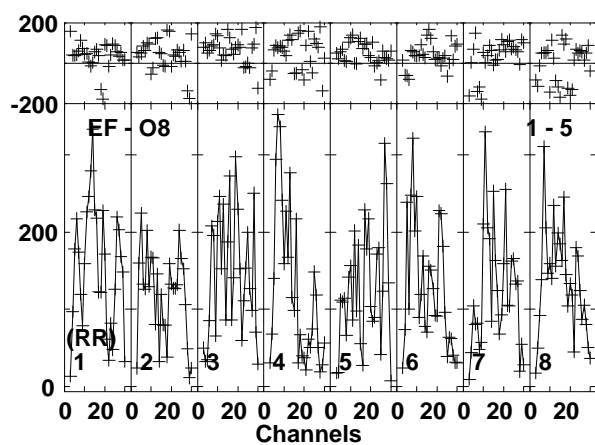
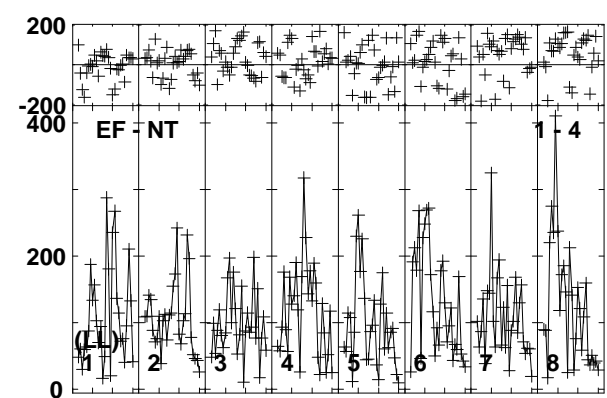
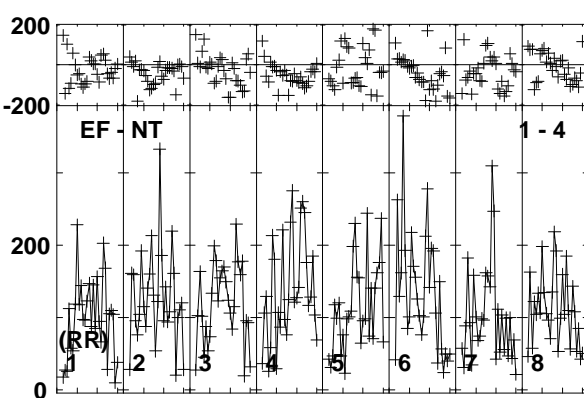
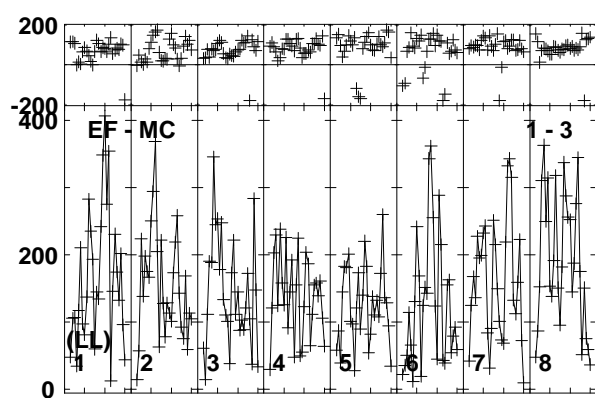
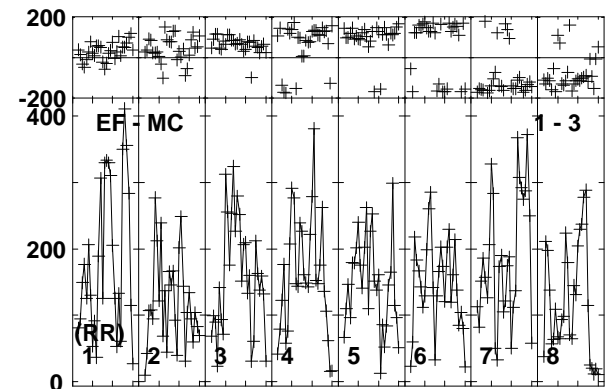
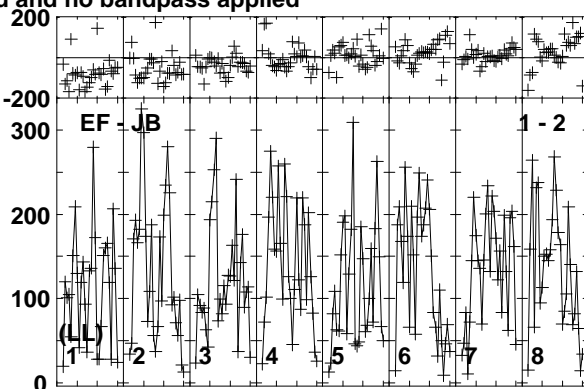
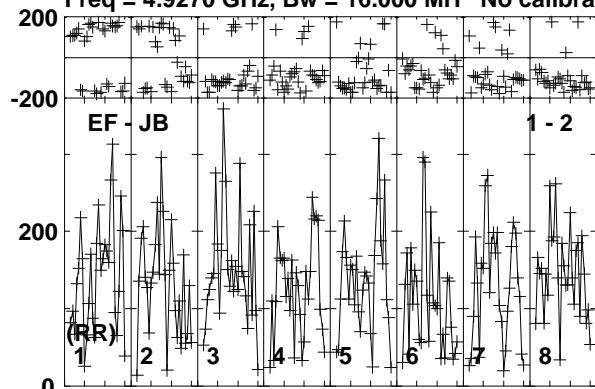

Lower frame: Micro Ampl Jy Top frame: Phas deg  
Vector averaged cross-power spectrum Baseline: EF (01) - JB (02)  
Timerange: 01/03:04:41 to 01/03:07:09

Plot file version 400 created 10-JUN-2016 17:22:42

CYGX1 RT013A.UVDATA.1

Freq = 4.9270 GHz, Bw = 16.000 MH No calibration applied and no bandpass applied

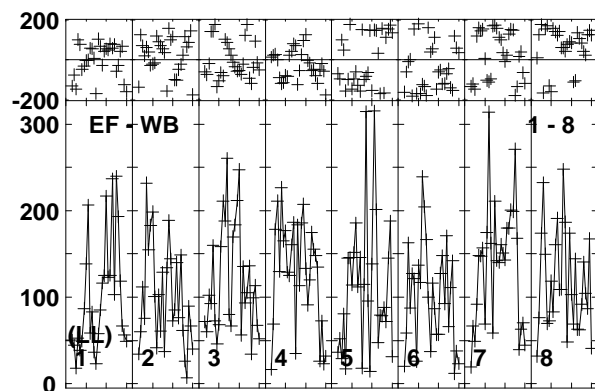
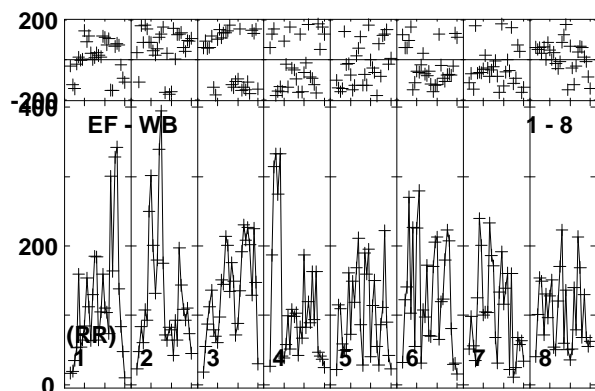
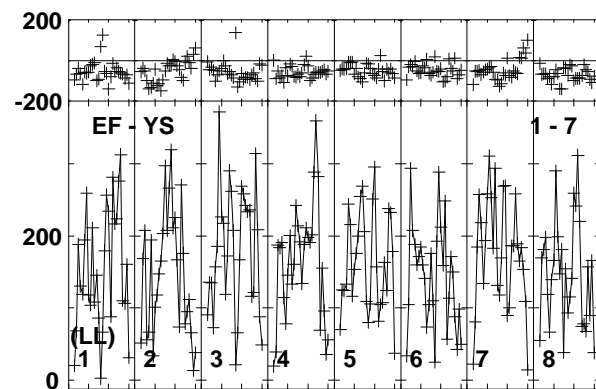
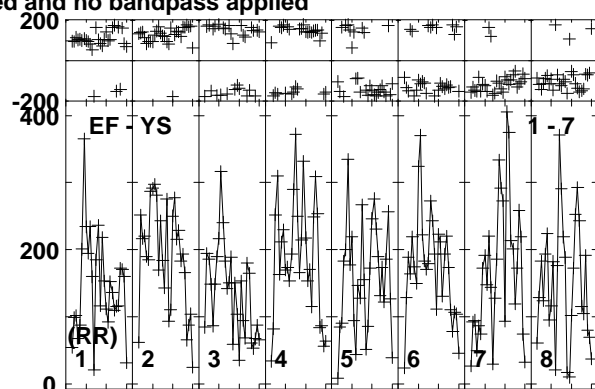
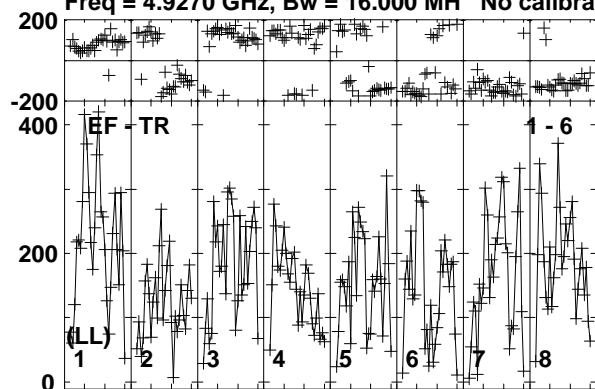

Lower frame: Micro Ampl Jy Top frame: Phas deg  
Vector averaged cross-power spectrum Baseline: EF (01) - TR (06)  
Timerange: 01/03:04:41 to 01/03:07:09

Plot file version 401 created 10-JUN-2016 17:22:43

J1957+3338 RT013A.UVDATA.1

Freq = 4.9270 GHz, Bw = 16.000 MH No calibration applied and no bandpass applied

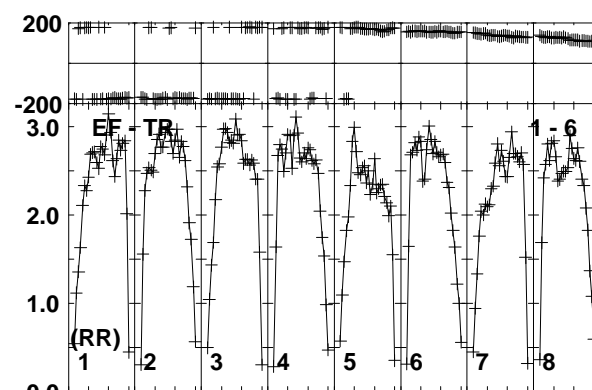
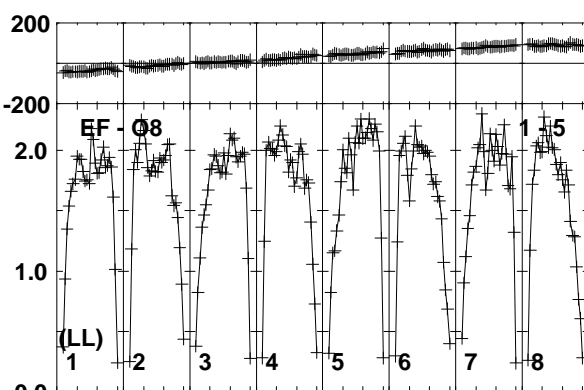
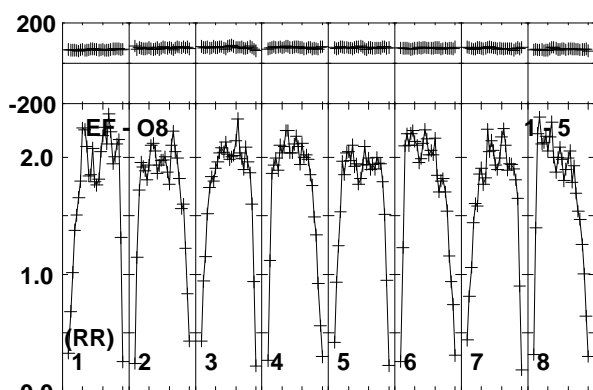
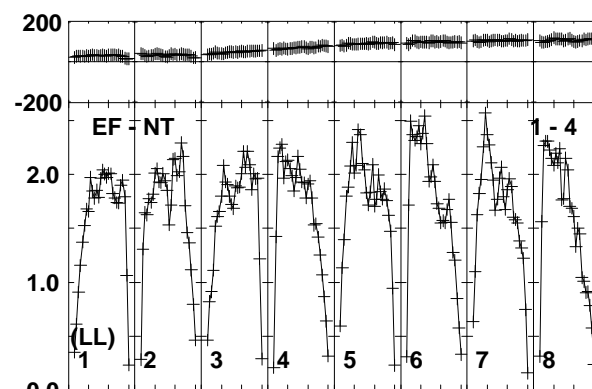
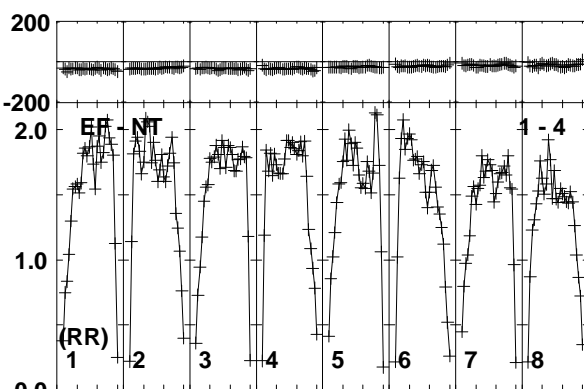
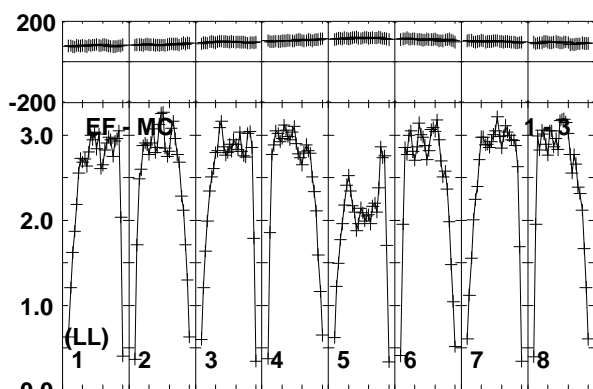
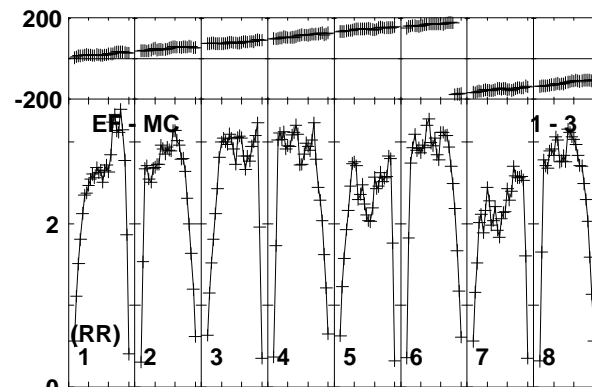
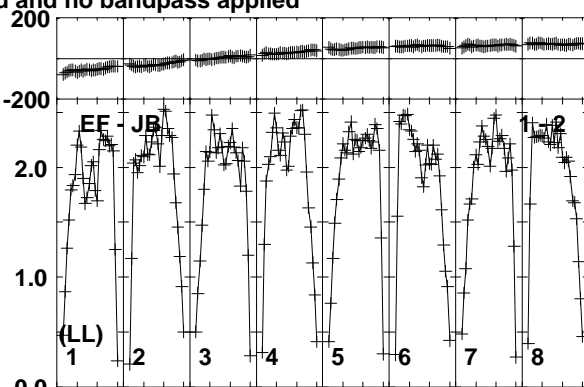
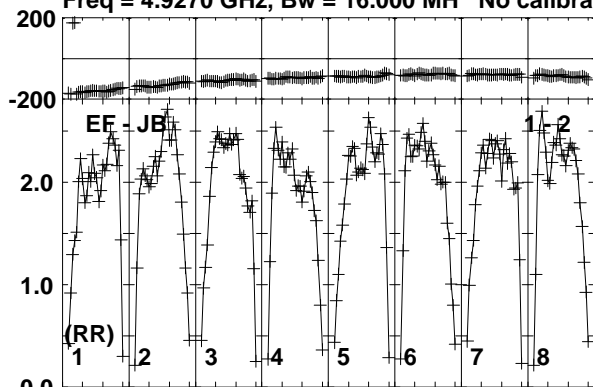

Lower frame: Milli Ampl Jy Top frame: Phas deg  
Vector averaged cross-power spectrum Baseline: EF (01) - JB (02)  
Timerange: 01/03:07:11 to 01/03:08:39

Plot file version 402 created 10-JUN-2016 17:22:43

J1957+3338 RT013A.UVDATA.1

Freq = 4.9270 GHz, Bw = 16.000 MH No calibration applied and no bandpass applied

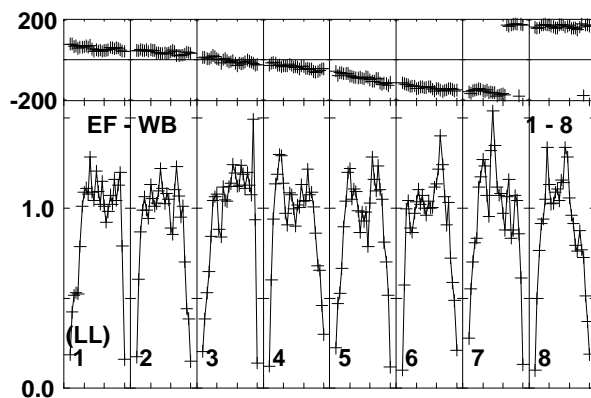
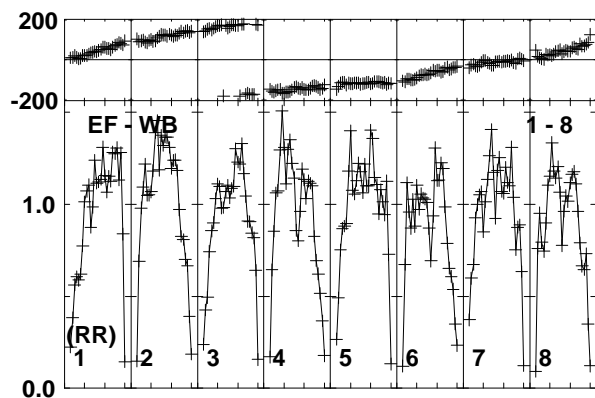
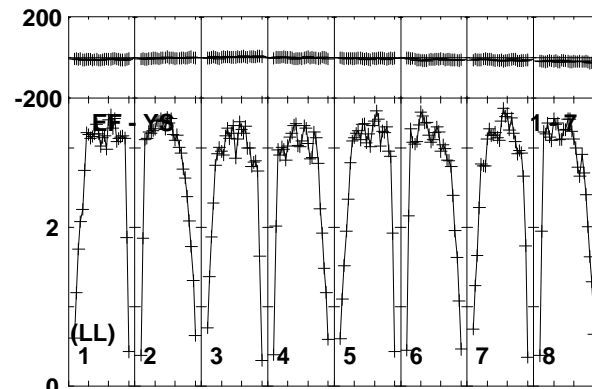
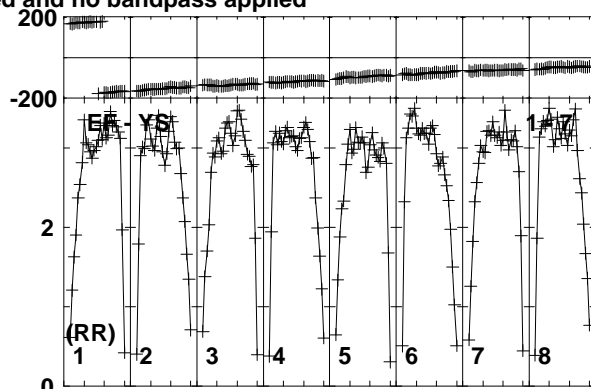
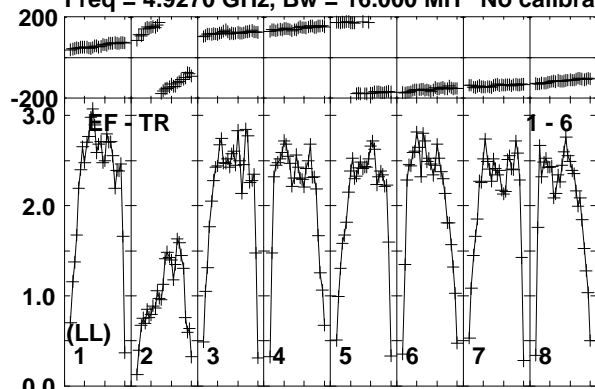

Lower frame: Milli Ampl Jy Top frame: Phas deg  
Vector averaged cross-power spectrum Baseline: EF (01) - TR (06)  
Timerange: 01/03:07:11 to 01/03:08:39



Plot file version 403 created 10-JUN-2016 17:22:43

CHECK RT013A.UVDATA.1

Freq = 4.9270 GHz, Bw = 16.000 MH No calibration applied and no bandpass applied

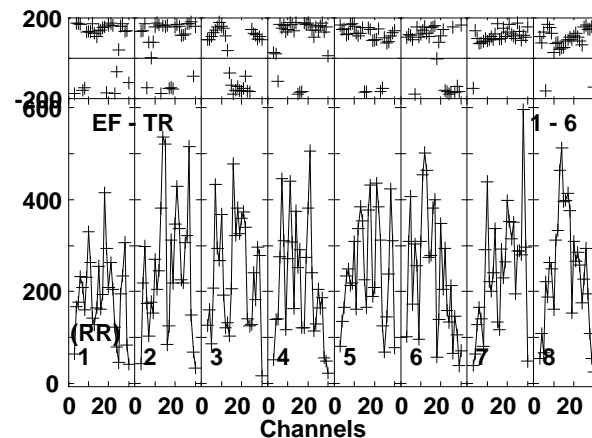
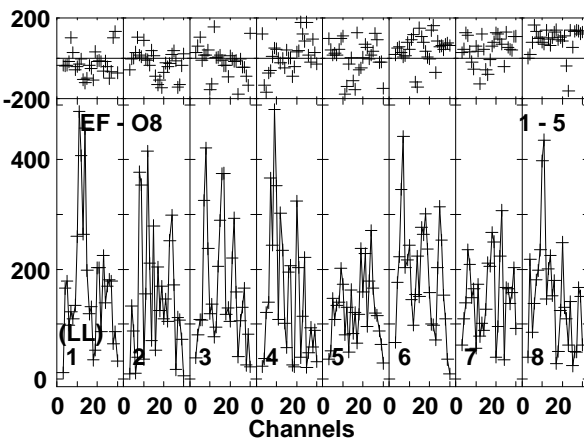
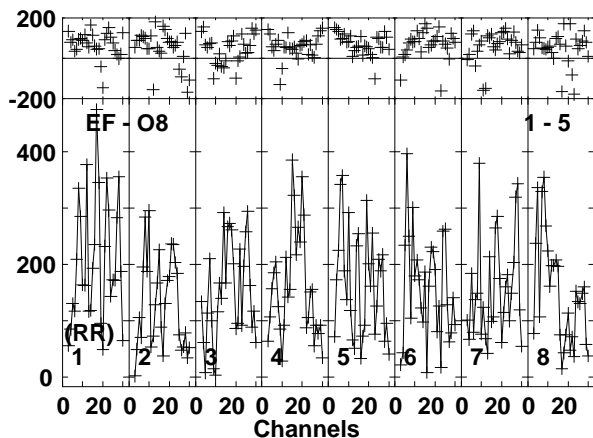
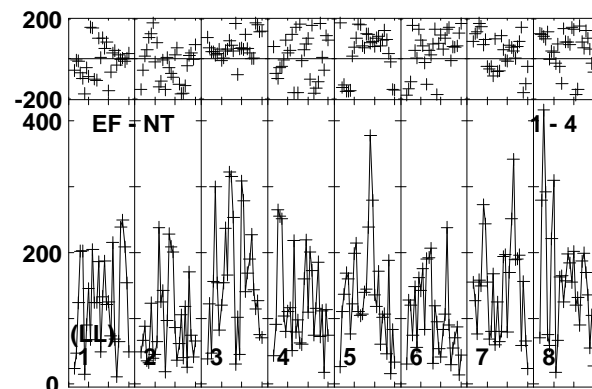
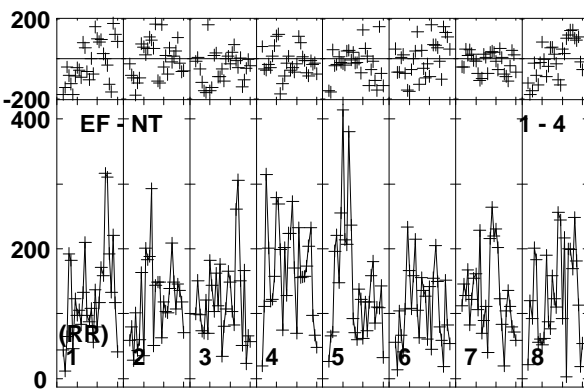
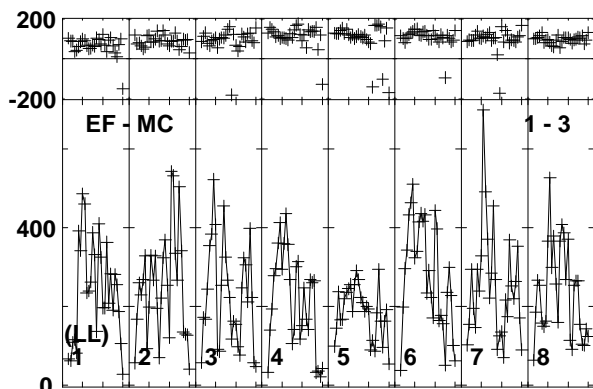
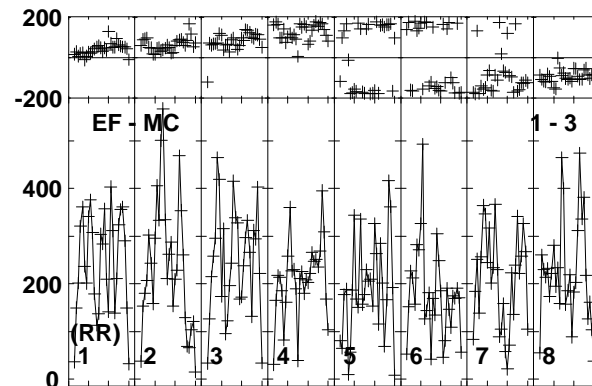
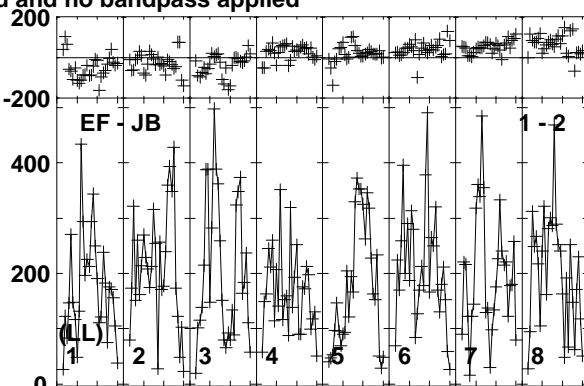
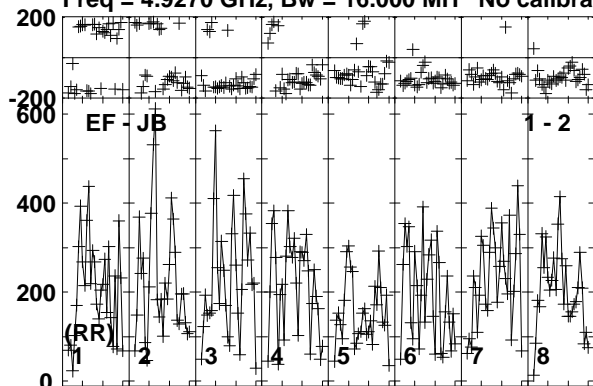

Lower frame: Micro Ampl Jy Top frame: Phas deg  
Vector averaged cross-power spectrum Baseline: EF (01) - JB (02)  
Timerange: 01/03:08:41 to 01/03:10:39

Plot file version 404 created 10-JUN-2016 17:22:43

CHECK RT013A.UVDATA.1

Freq = 4.9270 GHz, Bw = 16.000 MH No calibration applied and no bandpass applied

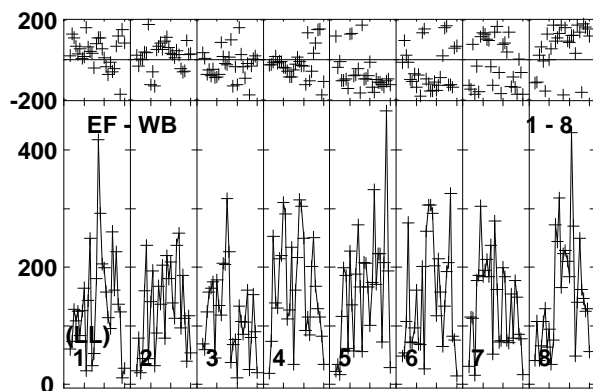
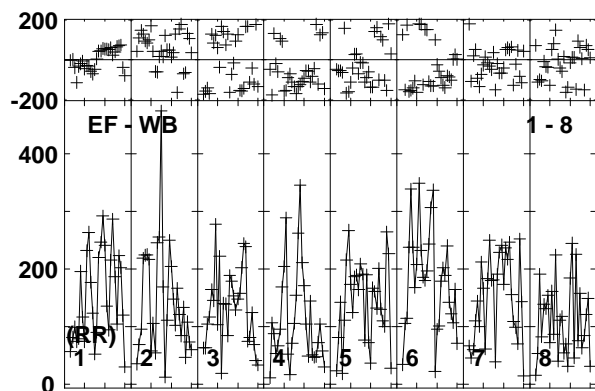
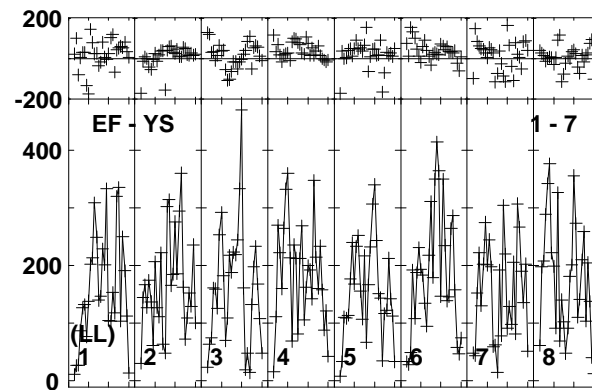
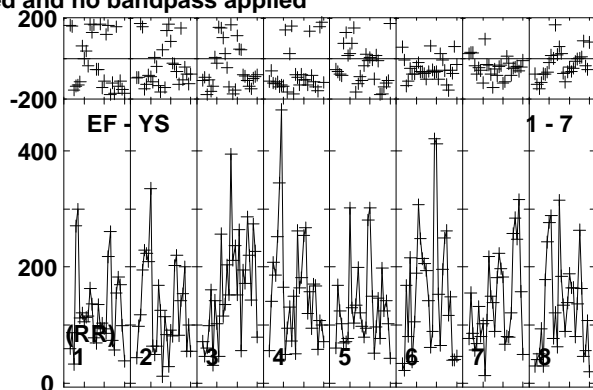
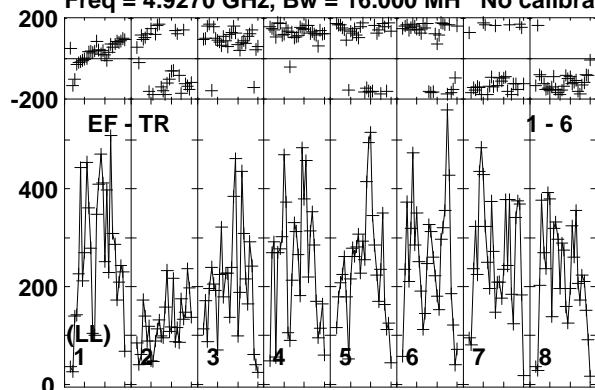

Lower frame: Micro Ampl Jy Top frame: Phas deg  
Vector averaged cross-power spectrum Baseline: EF (01) - TR (06)  
Timerange: 01/03:08:41 to 01/03:10:39

Plot file version 405 created 10-JUN-2016 17:22:43

CYGX1 RT013A.UVDATA.1

Freq = 4.9270 GHz, Bw = 16.000 MH No calibration applied and no bandpass applied

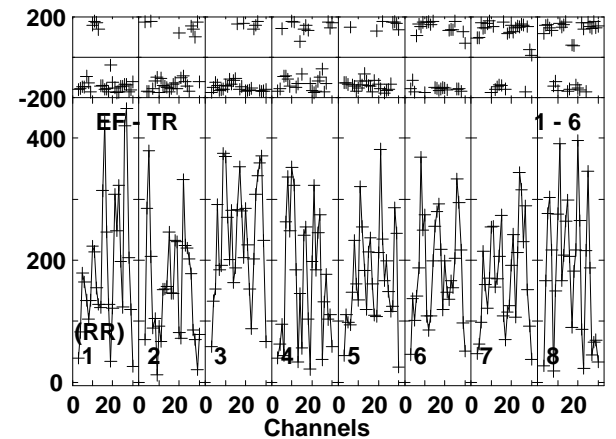
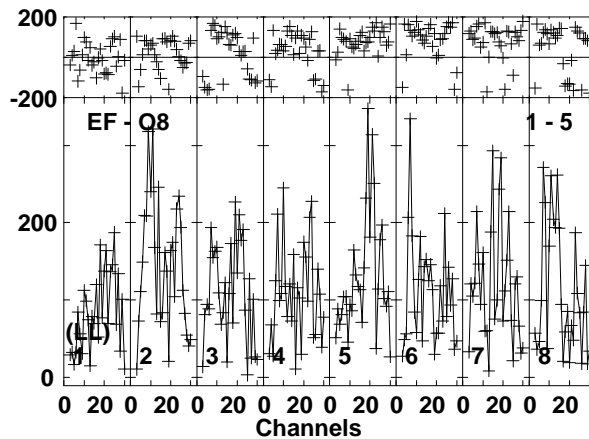
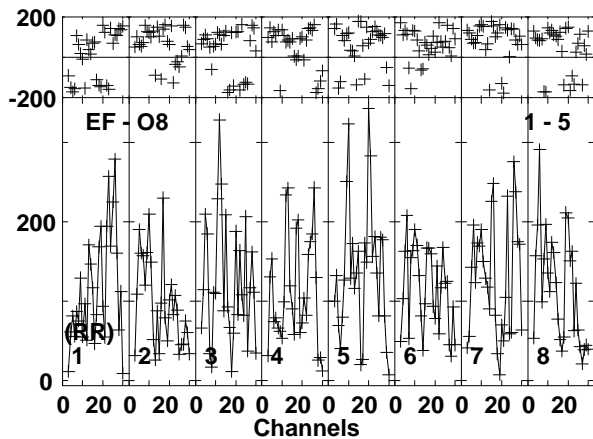
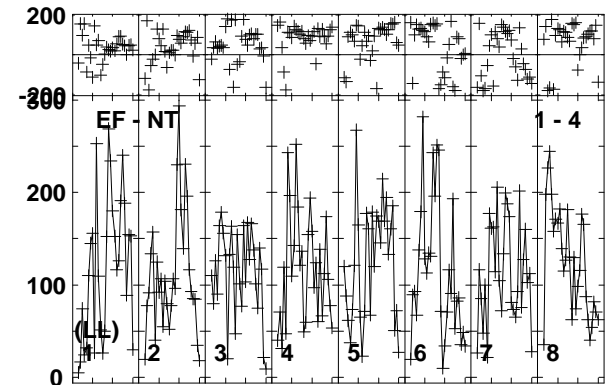
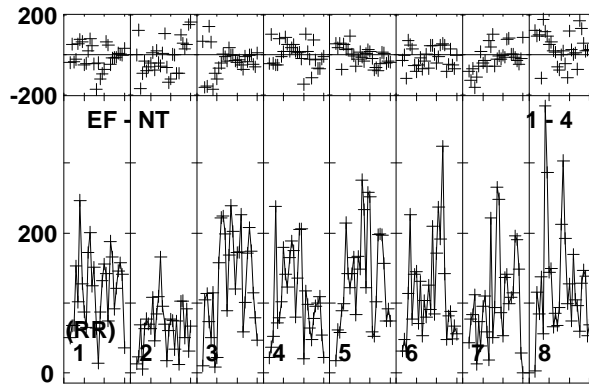
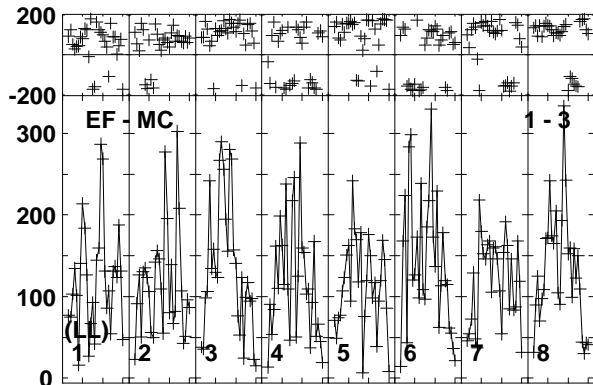
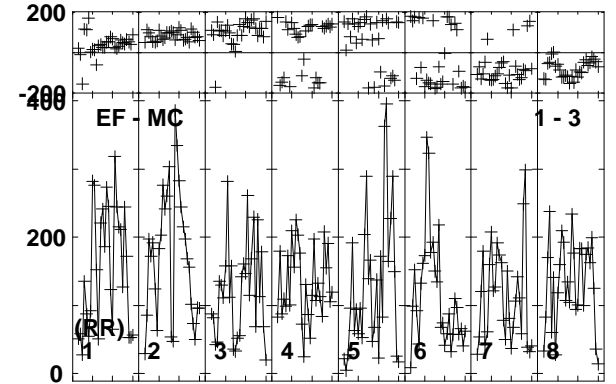
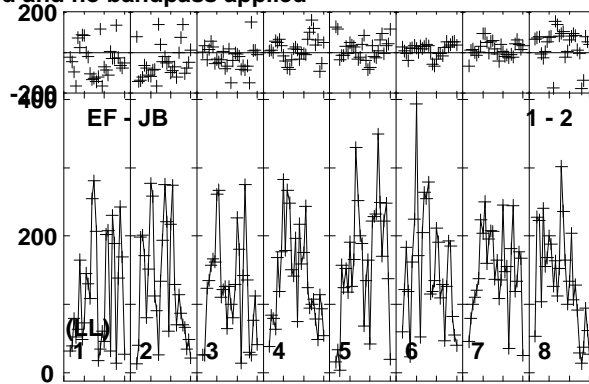
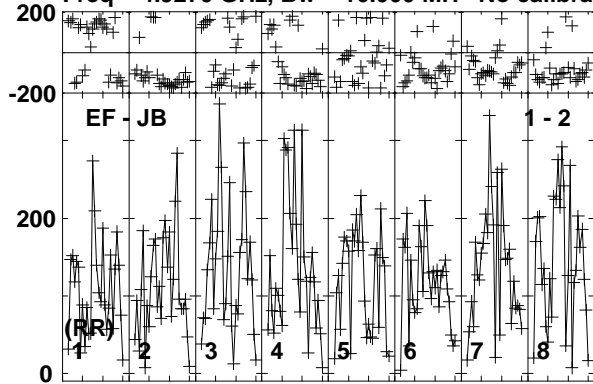

Lower frame: Micro Ampl Jy Top frame: Phas deg  
Vector averaged cross-power spectrum Baseline: EF (01) - JB (02)  
Timerange: 01/03:10:40 to 01/03:13:10

Plot file version 406 created 10-JUN-2016 17:22:43

CYGX1 RT013A.UVDATA.1

Freq = 4.9270 GHz, Bw = 16.000 MH No calibration applied and no bandpass applied

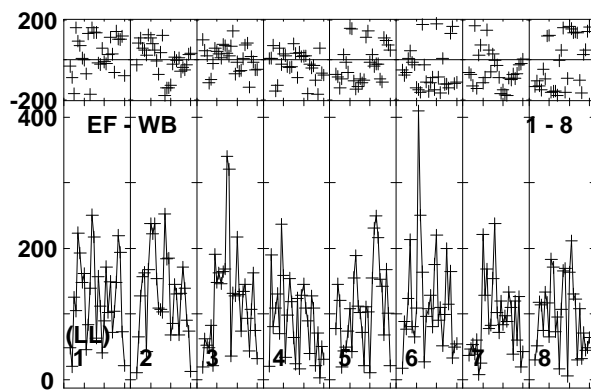
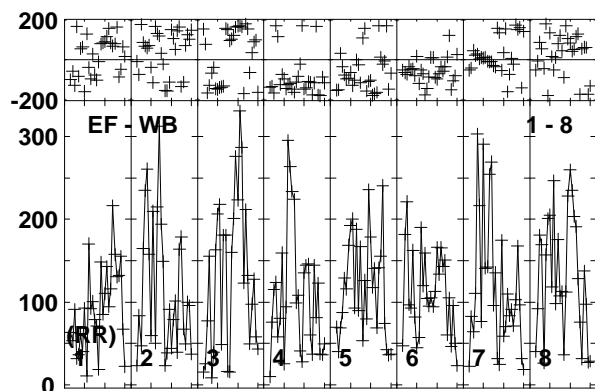
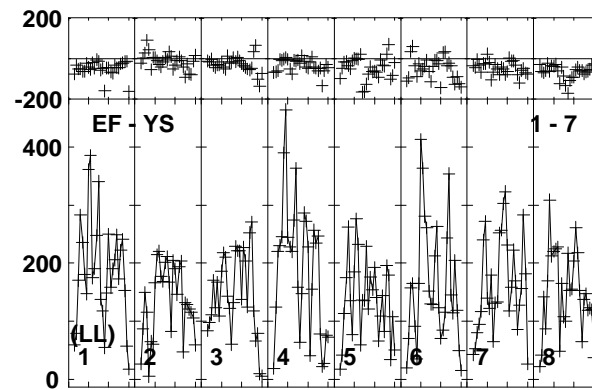
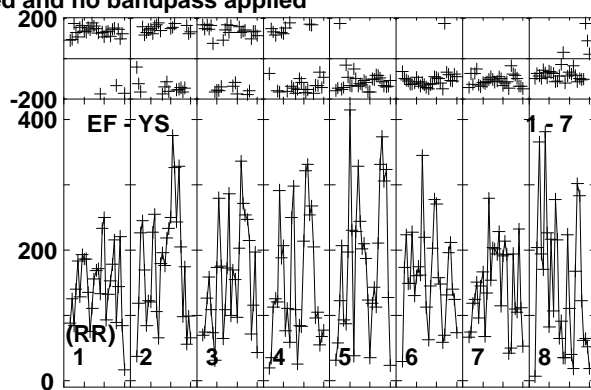
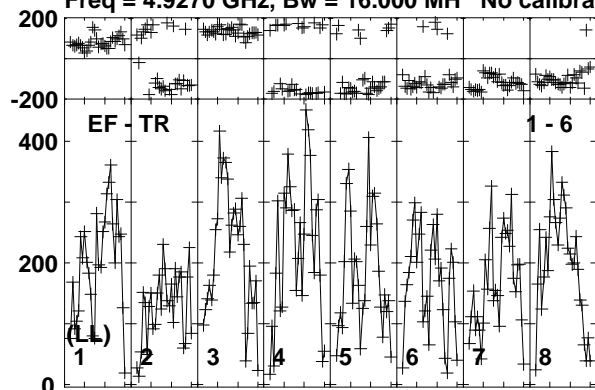

Lower frame: Micro Ampl Jy Top frame: Phas deg  
Vector averaged cross-power spectrum Baseline: EF (01) - TR (06)  
Timerange: 01/03:10:40 to 01/03:13:10

Plot file version 407 created 10-JUN-2016 17:22:43

J1957+3338 RT013A.UVDATA.1

Freq = 4.9270 GHz, Bw = 16.000 MH No calibration applied and no bandpass applied

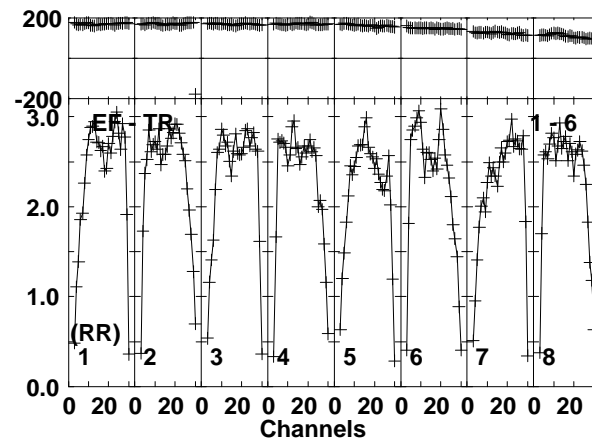
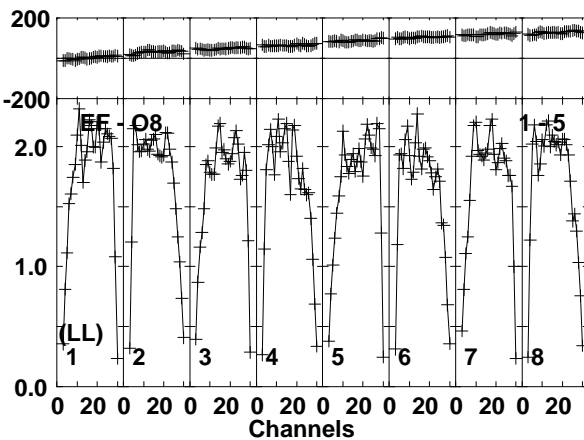
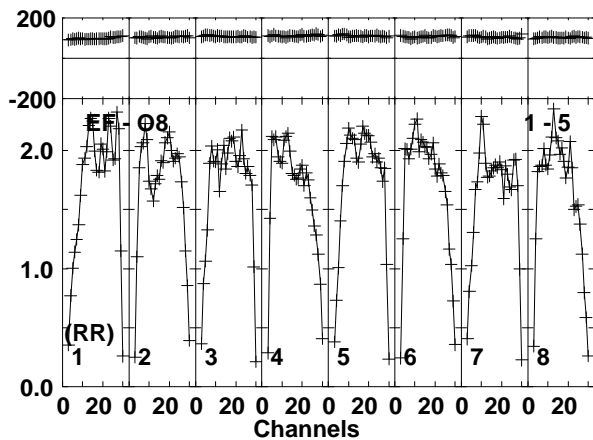
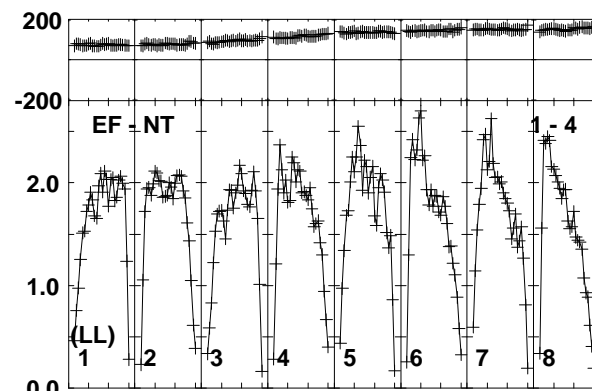
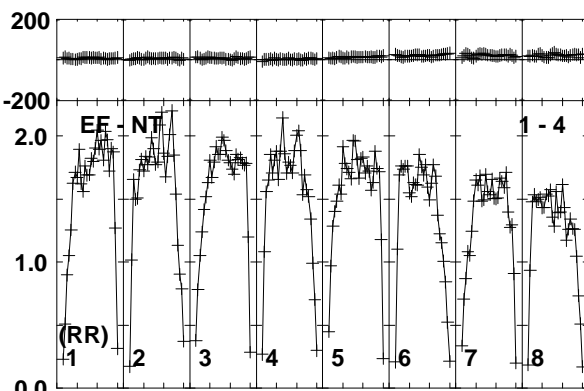
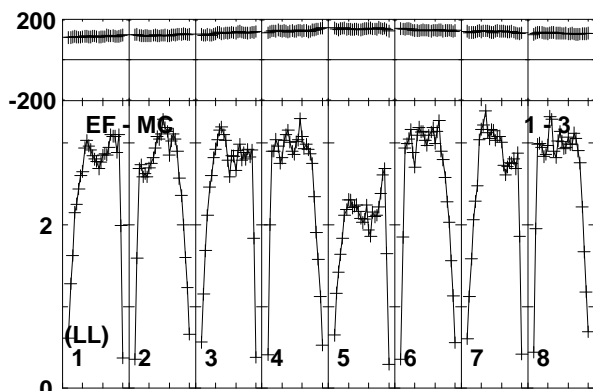
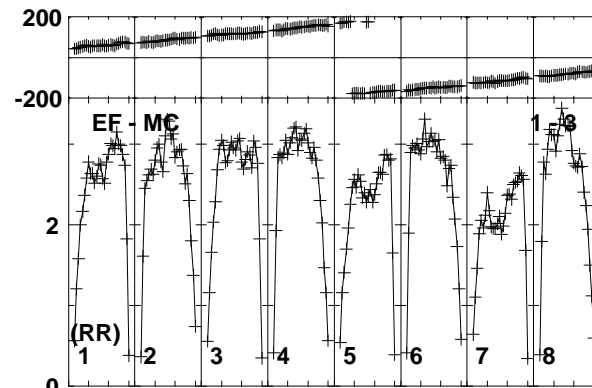
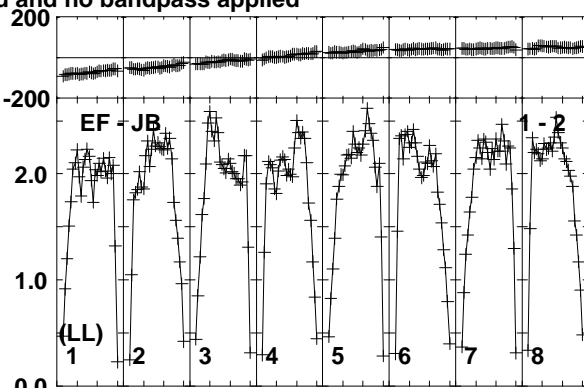
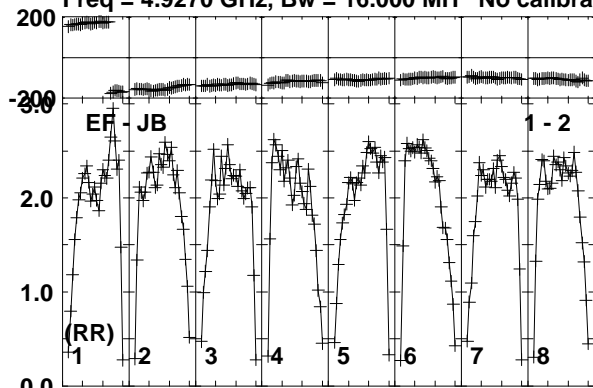

Lower frame: Milli Ampl Jy Top frame: Phas deg  
Vector averaged cross-power spectrum Baseline: EF (01) - JB (02)  
Timerange: 01/03:13:11 to 01/03:14:39

Plot file version 408 created 10-JUN-2016 17:22:43

J1957+3338 RT013A.UVDATA.1

Freq = 4.9270 GHz, Bw = 16.000 MH No calibration applied and no bandpass applied

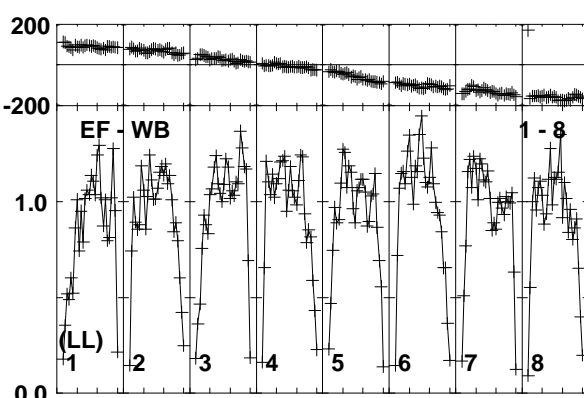
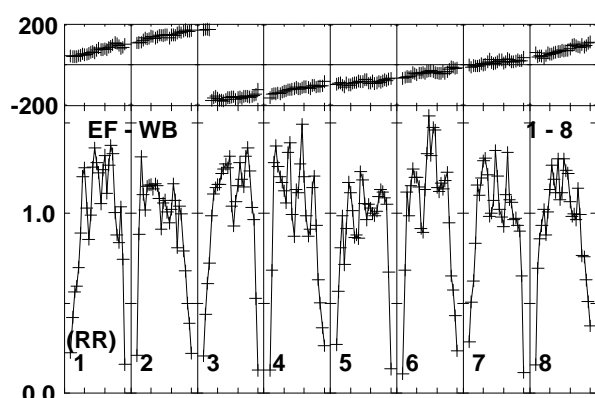
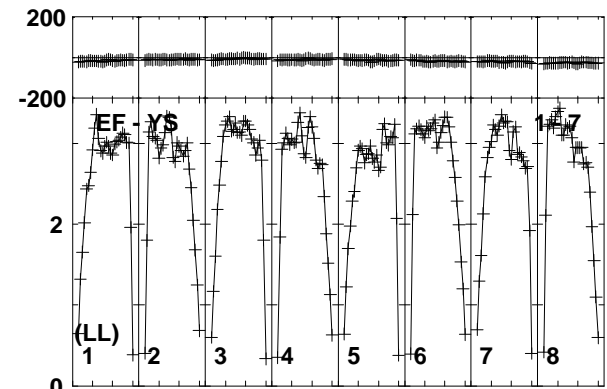
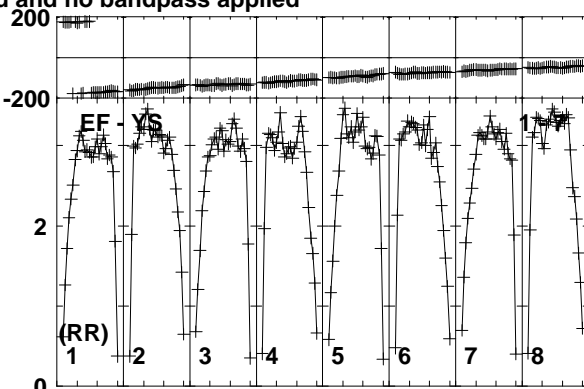
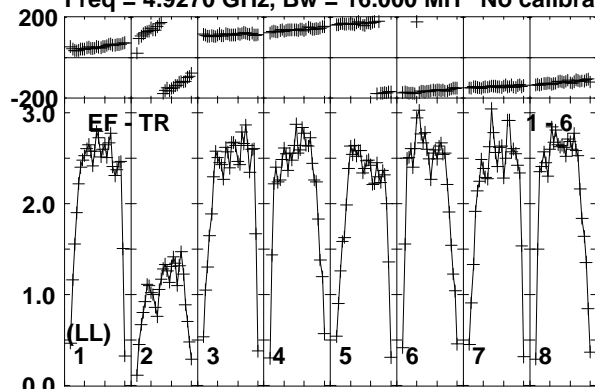

Lower frame: Milli Ampl Jy Top frame: Phas deg  
Vector averaged cross-power spectrum Baseline: EF (01) - TR (06)  
Timerange: 01/03:13:11 to 01/03:14:39

Plot file version 409 created 10-JUN-2016 17:22:43

CHECK RT013A.UVDATA.1

Freq = 4.9270 GHz, Bw = 16.000 MH No calibration applied and no bandpass applied

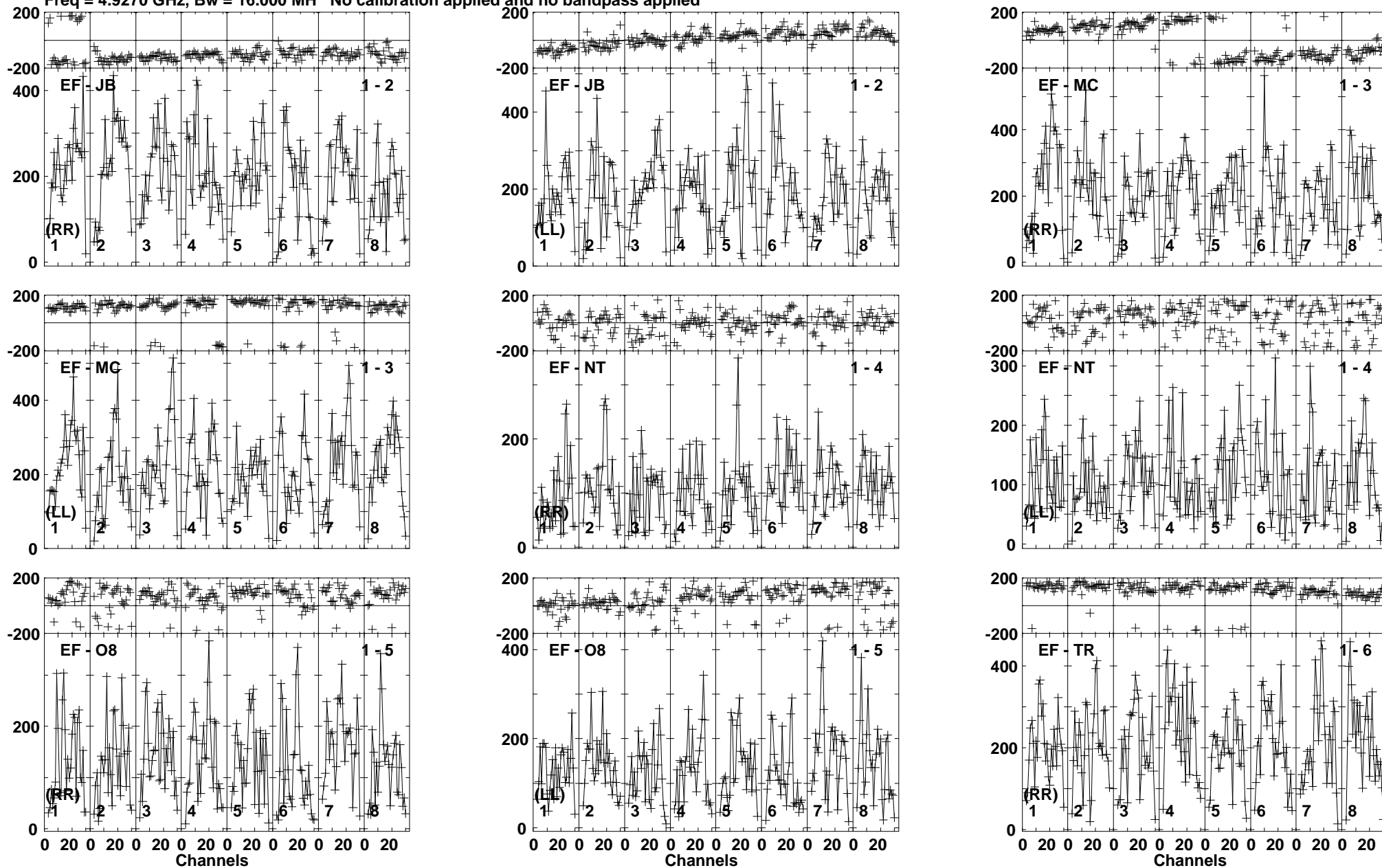

Lower frame: Micro Ampl Jy Top frame: Phas deg  
Vector averaged cross-power spectrum Baseline: EF (01) - JB (02)  
Timerange: 01/03:15:21 to 01/03:17:20

Plot file version 410 created 10-JUN-2016 17:22:43

CHECK RT013A.UVDATA.1

Freq = 4.9270 GHz, Bw = 16.000 MH No calibration applied and no bandpass applied

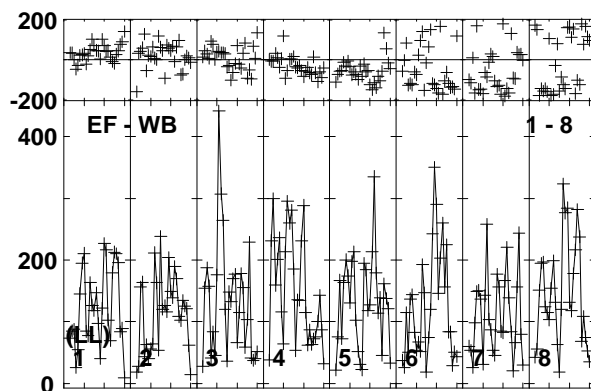
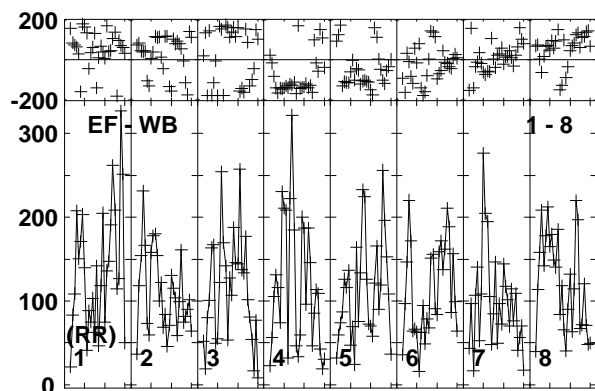
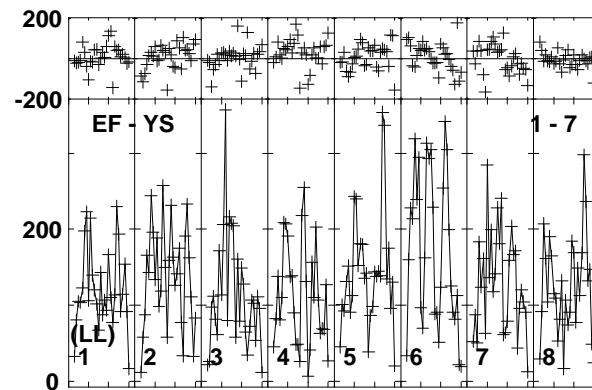
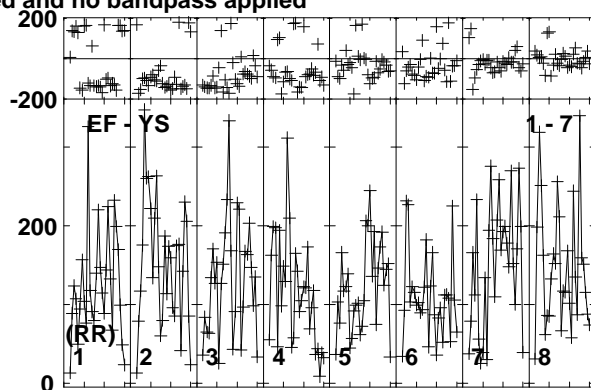
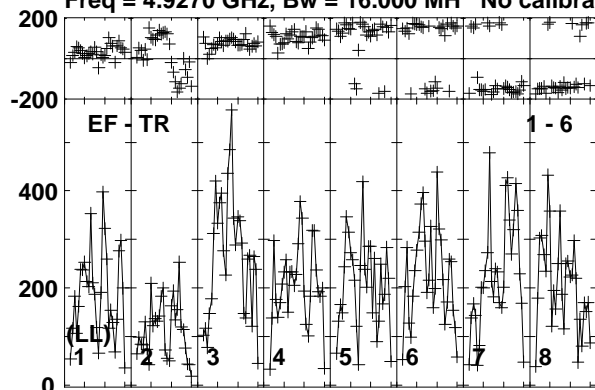

Lower frame: Micro Ampl Jy Top frame: Phas deg  
Vector averaged cross-power spectrum Baseline: EF (01) - TR (06)  
Timerange: 01/03:15:21 to 01/03:17:20



Plot file version 411 created 10-JUN-2016 17:22:44

CYGX1 RT013A.UVDATA.1

Freq = 4.9270 GHz, Bw = 16.000 MH No calibration applied and no bandpass applied

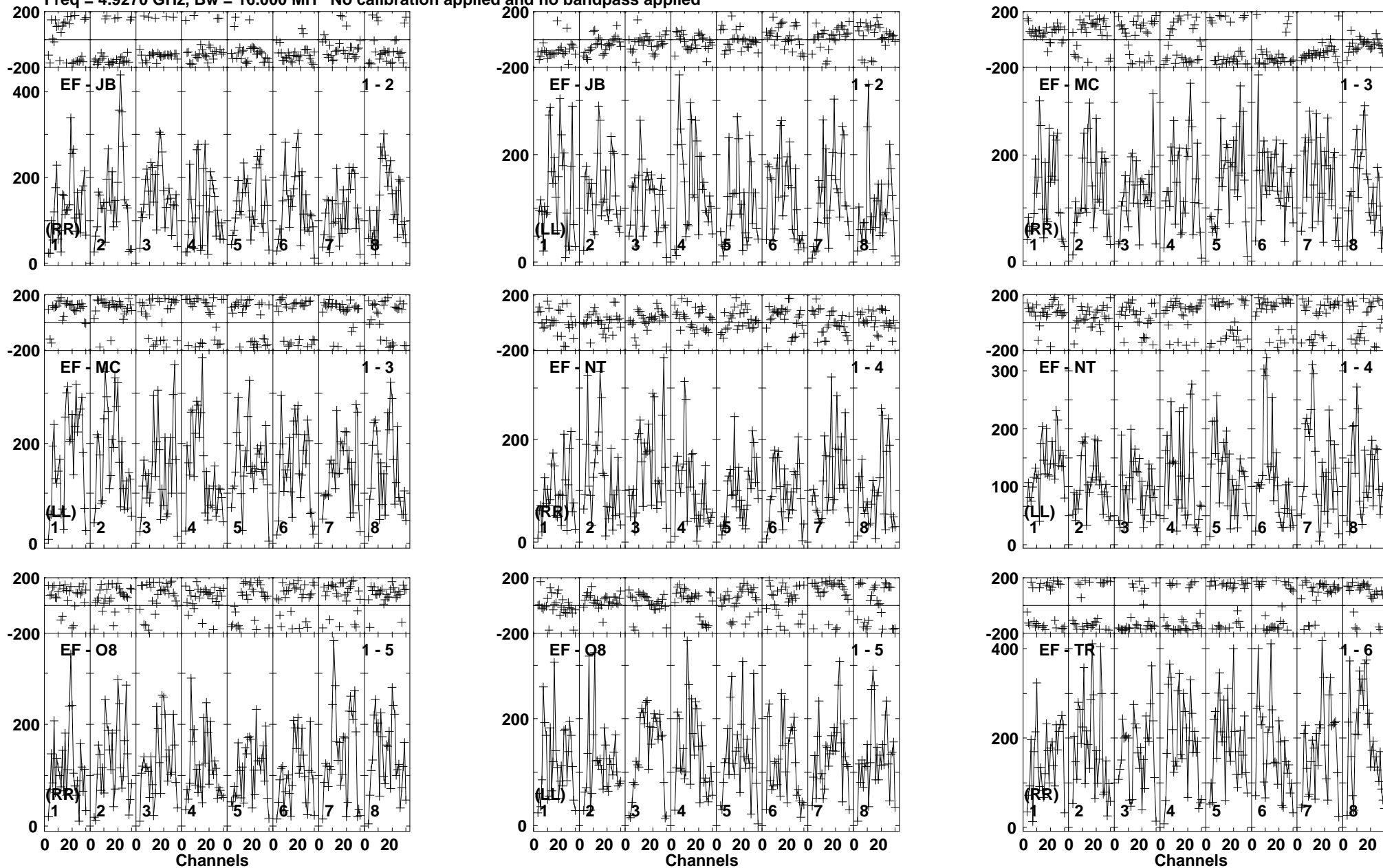

Lower frame: Micro Ampl Jy Top frame: Phas deg  
Vector averaged cross-power spectrum Baseline: EF (01) - JB (02)  
Timerange: 01/03:17:20 to 01/03:19:50

Plot file version 412 created 10-JUN-2016 17:22:44

CYGX1 RT013A.UVDATA.1

Freq = 4.9270 GHz, Bw = 16.000 MH No calibration applied and no bandpass applied

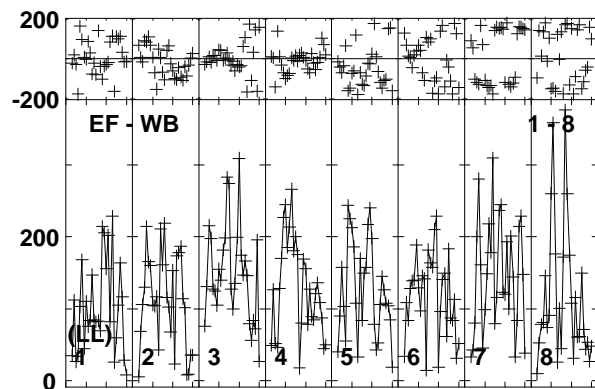
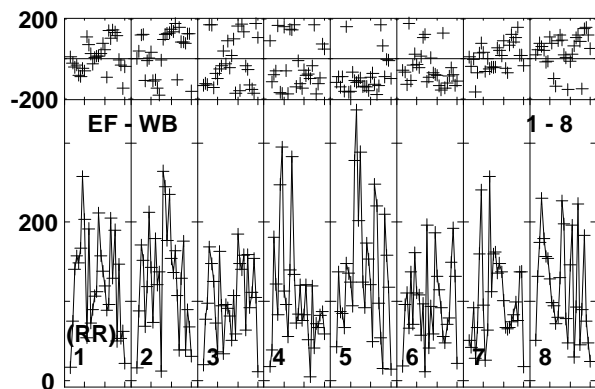
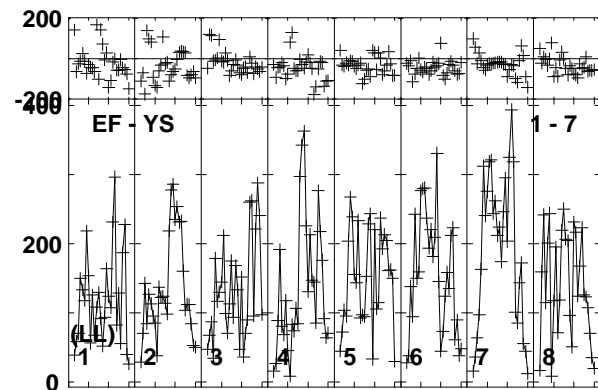
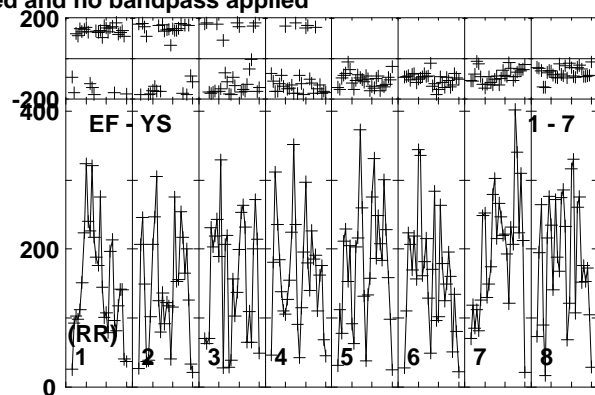
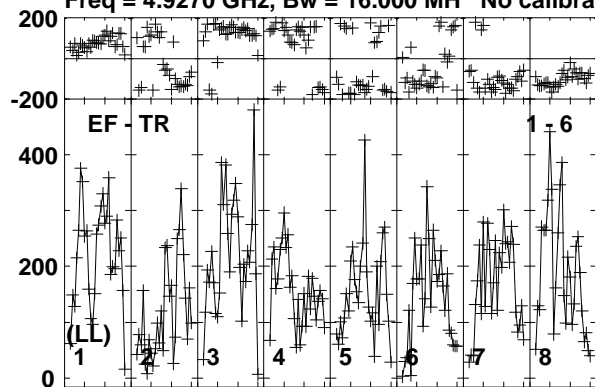

Lower frame: Micro Ampl Jy Top frame: Phas deg  
Vector averaged cross-power spectrum Baseline: EF (01) - TR (06)  
Timerange: 01/03:17:20 to 01/03:19:50

Plot file version 413 created 10-JUN-2016 17:22:44

J1957+3338 RT013A.UVDATA.1

Freq = 4.9270 GHz, Bw = 16.000 MH No calibration applied and no bandpass applied

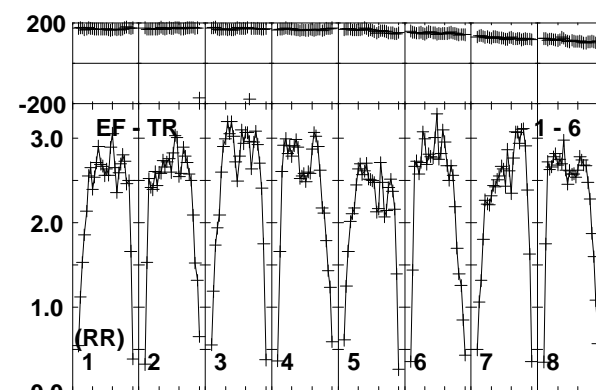
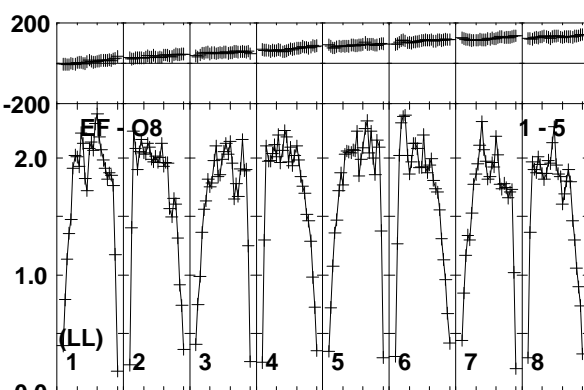
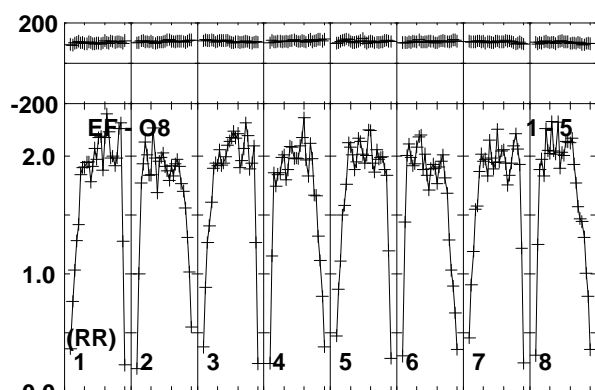
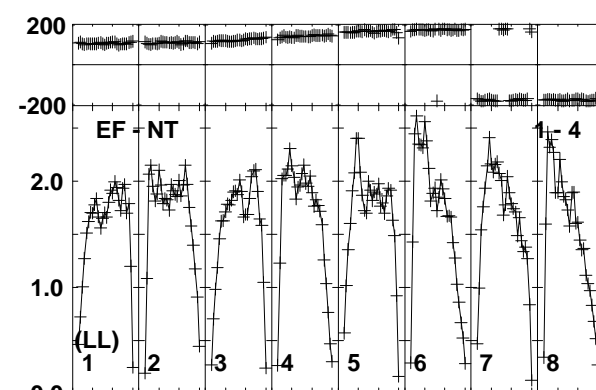
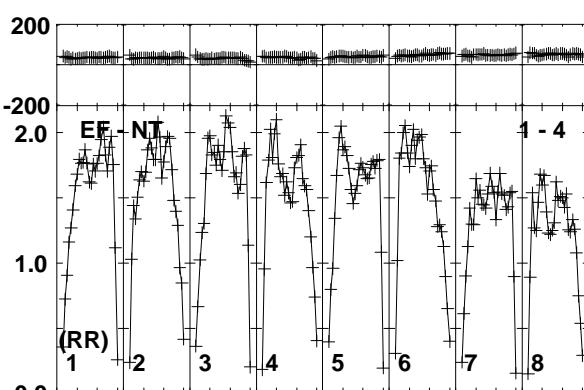
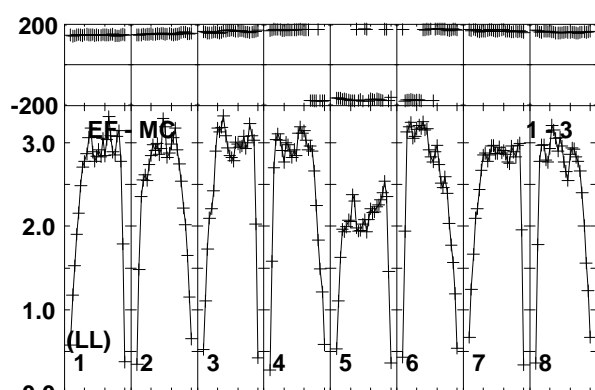
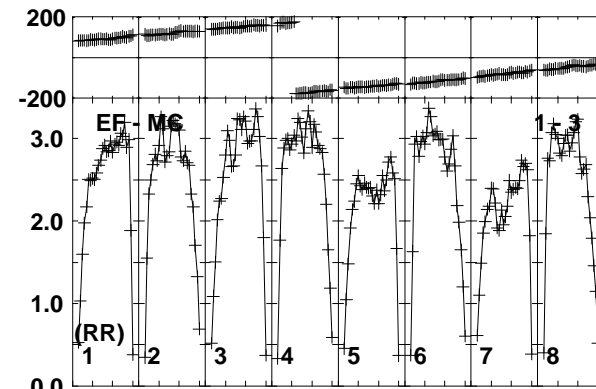
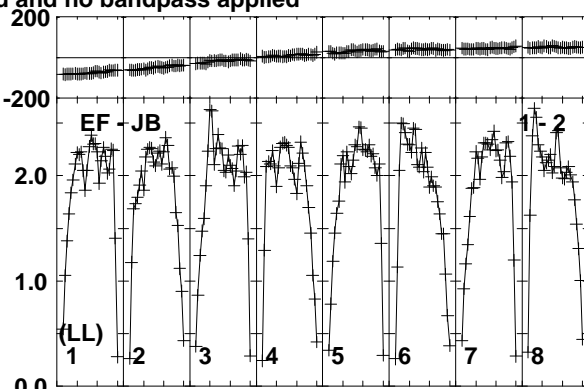
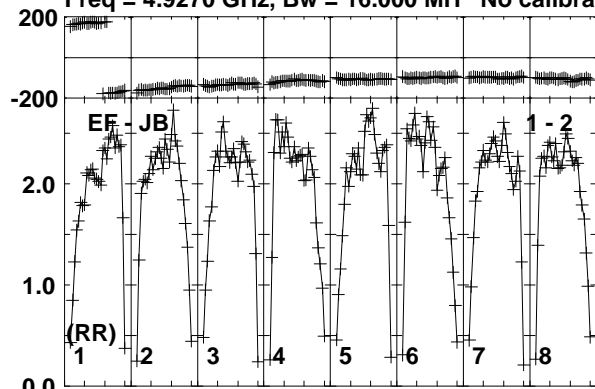

Lower frame: Milli Ampl Jy Top frame: Phas deg  
Vector averaged cross-power spectrum Baseline: EF (01) - JB (02)  
Timerange: 01/03:19:50 to 01/03:21:19

Plot file version 414 created 10-JUN-2016 17:22:44

J1957+3338 RT013A.UVDATA.1

Freq = 4.9270 GHz, Bw = 16.000 MH No calibration applied and no bandpass applied

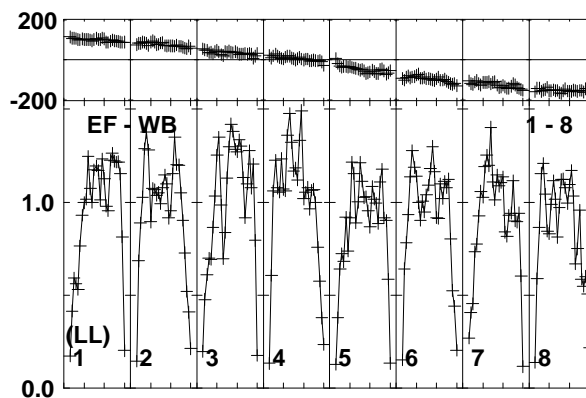
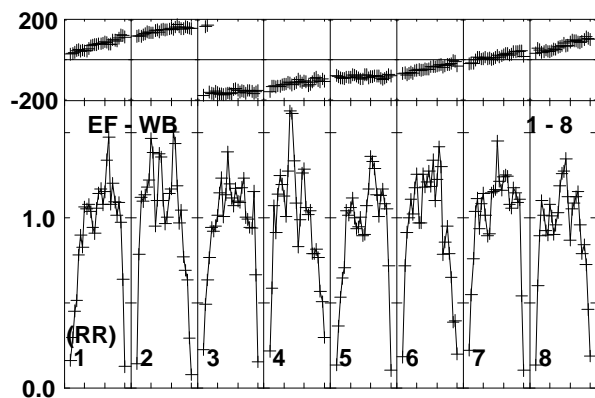
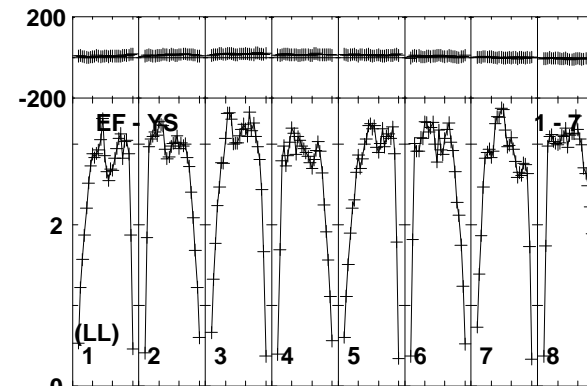
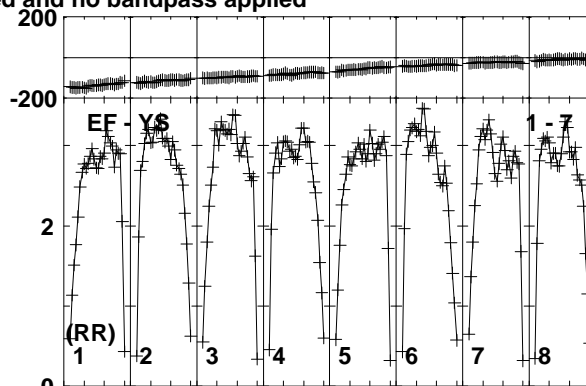
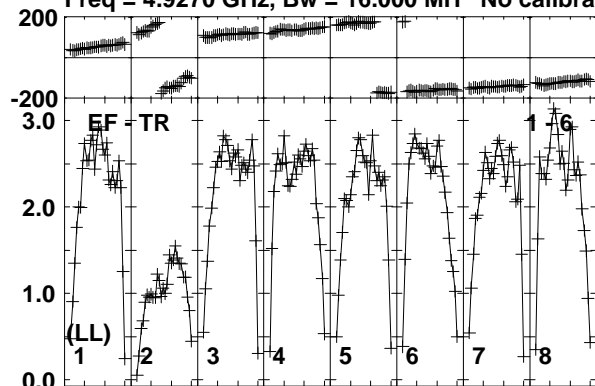

Lower frame: Milli Ampl Jy Top frame: Phas deg  
Vector averaged cross-power spectrum Baseline: EF (01) - TR (06)  
Timerange: 01/03:19:50 to 01/03:21:19

Plot file version 415 created 10-JUN-2016 17:22:44

CHECK RT013A.UVDATA.1

Freq = 4.9270 GHz, Bw = 16.000 MH No calibration applied and no bandpass applied

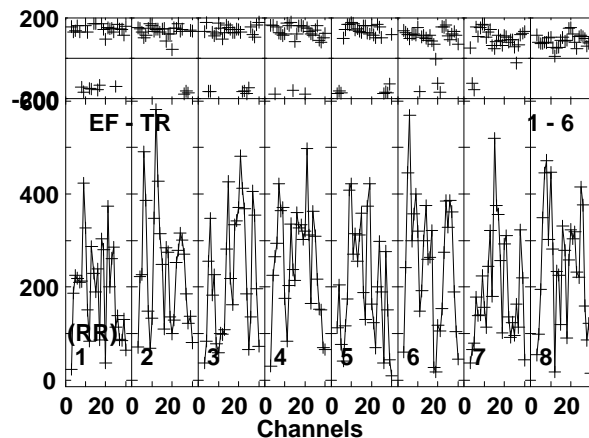
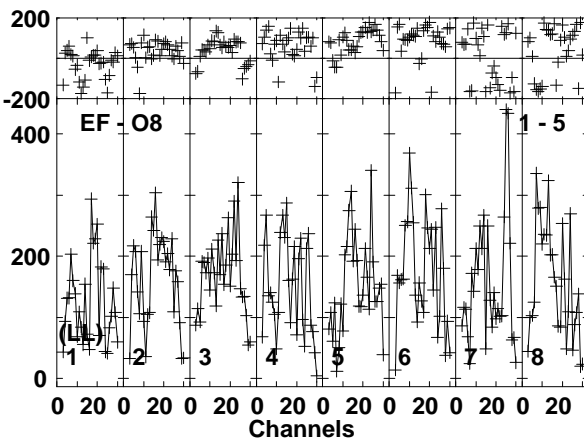
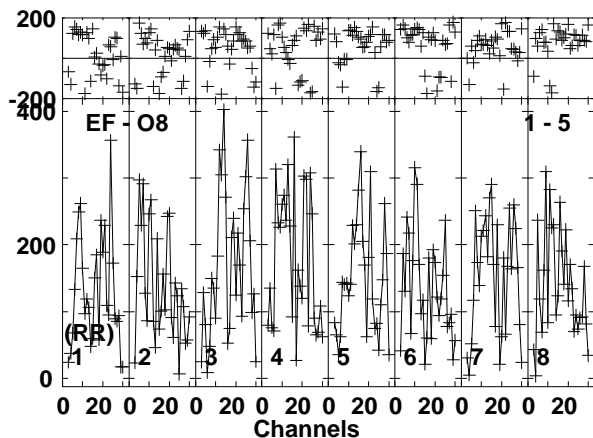
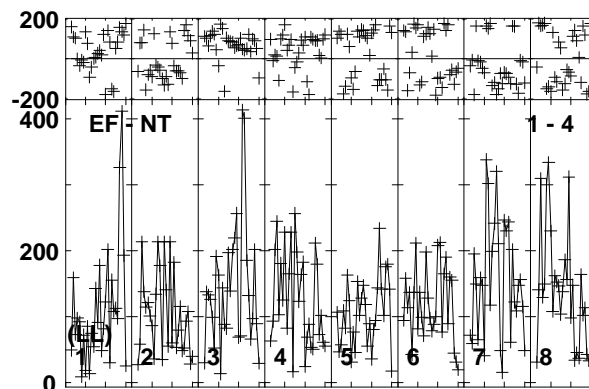
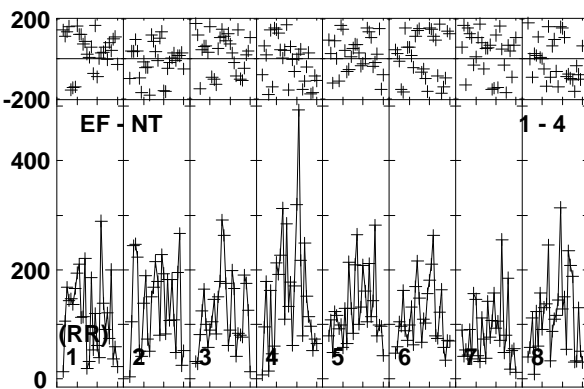
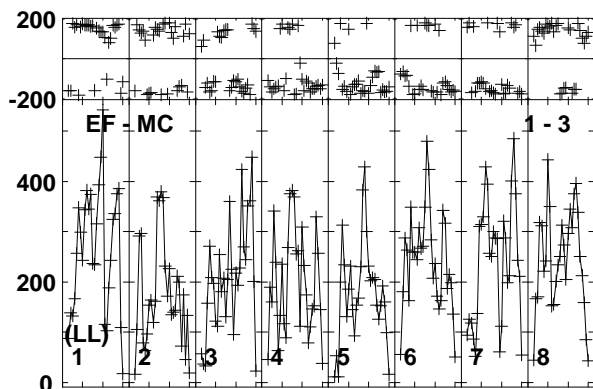
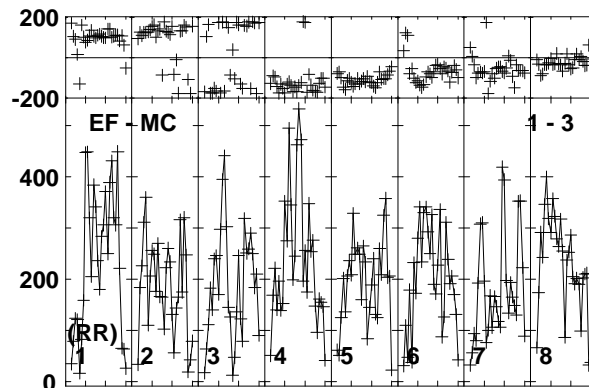
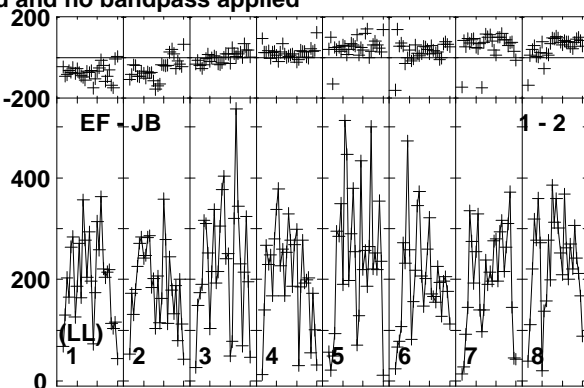
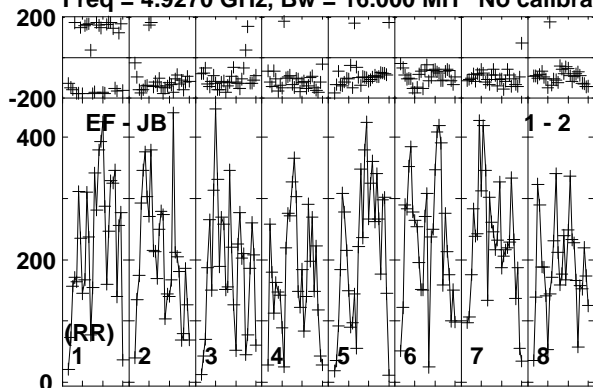

Lower frame: Micro Ampl Jy Top frame: Phas deg  
Vector averaged cross-power spectrum Baseline: EF (01) - JB (02)  
Timerange: 01/03:21:20 to 01/03:23:20

Plot file version 416 created 10-JUN-2016 17:22:44

CHECK RT013A.UVDATA.1

Freq = 4.9270 GHz, Bw = 16.000 MH No calibration applied and no bandpass applied

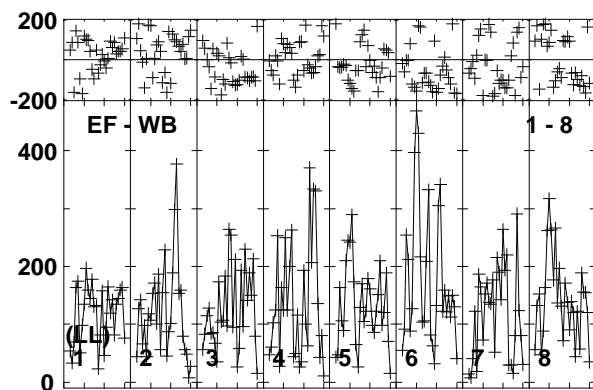
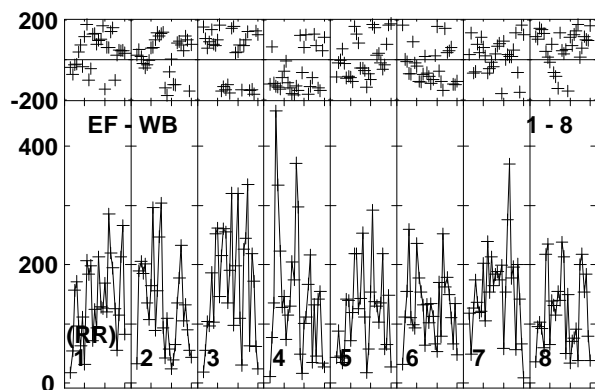
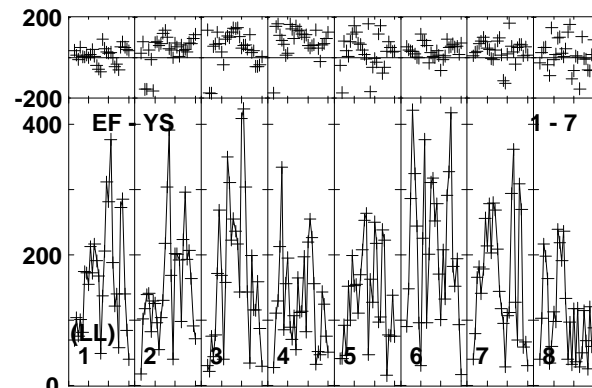
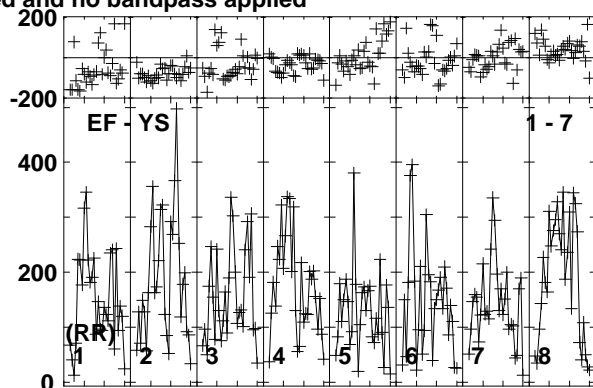
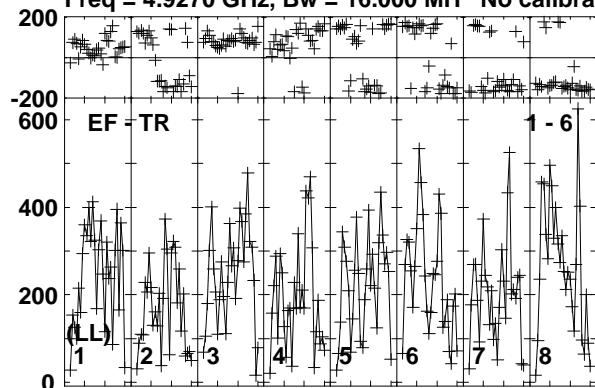

Lower frame: Micro Ampl Jy Top frame: Phas deg  
Vector averaged cross-power spectrum Baseline: EF (01) - TR (06)  
Timerange: 01/03:21:20 to 01/03:23:20

Plot file version 417 created 10-JUN-2016 17:22:44

CYGX1 RT013A.UVDATA.1

Freq = 4.9270 GHz, Bw = 16.000 MH No calibration applied and no bandpass applied

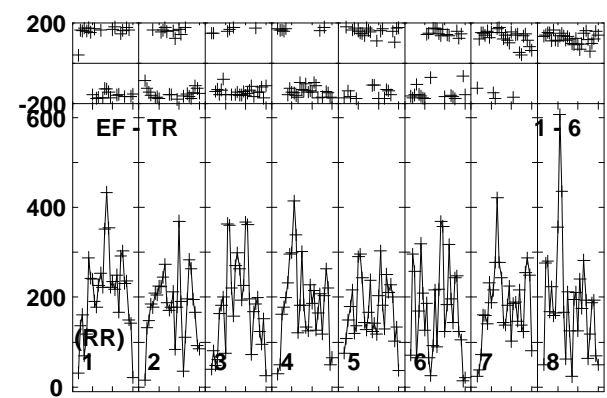
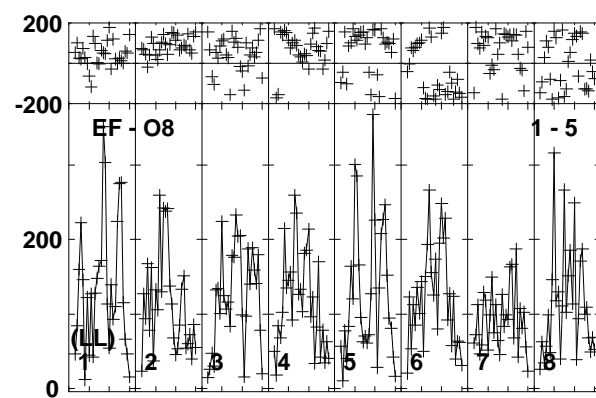
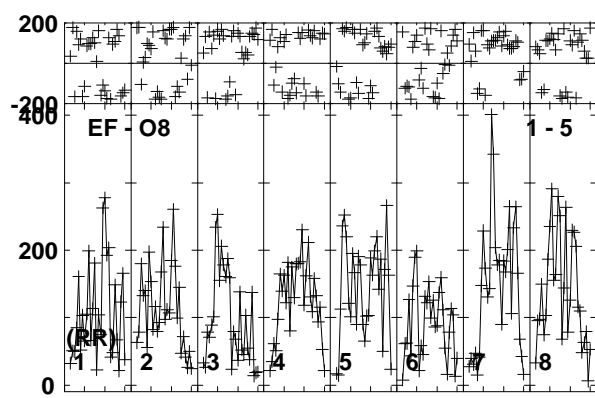
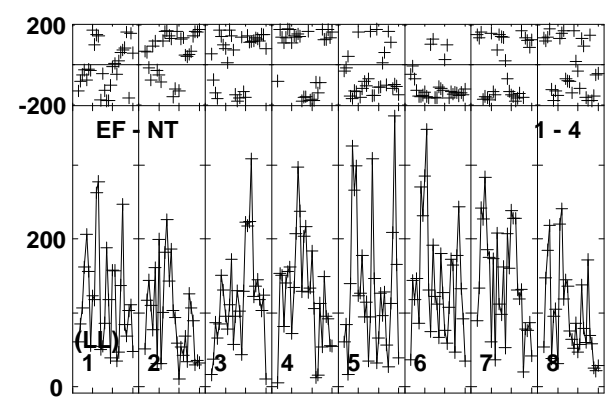
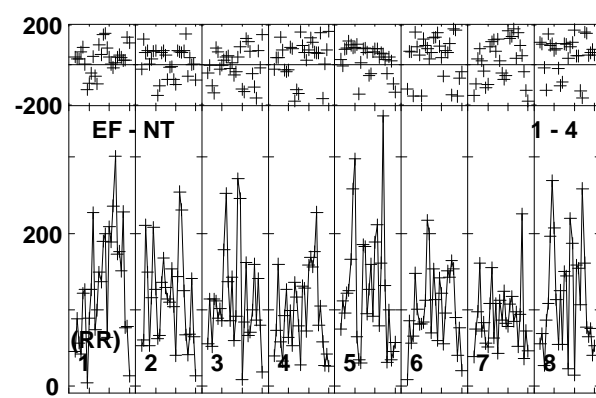
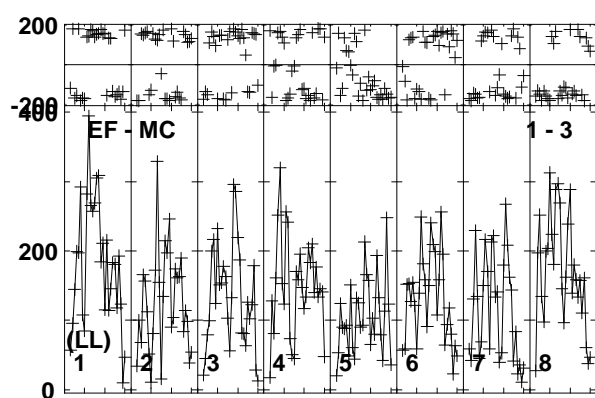
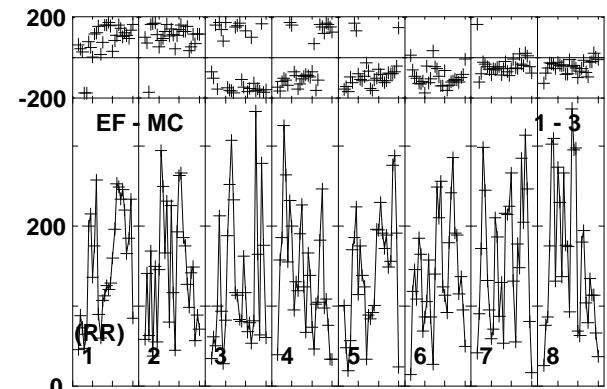
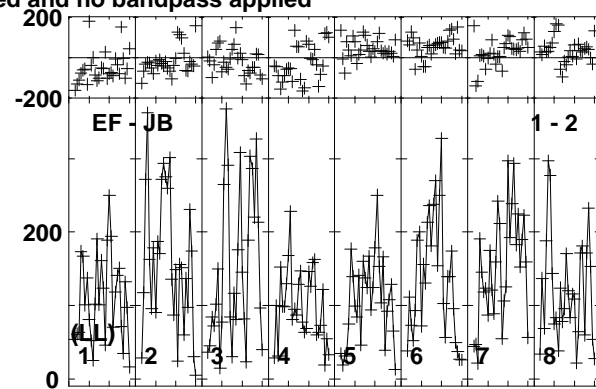
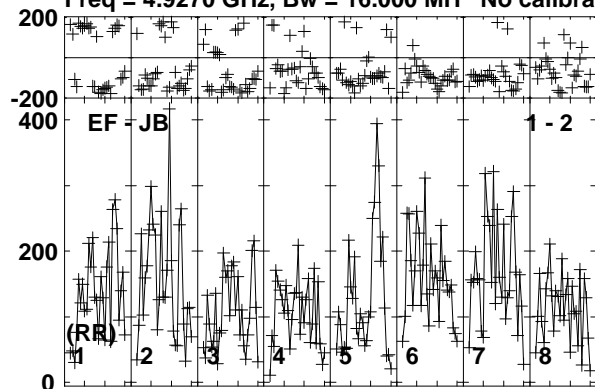

Lower frame: Micro Ampl Jy Top frame: Phas deg  
Vector averaged cross-power spectrum Baseline: EF (01) - JB (02)  
Timerange: 01/03:23:20 to 01/03:25:50

Plot file version 418 created 10-JUN-2016 17:22:44

CYGX1 RT013A.UVDATA.1

Freq = 4.9270 GHz, Bw = 16.000 MH No calibration applied and no bandpass applied

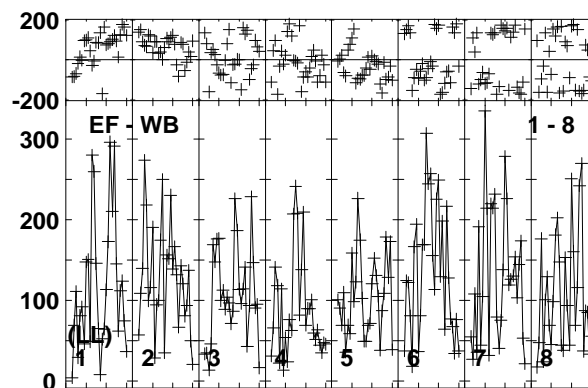
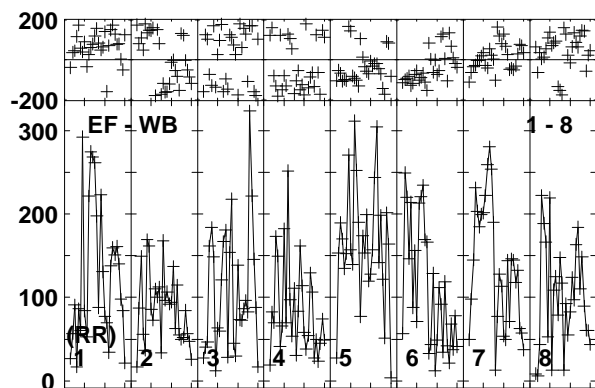
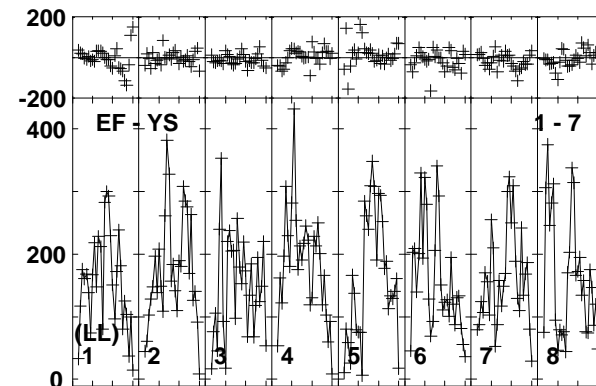
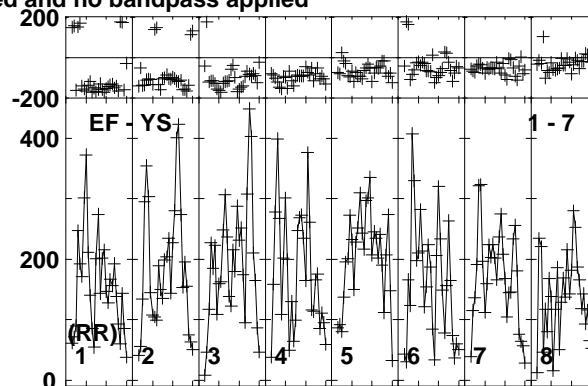
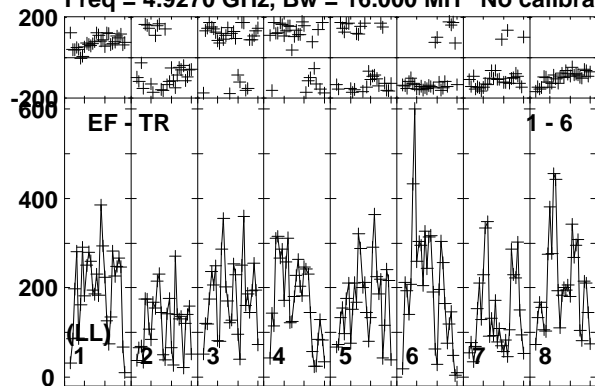

Lower frame: Micro Ampl Jy Top frame: Phas deg  
Vector averaged cross-power spectrum Baseline: EF (01) - TR (06)  
Timerange: 01/03:23:20 to 01/03:25:50



Plot file version 419 created 10-JUN-2016 17:22:44

J1957+3338 RT013A.UVDATA.1

Freq = 4.9270 GHz, Bw = 16.000 MH No calibration applied and no bandpass applied

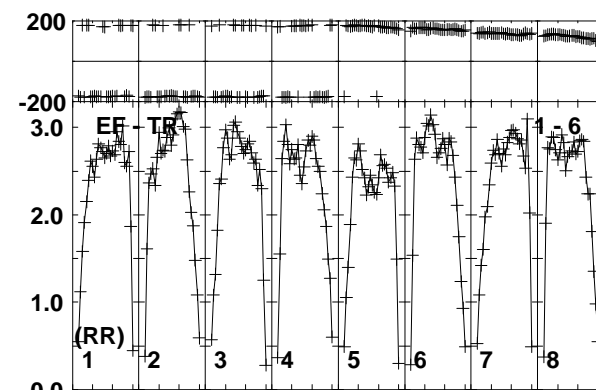
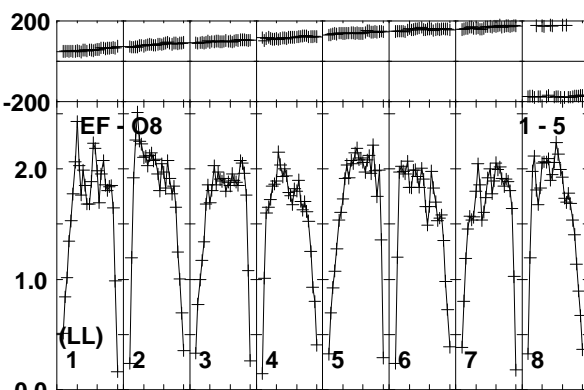
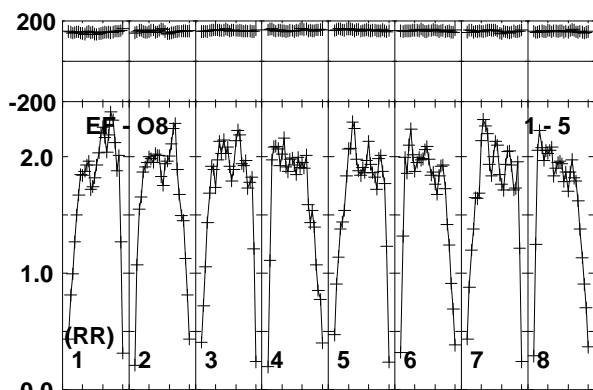
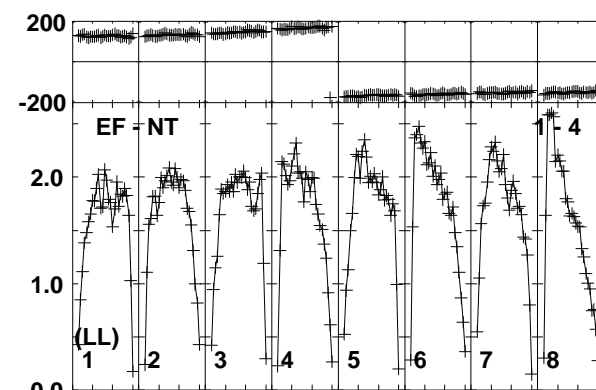
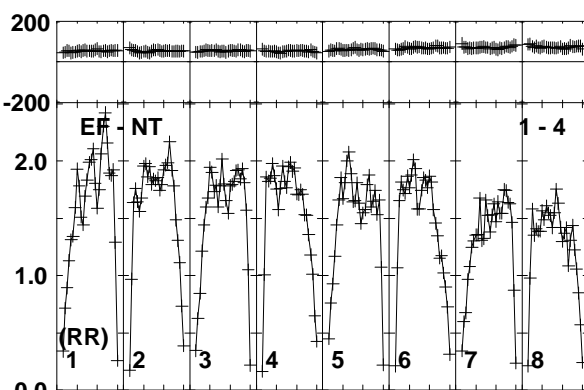
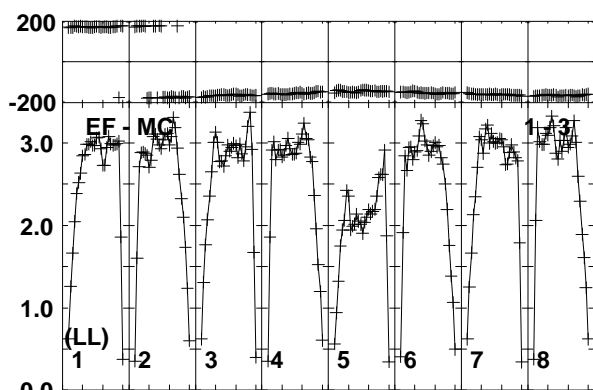
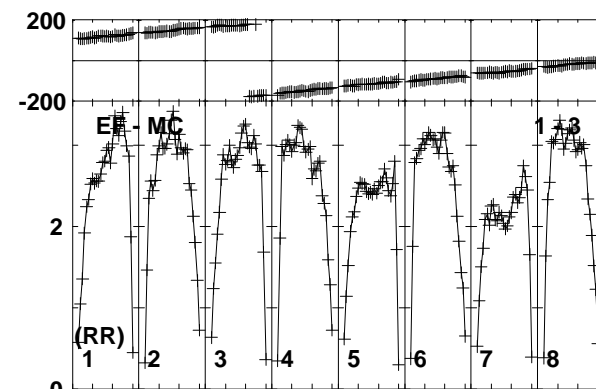
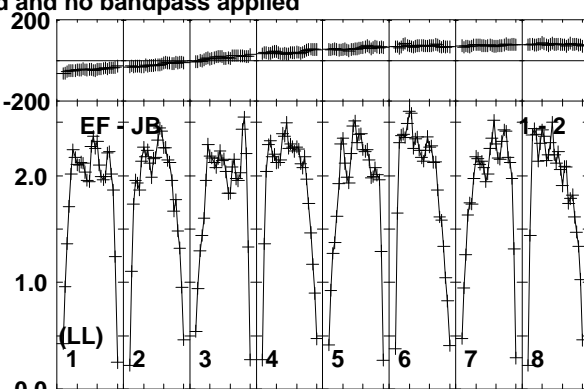
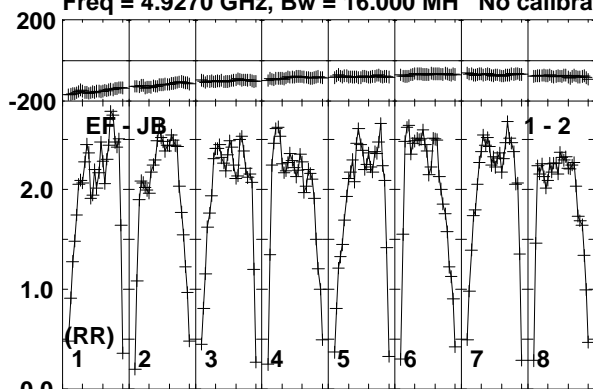

Lower frame: Milli Ampl Jy Top frame: Phas deg  
Vector averaged cross-power spectrum Baseline: EF (01) - JB (02)  
Timerange: 01/03:25:51 to 01/03:27:20

Plot file version 420 created 10-JUN-2016 17:22:44

J1957+3338 RT013A.UVDATA.1

Freq = 4.9270 GHz, Bw = 16.000 MH No calibration applied and no bandpass applied

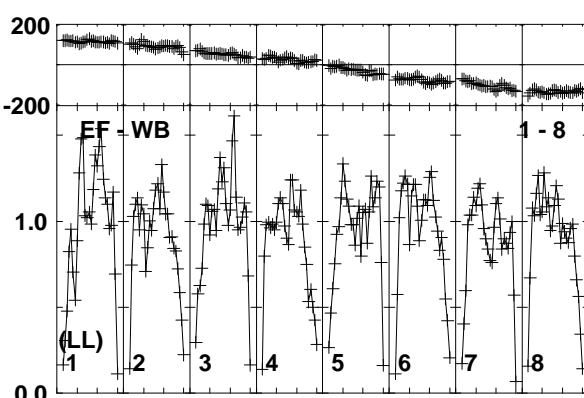
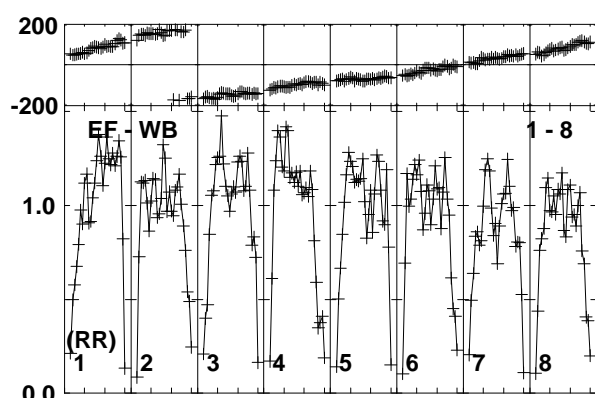
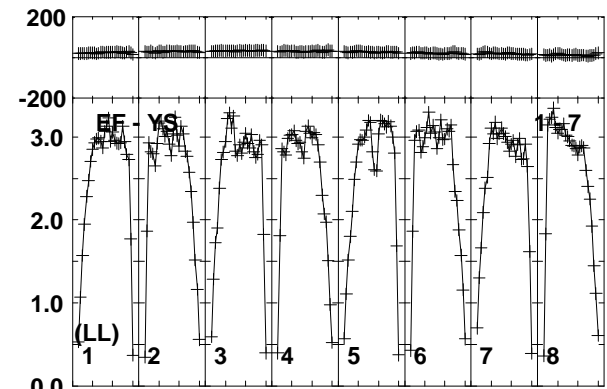
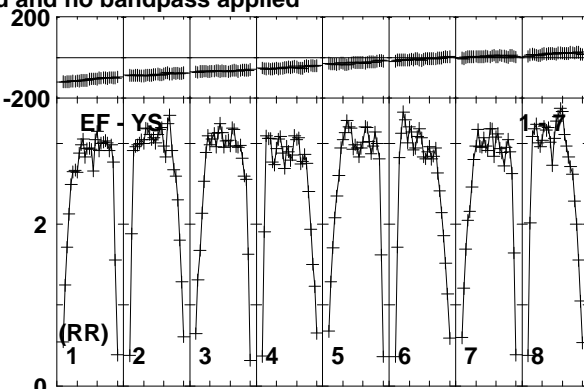
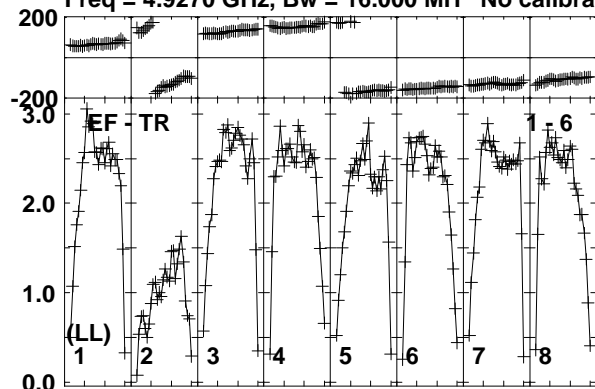

Lower frame: Milli Ampl Jy Top frame: Phas deg  
Vector averaged cross-power spectrum Baseline: EF (01) - TR (06)  
Timerange: 01/03:25:51 to 01/03:27:20

Plot file version 421 created 10-JUN-2016 17:22:44

CHECK RT013A.UVDATA.1

Freq = 4.9270 GHz, Bw = 16.000 MH No calibration applied and no bandpass applied

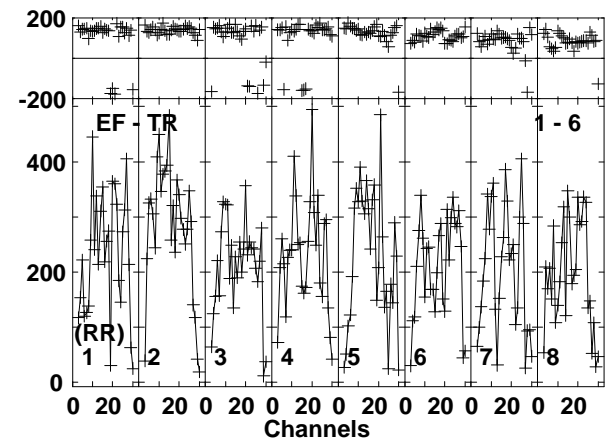
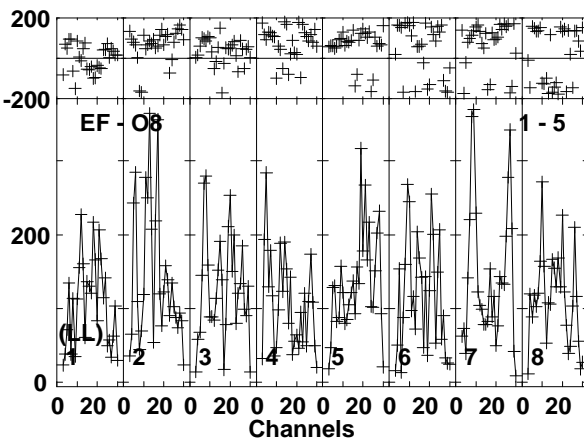
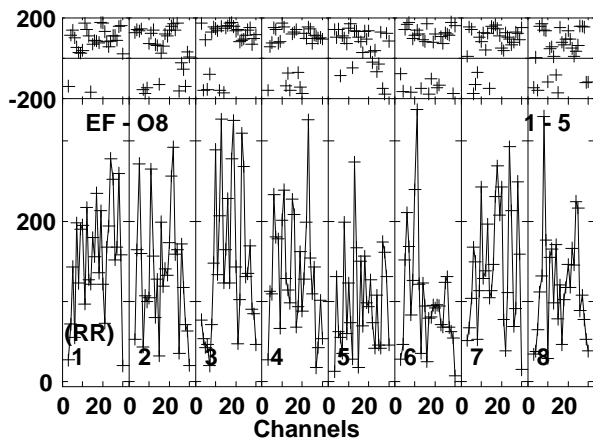
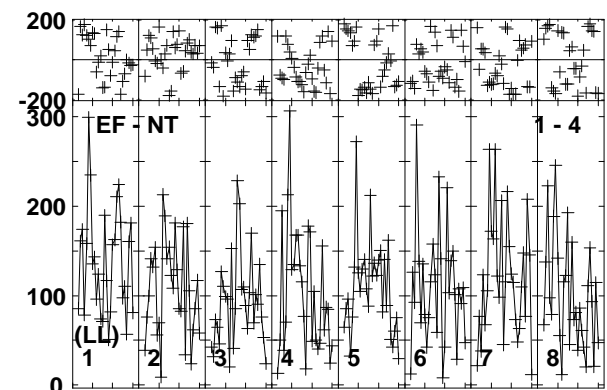
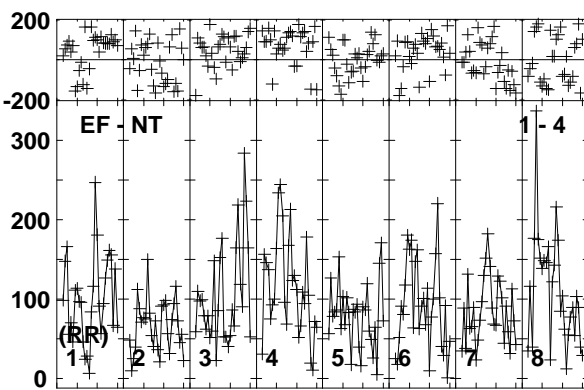
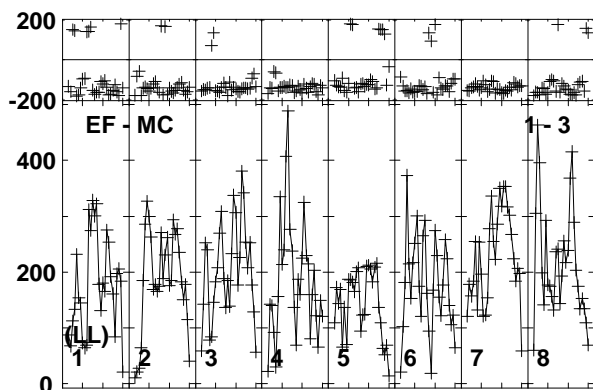
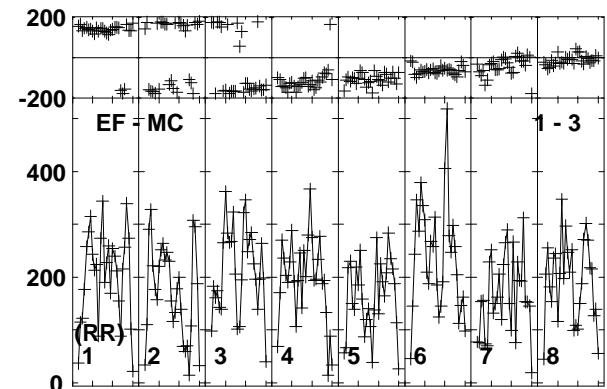
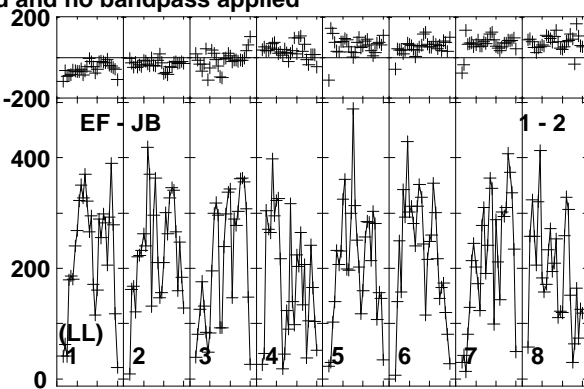
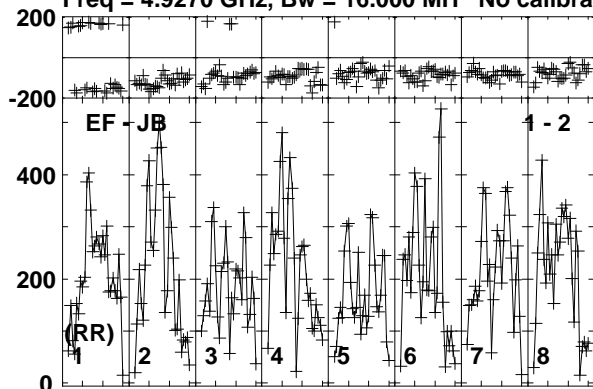

Lower frame: Micro Ampl Jy Top frame: Phas deg  
Vector averaged cross-power spectrum Baseline: EF (01) - JB (02)  
Timerange: 01/03:28:00 to 01/03:29:59

Plot file version 422 created 10-JUN-2016 17:22:45

CHECK RT013A.UVDATA.1

Freq = 4.9270 GHz, Bw = 16.000 MH No calibration applied and no bandpass applied

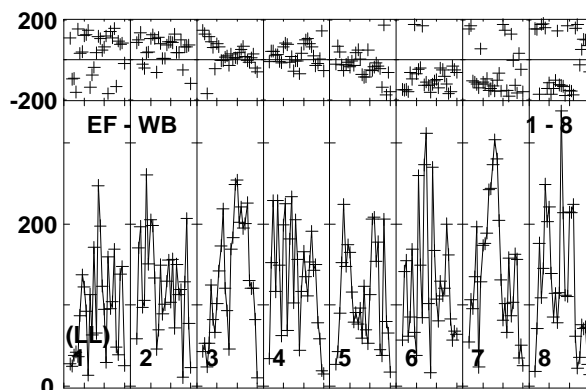
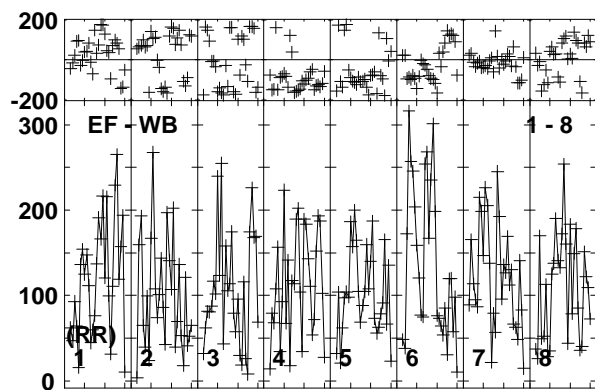
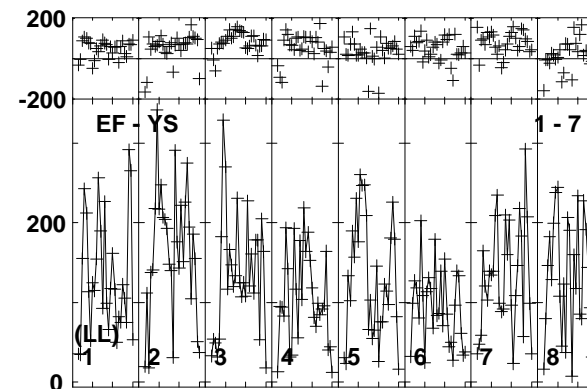
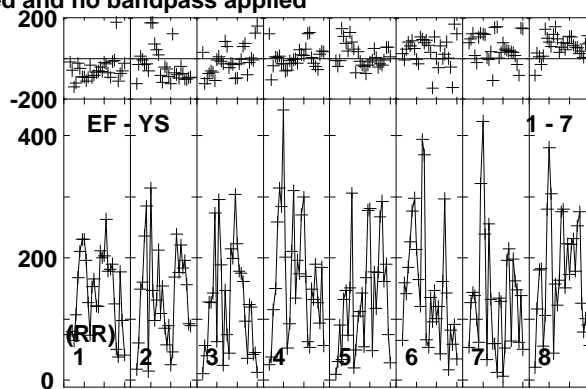
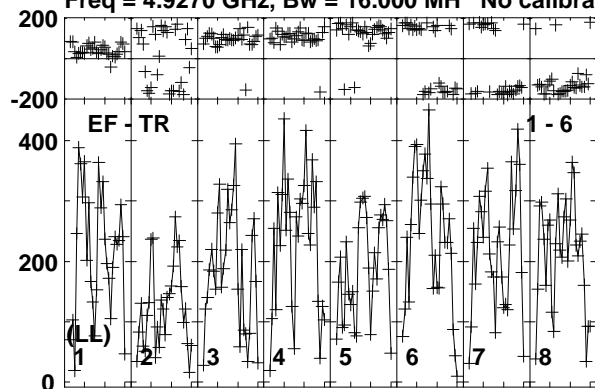

Lower frame: Micro Ampl Jy Top frame: Phas deg  
Vector averaged cross-power spectrum Baseline: EF (01) - TR (06)  
Timerange: 01/03:28:00 to 01/03:29:59

Plot file version 423 created 10-JUN-2016 17:22:45

CYGX1 RT013A.UVDATA.1

Freq = 4.9270 GHz, Bw = 16.000 MH No calibration applied and no bandpass applied

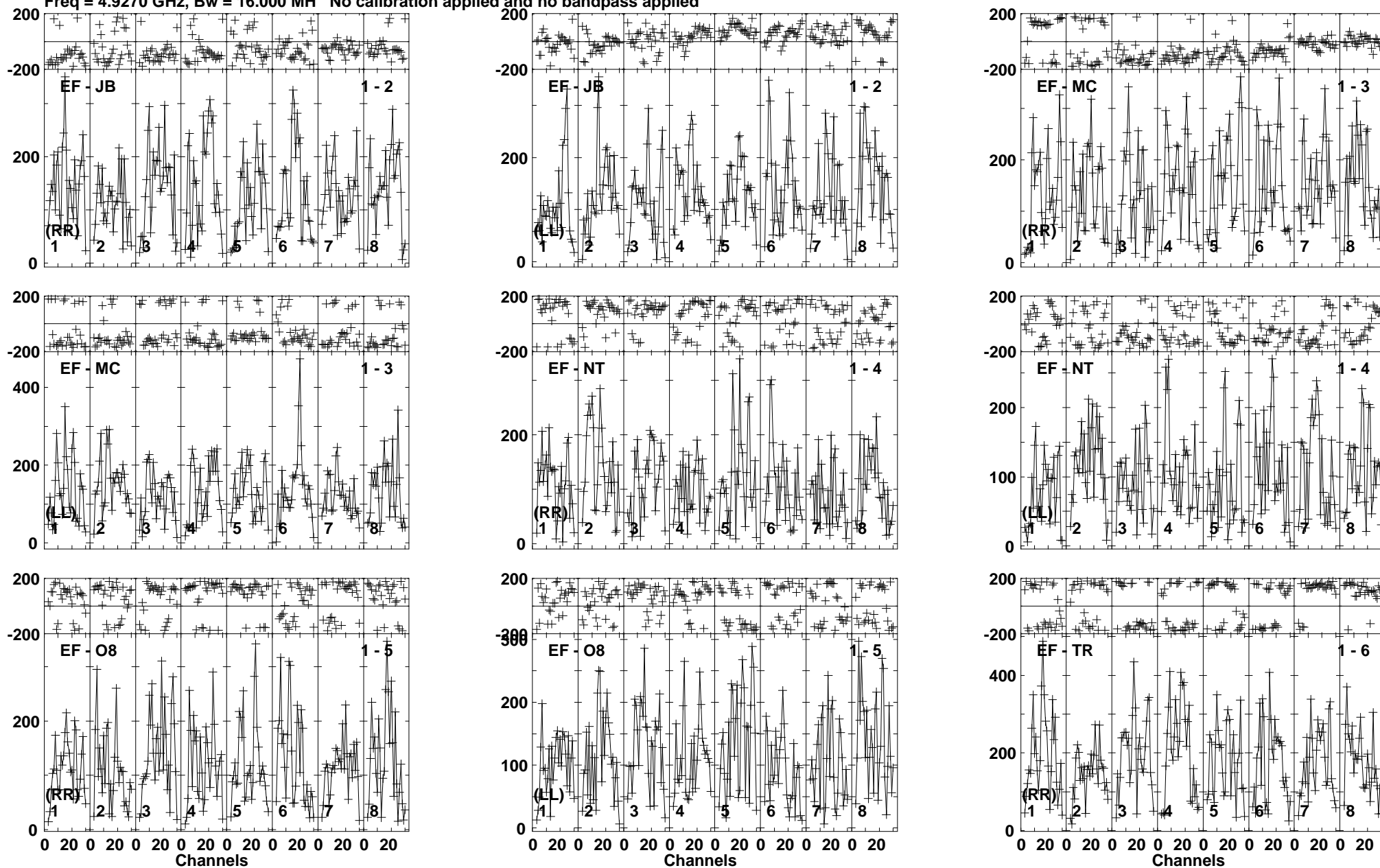

Lower frame: Micro Ampl Jy Top frame: Phas deg  
Vector averaged cross-power spectrum Baseline: EF (01) - JB (02)  
Timerange: 01/03:30:00 to 01/03:32:30

Plot file version 424 created 10-JUN-2016 17:22:45

CYGX1 RT013A.UVDATA.1

Freq = 4.9270 GHz, Bw = 16.000 MH No calibration applied and no bandpass applied

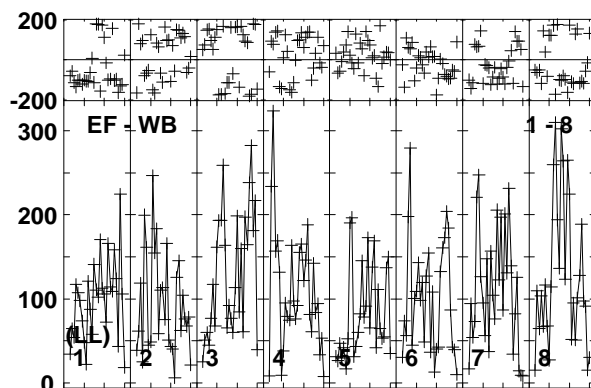
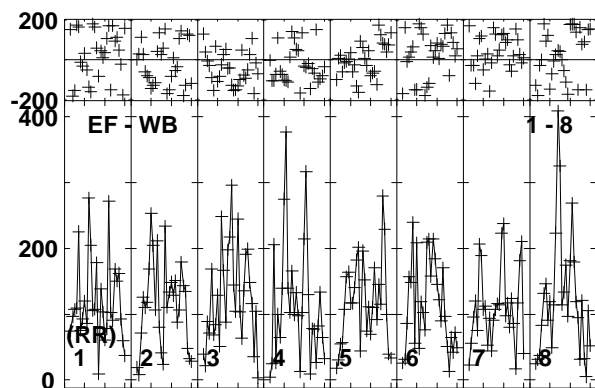
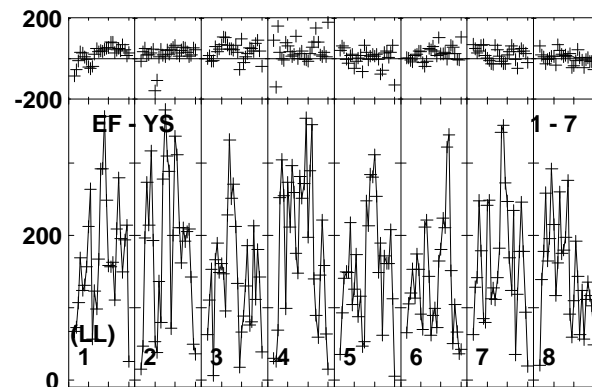
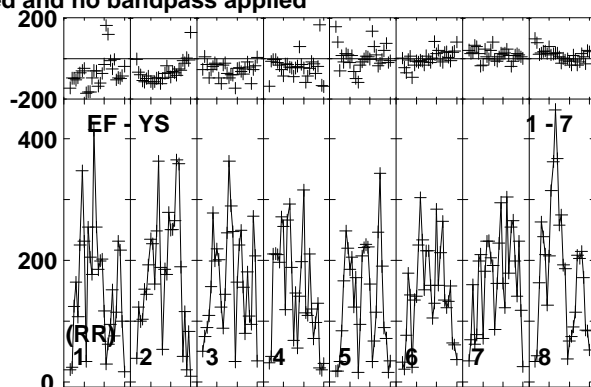
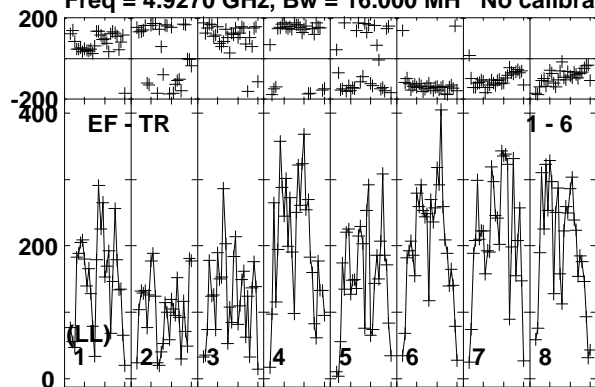

Lower frame: Micro Ampl Jy Top frame: Phas deg  
Vector averaged cross-power spectrum Baseline: EF (01) - TR (06)  
Timerange: 01/03:30:00 to 01/03:32:30

Plot file version 425 created 10-JUN-2016 17:22:45

J1957+3338 RT013A.UVDATA.1

Freq = 4.9270 GHz, Bw = 16.000 MH No calibration applied and no bandpass applied

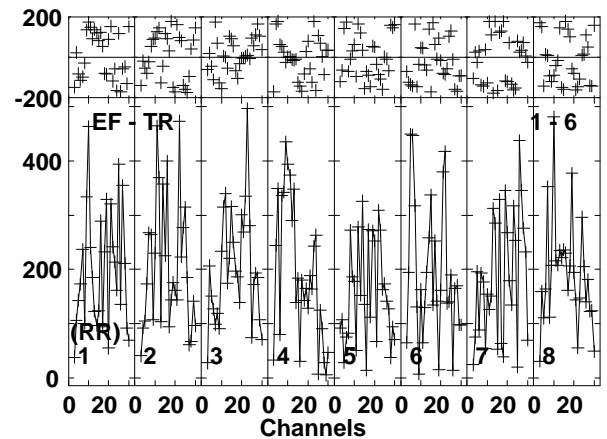
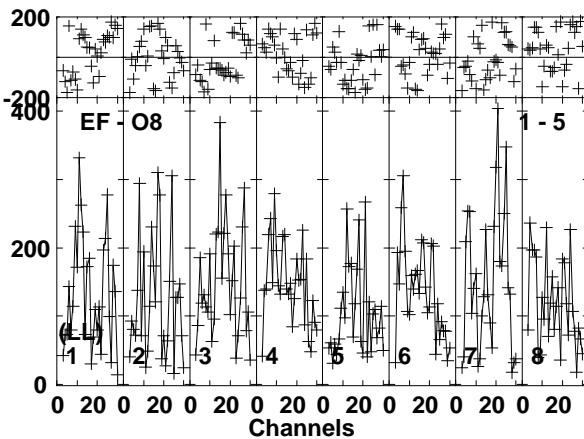
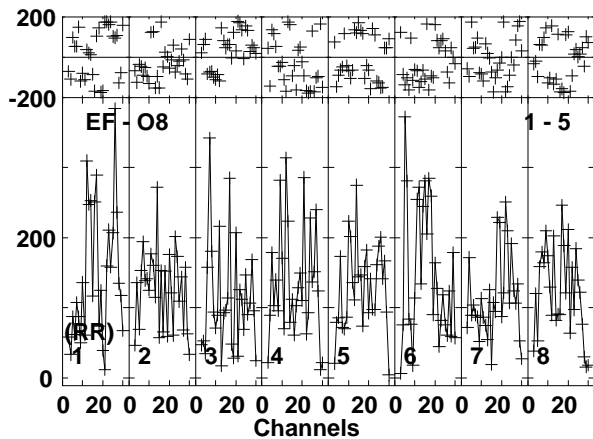
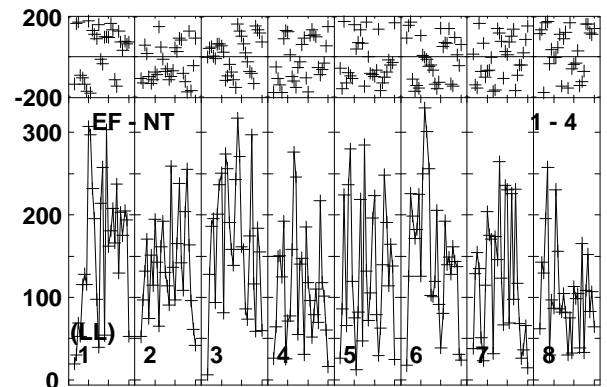
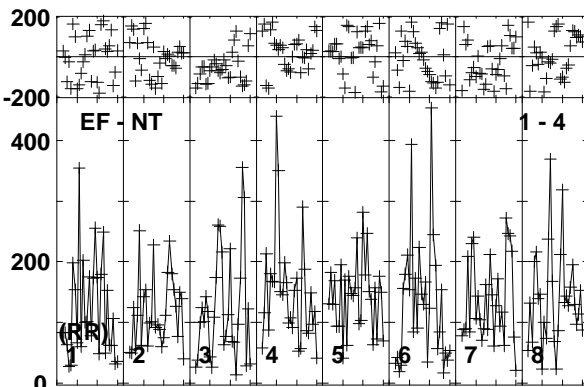
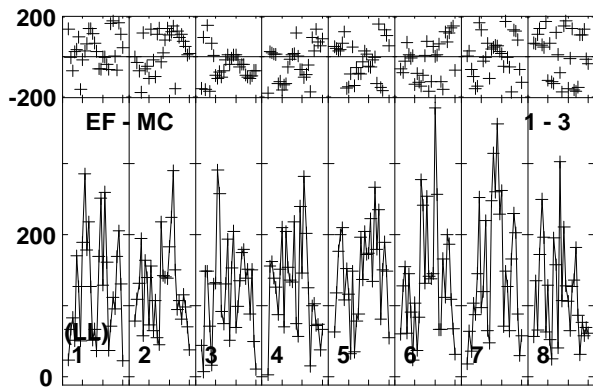
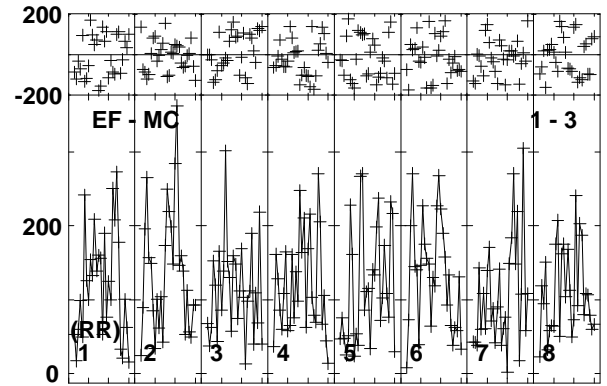
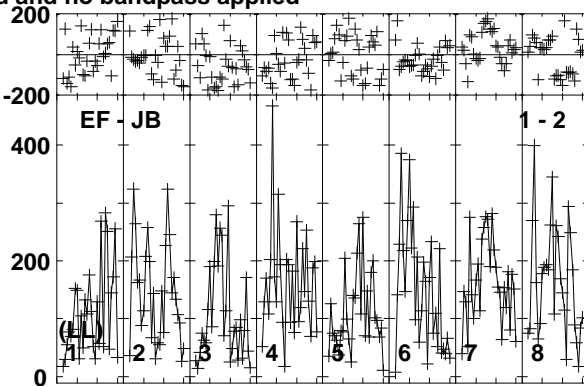
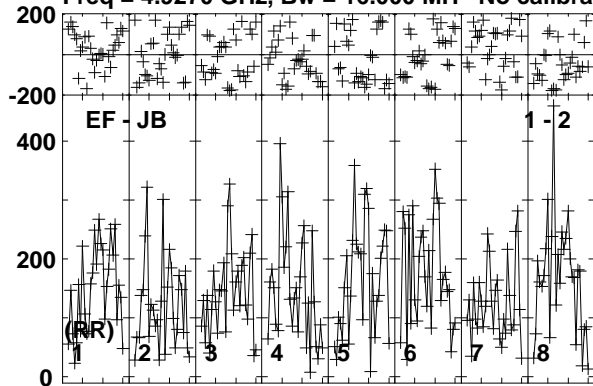

Lower frame: Micro Ampl Jy Top frame: Phas deg  
Vector averaged cross-power spectrum Baseline: EF (01) - JB (02)  
Timerange: 01/03:32:31 to 01/03:34:00

Plot file version 426 created 10-JUN-2016 17:22:45

J1957+3338 RT013A.UVDATA.1

Freq = 4.9270 GHz, Bw = 16.000 MH No calibration applied and no bandpass applied

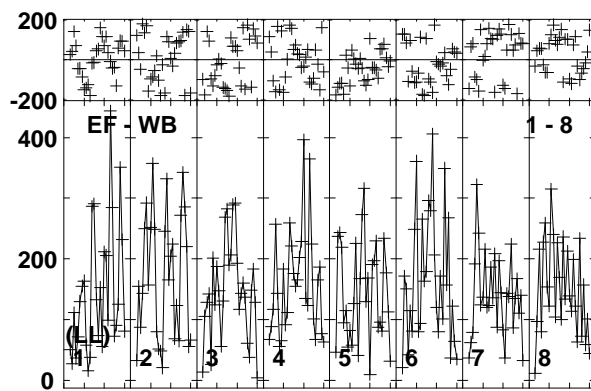
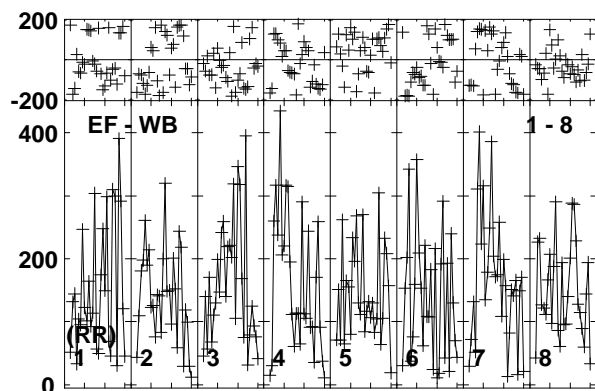
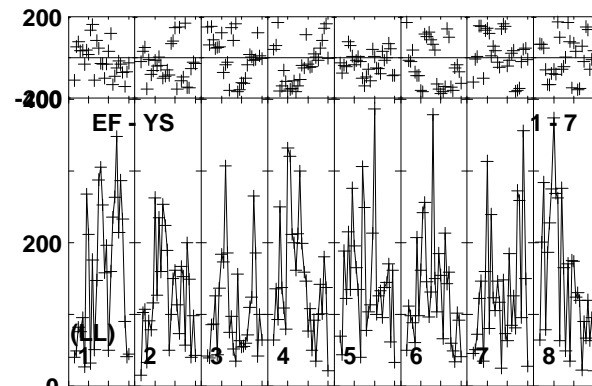
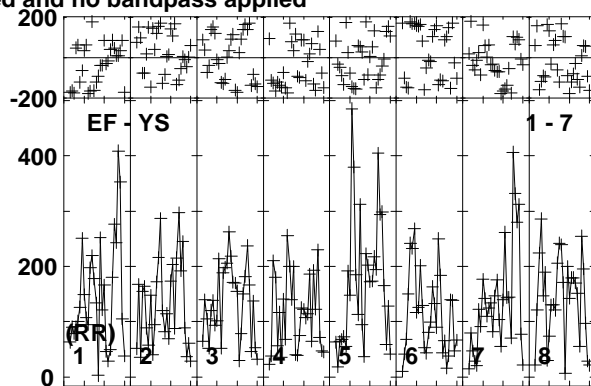
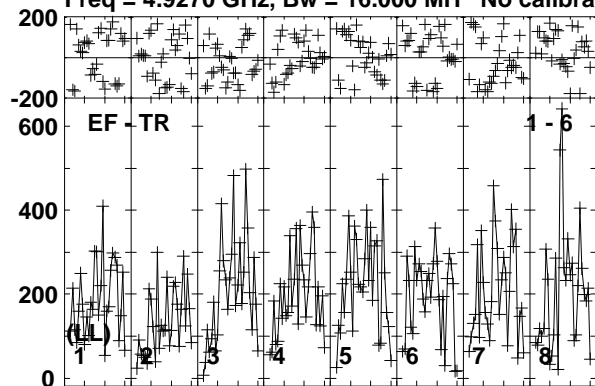

Lower frame: Micro Ampl Jy Top frame: Phas deg  
Vector averaged cross-power spectrum Baseline: EF (01) - TR (06)  
Timerange: 01/03:32:31 to 01/03:34:00



Plot file version 427 created 10-JUN-2016 17:22:45

CHECK RT013A.UVDATA.1

Freq = 4.9270 GHz, Bw = 16.000 MH No calibration applied and no bandpass applied

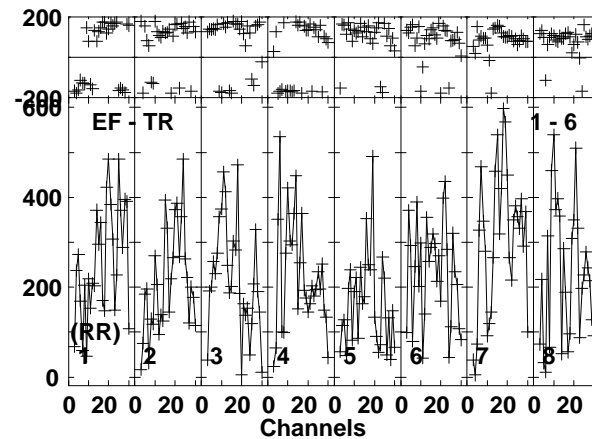
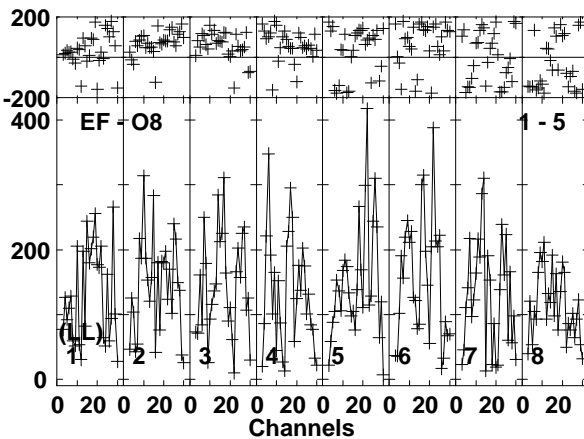
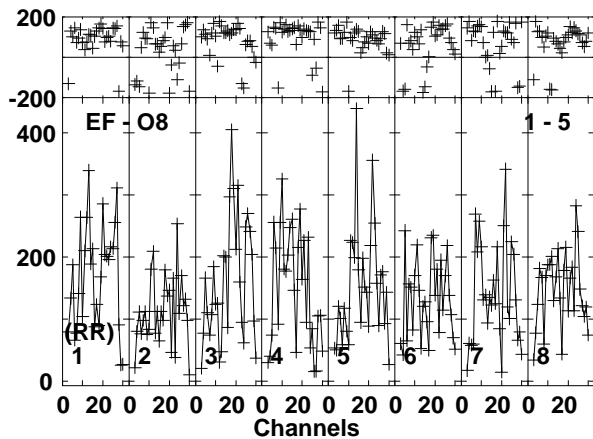
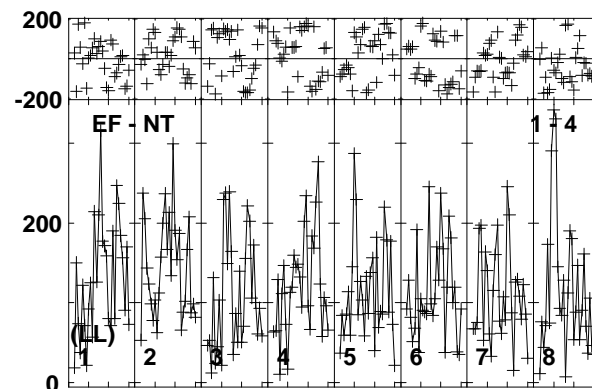
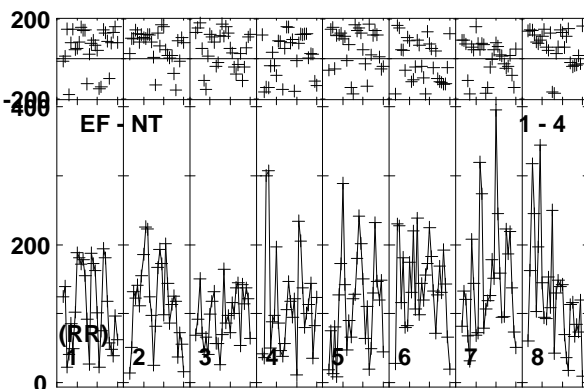
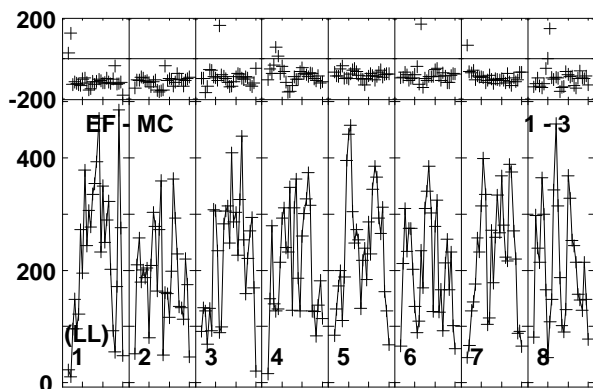
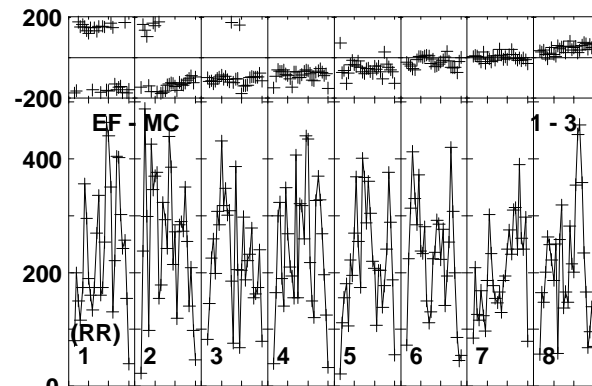
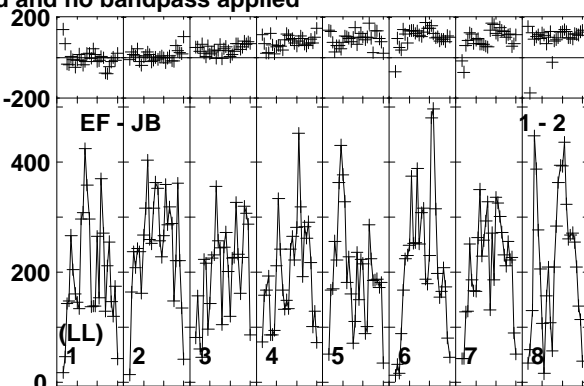
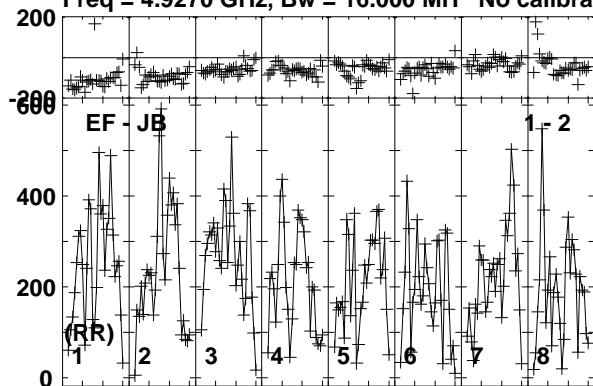

Lower frame: Micro Ampl Jy Top frame: Phas deg  
Vector averaged cross-power spectrum Baseline: EF (01) - JB (02)  
Timerange: 01/03:34:01 to 01/03:36:00

Plot file version 428 created 10-JUN-2016 17:22:45

CHECK RT013A.UVDATA.1

Freq = 4.9270 GHz, Bw = 16.000 MH No calibration applied and no bandpass applied

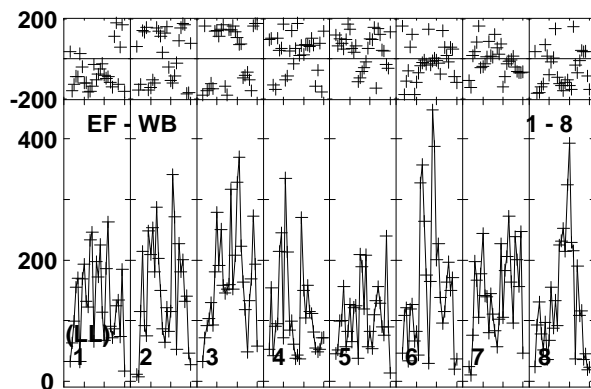
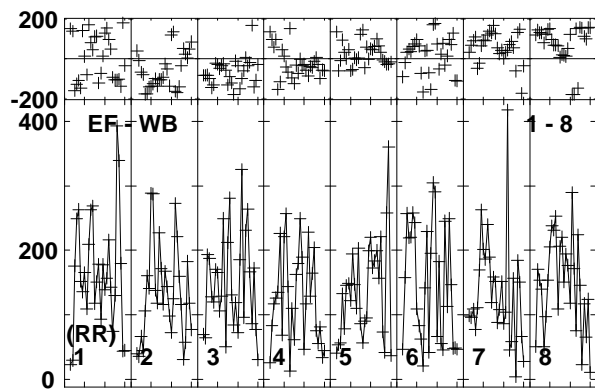
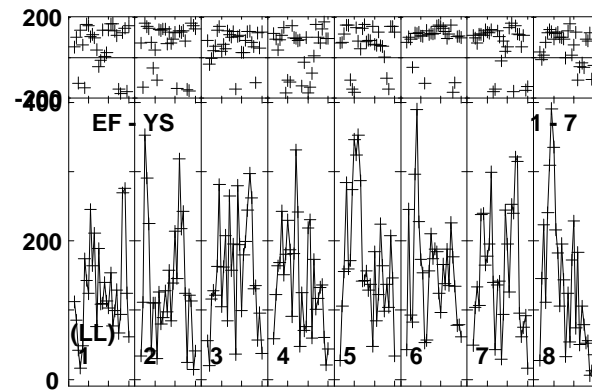
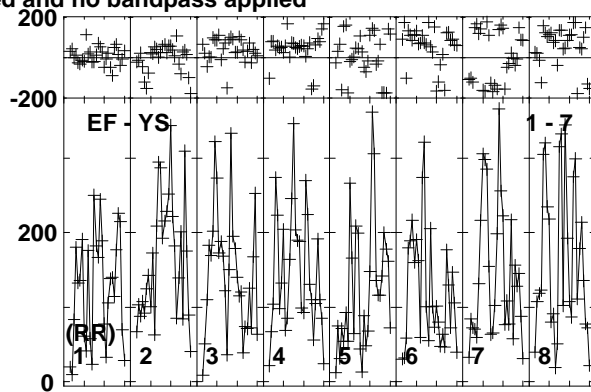
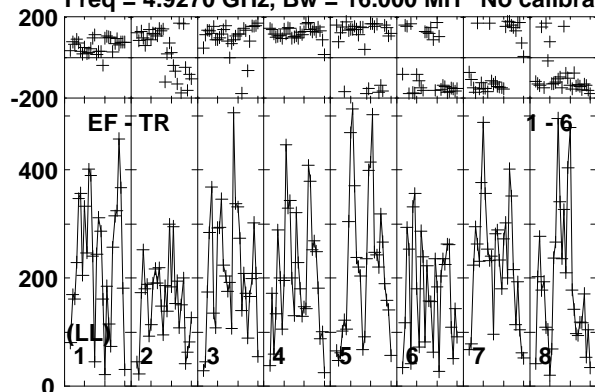

Lower frame: Micro Ampl Jy Top frame: Phas deg  
Vector averaged cross-power spectrum Baseline: EF (01) - TR (06)  
Timerange: 01/03:34:01 to 01/03:36:00

Plot file version 429 created 10-JUN-2016 17:22:45

CYGX1 RT013A.UVDATA.1

Freq = 4.9270 GHz, Bw = 16.000 MH No calibration applied and no bandpass applied

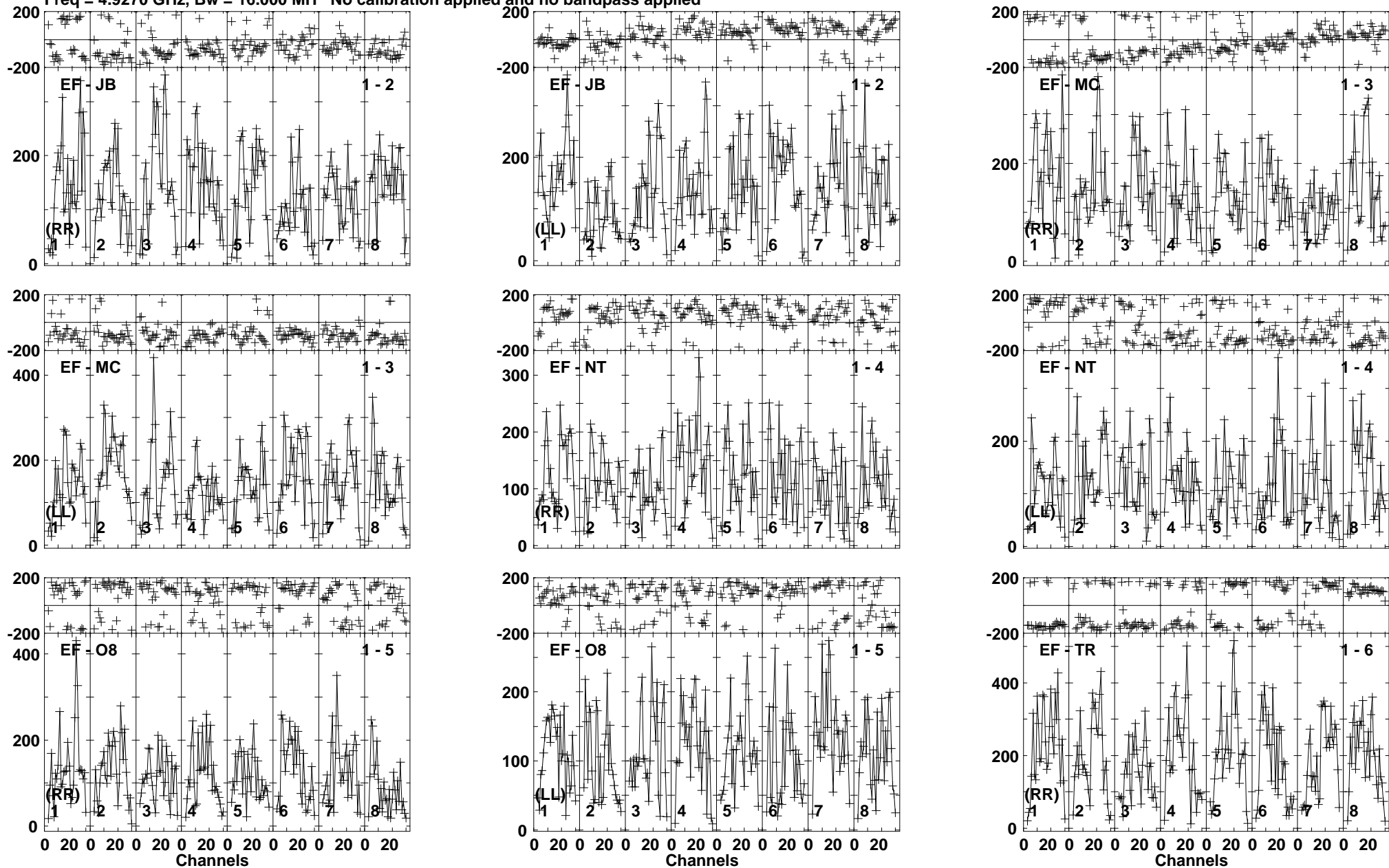

Lower frame: Micro Ampl Jy Top frame: Phas deg  
Vector averaged cross-power spectrum Baseline: EF (01) - JB (02)  
Timerange: 01/03:36:01 to 01/03:38:29

Plot file version 430 created 10-JUN-2016 17:22:45

CYGX1 RT013A.UVDATA.1

Freq = 4.9270 GHz, Bw = 16.000 MH No calibration applied and no bandpass applied

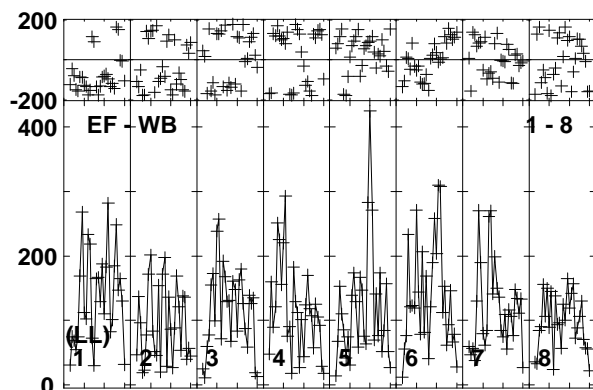
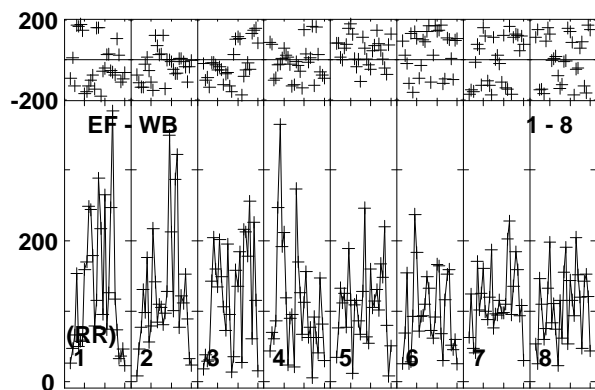
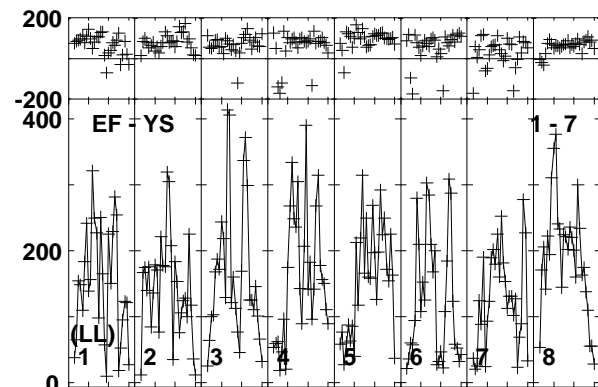
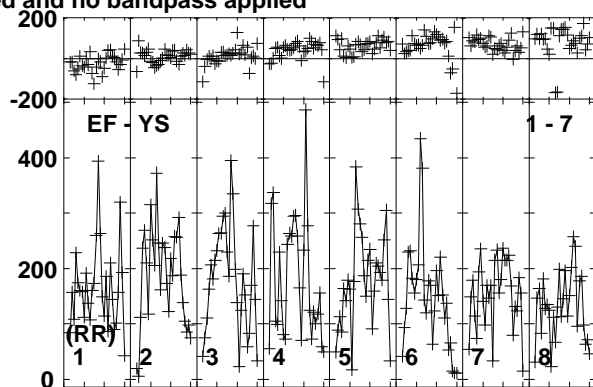
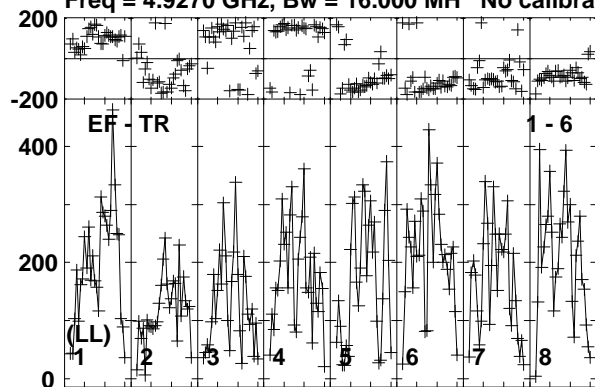

Lower frame: Micro Ampl Jy Top frame: Phas deg  
Vector averaged cross-power spectrum Baseline: EF (01) - TR (06)  
Timerange: 01/03:36:01 to 01/03:38:29

Plot file version 431 created 10-JUN-2016 17:22:45

J1957+3338 RT013A.UVDATA.1

Freq = 4.9270 GHz, Bw = 16.000 MH No calibration applied and no bandpass applied

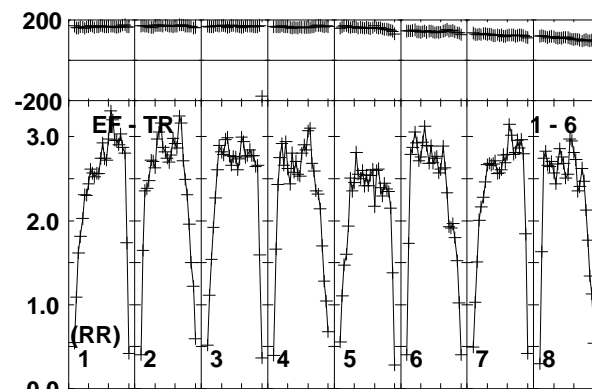
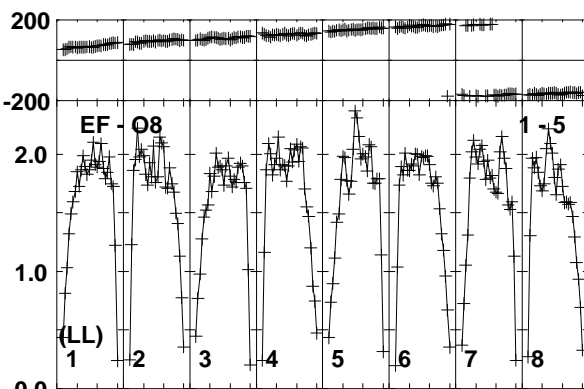
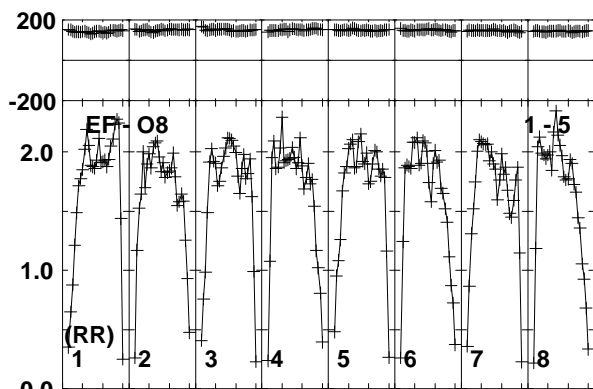
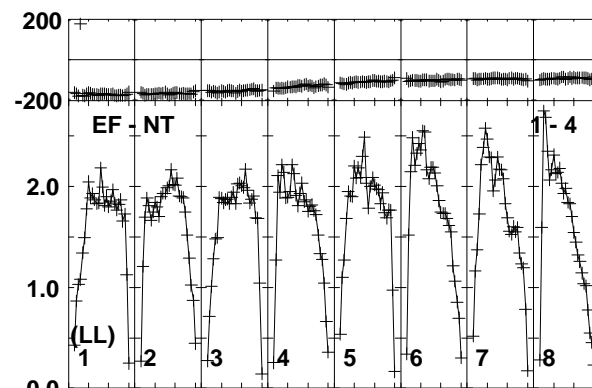
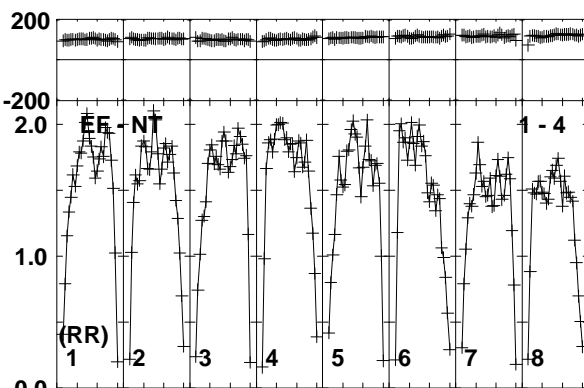
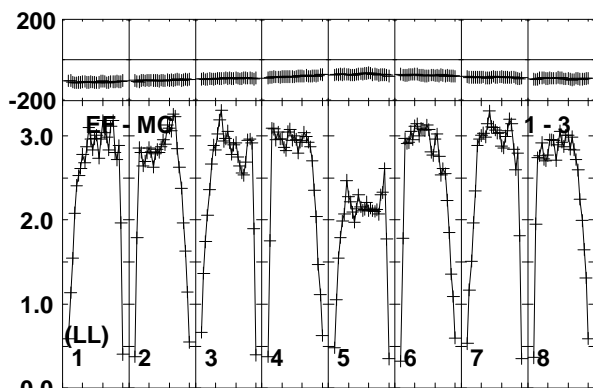
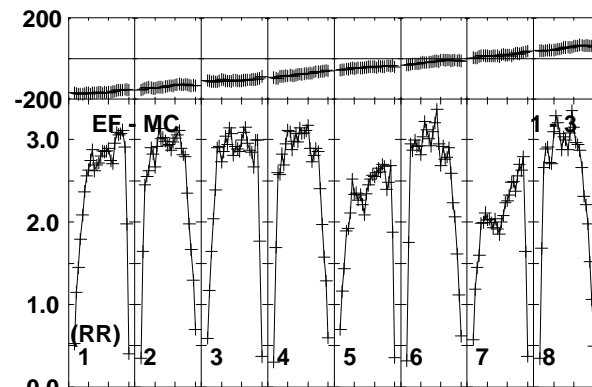
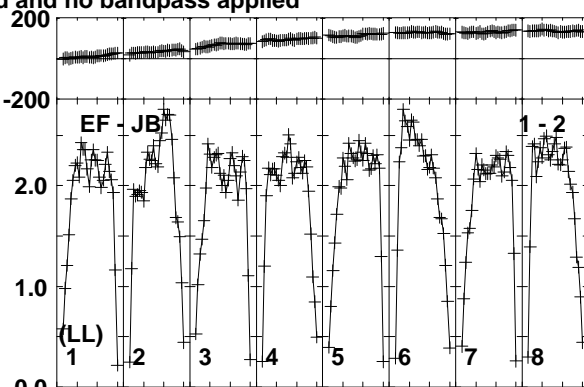
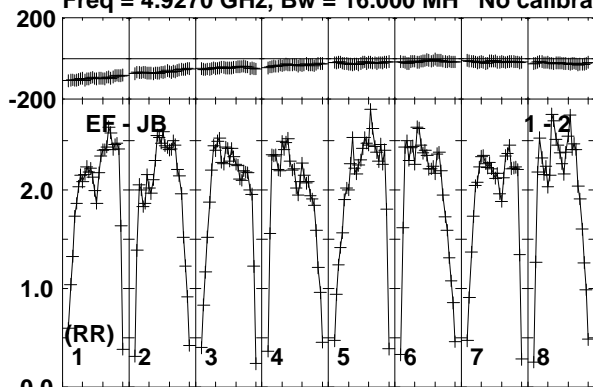

Lower frame: Milli Ampl Jy Top frame: Phas deg  
Vector averaged cross-power spectrum Baseline: EF (01) - JB (02)  
Timerange: 01/03:38:31 to 01/03:39:59

Plot file version 432 created 10-JUN-2016 17:22:45

J1957+3338 RT013A.UVDATA.1

Freq = 4.9270 GHz, Bw = 16.000 MH No calibration applied and no bandpass applied

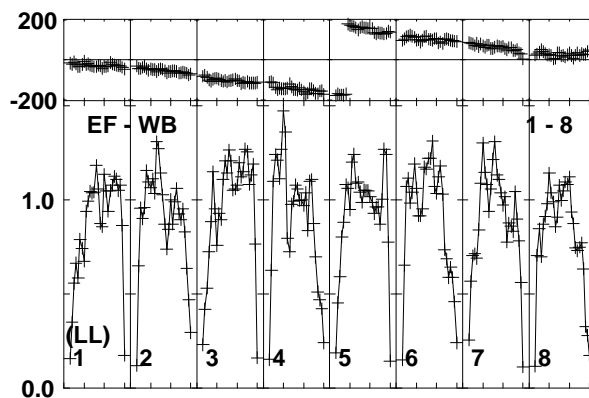
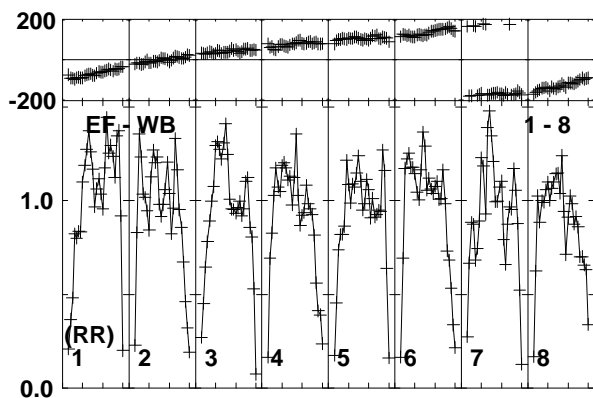
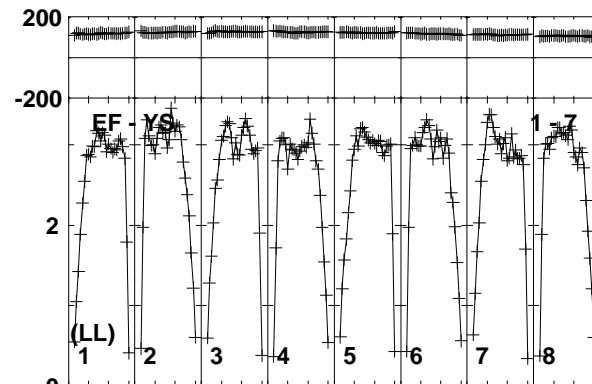
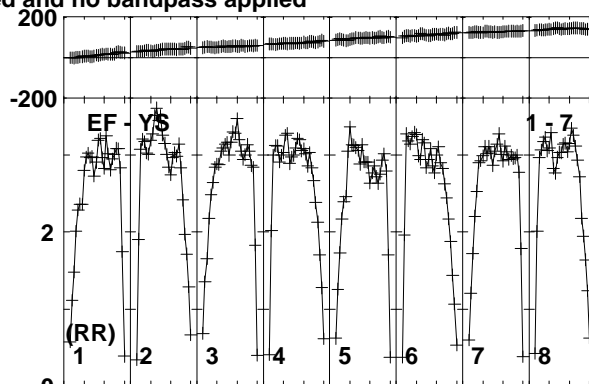
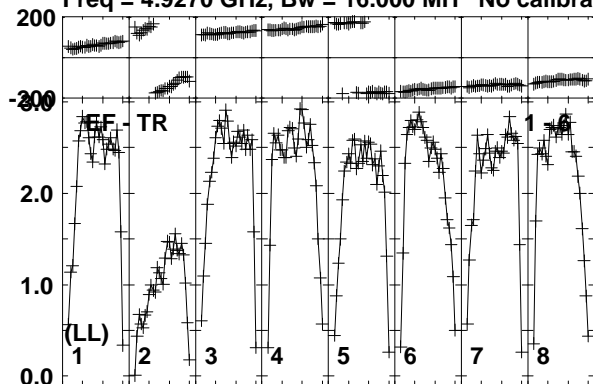

Lower frame: Milli Ampl Jy Top frame: Phas deg  
Vector averaged cross-power spectrum Baseline: EF (01) - TR (06)  
Timerange: 01/03:38:31 to 01/03:39:59

Plot file version 433 created 10-JUN-2016 17:22:46

CHECK RT013A.UVDATA.1

Freq = 4.9270 GHz, Bw = 16.000 MH No calibration applied and no bandpass applied

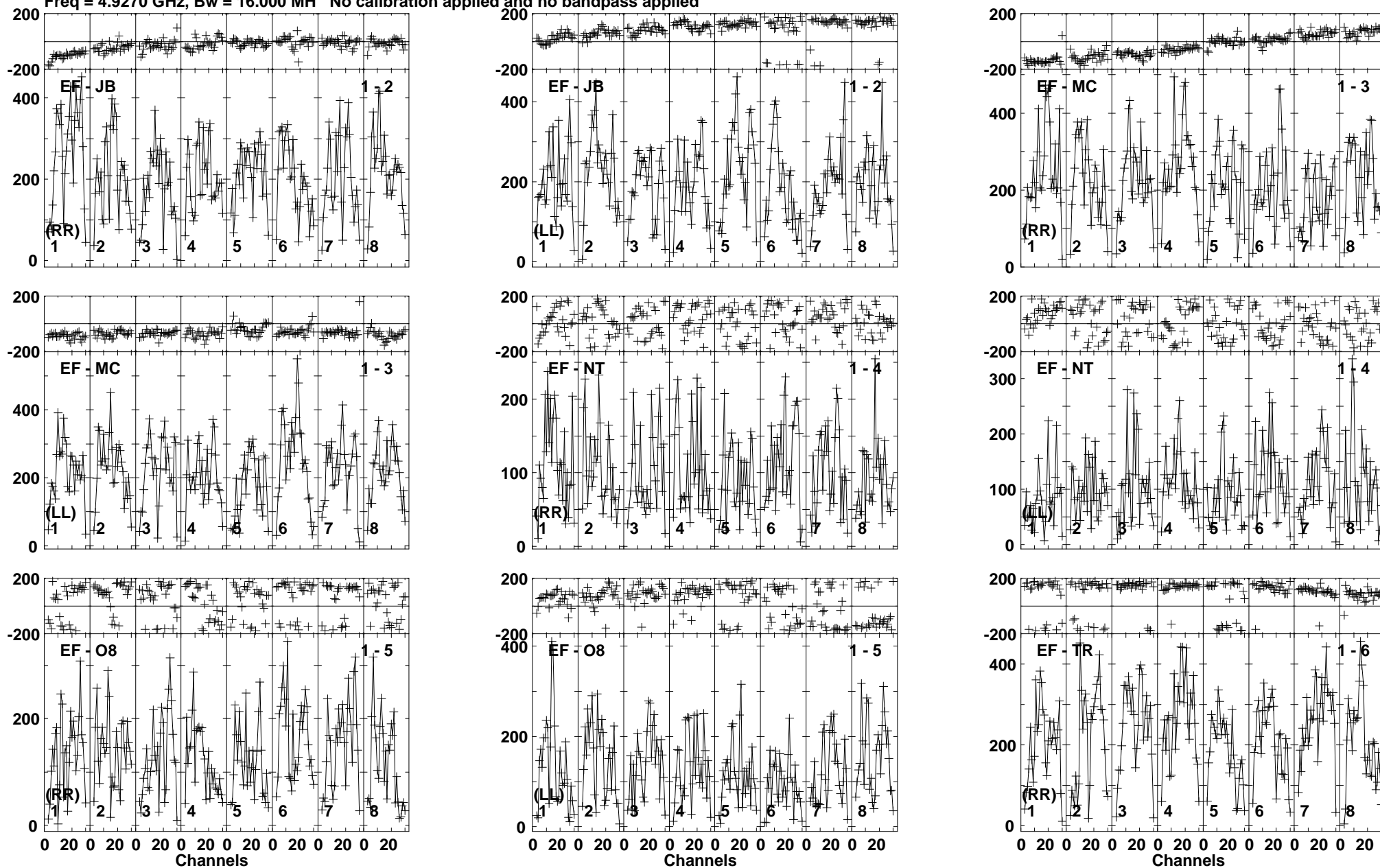

Lower frame: Micro Ampl Jy Top frame: Phas deg  
Vector averaged cross-power spectrum Baseline: EF (01) - JB (02)  
Timerange: 01/03:40:40 to 01/03:42:40

Plot file version 434 created 10-JUN-2016 17:22:46

CHECK RT013A.UVDATA.1

Freq = 4.9270 GHz, Bw = 16.000 MH No calibration applied and no bandpass applied

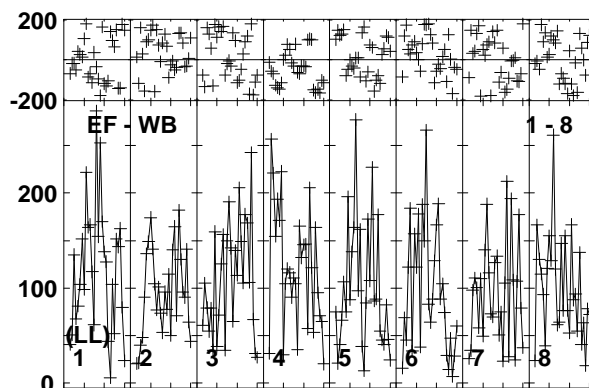
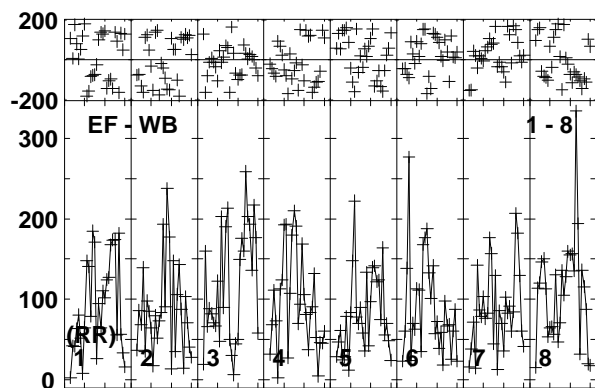
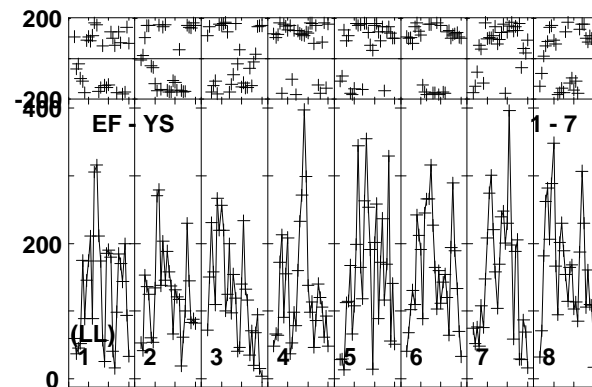
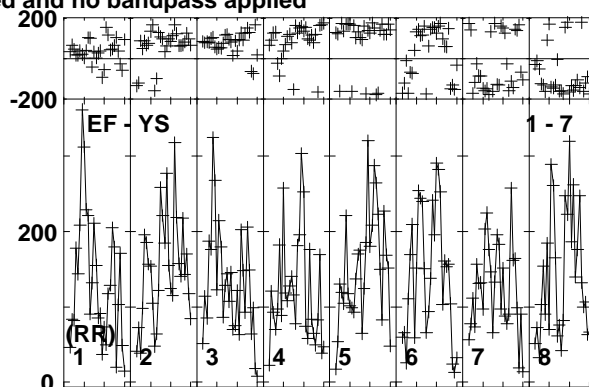
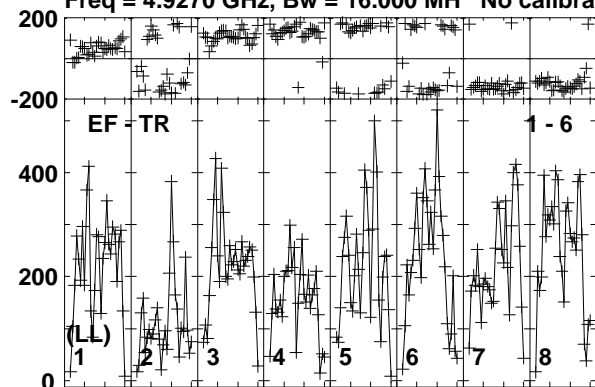

Lower frame: Micro Ampl Jy Top frame: Phas deg  
Vector averaged cross-power spectrum Baseline: EF (01) - TR (06)  
Timerange: 01/03:40:40 to 01/03:42:40



Plot file version 435 created 10-JUN-2016 17:22:46

CYGX1 RT013A.UVDATA.1

Freq = 4.9270 GHz, Bw = 16.000 MH No calibration applied and no bandpass applied

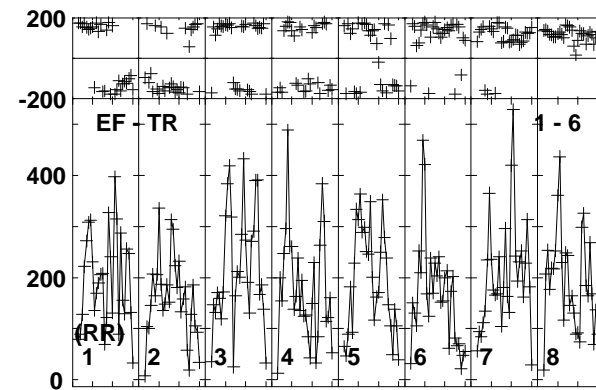
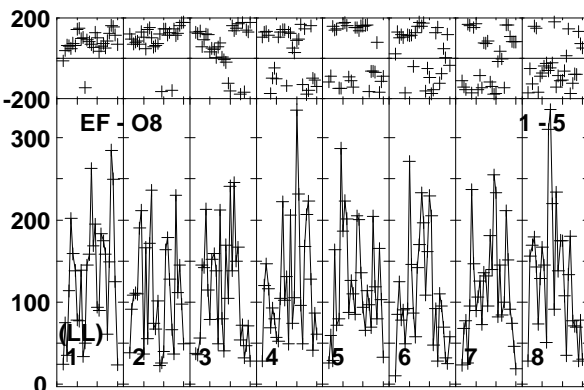
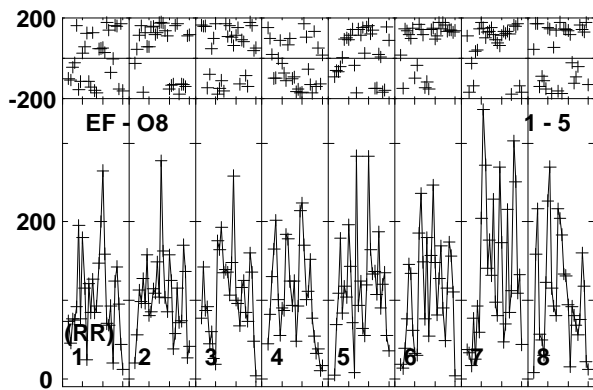
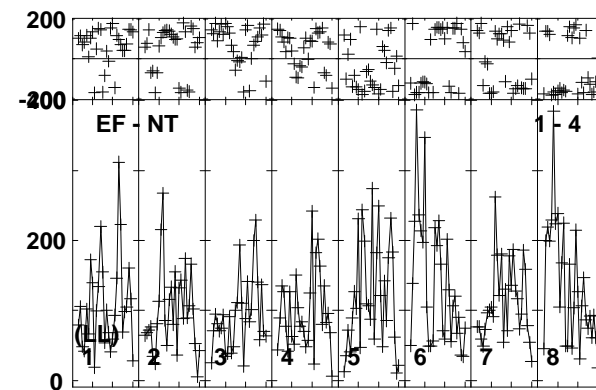
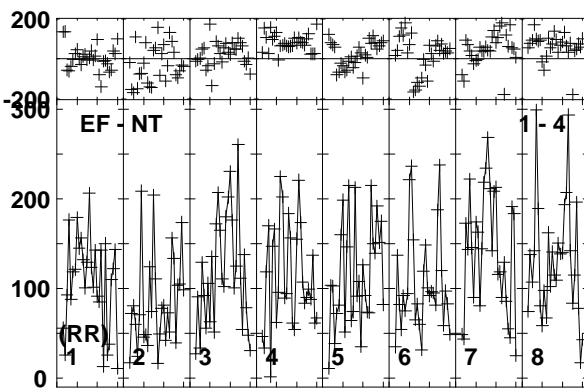
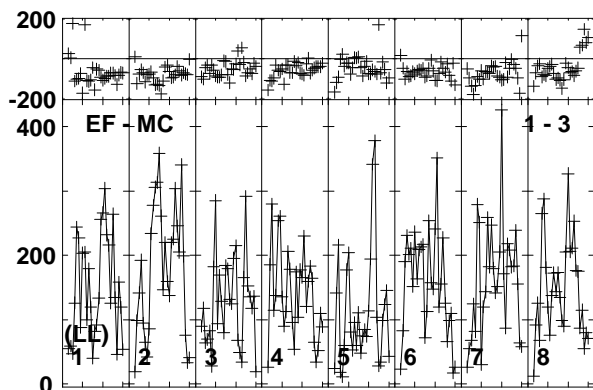
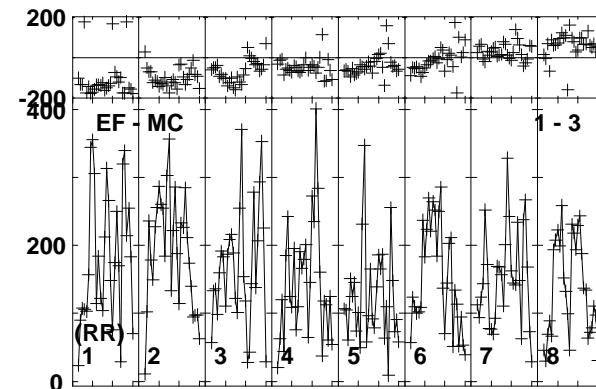
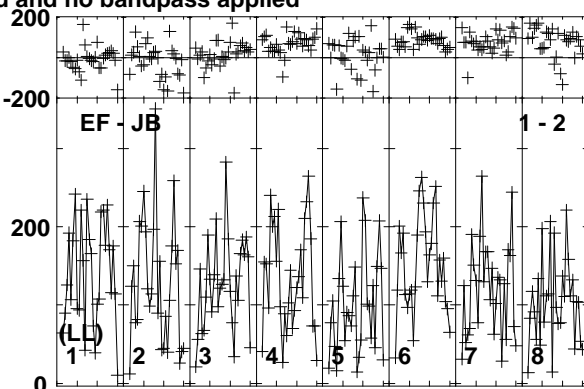
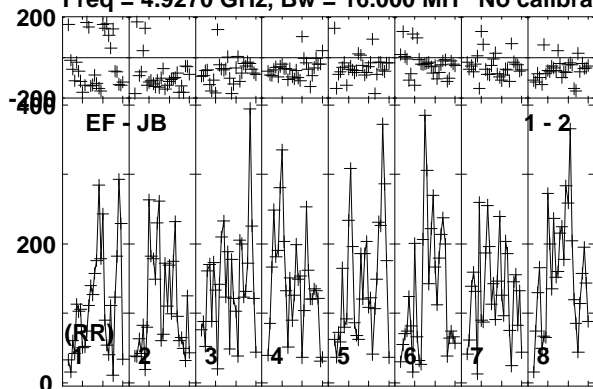

Lower frame: Micro Ampl Jy Top frame: Phas deg  
Vector averaged cross-power spectrum Baseline: EF (01) - JB (02)  
Timerange: 01/03:42:41 to 01/03:45:09

Plot file version 436 created 10-JUN-2016 17:22:46

CYGX1 RT013A.UVDATA.1

Freq = 4.9270 GHz, Bw = 16.000 MH No calibration applied and no bandpass applied

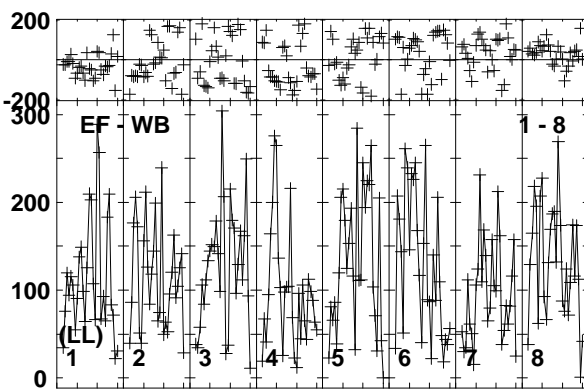
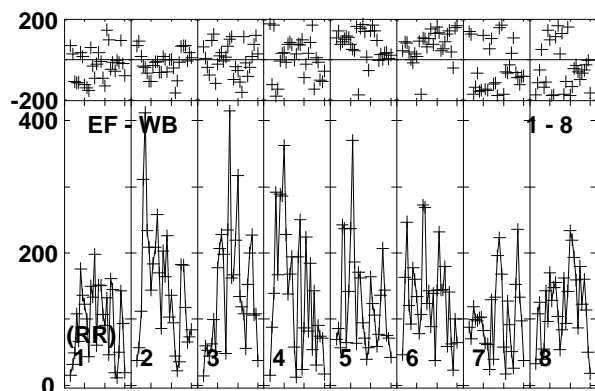
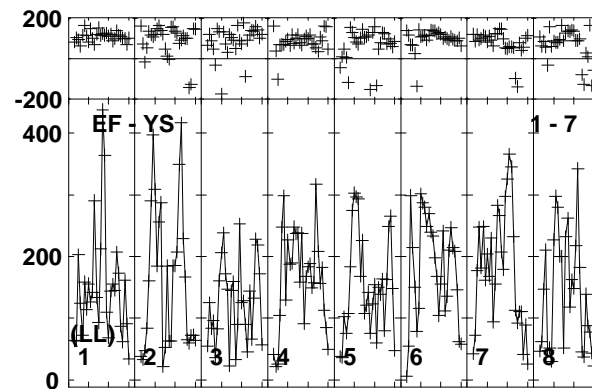
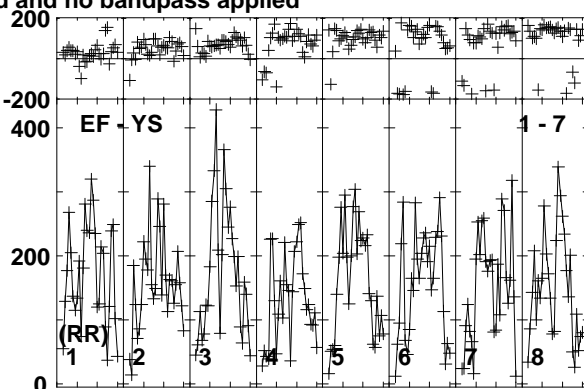
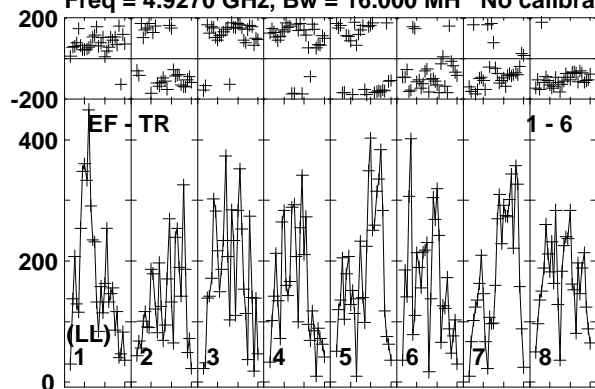

Lower frame: Micro Ampl Jy Top frame: Phas deg  
Vector averaged cross-power spectrum Baseline: EF (01) - TR (06)  
Timerange: 01/03:42:41 to 01/03:45:09

Plot file version 437 created 10-JUN-2016 17:22:46

J1957+3338 RT013A.UVDATA.1

Freq = 4.9270 GHz, Bw = 16.000 MH No calibration applied and no bandpass applied

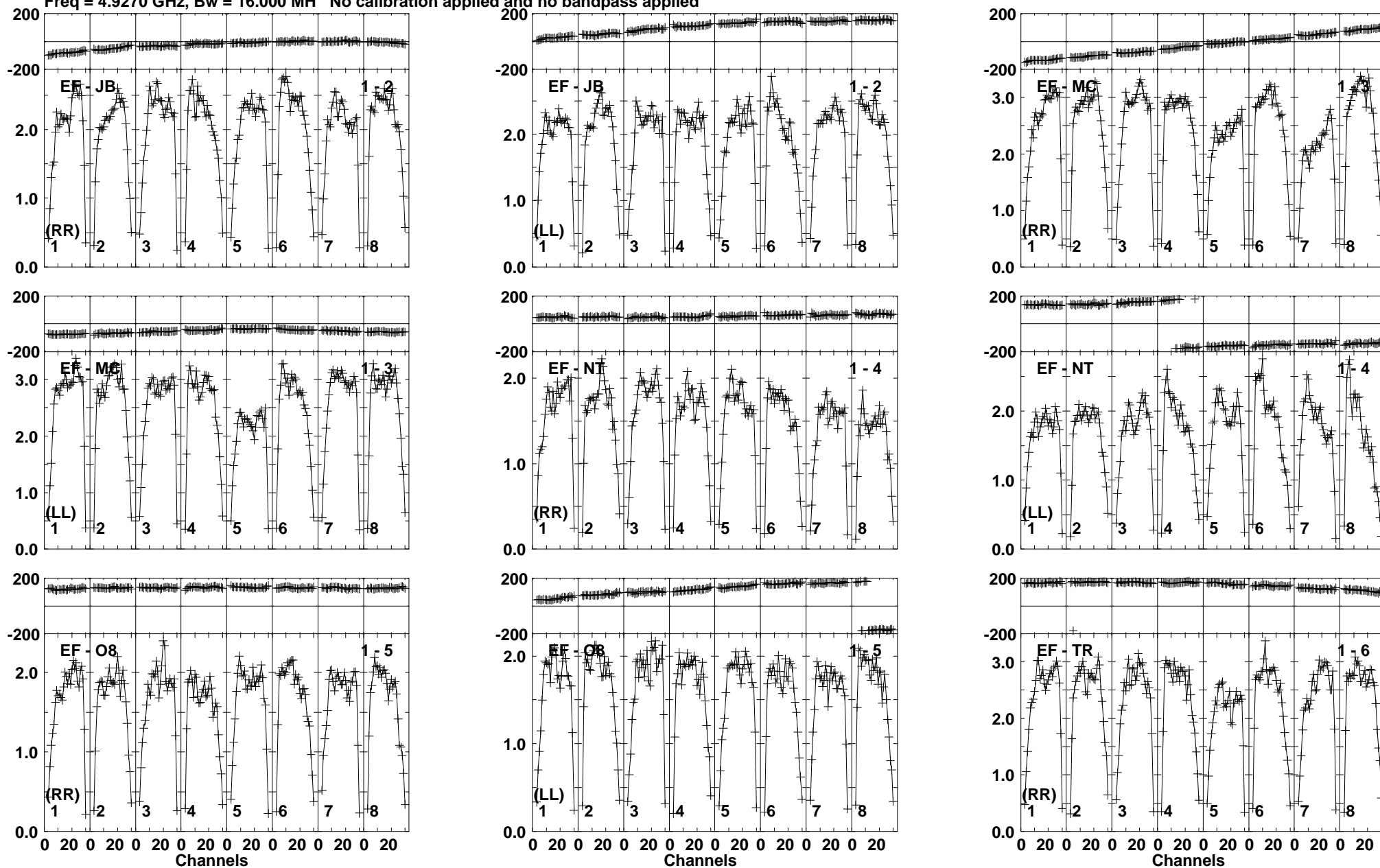

Lower frame: Milli Ampl Jy Top frame: Phas deg  
Vector averaged cross-power spectrum Baseline: EF (01) - JB (02)  
Timerange: 01/03:45:11 to 01/03:46:39

Plot file version 438 created 10-JUN-2016 17:22:46

J1957+3338 RT013A.UVDATA.1

Freq = 4.9270 GHz, Bw = 16.000 MH No calibration applied and no bandpass applied

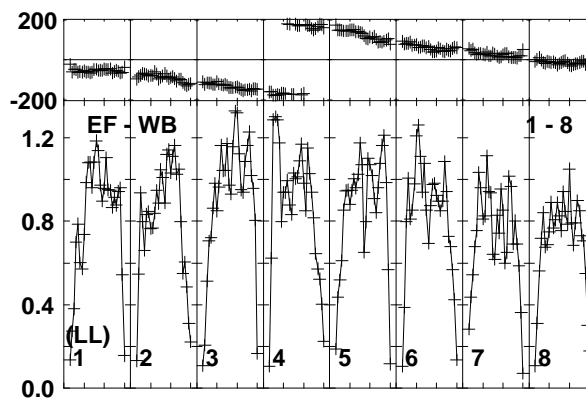
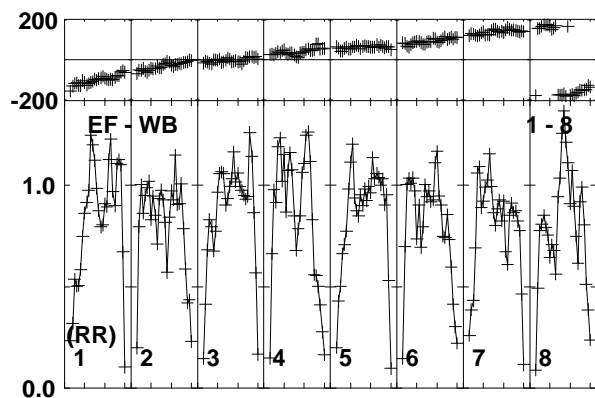
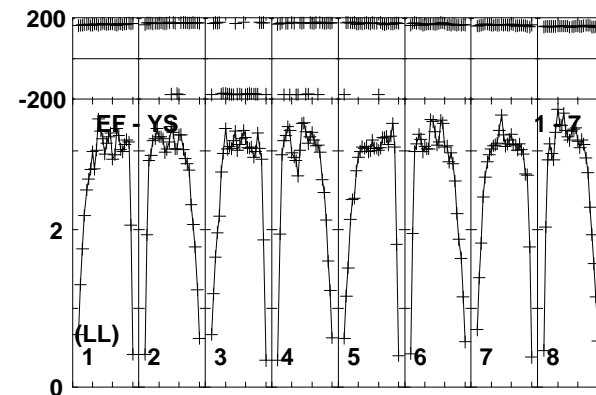
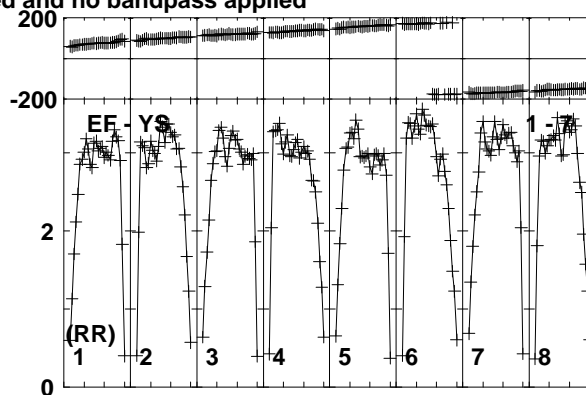
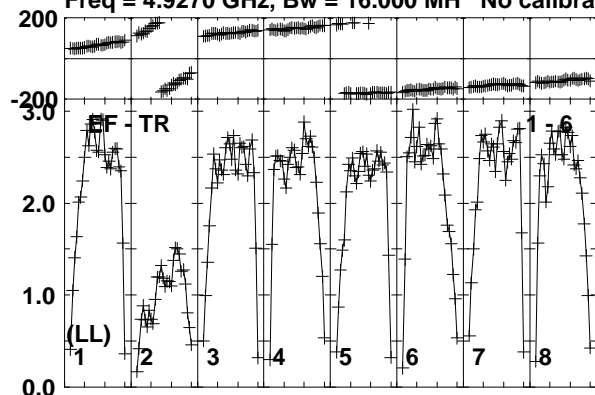

Lower frame: Milli Ampl Jy Top frame: Phas deg  
Vector averaged cross-power spectrum Baseline: EF (01) - TR (06)  
Timerange: 01/03:45:11 to 01/03:46:39

Plot file version 439 created 10-JUN-2016 17:22:46

CHECK RT013A.UVDATA.1

Freq = 4.9270 GHz, Bw = 16.000 MH No calibration applied and no bandpass applied

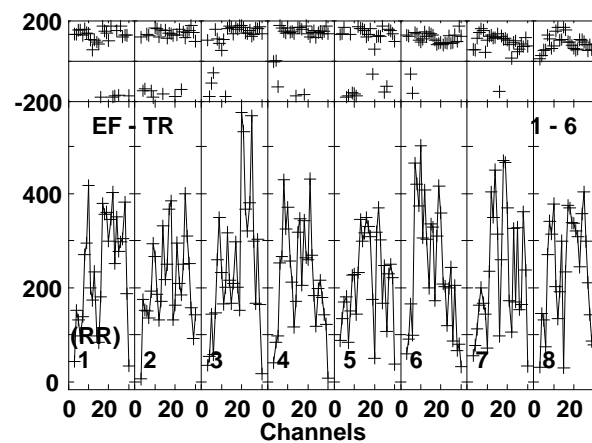
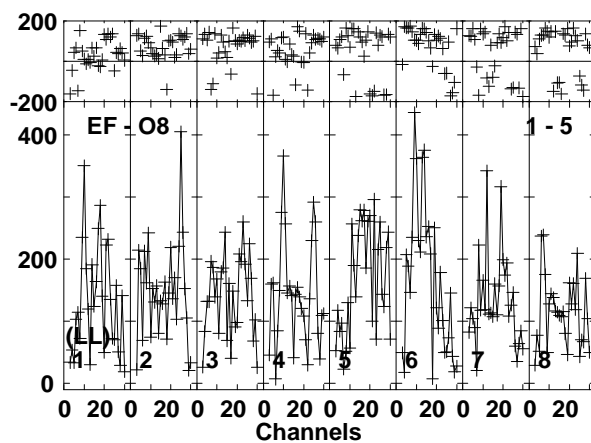
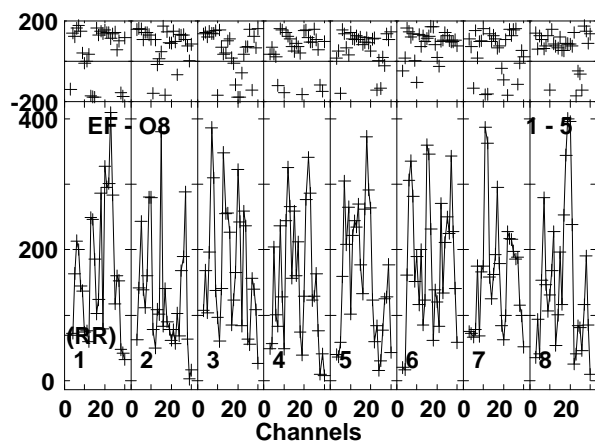
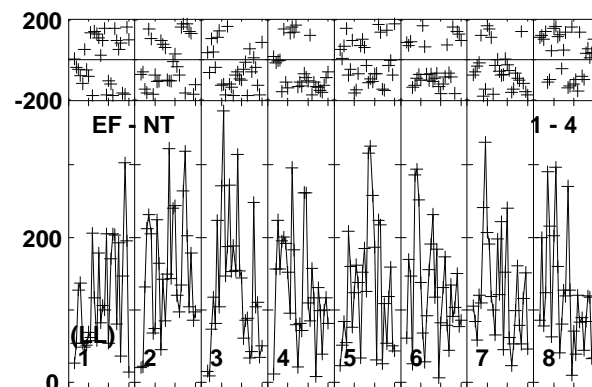
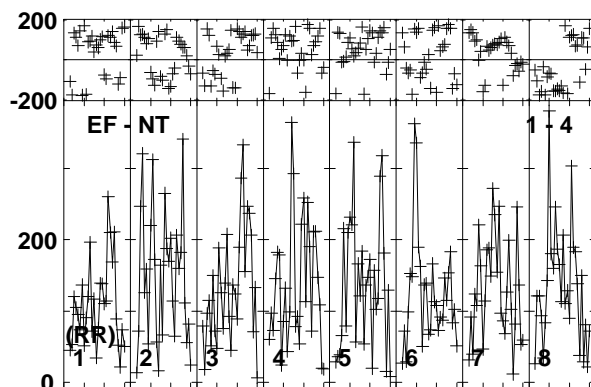
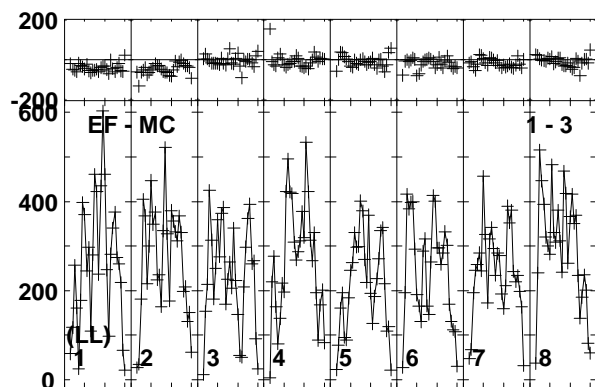
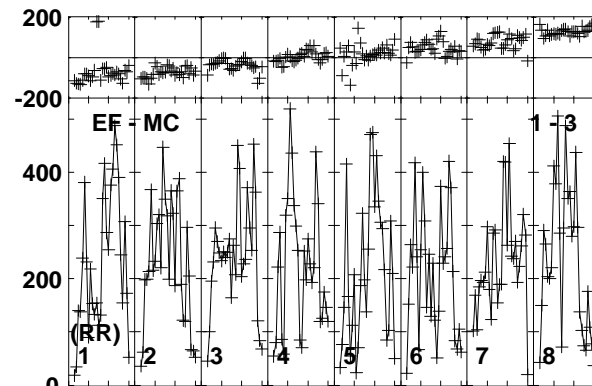
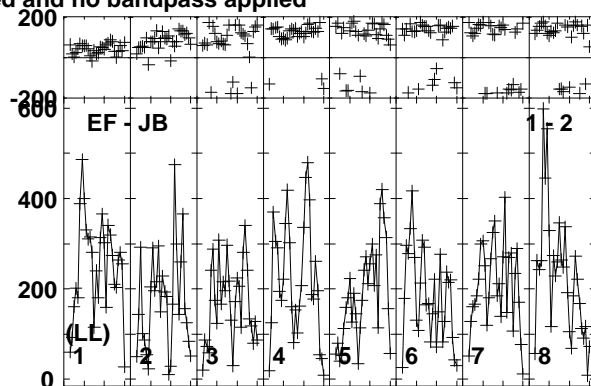
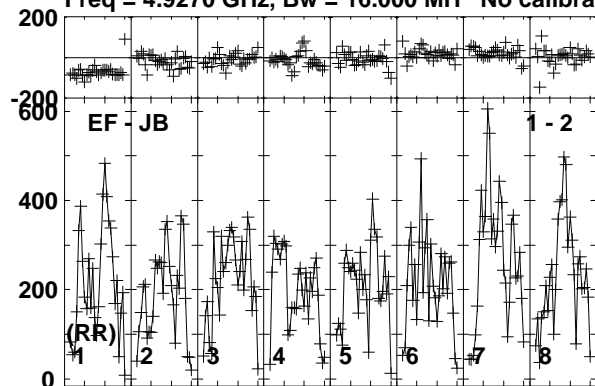

Lower frame: Micro Ampl Jy Top frame: Phas deg  
Vector averaged cross-power spectrum Baseline: EF (01) - JB (02)  
Timerange: 01/03:46:41 to 01/03:48:39

Plot file version 440 created 10-JUN-2016 17:22:46

CHECK RT013A.UVDATA.1

Freq = 4.9270 GHz, Bw = 16.000 MH No calibration applied and no bandpass applied

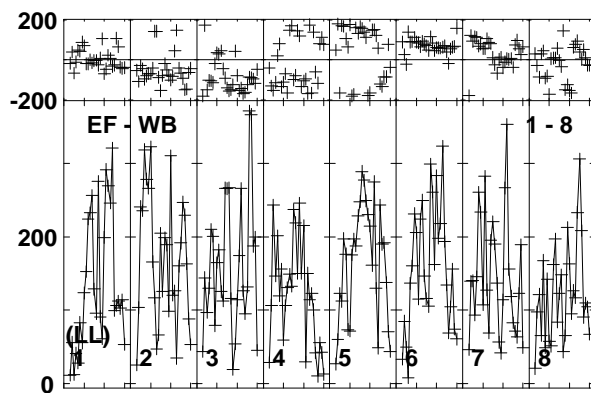
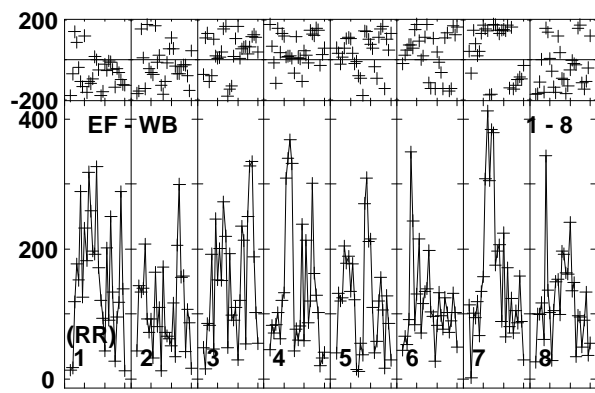
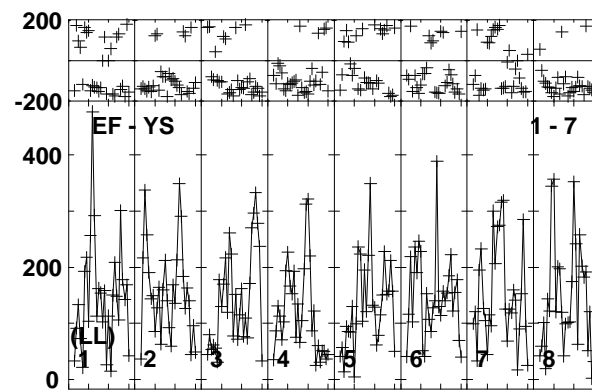
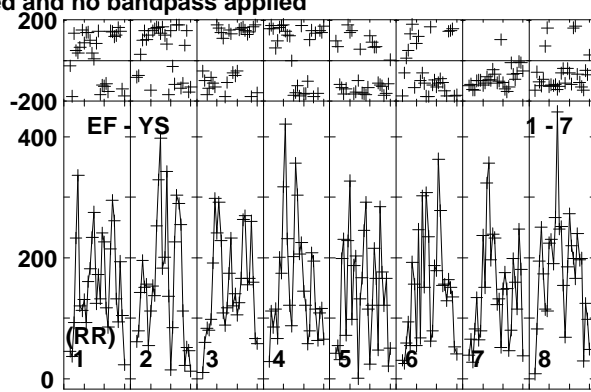
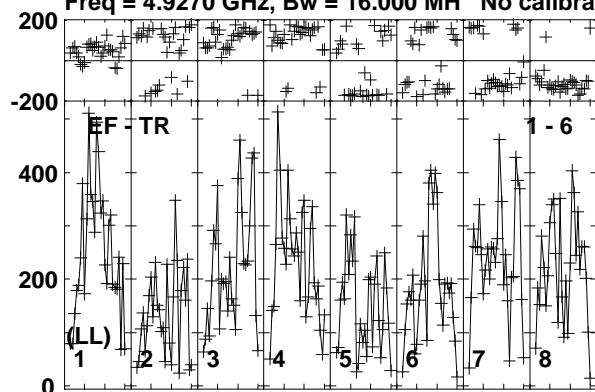

Lower frame: Micro Ampl Jy Top frame: Phas deg  
Vector averaged cross-power spectrum Baseline: EF (01) - TR (06)  
Timerange: 01/03:46:41 to 01/03:48:39

Plot file version 441 created 10-JUN-2016 17:22:46

CYGX1 RT013A.UVDATA.1

Freq = 4.9270 GHz, Bw = 16.000 MH No calibration applied and no bandpass applied

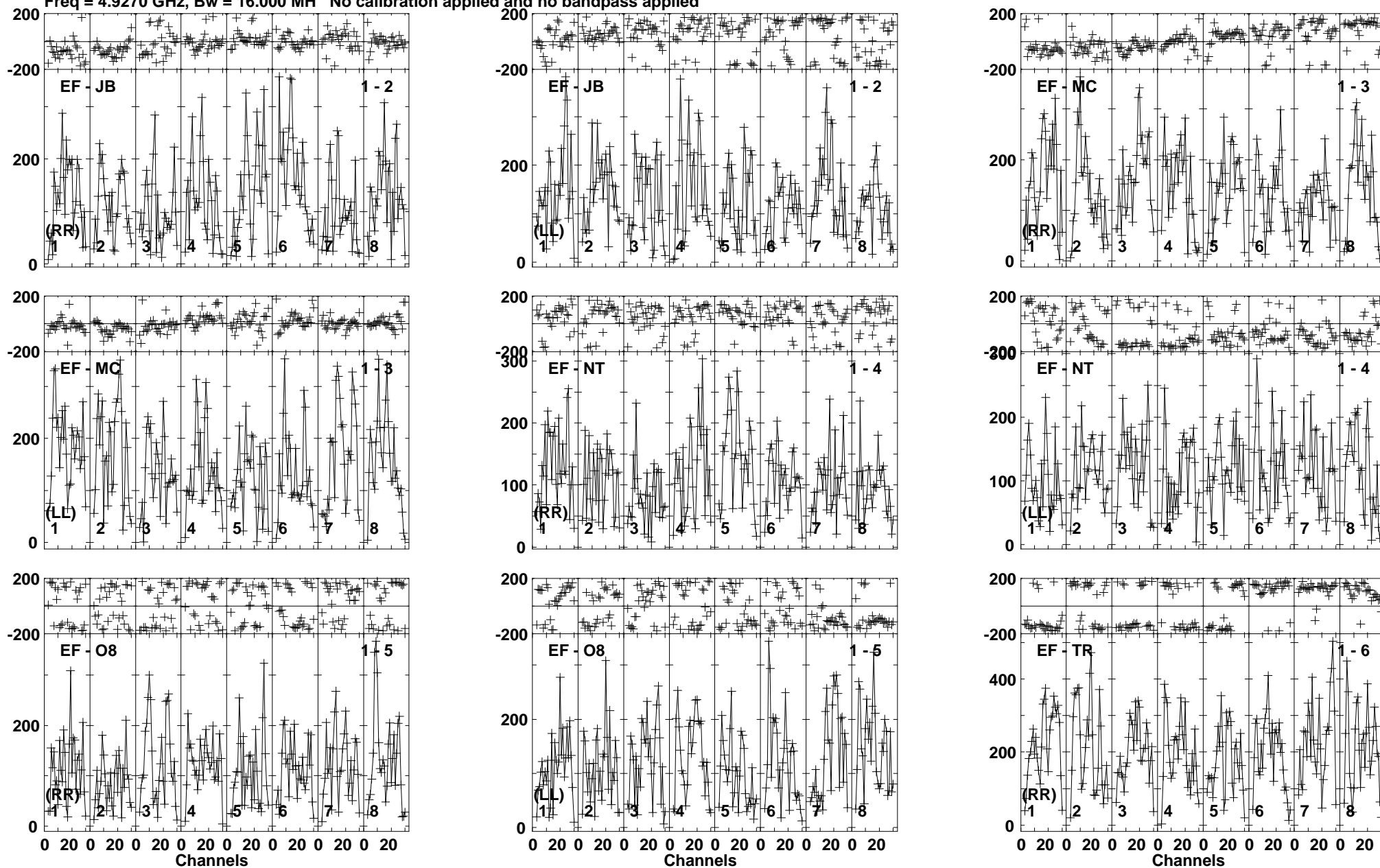

Lower frame: Micro Ampl Jy Top frame: Phas deg  
Vector averaged cross-power spectrum Baseline: EF (01) - JB (02)  
Timerange: 01/03:48:40 to 01/03:51:10

Plot file version 442 created 10-JUN-2016 17:22:46

CYGX1 RT013A.UVDATA.1

Freq = 4.9270 GHz, Bw = 16.000 MH No calibration applied and no bandpass applied

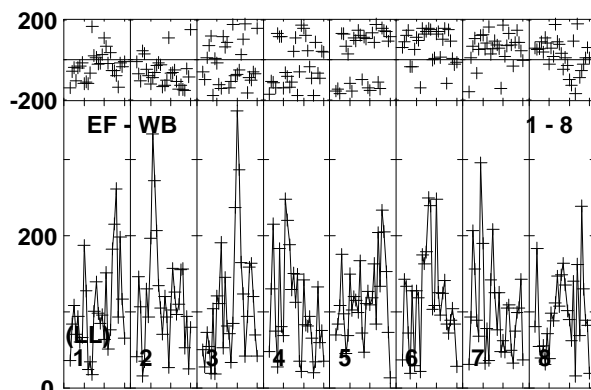
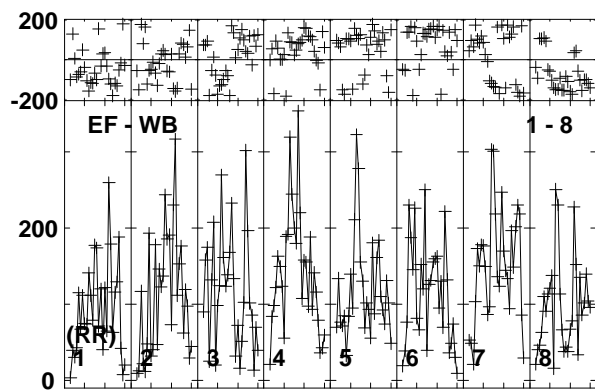
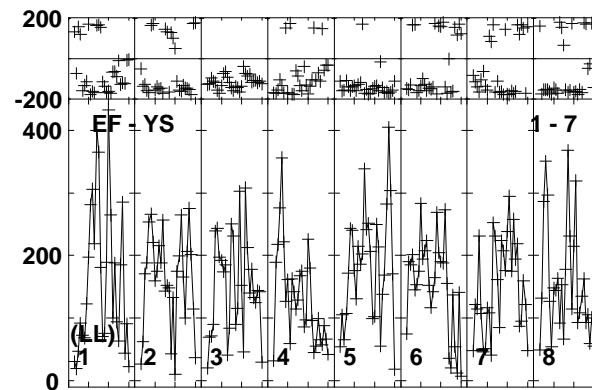
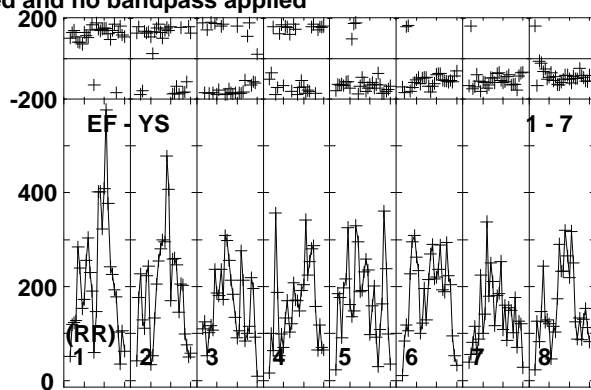
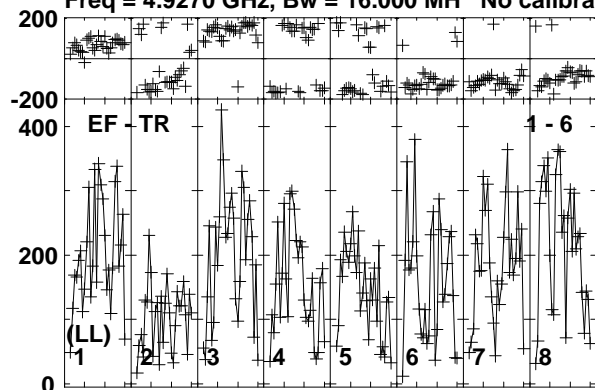

Lower frame: Micro Ampl Jy Top frame: Phas deg  
Vector averaged cross-power spectrum Baseline: EF (01) - TR (06)  
Timerange: 01/03:48:40 to 01/03:51:10



Plot file version 443 created 10-JUN-2016 17:22:46

J1957+3338 RT013A.UVDATA.1

Freq = 4.9270 GHz, Bw = 16.000 MH No calibration applied and no bandpass applied

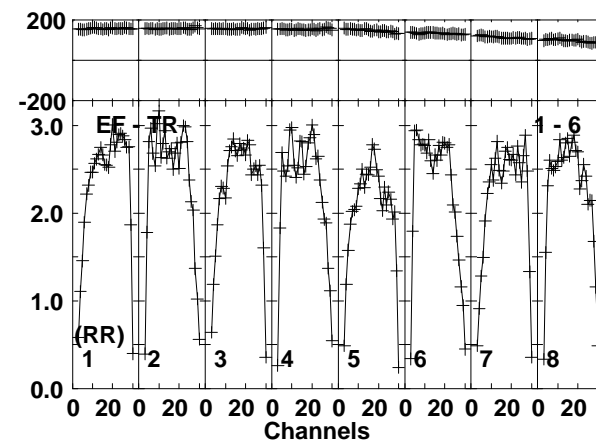
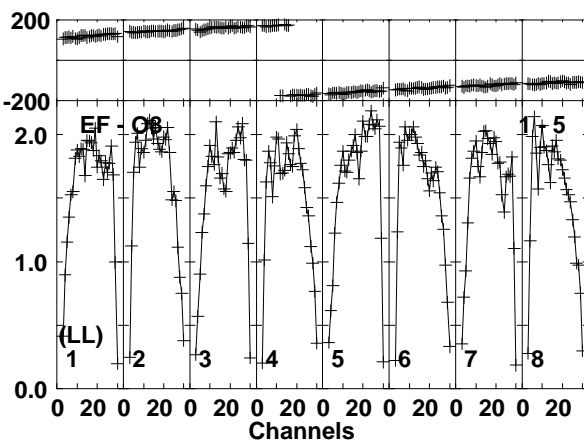
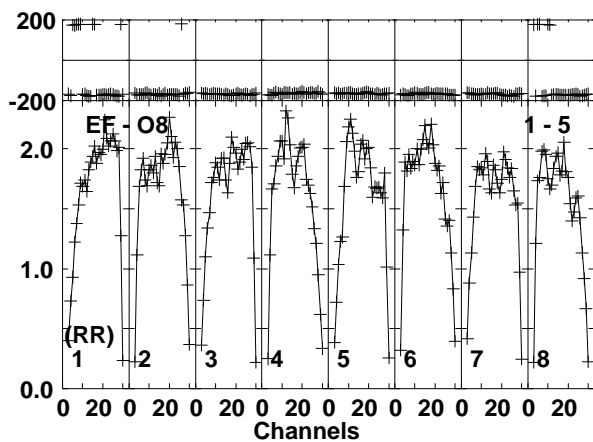
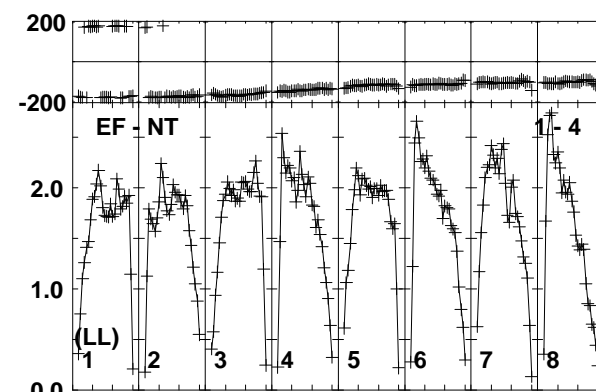
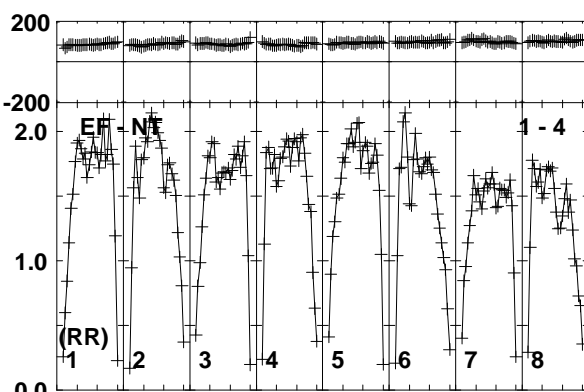
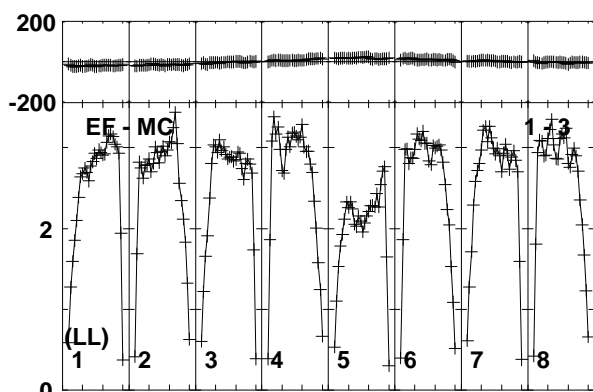
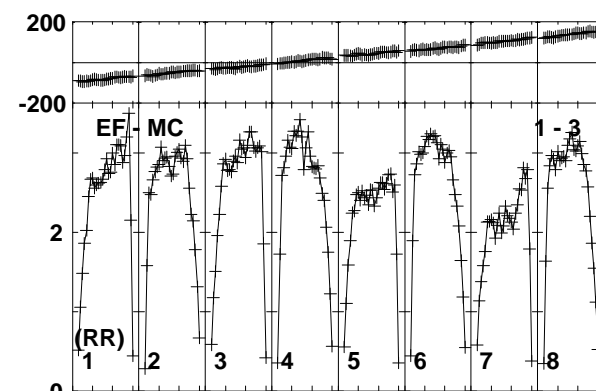
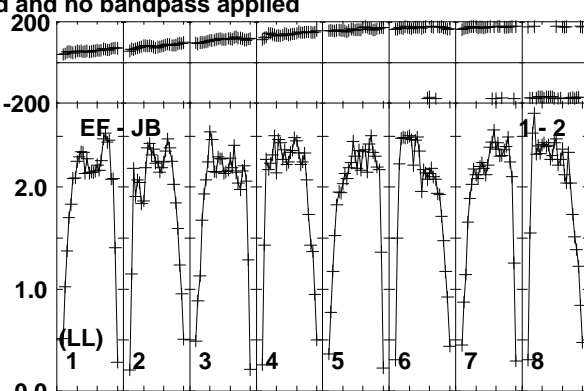
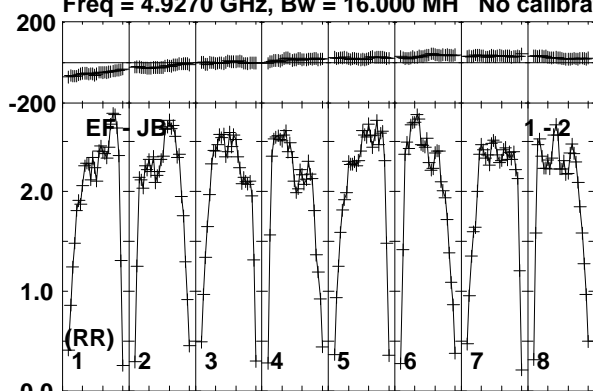

Lower frame: Milli Ampl Jy Top frame: Phas deg  
Vector averaged cross-power spectrum Baseline: EF (01) - JB (02)  
Timerange: 01/03:51:11 to 01/03:52:39

Plot file version 444 created 10-JUN-2016 17:22:47

J1957+3338 RT013A.UVDATA.1

Freq = 4.9270 GHz, Bw = 16.000 MH No calibration applied and no bandpass applied

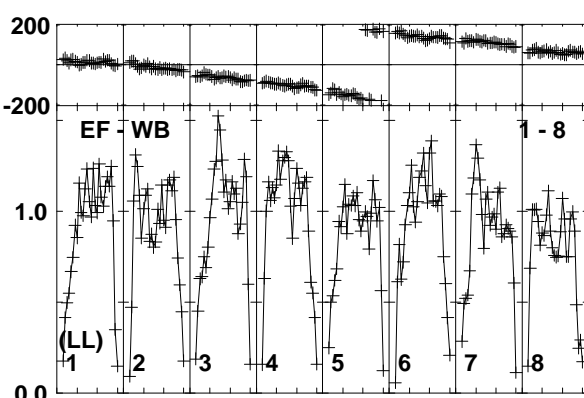
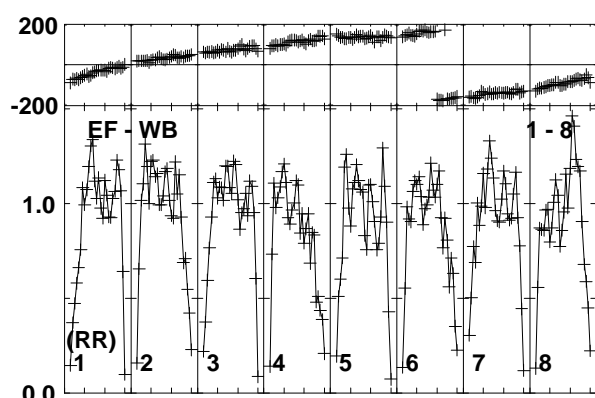
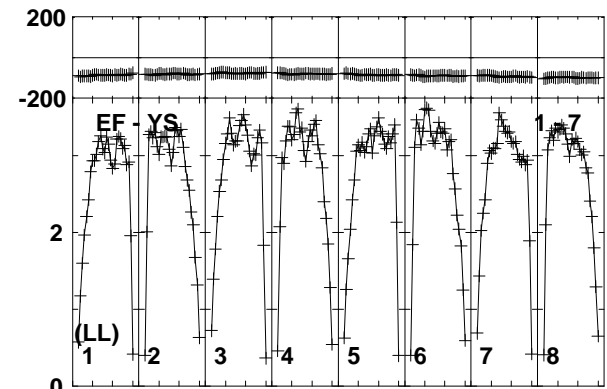
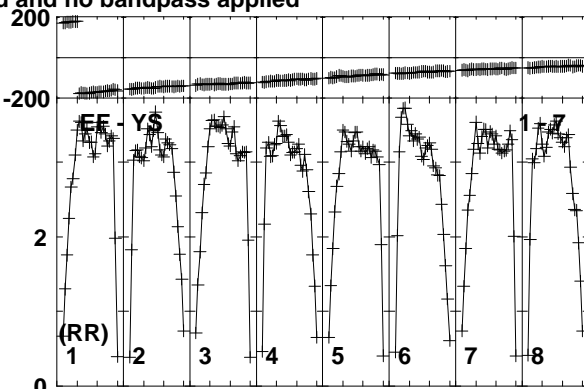
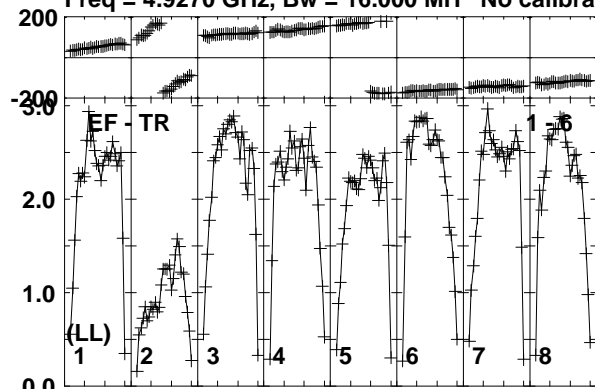

Lower frame: Milli Ampl Jy Top frame: Phas deg  
Vector averaged cross-power spectrum Baseline: EF (01) - TR (06)  
Timerange: 01/03:51:11 to 01/03:52:39

Plot file version 445 created 10-JUN-2016 17:22:47

CHECK RT013A.UVDATA.1

Freq = 4.9270 GHz, Bw = 16.000 MH No calibration applied and no bandpass applied

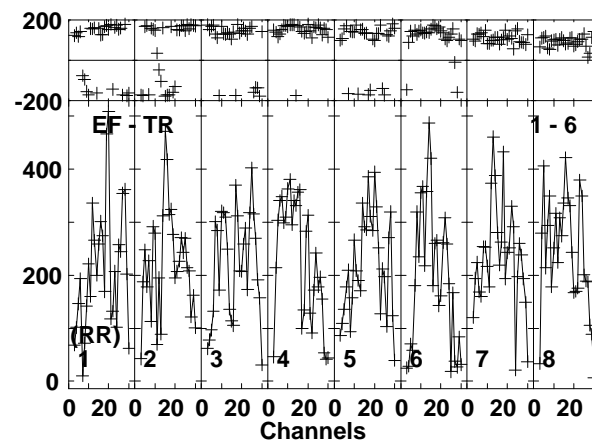
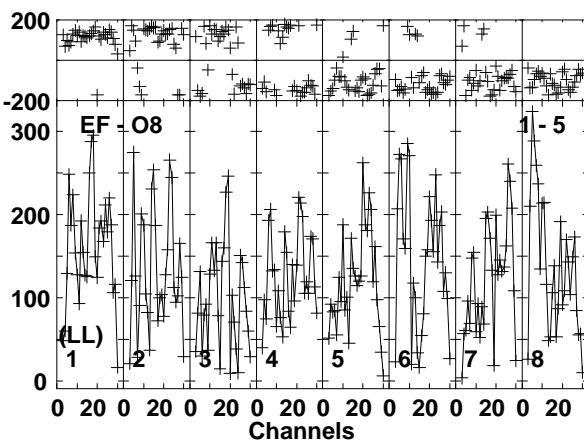
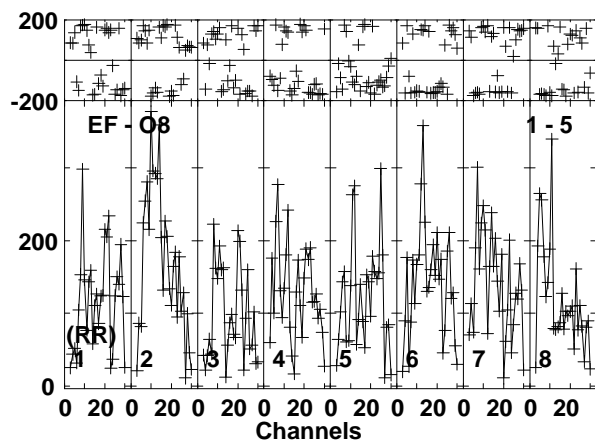
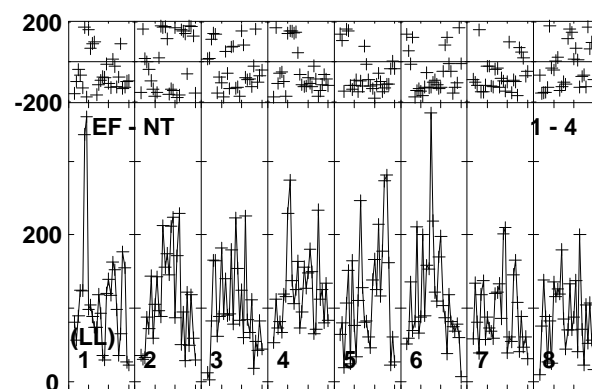
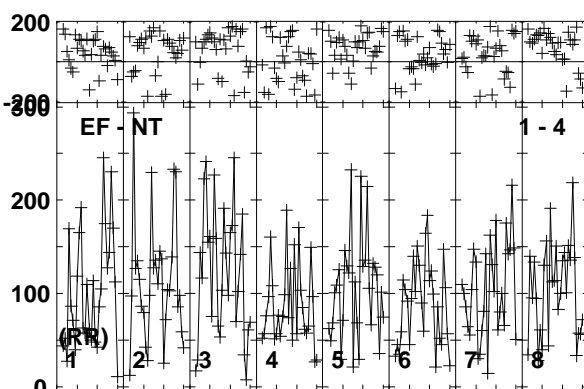
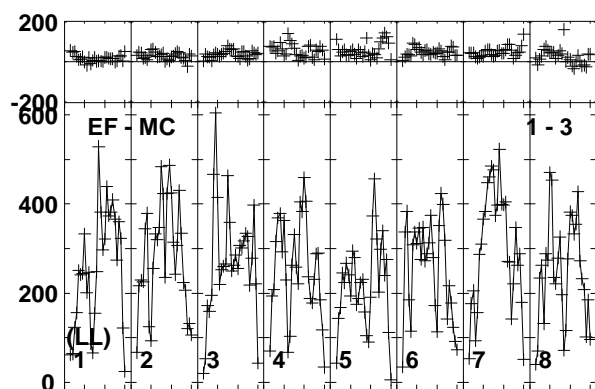
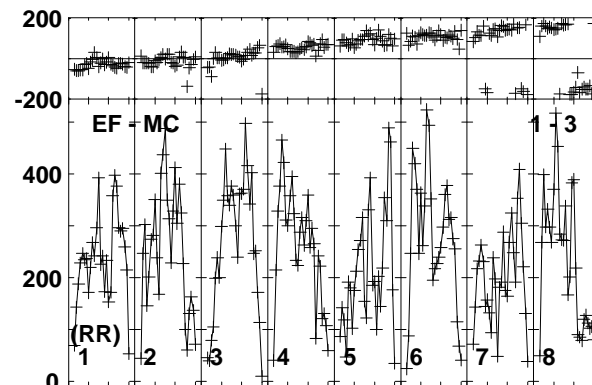
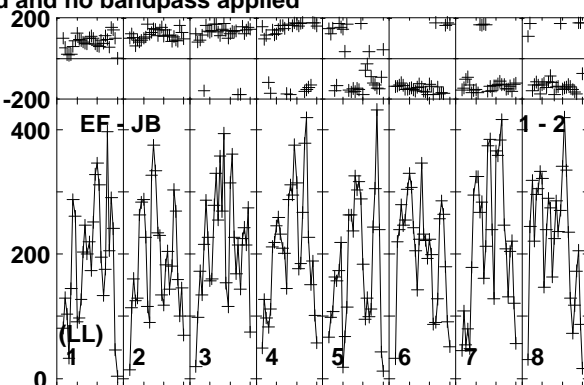
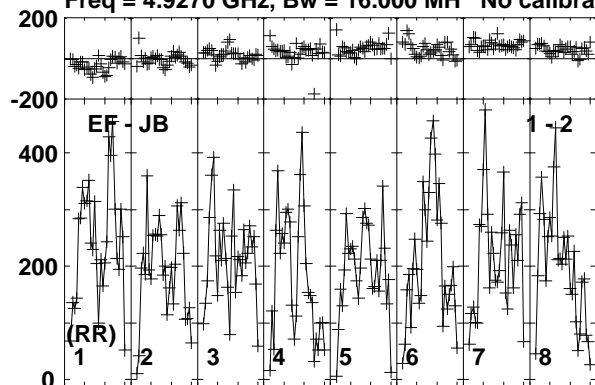

Lower frame: Micro Ampl Jy Top frame: Phas deg  
Vector averaged cross-power spectrum Baseline: EF (01) - JB (02)  
Timerange: 01/03:53:21 to 01/03:55:20

Plot file version 446 created 10-JUN-2016 17:22:47

CHECK RT013A.UVDATA.1

Freq = 4.9270 GHz, Bw = 16.000 MH No calibration applied and no bandpass applied

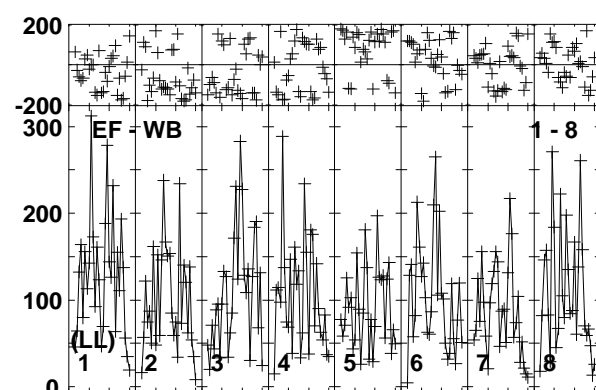
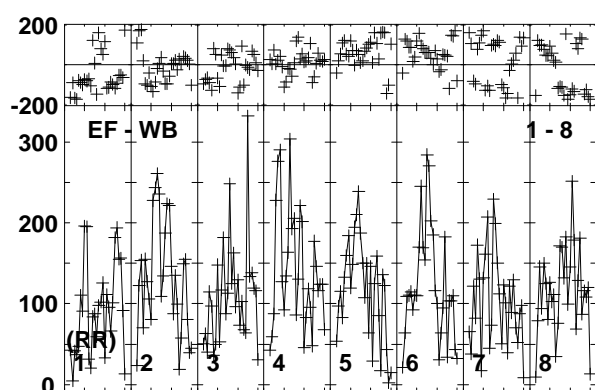
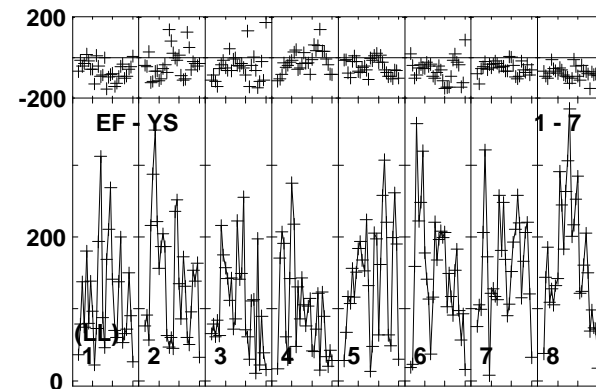
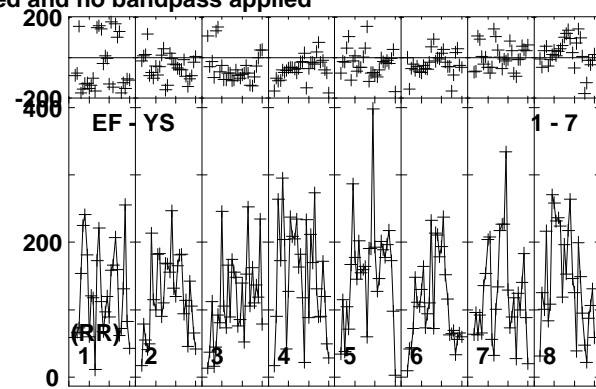
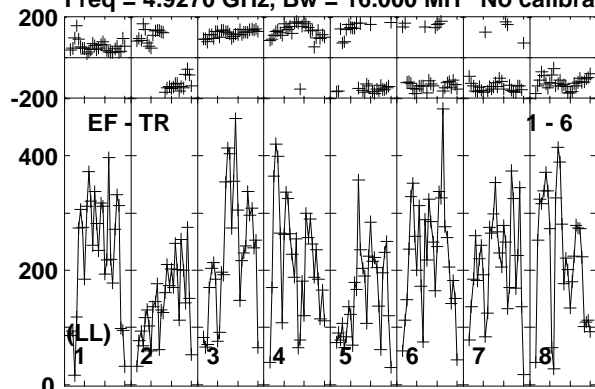

Lower frame: Micro Ampl Jy Top frame: Phas deg  
Vector averaged cross-power spectrum Baseline: EF (01) - TR (06)  
Timerange: 01/03:53:21 to 01/03:55:20

Plot file version 447 created 10-JUN-2016 17:22:47

CYGX1 RT013A.UVDATA.1

Freq = 4.9270 GHz, Bw = 16.000 MH No calibration applied and no bandpass applied

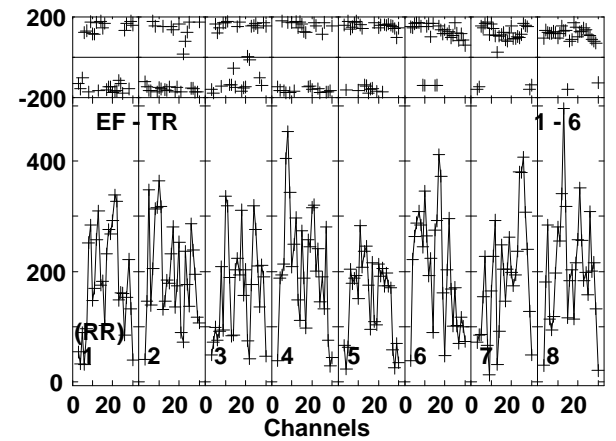
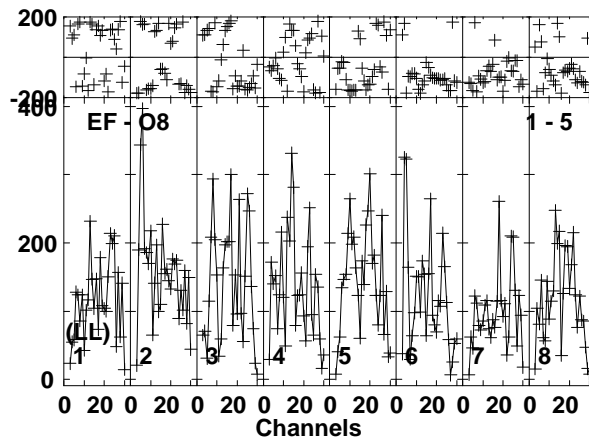
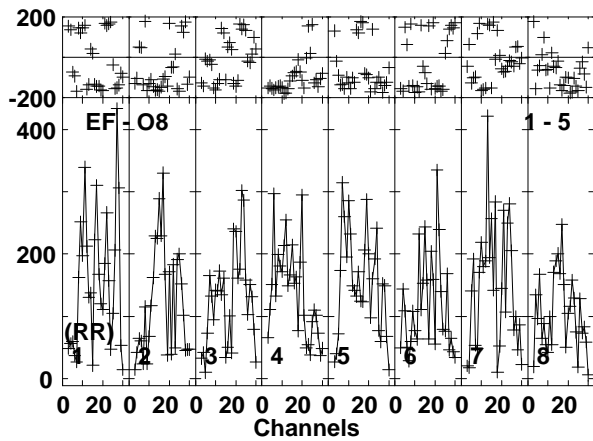
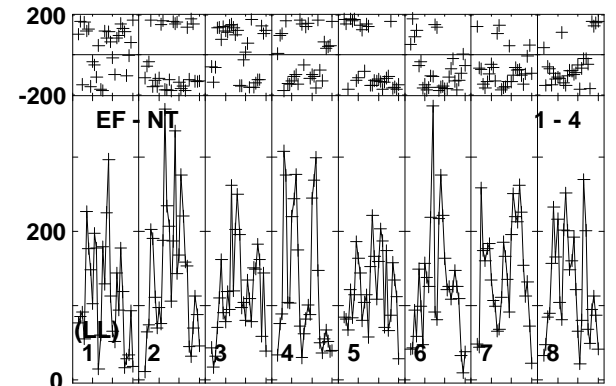
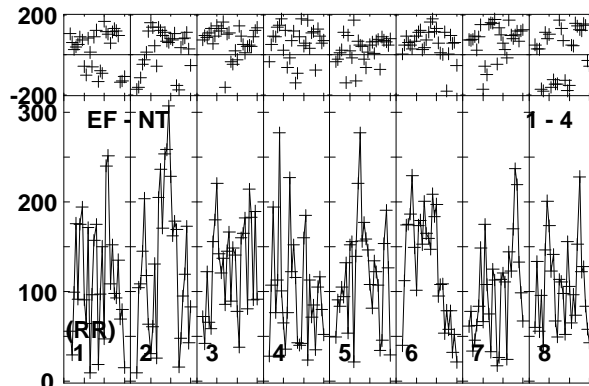
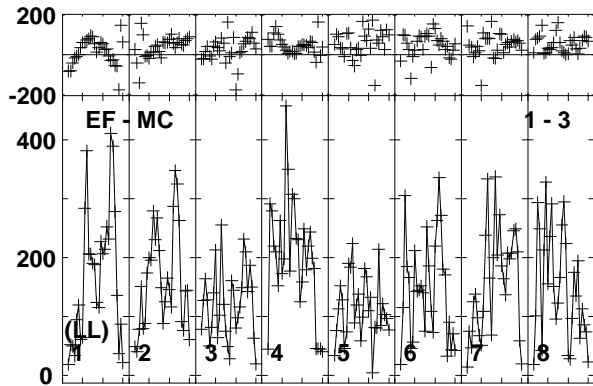
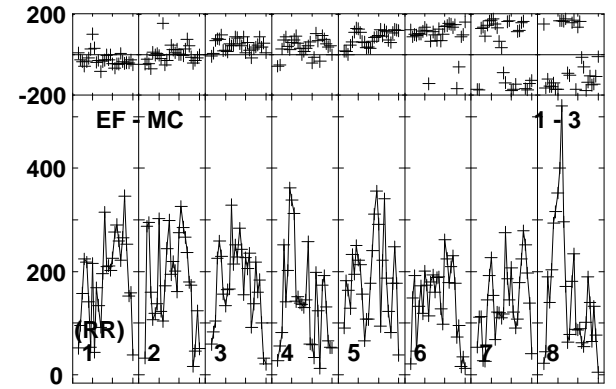
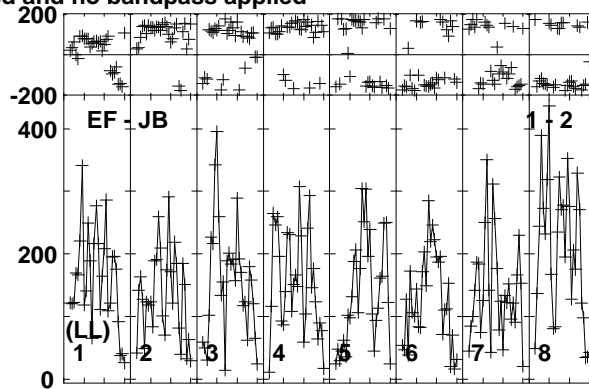
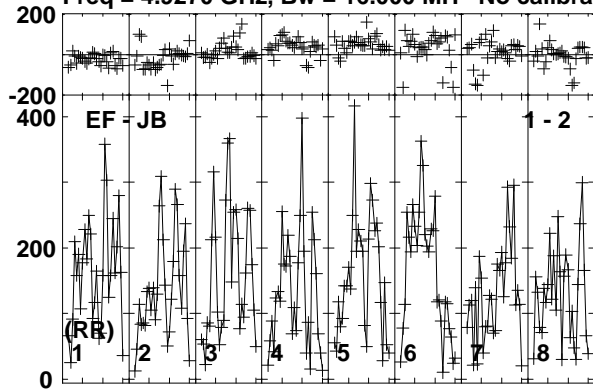

Lower frame: Micro Ampl Jy Top frame: Phas deg  
Vector averaged cross-power spectrum Baseline: EF (01) - JB (02)  
Timerange: 01/03:55:21 to 01/03:57:49

Plot file version 448 created 10-JUN-2016 17:22:47

CYGX1 RT013A.UVDATA.1

Freq = 4.9270 GHz, Bw = 16.000 MH No calibration applied and no bandpass applied

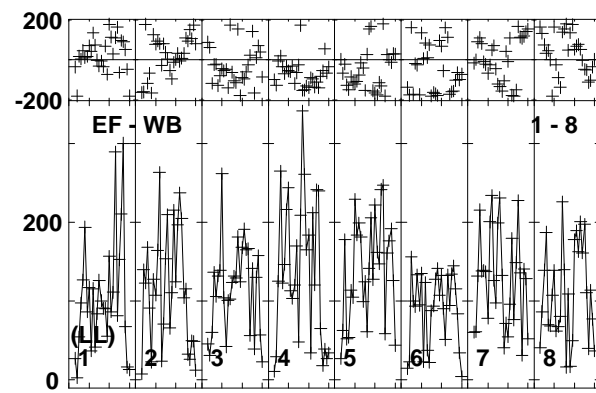
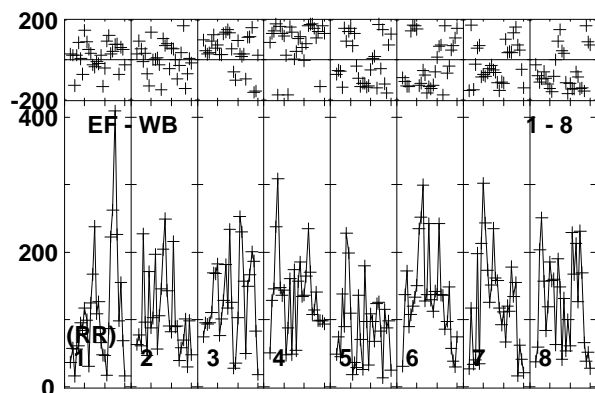
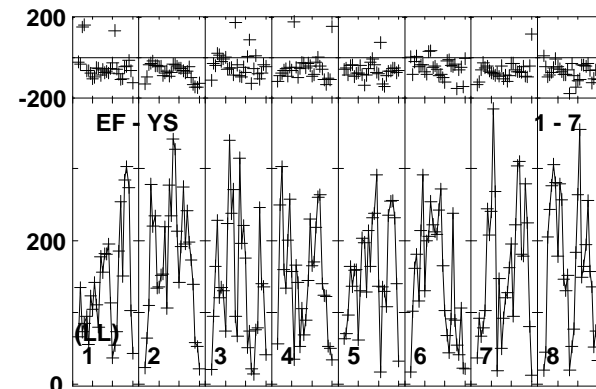
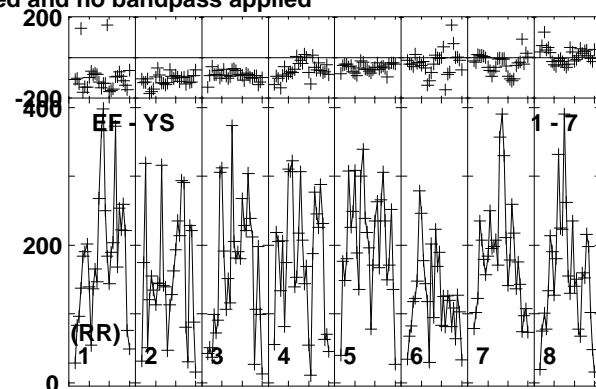
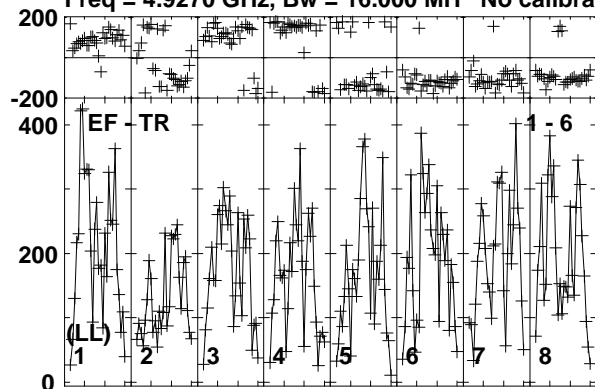

Lower frame: Micro Ampl Jy Top frame: Phas deg  
Vector averaged cross-power spectrum Baseline: EF (01) - TR (06)  
Timerange: 01/03:55:21 to 01/03:57:49

Plot file version 449 created 10-JUN-2016 17:22:47

J1957+3338 RT013A.UVDATA.1

Freq = 4.9270 GHz, Bw = 16.000 MH No calibration applied and no bandpass applied

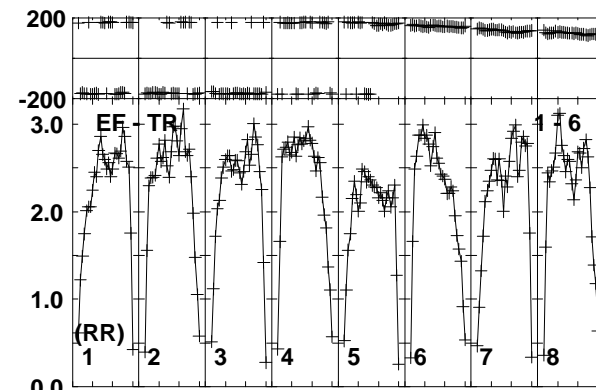
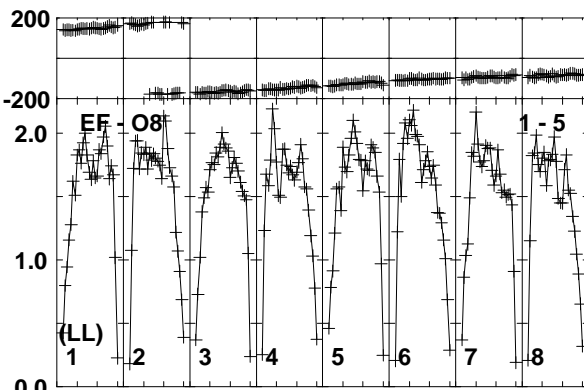
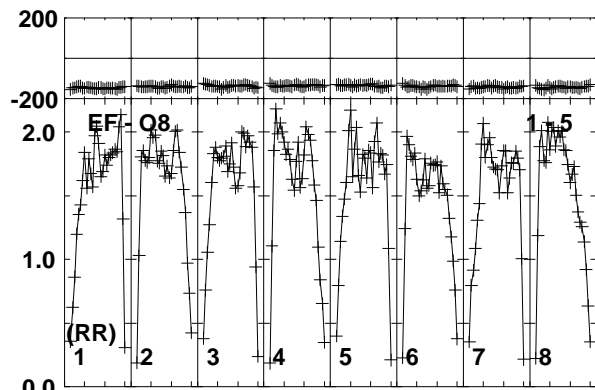
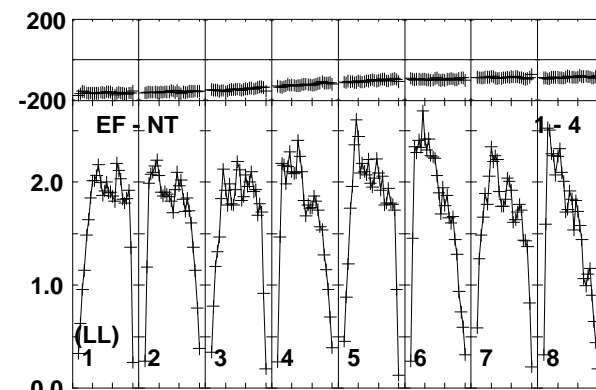
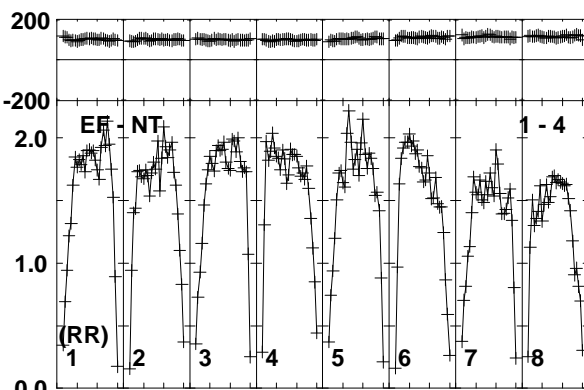
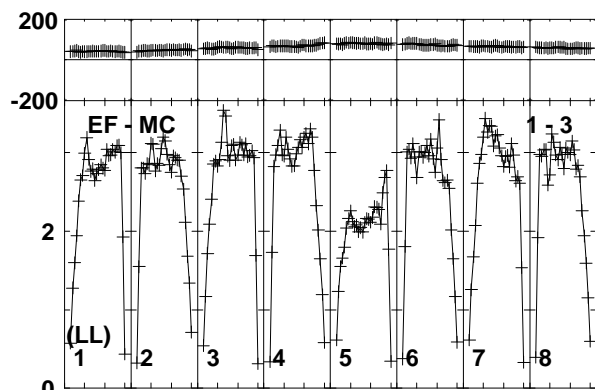
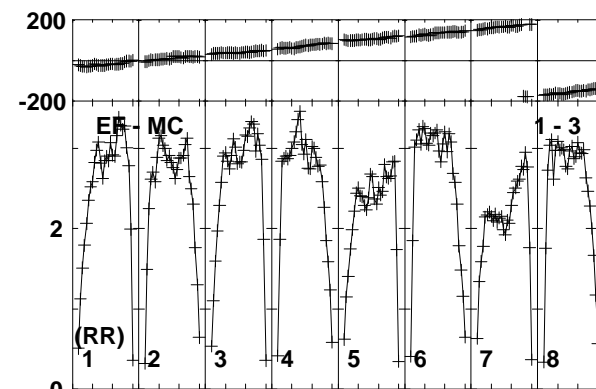
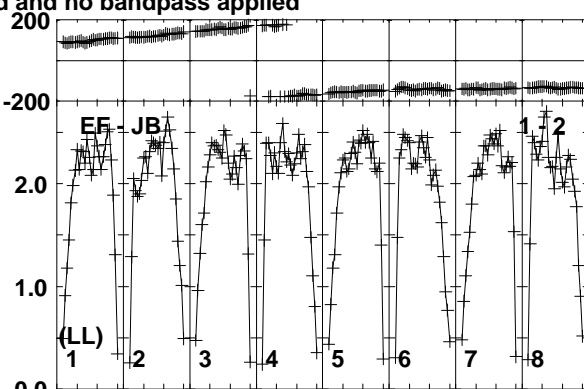
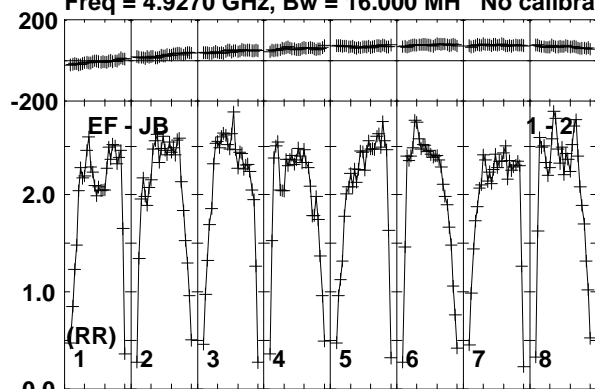

Lower frame: Milli Ampl Jy Top frame: Phas deg  
Vector averaged cross-power spectrum Baseline: EF (01) - JB (02)  
Timerange: 01/03:57:50 to 01/03:59:19

Plot file version 450 created 10-JUN-2016 17:22:47

J1957+3338 RT013A.UVDATA.1

Freq = 4.9270 GHz, Bw = 16.000 MH No calibration applied and no bandpass applied

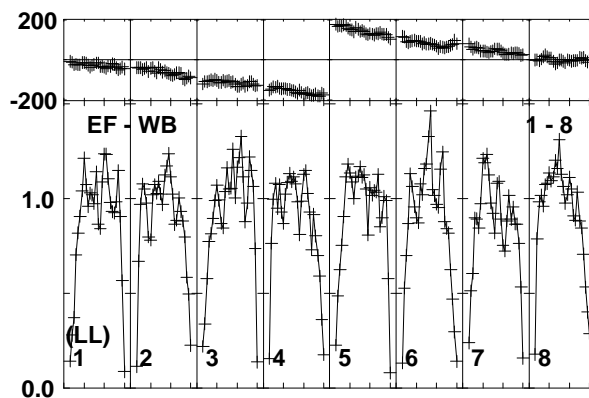
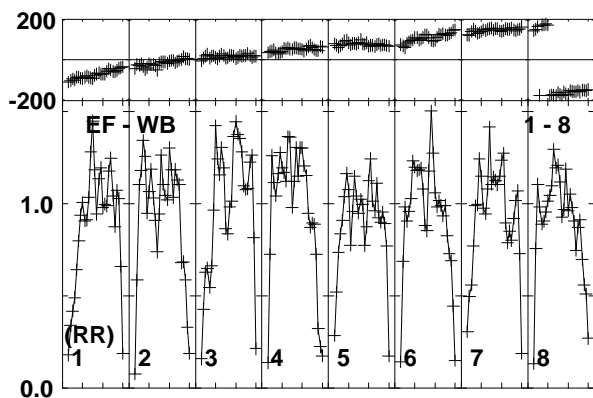
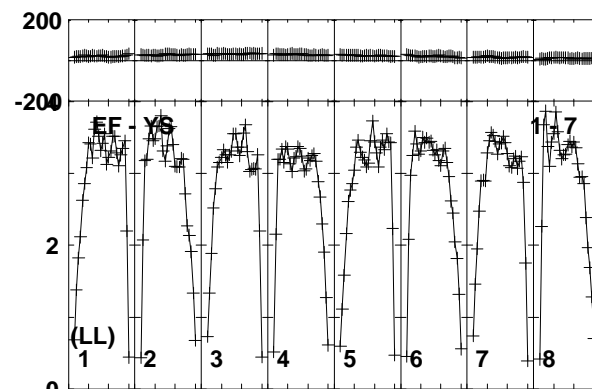
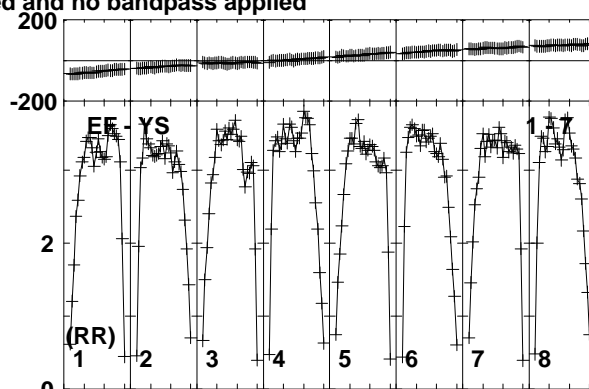
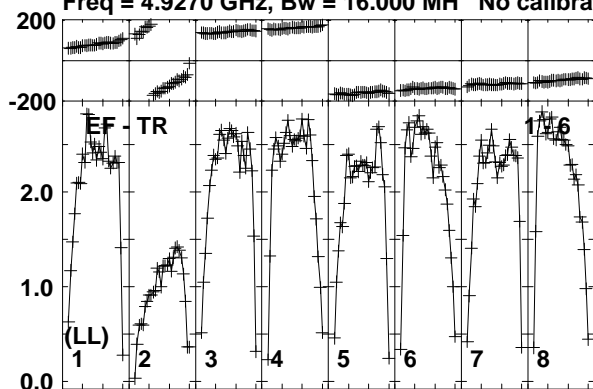

Lower frame: Milli Ampl Jy Top frame: Phas deg  
Vector averaged cross-power spectrum Baseline: EF (01) - TR (06)  
Timerange: 01/03:57:50 to 01/03:59:19



Plot file version 451 created 10-JUN-2016 17:22:47

CHECK RT013A.UVDATA.1

Freq = 4.9270 GHz, Bw = 16.000 MH No calibration applied and no bandpass applied

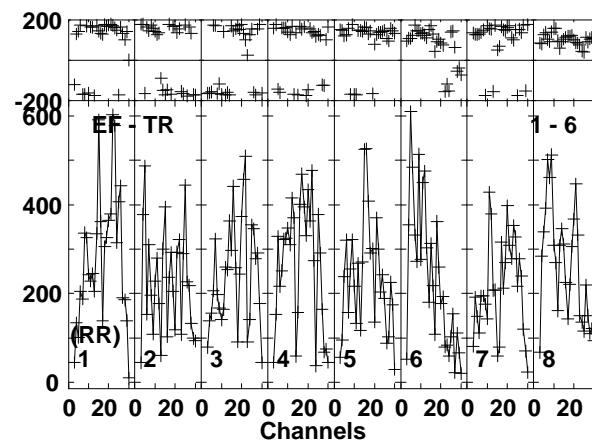
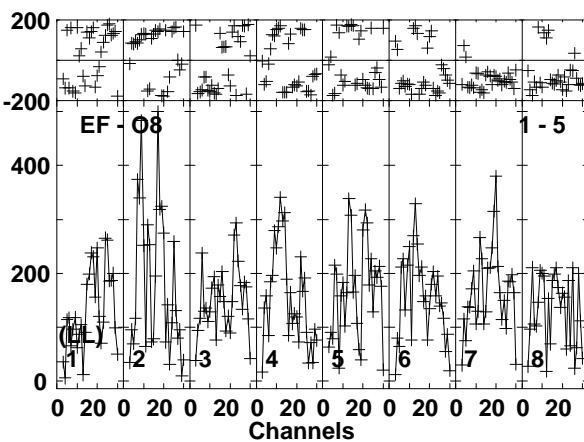
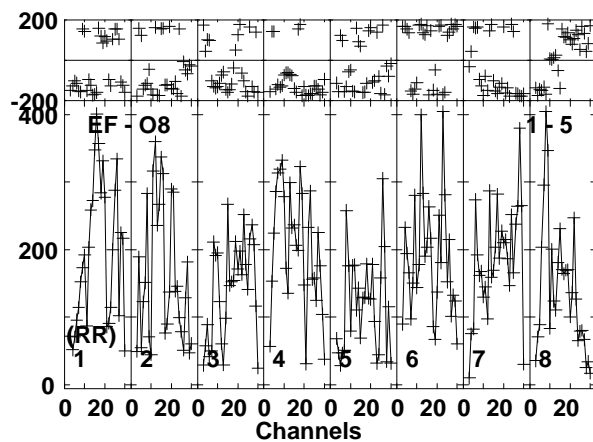
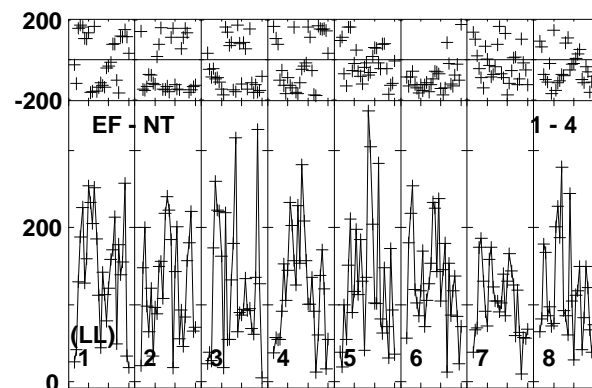
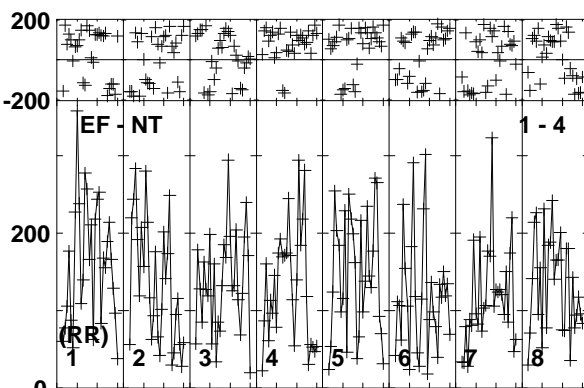
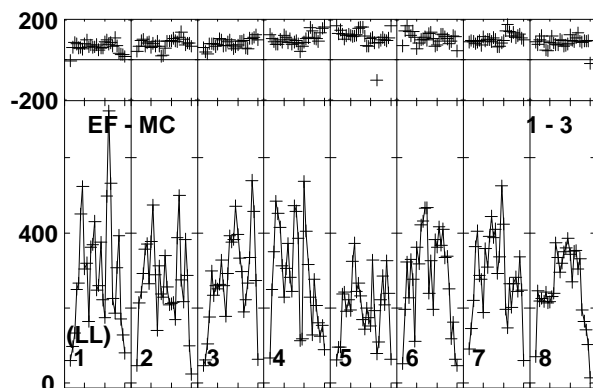
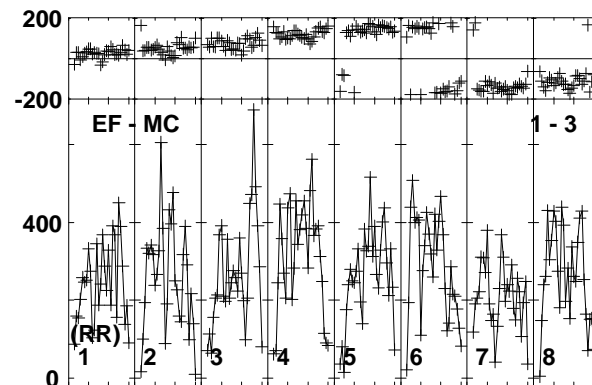
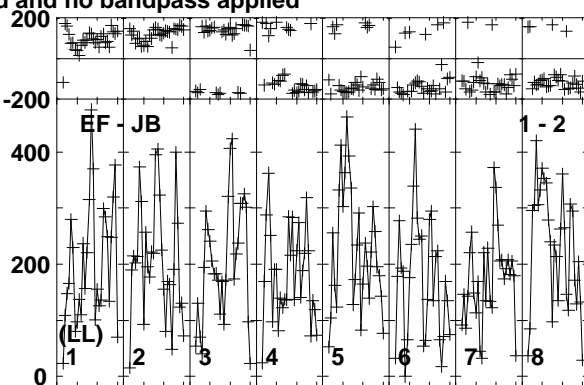
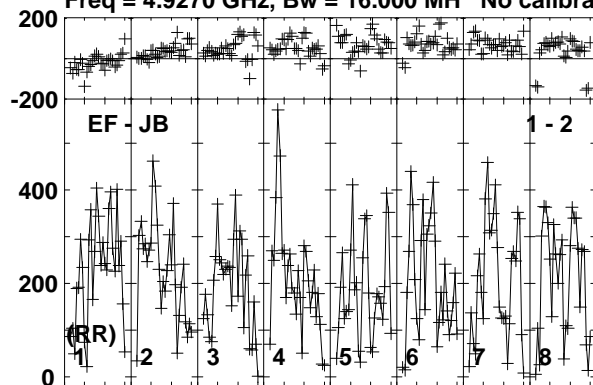

Lower frame: Micro Ampl Jy Top frame: Phas deg  
Vector averaged cross-power spectrum Baseline: EF (01) - JB (02)  
Timerange: 01/03:59:20 to 01/04:01:19

Plot file version 452 created 10-JUN-2016 17:22:47

CHECK RT013A.UVDATA.1

Freq = 4.9270 GHz, Bw = 16.000 MH No calibration applied and no bandpass applied

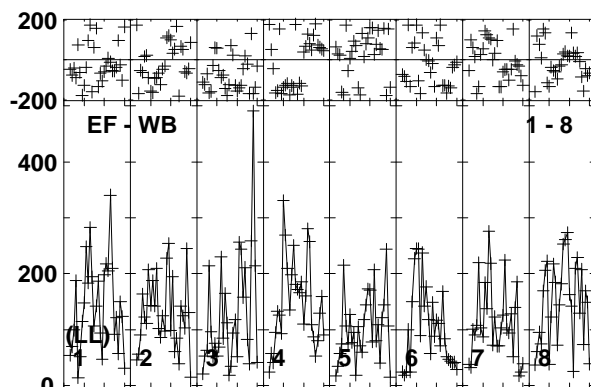
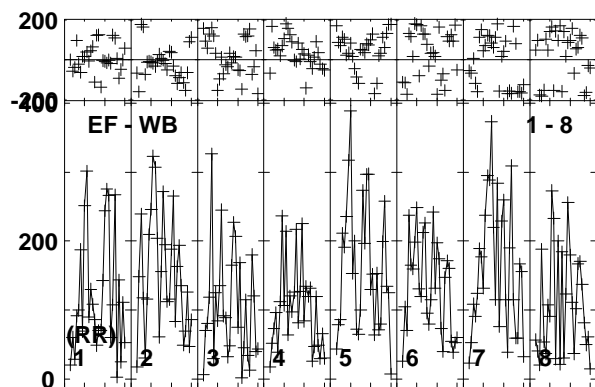
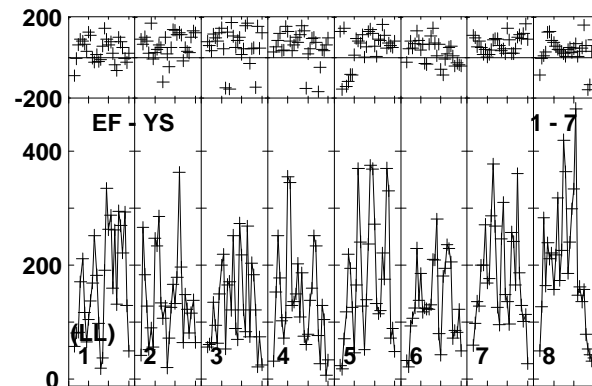
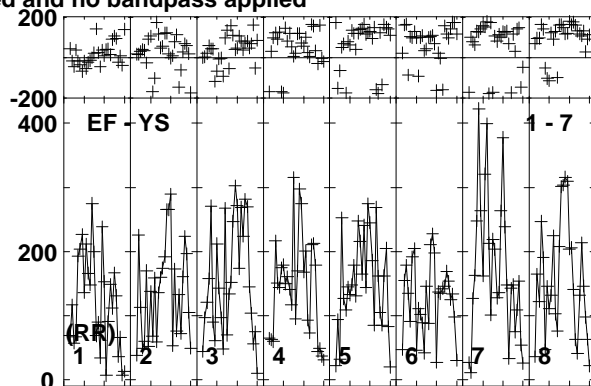
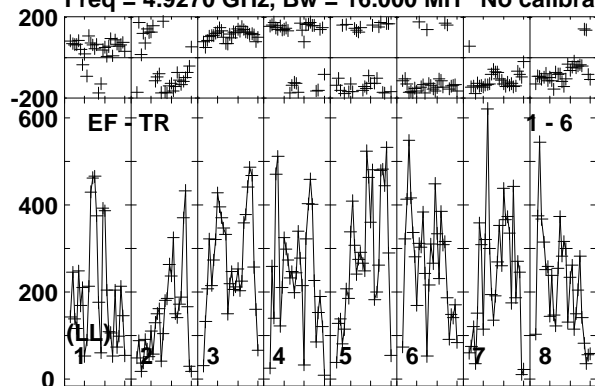

Lower frame: Micro Ampl Jy Top frame: Phas deg  
Vector averaged cross-power spectrum Baseline: EF (01) - TR (06)  
Timerange: 01/03:59:20 to 01/04:01:19

Plot file version 453 created 10-JUN-2016 17:22:47

CYGX1 RT013A.UVDATA.1

Freq = 4.9270 GHz, Bw = 16.000 MH No calibration applied and no bandpass applied

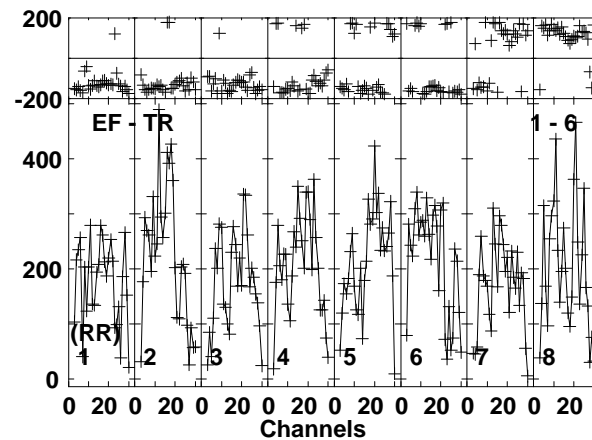
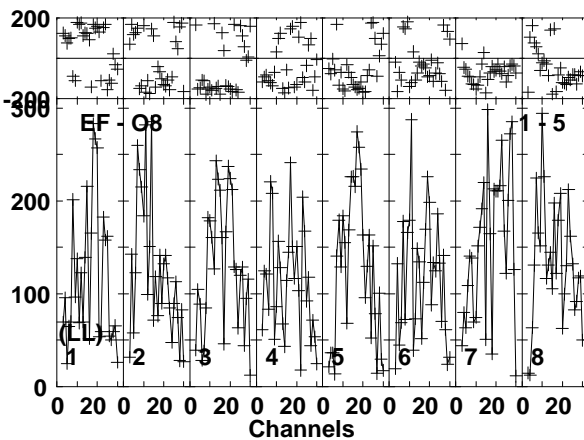
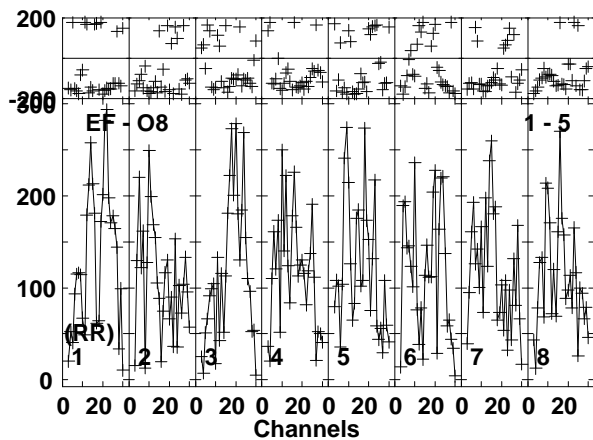
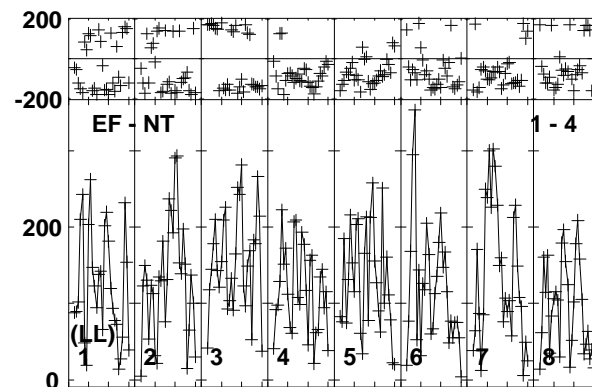
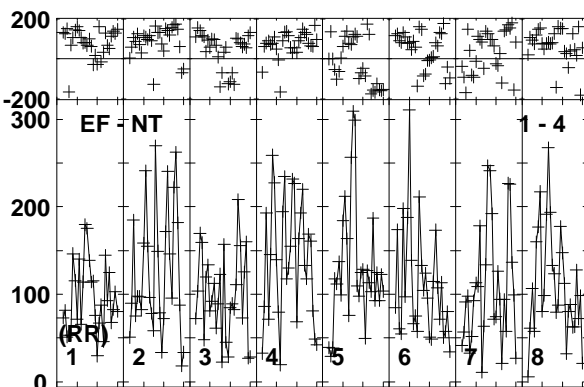
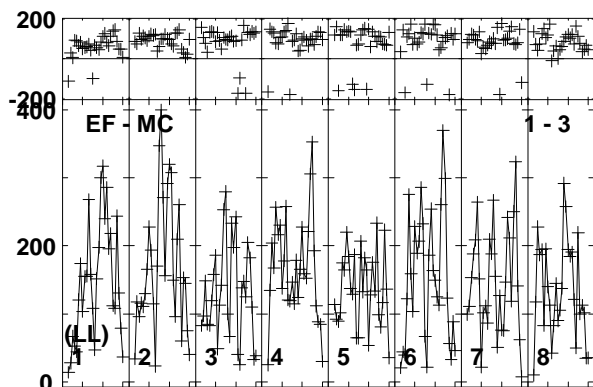
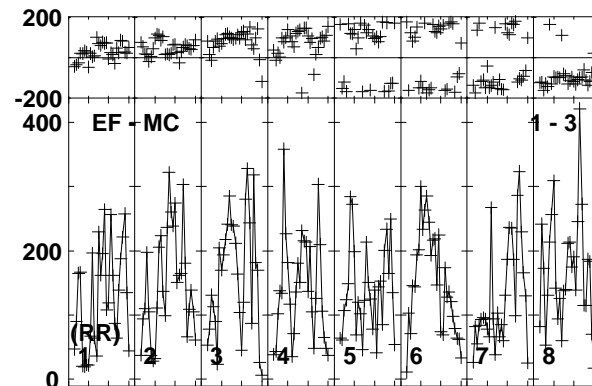
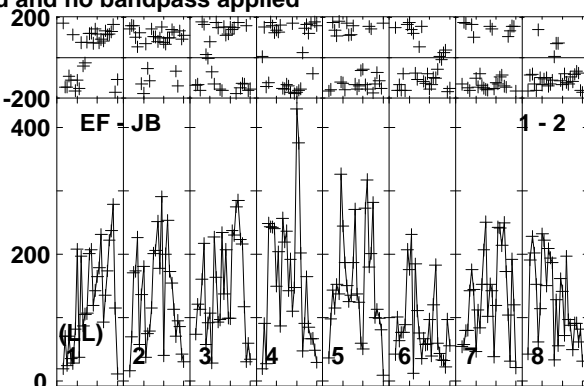
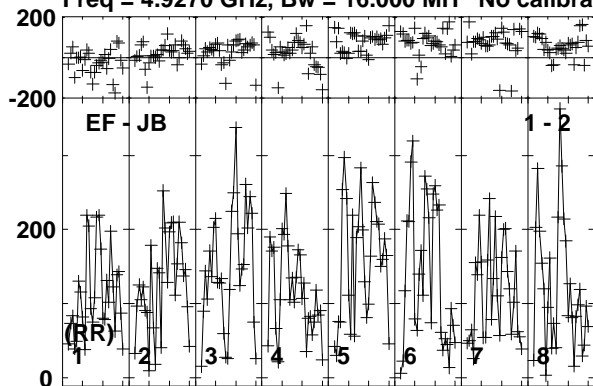

Lower frame: Micro Ampl Jy Top frame: Phas deg  
Vector averaged cross-power spectrum Baseline: EF (01) - JB (02)  
Timerange: 01/04:01:20 to 01/04:03:50

Plot file version 454 created 10-JUN-2016 17:22:48

CYGX1 RT013A.UVDATA.1

Freq = 4.9270 GHz, Bw = 16.000 MH No calibration applied and no bandpass applied

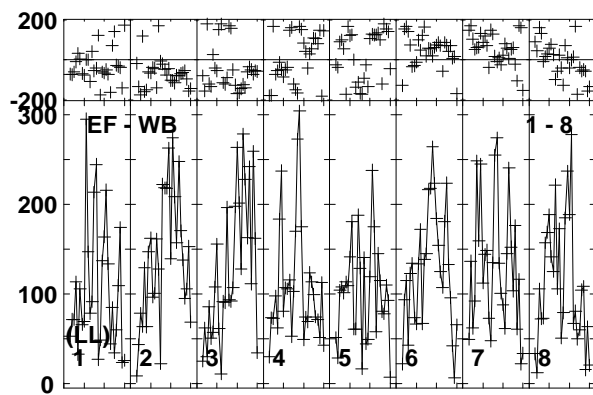
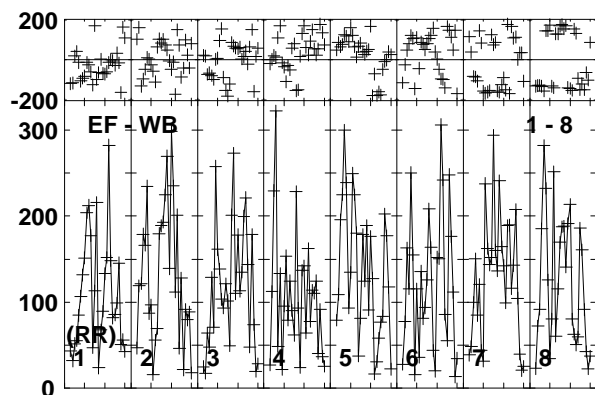
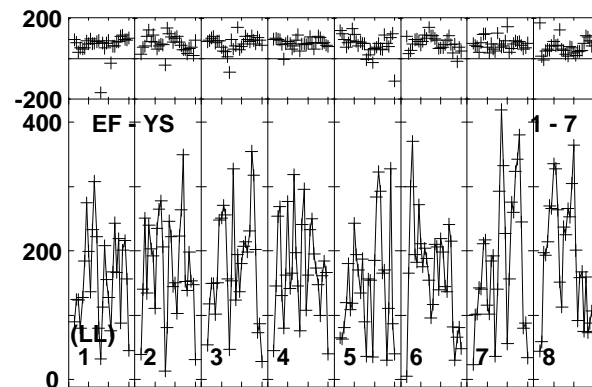
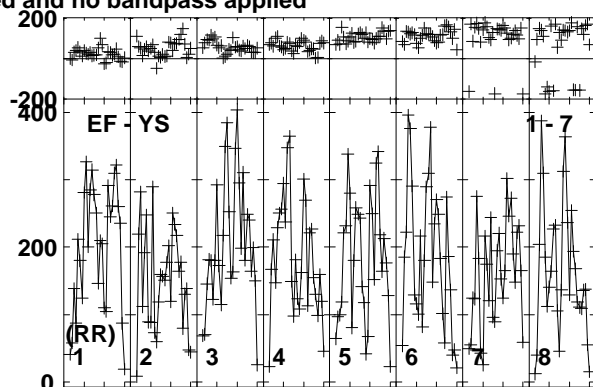
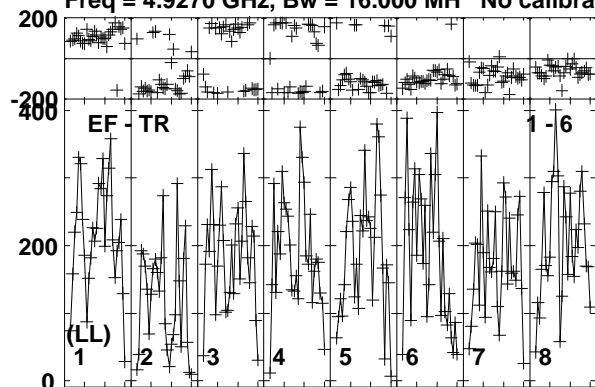

Lower frame: Micro Ampl Jy Top frame: Phas deg  
Vector averaged cross-power spectrum Baseline: EF (01) - TR (06)  
Timerange: 01/04:01:20 to 01/04:03:50

Plot file version 455 created 10-JUN-2016 17:22:48

J1957+3338 RT013A.UVDATA.1

Freq = 4.9270 GHz, Bw = 16.000 MH No calibration applied and no bandpass applied

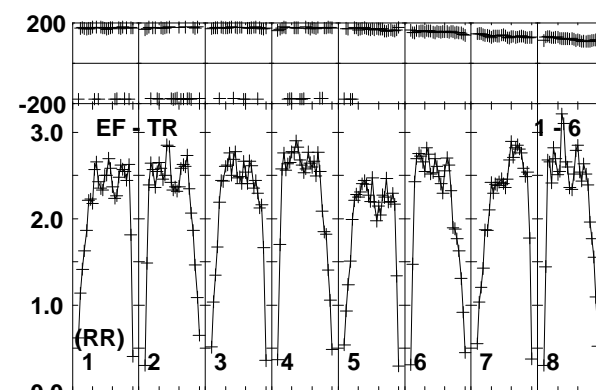
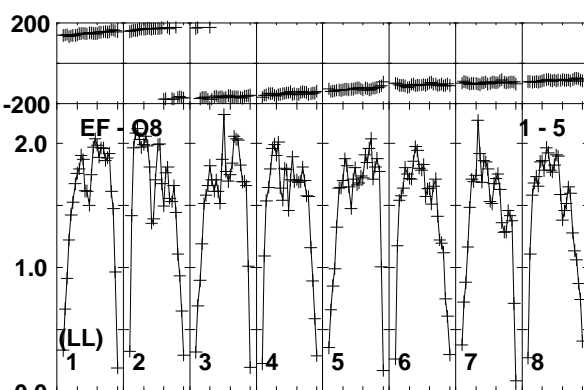
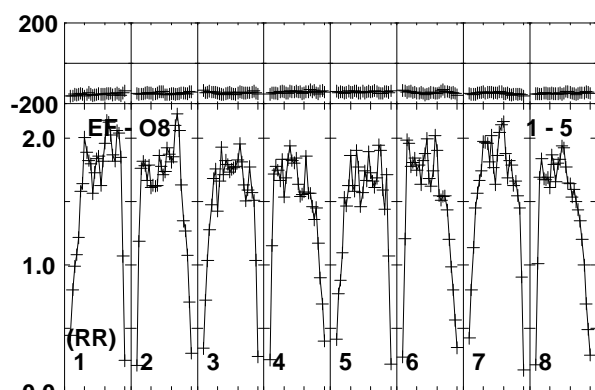
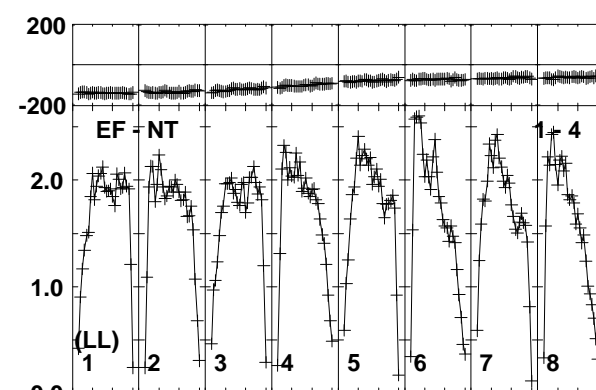
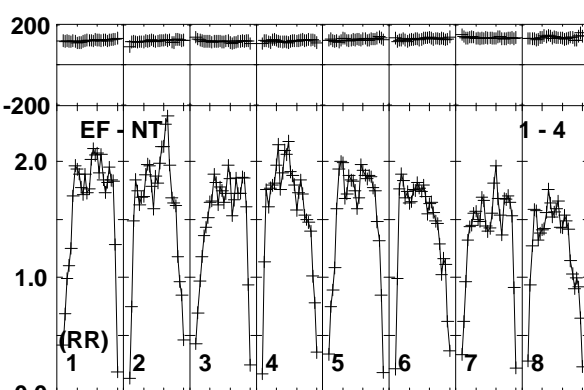
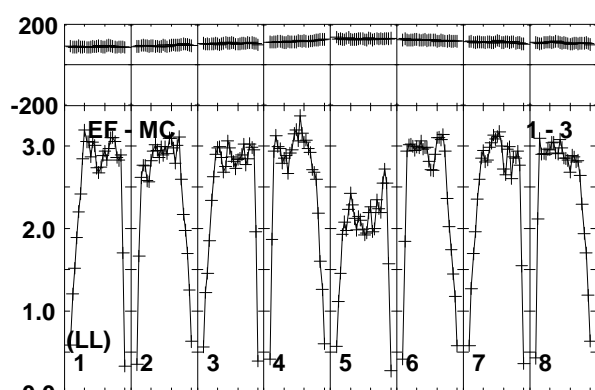
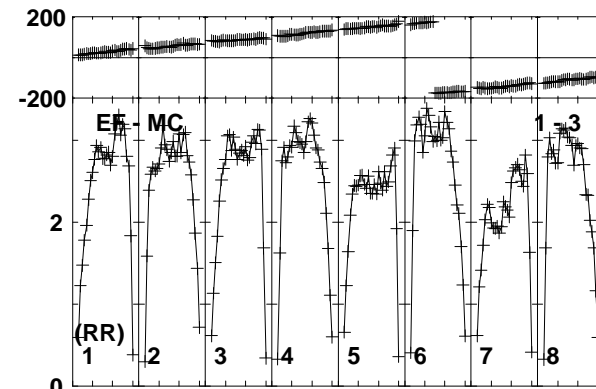
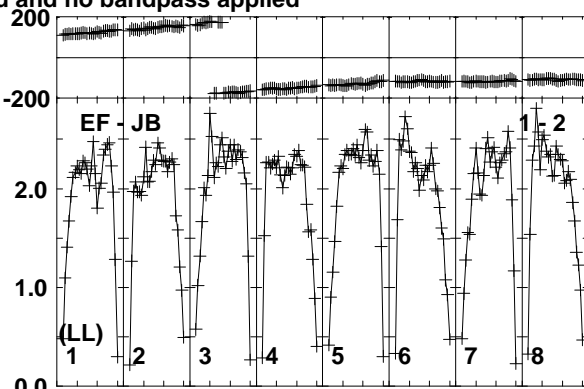
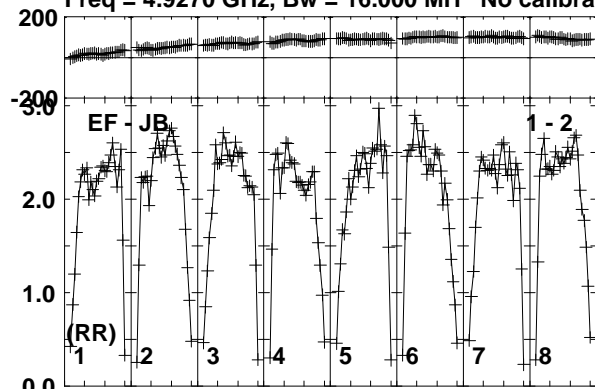

Lower frame: Milli Ampl Jy Top frame: Phas deg  
Vector averaged cross-power spectrum Baseline: EF (01) - JB (02)  
Timerange: 01/04:03:51 to 01/04:05:20

Plot file version 456 created 10-JUN-2016 17:22:48

J1957+3338 RT013A.UVDATA.1

Freq = 4.9270 GHz, Bw = 16.000 MH No calibration applied and no bandpass applied

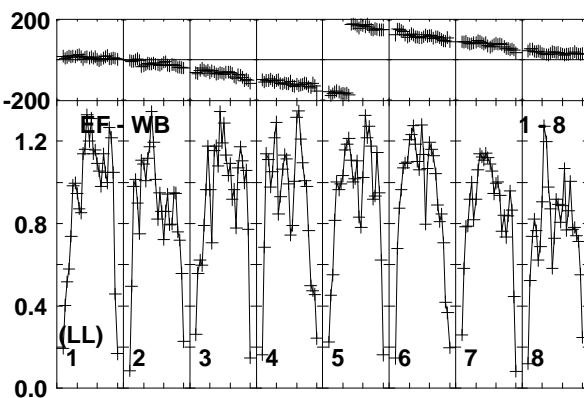
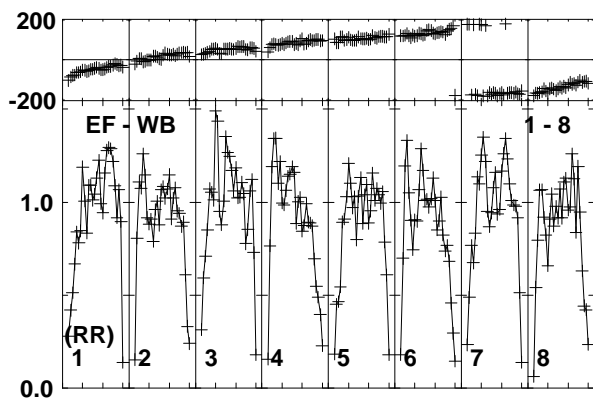
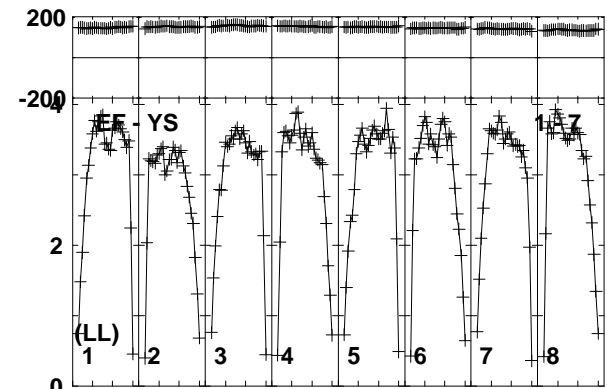
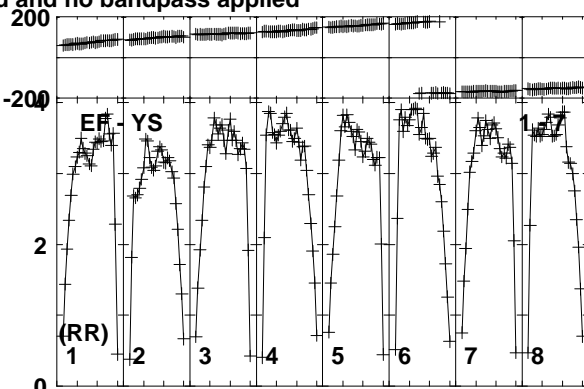
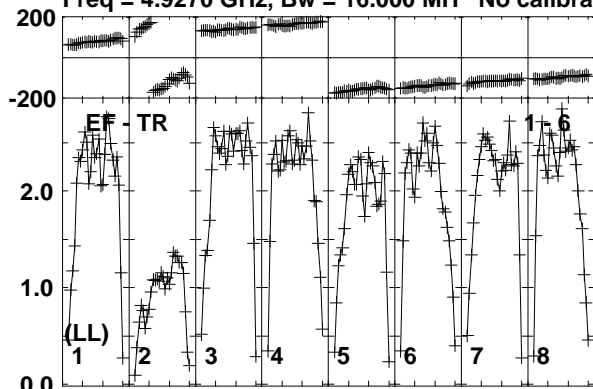

Lower frame: Milli Ampl Jy Top frame: Phas deg  
Vector averaged cross-power spectrum Baseline: EF (01) - TR (06)  
Timerange: 01/04:03:51 to 01/04:05:20

Plot file version 457 created 10-JUN-2016 17:22:48

CHECK RT013A.UVDATA.1

Freq = 4.9270 GHz, Bw = 16.000 MH No calibration applied and no bandpass applied

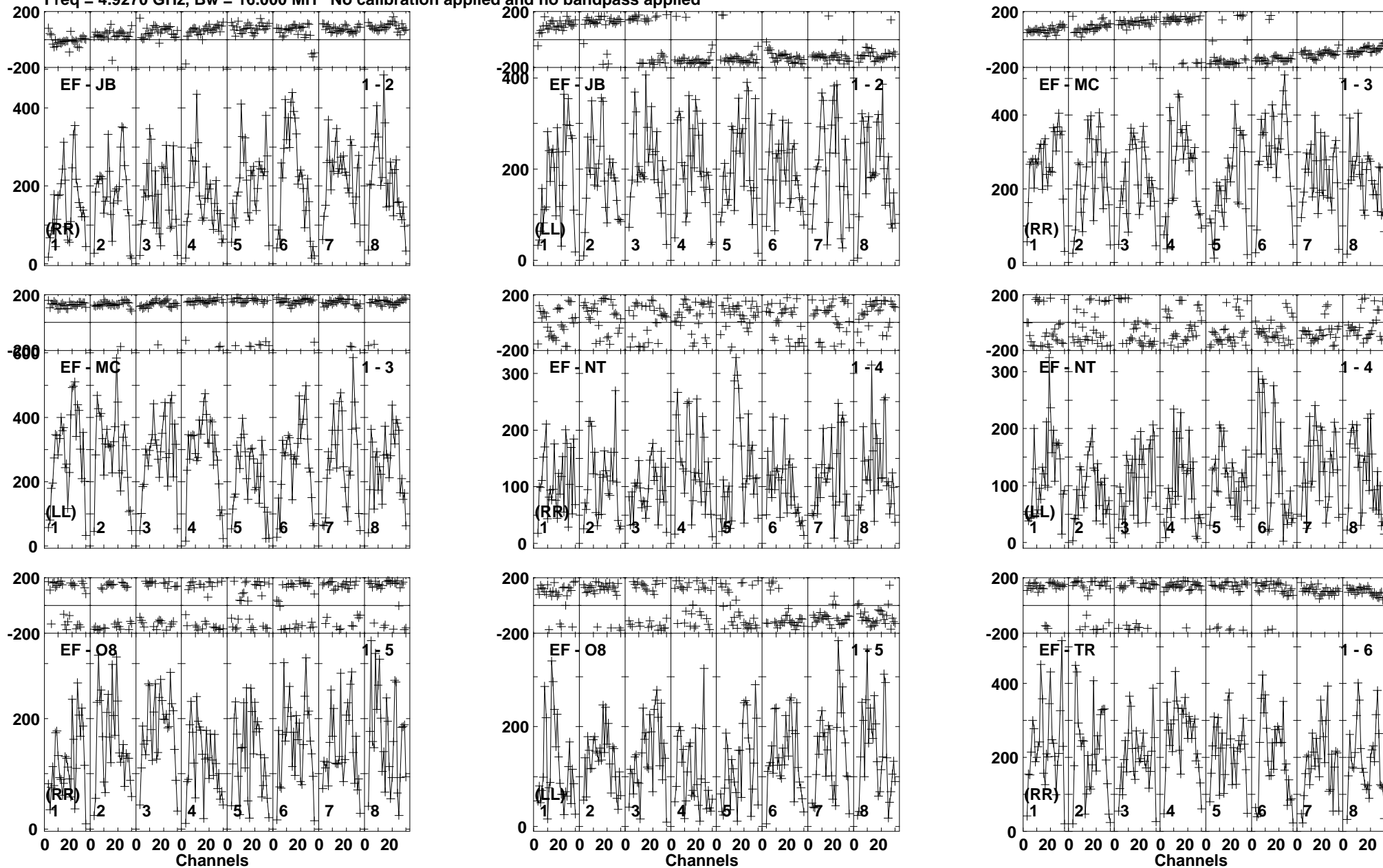

Lower frame: Micro Ampl Jy Top frame: Phas deg  
Vector averaged cross-power spectrum Baseline: EF (01) - JB (02)  
Timerange: 01/04:06:00 to 01/04:07:59

Plot file version 458 created 10-JUN-2016 17:22:48

CHECK RT013A.UVDATA.1

Freq = 4.9270 GHz, Bw = 16.000 MH No calibration applied and no bandpass applied

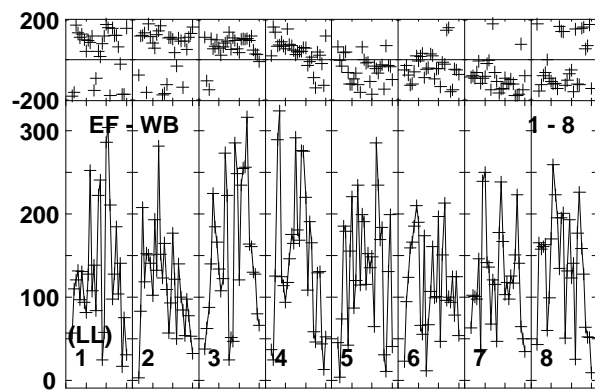
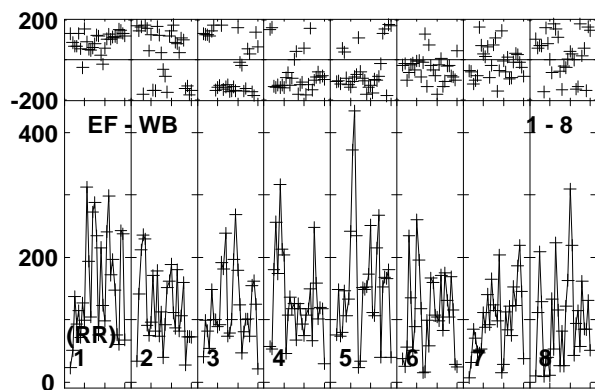
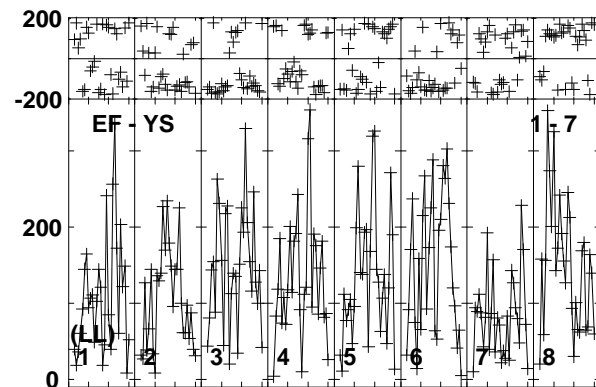
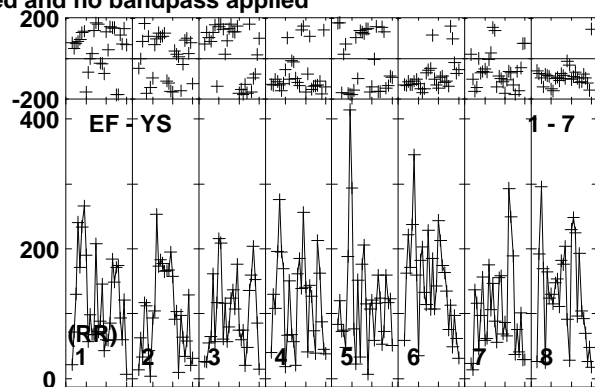
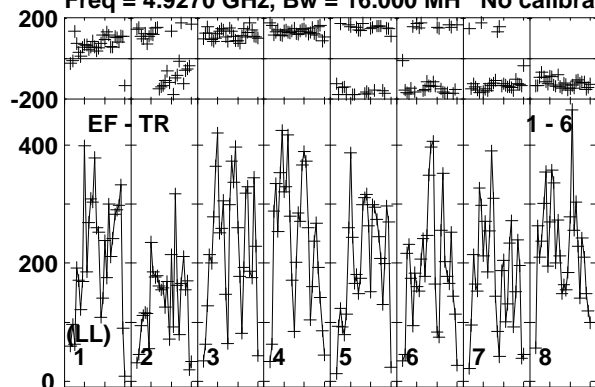

Lower frame: Micro Ampl Jy Top frame: Phas deg  
Vector averaged cross-power spectrum Baseline: EF (01) - TR (06)  
Timerange: 01/04:06:00 to 01/04:07:59



Plot file version 459 created 10-JUN-2016 17:22:48

CYGX1 RT013A.UVDATA.1

Freq = 4.9270 GHz, Bw = 16.000 MH No calibration applied and no bandpass applied

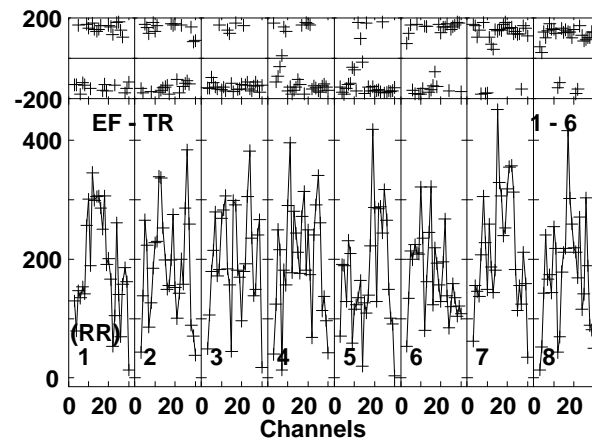
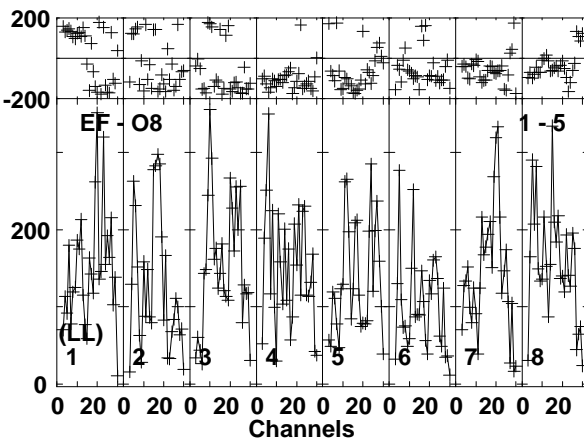
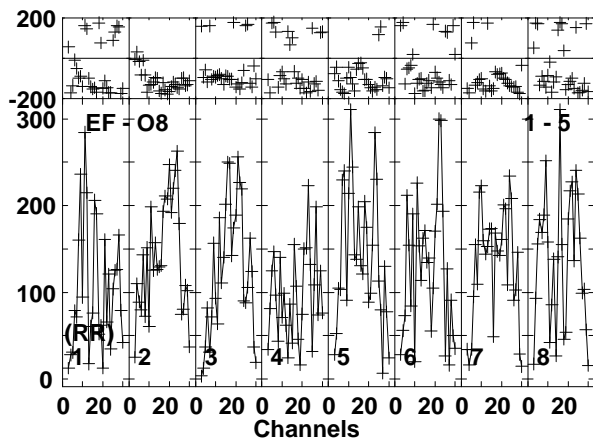
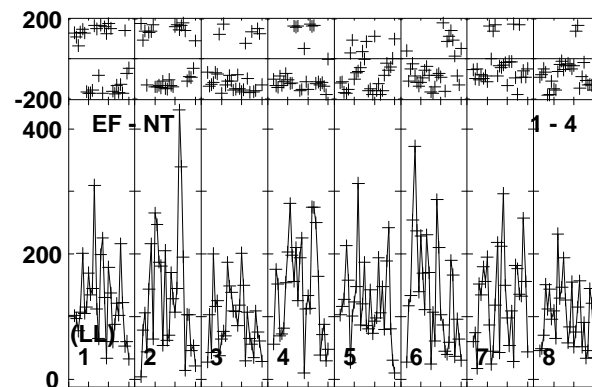
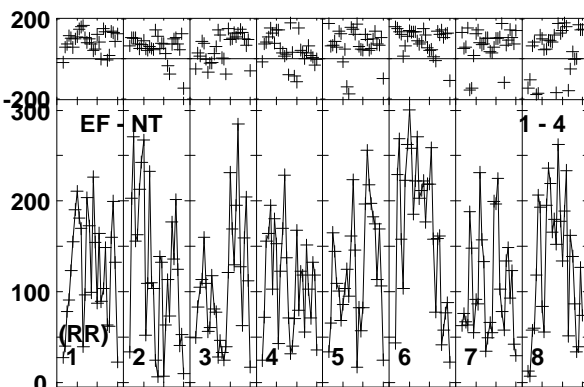
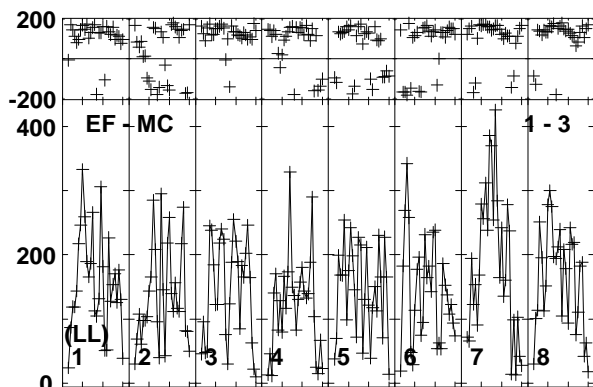
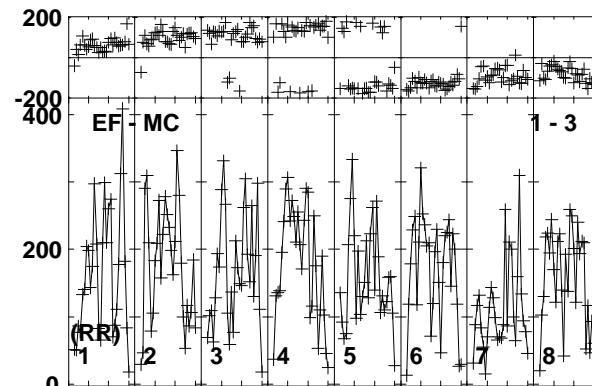
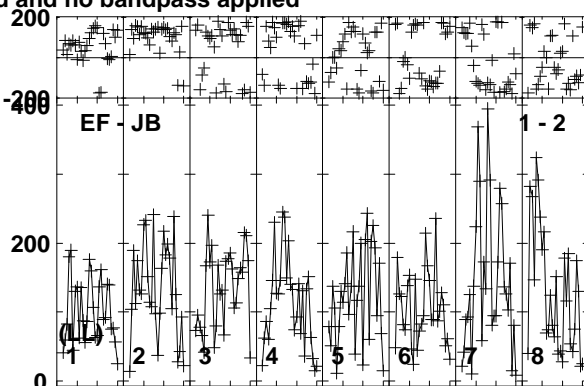
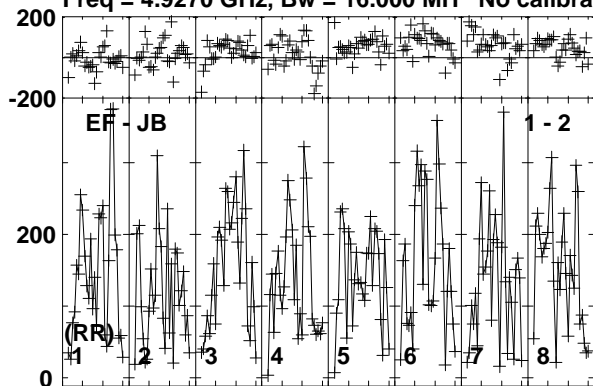

Lower frame: Micro Ampl Jy Top frame: Phas deg  
Vector averaged cross-power spectrum Baseline: EF (01) - JB (02)  
Timerange: 01/04:08:00 to 01/04:10:30

Plot file version 460 created 10-JUN-2016 17:22:48

CYGX1 RT013A.UVDATA.1

Freq = 4.9270 GHz, Bw = 16.000 MH No calibration applied and no bandpass applied

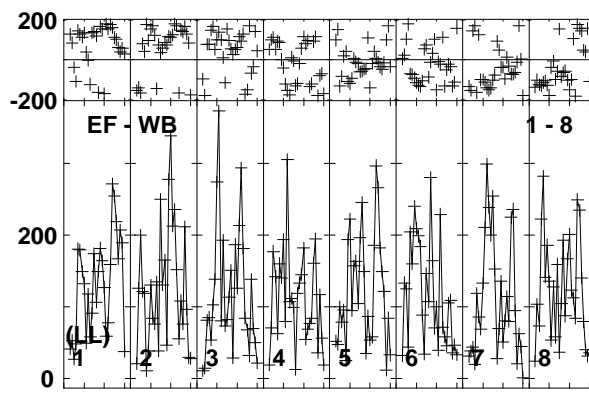
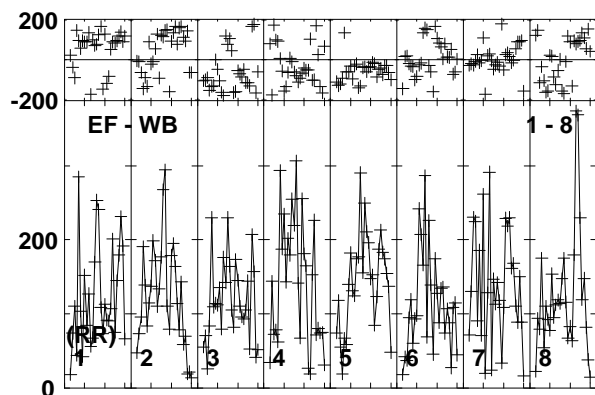
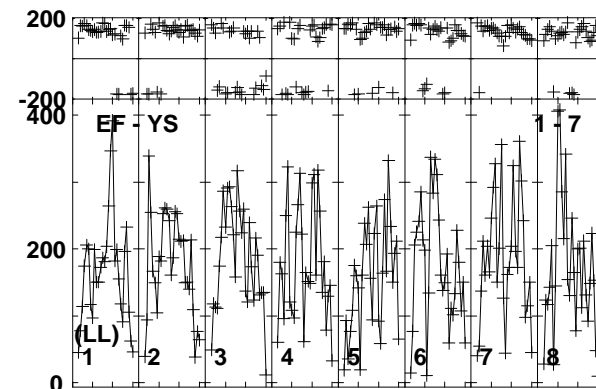
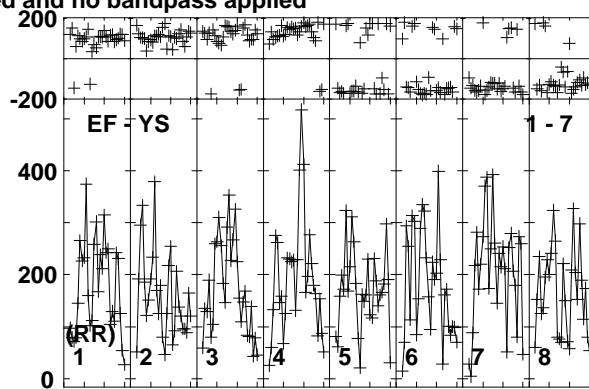
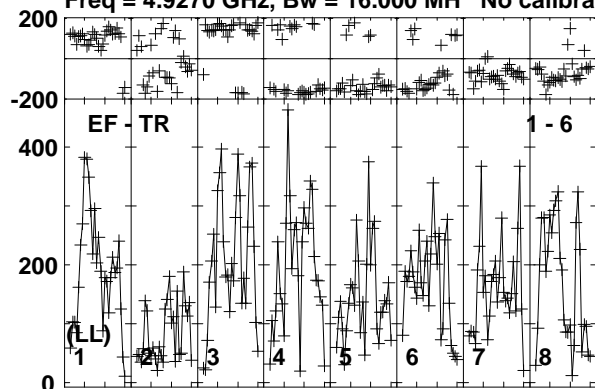

Lower frame: Micro Ampl Jy Top frame: Phas deg  
Vector averaged cross-power spectrum Baseline: EF (01) - TR (06)  
Timerange: 01/04:08:00 to 01/04:10:30

Plot file version 461 created 10-JUN-2016 17:22:48

J1957+3338 RT013A.UVDATA.1

Freq = 4.9270 GHz, Bw = 16.000 MH No calibration applied and no bandpass applied

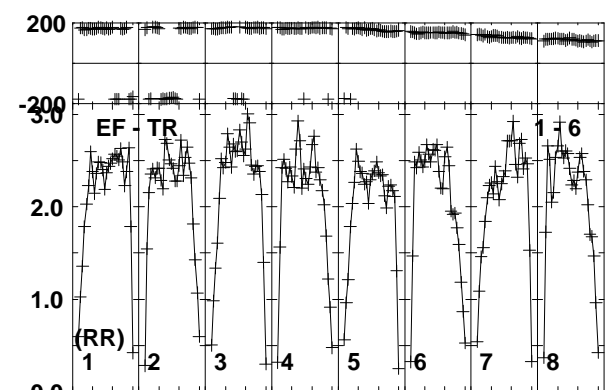
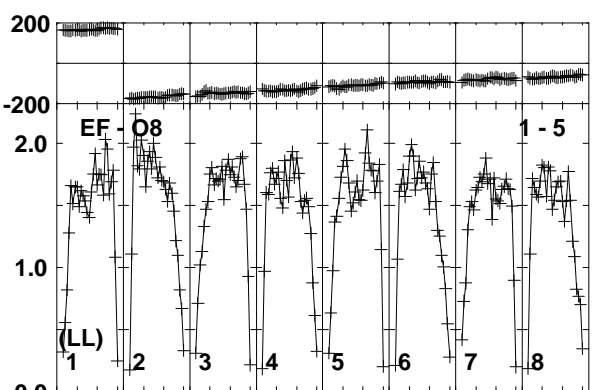
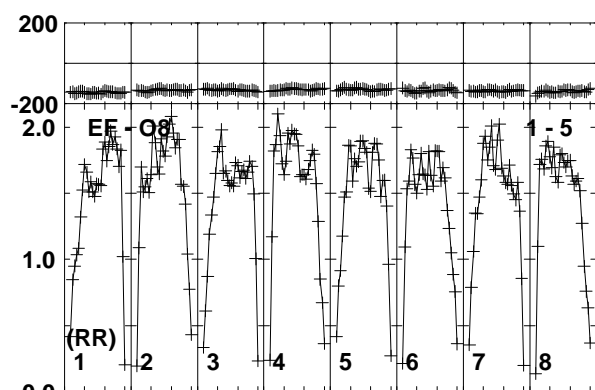
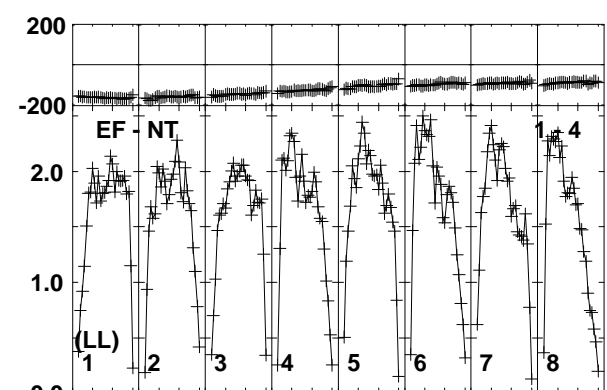
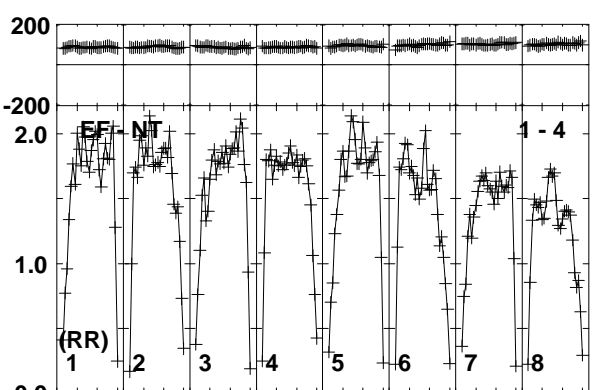
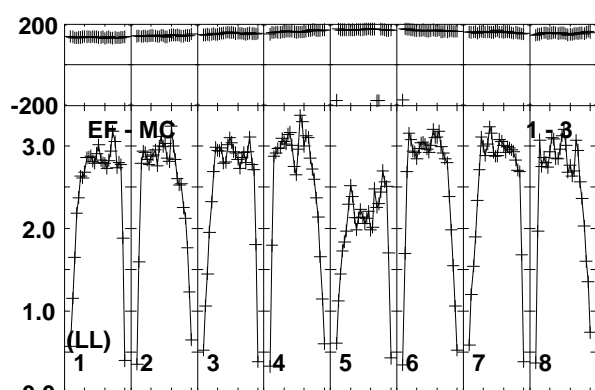
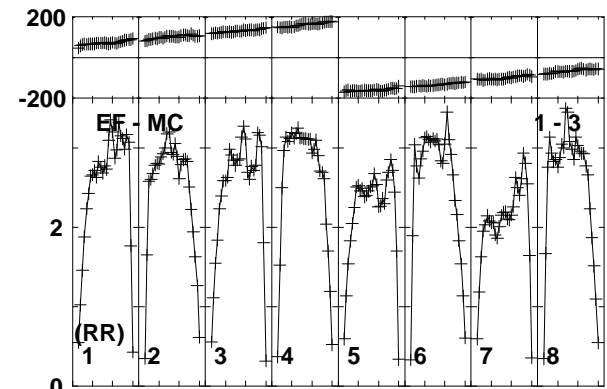
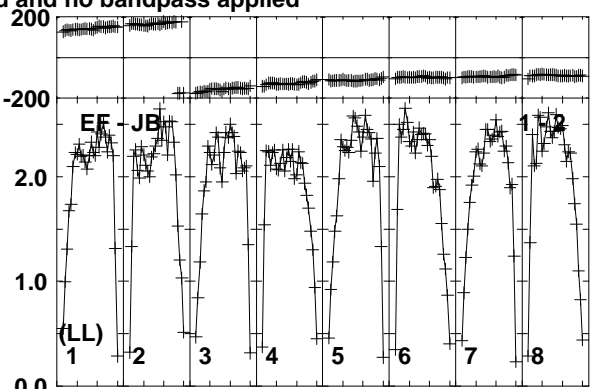
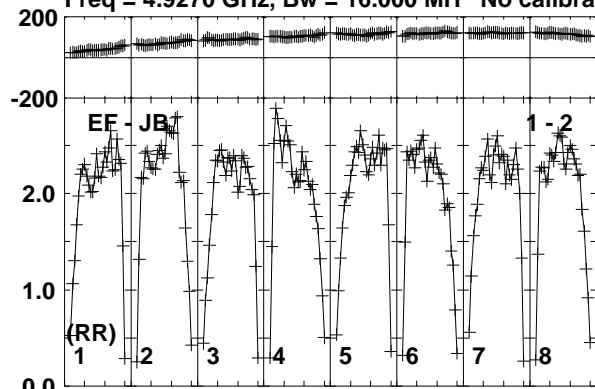

Lower frame: Milli Ampl Jy Top frame: Phas deg  
Vector averaged cross-power spectrum Baseline: EF (01) - JB (02)  
Timerange: 01/04:10:31 to 01/04:12:00

Plot file version 462 created 10-JUN-2016 17:22:48

J1957+3338 RT013A.UVDATA.1

Freq = 4.9270 GHz, Bw = 16.000 MH No calibration applied and no bandpass applied

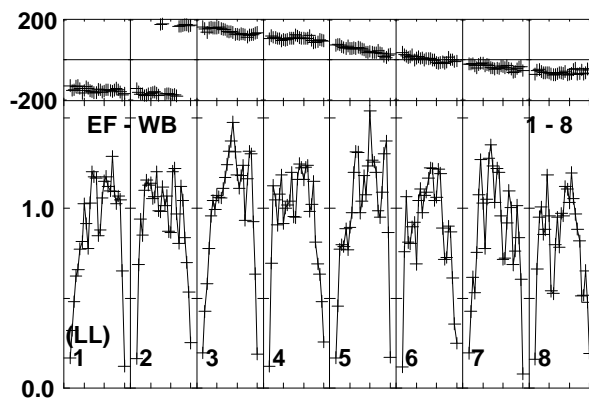
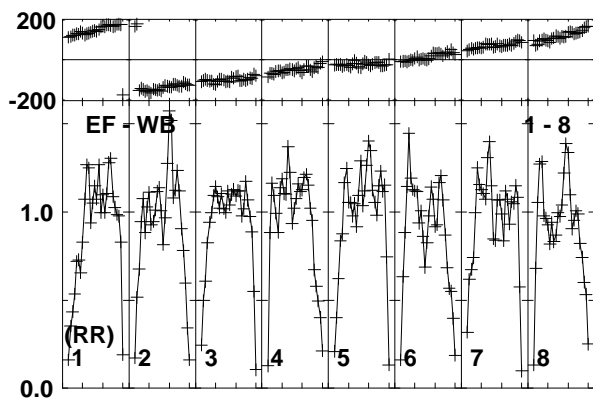
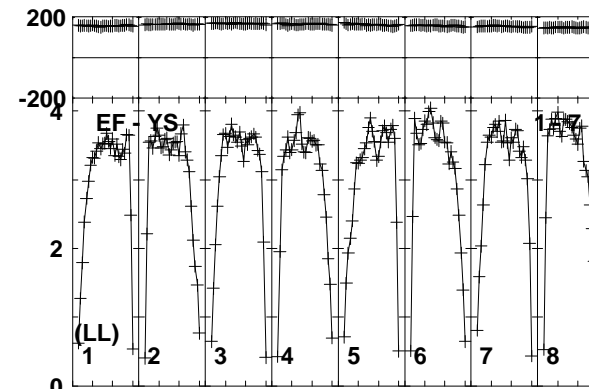
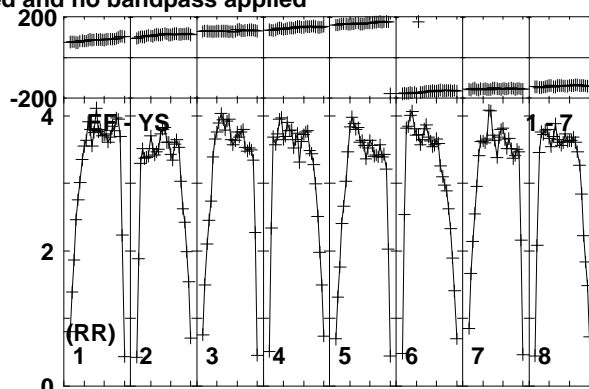
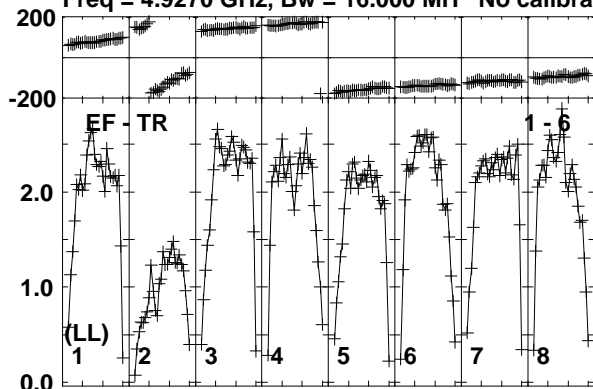

Lower frame: Milli Ampl Jy Top frame: Phas deg  
Vector averaged cross-power spectrum Baseline: EF (01) - TR (06)  
Timerange: 01/04:10:31 to 01/04:12:00

Plot file version 463 created 10-JUN-2016 17:22:48

CHECK RT013A.UVDATA.1

Freq = 4.9270 GHz, Bw = 16.000 MH No calibration applied and no bandpass applied

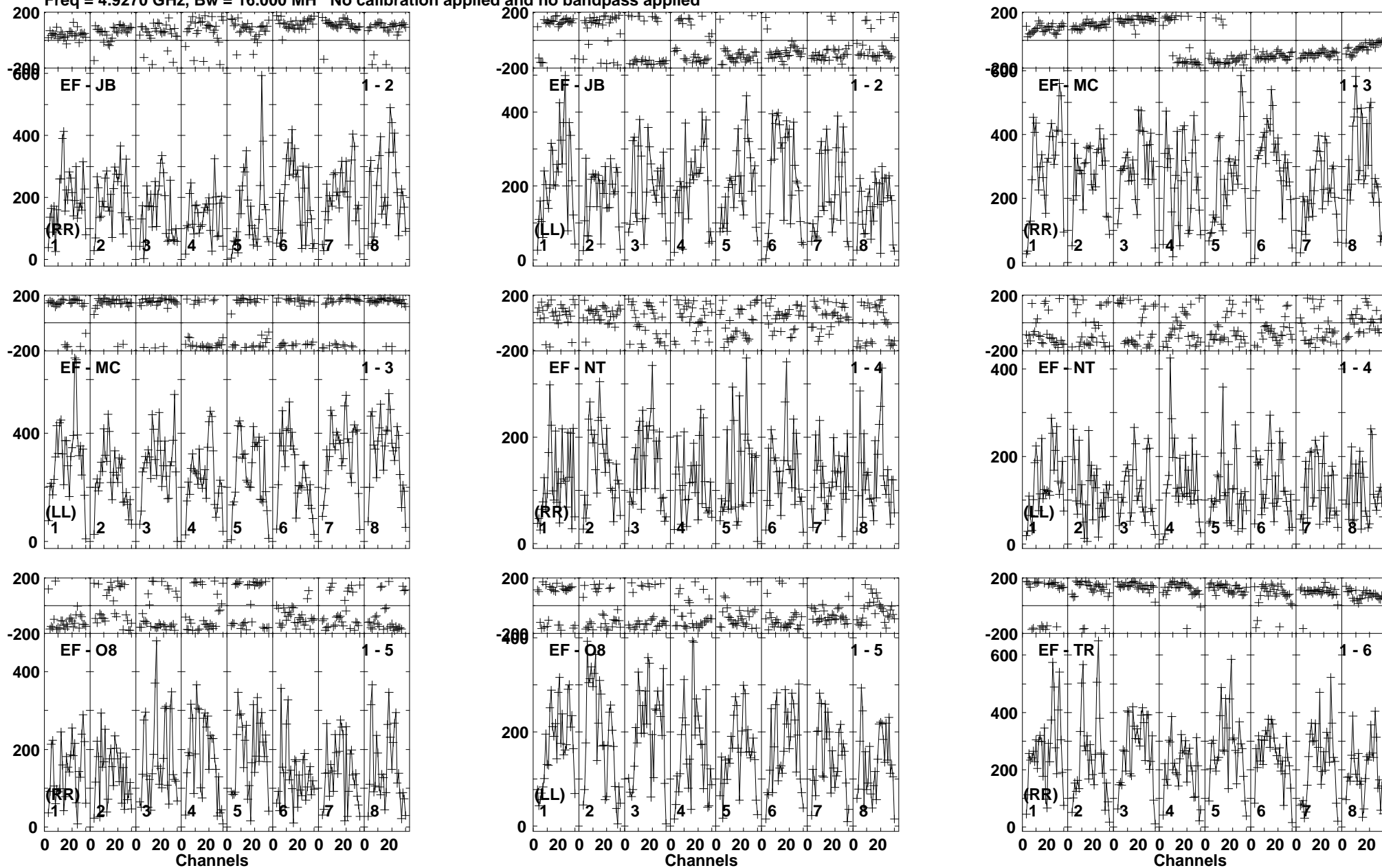

Lower frame: Micro Ampl Jy Top frame: Phas deg  
Vector averaged cross-power spectrum Baseline: EF (01) - JB (02)  
Timerange: 01/04:12:01 to 01/04:14:00

Plot file version 464 created 10-JUN-2016 17:22:49

CHECK RT013A.UVDATA.1

Freq = 4.9270 GHz, Bw = 16.000 MH No calibration applied and no bandpass applied

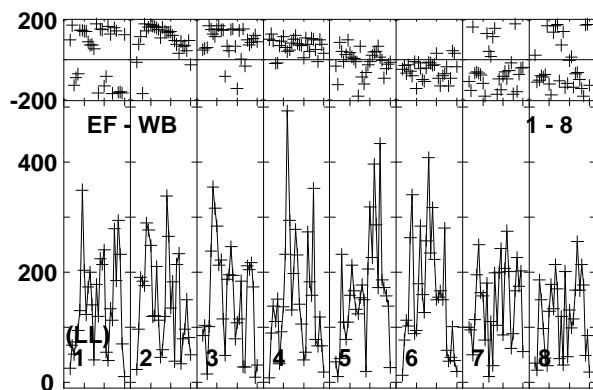
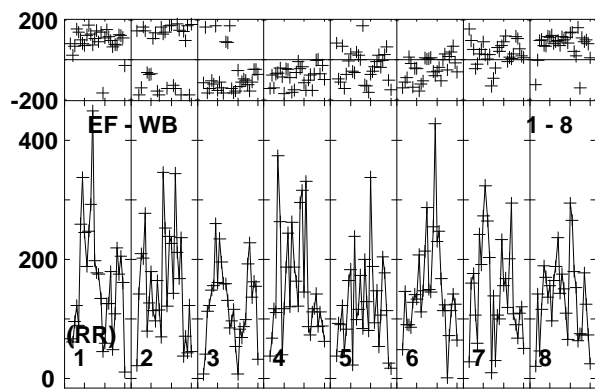
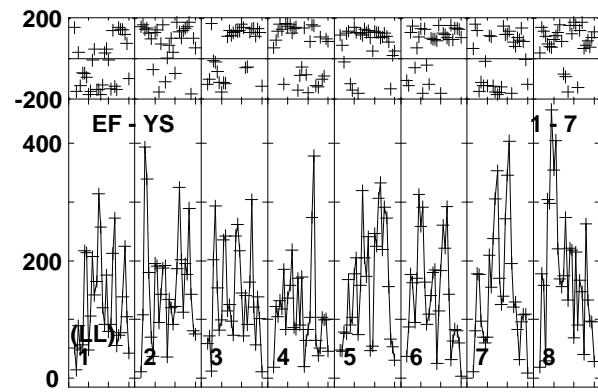
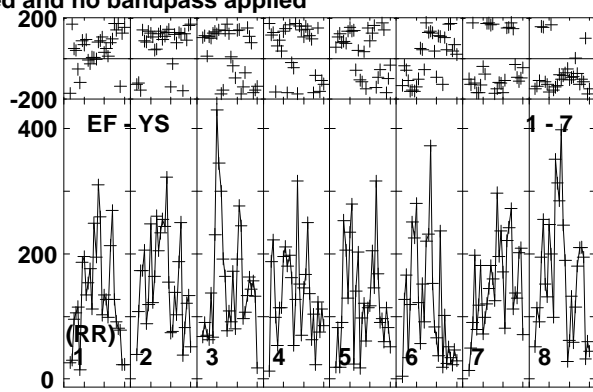
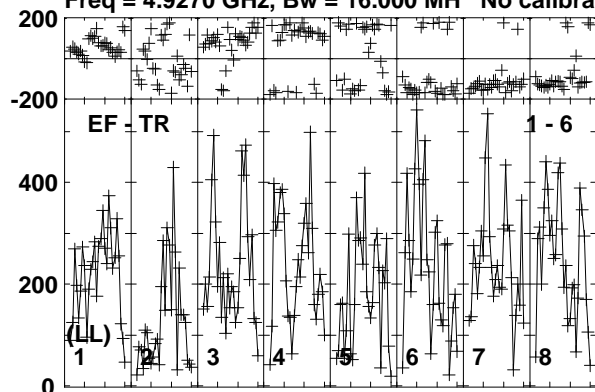

Lower frame: Micro Ampl Jy Top frame: Phas deg  
Vector averaged cross-power spectrum Baseline: EF (01) - TR (06)  
Timerange: 01/04:12:01 to 01/04:14:00

Plot file version 465 created 10-JUN-2016 17:22:49

CYGX1 RT013A.UVDATA.1

Freq = 4.9270 GHz, Bw = 16.000 MH No calibration applied and no bandpass applied

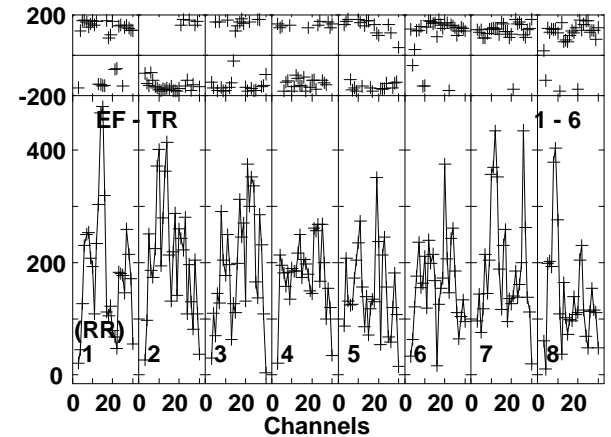
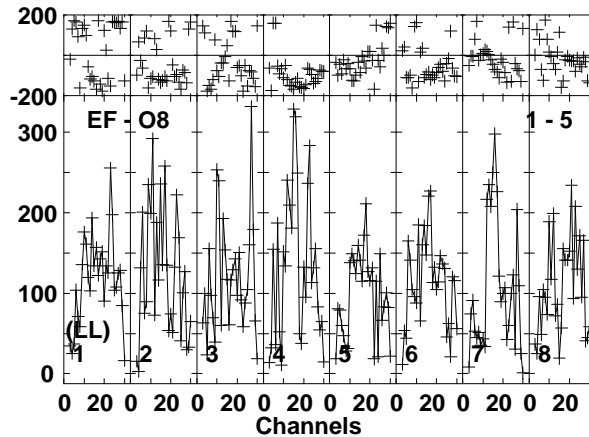
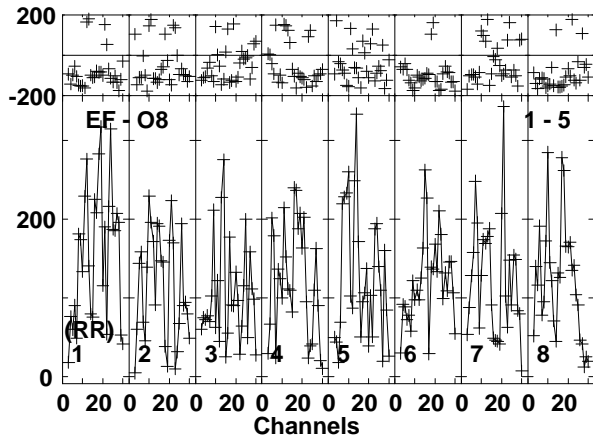
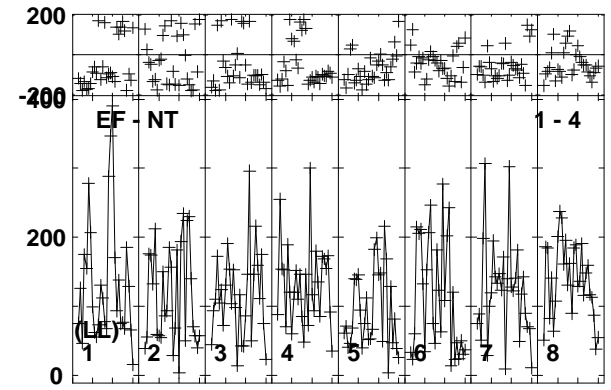
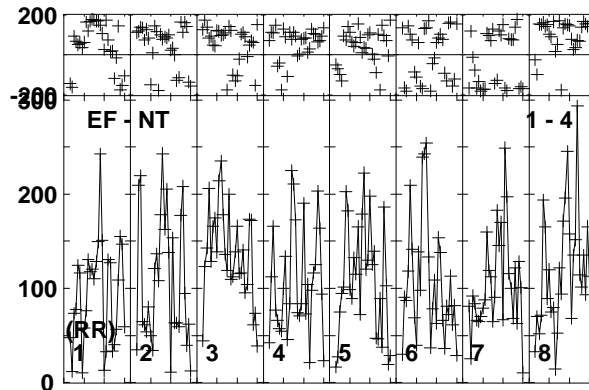
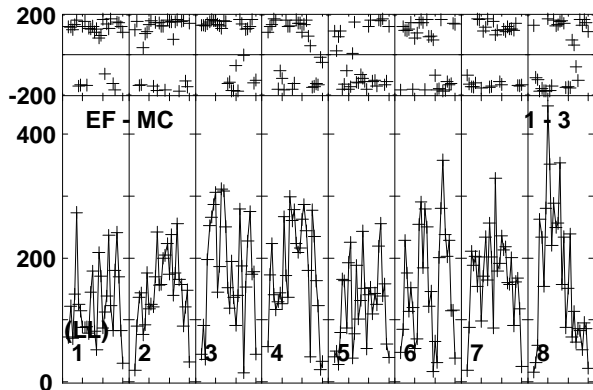
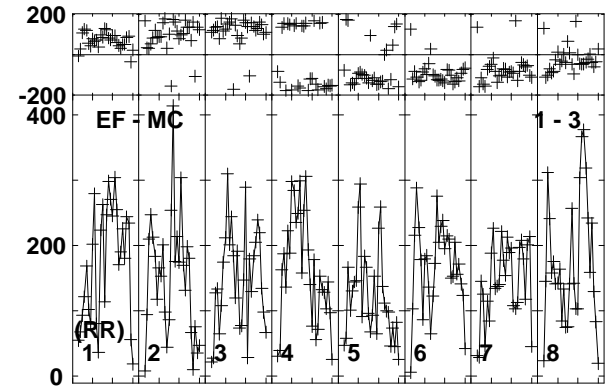
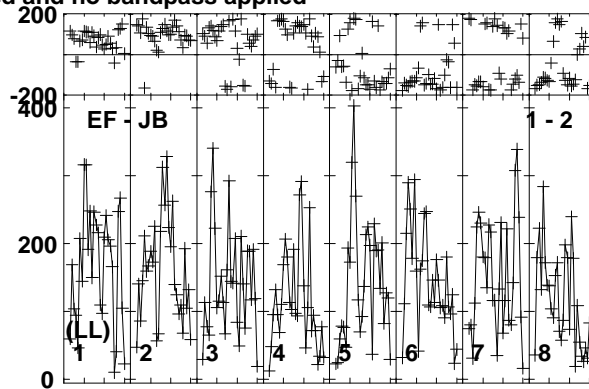
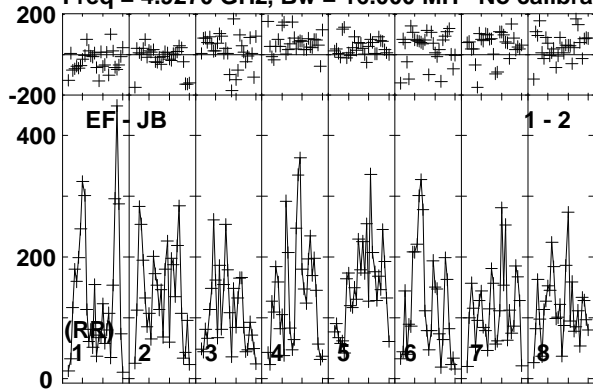

Lower frame: Micro Ampl Jy Top frame: Phas deg  
Vector averaged cross-power spectrum Baseline: EF (01) - JB (02)  
Timerange: 01/04:14:01 to 01/04:16:29

Plot file version 466 created 10-JUN-2016 17:22:49

CYGX1 RT013A.UVDATA.1

Freq = 4.9270 GHz, Bw = 16.000 MH No calibration applied and no bandpass applied

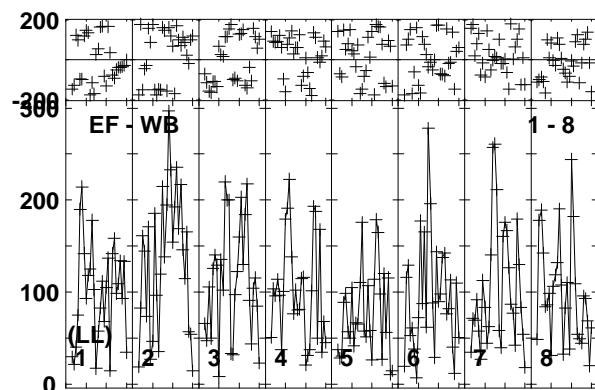
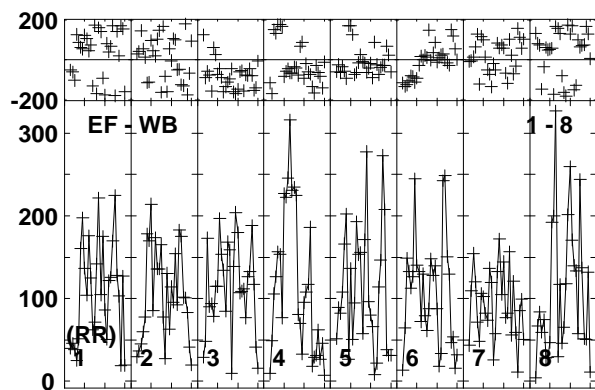
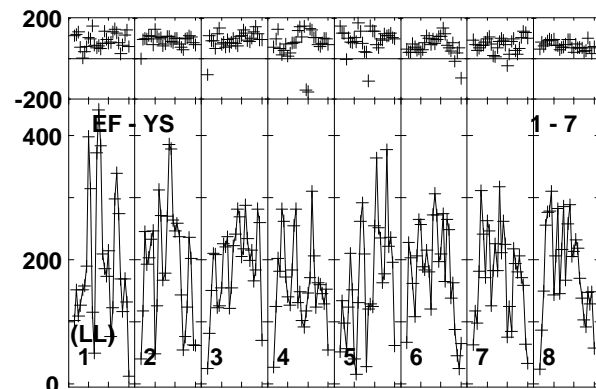
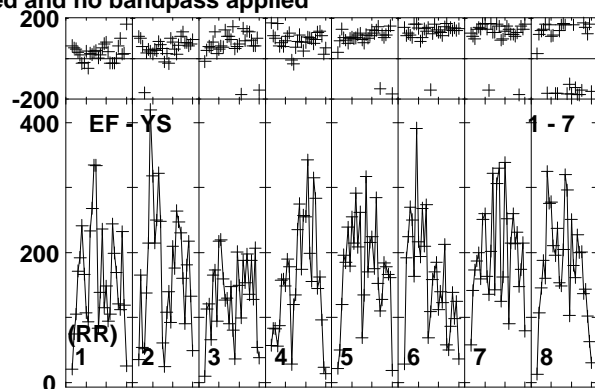
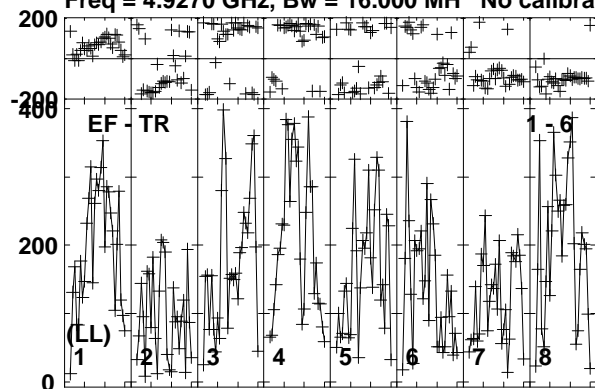

Lower frame: Micro Ampl Jy Top frame: Phas deg  
Vector averaged cross-power spectrum Baseline: EF (01) - TR (06)  
Timerange: 01/04:14:01 to 01/04:16:29



Plot file version 467 created 10-JUN-2016 17:22:49

J1957+3338 RT013A.UVDATA.1

Freq = 4.9270 GHz, Bw = 16.000 MH No calibration applied and no bandpass applied

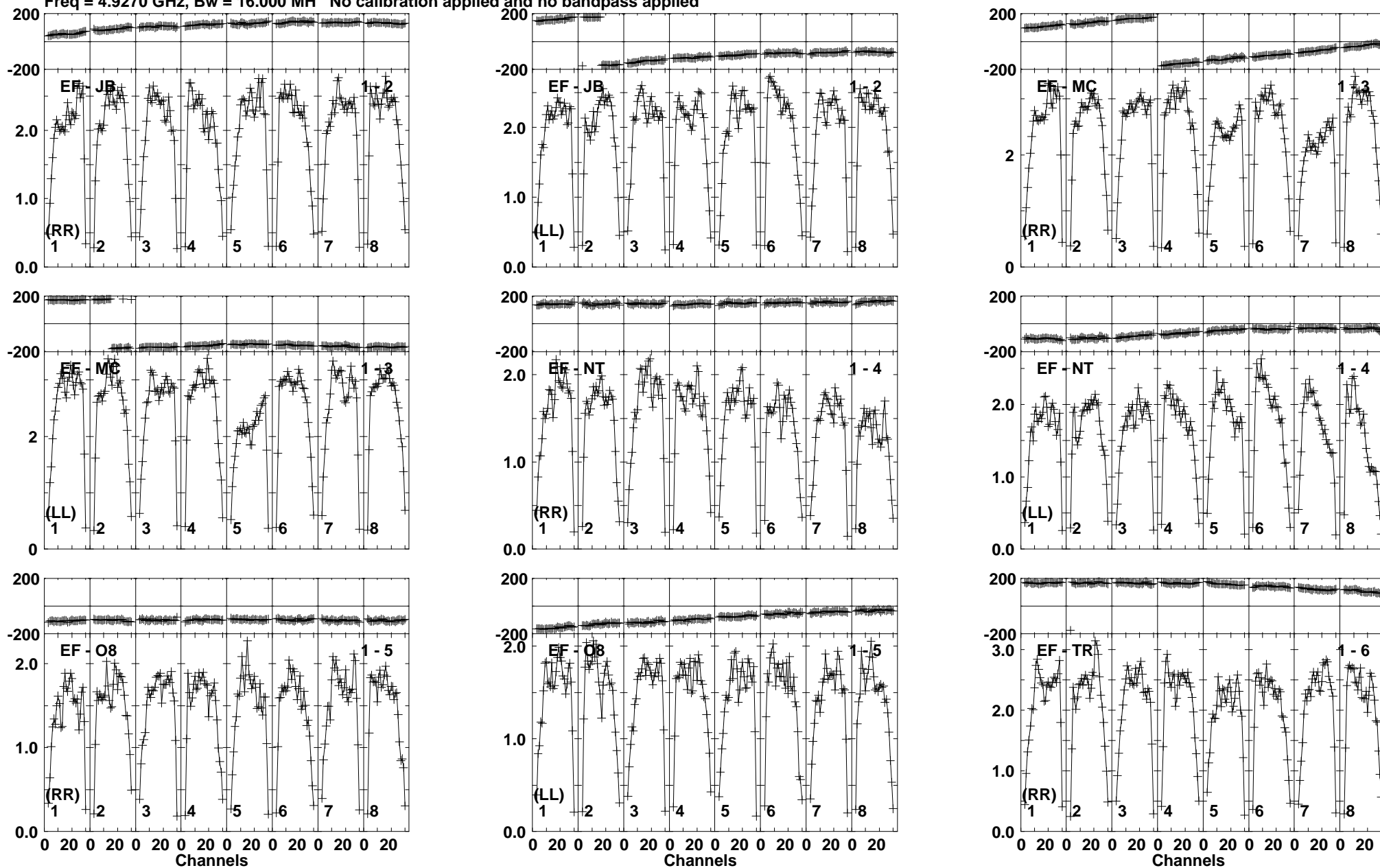

Lower frame: Milli Ampl Jy Top frame: Phas deg  
Vector averaged cross-power spectrum Baseline: EF (01) - JB (02)  
Timerange: 01/04:16:31 to 01/04:17:59

Plot file version 468 created 10-JUN-2016 17:22:49

J1957+3338 RT013A.UVDATA.1

Freq = 4.9270 GHz, Bw = 16.000 MH No calibration applied and no bandpass applied

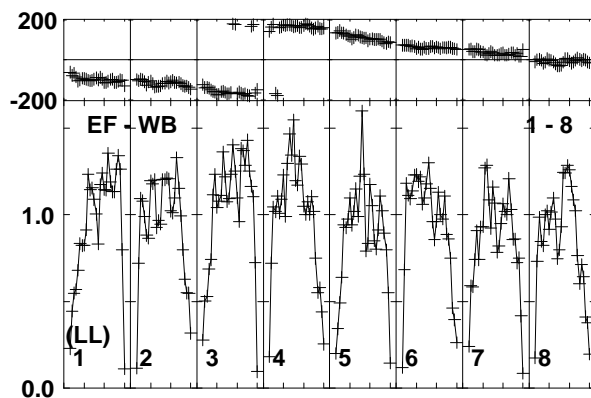
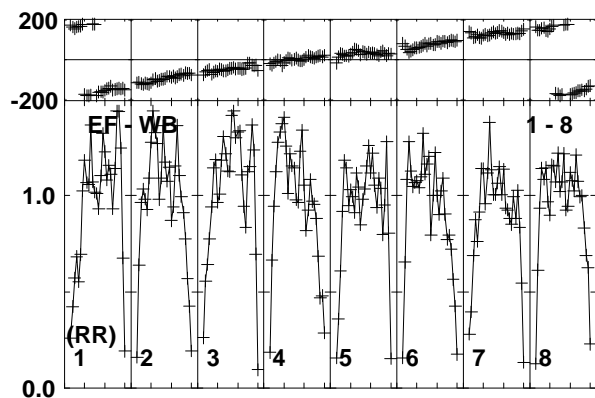
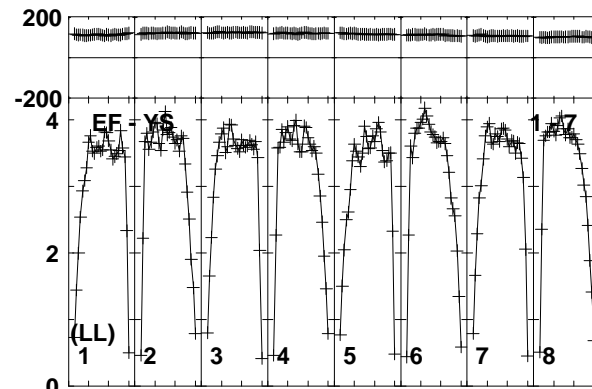
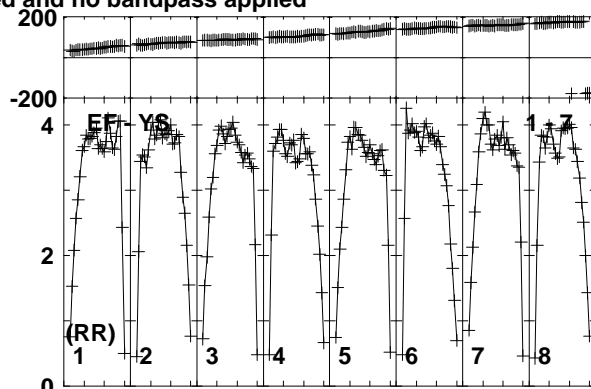
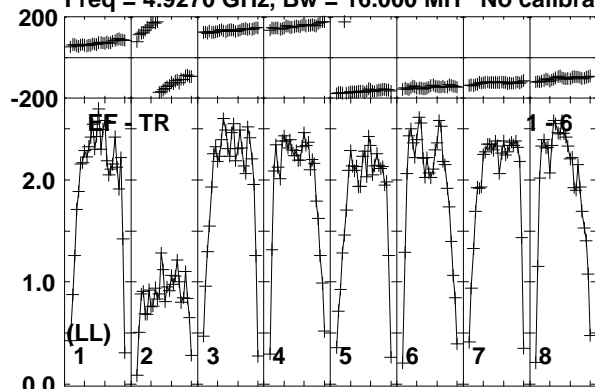

Lower frame: Milli Ampl Jy Top frame: Phas deg  
Vector averaged cross-power spectrum Baseline: EF (01) - TR (06)  
Timerange: 01/04:16:31 to 01/04:17:59

Plot file version 469 created 10-JUN-2016 17:22:49

CHECK RT013A.UVDATA.1

Freq = 4.9270 GHz, Bw = 16.000 MH No calibration applied and no bandpass applied

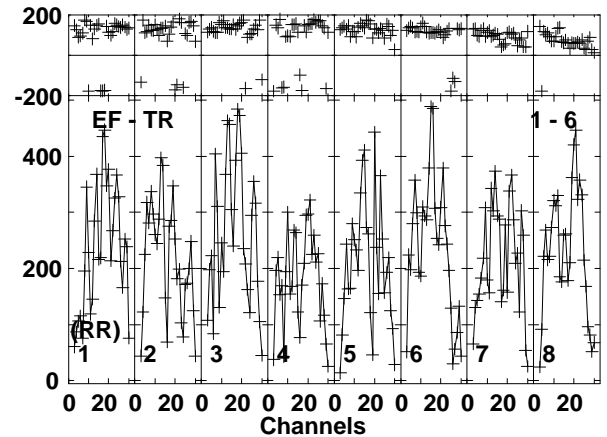
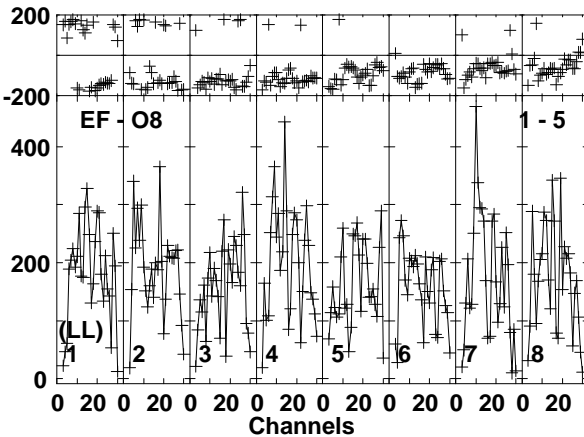
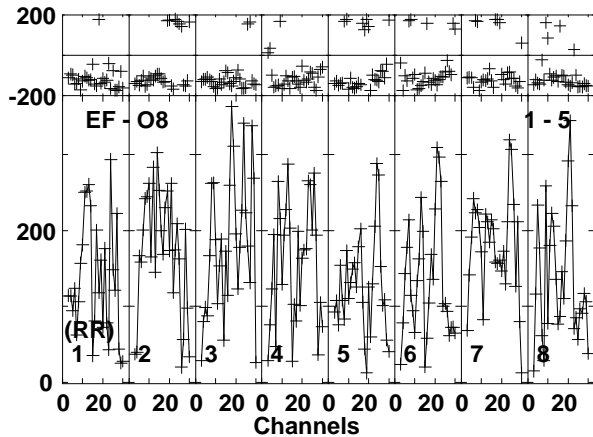
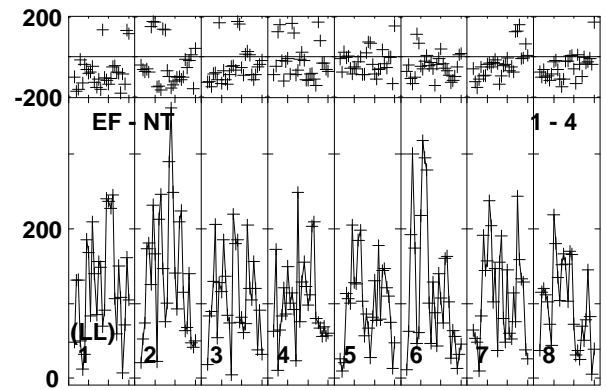
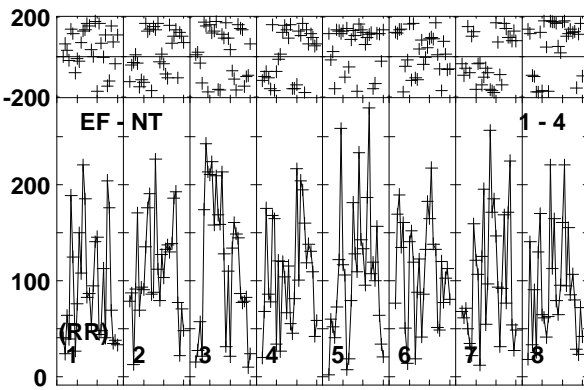
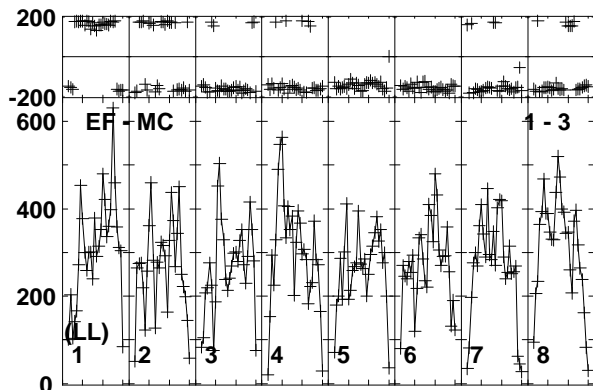
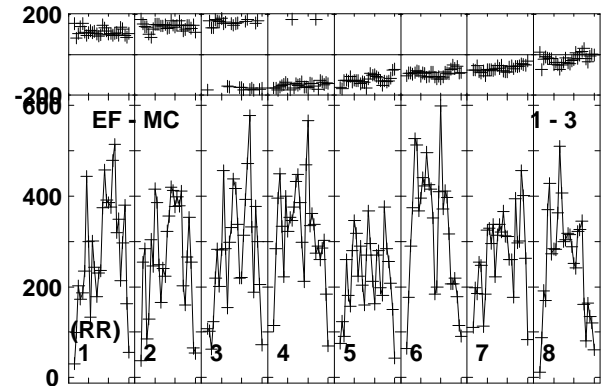
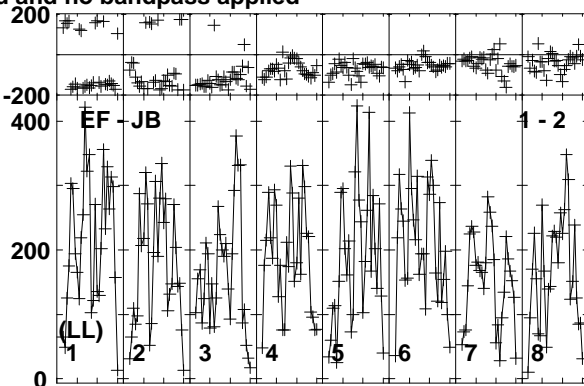
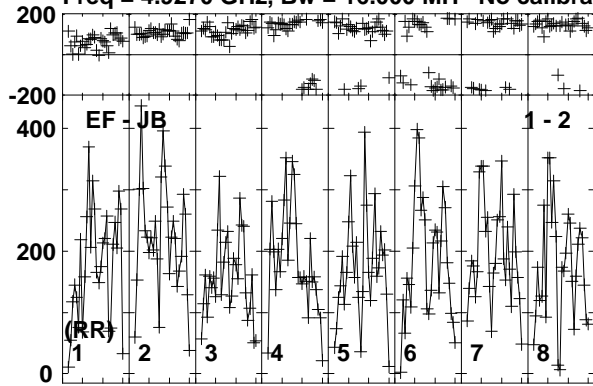

Lower frame: Micro Ampl Jy Top frame: Phas deg  
Vector averaged cross-power spectrum Baseline: EF (01) - JB (02)  
Timerange: 01/04:18:40 to 01/04:20:40

Plot file version 470 created 10-JUN-2016 17:22:49

CHECK RT013A.UVDATA.1

Freq = 4.9270 GHz, Bw = 16.000 MH No calibration applied and no bandpass applied

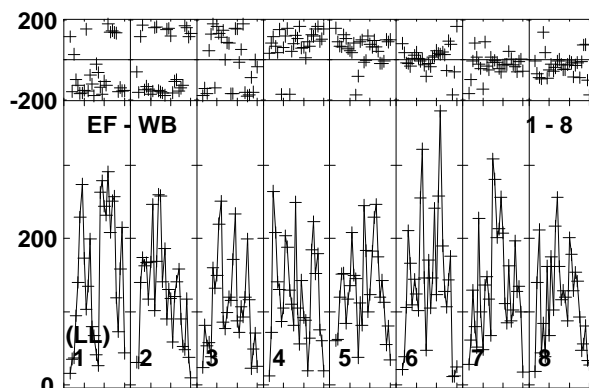
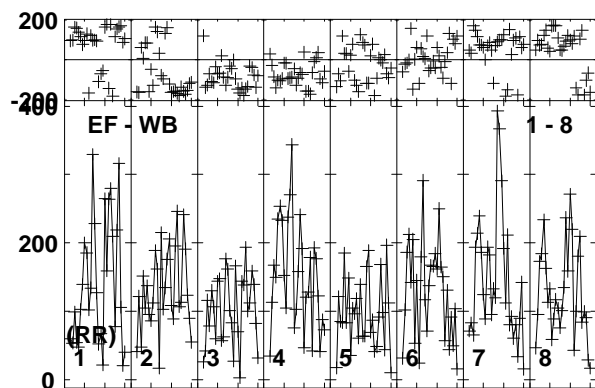
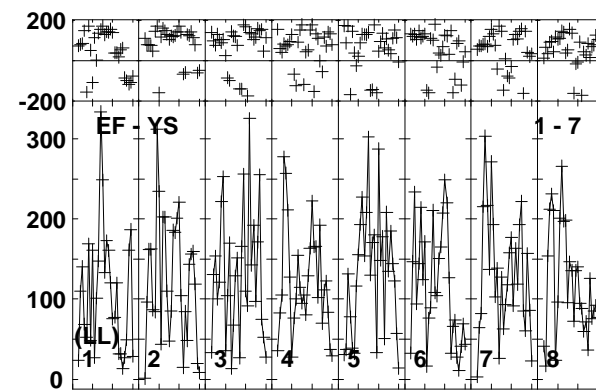
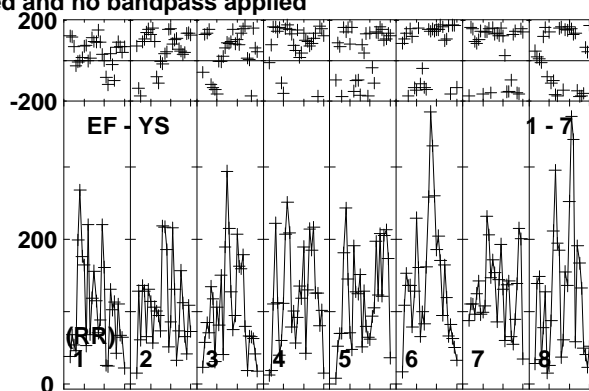
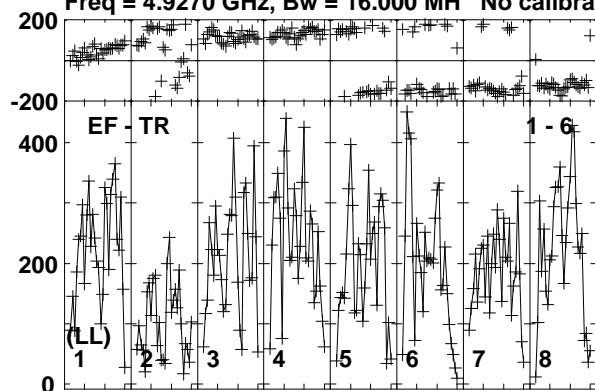

Lower frame: Micro Ampl Jy Top frame: Phas deg  
Vector averaged cross-power spectrum Baseline: EF (01) - TR (06)  
Timerange: 01/04:18:40 to 01/04:20:40

Plot file version 471 created 10-JUN-2016 17:22:49

CYGX1 RT013A.UVDATA.1

Freq = 4.9270 GHz, Bw = 16.000 MH No calibration applied and no bandpass applied

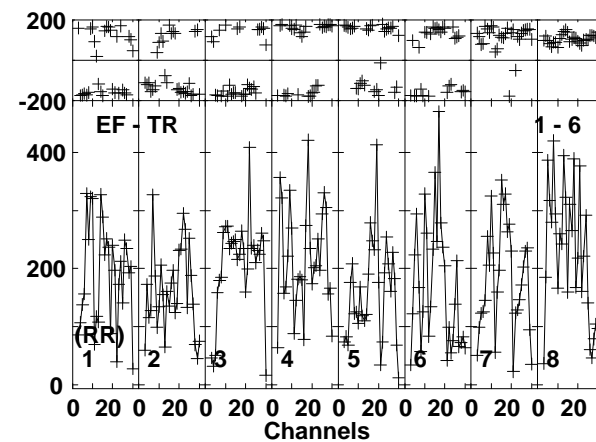
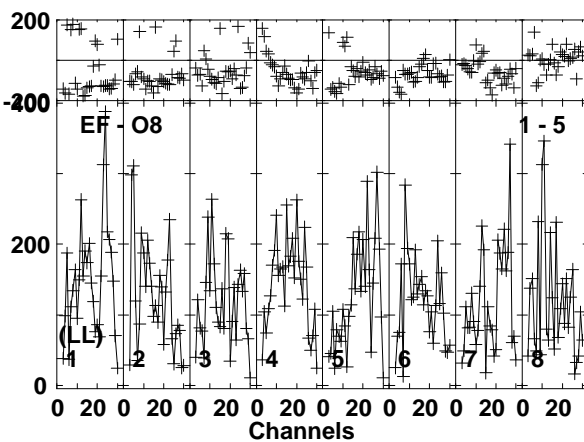
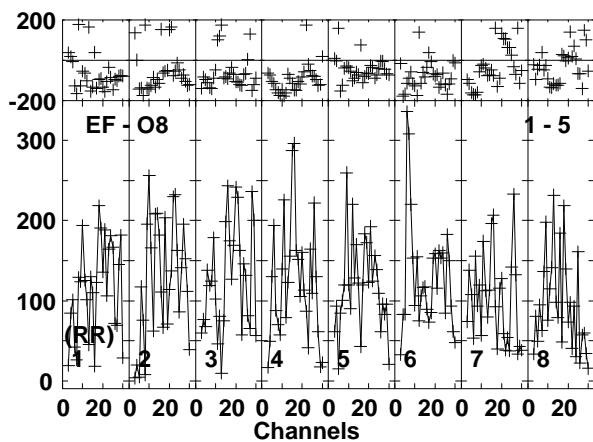
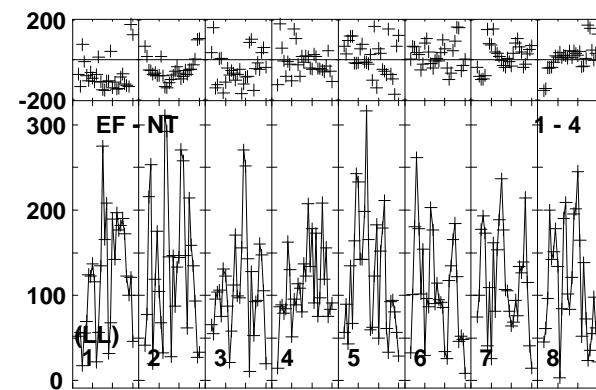
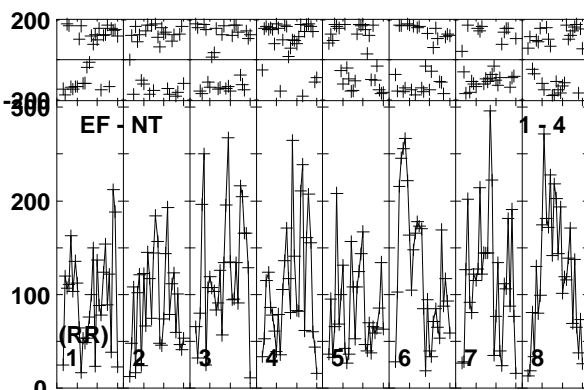
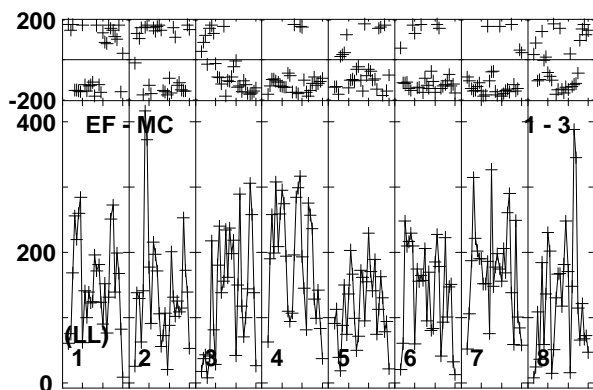
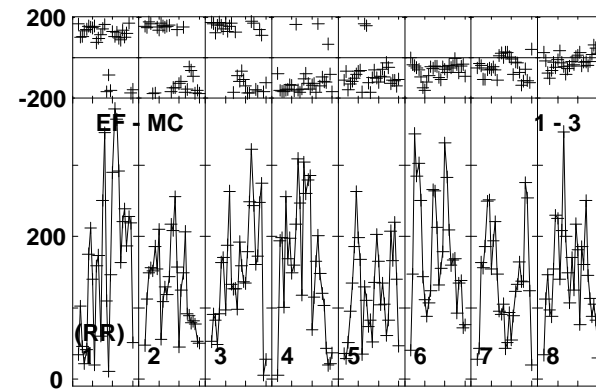
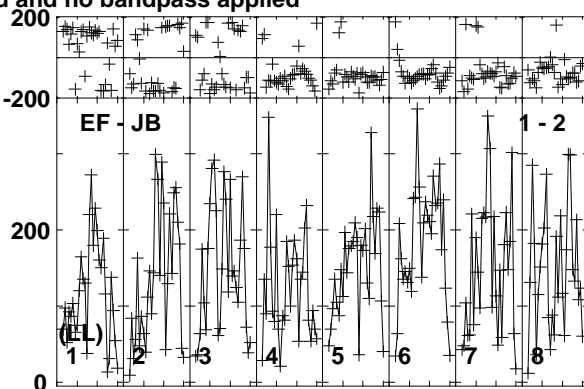
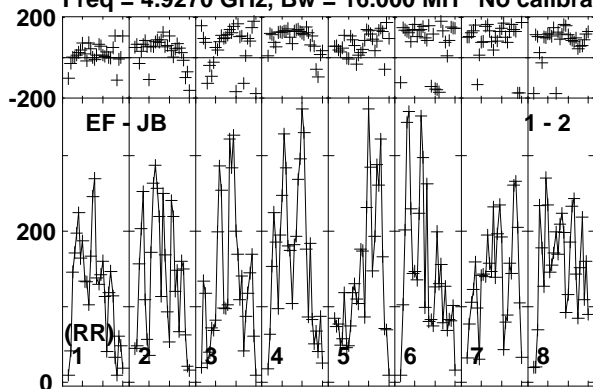

Lower frame: Micro Ampl Jy Top frame: Phas deg  
Vector averaged cross-power spectrum Baseline: EF (01) - JB (02)  
Timerange: 01/04:20:41 to 01/04:23:09

Plot file version 472 created 10-JUN-2016 17:22:49

CYGX1 RT013A.UVDATA.1

Freq = 4.9270 GHz, Bw = 16.000 MH No calibration applied and no bandpass applied

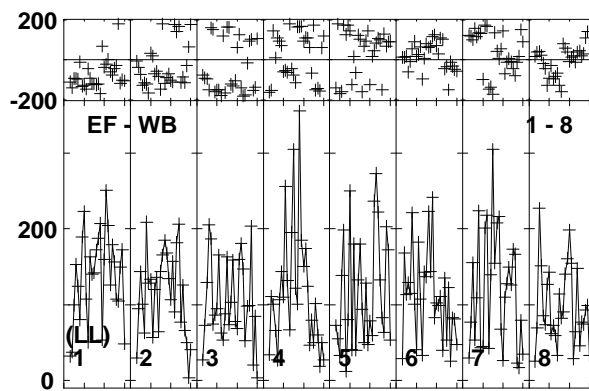
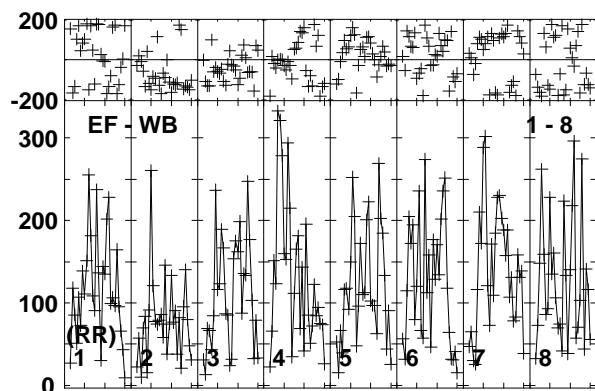
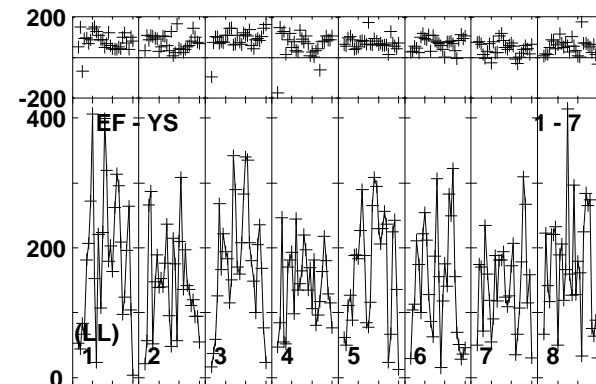
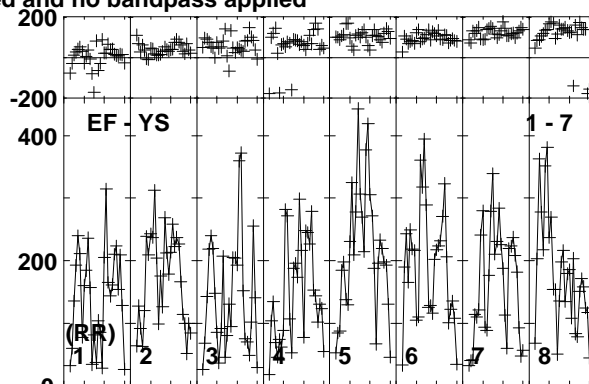
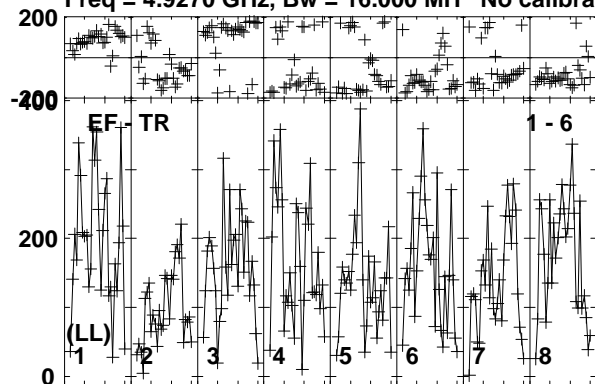

Lower frame: Micro Ampl Jy Top frame: Phas deg  
Vector averaged cross-power spectrum Baseline: EF (01) - TR (06)  
Timerange: 01/04:20:41 to 01/04:23:09

Plot file version 473 created 10-JUN-2016 17:22:49

J1957+3338 RT013A.UVDATA.1

Freq = 4.9270 GHz, Bw = 16.000 MH No calibration applied and no bandpass applied

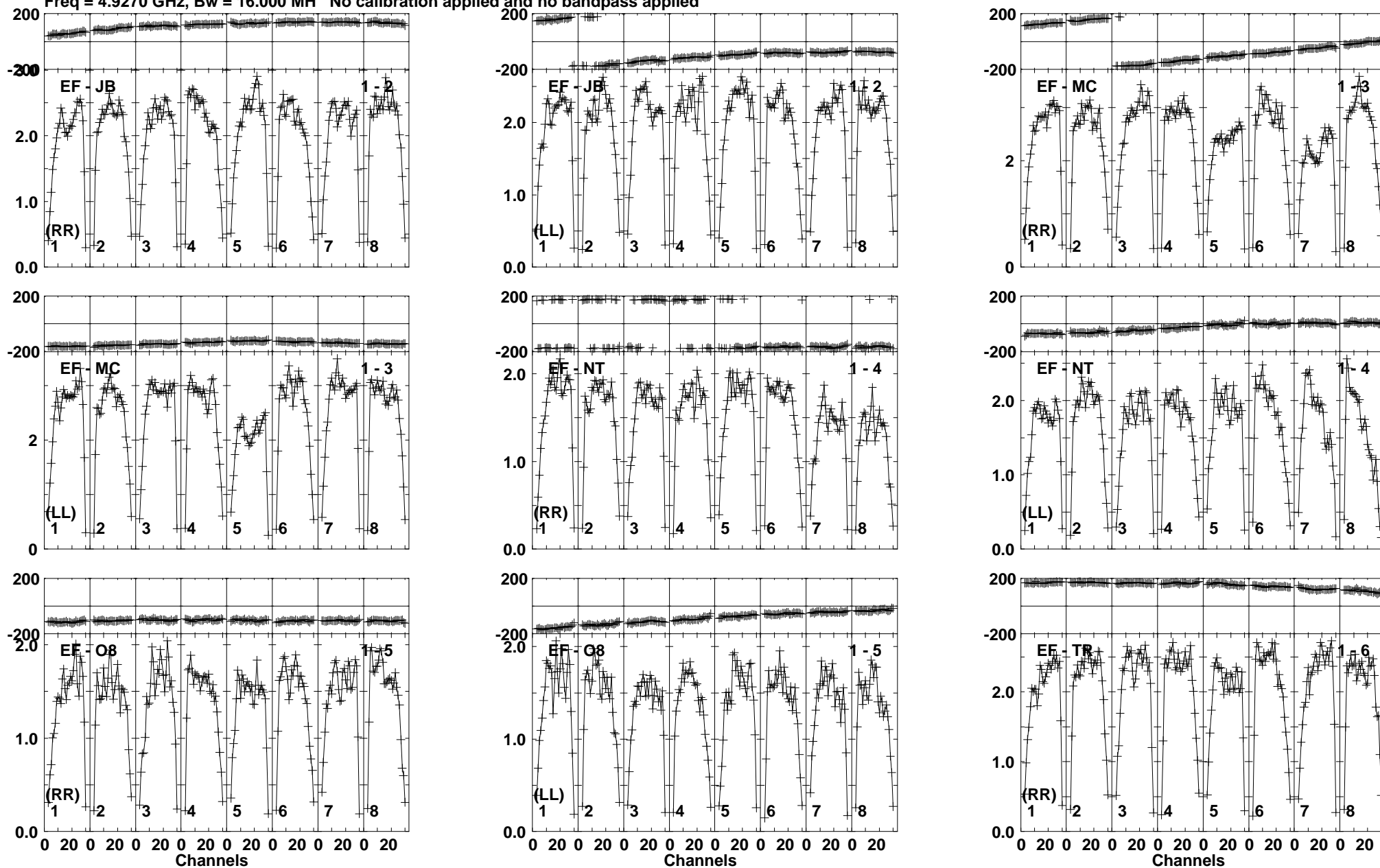

Lower frame: Milli Ampl Jy Top frame: Phas deg  
Vector averaged cross-power spectrum Baseline: EF (01) - JB (02)  
Timerange: 01/04:23:11 to 01/04:24:39

Plot file version 474 created 10-JUN-2016 17:22:50

J1957+3338 RT013A.UVDATA.1

Freq = 4.9270 GHz, Bw = 16.000 MH No calibration applied and no bandpass applied

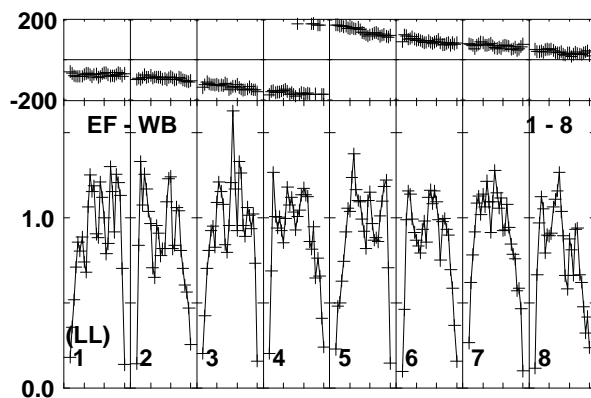
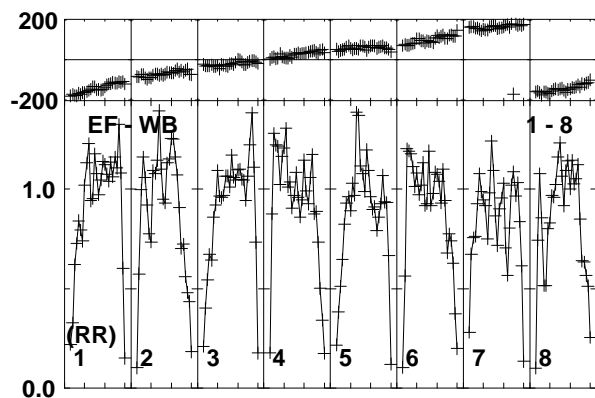
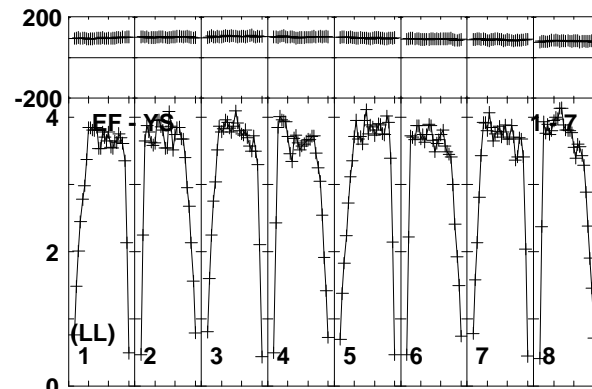
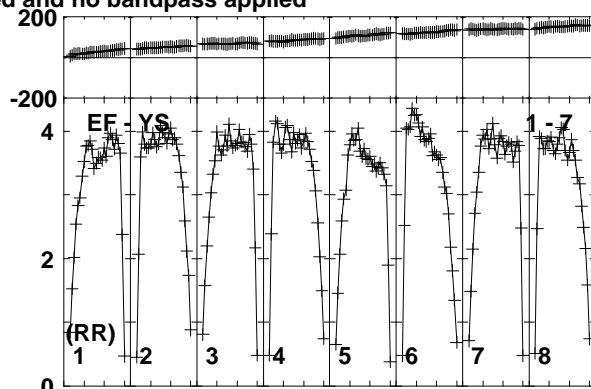
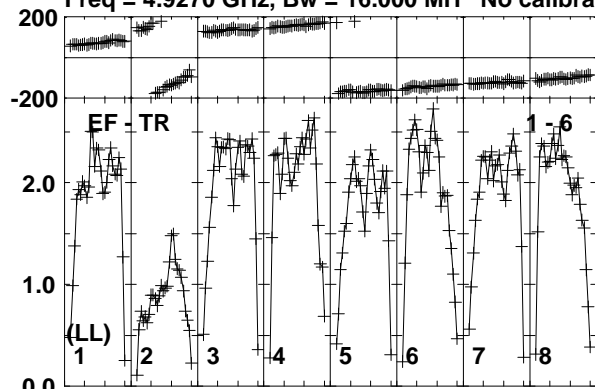

Lower frame: Milli Ampl Jy Top frame: Phas deg  
Vector averaged cross-power spectrum Baseline: EF (01) - TR (06)  
Timerange: 01/04:23:11 to 01/04:24:39



Plot file version 475 created 10-JUN-2016 17:22:50

CHECK RT013A.UVDATA.1

Freq = 4.9270 GHz, Bw = 16.000 MH No calibration applied and no bandpass applied

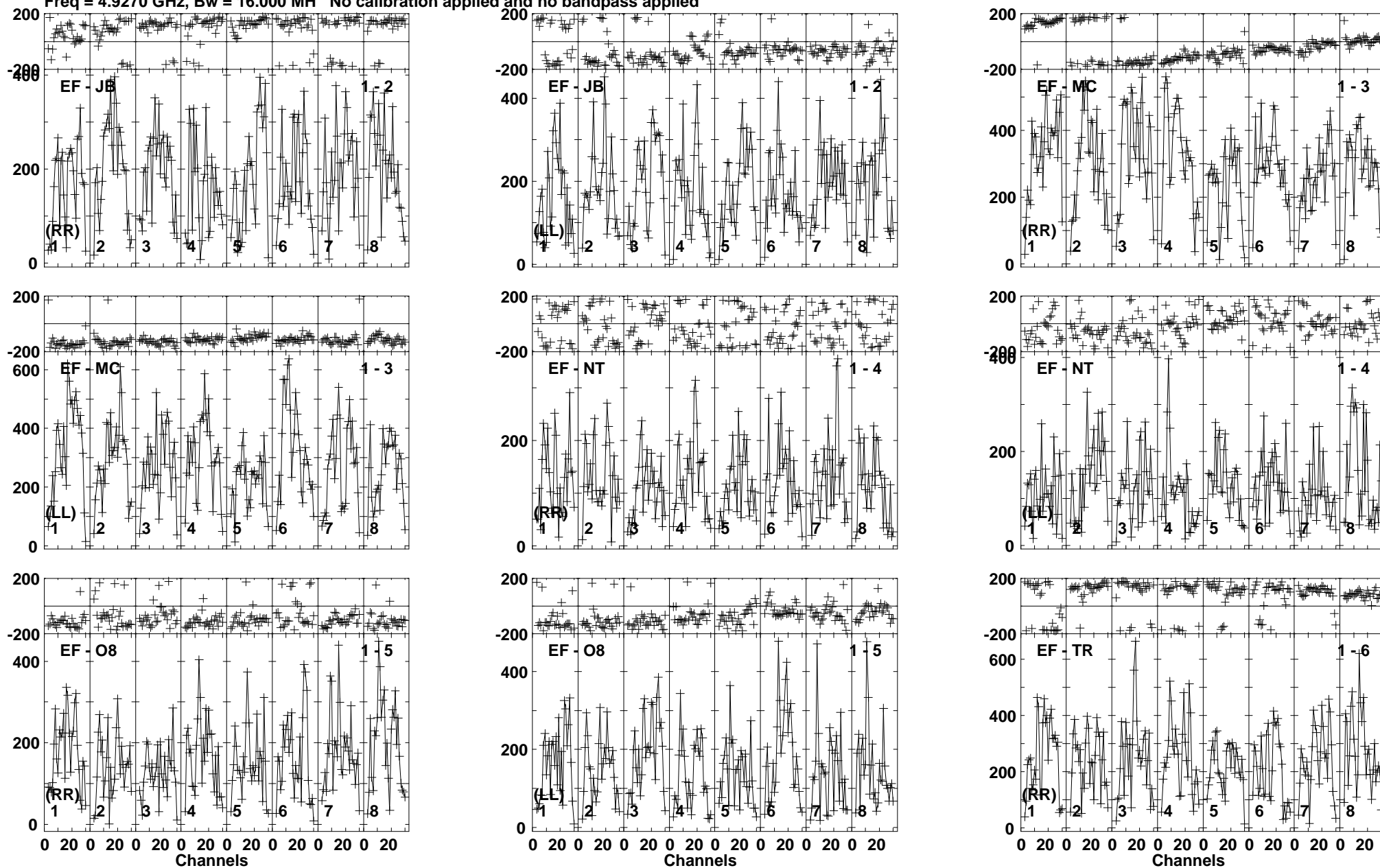

Lower frame: Micro Ampl Jy Top frame: Phas deg  
Vector averaged cross-power spectrum Baseline: EF (01) - JB (02)  
Timerange: 01/04:24:41 to 01/04:26:39

Plot file version 476 created 10-JUN-2016 17:22:50

CHECK RT013A.UVDATA.1

Freq = 4.9270 GHz, Bw = 16.000 MH No calibration applied and no bandpass applied

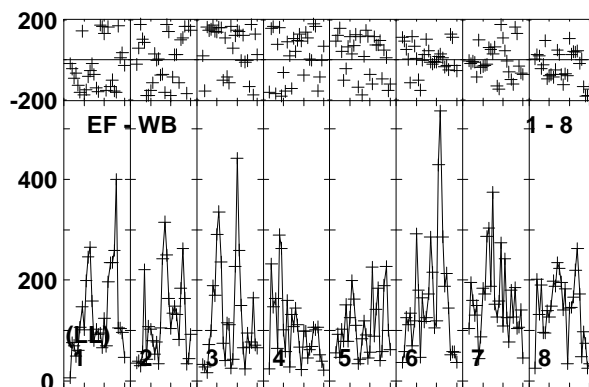
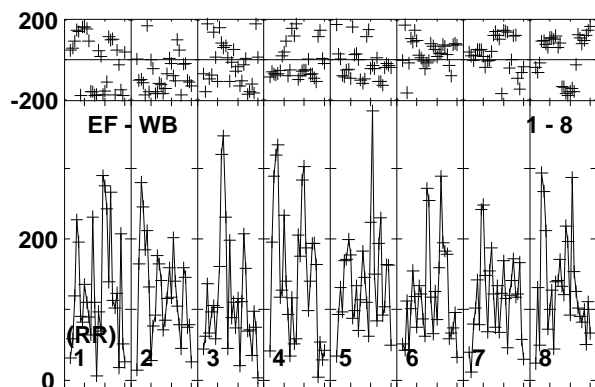
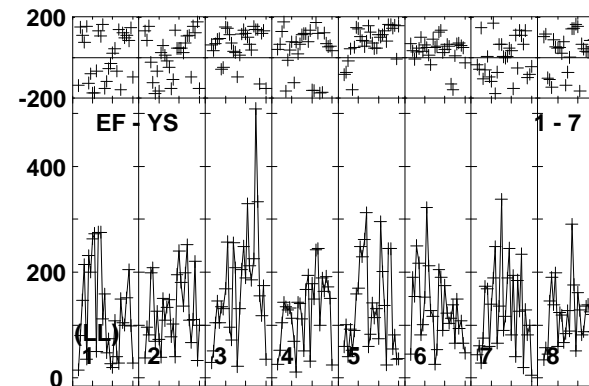
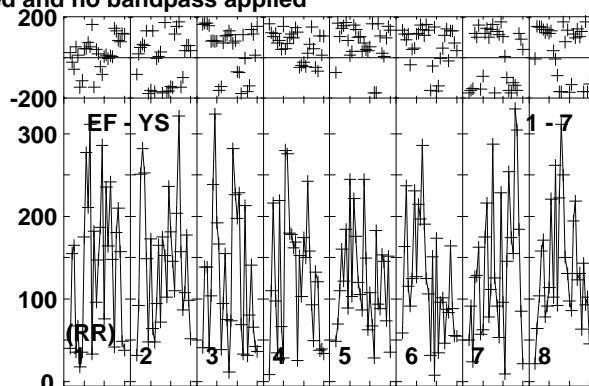
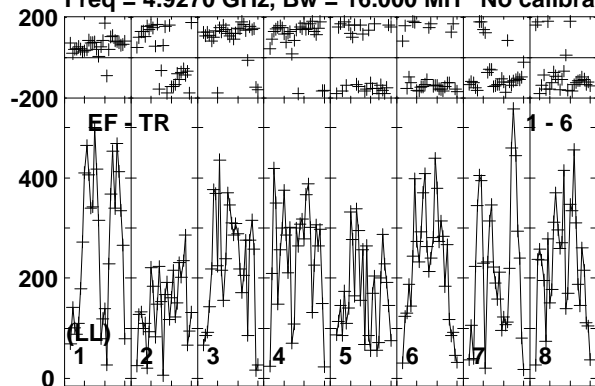

Lower frame: Micro Ampl Jy Top frame: Phas deg  
Vector averaged cross-power spectrum Baseline: EF (01) - TR (06)  
Timerange: 01/04:24:41 to 01/04:26:39

Plot file version 477 created 10-JUN-2016 17:22:50

CYGX1 RT013A.UVDATA.1

Freq = 4.9270 GHz, Bw = 16.000 MH No calibration applied and no bandpass applied

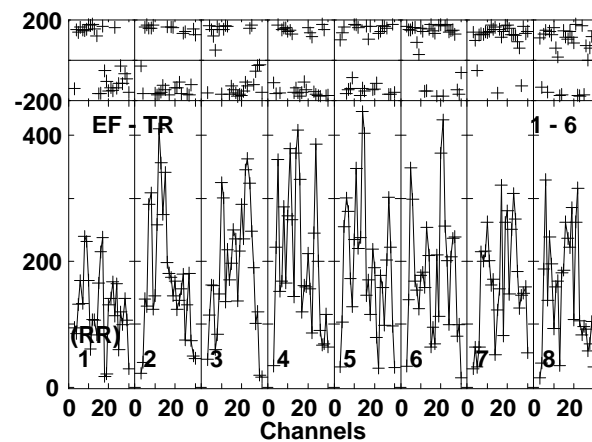
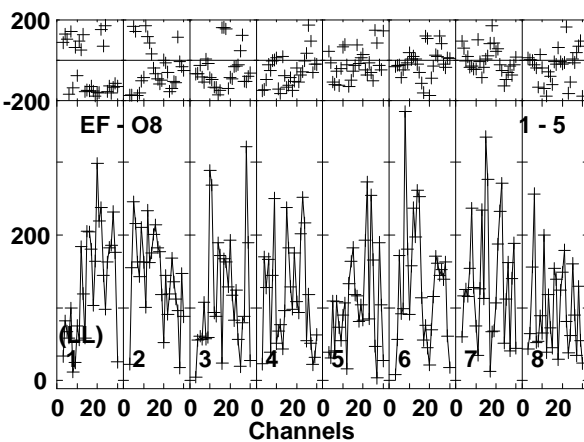
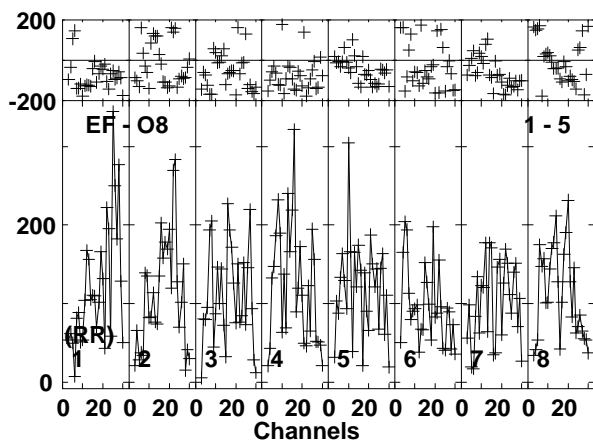
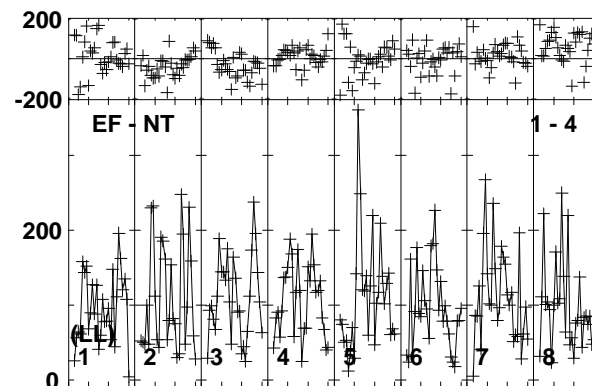
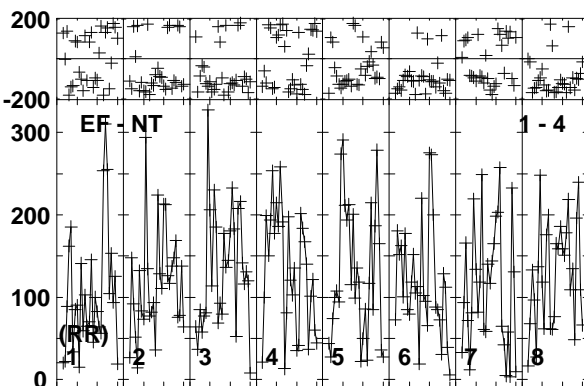
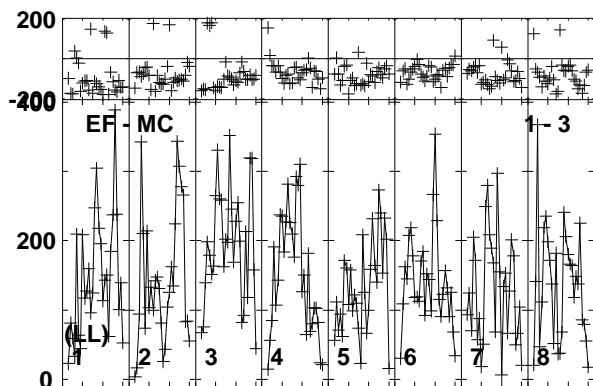
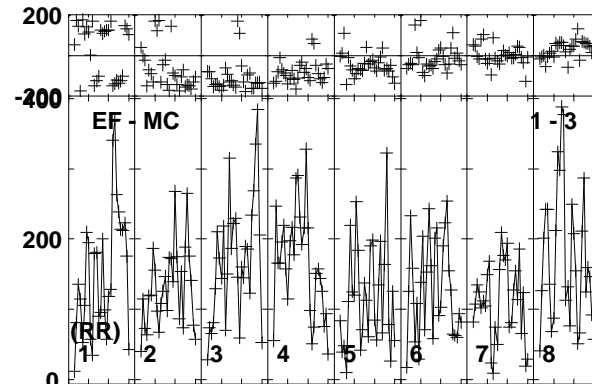
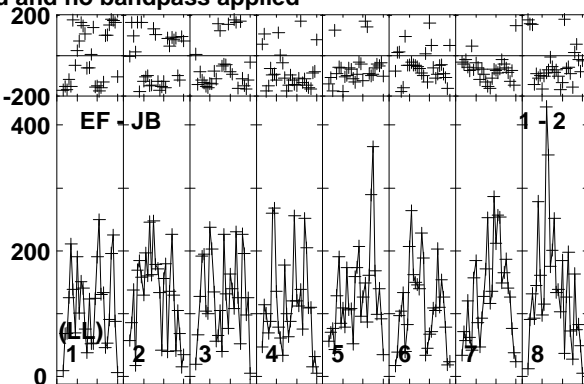
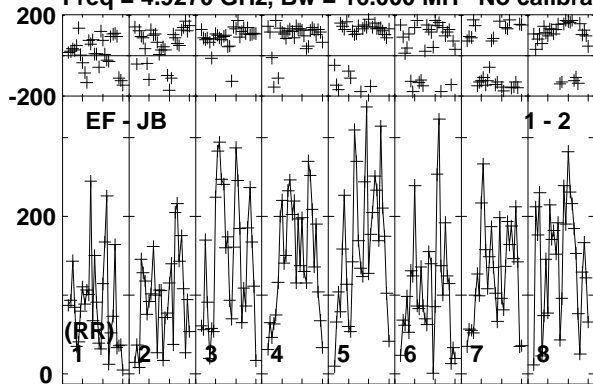

Lower frame: Micro Ampl Jy Top frame: Phas deg  
Vector averaged cross-power spectrum Baseline: EF (01) - JB (02)  
Timerange: 01/04:26:40 to 01/04:29:10

Plot file version 478 created 10-JUN-2016 17:22:50

CYGX1 RT013A.UVDATA.1

Freq = 4.9270 GHz, Bw = 16.000 MH No calibration applied and no bandpass applied

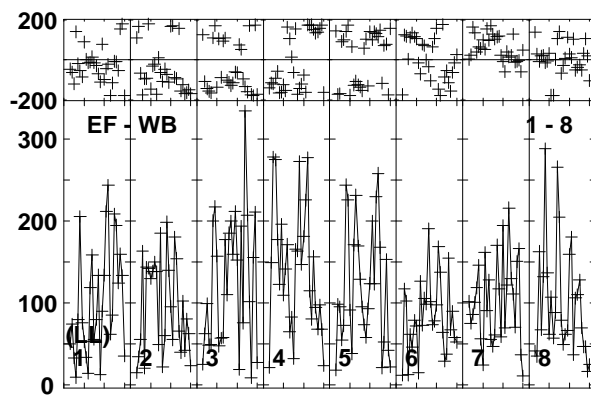
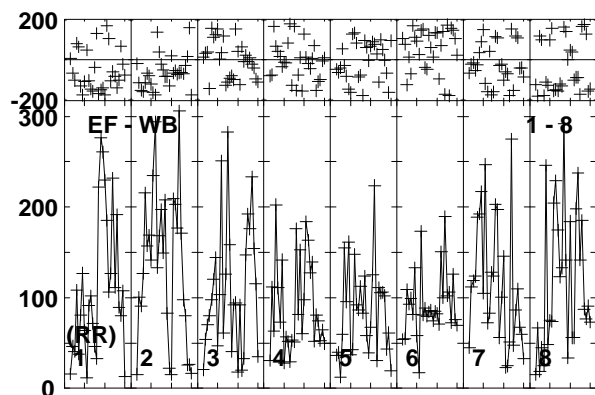
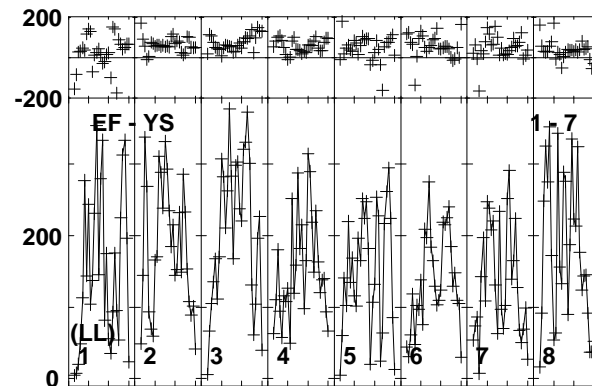
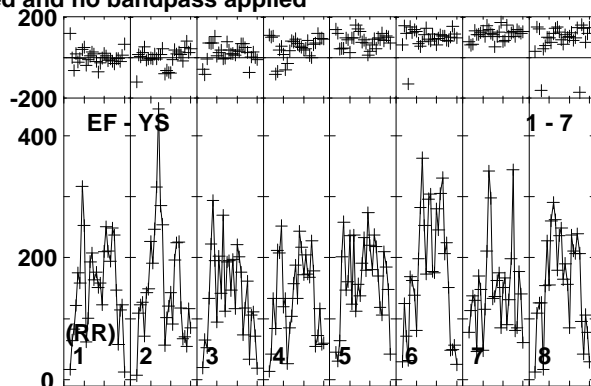
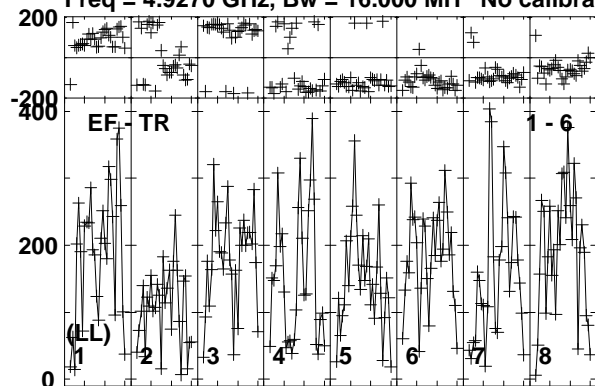

Lower frame: Micro Ampl Jy Top frame: Phas deg  
Vector averaged cross-power spectrum Baseline: EF (01) - TR (06)  
Timerange: 01/04:26:40 to 01/04:29:10

Plot file version 479 created 10-JUN-2016 17:22:50

J1957+3338 RT013A.UVDATA.1

Freq = 4.9270 GHz, Bw = 16.000 MH No calibration applied and no bandpass applied

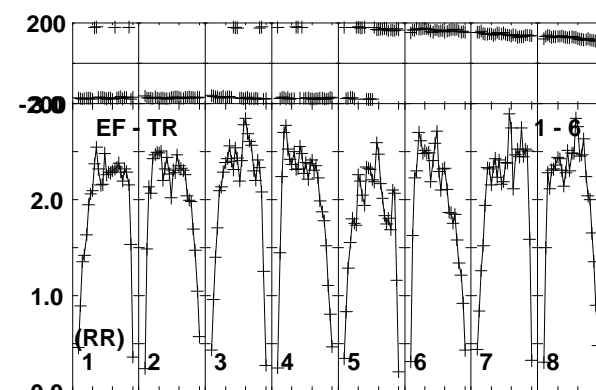
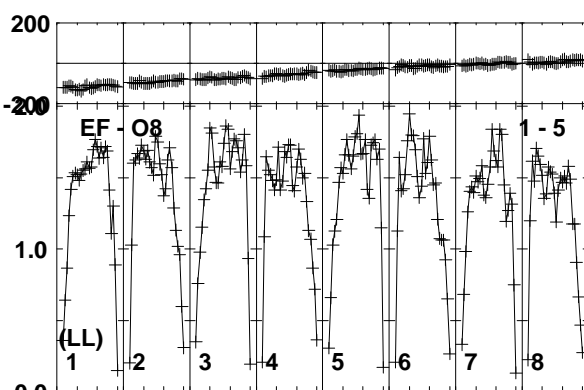
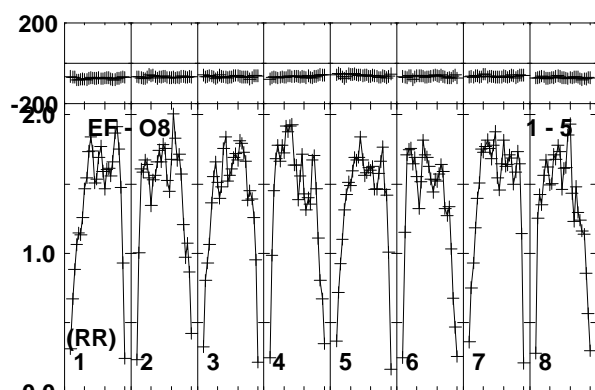
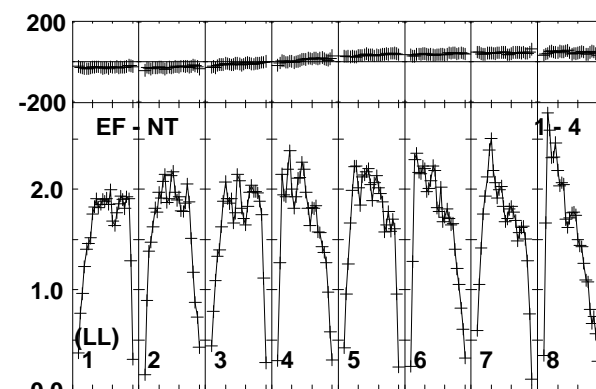
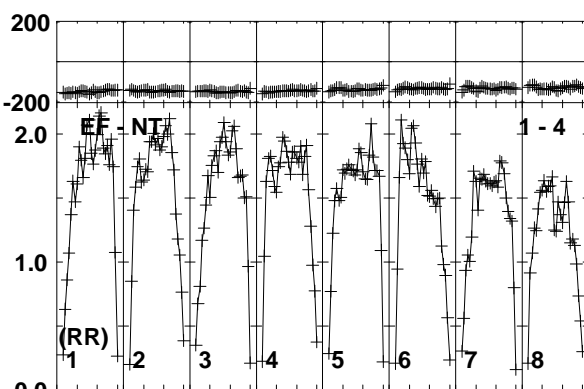
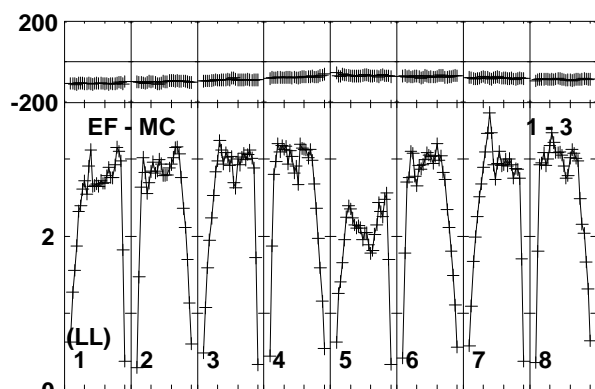
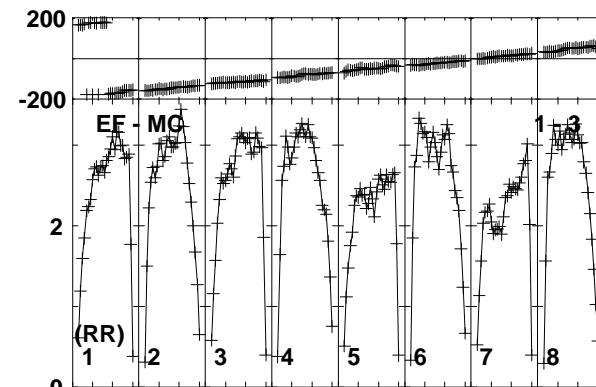
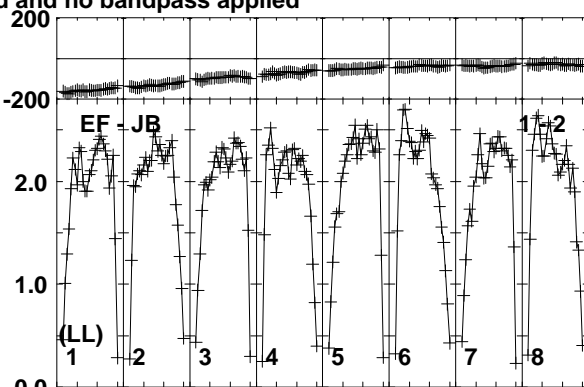
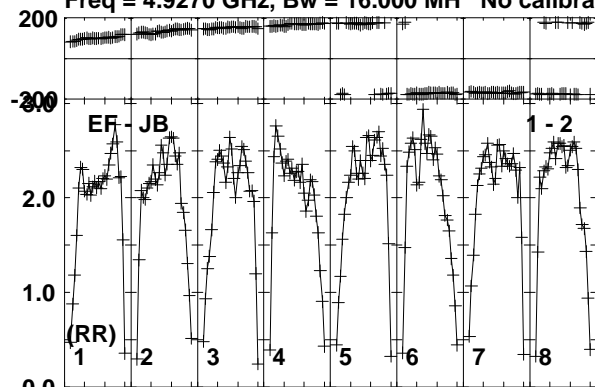

Lower frame: Milli Ampl Jy Top frame: Phas deg  
Vector averaged cross-power spectrum Baseline: EF (01) - JB (02)  
Timerange: 01/04:29:10 to 01/04:30:39

Plot file version 480 created 10-JUN-2016 17:22:50

J1957+3338 RT013A.UVDATA.1

Freq = 4.9270 GHz, Bw = 16.000 MH No calibration applied and no bandpass applied

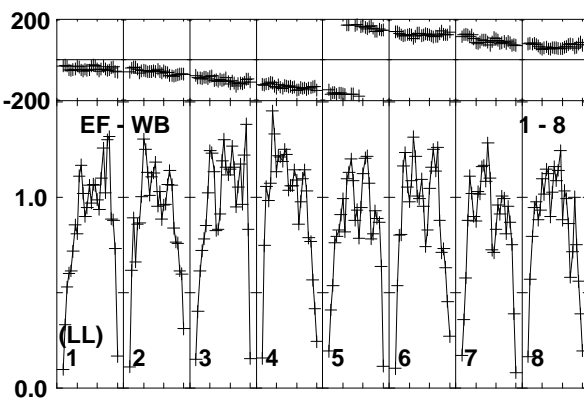
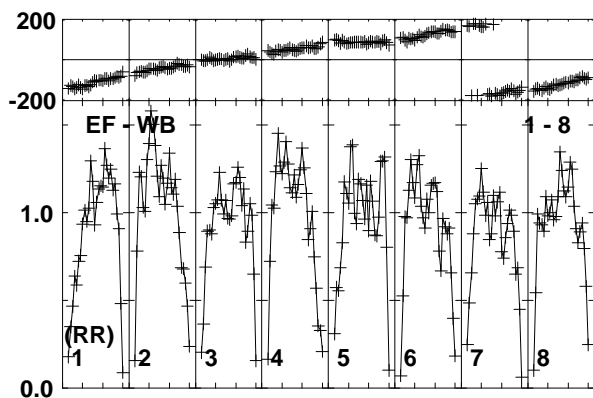
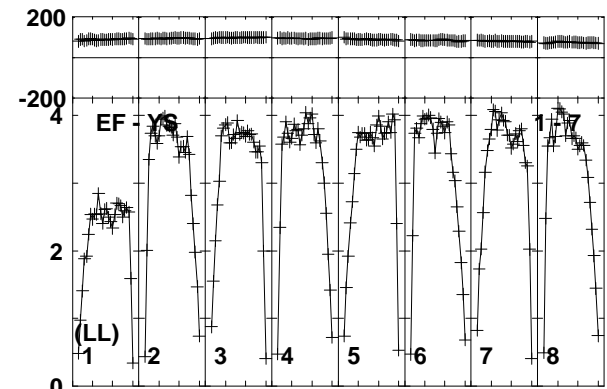
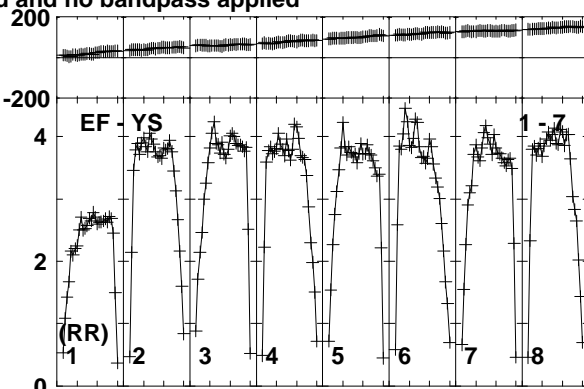
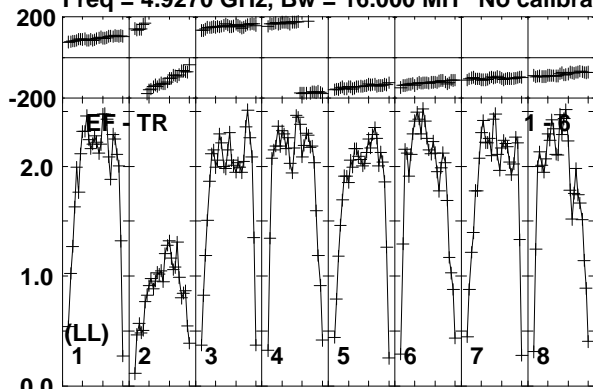

Lower frame: Milli Ampl Jy Top frame: Phas deg  
Vector averaged cross-power spectrum Baseline: EF (01) - TR (06)  
Timerange: 01/04:29:10 to 01/04:30:39

Plot file version 481 created 10-JUN-2016 17:22:50  
 CHECK RT013A.UVDATA.1  
 Freq = 4.9270 GHz, Bw = 16.000 MH No calibration applied and no bandpass applied

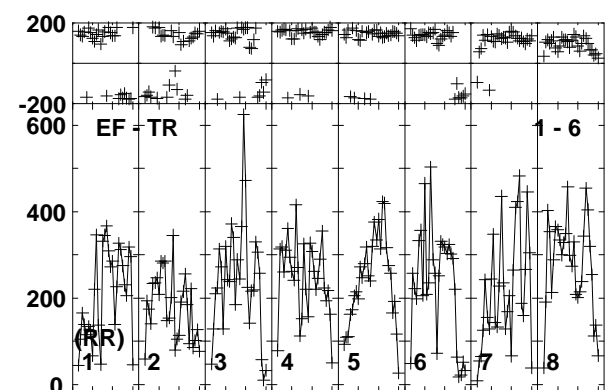
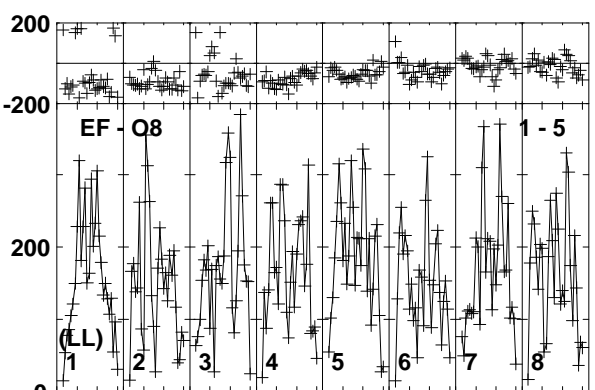
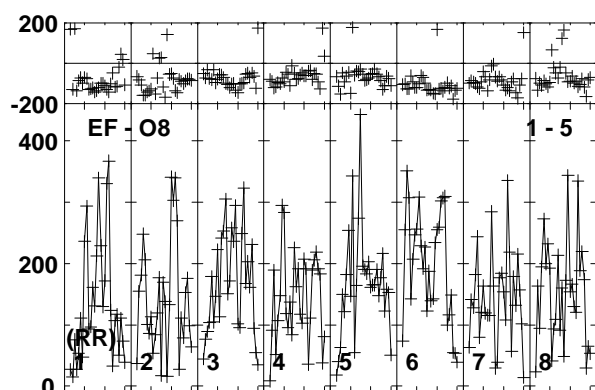
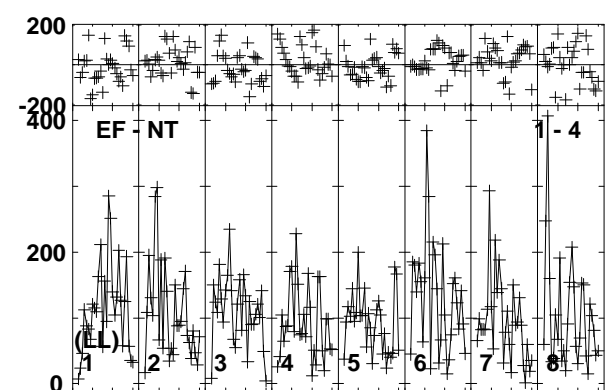
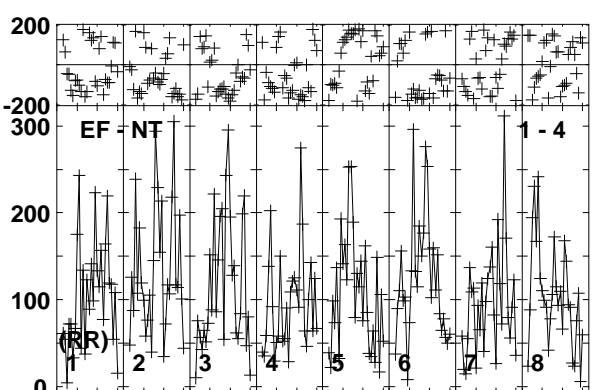
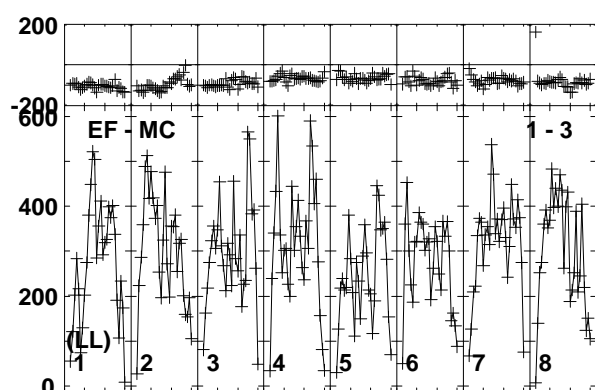
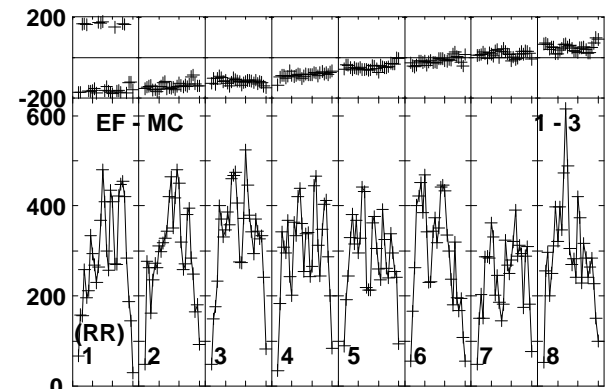
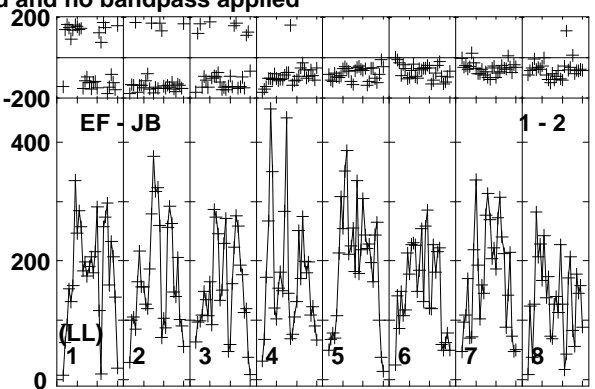
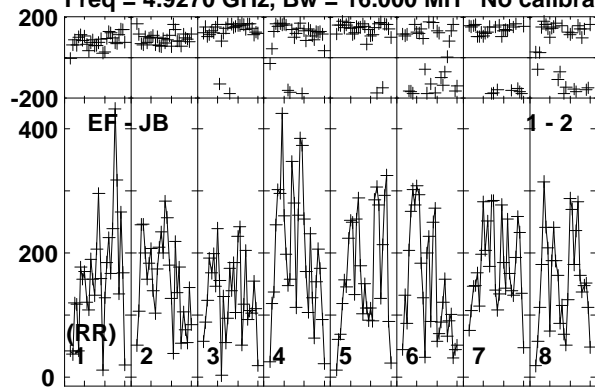

Lower frame: Micro Ampl Jy Top frame: Phas deg  
 Vector averaged cross-power spectrum Baseline: EF (01) - JB (02)  
 Timerange: 01/04:31:21 to 01/04:33:20

Plot file version 482 created 10-JUN-2016 17:22:50

CHECK RT013A.UVDATA.1

Freq = 4.9270 GHz, Bw = 16.000 MH No calibration applied and no bandpass applied

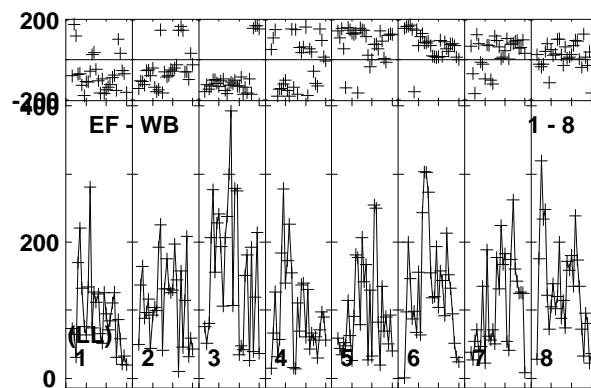
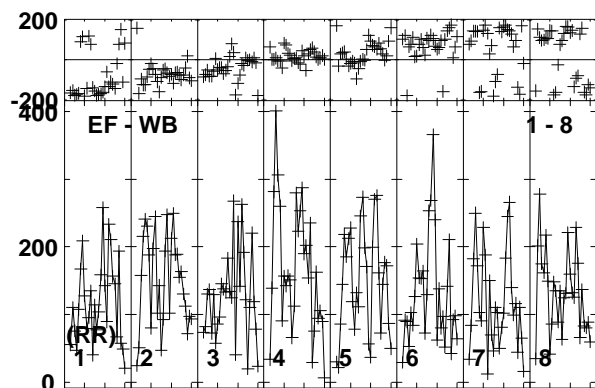
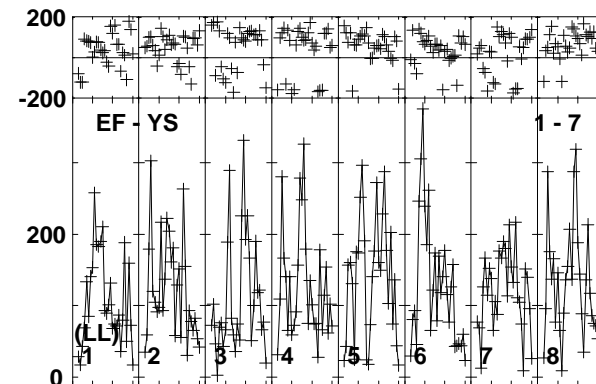
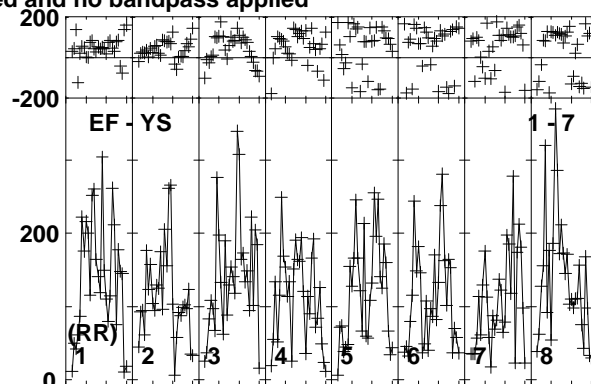
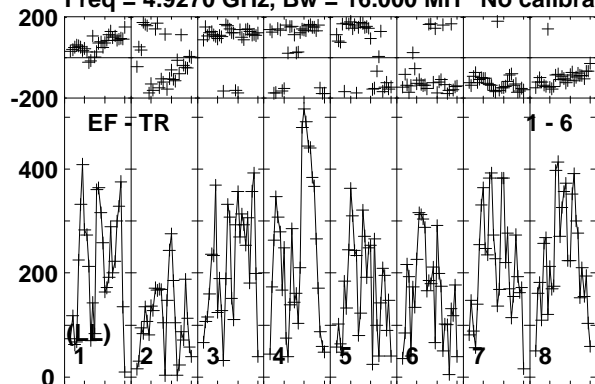

Lower frame: Micro Ampl Jy Top frame: Phas deg  
Vector averaged cross-power spectrum Baseline: EF (01) - TR (06)  
Timerange: 01/04:31:21 to 01/04:33:20



Plot file version 483 created 10-JUN-2016 17:22:50

CYGX1 RT013A.UVDATA.1

Freq = 4.9270 GHz, Bw = 16.000 MH No calibration applied and no bandpass applied

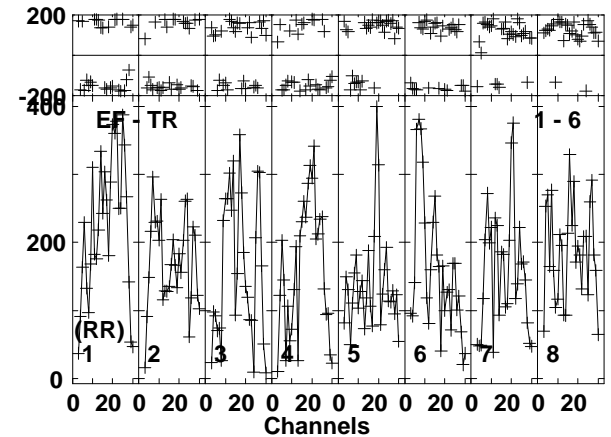
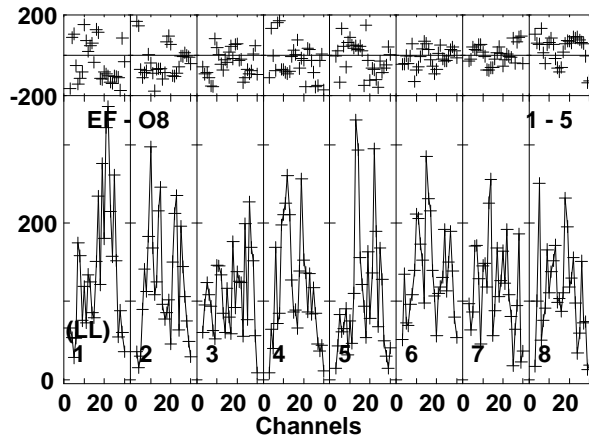
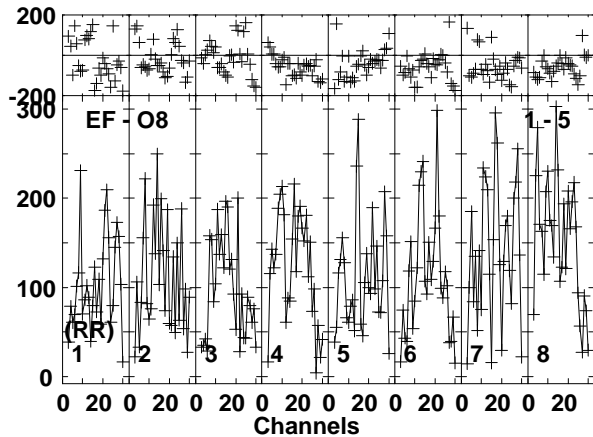
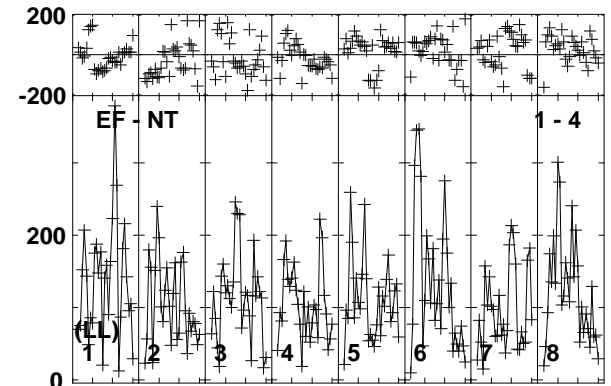
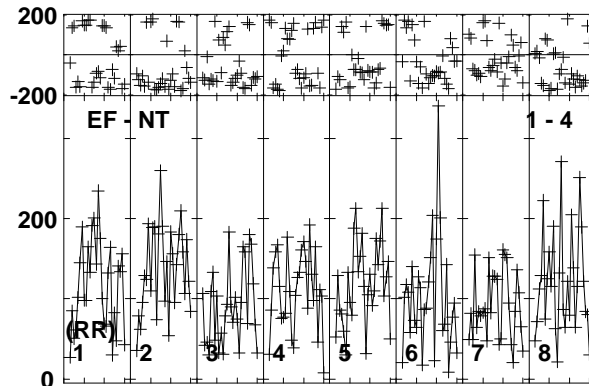
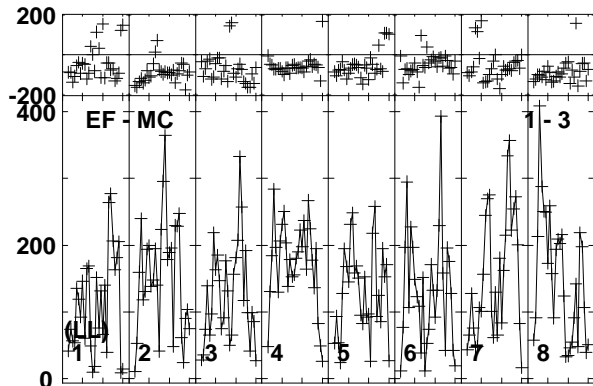
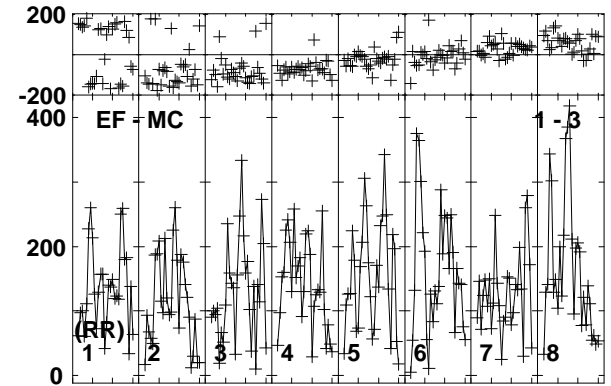
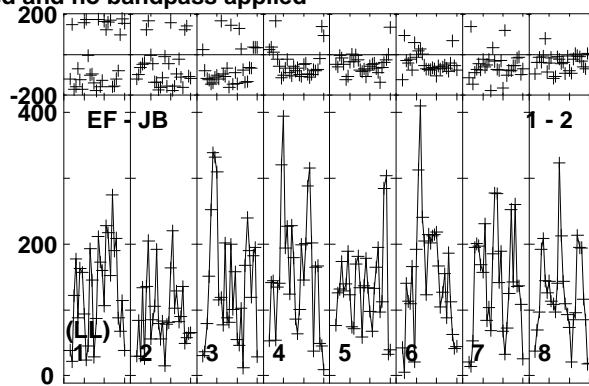
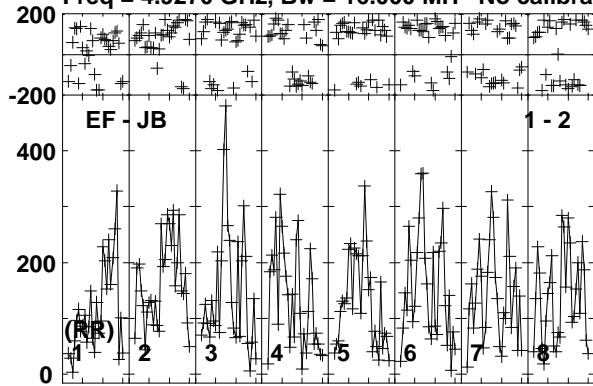

Lower frame: Micro Ampl Jy Top frame: Phas deg  
Vector averaged cross-power spectrum Baseline: EF (01) - JB (02)  
Timerange: 01/04:33:21 to 01/04:35:49

Plot file version 484 created 10-JUN-2016 17:22:51

CYGX1 RT013A.UVDATA.1

Freq = 4.9270 GHz, Bw = 16.000 MH No calibration applied and no bandpass applied

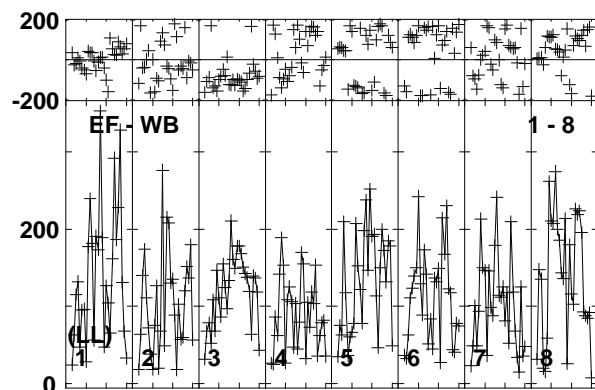
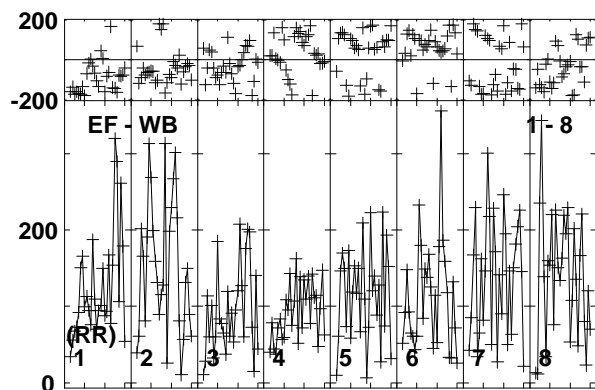
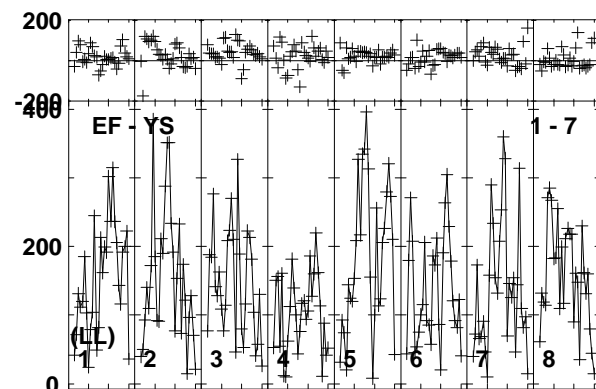
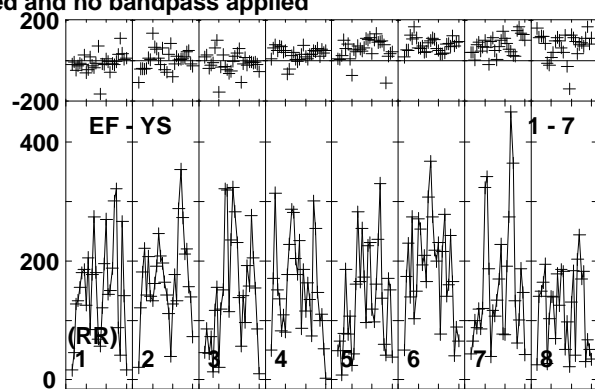
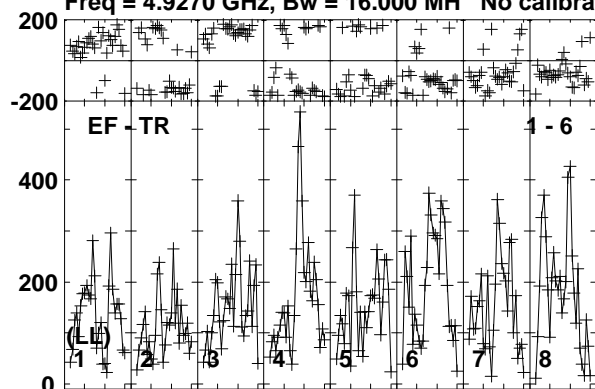

Lower frame: Micro Ampl Jy Top frame: Phas deg  
Vector averaged cross-power spectrum Baseline: EF (01) - TR (06)  
Timerange: 01/04:33:21 to 01/04:35:49

Plot file version 485 created 10-JUN-2016 17:22:51

J1957+3338 RT013A.UVDATA.1

Freq = 4.9270 GHz, Bw = 16.000 MH No calibration applied and no bandpass applied

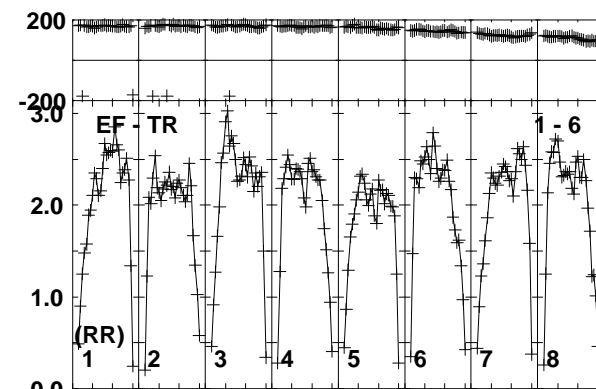
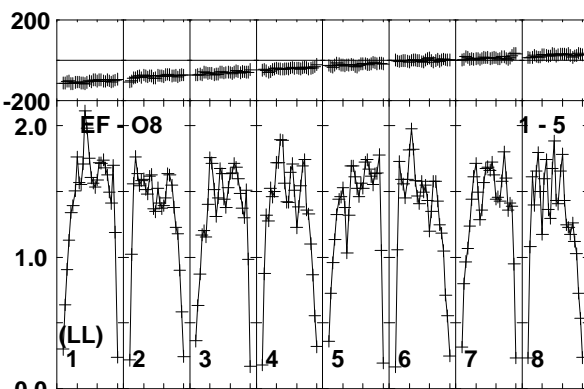
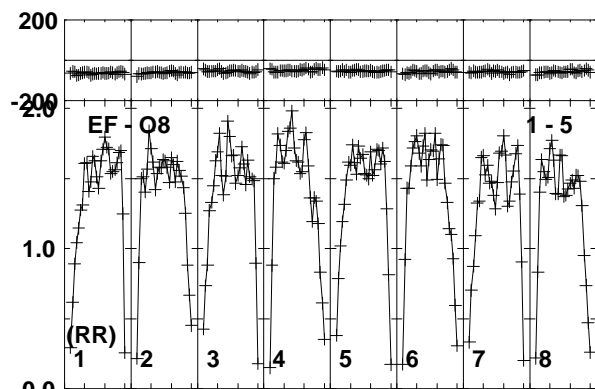
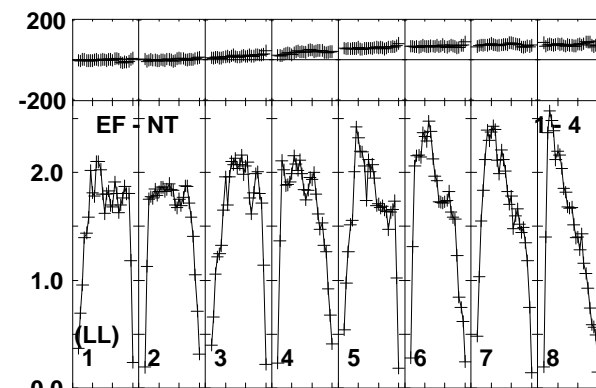
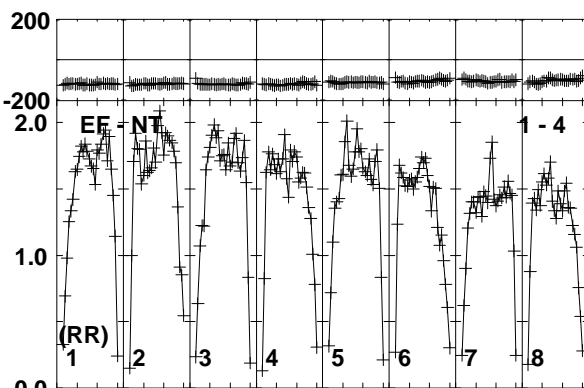
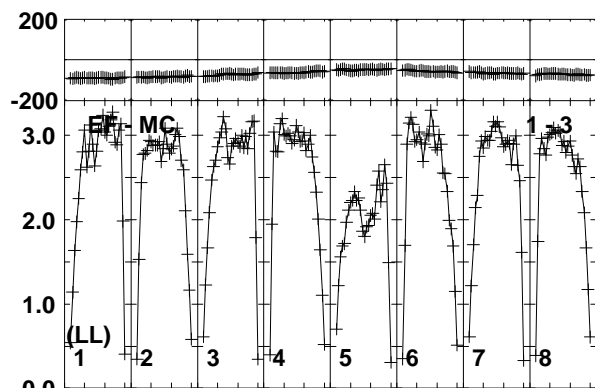
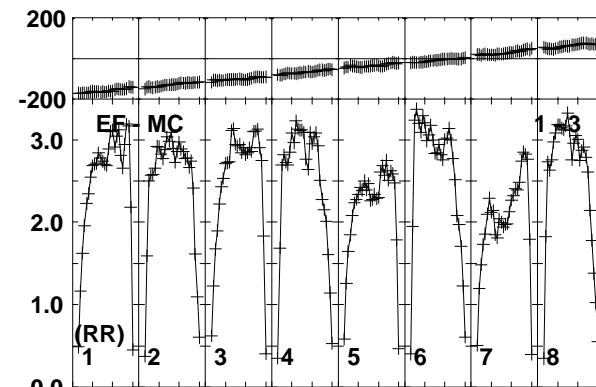
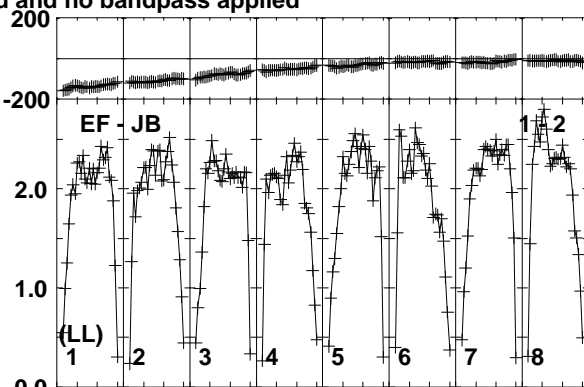
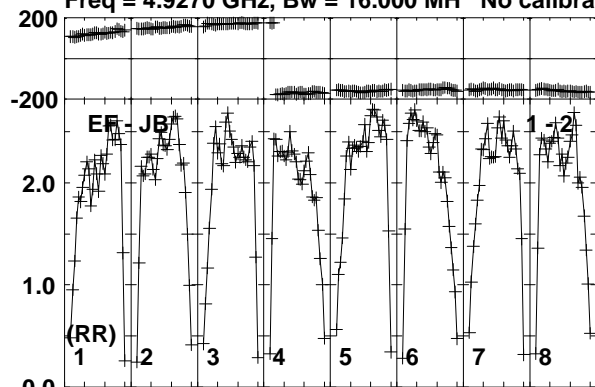

Lower frame: Milli Ampl Jy Top frame: Phas deg

Vector averaged cross-power spectrum Baseline: EF (01) - JB (02)

Timerange: 01/04:35:50 to 01/04:37:19

Plot file version 486 created 10-JUN-2016 17:22:51

J1957+3338 RT013A.UVDATA.1

Freq = 4.9270 GHz, Bw = 16.000 MH No calibration applied and no bandpass applied

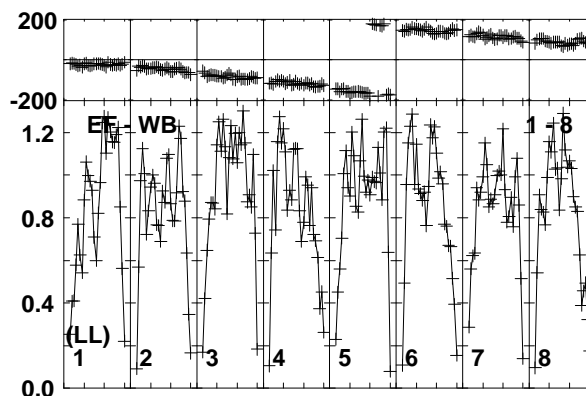
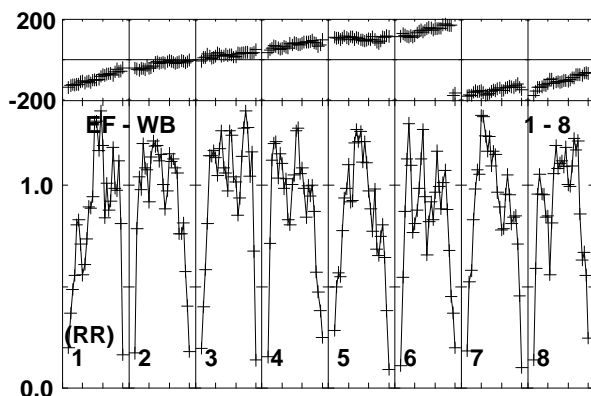
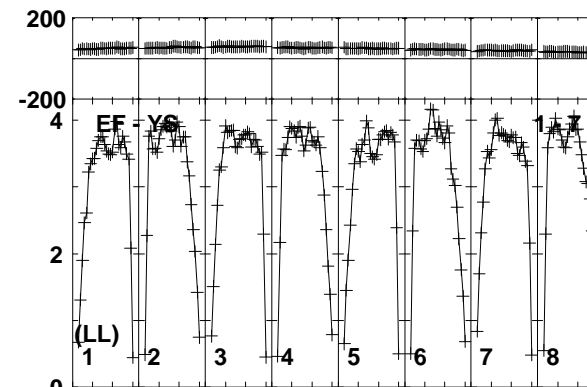
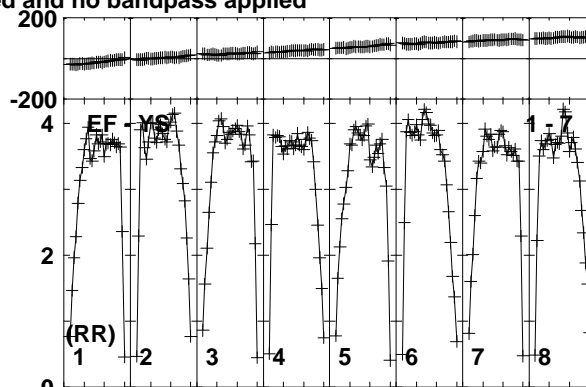
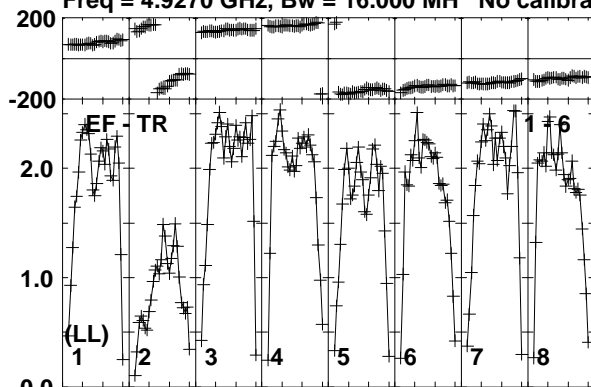

Lower frame: Milli Ampl Jy Top frame: Phas deg  
Vector averaged cross-power spectrum Baseline: EF (01) - TR (06)  
Timerange: 01/04:35:50 to 01/04:37:19

Plot file version 487 created 10-JUN-2016 17:22:51

CHECK RT013A.UVDATA.1

Freq = 4.9270 GHz, Bw = 16.000 MH No calibration applied and no bandpass applied

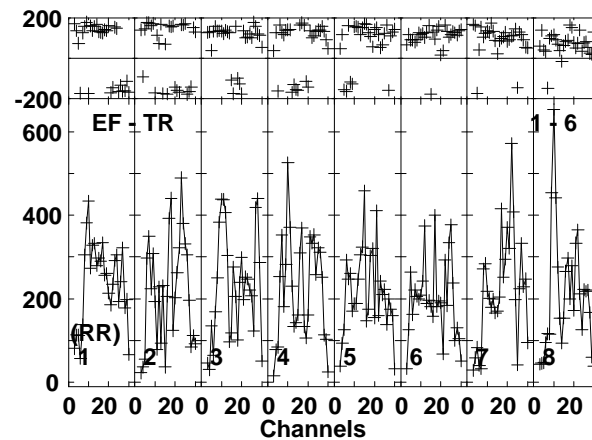
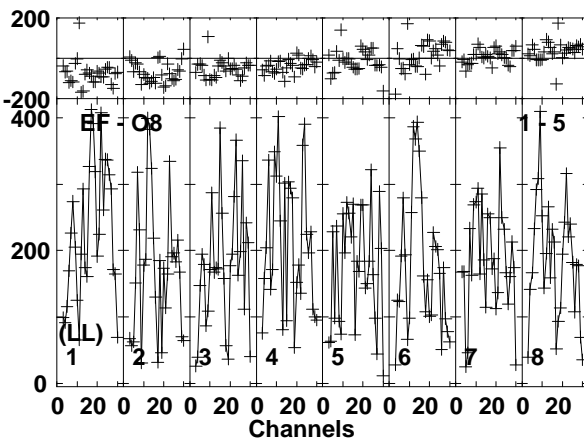
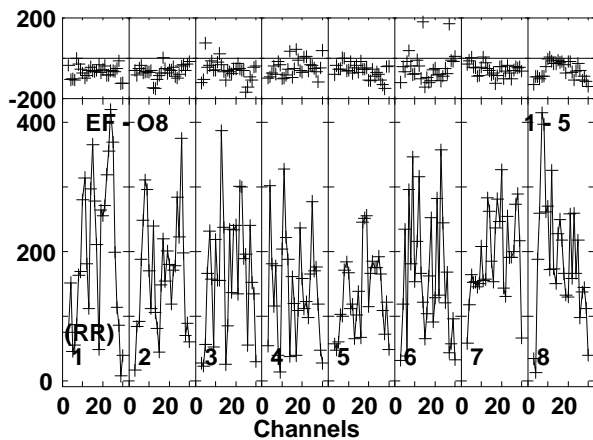
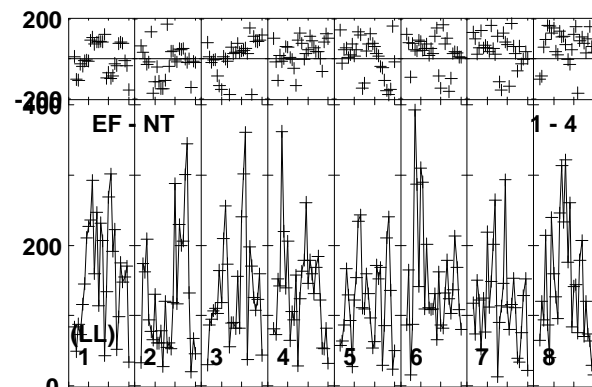
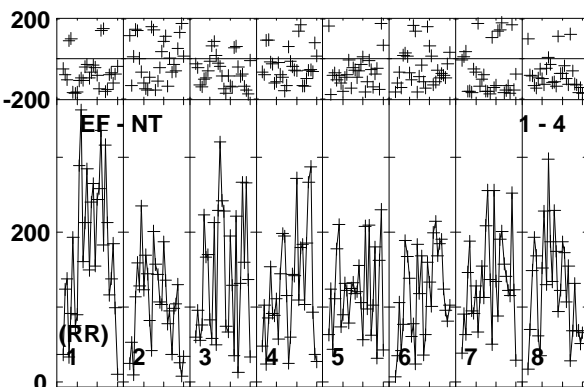
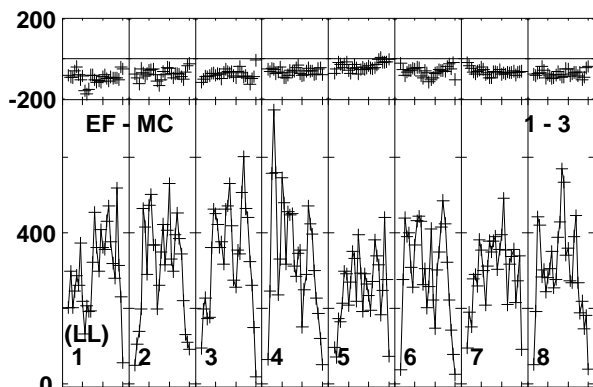
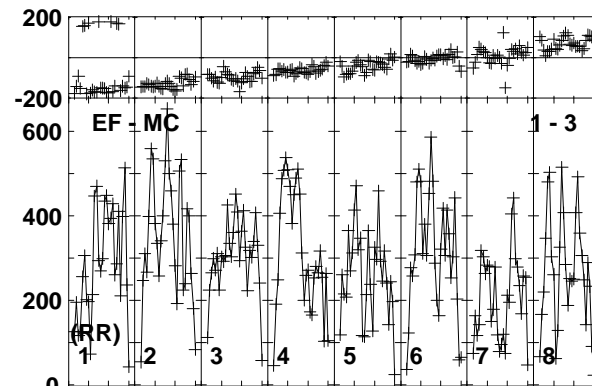
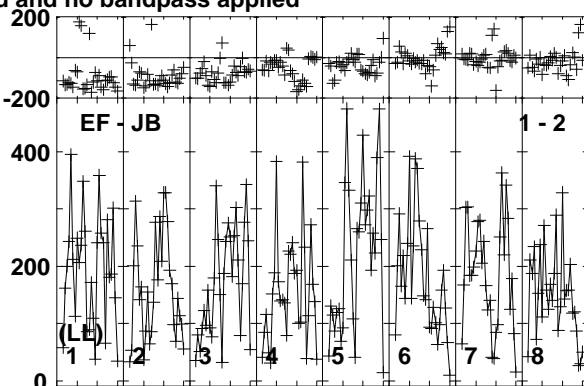
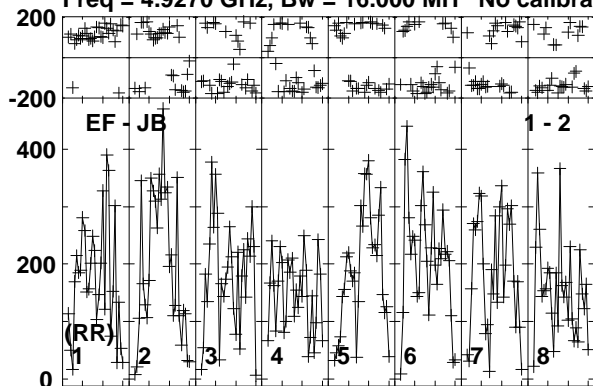

Lower frame: Micro Ampl Jy Top frame: Phas deg  
Vector averaged cross-power spectrum Baseline: EF (01) - JB (02)  
Timerange: 01/04:37:20 to 01/04:39:19

Plot file version 488 created 10-JUN-2016 17:22:51

CHECK RT013A.UVDATA.1

Freq = 4.9270 GHz, Bw = 16.000 MH No calibration applied and no bandpass applied

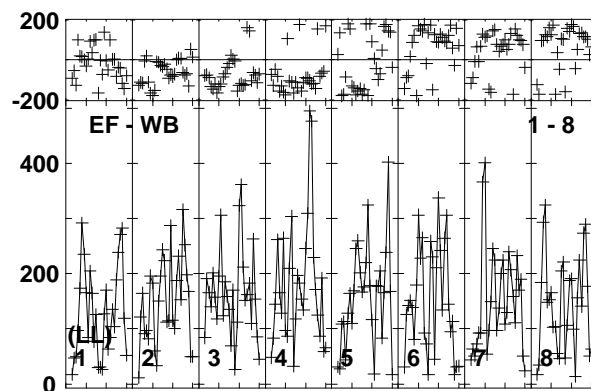
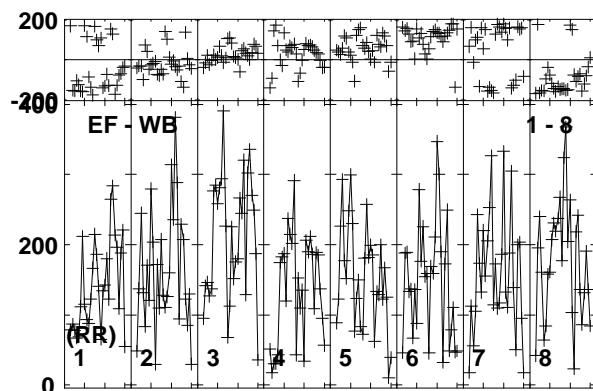
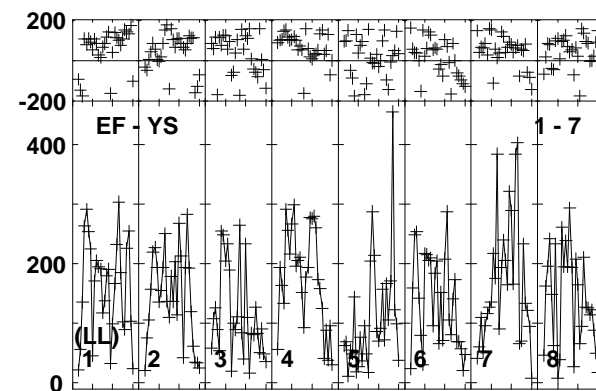
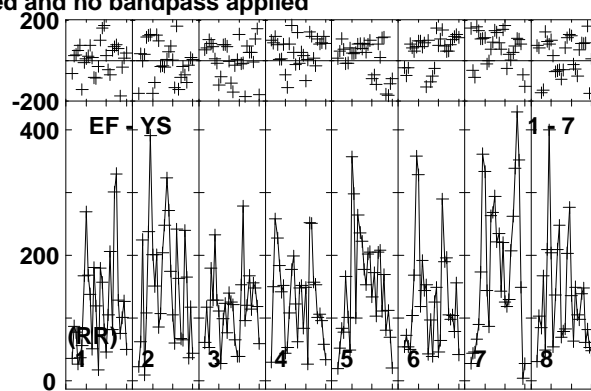
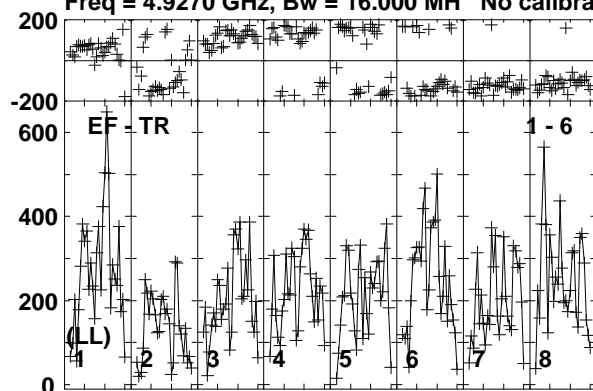

Lower frame: Micro Ampl Jy Top frame: Phas deg  
Vector averaged cross-power spectrum Baseline: EF (01) - TR (06)  
Timerange: 01/04:37:20 to 01/04:39:19

Plot file version 489 created 10-JUN-2016 17:22:51

CYGX1 RT013A.UVDATA.1

Freq = 4.9270 GHz, Bw = 16.000 MH No calibration applied and no bandpass applied

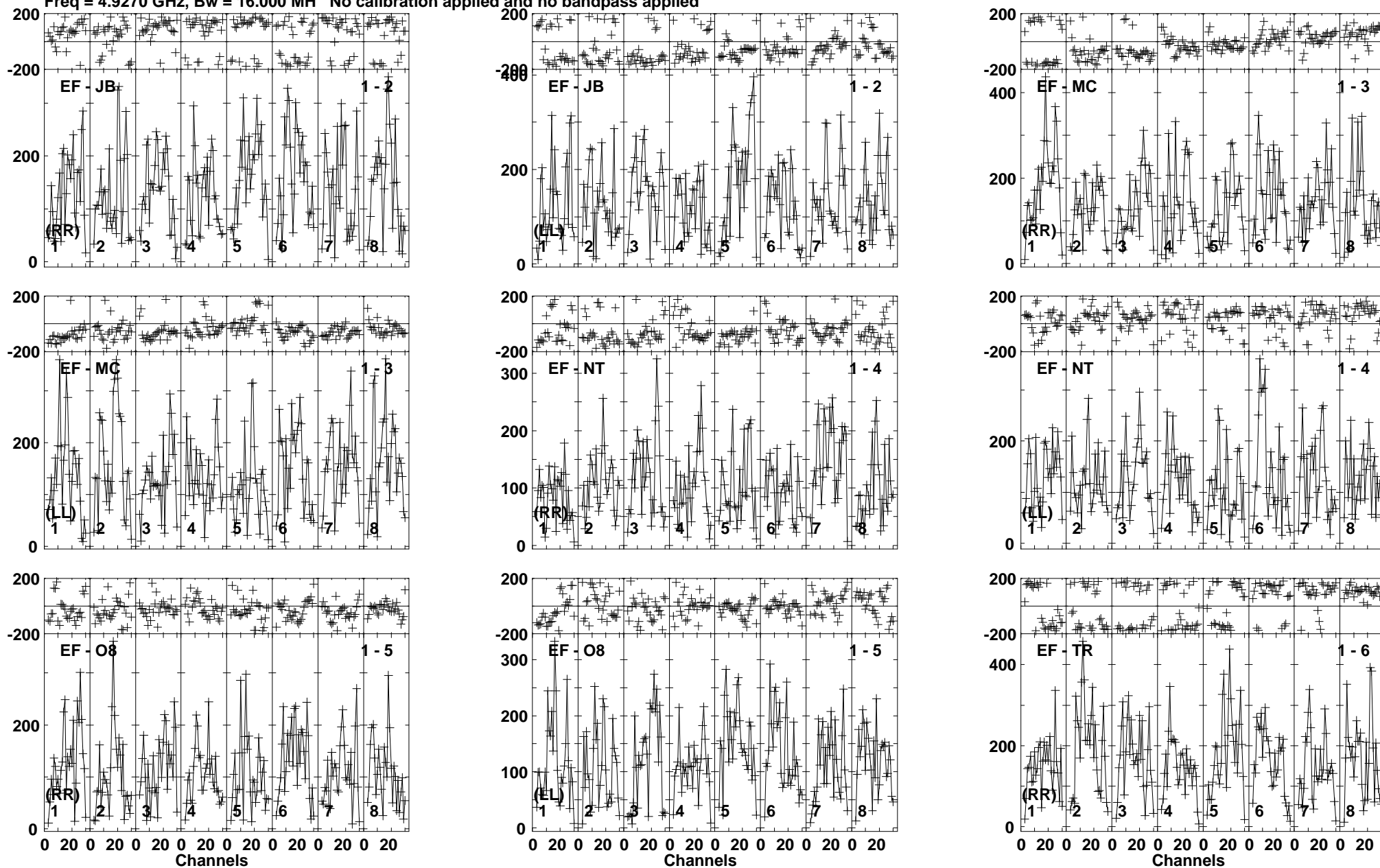

Lower frame: Micro Ampl Jy Top frame: Phas deg  
Vector averaged cross-power spectrum Baseline: EF (01) - JB (02)  
Timerange: 01/04:39:20 to 01/04:41:50

Plot file version 490 created 10-JUN-2016 17:22:51

CYGX1 RT013A.UVDATA.1

Freq = 4.9270 GHz, Bw = 16.000 MH No calibration applied and no bandpass applied

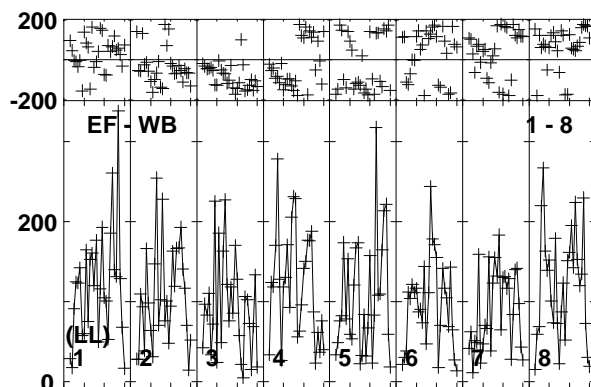
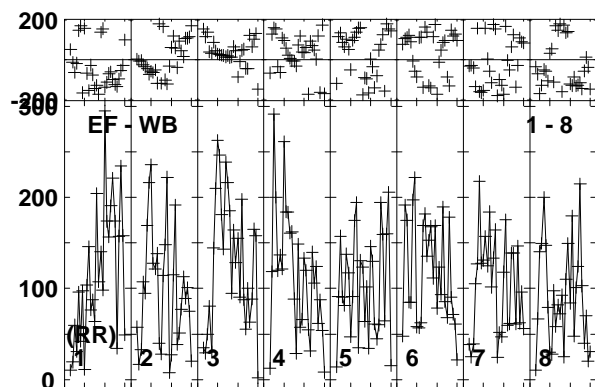
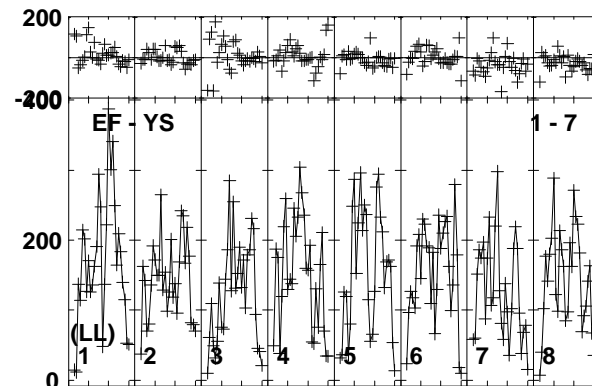
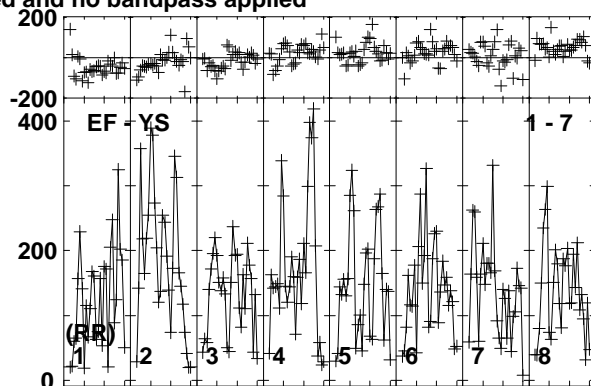
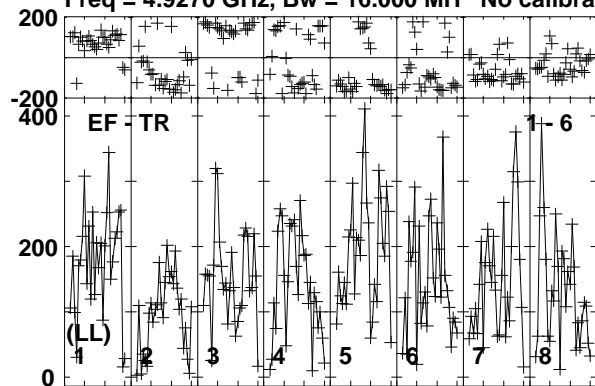

Lower frame: Micro Ampl Jy Top frame: Phas deg  
Vector averaged cross-power spectrum Baseline: EF (01) - TR (06)  
Timerange: 01/04:39:20 to 01/04:41:50



Plot file version 491 created 10-JUN-2016 17:22:51

J1957+3338 RT013A.UVDATA.1

Freq = 4.9270 GHz, Bw = 16.000 MH No calibration applied and no bandpass applied

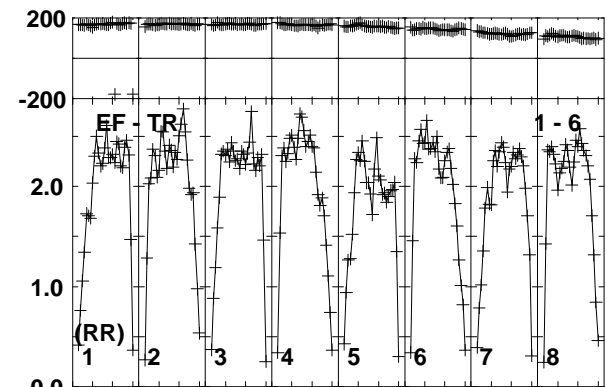
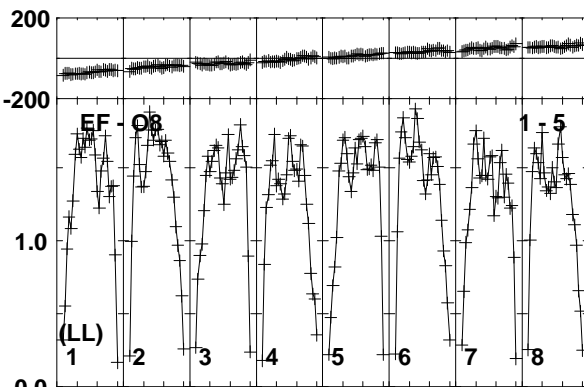
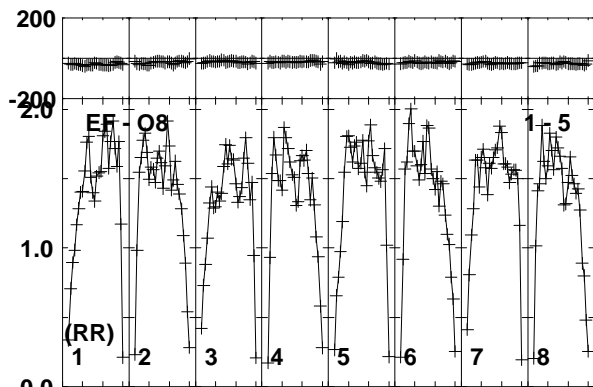
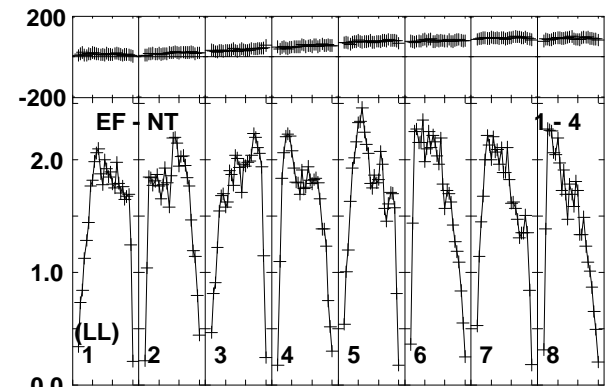
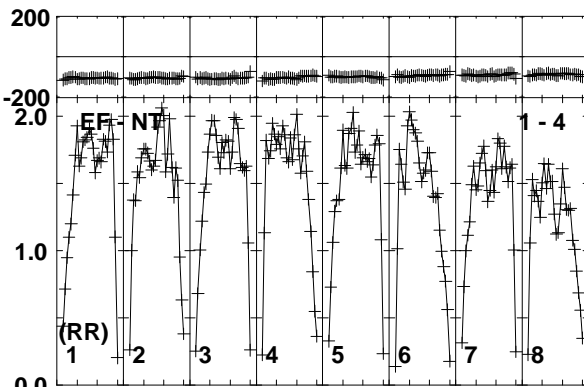
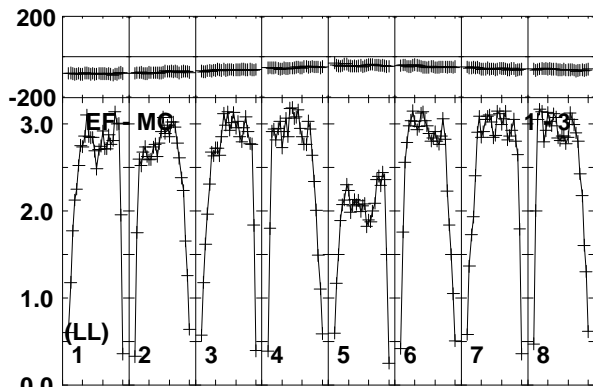
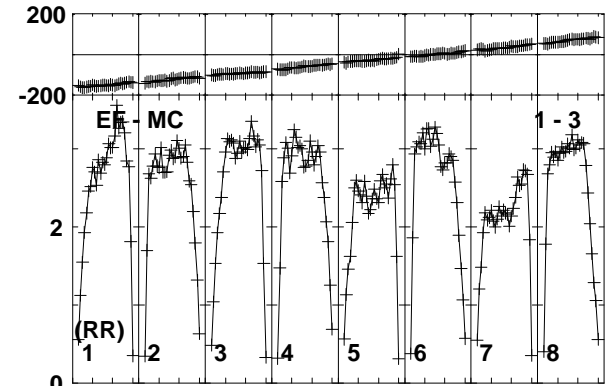
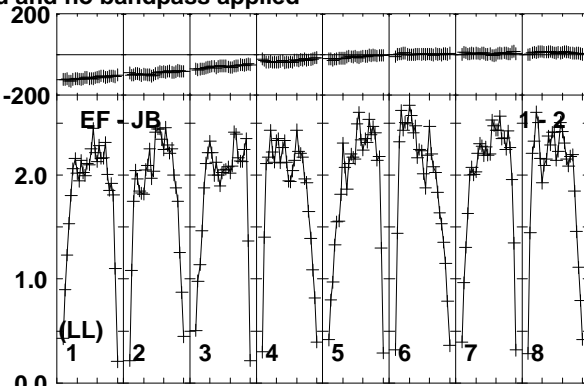
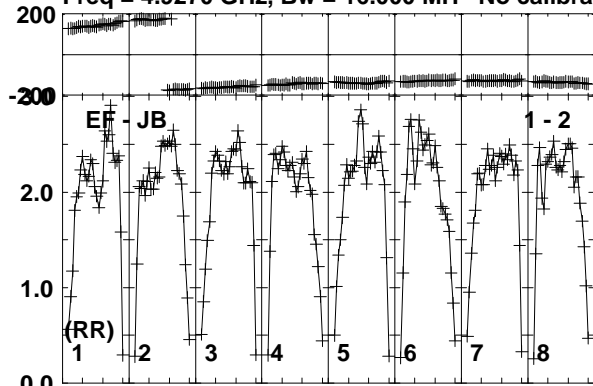

Lower frame: Milli Ampl Jy Top frame: Phas deg

Vector averaged cross-power spectrum Baseline: EF (01) - JB (02)

Timerange: 01/04:41:51 to 01/04:43:20

Plot file version 492 created 10-JUN-2016 17:22:51

J1957+3338 RT013A.UVDATA.1

Freq = 4.9270 GHz, Bw = 16.000 MH No calibration applied and no bandpass applied

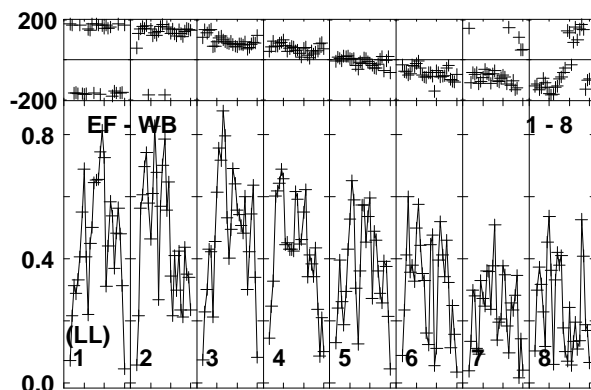
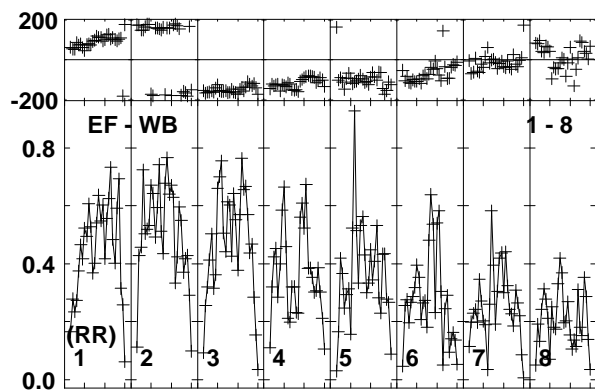
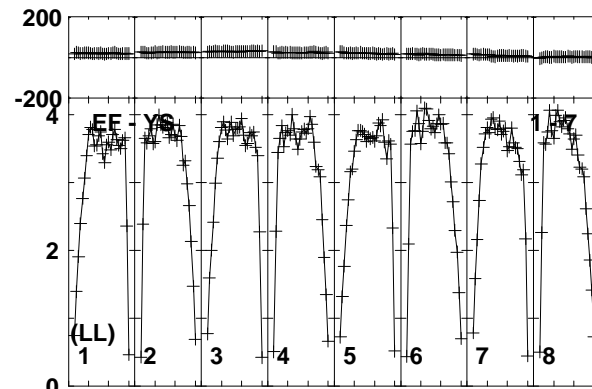
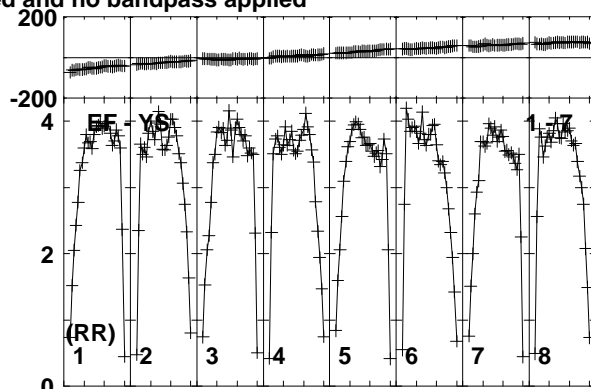
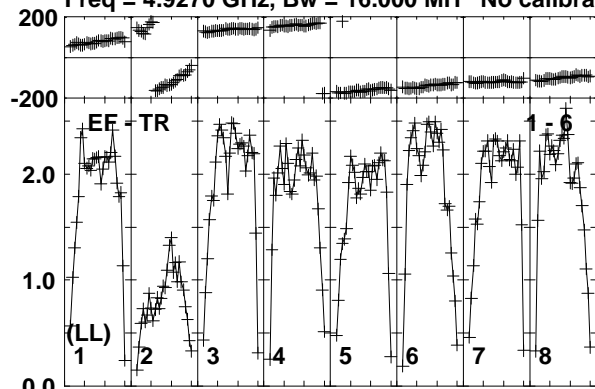

Lower frame: Milli Ampl Jy Top frame: Phas deg  
Vector averaged cross-power spectrum Baseline: EF (01) - TR (06)  
Timerange: 01/04:41:51 to 01/04:43:20

Plot file version 493 created 10-JUN-2016 17:22:51

CHECK RT013A.UVDATA.1

Freq = 4.9270 GHz, Bw = 16.000 MH No calibration applied and no bandpass applied

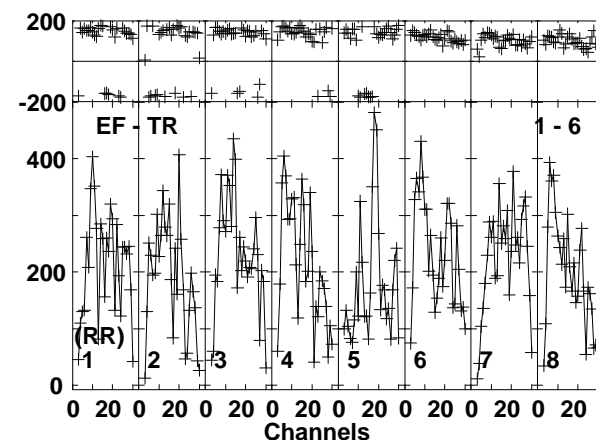
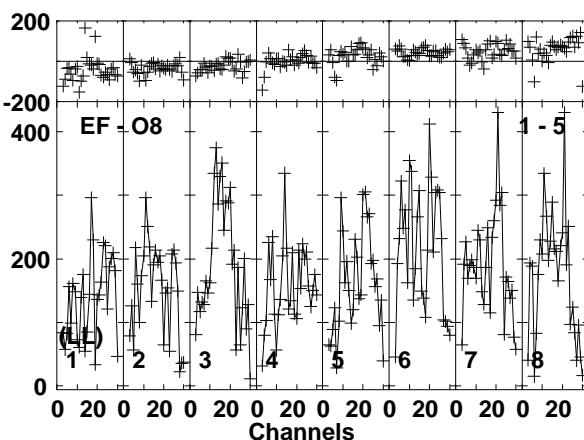
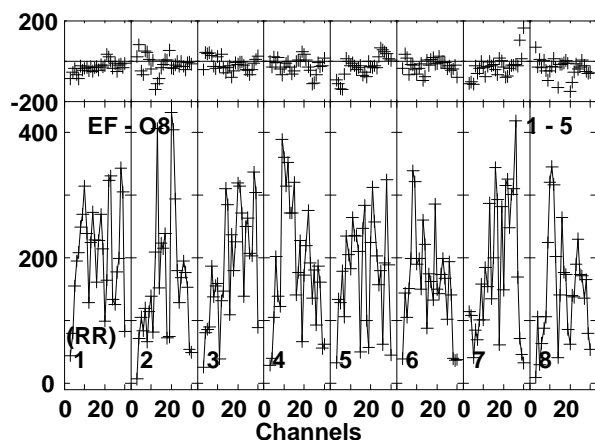
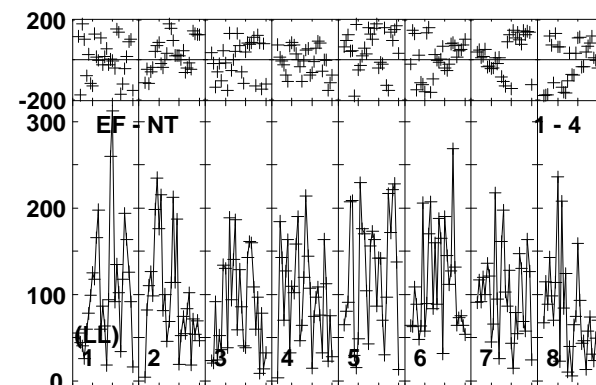
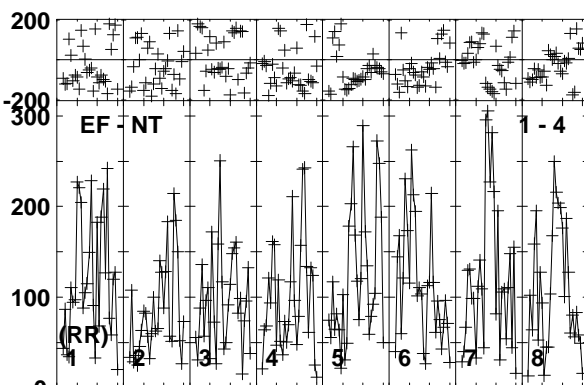
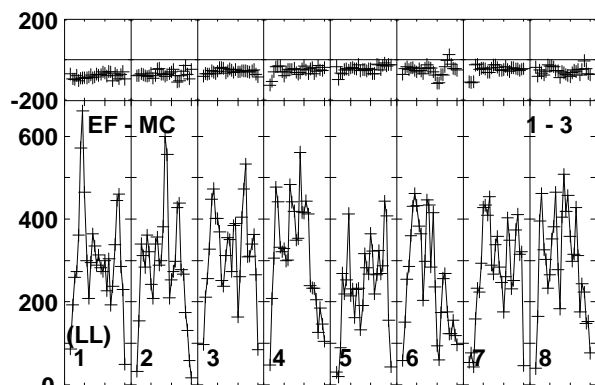
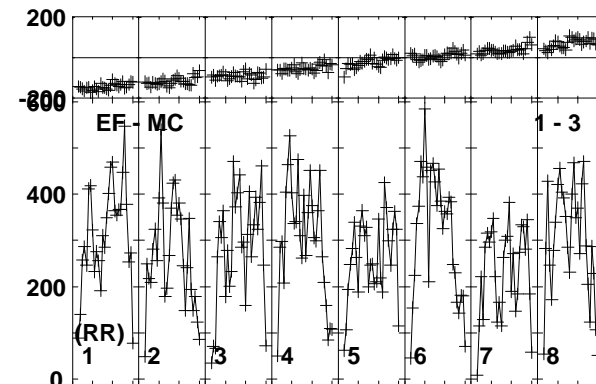
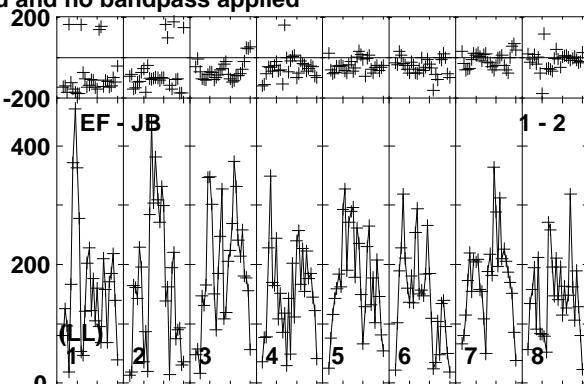
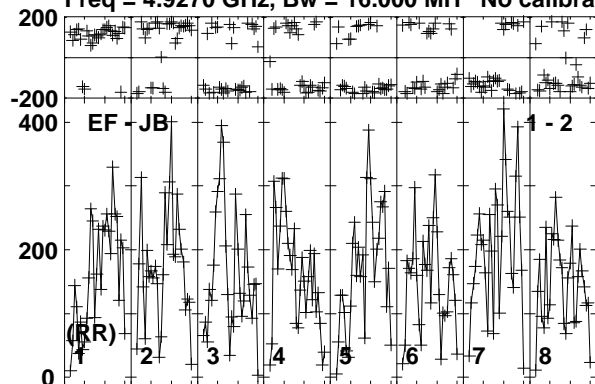

Lower frame: Micro Ampl Jy Top frame: Phas deg  
Vector averaged cross-power spectrum Baseline: EF (01) - JB (02)  
Timerange: 01/04:44:00 to 01/04:45:59

Plot file version 494 created 10-JUN-2016 17:22:51

CHECK RT013A.UVDATA.1

Freq = 4.9270 GHz, Bw = 16.000 MH No calibration applied and no bandpass applied

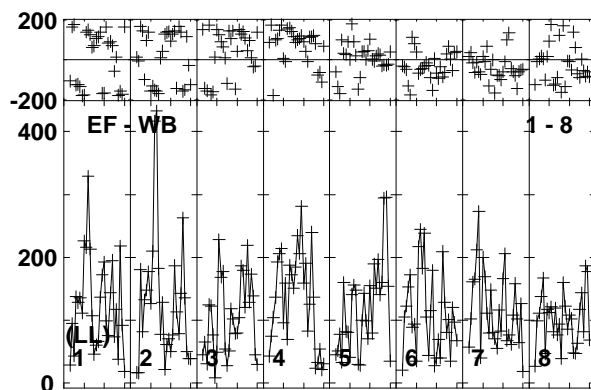
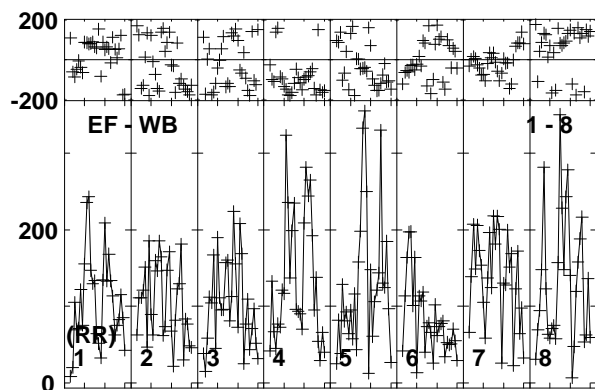
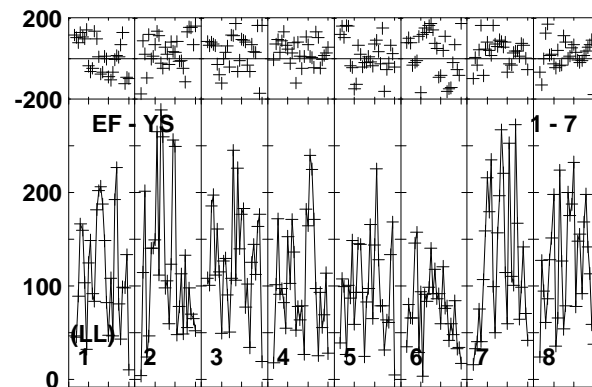
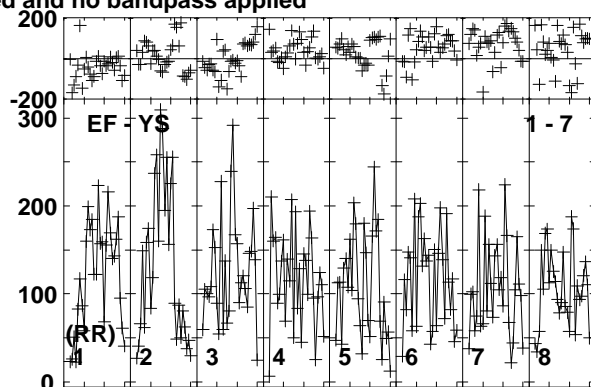
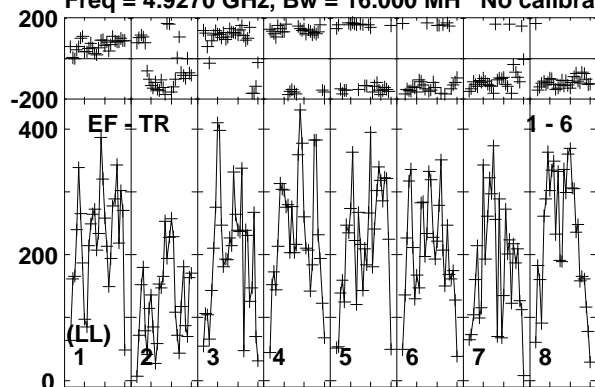

Lower frame: Micro Ampl Jy Top frame: Phas deg  
Vector averaged cross-power spectrum Baseline: EF (01) - TR (06)  
Timerange: 01/04:44:00 to 01/04:45:59

Plot file version 495 created 10-JUN-2016 17:22:52

CYGX1 RT013A.UVDATA.1

Freq = 4.9270 GHz, Bw = 16.000 MH No calibration applied and no bandpass applied

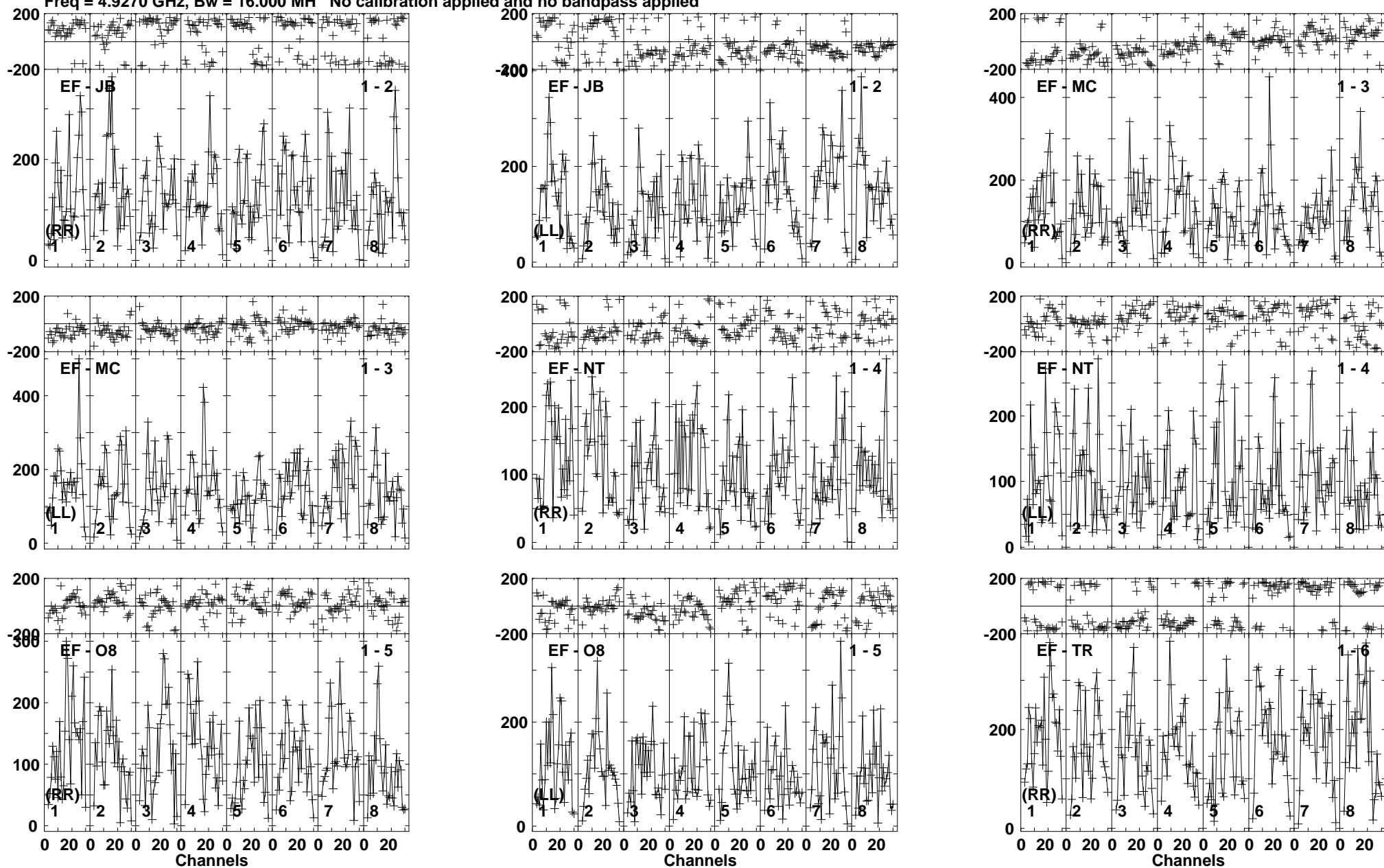

Lower frame: Micro Ampl Jy Top frame: Phas deg  
Vector averaged cross-power spectrum Baseline: EF (01) - JB (02)  
Timerange: 01/04:46:00 to 01/04:48:30

Plot file version 496 created 10-JUN-2016 17:22:52

CYGX1 RT013A.UVDATA.1

Freq = 4.9270 GHz, Bw = 16.000 MH No calibration applied and no bandpass applied

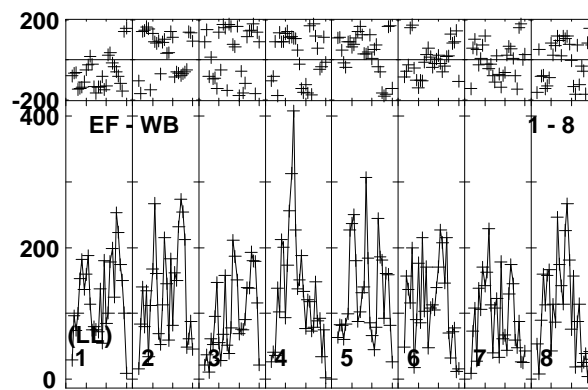
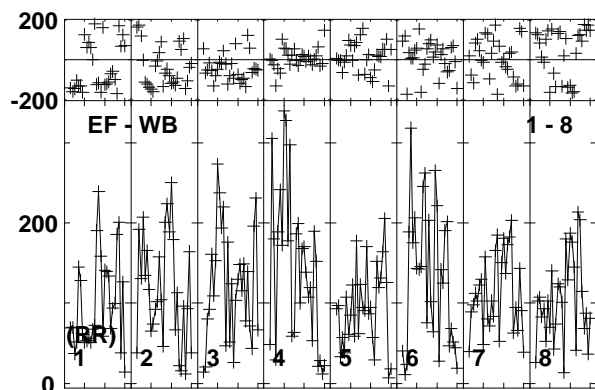
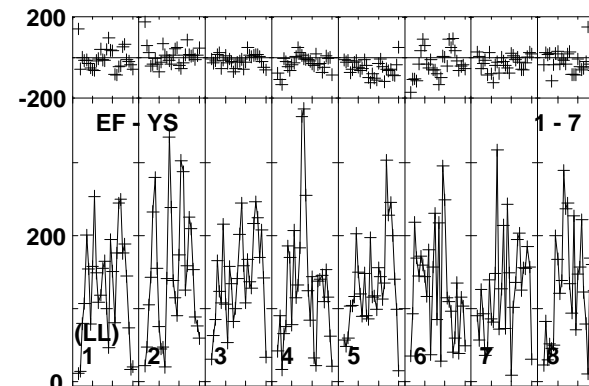
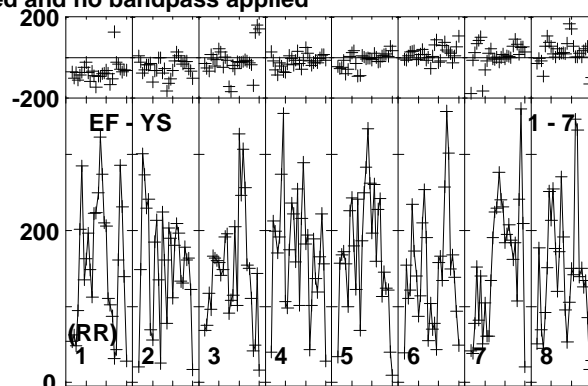
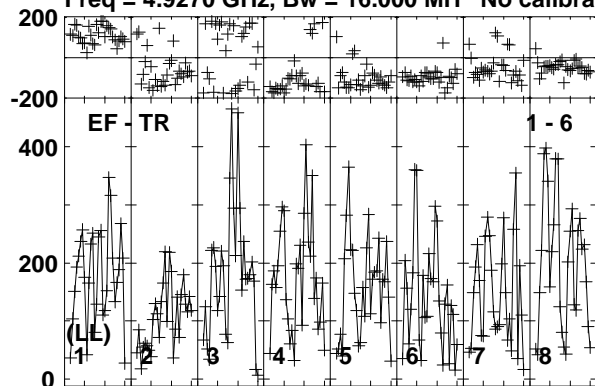

Lower frame: Micro Ampl Jy Top frame: Phas deg  
Vector averaged cross-power spectrum Baseline: EF (01) - TR (06)  
Timerange: 01/04:46:00 to 01/04:48:30

Plot file version 497 created 10-JUN-2016 17:22:52

J1957+3338 RT013A.UVDATA.1

Freq = 4.9270 GHz, Bw = 16.000 MH No calibration applied and no bandpass applied

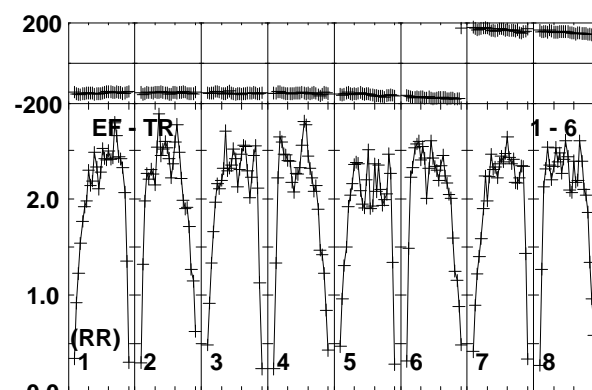
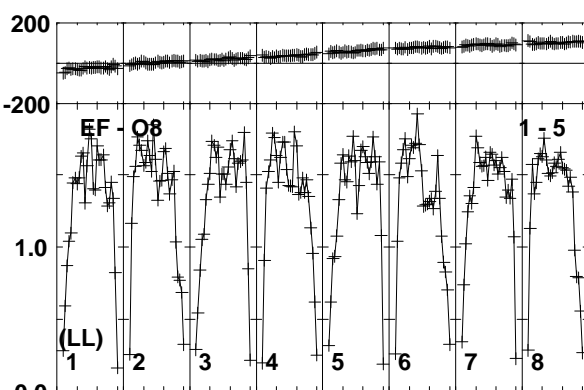
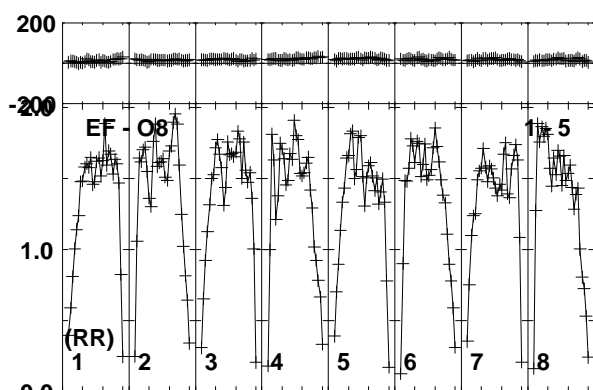
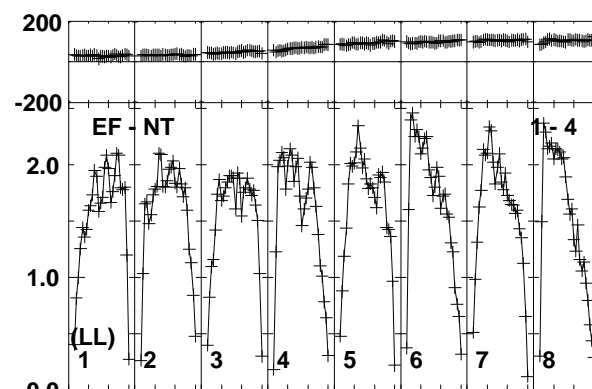
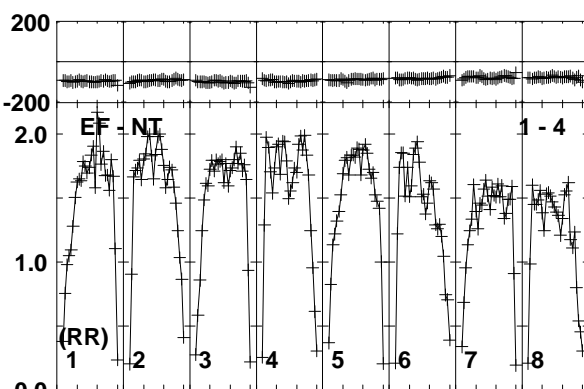
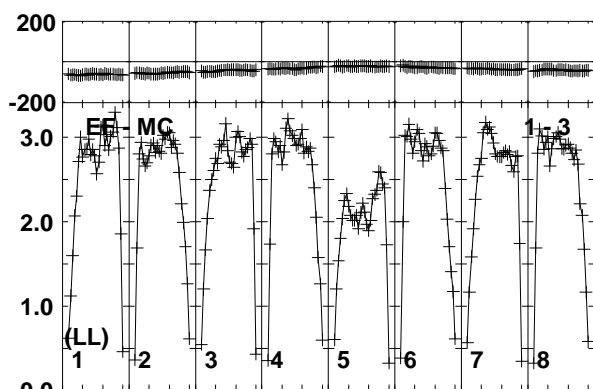
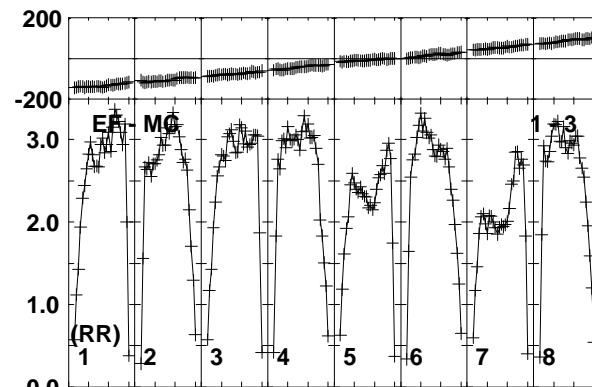
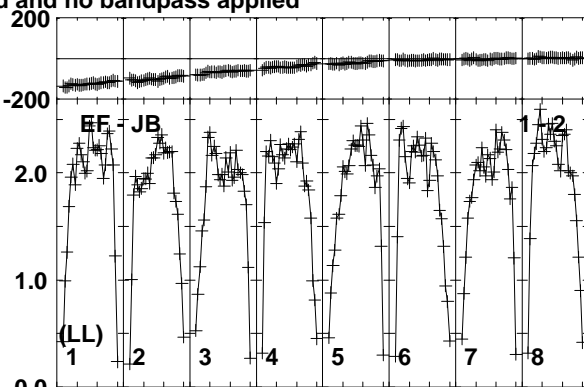
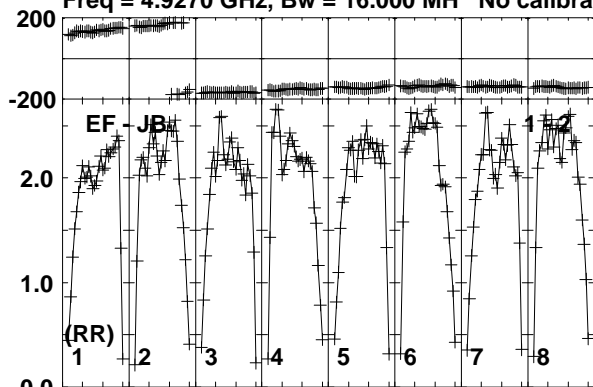

Lower frame: Milli Ampl Jy Top frame: Phas deg  
Vector averaged cross-power spectrum Baseline: EF (01) - JB (02)  
Timerange: 01/04:48:31 to 01/04:50:00

Plot file version 498 created 10-JUN-2016 17:22:52

J1957+3338 RT013A.UVDATA.1

Freq = 4.9270 GHz, Bw = 16.000 MH No calibration applied and no bandpass applied

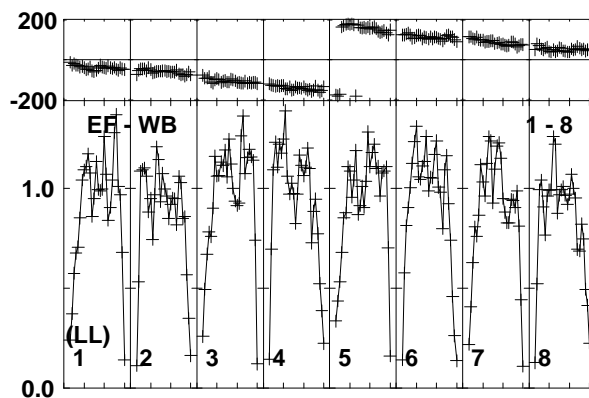
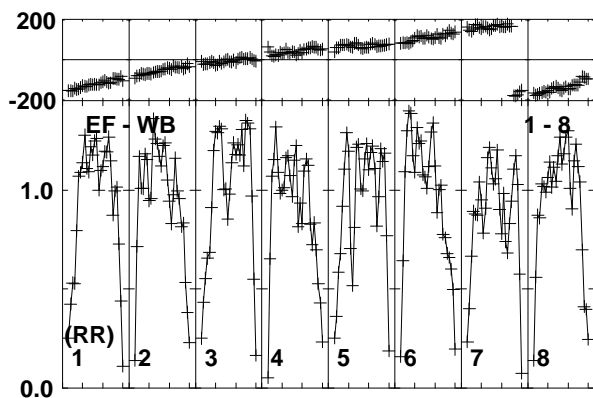
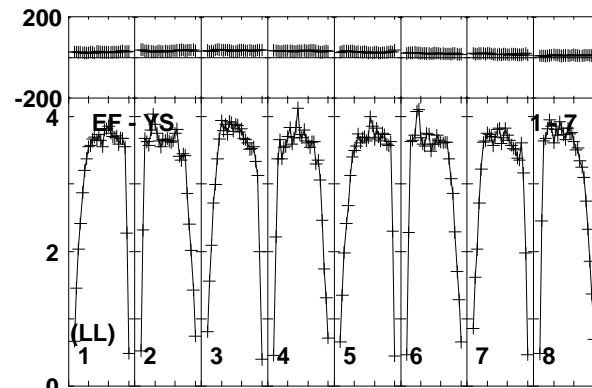
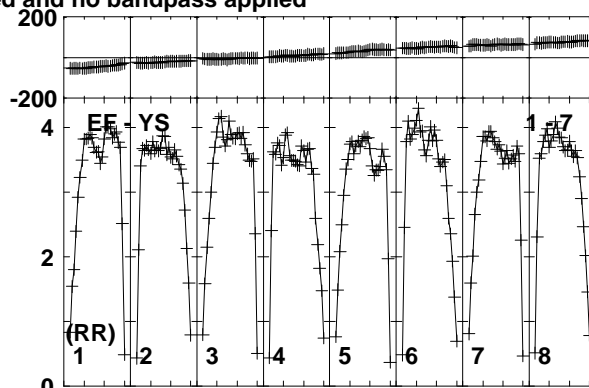
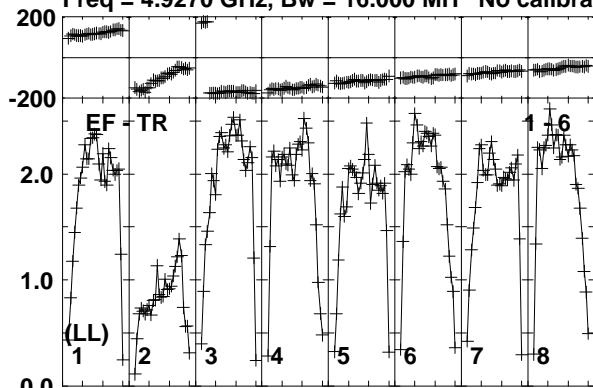

Lower frame: Milli Ampl Jy Top frame: Phas deg  
Vector averaged cross-power spectrum Baseline: EF (01) - TR (06)  
Timerange: 01/04:48:31 to 01/04:50:00



Plot file version 499 created 10-JUN-2016 17:22:52

CHECK RT013A.UVDATA.1

Freq = 4.9270 GHz, Bw = 16.000 MH No calibration applied and no bandpass applied

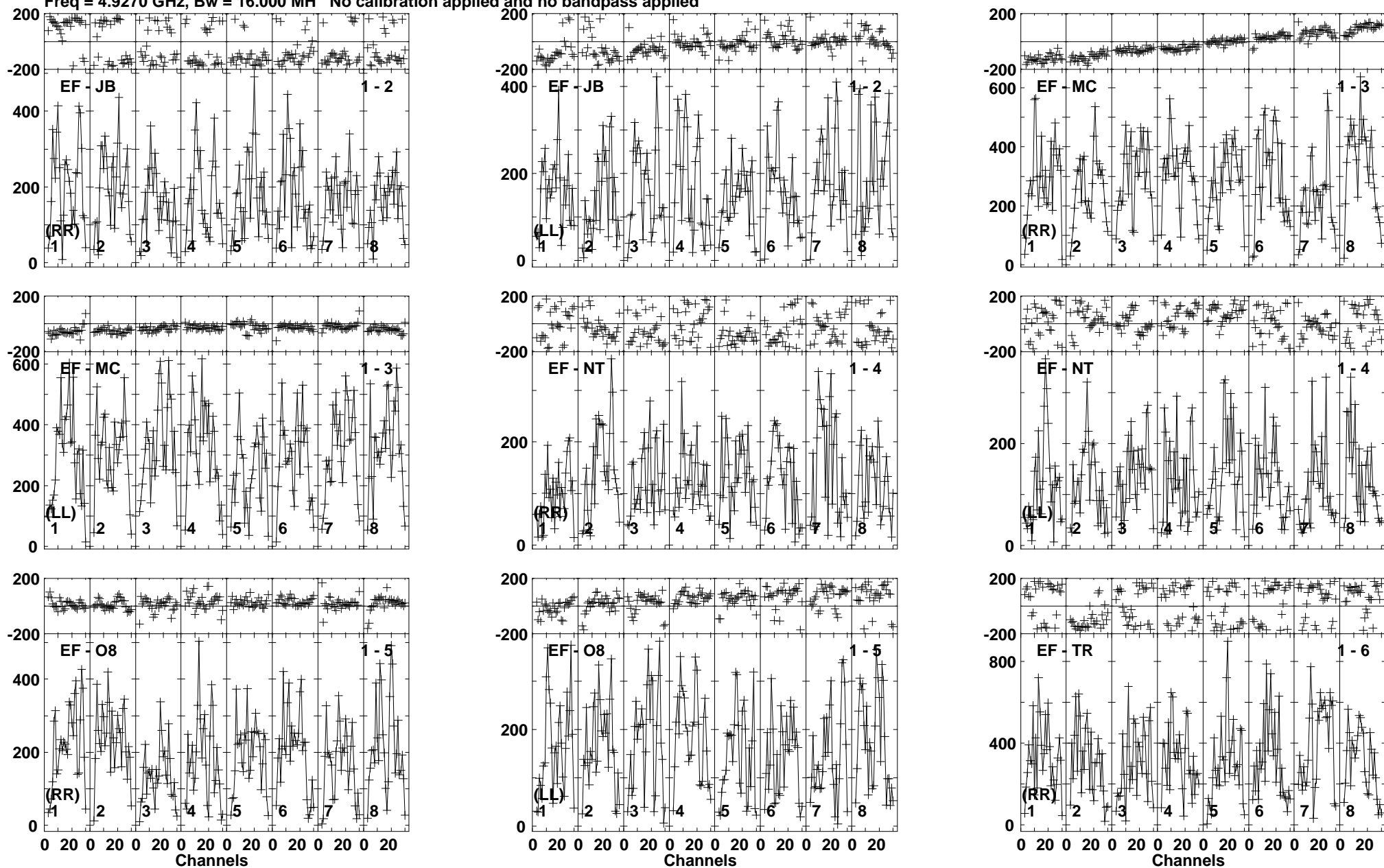

Lower frame: Micro Ampl Jy Top frame: Phas deg  
Vector averaged cross-power spectrum Baseline: EF (01) - JB (02)  
Timerange: 01/04:50:01 to 01/04:52:00

Plot file version 500 created 10-JUN-2016 17:22:52

CHECK RT013A.UVDATA.1

Freq = 4.9270 GHz, Bw = 16.000 MH No calibration applied and no bandpass applied

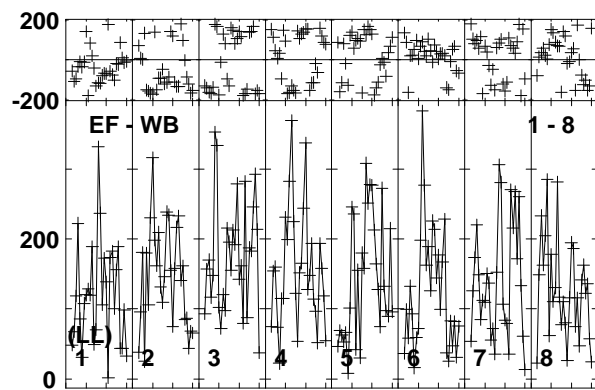
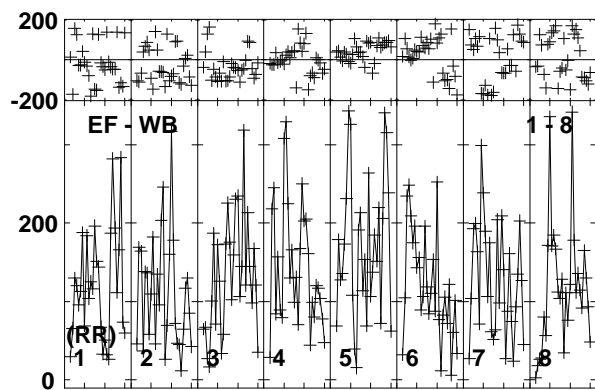
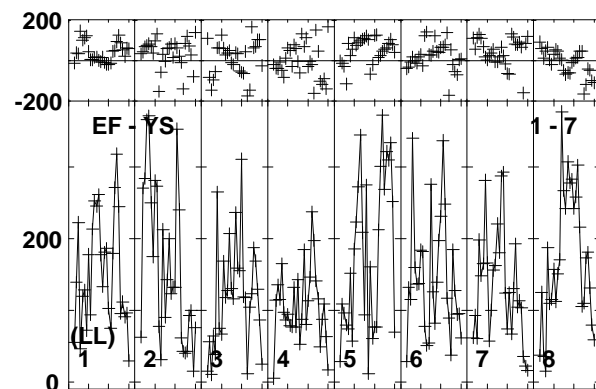
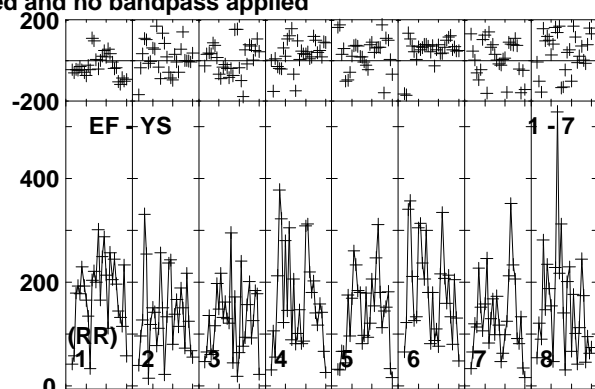
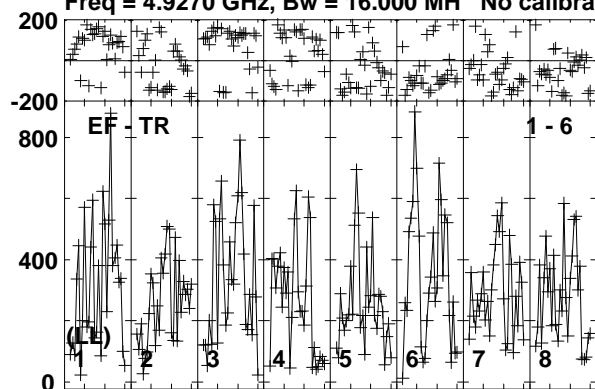

Lower frame: Micro Ampl Jy Top frame: Phas deg  
Vector averaged cross-power spectrum Baseline: EF (01) - TR (06)  
Timerange: 01/04:50:01 to 01/04:52:00

Plot file version 501 created 10-JUN-2016 17:22:52

CYGX1 RT013A.UVDATA.1

Freq = 4.9270 GHz, Bw = 16.000 MH No calibration applied and no bandpass applied

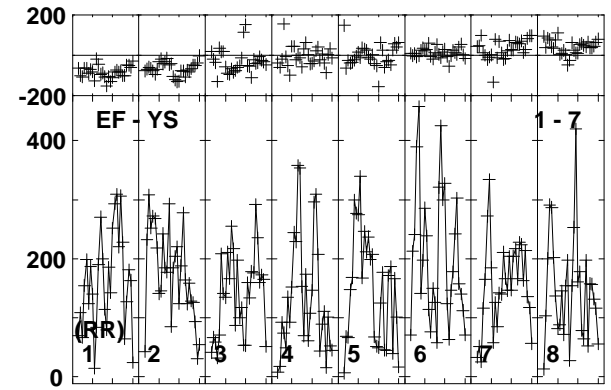
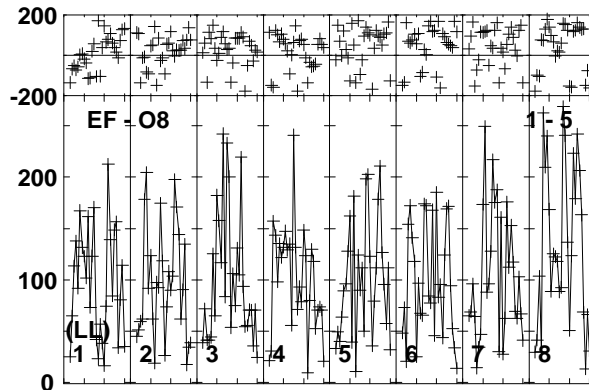
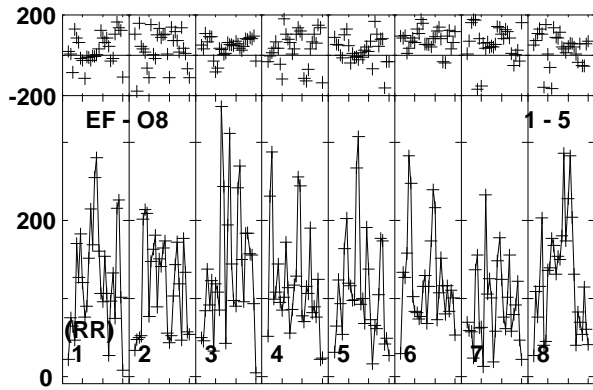
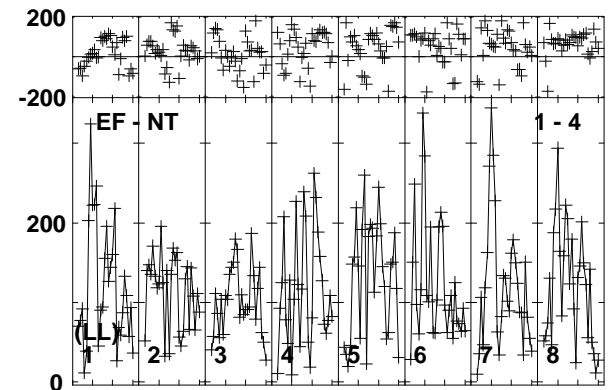
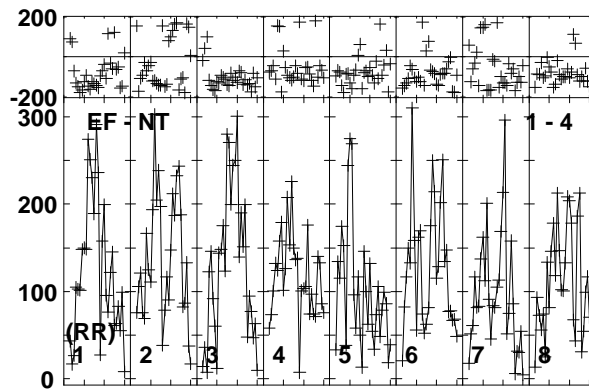
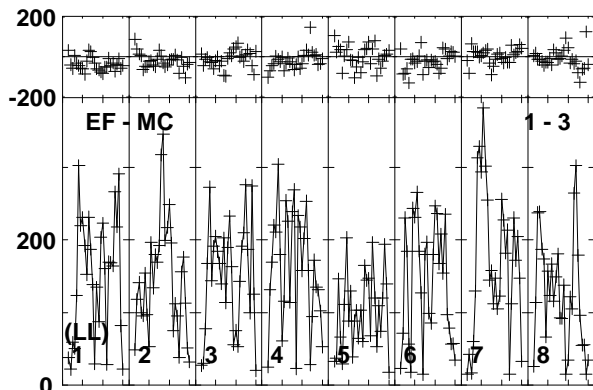
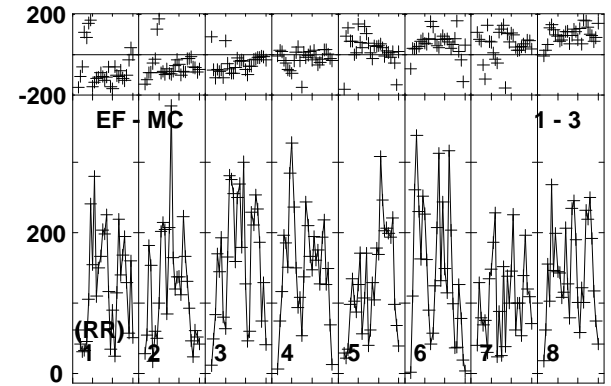
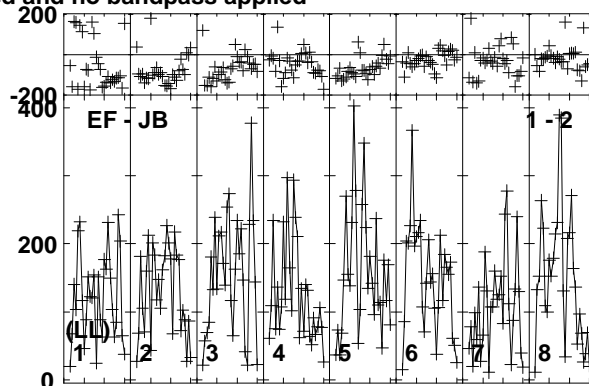
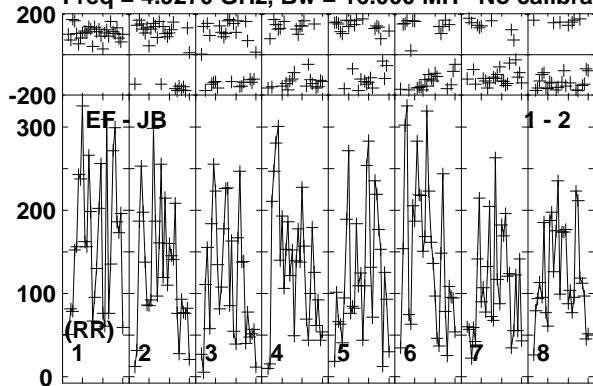

Lower frame: Micro Ampl Jy Top frame: Phas deg  
Vector averaged cross-power spectrum Baseline: EF (01) - JB (02)  
Timerange: 01/04:52:01 to 01/04:54:29

Plot file version 502 created 10-JUN-2016 17:22:52

CYGX1 RT013A.UVDATA.1

Freq = 4.9270 GHz, Bw = 16.000 MH No calibration applied and no bandpass applied

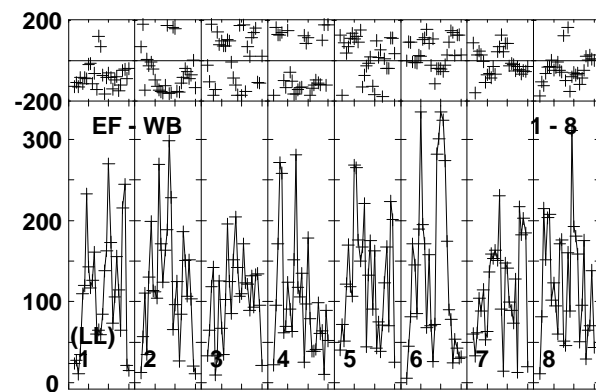
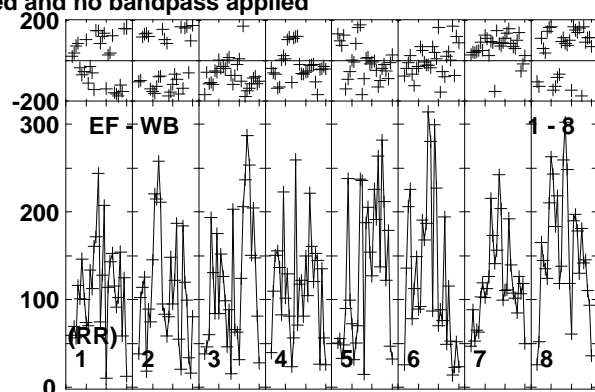
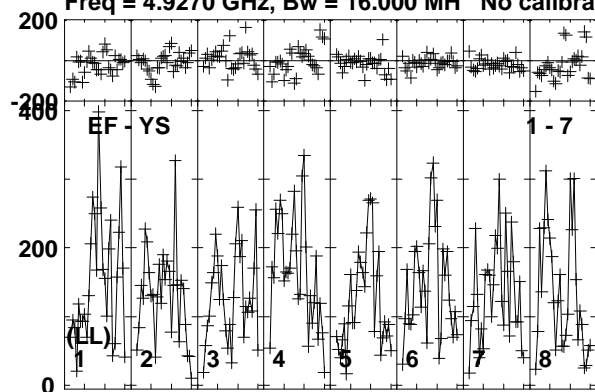

Lower frame: Micro Ampl Jy Top frame: Phas deg  
Vector averaged cross-power spectrum Baseline: EF (01) - YS (07)  
Timerange: 01/04:52:01 to 01/04:54:29

Plot file version 503 created 10-JUN-2016 17:22:52

J1957+3338 RT013A.UVDATA.1

Freq = 4.9270 GHz, Bw = 16.000 MH No calibration applied and no bandpass applied

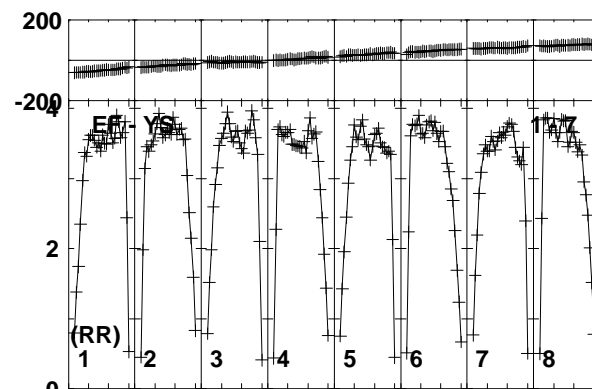
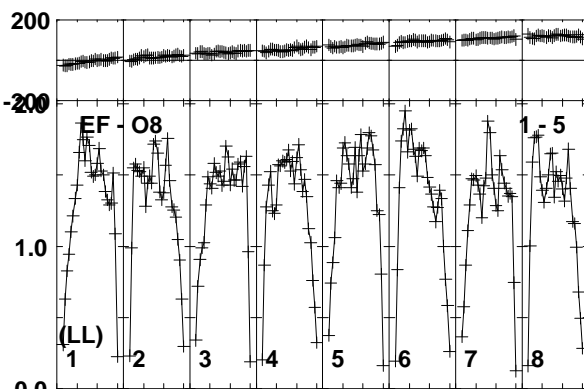
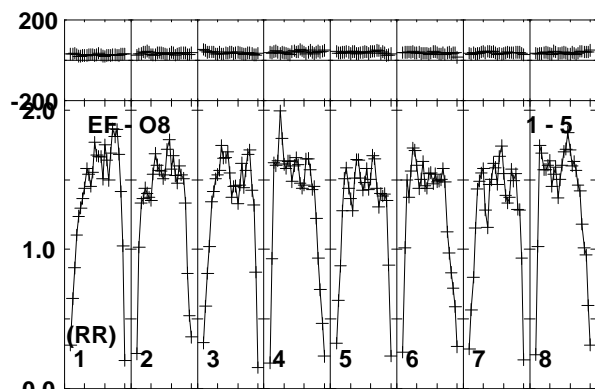
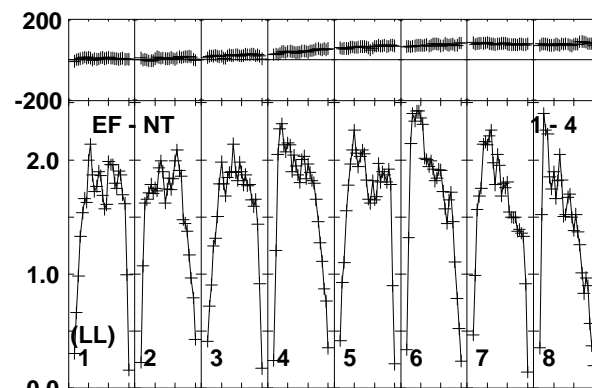
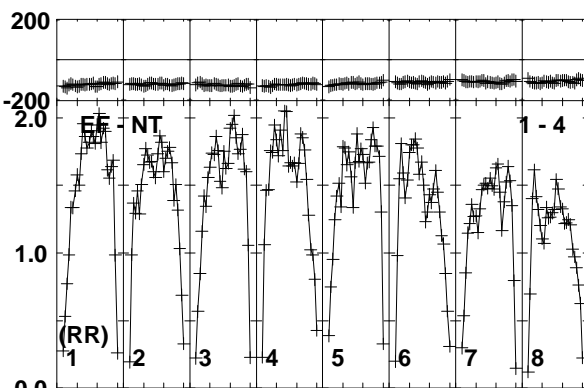
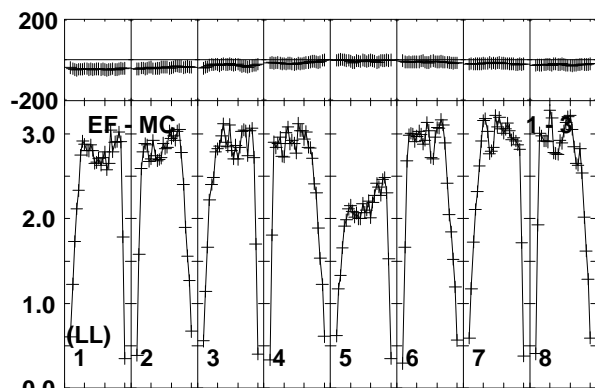
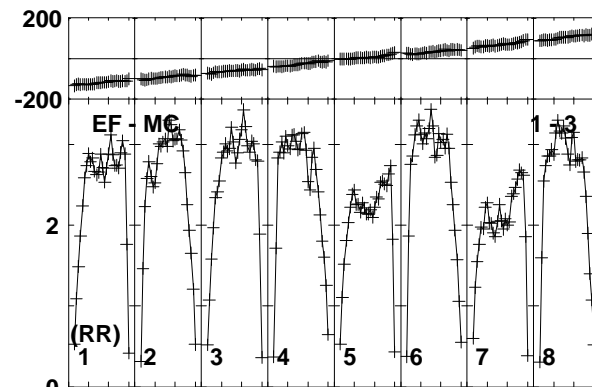
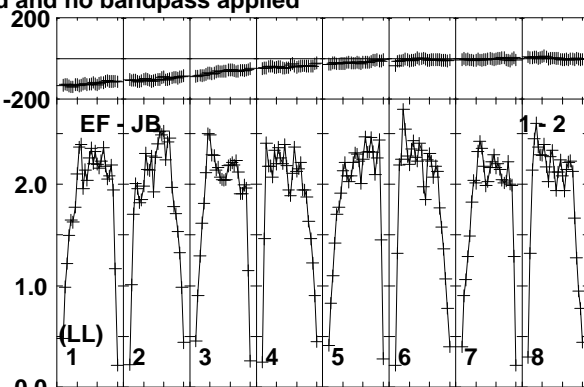
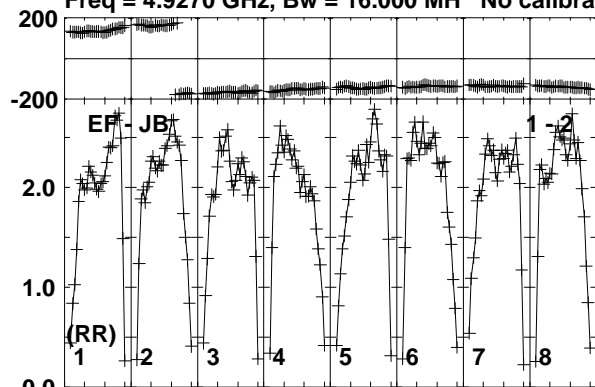

Lower frame: Milli Ampl Jy Top frame: Phas deg  
Vector averaged cross-power spectrum Baseline: EF (01) - JB (02)  
Timerange: 01/04:54:31 to 01/04:55:59

Plot file version 504 created 10-JUN-2016 17:22:52

J1957+3338 RT013A.UVDATA.1

Freq = 4.9270 GHz, Bw = 16.000 MH No calibration applied and no bandpass applied

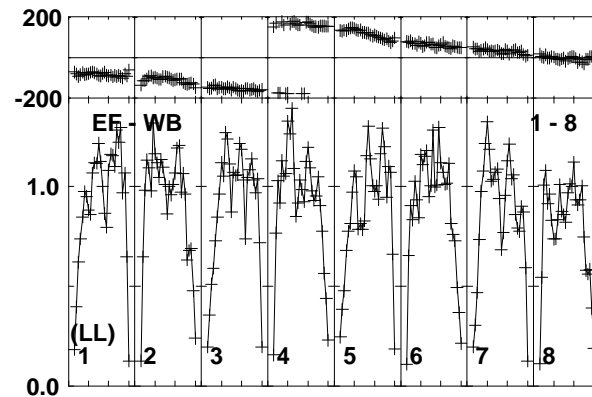
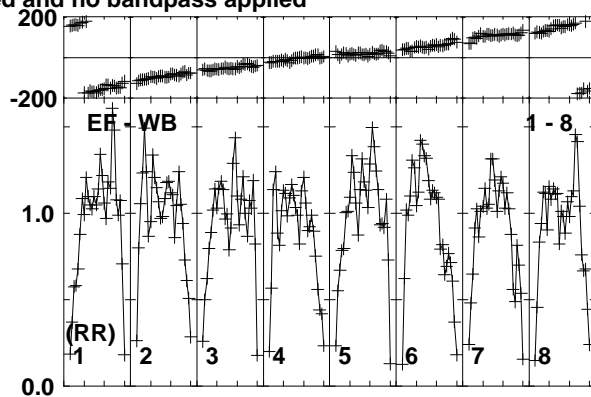
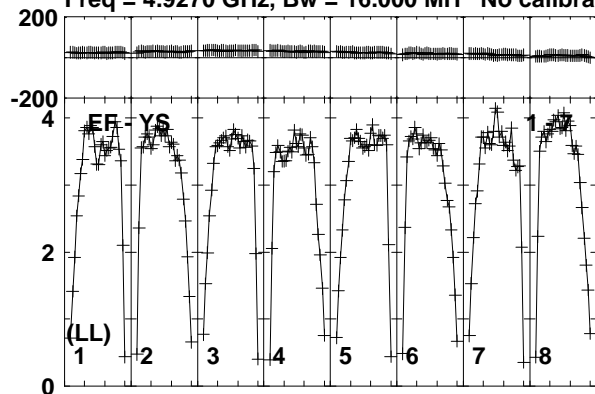

Lower frame: Milli Ampl Jy Top frame: Phas deg  
Vector averaged cross-power spectrum Baseline: EF (01) - YS (07)  
Timerange: 01/04:54:31 to 01/04:55:59

Plot file version 505 created 10-JUN-2016 17:22:52

CHECK RT013A.UVDATA.1

Freq = 4.9270 GHz, Bw = 16.000 MH No calibration applied and no bandpass applied

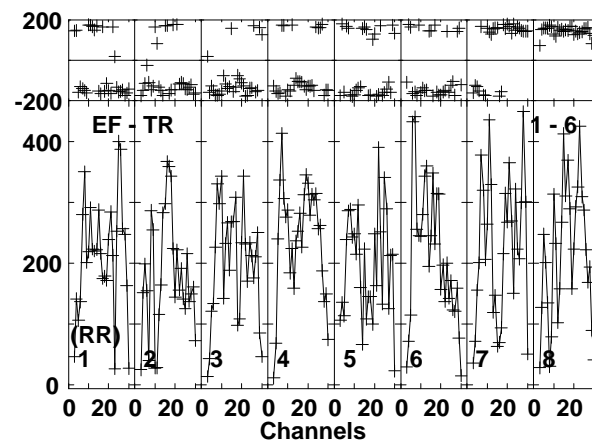
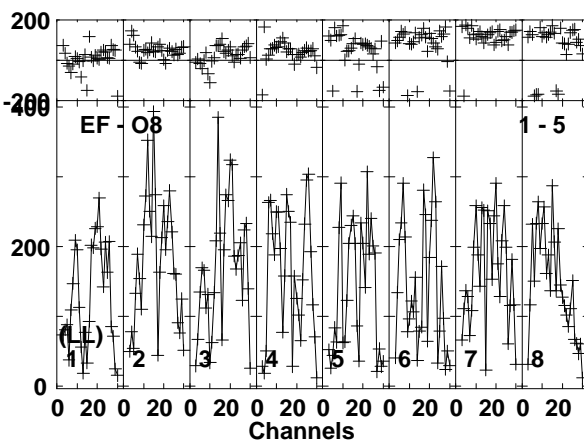
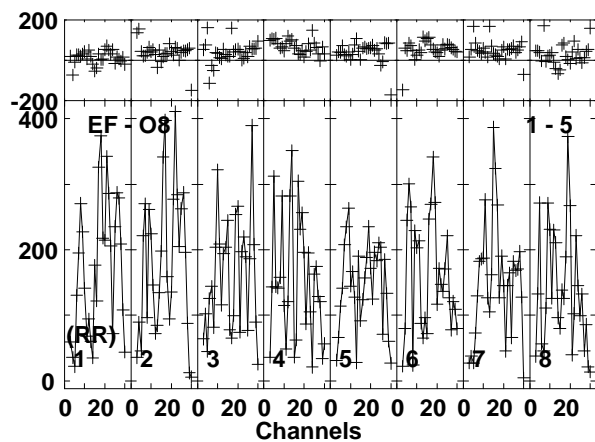
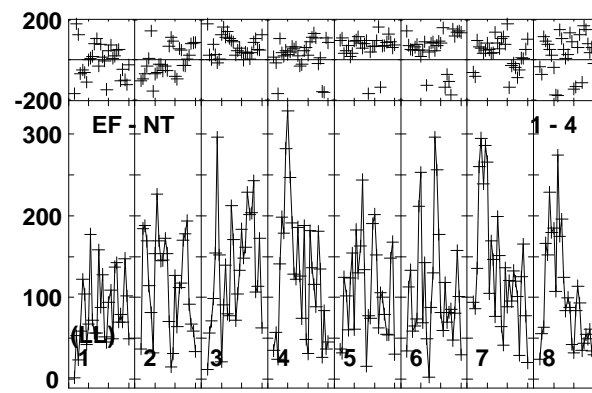
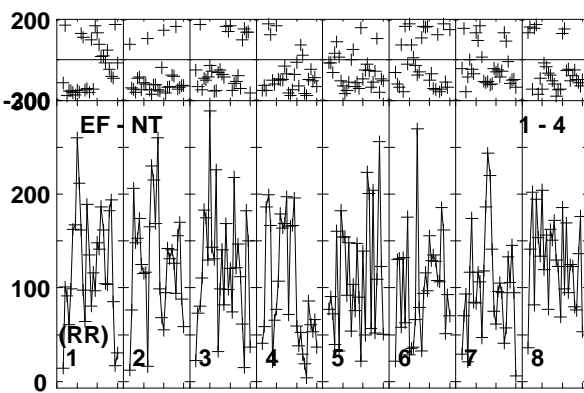
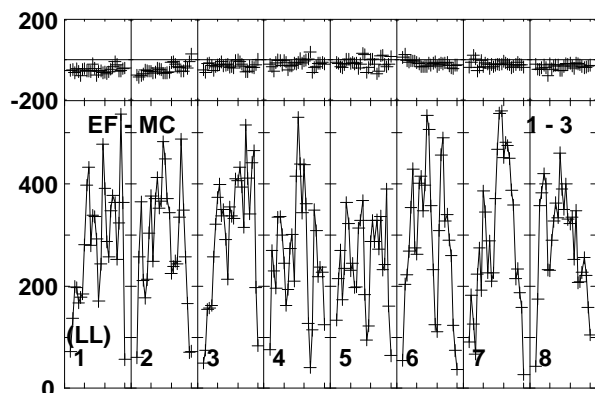
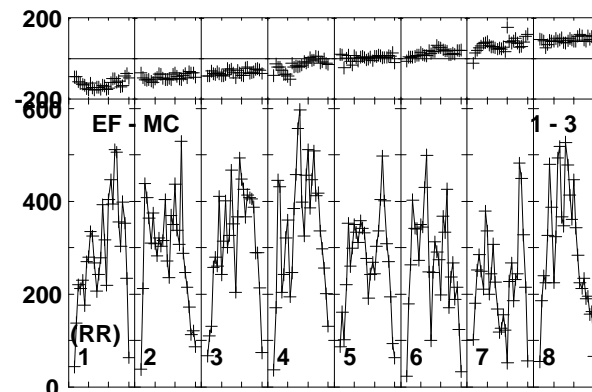
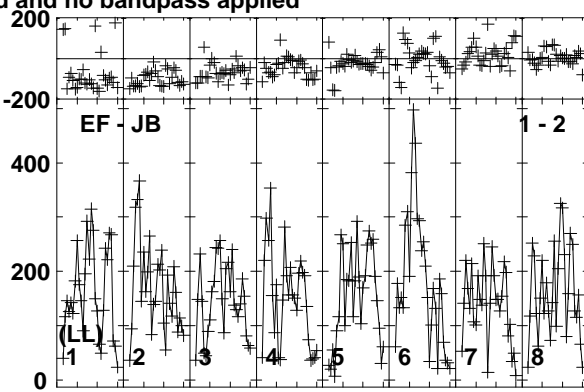
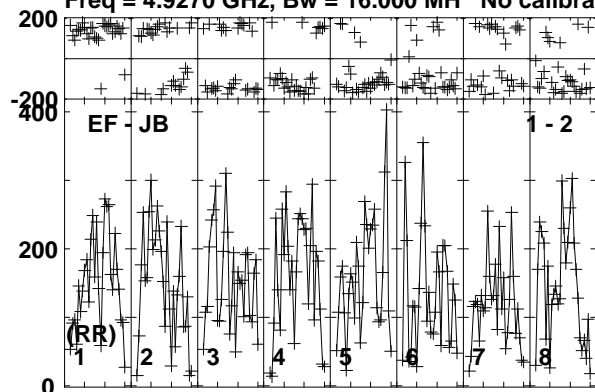

Lower frame: Micro Ampl Jy Top frame: Phas deg  
Vector averaged cross-power spectrum Baseline: EF (01) - JB (02)  
Timerange: 01/04:56:40 to 01/04:58:40

Plot file version 506 created 10-JUN-2016 17:22:52

CHECK RT013A.UVDATA.1

Freq = 4.9270 GHz, Bw = 16.000 MH No calibration applied and no bandpass applied

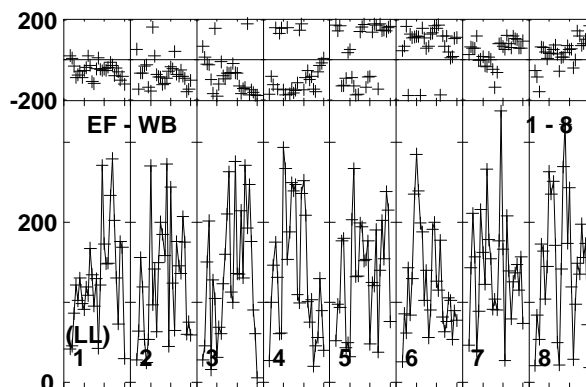
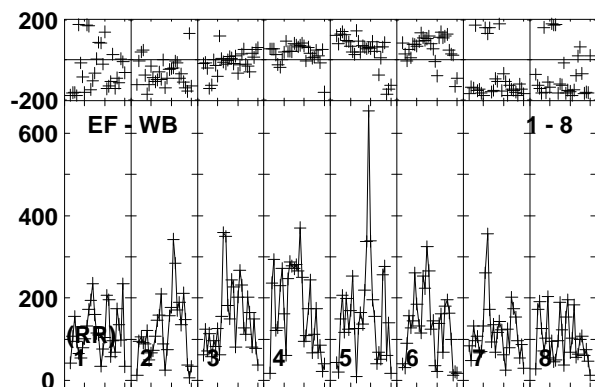
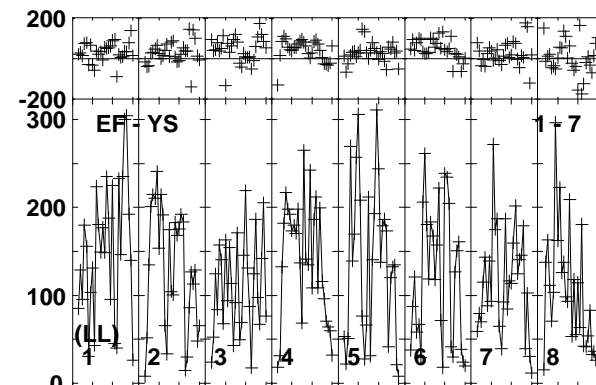
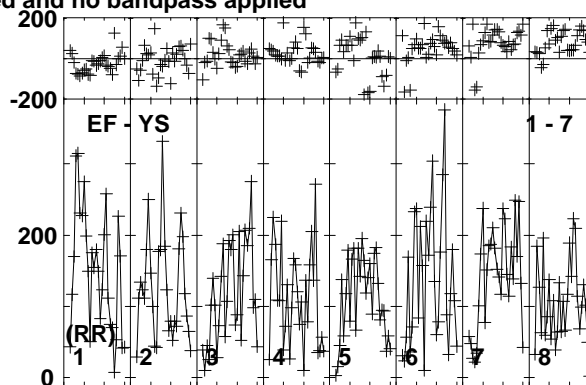
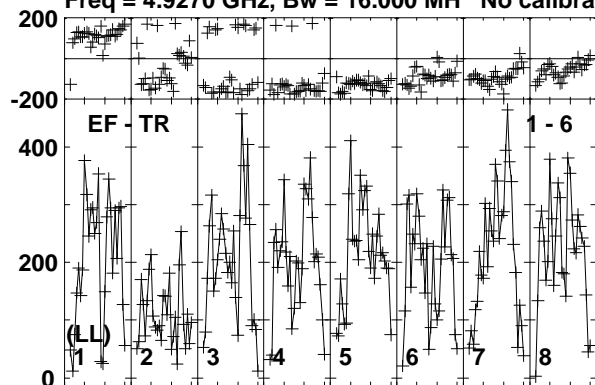

Lower frame: Micro Ampl Jy Top frame: Phas deg  
Vector averaged cross-power spectrum Baseline: EF (01) - TR (06)  
Timerange: 01/04:56:40 to 01/04:58:40



Plot file version 507 created 10-JUN-2016 17:22:53

CYGX1 RT013A.UVDATA.1

Freq = 4.9270 GHz, Bw = 16.000 MH No calibration applied and no bandpass applied

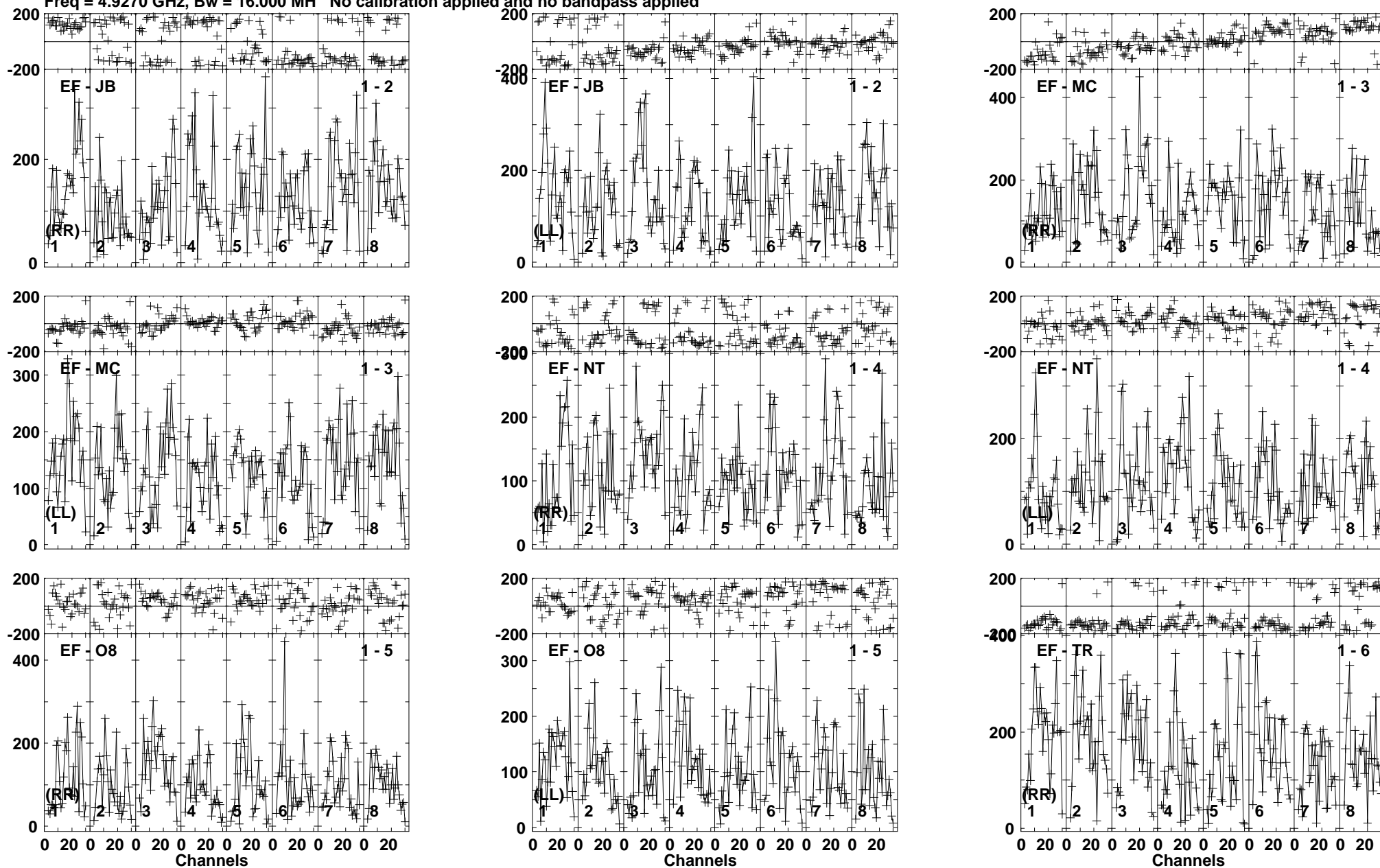

Lower frame: Micro Ampl Jy Top frame: Phas deg  
Vector averaged cross-power spectrum Baseline: EF (01) - JB (02)  
Timerange: 01/04:58:41 to 01/05:01:09

Plot file version 508 created 10-JUN-2016 17:22:53

CYGX1 RT013A.UVDATA.1

Freq = 4.9270 GHz, Bw = 16.000 MH No calibration applied and no bandpass applied

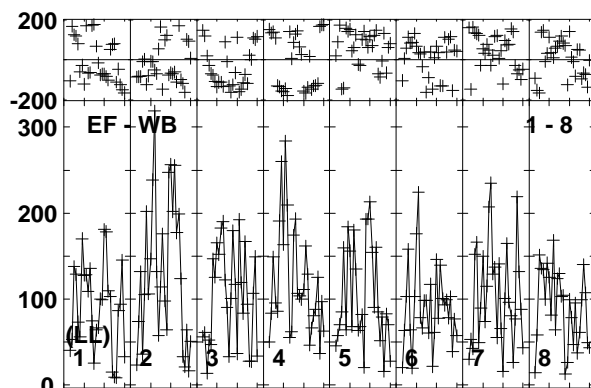
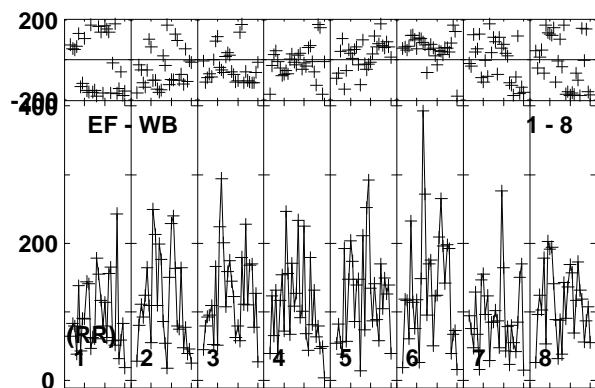
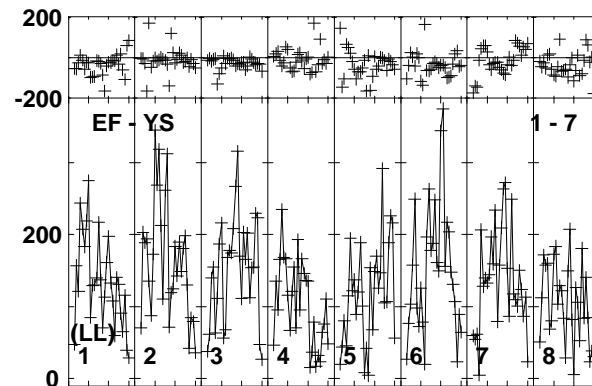
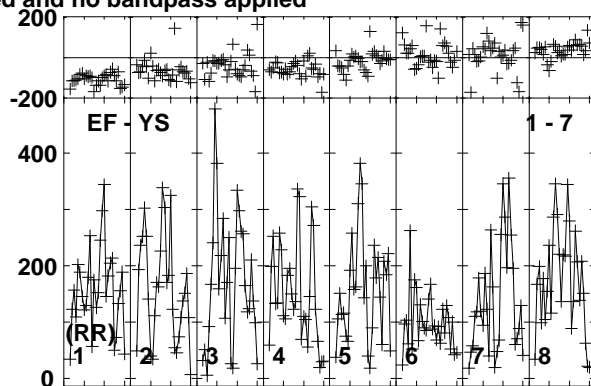
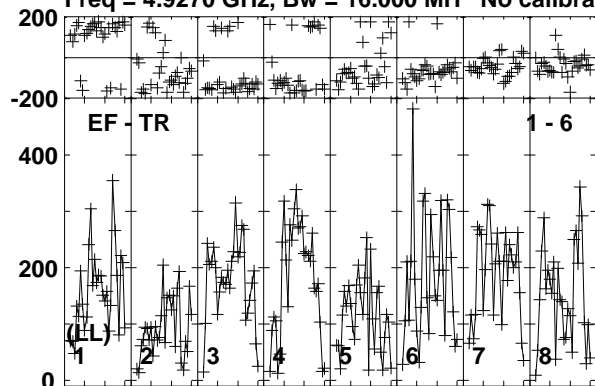

Lower frame: Micro Ampl Jy Top frame: Phas deg  
Vector averaged cross-power spectrum Baseline: EF (01) - TR (06)  
Timerange: 01/04:58:41 to 01/05:01:09

Plot file version 509 created 10-JUN-2016 17:22:53

J1957+3338 RT013A.UVDATA.1

Freq = 4.9270 GHz, Bw = 16.000 MH No calibration applied and no bandpass applied

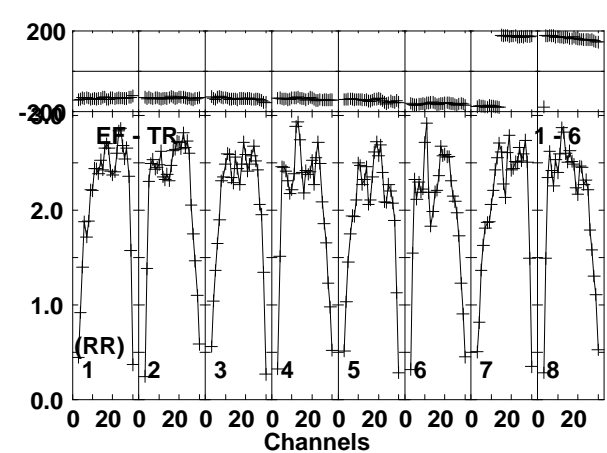
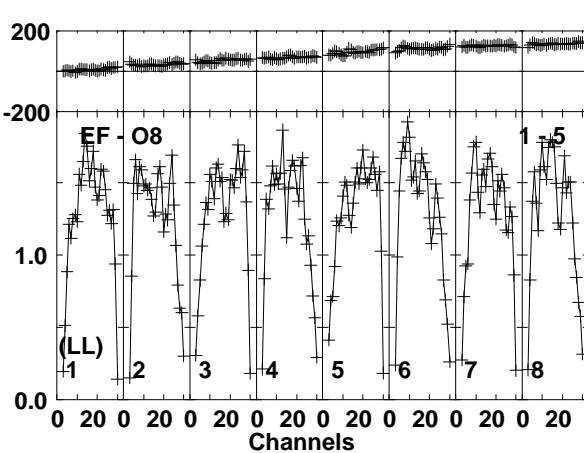
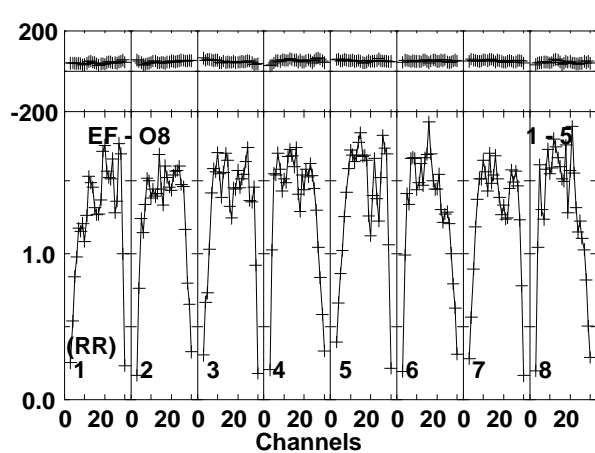
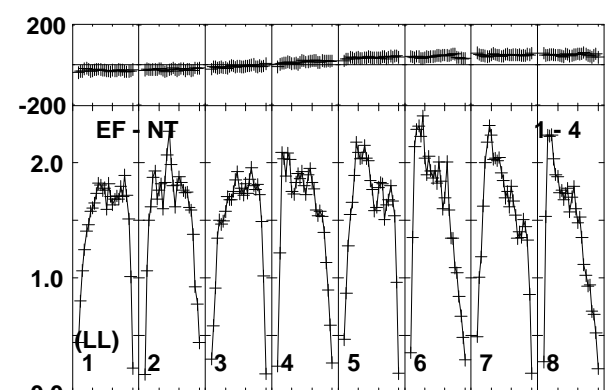
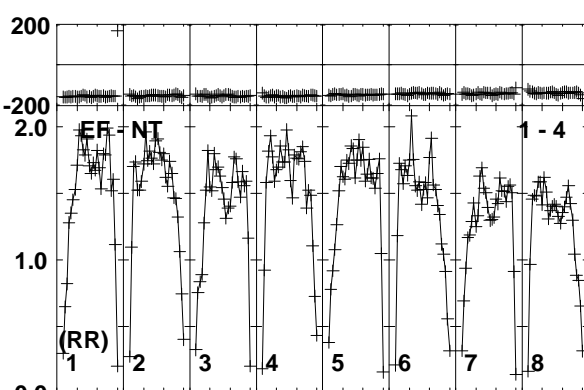
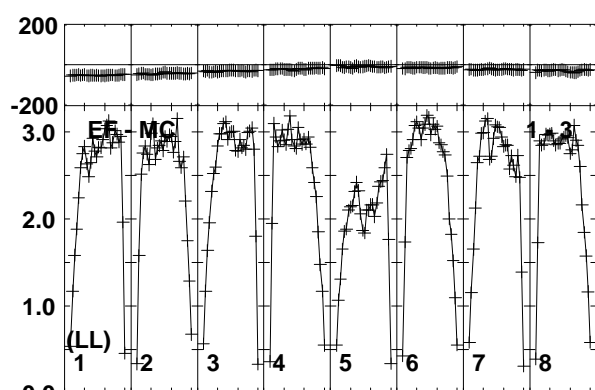
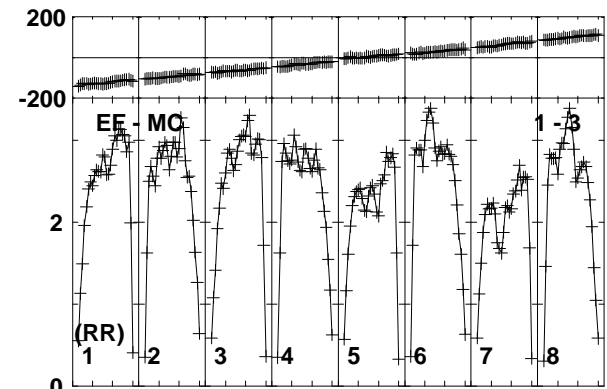
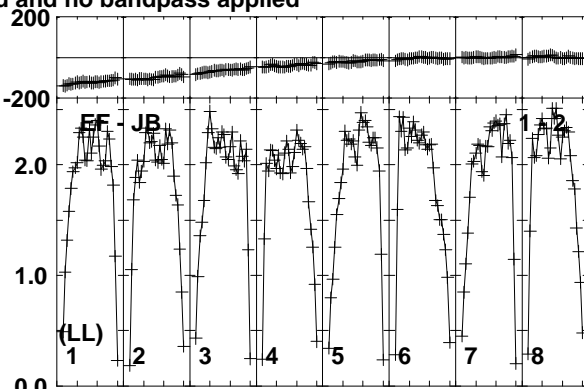
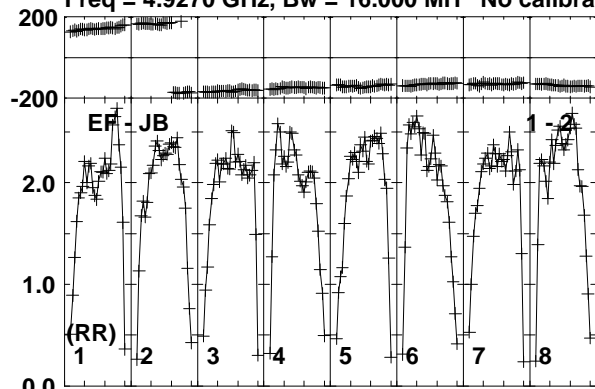

Lower frame: Milli Ampl Jy Top frame: Phas deg  
Vector averaged cross-power spectrum Baseline: EF (01) - JB (02)  
Timerange: 01/05:01:11 to 01/05:02:39

Plot file version 510 created 10-JUN-2016 17:22:53

J1957+3338 RT013A.UVDATA.1

Freq = 4.9270 GHz, Bw = 16.000 MH No calibration applied and no bandpass applied

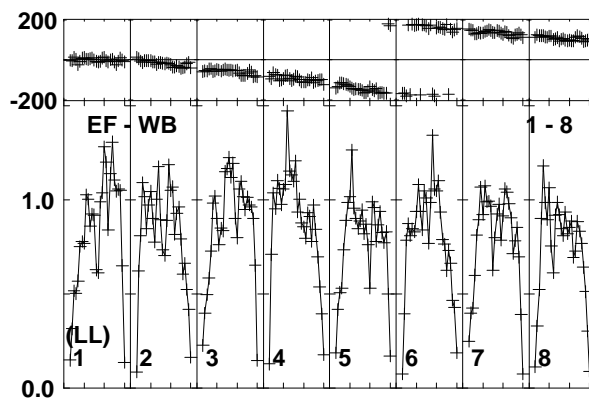
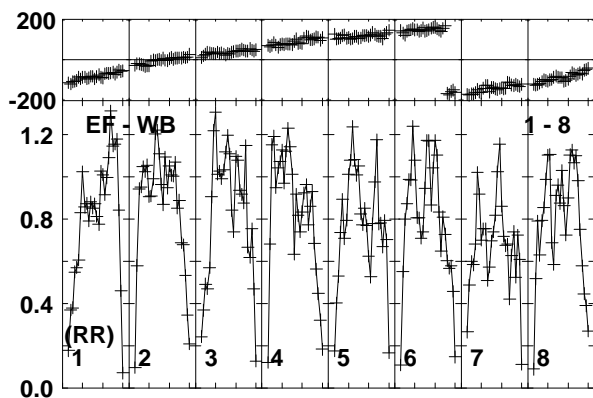
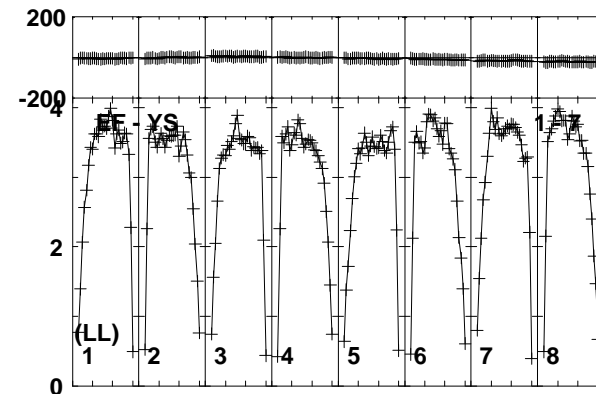
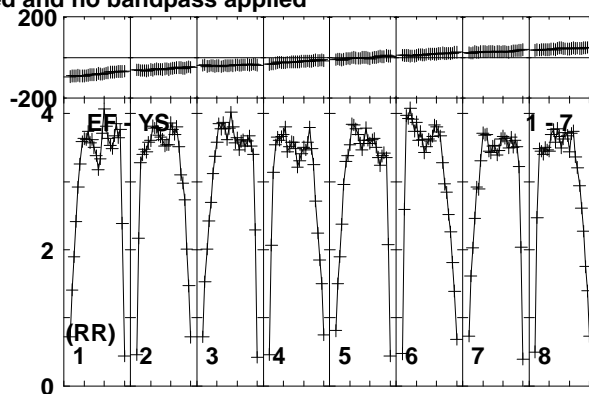
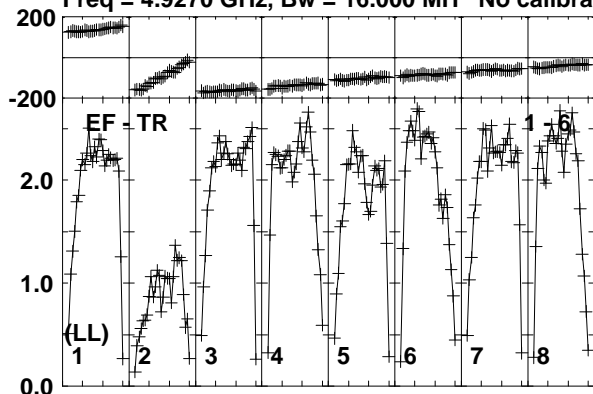

Lower frame: Milli Ampl Jy Top frame: Phas deg  
Vector averaged cross-power spectrum Baseline: EF (01) - TR (06)  
Timerange: 01/05:01:11 to 01/05:02:39

Plot file version 511 created 10-JUN-2016 17:22:53

CHECK RT013A.UVDATA.1

Freq = 4.9270 GHz, Bw = 16.000 MH No calibration applied and no bandpass applied

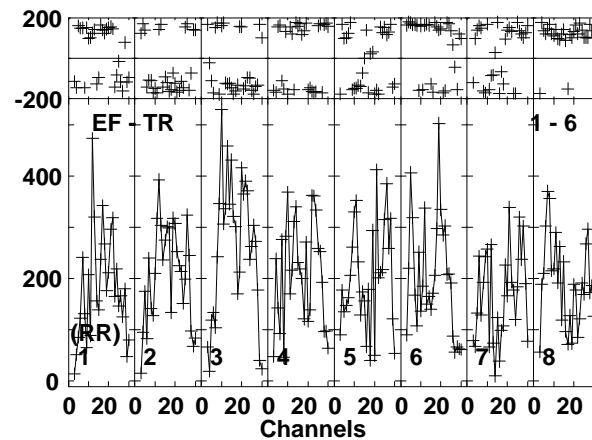
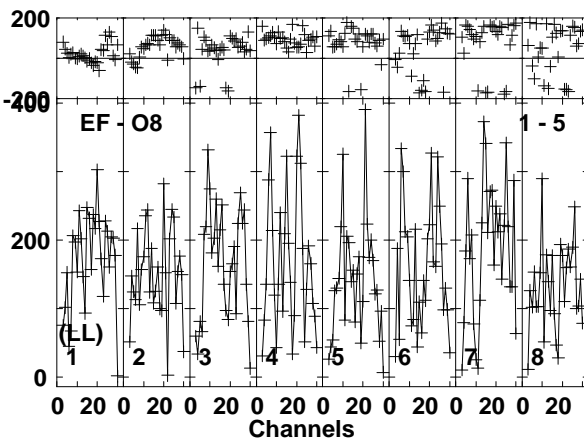
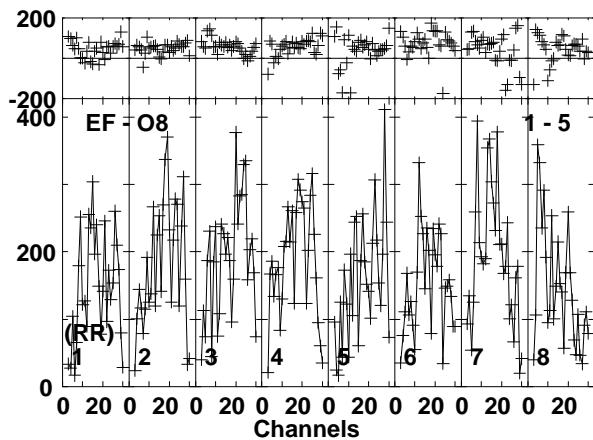
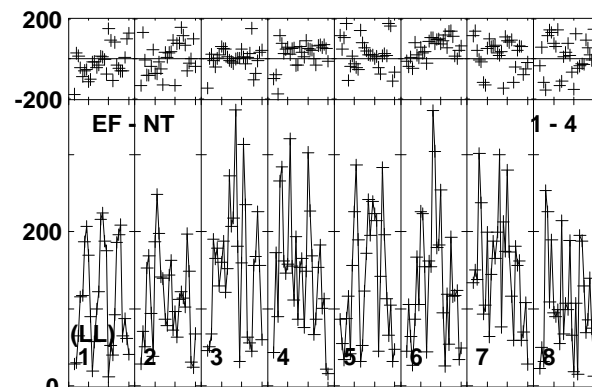
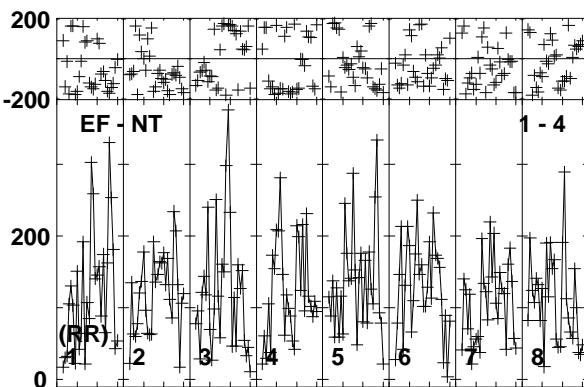
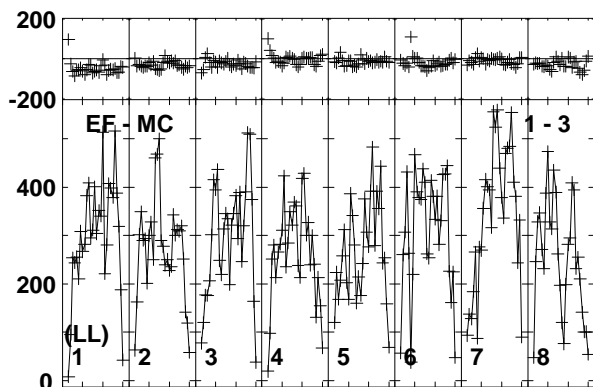
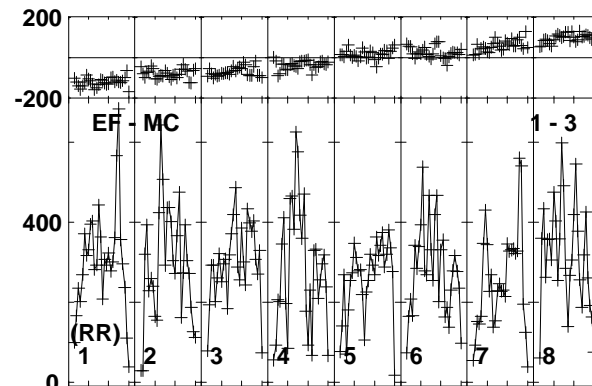
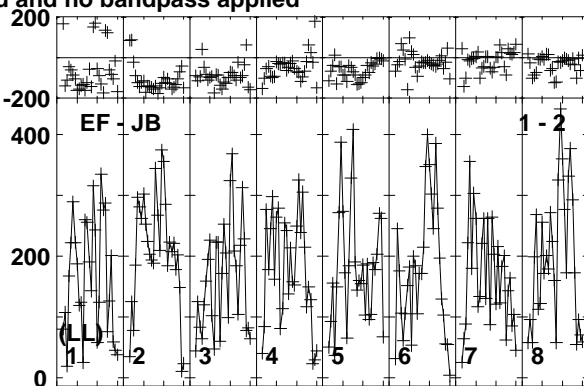
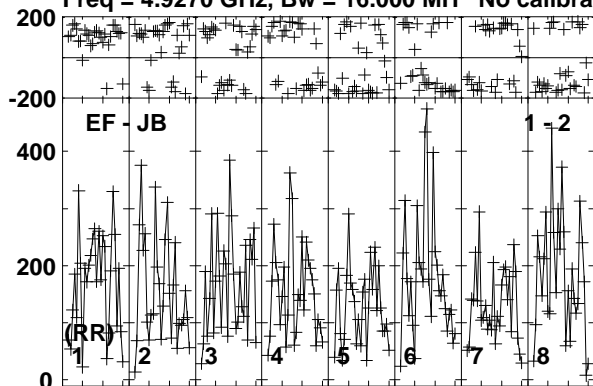

Lower frame: Micro Ampl Jy Top frame: Phas deg  
Vector averaged cross-power spectrum Baseline: EF (01) - JB (02)  
Timerange: 01/05:02:41 to 01/05:04:39

Plot file version 512 created 10-JUN-2016 17:22:53

CHECK RT013A.UVDATA.1

Freq = 4.9270 GHz, Bw = 16.000 MH No calibration applied and no bandpass applied

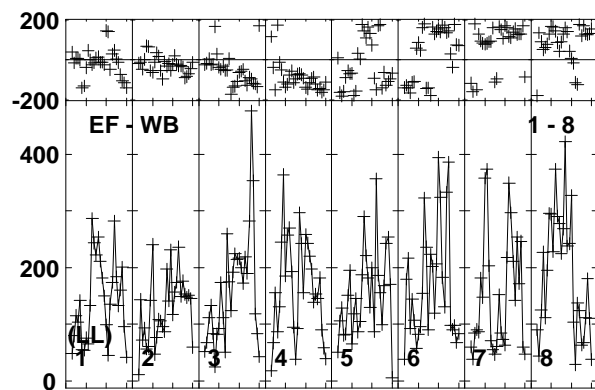
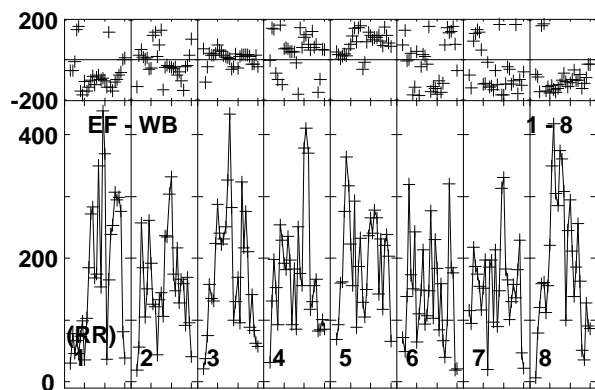
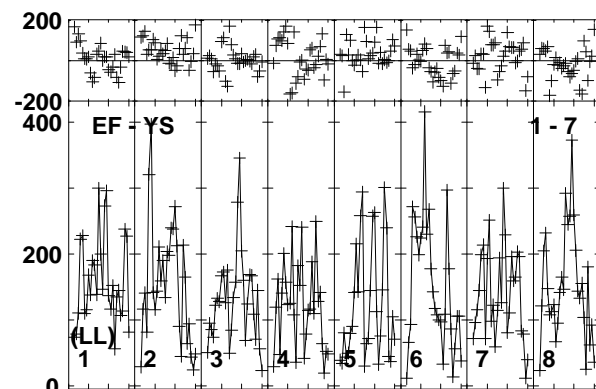
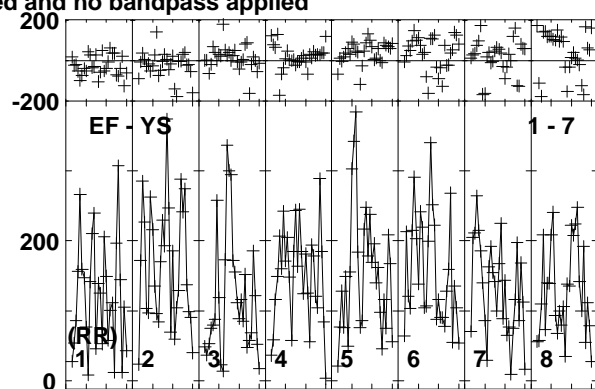
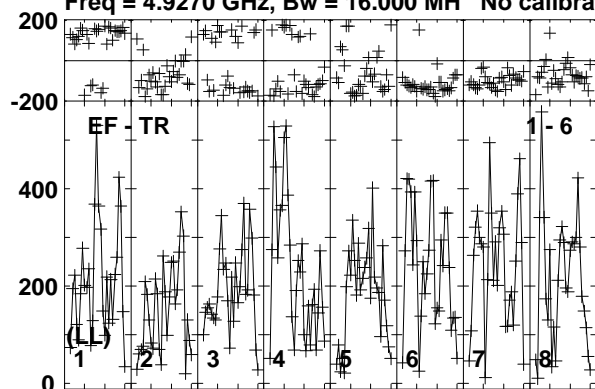

Lower frame: Micro Ampl Jy Top frame: Phas deg  
Vector averaged cross-power spectrum Baseline: EF (01) - TR (06)  
Timerange: 01/05:02:41 to 01/05:04:39

Plot file version 513 created 10-JUN-2016 17:22:53

CYGX1 RT013A.UVDATA.1

Freq = 4.9270 GHz, Bw = 16.000 MH No calibration applied and no bandpass applied

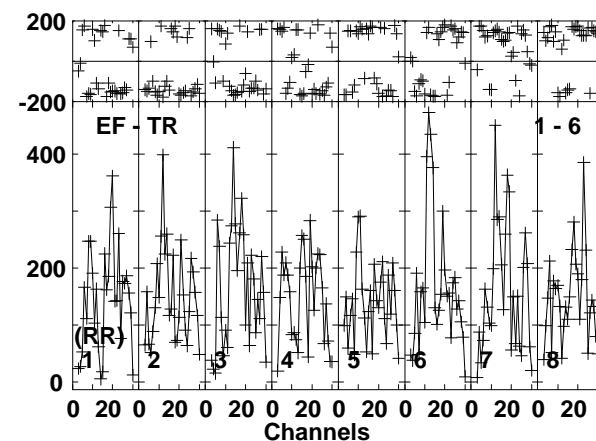
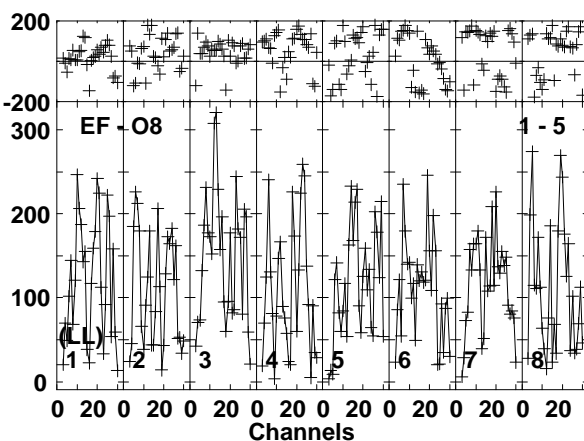
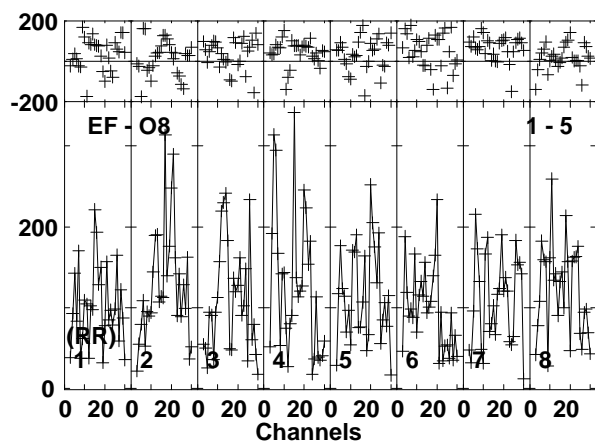
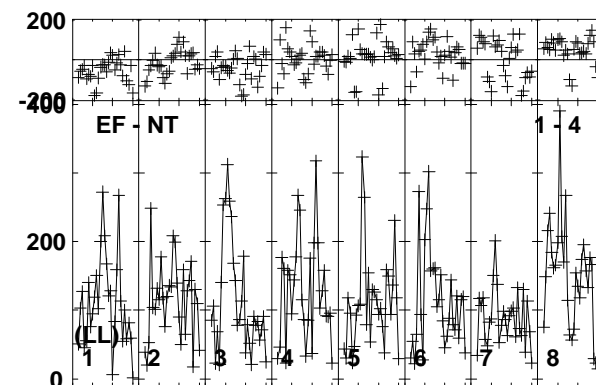
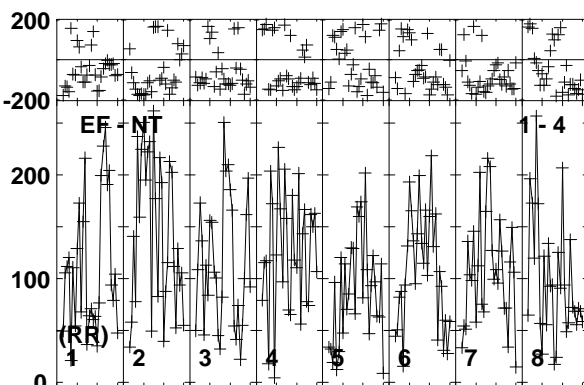
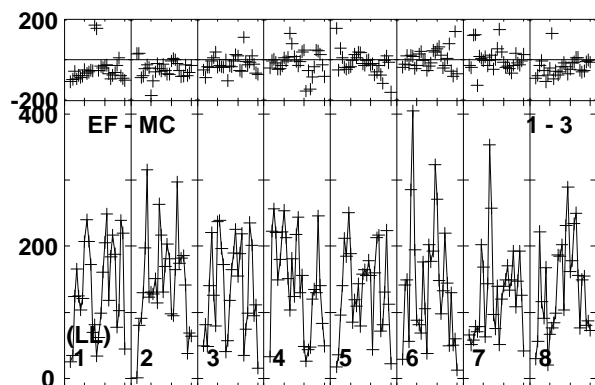
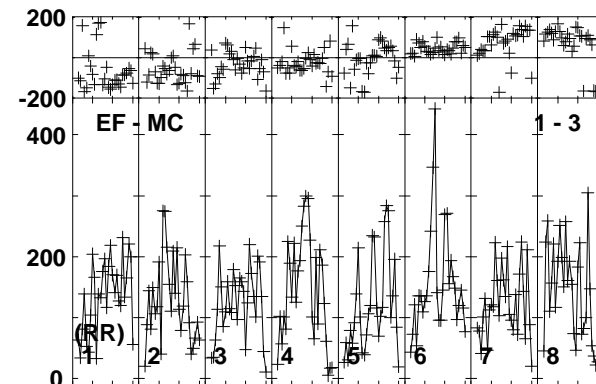
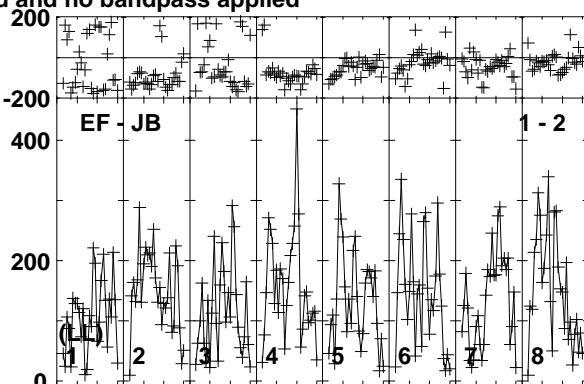
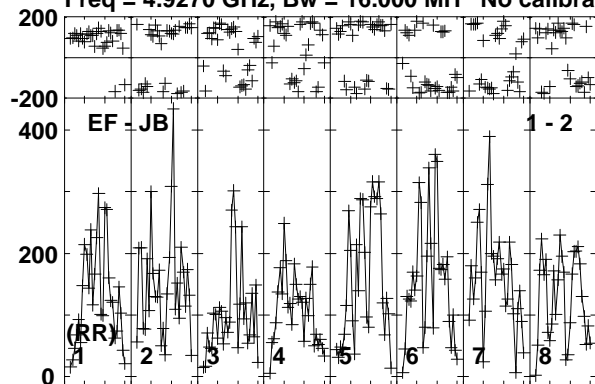

Lower frame: Micro Ampl Jy Top frame: Phas deg  
Vector averaged cross-power spectrum Baseline: EF (01) - JB (02)  
Timerange: 01/05:04:40 to 01/05:07:10

Plot file version 514 created 10-JUN-2016 17:22:53

CYGX1 RT013A.UVDATA.1

Freq = 4.9270 GHz, Bw = 16.000 MH No calibration applied and no bandpass applied

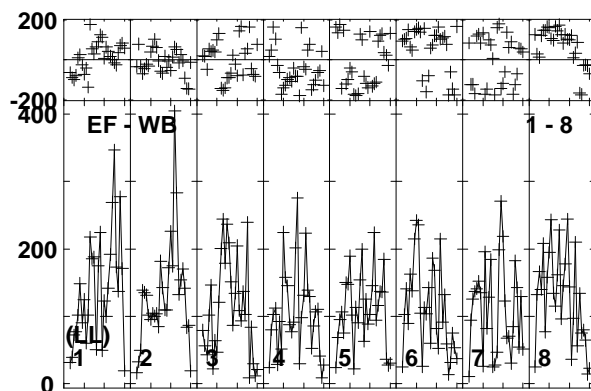
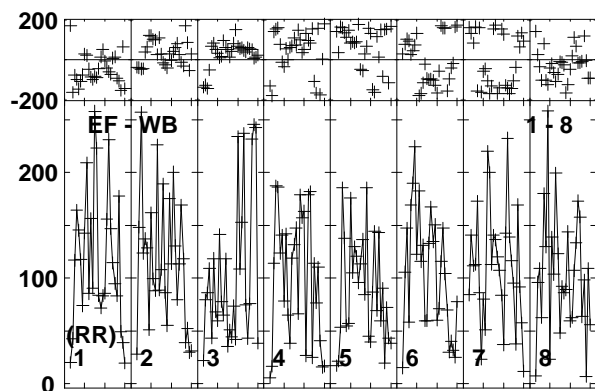
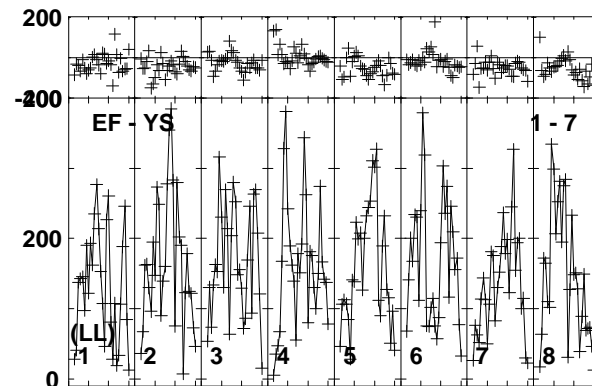
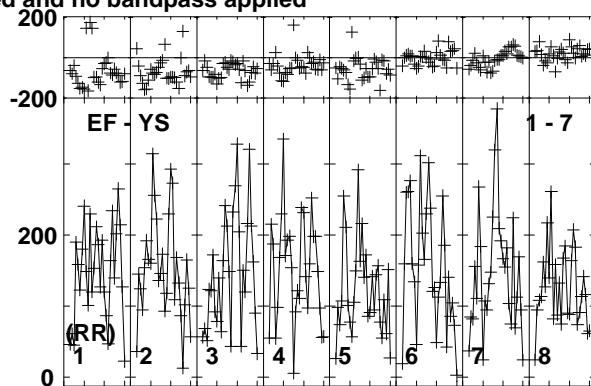
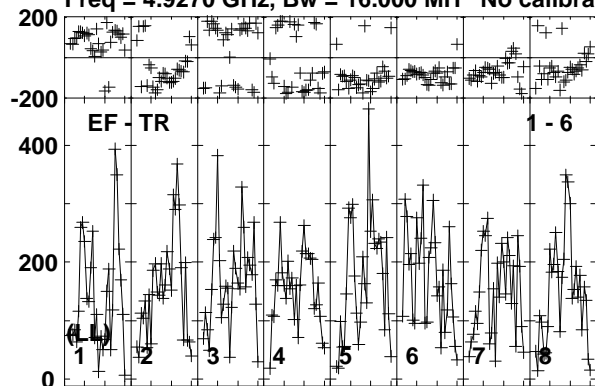

Lower frame: Micro Ampl Jy Top frame: Phas deg  
Vector averaged cross-power spectrum Baseline: EF (01) - TR (06)  
Timerange: 01/05:04:40 to 01/05:07:10



Plot file version 515 created 10-JUN-2016 17:22:53

J1957+3338 RT013A.UVDATA.1

Freq = 4.9270 GHz, Bw = 16.000 MH No calibration applied and no bandpass applied

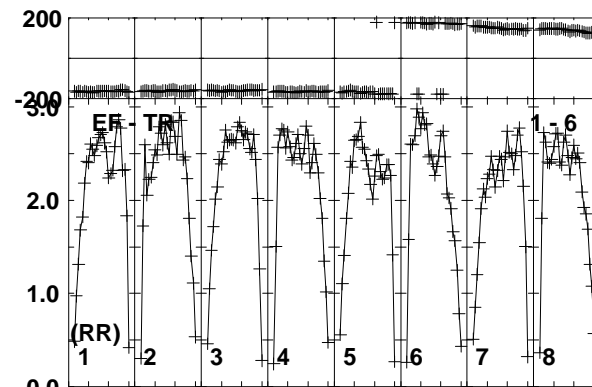
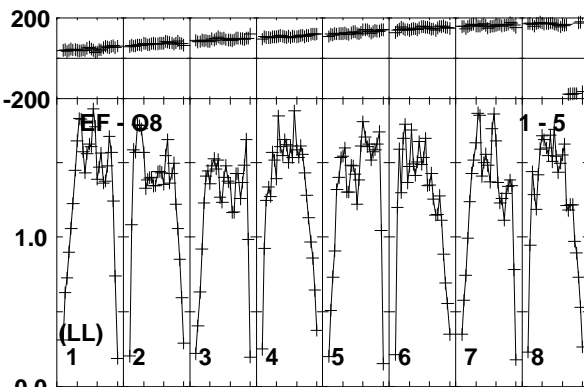
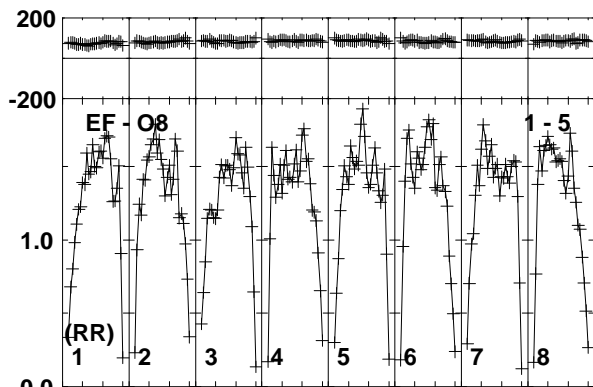
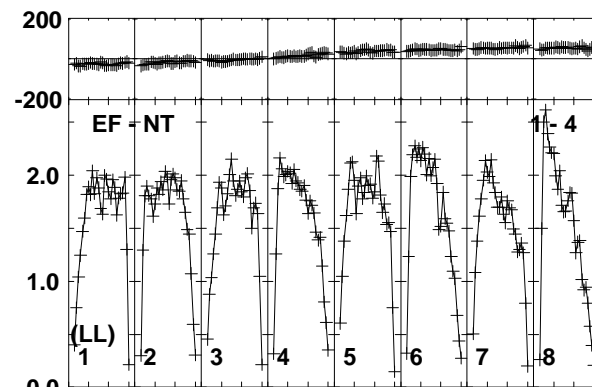
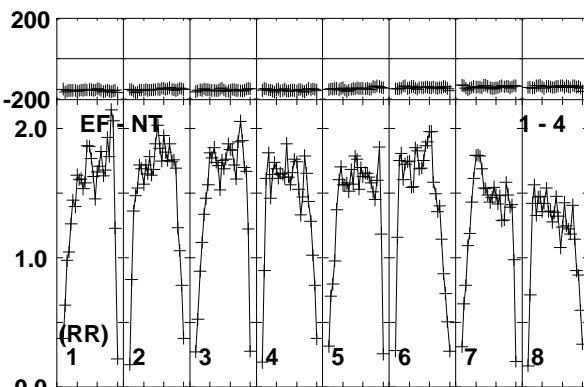
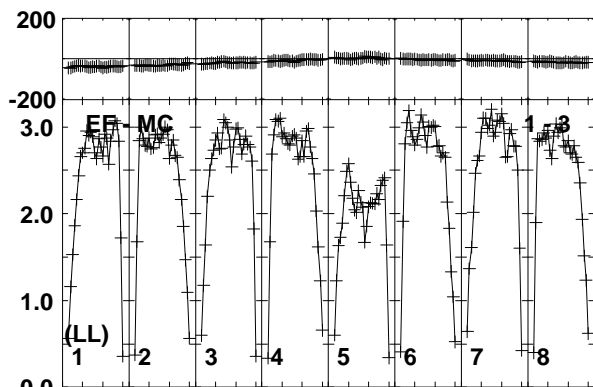
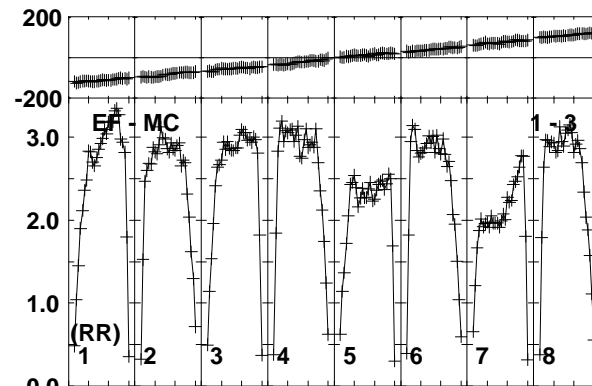
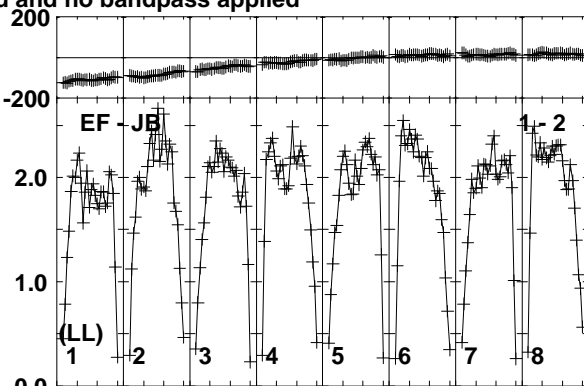
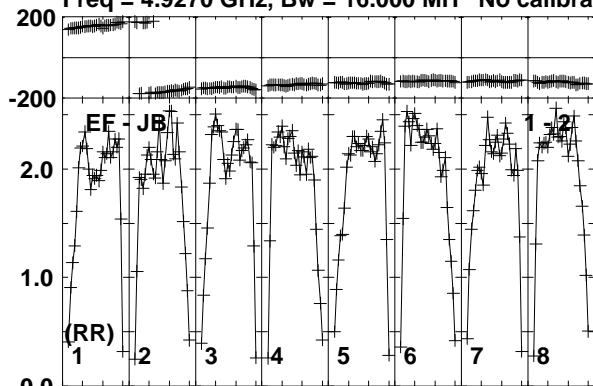

Lower frame: Milli Ampl Jy Top frame: Phas deg  
Vector averaged cross-power spectrum Baseline: EF (01) - JB (02)  
Timerange: 01/05:07:10 to 01/05:08:39

Plot file version 516 created 10-JUN-2016 17:22:53

J1957+3338 RT013A.UVDATA.1

Freq = 4.9270 GHz, Bw = 16.000 MH No calibration applied and no bandpass applied

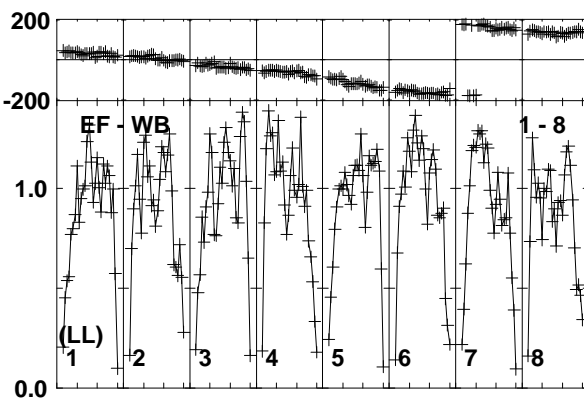
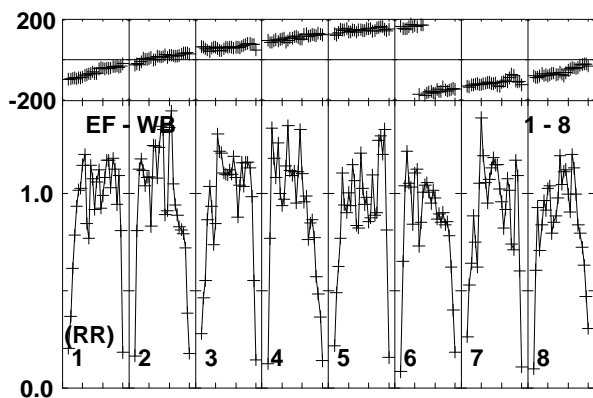
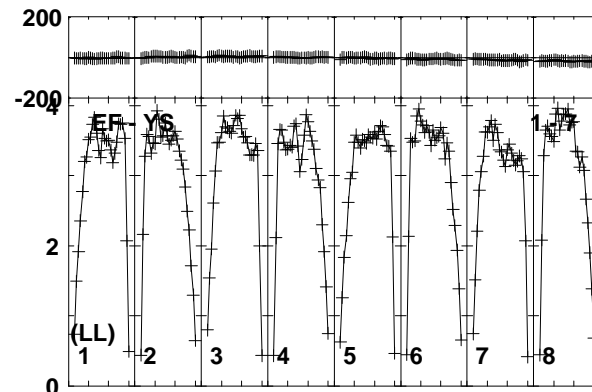
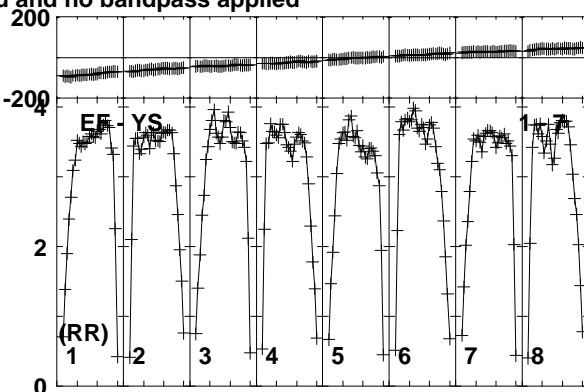
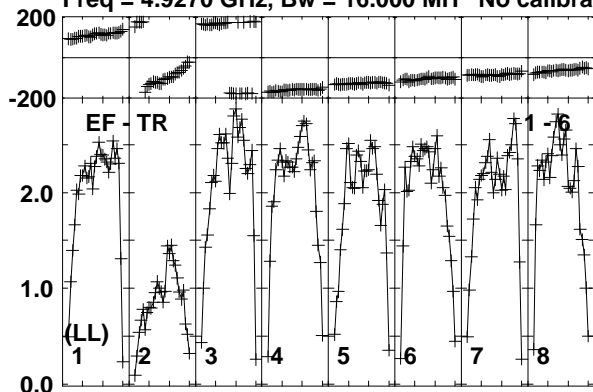

Lower frame: Milli Ampl Jy Top frame: Phas deg  
Vector averaged cross-power spectrum Baseline: EF (01) - TR (06)  
Timerange: 01/05:07:10 to 01/05:08:39

Plot file version 517 created 10-JUN-2016 17:22:53

CHECK RT013A.UVDATA.1

Freq = 4.9270 GHz, Bw = 16.000 MH No calibration applied and no bandpass applied

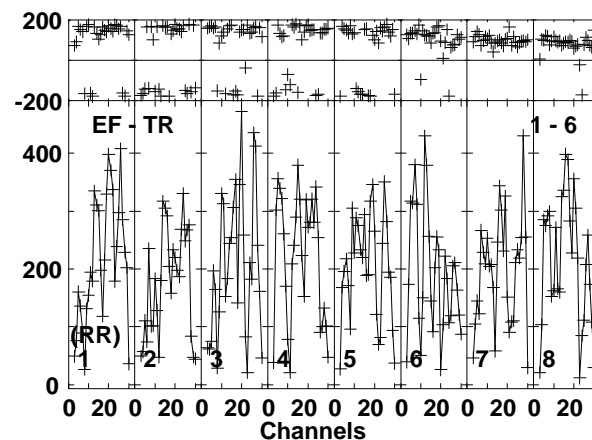
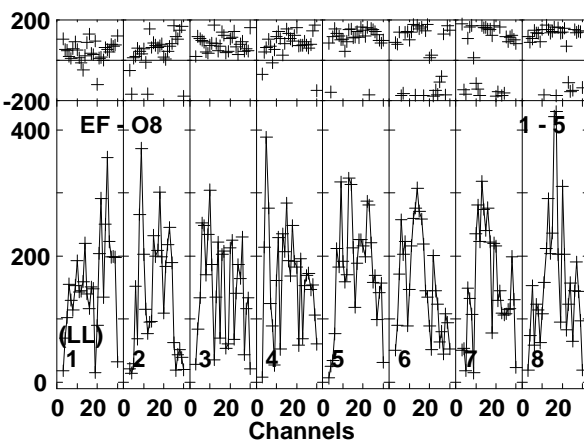
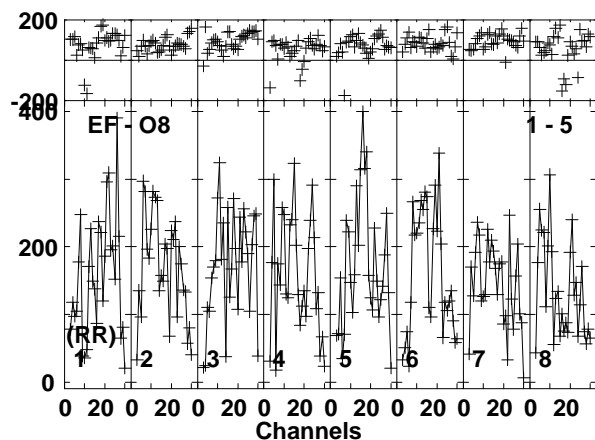
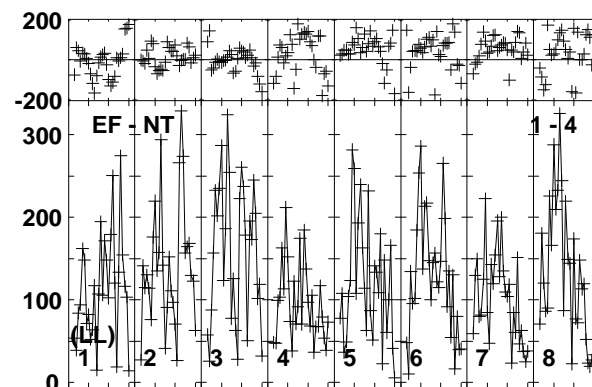
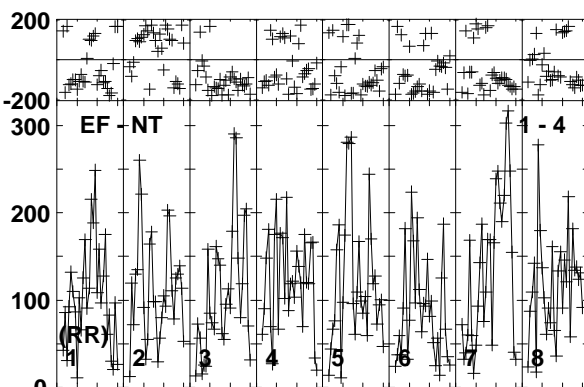
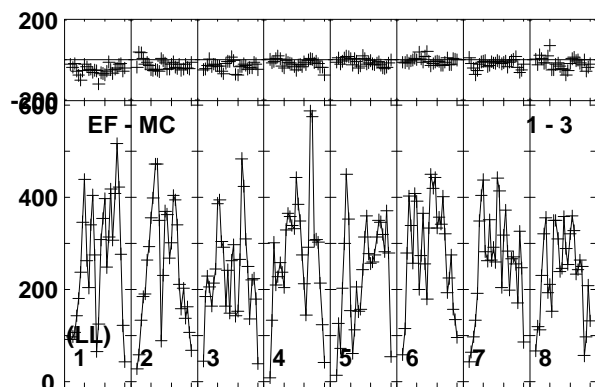
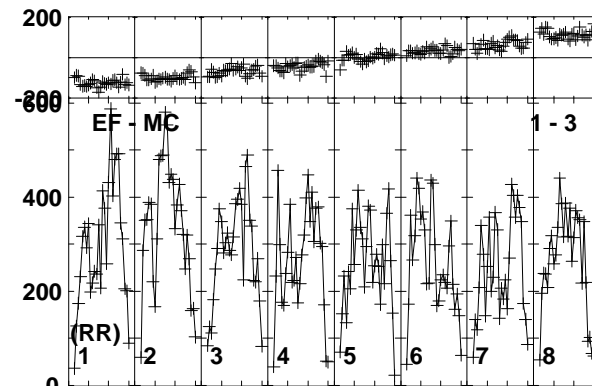
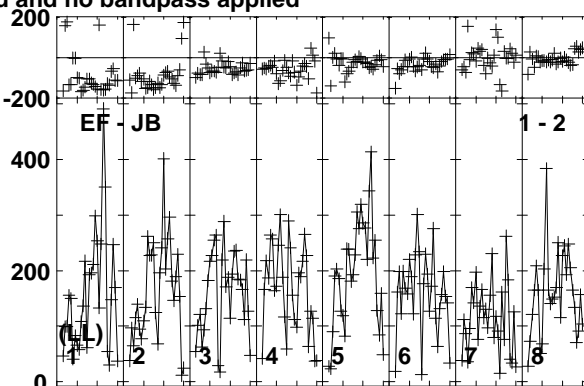
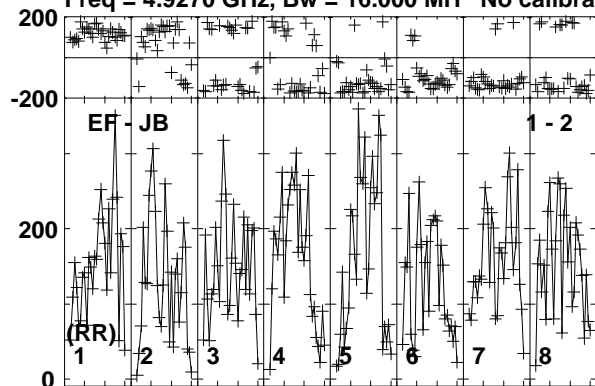

Lower frame: Micro Ampl Jy Top frame: Phas deg  
Vector averaged cross-power spectrum Baseline: EF (01) - JB (02)  
Timerange: 01/05:09:21 to 01/05:11:20

Plot file version 518 created 10-JUN-2016 17:22:54

CHECK RT013A.UVDATA.1

Freq = 4.9270 GHz, Bw = 16.000 MH No calibration applied and no bandpass applied

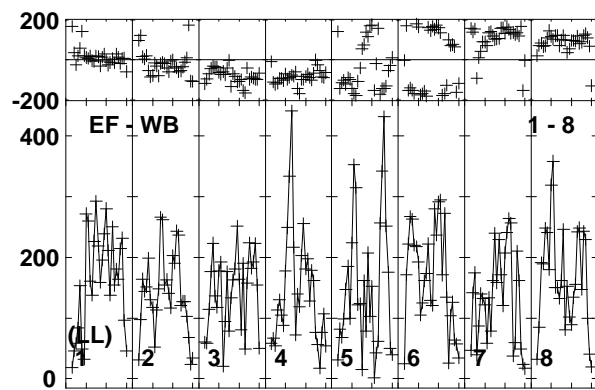
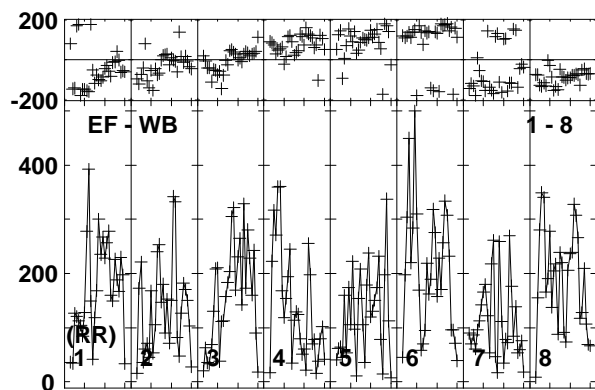
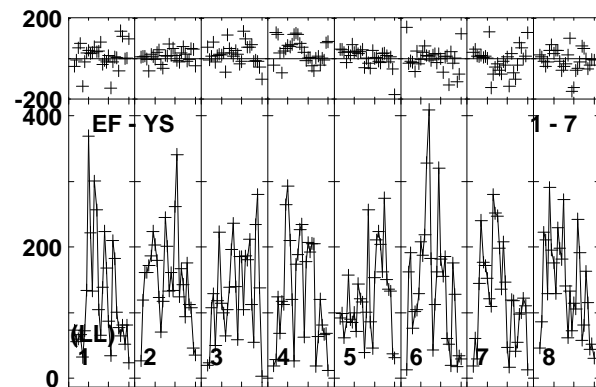
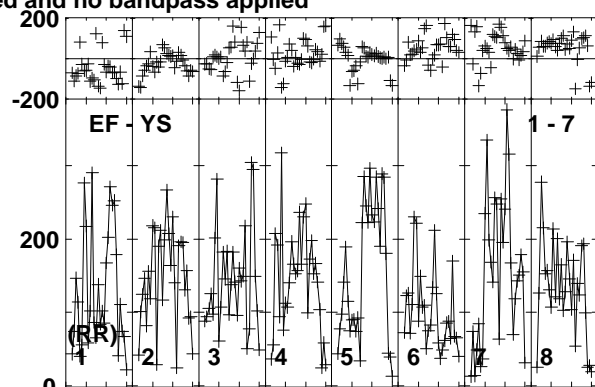
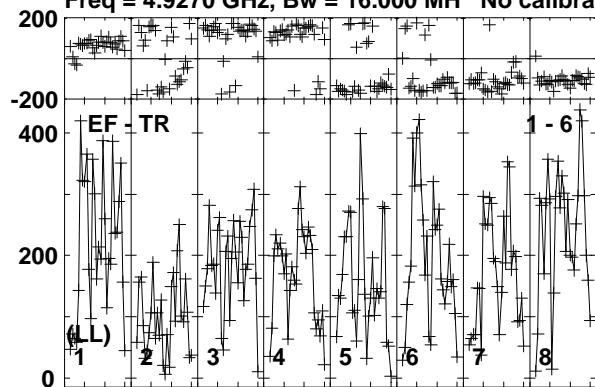

Lower frame: Micro Ampl Jy Top frame: Phas deg  
Vector averaged cross-power spectrum Baseline: EF (01) - TR (06)  
Timerange: 01/05:09:21 to 01/05:11:20

Plot file version 519 created 10-JUN-2016 17:22:54

CYGX1 RT013A.UVDATA.1

Freq = 4.9270 GHz, Bw = 16.000 MH No calibration applied and no bandpass applied

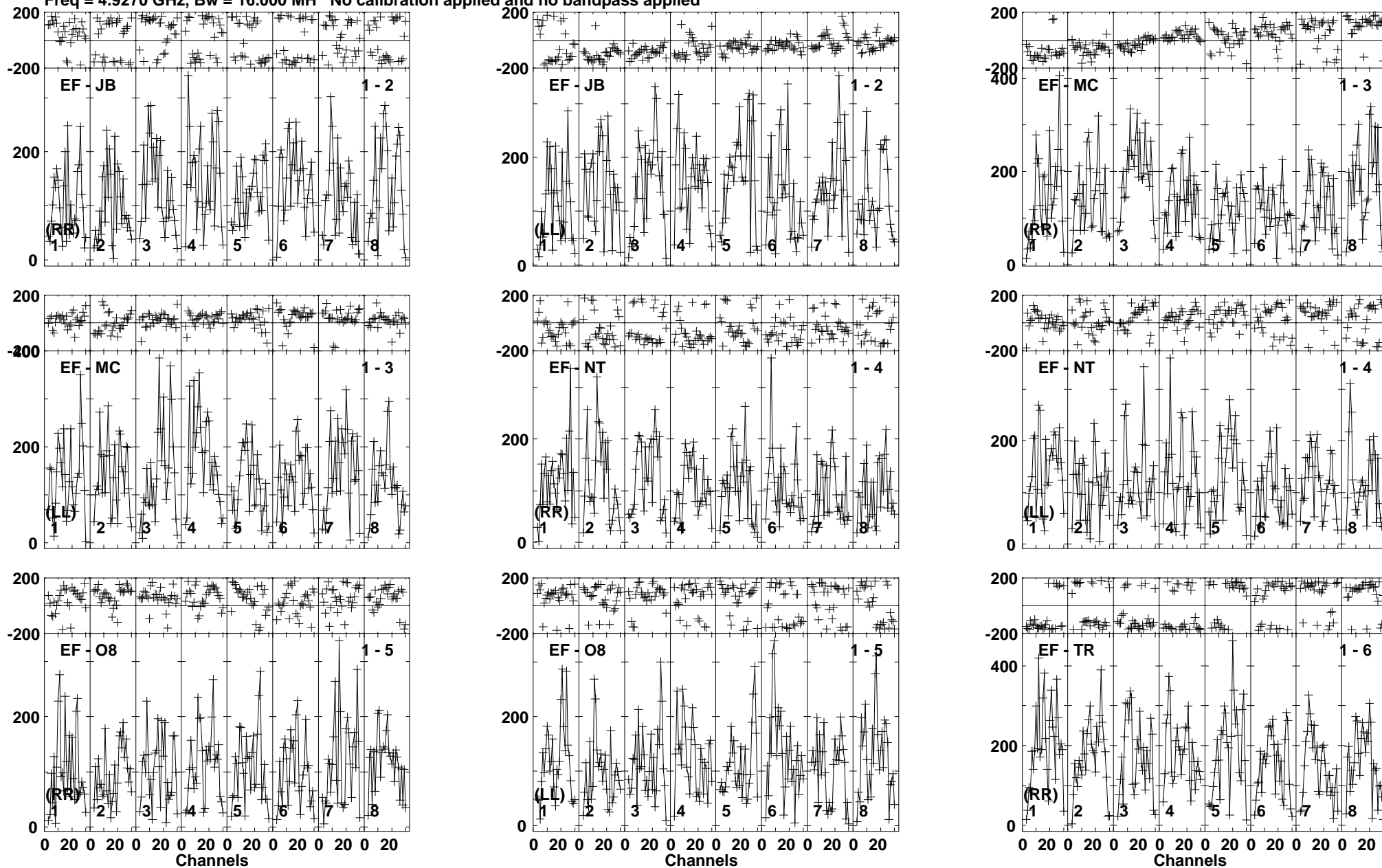

Lower frame: Micro Ampl Jy Top frame: Phas deg  
Vector averaged cross-power spectrum Baseline: EF (01) - JB (02)  
Timerange: 01/05:11:21 to 01/05:13:49

Plot file version 520 created 10-JUN-2016 17:22:54

CYGX1 RT013A.UVDATA.1

Freq = 4.9270 GHz, Bw = 16.000 MH No calibration applied and no bandpass applied

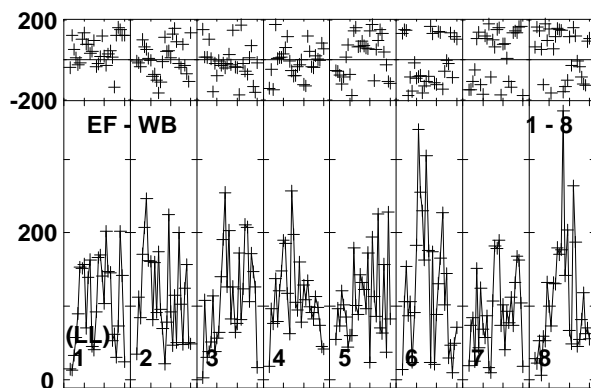
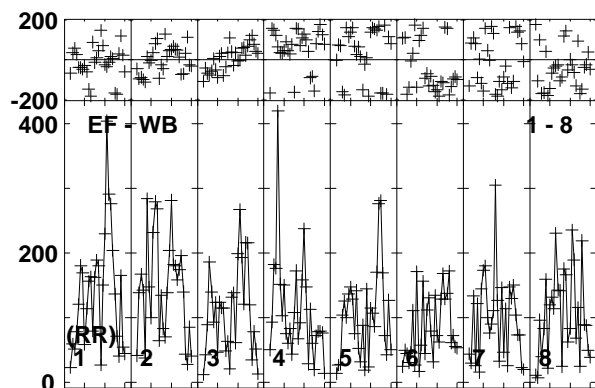
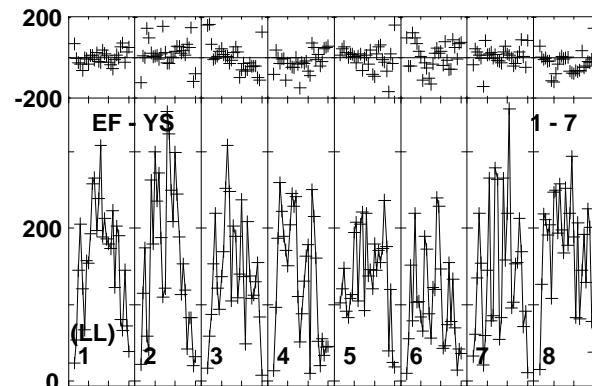
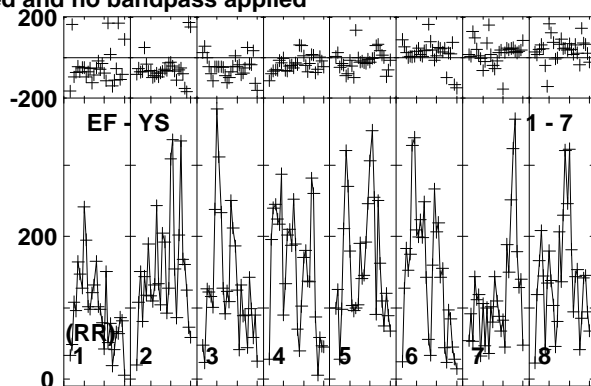
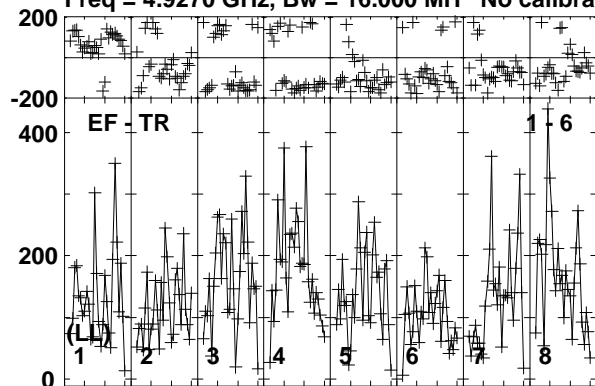

Lower frame: Micro Ampl Jy Top frame: Phas deg  
Vector averaged cross-power spectrum Baseline: EF (01) - TR (06)  
Timerange: 01/05:11:21 to 01/05:13:49

Plot file version 521 created 10-JUN-2016 17:22:54

J1957+3338 RT013A.UVDATA.1

Freq = 4.9270 GHz, Bw = 16.000 MH No calibration applied and no bandpass applied

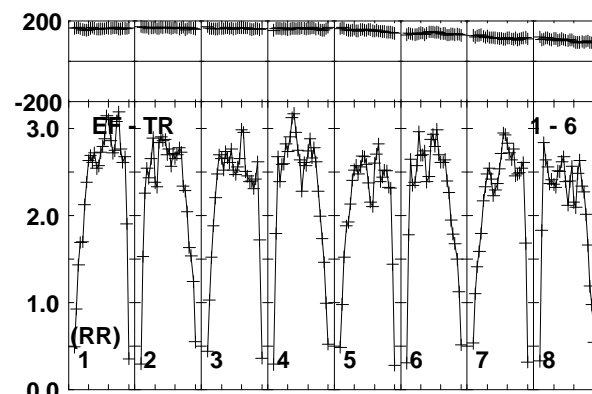
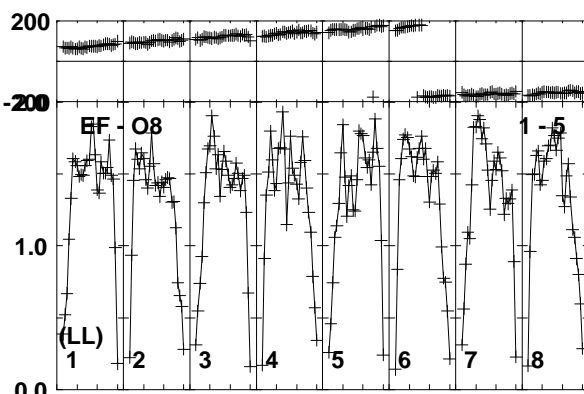
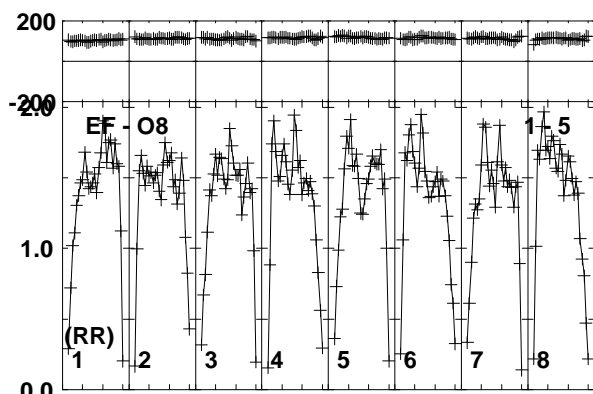
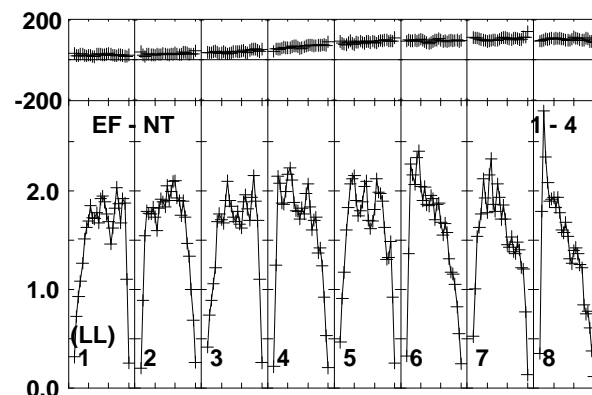
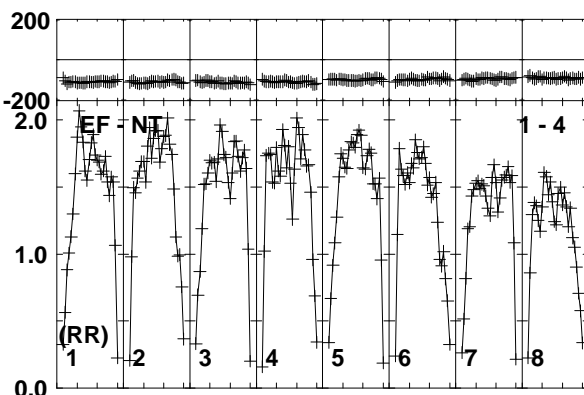
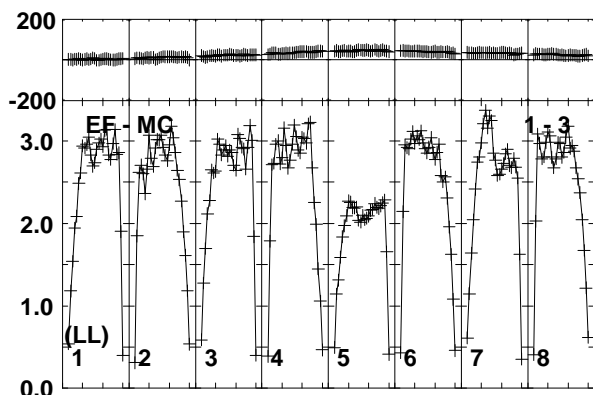
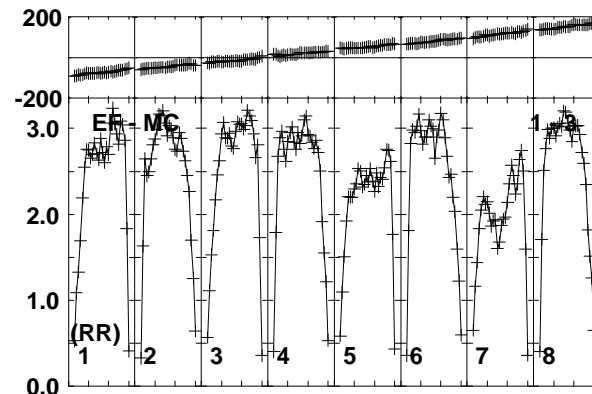
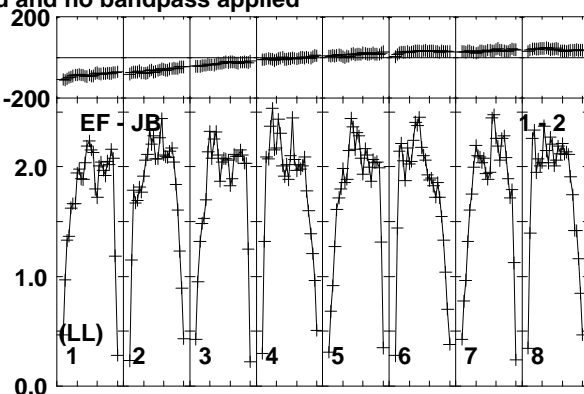
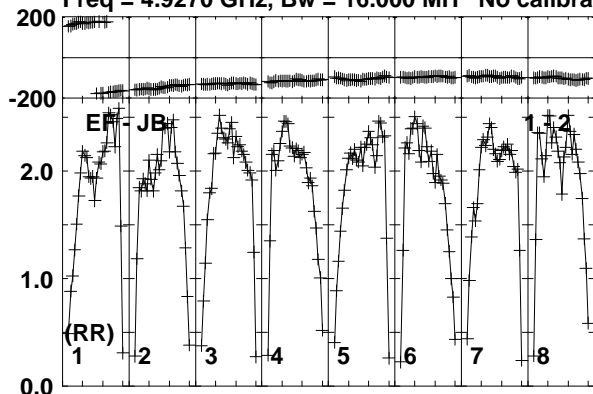

Lower frame: Milli Ampl Jy Top frame: Phas deg  
Vector averaged cross-power spectrum Baseline: EF (01) - JB (02)  
Timerange: 01/05:13:50 to 01/05:15:19

Plot file version 522 created 10-JUN-2016 17:22:54

J1957+3338 RT013A.UVDATA.1

Freq = 4.9270 GHz, Bw = 16.000 MH No calibration applied and no bandpass applied

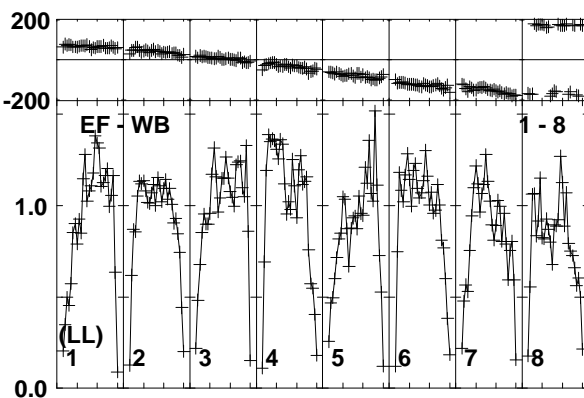
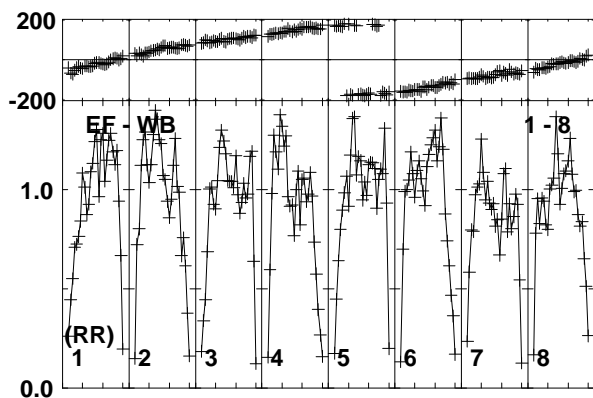
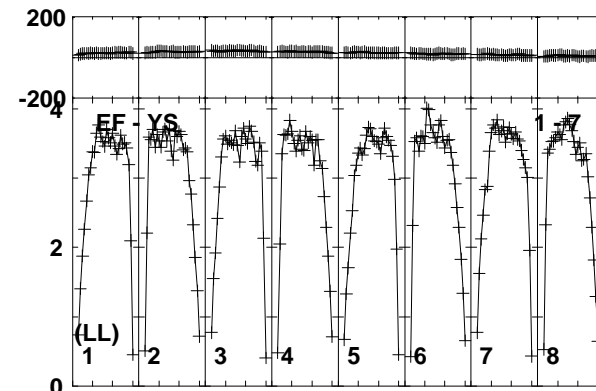
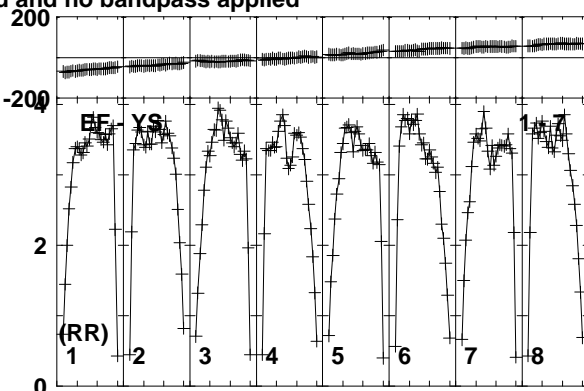
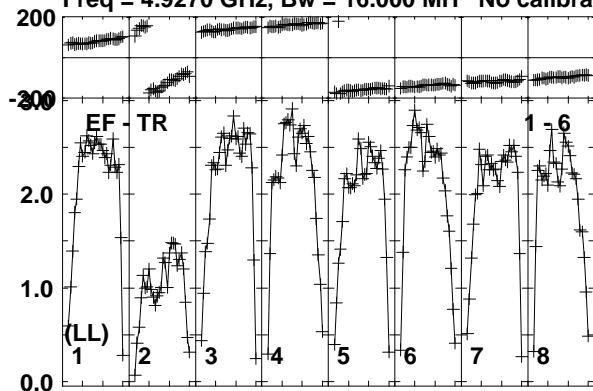

Lower frame: Milli Ampl Jy Top frame: Phas deg  
Vector averaged cross-power spectrum Baseline: EF (01) - TR (06)  
Timerange: 01/05:13:50 to 01/05:15:19



Plot file version 523 created 10-JUN-2016 17:22:54

CHECK RT013A.UVDATA.1

Freq = 4.9270 GHz, Bw = 16.000 MH No calibration applied and no bandpass applied

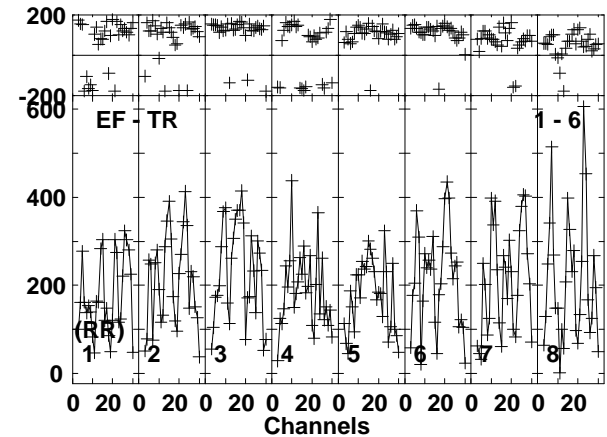
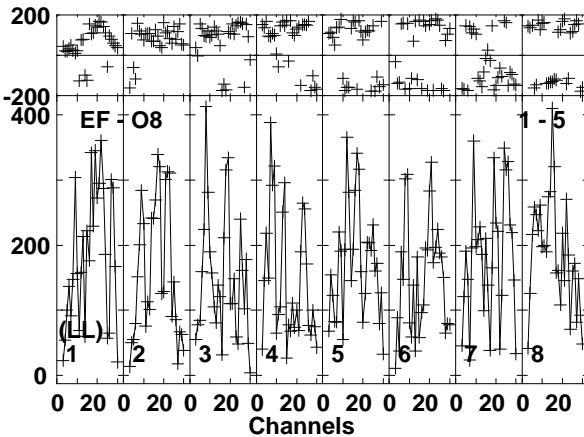
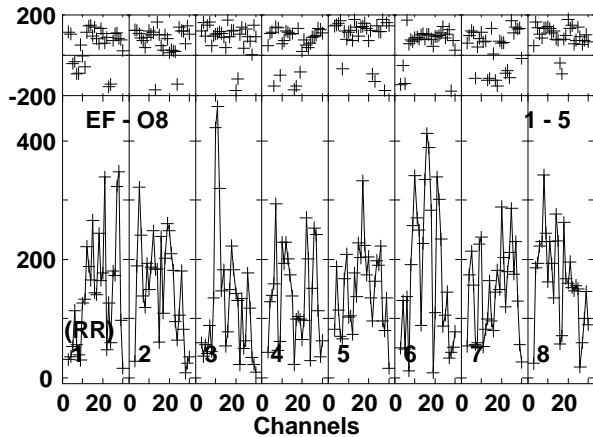
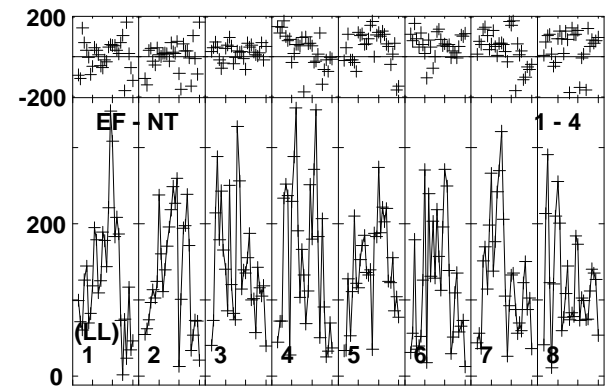
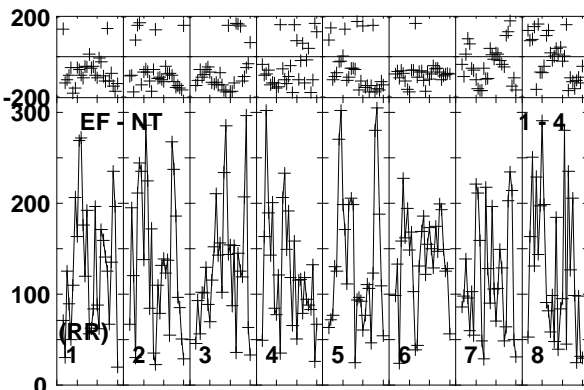
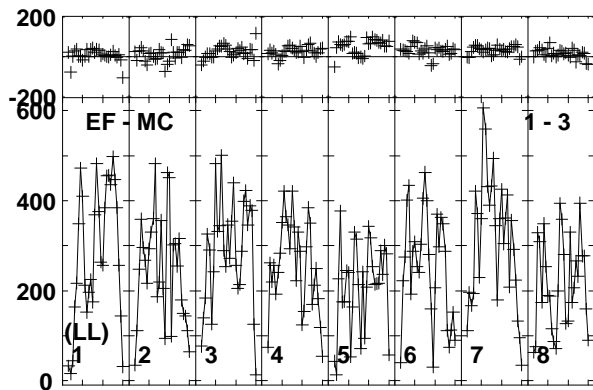
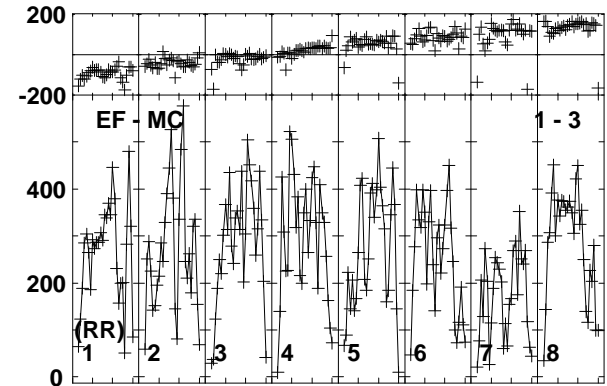
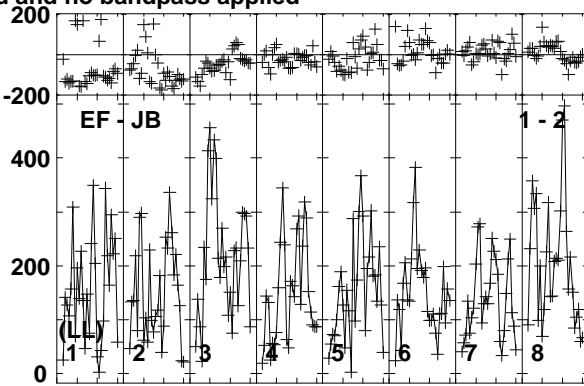
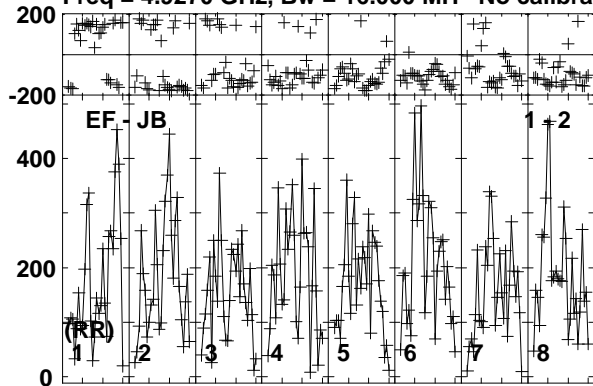

Lower frame: Micro Ampl Jy Top frame: Phas deg  
Vector averaged cross-power spectrum Baseline: EF (01) - JB (02)  
Timerange: 01/05:15:20 to 01/05:17:19

Plot file version 524 created 10-JUN-2016 17:22:54

CHECK RT013A.UVDATA.1

Freq = 4.9270 GHz, Bw = 16.000 MH No calibration applied and no bandpass applied

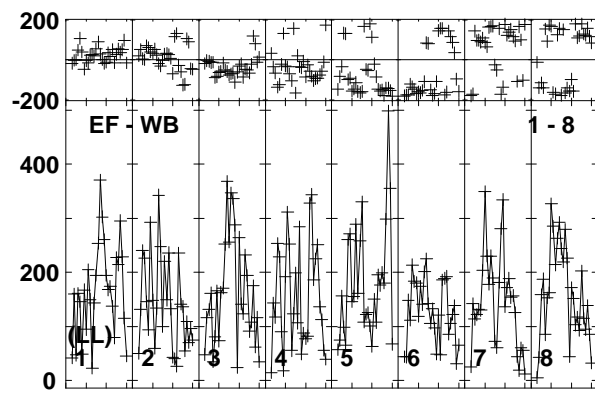
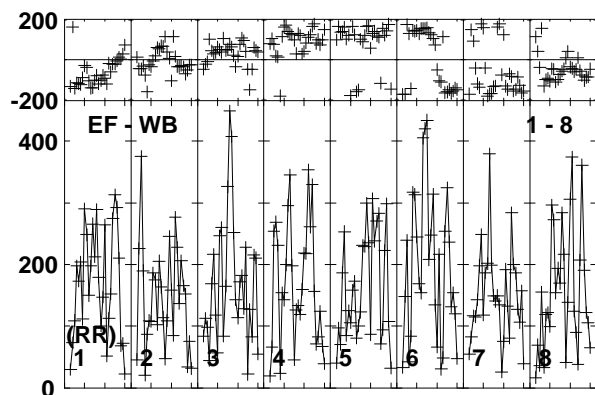
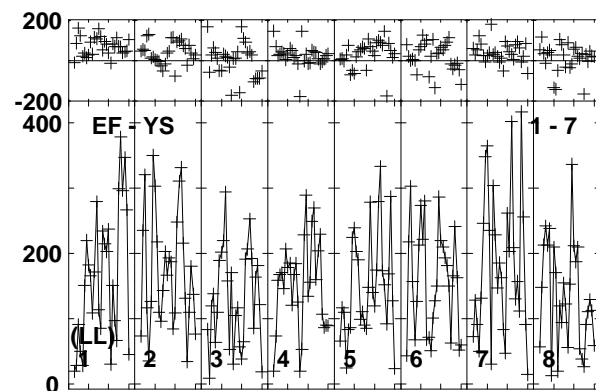
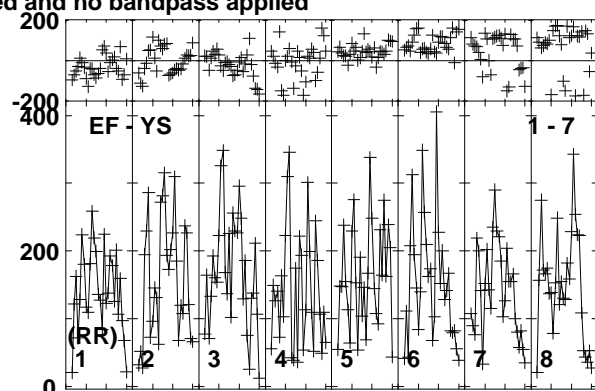
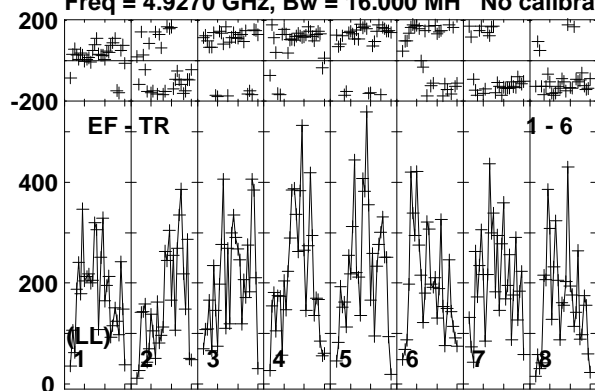

Lower frame: Micro Ampl Jy Top frame: Phas deg  
Vector averaged cross-power spectrum Baseline: EF (01) - TR (06)  
Timerange: 01/05:15:20 to 01/05:17:19

Plot file version 525 created 10-JUN-2016 17:22:54

CYGX1 RT013A.UVDATA.1

Freq = 4.9270 GHz, Bw = 16.000 MH No calibration applied and no bandpass applied

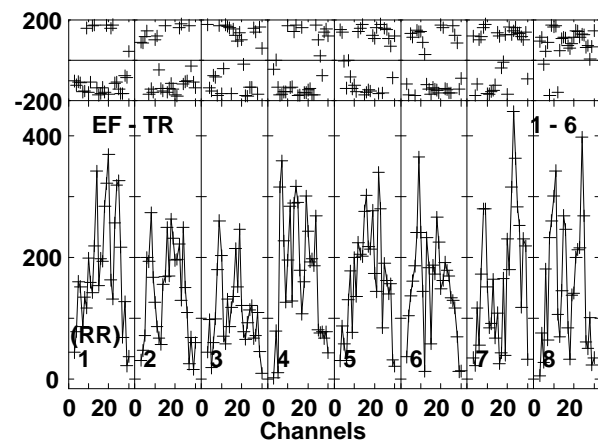
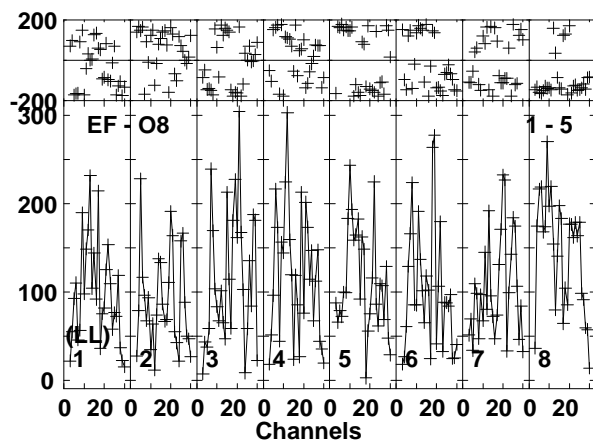
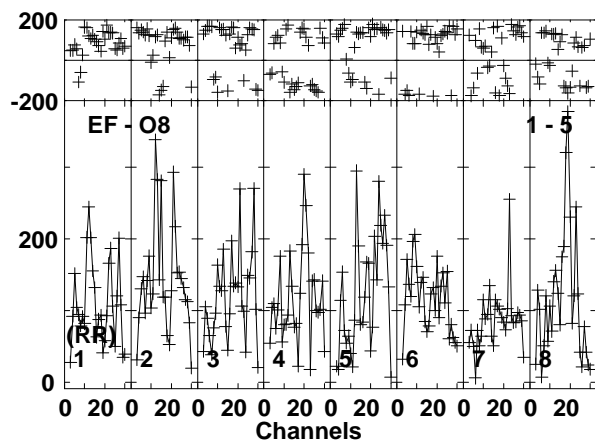
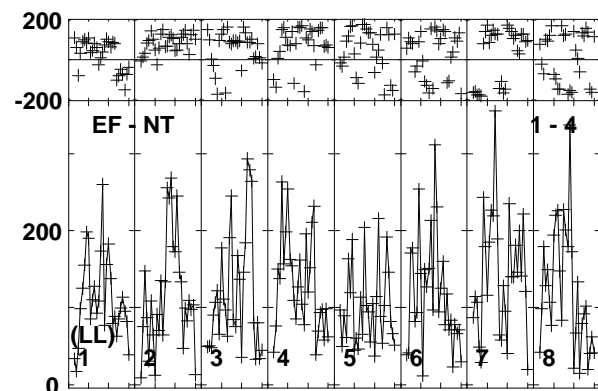
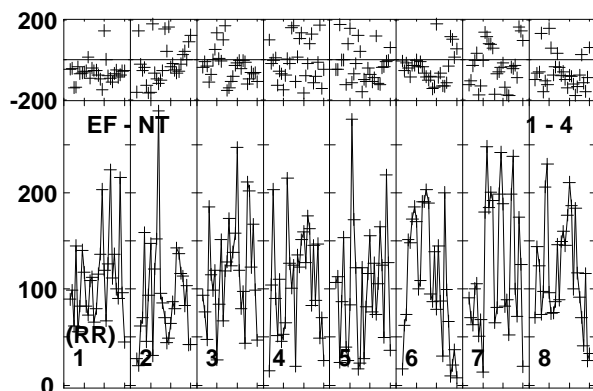
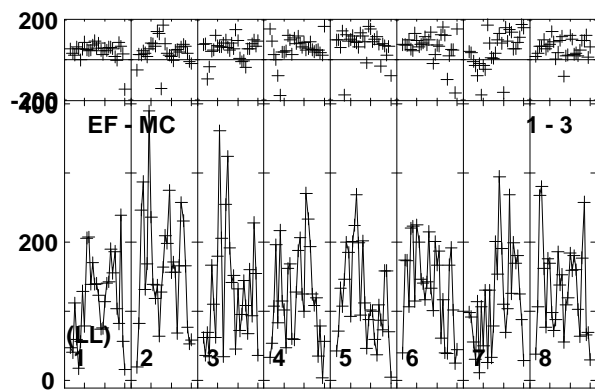
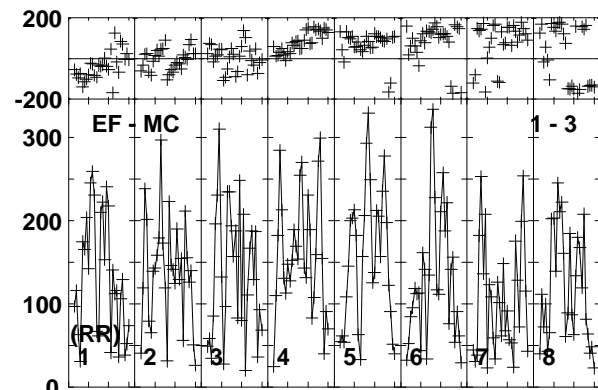
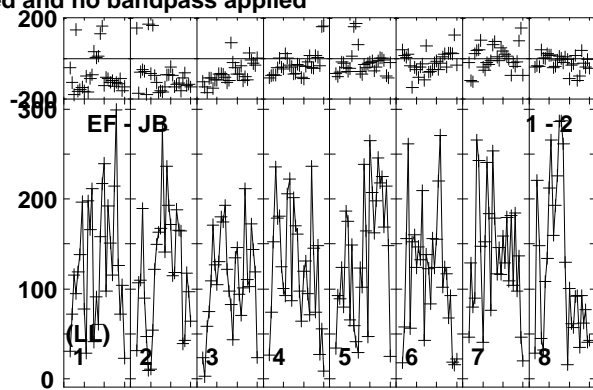
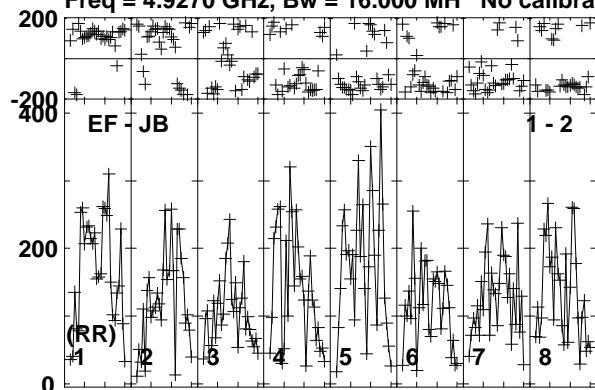

Lower frame: Micro Ampl Jy Top frame: Phas deg  
Vector averaged cross-power spectrum Baseline: EF (01) - JB (02)  
Timerange: 01/05:17:20 to 01/05:19:50

Plot file version 526 created 10-JUN-2016 17:22:54

CYGX1 RT013A.UVDATA.1

Freq = 4.9270 GHz, Bw = 16.000 MH No calibration applied and no bandpass applied

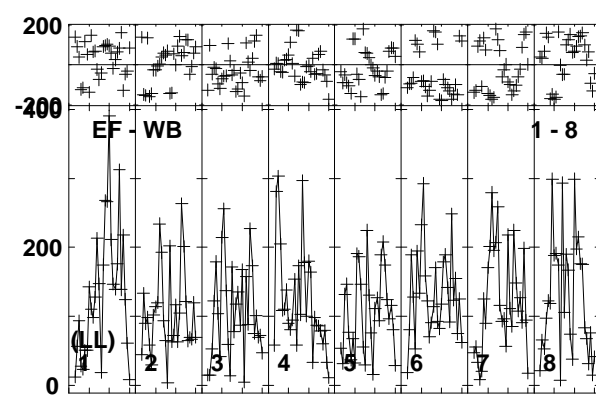
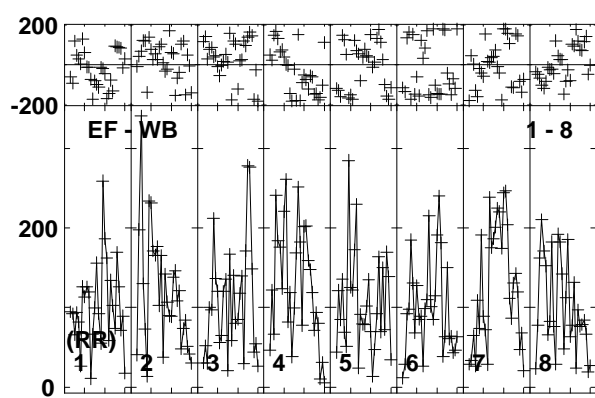
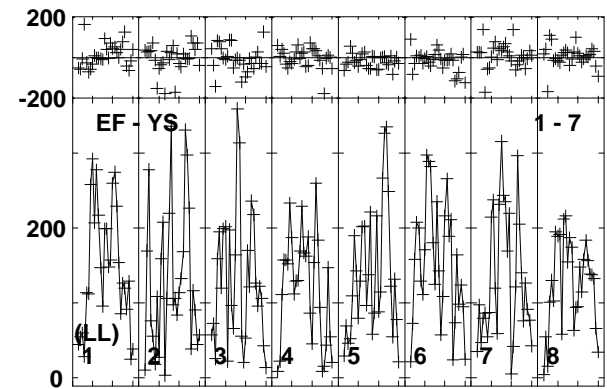
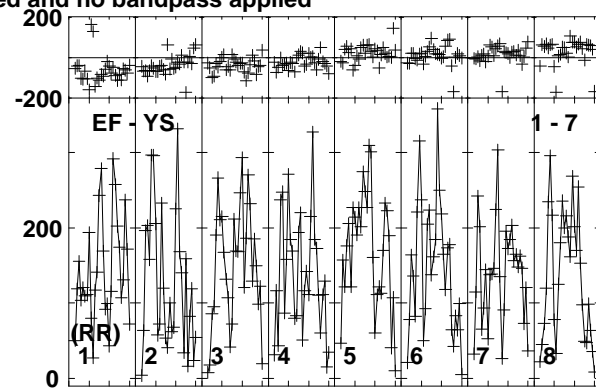
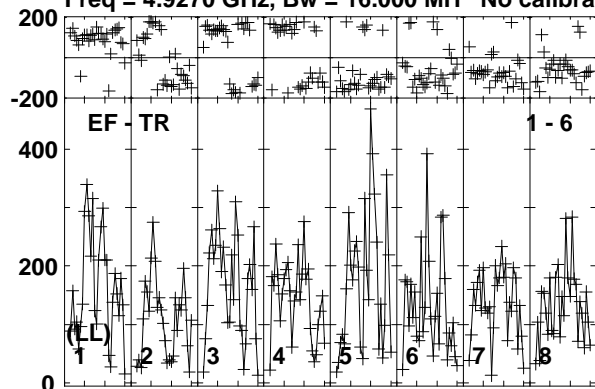

Lower frame: Micro Ampl Jy Top frame: Phas deg  
Vector averaged cross-power spectrum Baseline: EF (01) - TR (06)  
Timerange: 01/05:17:20 to 01/05:19:50

Plot file version 527 created 10-JUN-2016 17:22:54

J1957+3338 RT013A.UVDATA.1

Freq = 4.9270 GHz, Bw = 16.000 MH No calibration applied and no bandpass applied

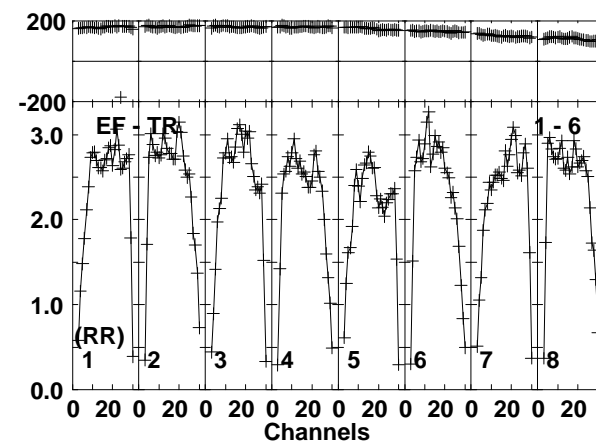
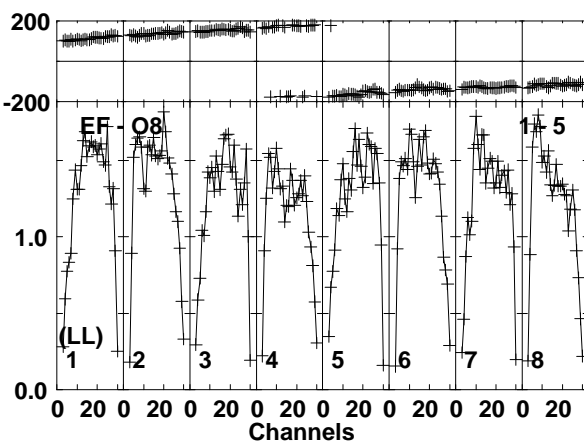
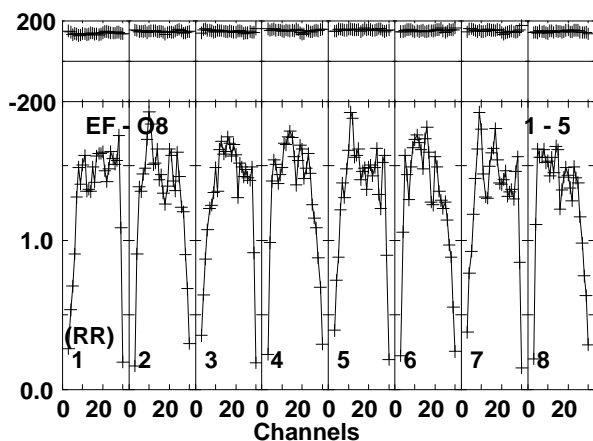
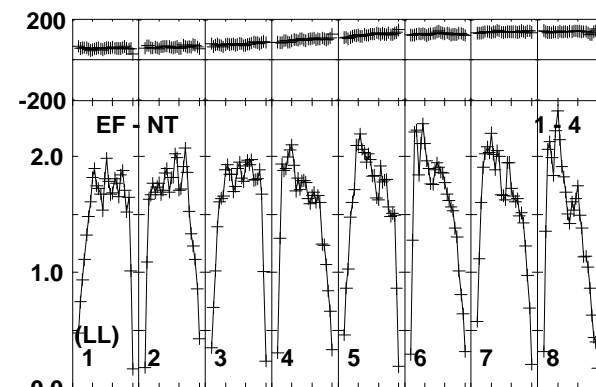
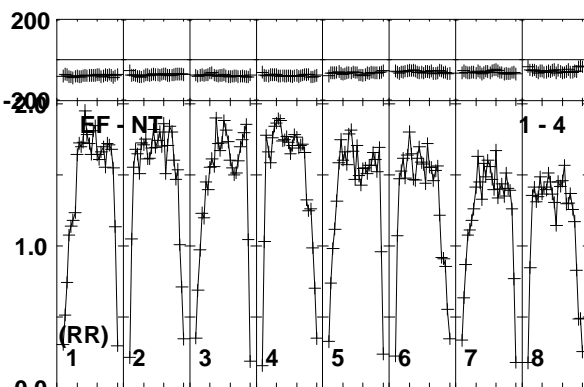
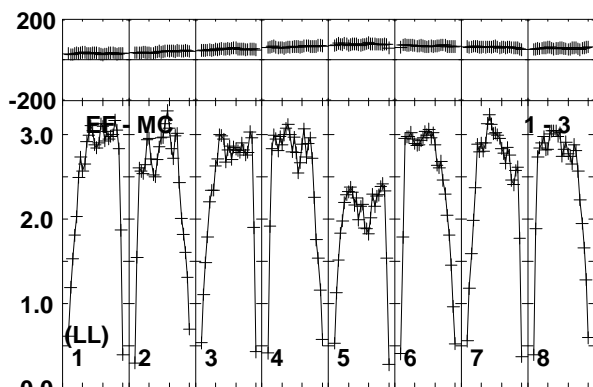
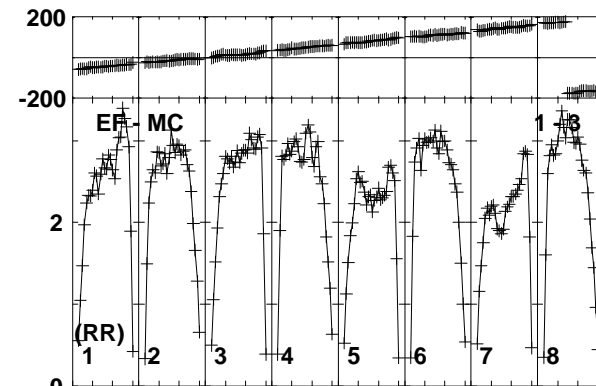
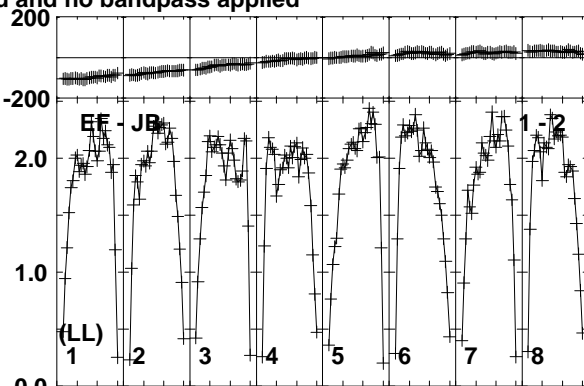
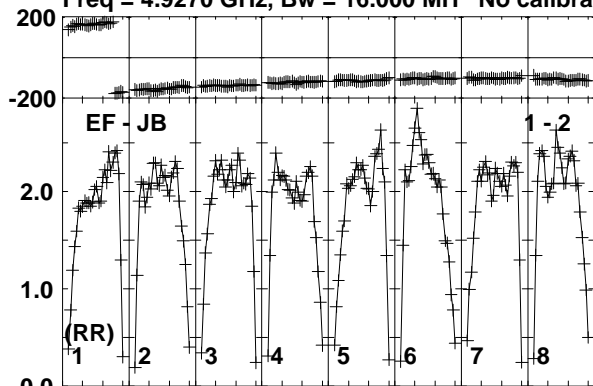

Lower frame: Milli Ampl Jy Top frame: Phas deg  
Vector averaged cross-power spectrum Baseline: EF (01) - JB (02)  
Timerange: 01/05:19:51 to 01/05:21:20

Plot file version 528 created 10-JUN-2016 17:22:54

J1957+3338 RT013A.UVDATA.1

Freq = 4.9270 GHz, Bw = 16.000 MH No calibration applied and no bandpass applied

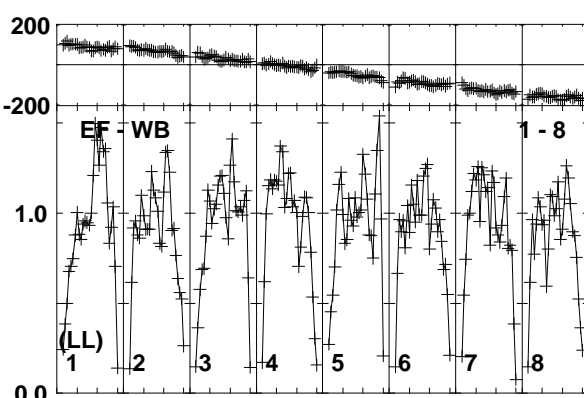
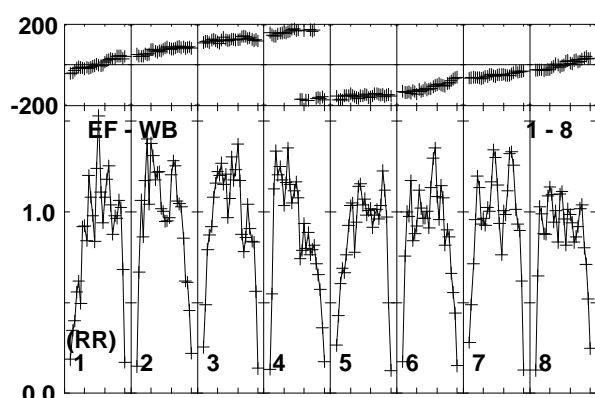
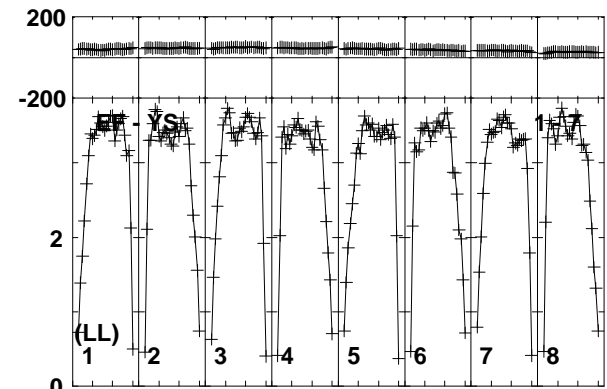
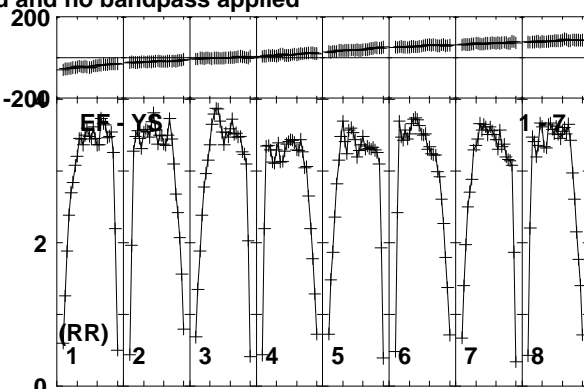
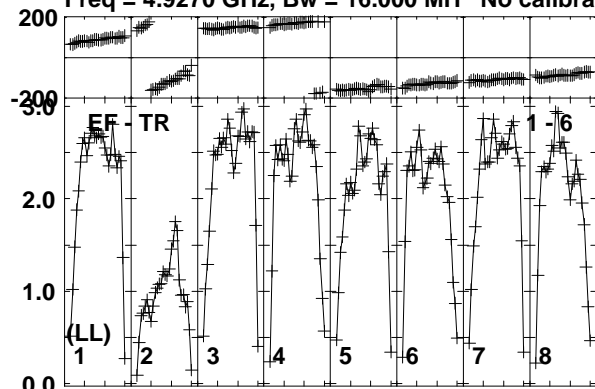

Lower frame: Milli Ampl Jy Top frame: Phas deg  
Vector averaged cross-power spectrum Baseline: EF (01) - TR (06)  
Timerange: 01/05:19:51 to 01/05:21:20

Plot file version 529 created 10-JUN-2016 17:22:55

CHECK RT013A.UVDATA.1

Freq = 4.9270 GHz, Bw = 16.000 MH No calibration applied and no bandpass applied

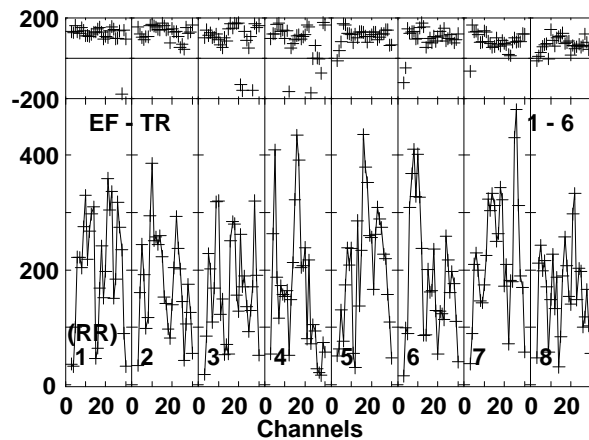
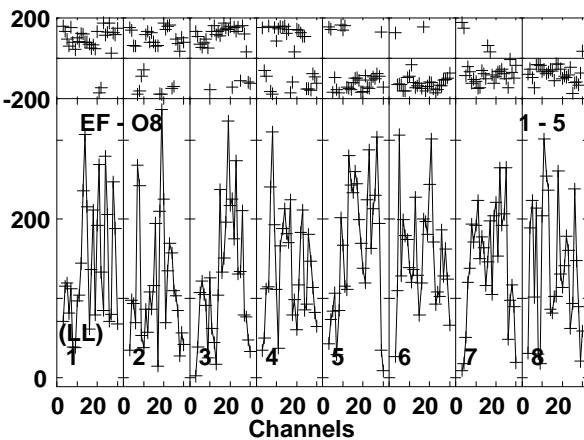
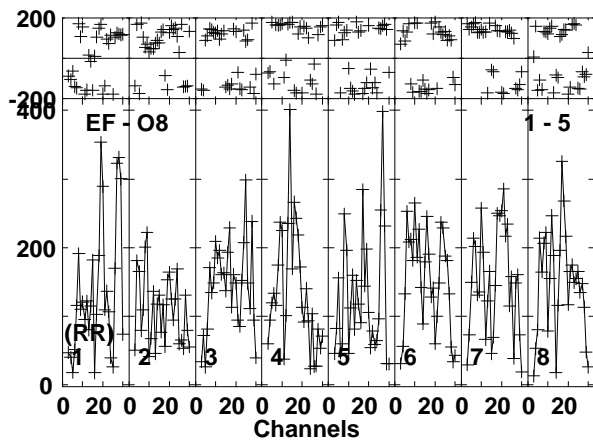
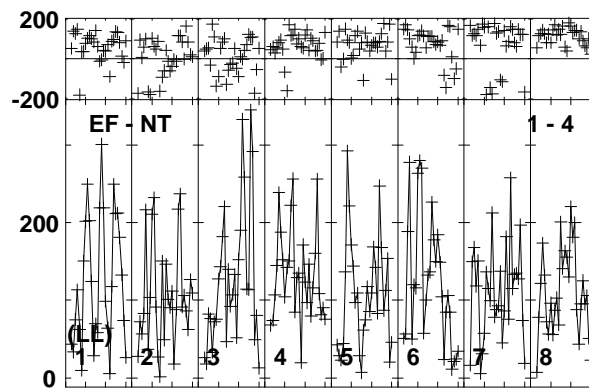
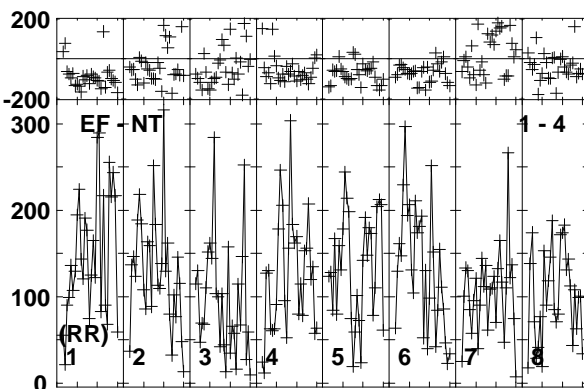
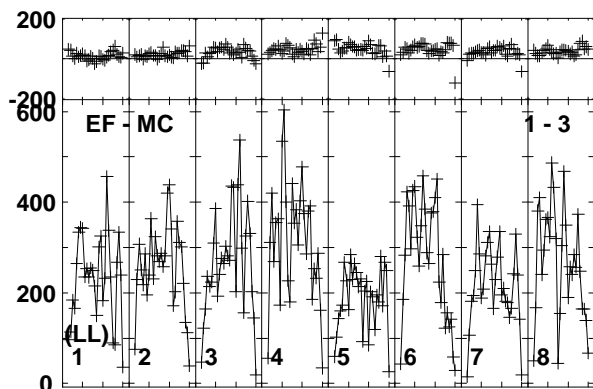
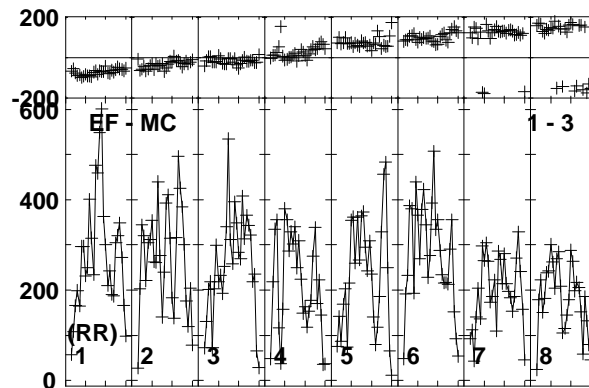
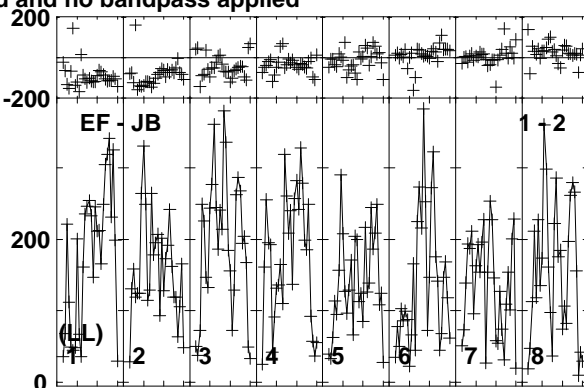
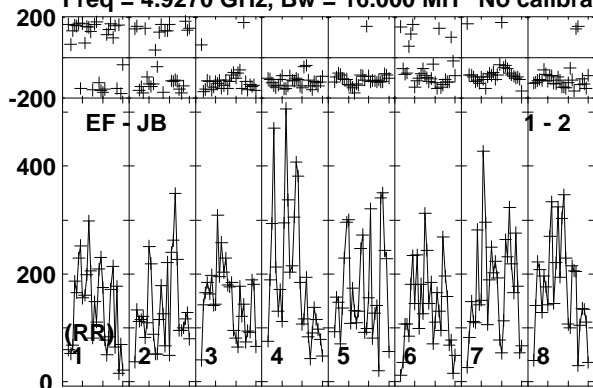

Lower frame: Micro Ampl Jy Top frame: Phas deg  
Vector averaged cross-power spectrum Baseline: EF (01) - JB (02)  
Timerange: 01/05:22:00 to 01/05:23:59

Plot file version 530 created 10-JUN-2016 17:22:55

CHECK RT013A.UVDATA.1

Freq = 4.9270 GHz, Bw = 16.000 MH No calibration applied and no bandpass applied

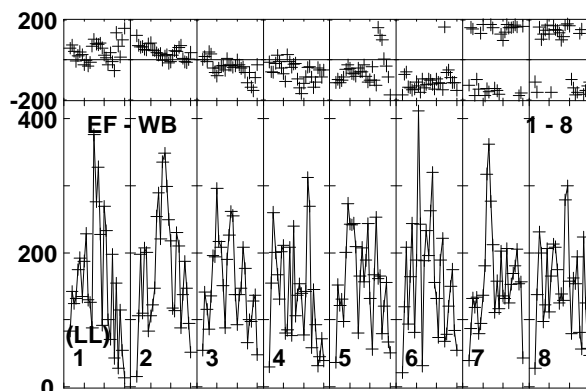
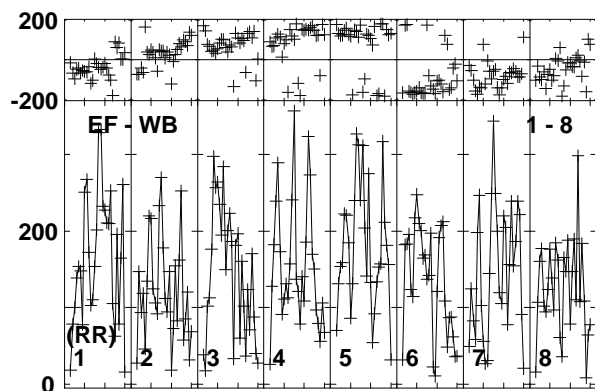
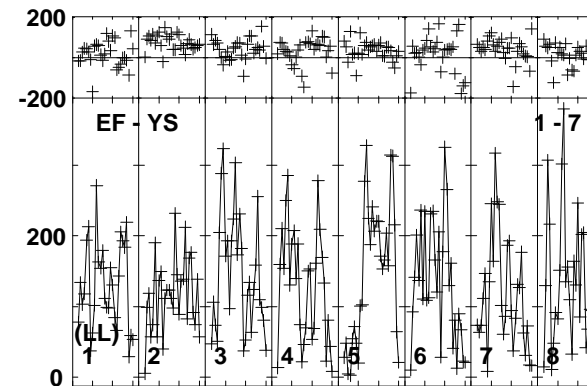
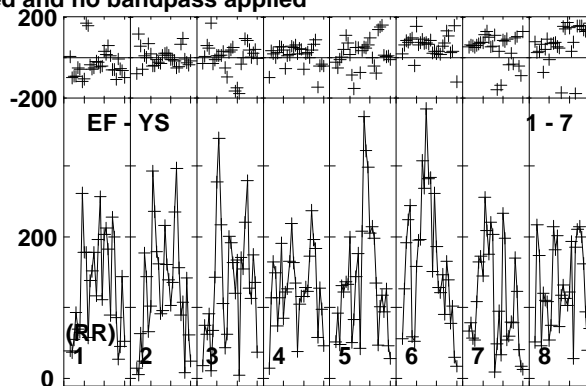
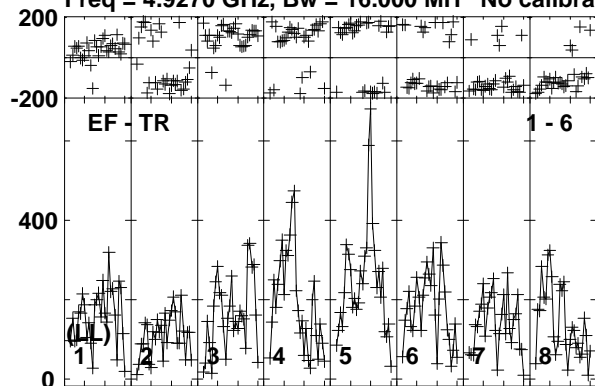

Lower frame: Micro Ampl Jy Top frame: Phas deg  
Vector averaged cross-power spectrum Baseline: EF (01) - TR (06)  
Timerange: 01/05:22:00 to 01/05:23:59



Plot file version 531 created 10-JUN-2016 17:22:55

CYGX1 RT013A.UVDATA.1

Freq = 4.9270 GHz, Bw = 16.000 MH No calibration applied and no bandpass applied

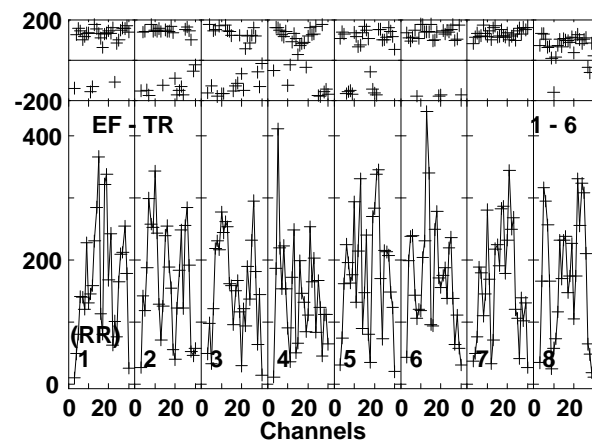
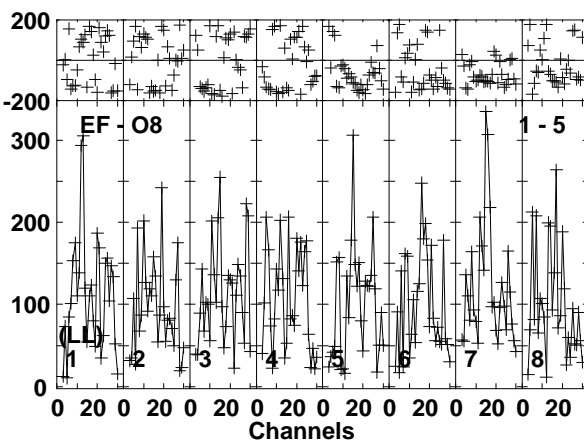
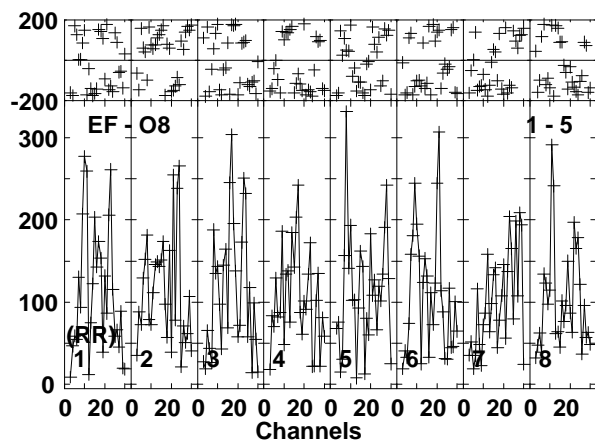
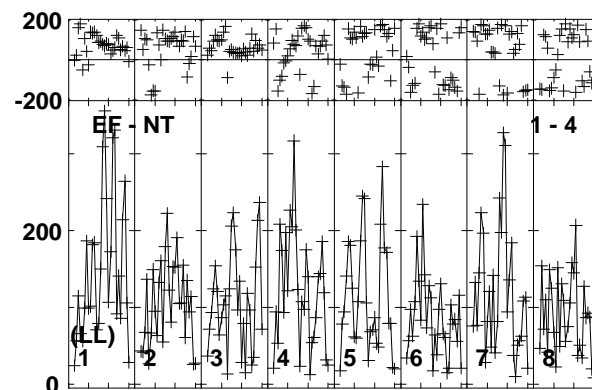
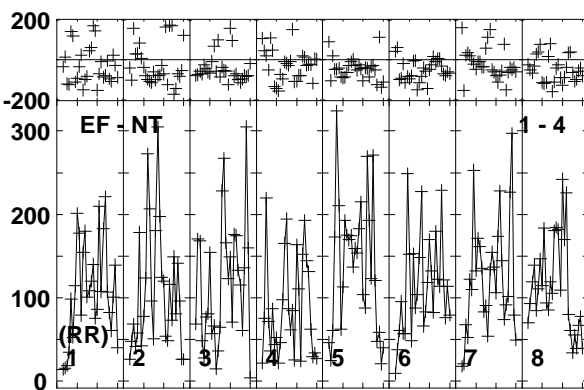
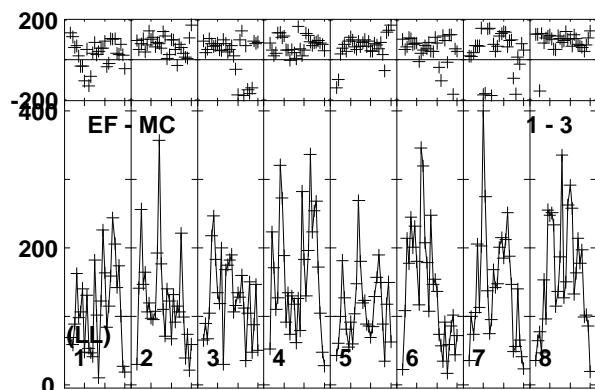
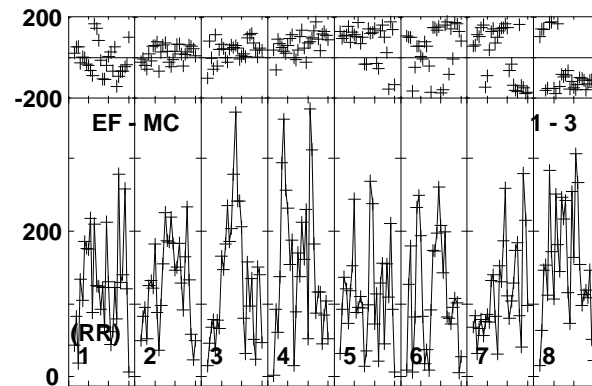
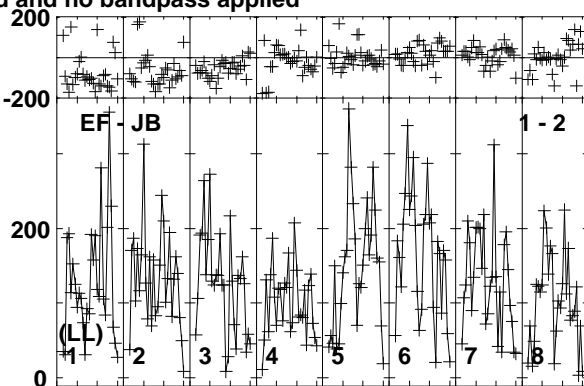
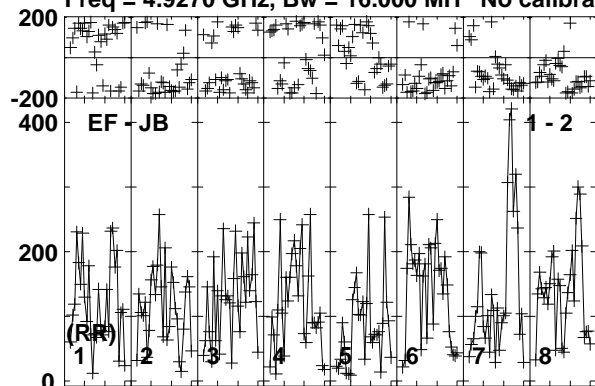

Lower frame: Micro Ampl Jy Top frame: Phas deg  
Vector averaged cross-power spectrum Baseline: EF (01) - JB (02)  
Timerange: 01/05:24:00 to 01/05:26:30

Plot file version 532 created 10-JUN-2016 17:22:55

CYGX1 RT013A.UVDATA.1

Freq = 4.9270 GHz, Bw = 16.000 MH No calibration applied and no bandpass applied

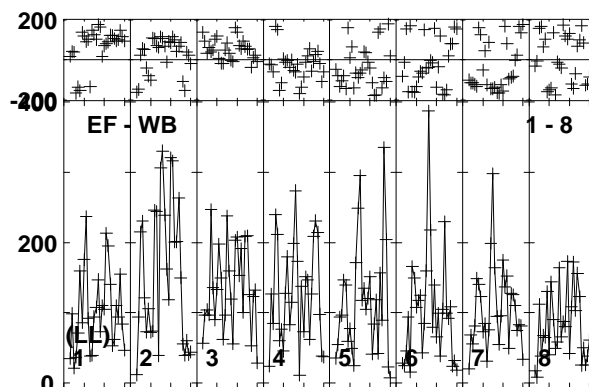
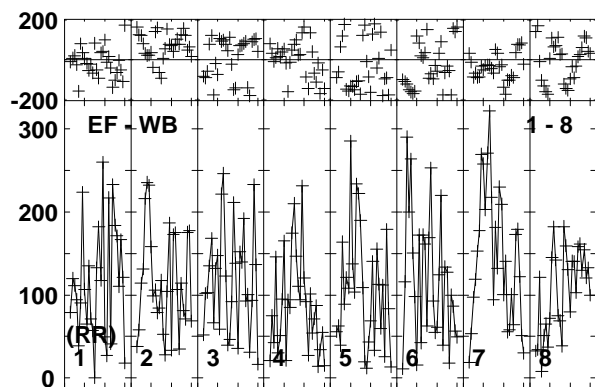
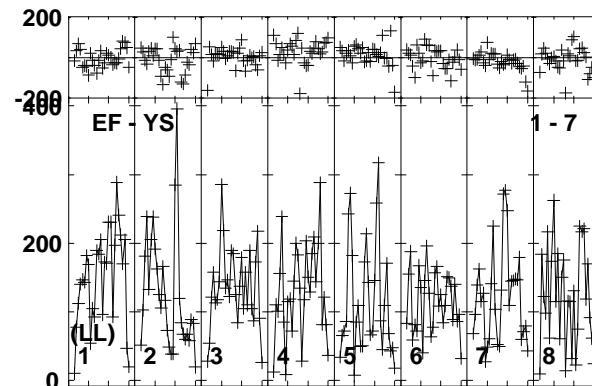
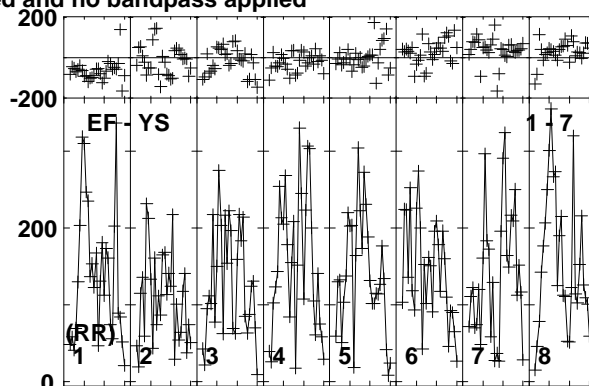
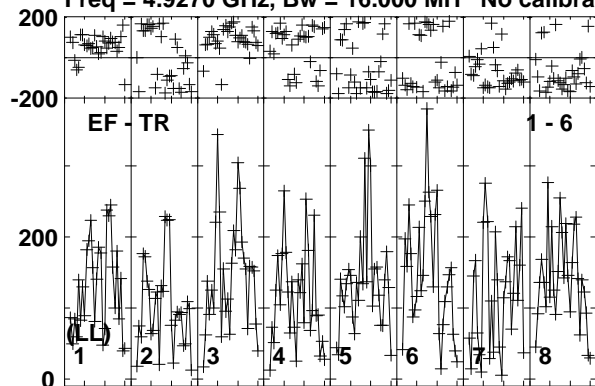

Lower frame: Micro Ampl Jy Top frame: Phas deg  
Vector averaged cross-power spectrum Baseline: EF (01) - TR (06)  
Timerange: 01/05:24:00 to 01/05:26:30

Plot file version 533 created 10-JUN-2016 17:22:55

J1957+3338 RT013A.UVDATA.1

Freq = 4.9270 GHz, Bw = 16.000 MH No calibration applied and no bandpass applied

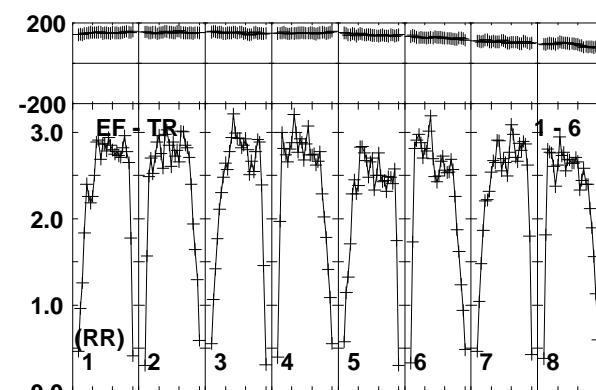
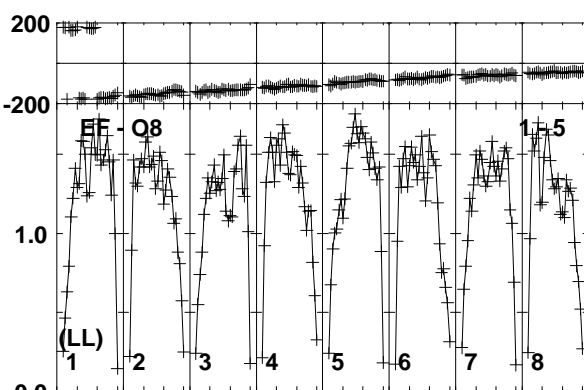
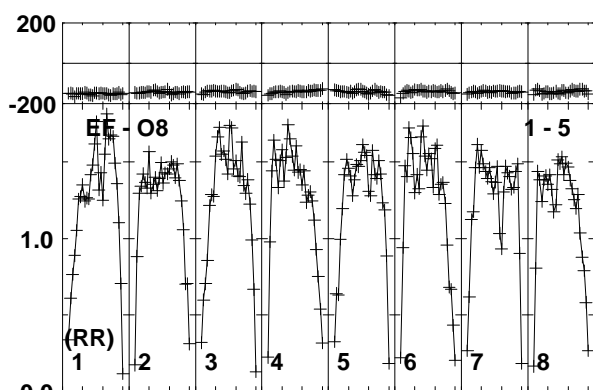
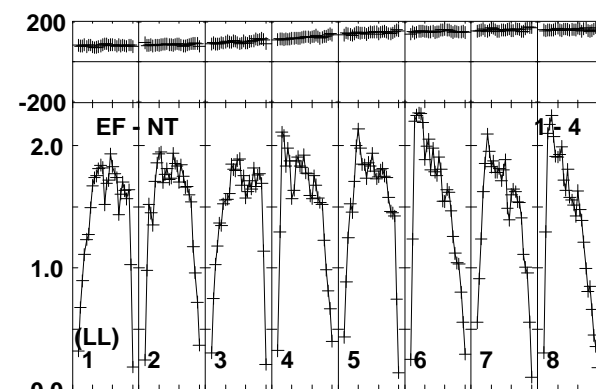
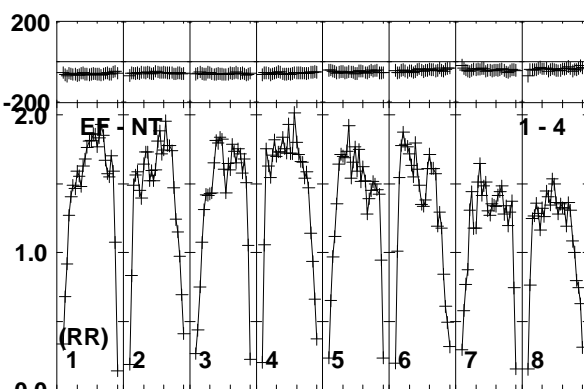
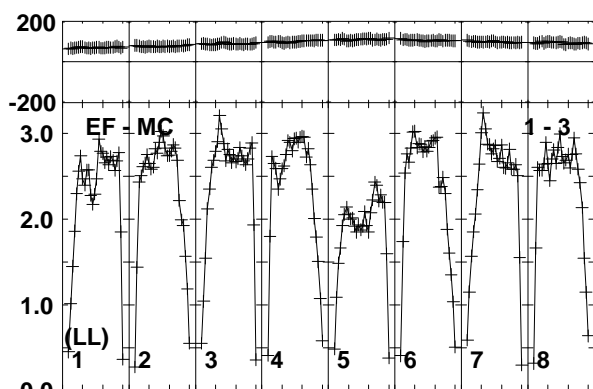
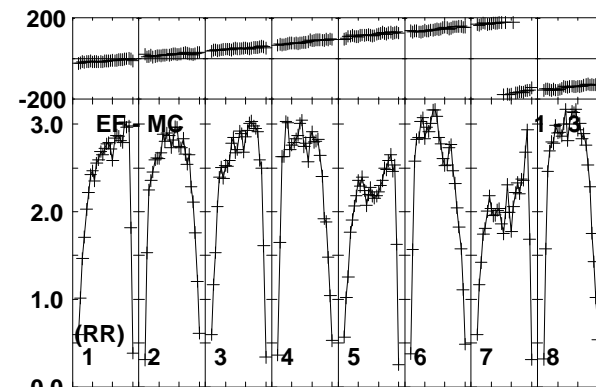
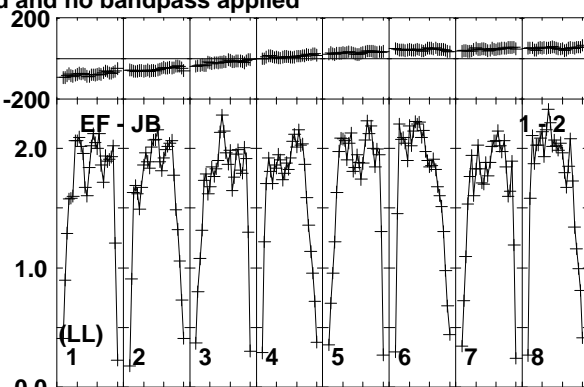
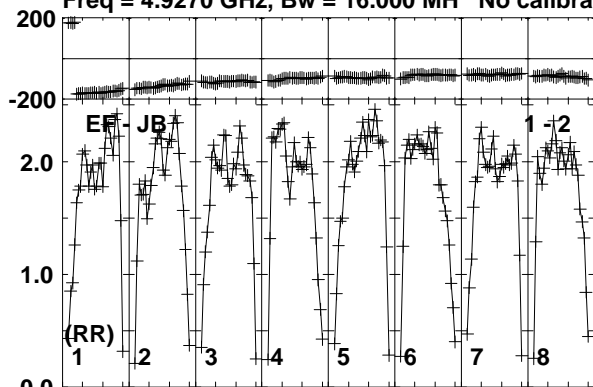

Lower frame: Milli Ampl Jy Top frame: Phas deg  
Vector averaged cross-power spectrum Baseline: EF (01) - JB (02)  
Timerange: 01/05:26:31 to 01/05:28:00

Plot file version 534 created 10-JUN-2016 17:22:55

J1957+3338 RT013A.UVDATA.1

Freq = 4.9270 GHz, Bw = 16.000 MH No calibration applied and no bandpass applied

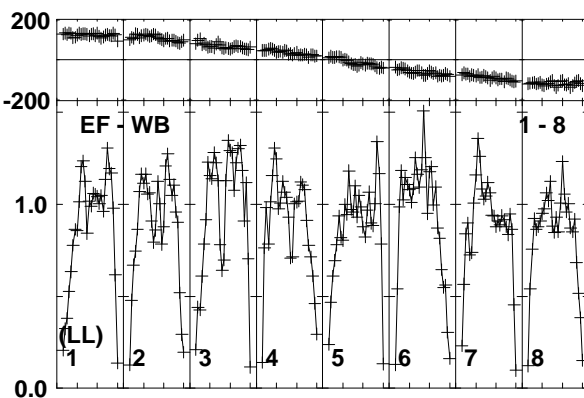
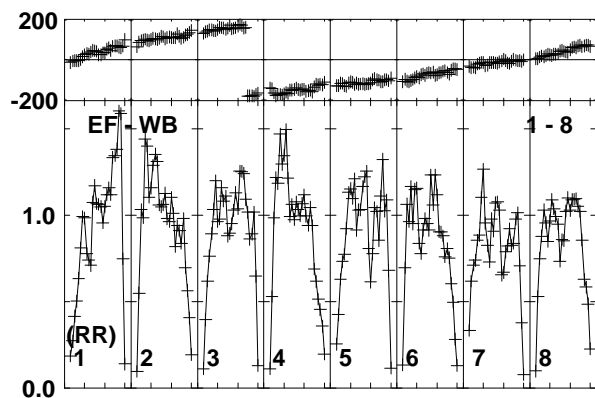
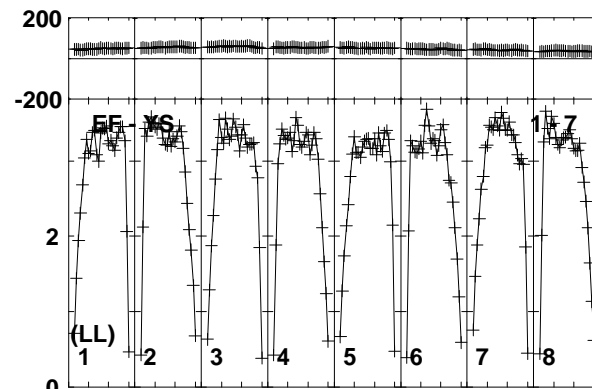
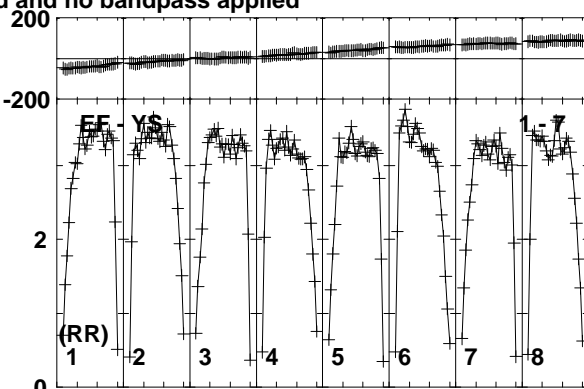
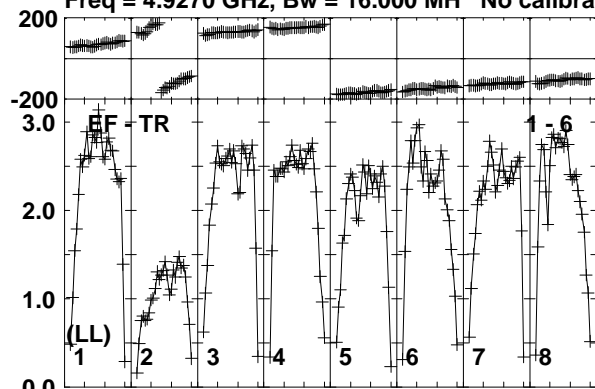

Lower frame: Milli Ampl Jy Top frame: Phas deg  
Vector averaged cross-power spectrum Baseline: EF (01) - TR (06)  
Timerange: 01/05:26:31 to 01/05:28:00

Plot file version 535 created 10-JUN-2016 17:22:55

CHECK RT013A.UVDATA.1

Freq = 4.9270 GHz, Bw = 16.000 MH No calibration applied and no bandpass applied

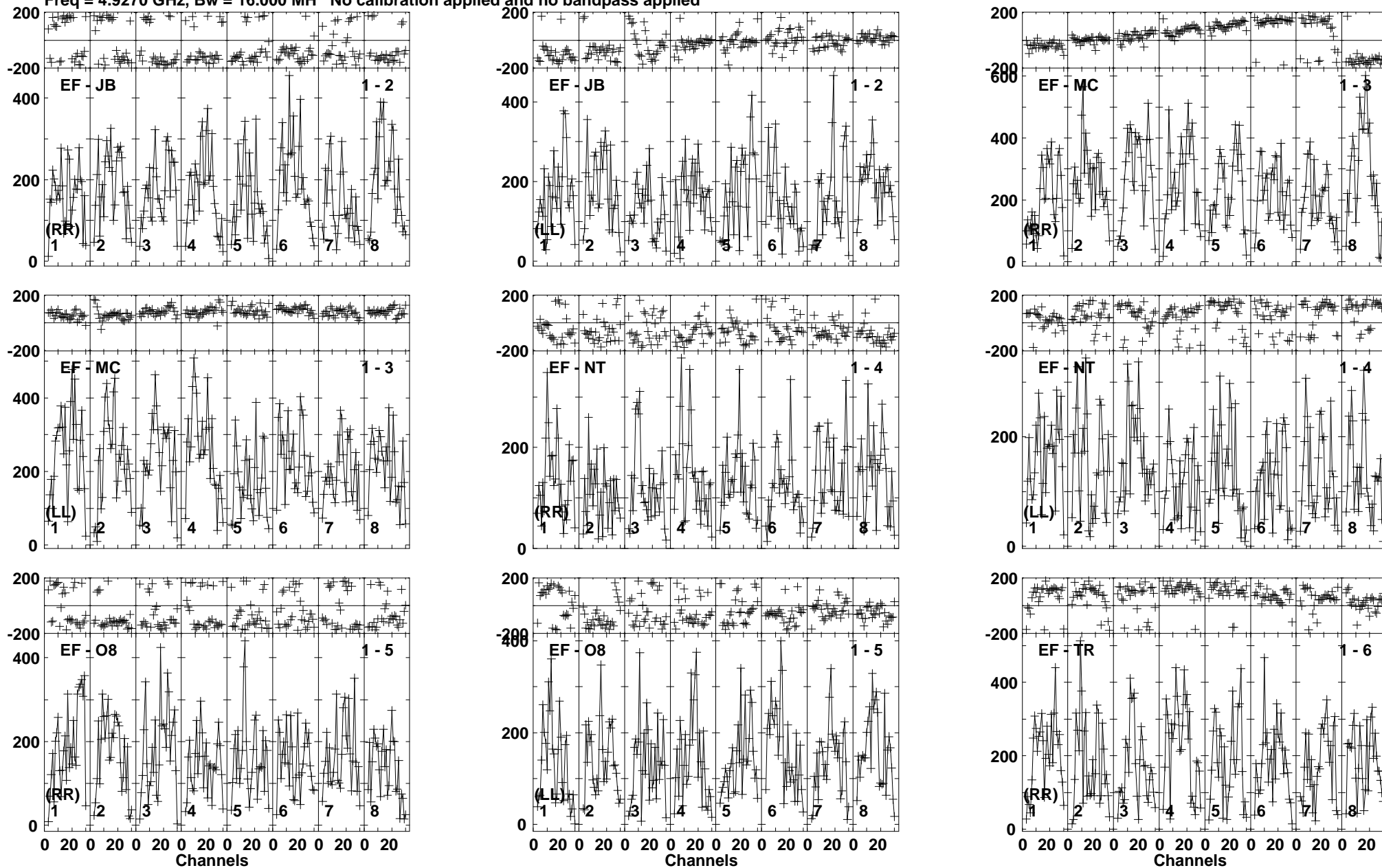

Lower frame: Micro Ampl Jy Top frame: Phas deg  
Vector averaged cross-power spectrum Baseline: EF (01) - JB (02)  
Timerange: 01/05:28:00 to 01/05:30:00

Plot file version 536 created 10-JUN-2016 17:22:55

CHECK RT013A.UVDATA.1

Freq = 4.9270 GHz, Bw = 16.000 MH No calibration applied and no bandpass applied

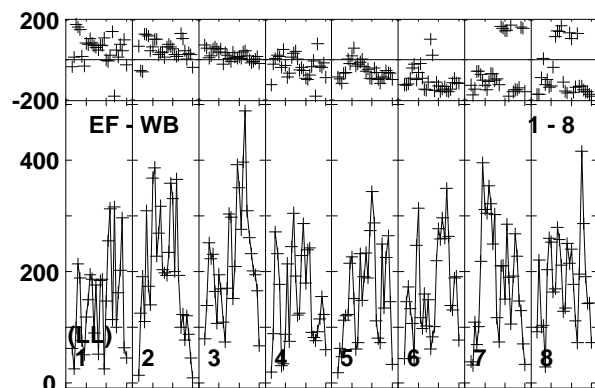
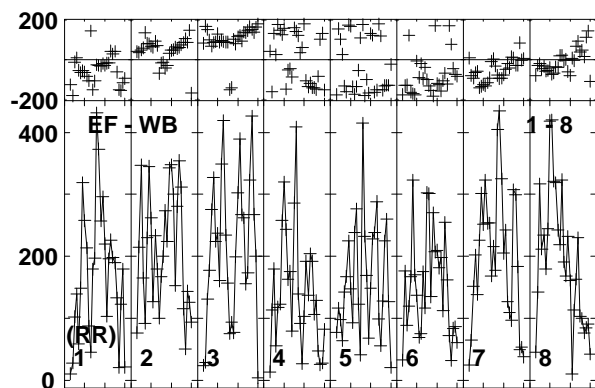
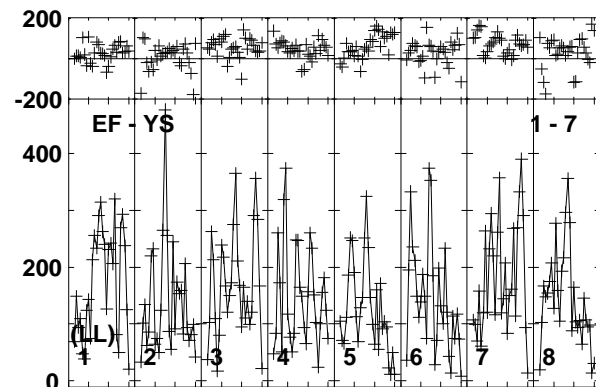
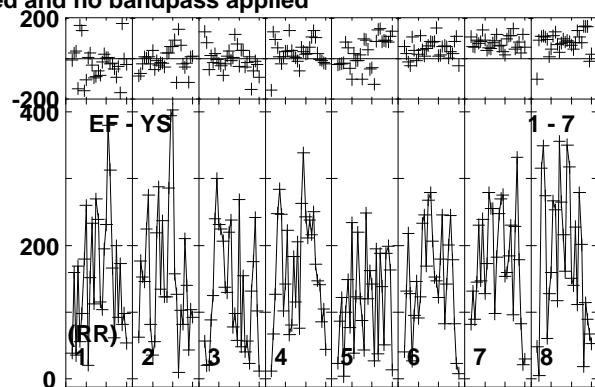
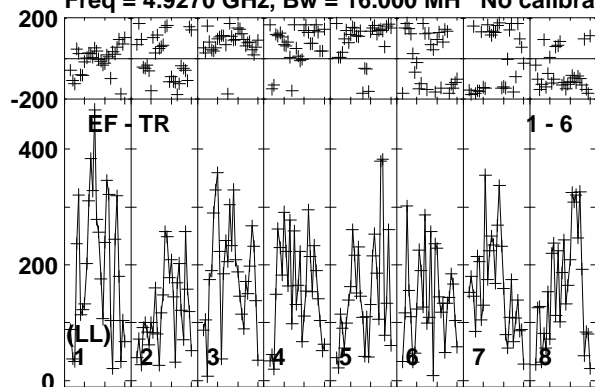

Lower frame: Micro Ampl Jy Top frame: Phas deg  
Vector averaged cross-power spectrum Baseline: EF (01) - TR (06)  
Timerange: 01/05:28:00 to 01/05:30:00

Plot file version 537 created 10-JUN-2016 17:22:55

CYGX1 RT013A.UVDATA.1

Freq = 4.9270 GHz, Bw = 16.000 MH No calibration applied and no bandpass applied

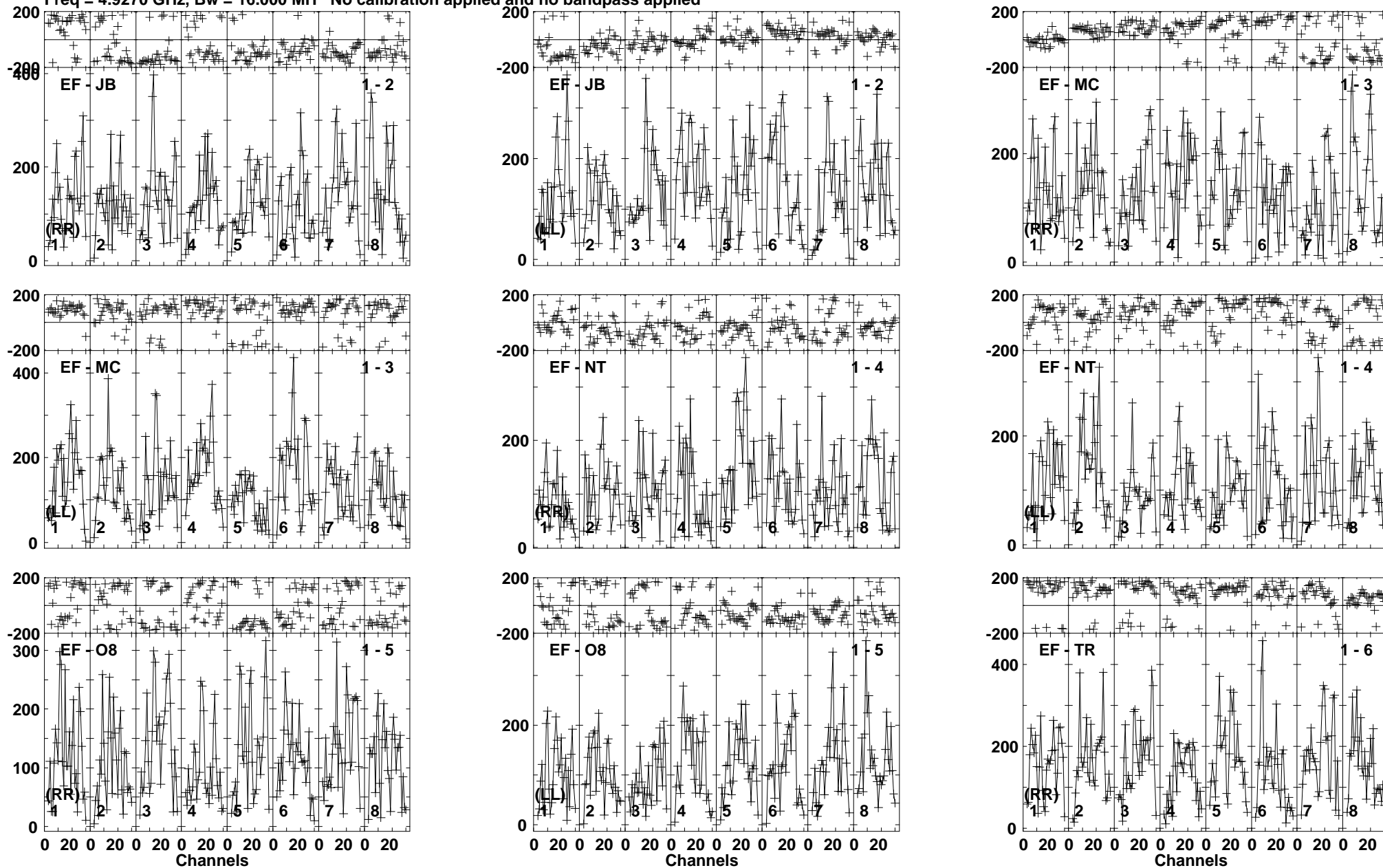

Lower frame: Micro Ampl Jy Top frame: Phas deg  
Vector averaged cross-power spectrum Baseline: EF (01) - JB (02)  
Timerange: 01/05:30:01 to 01/05:32:29

Plot file version 538 created 10-JUN-2016 17:22:55

CYGX1 RT013A.UVDATA.1

Freq = 4.9270 GHz, Bw = 16.000 MH No calibration applied and no bandpass applied

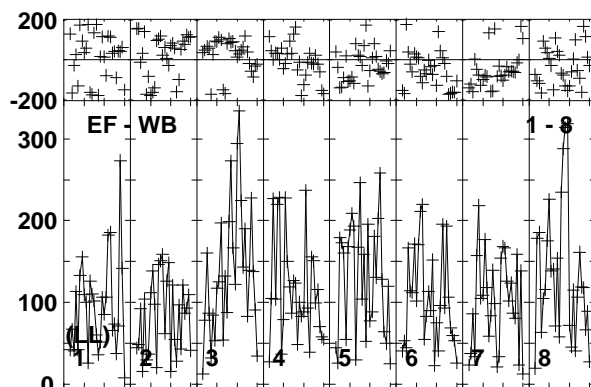
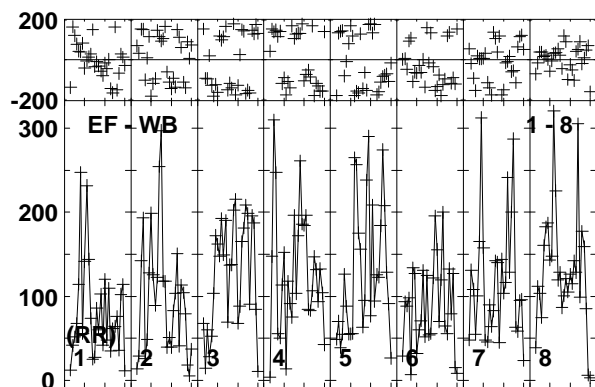
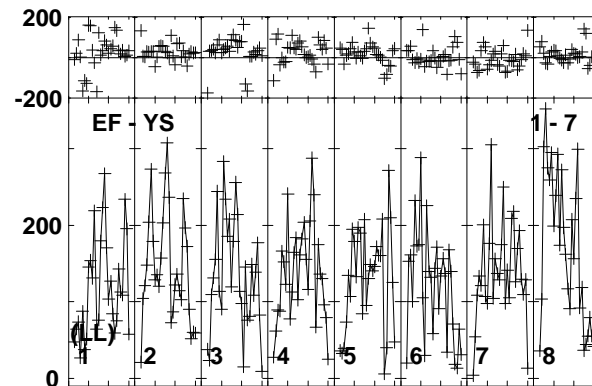
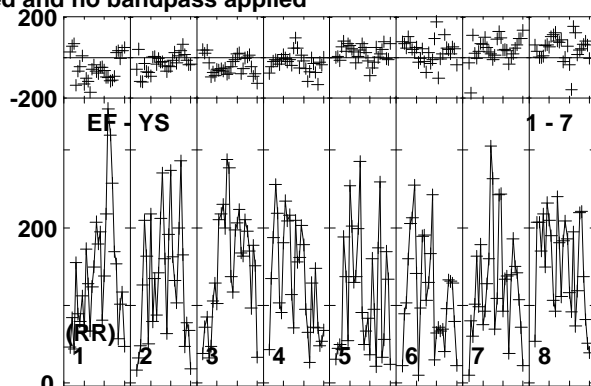
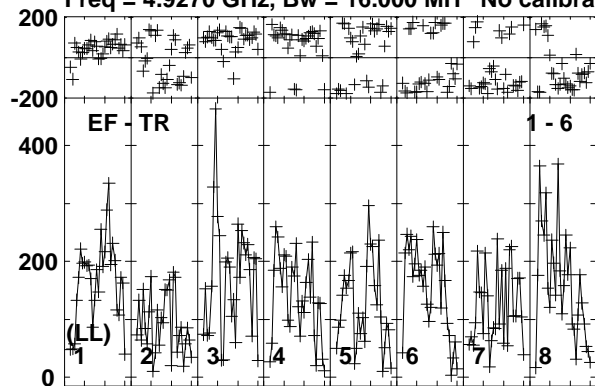

Lower frame: Micro Ampl Jy Top frame: Phas deg  
Vector averaged cross-power spectrum Baseline: EF (01) - TR (06)  
Timerange: 01/05:30:01 to 01/05:32:29



Plot file version 539 created 10-JUN-2016 17:22:56

J1957+3338 RT013A.UVDATA.1

Freq = 4.9270 GHz, Bw = 16.000 MH No calibration applied and no bandpass applied

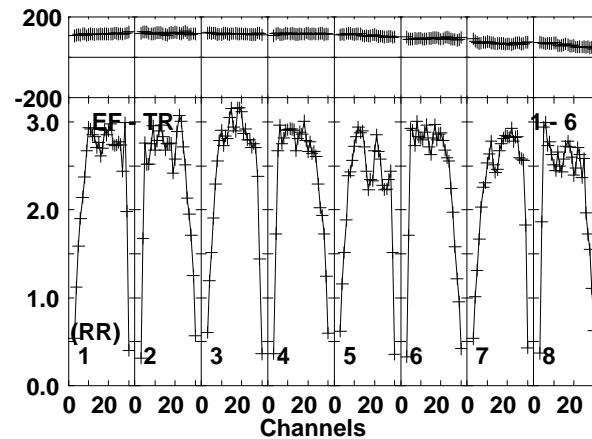
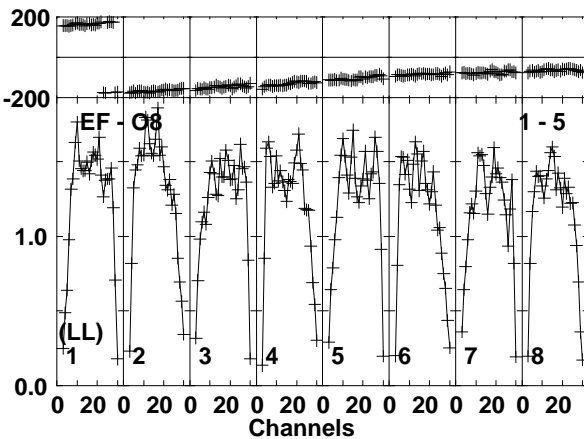
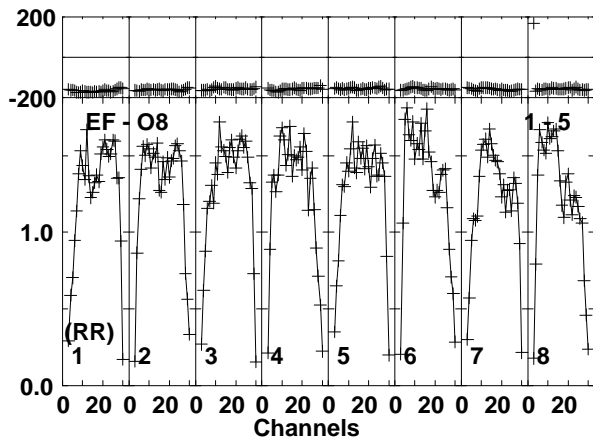
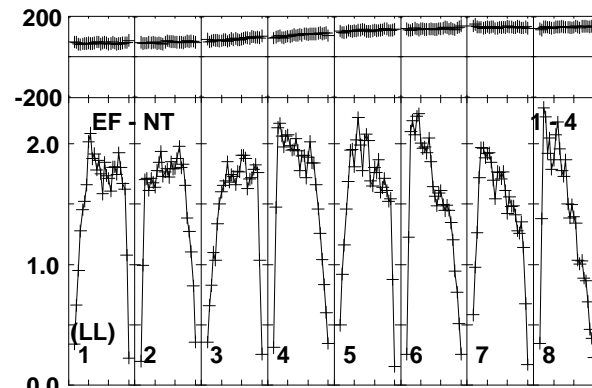
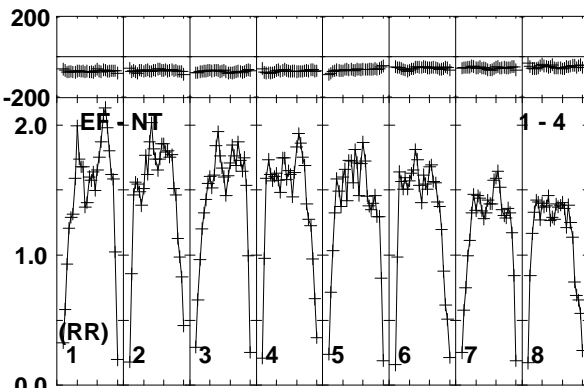
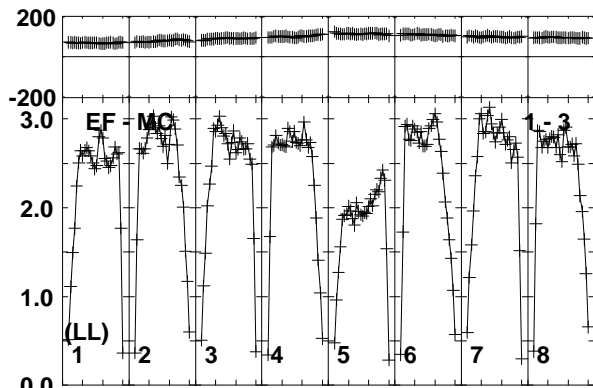
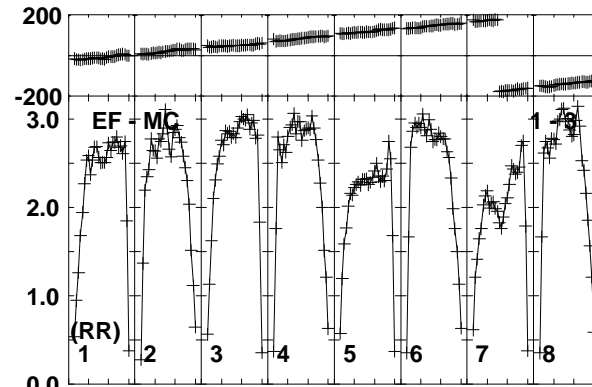
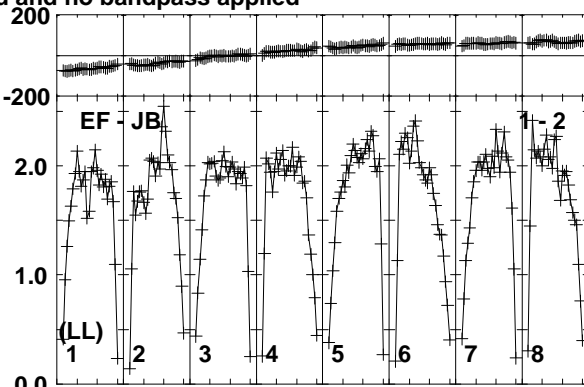
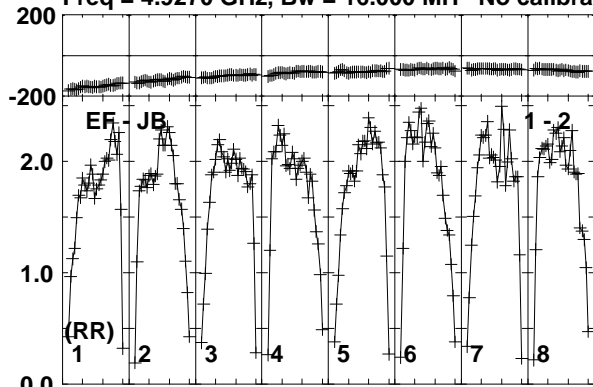

Lower frame: Milli Ampl Jy Top frame: Phas deg  
Vector averaged cross-power spectrum Baseline: EF (01) - JB (02)  
Timerange: 01/05:32:31 to 01/05:33:59

Plot file version 540 created 10-JUN-2016 17:22:56

J1957+3338 RT013A.UVDATA.1

Freq = 4.9270 GHz, Bw = 16.000 MH No calibration applied and no bandpass applied

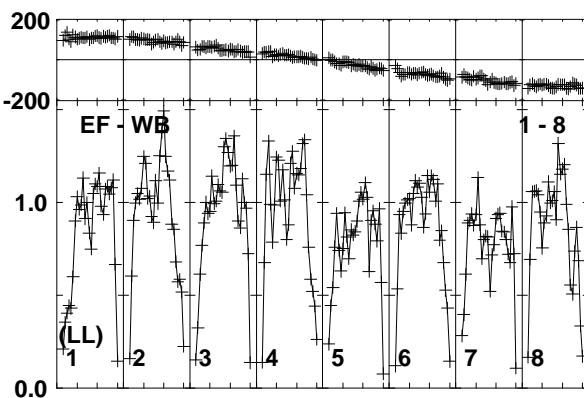
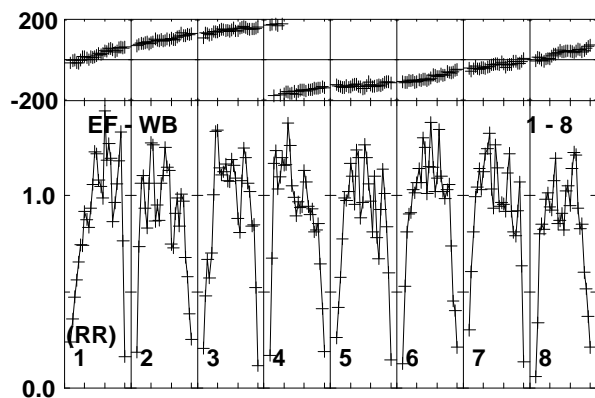
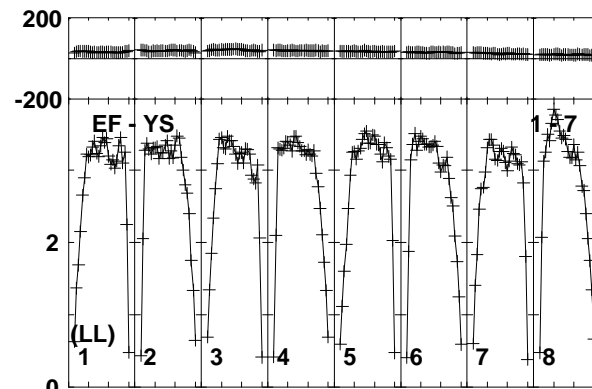
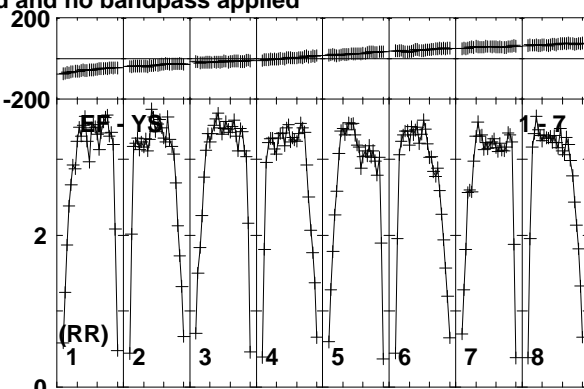
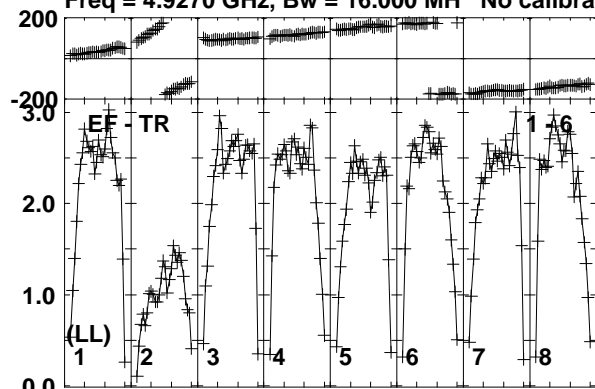

Lower frame: Milli Ampl Jy Top frame: Phas deg  
Vector averaged cross-power spectrum Baseline: EF (01) - TR (06)  
Timerange: 01/05:32:31 to 01/05:33:59

Plot file version 541 created 10-JUN-2016 17:22:56

CHECK RT013A.UVDATA.1

Freq = 4.9270 GHz, Bw = 16.000 MH No calibration applied and no bandpass applied

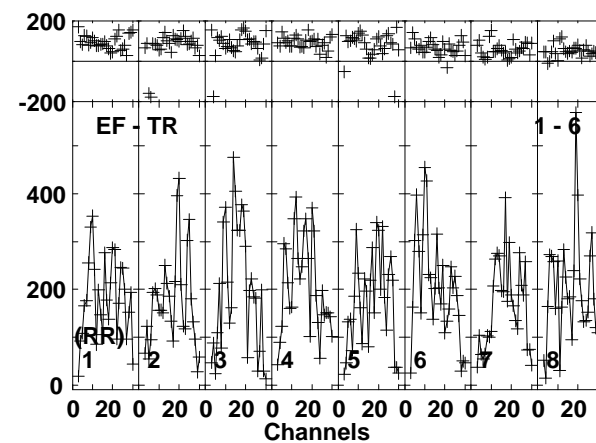
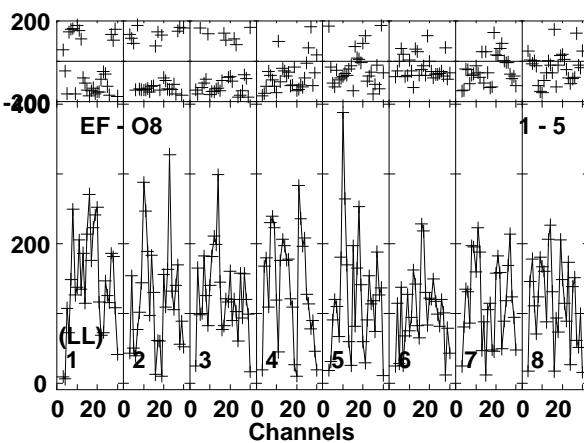
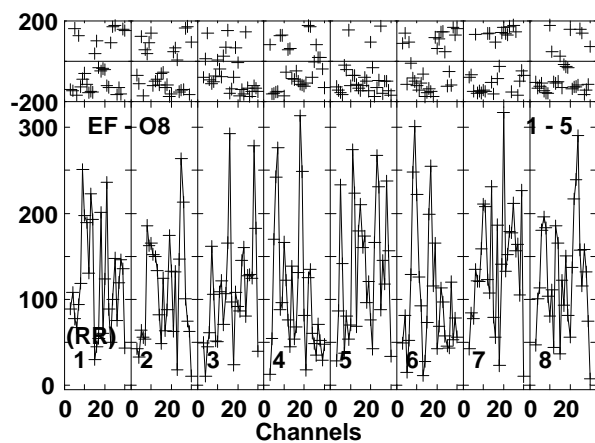
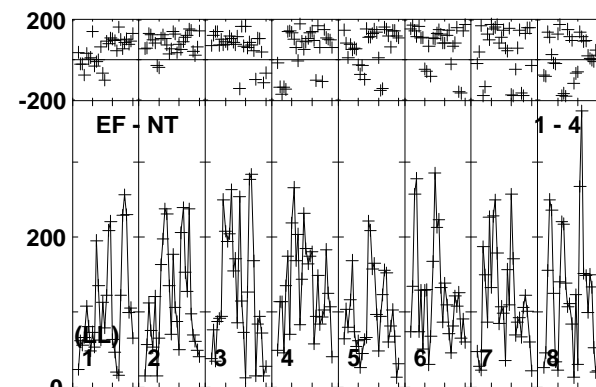
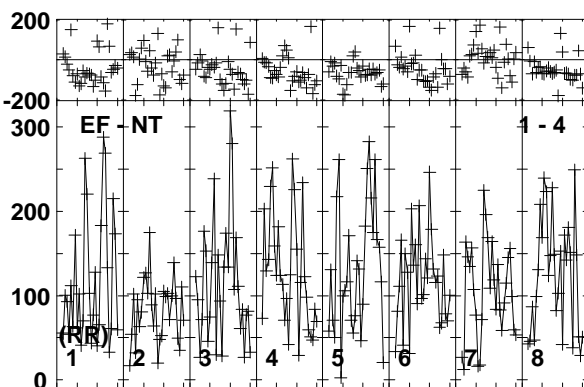
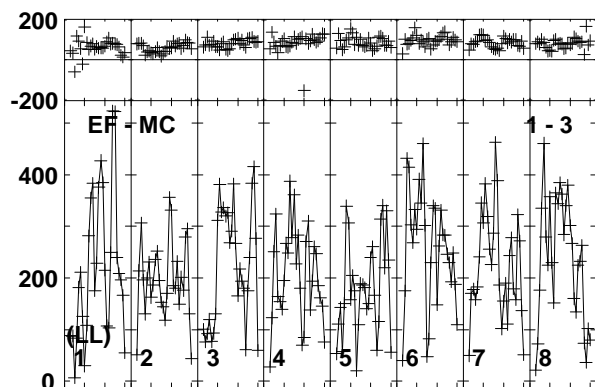
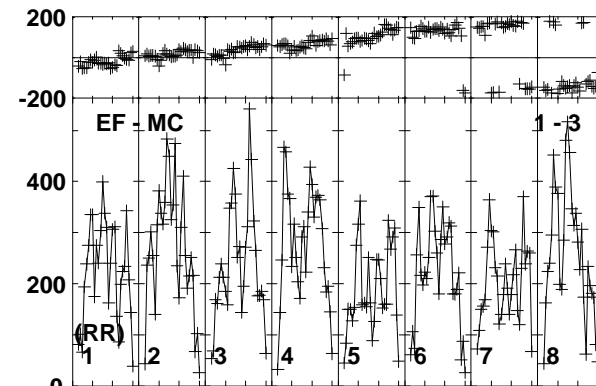
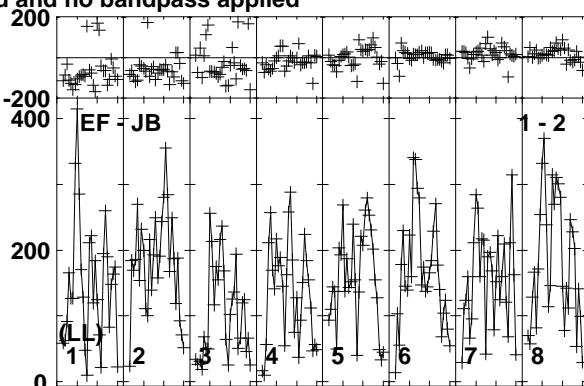
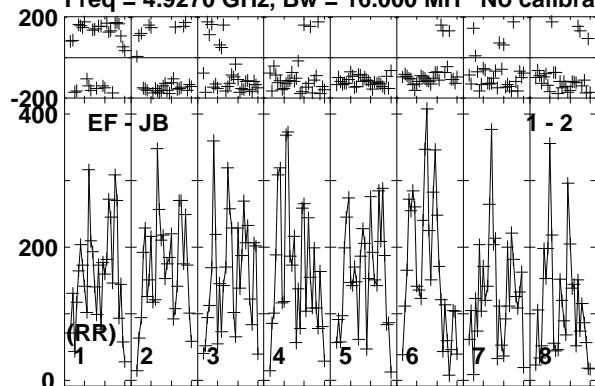

Lower frame: Micro Ampl Jy Top frame: Phas deg  
Vector averaged cross-power spectrum Baseline: EF (01) - JB (02)  
Timerange: 01/05:34:40 to 01/05:36:40

Plot file version 542 created 10-JUN-2016 17:22:56

CHECK RT013A.UVDATA.1

Freq = 4.9270 GHz, Bw = 16.000 MH No calibration applied and no bandpass applied

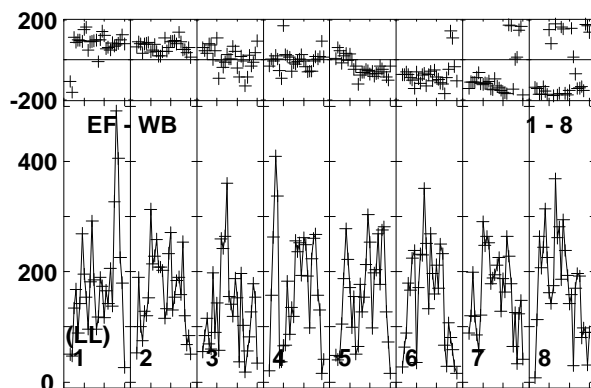
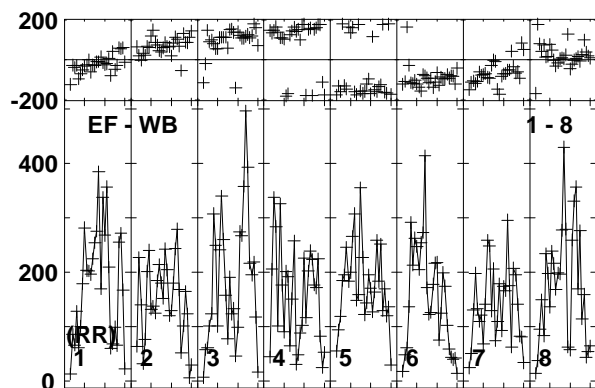
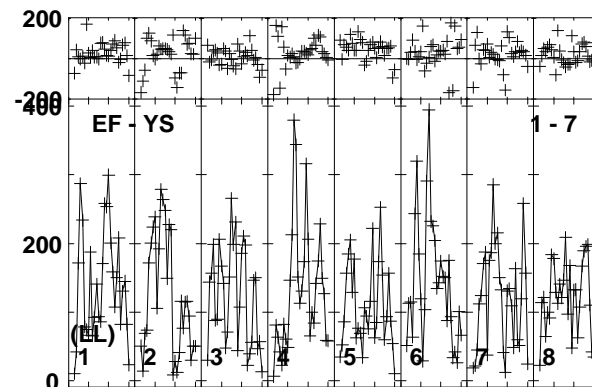
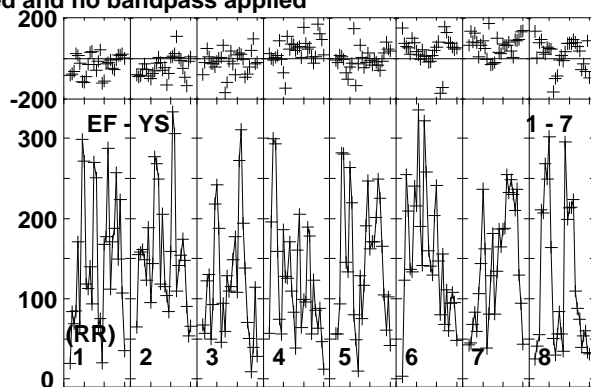
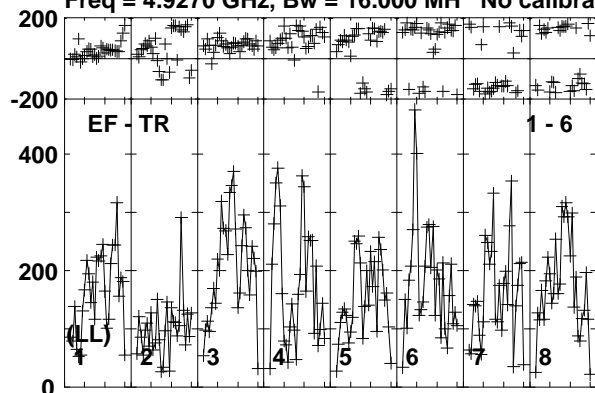

Lower frame: Micro Ampl Jy Top frame: Phas deg  
Vector averaged cross-power spectrum Baseline: EF (01) - TR (06)  
Timerange: 01/05:34:40 to 01/05:36:40

Plot file version 543 created 10-JUN-2016 17:22:56

CYGX1 RT013A.UVDATA.1

Freq = 4.9270 GHz, Bw = 16.000 MH No calibration applied and no bandpass applied

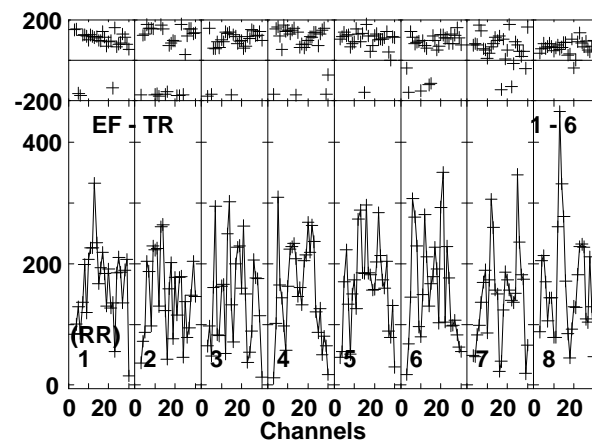
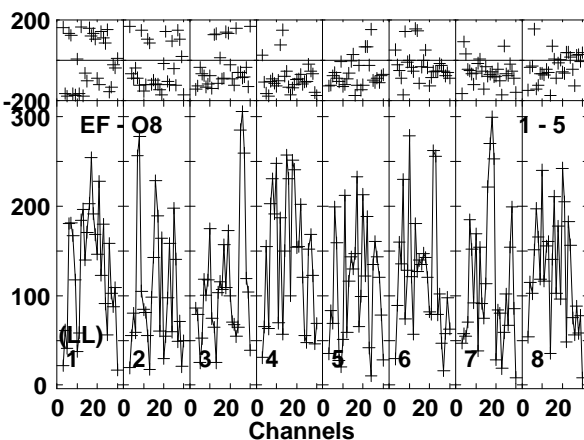
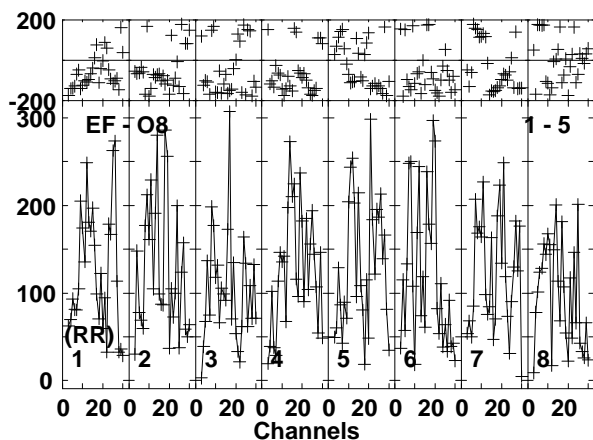
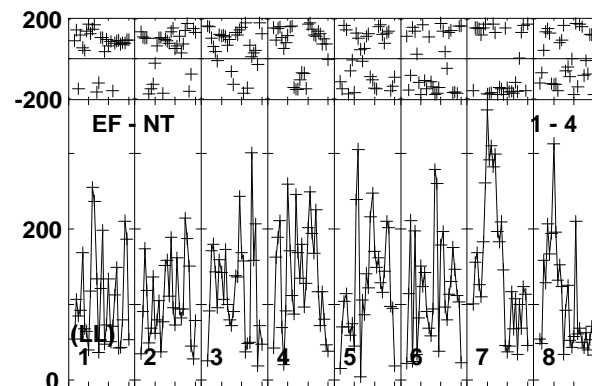
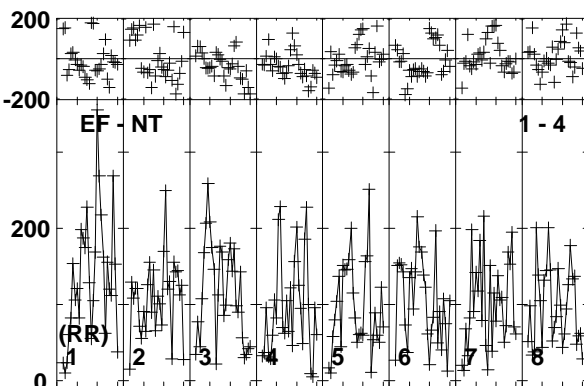
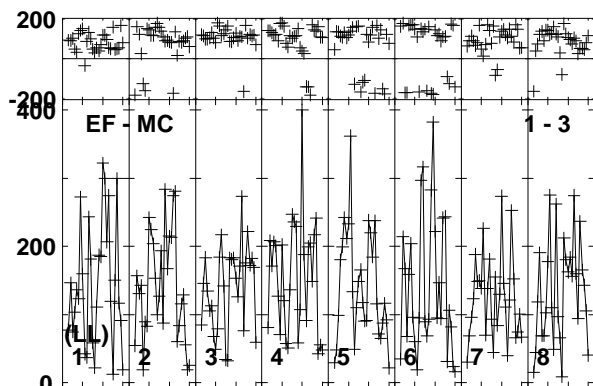
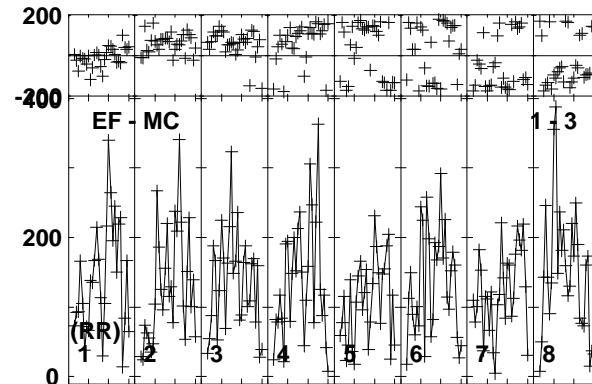
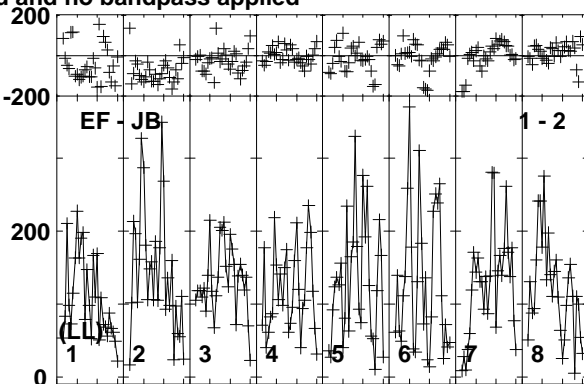
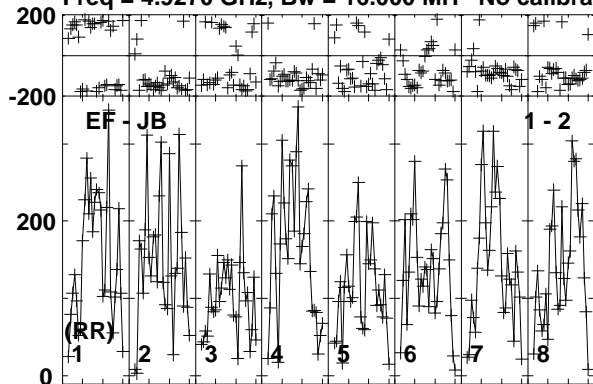

Lower frame: Micro Ampl Jy Top frame: Phas deg  
Vector averaged cross-power spectrum Baseline: EF (01) - JB (02)  
Timerange: 01/05:36:40 to 01/05:39:09

Plot file version 544 created 10-JUN-2016 17:22:56

CYGX1 RT013A.UVDATA.1

Freq = 4.9270 GHz, Bw = 16.000 MH No calibration applied and no bandpass applied

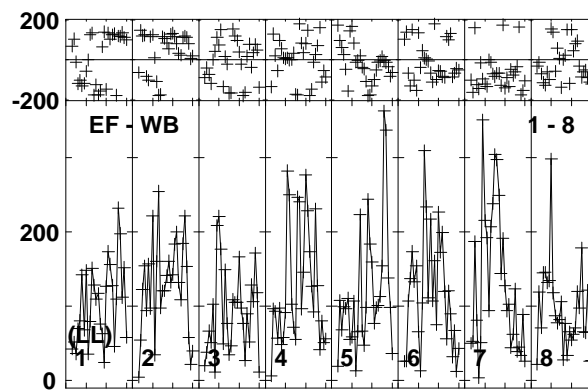
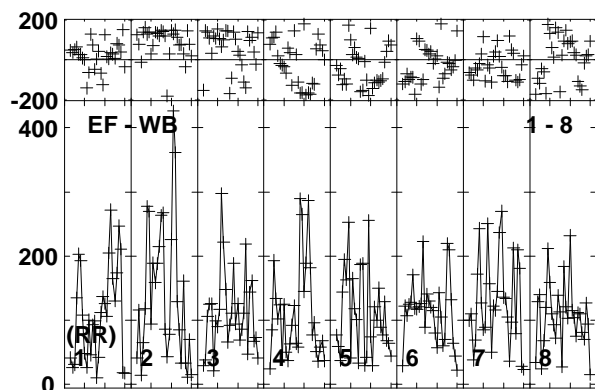
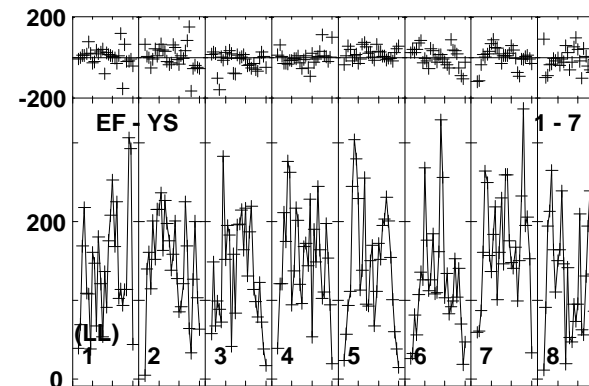
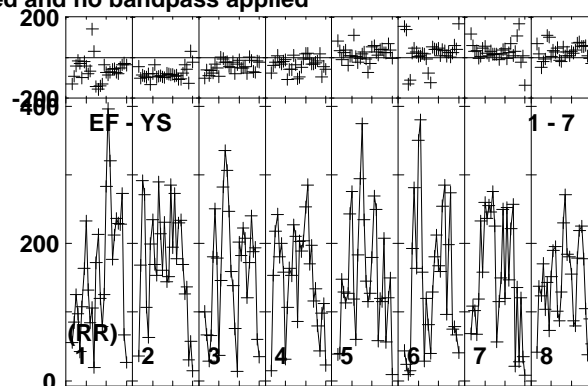
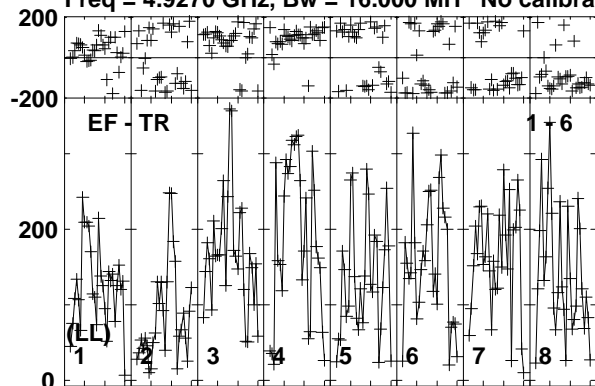

Lower frame: Micro Ampl Jy Top frame: Phas deg  
Vector averaged cross-power spectrum Baseline: EF (01) - TR (06)  
Timerange: 01/05:36:40 to 01/05:39:09

Plot file version 545 created 10-JUN-2016 17:22:56

J1957+3338 RT013A.UVDATA.1

Freq = 4.9270 GHz, Bw = 16.000 MH No calibration applied and no bandpass applied

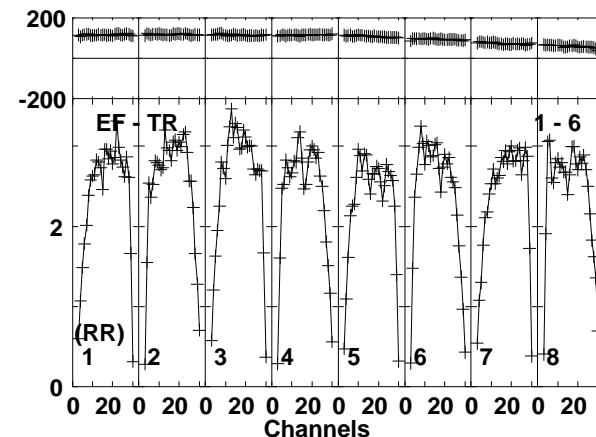
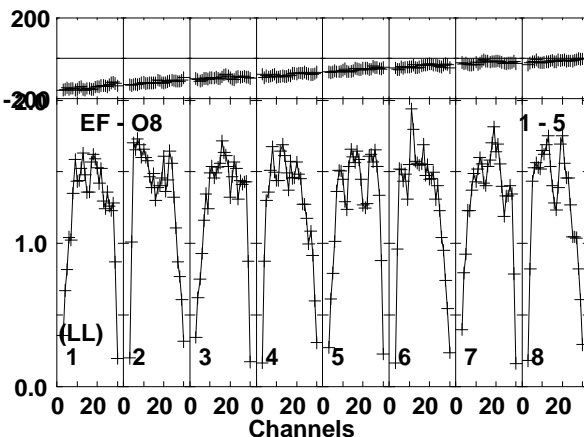
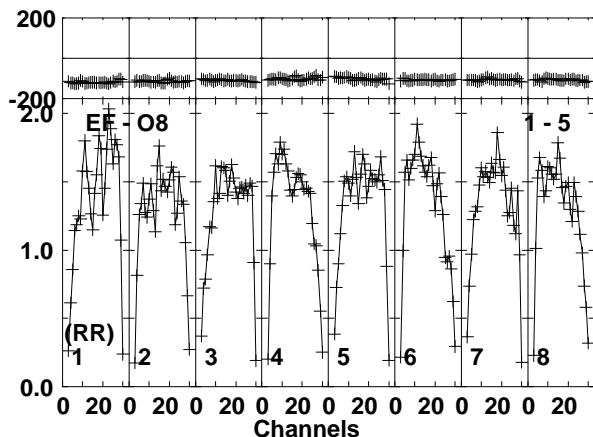
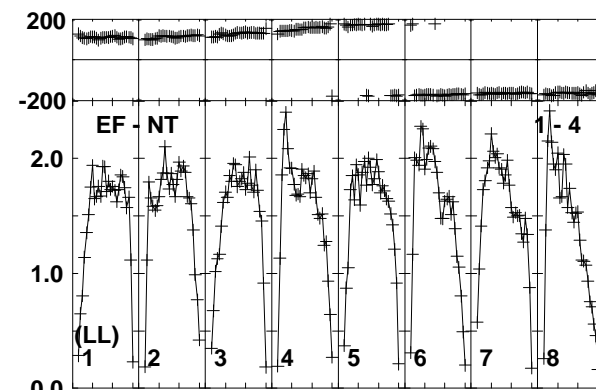
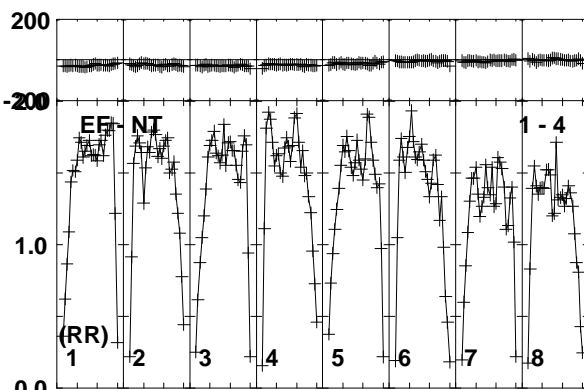
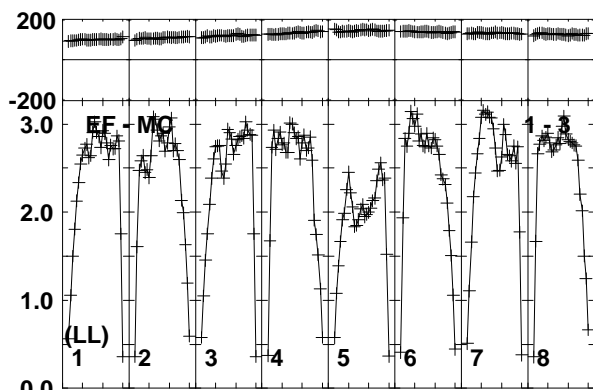
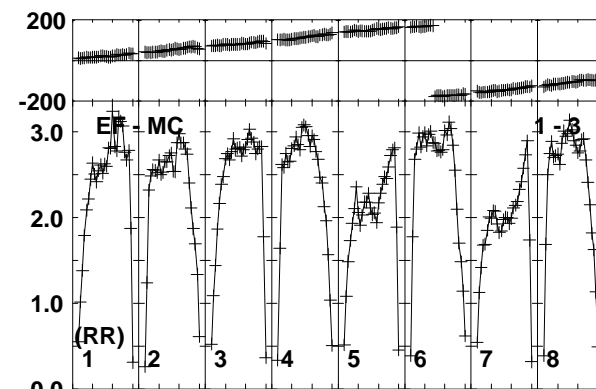
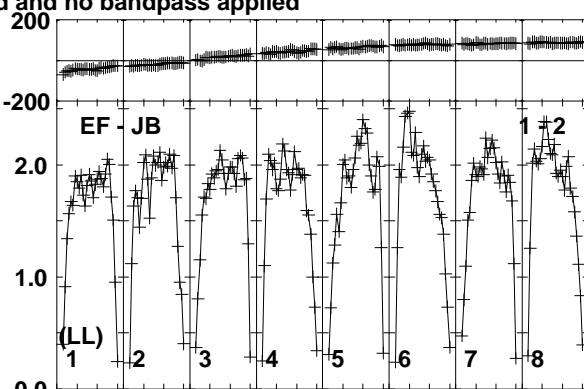
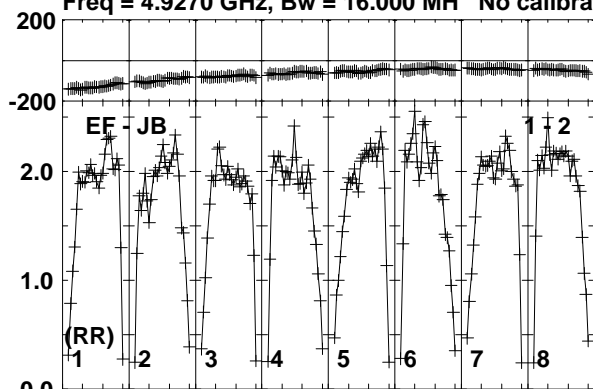

Lower frame: Milli Ampl Jy Top frame: Phas deg  
Vector averaged cross-power spectrum Baseline: EF (01) - JB (02)  
Timerange: 01/05:39:11 to 01/05:40:39

Plot file version 546 created 10-JUN-2016 17:22:56

J1957+3338 RT013A.UVDATA.1

Freq = 4.9270 GHz, Bw = 16.000 MH No calibration applied and no bandpass applied

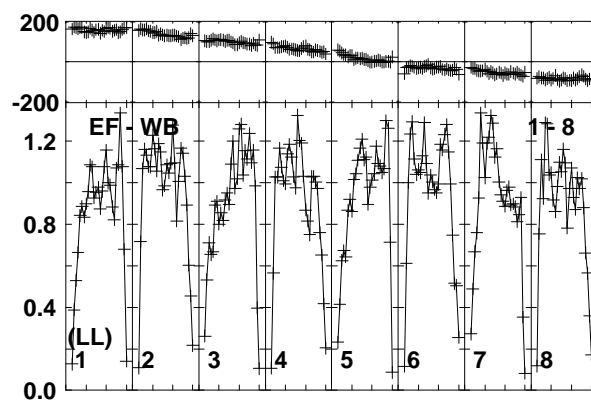
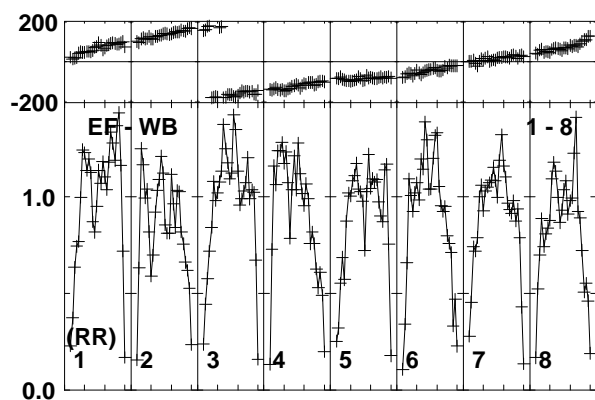
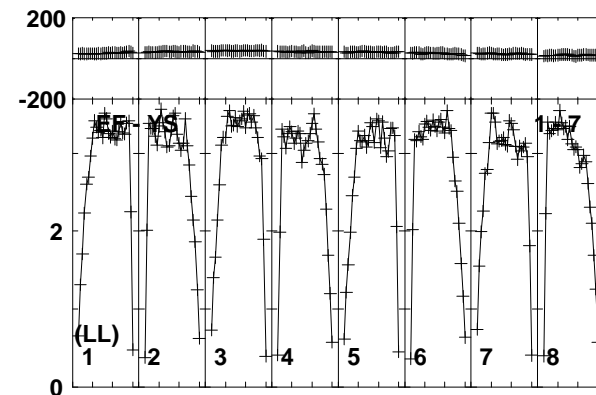
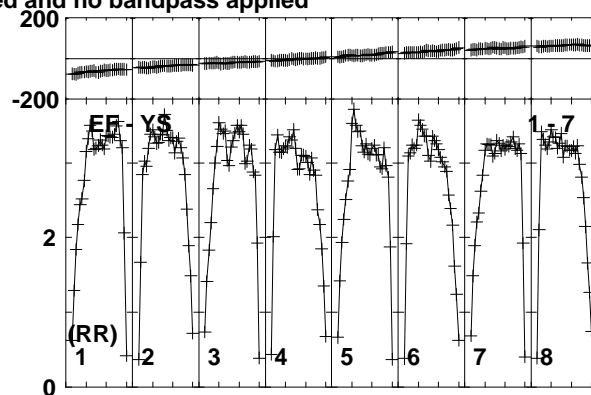
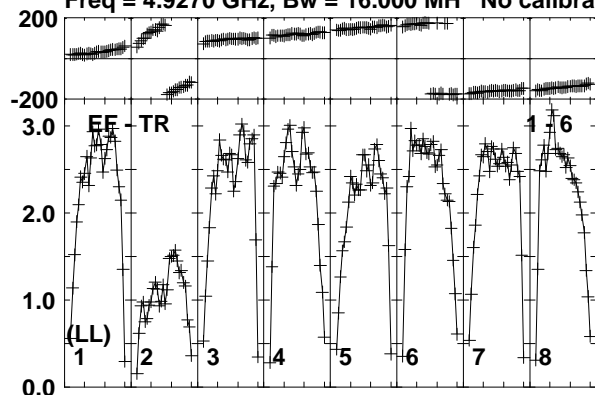

Lower frame: Milli Ampl Jy Top frame: Phas deg  
Vector averaged cross-power spectrum Baseline: EF (01) - TR (06)  
Timerange: 01/05:39:11 to 01/05:40:39



Plot file version 547 created 10-JUN-2016 17:22:56

CHECK RT013A.UVDATA.1

Freq = 4.9270 GHz, Bw = 16.000 MH No calibration applied and no bandpass applied

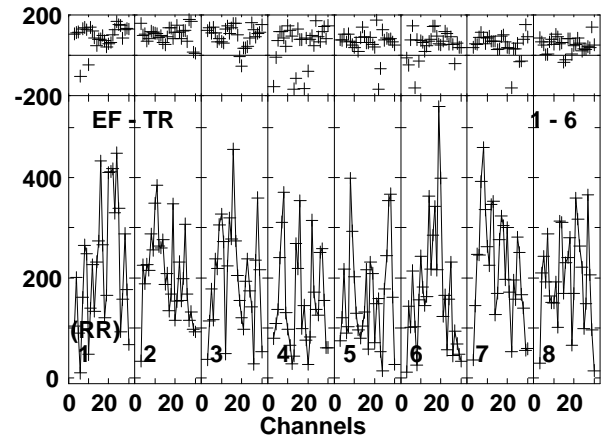
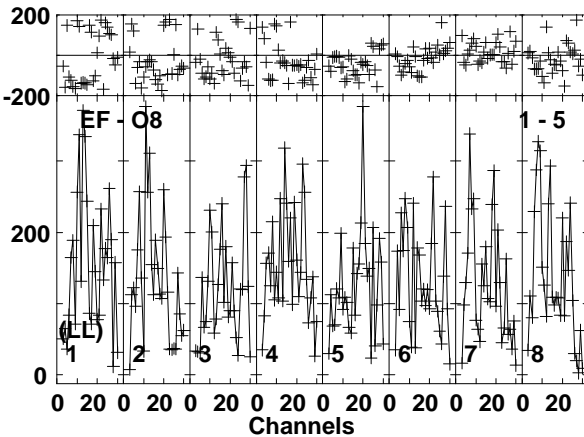
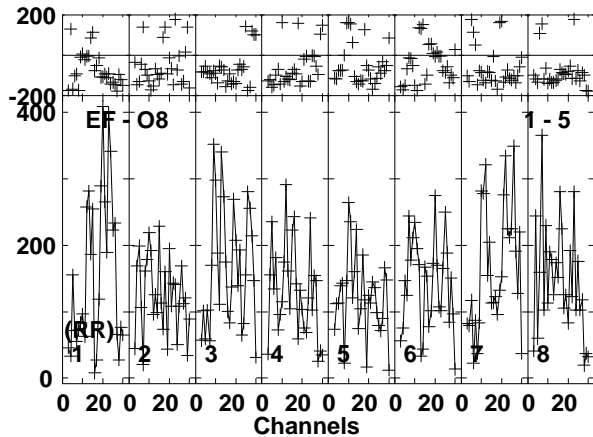
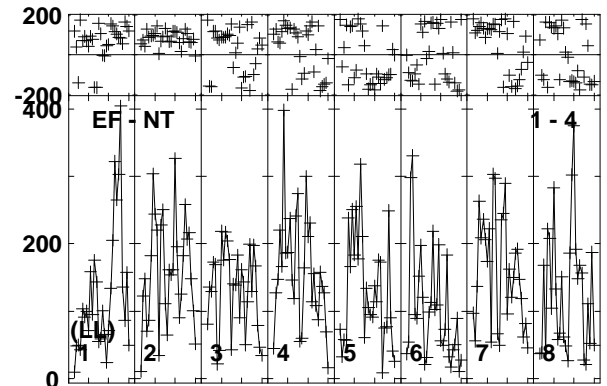
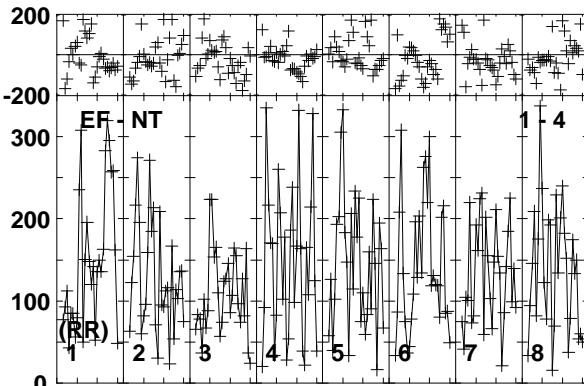
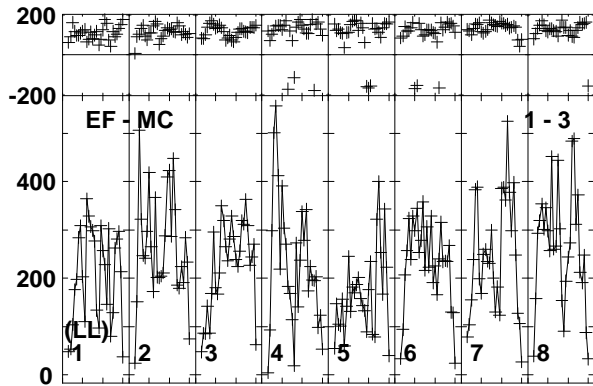
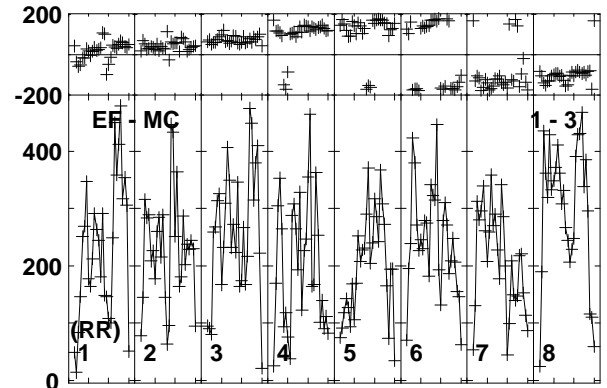
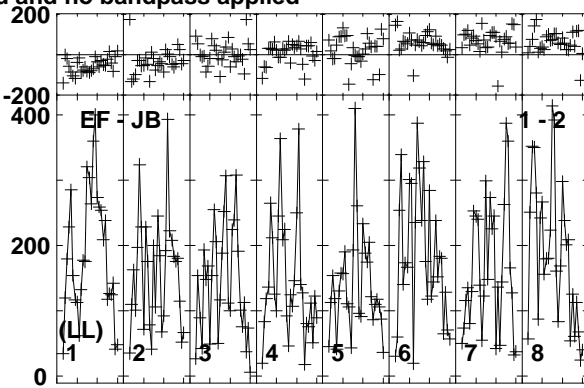
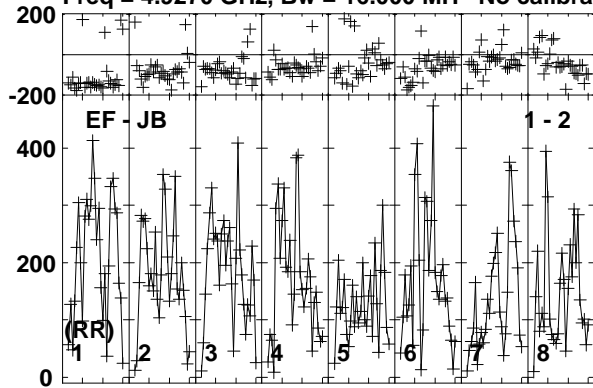

Lower frame: Micro Ampl Jy Top frame: Phas deg  
Vector averaged cross-power spectrum Baseline: EF (01) - JB (02)  
Timerange: 01/05:40:41 to 01/05:42:40

Plot file version 548 created 10-JUN-2016 17:22:56

CHECK RT013A.UVDATA.1

Freq = 4.9270 GHz, Bw = 16.000 MH No calibration applied and no bandpass applied

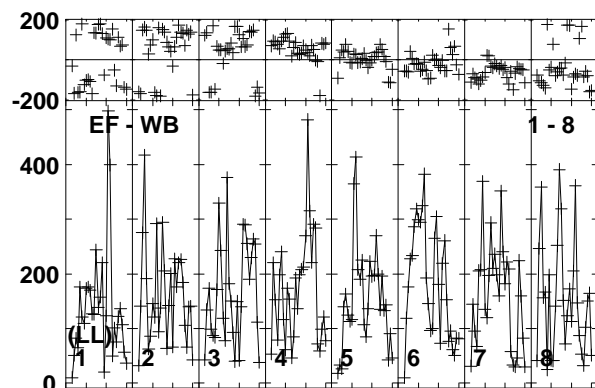
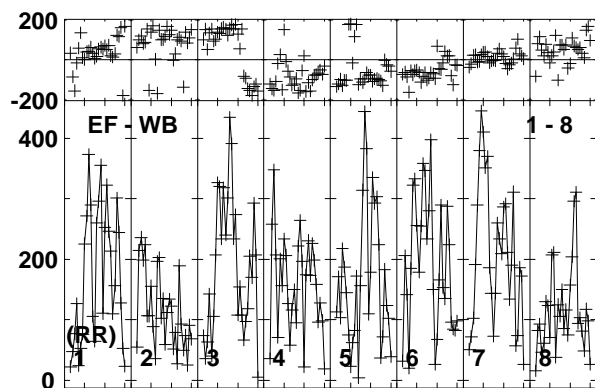
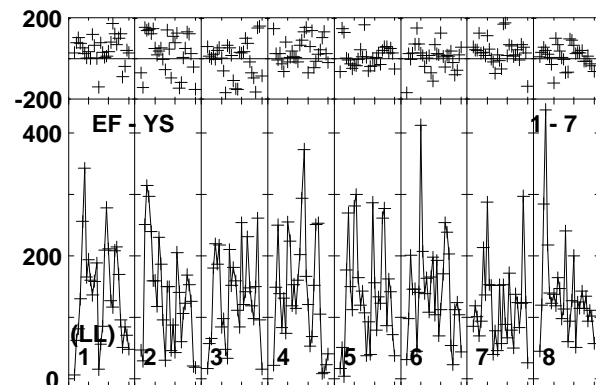
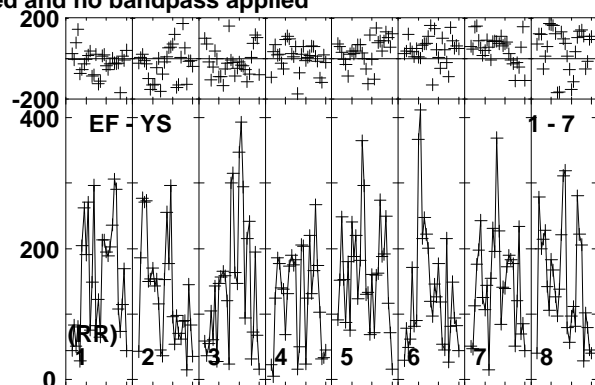
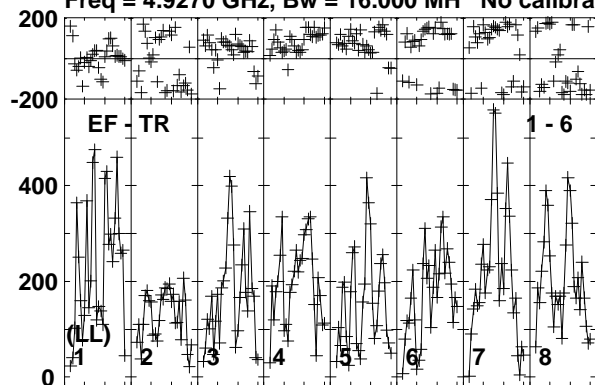

Lower frame: Micro Ampl Jy Top frame: Phas deg  
Vector averaged cross-power spectrum Baseline: EF (01) - TR (06)  
Timerange: 01/05:40:41 to 01/05:42:40

Plot file version 549 created 10-JUN-2016 17:22:57

CYGX1 RT013A.UVDATA.1

Freq = 4.9270 GHz, Bw = 16.000 MH No calibration applied and no bandpass applied

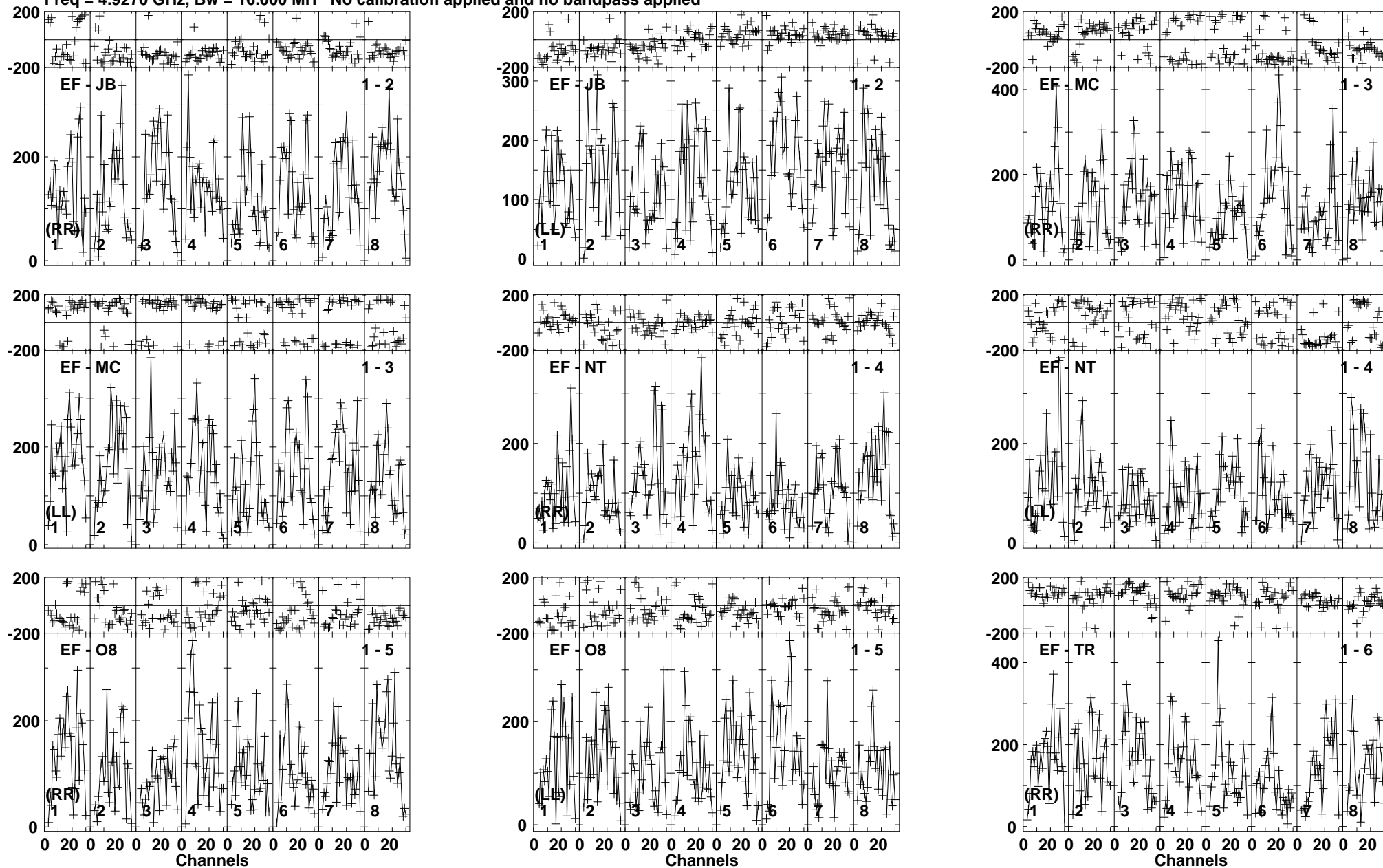

Lower frame: Micro Ampl Jy Top frame: Phas deg  
Vector averaged cross-power spectrum Baseline: EF (01) - JB (02)  
Timerange: 01/05:42:40 to 01/05:45:10

Plot file version 550 created 10-JUN-2016 17:22:57

CYGX1 RT013A.UVDATA.1

Freq = 4.9270 GHz, Bw = 16.000 MH No calibration applied and no bandpass applied

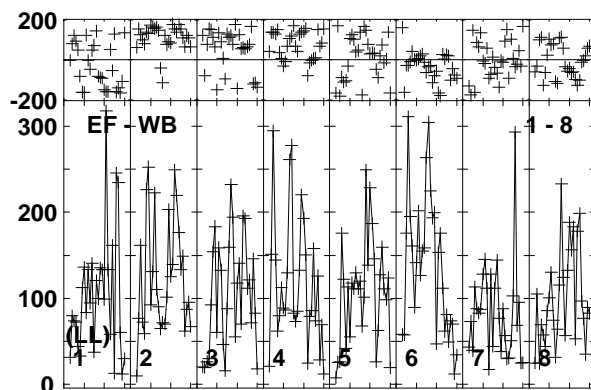
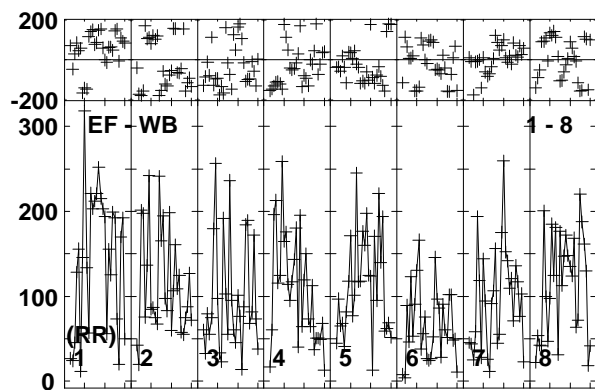
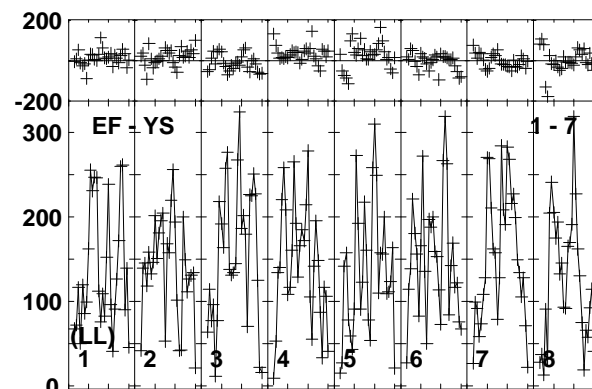
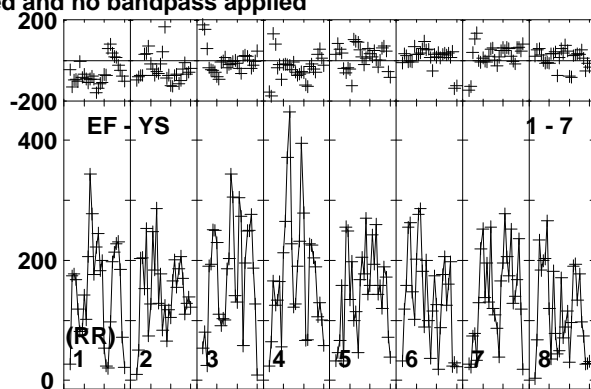
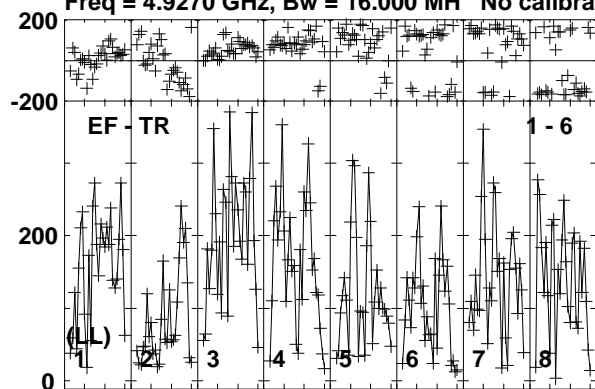

Lower frame: Micro Ampl Jy Top frame: Phas deg  
Vector averaged cross-power spectrum Baseline: EF (01) - TR (06)  
Timerange: 01/05:42:40 to 01/05:45:10

Plot file version 551 created 10-JUN-2016 17:22:57

J1957+3338 RT013A.UVDATA.1

Freq = 4.9270 GHz, Bw = 16.000 MH No calibration applied and no bandpass applied

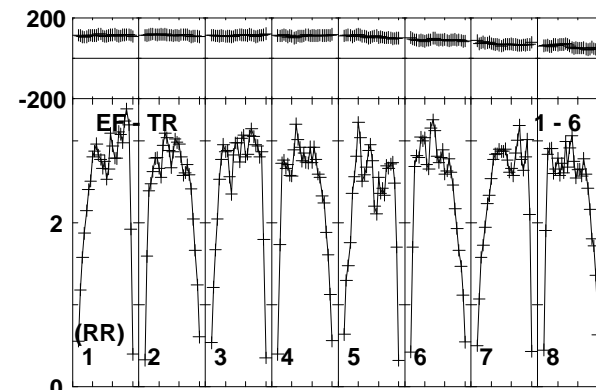
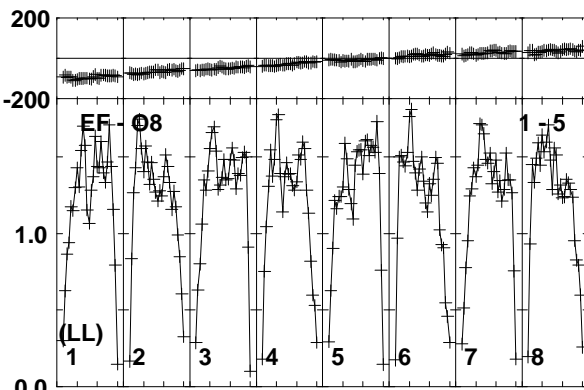
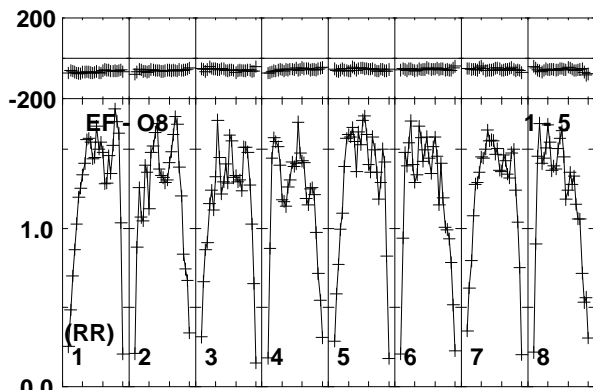
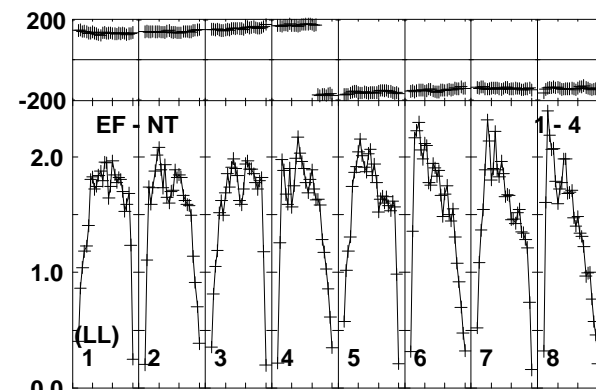
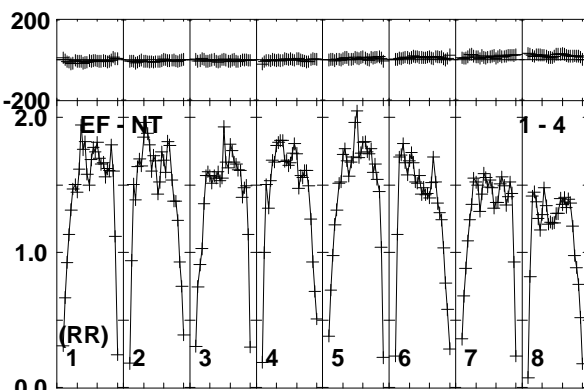
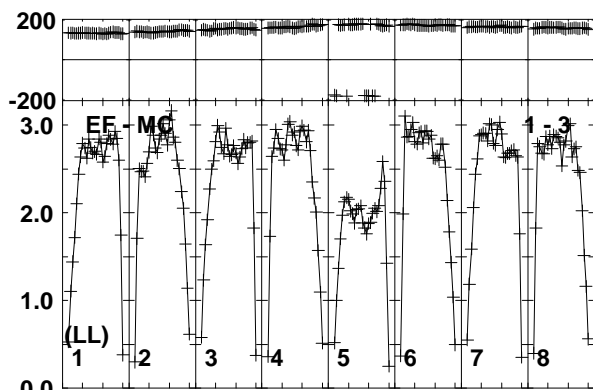
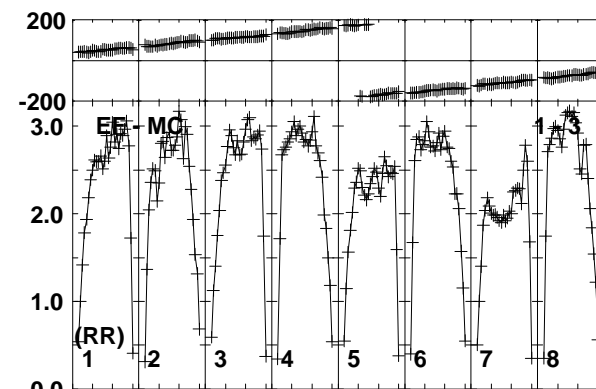
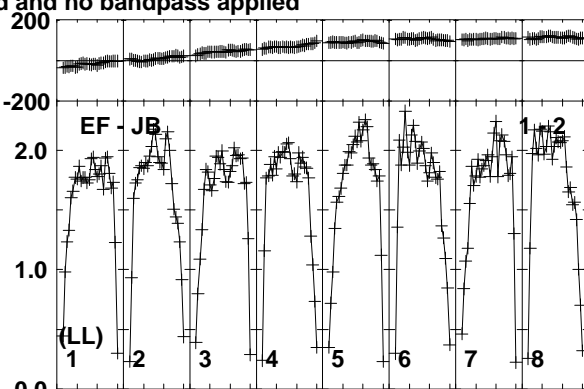
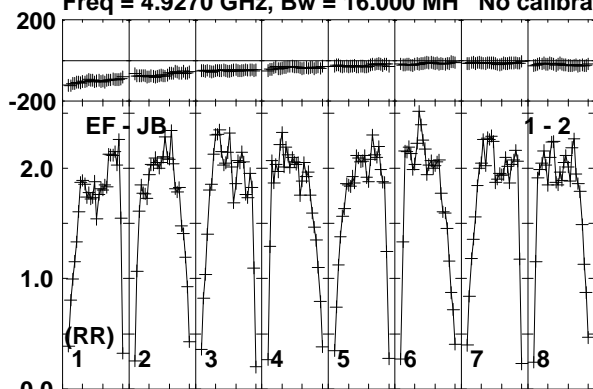

Lower frame: Milli Ampl Jy Top frame: Phas deg  
Vector averaged cross-power spectrum Baseline: EF (01) - JB (02)  
Timerange: 01/05:45:10 to 01/05:46:39

Plot file version 552 created 10-JUN-2016 17:22:57

J1957+3338 RT013A.UVDATA.1

Freq = 4.9270 GHz, Bw = 16.000 MH No calibration applied and no bandpass applied

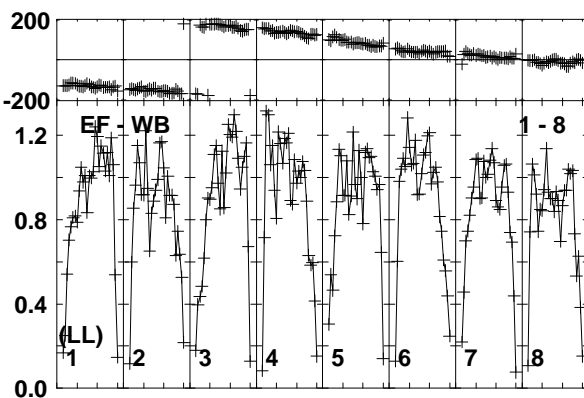
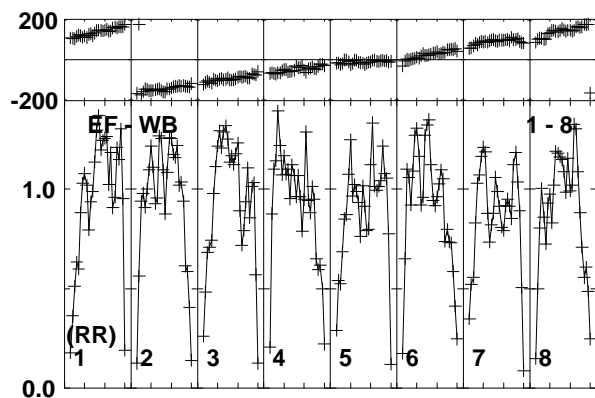
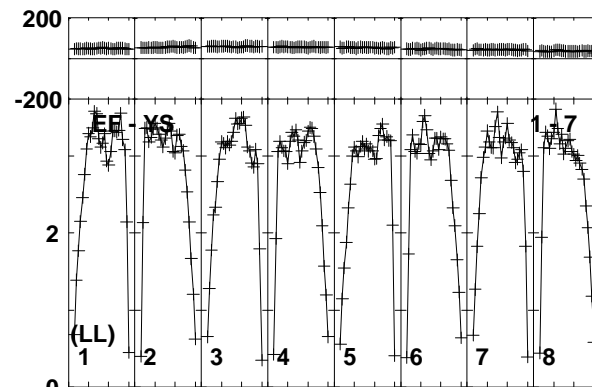
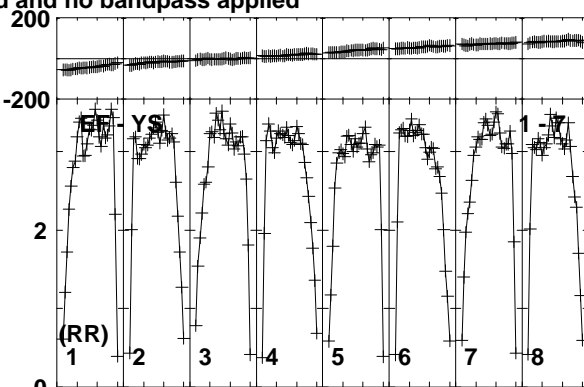
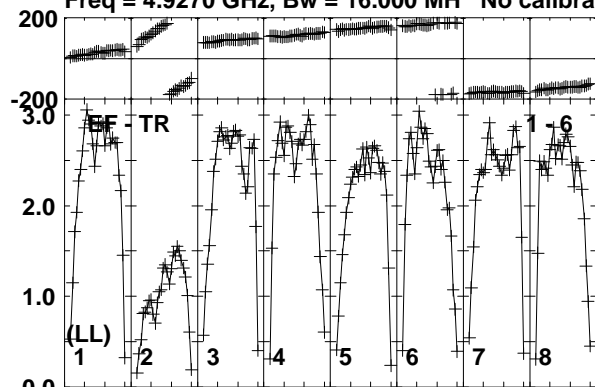

Lower frame: Milli Ampl Jy Top frame: Phas deg  
Vector averaged cross-power spectrum Baseline: EF (01) - TR (06)  
Timerange: 01/05:45:10 to 01/05:46:39

Plot file version 553 created 10-JUN-2016 17:22:57

CHECK RT013A.UVDATA.1

Freq = 4.9270 GHz, Bw = 16.000 MH No calibration applied and no bandpass applied

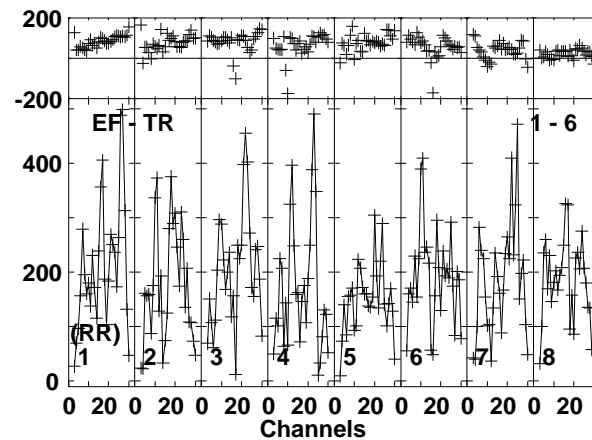
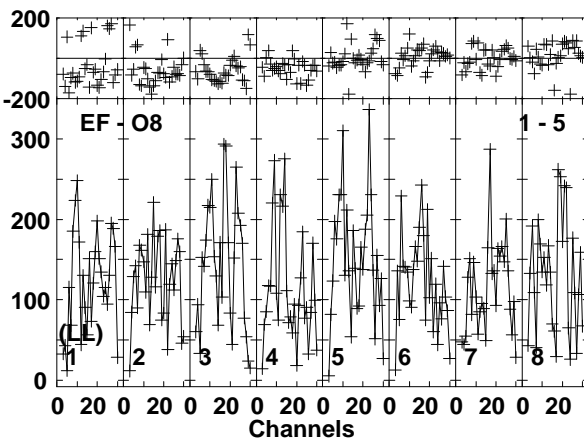
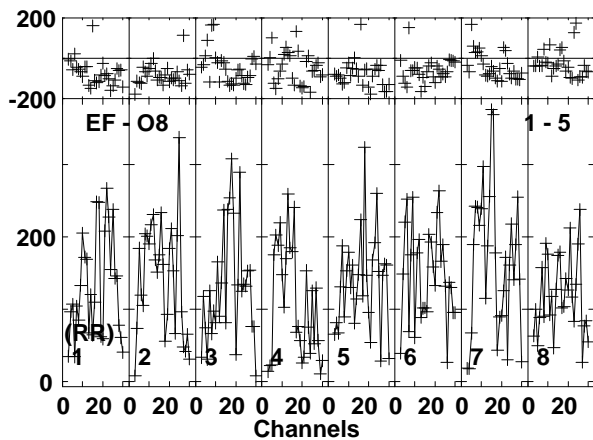
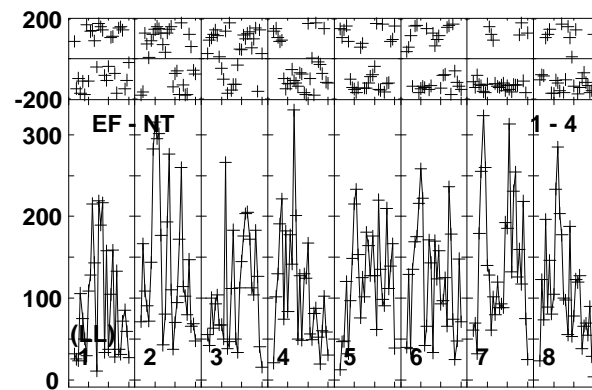
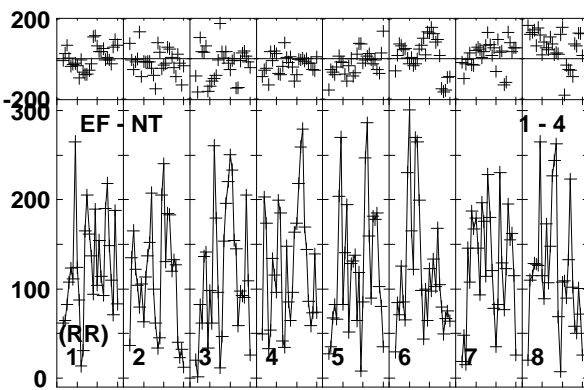
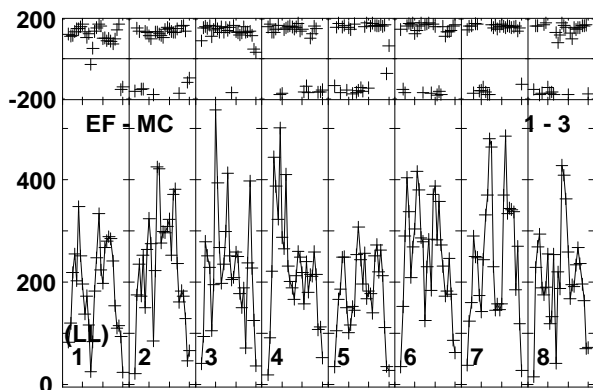
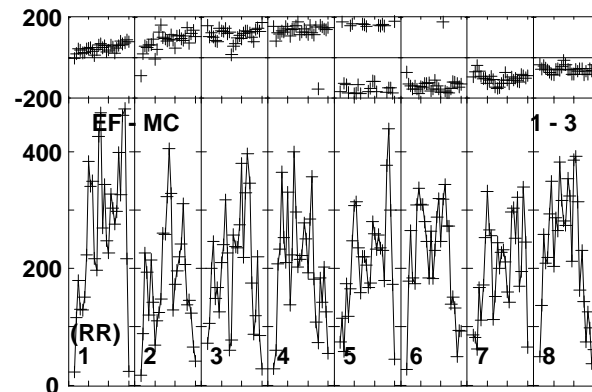
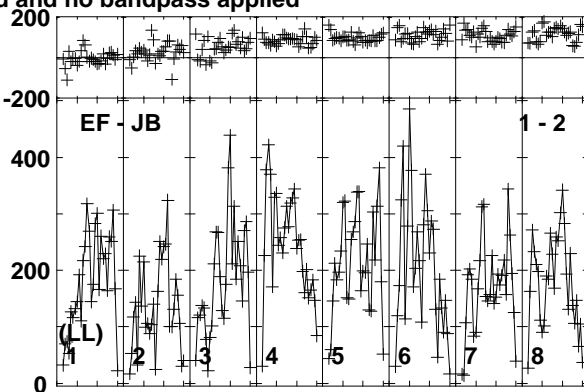
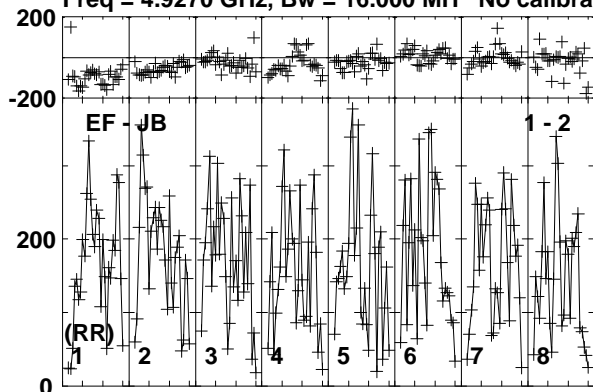

Lower frame: Micro Ampl Jy Top frame: Phas deg  
Vector averaged cross-power spectrum Baseline: EF (01) - JB (02)  
Timerange: 01/05:47:21 to 01/05:49:20

Plot file version 554 created 10-JUN-2016 17:22:57

CHECK RT013A.UVDATA.1

Freq = 4.9270 GHz, Bw = 16.000 MH No calibration applied and no bandpass applied

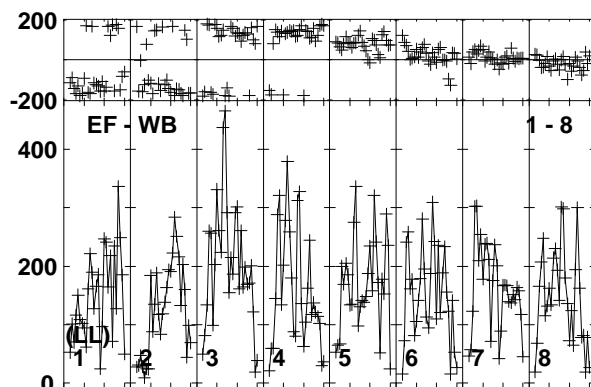
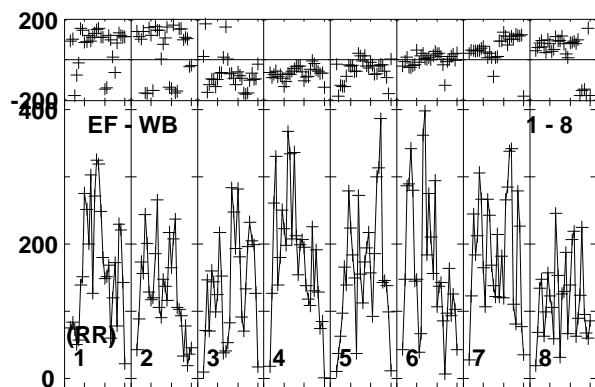
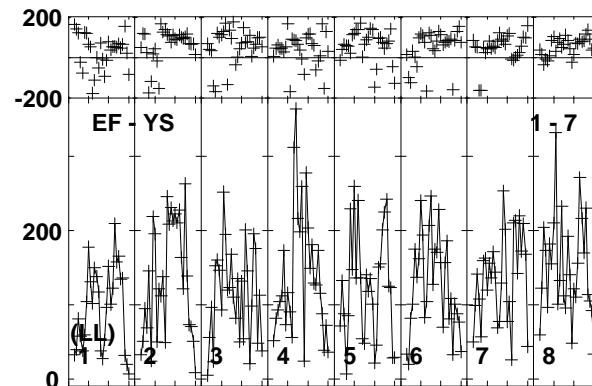
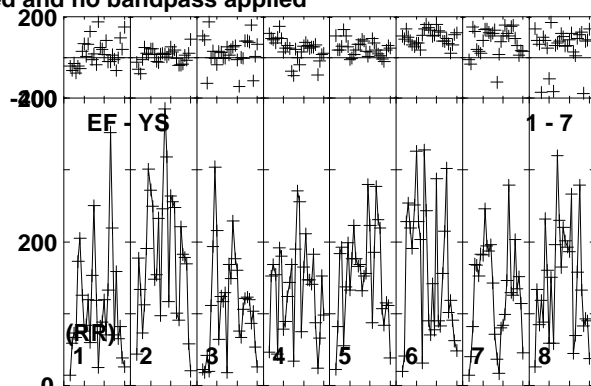
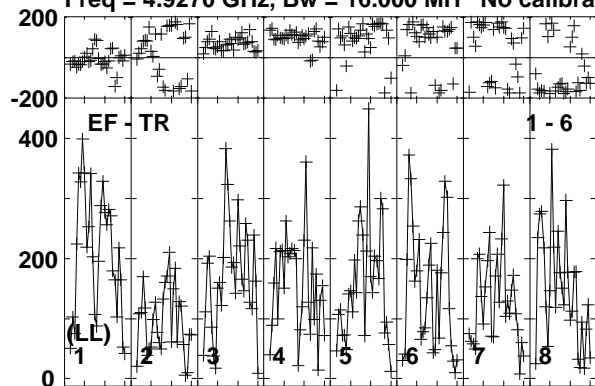

Lower frame: Micro Ampl Jy Top frame: Phas deg  
Vector averaged cross-power spectrum Baseline: EF (01) - TR (06)  
Timerange: 01/05:47:21 to 01/05:49:20



Plot file version 555 created 10-JUN-2016 17:22:57

CYGX1 RT013A.UVDATA.1

Freq = 4.9270 GHz, Bw = 16.000 MH No calibration applied and no bandpass applied

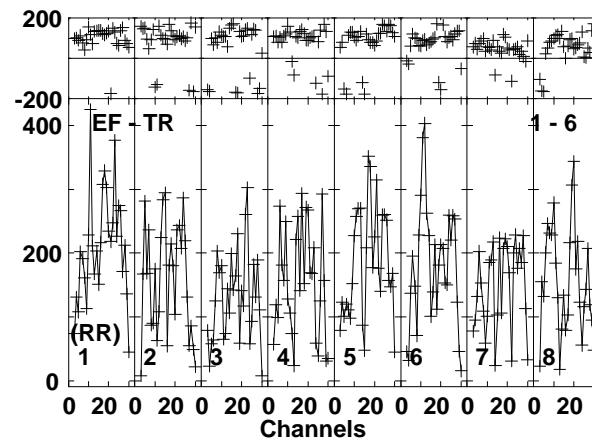
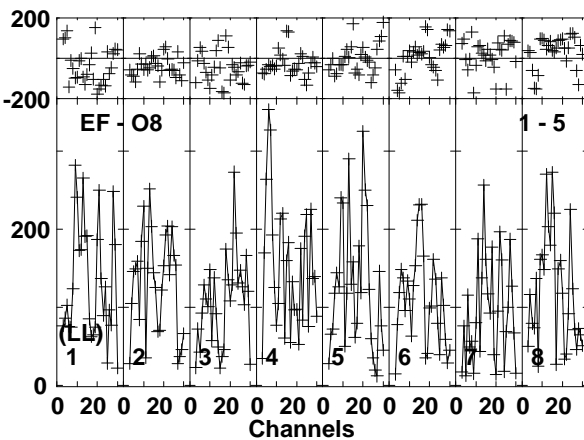
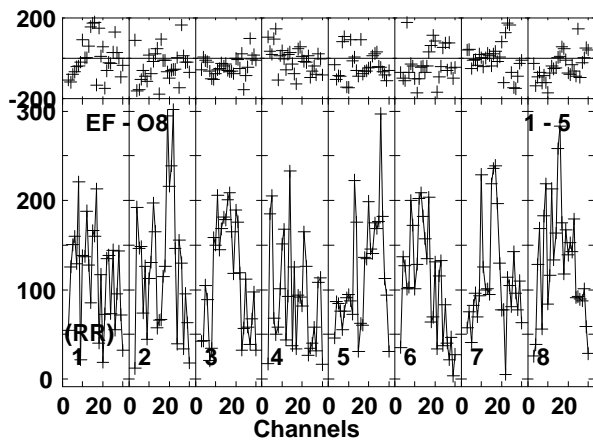
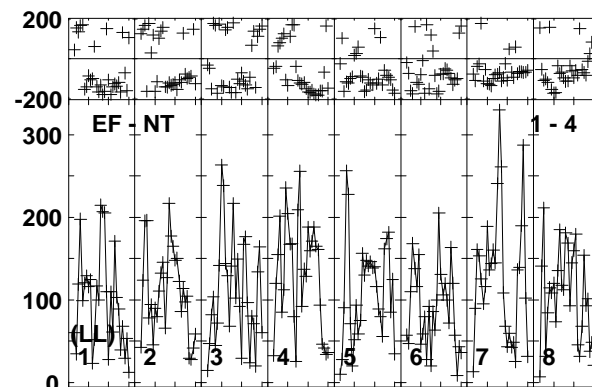
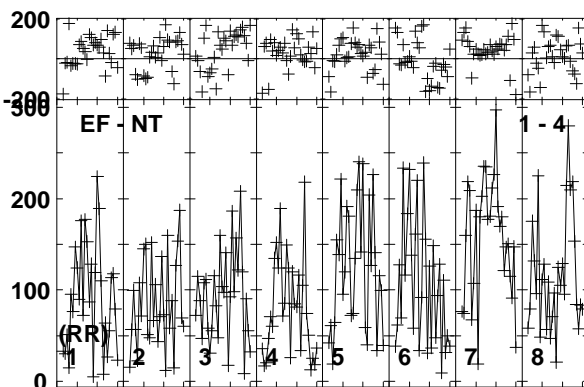
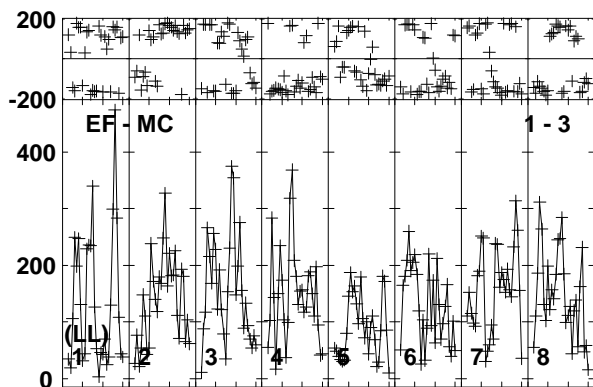
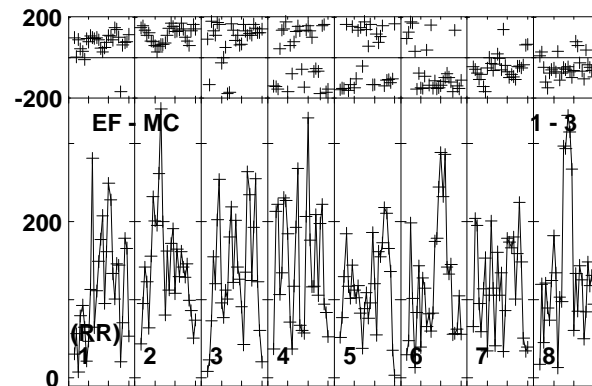
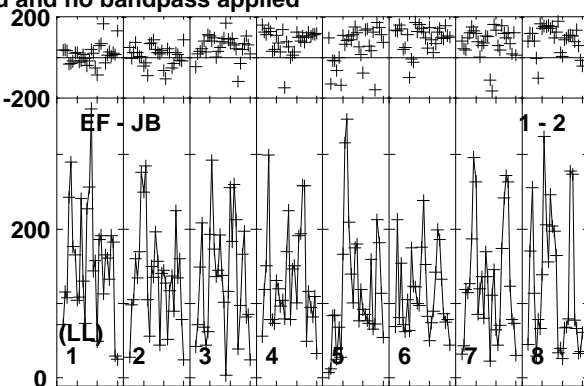
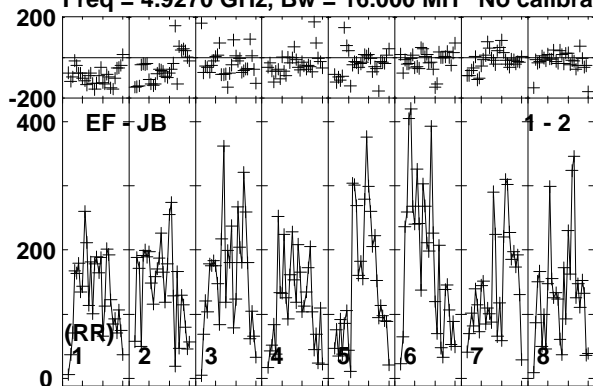

Lower frame: Micro Ampl Jy Top frame: Phas deg  
Vector averaged cross-power spectrum Baseline: EF (01) - JB (02)  
Timerange: 01/05:49:21 to 01/05:51:49

Plot file version 556 created 10-JUN-2016 17:22:57

CYGX1 RT013A.UVDATA.1

Freq = 4.9270 GHz, Bw = 16.000 MH No calibration applied and no bandpass applied

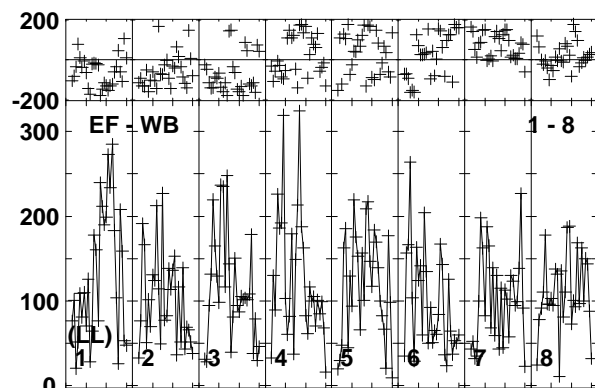
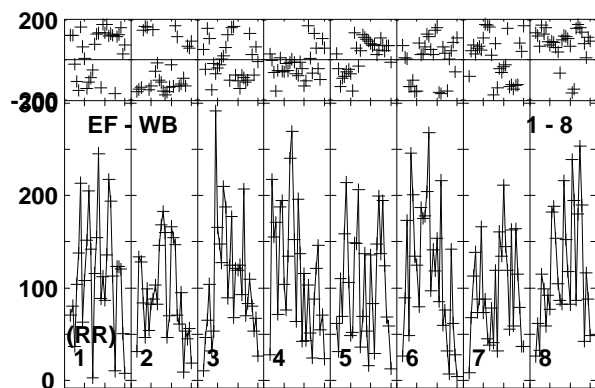
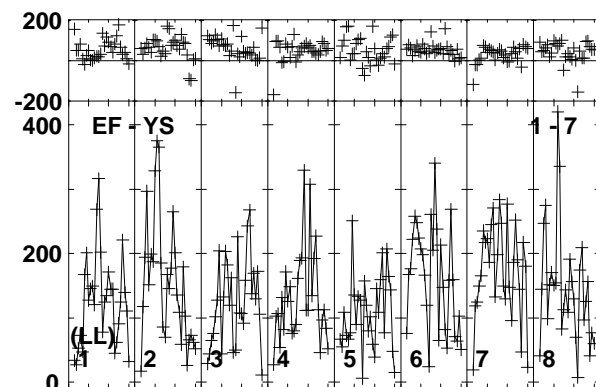
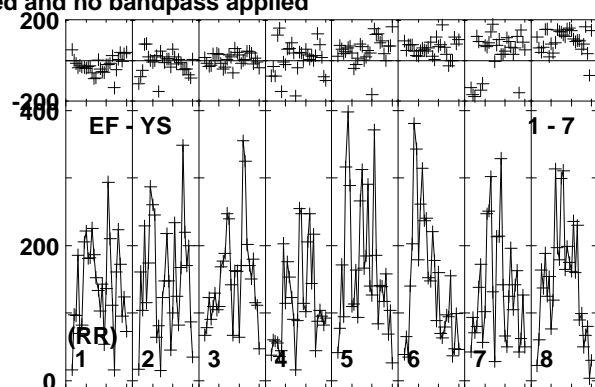
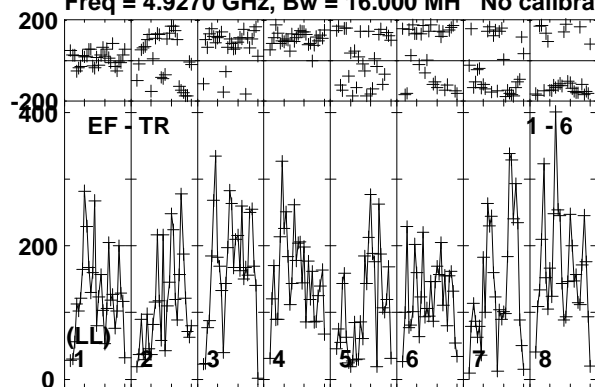

Lower frame: Micro Ampl Jy Top frame: Phas deg  
Vector averaged cross-power spectrum Baseline: EF (01) - TR (06)  
Timerange: 01/05:49:21 to 01/05:51:49

Plot file version 557 created 10-JUN-2016 17:22:57

J1957+3338 RT013A.UVDATA.1

Freq = 4.9270 GHz, Bw = 16.000 MH No calibration applied and no bandpass applied

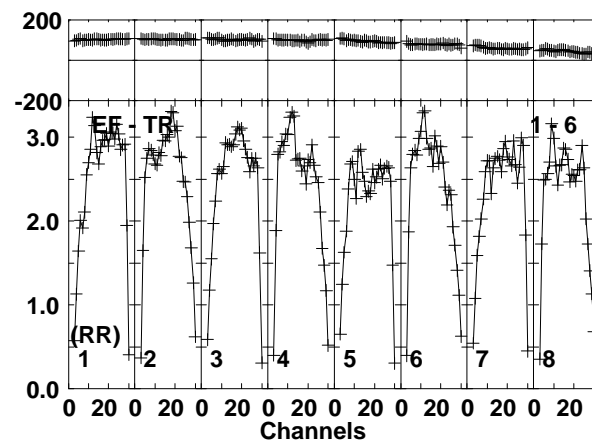
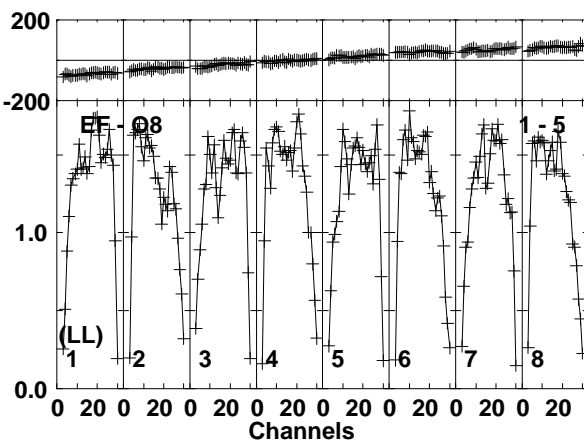
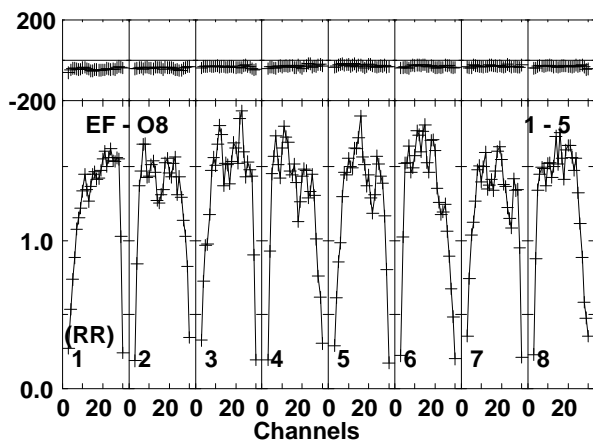
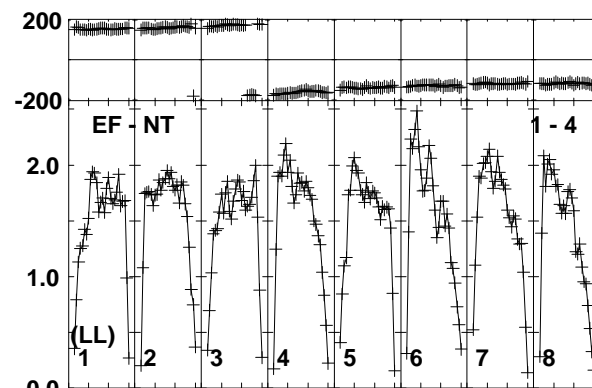
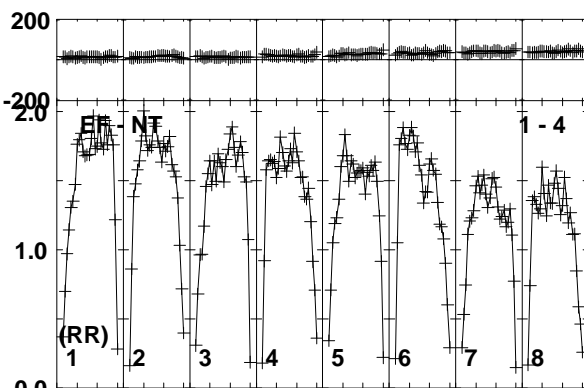
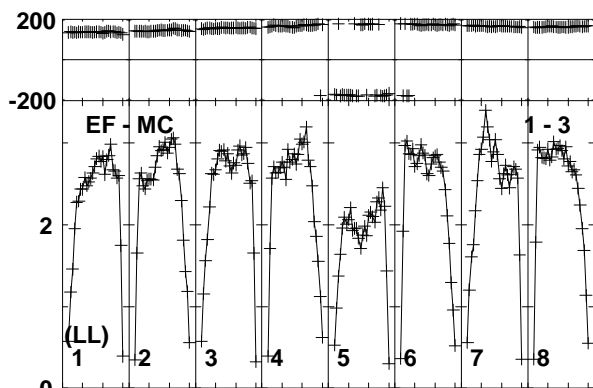
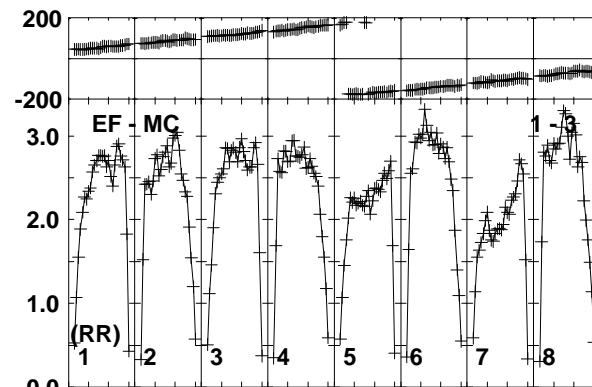
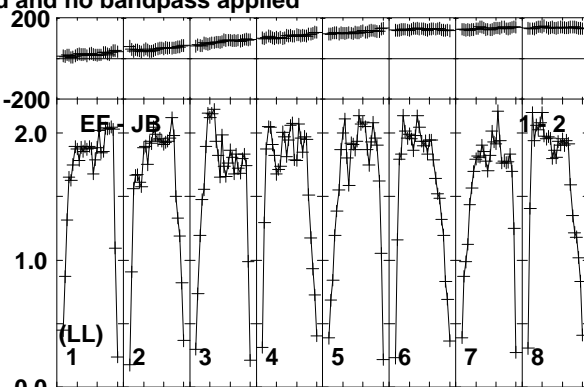
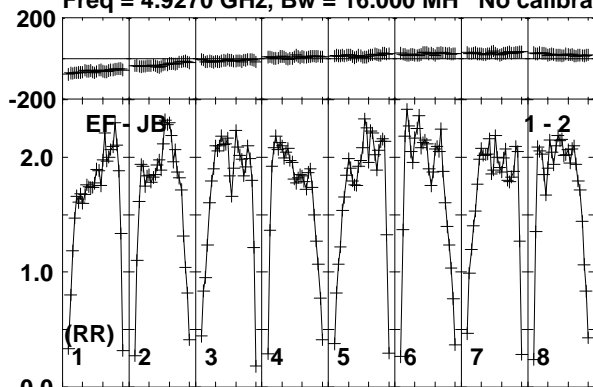

Lower frame: Milli Ampl Jy Top frame: Phas deg  
Vector averaged cross-power spectrum Baseline: EF (01) - JB (02)  
Timerange: 01/05:51:50 to 01/05:53:19

Plot file version 558 created 10-JUN-2016 17:22:58

J1957+3338 RT013A.UVDATA.1

Freq = 4.9270 GHz, Bw = 16.000 MH No calibration applied and no bandpass applied

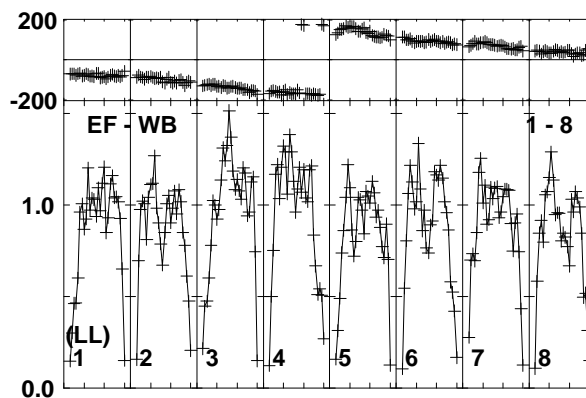
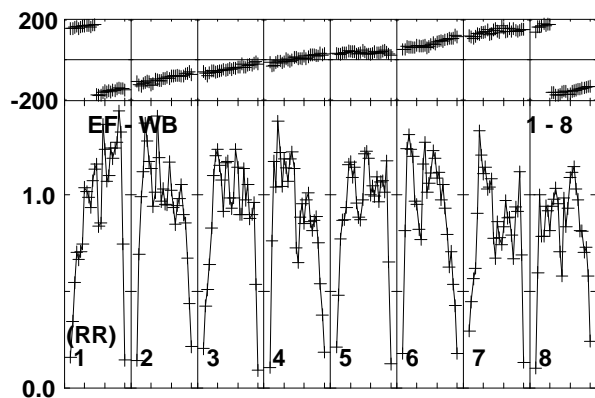
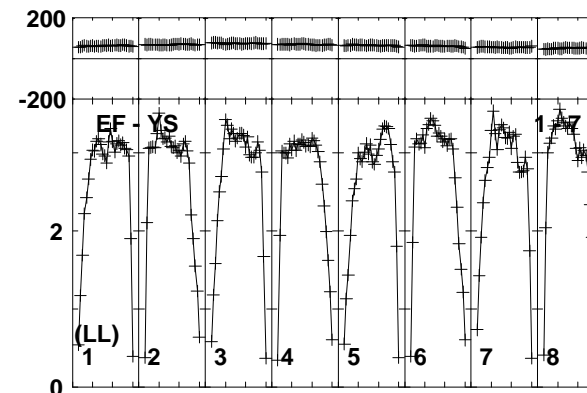
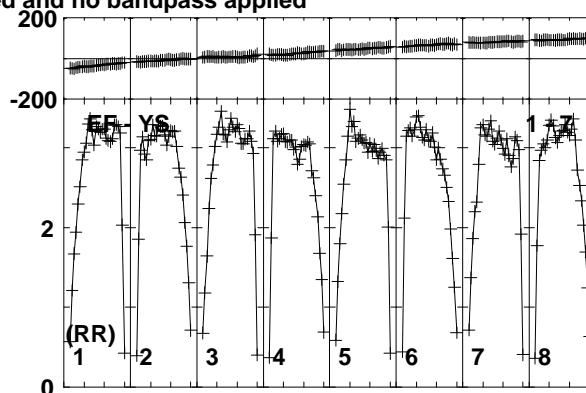
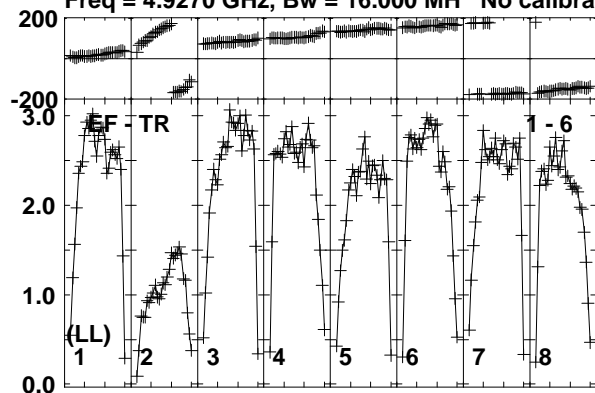

Lower frame: Milli Ampl Jy Top frame: Phas deg  
Vector averaged cross-power spectrum Baseline: EF (01) - TR (06)  
Timerange: 01/05:51:50 to 01/05:53:19

Plot file version 559 created 10-JUN-2016 17:22:58

CHECK RT013A.UVDATA.1

Freq = 4.9270 GHz, Bw = 16.000 MH No calibration applied and no bandpass applied

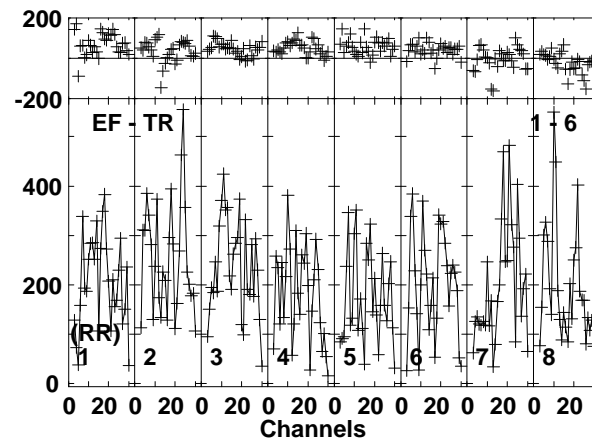
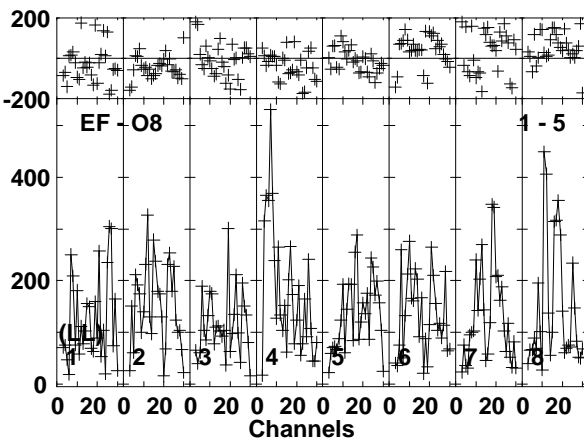
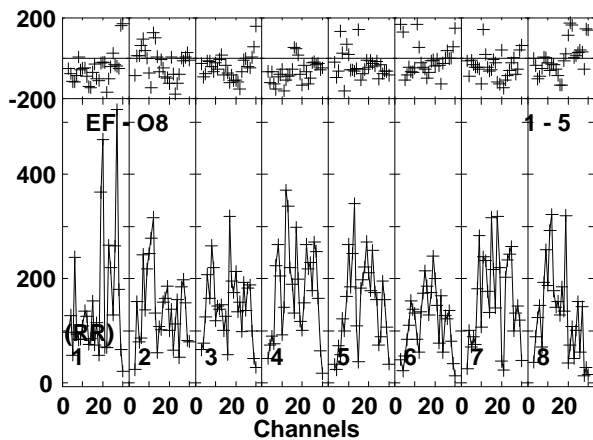
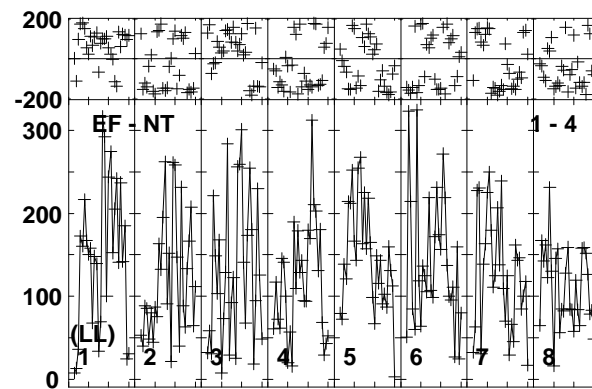
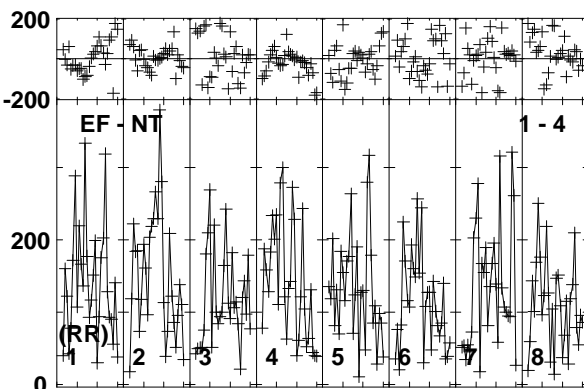
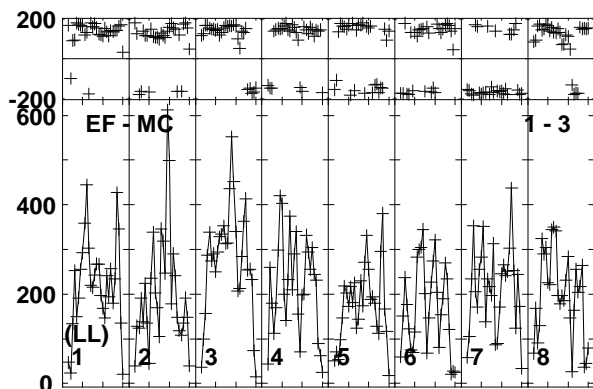
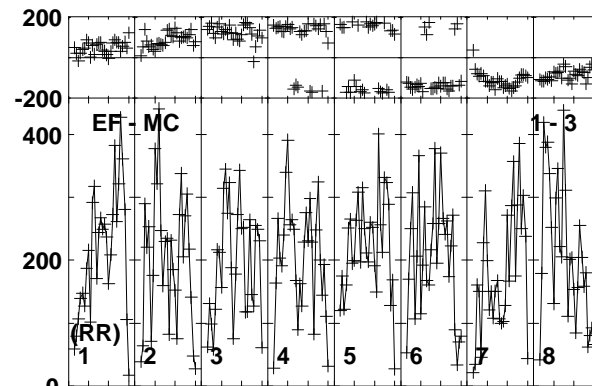
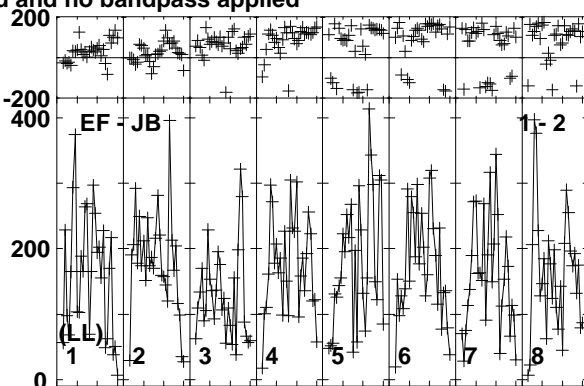
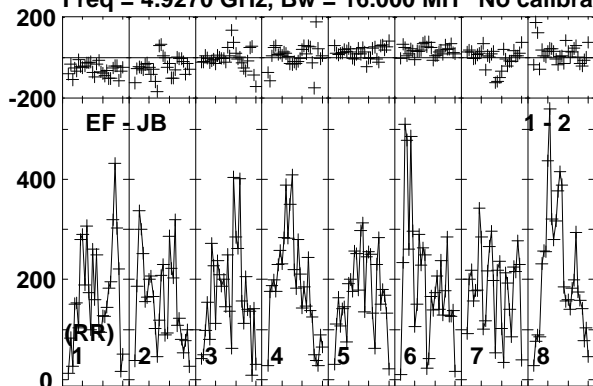

Lower frame: Micro Ampl Jy Top frame: Phas deg  
Vector averaged cross-power spectrum Baseline: EF (01) - JB (02)  
Timerange: 01/05:53:20 to 01/05:55:19

Plot file version 560 created 10-JUN-2016 17:22:58

CHECK RT013A.UVDATA.1

Freq = 4.9270 GHz, Bw = 16.000 MH No calibration applied and no bandpass applied

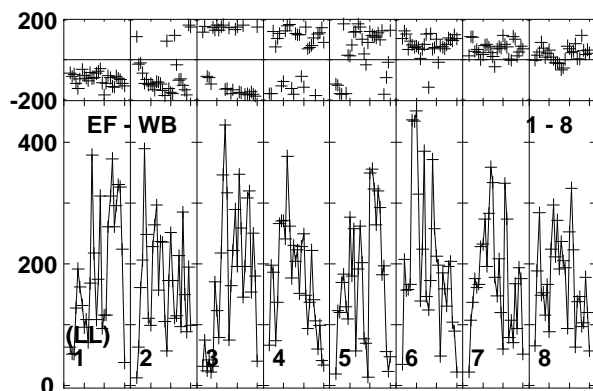
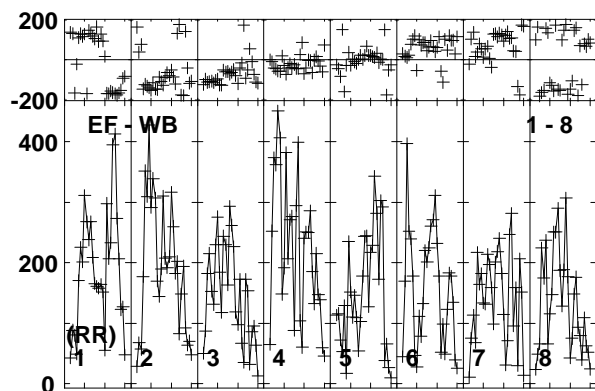
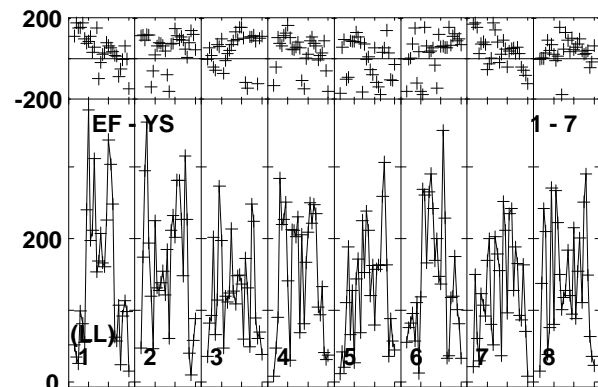
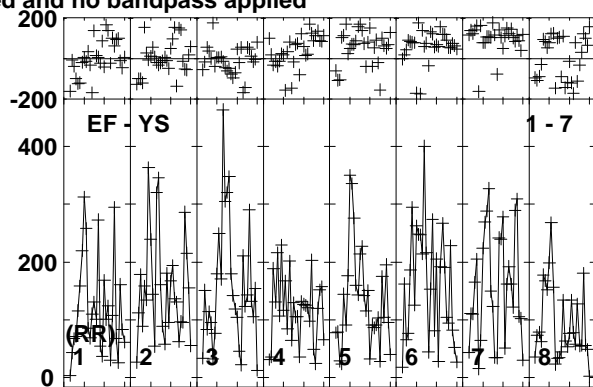
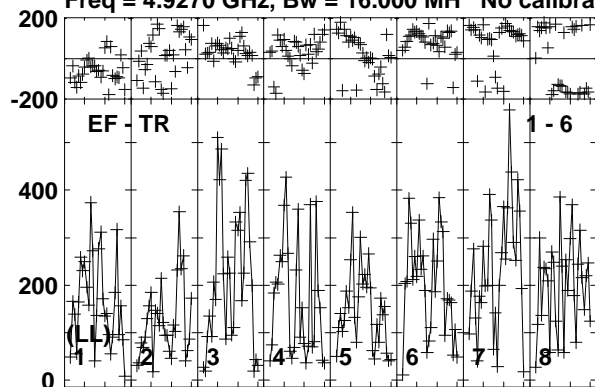

Lower frame: Micro Ampl Jy Top frame: Phas deg  
Vector averaged cross-power spectrum Baseline: EF (01) - TR (06)  
Timerange: 01/05:53:20 to 01/05:55:19

Plot file version 561 created 10-JUN-2016 17:22:58

CYGX1 RT013A.UVDATA.1

Freq = 4.9270 GHz, Bw = 16.000 MH No calibration applied and no bandpass applied

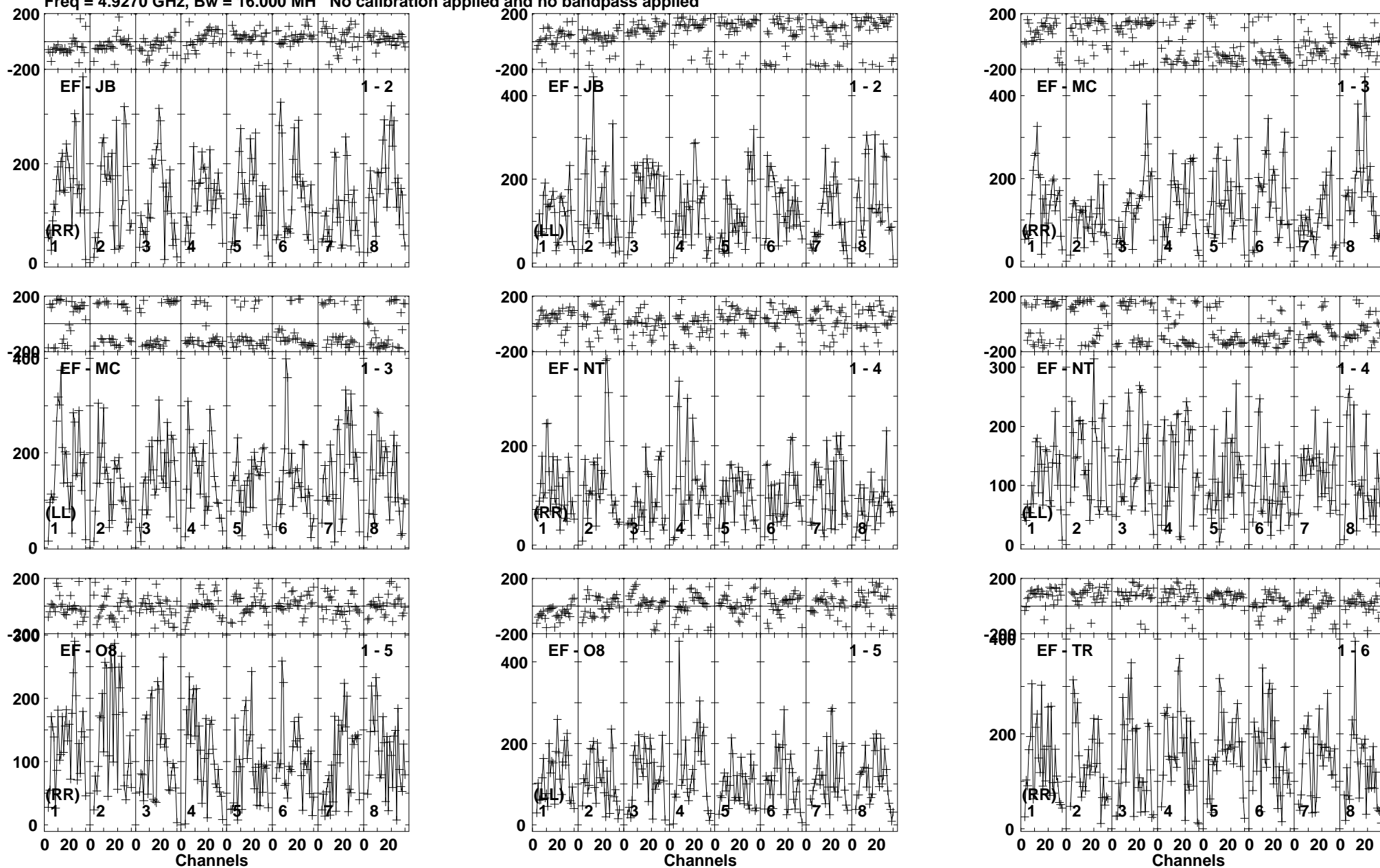

Lower frame: Micro Ampl Jy Top frame: Phas deg  
Vector averaged cross-power spectrum Baseline: EF (01) - JB (02)  
Timerange: 01/05:55:20 to 01/05:57:50

Plot file version 562 created 10-JUN-2016 17:22:58

CYGX1 RT013A.UVDATA.1

Freq = 4.9270 GHz, Bw = 16.000 MH No calibration applied and no bandpass applied

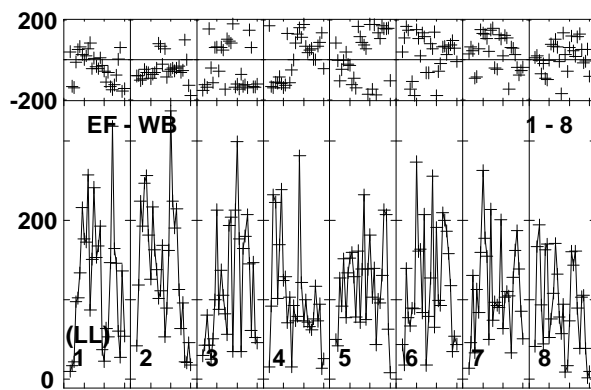
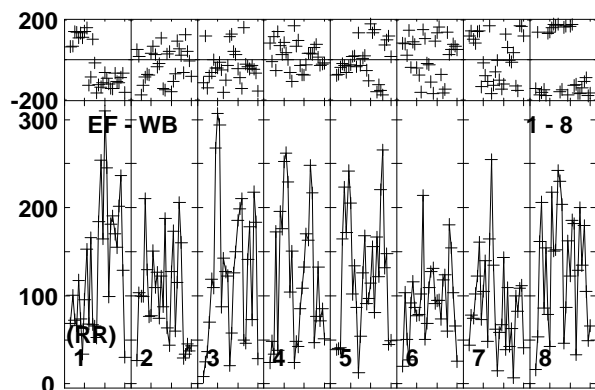
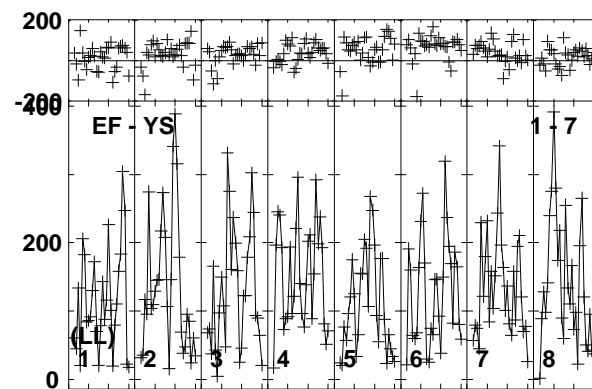
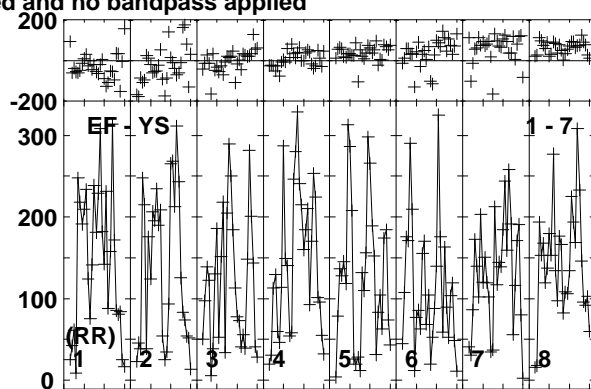
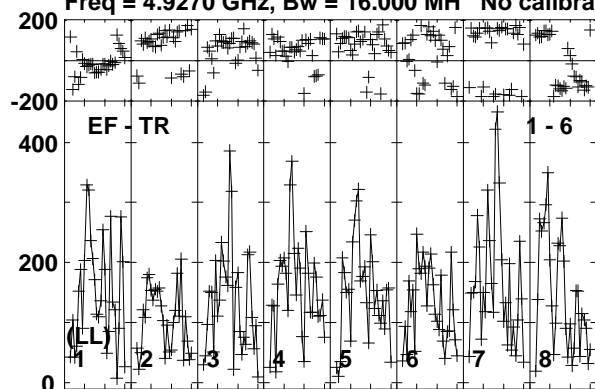

Lower frame: Micro Ampl Jy Top frame: Phas deg  
Vector averaged cross-power spectrum Baseline: EF (01) - TR (06)  
Timerange: 01/05:55:20 to 01/05:57:50



Plot file version 563 created 10-JUN-2016 17:22:58

J1957+3338 RT013A.UVDATA.1

Freq = 4.9270 GHz, Bw = 16.000 MH No calibration applied and no bandpass applied

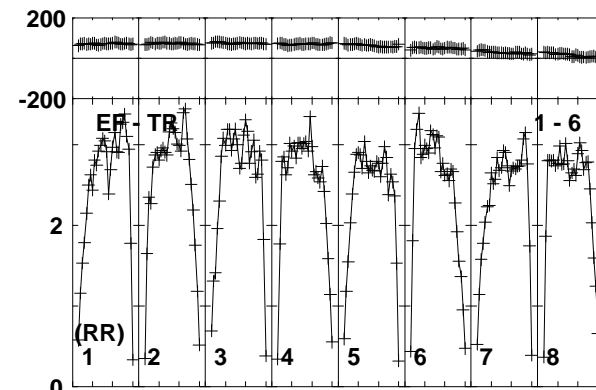
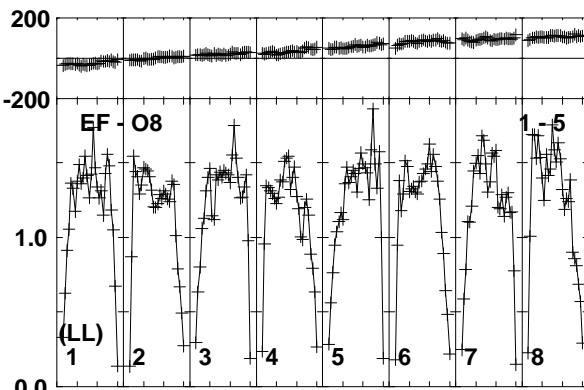
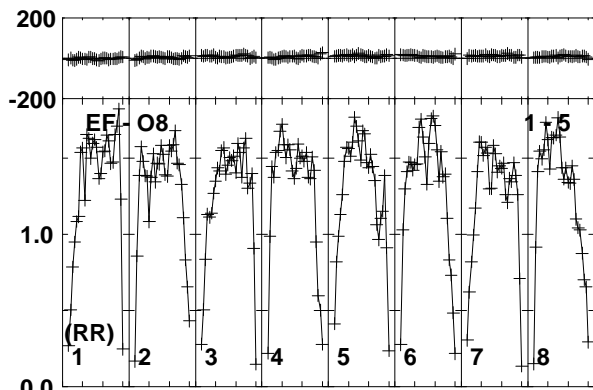
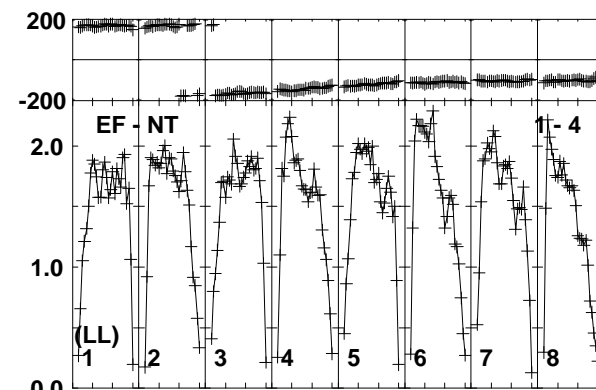
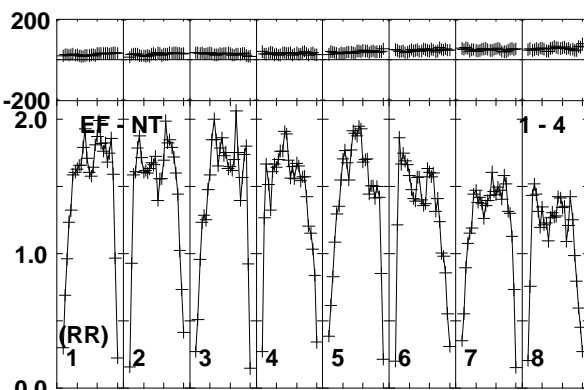
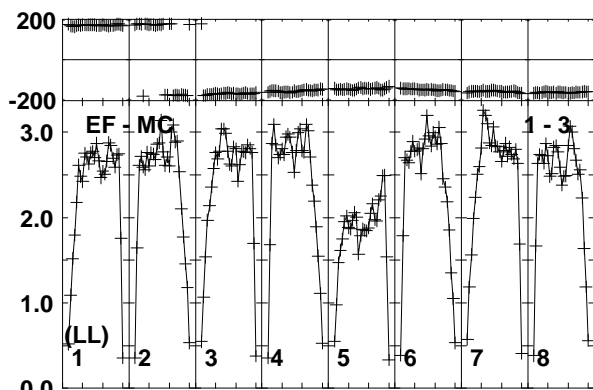
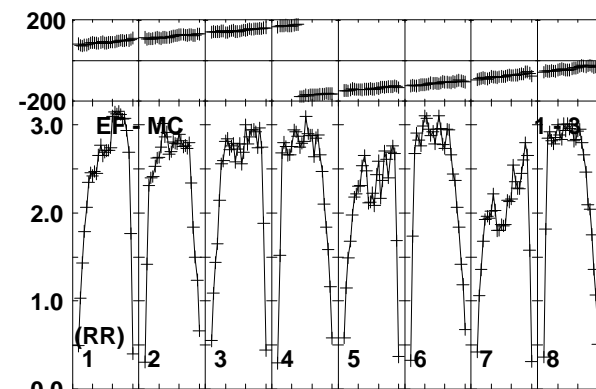
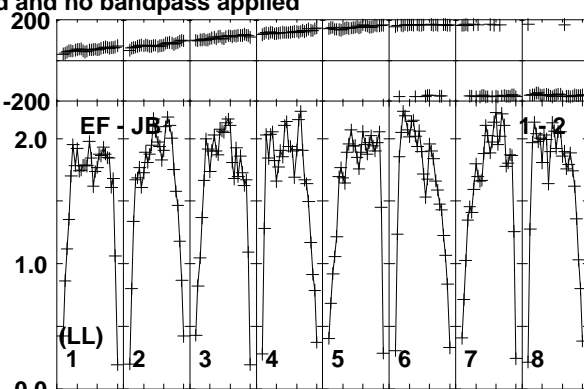
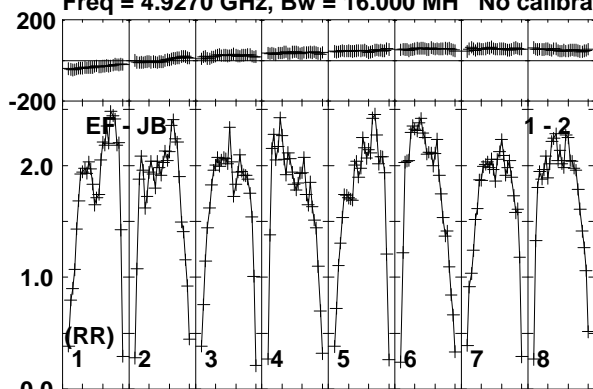

Lower frame: Milli Ampl Jy Top frame: Phas deg  
Vector averaged cross-power spectrum Baseline: EF (01) - JB (02)  
Timerange: 01/05:57:51 to 01/05:59:20

Plot file version 564 created 10-JUN-2016 17:22:58

J1957+3338 RT013A.UVDATA.1

Freq = 4.9270 GHz, Bw = 16.000 MH No calibration applied and no bandpass applied

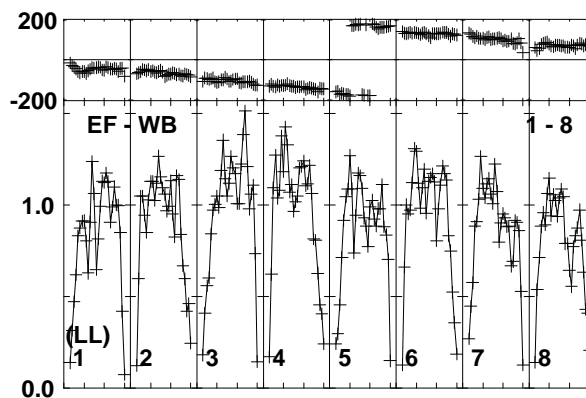
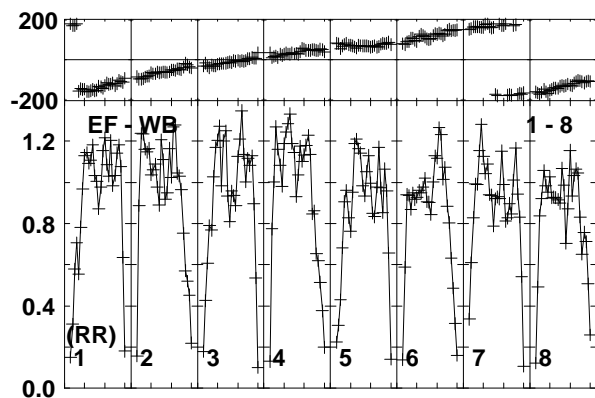
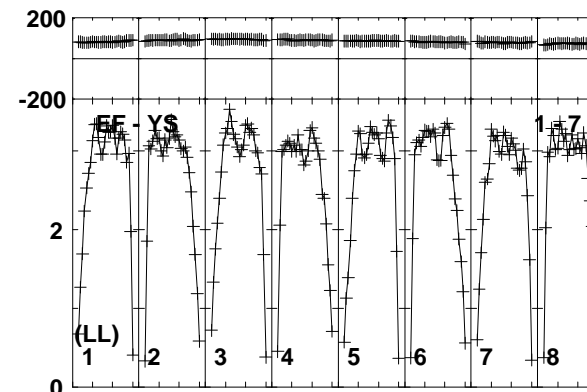
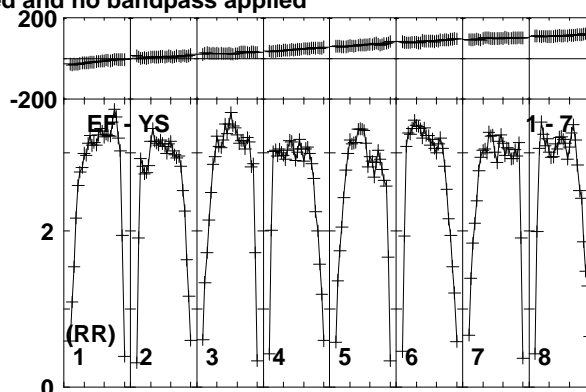
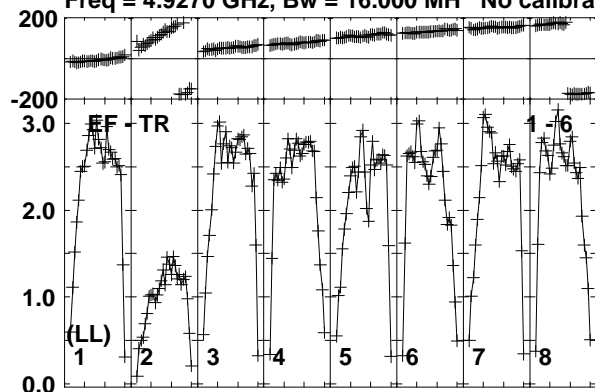

Lower frame: Milli Ampl Jy Top frame: Phas deg  
Vector averaged cross-power spectrum Baseline: EF (01) - TR (06)  
Timerange: 01/05:57:51 to 01/05:59:20

Plot file version 565 created 10-JUN-2016 17:22:58

CHECK RT013A.UVDATA.1

Freq = 4.9270 GHz, Bw = 16.000 MH No calibration applied and no bandpass applied

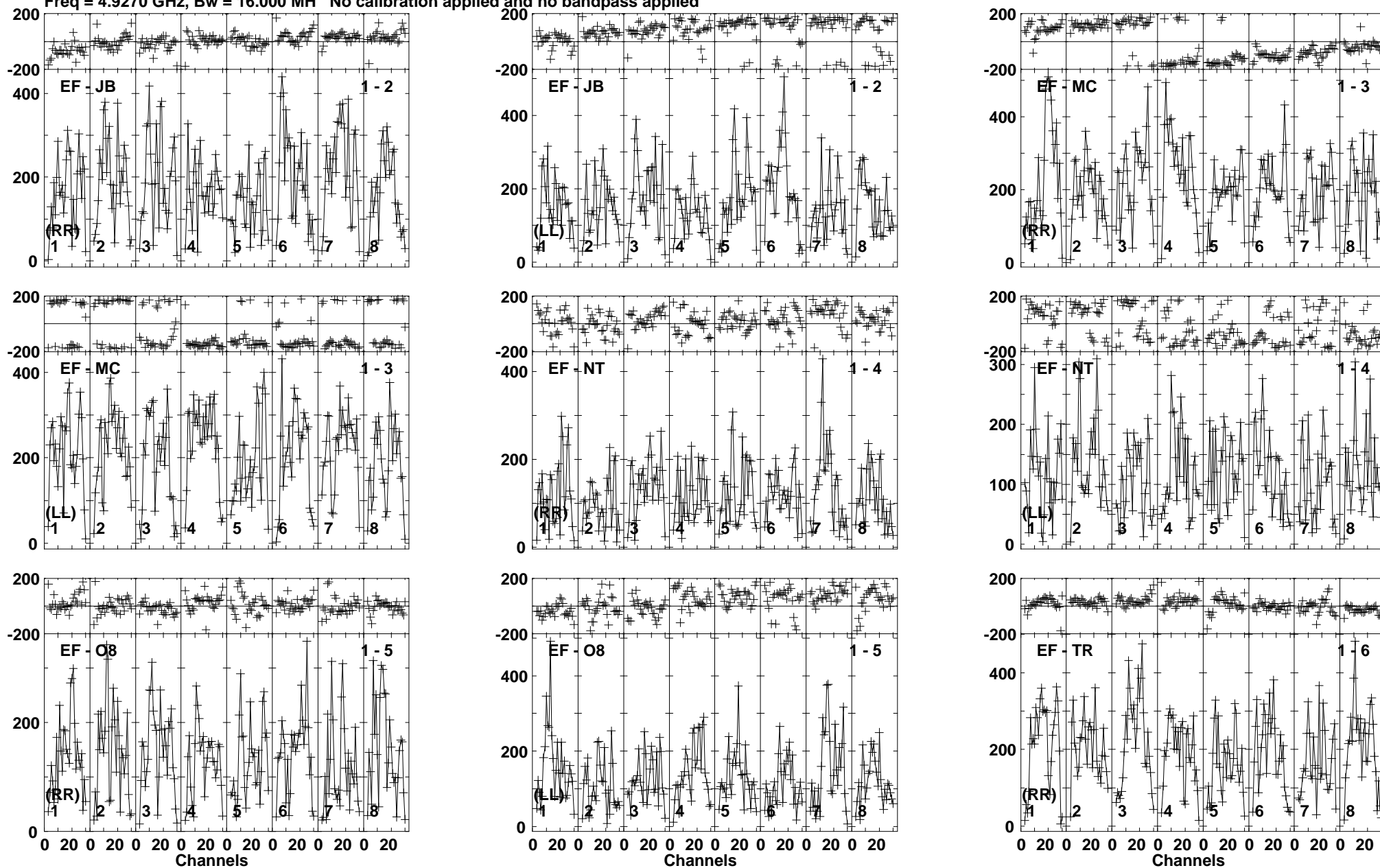

Lower frame: Micro Ampl Jy Top frame: Phas deg  
Vector averaged cross-power spectrum Baseline: EF (01) - JB (02)  
Timerange: 01/06:00:00 to 01/06:01:59

Plot file version 566 created 10-JUN-2016 17:22:58

CHECK RT013A.UVDATA.1

Freq = 4.9270 GHz, Bw = 16.000 MH No calibration applied and no bandpass applied

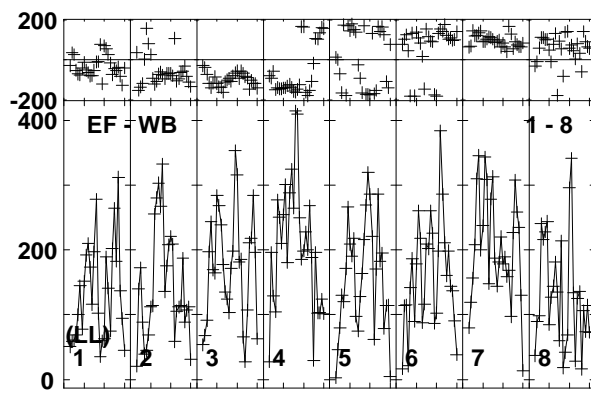
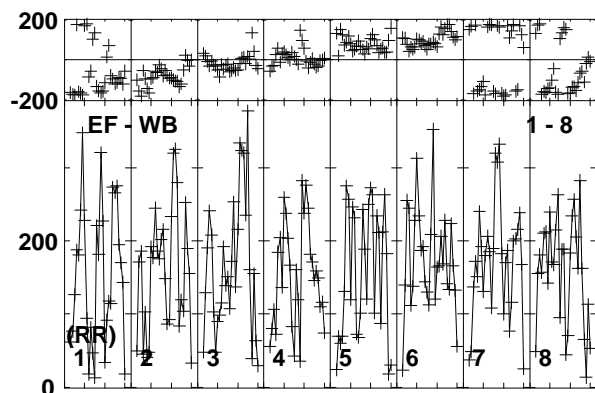
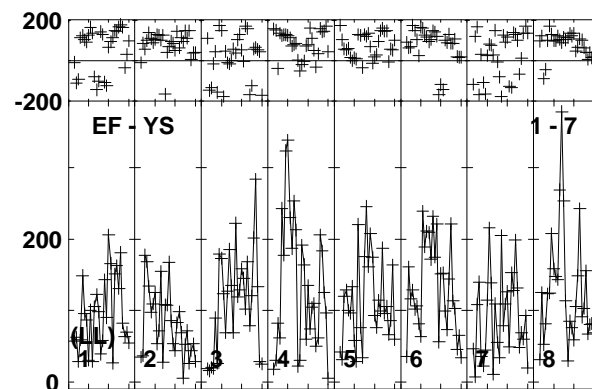
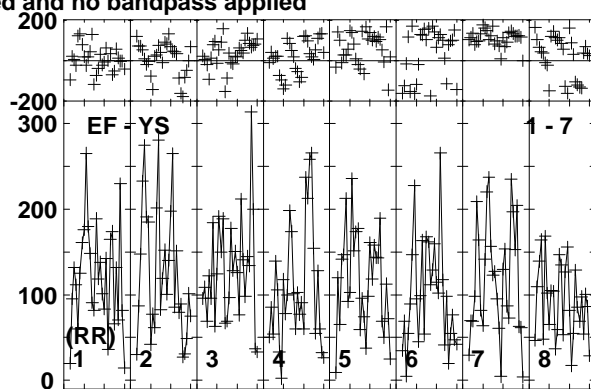
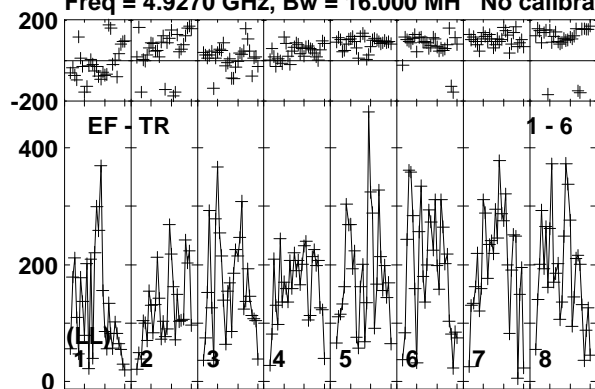

Lower frame: Micro Ampl Jy Top frame: Phas deg  
Vector averaged cross-power spectrum Baseline: EF (01) - TR (06)  
Timerange: 01/06:00:00 to 01/06:01:59

Plot file version 567 created 10-JUN-2016 17:22:58

CYGX1 RT013A.UVDATA.1

Freq = 4.9270 GHz, Bw = 16.000 MH No calibration applied and no bandpass applied

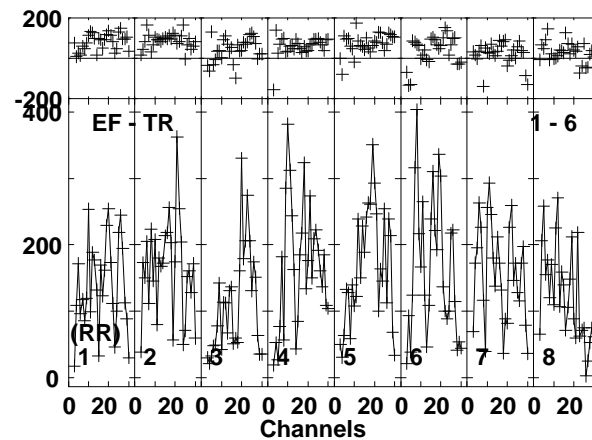
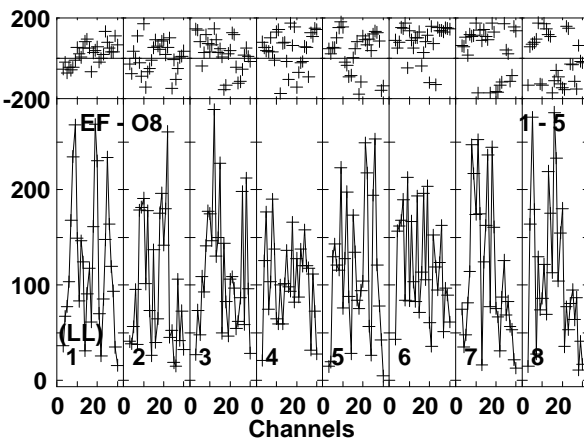
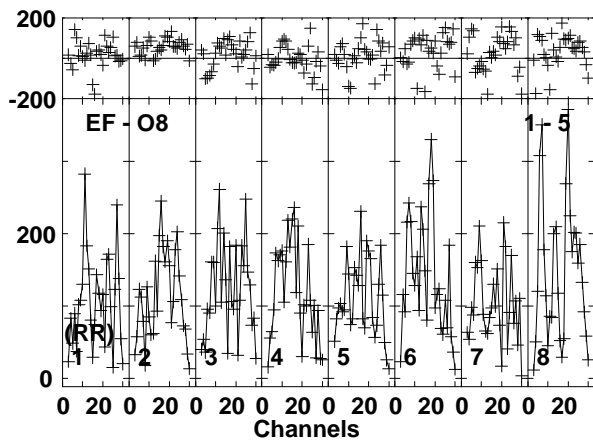
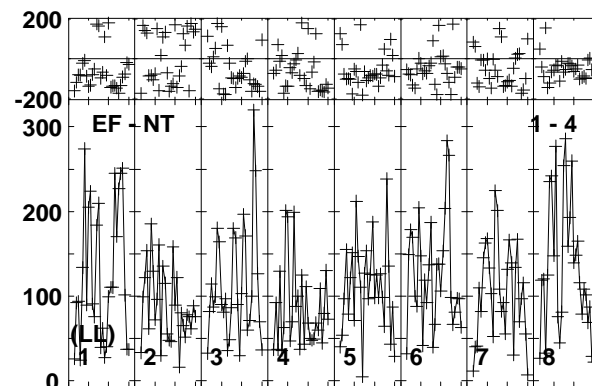
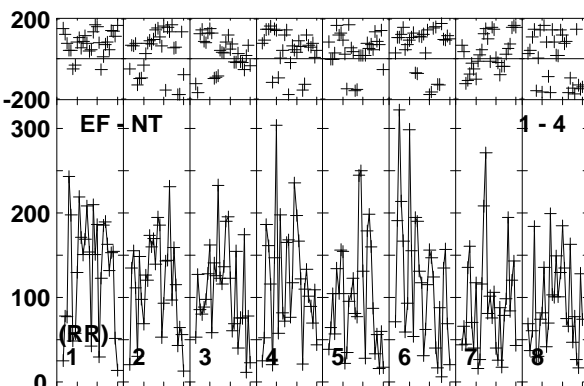
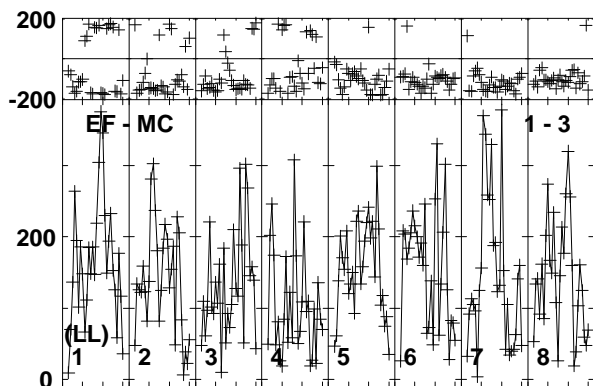
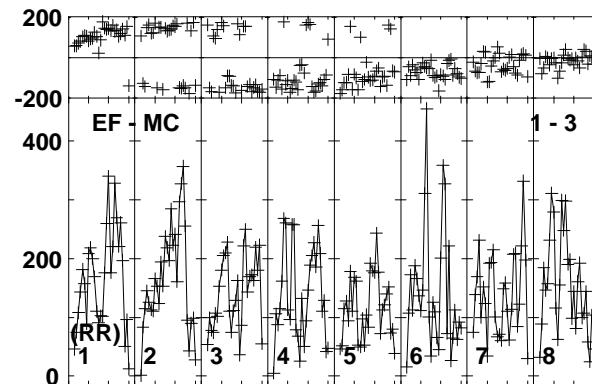
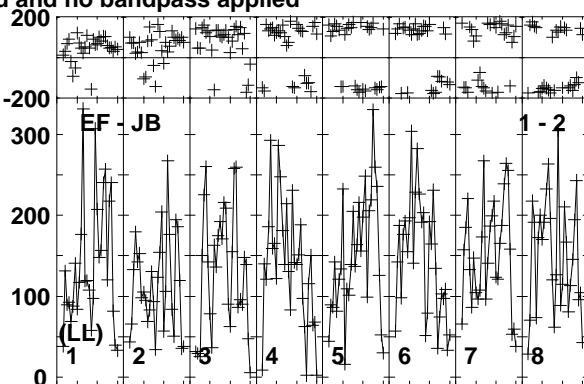
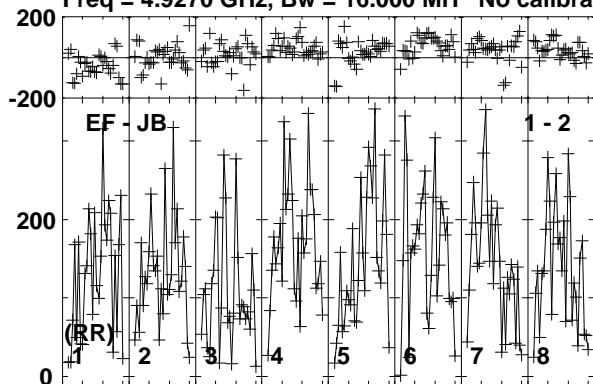

Lower frame: Micro Ampl Jy Top frame: Phas deg  
Vector averaged cross-power spectrum Baseline: EF (01) - JB (02)  
Timerange: 01/06:02:01 to 01/06:04:30

Plot file version 568 created 10-JUN-2016 17:22:59

CYGX1 RT013A.UVDATA.1

Freq = 4.9270 GHz, Bw = 16.000 MH No calibration applied and no bandpass applied

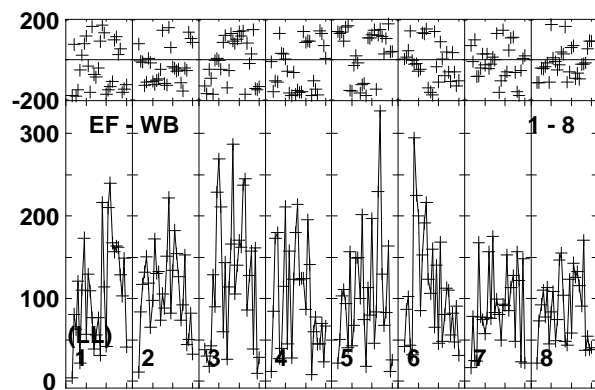
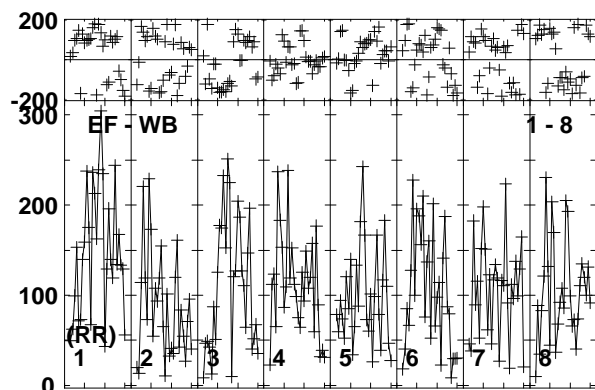
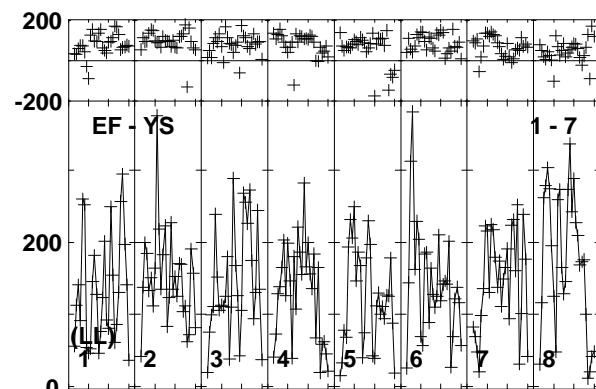
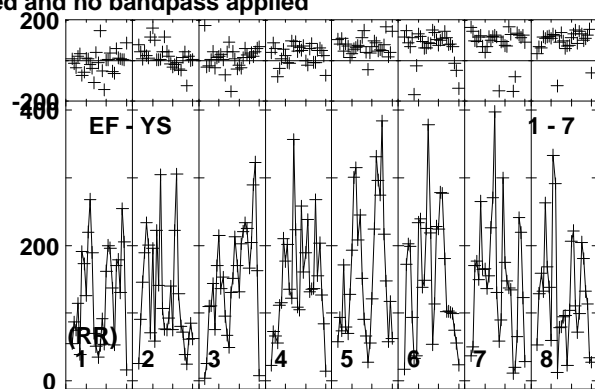
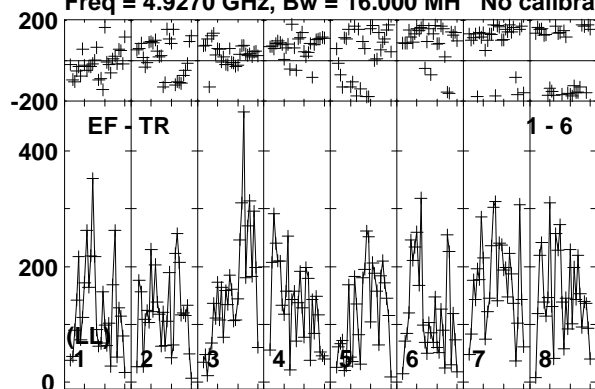

Lower frame: Micro Ampl Jy Top frame: Phas deg  
Vector averaged cross-power spectrum Baseline: EF (01) - TR (06)  
Timerange: 01/06:02:01 to 01/06:04:30

Plot file version 569 created 10-JUN-2016 17:22:59

J1957+3338 RT013A.UVDATA.1

Freq = 4.9270 GHz, Bw = 16.000 MH No calibration applied and no bandpass applied

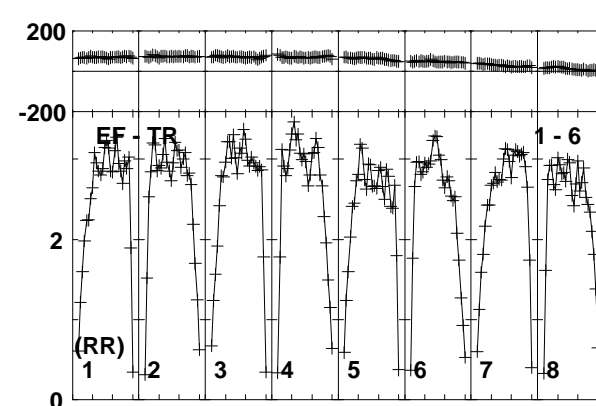
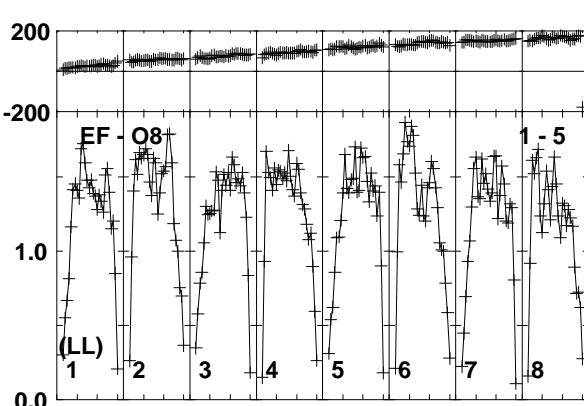
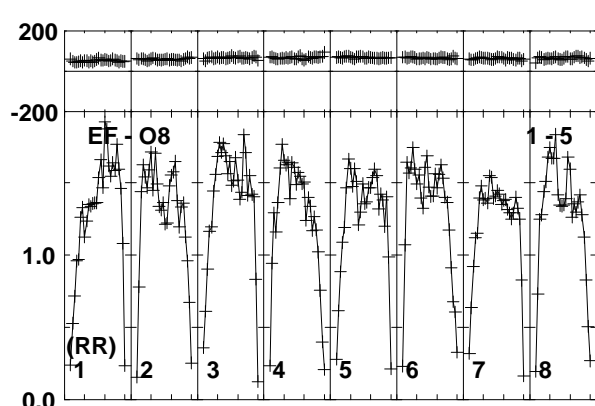
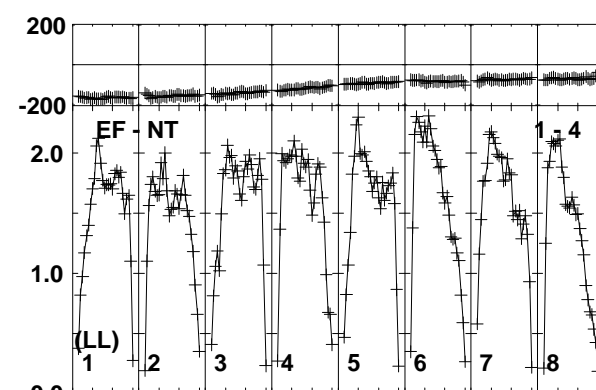
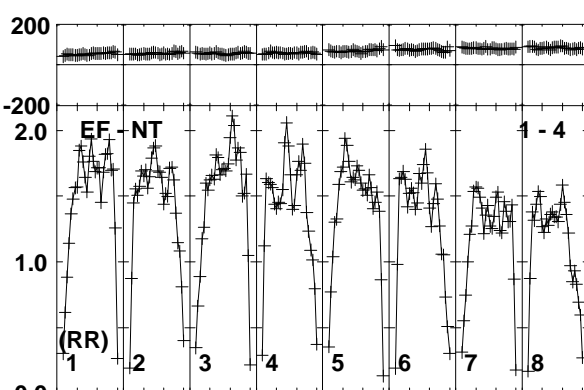
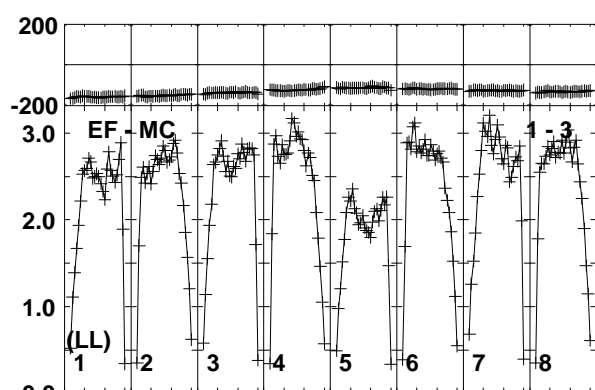
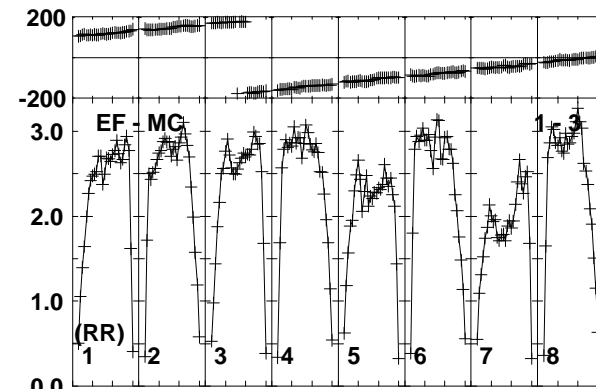
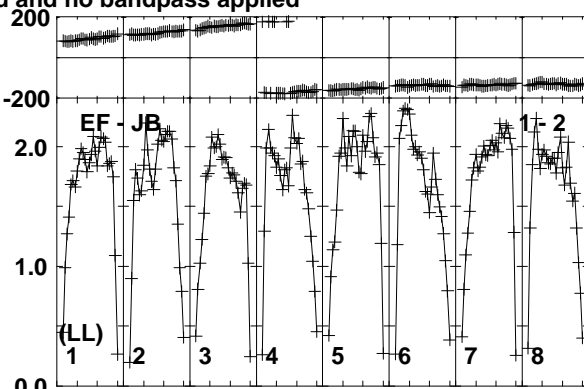
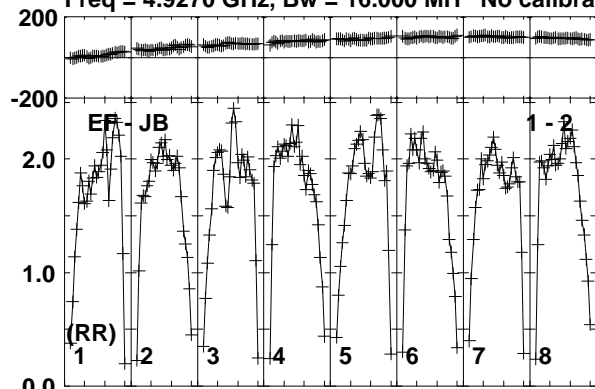

Lower frame: Milli Ampl Jy Top frame: Phas deg  
Vector averaged cross-power spectrum Baseline: EF (01) - JB (02)  
Timerange: 01/06:04:31 to 01/06:06:00

Plot file version 570 created 10-JUN-2016 17:22:59

J1957+3338 RT013A.UVDATA.1

Freq = 4.9270 GHz, Bw = 16.000 MH No calibration applied and no bandpass applied

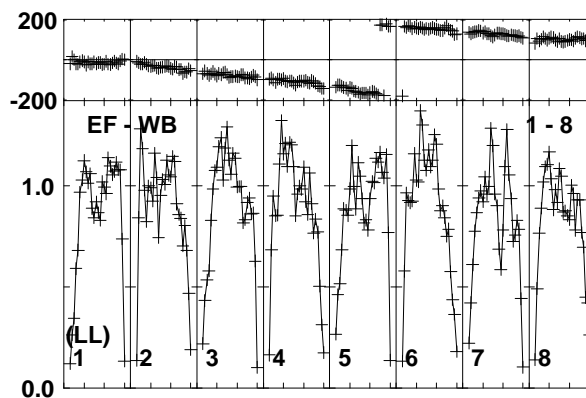
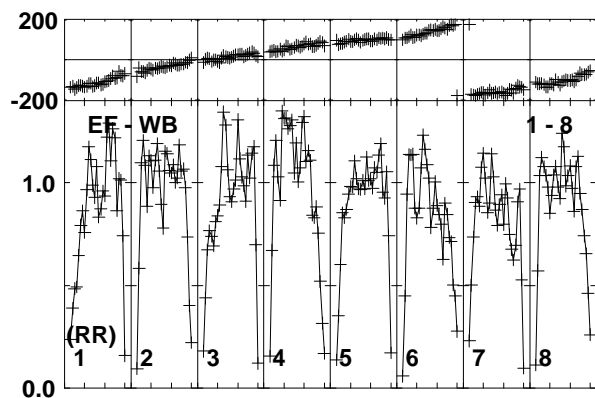
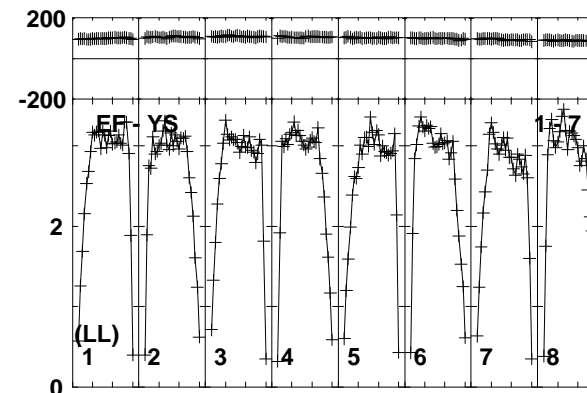
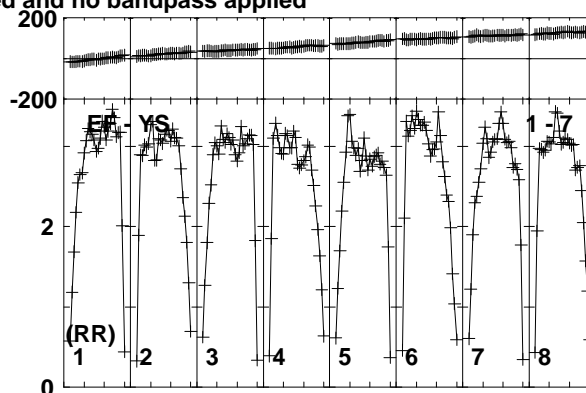
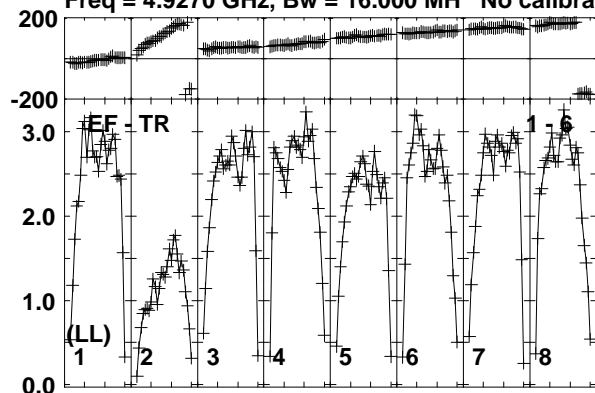

Lower frame: Milli Ampl Jy Top frame: Phas deg  
Vector averaged cross-power spectrum Baseline: EF (01) - TR (06)  
Timerange: 01/06:04:31 to 01/06:06:00



Plot file version 571 created 10-JUN-2016 17:22:59

CHECK RT013A.UVDATA.1

Freq = 4.9270 GHz, Bw = 16.000 MH No calibration applied and no bandpass applied

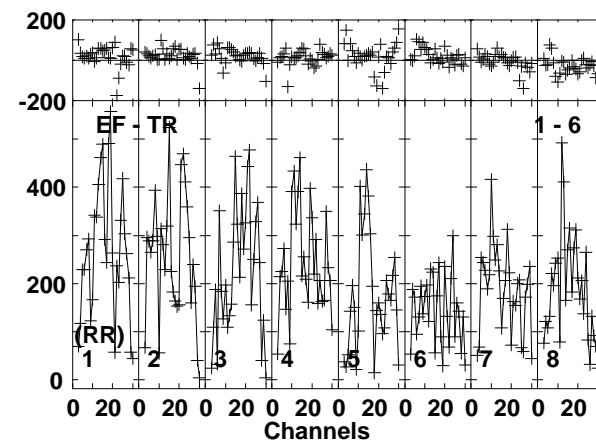
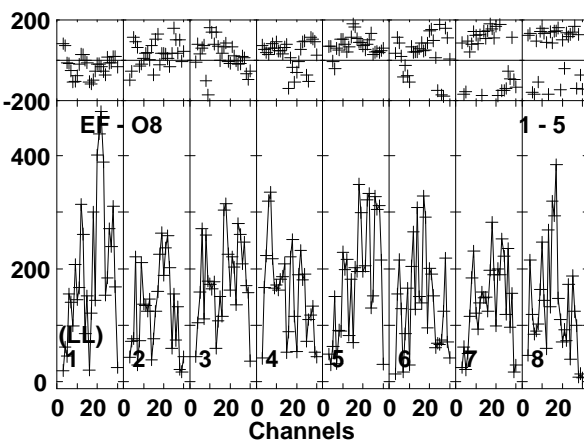
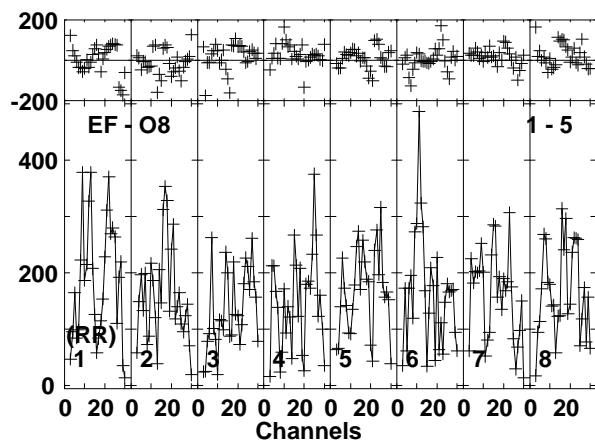
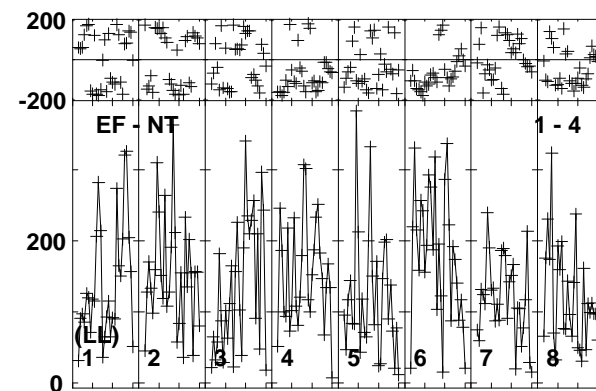
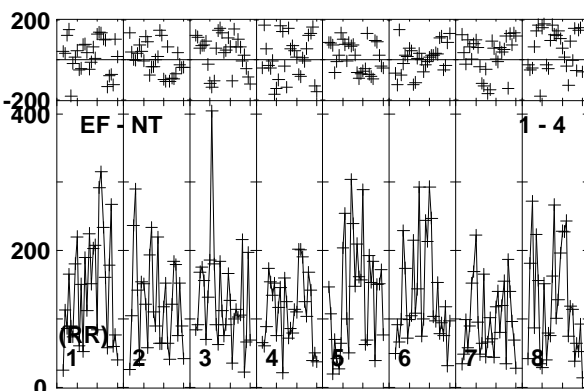
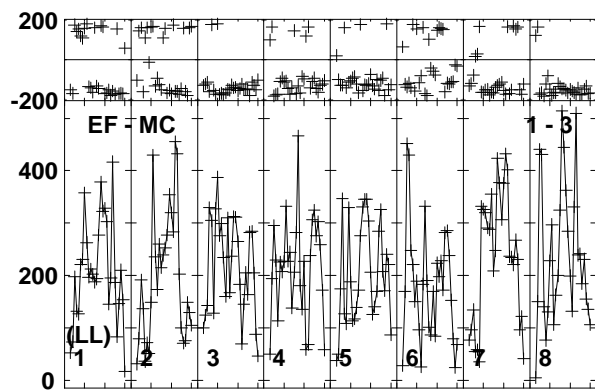
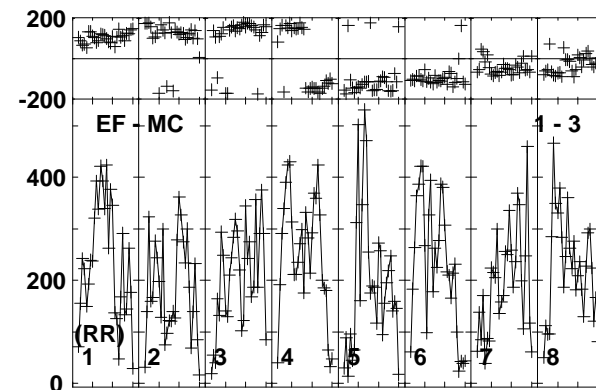
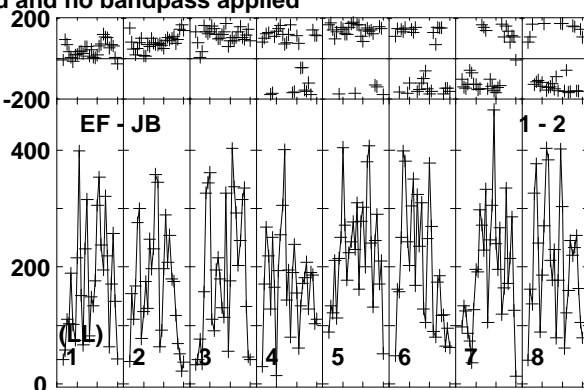
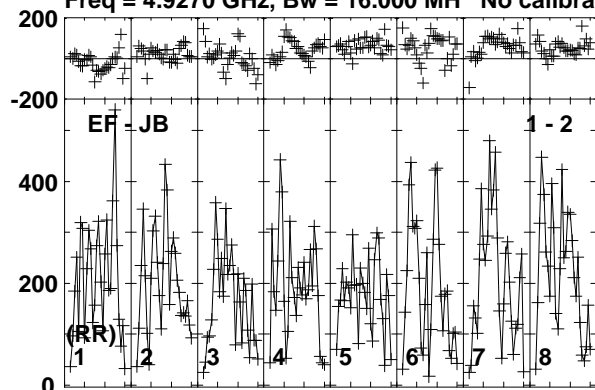

Lower frame: Micro Ampl Jy Top frame: Phas deg  
Vector averaged cross-power spectrum Baseline: EF (01) - JB (02)  
Timerange: 01/06:06:00 to 01/06:08:00

Plot file version 572 created 10-JUN-2016 17:22:59

CHECK RT013A.UVDATA.1

Freq = 4.9270 GHz, Bw = 16.000 MH No calibration applied and no bandpass applied

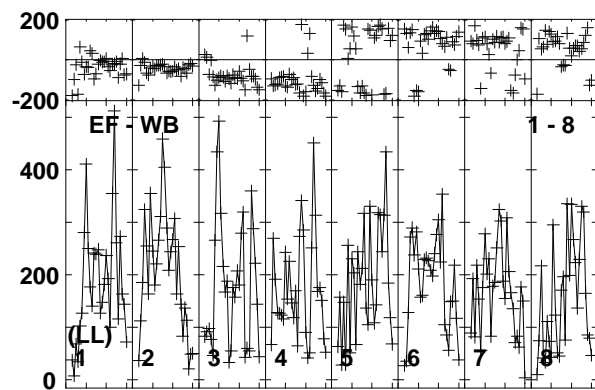
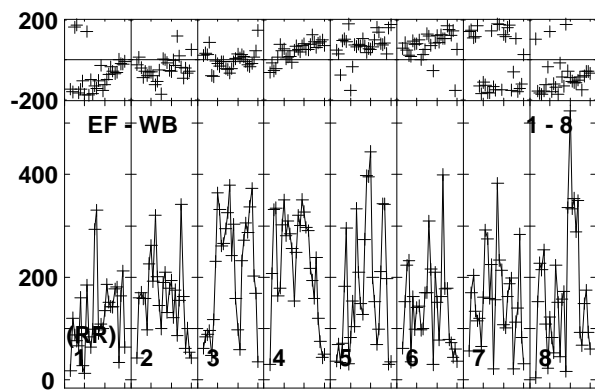
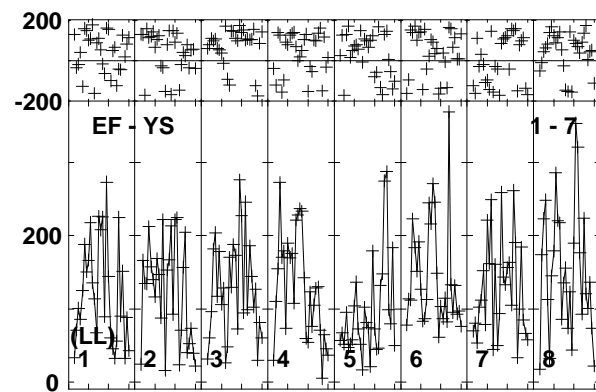
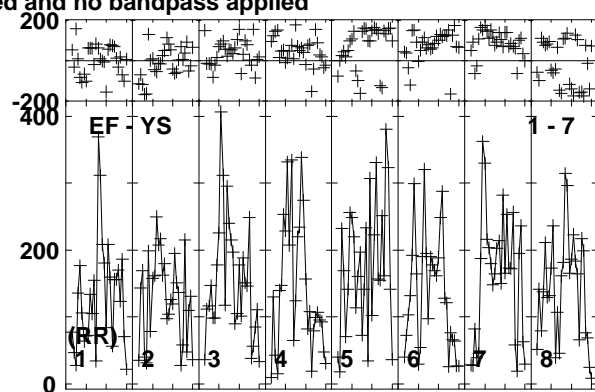
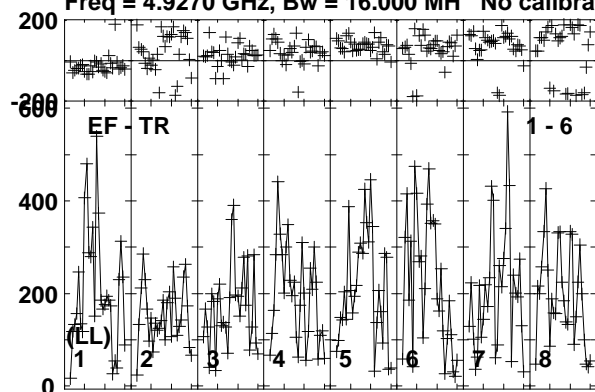

Lower frame: Micro Ampl Jy Top frame: Phas deg  
Vector averaged cross-power spectrum Baseline: EF (01) - TR (06)  
Timerange: 01/06:06:00 to 01/06:08:00

Plot file version 573 created 10-JUN-2016 17:22:59

CYGX1 RT013A.UVDATA.1

Freq = 4.9270 GHz, Bw = 16.000 MH No calibration applied and no bandpass applied

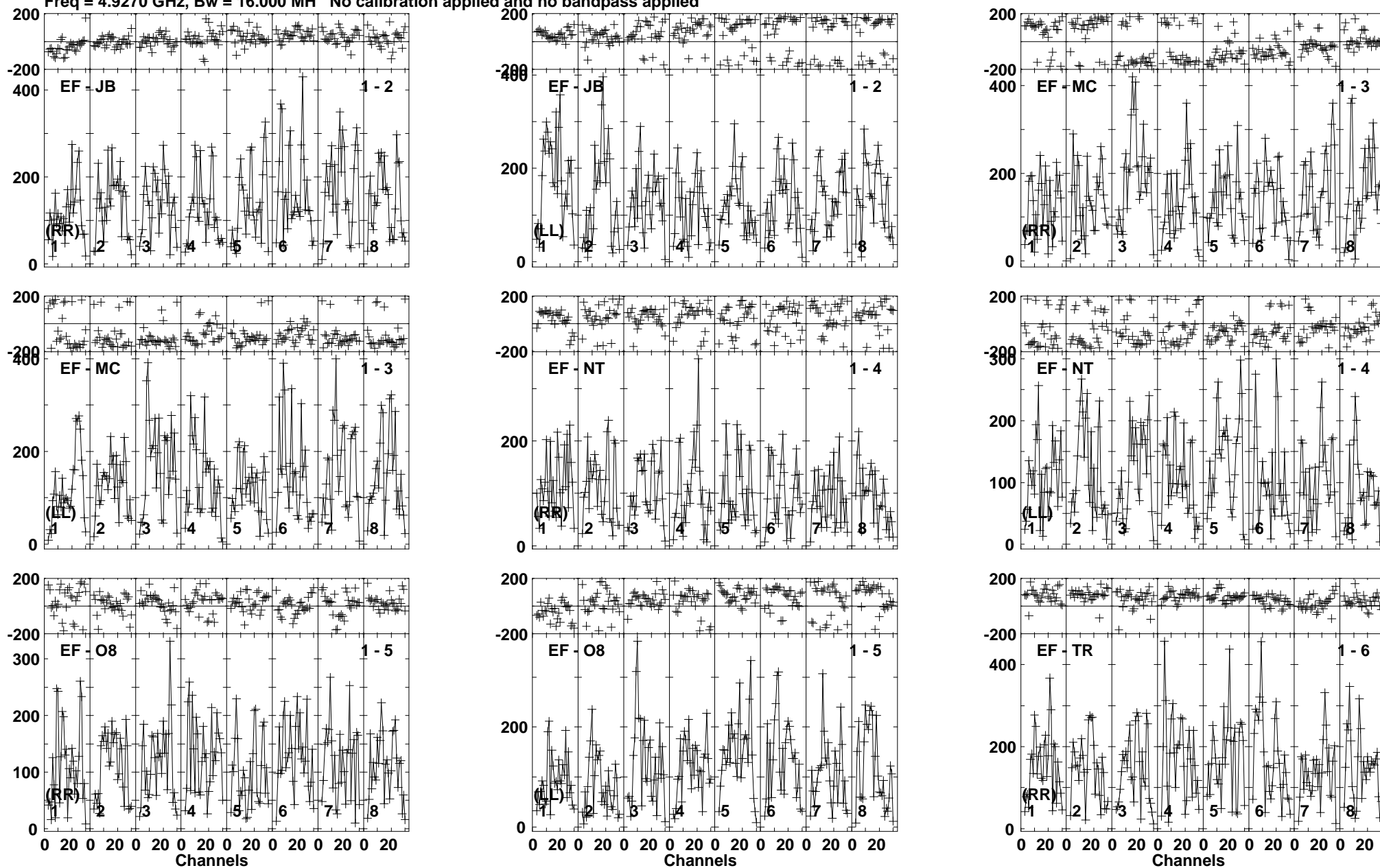

Lower frame: Micro Ampl Jy Top frame: Phas deg  
Vector averaged cross-power spectrum Baseline: EF (01) - JB (02)  
Timerange: 01/06:08:01 to 01/06:10:29

Plot file version 574 created 10-JUN-2016 17:22:59

CYGX1 RT013A.UVDATA.1

Freq = 4.9270 GHz, Bw = 16.000 MH No calibration applied and no bandpass applied

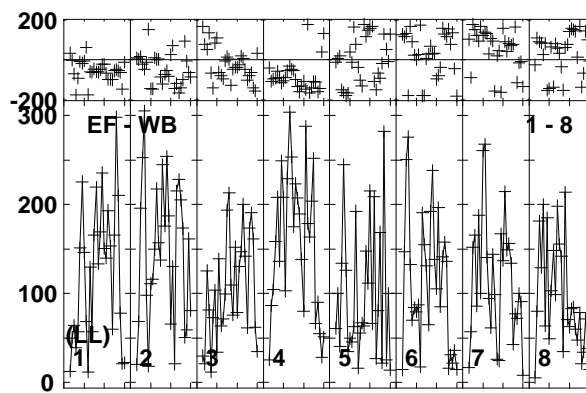
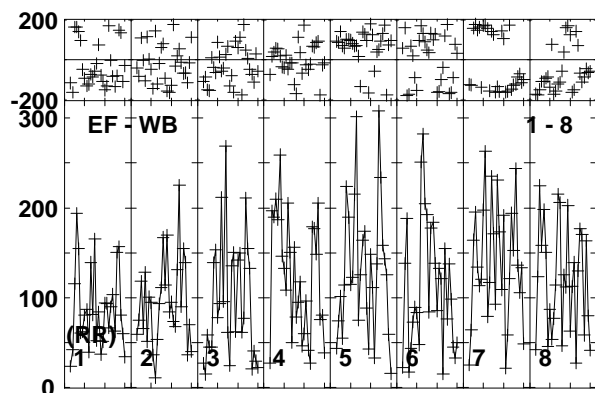
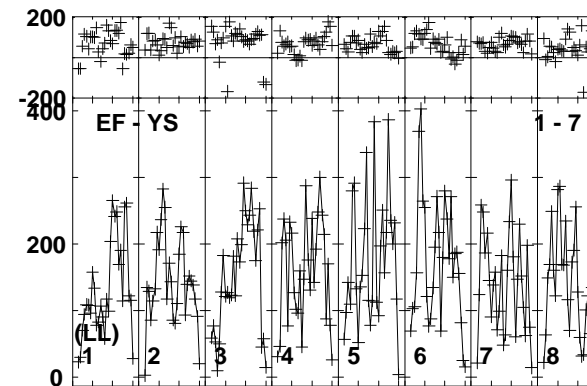
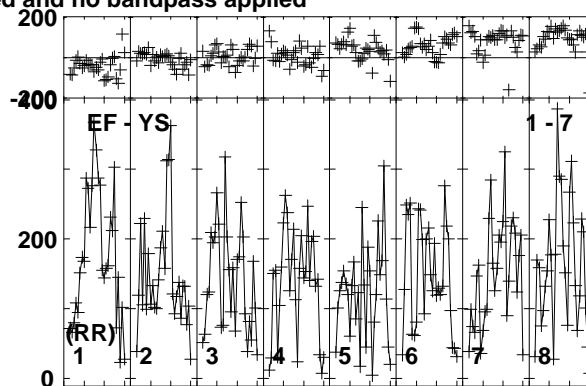
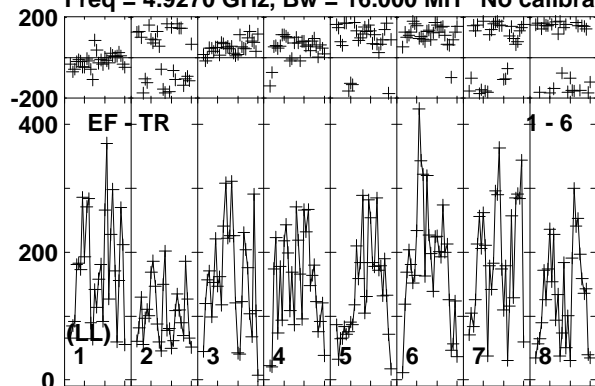

Lower frame: Micro Ampl Jy Top frame: Phas deg  
Vector averaged cross-power spectrum Baseline: EF (01) - TR (06)  
Timerange: 01/06:08:01 to 01/06:10:29

Plot file version 575 created 10-JUN-2016 17:22:59

J1957+3338 RT013A.UVDATA.1

Freq = 4.9270 GHz, Bw = 16.000 MH No calibration applied and no bandpass applied

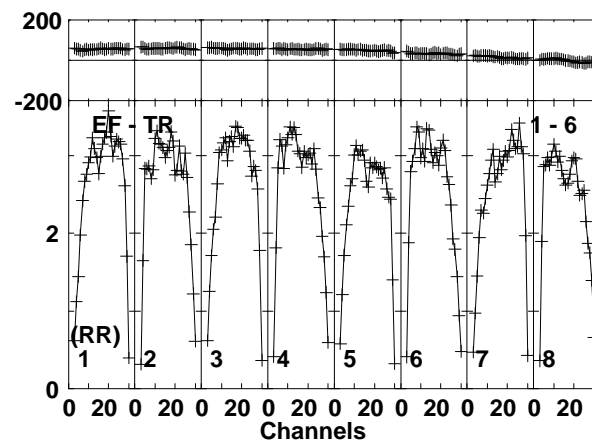
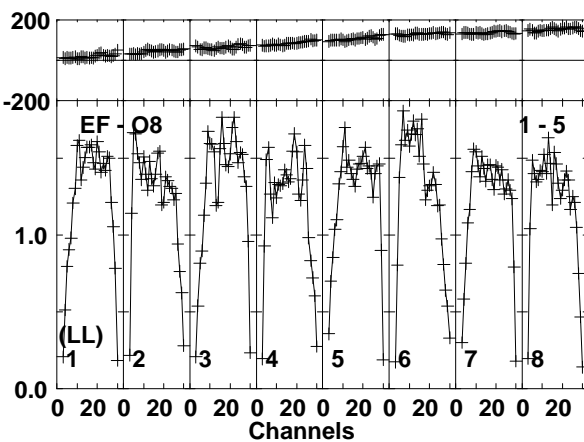
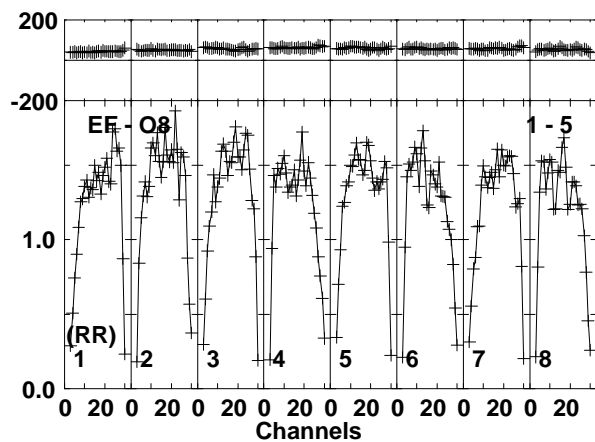
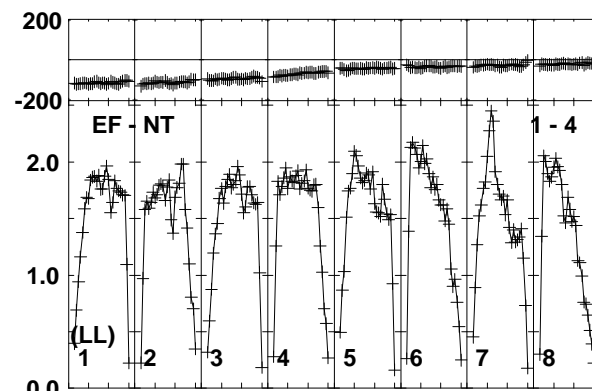
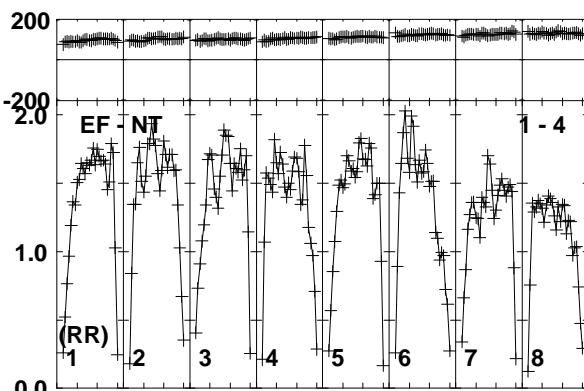
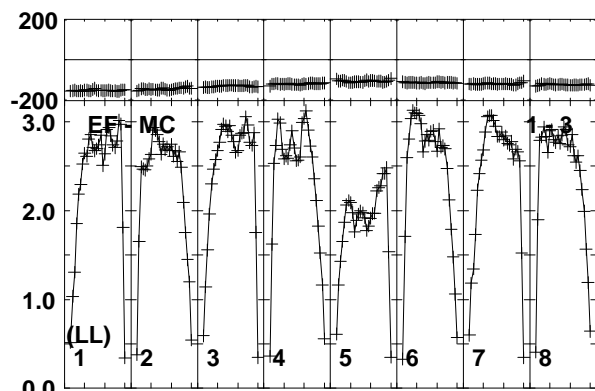
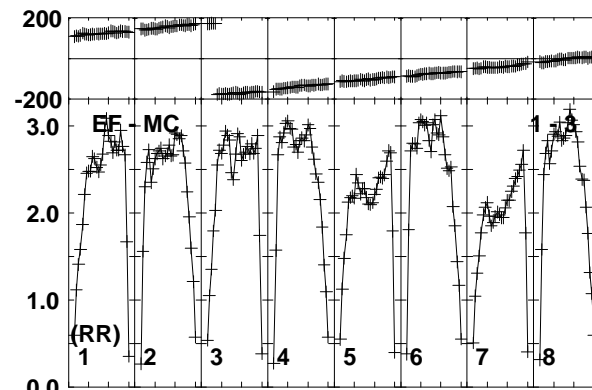
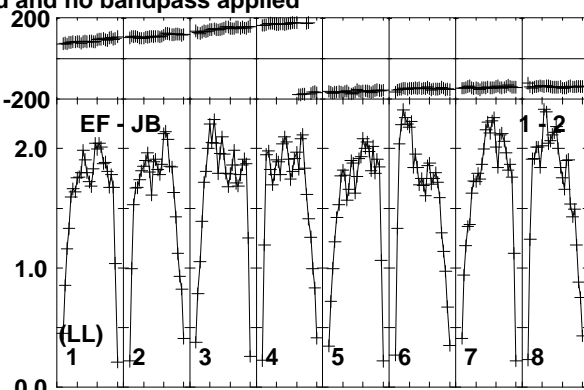
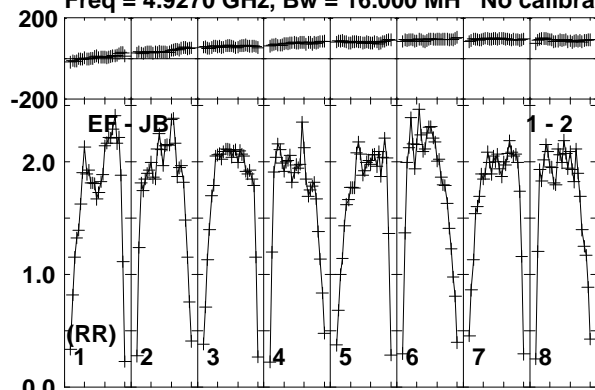

Lower frame: Milli Ampl Jy Top frame: Phas deg  
Vector averaged cross-power spectrum Baseline: EF (01) - JB (02)  
Timerange: 01/06:10:31 to 01/06:11:59

Plot file version 576 created 10-JUN-2016 17:22:59

J1957+3338 RT013A.UVDATA.1

Freq = 4.9270 GHz, Bw = 16.000 MH No calibration applied and no bandpass applied

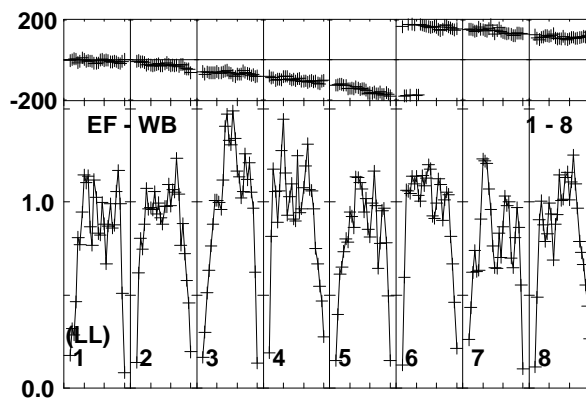
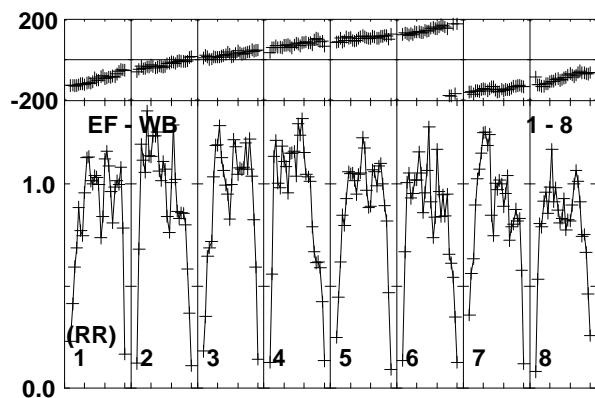
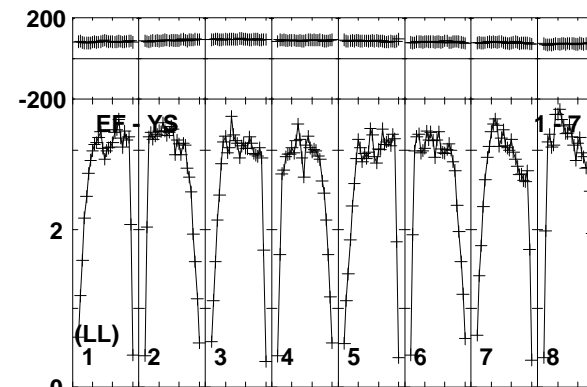
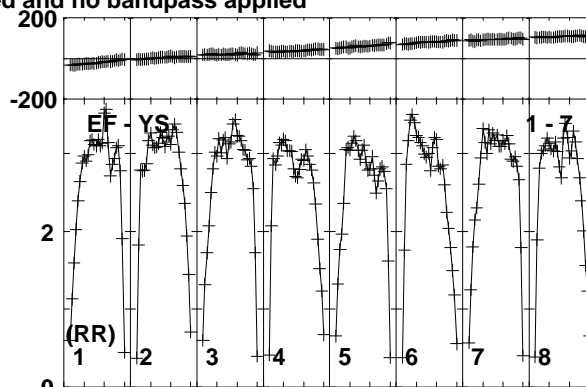
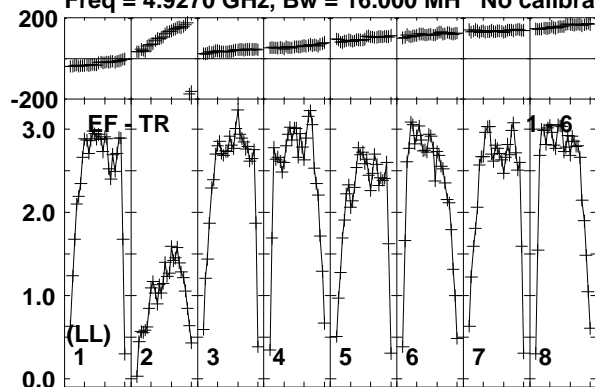

Lower frame: Milli Ampl Jy Top frame: Phas deg  
Vector averaged cross-power spectrum Baseline: EF (01) - TR (06)  
Timerange: 01/06:10:31 to 01/06:11:59

Plot file version 577 created 10-JUN-2016 17:22:59

CHECK RT013A.UVDATA.1

Freq = 4.9270 GHz, Bw = 16.000 MH No calibration applied and no bandpass applied

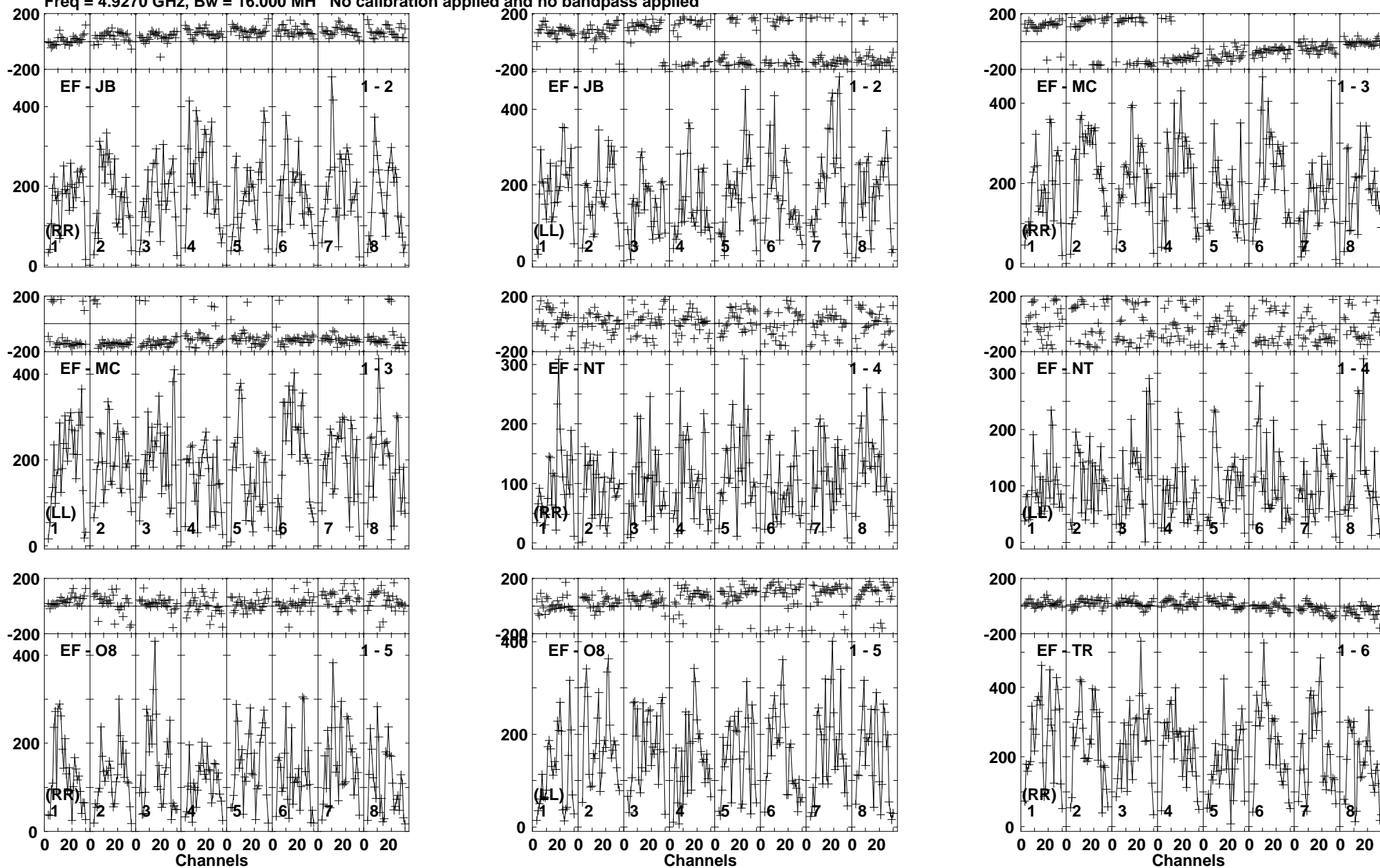

Lower frame: Micro Ampl Jy Top frame: Phas deg  
Vector averaged cross-power spectrum Baseline: EF (01) - JB (02)  
Timerange: 01/06:12:40 to 01/06:14:40

Plot file version 578 created 10-JUN-2016 17:23:00

CHECK RT013A.UVDATA.1

Freq = 4.9270 GHz, Bw = 16.000 MH No calibration applied and no bandpass applied

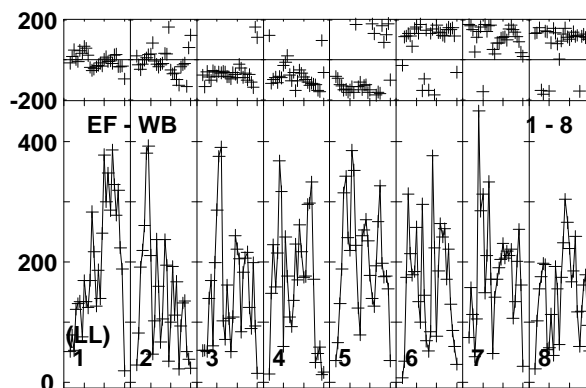
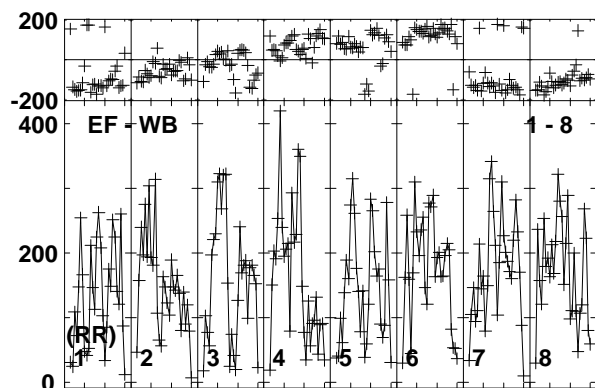
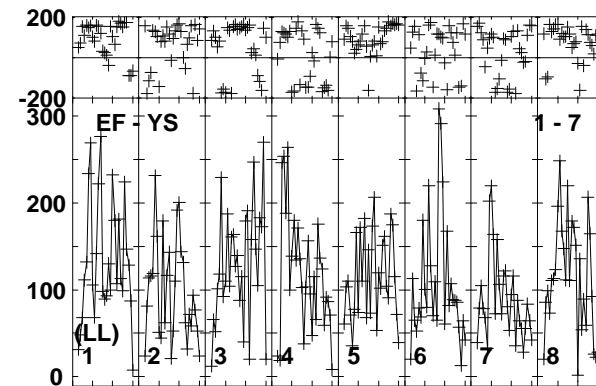
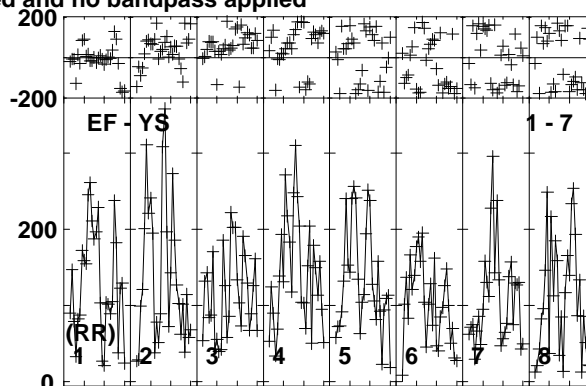
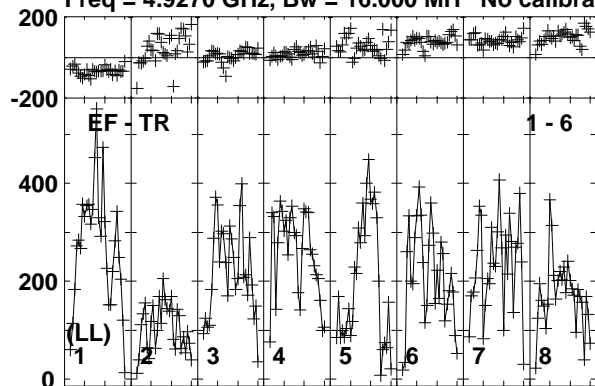

Lower frame: Micro Ampl Jy Top frame: Phas deg  
Vector averaged cross-power spectrum Baseline: EF (01) - TR (06)  
Timerange: 01/06:12:40 to 01/06:14:40



Plot file version 579 created 10-JUN-2016 17:23:00

CYGX1 RT013A.UVDATA.1

Freq = 4.9270 GHz, Bw = 16.000 MH No calibration applied and no bandpass applied

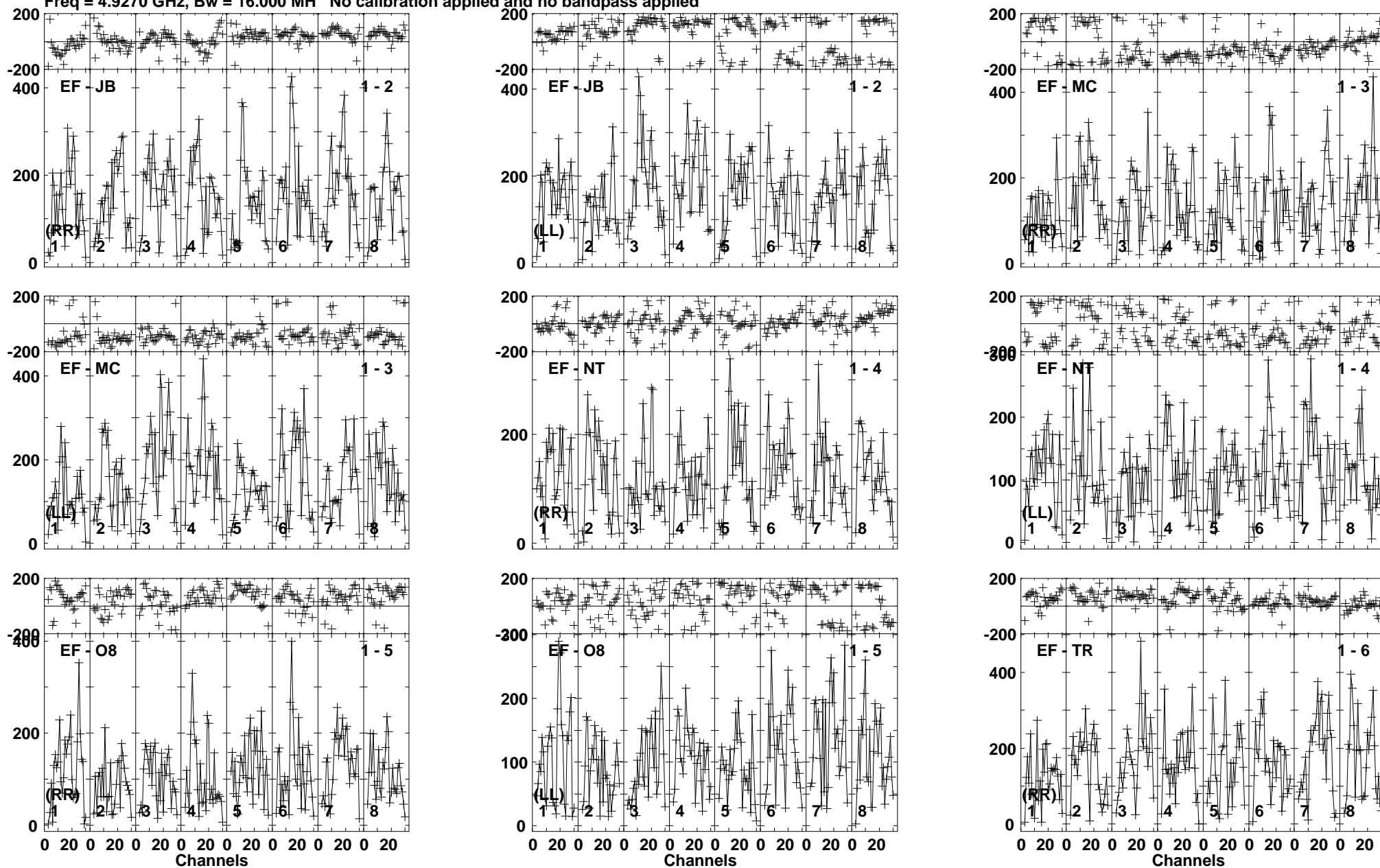

Lower frame: Micro Ampl Jy Top frame: Phas deg  
Vector averaged cross-power spectrum Baseline: EF (01) - JB (02)  
Timerange: 01/06:14:40 to 01/06:17:09

Plot file version 580 created 10-JUN-2016 17:23:00

CYGX1 RT013A.UVDATA.1

Freq = 4.9270 GHz, Bw = 16.000 MH No calibration applied and no bandpass applied

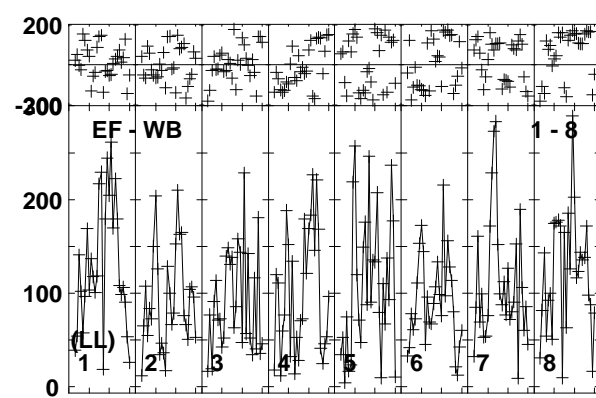
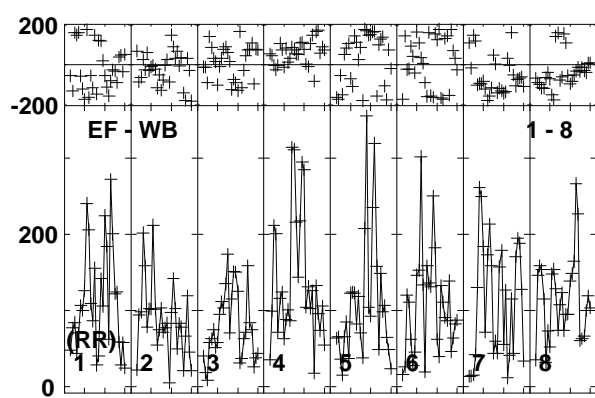
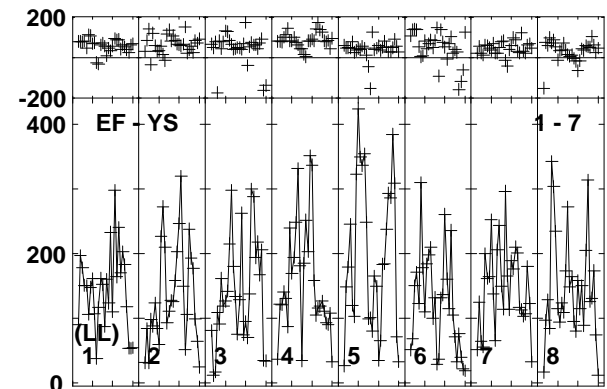
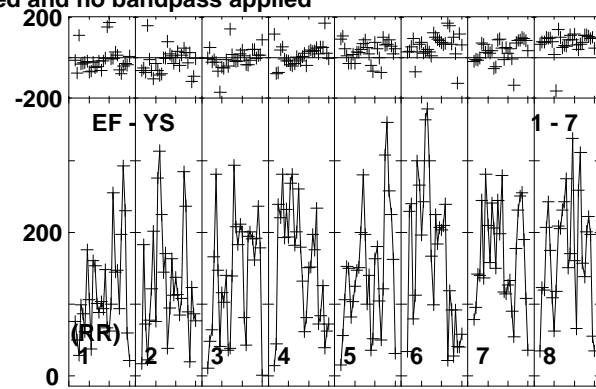
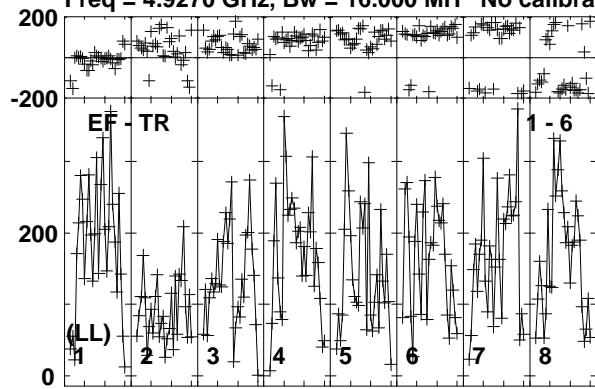

Lower frame: Micro Ampl Jy Top frame: Phas deg  
Vector averaged cross-power spectrum Baseline: EF (01) - TR (06)  
Timerange: 01/06:14:40 to 01/06:17:09

Plot file version 581 created 10-JUN-2016 17:23:00

J1957+3338 RT013A.UVDATA.1

Freq = 4.9270 GHz, Bw = 16.000 MH No calibration applied and no bandpass applied

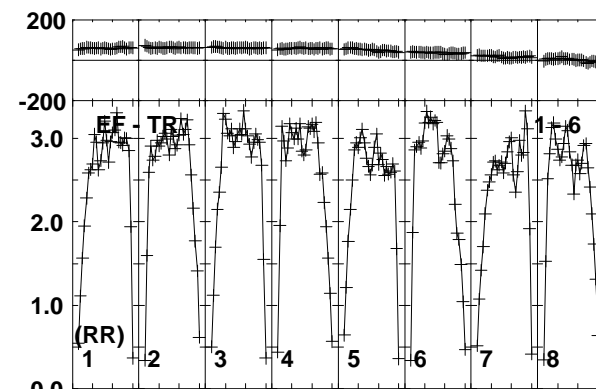
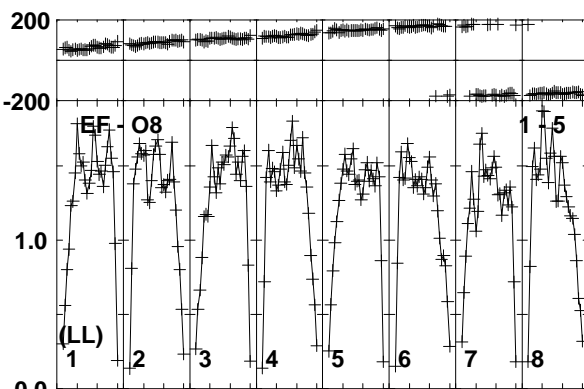
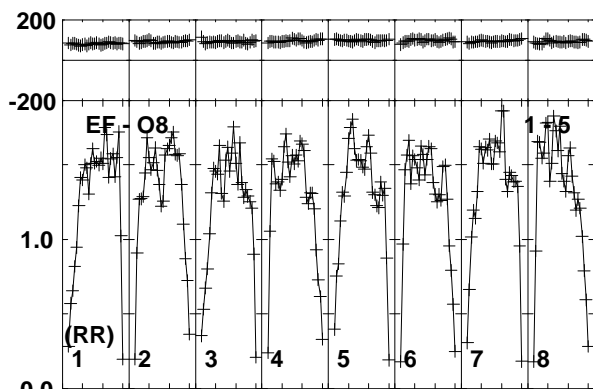
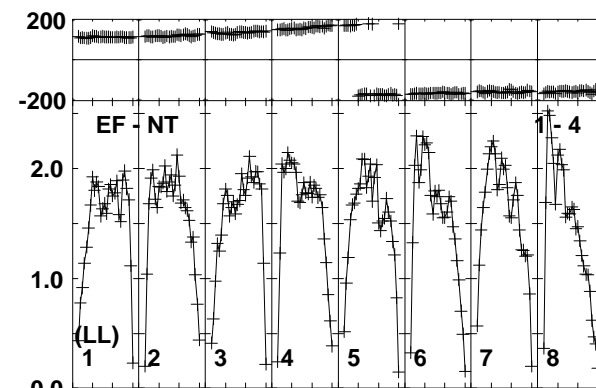
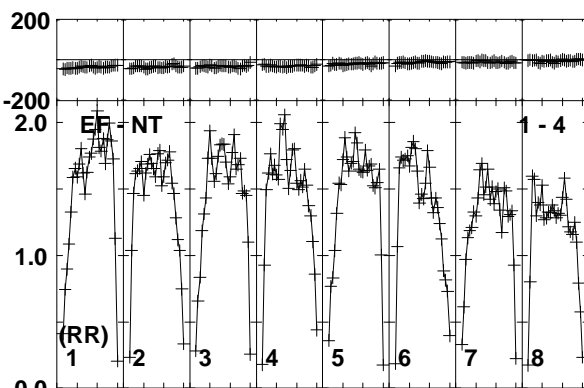
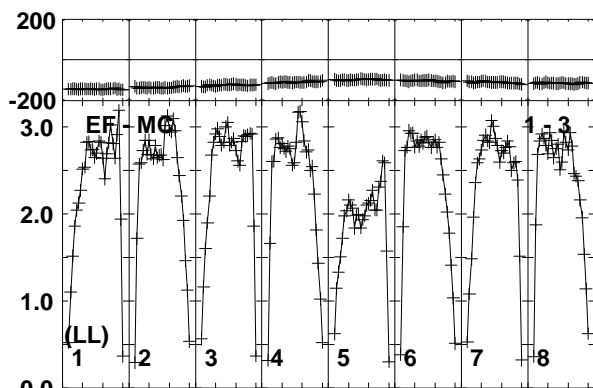
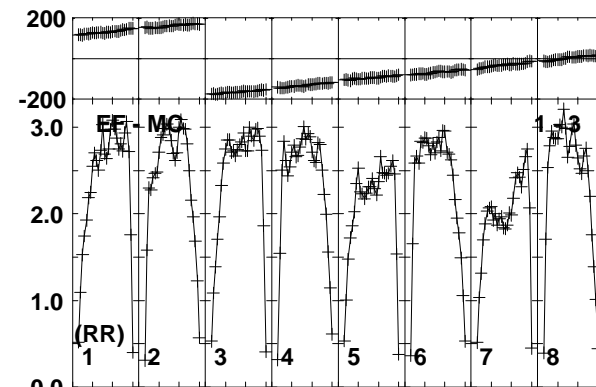
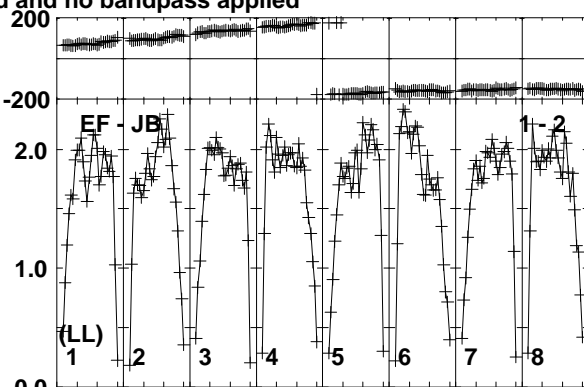
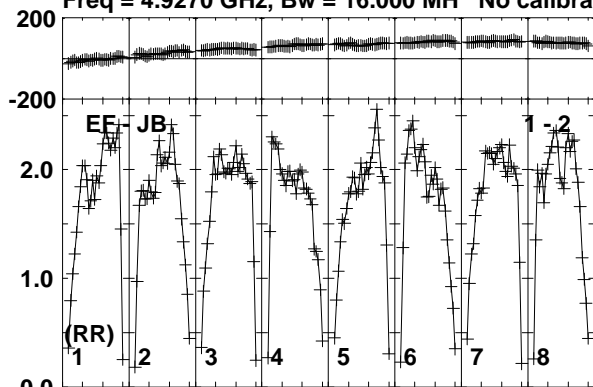

Lower frame: Milli Ampl Jy Top frame: Phas deg  
Vector averaged cross-power spectrum Baseline: EF (01) - JB (02)  
Timerange: 01/06:17:11 to 01/06:18:39

Plot file version 582 created 10-JUN-2016 17:23:00

J1957+3338 RT013A.UVDATA.1

Freq = 4.9270 GHz, Bw = 16.000 MH No calibration applied and no bandpass applied

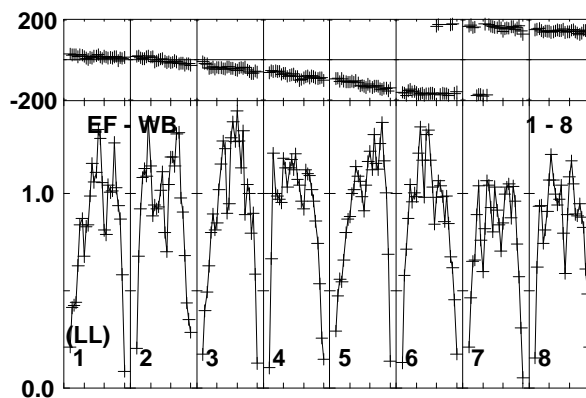
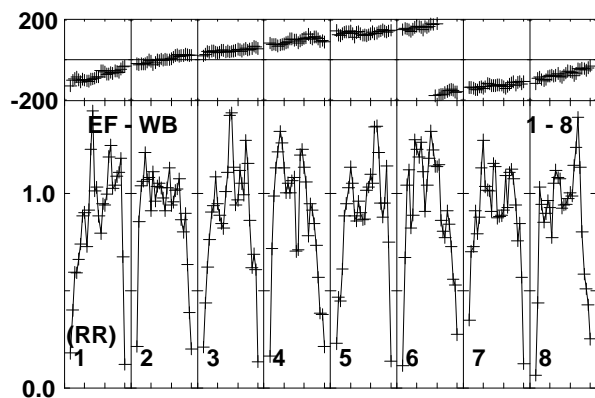
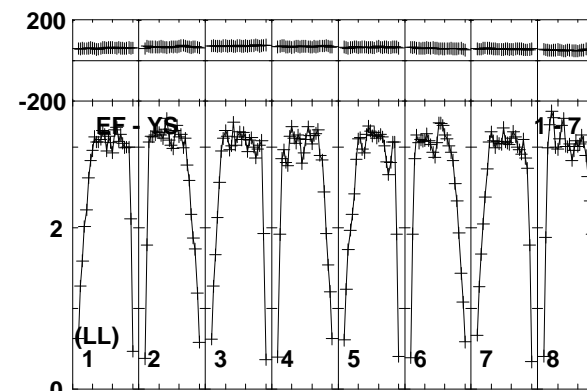
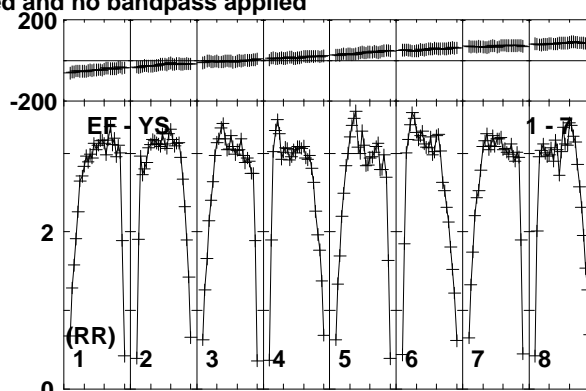
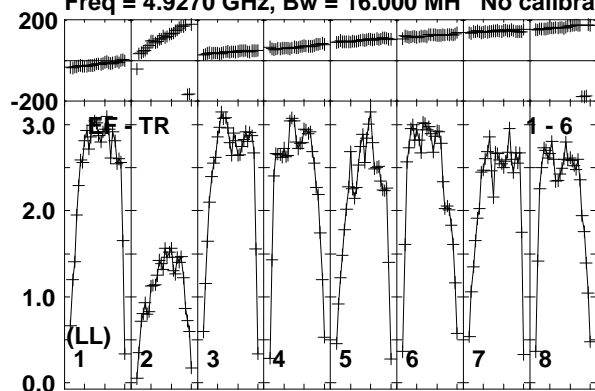

Lower frame: Milli Ampl Jy Top frame: Phas deg  
Vector averaged cross-power spectrum Baseline: EF (01) - TR (06)  
Timerange: 01/06:17:11 to 01/06:18:39

Plot file version 583 created 10-JUN-2016 17:23:00

CHECK RT013A.UVDATA.1

Freq = 4.9270 GHz, Bw = 16.000 MH No calibration applied and no bandpass applied

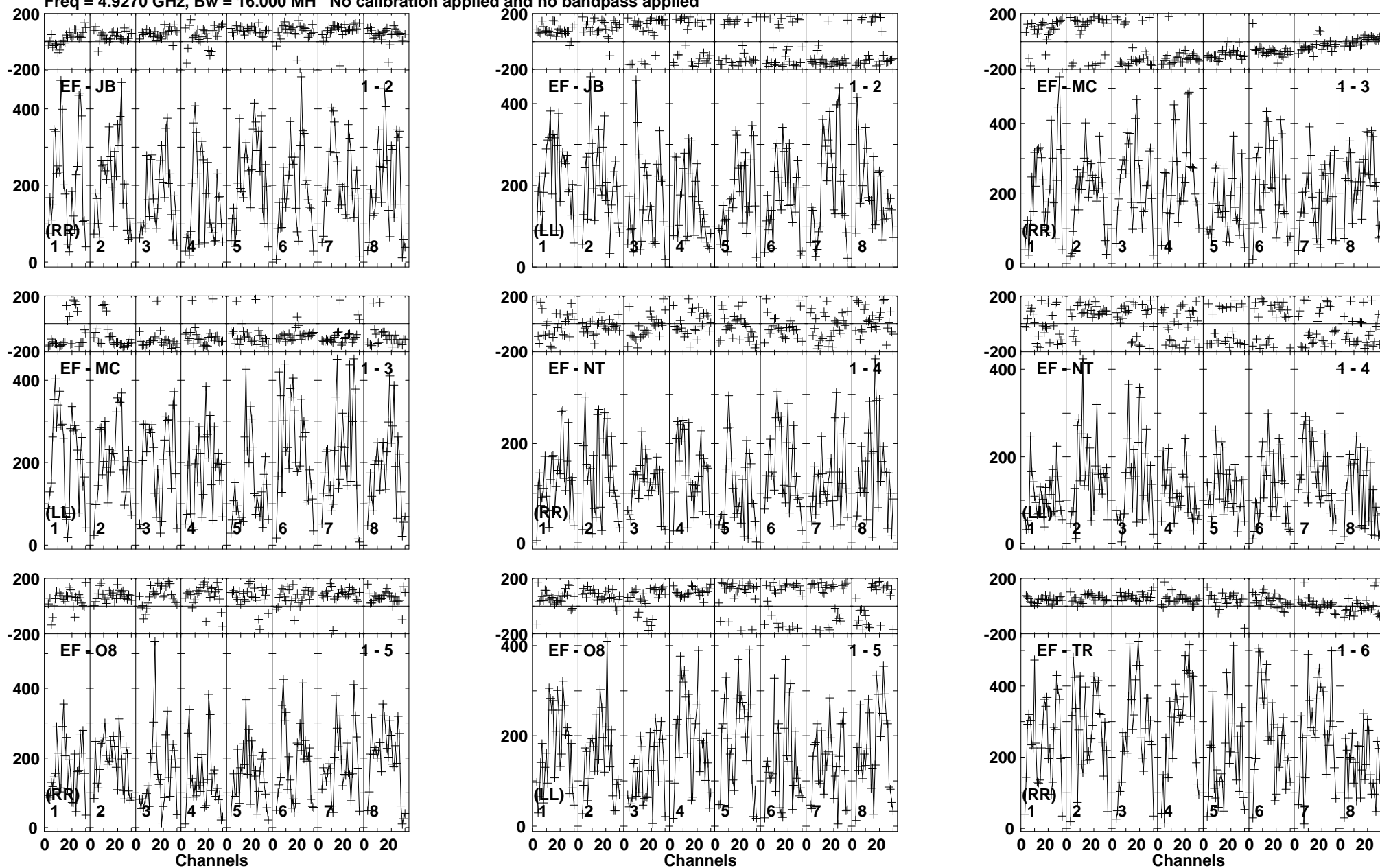

Lower frame: Micro Ampl Jy Top frame: Phas deg  
Vector averaged cross-power spectrum Baseline: EF (01) - JB (02)  
Timerange: 01/06:18:41 to 01/06:20:40

Plot file version 584 created 10-JUN-2016 17:23:00

CHECK RT013A.UVDATA.1

Freq = 4.9270 GHz, Bw = 16.000 MH No calibration applied and no bandpass applied

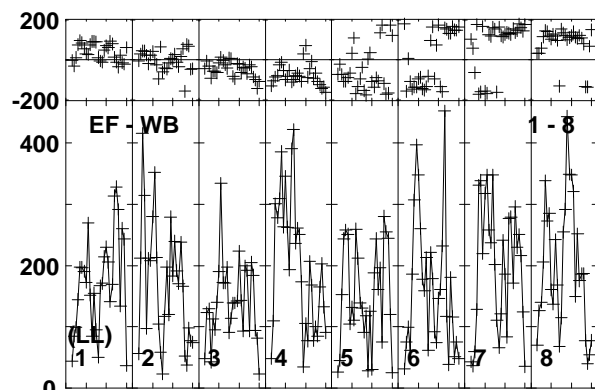
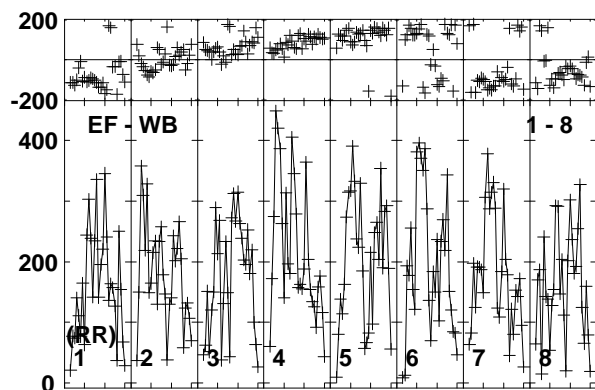
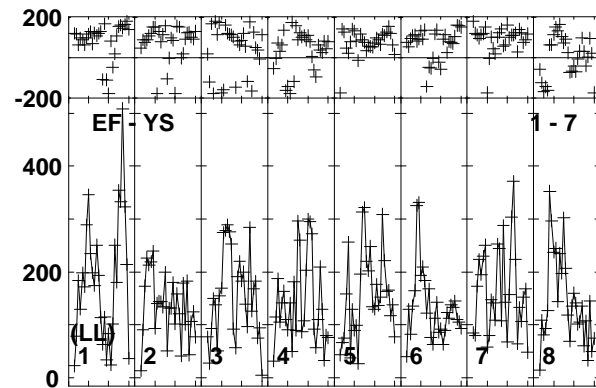
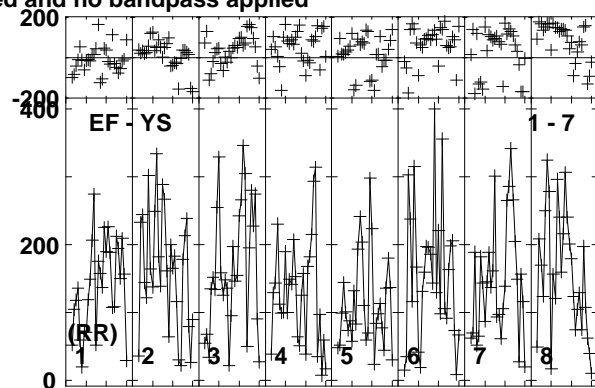
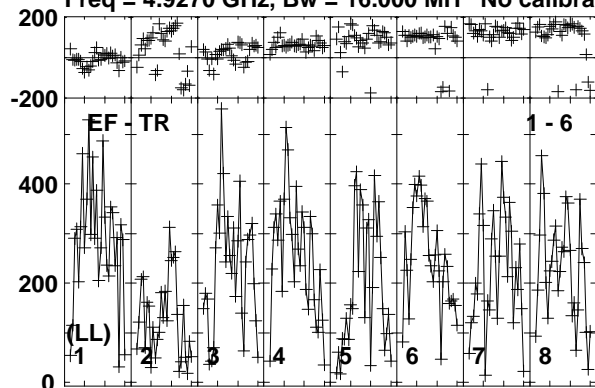

Lower frame: Micro Ampl Jy Top frame: Phas deg  
Vector averaged cross-power spectrum Baseline: EF (01) - TR (06)  
Timerange: 01/06:18:41 to 01/06:20:40

Plot file version 585 created 10-JUN-2016 17:23:00

CYGX1 RT013A.UVDATA.1

Freq = 4.9270 GHz, Bw = 16.000 MH No calibration applied and no bandpass applied

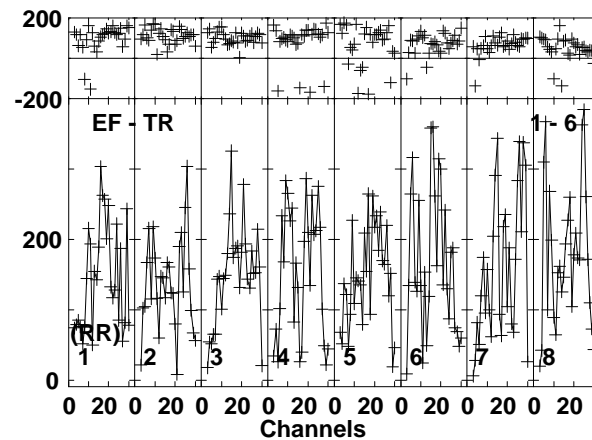
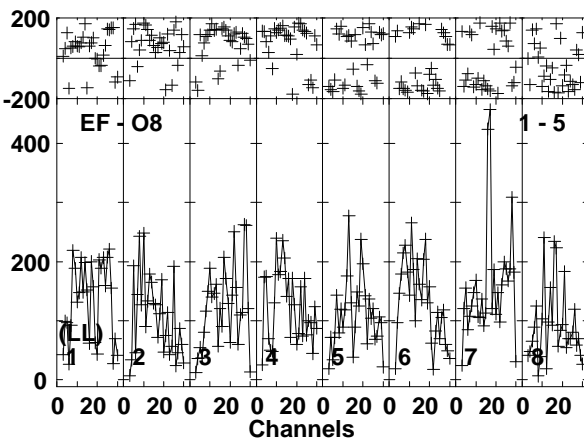
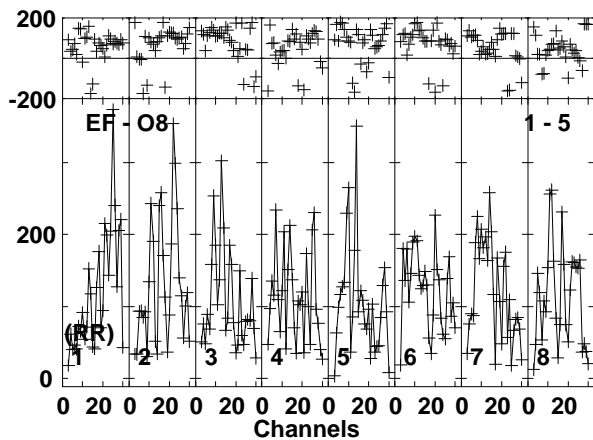
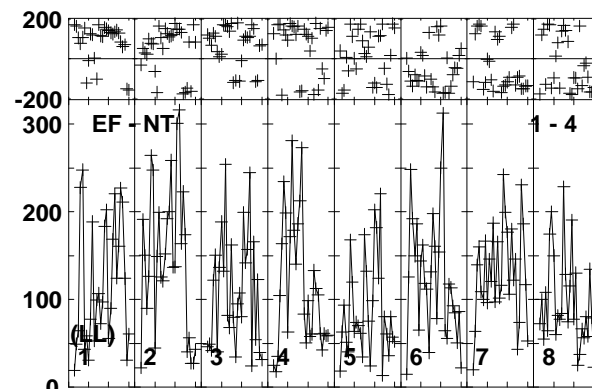
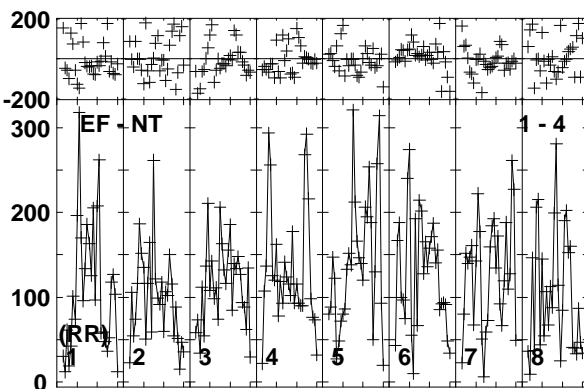
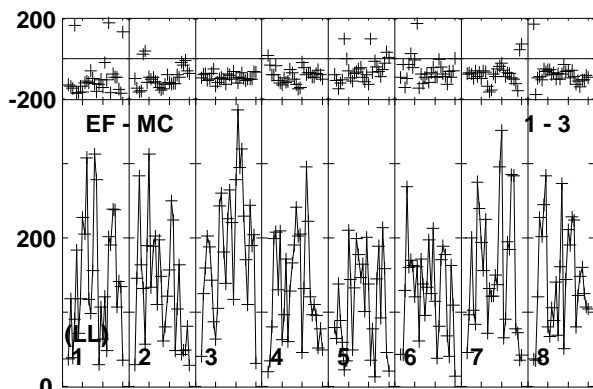
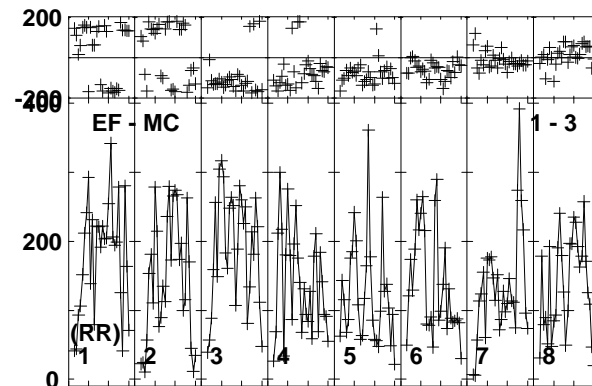
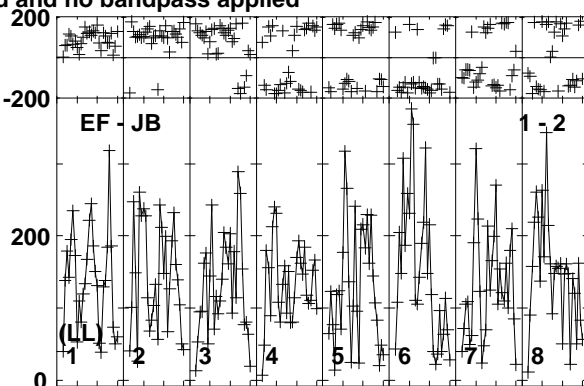
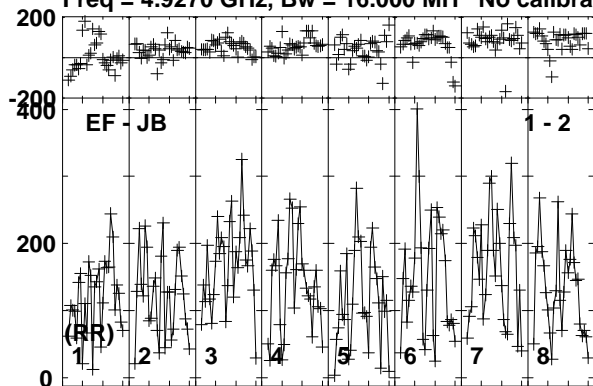

Lower frame: Micro Ampl Jy Top frame: Phas deg  
Vector averaged cross-power spectrum Baseline: EF (01) - JB (02)  
Timerange: 01/06:20:40 to 01/06:23:10

Plot file version 586 created 10-JUN-2016 17:23:00

CYGX1 RT013A.UVDATA.1

Freq = 4.9270 GHz, Bw = 16.000 MH No calibration applied and no bandpass applied

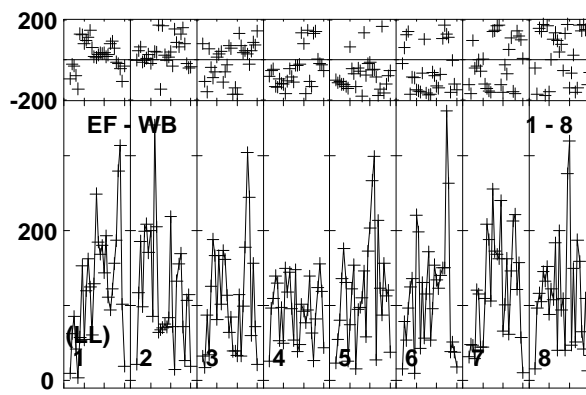
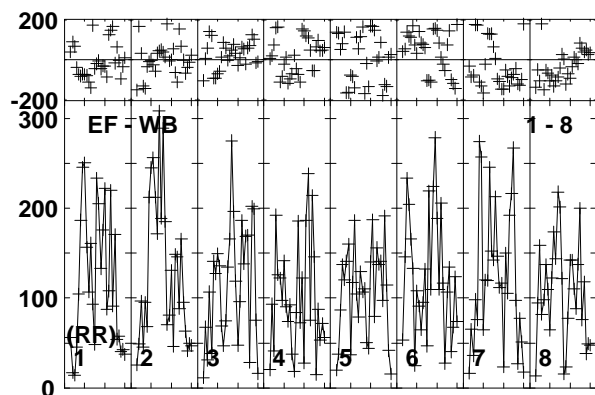
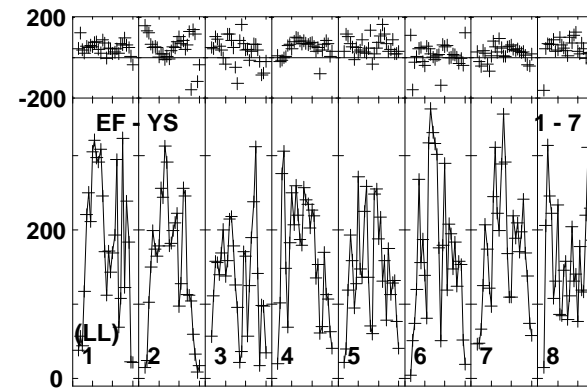
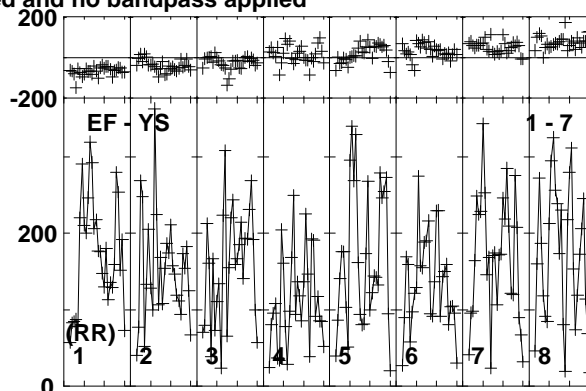
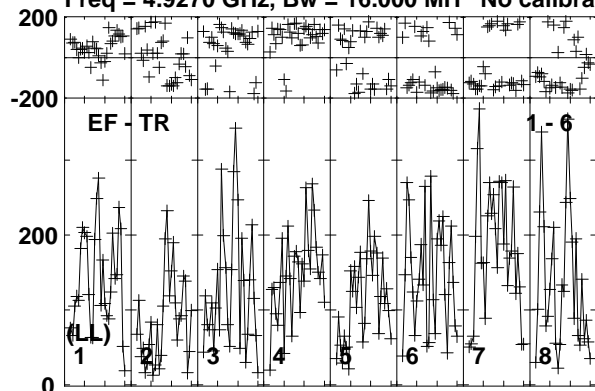

Lower frame: Micro Ampl Jy Top frame: Phas deg  
Vector averaged cross-power spectrum Baseline: EF (01) - TR (06)  
Timerange: 01/06:20:40 to 01/06:23:10



Plot file version 587 created 10-JUN-2016 17:23:00

J1957+3338 RT013A.UVDATA.1

Freq = 4.9270 GHz, Bw = 16.000 MH No calibration applied and no bandpass applied

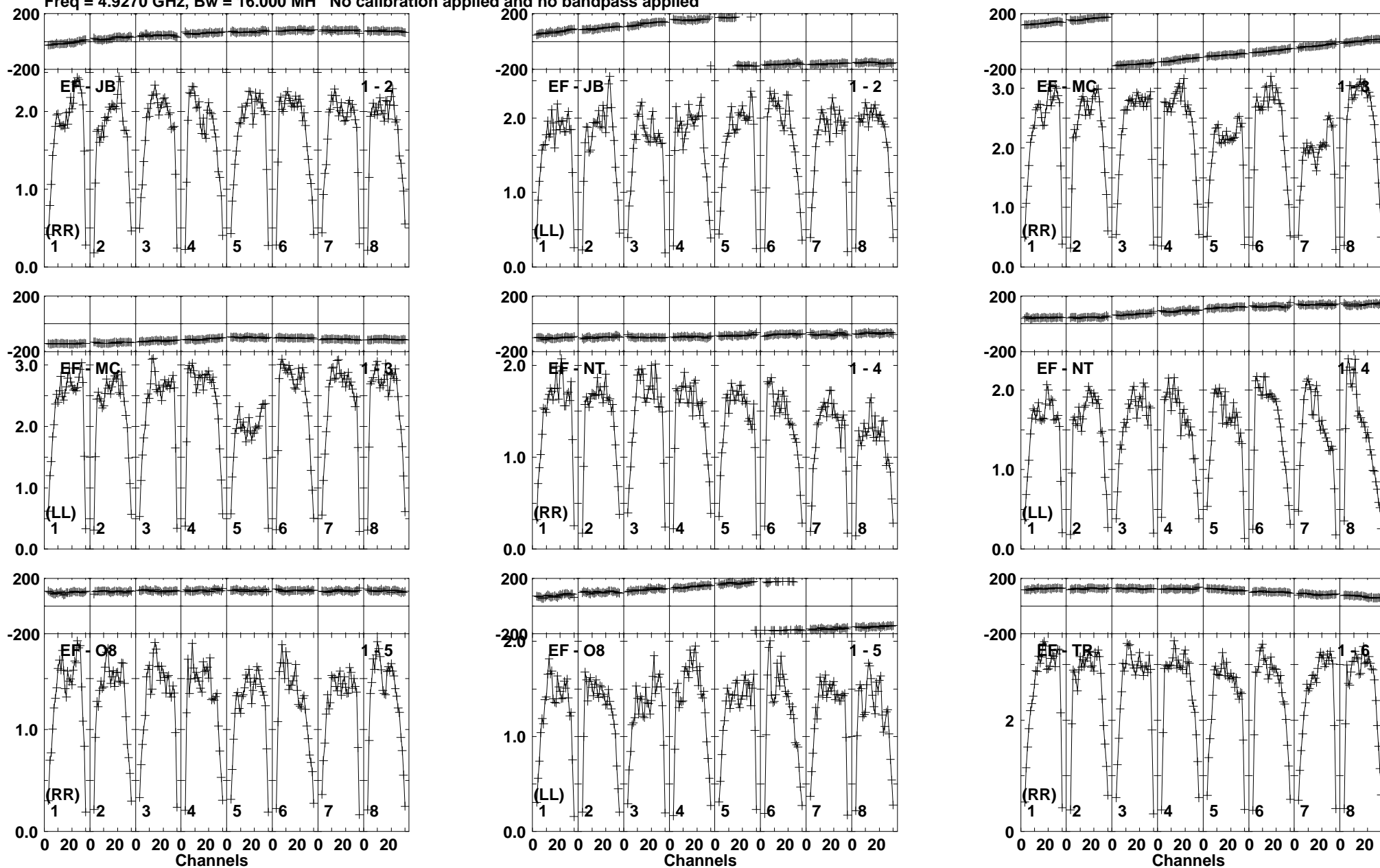

Lower frame: Milli Ampl Jy Top frame: Phas deg  
Vector averaged cross-power spectrum Baseline: EF (01) - JB (02)  
Timerange: 01/06:23:10 to 01/06:24:39

Plot file version 588 created 10-JUN-2016 17:23:01

J1957+3338 RT013A.UVDATA.1

Freq = 4.9270 GHz, Bw = 16.000 MH No calibration applied and no bandpass applied

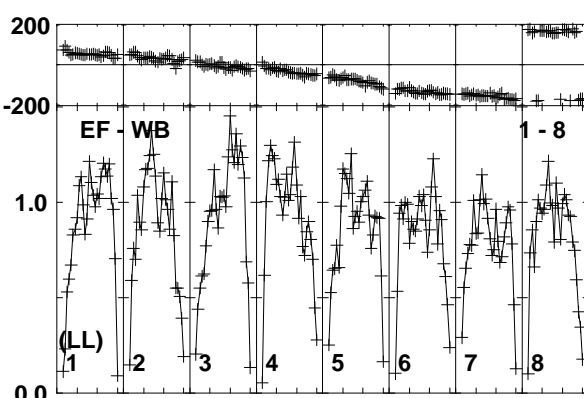
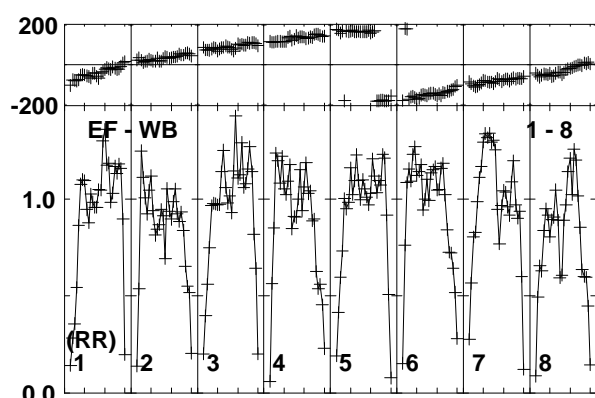
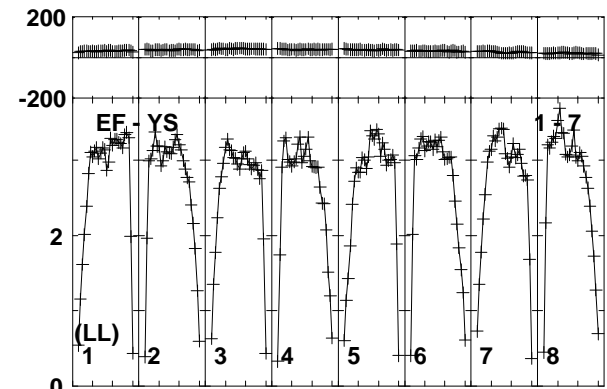
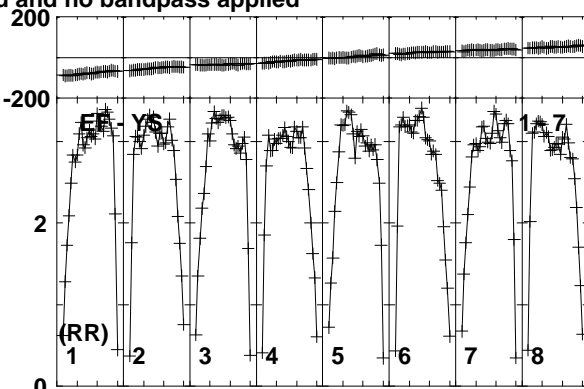
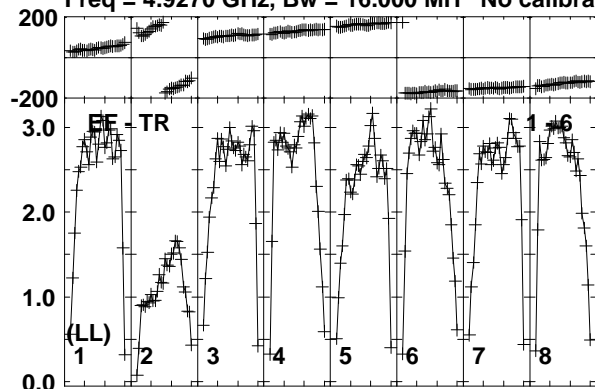

Lower frame: Milli Ampl Jy Top frame: Phas deg  
Vector averaged cross-power spectrum Baseline: EF (01) - TR (06)  
Timerange: 01/06:23:10 to 01/06:24:39

Plot file version 589 created 10-JUN-2016 17:23:01

CHECK RT013A.UVDATA.1

Freq = 4.9270 GHz, Bw = 16.000 MH No calibration applied and no bandpass applied

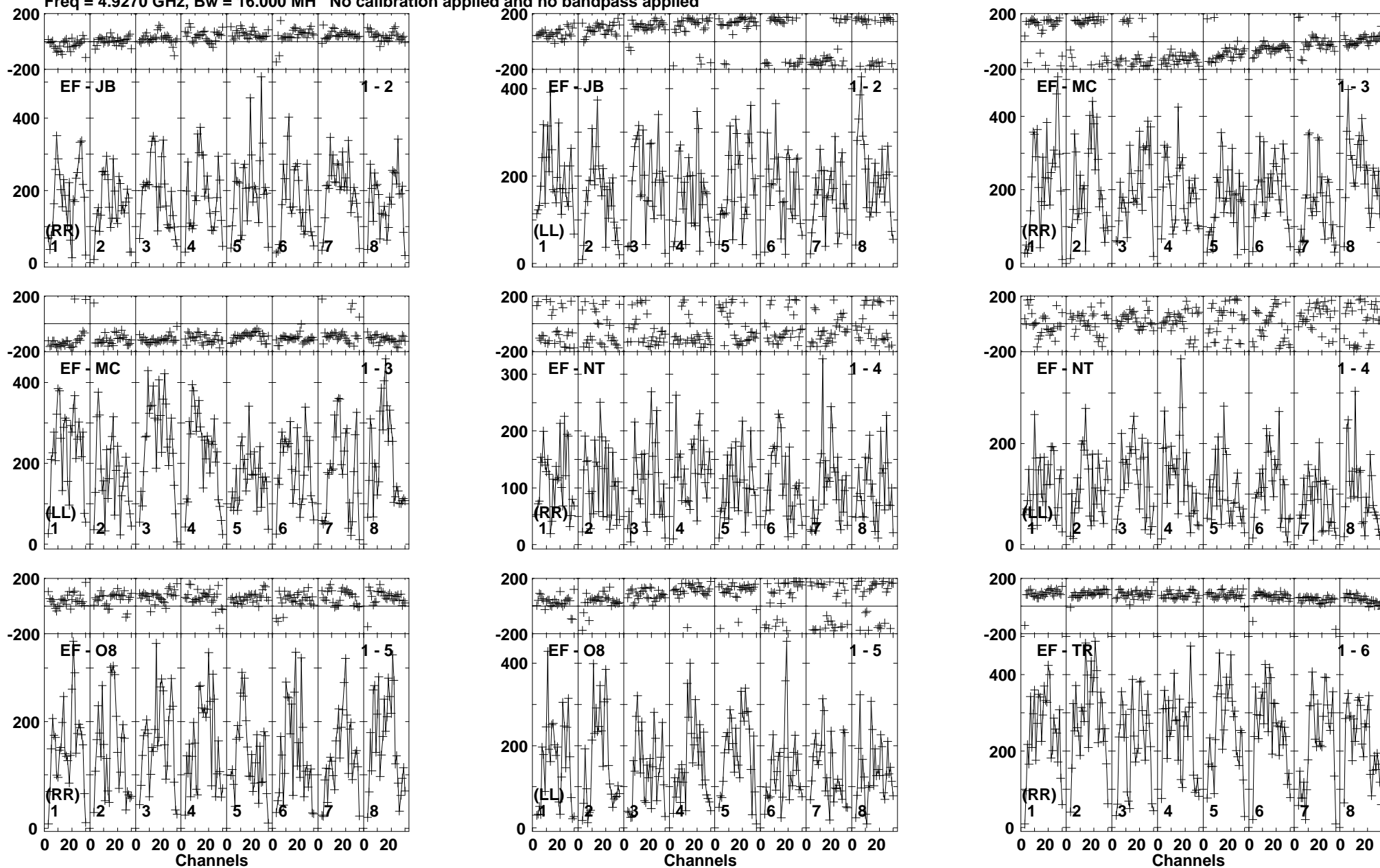

Lower frame: Micro Ampl Jy Top frame: Phas deg  
Vector averaged cross-power spectrum Baseline: EF (01) - JB (02)  
Timerange: 01/06:25:21 to 01/06:27:20

Plot file version 590 created 10-JUN-2016 17:23:01

CHECK RT013A.UVDATA.1

Freq = 4.9270 GHz, Bw = 16.000 MH No calibration applied and no bandpass applied

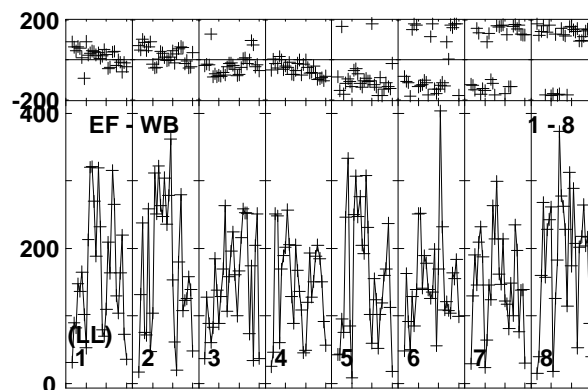
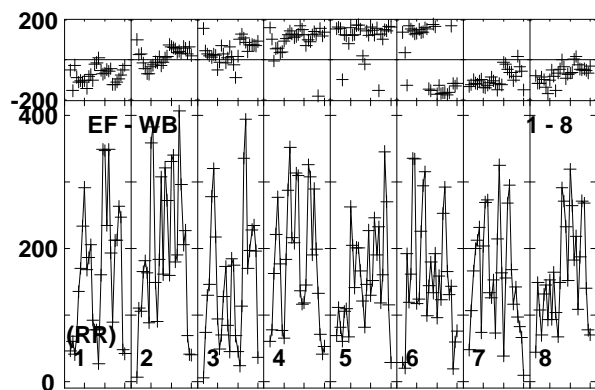
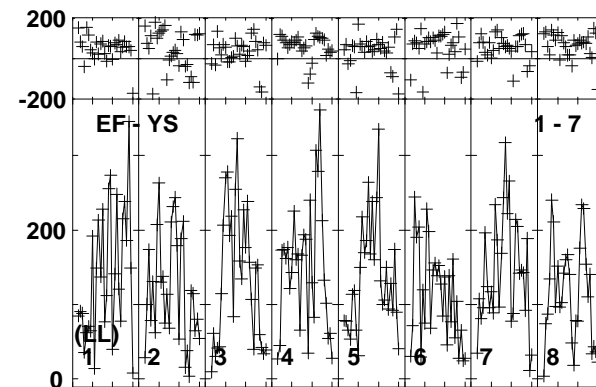
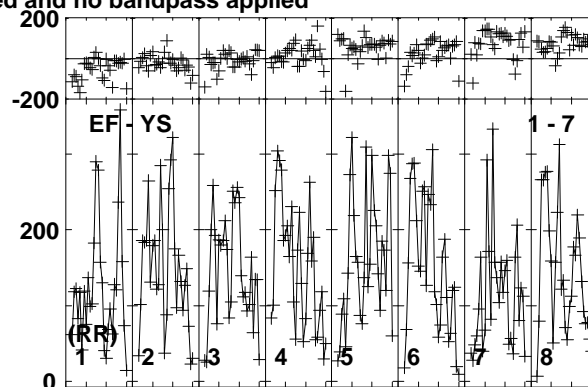
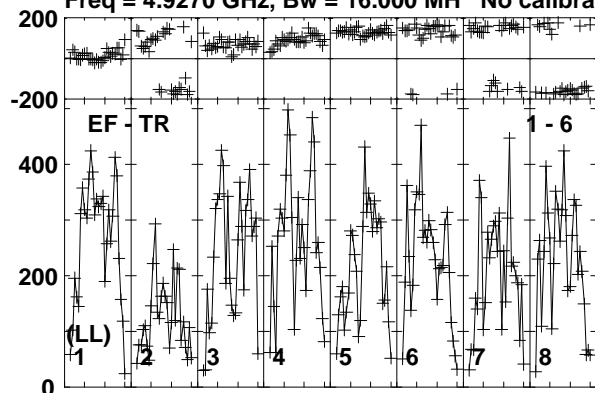

Lower frame: Micro Ampl Jy Top frame: Phas deg  
Vector averaged cross-power spectrum Baseline: EF (01) - TR (06)  
Timerange: 01/06:25:21 to 01/06:27:20

Plot file version 591 created 10-JUN-2016 17:23:01

CYGX1 RT013A.UVDATA.1

Freq = 4.9270 GHz, Bw = 16.000 MH No calibration applied and no bandpass applied

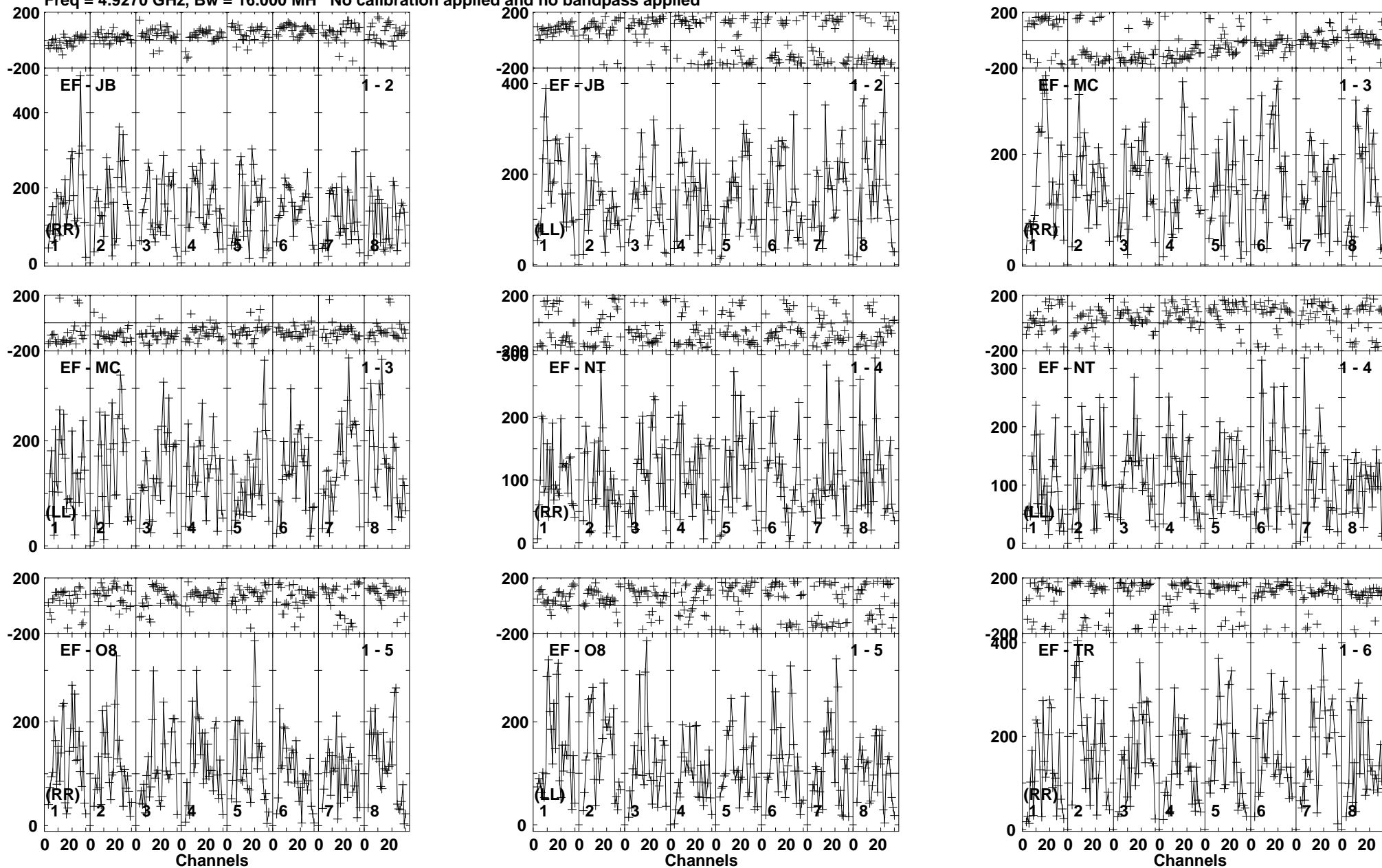

Lower frame: Micro Ampl Jy Top frame: Phas deg  
Vector averaged cross-power spectrum Baseline: EF (01) - JB (02)  
Timerange: 01/06:27:21 to 01/06:29:49

Plot file version 592 created 10-JUN-2016 17:23:01

CYGX1 RT013A.UVDATA.1

Freq = 4.9270 GHz, Bw = 16.000 MH No calibration applied and no bandpass applied

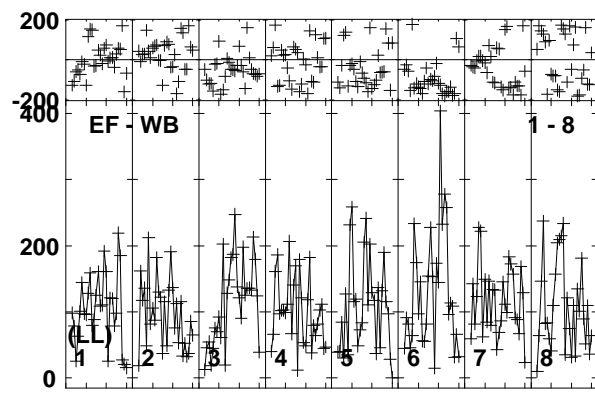
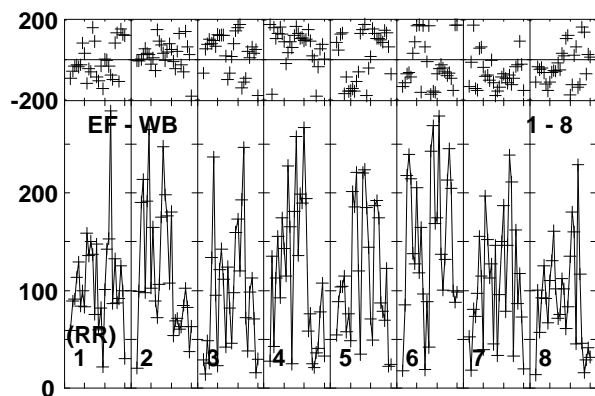
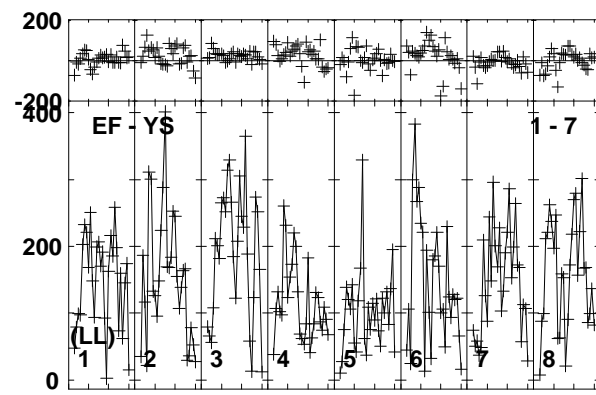
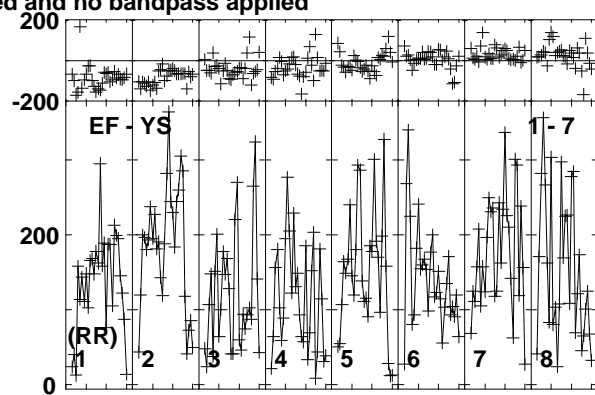
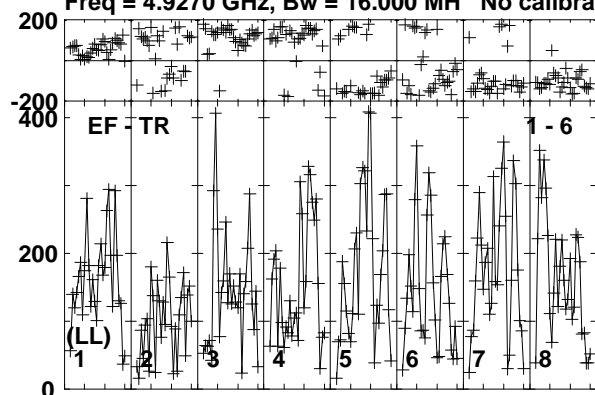

Lower frame: Micro Ampl Jy Top frame: Phas deg  
Vector averaged cross-power spectrum Baseline: EF (01) - TR (06)  
Timerange: 01/06:27:21 to 01/06:29:49

Plot file version 593 created 10-JUN-2016 17:23:01

J1957+3338 RT013A.UVDATA.1

Freq = 4.9270 GHz, Bw = 16.000 MH No calibration applied and no bandpass applied

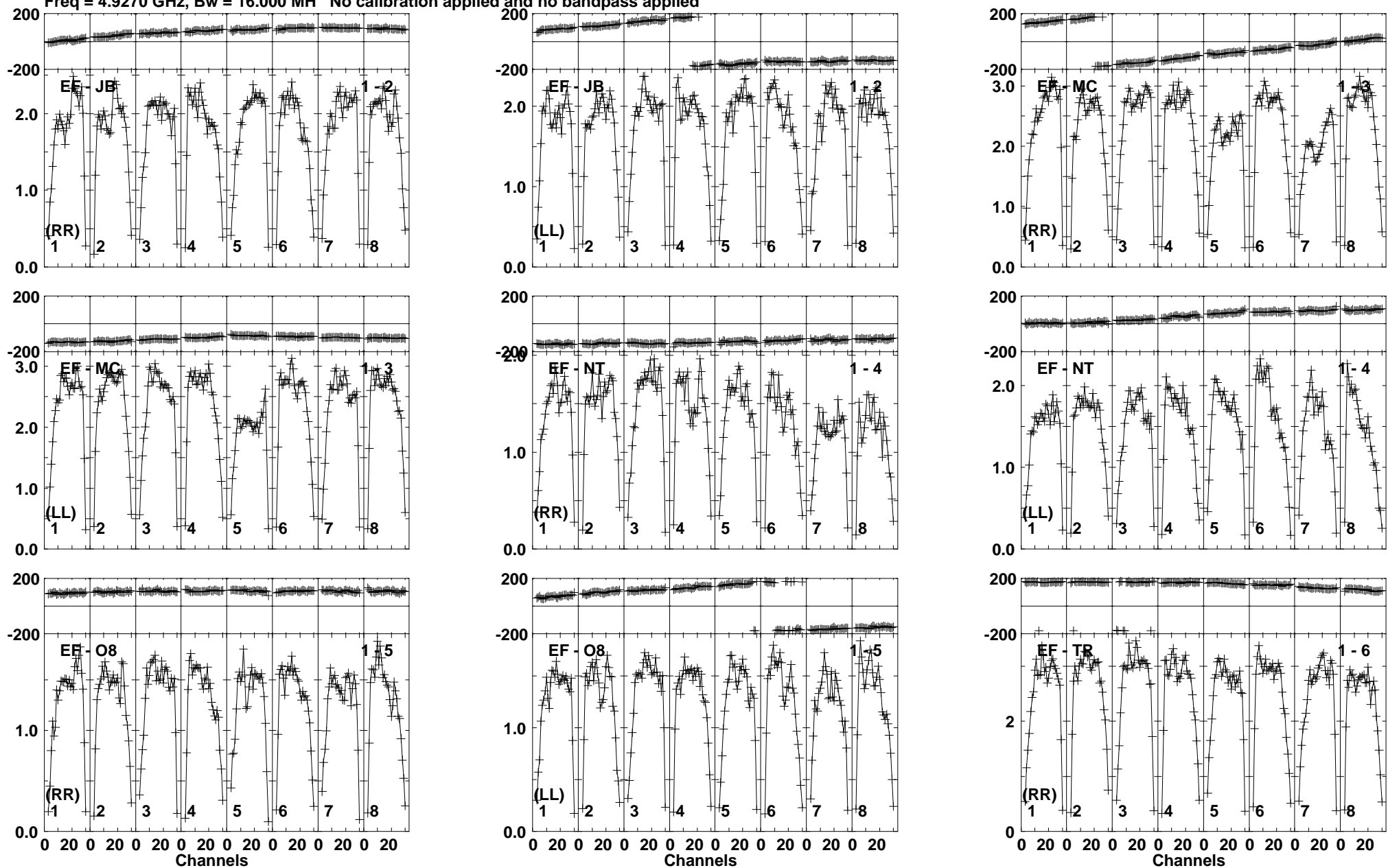

Lower frame: Milli Ampl Jy Top frame: Phas deg  
Vector averaged cross-power spectrum Baseline: EF (01) - JB (02)  
Timerange: 01/06:29:50 to 01/06:31:19

Plot file version 594 created 10-JUN-2016 17:23:01

J1957+3338 RT013A.UVDATA.1

Freq = 4.9270 GHz, Bw = 16.000 MH No calibration applied and no bandpass applied

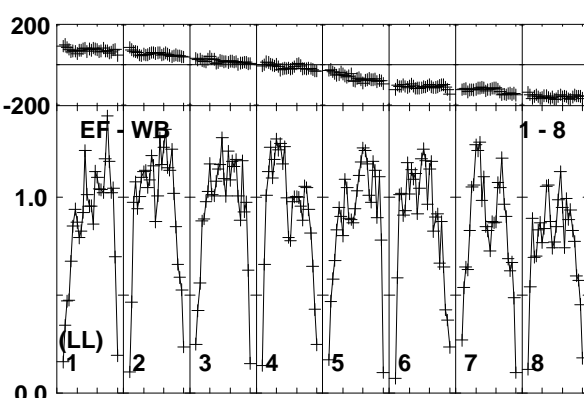
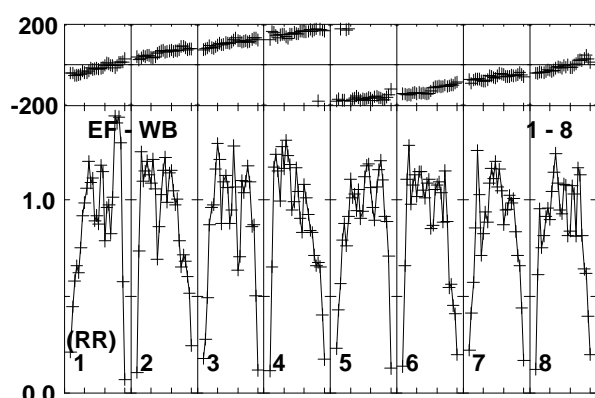
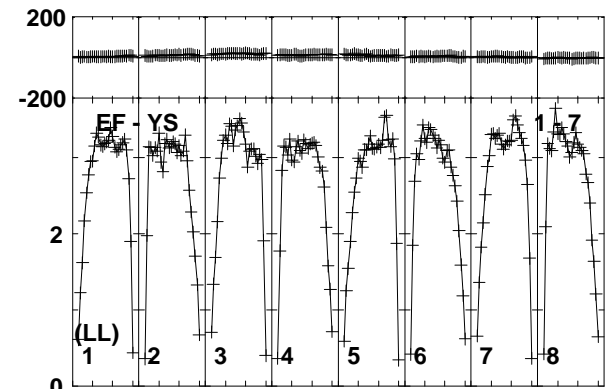
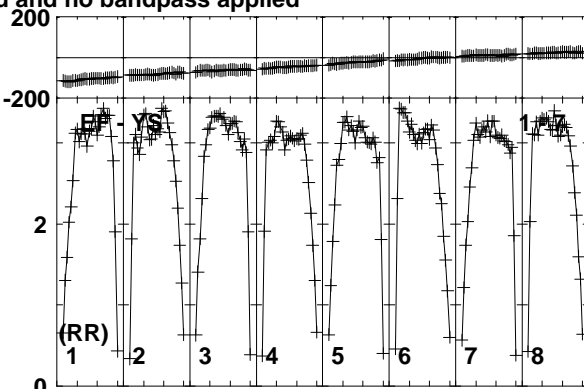
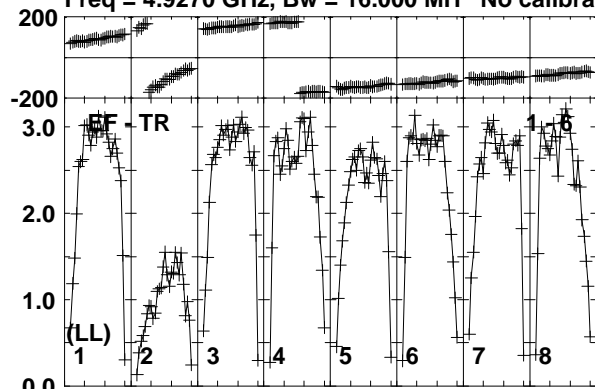

Lower frame: Milli Ampl Jy Top frame: Phas deg  
Vector averaged cross-power spectrum Baseline: EF (01) - TR (06)  
Timerange: 01/06:29:50 to 01/06:31:19



Plot file version 595 created 10-JUN-2016 17:23:01

CHECK RT013A.UVDATA.1

Freq = 4.9270 GHz, Bw = 16.000 MH No calibration applied and no bandpass applied

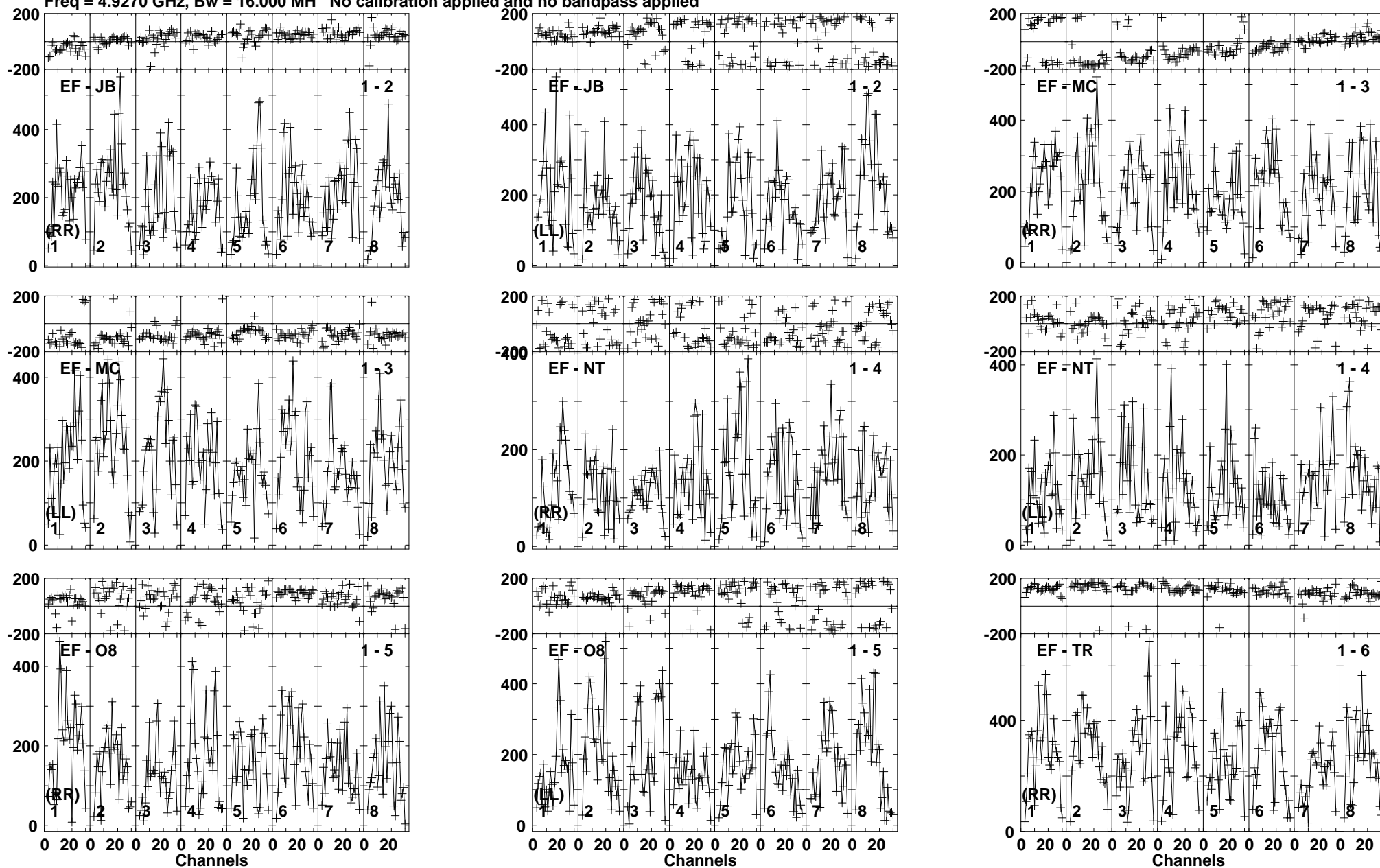

Lower frame: Micro Ampl Jy Top frame: Phas deg  
Vector averaged cross-power spectrum Baseline: EF (01) - JB (02)  
Timerange: 01/06:31:20 to 01/06:33:19

Plot file version 596 created 10-JUN-2016 17:23:01

CHECK RT013A.UVDATA.1

Freq = 4.9270 GHz, Bw = 16.000 MH No calibration applied and no bandpass applied

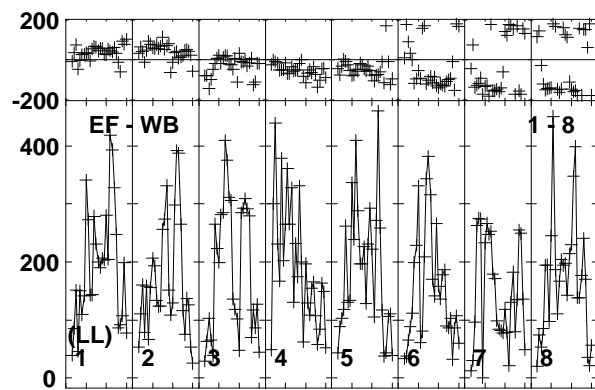
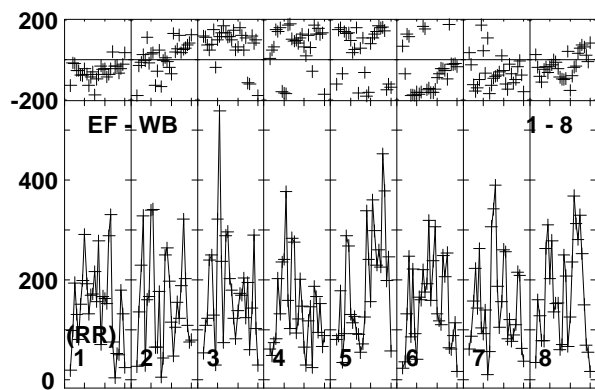
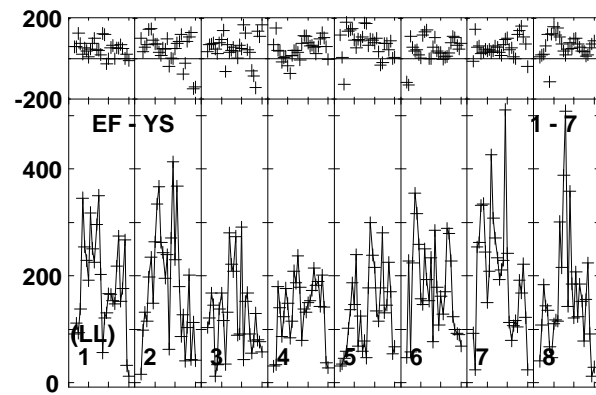
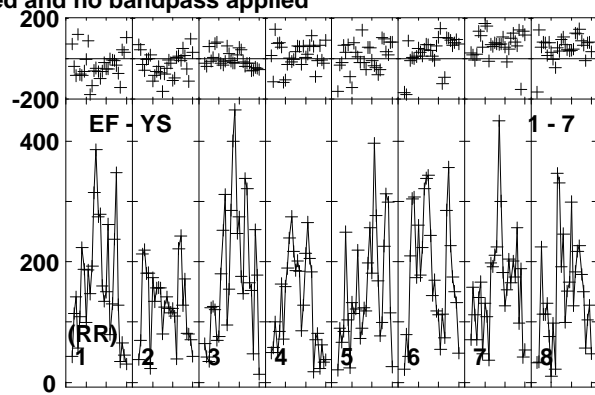
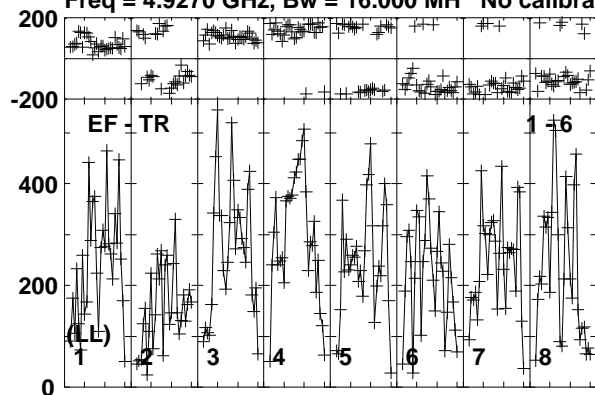

Lower frame: Micro Ampl Jy Top frame: Phas deg  
Vector averaged cross-power spectrum Baseline: EF (01) - TR (06)  
Timerange: 01/06:31:20 to 01/06:33:19

Plot file version 597 created 10-JUN-2016 17:23:01

CYGX1 RT013A.UVDATA.1

Freq = 4.9270 GHz, Bw = 16.000 MH No calibration applied and no bandpass applied

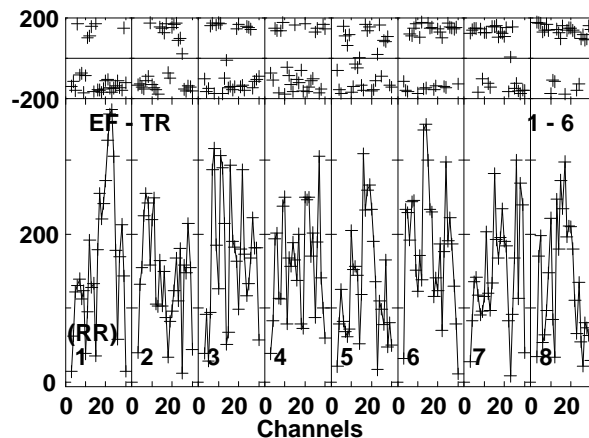
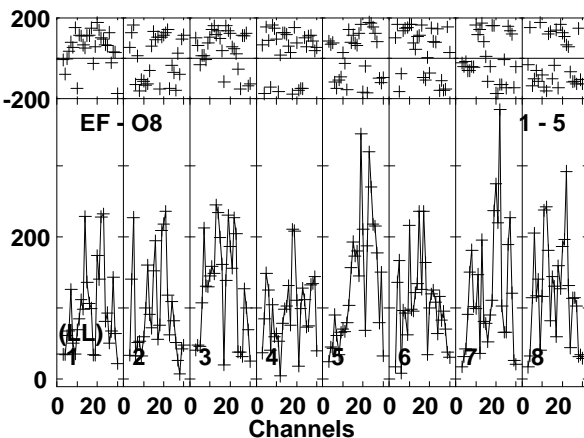
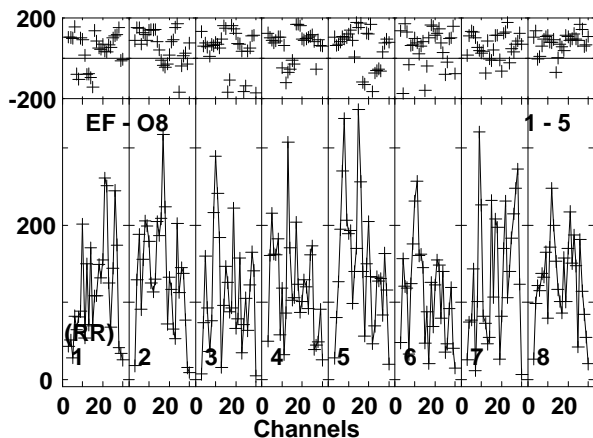
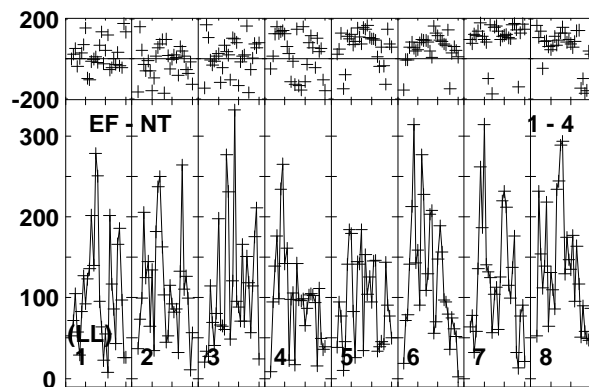
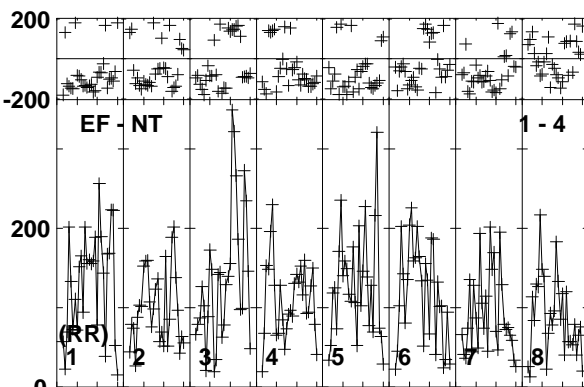
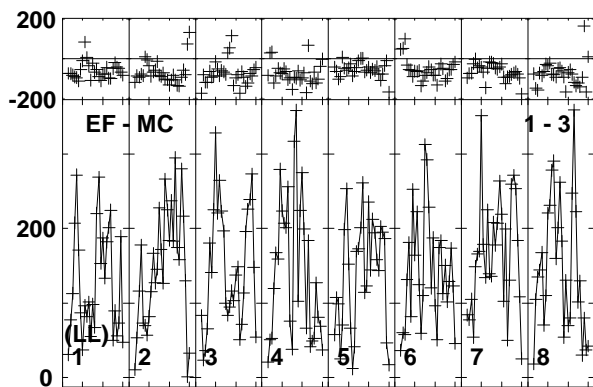
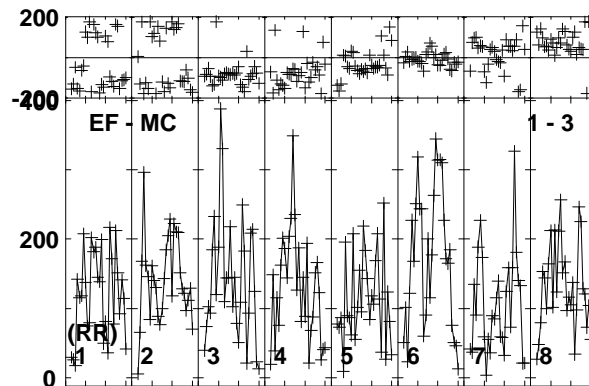
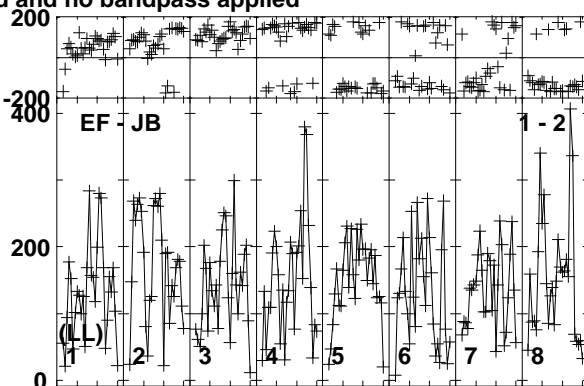
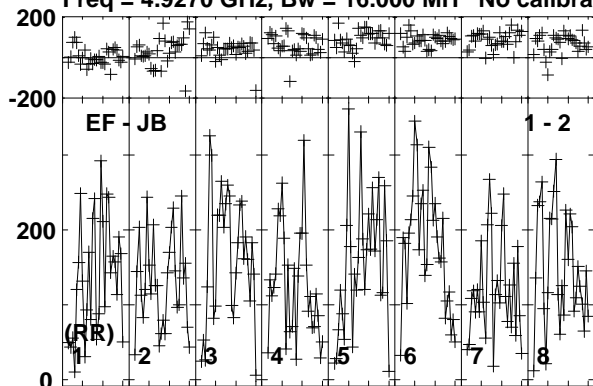

Lower frame: Micro Ampl Jy Top frame: Phas deg  
Vector averaged cross-power spectrum Baseline: EF (01) - JB (02)  
Timerange: 01/06:33:20 to 01/06:35:50

Plot file version 598 created 10-JUN-2016 17:23:01

CYGX1 RT013A.UVDATA.1

Freq = 4.9270 GHz, Bw = 16.000 MH No calibration applied and no bandpass applied

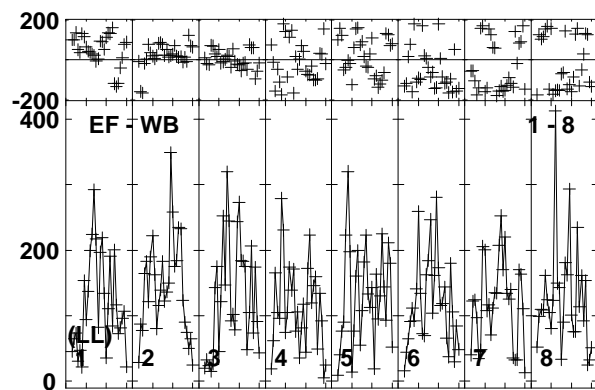
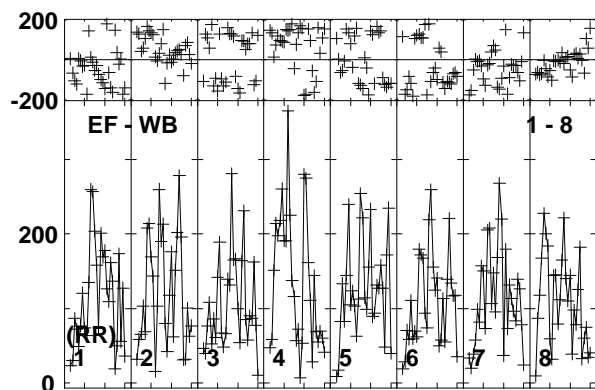
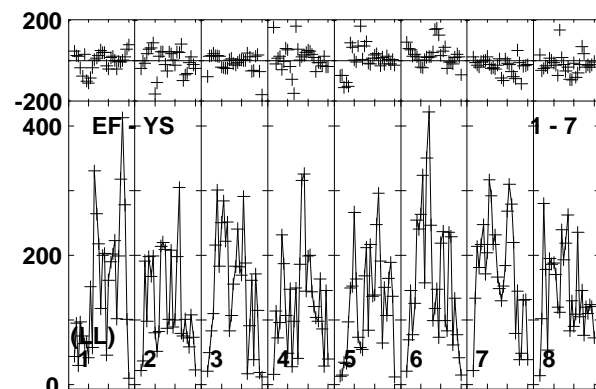
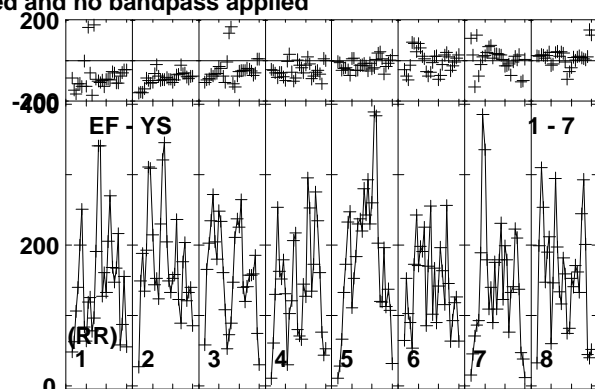
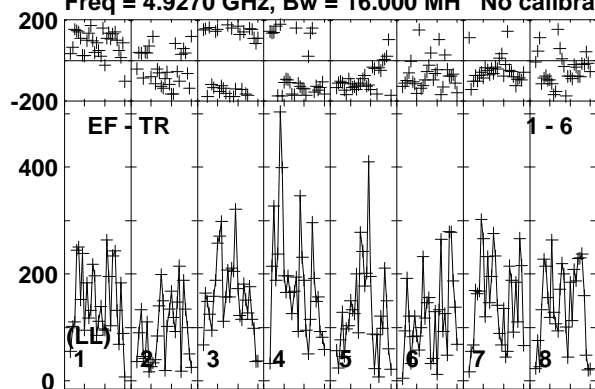

Lower frame: Micro Ampl Jy Top frame: Phas deg  
Vector averaged cross-power spectrum Baseline: EF (01) - TR (06)  
Timerange: 01/06:33:20 to 01/06:35:50

Plot file version 599 created 10-JUN-2016 17:23:02

J1957+3338 RT013A.UVDATA.1

Freq = 4.9270 GHz, Bw = 16.000 MH No calibration applied and no bandpass applied

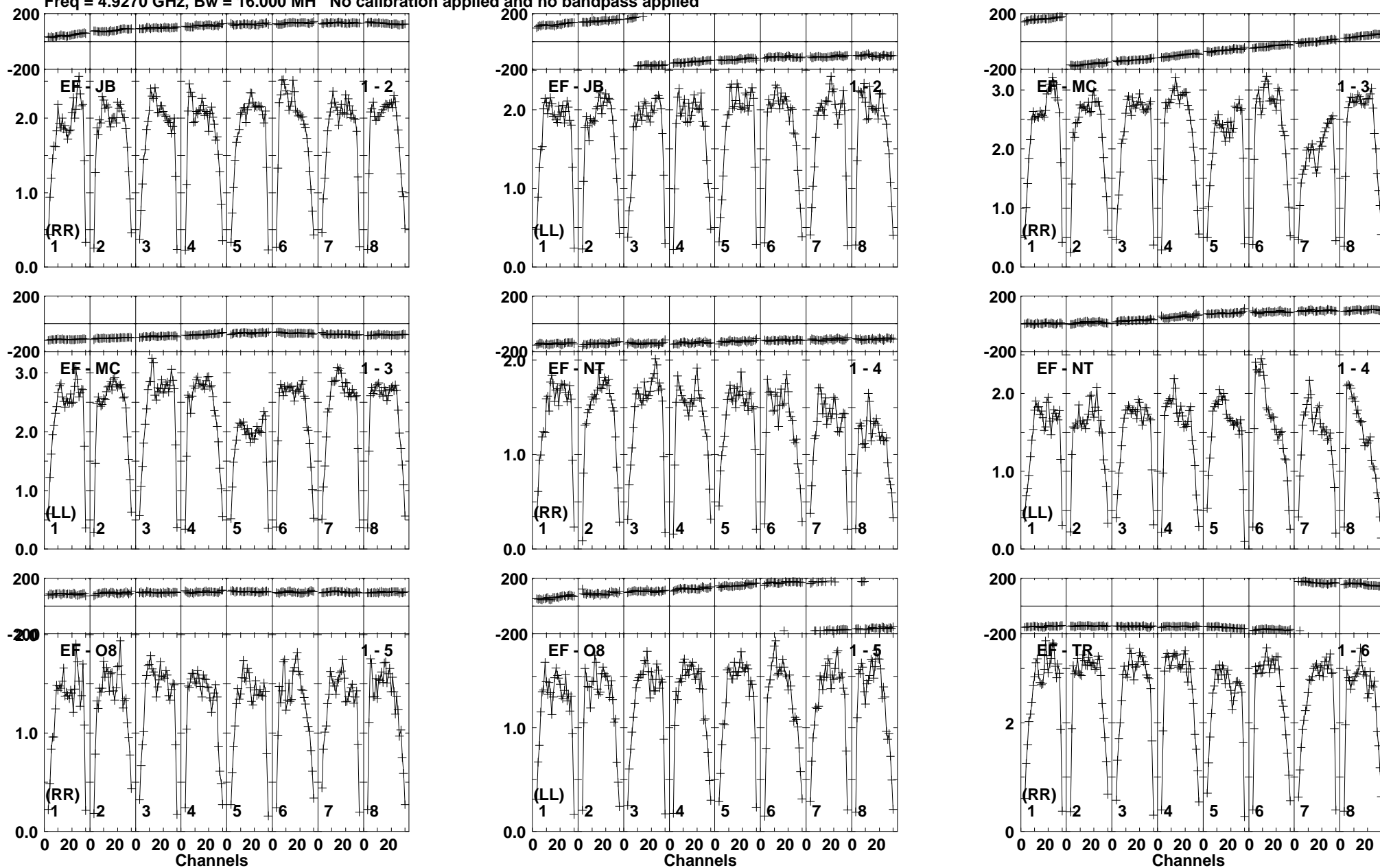

Lower frame: Milli Ampl Jy Top frame: Phas deg  
Vector averaged cross-power spectrum Baseline: EF (01) - JB (02)  
Timerange: 01/06:35:51 to 01/06:37:20

Plot file version 600 created 10-JUN-2016 17:23:02

J1957+3338 RT013A.UVDATA.1

Freq = 4.9270 GHz, Bw = 16.000 MH No calibration applied and no bandpass applied

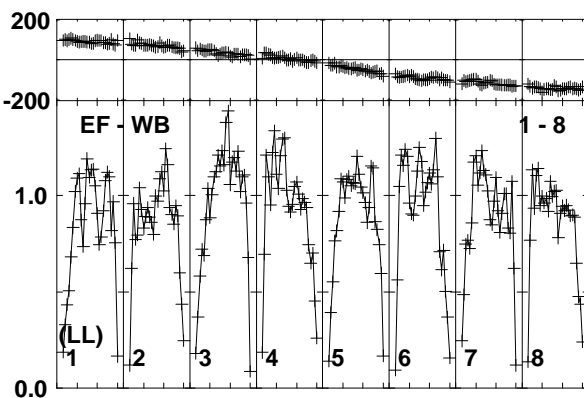
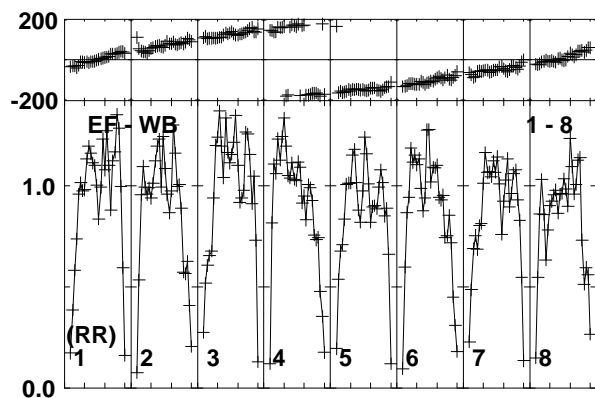
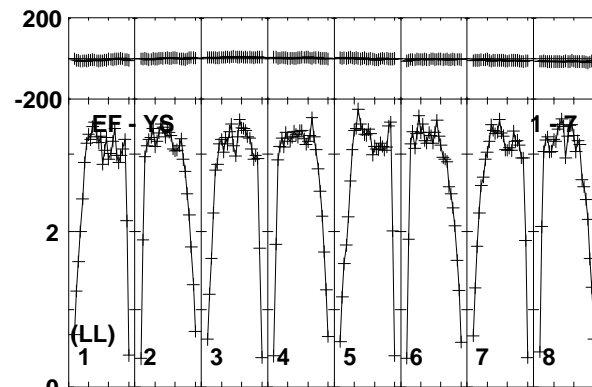
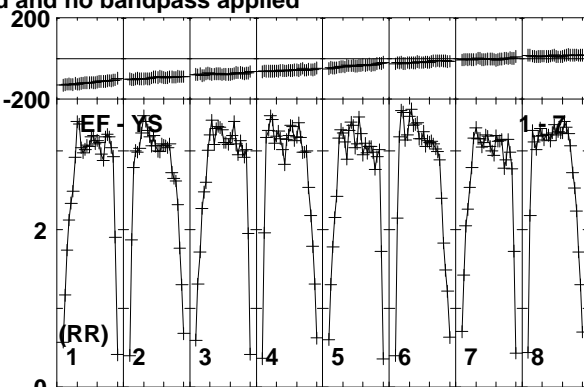
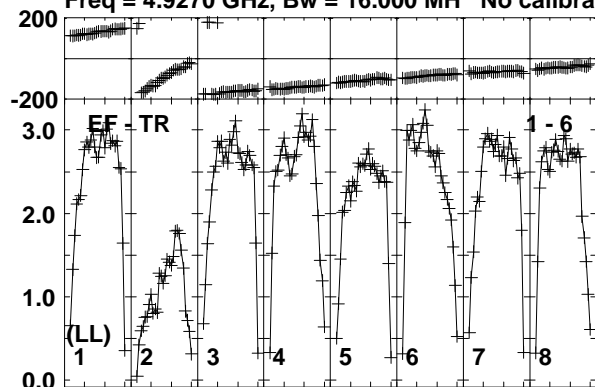

Lower frame: Milli Ampl Jy Top frame: Phas deg  
Vector averaged cross-power spectrum Baseline: EF (01) - TR (06)  
Timerange: 01/06:35:51 to 01/06:37:20

Plot file version 601 created 10-JUN-2016 17:23:02

CHECK RT013A.UVDATA.1

Freq = 4.9270 GHz, Bw = 16.000 MH No calibration applied and no bandpass applied

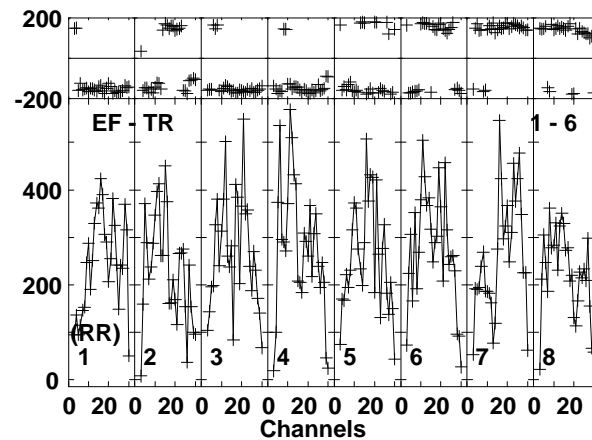
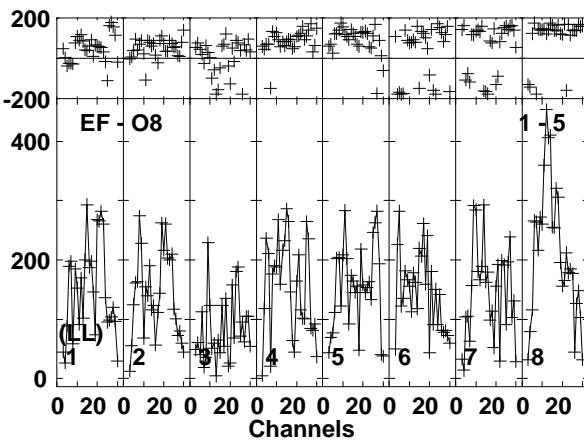
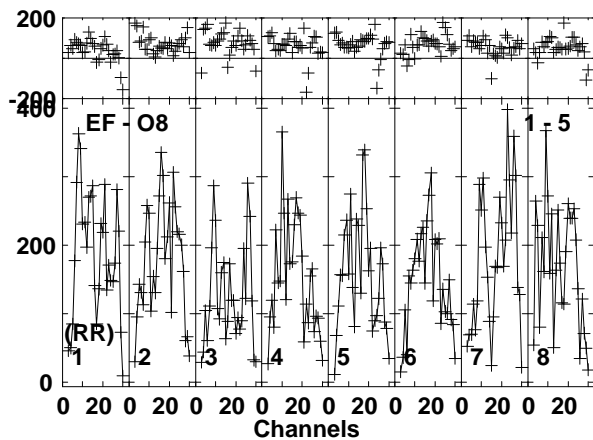
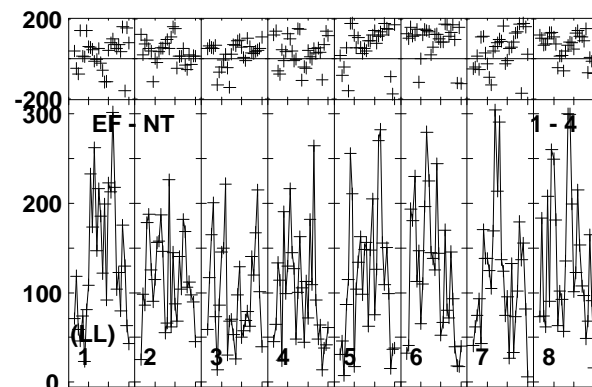
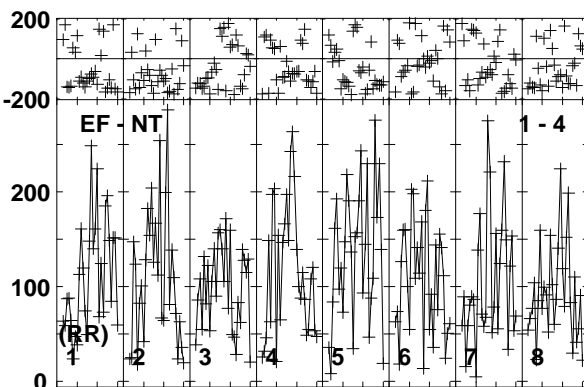
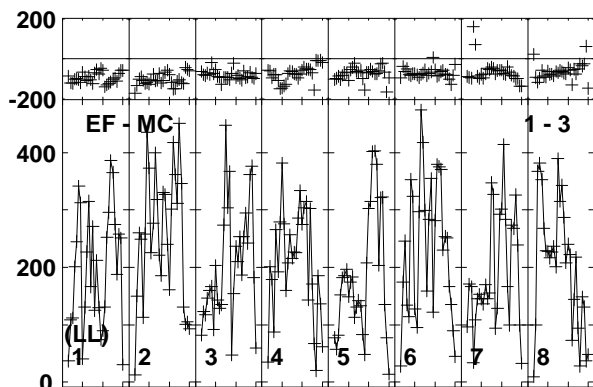
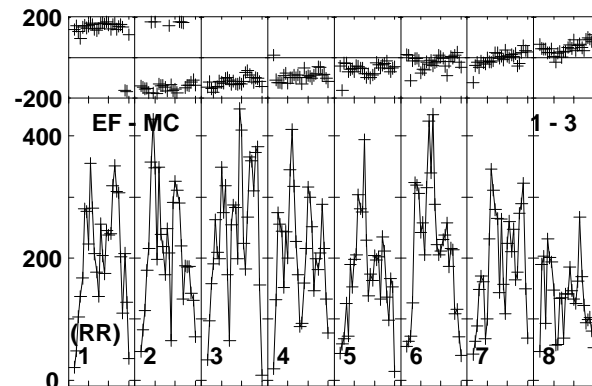
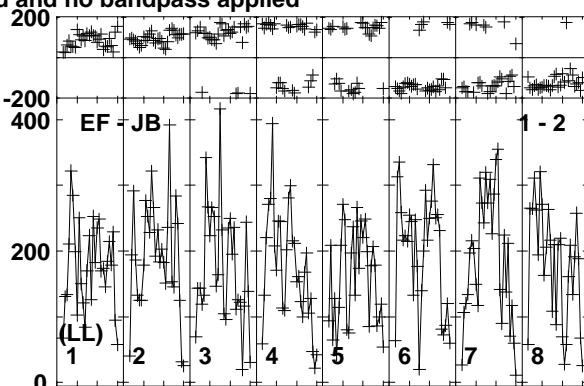
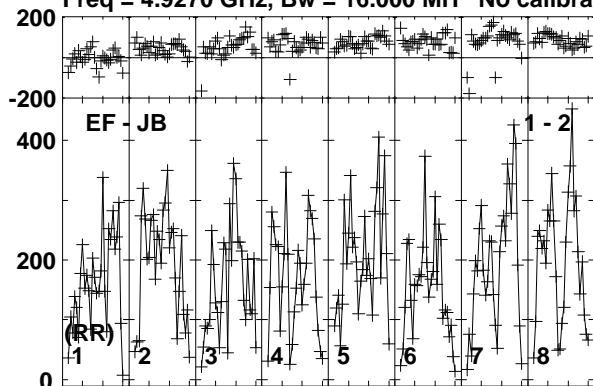

Lower frame: Micro Ampl Jy Top frame: Phas deg  
Vector averaged cross-power spectrum Baseline: EF (01) - JB (02)  
Timerange: 01/06:38:00 to 01/06:39:59

Plot file version 602 created 10-JUN-2016 17:23:02

CHECK RT013A.UVDATA.1

Freq = 4.9270 GHz, Bw = 16.000 MH No calibration applied and no bandpass applied

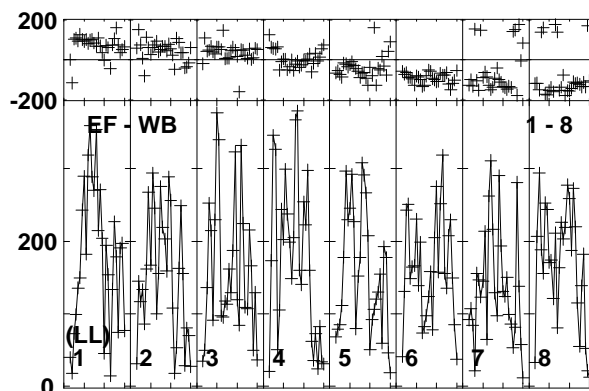
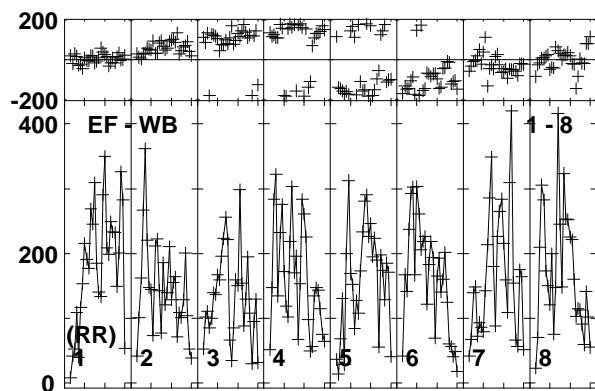
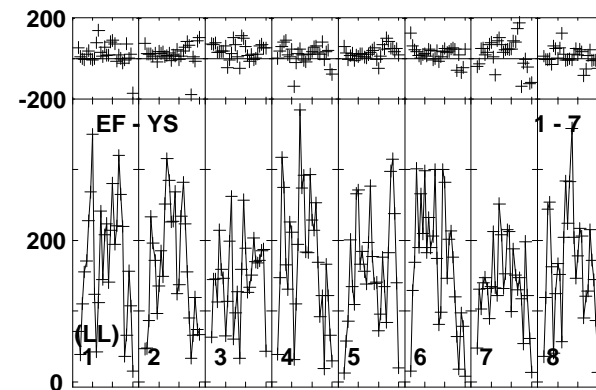
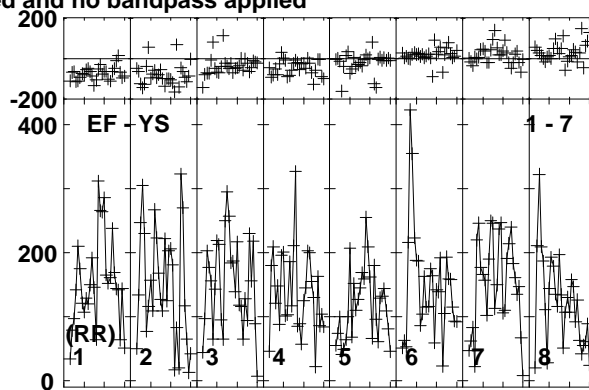
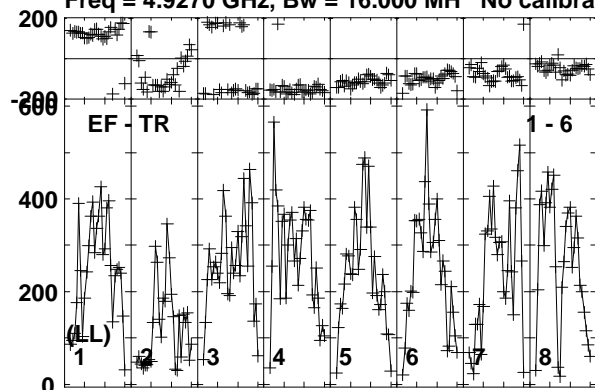

Lower frame: Micro Ampl Jy Top frame: Phas deg  
Vector averaged cross-power spectrum Baseline: EF (01) - TR (06)  
Timerange: 01/06:38:00 to 01/06:39:59



Plot file version 603 created 10-JUN-2016 17:23:02

CYGX1 RT013A.UVDATA.1

Freq = 4.9270 GHz, Bw = 16.000 MH No calibration applied and no bandpass applied

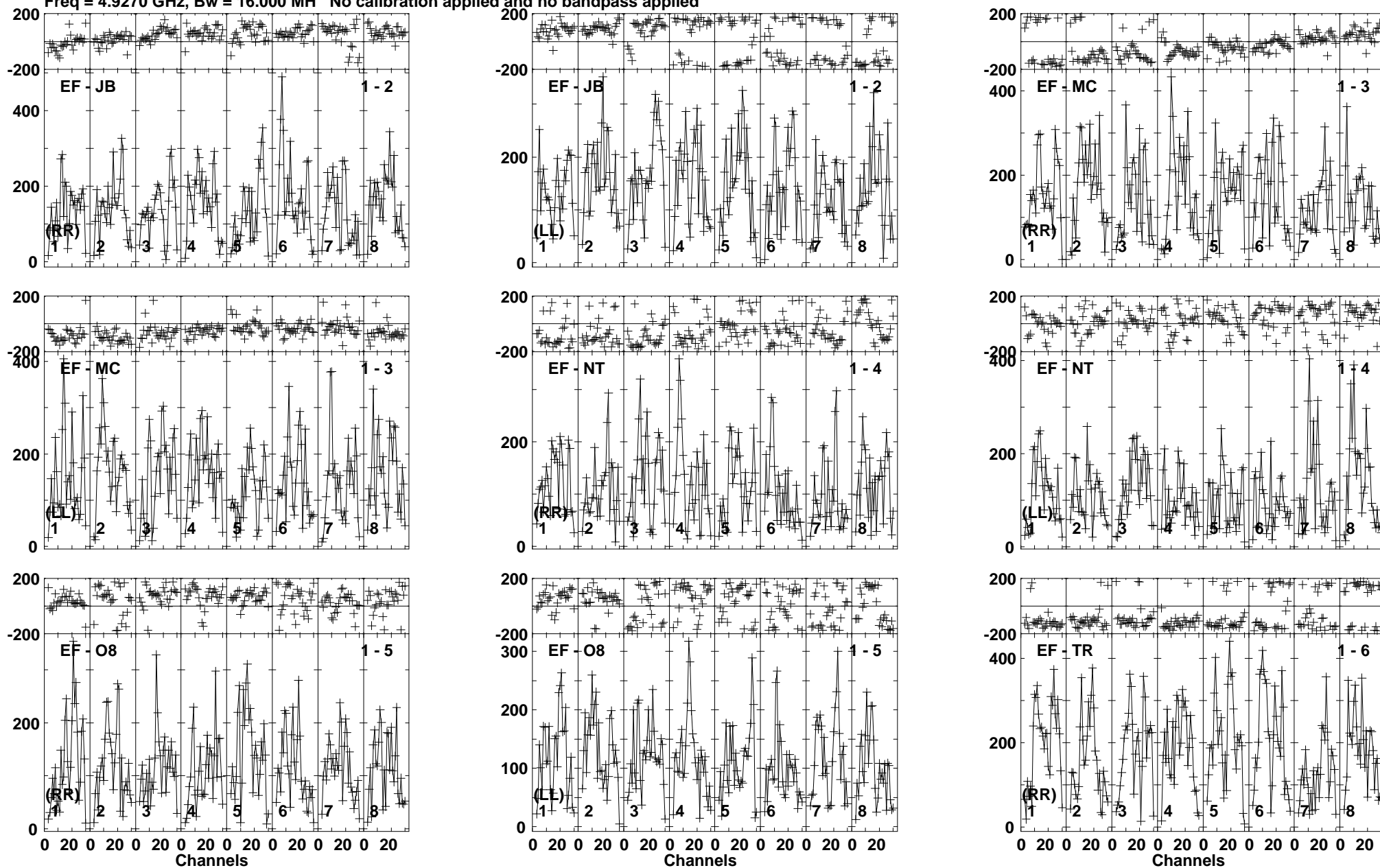

Lower frame: Micro Ampl Jy Top frame: Phas deg  
Vector averaged cross-power spectrum Baseline: EF (01) - JB (02)  
Timerange: 01/06:40:01 to 01/06:42:30

Plot file version 604 created 10-JUN-2016 17:23:02

CYGX1 RT013A.UVDATA.1

Freq = 4.9270 GHz, Bw = 16.000 MH No calibration applied and no bandpass applied

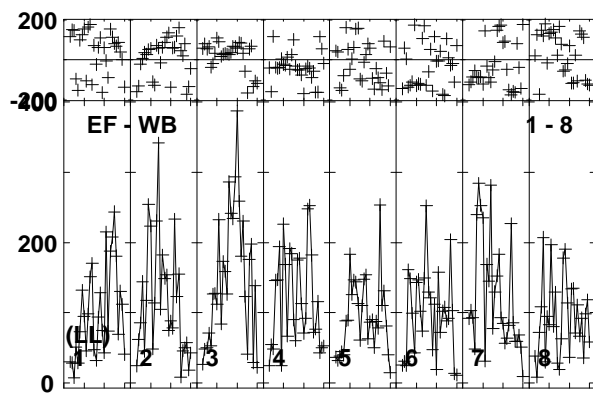
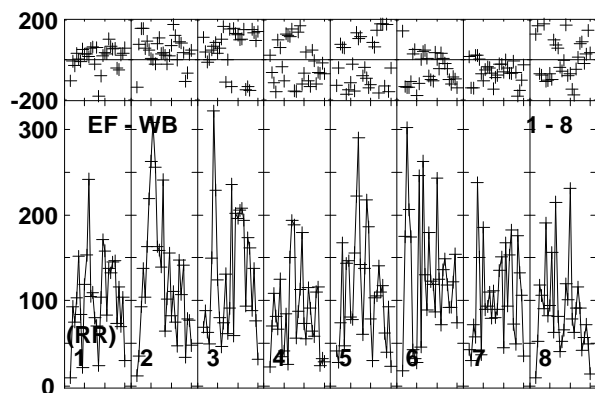
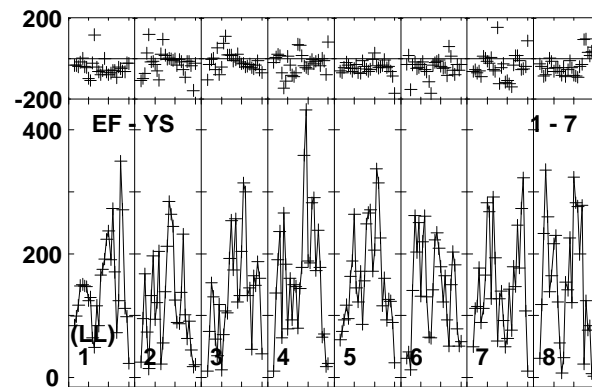
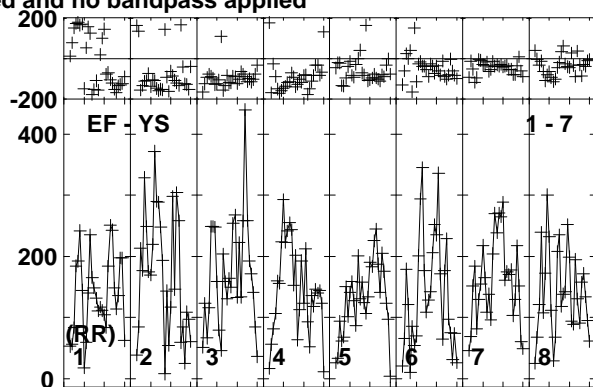
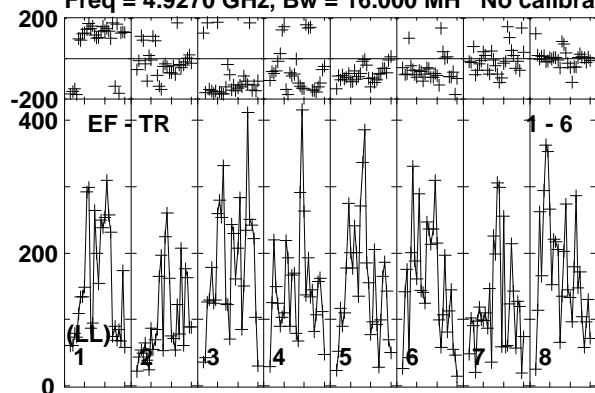

Lower frame: Micro Ampl Jy Top frame: Phas deg  
Vector averaged cross-power spectrum Baseline: EF (01) - TR (06)  
Timerange: 01/06:40:01 to 01/06:42:30

Plot file version 605 created 10-JUN-2016 17:23:02

J1957+3338 RT013A.UVDATA.1

Freq = 4.9270 GHz, Bw = 16.000 MH No calibration applied and no bandpass applied

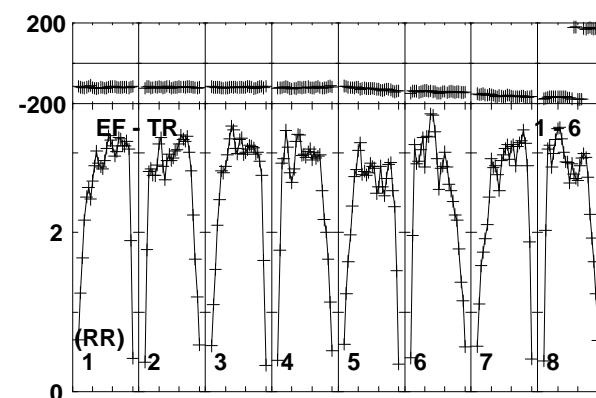
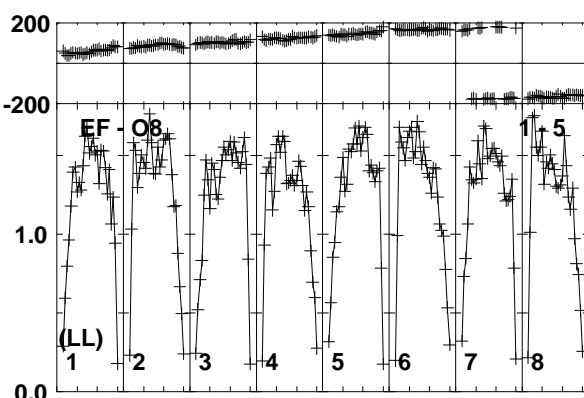
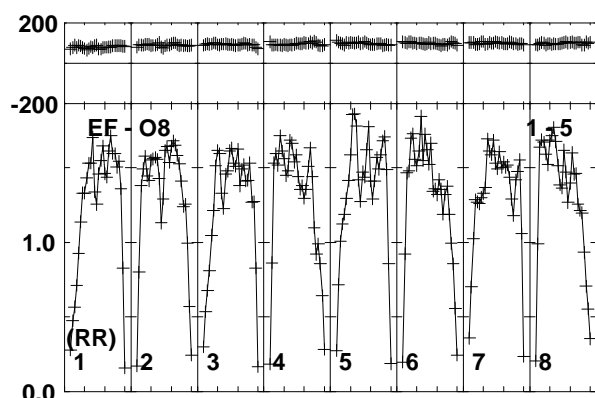
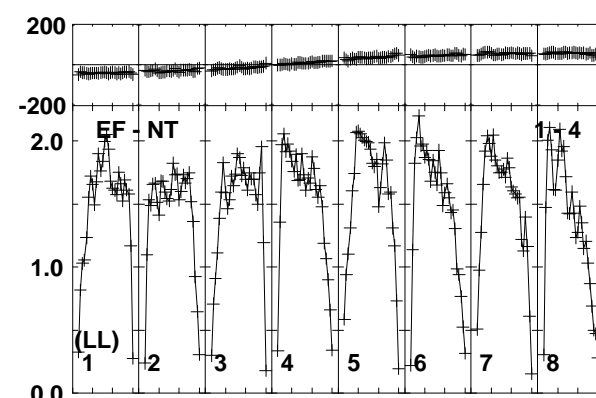
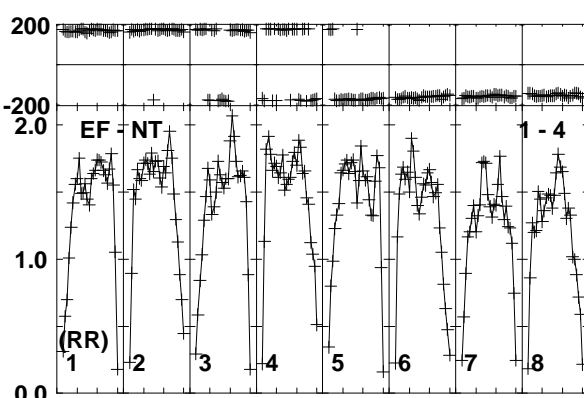
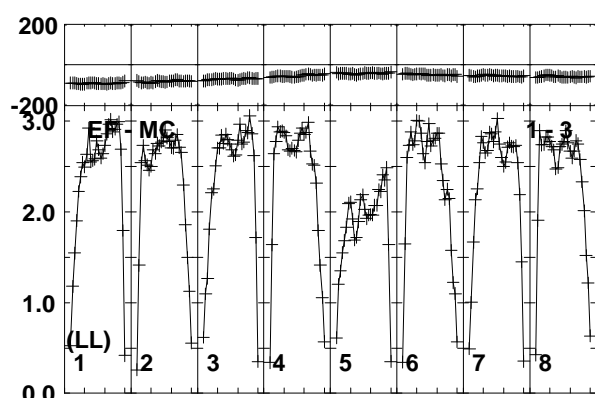
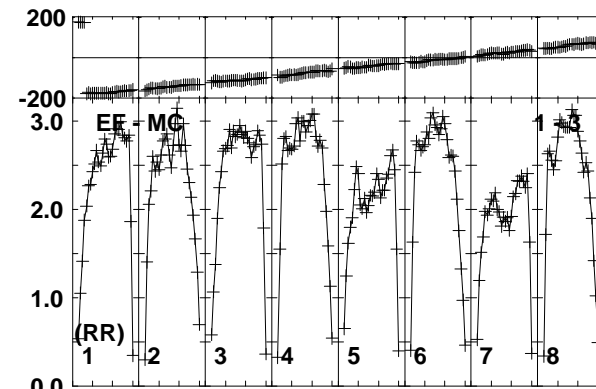
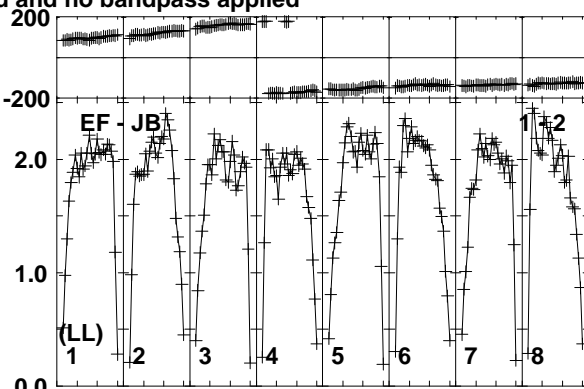
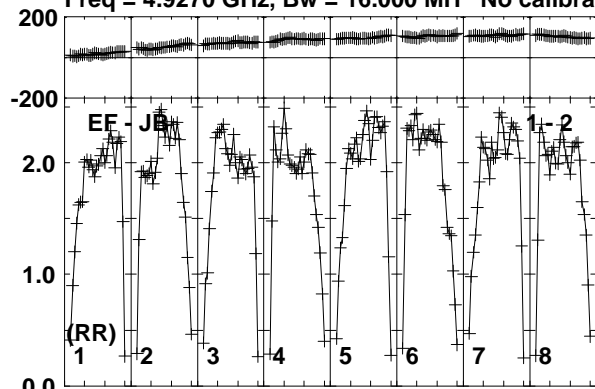

Lower frame: Milli Ampl Jy Top frame: Phas deg

Vector averaged cross-power spectrum Baseline: EF (01) - JB (02)

Timerange: 01/06:42:31 to 01/06:43:59

Plot file version 606 created 10-JUN-2016 17:23:02

J1957+3338 RT013A.UVDATA.1

Freq = 4.9270 GHz, Bw = 16.000 MH No calibration applied and no bandpass applied

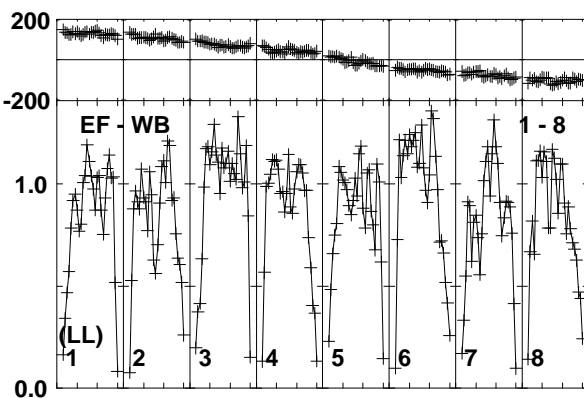
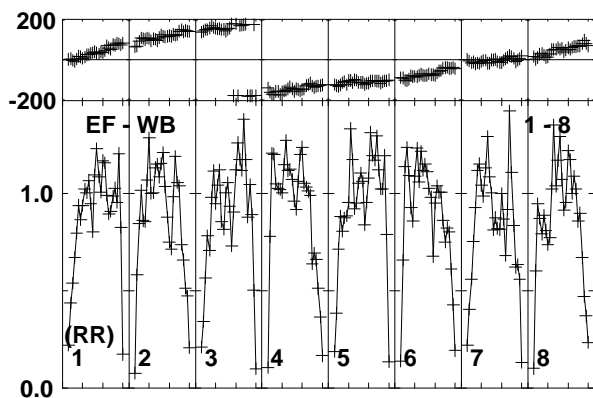
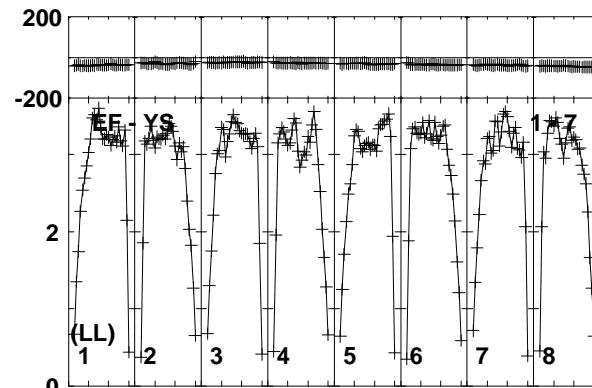
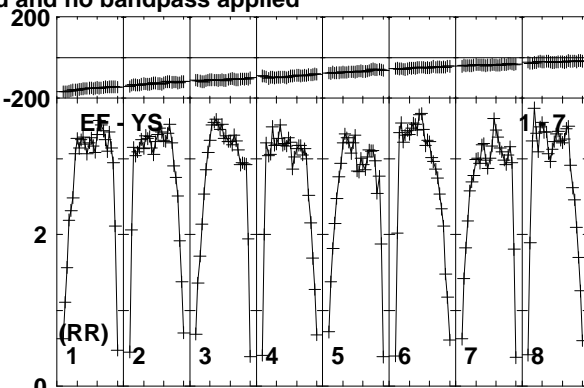
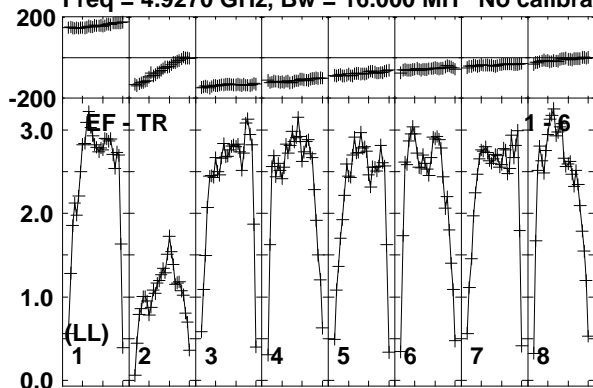

Lower frame: Milli Ampl Jy Top frame: Phas deg  
Vector averaged cross-power spectrum Baseline: EF (01) - TR (06)  
Timerange: 01/06:42:31 to 01/06:43:59

Plot file version 607 created 10-JUN-2016 17:23:02

CHECK RT013A.UVDATA.1

Freq = 4.9270 GHz, Bw = 16.000 MH No calibration applied and no bandpass applied

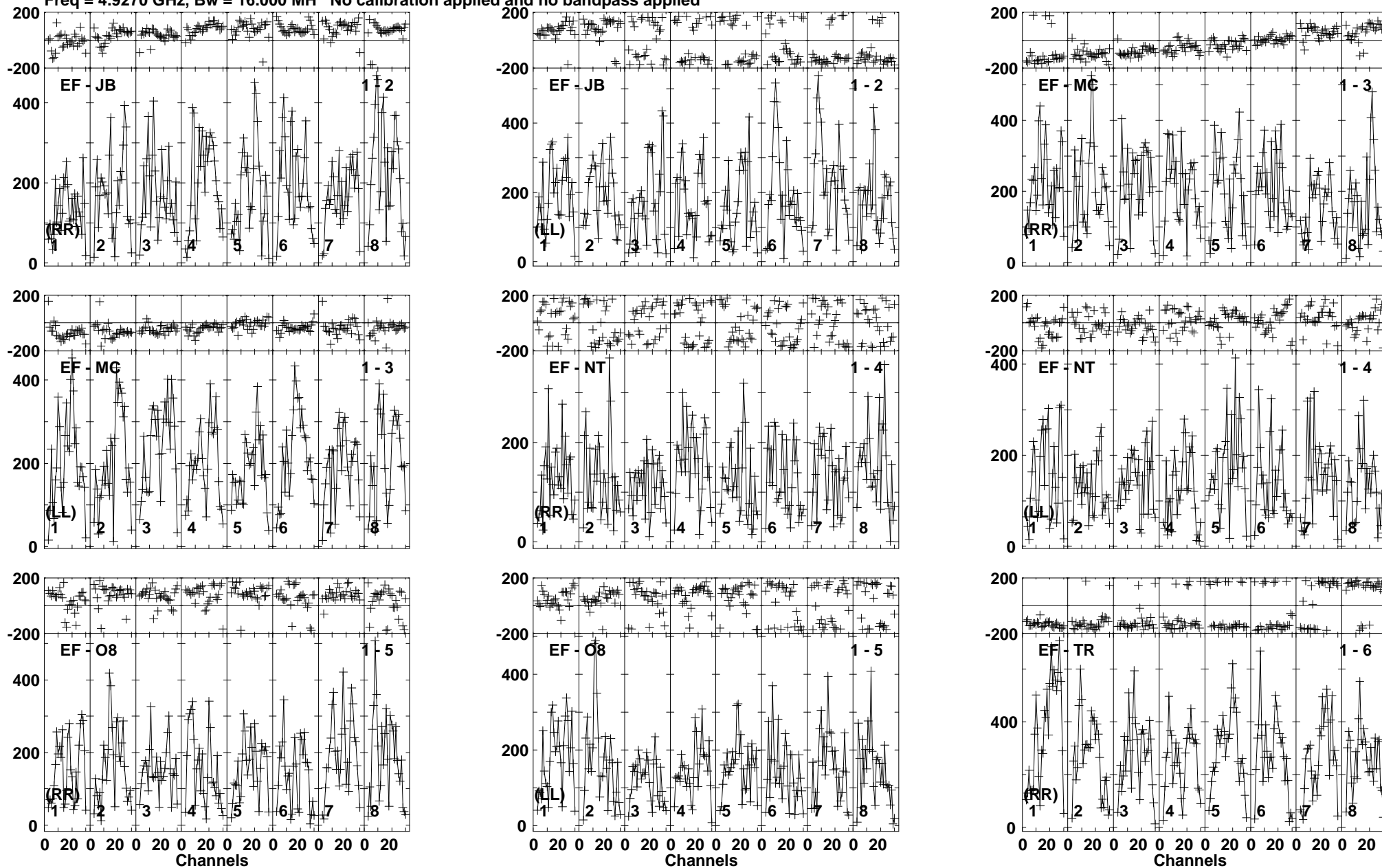

Lower frame: Micro Ampl Jy Top frame: Phas deg  
Vector averaged cross-power spectrum Baseline: EF (01) - JB (02)  
Timerange: 01/06:44:00 to 01/06:46:00

Plot file version 608 created 10-JUN-2016 17:23:02

CHECK RT013A.UVDATA.1

Freq = 4.9270 GHz, Bw = 16.000 MH No calibration applied and no bandpass applied

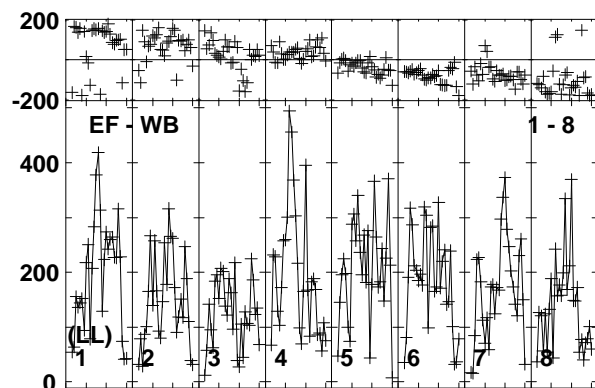
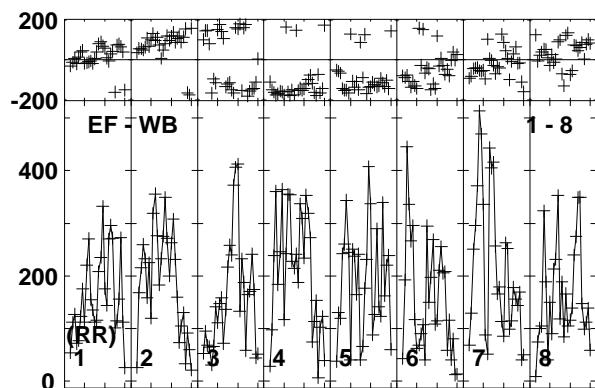
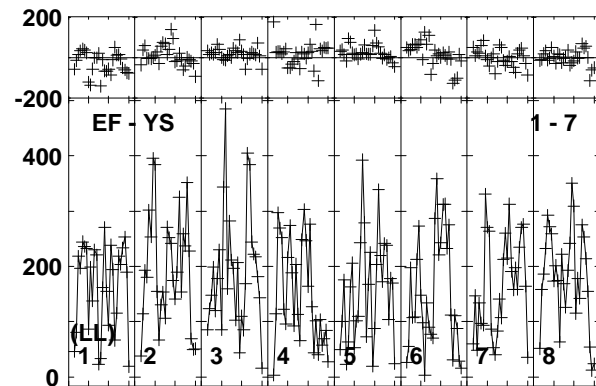
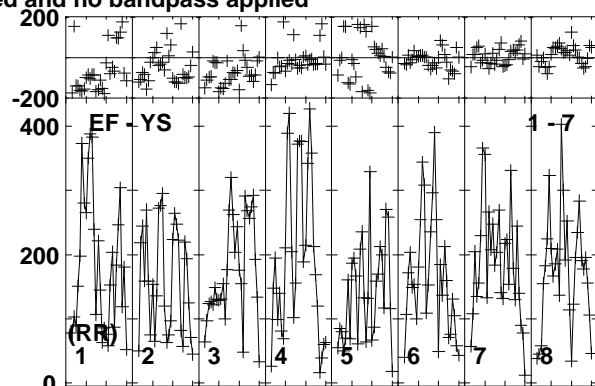
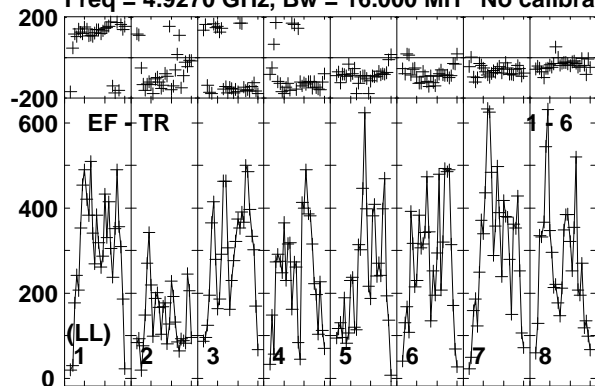

Lower frame: Micro Ampl Jy Top frame: Phas deg  
Vector averaged cross-power spectrum Baseline: EF (01) - TR (06)  
Timerange: 01/06:44:00 to 01/06:46:00

Plot file version 609 created 10-JUN-2016 17:23:02

CYGX1 RT013A.UVDATA.1

Freq = 4.9270 GHz, Bw = 16.000 MH No calibration applied and no bandpass applied

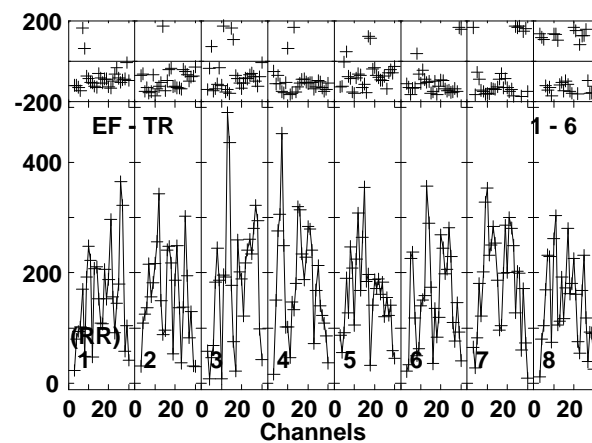
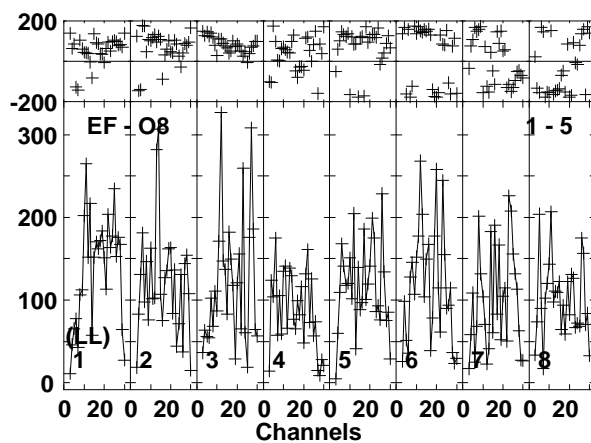
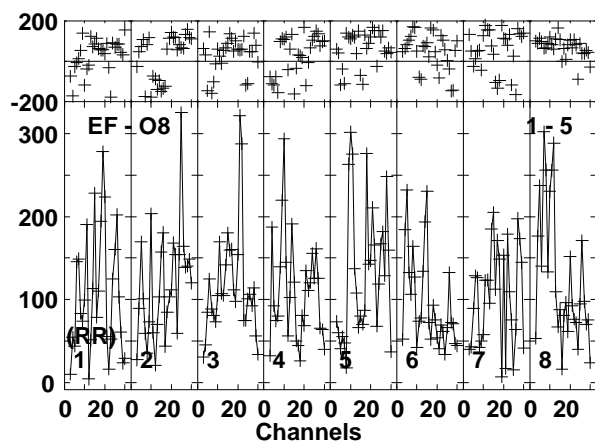
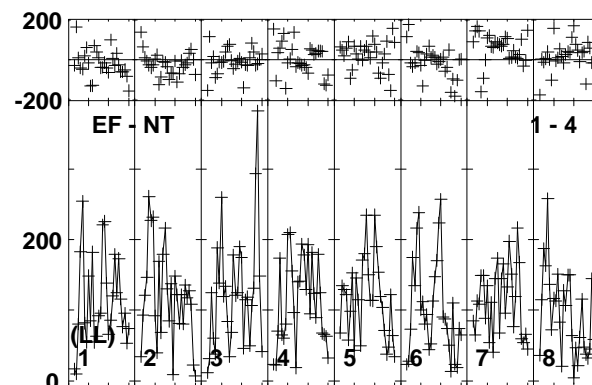
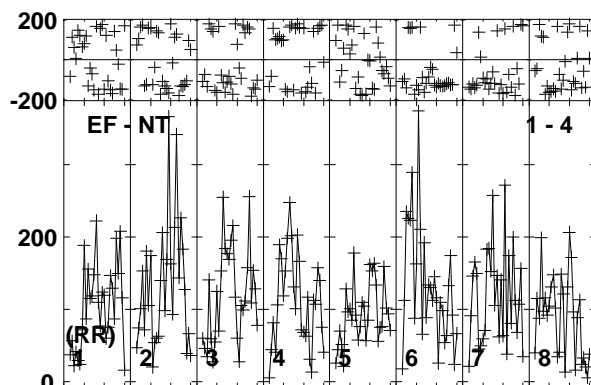
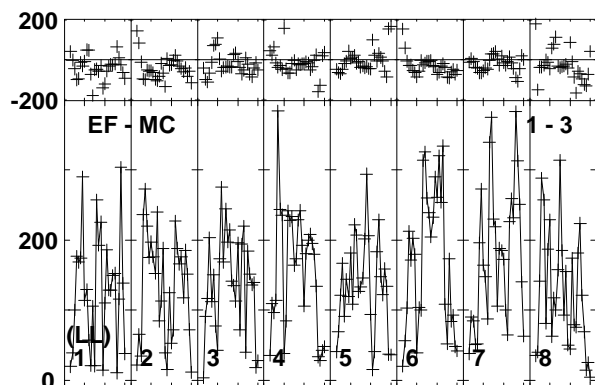
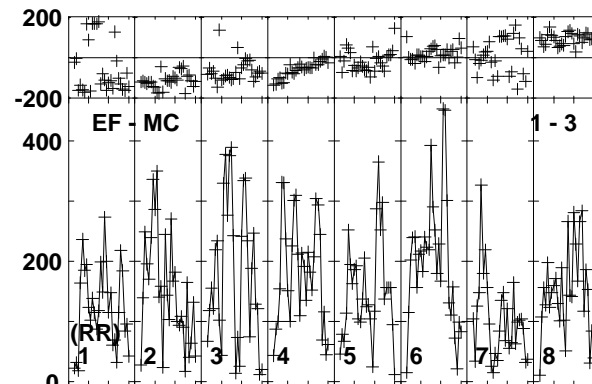
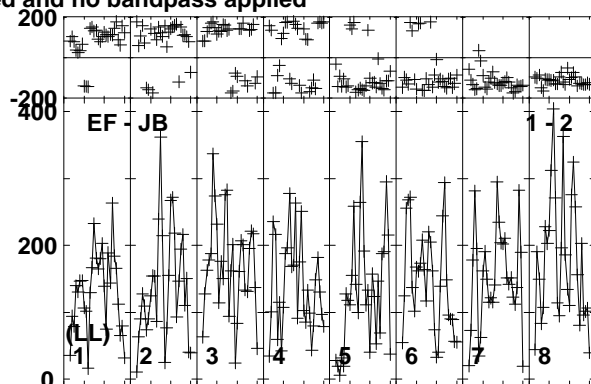
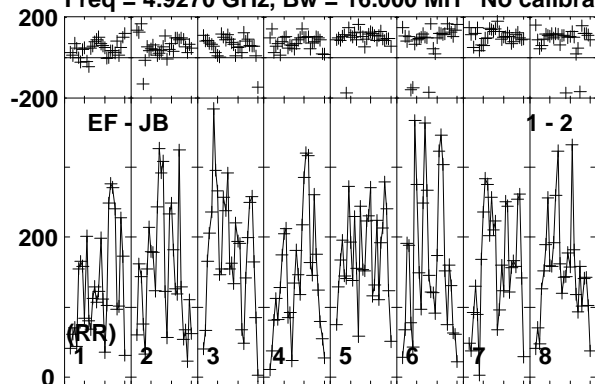

Lower frame: Micro Ampl Jy Top frame: Phas deg  
Vector averaged cross-power spectrum Baseline: EF (01) - JB (02)  
Timerange: 01/06:46:01 to 01/06:48:29

Plot file version 610 created 10-JUN-2016 17:23:03

CYGX1 RT013A.UVDATA.1

Freq = 4.9270 GHz, Bw = 16.000 MH No calibration applied and no bandpass applied

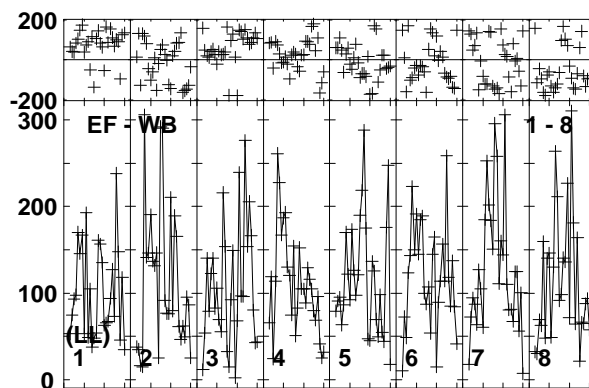
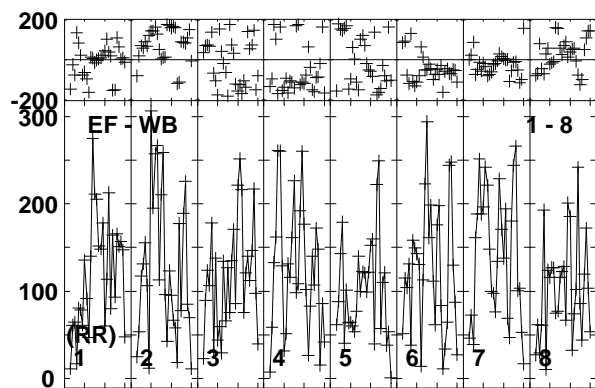
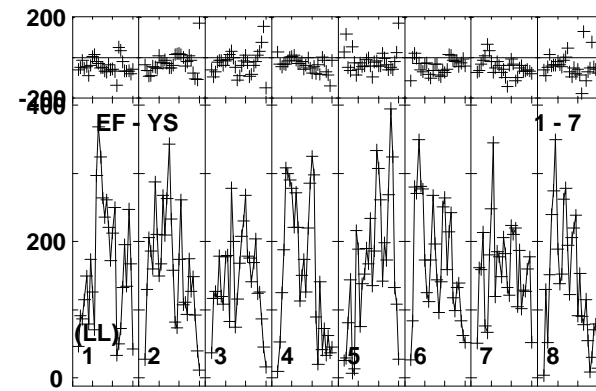
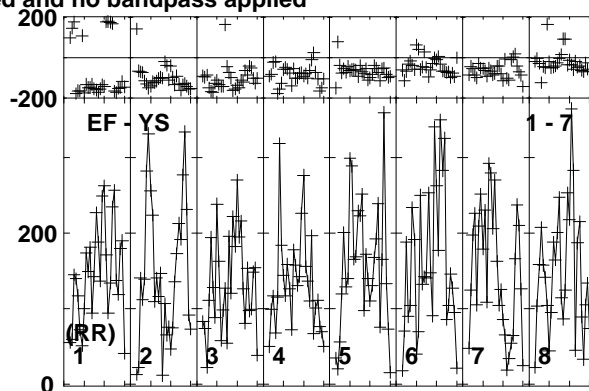
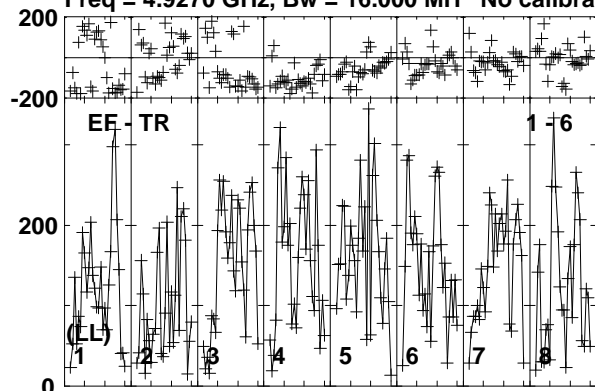

Lower frame: Micro Ampl Jy Top frame: Phas deg  
Vector averaged cross-power spectrum Baseline: EF (01) - TR (06)  
Timerange: 01/06:46:01 to 01/06:48:29



Plot file version 611 created 10-JUN-2016 17:23:03

J1957+3338 RT013A.UVDATA.1

Freq = 4.9270 GHz, Bw = 16.000 MH No calibration applied and no bandpass applied

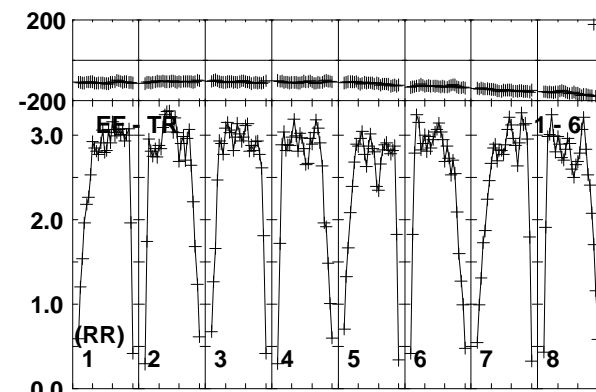
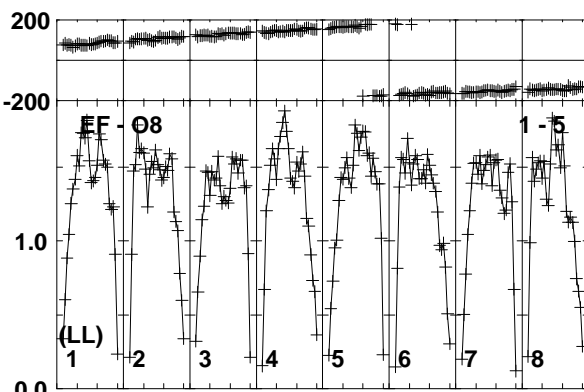
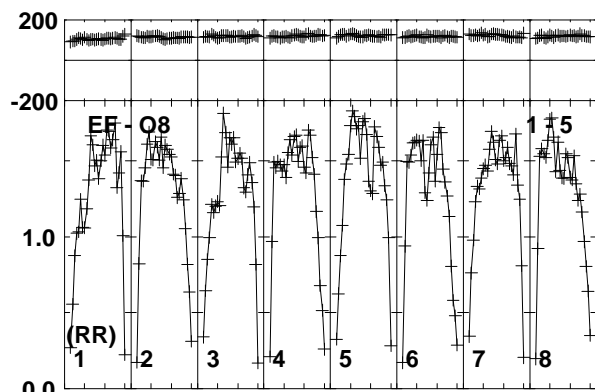
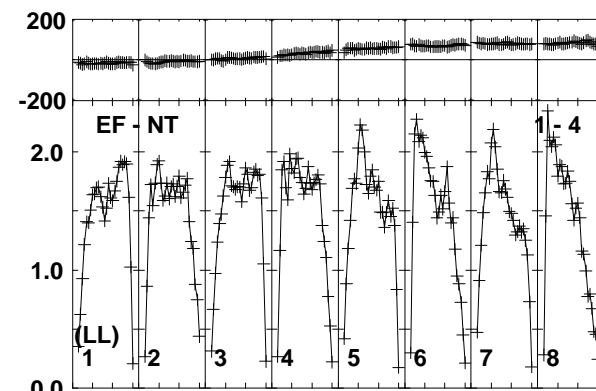
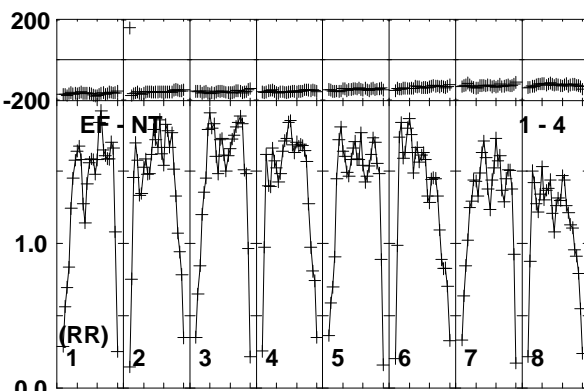
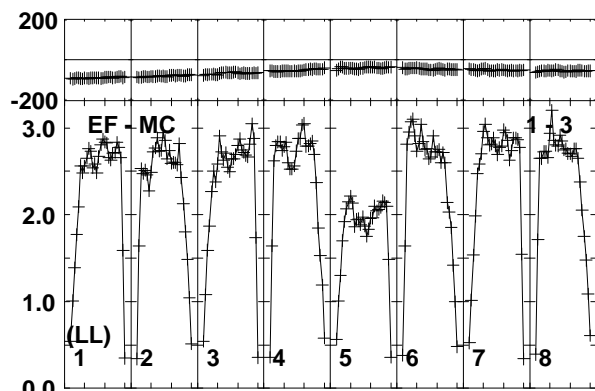
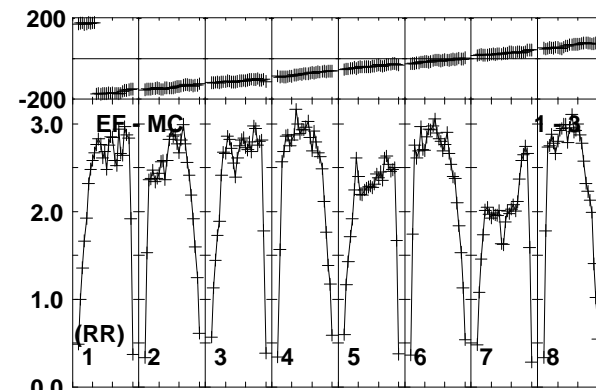
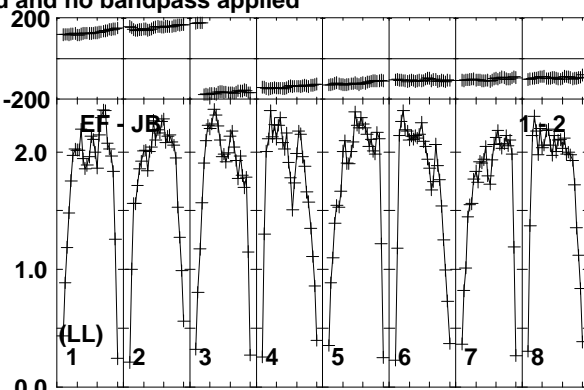
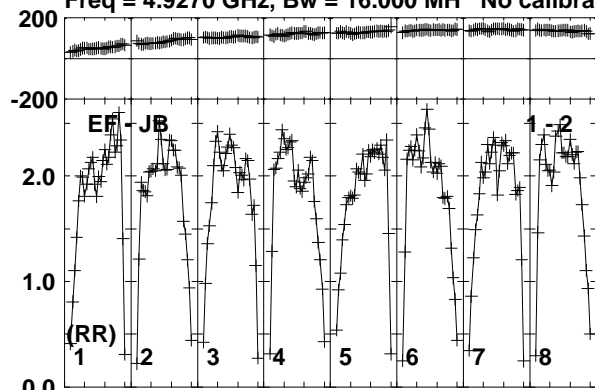

Lower frame: Milli Ampl Jy Top frame: Phas deg  
Vector averaged cross-power spectrum Baseline: EF (01) - JB (02)  
Timerange: 01/06:48:31 to 01/06:49:59

Plot file version 612 created 10-JUN-2016 17:23:03

J1957+3338 RT013A.UVDATA.1

Freq = 4.9270 GHz, Bw = 16.000 MH No calibration applied and no bandpass applied

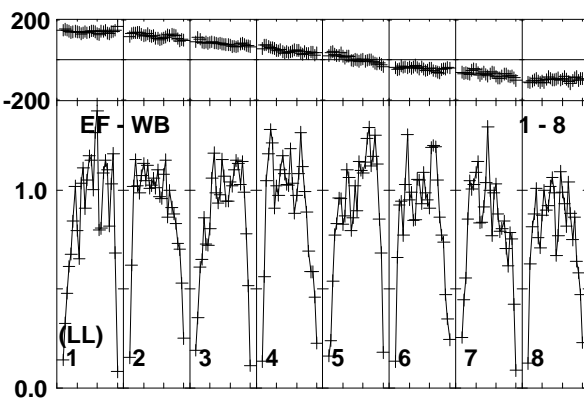
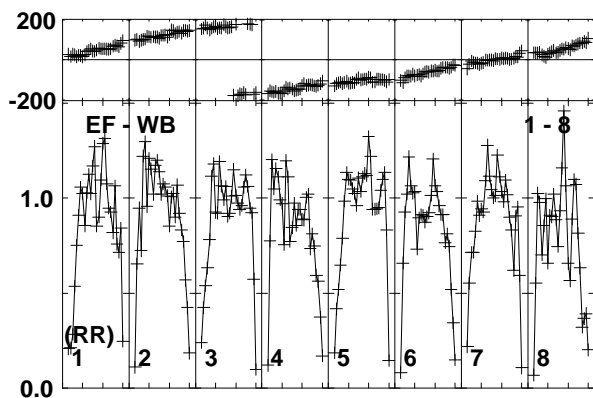
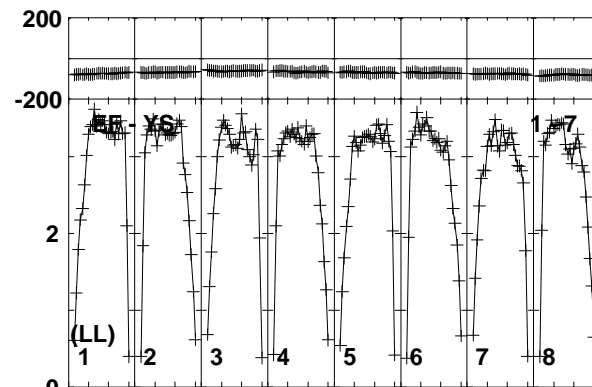
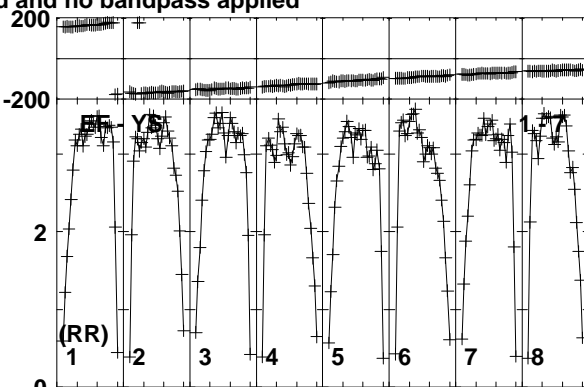
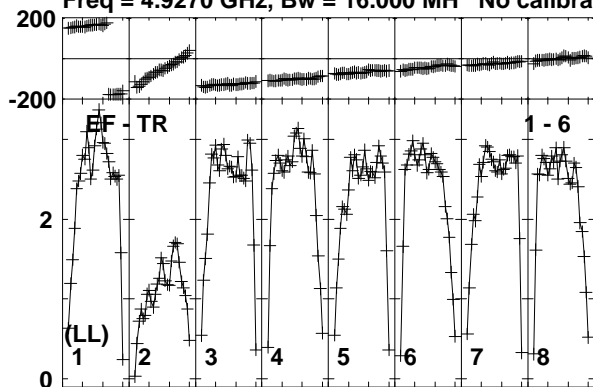

Lower frame: Milli Ampl Jy Top frame: Phas deg  
Vector averaged cross-power spectrum Baseline: EF (01) - TR (06)  
Timerange: 01/06:48:31 to 01/06:49:59

Plot file version 613 created 10-JUN-2016 17:23:03

CHECK RT013A.UVDATA.1

Freq = 4.9270 GHz, Bw = 16.000 MH No calibration applied and no bandpass applied

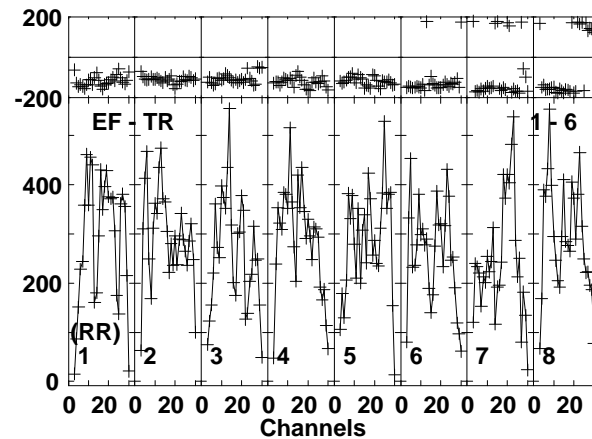
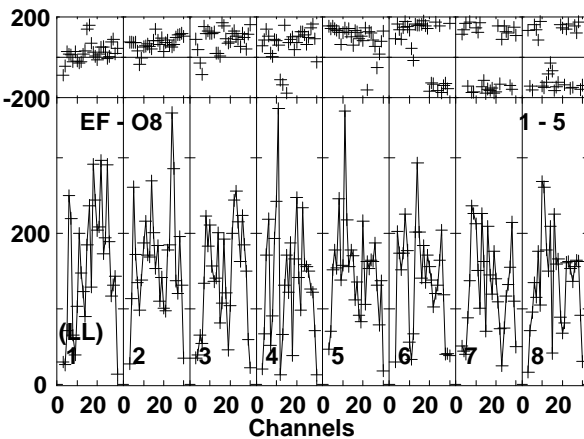
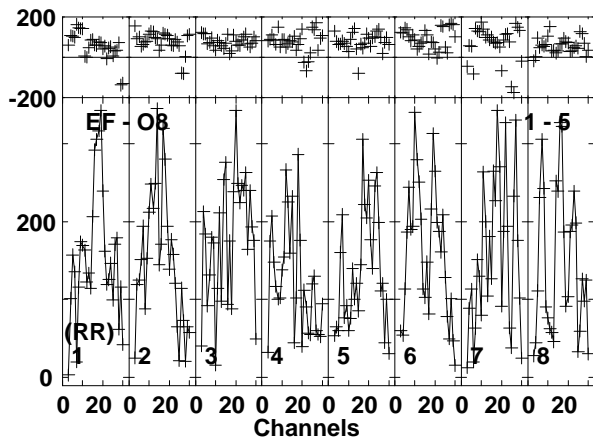
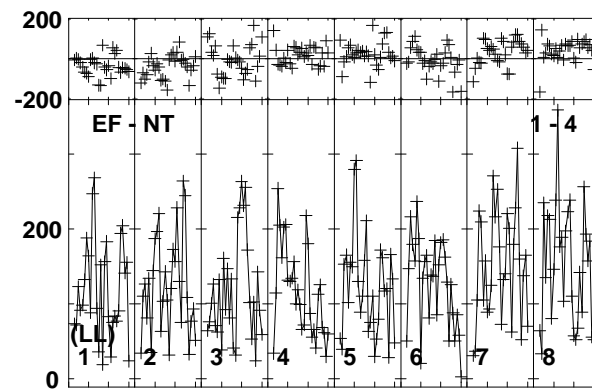
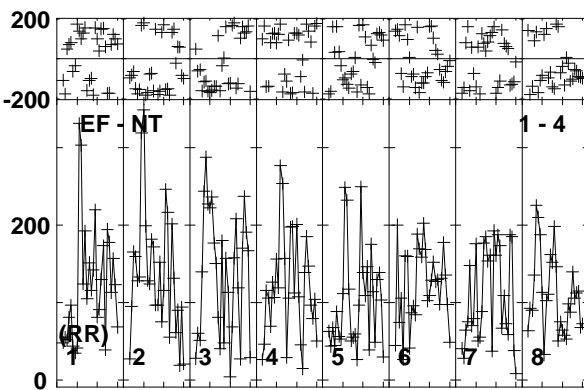
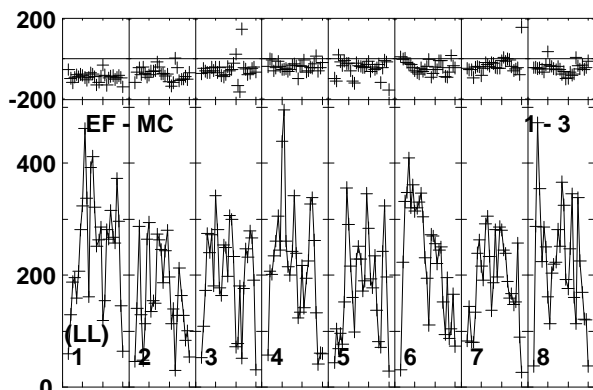
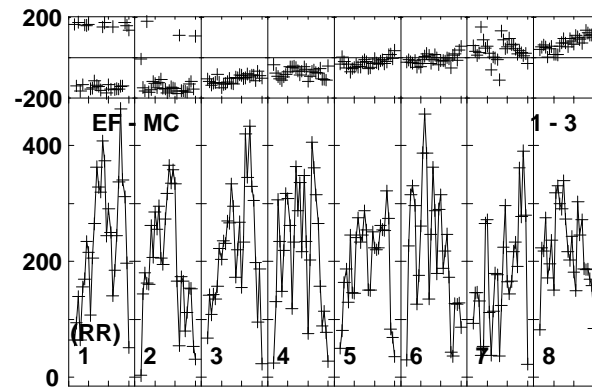
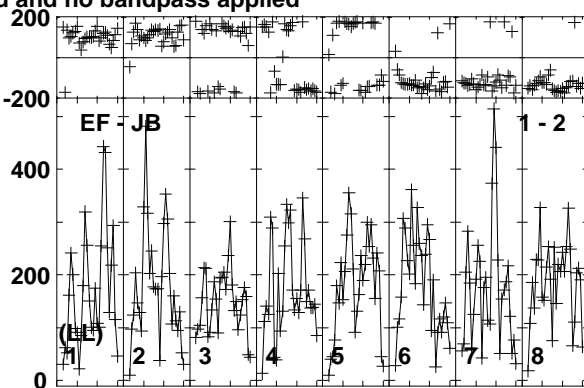
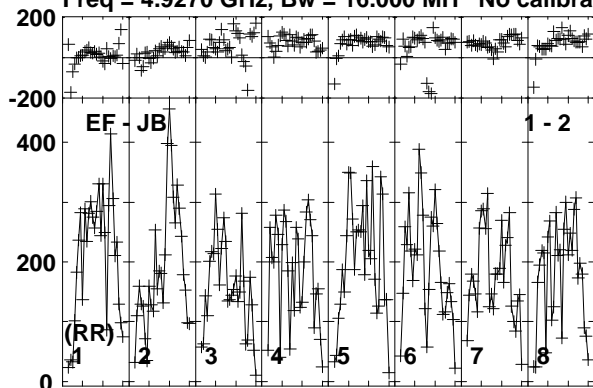

Lower frame: Micro Ampl Jy Top frame: Phas deg  
Vector averaged cross-power spectrum Baseline: EF (01) - JB (02)  
Timerange: 01/06:50:40 to 01/06:52:39

Plot file version 614 created 10-JUN-2016 17:23:03

CHECK RT013A.UVDATA.1

Freq = 4.9270 GHz, Bw = 16.000 MH No calibration applied and no bandpass applied

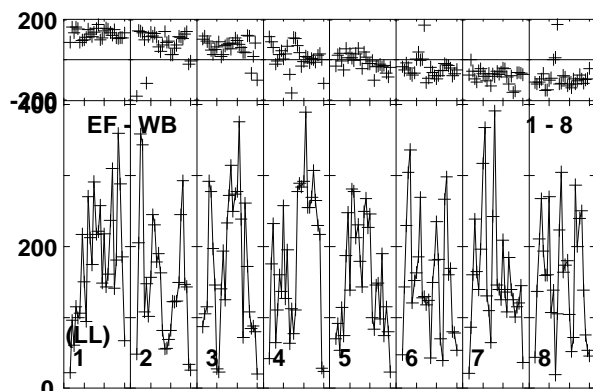
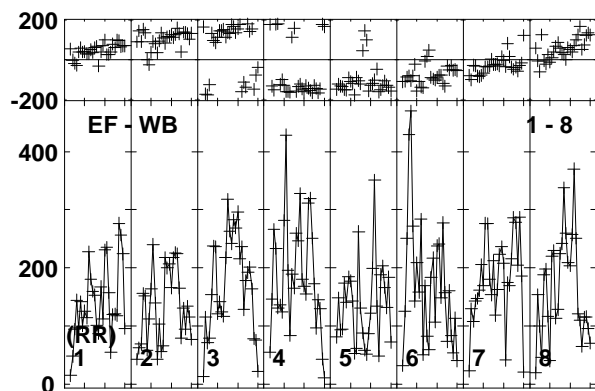
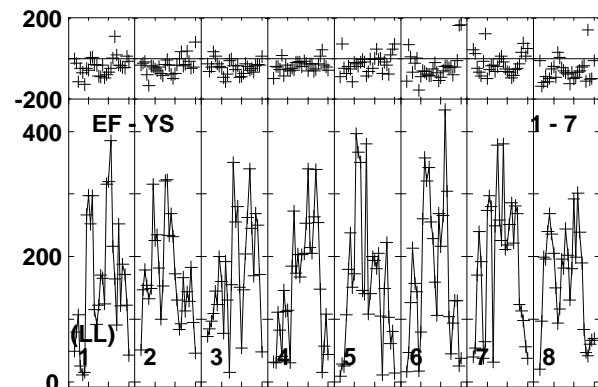
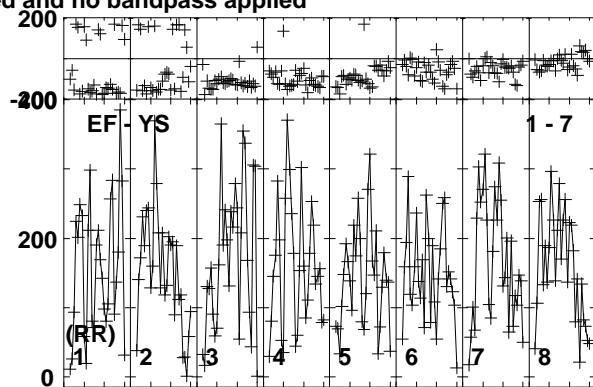
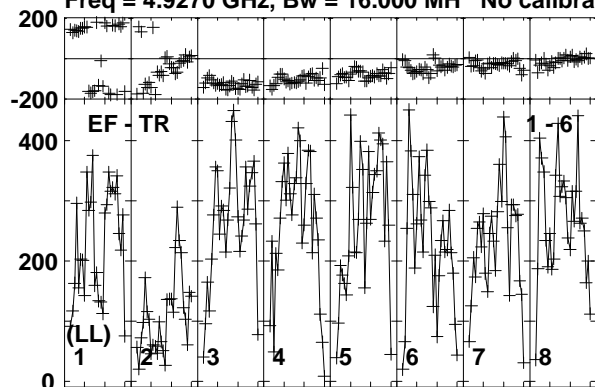

Lower frame: Micro Ampl Jy Top frame: Phas deg  
Vector averaged cross-power spectrum Baseline: EF (01) - TR (06)  
Timerange: 01/06:50:40 to 01/06:52:39

Plot file version 615 created 10-JUN-2016 17:23:03

CYGX1 RT013A.UVDATA.1

Freq = 4.9270 GHz, Bw = 16.000 MH No calibration applied and no bandpass applied

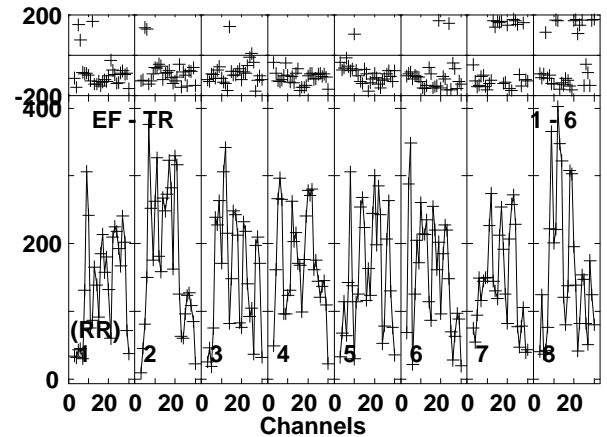
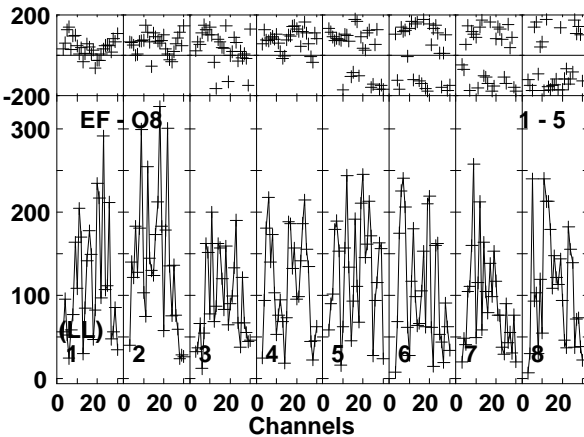
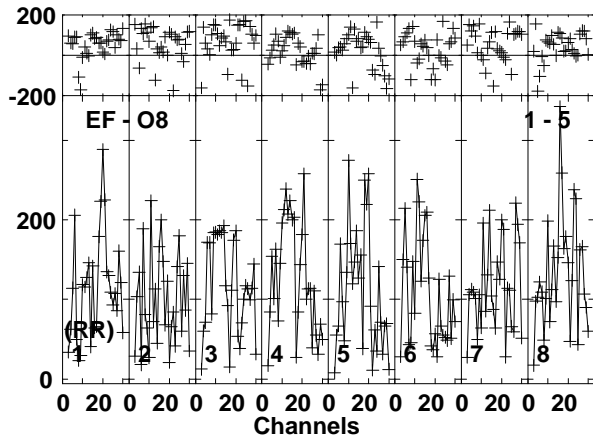
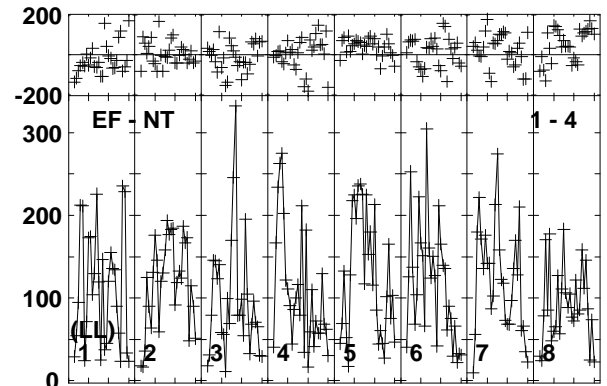
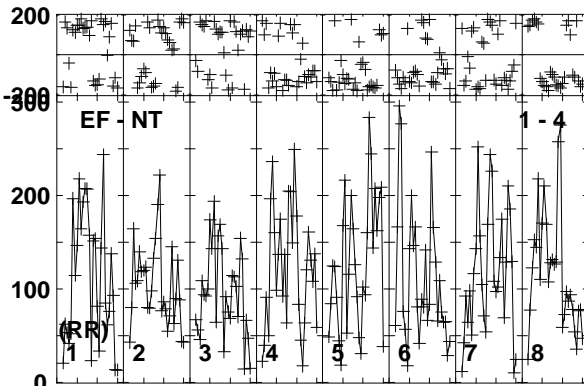
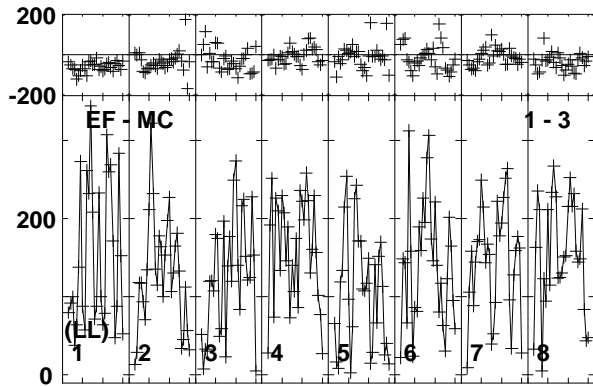
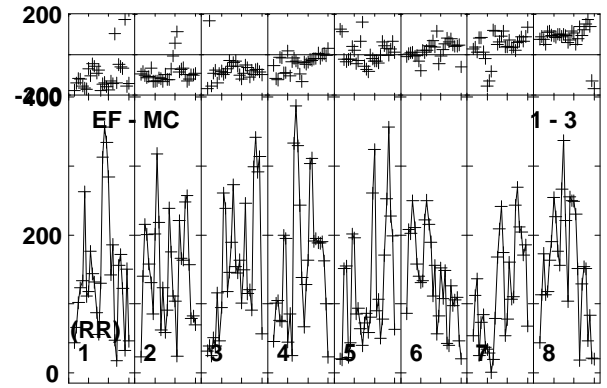
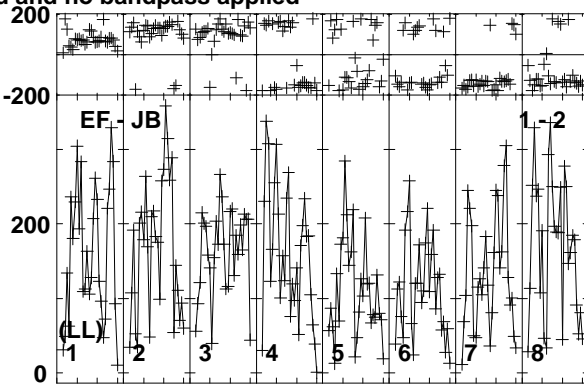
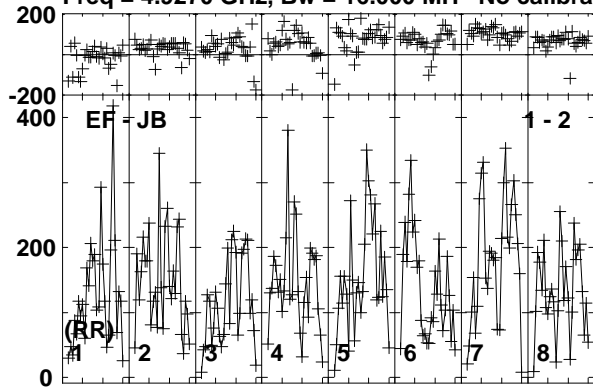

Lower frame: Micro Ampl Jy Top frame: Phas deg  
Vector averaged cross-power spectrum Baseline: EF (01) - JB (02)  
Timerange: 01/06:52:40 to 01/06:55:09

Plot file version 616 created 10-JUN-2016 17:23:03

CYGX1 RT013A.UVDATA.1

Freq = 4.9270 GHz, Bw = 16.000 MH No calibration applied and no bandpass applied

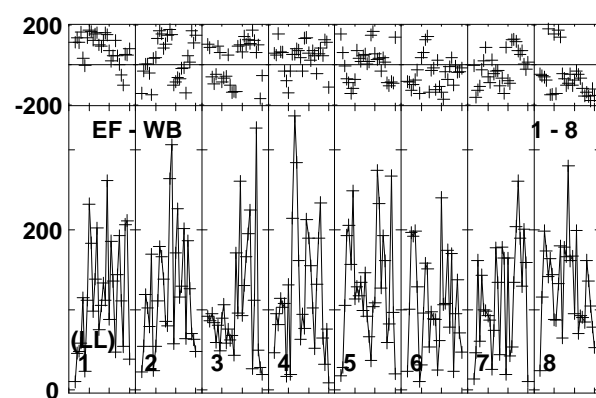
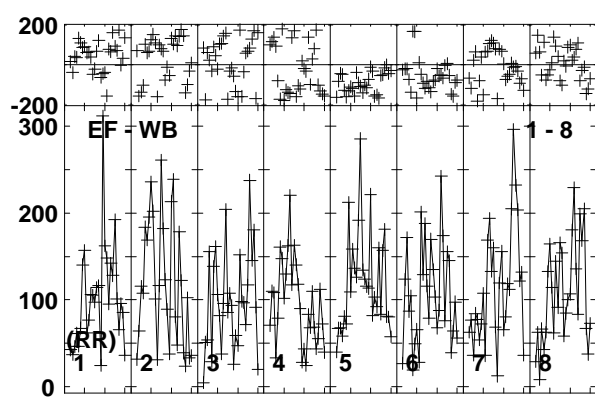
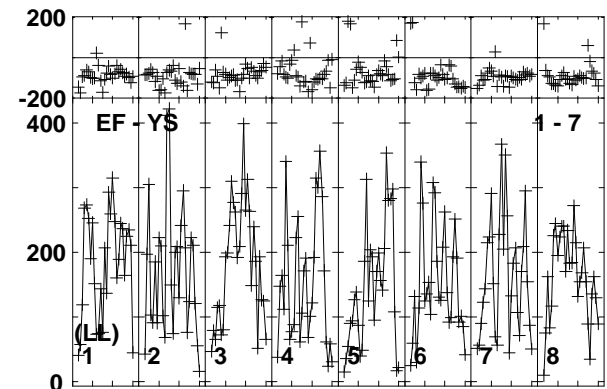
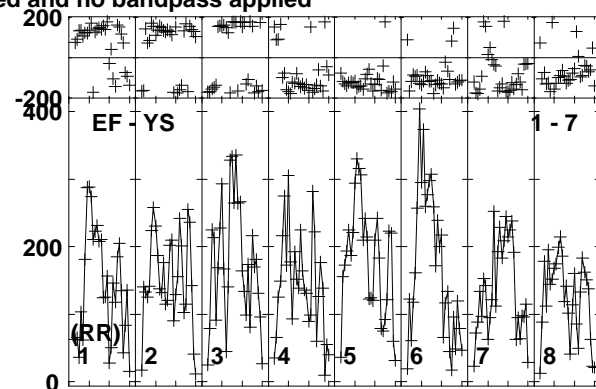
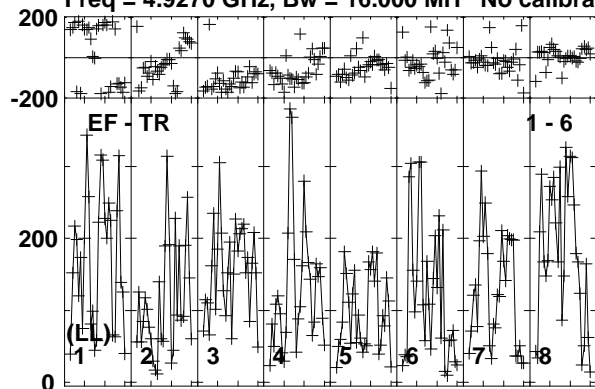

Lower frame: Micro Ampl Jy Top frame: Phas deg  
Vector averaged cross-power spectrum Baseline: EF (01) - TR (06)  
Timerange: 01/06:52:40 to 01/06:55:09

Plot file version 617 created 10-JUN-2016 17:23:03

J1957+3338 RT013A.UVDATA.1

Freq = 4.9270 GHz, Bw = 16.000 MH No calibration applied and no bandpass applied

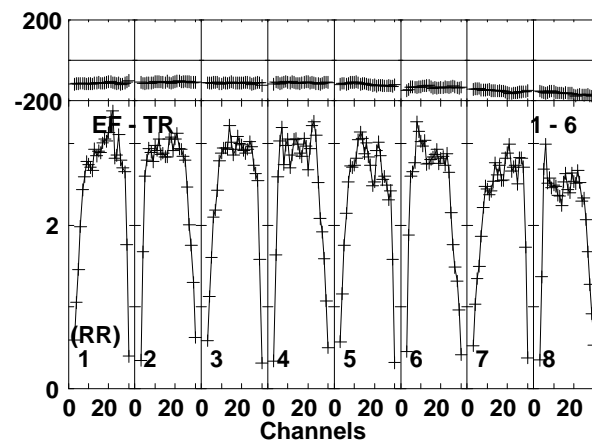
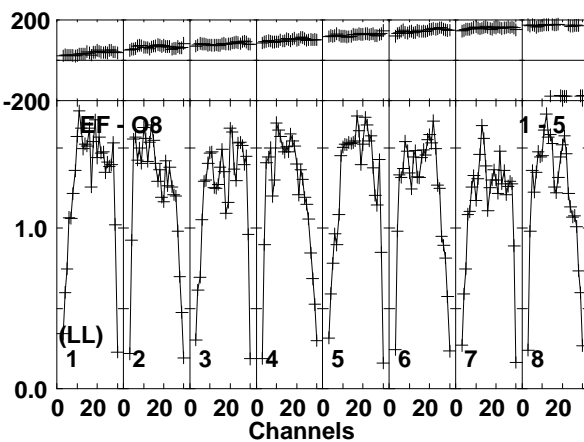
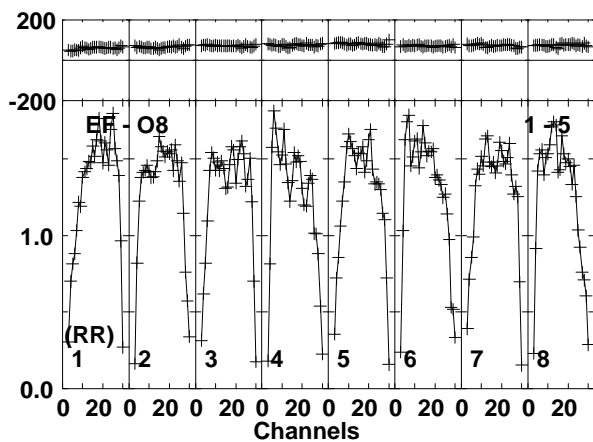
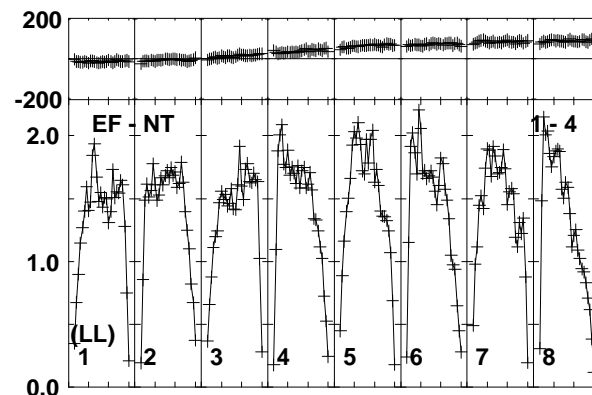
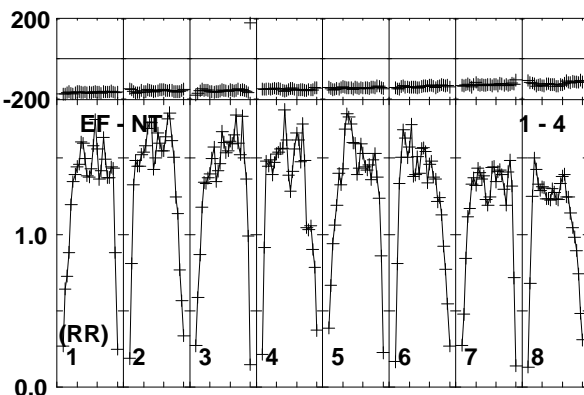
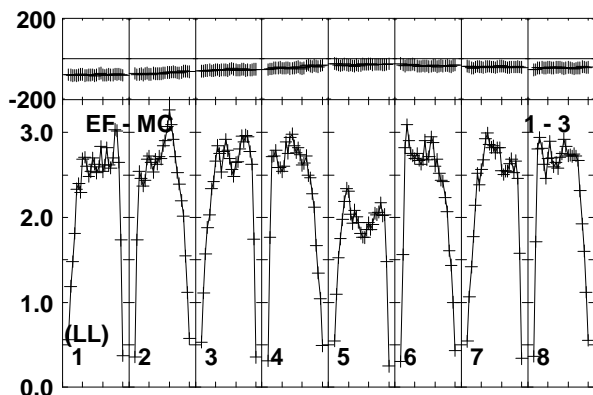
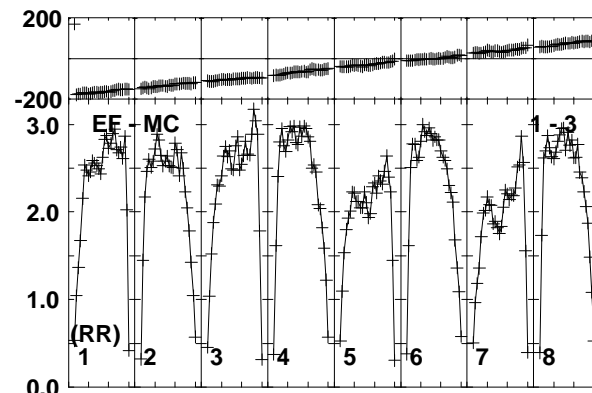
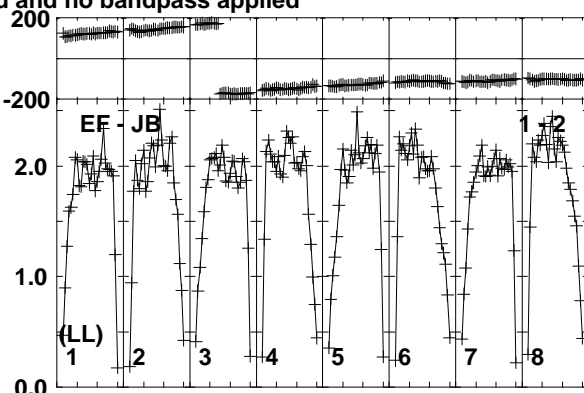
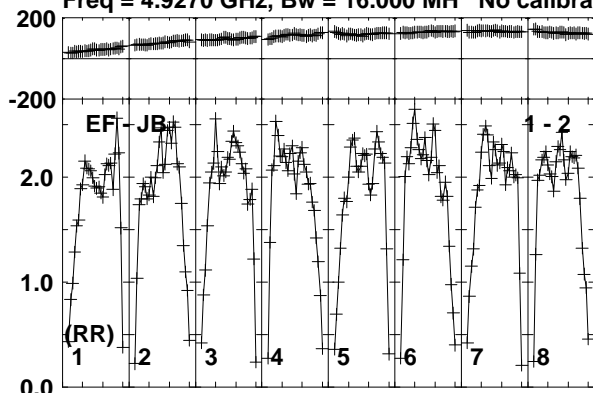

Lower frame: Milli Ampl Jy Top frame: Phas deg  
Vector averaged cross-power spectrum Baseline: EF (01) - JB (02)  
Timerange: 01/06:55:11 to 01/06:56:39

Plot file version 618 created 10-JUN-2016 17:23:03

J1957+3338 RT013A.UVDATA.1

Freq = 4.9270 GHz, Bw = 16.000 MH No calibration applied and no bandpass applied

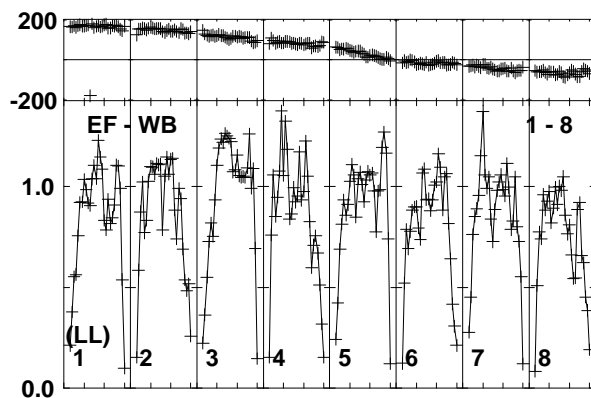
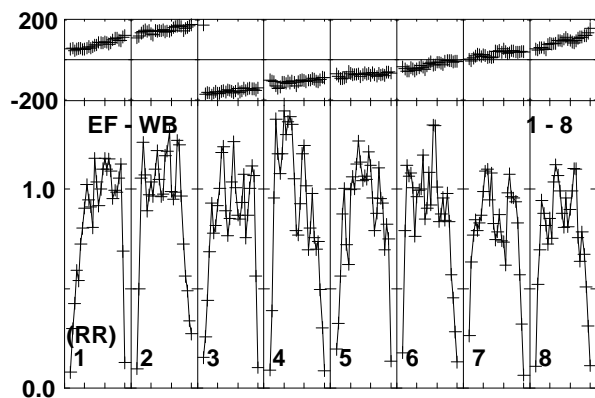
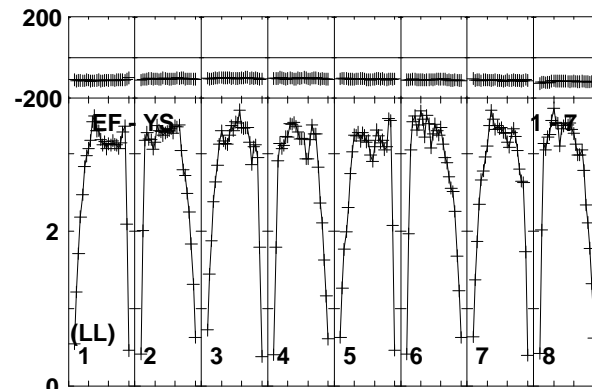
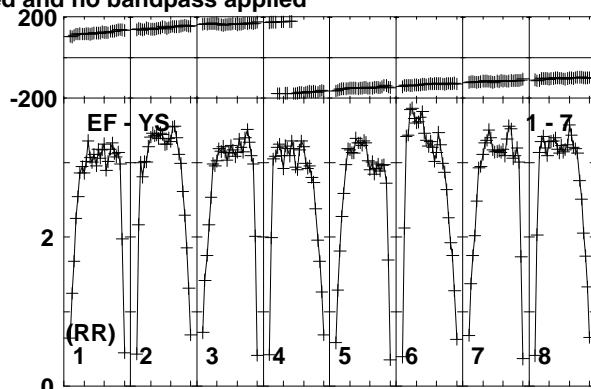
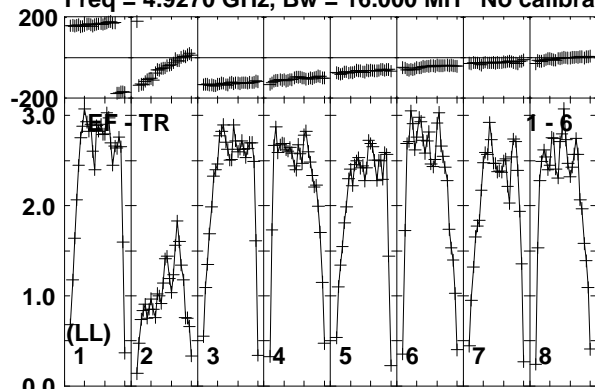

Lower frame: Milli Ampl Jy Top frame: Phas deg  
Vector averaged cross-power spectrum Baseline: EF (01) - TR (06)  
Timerange: 01/06:55:11 to 01/06:56:39



Plot file version 619 created 10-JUN-2016 17:23:03

CHECK RT013A.UVDATA.1

Freq = 4.9270 GHz, Bw = 16.000 MH No calibration applied and no bandpass applied

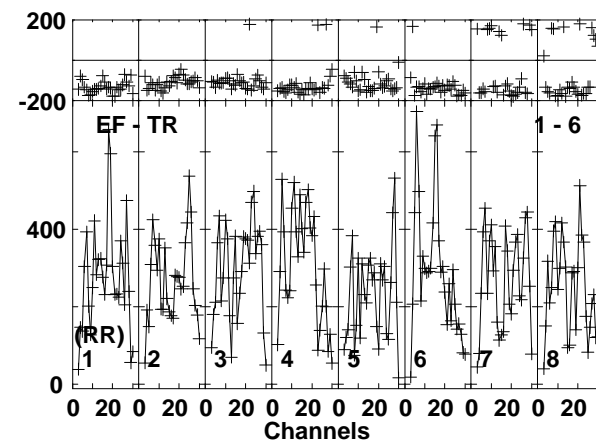
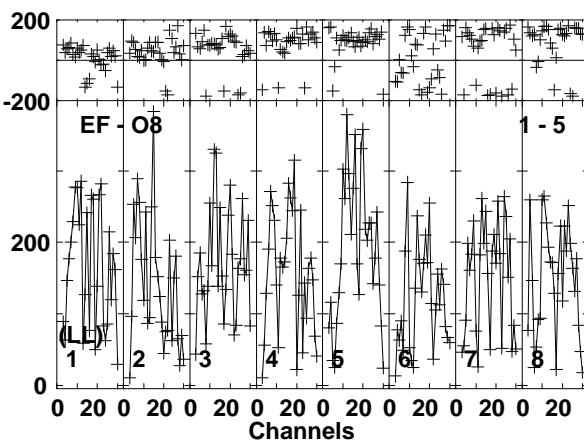
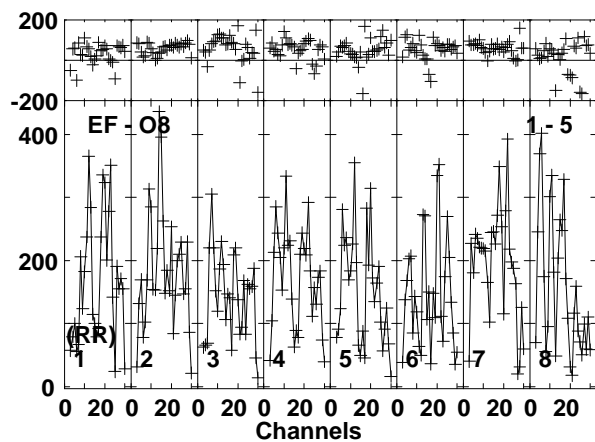
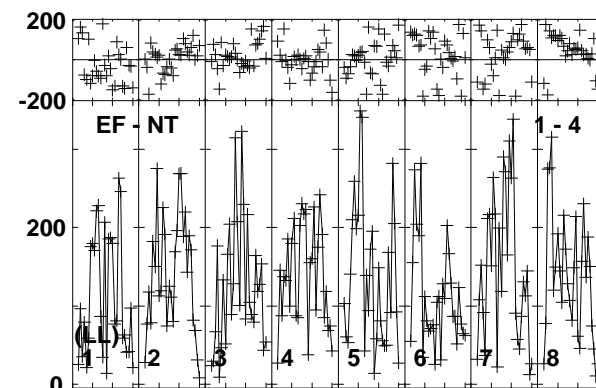
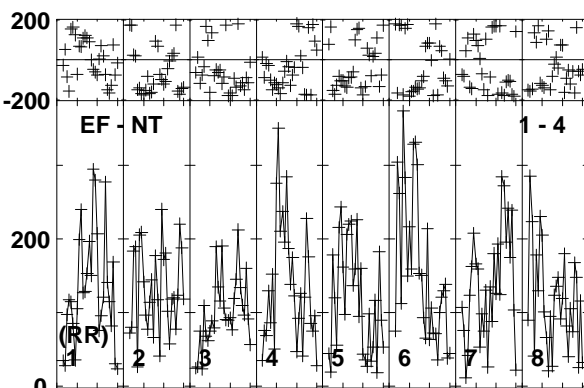
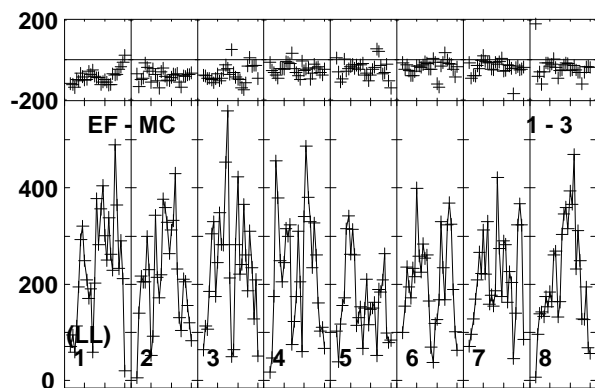
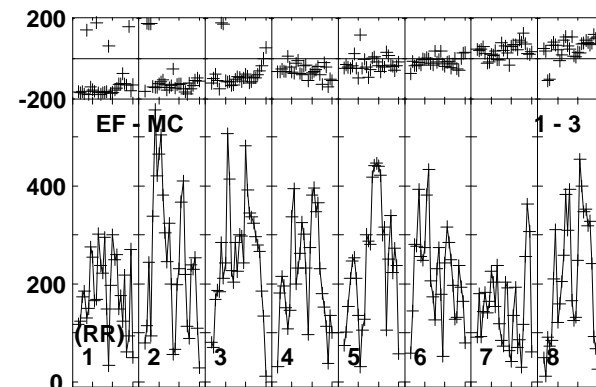
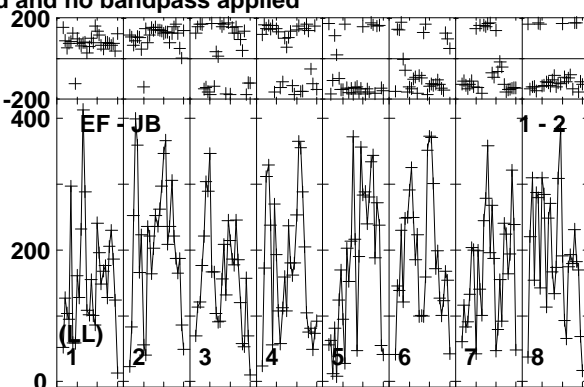
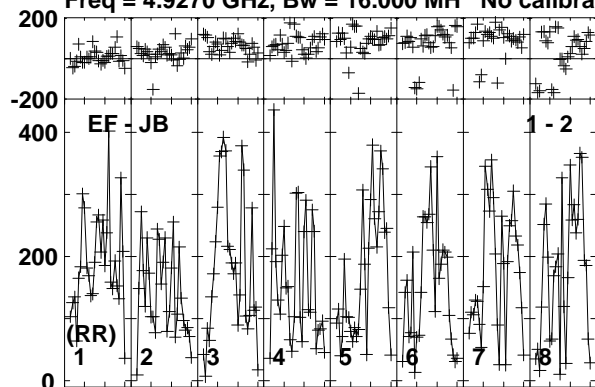

Lower frame: Micro Ampl Jy Top frame: Phas deg  
Vector averaged cross-power spectrum Baseline: EF (01) - JB (02)  
Timerange: 01/06:56:41 to 01/06:58:40

Plot file version 620 created 10-JUN-2016 17:23:03

CHECK RT013A.UVDATA.1

Freq = 4.9270 GHz, Bw = 16.000 MH No calibration applied and no bandpass applied

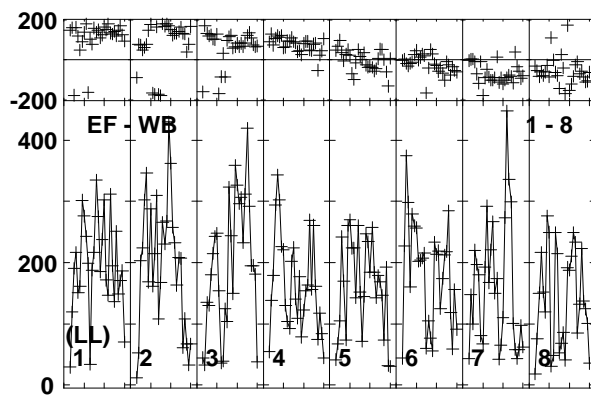
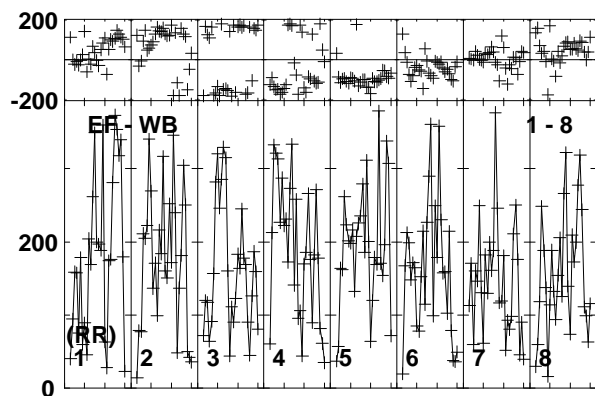
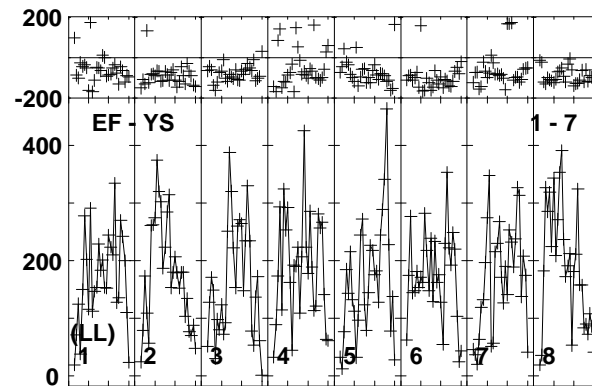
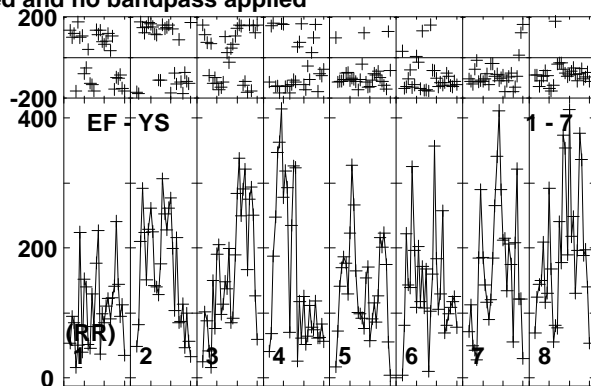
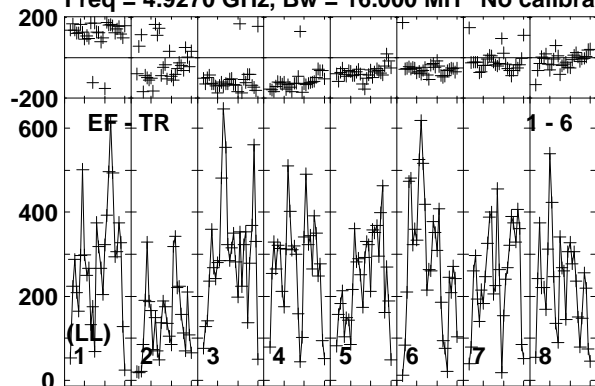

Lower frame: Micro Ampl Jy Top frame: Phas deg  
Vector averaged cross-power spectrum Baseline: EF (01) - TR (06)  
Timerange: 01/06:56:41 to 01/06:58:40

Plot file version 621 created 10-JUN-2016 17:23:04

CYGX1 RT013A.UVDATA.1

Freq = 4.9270 GHz, Bw = 16.000 MH No calibration applied and no bandpass applied

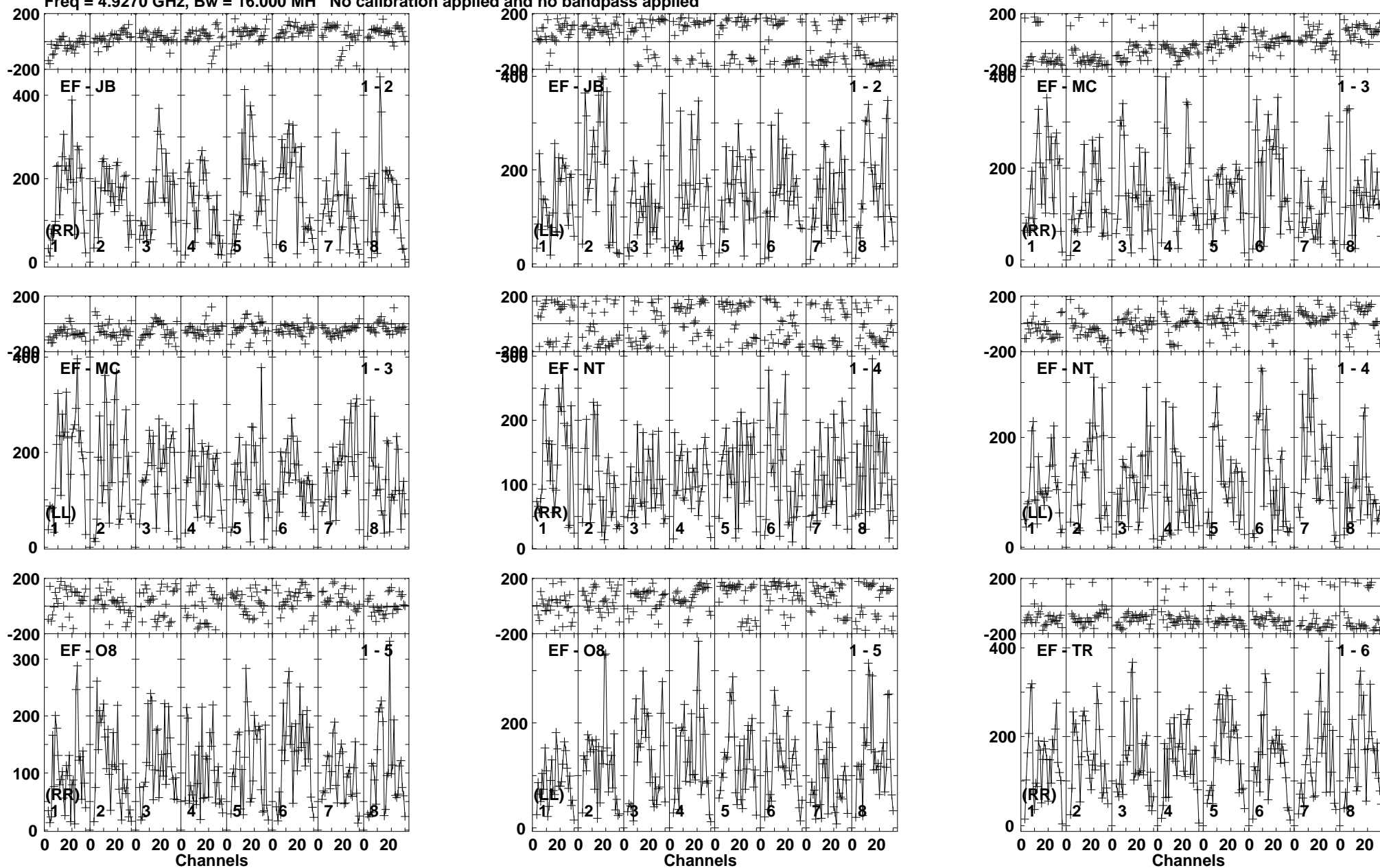

Lower frame: Micro Ampl Jy Top frame: Phas deg  
Vector averaged cross-power spectrum Baseline: EF (01) - JB (02)  
Timerange: 01/06:58:41 to 01/07:01:09

Plot file version 622 created 10-JUN-2016 17:23:04

CYGX1 RT013A.UVDATA.1

Freq = 4.9270 GHz, Bw = 16.000 MH No calibration applied and no bandpass applied

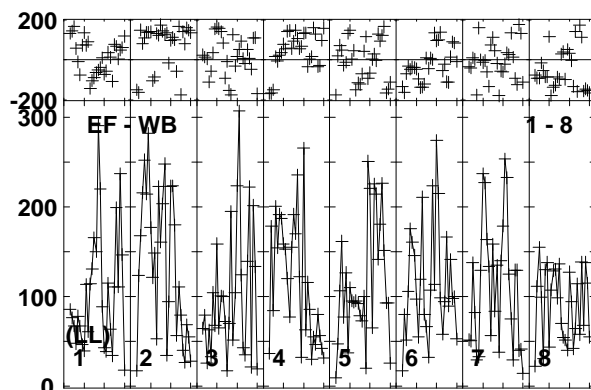
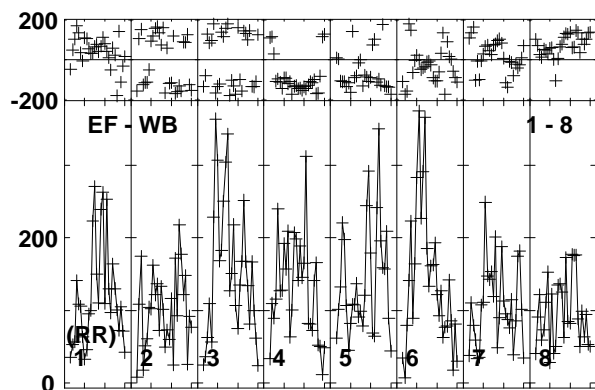
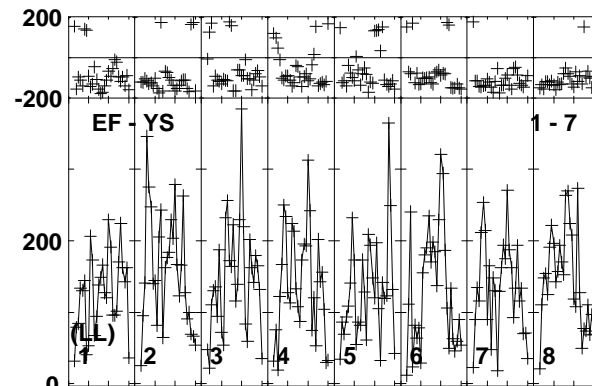
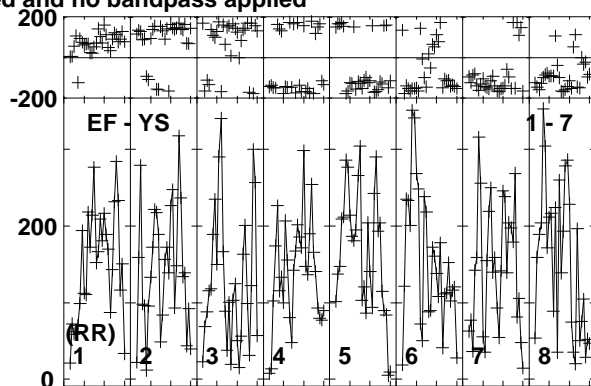
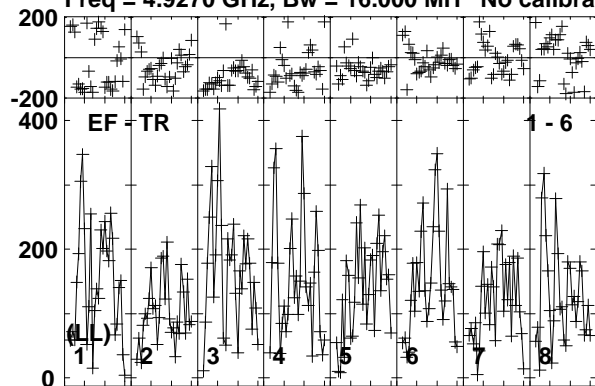

Lower frame: Micro Ampl Jy Top frame: Phas deg  
Vector averaged cross-power spectrum Baseline: EF (01) - TR (06)  
Timerange: 01/06:58:41 to 01/07:01:09

Plot file version 623 created 10-JUN-2016 17:23:04

J1957+3338 RT013A.UVDATA.1

Freq = 4.9270 GHz, Bw = 16.000 MH No calibration applied and no bandpass applied

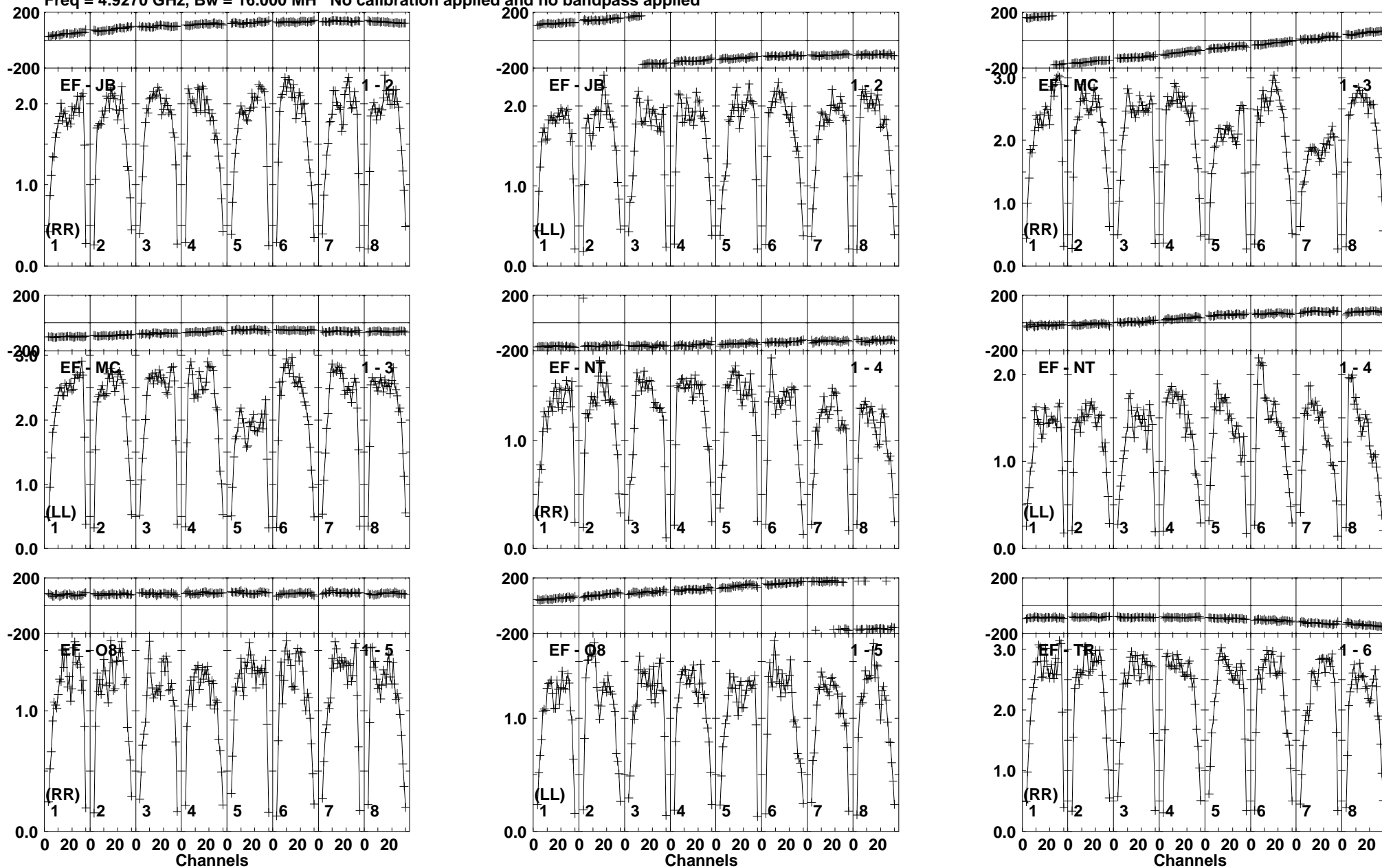

Lower frame: Milli Ampl Jy Top frame: Phas deg  
Vector averaged cross-power spectrum Baseline: EF (01) - JB (02)  
Timerange: 01/07:01:10 to 01/07:02:39

Plot file version 624 created 10-JUN-2016 17:23:04

J1957+3338 RT013A.UVDATA.1

Freq = 4.9270 GHz, Bw = 16.000 MH No calibration applied and no bandpass applied

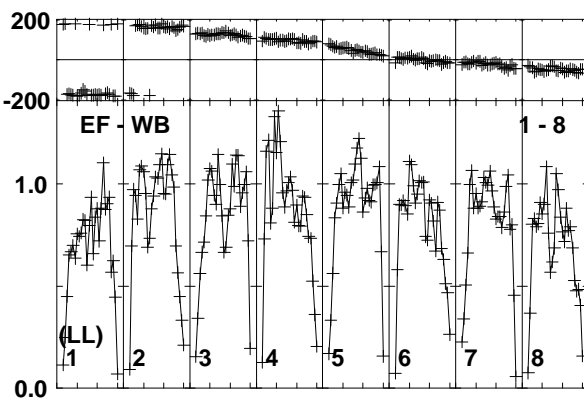
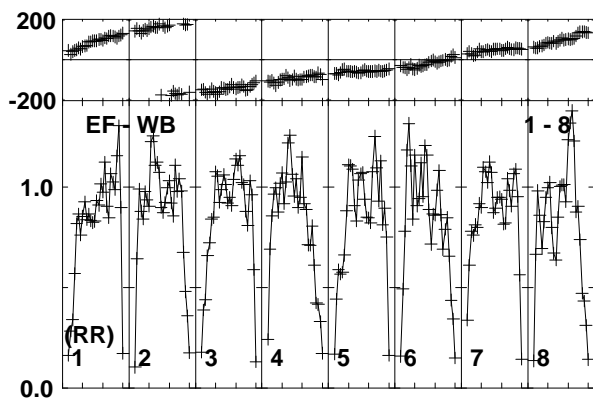
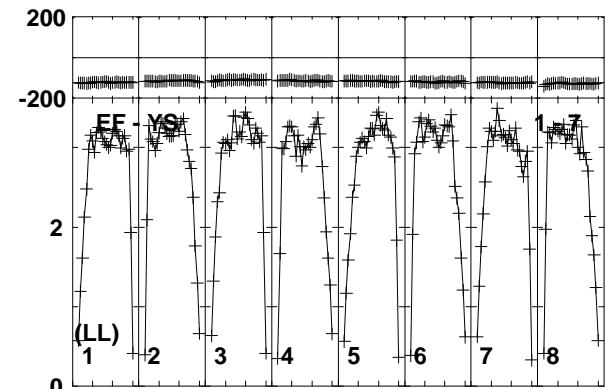
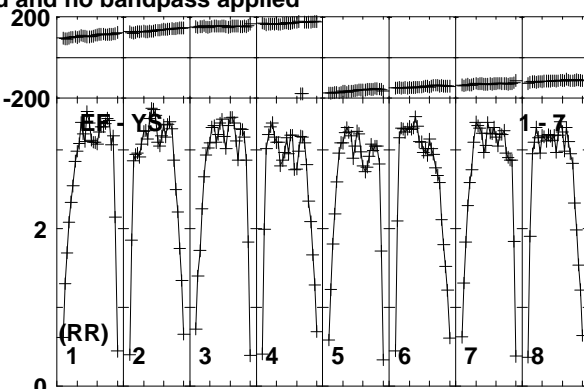
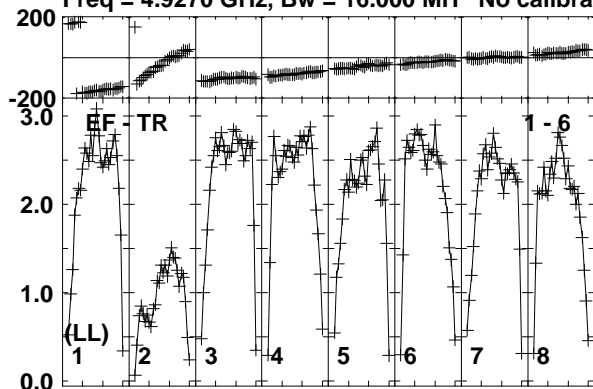

Lower frame: Milli Ampl Jy Top frame: Phas deg  
Vector averaged cross-power spectrum Baseline: EF (01) - TR (06)  
Timerange: 01/07:01:10 to 01/07:02:39

Plot file version 625 created 10-JUN-2016 17:23:04

CHECK RT013A.UVDATA.1

Freq = 4.9270 GHz, Bw = 16.000 MH No calibration applied and no bandpass applied

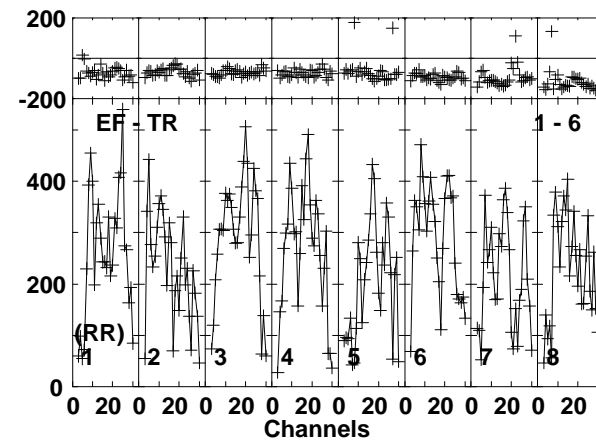
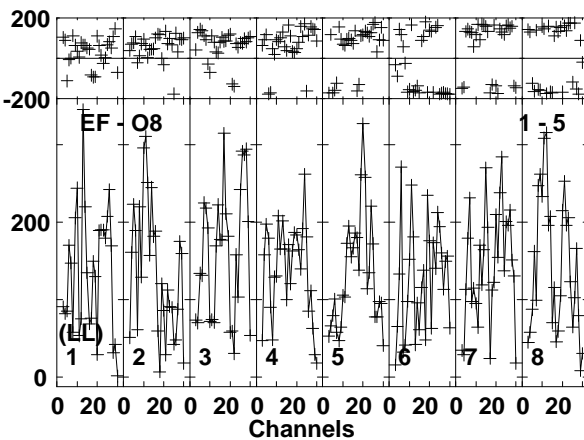
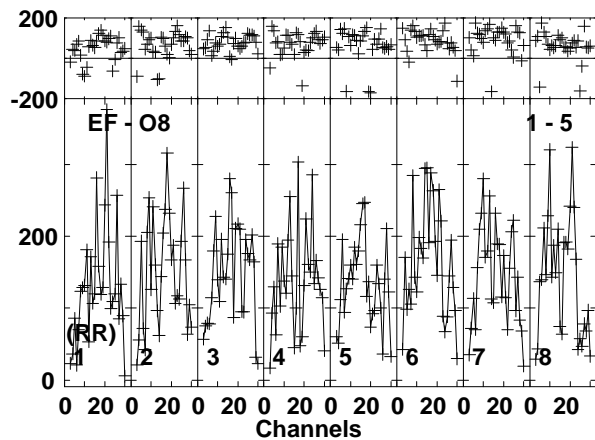
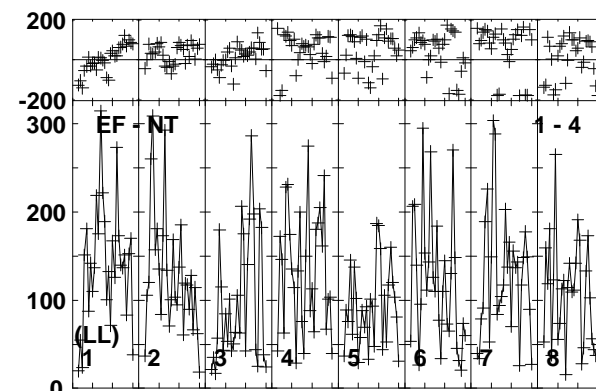
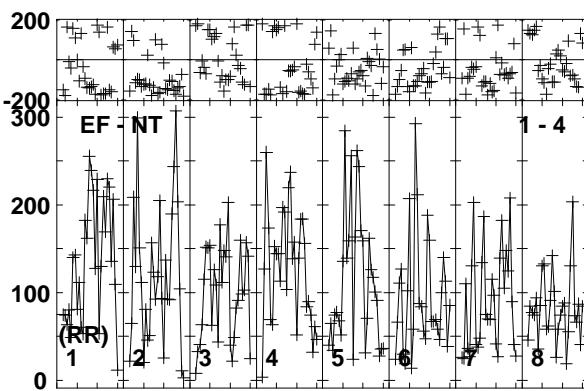
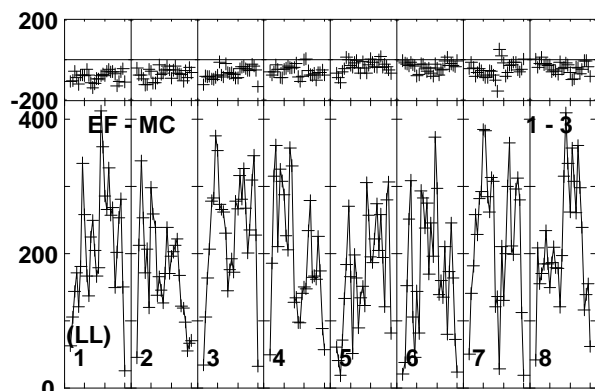
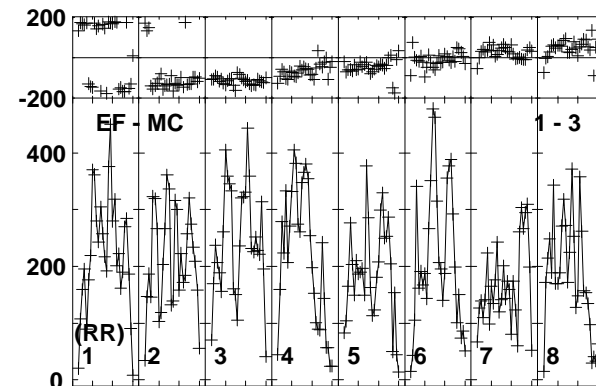
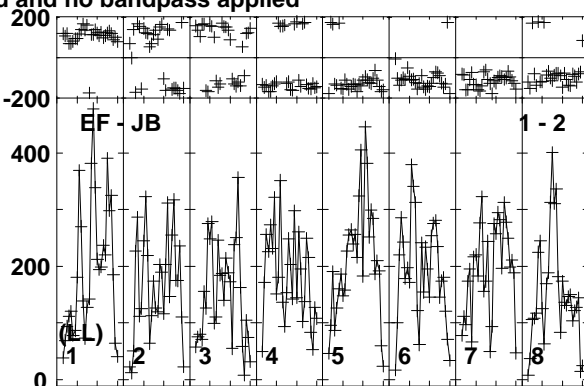
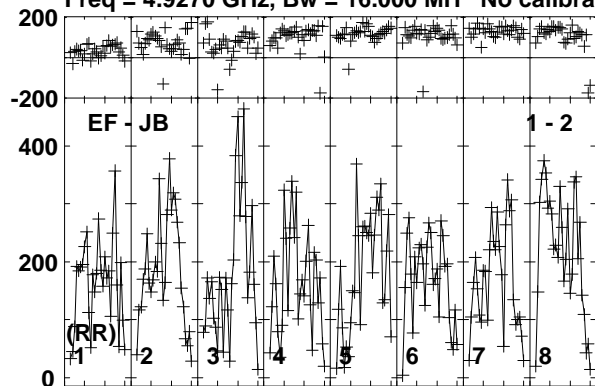

Lower frame: Micro Ampl Jy Top frame: Phas deg  
Vector averaged cross-power spectrum Baseline: EF (01) - JB (02)  
Timerange: 01/07:03:21 to 01/07:05:20

Plot file version 626 created 10-JUN-2016 17:23:04

CHECK RT013A.UVDATA.1

Freq = 4.9270 GHz, Bw = 16.000 MH No calibration applied and no bandpass applied

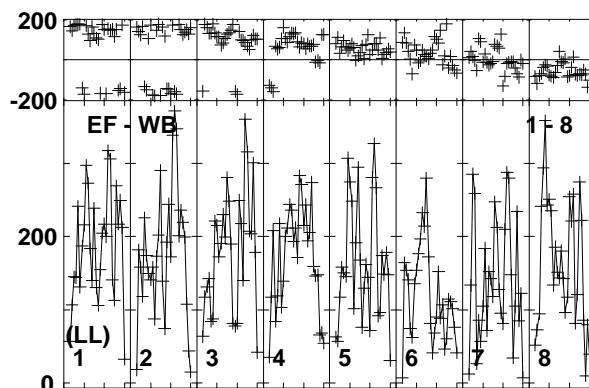
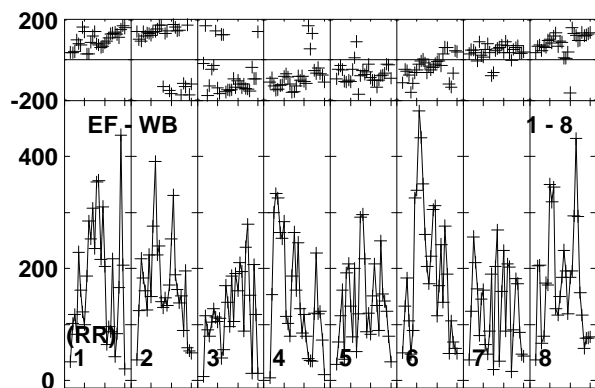
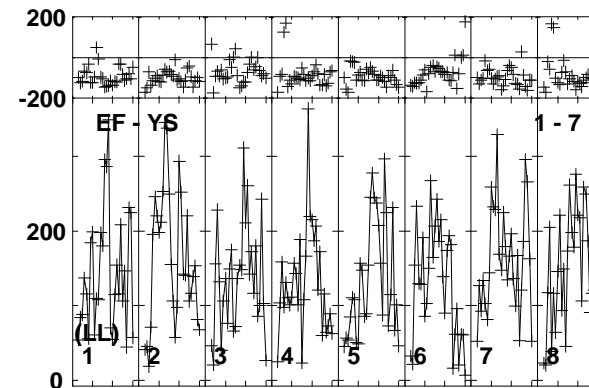
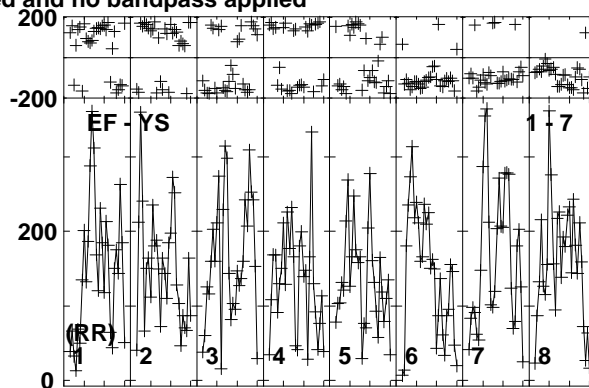
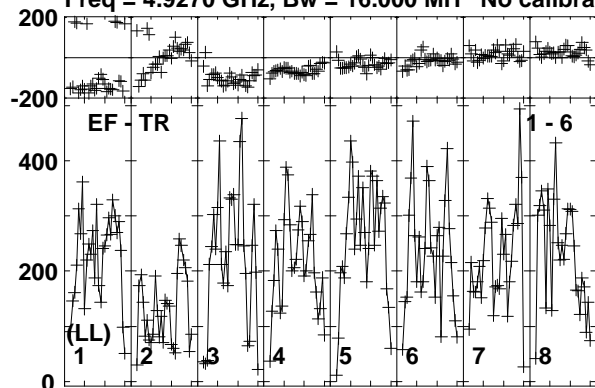

Lower frame: Micro Ampl Jy Top frame: Phas deg  
Vector averaged cross-power spectrum Baseline: EF (01) - TR (06)  
Timerange: 01/07:03:21 to 01/07:05:20



Plot file version 627 created 10-JUN-2016 17:23:04

CYGX1 RT013A.UVDATA.1

Freq = 4.9270 GHz, Bw = 16.000 MH No calibration applied and no bandpass applied

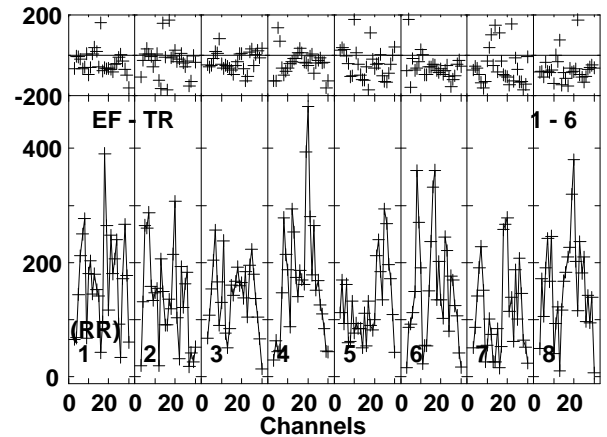
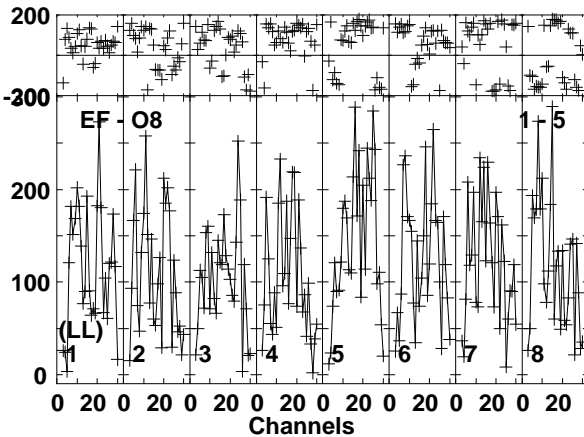
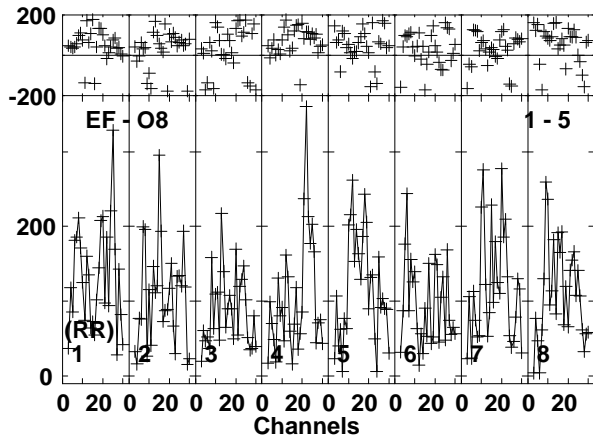
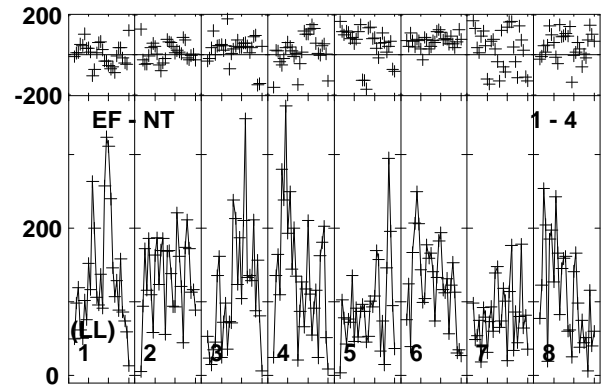
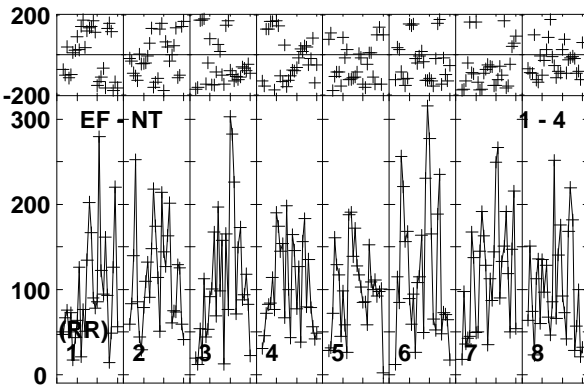
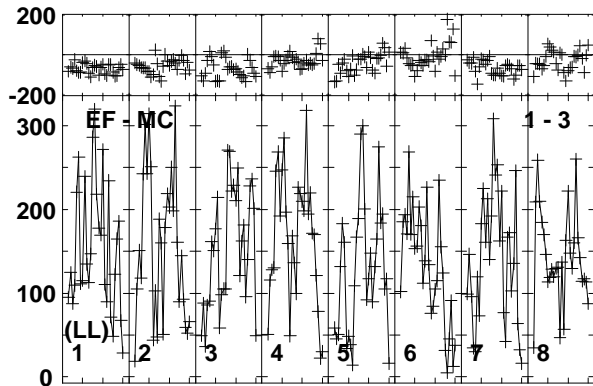
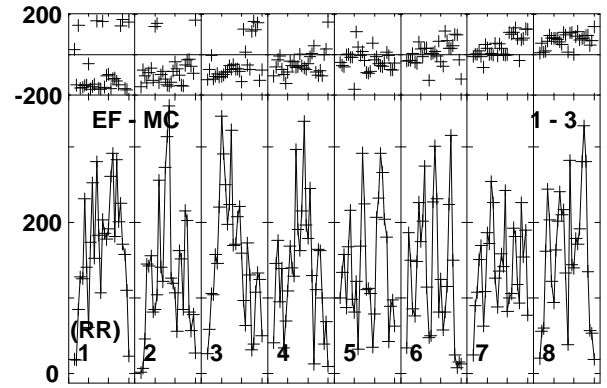
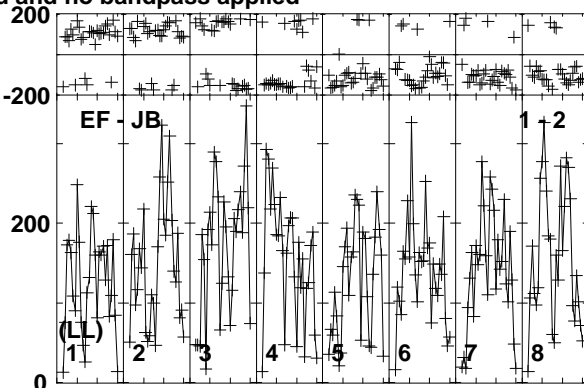
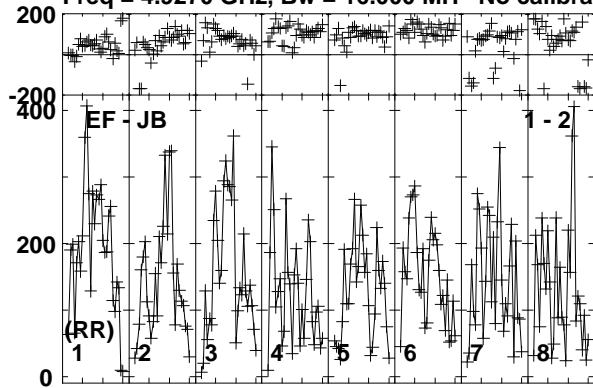

Lower frame: Micro Ampl Jy Top frame: Phas deg  
Vector averaged cross-power spectrum Baseline: EF (01) - JB (02)  
Timerange: 01/07:05:21 to 01/07:07:49

Plot file version 628 created 10-JUN-2016 17:23:04

CYGX1 RT013A.UVDATA.1

Freq = 4.9270 GHz, Bw = 16.000 MH No calibration applied and no bandpass applied

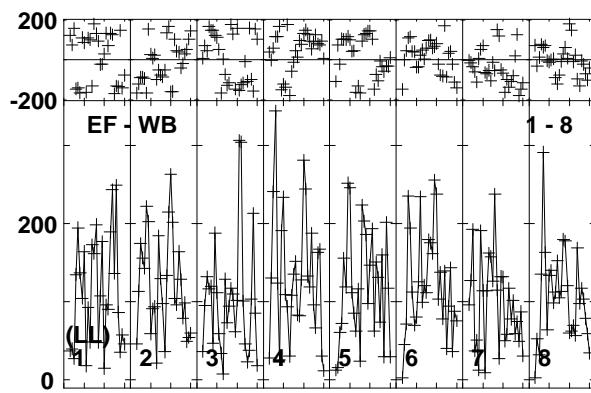
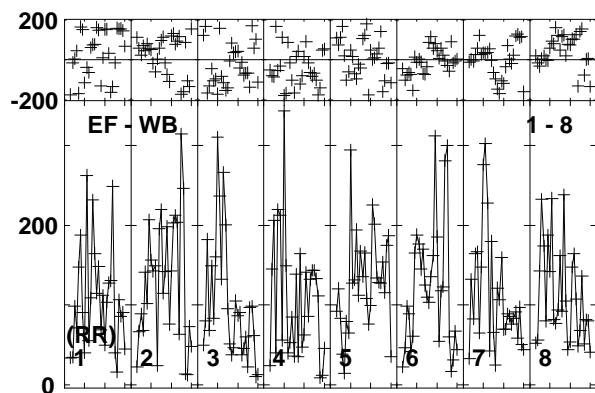
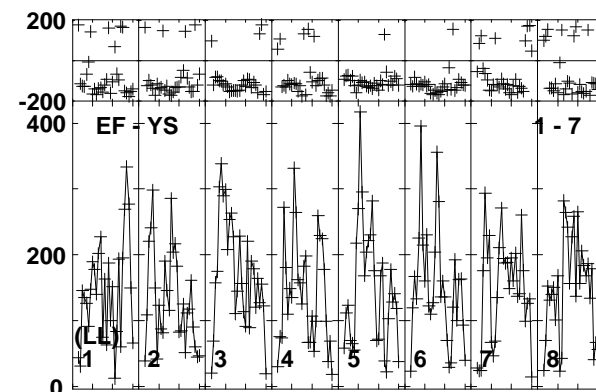
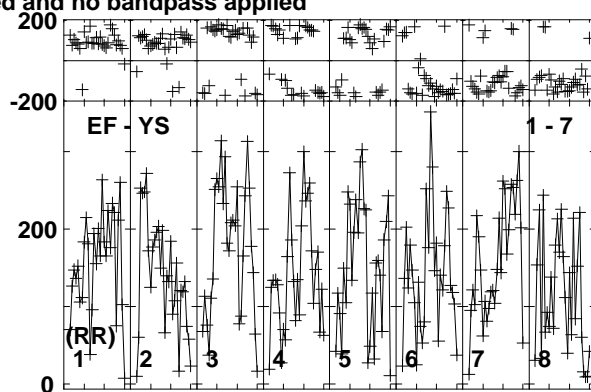
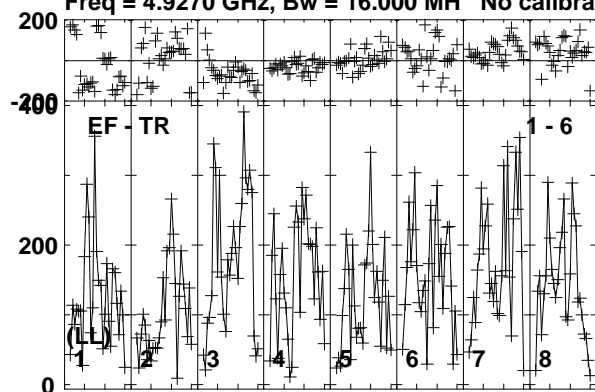

Lower frame: Micro Ampl Jy Top frame: Phas deg  
Vector averaged cross-power spectrum Baseline: EF (01) - TR (06)  
Timerange: 01/07:05:21 to 01/07:07:49

Plot file version 629 created 10-JUN-2016 17:23:04

J1957+3338 RT013A.UVDATA.1

Freq = 4.9270 GHz, Bw = 16.000 MH No calibration applied and no bandpass applied

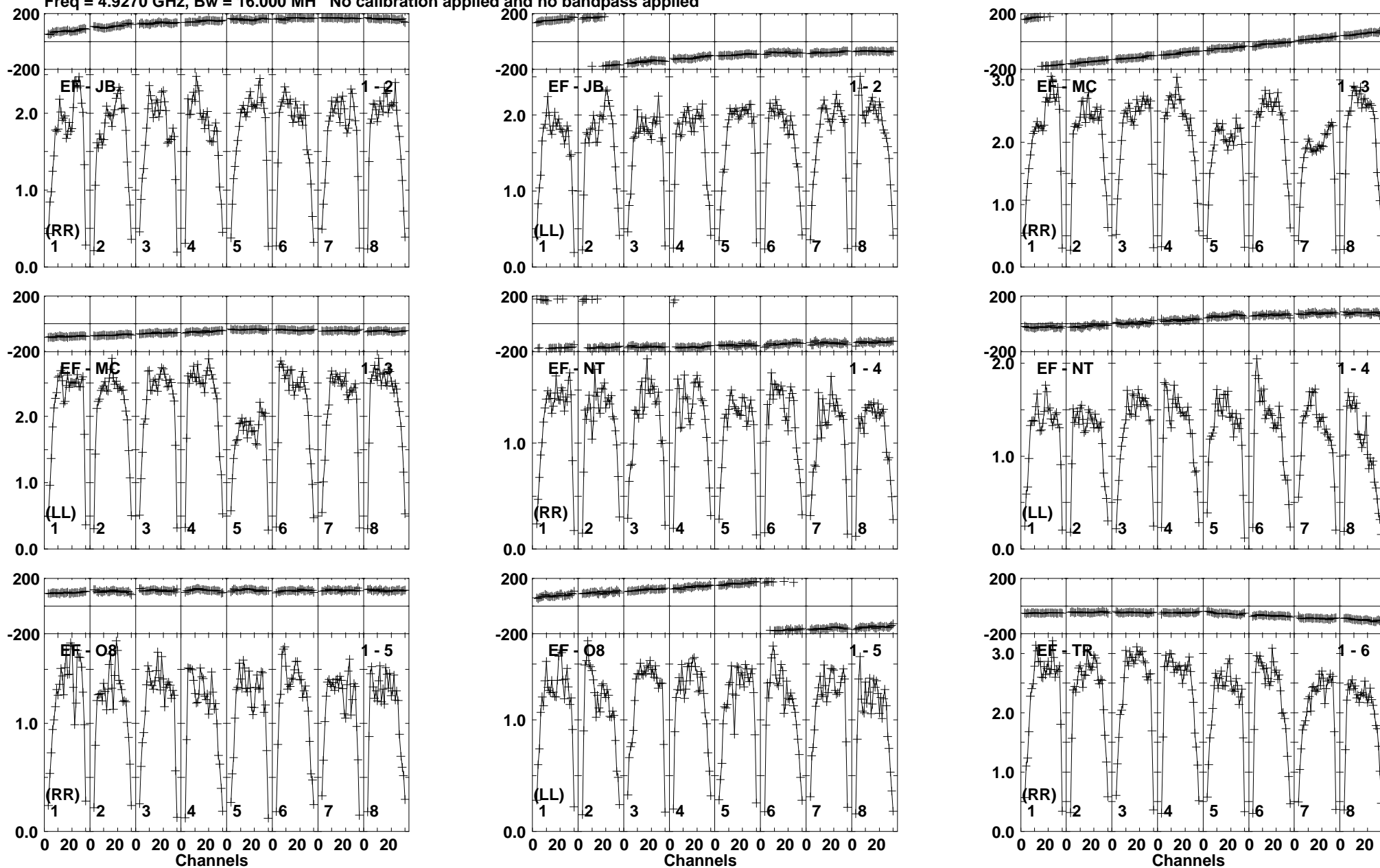

Lower frame: Milli Ampl Jy Top frame: Phas deg  
Vector averaged cross-power spectrum Baseline: EF (01) - JB (02)  
Timerange: 01/07:07:50 to 01/07:09:20

Plot file version 630 created 10-JUN-2016 17:23:04

J1957+3338 RT013A.UVDATA.1

Freq = 4.9270 GHz, Bw = 16.000 MH No calibration applied and no bandpass applied

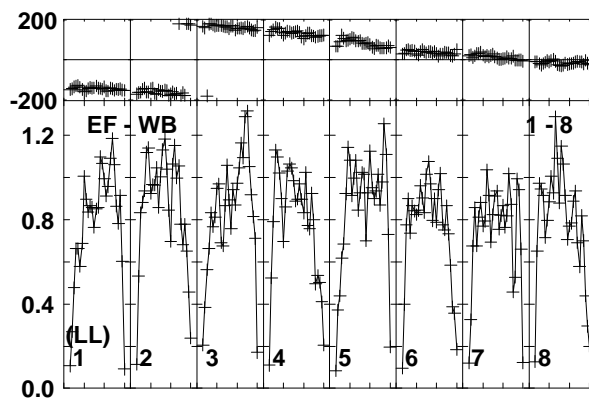
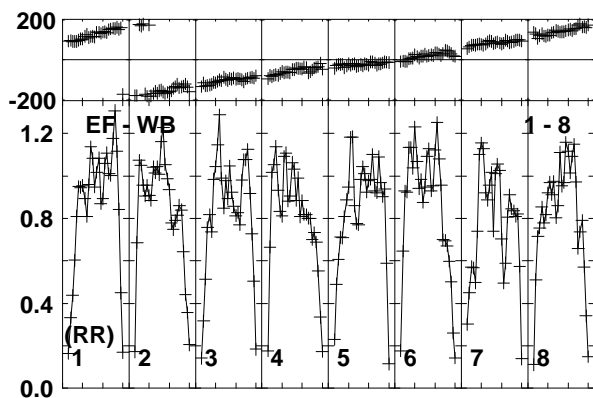
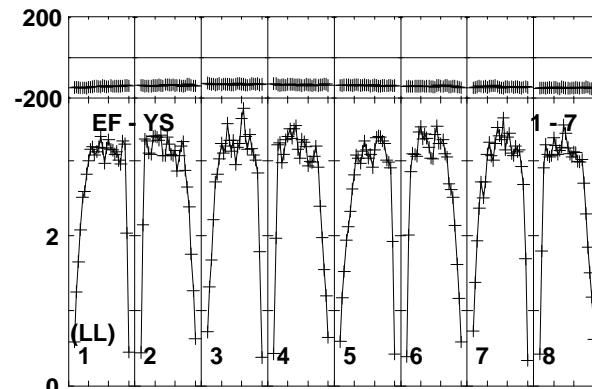
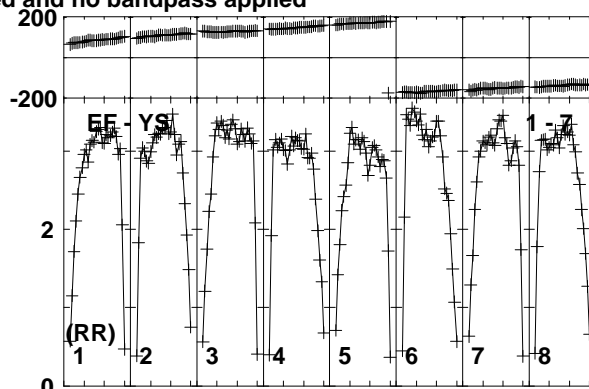
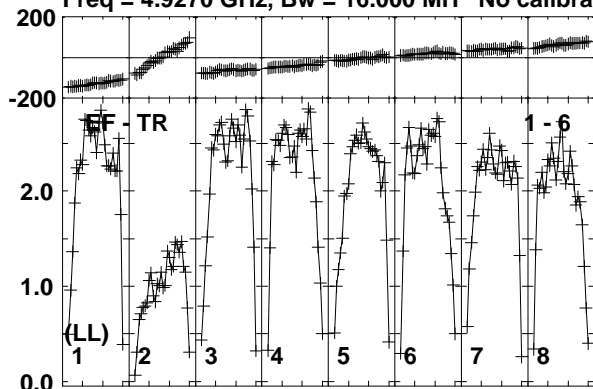

Lower frame: Milli Ampl Jy Top frame: Phas deg  
Vector averaged cross-power spectrum Baseline: EF (01) - TR (06)  
Timerange: 01/07:07:50 to 01/07:09:20

Plot file version 631 created 10-JUN-2016 17:23:04

CHECK RT013A.UVDATA.1

Freq = 4.9270 GHz, Bw = 16.000 MH No calibration applied and no bandpass applied

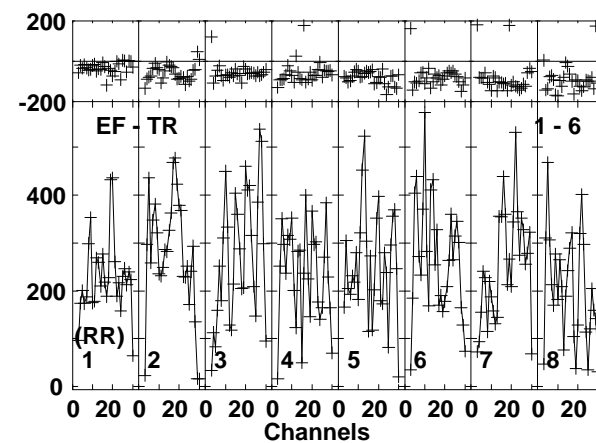
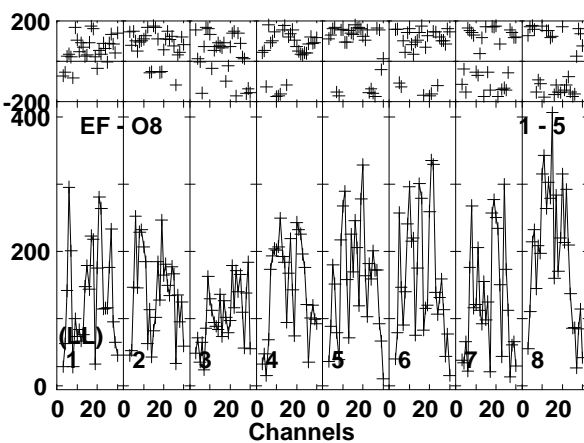
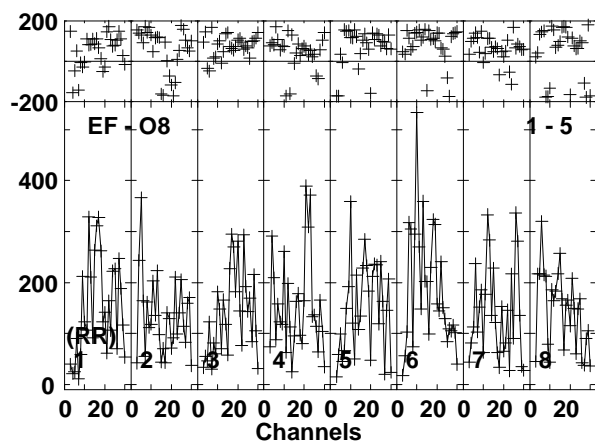
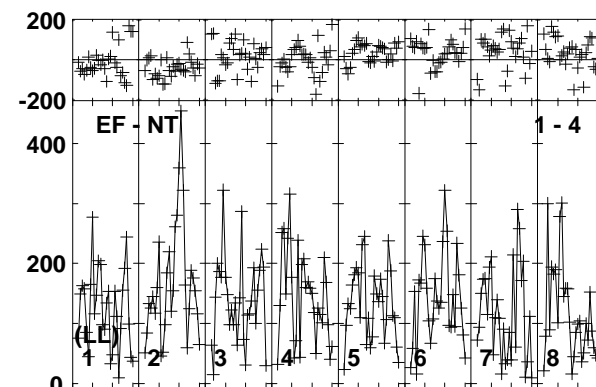
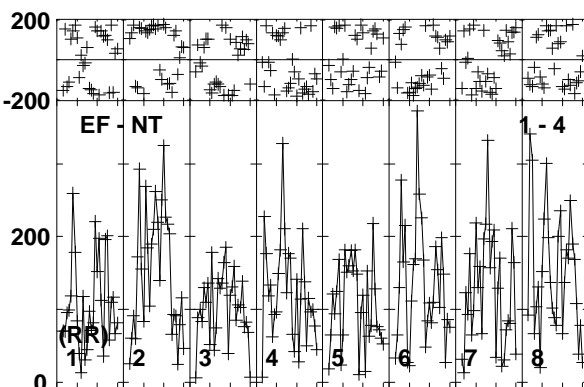
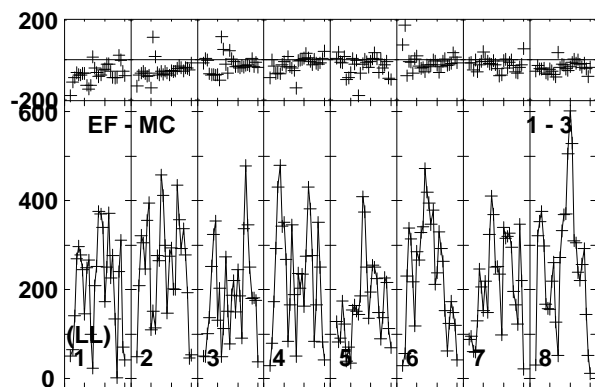
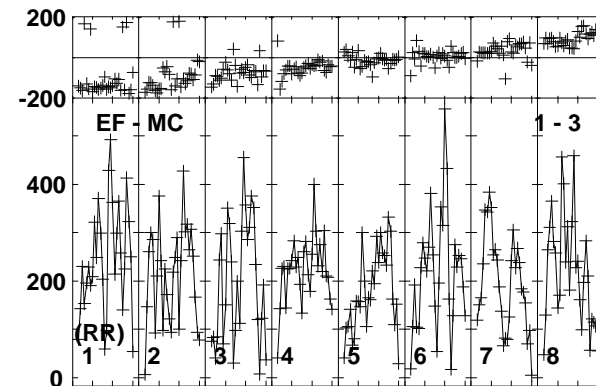
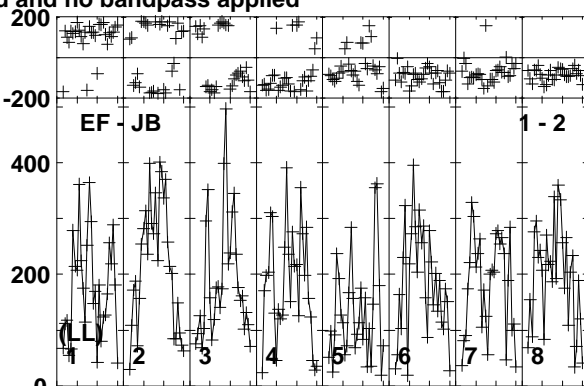
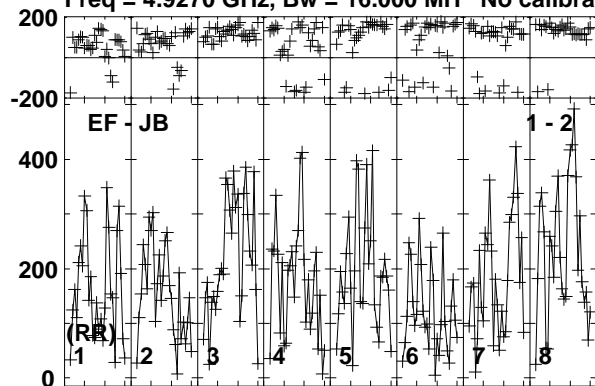

Lower frame: Micro Ampl Jy Top frame: Phas deg  
Vector averaged cross-power spectrum Baseline: EF (01) - JB (02)  
Timerange: 01/07:09:20 to 01/07:11:19

Plot file version 632 created 10-JUN-2016 17:23:05

CHECK RT013A.UVDATA.1

Freq = 4.9270 GHz, Bw = 16.000 MH No calibration applied and no bandpass applied

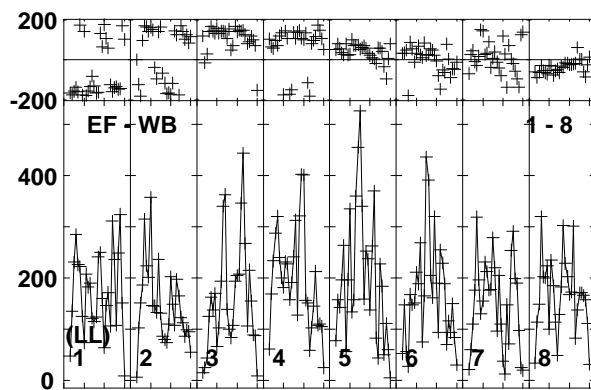
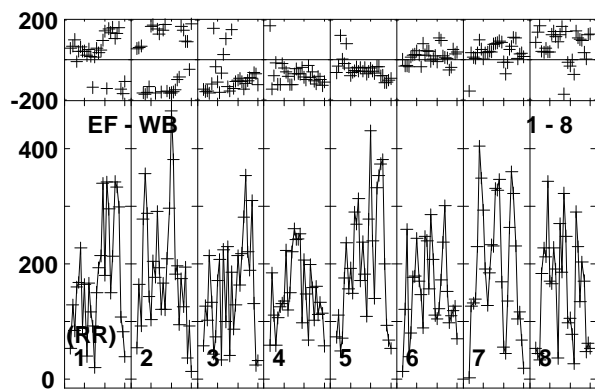
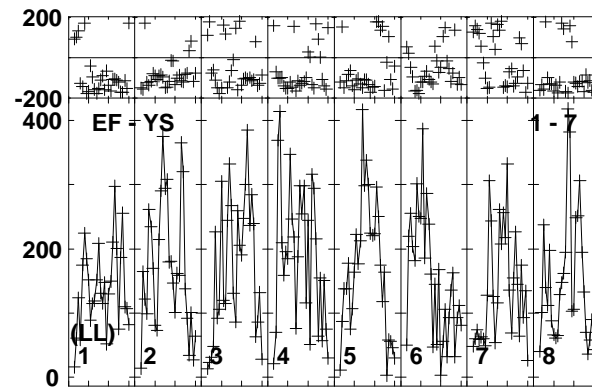
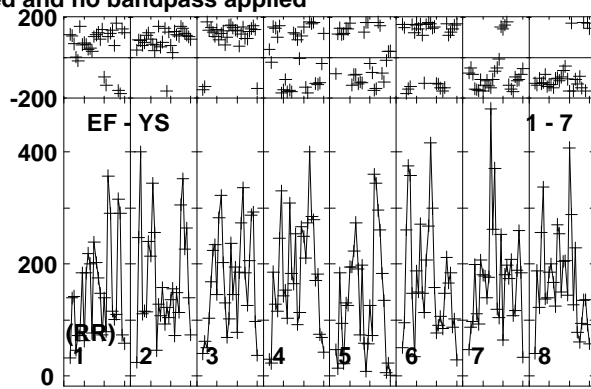
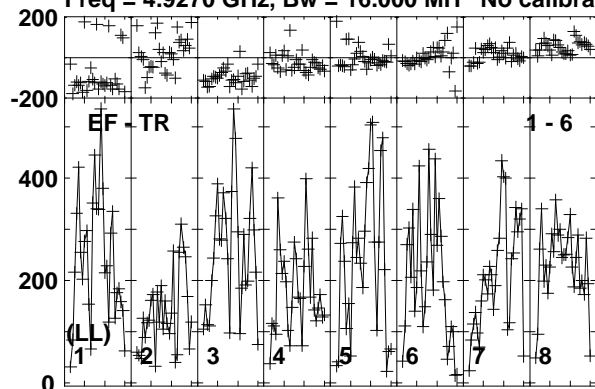

Lower frame: Micro Ampl Jy Top frame: Phas deg  
Vector averaged cross-power spectrum Baseline: EF (01) - TR (06)  
Timerange: 01/07:09:20 to 01/07:11:19

Plot file version 633 created 10-JUN-2016 17:23:05

CYGX1 RT013A.UVDATA.1

Freq = 4.9270 GHz, Bw = 16.000 MH No calibration applied and no bandpass applied

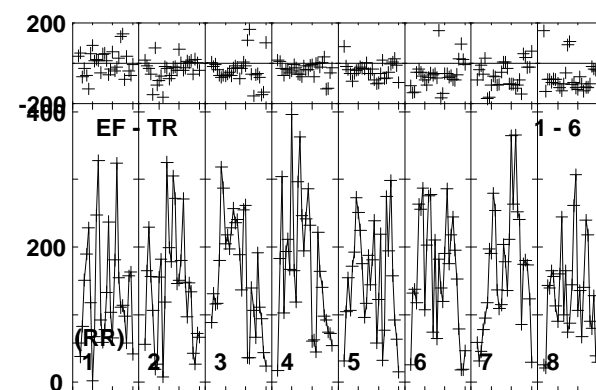
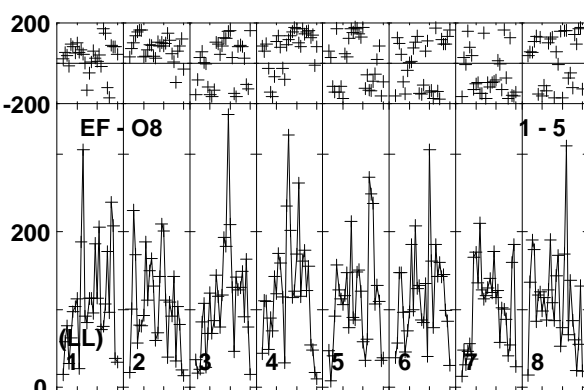
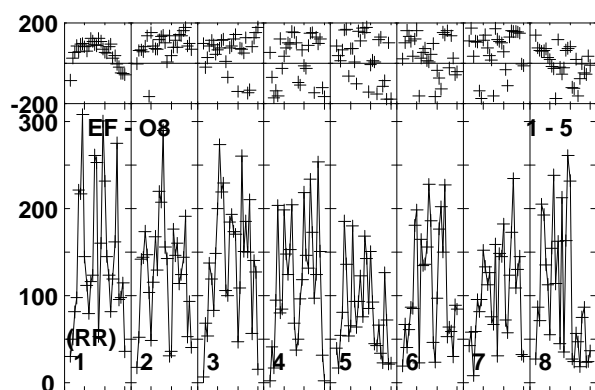
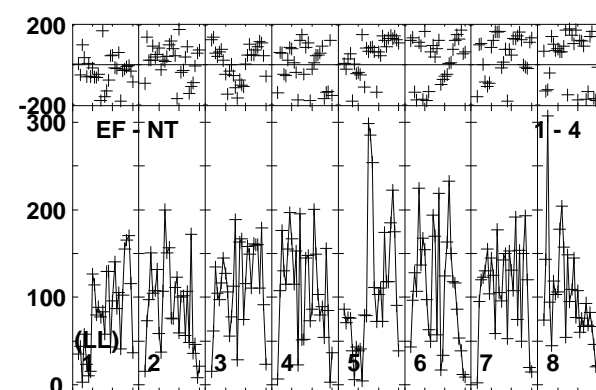
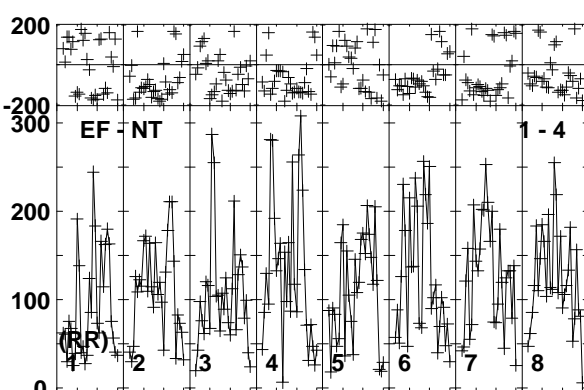
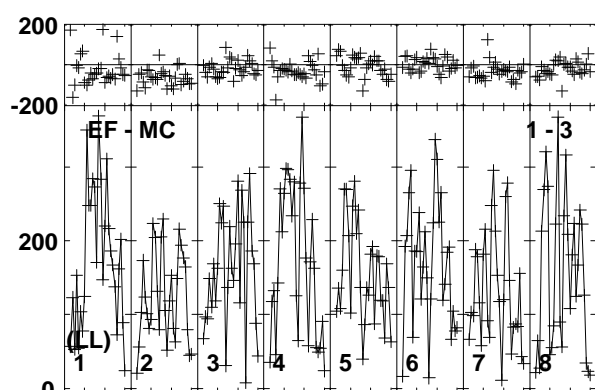
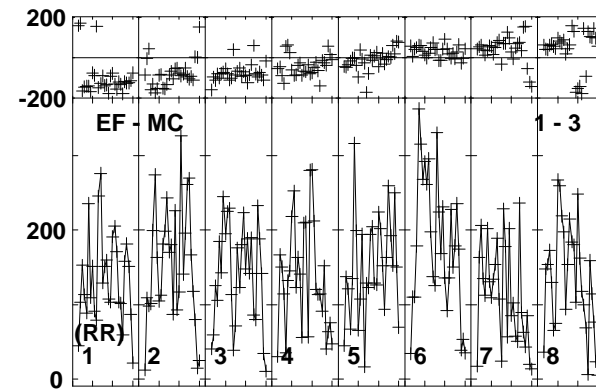
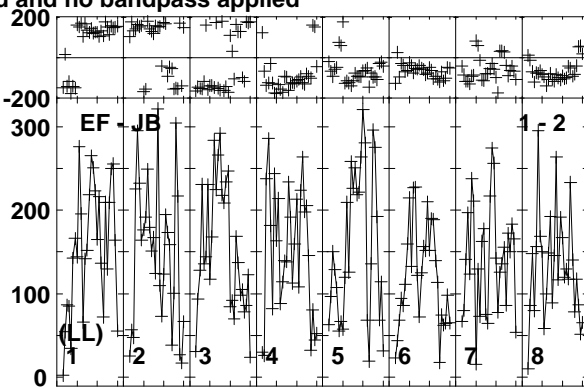
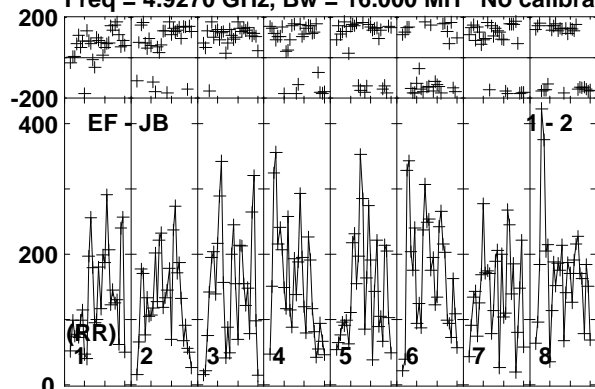

Lower frame: Micro Ampl Jy Top frame: Phas deg  
Vector averaged cross-power spectrum Baseline: EF (01) - JB (02)  
Timerange: 01/07:11:20 to 01/07:13:50

Plot file version 634 created 10-JUN-2016 17:23:05

CYGX1 RT013A.UVDATA.1

Freq = 4.9270 GHz, Bw = 16.000 MH No calibration applied and no bandpass applied

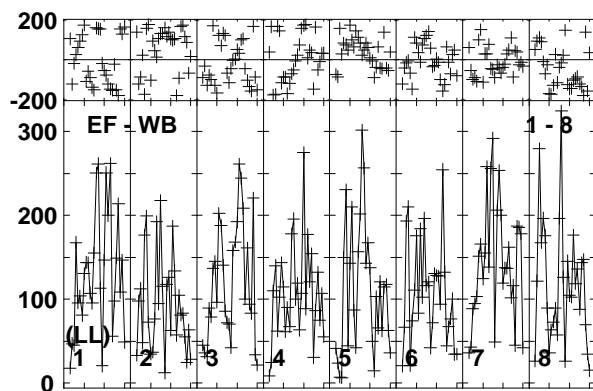
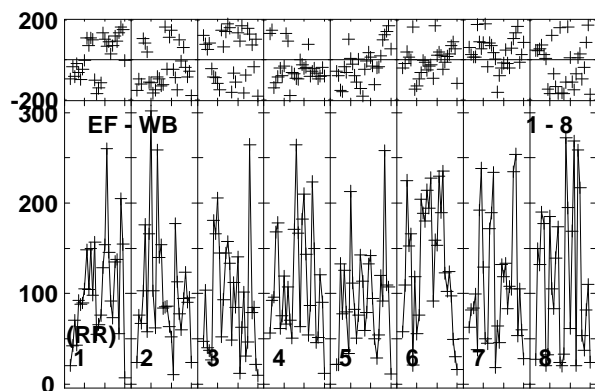
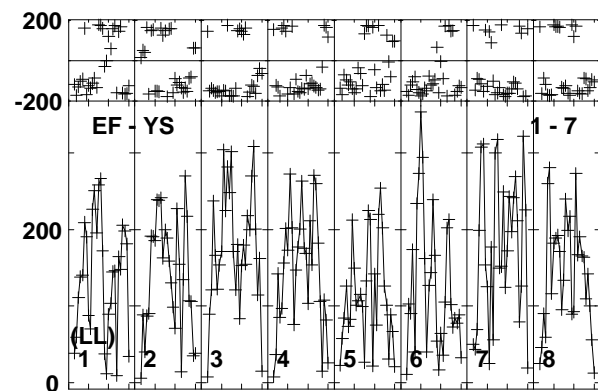
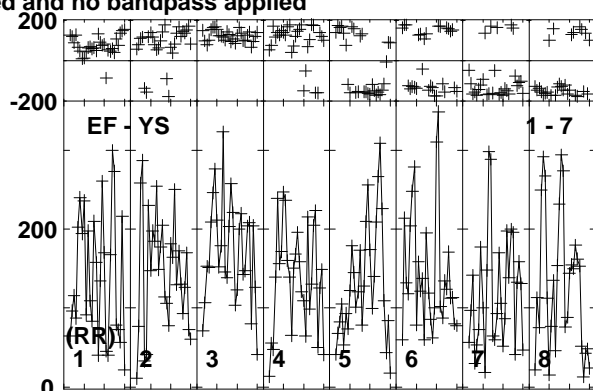
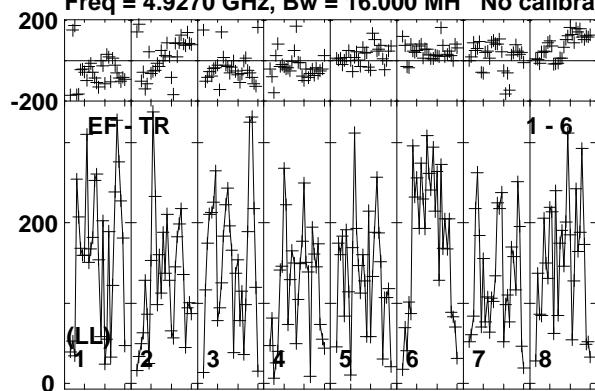

Lower frame: Micro Ampl Jy Top frame: Phas deg  
Vector averaged cross-power spectrum Baseline: EF (01) - TR (06)  
Timerange: 01/07:11:20 to 01/07:13:50



Plot file version 635 created 10-JUN-2016 17:23:05

J1957+3338 RT013A.UVDATA.1

Freq = 4.9270 GHz, Bw = 16.000 MH No calibration applied and no bandpass applied

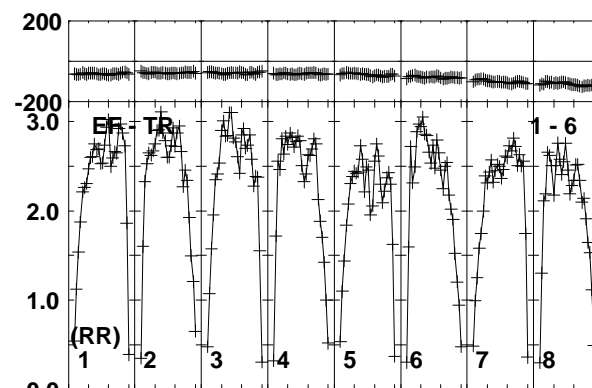
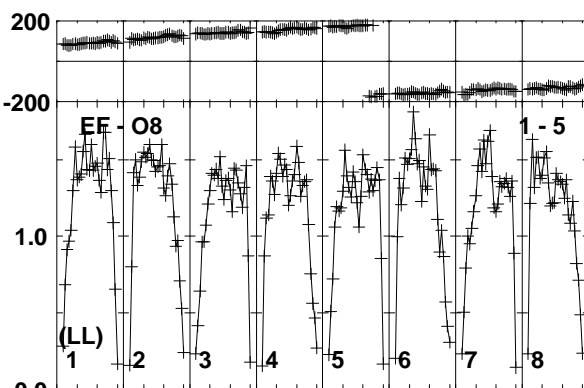
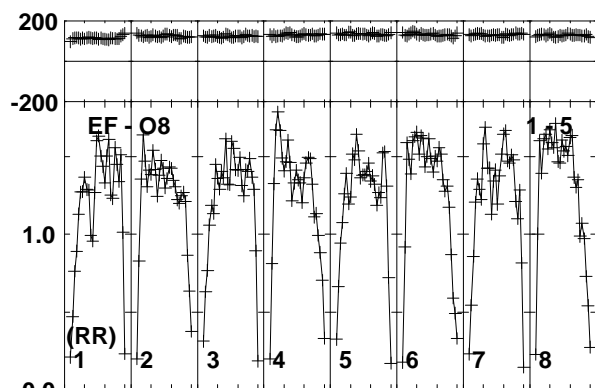
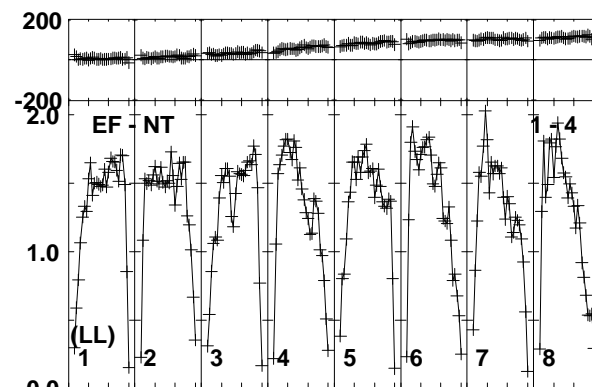
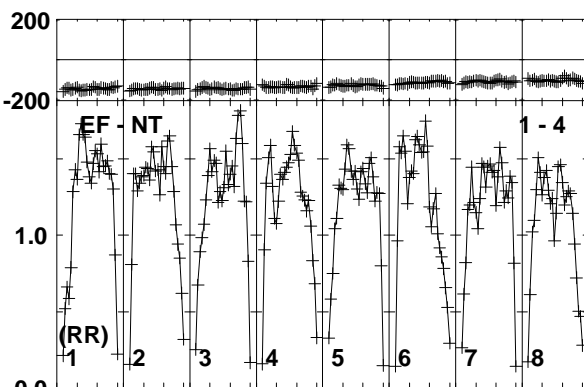
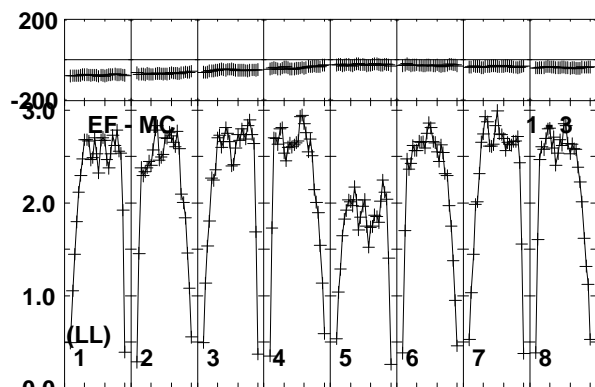
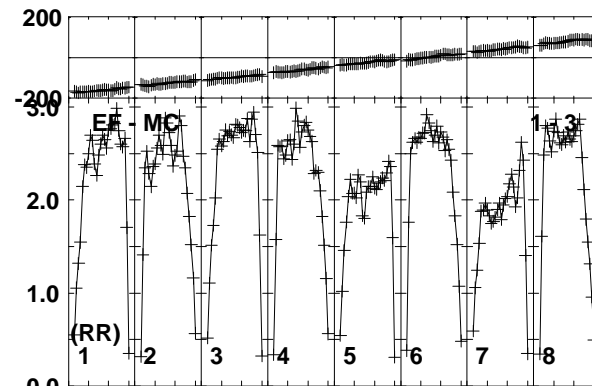
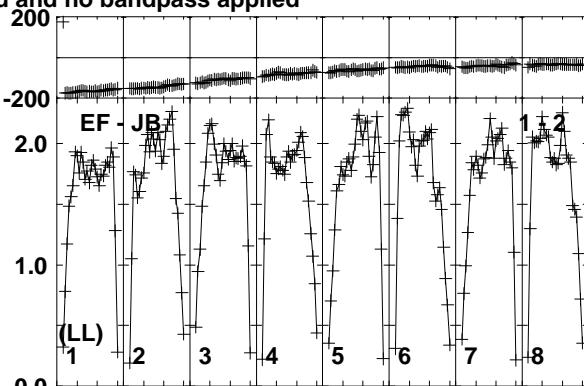
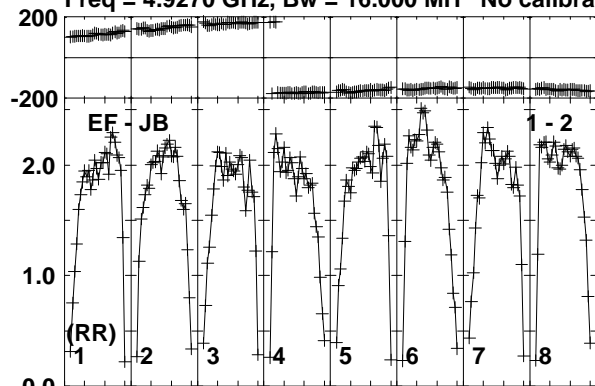

Lower frame: Milli Ampl Jy Top frame: Phas deg

Vector averaged cross-power spectrum Baseline: EF (01) - JB (02)

Timerange: 01/07:13:51 to 01/07:15:20

Plot file version 636 created 10-JUN-2016 17:23:05

J1957+3338 RT013A.UVDATA.1

Freq = 4.9270 GHz, Bw = 16.000 MH No calibration applied and no bandpass applied

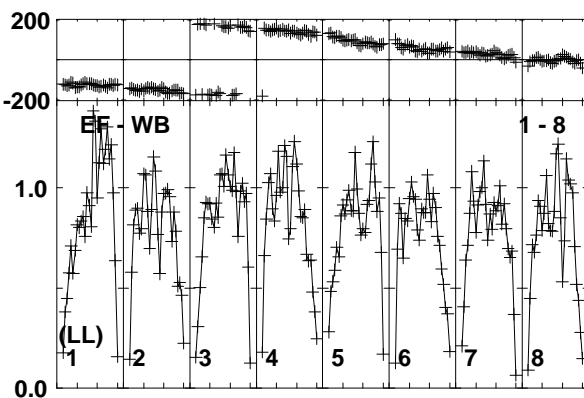
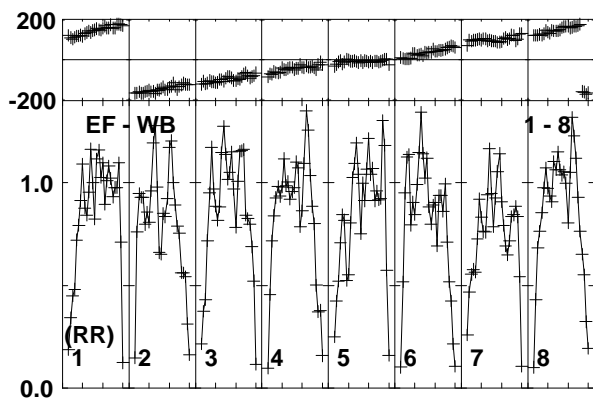
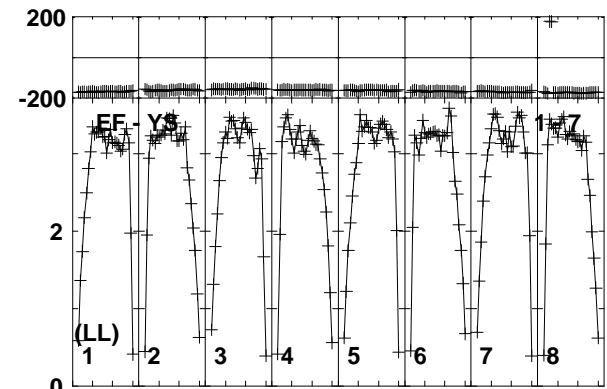
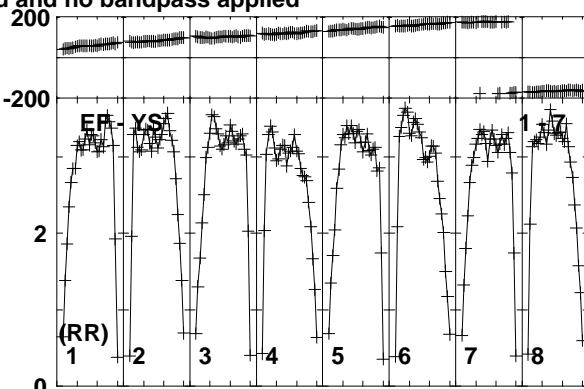
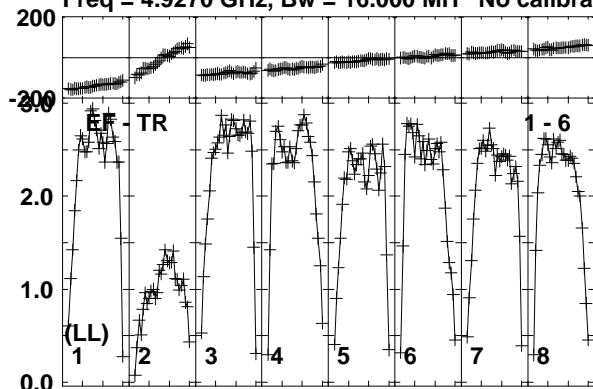

Lower frame: Milli Ampl Jy Top frame: Phas deg  
Vector averaged cross-power spectrum Baseline: EF (01) - TR (06)  
Timerange: 01/07:13:51 to 01/07:15:20

Plot file version 637 created 10-JUN-2016 17:23:05

CHECK RT013A.UVDATA.1

Freq = 4.9270 GHz, Bw = 16.000 MH No calibration applied and no bandpass applied

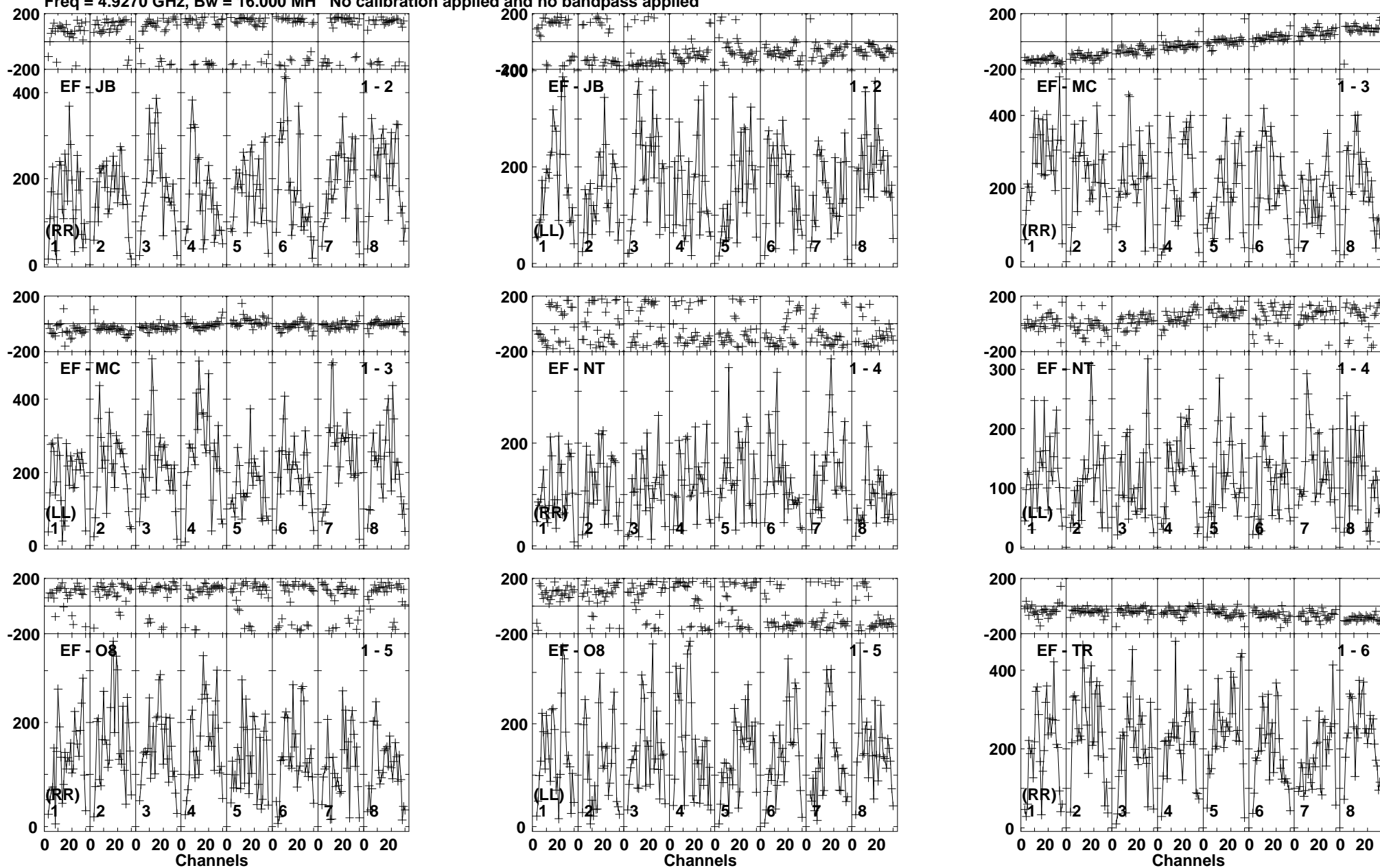

Lower frame: Micro Ampl Jy Top frame: Phas deg  
Vector averaged cross-power spectrum Baseline: EF (01) - JB (02)  
Timerange: 01/07:16:01 to 01/07:17:59

Plot file version 638 created 10-JUN-2016 17:23:05

CHECK RT013A.UVDATA.1

Freq = 4.9270 GHz, Bw = 16.000 MH No calibration applied and no bandpass applied

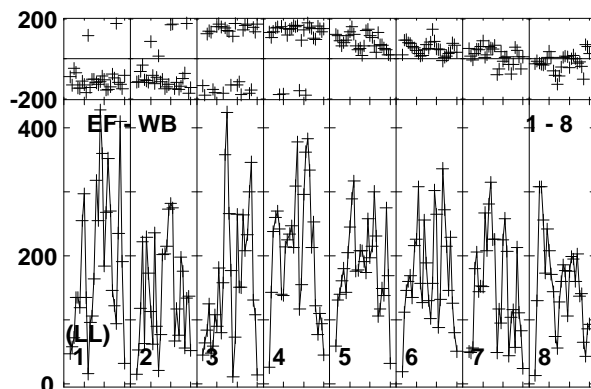
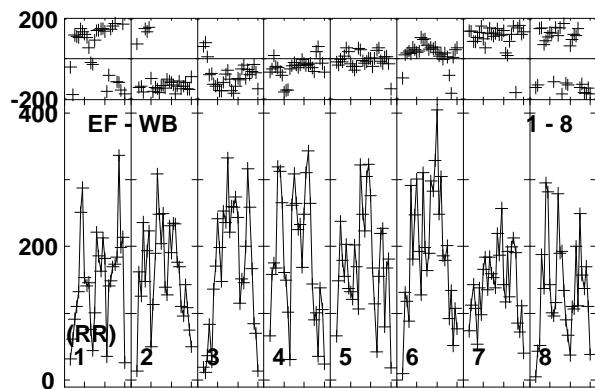
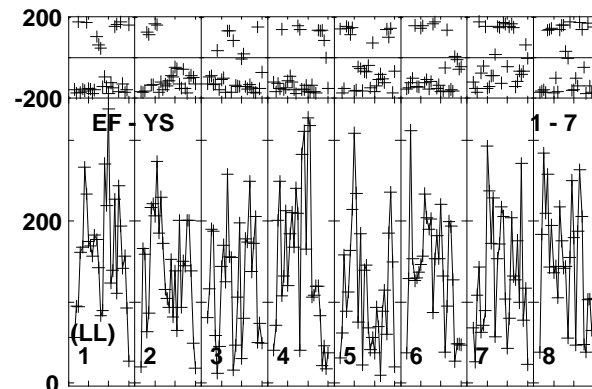
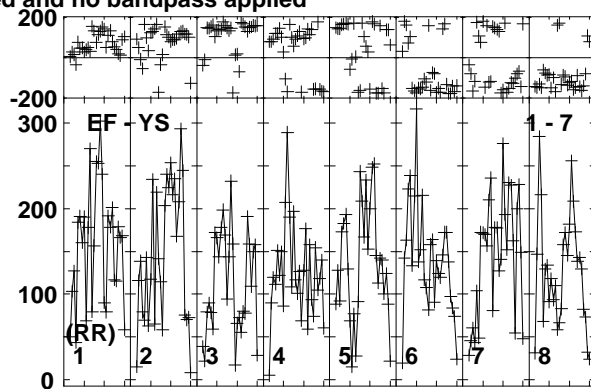
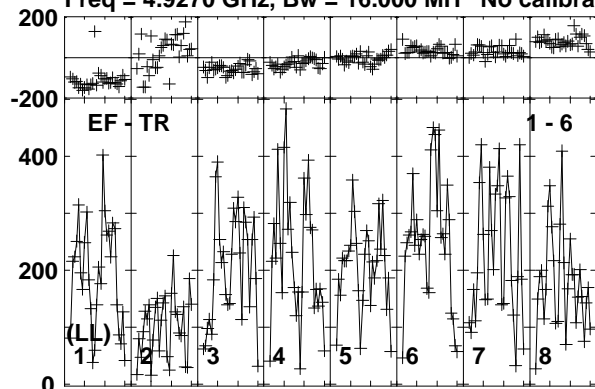

Lower frame: Micro Ampl Jy Top frame: Phas deg  
Vector averaged cross-power spectrum Baseline: EF (01) - TR (06)  
Timerange: 01/07:16:01 to 01/07:17:59

Plot file version 639 created 10-JUN-2016 17:23:05

CYGX1 RT013A.UVDATA.1

Freq = 4.9270 GHz, Bw = 16.000 MH No calibration applied and no bandpass applied

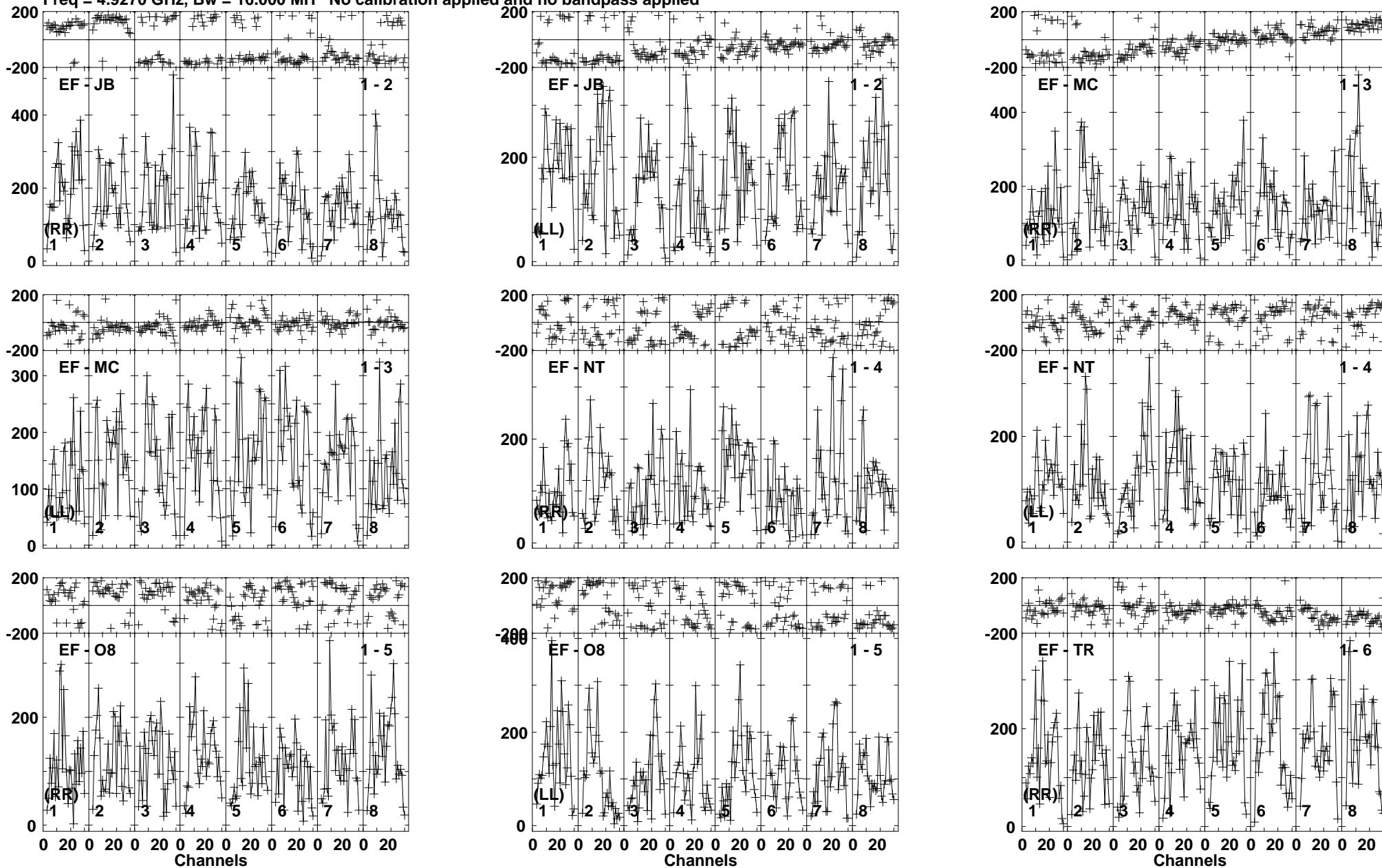

Lower frame: Micro Ampl Jy Top frame: Phas deg  
Vector averaged cross-power spectrum Baseline: EF (01) - JB (02)  
Timerange: 01/07:18:01 to 01/07:20:30

Plot file version 640 created 10-JUN-2016 17:23:05

CYGX1 RT013A.UVDATA.1

Freq = 4.9270 GHz, Bw = 16.000 MH No calibration applied and no bandpass applied

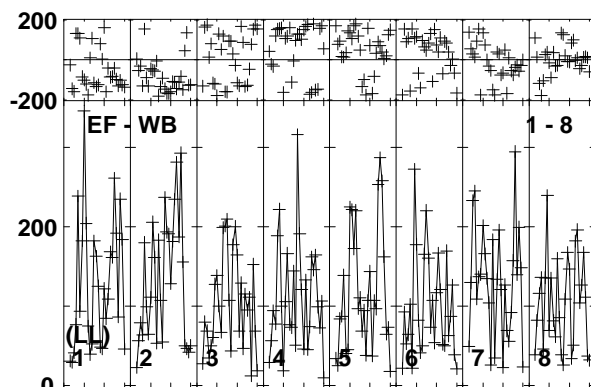
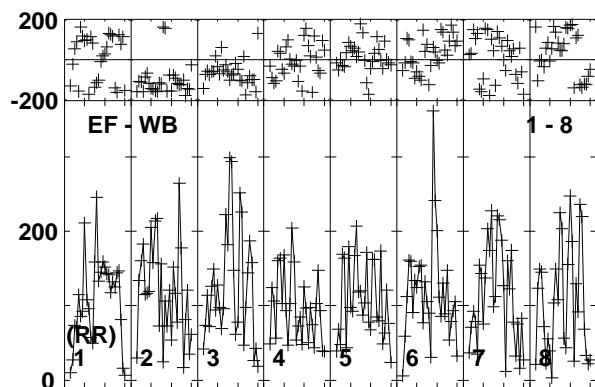
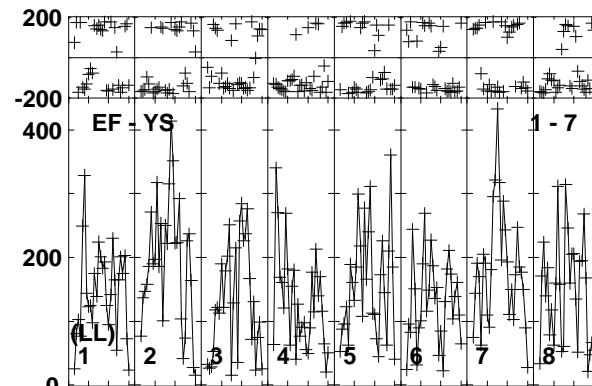
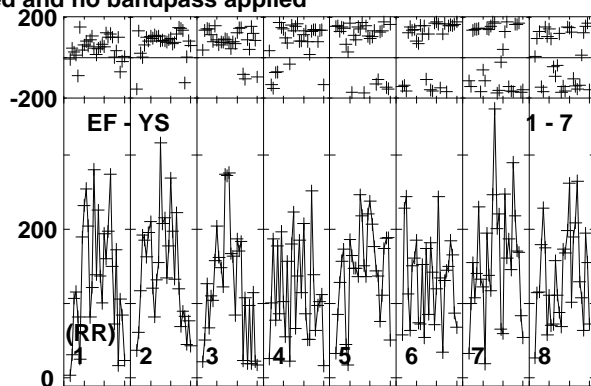
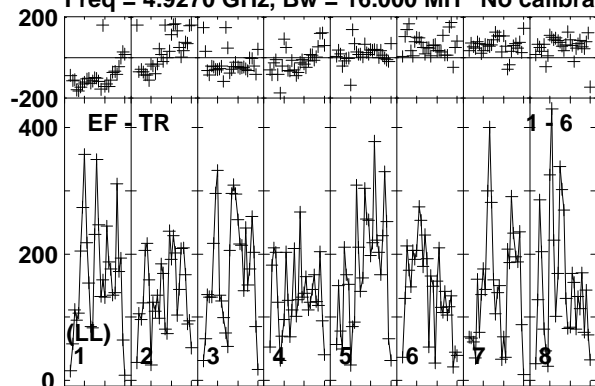

Lower frame: Micro Ampl Jy Top frame: Phas deg  
Vector averaged cross-power spectrum Baseline: EF (01) - TR (06)  
Timerange: 01/07:18:01 to 01/07:20:30

Plot file version 641 created 10-JUN-2016 17:23:05

J1957+3338 RT013A.UVDATA.1

Freq = 4.9270 GHz, Bw = 16.000 MH No calibration applied and no bandpass applied

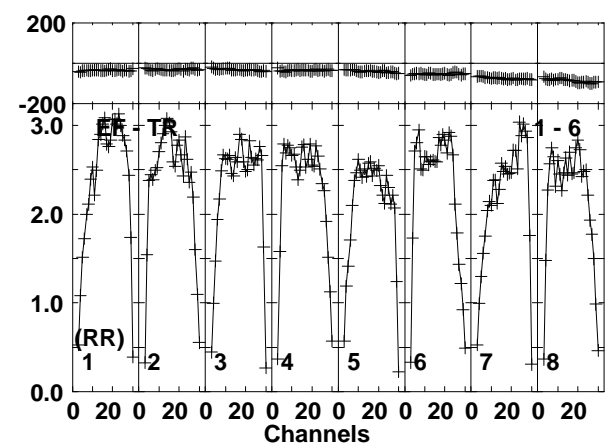
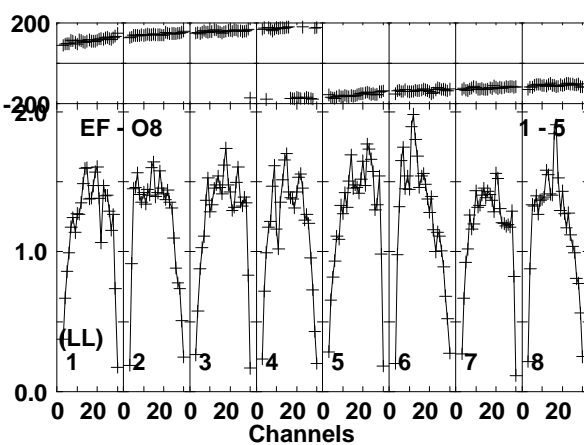
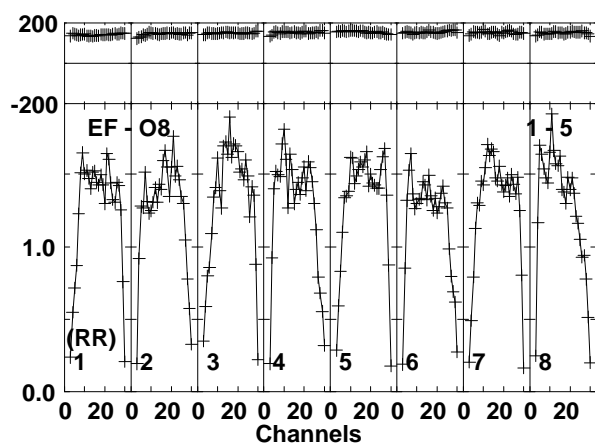
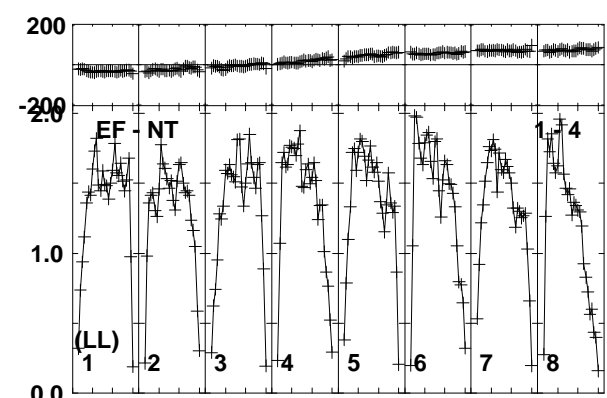
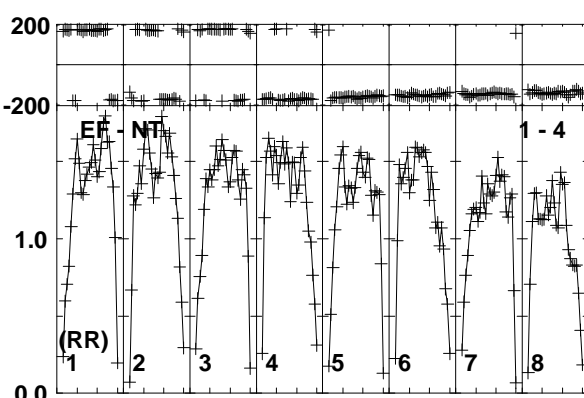
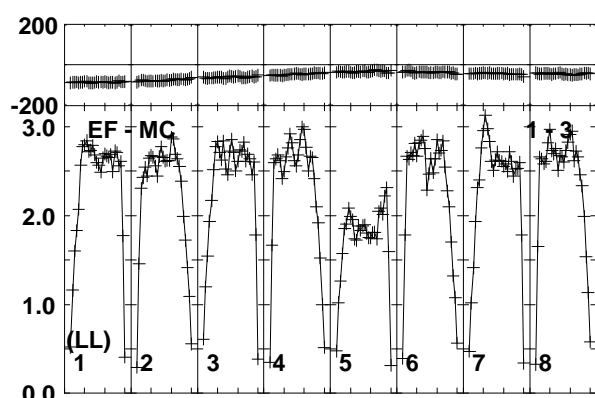
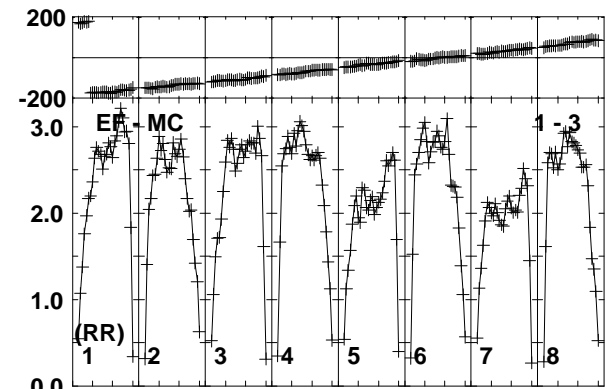
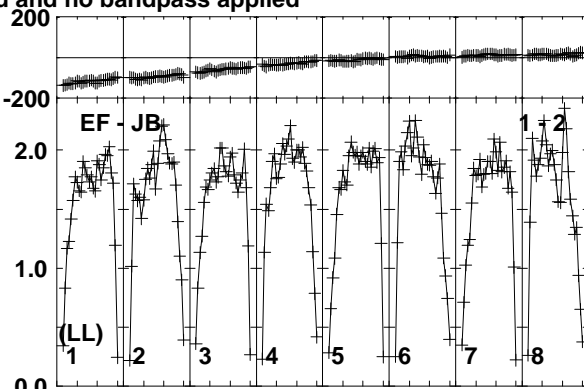
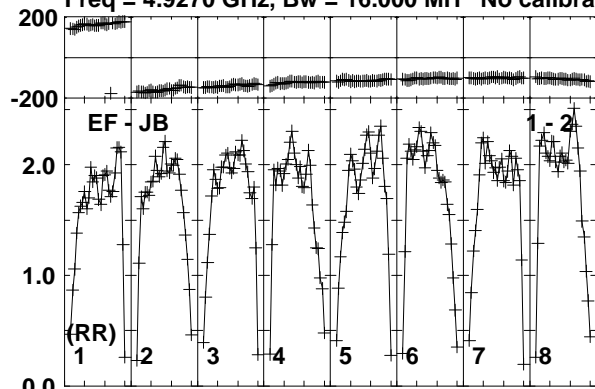

Lower frame: Milli Ampl Jy Top frame: Phas deg  
Vector averaged cross-power spectrum Baseline: EF (01) - JB (02)  
Timerange: 01/07:20:31 to 01/07:21:59

Plot file version 642 created 10-JUN-2016 17:23:05

J1957+3338 RT013A.UVDATA.1

Freq = 4.9270 GHz, Bw = 16.000 MH No calibration applied and no bandpass applied

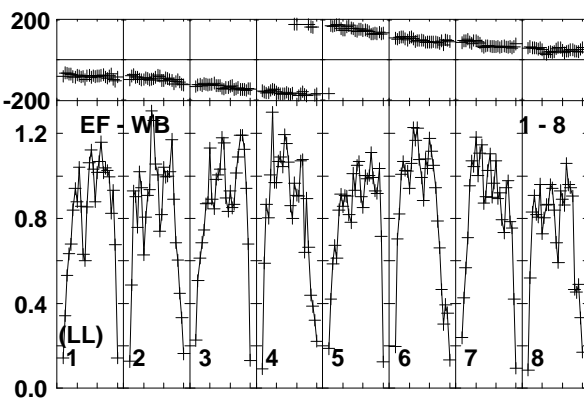
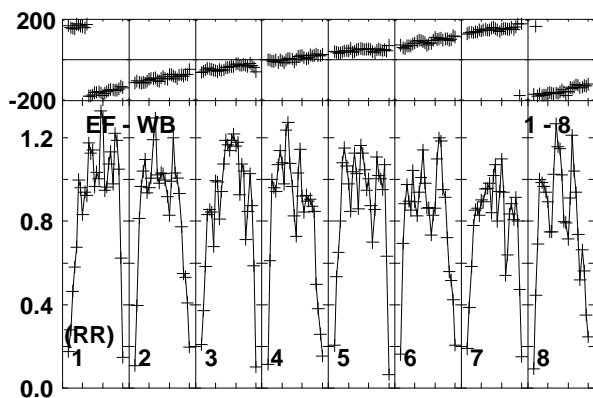
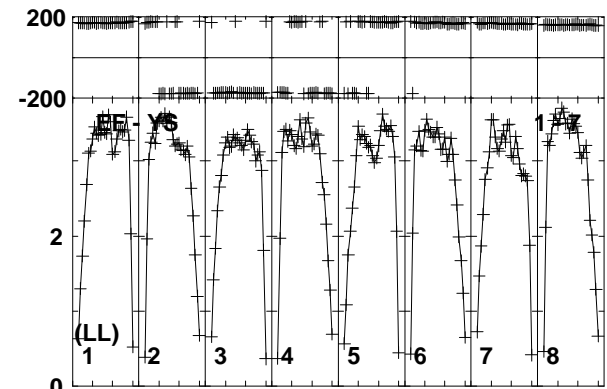
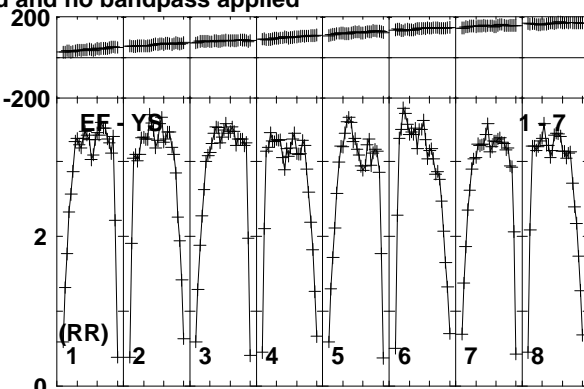
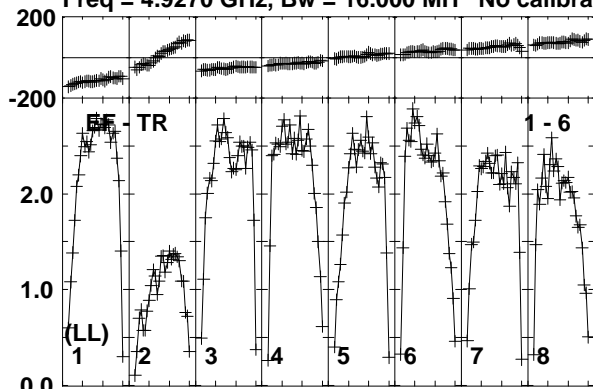

Lower frame: Milli Ampl Jy Top frame: Phas deg  
Vector averaged cross-power spectrum Baseline: EF (01) - TR (06)  
Timerange: 01/07:20:31 to 01/07:21:59



Plot file version 643 created 10-JUN-2016 17:23:06

CHECK RT013A.UVDATA.1

Freq = 4.9270 GHz, Bw = 16.000 MH No calibration applied and no bandpass applied

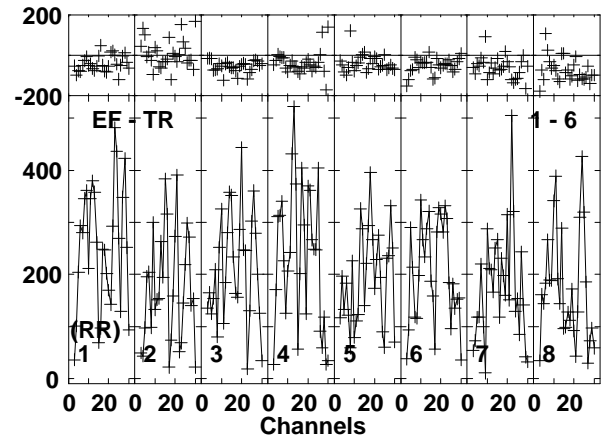
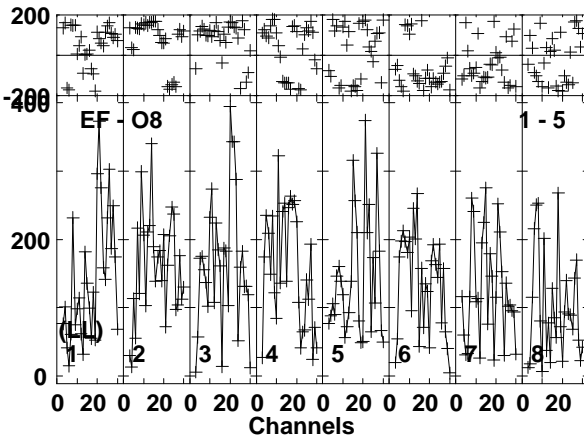
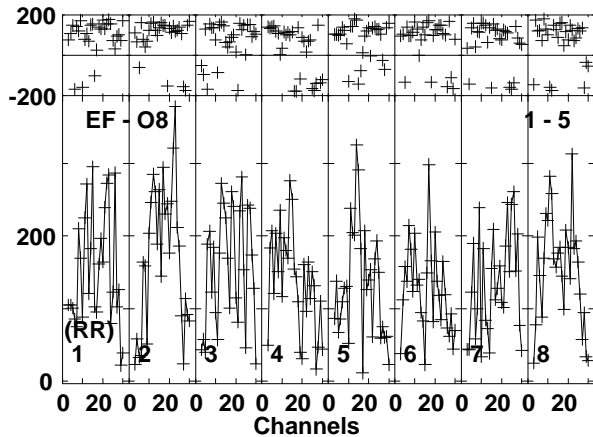
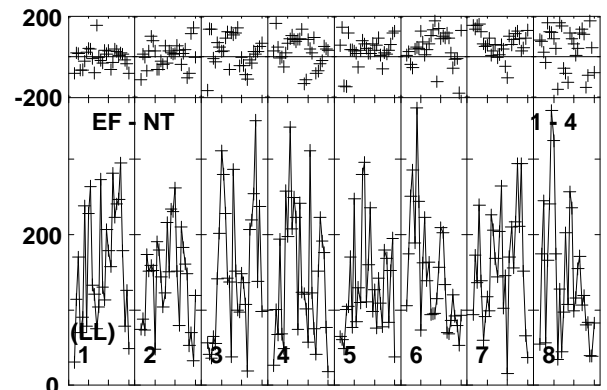
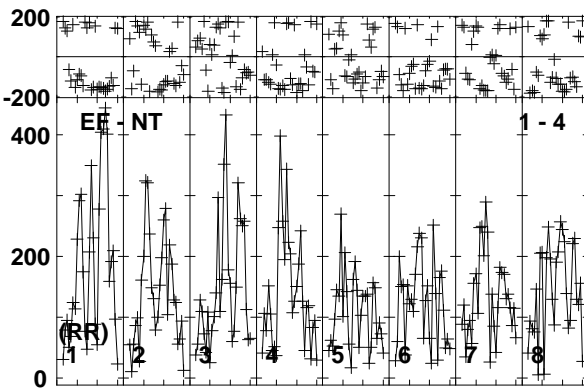
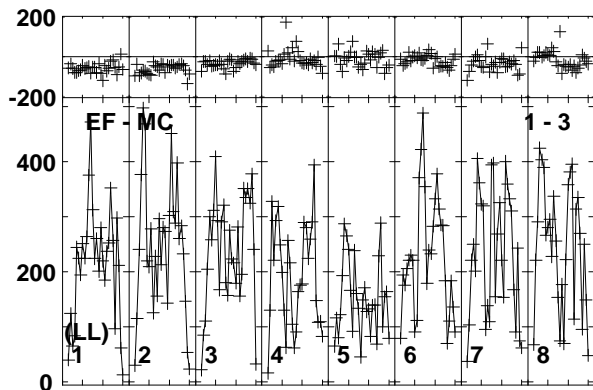
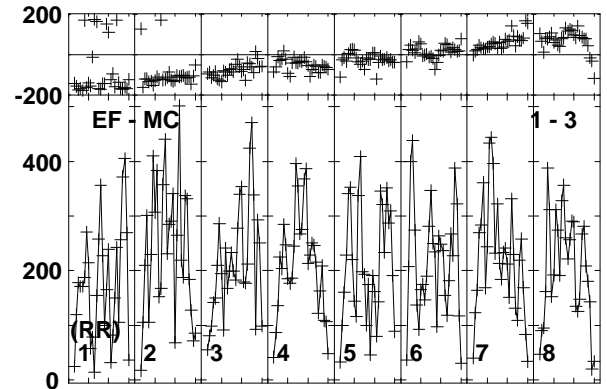
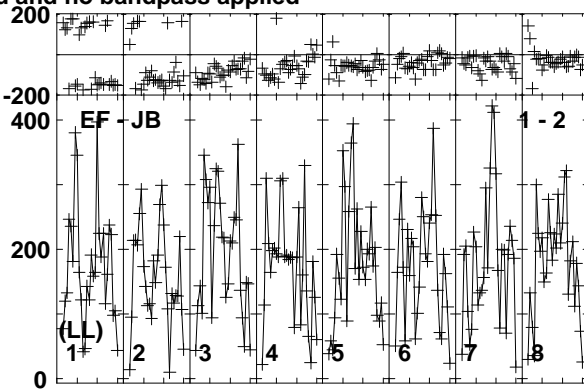
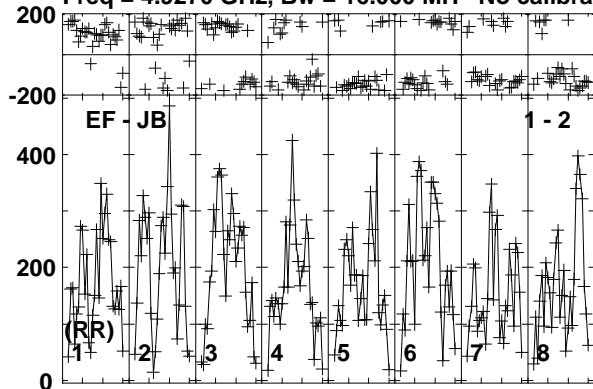

Lower frame: Micro Ampl Jy Top frame: Phas deg  
Vector averaged cross-power spectrum Baseline: EF (01) - JB (02)  
Timerange: 01/07:22:00 to 01/07:24:00

Plot file version 644 created 10-JUN-2016 17:23:06

CHECK RT013A.UVDATA.1

Freq = 4.9270 GHz, Bw = 16.000 MH No calibration applied and no bandpass applied

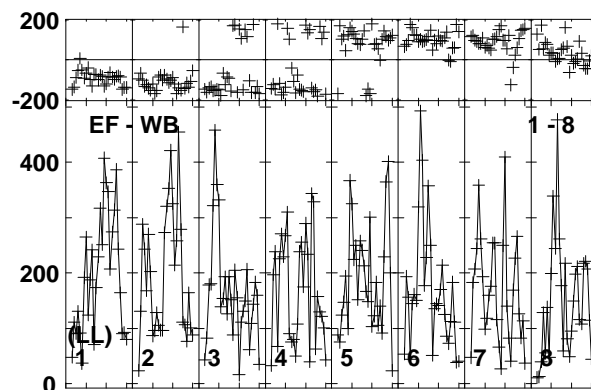
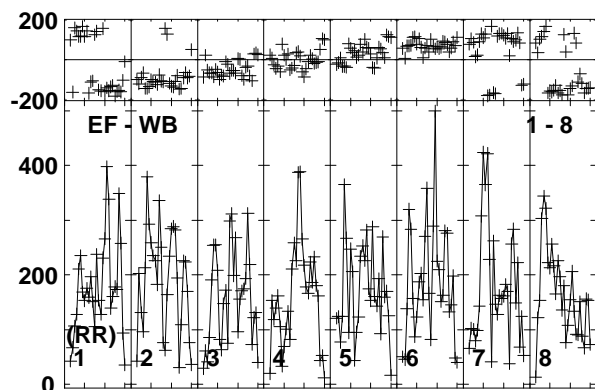
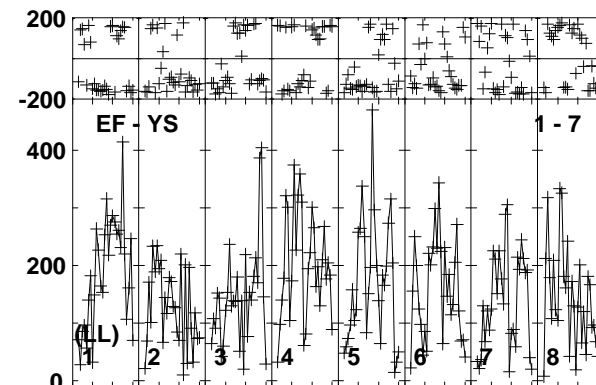
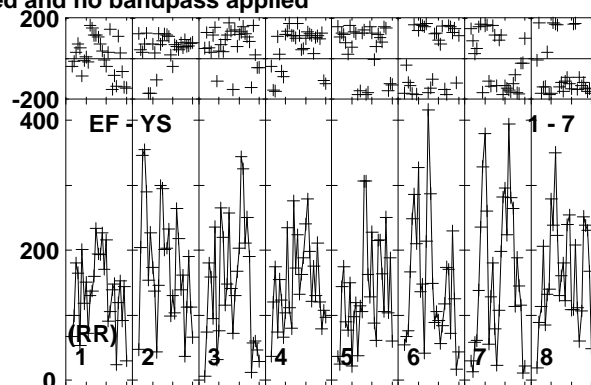
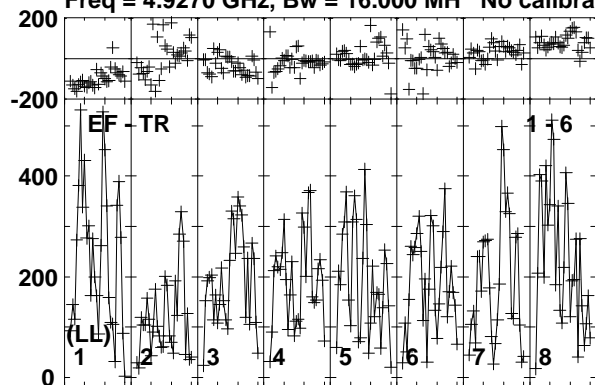

Lower frame: Micro Ampl Jy Top frame: Phas deg  
Vector averaged cross-power spectrum Baseline: EF (01) - TR (06)  
Timerange: 01/07:22:00 to 01/07:24:00

Plot file version 645 created 10-JUN-2016 17:23:06

CYGX1 RT013A.UVDATA.1

Freq = 4.9270 GHz, Bw = 16.000 MH No calibration applied and no bandpass applied

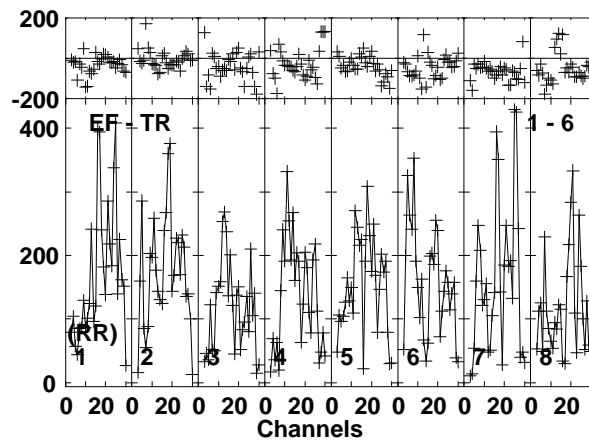
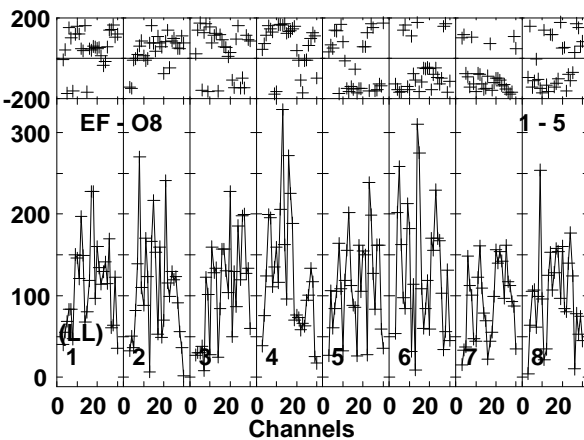
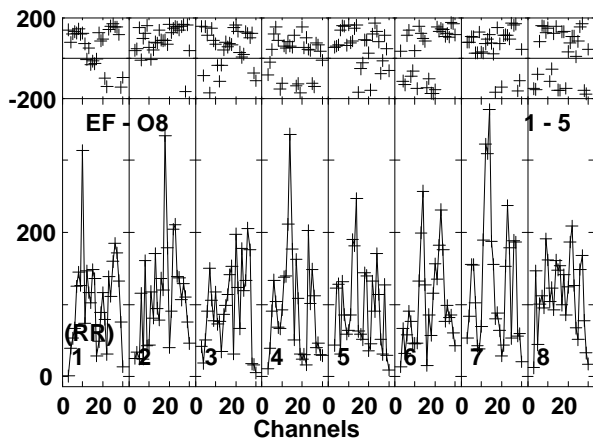
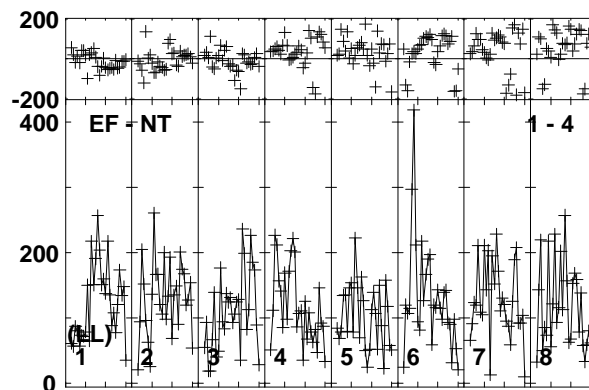
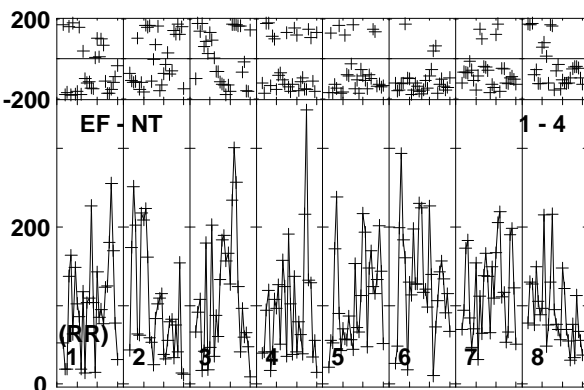
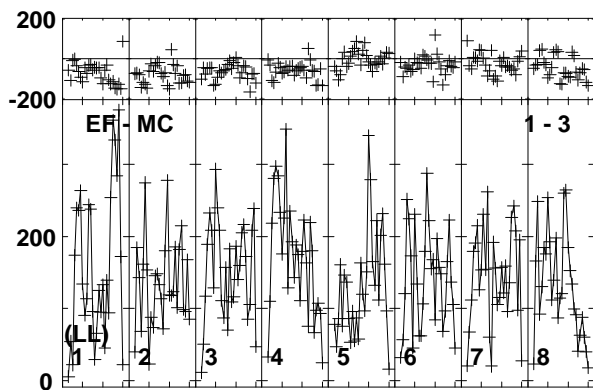
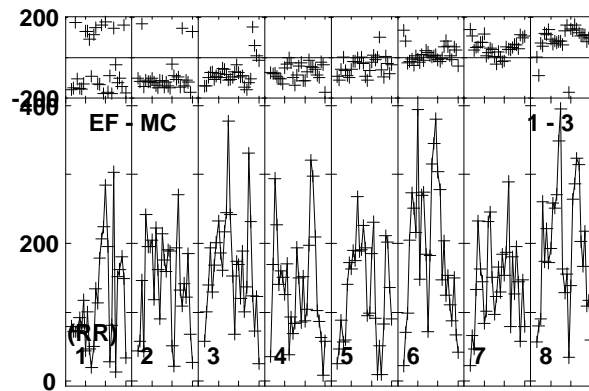
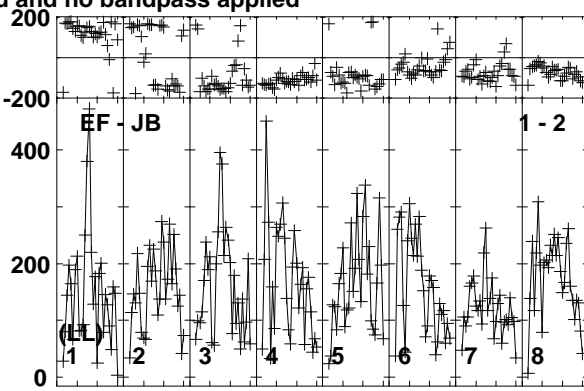
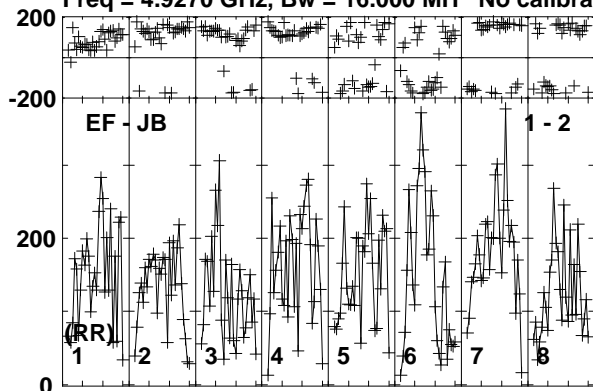

Lower frame: Micro Ampl Jy Top frame: Phas deg  
Vector averaged cross-power spectrum Baseline: EF (01) - JB (02)  
Timerange: 01/07:24:00 to 01/07:26:29

Plot file version 646 created 10-JUN-2016 17:23:06

CYGX1 RT013A.UVDATA.1

Freq = 4.9270 GHz, Bw = 16.000 MH No calibration applied and no bandpass applied

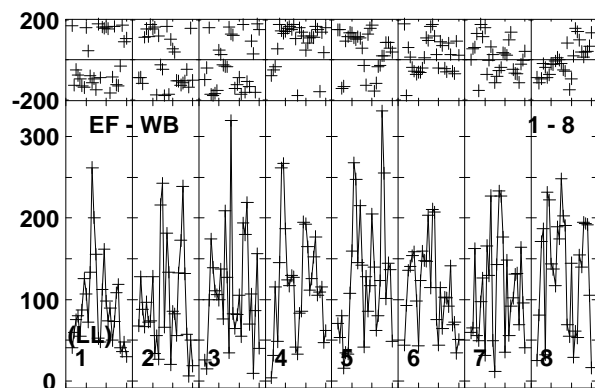
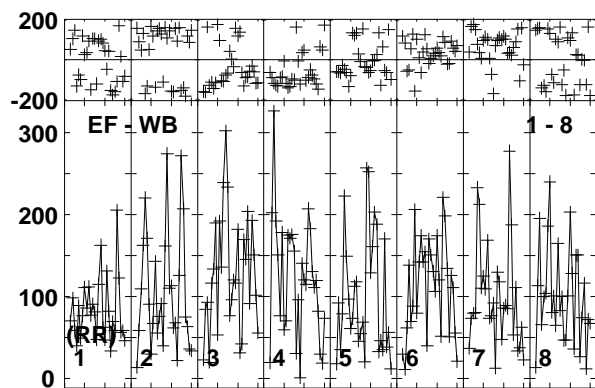
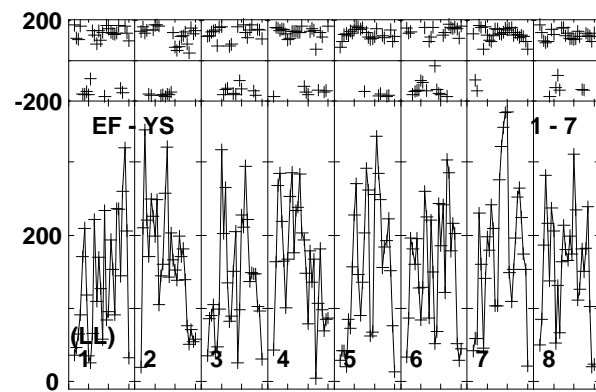
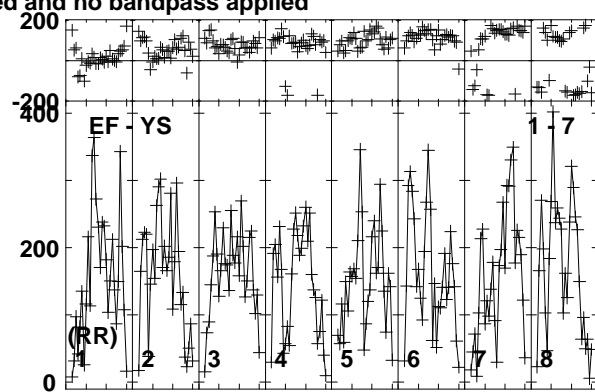
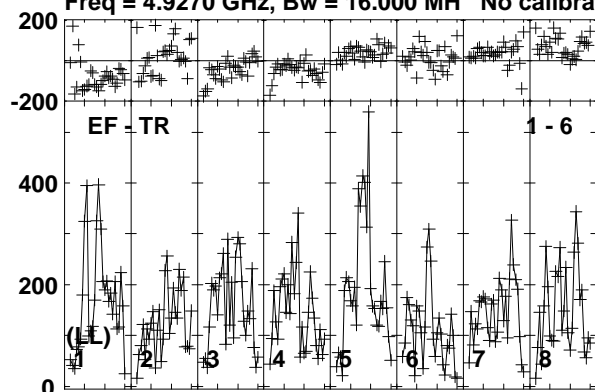

Lower frame: Micro Ampl Jy Top frame: Phas deg  
Vector averaged cross-power spectrum Baseline: EF (01) - TR (06)  
Timerange: 01/07:24:00 to 01/07:26:29

Plot file version 647 created 10-JUN-2016 17:23:06

J1957+3338 RT013A.UVDATA.1

Freq = 4.9270 GHz, Bw = 16.000 MH No calibration applied and no bandpass applied

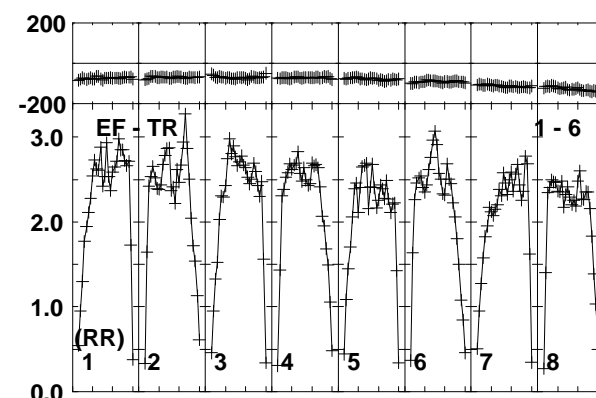
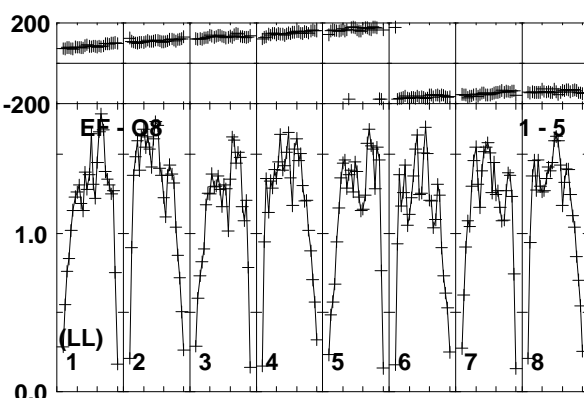
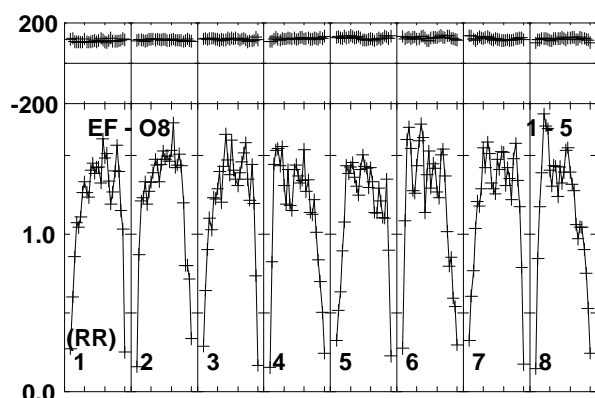
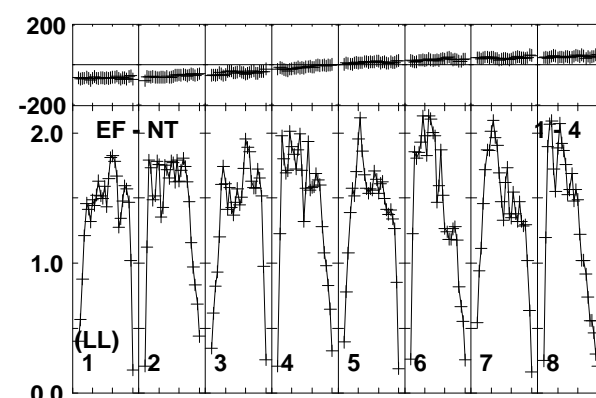
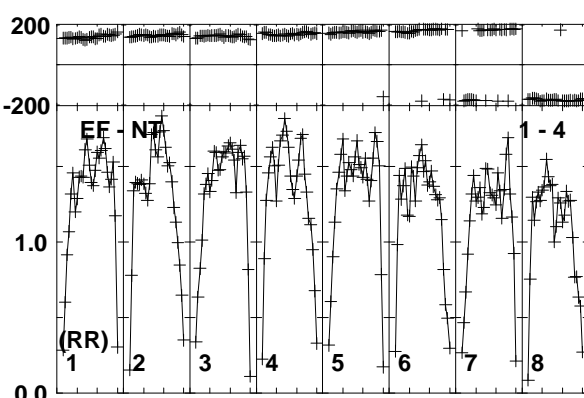
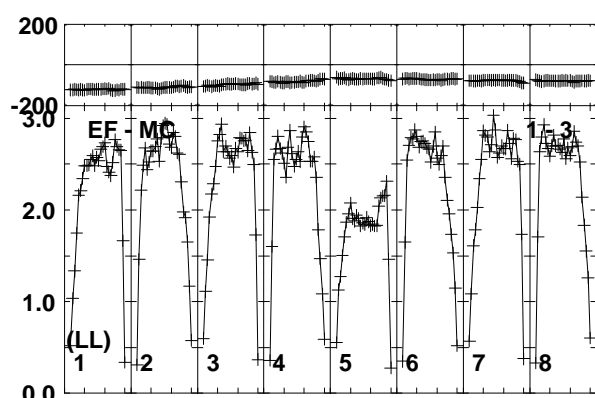
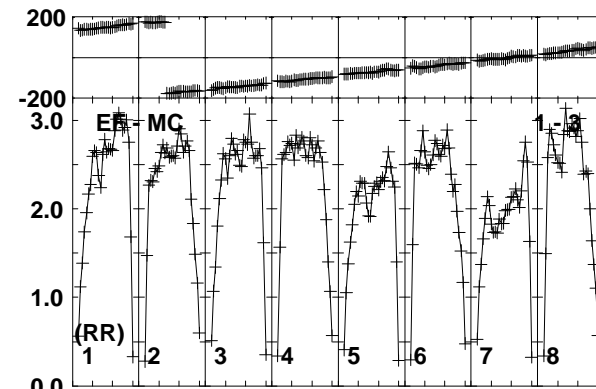
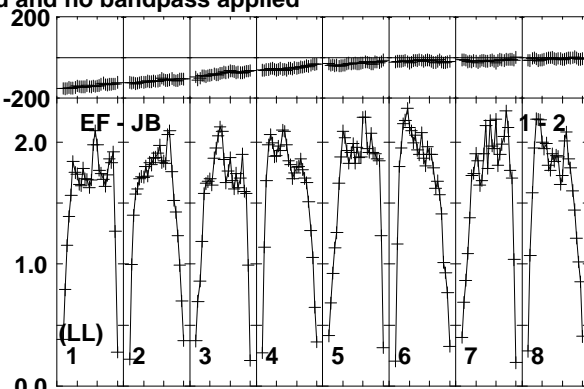
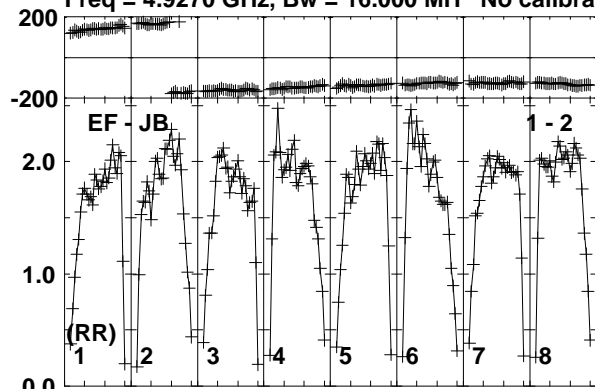

Lower frame: Milli Ampl Jy Top frame: Phas deg  
Vector averaged cross-power spectrum Baseline: EF (01) - JB (02)  
Timerange: 01/07:26:31 to 01/07:27:59

Plot file version 648 created 10-JUN-2016 17:23:06

J1957+3338 RT013A.UVDATA.1

Freq = 4.9270 GHz, Bw = 16.000 MH No calibration applied and no bandpass applied

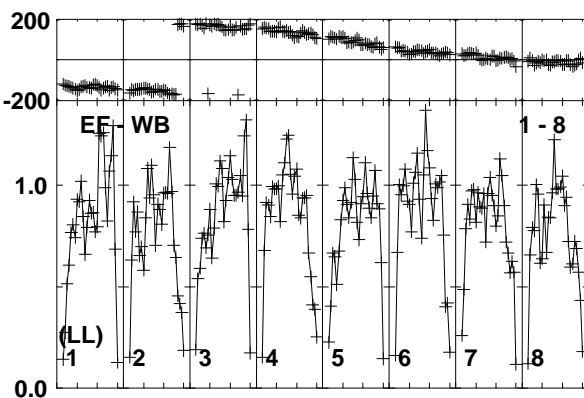
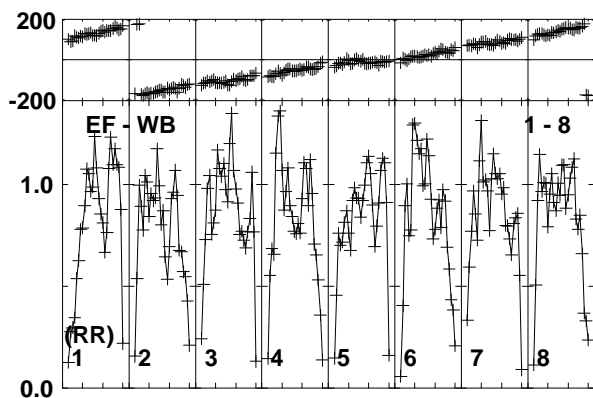
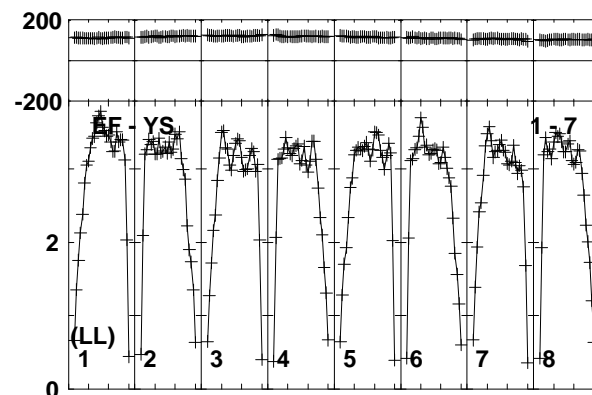
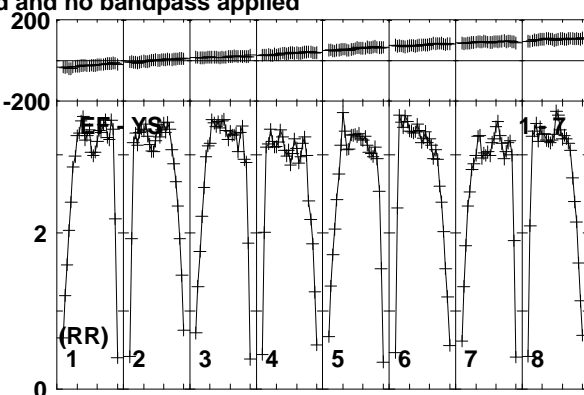
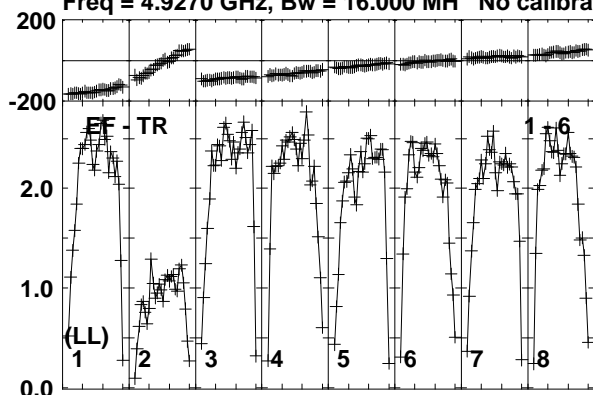

Lower frame: Milli Ampl Jy Top frame: Phas deg  
Vector averaged cross-power spectrum Baseline: EF (01) - TR (06)  
Timerange: 01/07:26:31 to 01/07:27:59

Plot file version 649 created 10-JUN-2016 17:23:06

CHECK RT013A.UVDATA.1

Freq = 4.9270 GHz, Bw = 16.000 MH No calibration applied and no bandpass applied

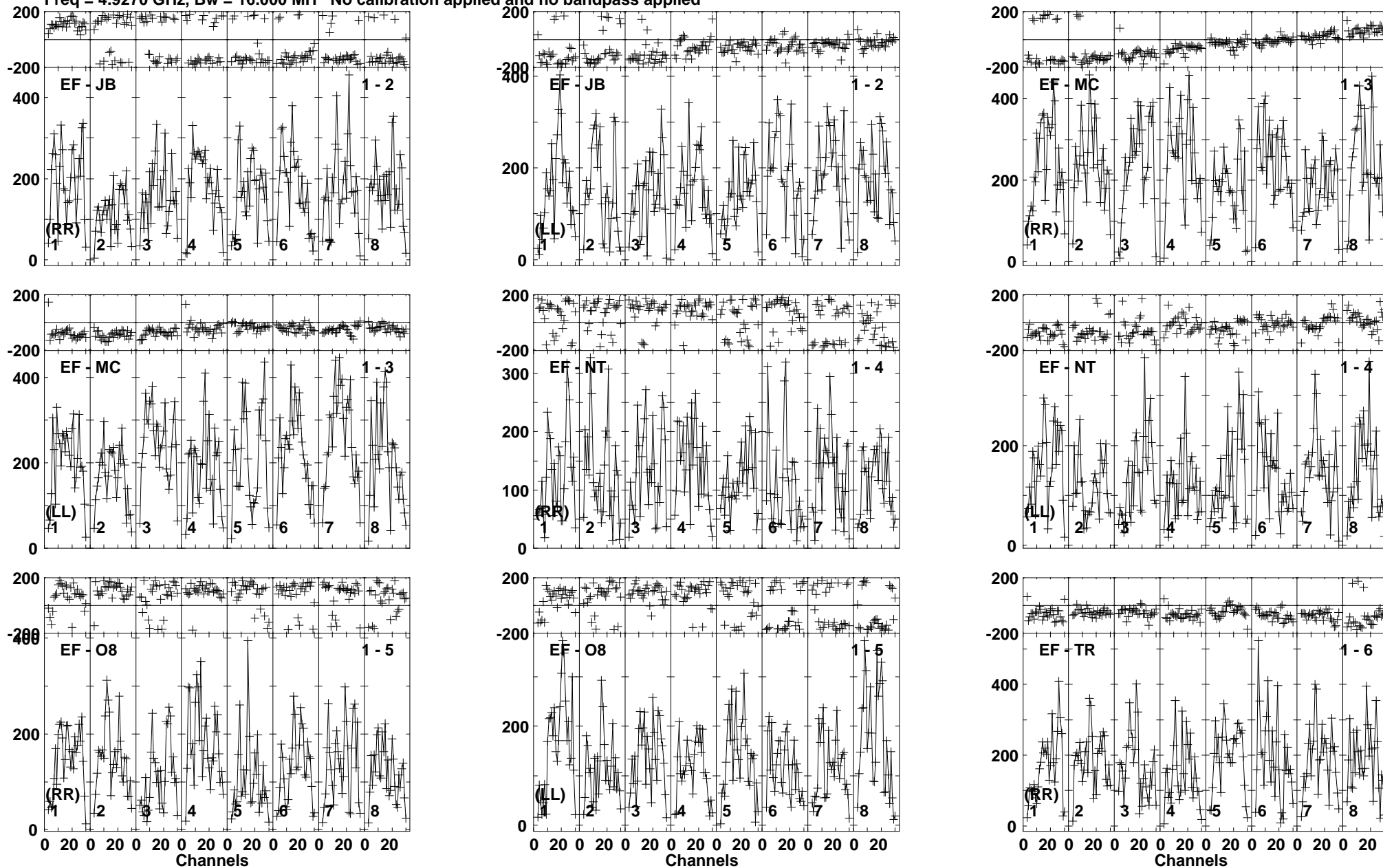

Lower frame: Micro Ampl Jy Top frame: Phas deg  
Vector averaged cross-power spectrum Baseline: EF (01) - JB (02)  
Timerange: 01/07:28:40 to 01/07:30:39

Plot file version 650 created 10-JUN-2016 17:23:06

CHECK RT013A.UVDATA.1

Freq = 4.9270 GHz, Bw = 16.000 MH No calibration applied and no bandpass applied

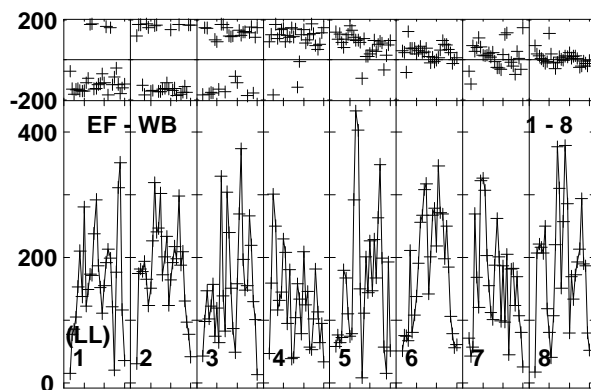
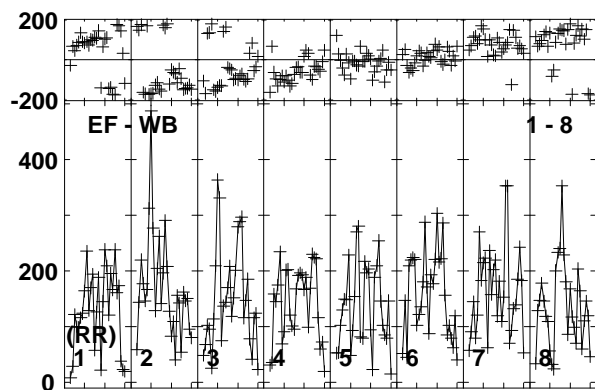
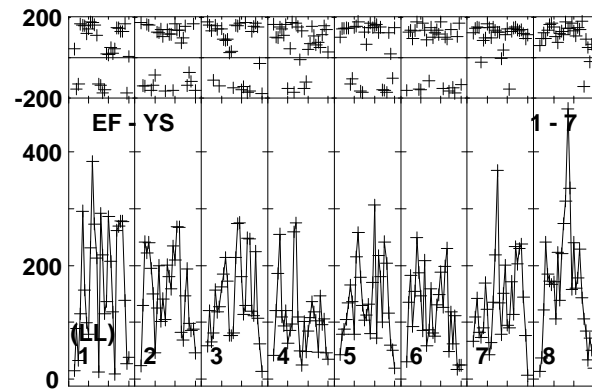
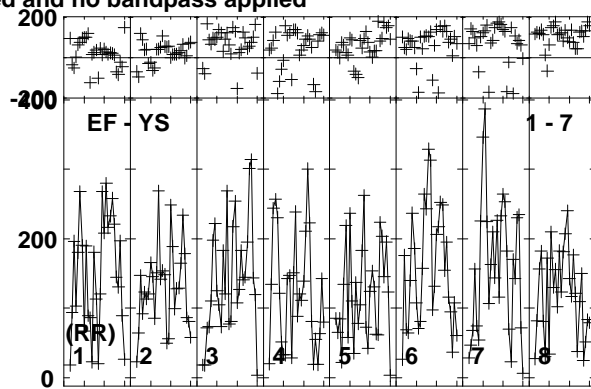
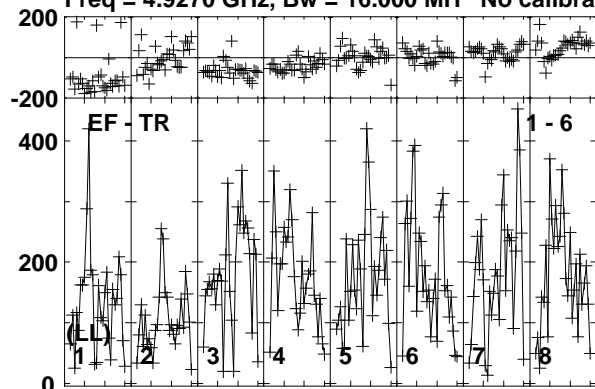

Lower frame: Micro Ampl Jy Top frame: Phas deg  
Vector averaged cross-power spectrum Baseline: EF (01) - TR (06)  
Timerange: 01/07:28:40 to 01/07:30:39



Plot file version 651 created 10-JUN-2016 17:23:06

CYGX1 RT013A.UVDATA.1

Freq = 4.9270 GHz, Bw = 16.000 MH No calibration applied and no bandpass applied

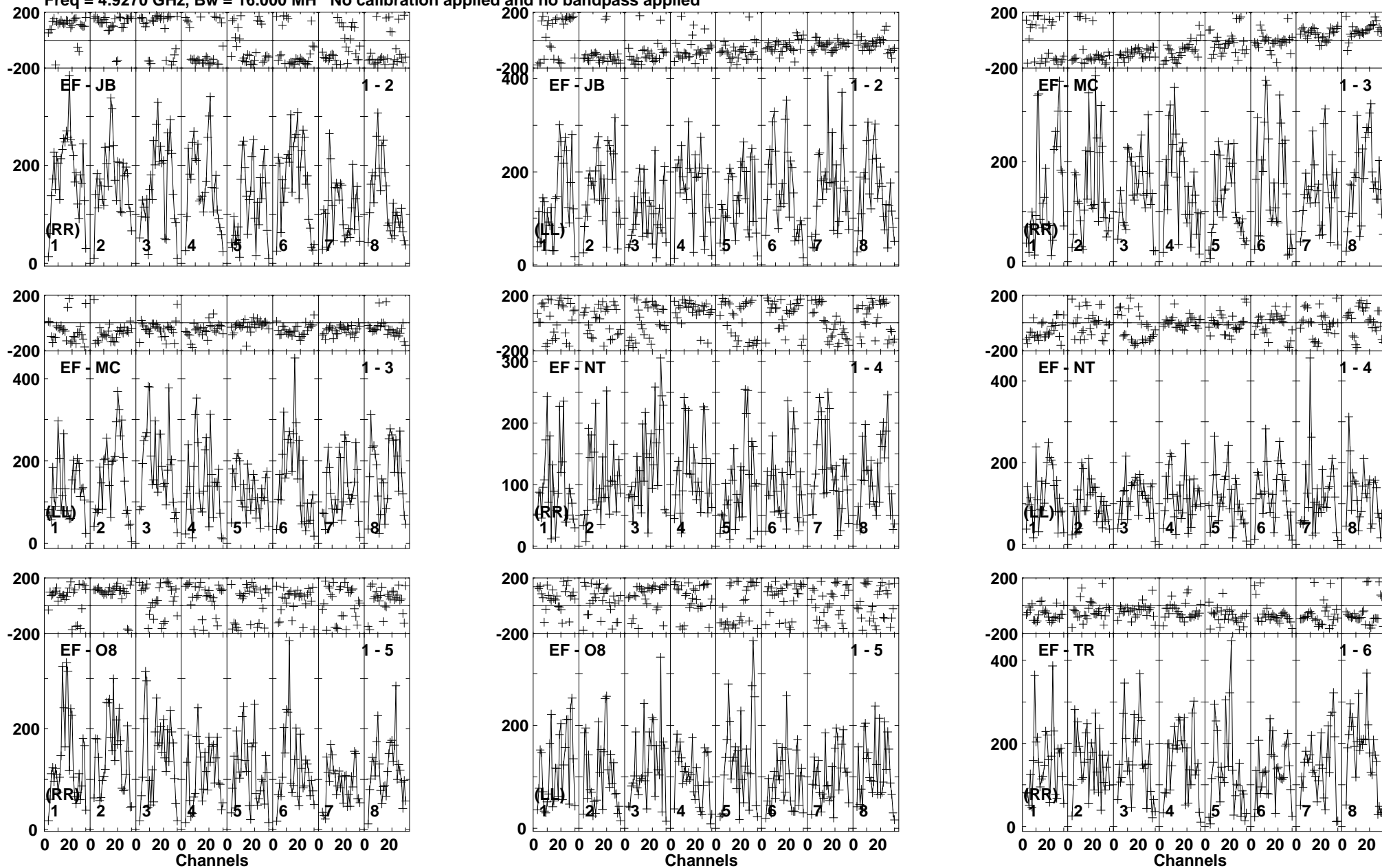

Lower frame: Micro Ampl Jy Top frame: Phas deg  
Vector averaged cross-power spectrum Baseline: EF (01) - JB (02)  
Timerange: 01/07:30:40 to 01/07:33:09

Plot file version 652 created 10-JUN-2016 17:23:07

CYGX1 RT013A.UVDATA.1

Freq = 4.9270 GHz, Bw = 16.000 MH No calibration applied and no bandpass applied

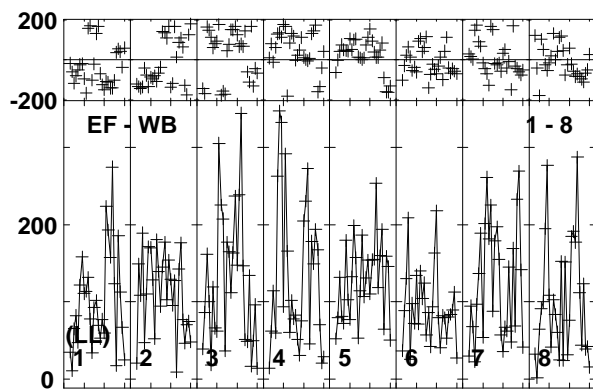
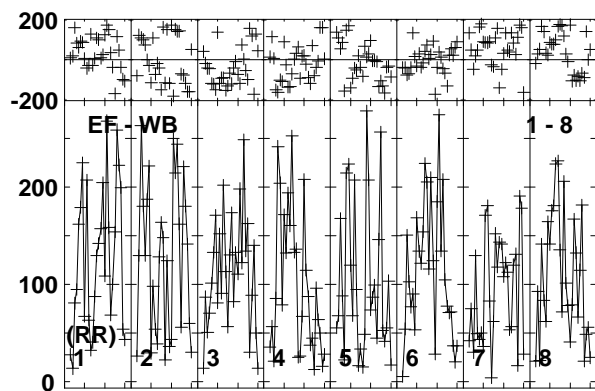
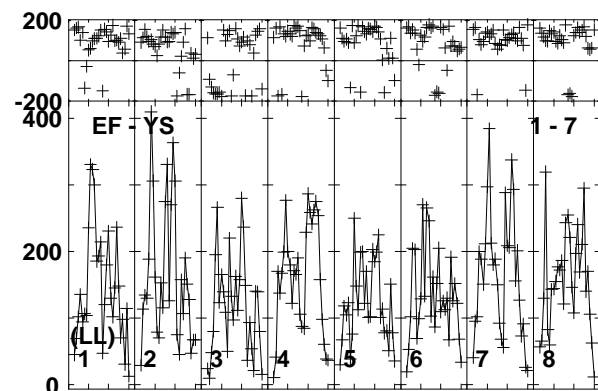
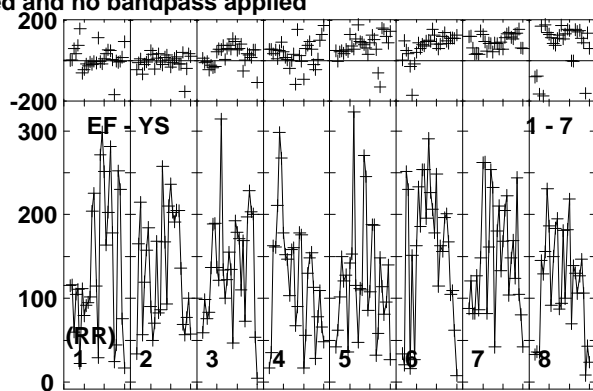
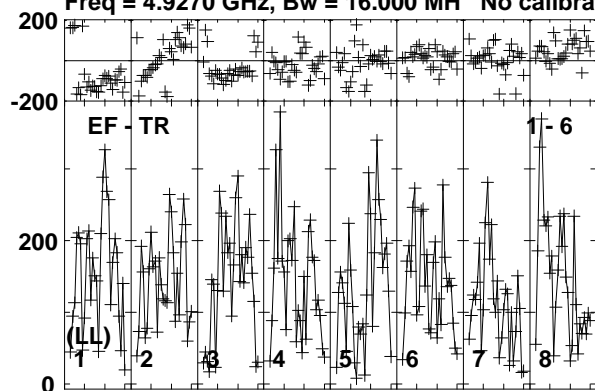

Lower frame: Micro Ampl Jy Top frame: Phas deg  
Vector averaged cross-power spectrum Baseline: EF (01) - TR (06)  
Timerange: 01/07:30:40 to 01/07:33:09

Plot file version 653 created 10-JUN-2016 17:23:07

J1957+3338 RT013A.UVDATA.1

Freq = 4.9270 GHz, Bw = 16.000 MH No calibration applied and no bandpass applied

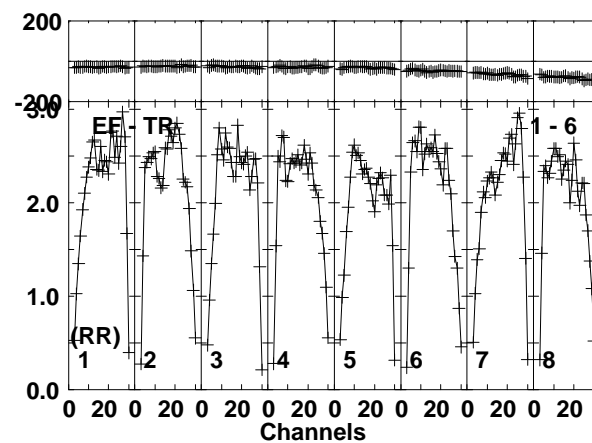
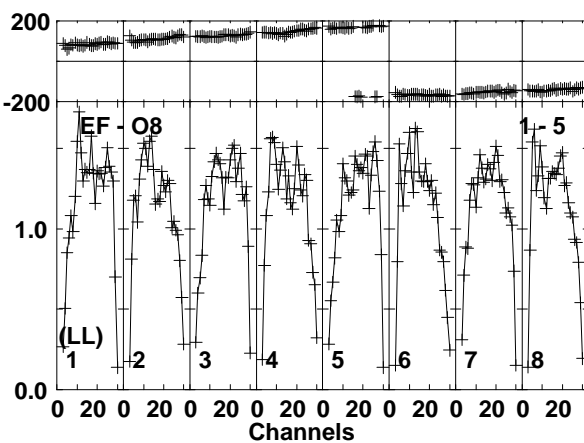
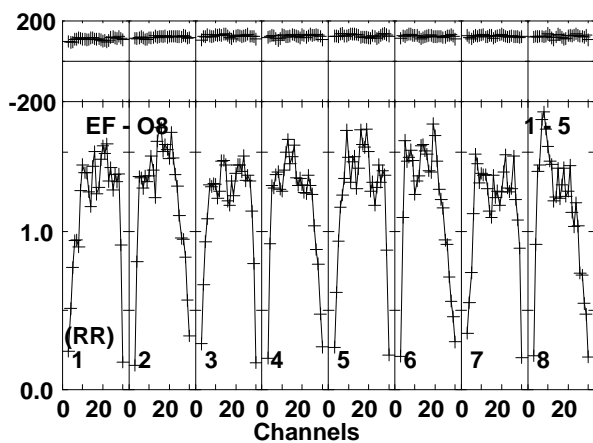
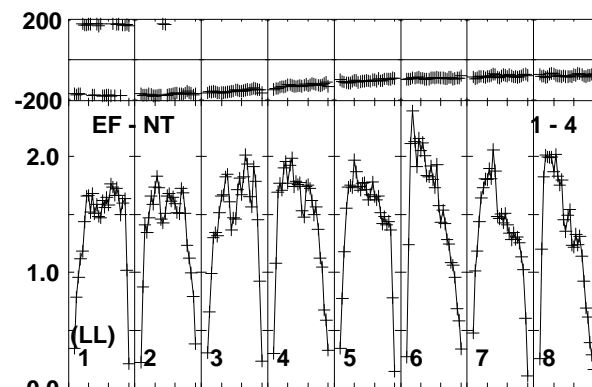
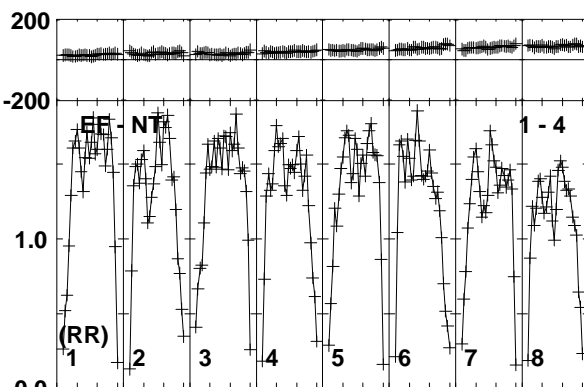
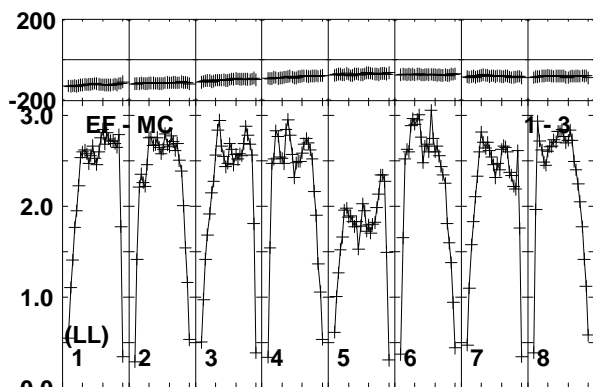
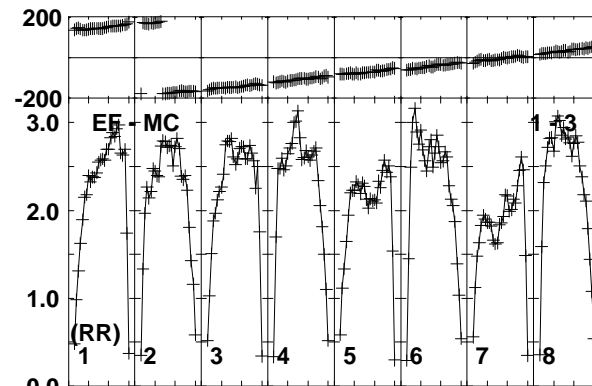
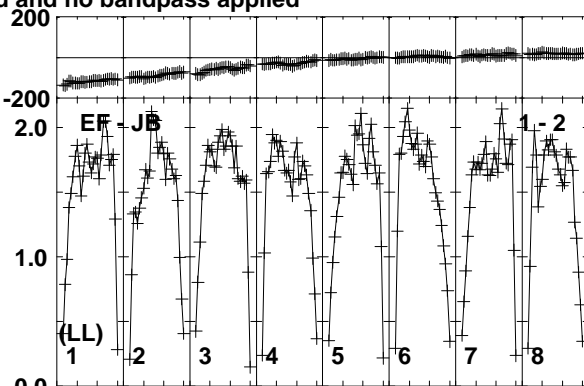
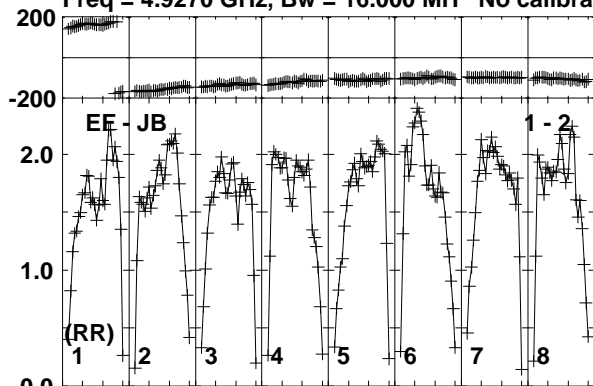

Lower frame: Milli Ampl Jy Top frame: Phas deg  
Vector averaged cross-power spectrum Baseline: EF (01) - JB (02)  
Timerange: 01/07:33:11 to 01/07:34:39

Plot file version 654 created 10-JUN-2016 17:23:07

J1957+3338 RT013A.UVDATA.1

Freq = 4.9270 GHz, Bw = 16.000 MH No calibration applied and no bandpass applied

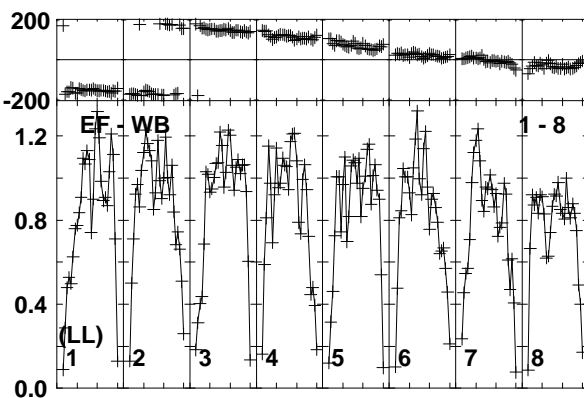
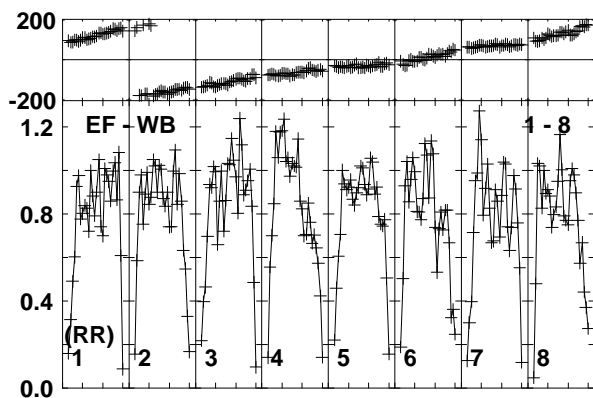
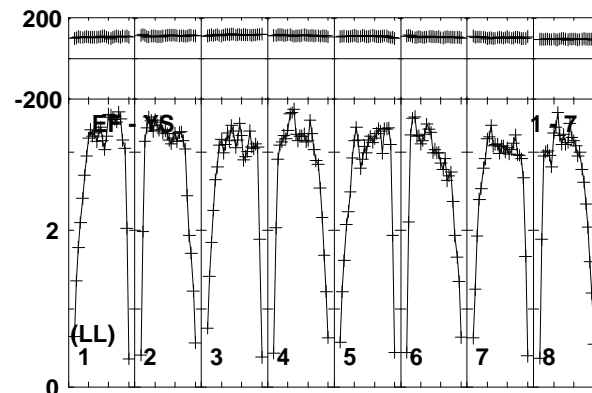
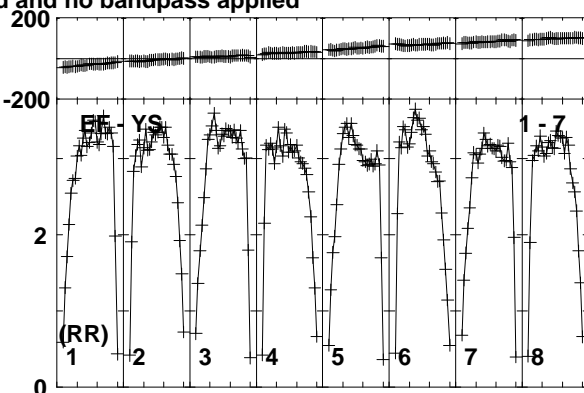
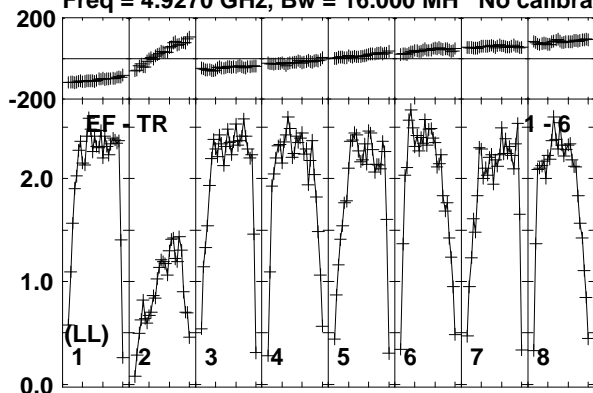

Lower frame: Milli Ampl Jy Top frame: Phas deg  
Vector averaged cross-power spectrum Baseline: EF (01) - TR (06)  
Timerange: 01/07:33:11 to 01/07:34:39

Plot file version 655 created 10-JUN-2016 17:23:07

CHECK RT013A.UVDATA.1

Freq = 4.9270 GHz, Bw = 16.000 MH No calibration applied and no bandpass applied

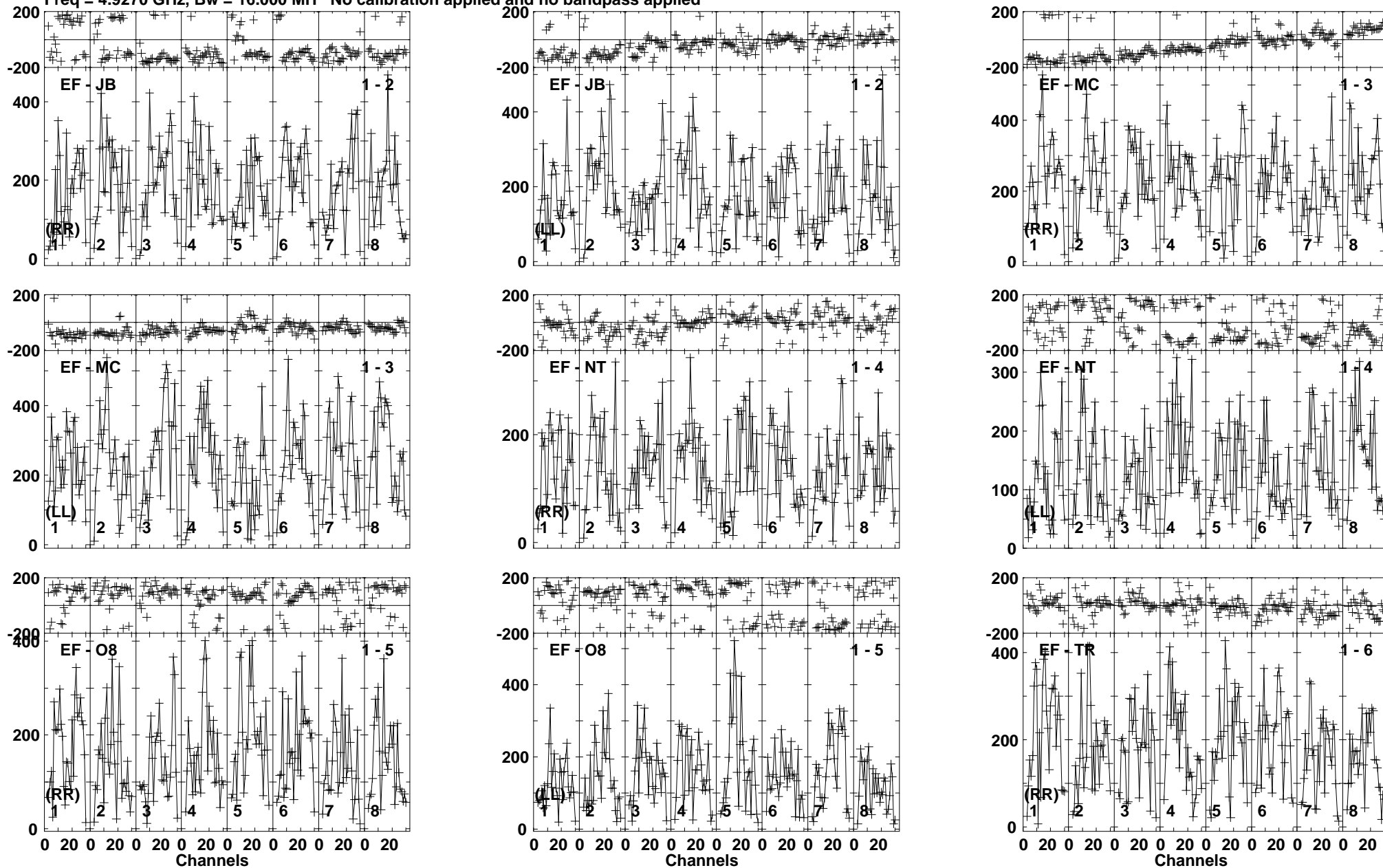

Lower frame: Micro Ampl Jy Top frame: Phas deg  
Vector averaged cross-power spectrum Baseline: EF (01) - JB (02)  
Timerange: 01/07:34:41 to 01/07:36:40

Plot file version 656 created 10-JUN-2016 17:23:07

CHECK RT013A.UVDATA.1

Freq = 4.9270 GHz, Bw = 16.000 MH No calibration applied and no bandpass applied

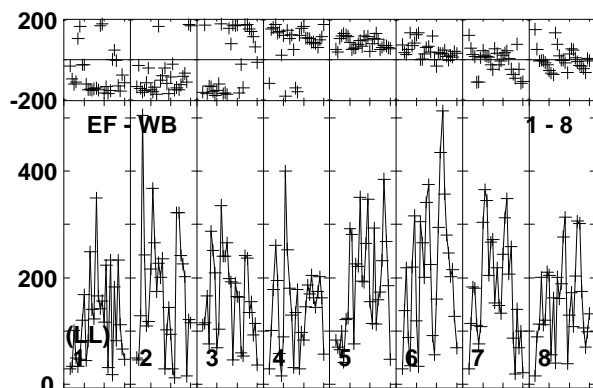
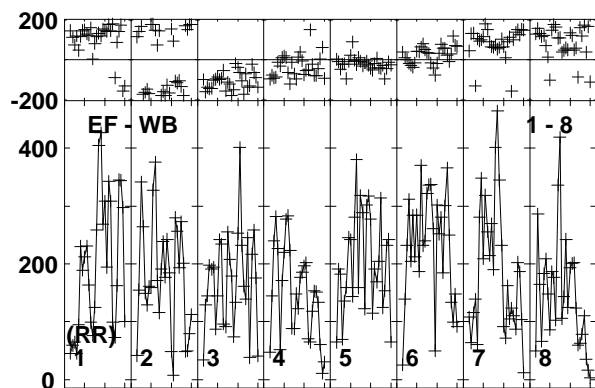
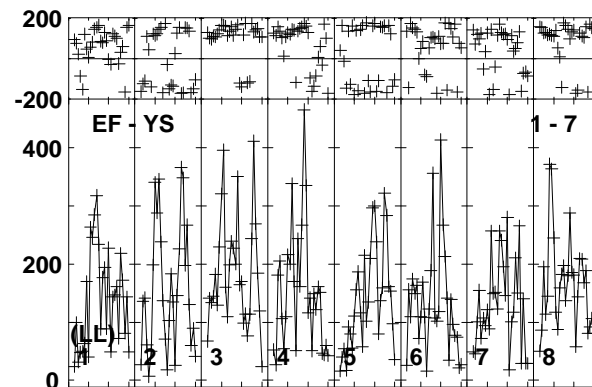
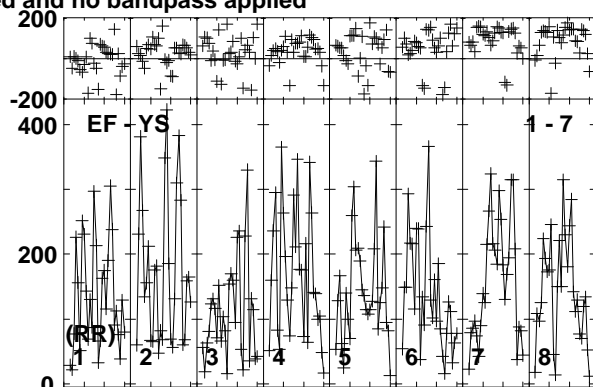
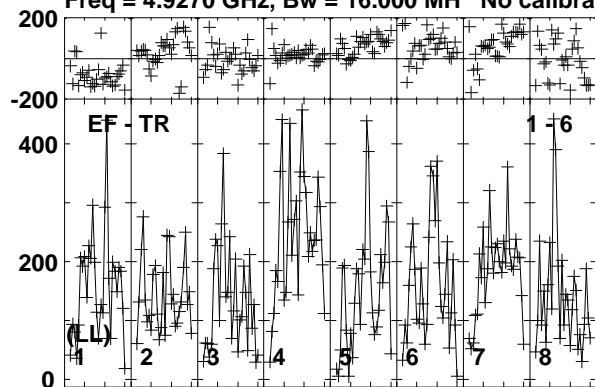

Lower frame: Micro Ampl Jy Top frame: Phas deg  
Vector averaged cross-power spectrum Baseline: EF (01) - TR (06)  
Timerange: 01/07:34:41 to 01/07:36:40

Plot file version 657 created 10-JUN-2016 17:23:07

CYGX1 RT013A.UVDATA.1

Freq = 4.9270 GHz, Bw = 16.000 MH No calibration applied and no bandpass applied

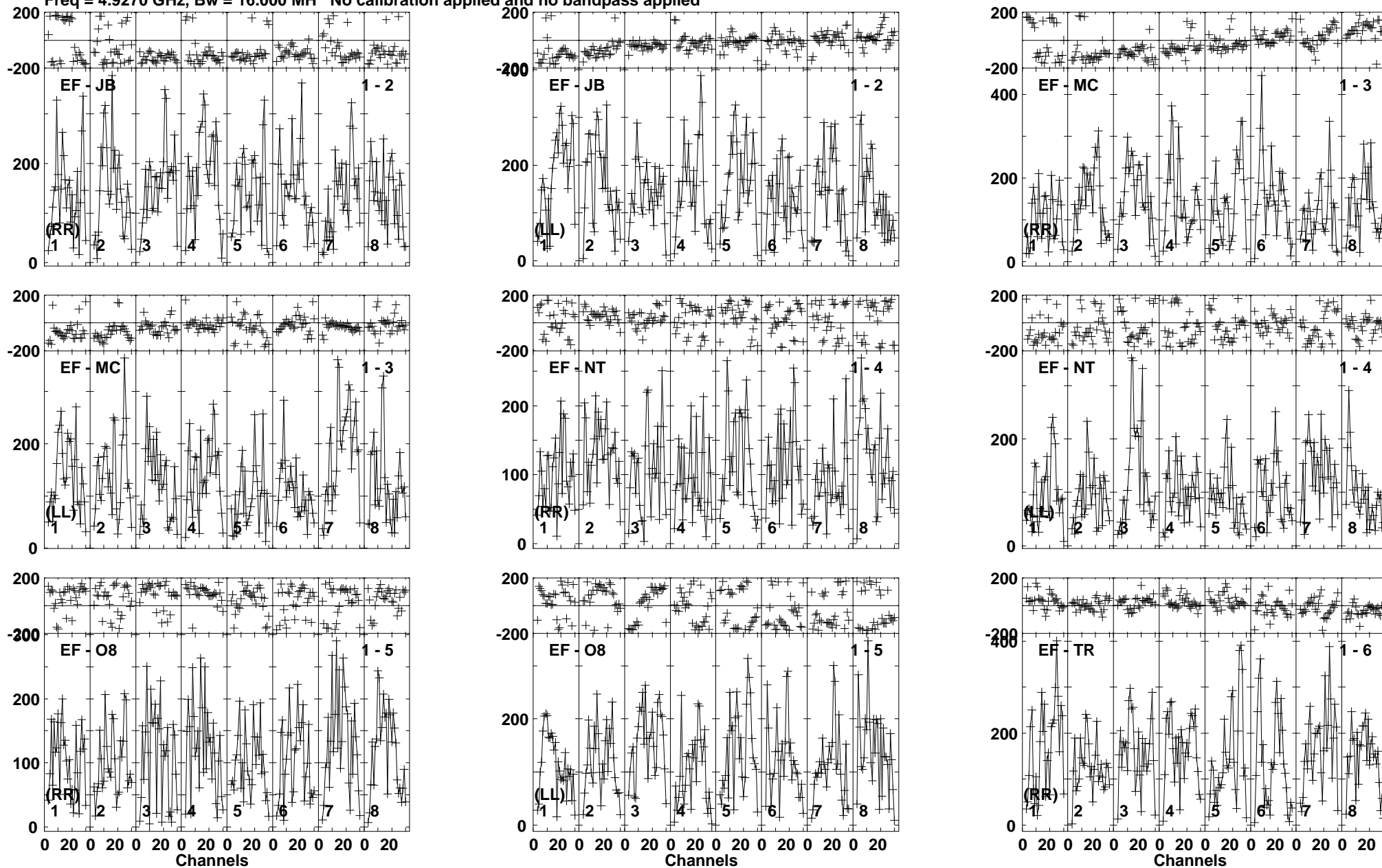

Lower frame: Micro Ampl Jy Top frame: Phas deg  
Vector averaged cross-power spectrum Baseline: EF (01) - JB (02)  
Timerange: 01/07:36:41 to 01/07:39:09

Plot file version 658 created 10-JUN-2016 17:23:07

CYGX1 RT013A.UVDATA.1

Freq = 4.9270 GHz, Bw = 16.000 MH No calibration applied and no bandpass applied

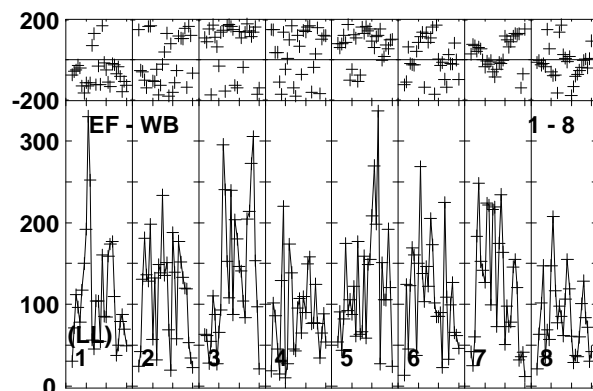
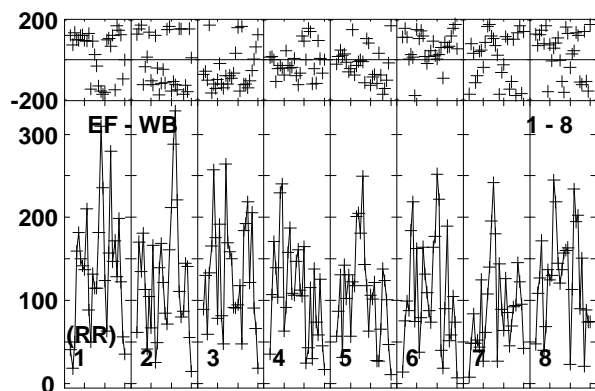
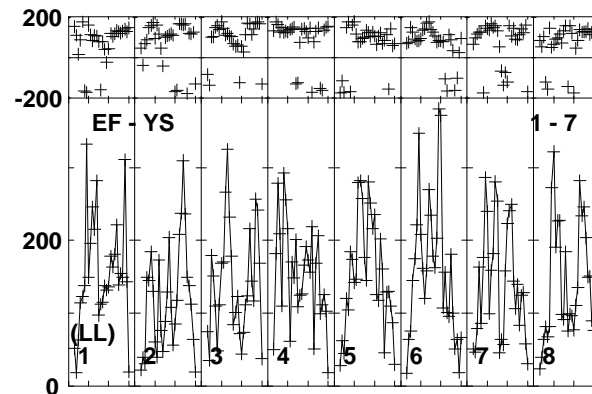
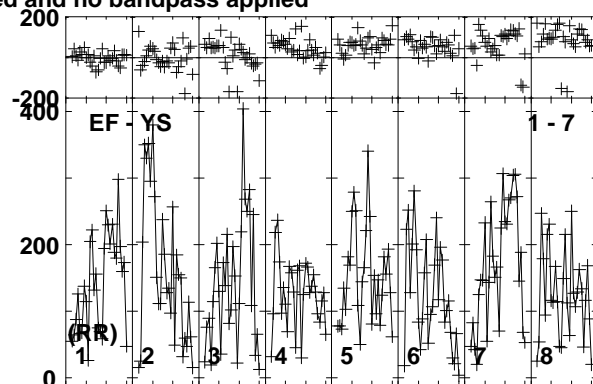
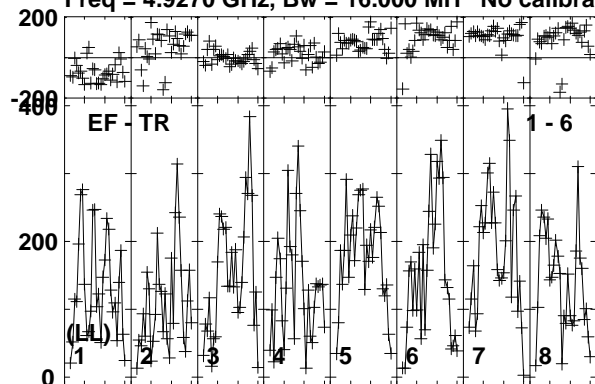

Lower frame: Micro Ampl Jy Top frame: Phas deg  
Vector averaged cross-power spectrum Baseline: EF (01) - TR (06)  
Timerange: 01/07:36:41 to 01/07:39:09



Plot file version 659 created 10-JUN-2016 17:23:07

J1957+3338 RT013A.UVDATA.1

Freq = 4.9270 GHz, Bw = 16.000 MH No calibration applied and no bandpass applied

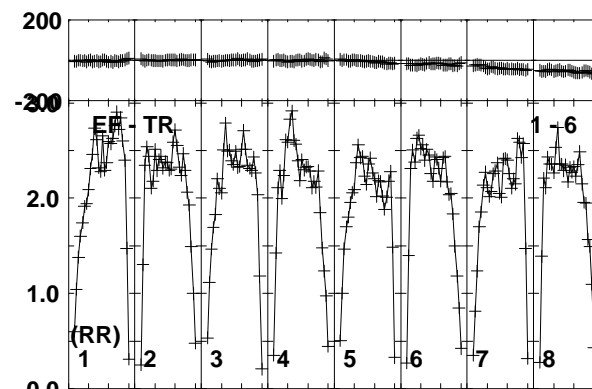
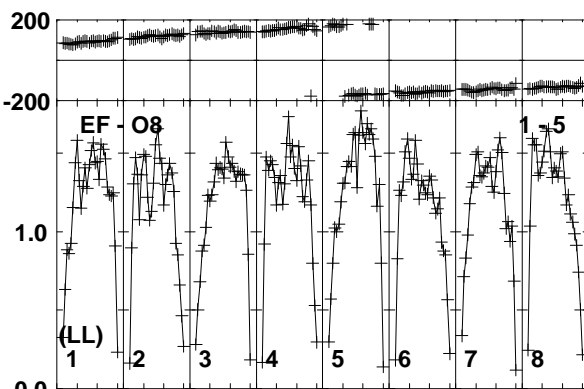
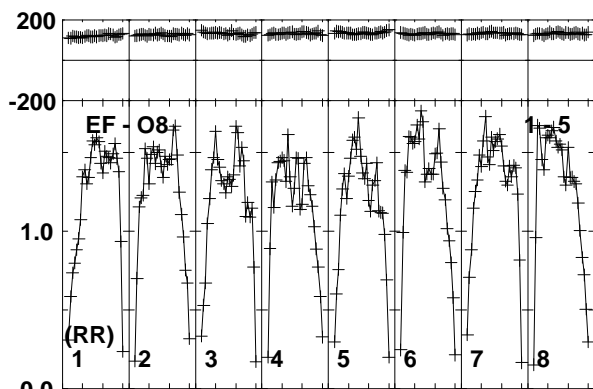
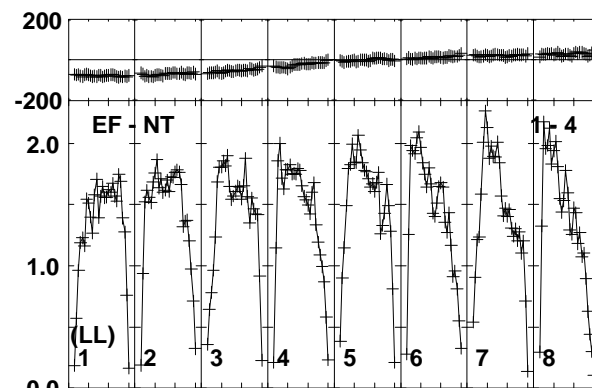
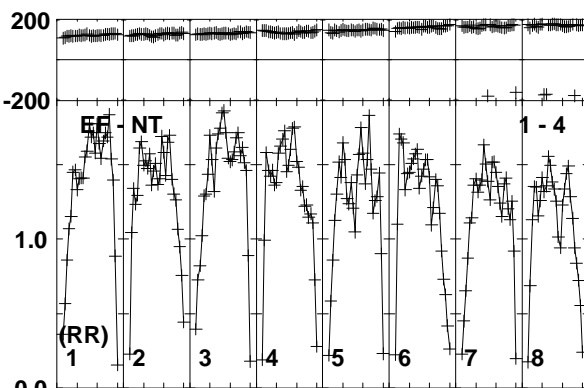
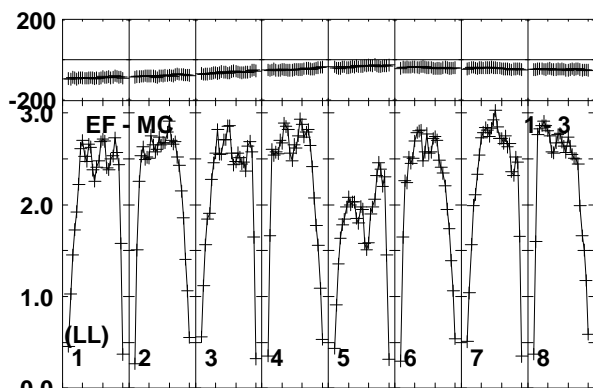
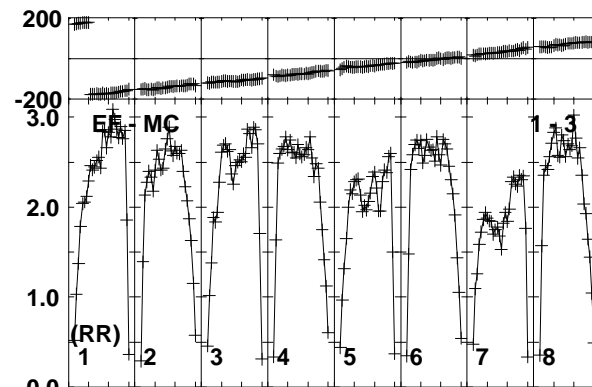
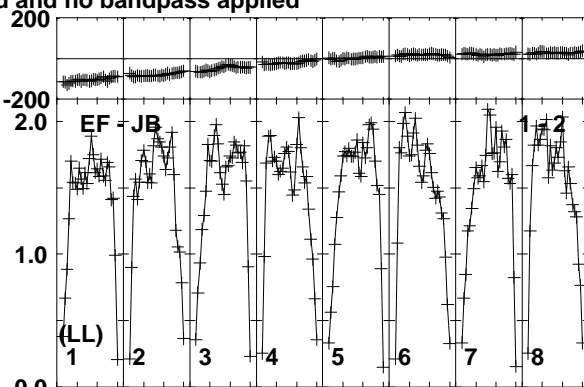
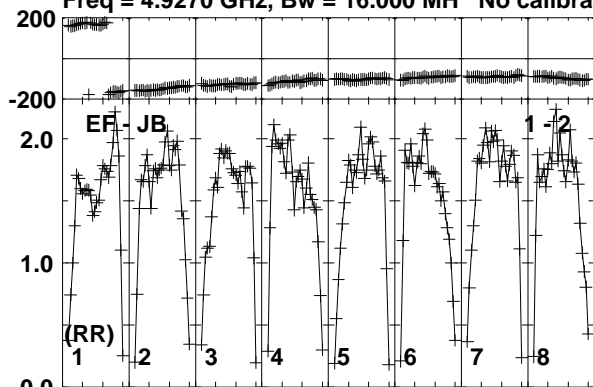

Lower frame: Milli Ampl Jy Top frame: Phas deg  
Vector averaged cross-power spectrum Baseline: EF (01) - JB (02)  
Timerange: 01/07:39:10 to 01/07:40:39

Plot file version 660 created 10-JUN-2016 17:23:07

J1957+3338 RT013A.UVDATA.1

Freq = 4.9270 GHz, Bw = 16.000 MH No calibration applied and no bandpass applied

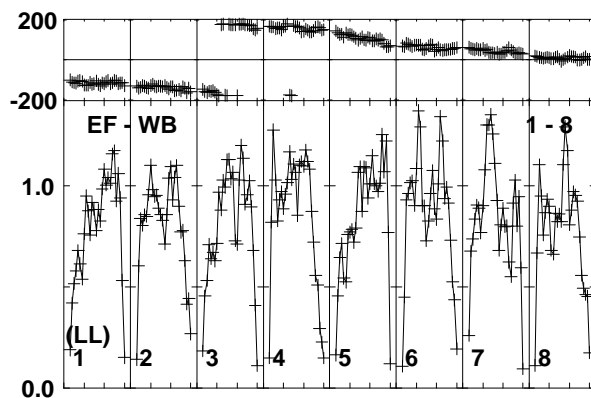
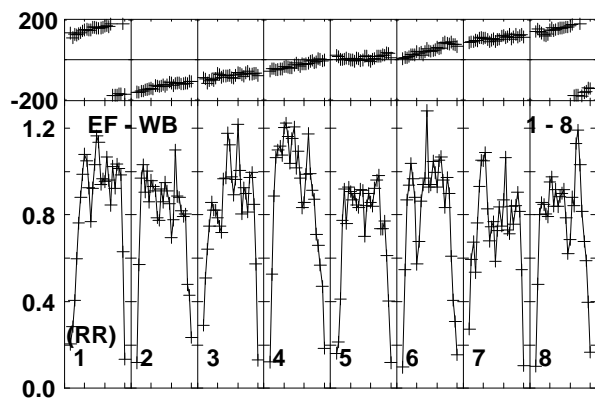
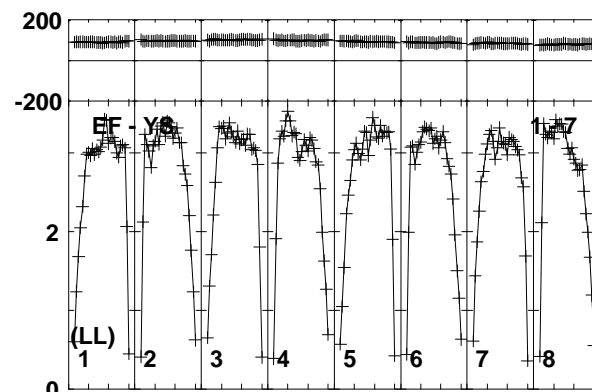
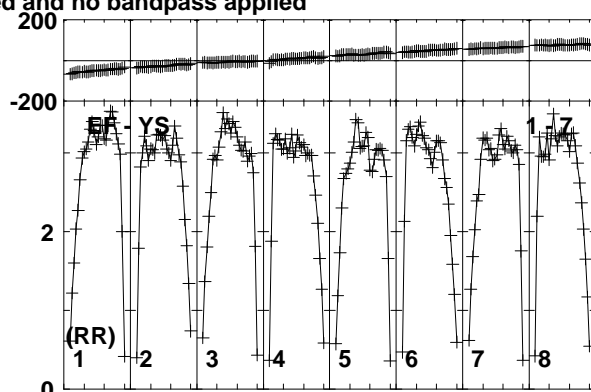
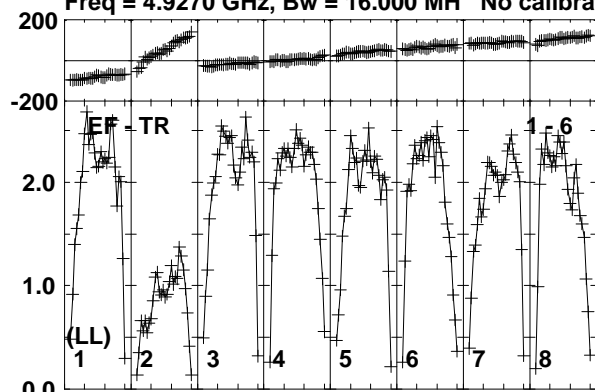

Lower frame: Milli Ampl Jy Top frame: Phas deg  
Vector averaged cross-power spectrum Baseline: EF (01) - TR (06)  
Timerange: 01/07:39:10 to 01/07:40:39

Plot file version 661 created 10-JUN-2016 17:23:07

CHECK RT013A.UVDATA.1

Freq = 4.9270 GHz, Bw = 16.000 MH No calibration applied and no bandpass applied

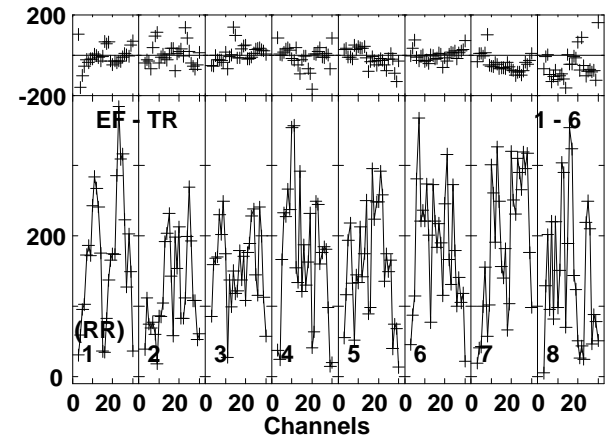
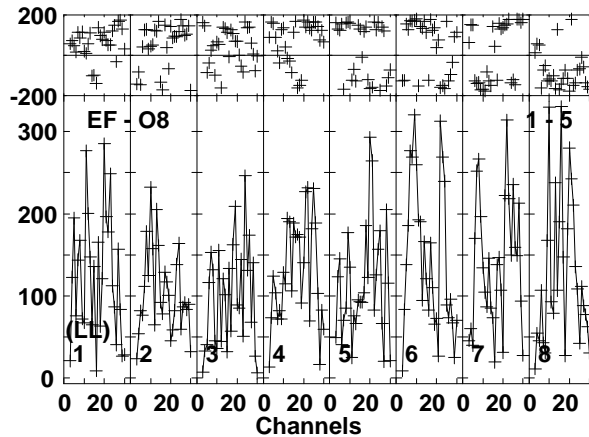
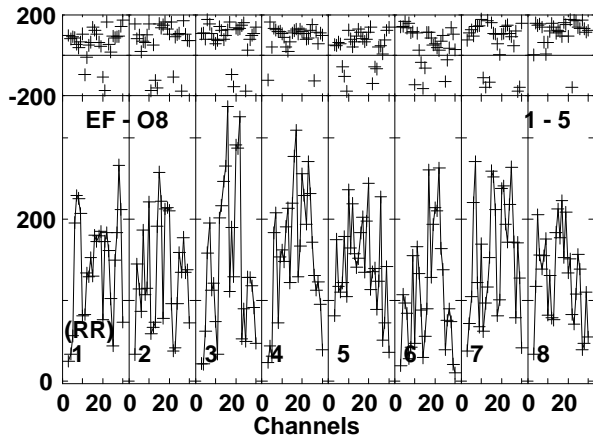
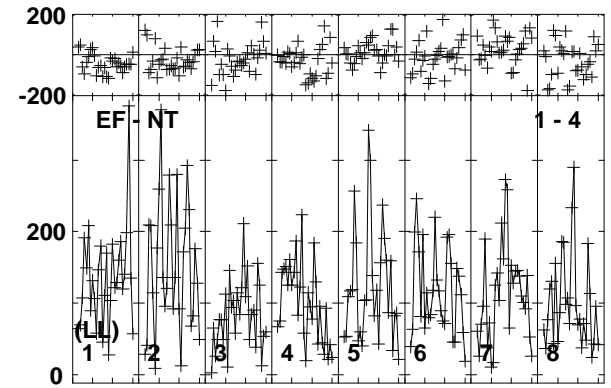
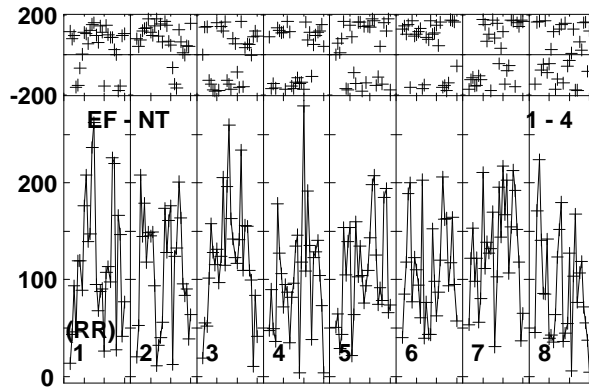
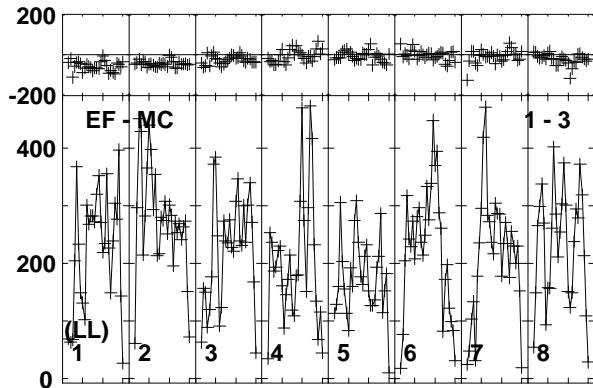
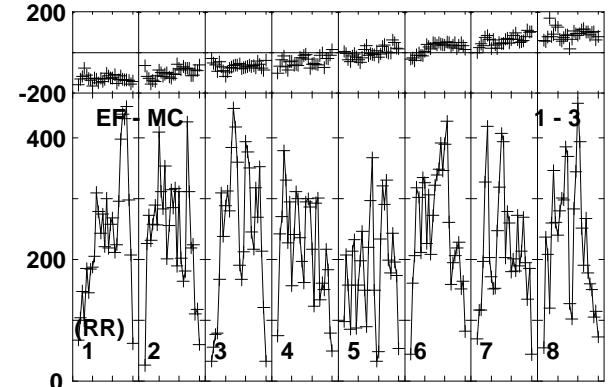
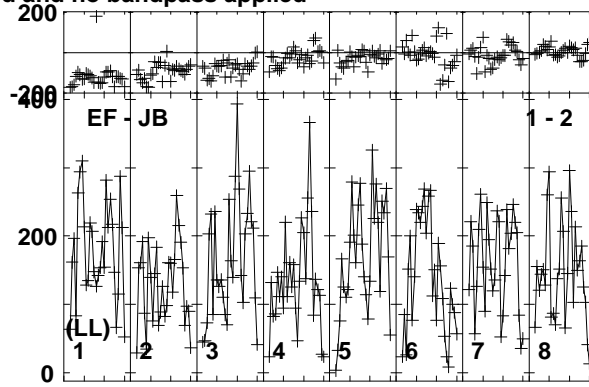
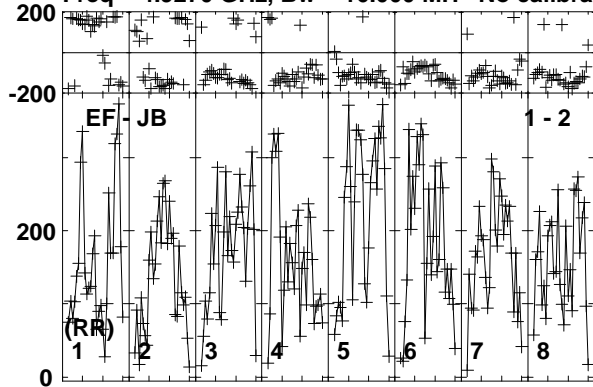

Lower frame: Micro Ampl Jy Top frame: Phas deg  
Vector averaged cross-power spectrum Baseline: EF (01) - JB (02)  
Timerange: 01/07:41:21 to 01/07:43:20

Plot file version 662 created 10-JUN-2016 17:23:07

CHECK RT013A.UVDATA.1

Freq = 4.9270 GHz, Bw = 16.000 MH No calibration applied and no bandpass applied

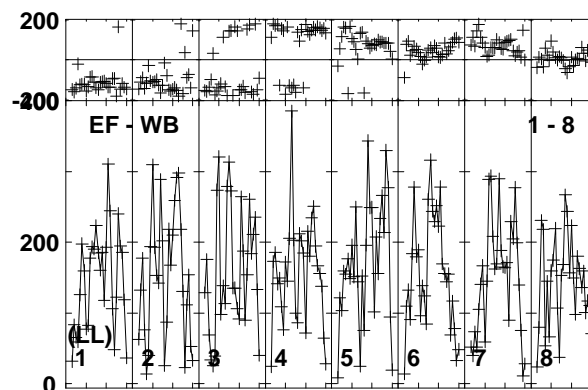
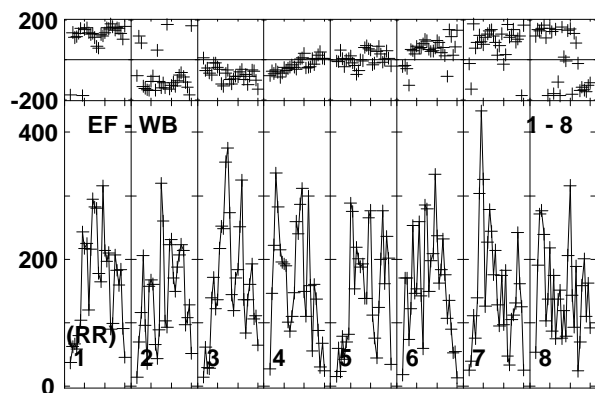
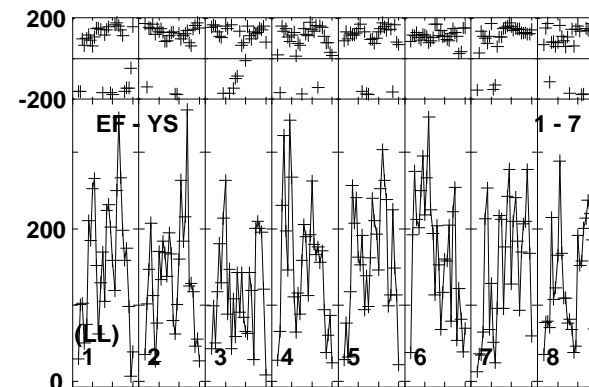
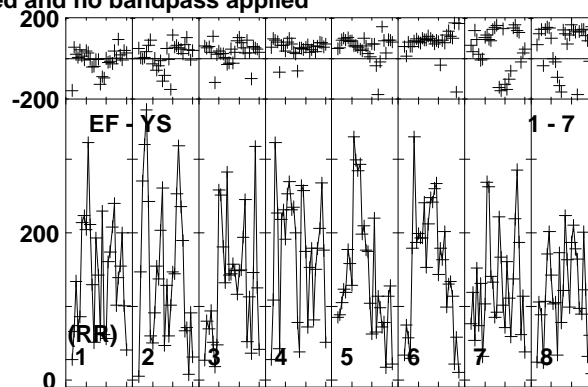
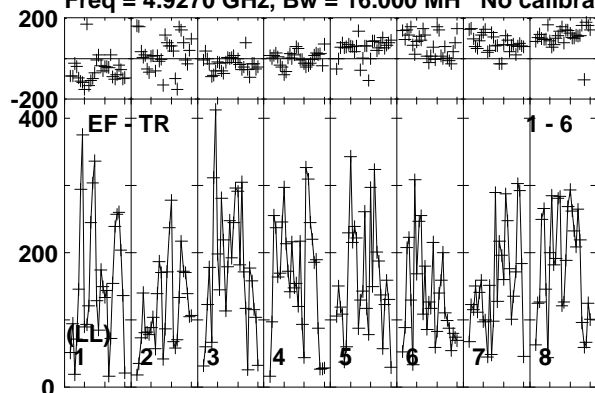

Lower frame: Micro Ampl Jy Top frame: Phas deg  
Vector averaged cross-power spectrum Baseline: EF (01) - TR (06)  
Timerange: 01/07:41:21 to 01/07:43:20

Plot file version 663 created 10-JUN-2016 17:23:08

CYGX1 RT013A.UVDATA.1

Freq = 4.9270 GHz, Bw = 16.000 MH No calibration applied and no bandpass applied

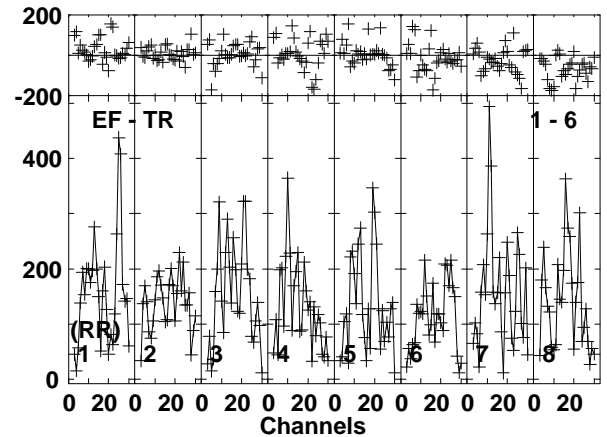
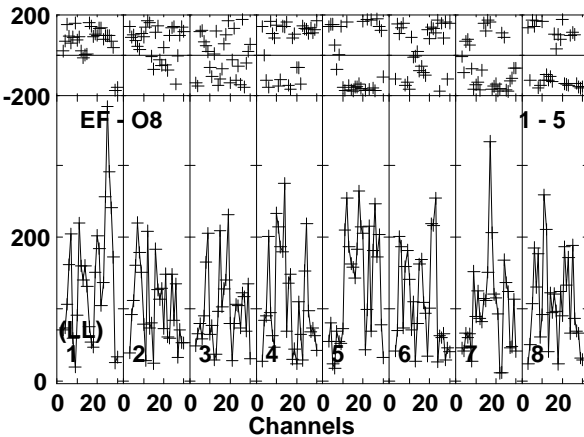
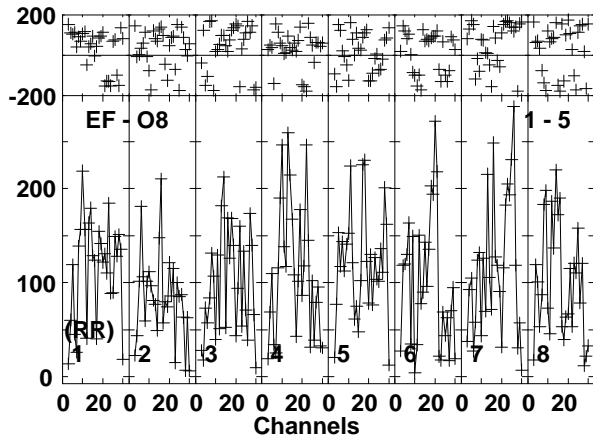
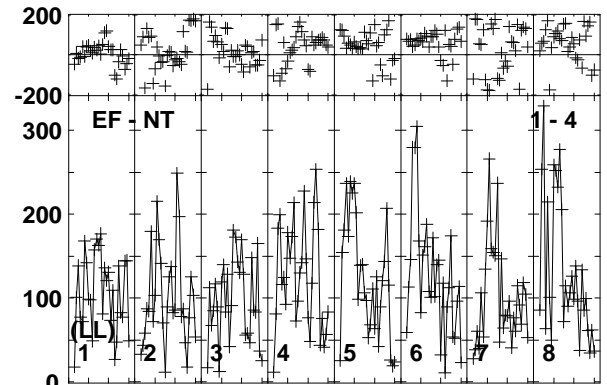
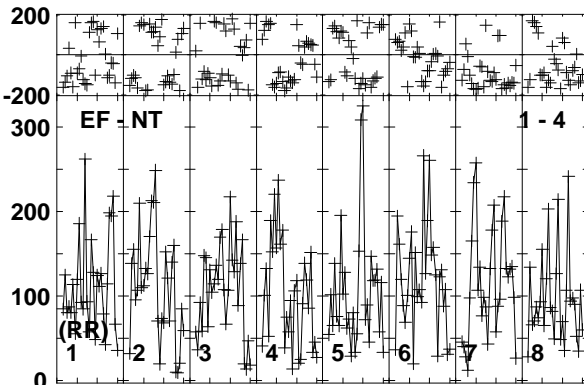
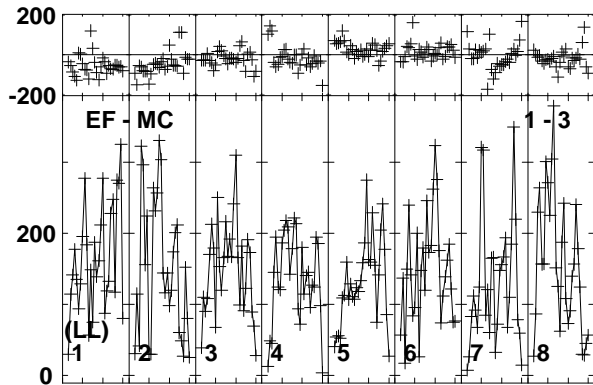
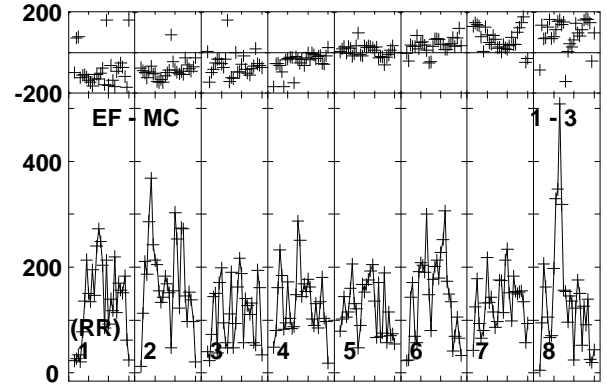
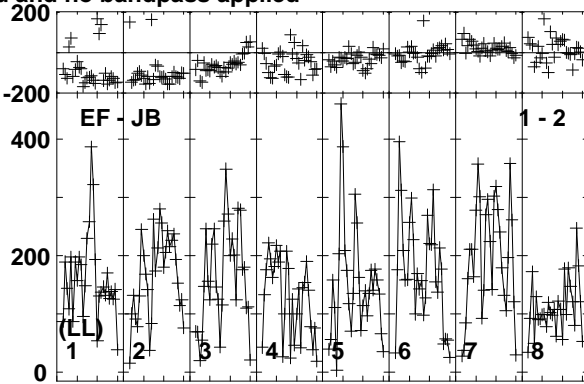
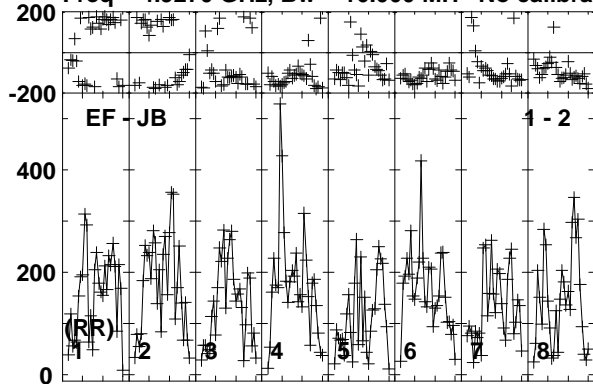

Lower frame: Micro Ampl Jy Top frame: Phas deg  
Vector averaged cross-power spectrum Baseline: EF (01) - JB (02)  
Timerange: 01/07:43:21 to 01/07:45:49

Plot file version 664 created 10-JUN-2016 17:23:08

CYGX1 RT013A.UVDATA.1

Freq = 4.9270 GHz, Bw = 16.000 MH No calibration applied and no bandpass applied

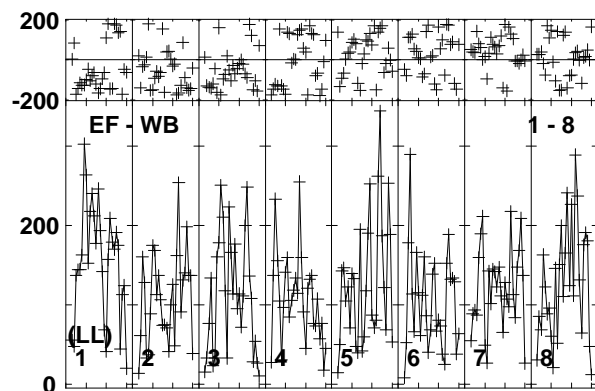
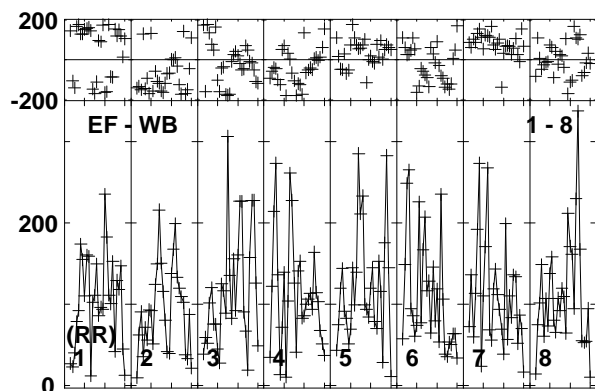
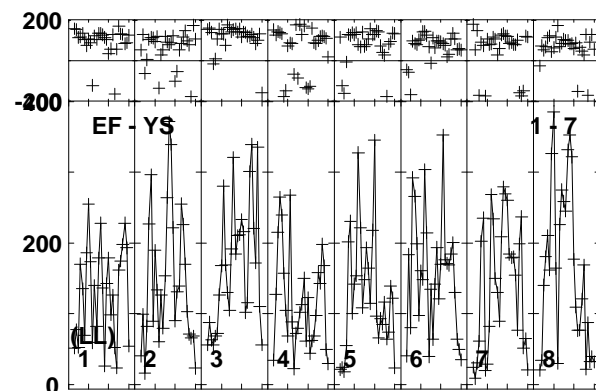
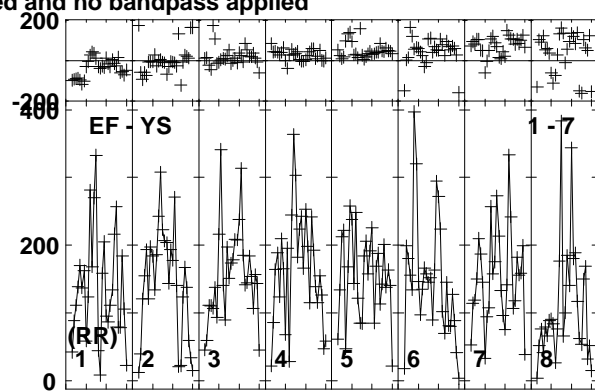
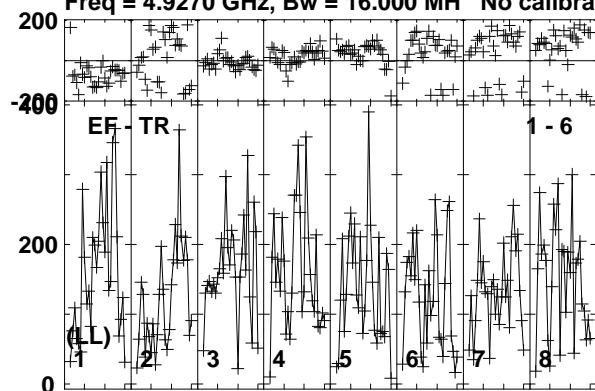

Lower frame: Micro Ampl Jy Top frame: Phas deg  
Vector averaged cross-power spectrum Baseline: EF (01) - TR (06)  
Timerange: 01/07:43:21 to 01/07:45:49

Plot file version 665 created 10-JUN-2016 17:23:08

J1957+3338 RT013A.UVDATA.1

Freq = 4.9270 GHz, Bw = 16.000 MH No calibration applied and no bandpass applied

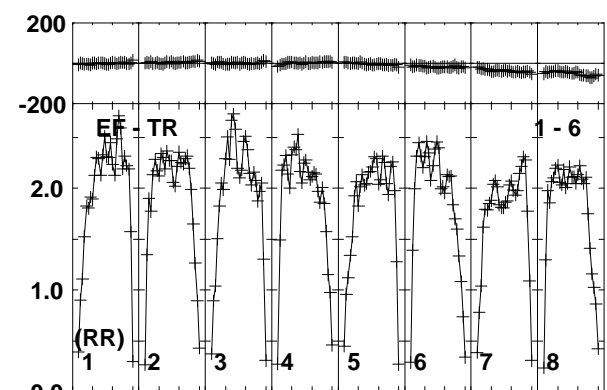
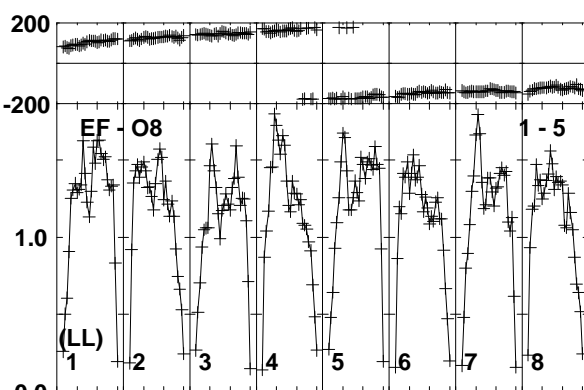
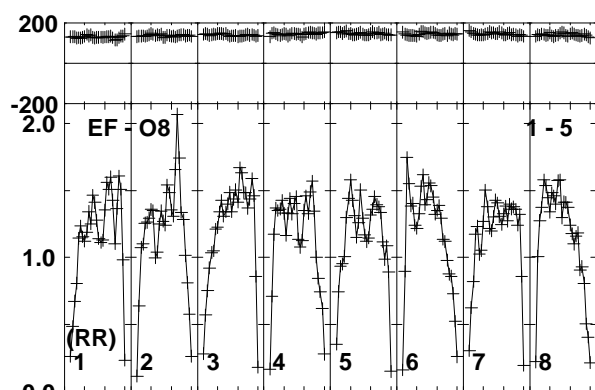
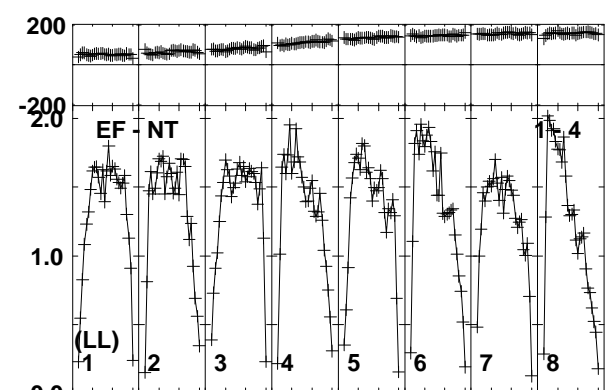
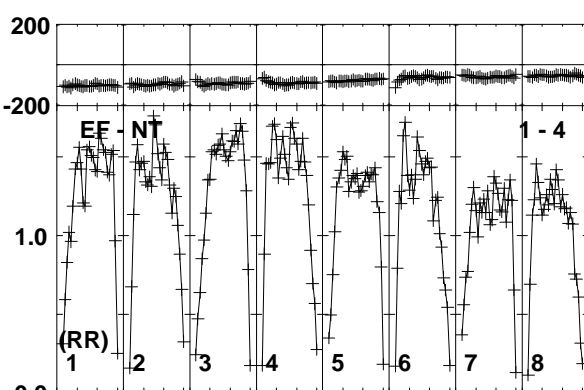
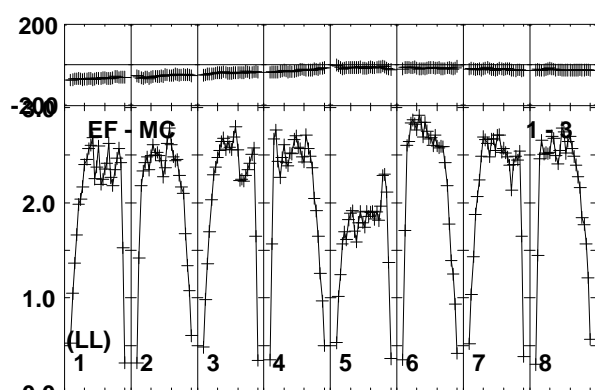
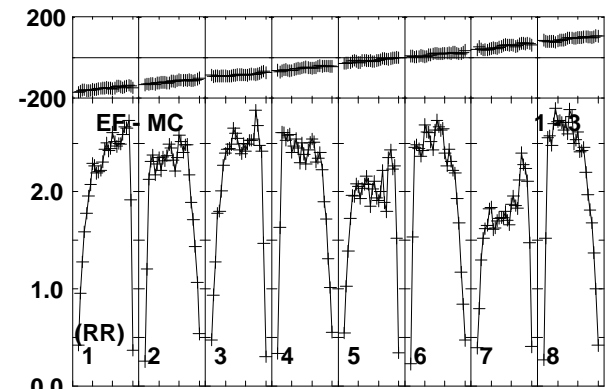
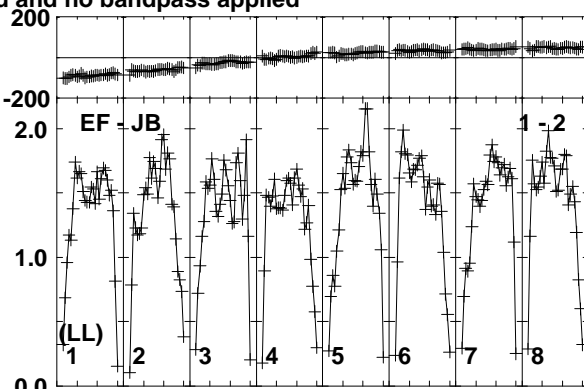
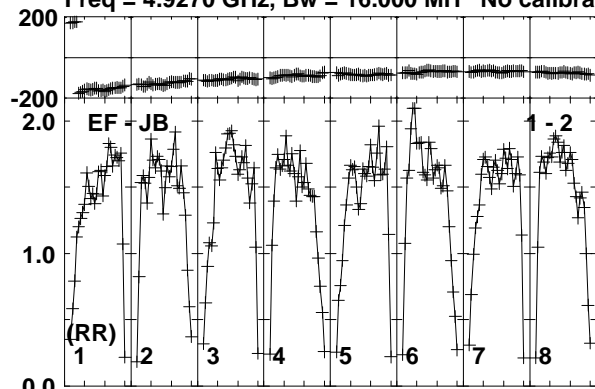

Lower frame: Milli Ampl Jy Top frame: Phas deg

Vector averaged cross-power spectrum Baseline: EF (01) - JB (02)

Timerange: 01/07:45:50 to 01/07:47:20

Plot file version 666 created 10-JUN-2016 17:23:08

J1957+3338 RT013A.UVDATA.1

Freq = 4.9270 GHz, Bw = 16.000 MH No calibration applied and no bandpass applied

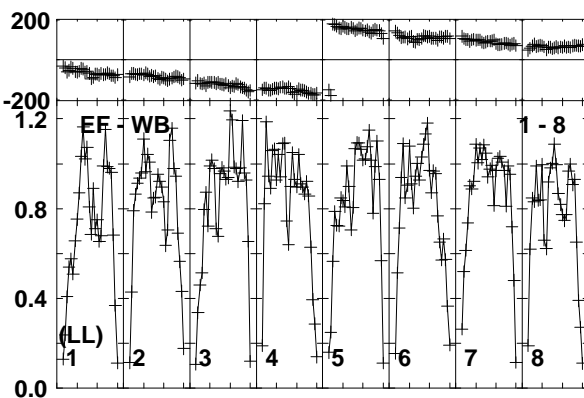
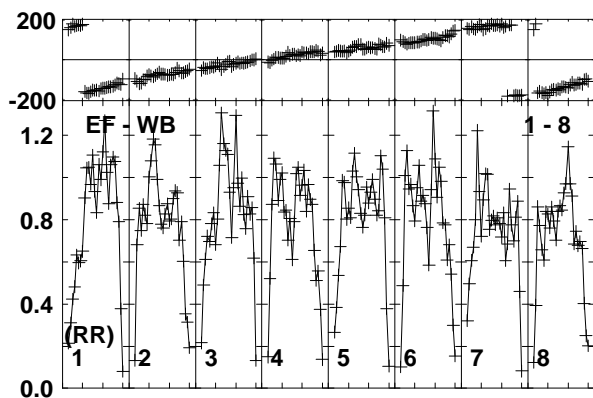
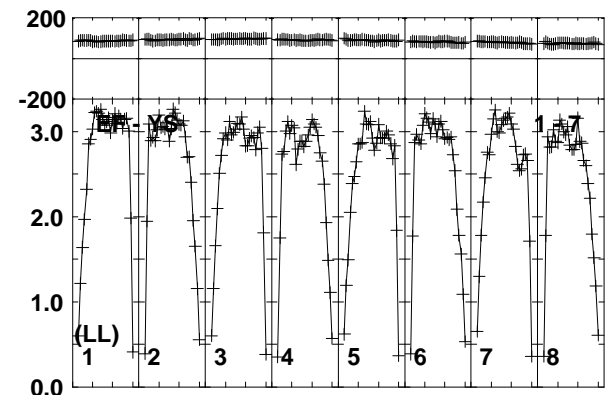
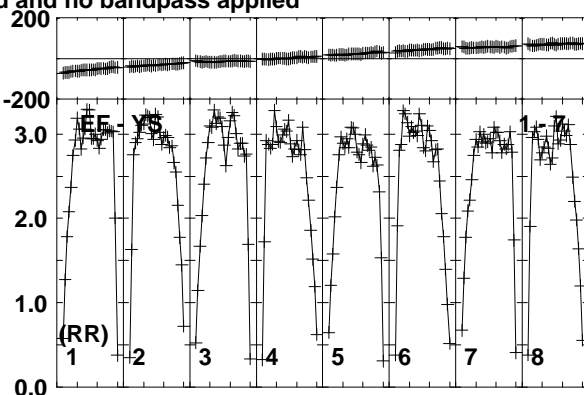
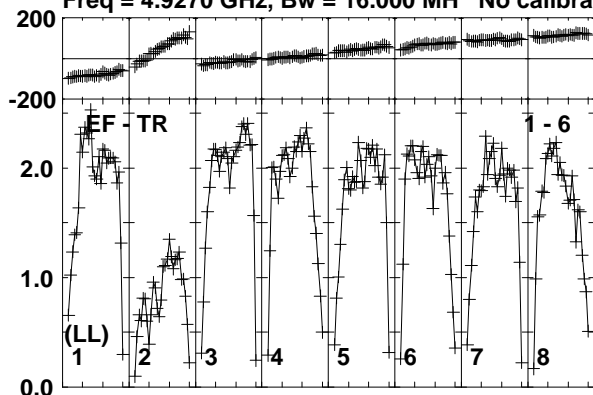

Lower frame: Milli Ampl Jy Top frame: Phas deg  
Vector averaged cross-power spectrum Baseline: EF (01) - TR (06)  
Timerange: 01/07:45:50 to 01/07:47:20



Plot file version 667 created 10-JUN-2016 17:23:08

CHECK RT013A.UVDATA.1

Freq = 4.9270 GHz, Bw = 16.000 MH No calibration applied and no bandpass applied

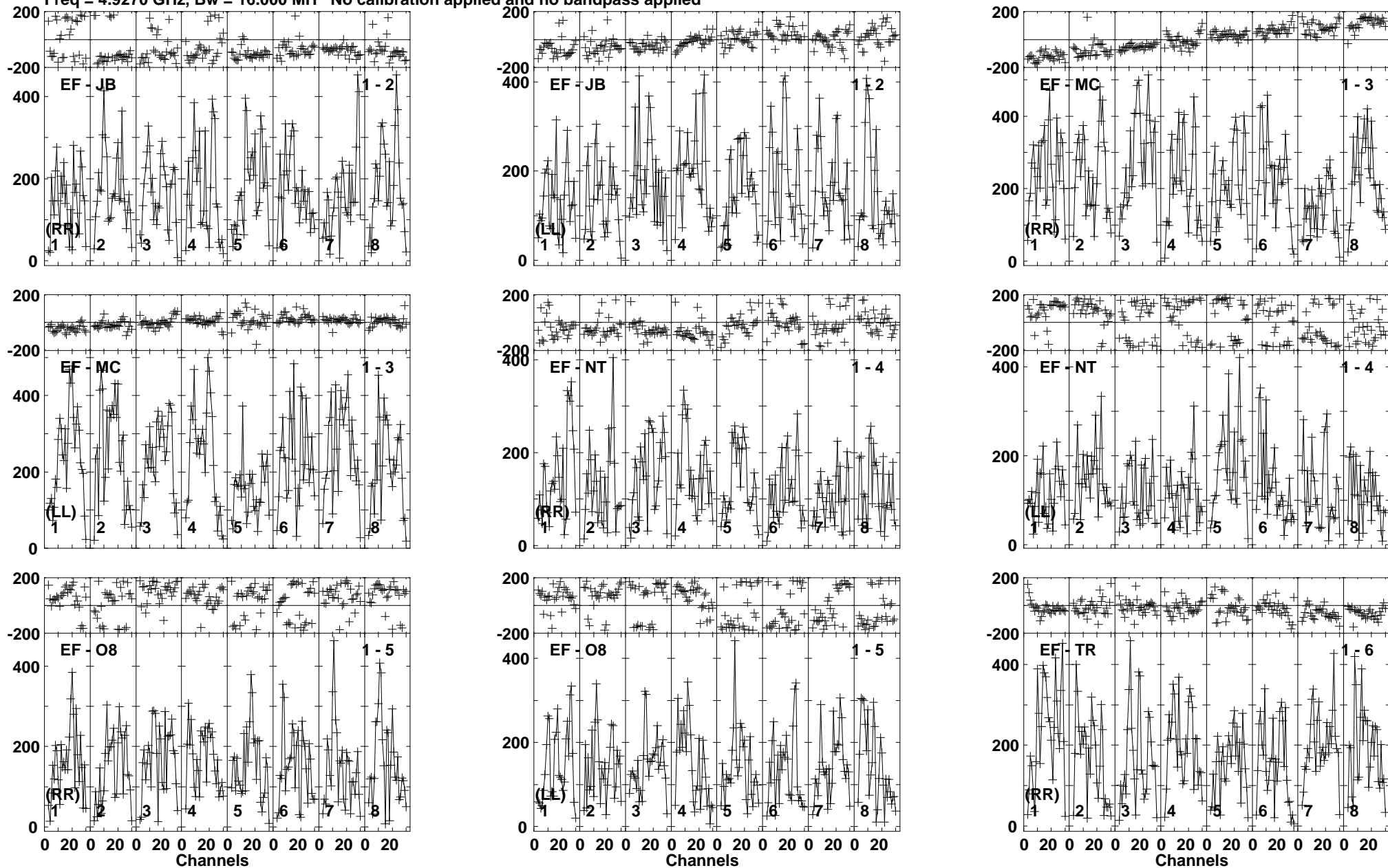

Lower frame: Micro Ampl Jy Top frame: Phas deg  
Vector averaged cross-power spectrum Baseline: EF (01) - JB (02)  
Timerange: 01/07:47:20 to 01/07:49:19

Plot file version 668 created 10-JUN-2016 17:23:08

CHECK RT013A.UVDATA.1

Freq = 4.9270 GHz, Bw = 16.000 MH No calibration applied and no bandpass applied

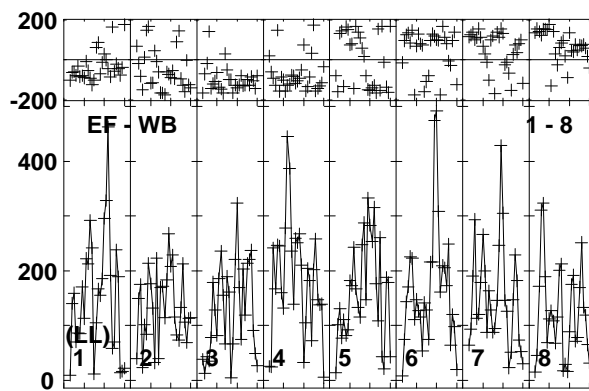
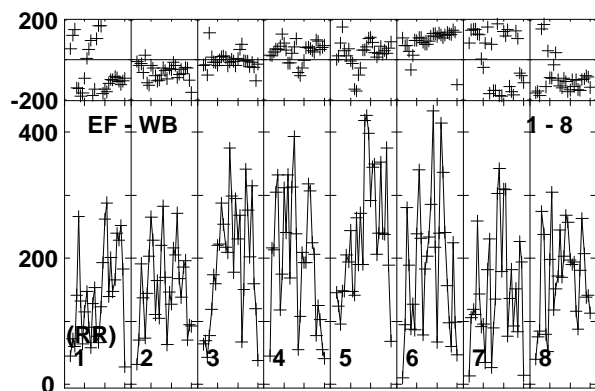
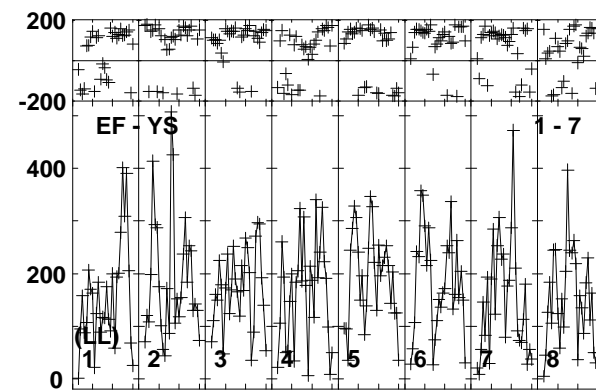
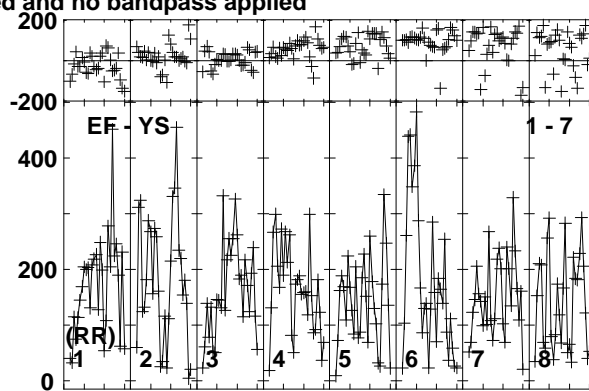
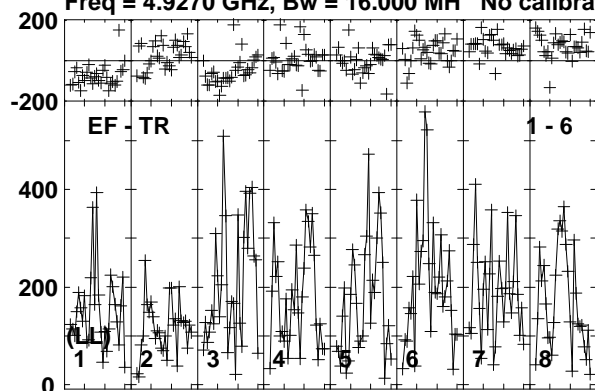

Lower frame: Micro Ampl Jy Top frame: Phas deg  
Vector averaged cross-power spectrum Baseline: EF (01) - TR (06)  
Timerange: 01/07:47:20 to 01/07:49:19

Plot file version 669 created 10-JUN-2016 17:23:08

CYGX1 RT013A.UVDATA.1

Freq = 4.9270 GHz, Bw = 16.000 MH No calibration applied and no bandpass applied

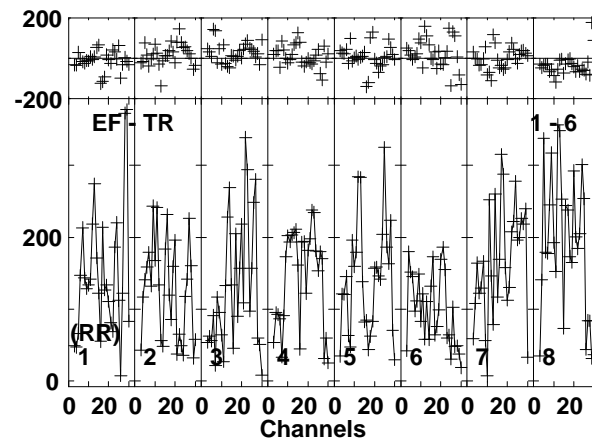
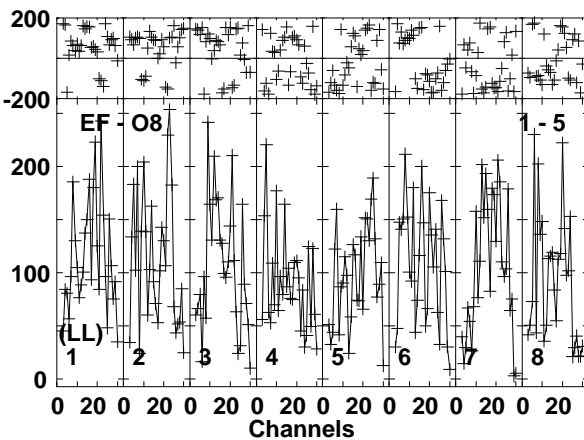
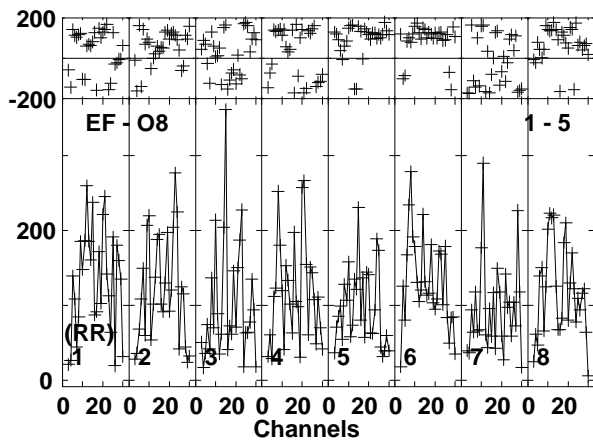
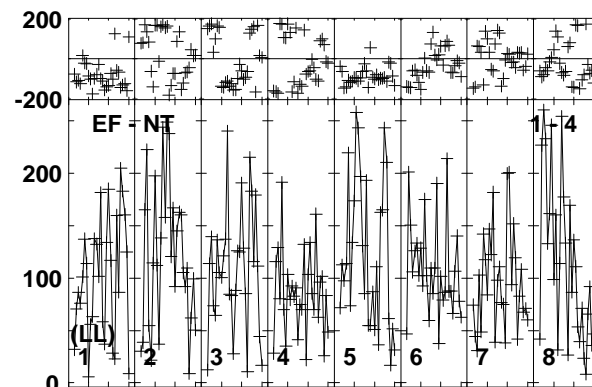
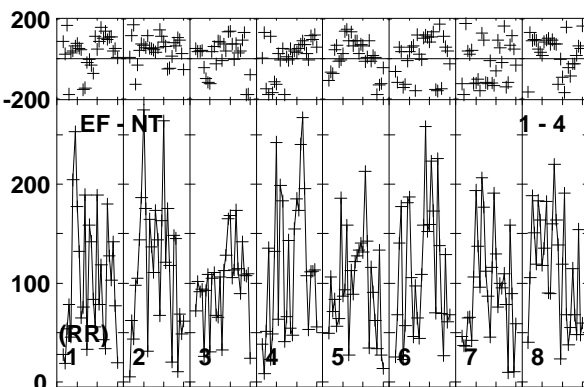
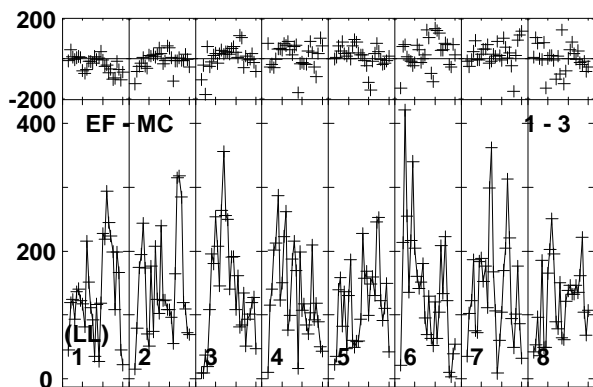
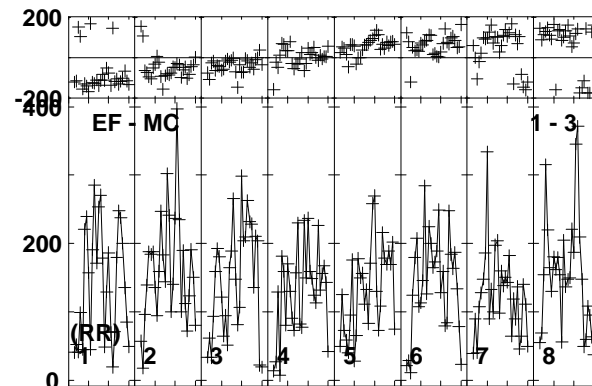
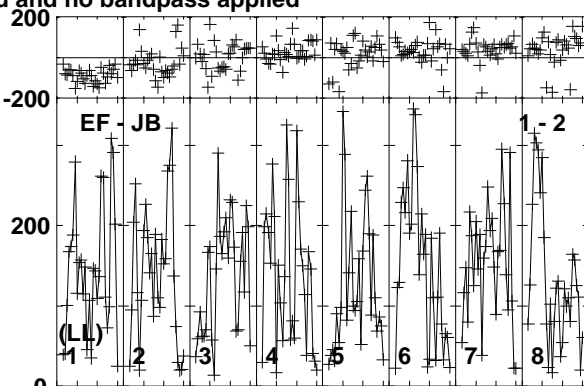
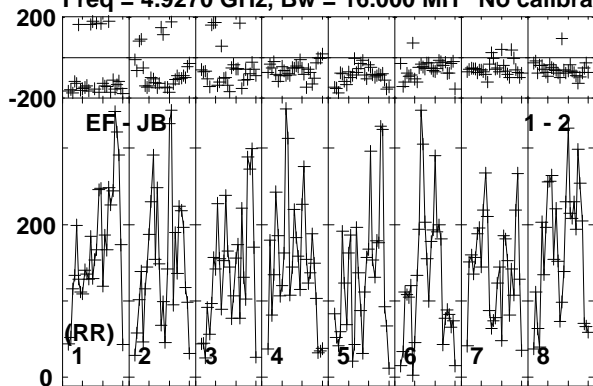

Lower frame: Micro Ampl Jy Top frame: Phas deg  
Vector averaged cross-power spectrum Baseline: EF (01) - JB (02)  
Timerange: 01/07:49:21 to 01/07:51:50

Plot file version 670 created 10-JUN-2016 17:23:08

CYGX1 RT013A.UVDATA.1

Freq = 4.9270 GHz, Bw = 16.000 MH No calibration applied and no bandpass applied

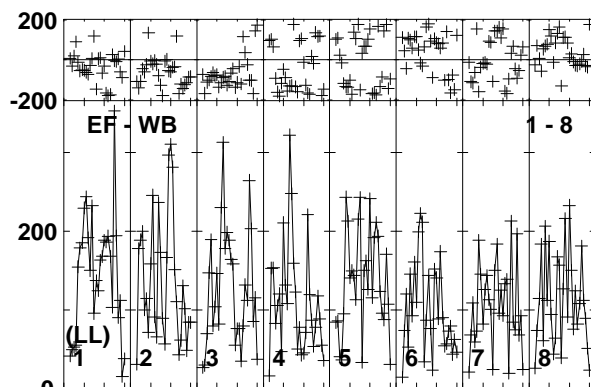
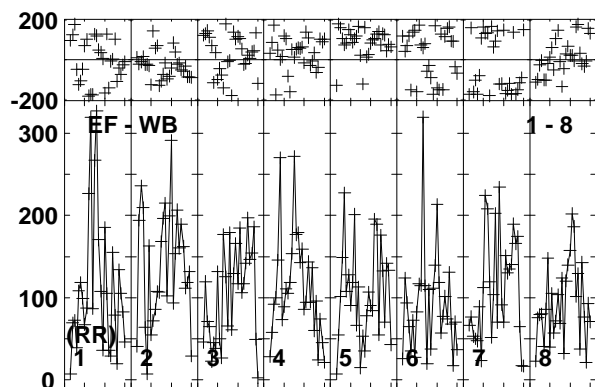
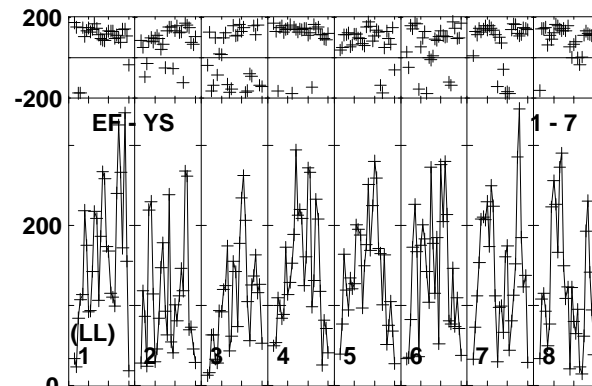
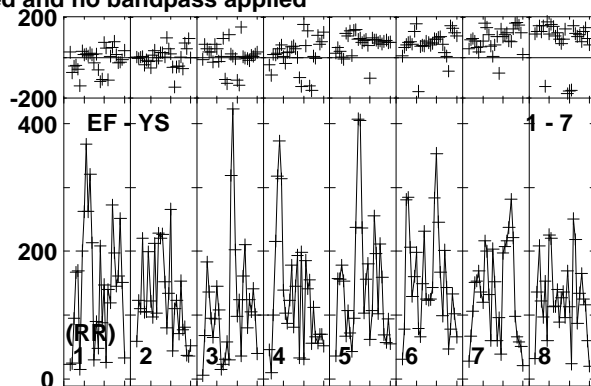
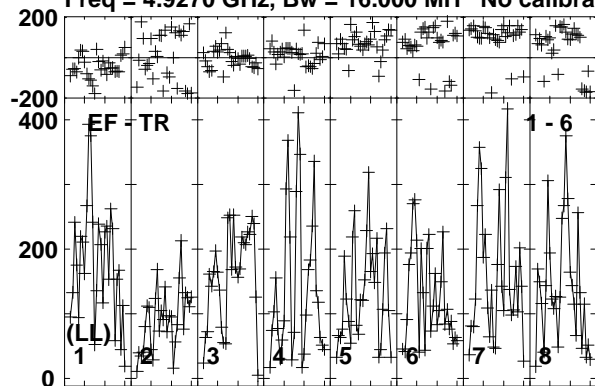

Lower frame: Micro Ampl Jy Top frame: Phas deg  
Vector averaged cross-power spectrum Baseline: EF (01) - TR (06)  
Timerange: 01/07:49:21 to 01/07:51:50

Plot file version 671 created 10-JUN-2016 17:23:08

J1957+3338 RT013A.UVDATA.1

Freq = 4.9270 GHz, Bw = 16.000 MH No calibration applied and no bandpass applied

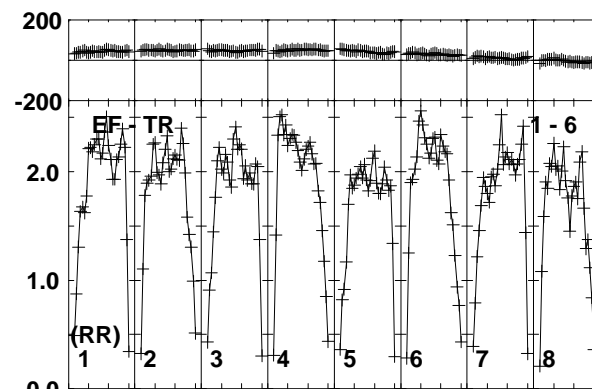
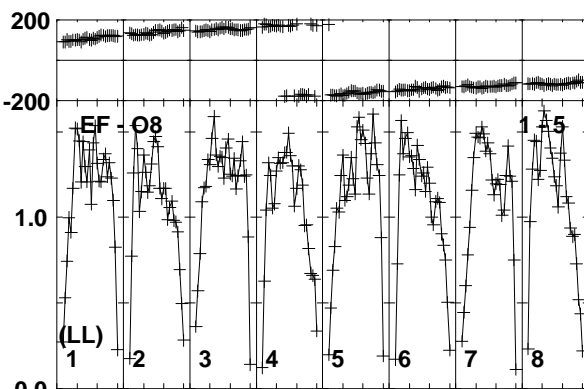
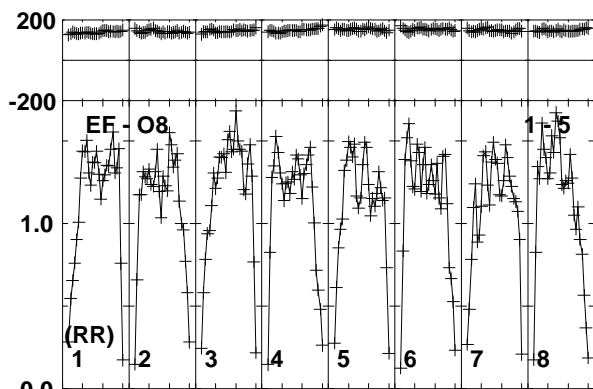
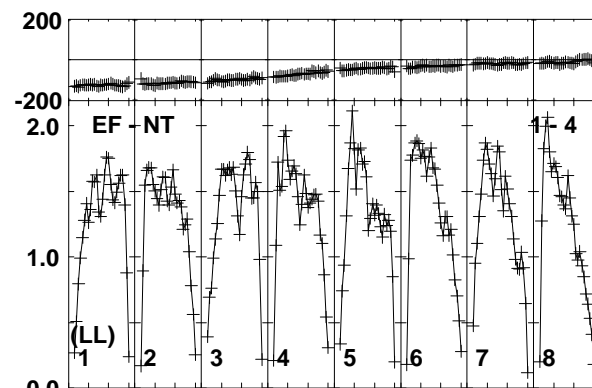
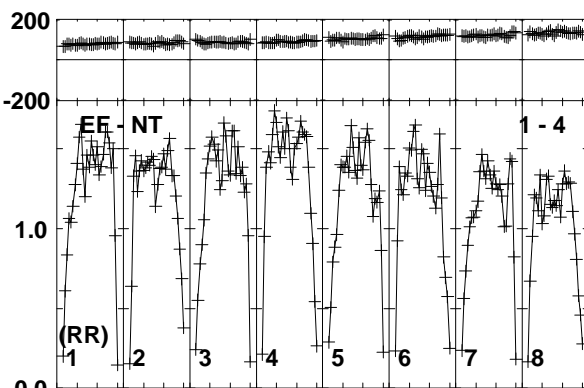
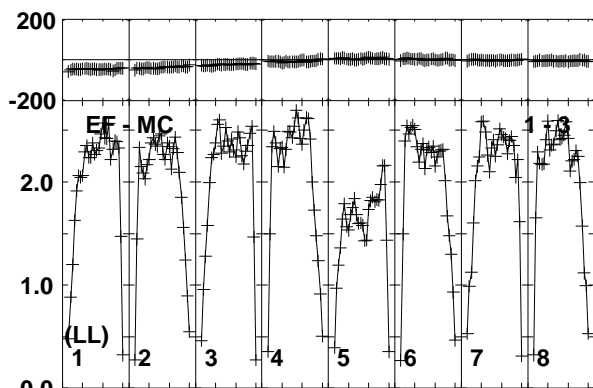
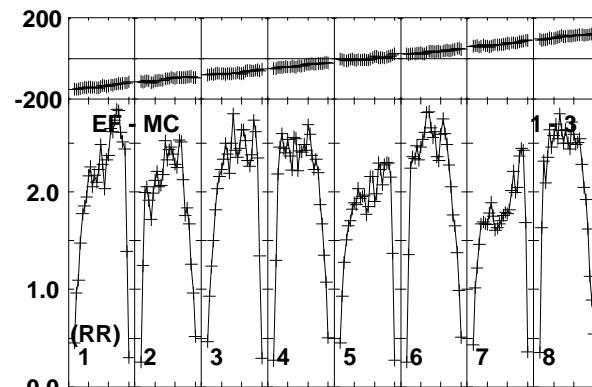
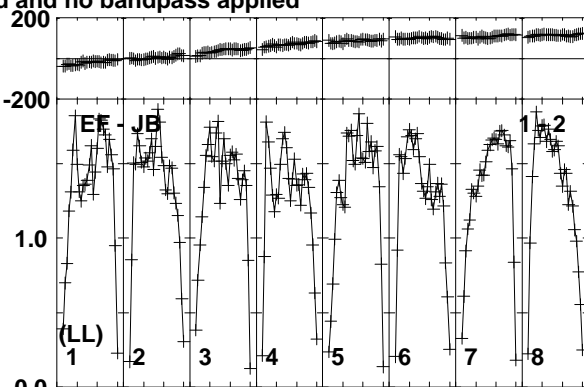
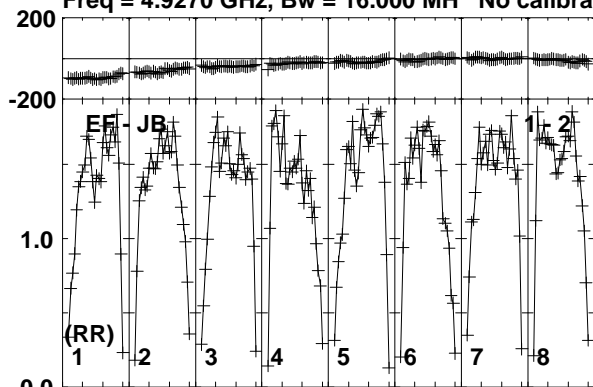

Lower frame: Milli Ampl Jy Top frame: Phas deg  
Vector averaged cross-power spectrum Baseline: EF (01) - JB (02)  
Timerange: 01/07:51:51 to 01/07:53:20

Plot file version 672 created 10-JUN-2016 17:23:08

J1957+3338 RT013A.UVDATA.1

Freq = 4.9270 GHz, Bw = 16.000 MH No calibration applied and no bandpass applied

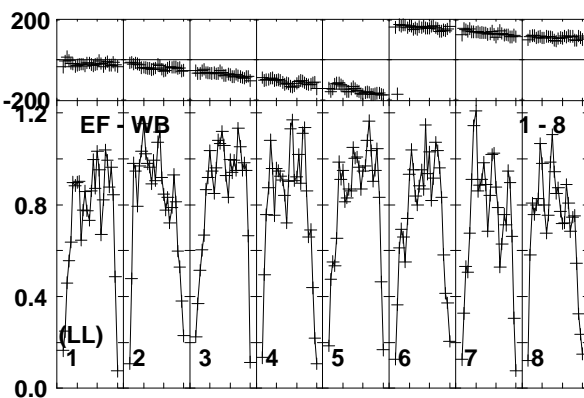
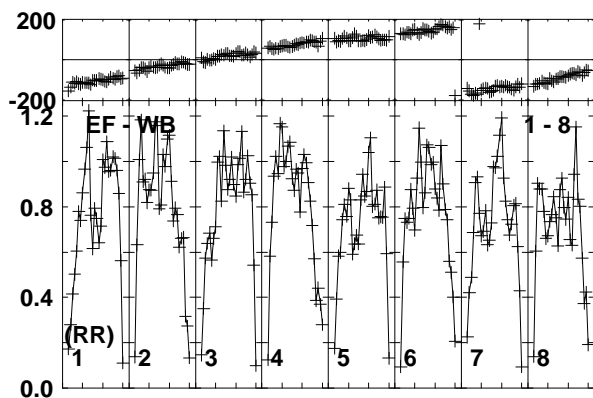
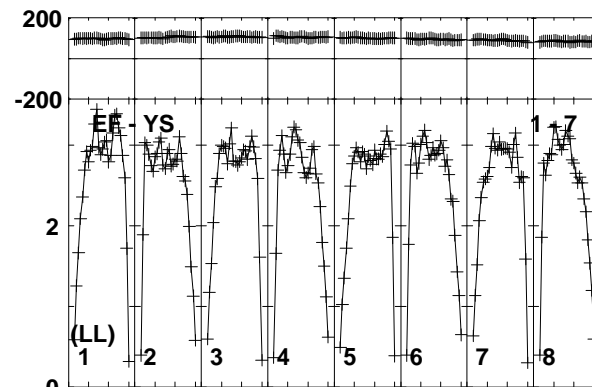
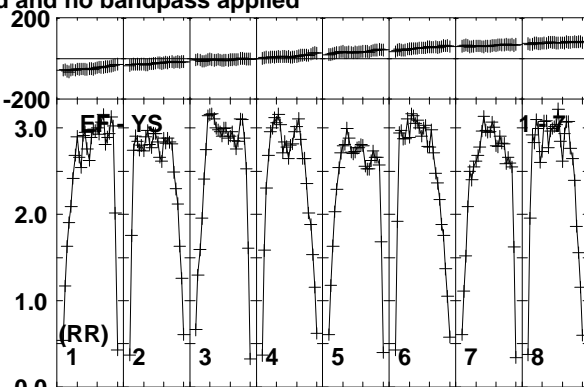
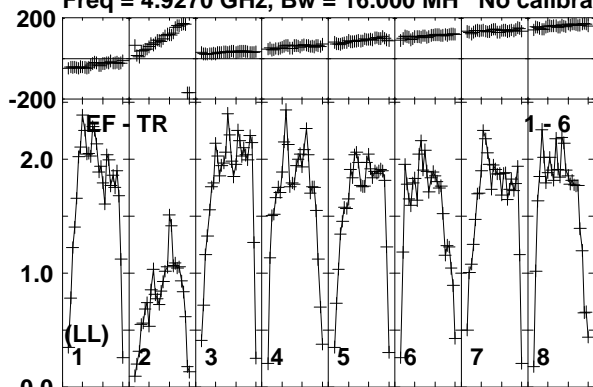

Lower frame: Milli Ampl Jy Top frame: Phas deg  
Vector averaged cross-power spectrum Baseline: EF (01) - TR (06)  
Timerange: 01/07:51:51 to 01/07:53:20

Plot file version 673 created 10-JUN-2016 17:23:08

CHECK RT013A.UVDATA.1

Freq = 4.9270 GHz, Bw = 16.000 MH No calibration applied and no bandpass applied

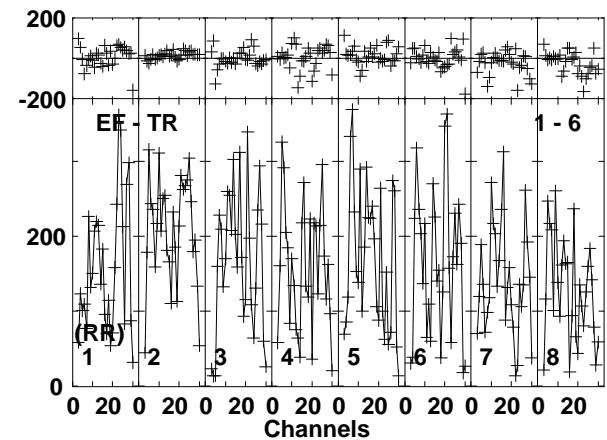
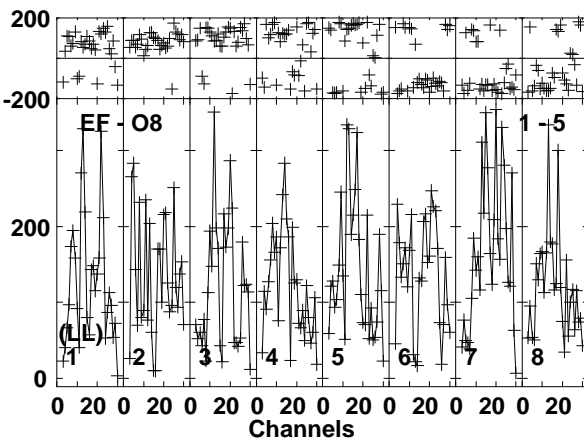
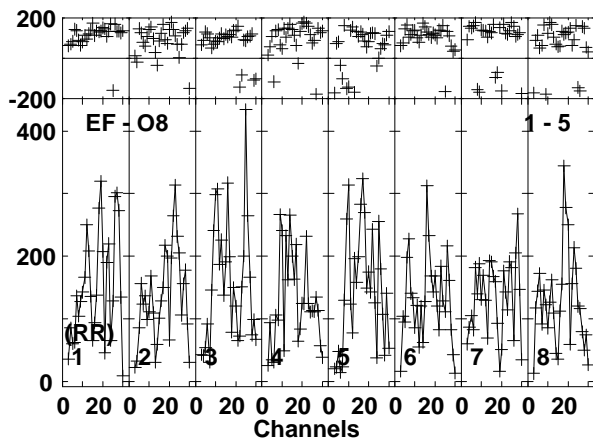
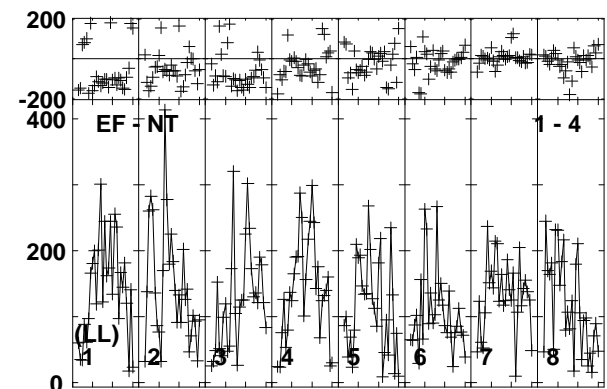
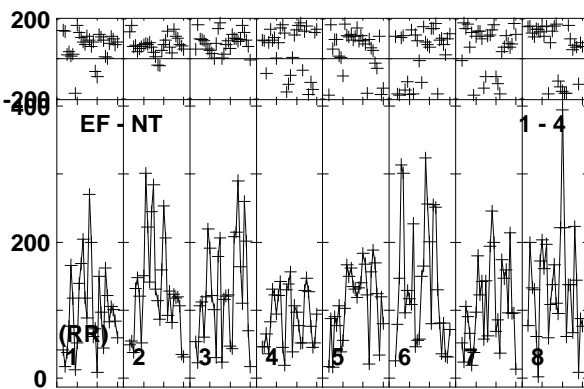
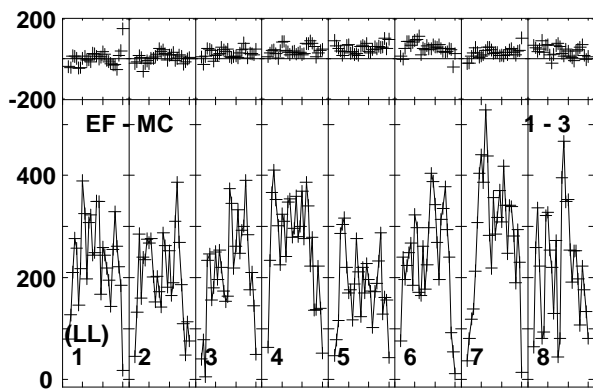
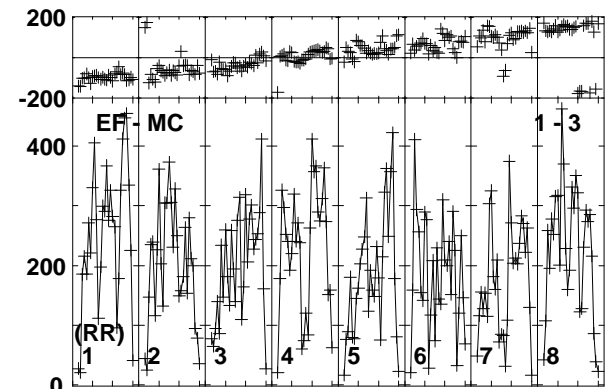
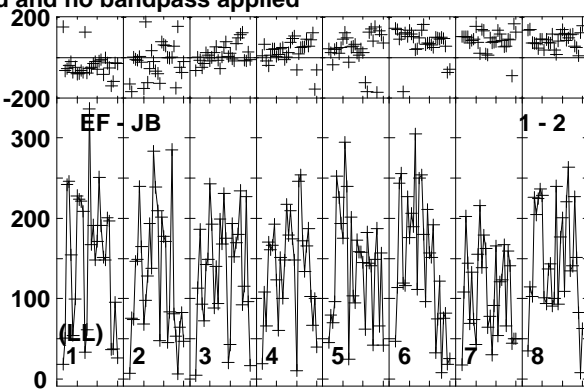
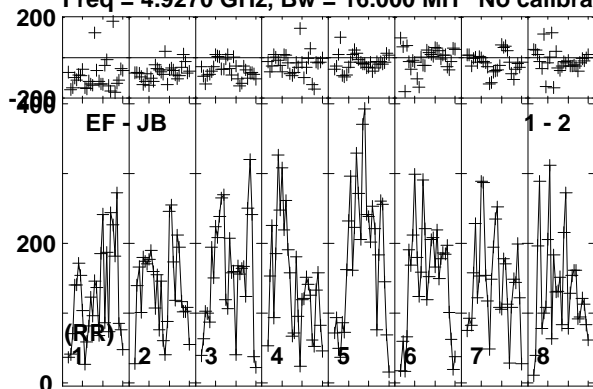

Lower frame: Micro Ampl Jy Top frame: Phas deg  
Vector averaged cross-power spectrum Baseline: EF (01) - JB (02)  
Timerange: 01/07:54:01 to 01/07:55:59

Plot file version 674 created 10-JUN-2016 17:23:09

CHECK RT013A.UVDATA.1

Freq = 4.9270 GHz, Bw = 16.000 MH No calibration applied and no bandpass applied

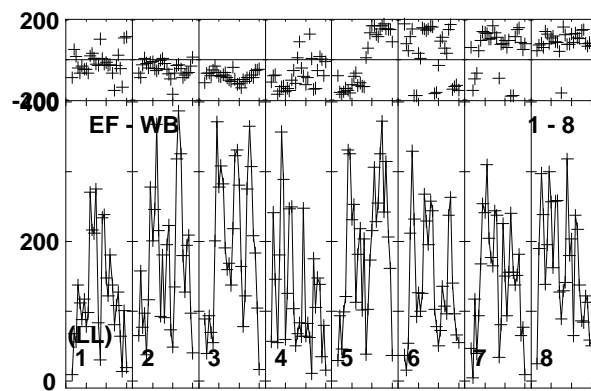
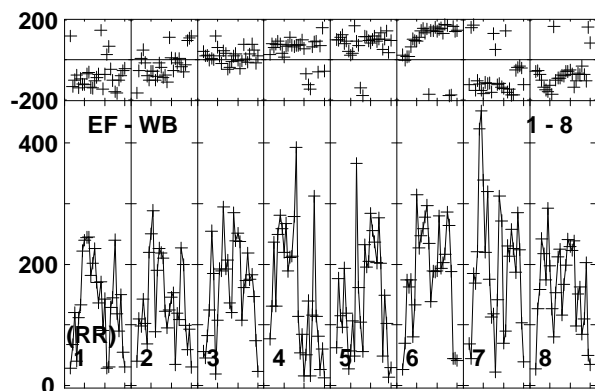
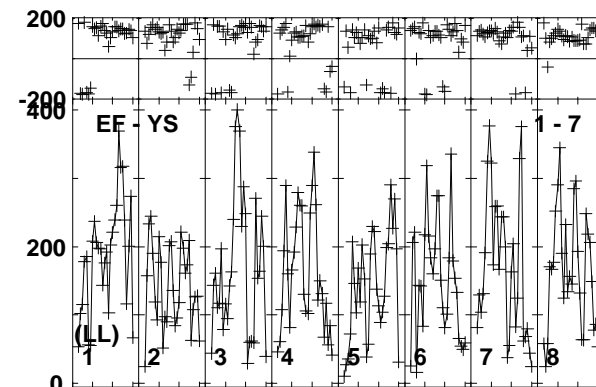
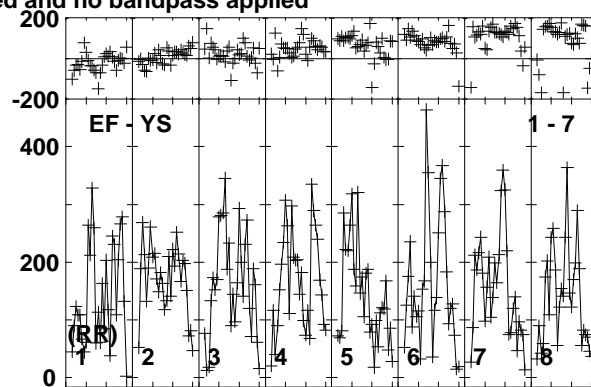
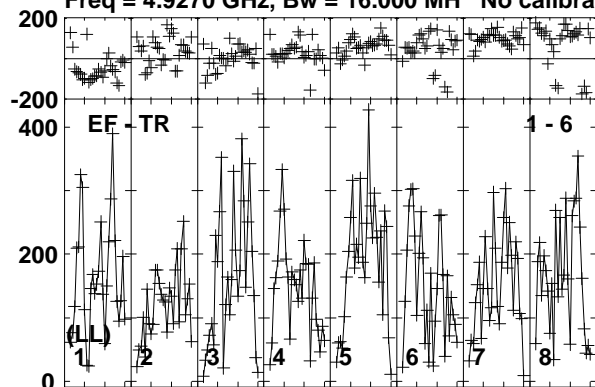

Lower frame: Micro Ampl Jy Top frame: Phas deg  
Vector averaged cross-power spectrum Baseline: EF (01) - TR (06)  
Timerange: 01/07:54:01 to 01/07:55:59



Plot file version 675 created 10-JUN-2016 17:23:09

CYGX1 RT013A.UVDATA.1

Freq = 4.9270 GHz, Bw = 16.000 MH No calibration applied and no bandpass applied

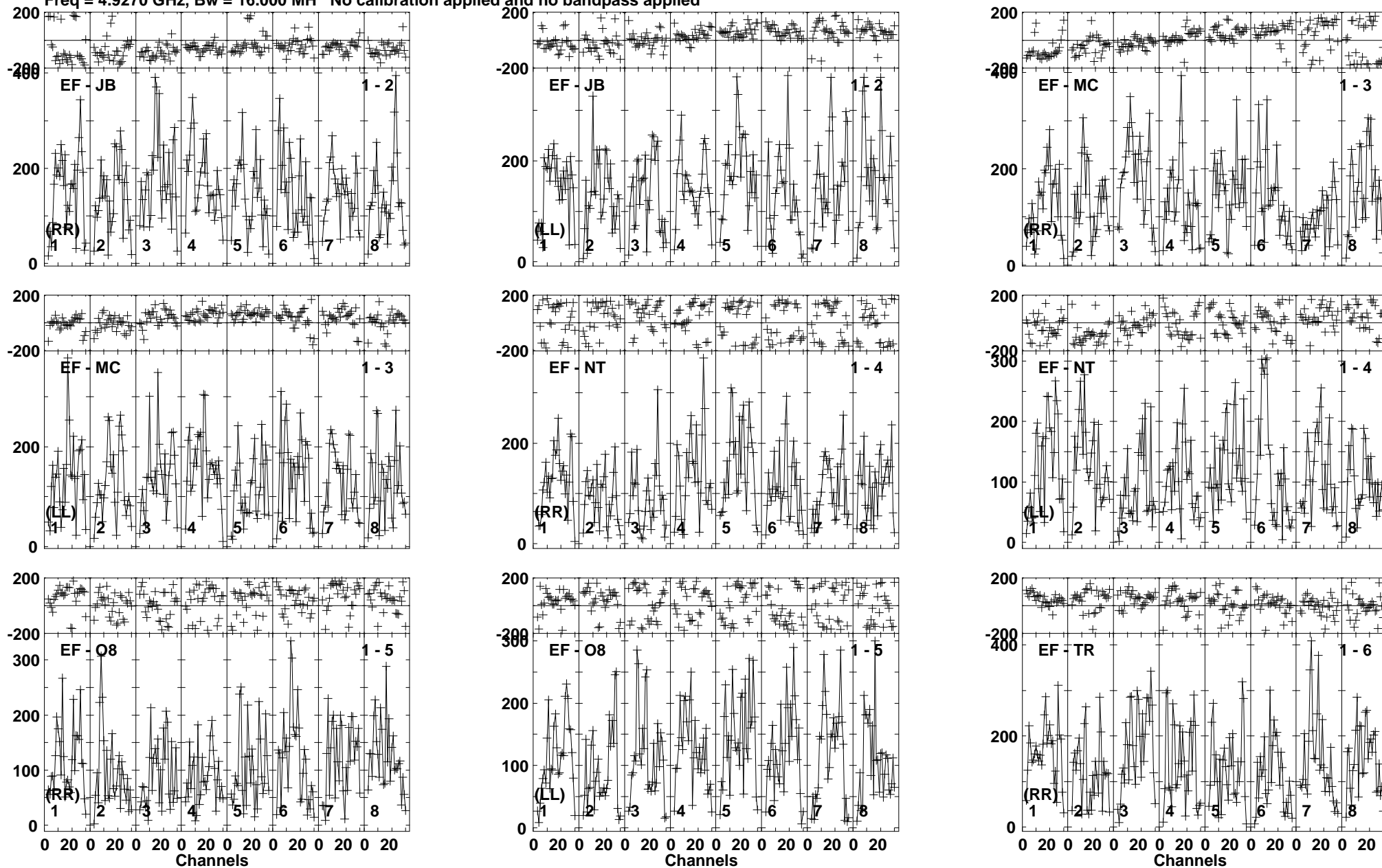

Lower frame: Micro Ampl Jy Top frame: Phas deg  
Vector averaged cross-power spectrum Baseline: EF (01) - JB (02)  
Timerange: 01/07:56:01 to 01/07:58:30

Plot file version 676 created 10-JUN-2016 17:23:09

CYGX1 RT013A.UVDATA.1

Freq = 4.9270 GHz, Bw = 16.000 MH No calibration applied and no bandpass applied

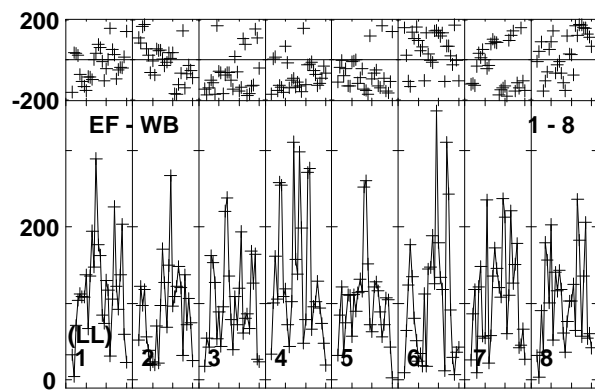
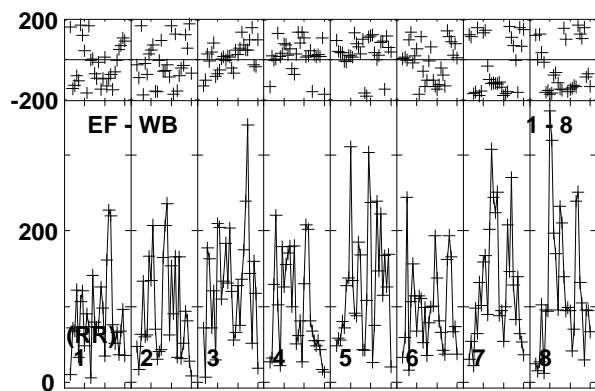
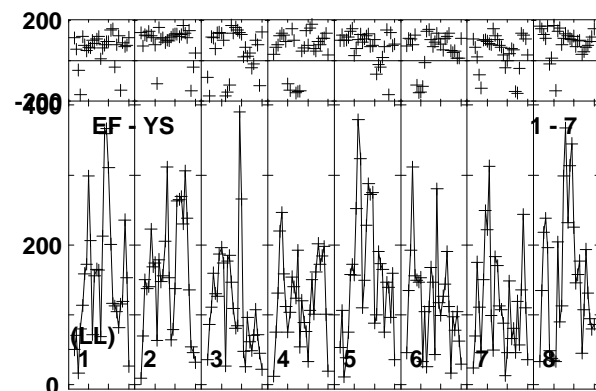
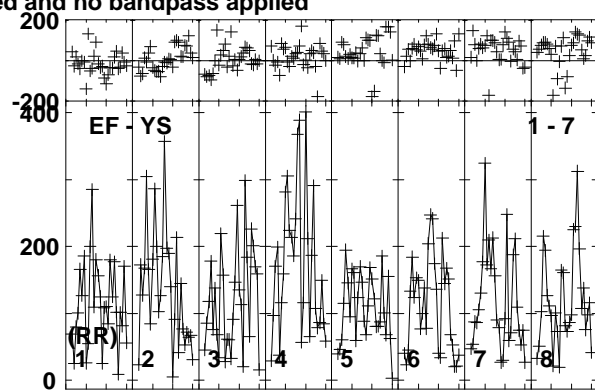
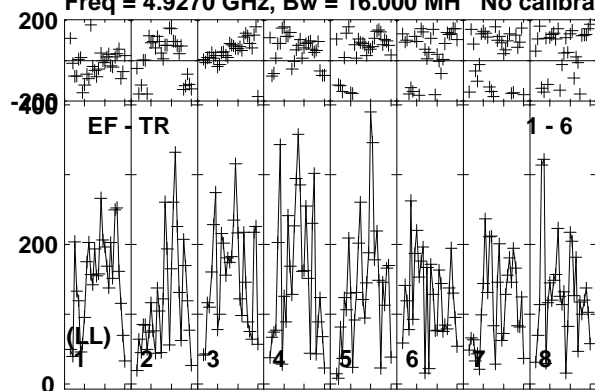

Lower frame: Micro Ampl Jy Top frame: Phas deg  
Vector averaged cross-power spectrum Baseline: EF (01) - TR (06)  
Timerange: 01/07:56:01 to 01/07:58:30

Plot file version 677 created 10-JUN-2016 17:23:09

J1957+3338 RT013A.UVDATA.1

Freq = 4.9270 GHz, Bw = 16.000 MH No calibration applied and no bandpass applied

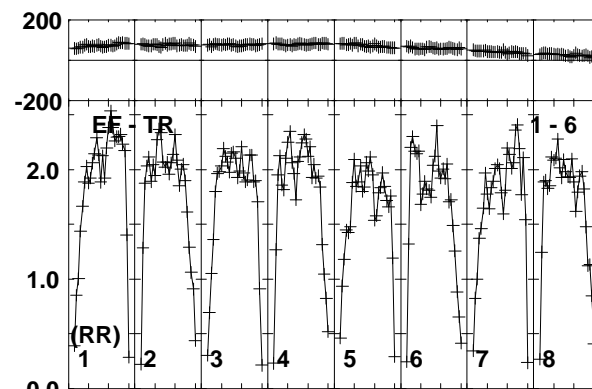
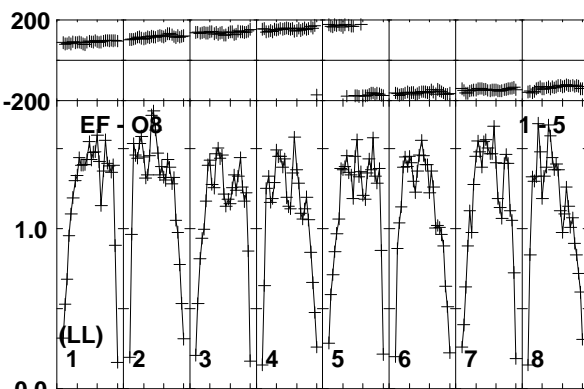
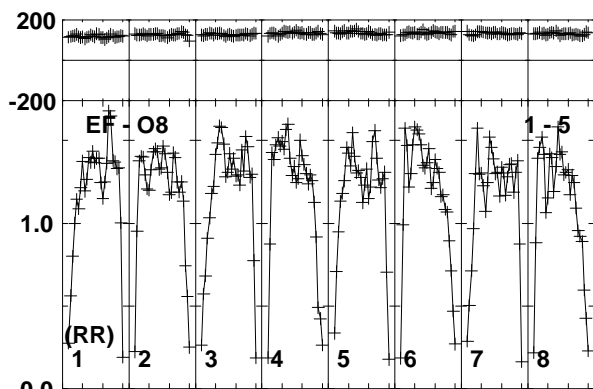
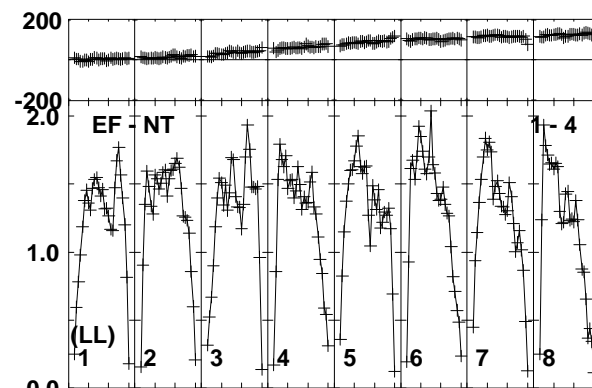
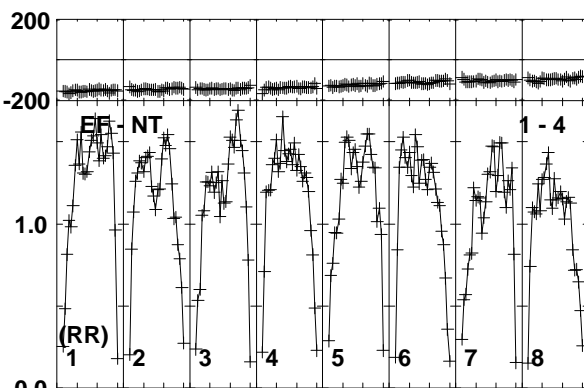
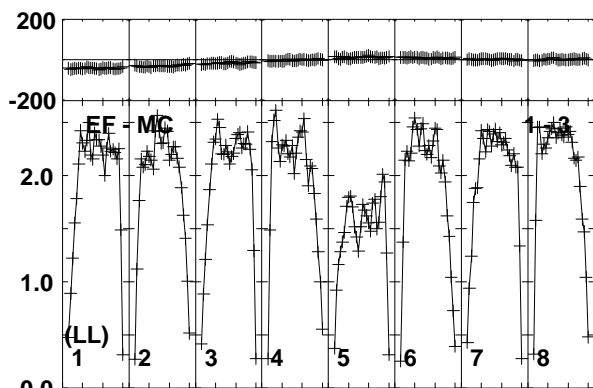
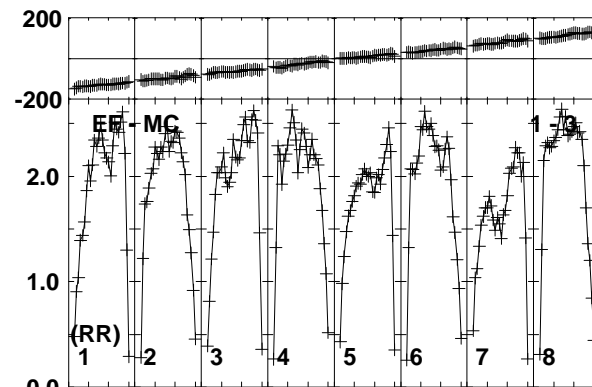
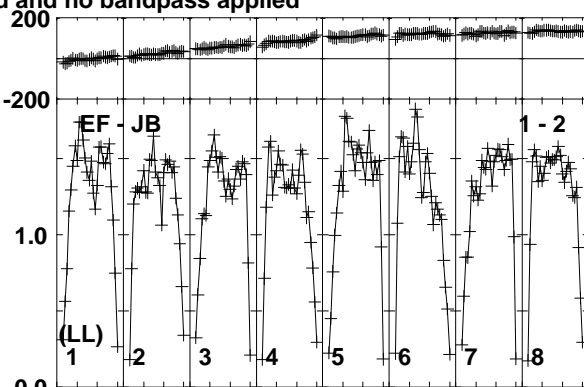
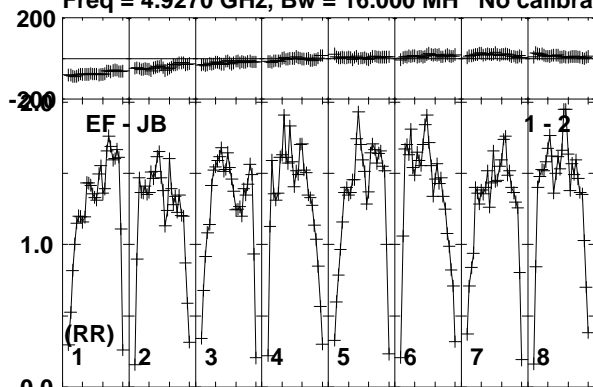

Lower frame: Milli Ampl Jy Top frame: Phas deg

Vector averaged cross-power spectrum Baseline: EF (01) - JB (02)

Timerange: 01/07:58:31 to 01/07:59:59

Plot file version 678 created 10-JUN-2016 17:23:09

J1957+3338 RT013A.UVDATA.1

Freq = 4.9270 GHz, Bw = 16.000 MH No calibration applied and no bandpass applied

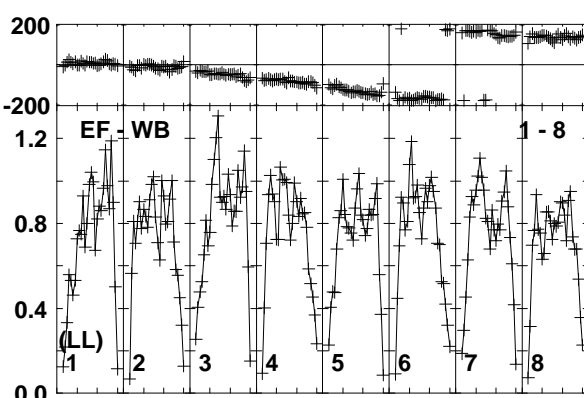
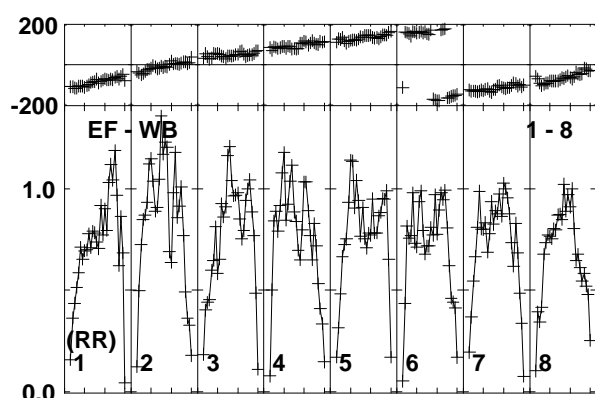
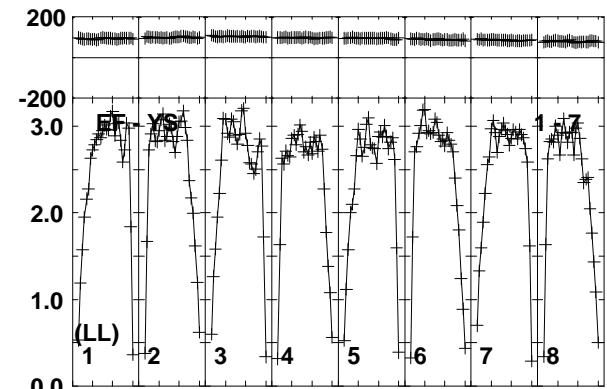
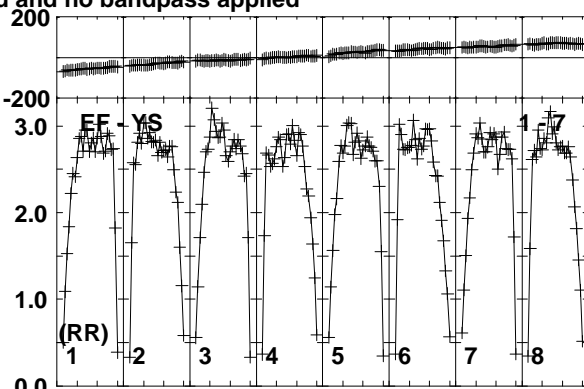
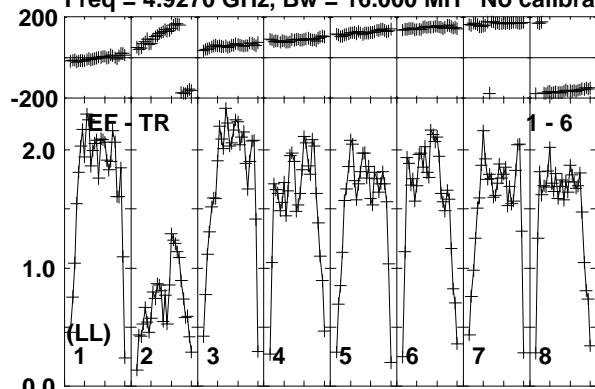

Lower frame: Milli Ampl Jy Top frame: Phas deg  
Vector averaged cross-power spectrum Baseline: EF (01) - TR (06)  
Timerange: 01/07:58:31 to 01/07:59:59

Plot file version 679 created 10-JUN-2016 17:23:09

CHECK RT013A.UVDATA.1

Freq = 4.9270 GHz, Bw = 16.000 MH No calibration applied and no bandpass applied

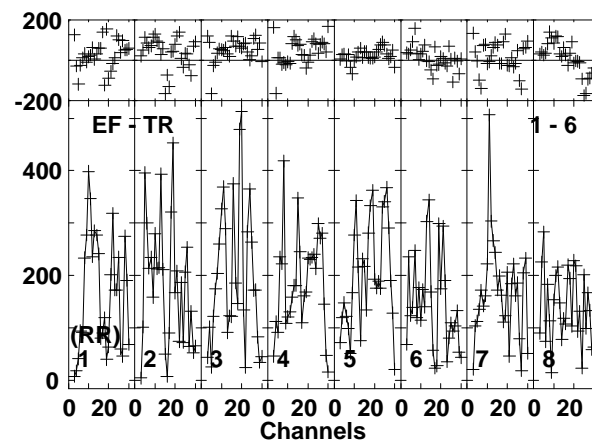
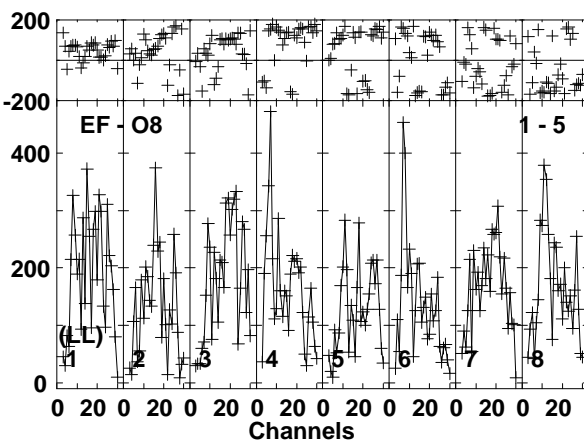
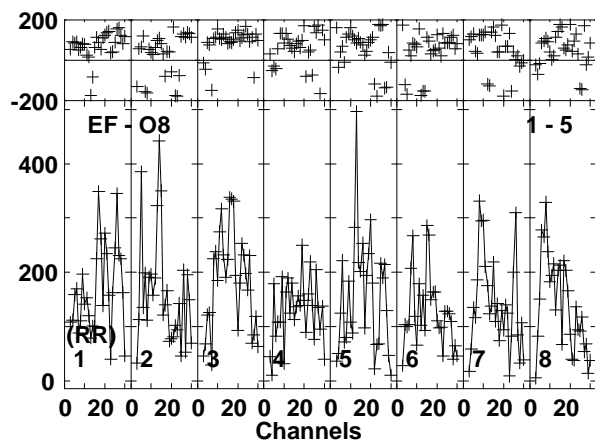
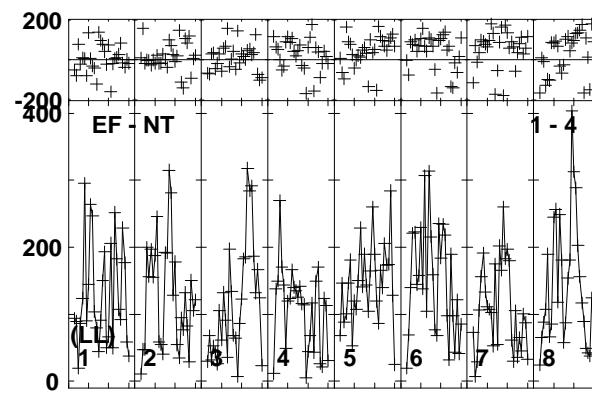
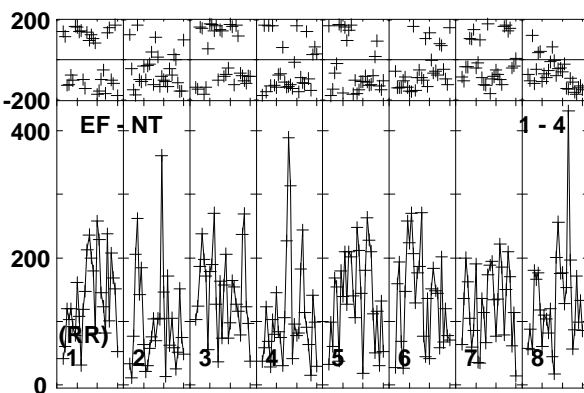
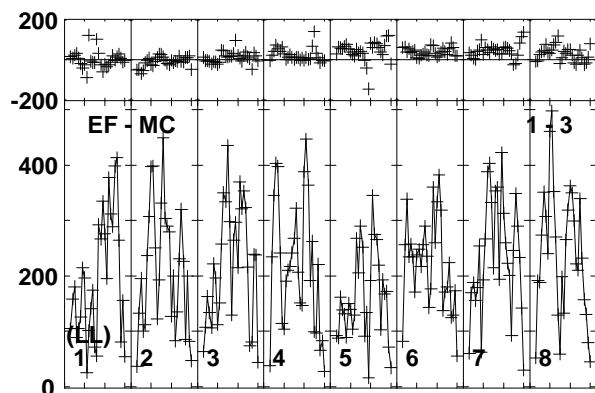
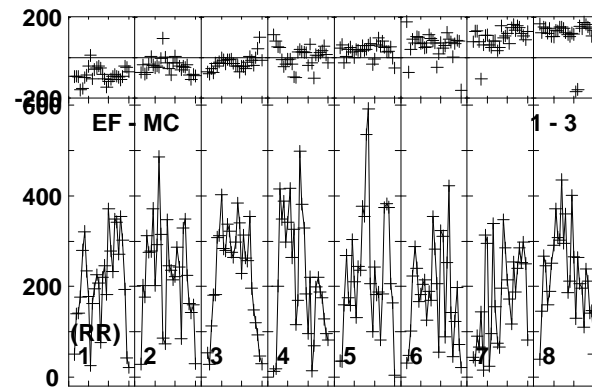
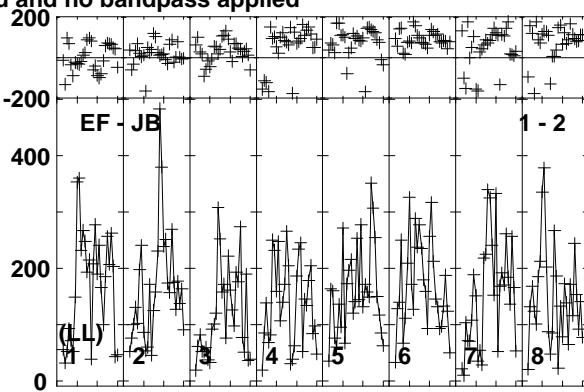
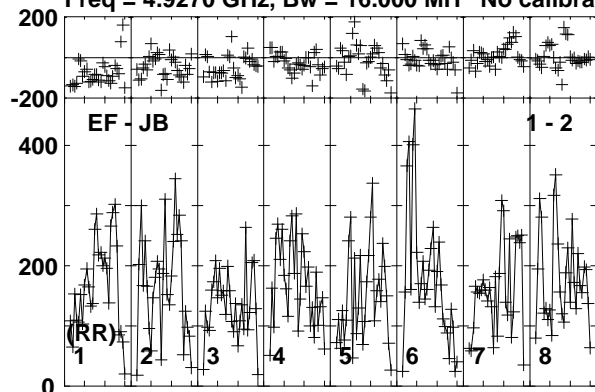

Lower frame: Micro Ampl Jy Top frame: Phas deg  
Vector averaged cross-power spectrum Baseline: EF (01) - JB (02)  
Timerange: 01/08:00:00 to 01/08:02:00

Plot file version 680 created 10-JUN-2016 17:23:09

CHECK RT013A.UVDATA.1

Freq = 4.9270 GHz, Bw = 16.000 MH No calibration applied and no bandpass applied

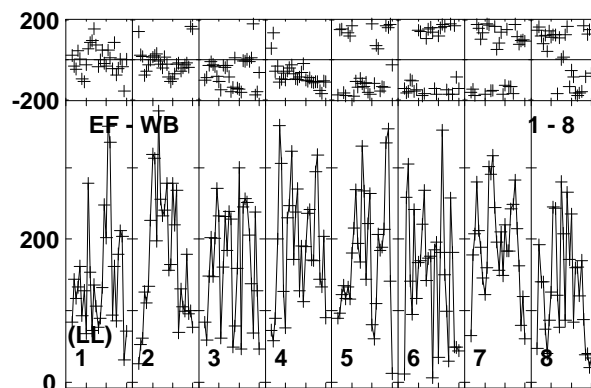
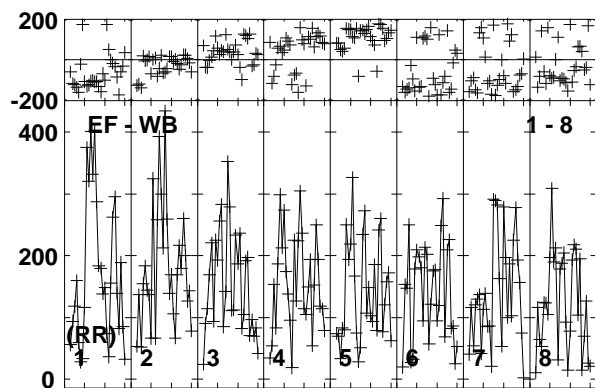
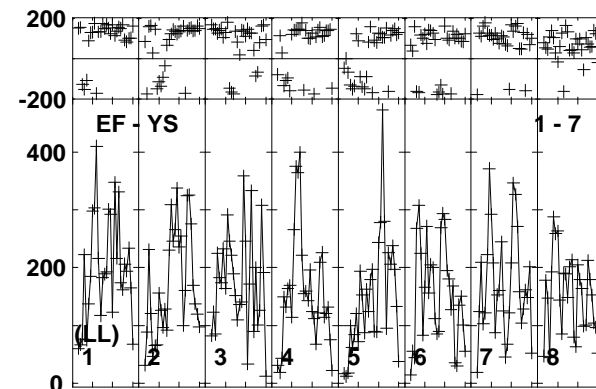
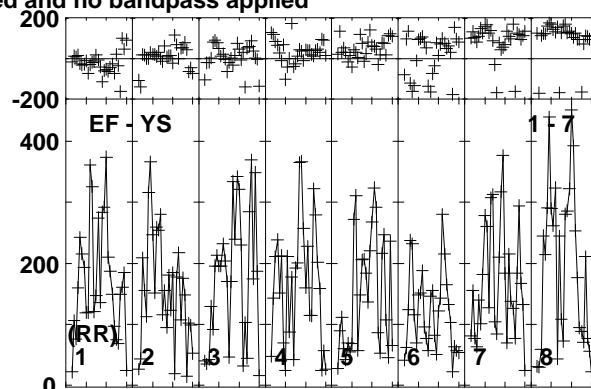
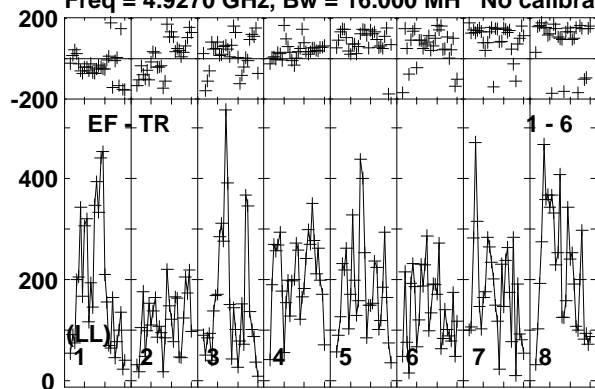

Lower frame: Micro Ampl Jy Top frame: Phas deg  
Vector averaged cross-power spectrum Baseline: EF (01) - TR (06)  
Timerange: 01/08:00:00 to 01/08:02:00

Plot file version 681 created 10-JUN-2016 17:23:09

CYGX1 RT013A.UVDATA.1

Freq = 4.9270 GHz, Bw = 16.000 MH No calibration applied and no bandpass applied

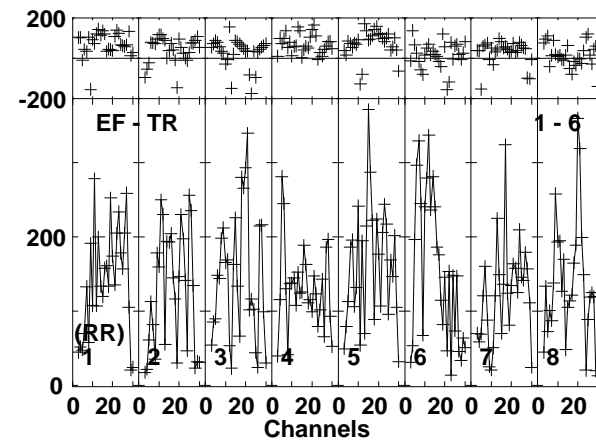
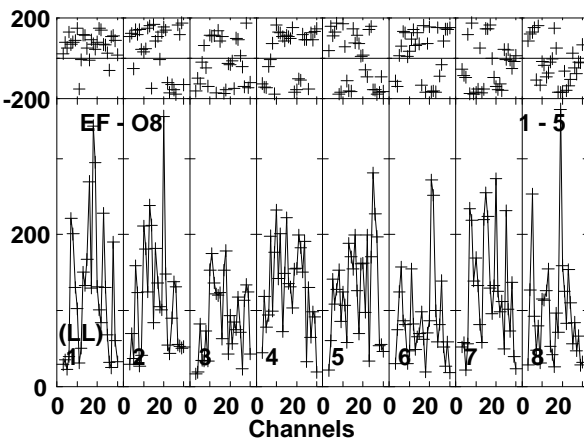
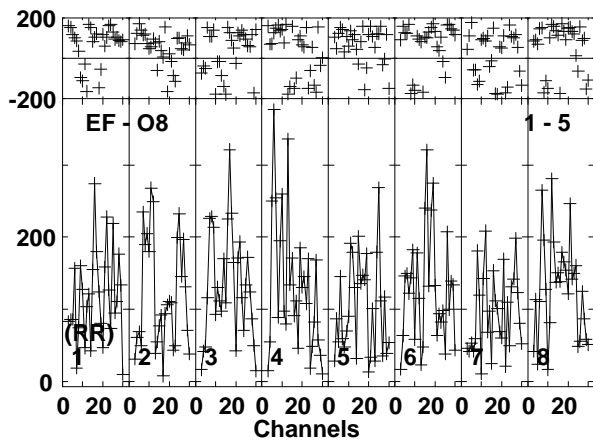
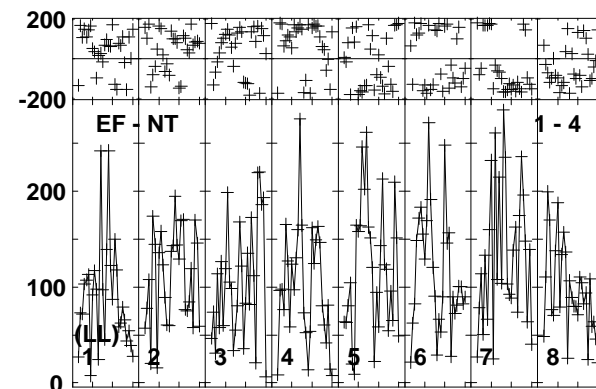
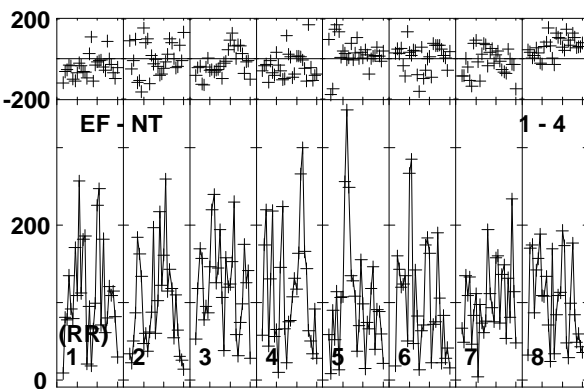
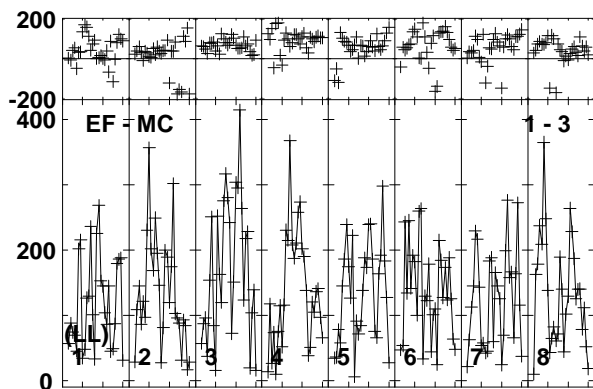
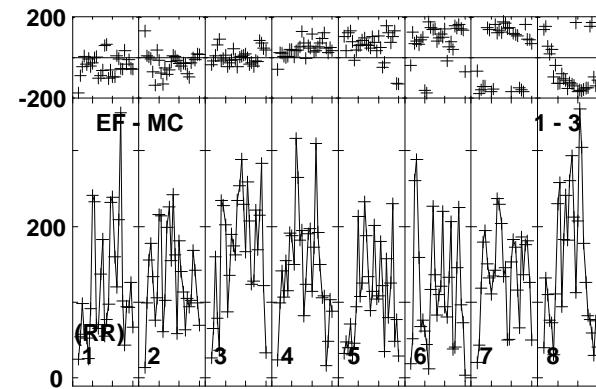
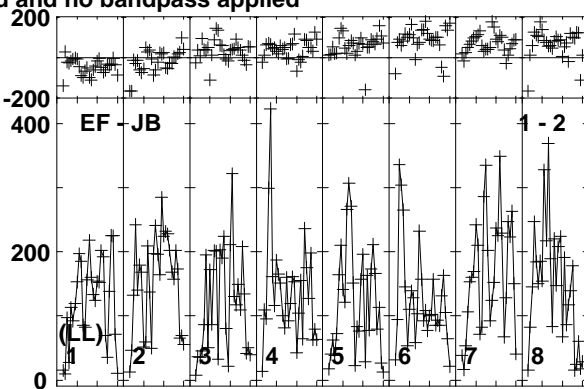
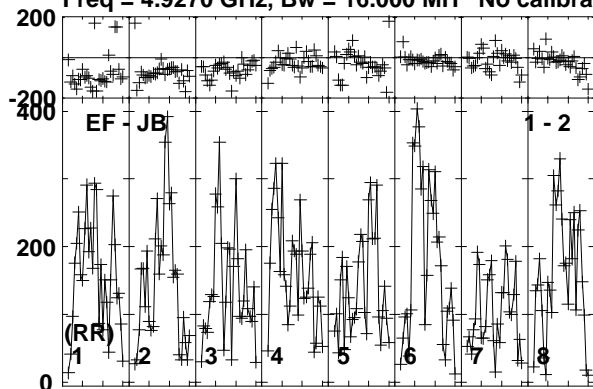

Lower frame: Micro Ampl Jy Top frame: Phas deg  
Vector averaged cross-power spectrum Baseline: EF (01) - JB (02)  
Timerange: 01/08:02:00 to 01/08:04:29

Plot file version 682 created 10-JUN-2016 17:23:09

CYGX1 RT013A.UVDATA.1

Freq = 4.9270 GHz, Bw = 16.000 MH No calibration applied and no bandpass applied

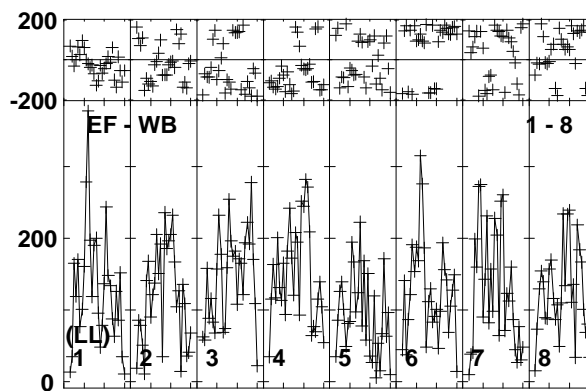
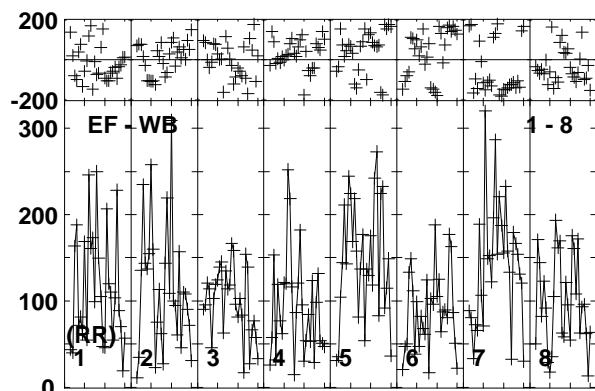
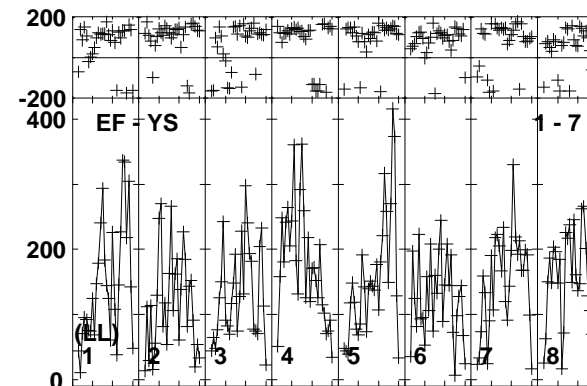
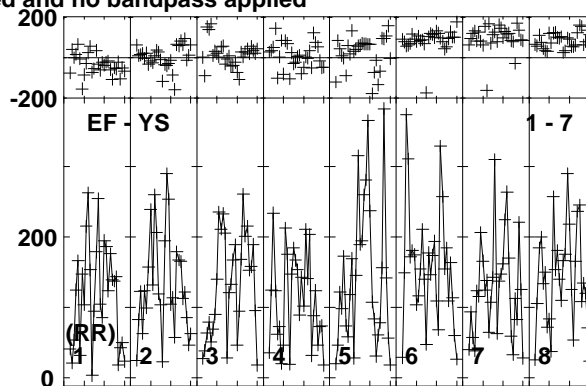
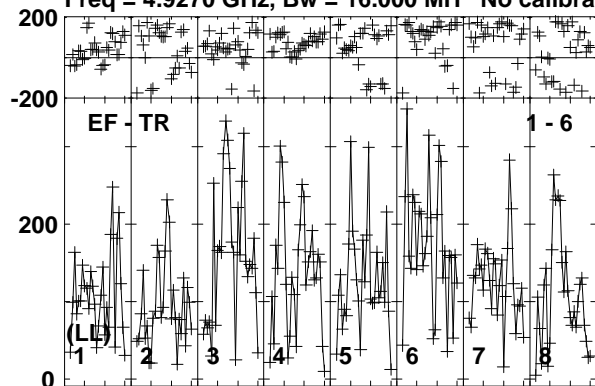

Lower frame: Micro Ampl Jy Top frame: Phas deg  
Vector averaged cross-power spectrum Baseline: EF (01) - TR (06)  
Timerange: 01/08:02:00 to 01/08:04:29



Plot file version 683 created 10-JUN-2016 17:23:09

J1957+3338 RT013A.UVDATA.1

Freq = 4.9270 GHz, Bw = 16.000 MH No calibration applied and no bandpass applied

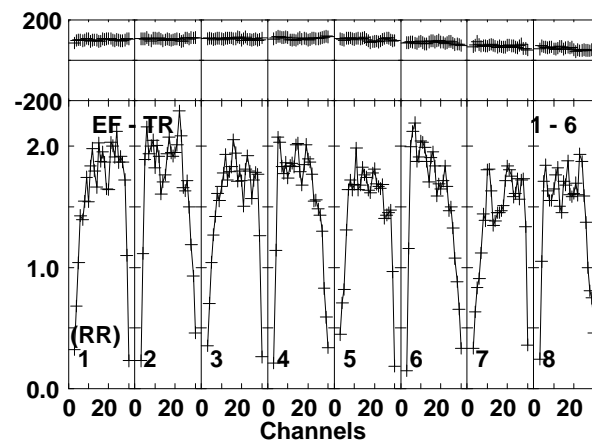
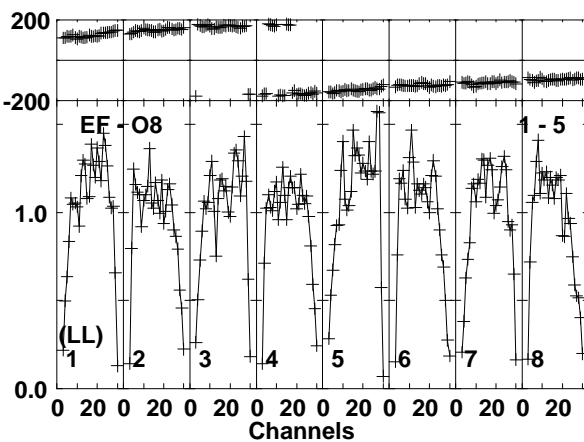
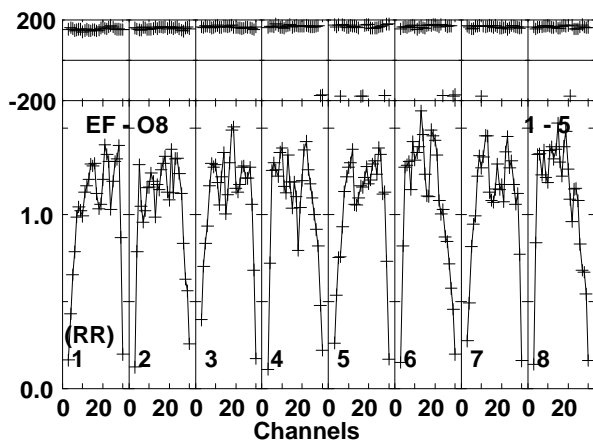
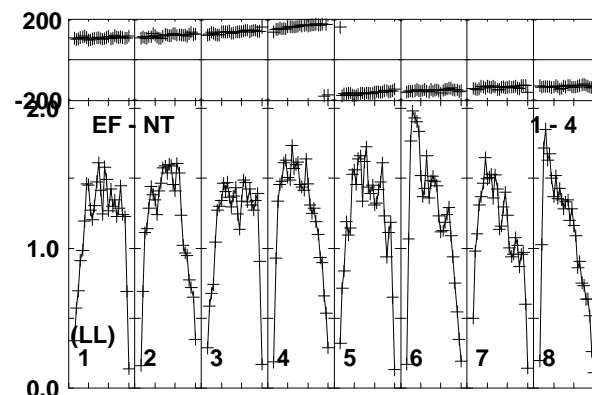
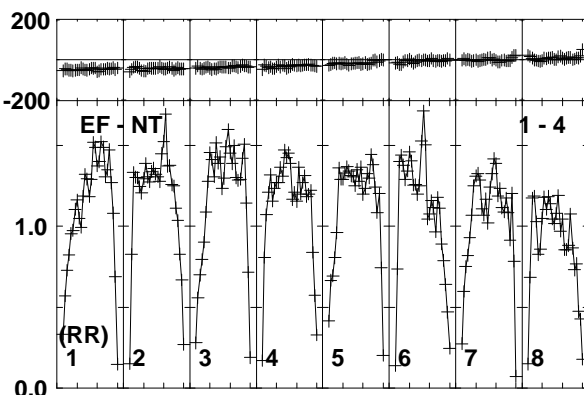
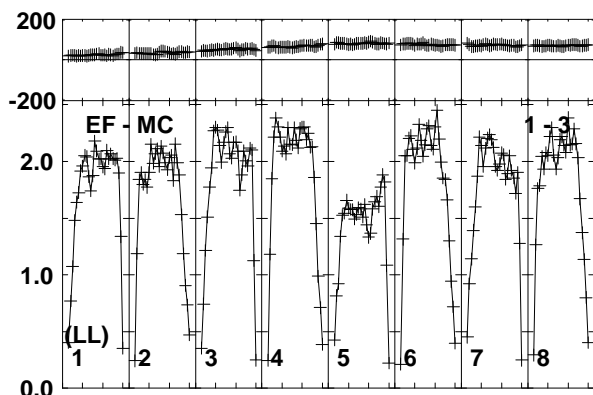
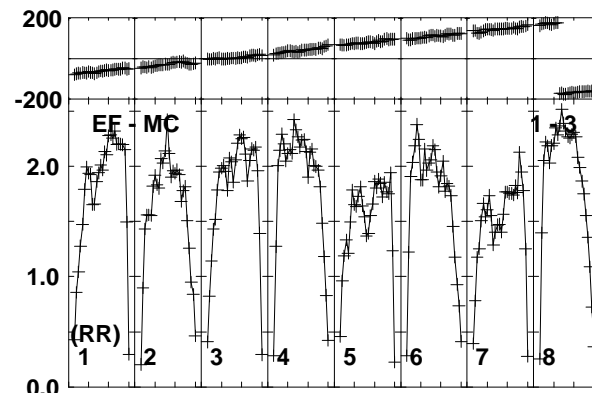
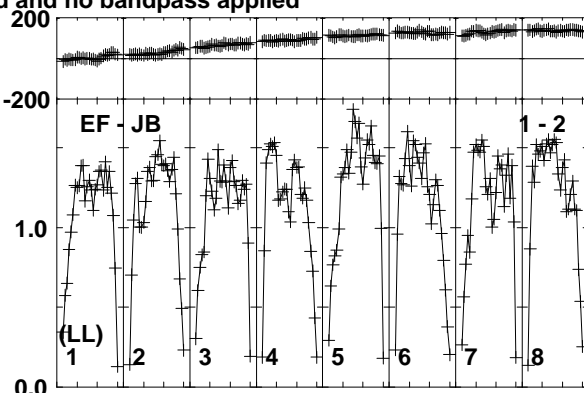
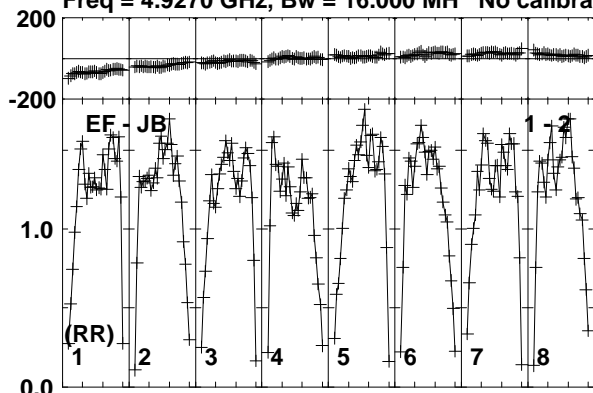

Lower frame: Milli Ampl Jy Top frame: Phas deg  
Vector averaged cross-power spectrum Baseline: EF (01) - JB (02)  
Timerange: 01/08:04:31 to 01/08:05:59

Plot file version 684 created 10-JUN-2016 17:23:10

J1957+3338 RT013A.UVDATA.1

Freq = 4.9270 GHz, Bw = 16.000 MH No calibration applied and no bandpass applied

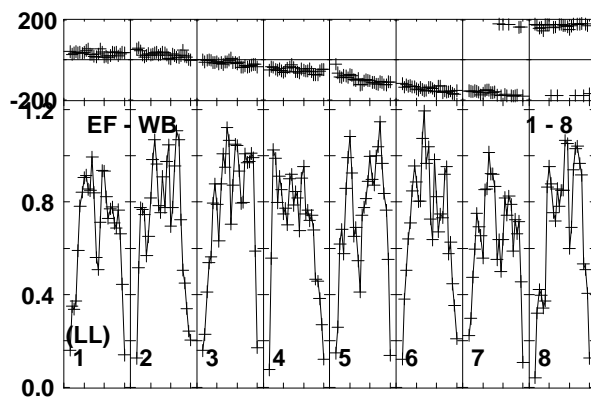
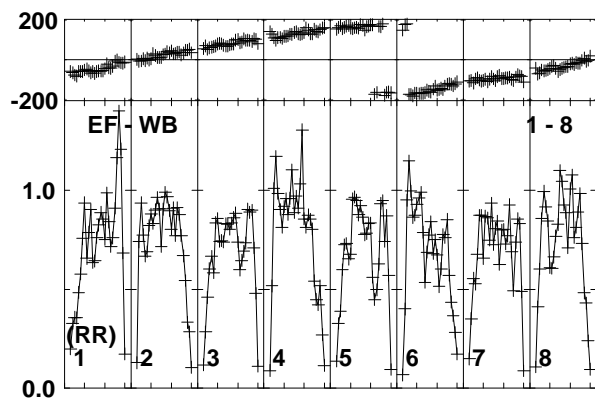
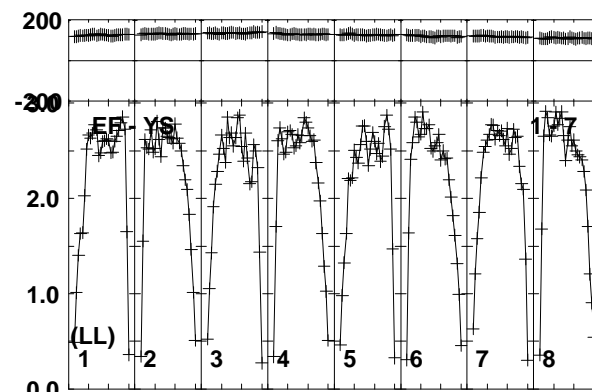
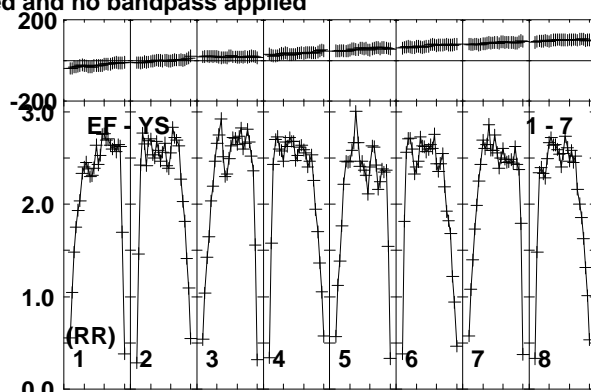
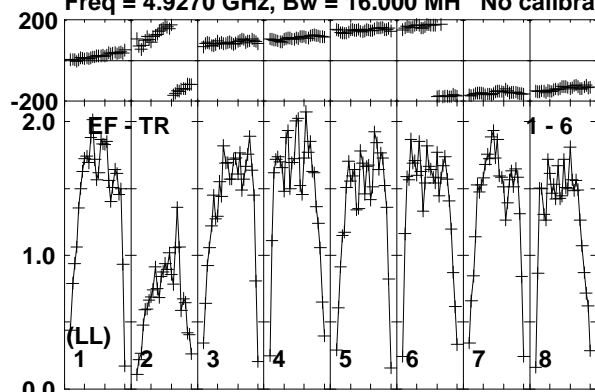

Lower frame: Milli Ampl Jy Top frame: Phas deg  
Vector averaged cross-power spectrum Baseline: EF (01) - TR (06)  
Timerange: 01/08:04:31 to 01/08:05:59

Plot file version 685 created 10-JUN-2016 17:23:10

BLLAC RT013A.UVDATA.1

Freq = 4.9270 GHz, Bw = 16.000 MH No calibration applied and no bandpass applied

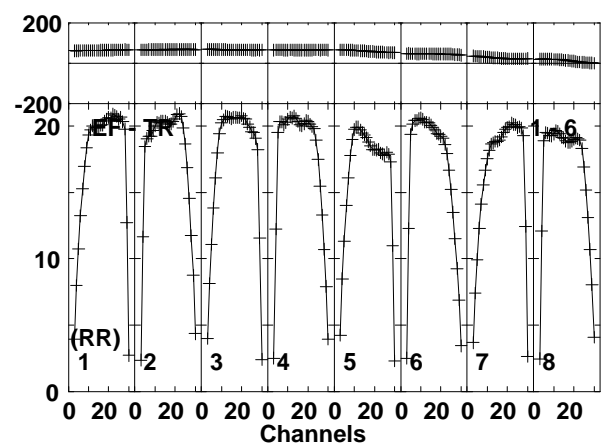
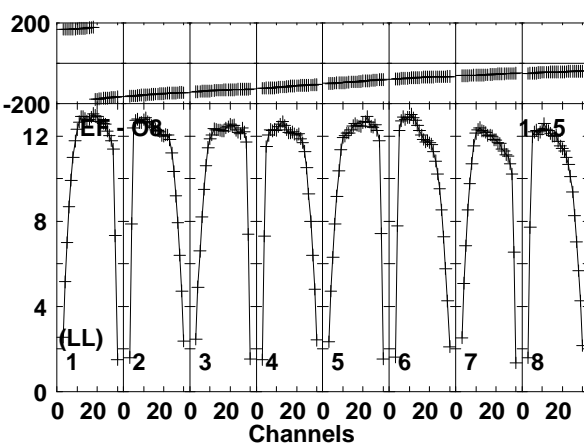
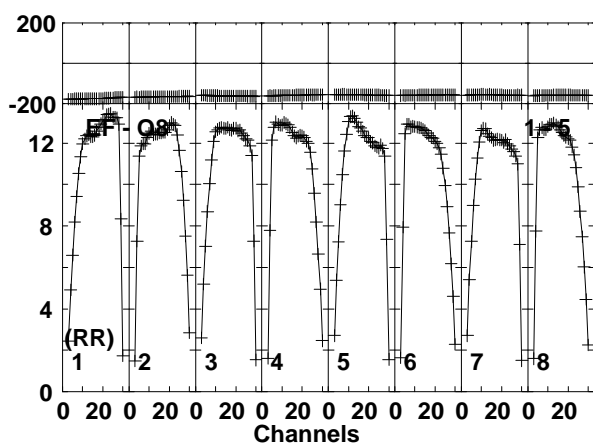
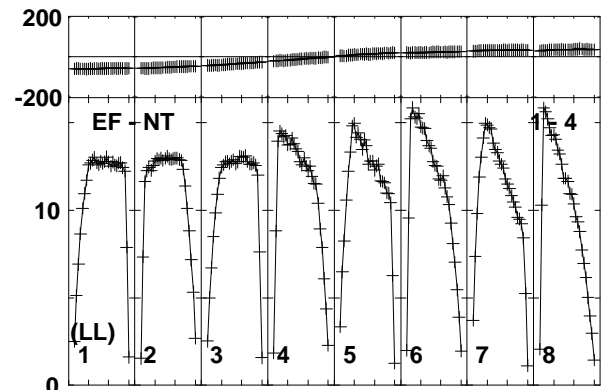
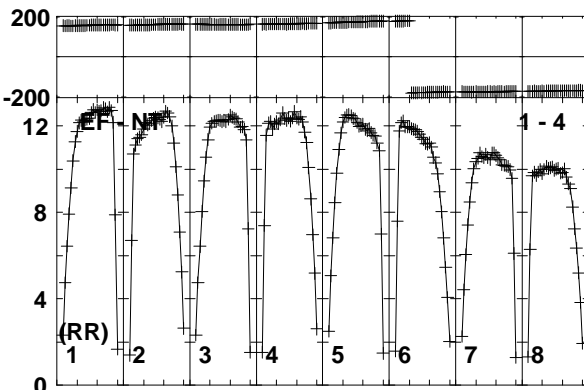
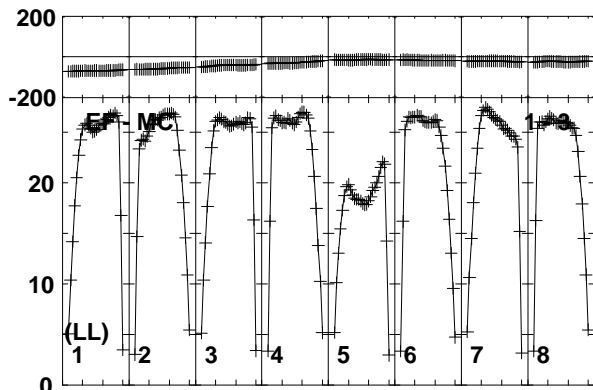
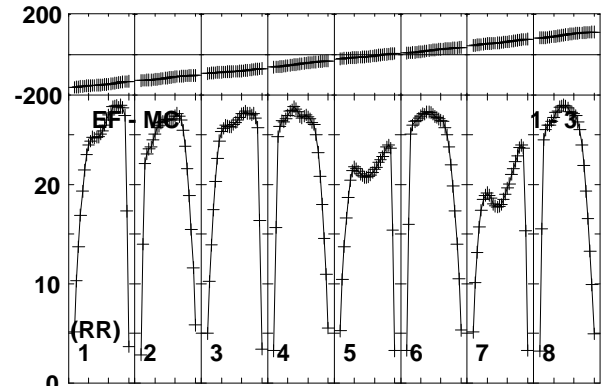
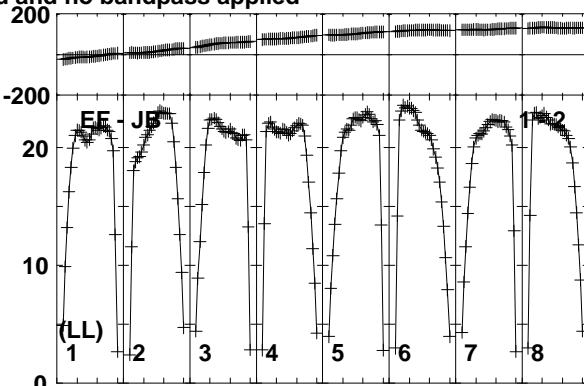
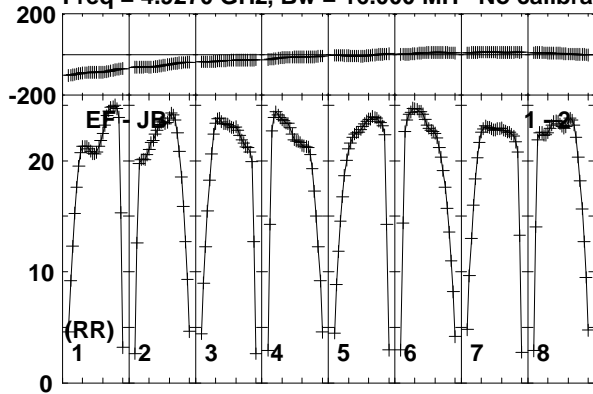

Lower frame: Milli Ampl Jy Top frame: Phas deg  
Vector averaged cross-power spectrum Baseline: EF (01) - JB (02)  
Timerange: 01/08:08:11 to 01/08:14:10

Plot file version 686 created 10-JUN-2016 17:23:10

BLLAC RT013A.UVDATA.1

Freq = 4.9270 GHz, Bw = 16.000 MH No calibration applied and no bandpass applied

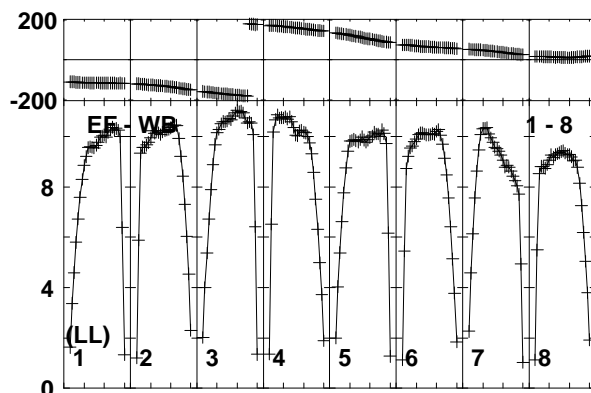
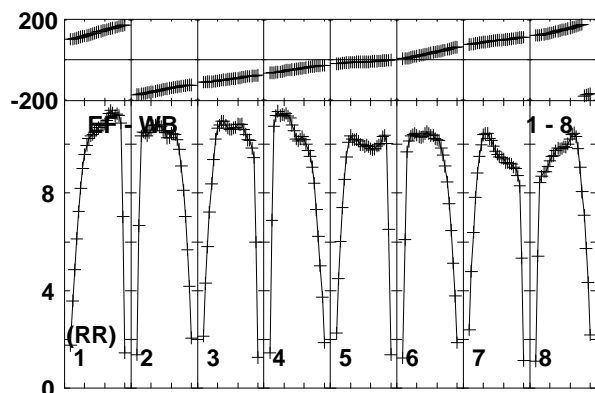
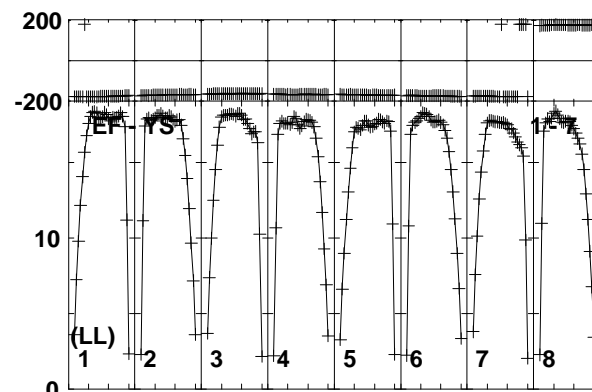
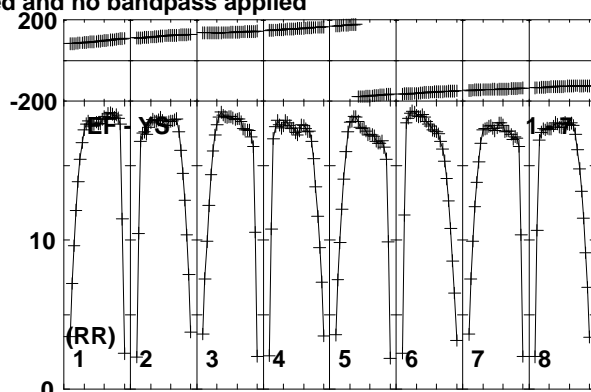
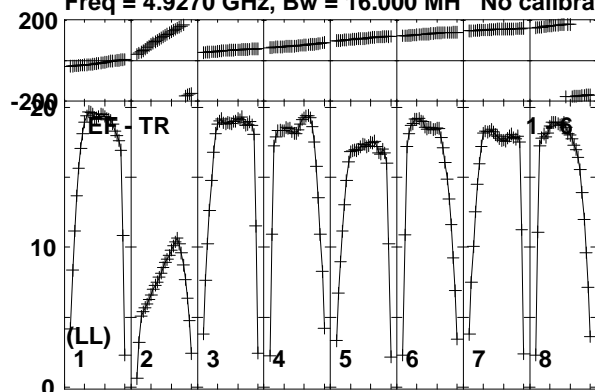

Lower frame: Milli Ampl Jy Top frame: Phas deg  
Vector averaged cross-power spectrum Baseline: EF (01) - TR (06)  
Timerange: 01/08:08:11 to 01/08:14:10

Plot file version 687 created 10-JUN-2016 17:23:10

DA193 RT013A.UVDATA.1

Freq = 4.9270 GHz, Bw = 16.000 MH No calibration applied and no bandpass applied

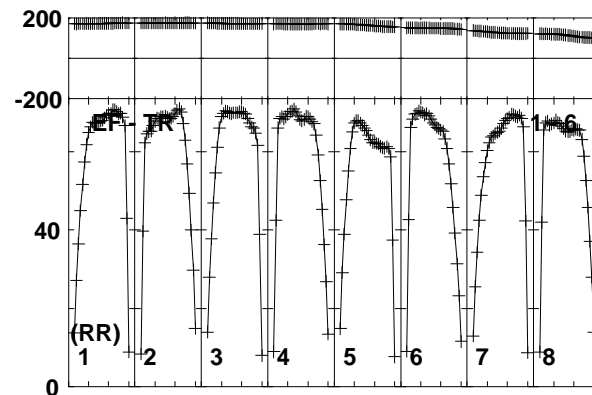
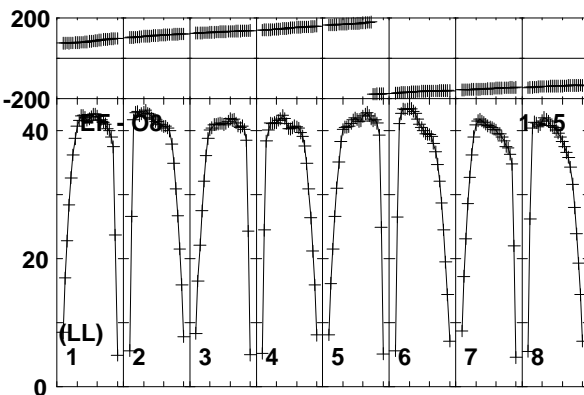
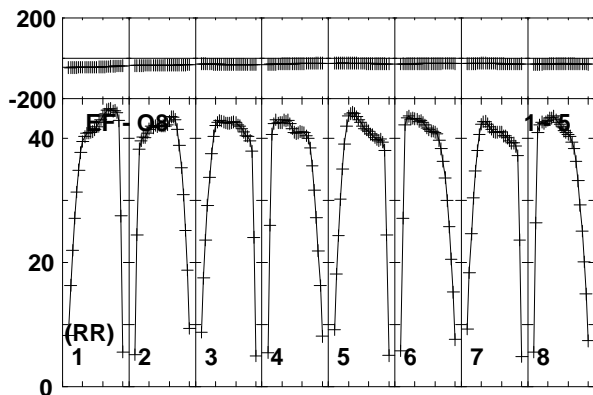
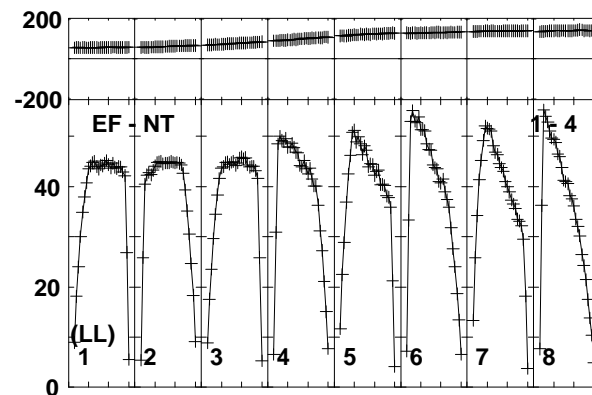
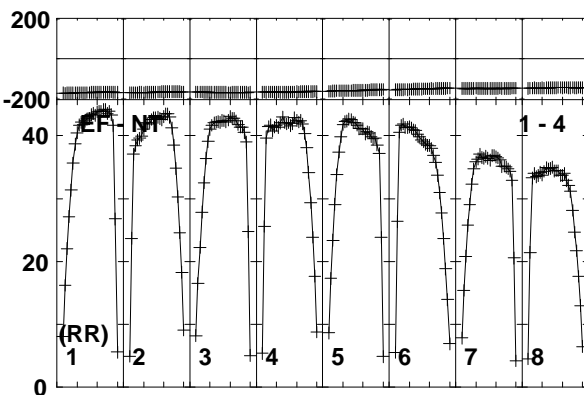
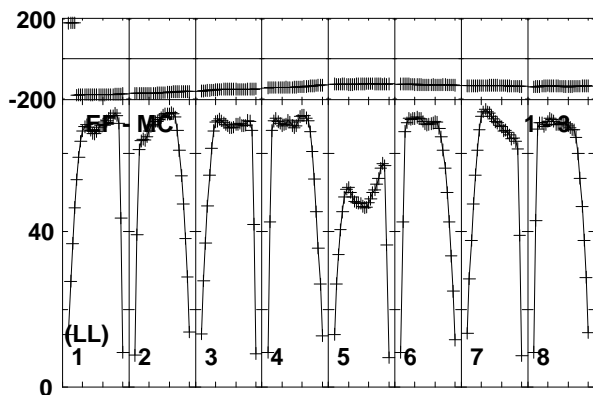
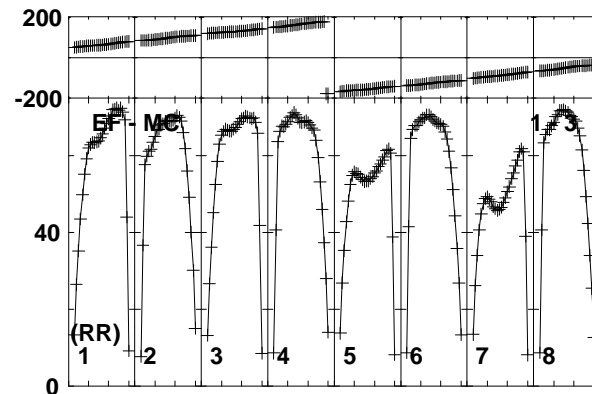
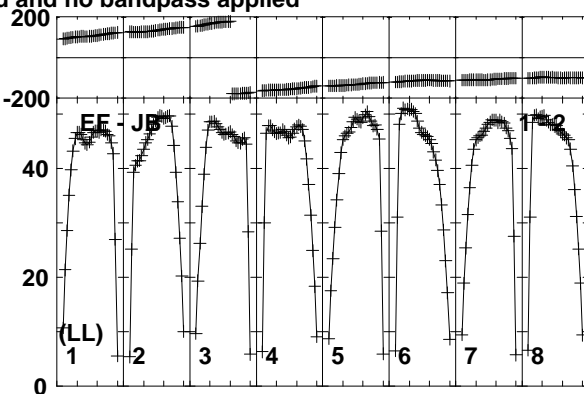
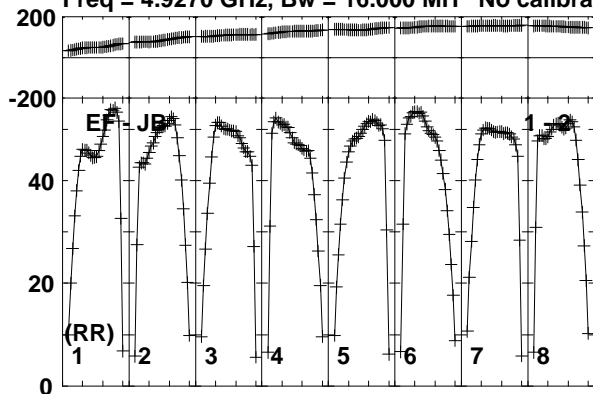

Lower frame: Milli Ampl Jy Top frame: Phas deg  
Vector averaged cross-power spectrum Baseline: EF (01) - JB (02)  
Timerange: 01/08:24:20 to 01/08:30:19

Plot file version 688 created 10-JUN-2016 17:23:10

DA193 RT013A.UVDATA.1

Freq = 4.9270 GHz, Bw = 16.000 MH No calibration applied and no bandpass applied

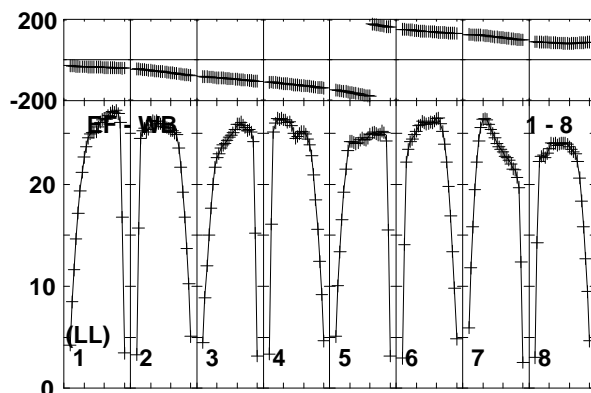
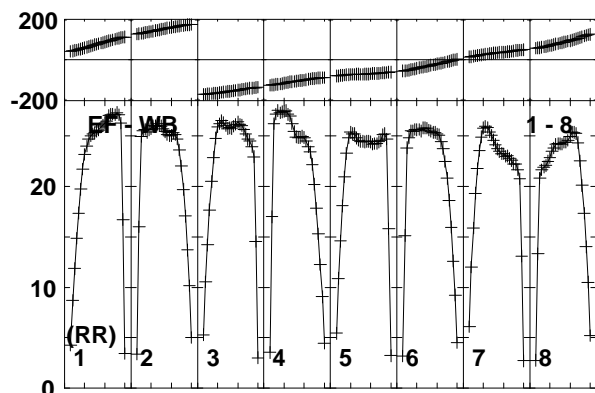
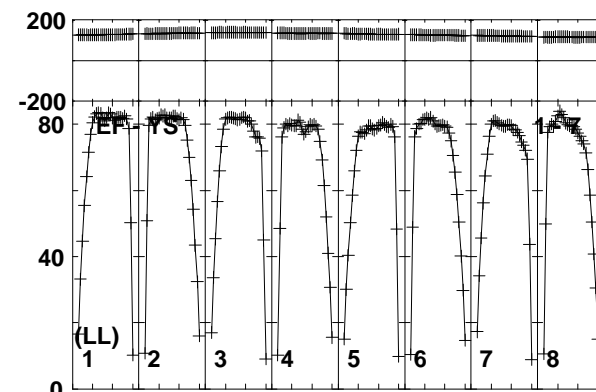
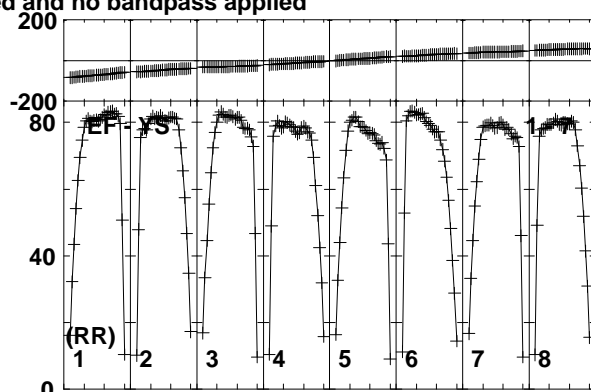
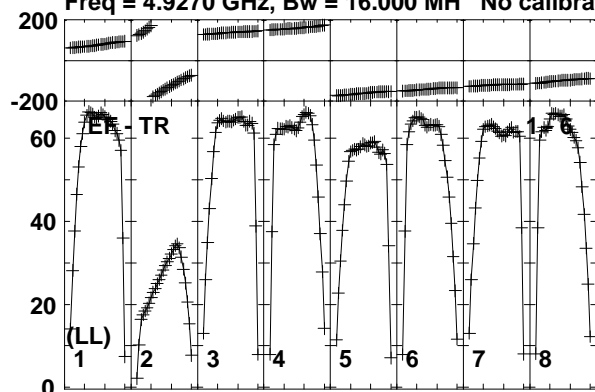

Lower frame: Milli Ampl Jy Top frame: Phas deg  
Vector averaged cross-power spectrum Baseline: EF (01) - TR (06)  
Timerange: 01/08:24:20 to 01/08:30:19